

OS181 NEUTRON ACER TENDL-2019 LIBRARY; T=293.16K
Principal cross sections

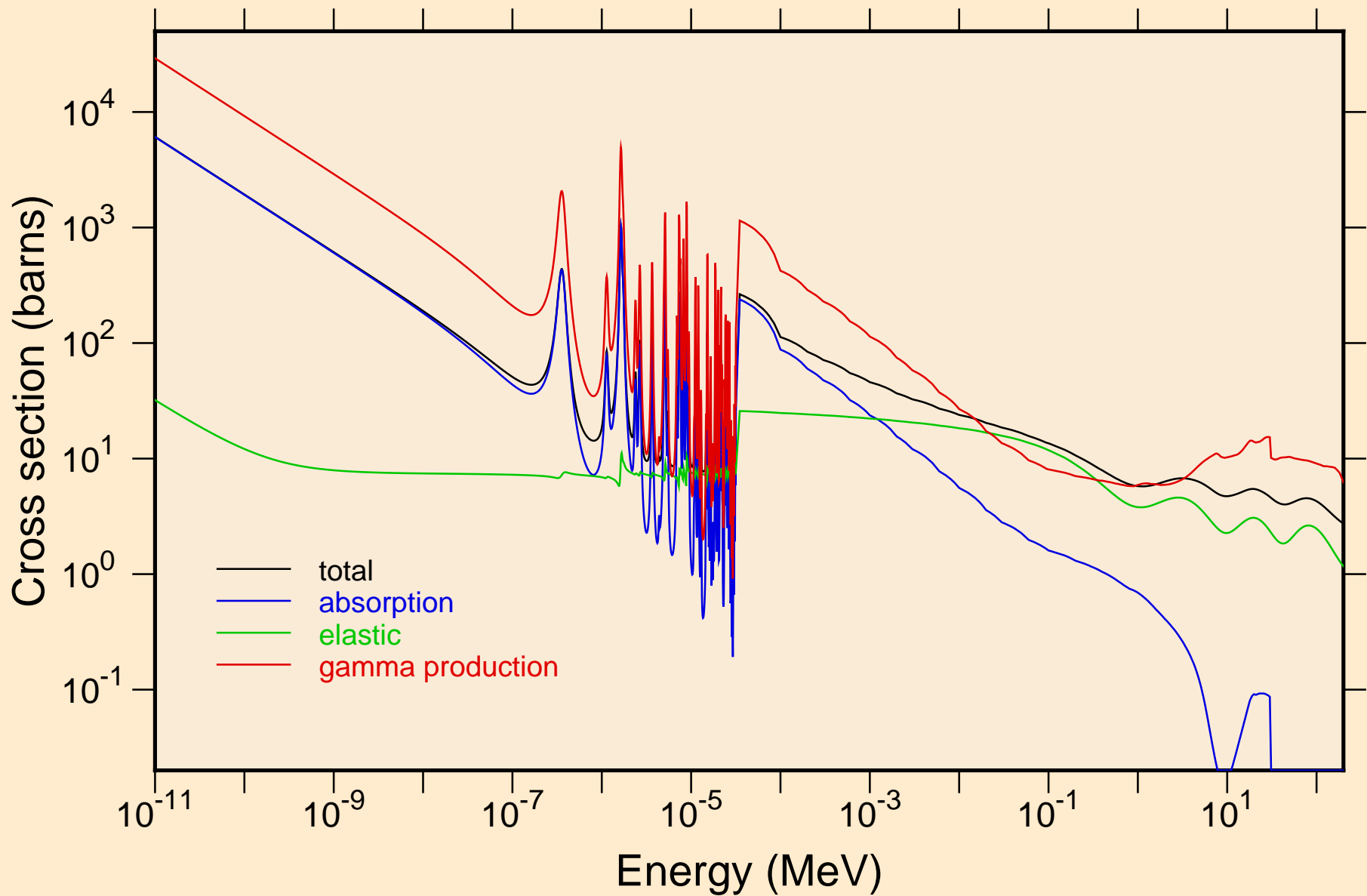

OS181 NEUTRON ACER TENDL-2019 LIBRARY; T=293.16K
resonance total cross section

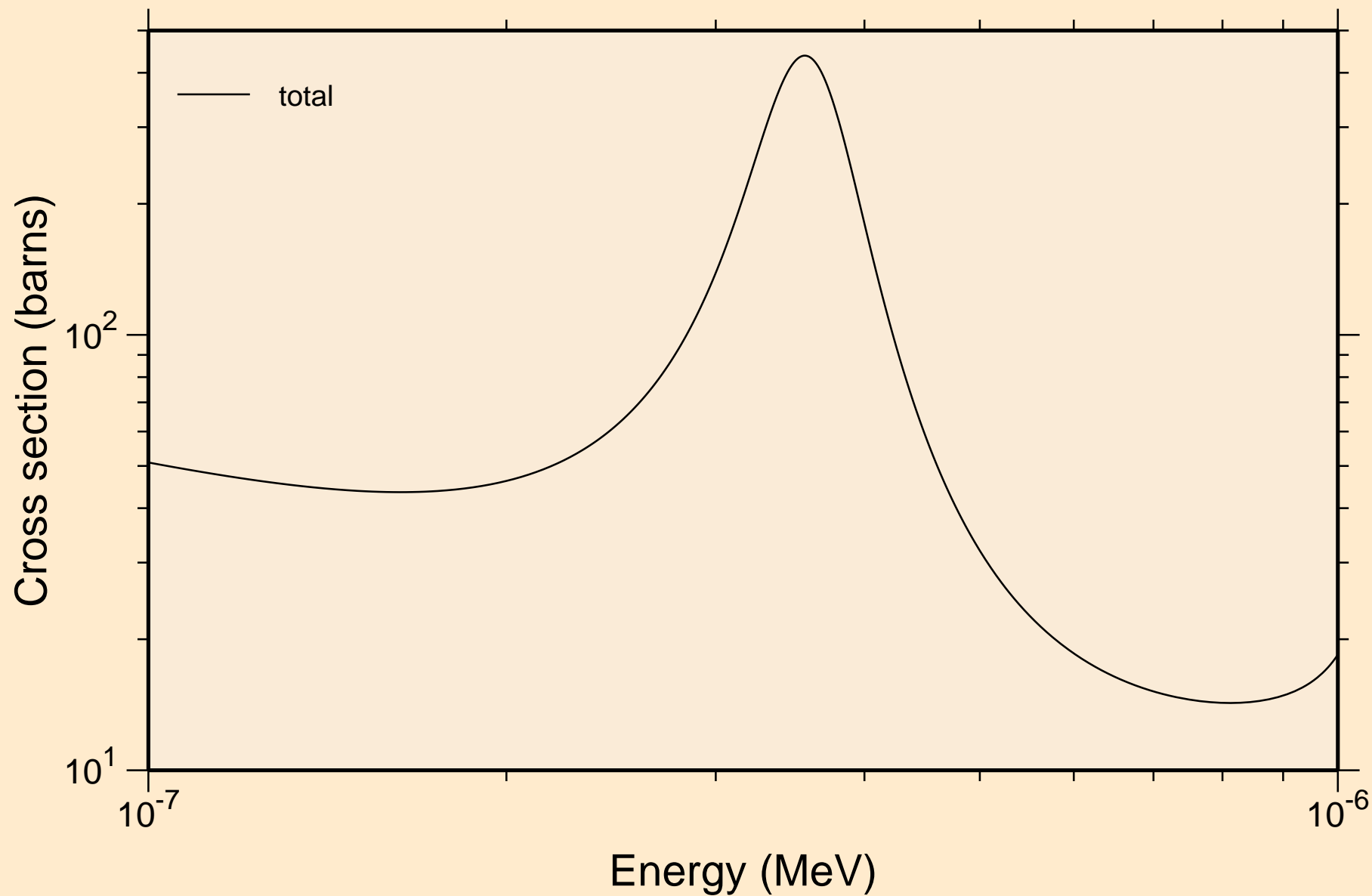

OS181 NEUTRON ACER TENDL-2019 LIBRARY; T=293.16K
resonance total cross section

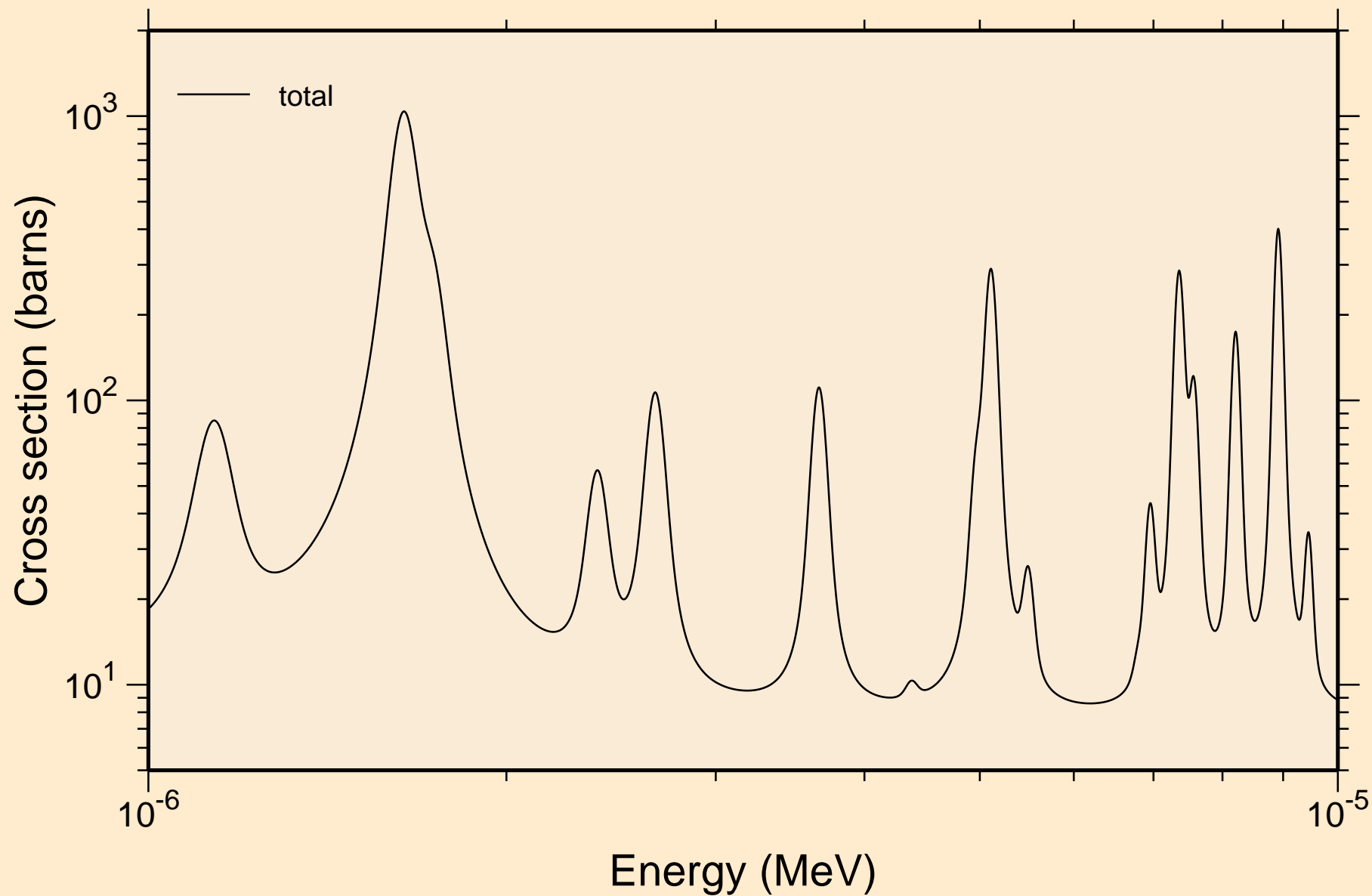

OS181 NEUTRON ACER TENDL-2019 LIBRARY; T=293.16K
resonance total cross section

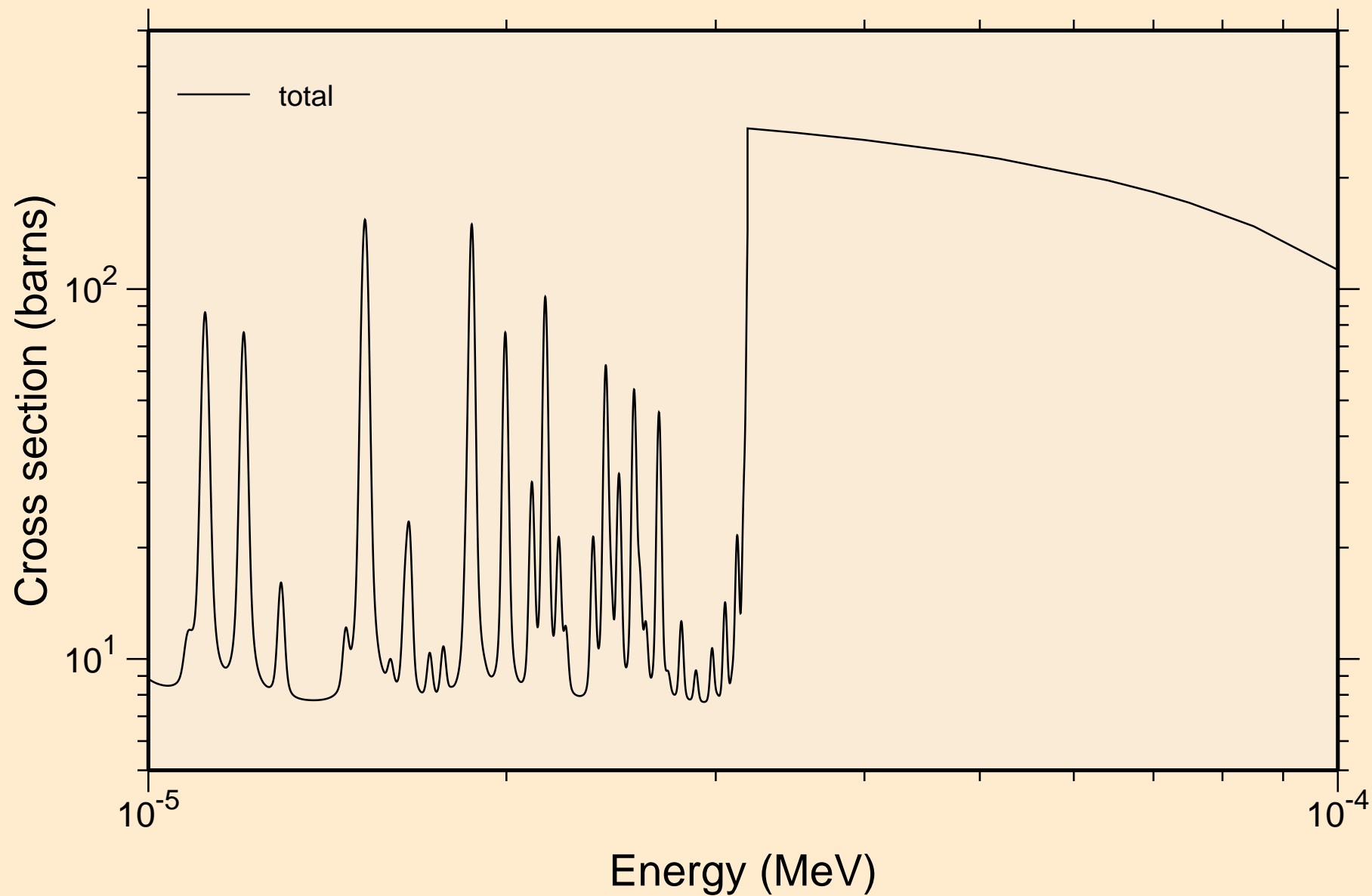

OS181 NEUTRON ACER TENDL-2019 LIBRARY; T=293.16K
resonance total cross section

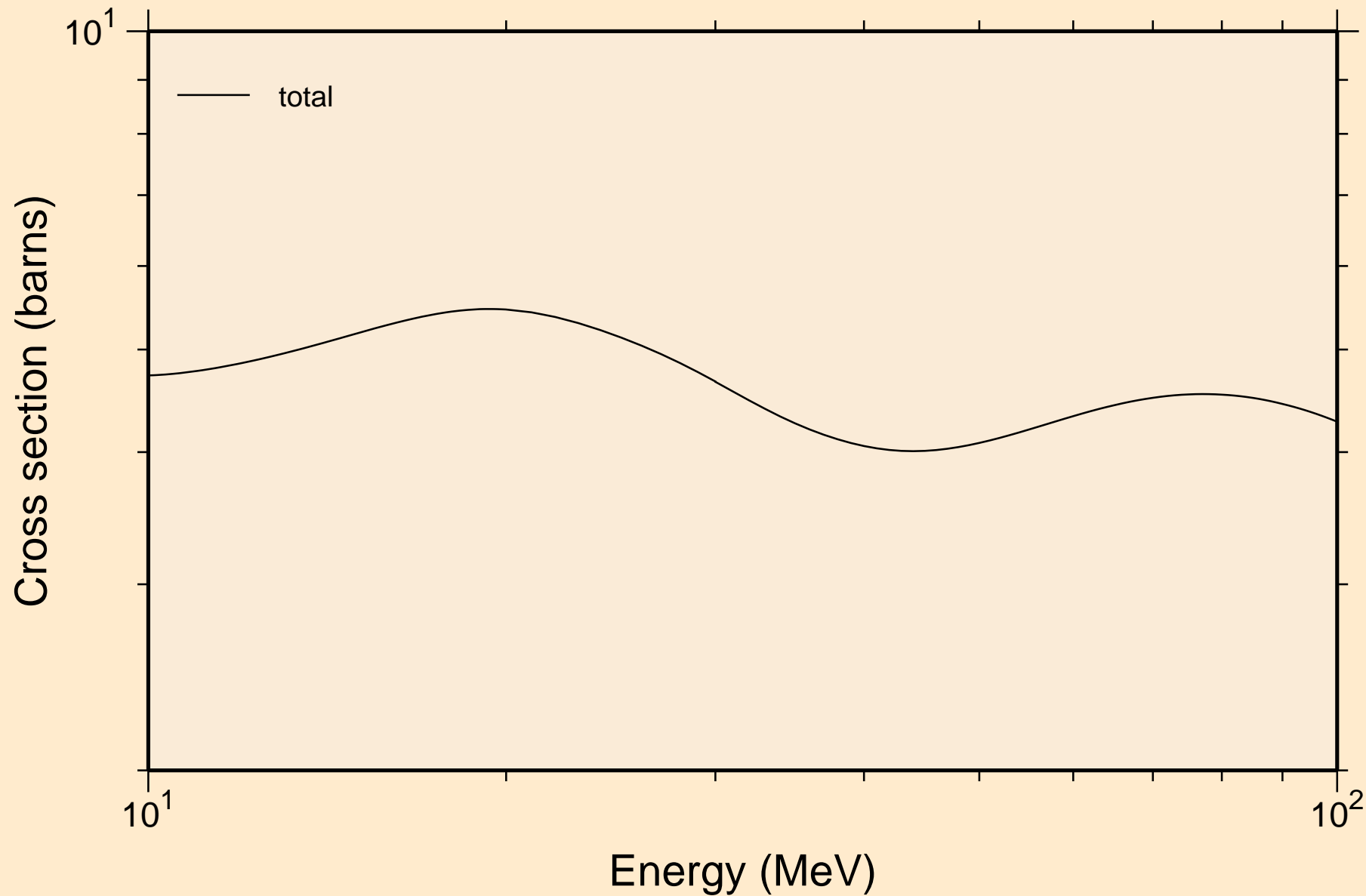

OS181 NEUTRON ACER TENDL-2019 LIBRARY; T=293.16K
resonance absorption cross sections

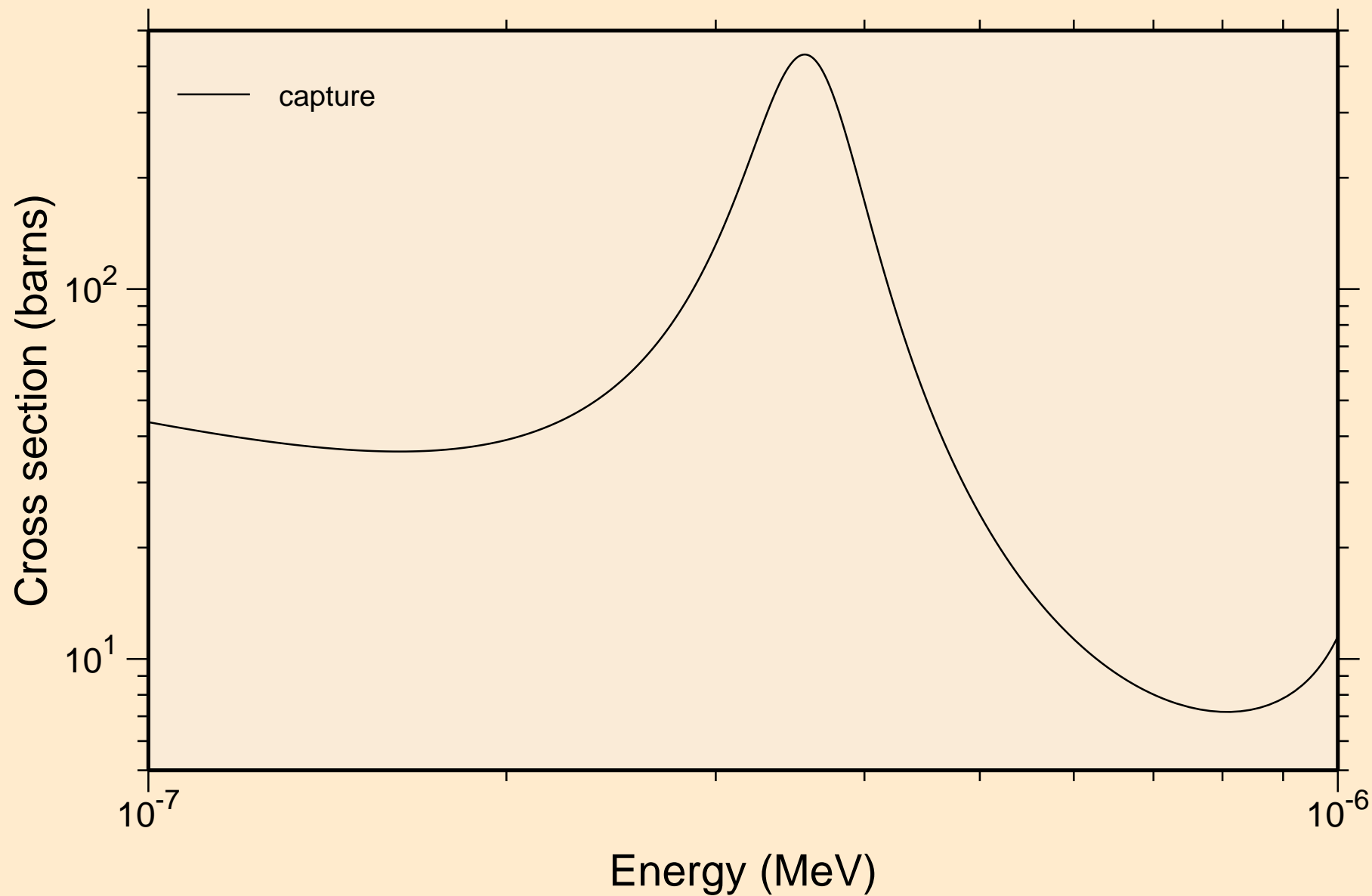

OS181 NEUTRON ACER TENDL-2019 LIBRARY; T=293.16K
resonance absorption cross sections

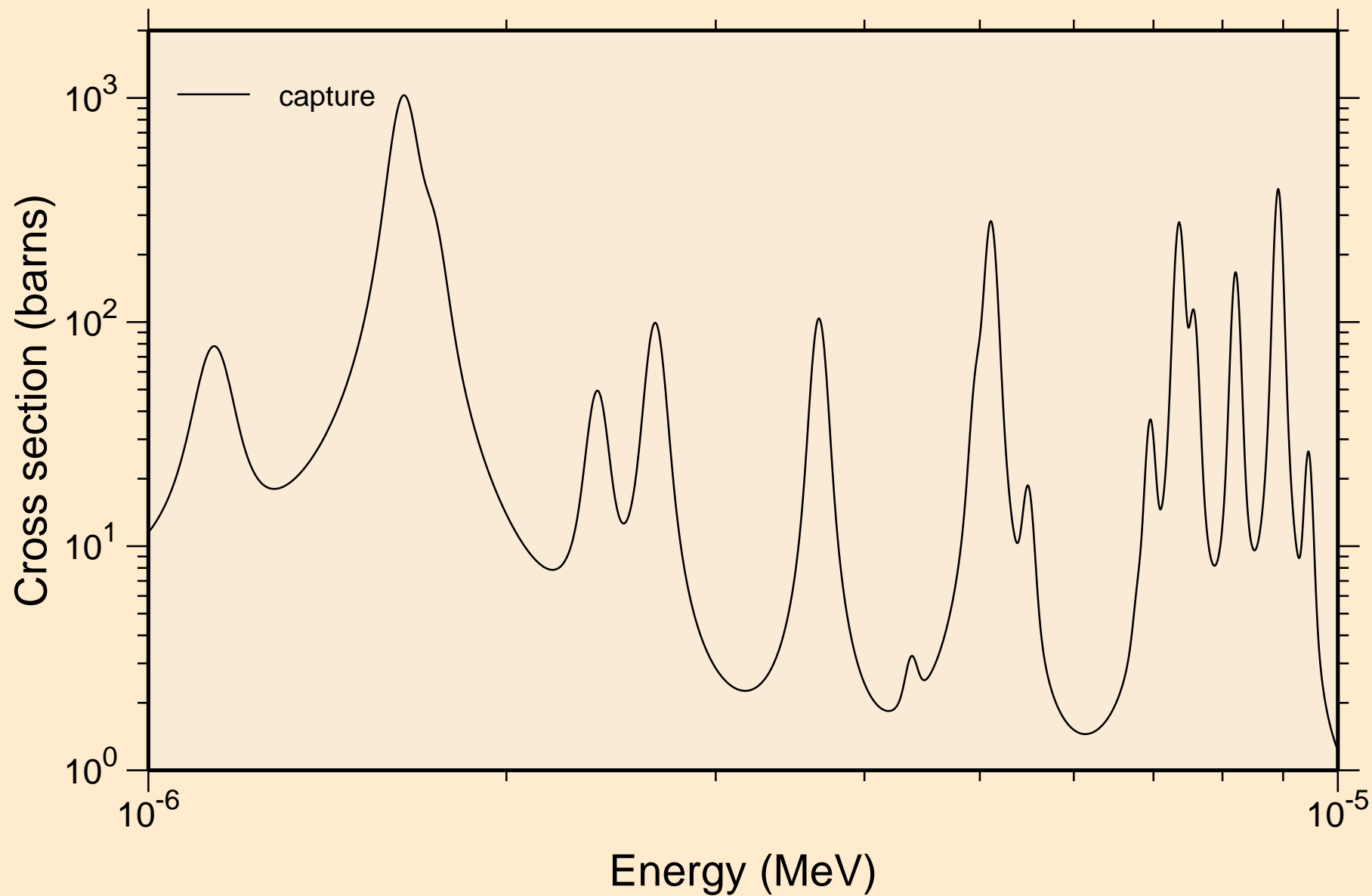

OS181 NEUTRON ACER TENDL-2019 LIBRARY; T=293.16K
resonance absorption cross sections

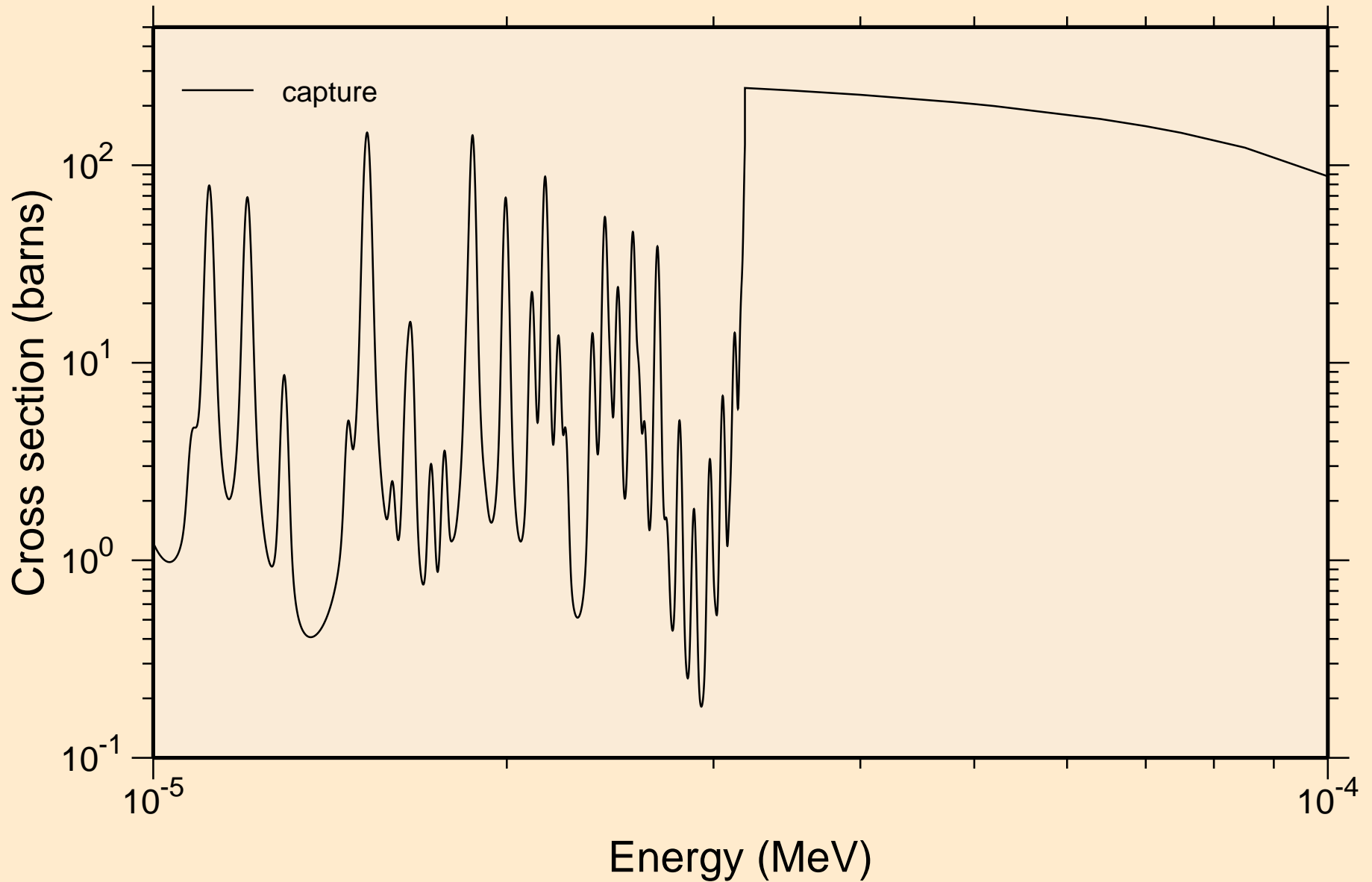

OS181 NEUTRON ACER TENDL-2019 LIBRARY; T=293.16K
resonance absorption cross sections

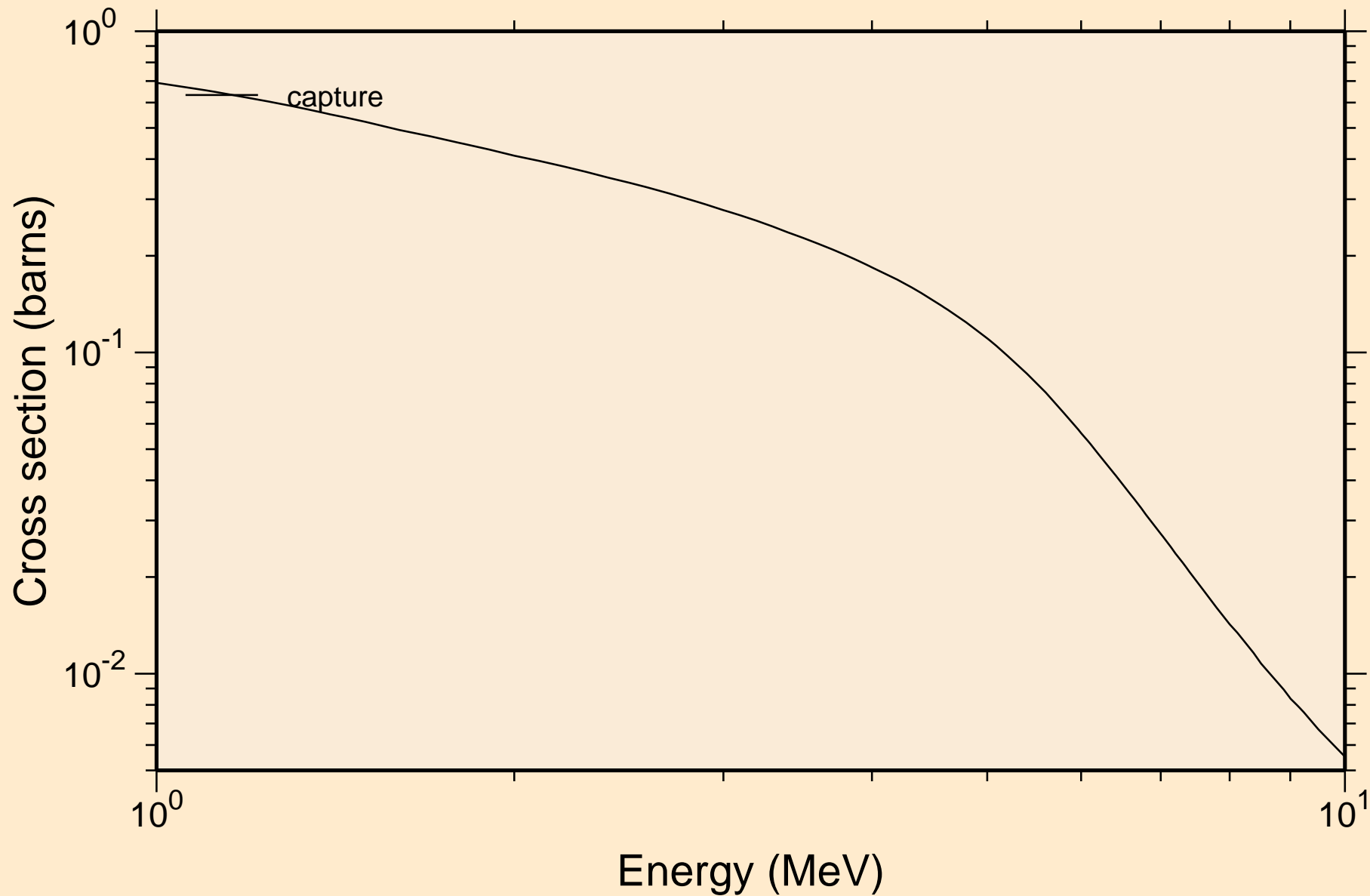

OS181 NEUTRON ACER TENDL-2019 LIBRARY; T=293.16K
Heating

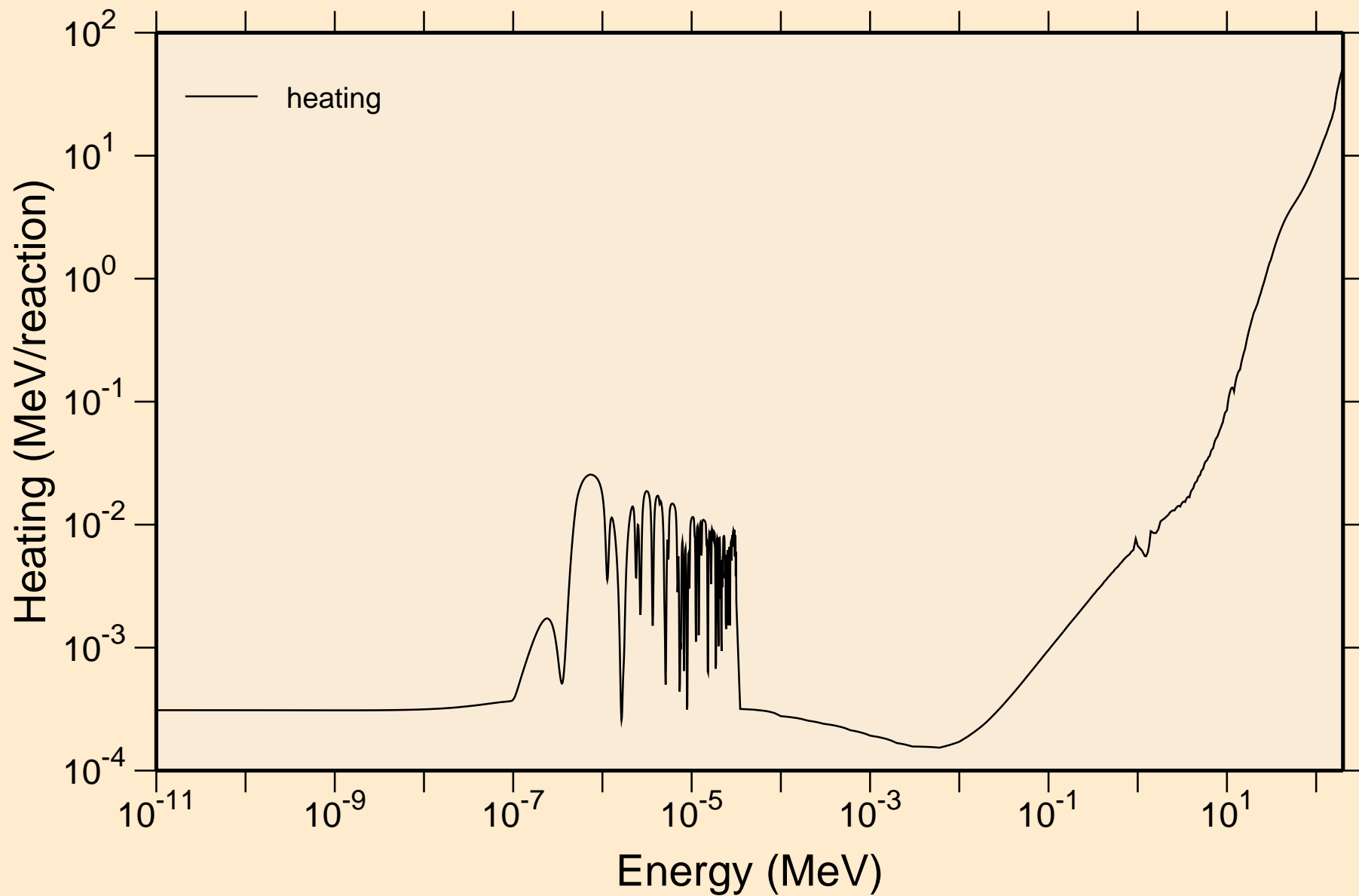

OS181 NEUTRON ACER TENDL-2019 LIBRARY; T=293.16K
Damage

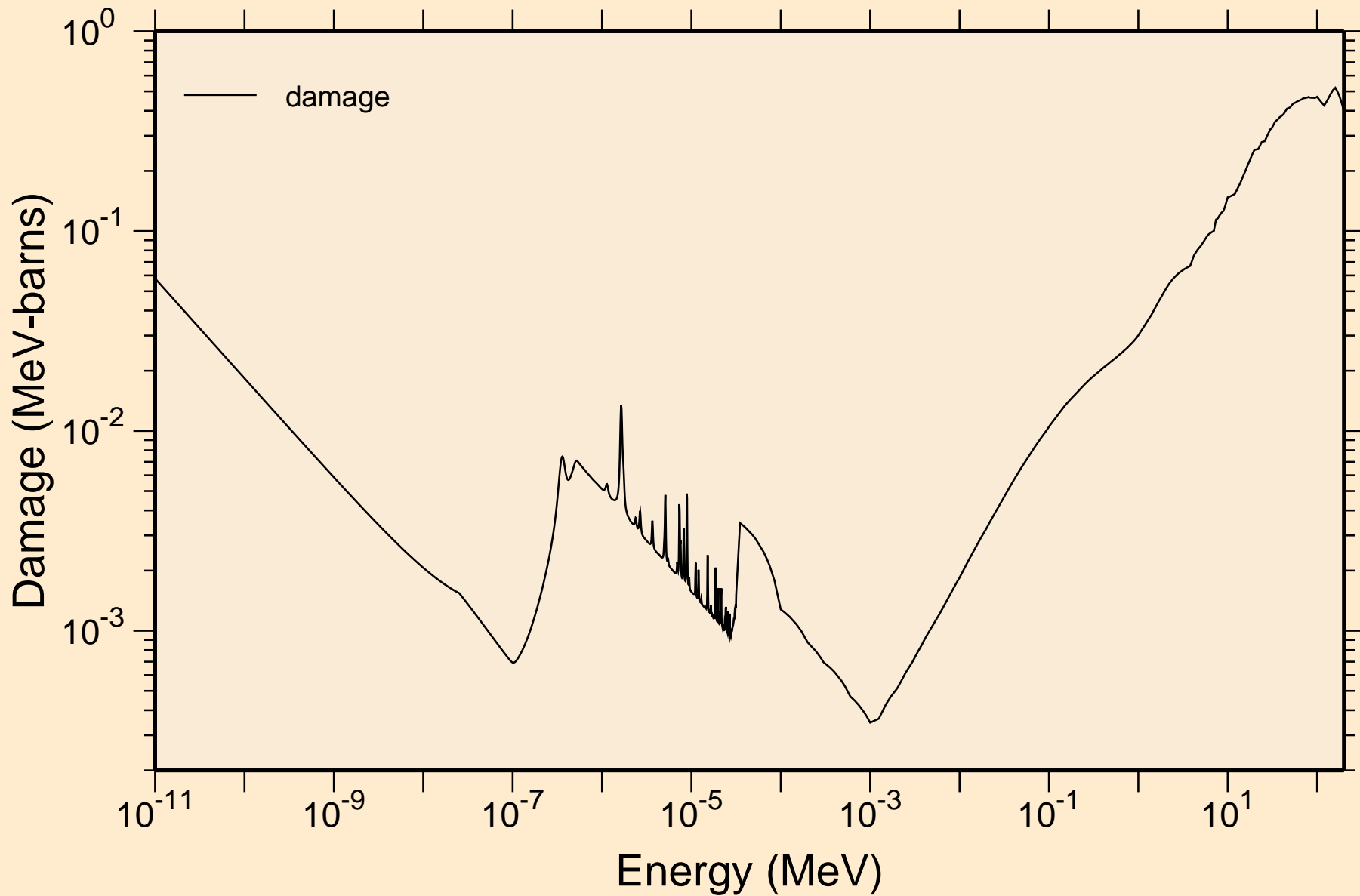

OS181 NEUTRON ACER TENDL-2019 LIBRARY; T=293.16K
Non-threshold reactions

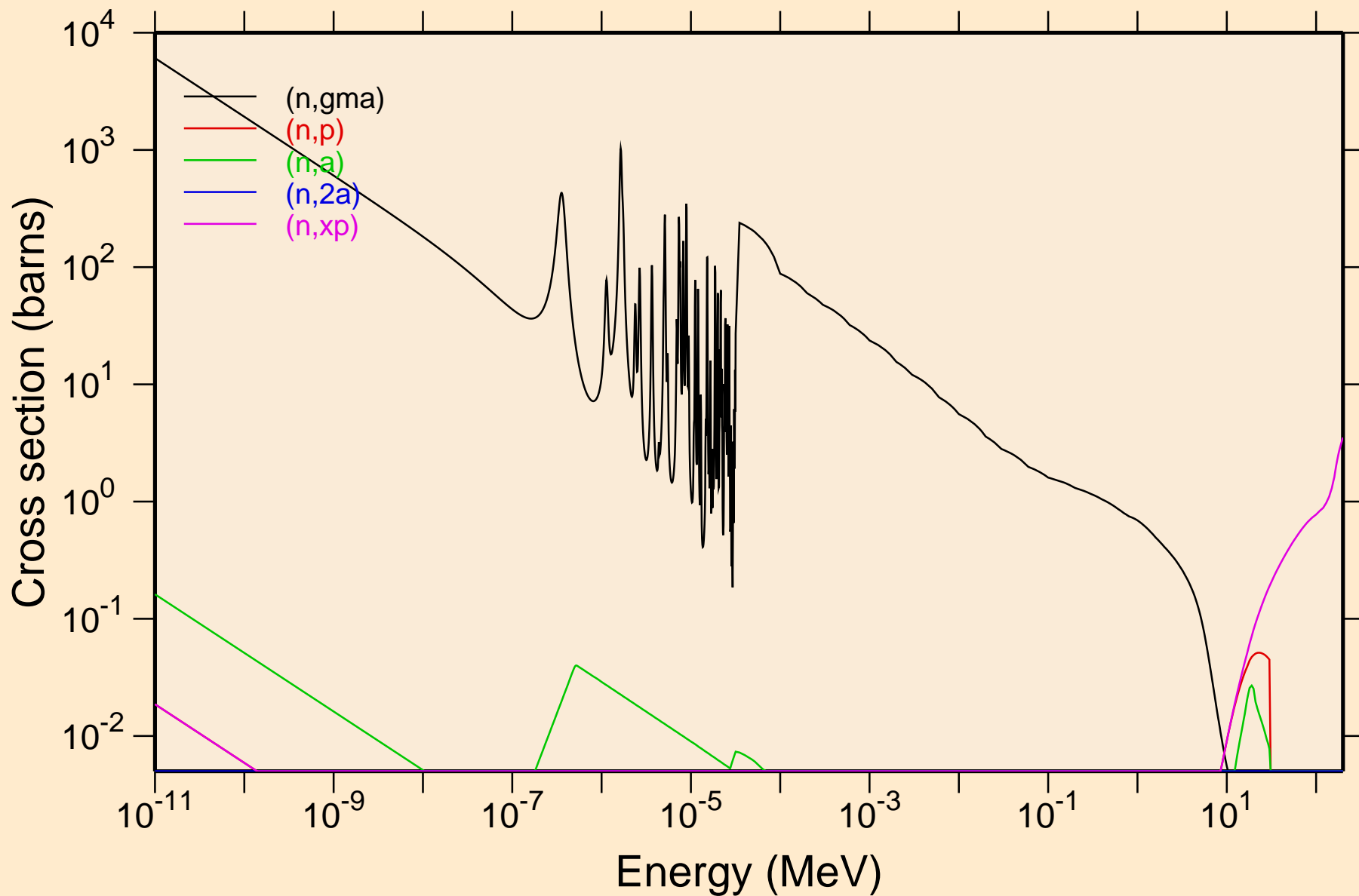

OS181 NEUTRON ACER TENDL-2019 LIBRARY; T=293.16K
Non-threshold reactions

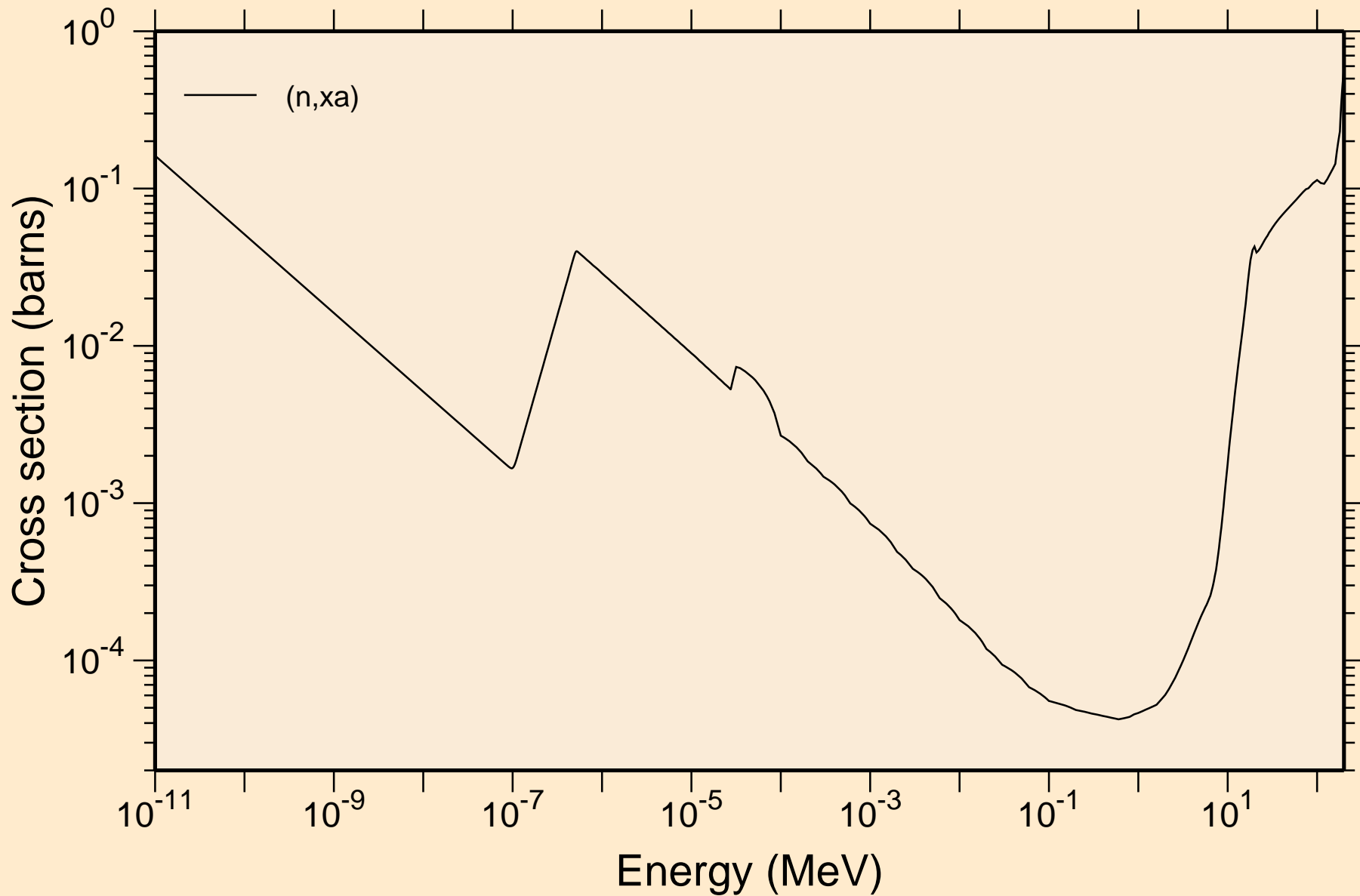

OS181 NEUTRON ACER TENDL-2019 LIBRARY; T=293.16K
Principal cross sections

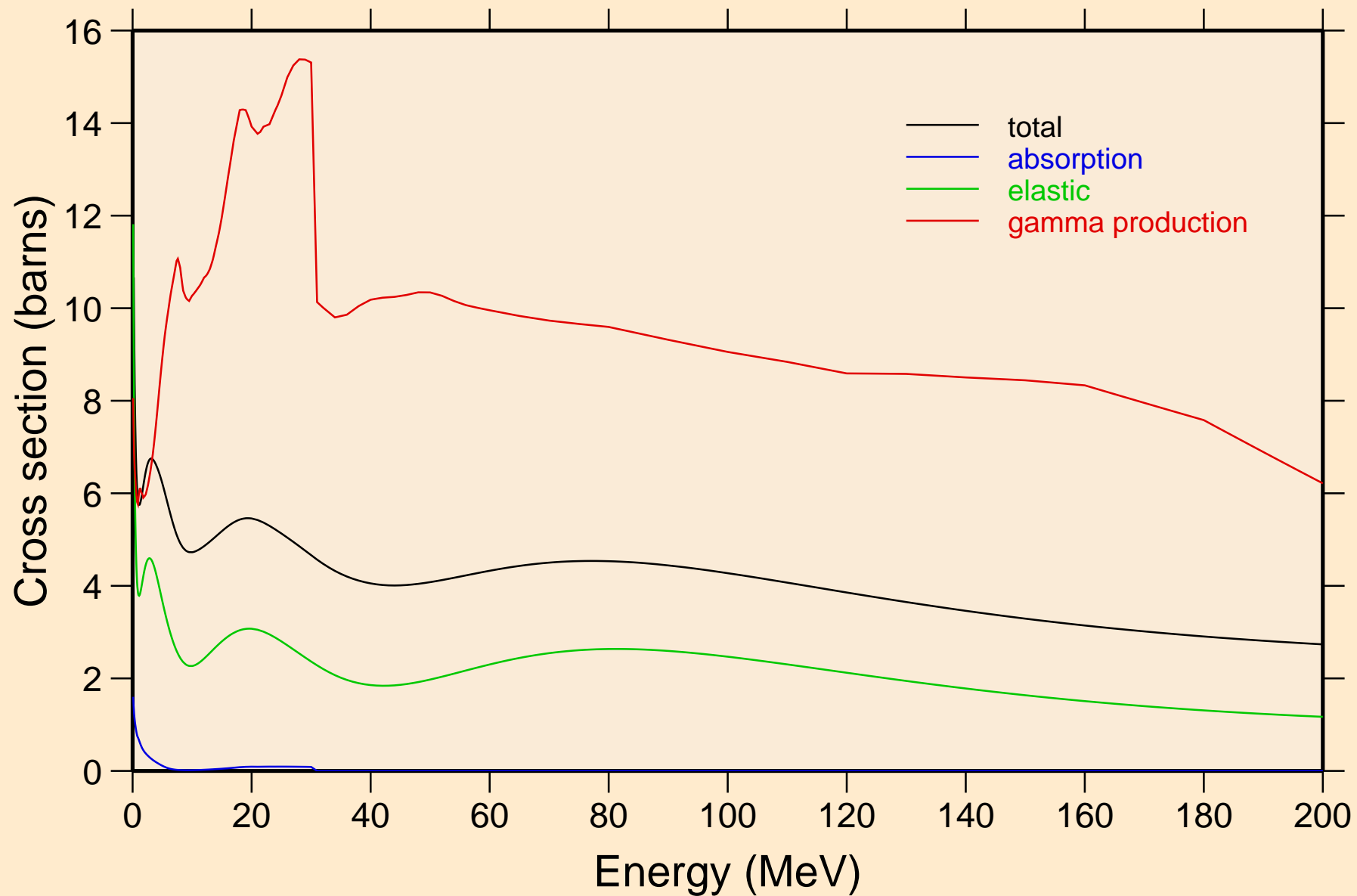

OS181 NEUTRON ACER TENDL-2019 LIBRARY; T=293.16K
Heating

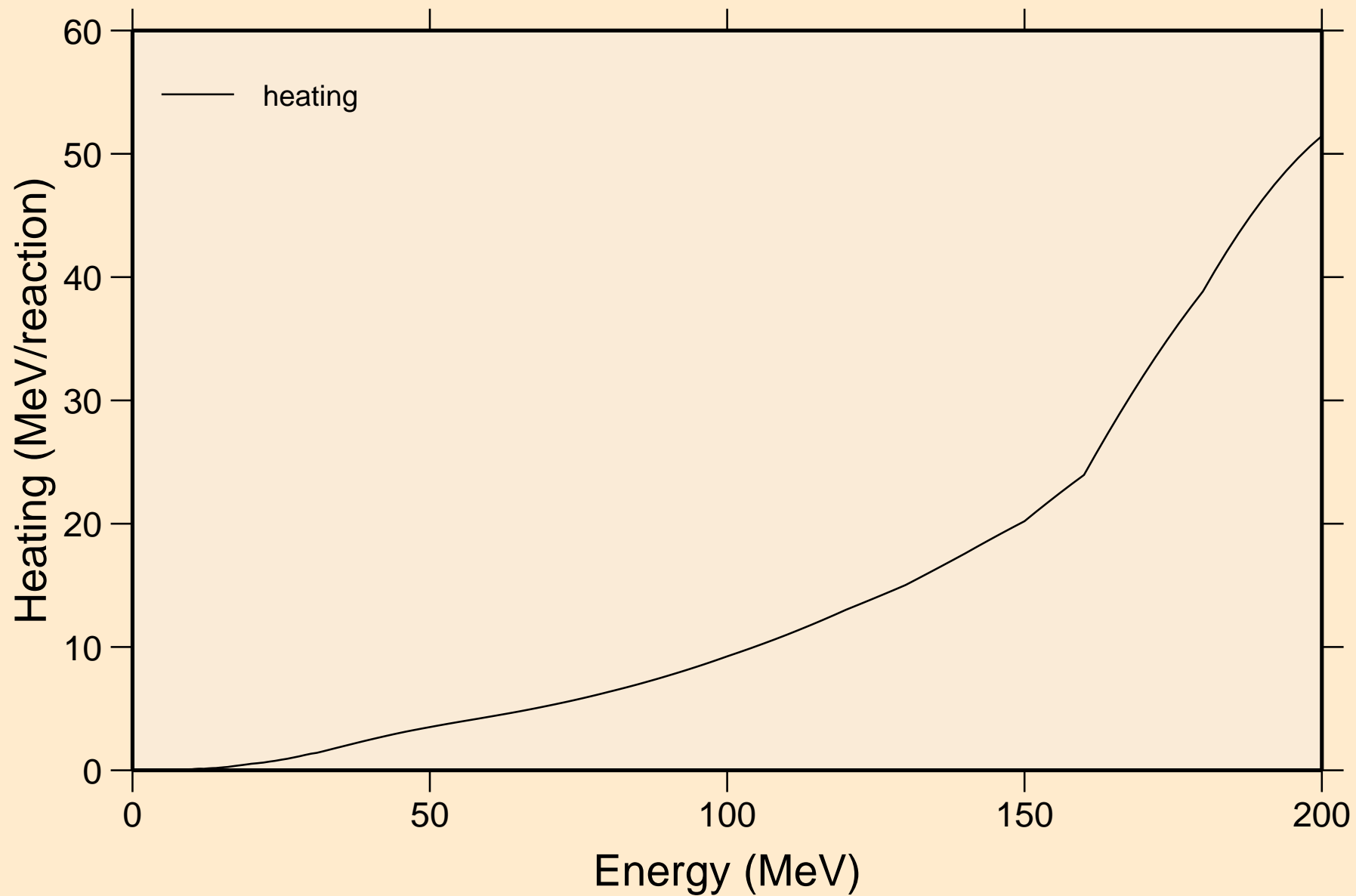

OS181 NEUTRON ACER TENDL-2019 LIBRARY; T=293.16K
Damage

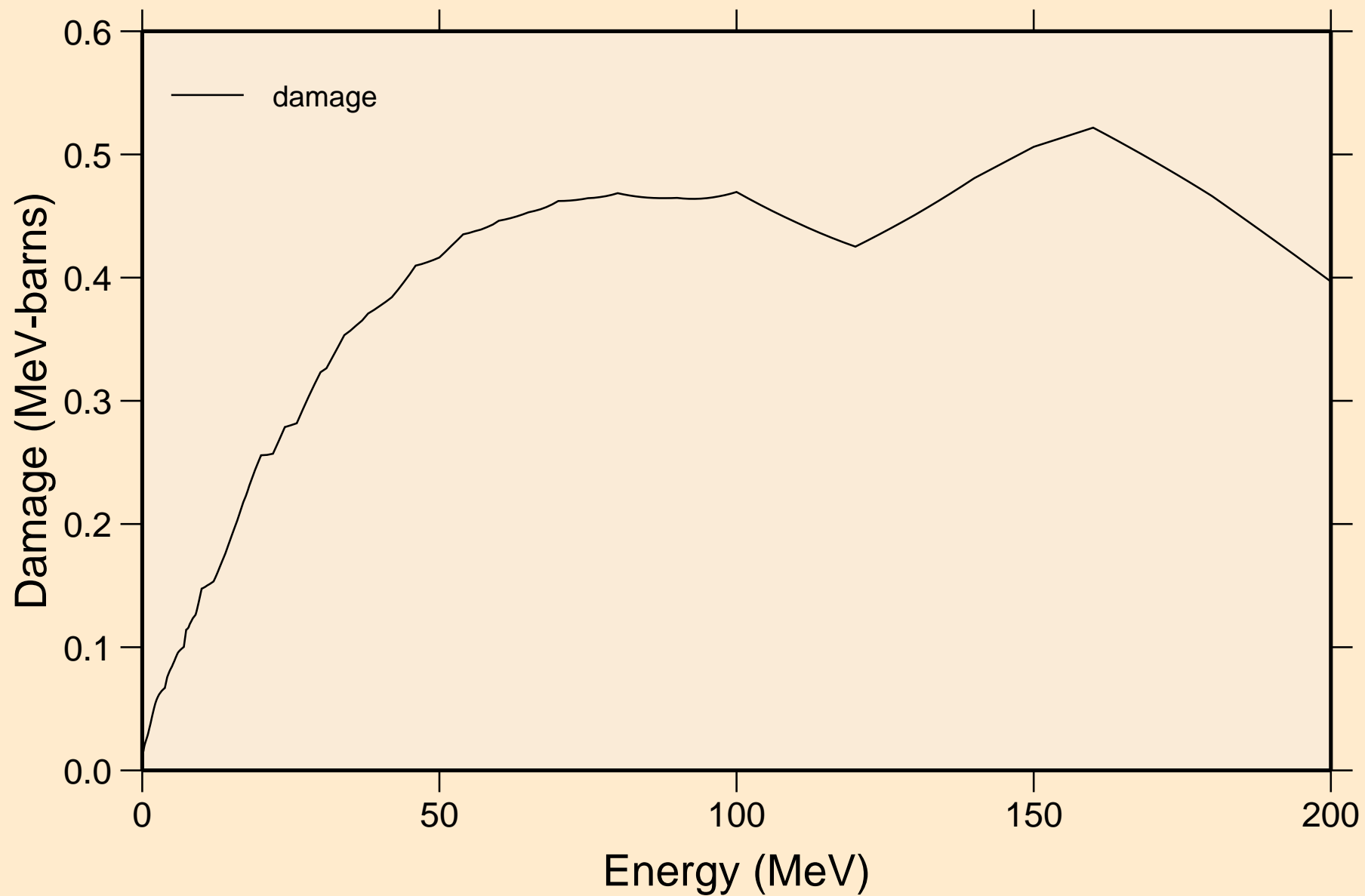

OS181 NEUTRON ACER TENDL-2019 LIBRARY; T=293.16K
Non-threshold reactions

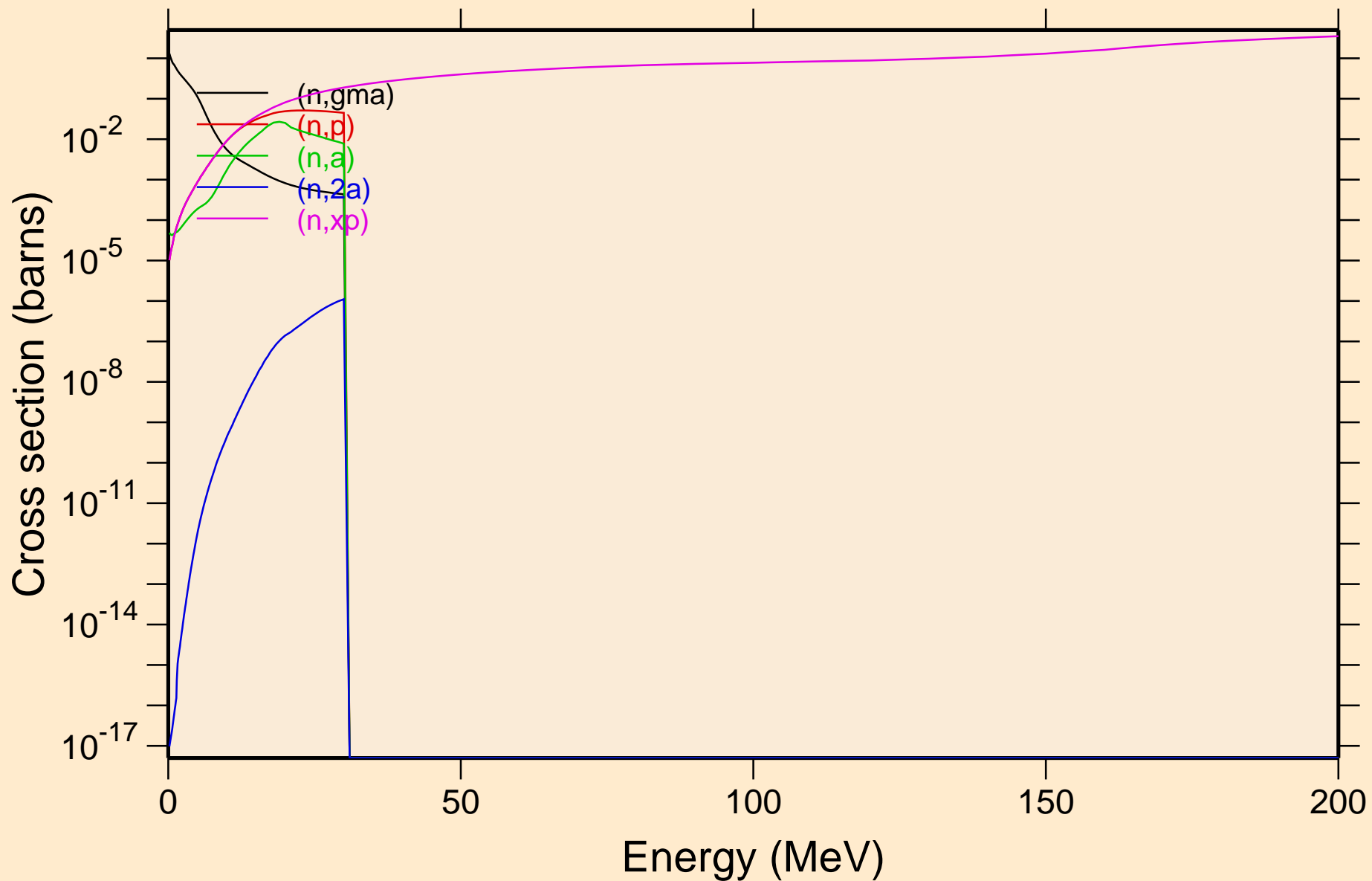

OS181 NEUTRON ACER TENDL-2019 LIBRARY; T=293.16K
Non-threshold reactions

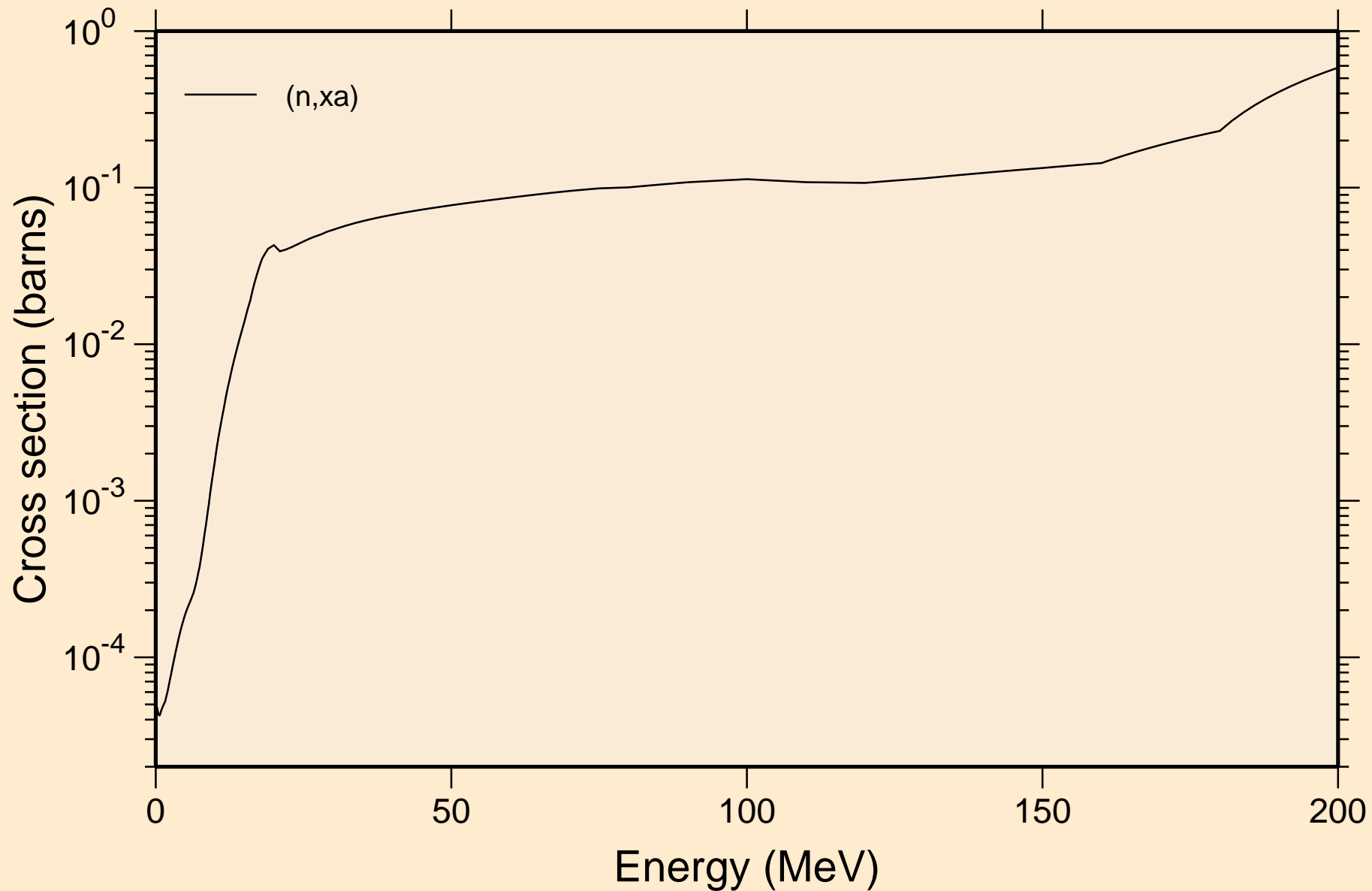

OS181 NEUTRON ACER TENDL-2019 LIBRARY; T=293.16K
Inelastic levels

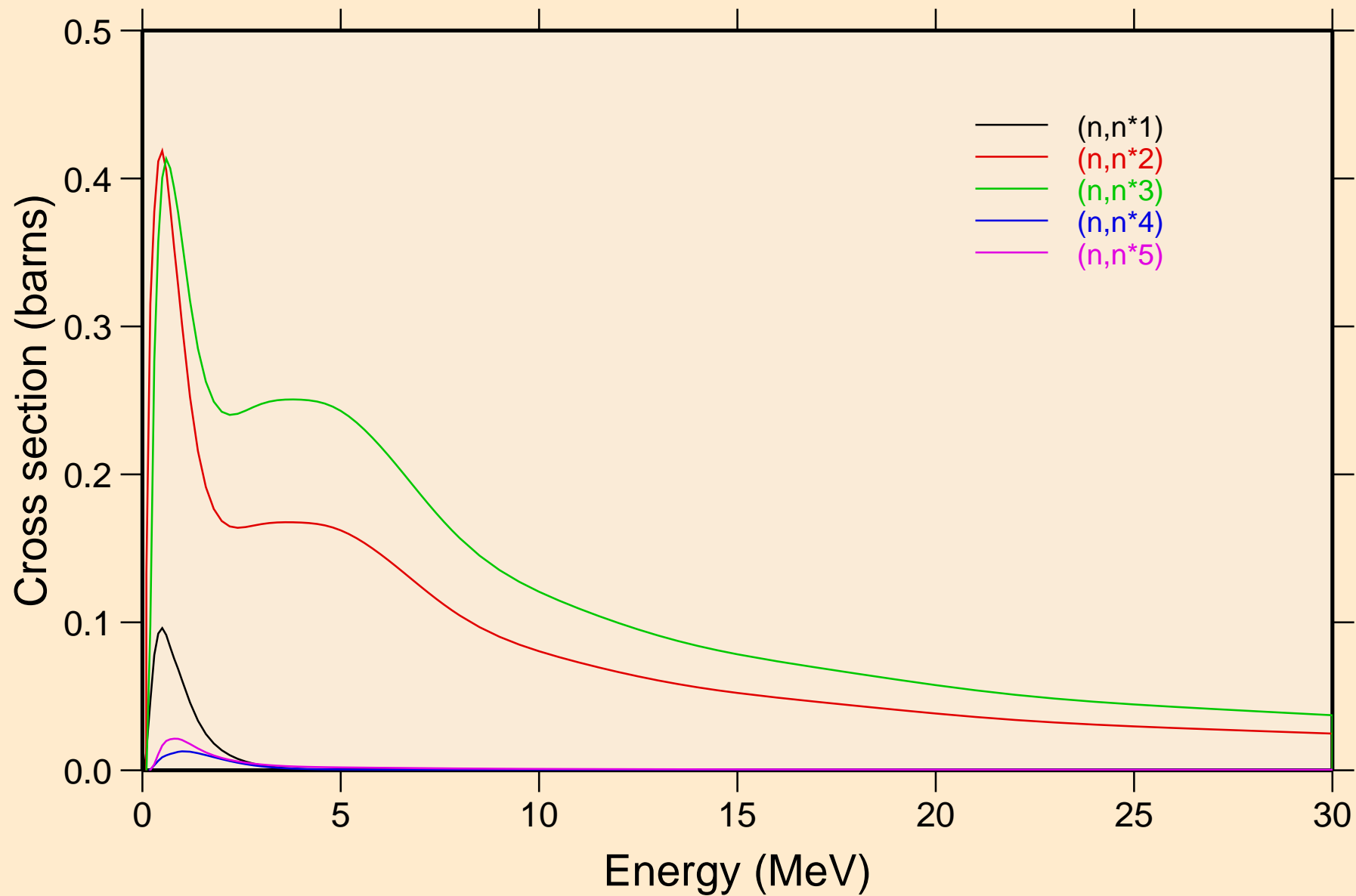

OS181 NEUTRON ACER TENDL-2019 LIBRARY; T=293.16K
Inelastic levels

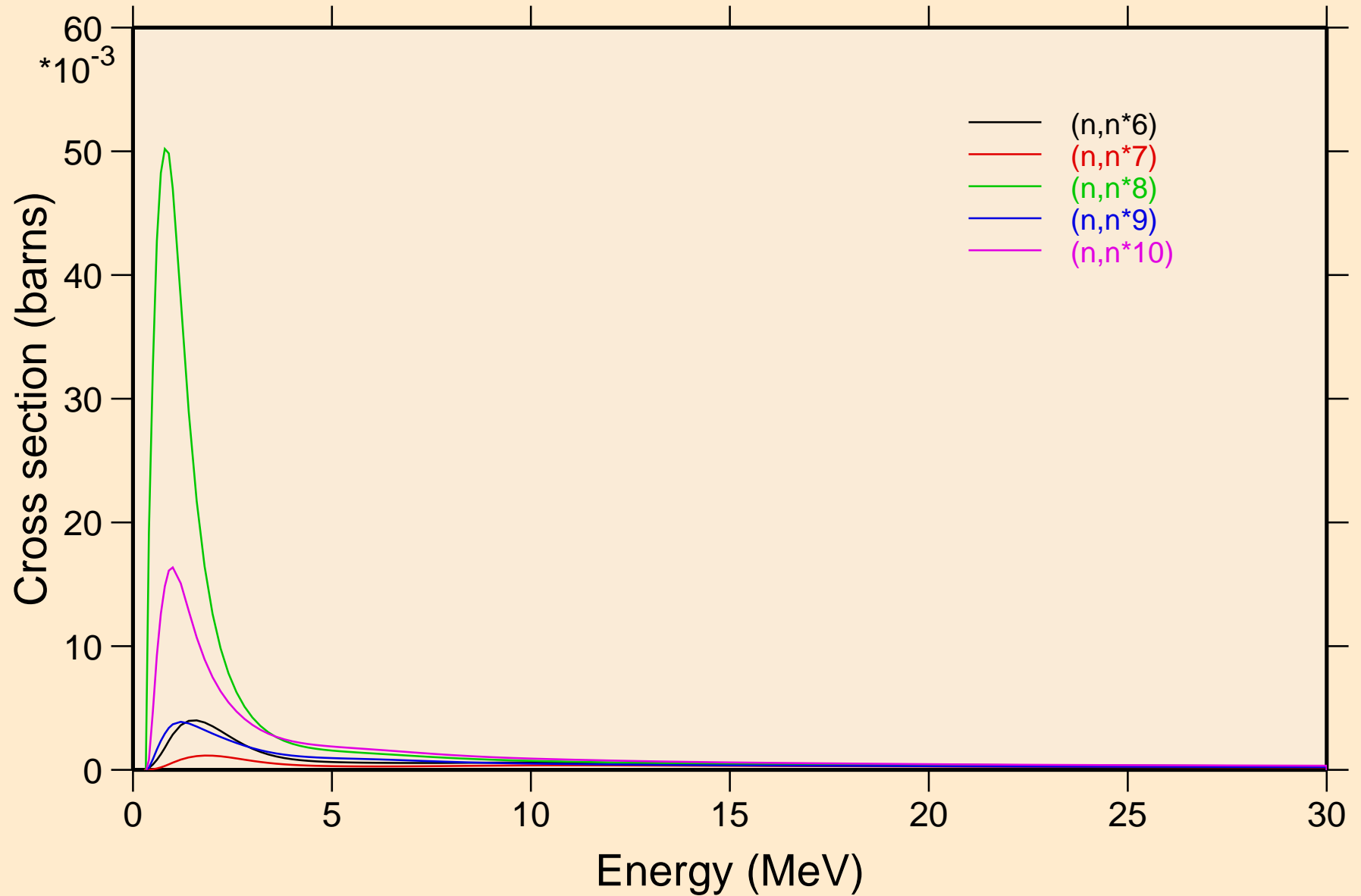

OS181 NEUTRON ACER TENDL-2019 LIBRARY; T=293.16K
Inelastic levels

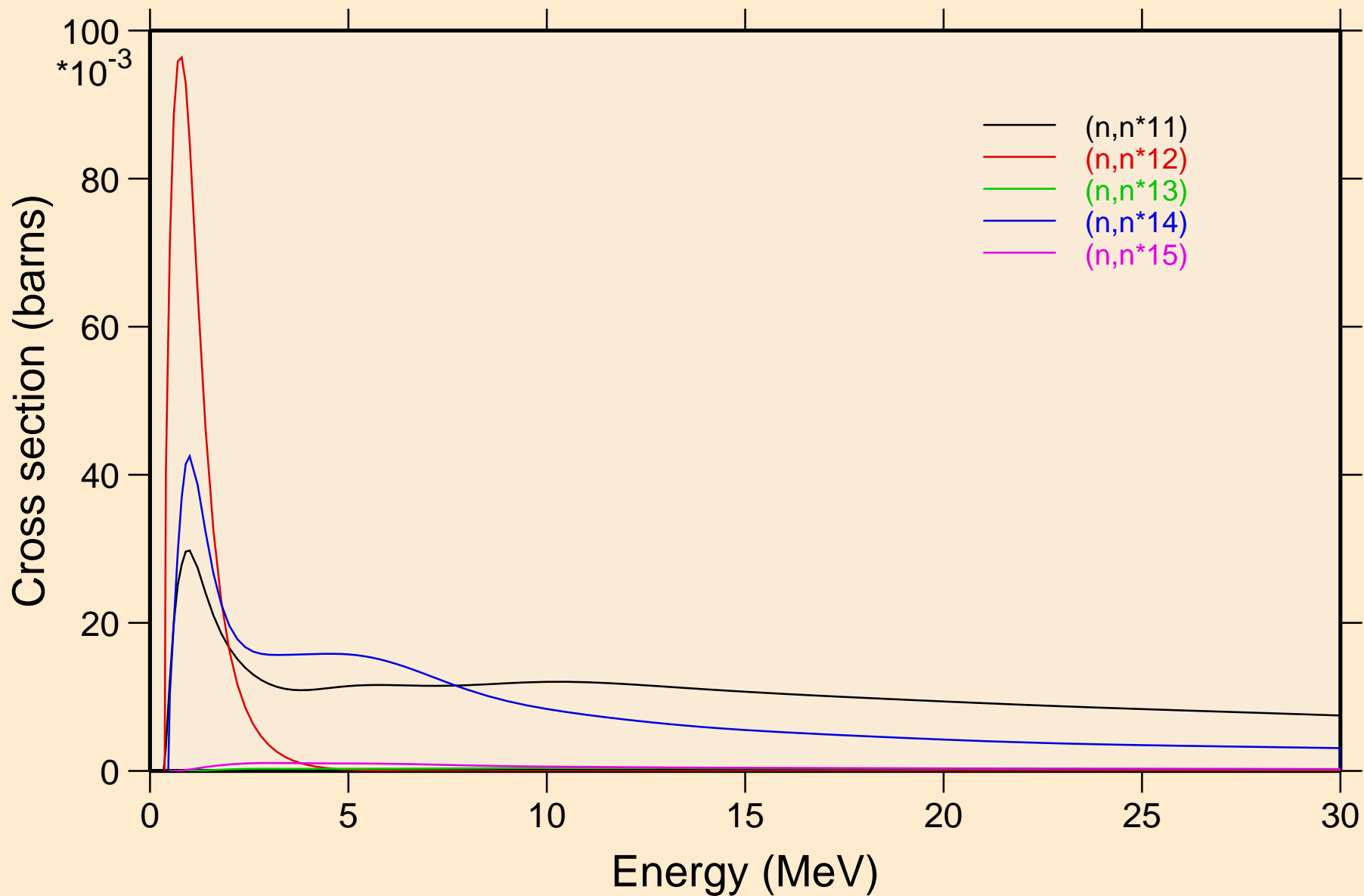

OS181 NEUTRON ACER TENDL-2019 LIBRARY; T=293.16K
Inelastic levels

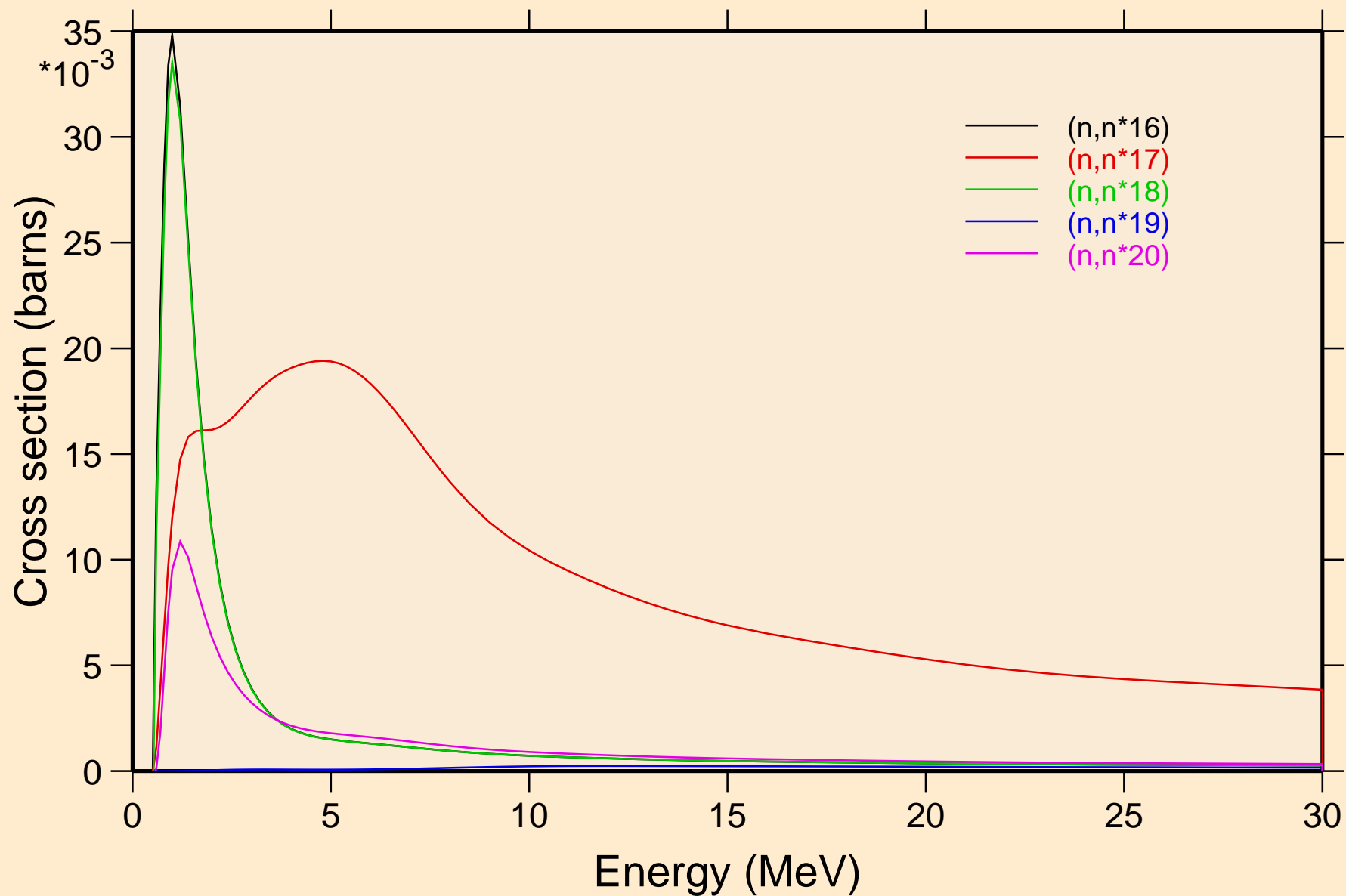

OS181 NEUTRON ACER TENDL-2019 LIBRARY; T=293.16K
Inelastic levels

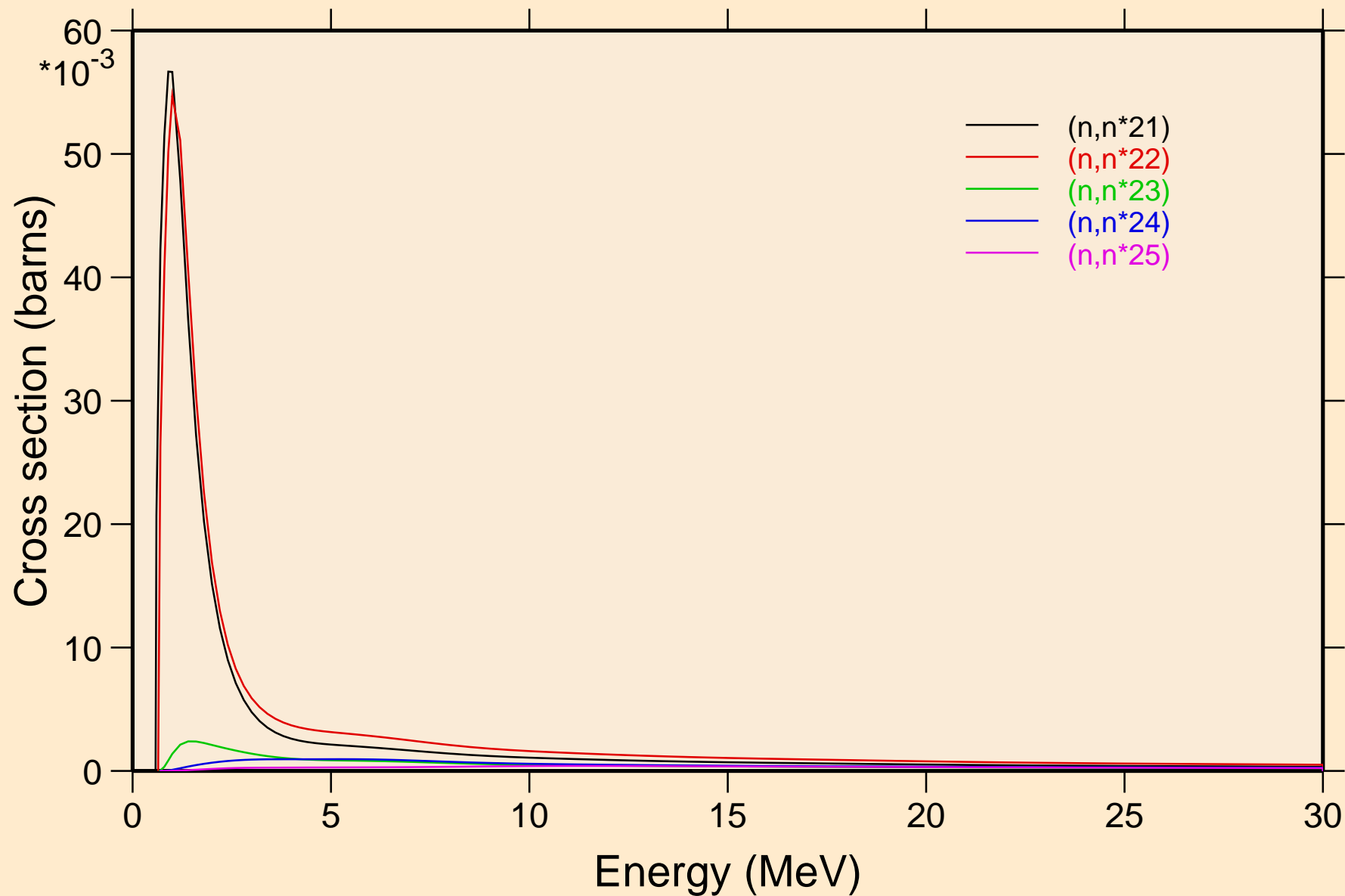

OS181 NEUTRON ACER TENDL-2019 LIBRARY; T=293.16K
Inelastic levels

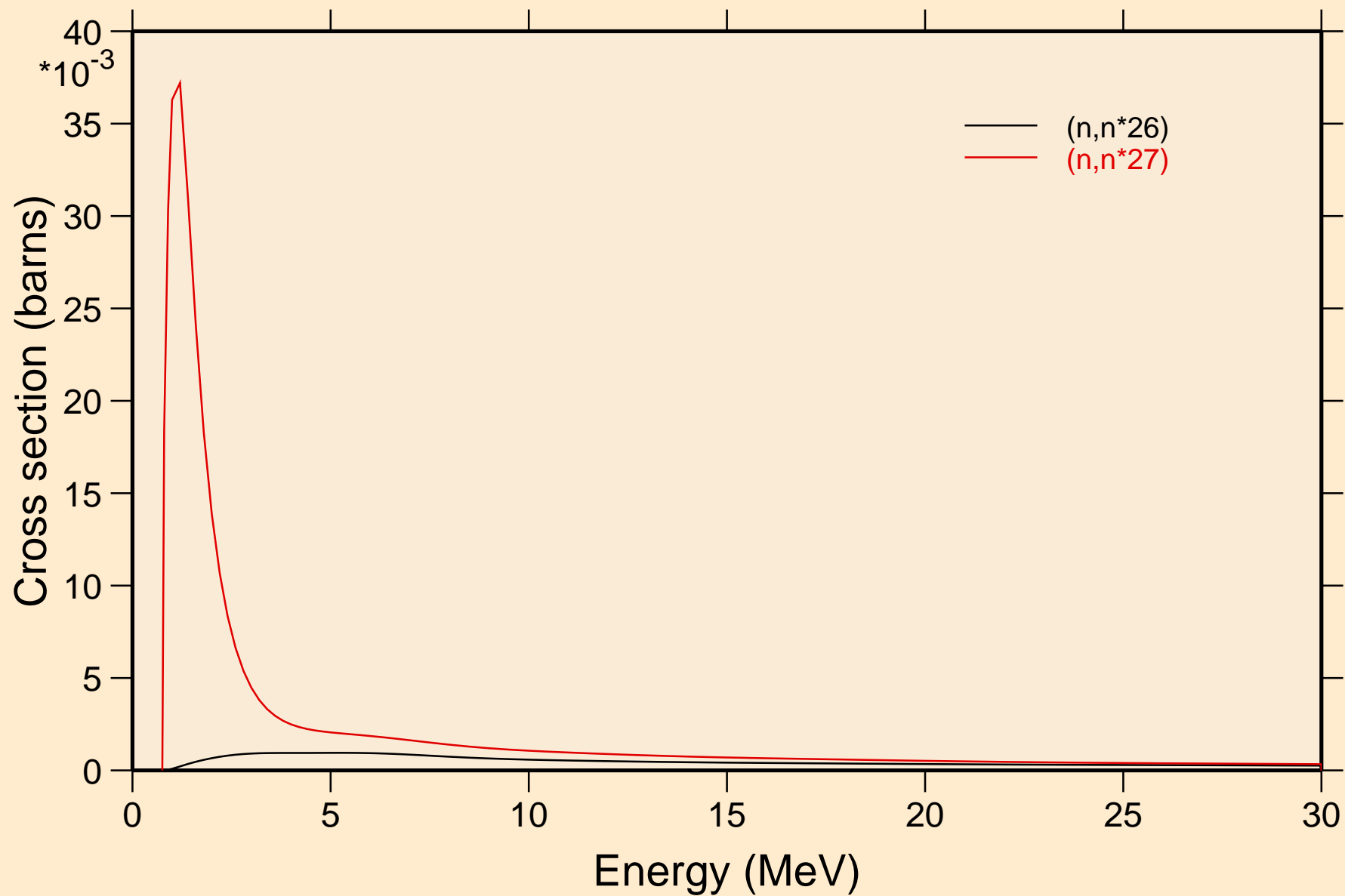

OS181 NEUTRON ACER TENDL-2019 LIBRARY; T=293.16K
Threshold reactions

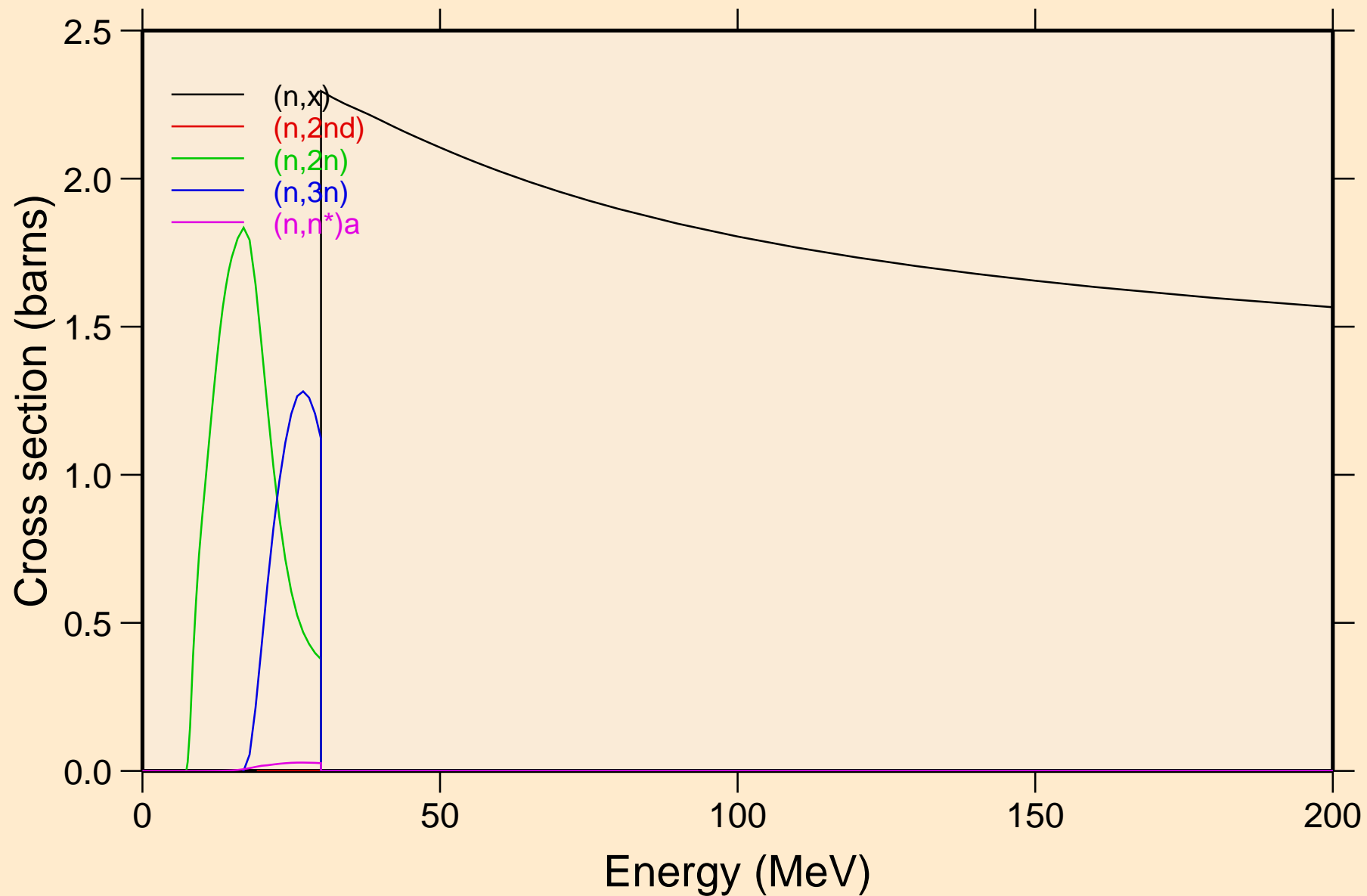

OS181 NEUTRON ACER TENDL-2019 LIBRARY; T=293.16K
Threshold reactions

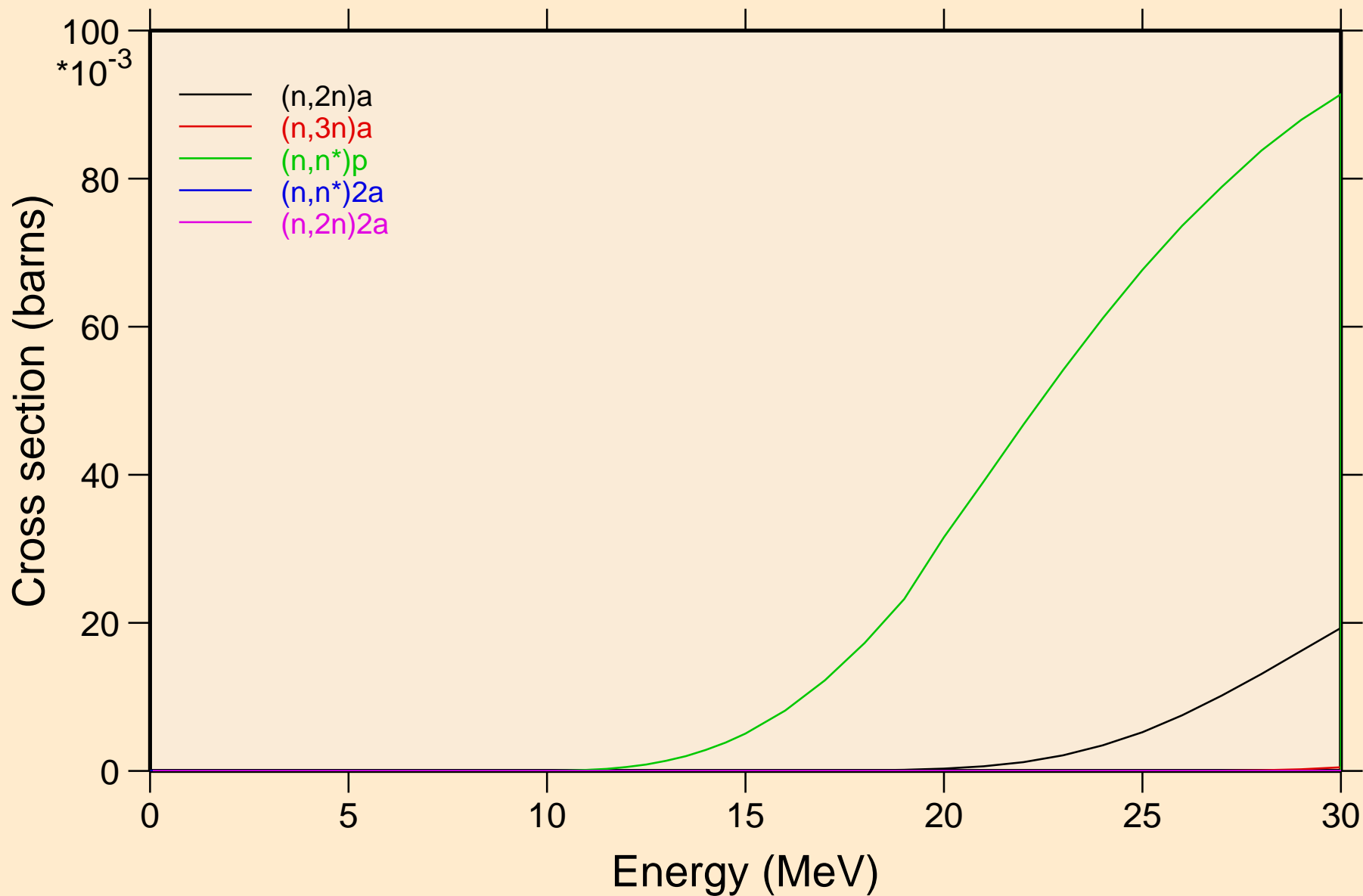

OS181 NEUTRON ACER TENDL-2019 LIBRARY; T=293.16K

Threshold reactions

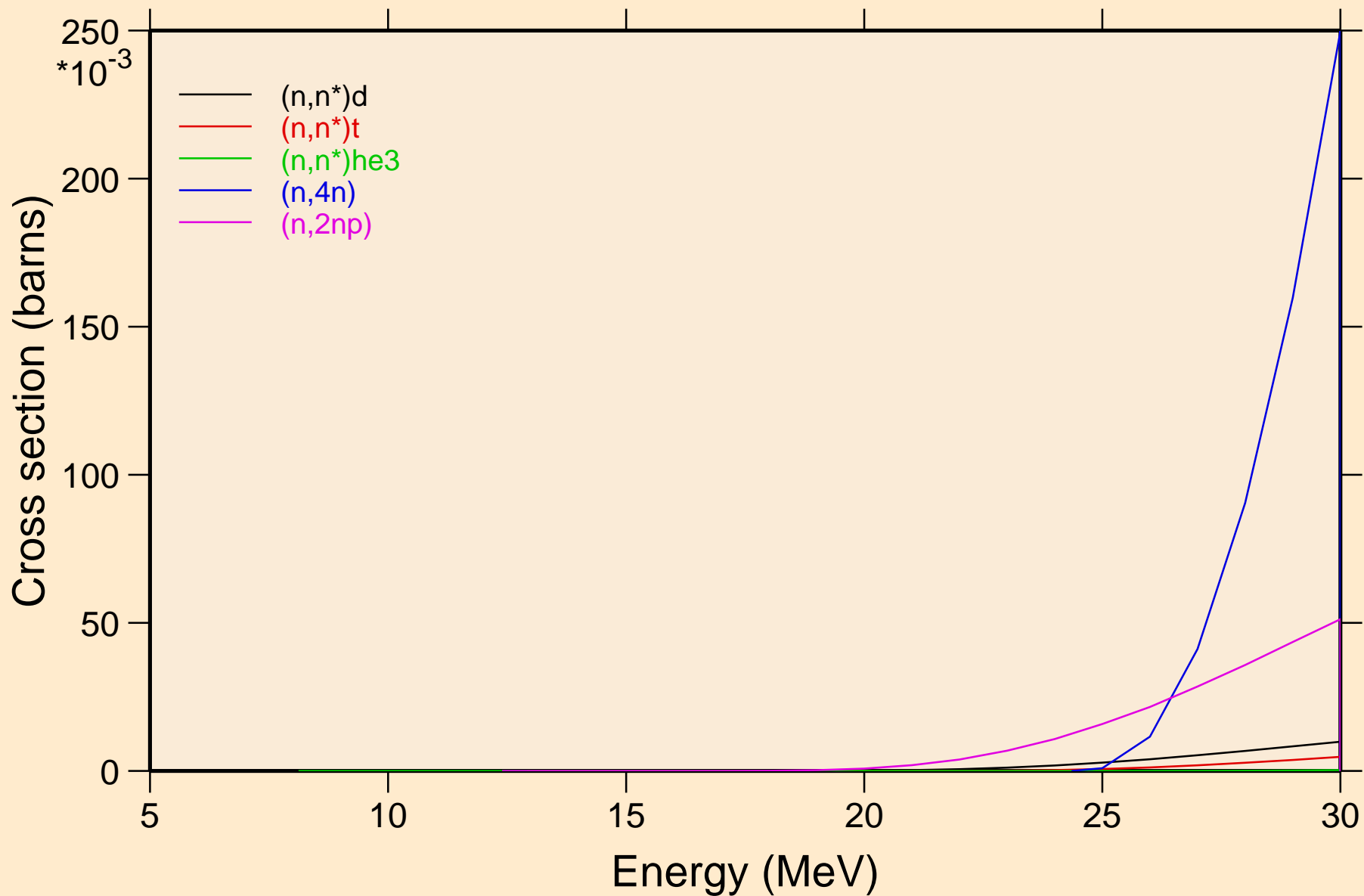

OS181 NEUTRON ACER TENDL-2019 LIBRARY; T=293.16K
Threshold reactions

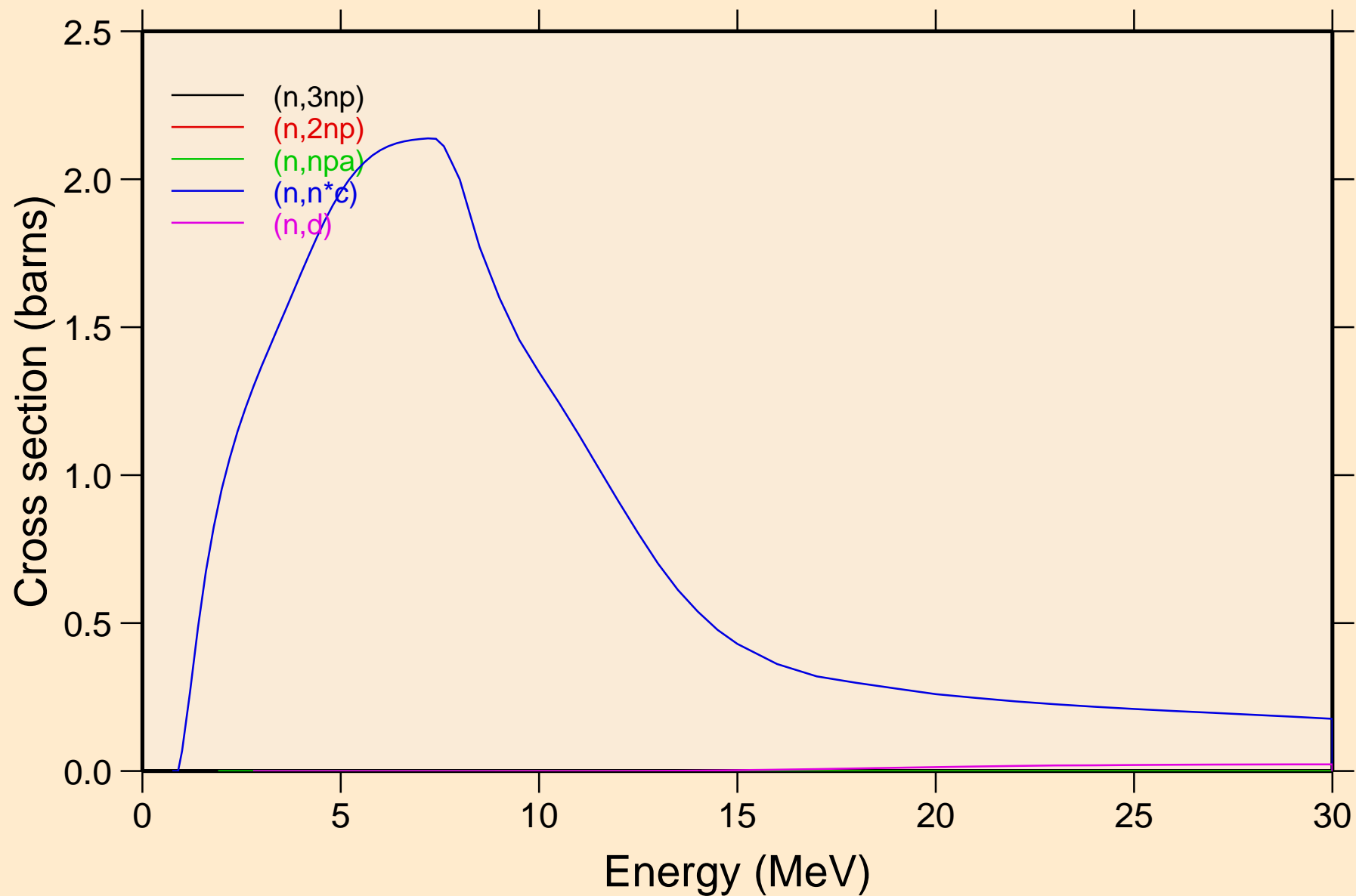

OS181 NEUTRON ACER TENDL-2019 LIBRARY; T=293.16K
Threshold reactions

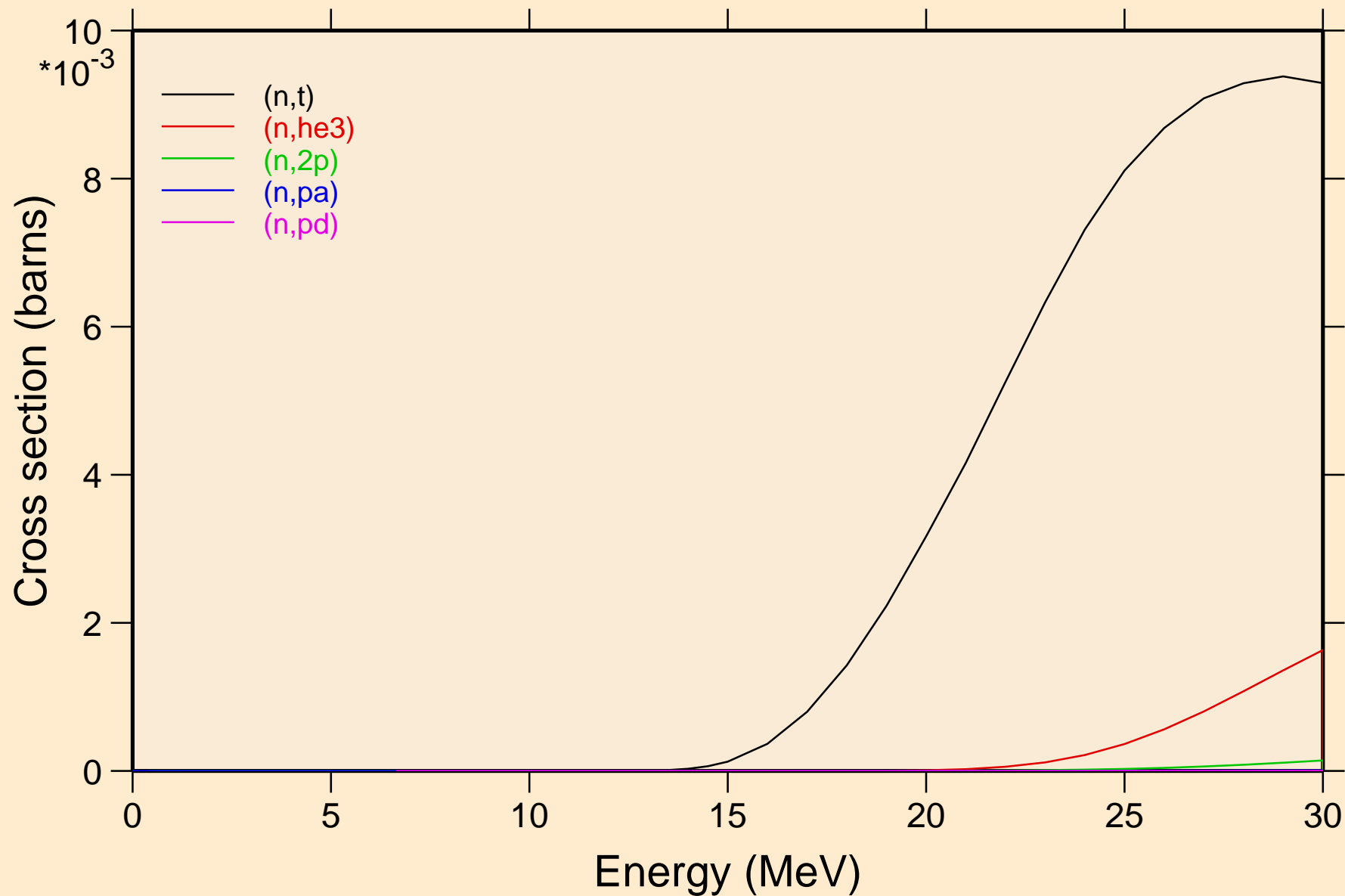

OS181 NEUTRON ACER TENDL-2019 LIBRARY; T=293.16K
Threshold reactions

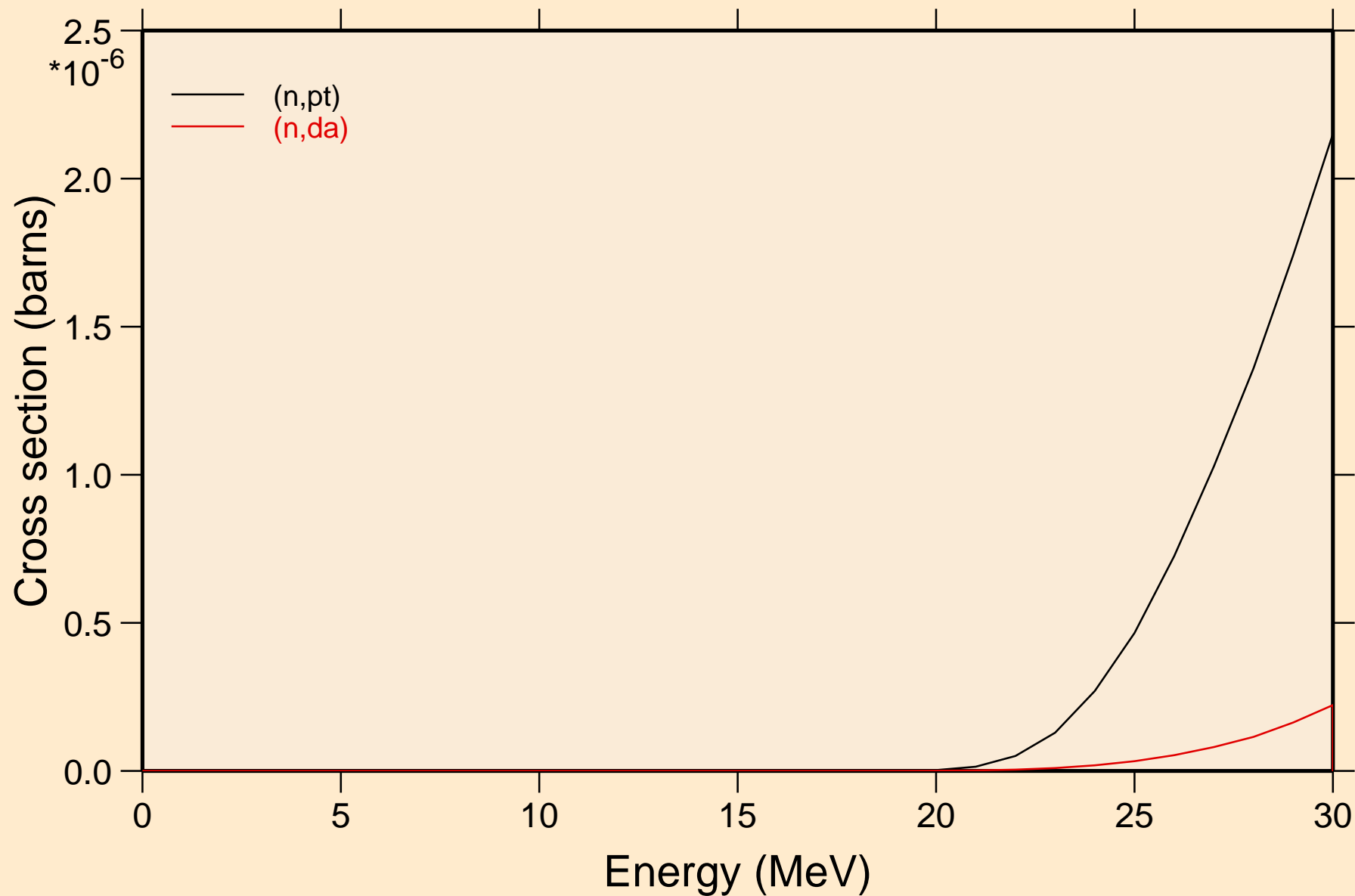

OS181 NEUTRON ACER TENDL-2019 LIBRARY; T=293.16K
Threshold reactions

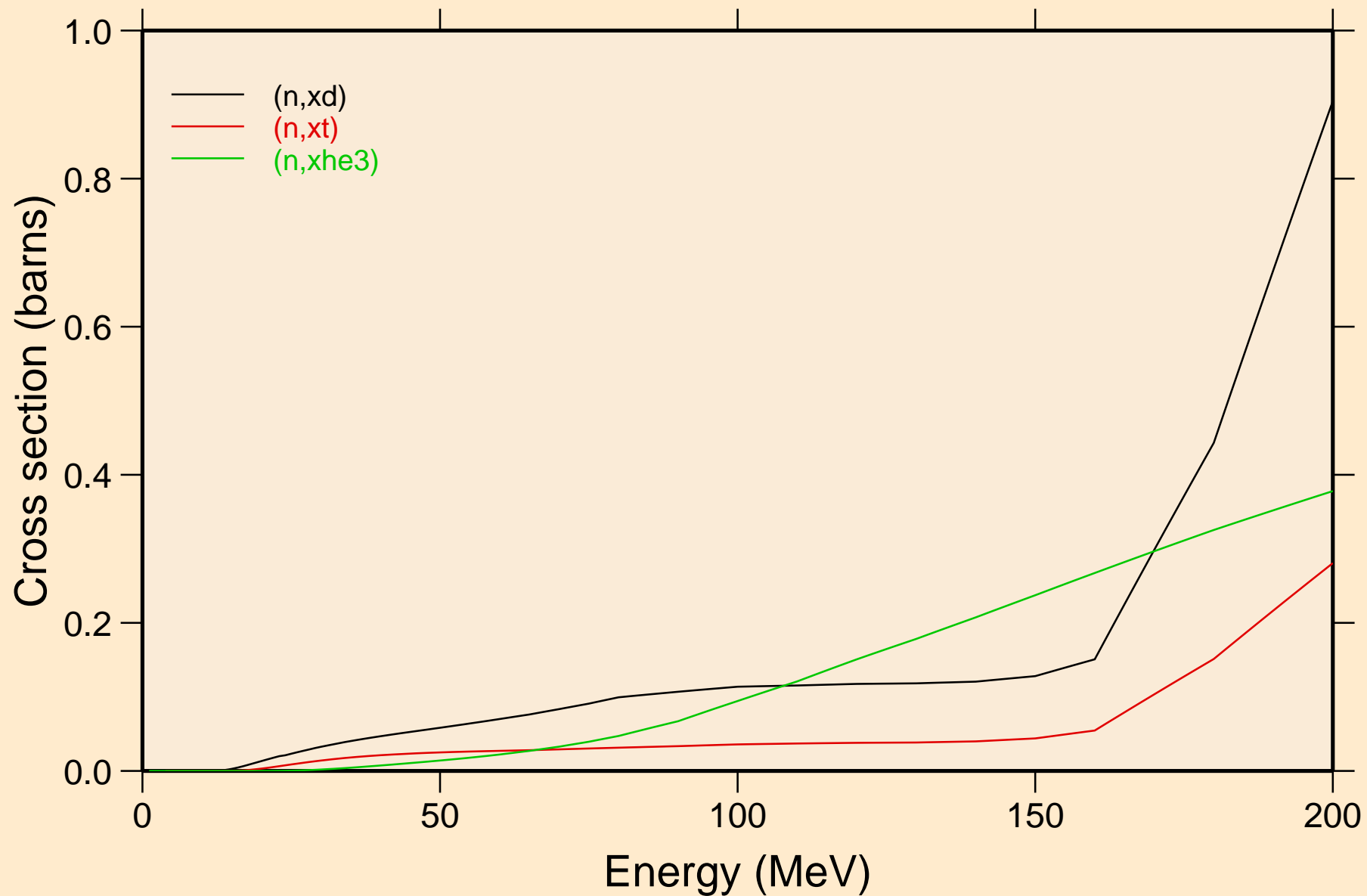

OS181 NEUTRON ACER TENDL-2019 LIBRARY; T=293.16K
angular distribution for elastic

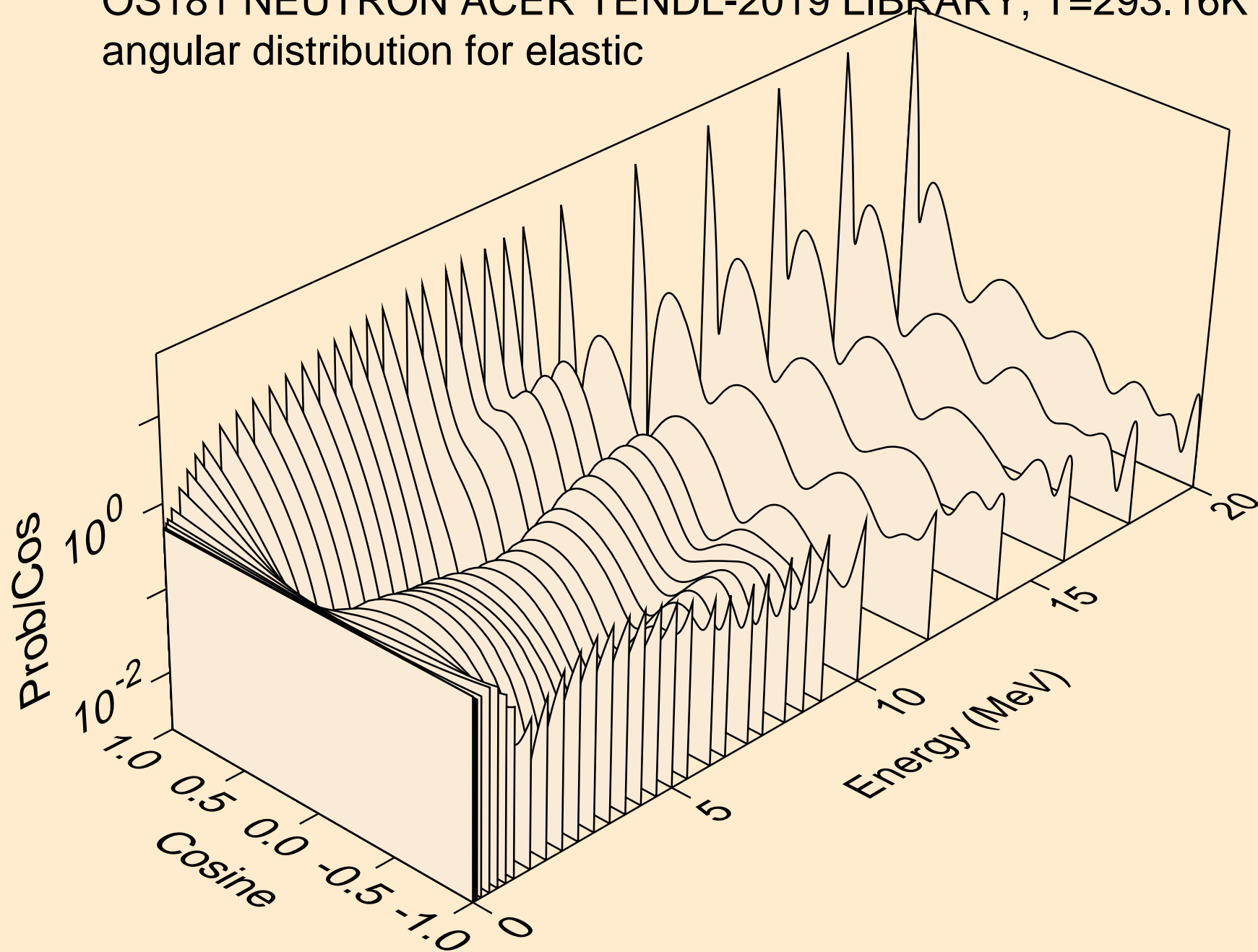

OS181 NEUTRON ACER TENDL-2019 LIBRARY; T=293.16K
angular distribution for elastic

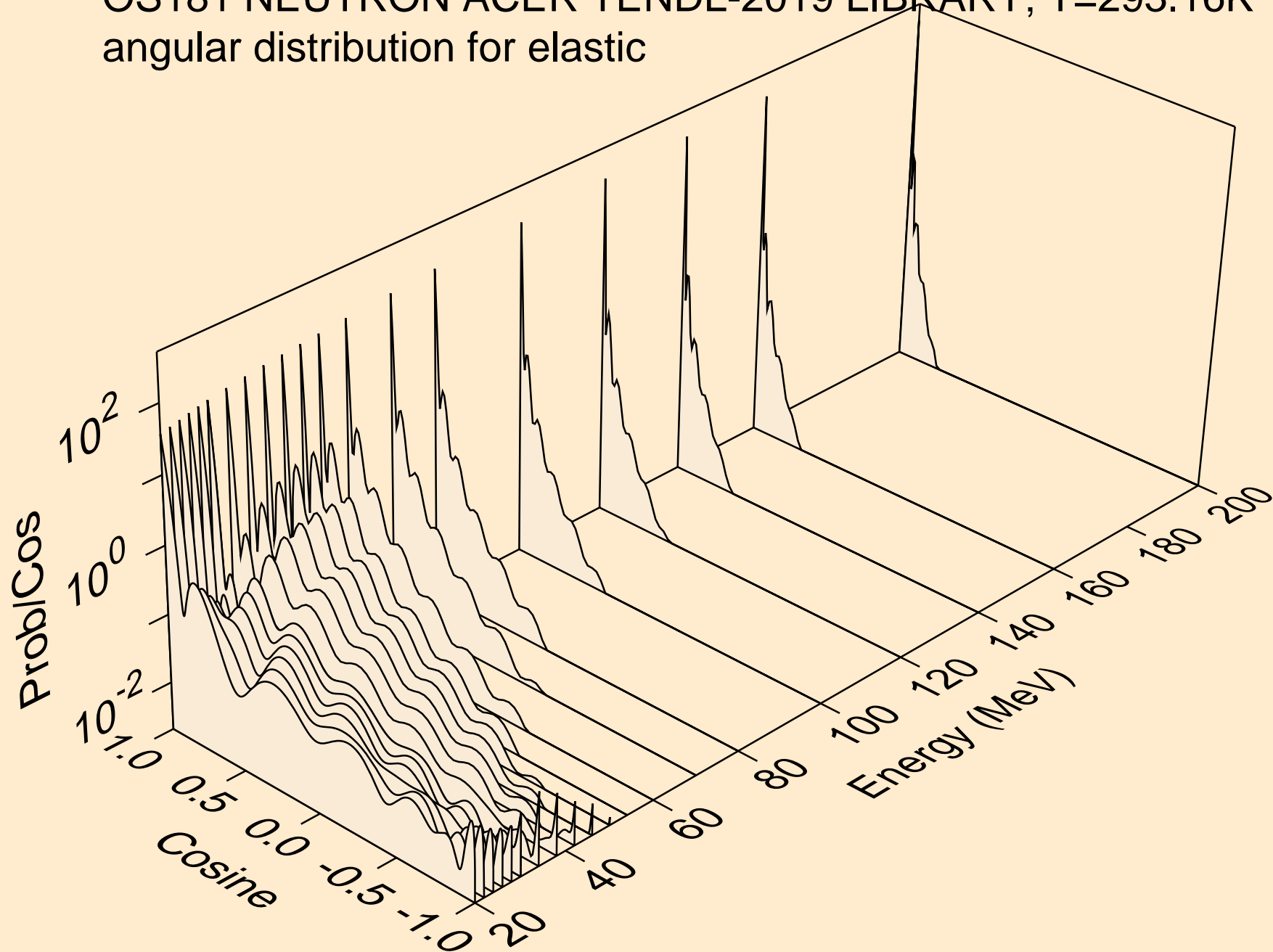

OS181 NEUTRON ACER TENDL-2019 LIBRARY; T=293.16K
angular distribution for (n,n*1)

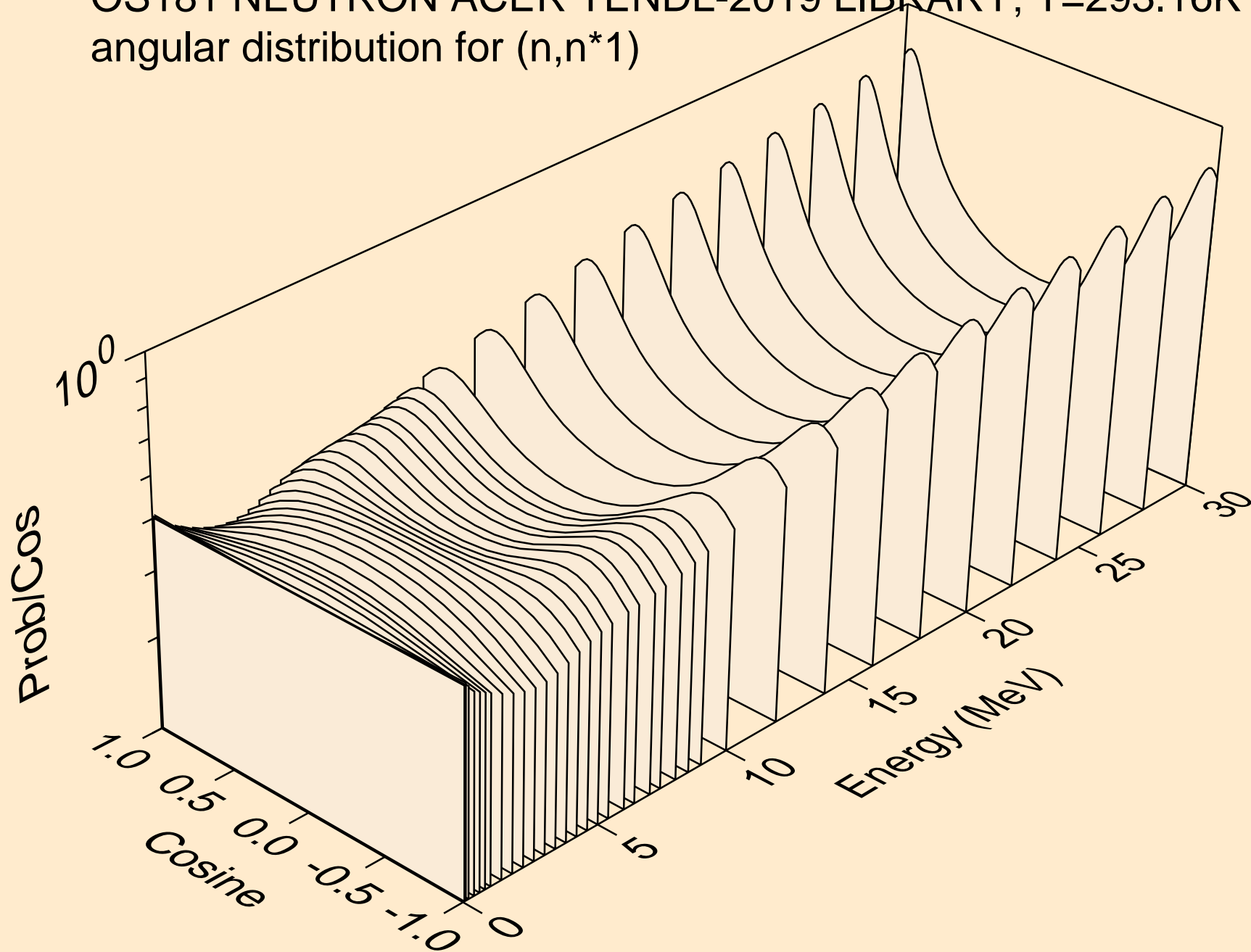

OS181 NEUTRON ACER TENDL-2019 LIBRARY; T=293.16K
angular distribution for (n,n*2)

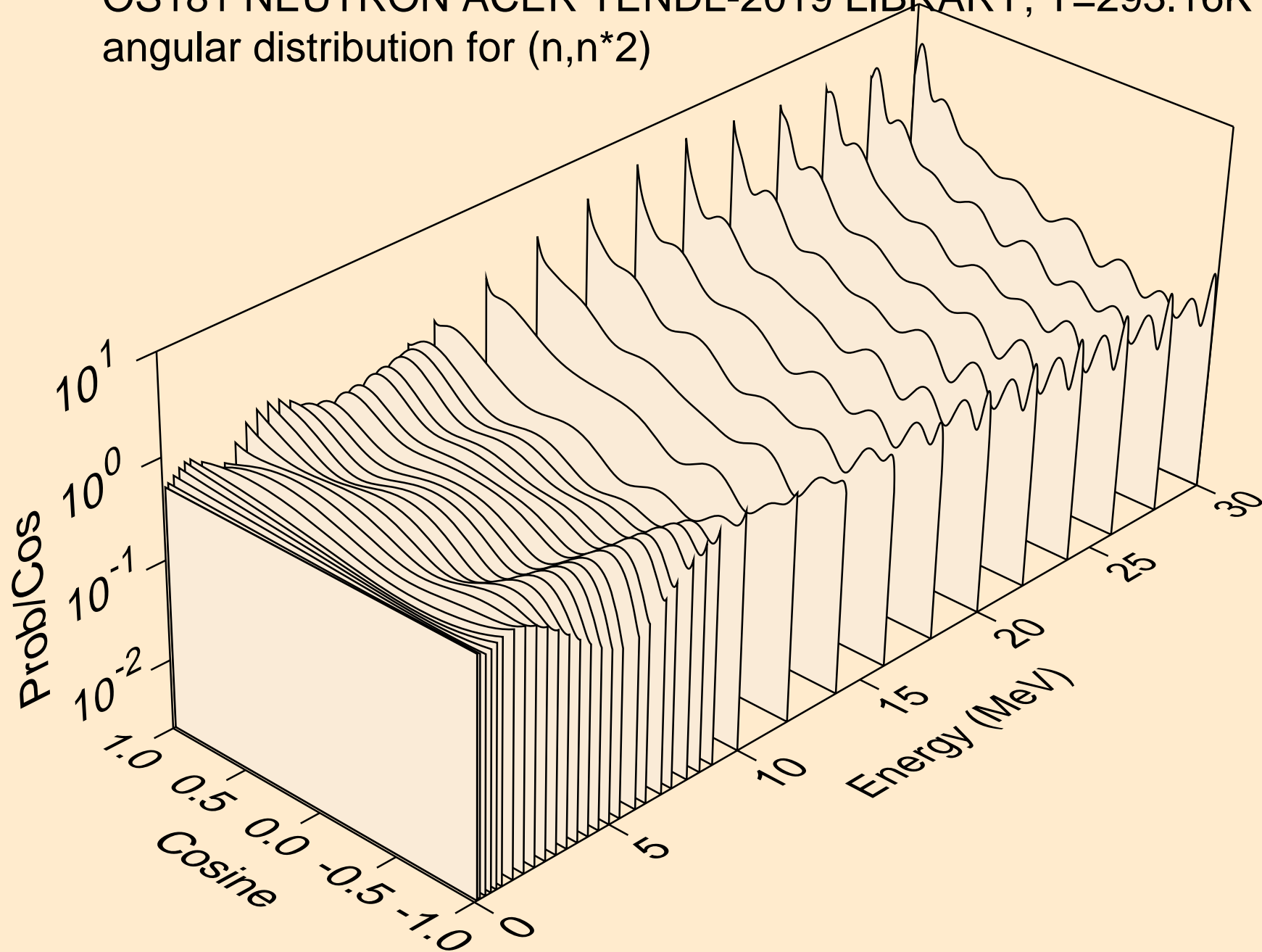

OS181 NEUTRON ACER TENDL-2019 LIBRARY; T=293.16K
angular distribution for (n,n*3)

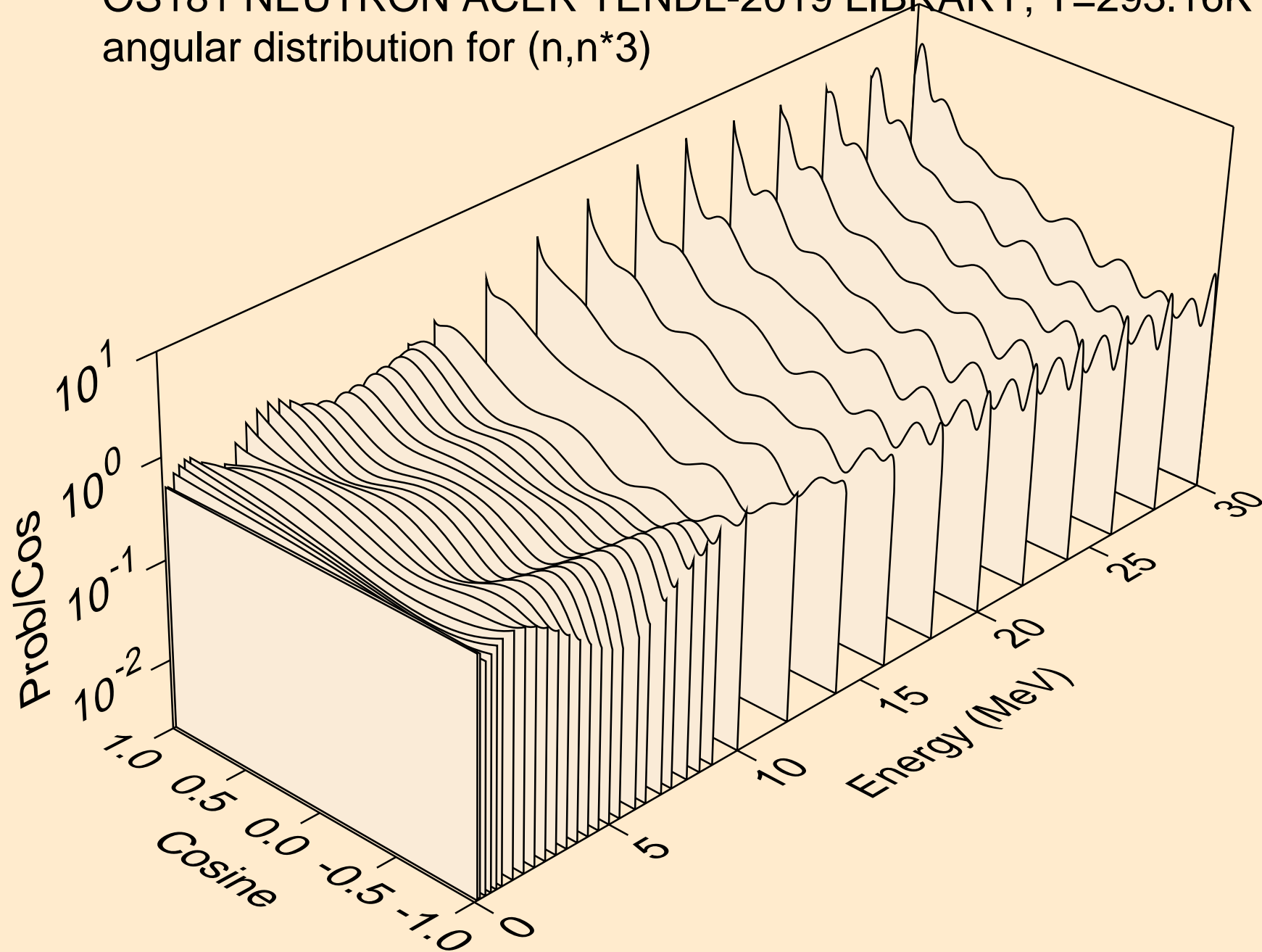

OS181 NEUTRON ACER TENDL-2019 LIBRARY; T=293.16K
angular distribution for (n,n*4)

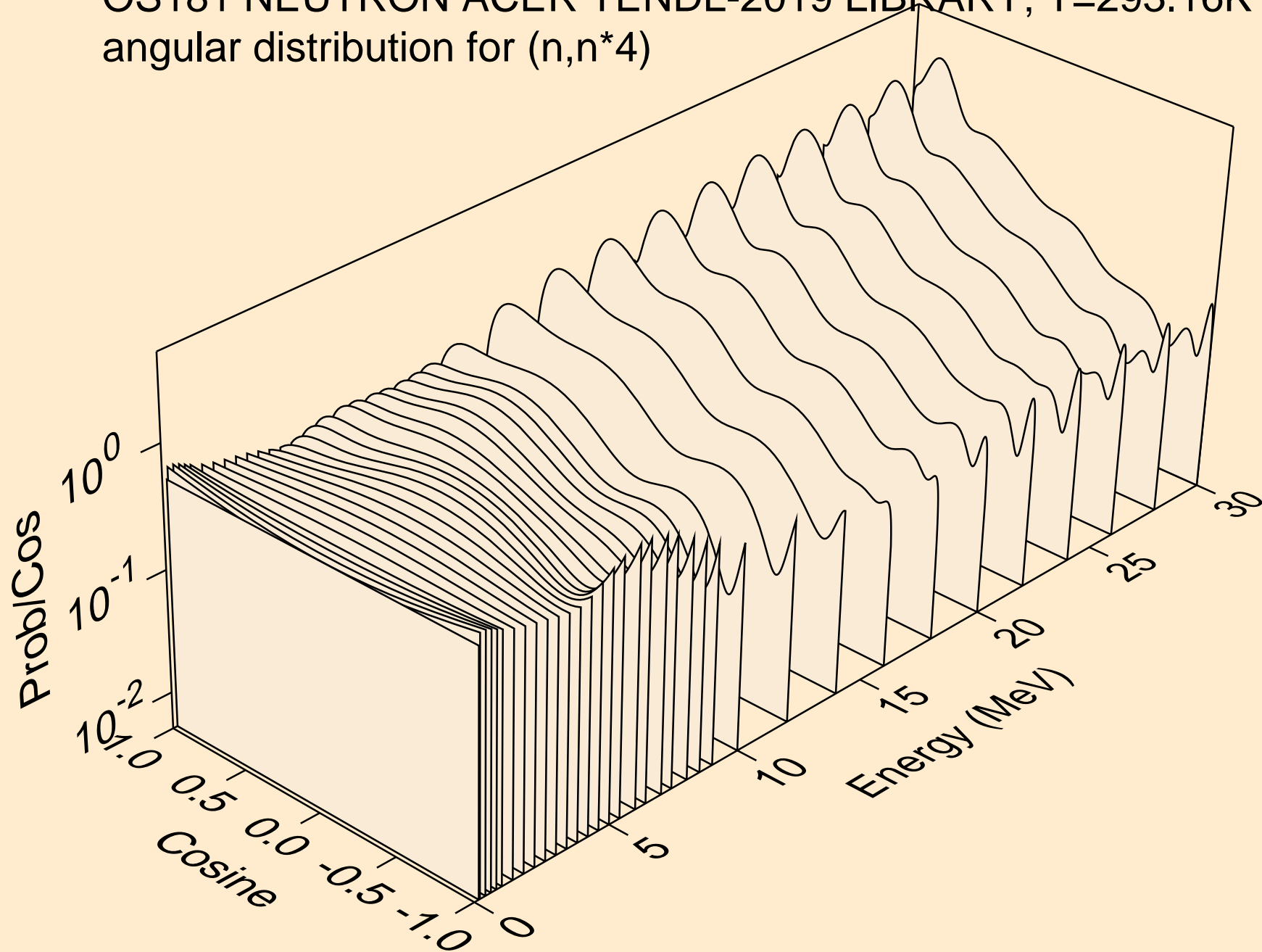

OS181 NEUTRON ACER TENDL-2019 LIBRARY; T=293.16K
angular distribution for (n,n*5)

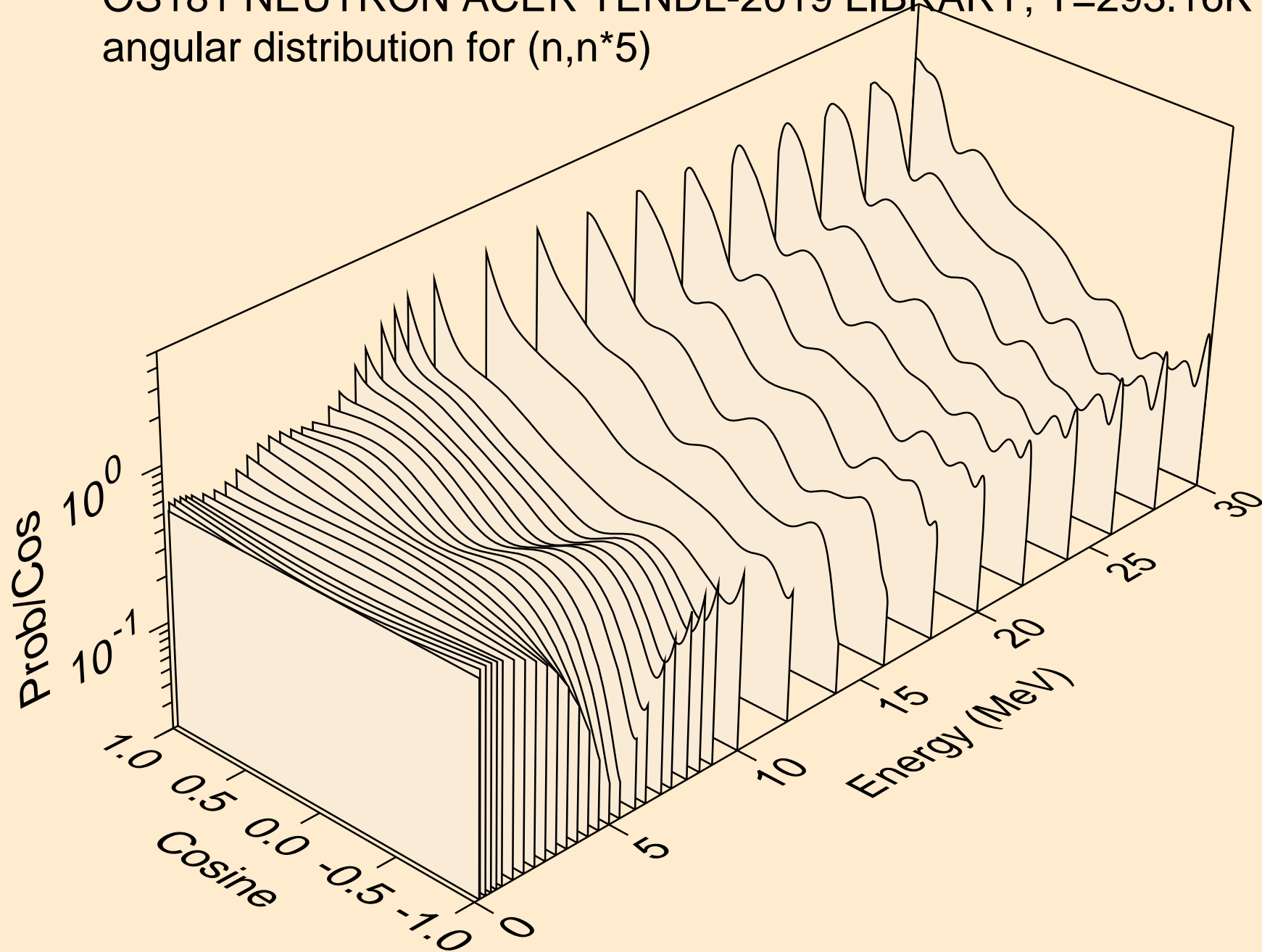

OS181 NEUTRON ACER TENDL-2019 LIBRARY; T=293.16K
angular distribution for (n,n*6)

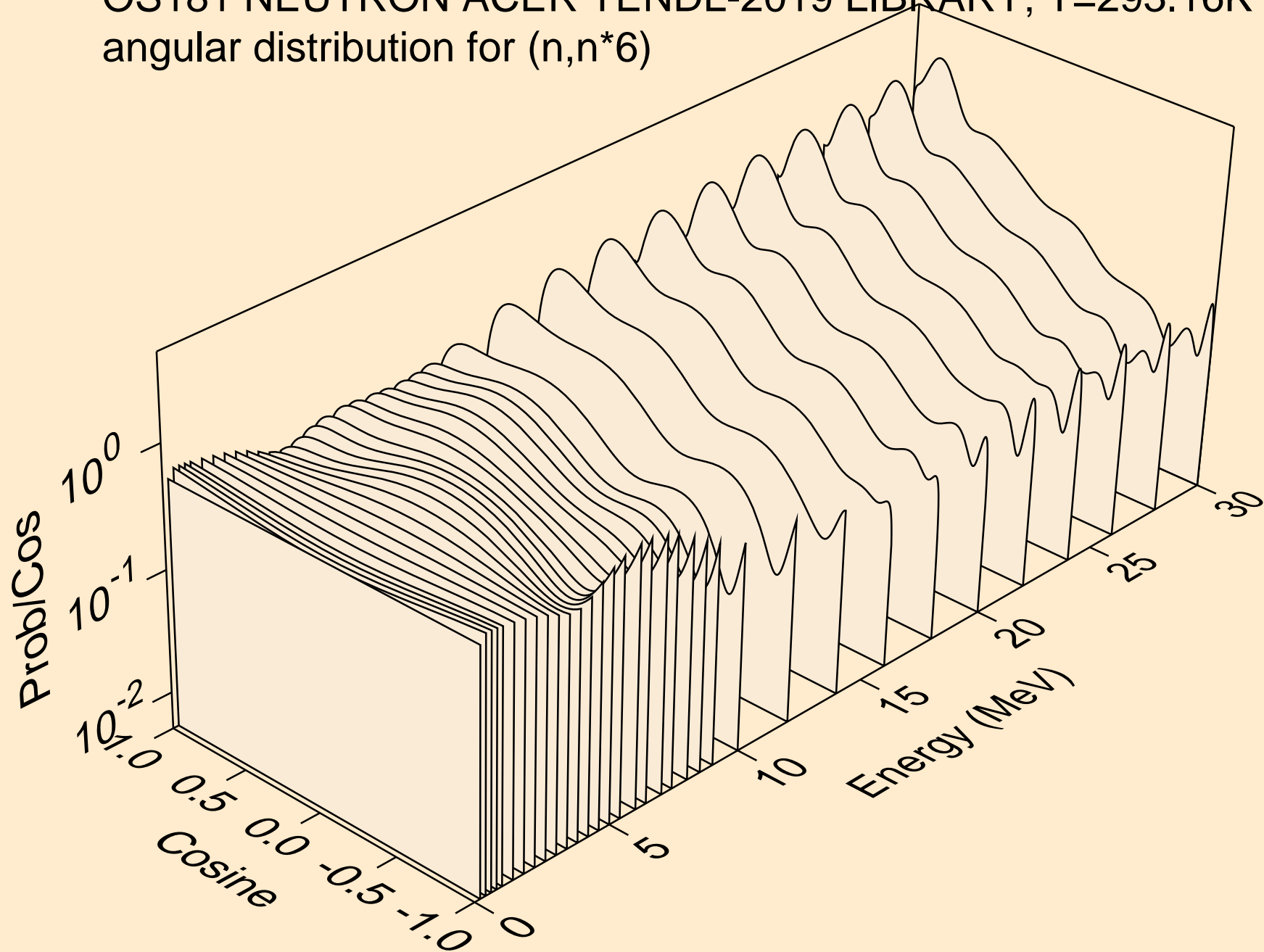

OS181 NEUTRON ACER TENDL-2019 LIBRARY; T=293.16K
angular distribution for (n,n*7)

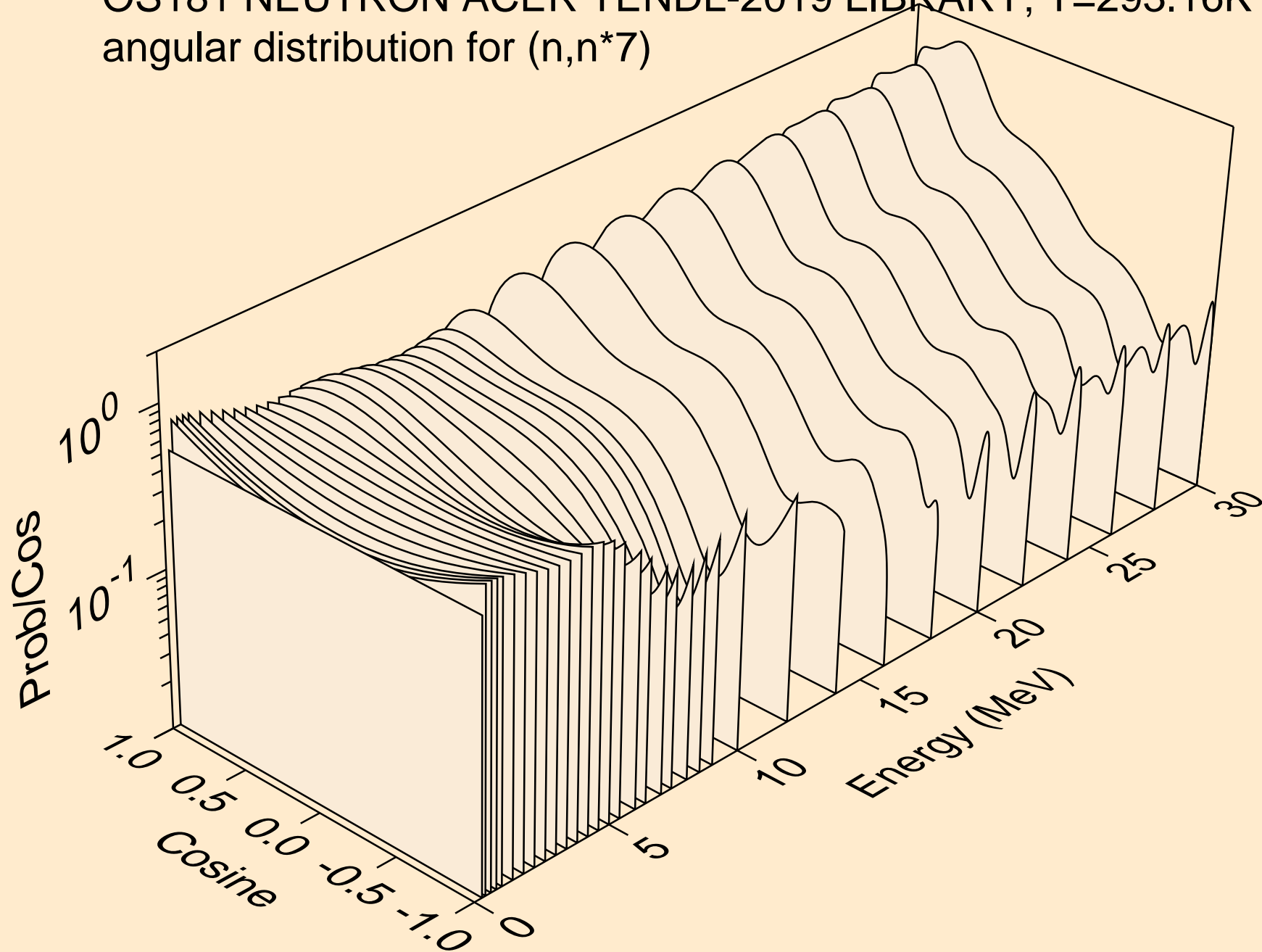

OS181 NEUTRON ACER TENDL-2019 LIBRARY; T=293.16K
angular distribution for (n,n*8)

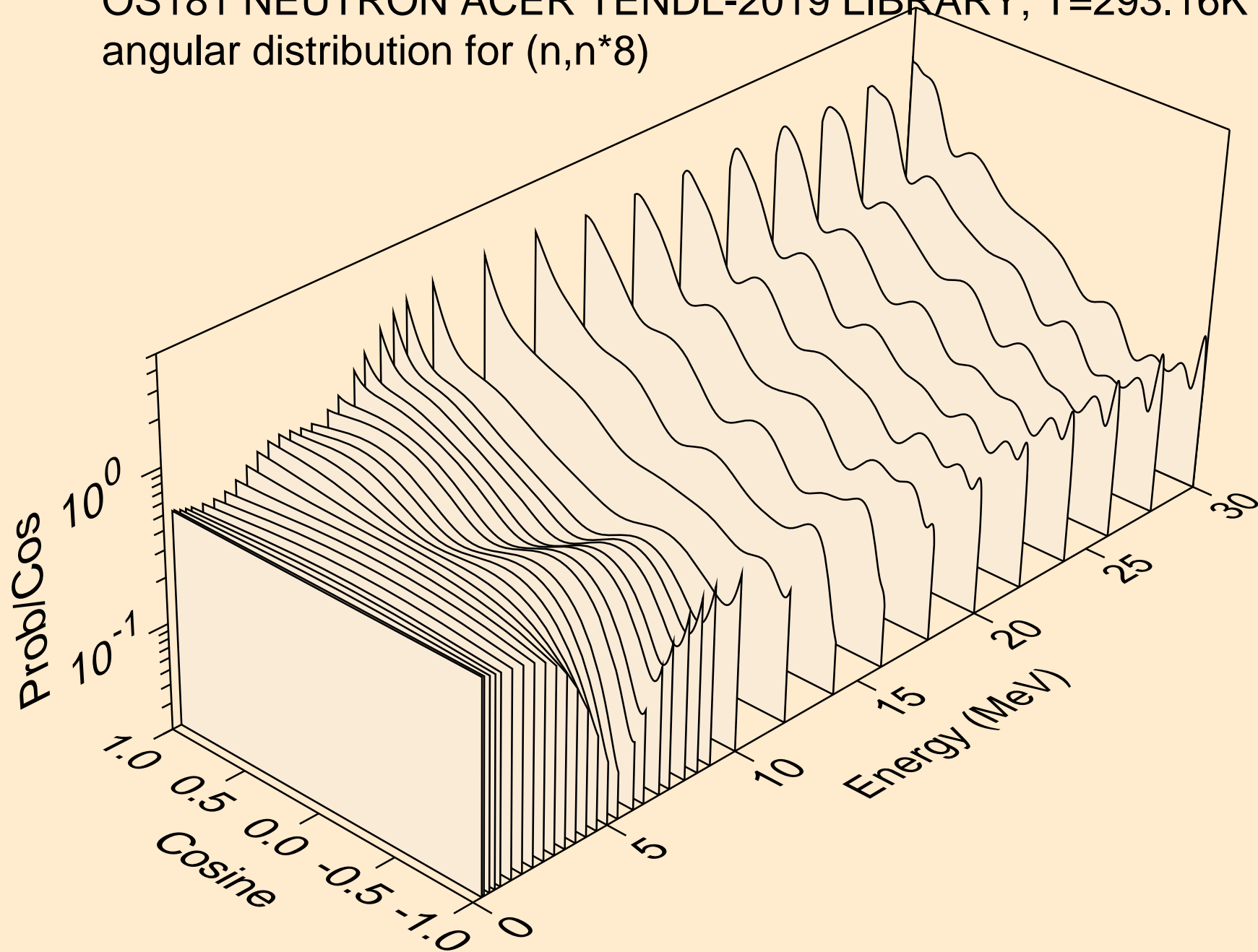

OS181 NEUTRON ACER TENDL-2019 LIBRARY; T=293.16K
angular distribution for (n,n*9)

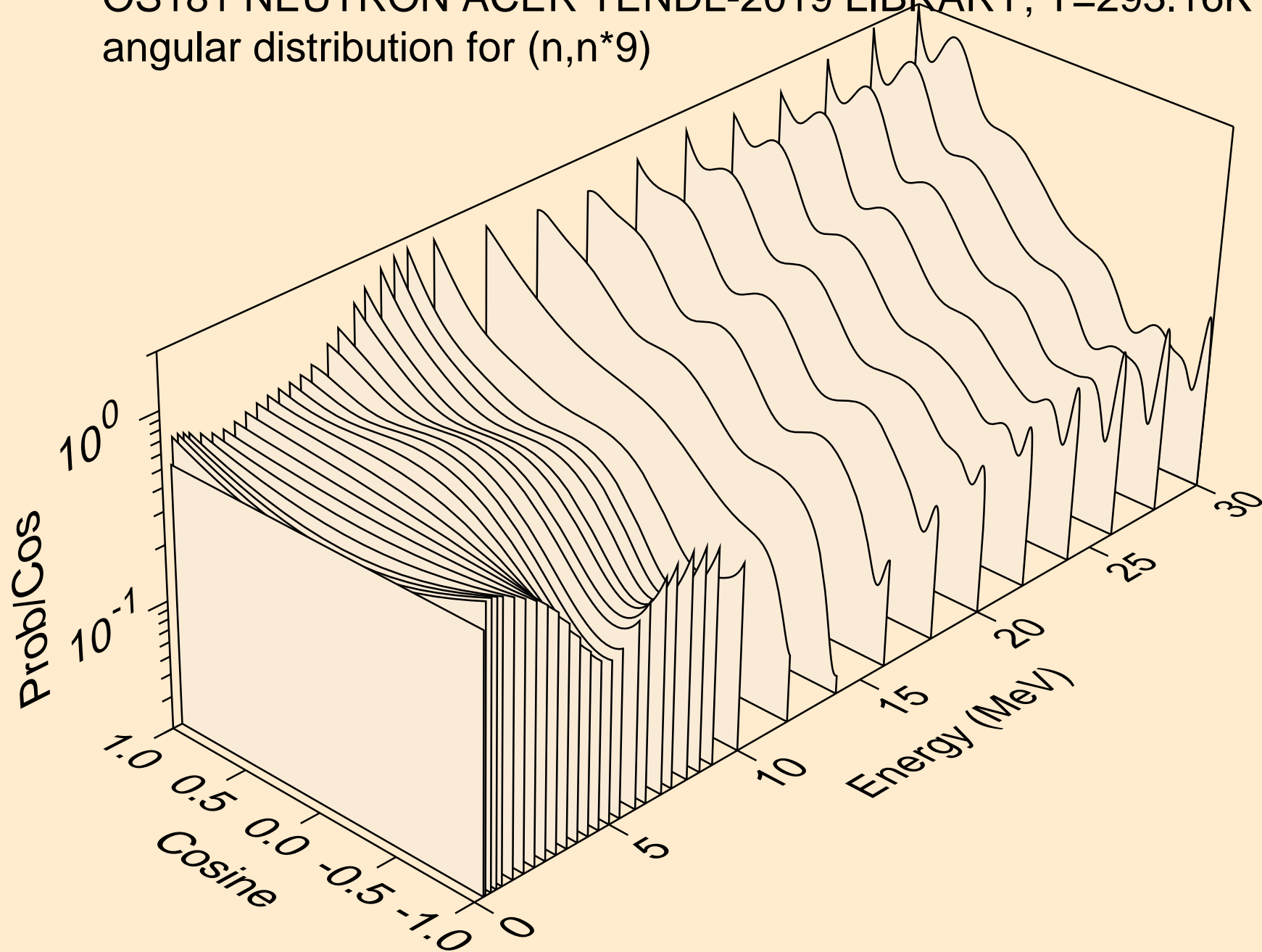

OS181 NEUTRON ACER TENDL-2019 LIBRARY; T=293.16K
angular distribution for (n,n*10)

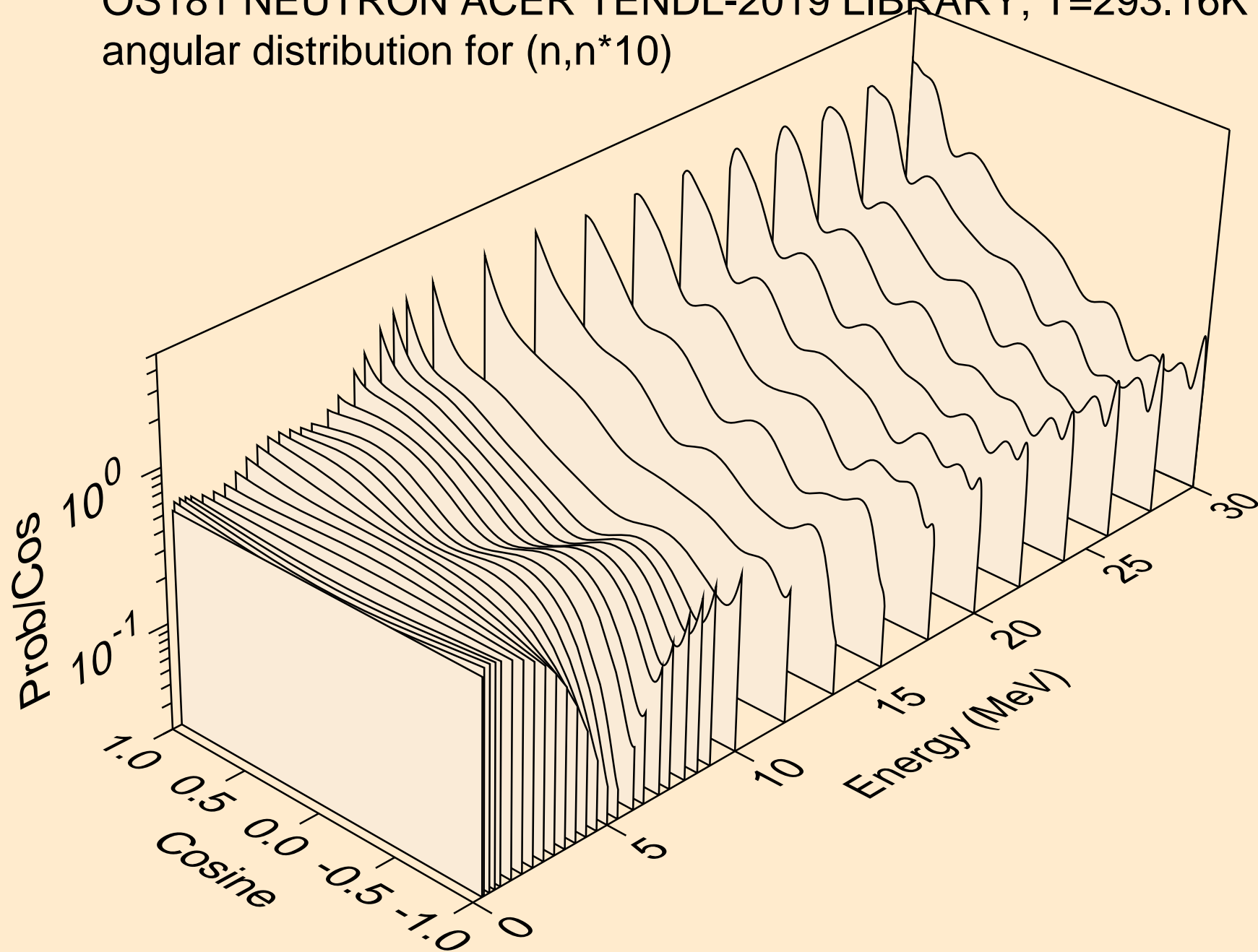

OS181 NEUTRON ACER TENDL-2019 LIBRARY; T=293.16K
angular distribution for (n,n*11)

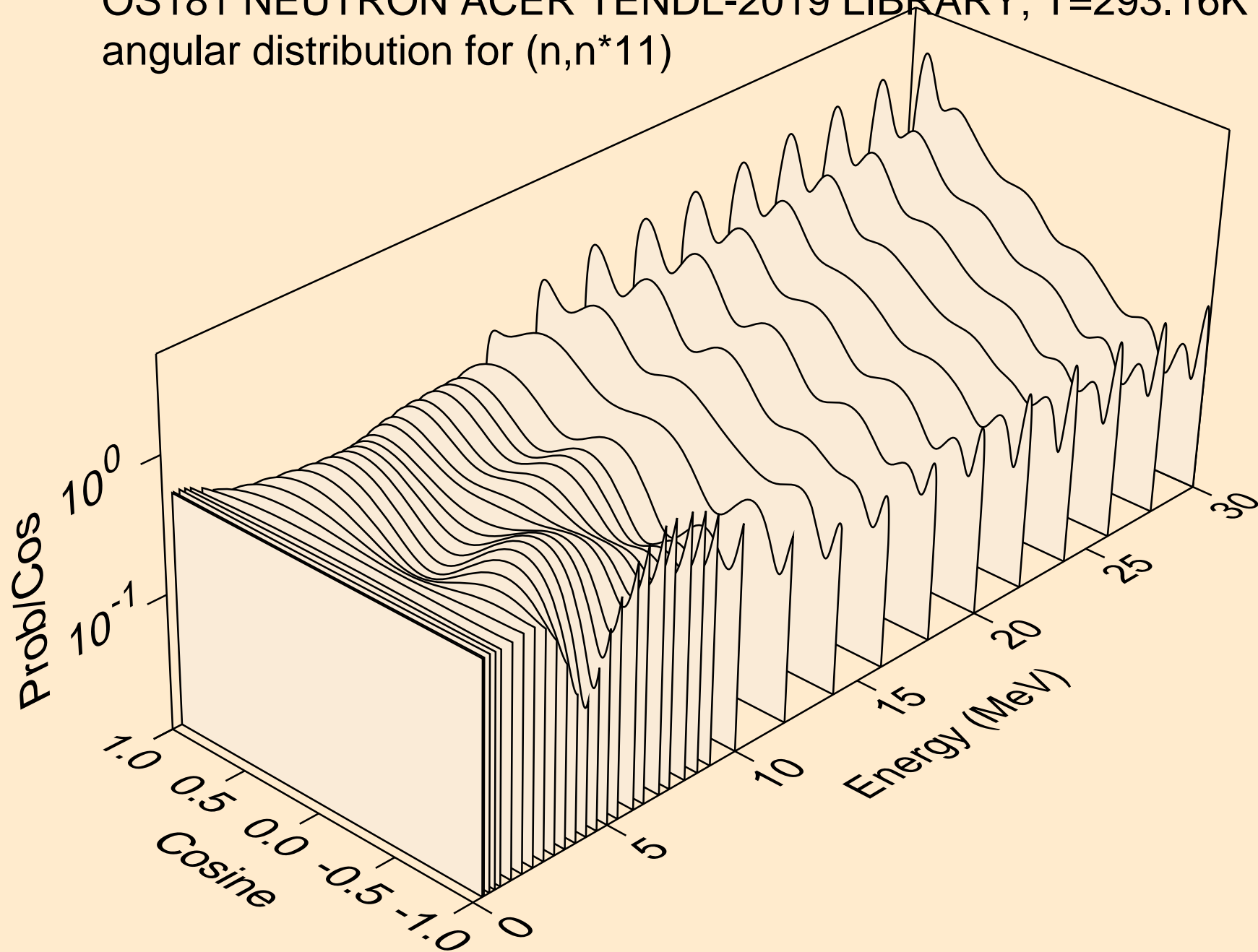

OS181 NEUTRON ACER TENDL-2019 LIBRARY; T=293.16K
angular distribution for (n,n*12)

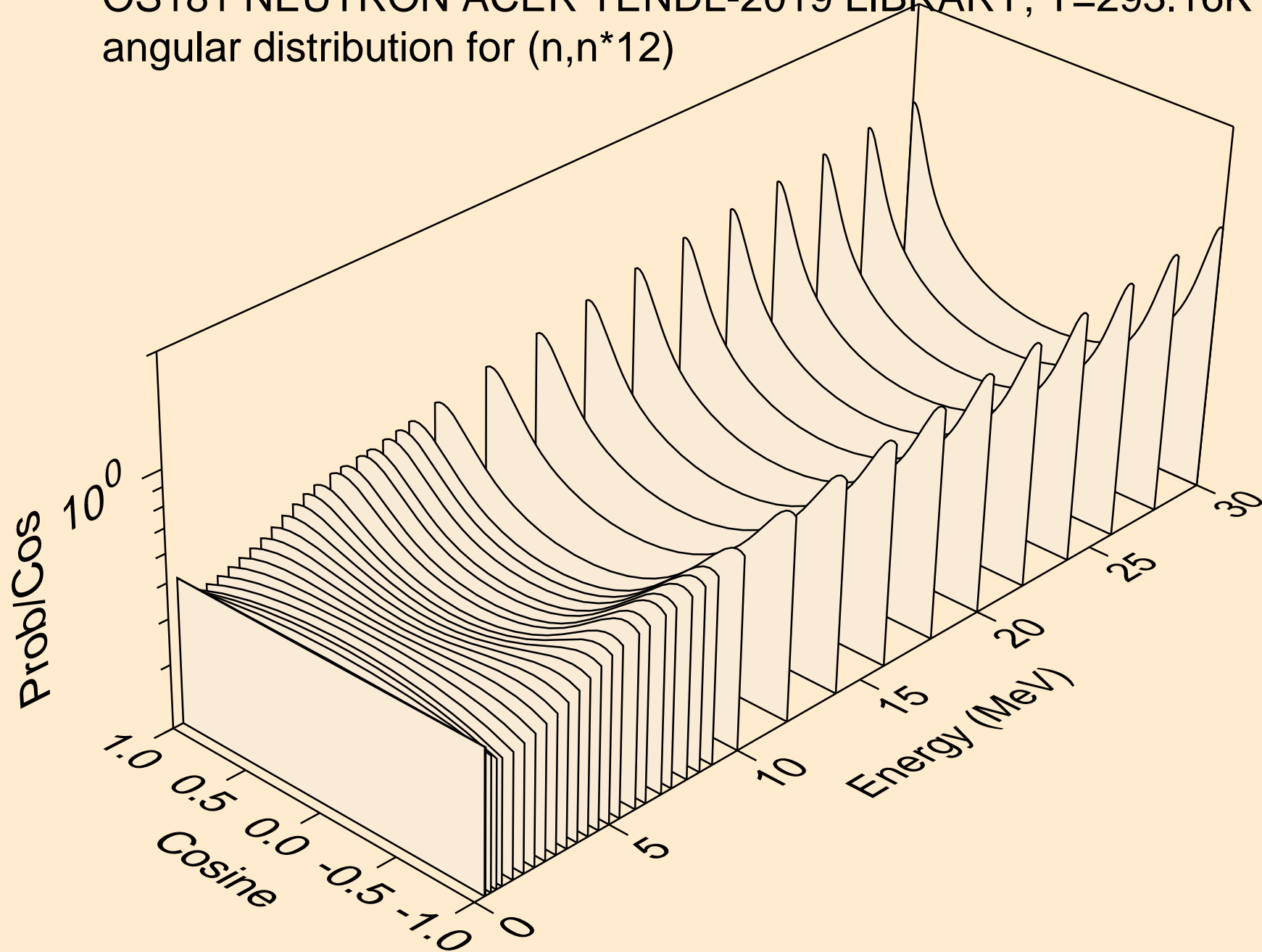

OS181 NEUTRON ACER TENDL-2019 LIBRARY; T=293.16K
angular distribution for (n,n*13)

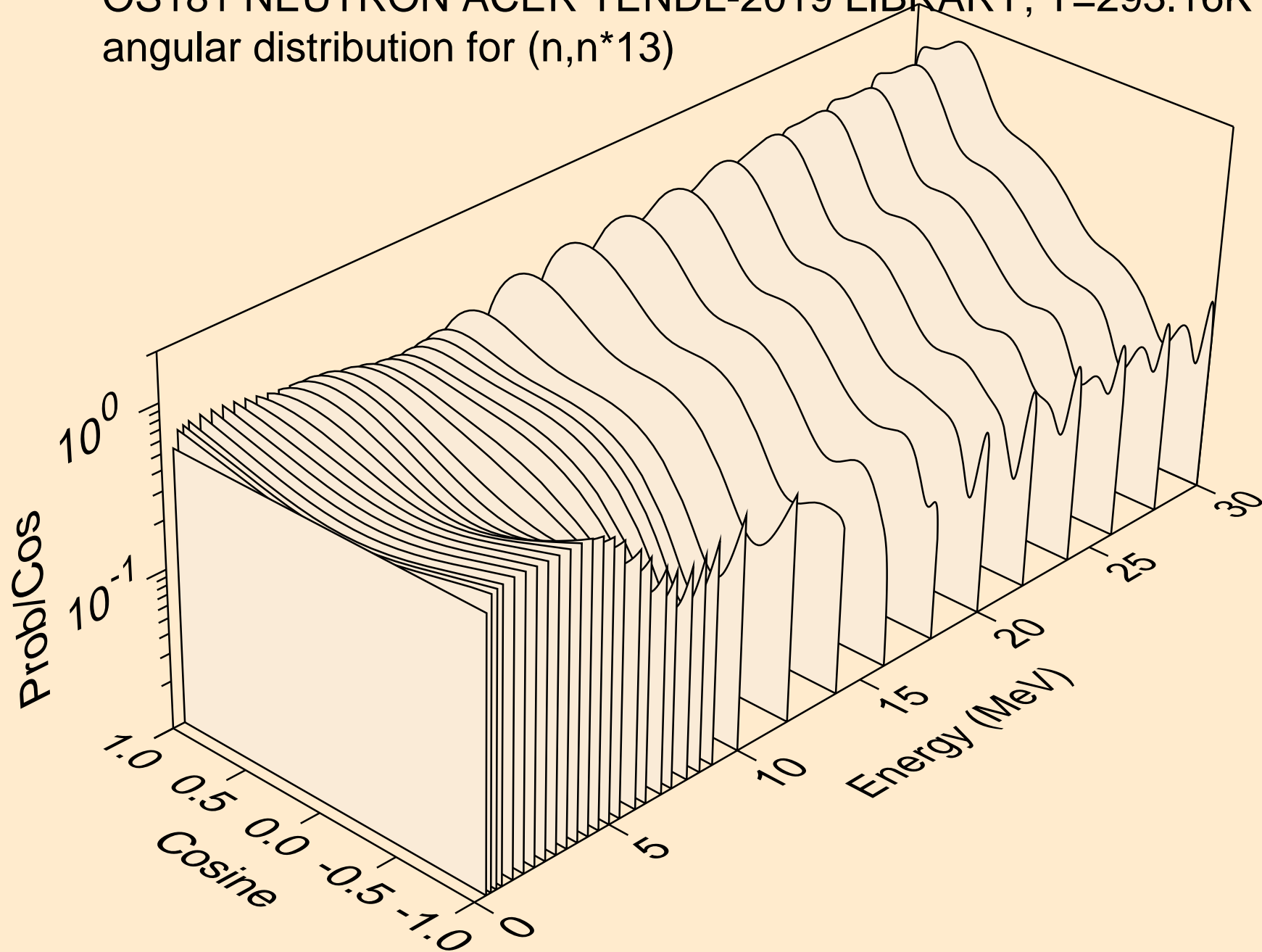

OS181 NEUTRON ACER TENDL-2019 LIBRARY; T=293.16K
angular distribution for (n,n*14)

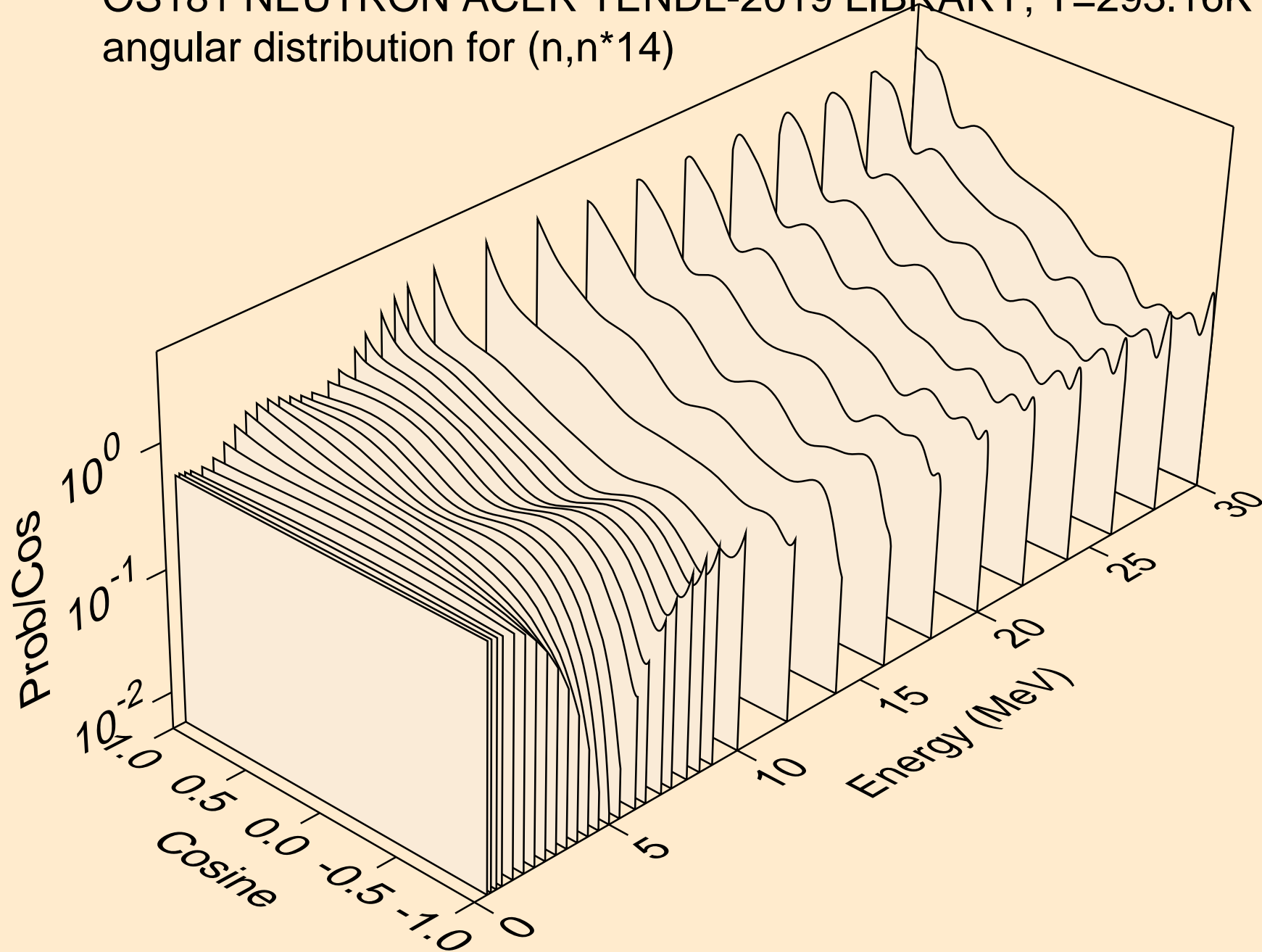

OS181 NEUTRON ACER TENDL-2019 LIBRARY; T=293.16K
angular distribution for (n,n*15)

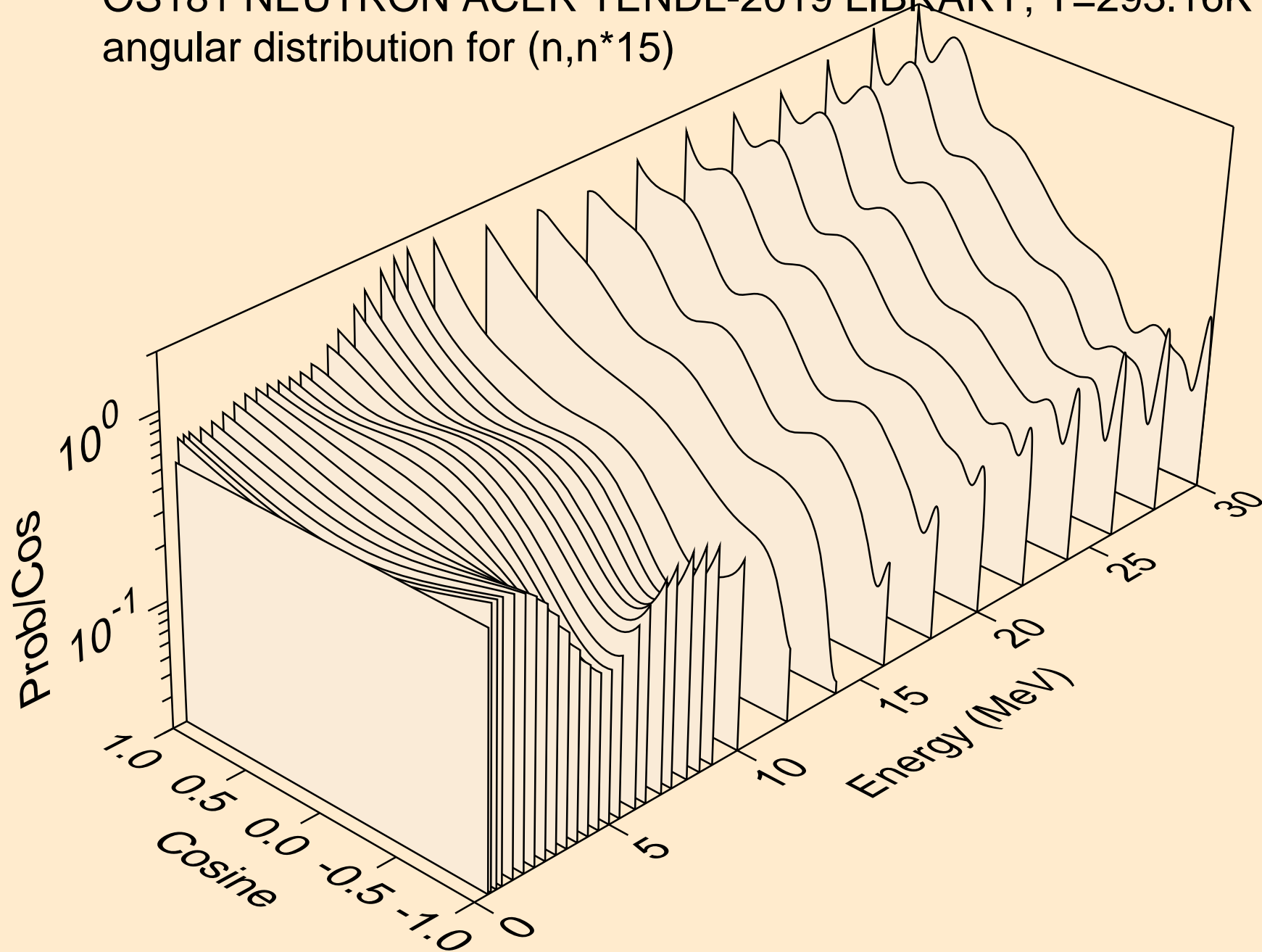

OS181 NEUTRON ACER TENDL-2019 LIBRARY; T=293.16K
angular distribution for (n,n*16)

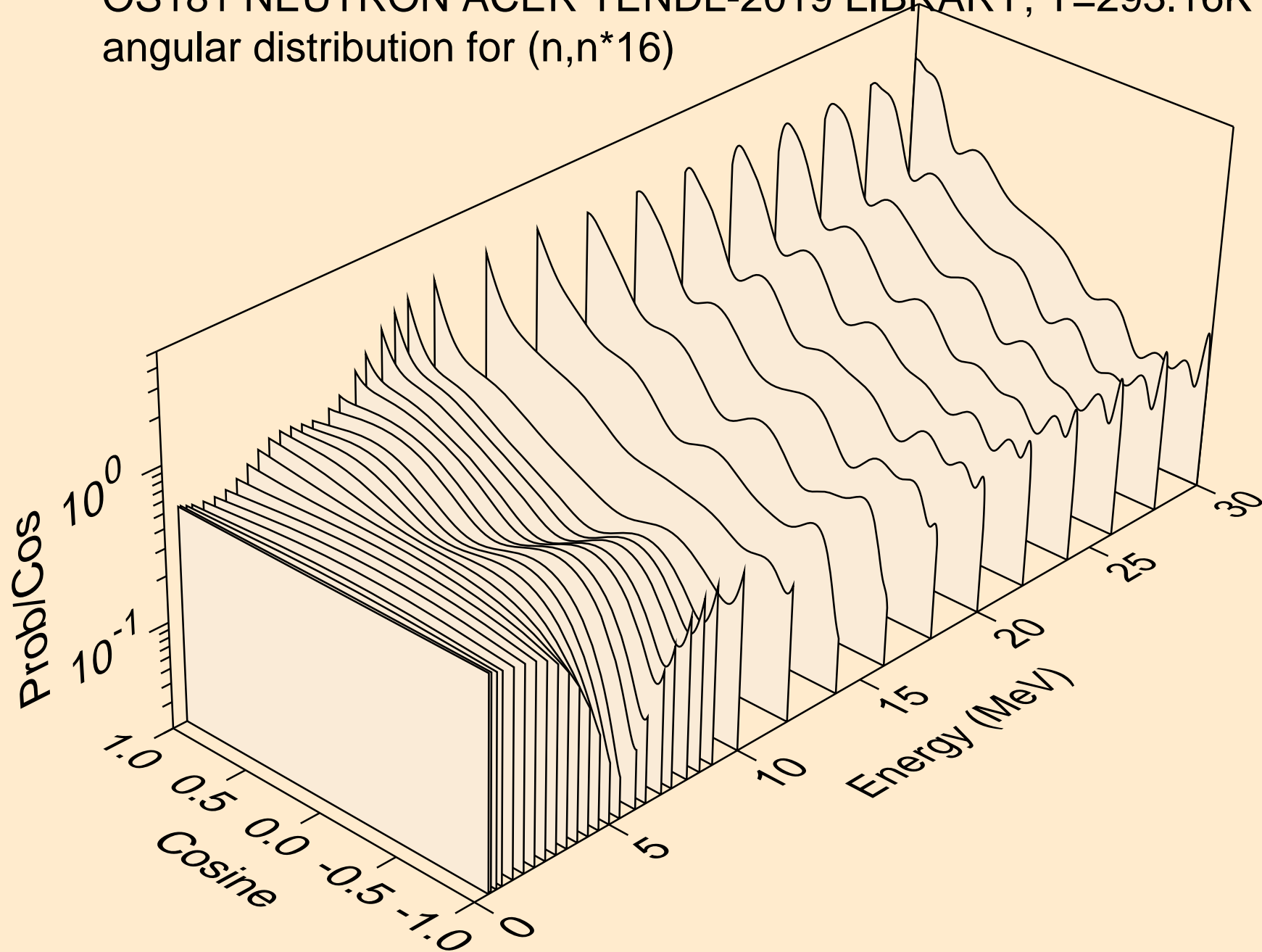

OS181 NEUTRON ACER TENDL-2019 LIBRARY; T=293.16K
angular distribution for (n,n*17)

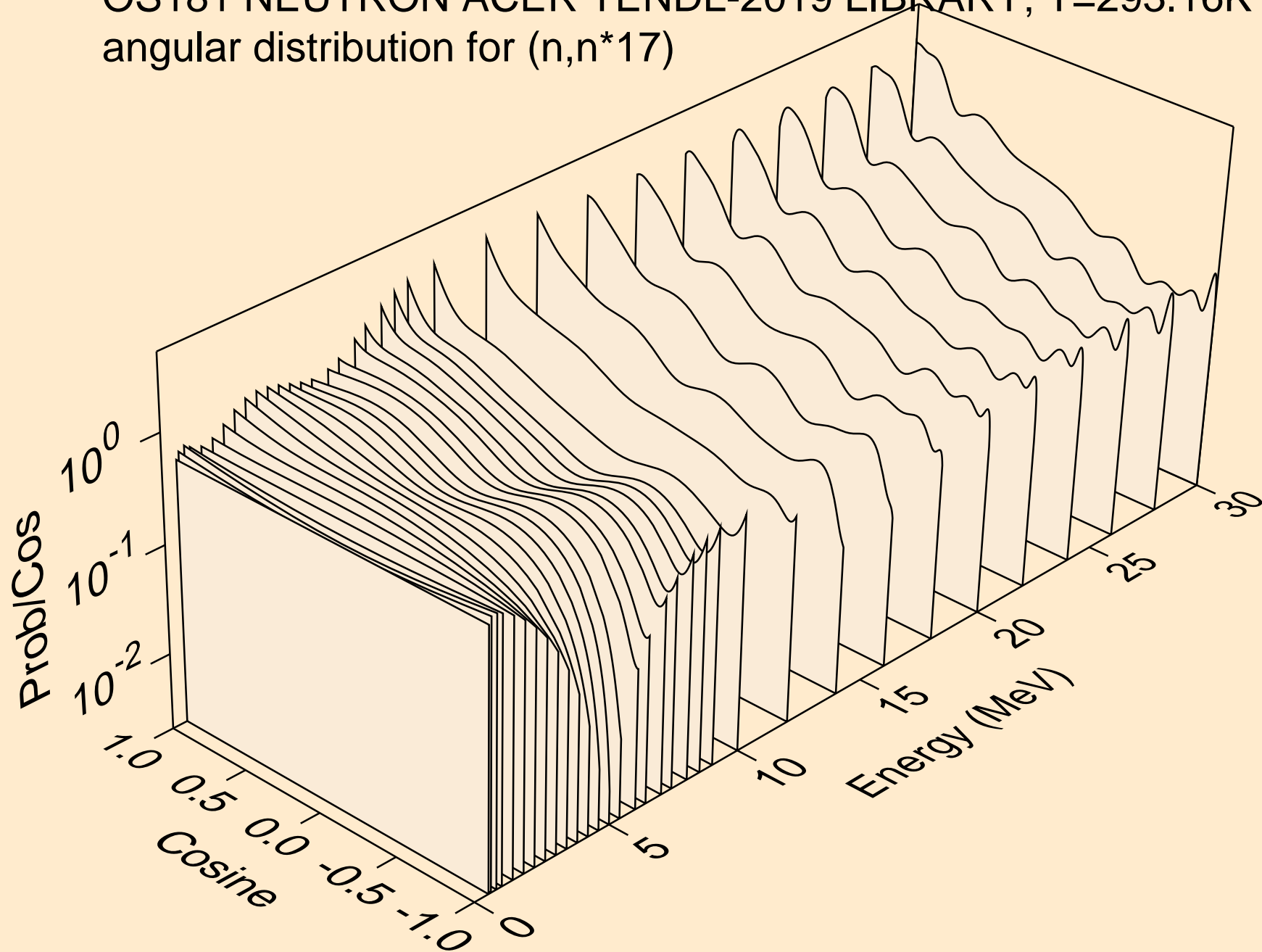

OS181 NEUTRON ACER TENDL-2019 LIBRARY; T=293.16K
angular distribution for (n,n*18)

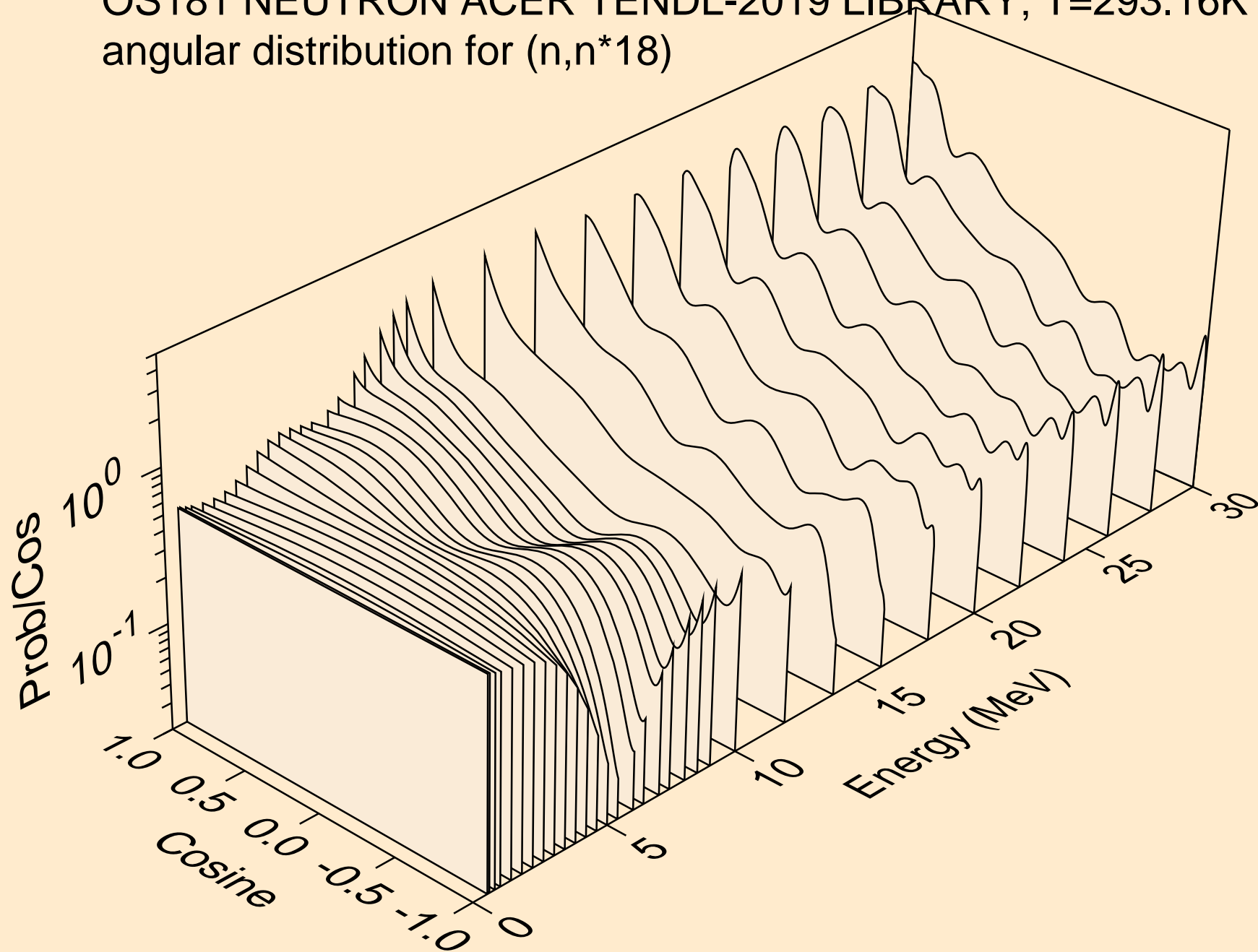

OS181 NEUTRON ACER TENDL-2019 LIBRARY; T=293.16K
angular distribution for (n,n*19)

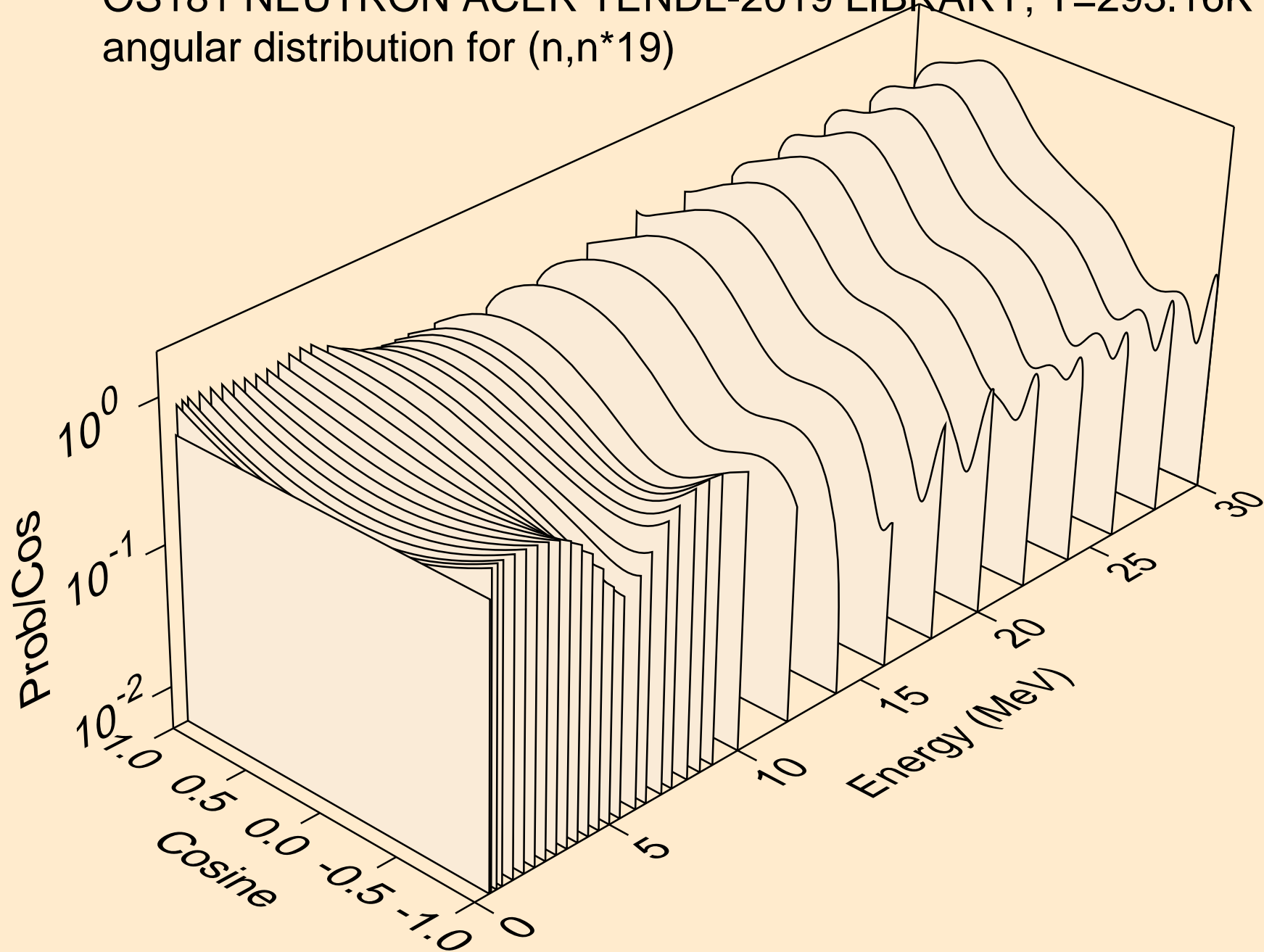

OS181 NEUTRON ACER TENDL-2019 LIBRARY; T=293.16K
angular distribution for (n,n*20)

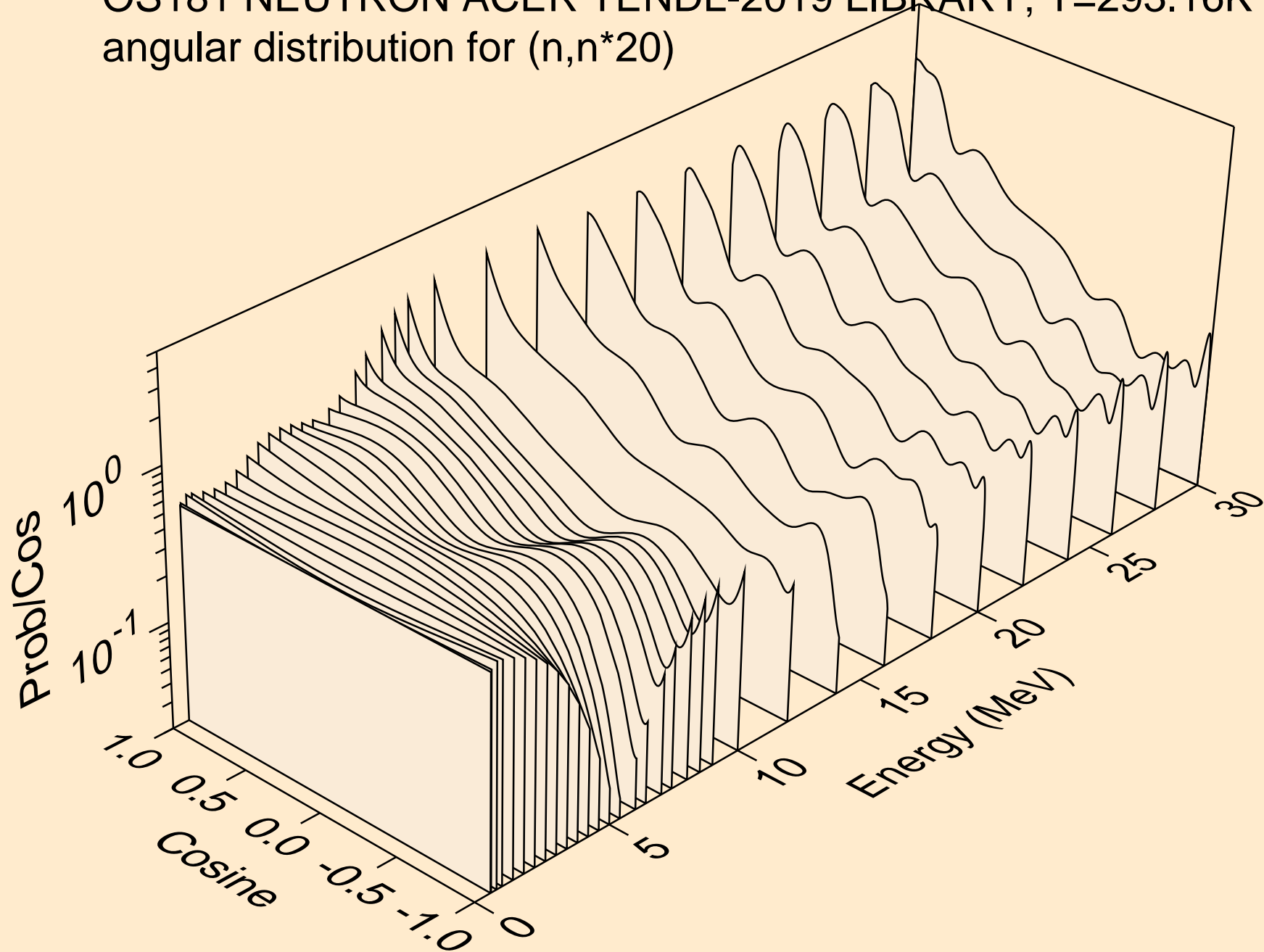

OS181 NEUTRON ACER TENDL-2019 LIBRARY; T=293.16K
angular distribution for (n,n*21)

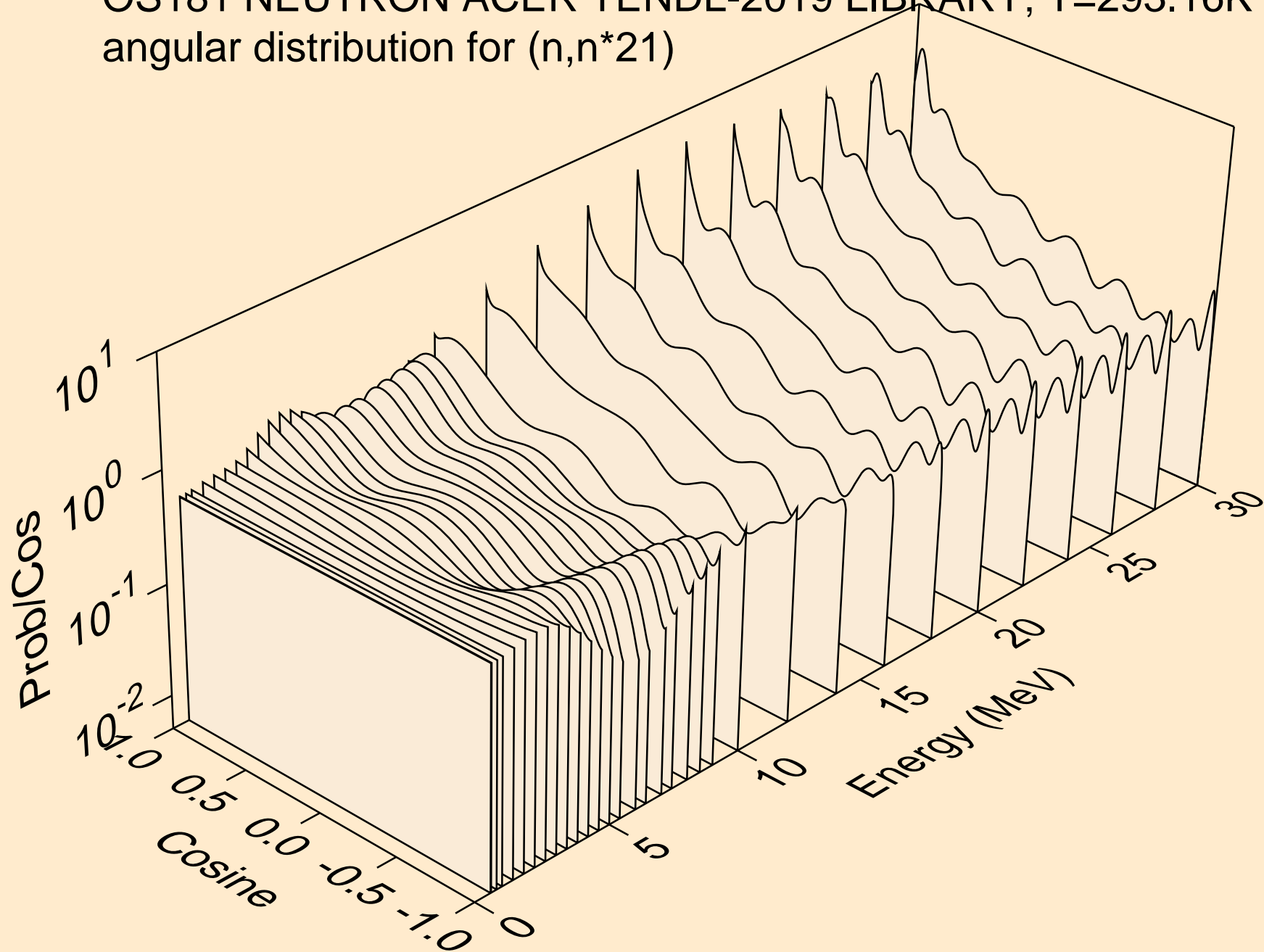

OS181 NEUTRON ACER TENDL-2019 LIBRARY; T=293.16K
angular distribution for (n,n*22)

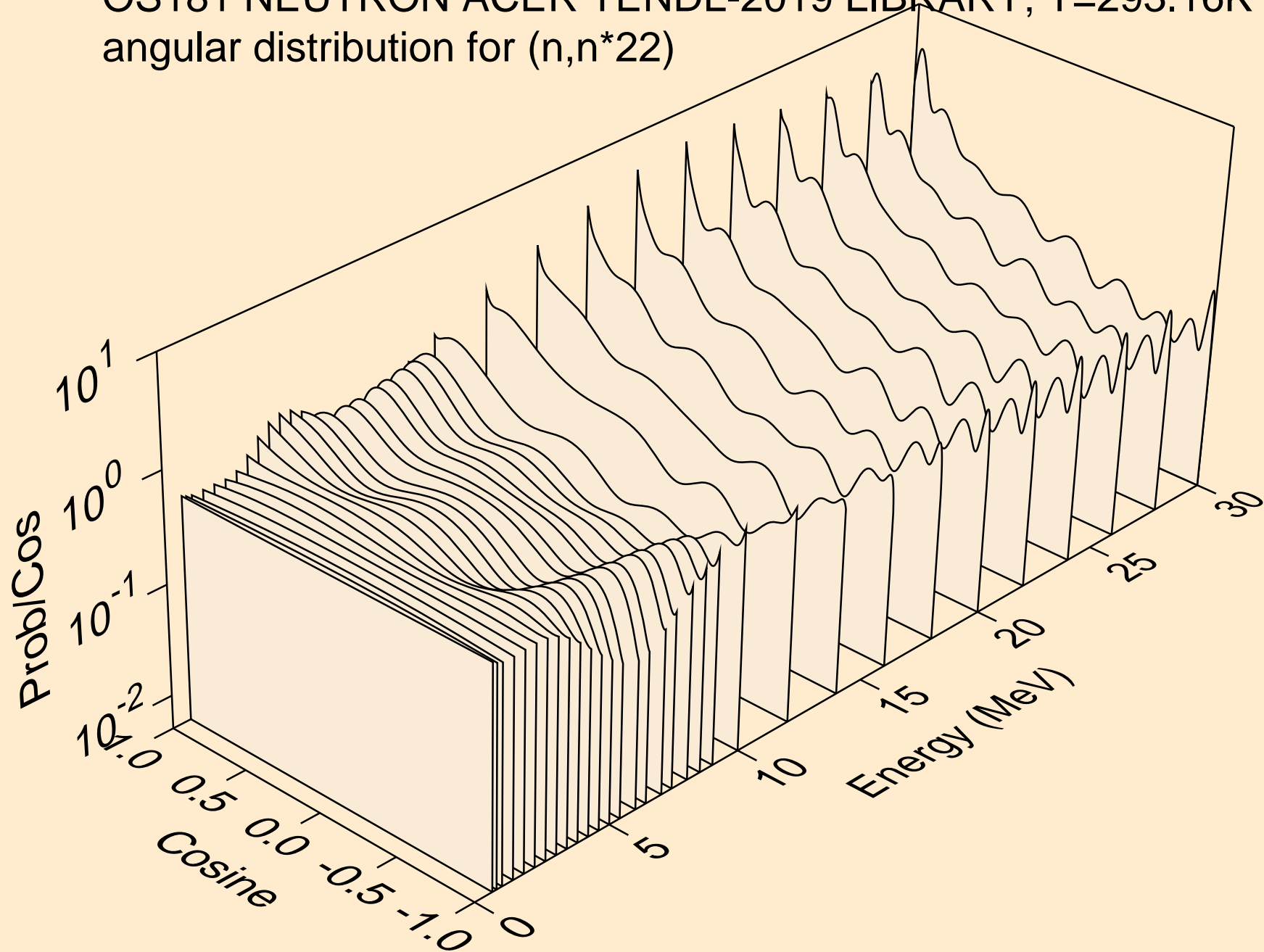

OS181 NEUTRON ACER TENDL-2019 LIBRARY; T=293.16K
angular distribution for (n,n*23)

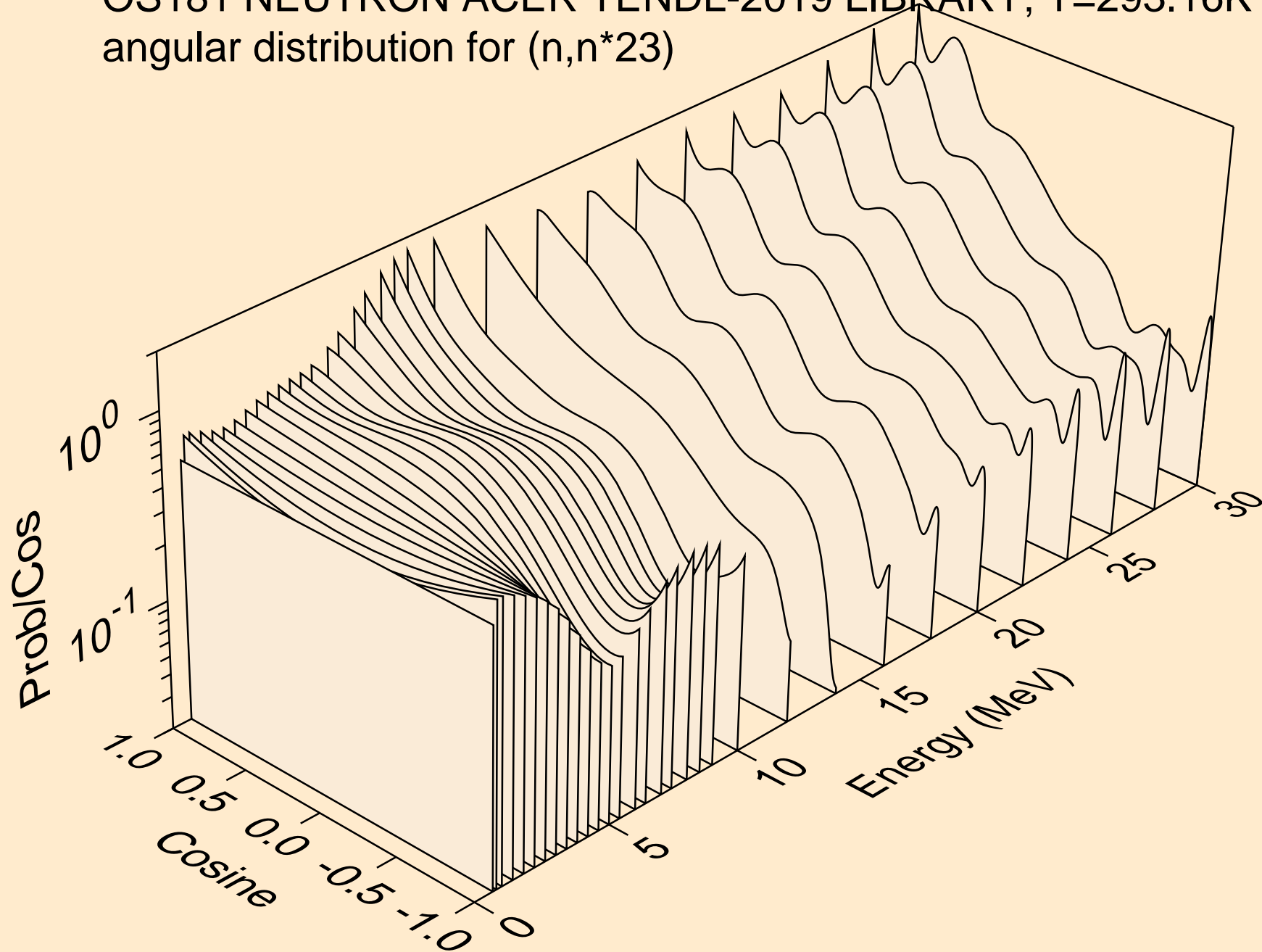

OS181 NEUTRON ACER TENDL-2019 LIBRARY; T=293.16K
angular distribution for (n,n*24)

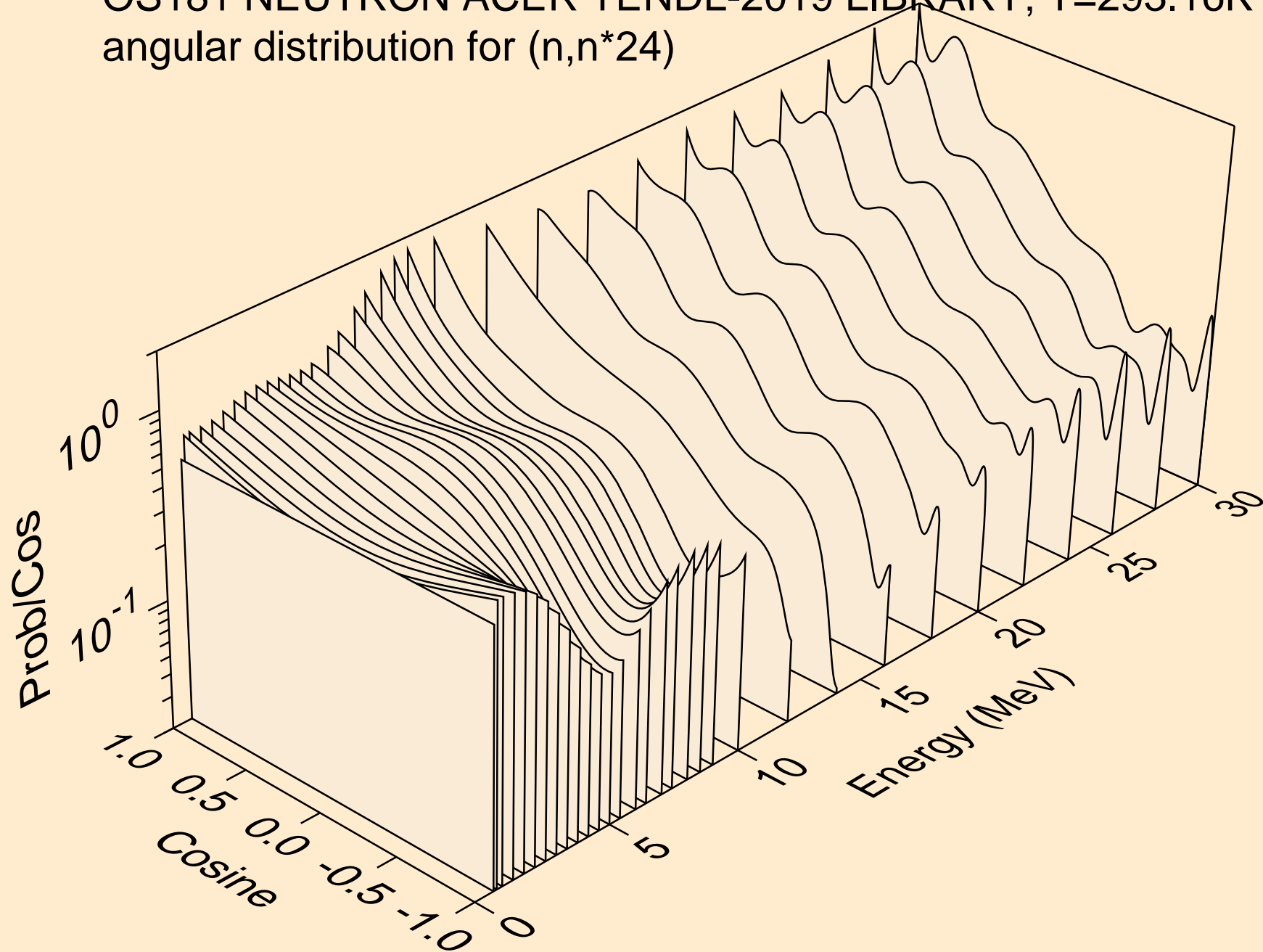

OS181 NEUTRON ACER TENDL-2019 LIBRARY; T=293.16K
angular distribution for (n,n*25)

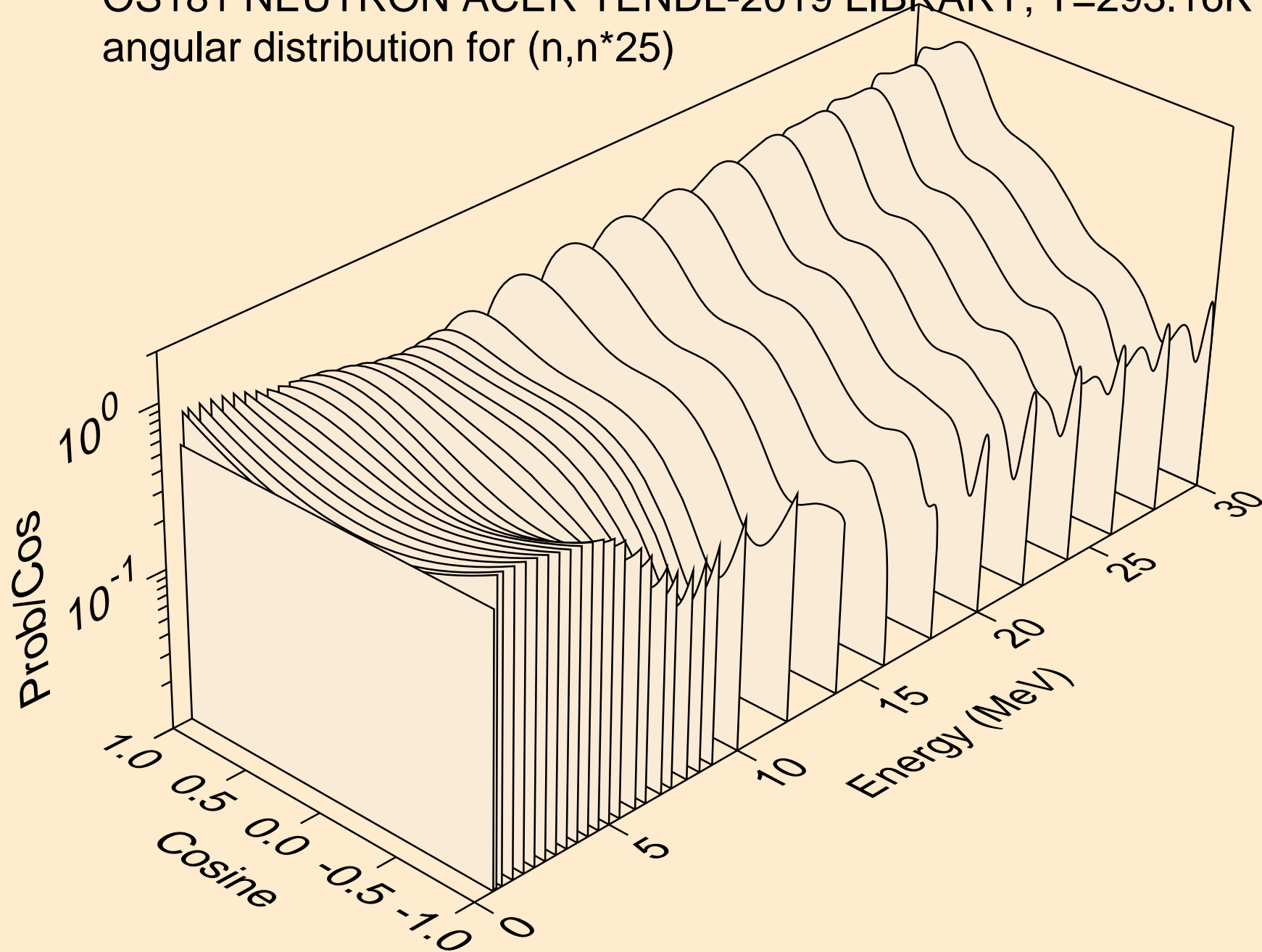

OS181 NEUTRON ACER TENDL-2019 LIBRARY; T=293.16K
angular distribution for (n,n*26)

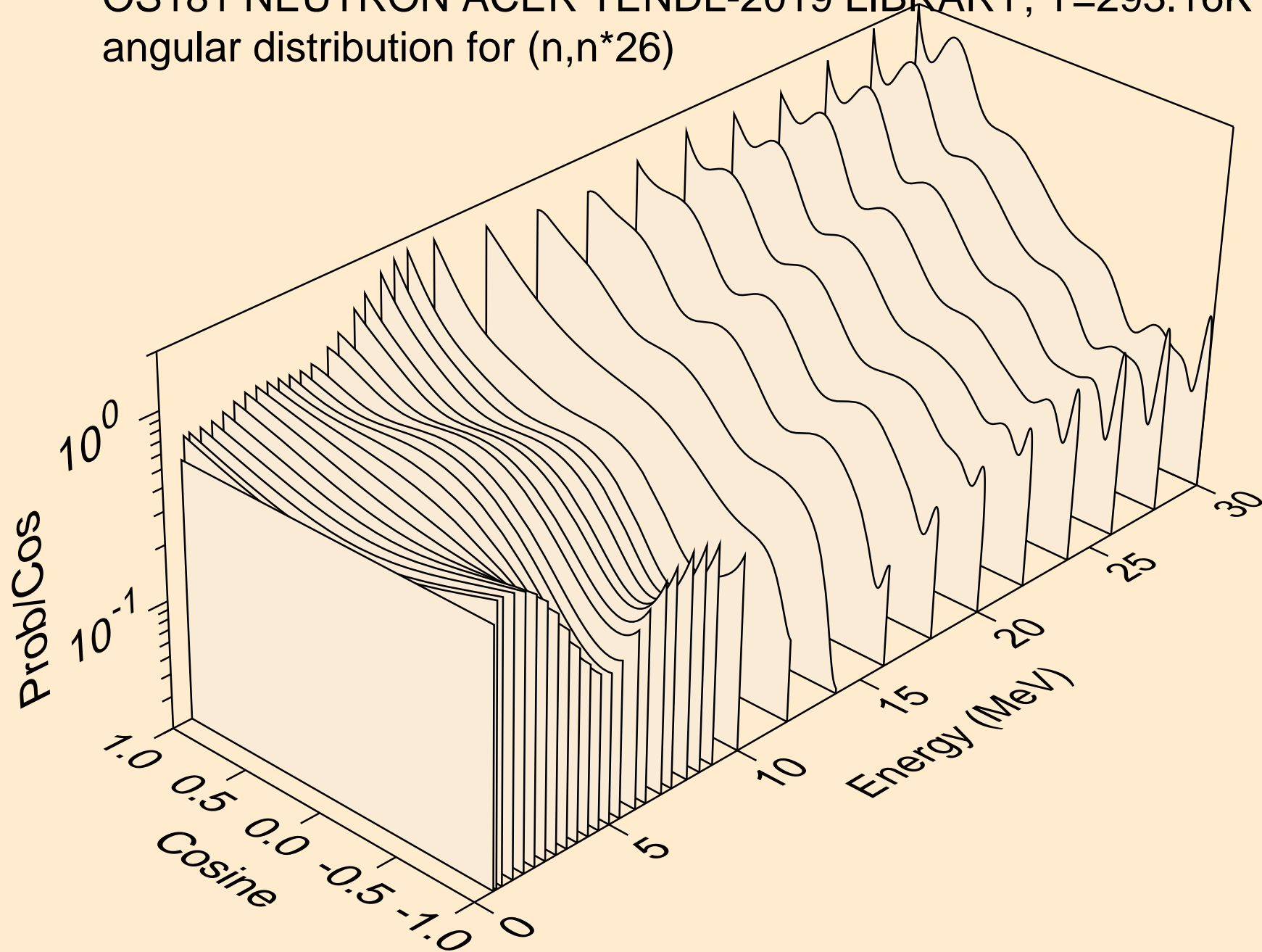

OS181 NEUTRON ACER TENDL-2019 LIBRARY; T=293.16K
angular distribution for (n,n*27)

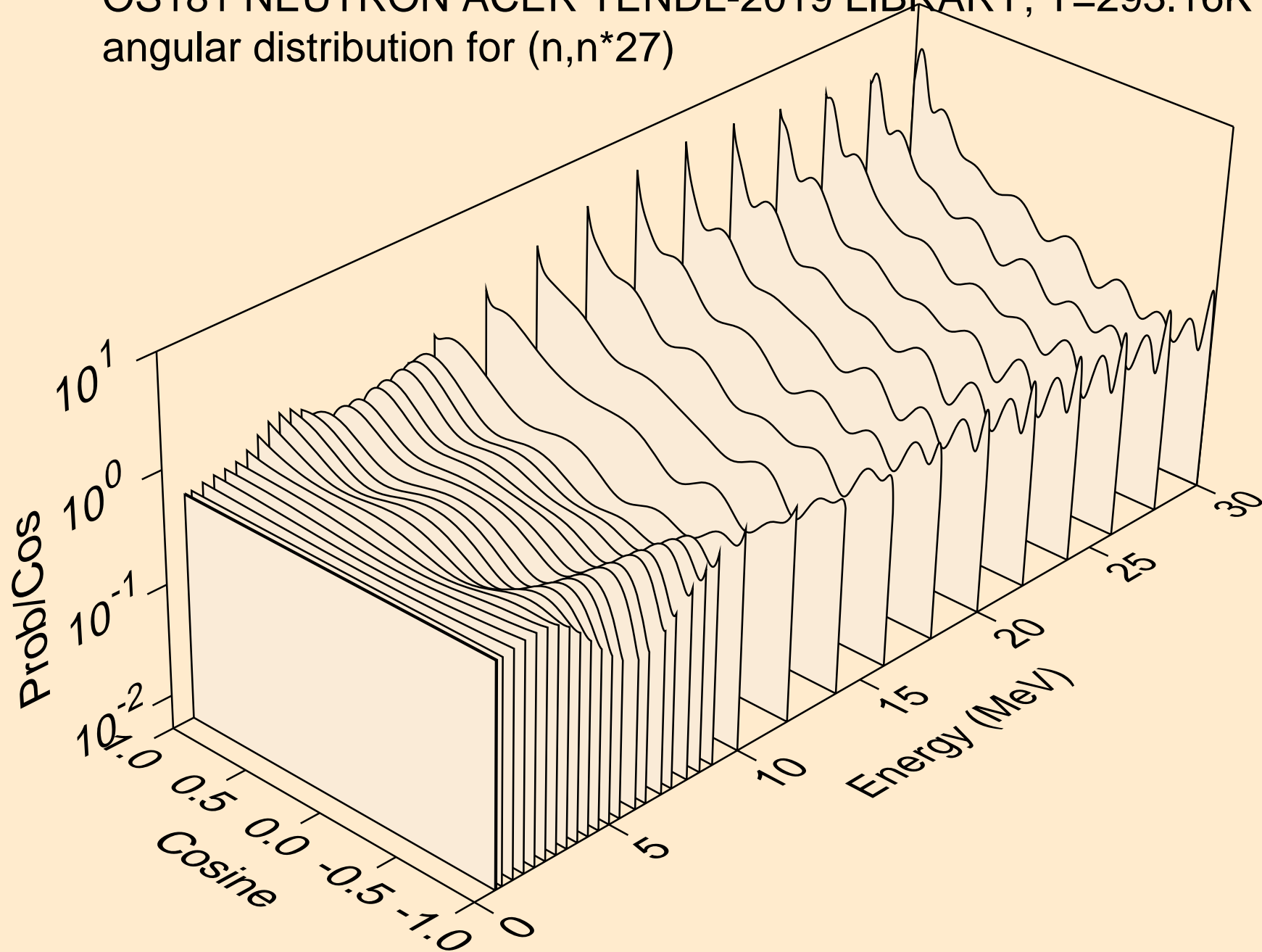

OS181 NEUTRON ACER TENDL-2019 LIBRARY; T=293.16K
Neutron emission for (n,x)

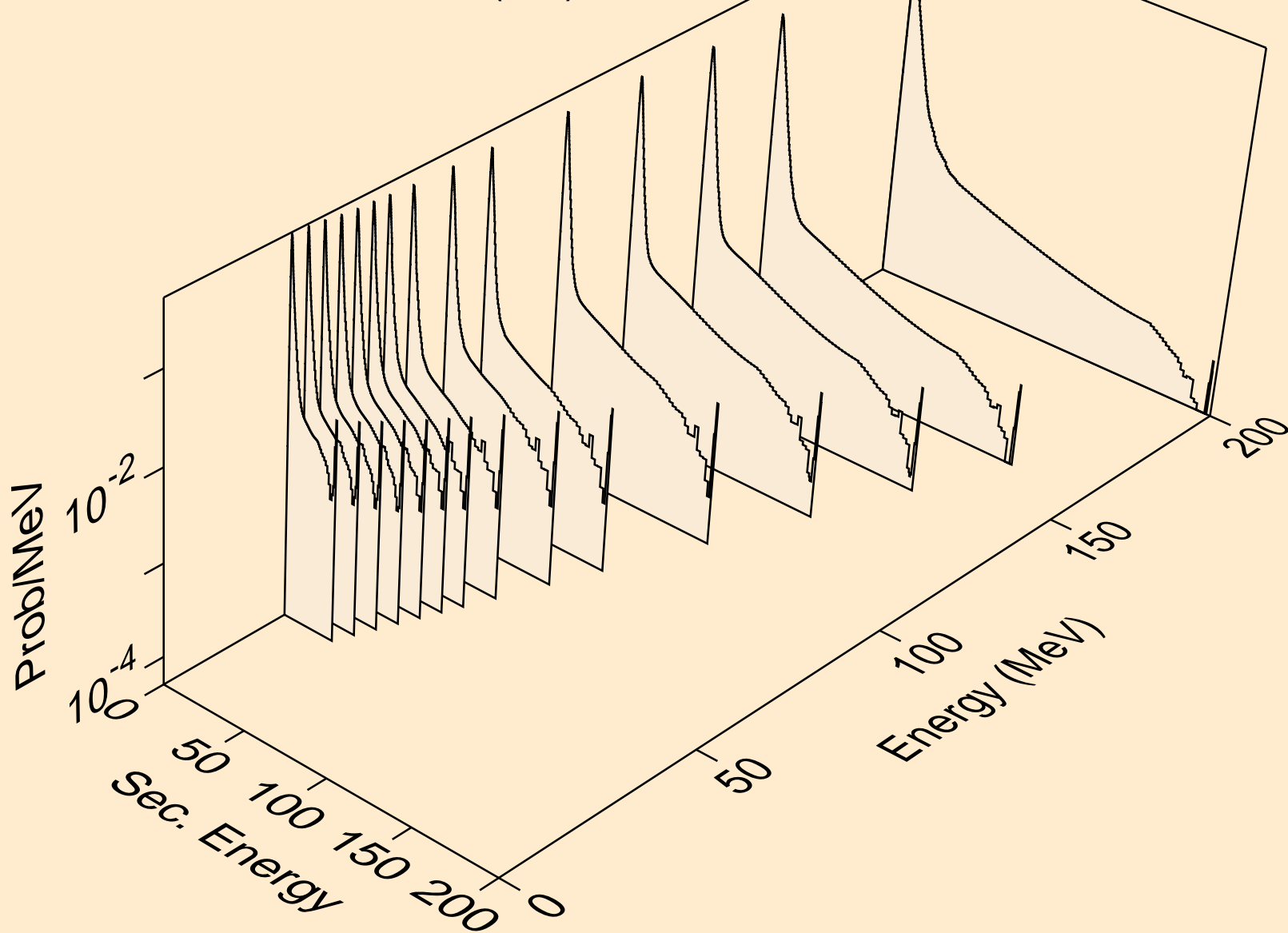

OS181 NEUTRON ACER TENDL-2019 LIBRARY; T=293.16K
Neutron emission for (n,2nd)

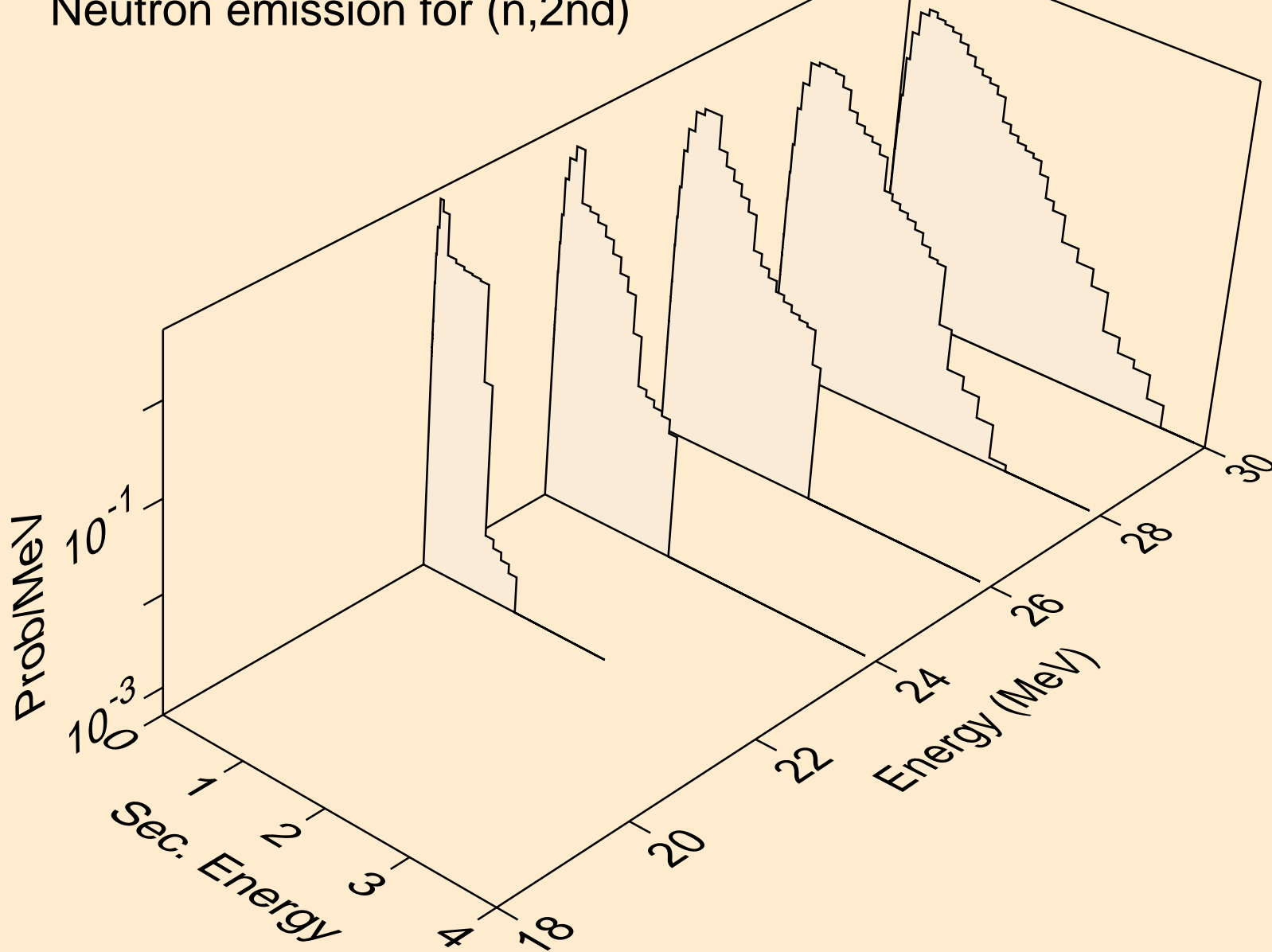

OS181 NEUTRON ACER TENDL-2019 LIBRARY; T=293.16K
Neutron emission for (n,2n)

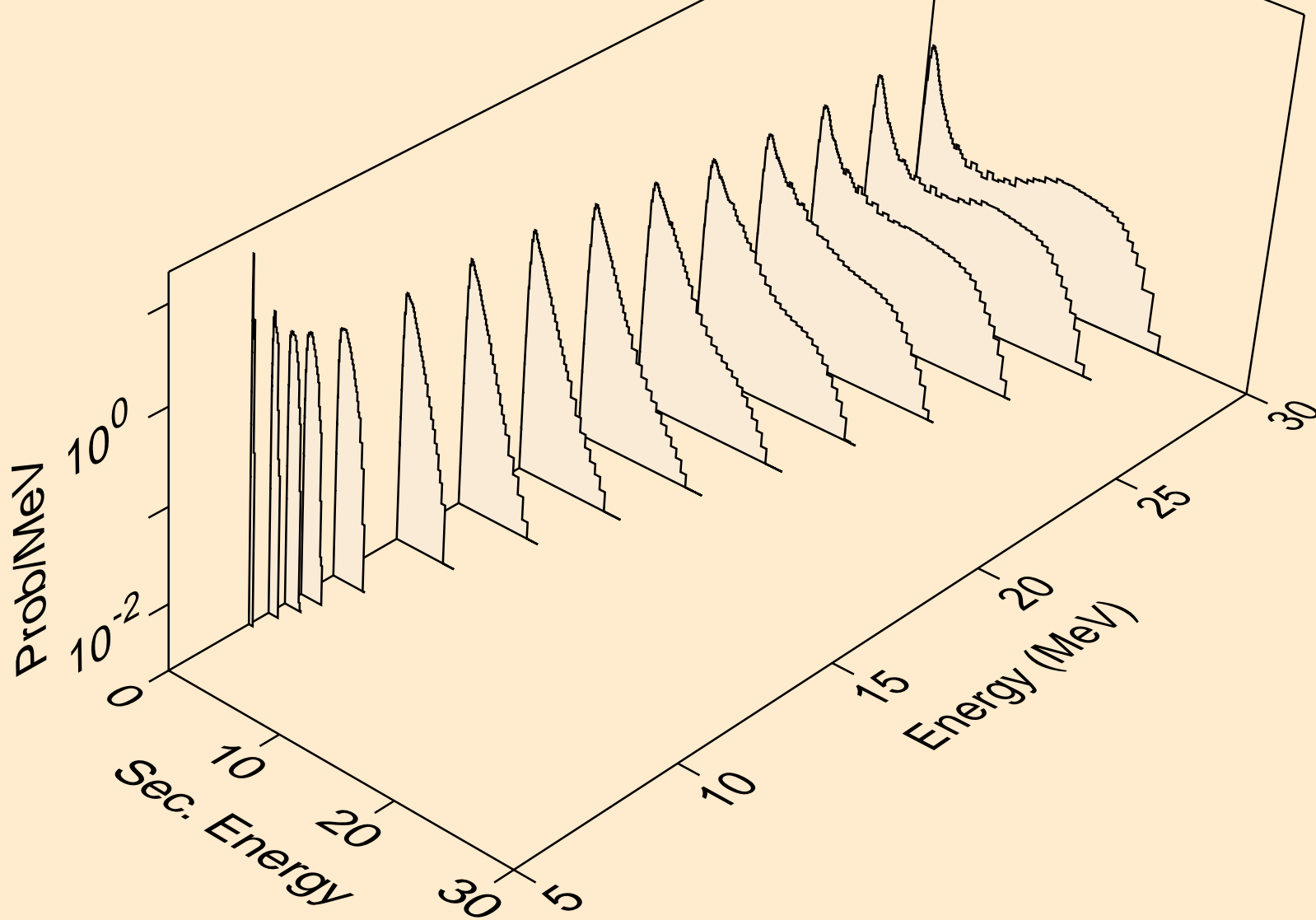

OS181 NEUTRON ACER TENDL-2019 LIBRARY; T=293.16K
Neutron emission for (n,3n)

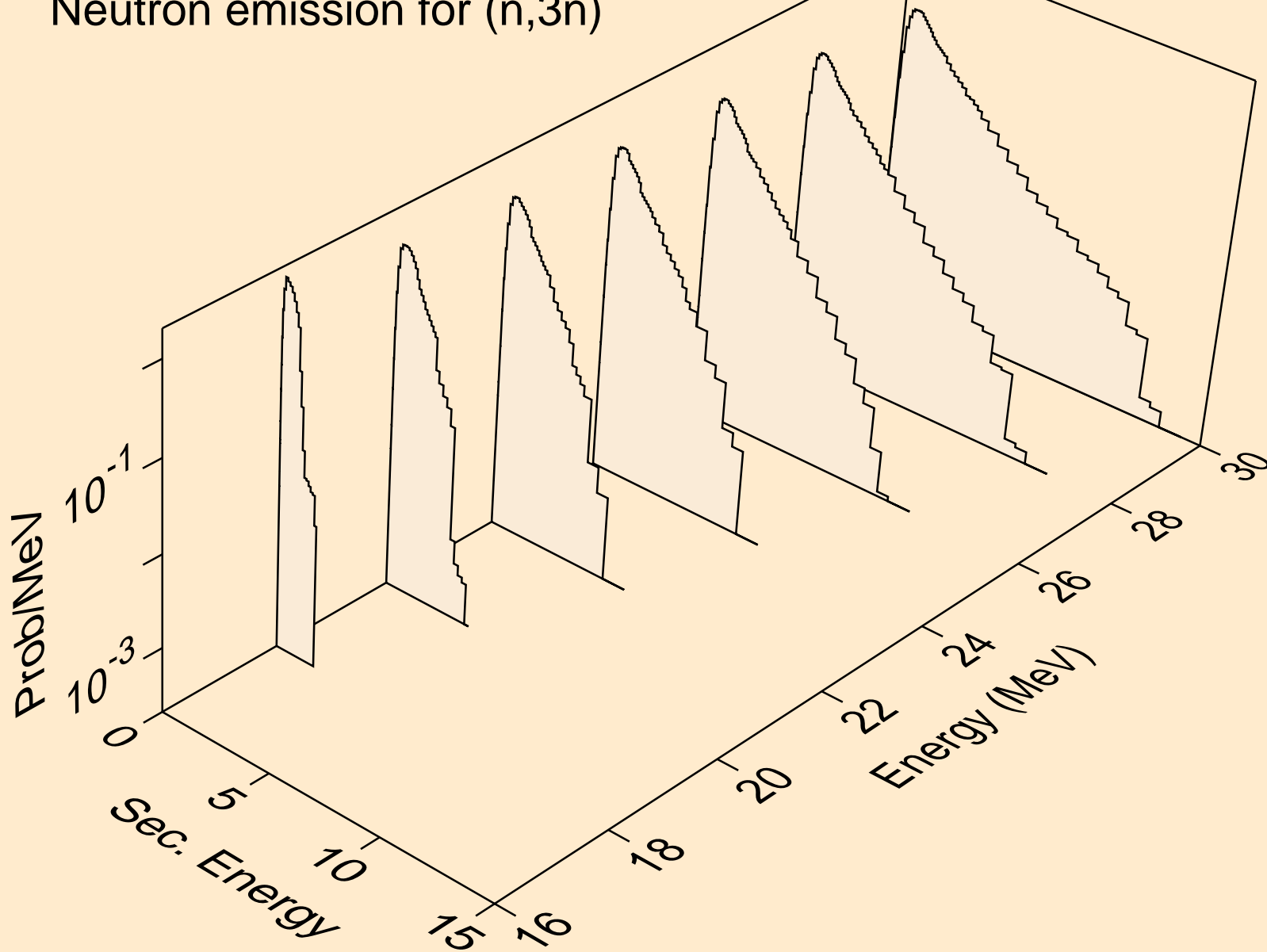

OS181 NEUTRON ACER TENDL-2019 LIBRARY; T=293.16K
Neutron emission for (n,n*)a

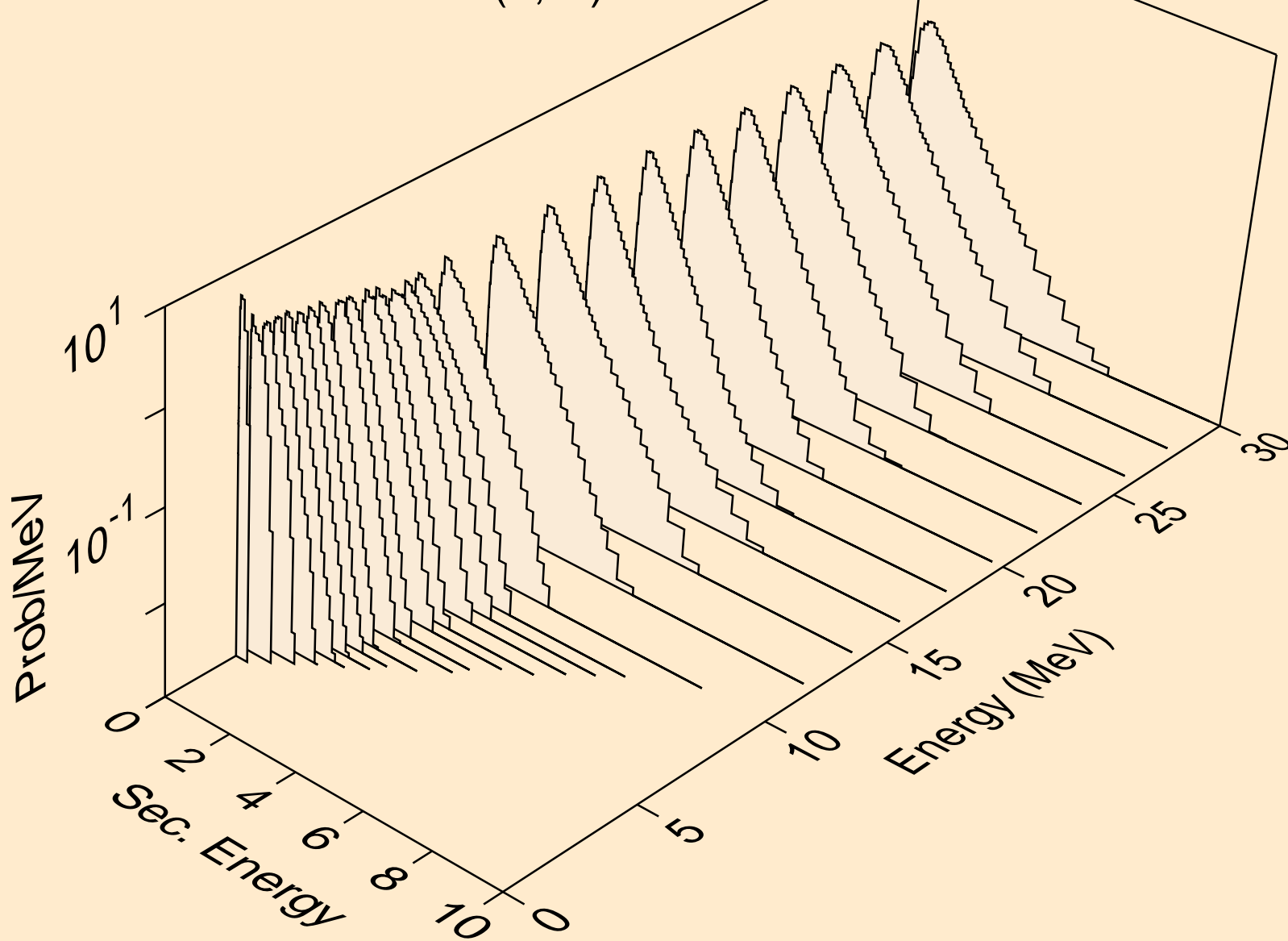

OS181 NEUTRON ACER TENDL-2019 LIBRARY; T=293.16K
Neutron emission for (n,2n)_a

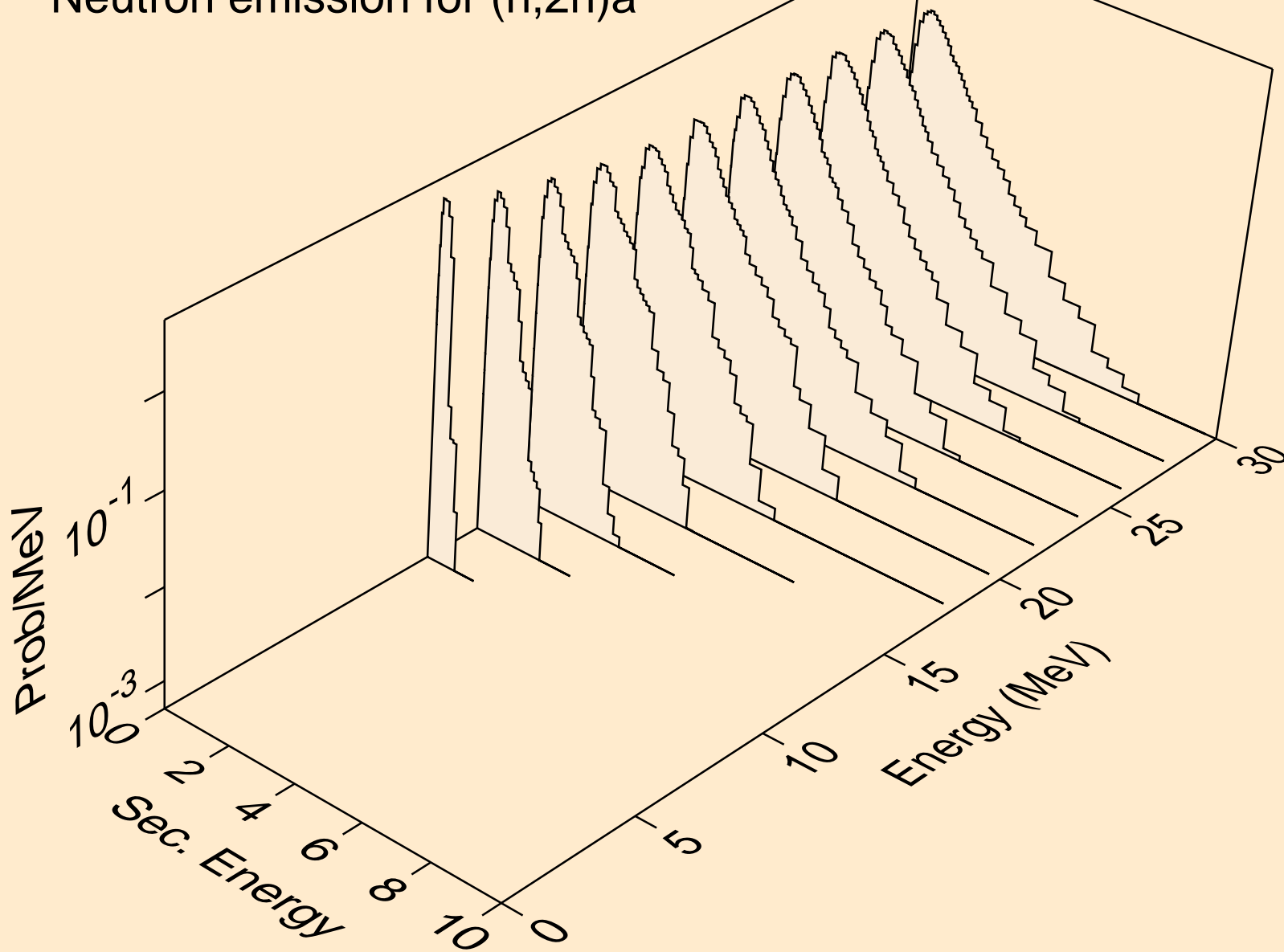

OS181 NEUTRON ACER TENDL-2019 LIBRARY; T=293.16K
Neutron emission for (n,3n)a

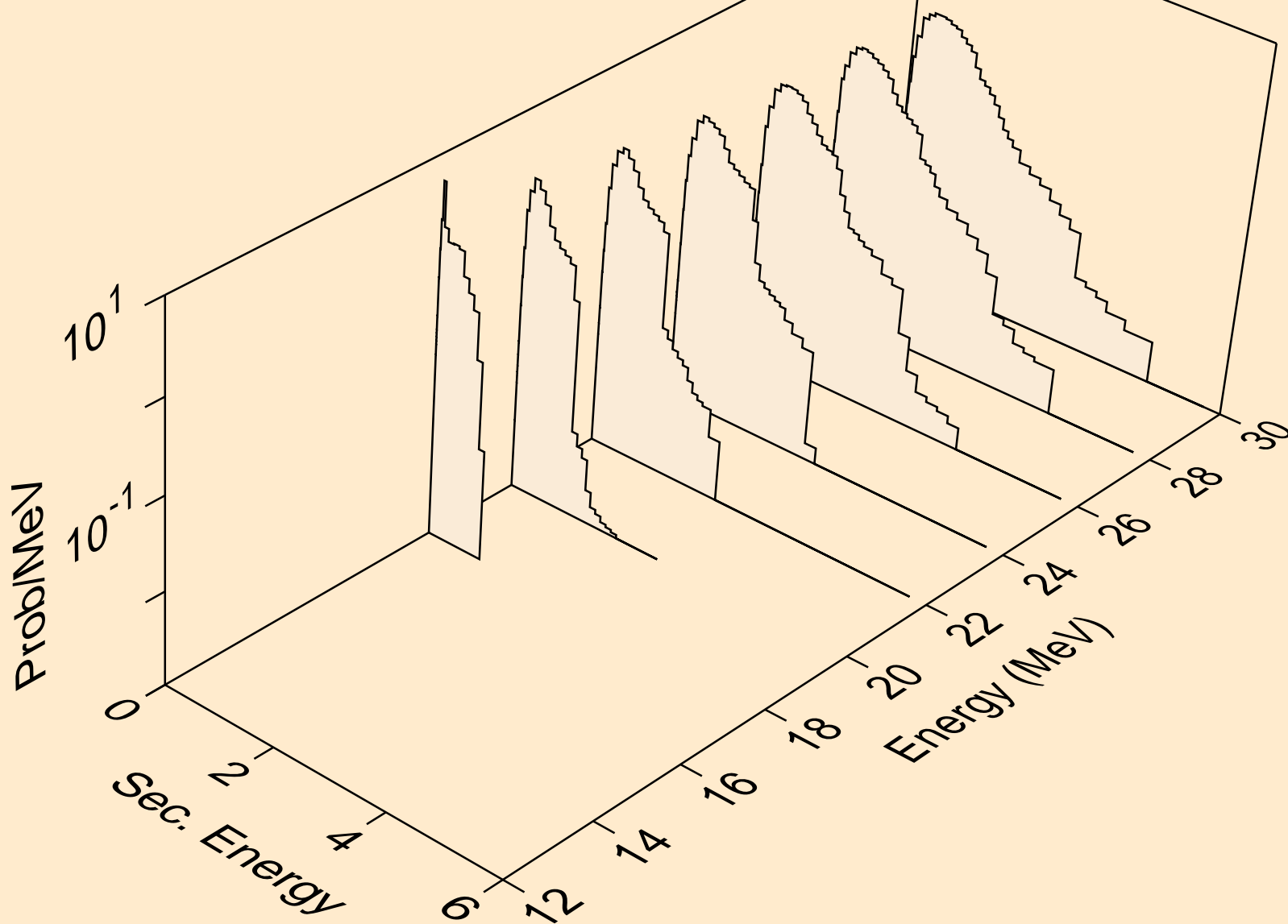

OS181 NEUTRON ACER TENDL-2019 LIBRARY; T=293.16K
Neutron emission for (n,n*)p

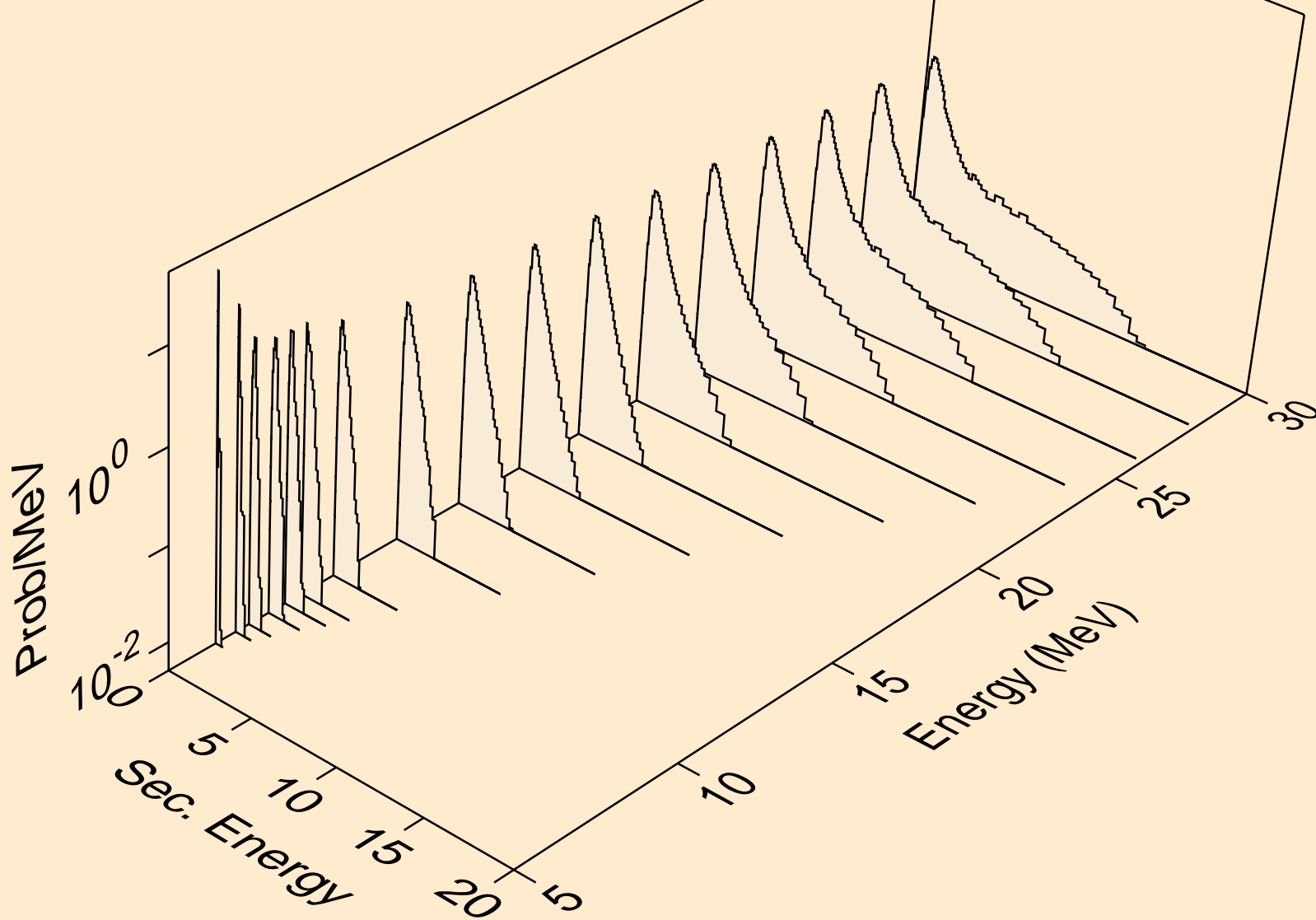

OS181 NEUTRON ACER TENDL-2019 LIBRARY; T=293.16K
Neutron emission for (n,n*)2a

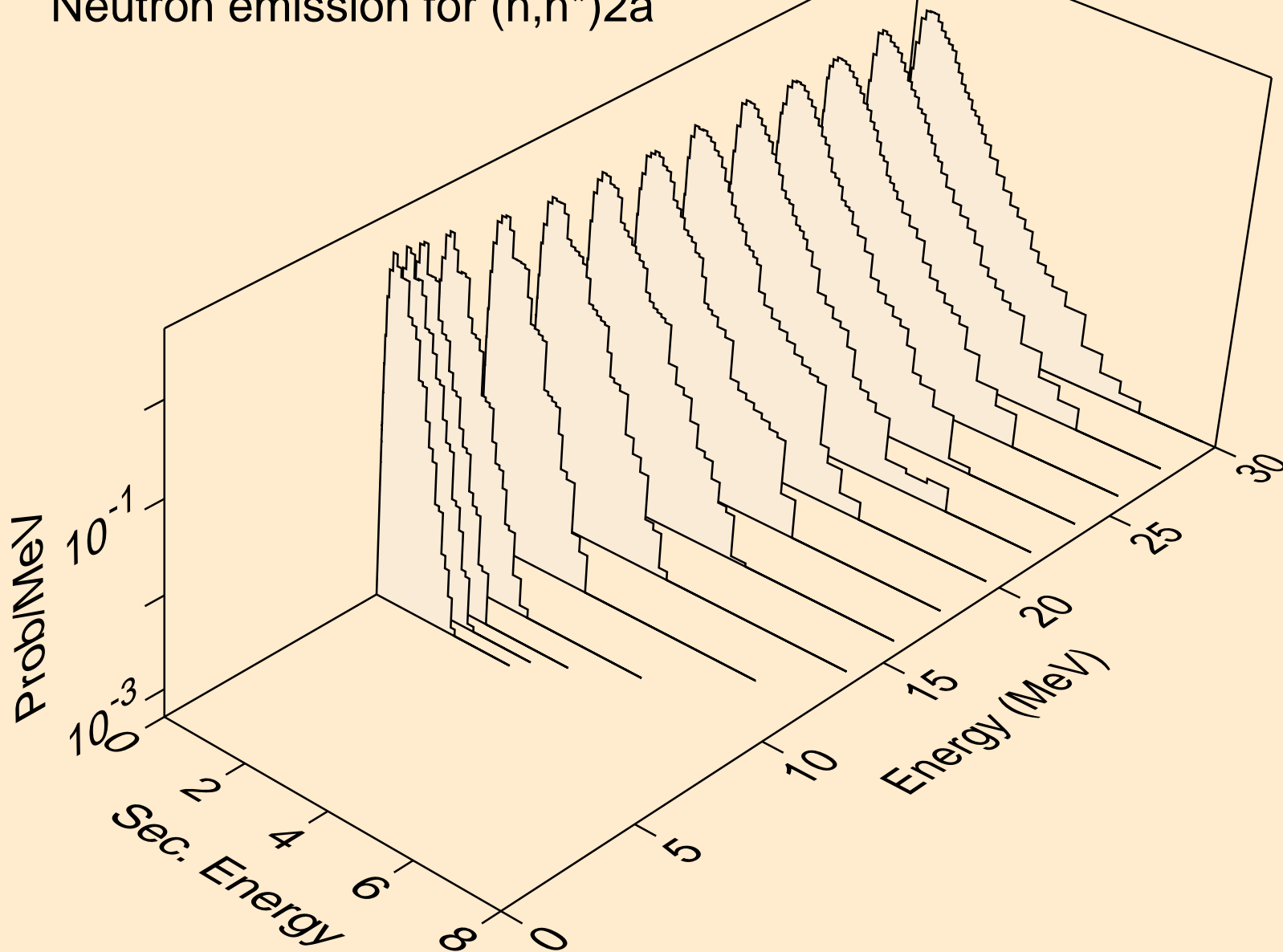

OS181 NEUTRON ACER TENDL-2019 LIBRARY; T=293.16K
Neutron emission for (n,2n)2a

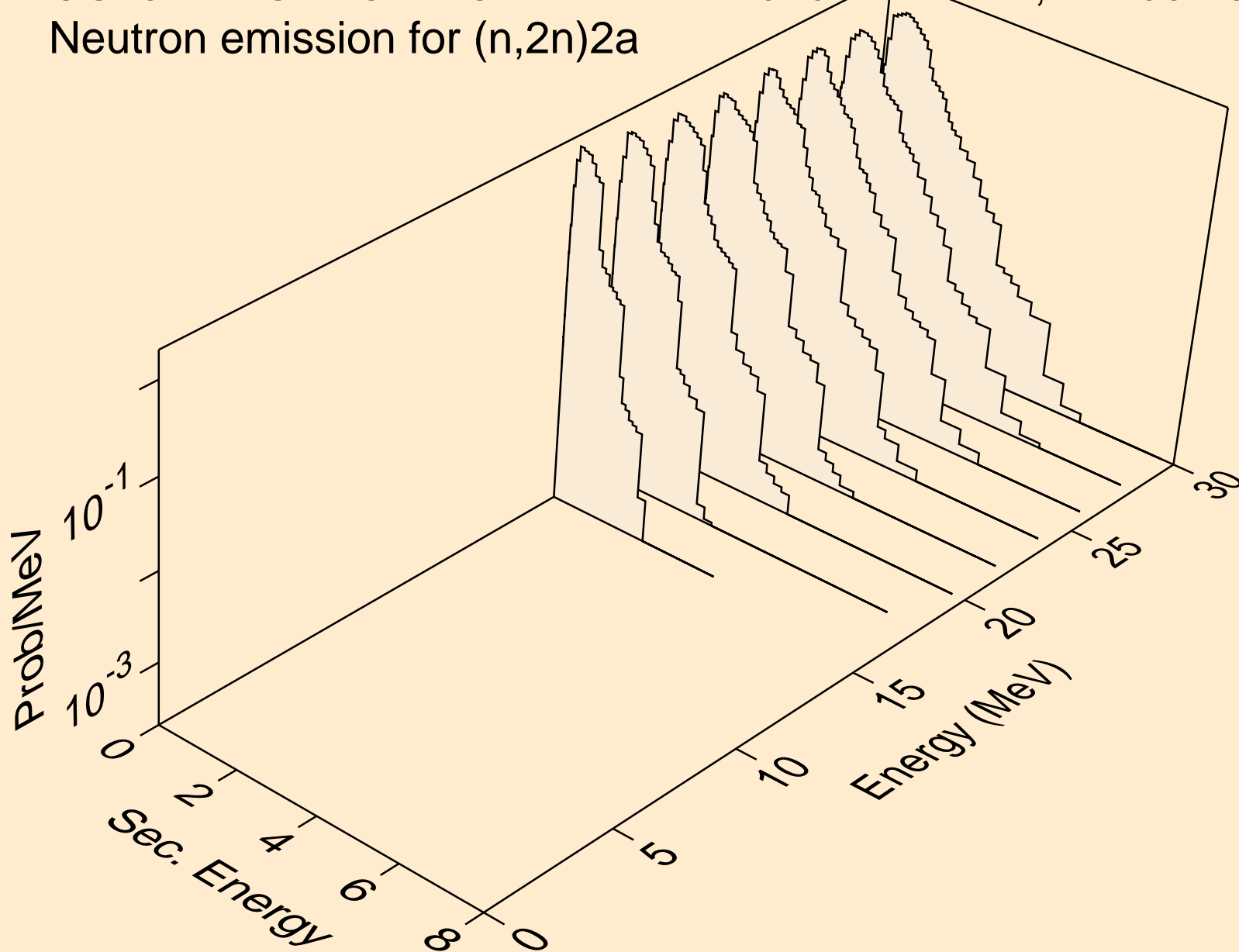

OS181 NEUTRON ACER TENDL-2019 LIBRARY; T=293.16K
Neutron emission for (n,n*)d

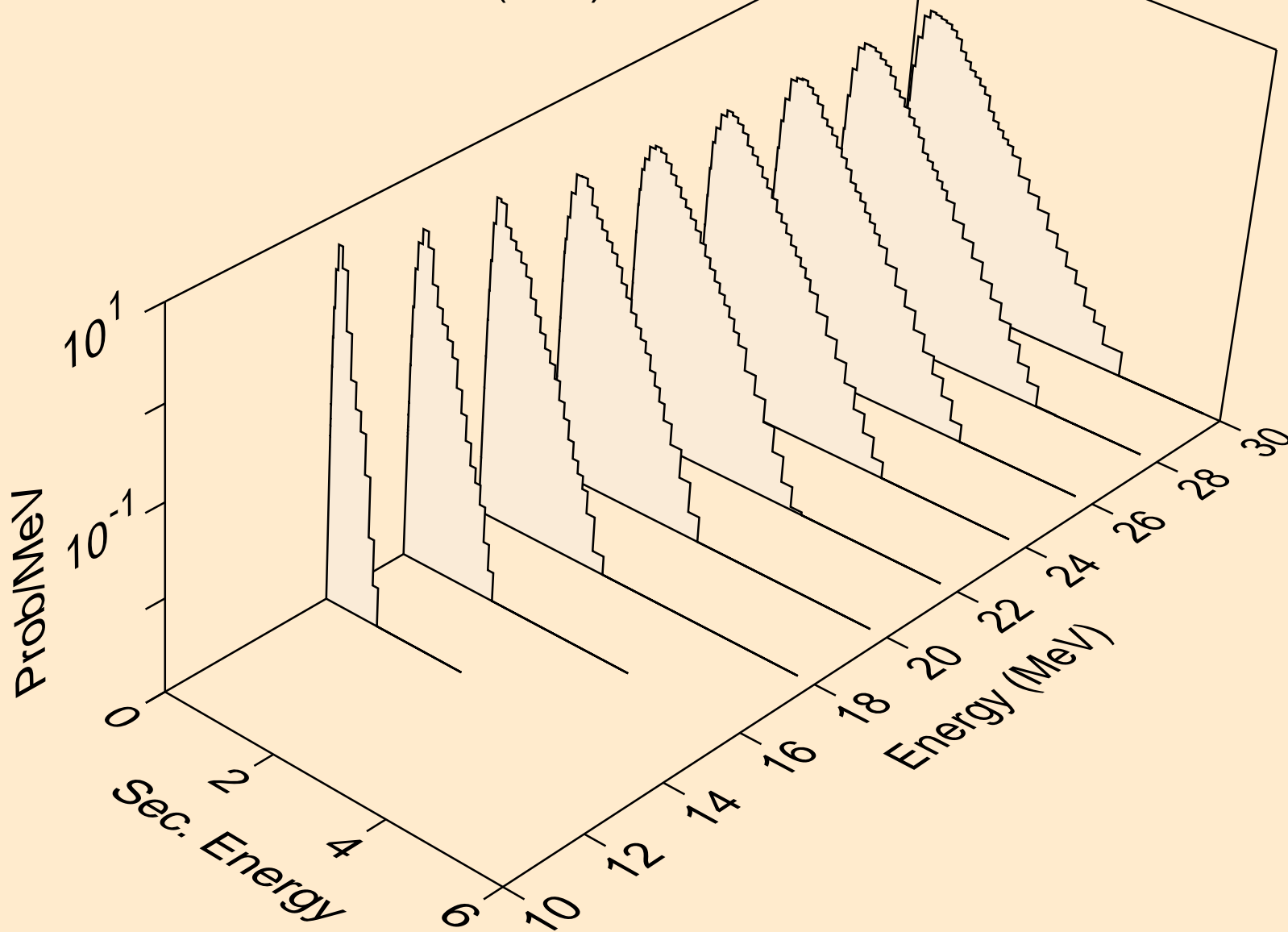

OS181 NEUTRON ACER TENDL-2019 LIBRARY; T=293.16K
Neutron emission for (n,n*)t

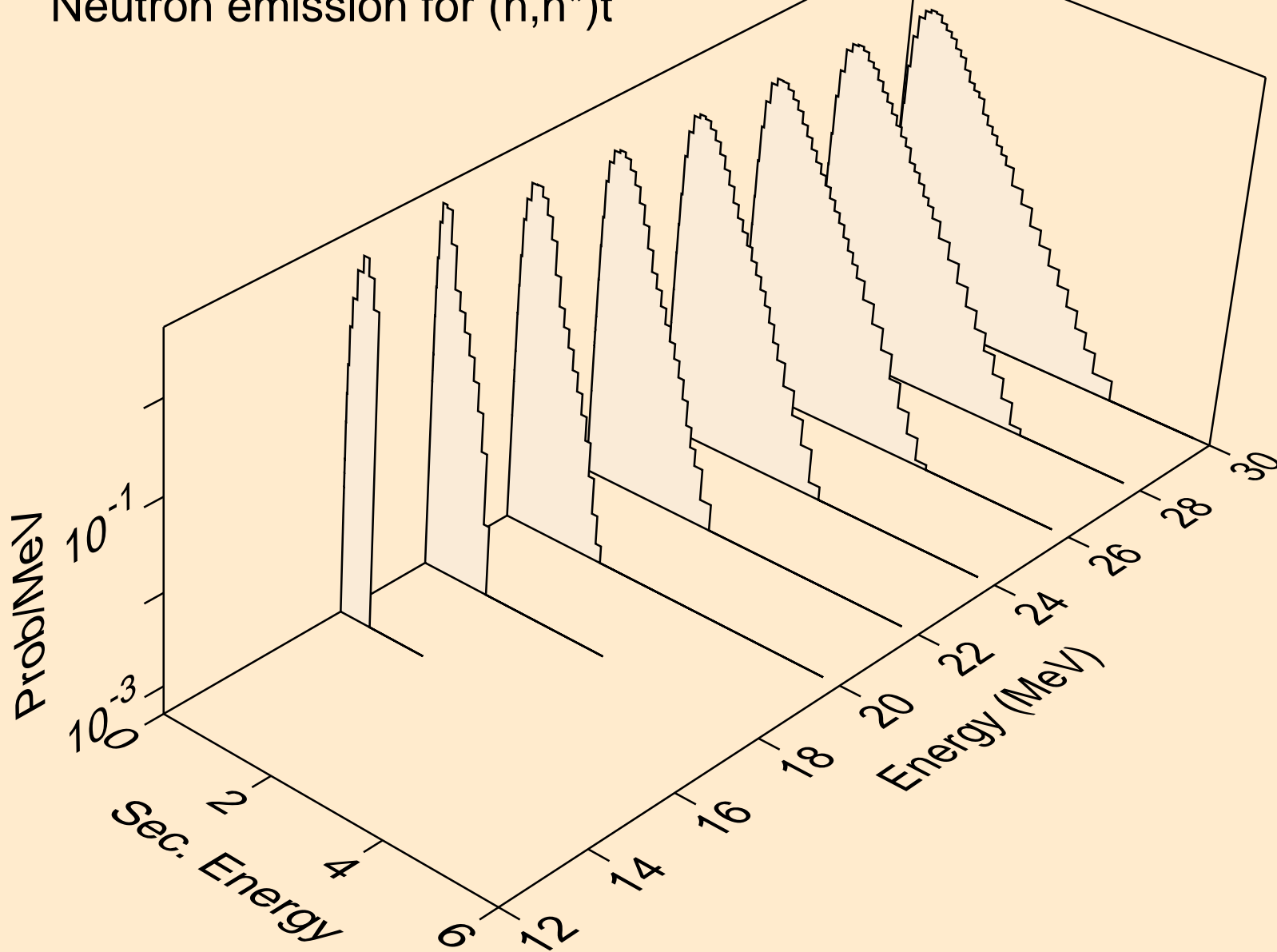

OS181 NEUTRON ACER TENDL-2019 LIBRARY; T=293.16K
Neutron emission for (n,n*)he3

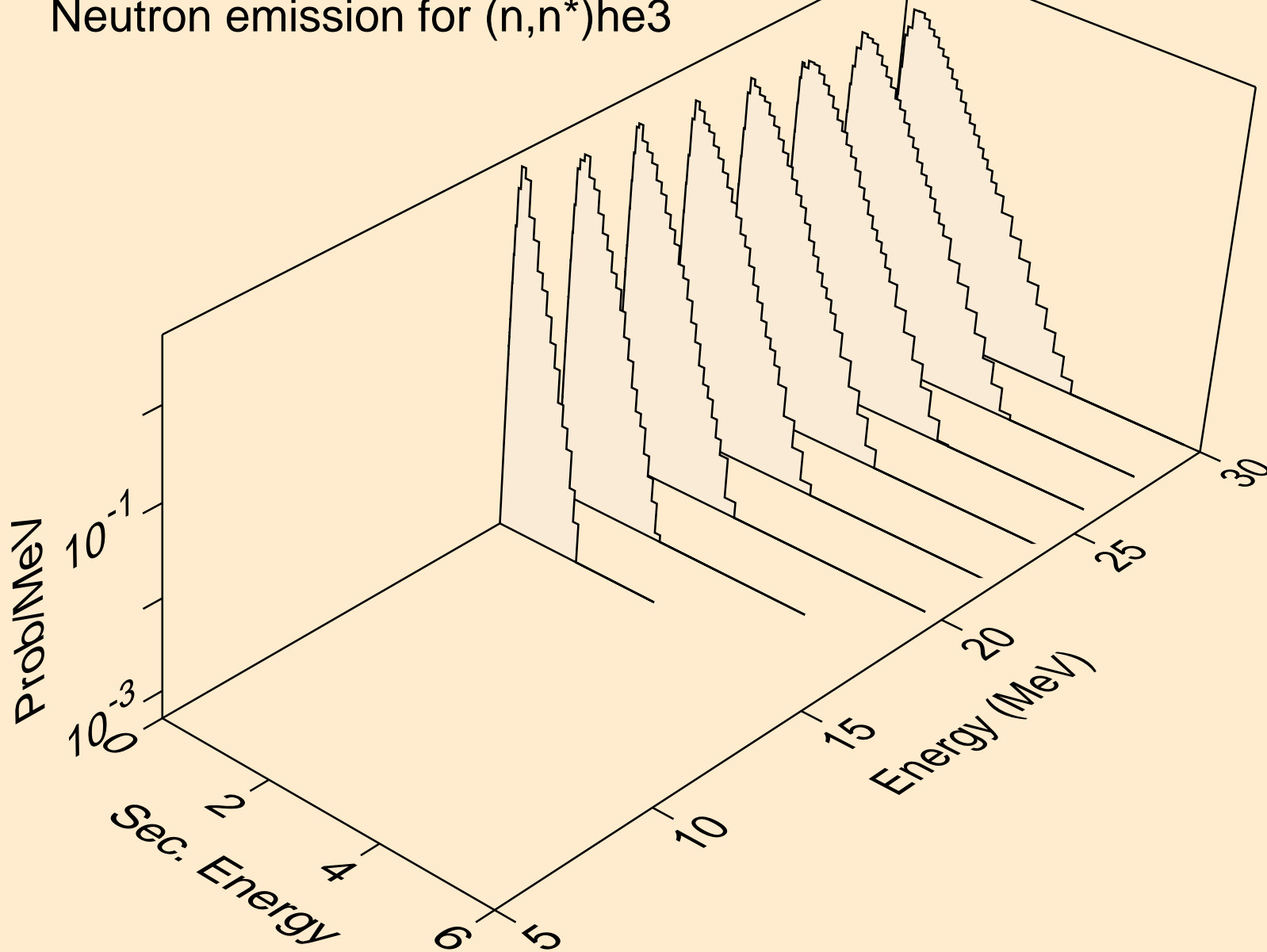

OS181 NEUTRON ACER TENDL-2019 LIBRARY; T=293.16K
Neutron emission for (n,4n)

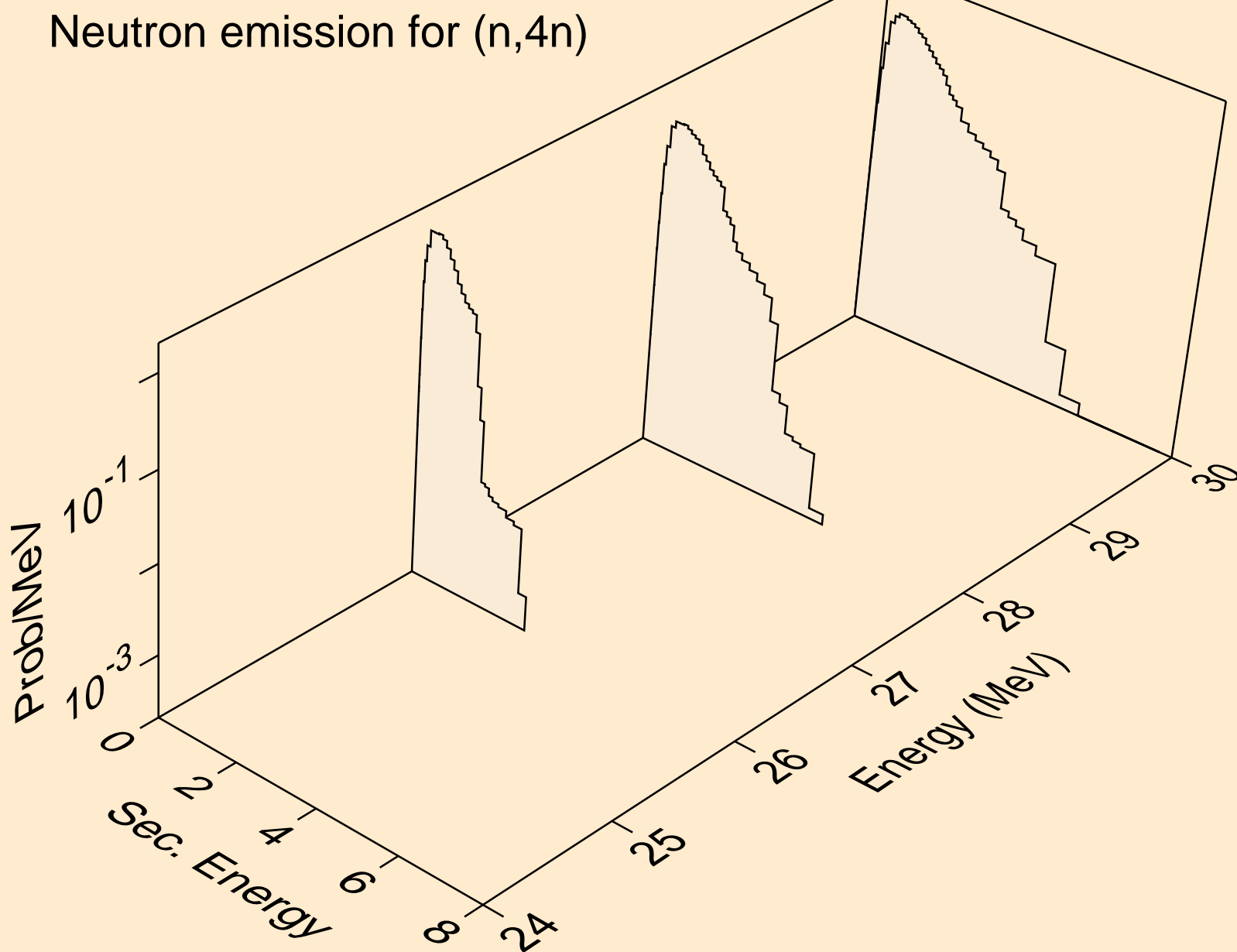

OS181 NEUTRON ACER TENDL-2019 LIBRARY; T=293.16K
Neutron emission for (n,2np)

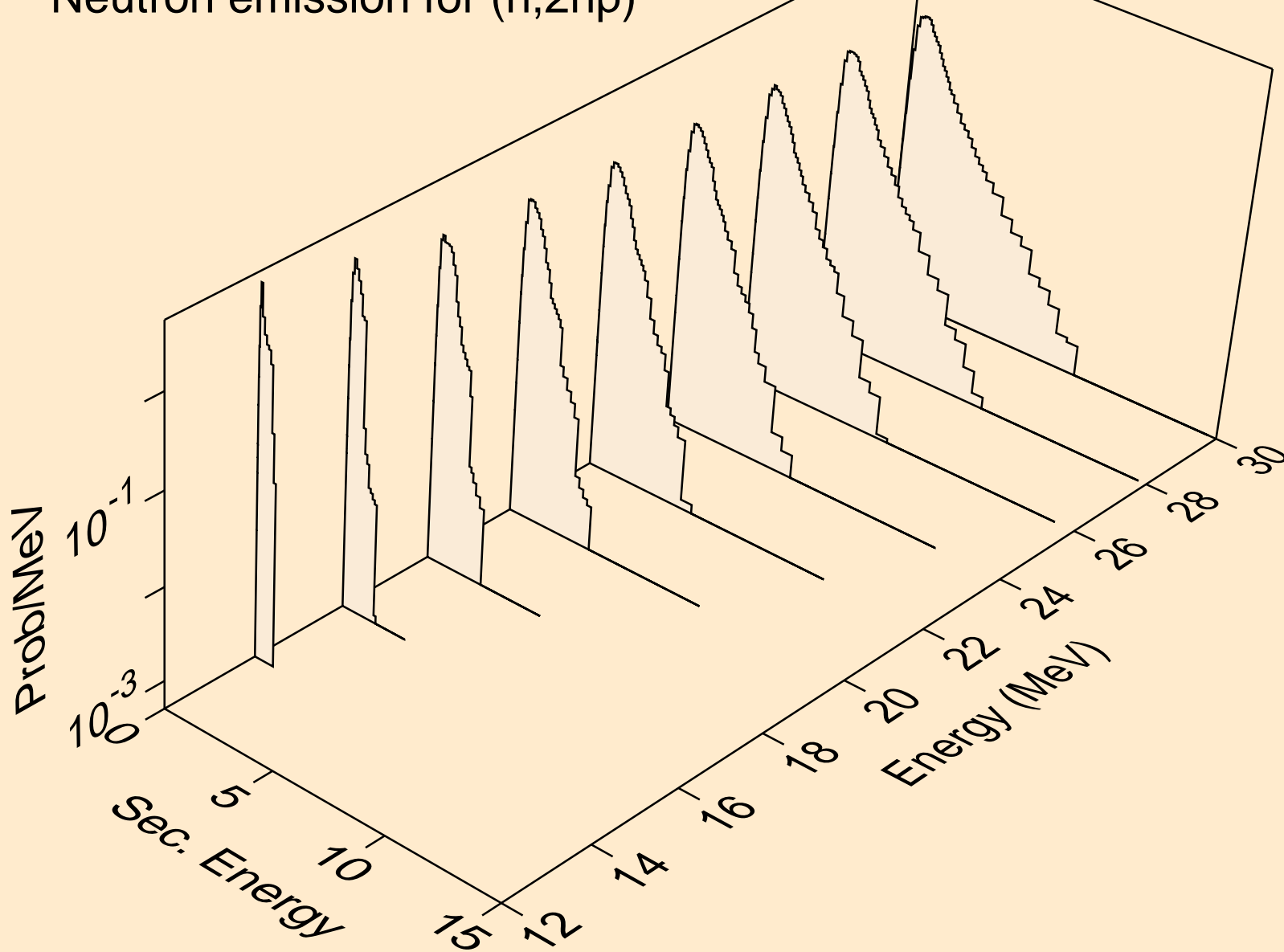

OS181 NEUTRON ACER TENDL-2019 LIBRARY; T=293.16K
Neutron emission for (n,3np)

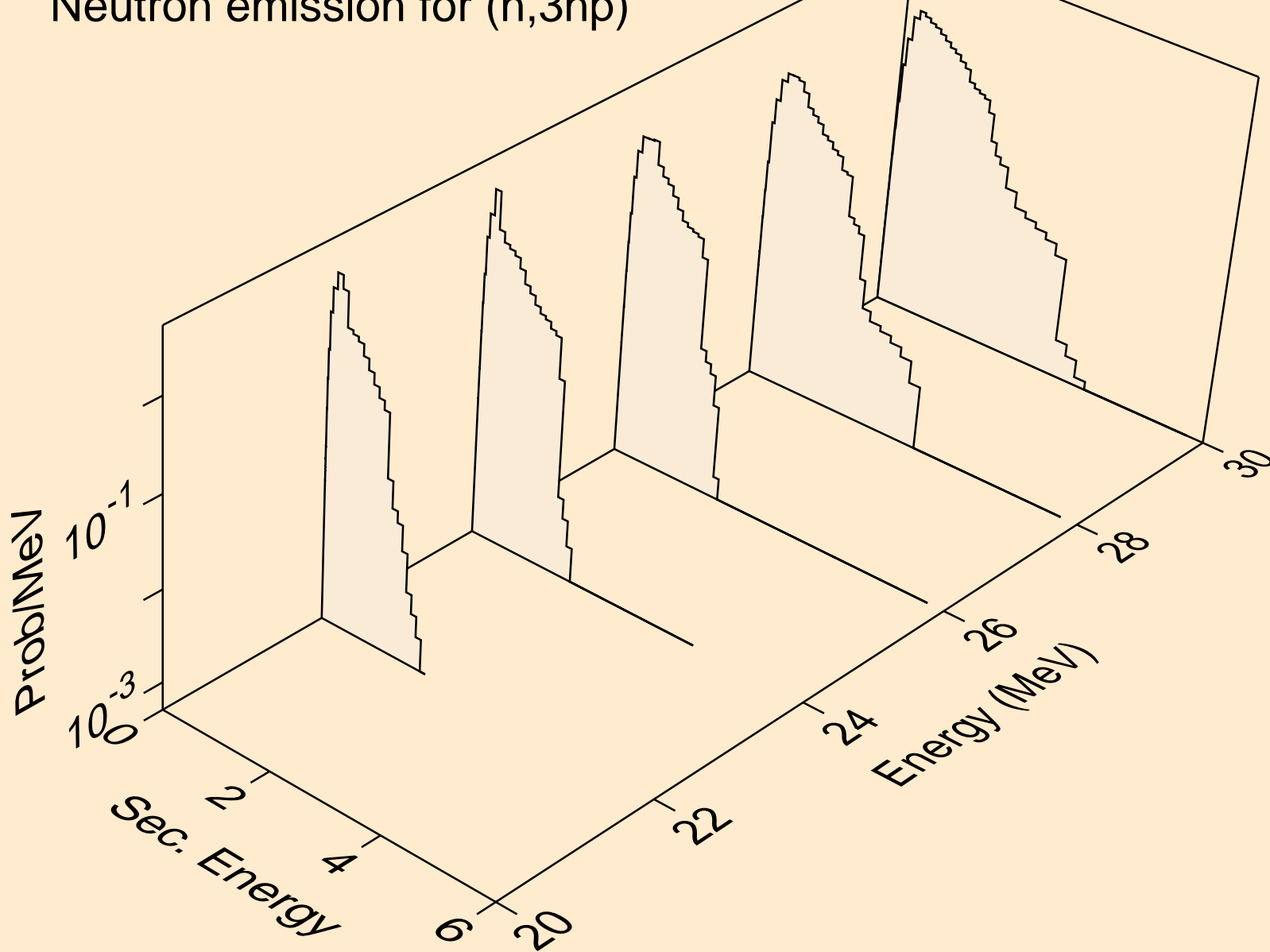

OS181 NEUTRON ACER TENDL-2019 LIBRARY; T=293.16K
Neutron emission for (n,2np)

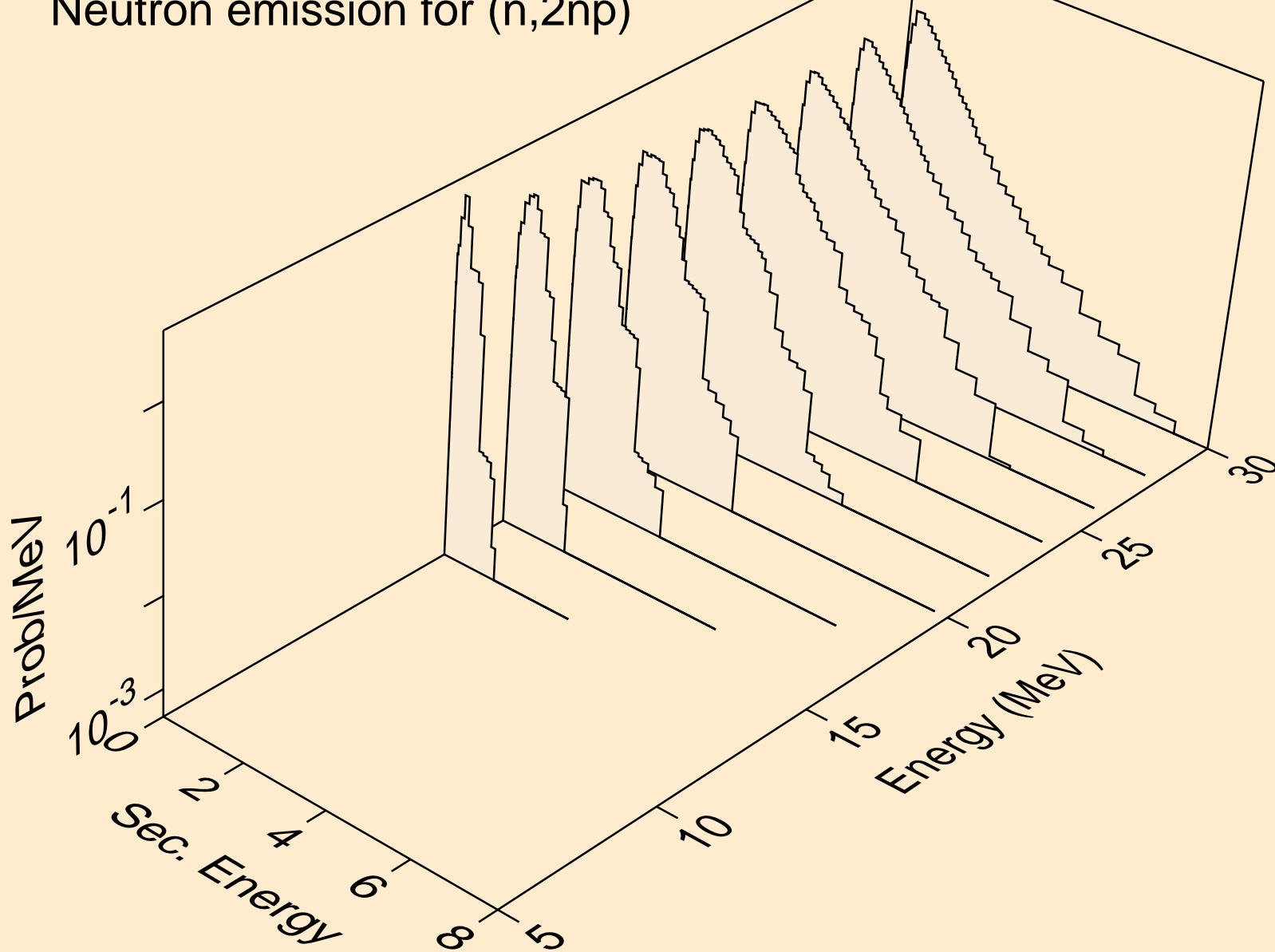

OS181 NEUTRON ACER TENDL-2019 LIBRARY; T=293.16K
Neutron emission for (n,npa)

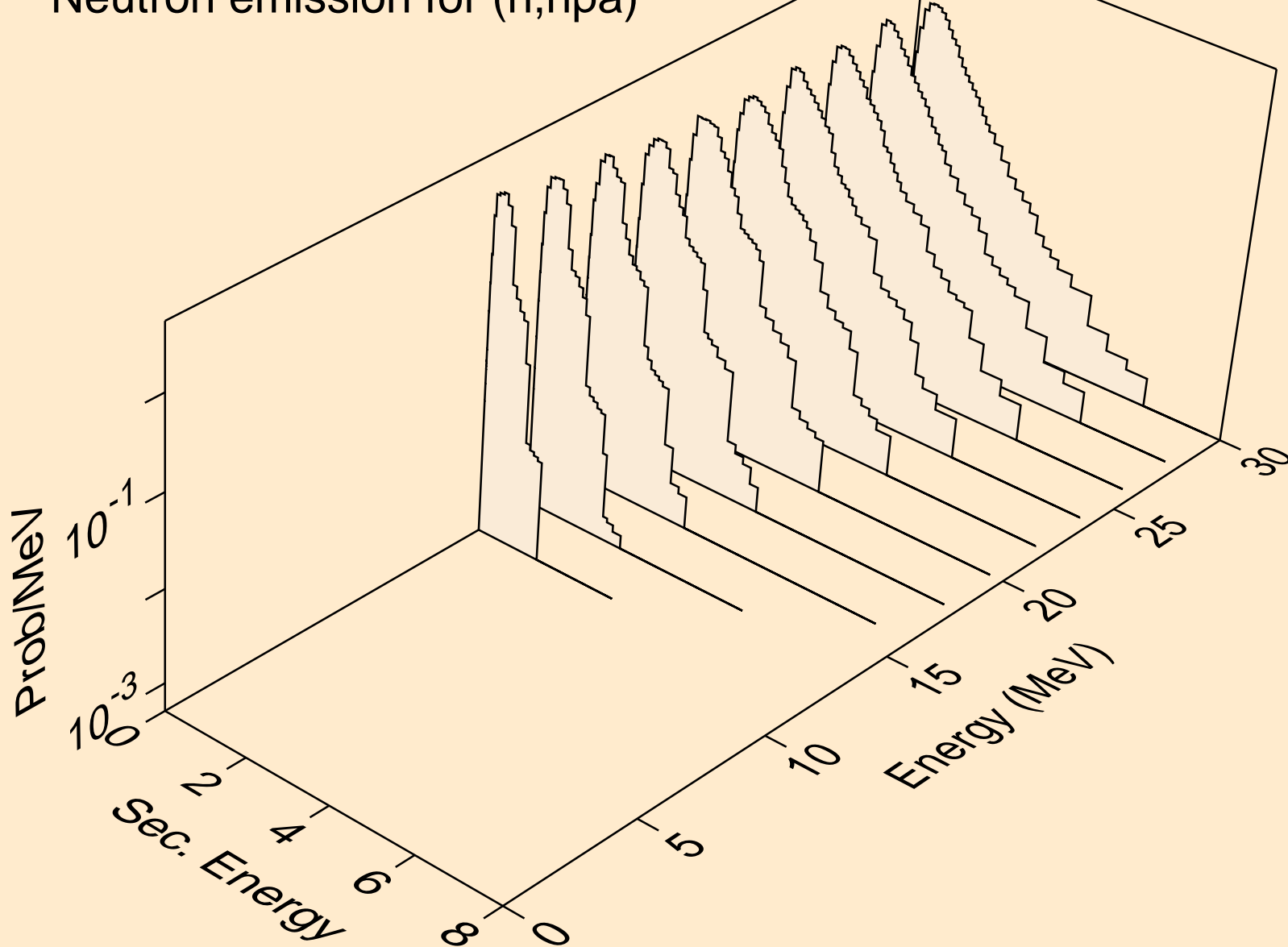

OS181 NEUTRON ACER TENDL-2019 LIBRARY; T=293.16K
Neutron emission for (n,n*c)

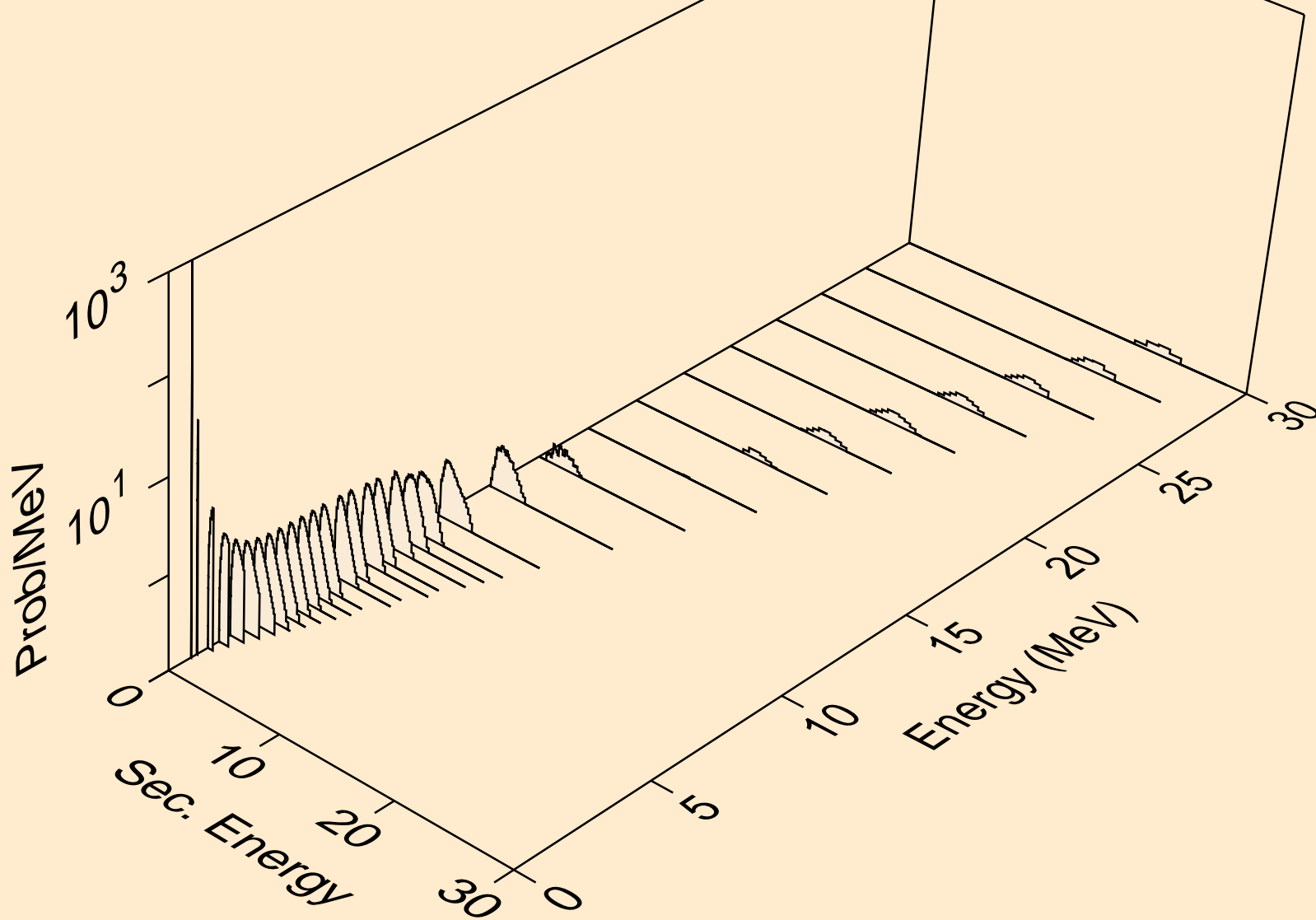

OS181 NEUTRON ACER TENDL-2019 LIBRARY; T=293.16K
Photon emission for (n,x)

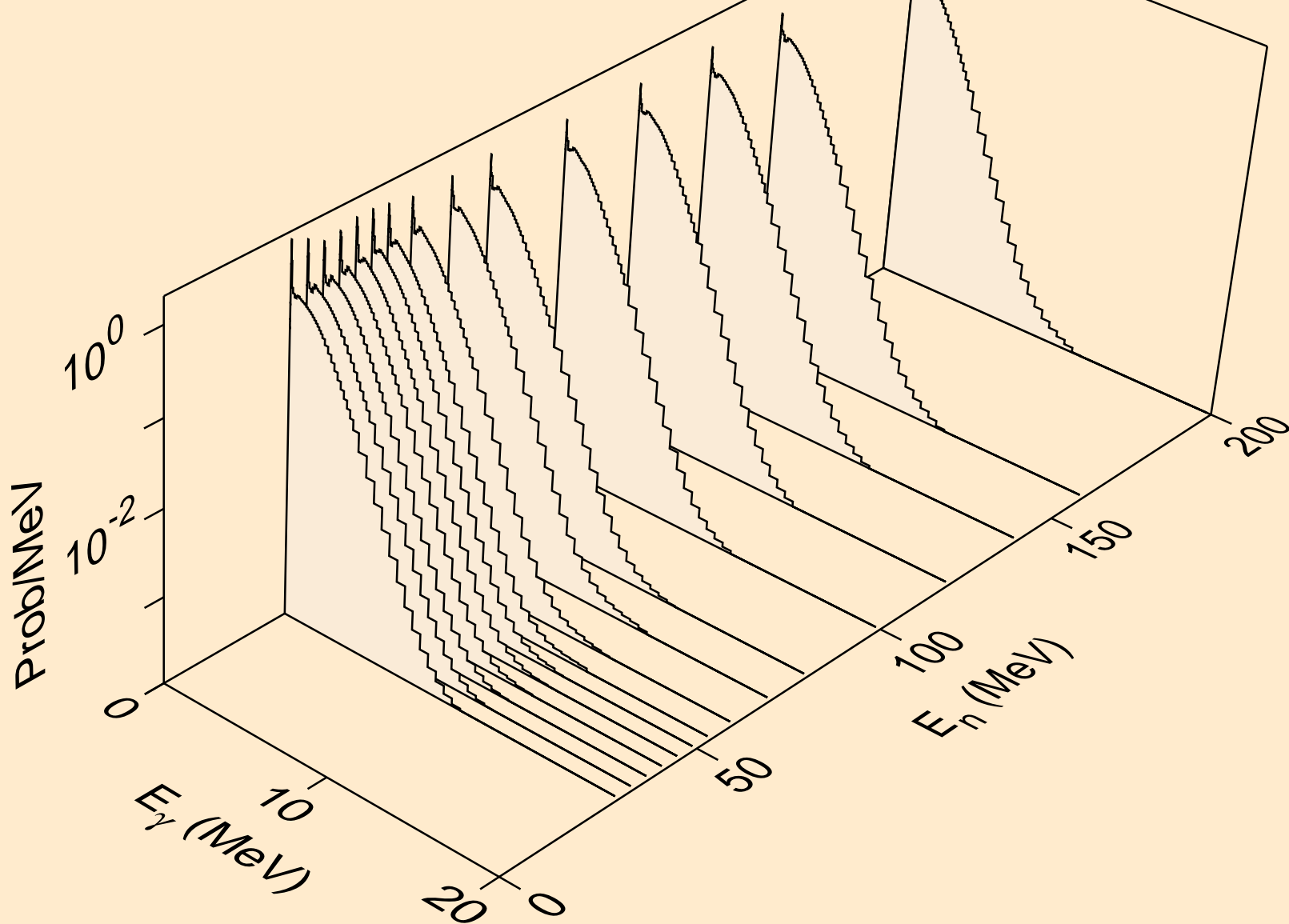

OS181 NEUTRON ACER TENDL-2019 LIBRARY; T=293.16K
Photon emission for (n,2nd)

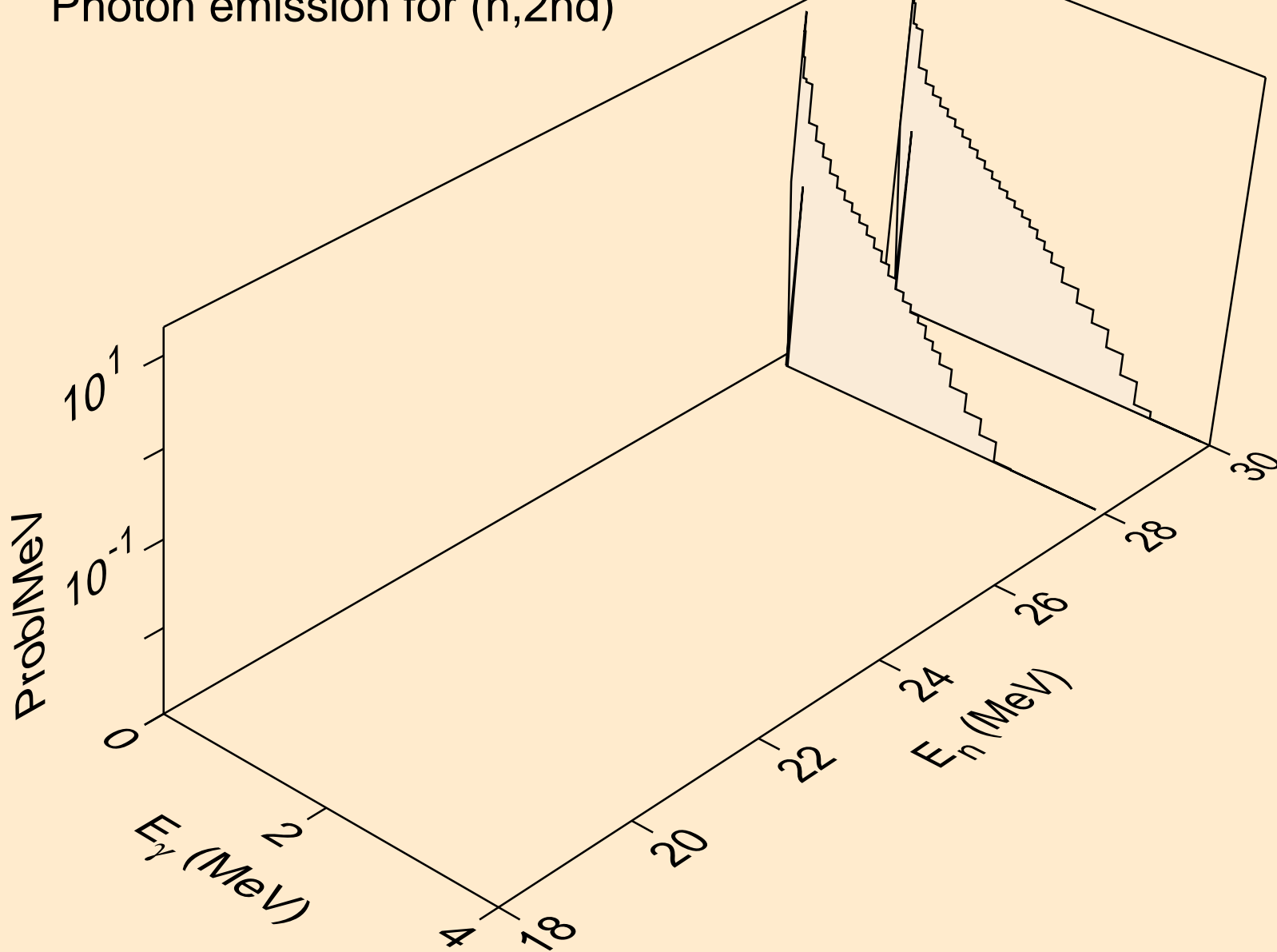

OS181 NEUTRON ACER TENDL-2019 LIBRARY; T=293.16K
Photon emission for (n,2n)

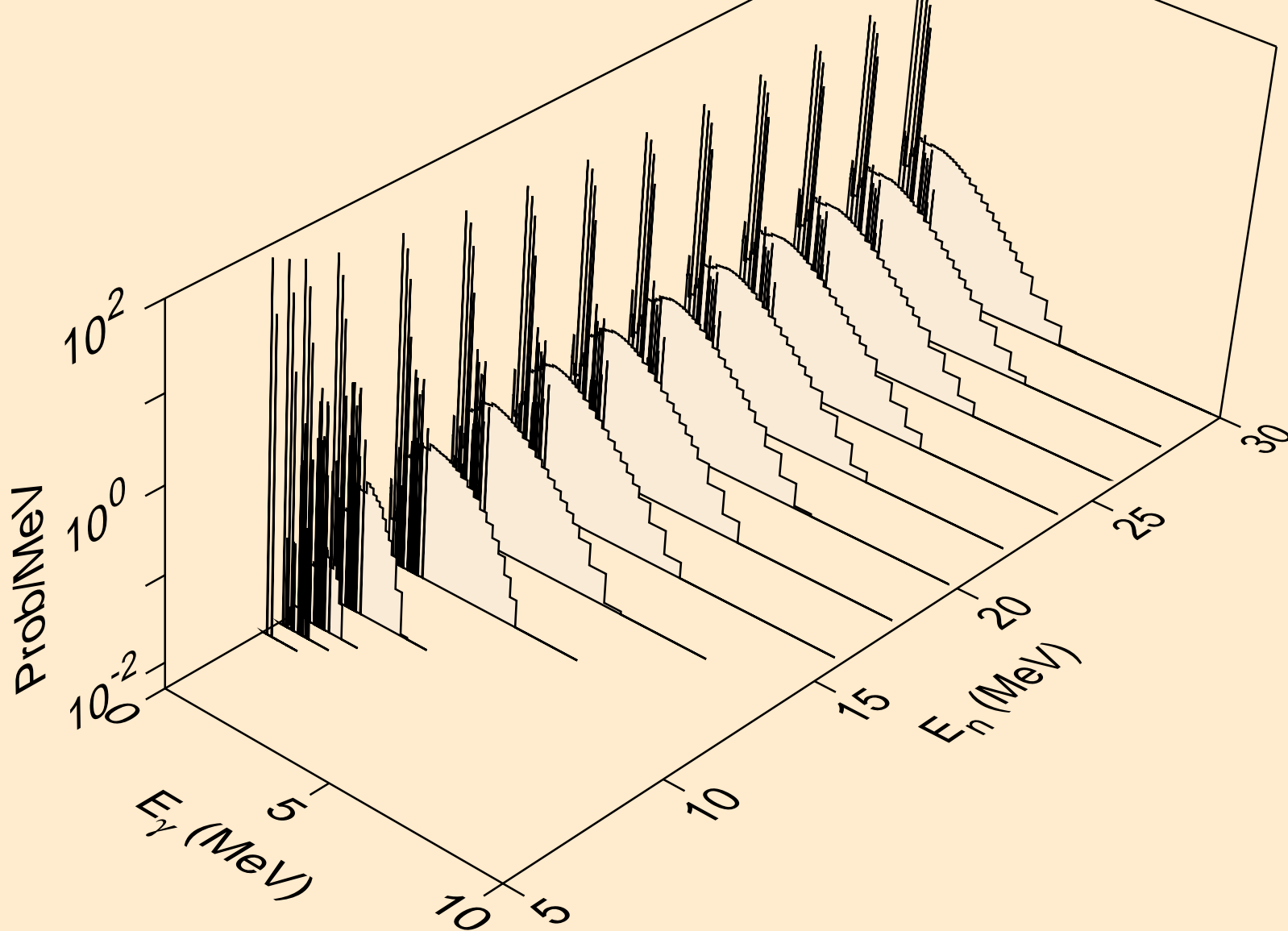

OS181 NEUTRON ACER TENDL-2019 LIBRARY; T=293.16K
Photon emission for (n,3n)

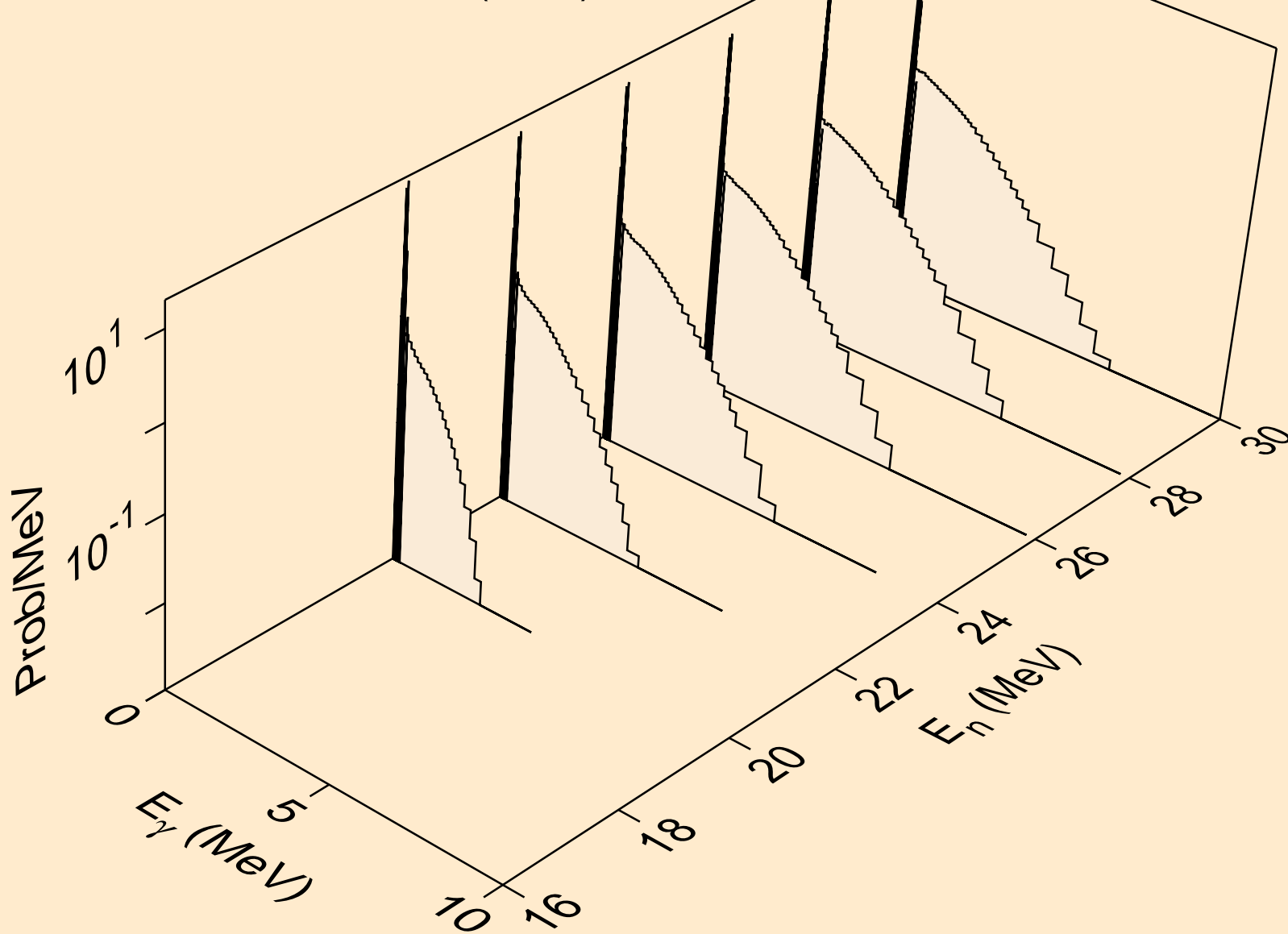

OS181 NEUTRON ACER TENDL-2019 LIBRARY; T=293.16K
Photon emission for (n,n*)a

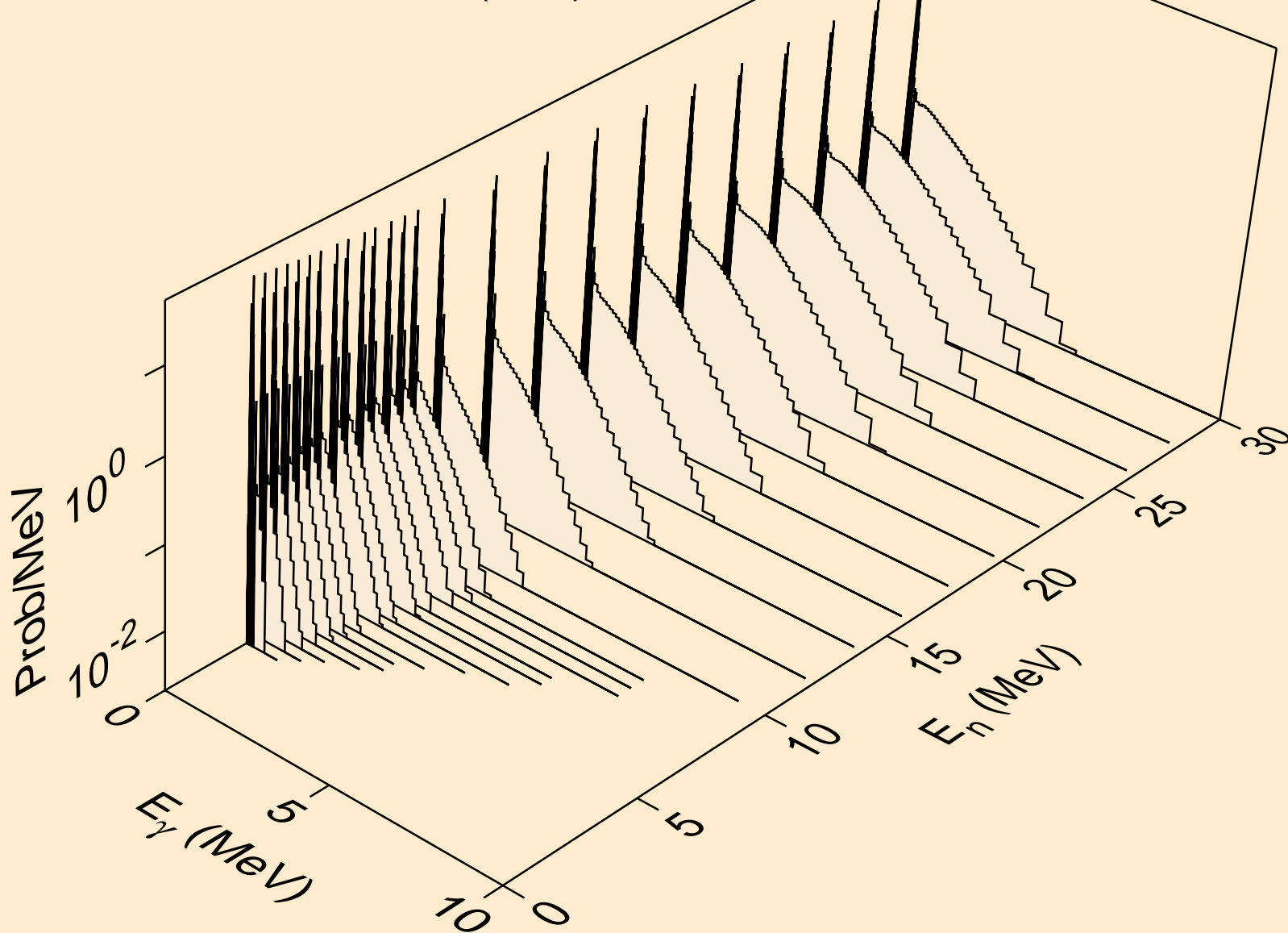

OS181 NEUTRON ACER TENDL-2019 LIBRARY; T=293.16K
Photon emission for (n,2n)a

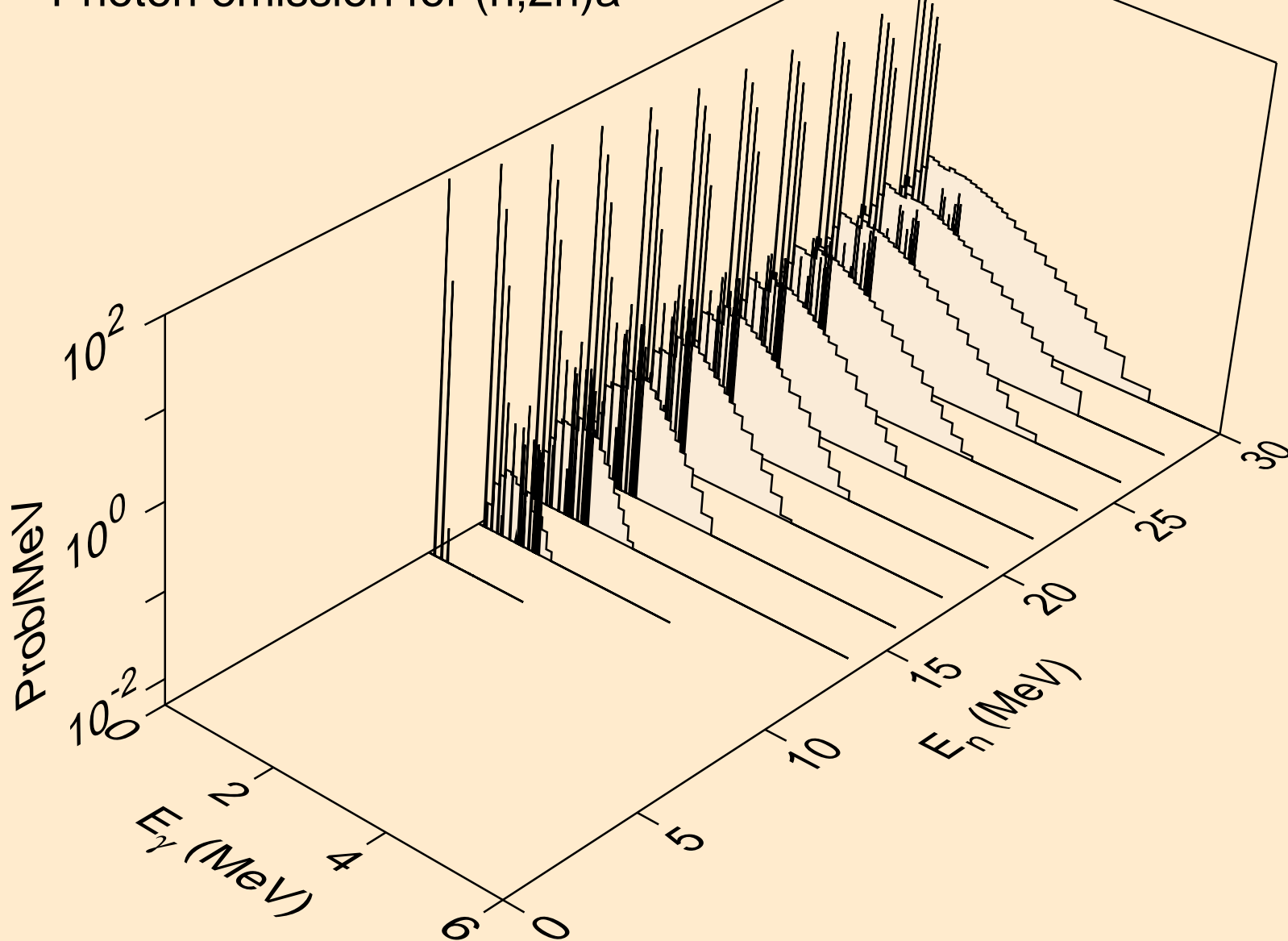

OS181 NEUTRON ACER TENDL-2019 LIBRARY; T=293.16K
Photon emission for (n,3n)a

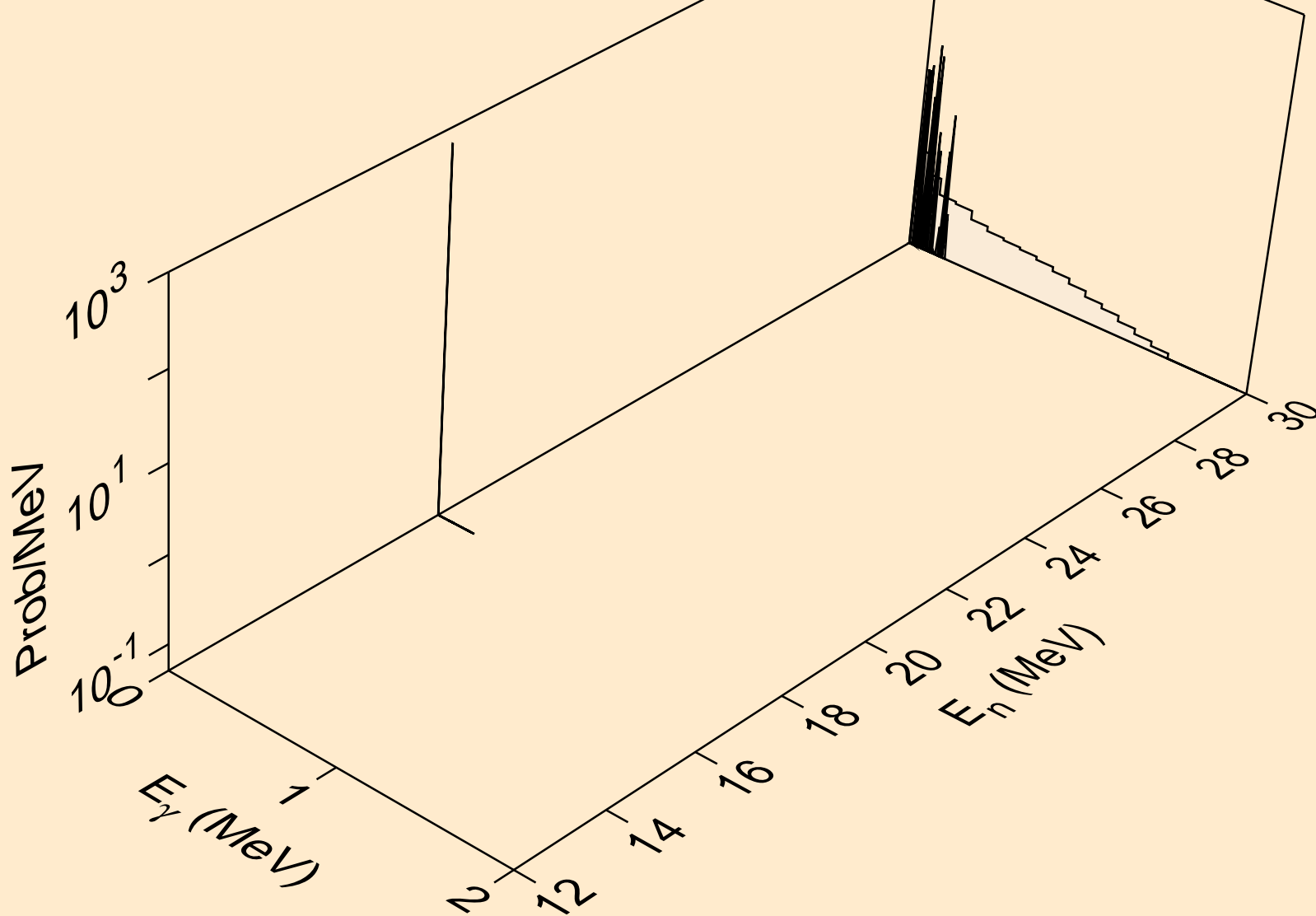

OS181 NEUTRON ACER TENDL-2019 LIBRARY; T=293.16K
Photon emission for (n,n*)p

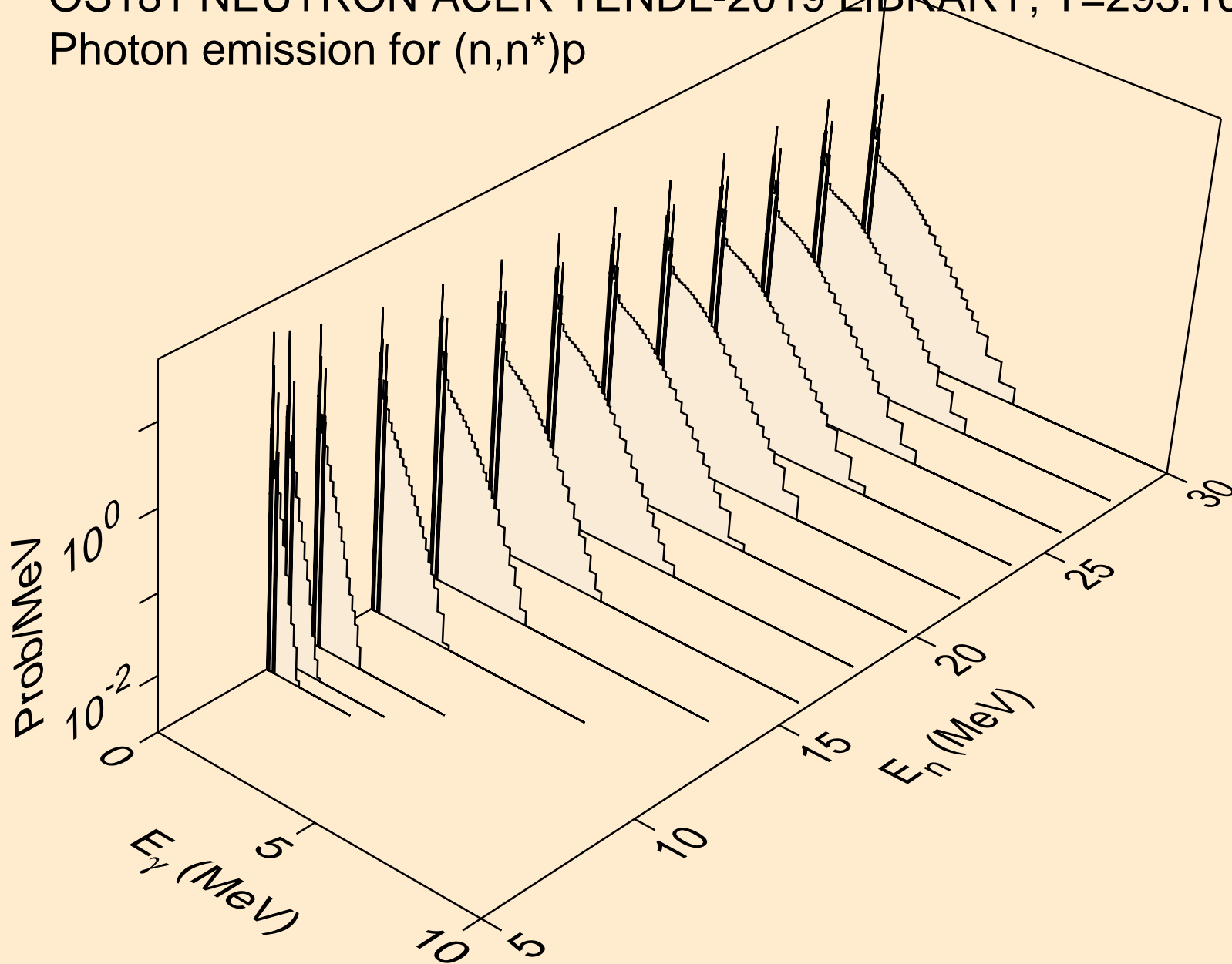

OS181 NEUTRON ACER TENDL-2019 LIBRARY; T=293.16K
Photon emission for (n,n*)2a

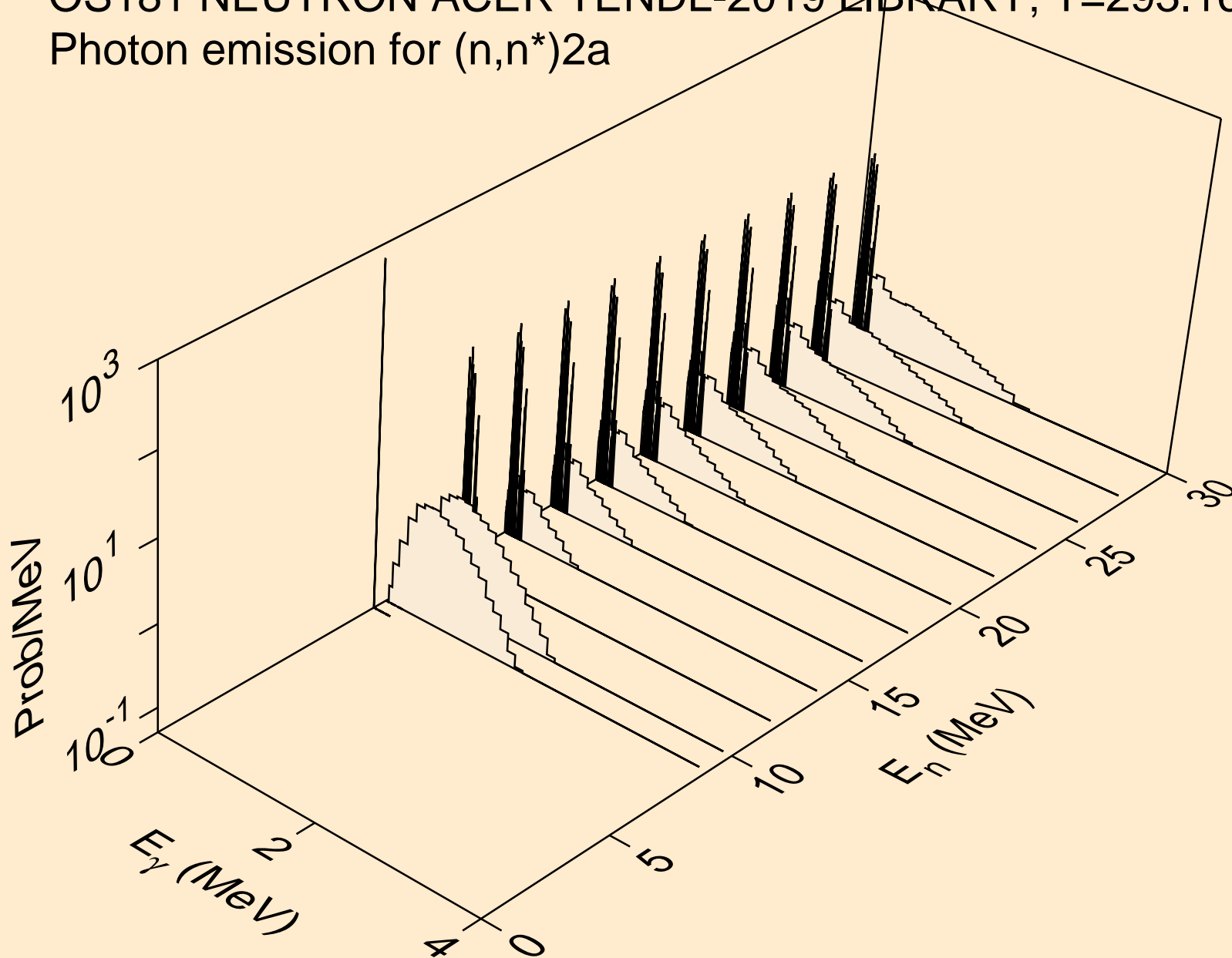

OS181 NEUTRON ACER TENDL-2019 LIBRARY; T=293.16K
Photon emission for (n,2n)2a

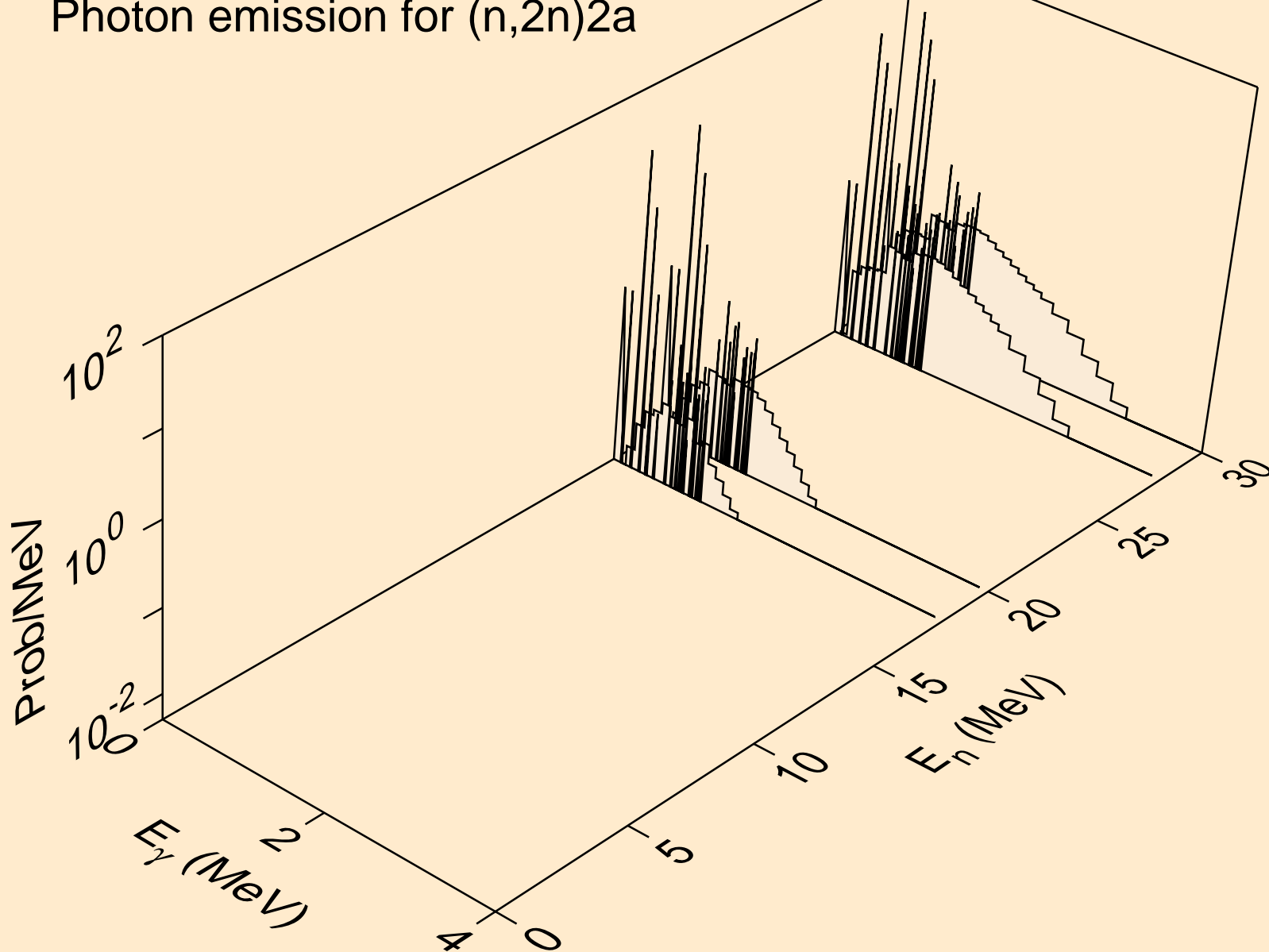

OS181 NEUTRON ACER TENDL-2019 LIBRARY; T=293.16K
Photon emission for (n,n*)d

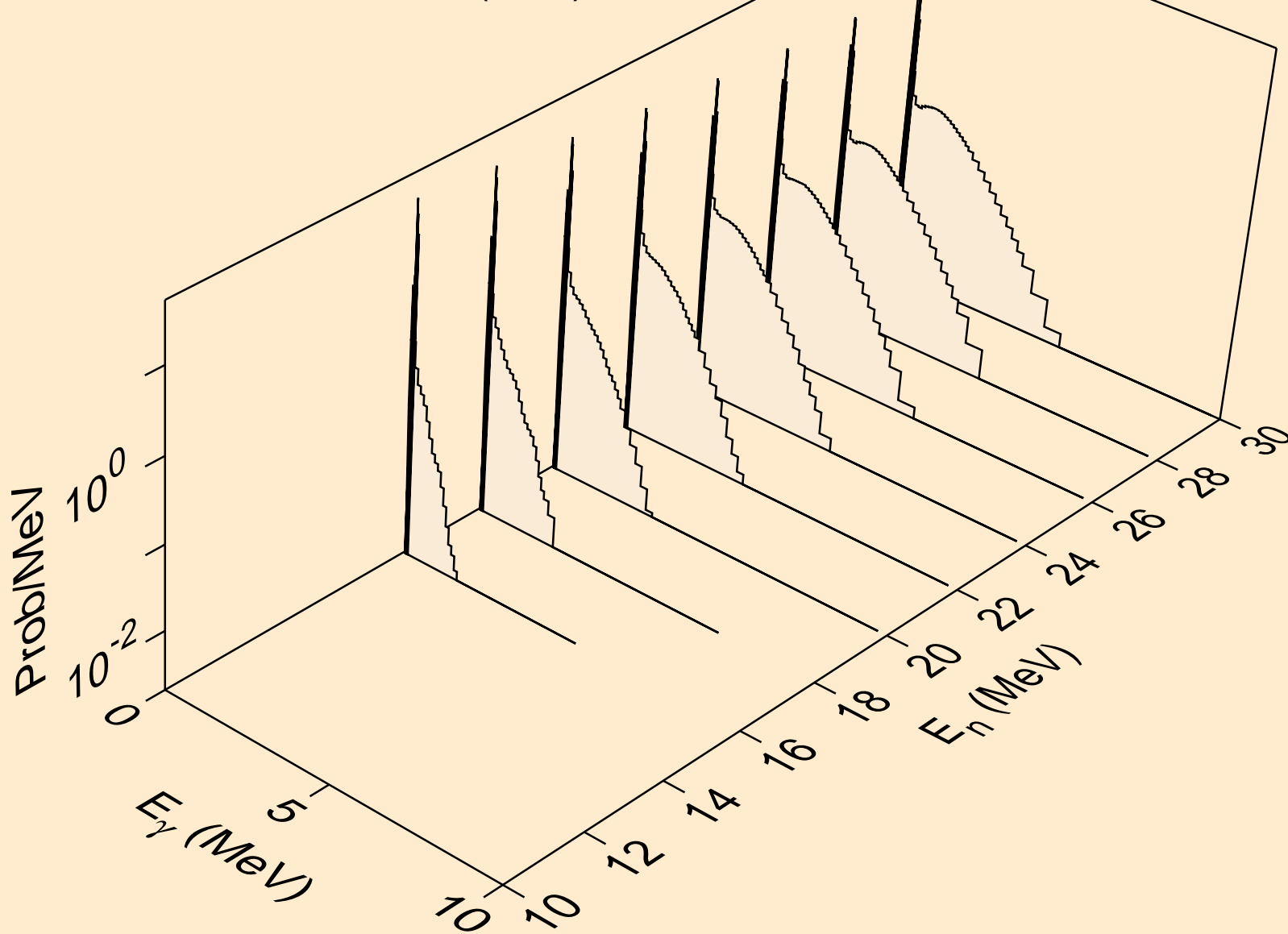

OS181 NEUTRON ACER TENDL-2019 LIBRARY; T=293.16K
Photon emission for (n,n*)t

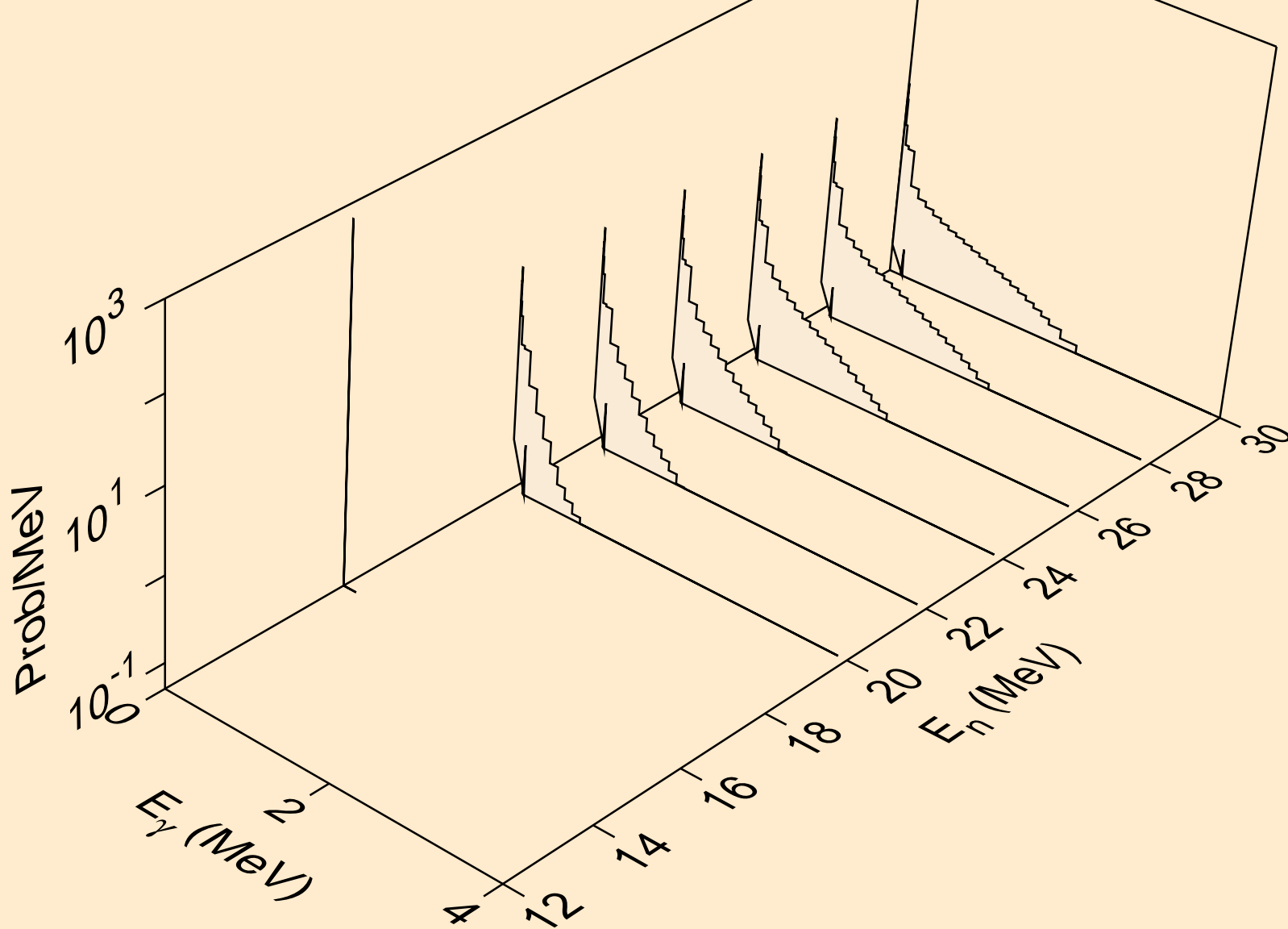

OS181 NEUTRON ACER TENDL-2019 LIBRARY; T=293.16K
Photon emission for (n,n*)he3

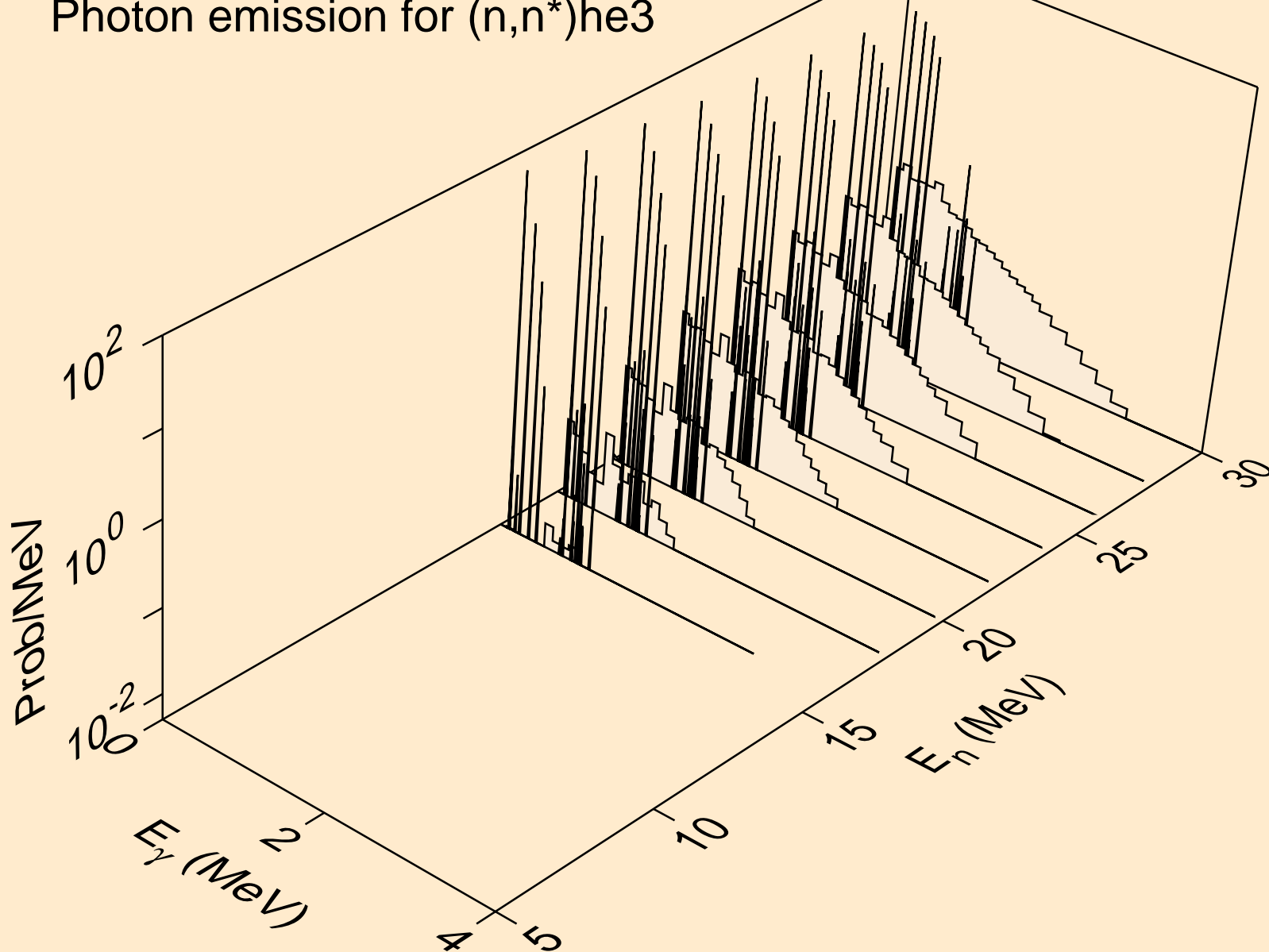

OS181 NEUTRON ACER TENDL-2019 LIBRARY; T=293.16K
Photon emission for (n,4n)

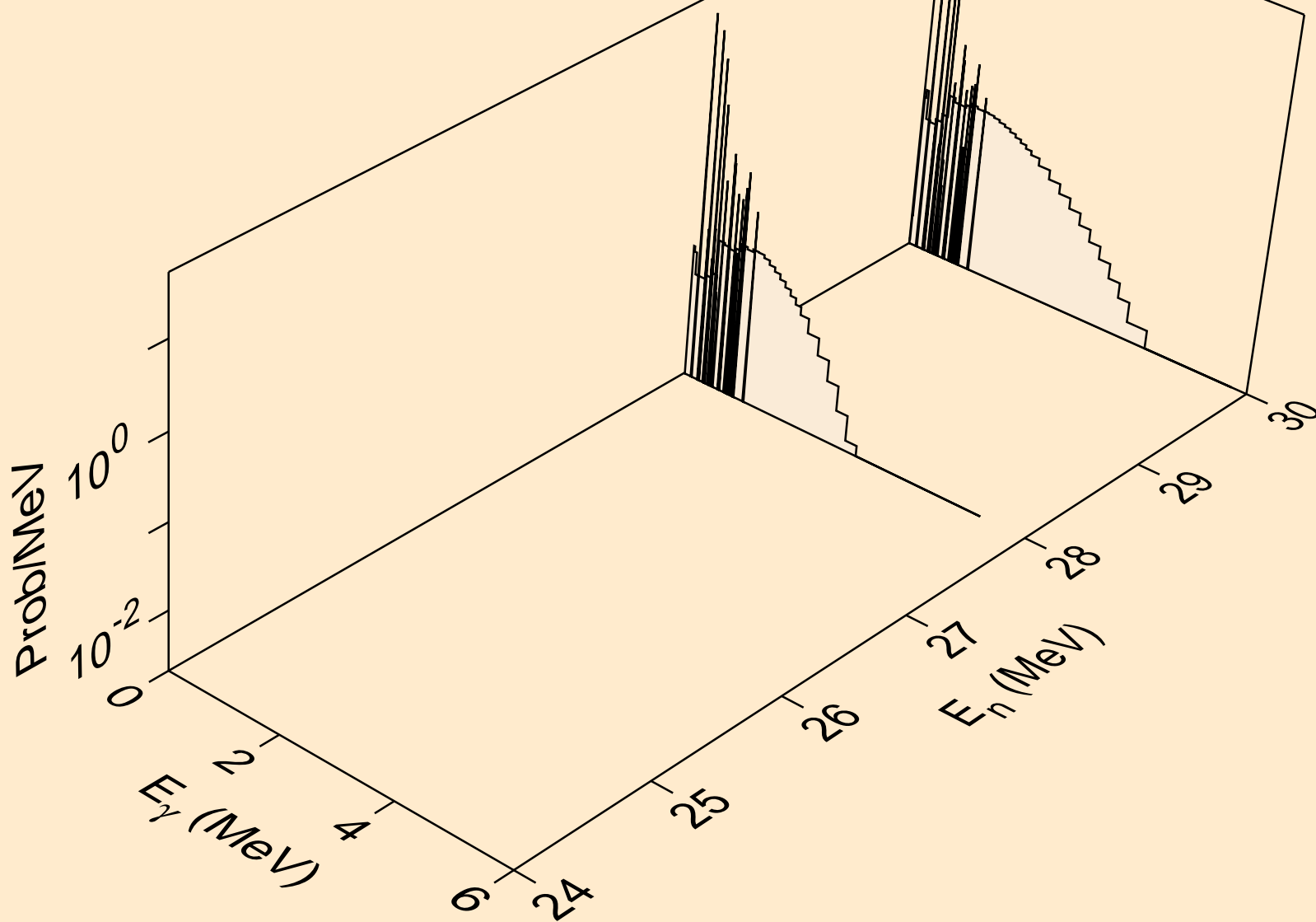

OS181 NEUTRON ACER TENDL-2019 LIBRARY; T=293.16K
Photon emission for (n,2np)

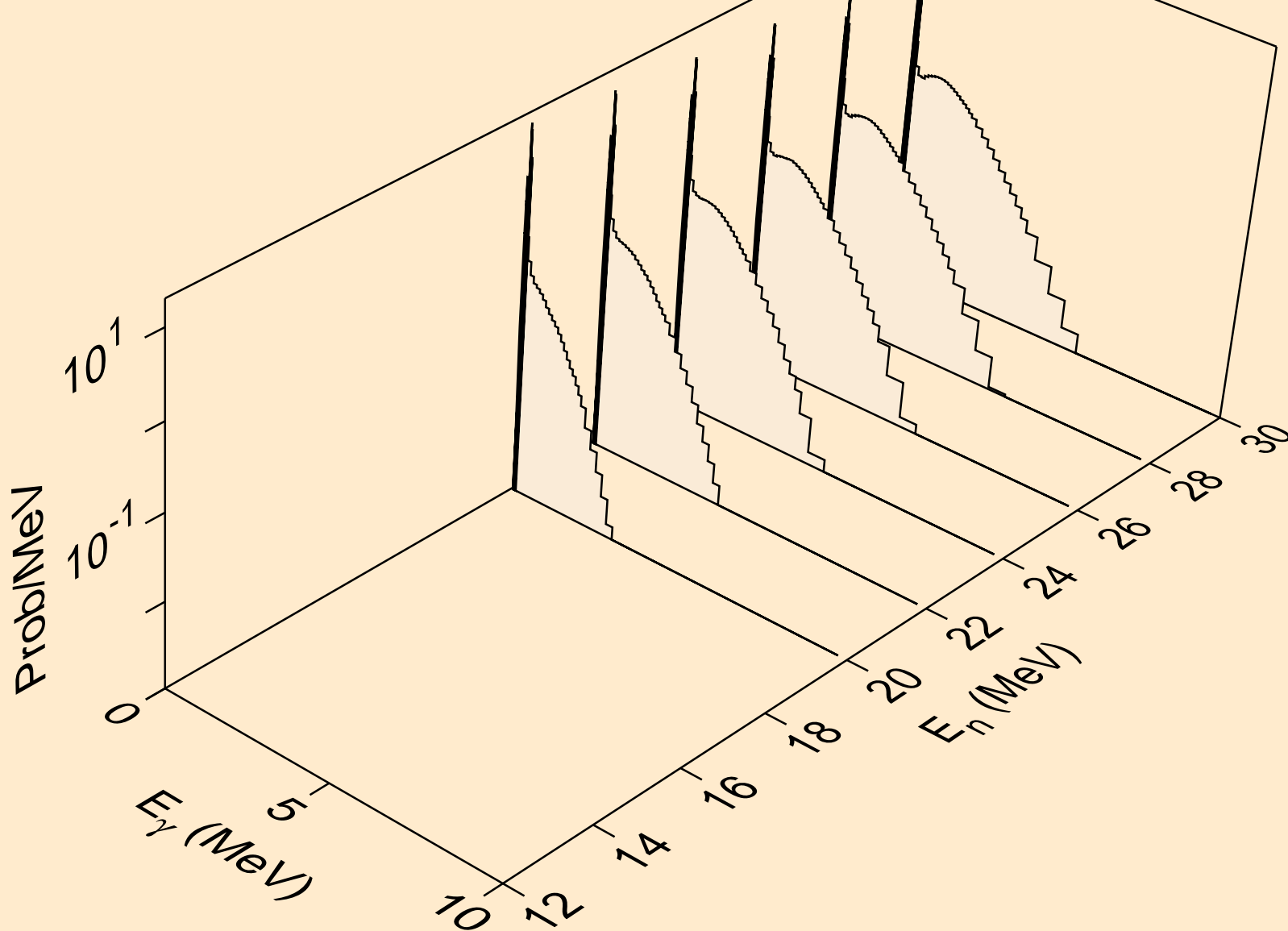

OS181 NEUTRON ACER TENDL-2019 LIBRARY; T=293.16K
Photon emission for (n,3np)

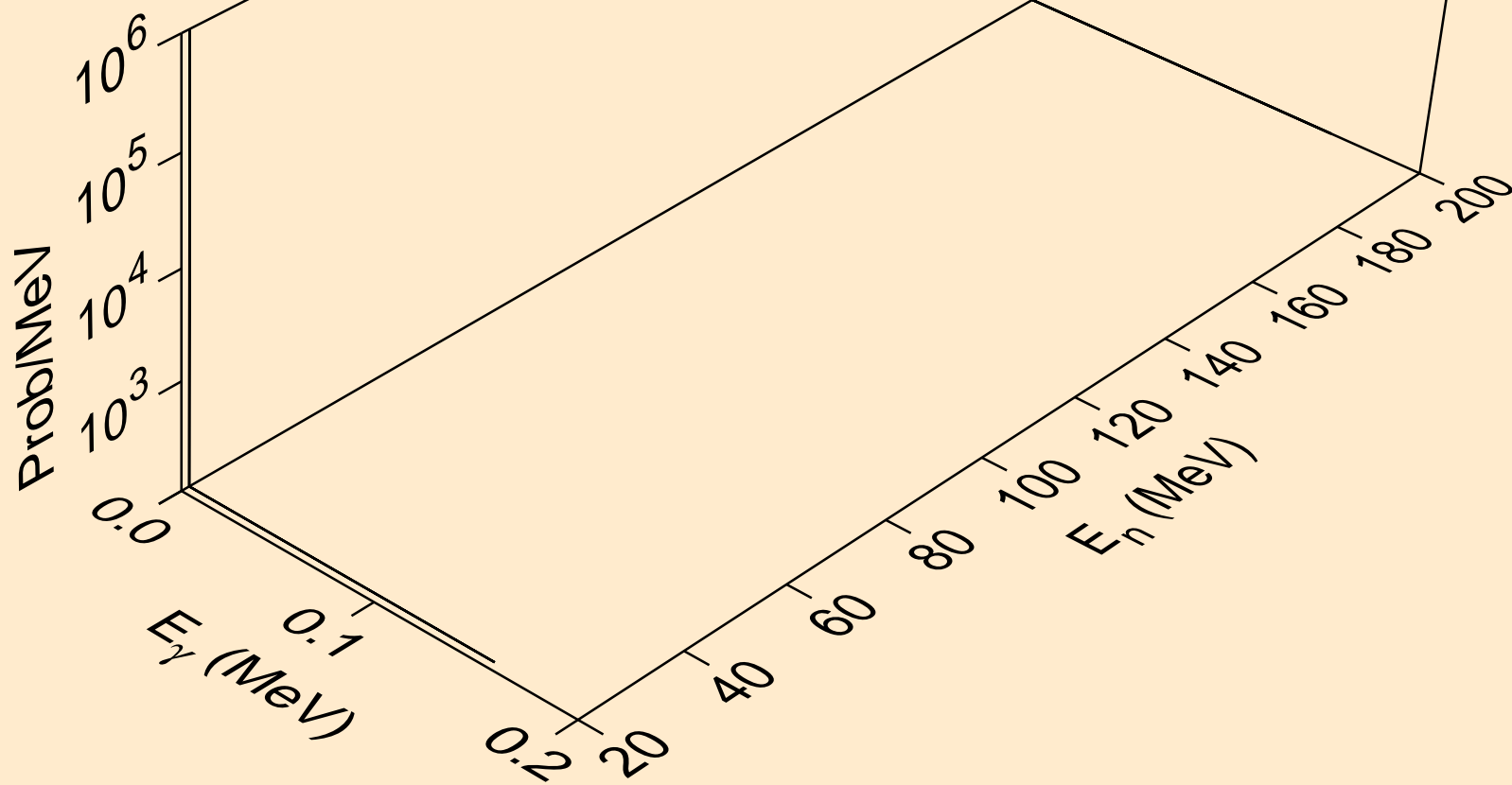

OS181 NEUTRON ACER TENDL-2019 LIBRARY; T=293.16K
Photon emission for (n,2np)

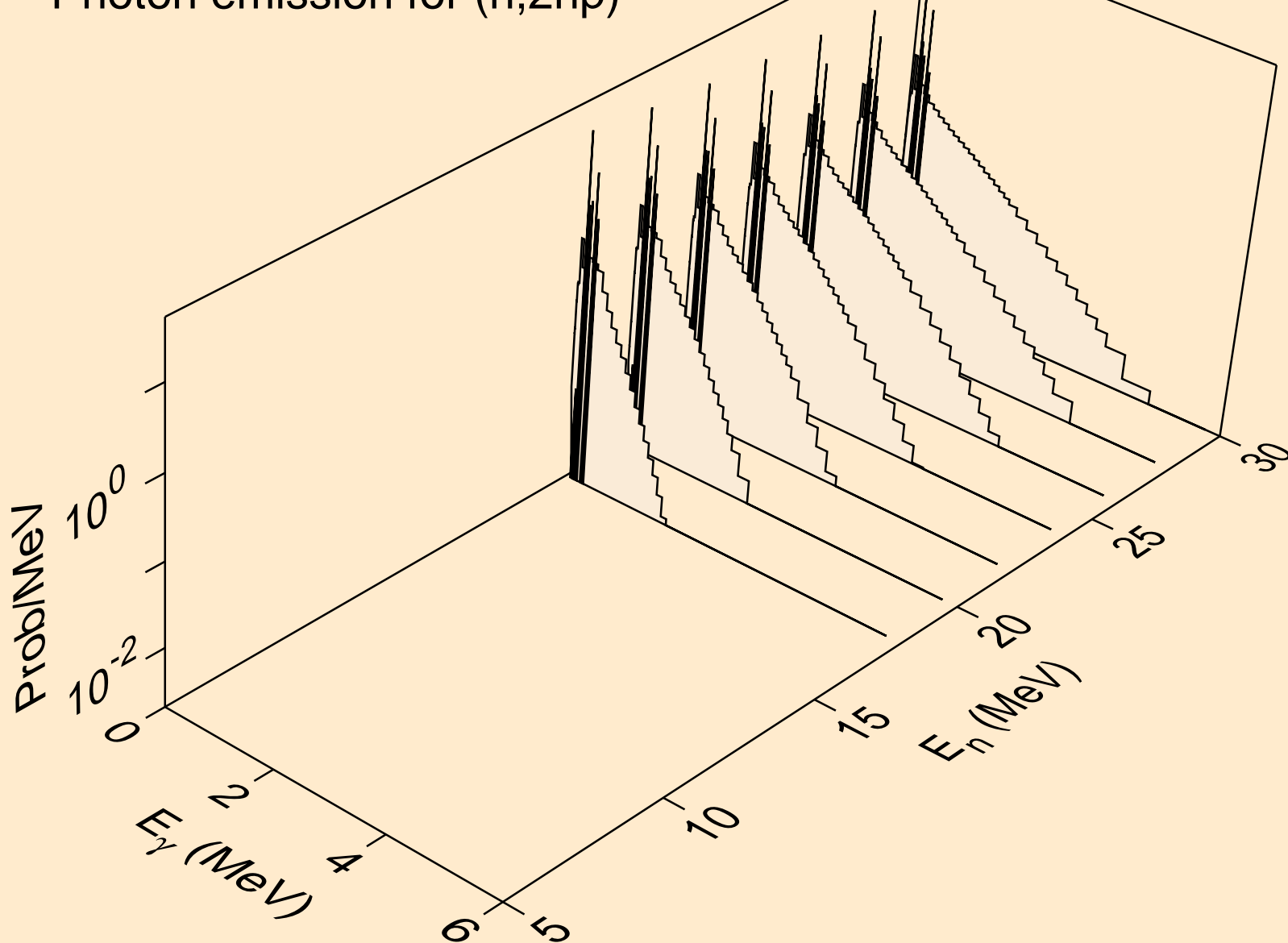

OS181 NEUTRON ACER TENDL-2019 LIBRARY; T=293.16K
Photon emission for (n,npa)

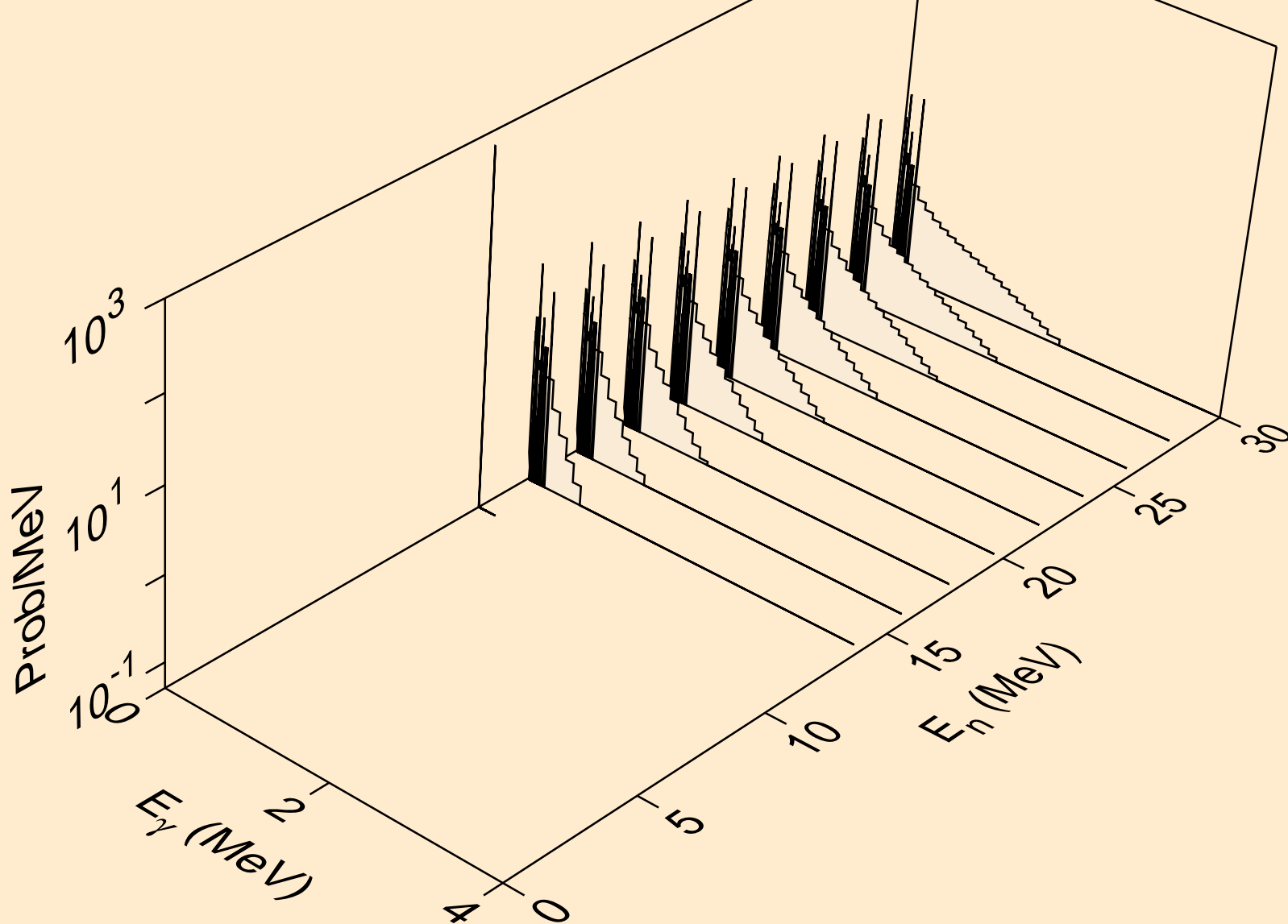

OS181 NEUTRON ACER TENDL-2019 LIBRARY; T=293.16K
Photon emission for (n,n*c)

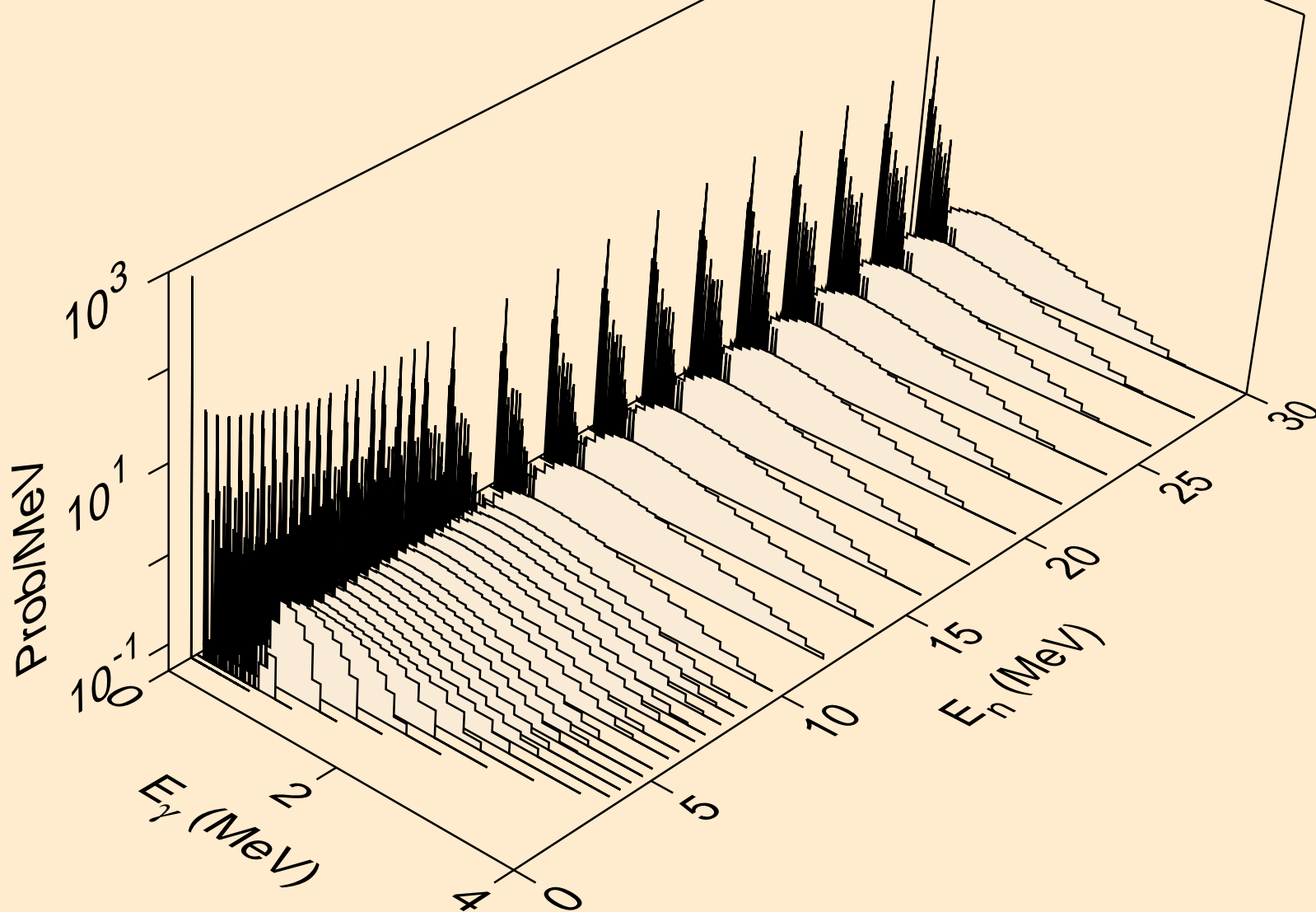

OS181 NEUTRON ACER TENDL-2019 LIBRARY; T=293.16K
Photon emission for (n,gma)

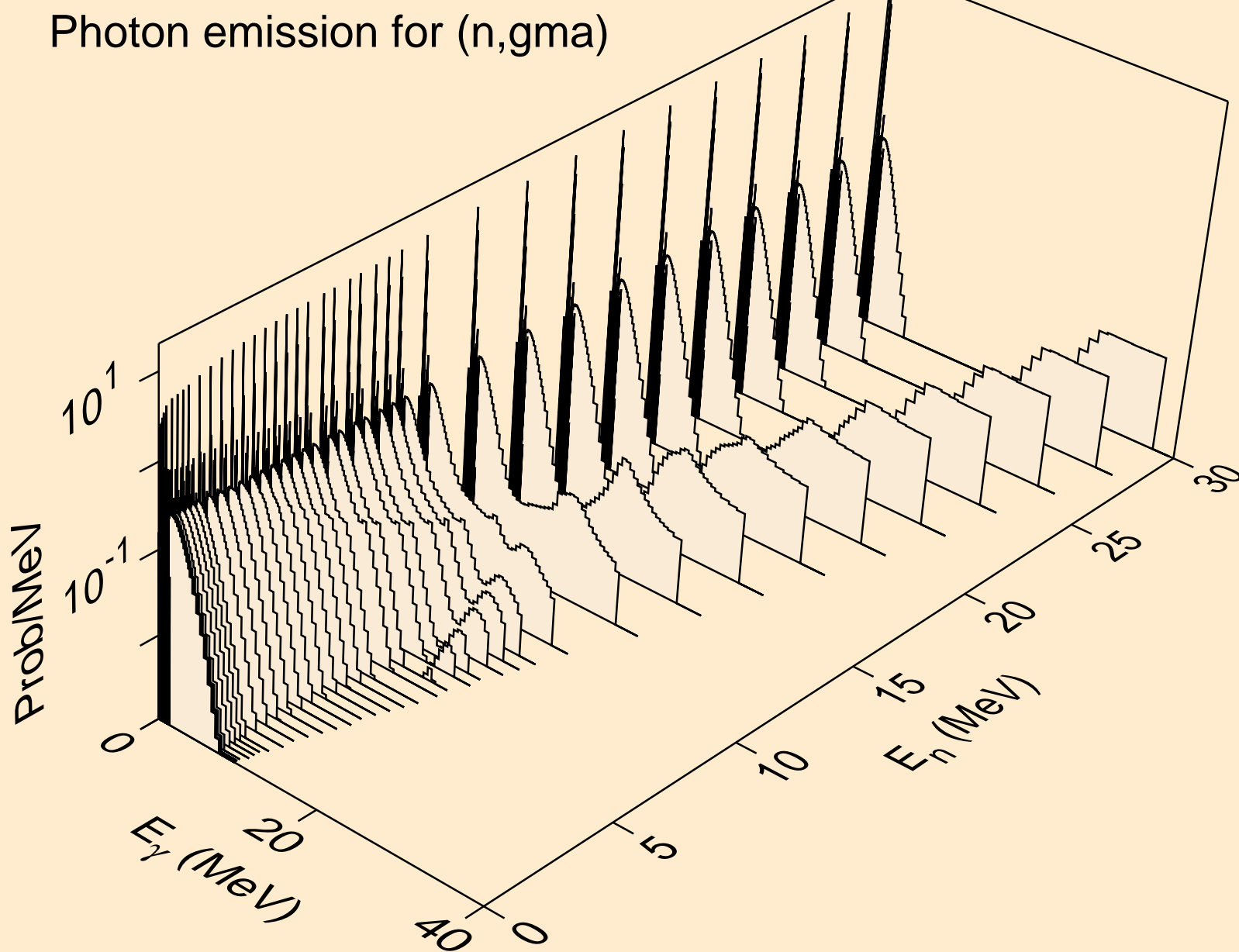

OS181 NEUTRON ACER TENDL-2019 LIBRARY; T=293.16K
Photon emission for (n,p)

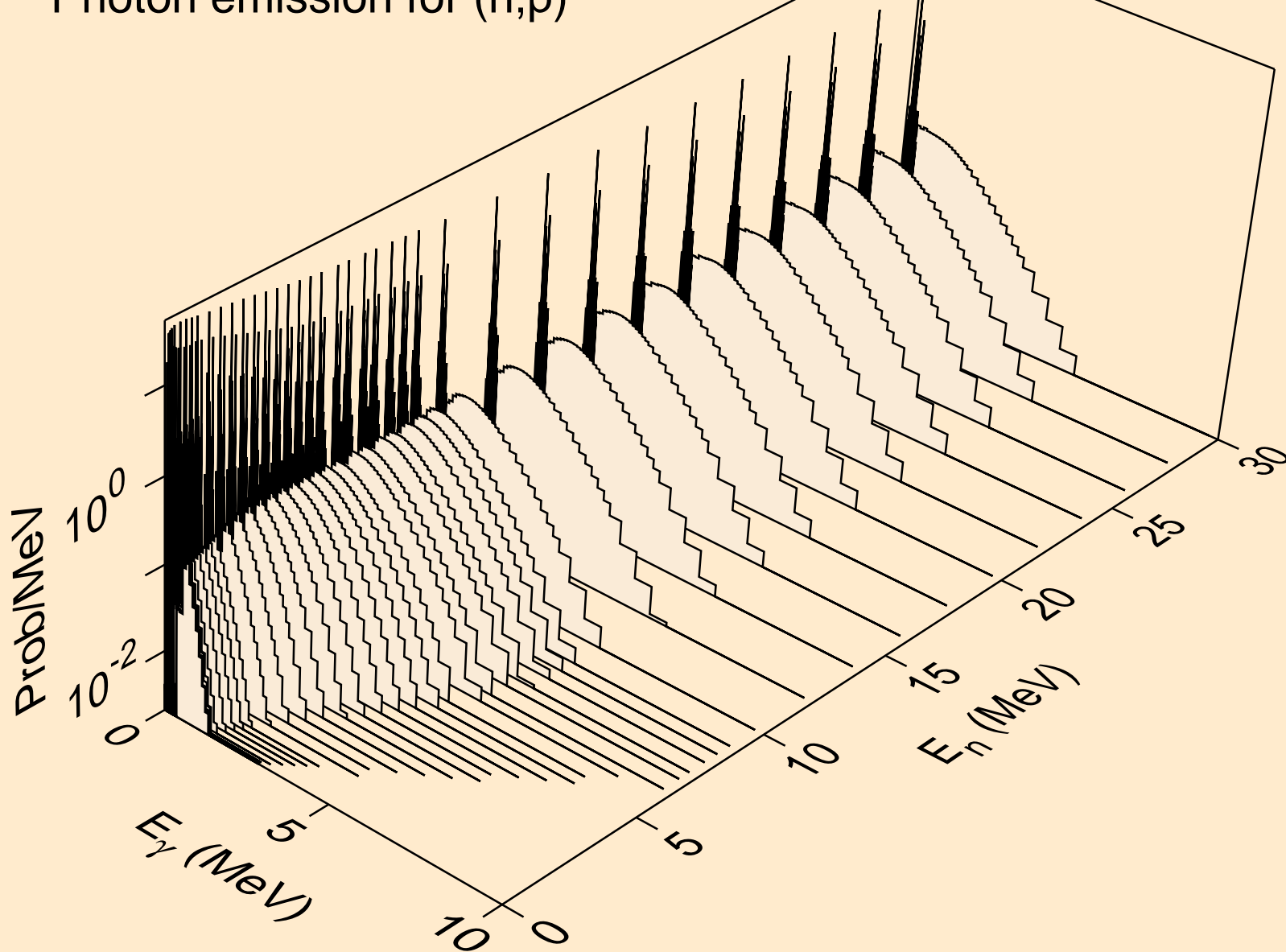

OS181 NEUTRON ACER TENDL-2019 LIBRARY; T=293.16K
Photon emission for (n,d)

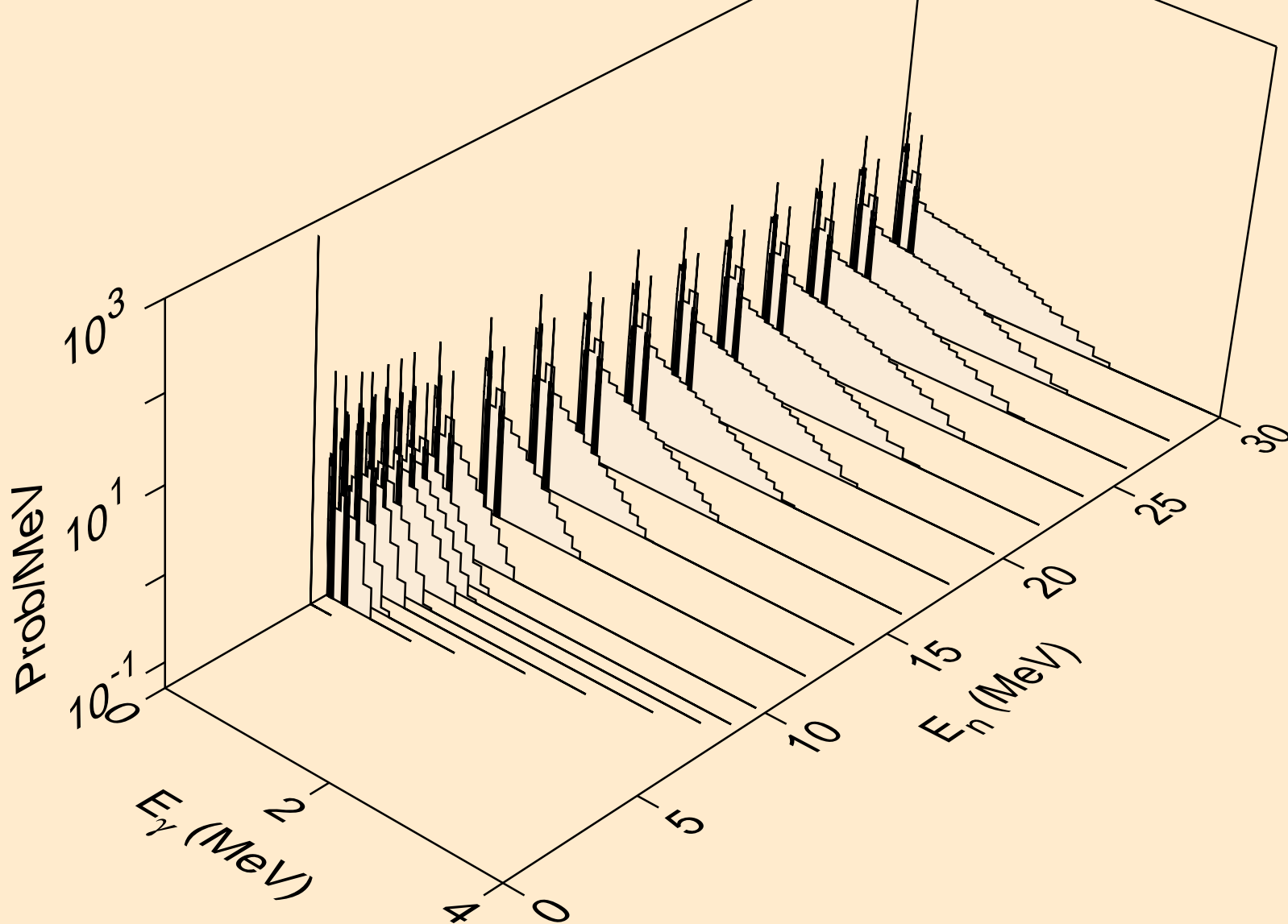

OS181 NEUTRON ACER TENDL-2019 LIBRARY; T=293.16K
Photon emission for (n,t)

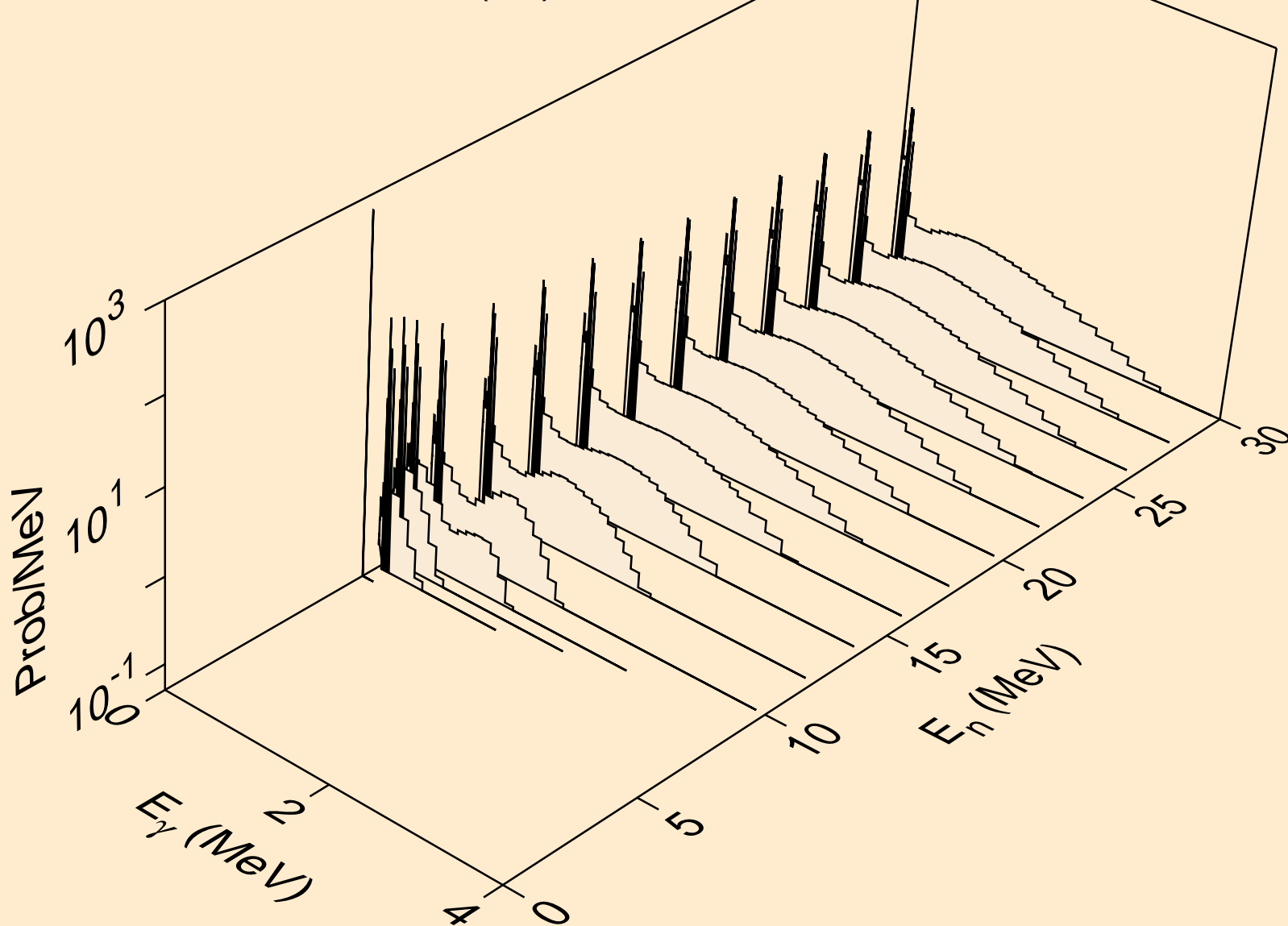

OS181 NEUTRON ACER TENDL-2019 LIBRARY; T=293.16K
Photon emission for (n,he3)

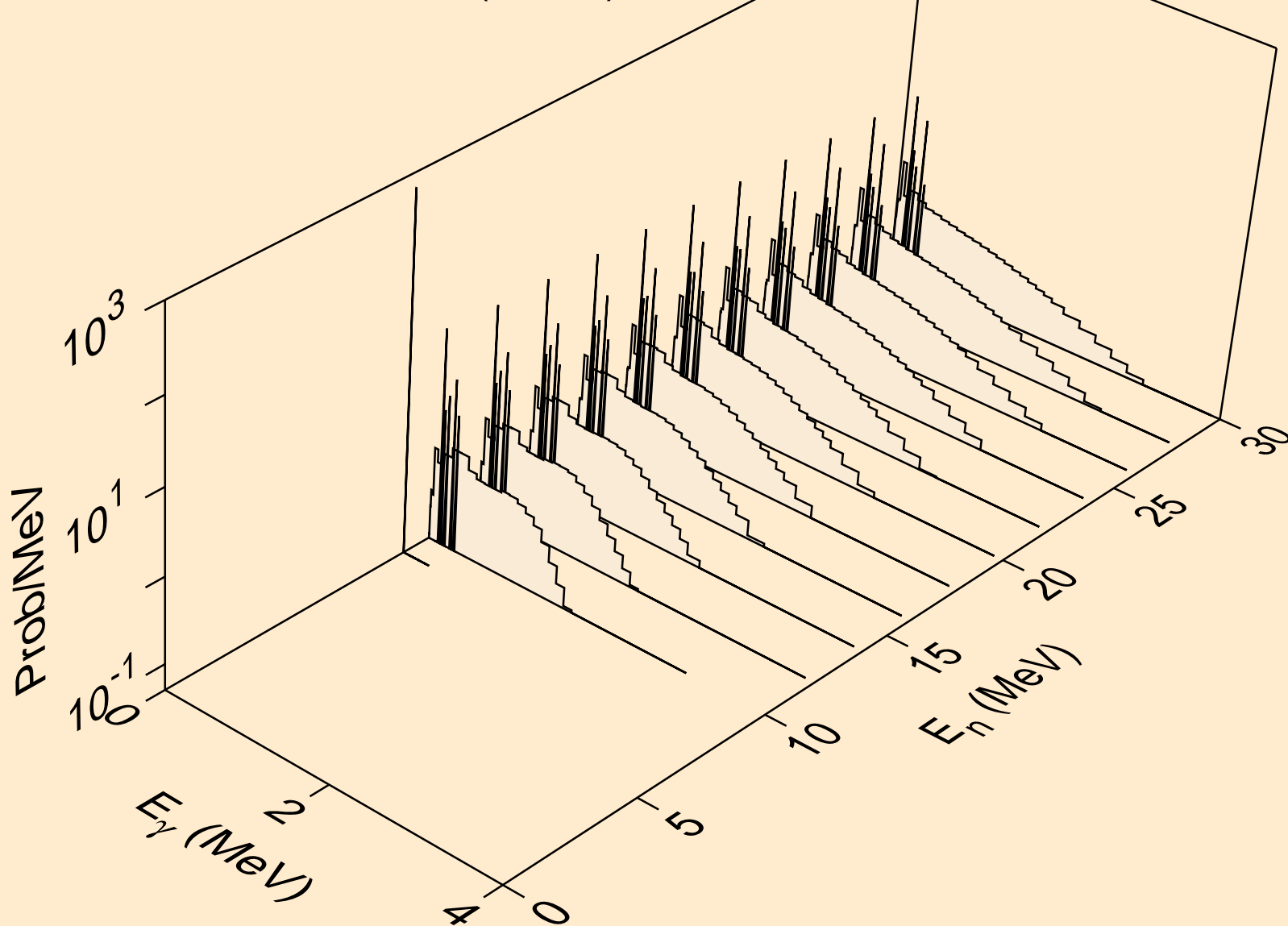

OS181 NEUTRON ACER TENDL-2019 LIBRARY; T=293.16K
Photon emission for (n,a)

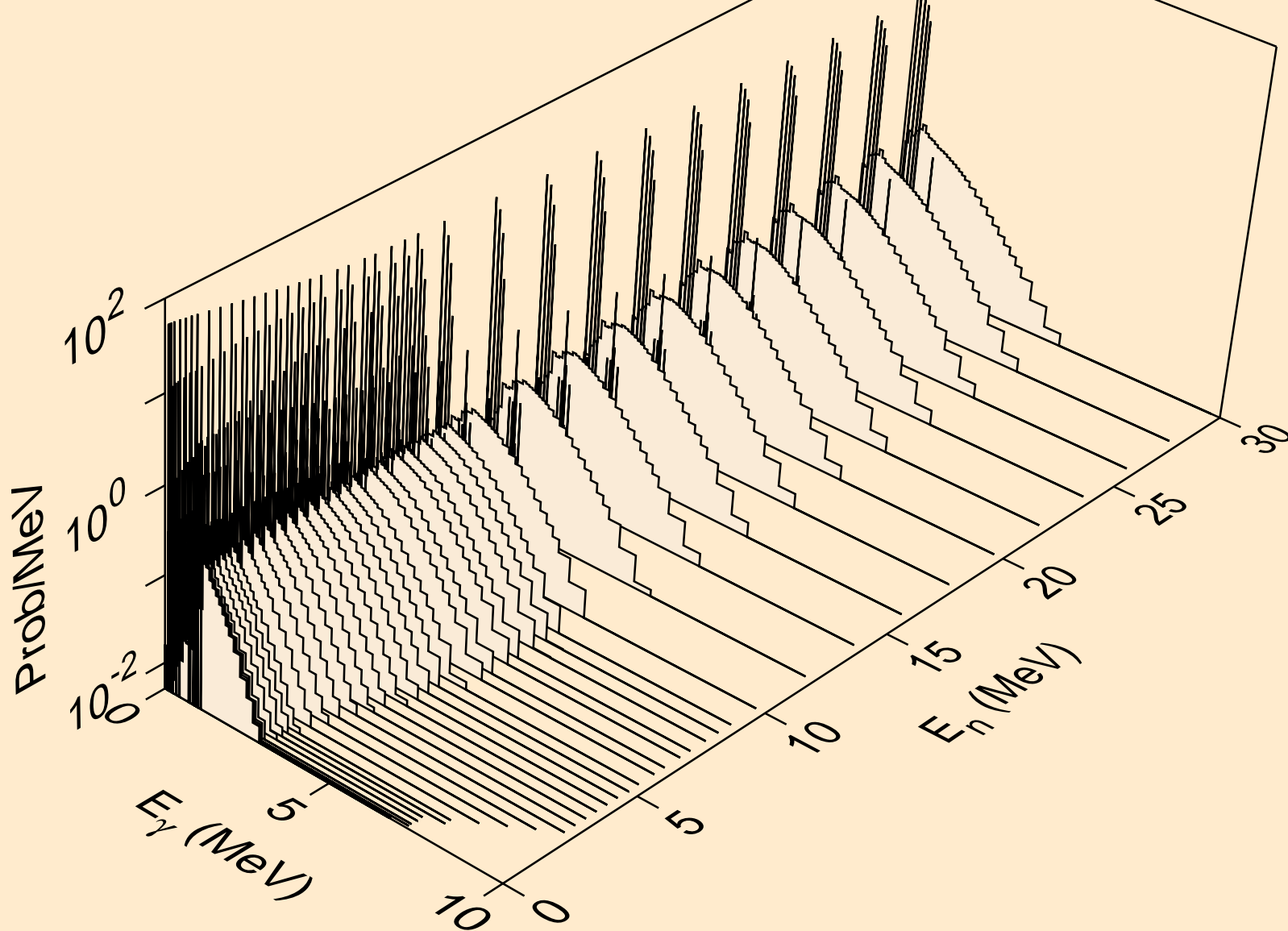

OS181 NEUTRON ACER TENDL-2019 LIBRARY; T=293.16K
Photon emission for (n,2a)

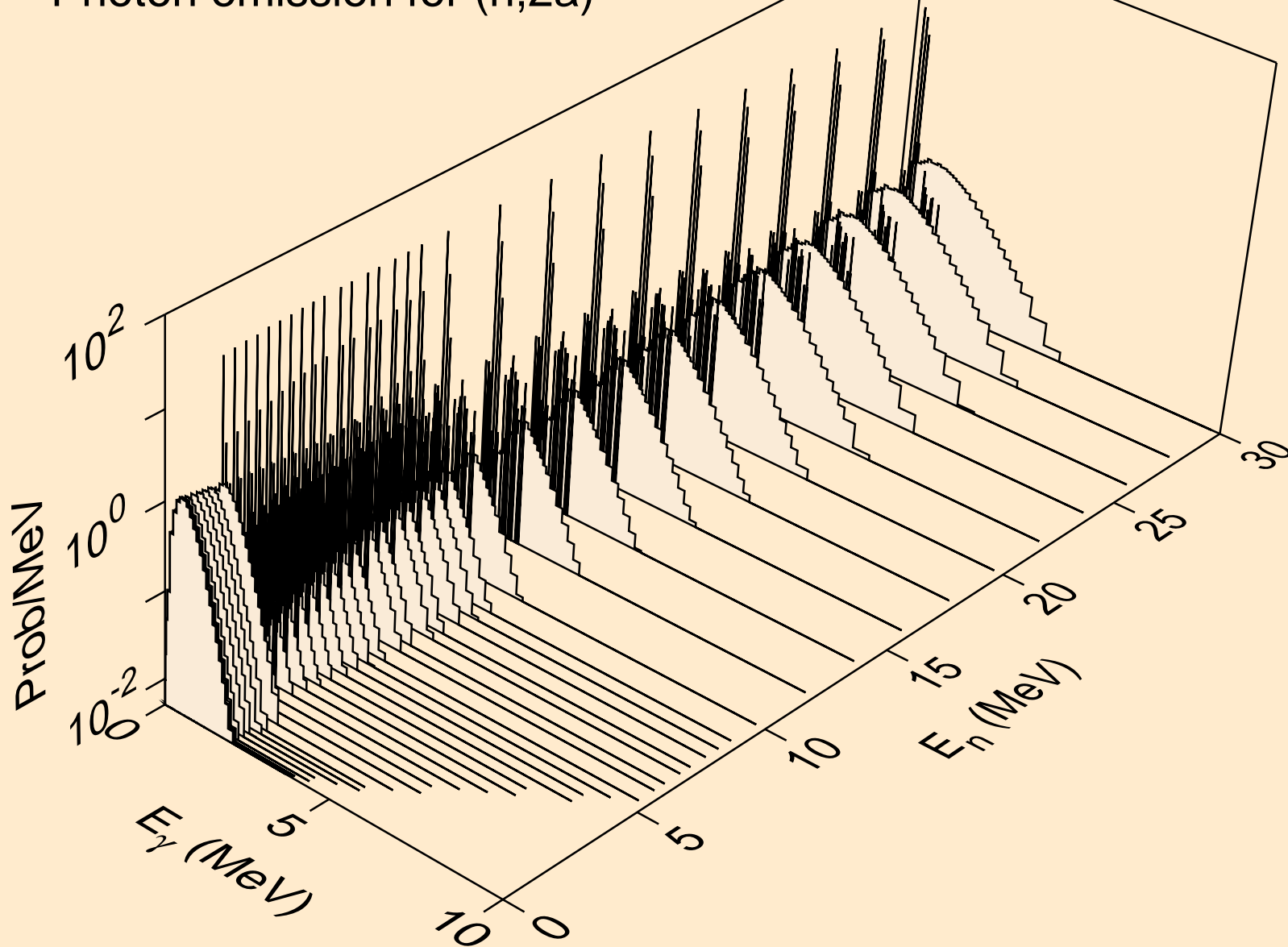

OS181 NEUTRON ACER TENDL-2019 LIBRARY; T=293.16K
Photon emission for (n,2p)

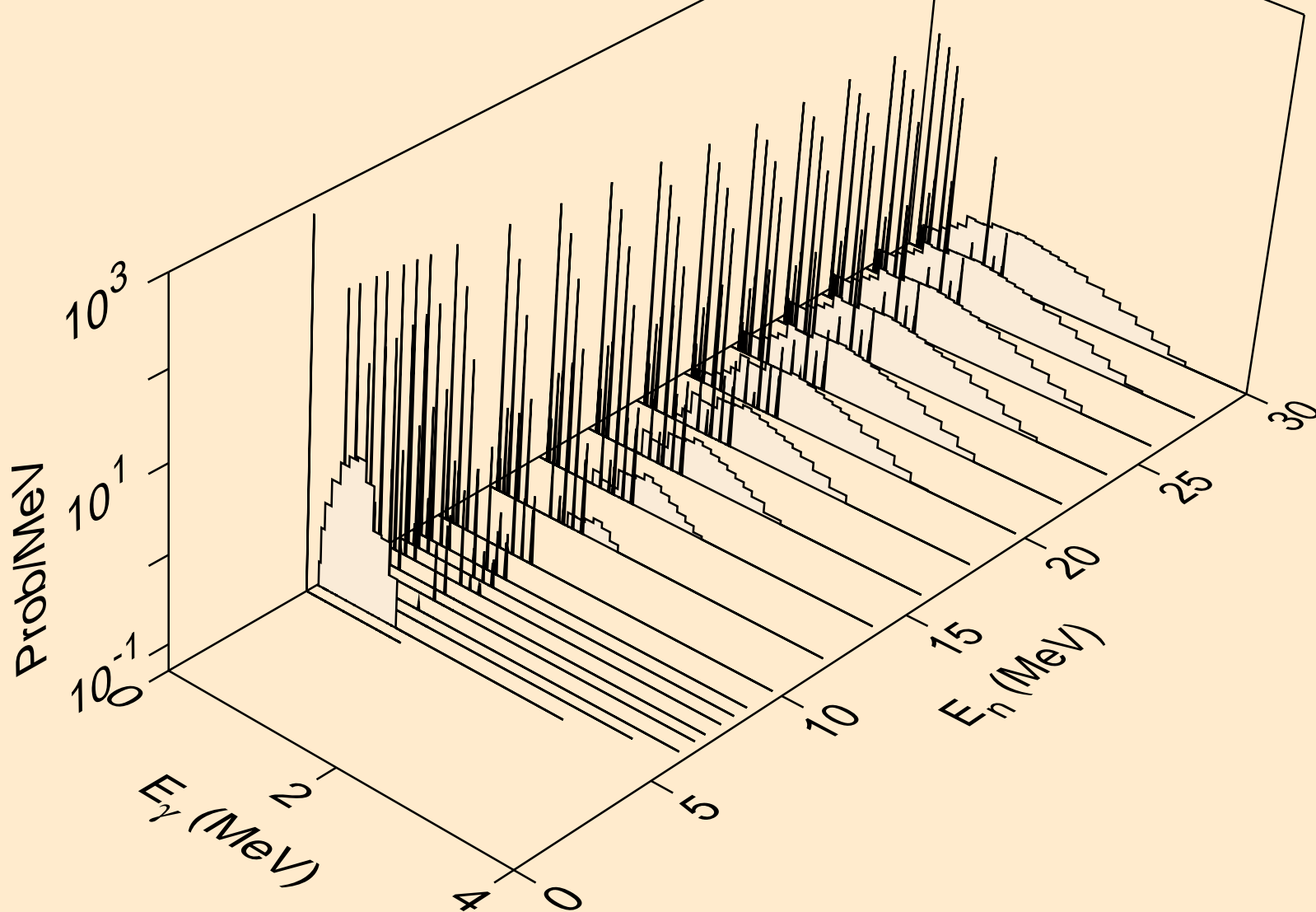

OS181 NEUTRON ACER TENDL-2019 LIBRARY; T=293.16K
Photon emission for (n,p α)

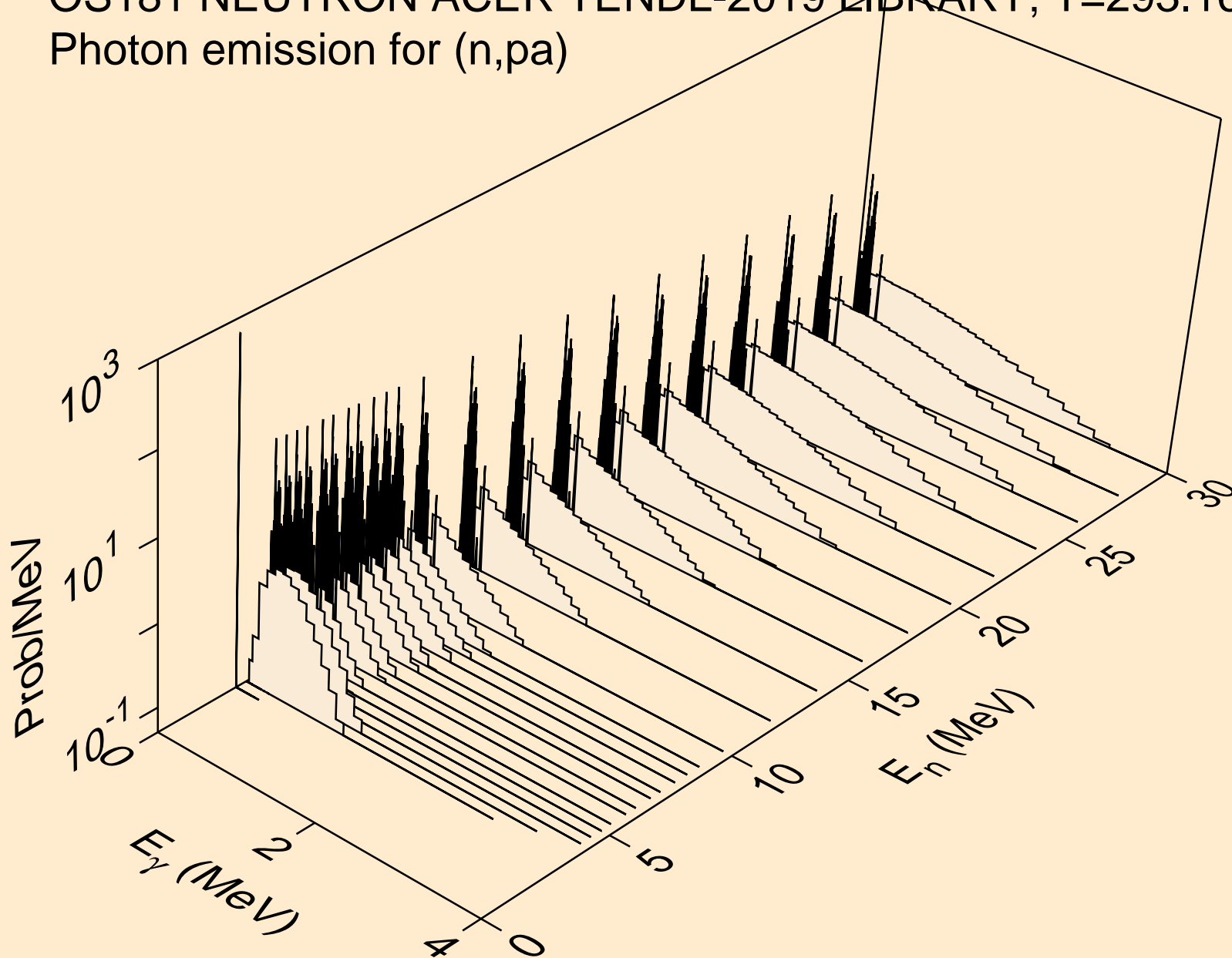

OS181 NEUTRON ACER TENDL-2019 LIBRARY; T=293.16K
Photon emission for (n,pd)

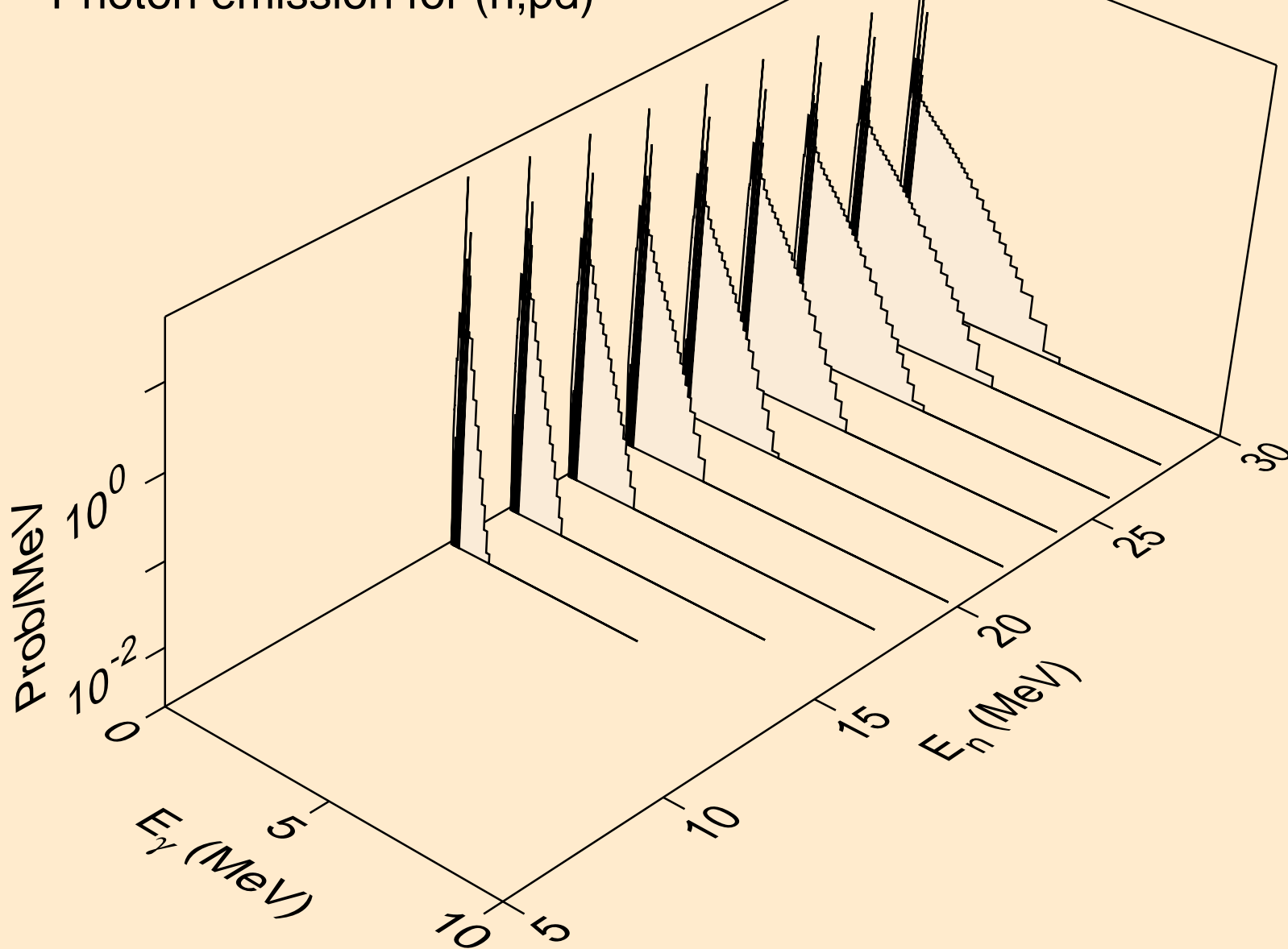

OS181 NEUTRON ACER TENDL-2019 LIBRARY; T=293.16K
Photon emission for (n,pt)

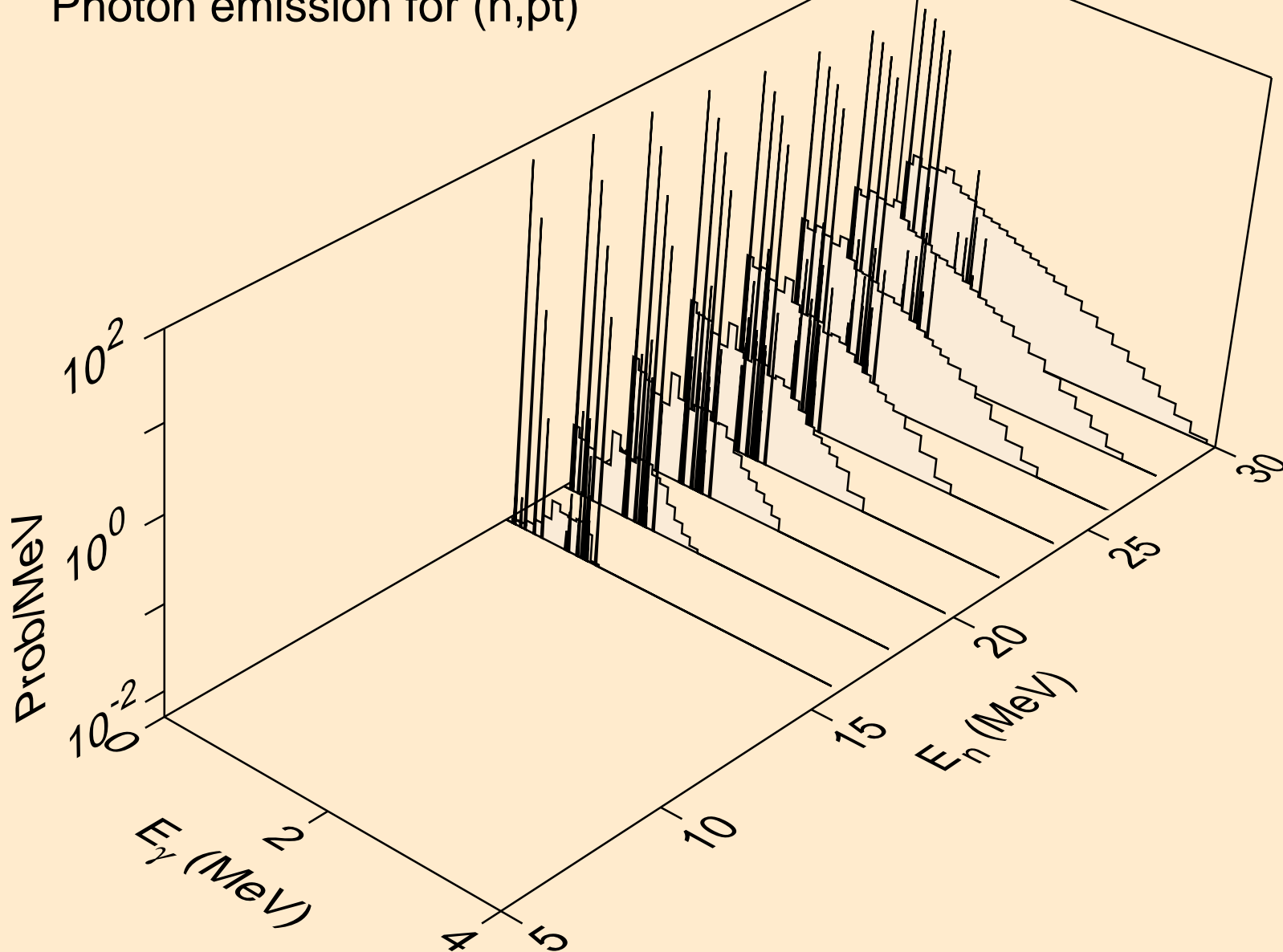

OS181 NEUTRON ACER TENDL-2019 LIBRARY; T=293.16K
Photon emission for (n,da)

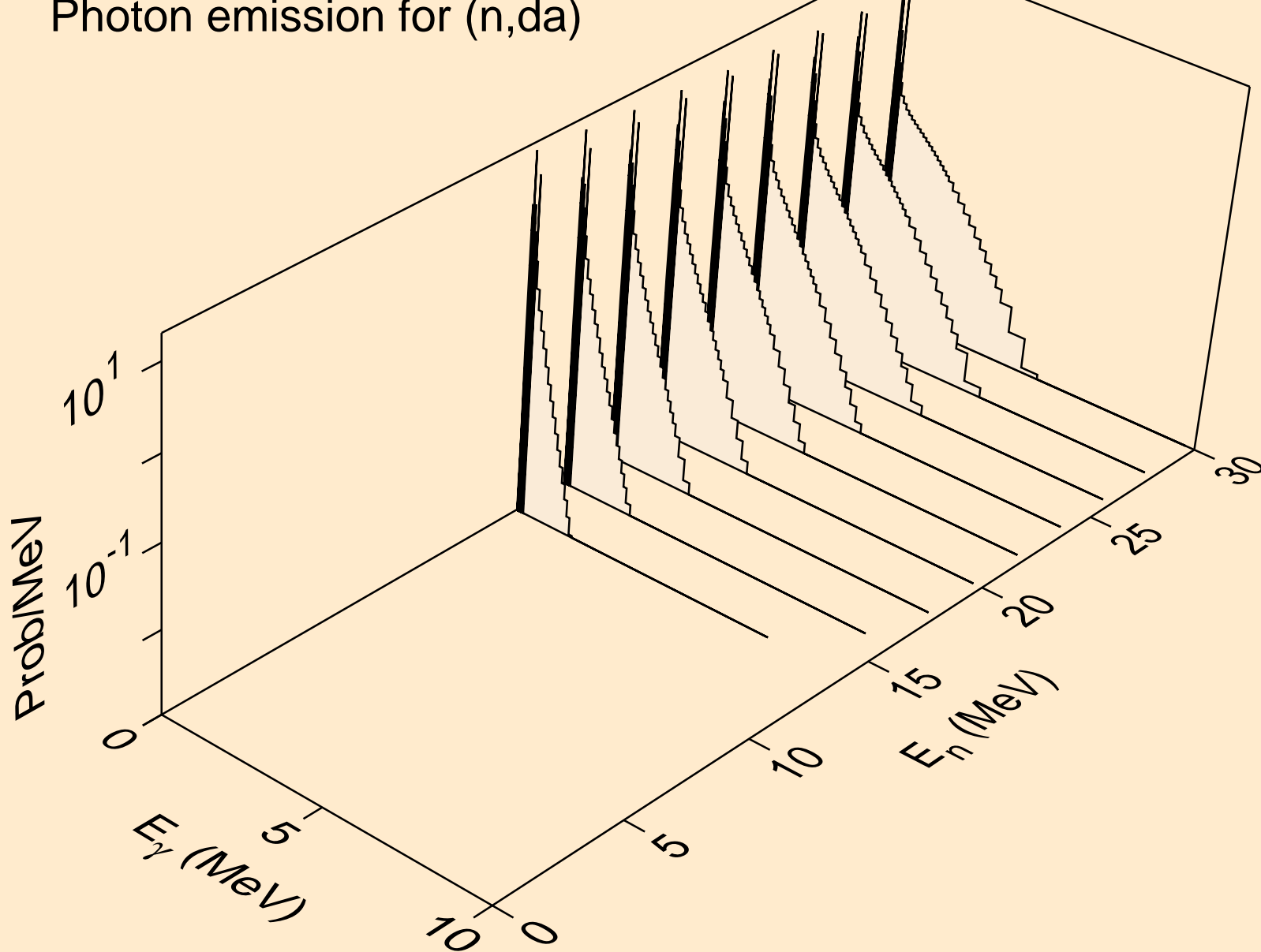

OS181 NEUTRON ACER TENDL-2019 LIBRARY; T=293.16K
thermal capture photon spectrum

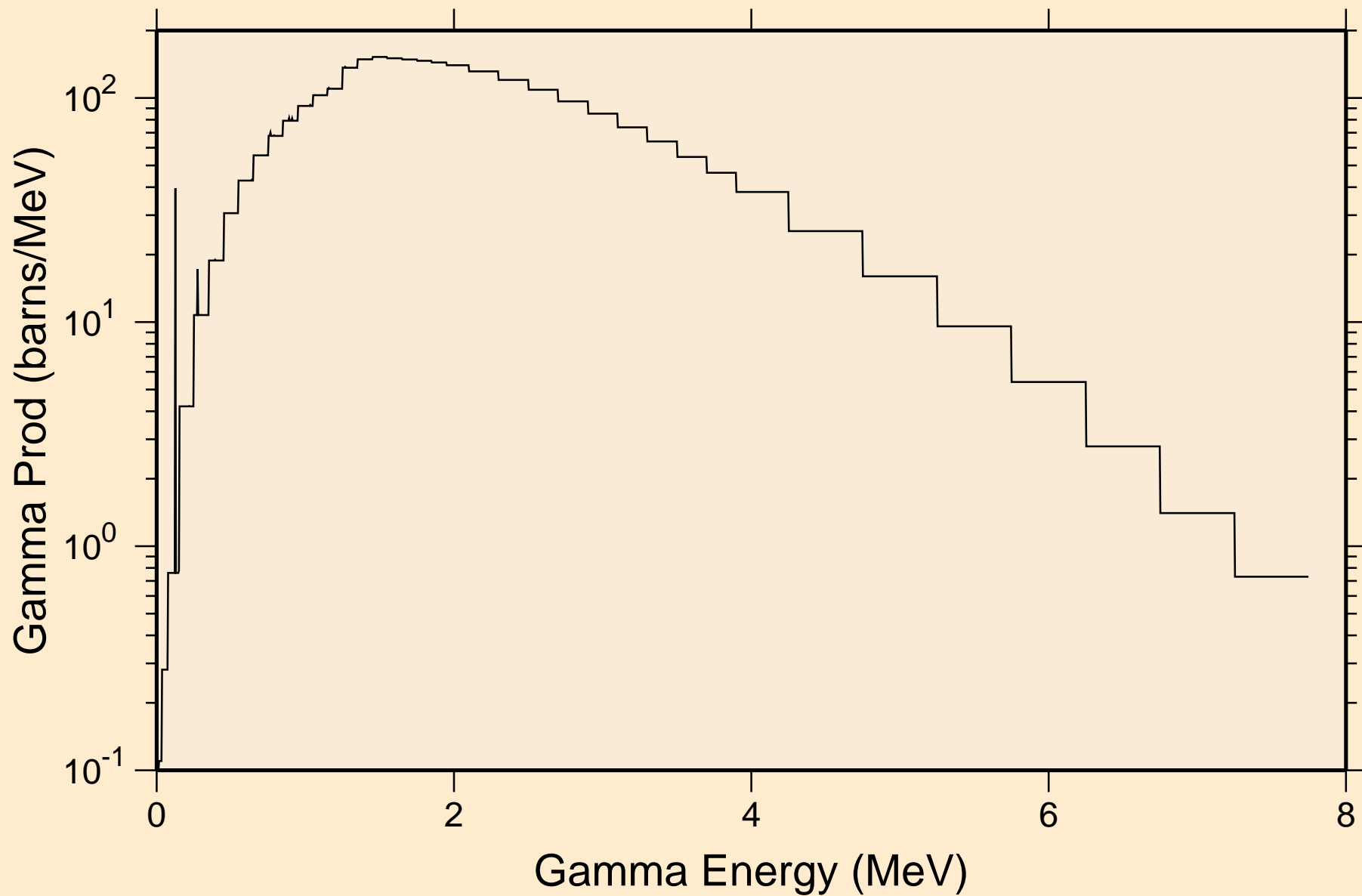

OS181 NEUTRON ACER TENDL-2019 LIBRARY; T=293.16K
14 MeV photon spectrum

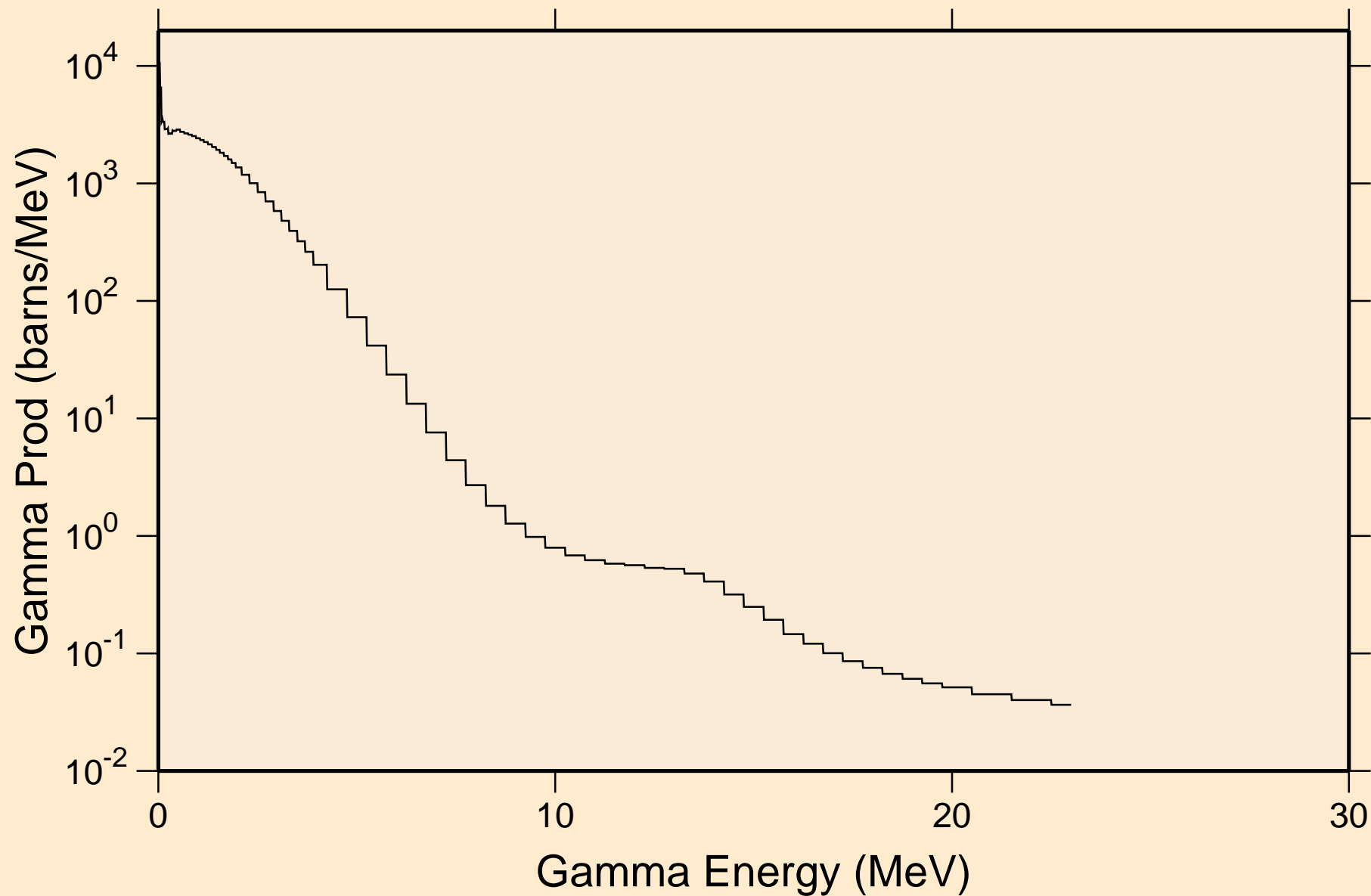

OS181 NEUTRON ACER TENDL-2019 LIBRARY; T=293.16K

Particle heating contributions

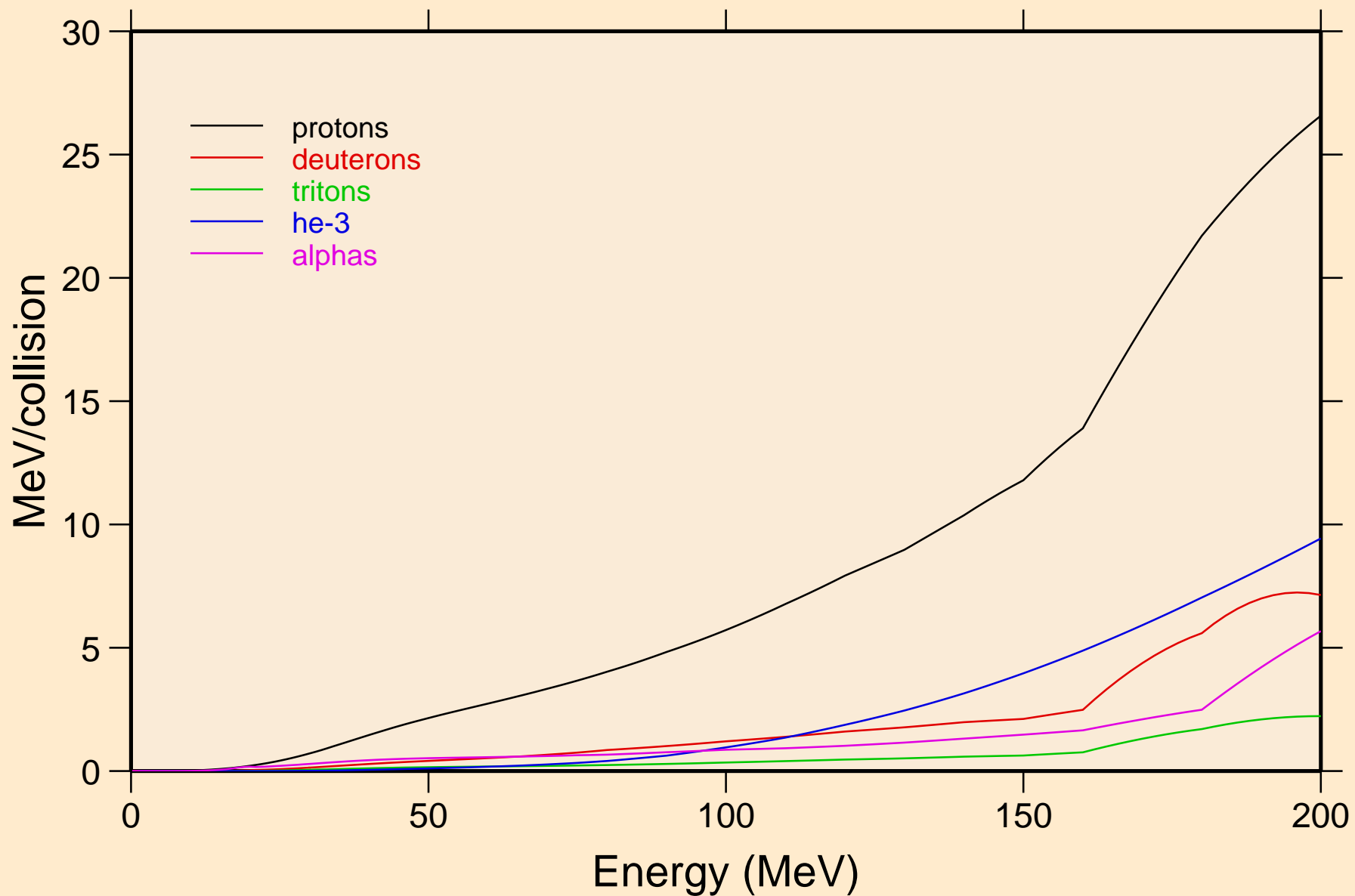

OS181 NEUTRON ACER TENDL-2019 LIBRARY; T=293.16K

Recoil Heating

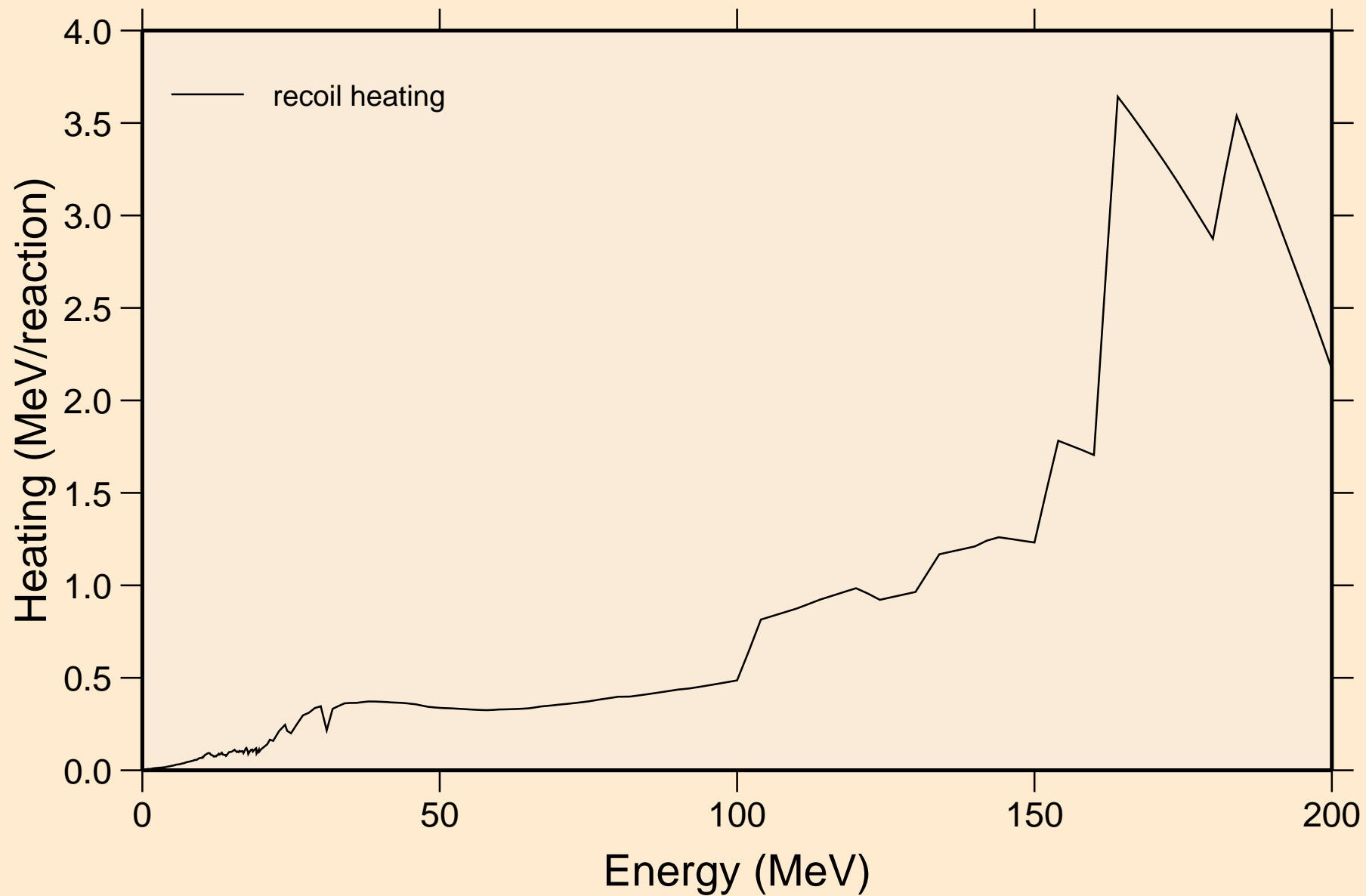

OS181 NEUTRON ACER TENDL-2019 LIBRARY; T=293.16K

Particle production cross sections

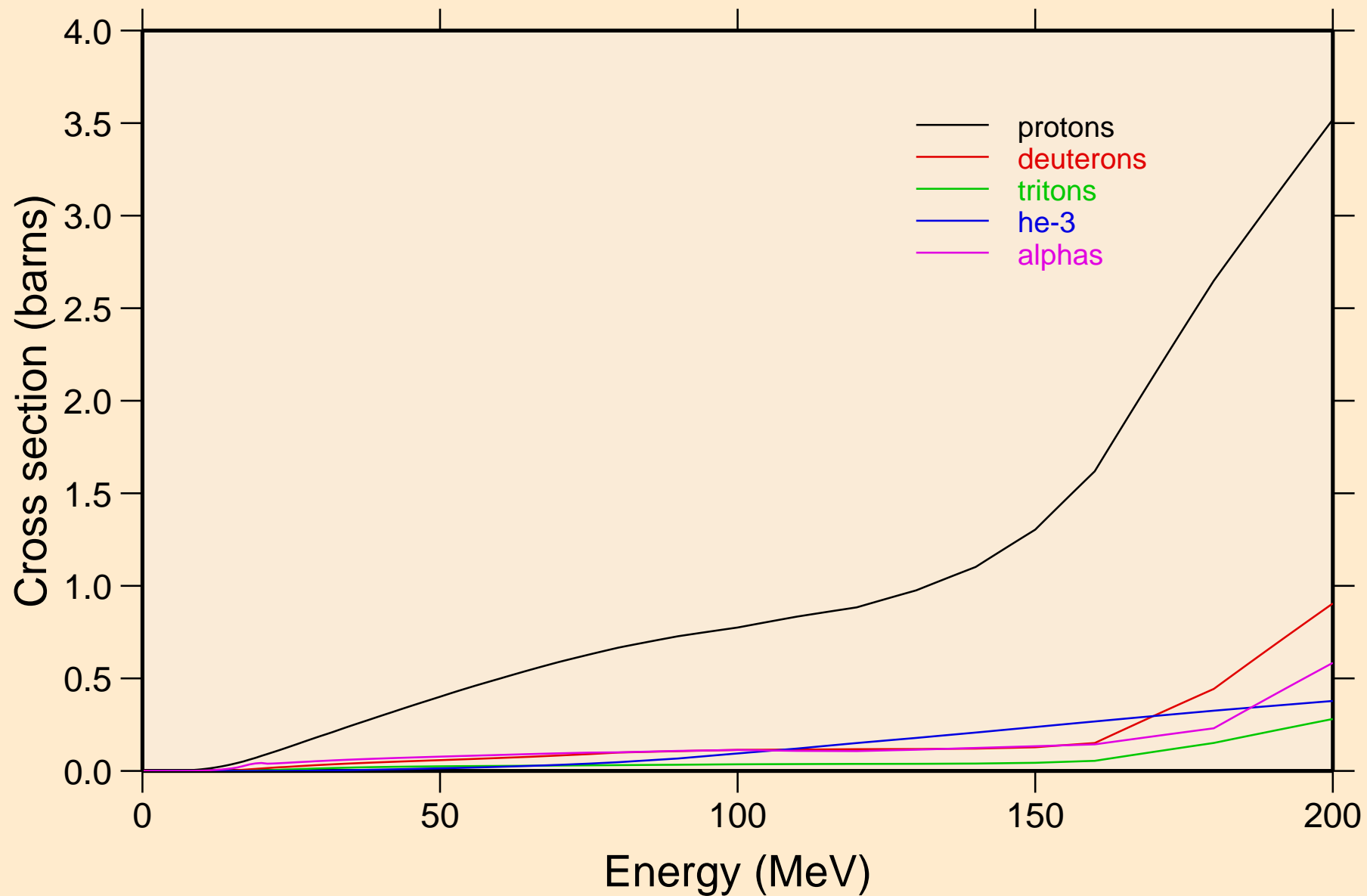

OS181 NEUTRON ACER TENDL-2019 LIBRARY; T=293.16K
protons from (n,x)

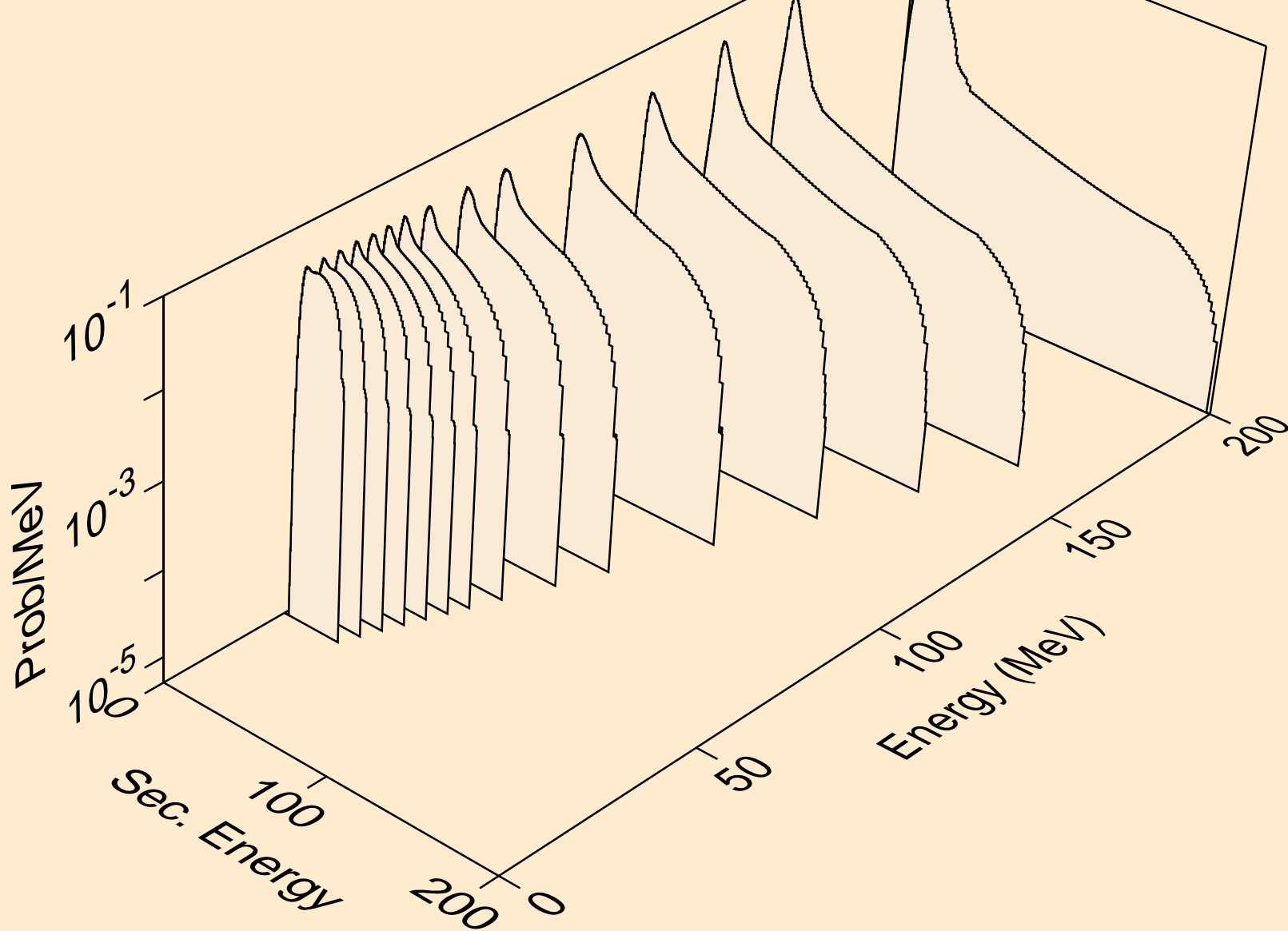

OS181 NEUTRON ACER TENDL-2019 LIBRARY; T=293.16K
protons from (n,n*)p

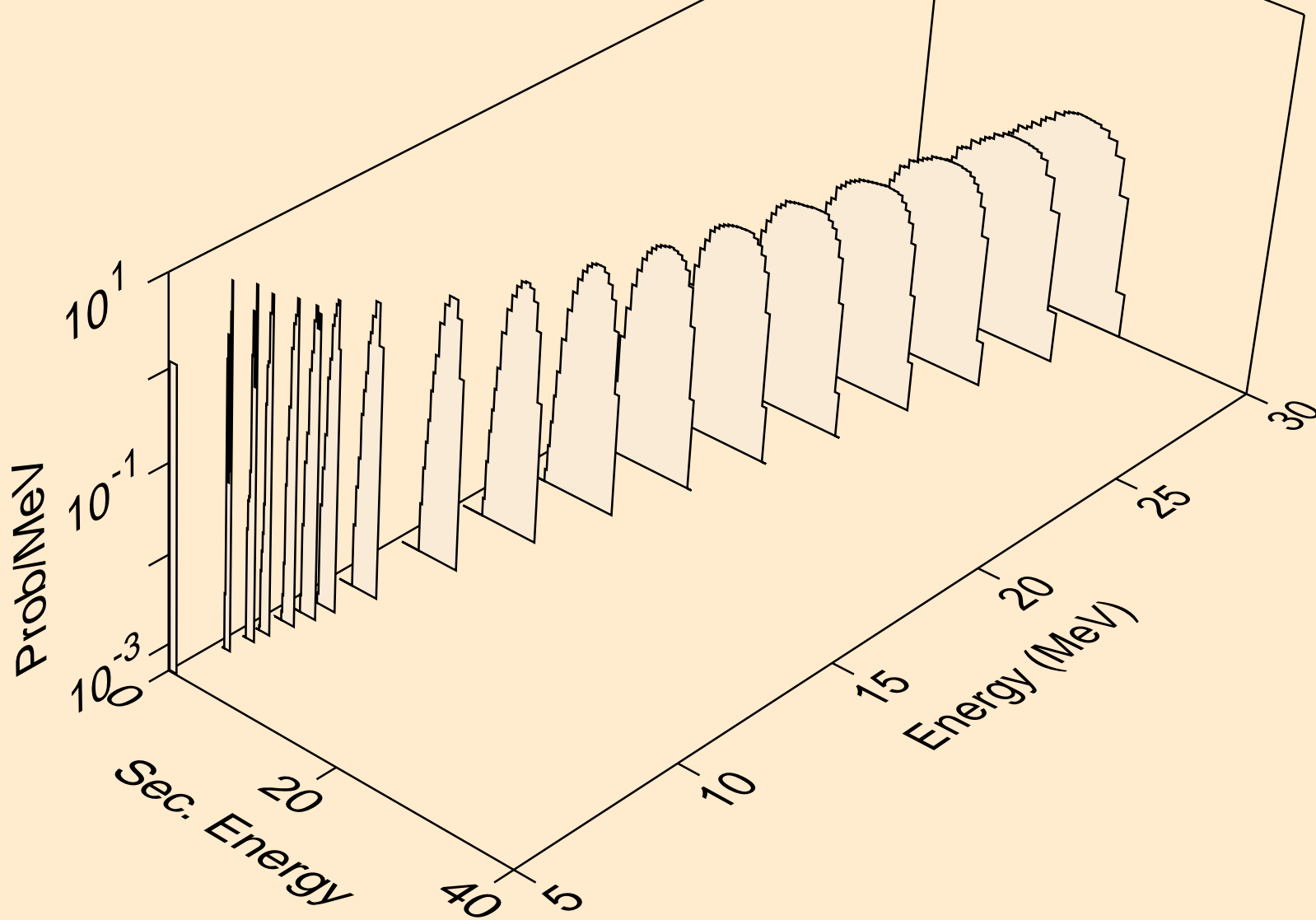

OS181 NEUTRON ACER TENDL-2019 LIBRARY; T=293.16K
protons from (n,2np)

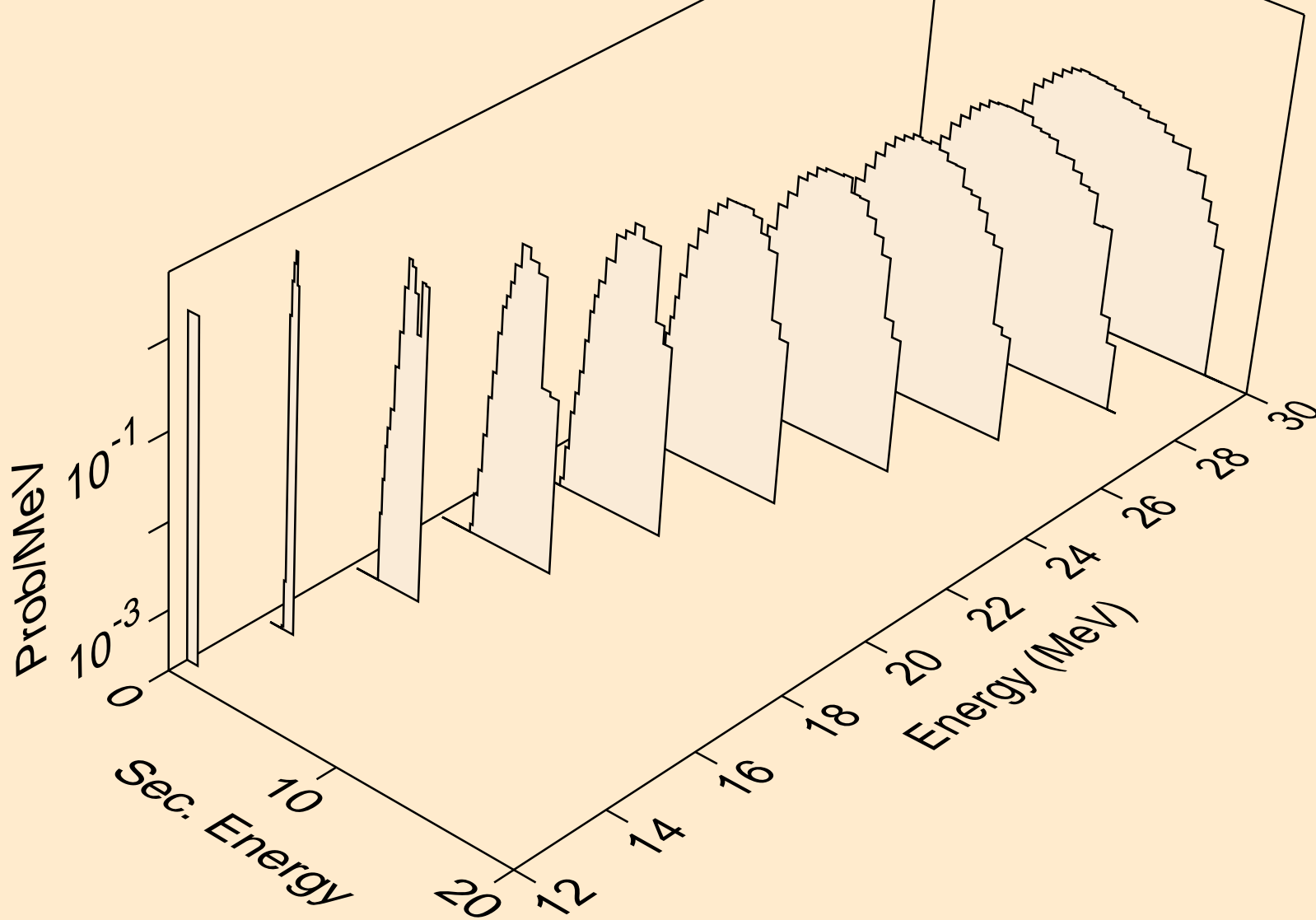

OS181 NEUTRON ACER TENDL-2019 LIBRARY; T=293.16K
protons from (n,3np)

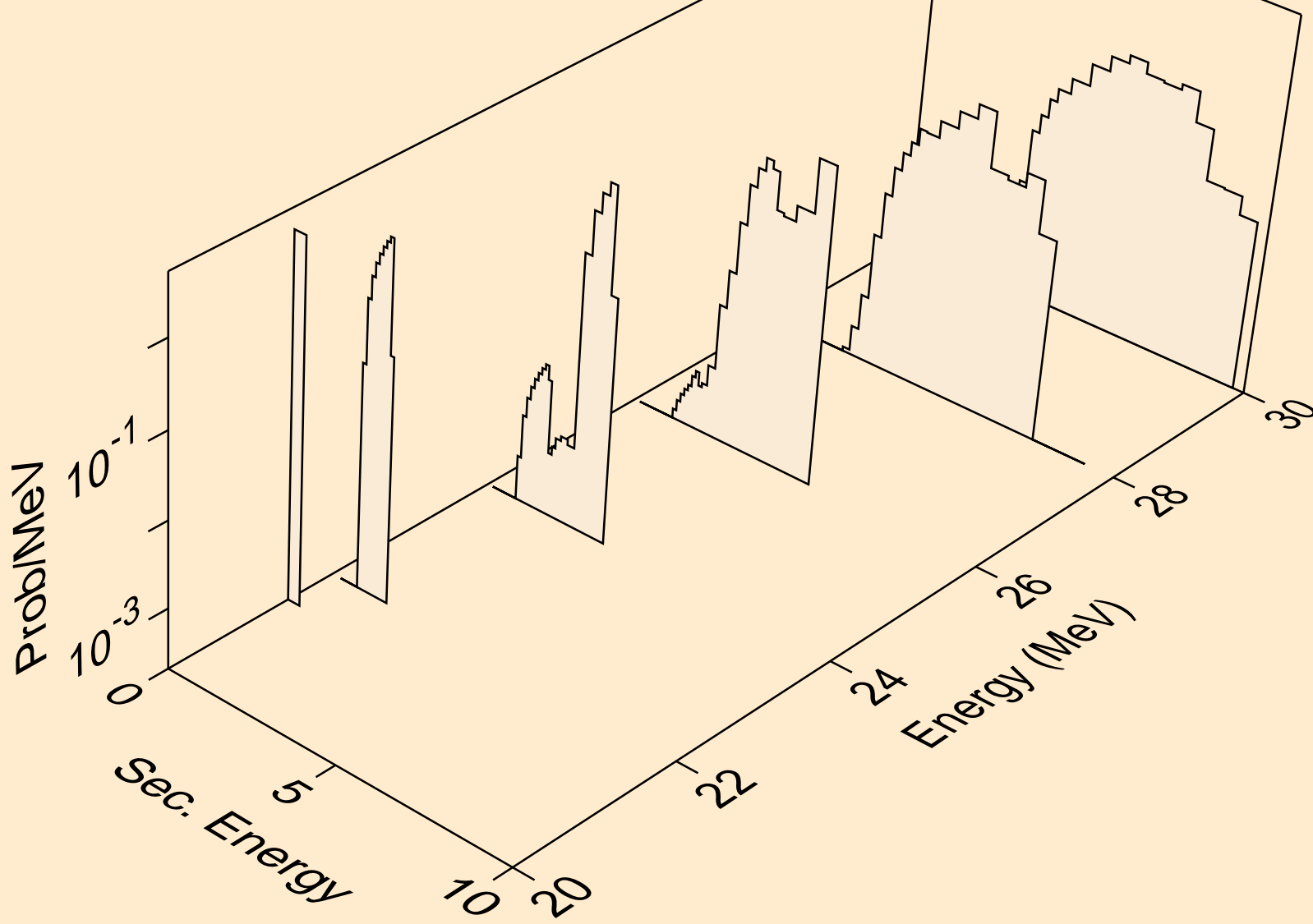

OS181 NEUTRON ACER TENDL-2019 LIBRARY; T=293.16K
protons from (n,2np)

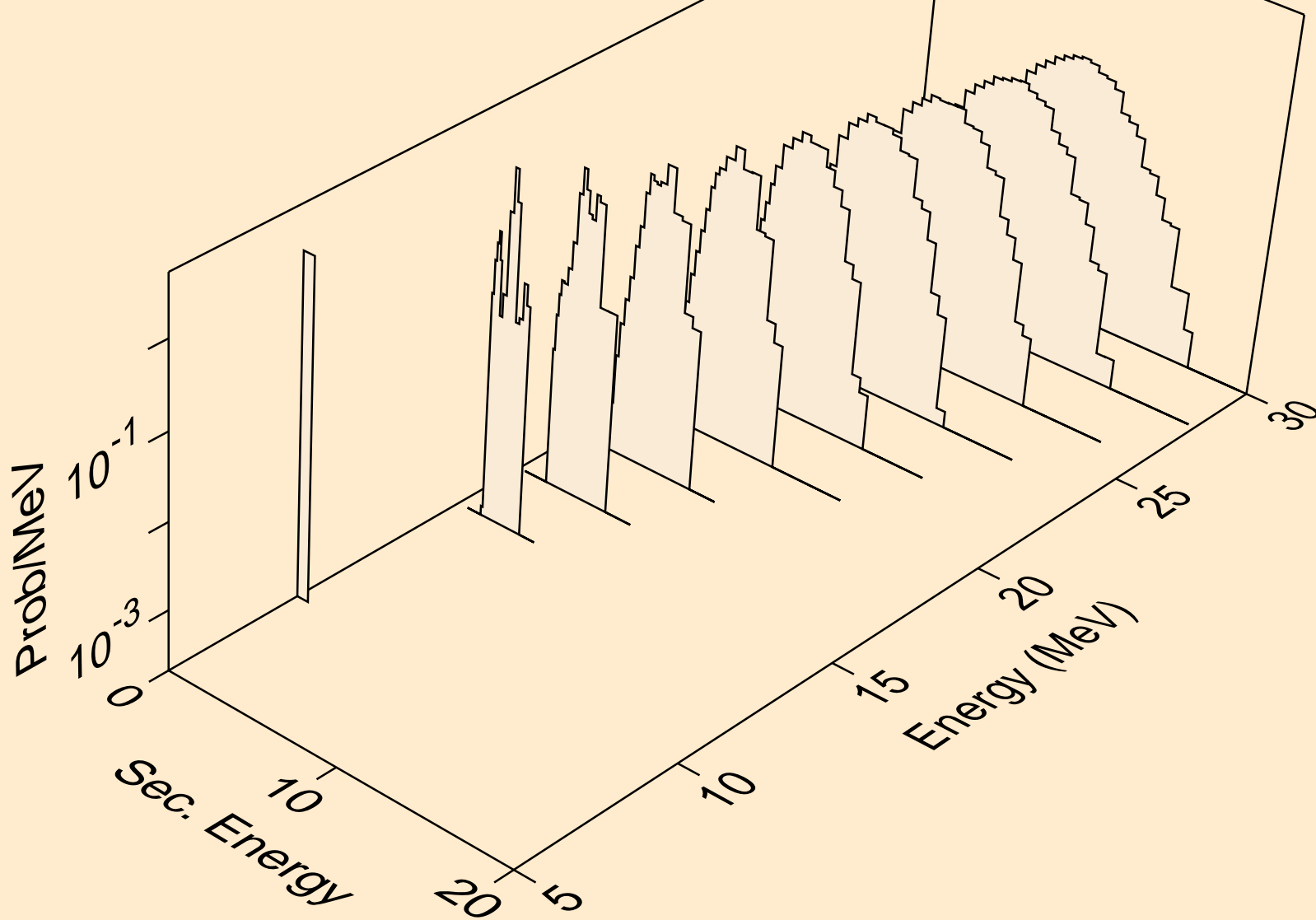

OS181 NEUTRON ACER TENDL-2019 LIBRARY; T=293.16K
protons from (n,npa)

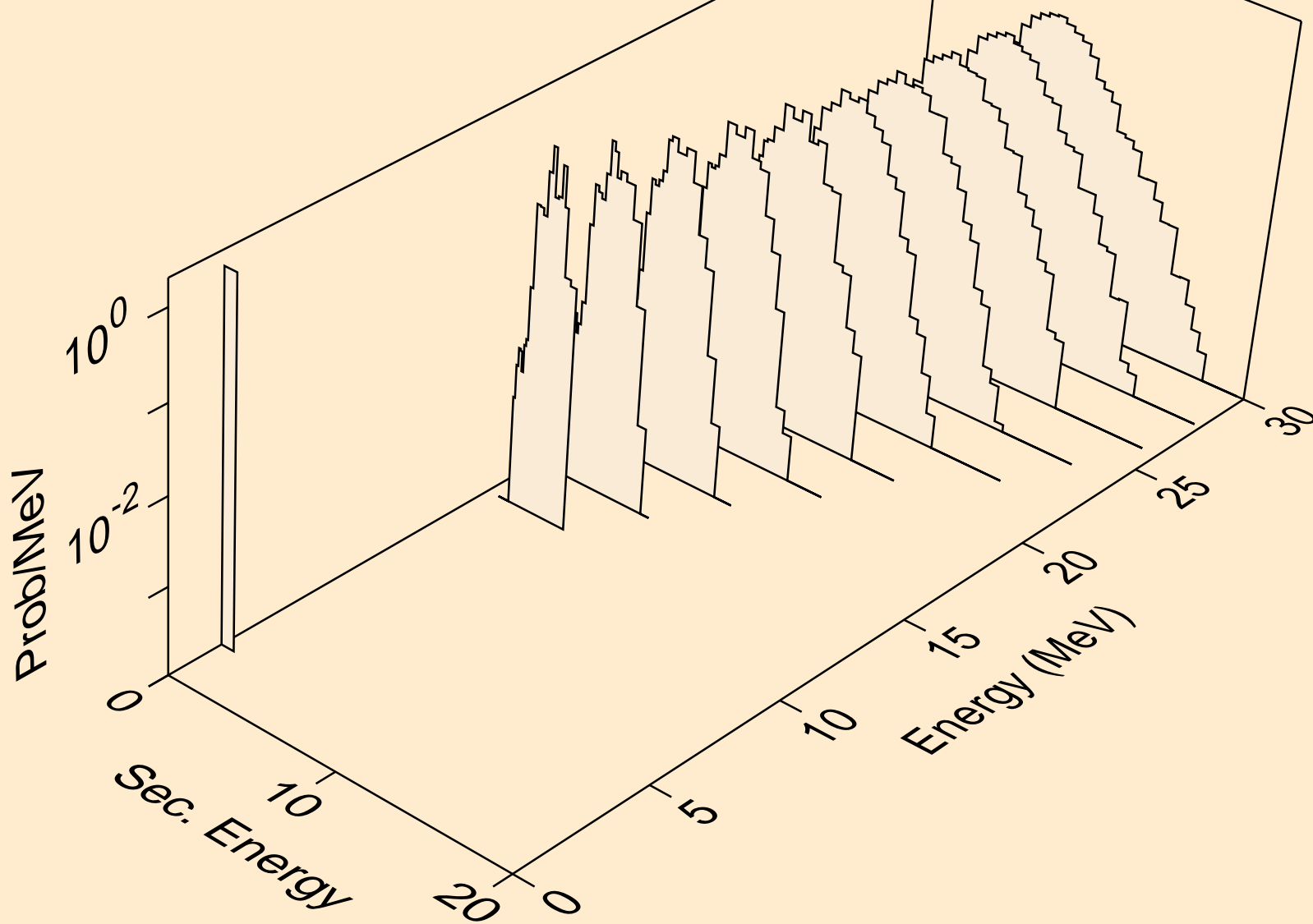

OS181 NEUTRON ACER TENDL-2019 LIBRARY; T=293.16K
protons from (n,p)

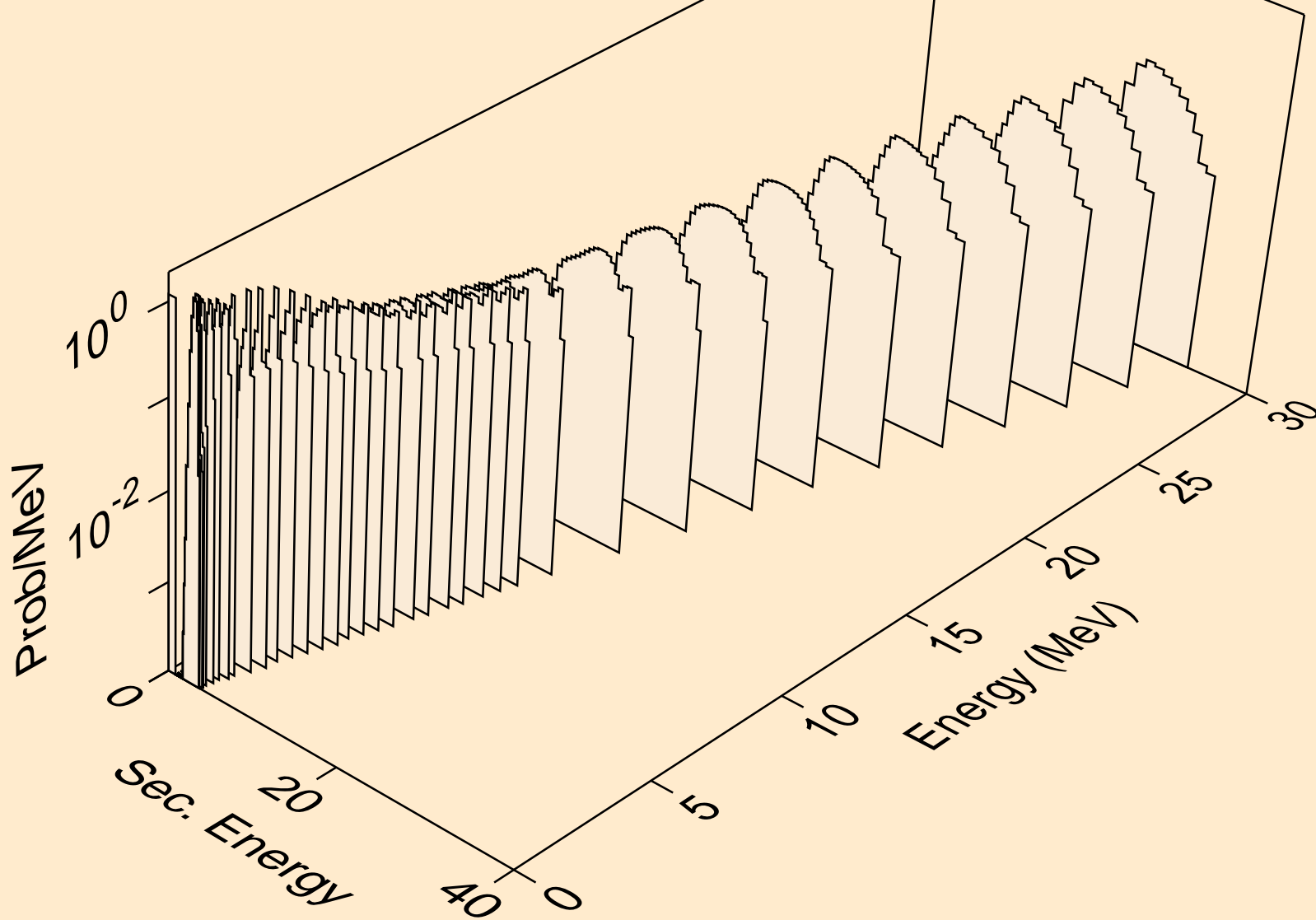

OS181 NEUTRON ACER TENDL-2019 LIBRARY; T=293.16K
protons from (n,2p)

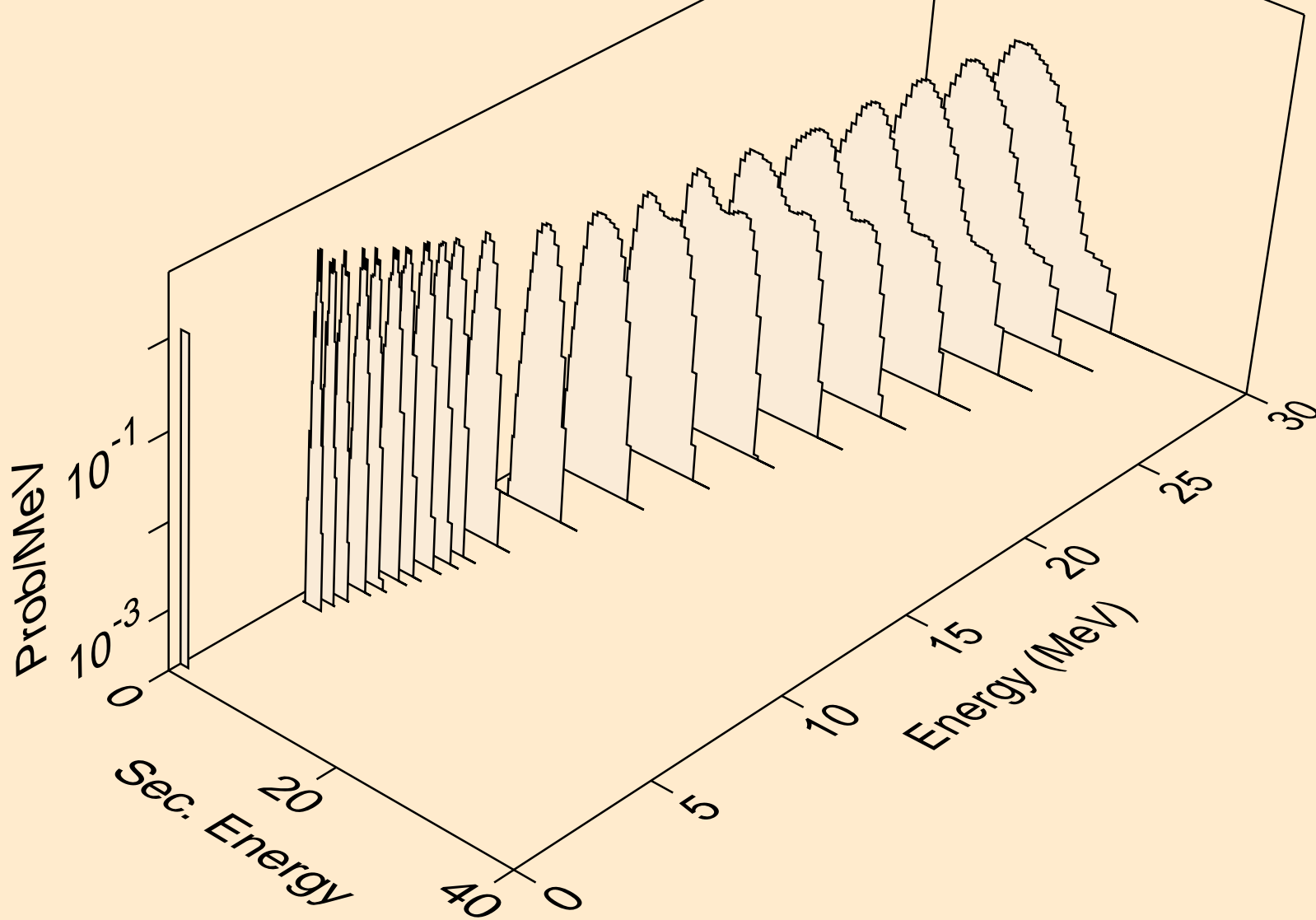

OS181 NEUTRON ACER TENDL-2019 LIBRARY; T=293.16K
protons from (n,p)

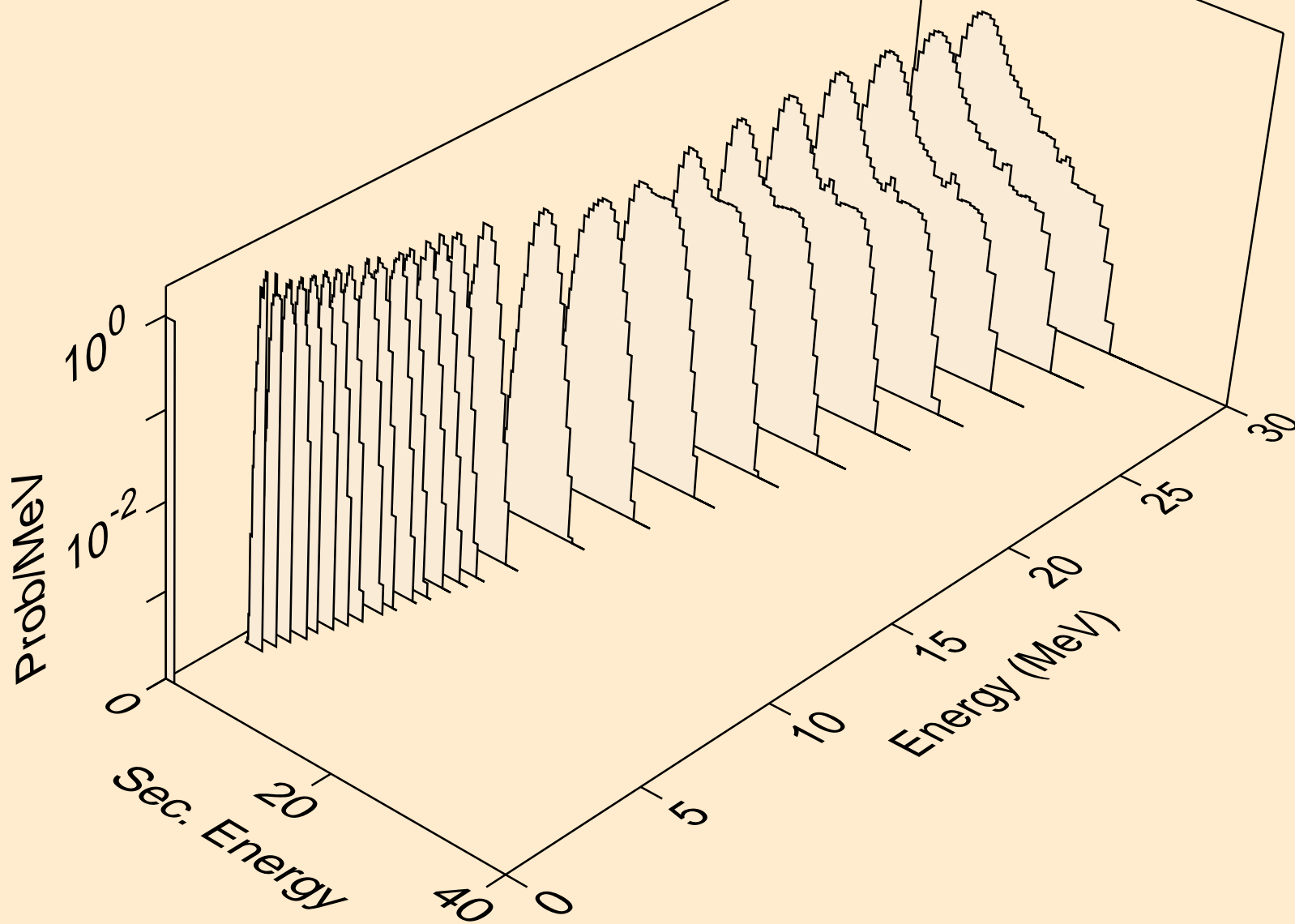

OS181 NEUTRON ACER TENDL-2019 LIBRARY; T=293.16K
protons from (n,pd)

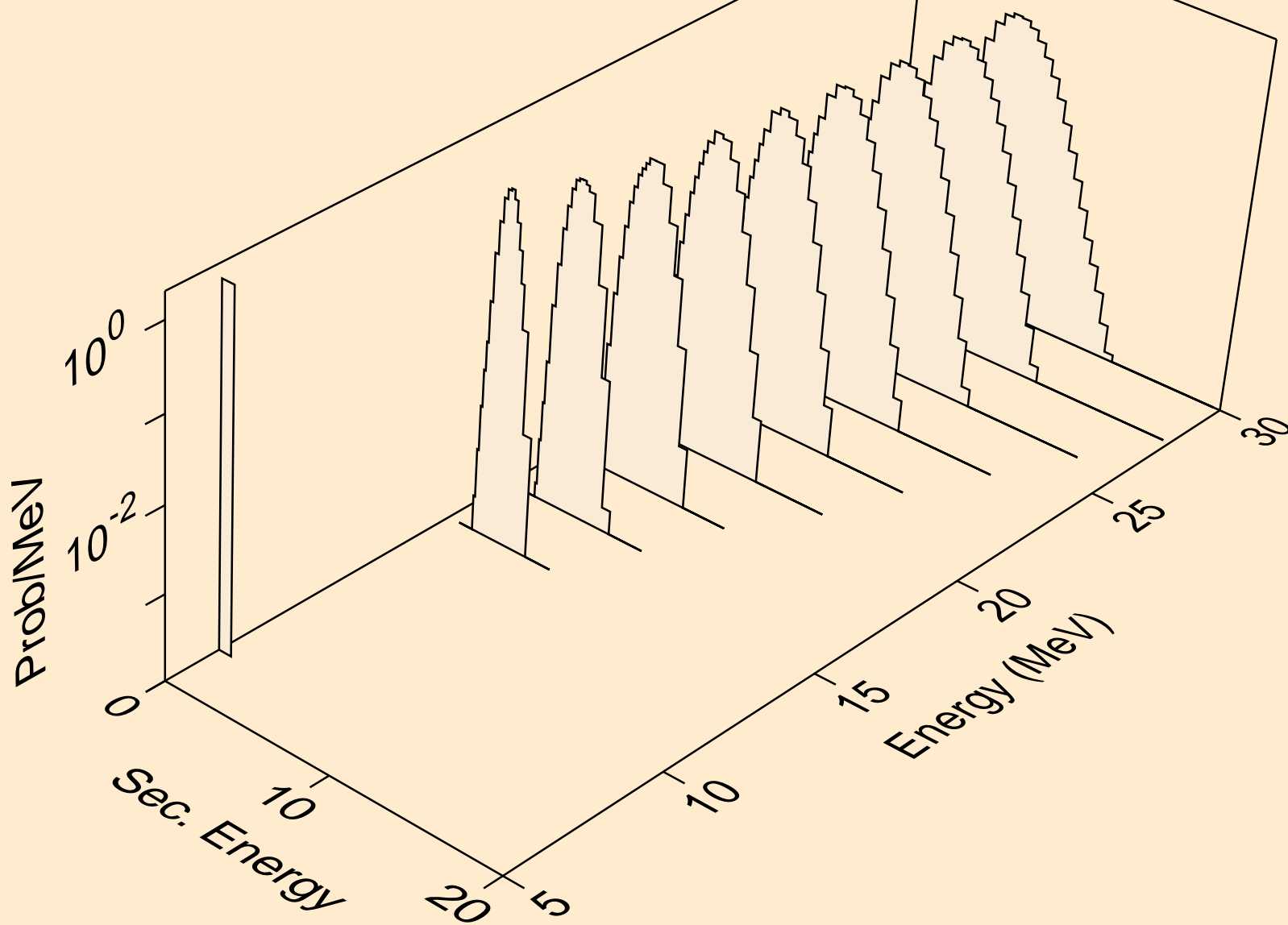

OS181 NEUTRON ACER TENDL-2019 LIBRARY; T=293.16K
protons from (n,pt)

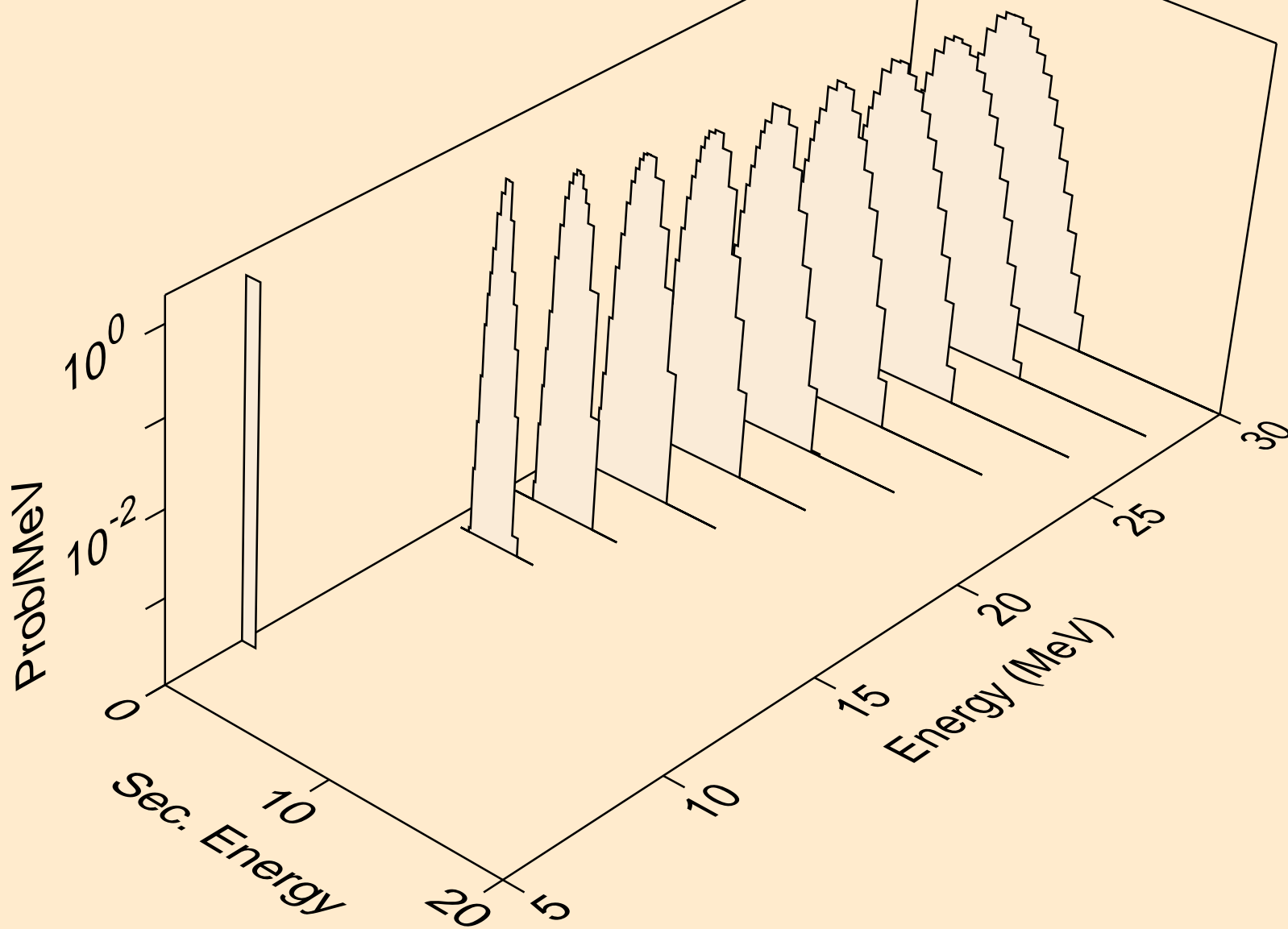

OS181 NEUTRON ACER TENDL-2019 LIBRARY; T=293.16K
deuterons from (n,x)

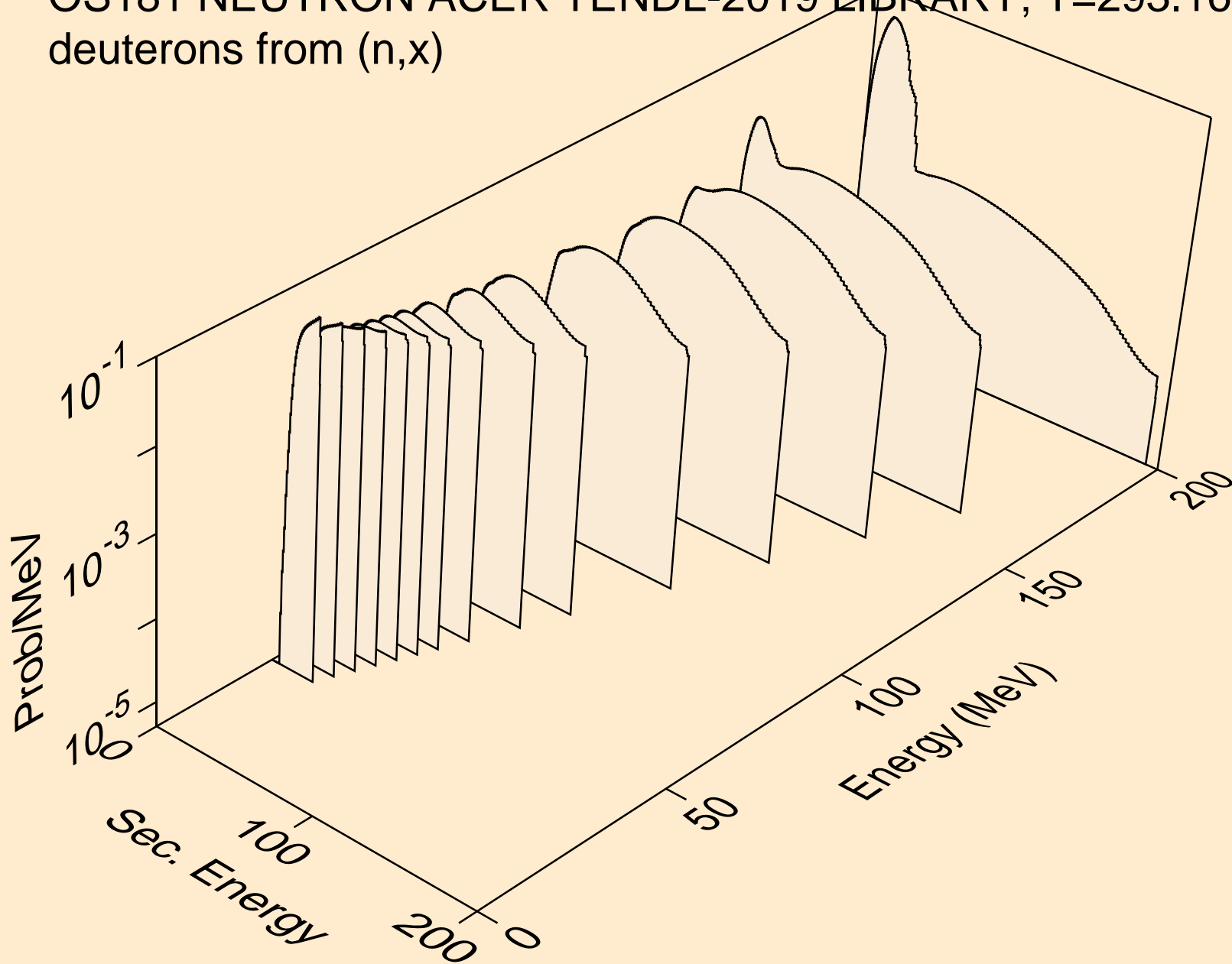

OS181 NEUTRON ACER TENDL-2019 LIBRARY; T=293.16K
deuterons from (n,2nd)

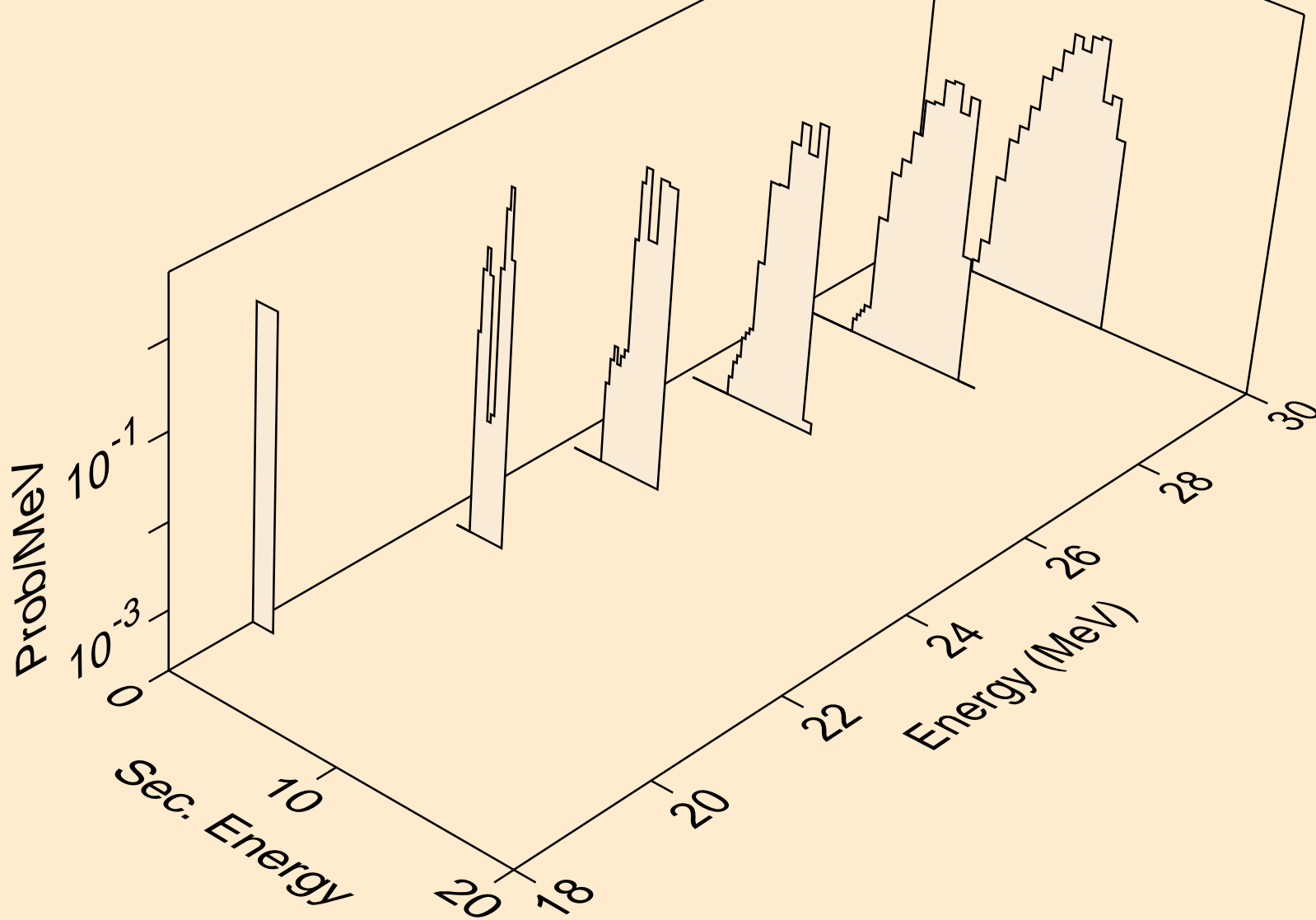

OS181 NEUTRON ACER TENDL-2019 LIBRARY; T=293.16K
deuterons from (n,n*)d

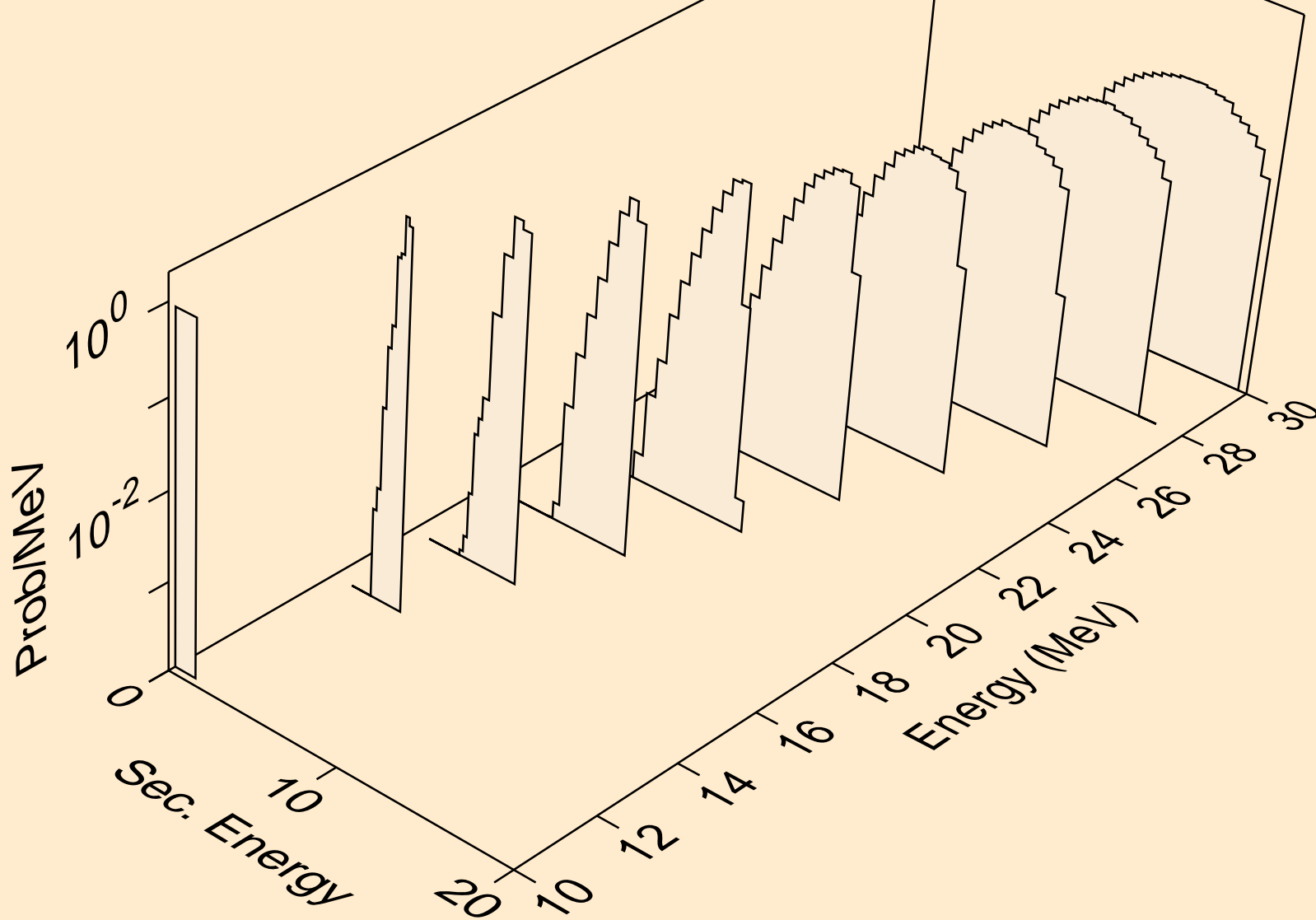

OS181 NEUTRON ACER TENDL-2019 LIBRARY; T=293.16K
deuterons from (n,d)

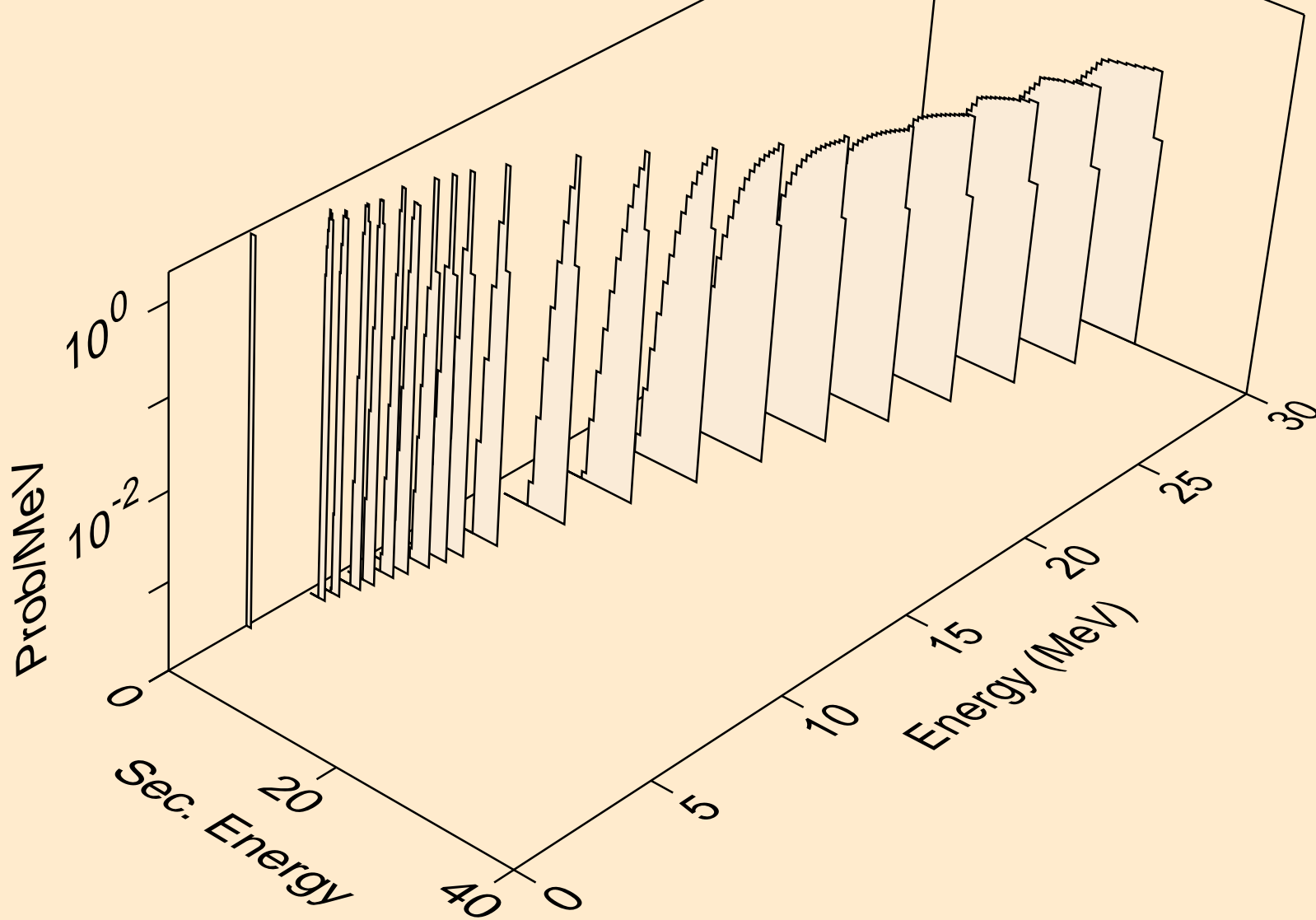

OS181 NEUTRON ACER TENDL-2019 LIBRARY; T=293.16K
deuterons from (n,pd)

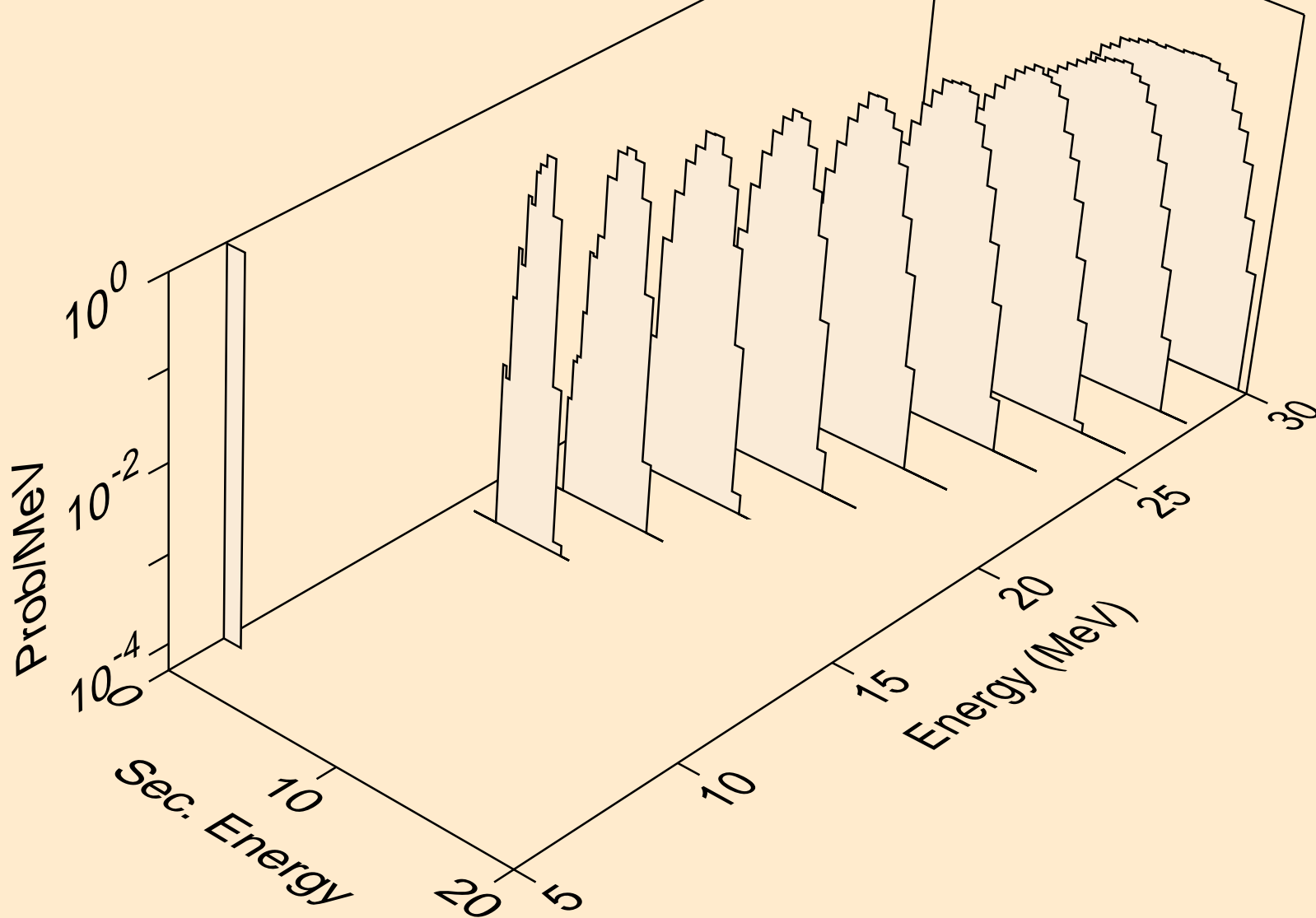

OS181 NEUTRON ACER TENDL-2019 LIBRARY; T=293.16K
deuterons from (n,da)

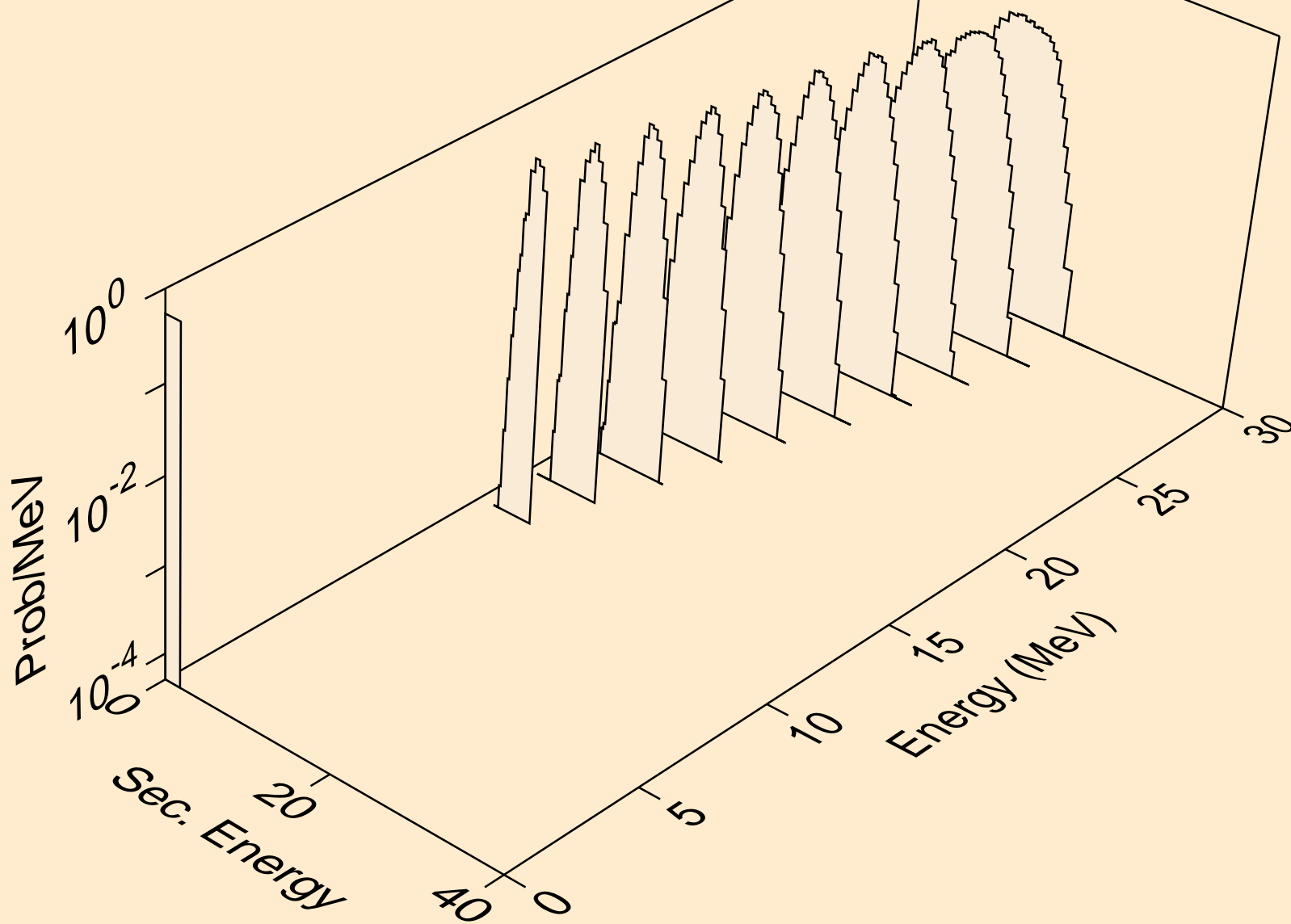

OS181 NEUTRON ACER TENDL-2019 LIBRARY; T=293.16K
tritons from (n,x)

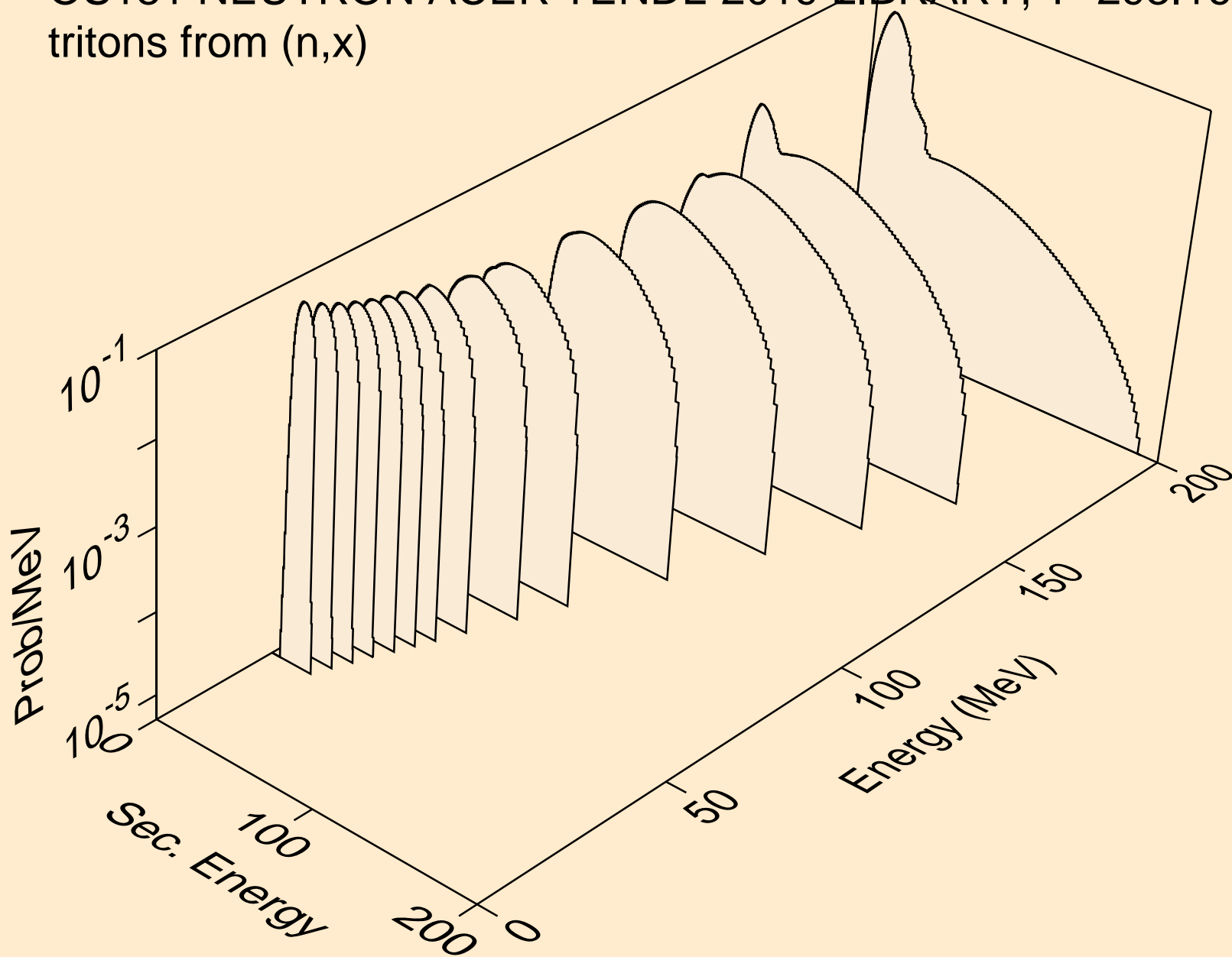

OS181 NEUTRON ACER TENDL-2019 LIBRARY; T=293.16K
tritons from (n,n*)t

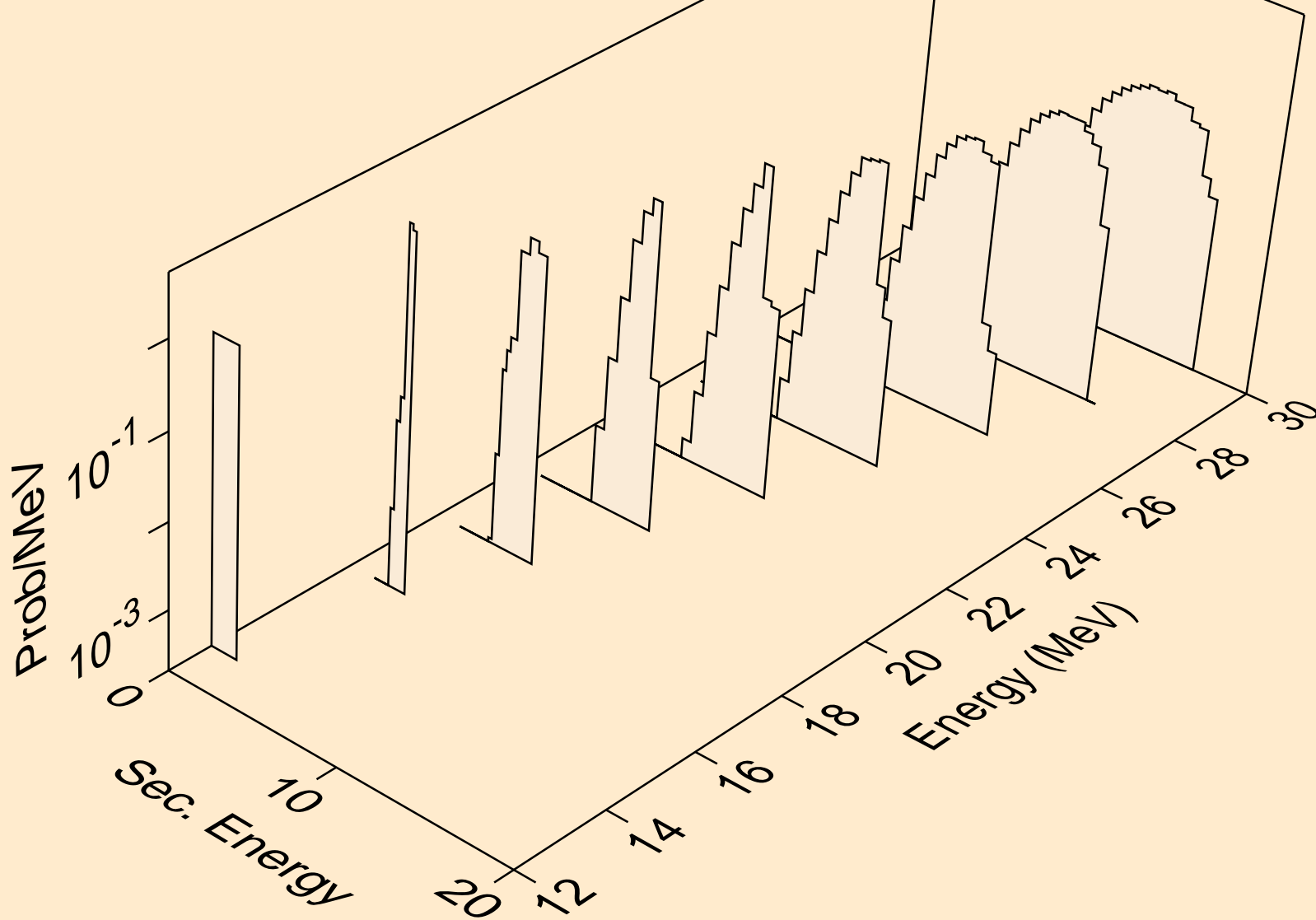

OS181 NEUTRON ACER TENDL-2019 LIBRARY; T=293.16K
tritons from (n,t)

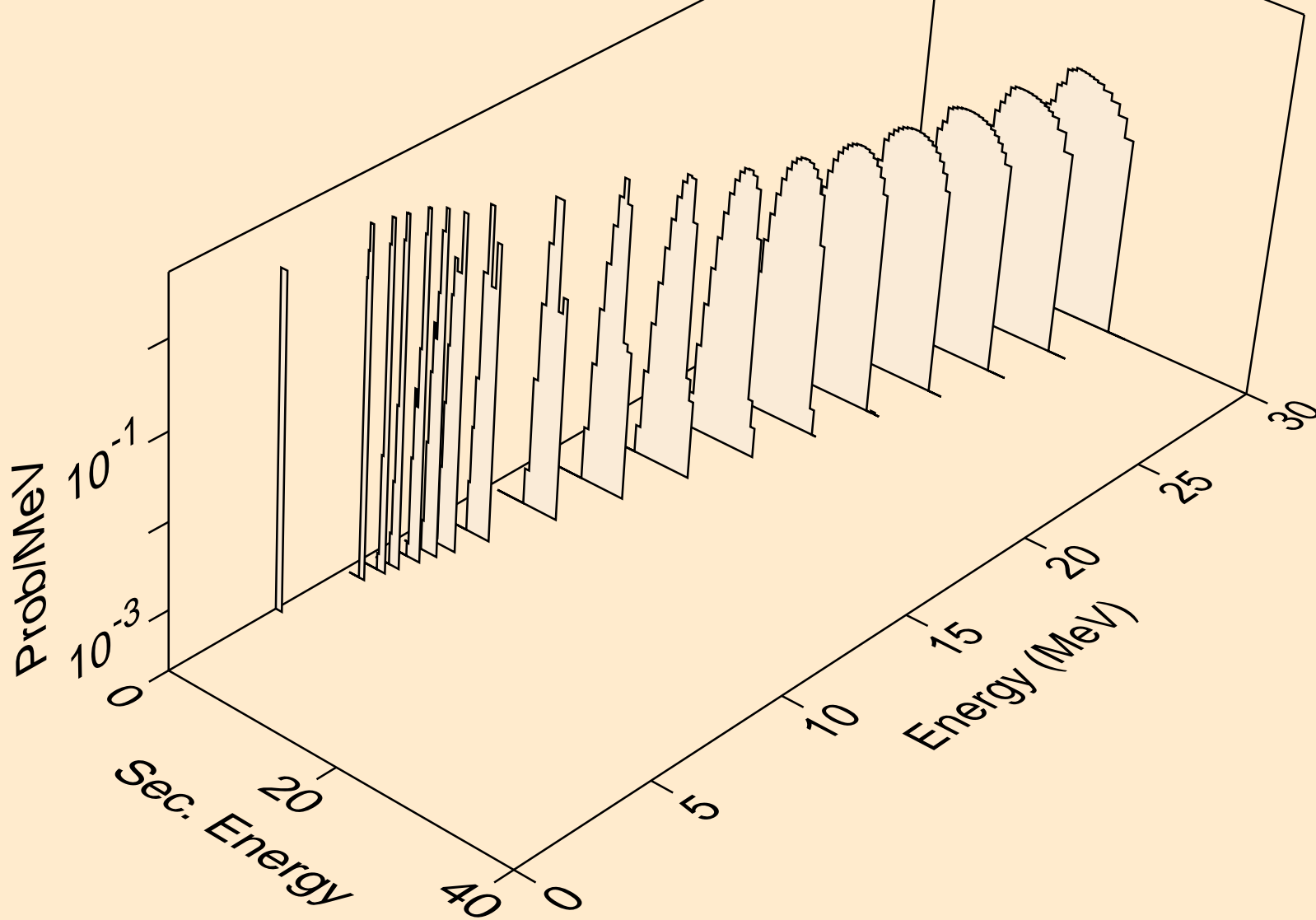

OS181 NEUTRON ACER TENDL-2019 LIBRARY; T=293.16K
tritons from (n,pt)

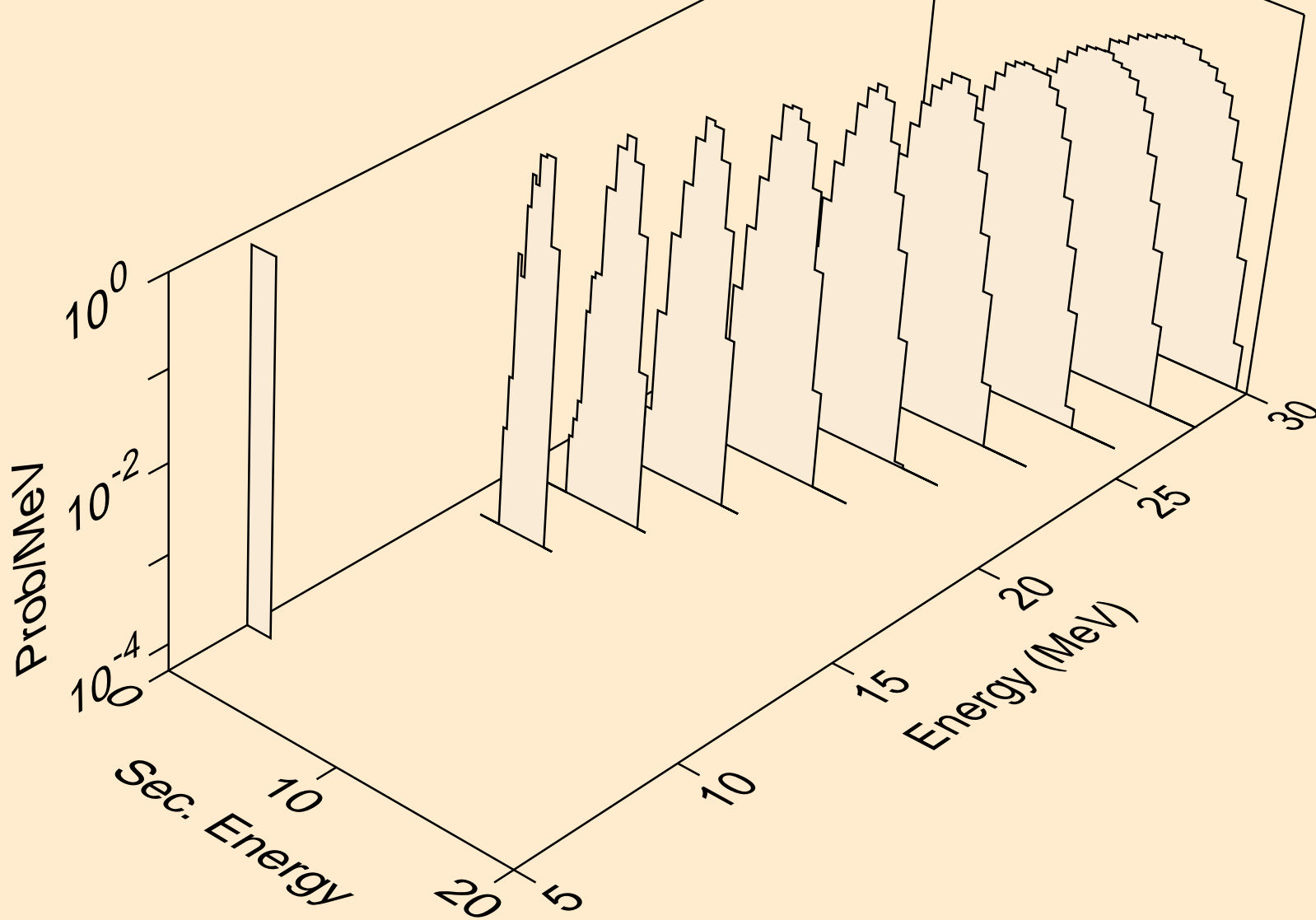

OS181 NEUTRON ACER TENDL-2019 LIBRARY; T=293.16K
he3s from (n,x)

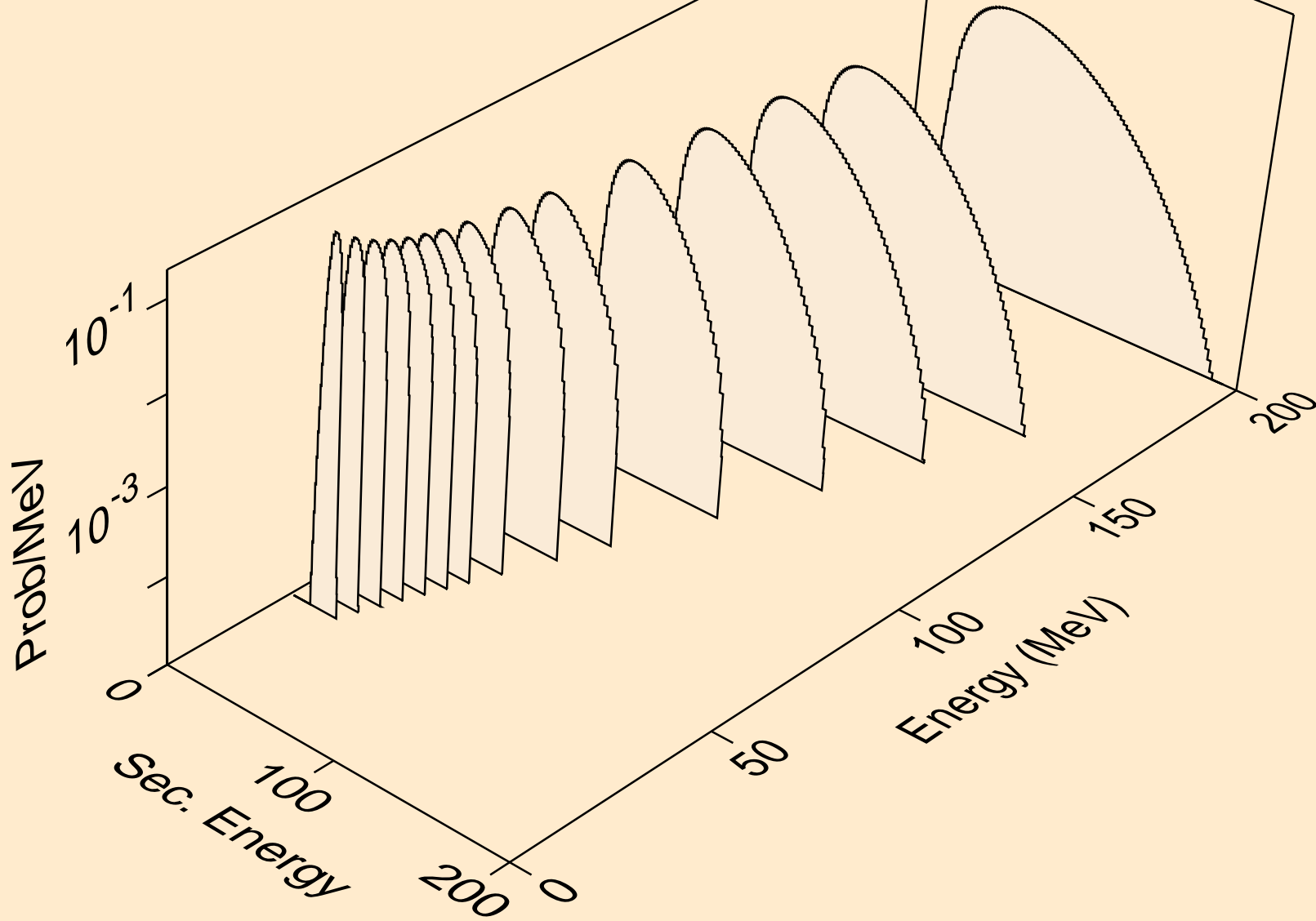

OS181 NEUTRON ACER TENDL-2019 LIBRARY; T=293.16K
he3s from (n,n*)he3

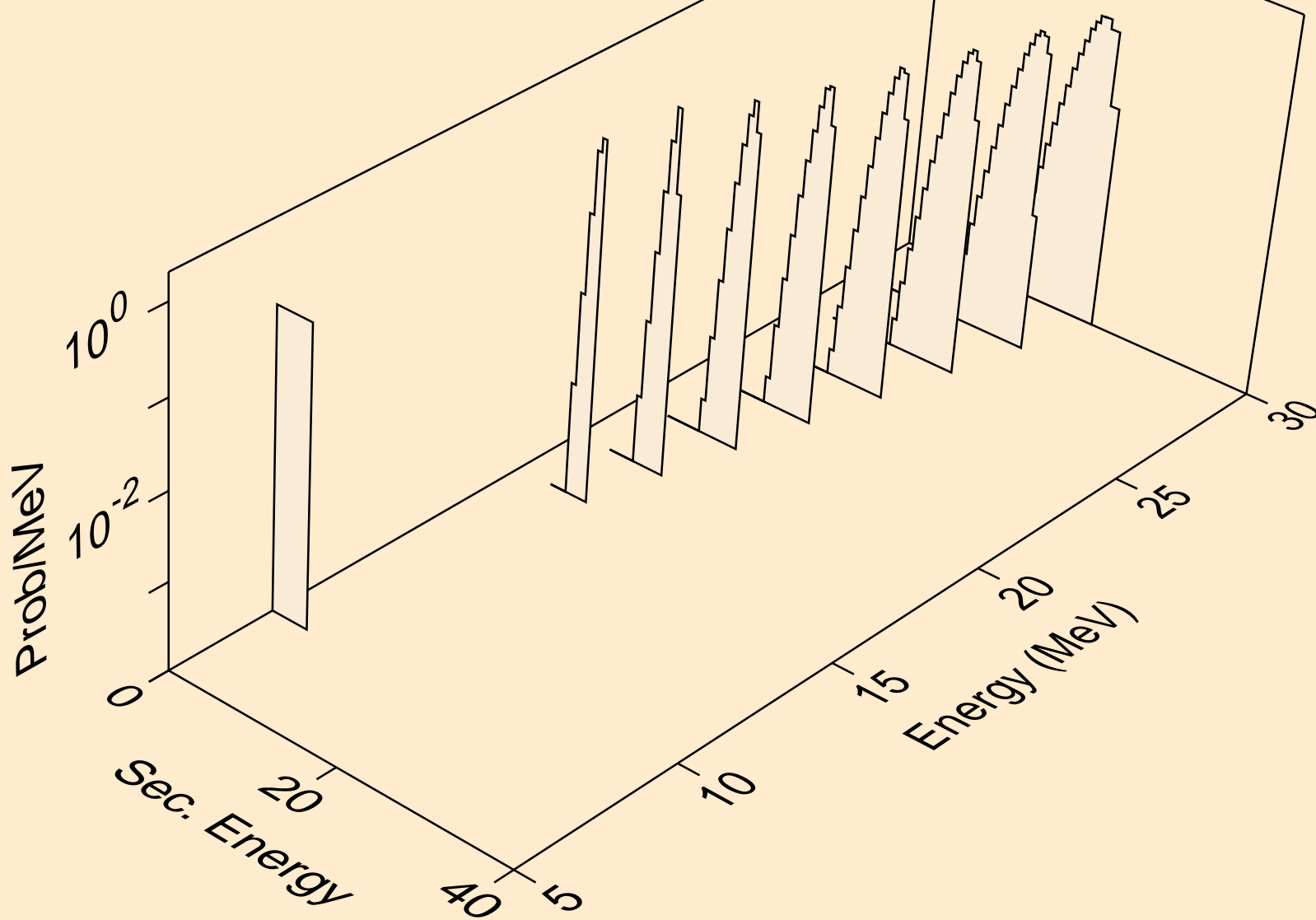

OS181 NEUTRON ACER TENDL-2019 LIBRARY; T=293.16K
he3s from (n,he3)

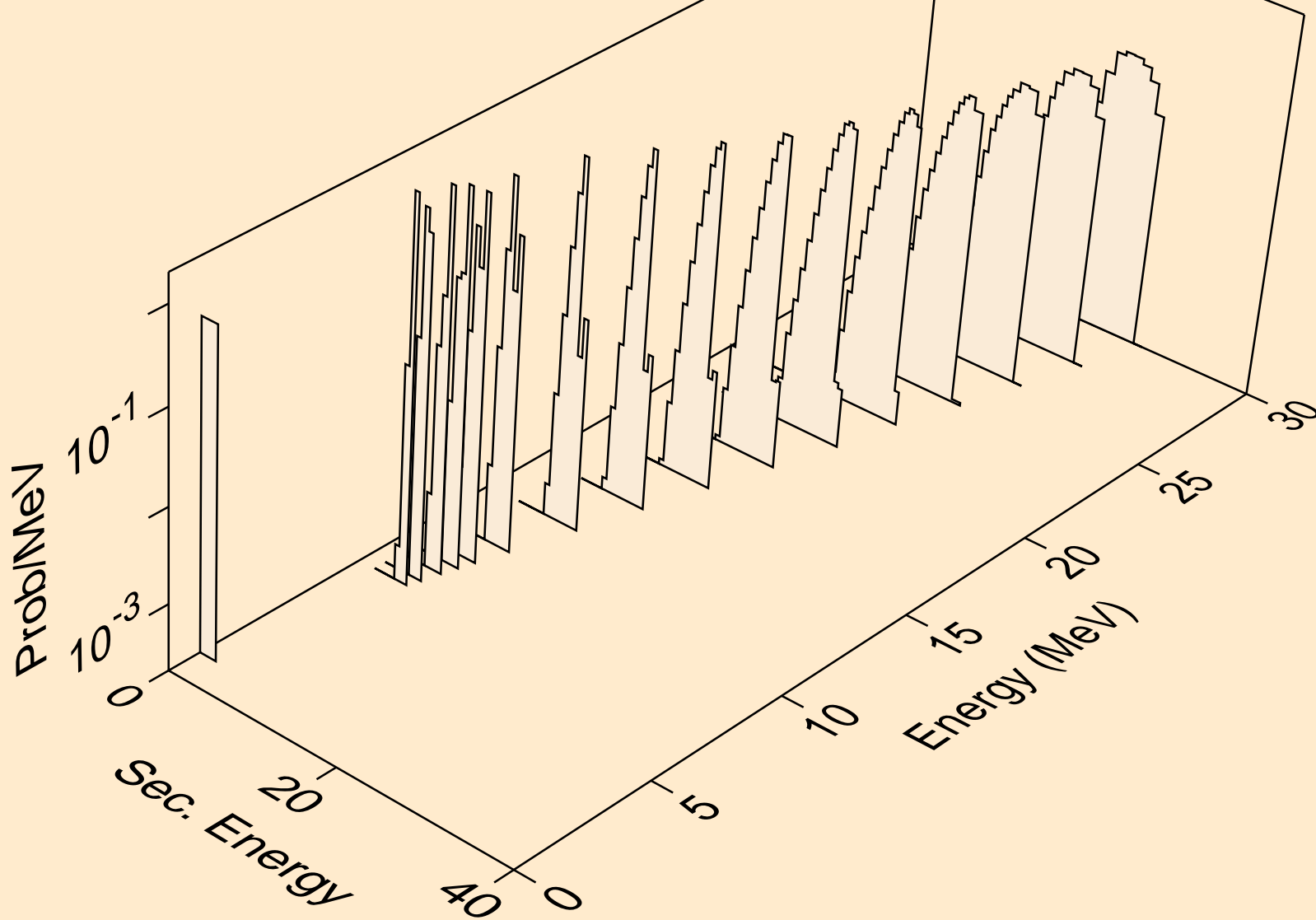

OS181 NEUTRON ACER TENDL-2019 LIBRARY; T=293.16K
alphas from (n,x)

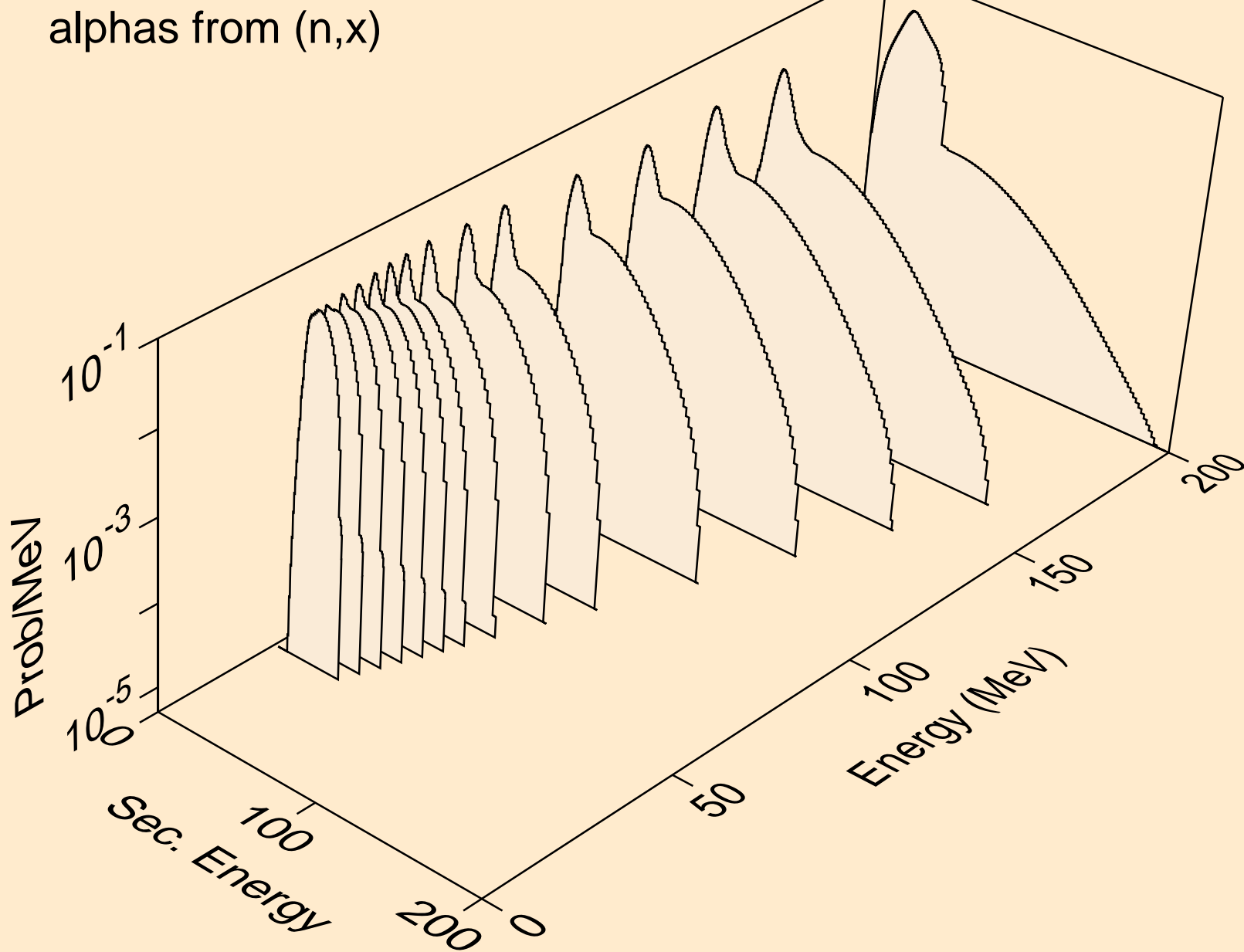

OS181 NEUTRON ACER TENDL-2019 LIBRARY; T=293.16K
alphas from (n,n*)a

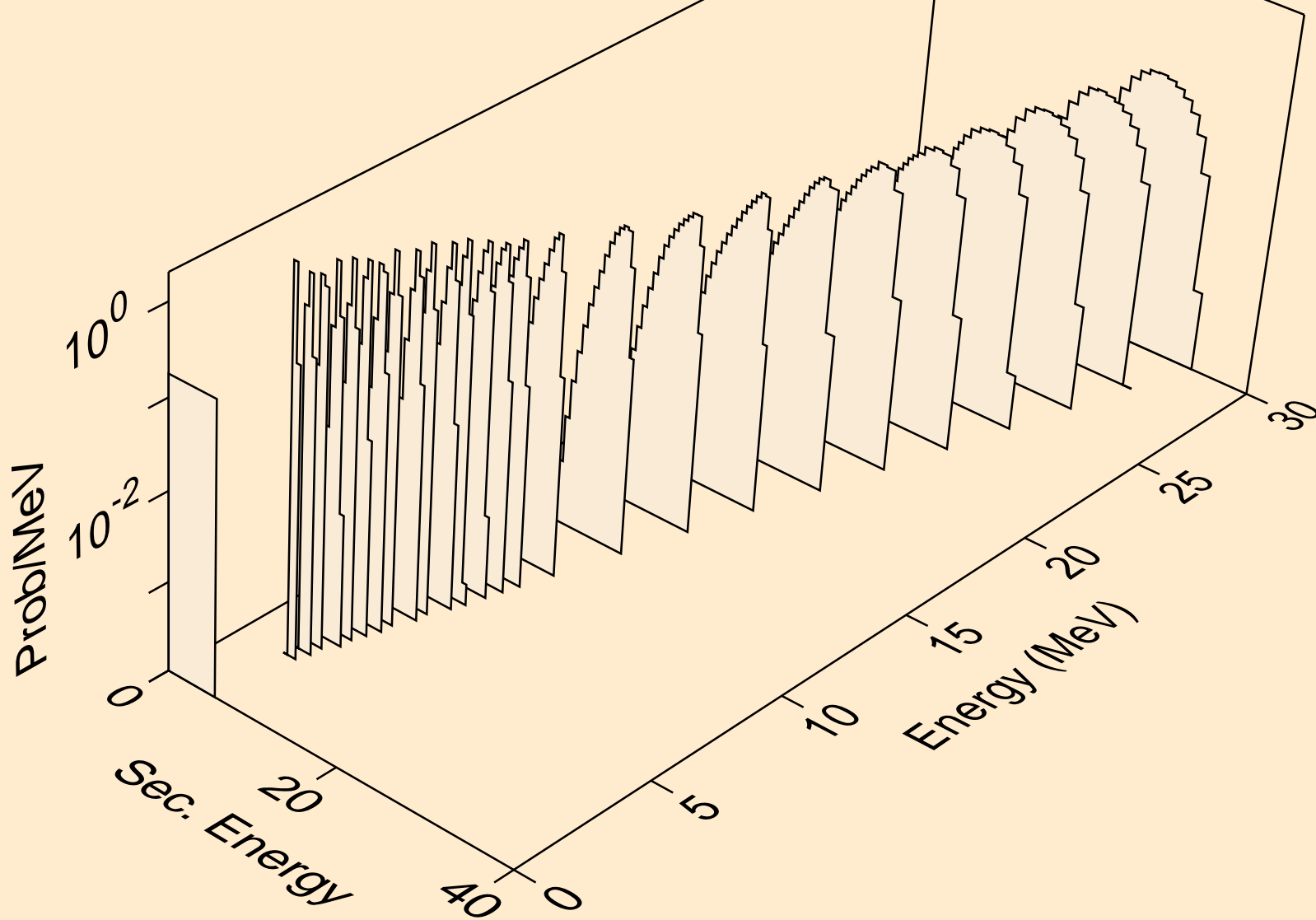

OS181 NEUTRON ACER TENDL-2019 LIBRARY; T=293.16K
alphas from (n,2n)a

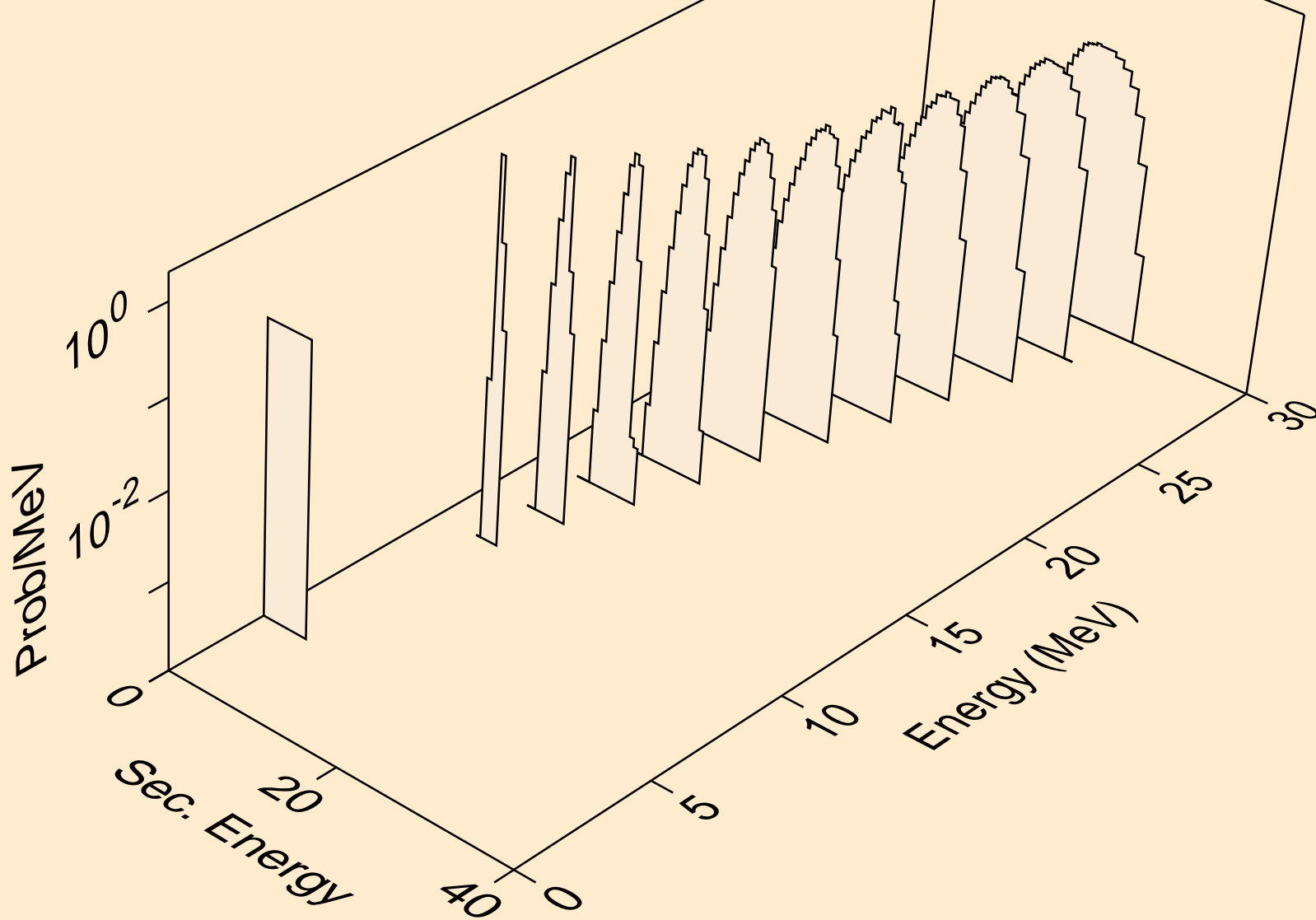

OS181 NEUTRON ACER TENDL-2019 LIBRARY; T=293.16K
alphas from (n,3n)a

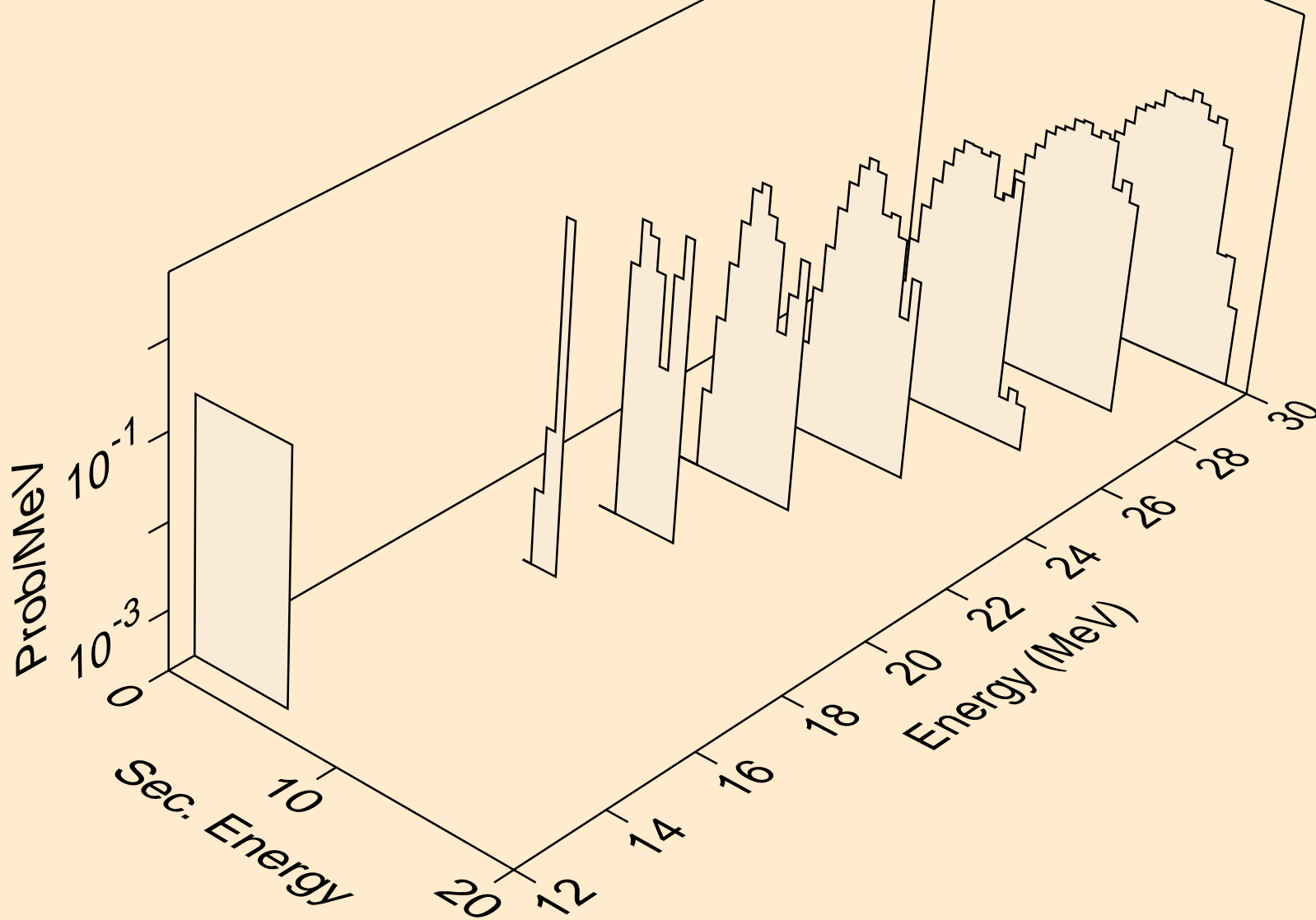

OS181 NEUTRON ACER TENDL-2019 LIBRARY; T=293.16K
alphas from (n,n*)2a

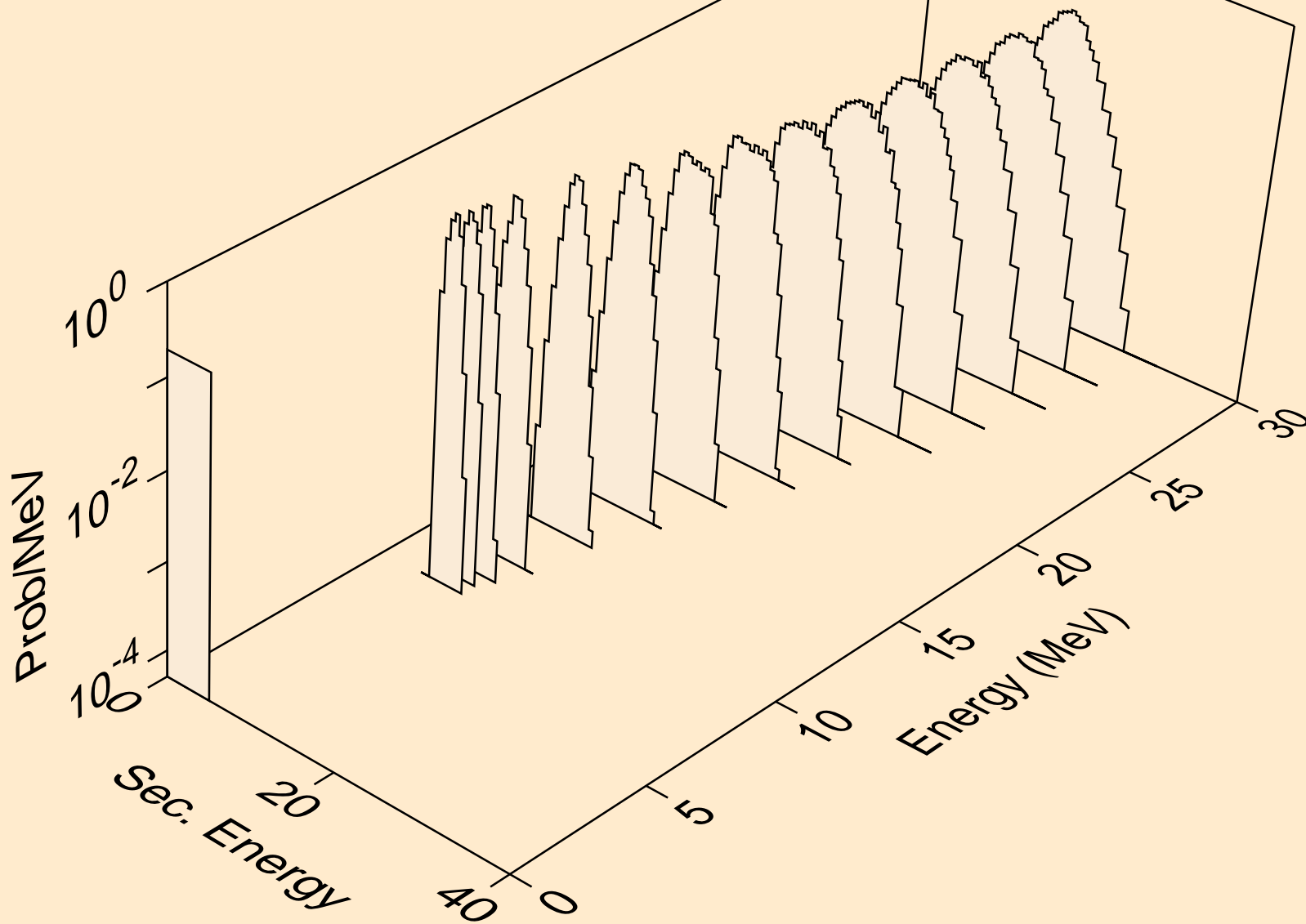

OS181 NEUTRON ACER TENDL-2019 LIBRARY; T=293.16K
alphas from (n,2n)2a

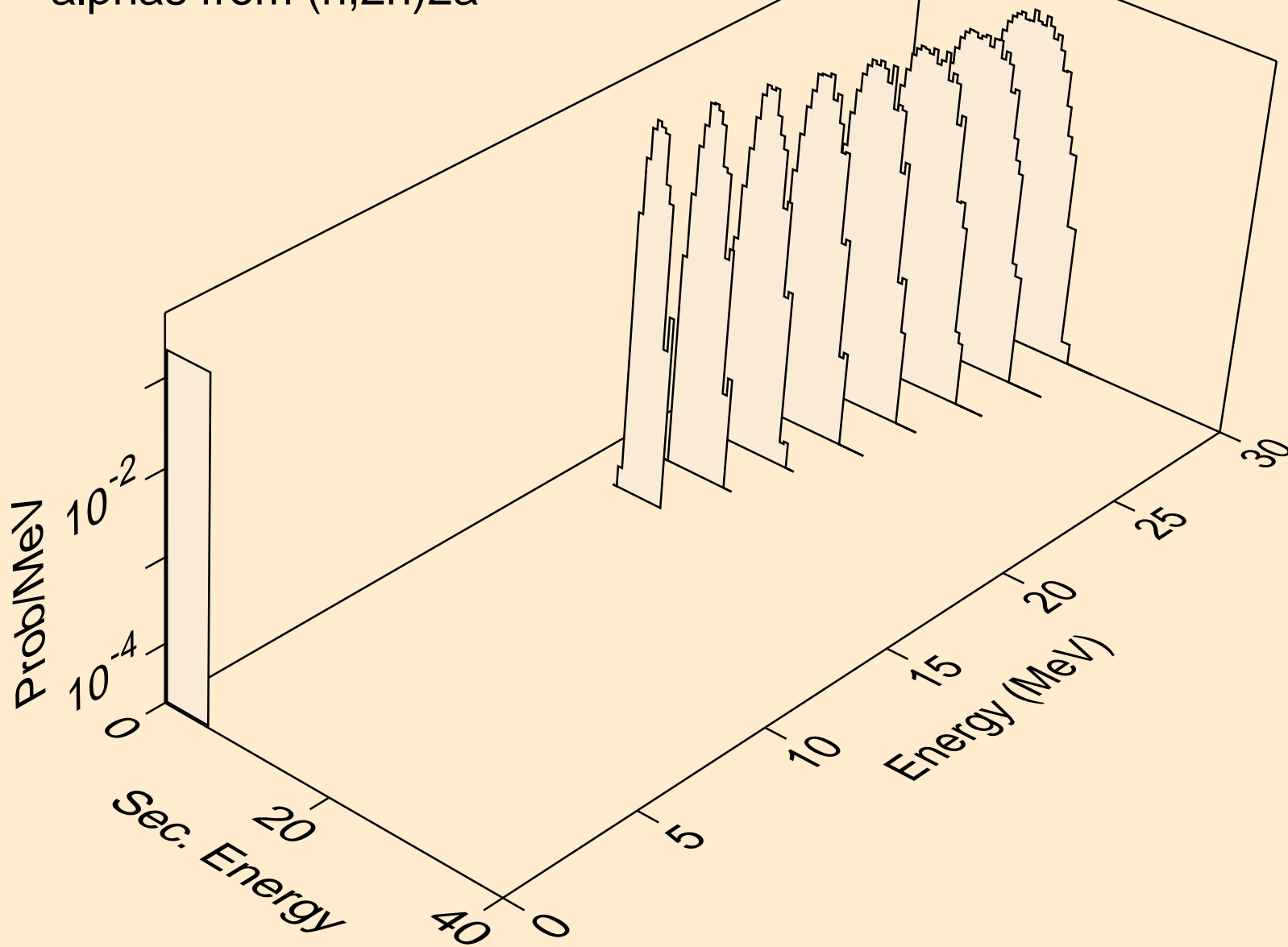

OS181 NEUTRON ACER TENDL-2019 LIBRARY; T=293.16K
alphas from (n,npa)

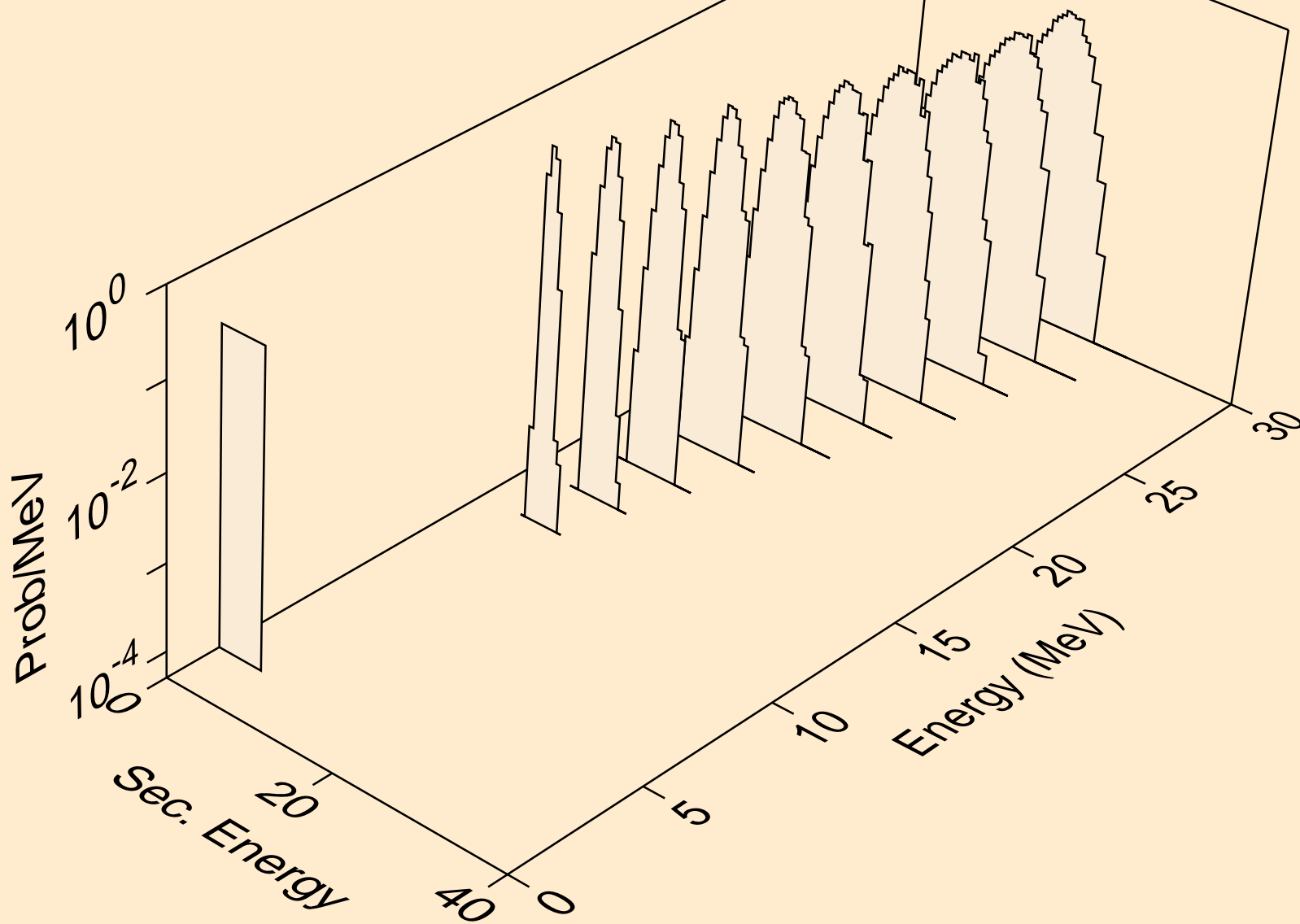

OS181 NEUTRON ACER TENDL-2019 LIBRARY; T=293.16K
alphas from (n,a)

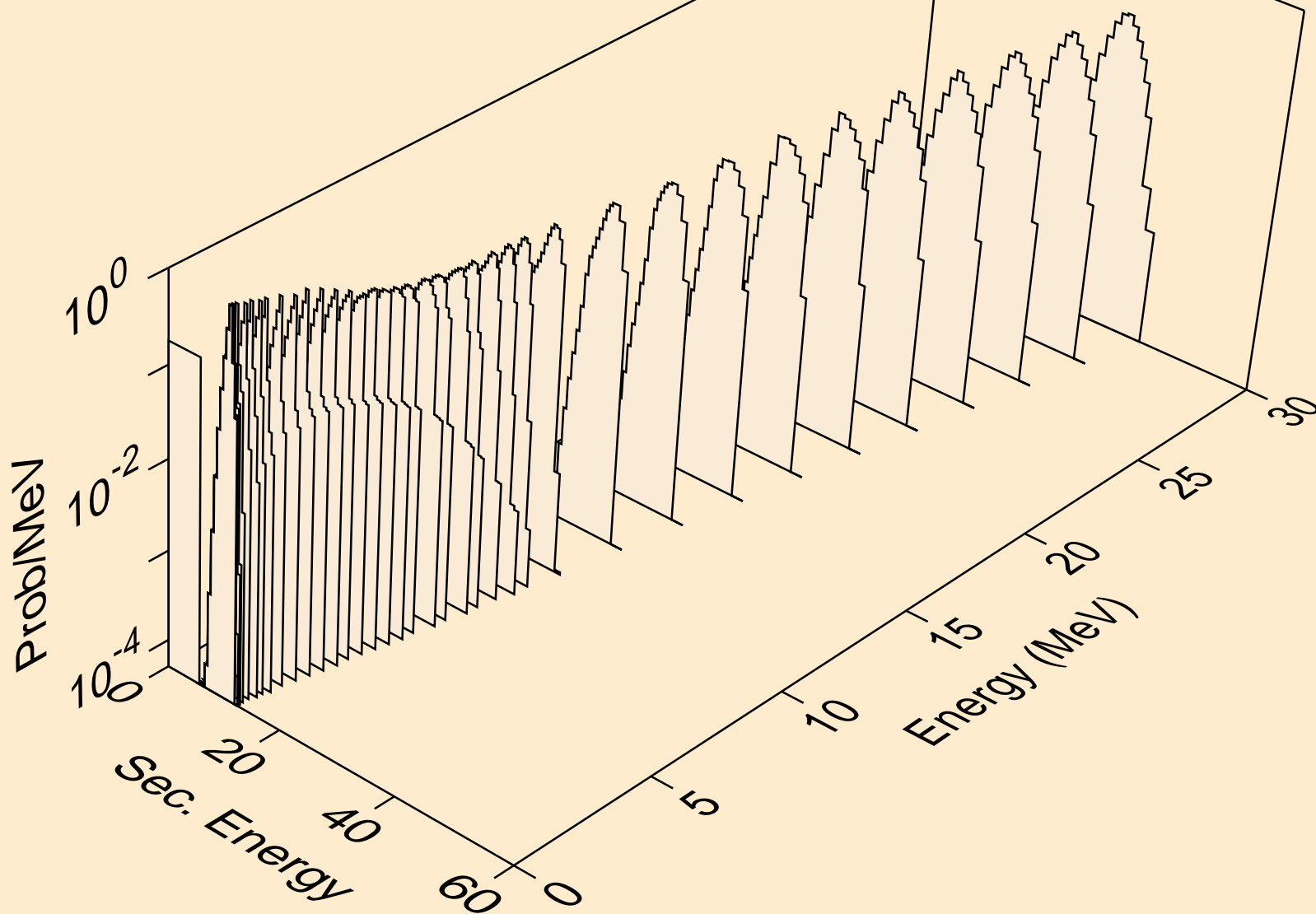

OS181 NEUTRON ACER TENDL-2019 LIBRARY; T=293.16K
alphas from (n,2a)

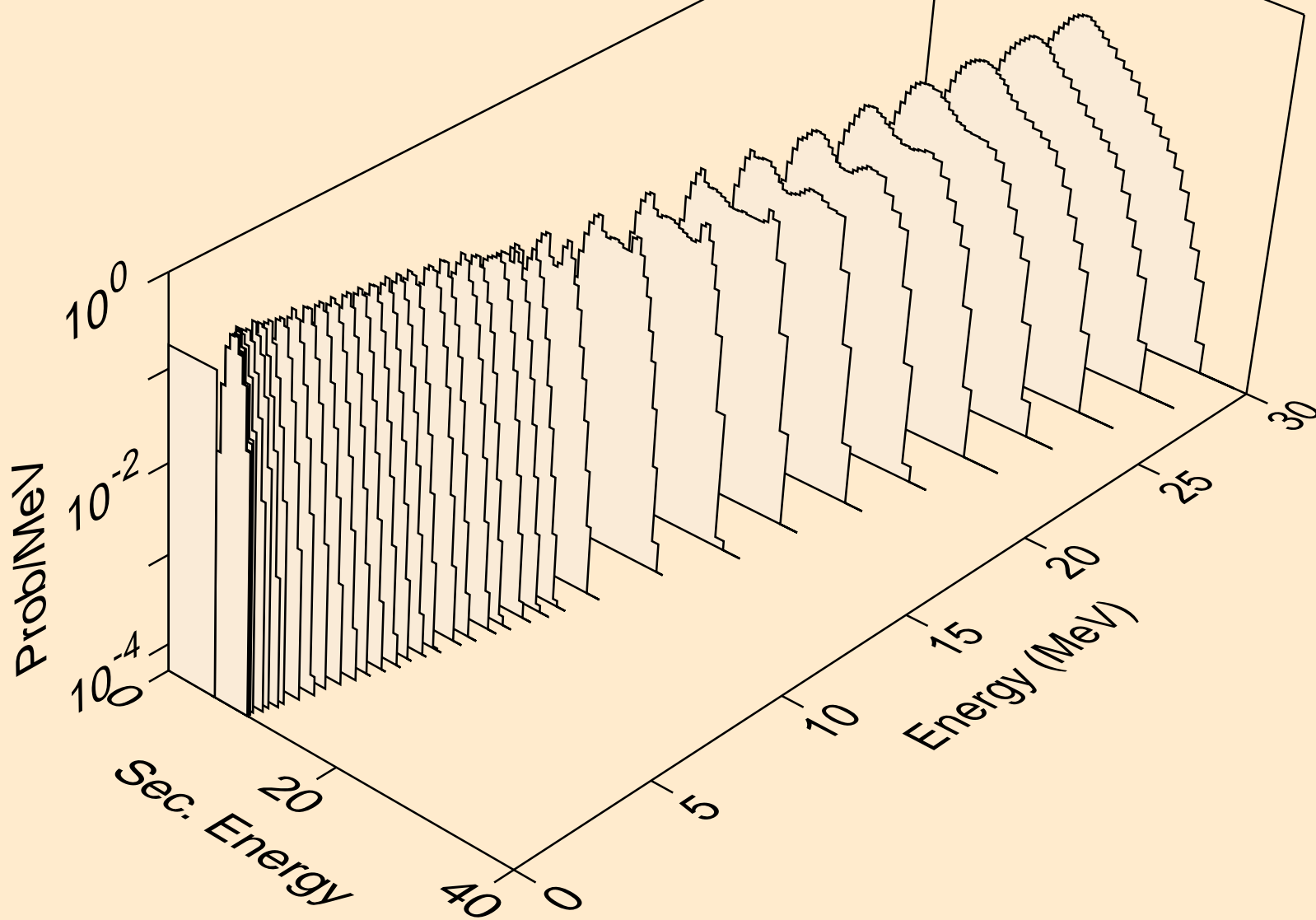

OS181 NEUTRON ACER TENDL-2019 LIBRARY; T=293.16K
alphas from (n,pa)

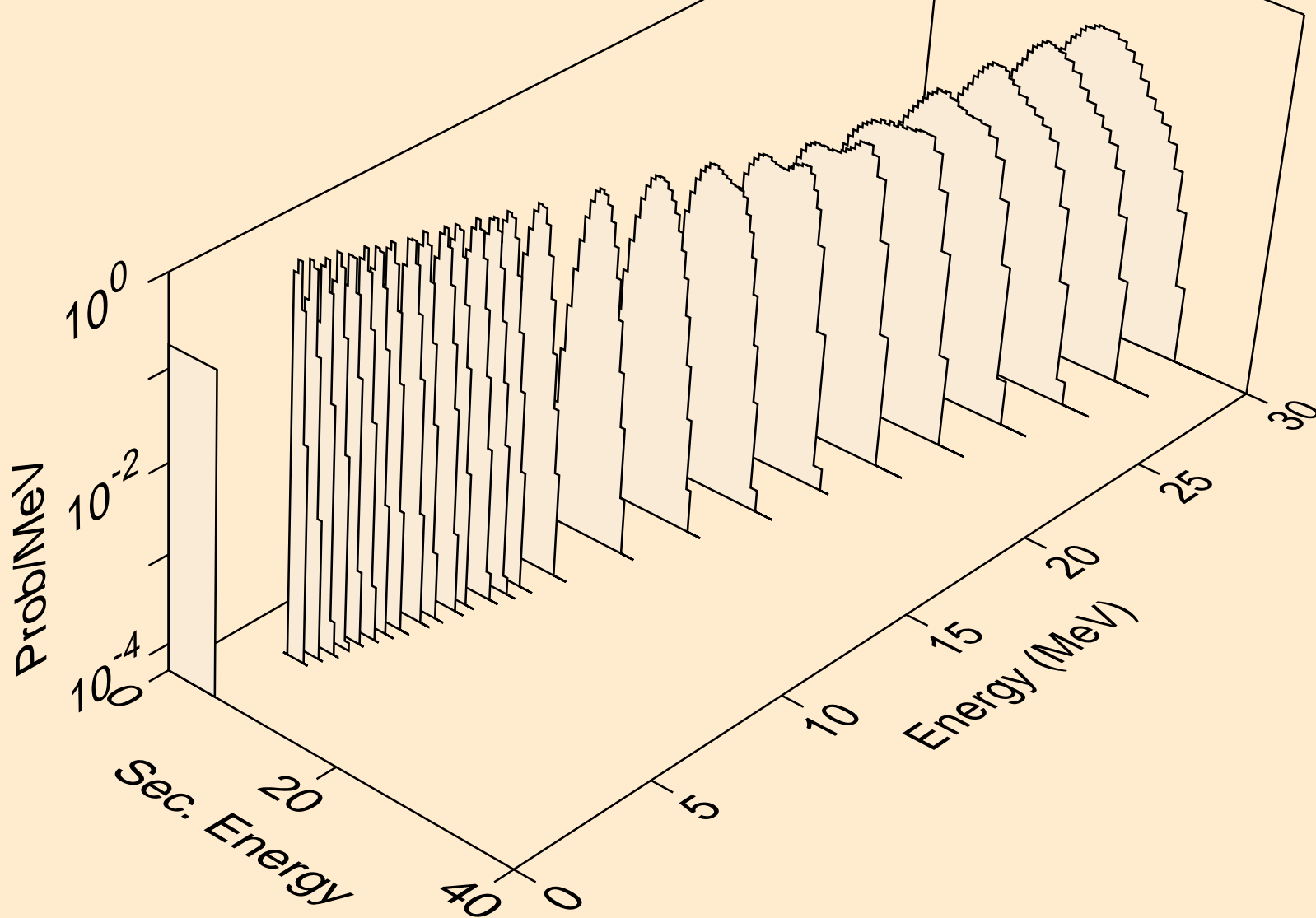

OS181 NEUTRON ACER TENDL-2019 LIBRARY; T=293.16K
alphas from (n,da)

