

OS182 NEUTRON ACER TENDL-2019 LIBRARY; T=293.16K  
Principal cross sections

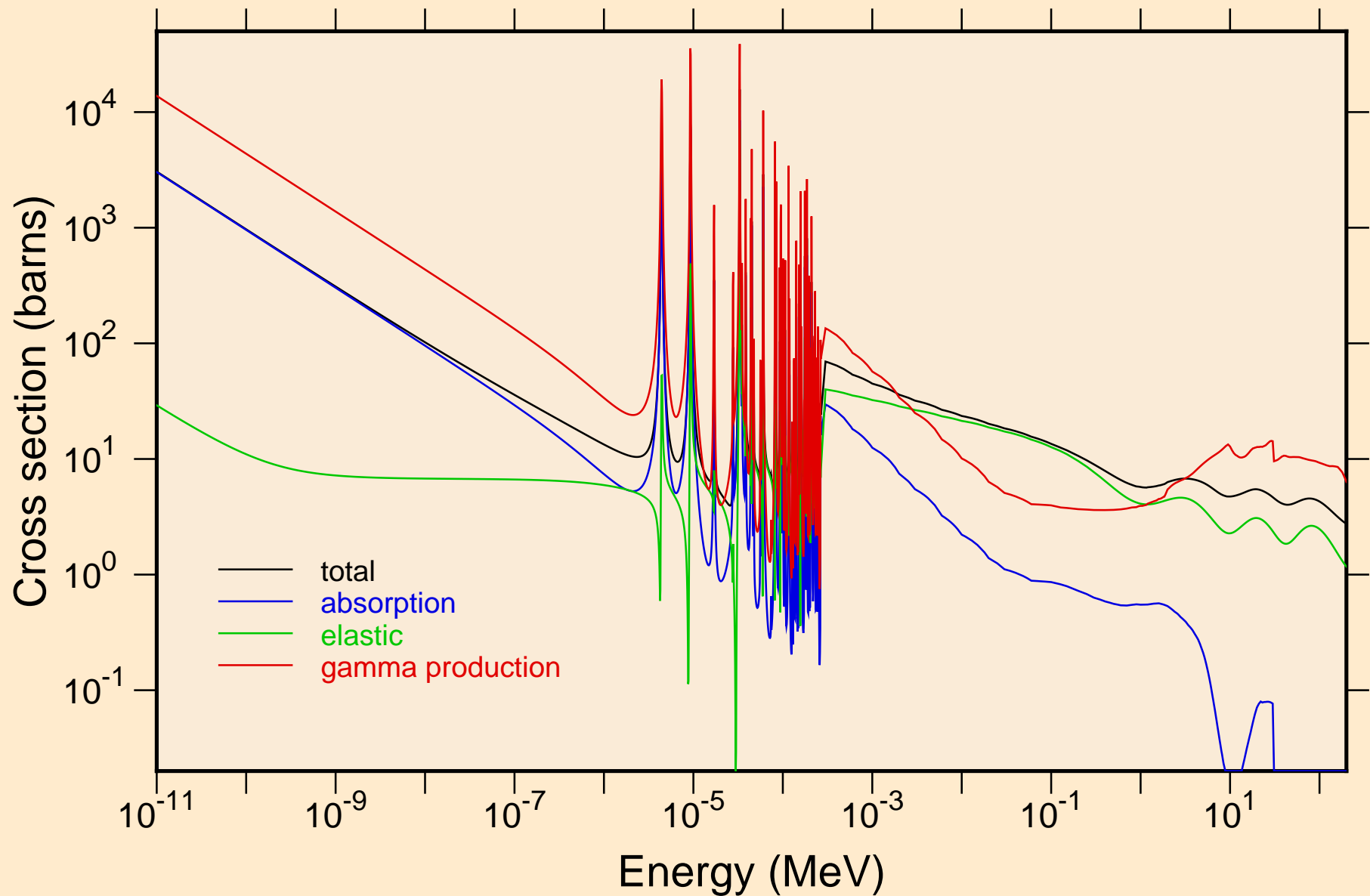

OS182 NEUTRON ACER TENDL-2019 LIBRARY; T=293.16K  
resonance total cross section

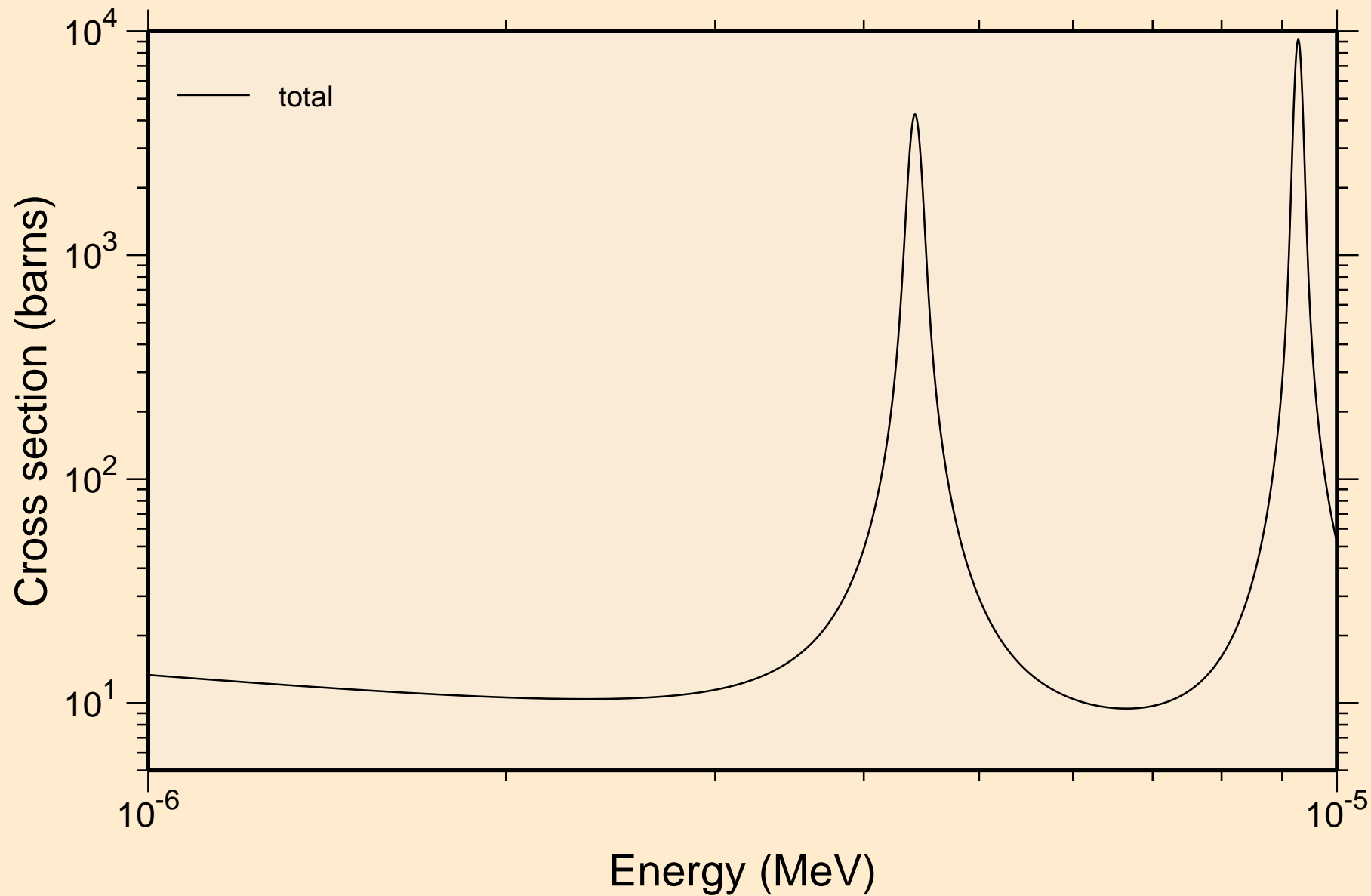

OS182 NEUTRON ACER TENDL-2019 LIBRARY; T=293.16K  
resonance total cross section

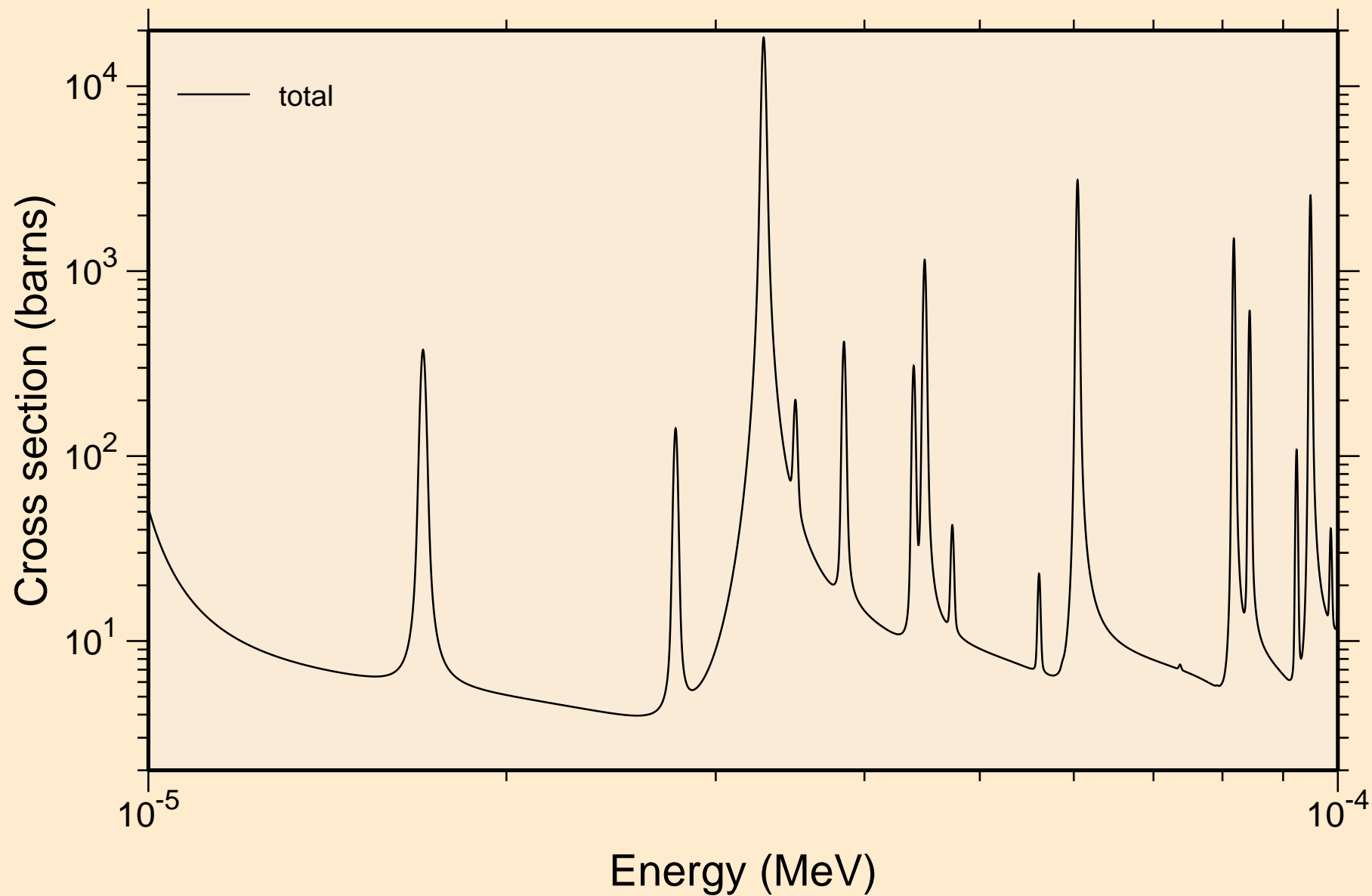

OS182 NEUTRON ACER TENDL-2019 LIBRARY; T=293.16K  
resonance total cross section

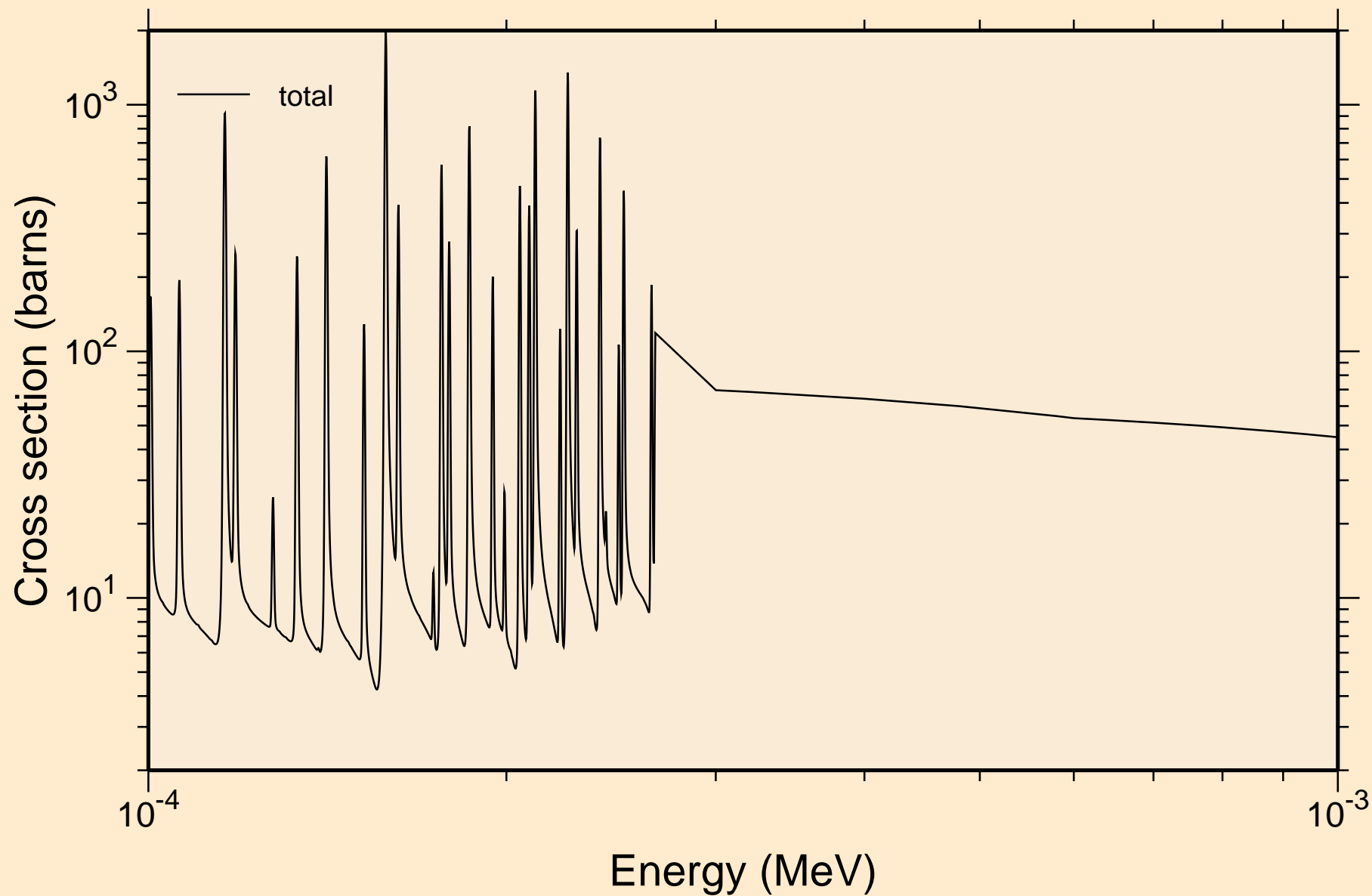

OS182 NEUTRON ACER TENDL-2019 LIBRARY; T=293.16K  
resonance total cross section

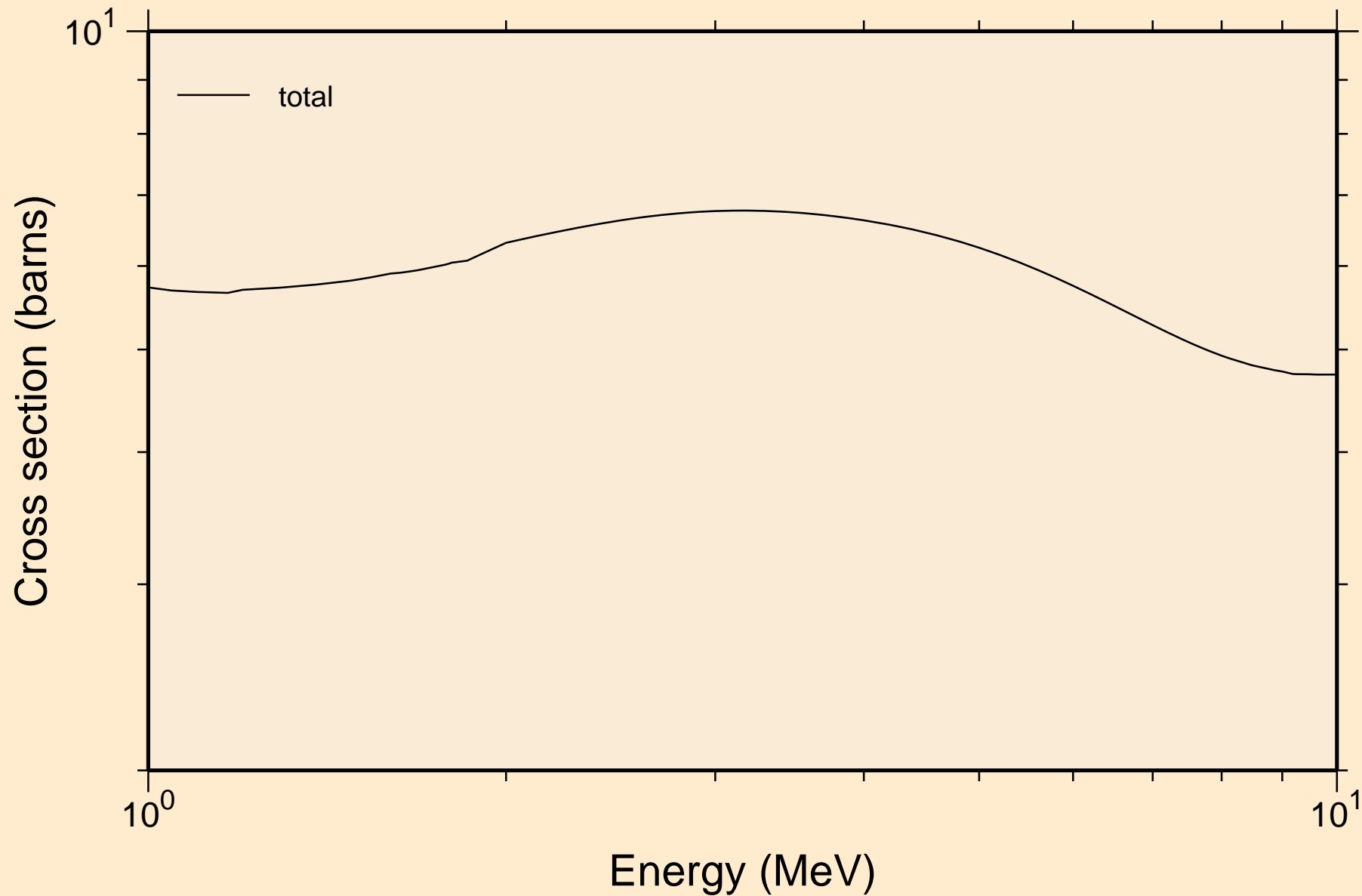

OS182 NEUTRON ACER TENDL-2019 LIBRARY; T=293.16K  
resonance absorption cross sections

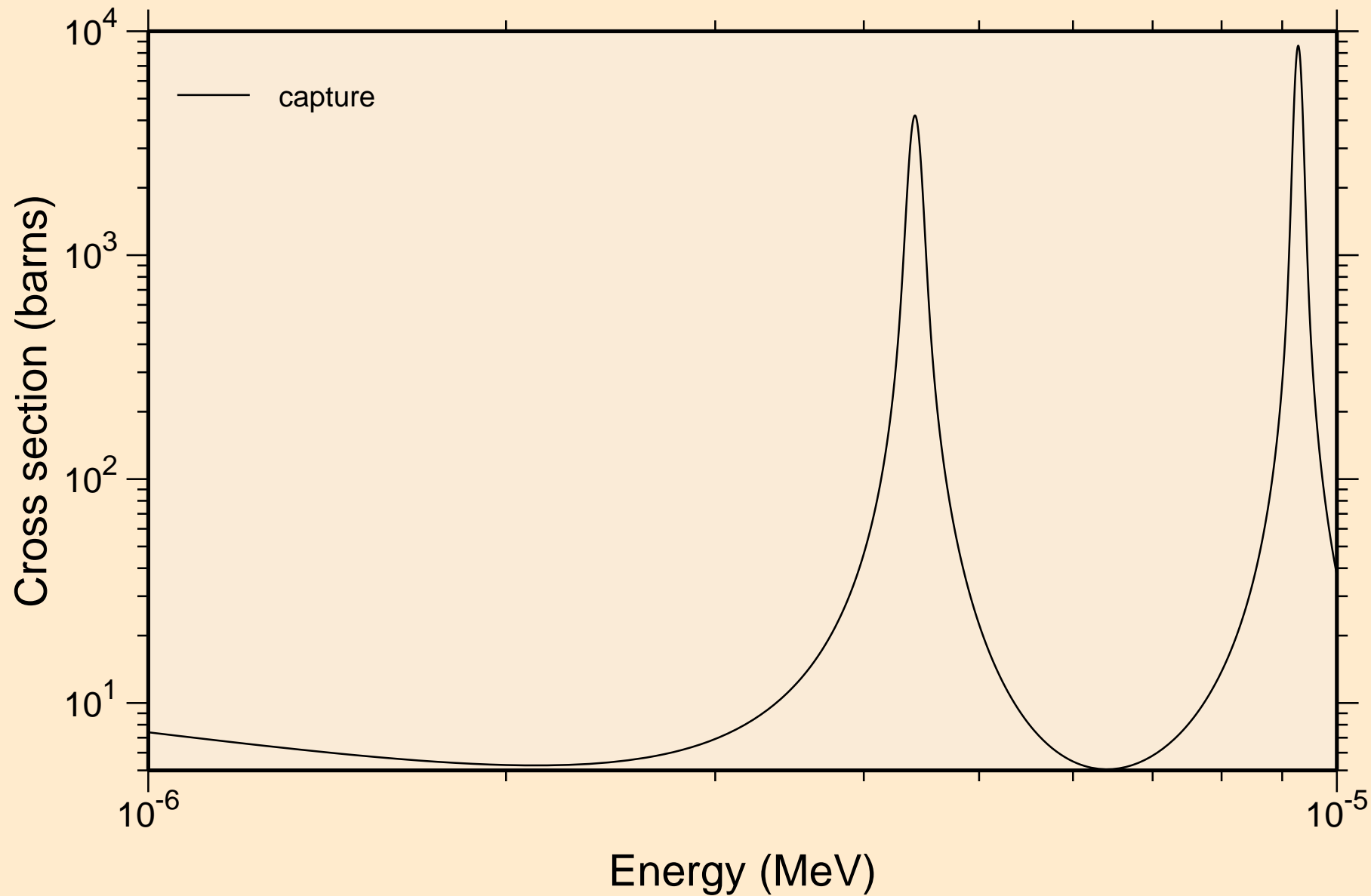

OS182 NEUTRON ACER TENDL-2019 LIBRARY; T=293.16K  
resonance absorption cross sections

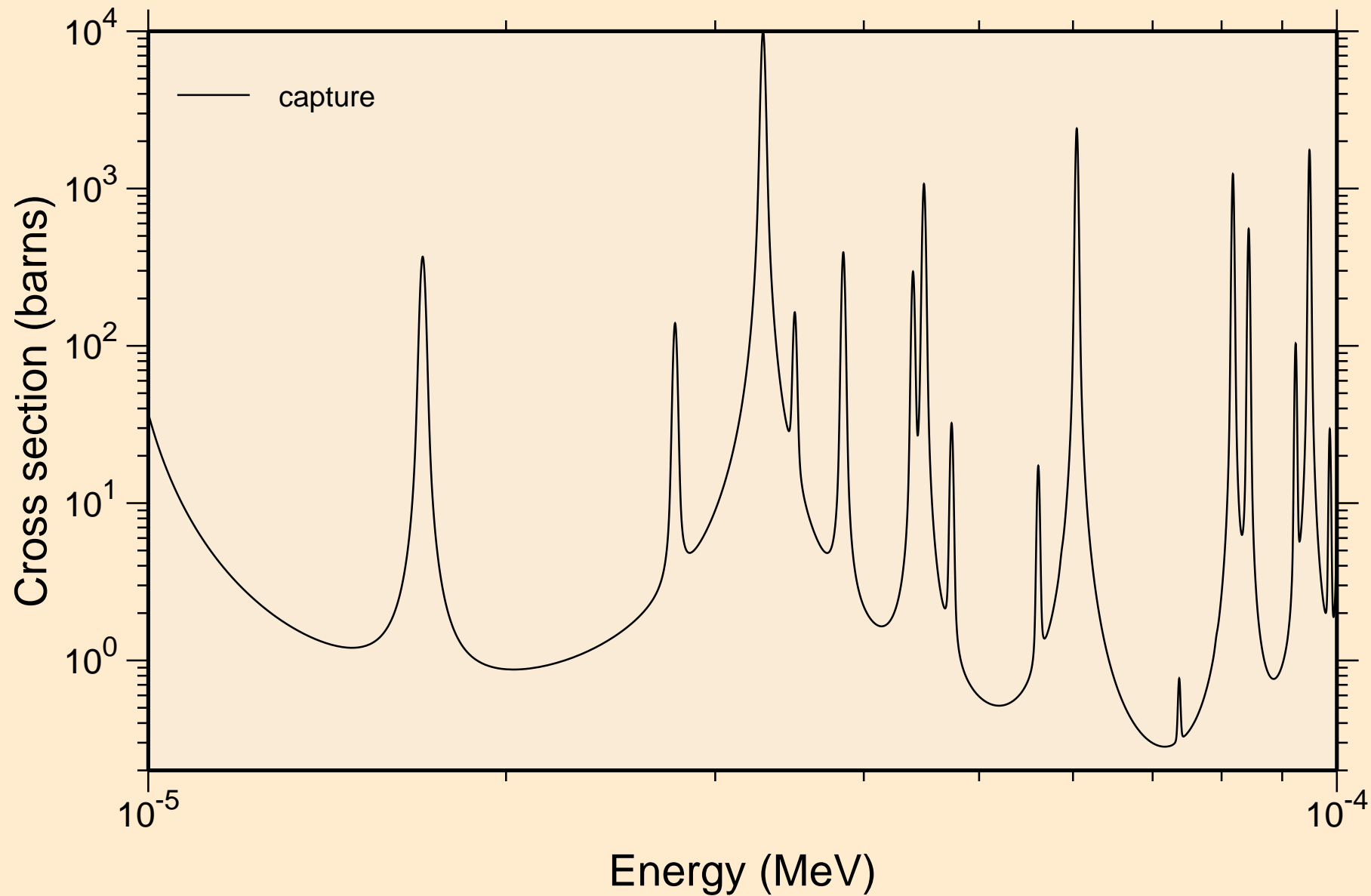

OS182 NEUTRON ACER TENDL-2019 LIBRARY; T=293.16K  
resonance absorption cross sections

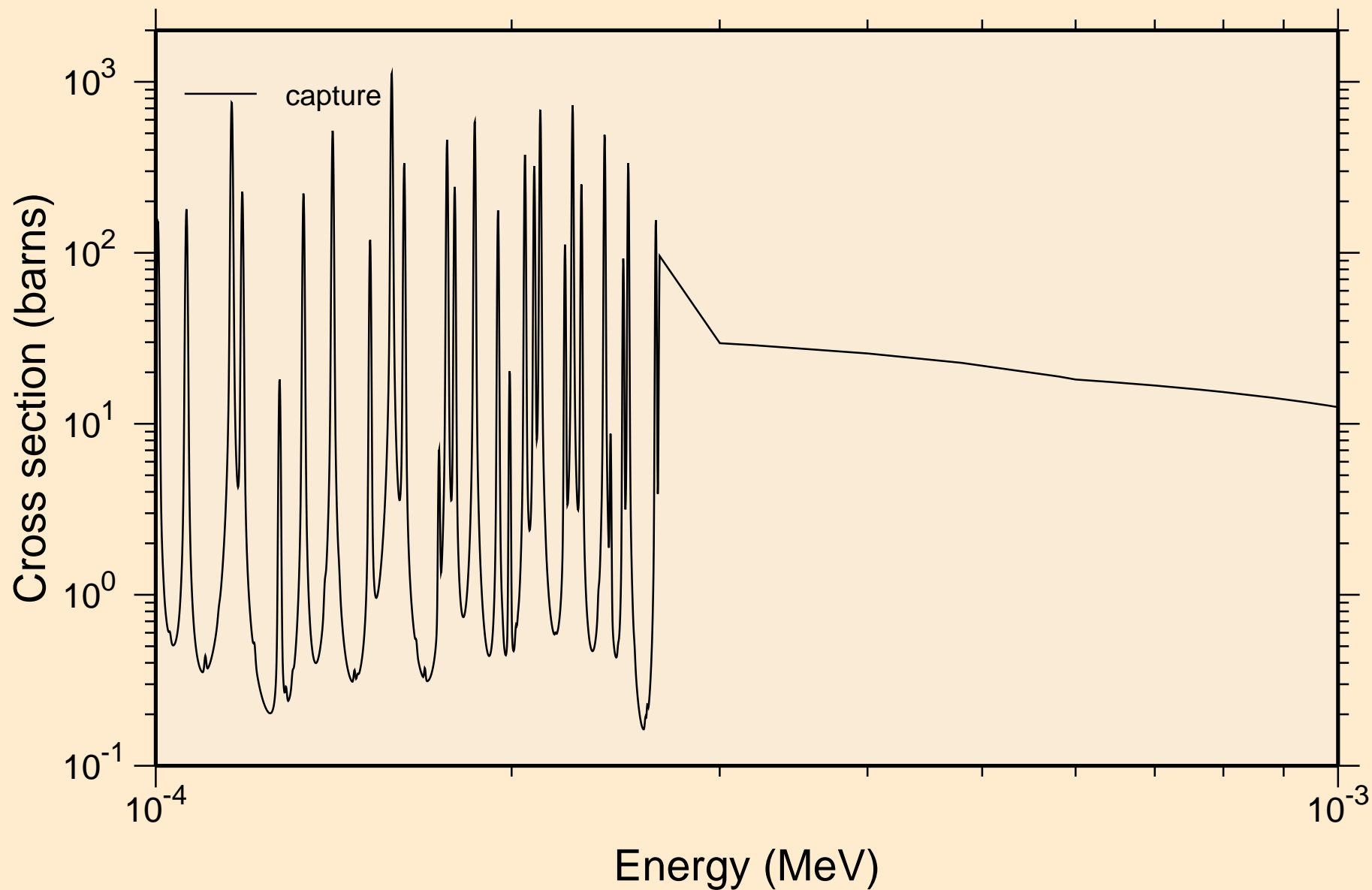



OS182 NEUTRON ACER TENDL-2019 LIBRARY; T=293.16K  
resonance absorption cross sections

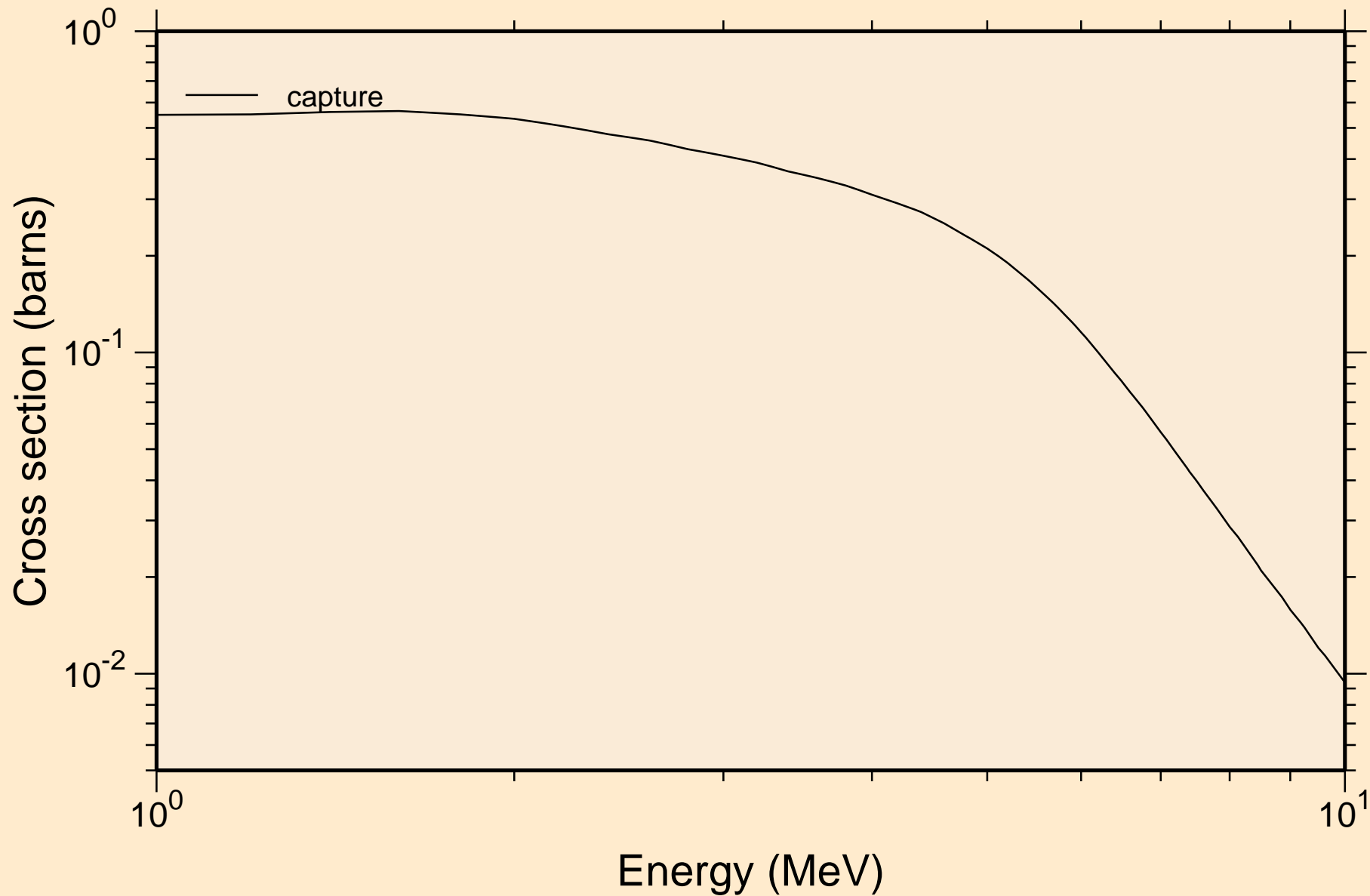

OS182 NEUTRON ACER TENDL-2019 LIBRARY; T=293.16K  
Heating

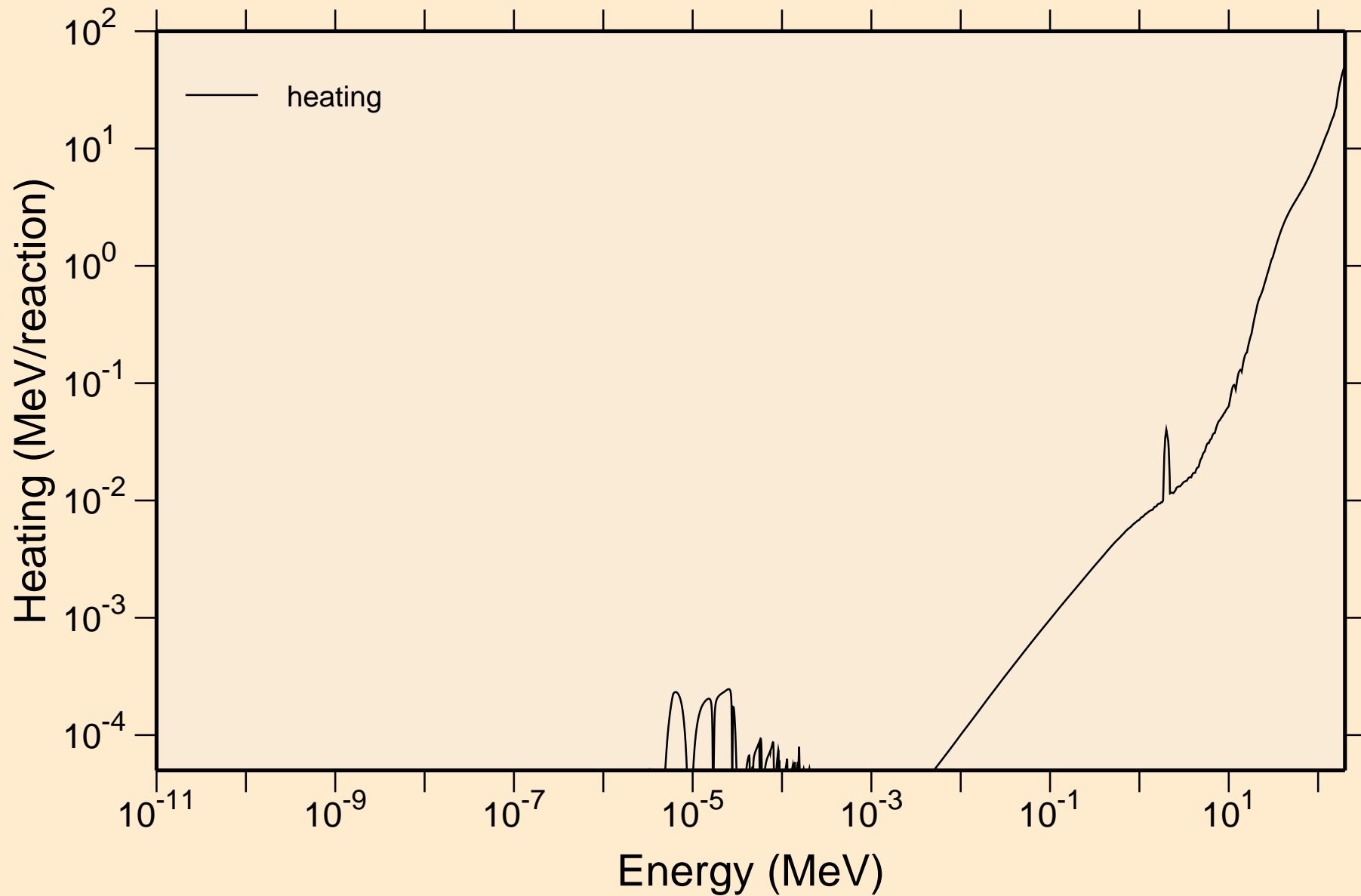

OS182 NEUTRON ACER TENDL-2019 LIBRARY; T=293.16K  
Damage

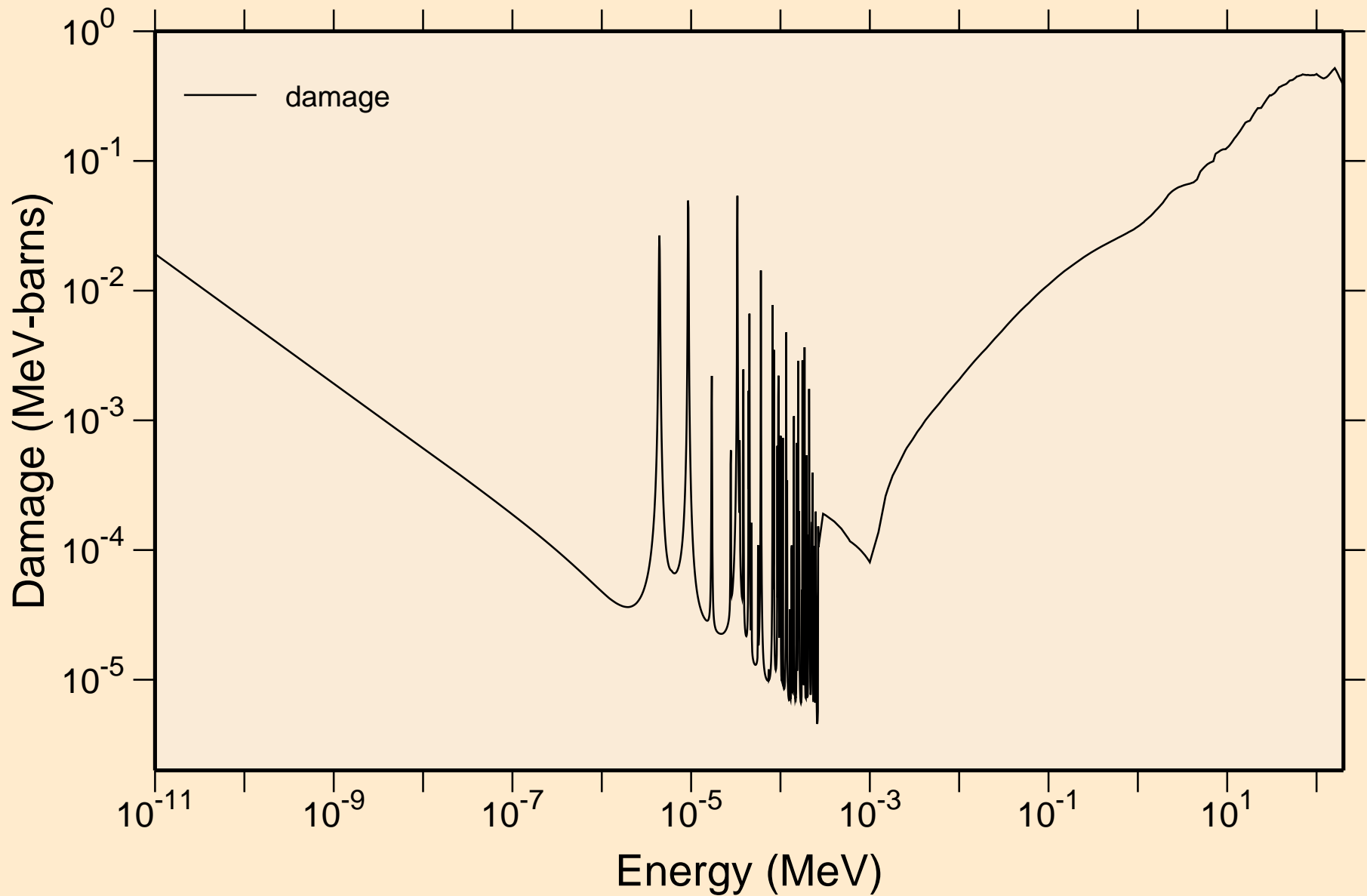

OS182 NEUTRON ACER TENDL-2019 LIBRARY; T=293.16K  
Non-threshold reactions

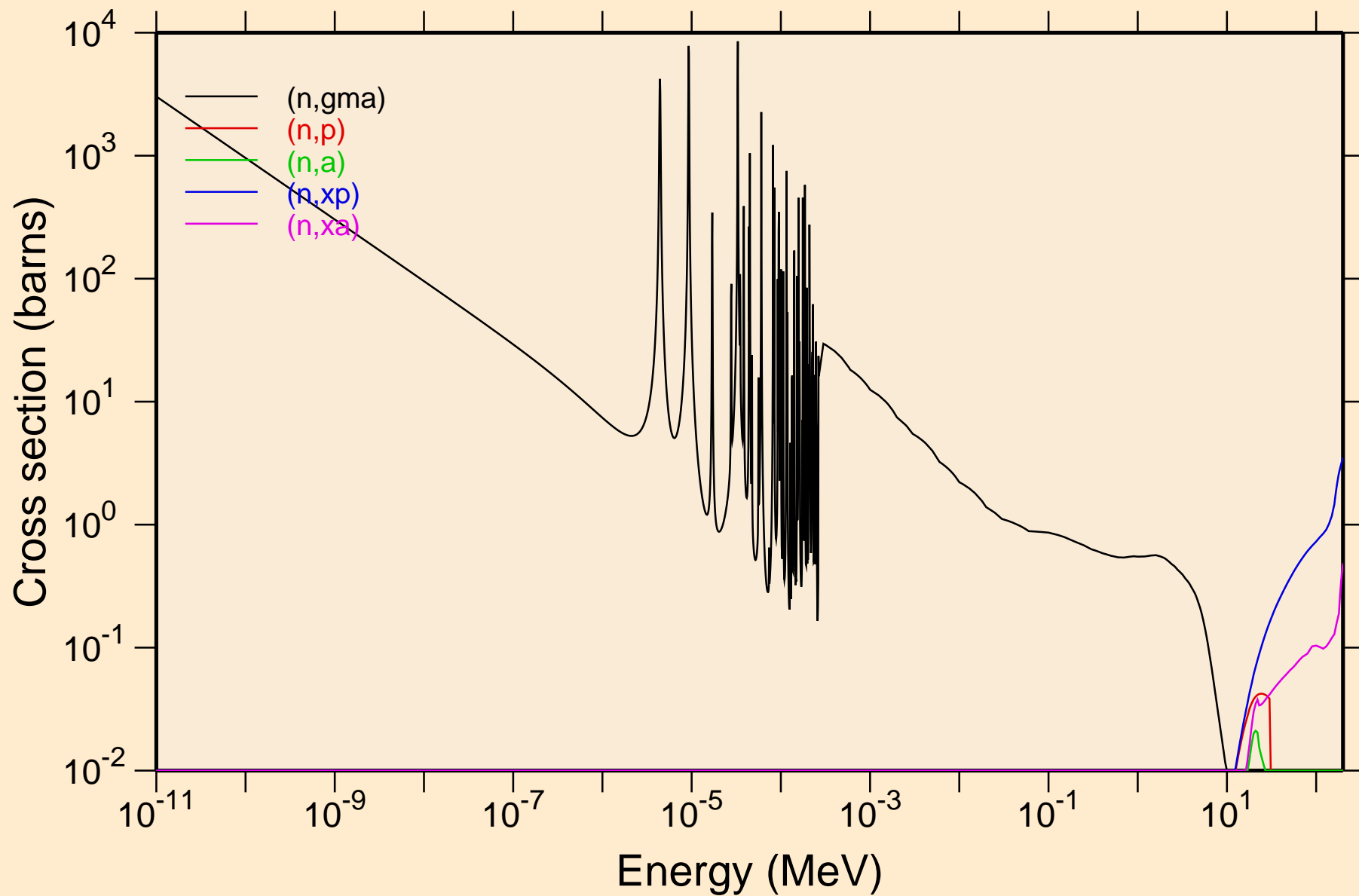

# OS182 NEUTRON ACER TENDL-2019 LIBRARY; T=293.16K

## Principal cross sections

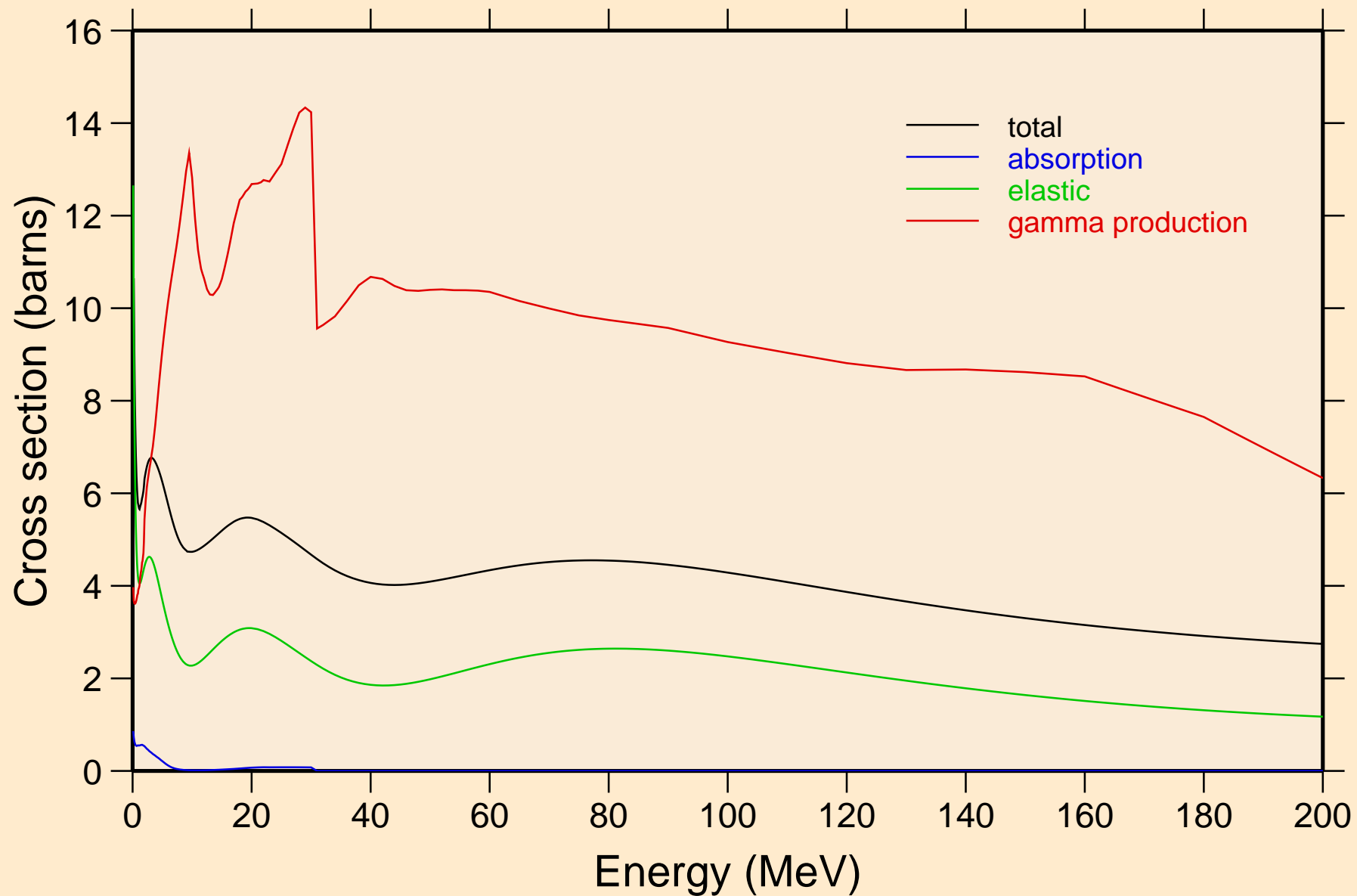

OS182 NEUTRON ACER TENDL-2019 LIBRARY; T=293.16K  
Heating

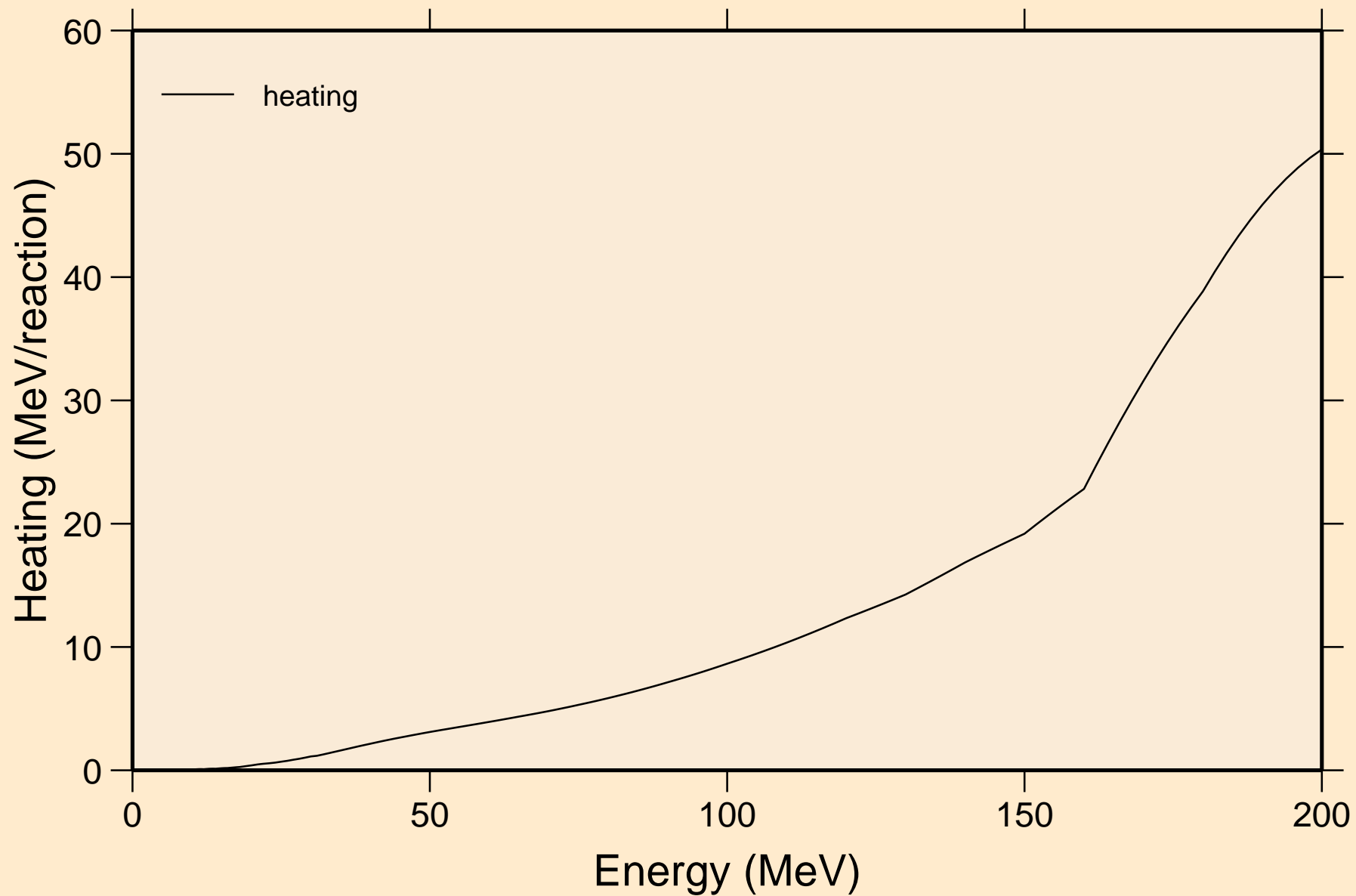

# OS182 NEUTRON ACER TENDL-2019 LIBRARY; T=293.16K Damage

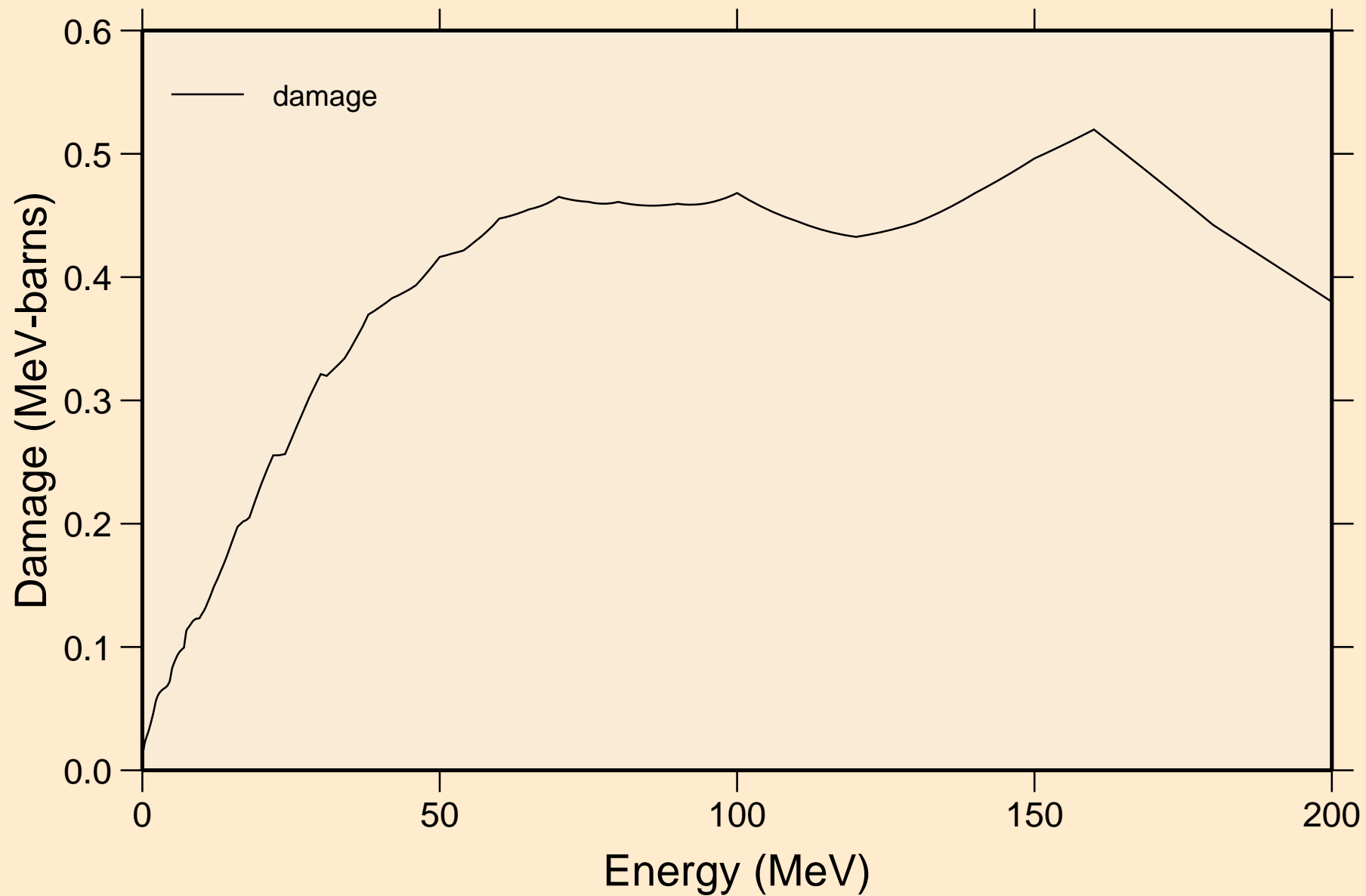

OS182 NEUTRON ACER TENDL-2019 LIBRARY; T=293.16K  
Non-threshold reactions

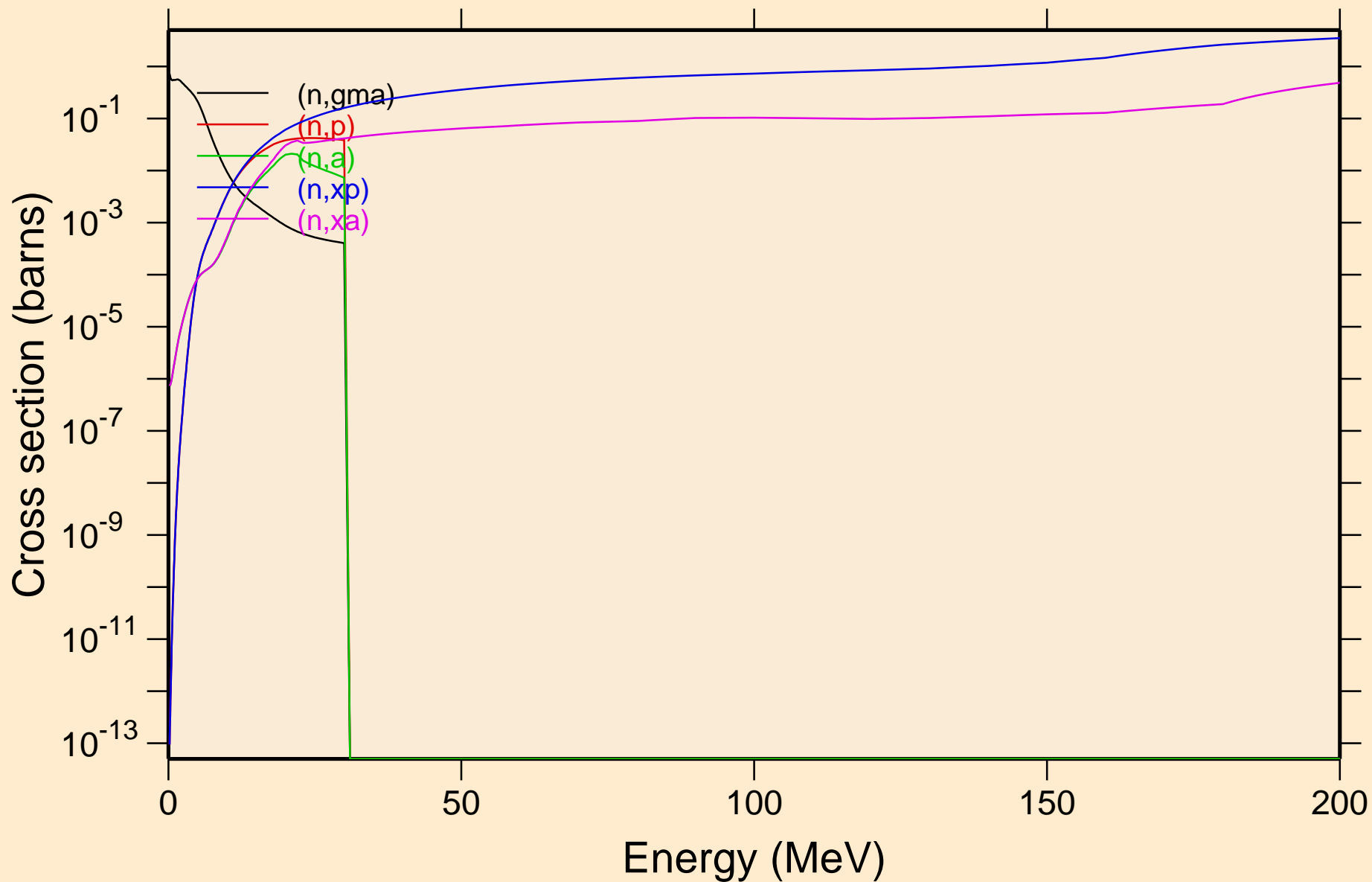



OS182 NEUTRON ACER TENDL-2019 LIBRARY; T=293.16K  
Inelastic levels

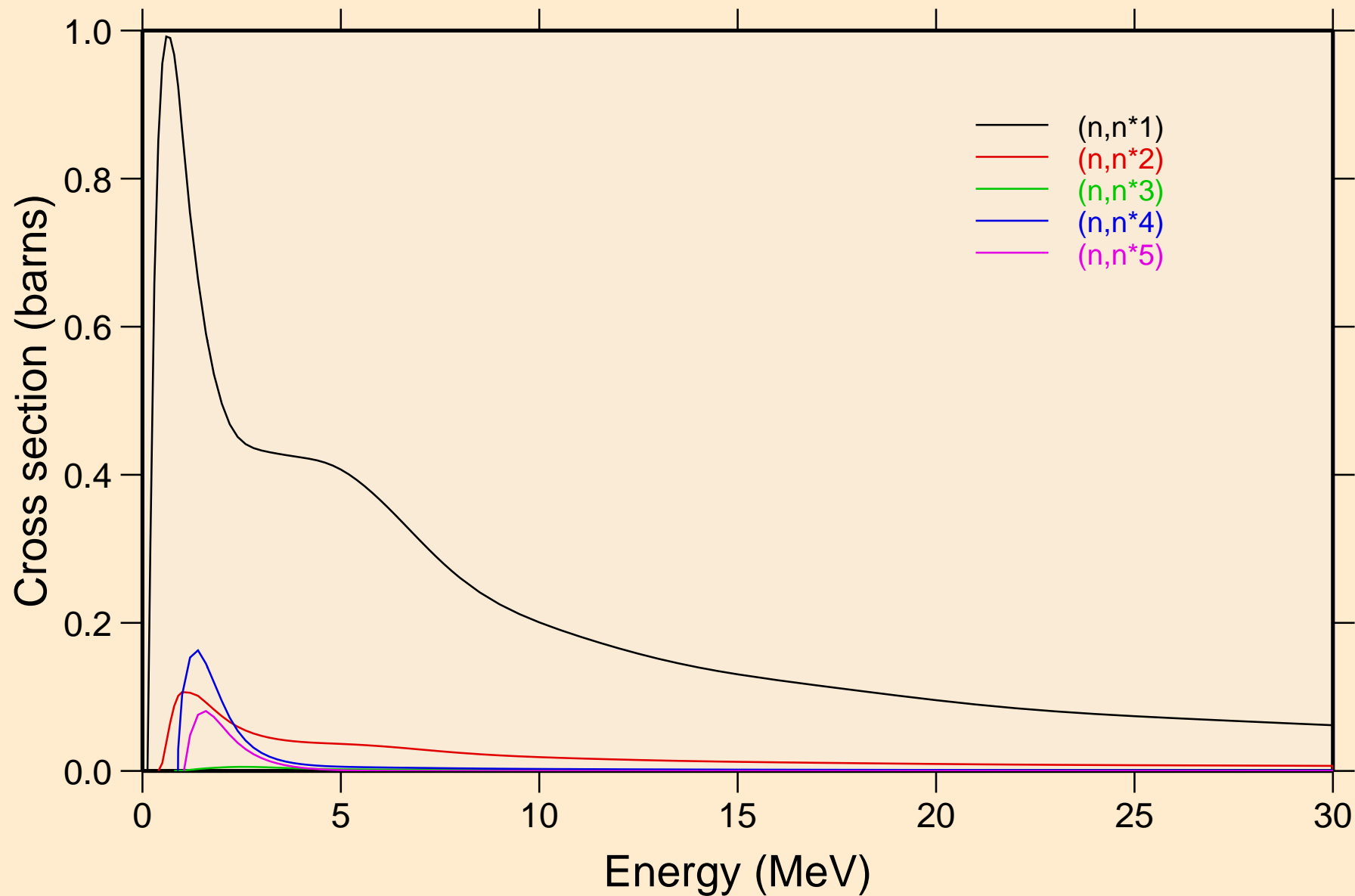

OS182 NEUTRON ACER TENDL-2019 LIBRARY; T=293.16K  
Inelastic levels

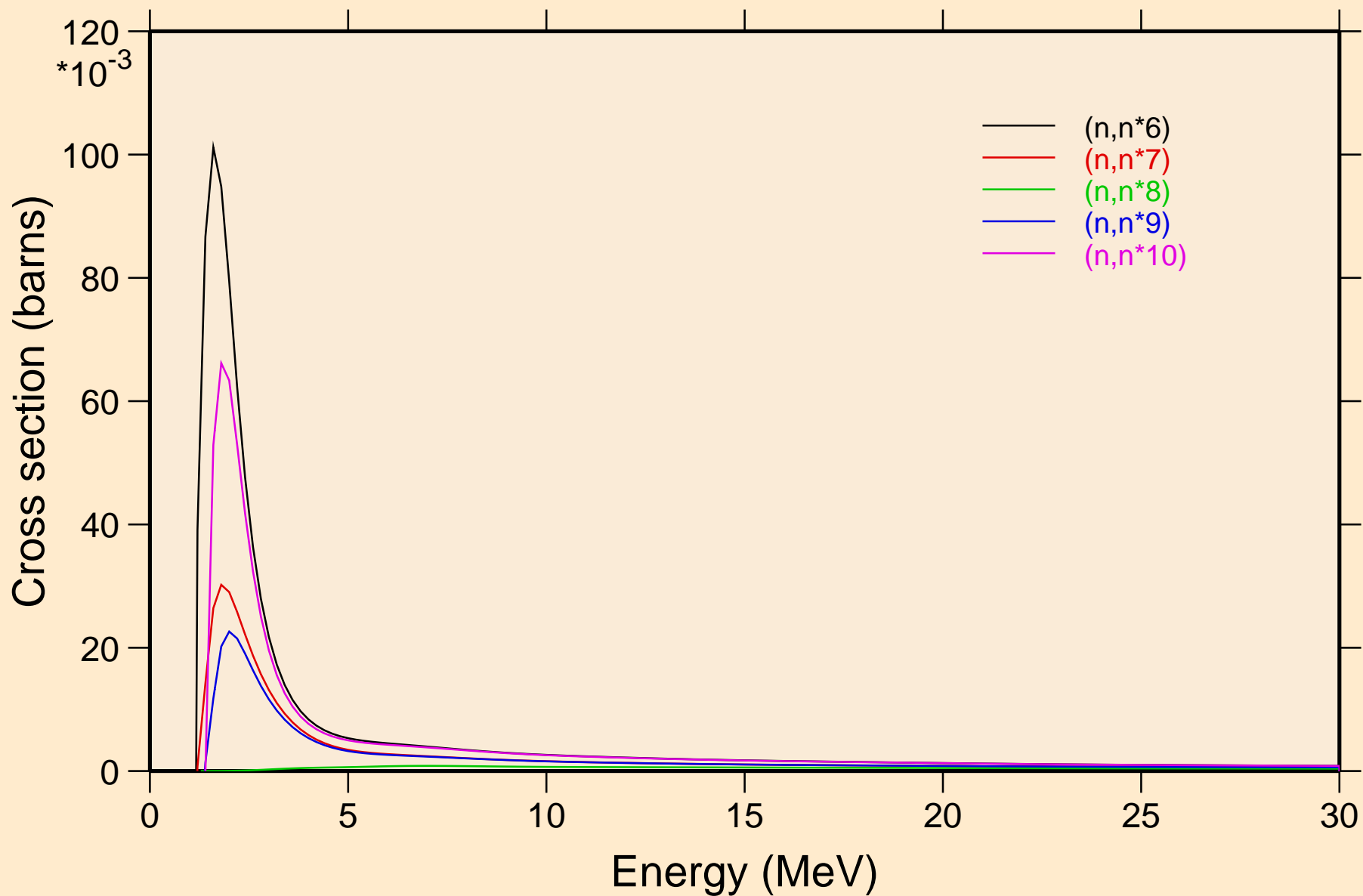

OS182 NEUTRON ACER TENDL-2019 LIBRARY; T=293.16K  
Inelastic levels

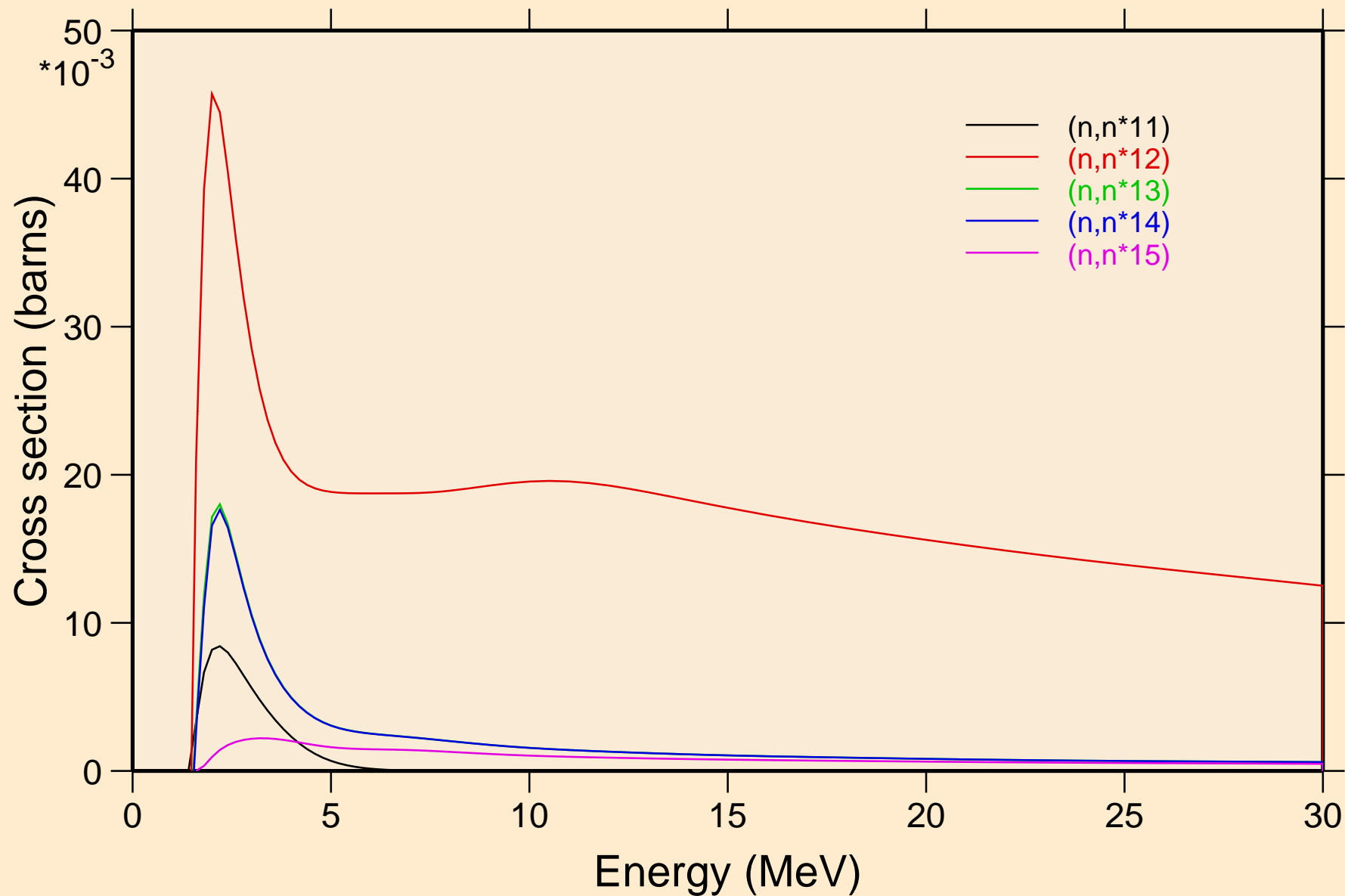

OS182 NEUTRON ACER TENDL-2019 LIBRARY; T=293.16K  
Inelastic levels

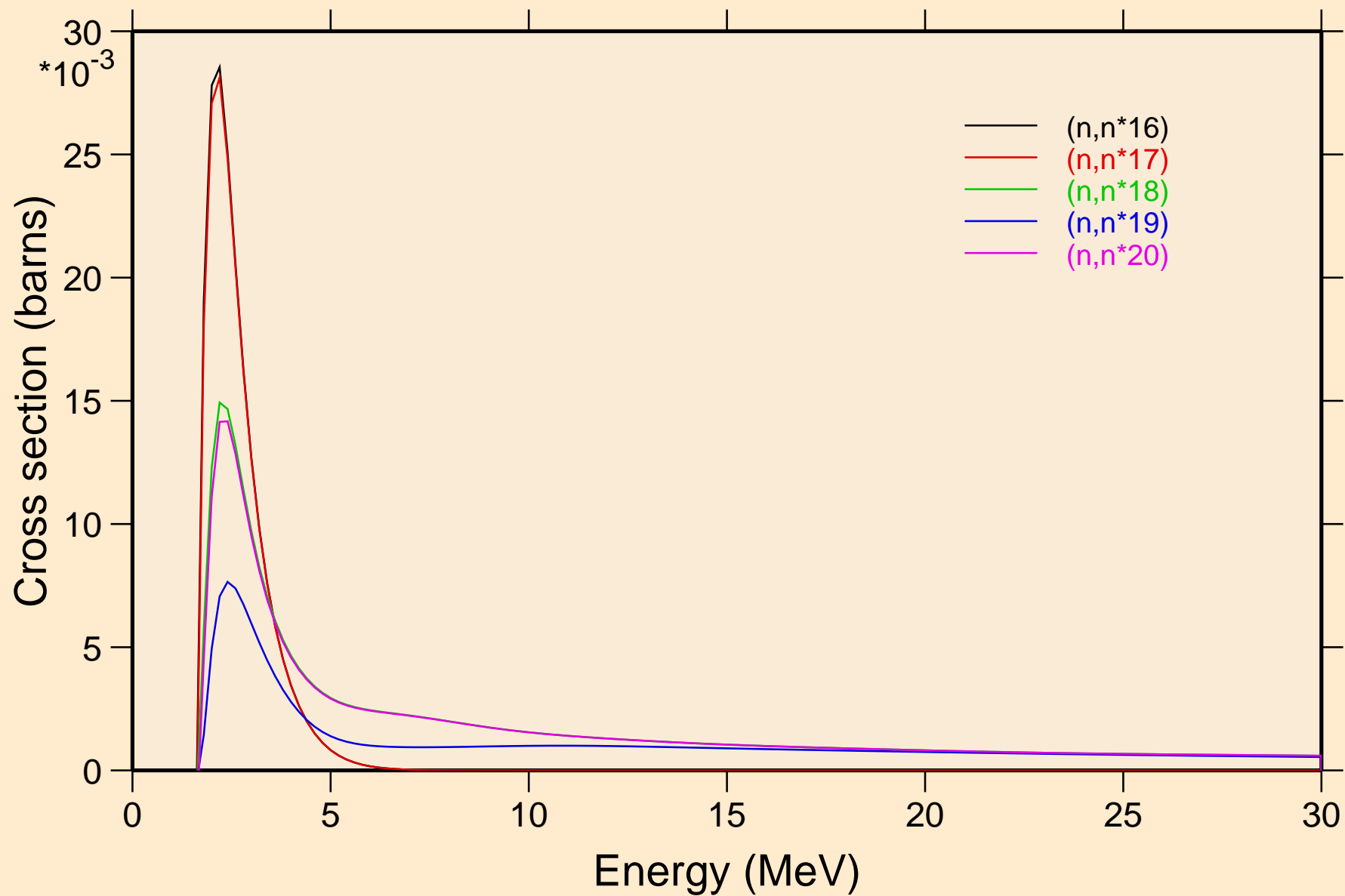

OS182 NEUTRON ACER TENDL-2019 LIBRARY; T=293.16K  
Inelastic levels

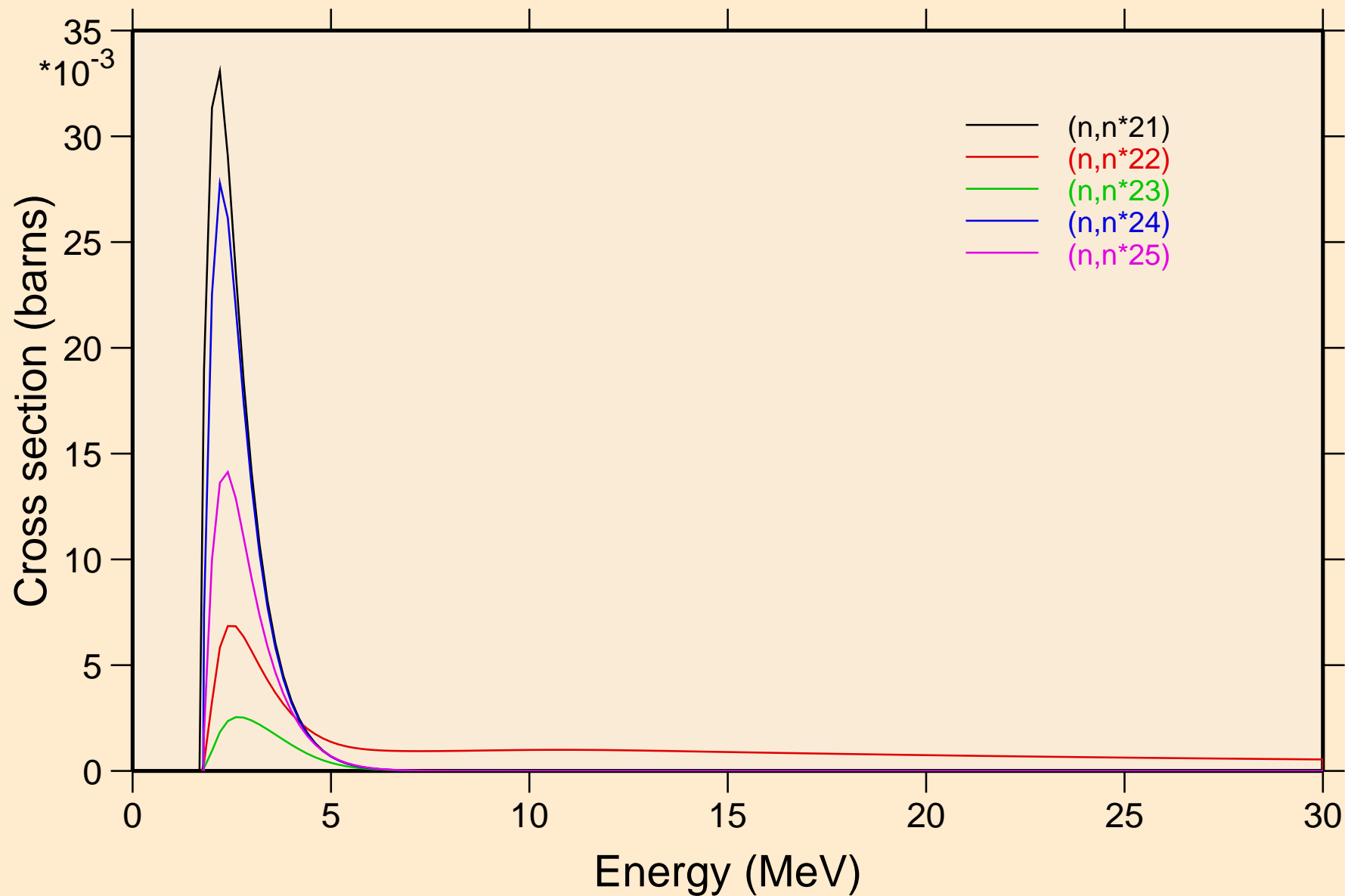

OS182 NEUTRON ACER TENDL-2019 LIBRARY; T=293.16K  
Inelastic levels

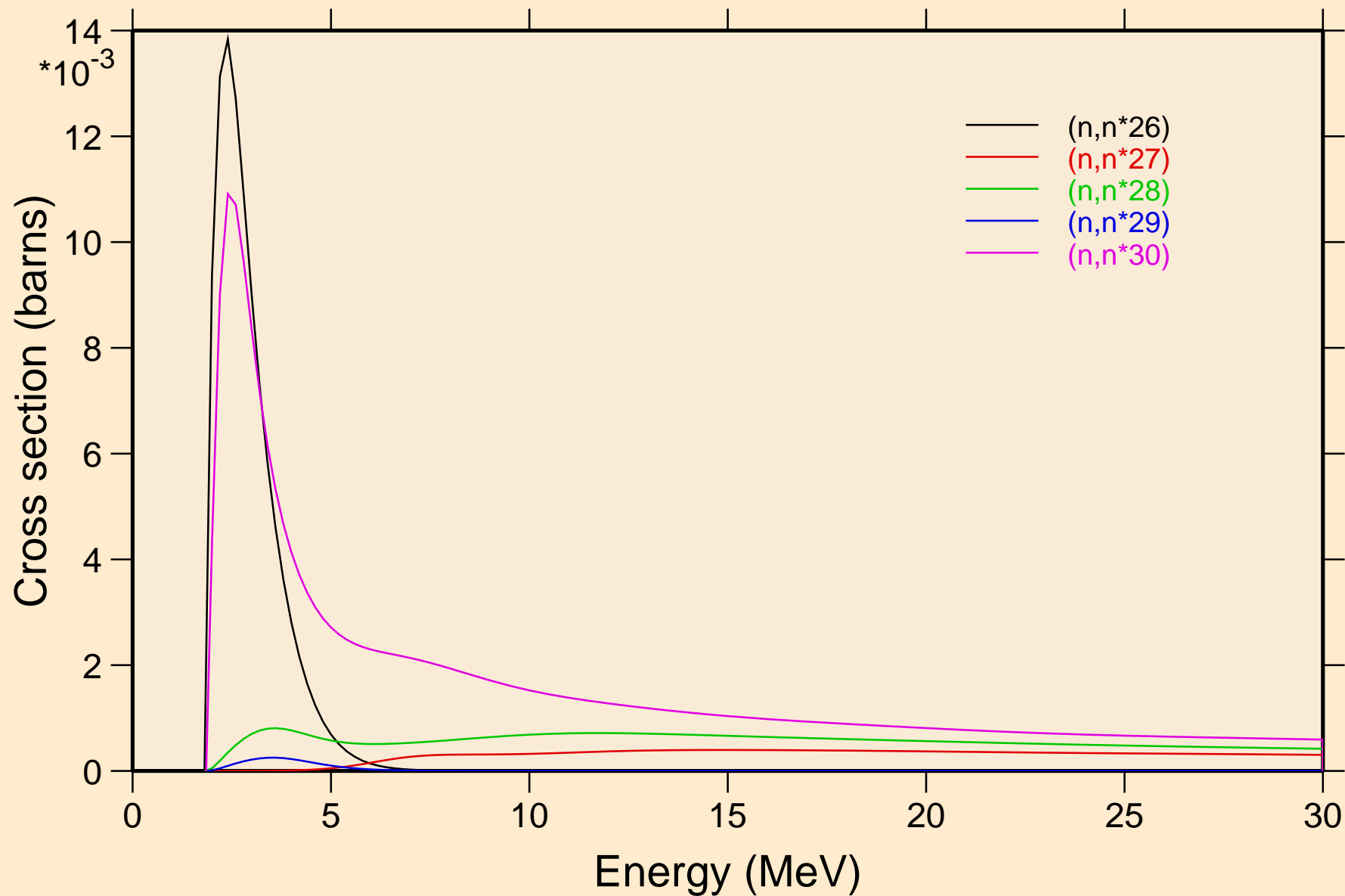

OS182 NEUTRON ACER TENDL-2019 LIBRARY; T=293.16K  
Threshold reactions

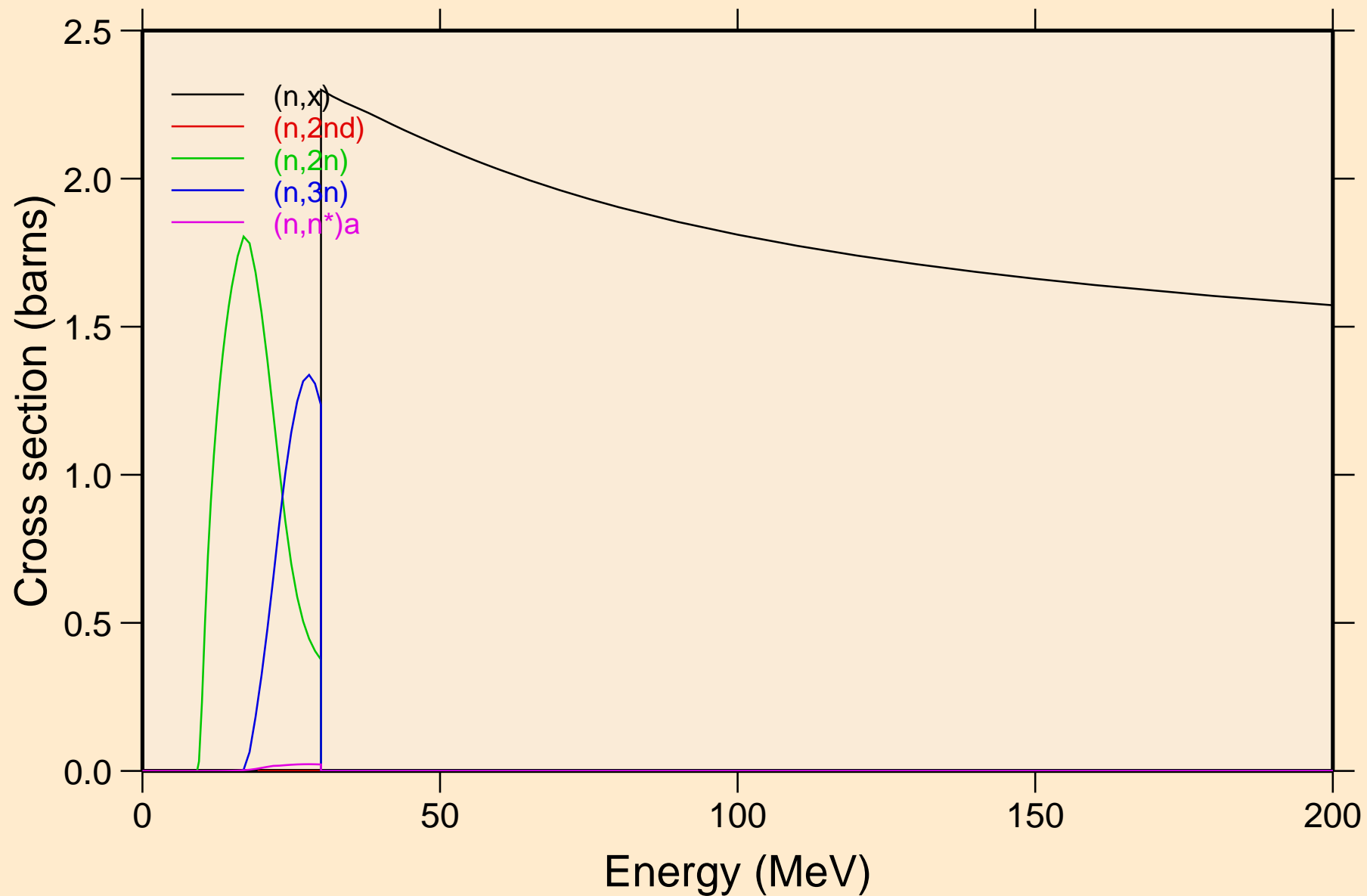

OS182 NEUTRON ACER TENDL-2019 LIBRARY; T=293.16K  
Threshold reactions

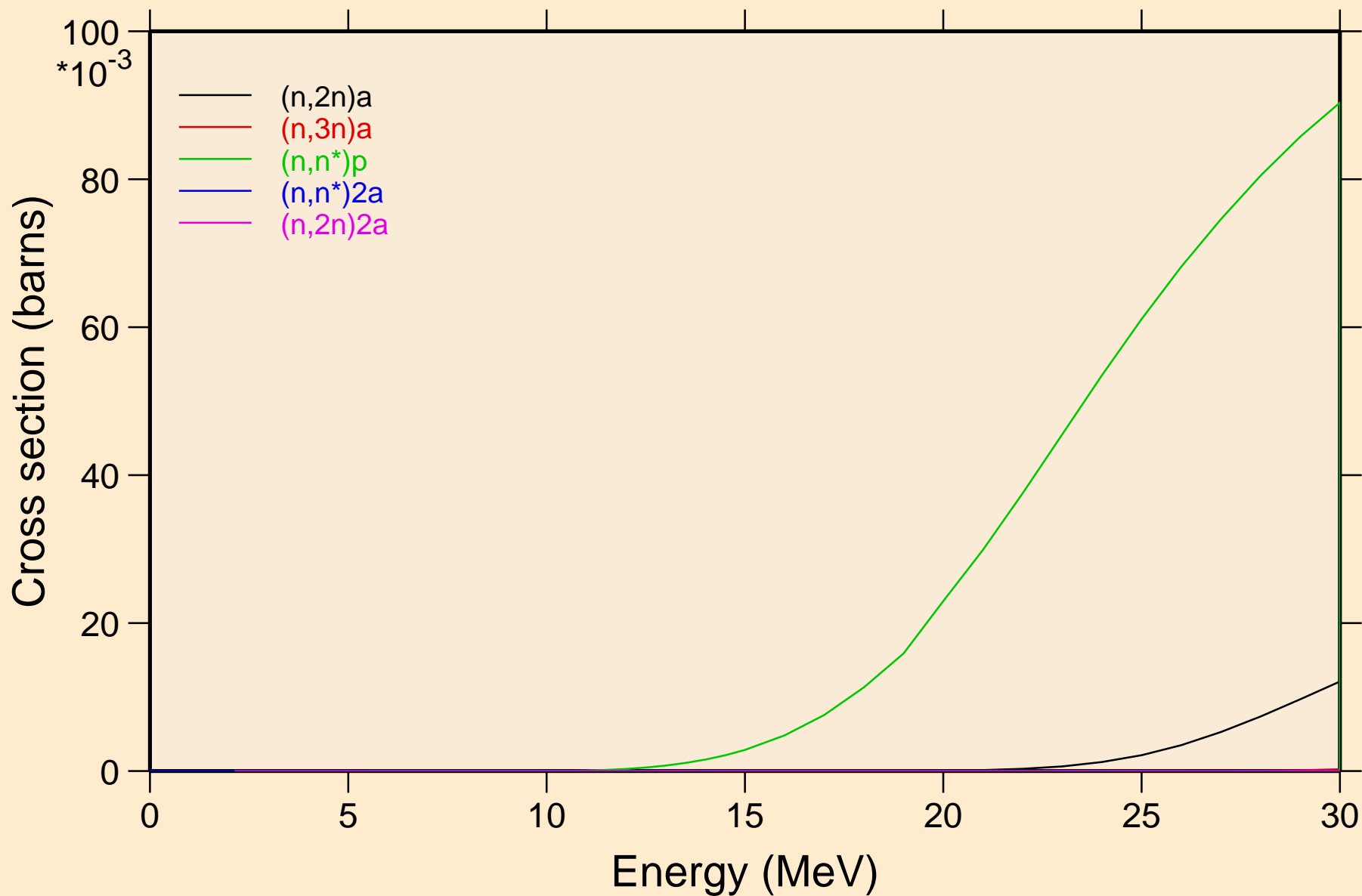



OS182 NEUTRON ACER TENDL-2019 LIBRARY; T=293.16K  
Threshold reactions

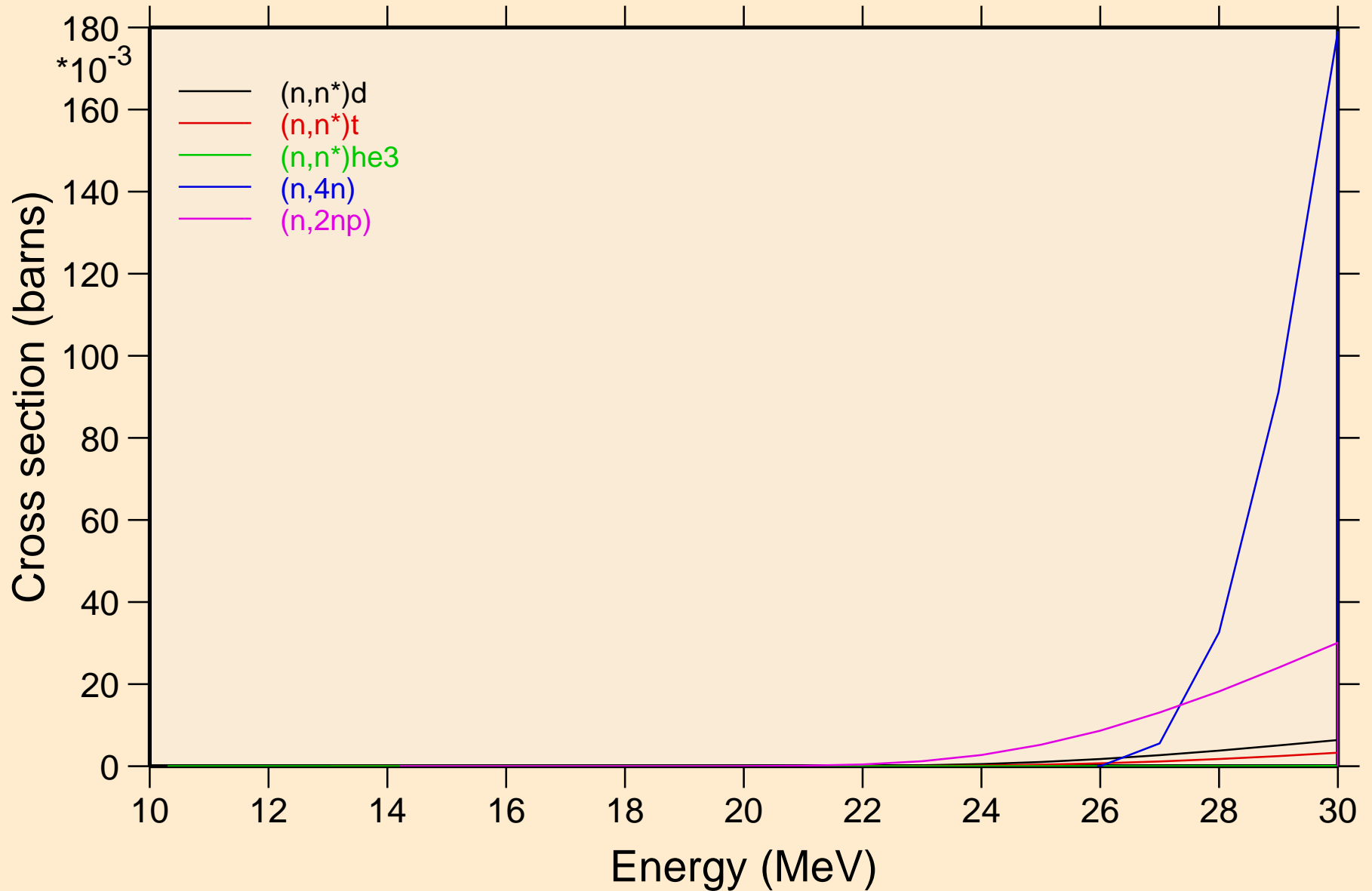

OS182 NEUTRON ACER TENDL-2019 LIBRARY; T=293.16K  
Threshold reactions

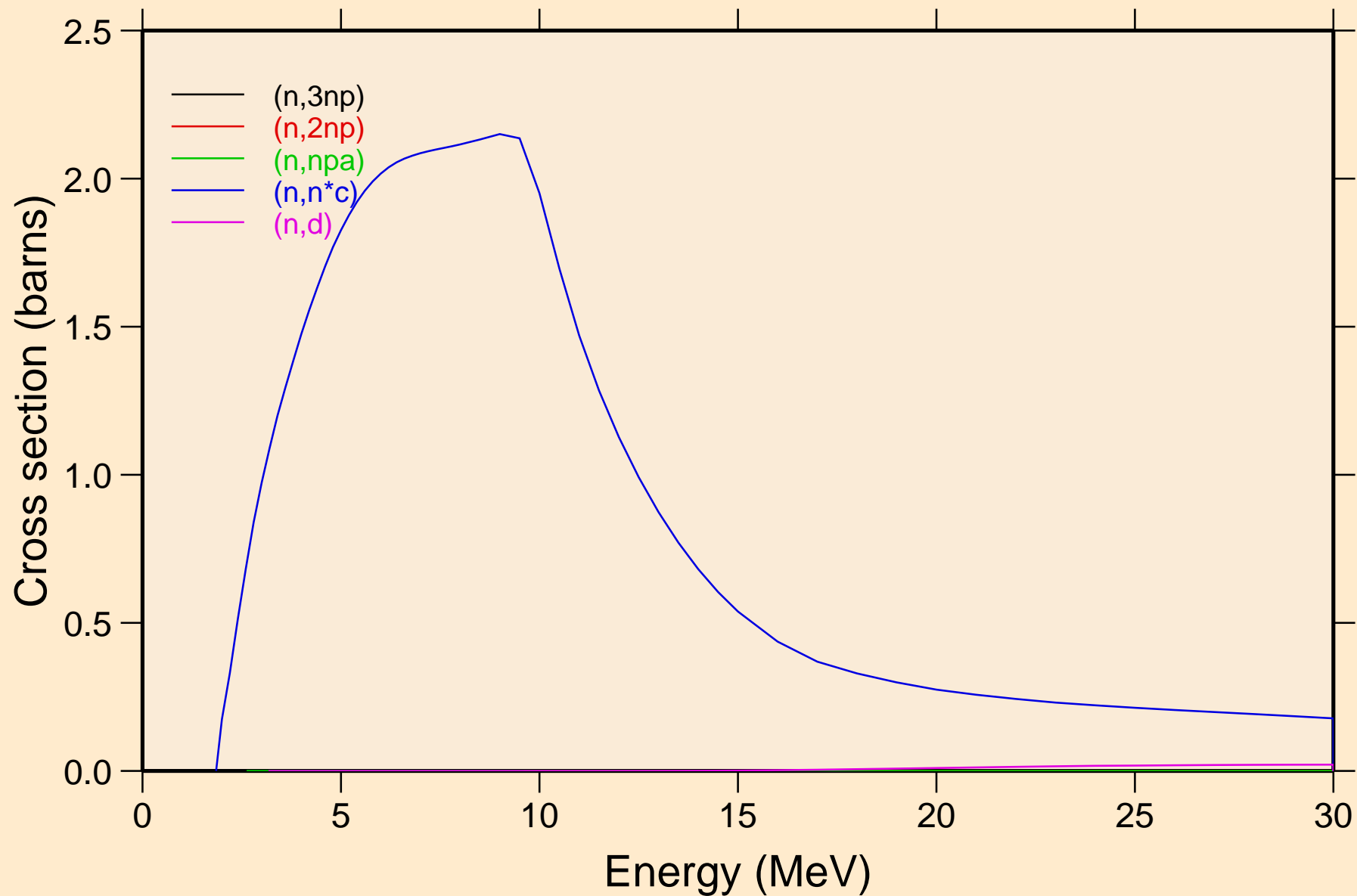

OS182 NEUTRON ACER TENDL-2019 LIBRARY; T=293.16K  
Threshold reactions

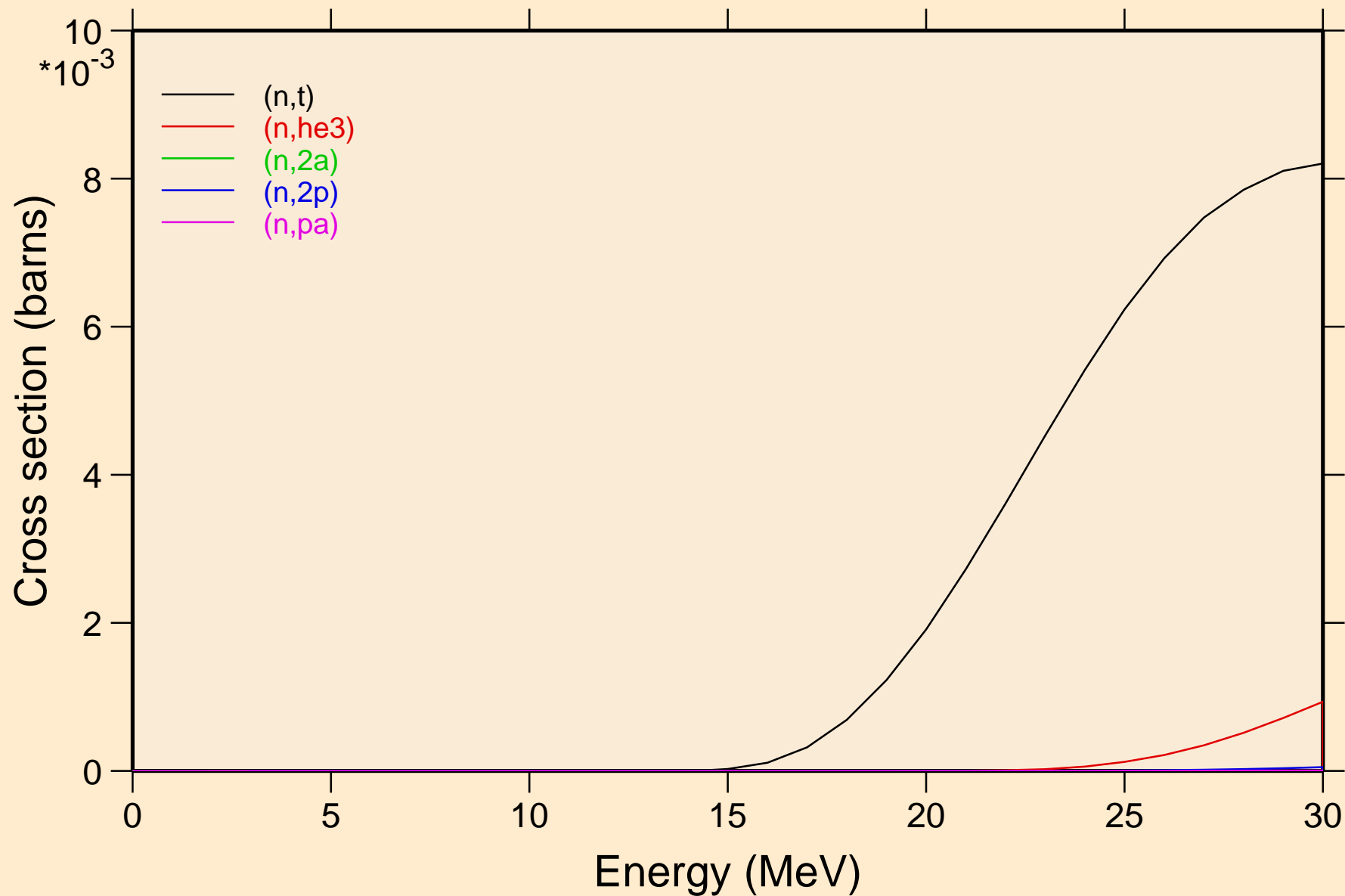

OS182 NEUTRON ACER TENDL-2019 LIBRARY; T=293.16K  
Threshold reactions

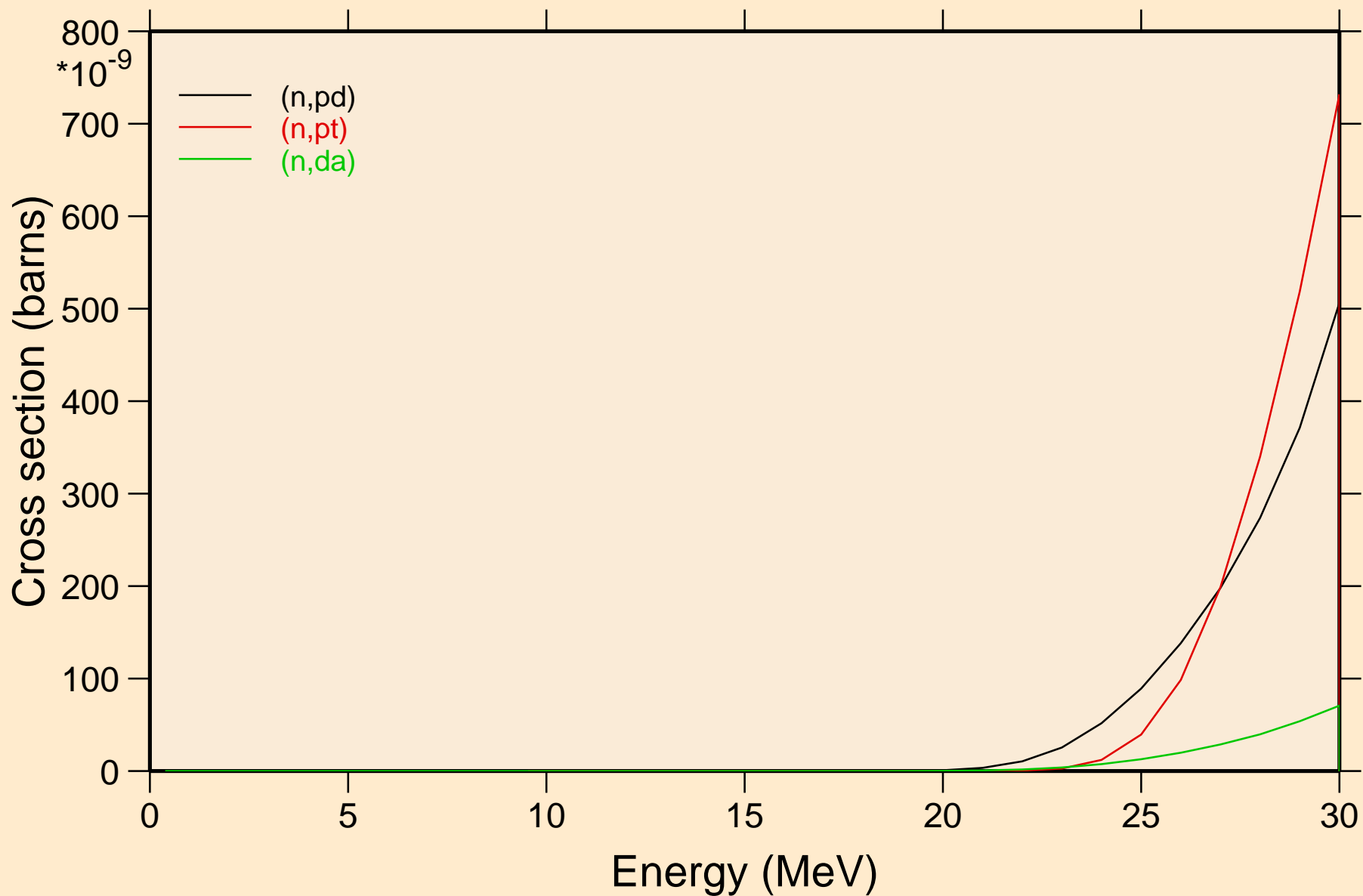

OS182 NEUTRON ACER TENDL-2019 LIBRARY; T=293.16K  
Threshold reactions

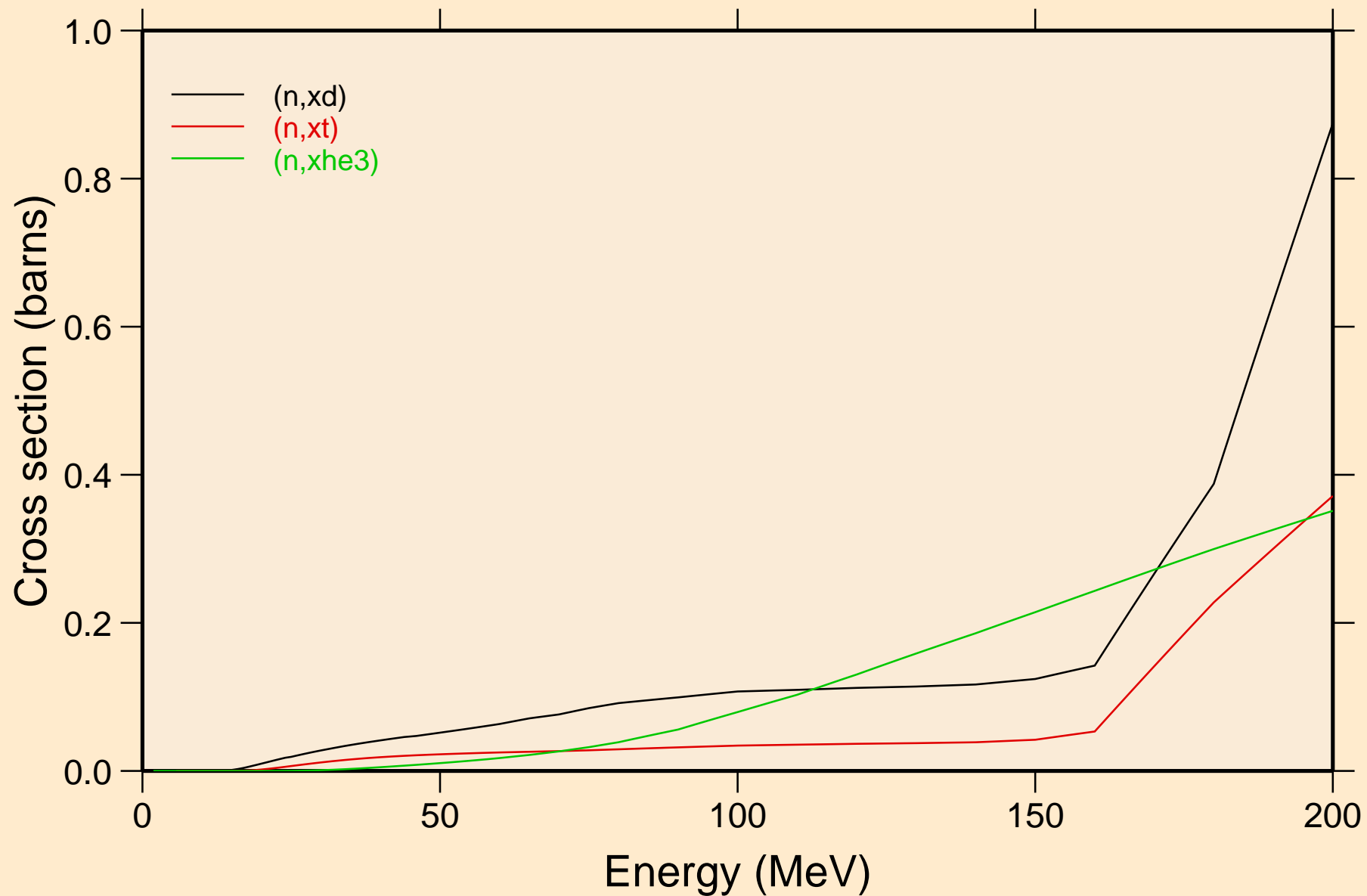

OS182 NEUTRON ACER TENDL-2019 LIBRARY; T=293.16K  
angular distribution for elastic

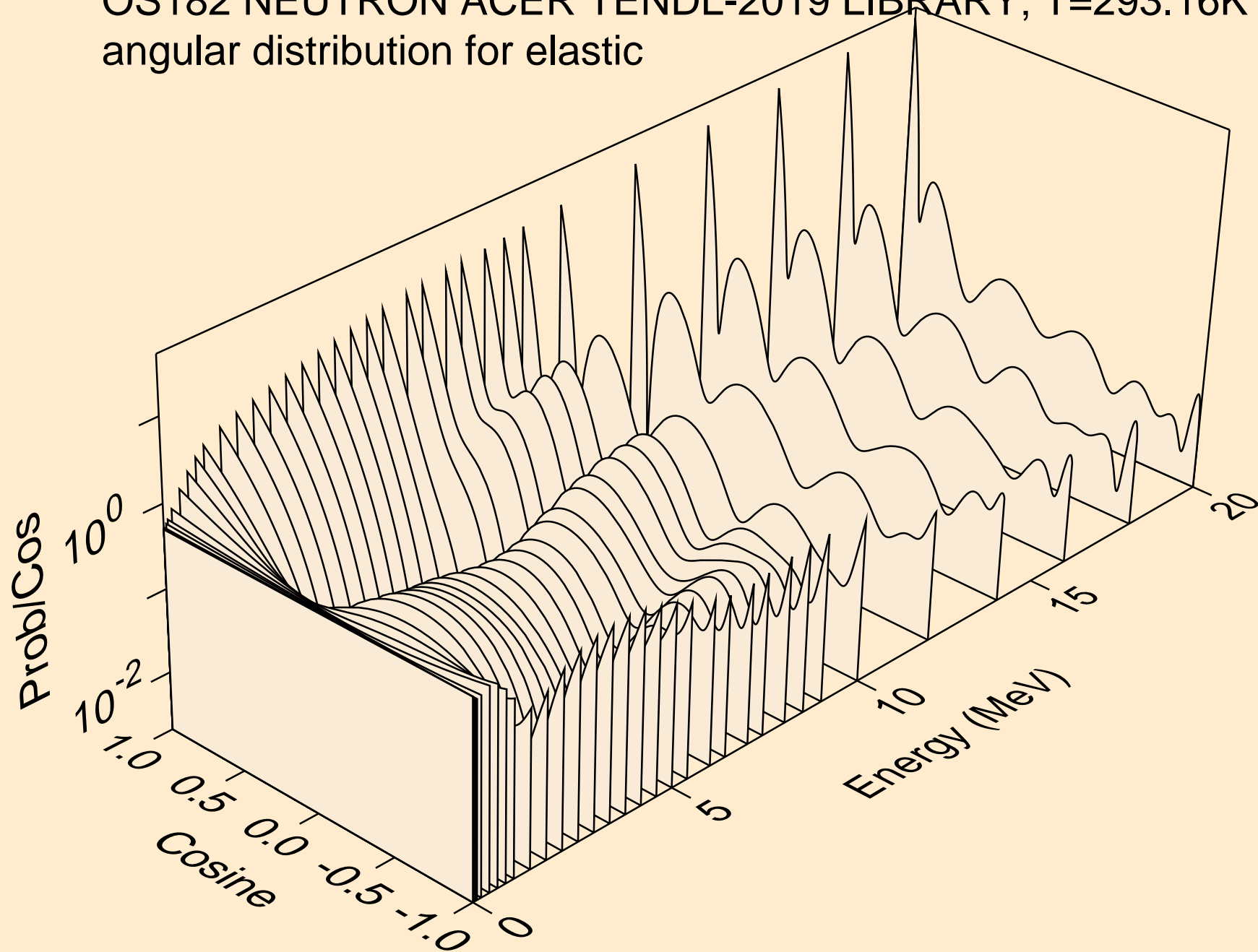

OS182 NEUTRON ACER TENDL-2019 LIBRARY; T=293.16K  
angular distribution for elastic

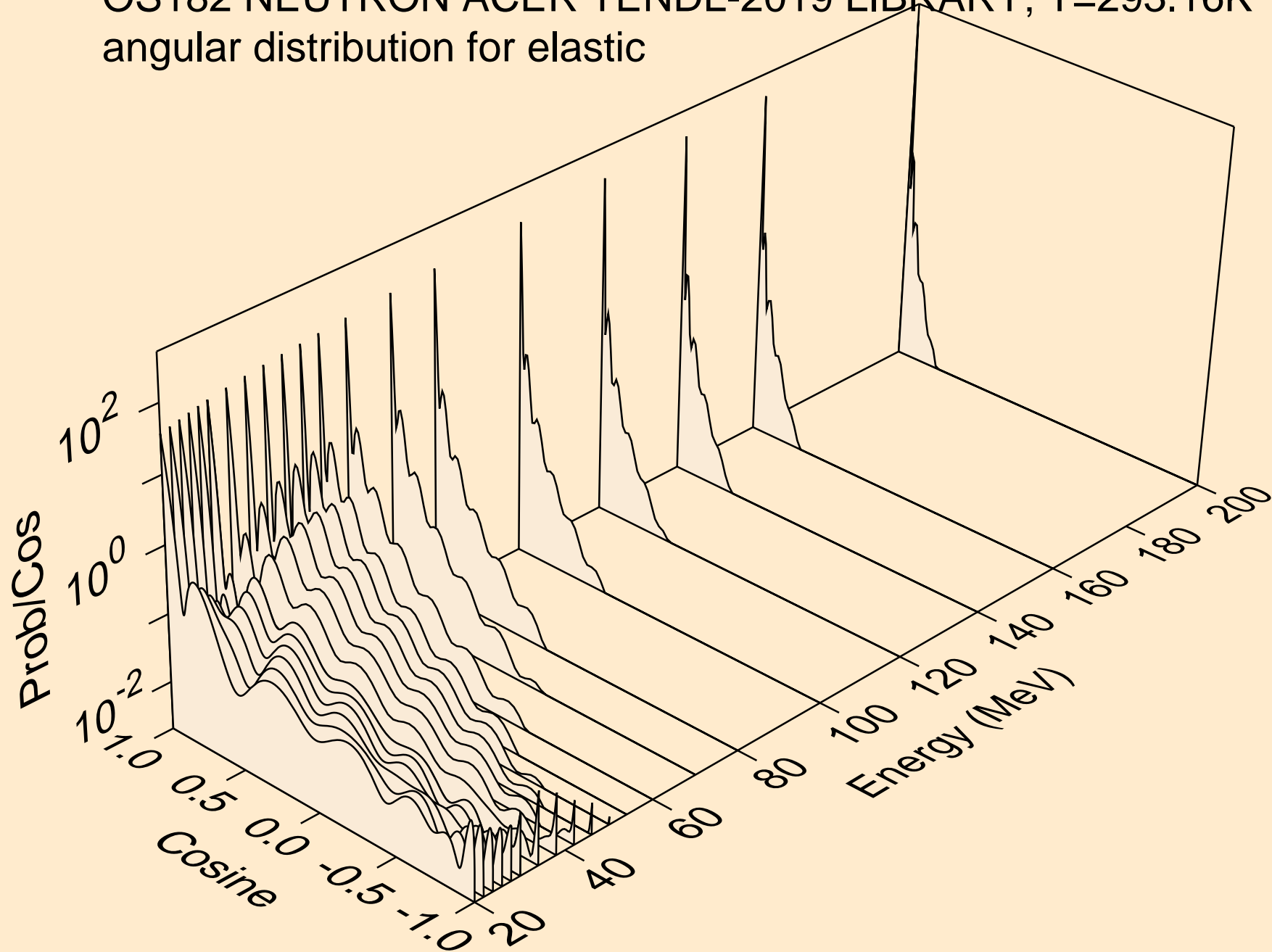

OS182 NEUTRON ACER TENDL-2019 LIBRARY; T=293.16K  
angular distribution for (n,n\*1)

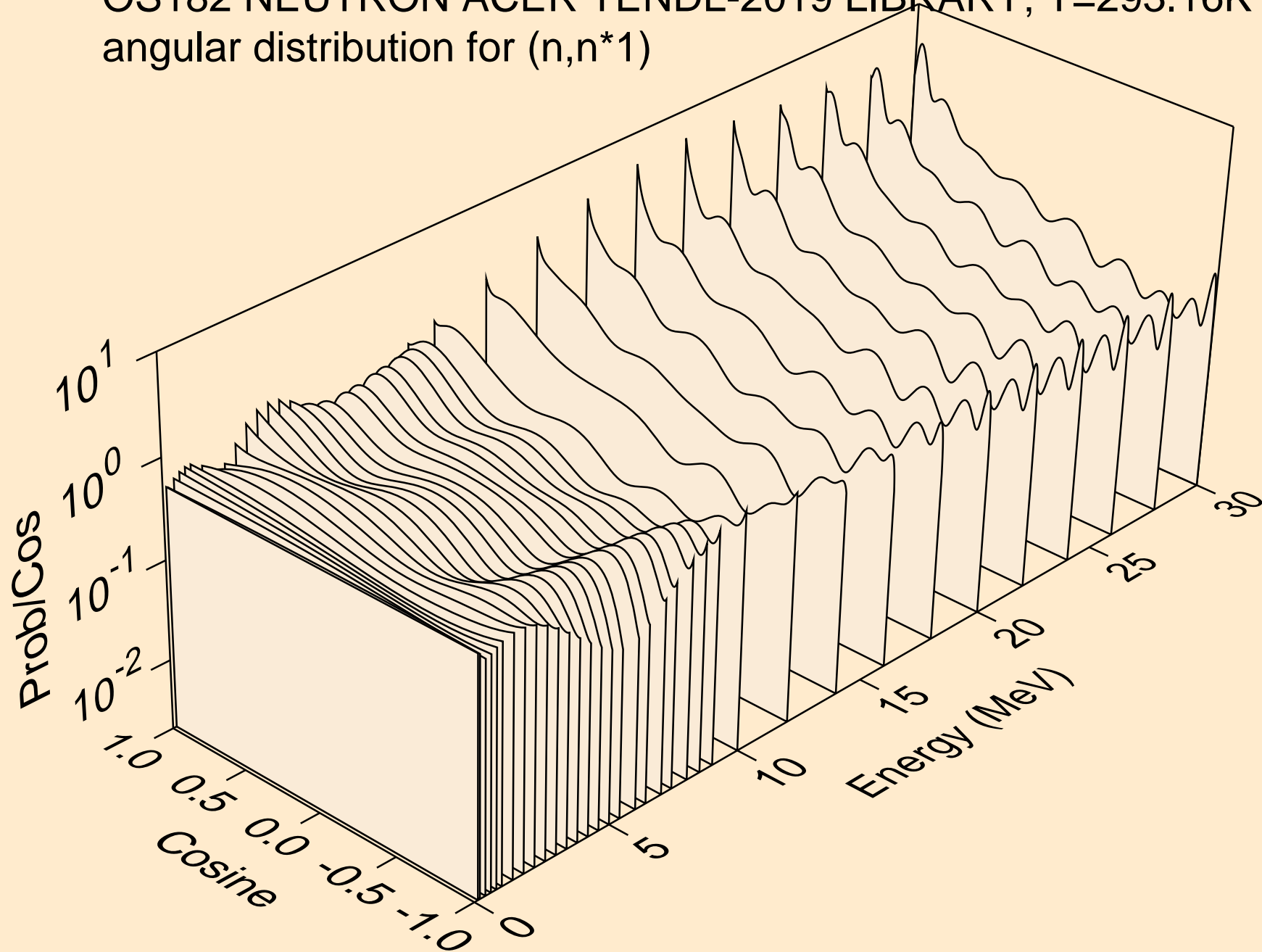



OS182 NEUTRON ACER TENDL-2019 LIBRARY; T=293.16K  
angular distribution for (n,n\*2)

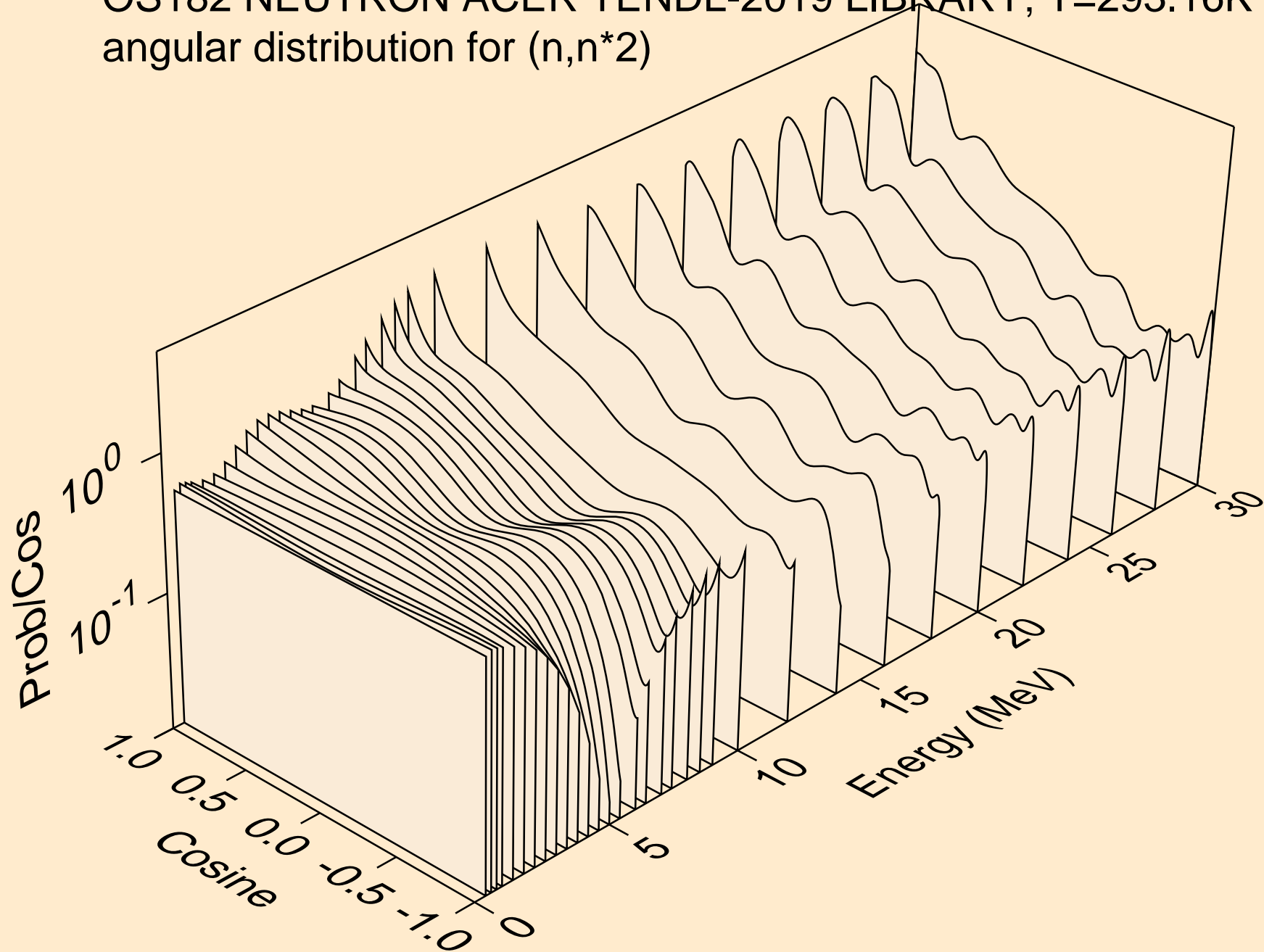

OS182 NEUTRON ACER TENDL-2019 LIBRARY; T=293.16K  
angular distribution for (n,n\*3)

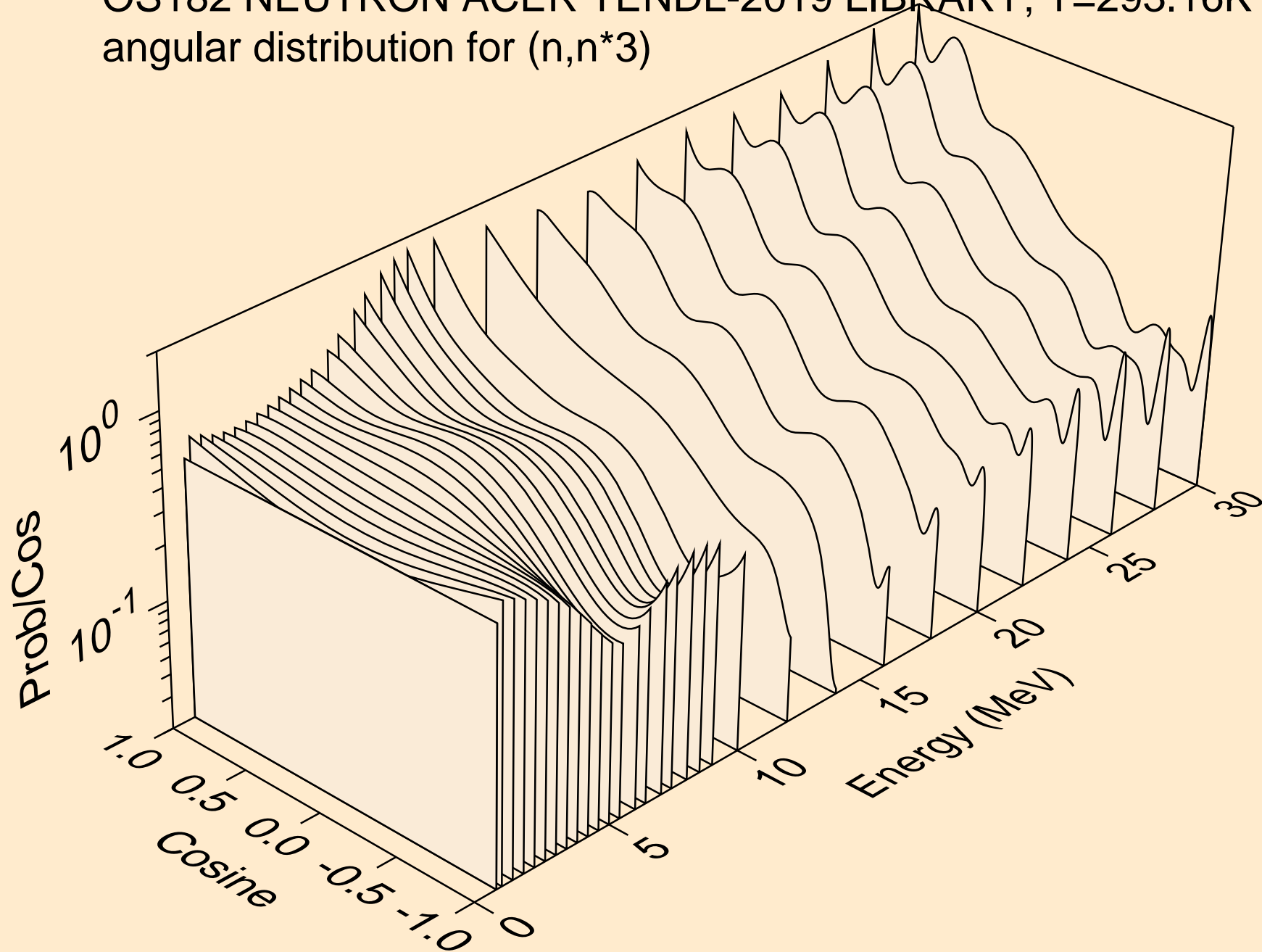

OS182 NEUTRON ACER TENDL-2019 LIBRARY; T=293.16K  
angular distribution for (n,n\*4)

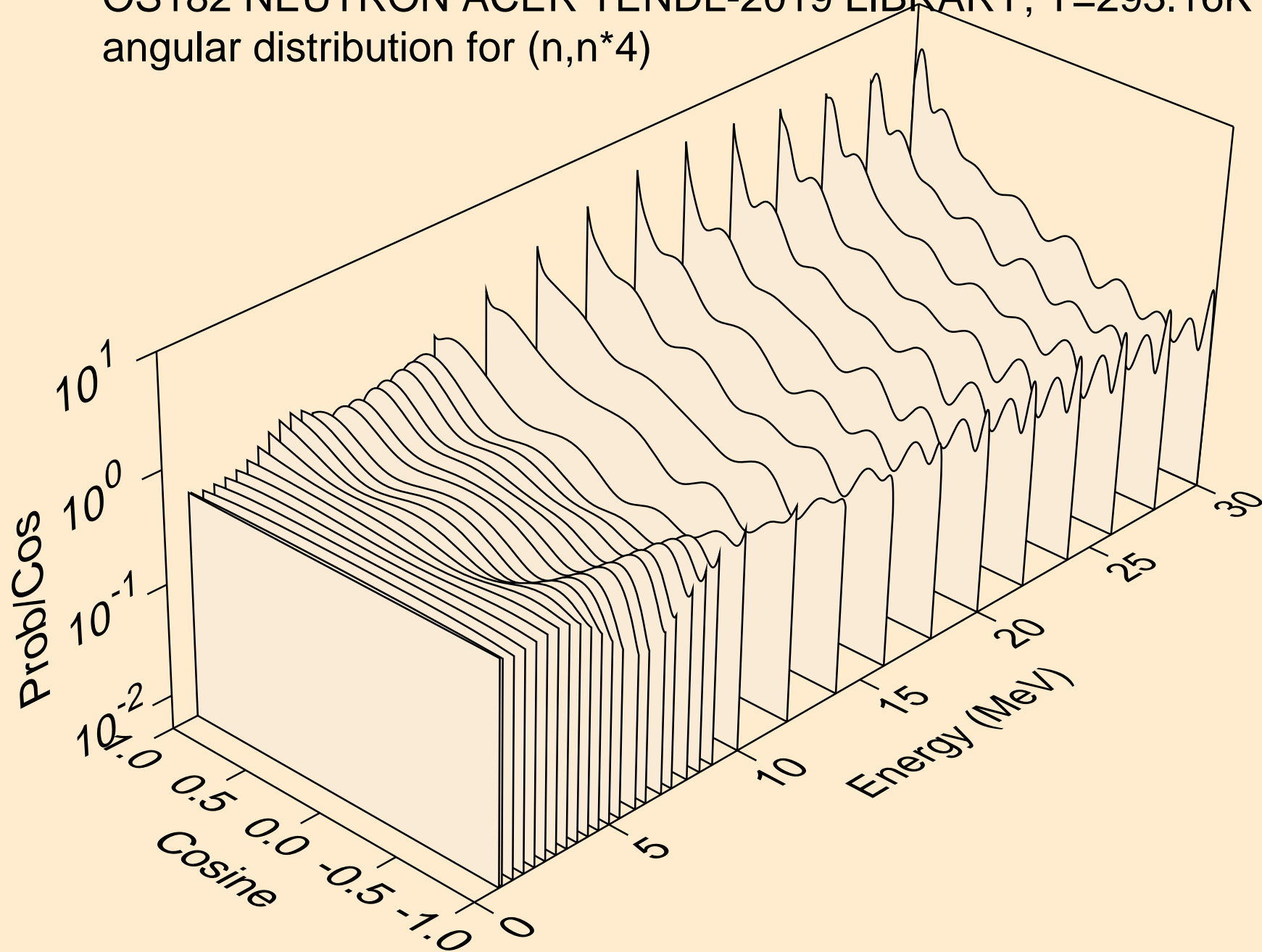

OS182 NEUTRON ACER TENDL-2019 LIBRARY; T=293.16K  
angular distribution for (n,n\*5)

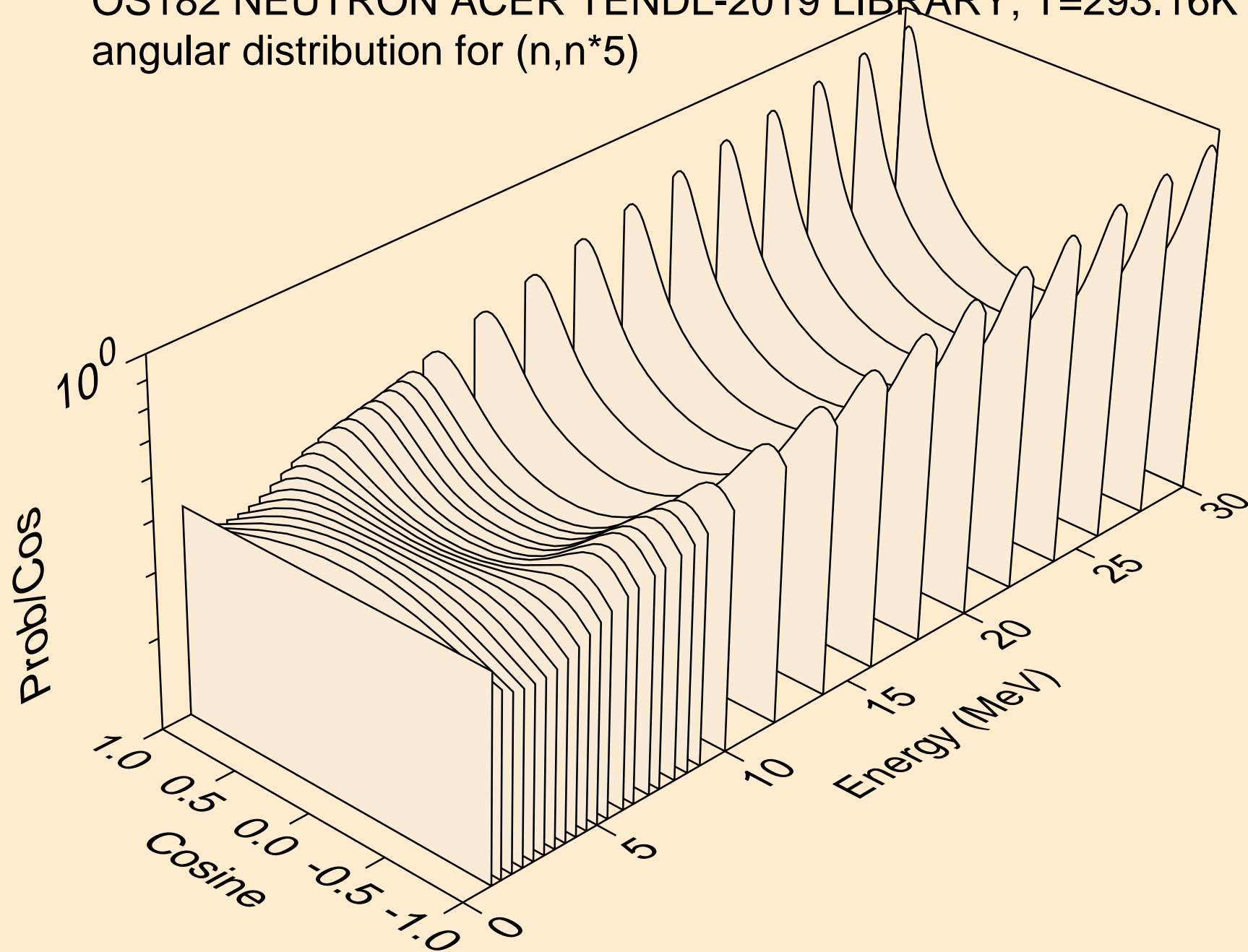

OS182 NEUTRON ACER TENDL-2019 LIBRARY; T=293.16K  
angular distribution for (n,n\*6)

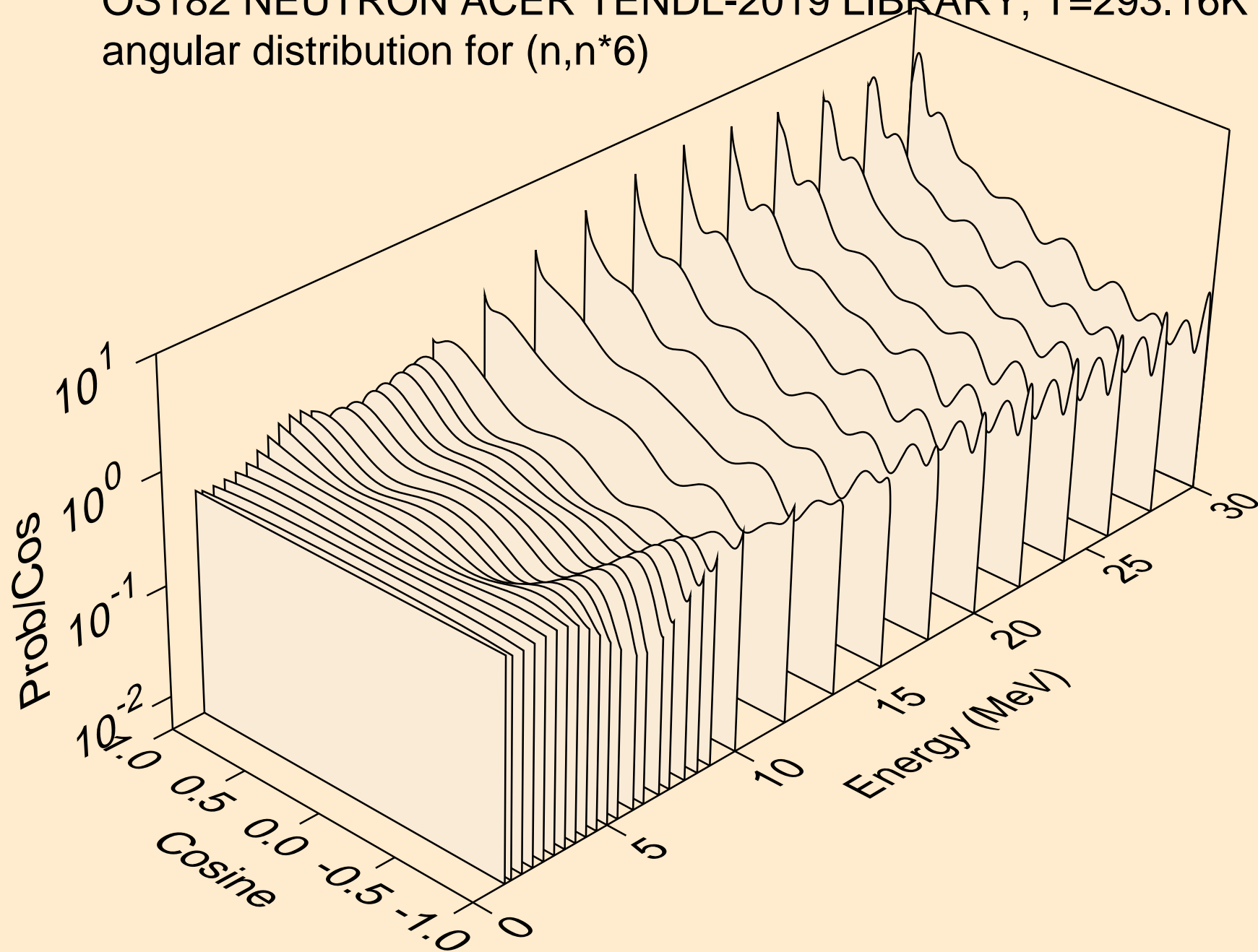

OS182 NEUTRON ACER TENDL-2019 LIBRARY; T=293.16K  
angular distribution for (n,n\*7)

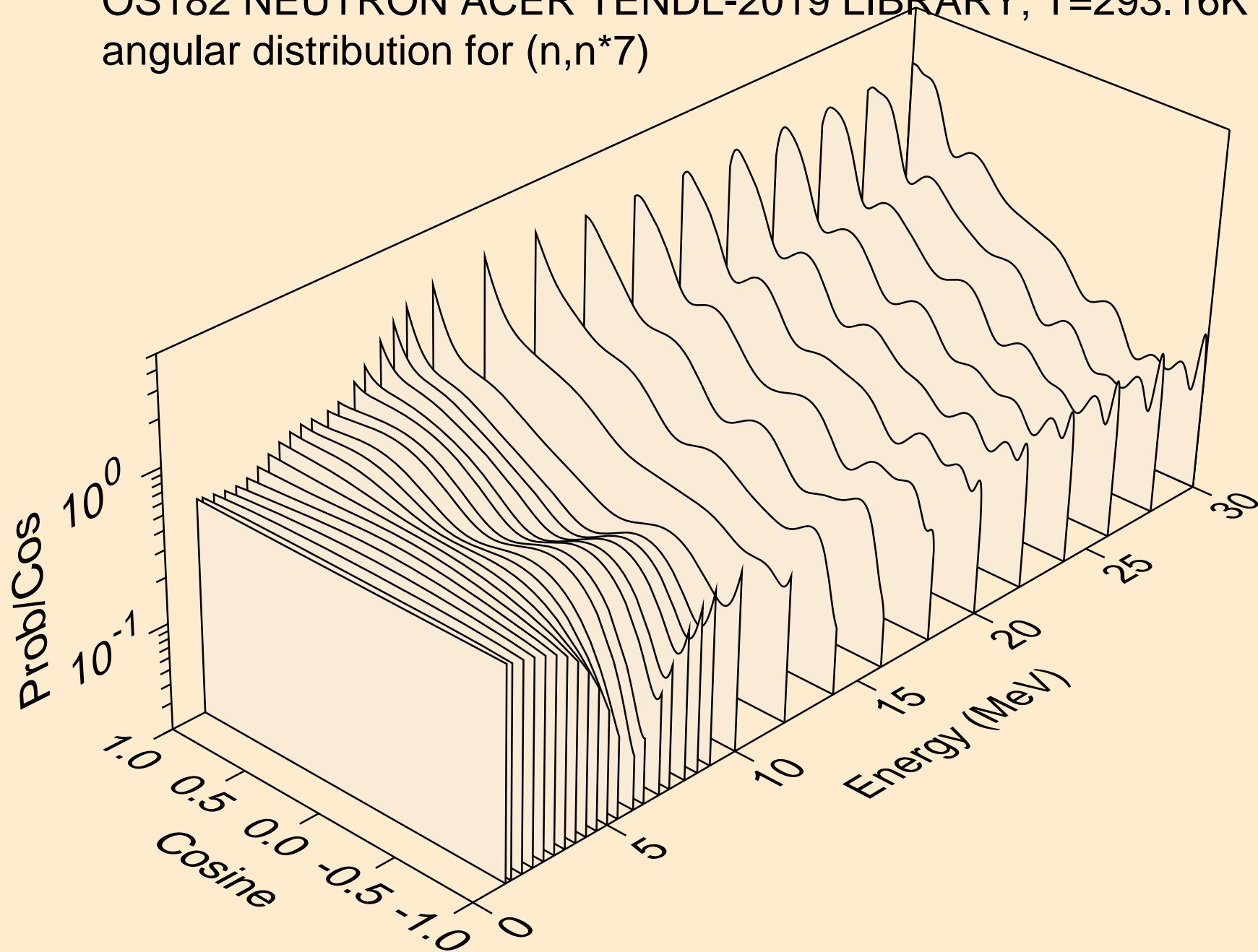

OS182 NEUTRON ACER TENDL-2019 LIBRARY; T=293.16K  
angular distribution for (n,n\*8)

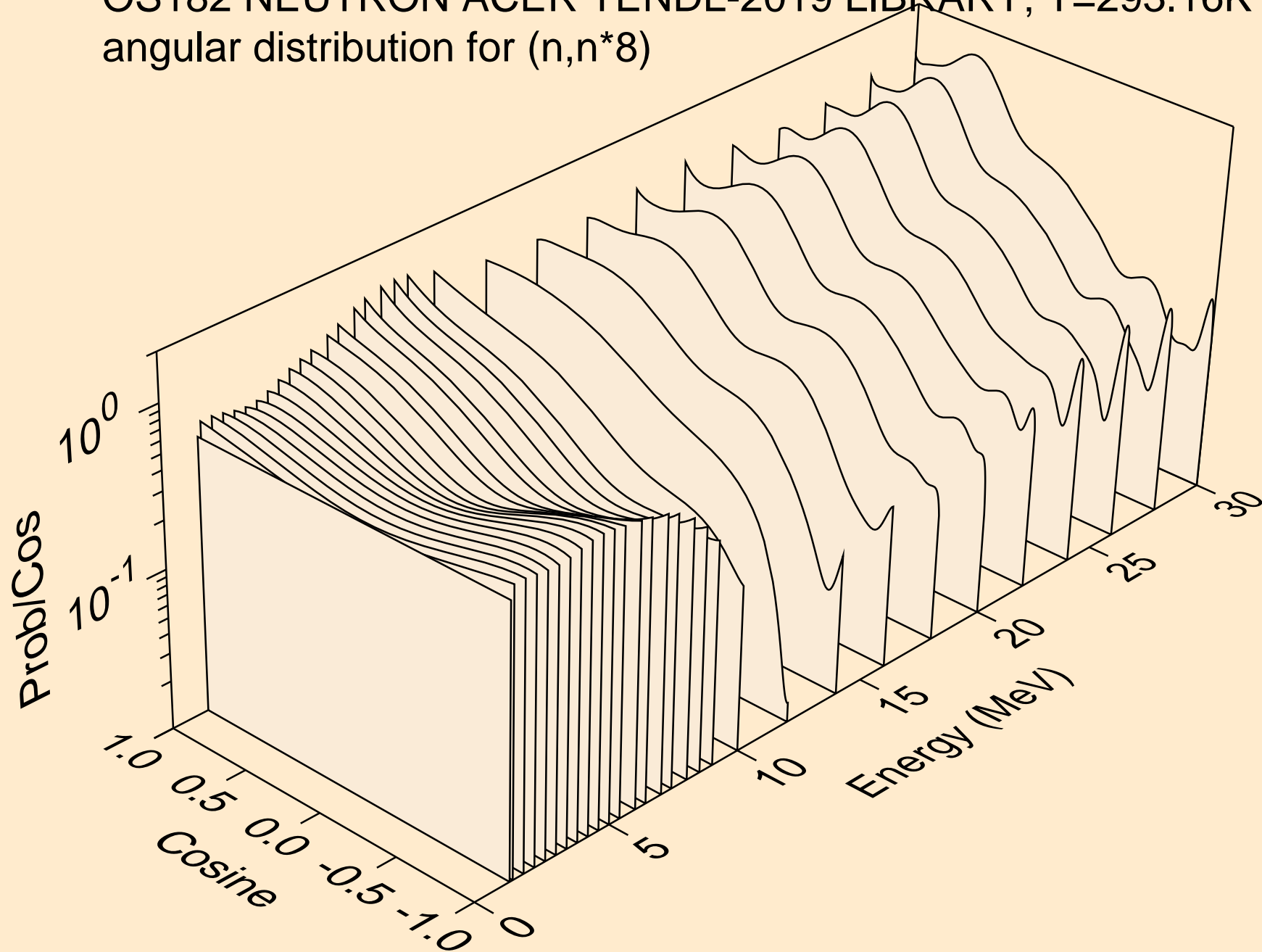

OS182 NEUTRON ACER TENDL-2019 LIBRARY; T=293.16K  
angular distribution for (n,n\*9)

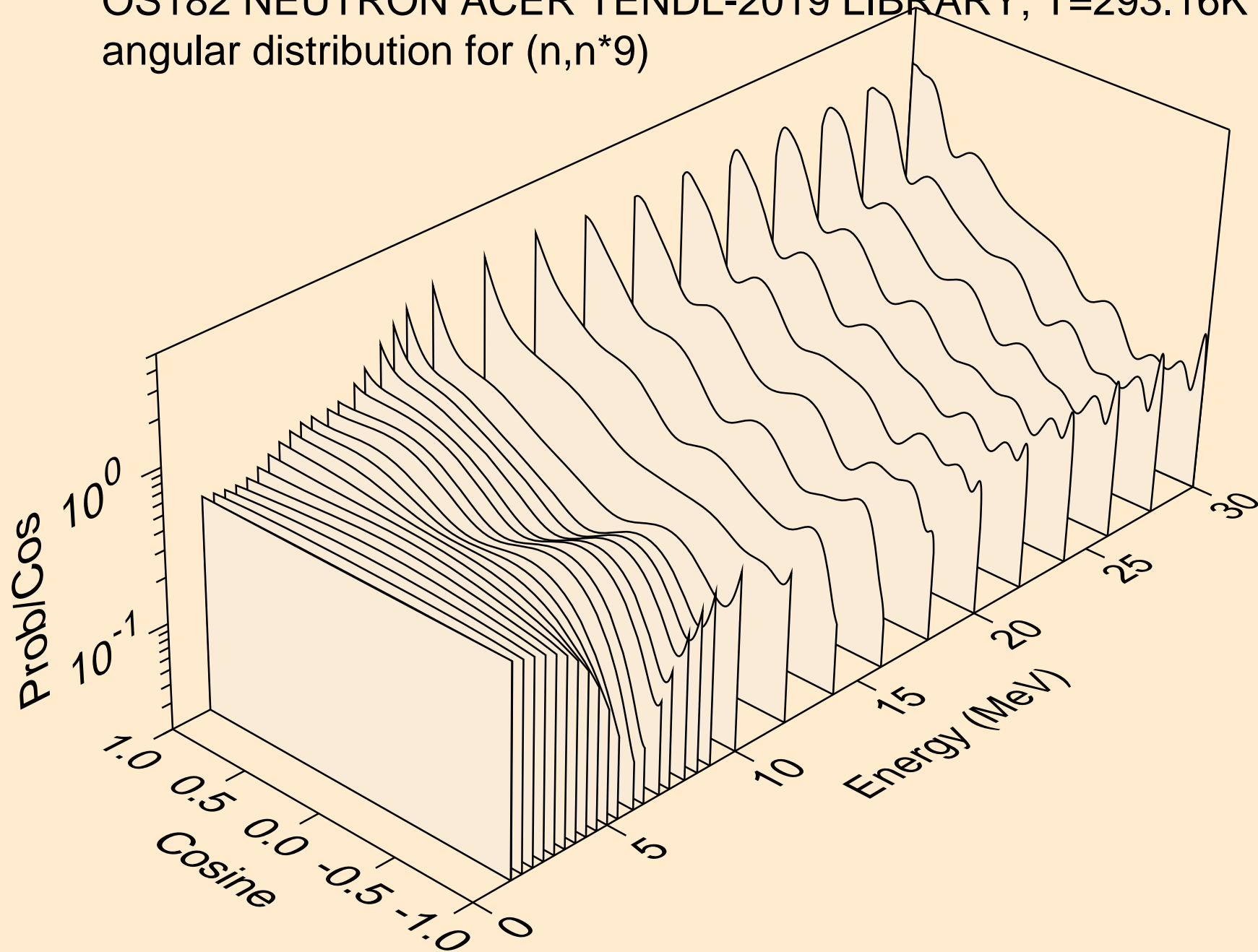



OS182 NEUTRON ACER TENDL-2019 LIBRARY; T=293.16K  
angular distribution for (n,n\*10)

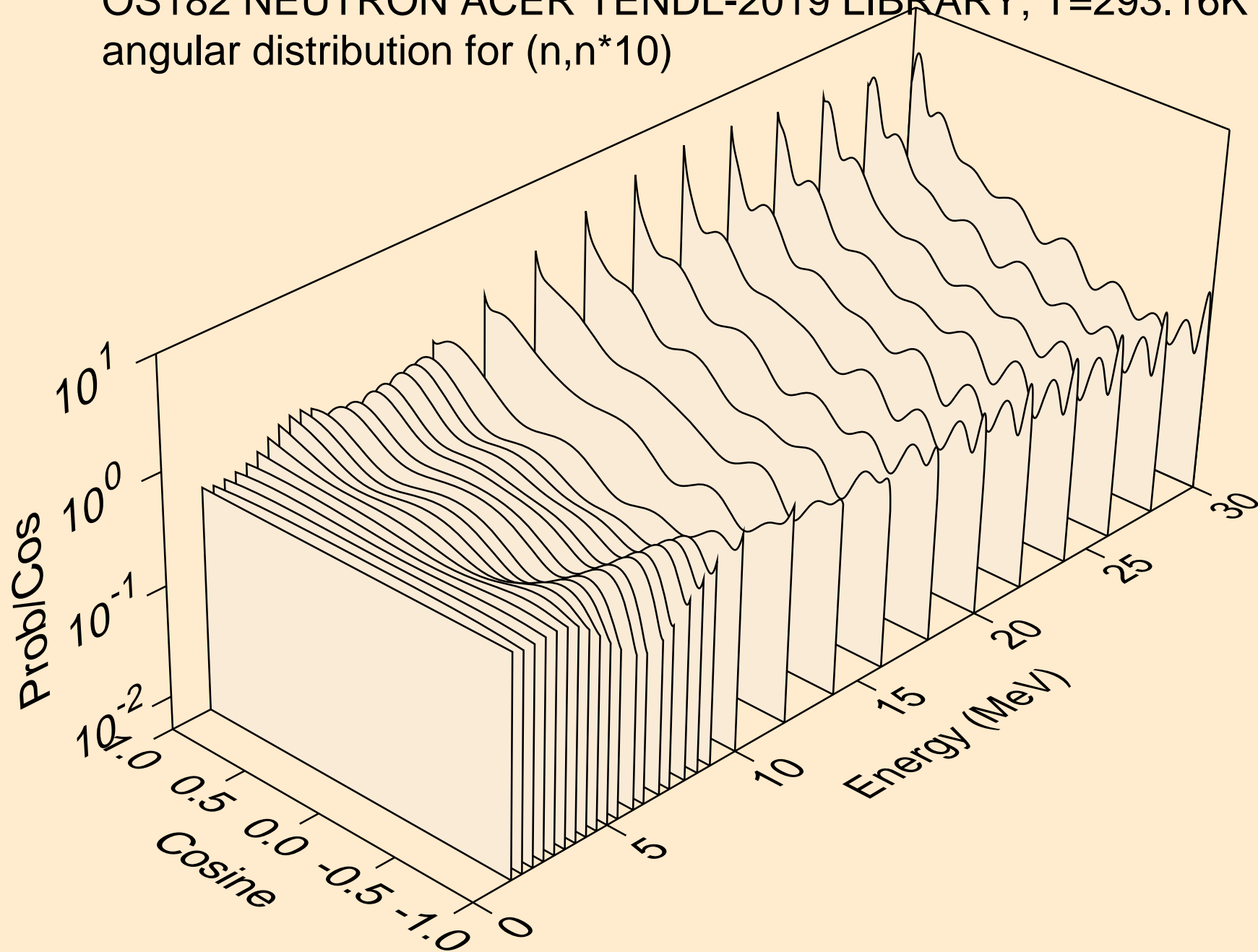

OS182 NEUTRON ACER TENDL-2019 LIBRARY; T=293.16K  
angular distribution for (n,n\*11)

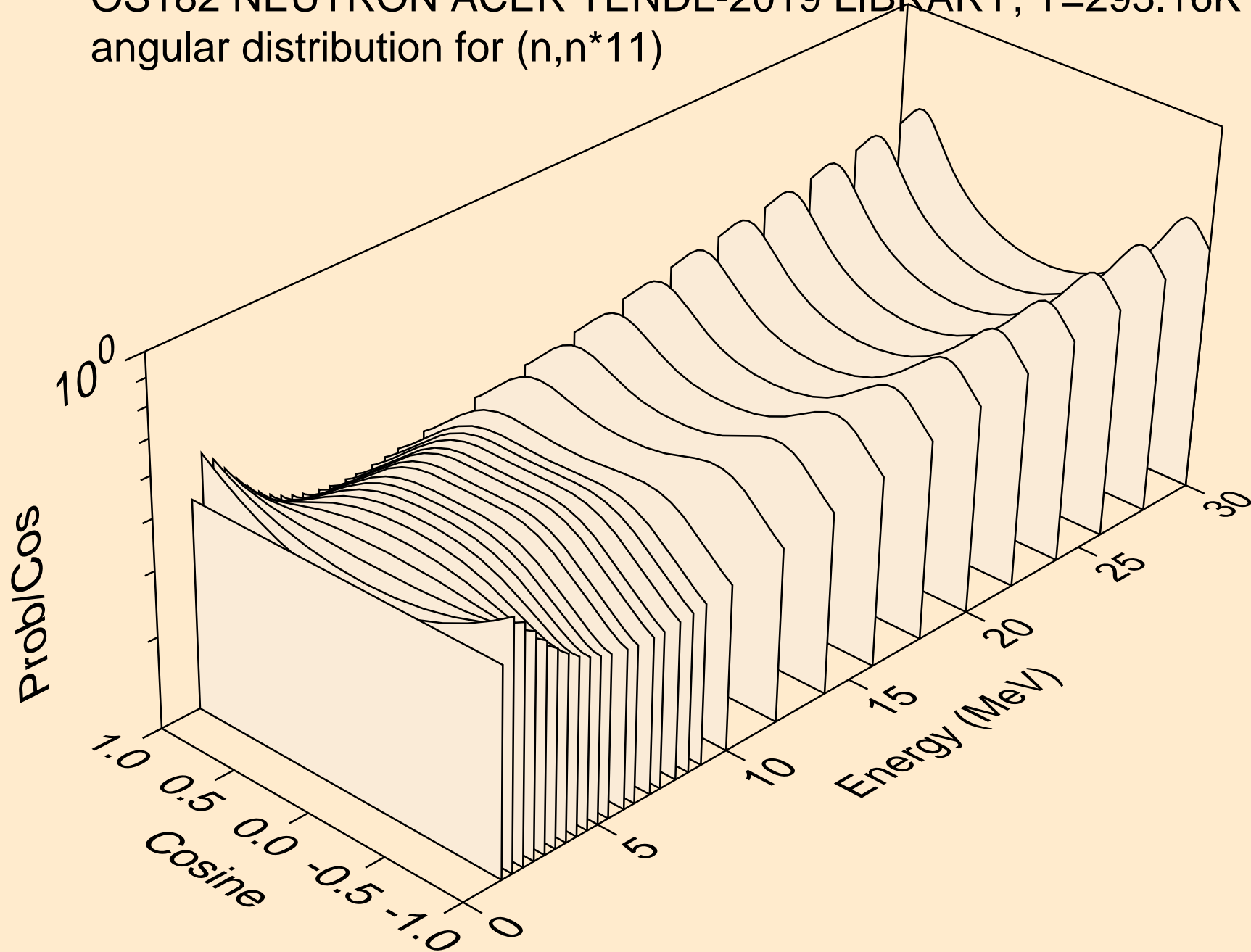

OS182 NEUTRON ACER TENDL-2019 LIBRARY; T=293.16K  
angular distribution for (n,n\*12)

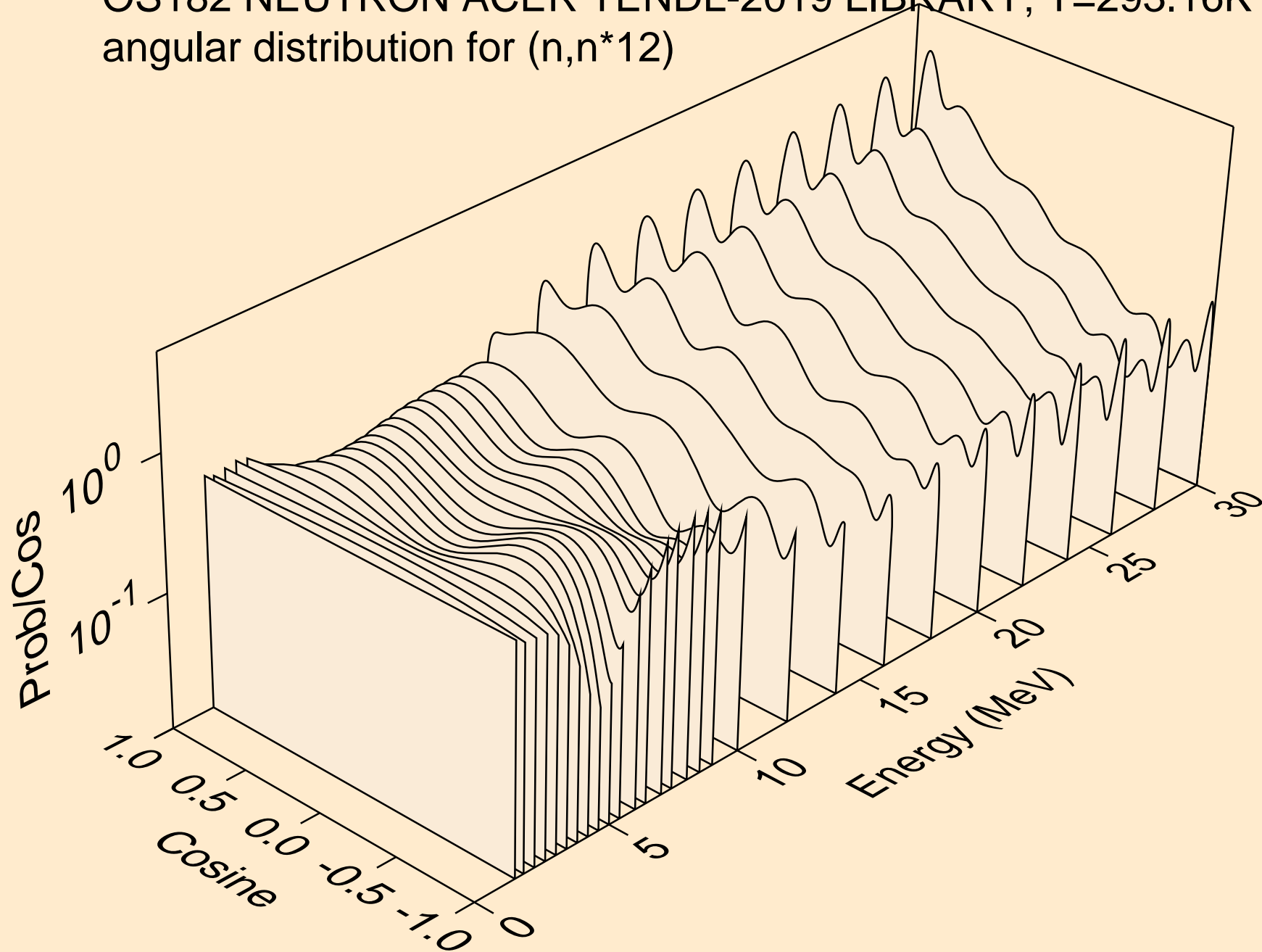

OS182 NEUTRON ACER TENDL-2019 LIBRARY; T=293.16K  
angular distribution for (n,n\*13)

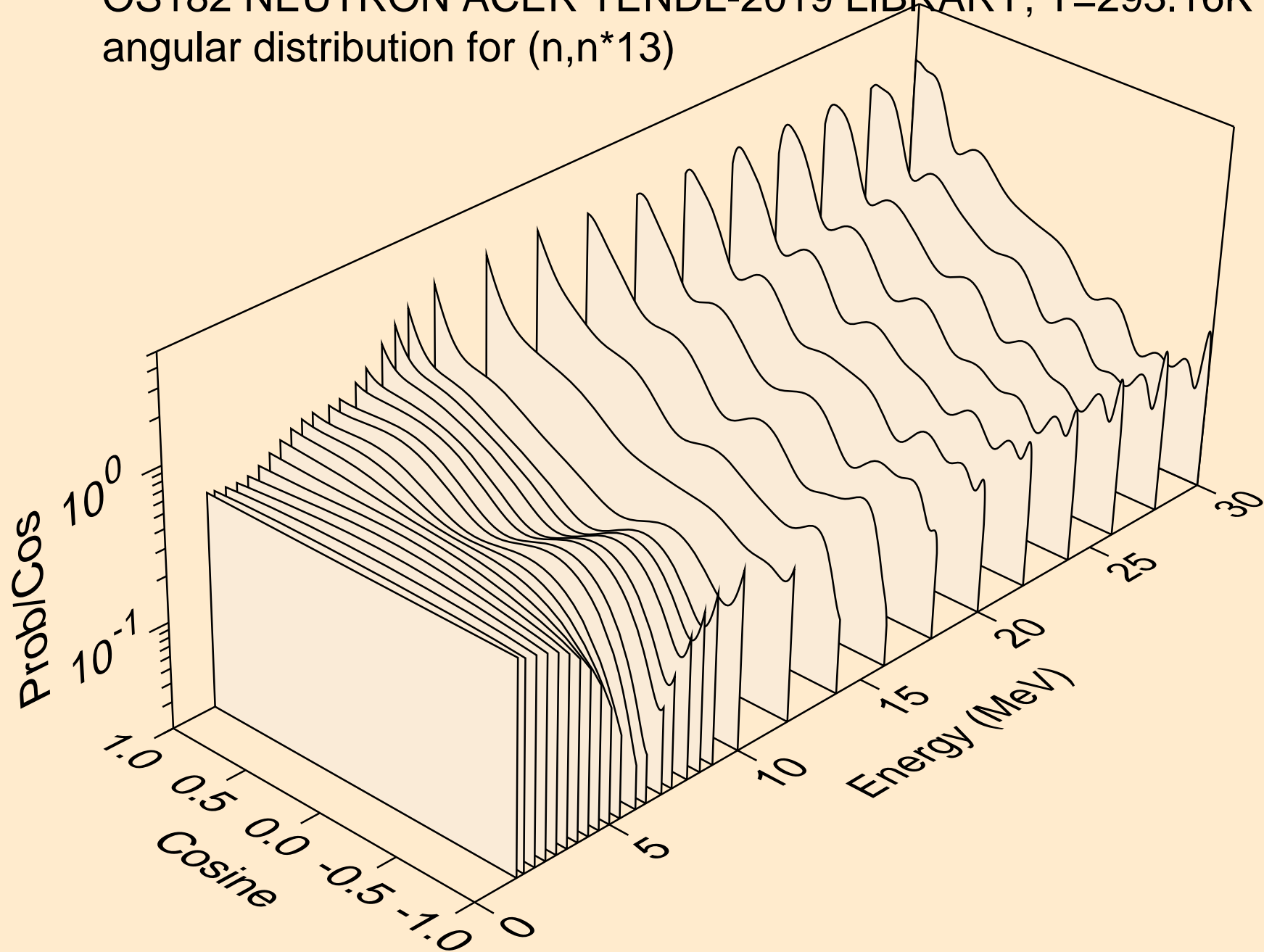

OS182 NEUTRON ACER TENDL-2019 LIBRARY; T=293.16K  
angular distribution for (n,n\*14)

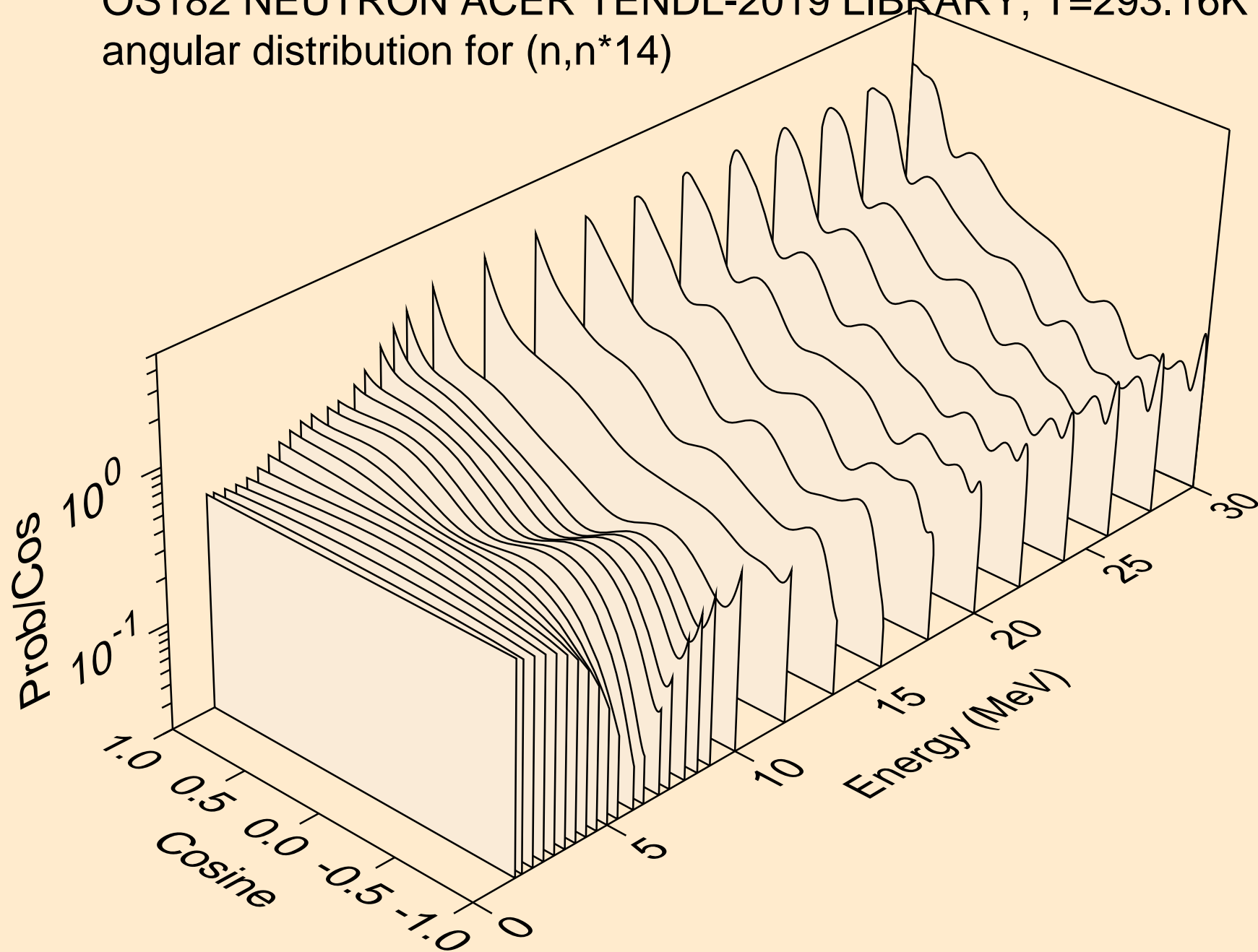

OS182 NEUTRON ACER TENDL-2019 LIBRARY; T=293.16K  
angular distribution for (n,n\*15)

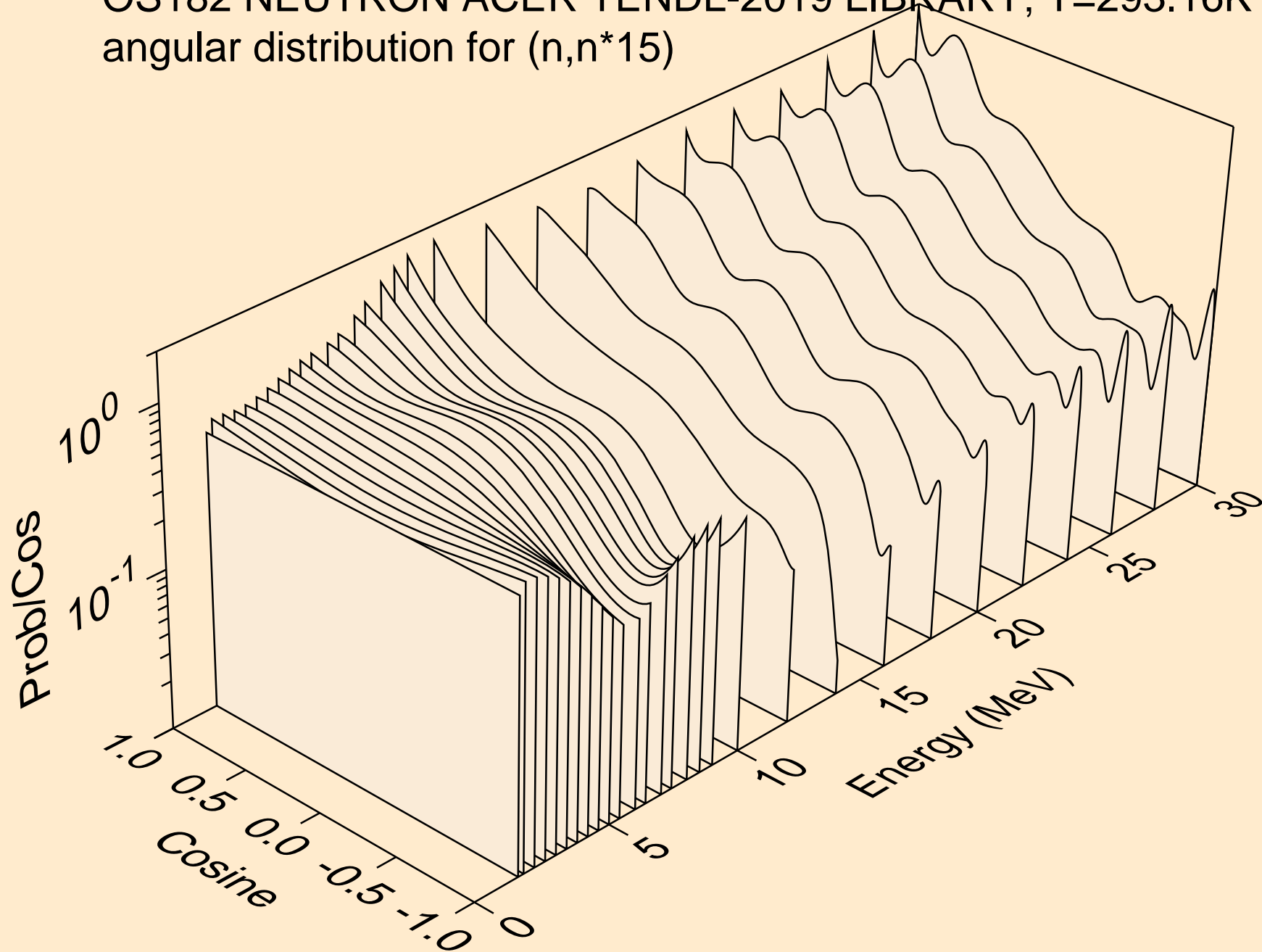

OS182 NEUTRON ACER TENDL-2019 LIBRARY; T=293.16K  
angular distribution for (n,n\*16)

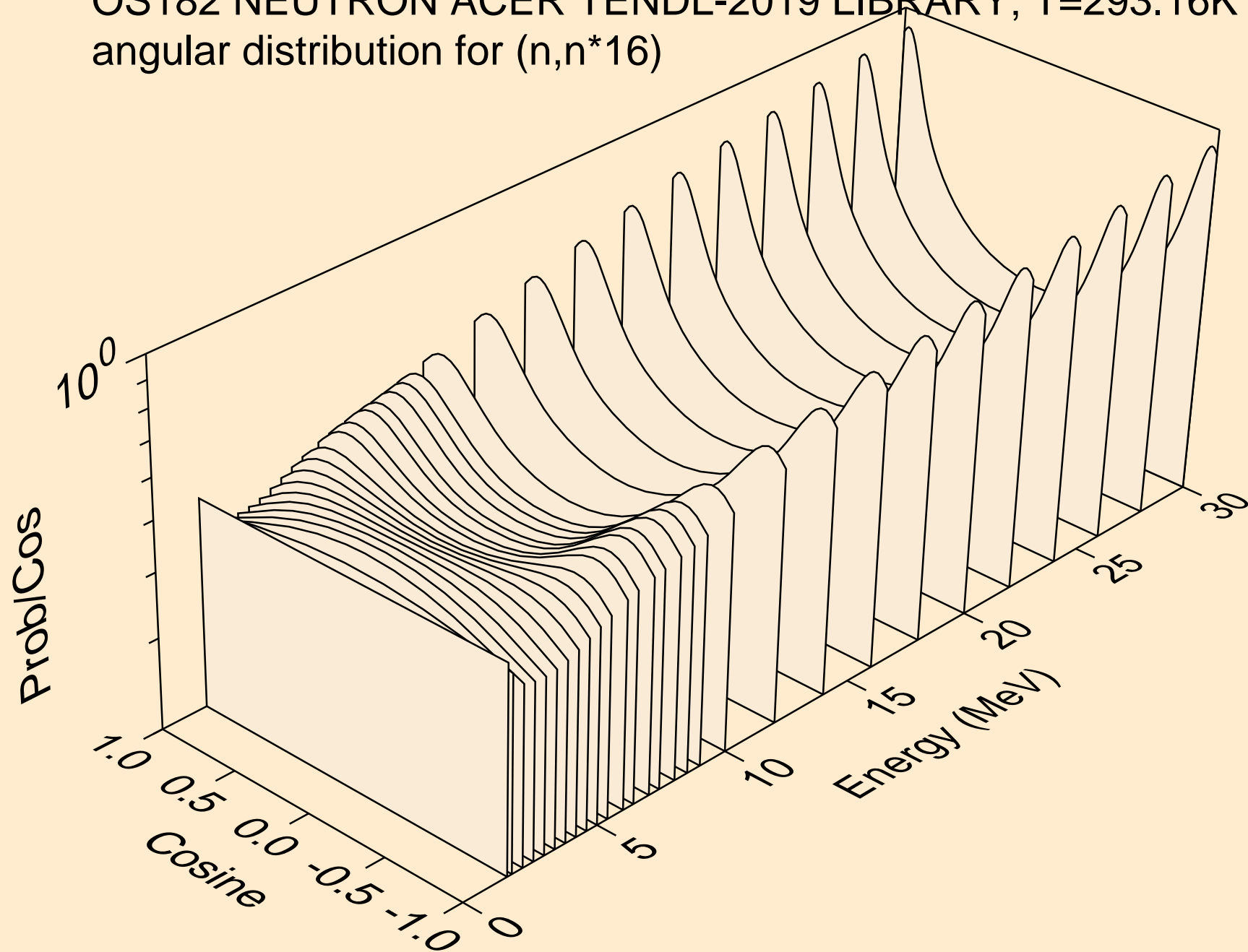

OS182 NEUTRON ACER TENDL-2019 LIBRARY; T=293.16K  
angular distribution for (n,n\*17)

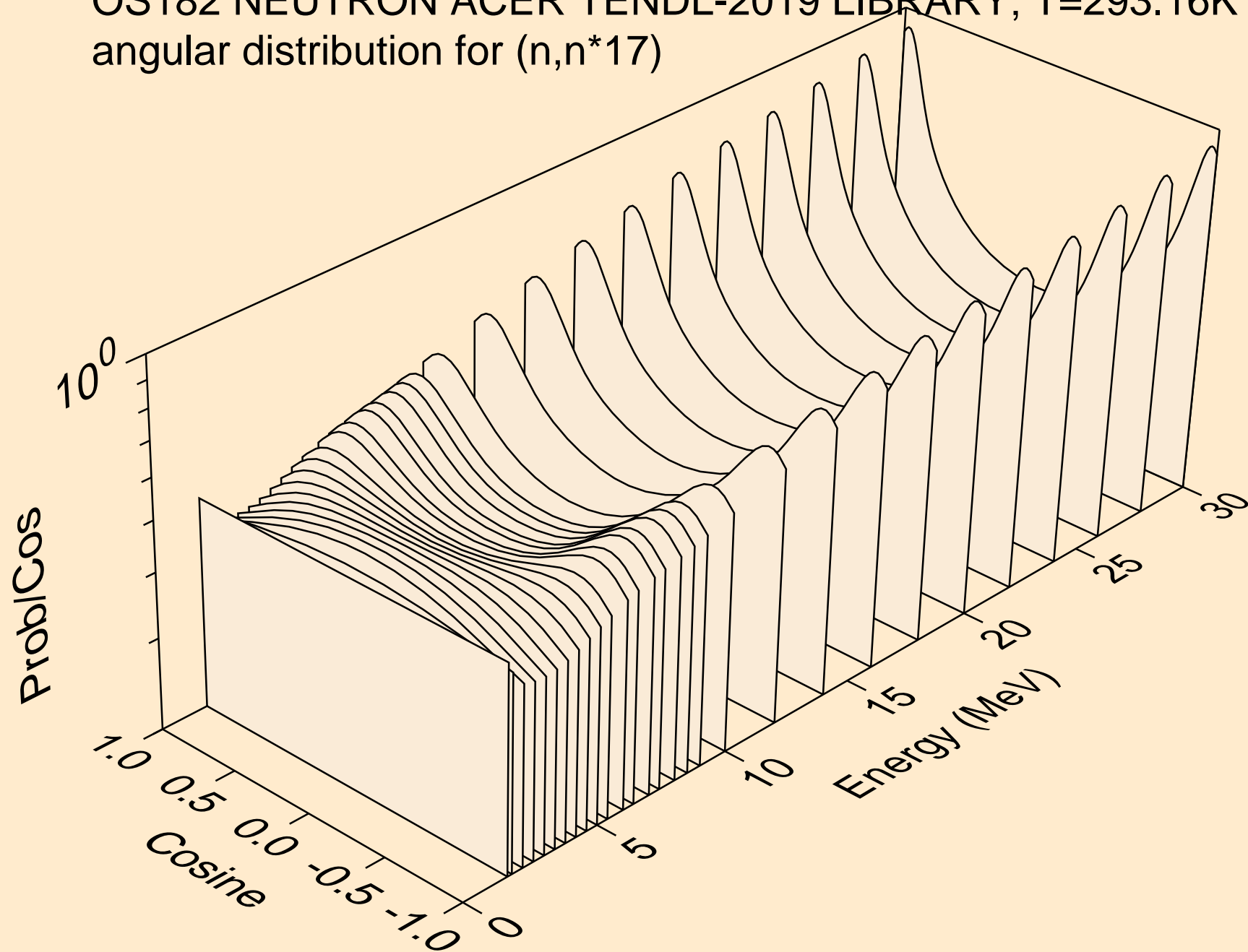



OS182 NEUTRON ACER TENDL-2019 LIBRARY; T=293.16K  
angular distribution for (n,n\*18)

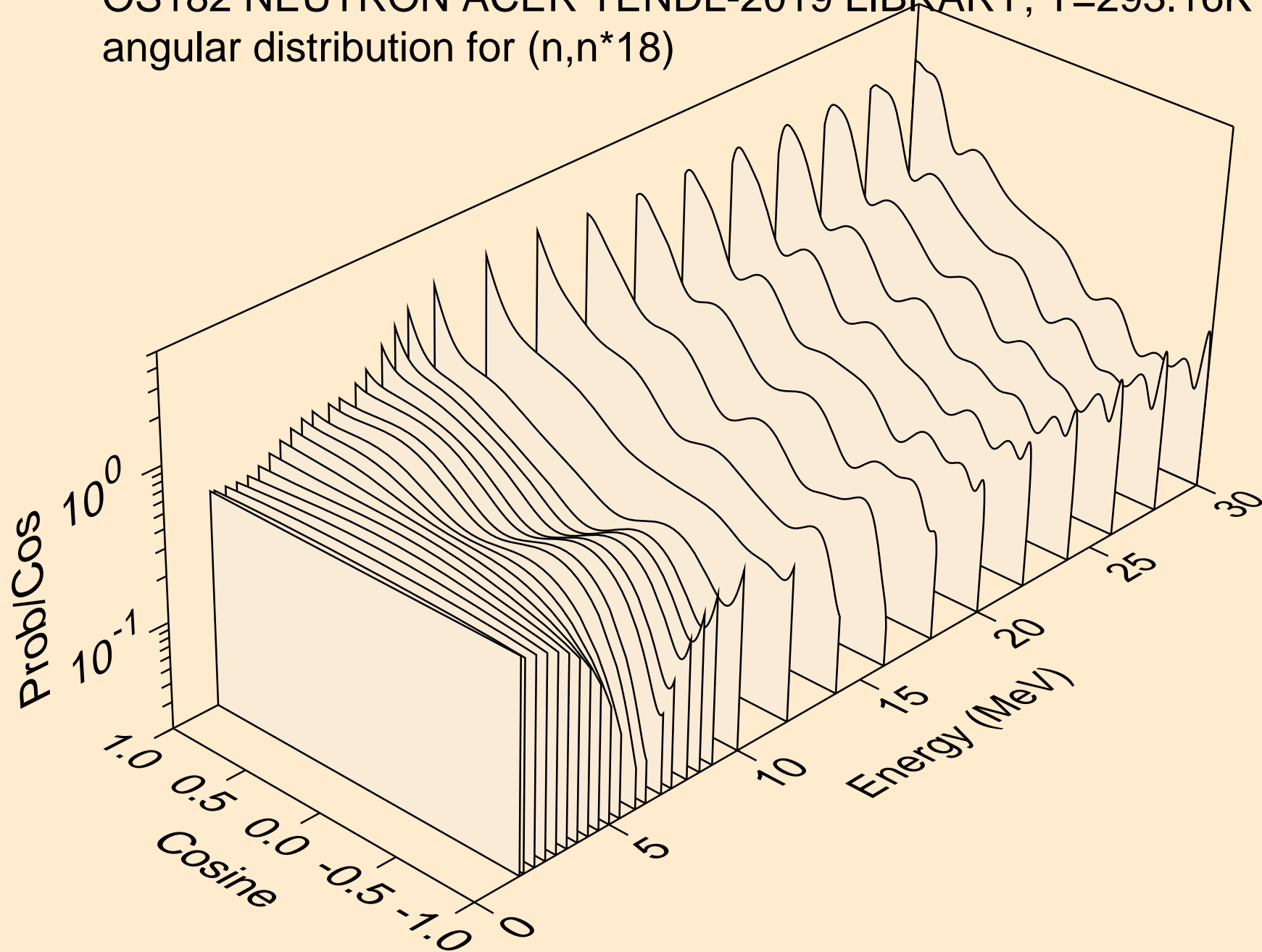

OS182 NEUTRON ACER TENDL-2019 LIBRARY; T=293.16K  
angular distribution for (n,n\*19)

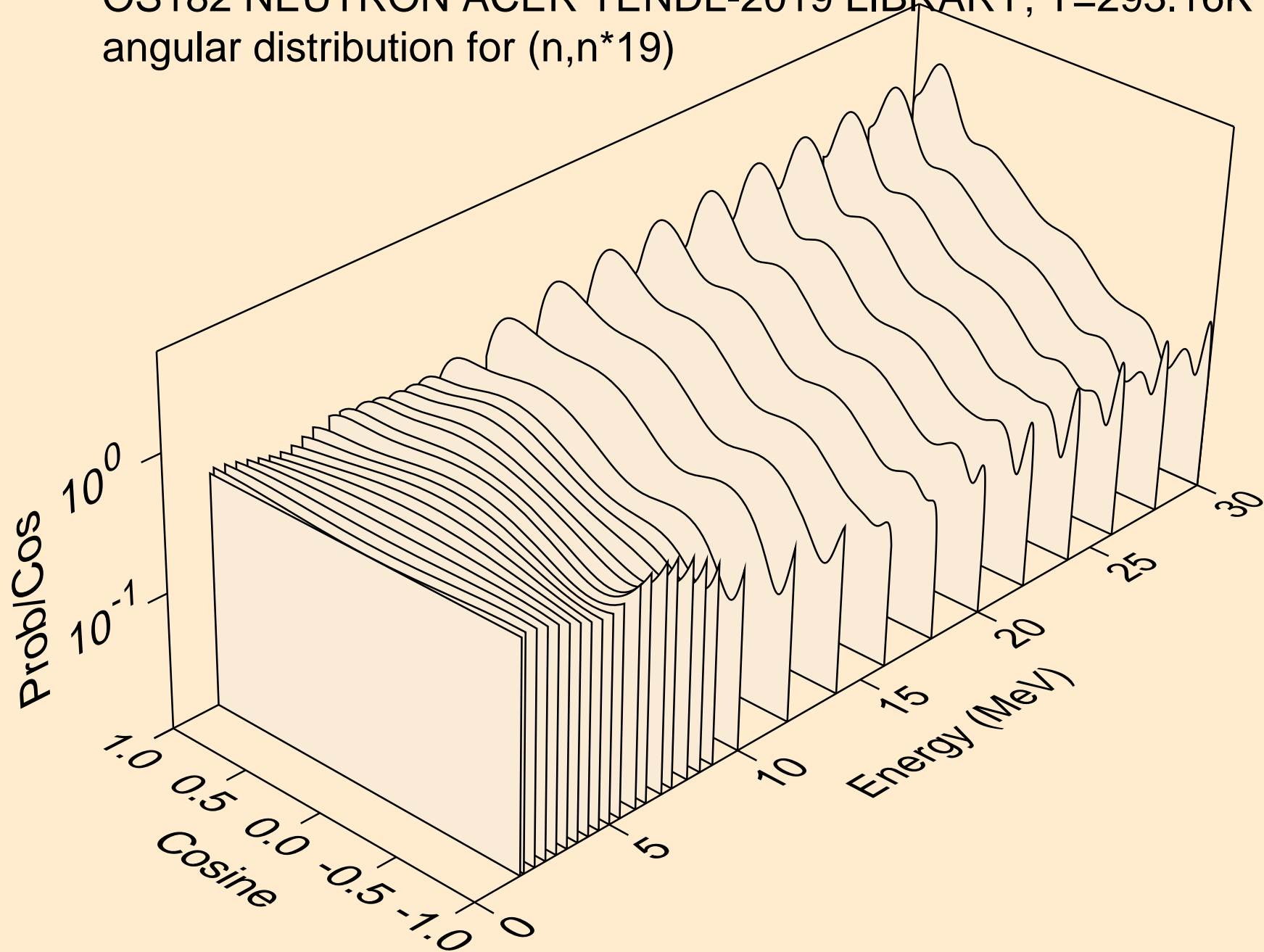

OS182 NEUTRON ACER TENDL-2019 LIBRARY; T=293.16K  
angular distribution for (n,n\*20)

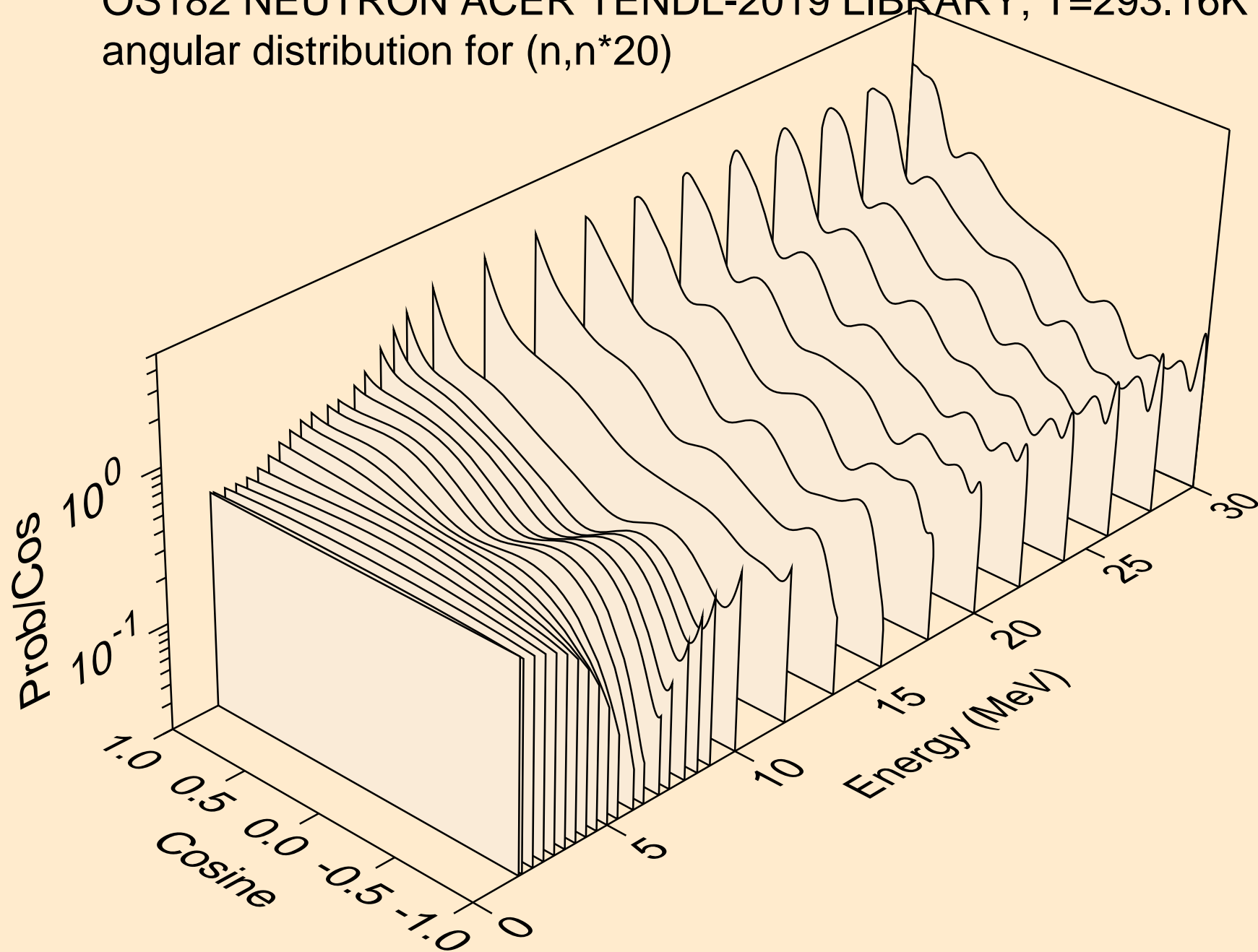

OS182 NEUTRON ACER TENDL-2019 LIBRARY; T=293.16K  
angular distribution for (n,n\*21)

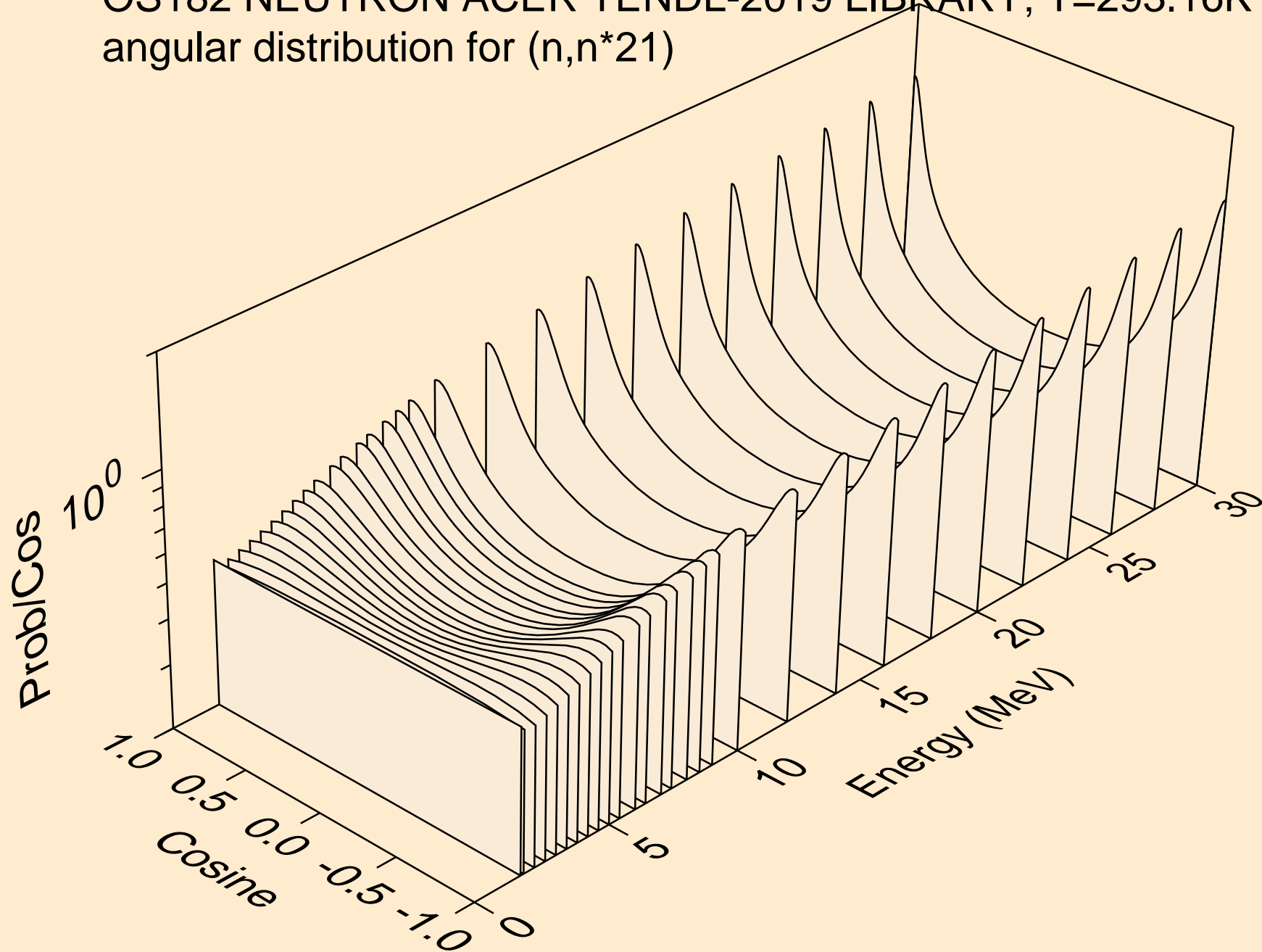

OS182 NEUTRON ACER TENDL-2019 LIBRARY; T=293.16K  
angular distribution for (n,n\*22)

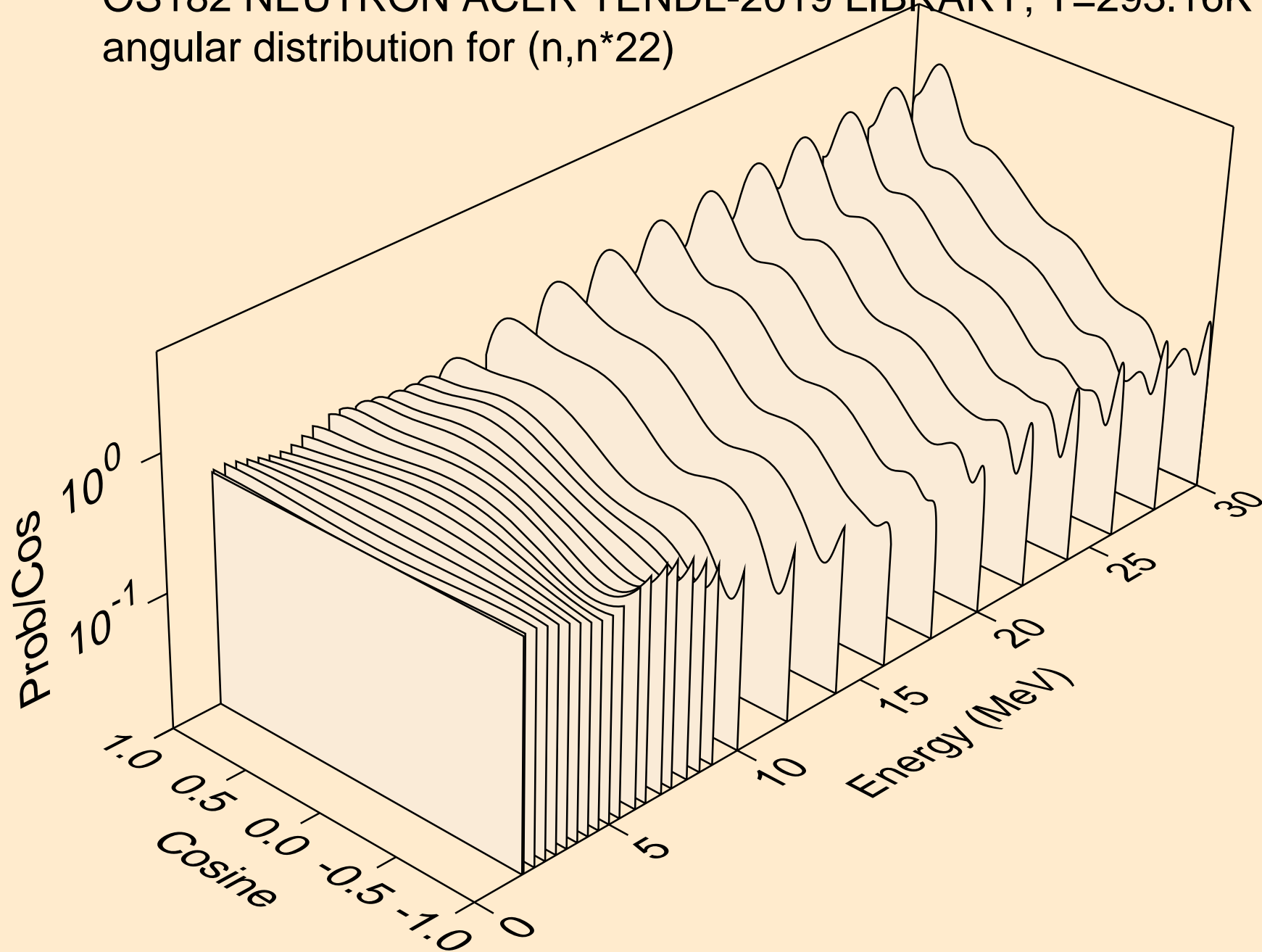

OS182 NEUTRON ACER TENDL-2019 LIBRARY; T=293.16K  
angular distribution for (n,n\*23)

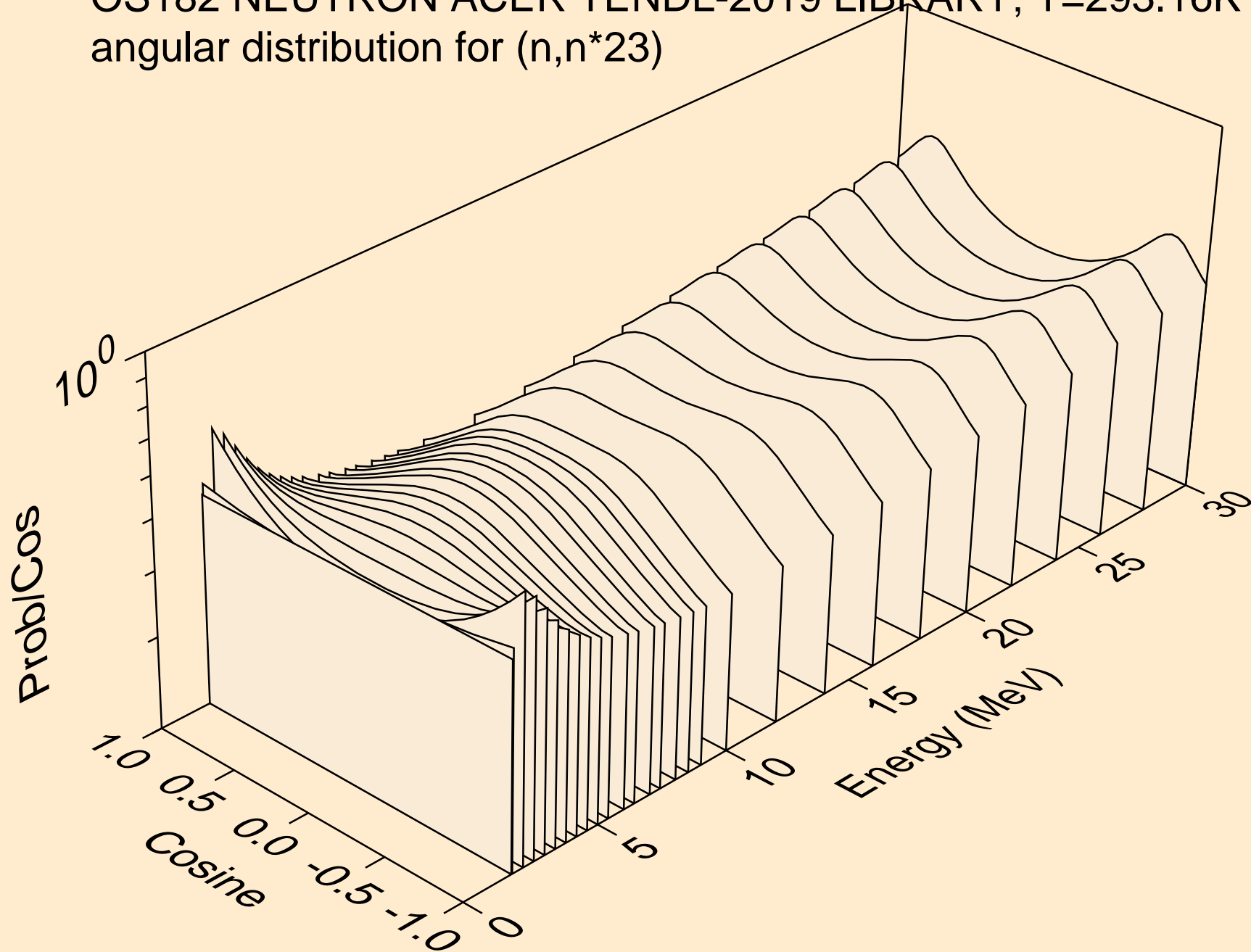

OS182 NEUTRON ACER TENDL-2019 LIBRARY; T=293.16K  
angular distribution for (n,n\*24)

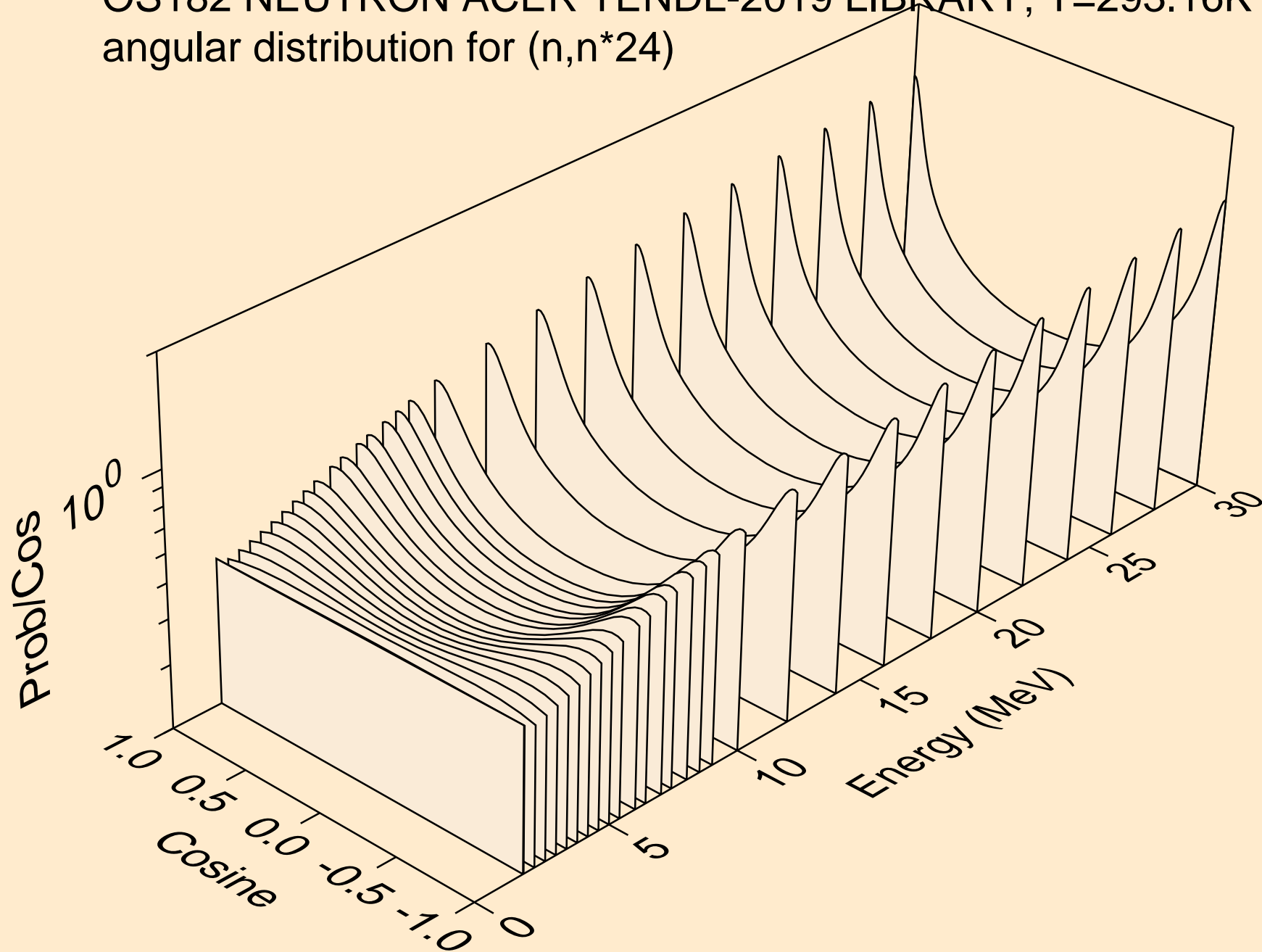

OS182 NEUTRON ACER TENDL-2019 LIBRARY; T=293.16K  
angular distribution for (n,n\*25)

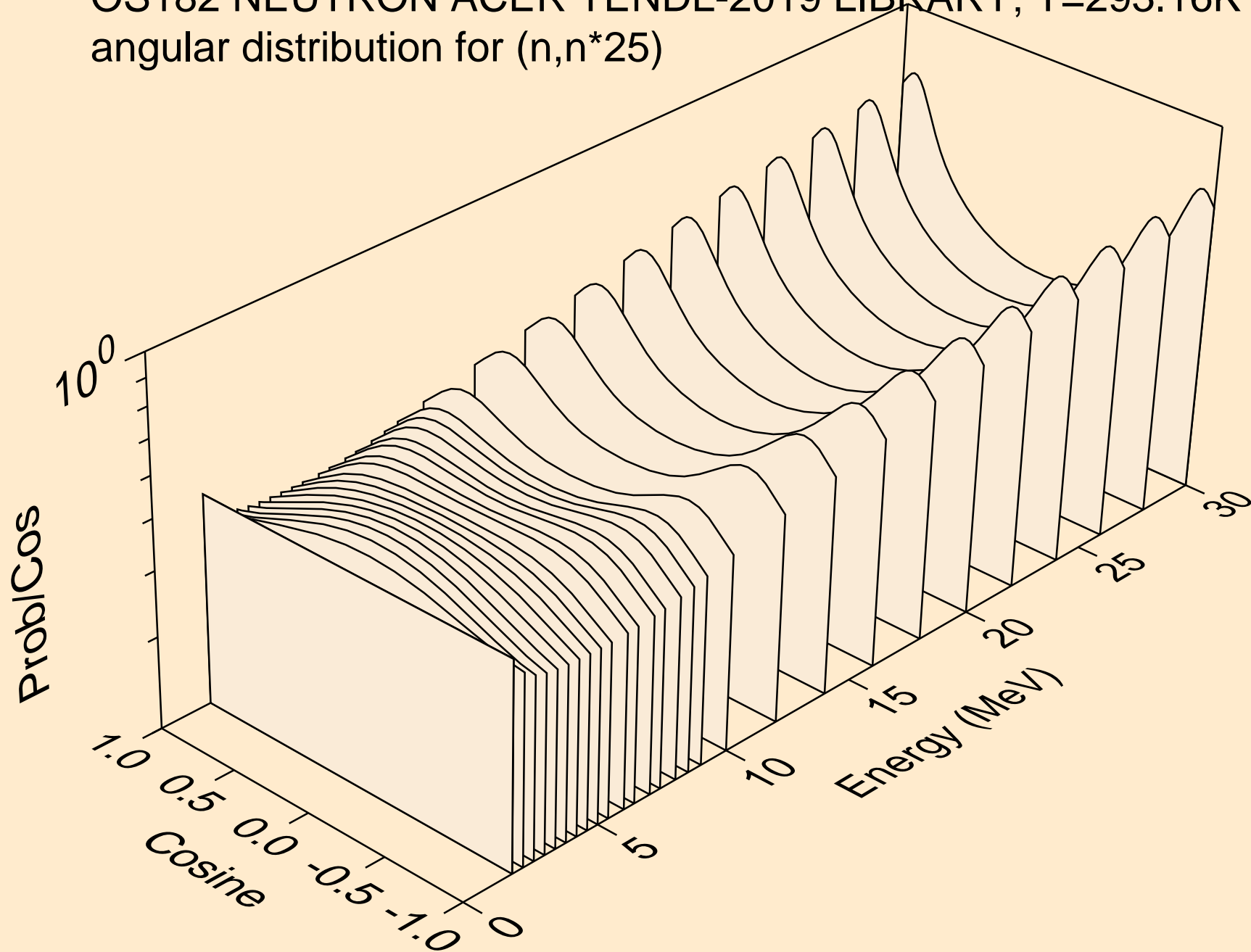



OS182 NEUTRON ACER TENDL-2019 LIBRARY; T=293.16K  
angular distribution for (n,n\*26)

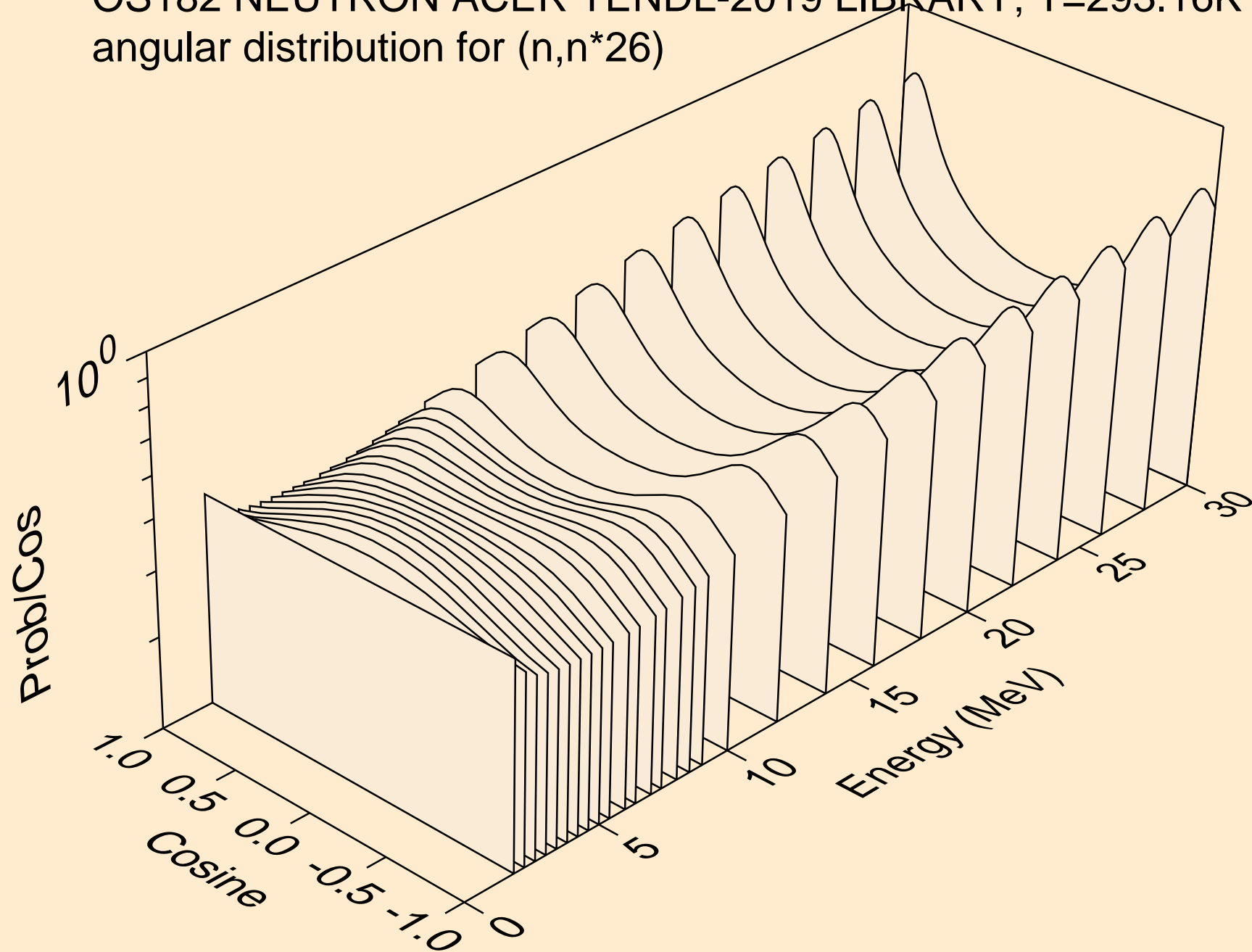

OS182 NEUTRON ACER TENDL-2019 LIBRARY; T=293.16K  
angular distribution for (n,n\*27)

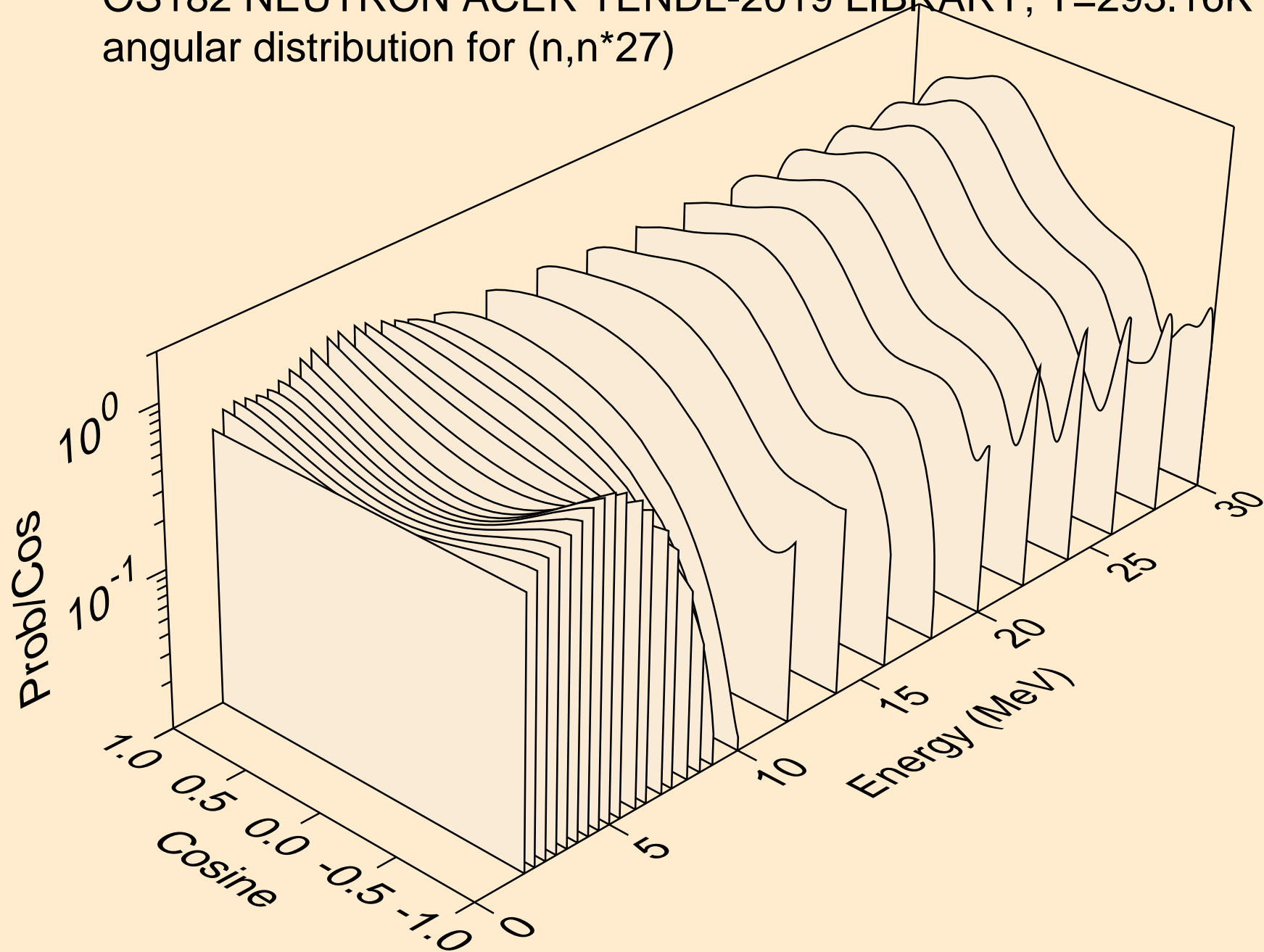

OS182 NEUTRON ACER TENDL-2019 LIBRARY; T=293.16K  
angular distribution for (n,n\*28)

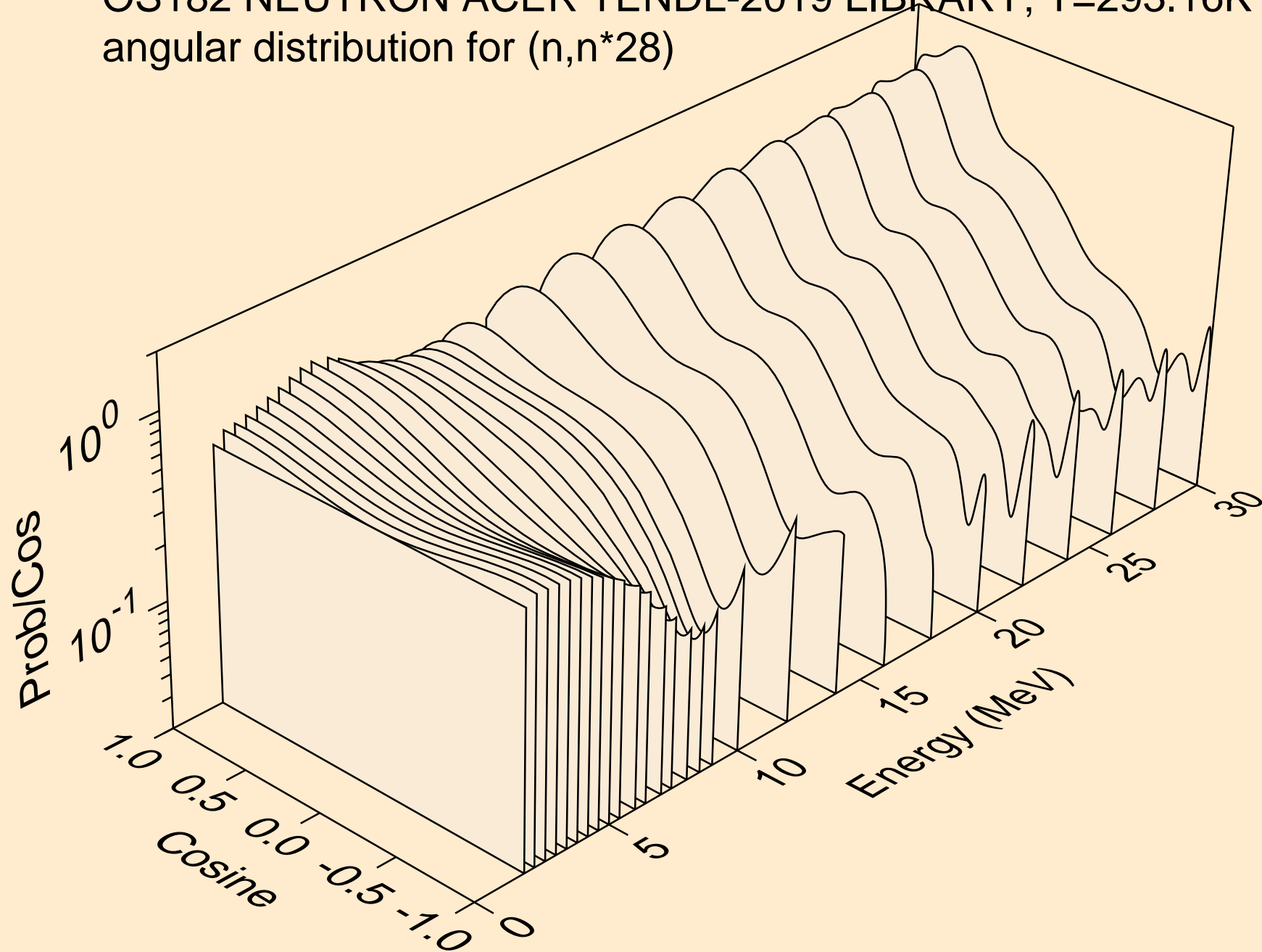

OS182 NEUTRON ACER TENDL-2019 LIBRARY; T=293.16K  
angular distribution for (n,n\*29)

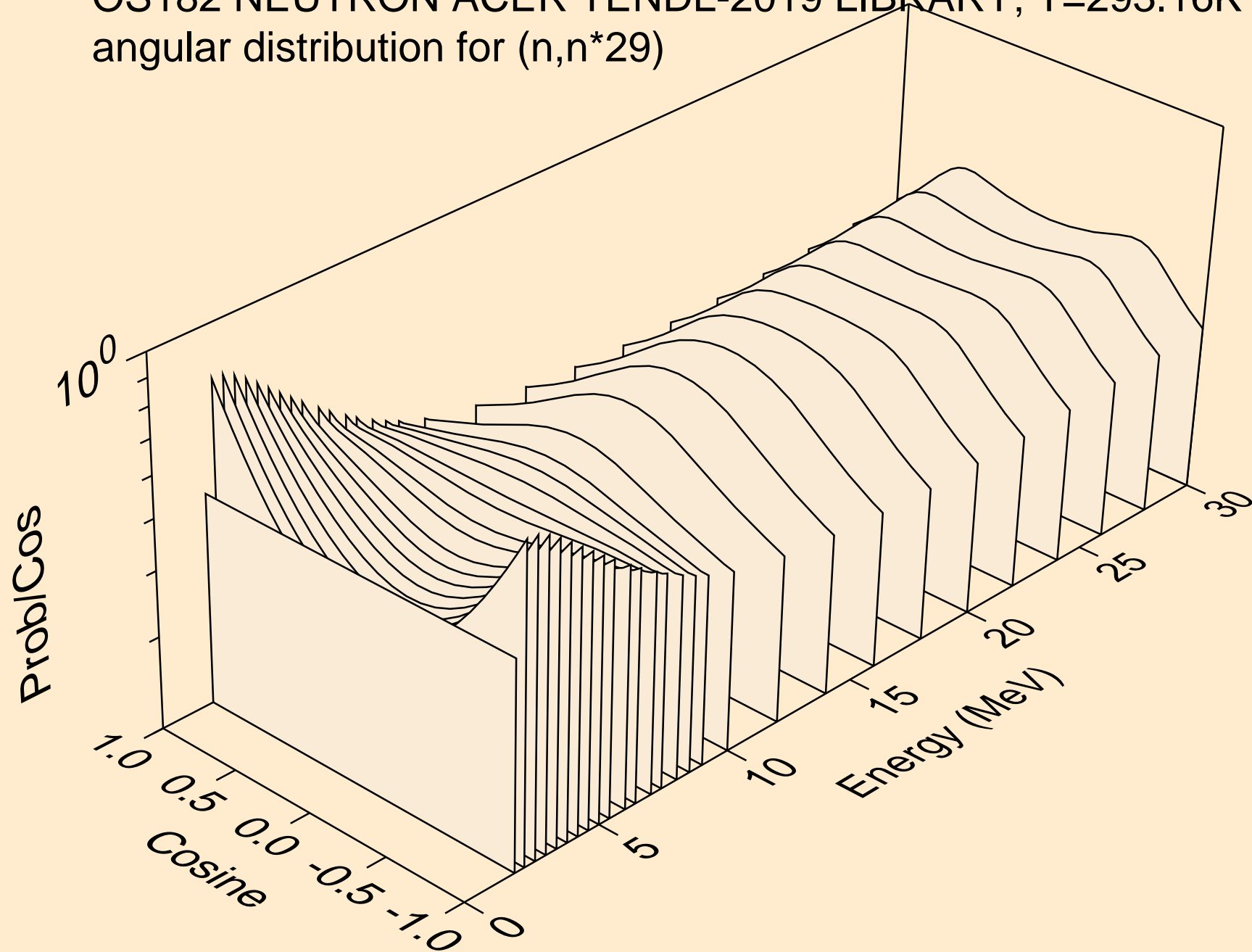

OS182 NEUTRON ACER TENDL-2019 LIBRARY; T=293.16K  
angular distribution for (n,n\*30)

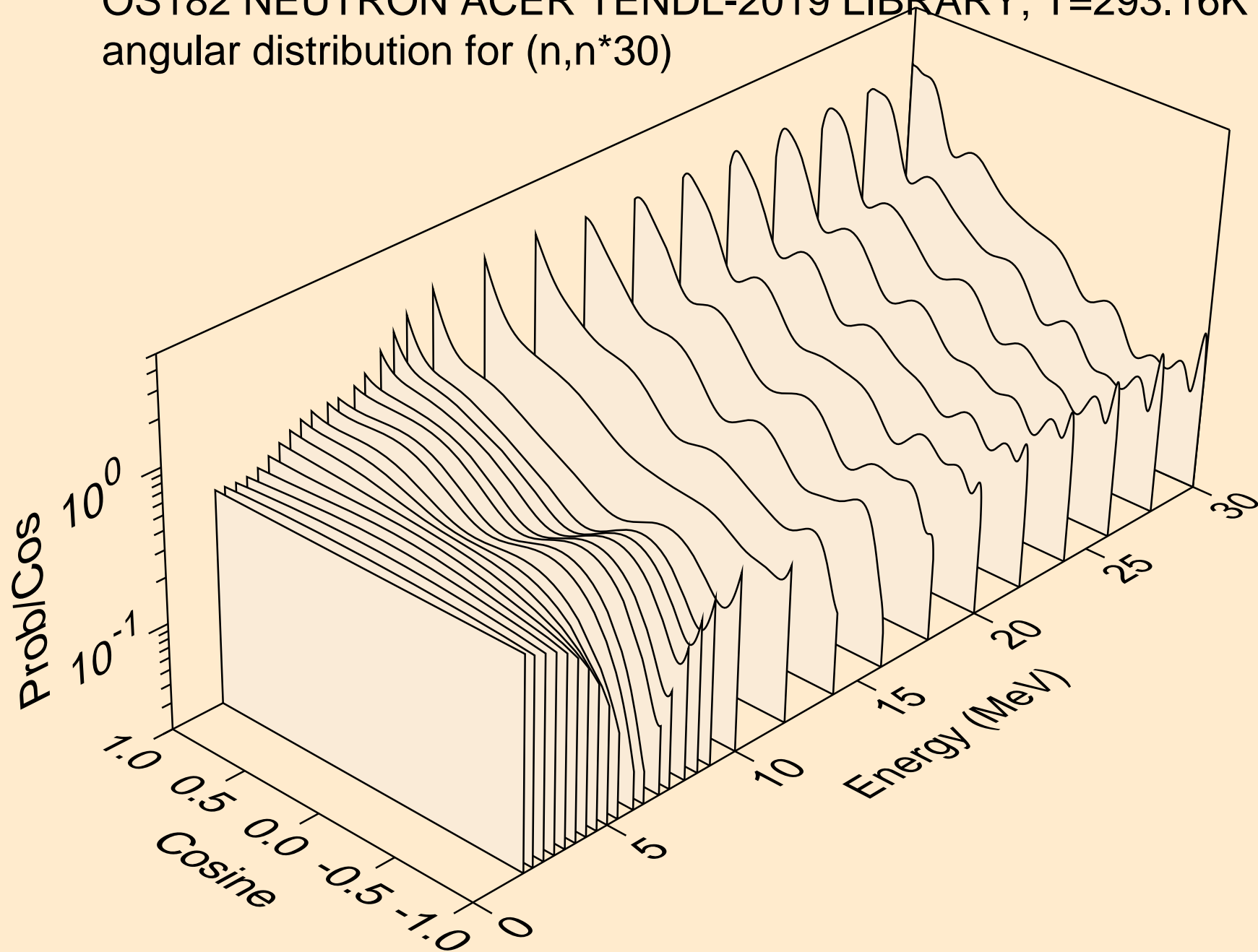

OS182 NEUTRON ACER TENDL-2019 LIBRARY; T=293.16K  
Neutron emission for (n,x)

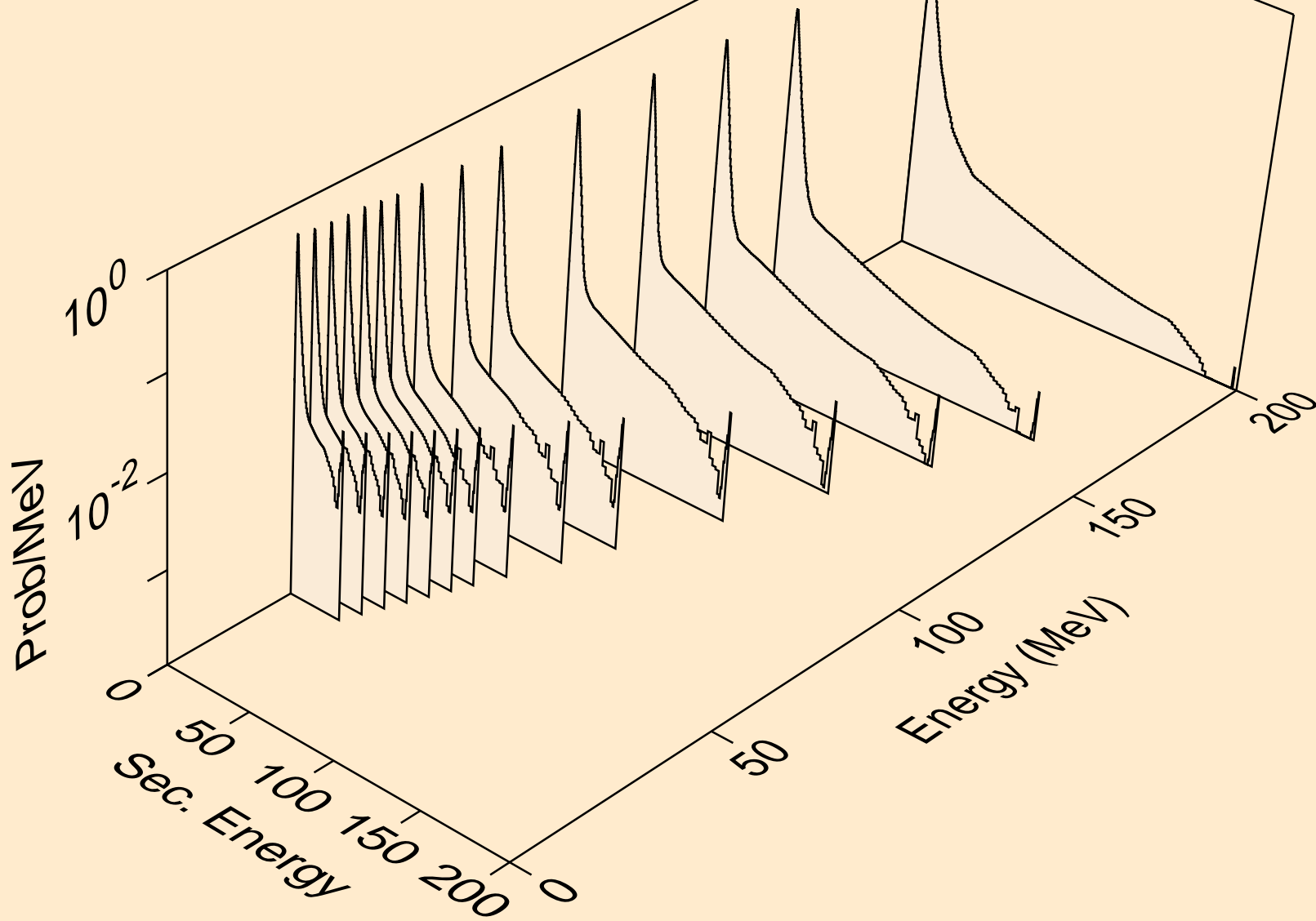

OS182 NEUTRON ACER TENDL-2019 LIBRARY; T=293.16K  
Neutron emission for (n,2nd)

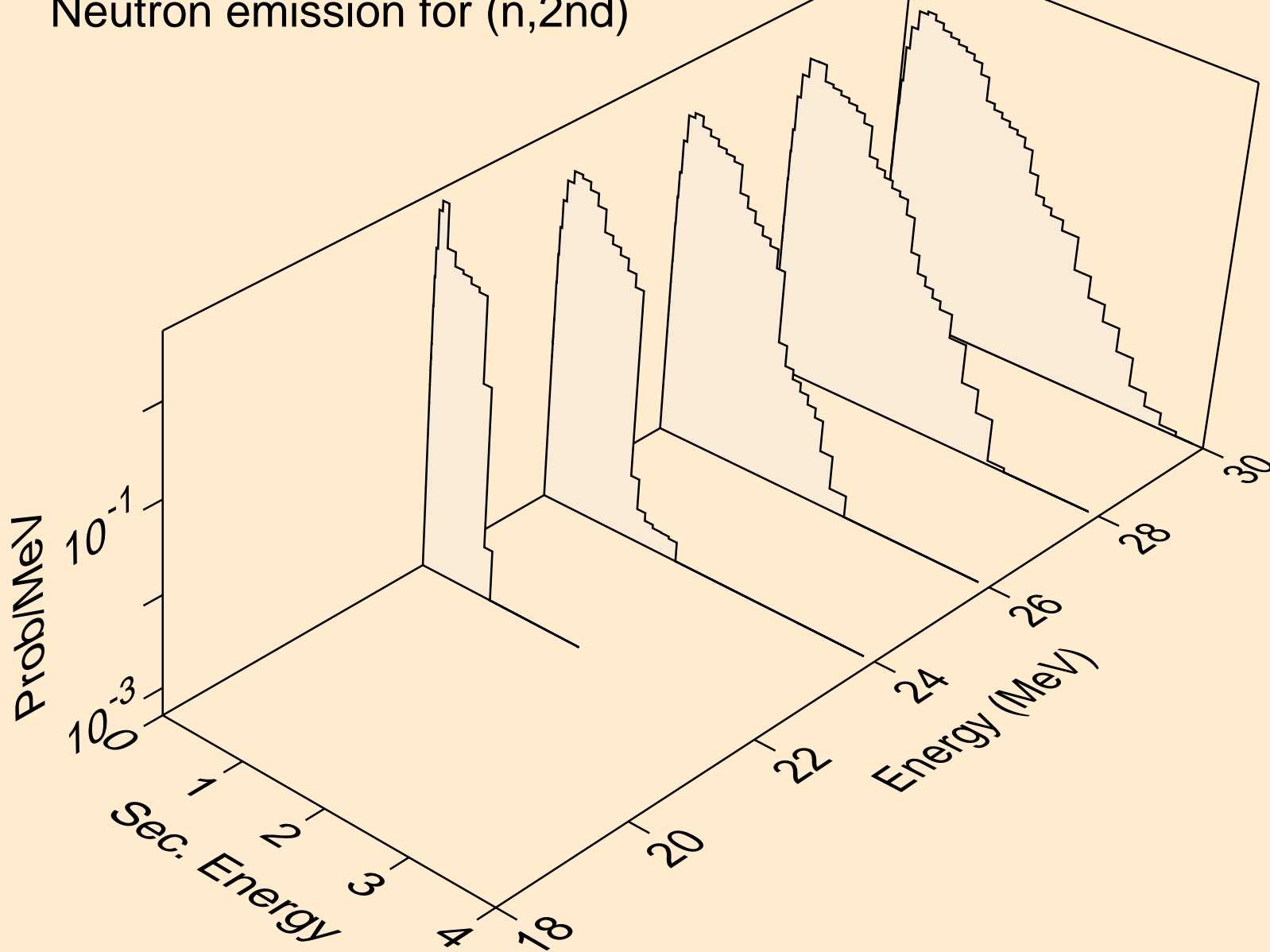

OS182 NEUTRON ACER TENDL-2019 LIBRARY; T=293.16K  
Neutron emission for (n,2n)

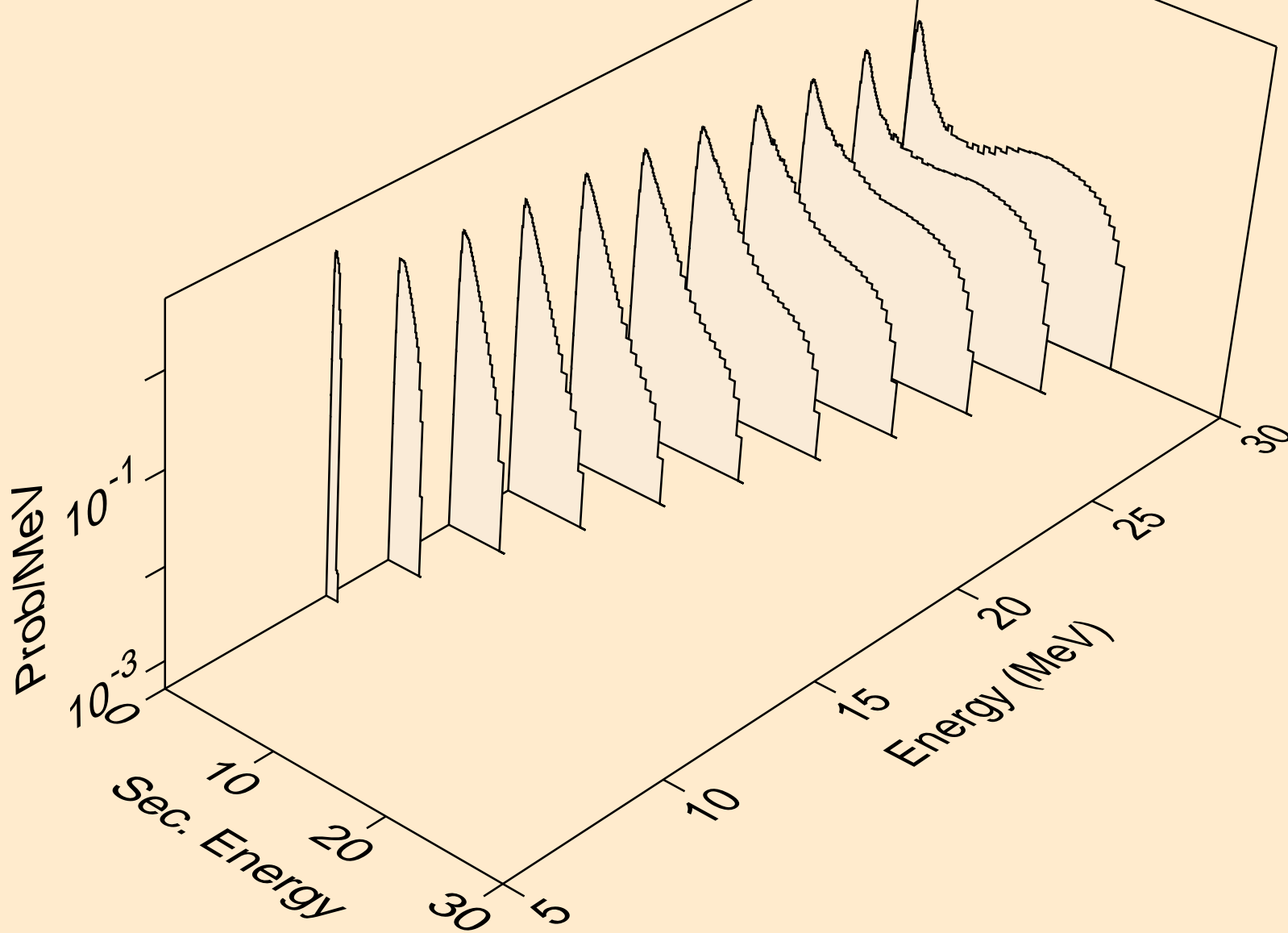



OS182 NEUTRON ACER TENDL-2019 LIBRARY; T=293.16K  
Neutron emission for (n,3n)

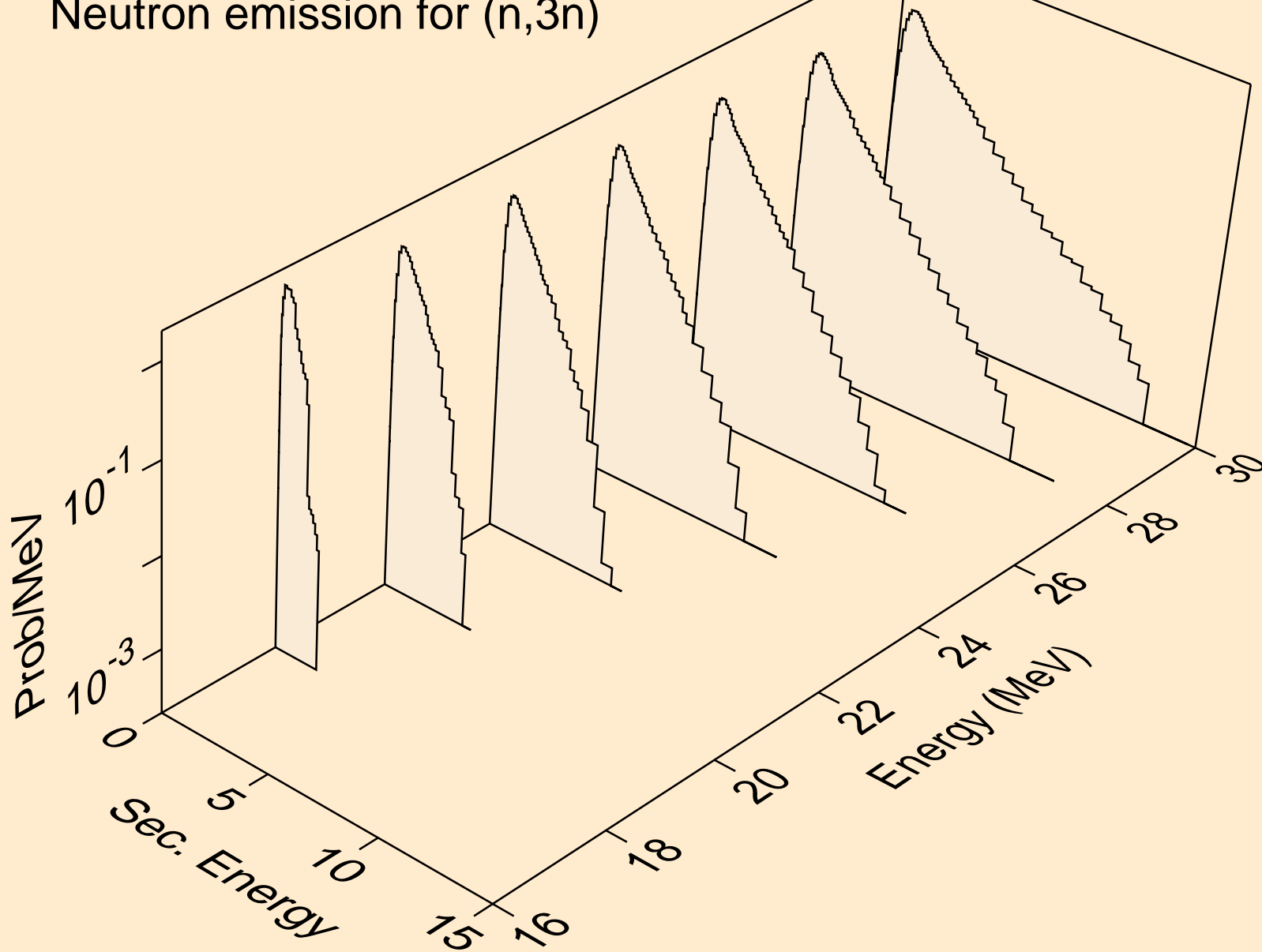

OS182 NEUTRON ACER TENDL-2019 LIBRARY; T=293.16K  
Neutron emission for (n,n\*)a

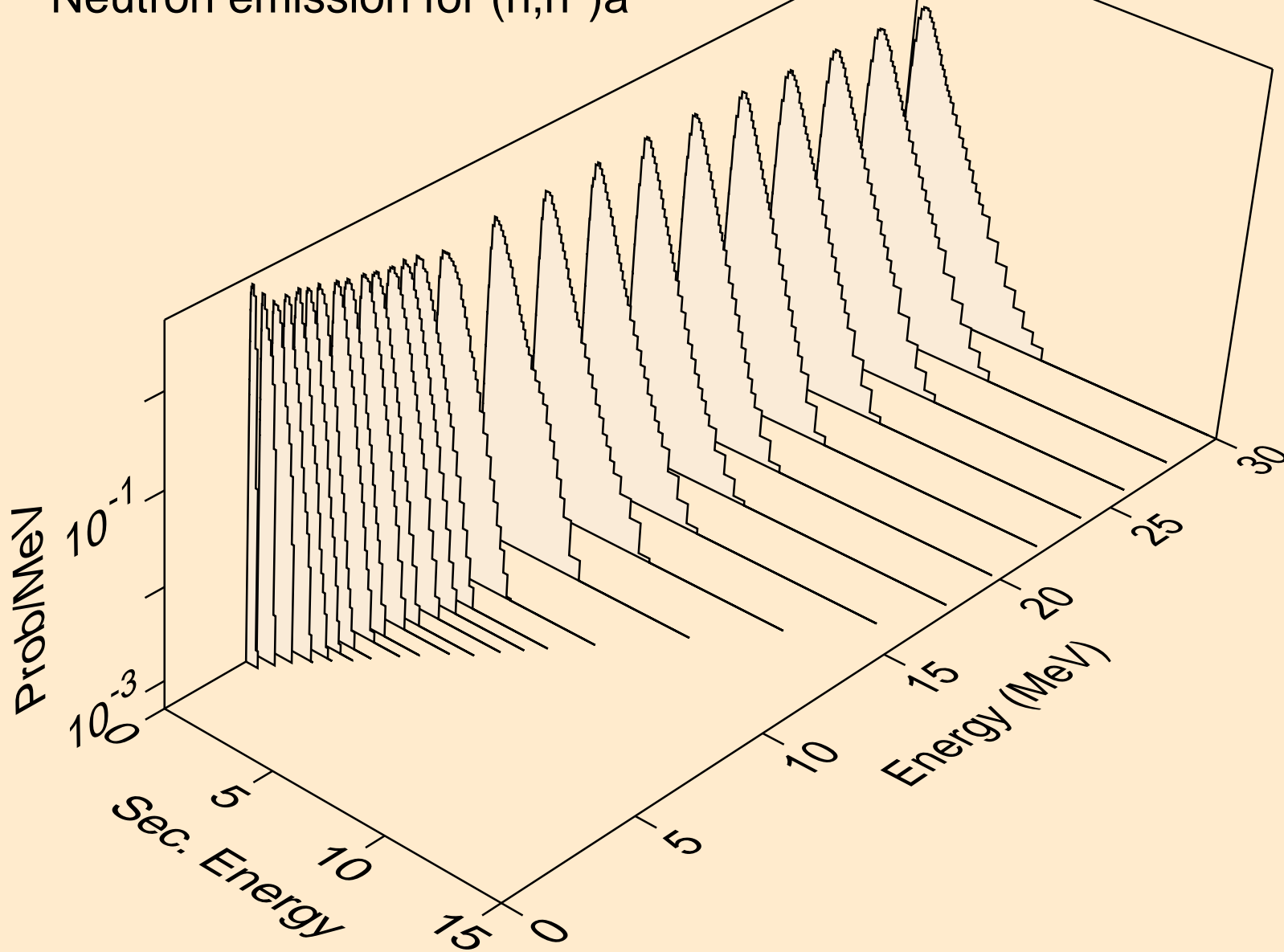

OS182 NEUTRON ACER TENDL-2019 LIBRARY; T=293.16K  
Neutron emission for (n,2n)a

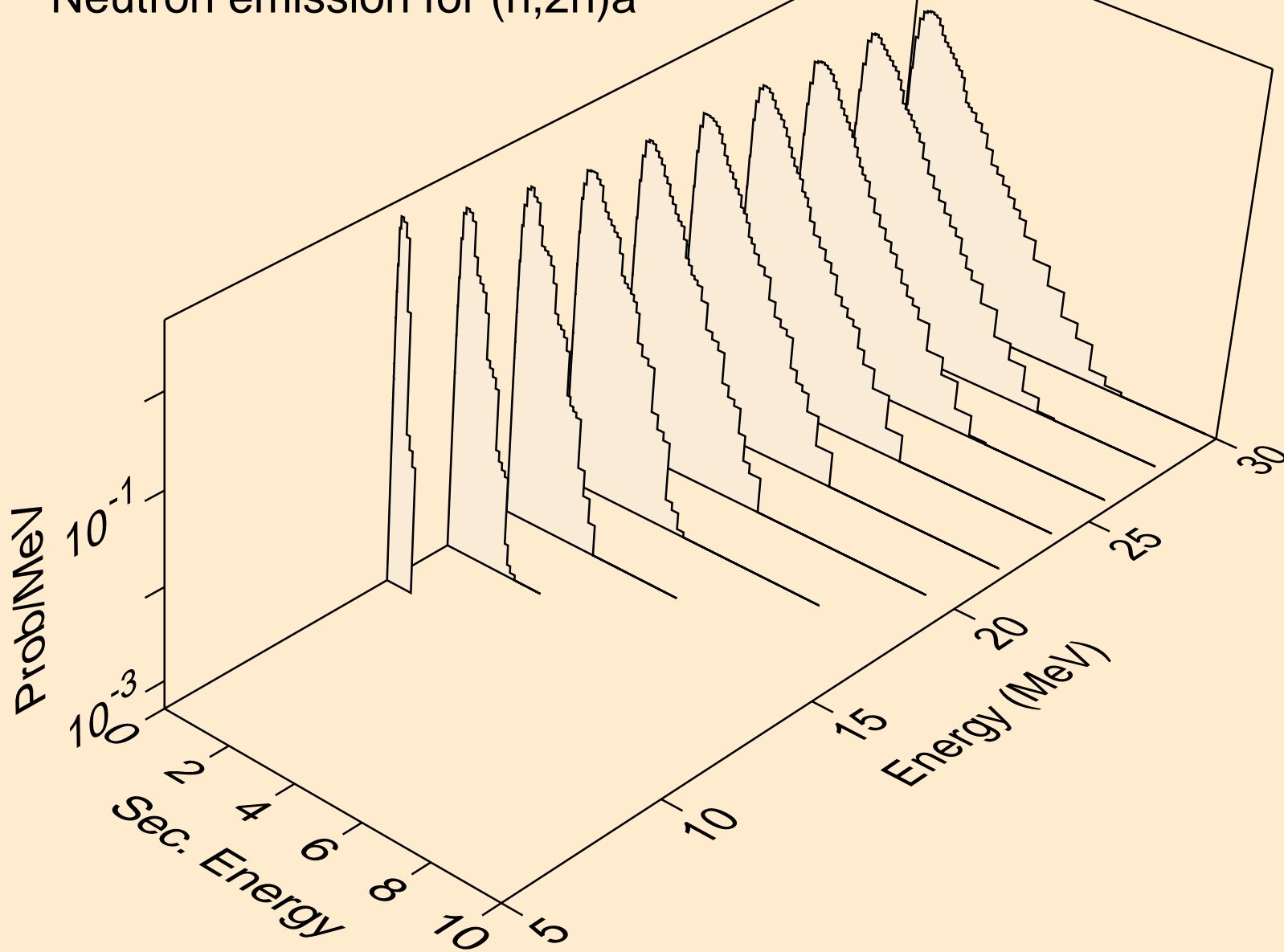

OS182 NEUTRON ACER TENDL-2019 LIBRARY; T=293.16K  
Neutron emission for (n,3n)a

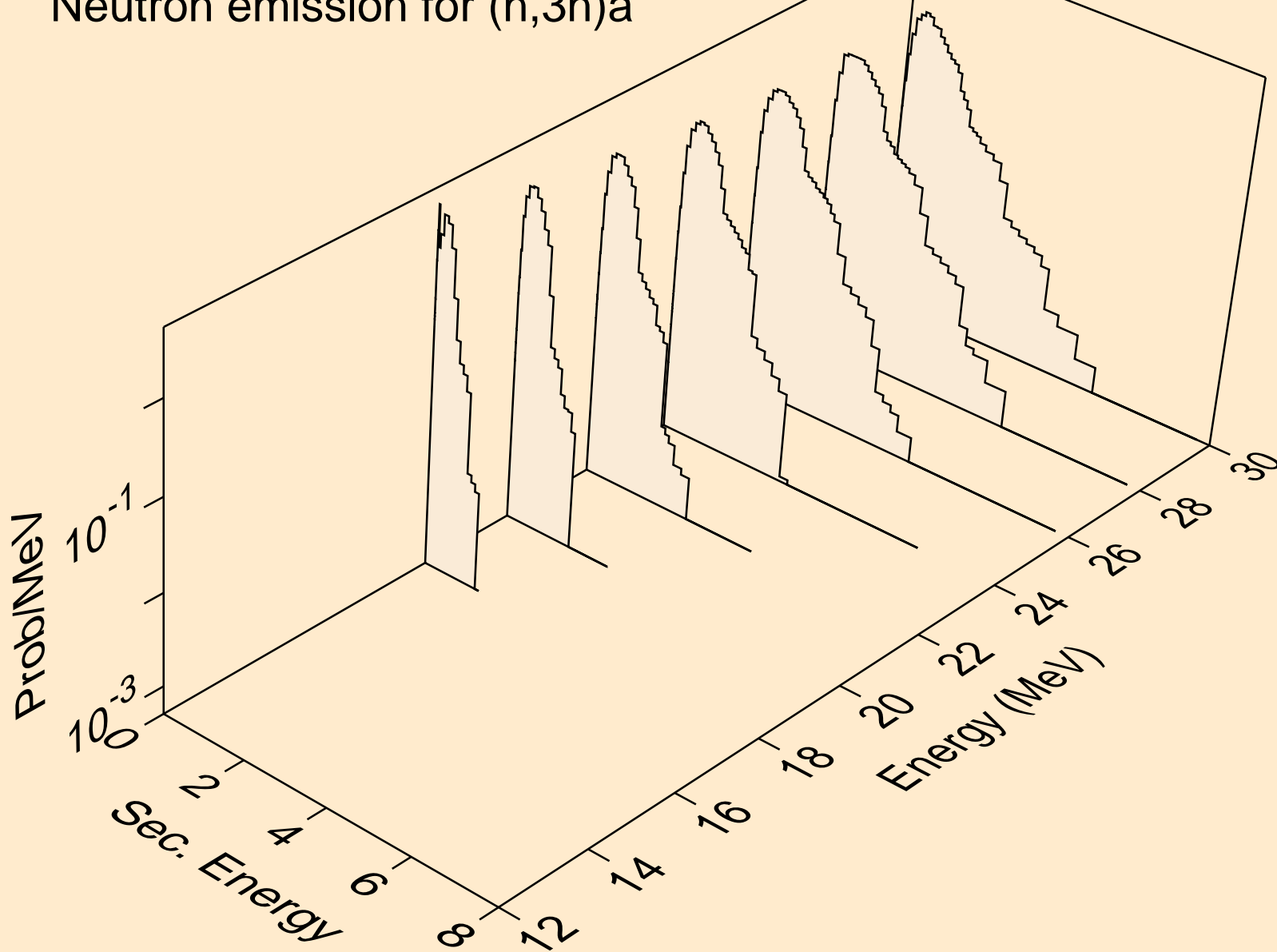

OS182 NEUTRON ACER TENDL-2019 LIBRARY; T=293.16K  
Neutron emission for (n,n\*)p

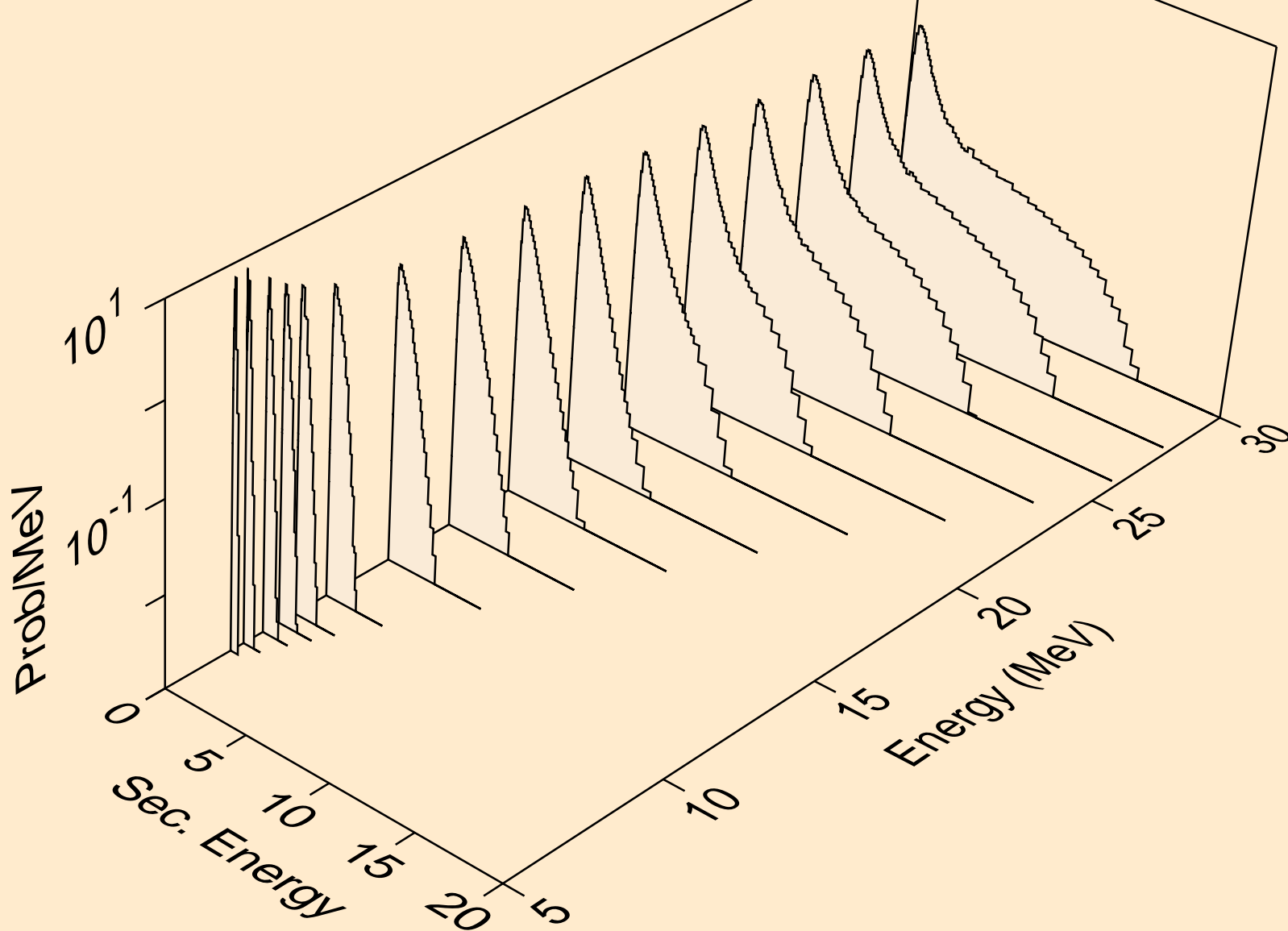

OS182 NEUTRON ACER TENDL-2019 LIBRARY; T=293.16K  
Neutron emission for (n,n\*)2a

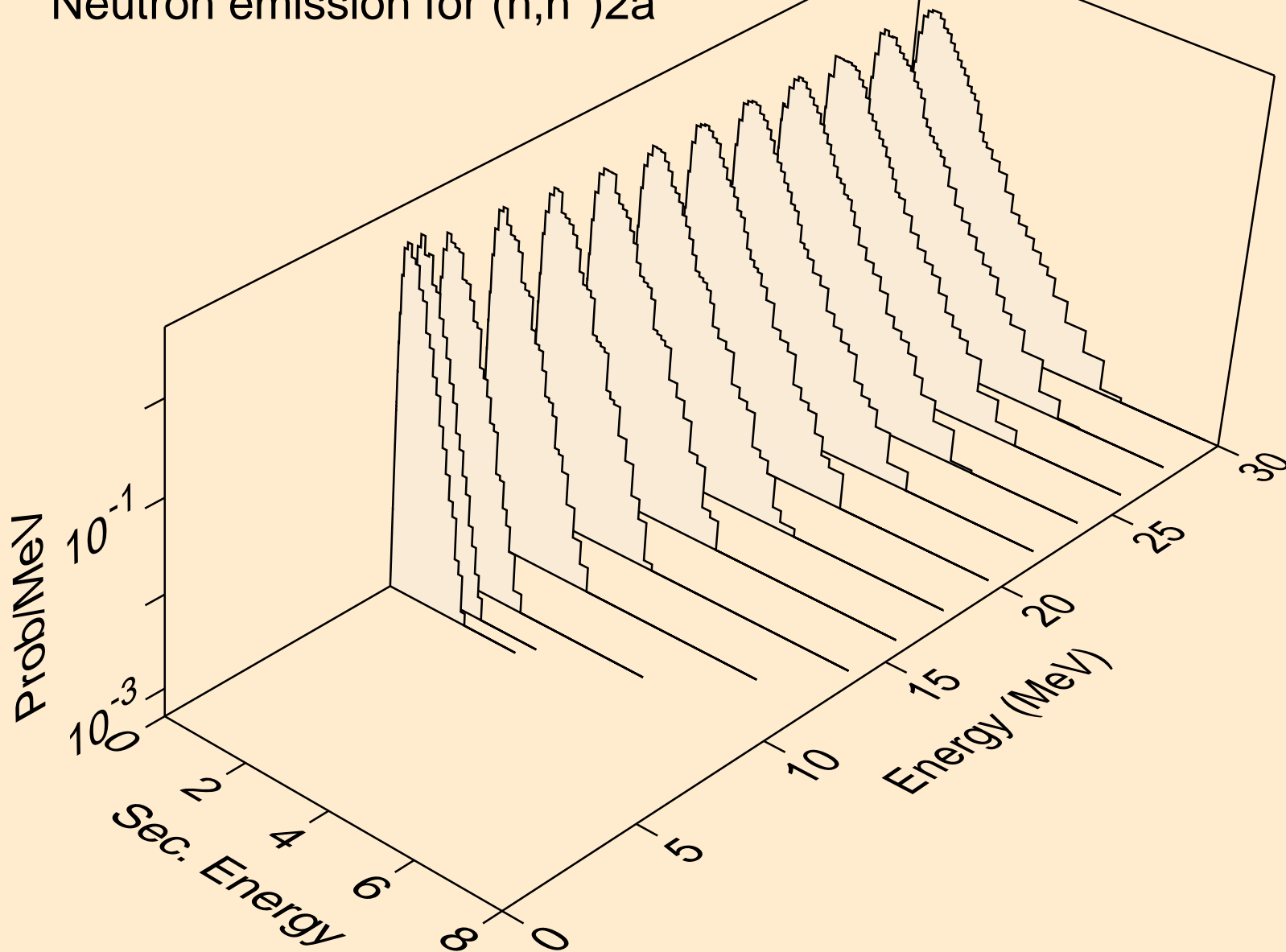

OS182 NEUTRON ACER TENDL-2019 LIBRARY; T=293.16K  
Neutron emission for (n,2n)2a

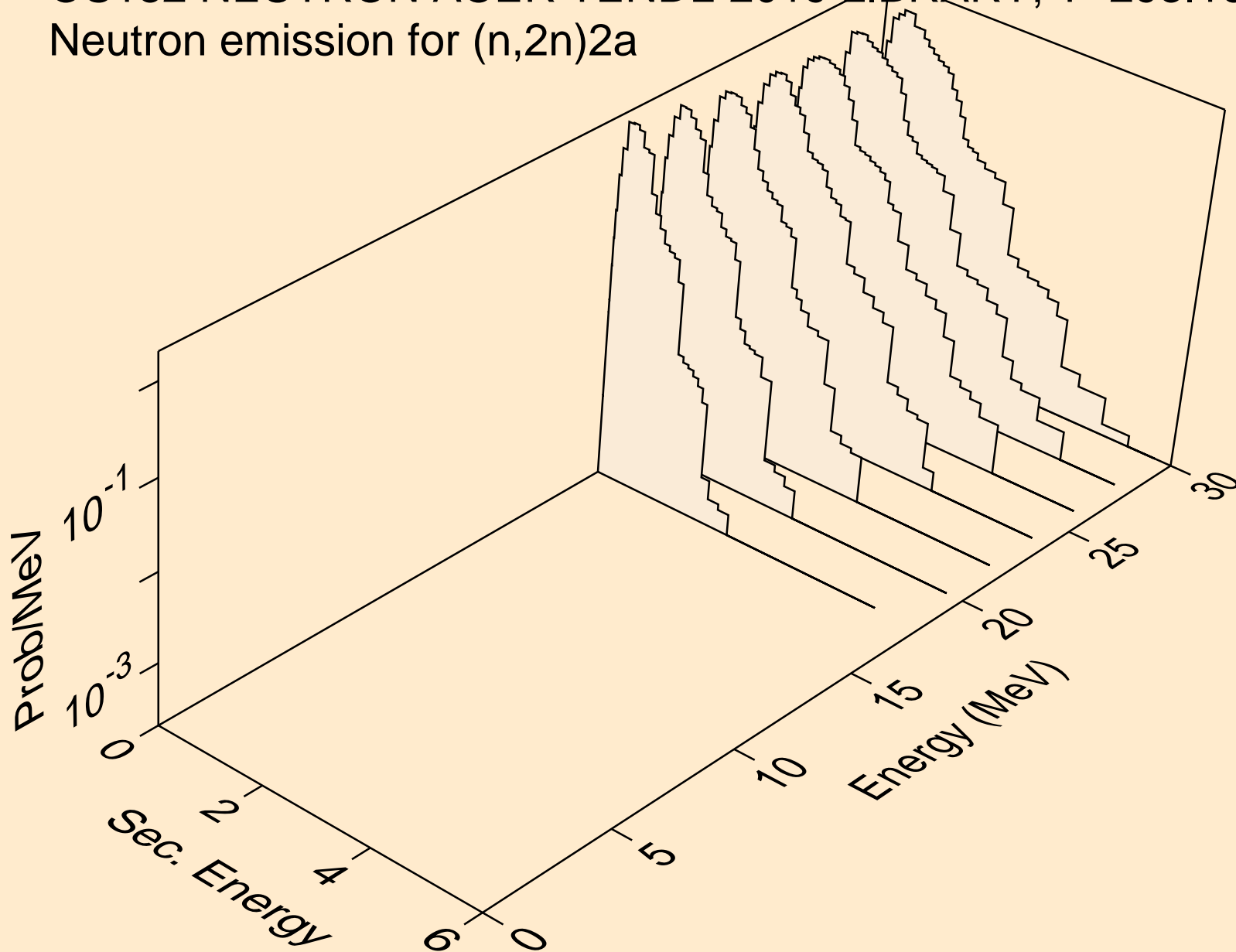

OS182 NEUTRON ACER TENDL-2019 LIBRARY; T=293.16K  
Neutron emission for (n,n\*)d

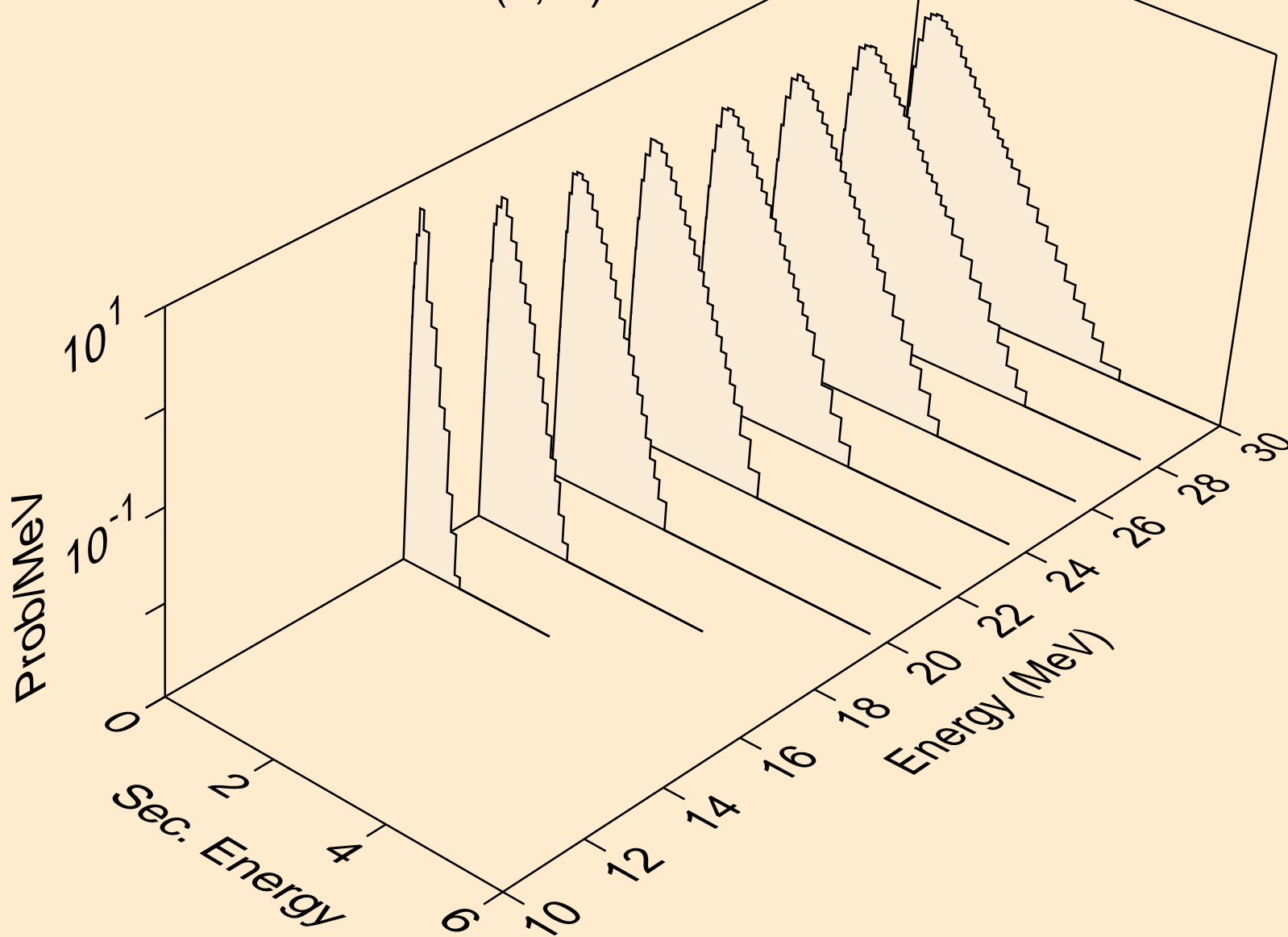



OS182 NEUTRON ACER TENDL-2019 LIBRARY; T=293.16K  
Neutron emission for (n,n\*)t

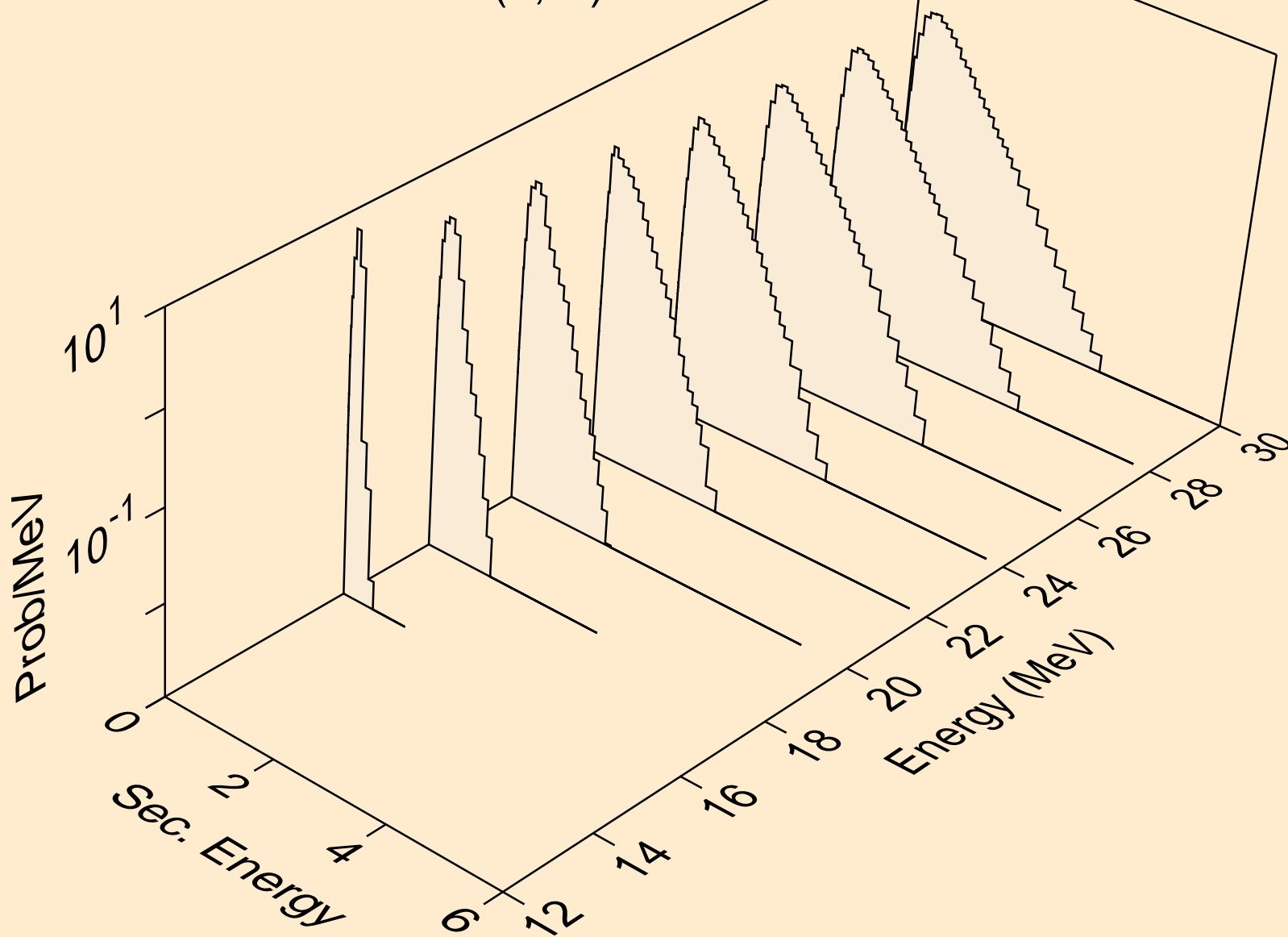

OS182 NEUTRON ACER TENDL-2019 LIBRARY; T=293.16K  
Neutron emission for (n,n\*)he3

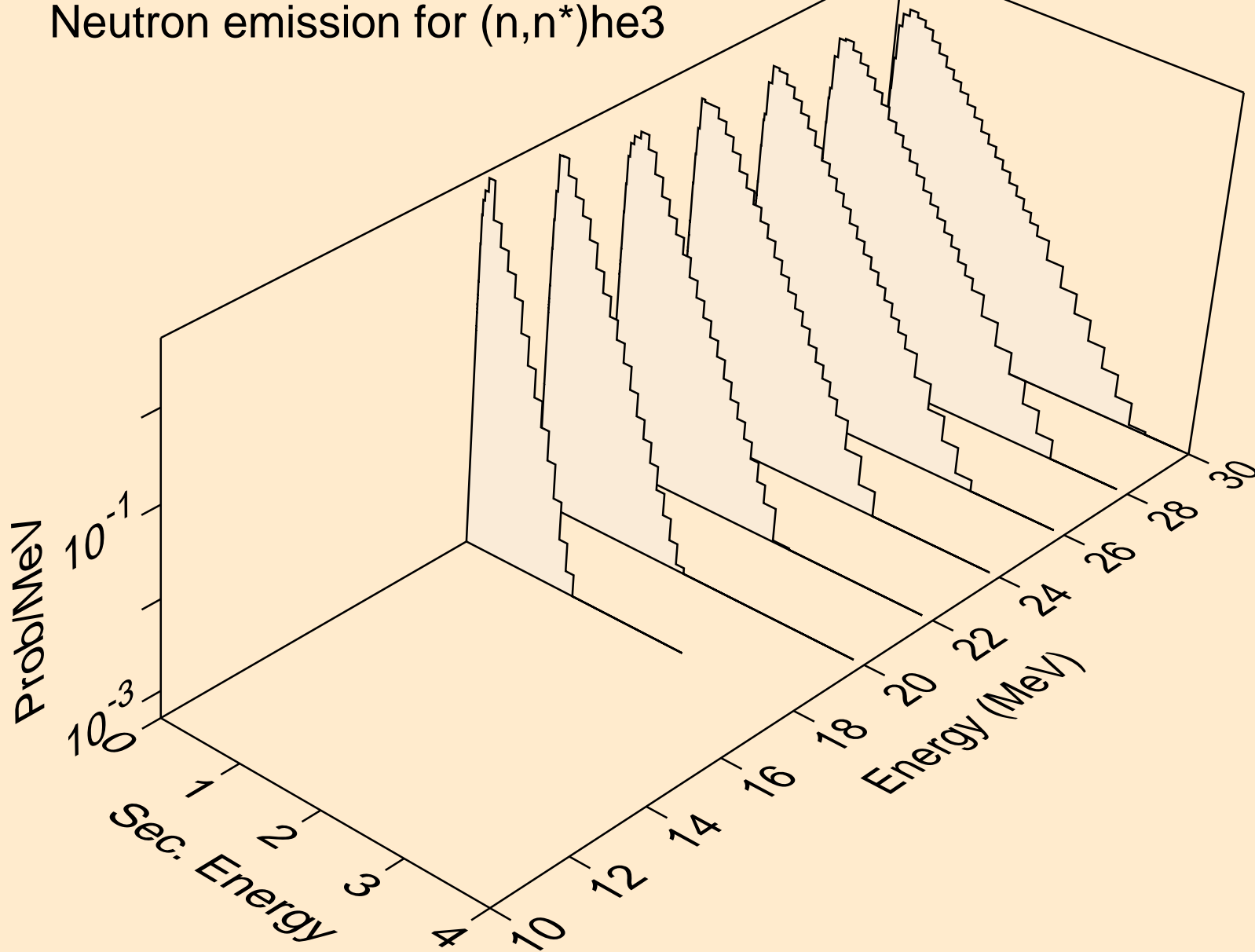

OS182 NEUTRON ACER TENDL-2019 LIBRARY; T=293.16K  
Neutron emission for (n,4n)

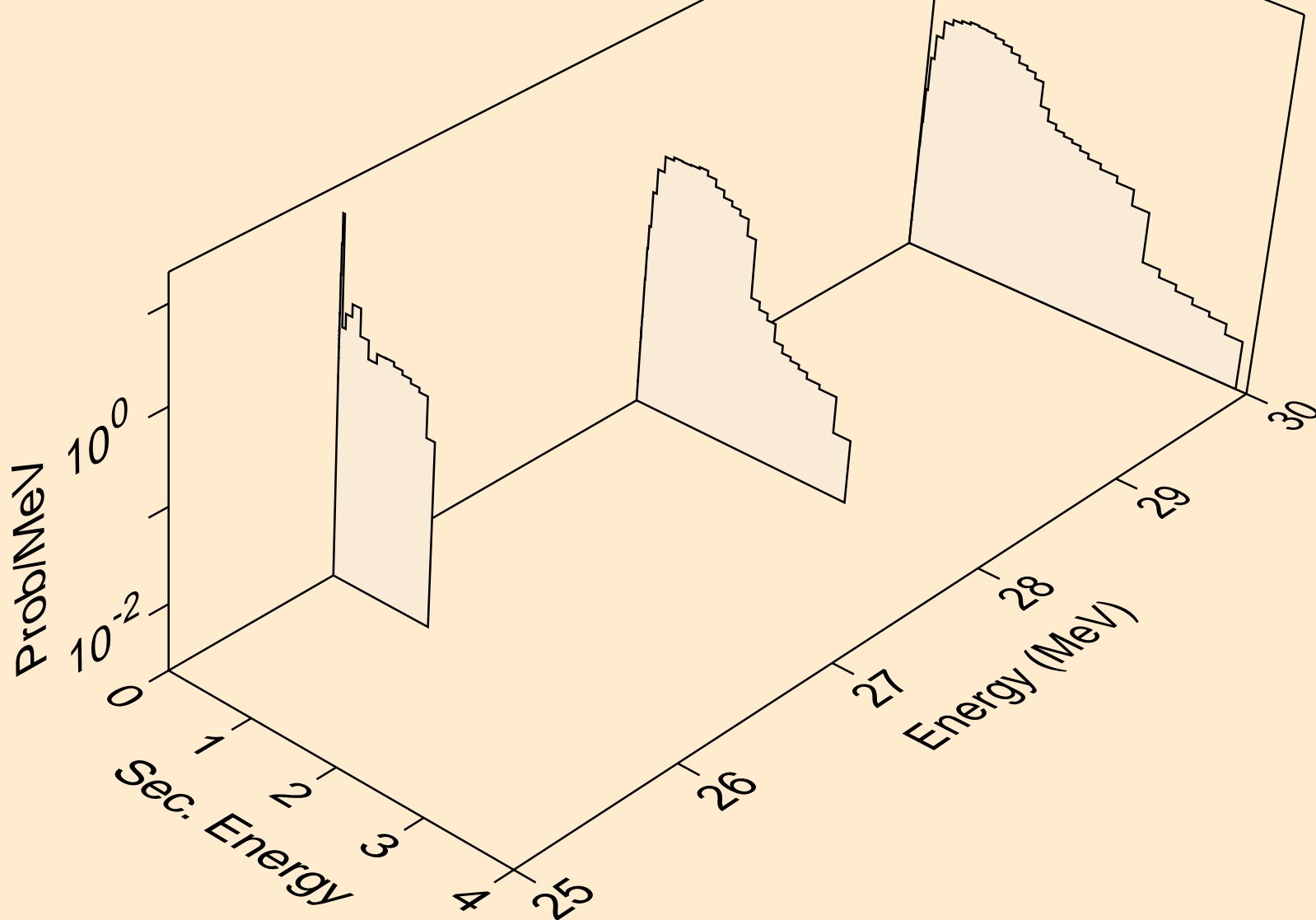

OS182 NEUTRON ACER TENDL-2019 LIBRARY; T=293.16K  
Neutron emission for (n,2np)

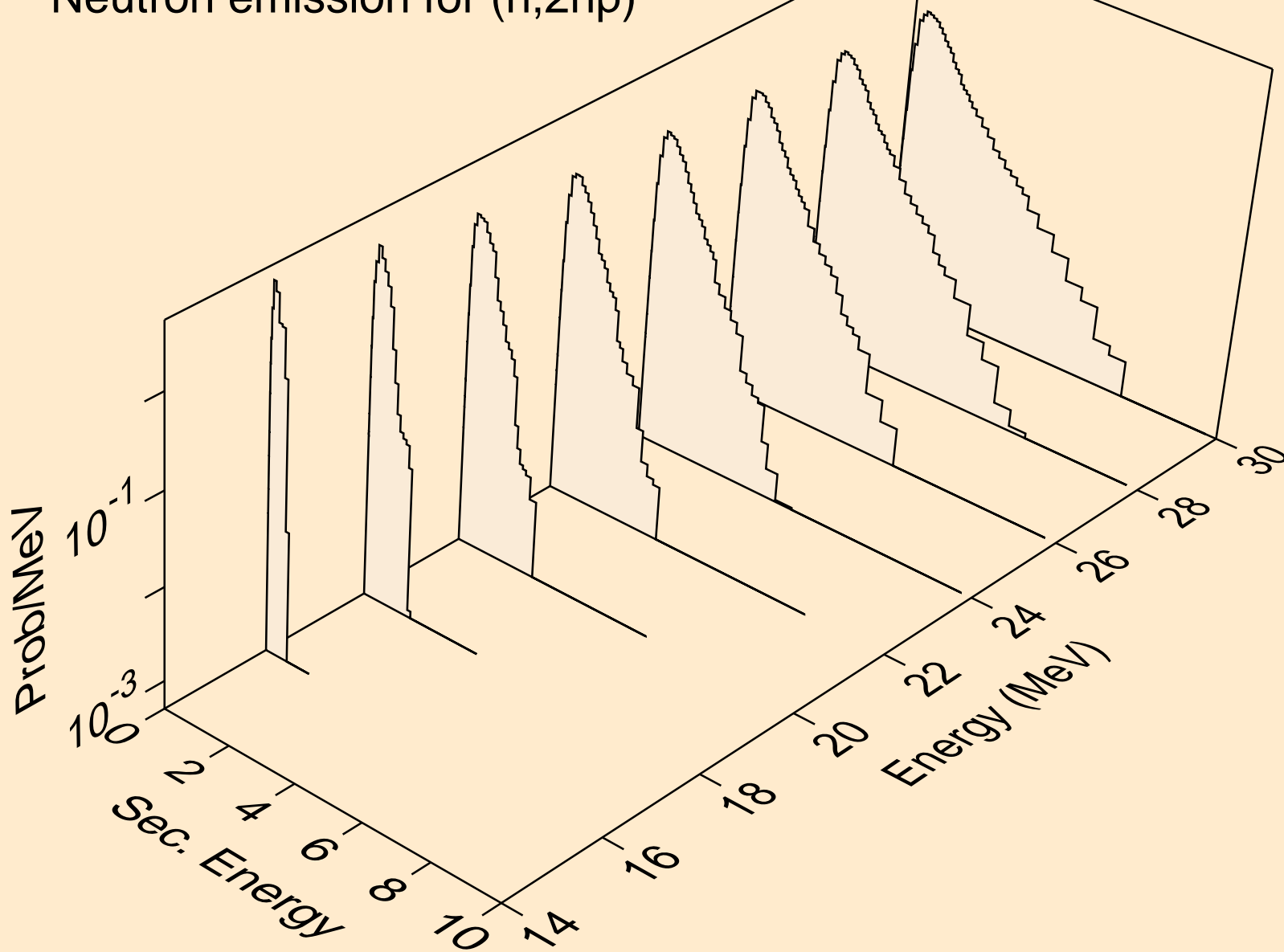

OS182 NEUTRON ACER TENDL-2019 LIBRARY; T=293.16K  
Neutron emission for (n,3np)

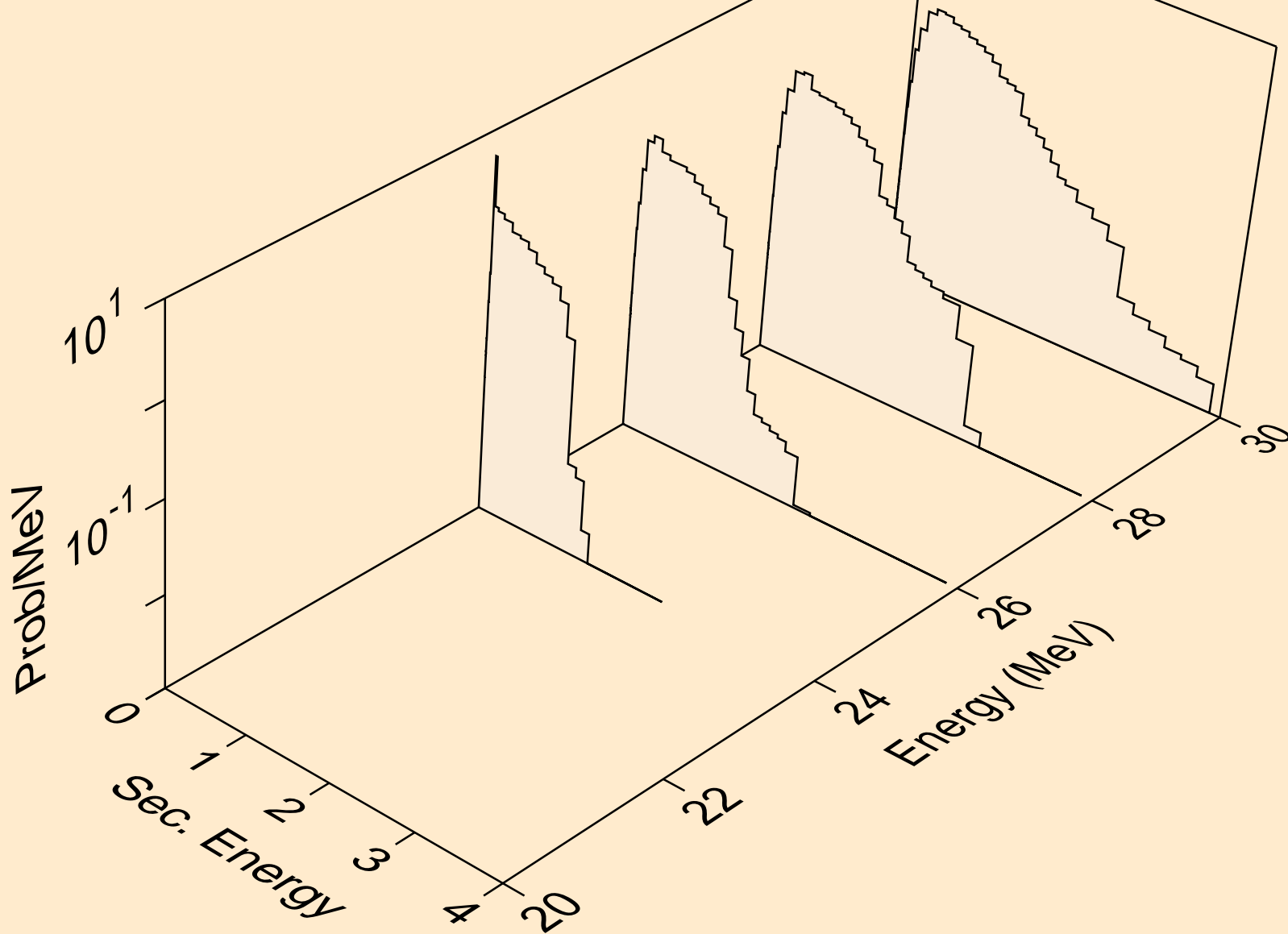

OS182 NEUTRON ACER TENDL-2019 LIBRARY; T=293.16K  
Neutron emission for (n,2np)

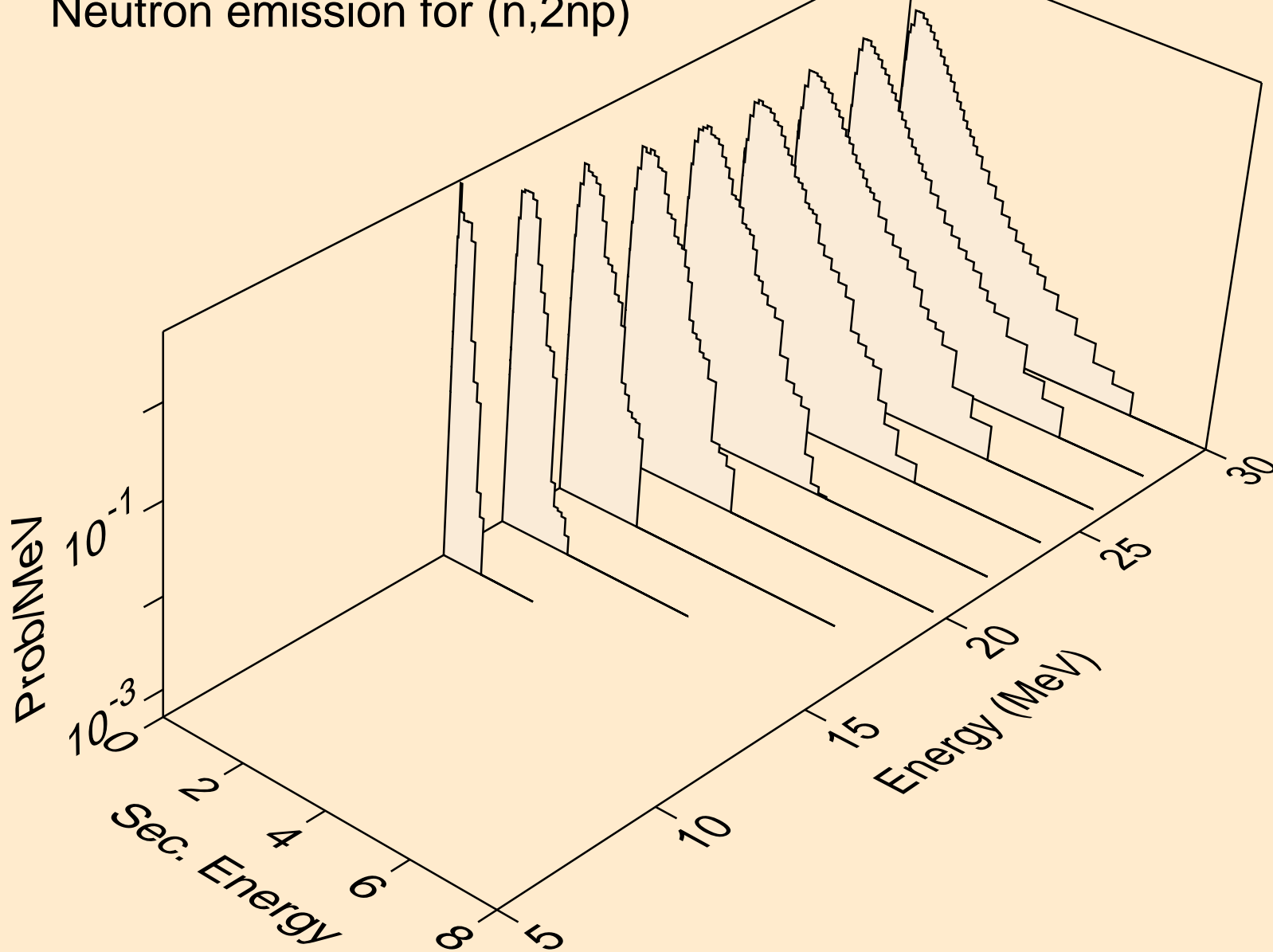

OS182 NEUTRON ACER TENDL-2019 LIBRARY; T=293.16K  
Neutron emission for (n,npa)

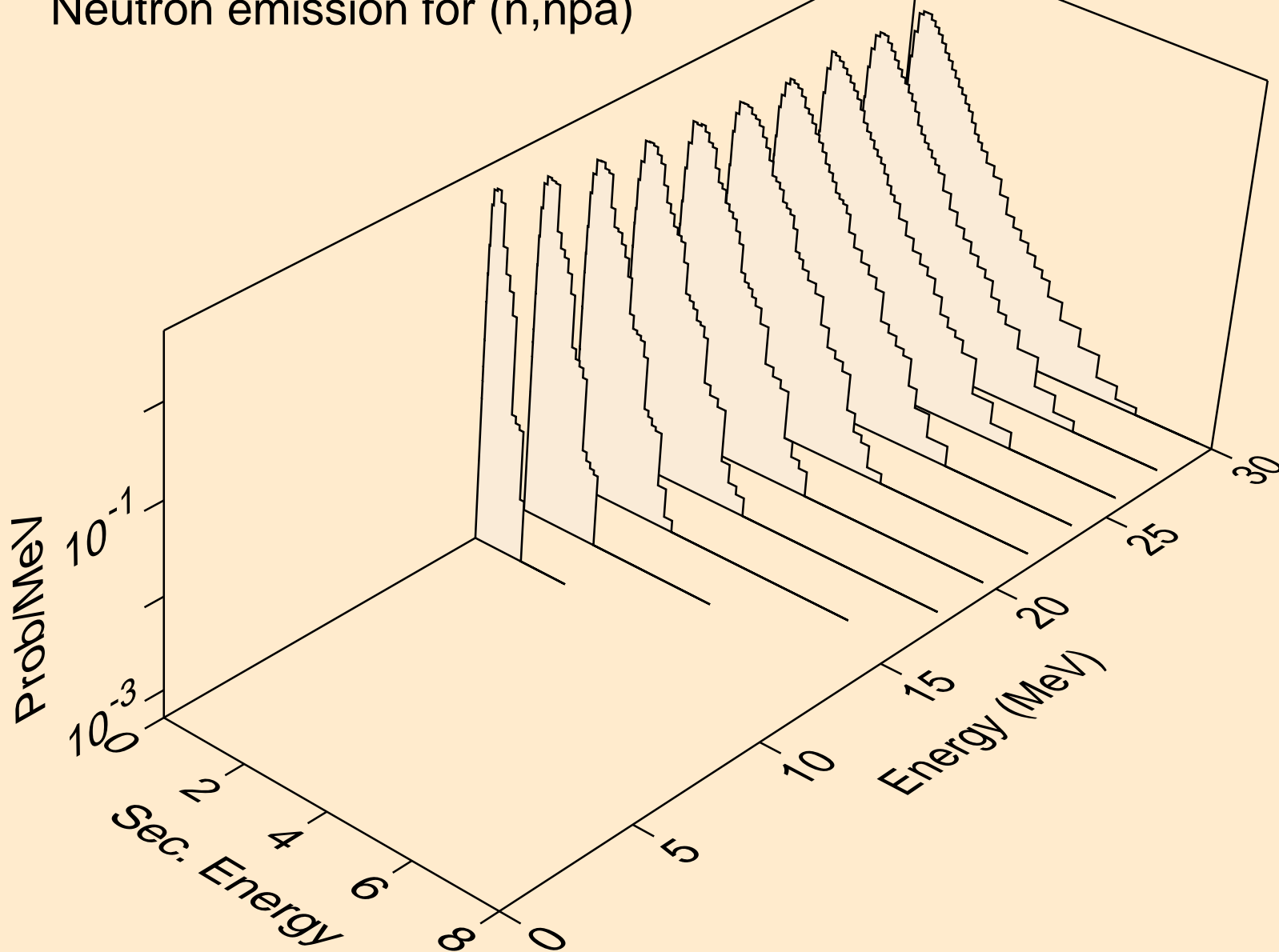

OS182 NEUTRON ACER TENDL-2019 LIBRARY; T=293.16K  
Neutron emission for (n,n\*c)

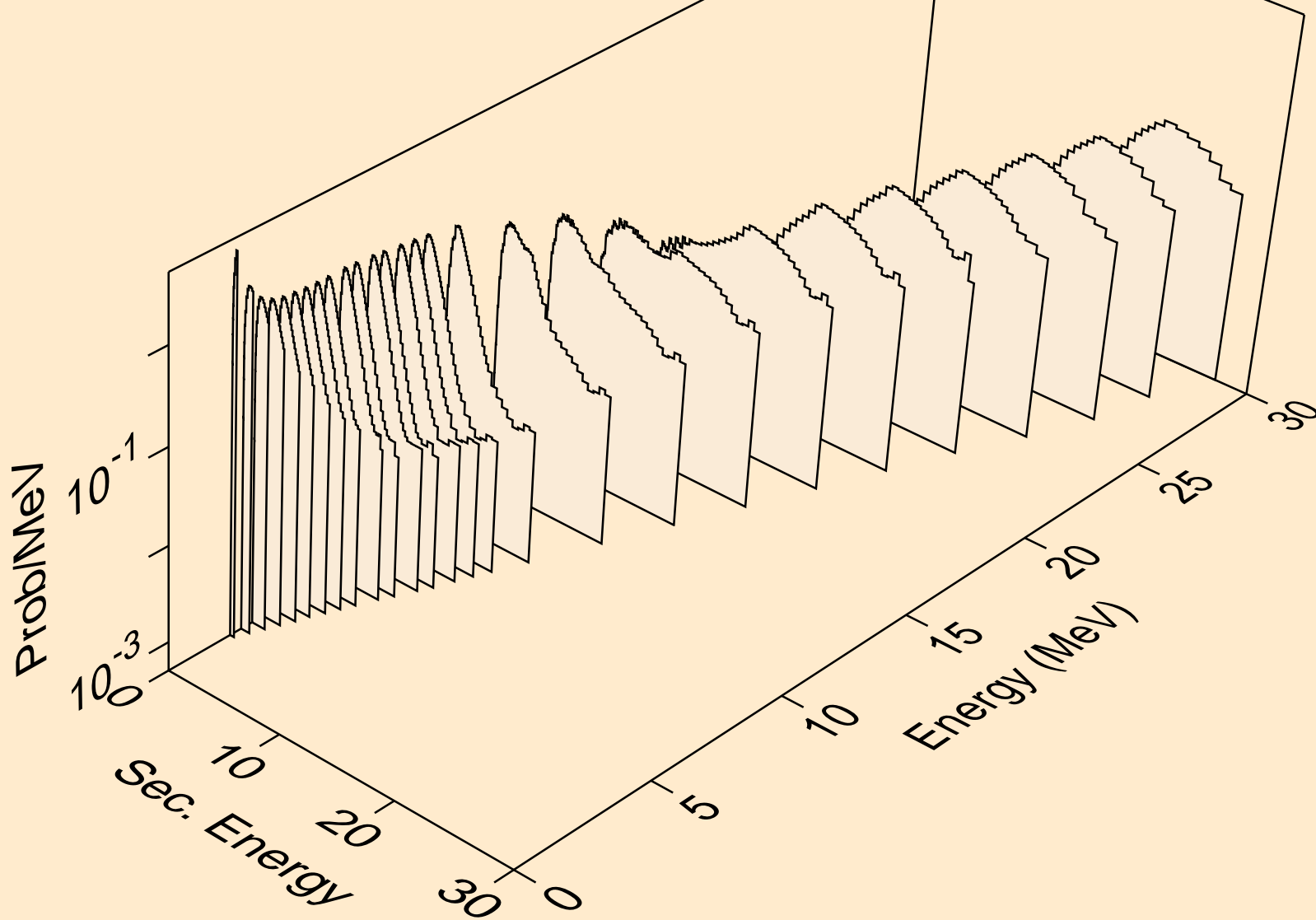



OS182 NEUTRON ACER TENDL-2019 LIBRARY; T=293.16K  
Photon emission for (n,x)

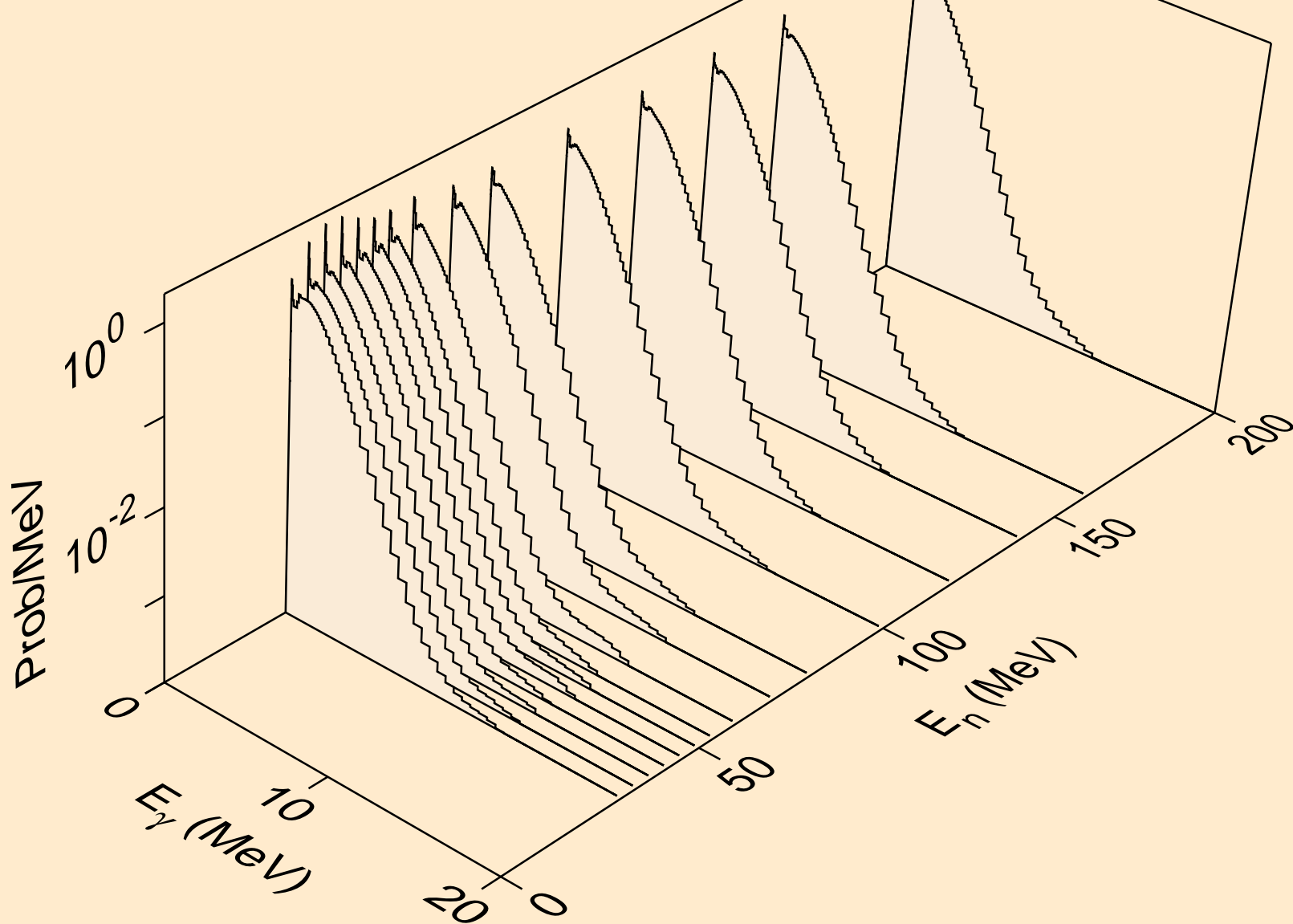

OS182 NEUTRON ACER TENDL-2019 LIBRARY; T=293.16K  
Photon emission for (n,2nd)

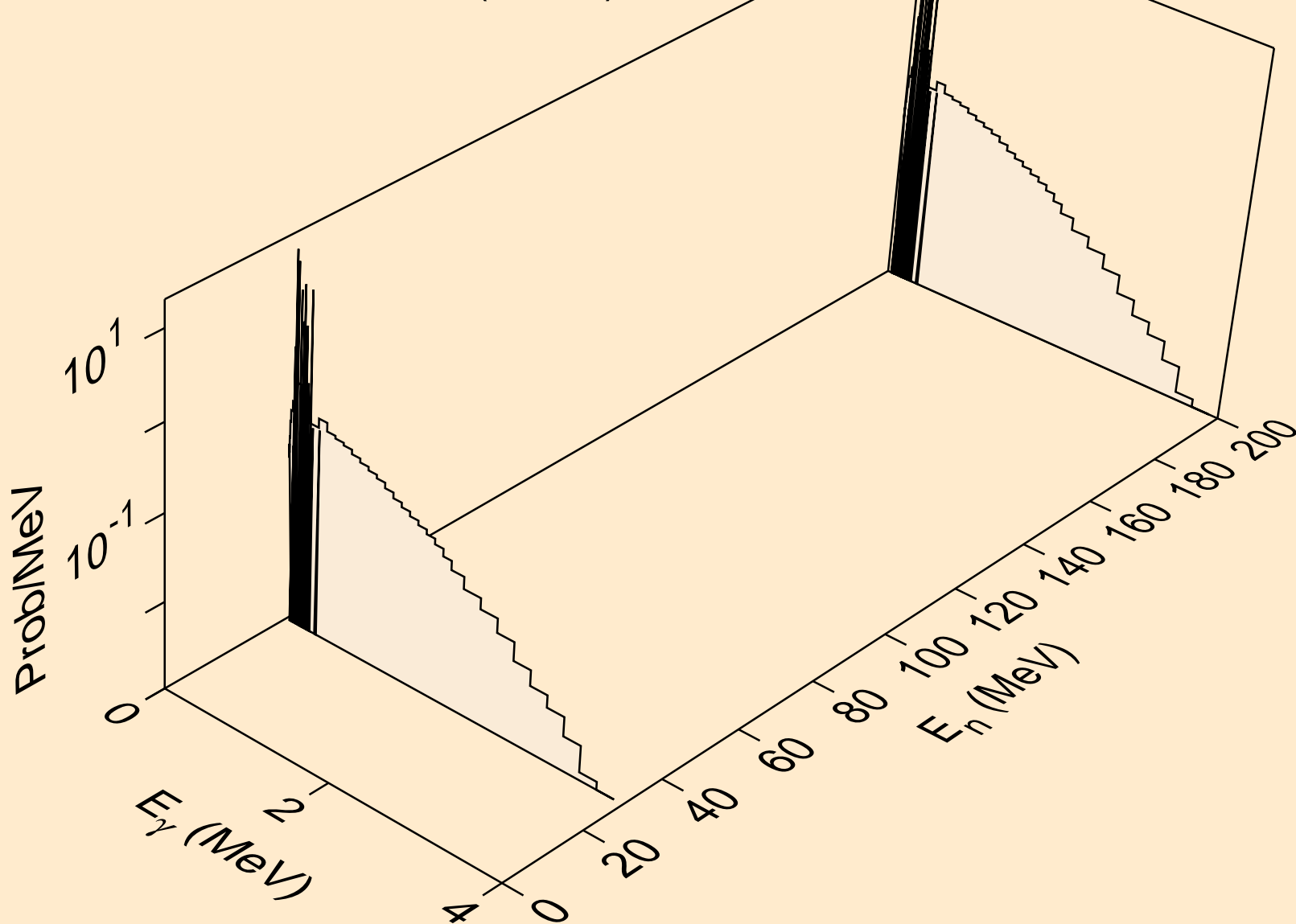

OS182 NEUTRON ACER TENDL-2019 LIBRARY; T=293.16K  
Photon emission for (n,2n)

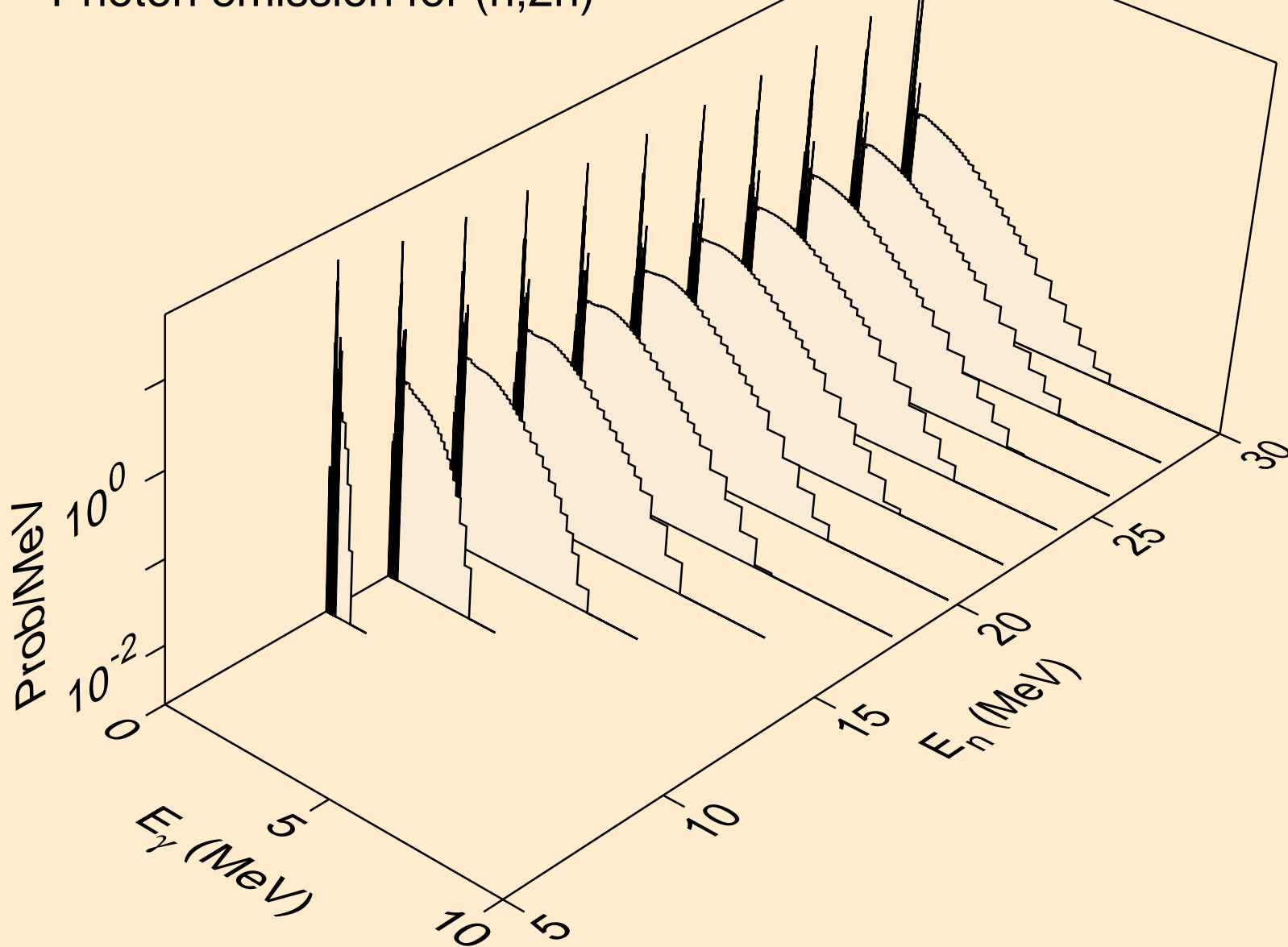

OS182 NEUTRON ACER TENDL-2019 LIBRARY; T=293.16K  
Photon emission for (n,3n)

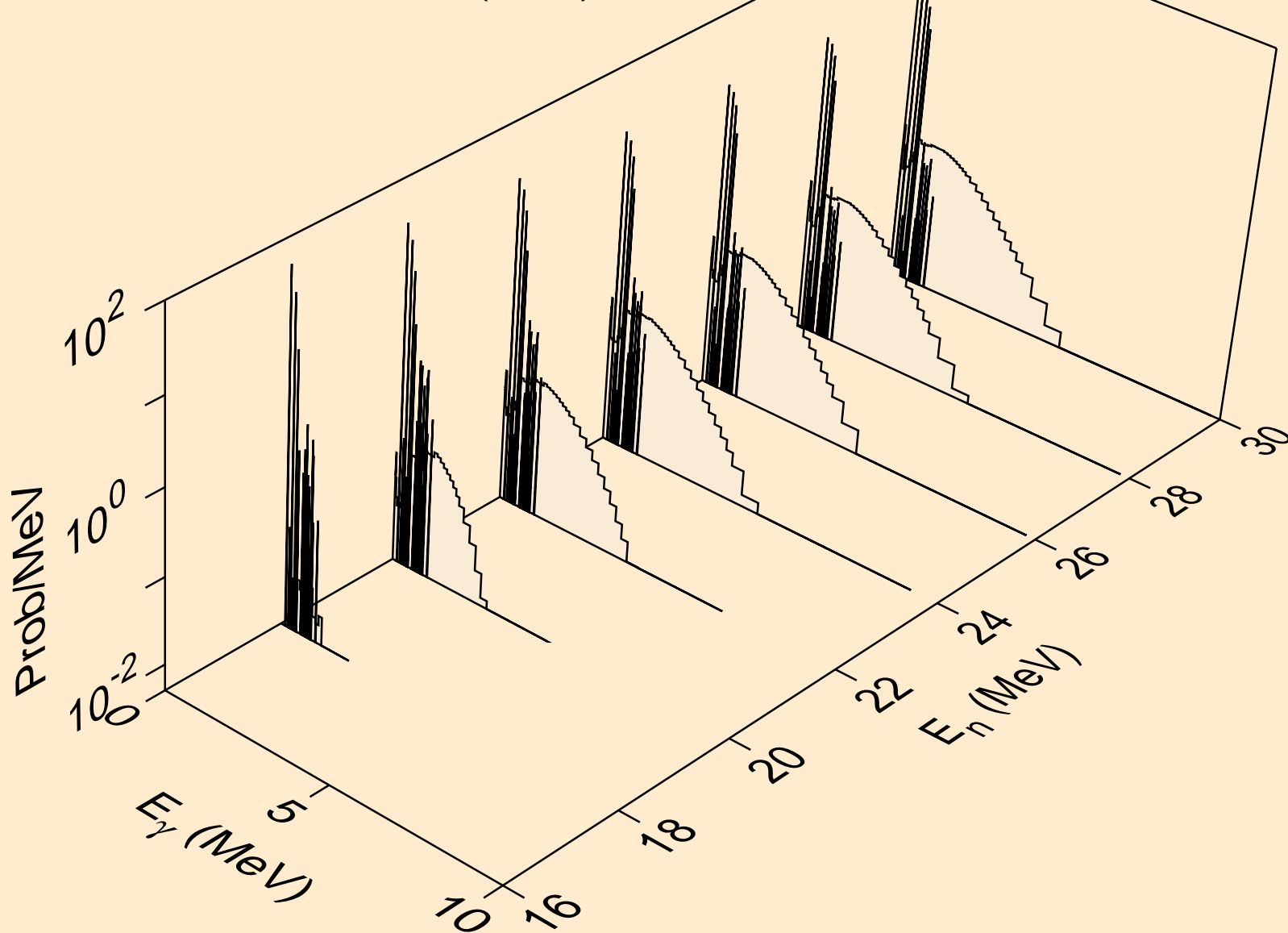

OS182 NEUTRON ACER TENDL-2019 LIBRARY; T=293.16K  
Photon emission for (n,n\*)a

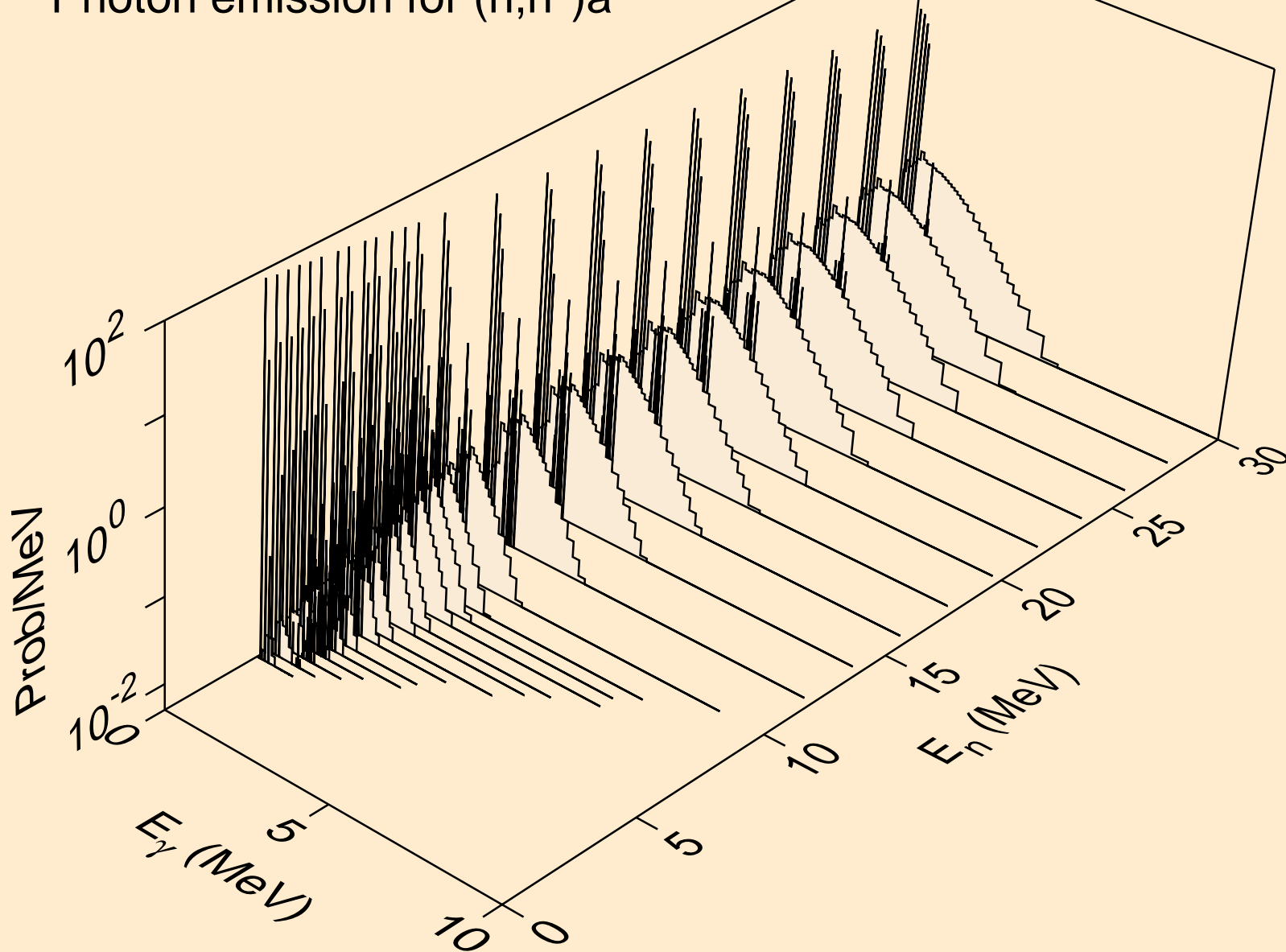

OS182 NEUTRON ACER TENDL-2019 LIBRARY; T=293.16K  
Photon emission for (n,2n)a

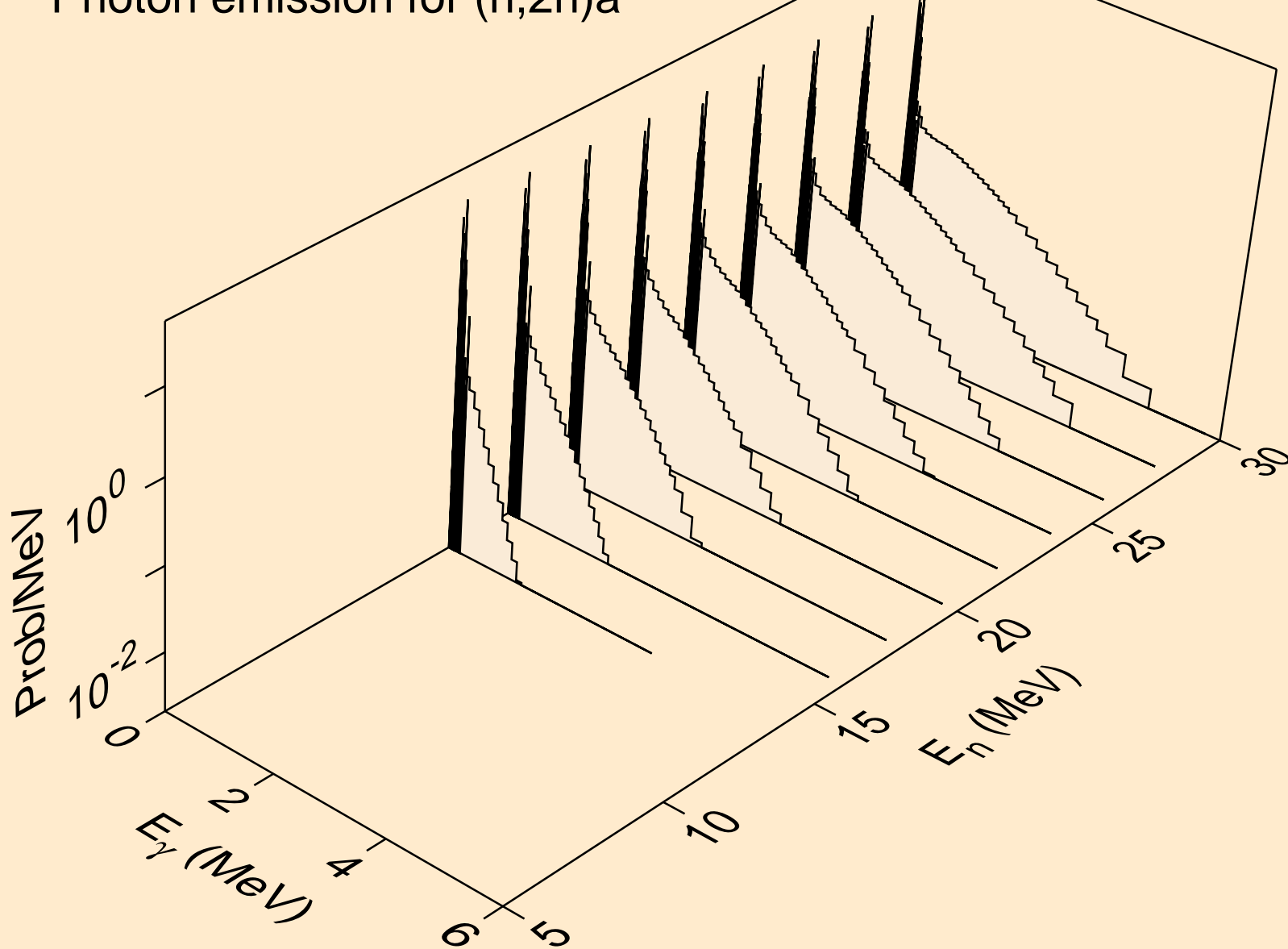

OS182 NEUTRON ACER TENDL-2019 LIBRARY; T=293.16K  
Photon emission for (n,3n)a

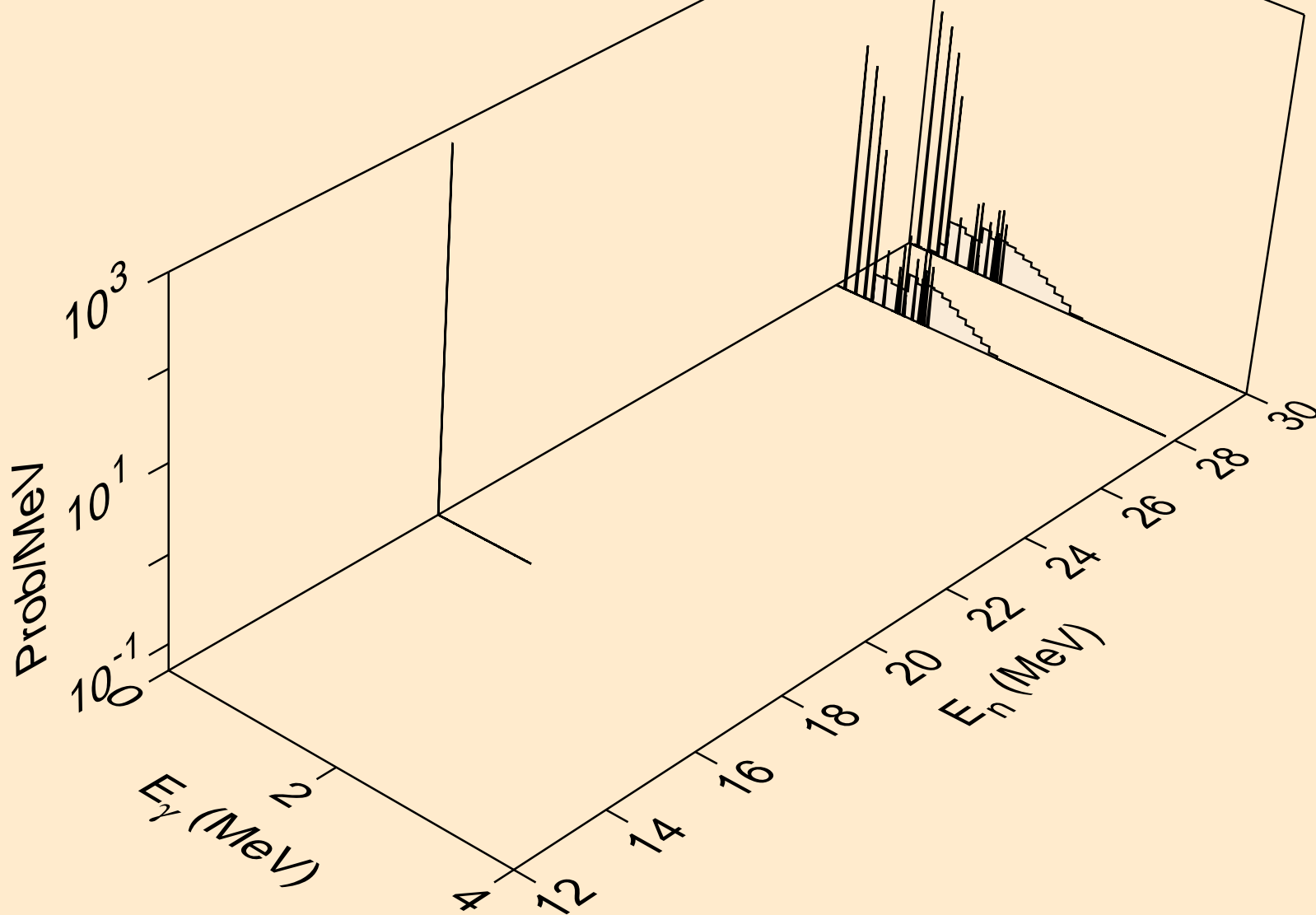

OS182 NEUTRON ACER TENDL-2019 LIBRARY; T=293.16K  
Photon emission for (n,n\*)p

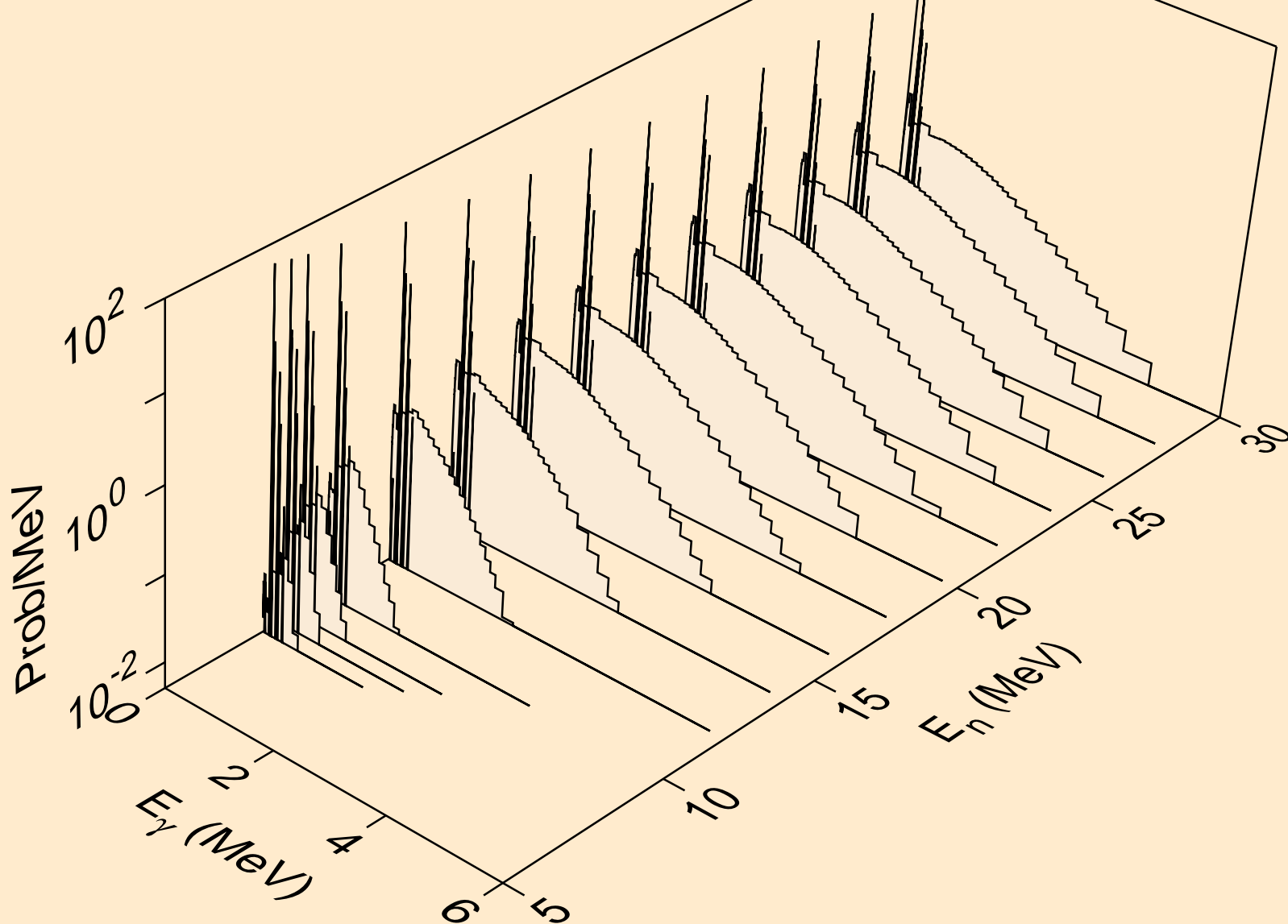



OS182 NEUTRON ACER TENDL-2019 LIBRARY; T=293.16K  
Photon emission for (n,n\*)2a

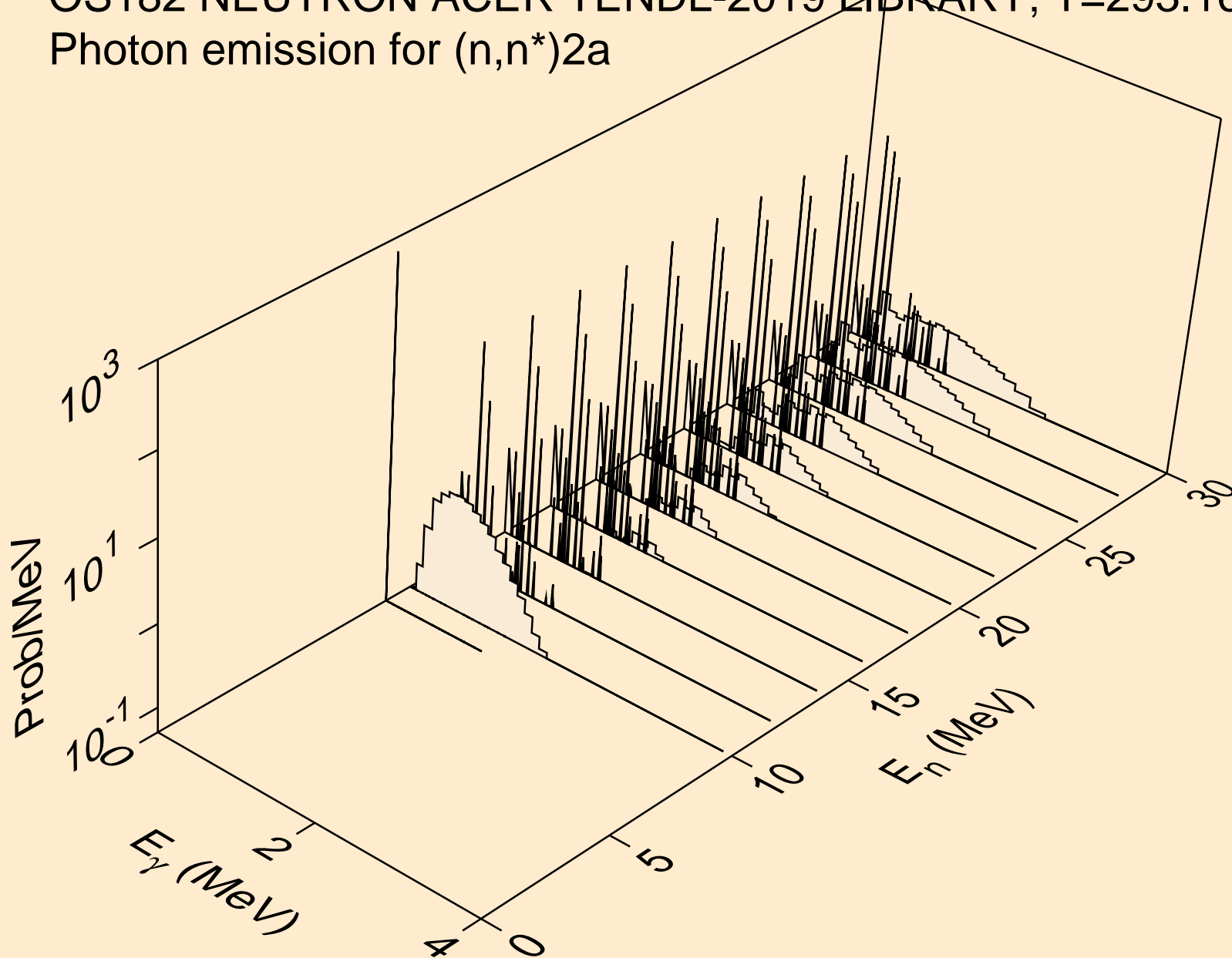

OS182 NEUTRON ACER TENDL-2019 LIBRARY; T=293.16K  
Photon emission for (n,2n)2a

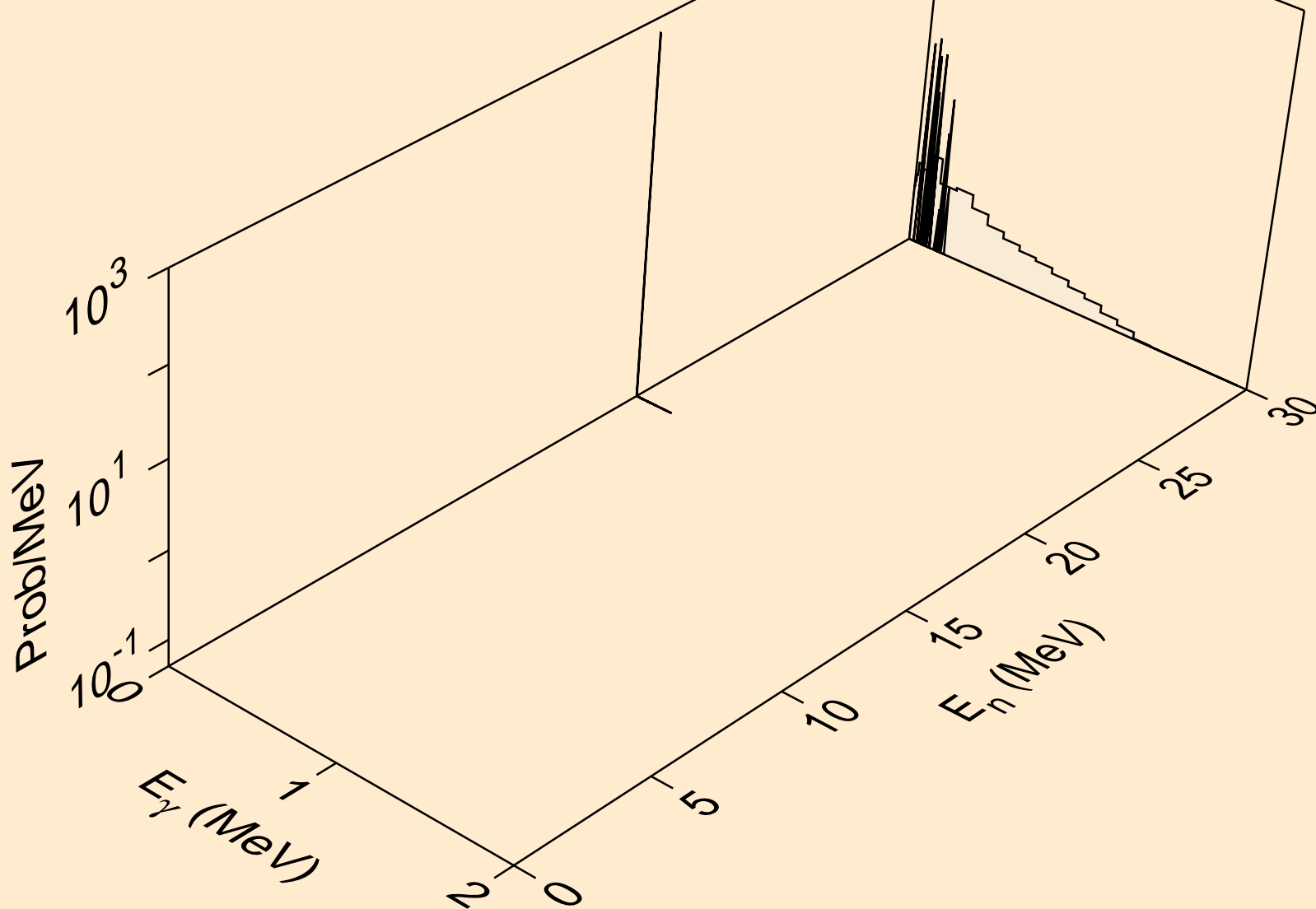

OS182 NEUTRON ACER TENDL-2019 LIBRARY; T=293.16K  
Photon emission for (n,n\*)d

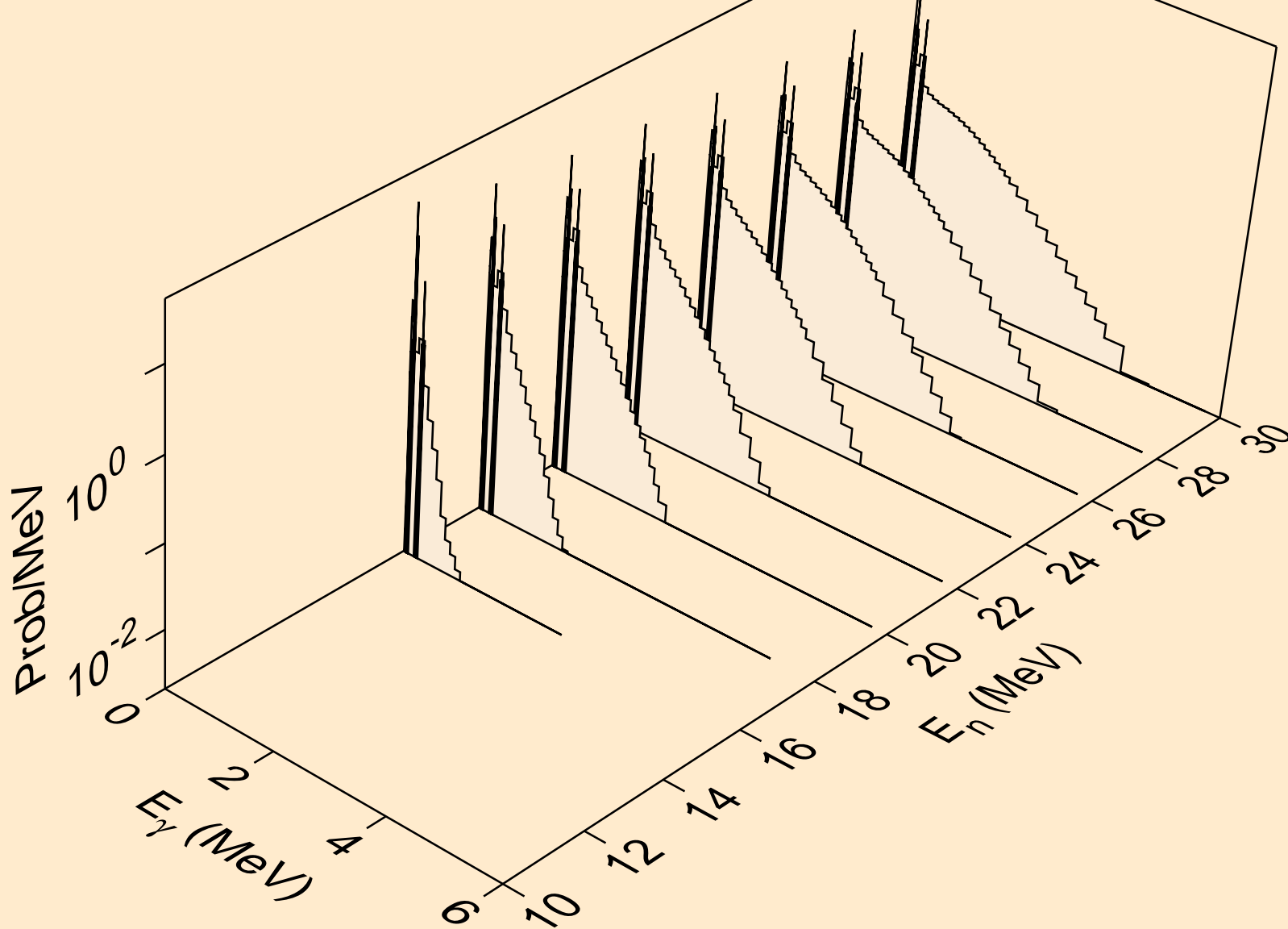

OS182 NEUTRON ACER TENDL-2019 LIBRARY; T=293.16K  
Photon emission for (n,n\*)t

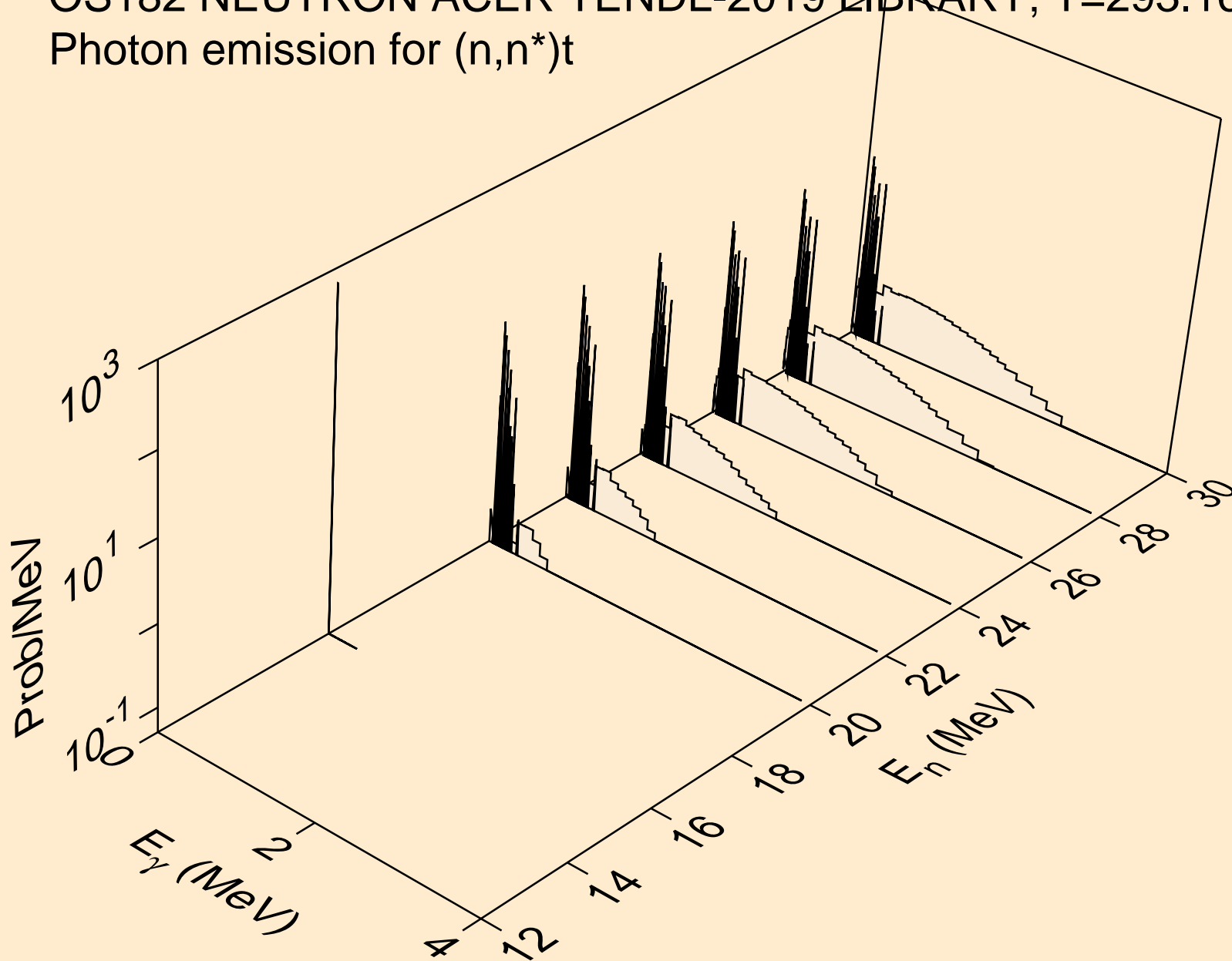

OS182 NEUTRON ACER TENDL-2019 LIBRARY; T=293.16K  
Photon emission for (n,n\*)he3

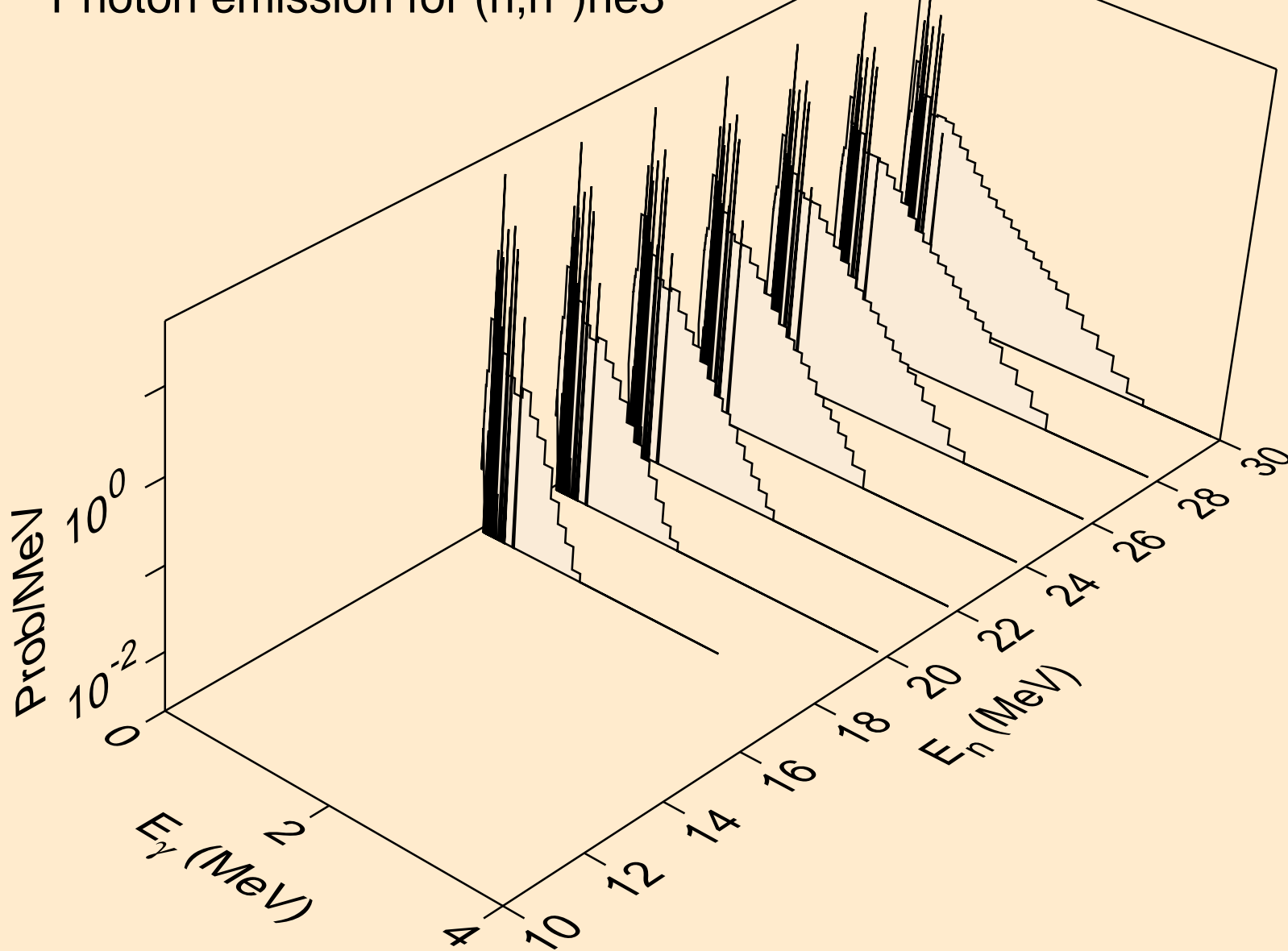

OS182 NEUTRON ACER TENDL-2019 LIBRARY; T=293.16K  
Photon emission for (n,4n)

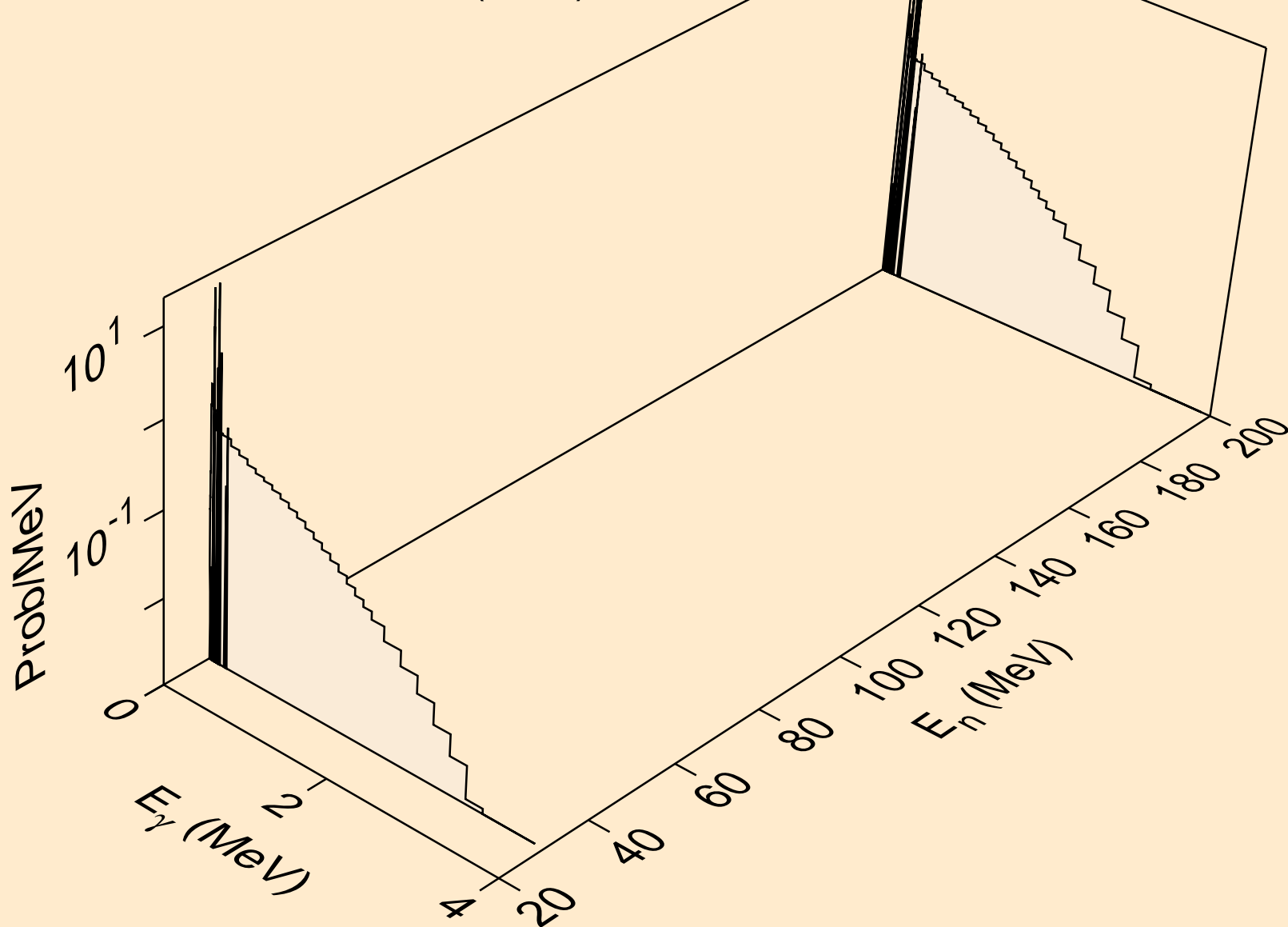

OS182 NEUTRON ACER TENDL-2019 LIBRARY; T=293.16K  
Photon emission for (n,2np)

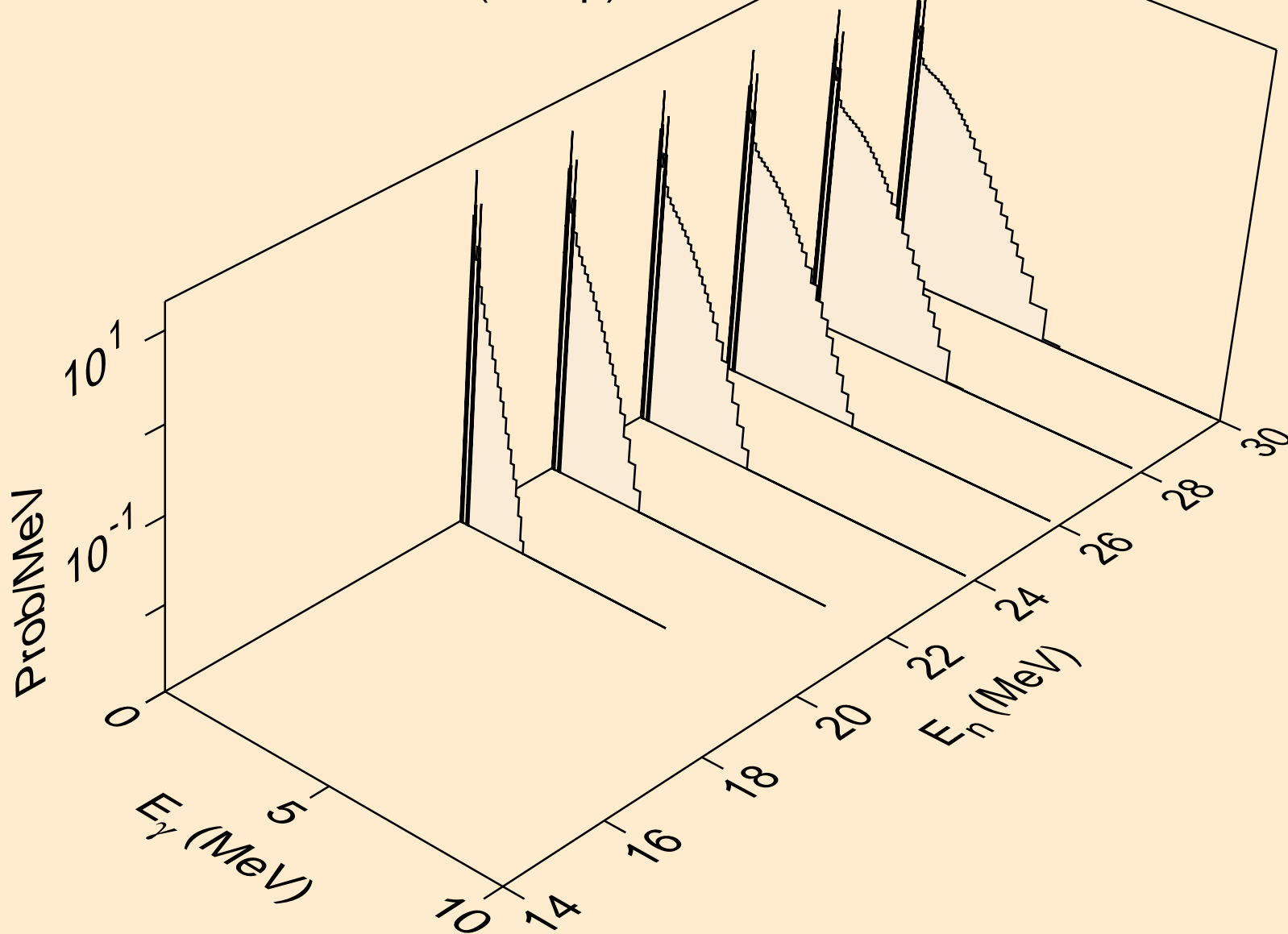

OS182 NEUTRON ACER TENDL-2019 LIBRARY; T=293.16K  
Photon emission for (n,3np)

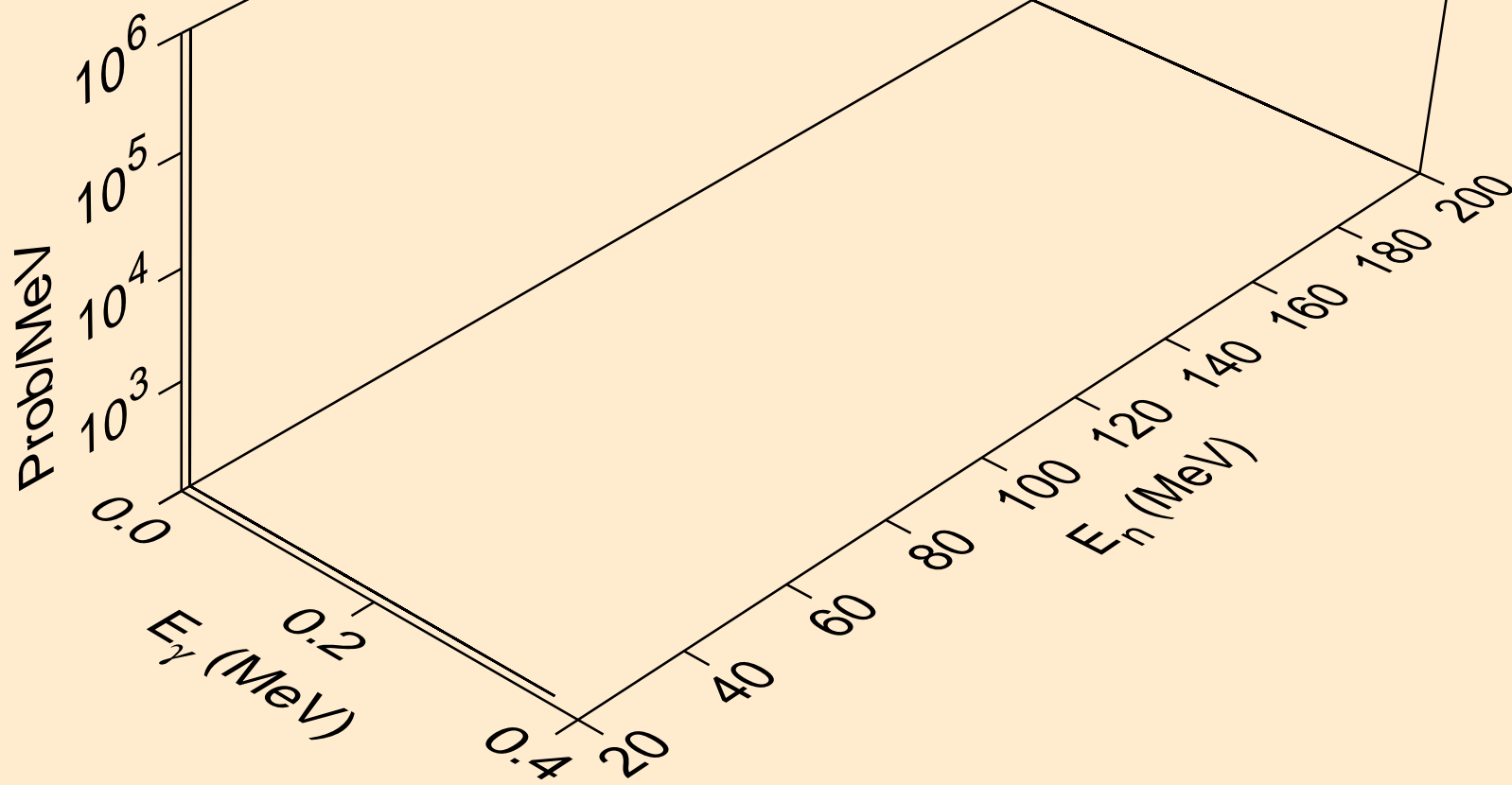



OS182 NEUTRON ACER TENDL-2019 LIBRARY; T=293.16K  
Photon emission for (n,2np)

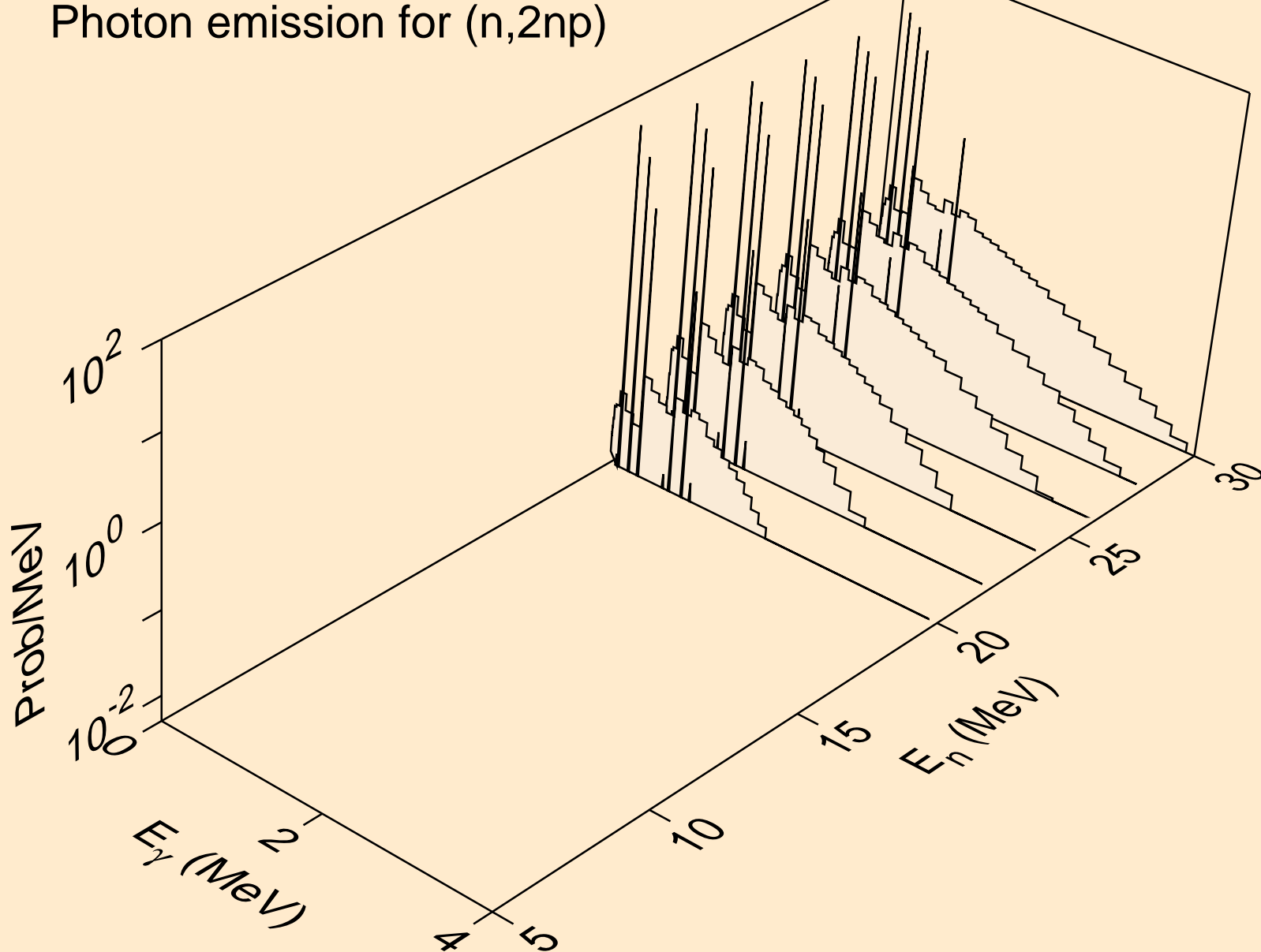

OS182 NEUTRON ACER TENDL-2019 LIBRARY; T=293.16K  
Photon emission for (n,npa)

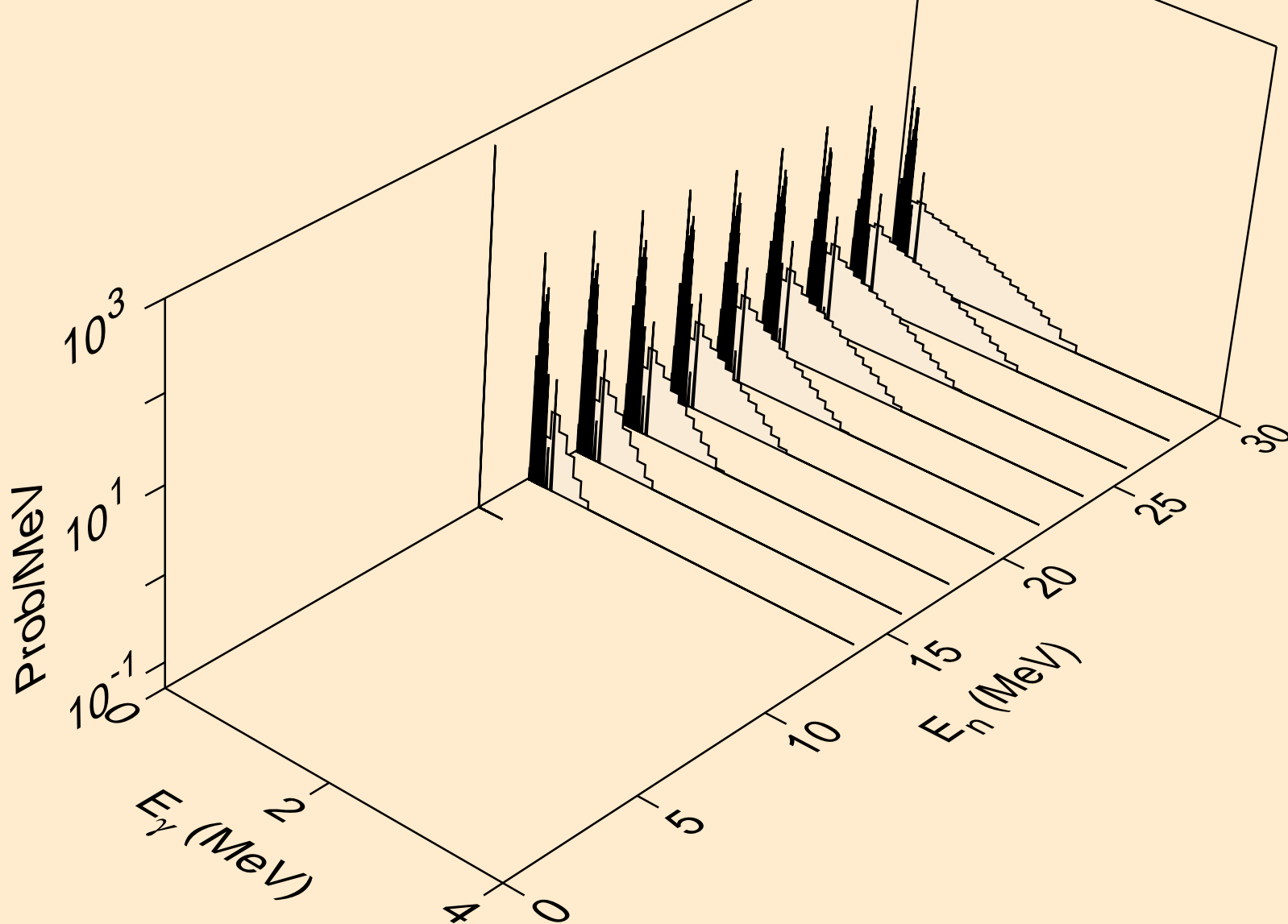

OS182 NEUTRON ACER TENDL-2019 LIBRARY; T=293.16K  
Photon emission for (n,n\*c)

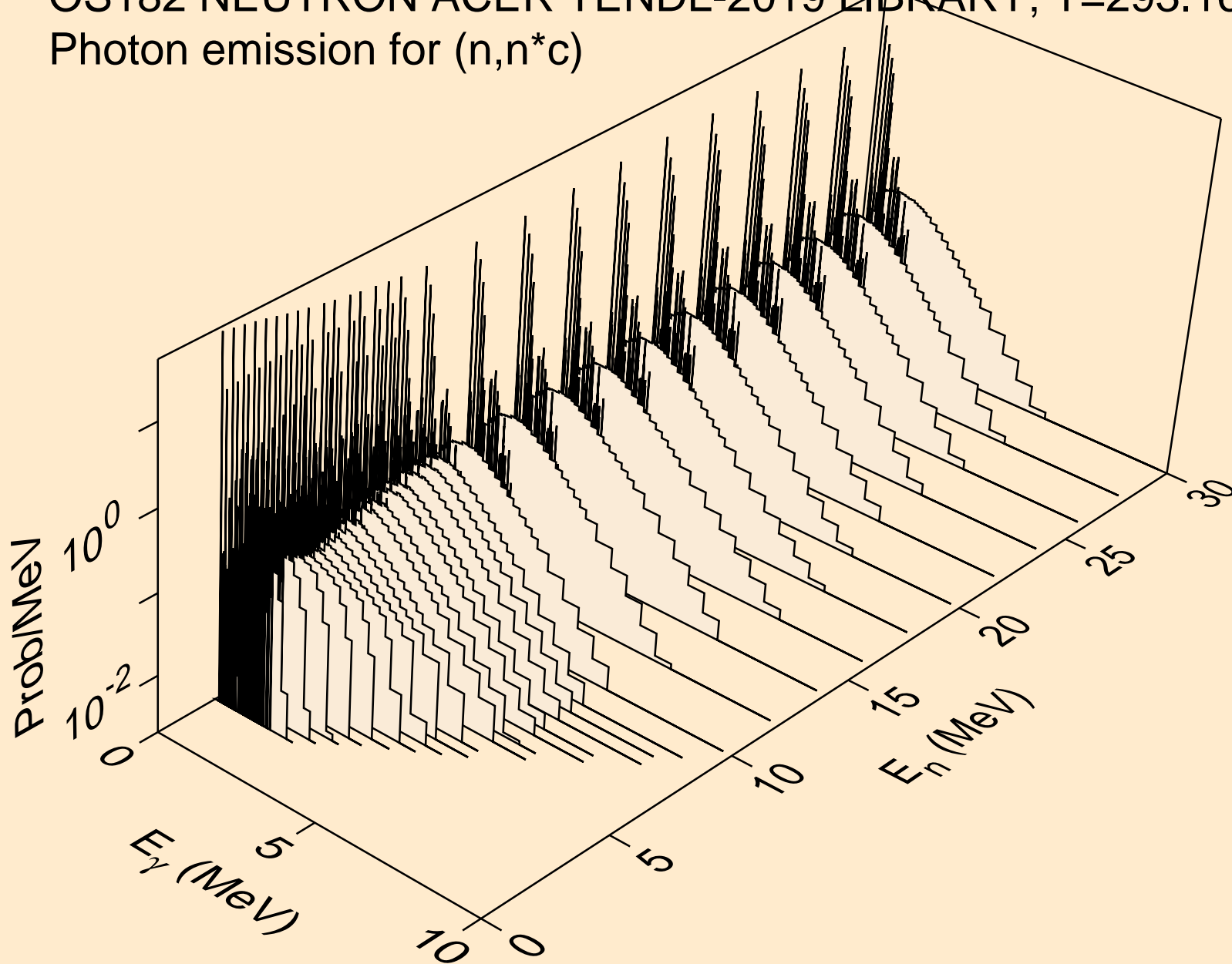

OS182 NEUTRON ACER TENDL-2019 LIBRARY; T=293.16K  
Photon emission for (n,gma)

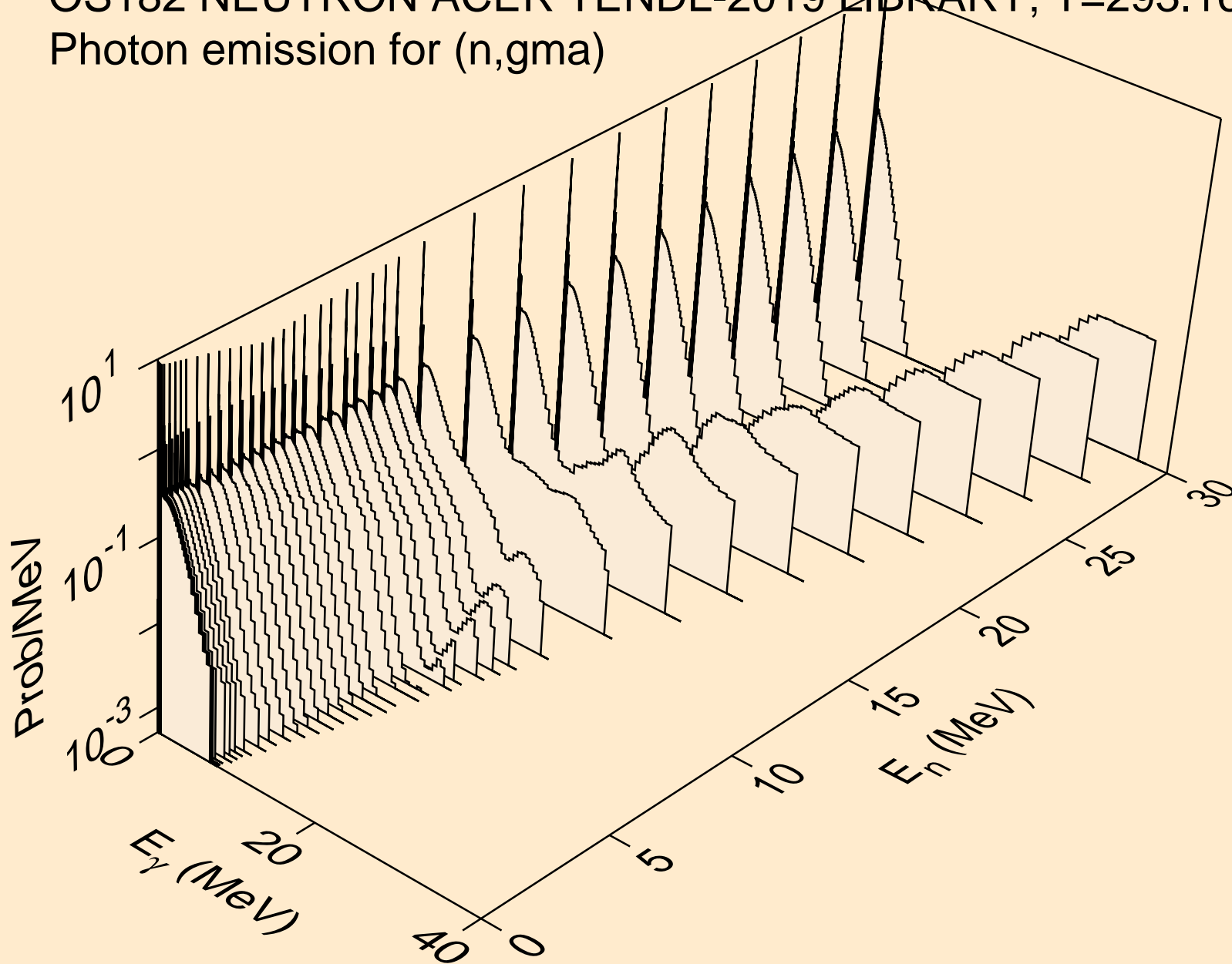

OS182 NEUTRON ACER TENDL-2019 LIBRARY; T=293.16K  
Photon emission for (n,p)

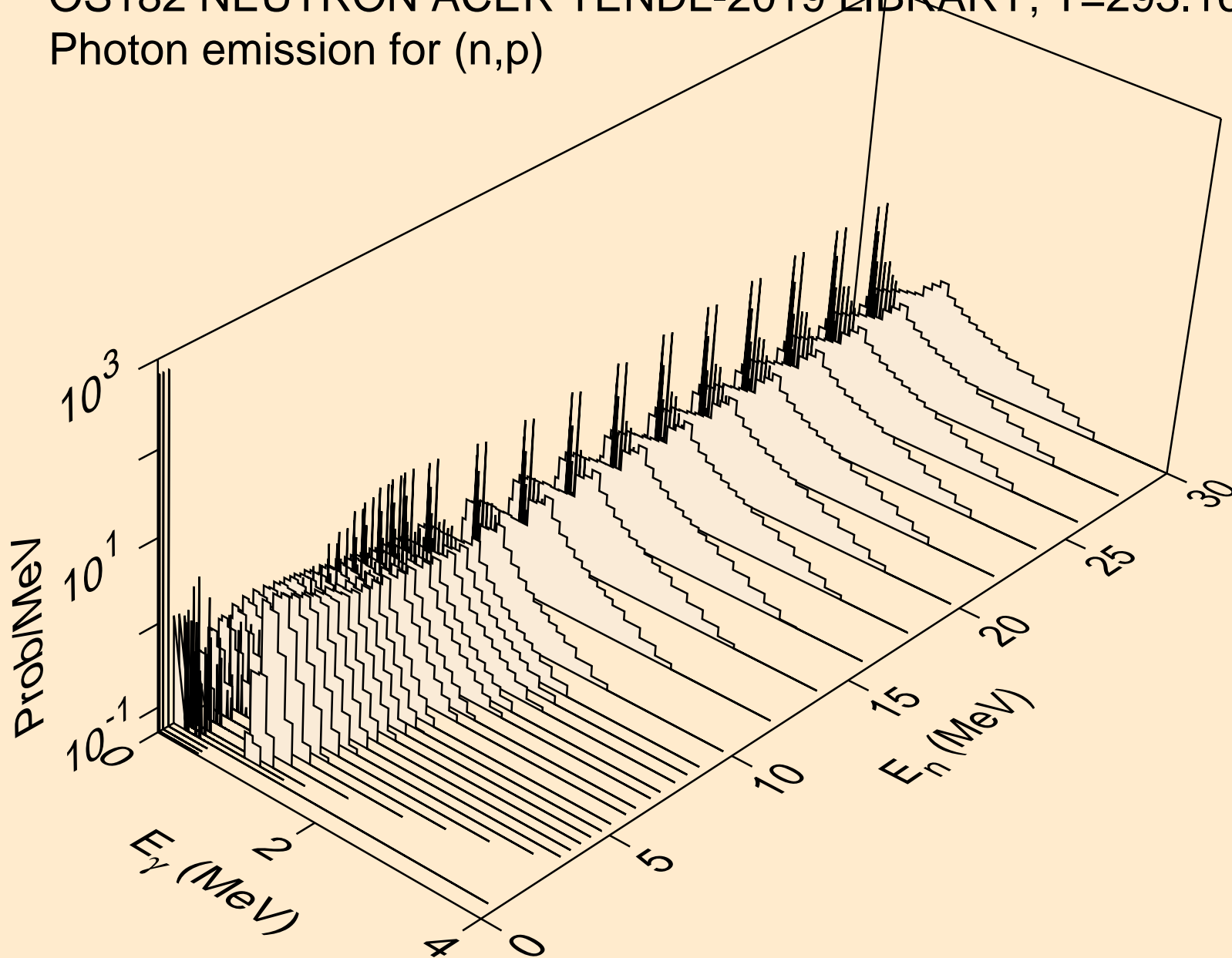

OS182 NEUTRON ACER TENDL-2019 LIBRARY; T=293.16K  
Photon emission for (n,d)

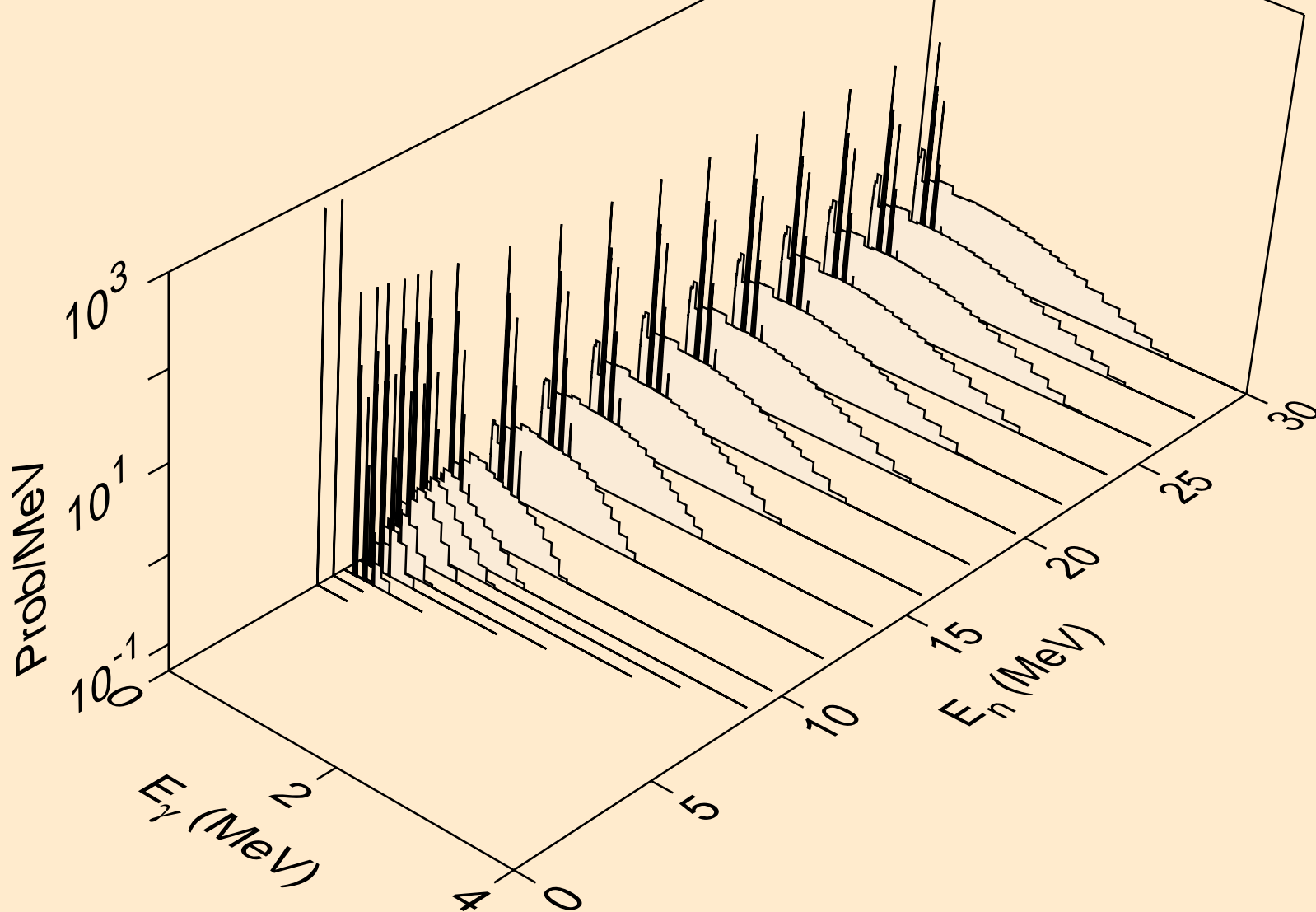

OS182 NEUTRON ACER TENDL-2019 LIBRARY; T=293.16K  
Photon emission for (n,t)

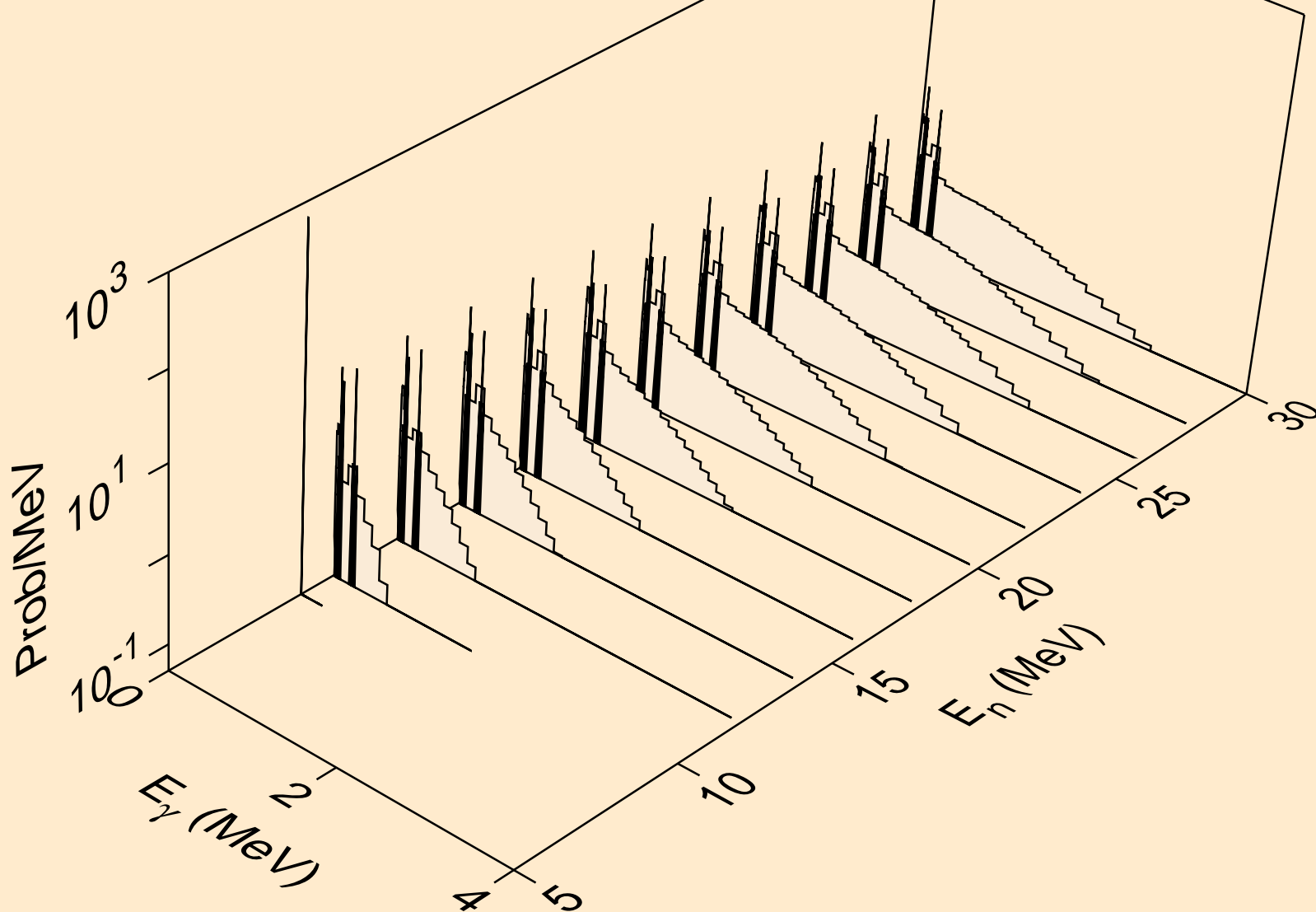

OS182 NEUTRON ACER TENDL-2019 LIBRARY; T=293.16K  
Photon emission for (n,he3)

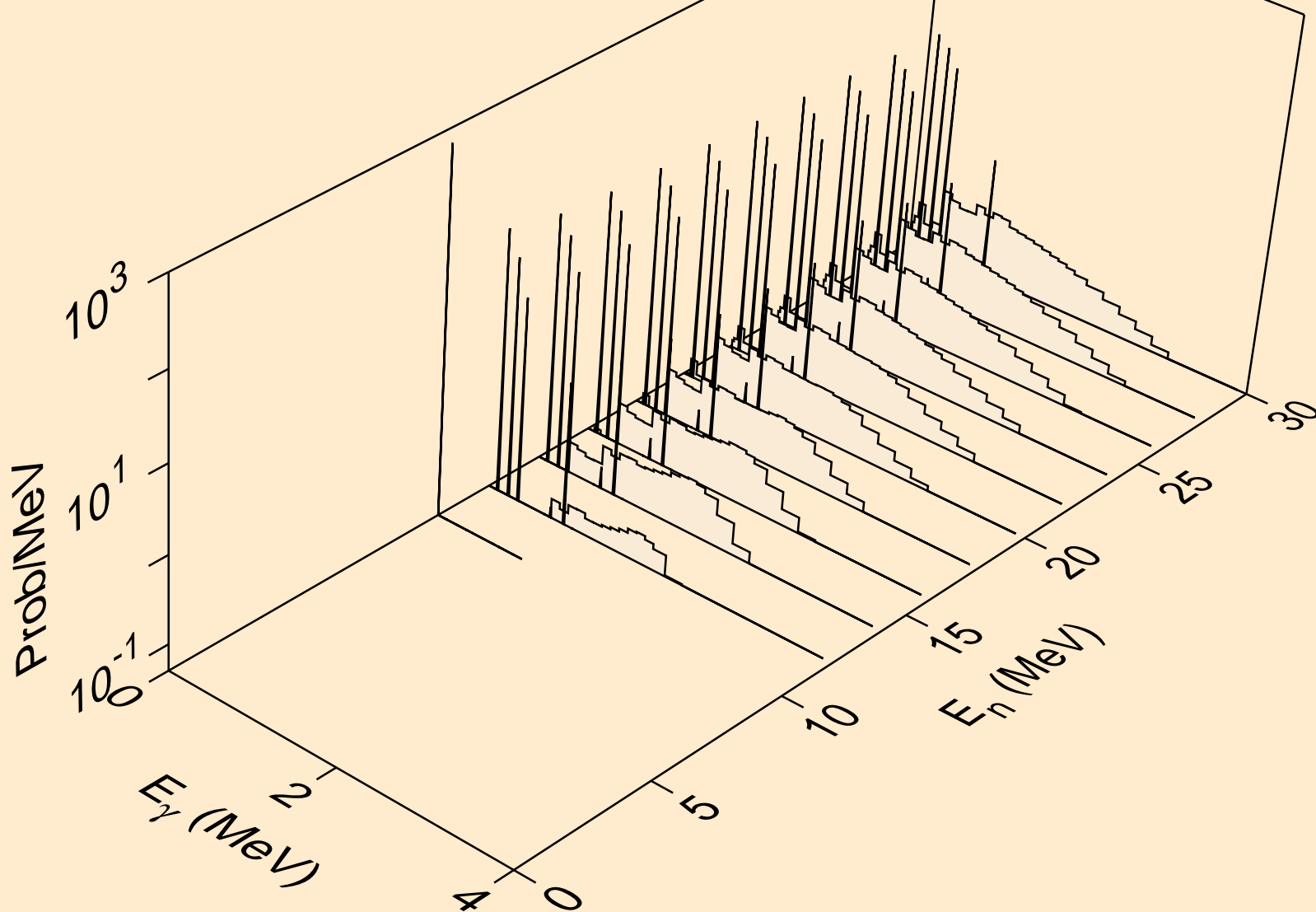



OS182 NEUTRON ACER TENDL-2019 LIBRARY; T=293.16K  
Photon emission for (n,a)

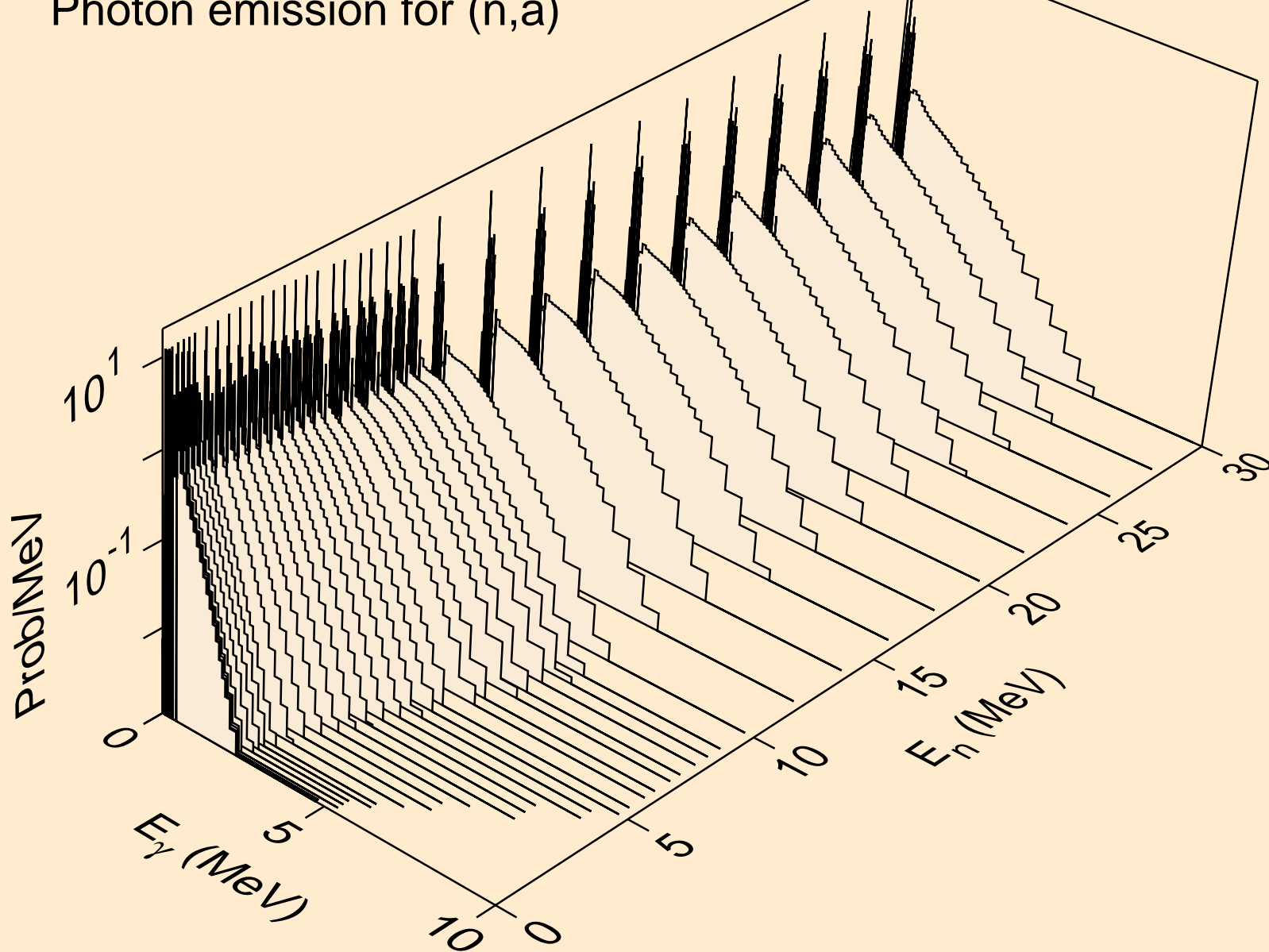

OS182 NEUTRON ACER TENDL-2019 LIBRARY; T=293.16K  
Photon emission for (n,2a)

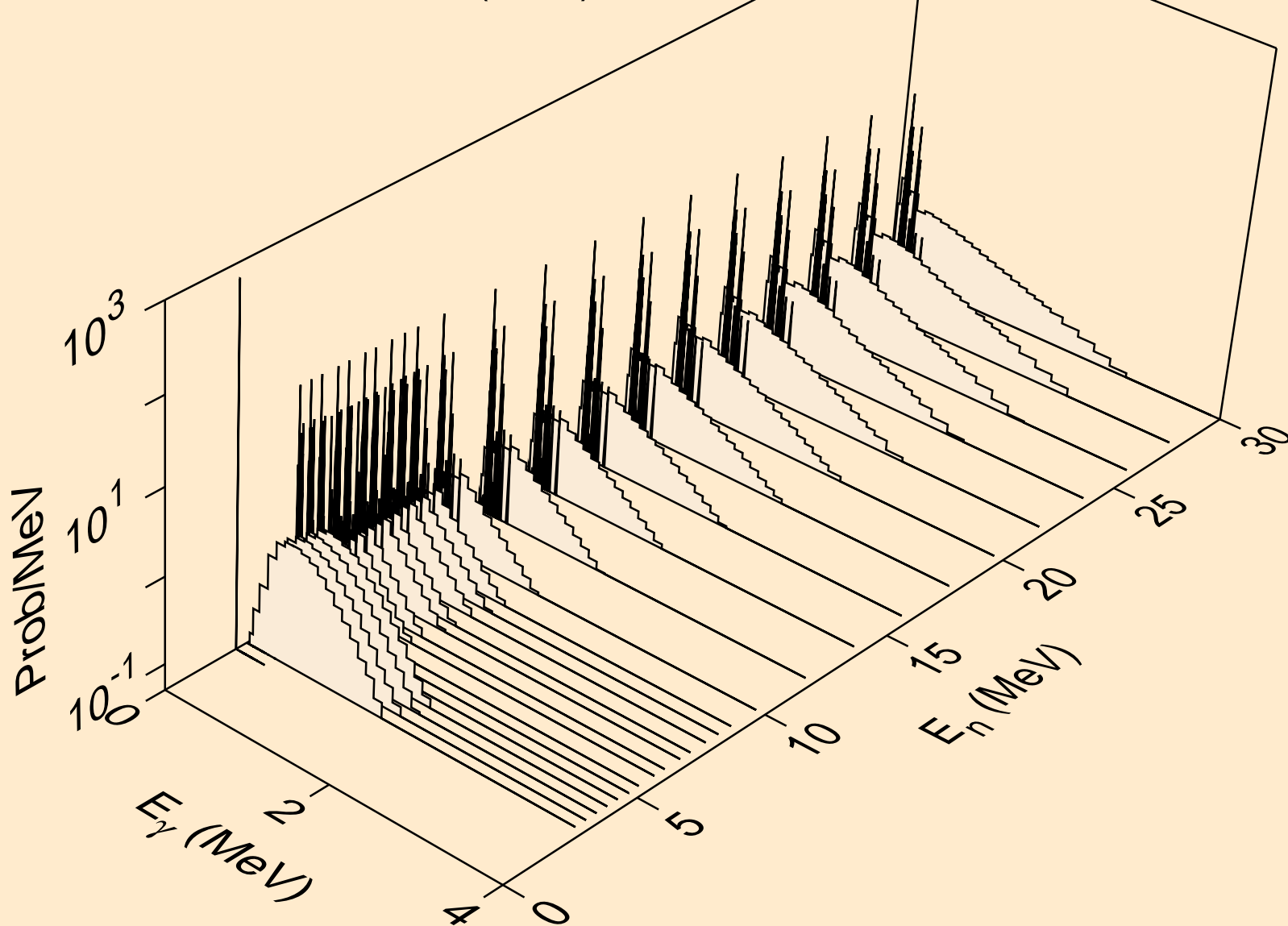

OS182 NEUTRON ACER TENDL-2019 LIBRARY; T=293.16K  
Photon emission for (n,2p)

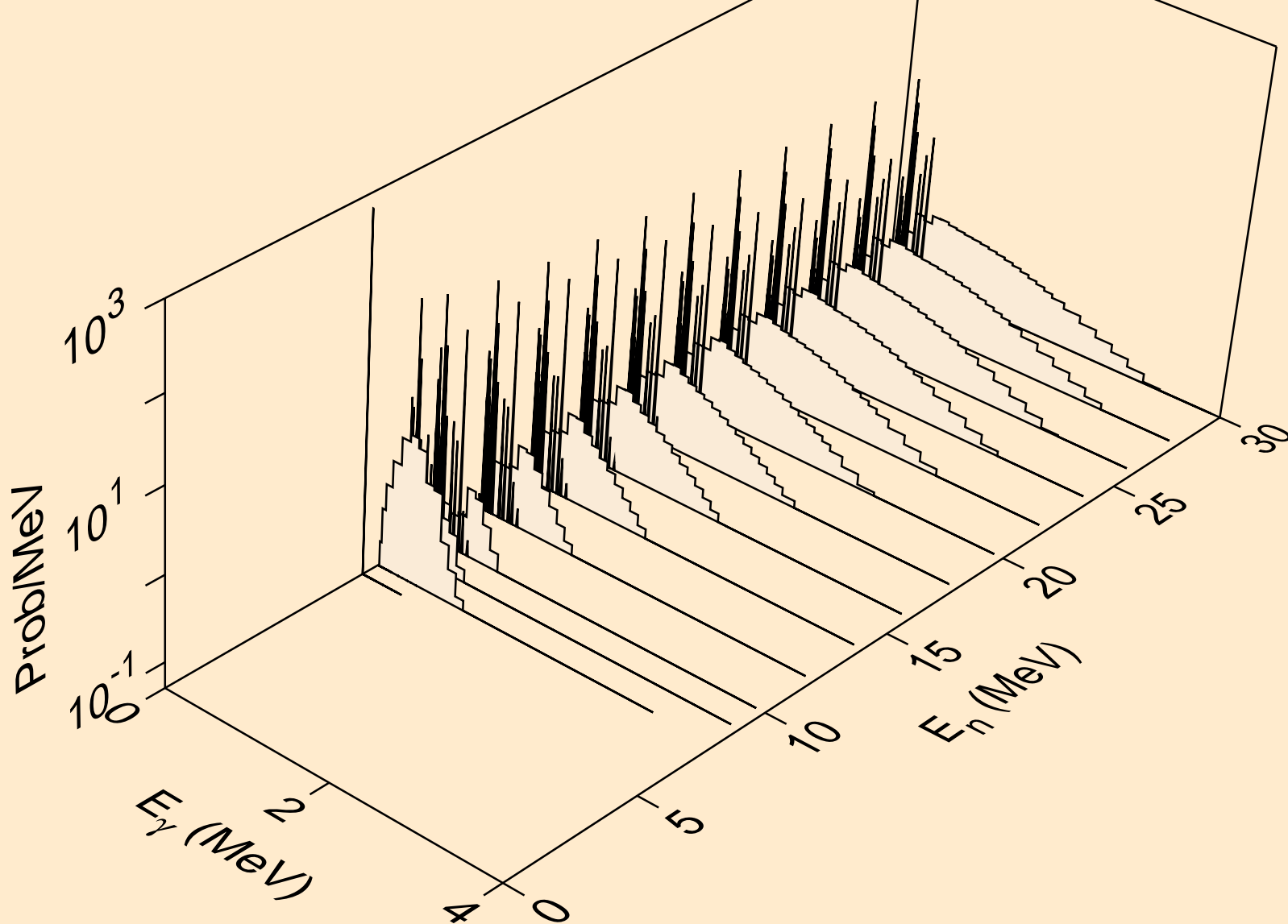

OS182 NEUTRON ACER TENDL-2019 LIBRARY; T=293.16K  
Photon emission for (n,p $\alpha$ )

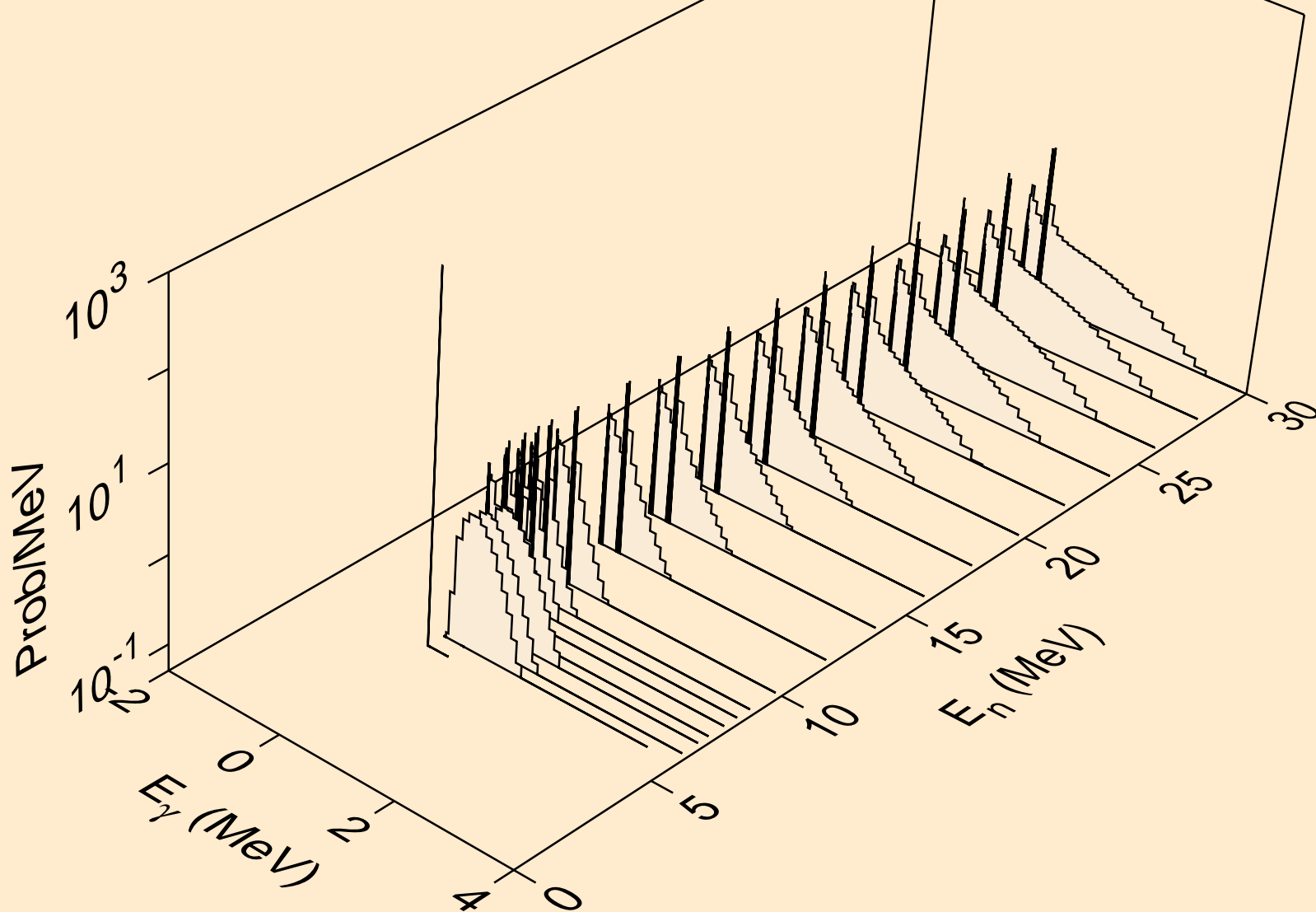

OS182 NEUTRON ACER TENDL-2019 LIBRARY; T=293.16K  
Photon emission for (n,pd)

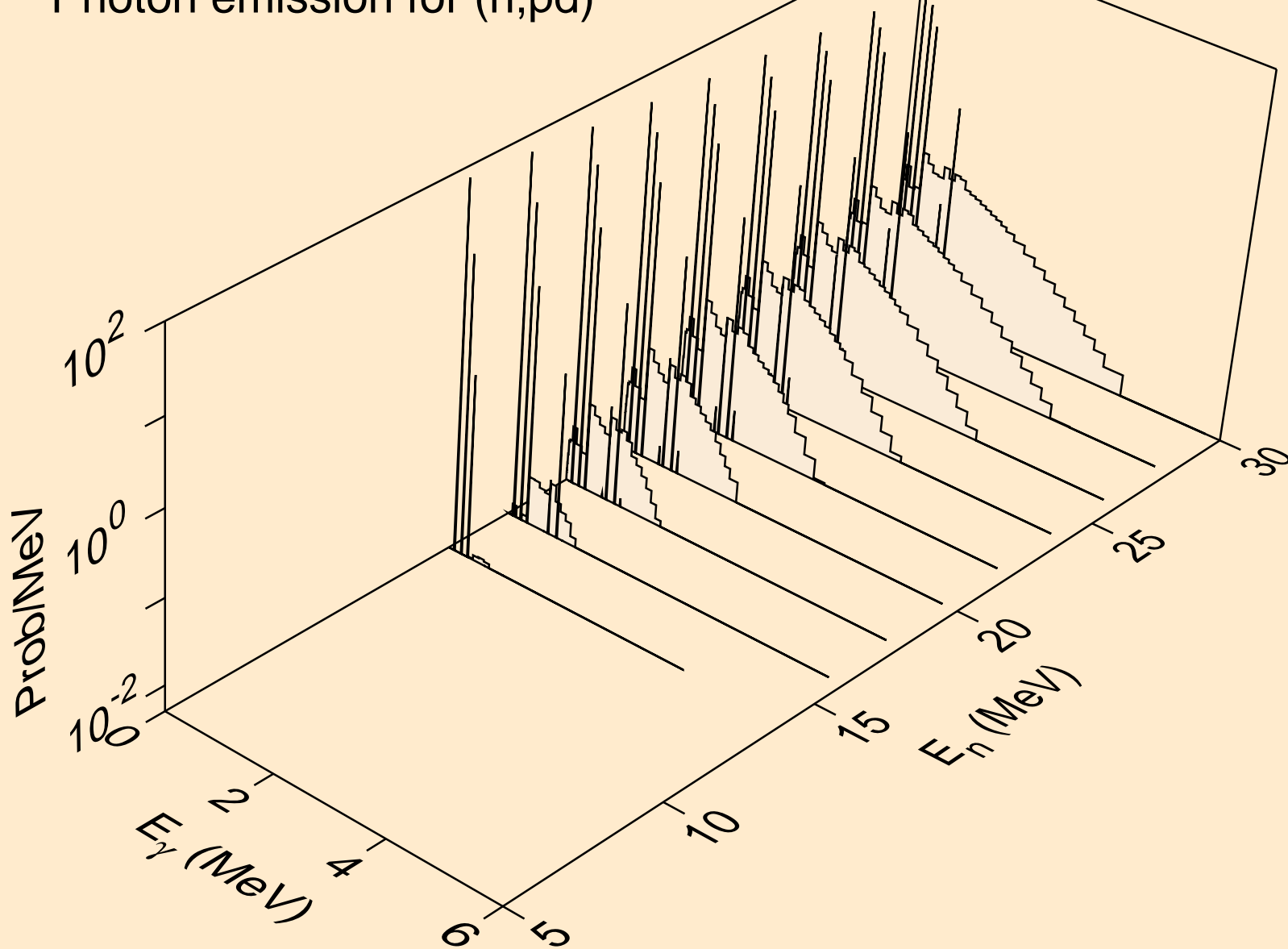

OS182 NEUTRON ACER TENDL-2019 LIBRARY; T=293.16K  
Photon emission for (n,pt)

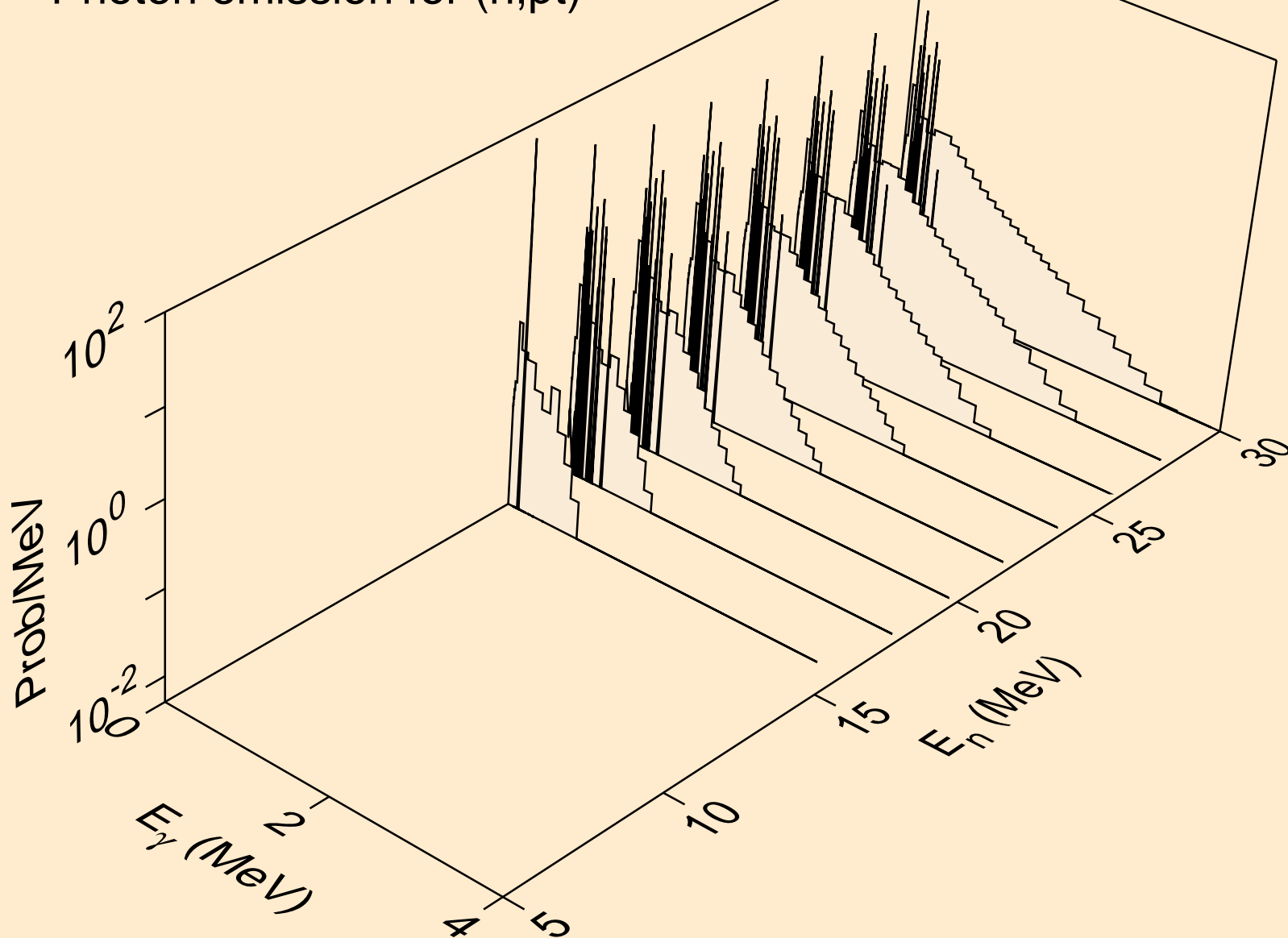

OS182 NEUTRON ACER TENDL-2019 LIBRARY; T=293.16K  
Photon emission for (n,da)

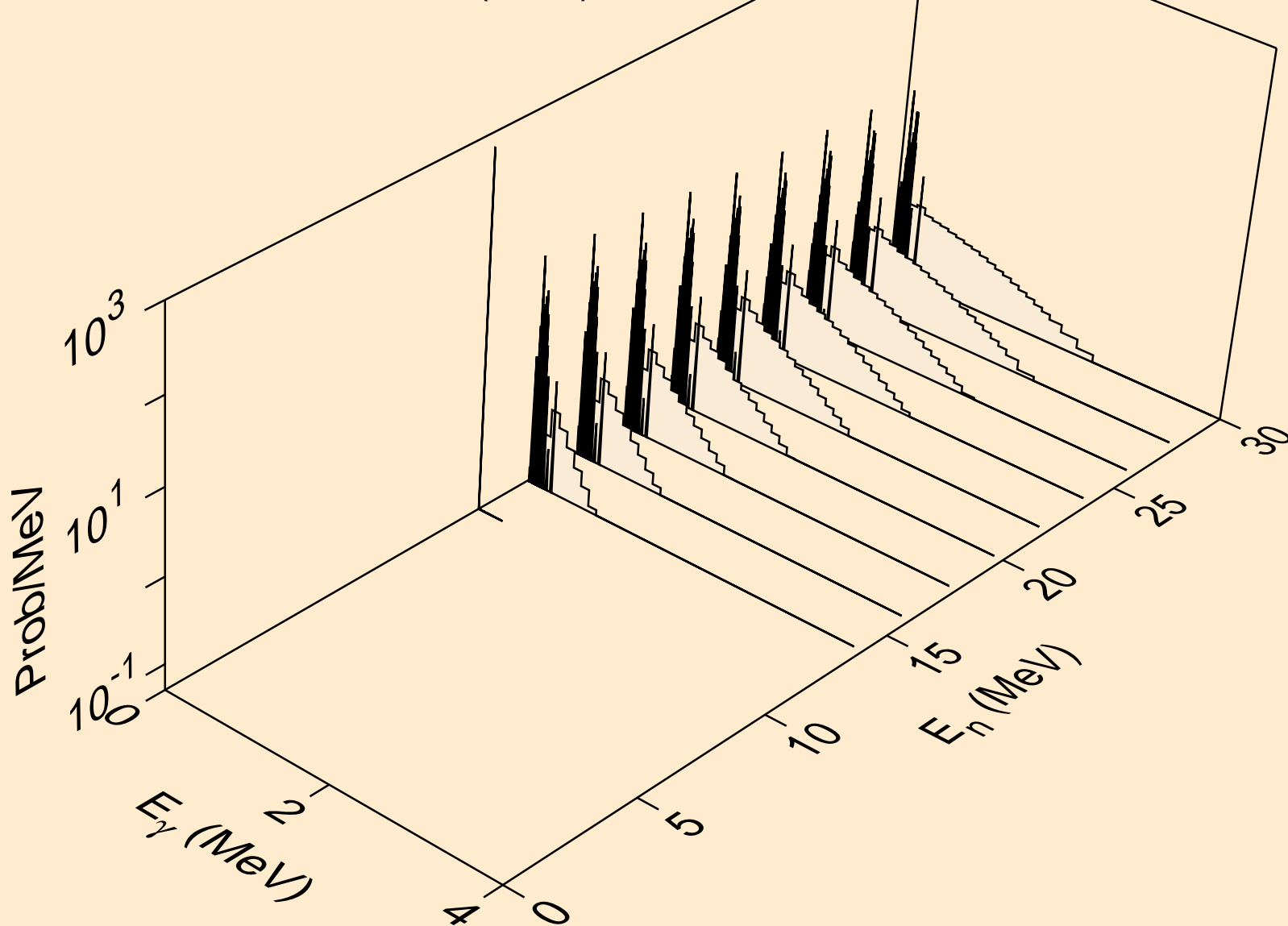

OS182 NEUTRON ACER TENDL-2019 LIBRARY; T=293.16K  
thermal capture photon spectrum

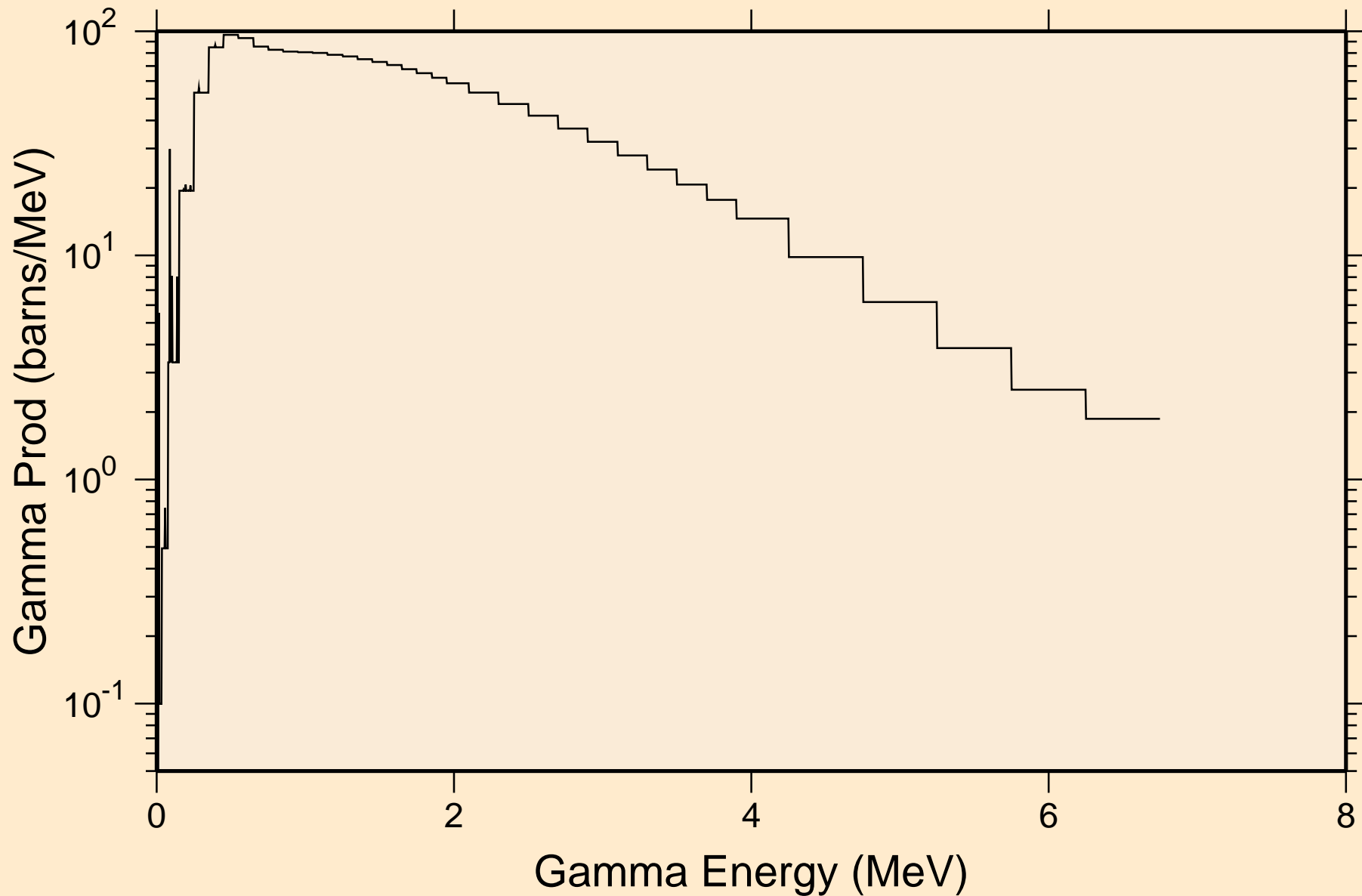



OS182 NEUTRON ACER TENDL-2019 LIBRARY; T=293.16K  
14 MeV photon spectrum

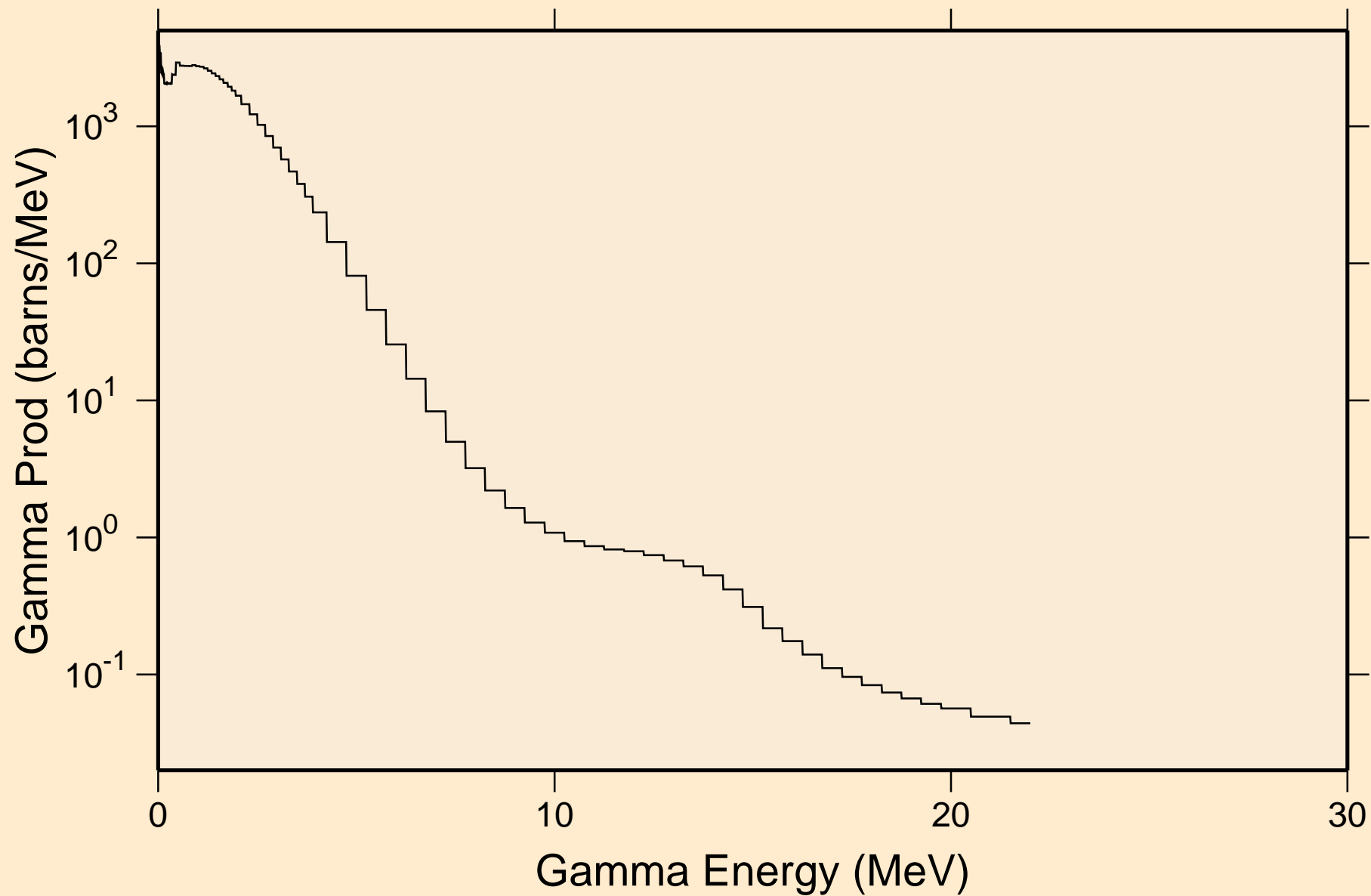

OS182 NEUTRON ACER TENDL-2019 LIBRARY; T=293.16K  
Particle heating contributions

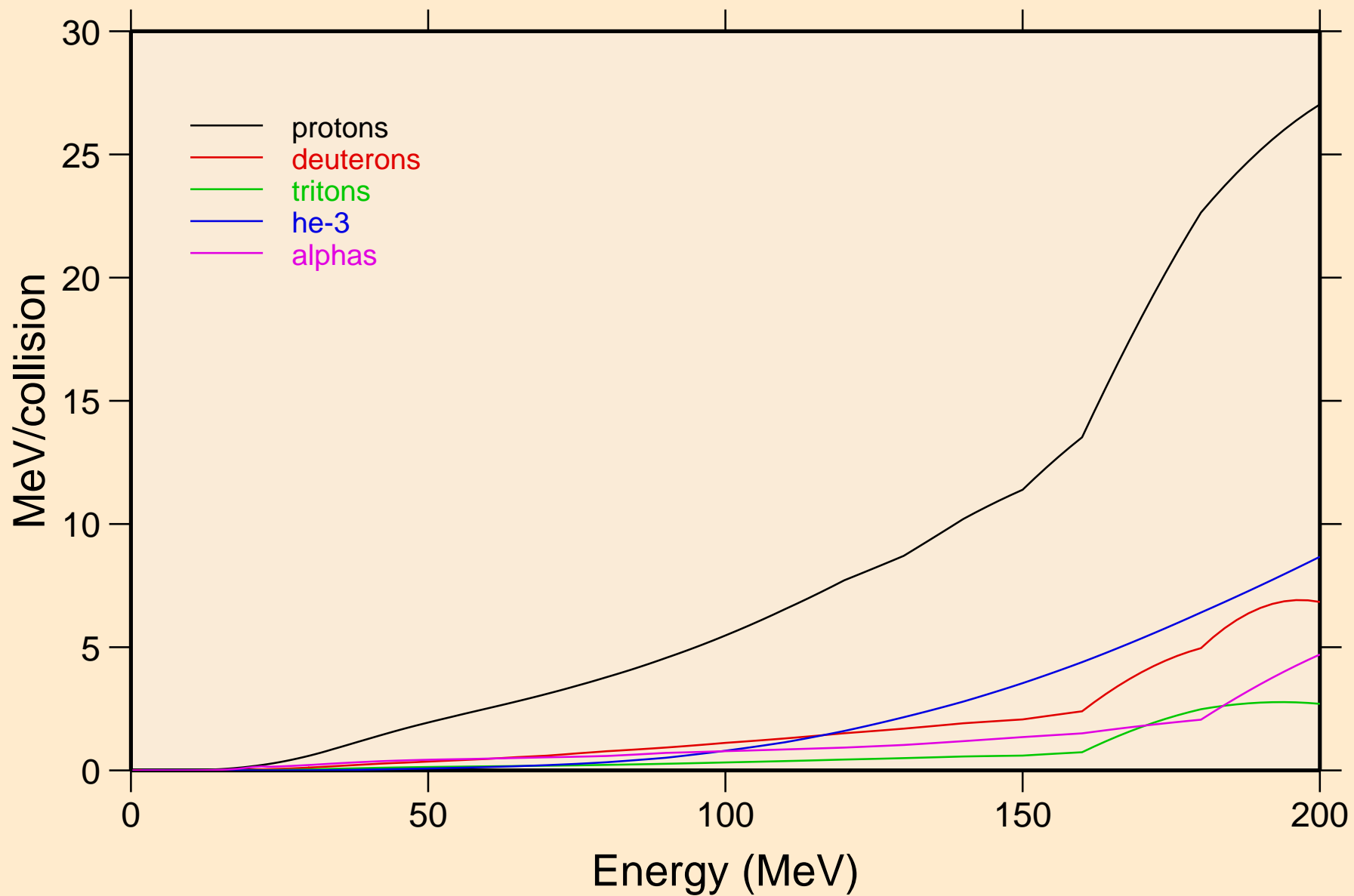

OS182 NEUTRON ACER TENDL-2019 LIBRARY; T=293.16K  
Recoil Heating

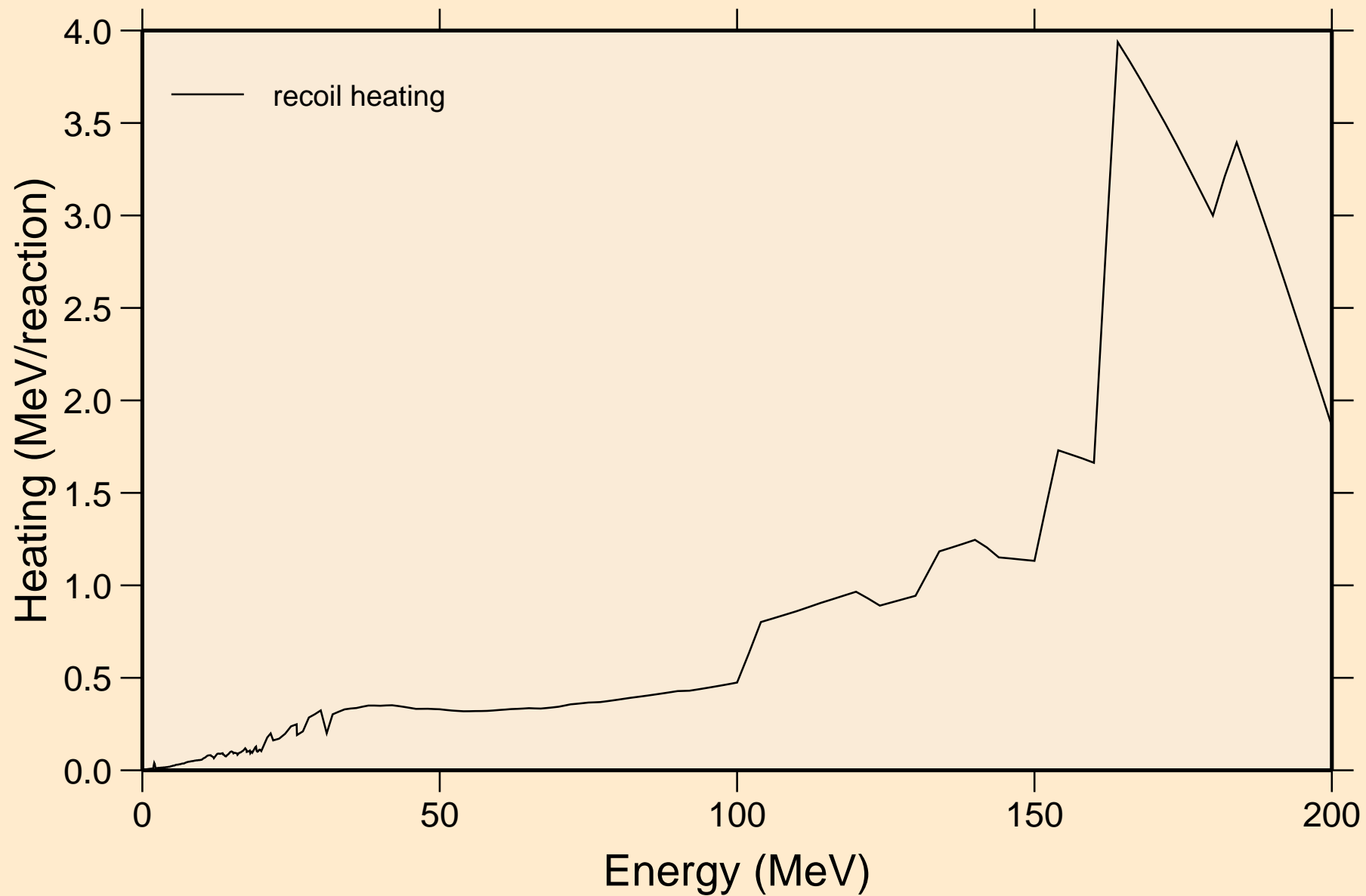

OS182 NEUTRON ACER TENDL-2019 LIBRARY; T=293.16K  
Particle production cross sections

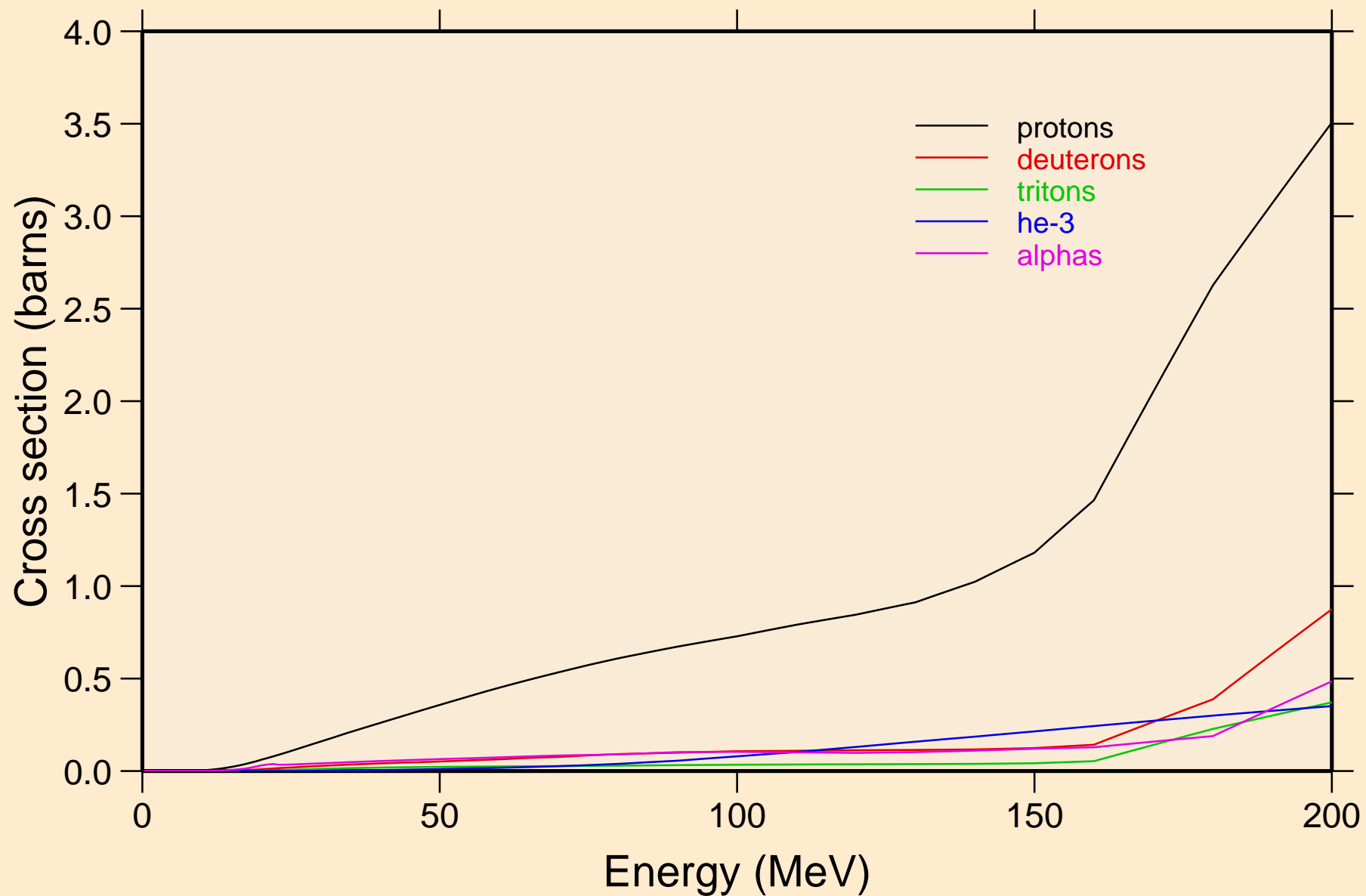

OS182 NEUTRON ACER TENDL-2019 LIBRARY; T=293.16K  
protons from (n,x)

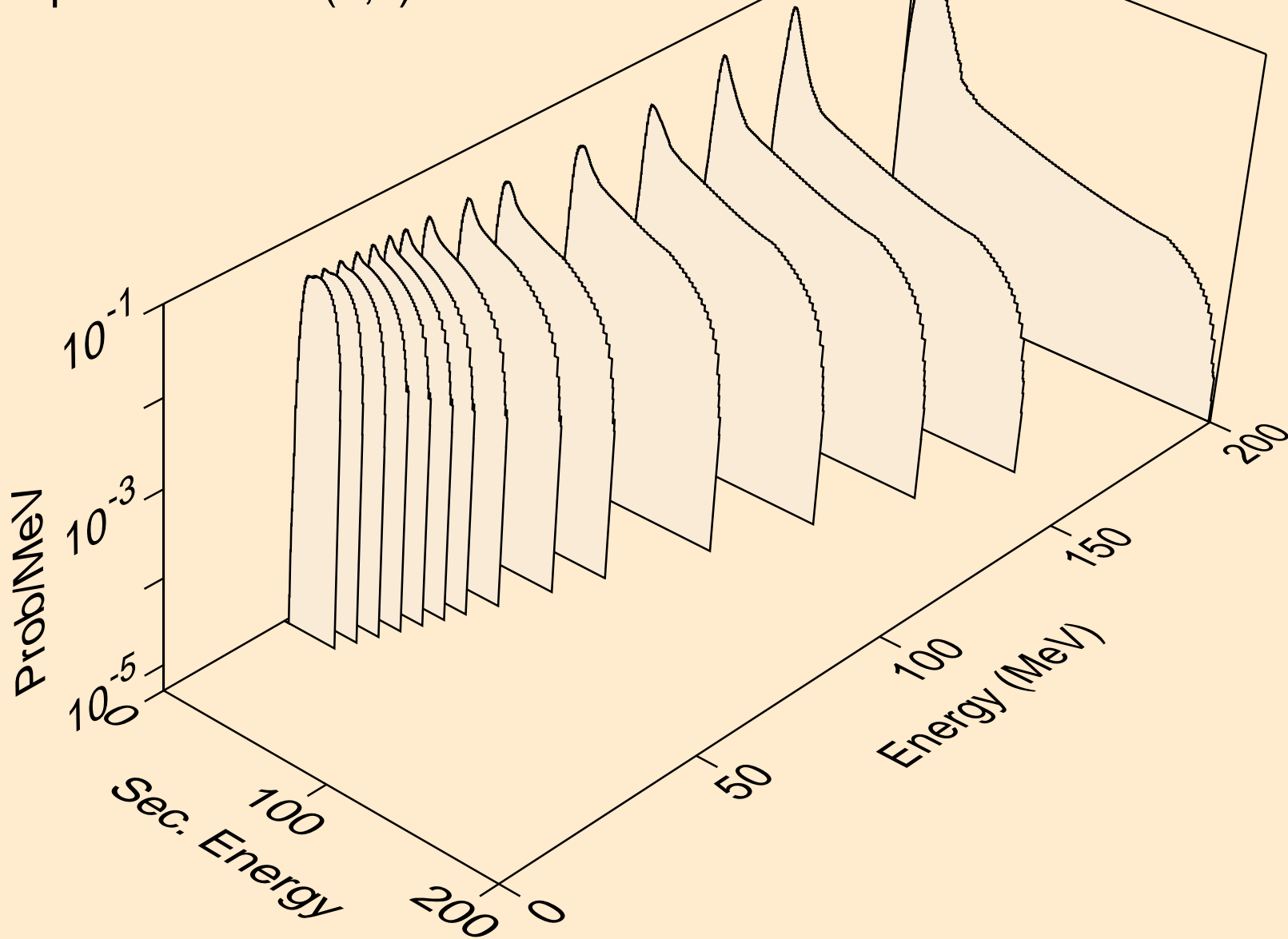

OS182 NEUTRON ACER TENDL-2019 LIBRARY; T=293.16K  
protons from (n,n\*)p

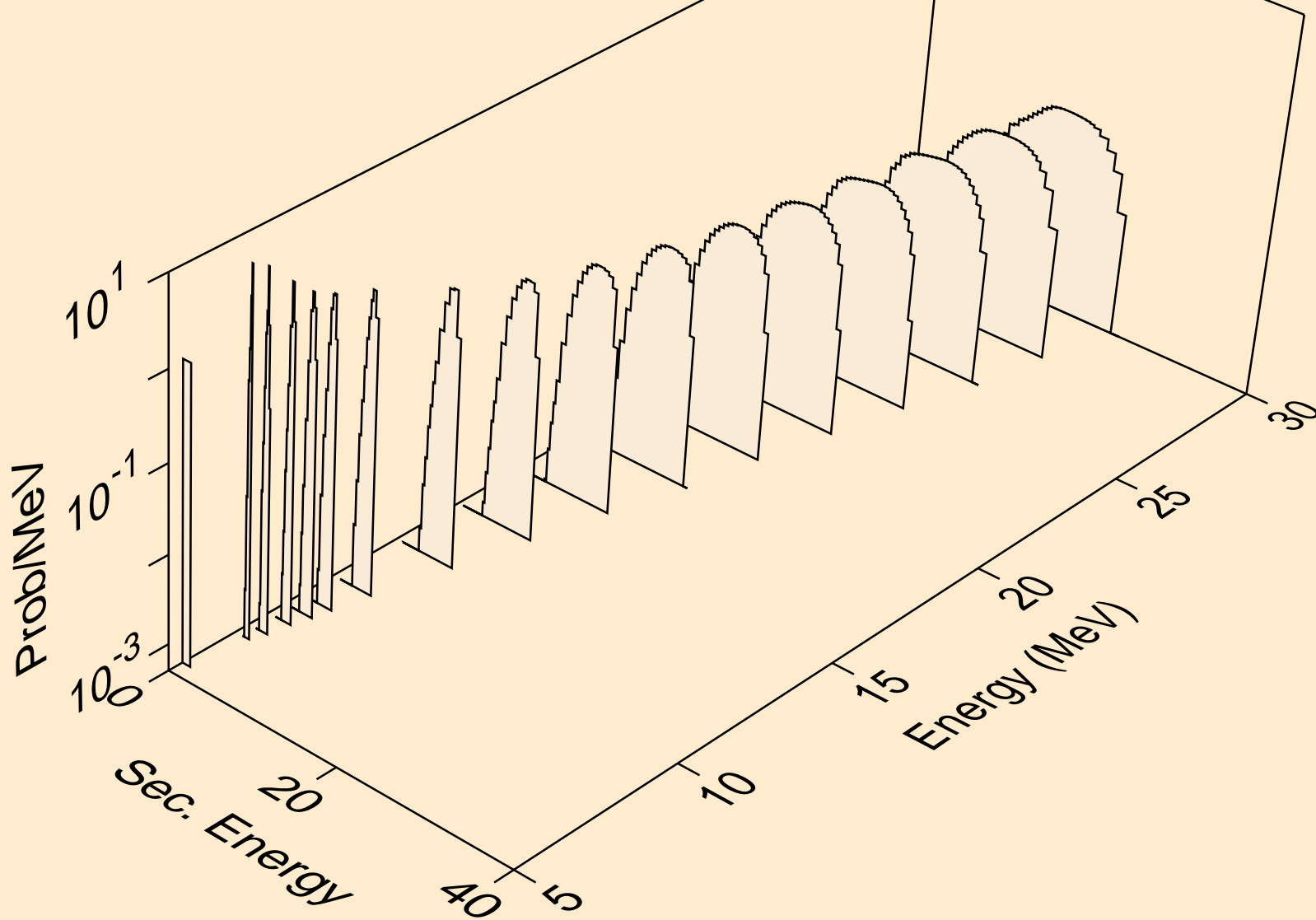

OS182 NEUTRON ACER TENDL-2019 LIBRARY; T=293.16K  
protons from (n,2np)

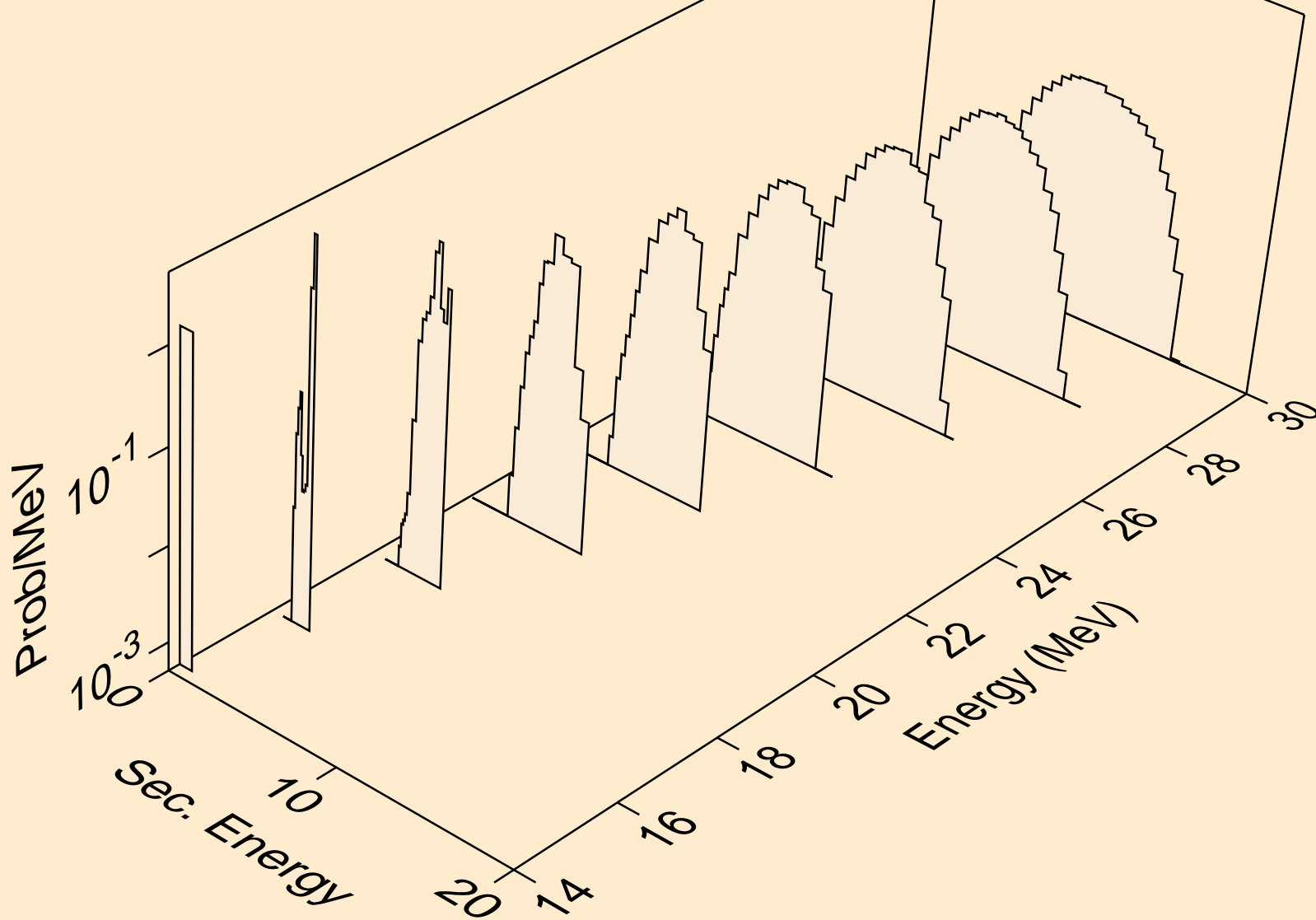

OS182 NEUTRON ACER TENDL-2019 LIBRARY; T=293.16K  
protons from (n,3np)

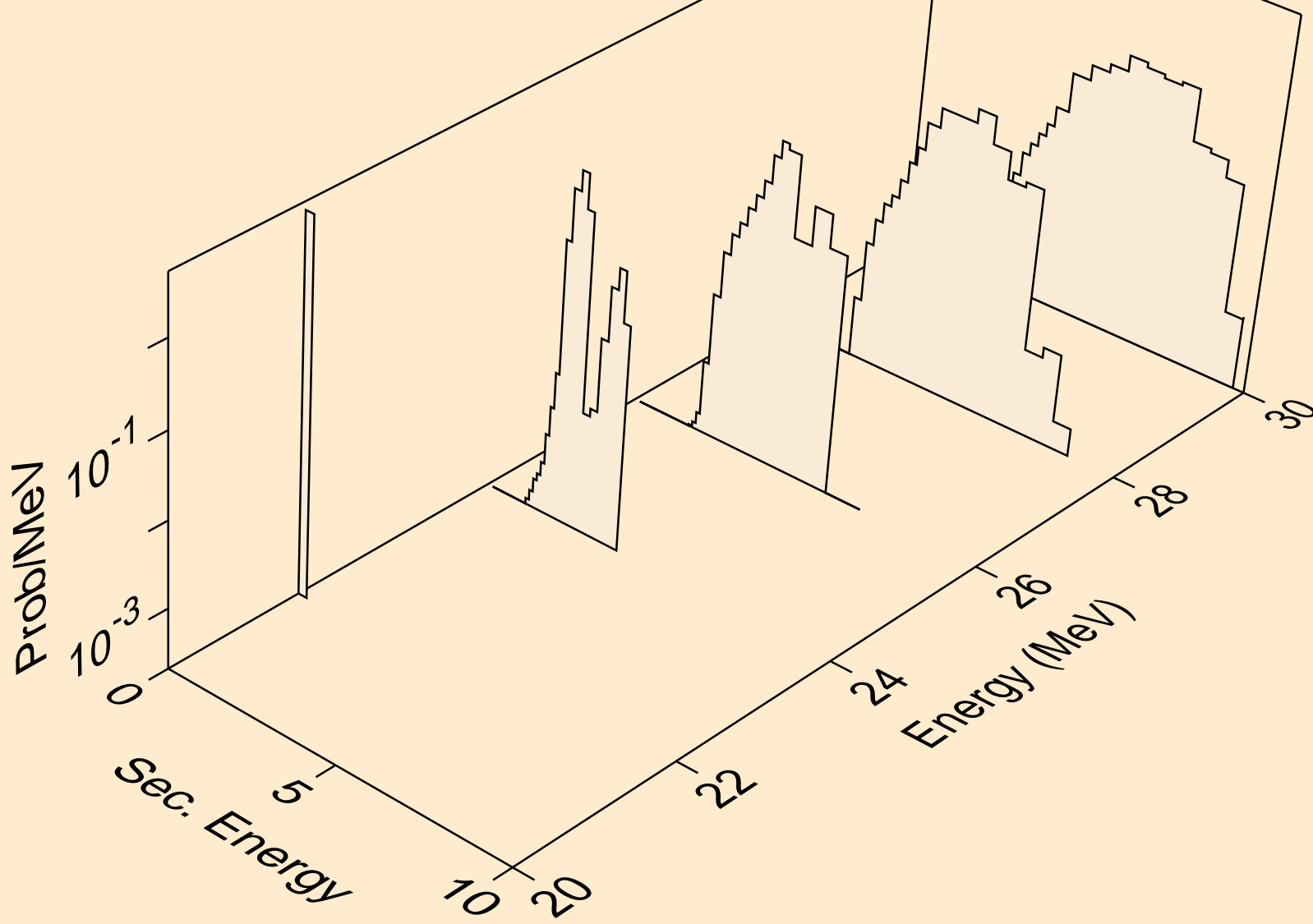



OS182 NEUTRON ACER TENDL-2019 LIBRARY; T=293.16K  
protons from (n,2np)

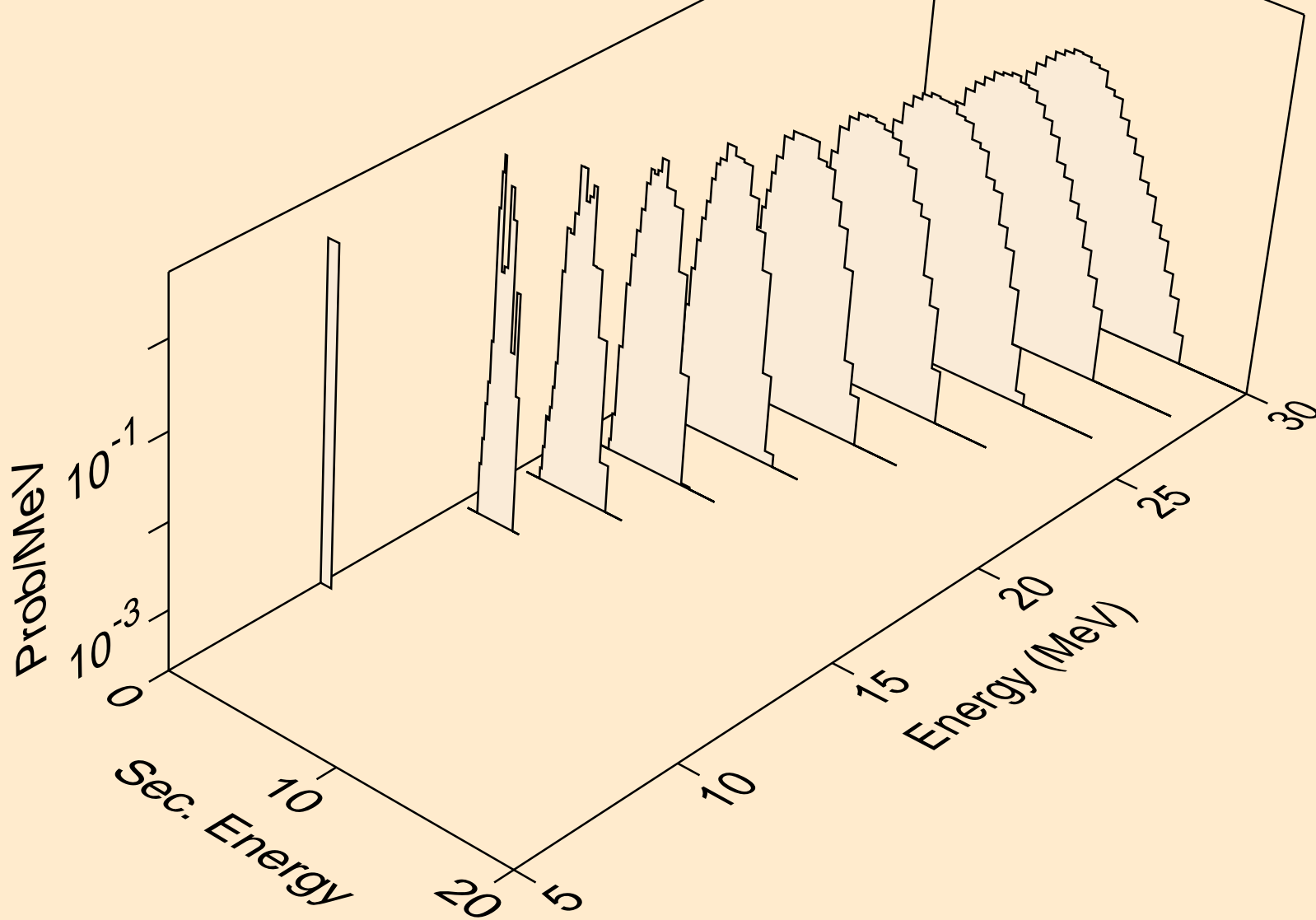

OS182 NEUTRON ACER TENDL-2019 LIBRARY; T=293.16K  
protons from (n,npa)

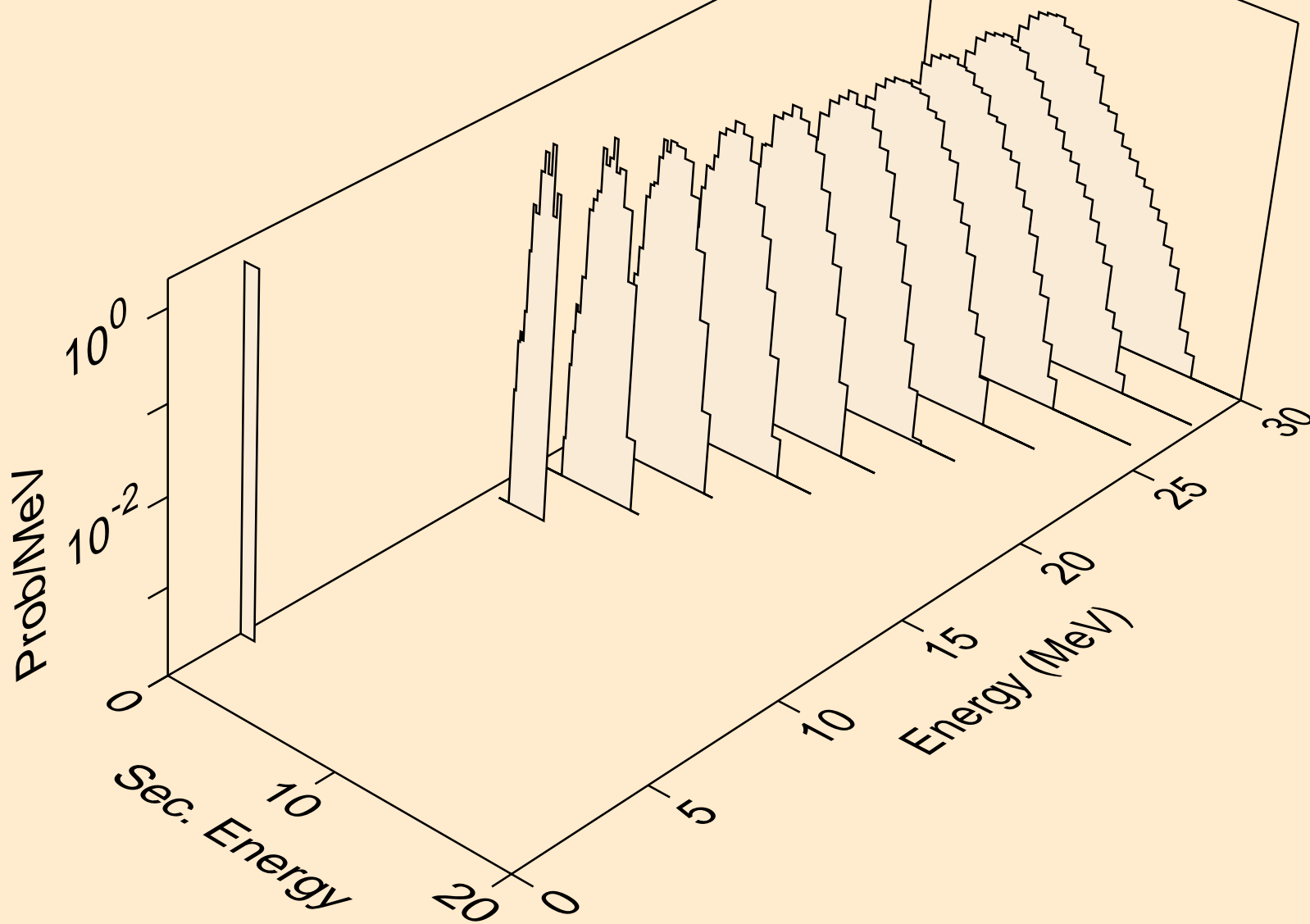

OS182 NEUTRON ACER TENDL-2019 LIBRARY; T=293.16K  
protons from (n,p)

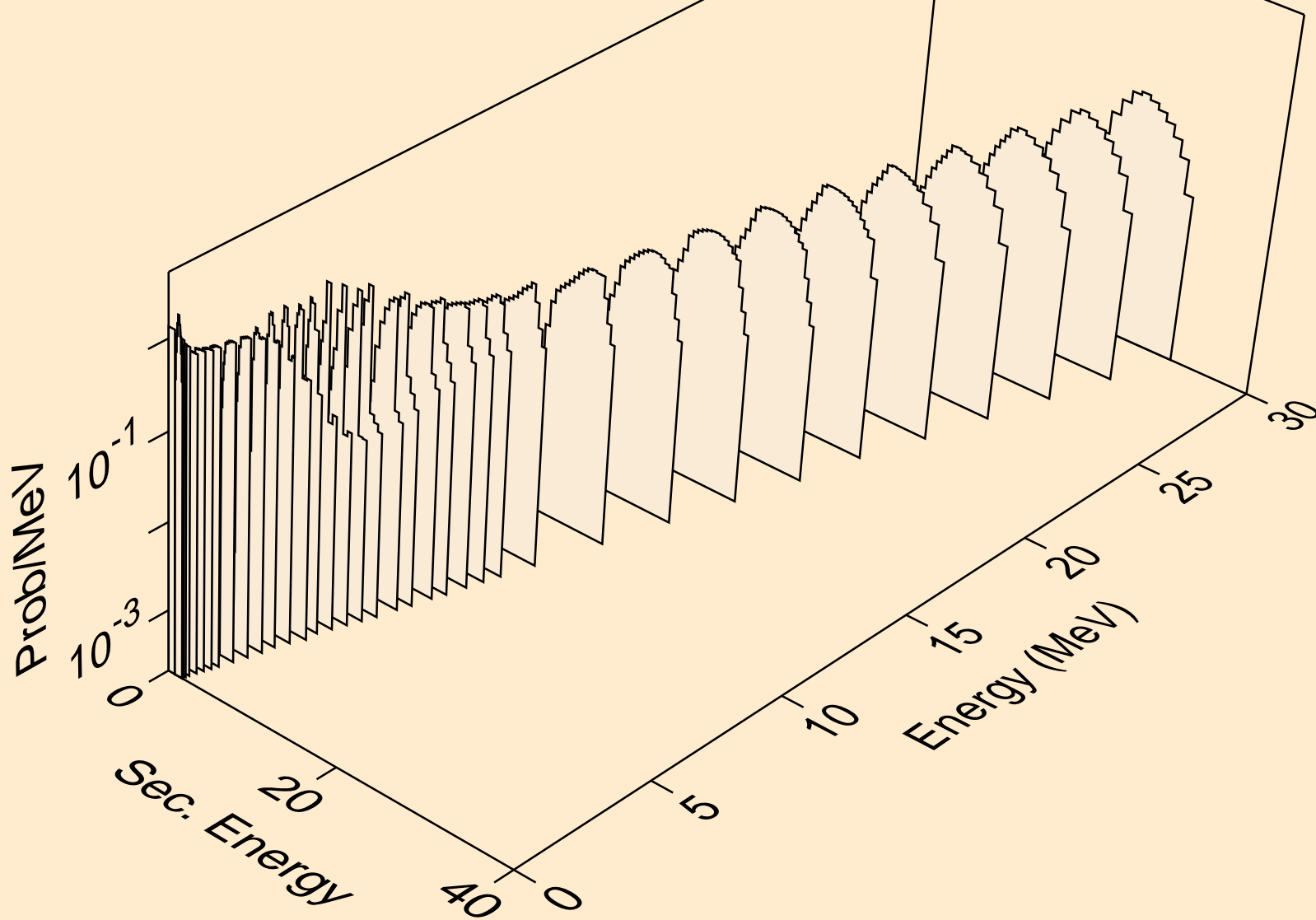

OS182 NEUTRON ACER TENDL-2019 LIBRARY; T=293.16K  
protons from (n,2p)

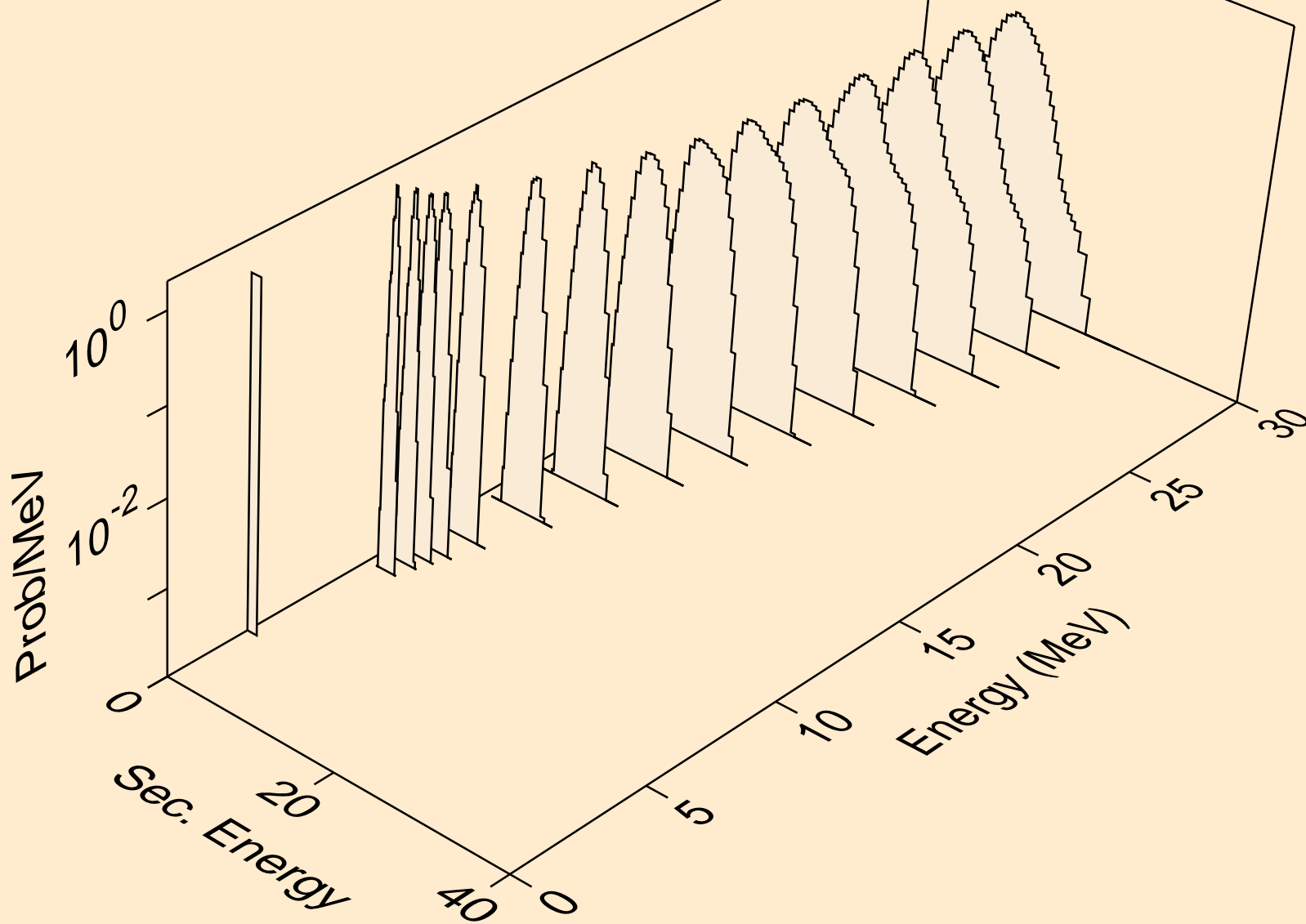

OS182 NEUTRON ACER TENDL-2019 LIBRARY; T=293.16K  
protons from (n,p)

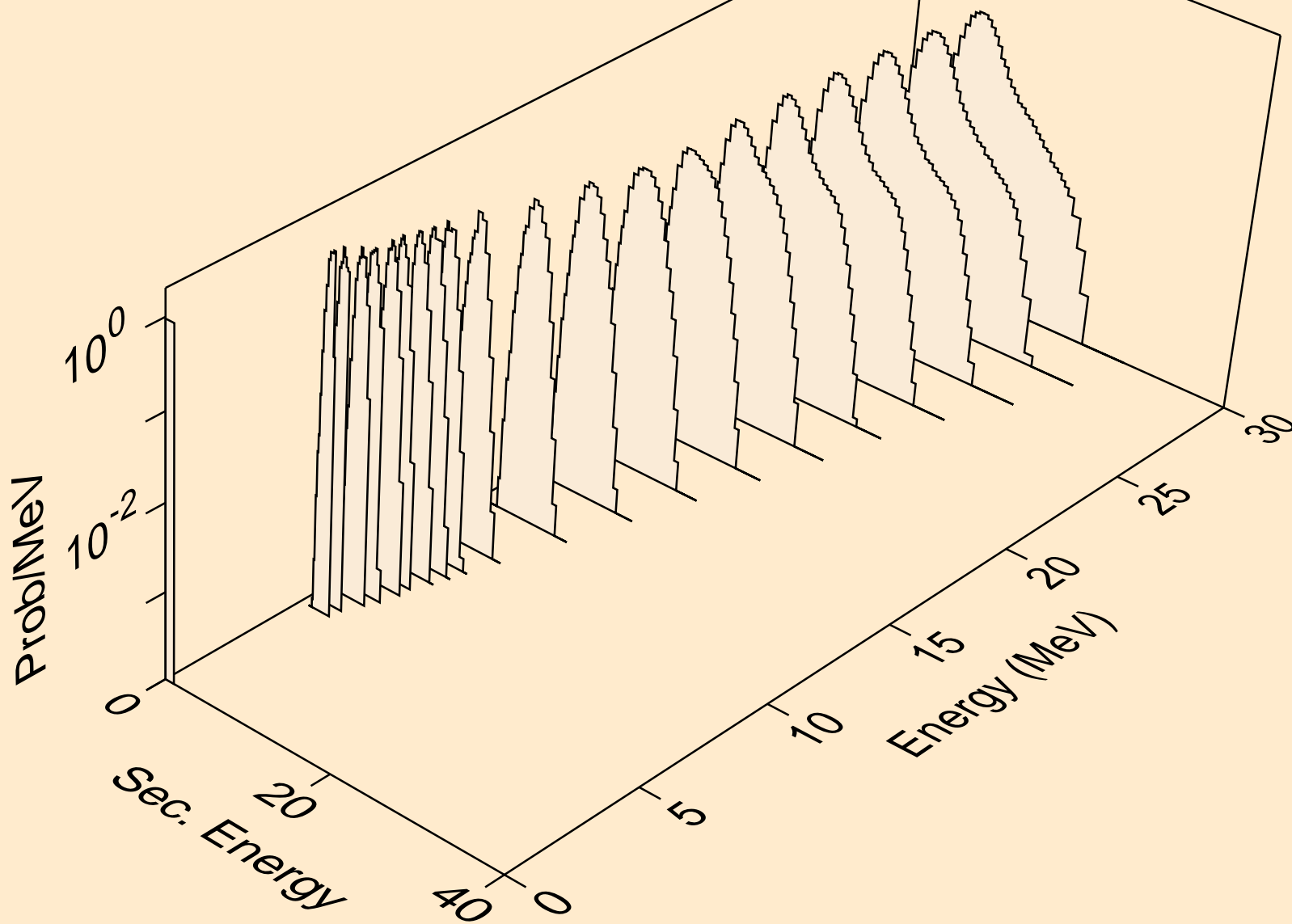

OS182 NEUTRON ACER TENDL-2019 LIBRARY; T=293.16K  
protons from (n,pd)

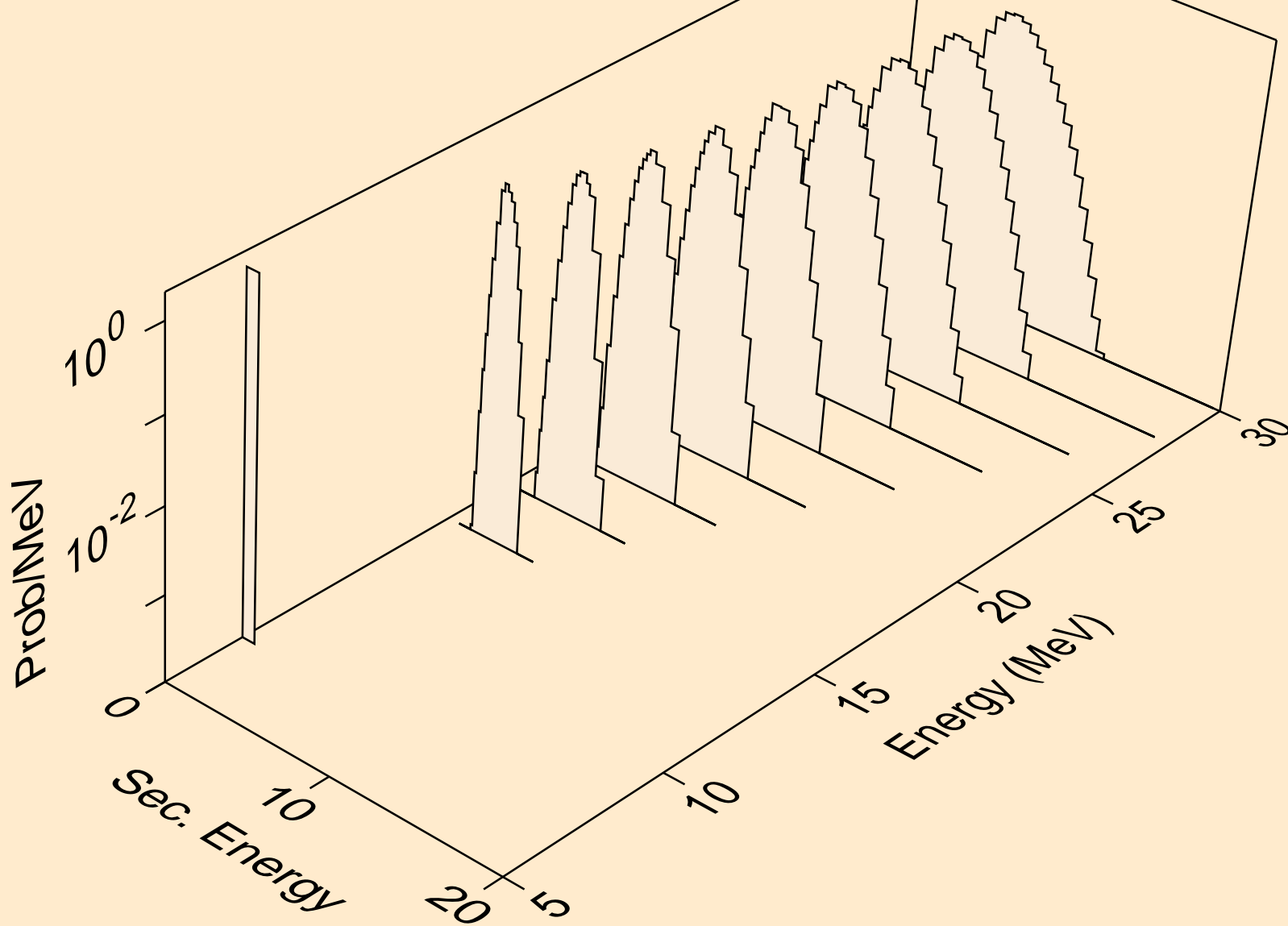

OS182 NEUTRON ACER TENDL-2019 LIBRARY; T=293.16K  
protons from (n,pt)

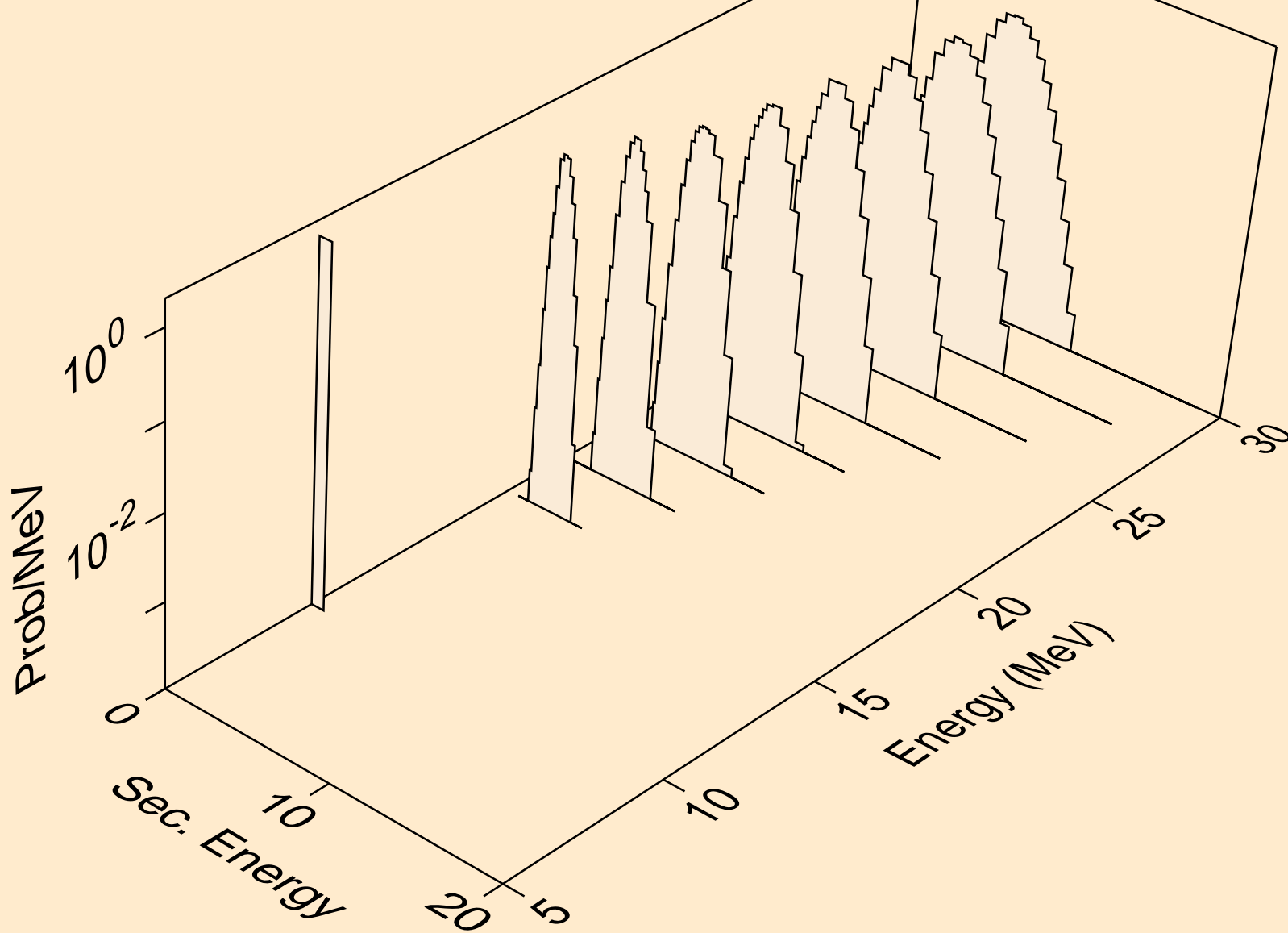

OS182 NEUTRON ACER TENDL-2019 LIBRARY; T=293.16K  
deuterons from (n,x)

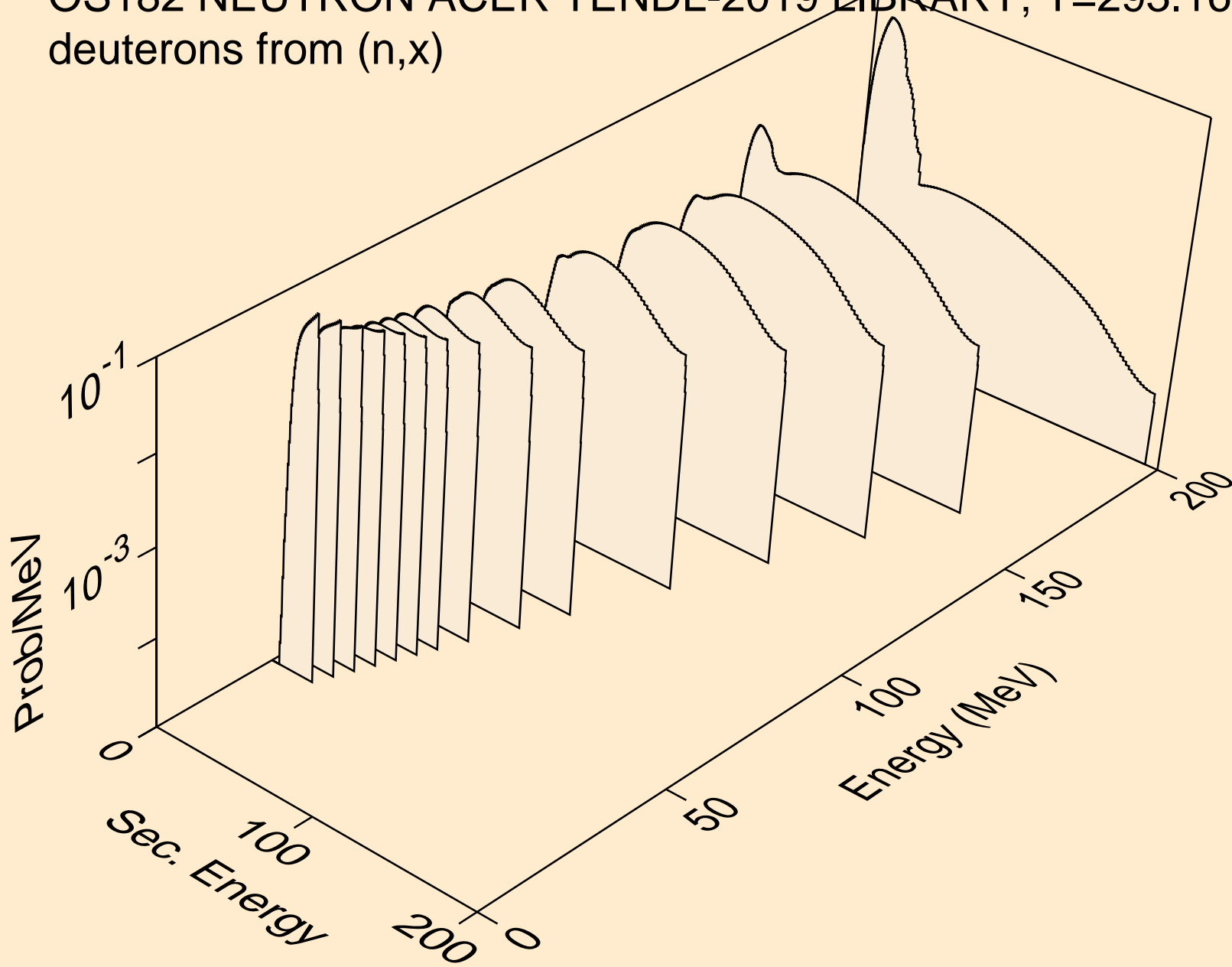



OS182 NEUTRON ACER TENDL-2019 LIBRARY; T=293.16K  
deuterons from (n,2nd)

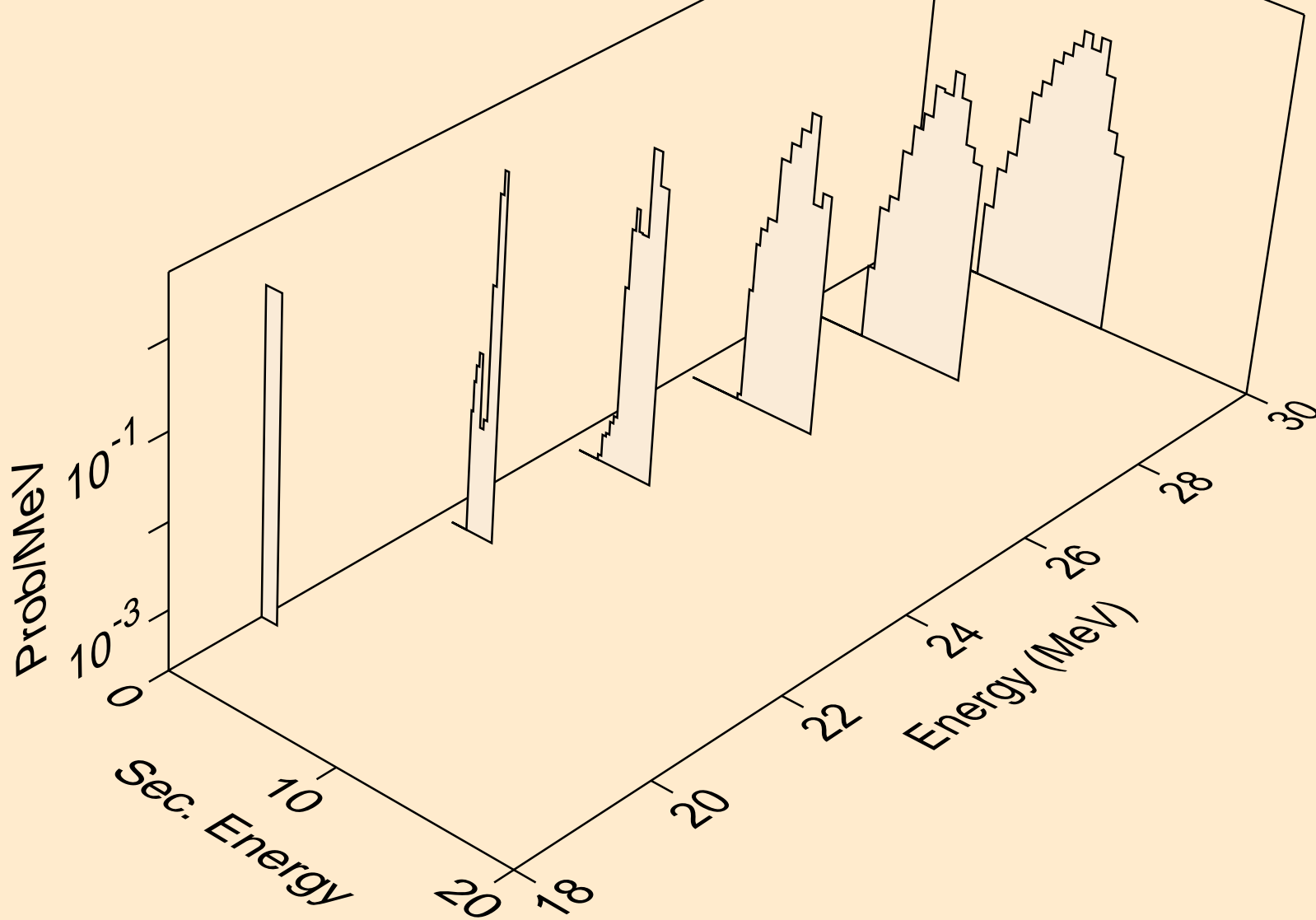

OS182 NEUTRON ACER TENDL-2019 LIBRARY; T=293.16K  
deuterons from (n,n\*)d

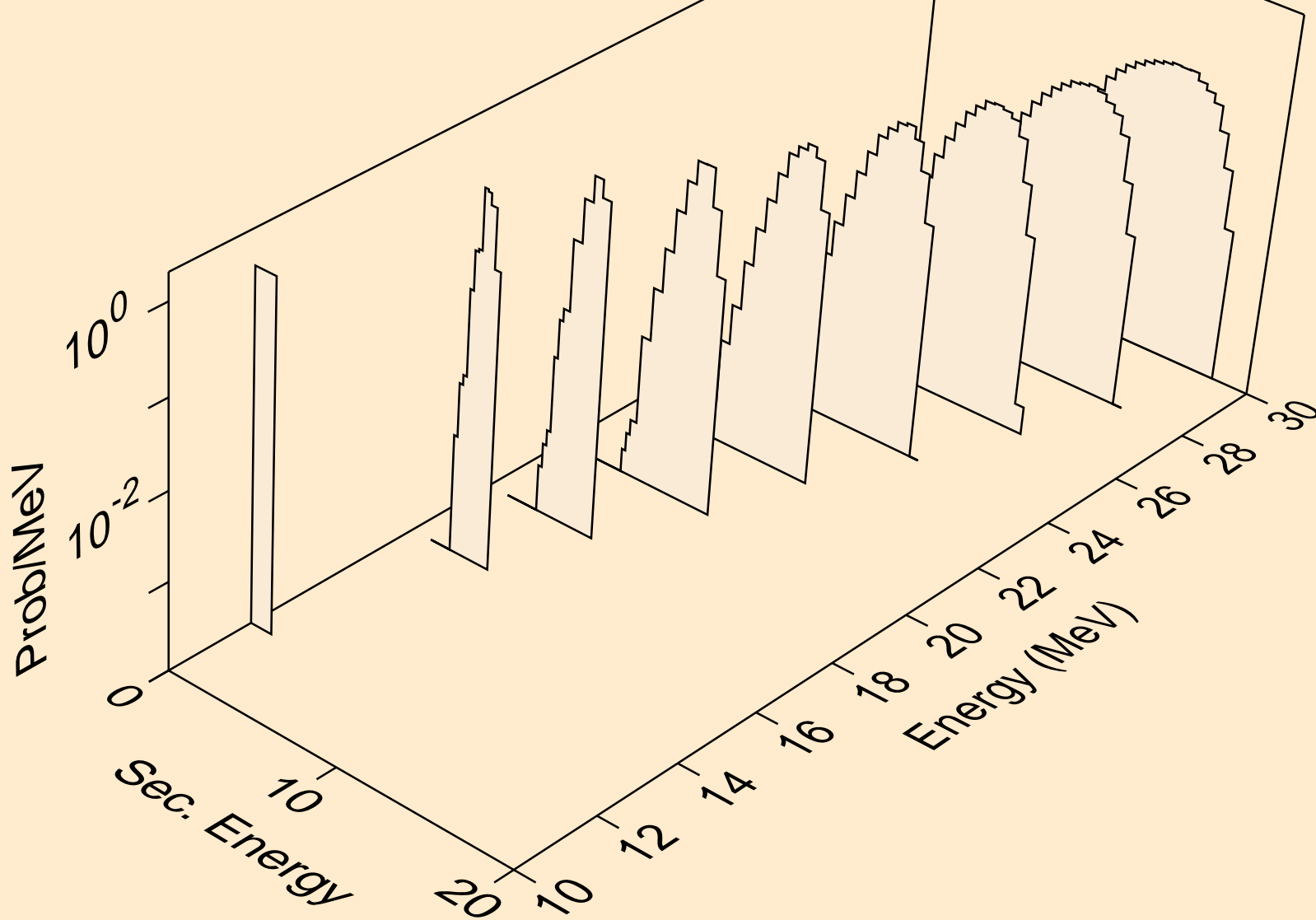

OS182 NEUTRON ACER TENDL-2019 LIBRARY; T=293.16K  
deuterons from (n,d)

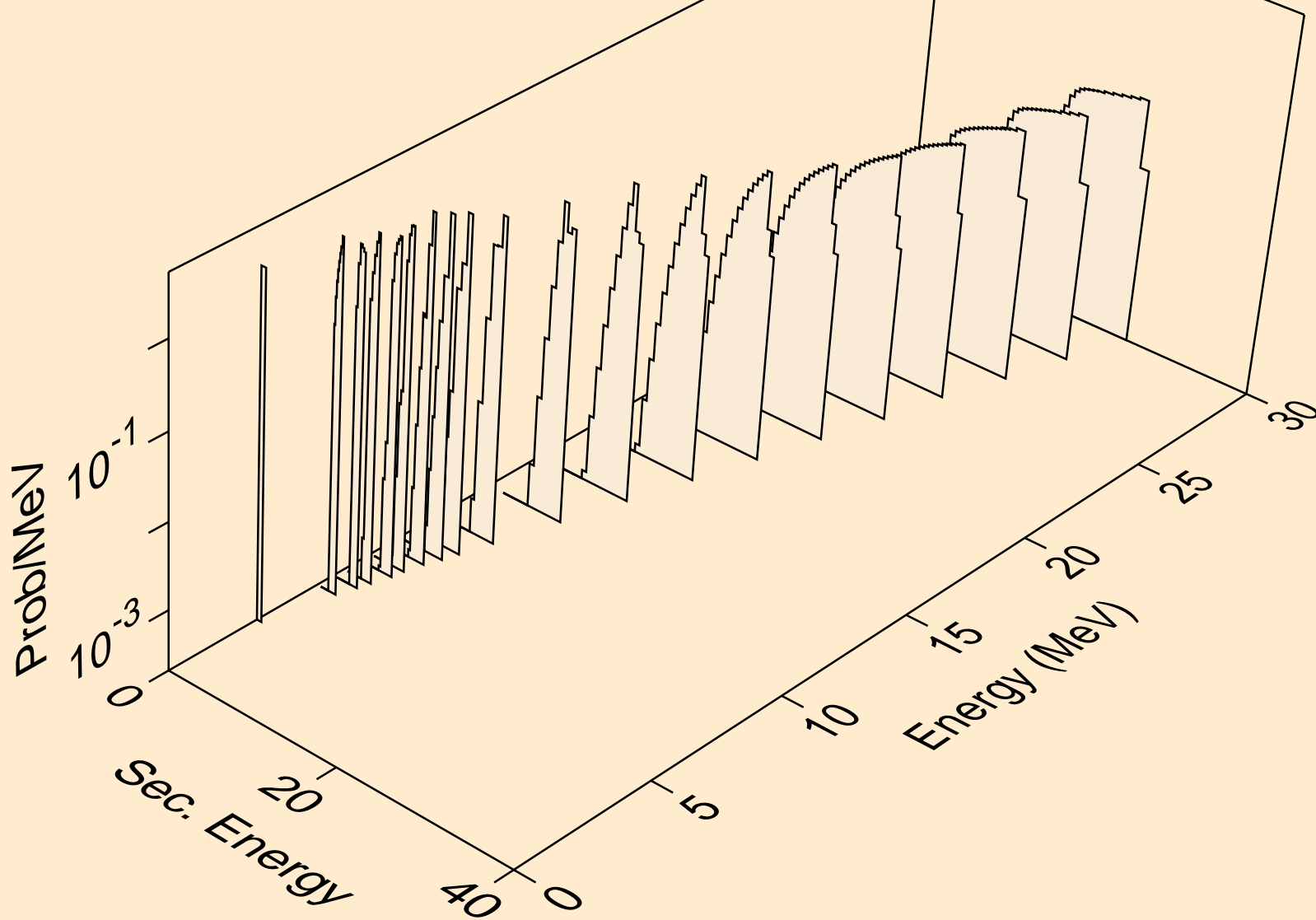

OS182 NEUTRON ACER TENDL-2019 LIBRARY; T=293.16K  
deuterons from (n,pd)

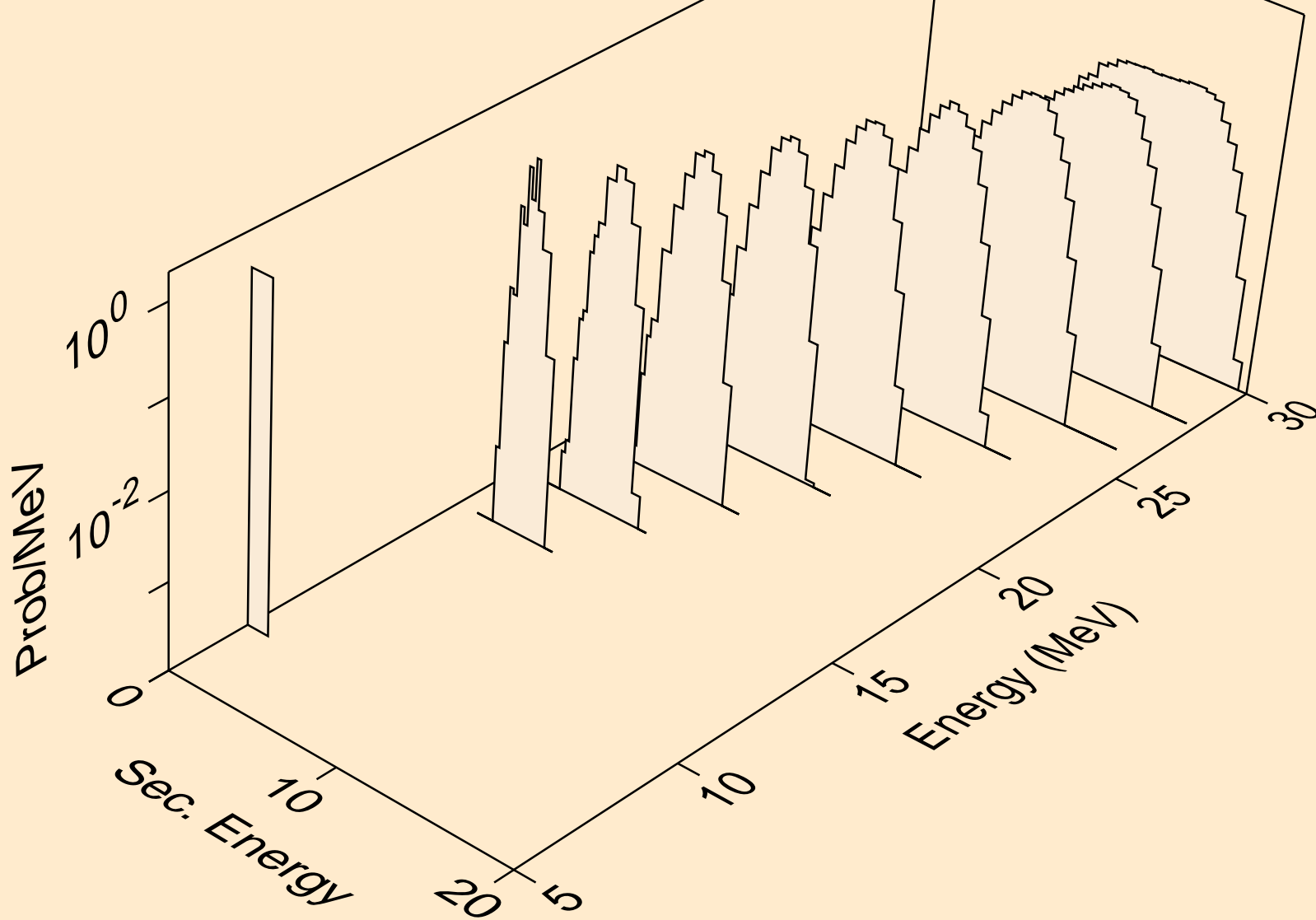

OS182 NEUTRON ACER TENDL-2019 LIBRARY; T=293.16K  
deuterons from (n,da)

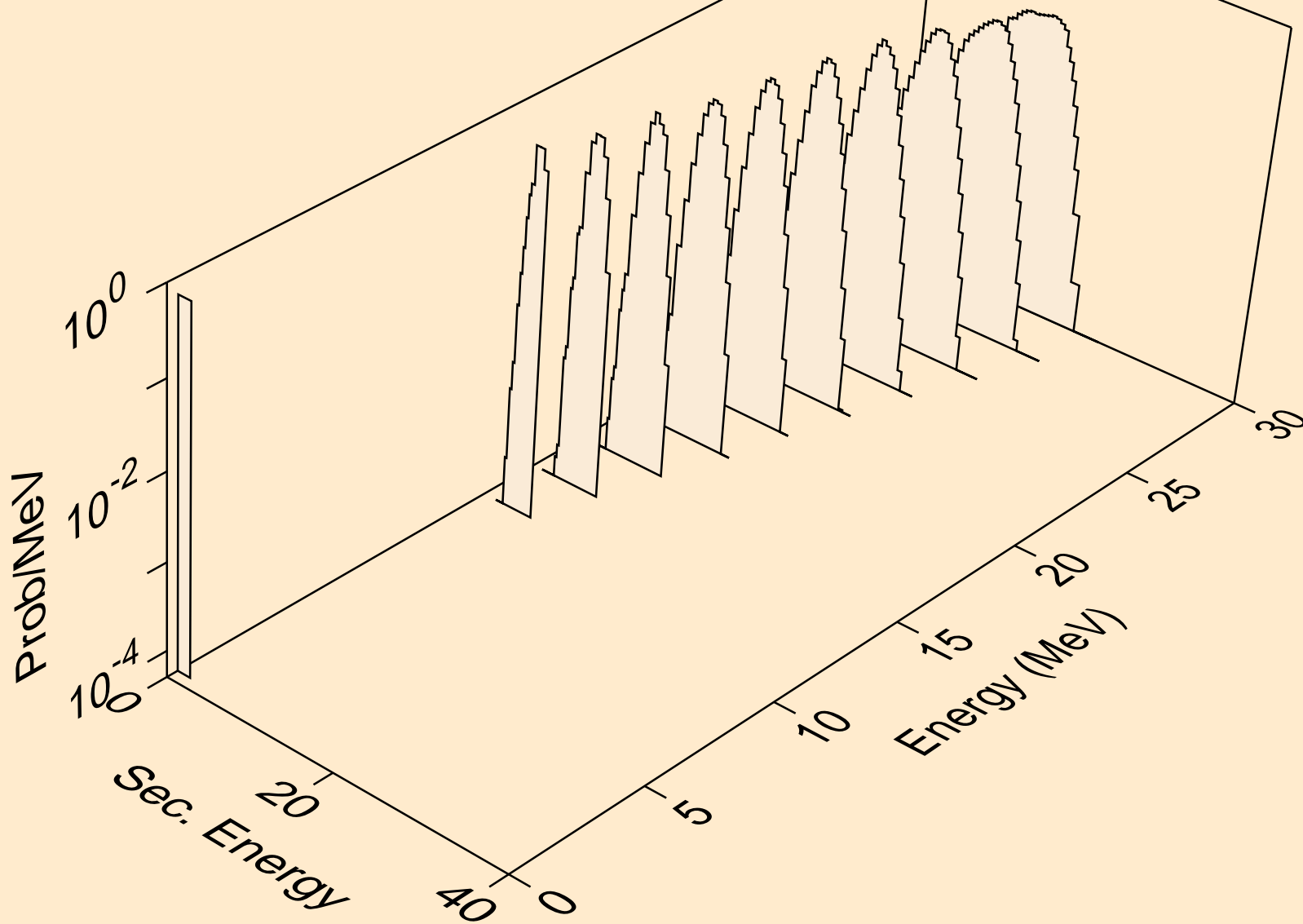

OS182 NEUTRON ACER TENDL-2019 LIBRARY; T=293.16K  
tritons from (n,x)

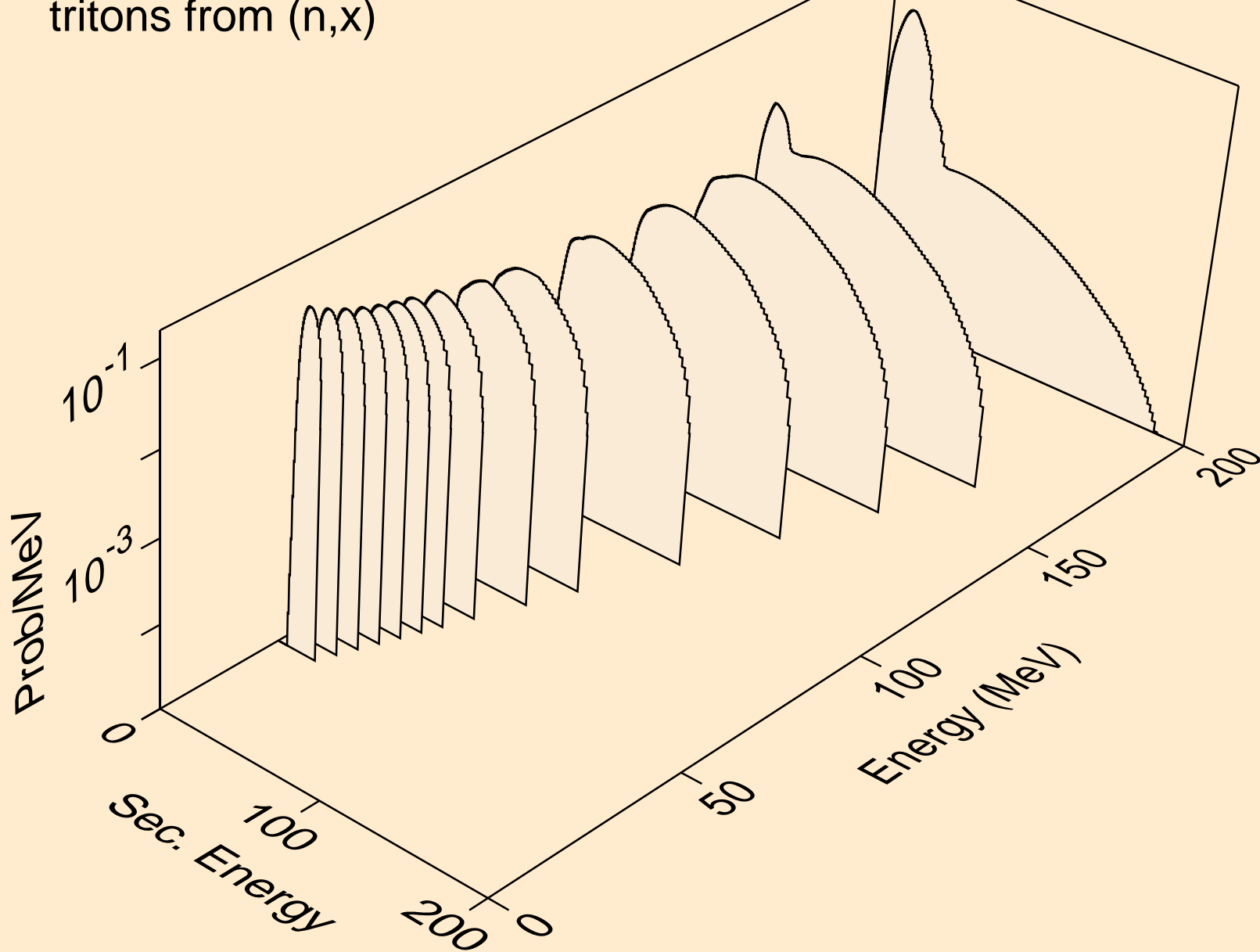

OS182 NEUTRON ACER TENDL-2019 LIBRARY; T=293.16K  
tritons from (n,n\*)t

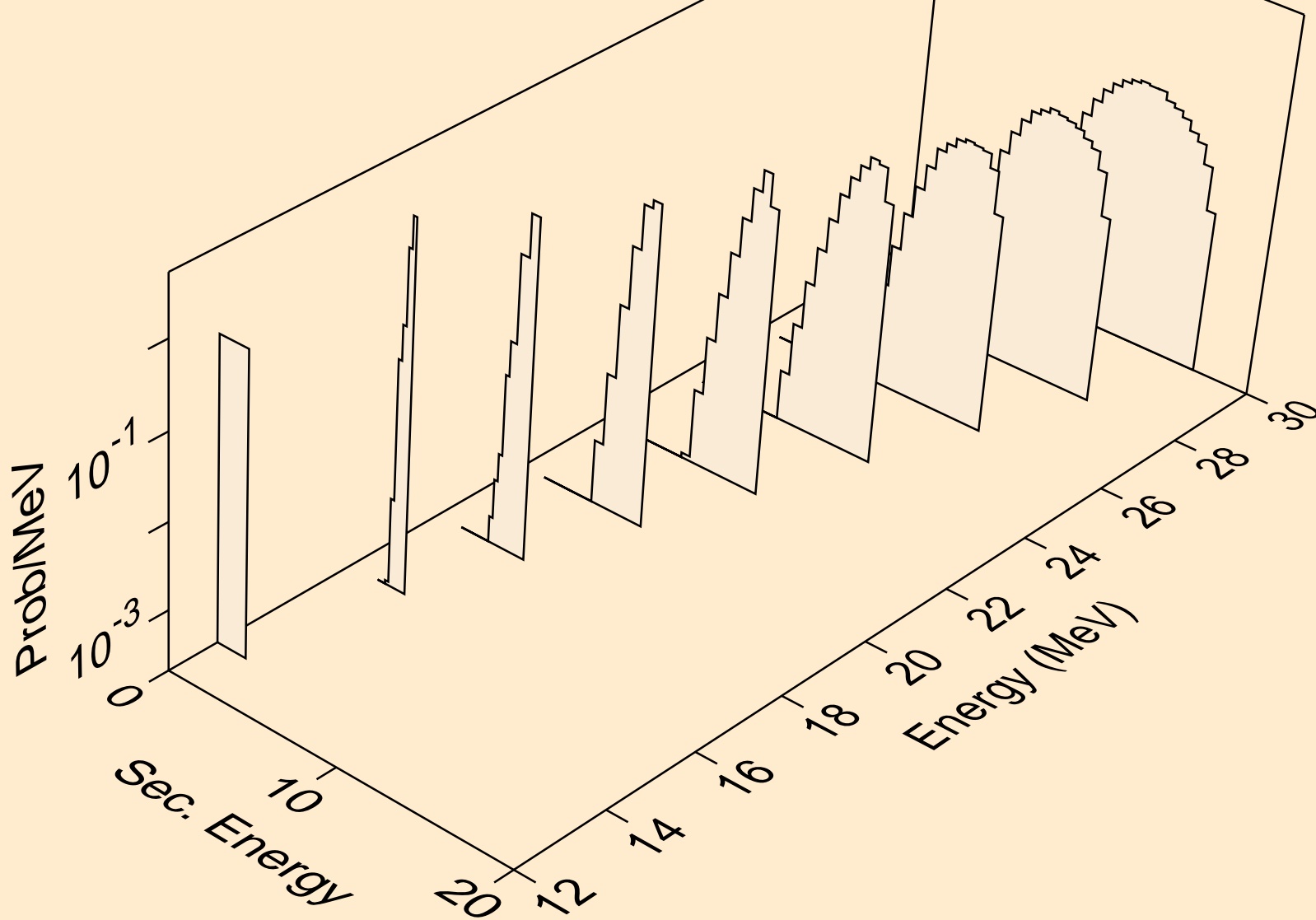

OS182 NEUTRON ACER TENDL-2019 LIBRARY; T=293.16K  
tritons from (n,t)

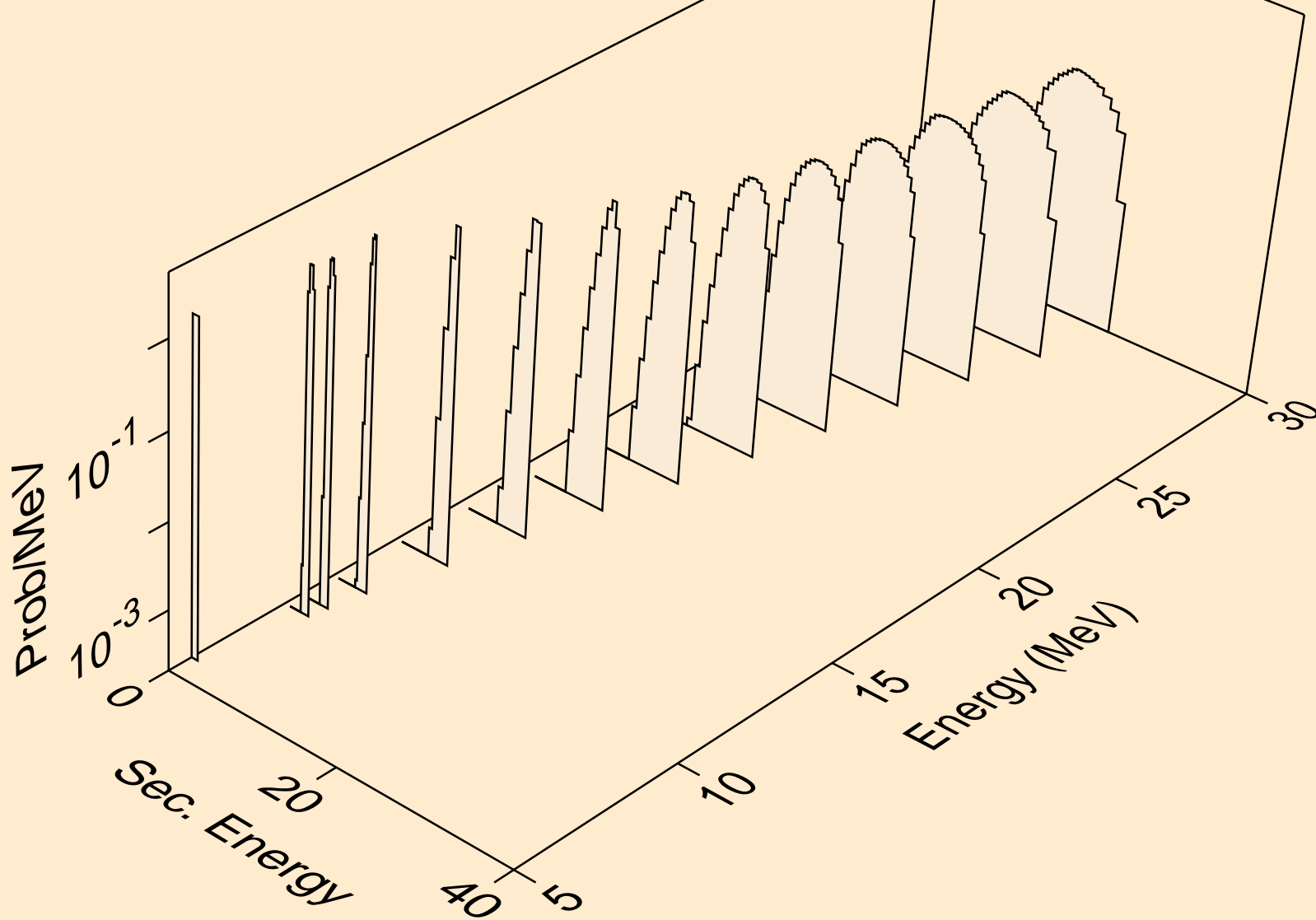



OS182 NEUTRON ACER TENDL-2019 LIBRARY; T=293.16K  
tritons from (n,pt)

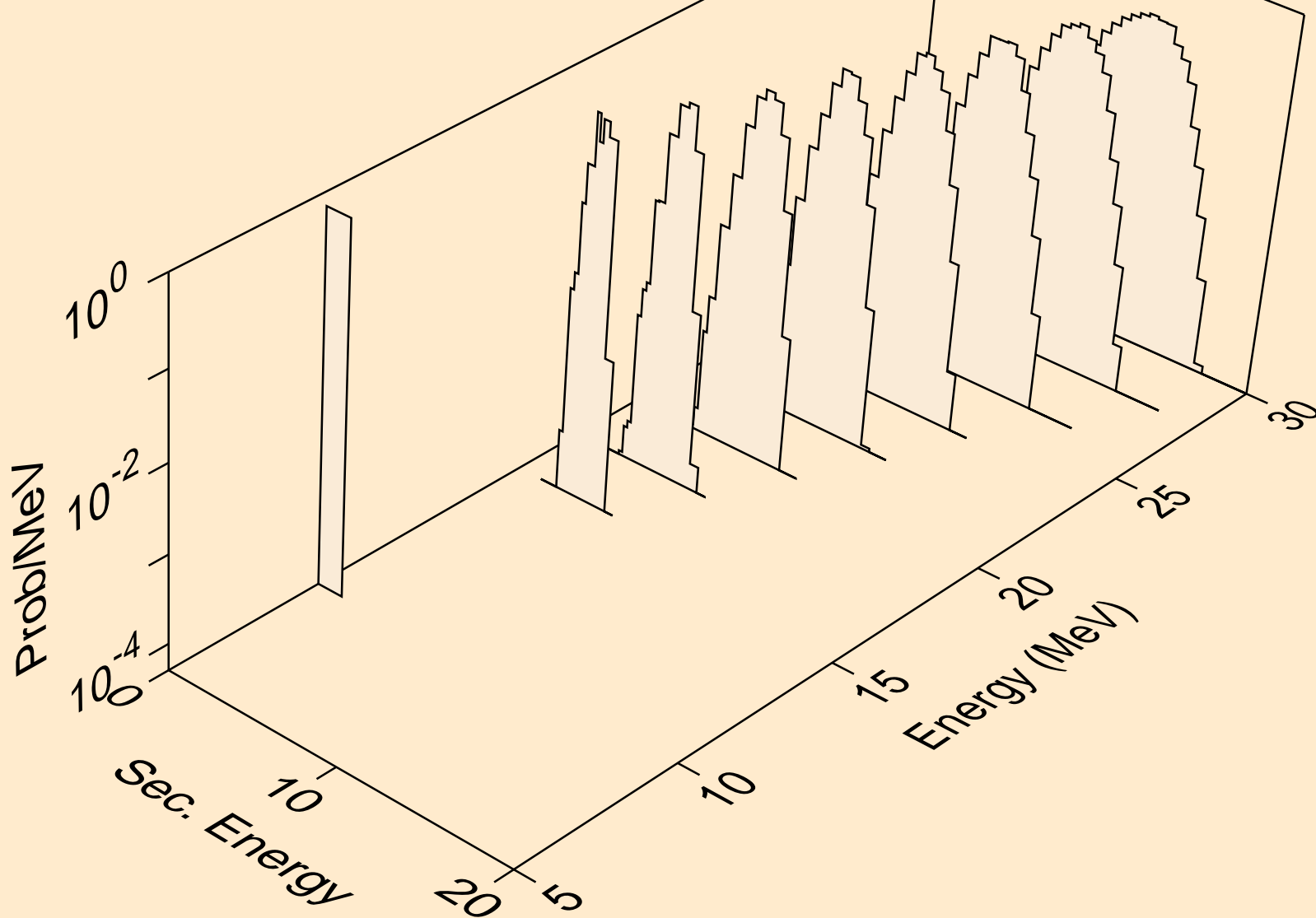

OS182 NEUTRON ACER TENDL-2019 LIBRARY; T=293.16K  
he3s from (n,x)

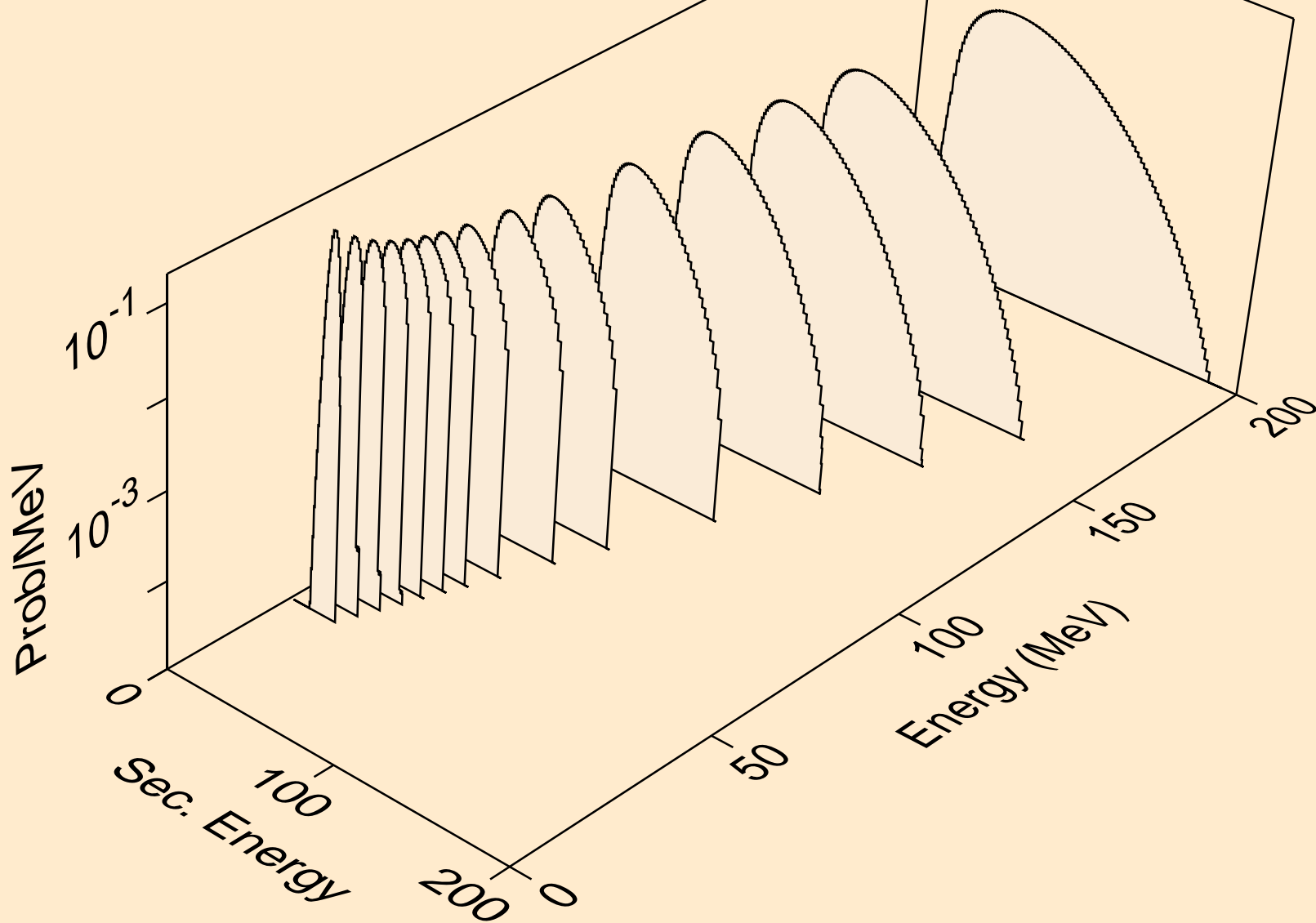

OS182 NEUTRON ACER TENDL-2019 LIBRARY; T=293.16K  
he3s from (n,n\*)he3

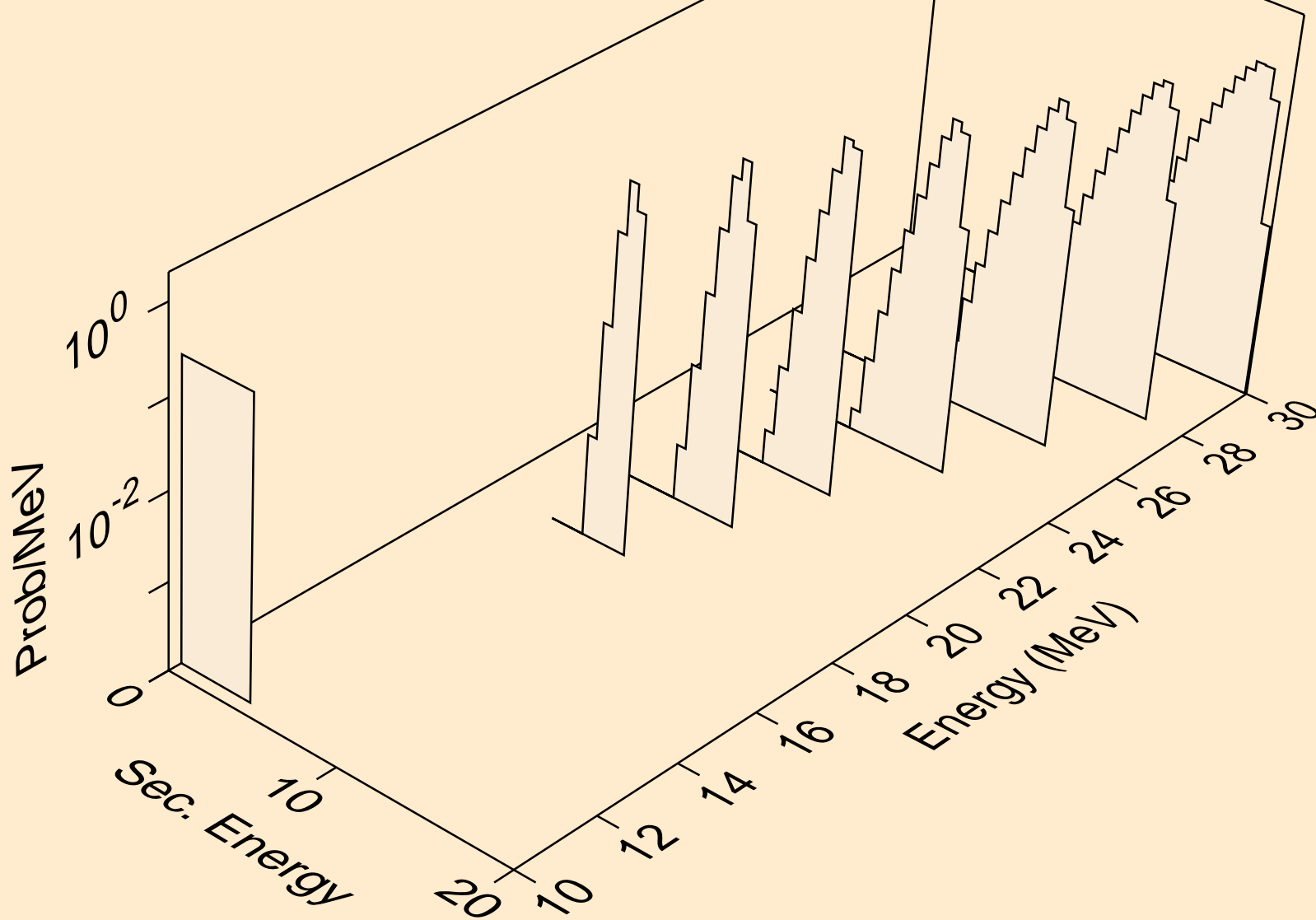

OS182 NEUTRON ACER TENDL-2019 LIBRARY; T=293.16K  
he3s from (n,he3)

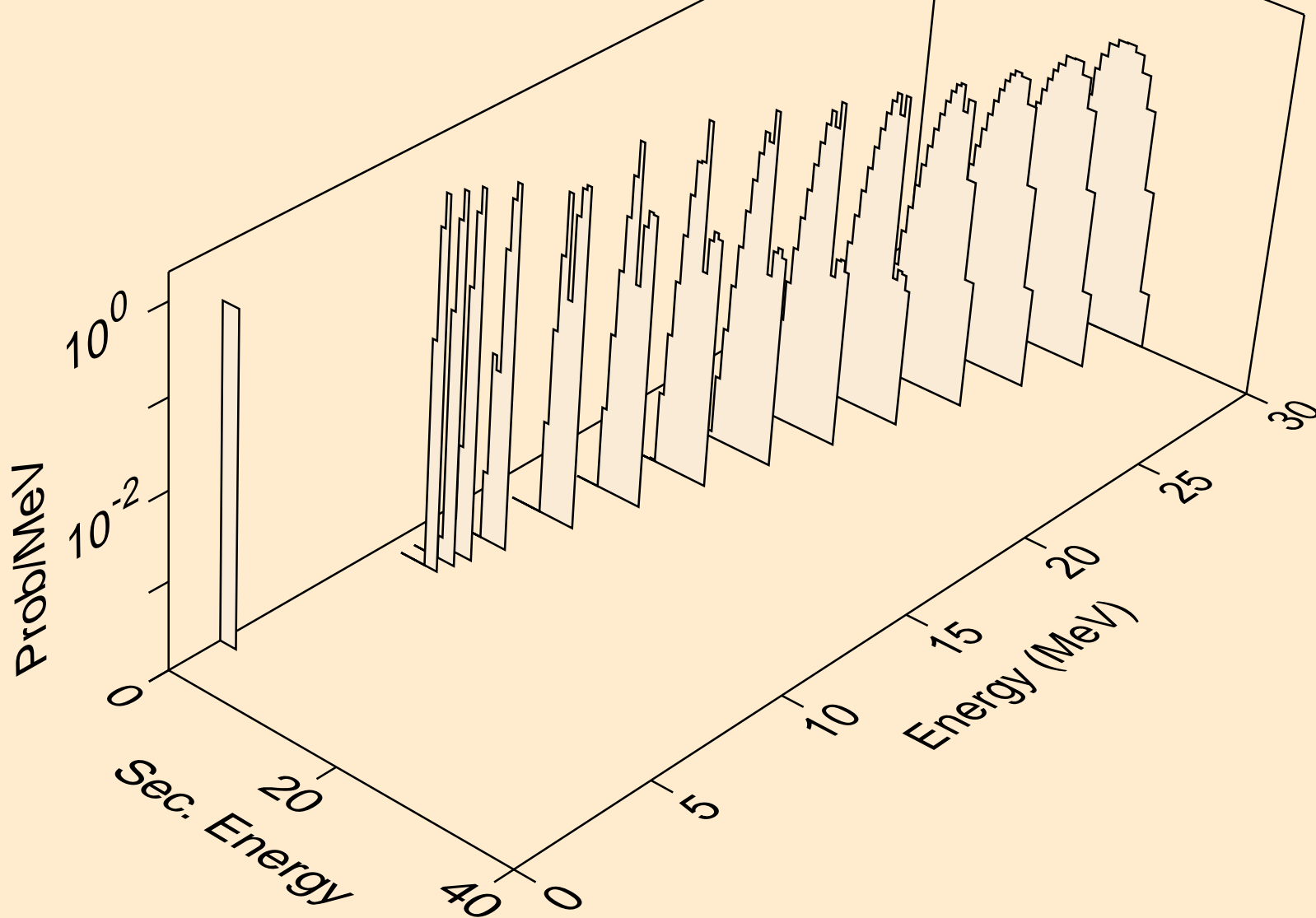

OS182 NEUTRON ACER TENDL-2019 LIBRARY; T=293.16K  
alphas from (n,x)

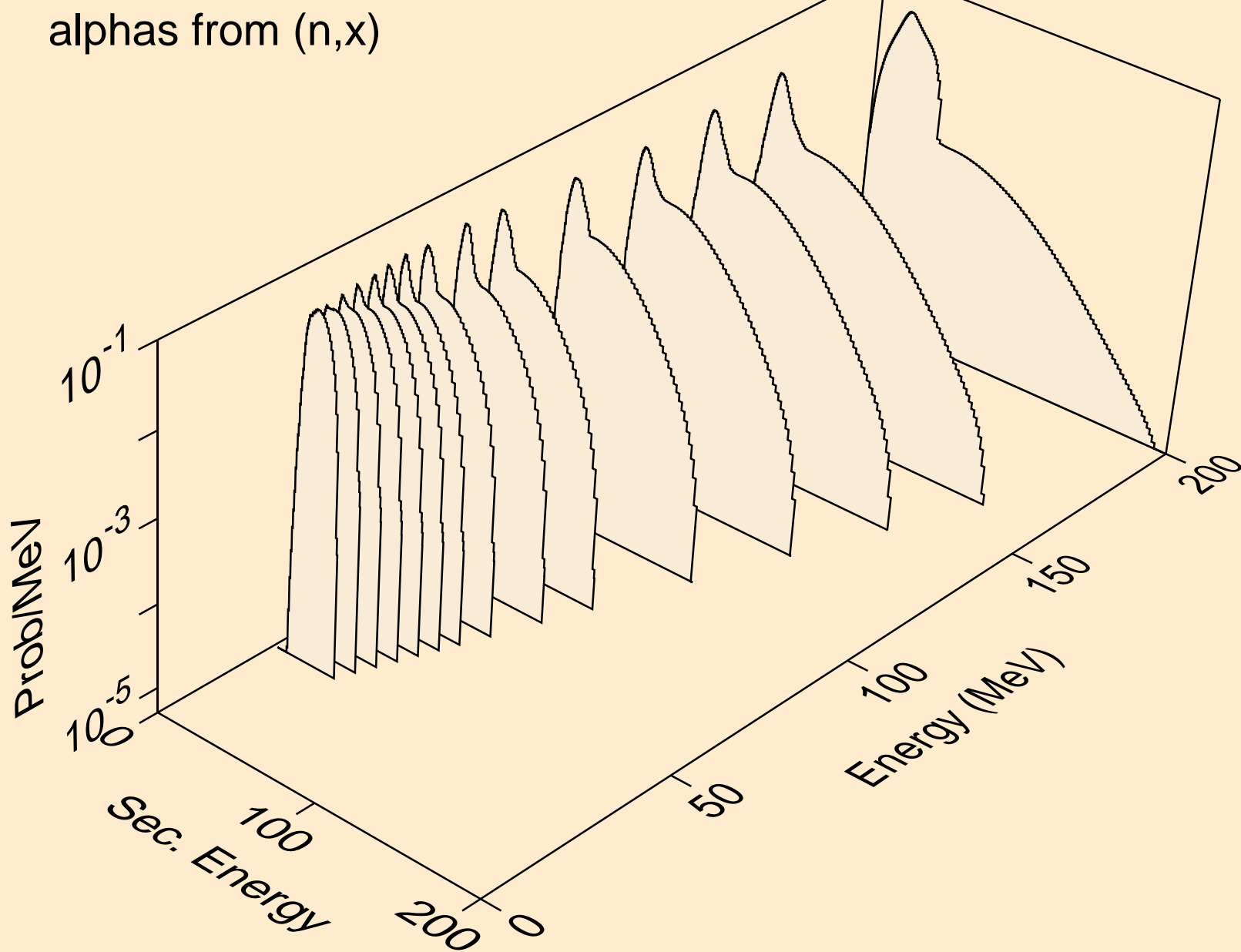

OS182 NEUTRON ACER TENDL-2019 LIBRARY; T=293.16K  
alphas from (n,n\*)a

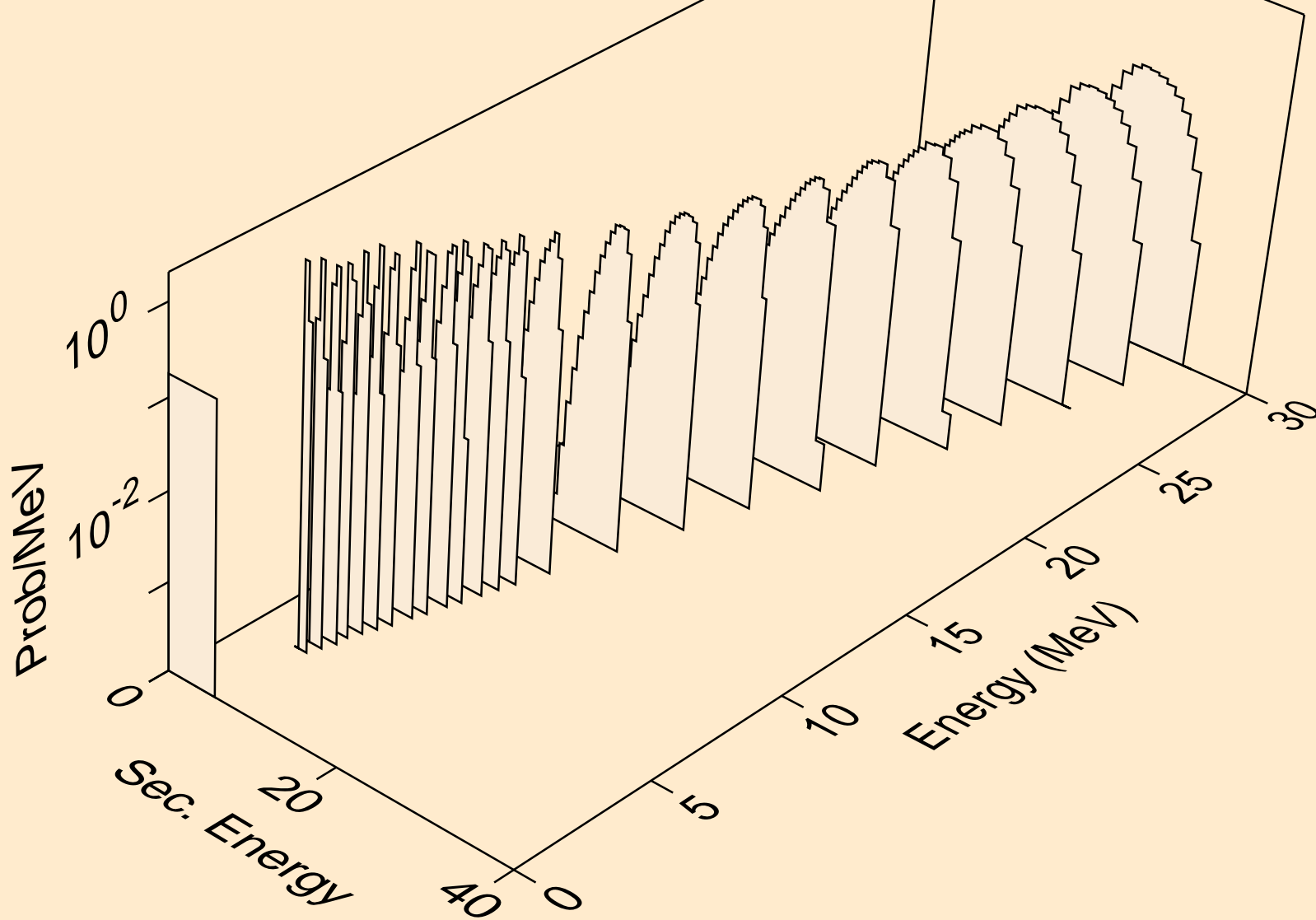

OS182 NEUTRON ACER TENDL-2019 LIBRARY; T=293.16K  
alphas from (n,2n)a

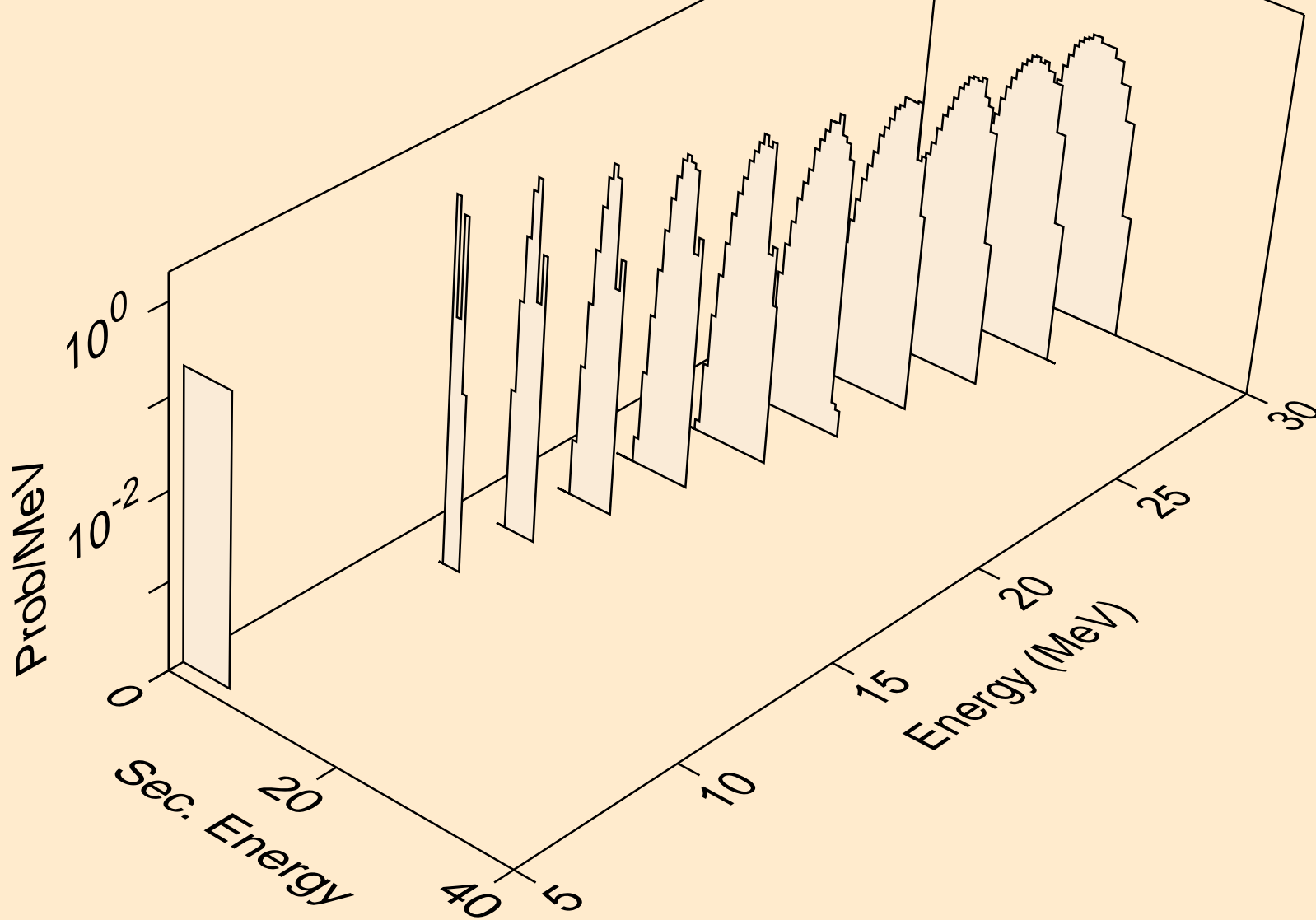

OS182 NEUTRON ACER TENDL-2019 LIBRARY; T=293.16K  
alphas from (n,3n)a

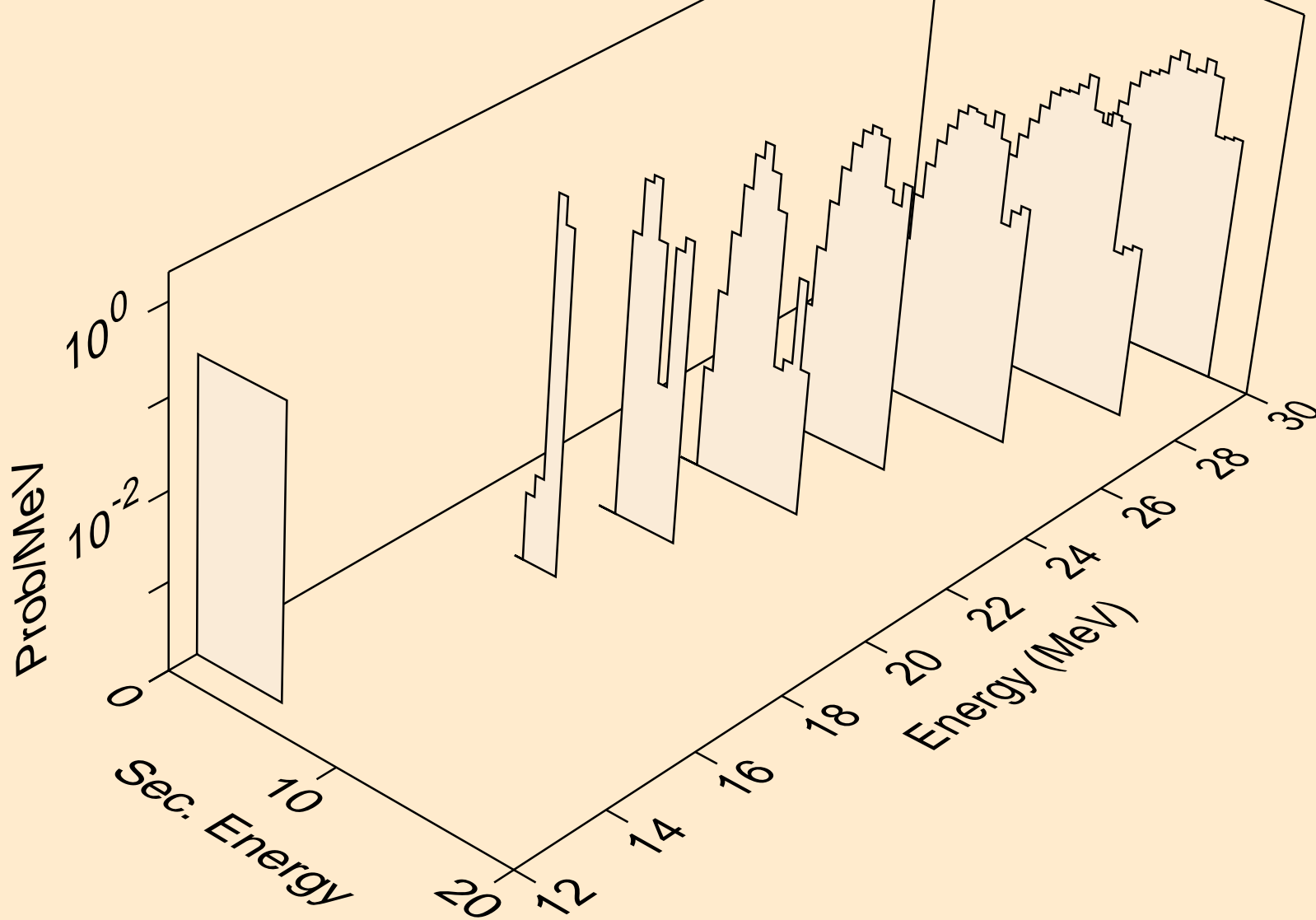



OS182 NEUTRON ACER TENDL-2019 LIBRARY; T=293.16K  
alphas from (n,n\*)2a

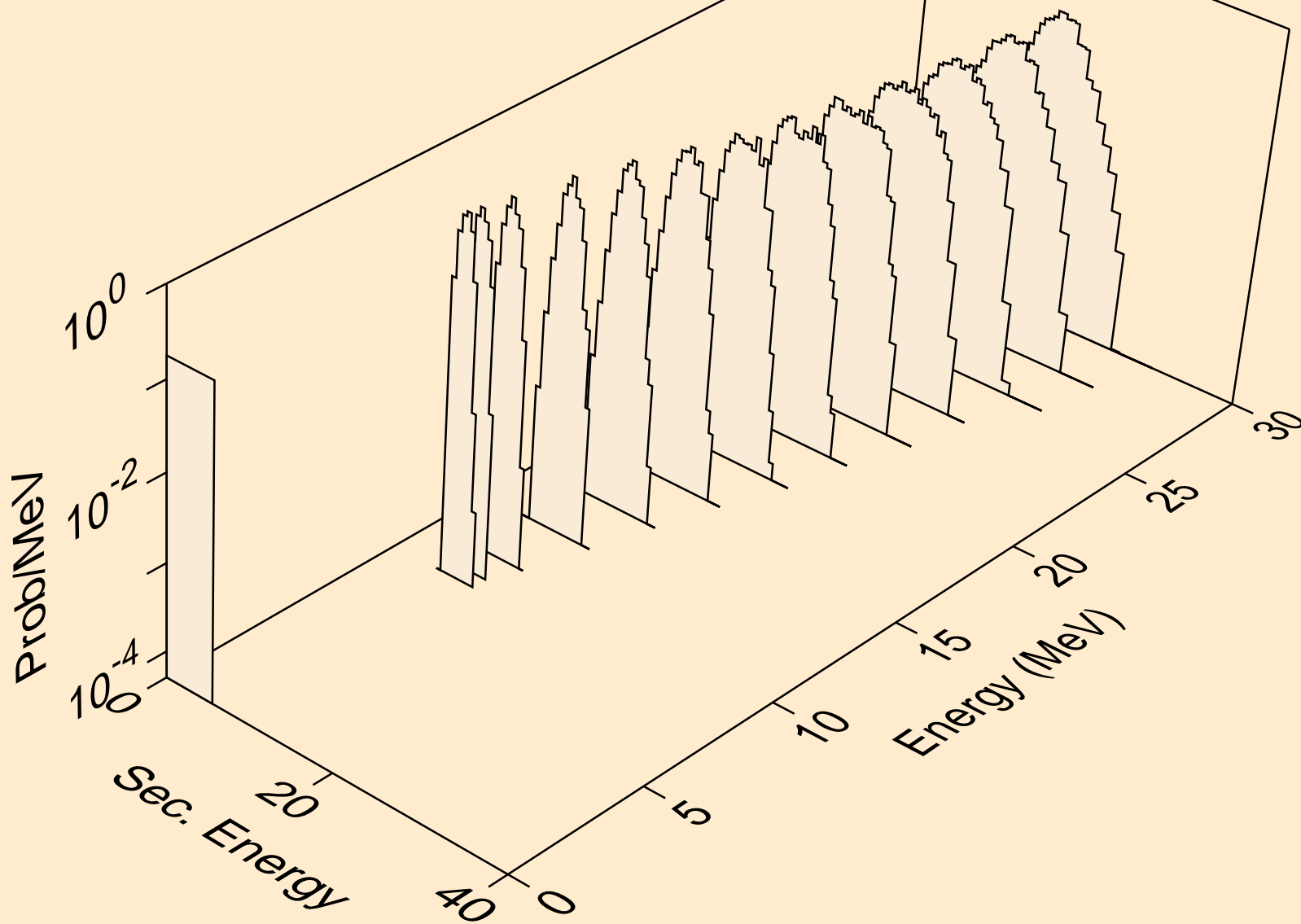

OS182 NEUTRON ACER TENDL-2019 LIBRARY; T=293.16K  
alphas from (n,2n)2a

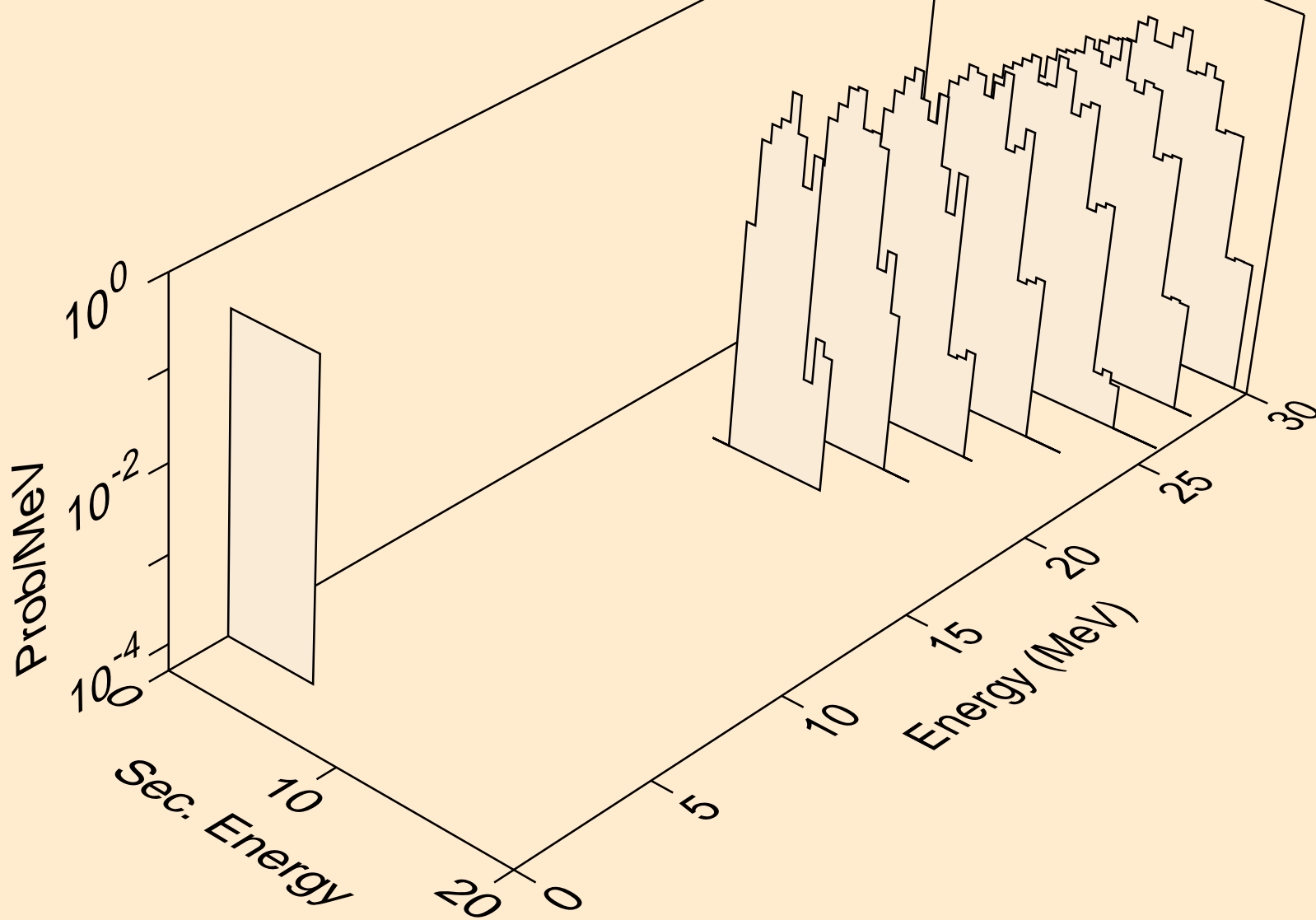

OS182 NEUTRON ACER TENDL-2019 LIBRARY; T=293.16K  
alphas from (n,npa)

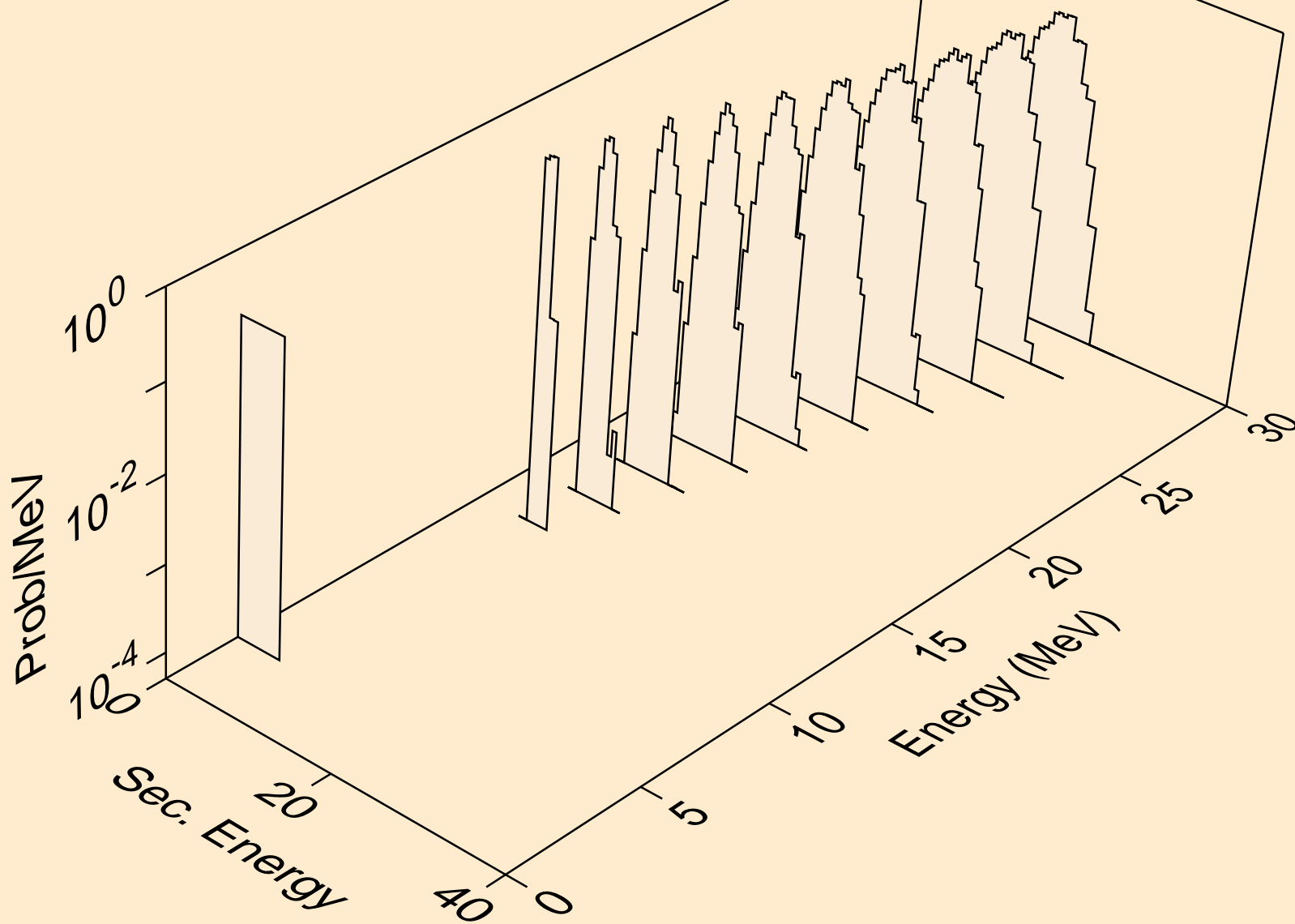

OS182 NEUTRON ACER TENDL-2019 LIBRARY; T=293.16K  
alphas from (n,a)

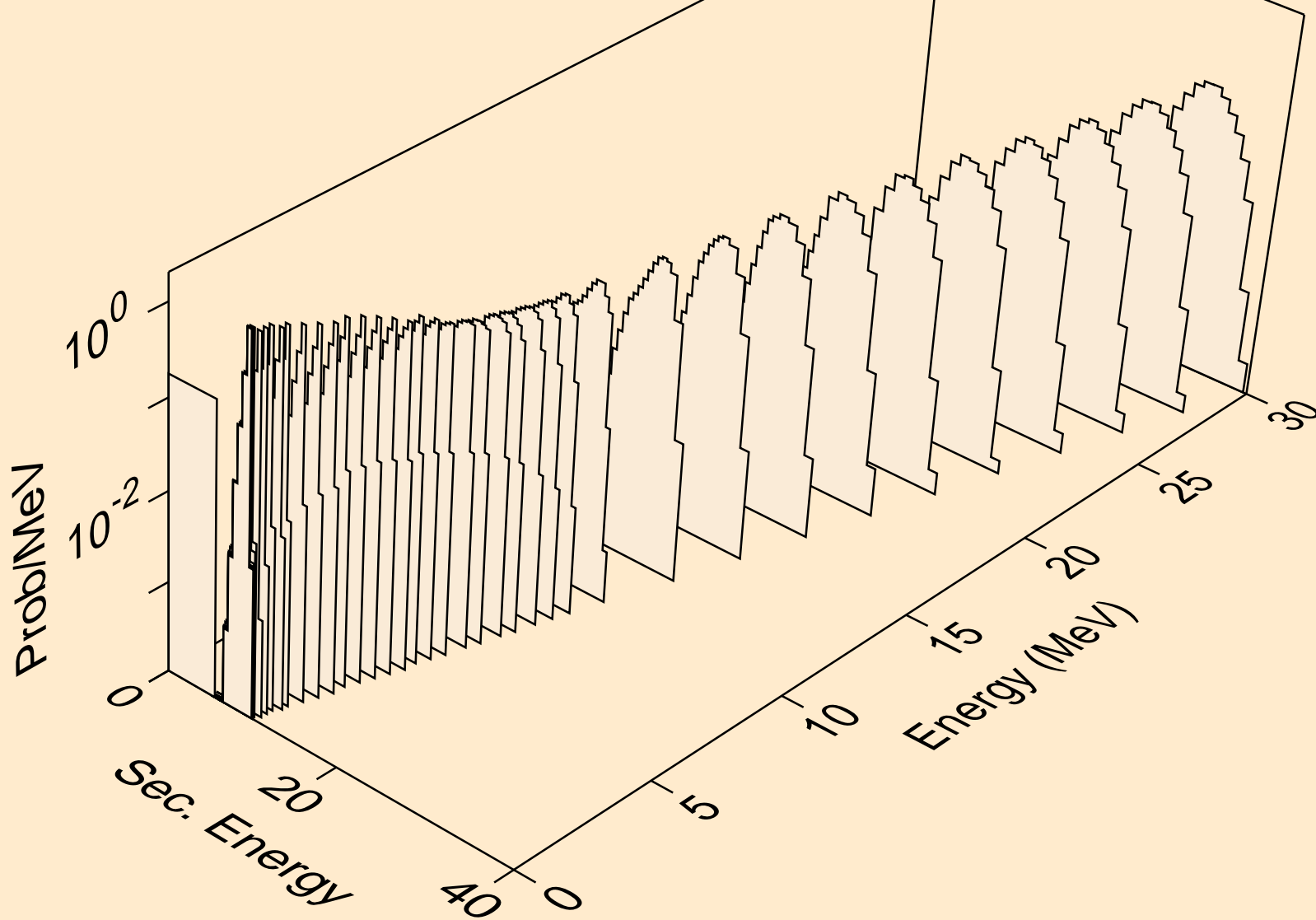

OS182 NEUTRON ACER TENDL-2019 LIBRARY; T=293.16K  
alphas from (n,2a)

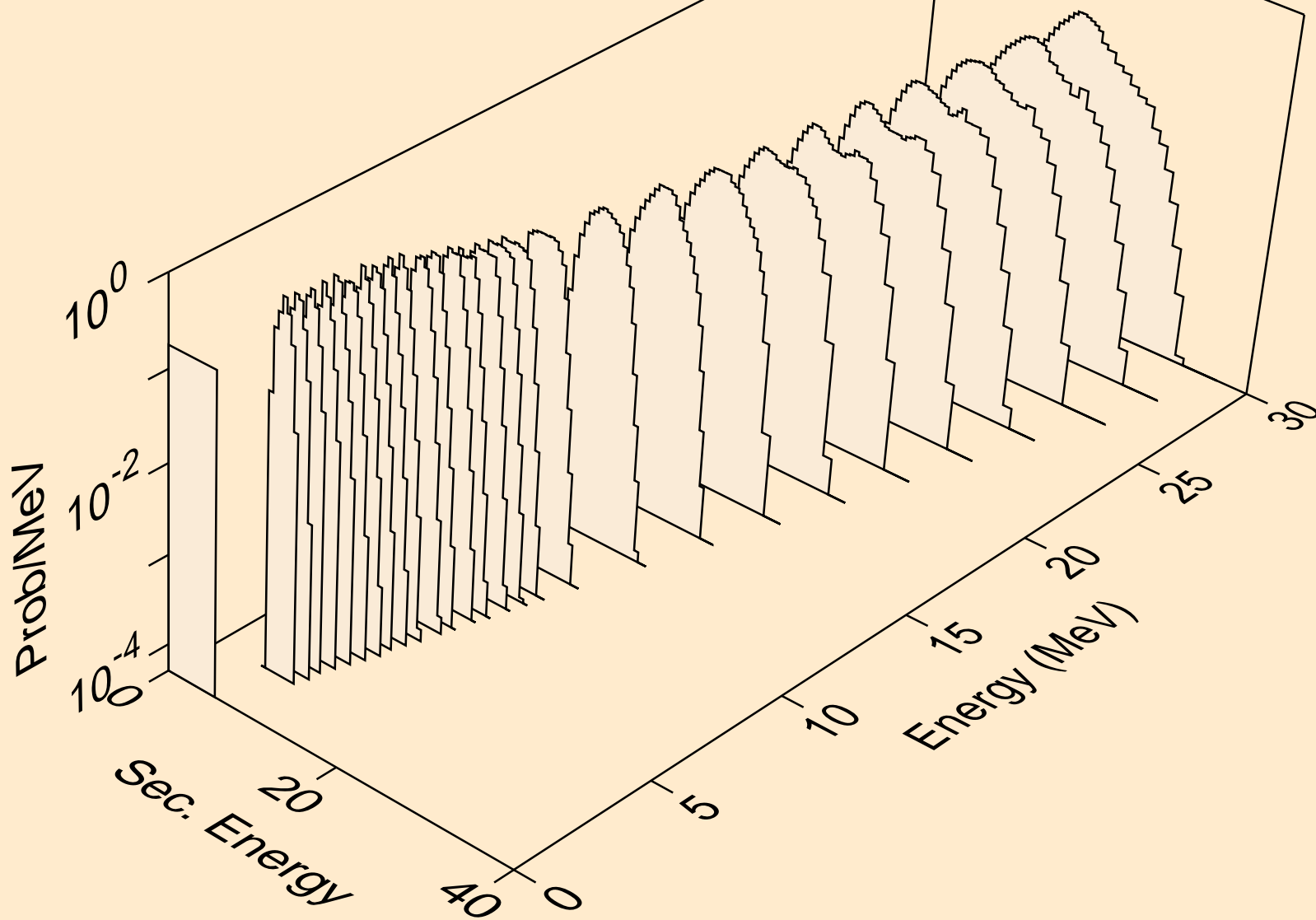

OS182 NEUTRON ACER TENDL-2019 LIBRARY; T=293.16K  
alphas from (n,pa)

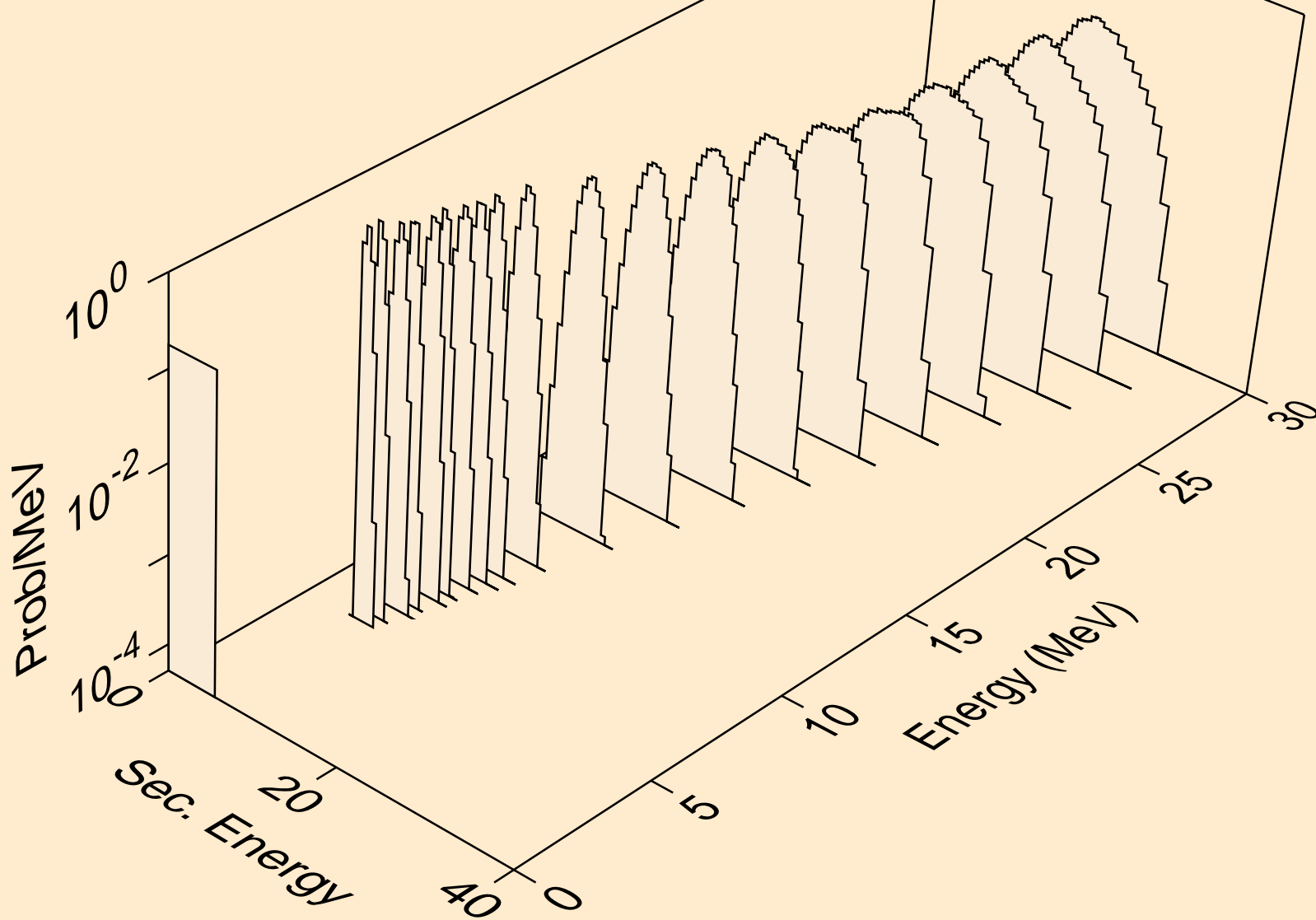

OS182 NEUTRON ACER TENDL-2019 LIBRARY; T=293.16K  
alphas from (n,da)

