

P035 NEUTRON ACER TENDL-2019 LIBRARY; T=293.16K
Principal cross sections

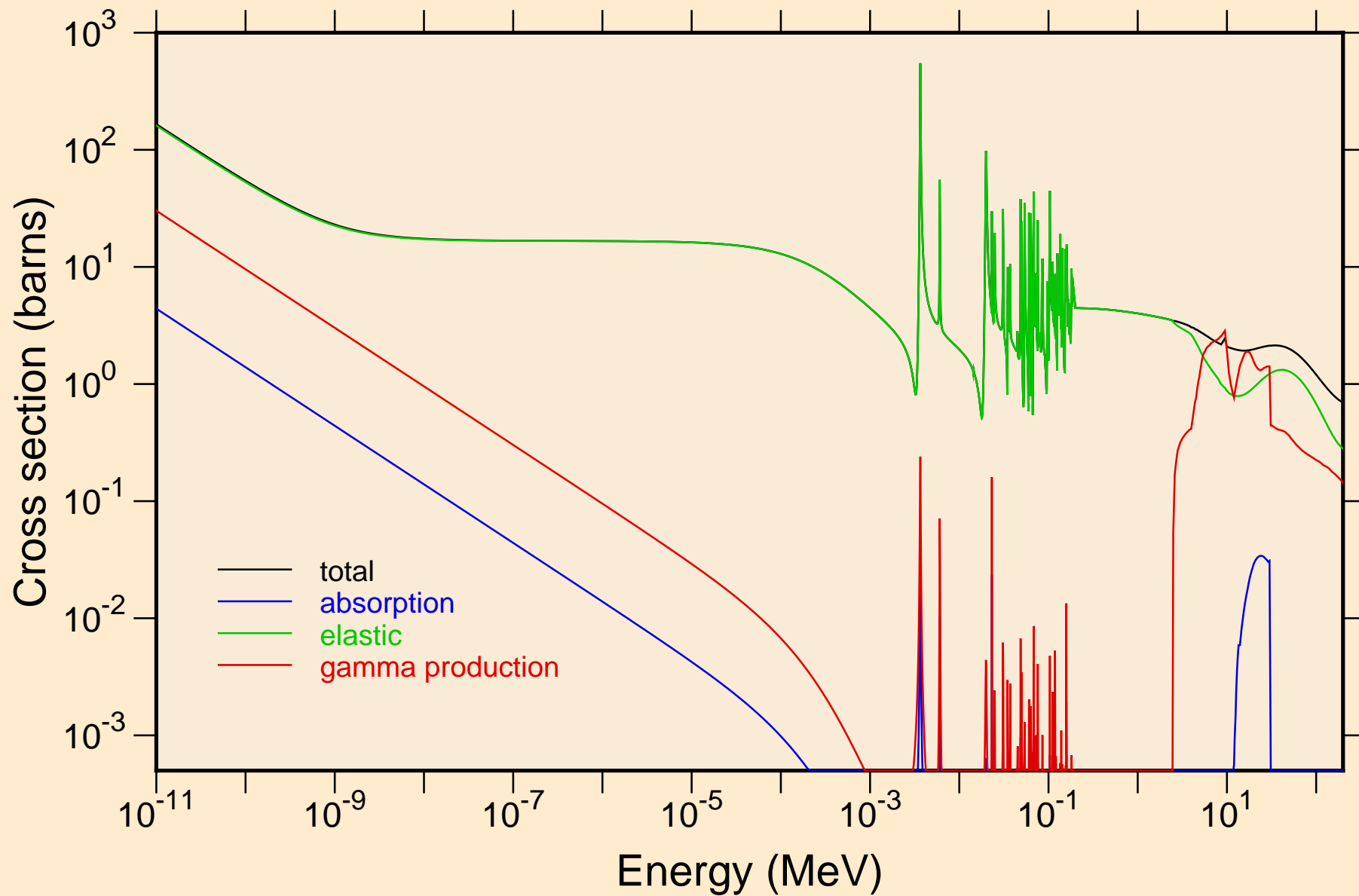

P035 NEUTRON ACER TENDL-2019 LIBRARY; T=293.16K
resonance total cross section

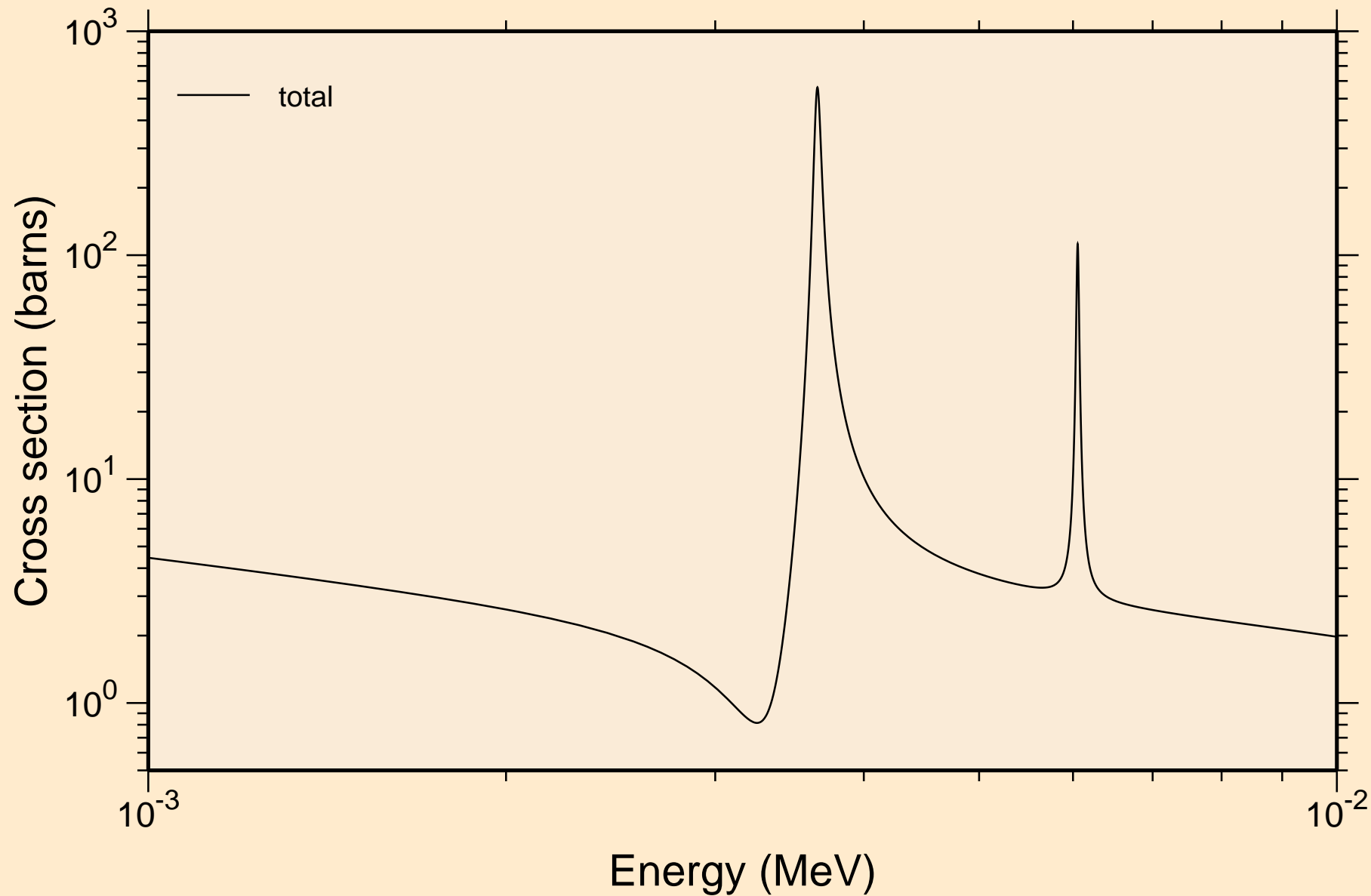

P035 NEUTRON ACER TENDL-2019 LIBRARY; T=293.16K
resonance total cross section

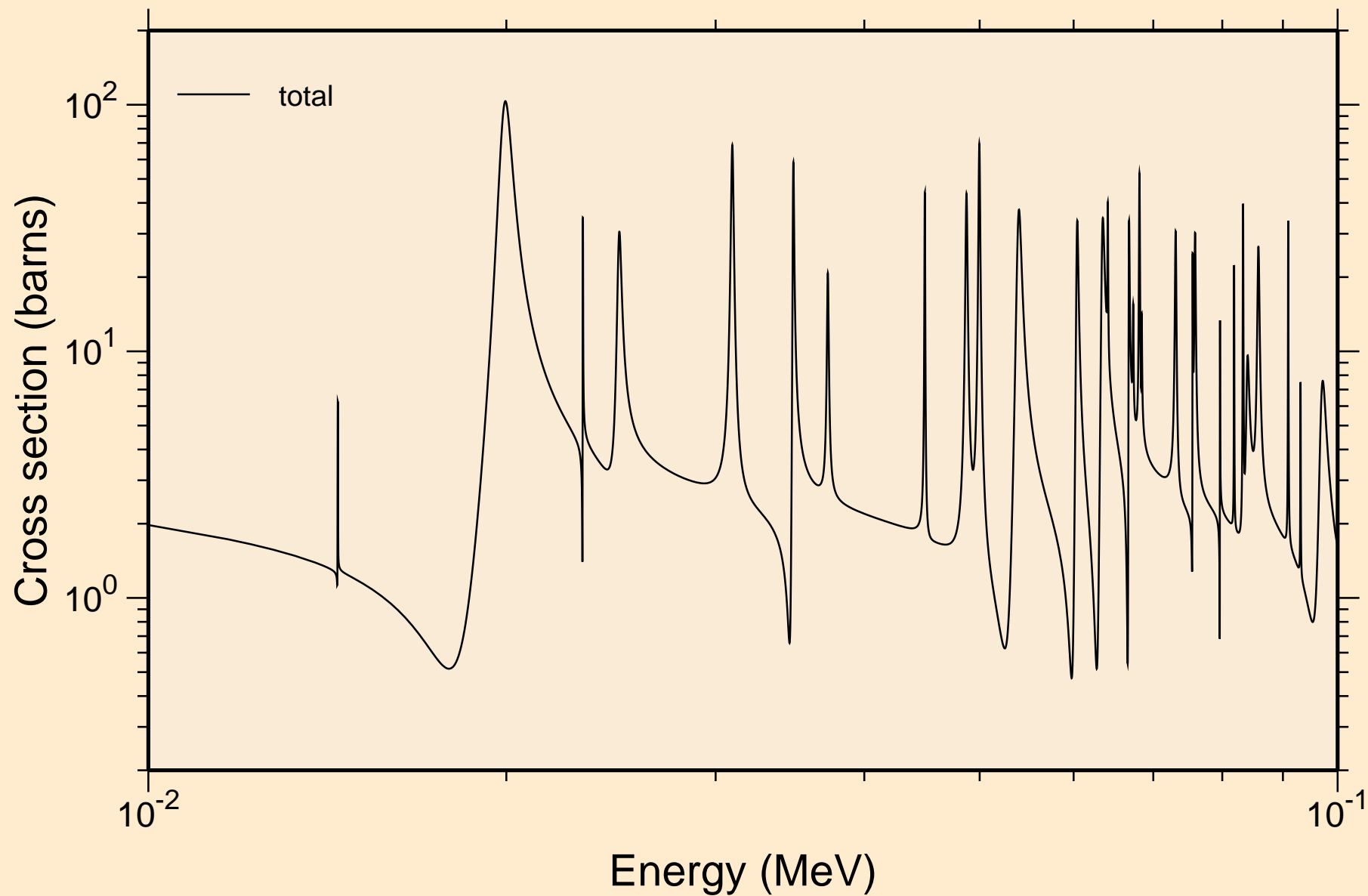

P035 NEUTRON ACER TENDL-2019 LIBRARY; T=293.16K
resonance total cross section

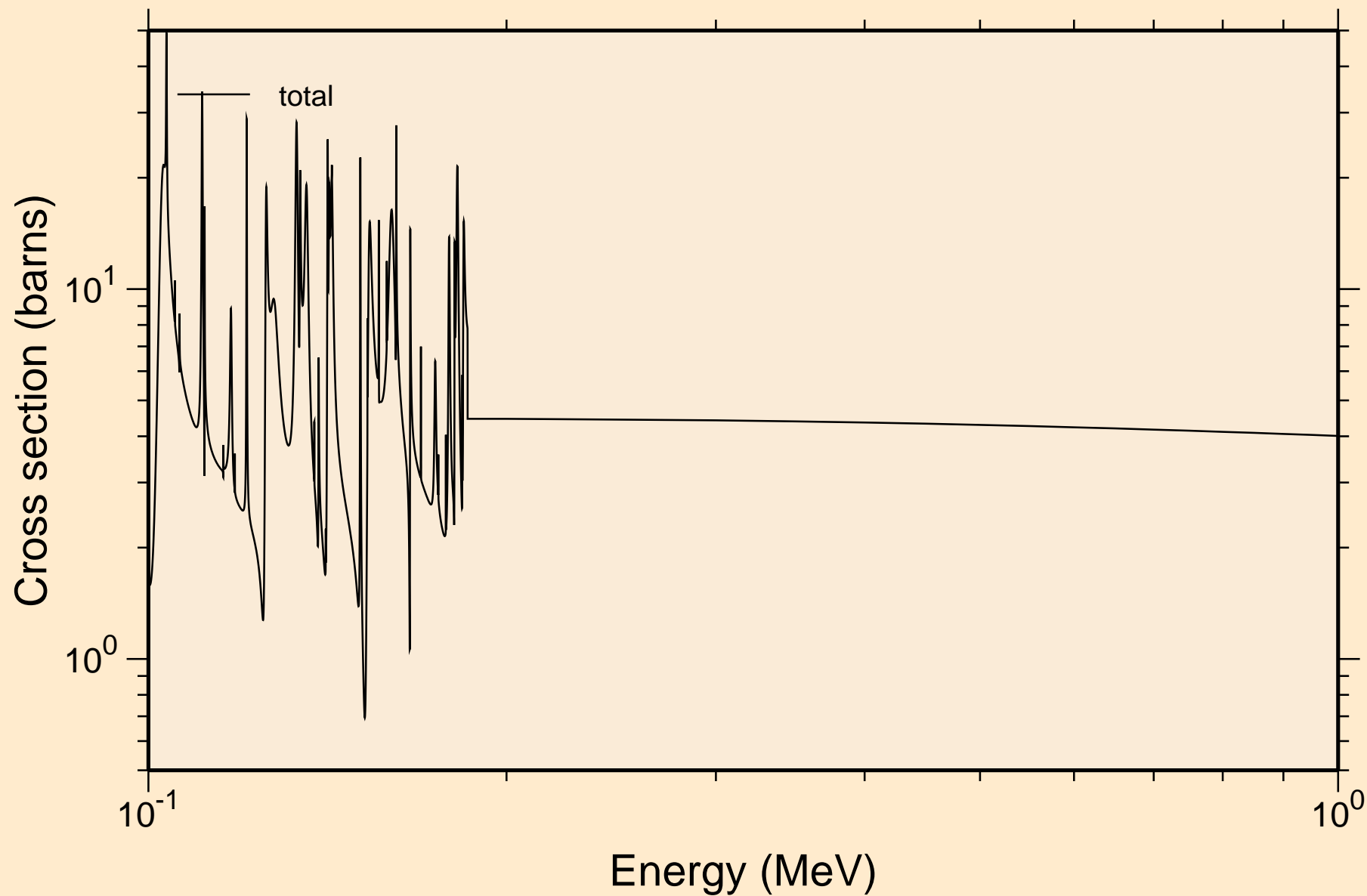

P035 NEUTRON ACER TENDL-2019 LIBRARY; T=293.16K
resonance total cross section

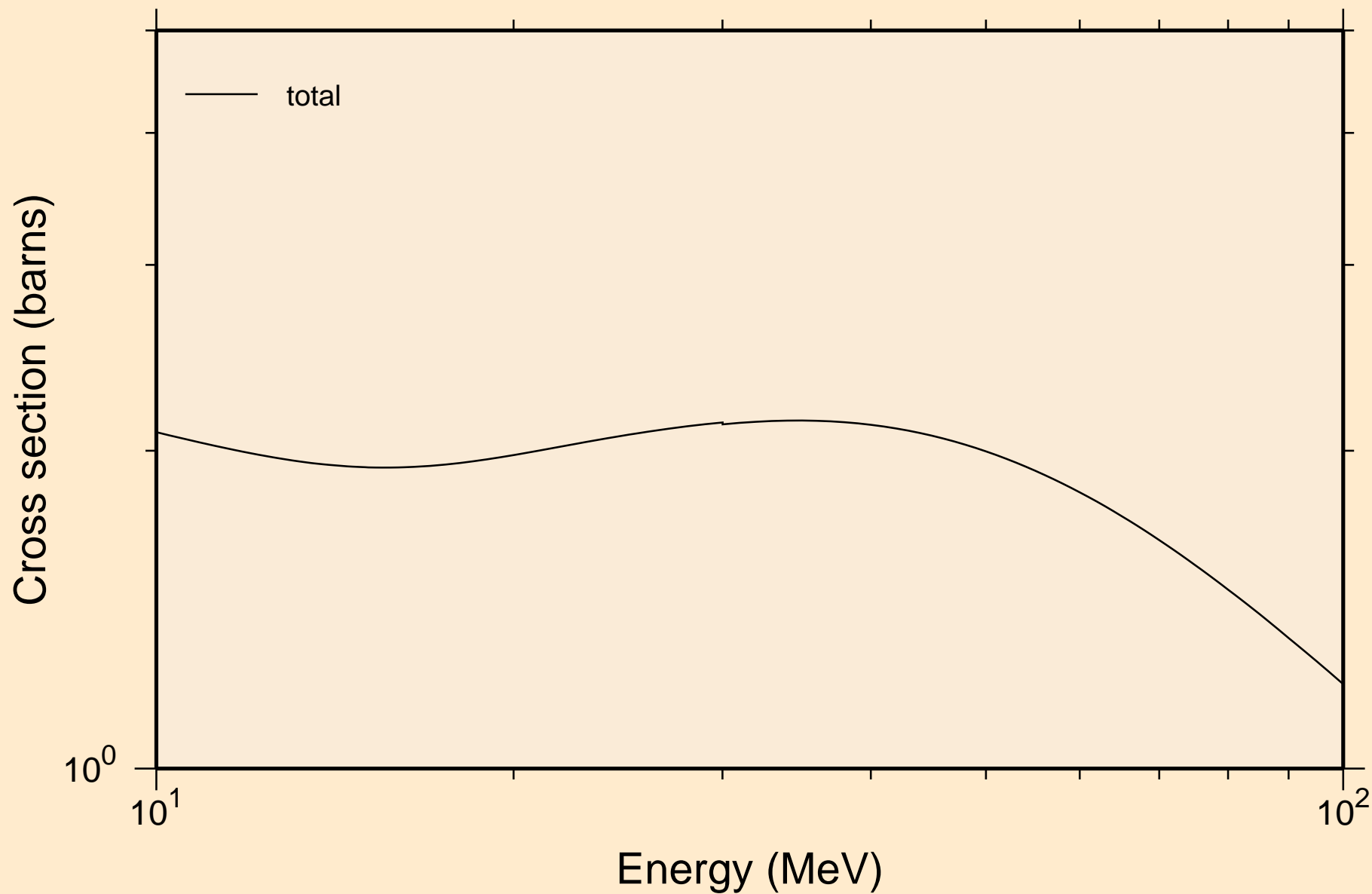

P035 NEUTRON ACER TENDL-2019 LIBRARY; T=293.16K
resonance absorption cross sections

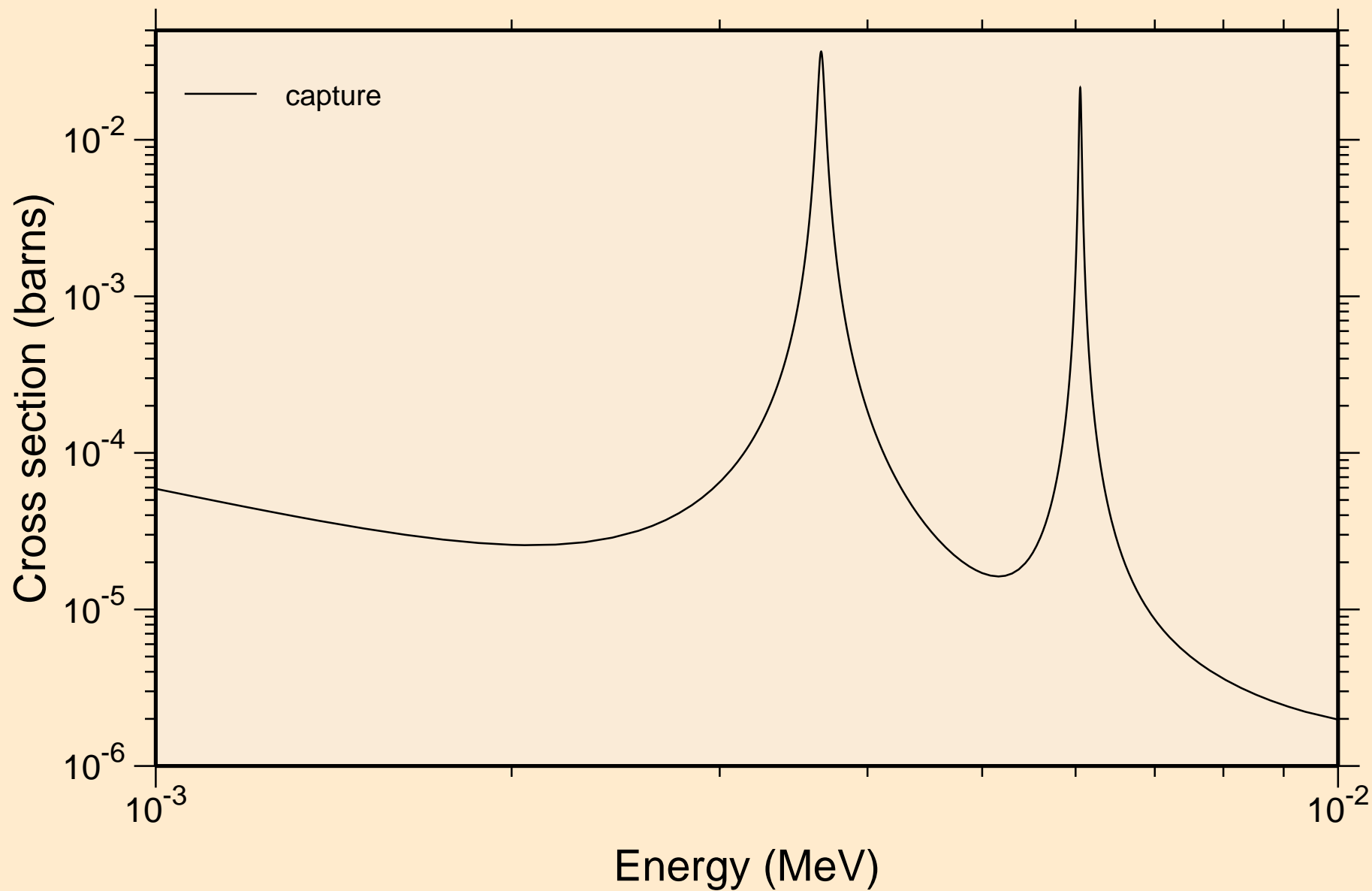

P035 NEUTRON ACER TENDL-2019 LIBRARY; T=293.16K
resonance absorption cross sections

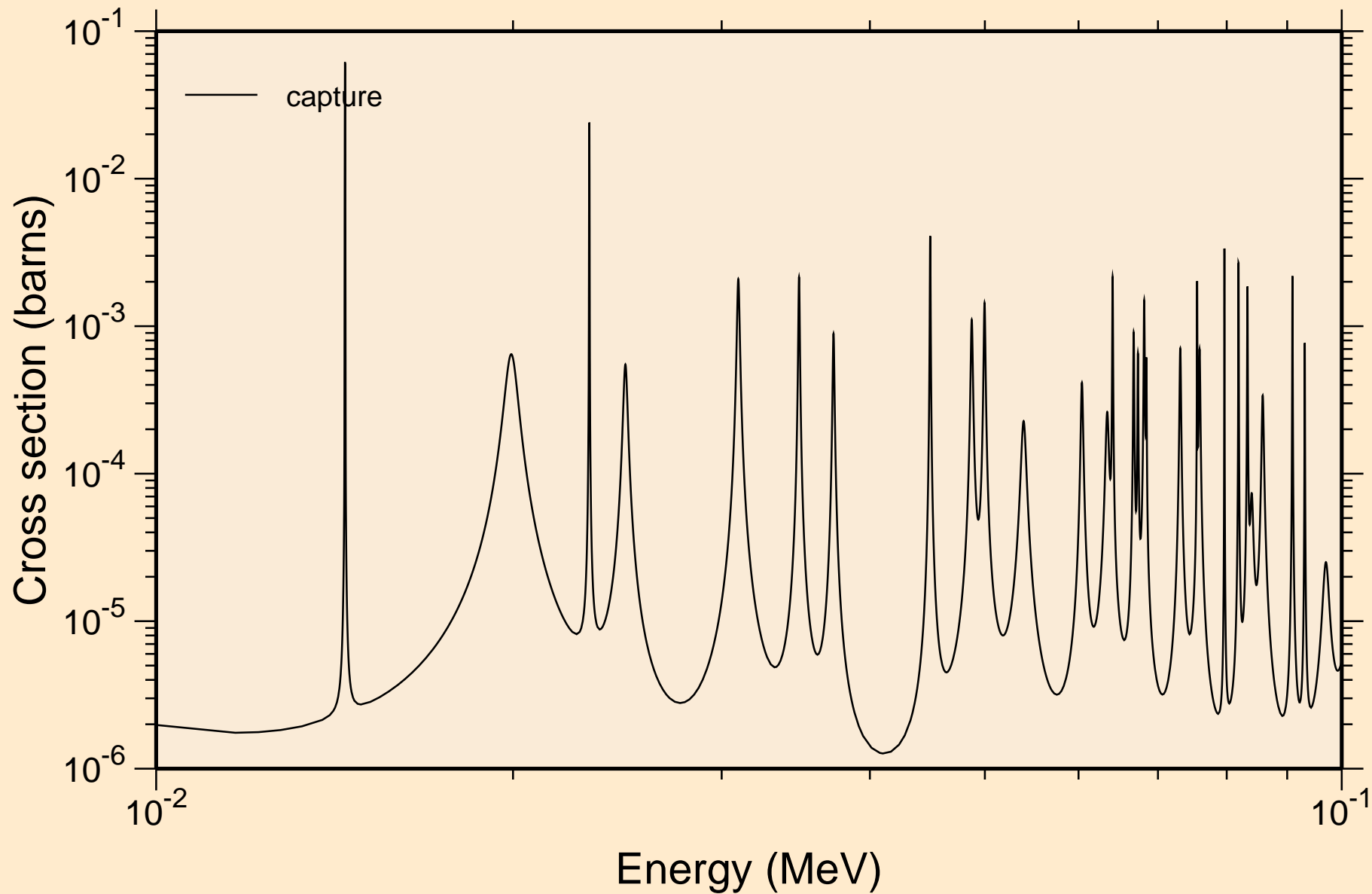

P035 NEUTRON ACER TENDL-2019 LIBRARY; T=293.16K
resonance absorption cross sections

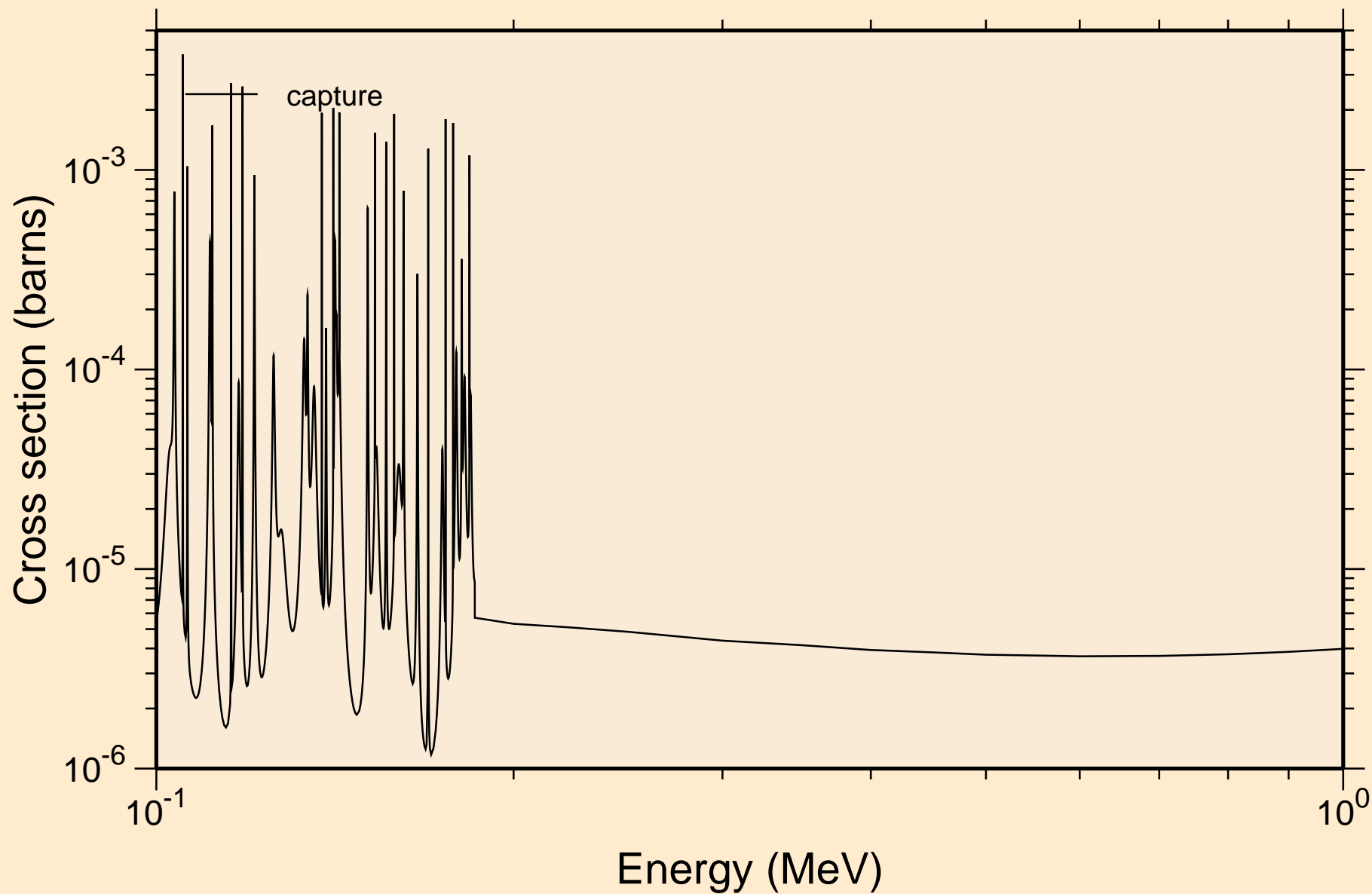

P035 NEUTRON ACER TENDL-2019 LIBRARY; T=293.16K
resonance absorption cross sections

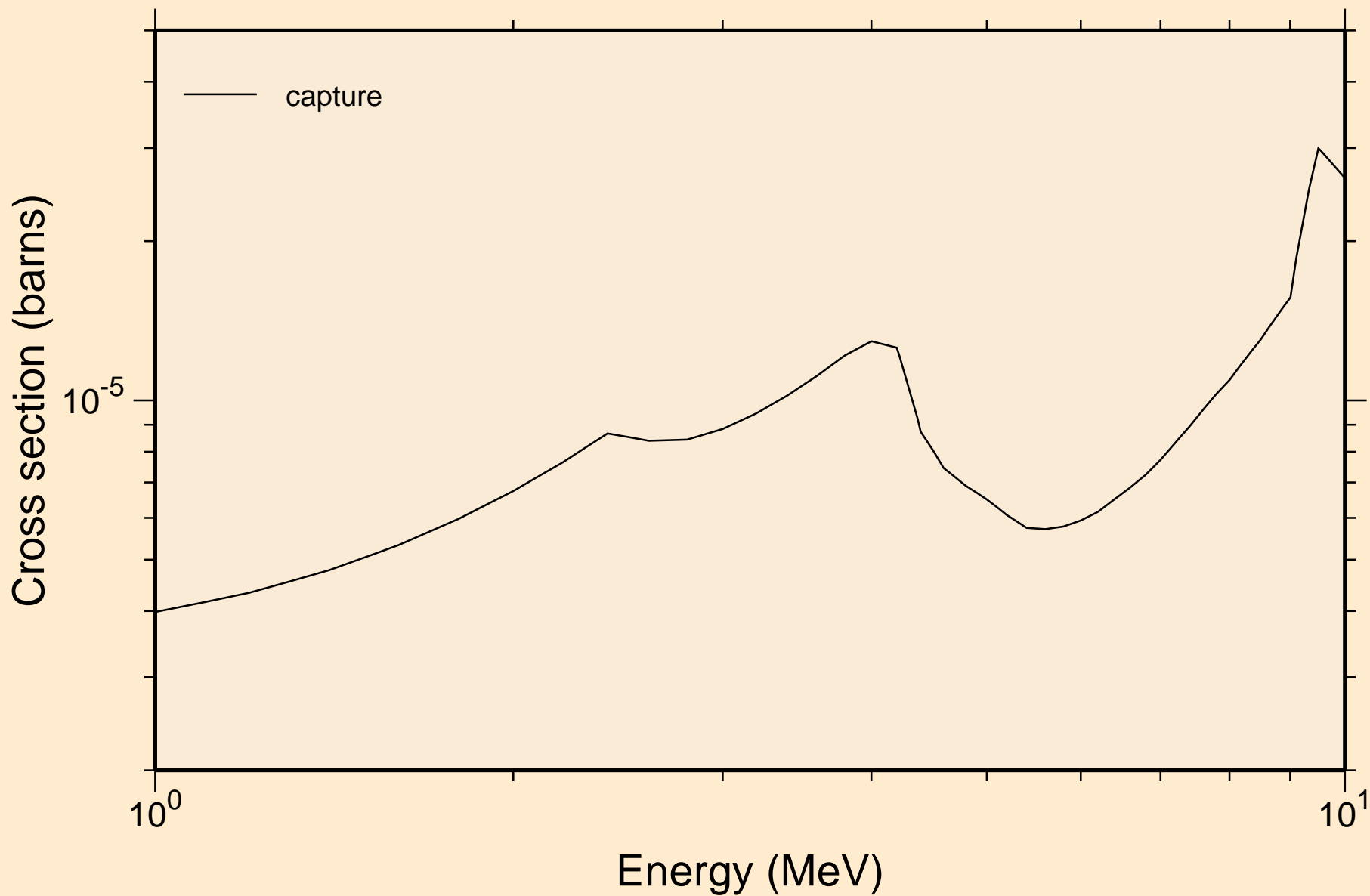

P035 NEUTRON ACER TENDL-2019 LIBRARY; T=293.16K
Heating

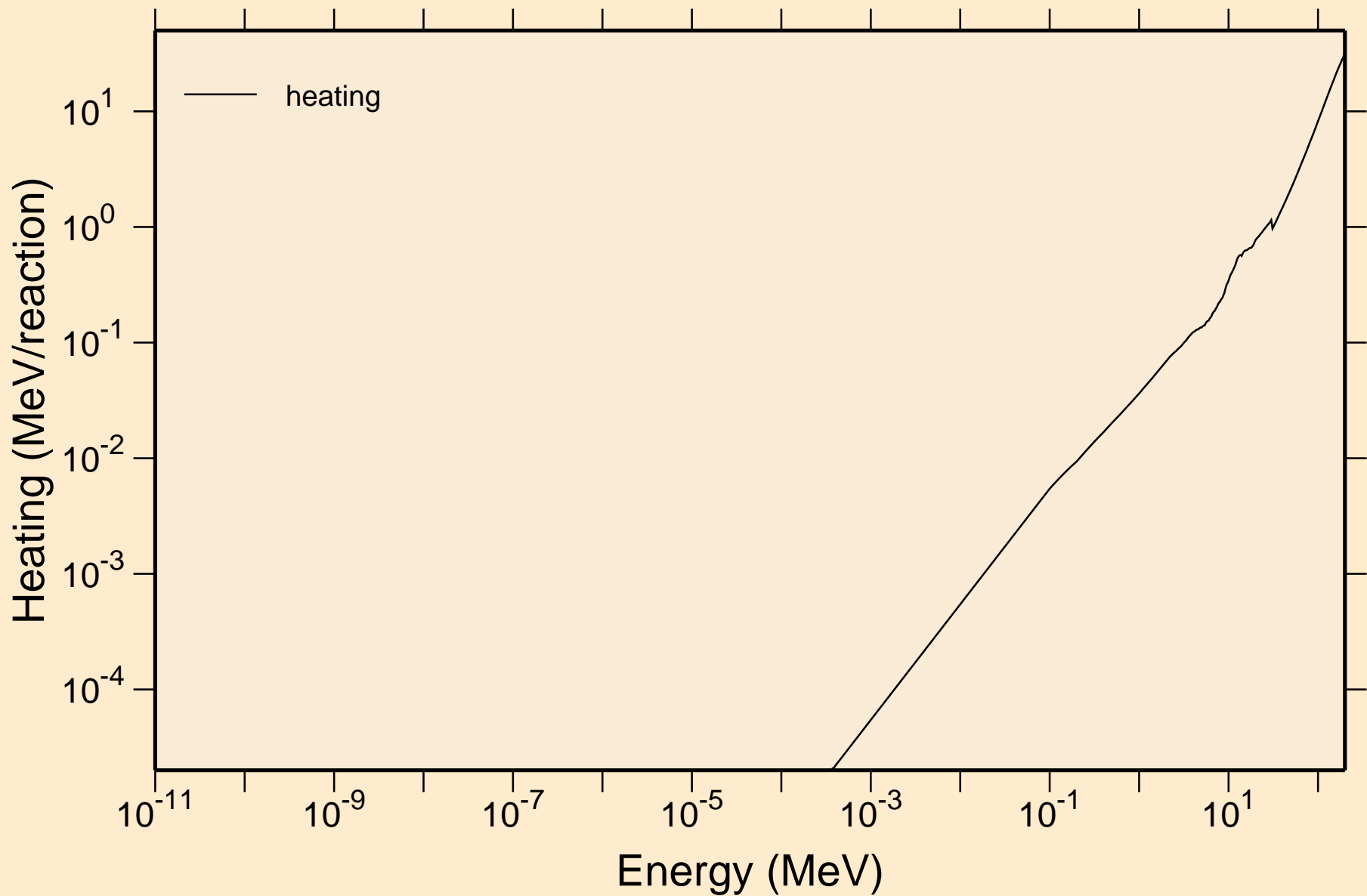

P035 NEUTRON ACER TENDL-2019 LIBRARY; T=293.16K
Damage

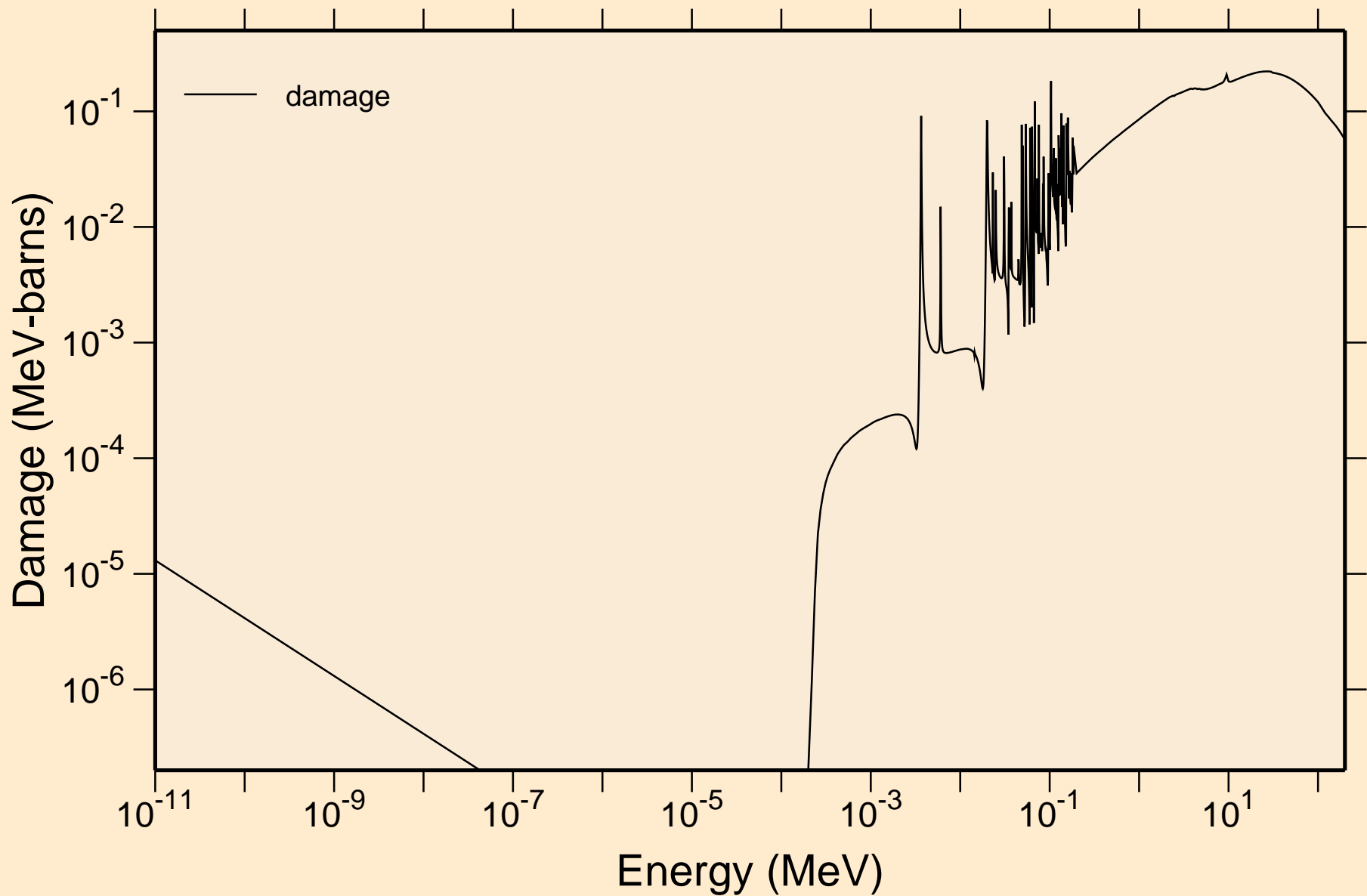

P035 NEUTRON ACER TENDL-2019 LIBRARY; T=293.16K
Non-threshold reactions

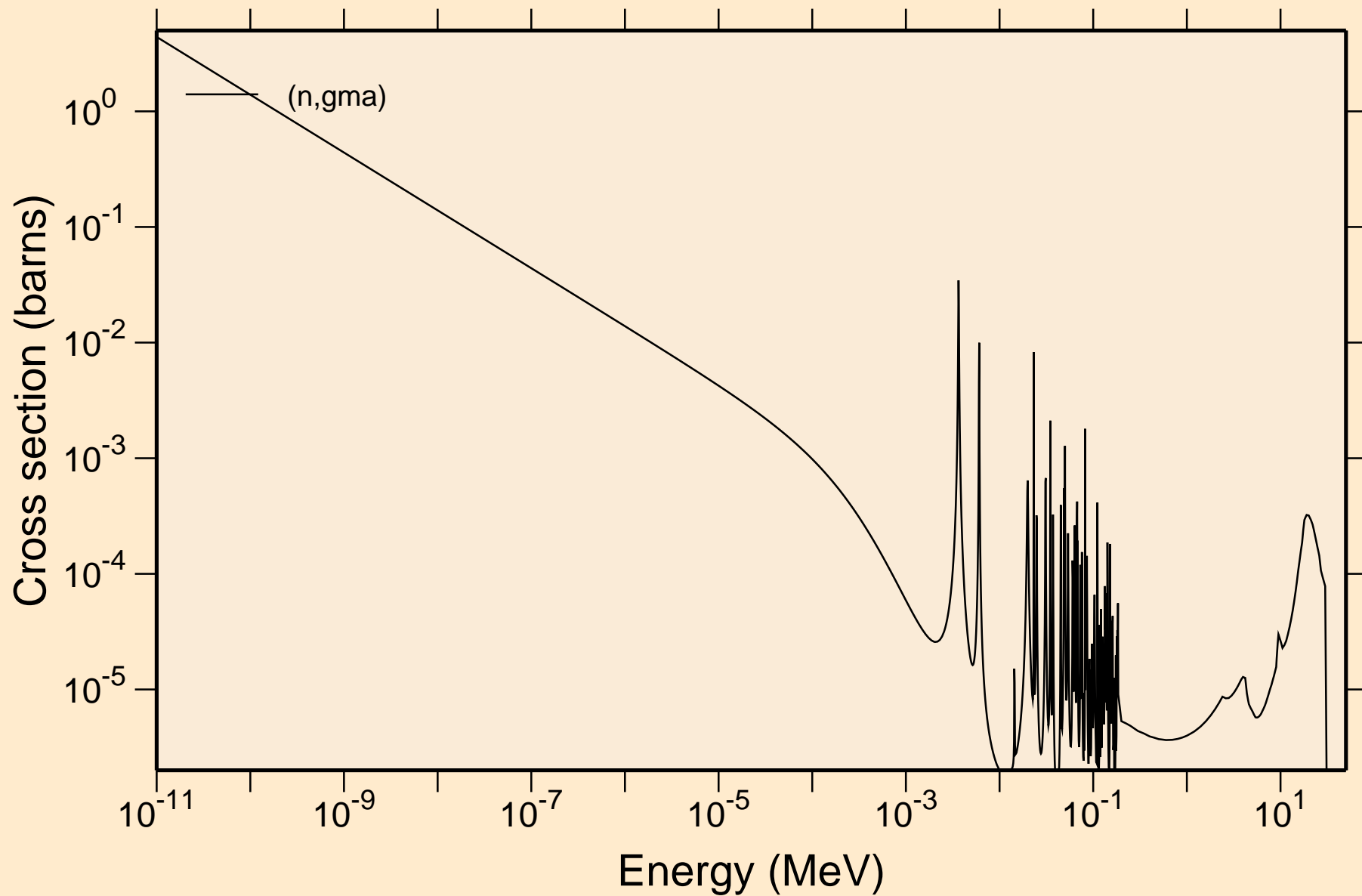

P035 NEUTRON ACER TENDL-2019 LIBRARY; T=293.16K
Principal cross sections

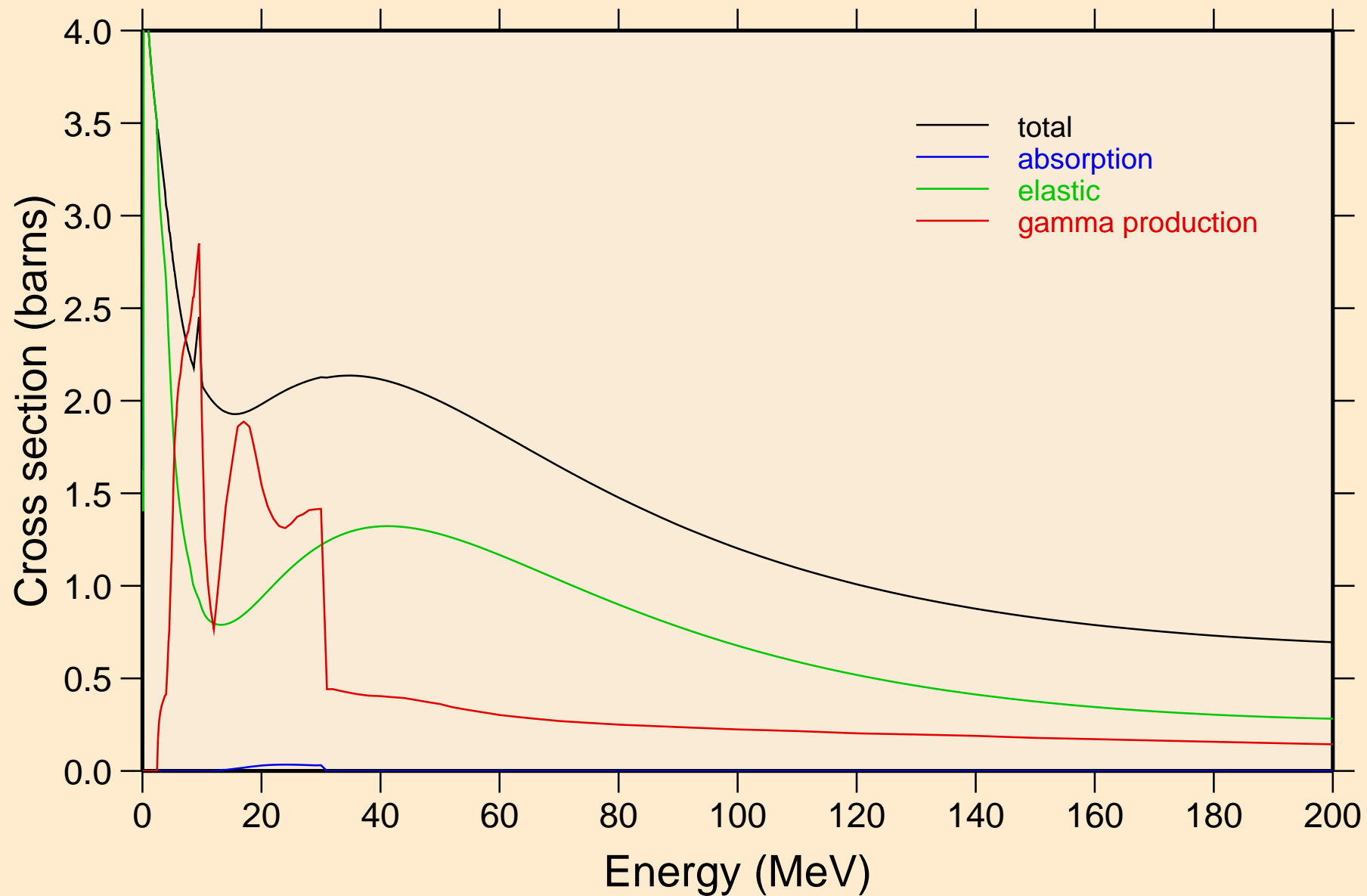

P035 NEUTRON ACER TENDL-2019 LIBRARY; T=293.16K
Heating

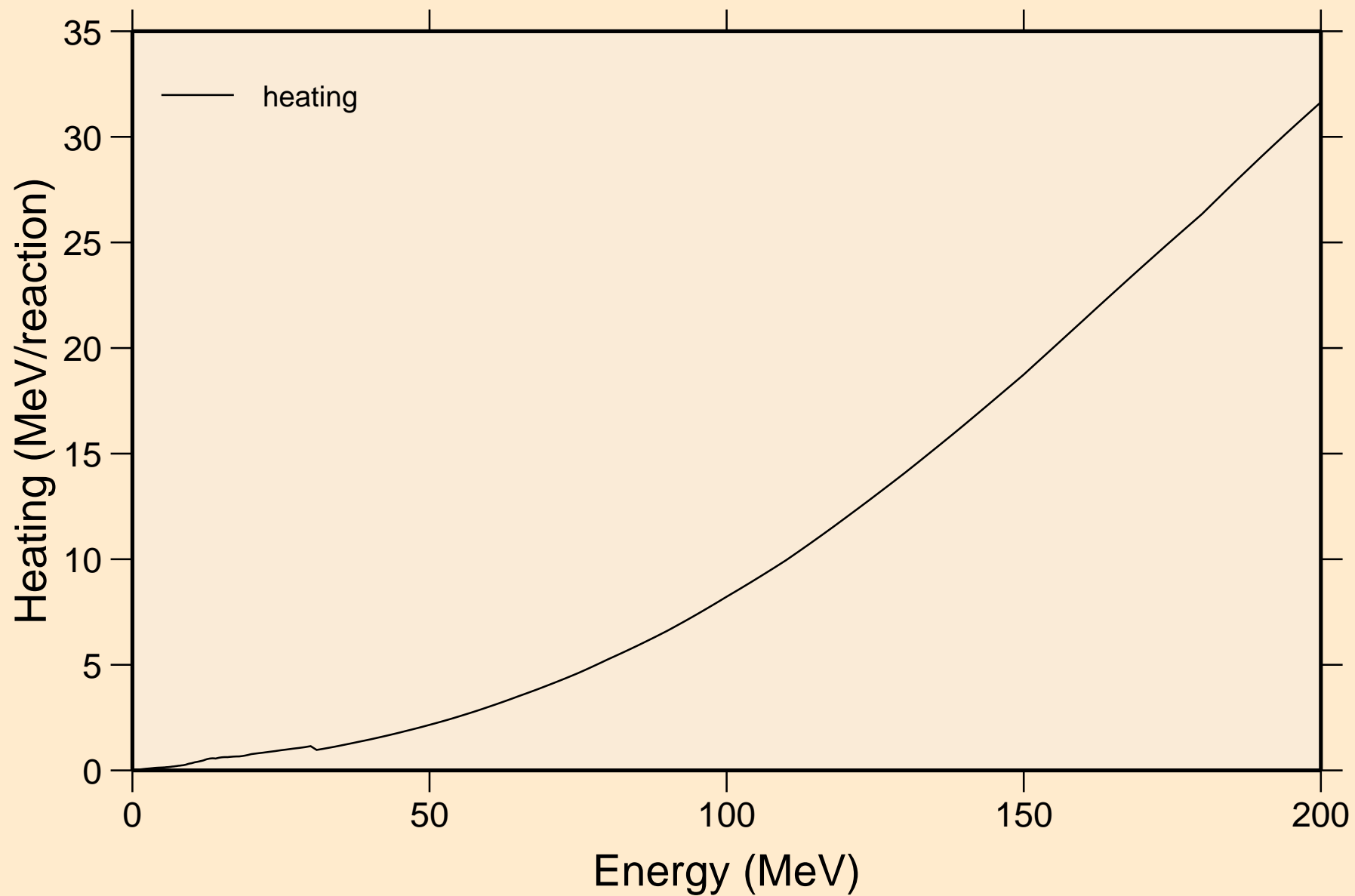

P035 NEUTRON ACER TENDL-2019 LIBRARY; T=293.16K
Damage

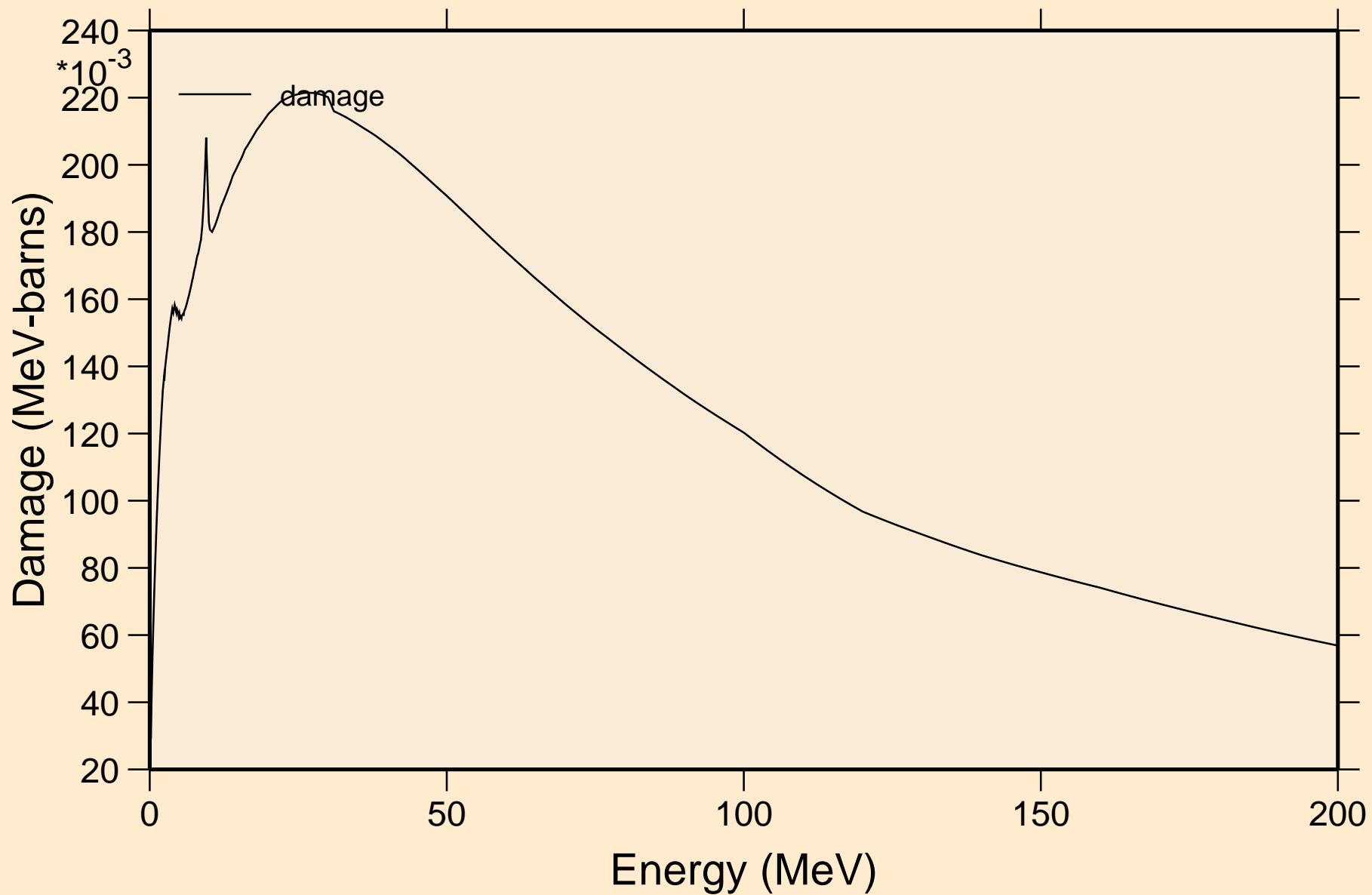

P035 NEUTRON ACER TENDL-2019 LIBRARY; T=293.16K
Non-threshold reactions

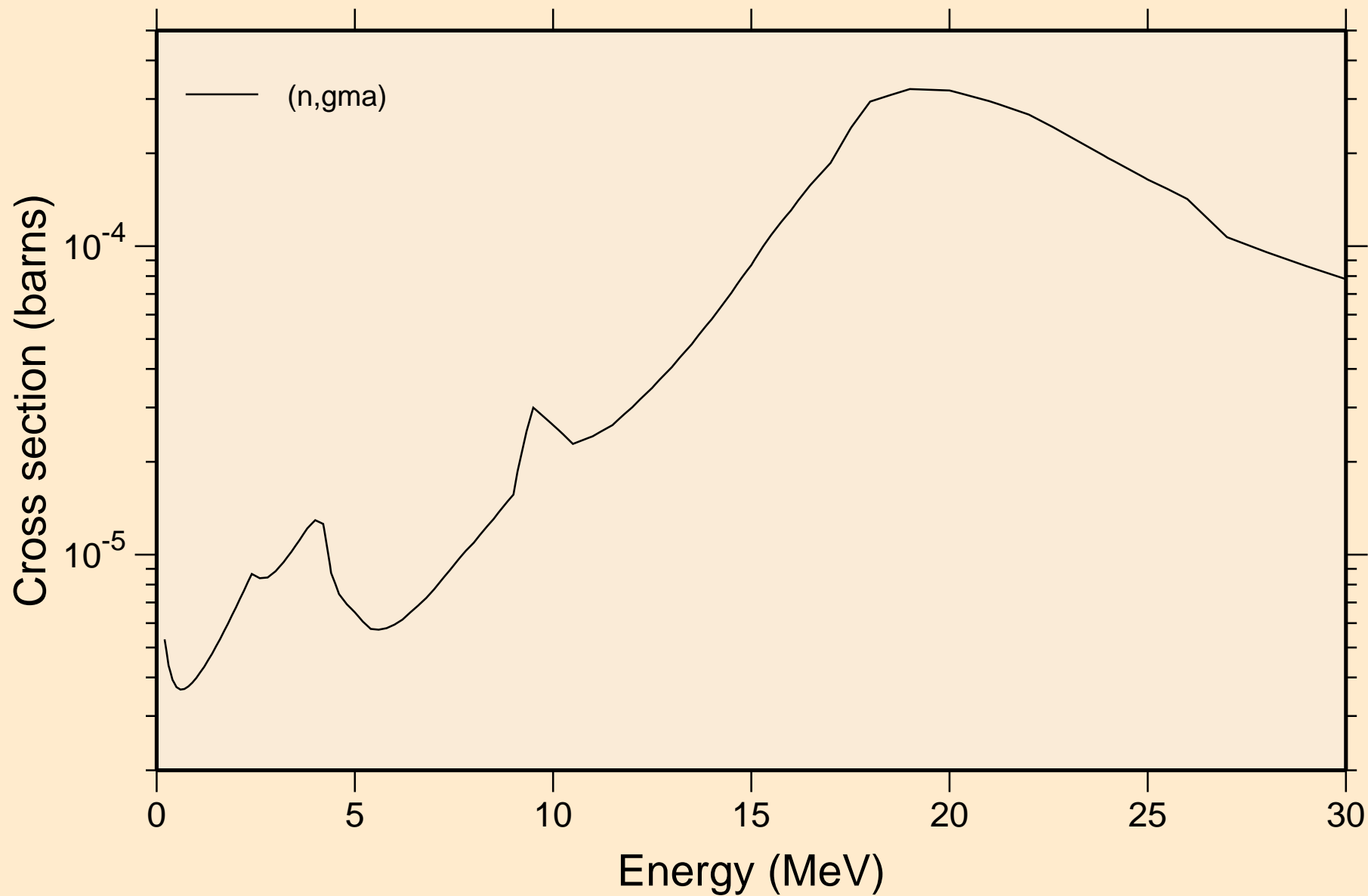

P035 NEUTRON ACER TENDL-2019 LIBRARY; T=293.16K
Inelastic levels

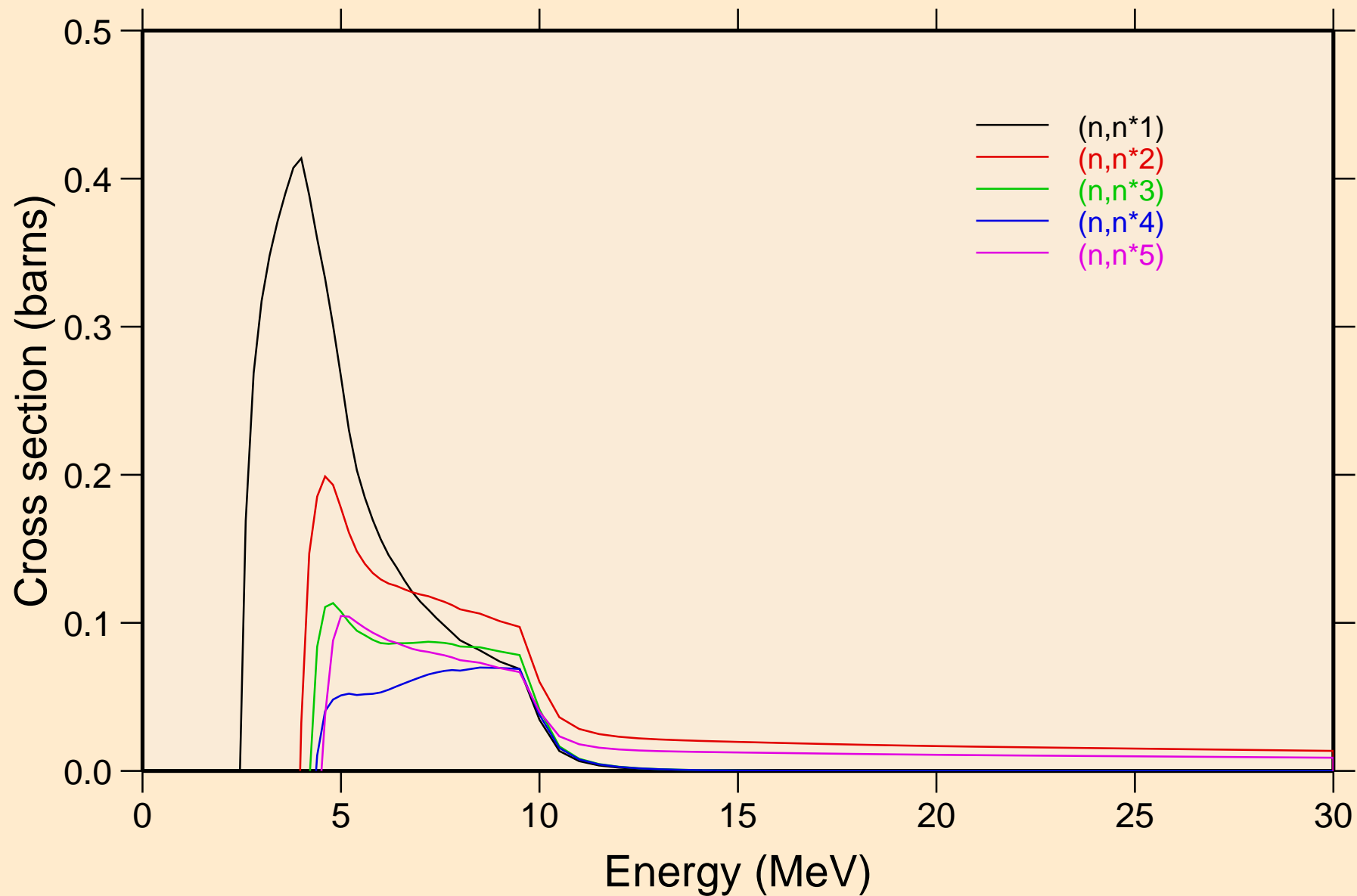

P035 NEUTRON ACER TENDL-2019 LIBRARY; T=293.16K
Inelastic levels

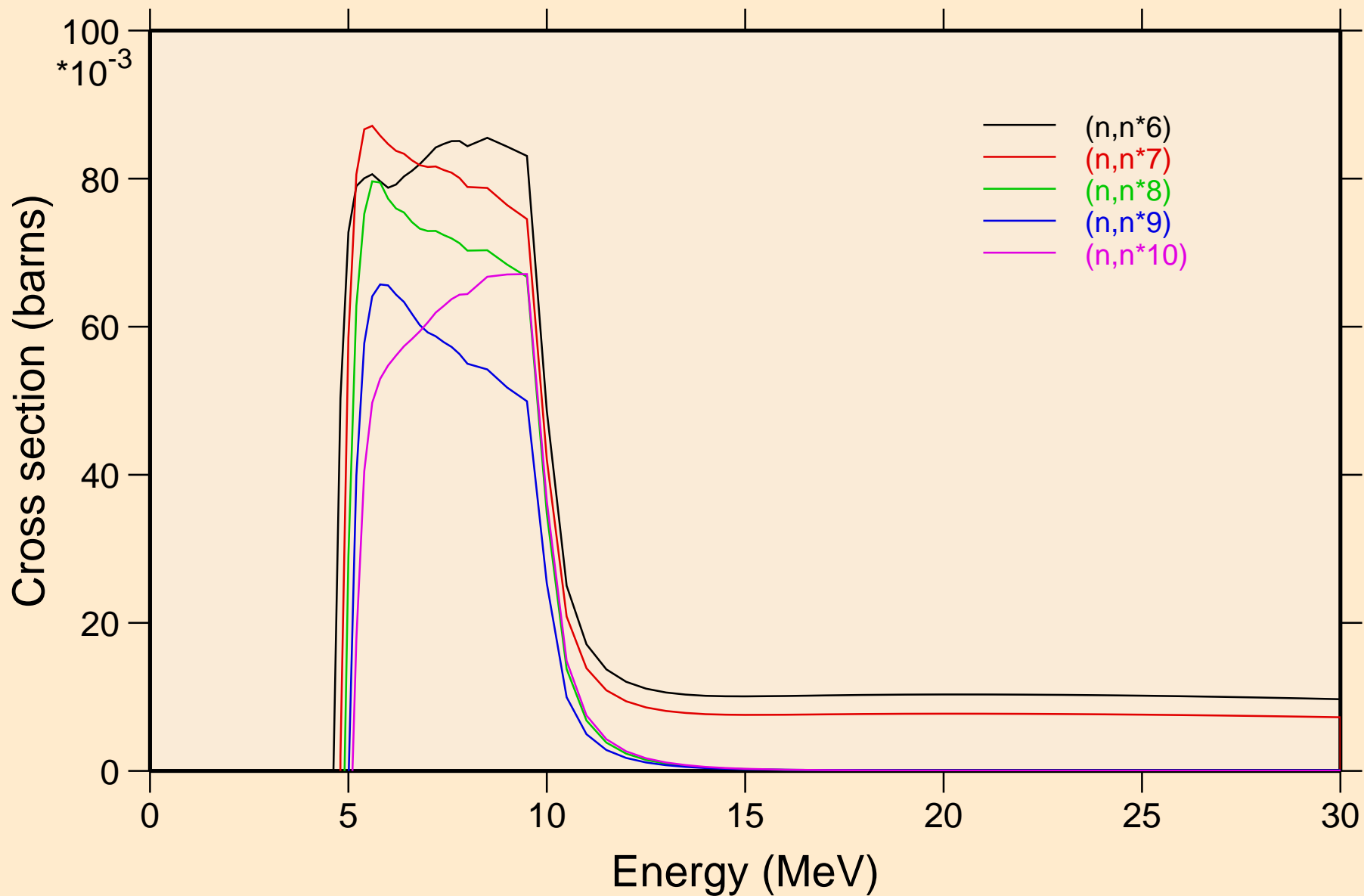

P035 NEUTRON ACER TENDL-2019 LIBRARY; T=293.16K
Inelastic levels

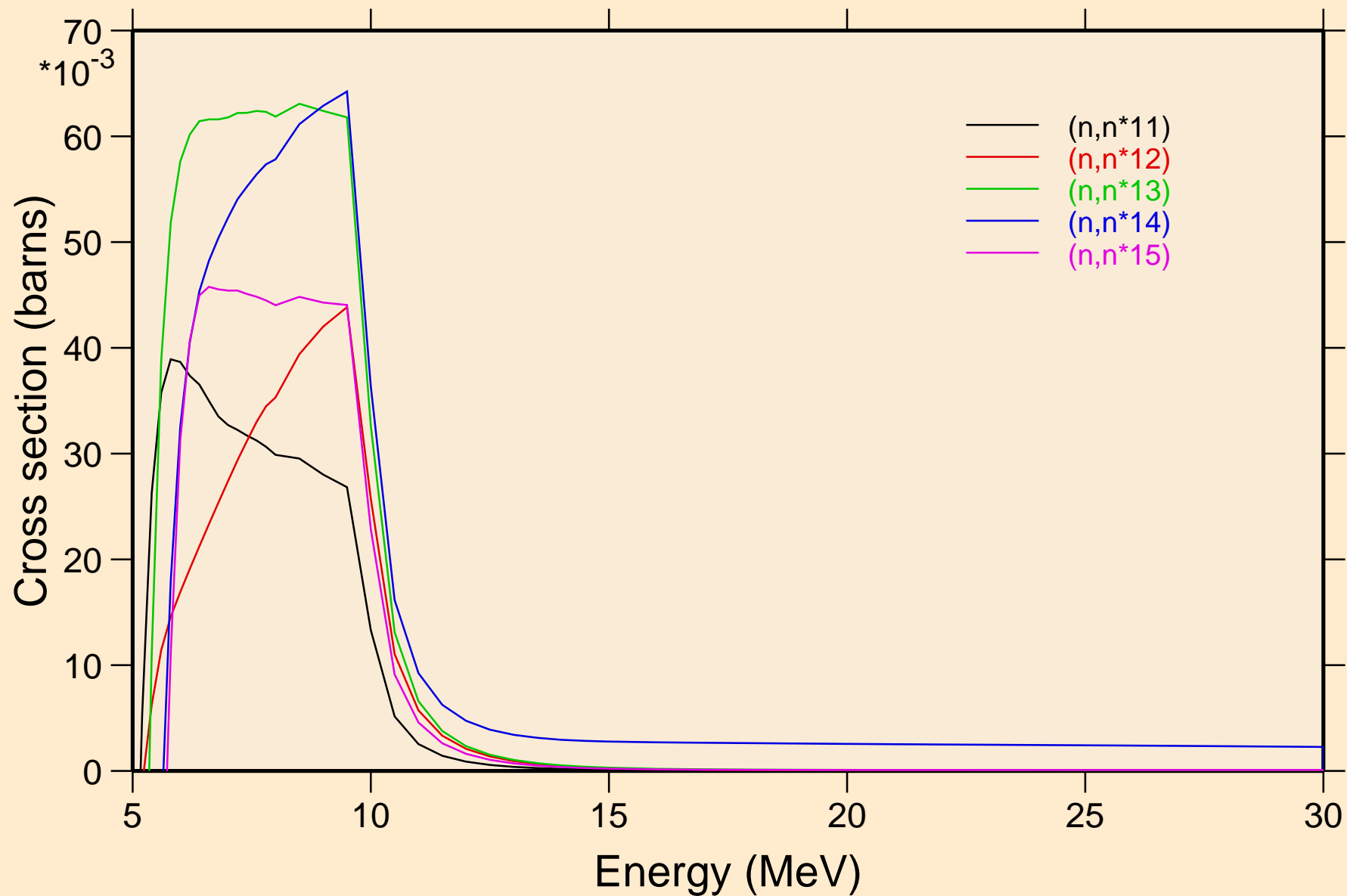

P035 NEUTRON ACER TENDL-2019 LIBRARY; T=293.16K
Inelastic levels

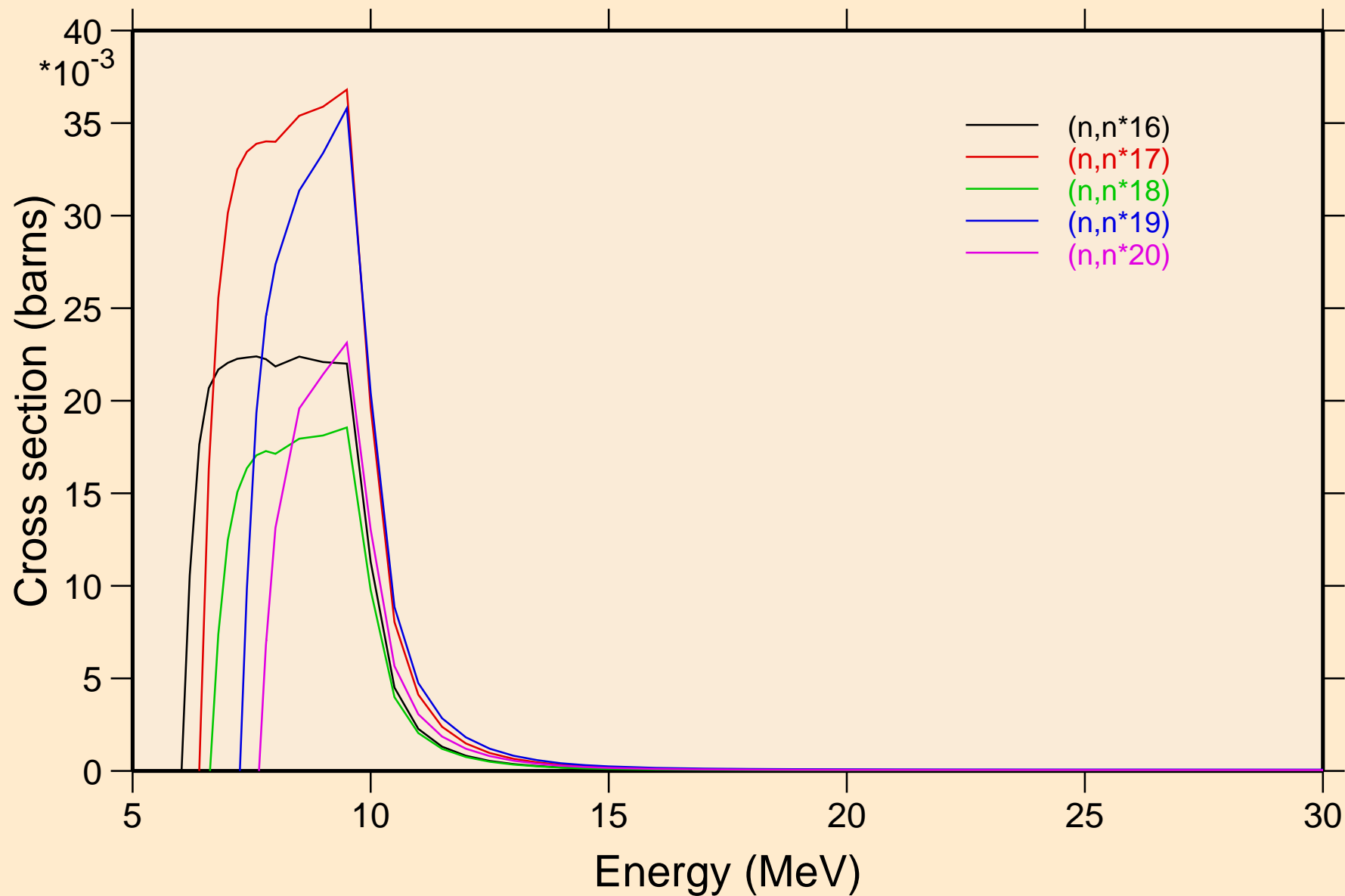

P035 NEUTRON ACER TENDL-2019 LIBRARY; T=293.16K
Inelastic levels

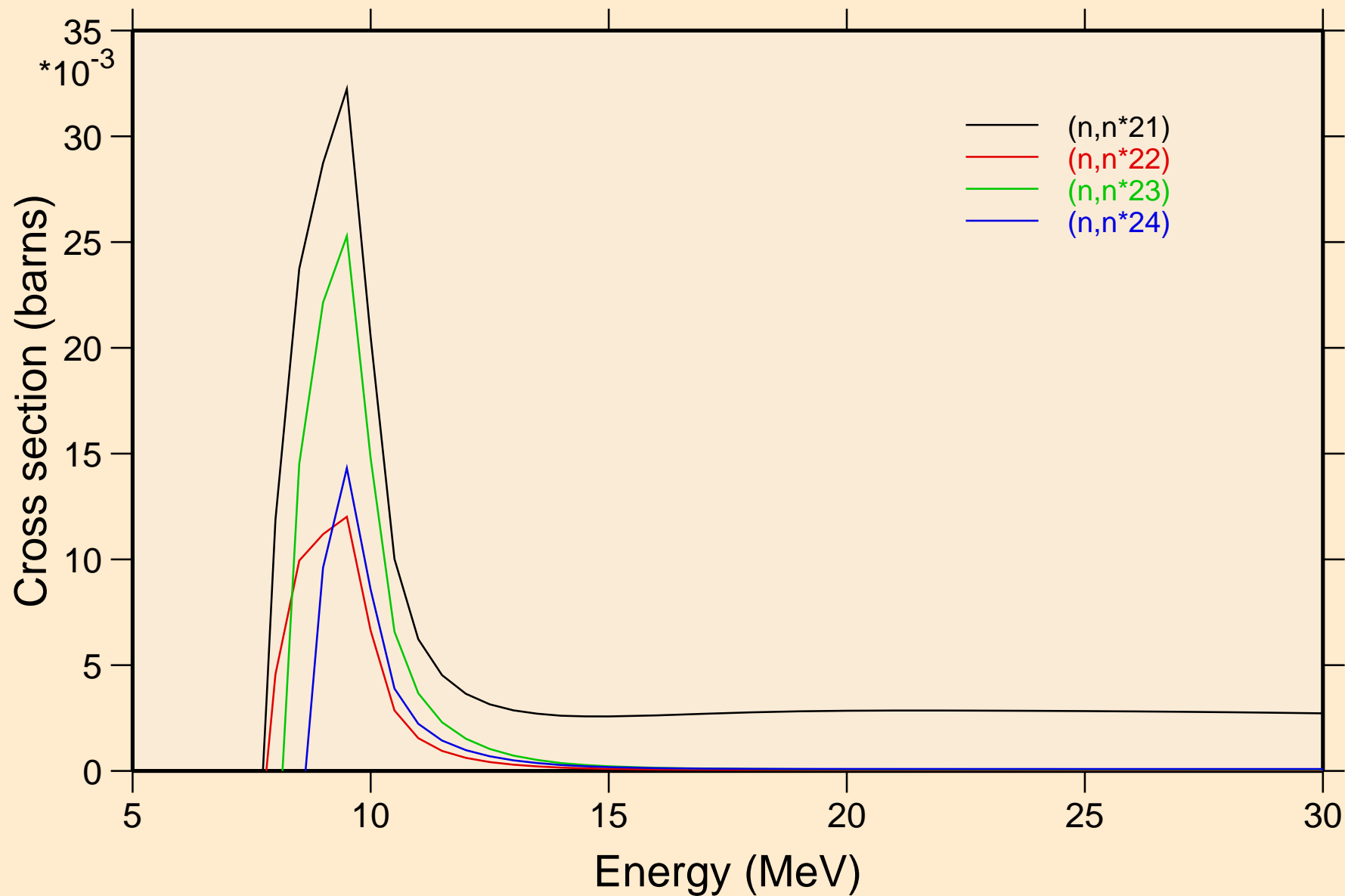

P035 NEUTRON ACER TENDL-2019 LIBRARY; T=293.16K
Threshold reactions

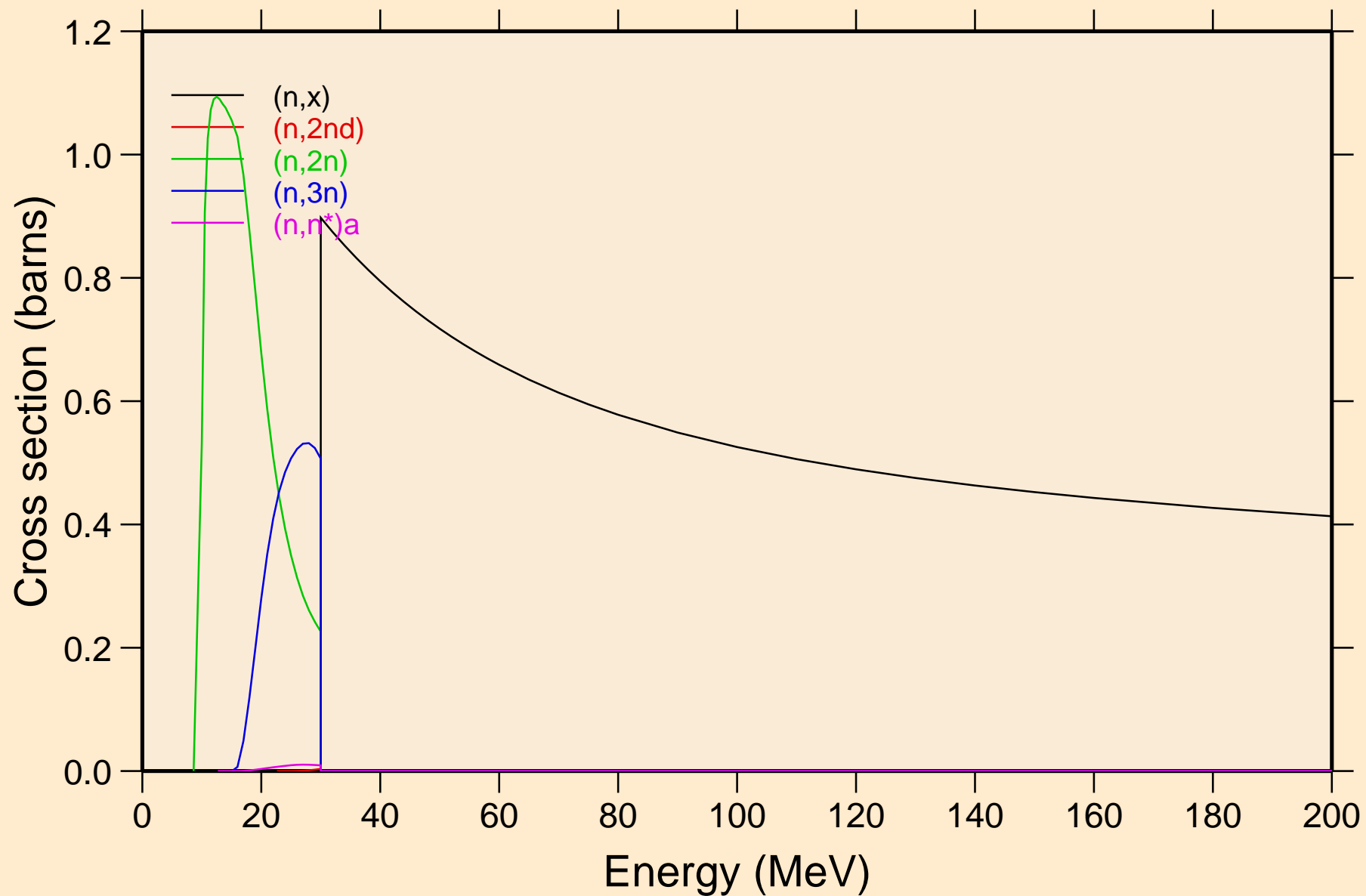

P035 NEUTRON ACER TENDL-2019 LIBRARY; T=293.16K
Threshold reactions

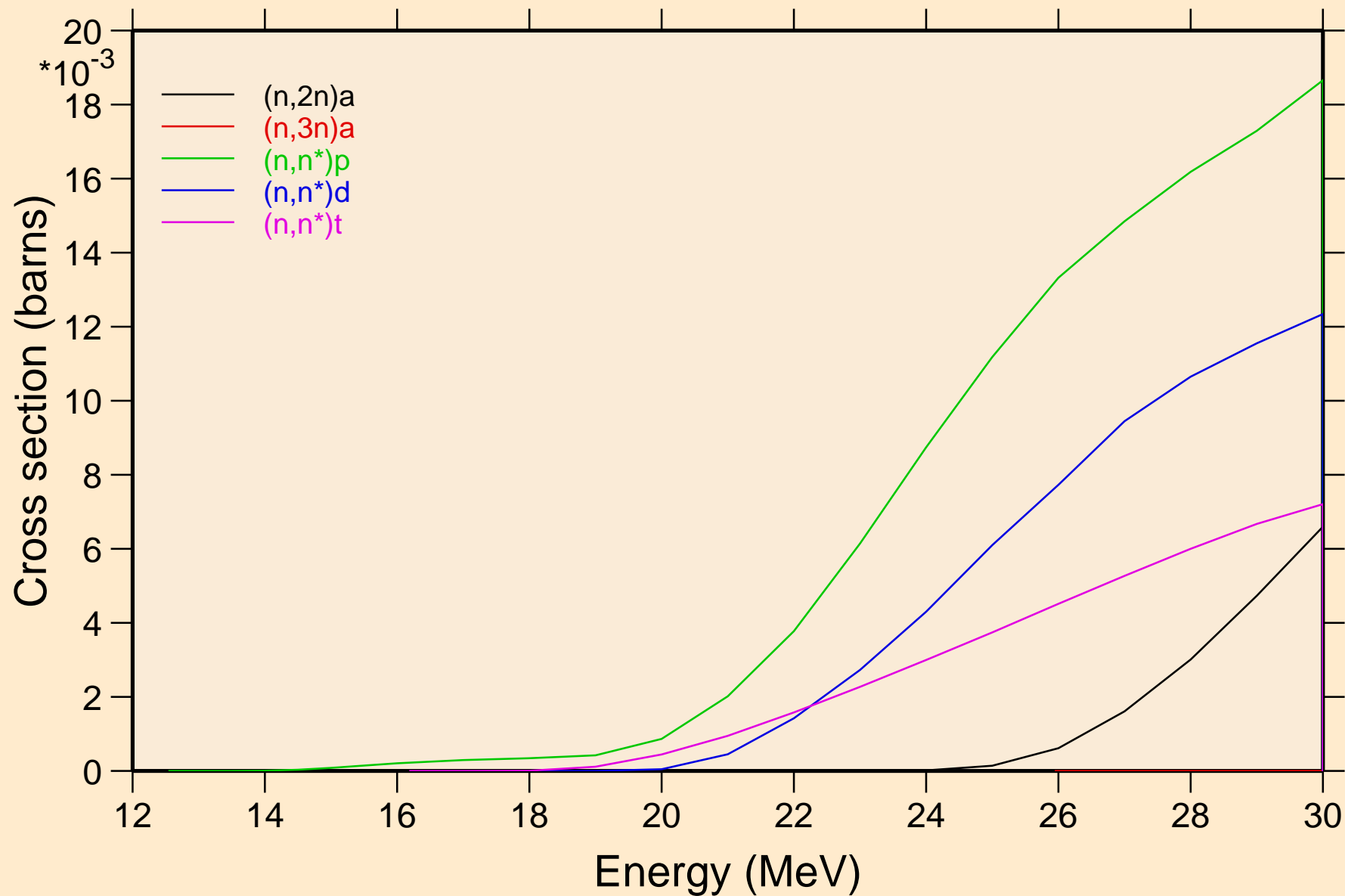

P035 NEUTRON ACER TENDL-2019 LIBRARY; T=293.16K
Threshold reactions

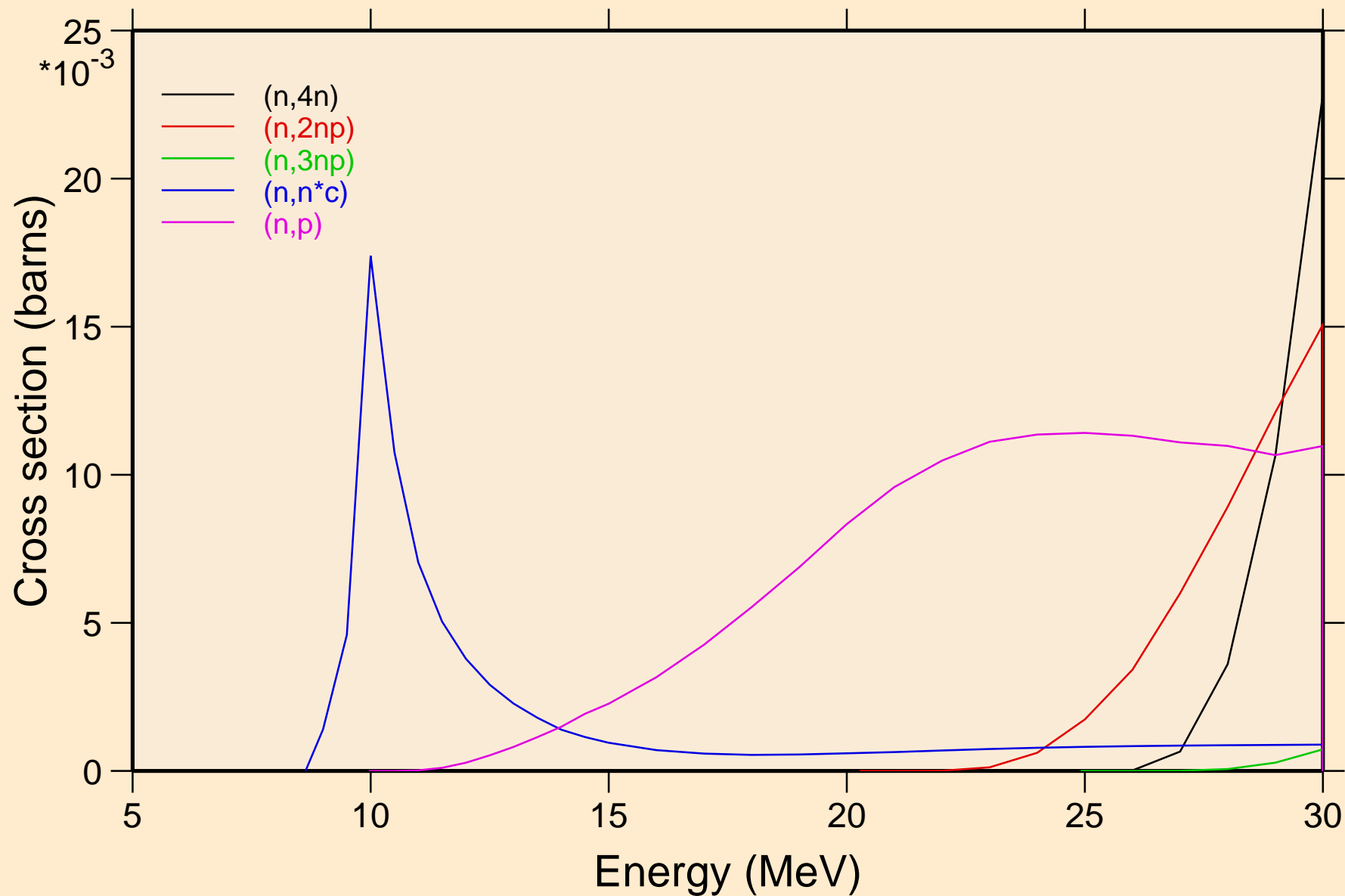

P035 NEUTRON ACER TENDL-2019 LIBRARY; T=293.16K
Threshold reactions

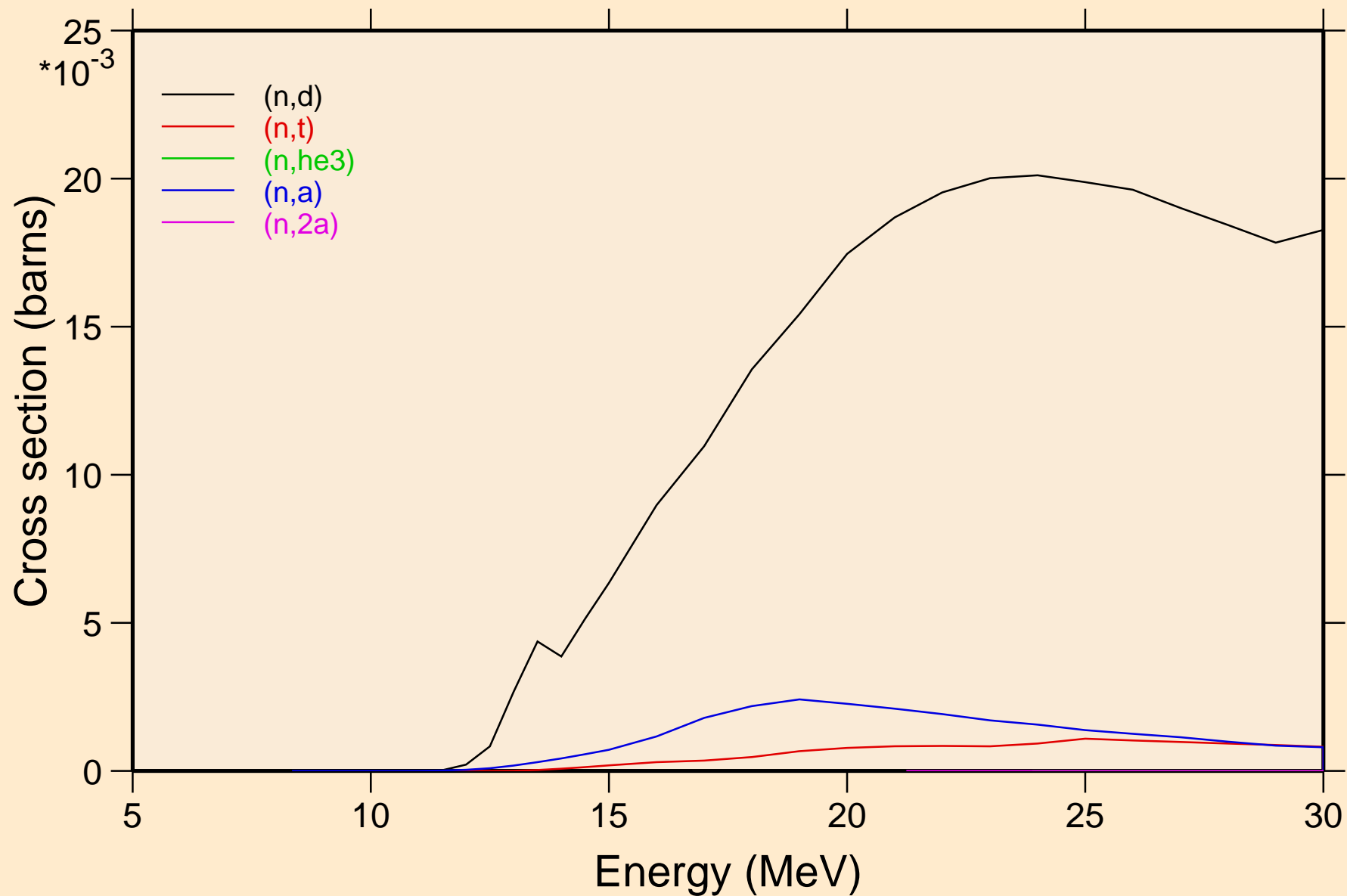

P035 NEUTRON ACER TENDL-2019 LIBRARY; T=293.16K
Threshold reactions

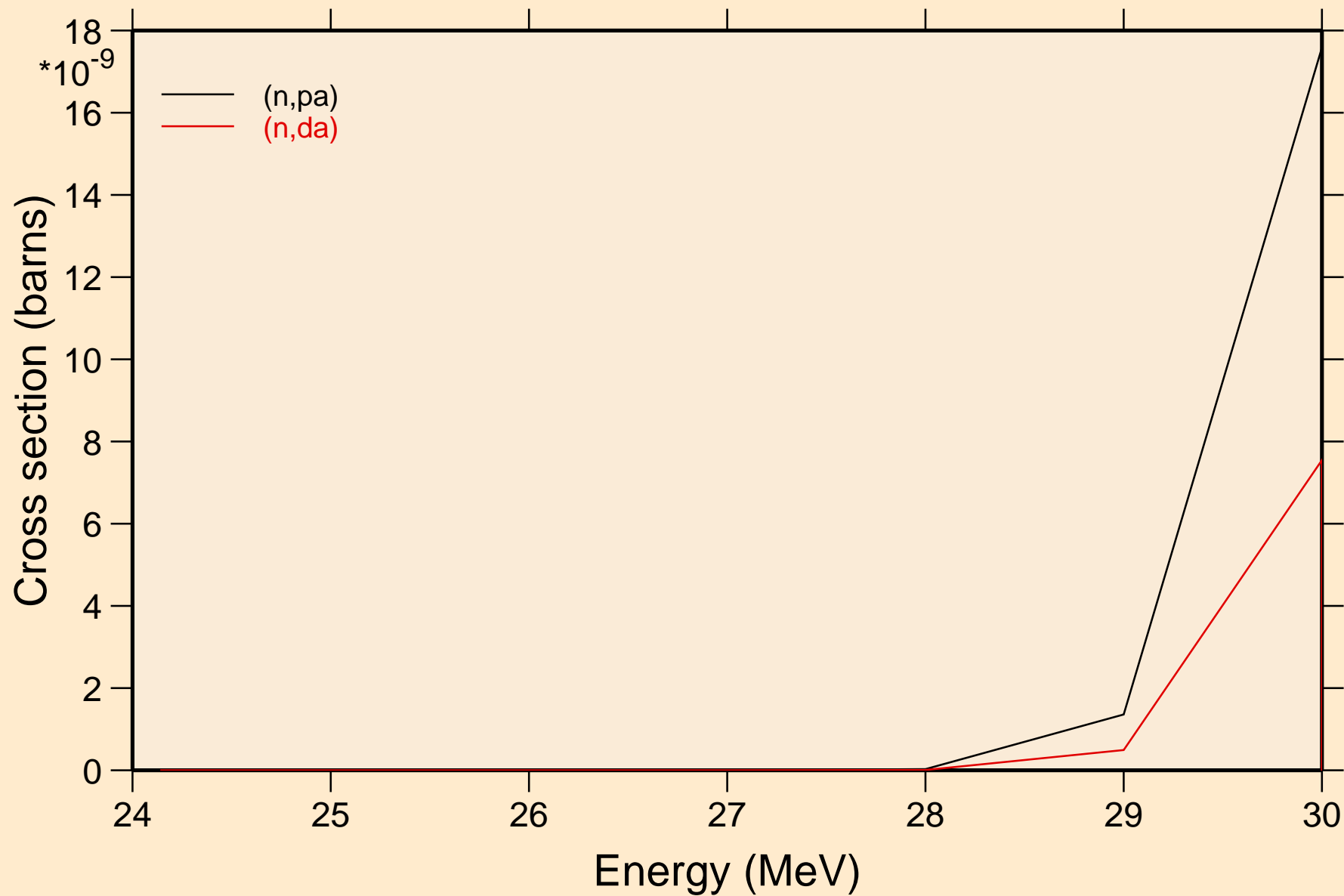

P035 NEUTRON ACER TENDL-2019 LIBRARY; T=293.16K
Threshold reactions

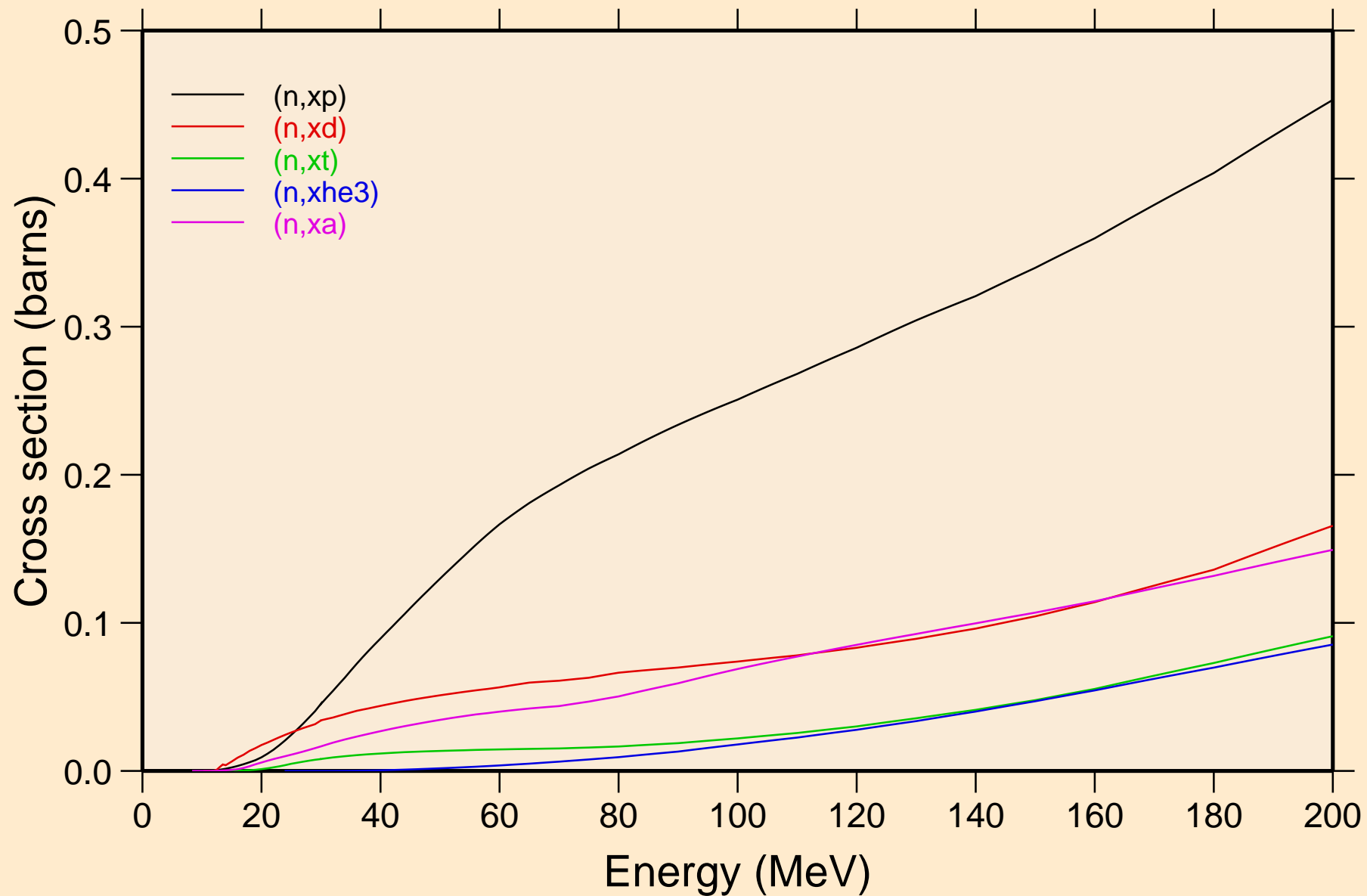

P035 NEUTRON ACER TENDL-2019 LIBRARY; T=293.16K
angular distribution for elastic

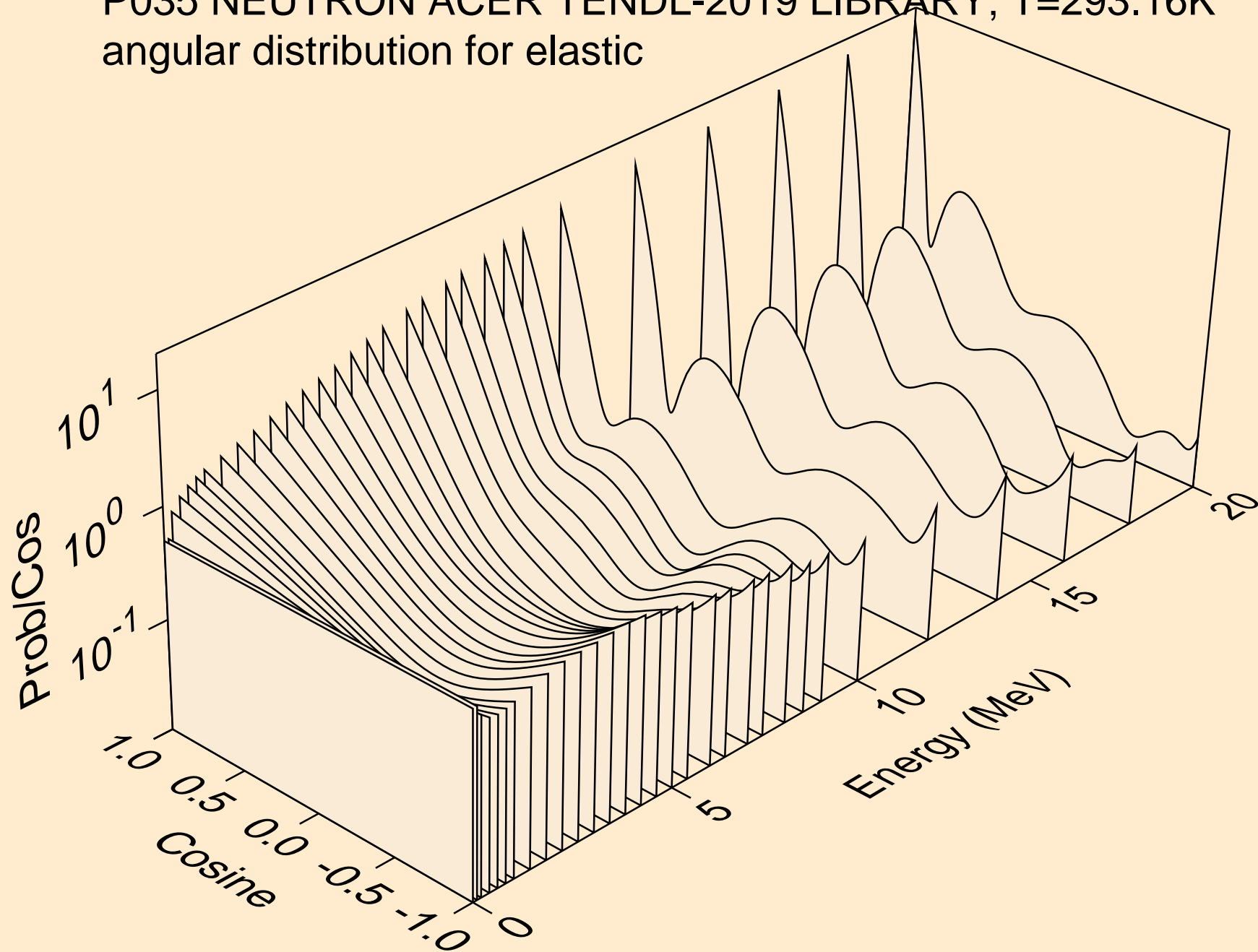

P035 NEUTRON ACER TENDL-2019 LIBRARY; T=293.16K
angular distribution for elastic

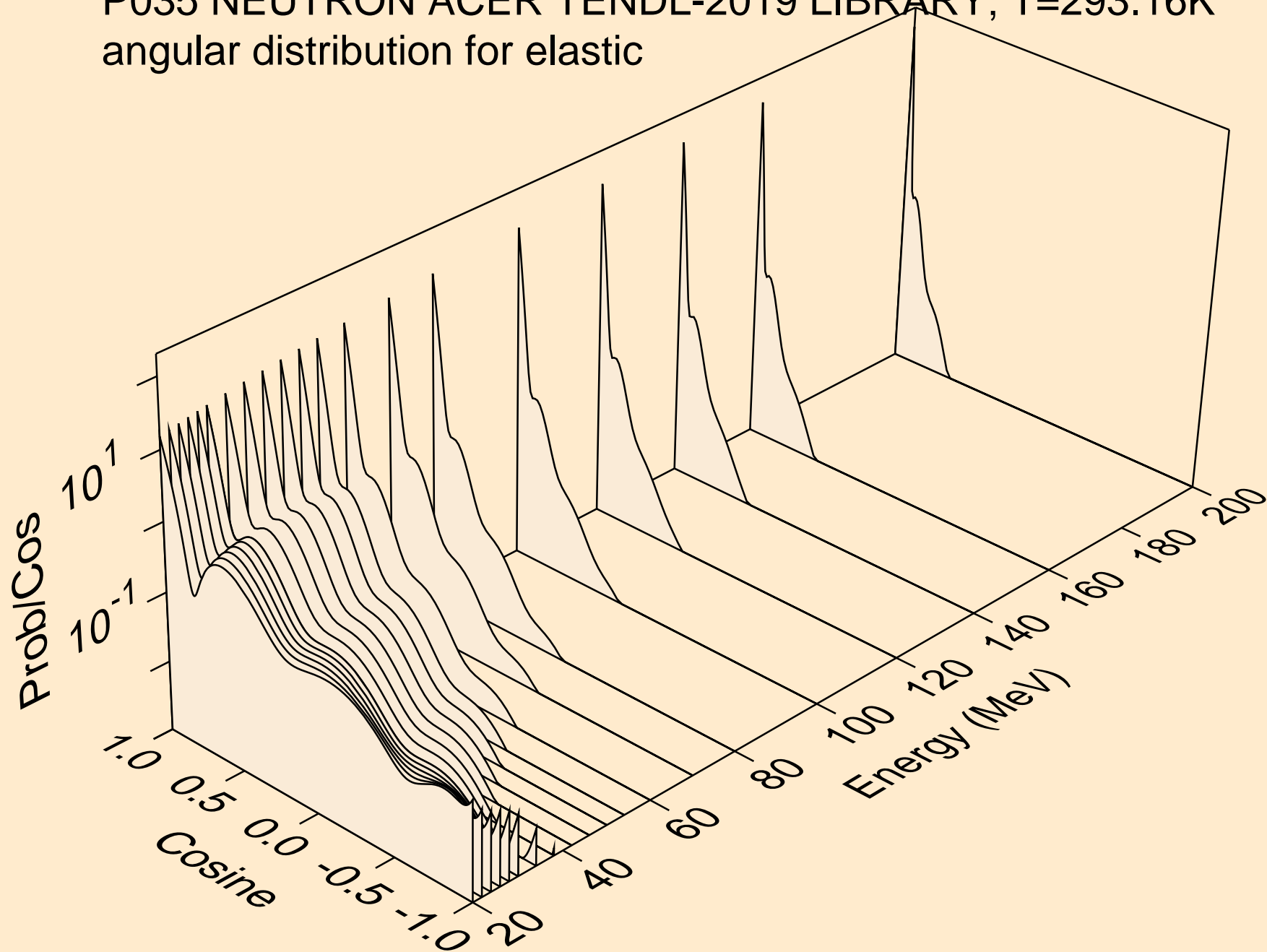

P035 NEUTRON ACER TENDL-2019 LIBRARY; T=293.16K
angular distribution for (n,n*1)

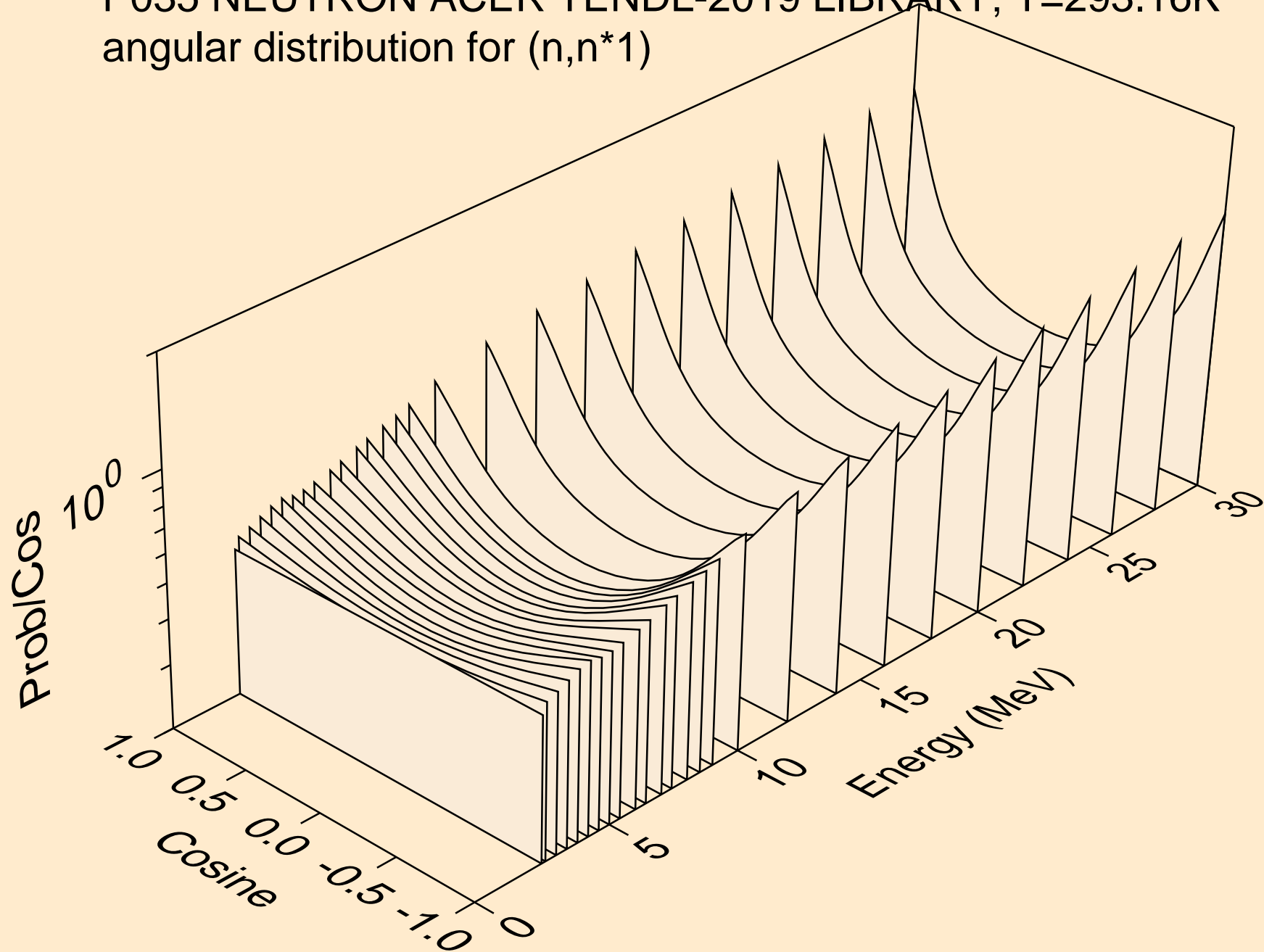

P035 NEUTRON ACER TENDL-2019 LIBRARY; T=293.16K
angular distribution for (n,n*2)

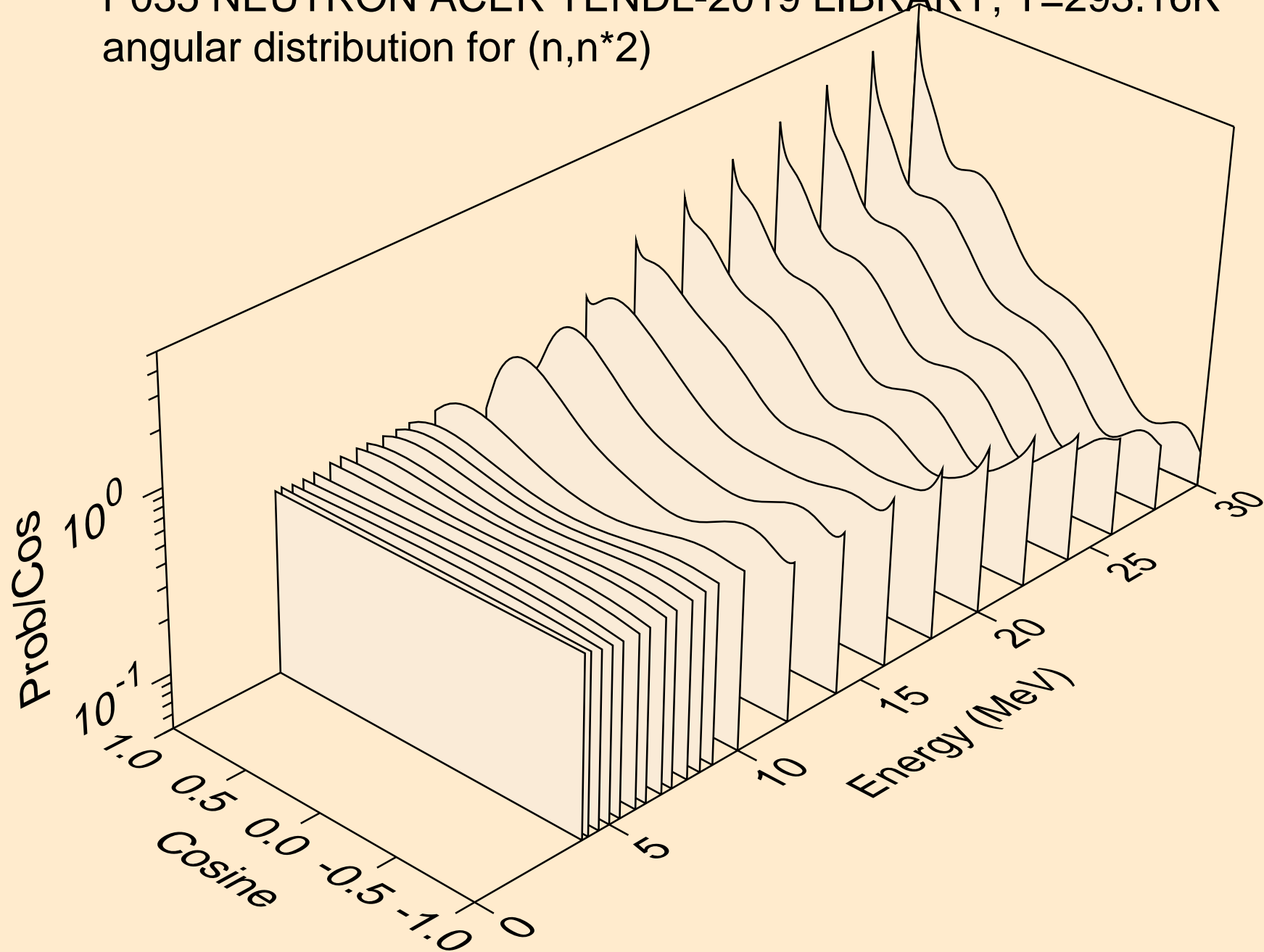

P035 NEUTRON ACER TENDL-2019 LIBRARY; T=293.16K
angular distribution for (n,n*3)

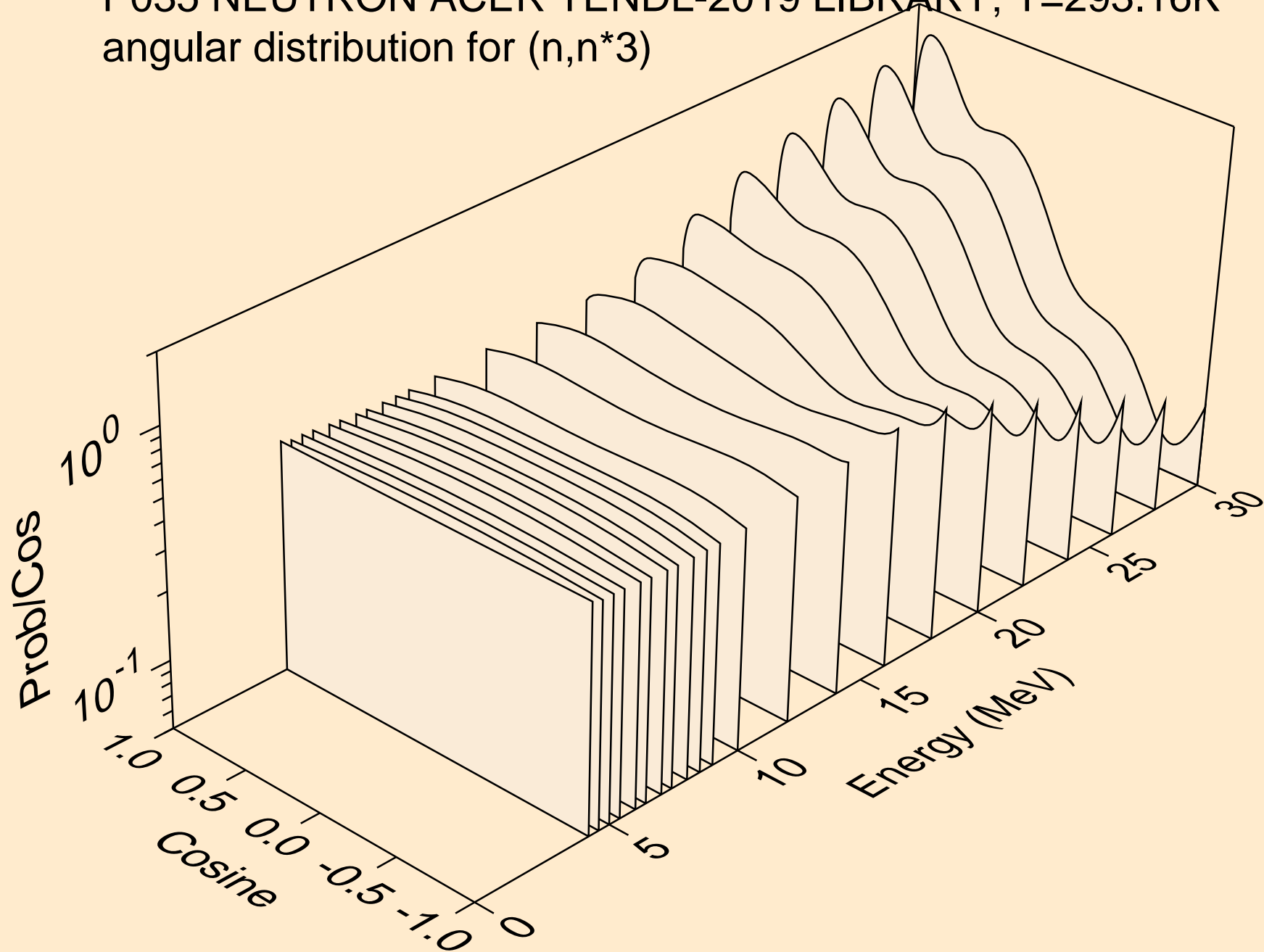

P035 NEUTRON ACER TENDL-2019 LIBRARY; T=293.16K
angular distribution for (n,n*4)

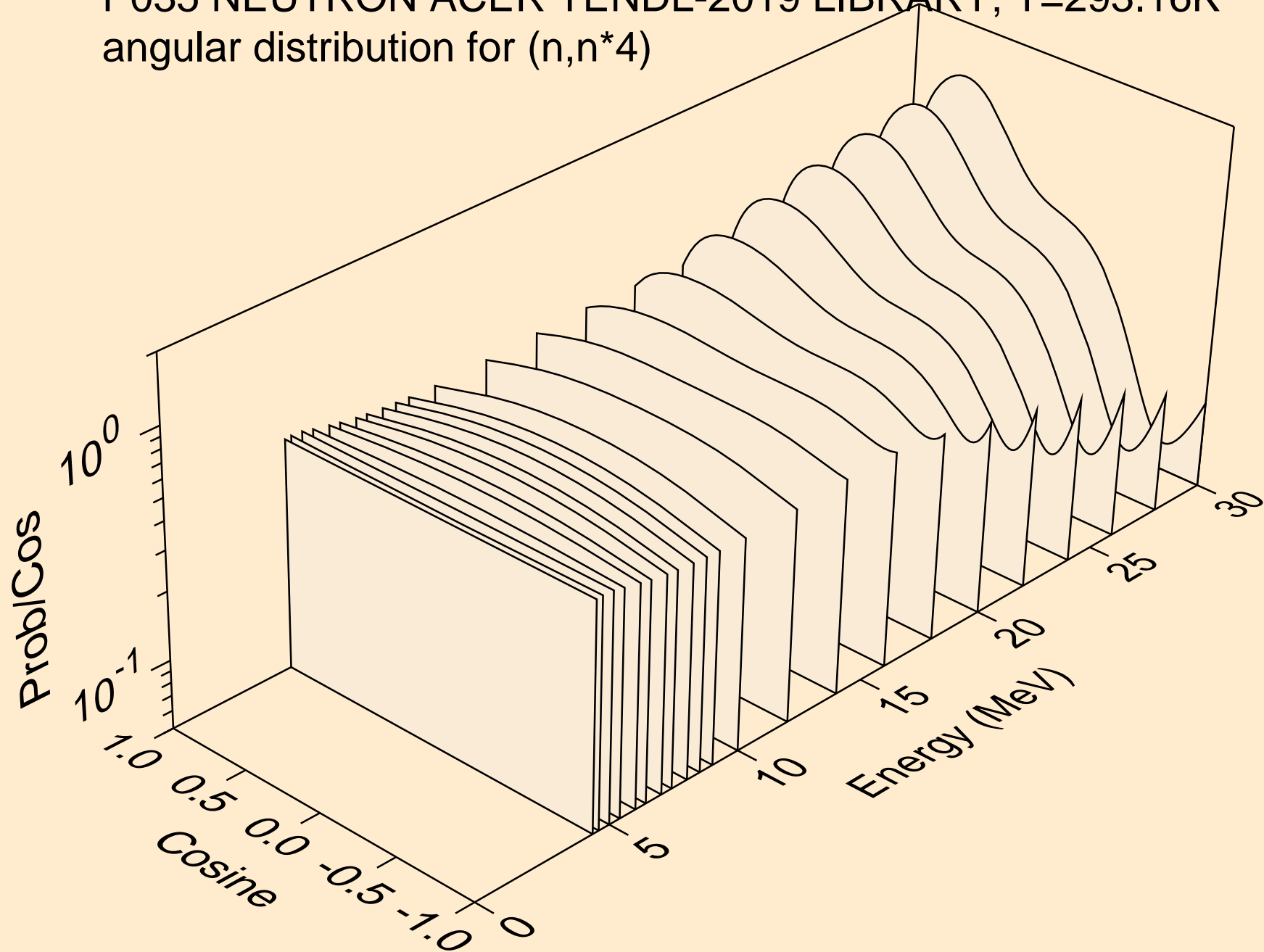

P035 NEUTRON ACER TENDL-2019 LIBRARY; T=293.16K
angular distribution for (n,n*5)

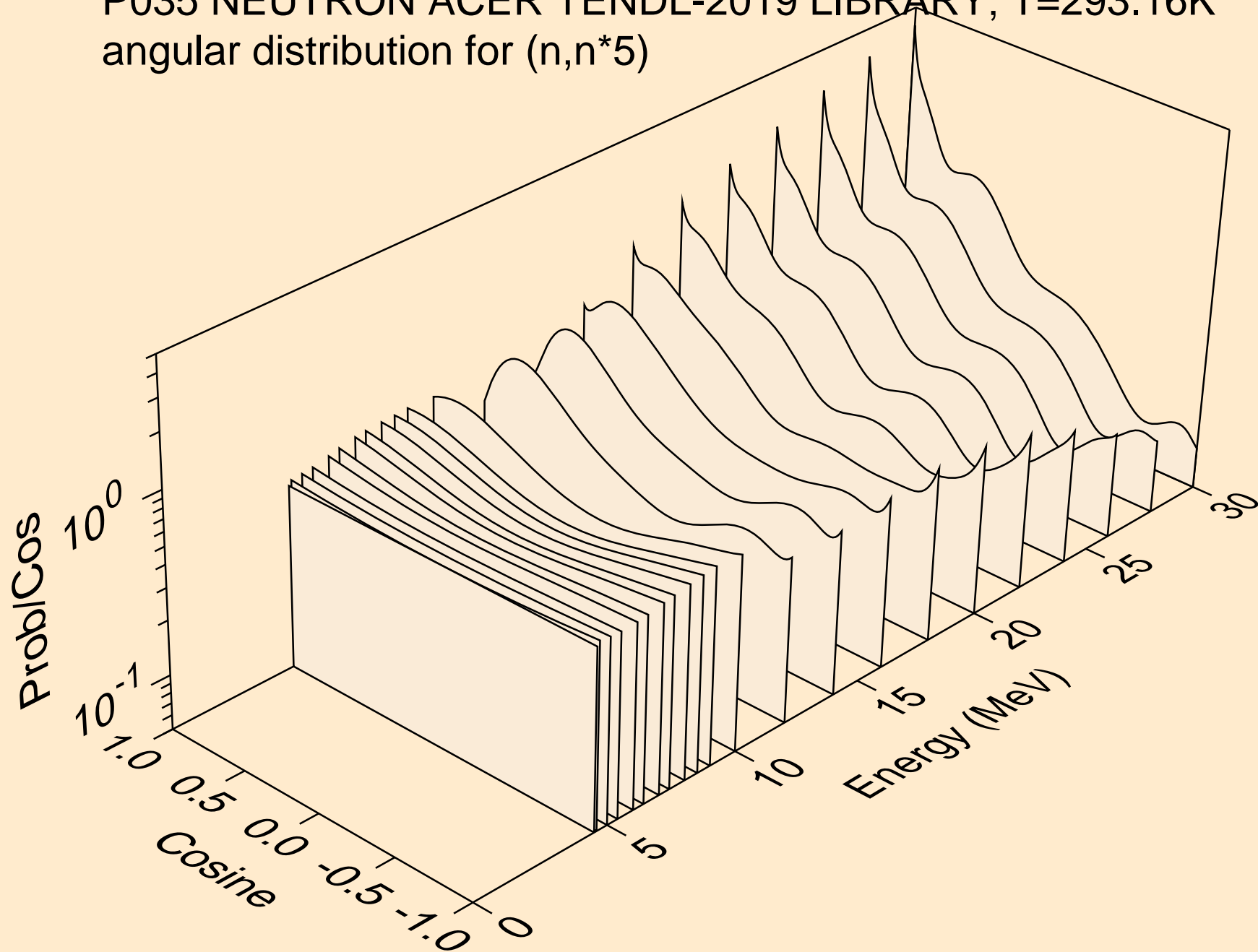

P035 NEUTRON ACER TENDL-2019 LIBRARY; T=293.16K
angular distribution for (n,n*6)

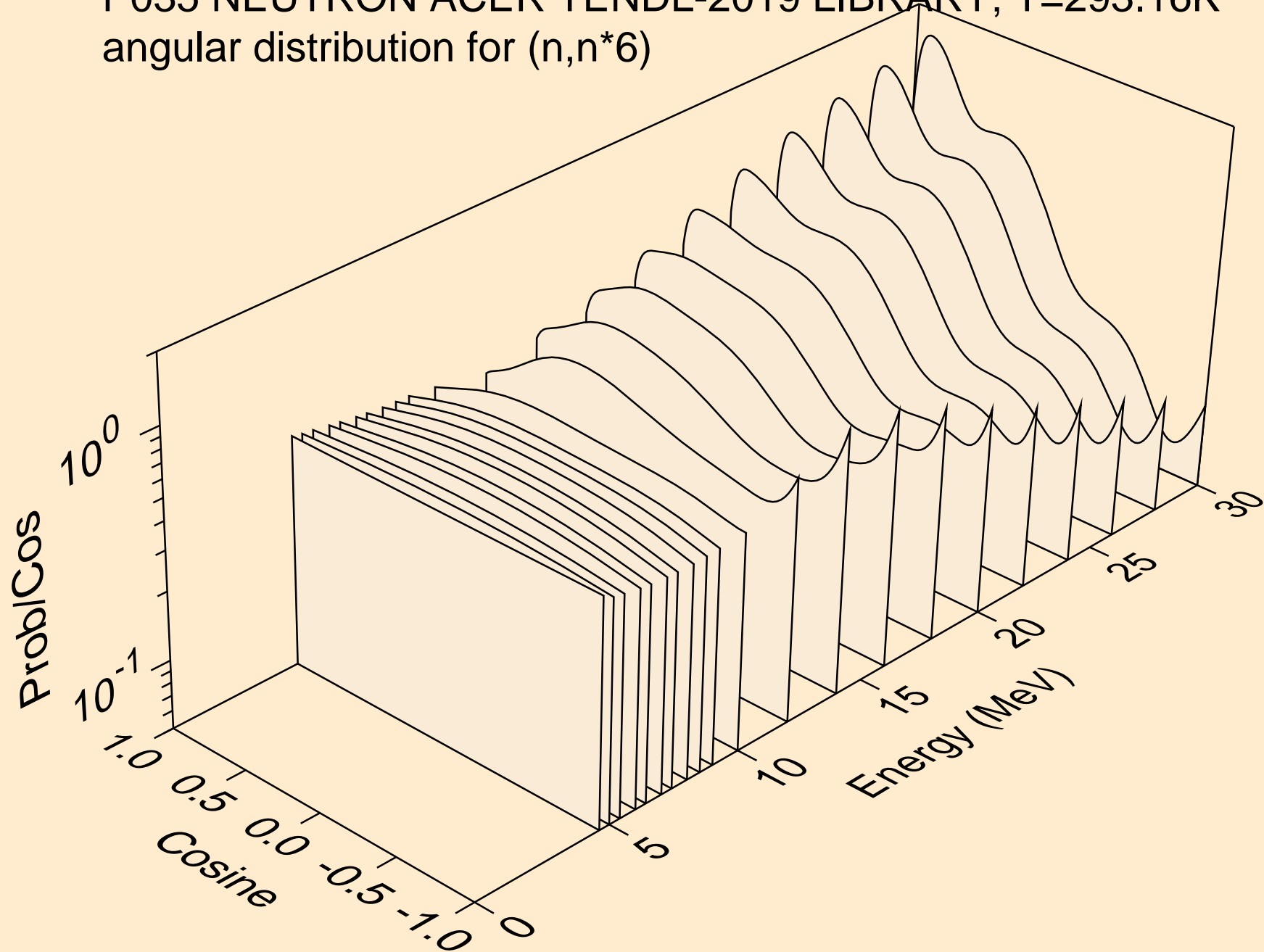

P035 NEUTRON ACER TENDL-2019 LIBRARY; T=293.16K
angular distribution for (n,n*7)

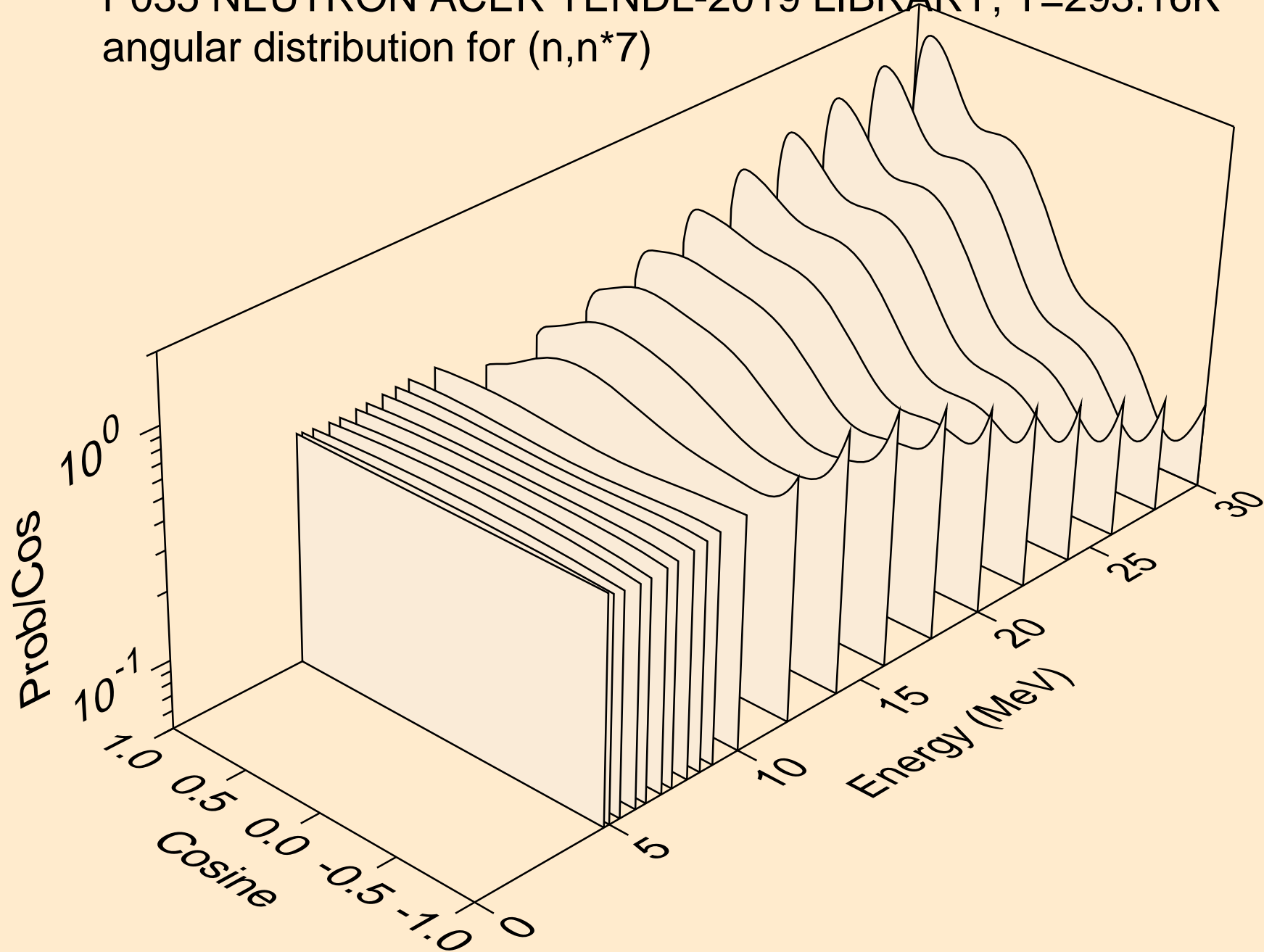

P035 NEUTRON ACER TENDL-2019 LIBRARY; T=293.16K
angular distribution for (n,n*8)

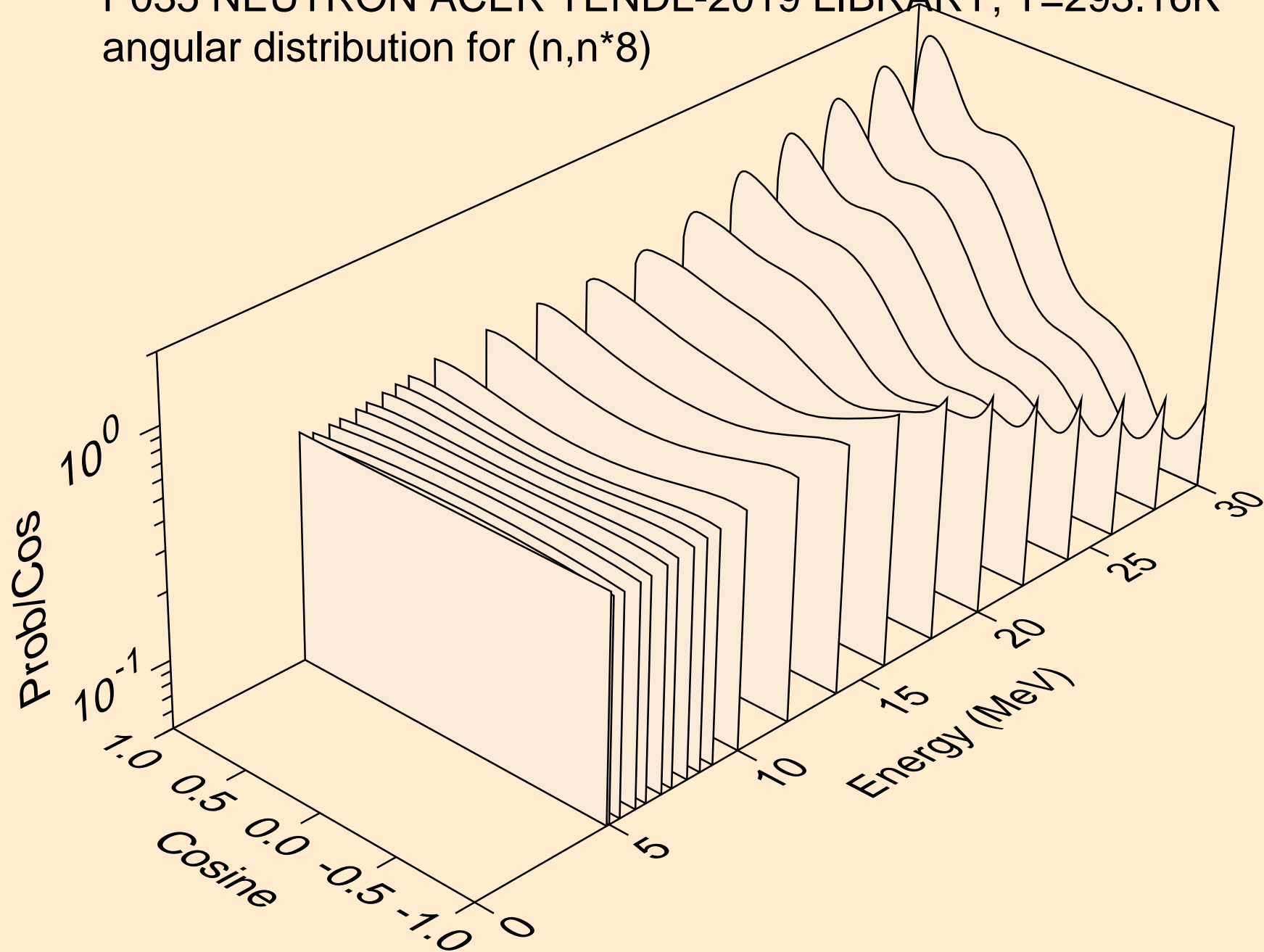

P035 NEUTRON ACER TENDL-2019 LIBRARY; T=293.16K
angular distribution for (n,n*9)

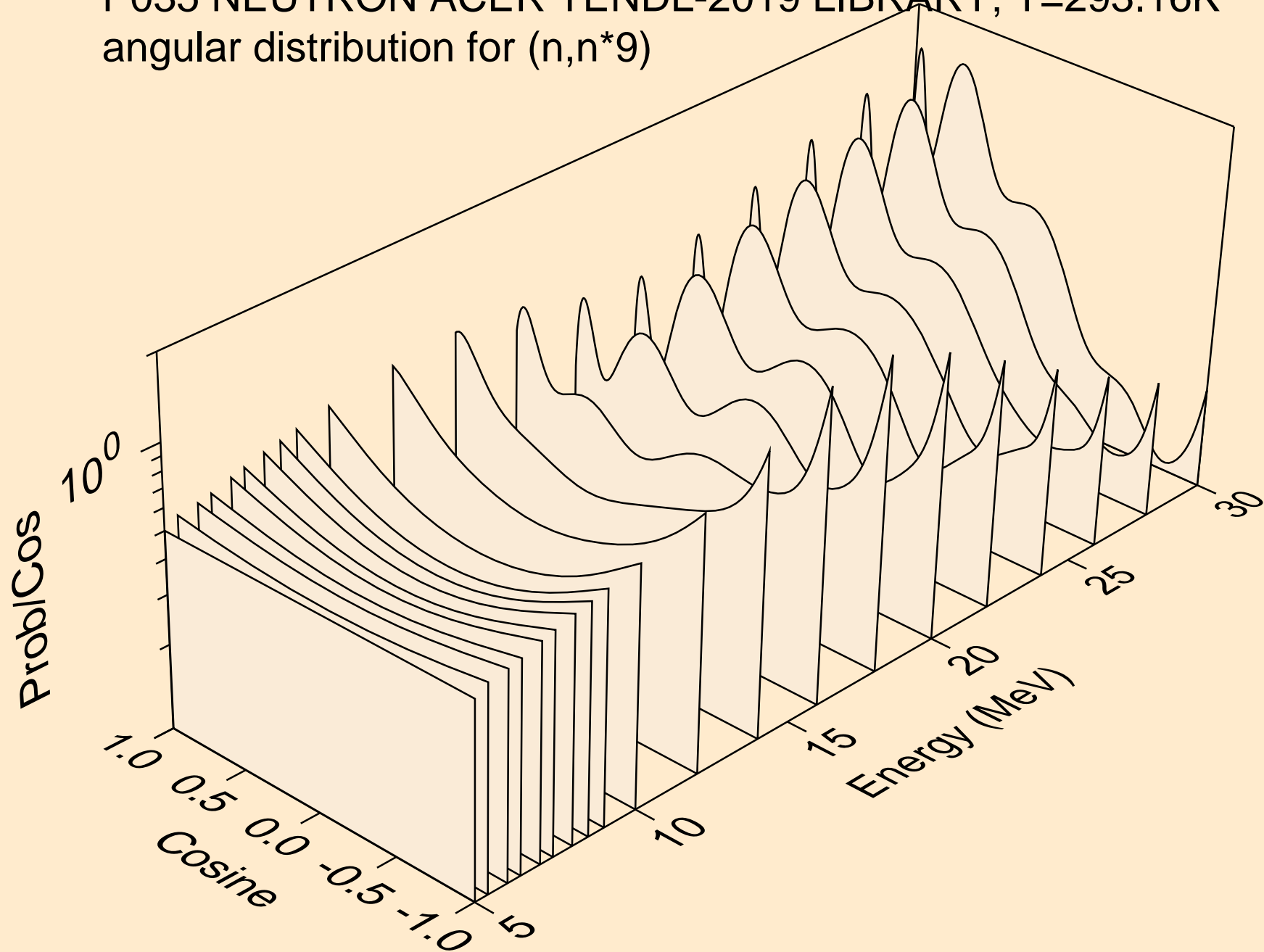

P035 NEUTRON ACER TENDL-2019 LIBRARY; T=293.16K
angular distribution for (n,n*10)

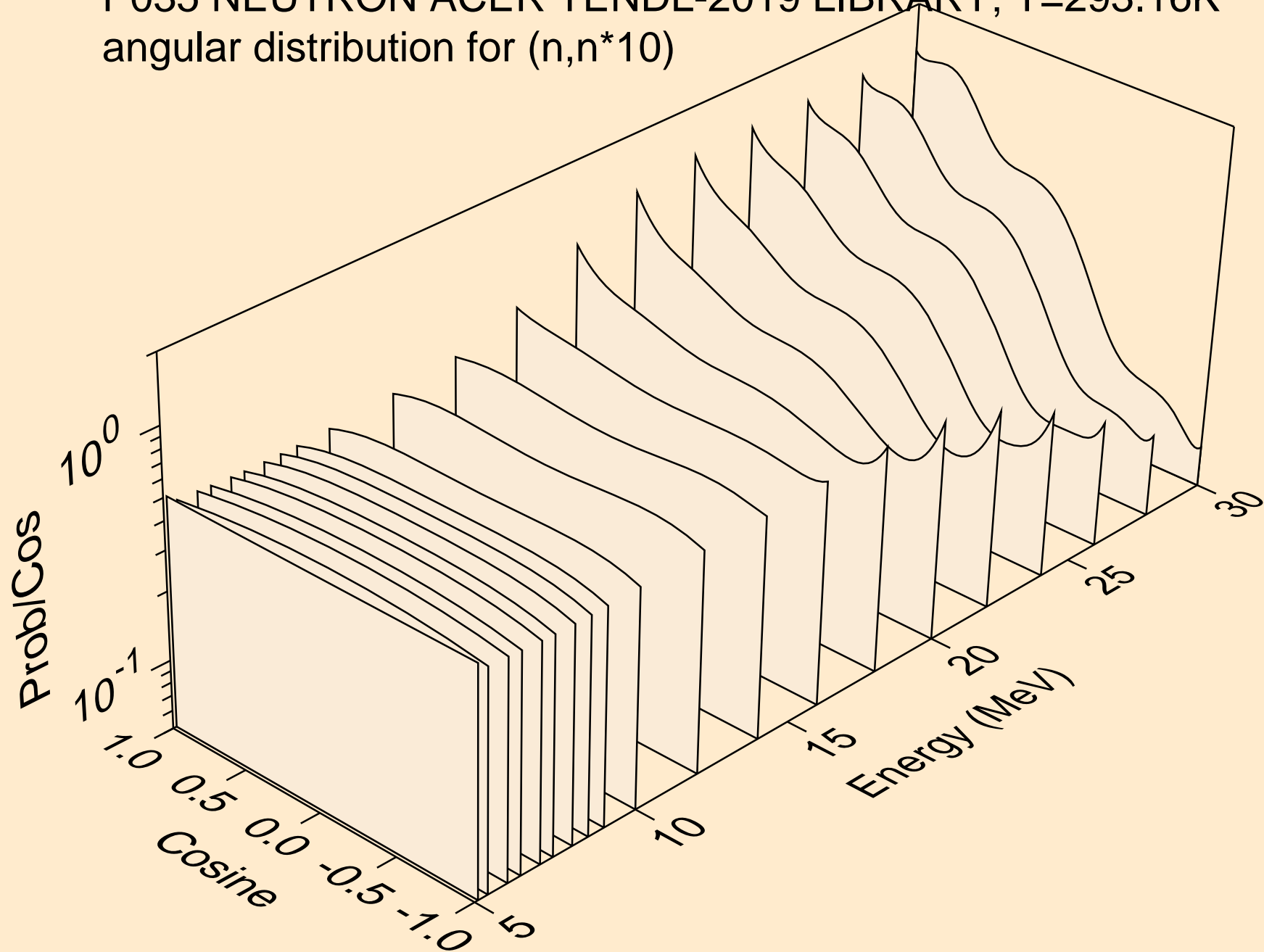

P035 NEUTRON ACER TENDL-2019 LIBRARY; T=293.16K
angular distribution for (n,n*11)

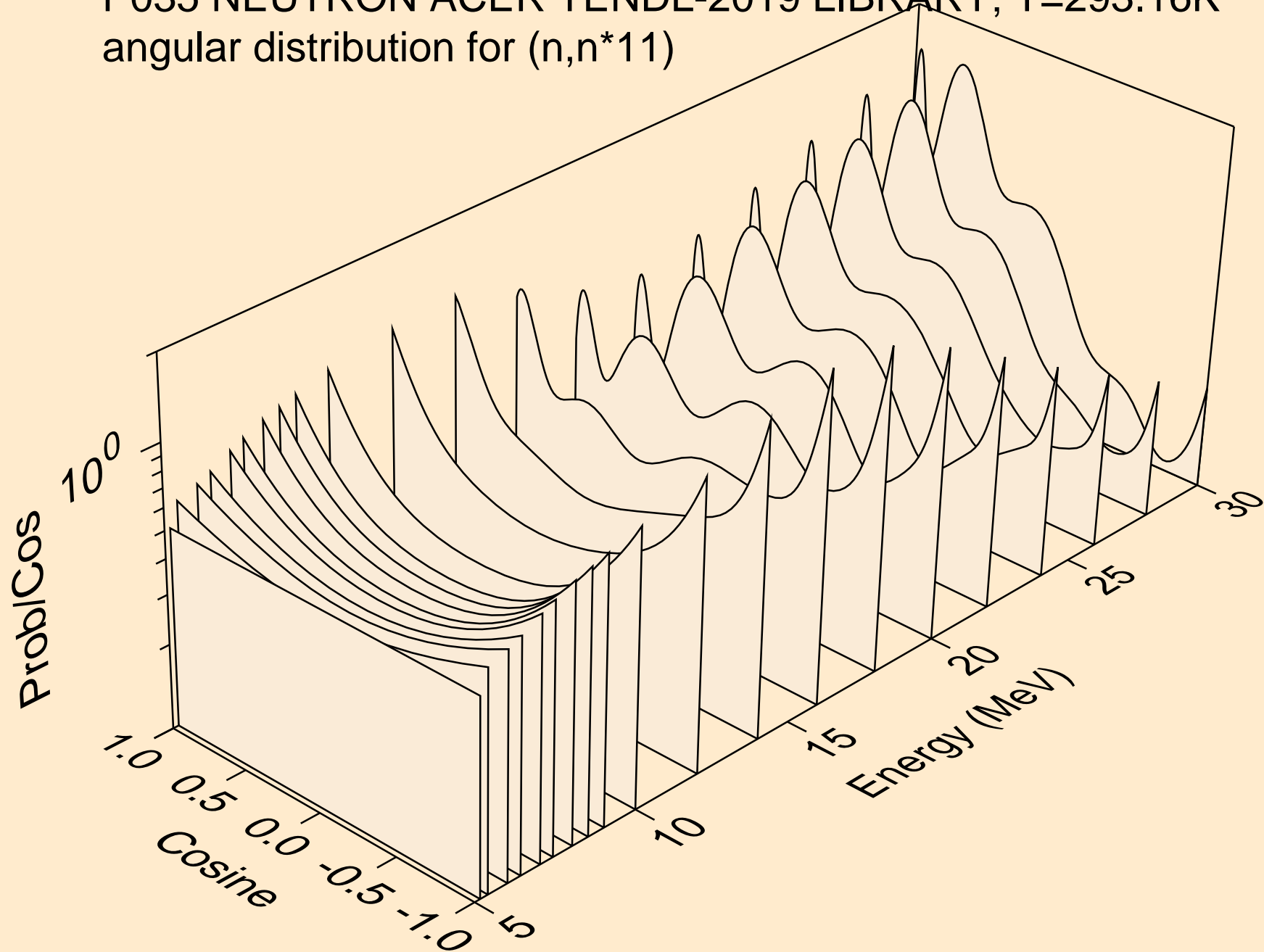

P035 NEUTRON ACER TENDL-2019 LIBRARY; T=293.16K
angular distribution for (n,n*12)

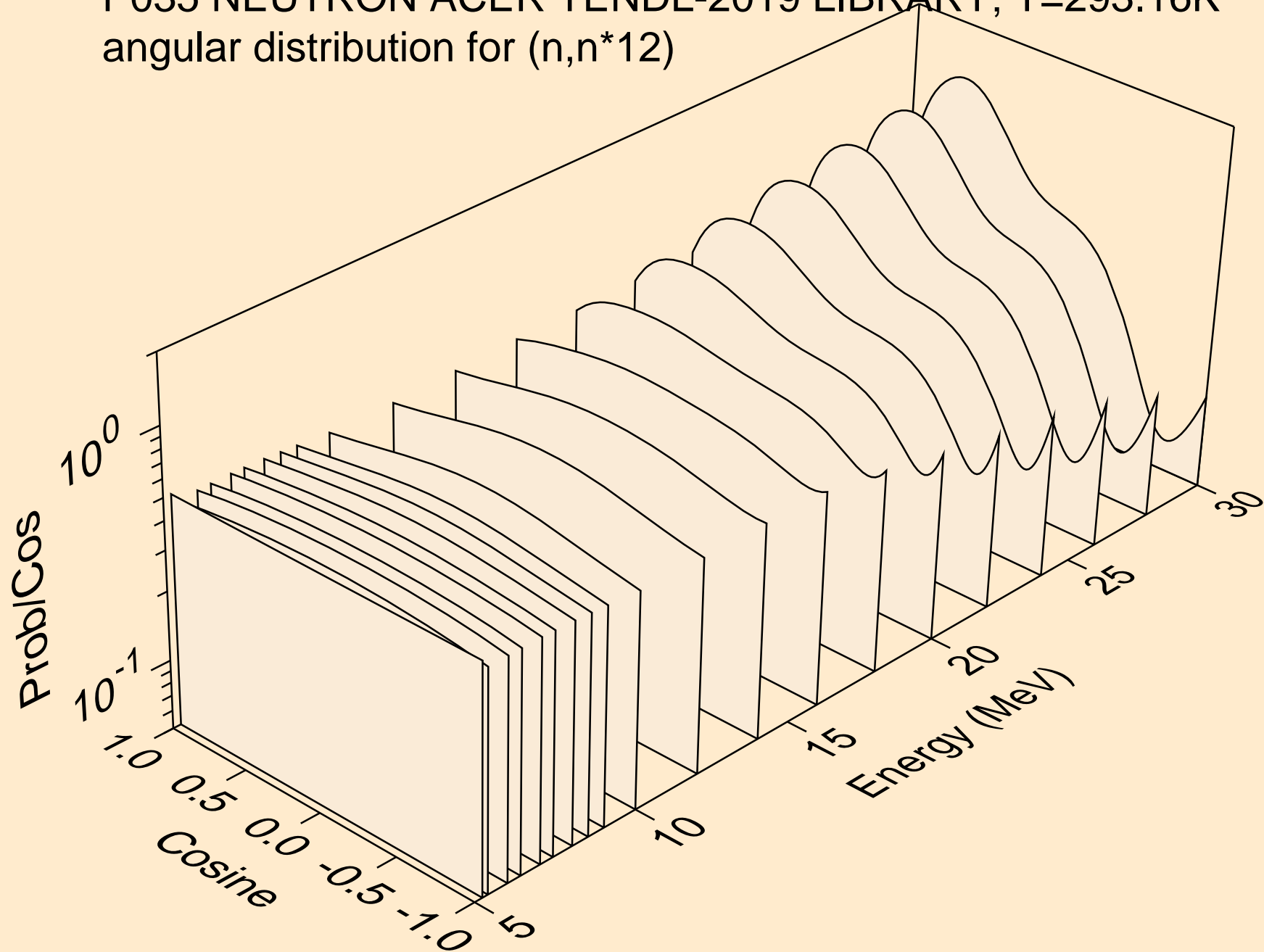

P035 NEUTRON ACER TENDL-2019 LIBRARY; T=293.16K
angular distribution for (n,n*13)

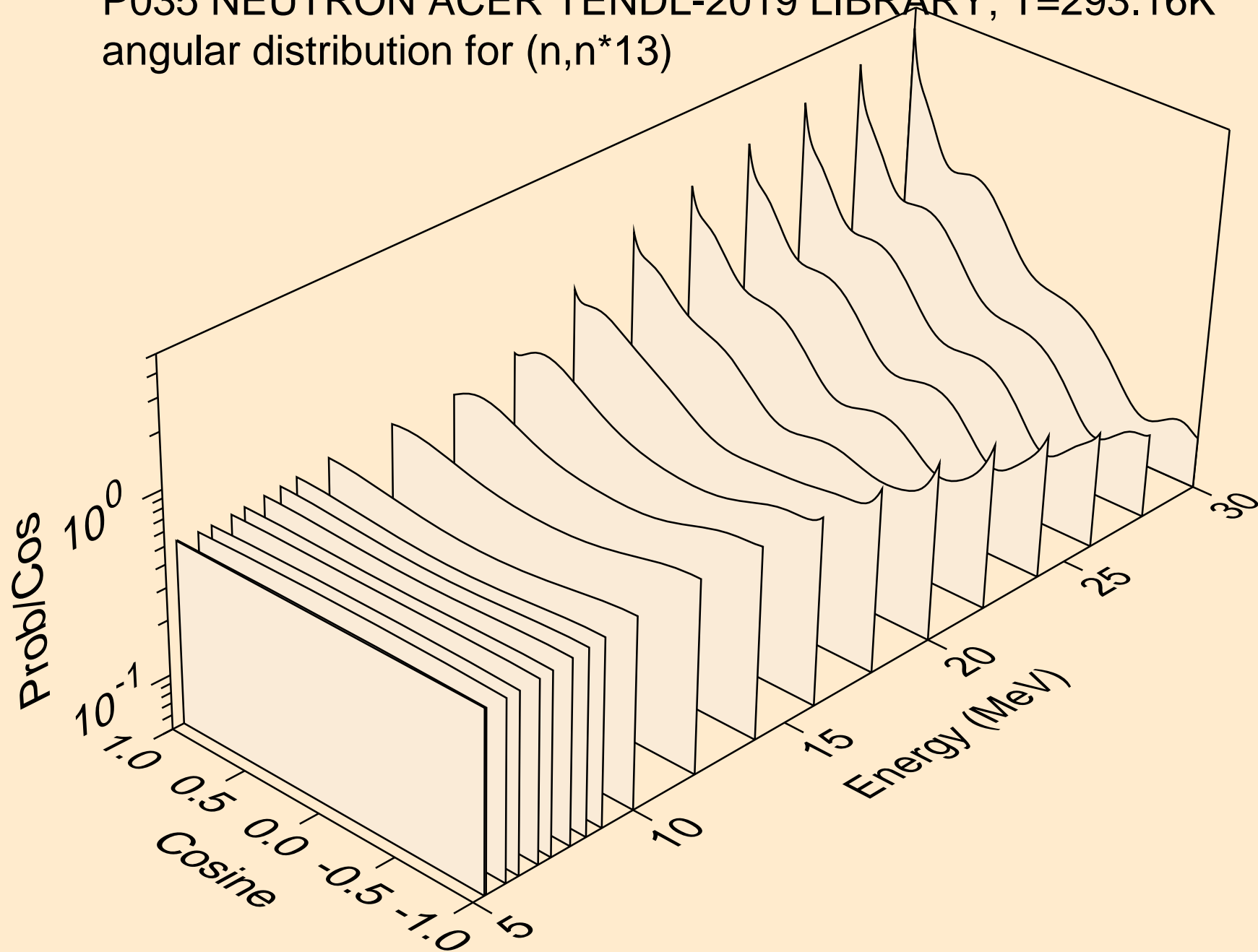

P035 NEUTRON ACER TENDL-2019 LIBRARY; T=293.16K
angular distribution for (n,n*14)

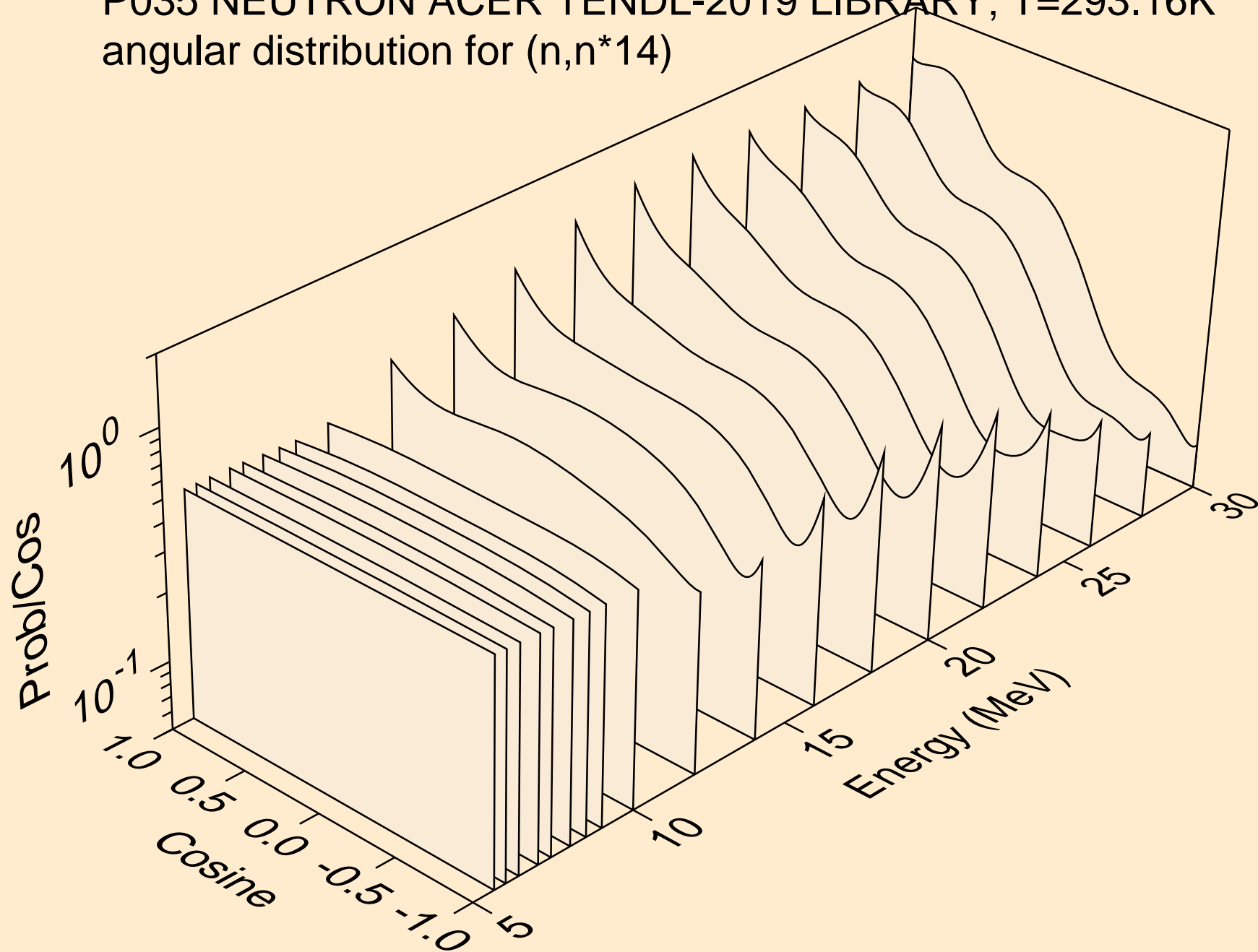

P035 NEUTRON ACER TENDL-2019 LIBRARY; T=293.16K
angular distribution for (n,n*15)

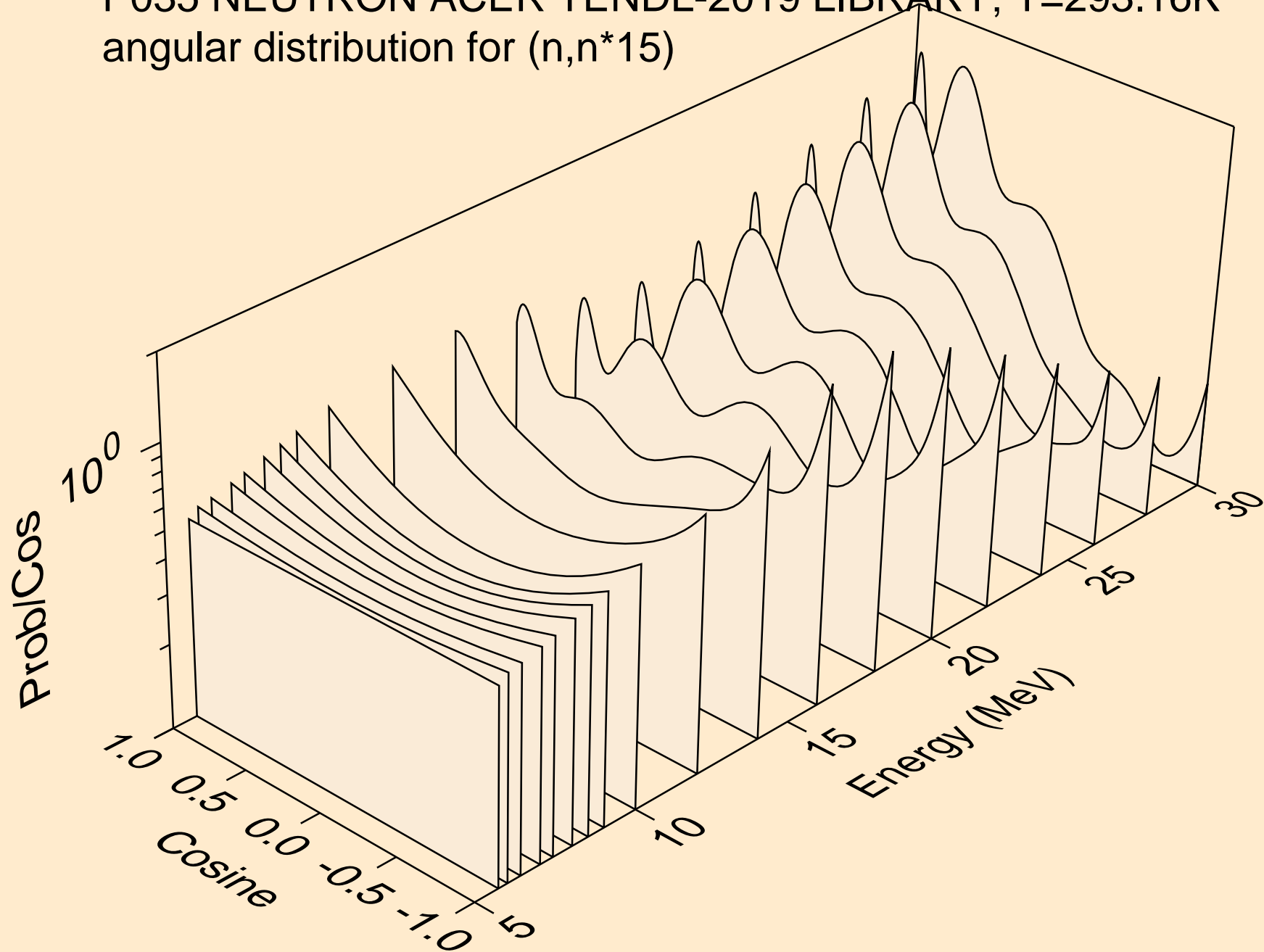

P035 NEUTRON ACER TENDL-2019 LIBRARY; T=293.16K
angular distribution for (n,n*16)

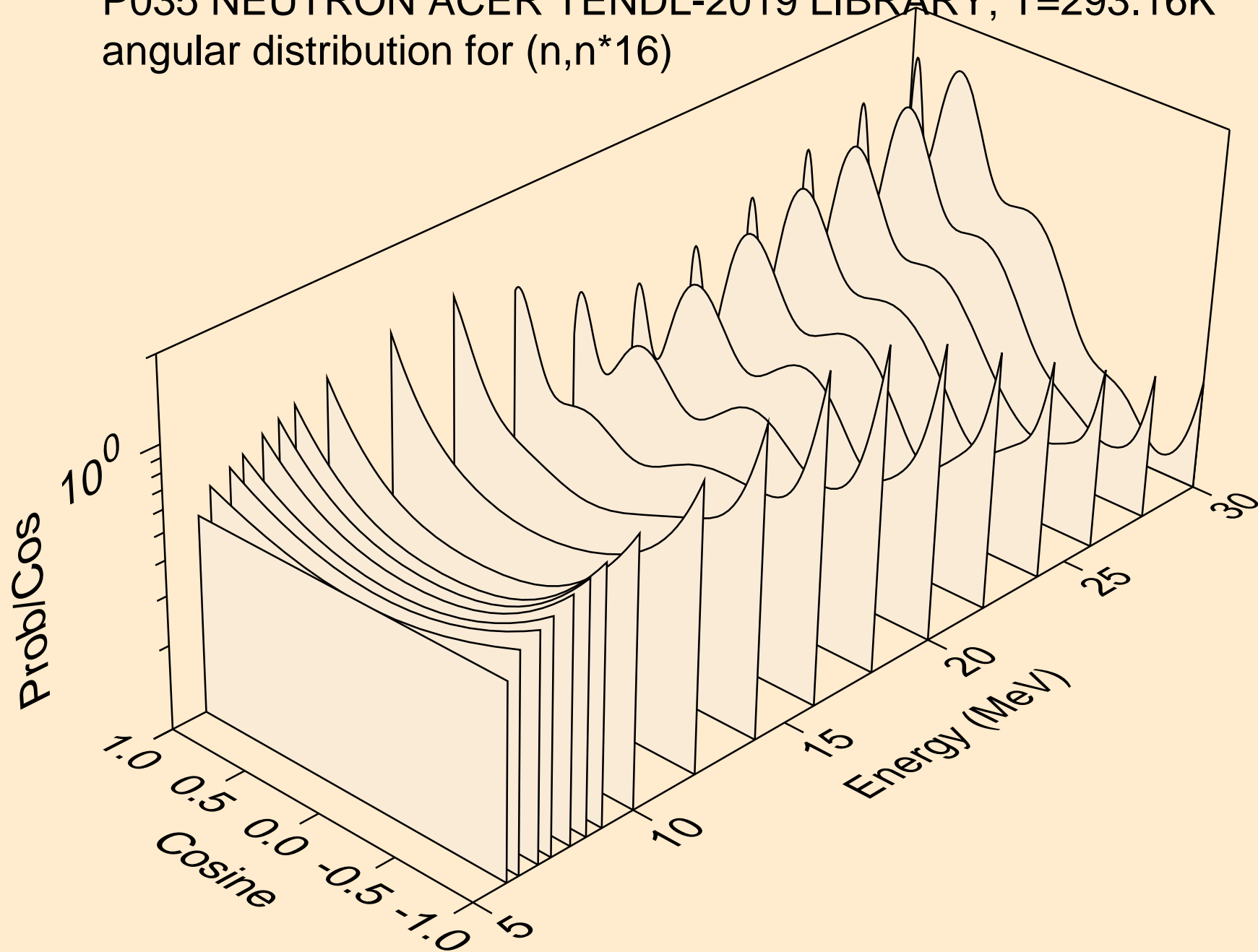

P035 NEUTRON ACER TENDL-2019 LIBRARY; T=293.16K
angular distribution for (n,n*17)

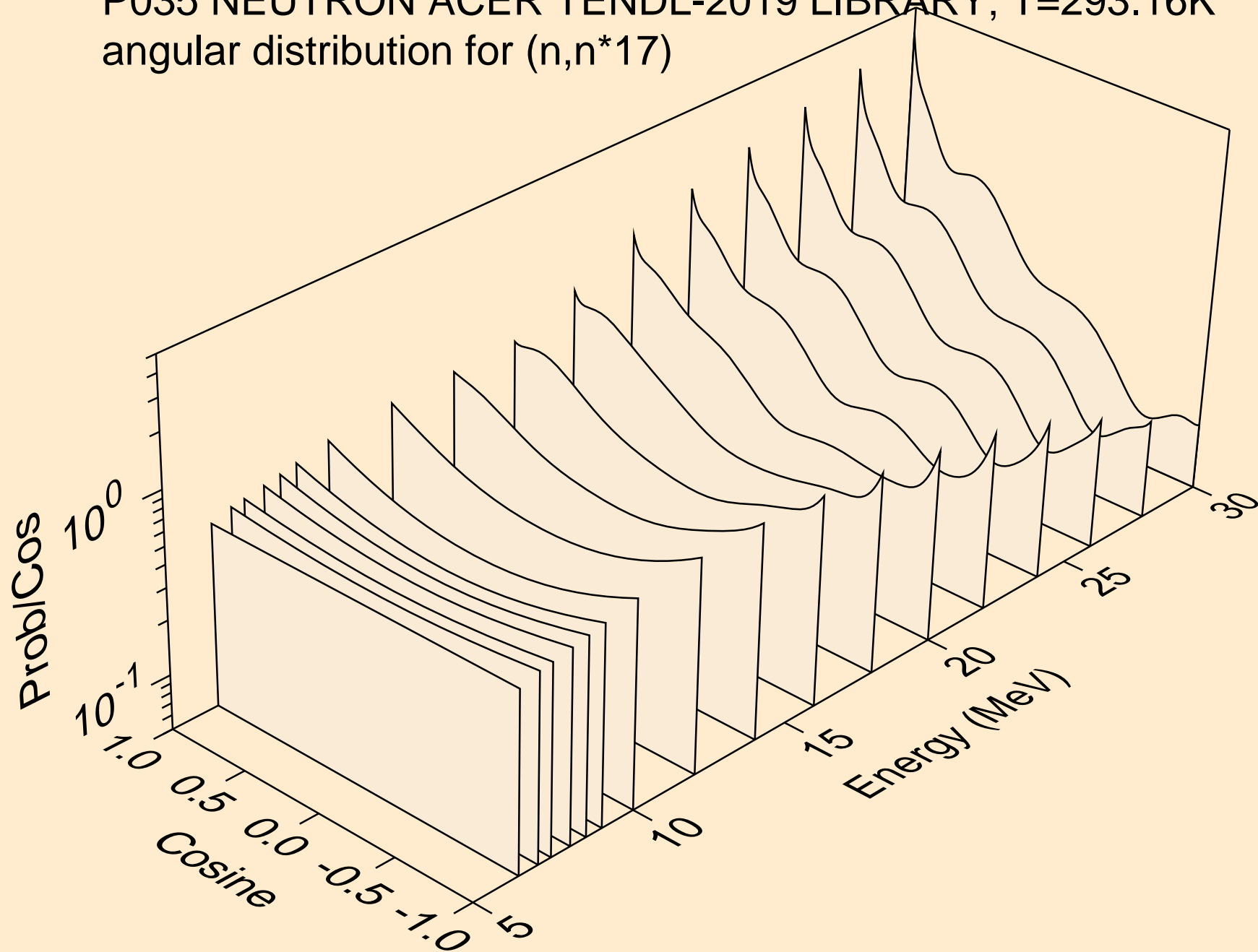

P035 NEUTRON ACER TENDL-2019 LIBRARY; T=293.16K
angular distribution for (n,n*18)

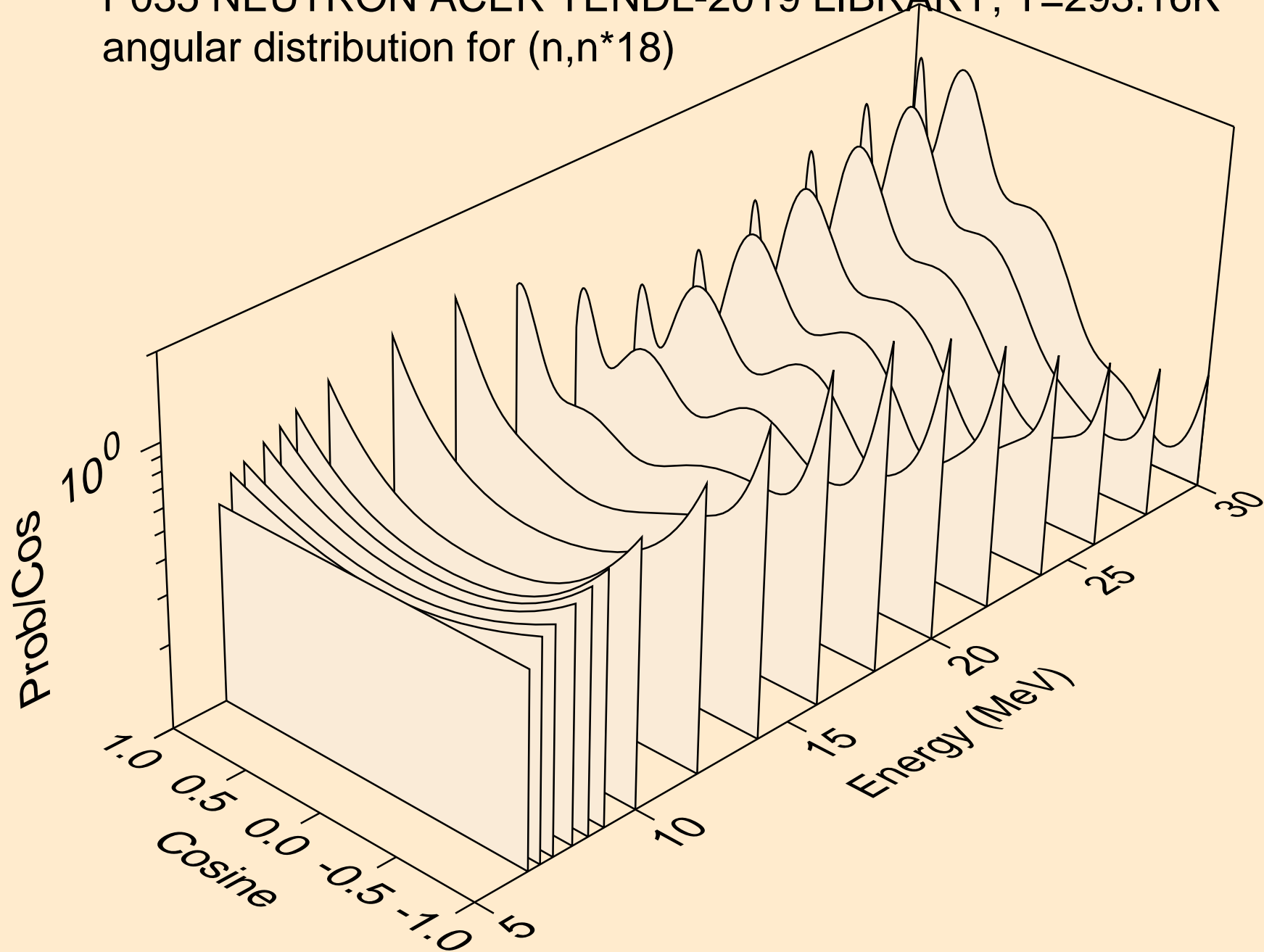

P035 NEUTRON ACER TENDL-2019 LIBRARY; T=293.16K
angular distribution for (n,n*19)

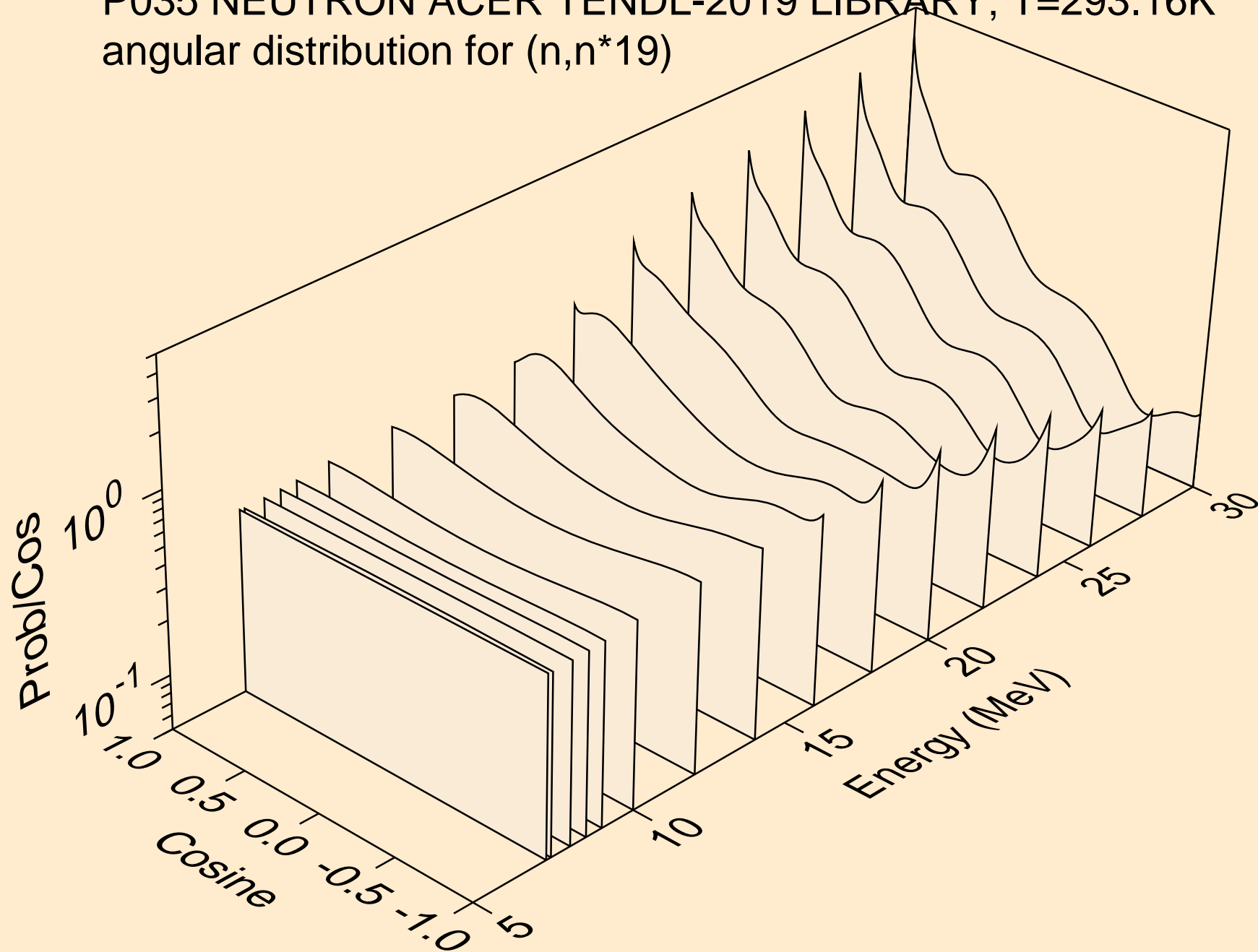

P035 NEUTRON ACER TENDL-2019 LIBRARY; T=293.16K
angular distribution for (n,n*20)

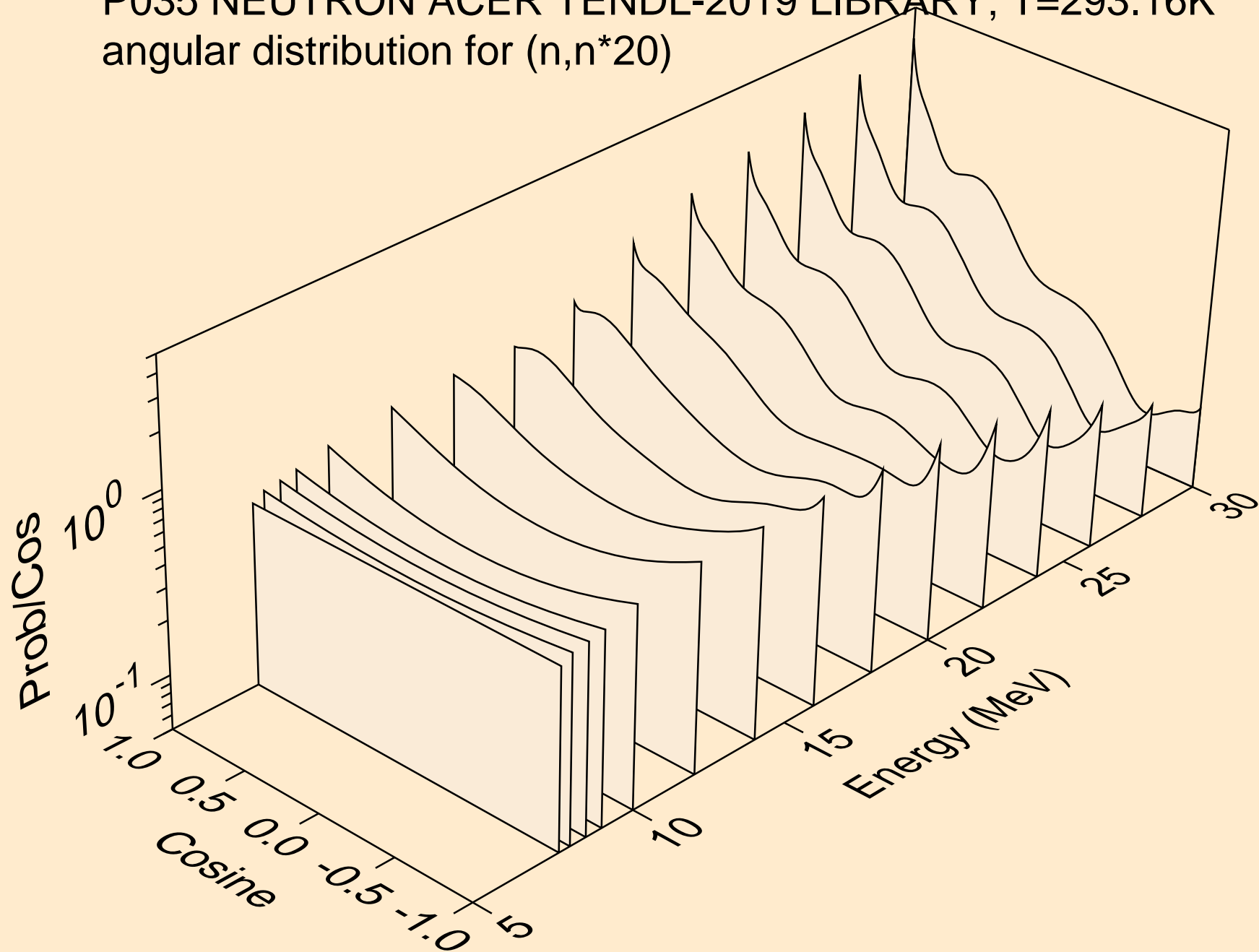

P035 NEUTRON ACER TENDL-2019 LIBRARY; T=293.16K
angular distribution for (n,n*21)

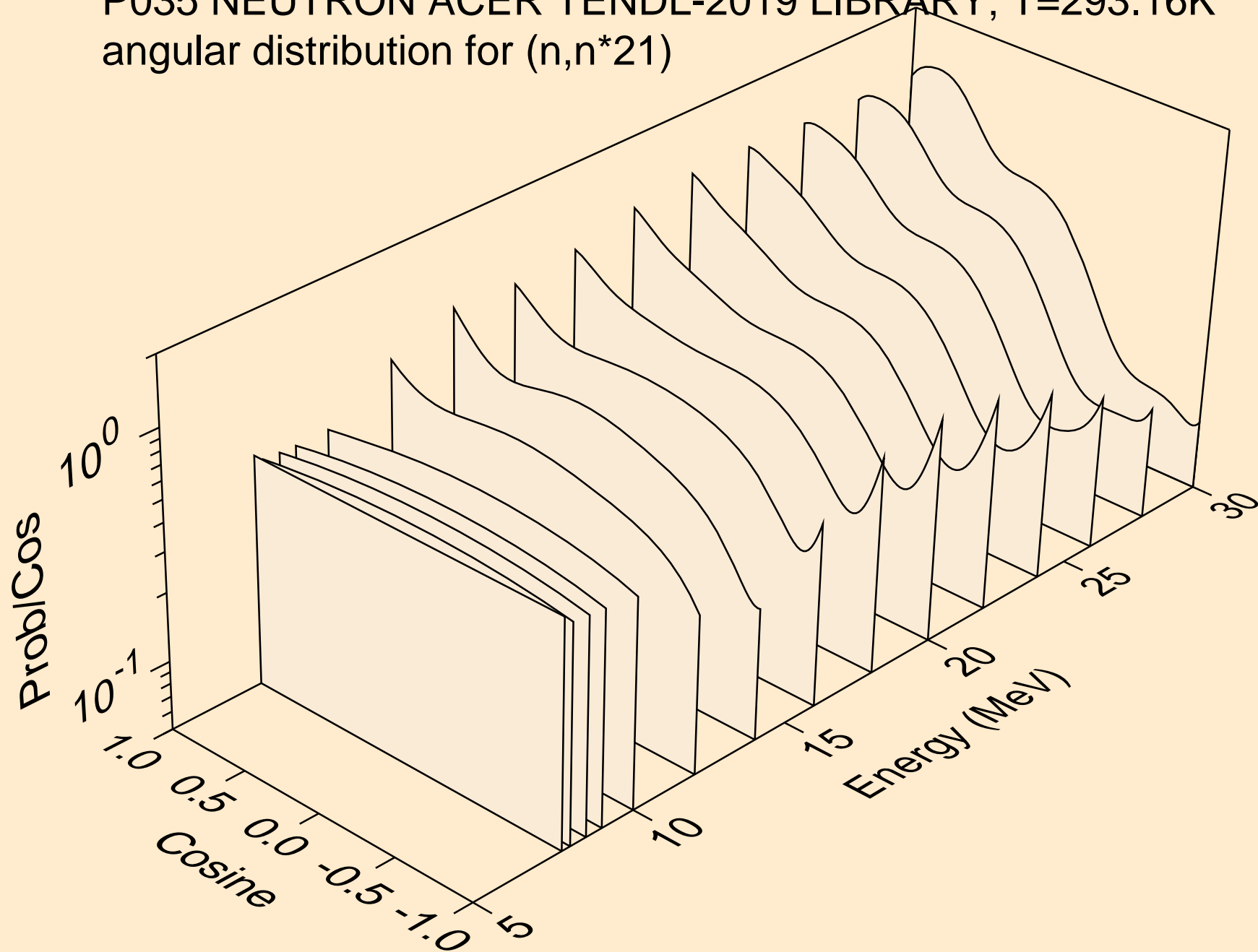

P035 NEUTRON ACER TENDL-2019 LIBRARY; T=293.16K
angular distribution for (n,n*22)

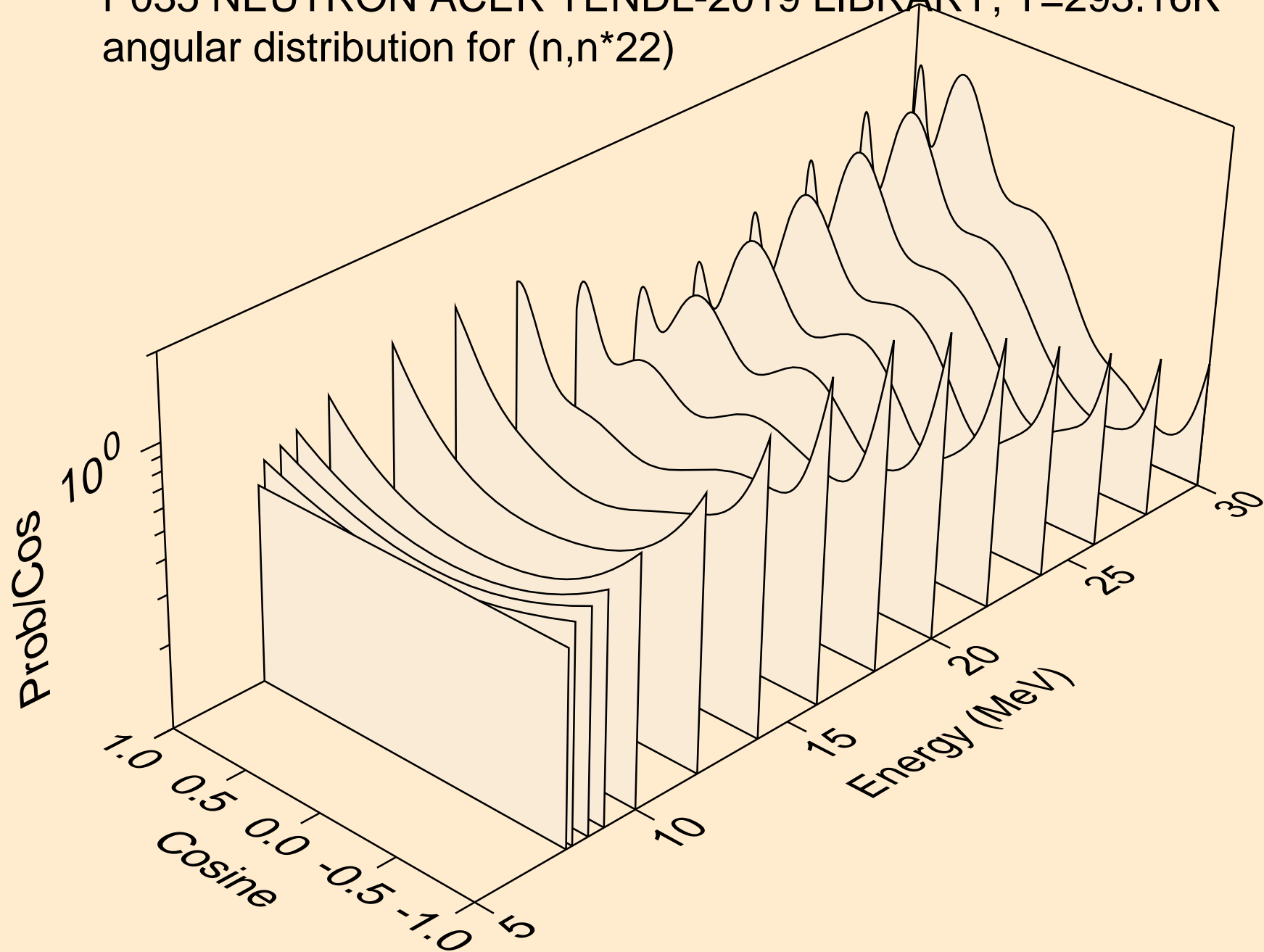

P035 NEUTRON ACER TENDL-2019 LIBRARY; T=293.16K
angular distribution for (n,n*23)

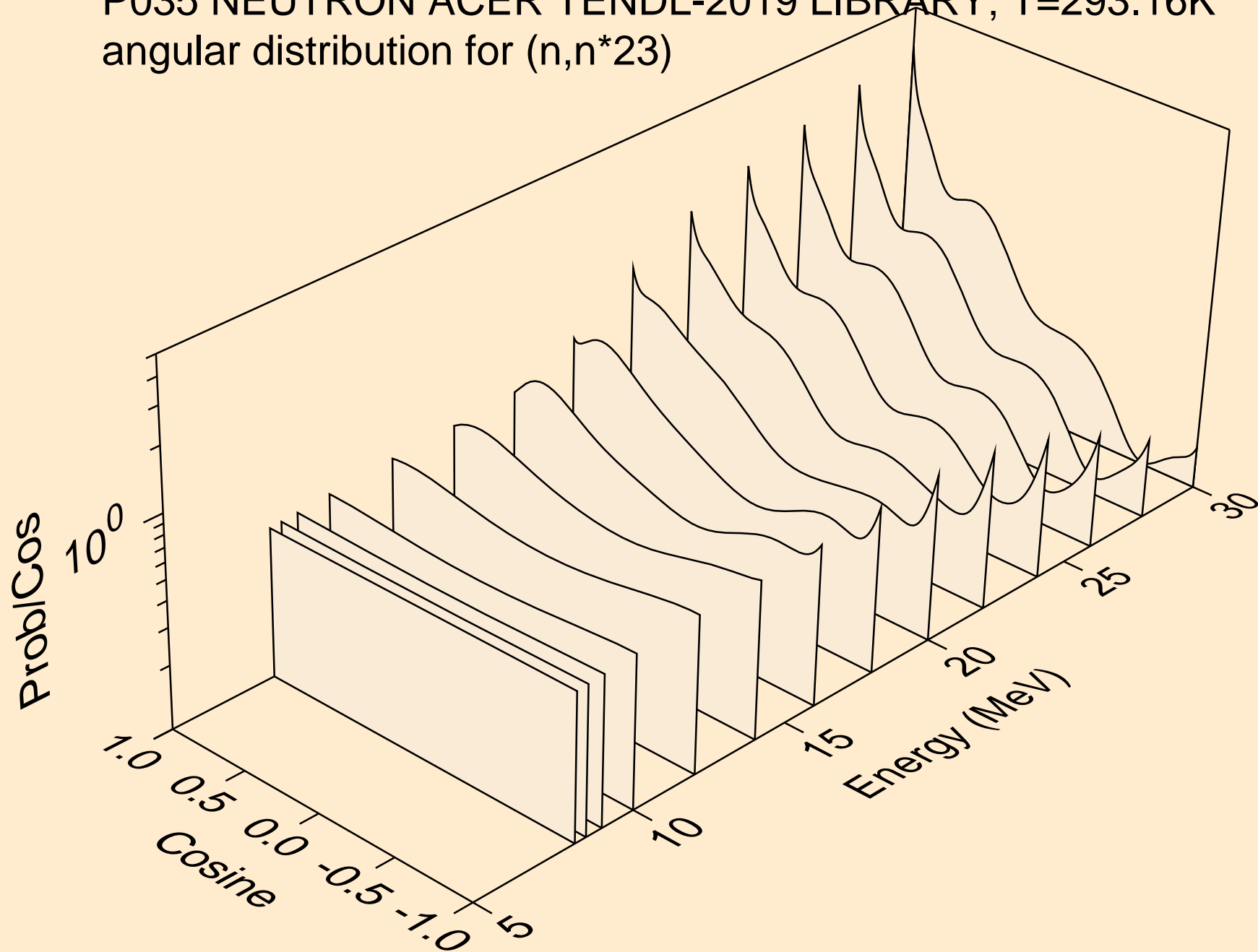

P035 NEUTRON ACER TENDL-2019 LIBRARY; T=293.16K
angular distribution for (n,n*24)

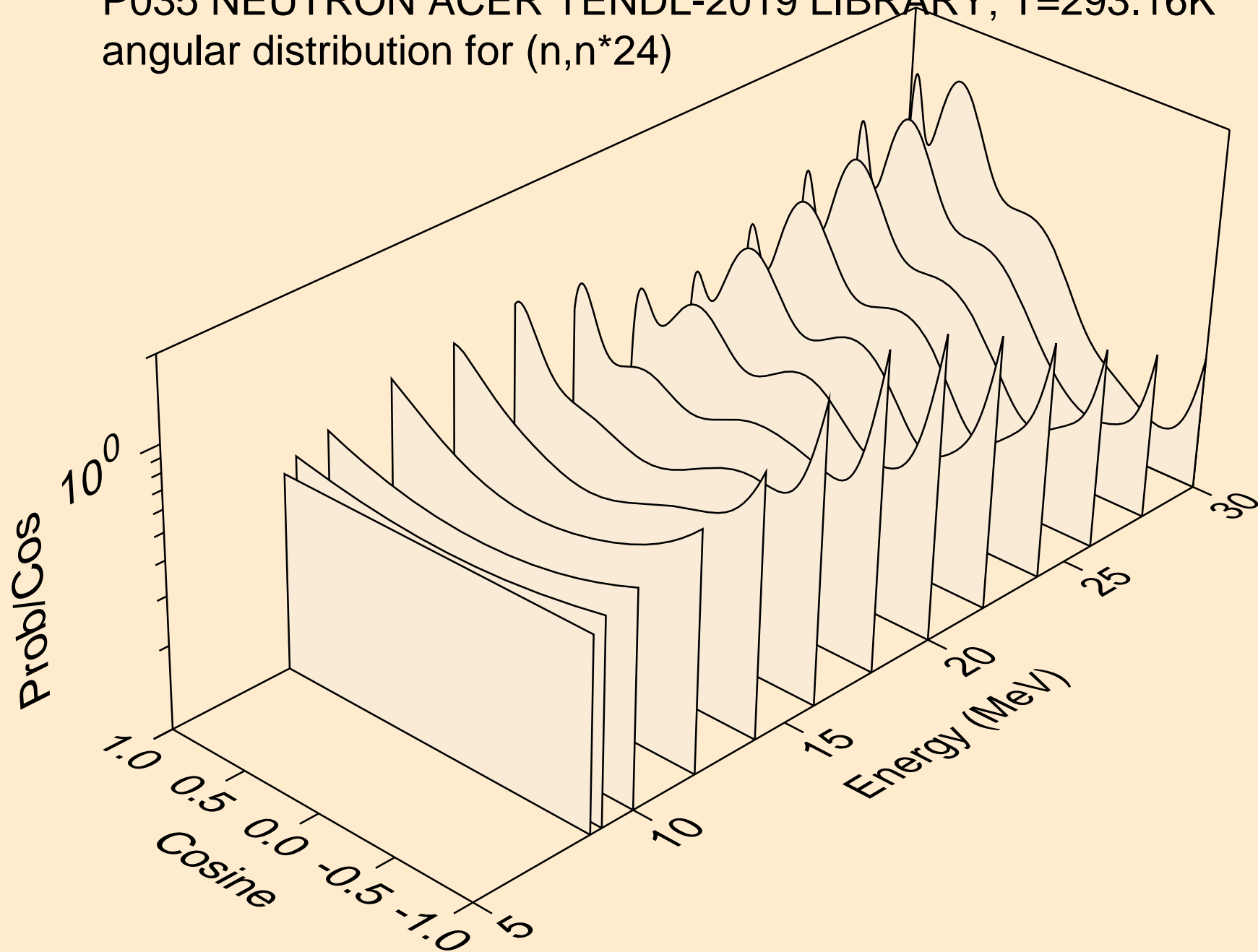

P035 NEUTRON ACER TENDL-2019 LIBRARY; T=293.16K
Neutron emission for (n,x)

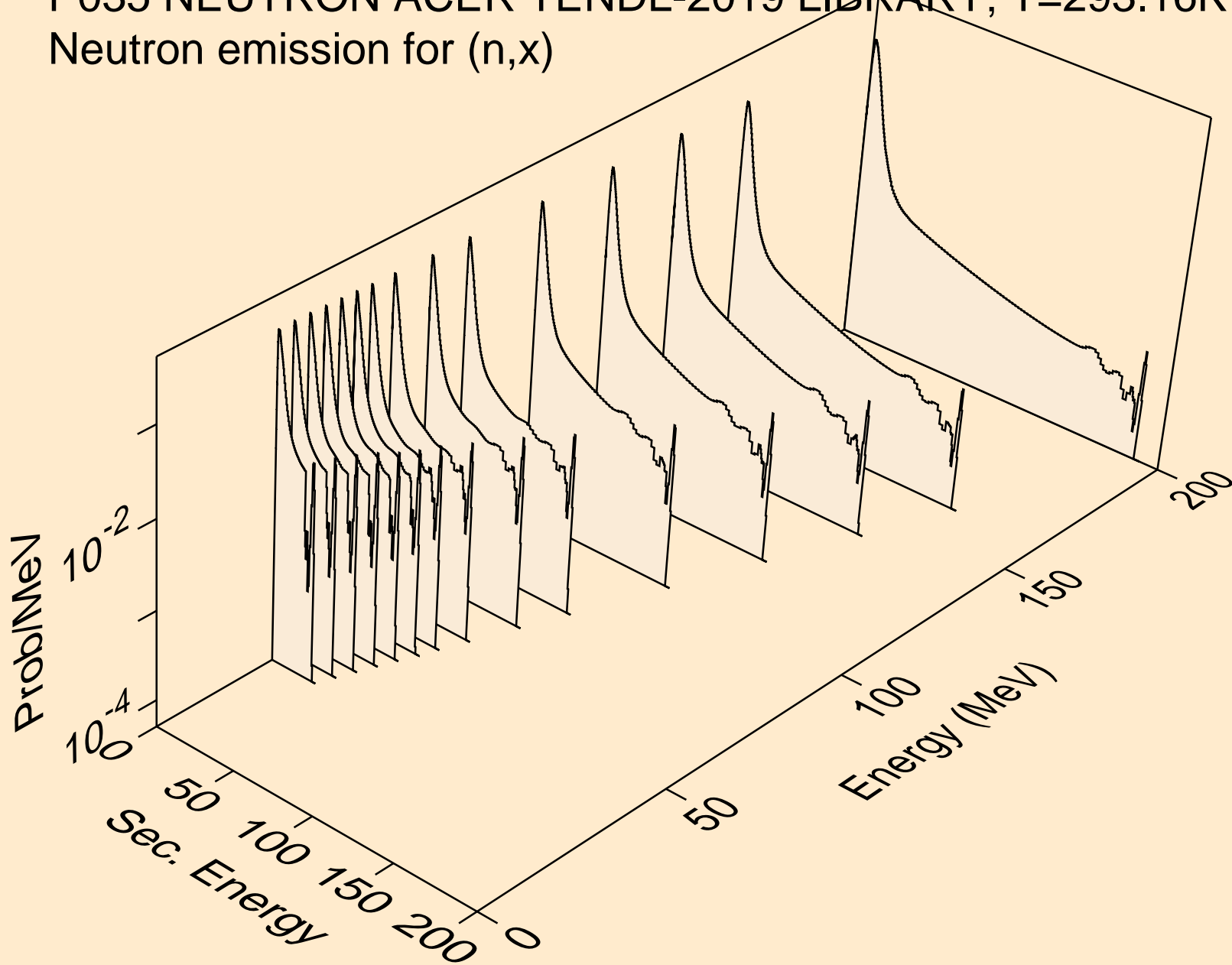

P035 NEUTRON ACER TENDL-2019 LIBRARY; T=293.16K
Neutron emission for (n,2nd)

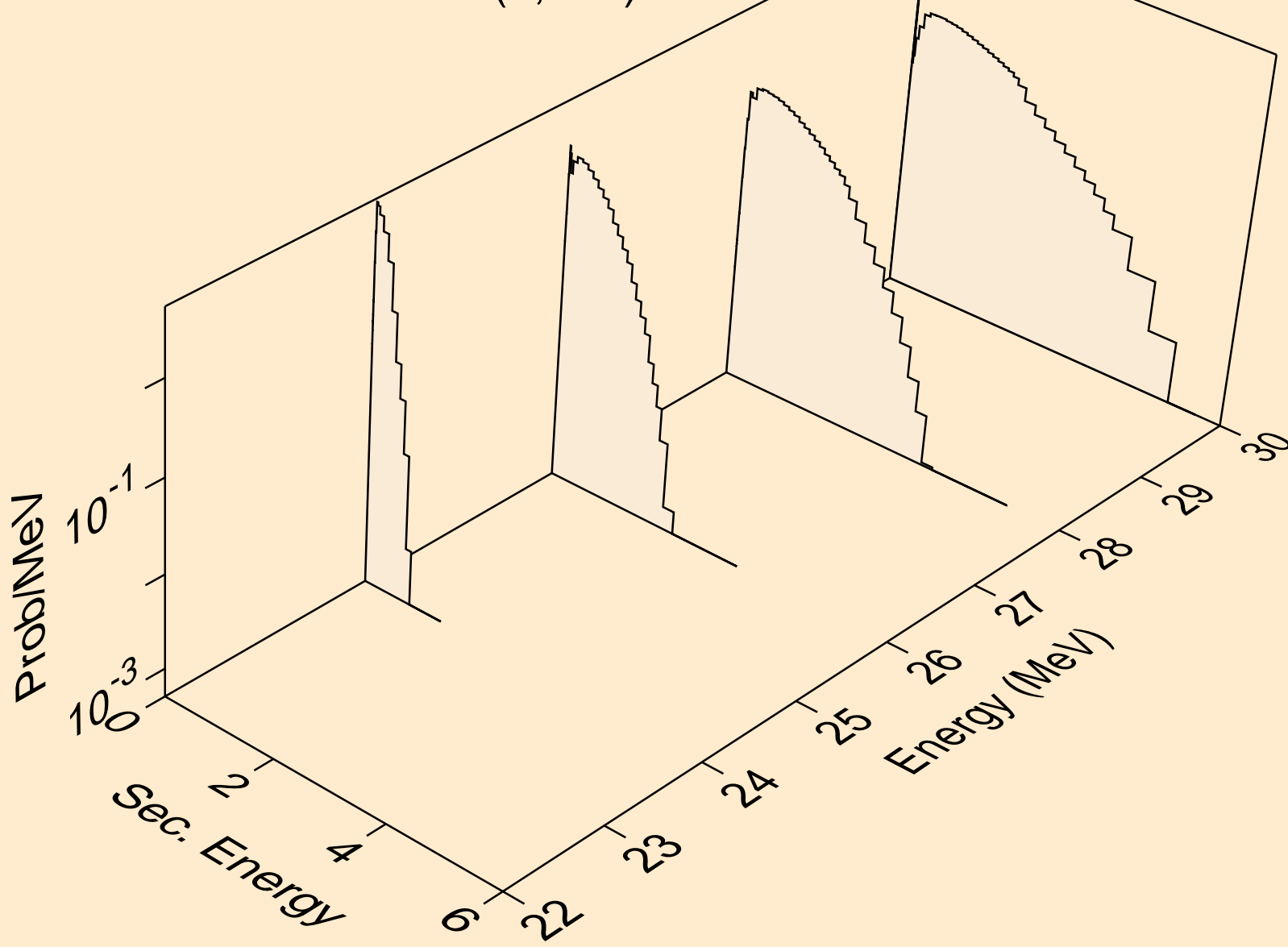

P035 NEUTRON ACER TENDL-2019 LIBRARY; T=293.16K
Neutron emission for (n,2n)

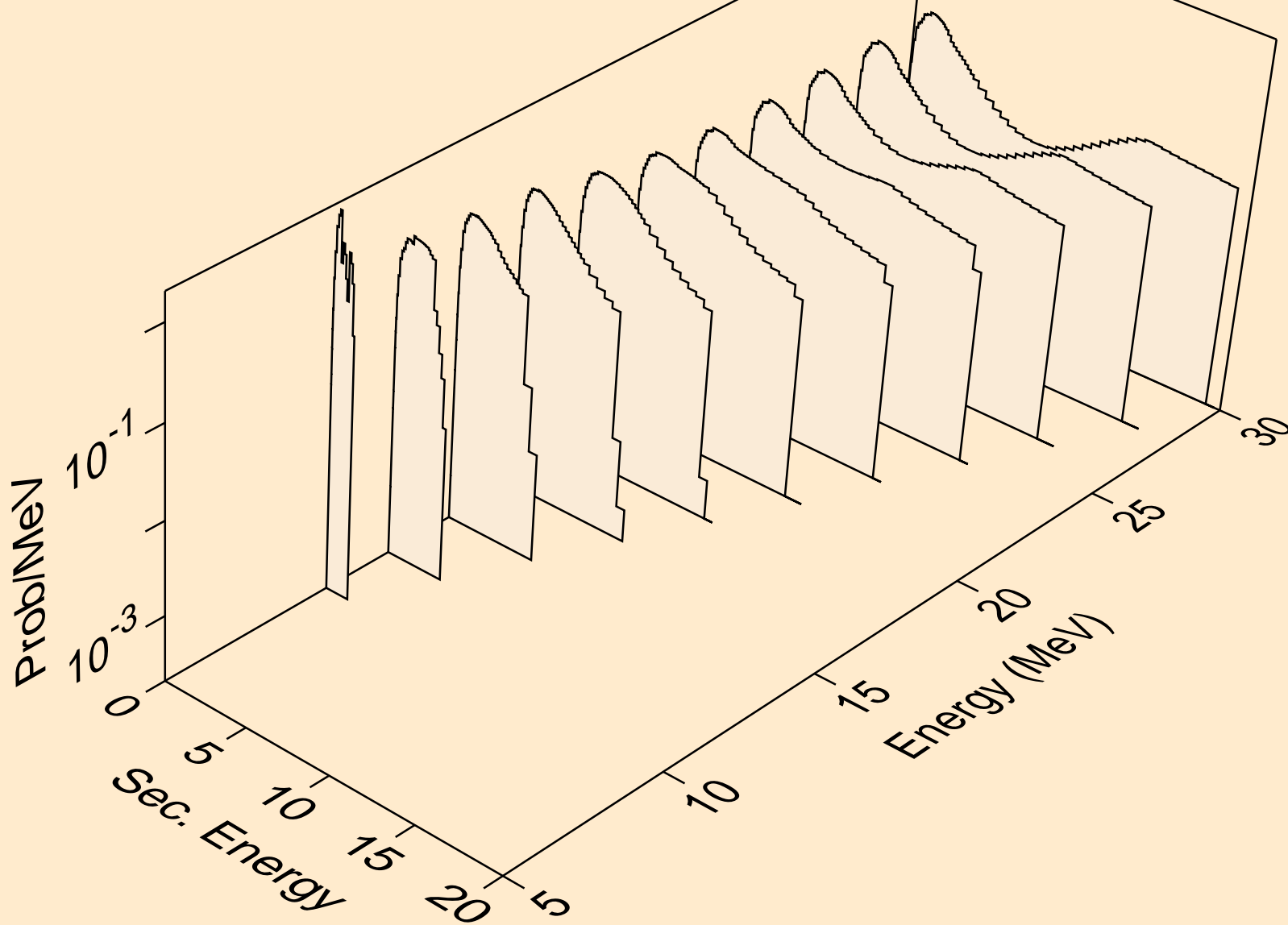

P035 NEUTRON ACER TENDL-2019 LIBRARY; T=293.16K
Neutron emission for (n,3n)

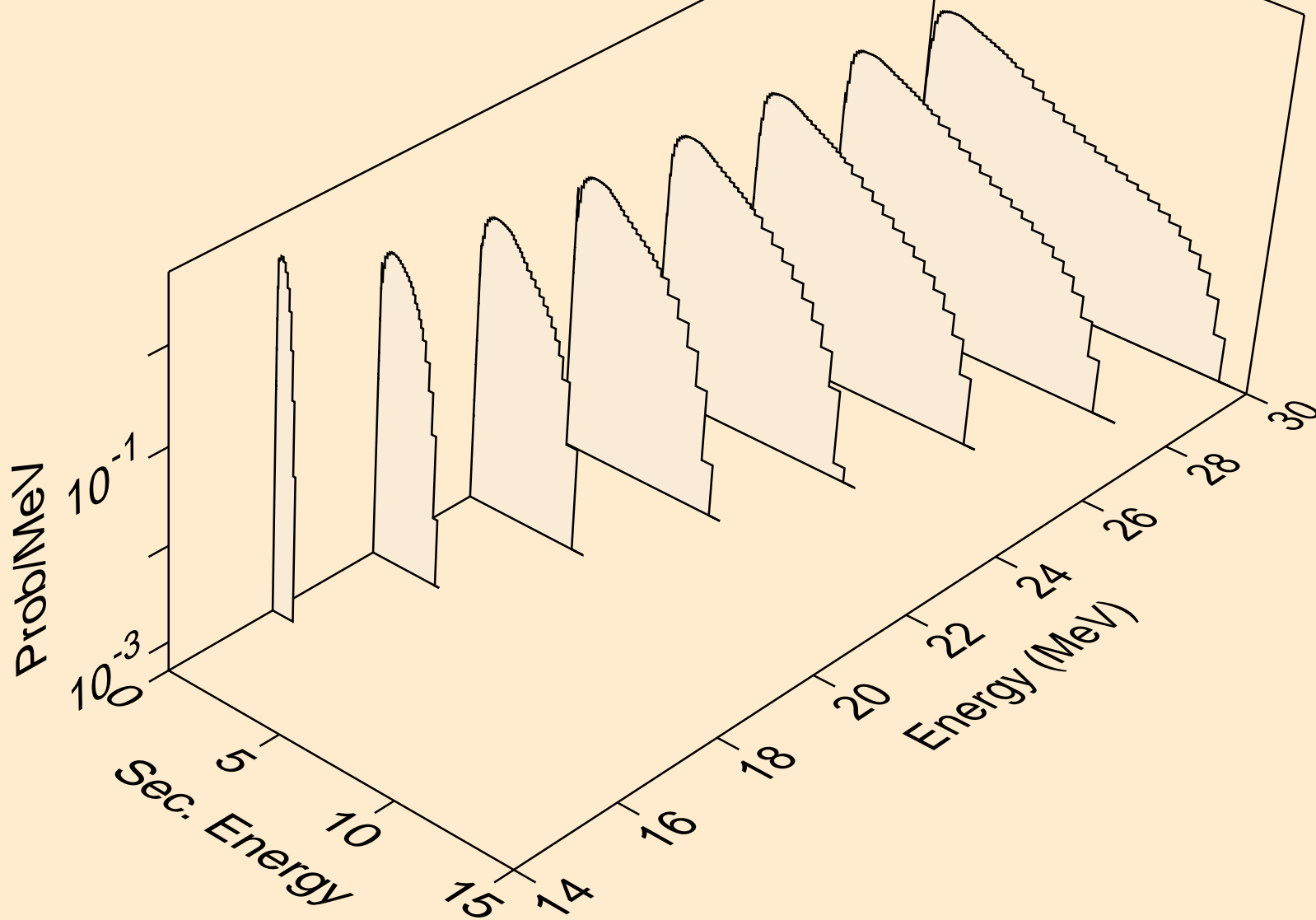

P035 NEUTRON ACER TENDL-2019 LIBRARY; T=293.16K
Neutron emission for (n,n*)a

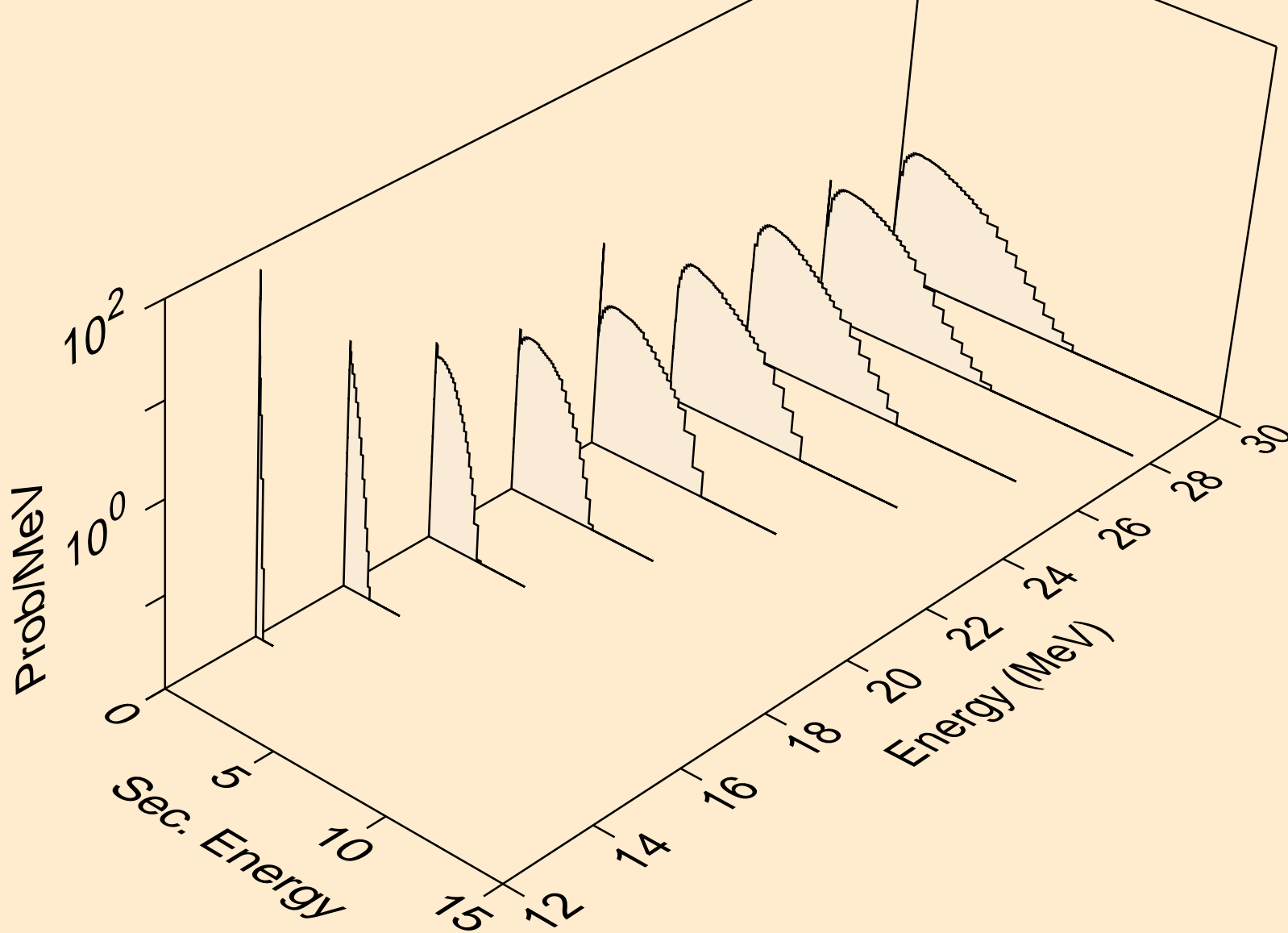

P035 NEUTRON ACER TENDL-2019 LIBRARY; T=293.16K
Neutron emission for (n,2n)a

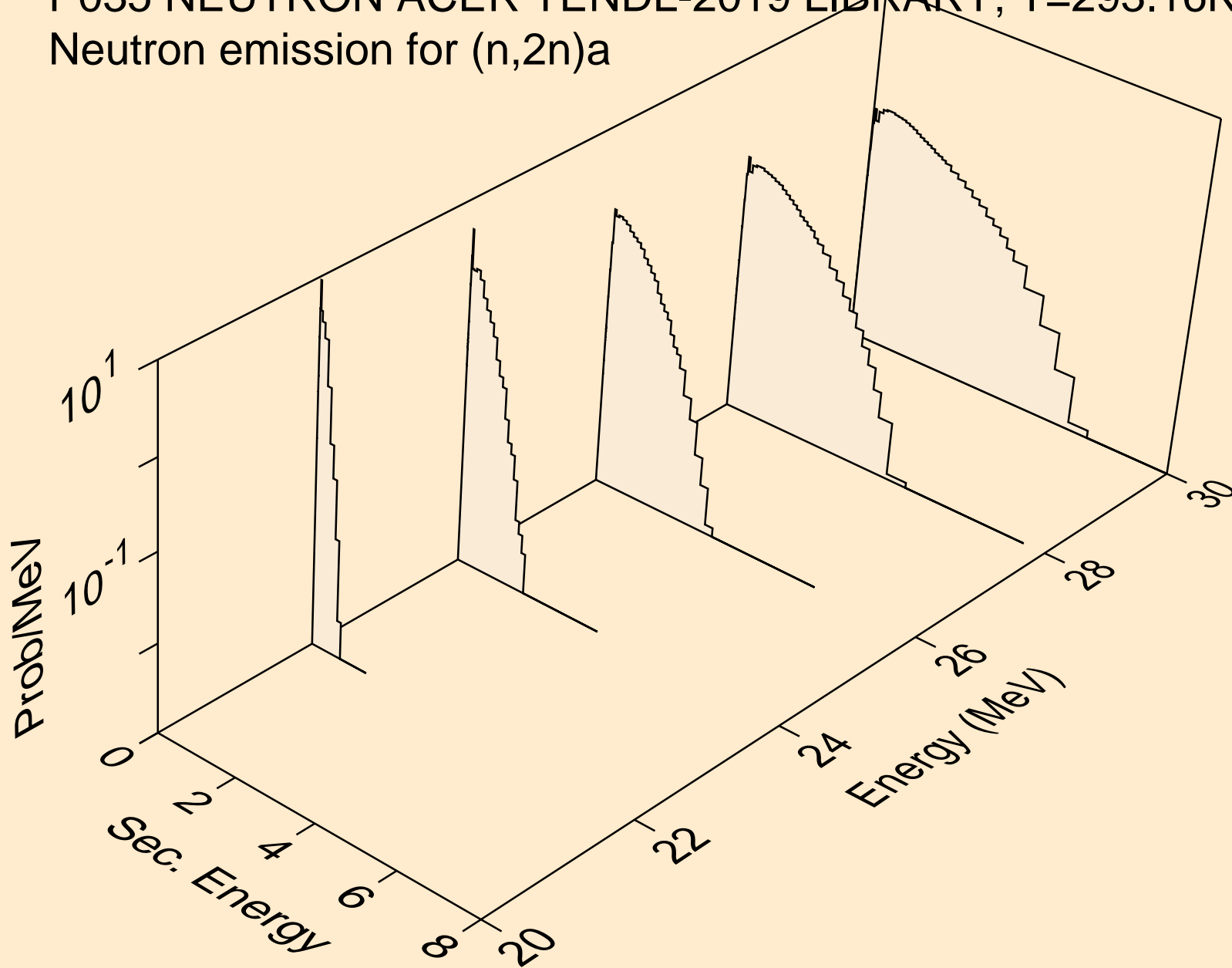

P035 NEUTRON ACER TENDL-2019 LIBRARY; T=293.16K
Neutron emission for (n,3n)a

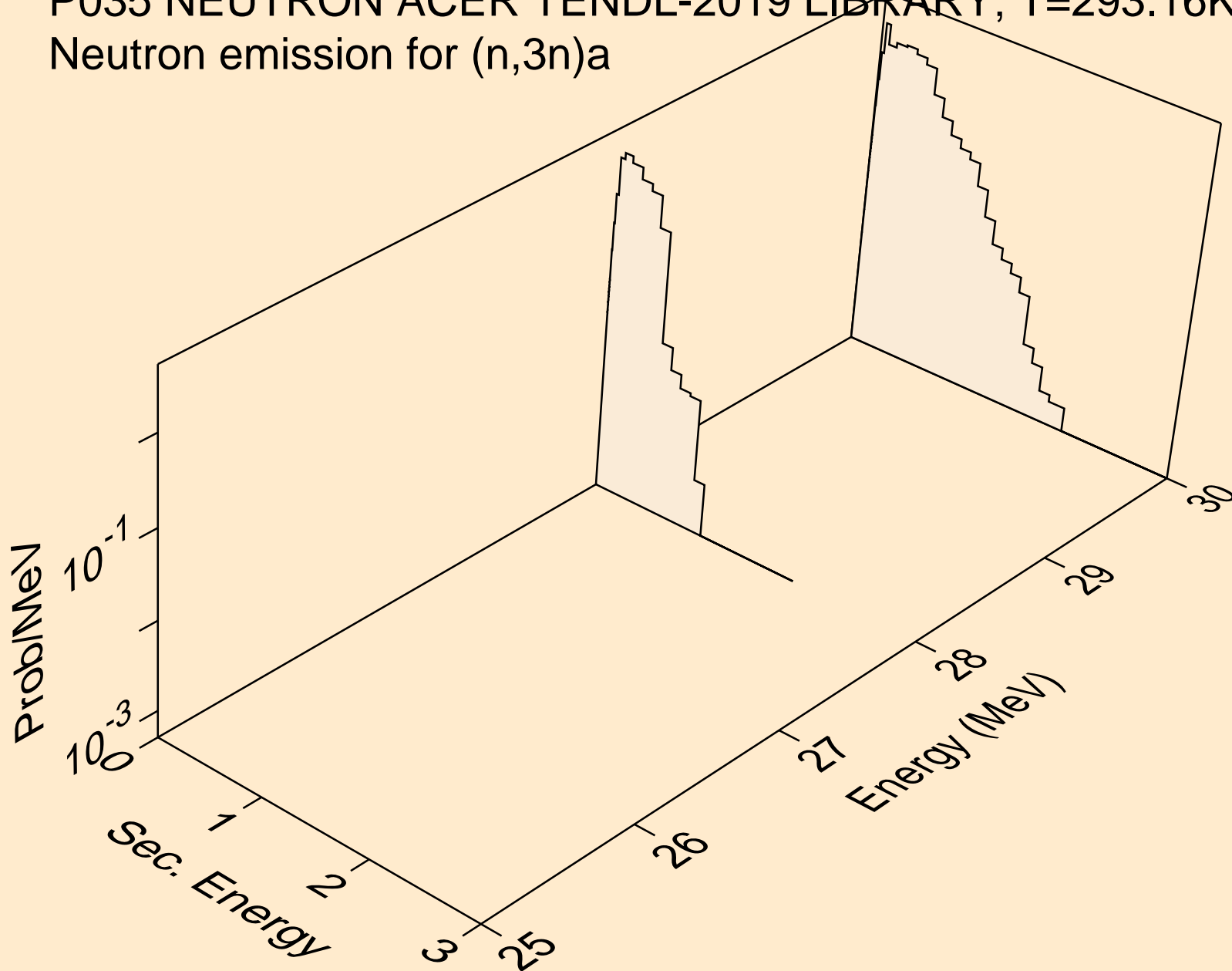

P035 NEUTRON ACER TENDL-2019 LIBRARY; T=293.16K
Neutron emission for (n,n*)p

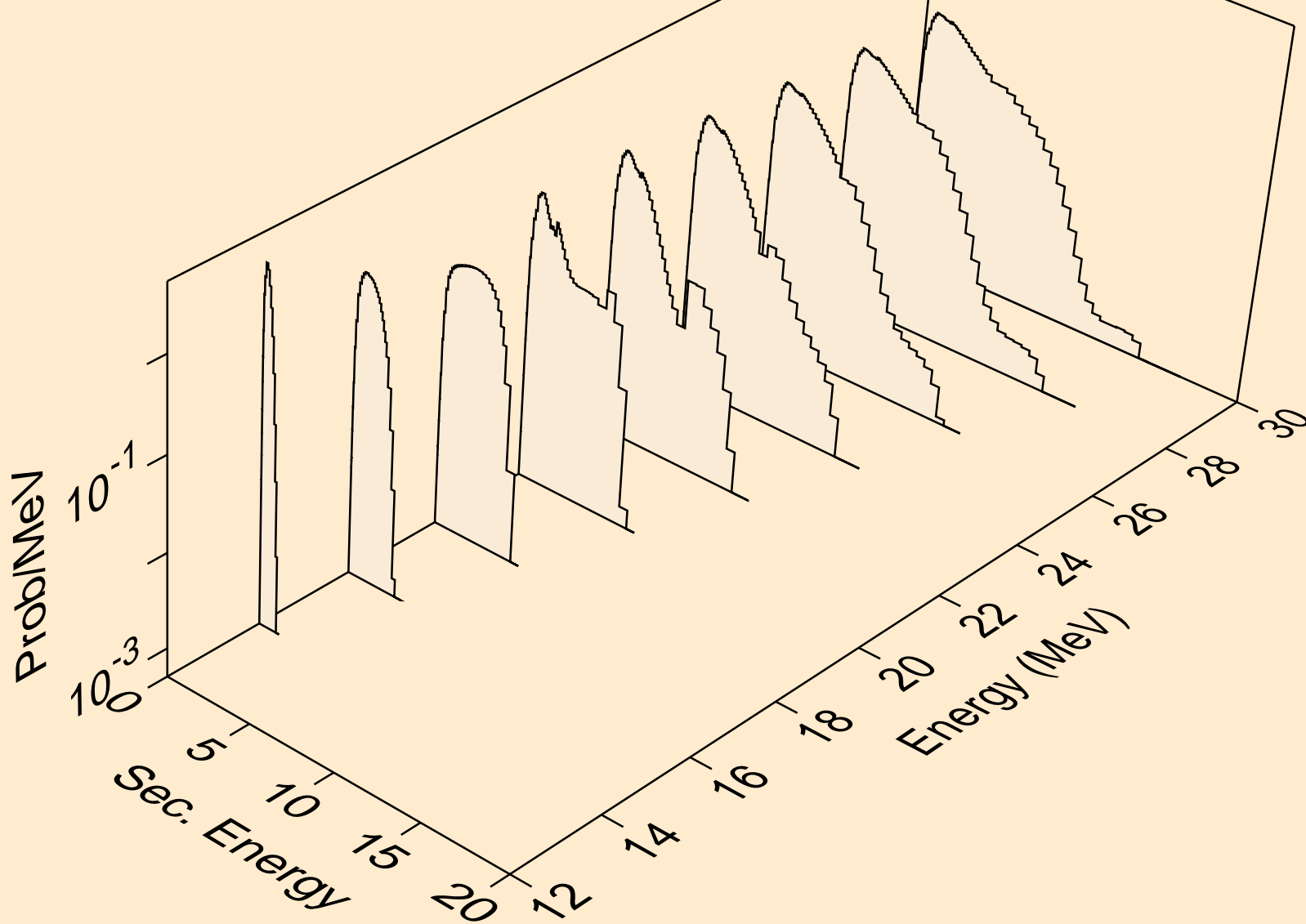

P035 NEUTRON ACER TENDL-2019 LIBRARY; T=293.16K
Neutron emission for (n,n*)d

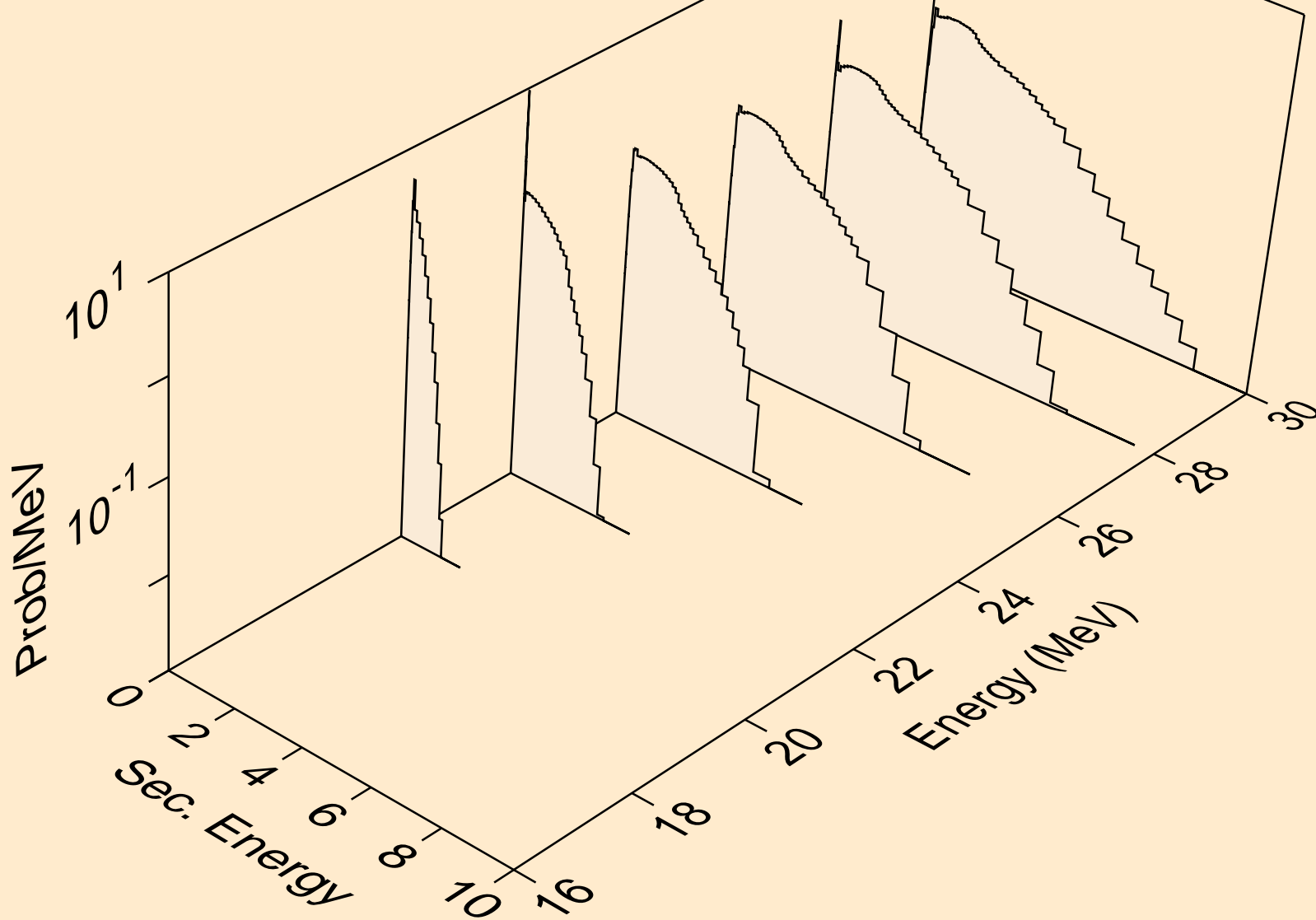

P035 NEUTRON ACER TENDL-2019 LIBRARY; T=293.16K
Neutron emission for (n,n*)t

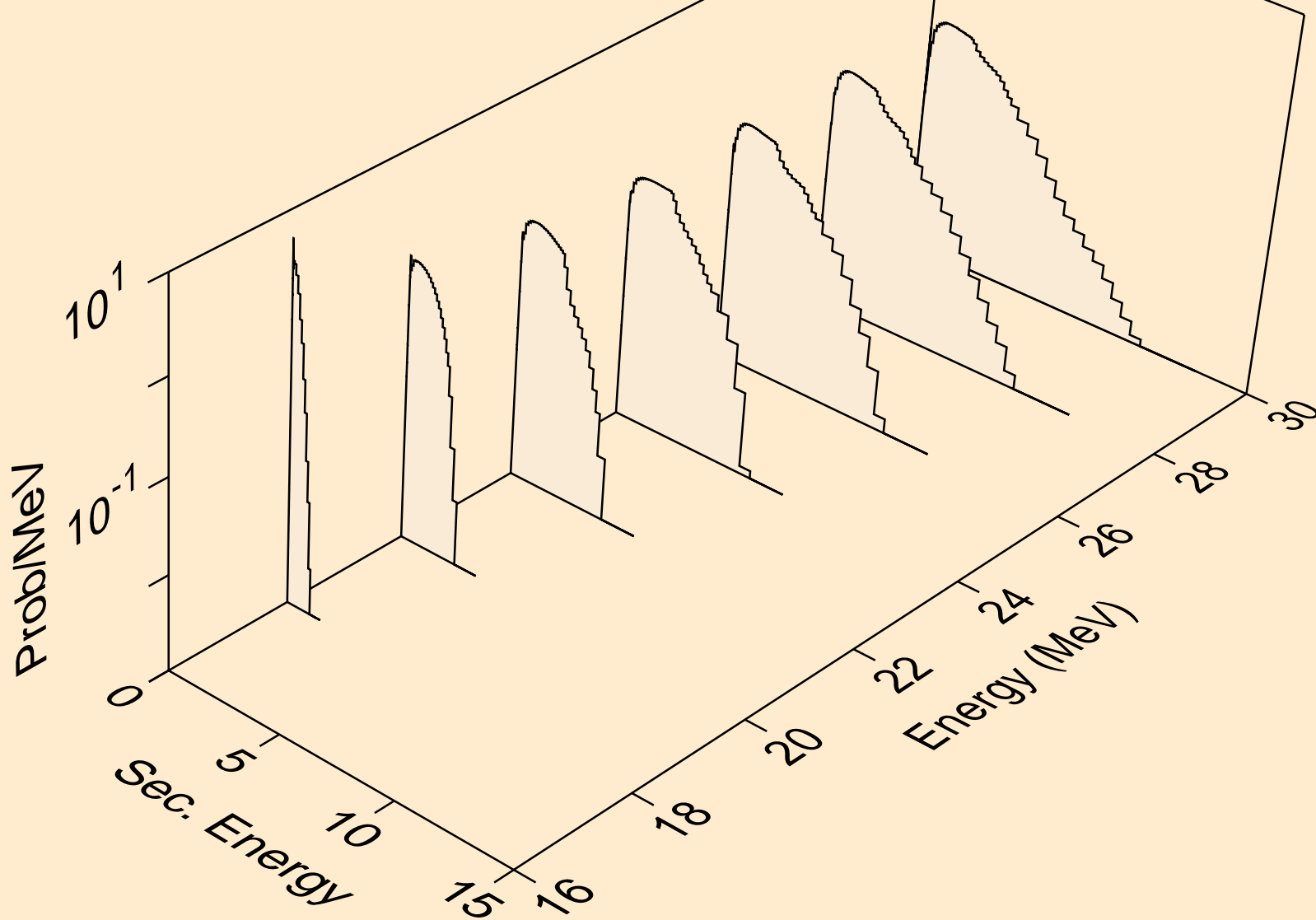

P035 NEUTRON ACER TENDL-2019 LIBRARY; T=293.16K
Neutron emission for (n,4n)

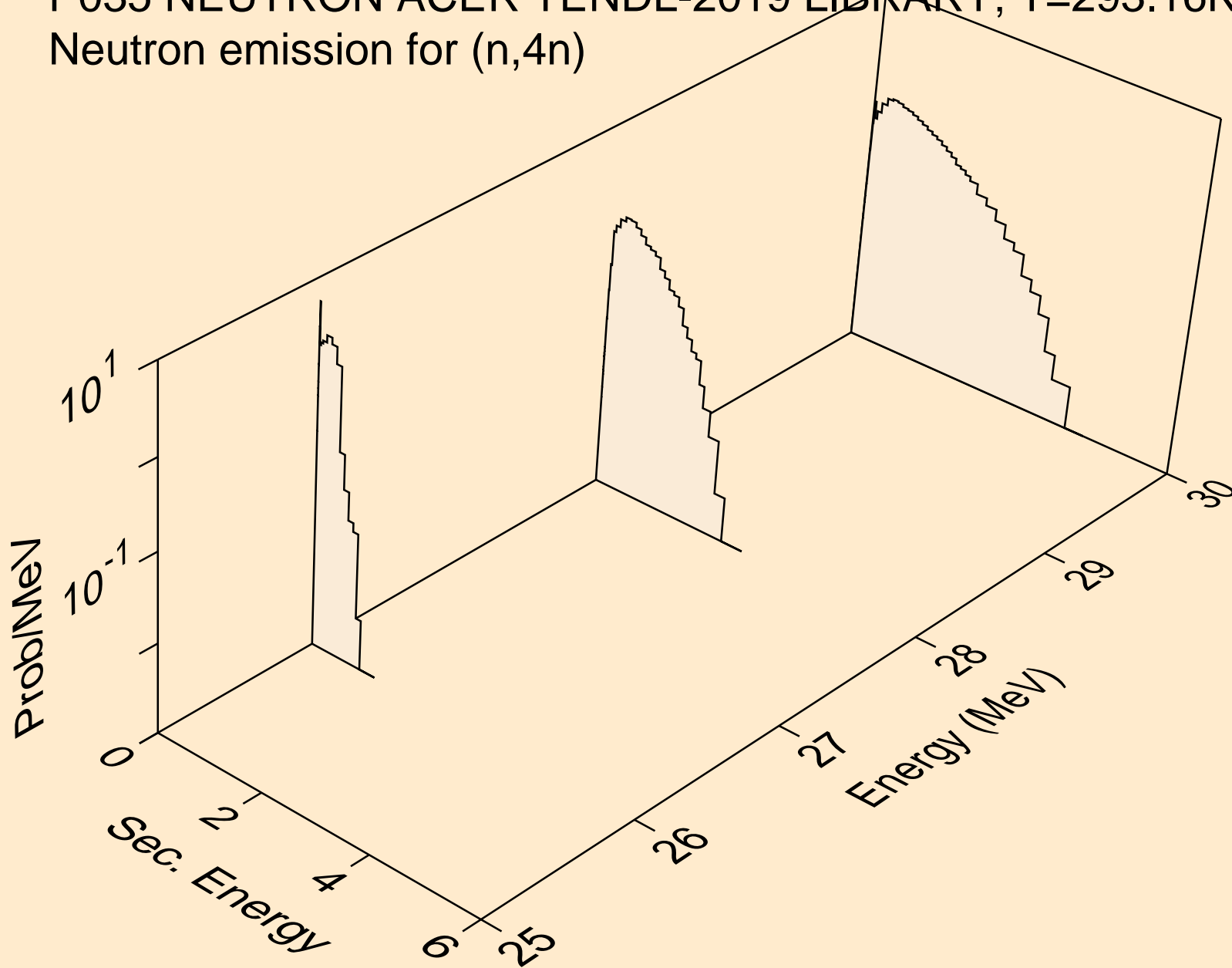

P035 NEUTRON ACER TENDL-2019 LIBRARY; T=293.16K
Neutron emission for (n,2np)

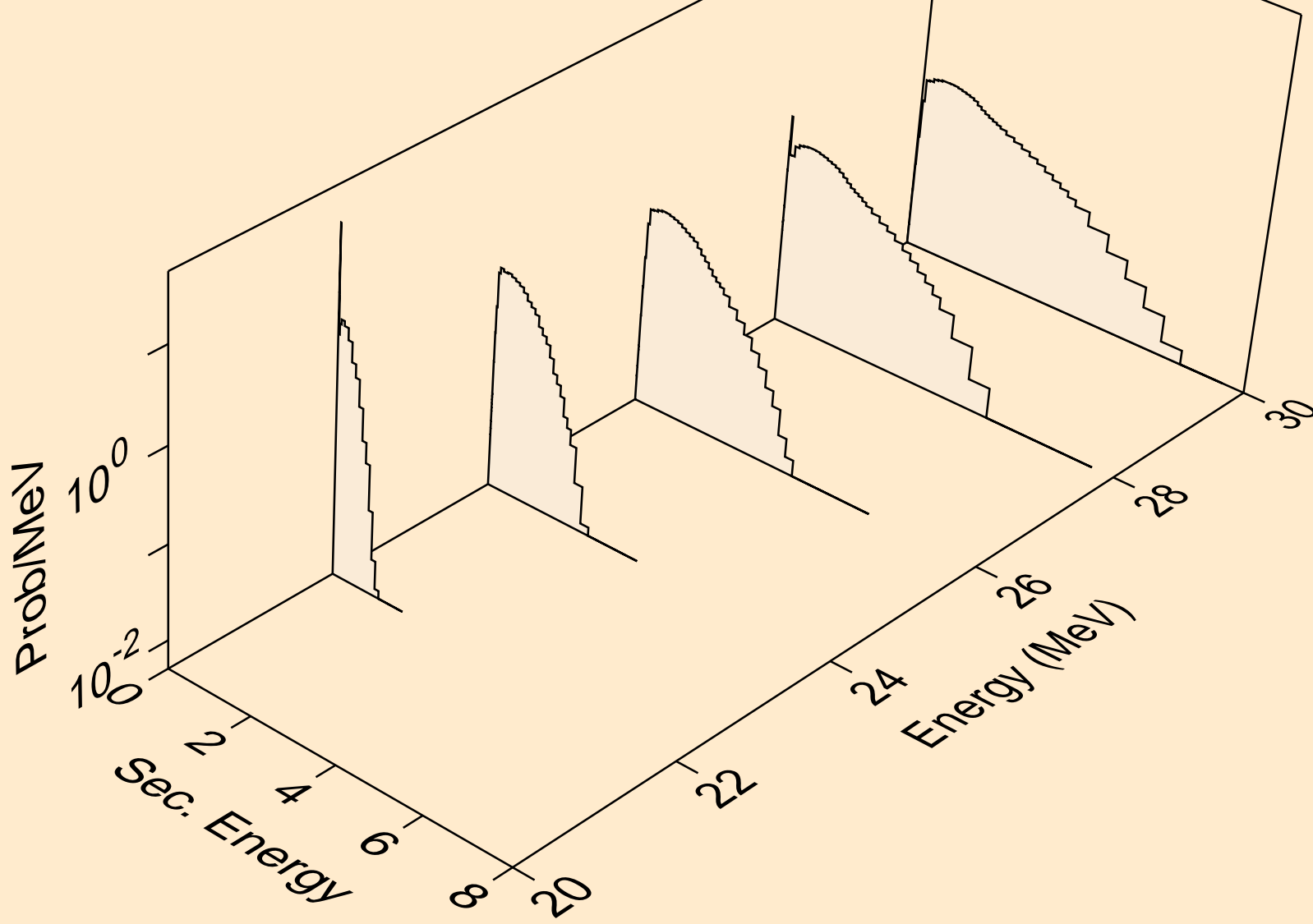

P035 NEUTRON ACER TENDL-2019 LIBRARY; T=293.16K
Neutron emission for (n,3np)

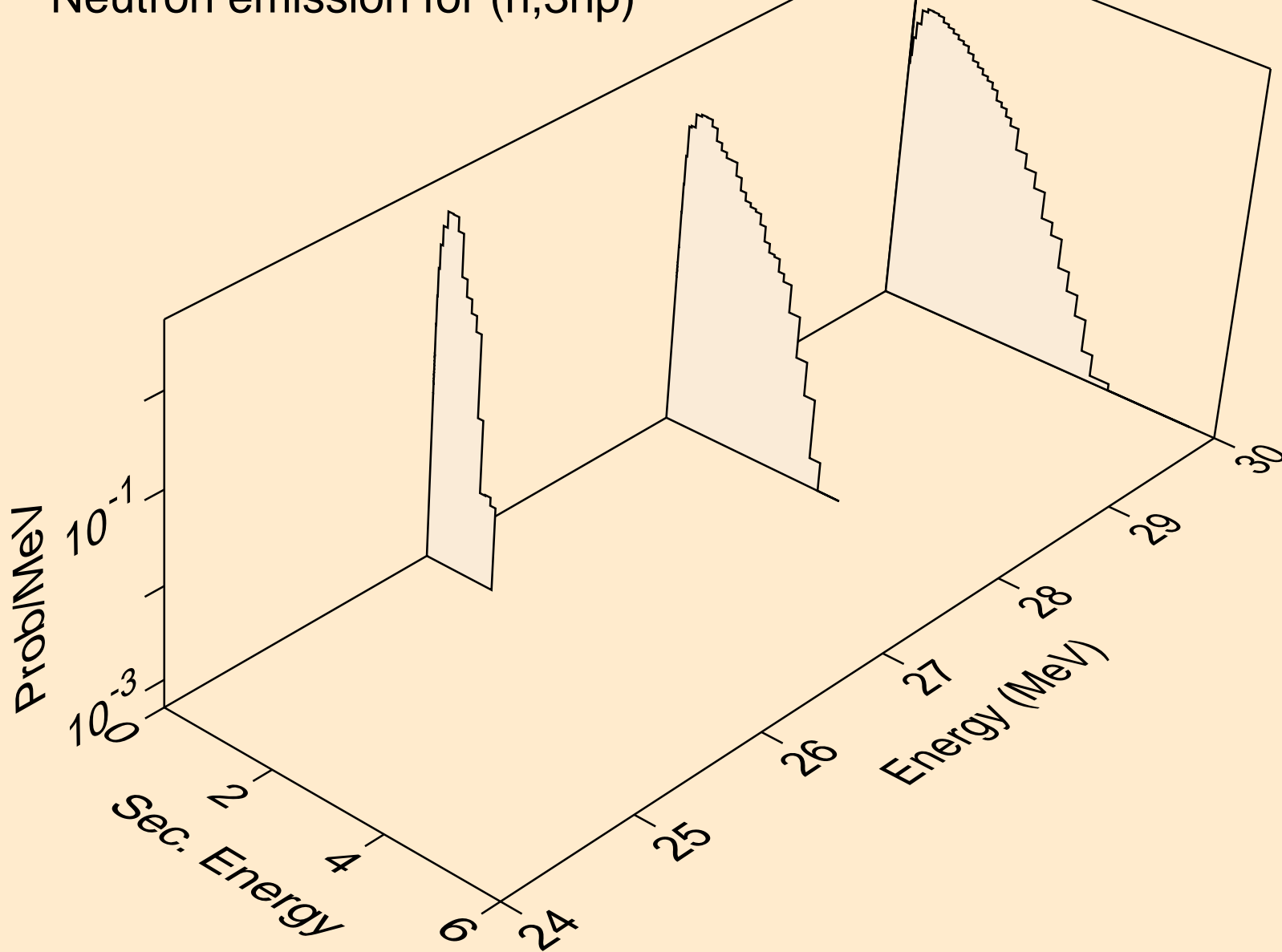

P035 NEUTRON ACER TENDL-2019 LIBRARY; T=293.16K
Neutron emission for (n,n*c)

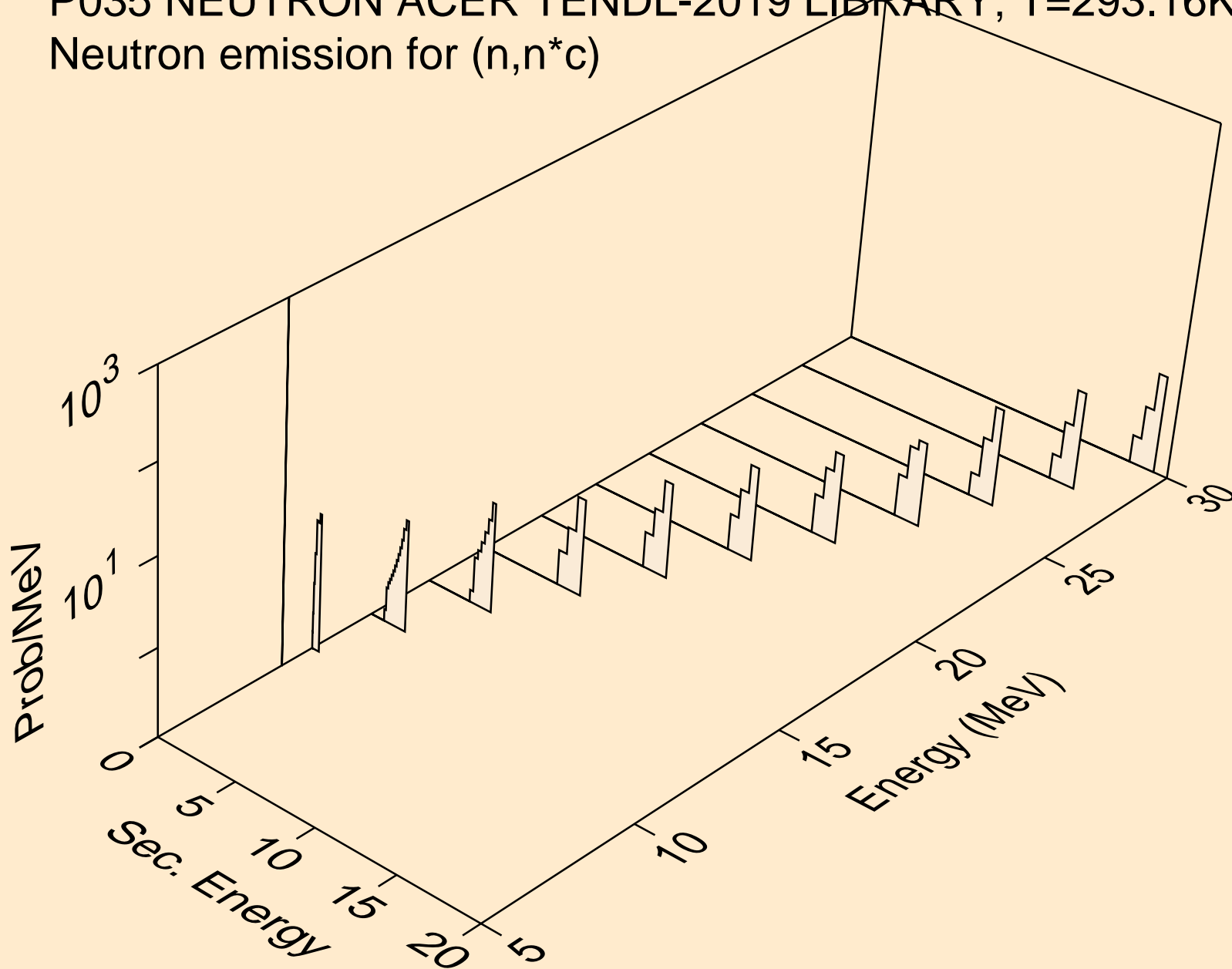

P035 NEUTRON ACER TENDL-2019 LIBRARY; T=293.16K
Photon emission for (n,x)

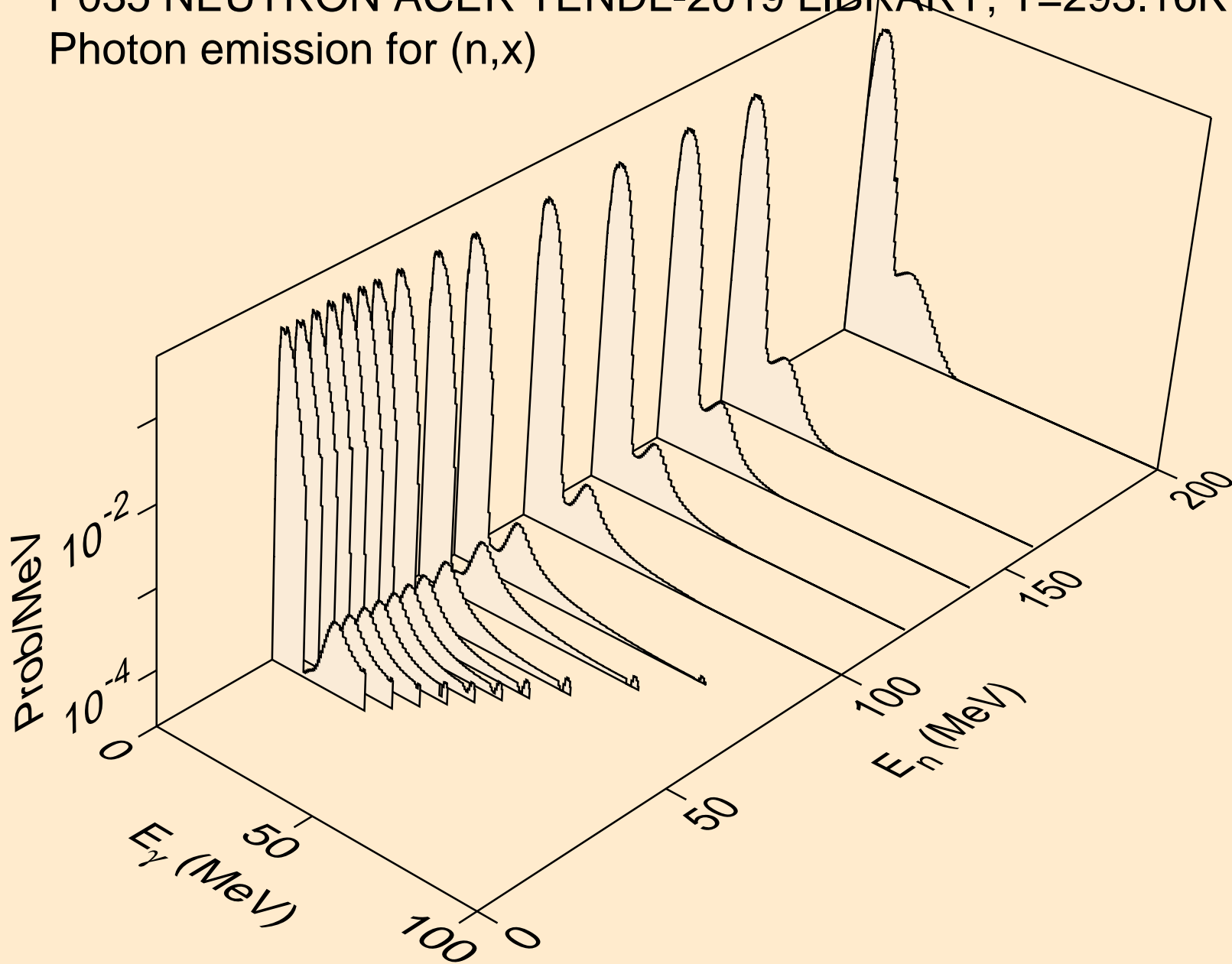

P035 NEUTRON ACER TENDL-2019 LIBRARY; T=293.16K
Photon emission for (n,2nd)

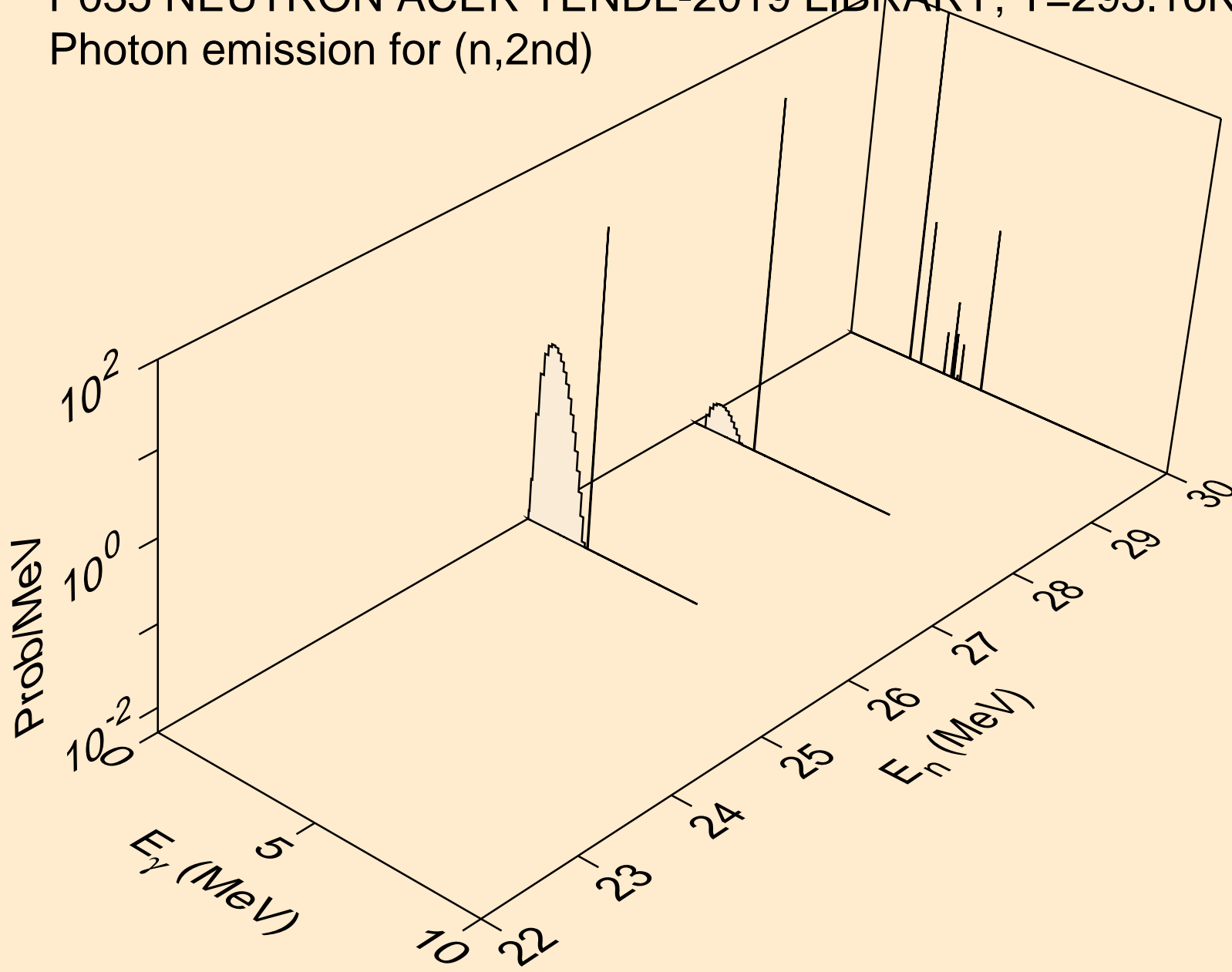

P035 NEUTRON ACER TENDL-2019 LIBRARY; T=293.16K
Photon emission for (n,2n)

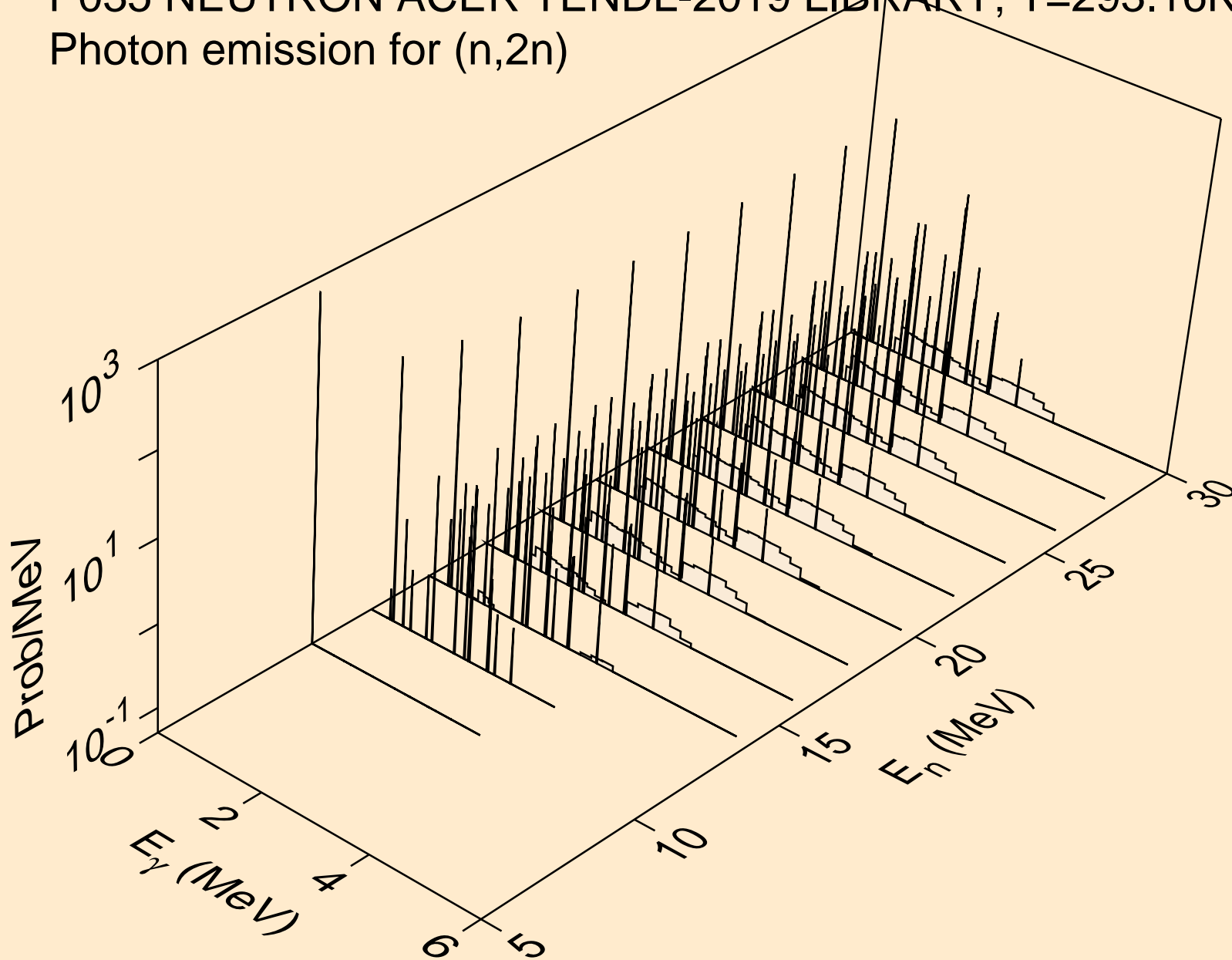

P035 NEUTRON ACER TENDL-2019 LIBRARY; T=293.16K
Photon emission for (n,3n)

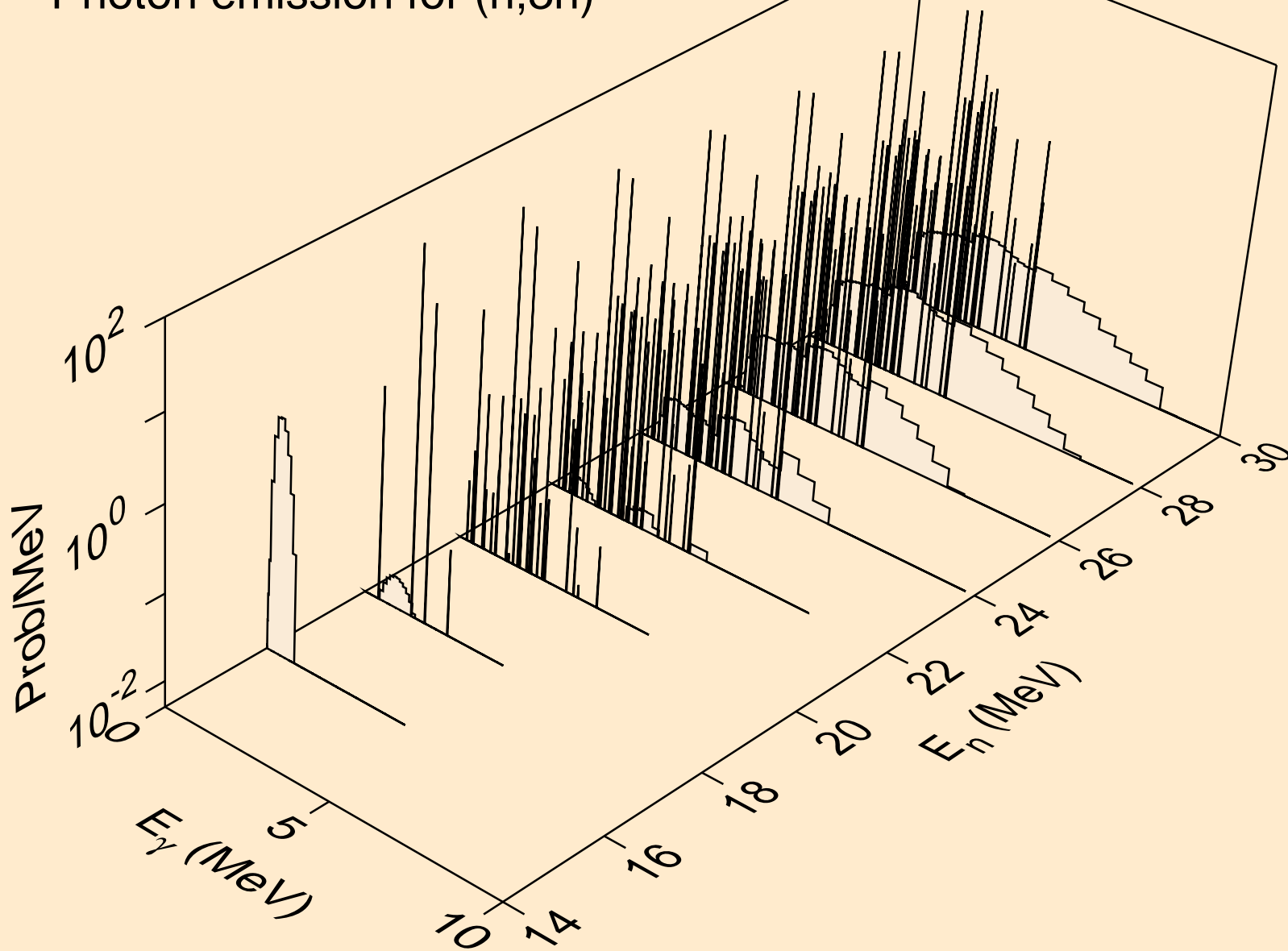

P035 NEUTRON ACER TENDL-2019 LIBRARY; T=293.16K
Photon emission for (n,n*)a

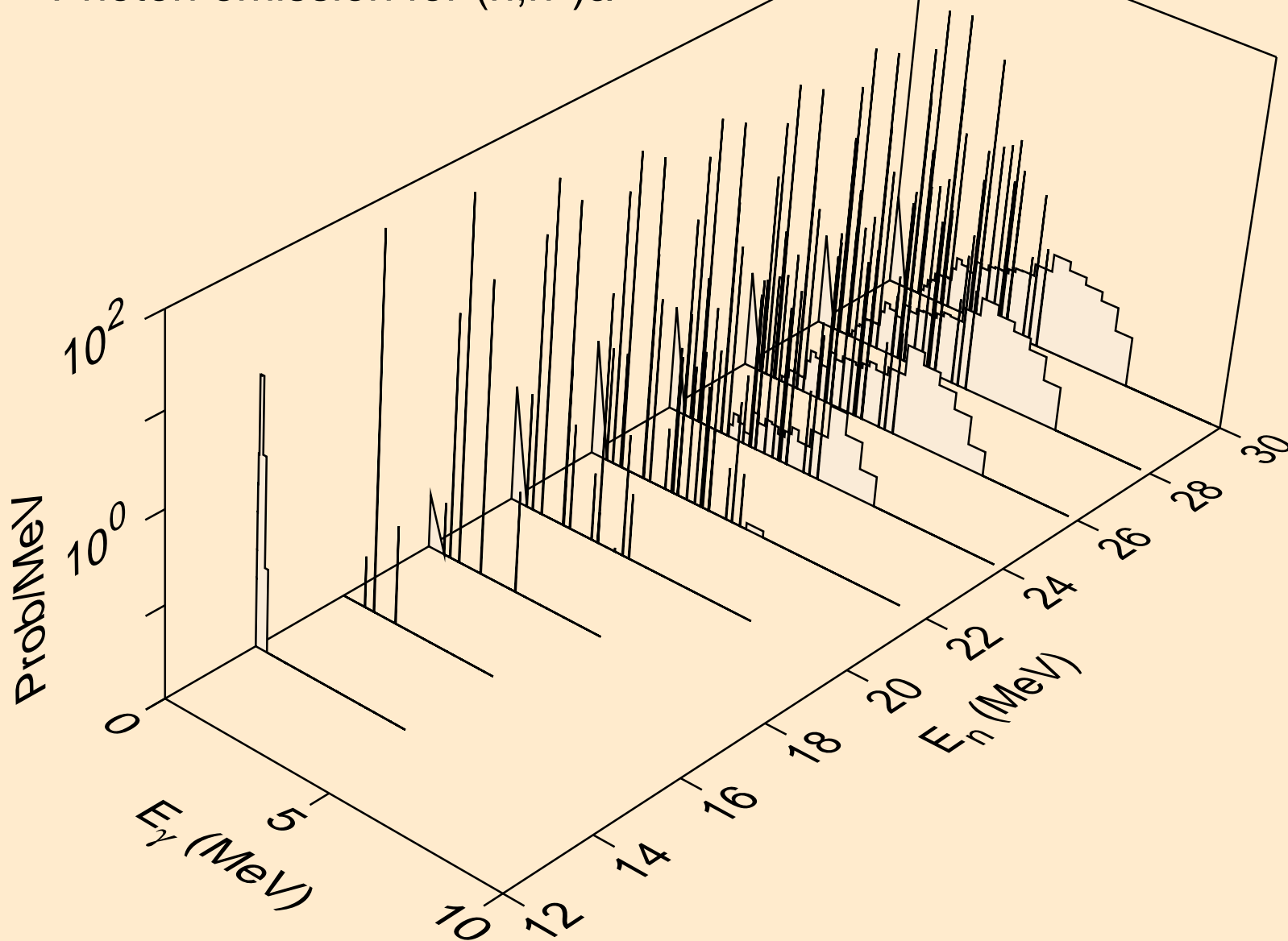

P035 NEUTRON ACER TENDL-2019 LIBRARY; T=293.16K
Photon emission for (n,2n)a

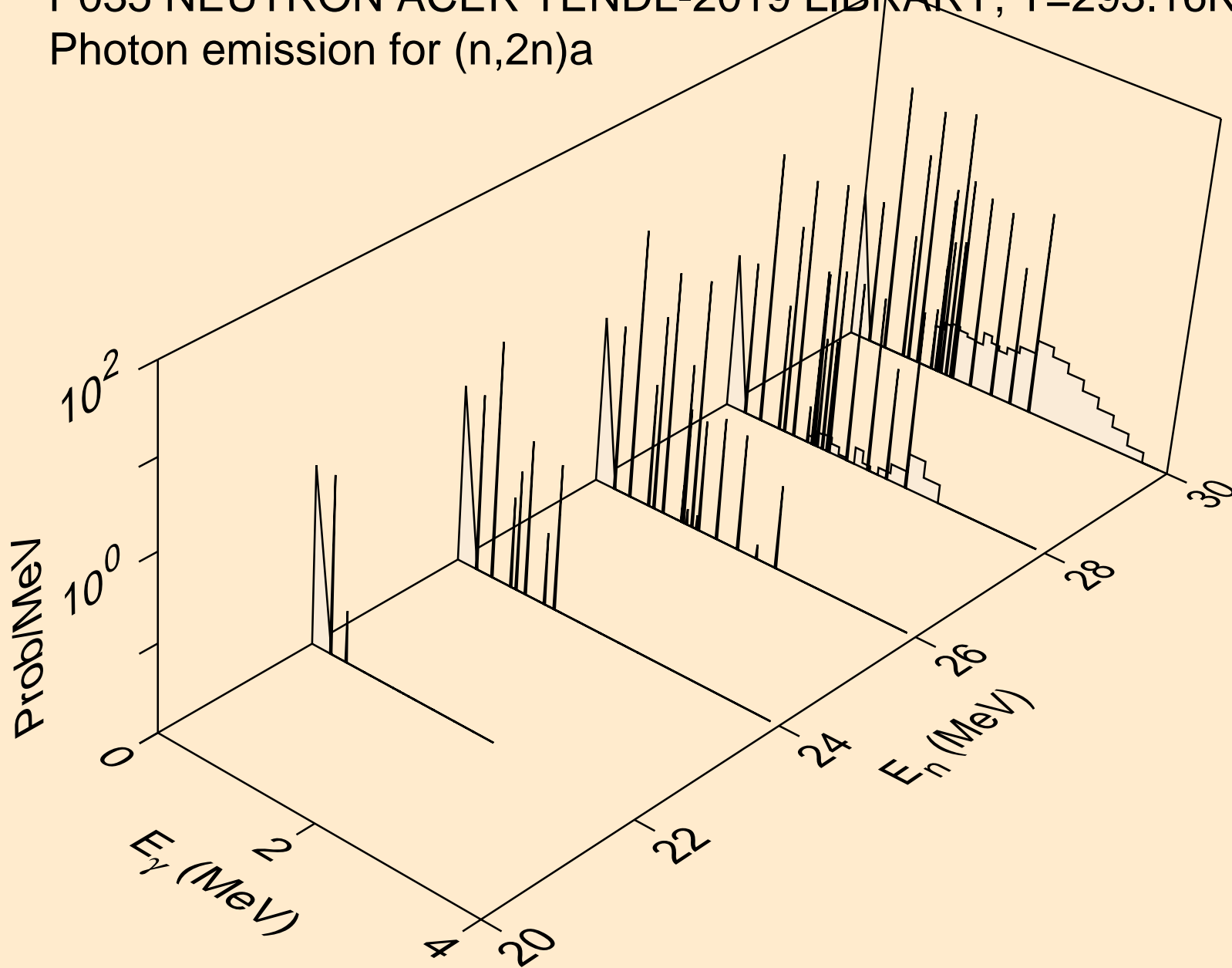

P035 NEUTRON ACER TENDL-2019 LIBRARY; T=293.16K
Photon emission for (n,3n)a

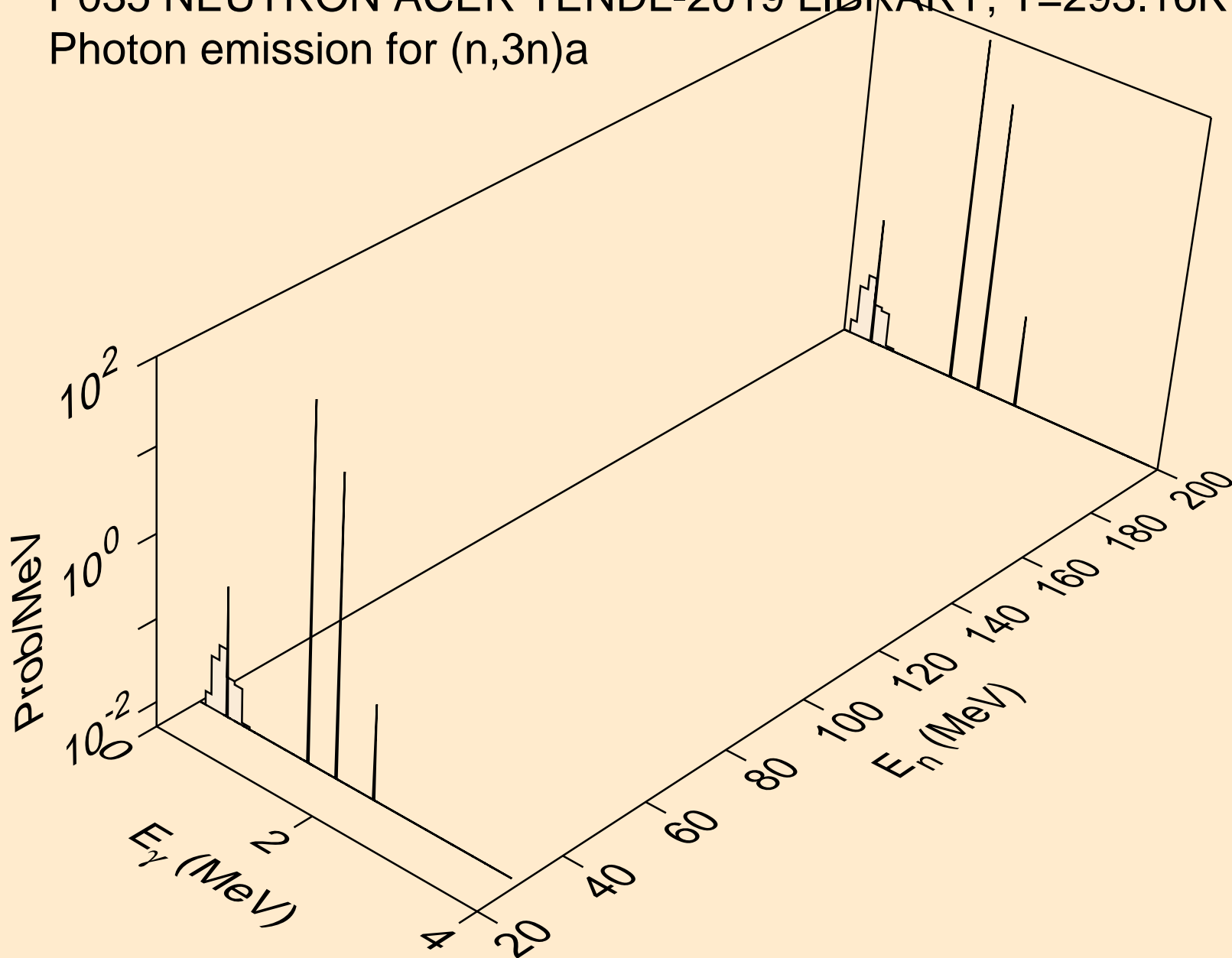

P035 NEUTRON ACER TENDL-2019 LIBRARY; T=293.16K
Photon emission for (n,n*)p

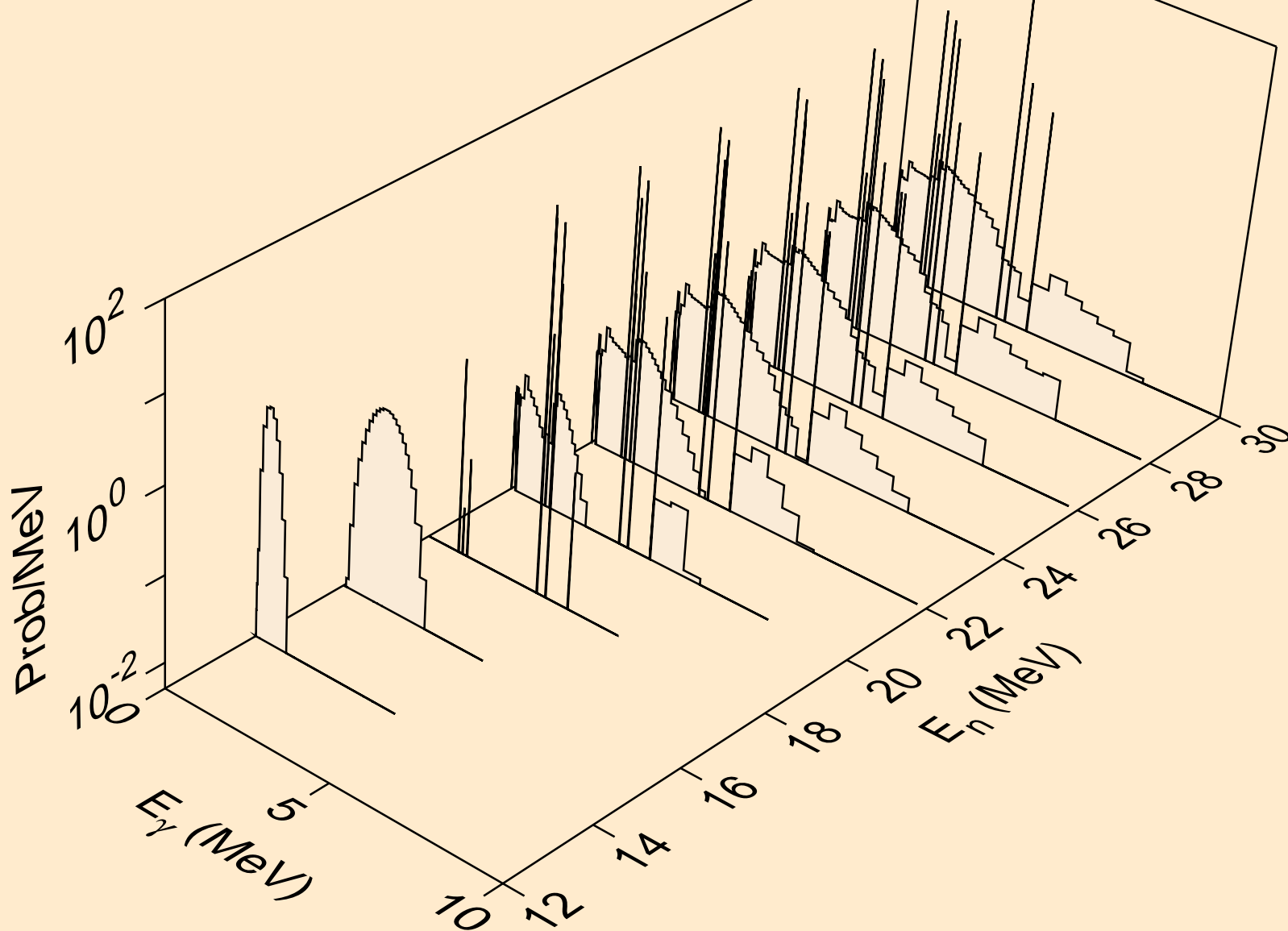

P035 NEUTRON ACER TENDL-2019 LIBRARY; T=293.16K
Photon emission for (n,n*)d

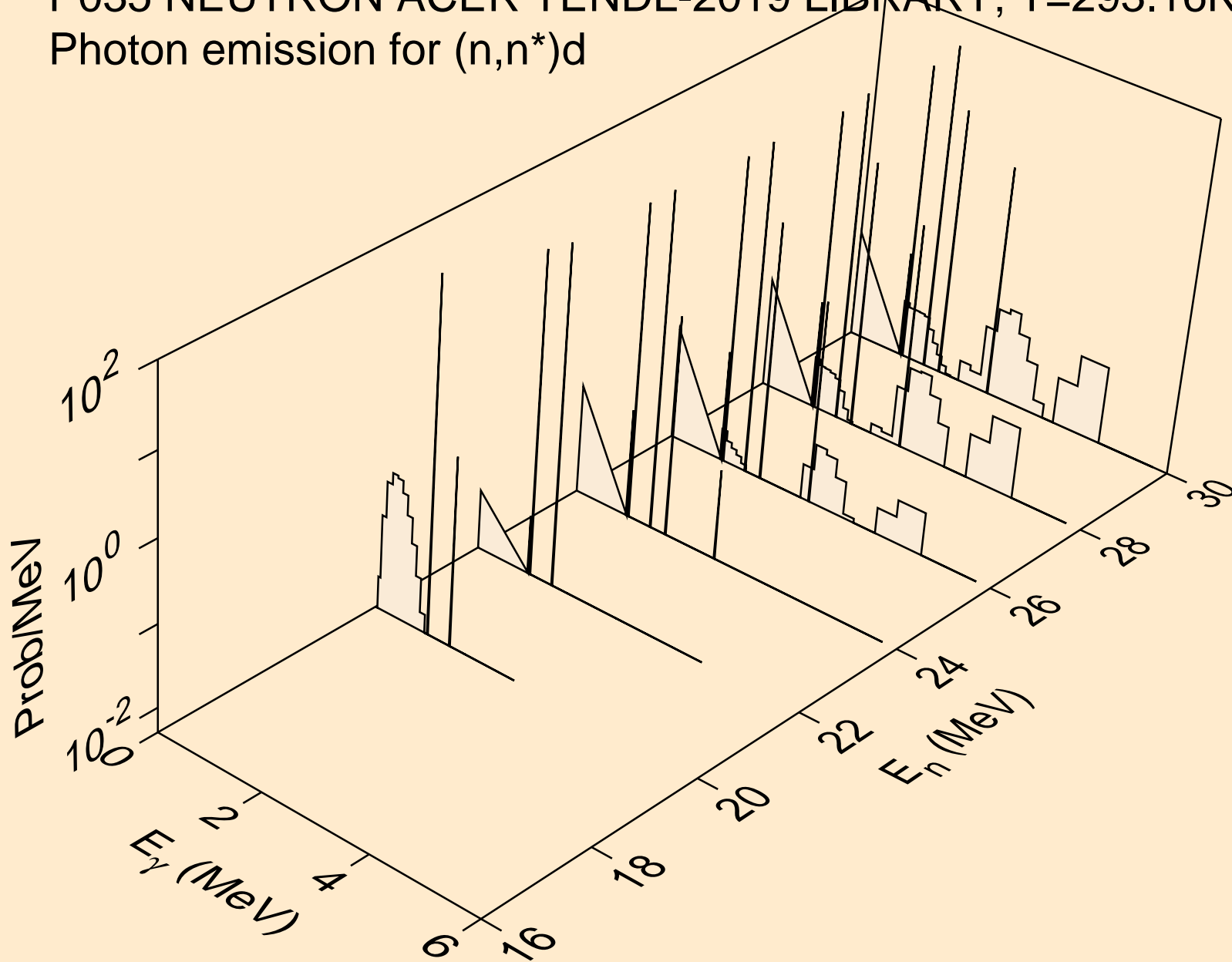

P035 NEUTRON ACER TENDL-2019 LIBRARY; T=293.16K
Photon emission for (n,n*)t

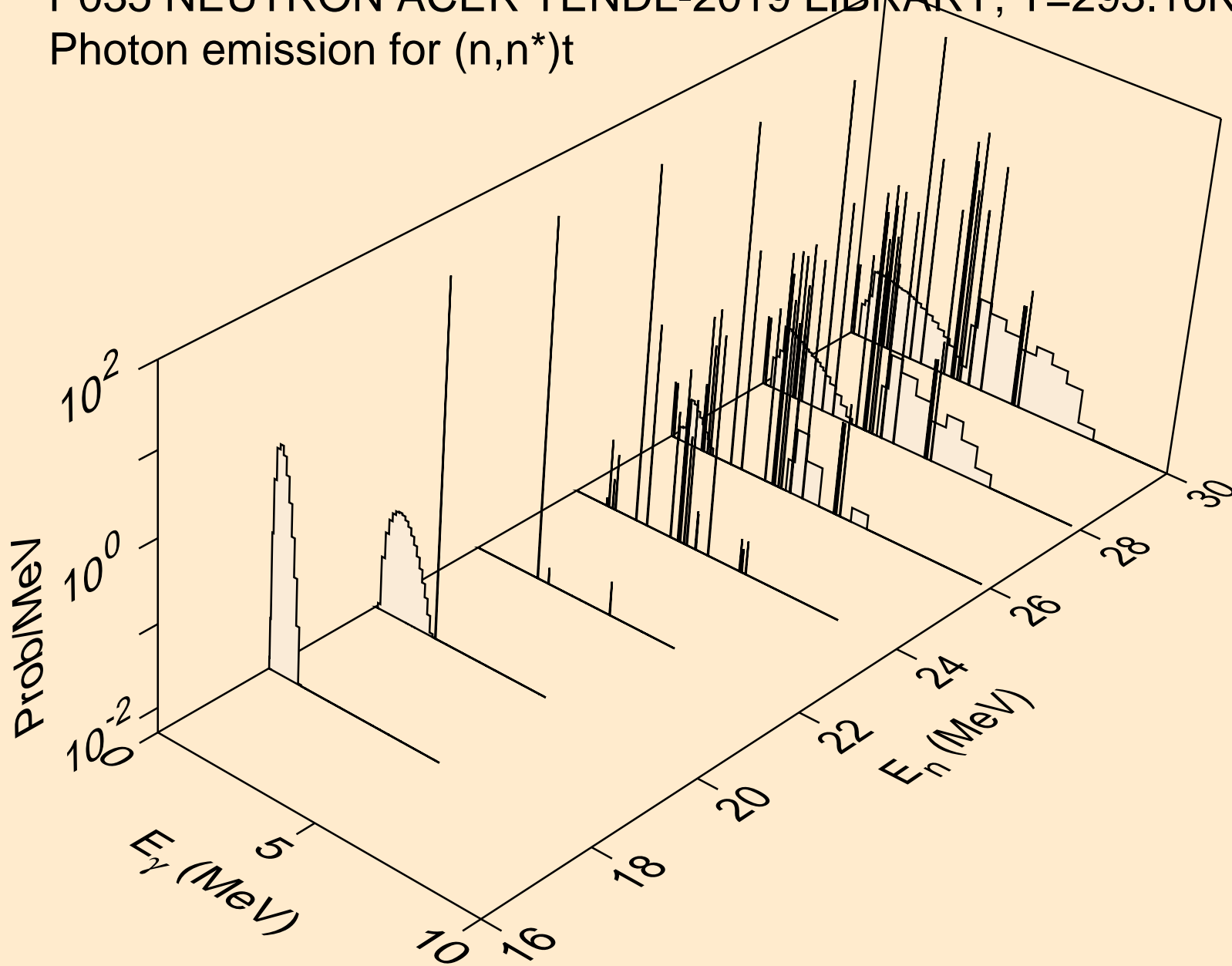

P035 NEUTRON ACER TENDL-2019 LIBRARY; T=293.16K
Photon emission for (n,4n)

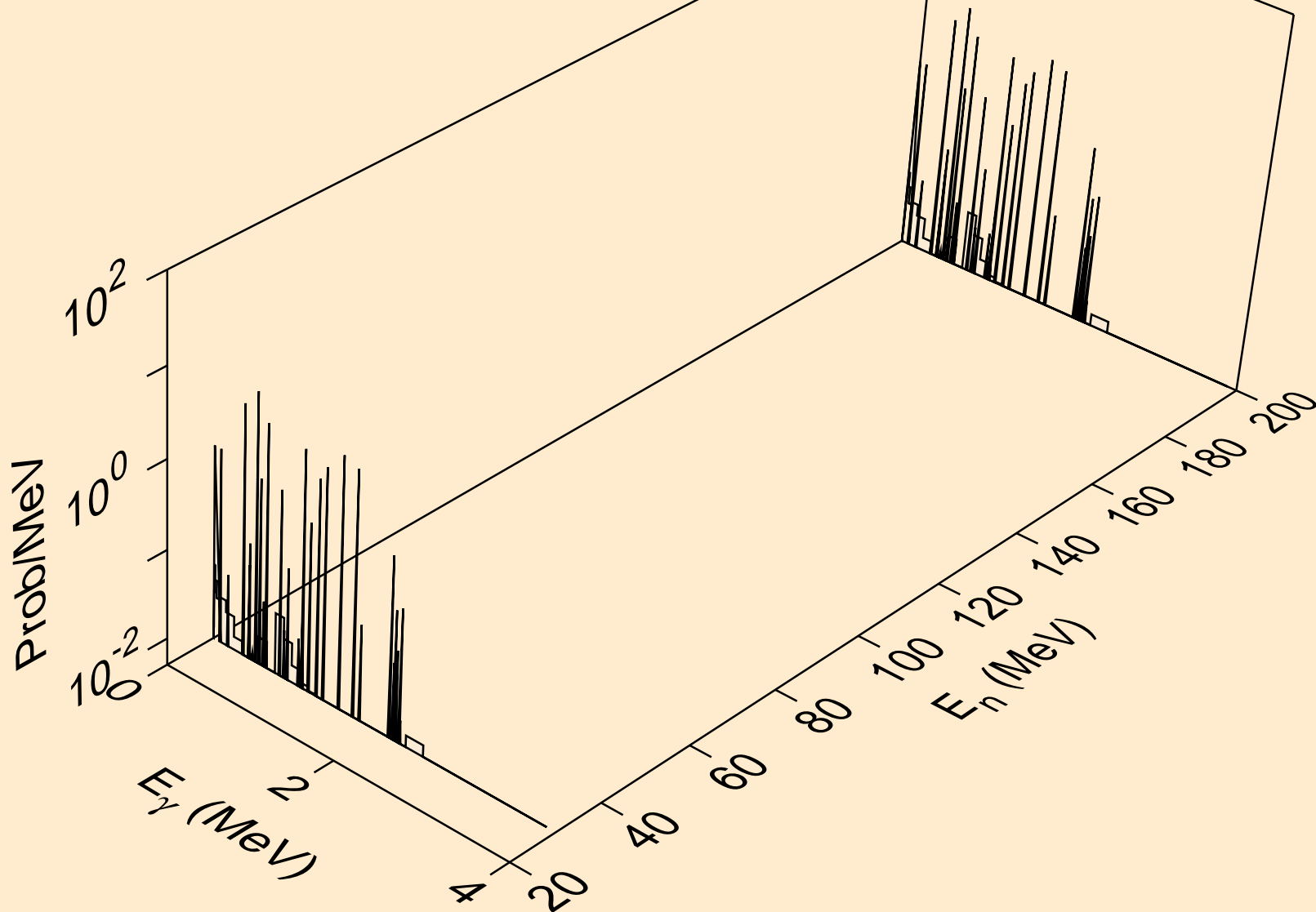

P035 NEUTRON ACER TENDL-2019 LIBRARY; T=293.16K
Photon emission for (n,2np)

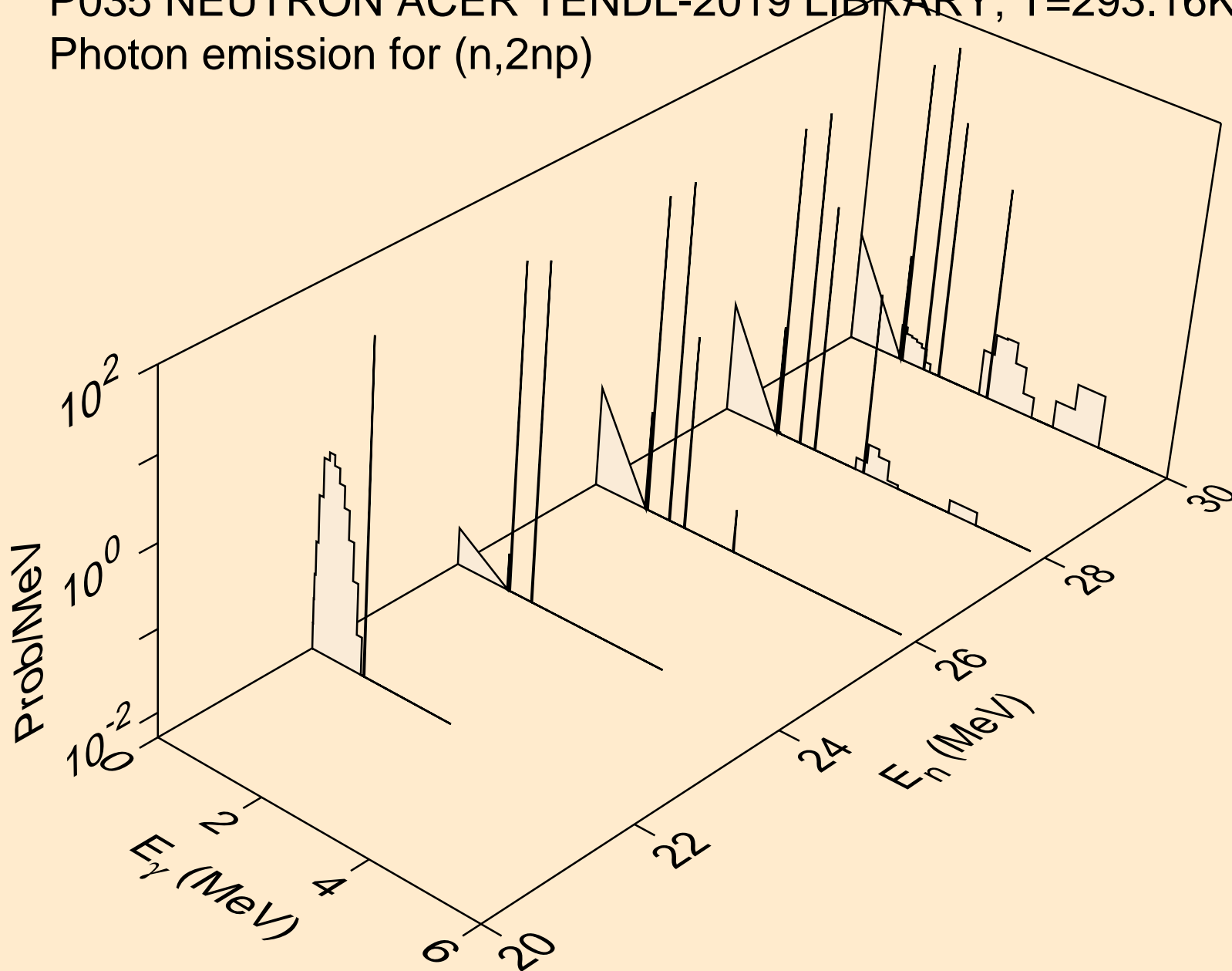

P035 NEUTRON ACER TENDL-2019 LIBRARY; T=293.16K
Photon emission for (n,3np)

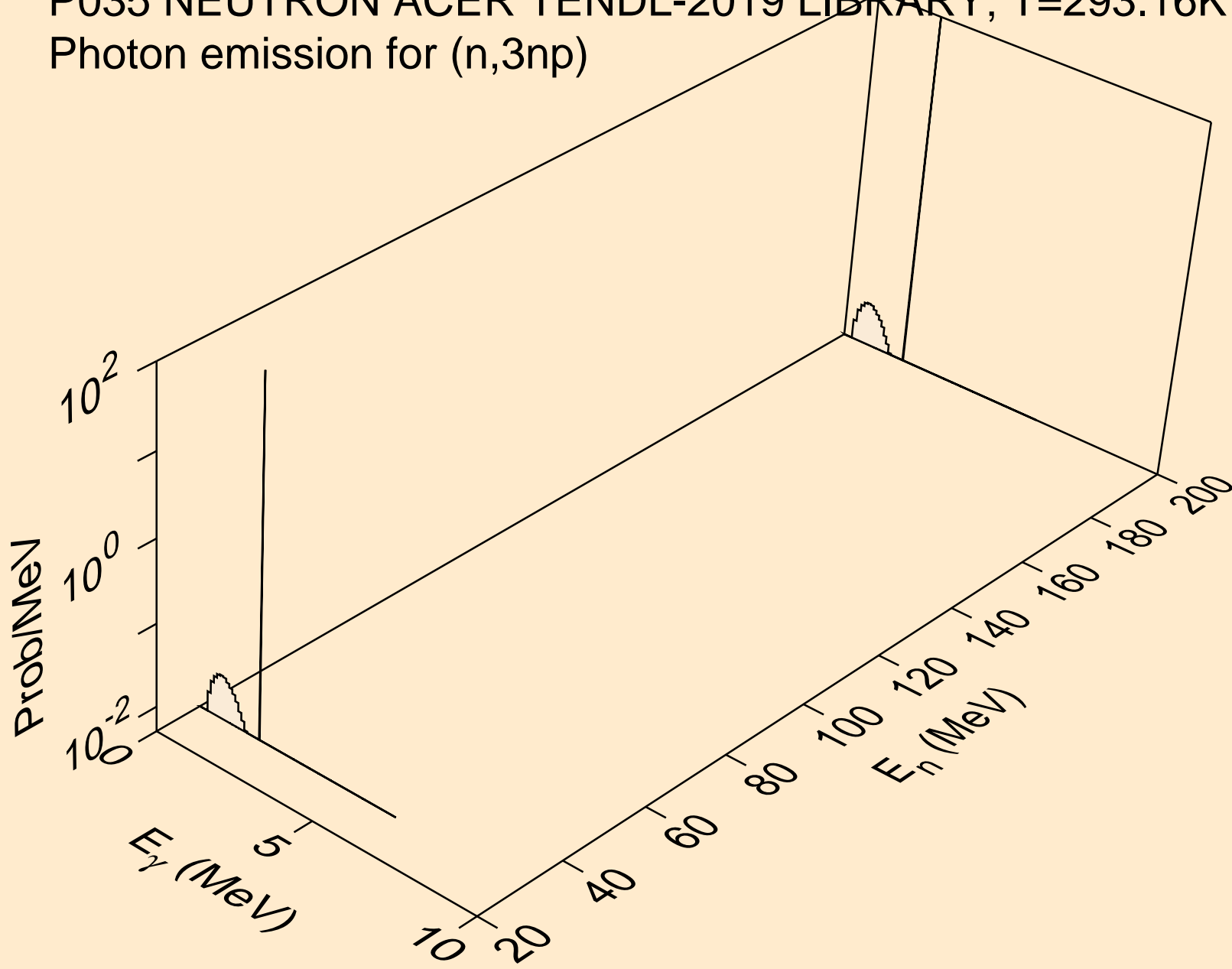

P035 NEUTRON ACER TENDL-2019 LIBRARY; T=293.16K
Photon emission for (n,n*c)

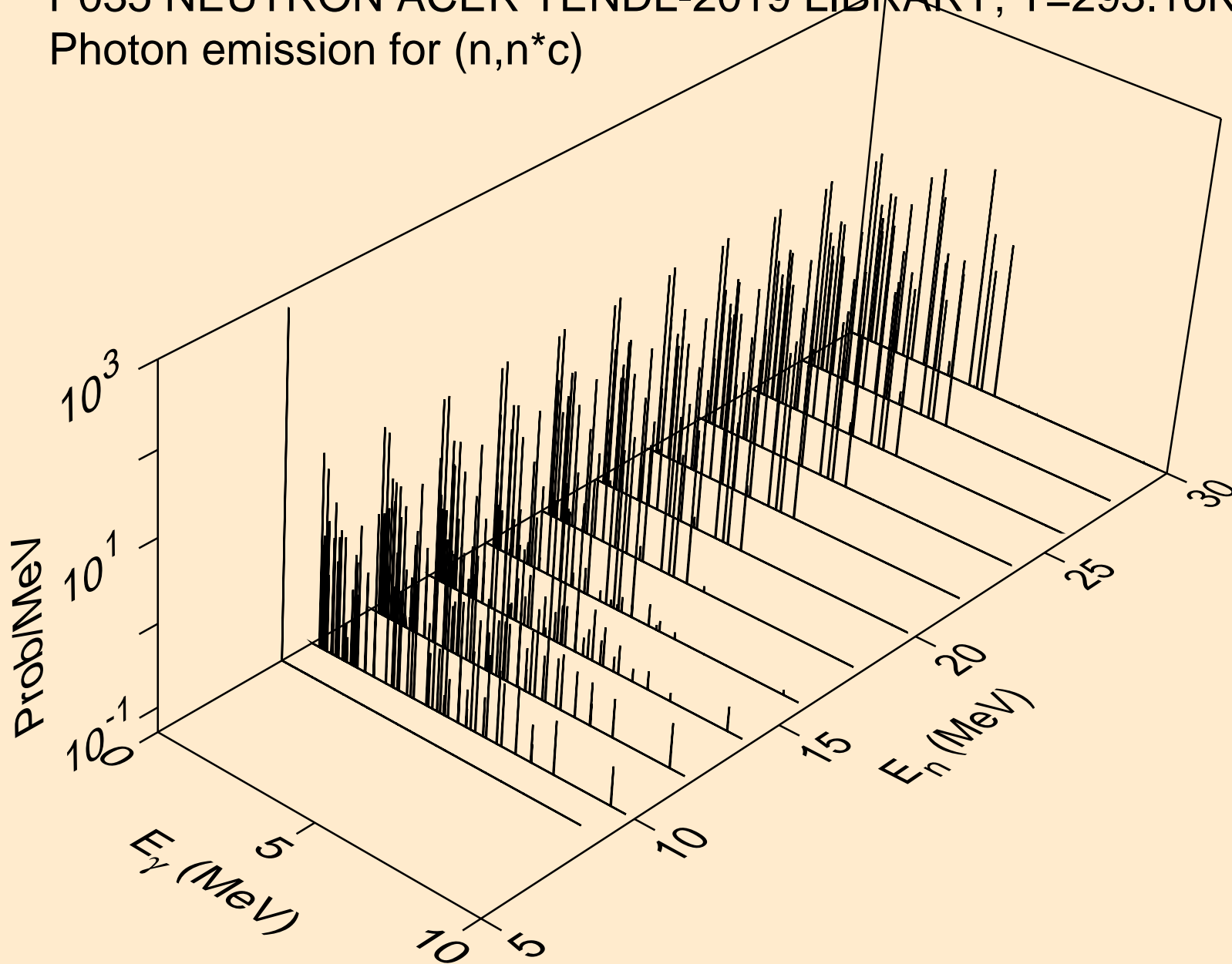

P035 NEUTRON ACER TENDL-2019 LIBRARY; T=293.16K
Photon emission for (n,gma)

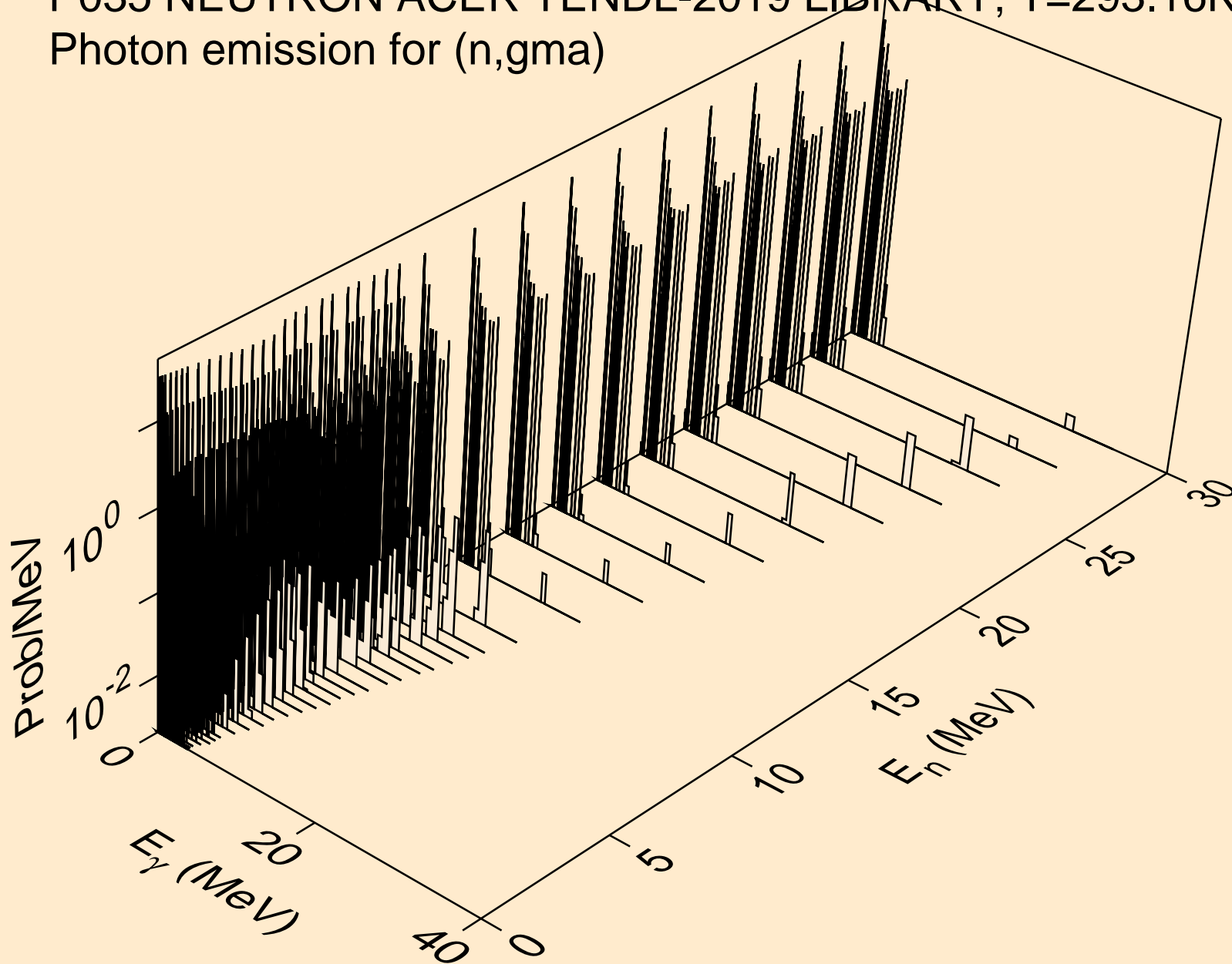

P035 NEUTRON ACER TENDL-2019 LIBRARY; T=293.16K
Photon emission for (n,p)

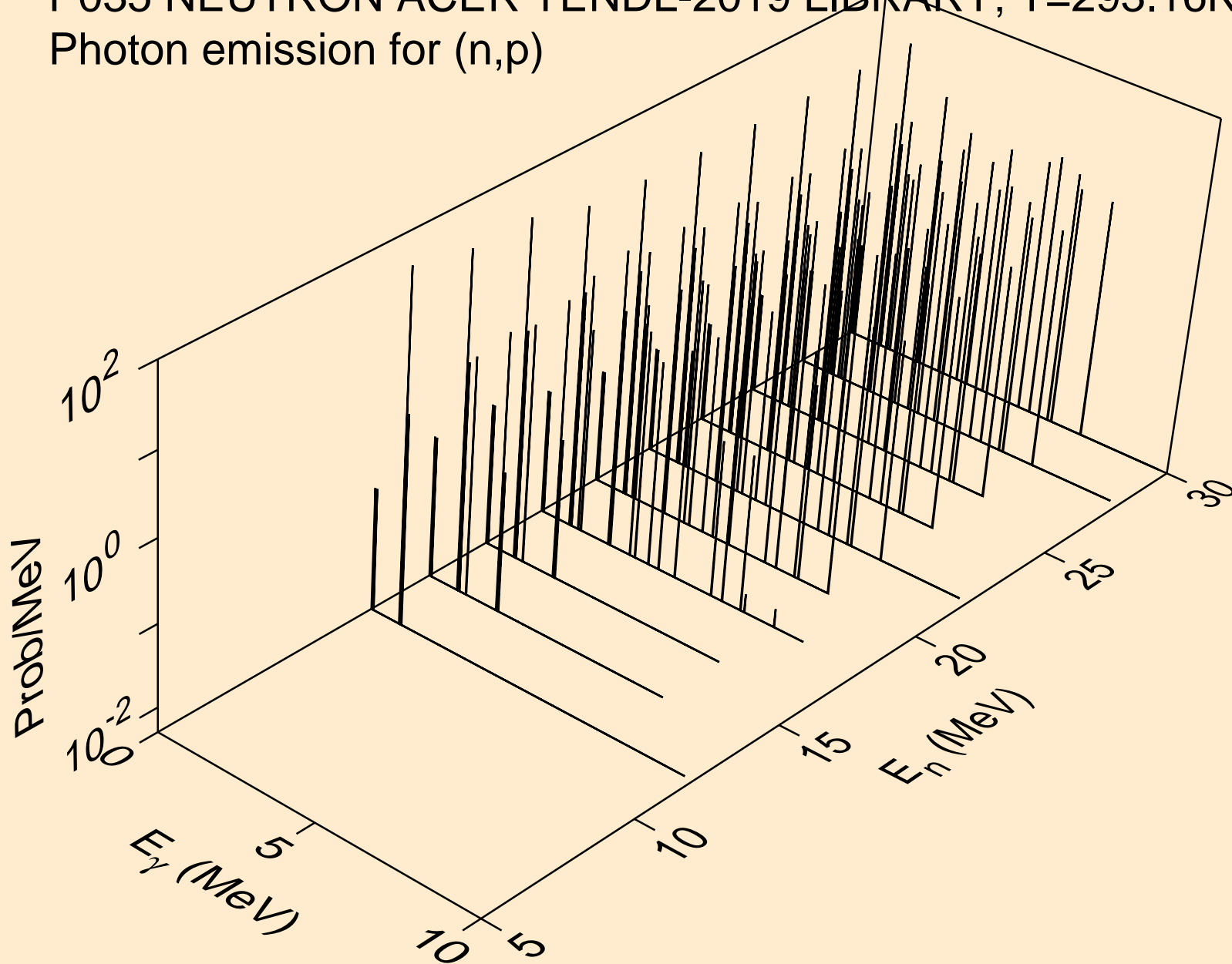

P035 NEUTRON ACER TENDL-2019 LIBRARY; T=293.16K
Photon emission for (n,d)

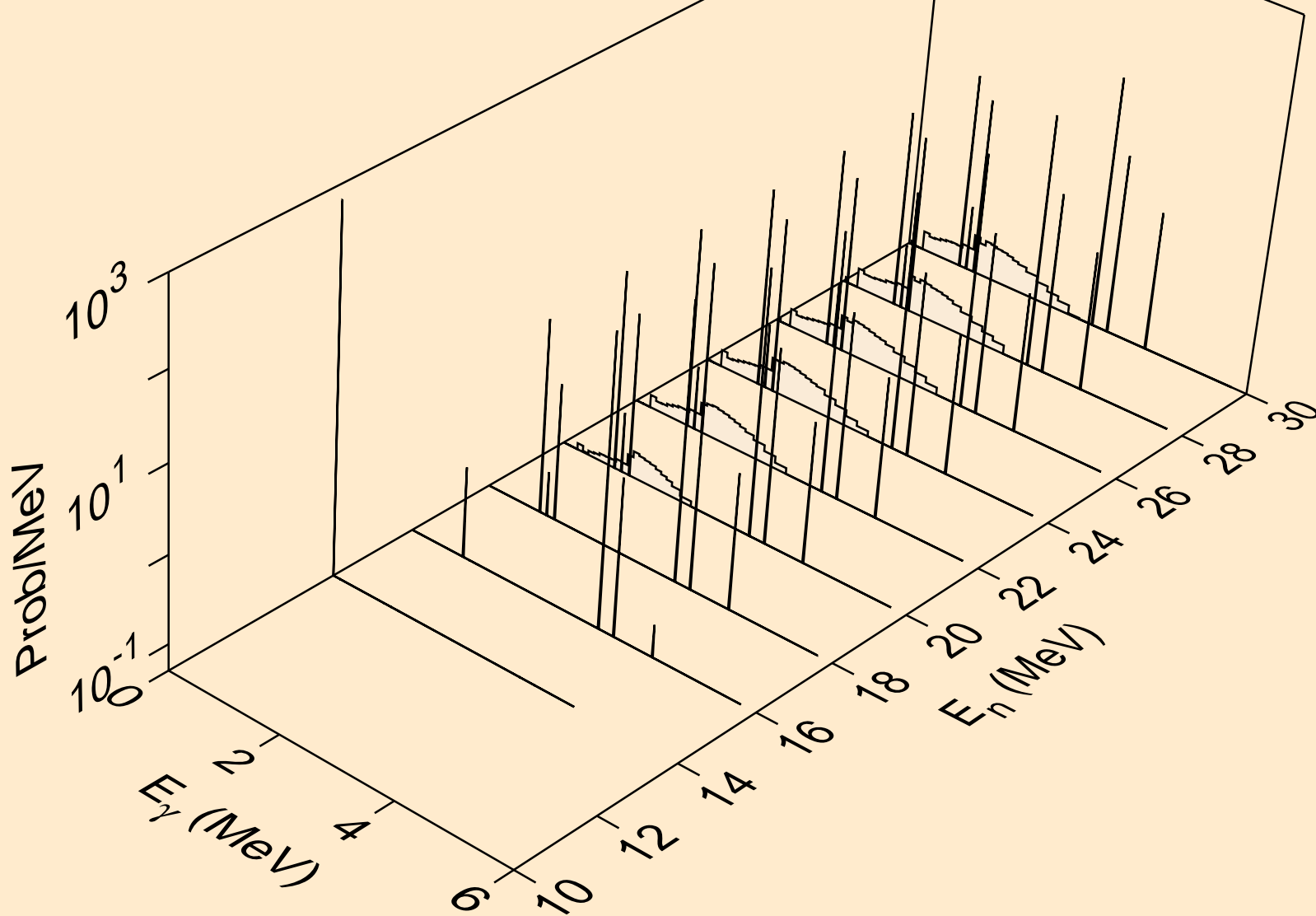

P035 NEUTRON ACER TENDL-2019 LIBRARY; T=293.16K
Photon emission for (n,t)

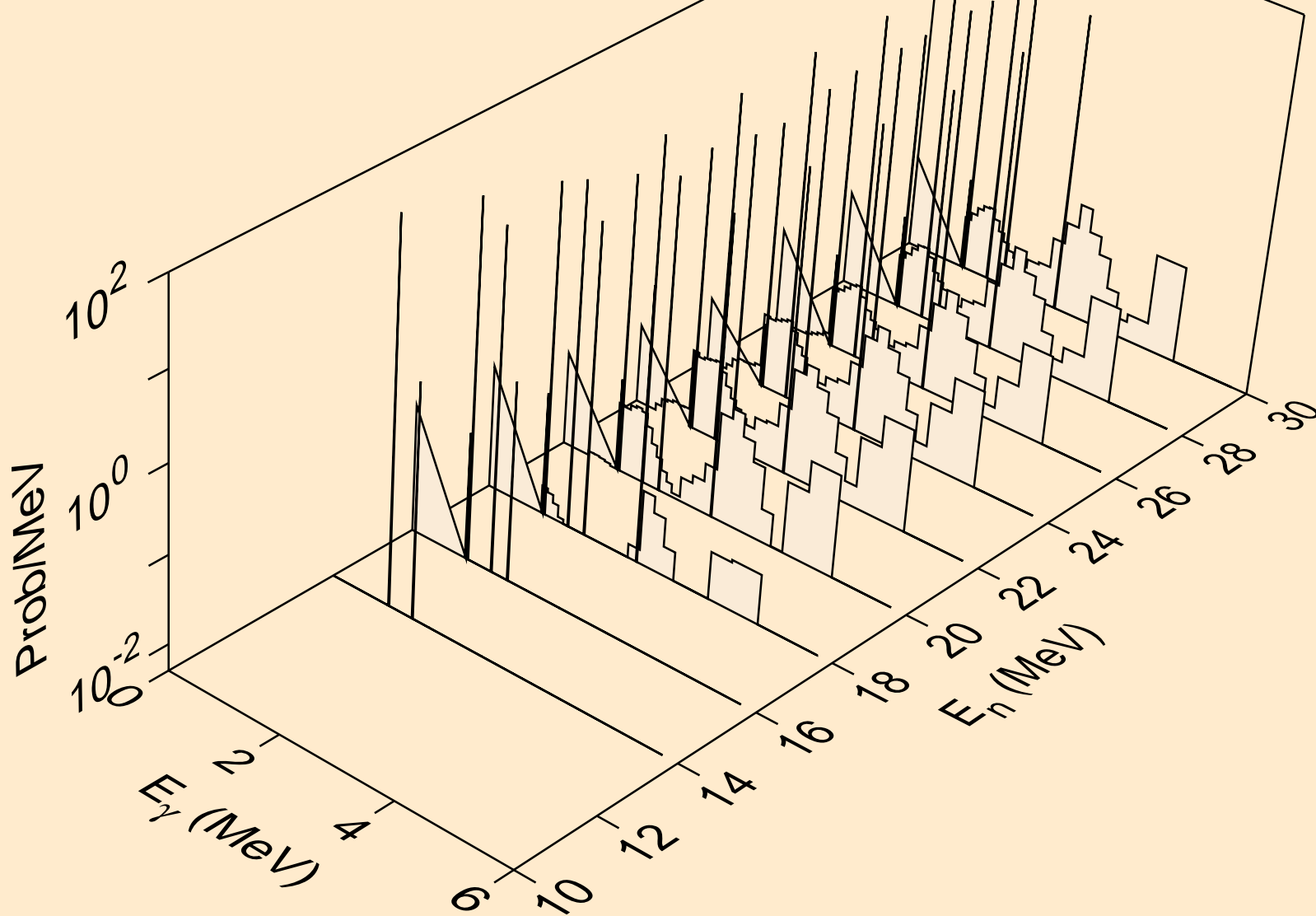

P035 NEUTRON ACER TENDL-2019 LIBRARY; T=293.16K
Photon emission for (n,he3)

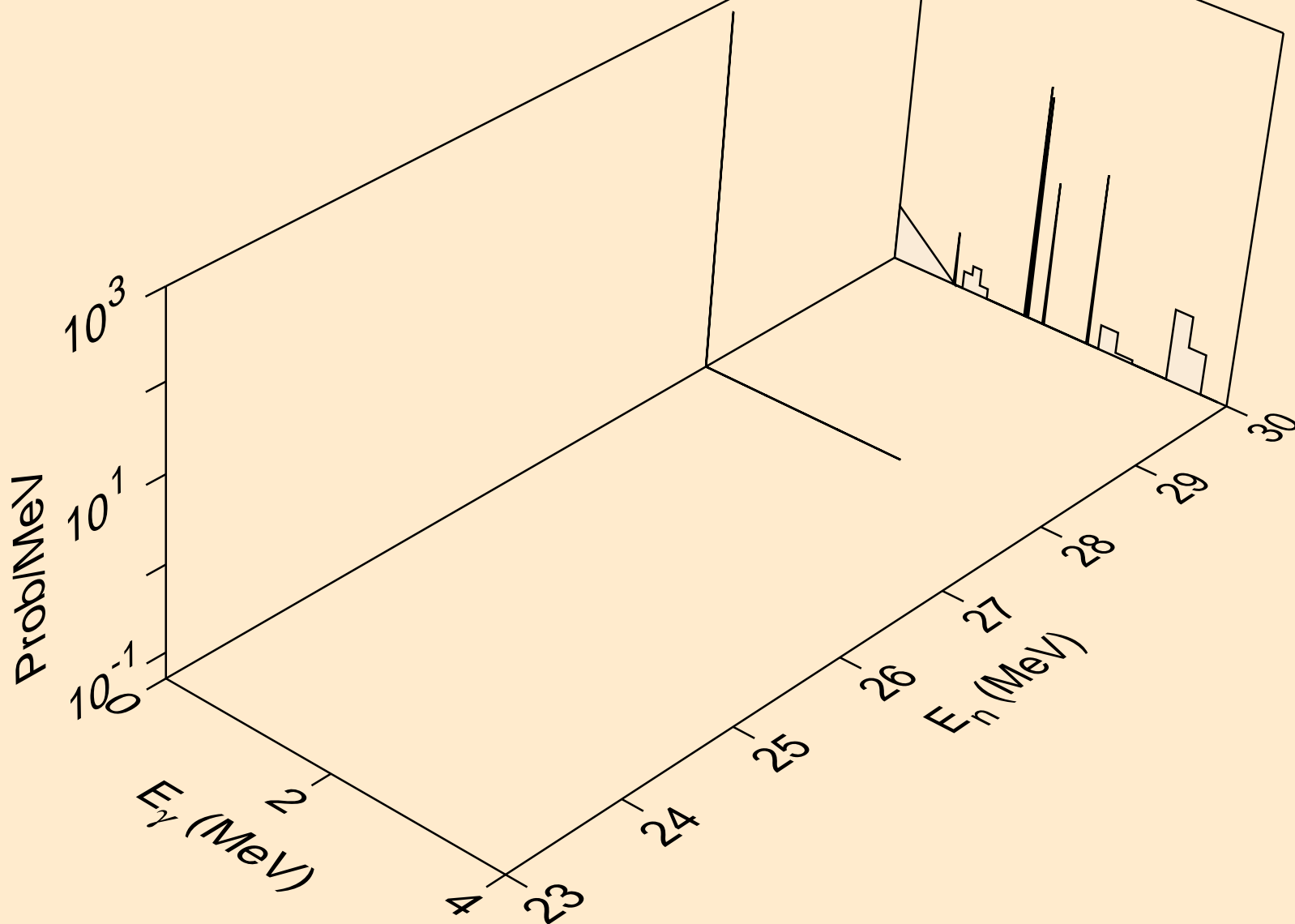

P035 NEUTRON ACER TENDL-2019 LIBRARY; T=293.16K
Photon emission for (n,a)

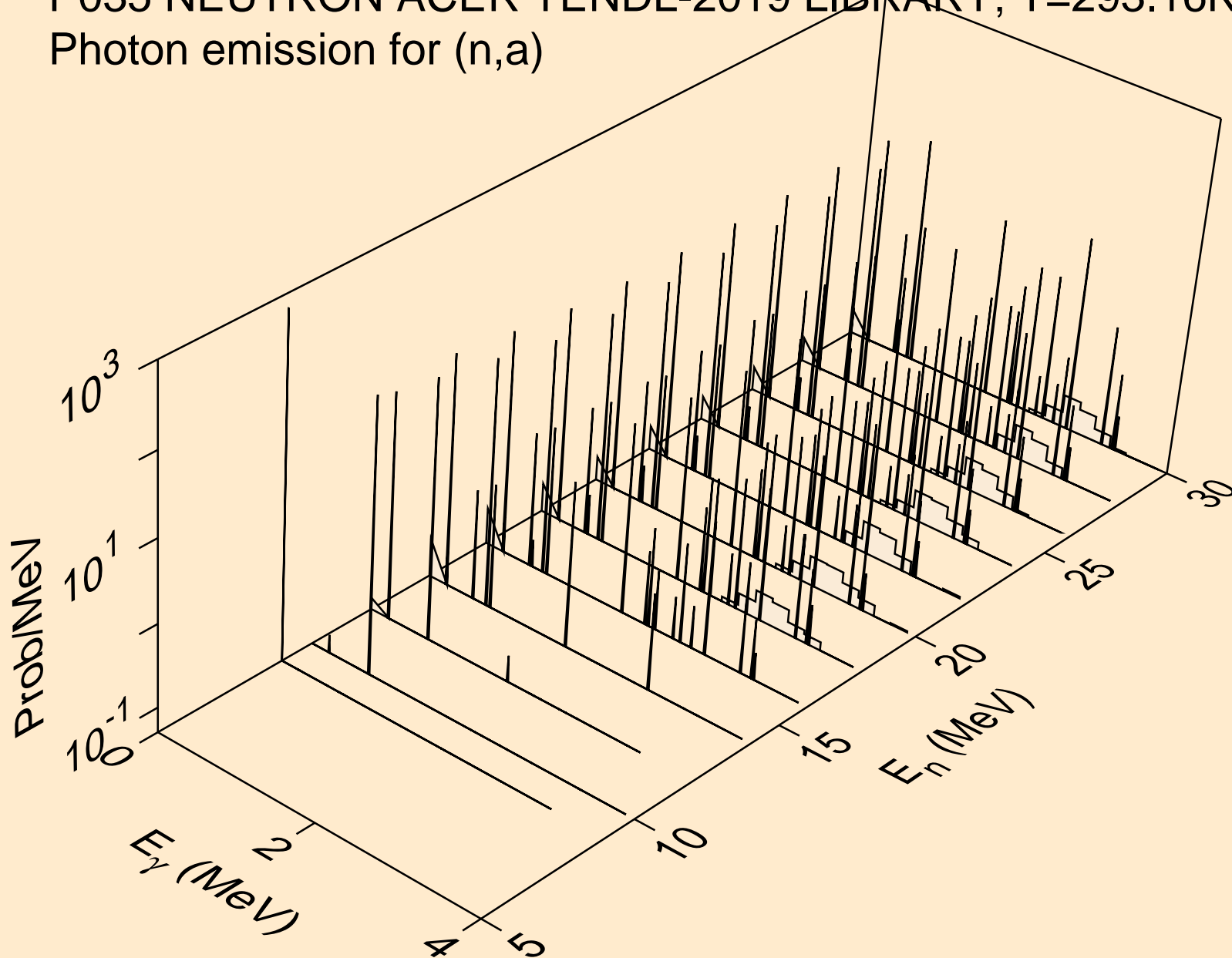

P035 NEUTRON ACER TENDL-2019 LIBRARY; T=293.16K
Photon emission for (n,2a)

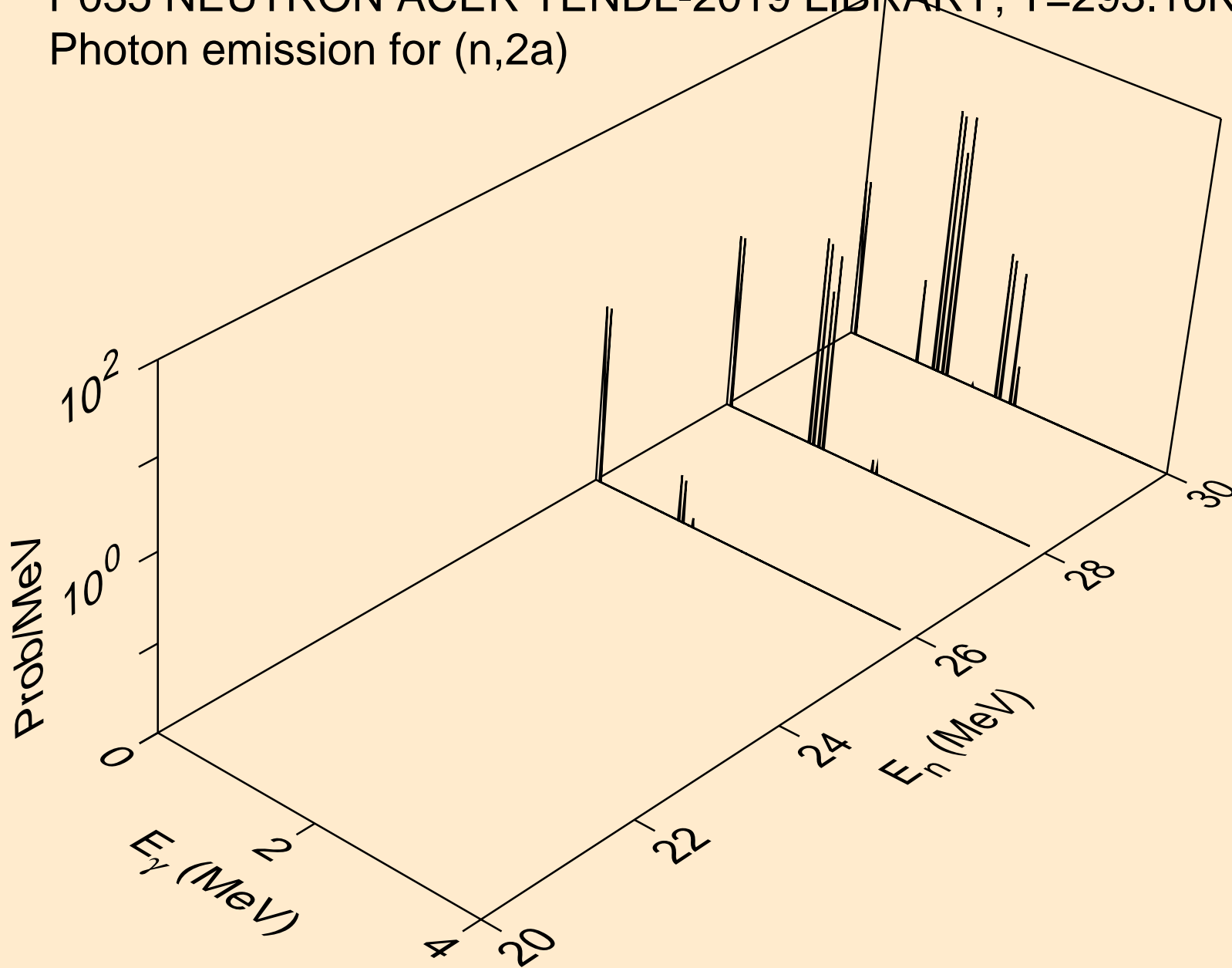

P035 NEUTRON ACER TENDL-2019 LIBRARY; T=293.16K
Photon emission for (n,p)

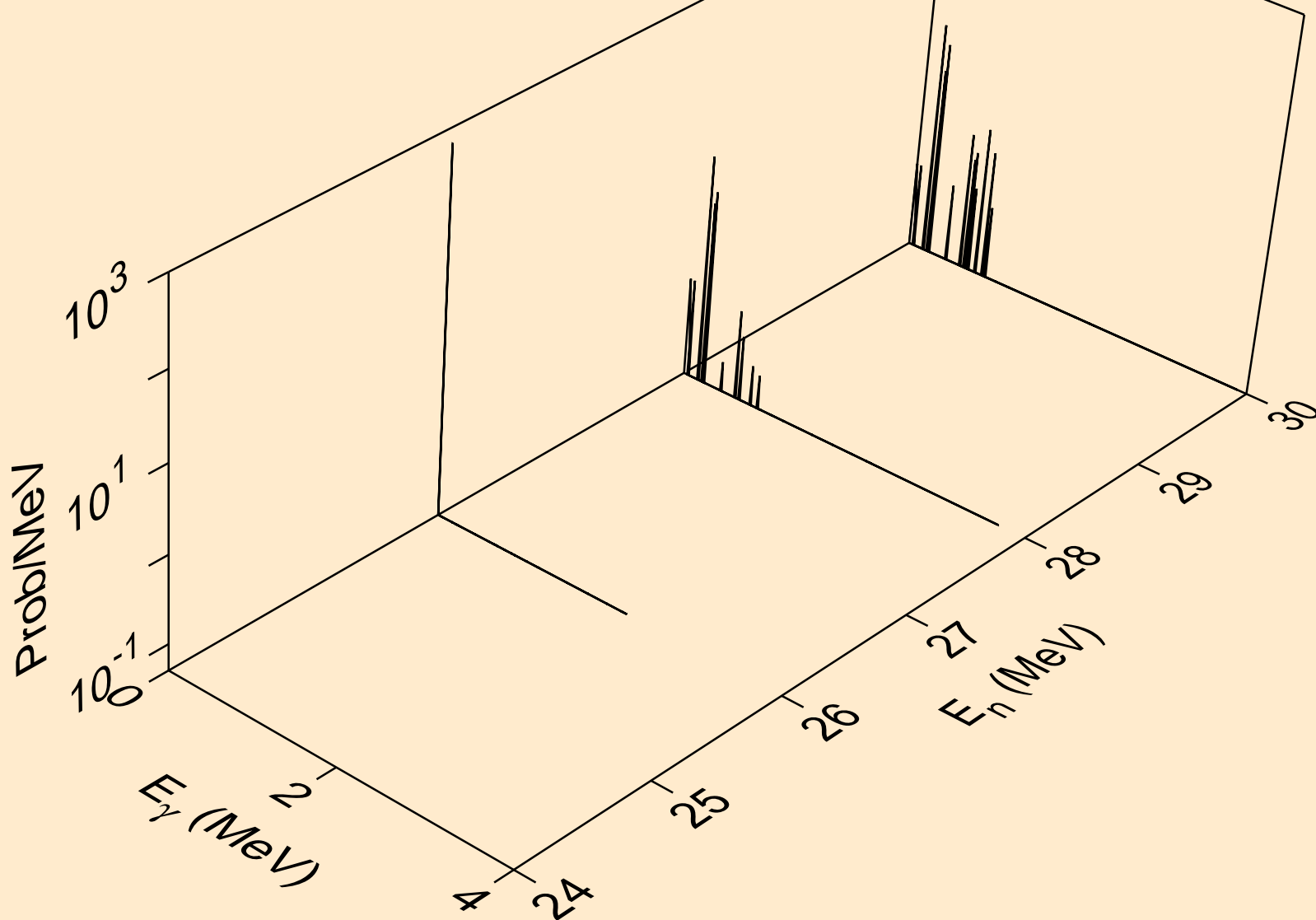

P035 NEUTRON ACER TENDL-2019 LIBRARY; T=293.16K
Photon emission for (n,da)

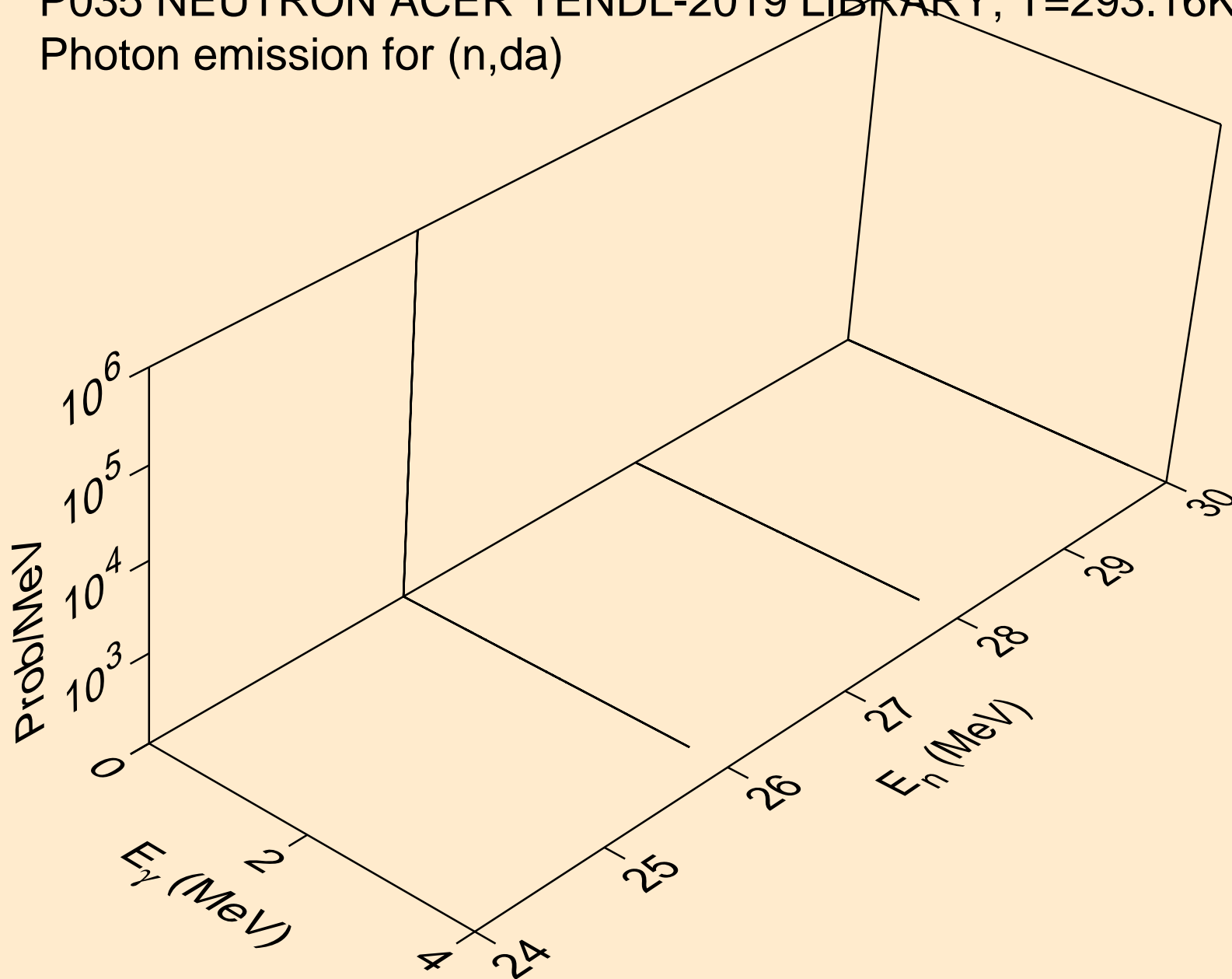

P035 NEUTRON ACER TENDL-2019 LIBRARY; T=293.16K
thermal capture photon spectrum

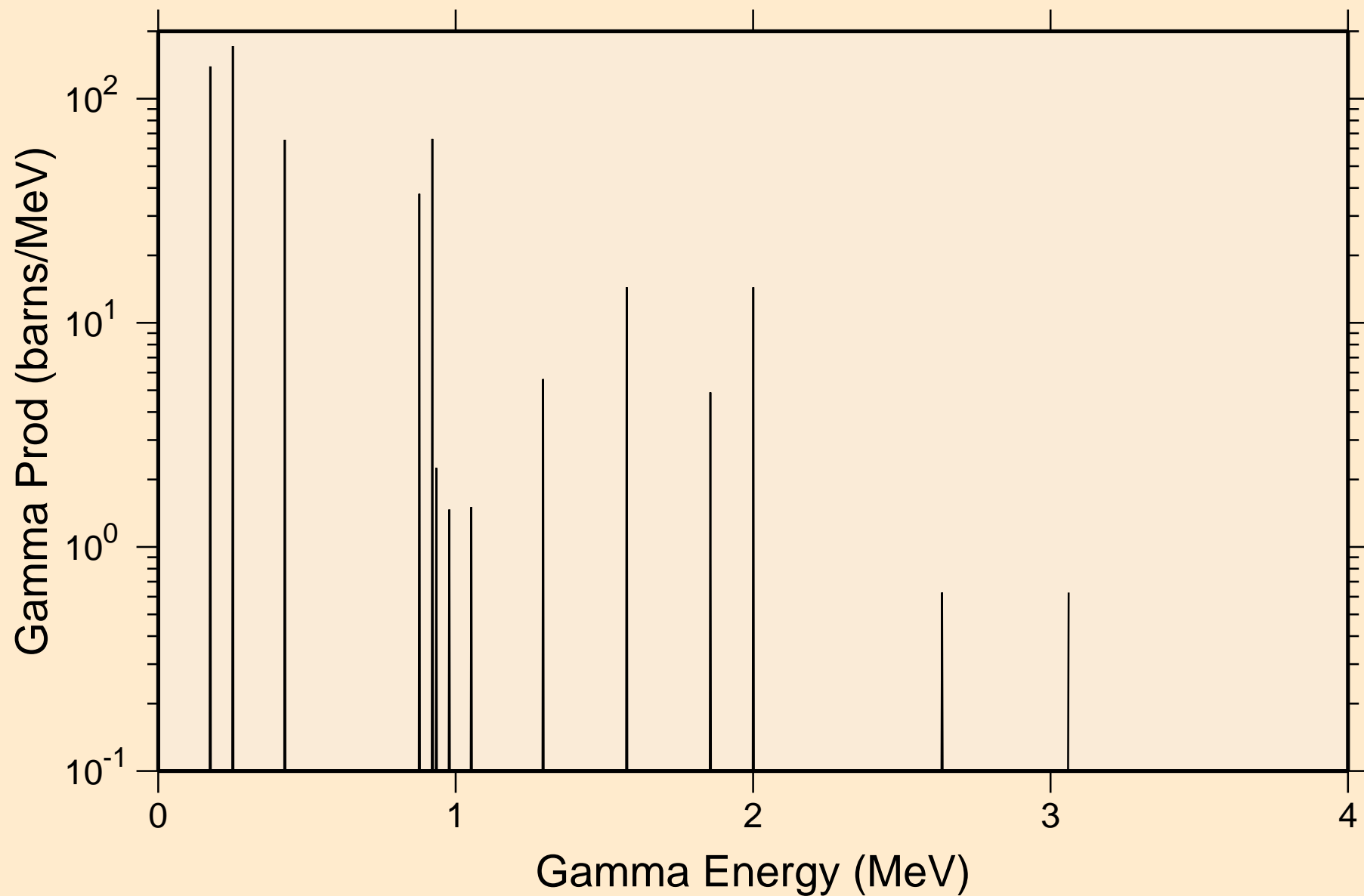

P035 NEUTRON ACER TENDL-2019 LIBRARY; T=293.16K
14 MeV photon spectrum

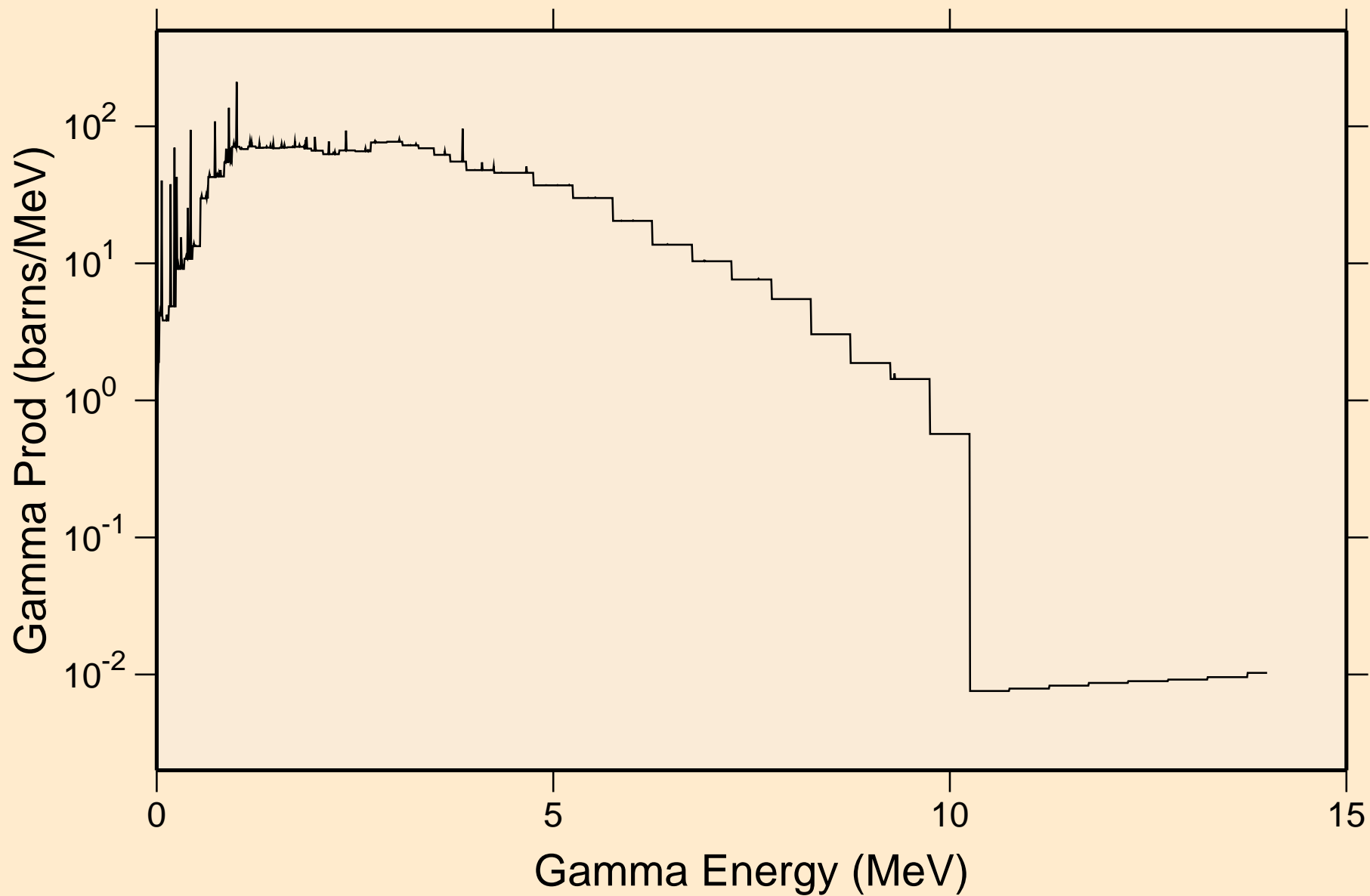

P035 NEUTRON ACER TENDL-2019 LIBRARY; T=293.16K
Particle heating contributions

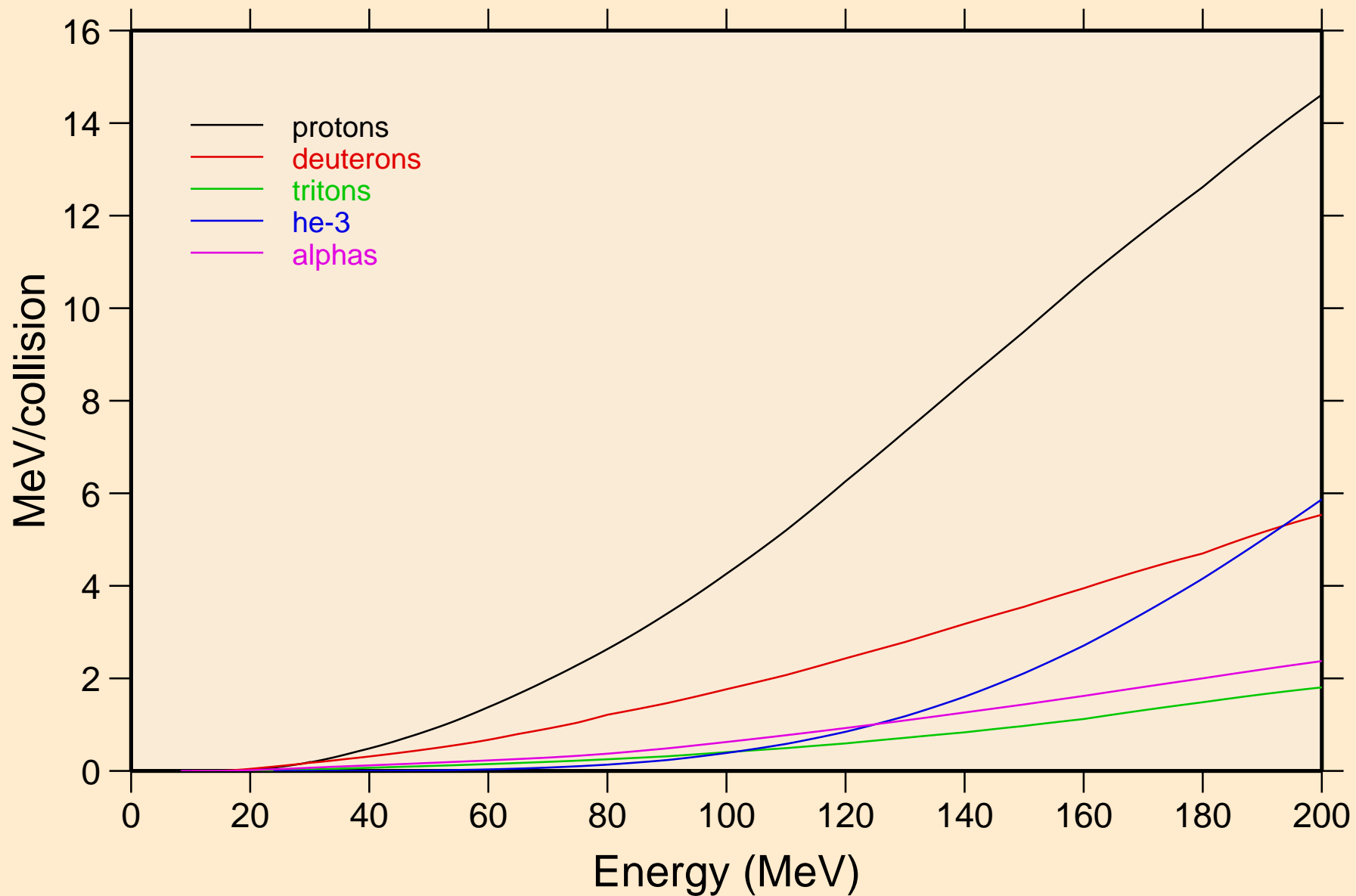

P035 NEUTRON ACER TENDL-2019 LIBRARY; T=293.16K
Recoil Heating

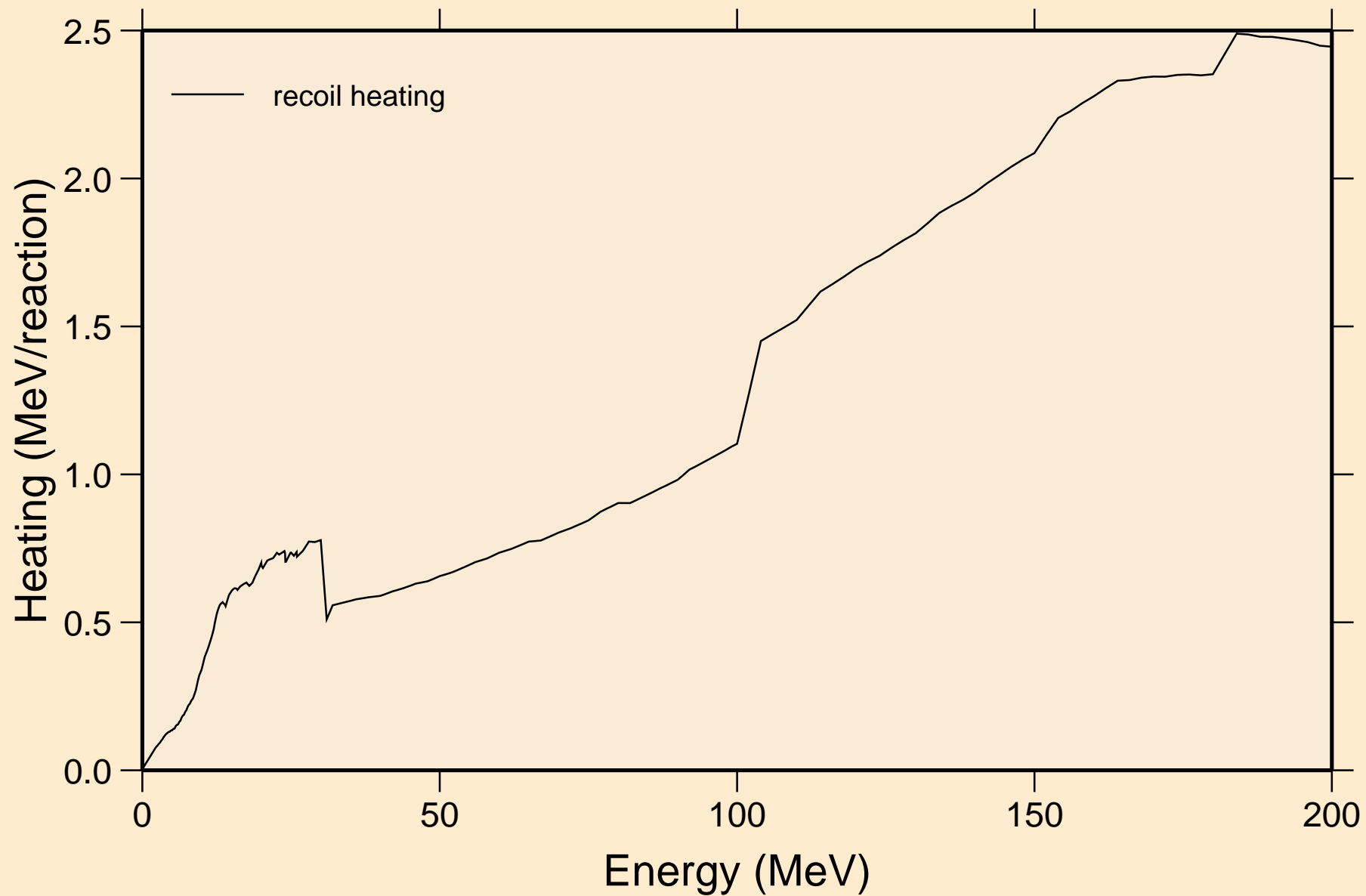

P035 NEUTRON ACER TENDL-2019 LIBRARY; T=293.16K
Particle production cross sections

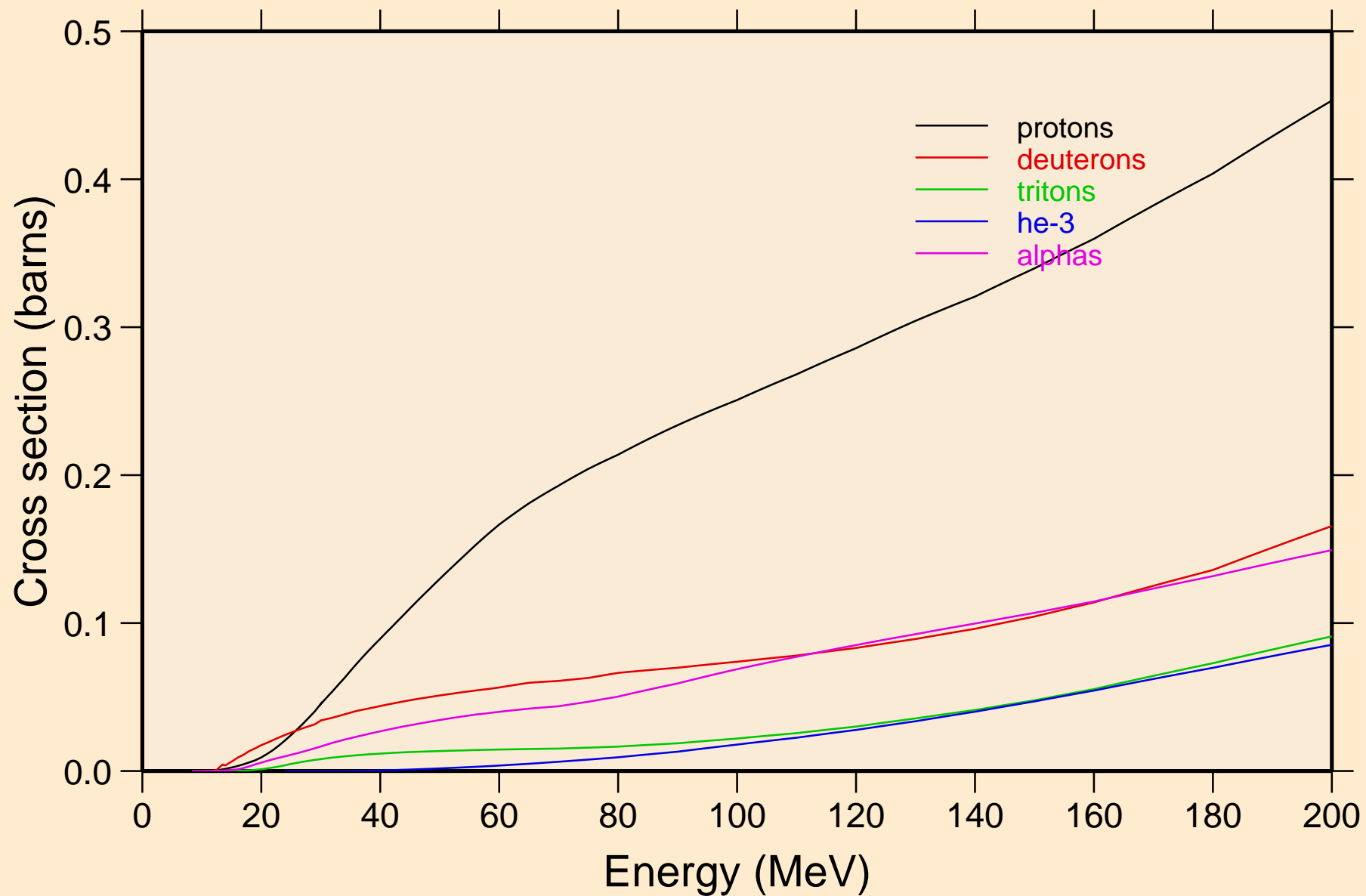

P035 NEUTRON ACER TENDL-2019 LIBRARY; T=293.16K
protons from (n,x)

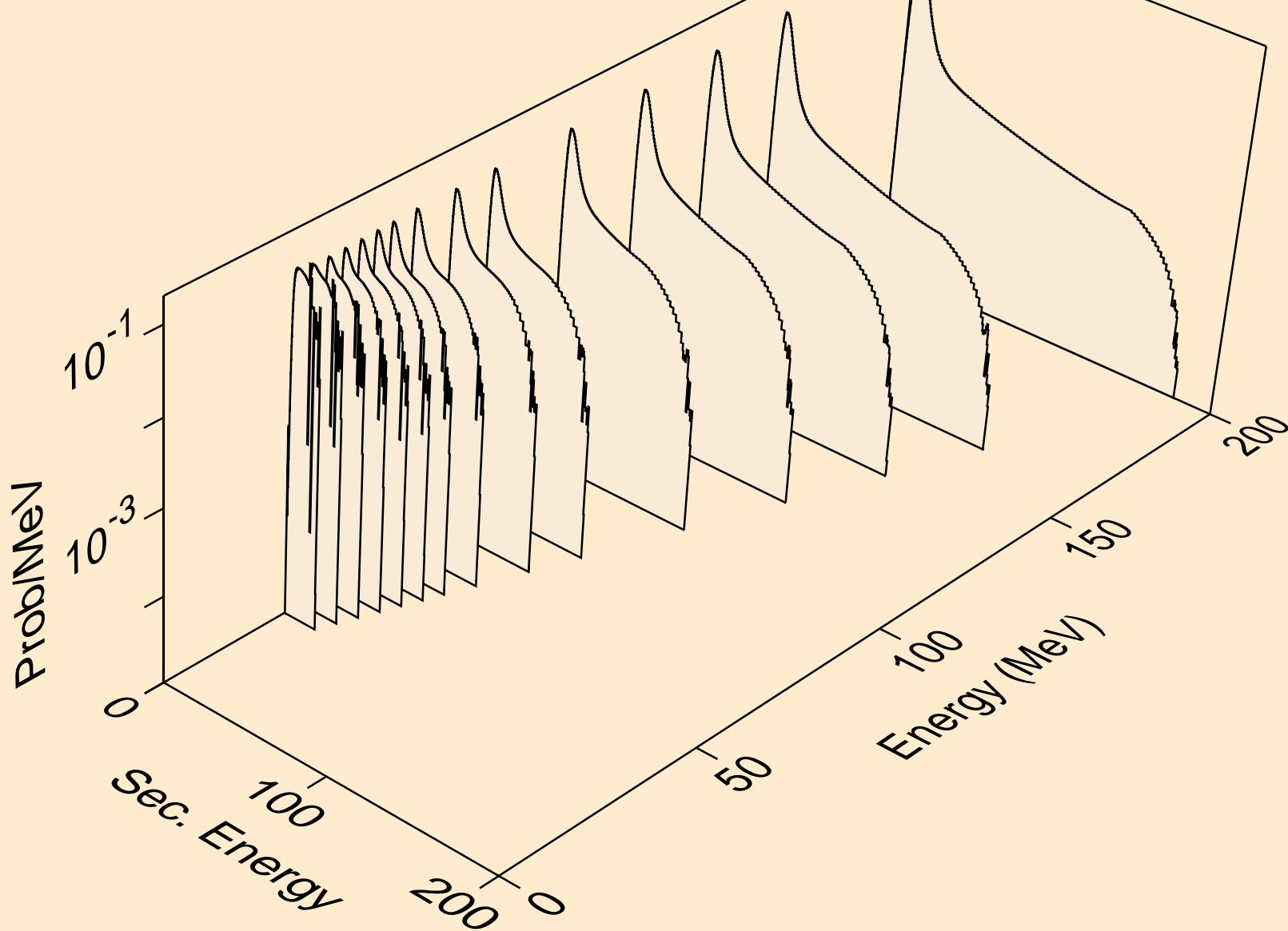

P035 NEUTRON ACER TENDL-2019 LIBRARY; T=293.16K
protons from (n,n*)p

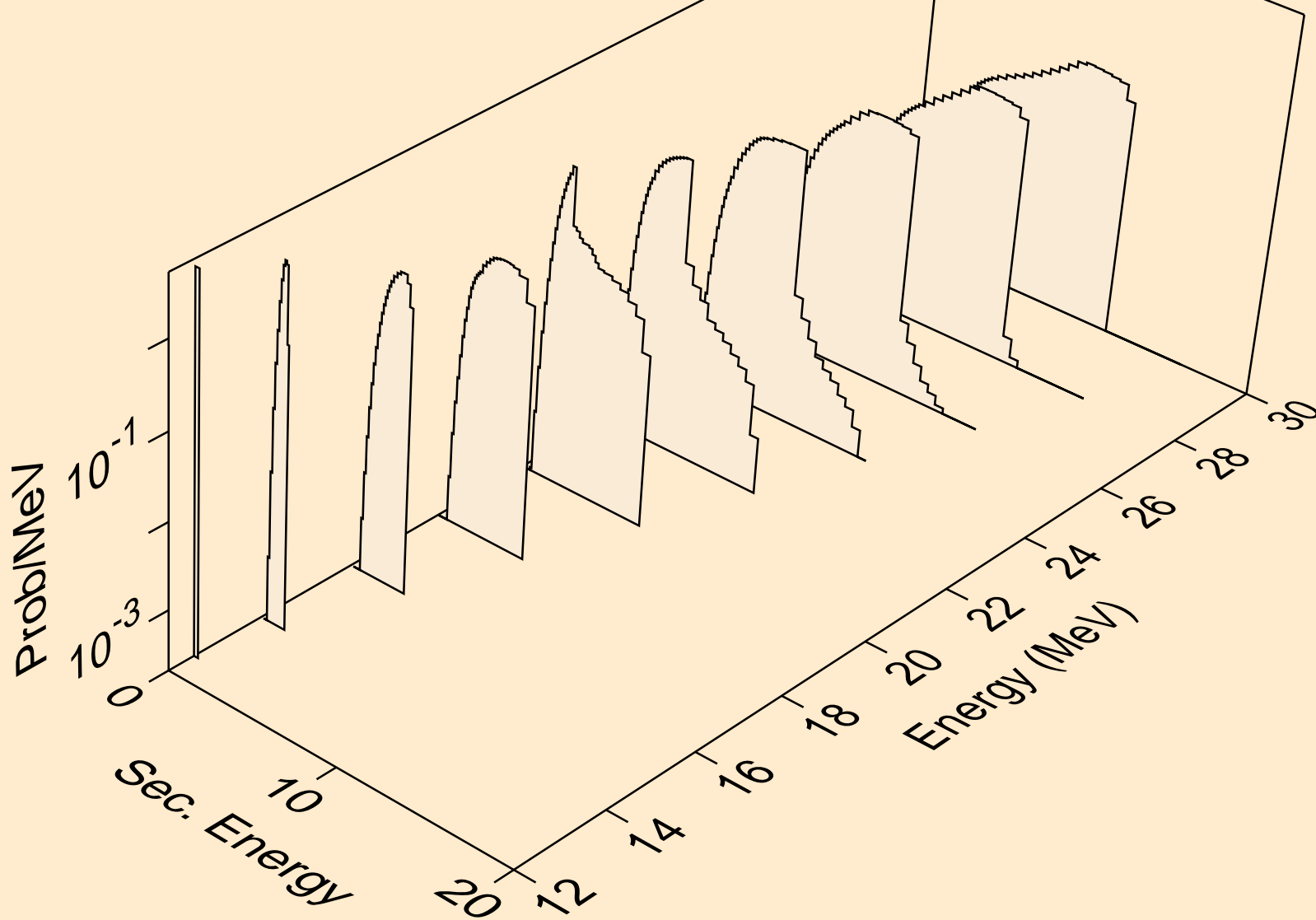

P035 NEUTRON ACER TENDL-2019 LIBRARY; T=293.16K
protons from (n,2np)

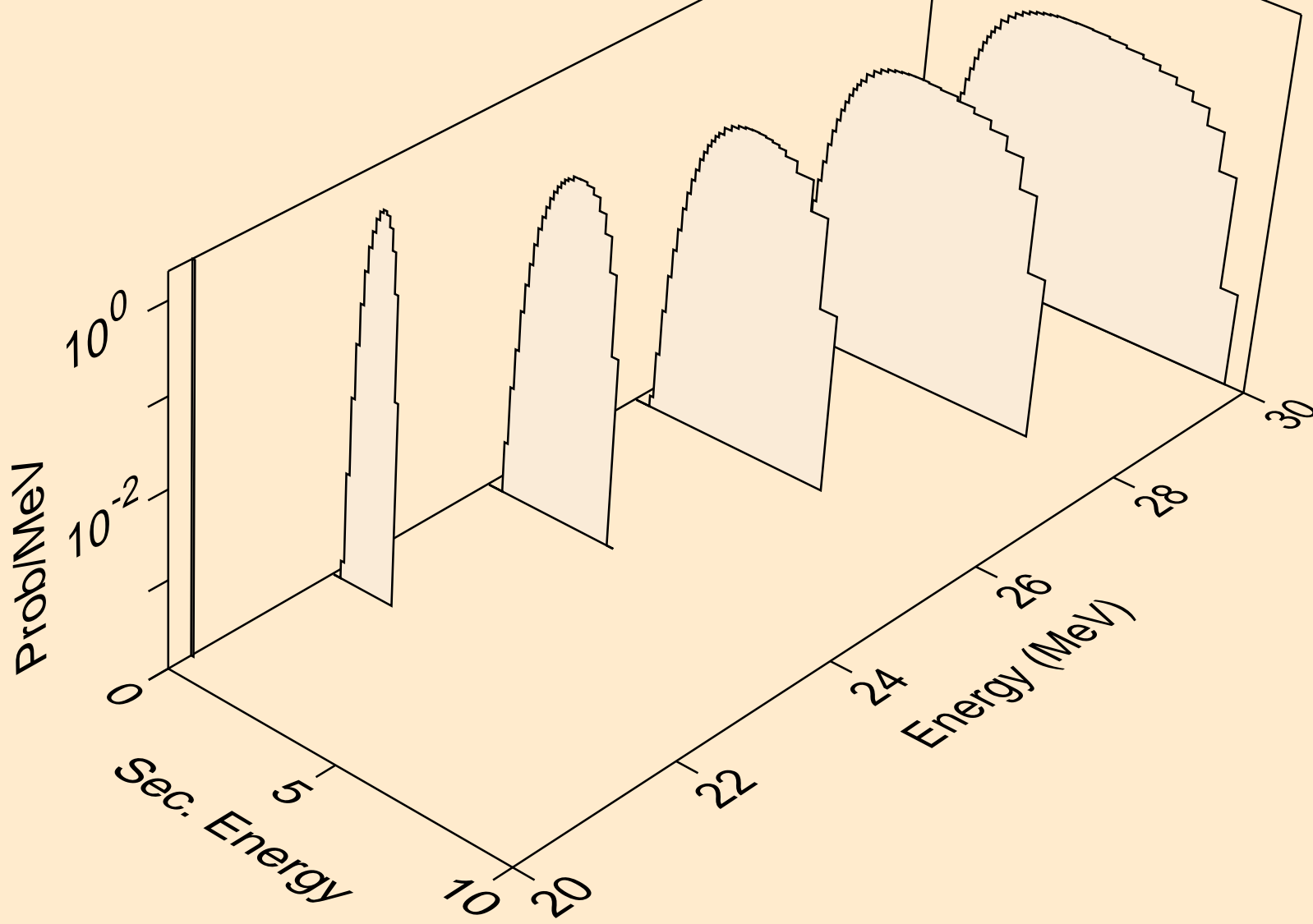

P035 NEUTRON ACER TENDL-2019 LIBRARY; T=293.16K
protons from (n,3np)

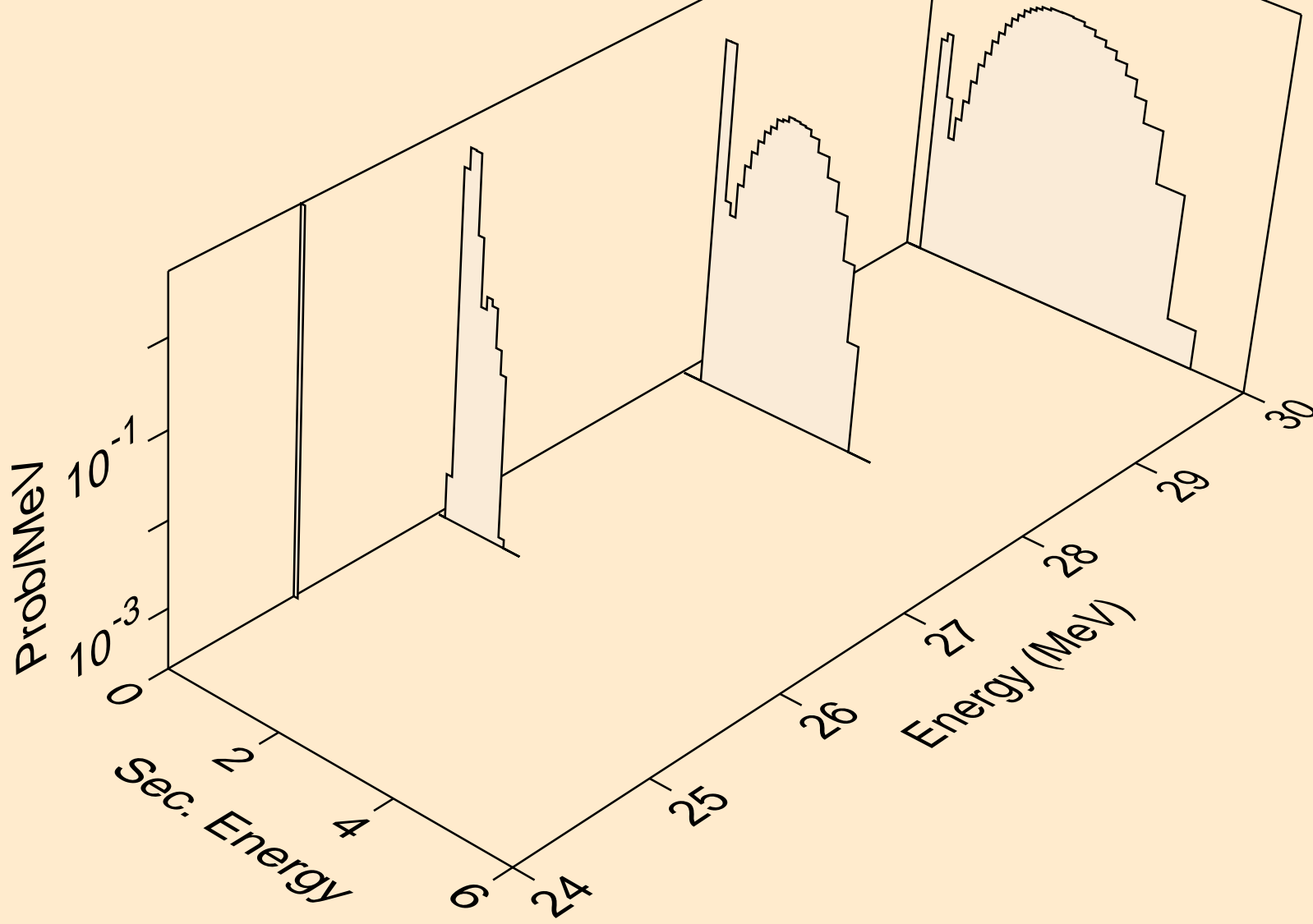

P035 NEUTRON ACER TENDL-2019 LIBRARY; T=293.16K
protons from (n,p)

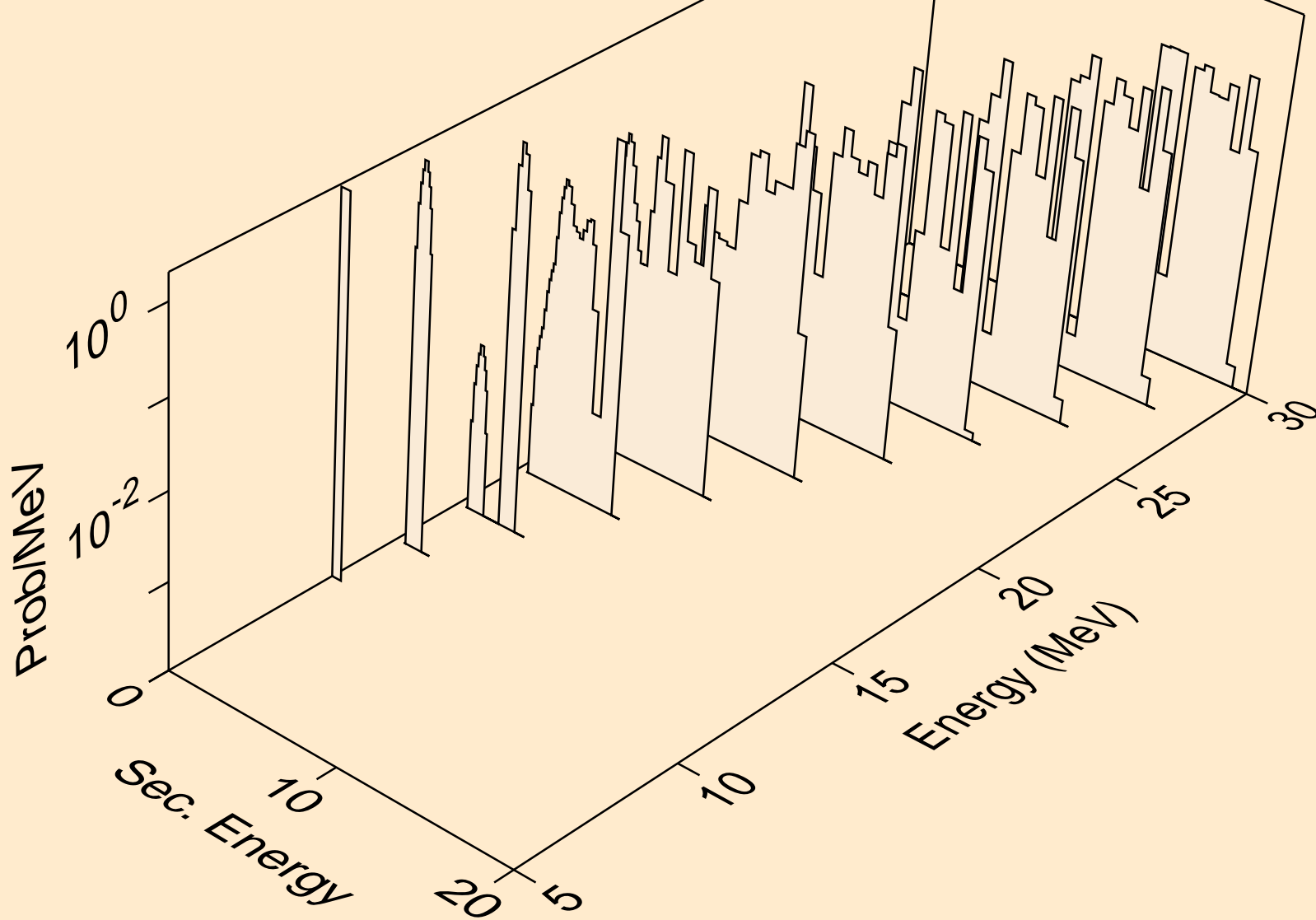

P035 NEUTRON ACER TENDL-2019 LIBRARY; T=293.16K
protons from (n,p)

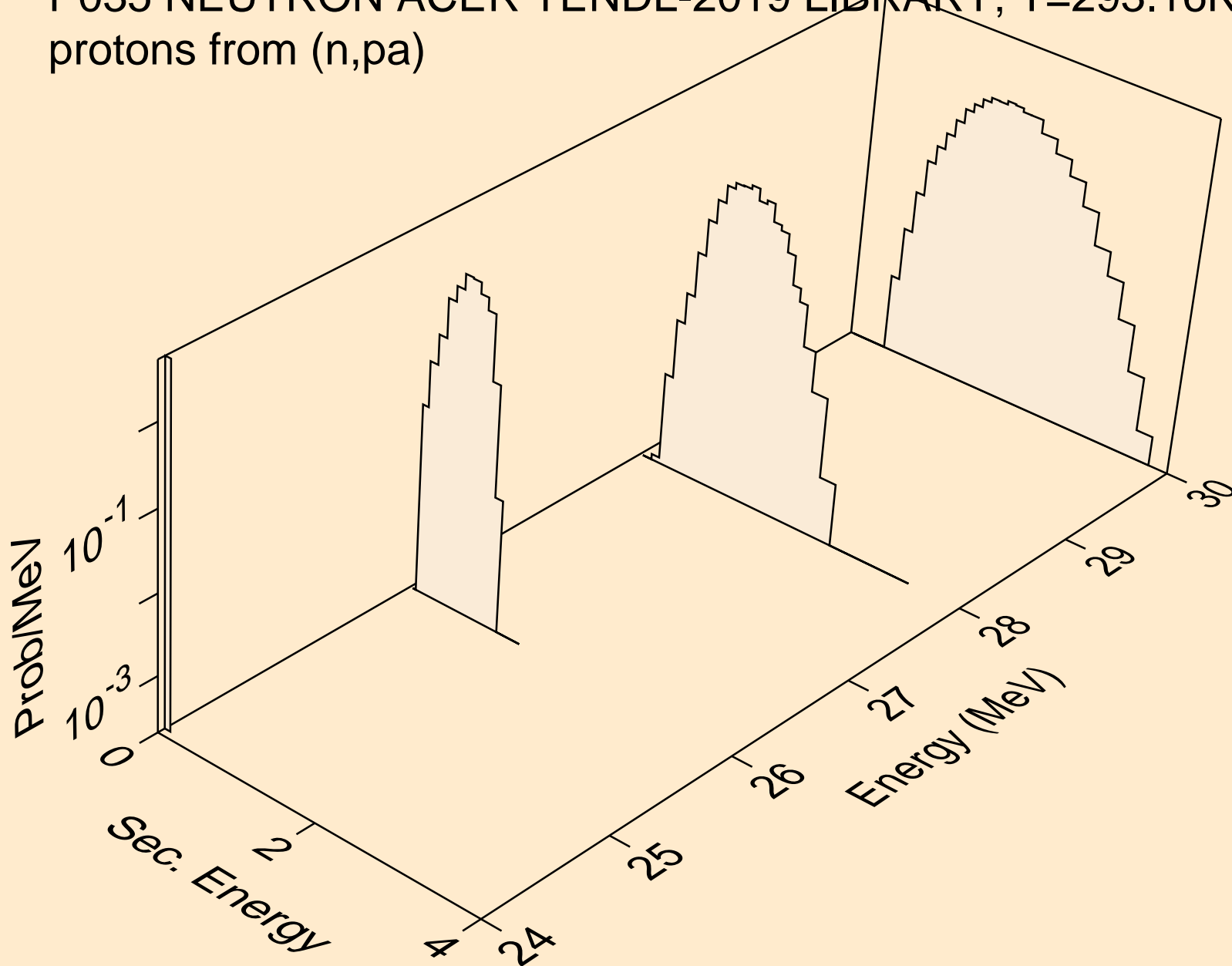

P035 NEUTRON ACER TENDL-2019 LIBRARY; T=293.16K
deuterons from (n,x)

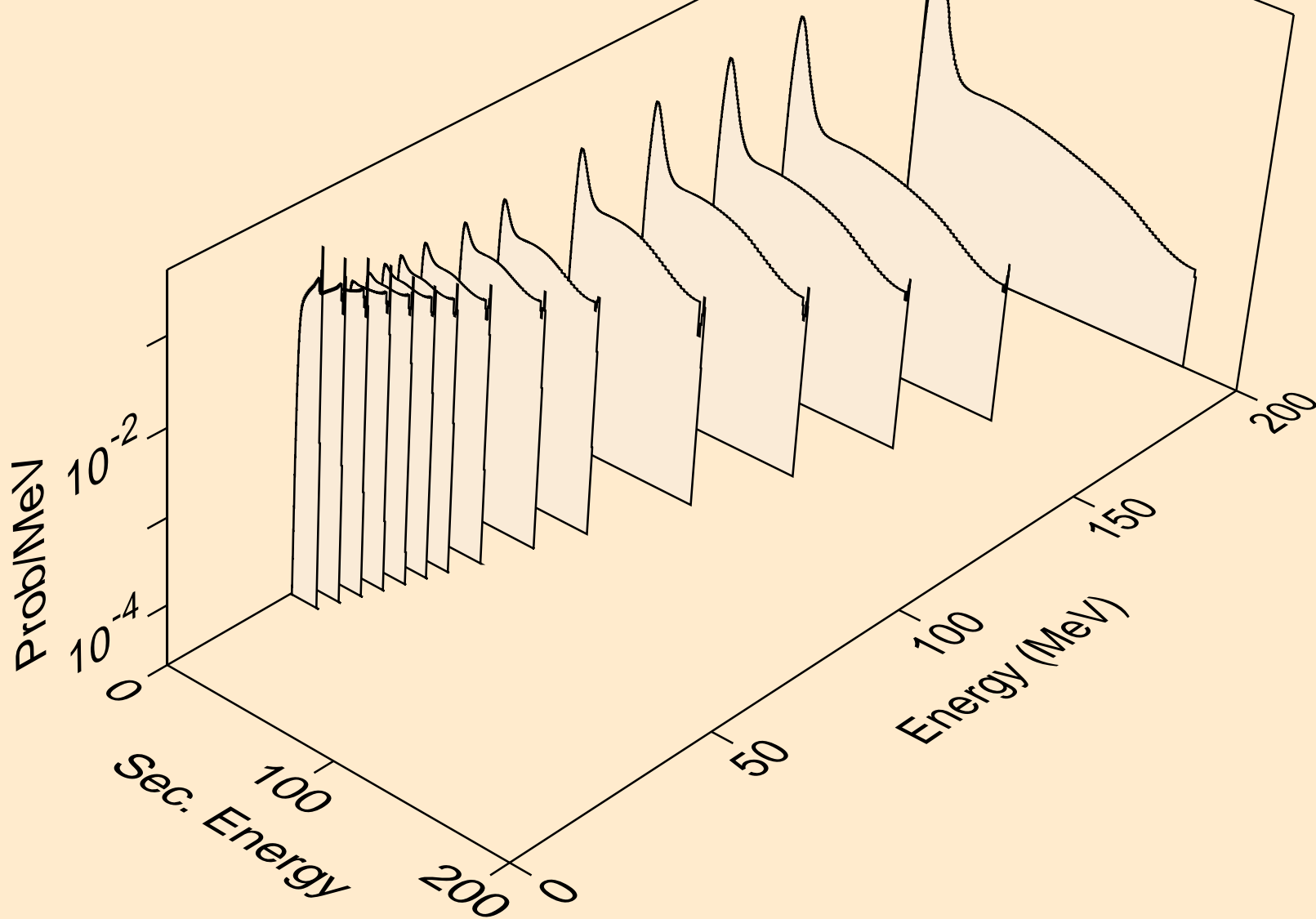

P035 NEUTRON ACER TENDL-2019 LIBRARY; T=293.16K
deuterons from (n,2nd)

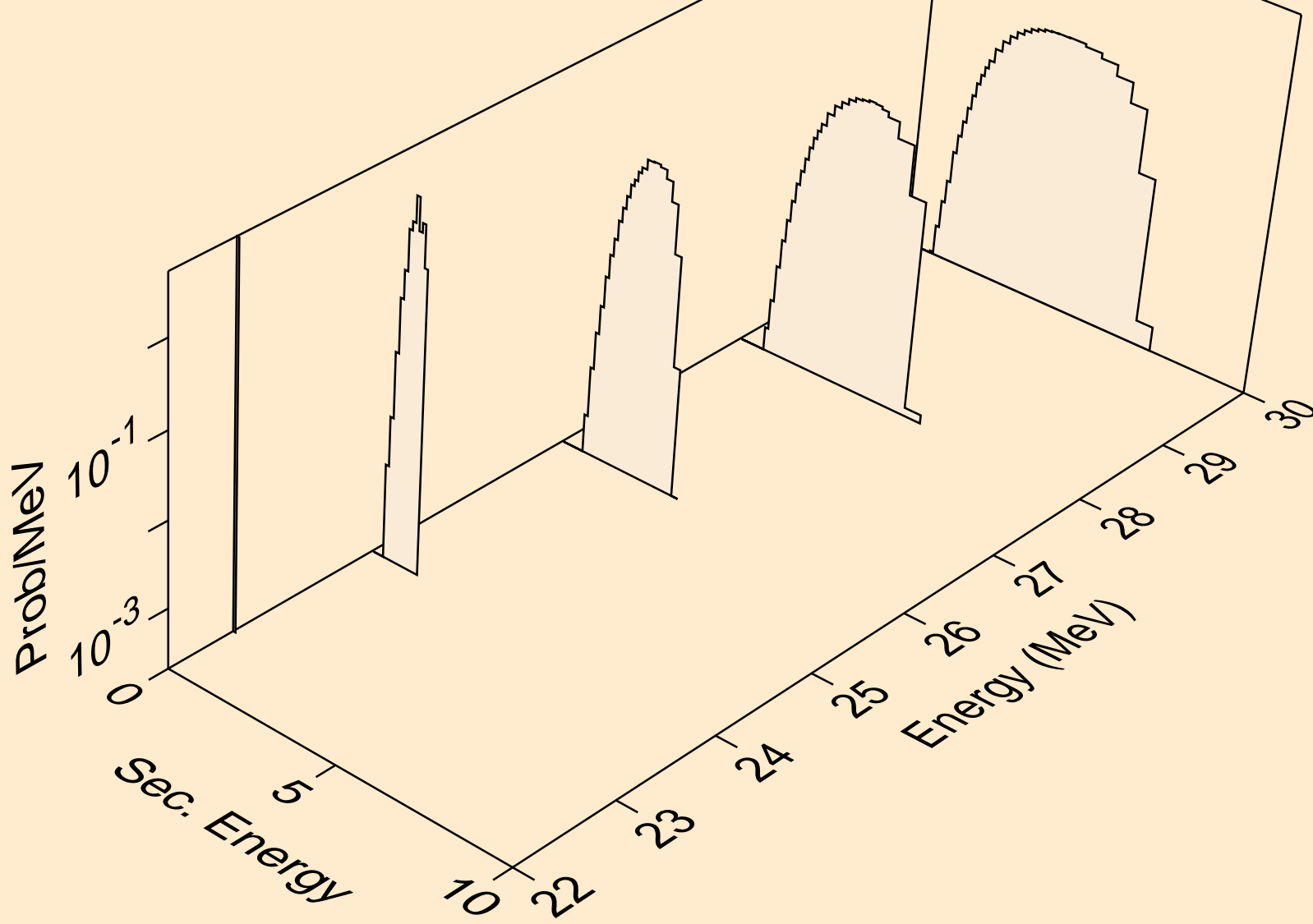

P035 NEUTRON ACER TENDL-2019 LIBRARY; T=293.16K
deuterons from (n,n*)d

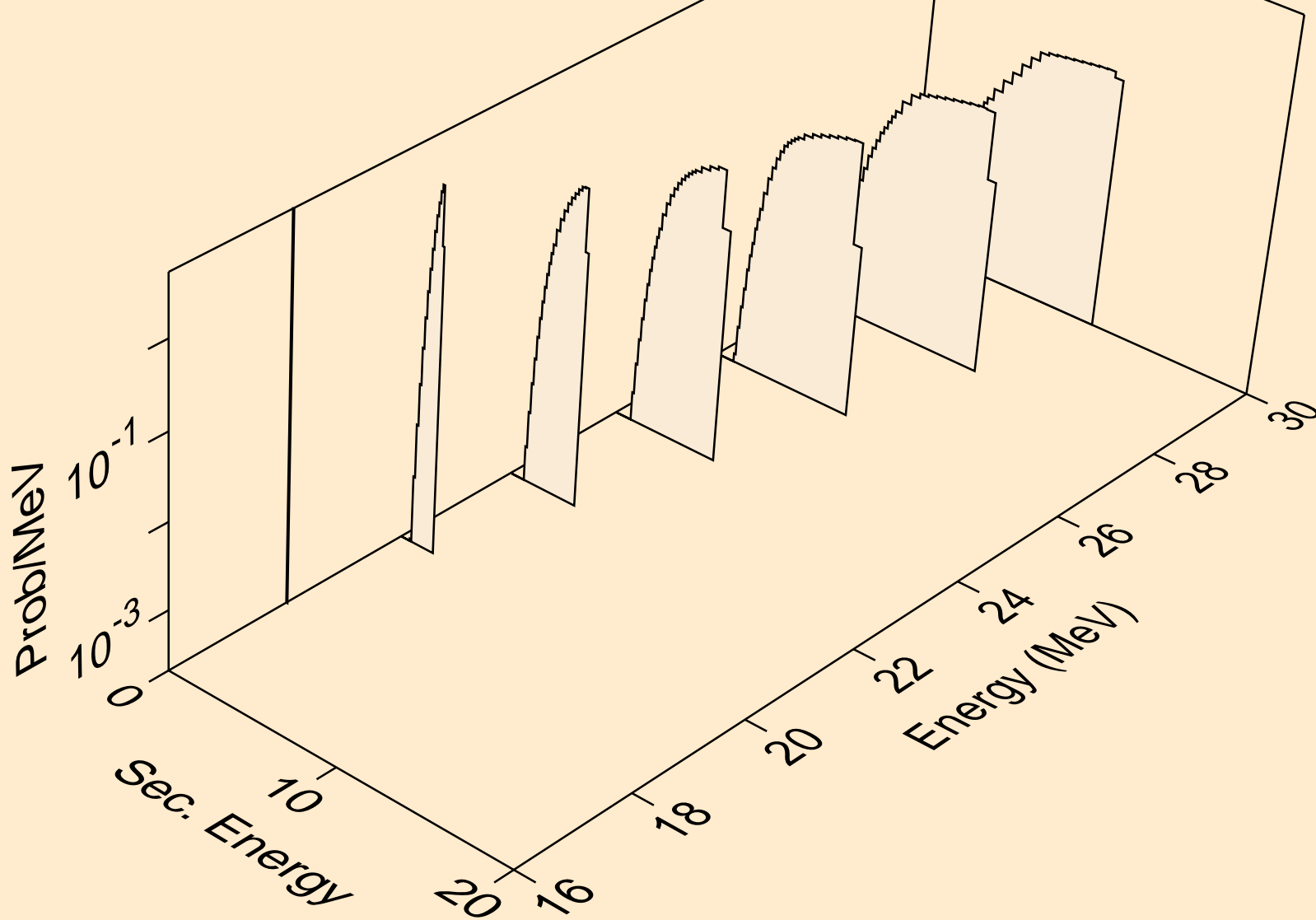

P035 NEUTRON ACER TENDL-2019 LIBRARY; T=293.16K
deuterons from (n,d)

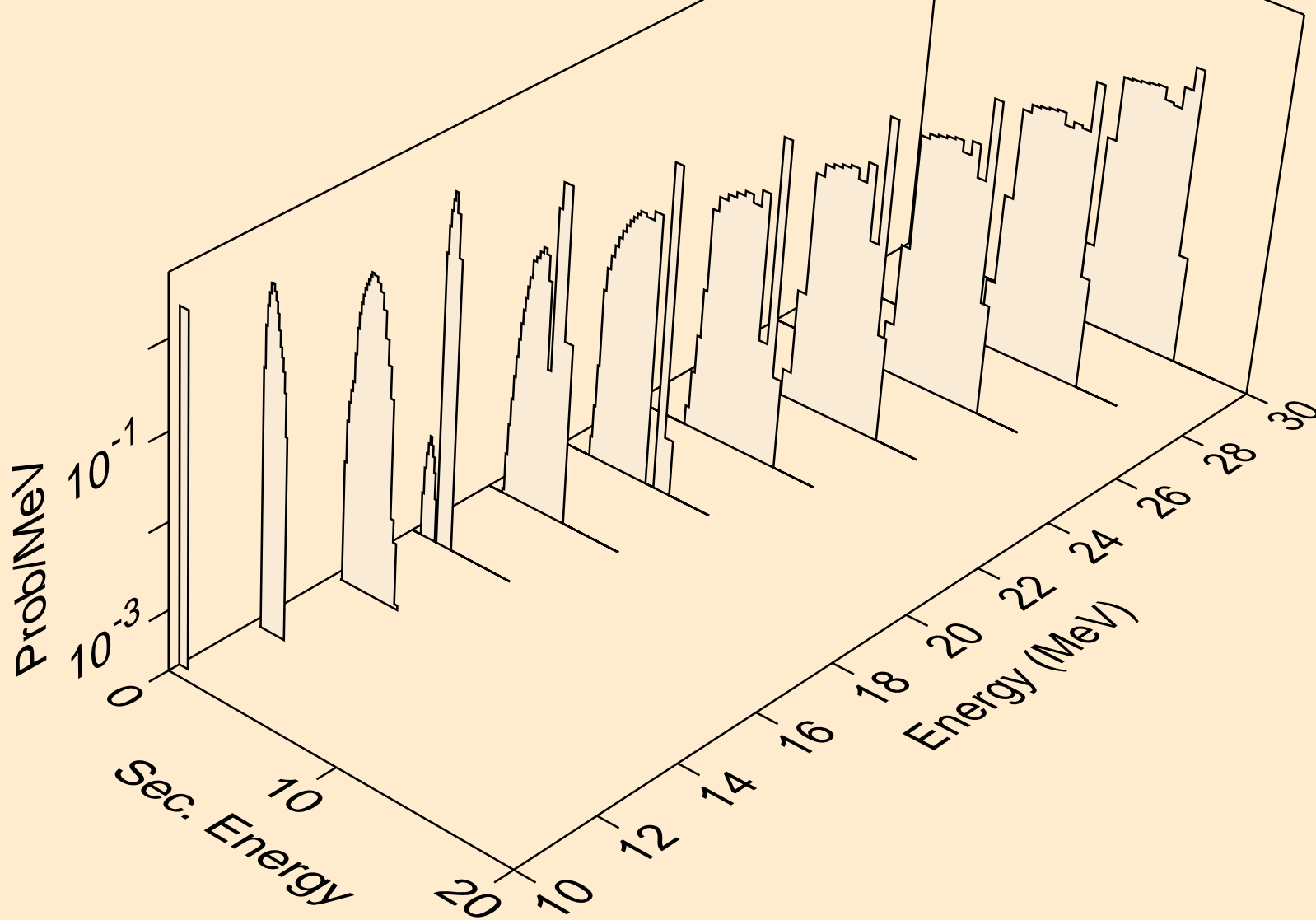

P035 NEUTRON ACER TENDL-2019 LIBRARY; T=293.16K
deuterons from (n,da)

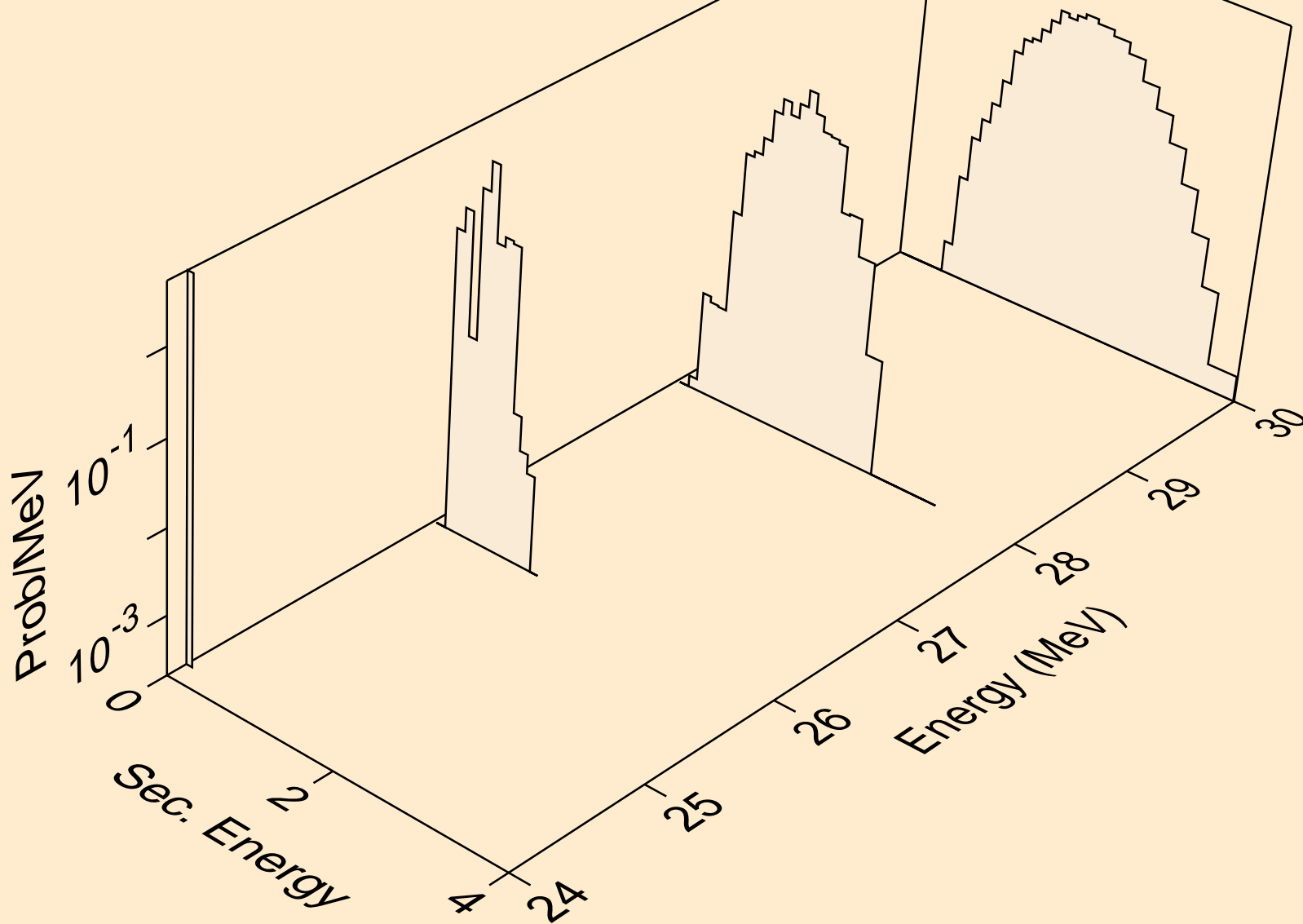

P035 NEUTRON ACER TENDL-2019 LIBRARY; T=293.16K
tritons from (n,x)

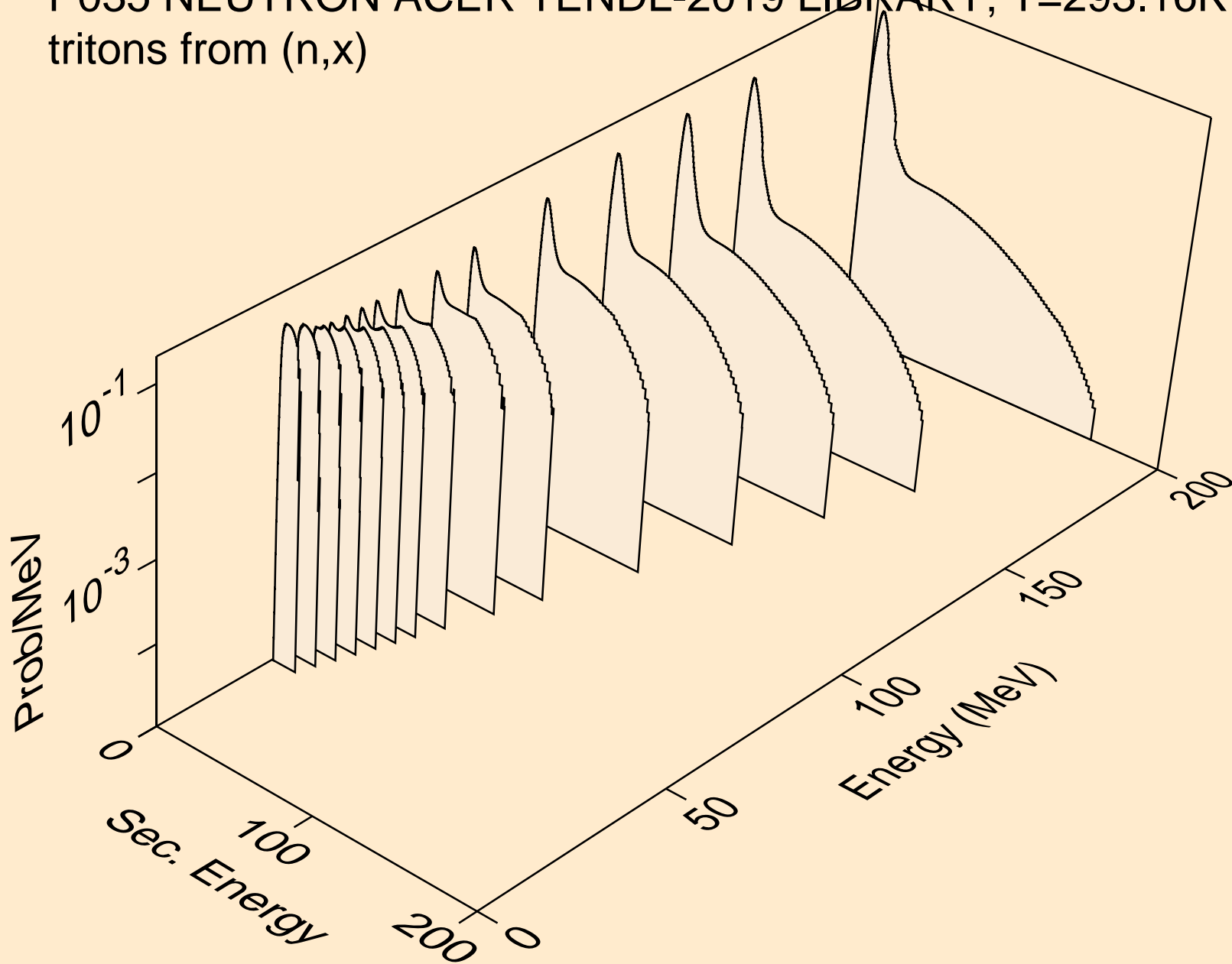

P035 NEUTRON ACER TENDL-2019 LIBRARY; T=293.16K
tritons from (n,n*)t

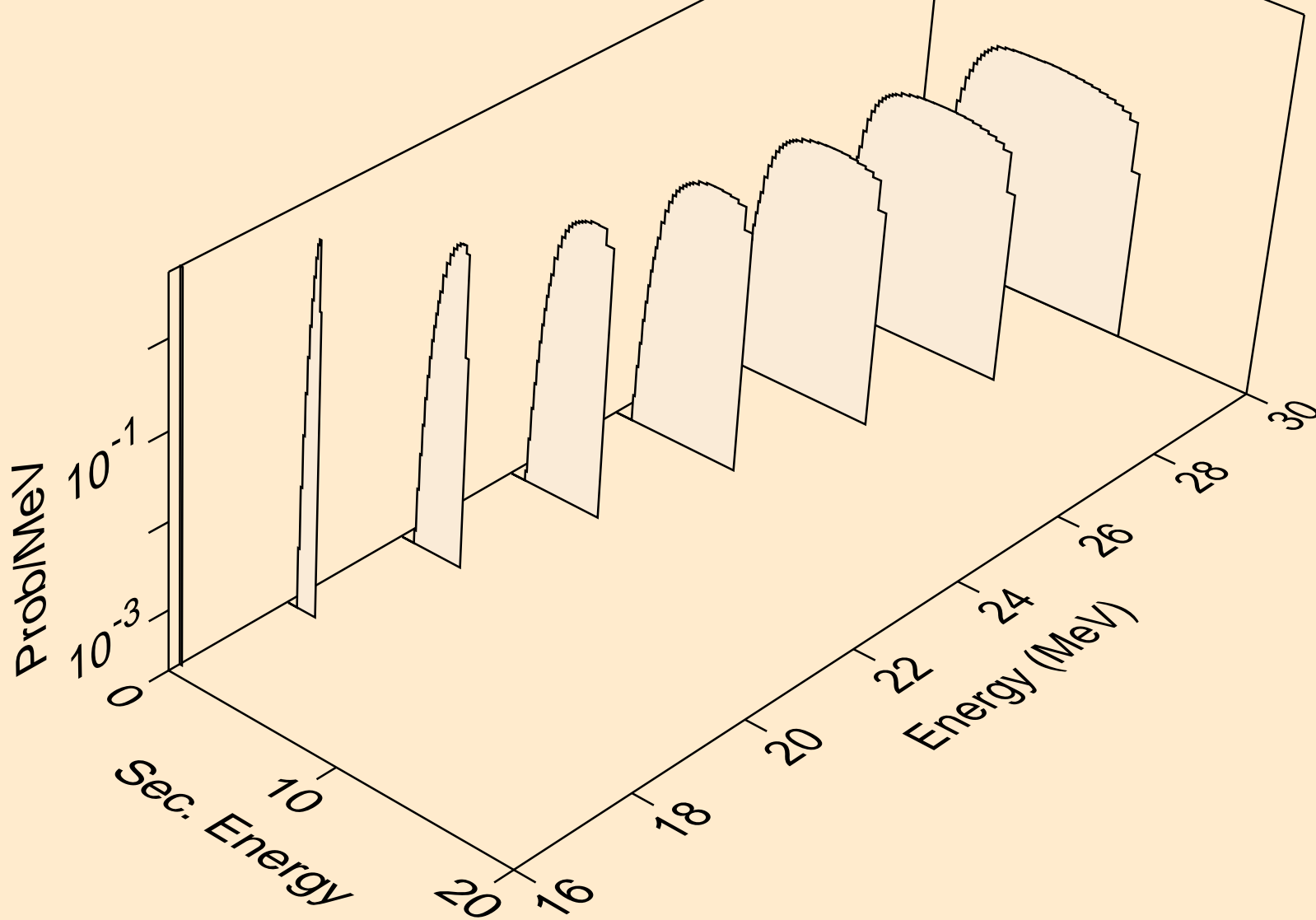

P035 NEUTRON ACER TENDL-2019 LIBRARY; T=293.16K
tritons from (n,t)

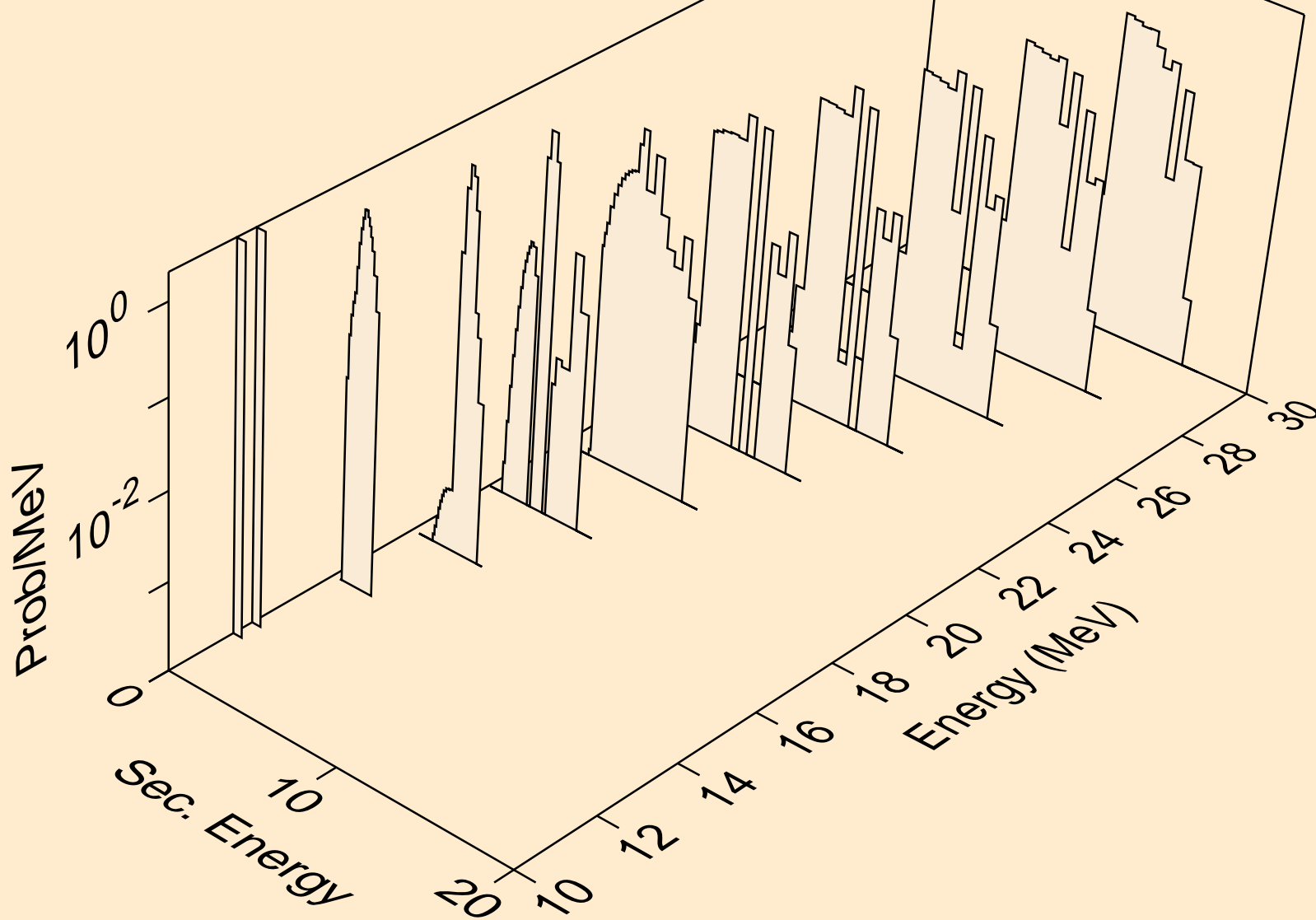

P035 NEUTRON ACER TENDL-2019 LIBRARY; T=293.16K
he3s from (n,x)

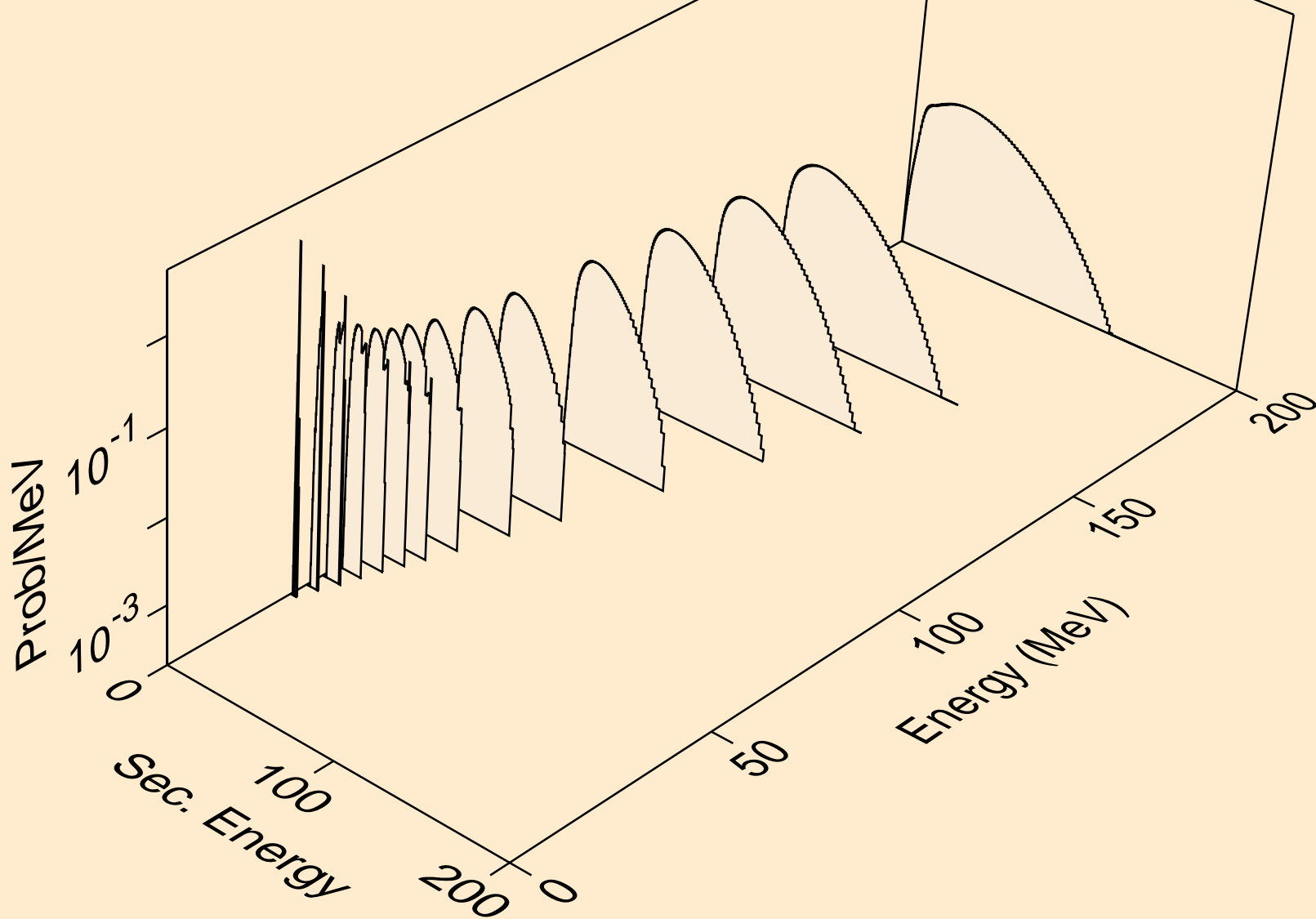

P035 NEUTRON ACER TENDL-2019 LIBRARY; T=293.16K
he3s from (n,he3)

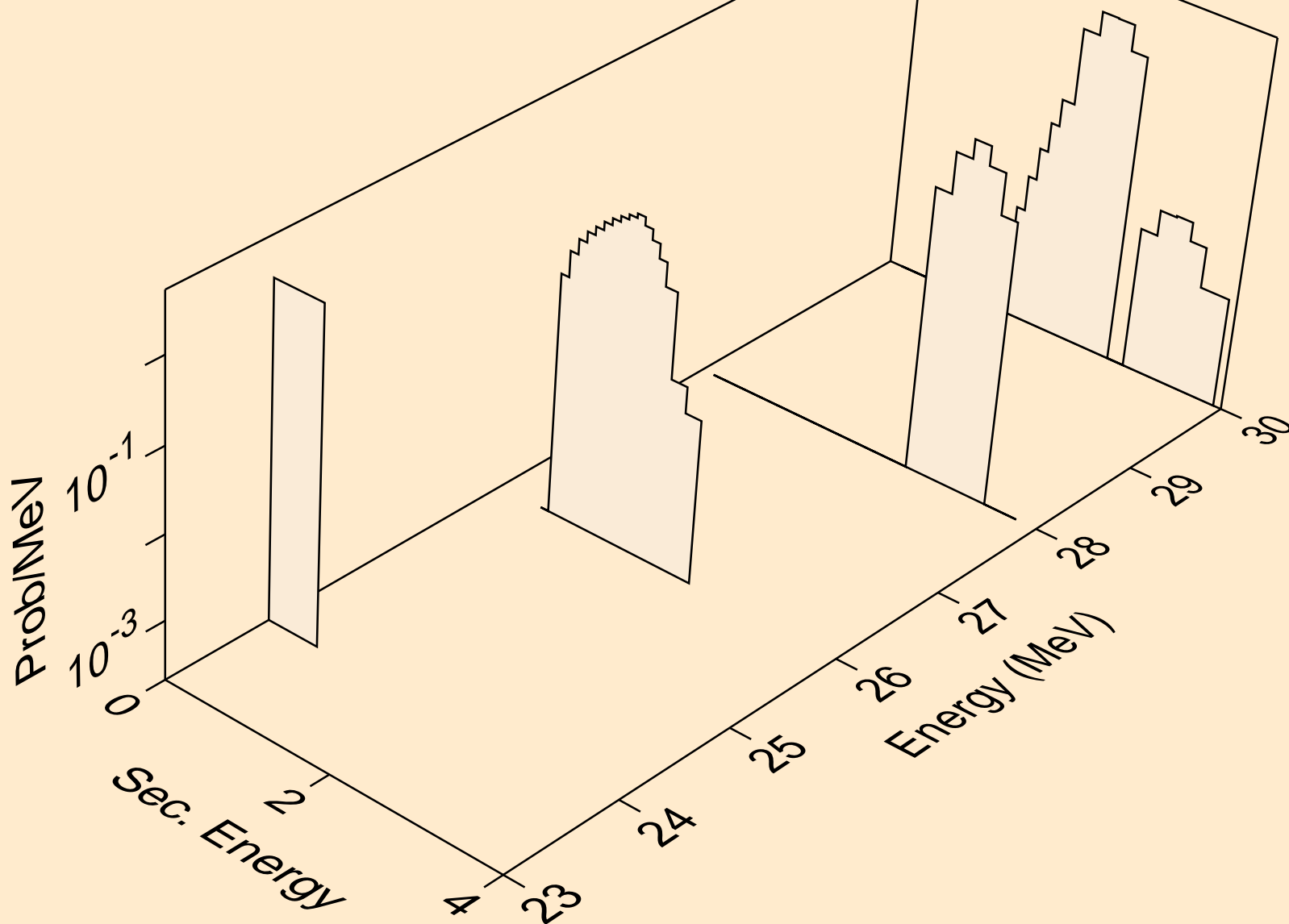

P035 NEUTRON ACER TENDL-2019 LIBRARY; T=293.16K
alphas from (n,x)

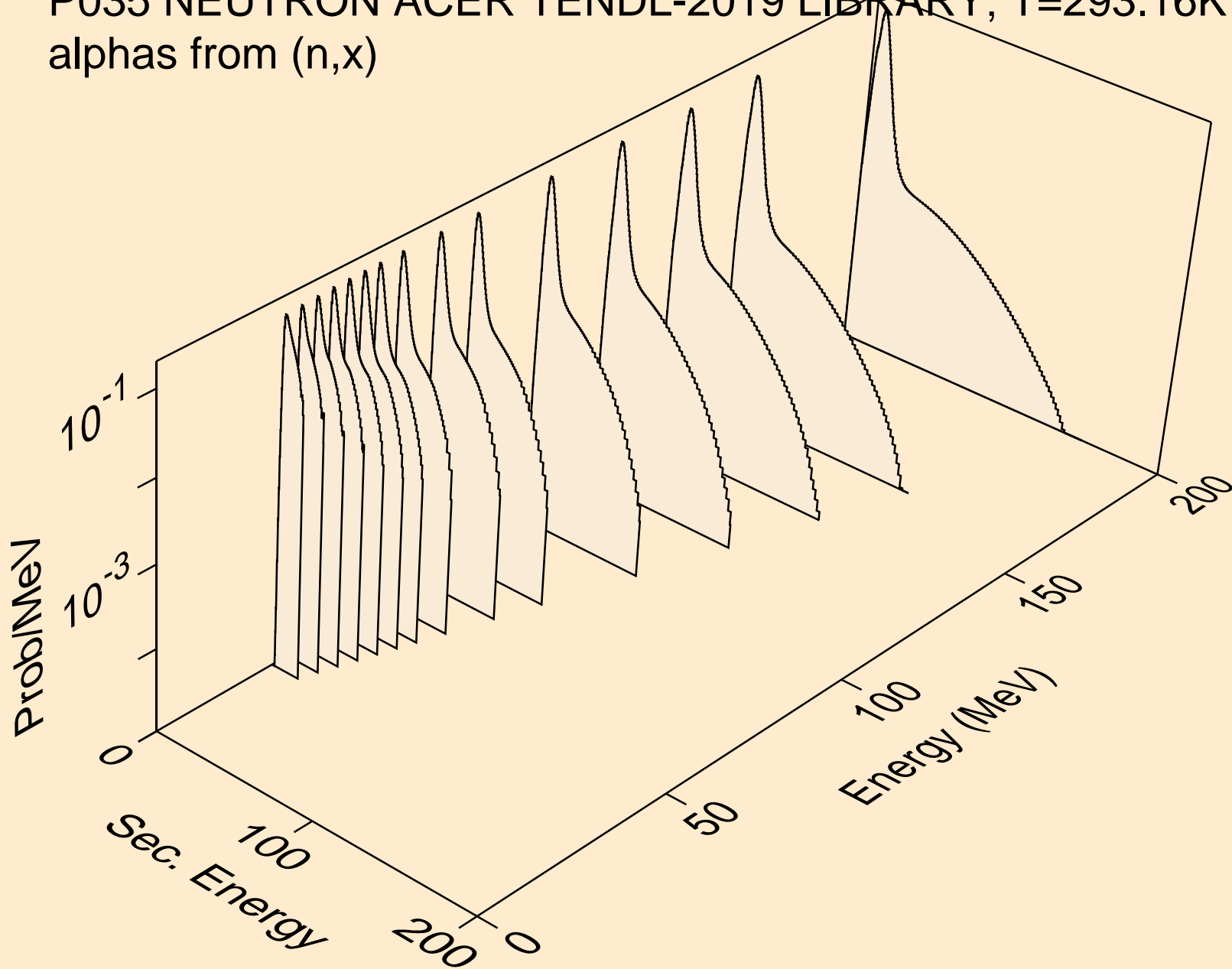

P035 NEUTRON ACER TENDL-2019 LIBRARY; T=293.16K
alphas from (n,n*)a

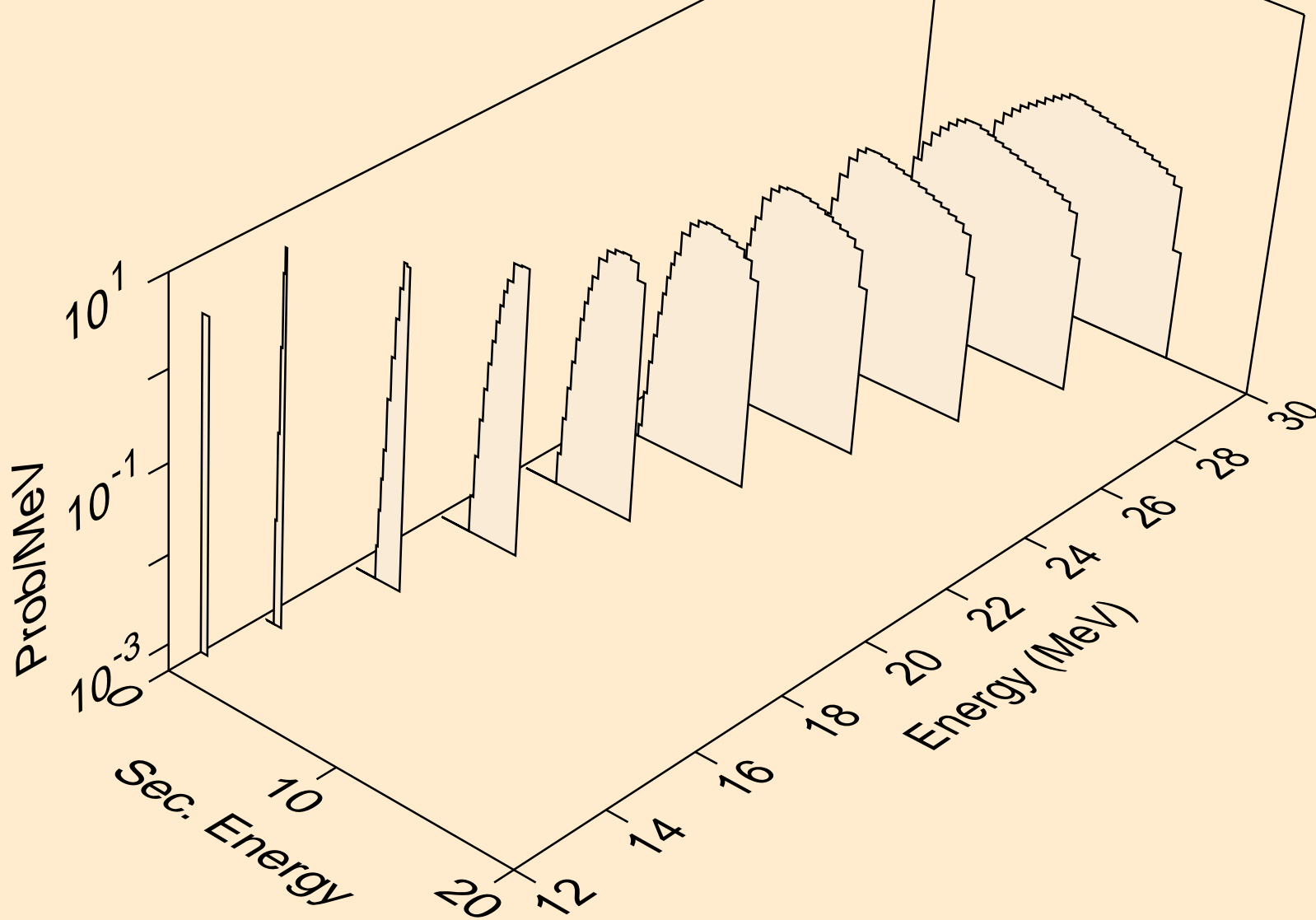

P035 NEUTRON ACER TENDL-2019 LIBRARY; T=293.16K
alphas from (n,2n)a

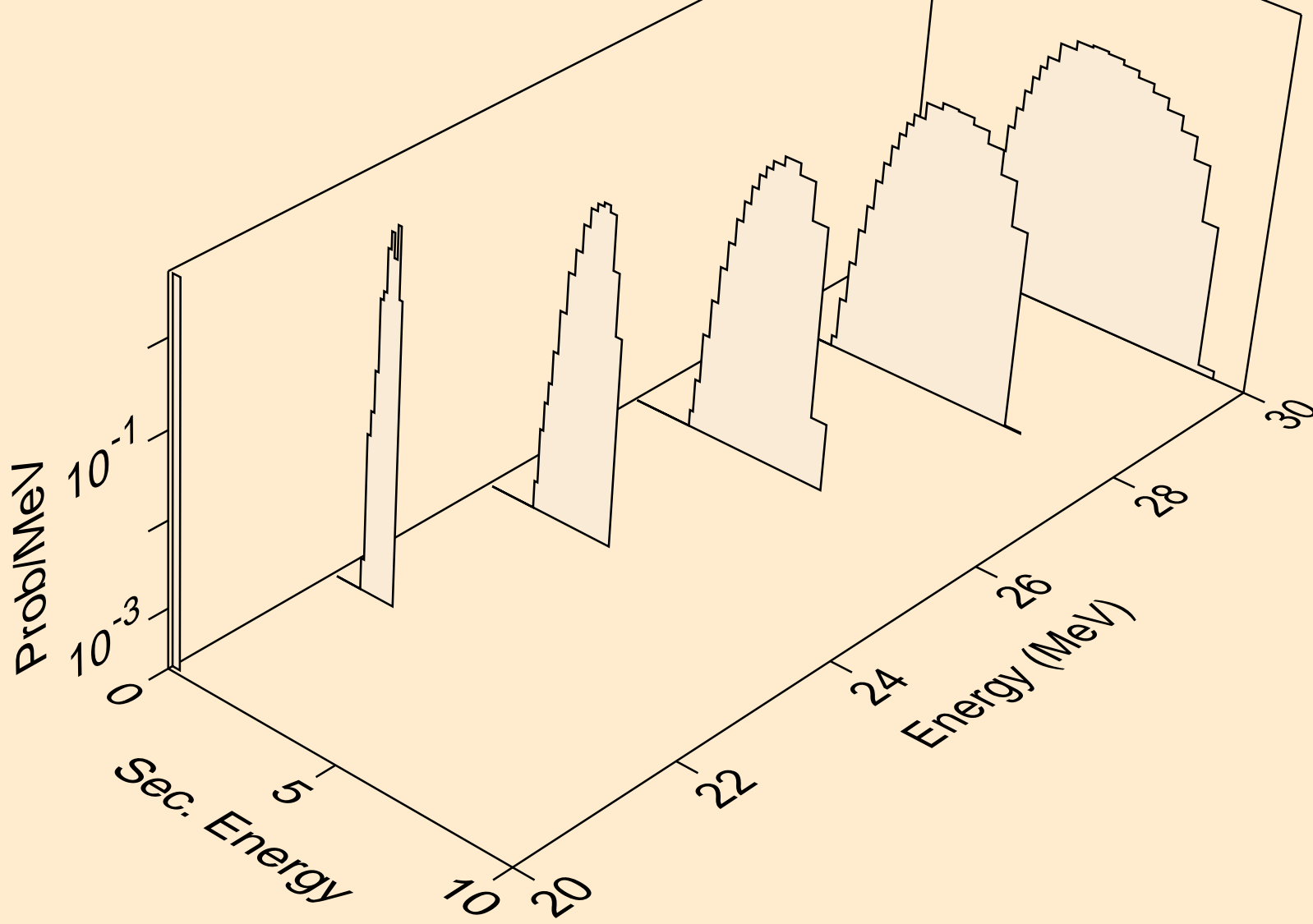

P035 NEUTRON ACER TENDL-2019 LIBRARY; T=293.16K
alphas from (n,3n)a

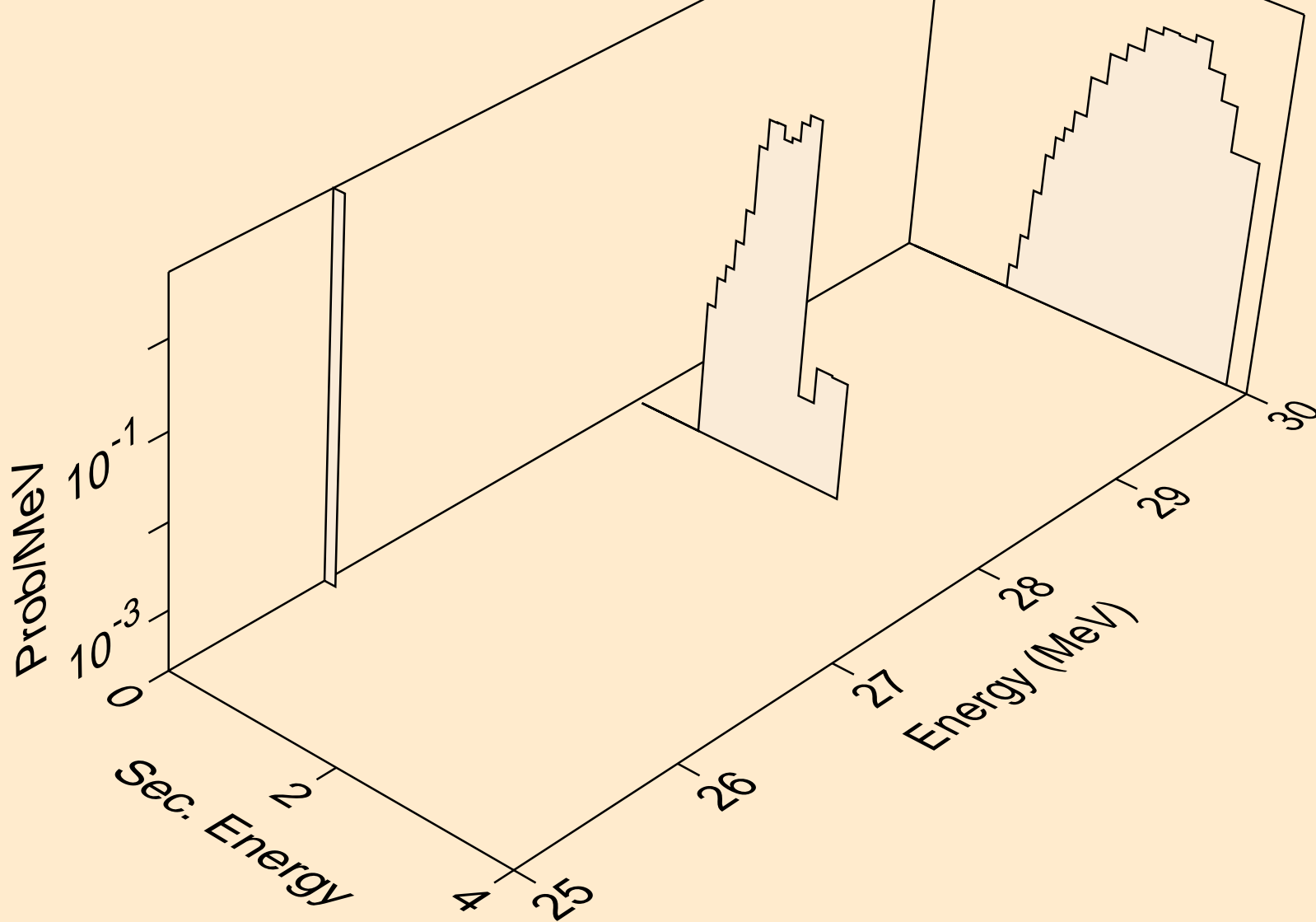

P035 NEUTRON ACER TENDL-2019 LIBRARY; T=293.16K
alphas from (n,a)

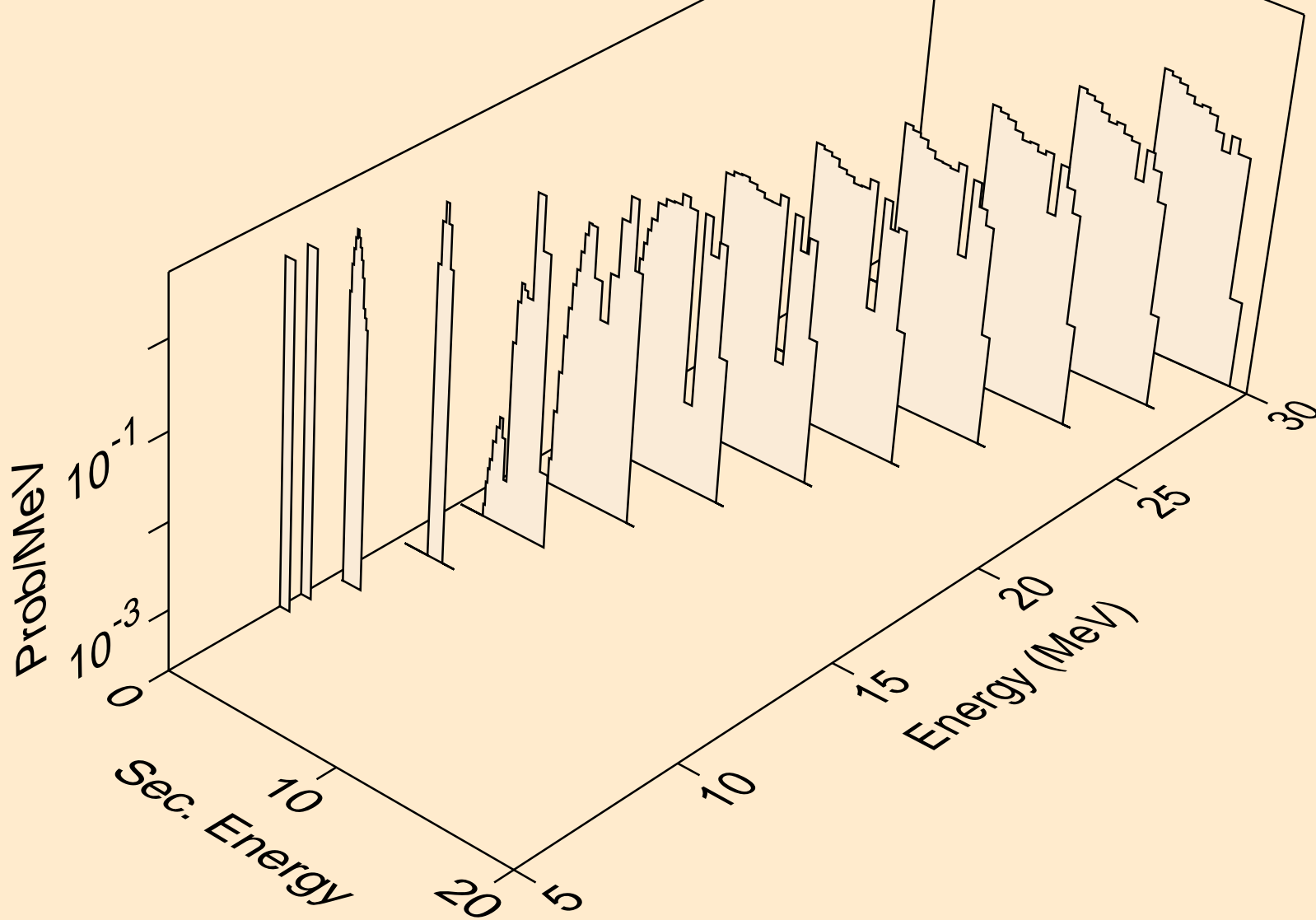

P035 NEUTRON ACER TENDL-2019 LIBRARY; T=293.16K
alphas from (n,2a)

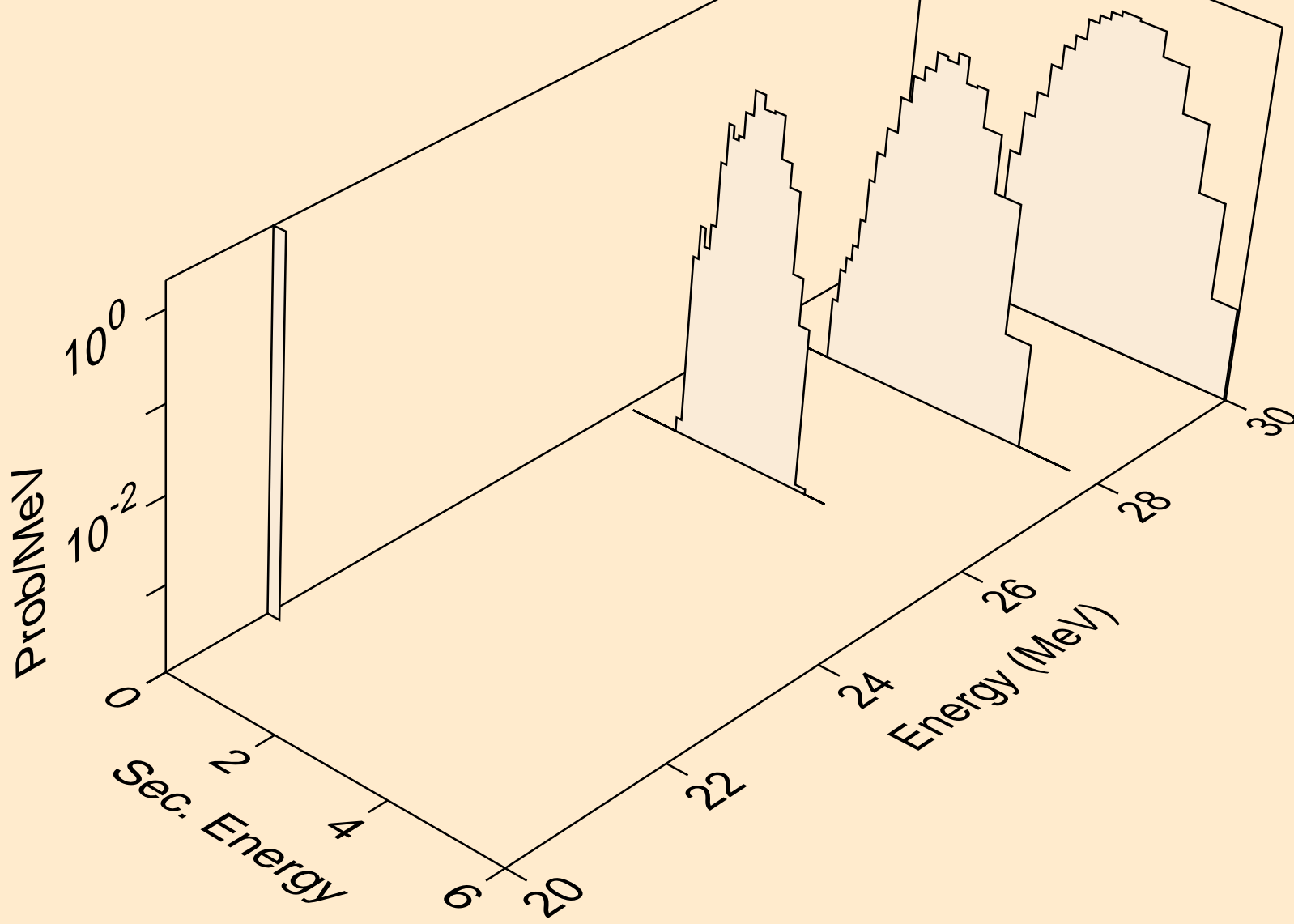

P035 NEUTRON ACER TENDL-2019 LIBRARY; T=293.16K
alphas from (n,pa)

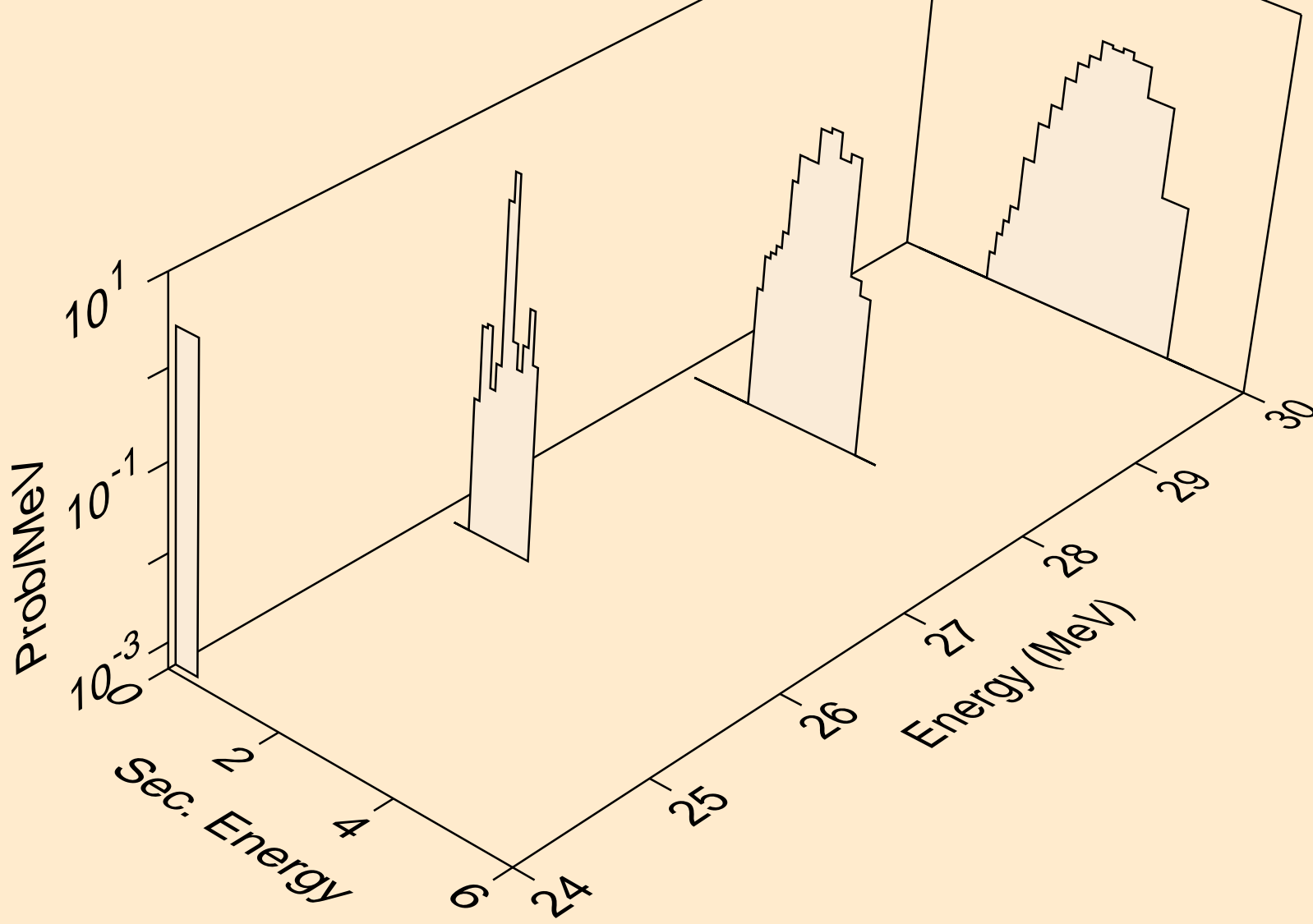

P035 NEUTRON ACER TENDL-2019 LIBRARY; T=293.16K
alphas from (n,da)

