

PB203 NEUTRON ACER TENDL-2019 LIBRARY; T=293.16K
Principal cross sections

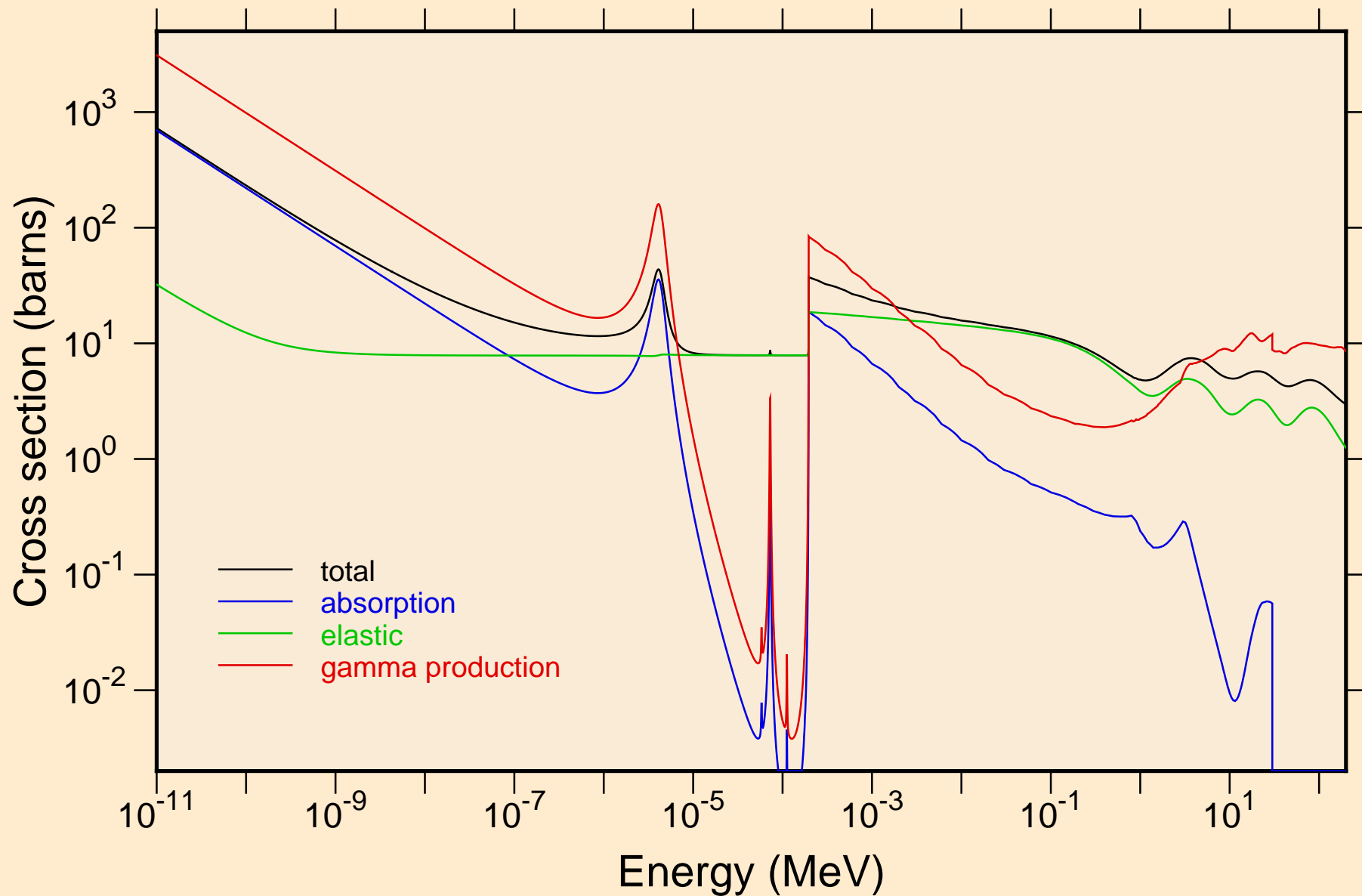

PB203 NEUTRON ACER TENDL-2019 LIBRARY; T=293.16K
Heating

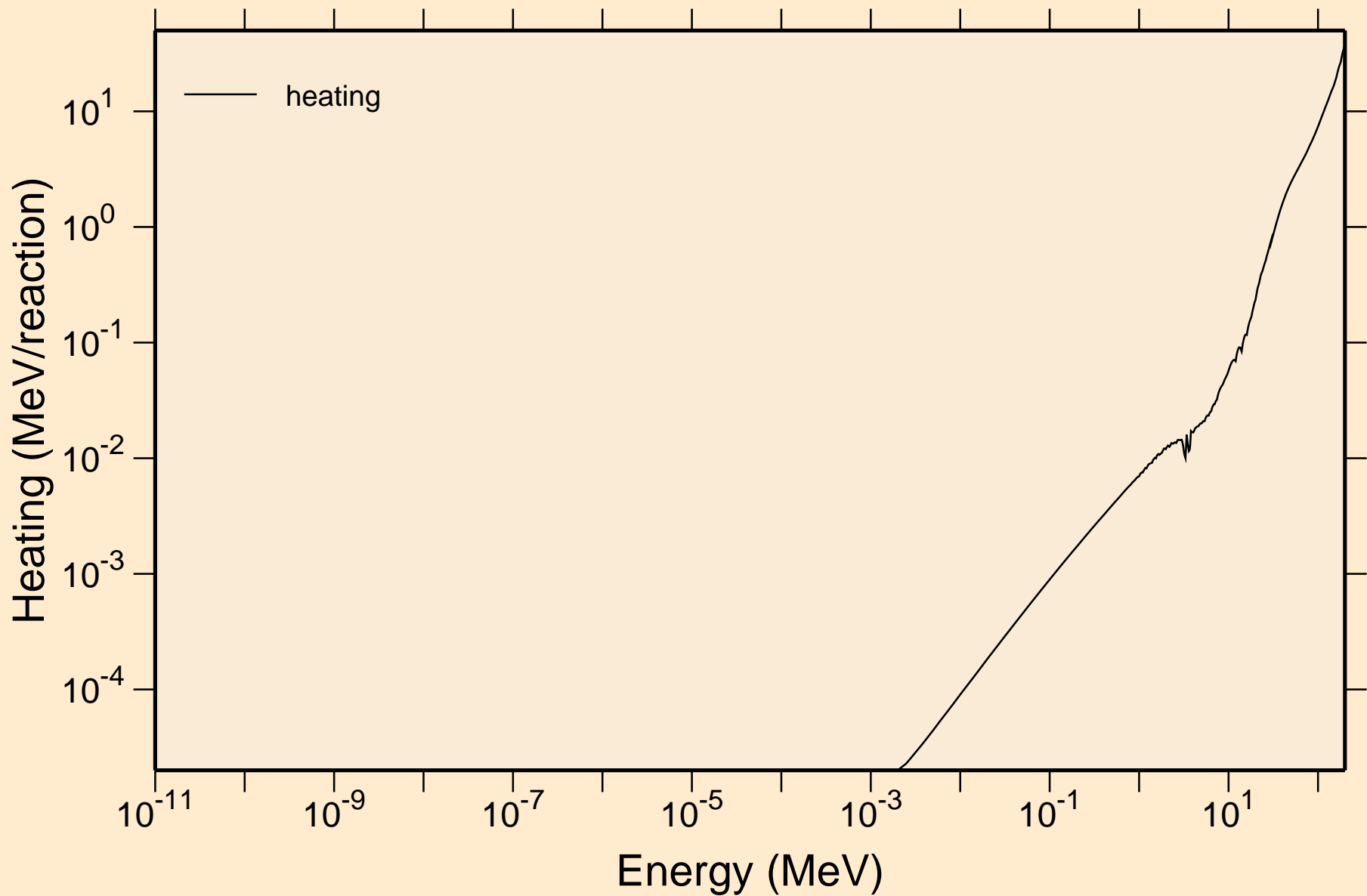

PB203 NEUTRON ACER TENDL-2019 LIBRARY; T=293.16K
Damage

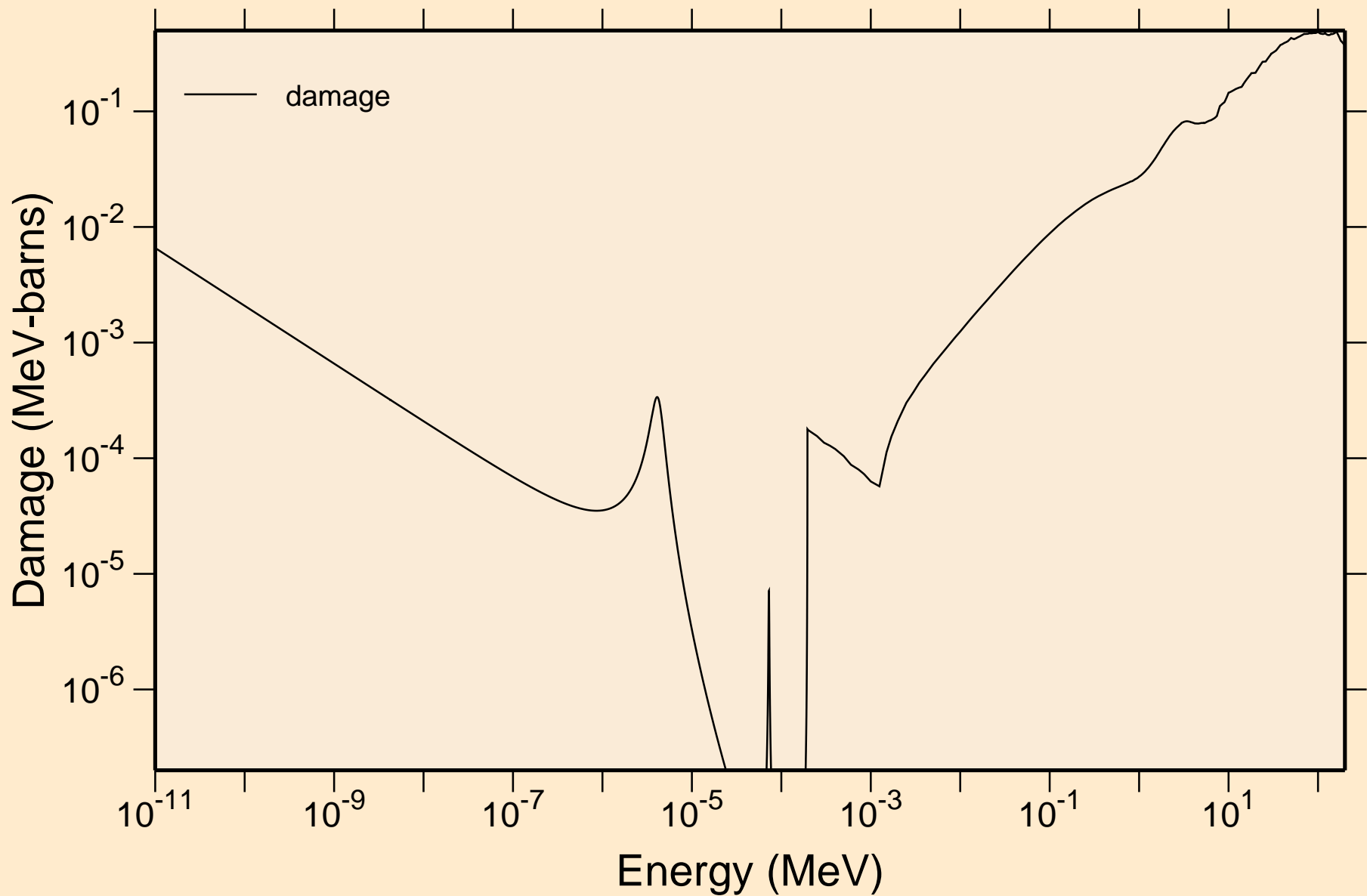

PB203 NEUTRON ACER TENDL-2019 LIBRARY; T=293.16K
Non-threshold reactions

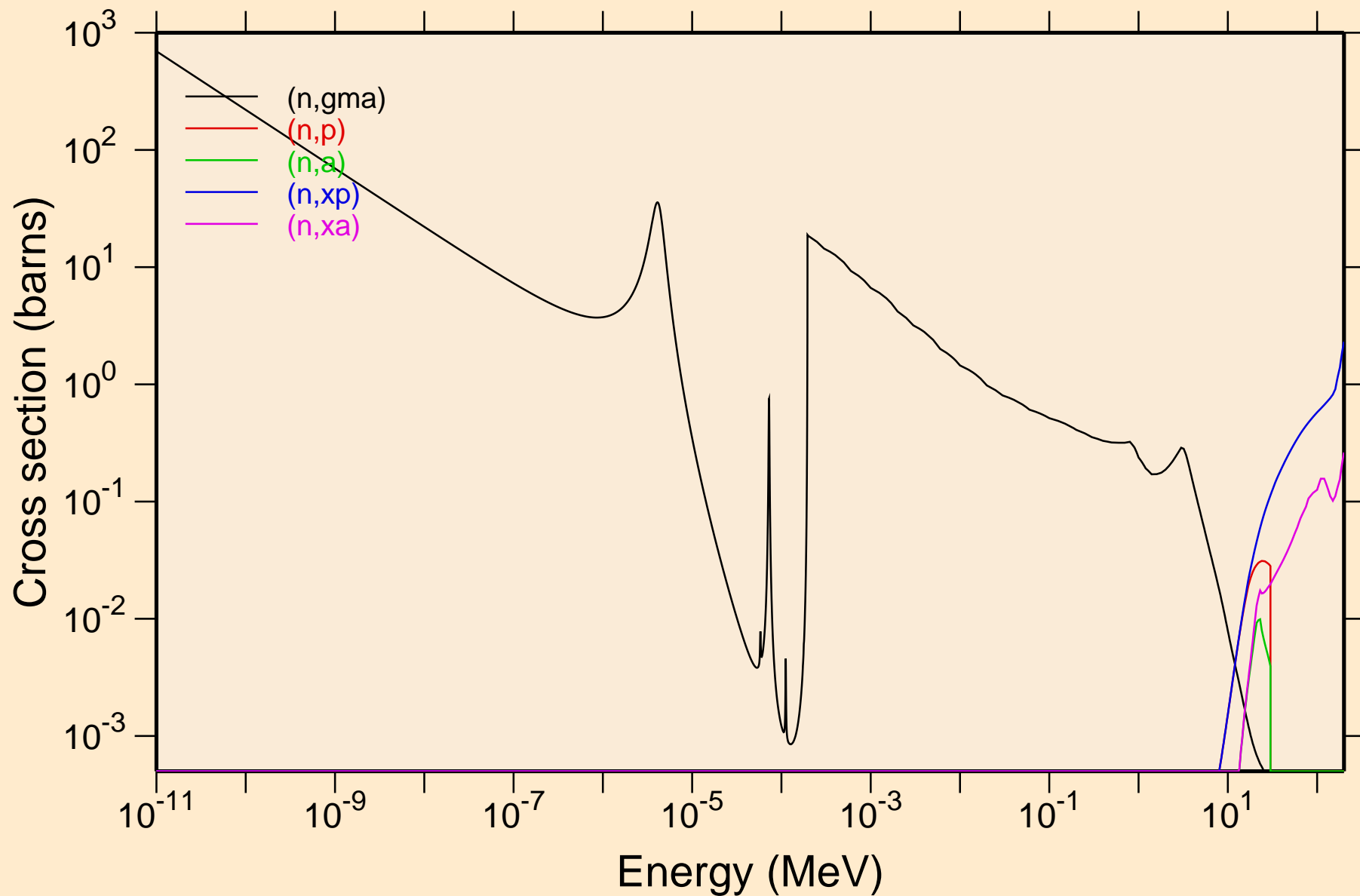

PB203 NEUTRON ACER TENDL-2019 LIBRARY; T=293.16K
Principal cross sections

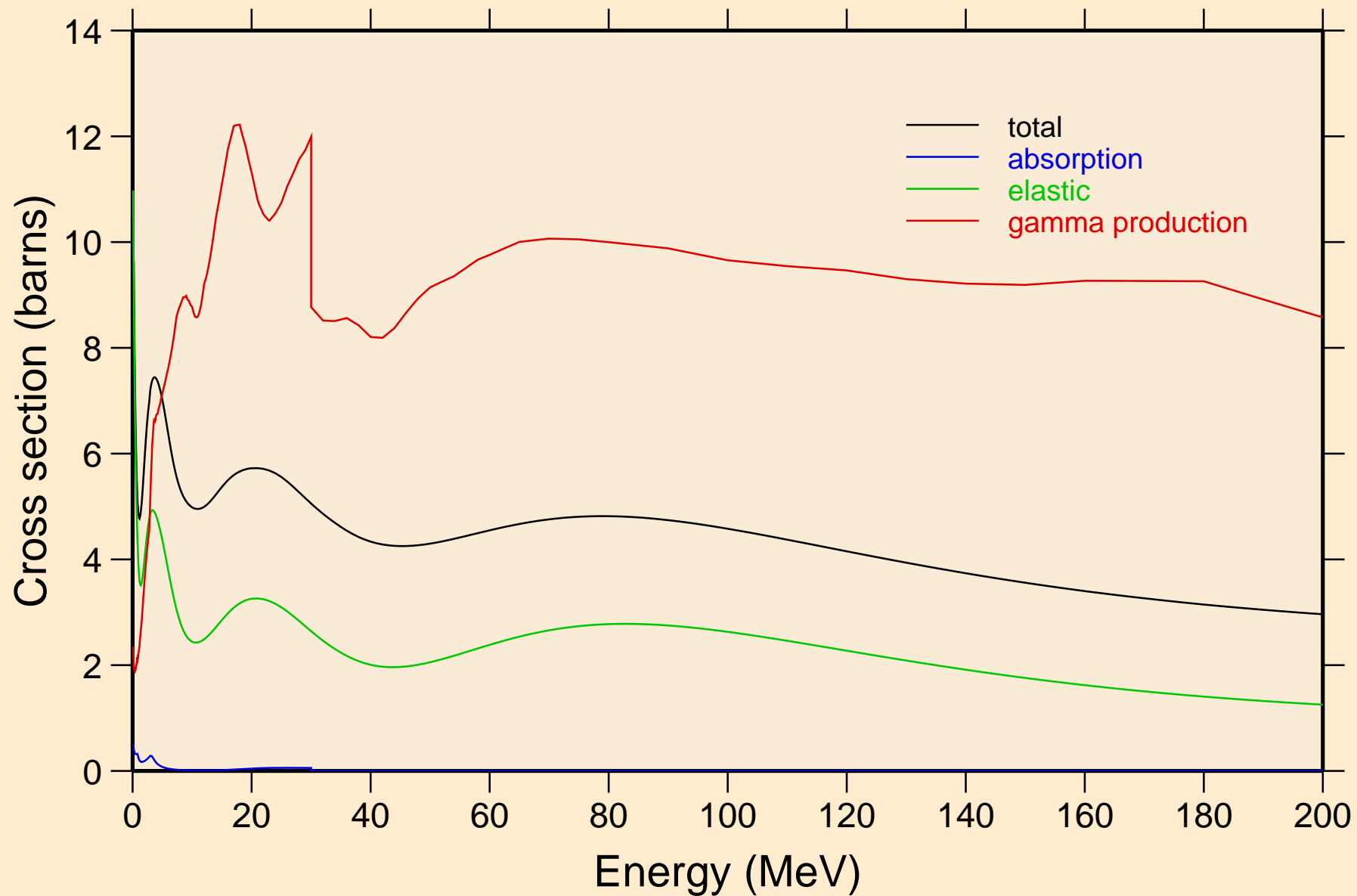

PB203 NEUTRON ACER TENDL-2019 LIBRARY; T=293.16K
Heating

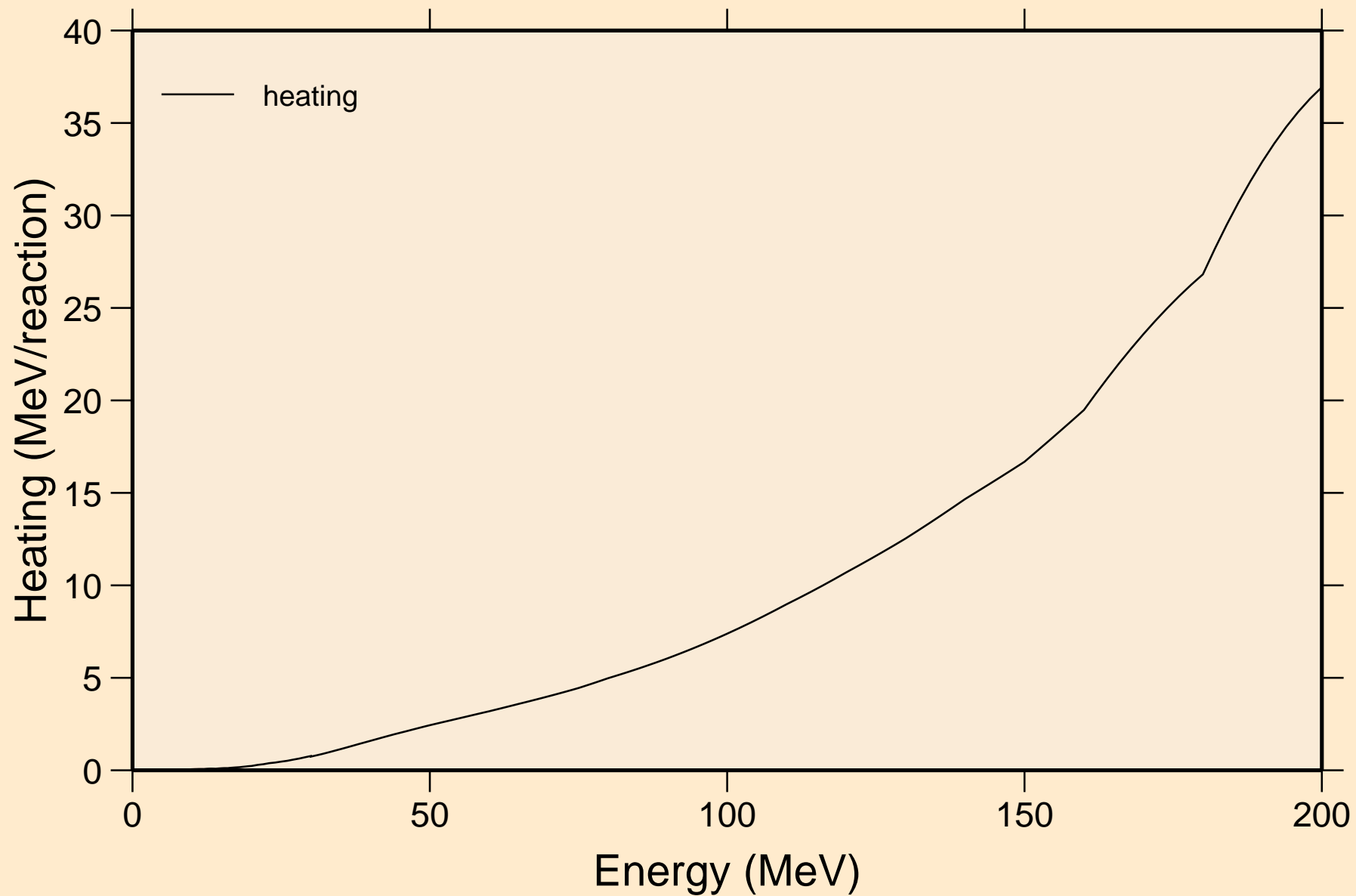

PB203 NEUTRON ACER TENDL-2019 LIBRARY; T=293.16K
Damage

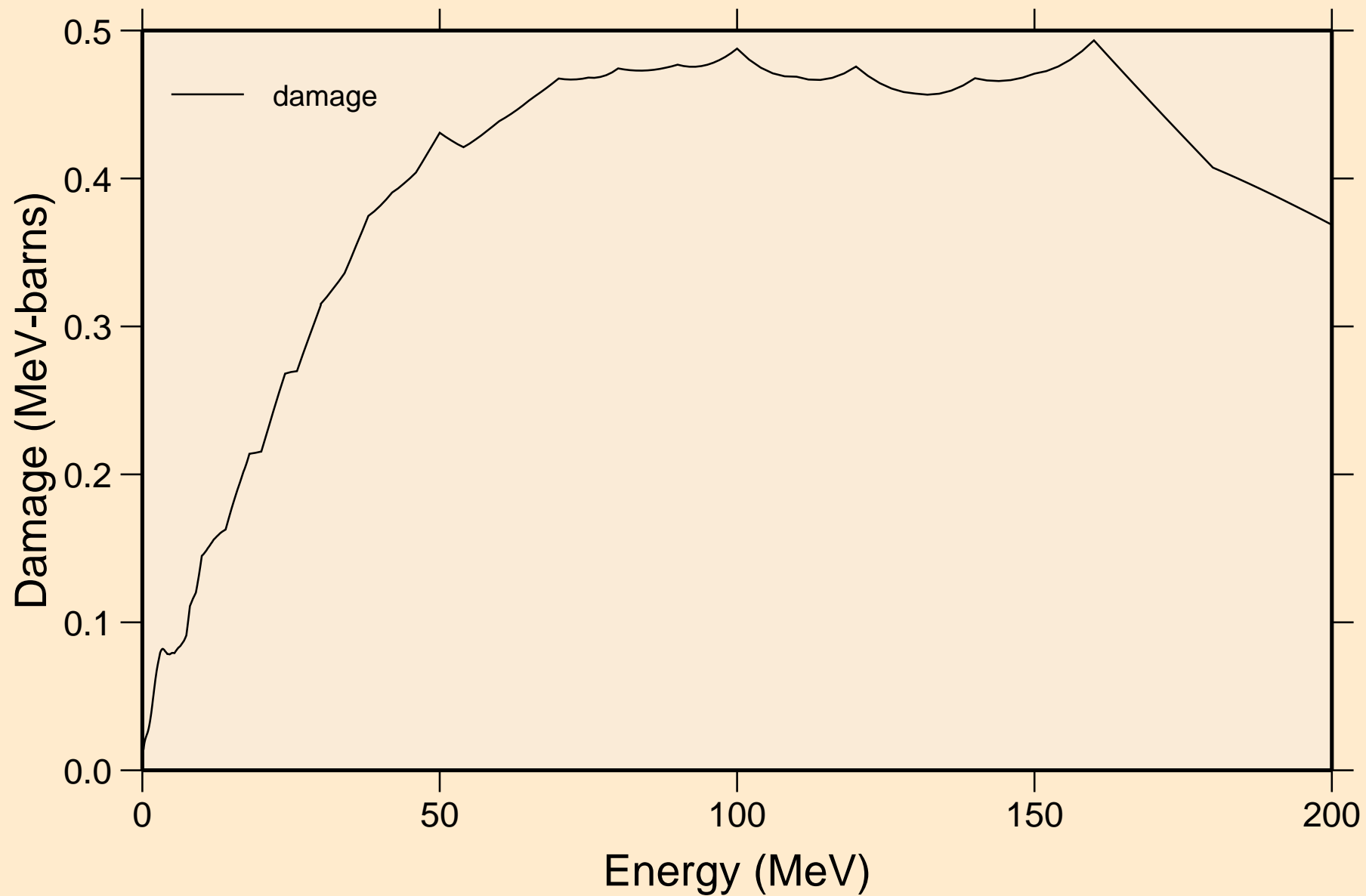

PB203 NEUTRON ACER TENDL-2019 LIBRARY; T=293.16K
Non-threshold reactions

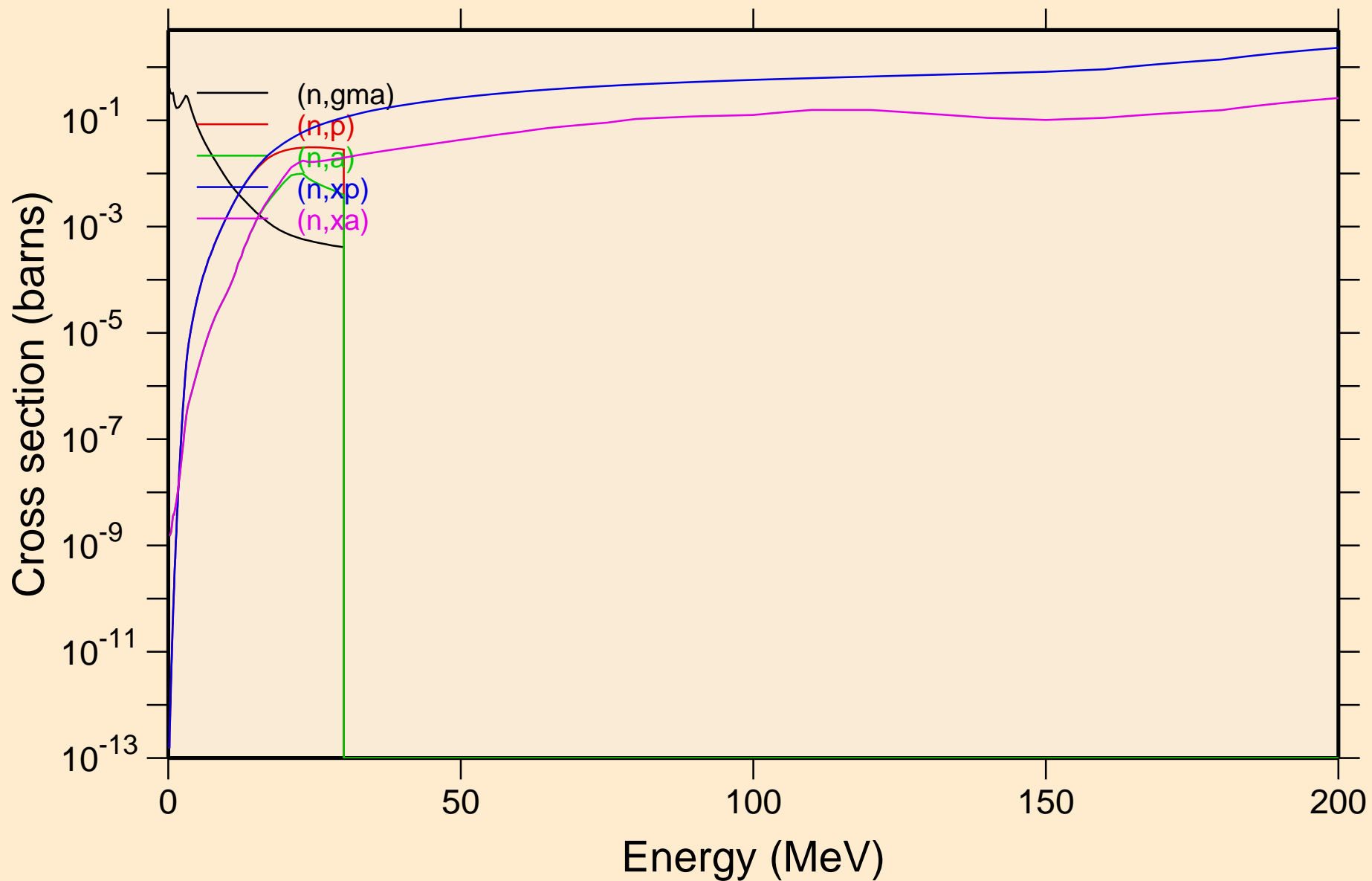

PB203 NEUTRON ACER TENDL-2019 LIBRARY; T=293.16K
Inelastic levels

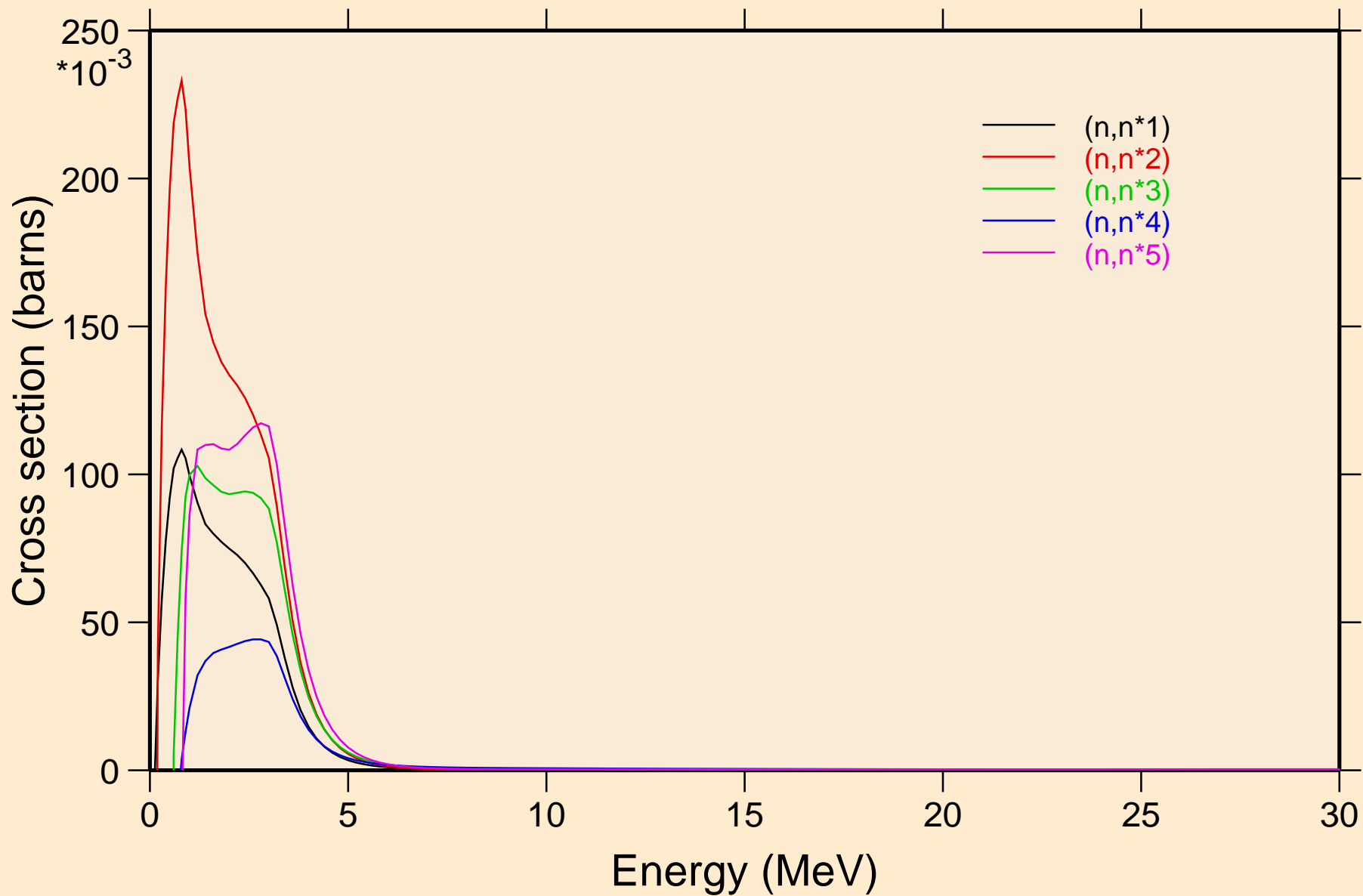

PB203 NEUTRON ACER TENDL-2019 LIBRARY; T=293.16K
Inelastic levels

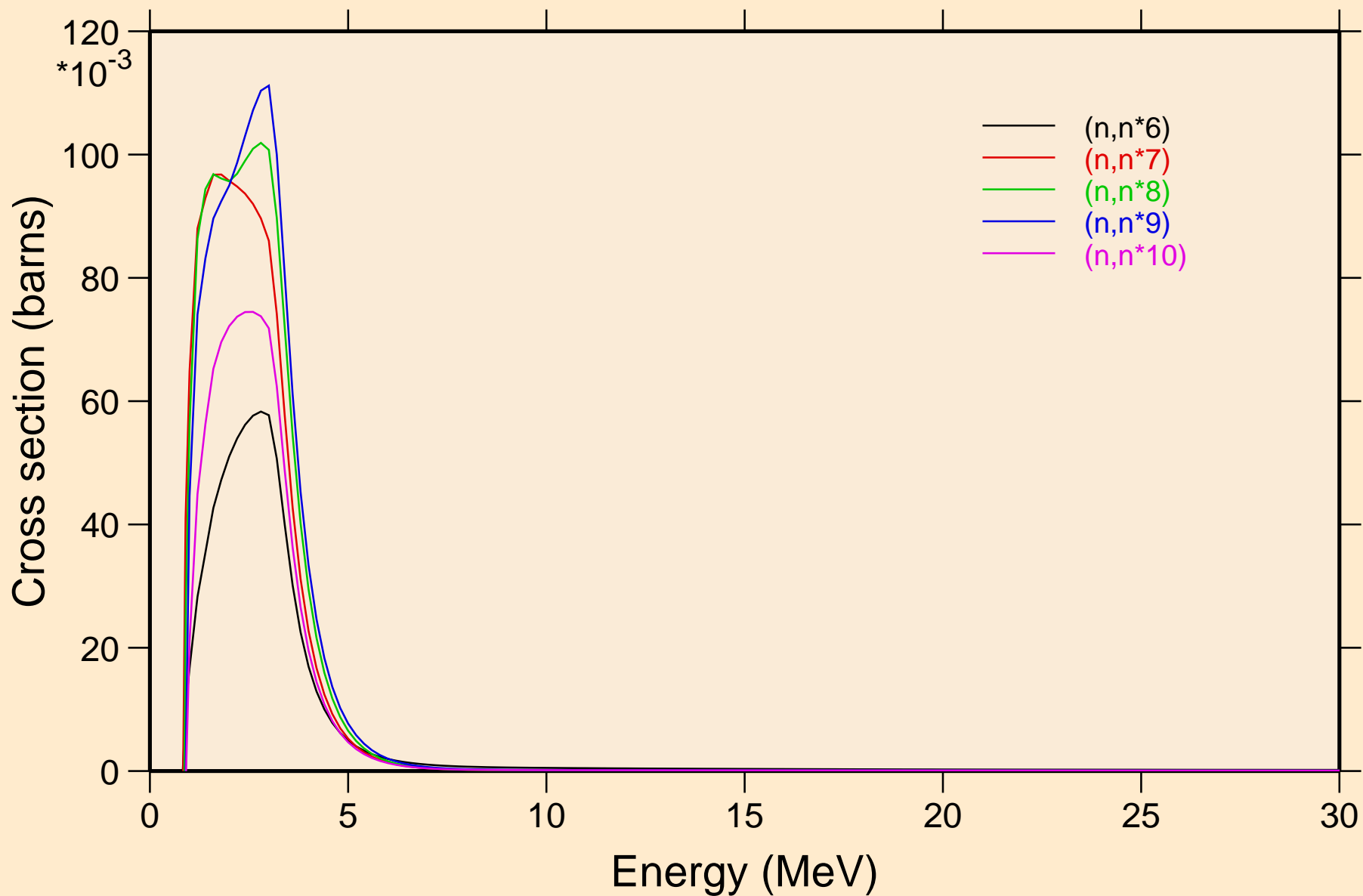

PB203 NEUTRON ACER TENDL-2019 LIBRARY; T=293.16K
Inelastic levels

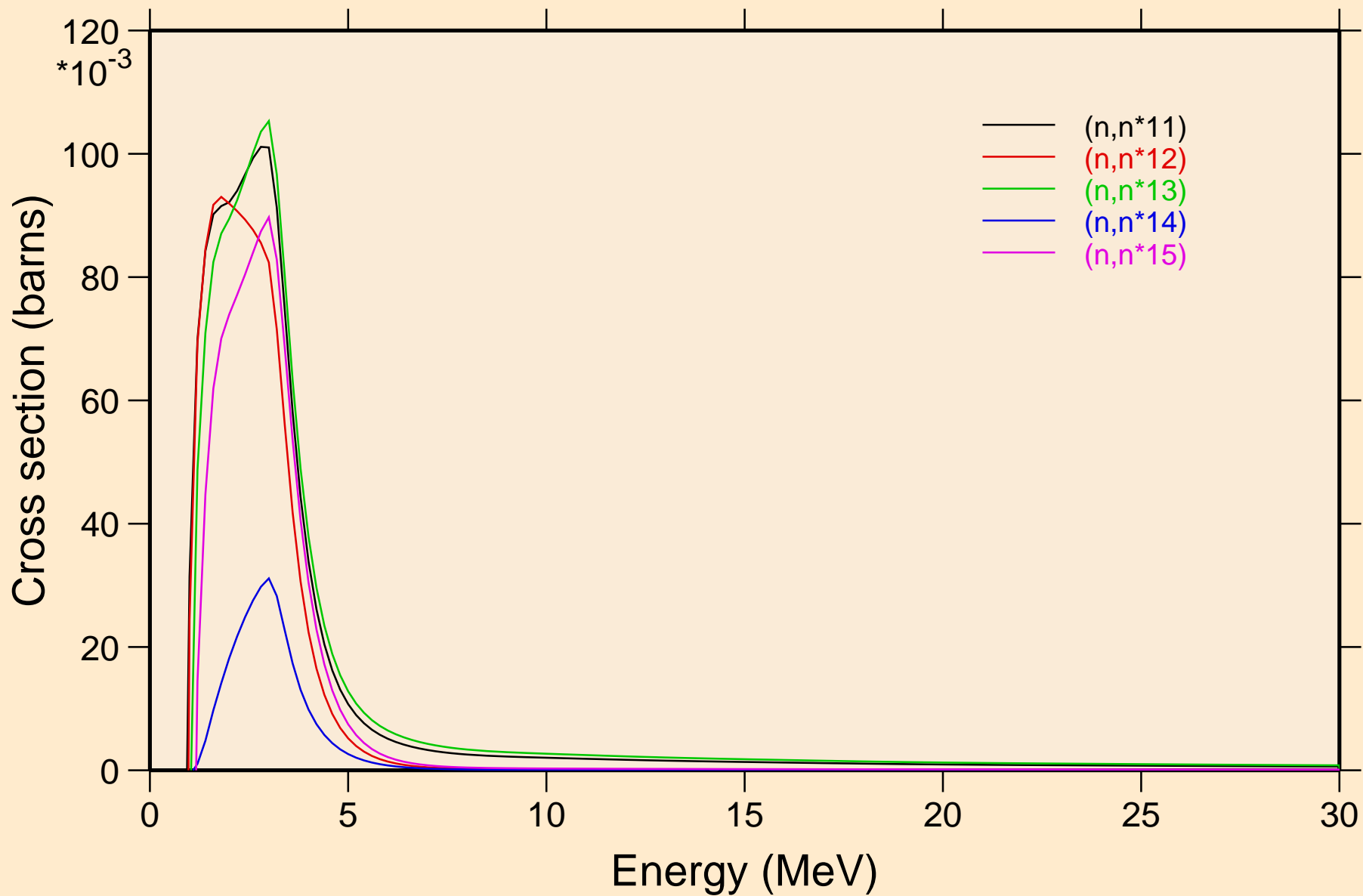

PB203 NEUTRON ACER TENDL-2019 LIBRARY; T=293.16K
Inelastic levels

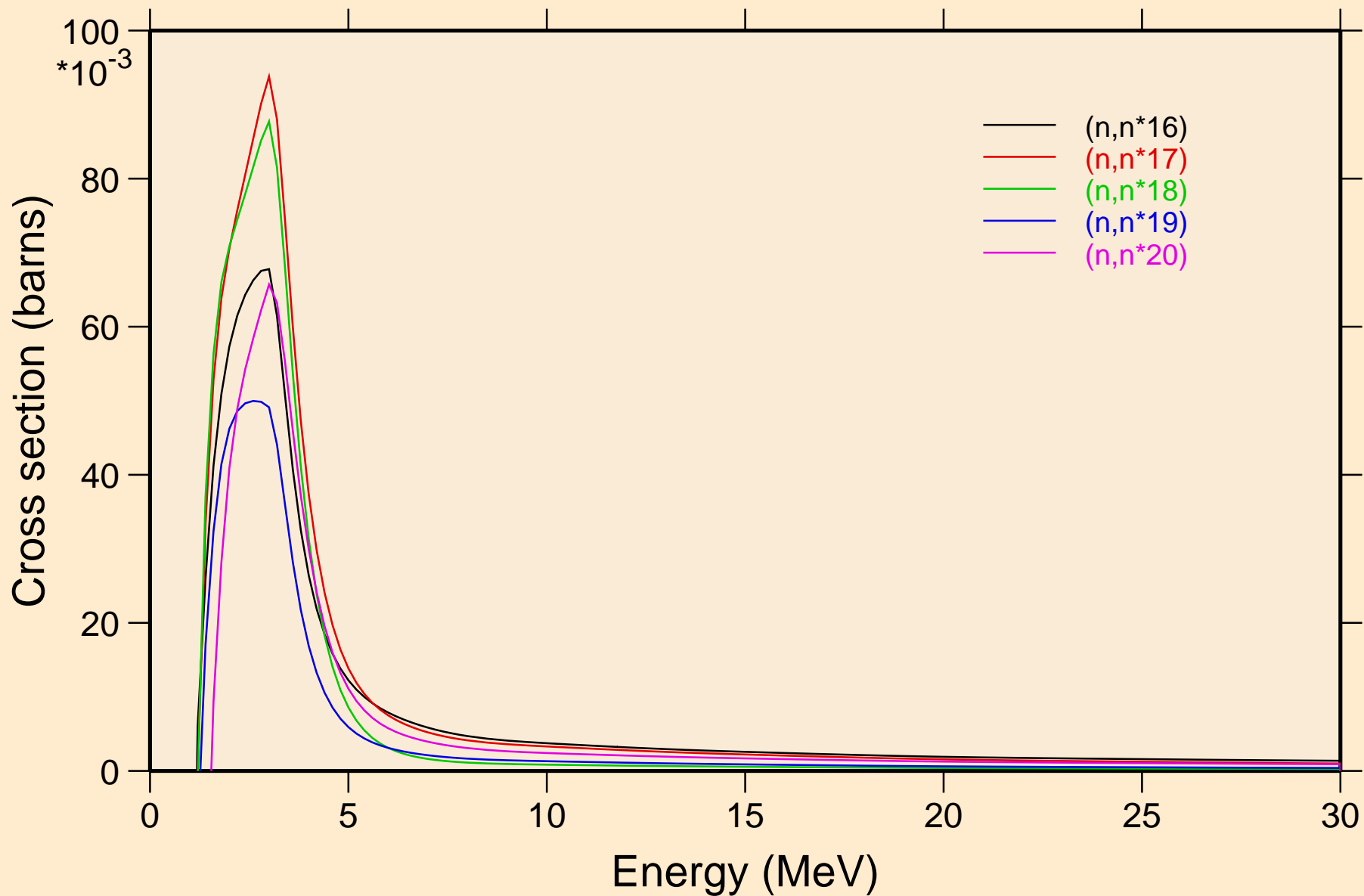

PB203 NEUTRON ACER TENDL-2019 LIBRARY; T=293.16K
Inelastic levels

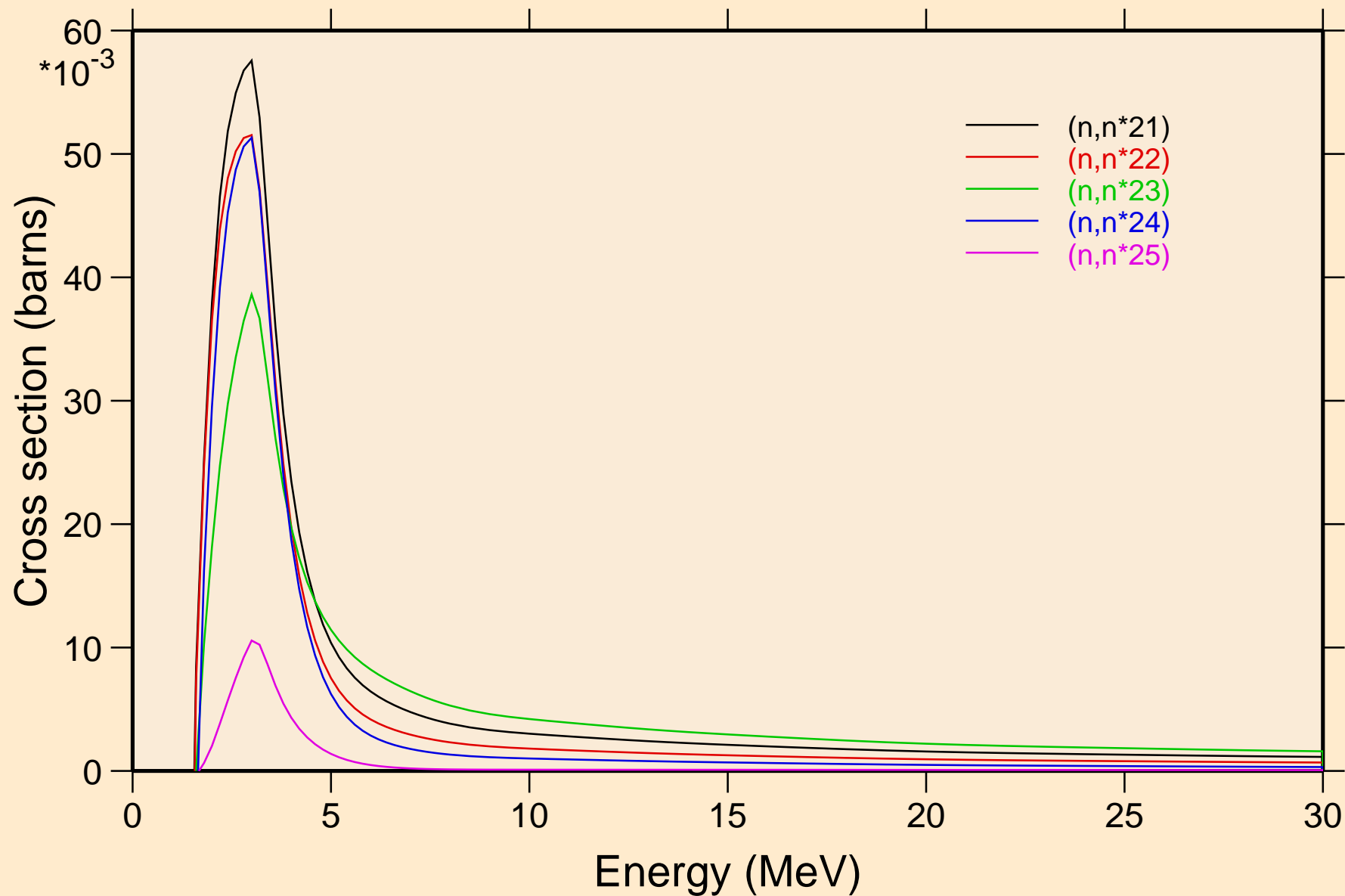

PB203 NEUTRON ACER TENDL-2019 LIBRARY; T=293.16K
Inelastic levels

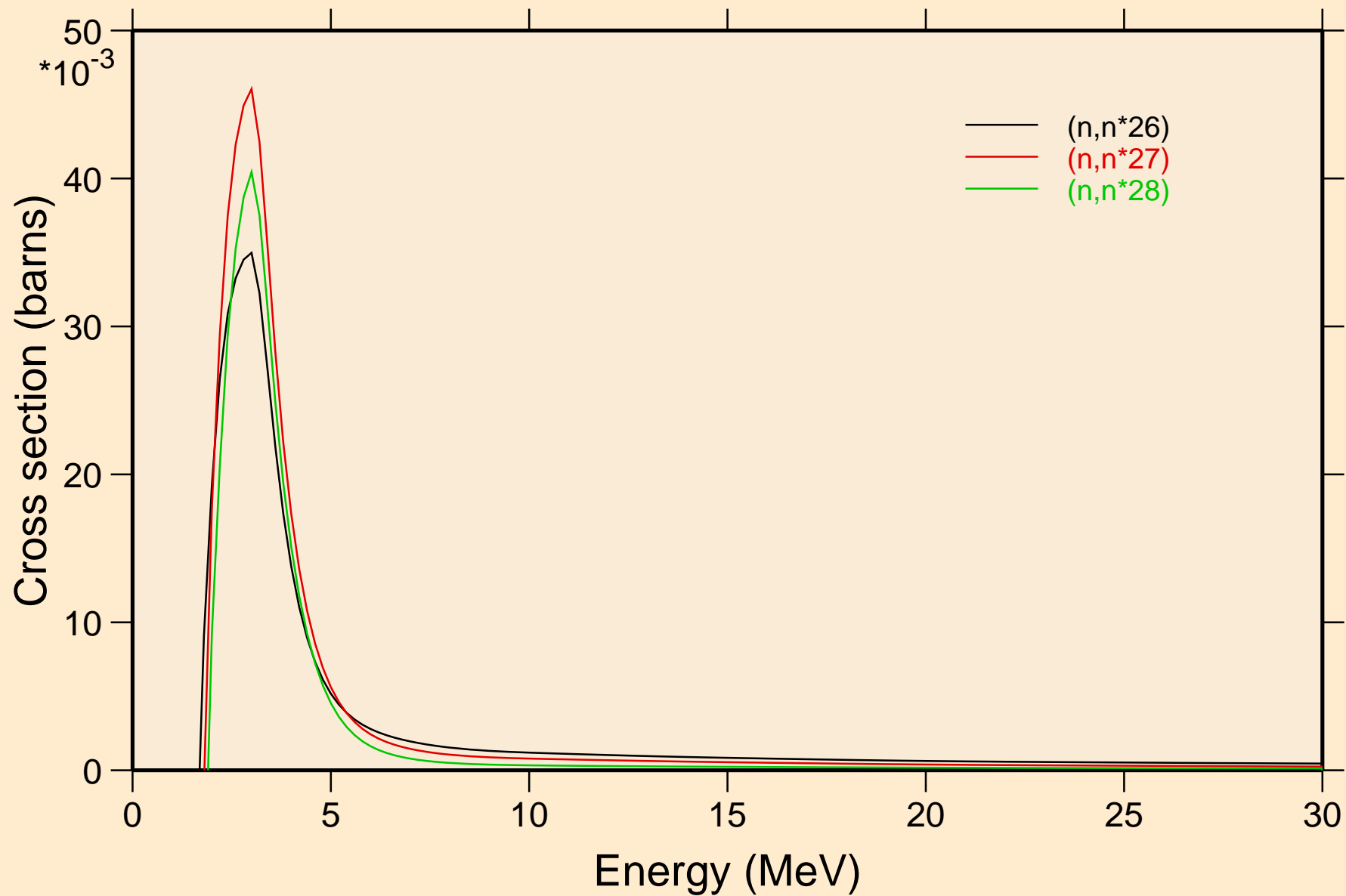

PB203 NEUTRON ACER TENDL-2019 LIBRARY; T=293.16K
Threshold reactions

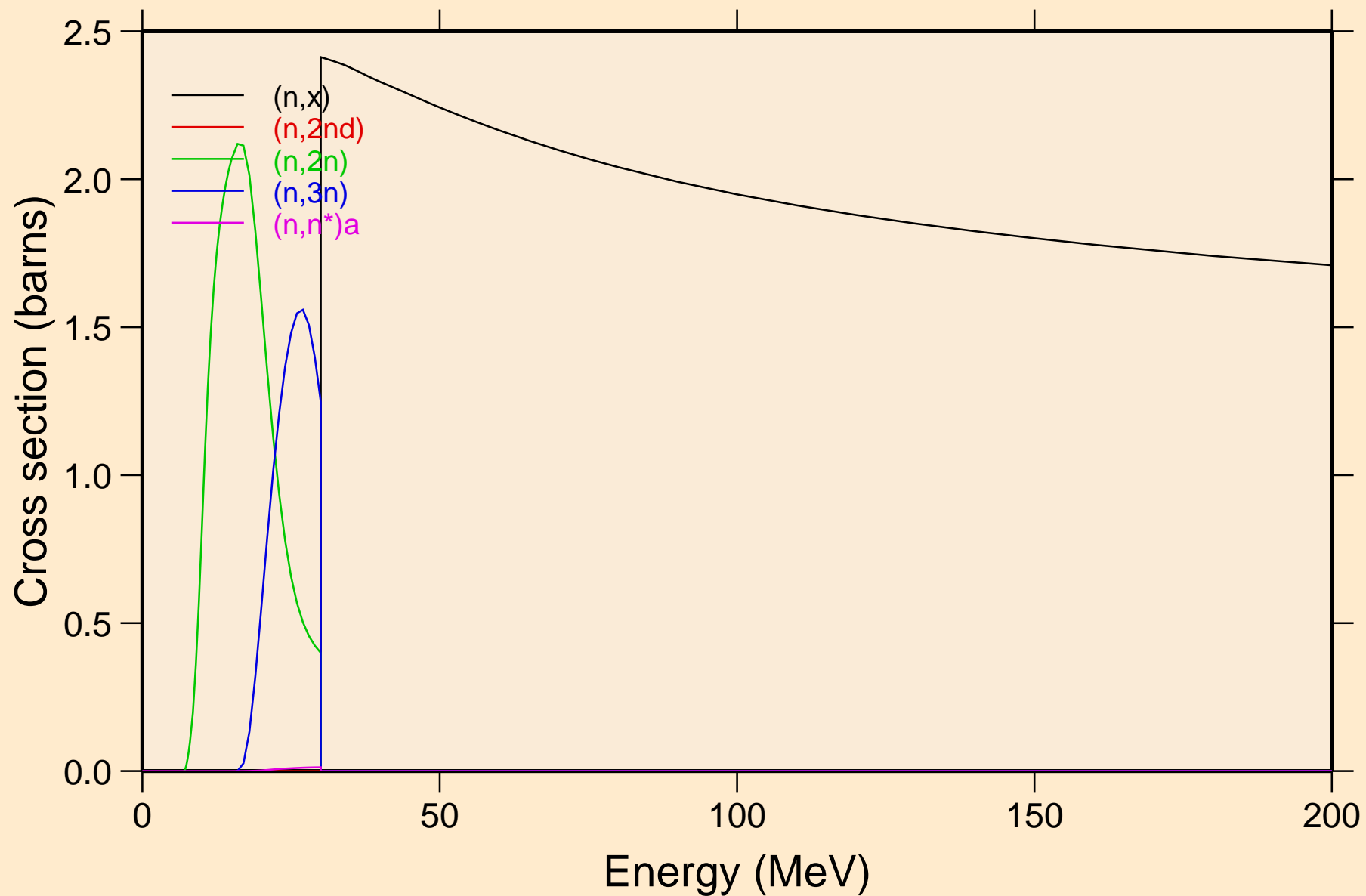

PB203 NEUTRON ACER TENDL-2019 LIBRARY; T=293.16K
Threshold reactions

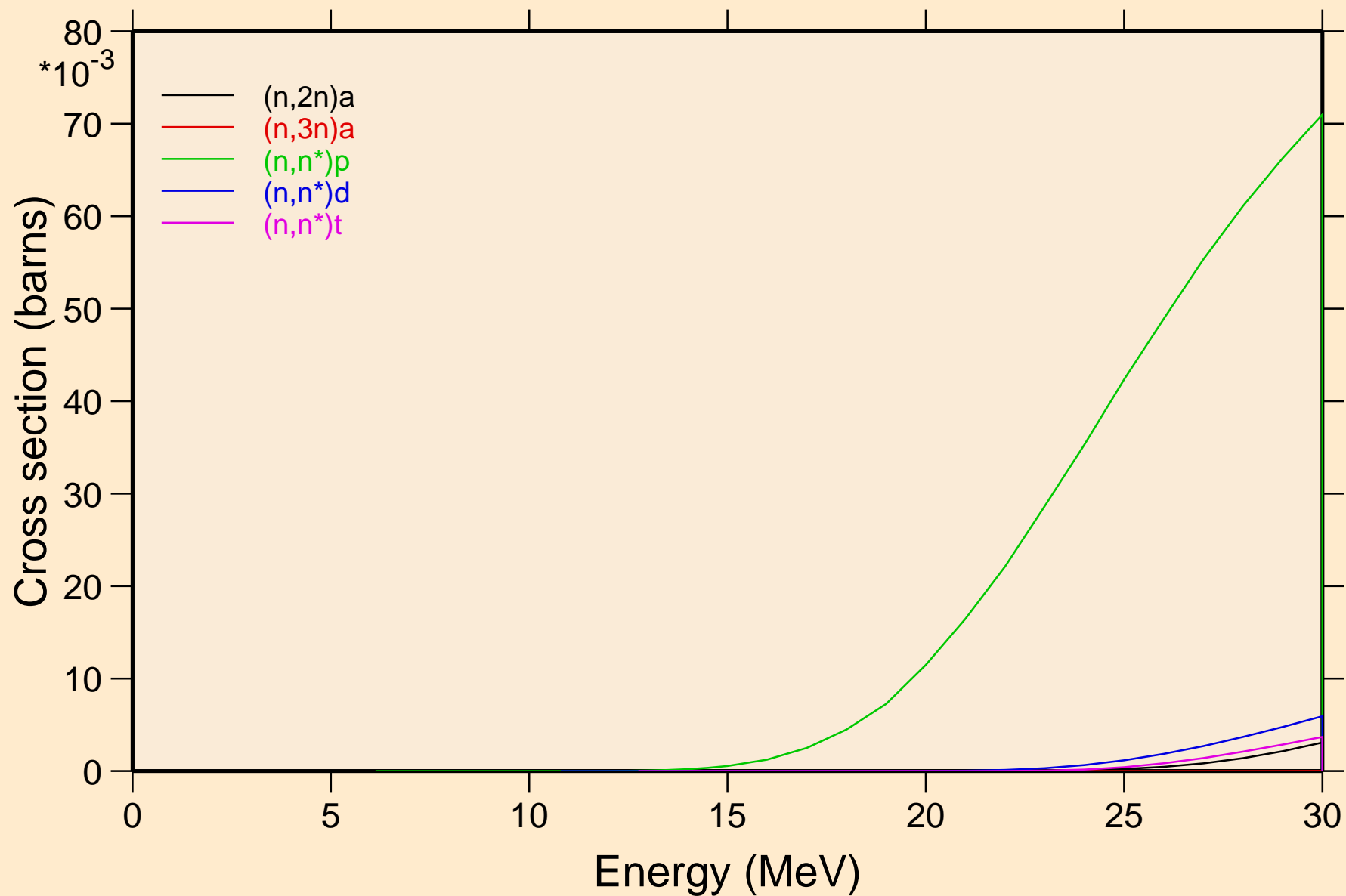

PB203 NEUTRON ACER TENDL-2019 LIBRARY; T=293.16K
Threshold reactions

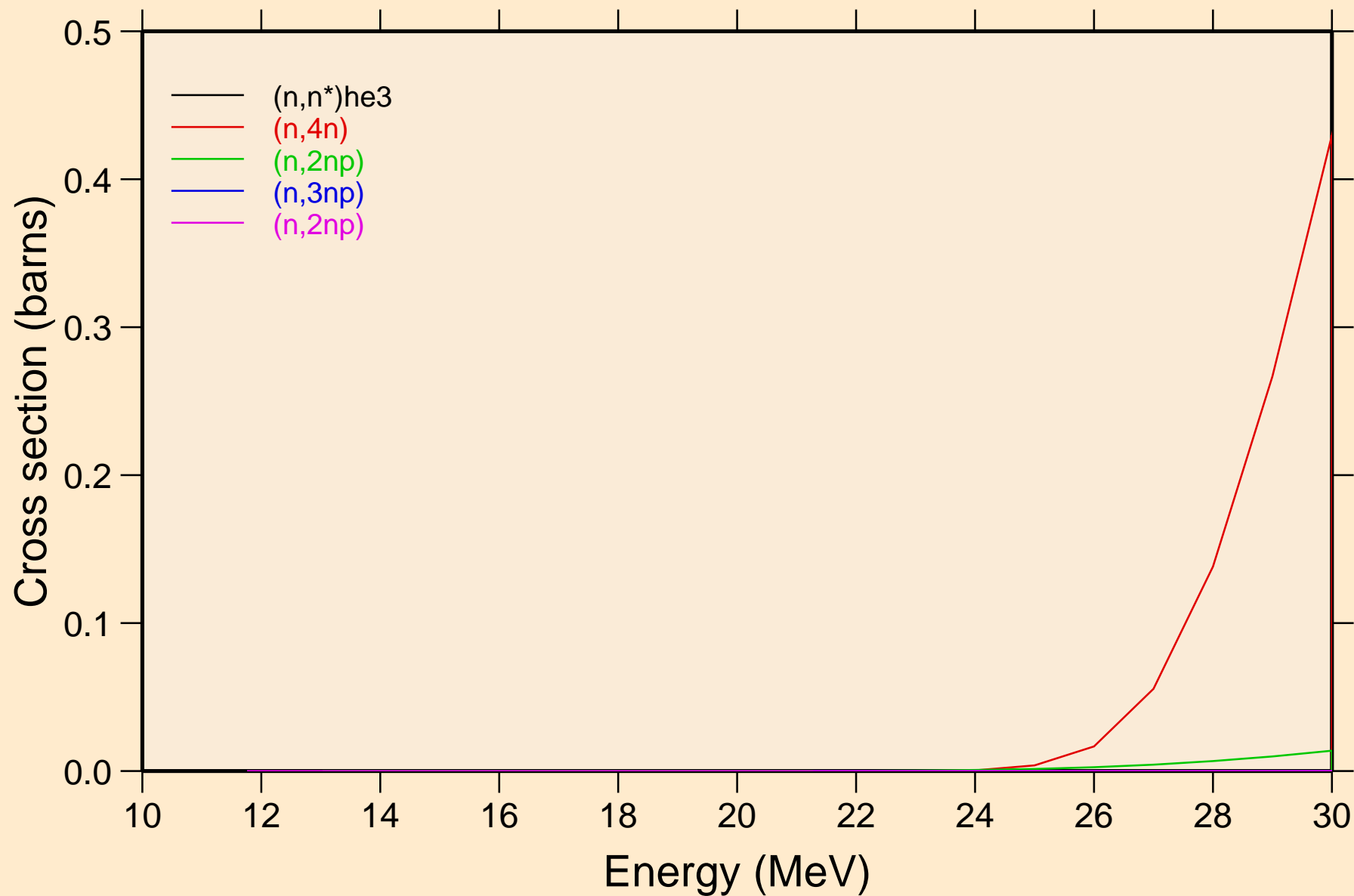

PB203 NEUTRON ACER TENDL-2019 LIBRARY; T=293.16K
Threshold reactions

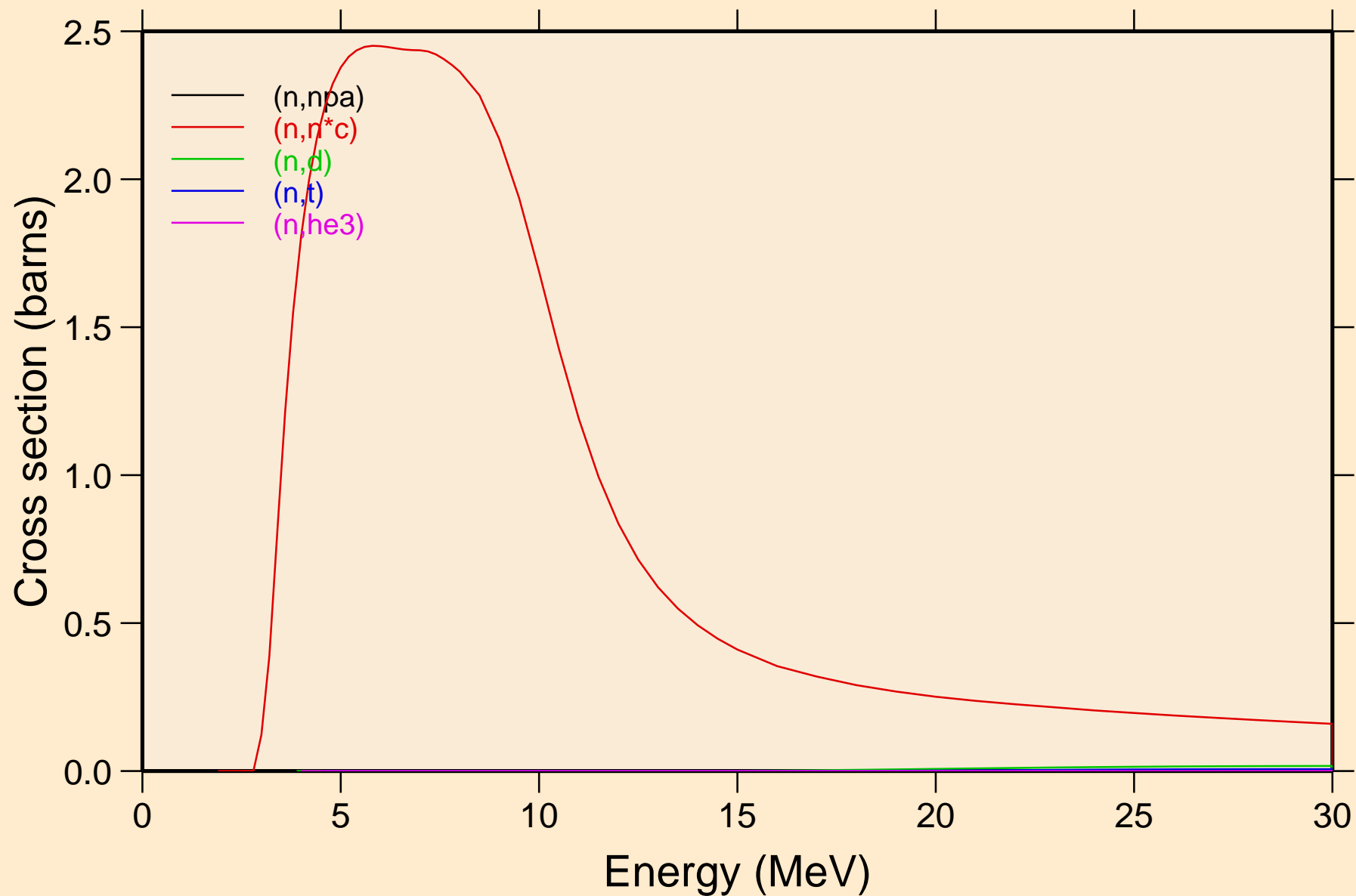

PB203 NEUTRON ACER TENDL-2019 LIBRARY; T=293.16K
Threshold reactions

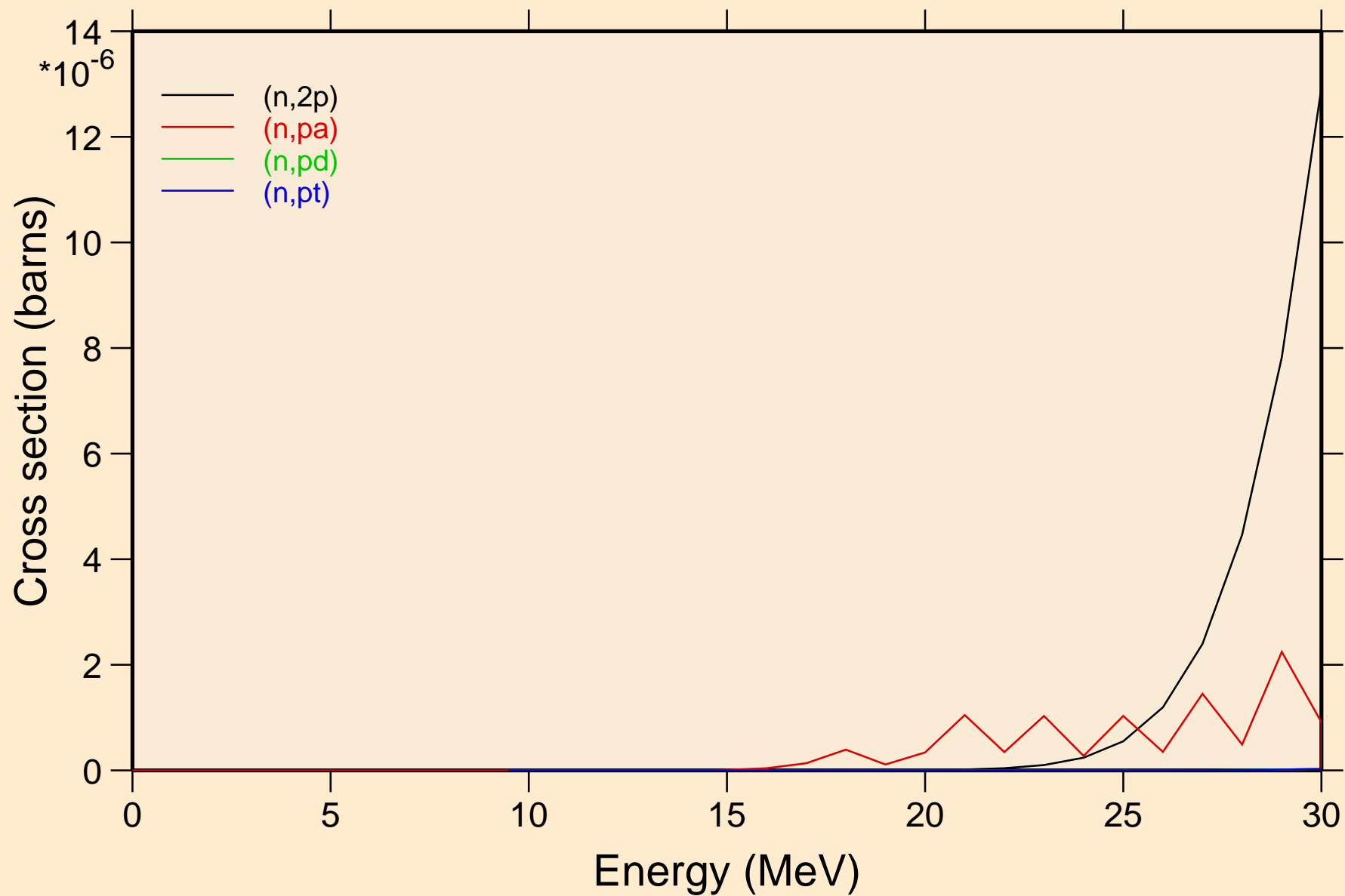

PB203 NEUTRON ACER TENDL-2019 LIBRARY; T=293.16K
Threshold reactions

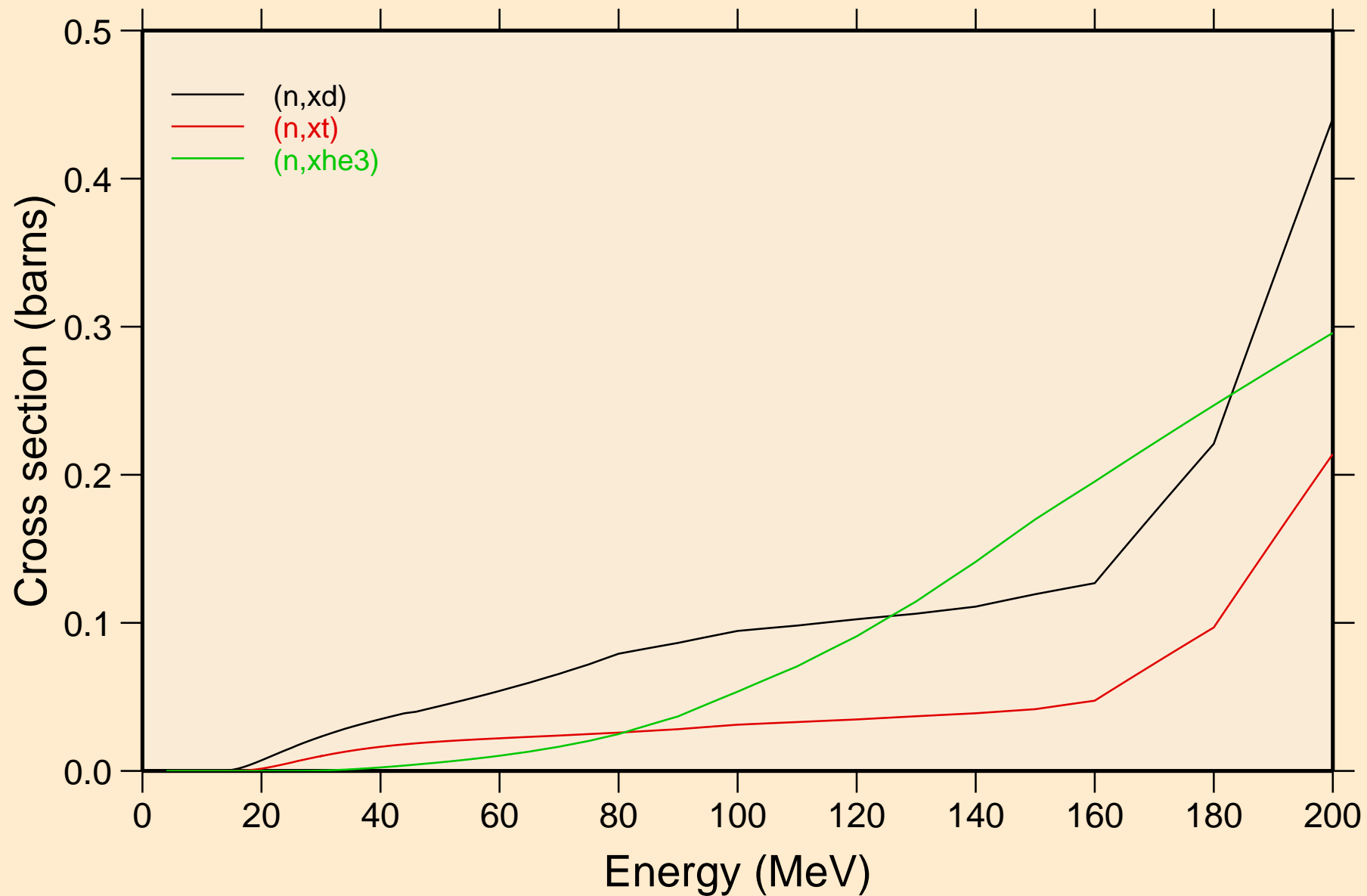

PB203 NEUTRON ACER TENDL-2019 LIBRARY; T=293.16K
angular distribution for elastic

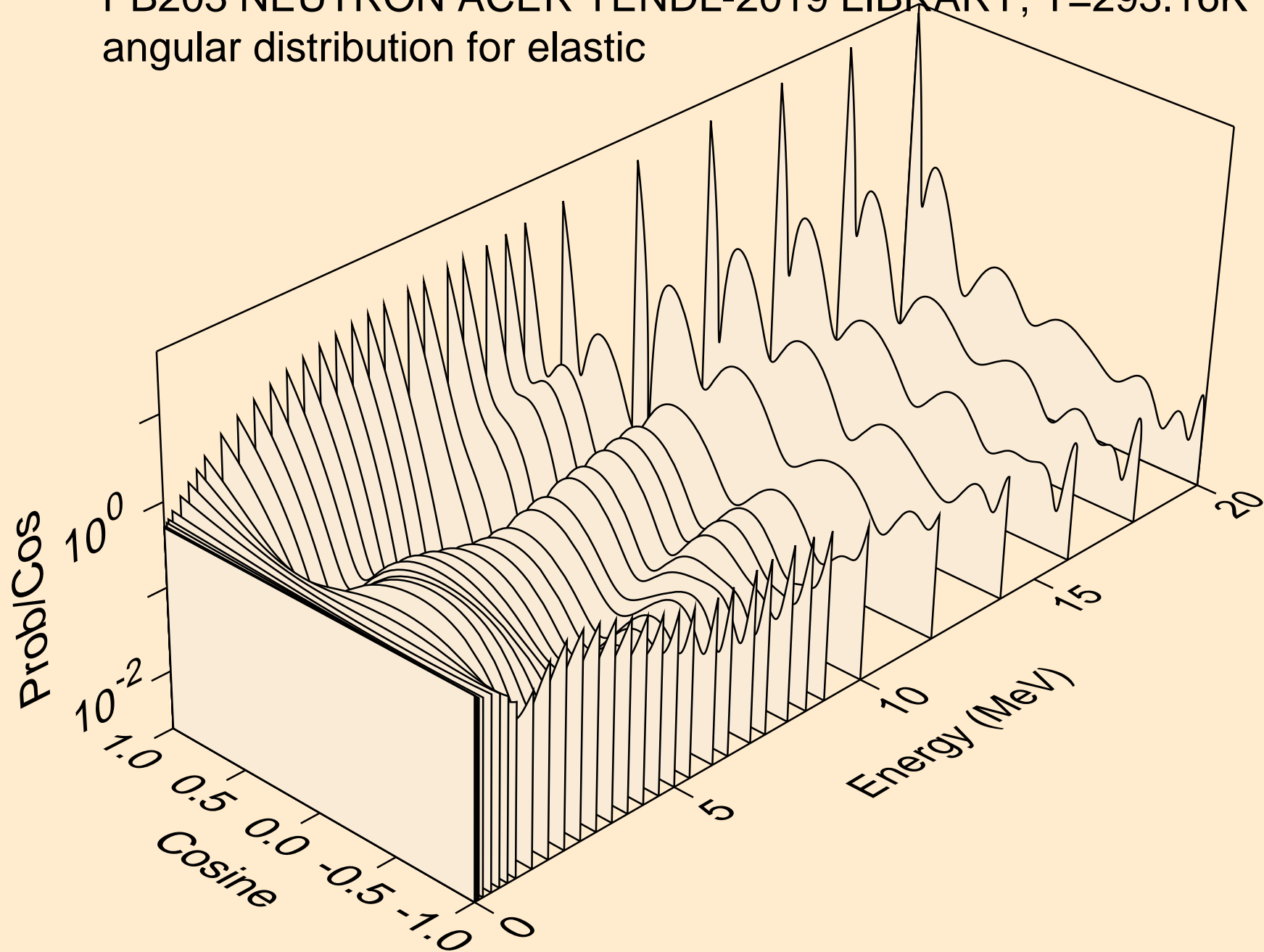

PB203 NEUTRON ACER TENDL-2019 LIBRARY; T=293.16K
angular distribution for elastic

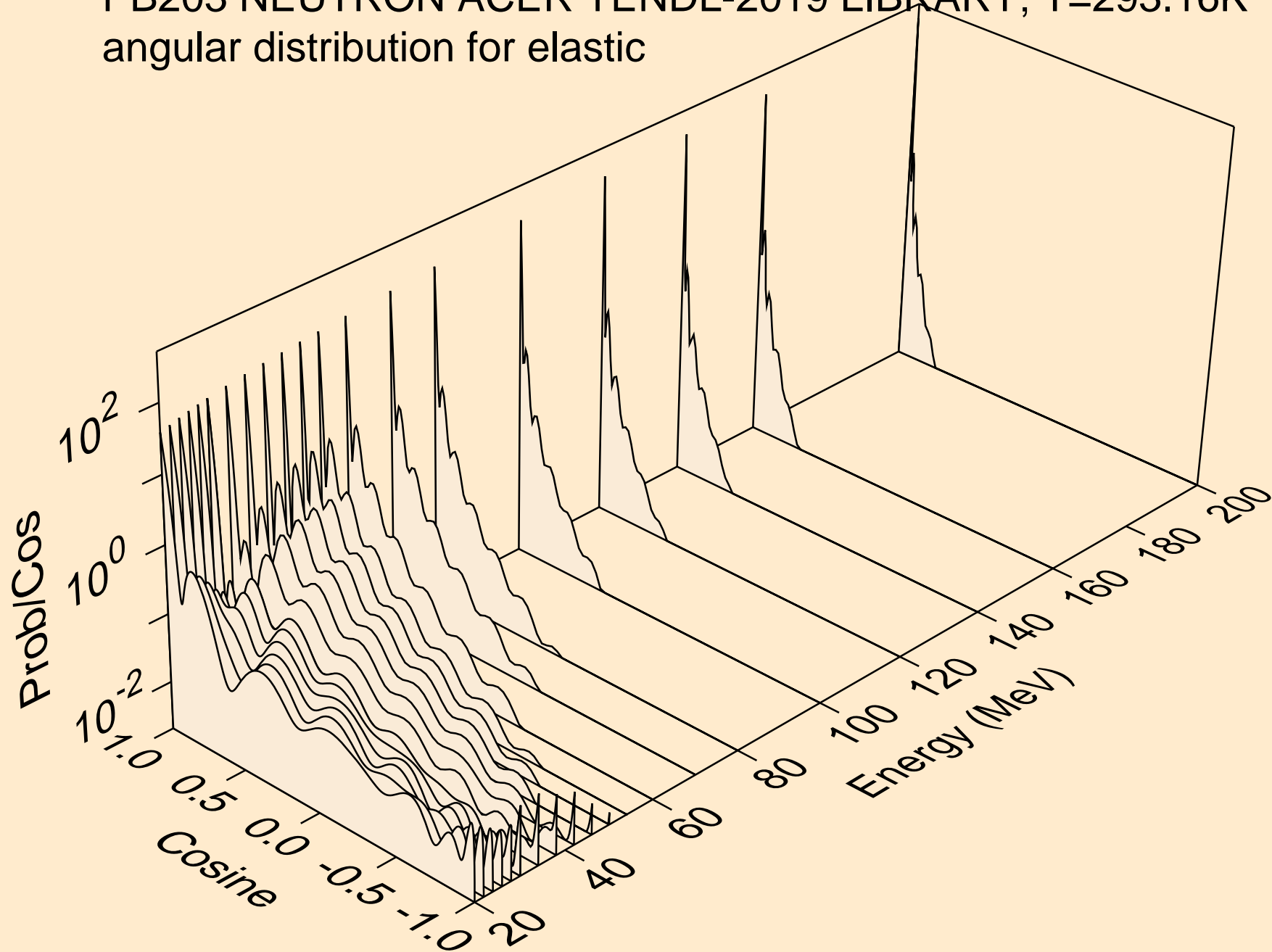

PB203 NEUTRON ACER TENDL-2019 LIBRARY; T=293.16K
angular distribution for (n,n*1)

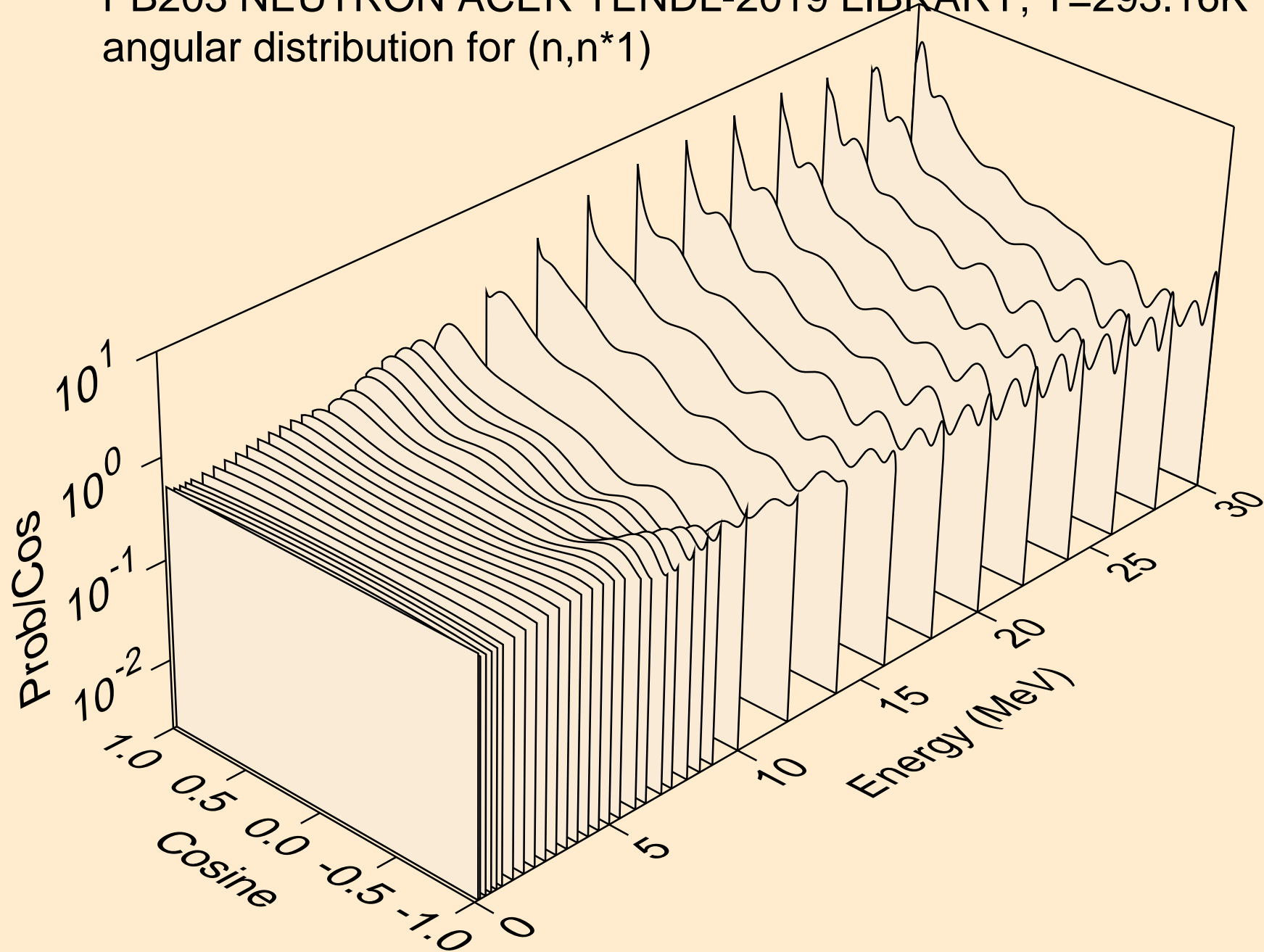

PB203 NEUTRON ACER TENDL-2019 LIBRARY; T=293.16K
angular distribution for (n,n*2)

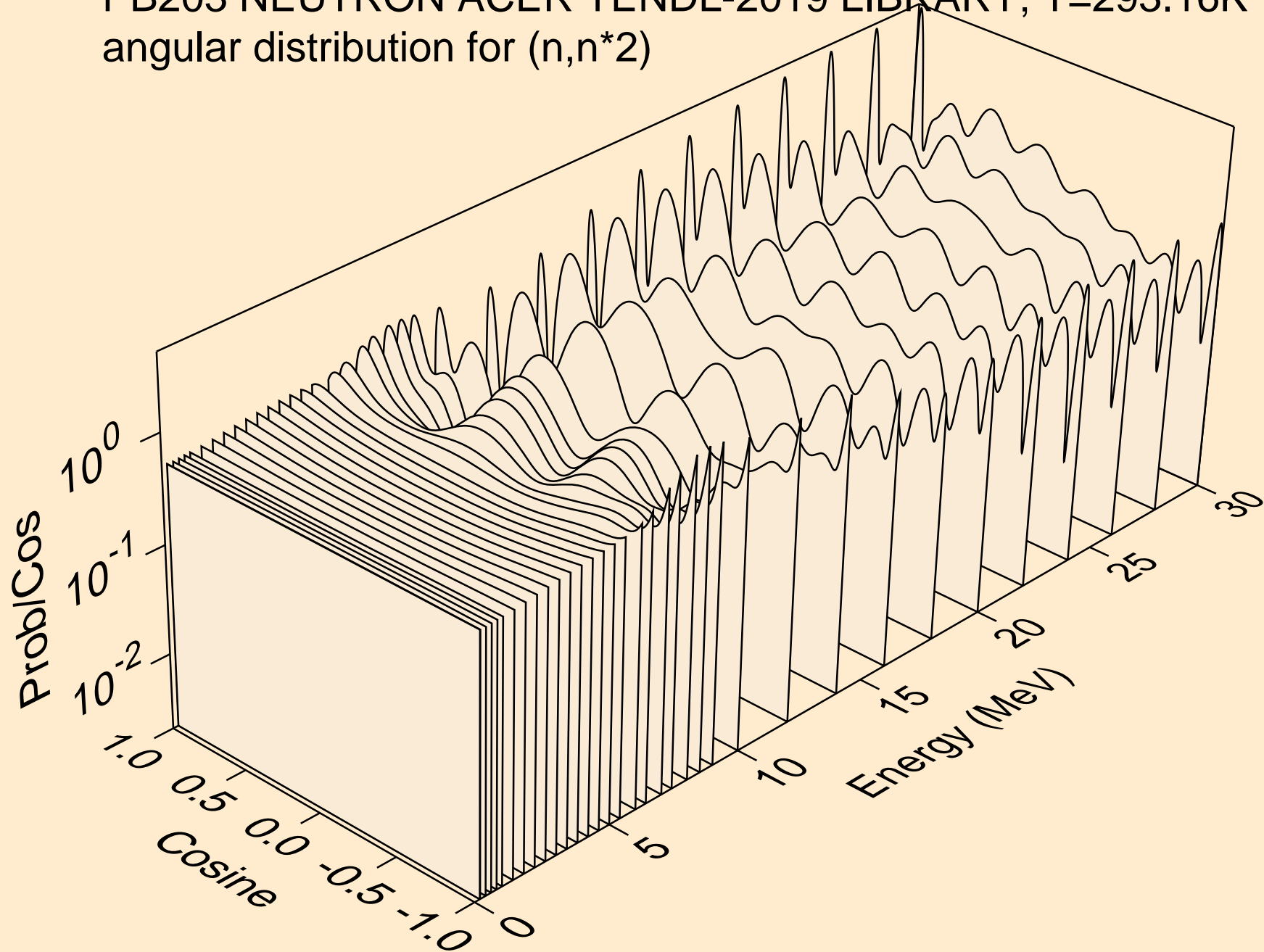

PB203 NEUTRON ACER TENDL-2019 LIBRARY; T=293.16K
angular distribution for (n,n*3)

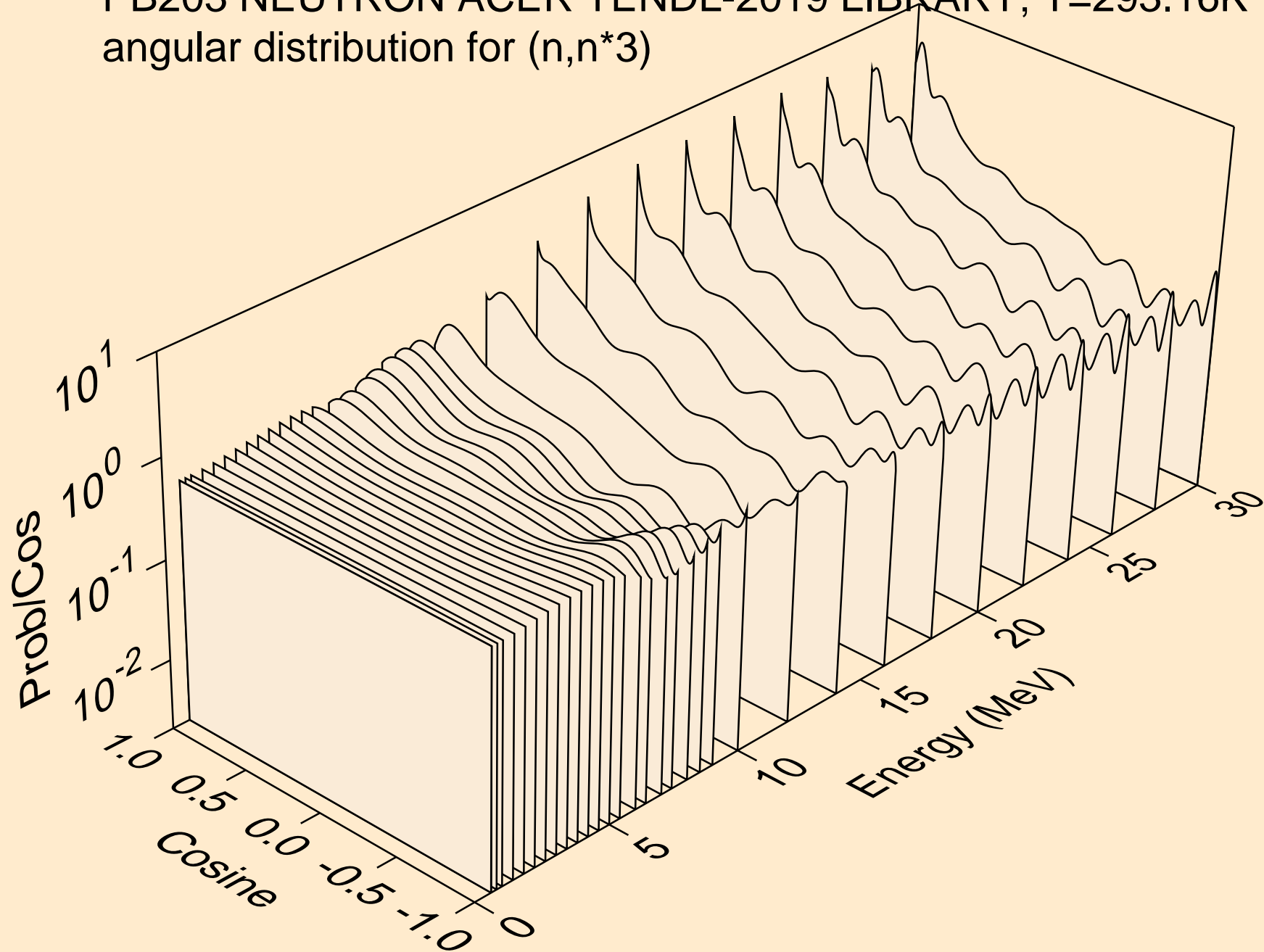

PB203 NEUTRON ACER TENDL-2019 LIBRARY; T=293.16K
angular distribution for (n,n*4)

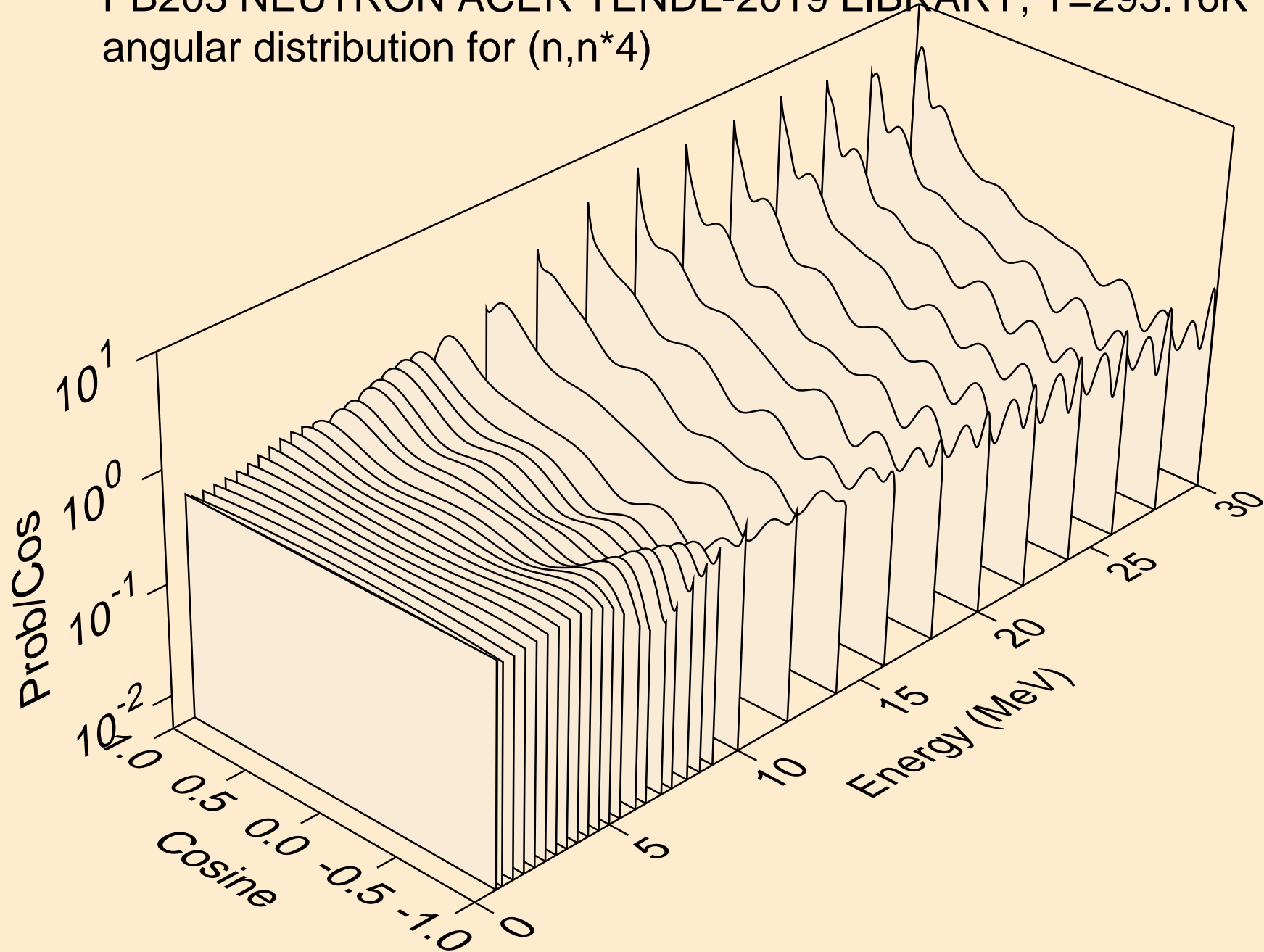

PB203 NEUTRON ACER TENDL-2019 LIBRARY; T=293.16K
angular distribution for (n,n*5)

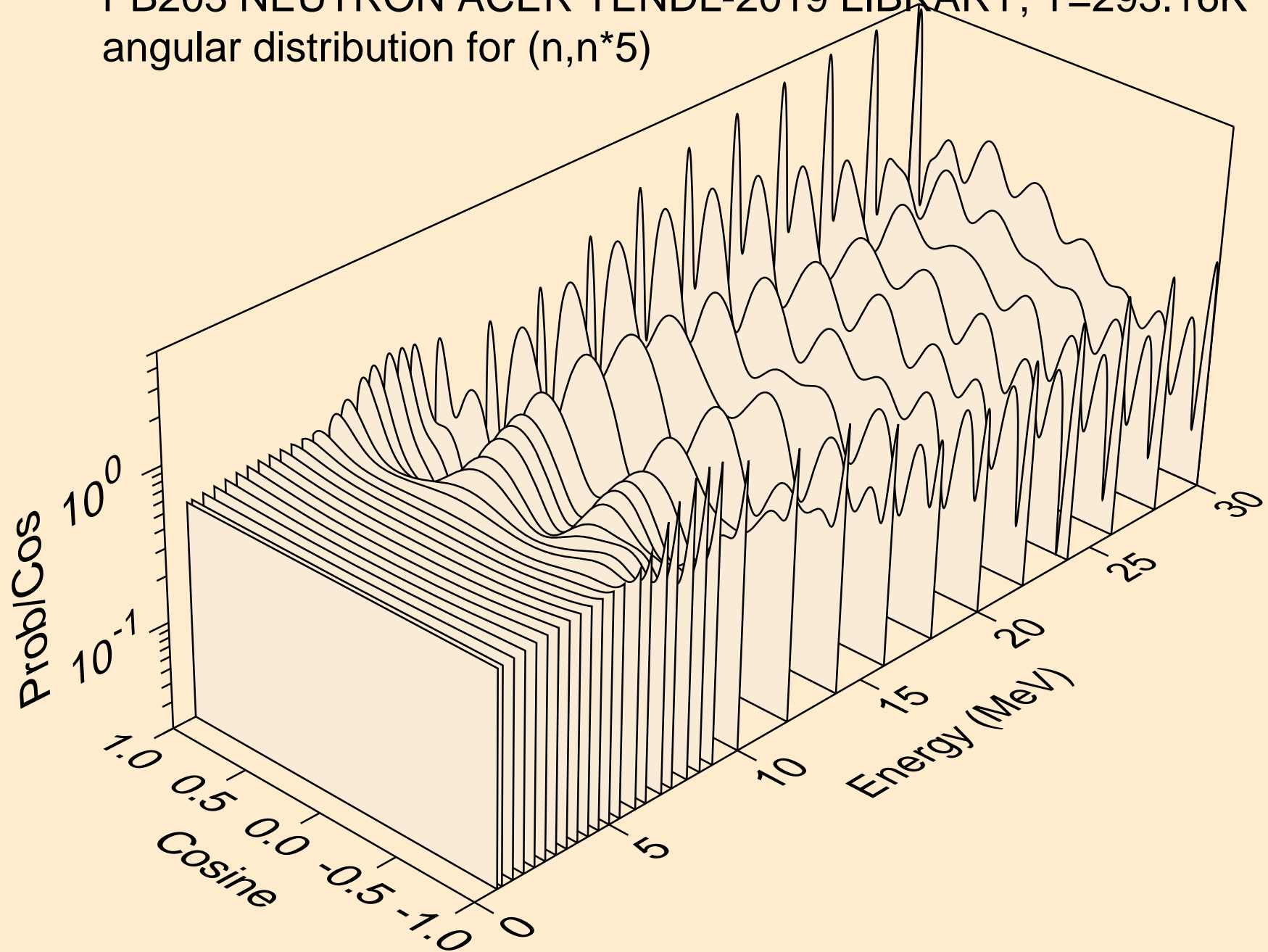

PB203 NEUTRON ACER TENDL-2019 LIBRARY; T=293.16K
angular distribution for (n,n*6)

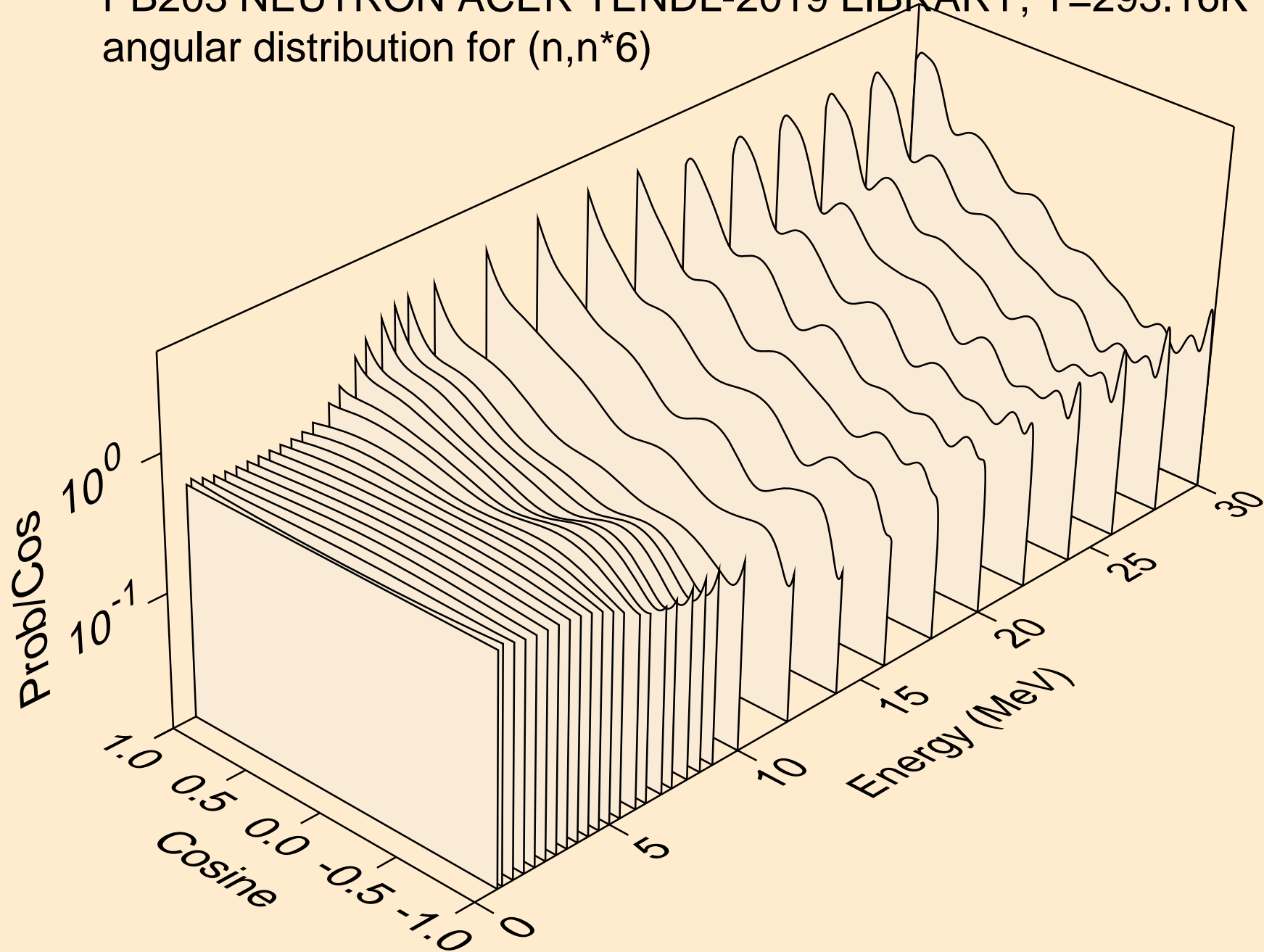

PB203 NEUTRON ACER TENDL-2019 LIBRARY; T=293.16K
angular distribution for (n,n*7)

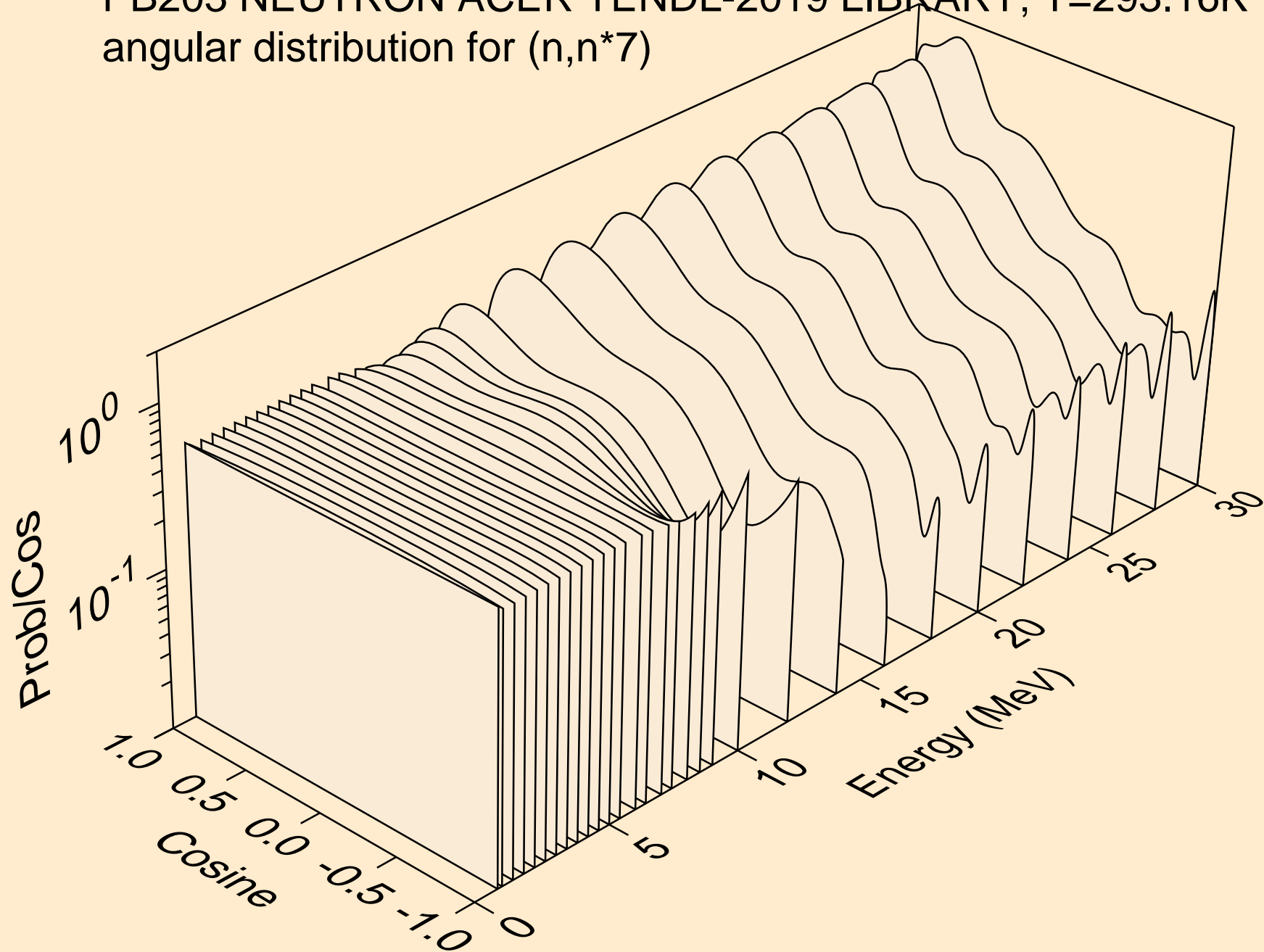

PB203 NEUTRON ACER TENDL-2019 LIBRARY; T=293.16K
angular distribution for (n,n*8)

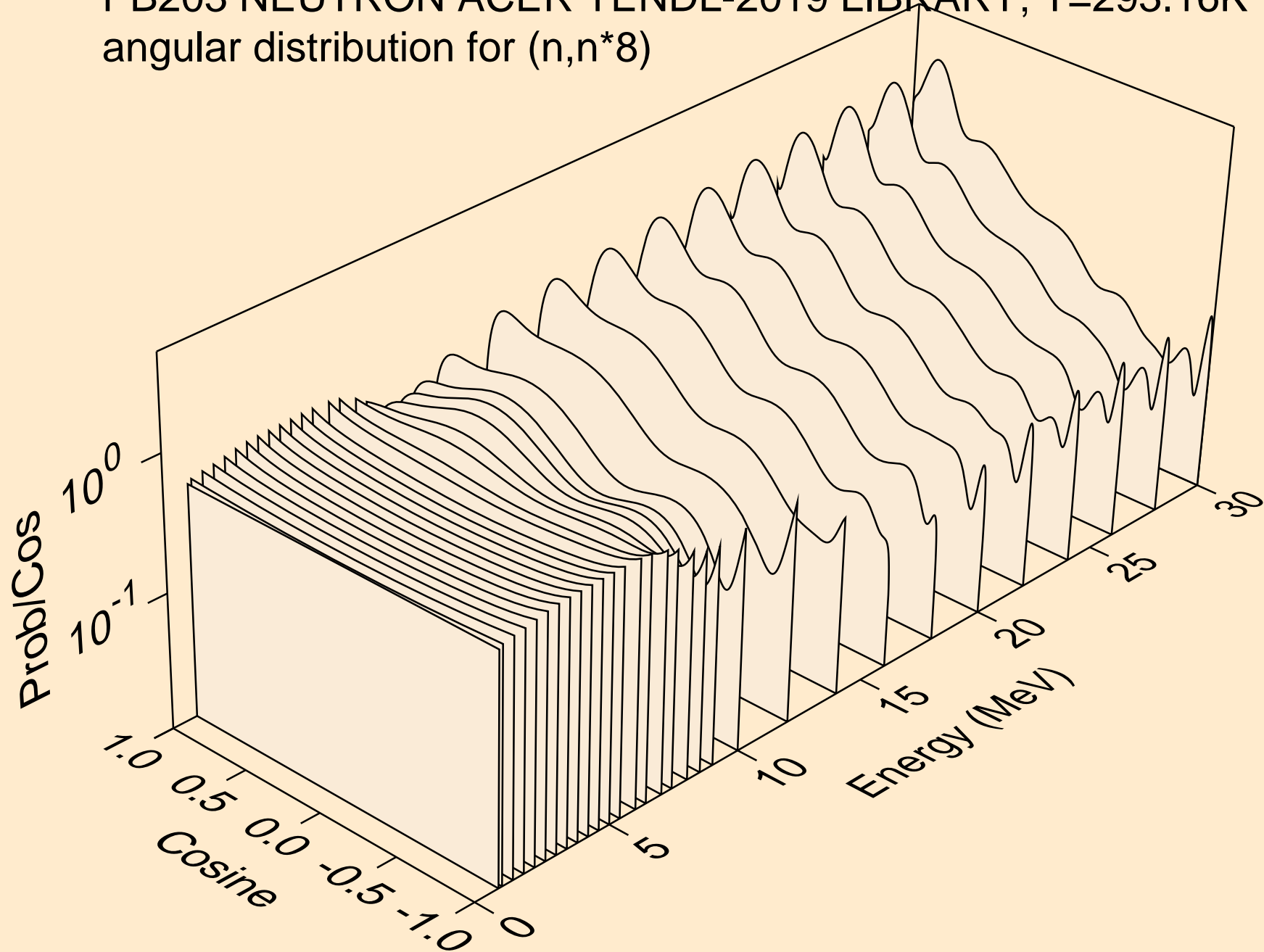

PB203 NEUTRON ACER TENDL-2019 LIBRARY; T=293.16K
angular distribution for (n,n*9)

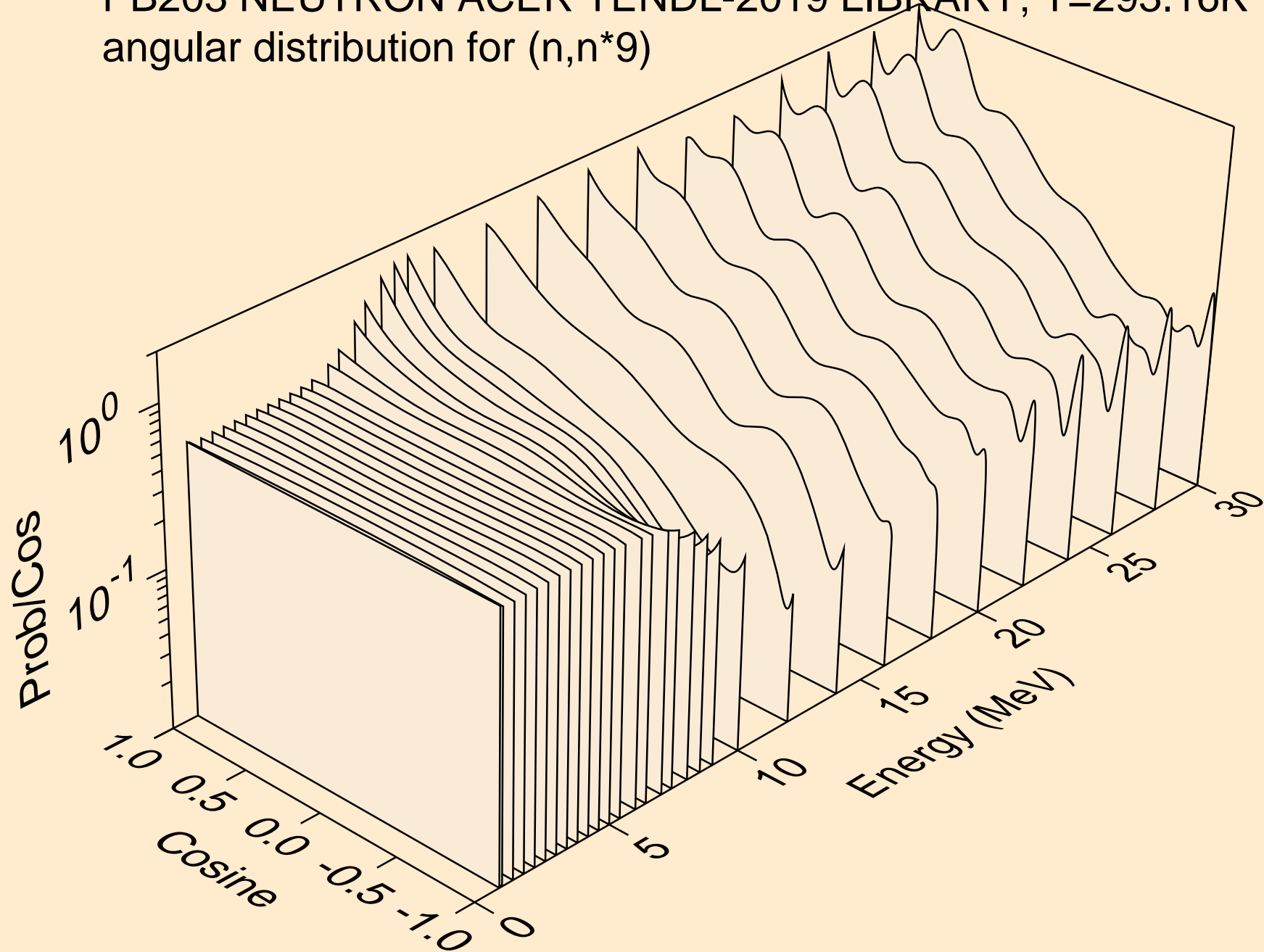

PB203 NEUTRON ACER TENDL-2019 LIBRARY; T=293.16K
angular distribution for (n,n*10)

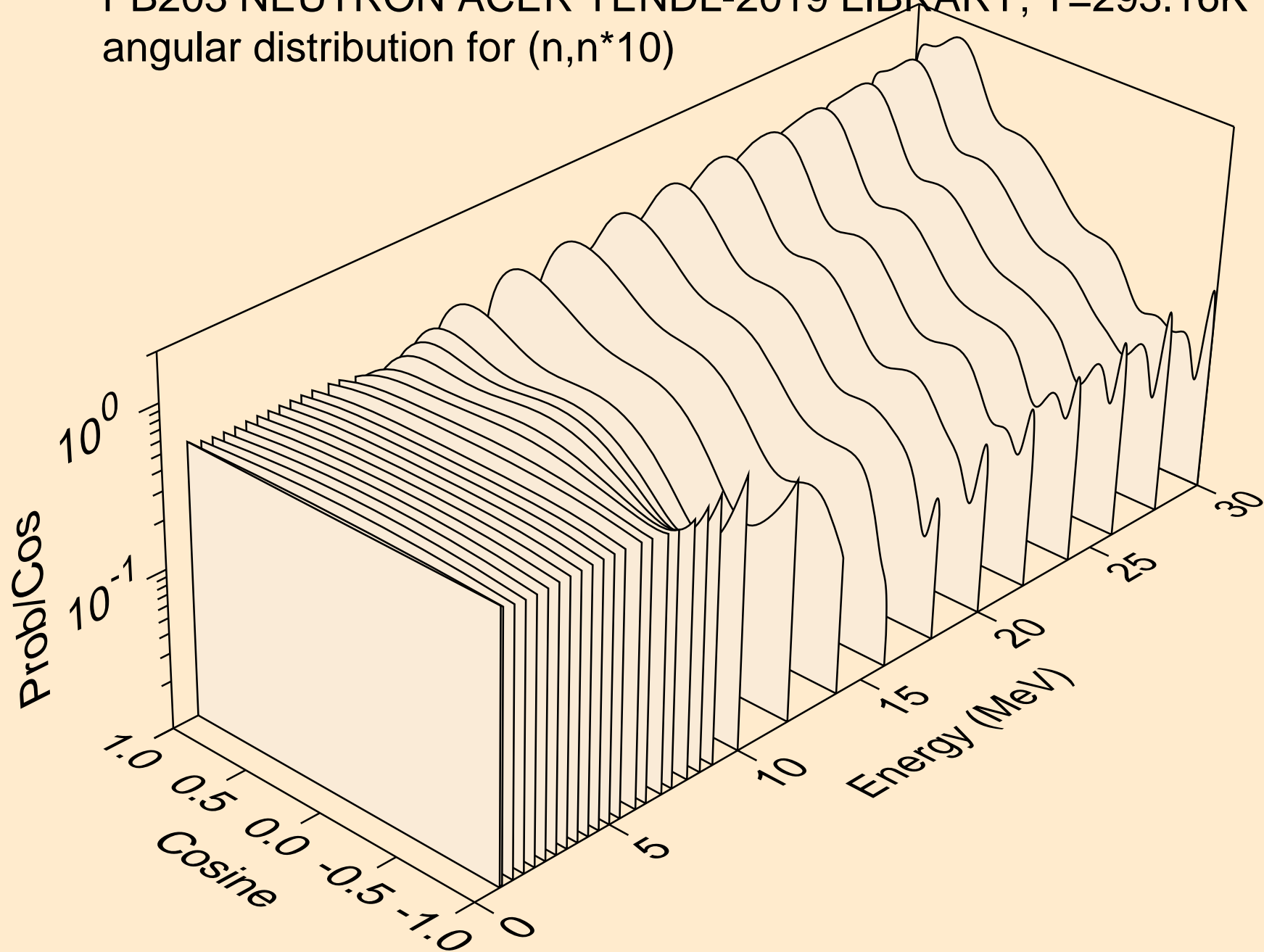

PB203 NEUTRON ACER TENDL-2019 LIBRARY; T=293.16K
angular distribution for (n,n*11)

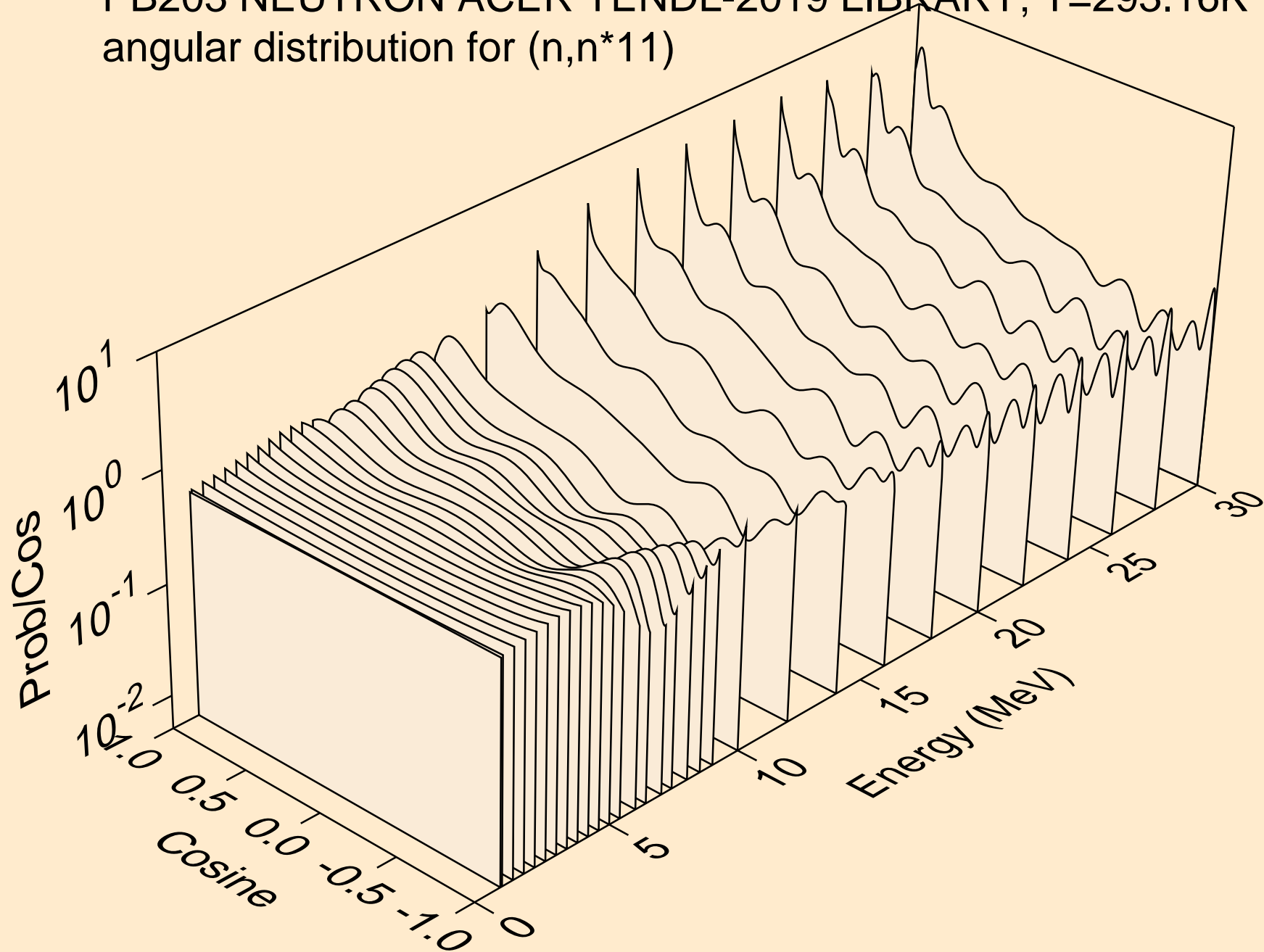

PB203 NEUTRON ACER TENDL-2019 LIBRARY; T=293.16K
angular distribution for (n,n*12)

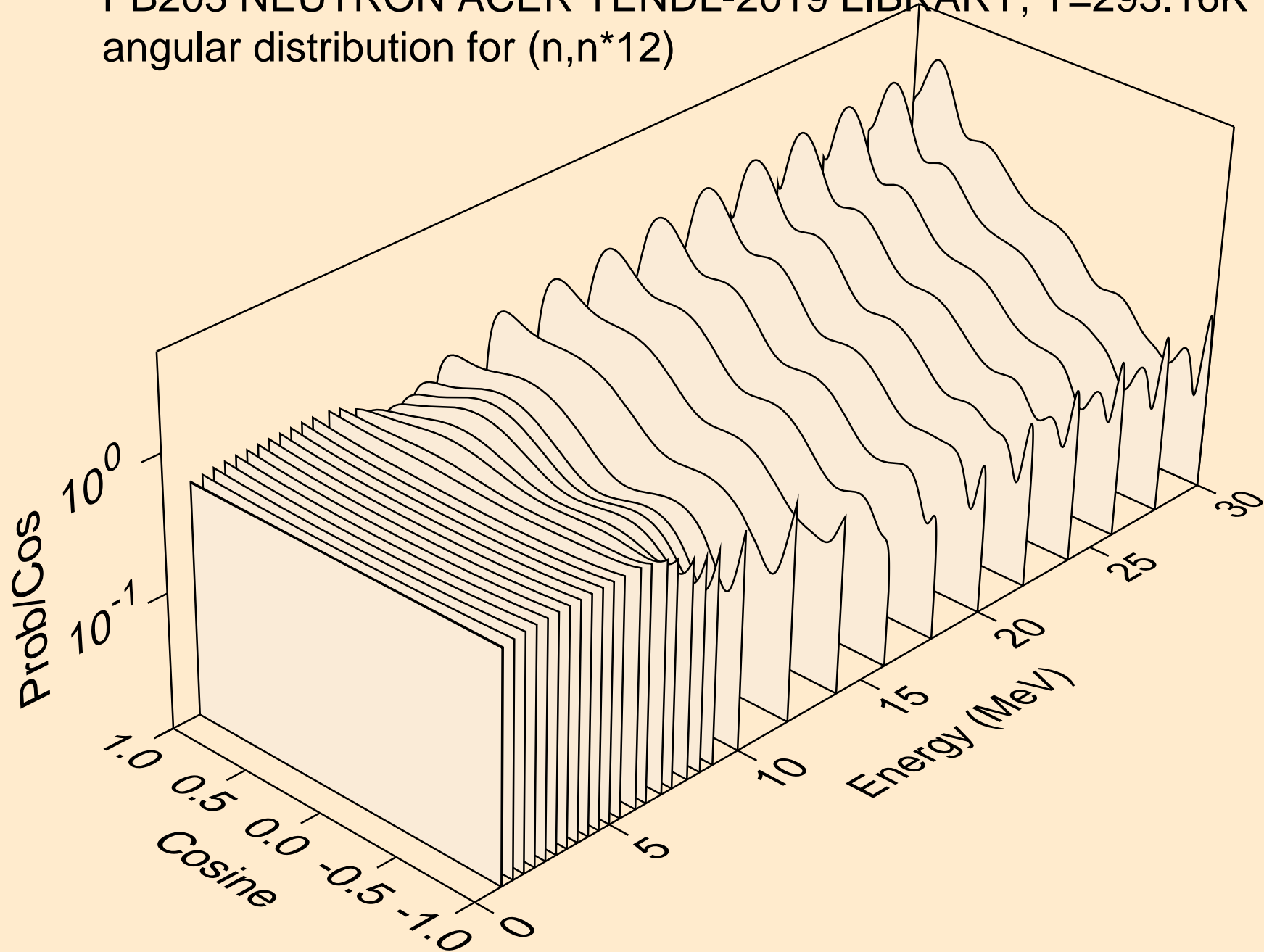

PB203 NEUTRON ACER TENDL-2019 LIBRARY; T=293.16K
angular distribution for (n,n*13)

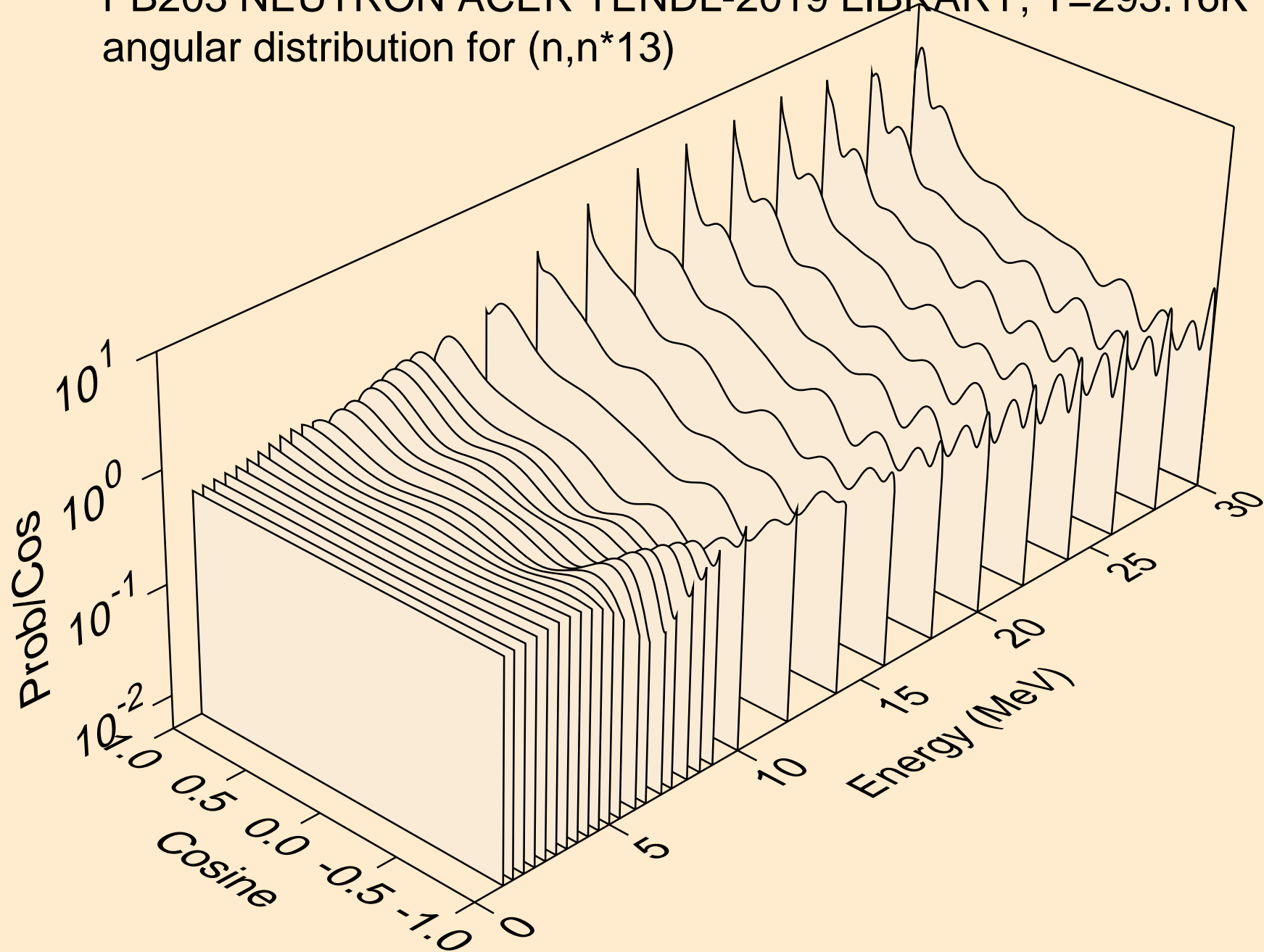

PB203 NEUTRON ACER TENDL-2019 LIBRARY; T=293.16K
angular distribution for (n,n*14)

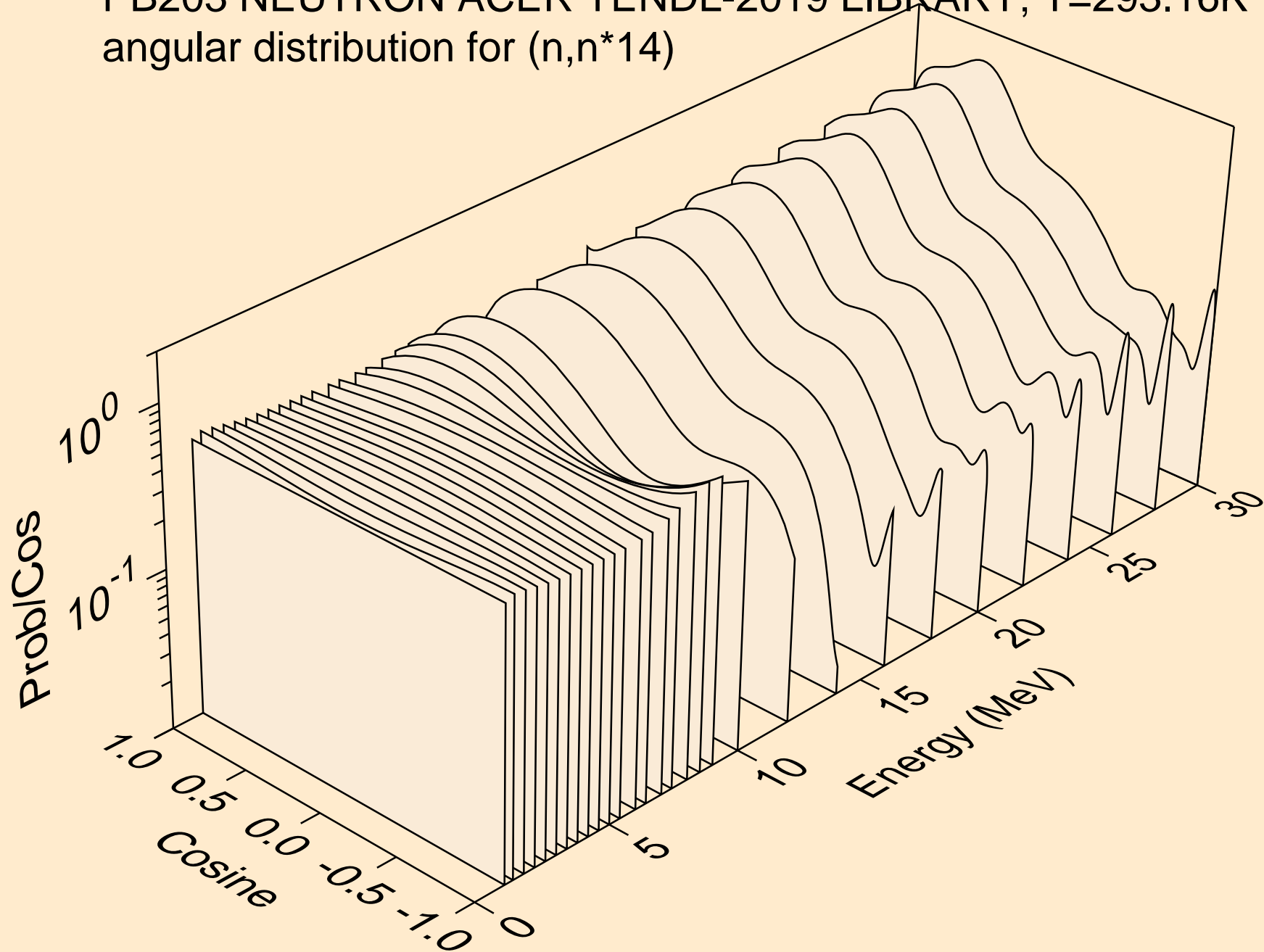

PB203 NEUTRON ACER TENDL-2019 LIBRARY; T=293.16K
angular distribution for (n,n*15)

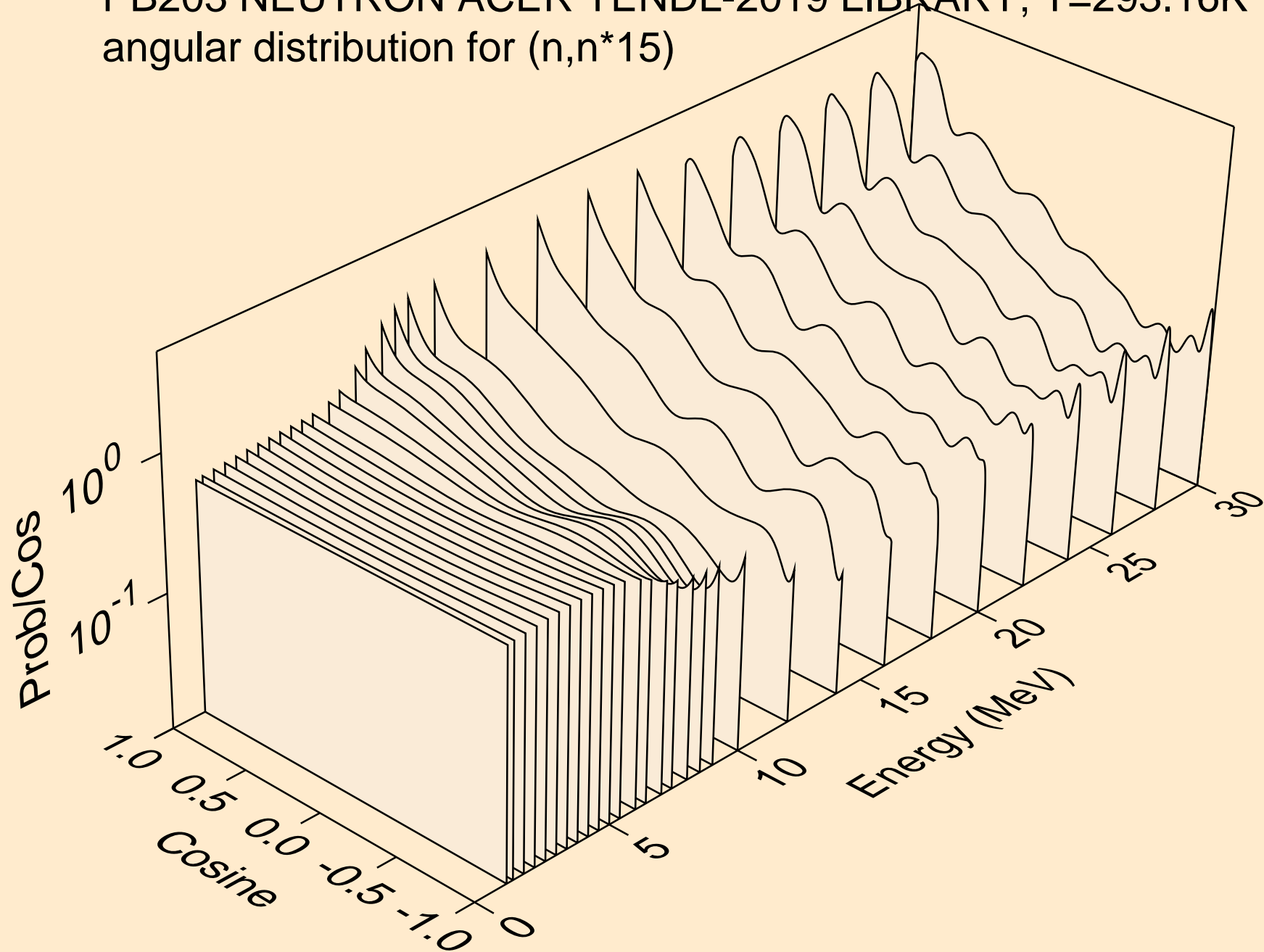

PB203 NEUTRON ACER TENDL-2019 LIBRARY; T=293.16K
angular distribution for (n,n*16)

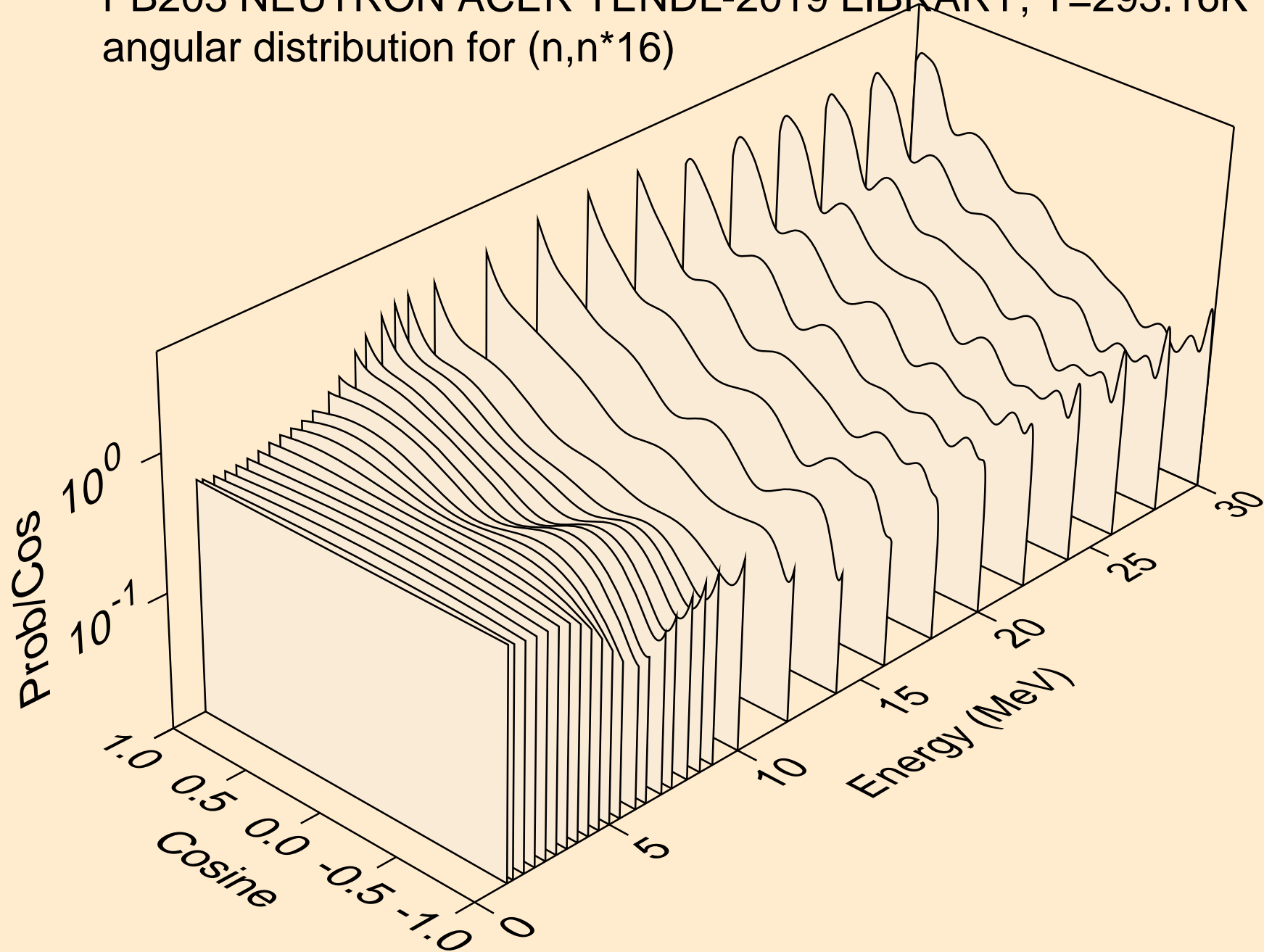

PB203 NEUTRON ACER TENDL-2019 LIBRARY; T=293.16K
angular distribution for (n,n*17)

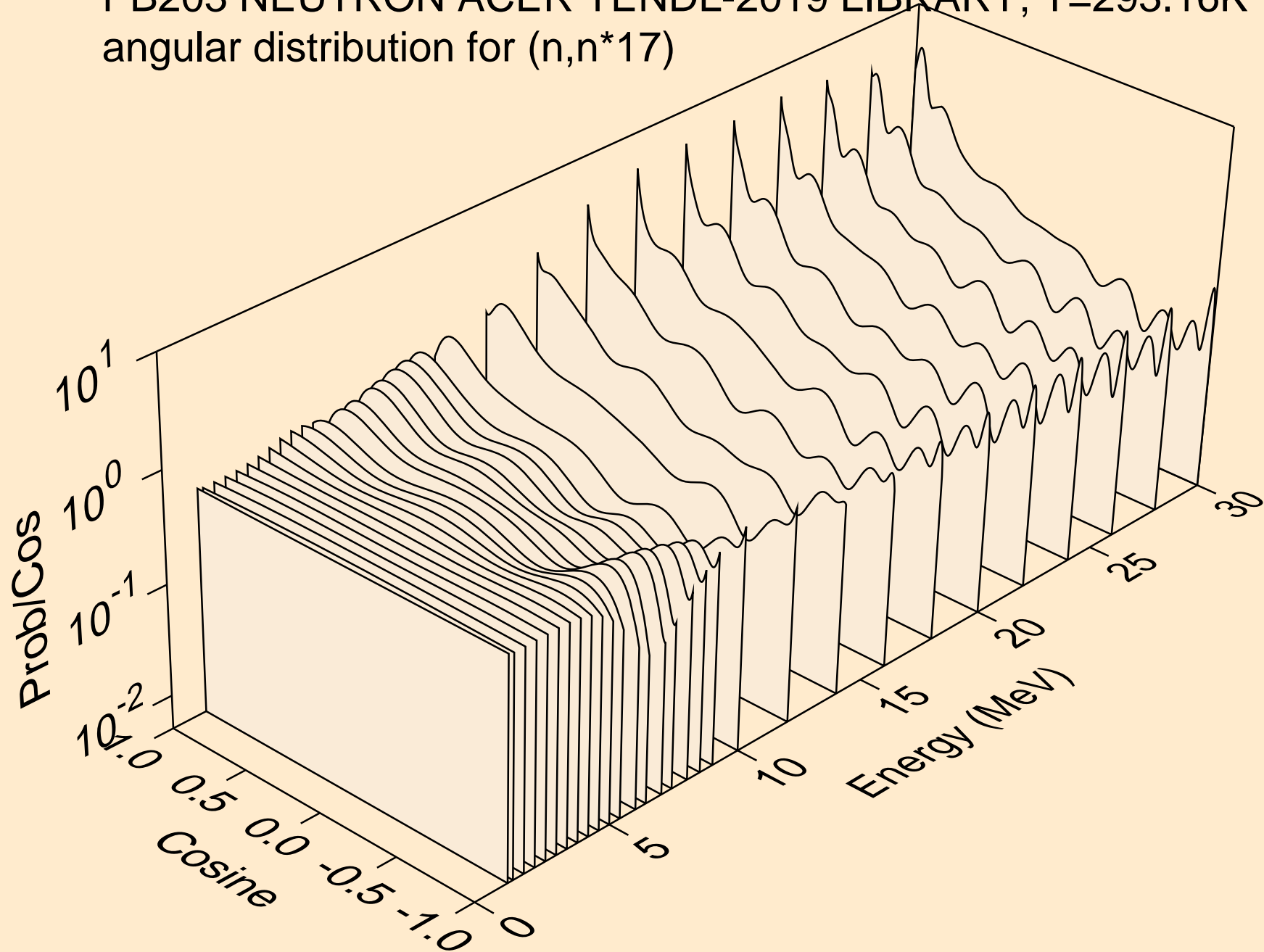

PB203 NEUTRON ACER TENDL-2019 LIBRARY; T=293.16K
angular distribution for (n,n*18)

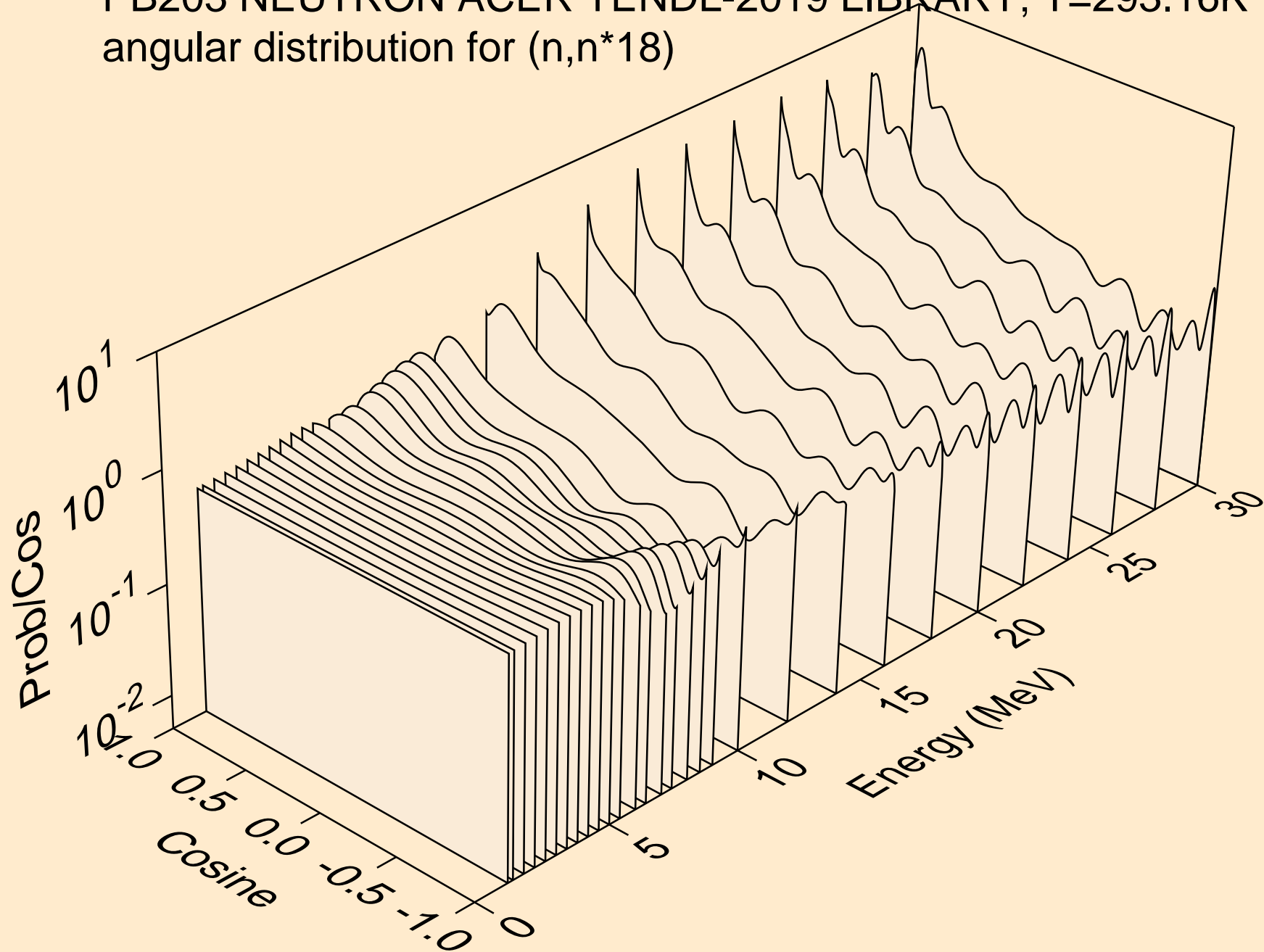

PB203 NEUTRON ACER TENDL-2019 LIBRARY; T=293.16K
angular distribution for (n,n*19)

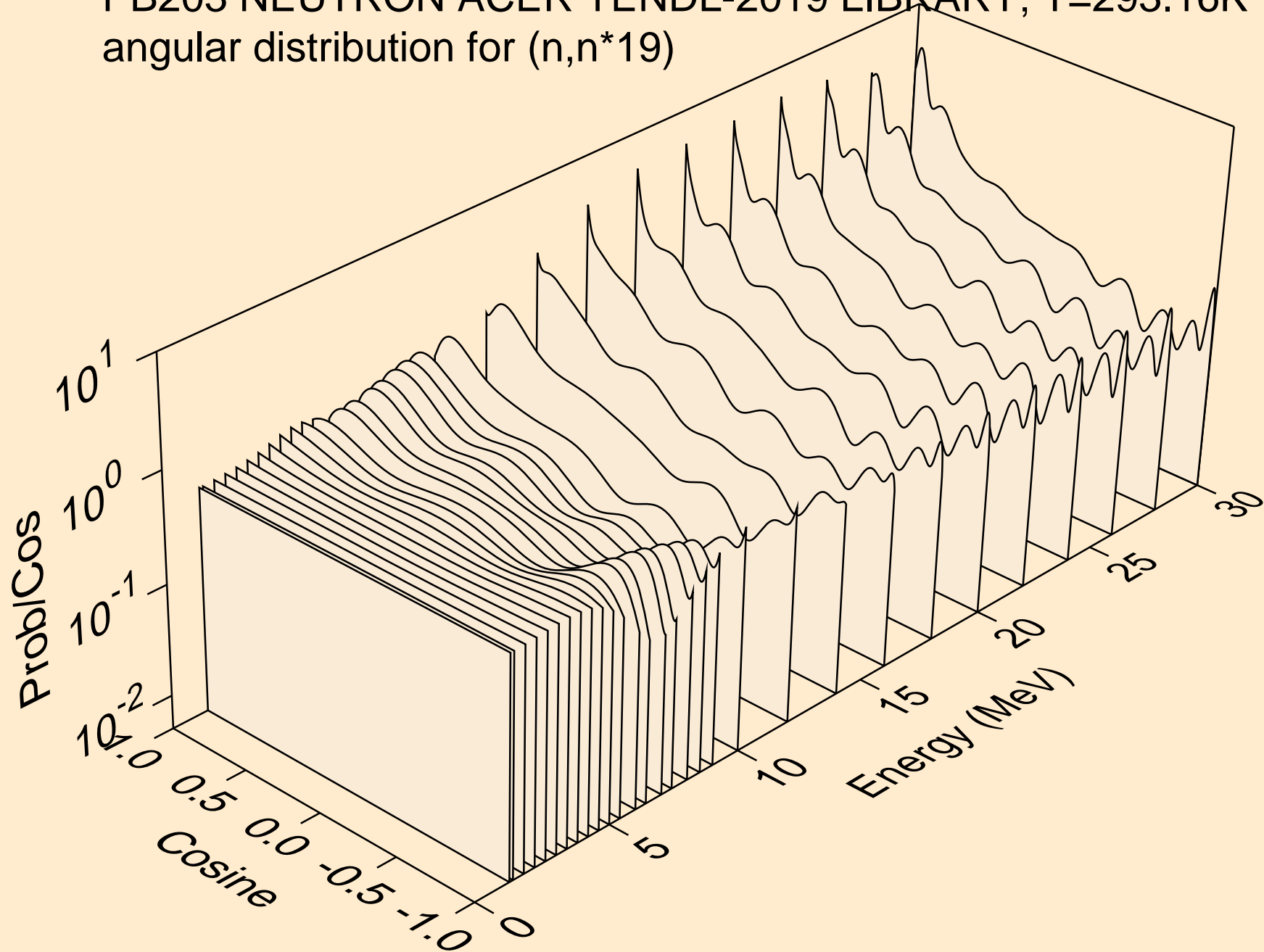

PB203 NEUTRON ACER TENDL-2019 LIBRARY; T=293.16K
angular distribution for (n,n*20)

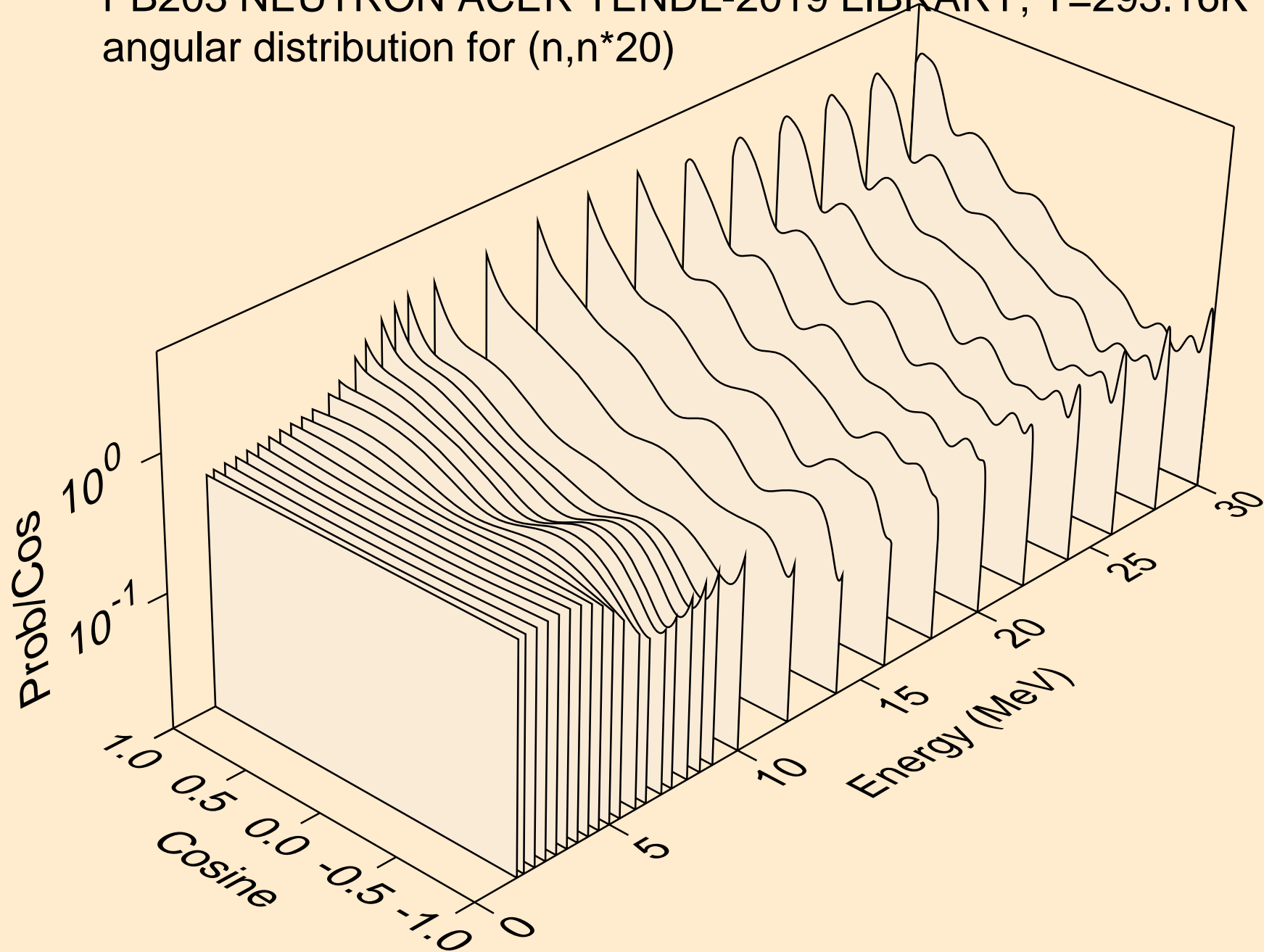

PB203 NEUTRON ACER TENDL-2019 LIBRARY; T=293.16K
angular distribution for (n,n*21)

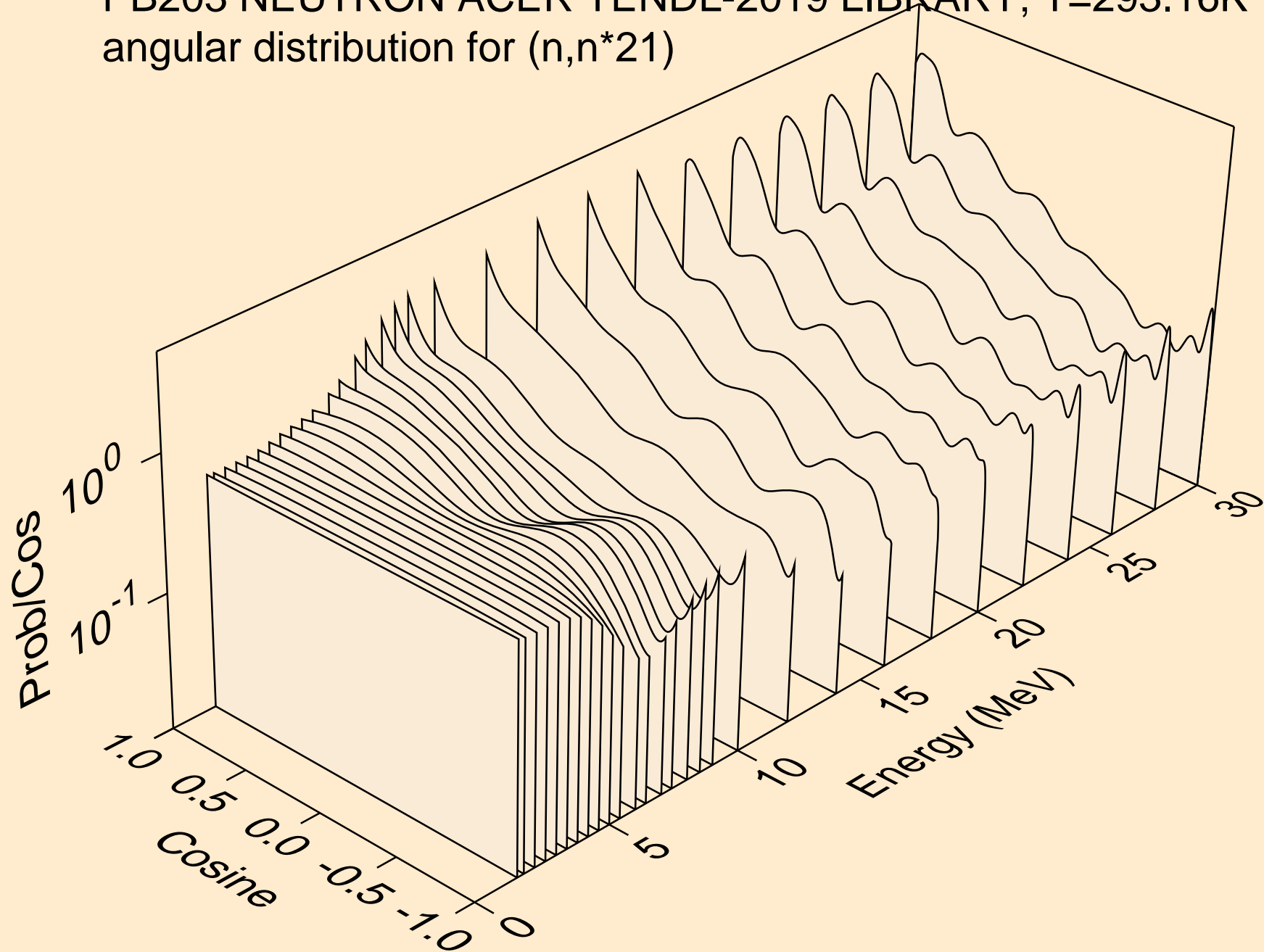

PB203 NEUTRON ACER TENDL-2019 LIBRARY; T=293.16K
angular distribution for (n,n*22)

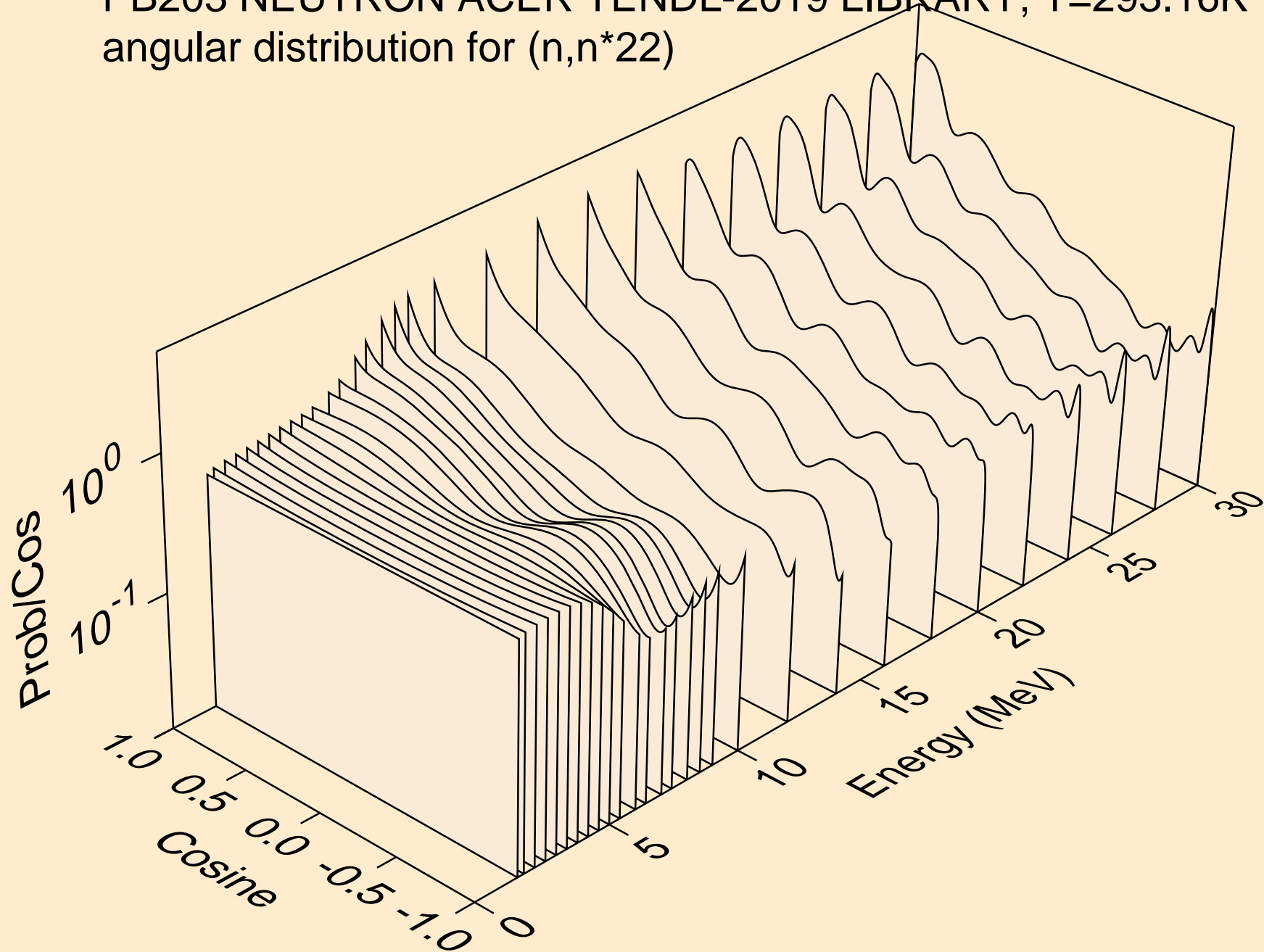

PB203 NEUTRON ACER TENDL-2019 LIBRARY; T=293.16K
angular distribution for (n,n*23)

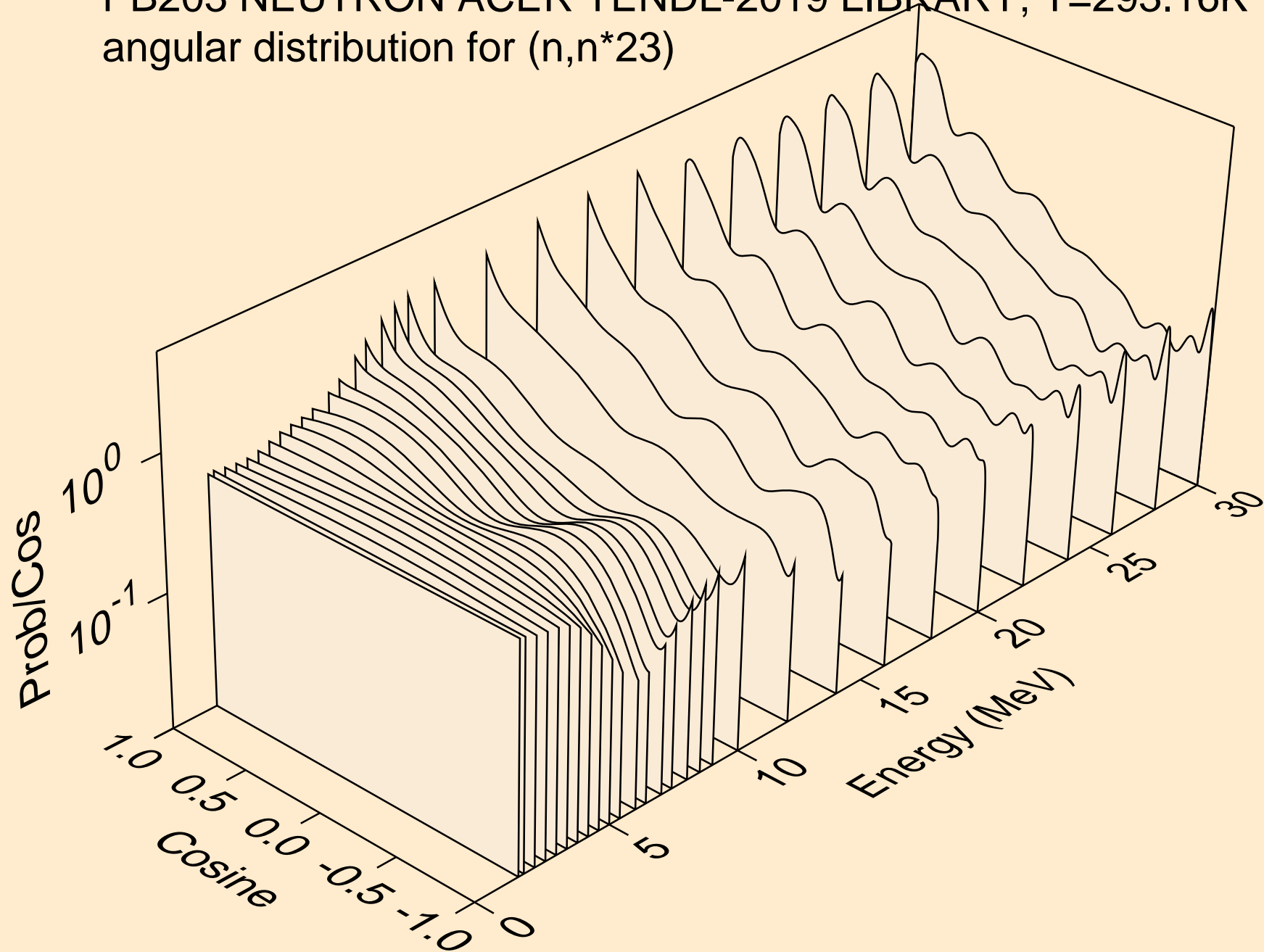

PB203 NEUTRON ACER TENDL-2019 LIBRARY; T=293.16K
angular distribution for (n,n*24)

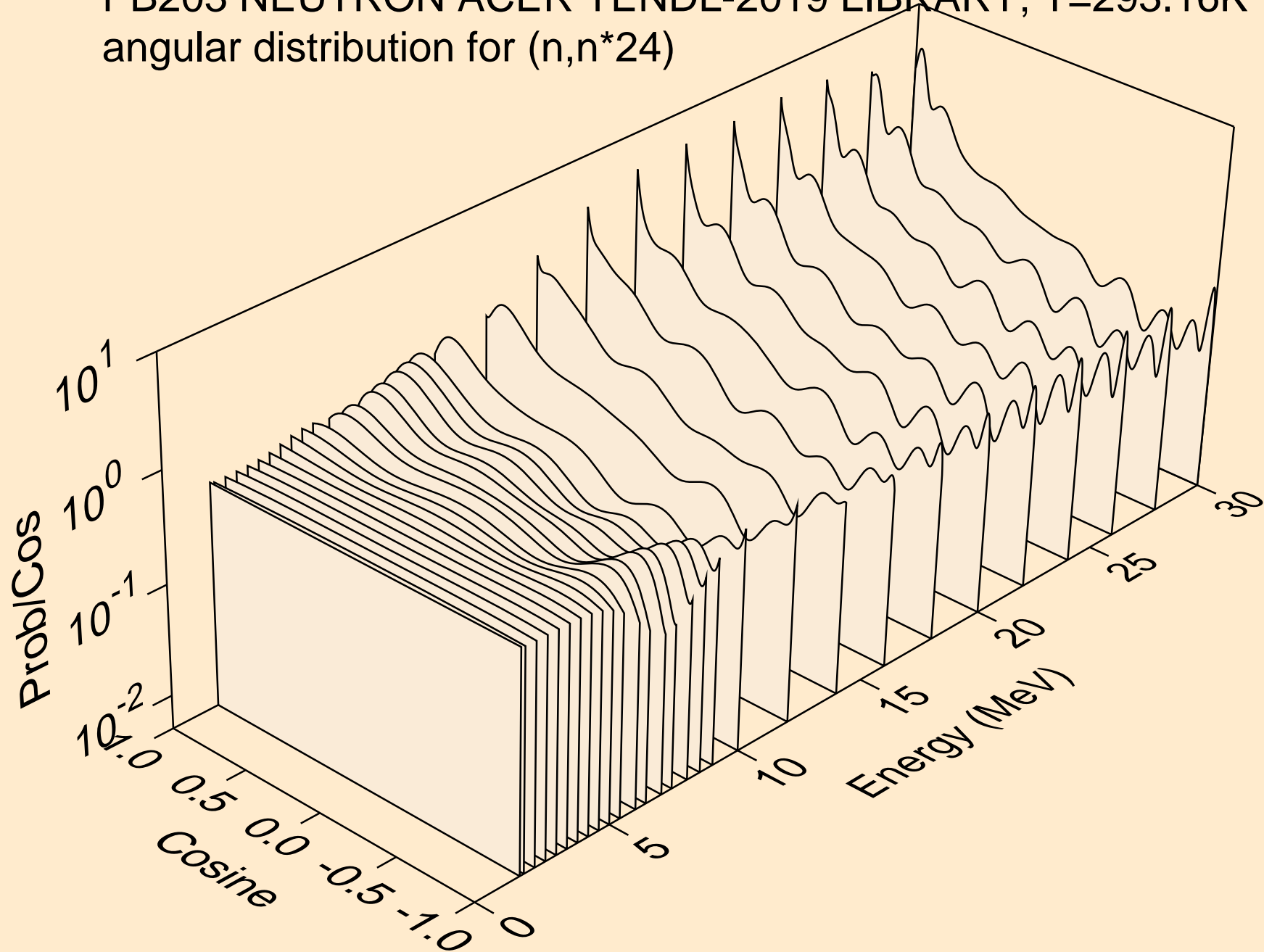

PB203 NEUTRON ACER TENDL-2019 LIBRARY; T=293.16K
angular distribution for (n,n*25)

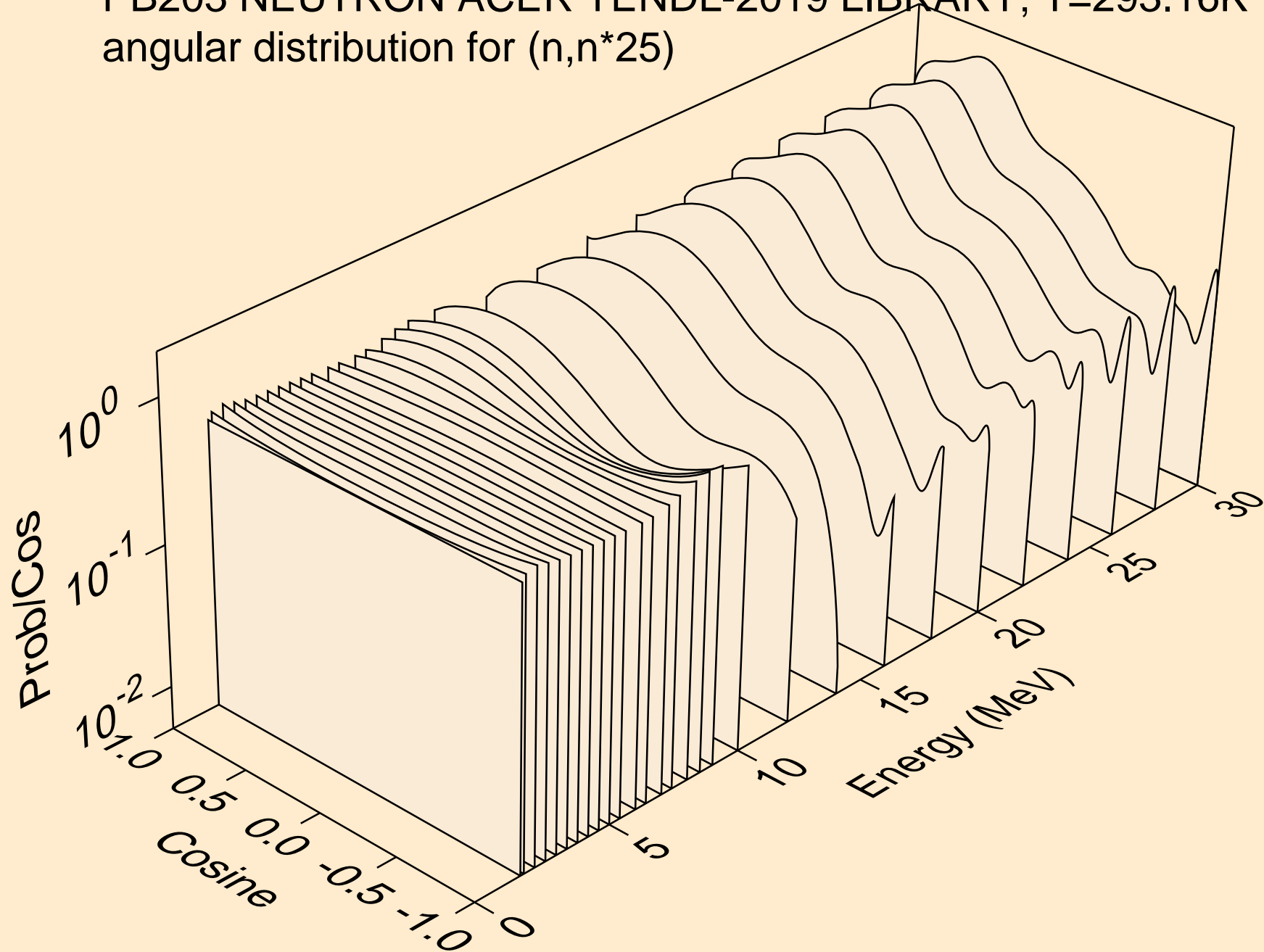

PB203 NEUTRON ACER TENDL-2019 LIBRARY; T=293.16K
angular distribution for (n,n*26)

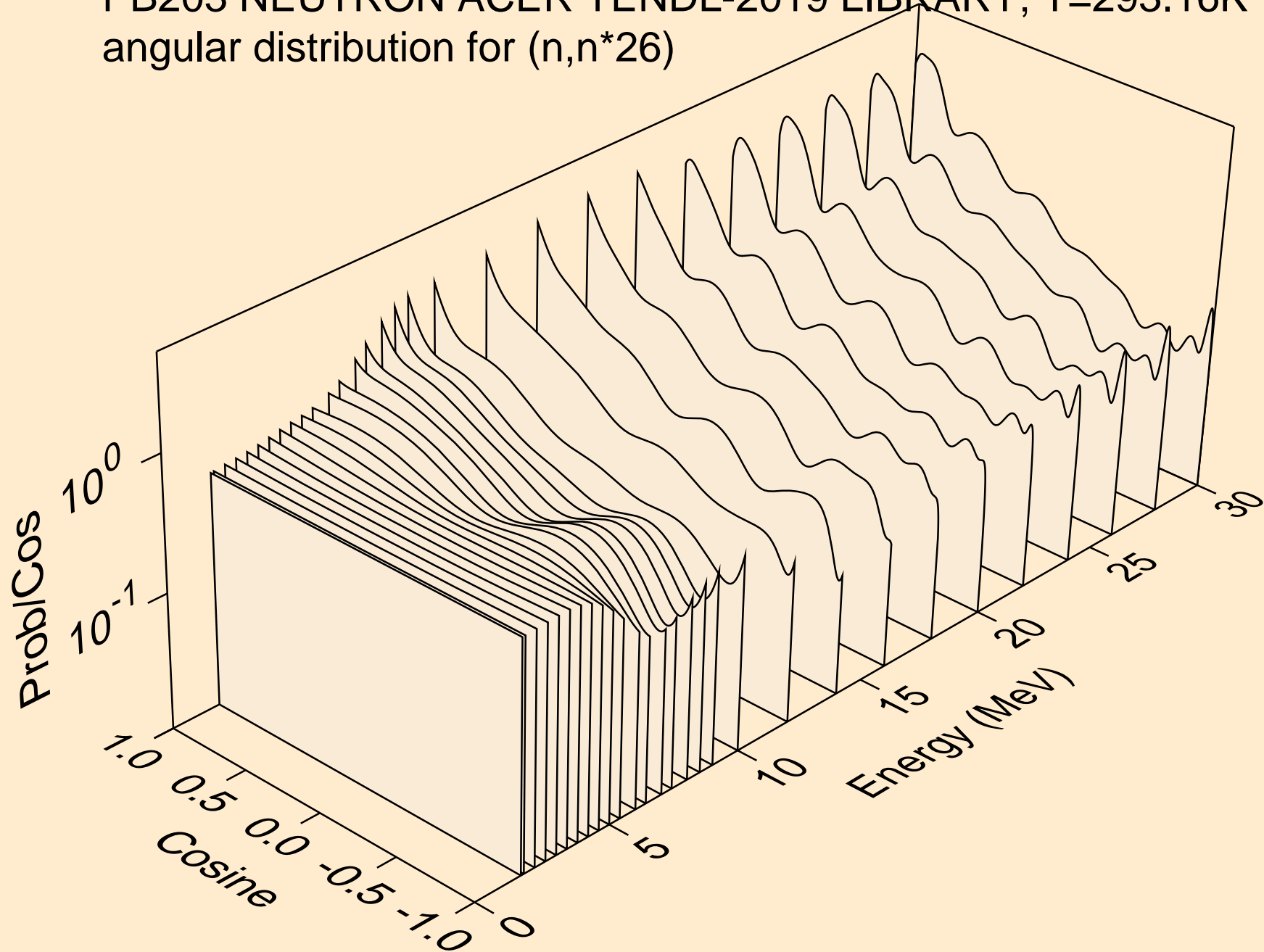

PB203 NEUTRON ACER TENDL-2019 LIBRARY; T=293.16K
angular distribution for (n,n*27)

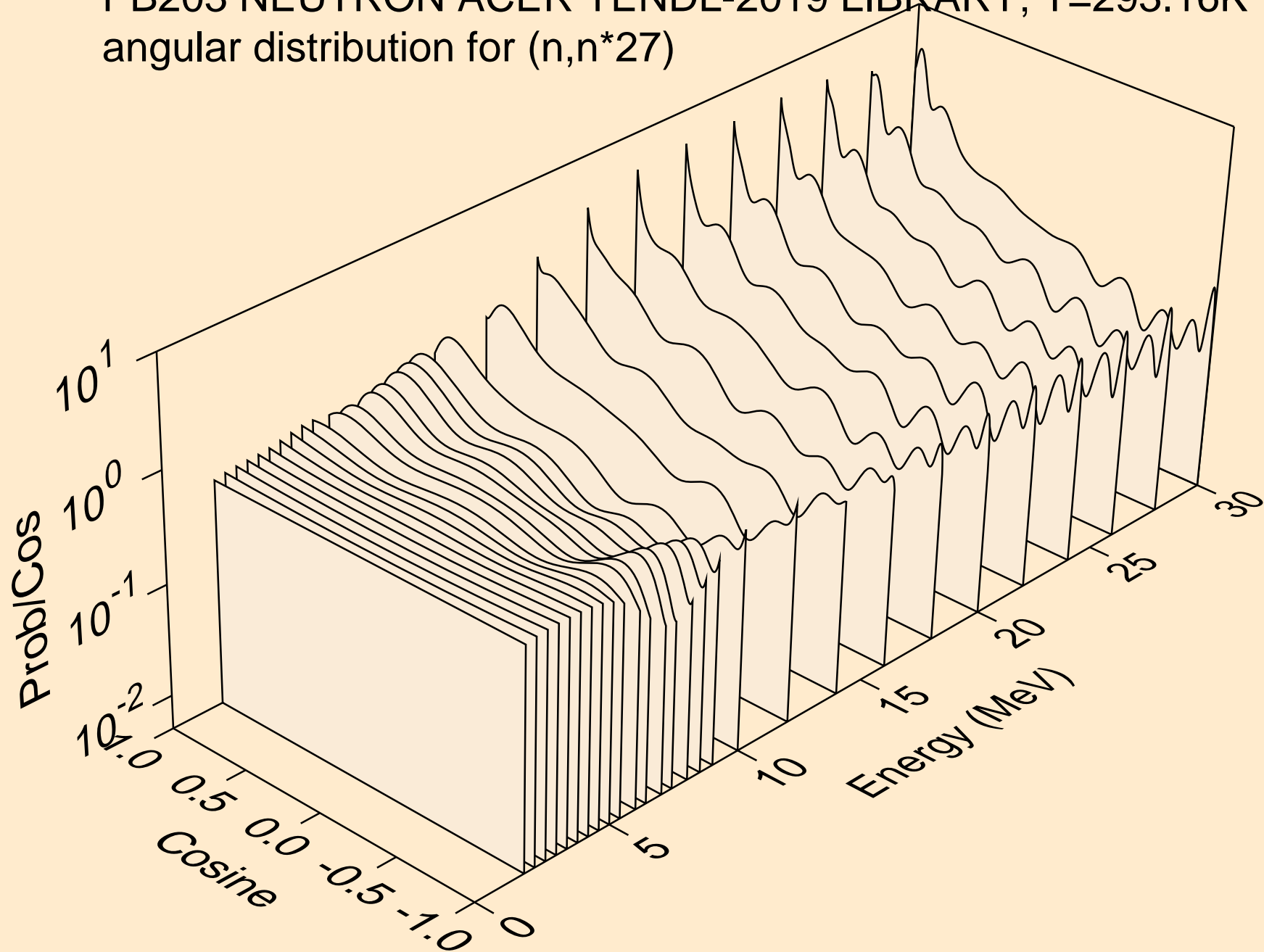

PB203 NEUTRON ACER TENDL-2019 LIBRARY; T=293.16K
angular distribution for (n,n*28)

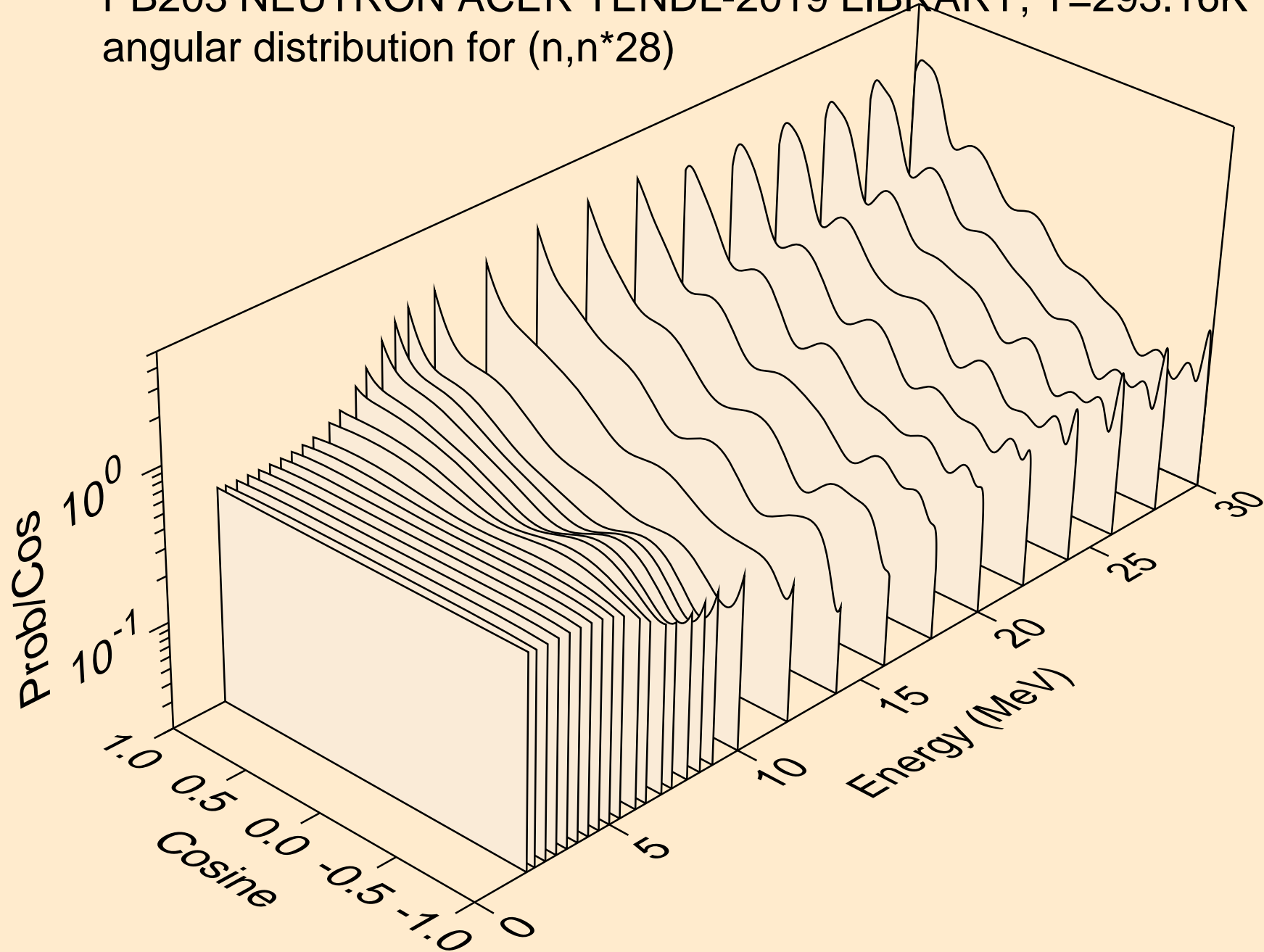

PB203 NEUTRON ACER TENDL-2019 LIBRARY; T=293.16K
Neutron emission for (n,x)

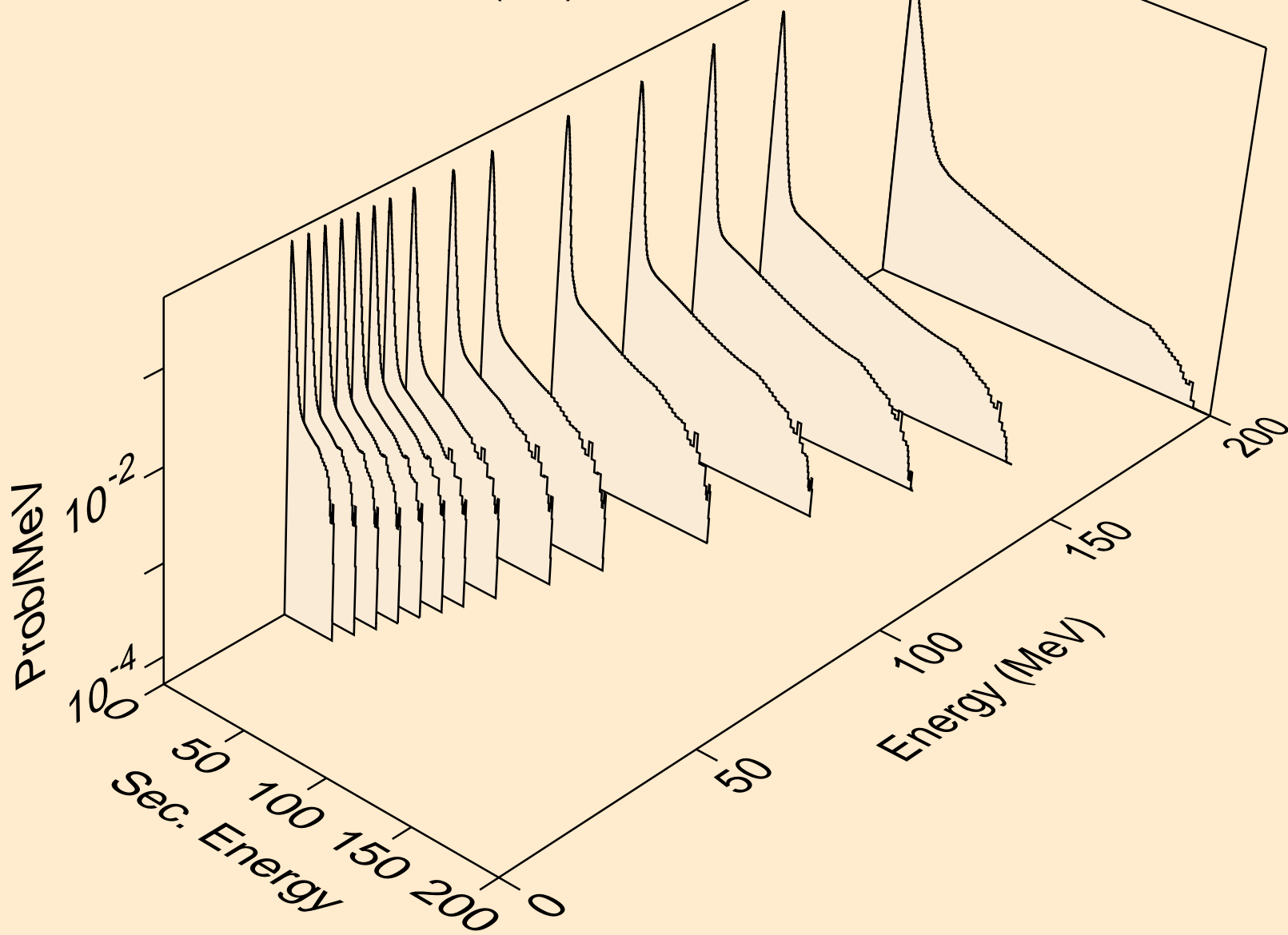

PB203 NEUTRON ACER TENDL-2019 LIBRARY; T=293.16K
Neutron emission for (n,2nd)

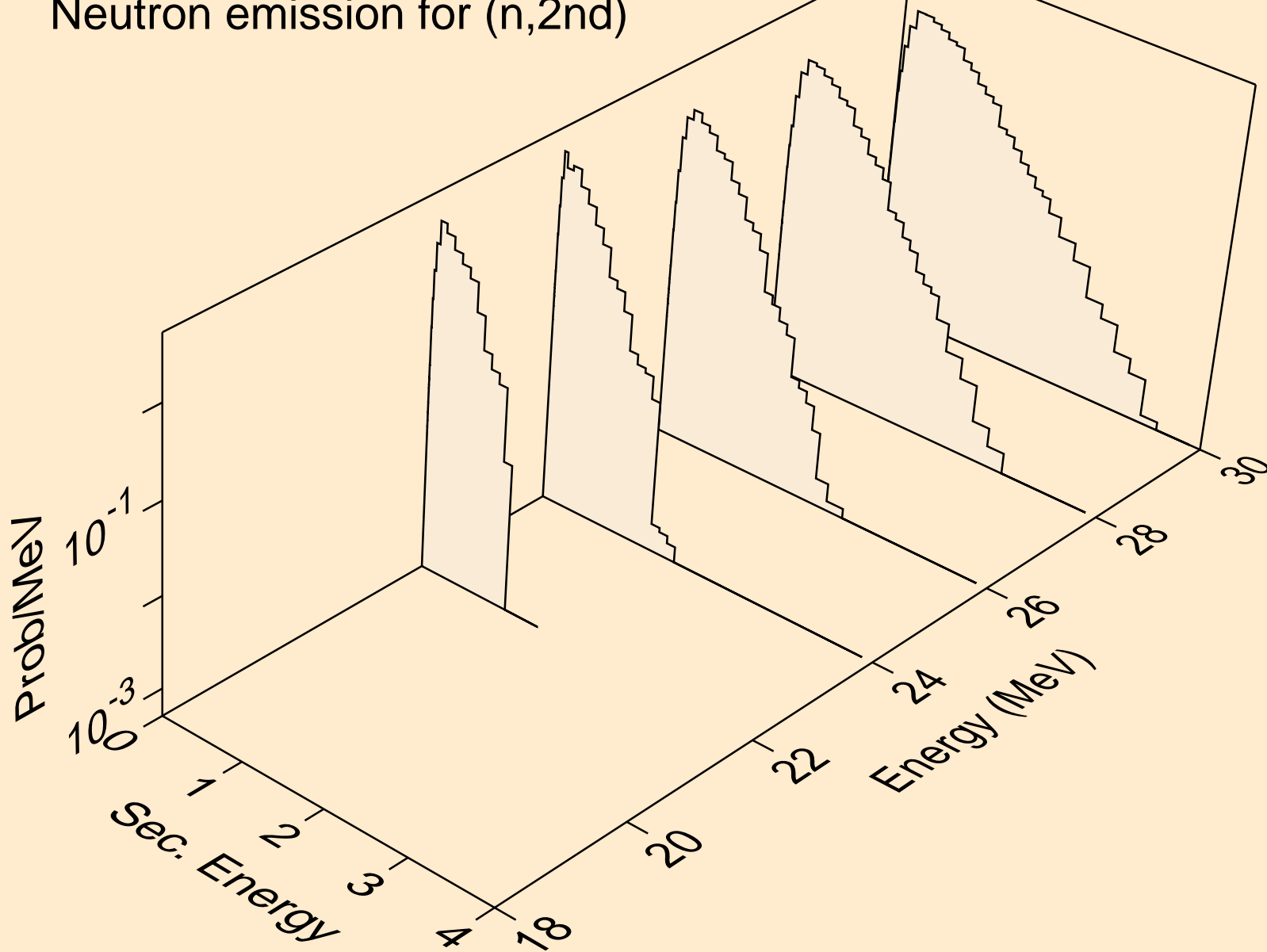

PB203 NEUTRON ACER TENDL-2019 LIBRARY; T=293.16K
Neutron emission for (n,2n)

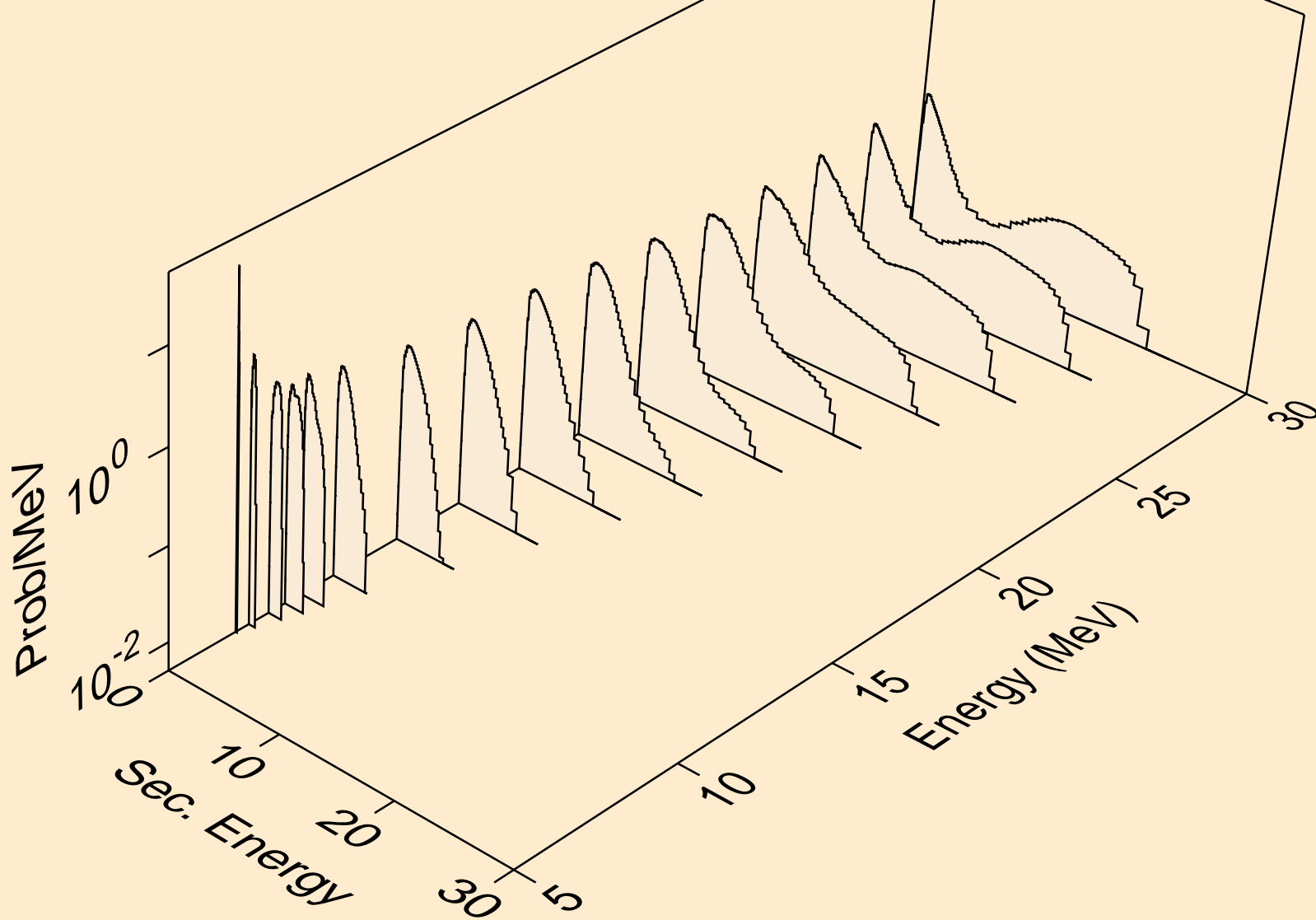

PB203 NEUTRON ACER TENDL-2019 LIBRARY; T=293.16K
Neutron emission for (n,3n)

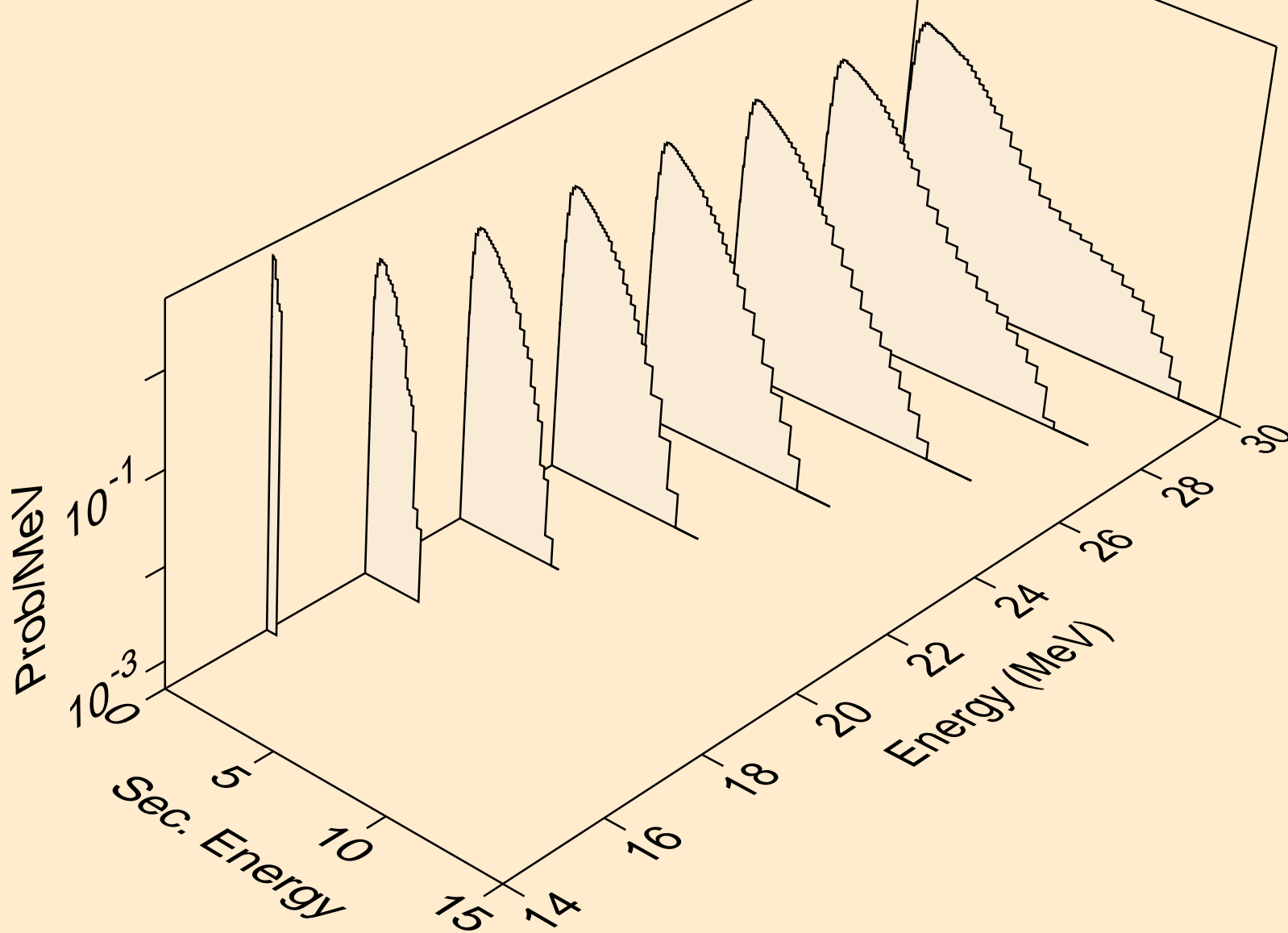

PB203 NEUTRON ACER TENDL-2019 LIBRARY; T=293.16K
Neutron emission for (n,n*)a

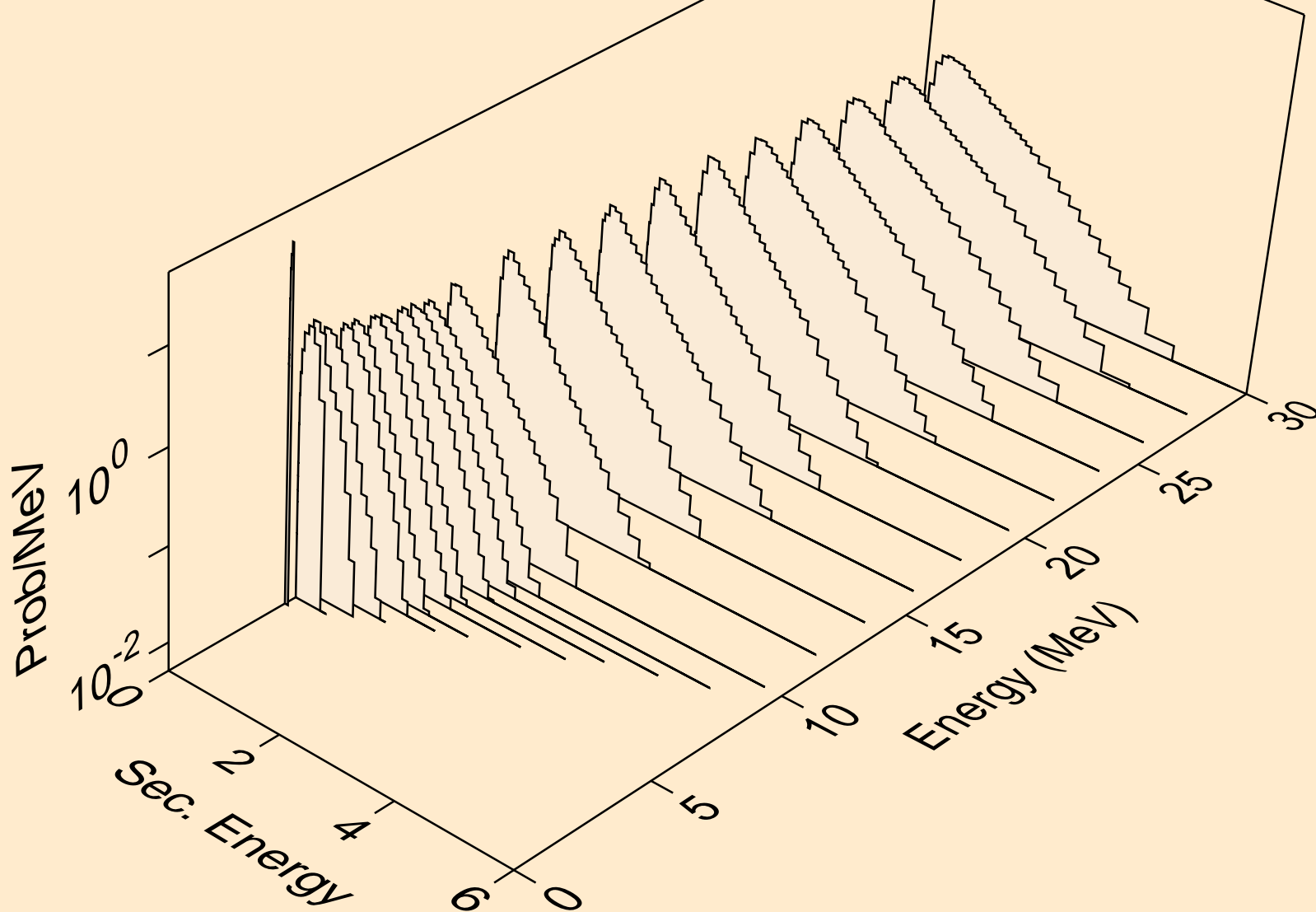

PB203 NEUTRON ACER TENDL-2019 LIBRARY; T=293.16K
Neutron emission for (n,2n)a

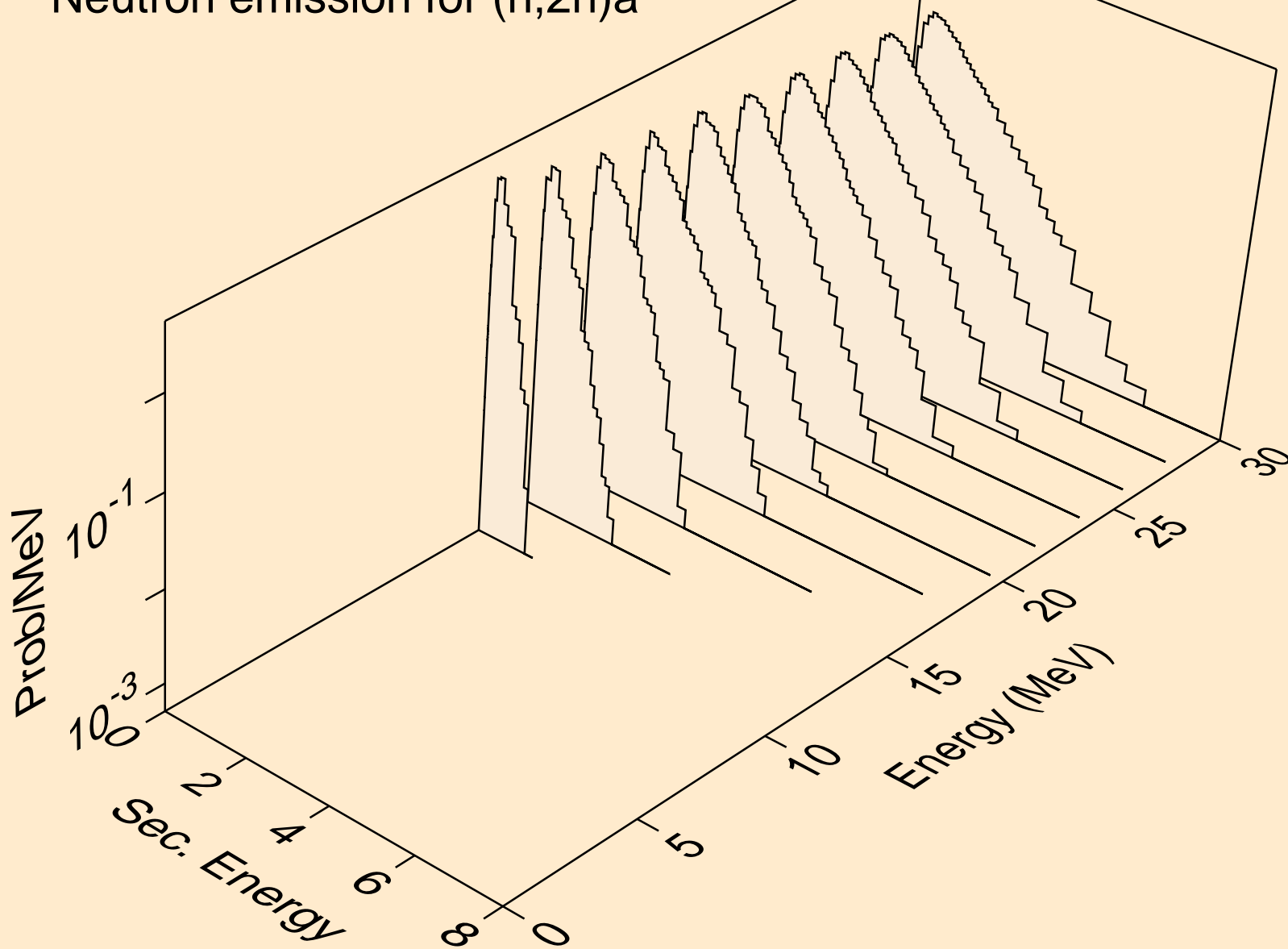

PB203 NEUTRON ACER TENDL-2019 LIBRARY; T=293.16K
Neutron emission for (n,3n)a

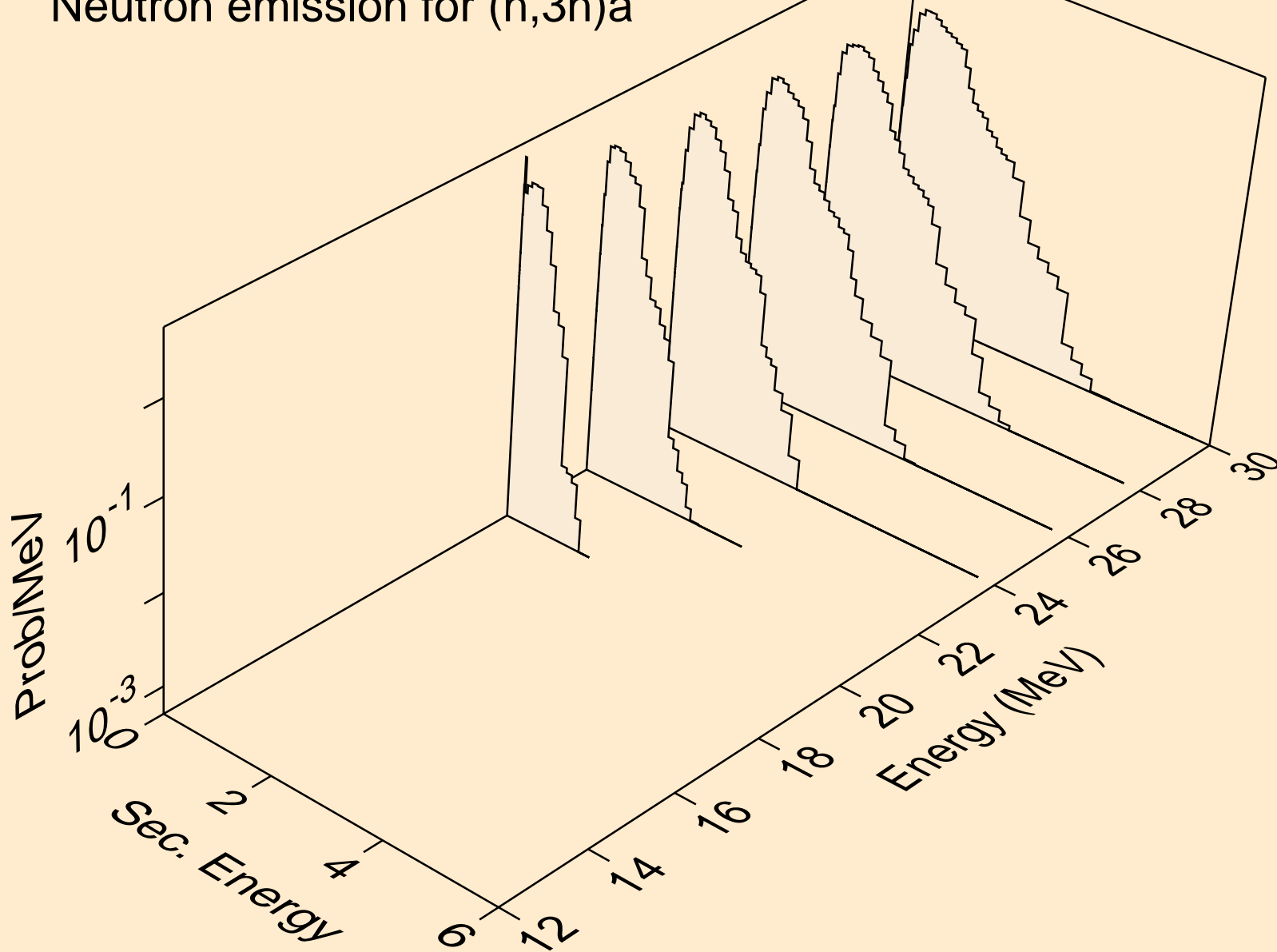

PB203 NEUTRON ACER TENDL-2019 LIBRARY; T=293.16K
Neutron emission for (n,n*)p

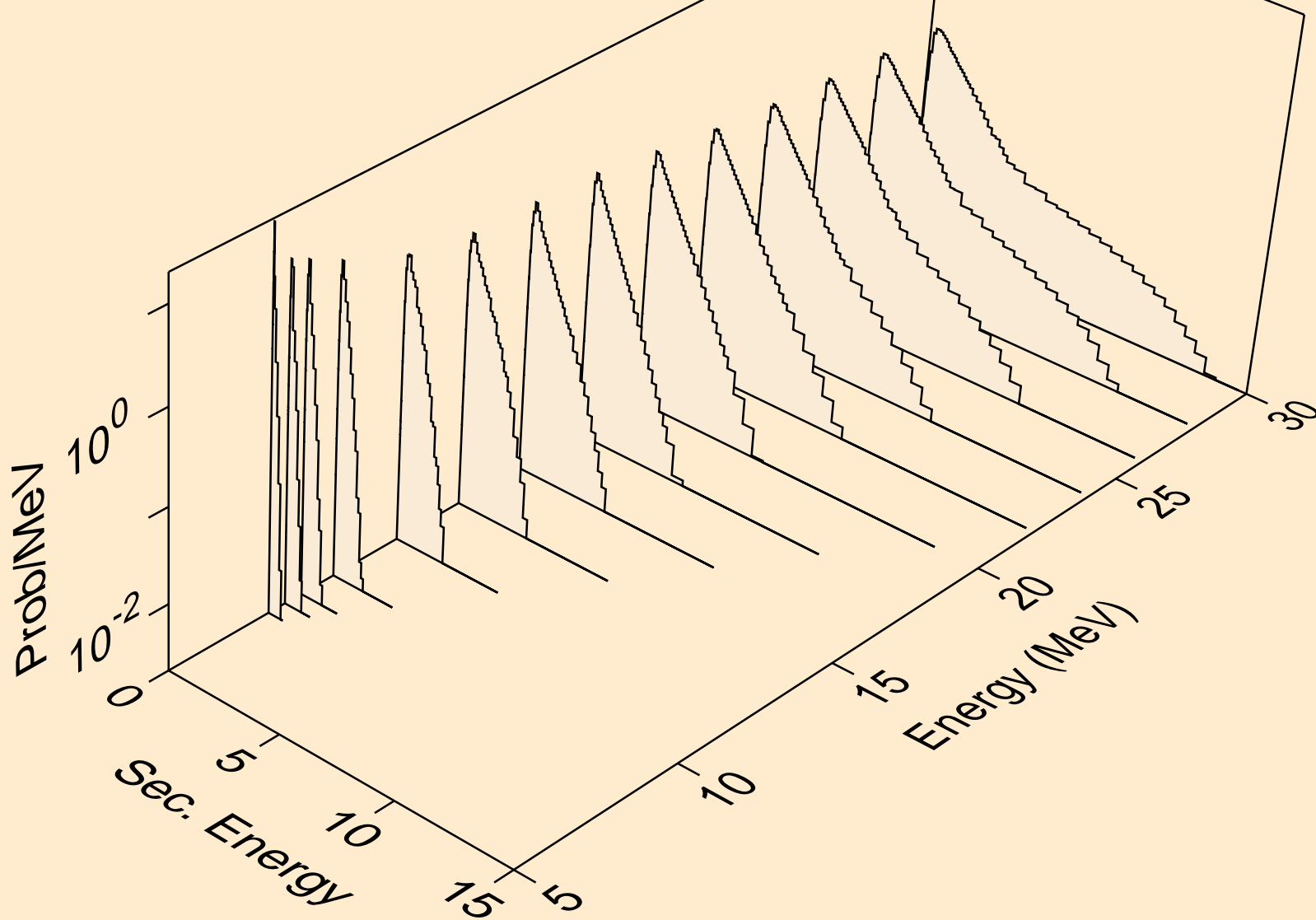

PB203 NEUTRON ACER TENDL-2019 LIBRARY; T=293.16K
Neutron emission for (n,n*)d

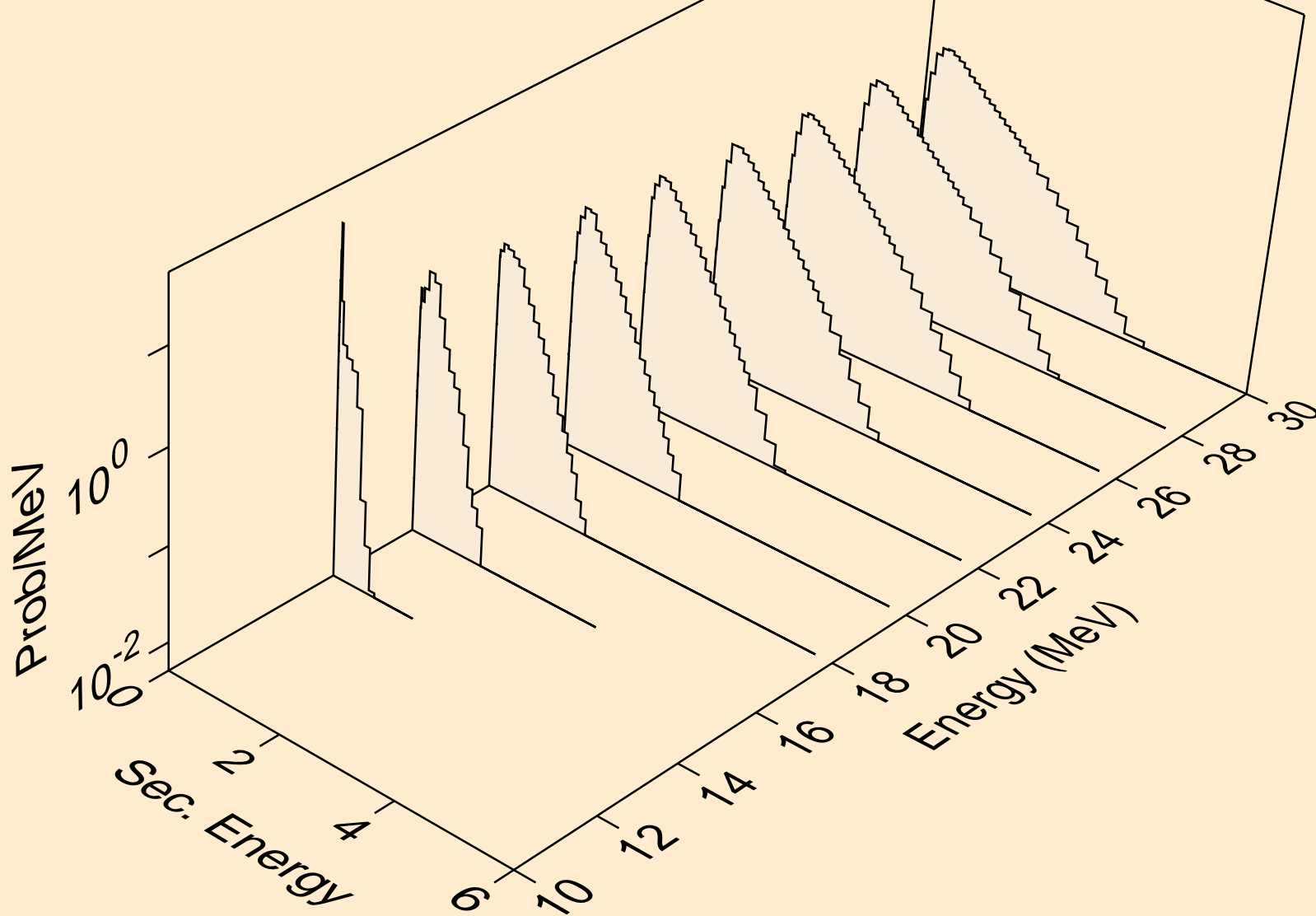

PB203 NEUTRON ACER TENDL-2019 LIBRARY; T=293.16K
Neutron emission for (n,n*)t

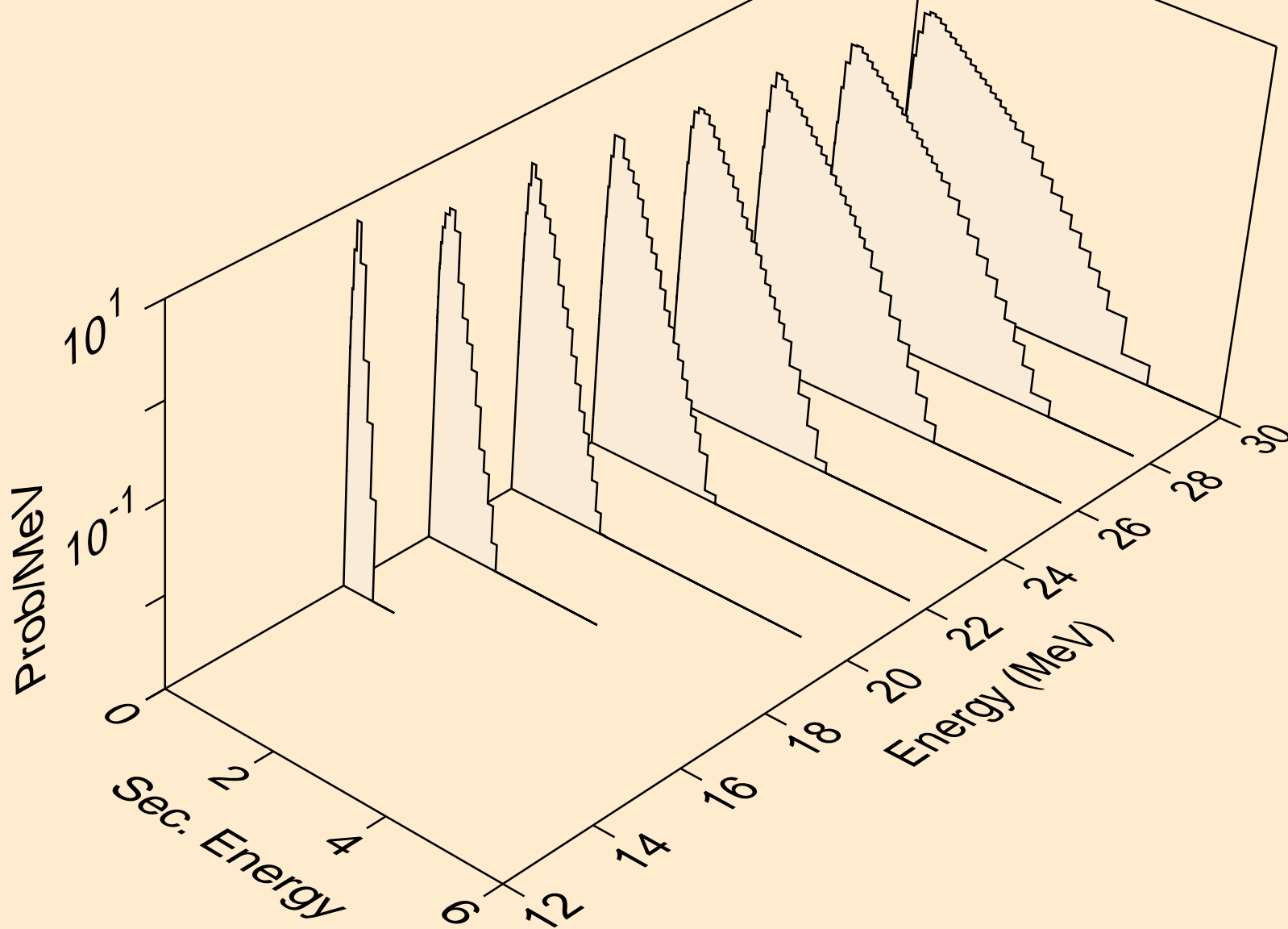

PB203 NEUTRON ACER TENDL-2019 LIBRARY; T=293.16K
Neutron emission for (n,n*)he3

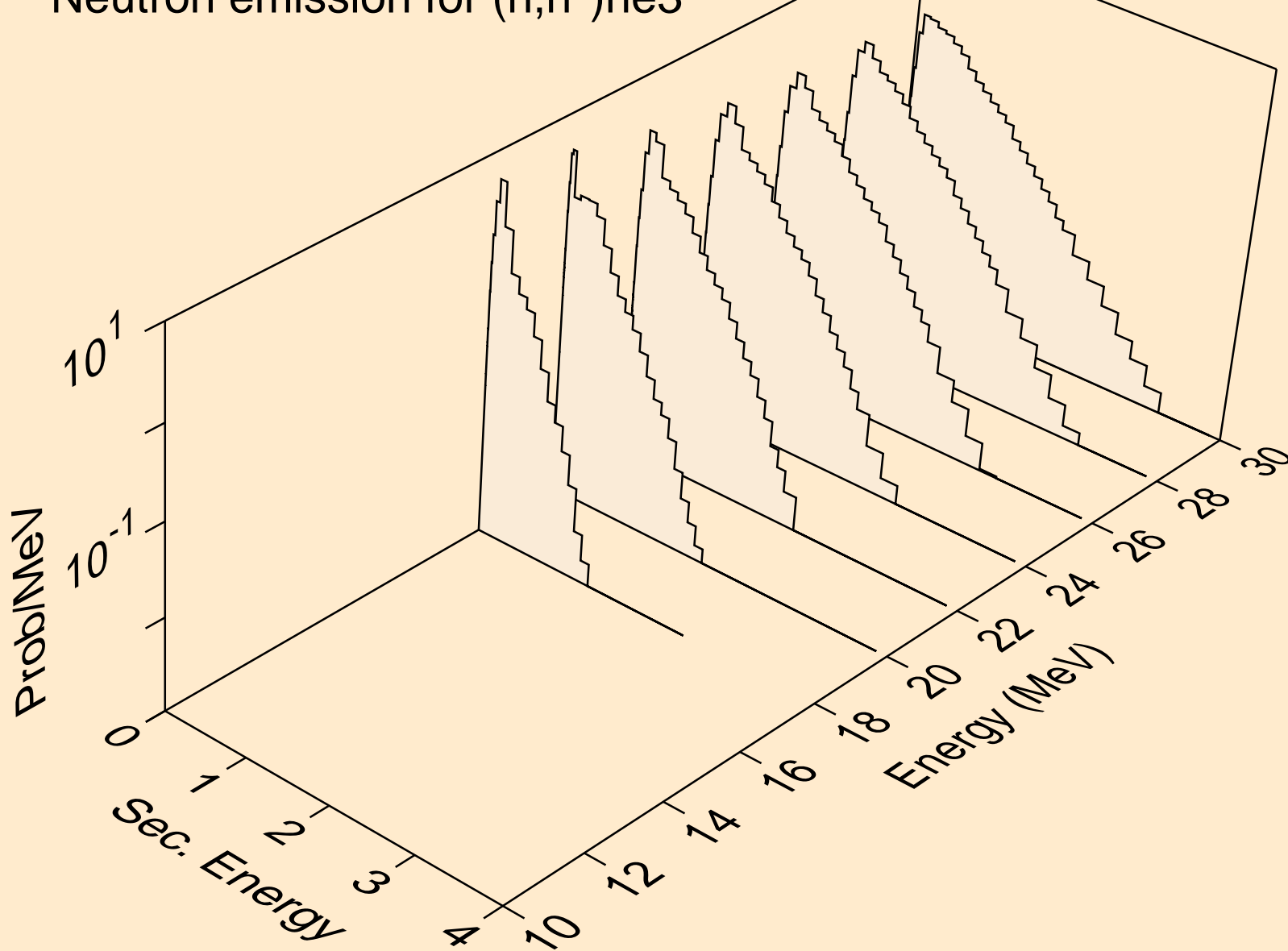

PB203 NEUTRON ACER TENDL-2019 LIBRARY; T=293.16K
Neutron emission for (n,4n)

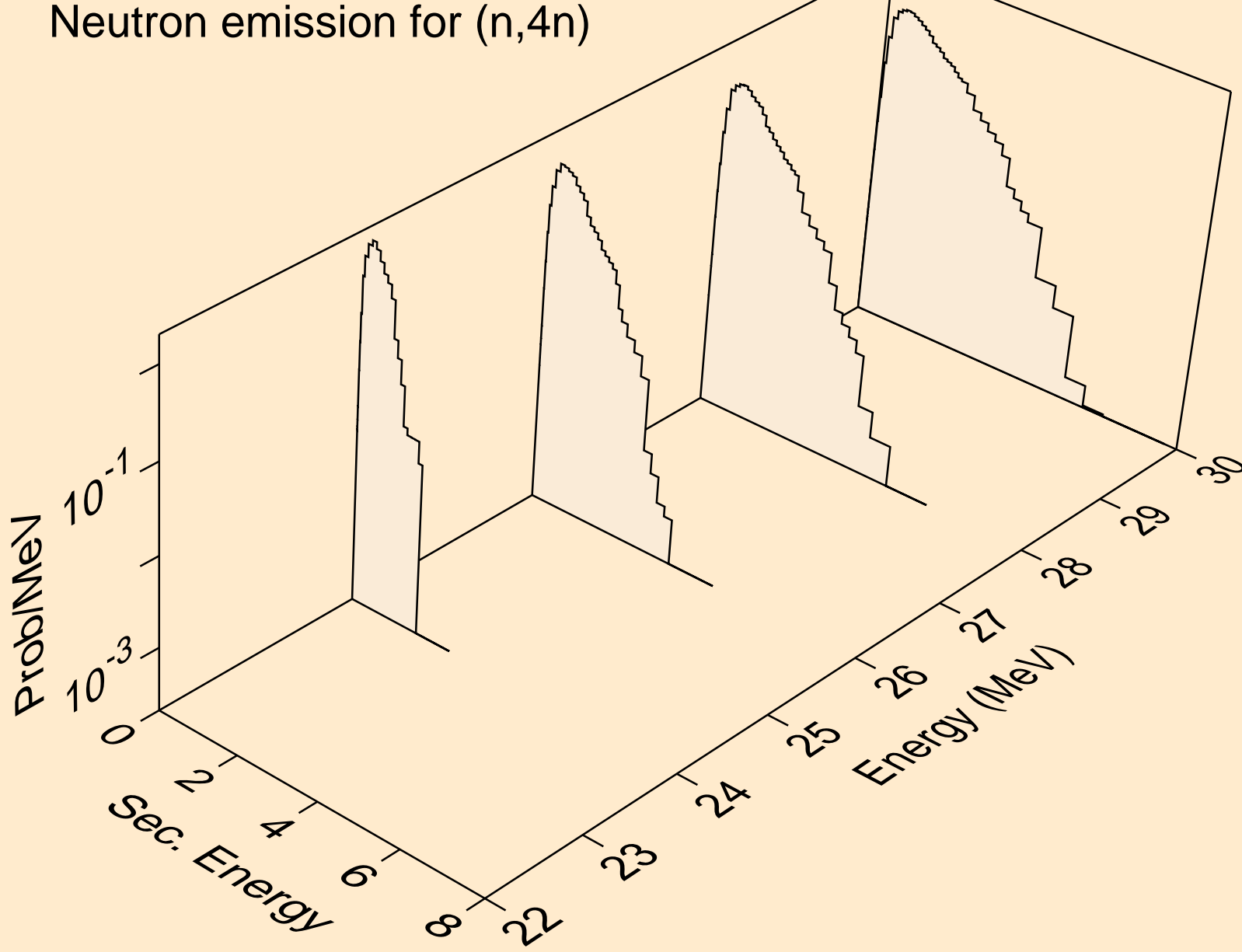

PB203 NEUTRON ACER TENDL-2019 LIBRARY; T=293.16K
Neutron emission for (n,2np)

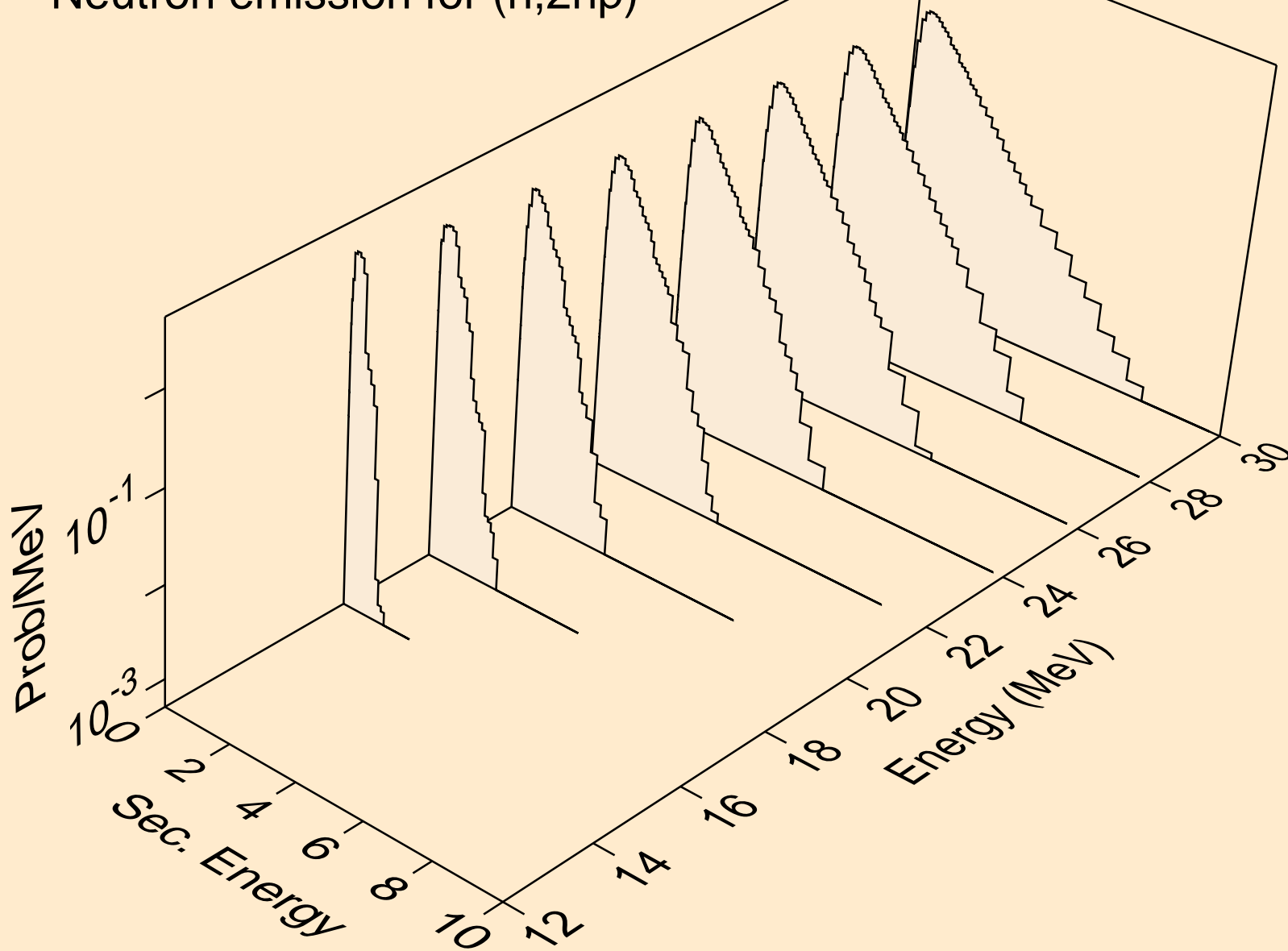

PB203 NEUTRON ACER TENDL-2019 LIBRARY; T=293.16K
Neutron emission for (n,3np)

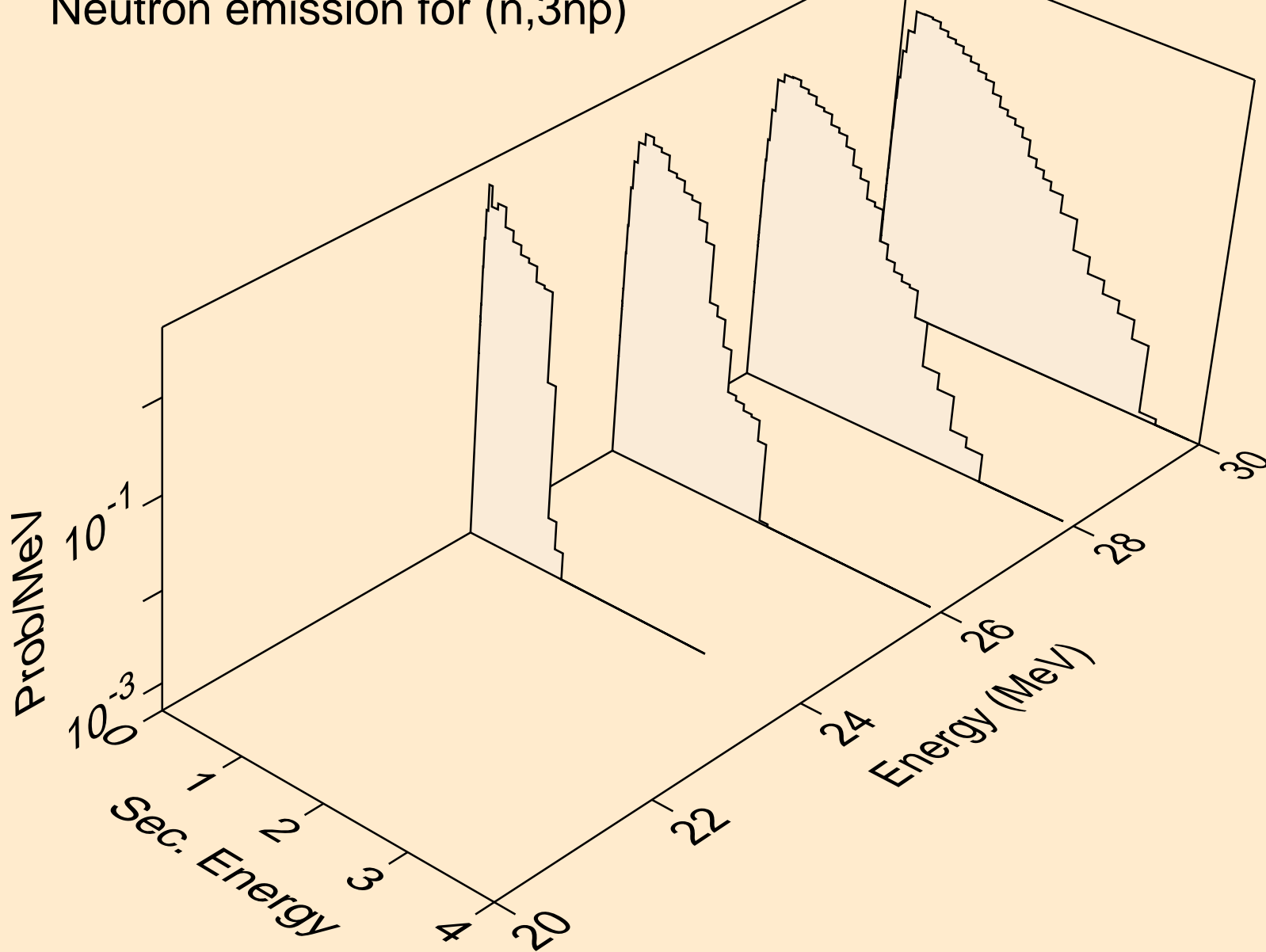

PB203 NEUTRON ACER TENDL-2019 LIBRARY; T=293.16K
Neutron emission for (n,2np)

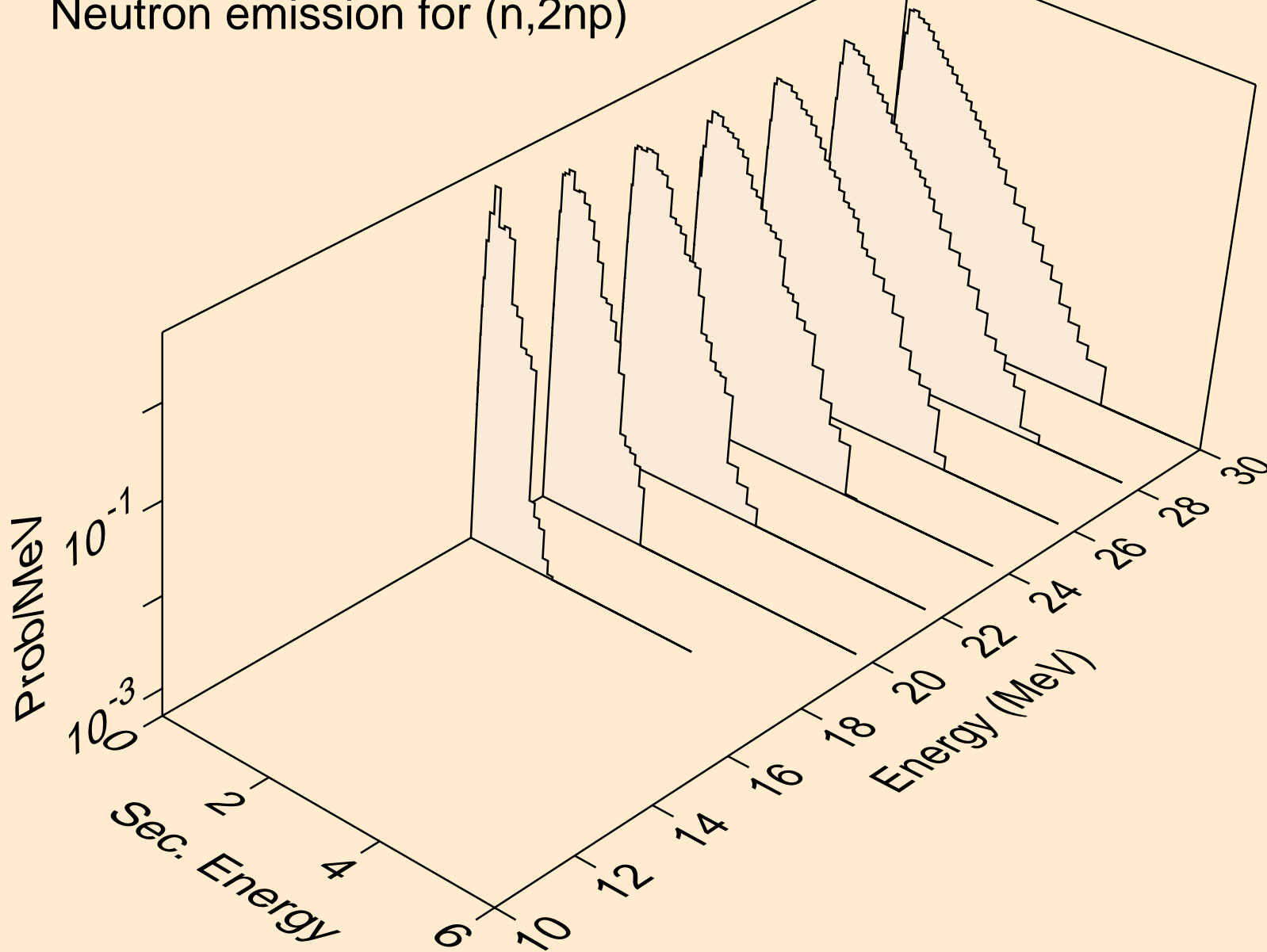

PB203 NEUTRON ACER TENDL-2019 LIBRARY; T=293.16K
Neutron emission for (n,npa)

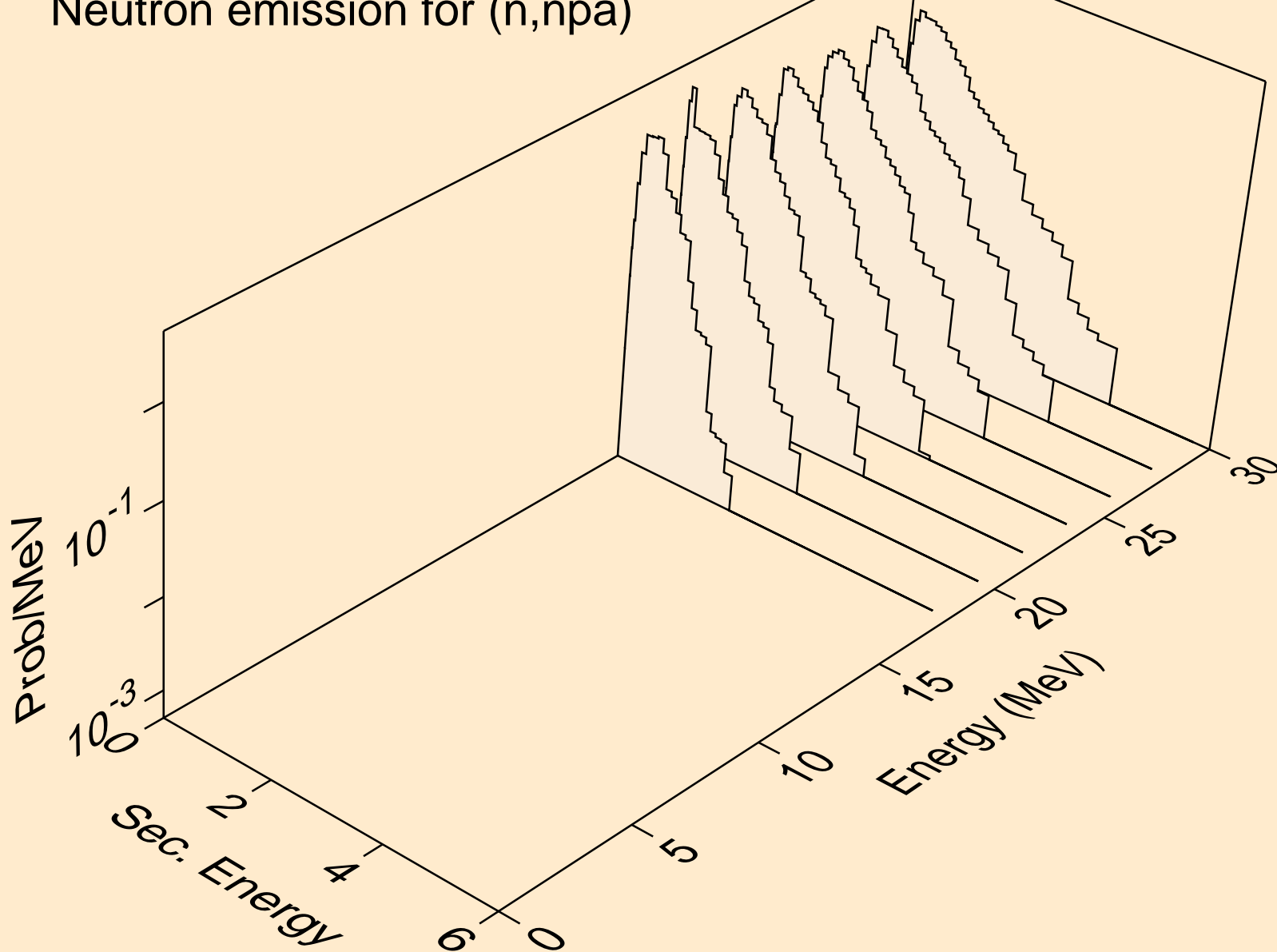

PB203 NEUTRON ACER TENDL-2019 LIBRARY; T=293.16K
Neutron emission for (n,n*c)

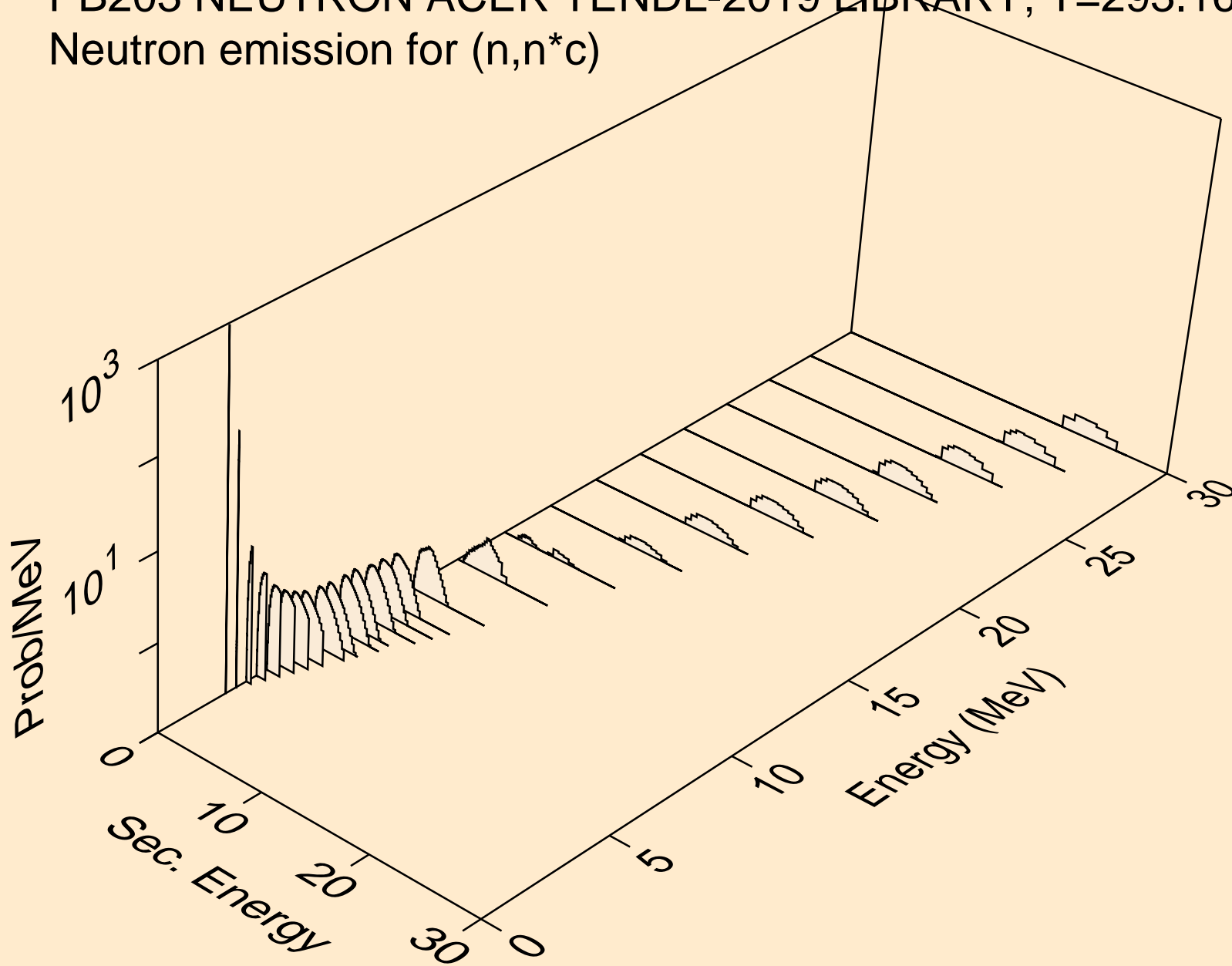

PB203 NEUTRON ACER TENDL-2019 LIBRARY; T=293.16K
Photon emission for (n,x)

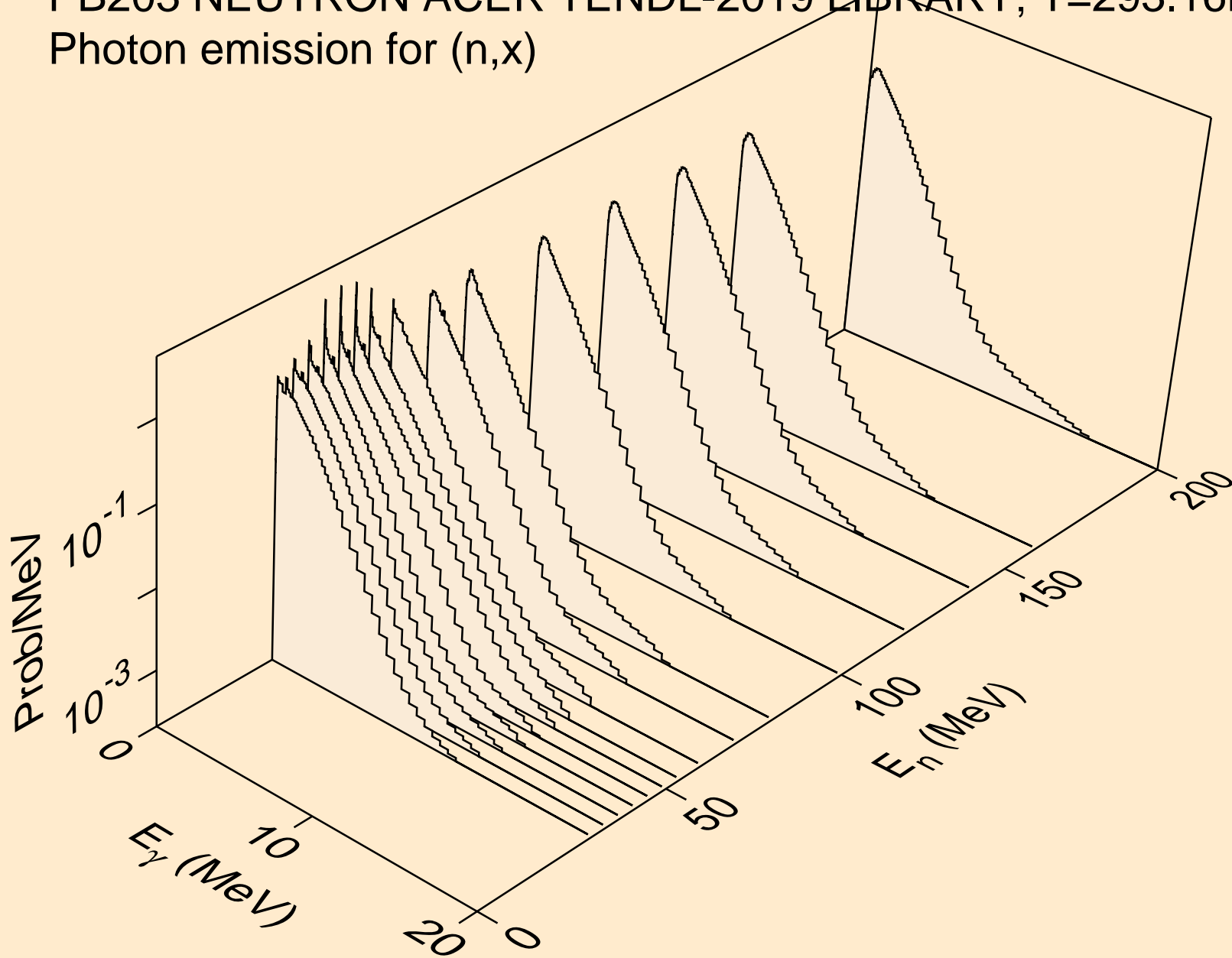

PB203 NEUTRON ACER TENDL-2019 LIBRARY; T=293.16K
Photon emission for (n,2nd)

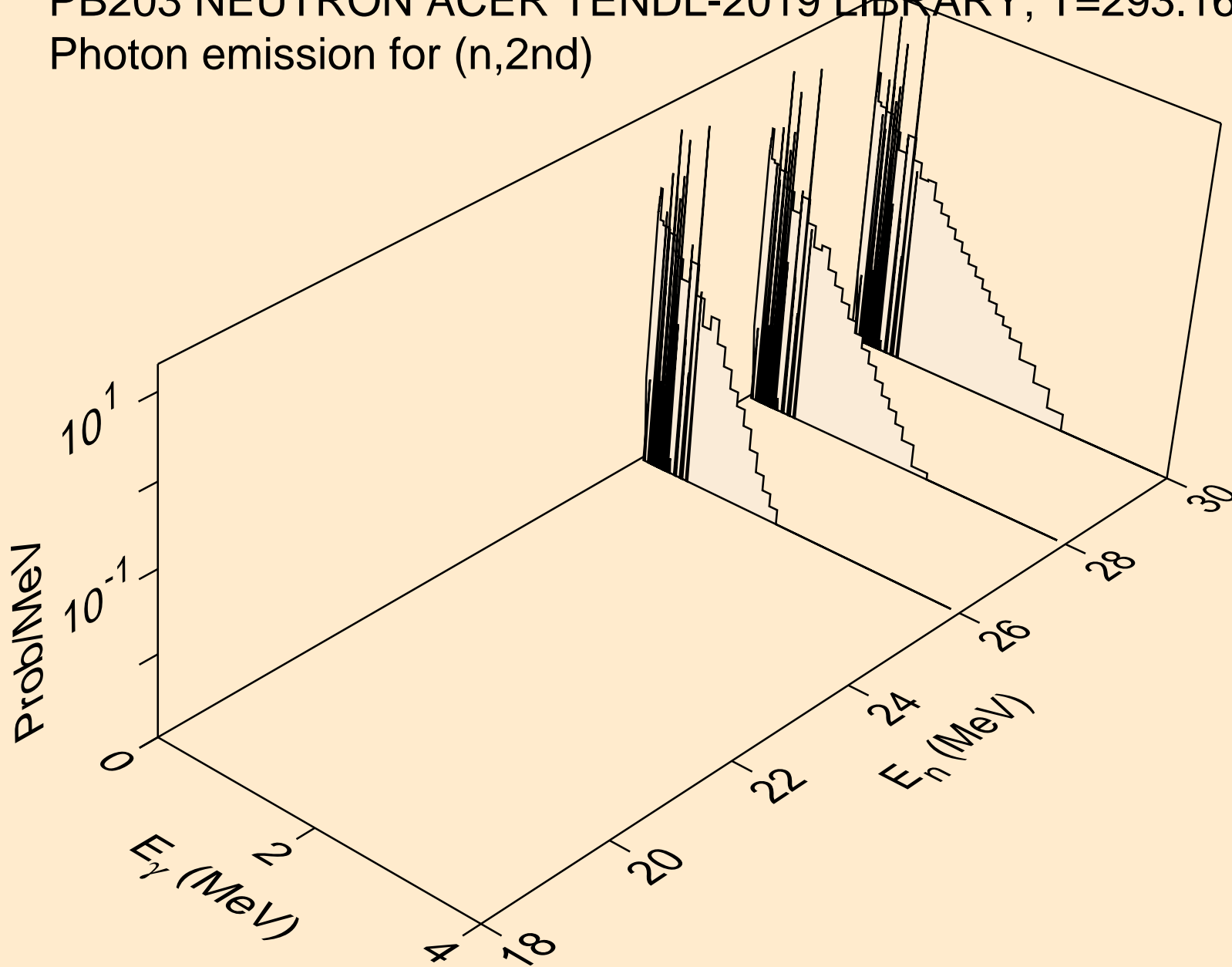

PB203 NEUTRON ACER TENDL-2019 LIBRARY; T=293.16K
Photon emission for (n,2n)

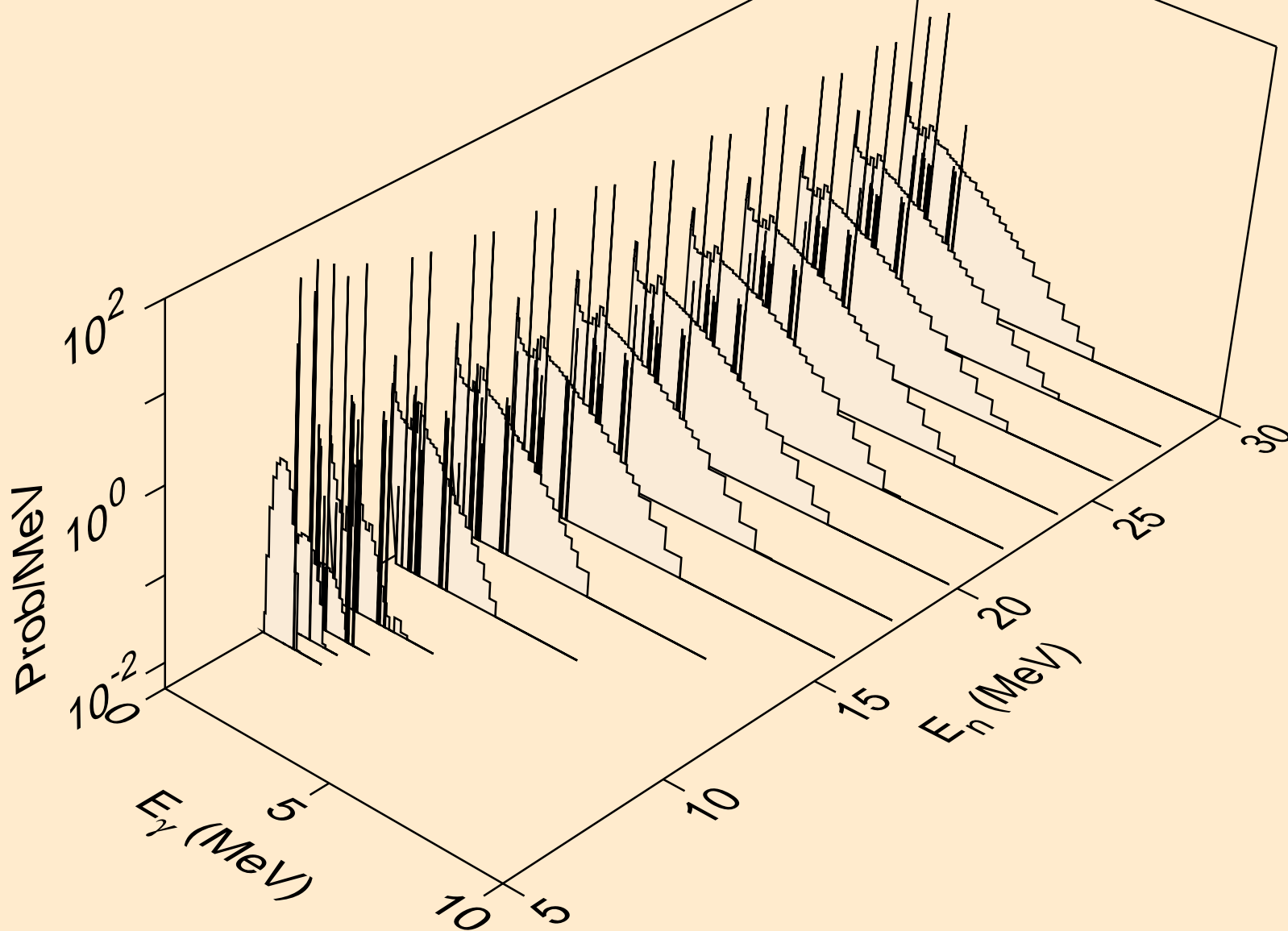

PB203 NEUTRON ACER TENDL-2019 LIBRARY; T=293.16K
Photon emission for (n,3n)

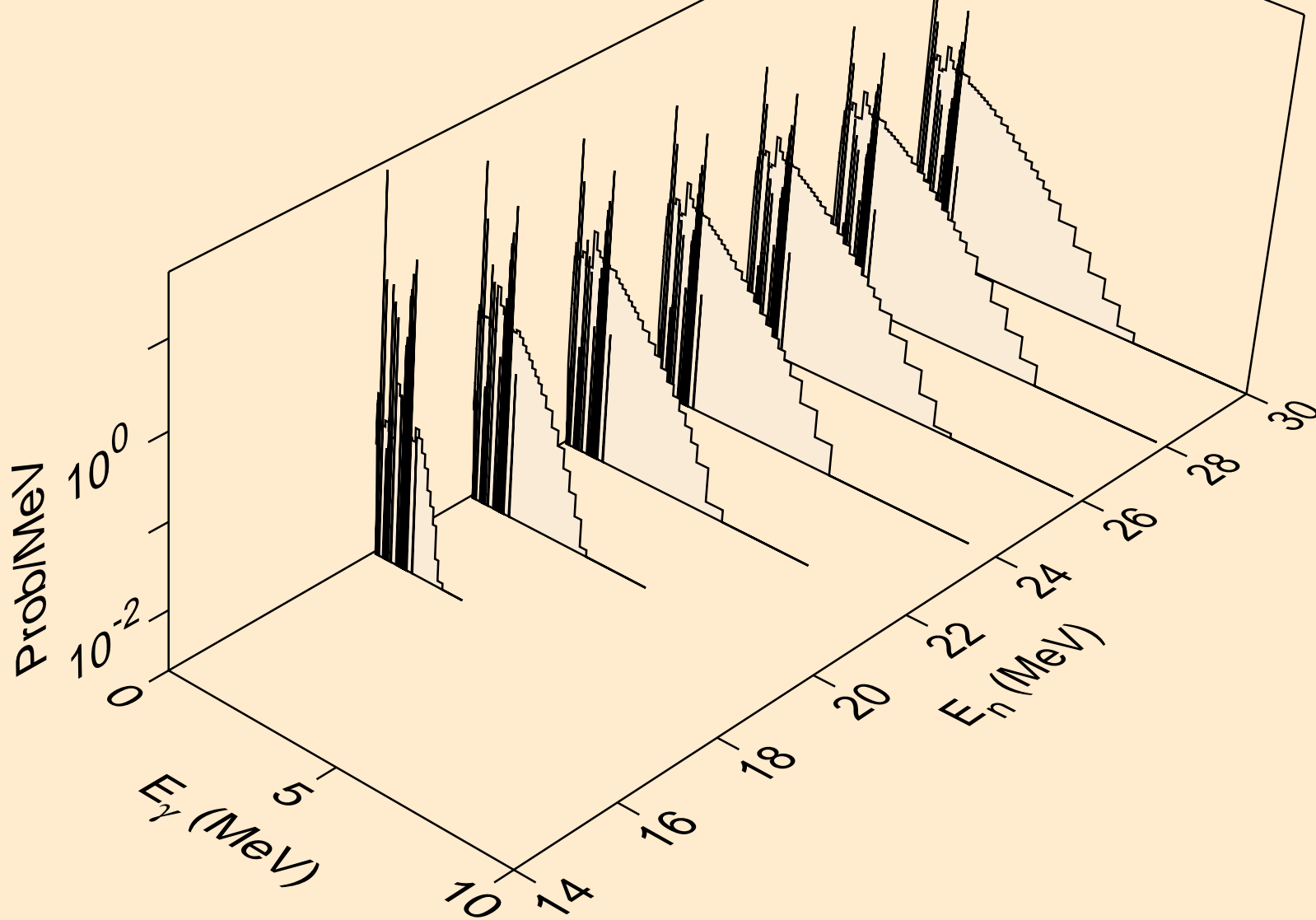

PB203 NEUTRON ACER TENDL-2019 LIBRARY; T=293.16K
Photon emission for (n,n*)a

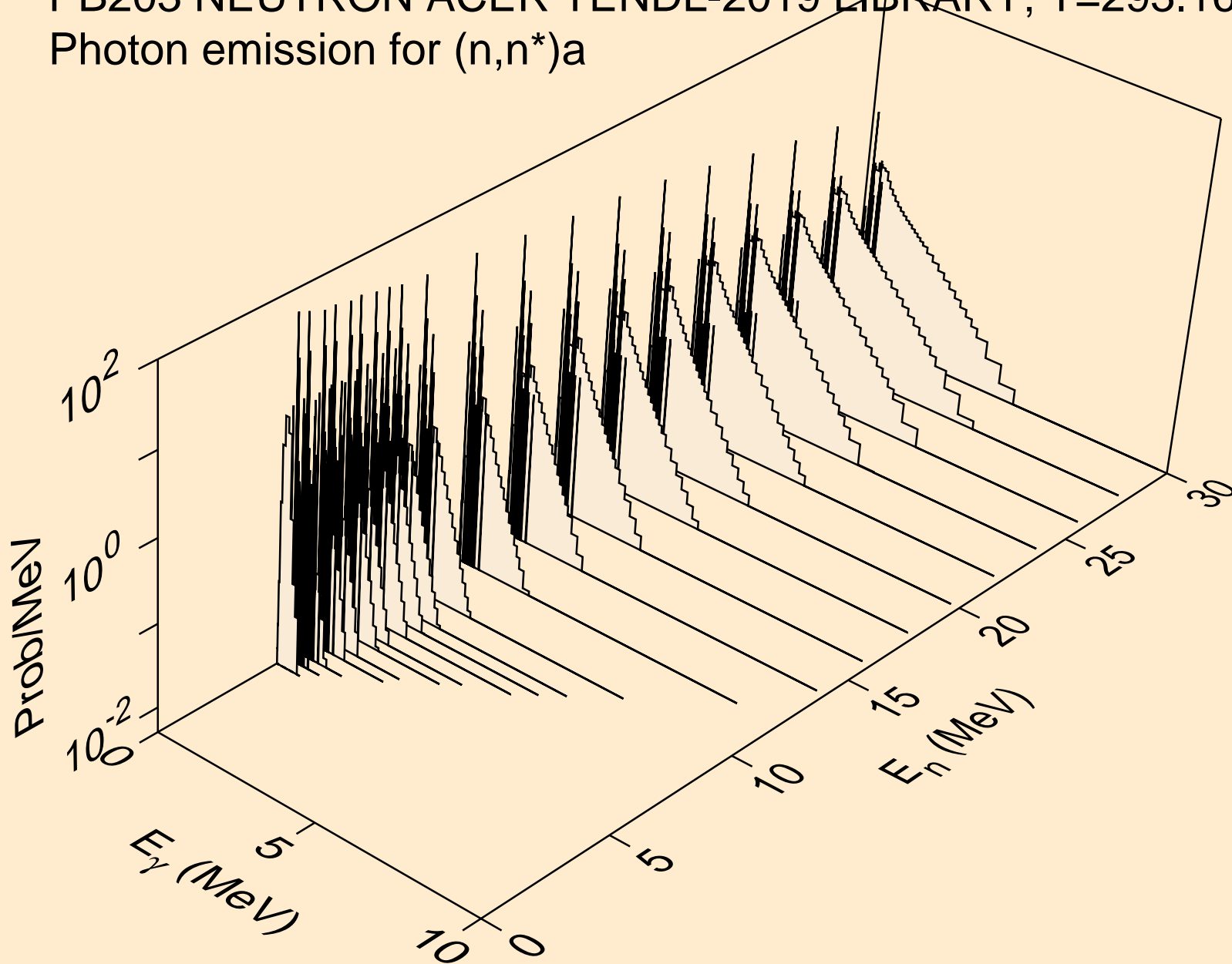

PB203 NEUTRON ACER TENDL-2019 LIBRARY; T=293.16K
Photon emission for (n,2n) α

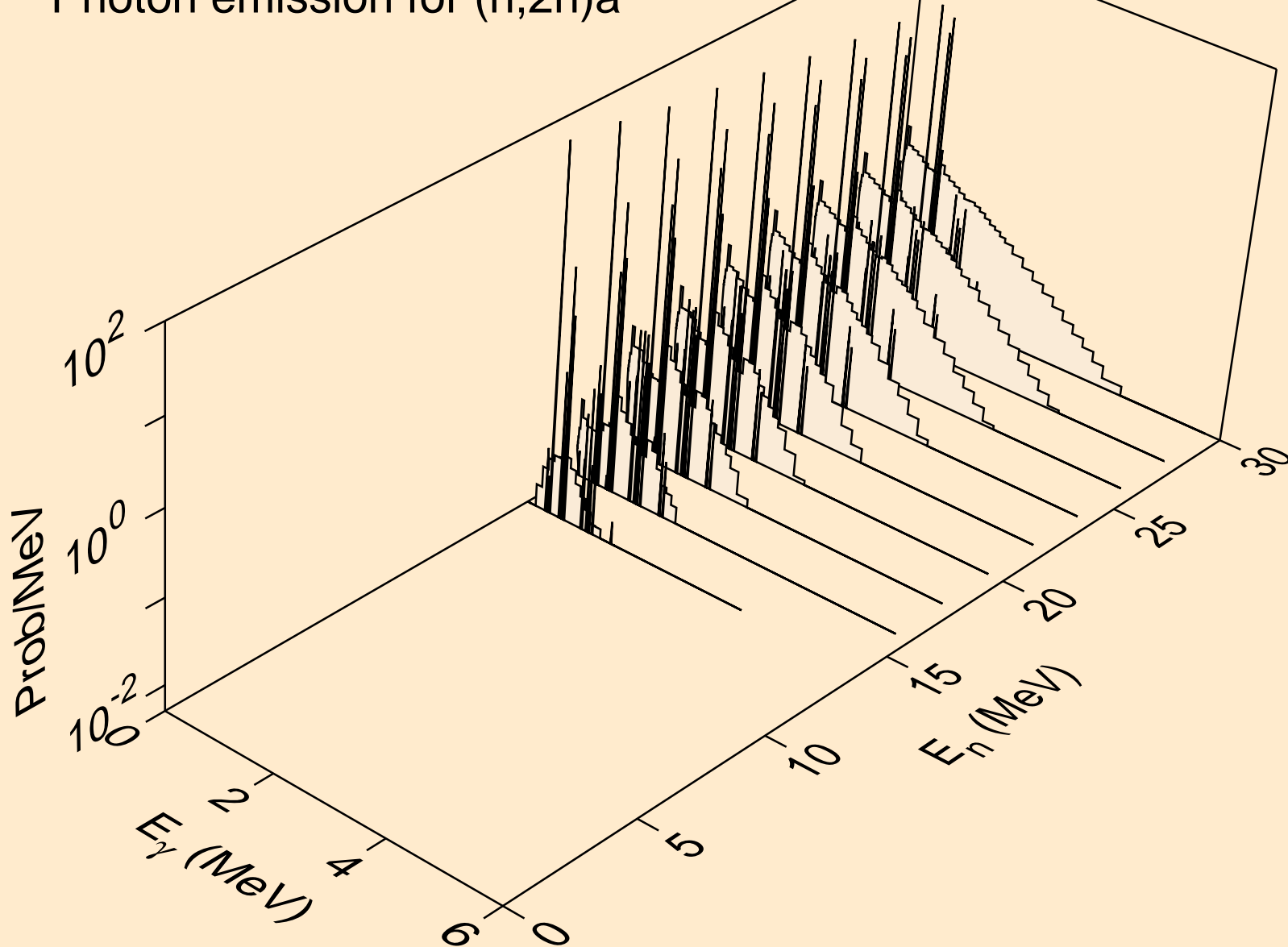

PB203 NEUTRON ACER TENDL-2019 LIBRARY; T=293.16K
Photon emission for (n,3n)a

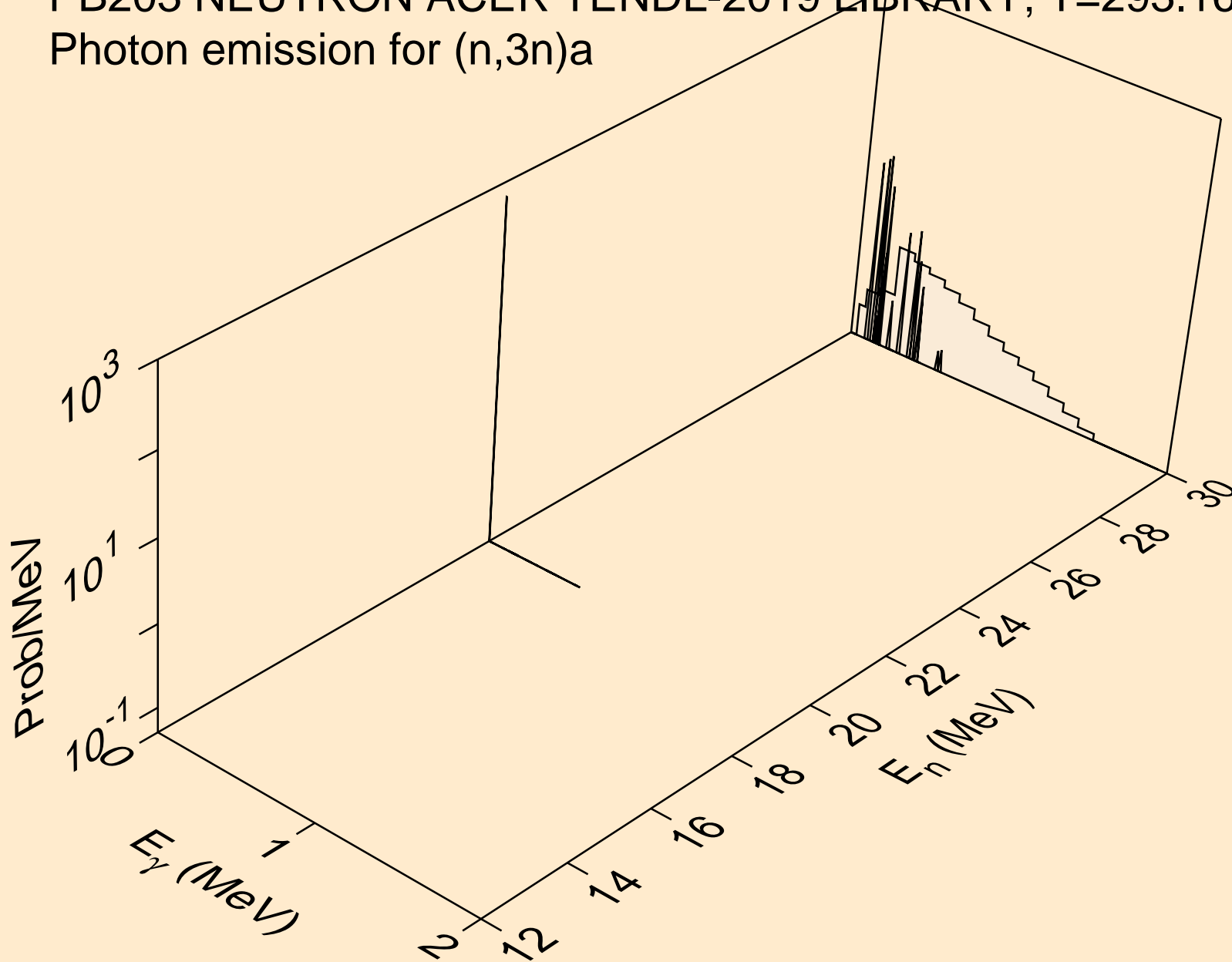

PB203 NEUTRON ACER TENDL-2019 LIBRARY; T=293.16K
Photon emission for (n,n*)p

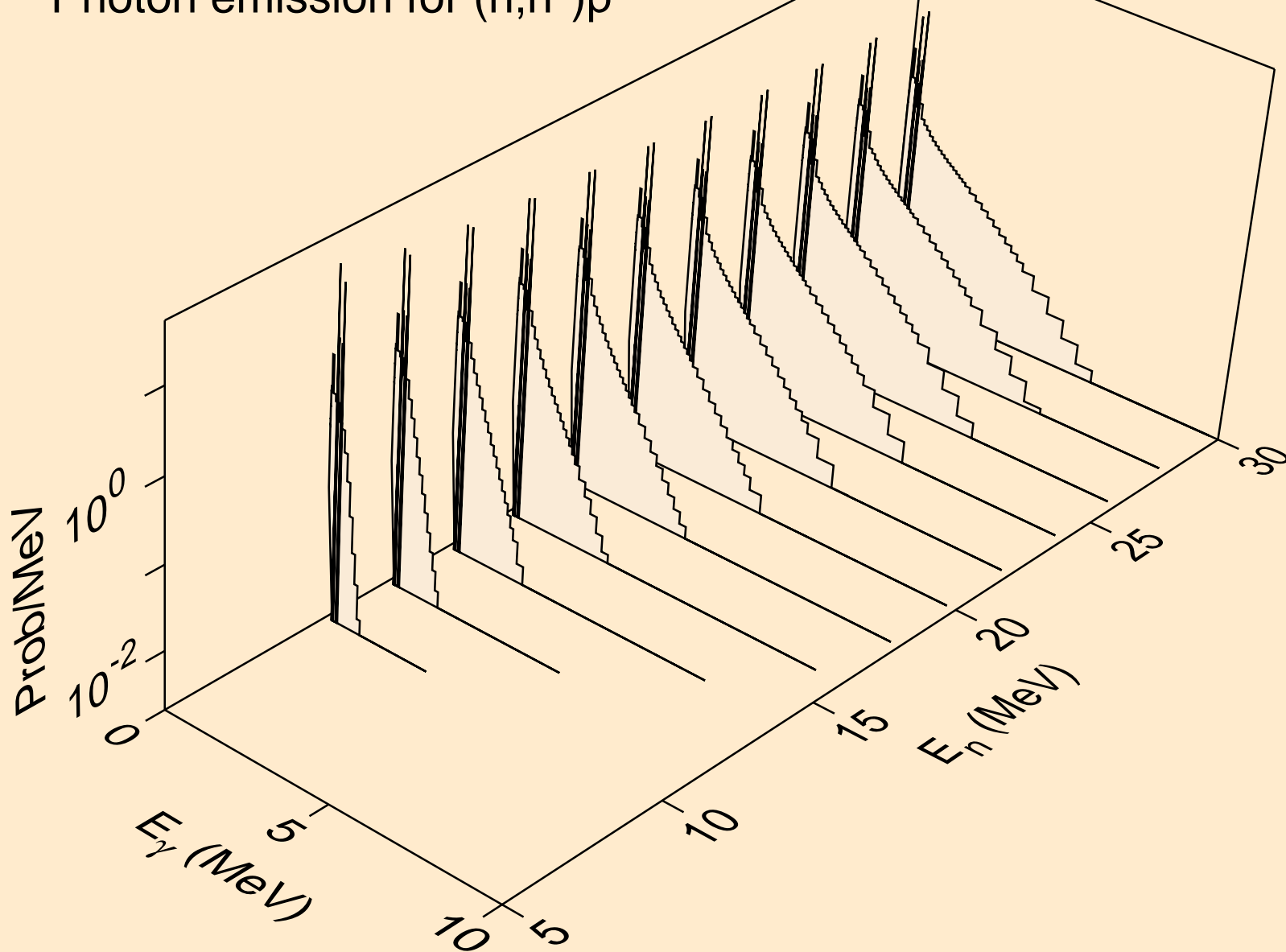

PB203 NEUTRON ACER TENDL-2019 LIBRARY; T=293.16K
Photon emission for (n,n*)d

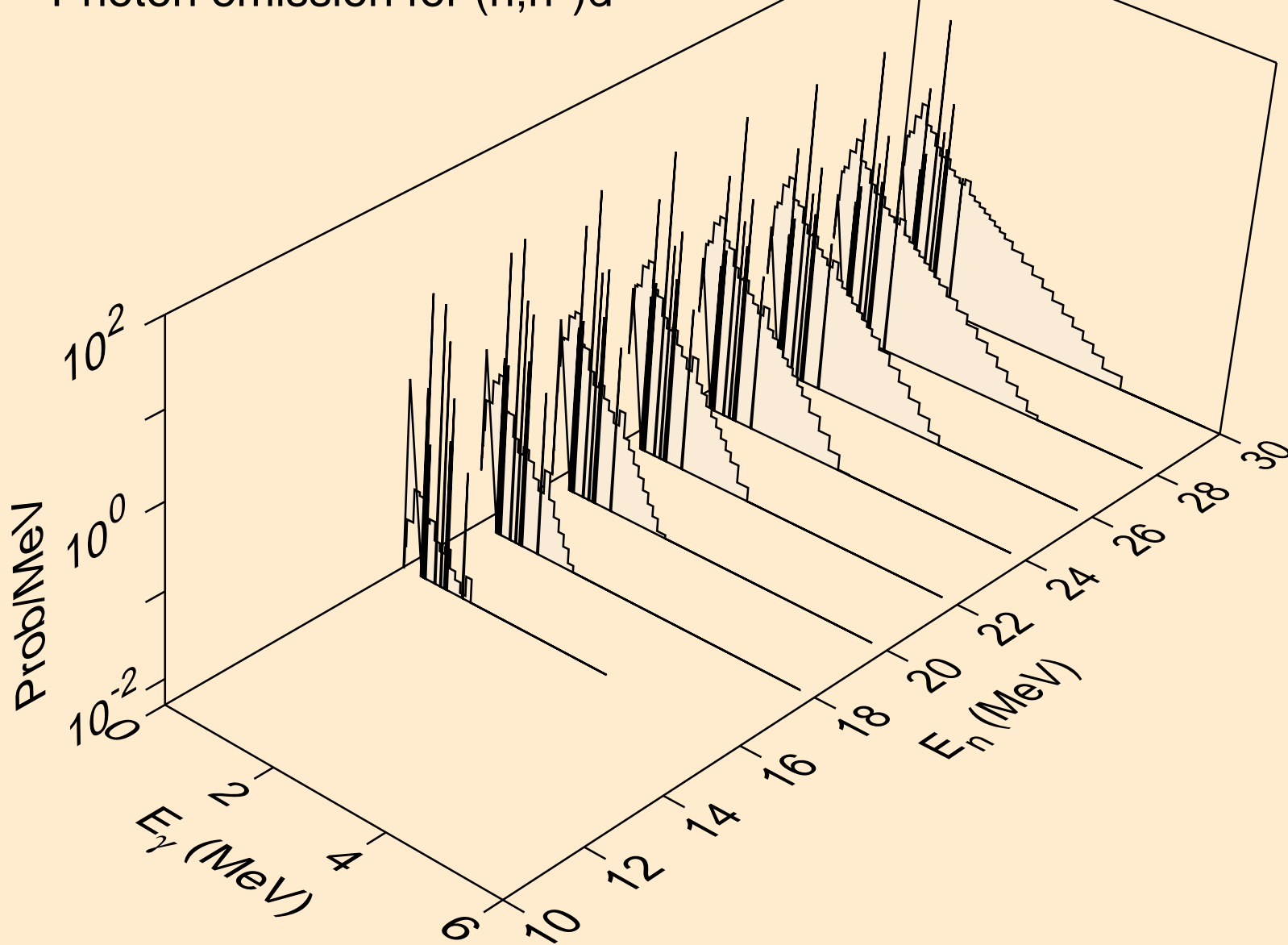

PB203 NEUTRON ACER TENDL-2019 LIBRARY; T=293.16K
Photon emission for (n,n*)t

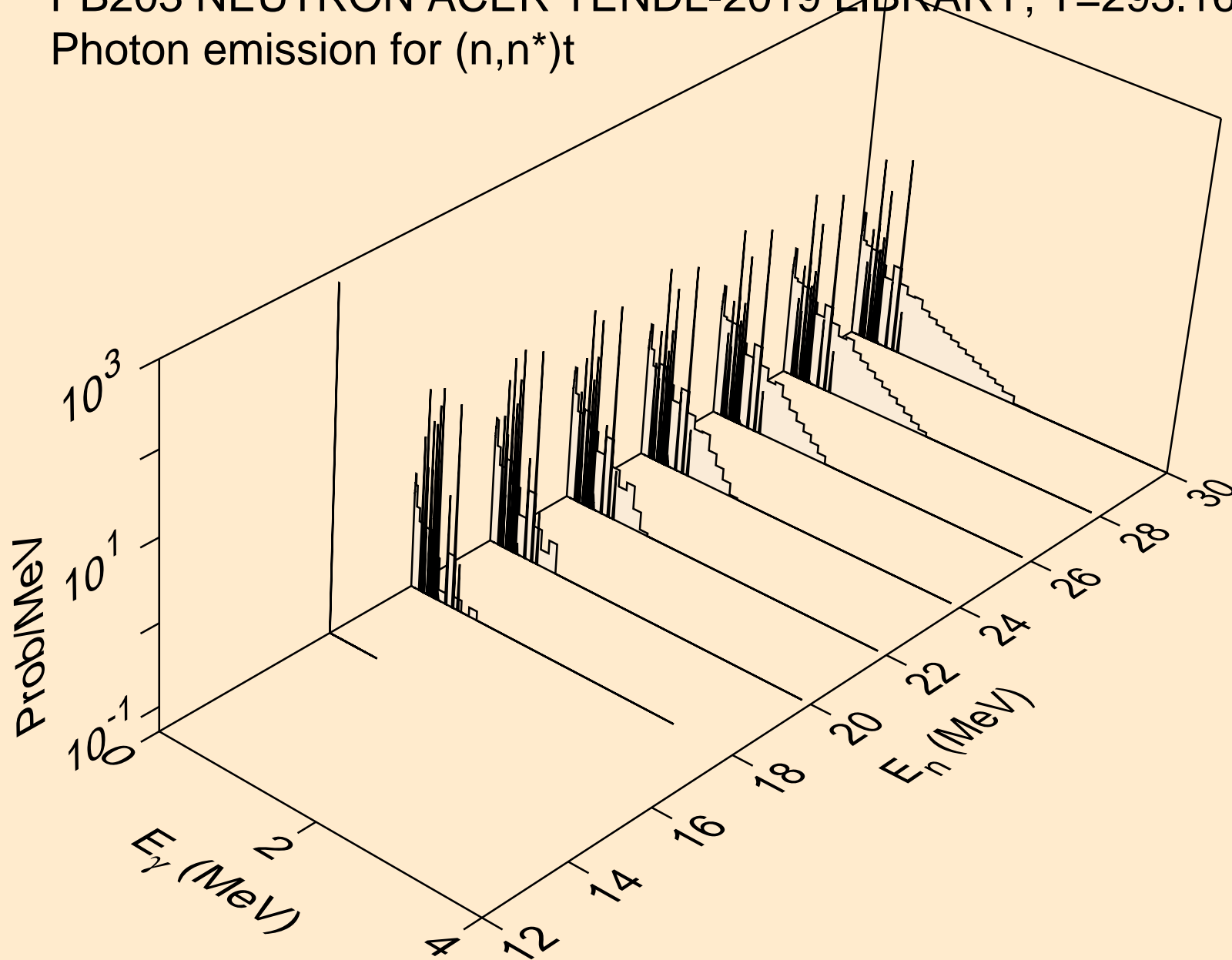

PB203 NEUTRON ACER TENDL-2019 LIBRARY; T=293.16K
Photon emission for (n,n*)he3

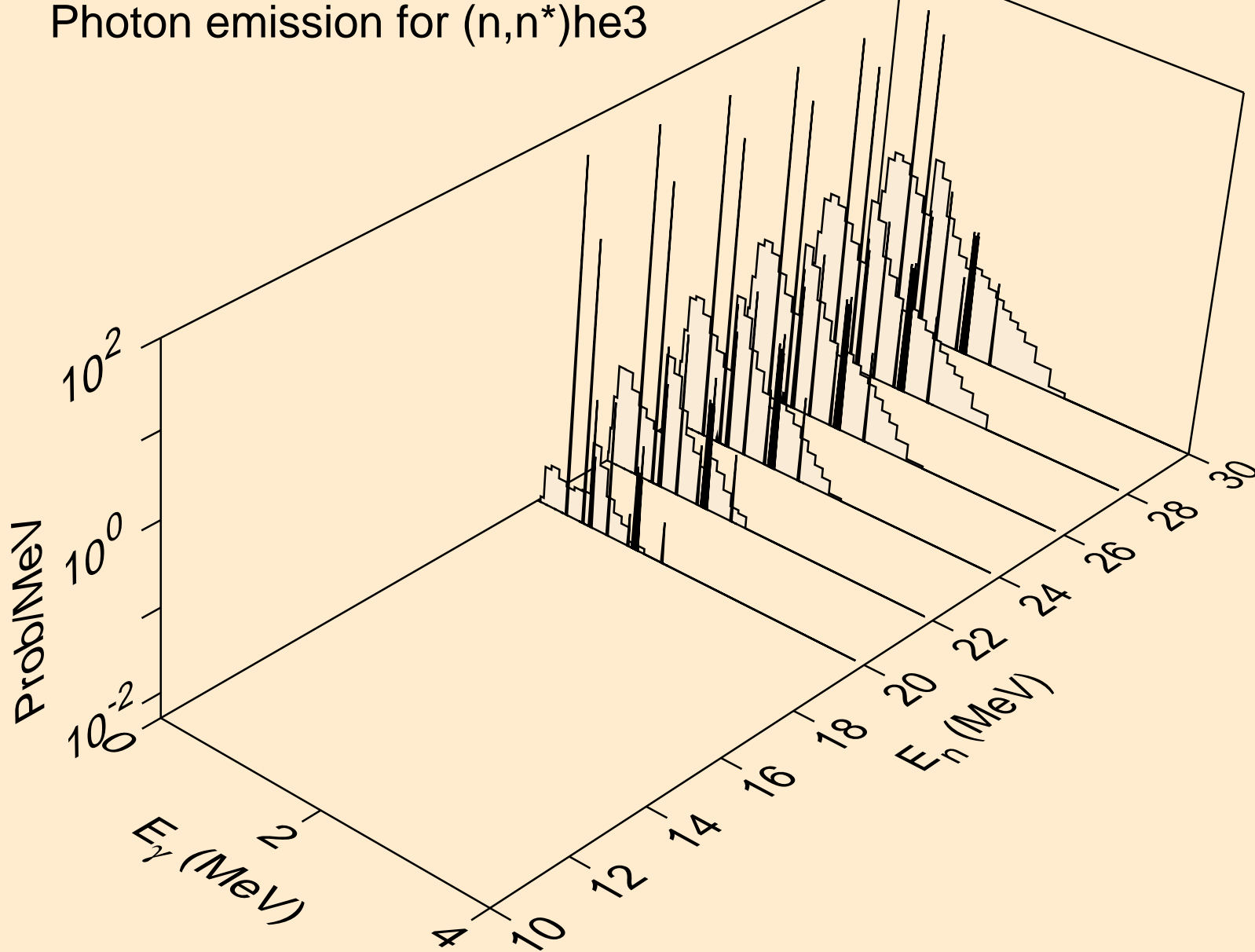

PB203 NEUTRON ACER TENDL-2019 LIBRARY; T=293.16K
Photon emission for (n,4n)

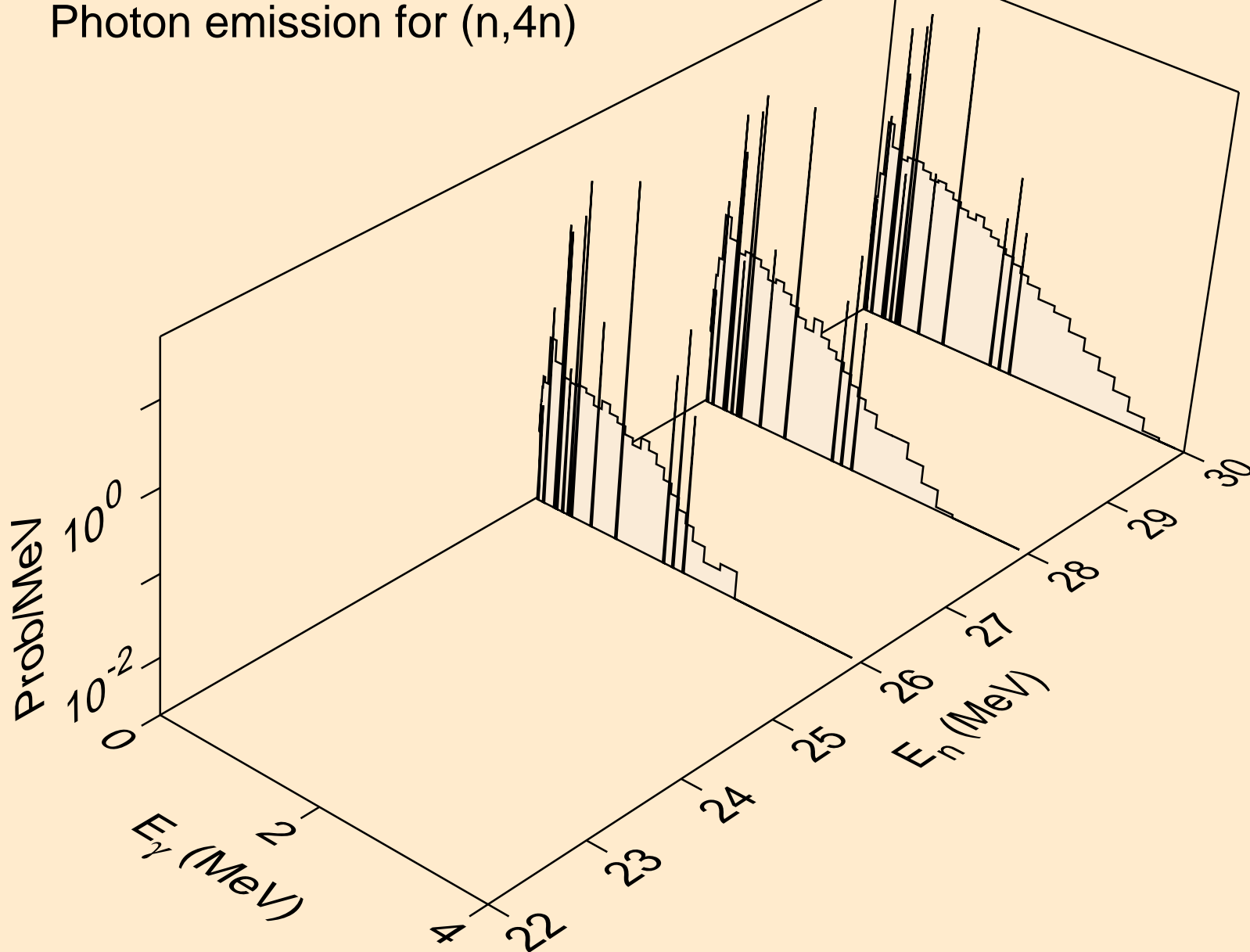

PB203 NEUTRON ACER TENDL-2019 LIBRARY; T=293.16K
Photon emission for (n,2np)

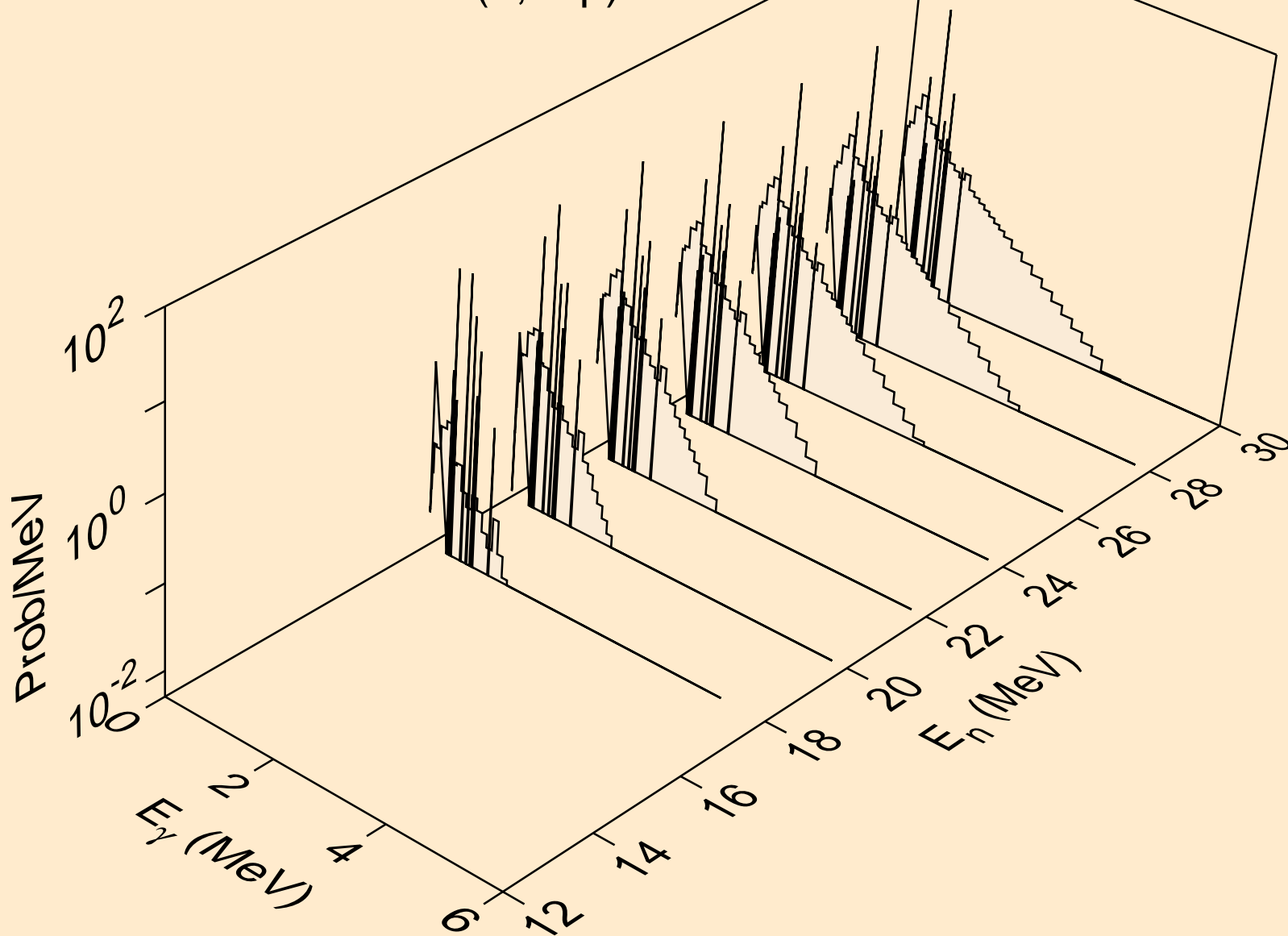

PB203 NEUTRON ACER TENDL-2019 LIBRARY; T=293.16K
Photon emission for (n,3np)

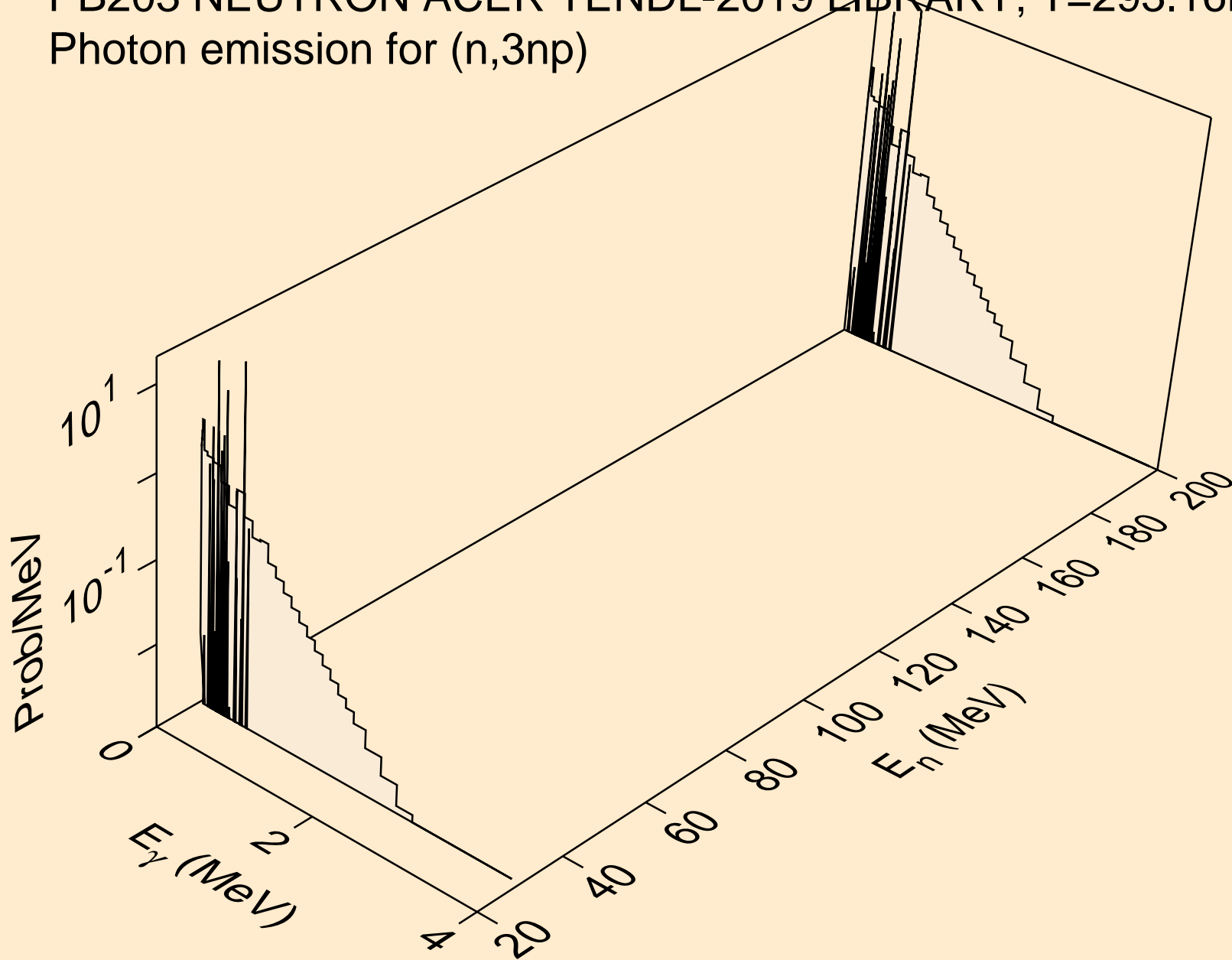

PB203 NEUTRON ACER TENDL-2019 LIBRARY; T=293.16K
Photon emission for (n,2np)

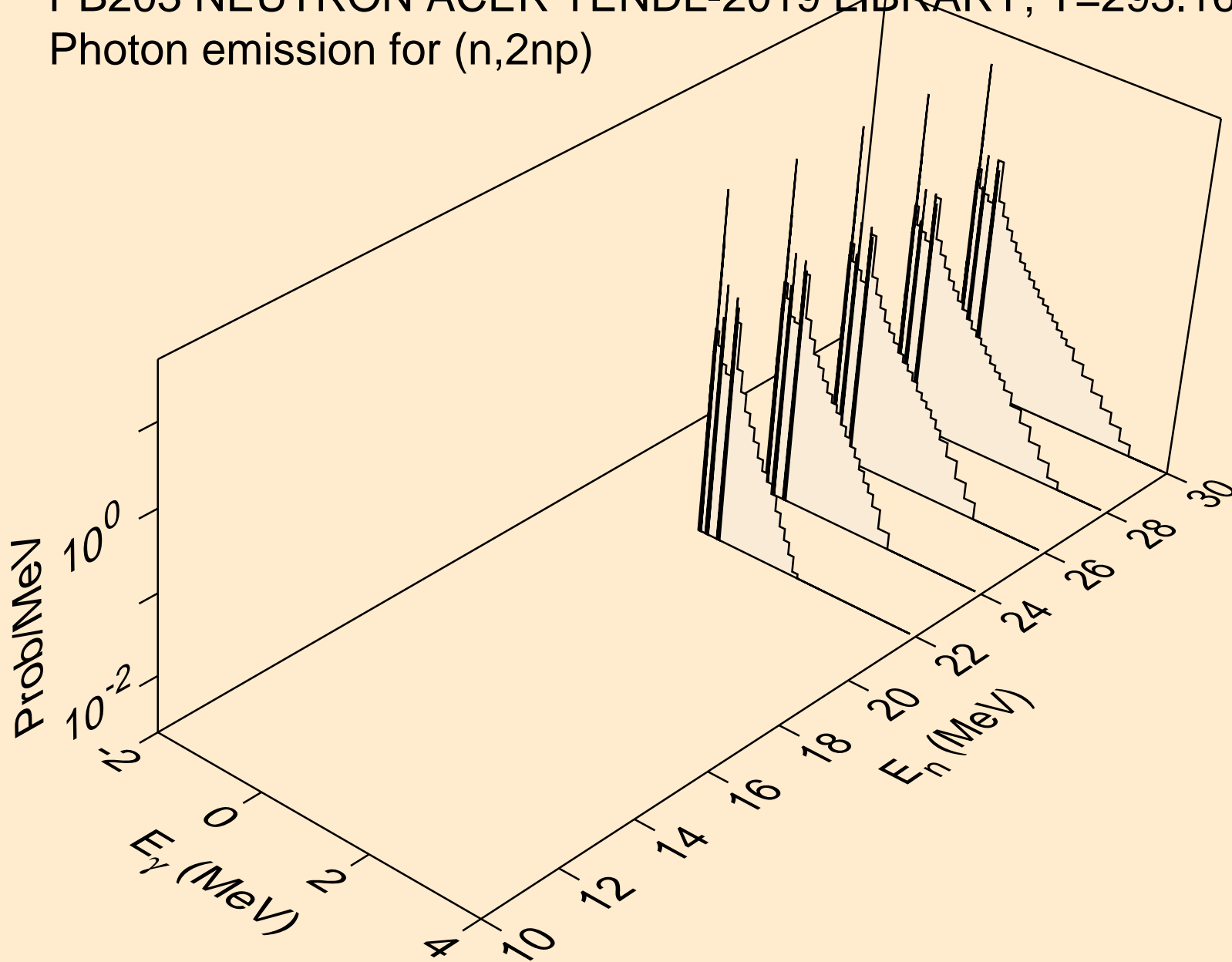

PB203 NEUTRON ACER TENDL-2019 LIBRARY; T=293.16K
Photon emission for (n,npa)

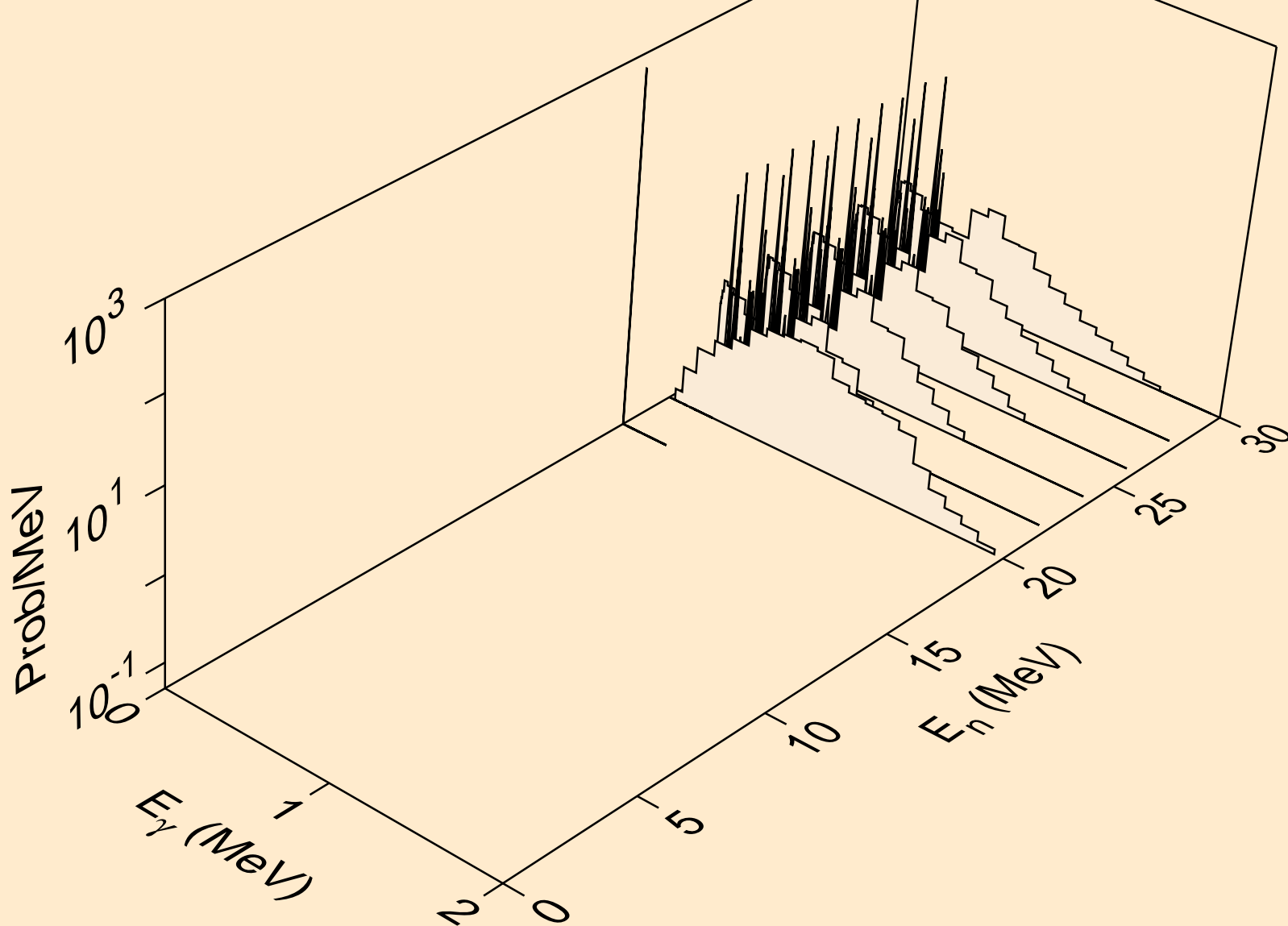

PB203 NEUTRON ACER TENDL-2019 LIBRARY; T=293.16K
Photon emission for (n,n*c)

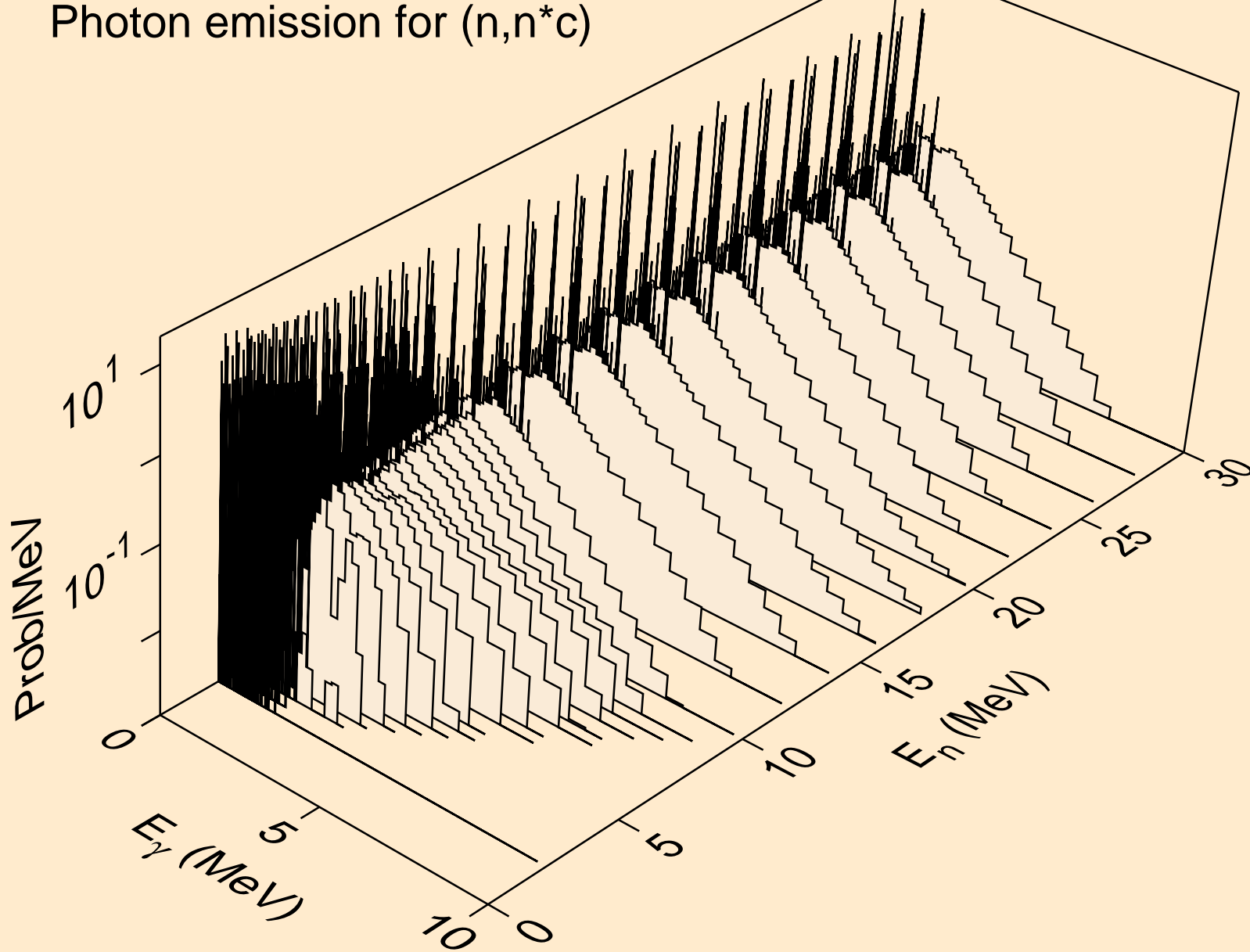

PB203 NEUTRON ACER TENDL-2019 LIBRARY; T=293.16K
Photon emission for (n,gma)

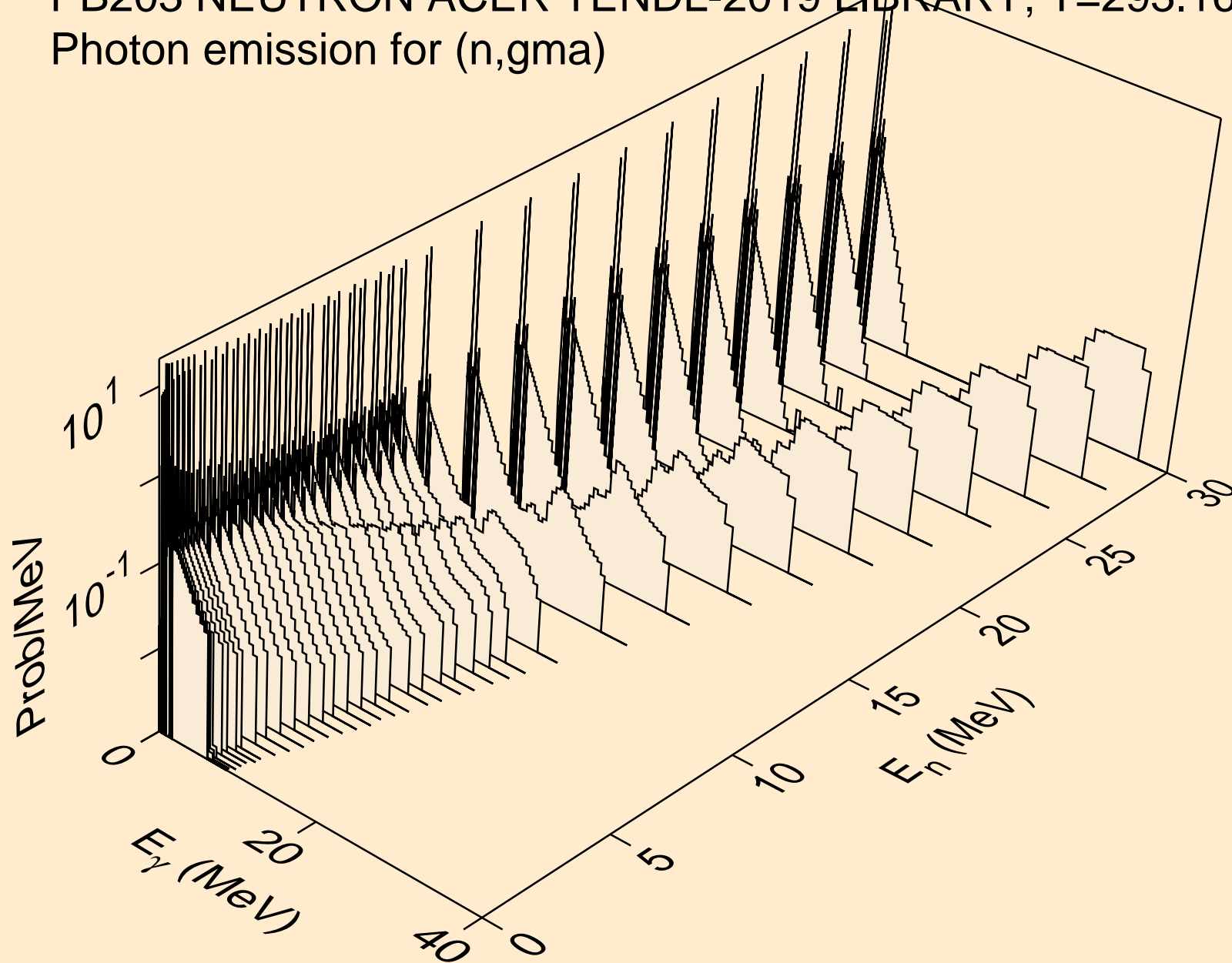

PB203 NEUTRON ACER TENDL-2019 LIBRARY; T=293.16K
Photon emission for (n,p)

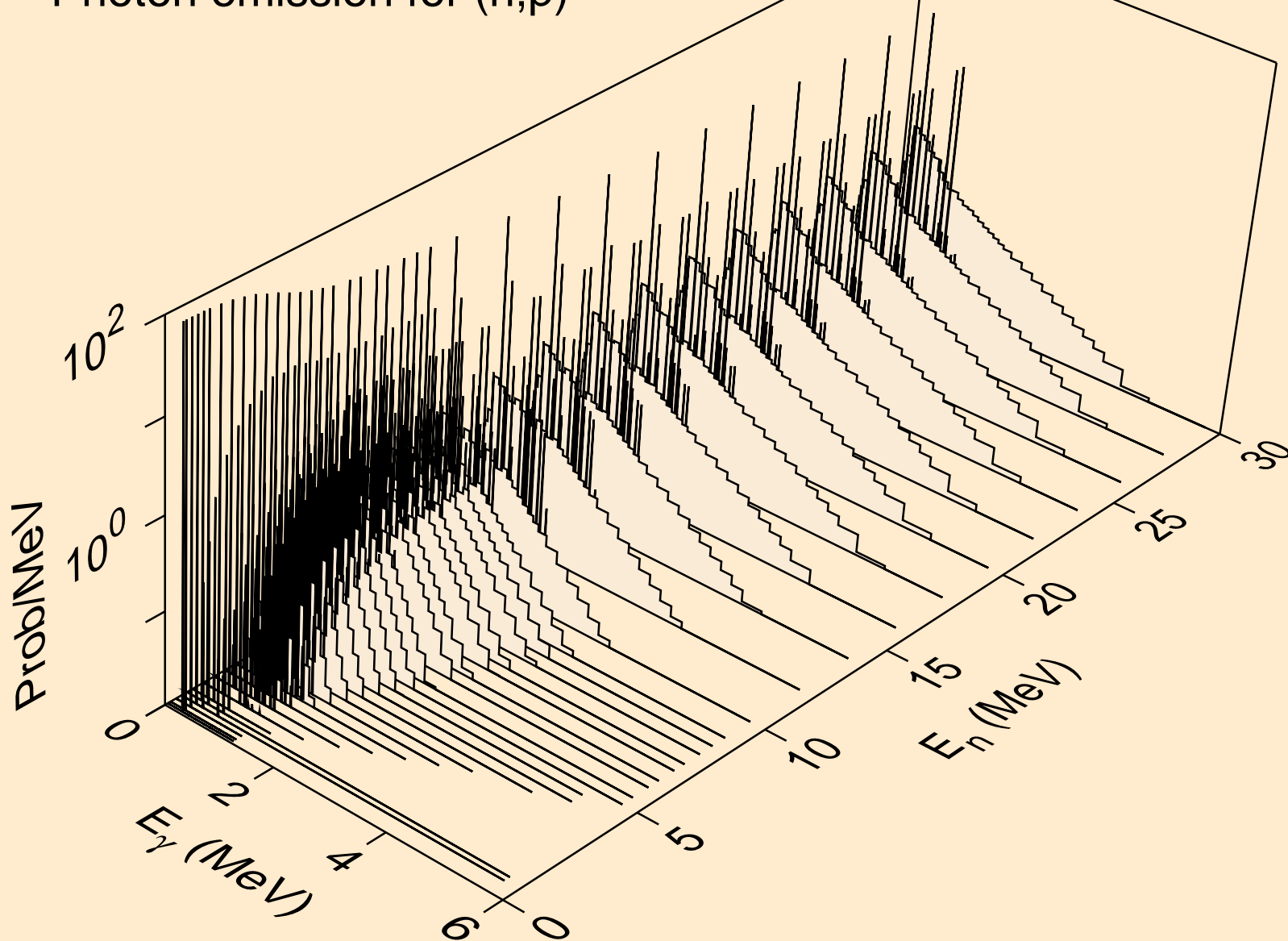

PB203 NEUTRON ACER TENDL-2019 LIBRARY; T=293.16K
Photon emission for (n,d)

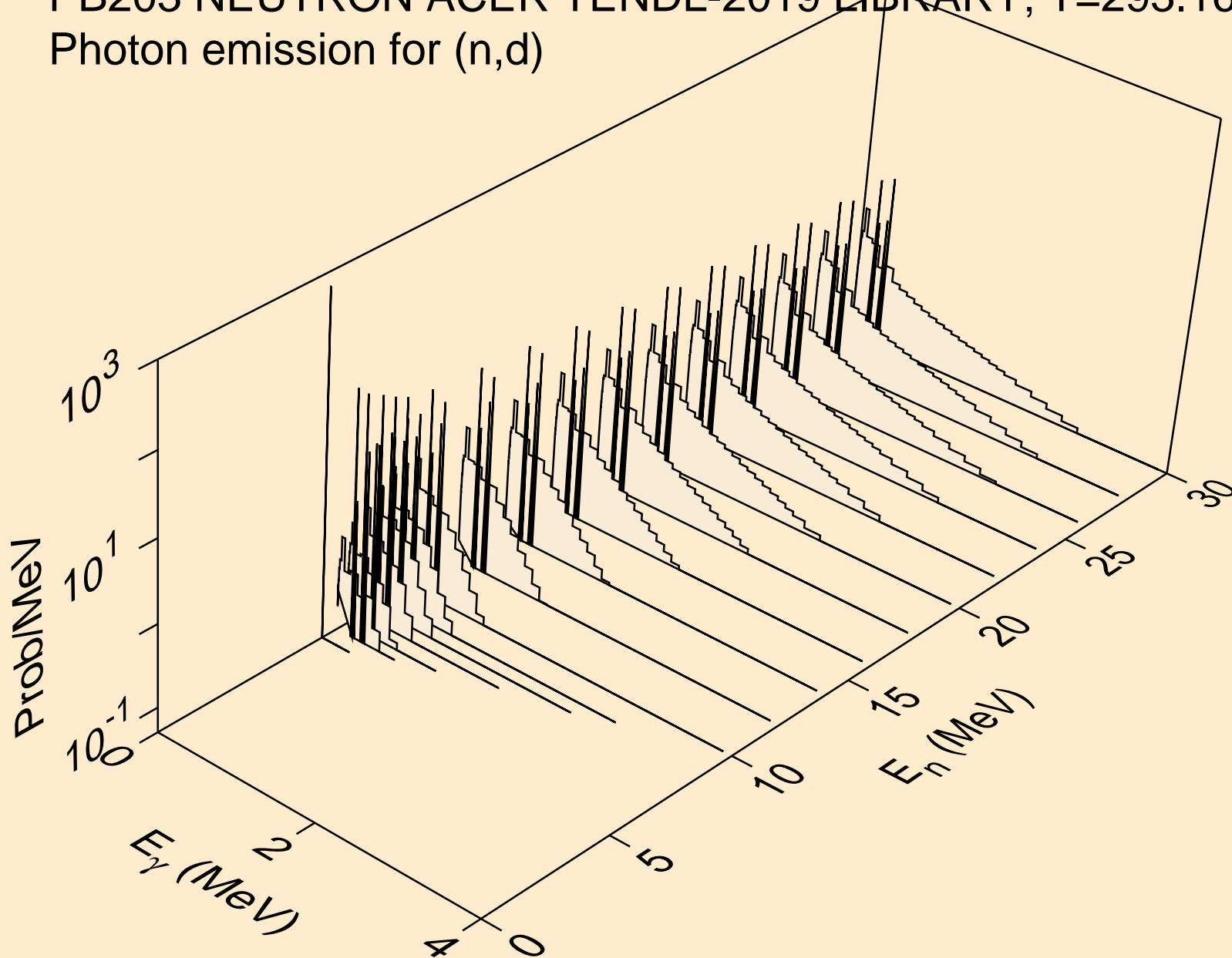

PB203 NEUTRON ACER TENDL-2019 LIBRARY; T=293.16K
Photon emission for (n,t)

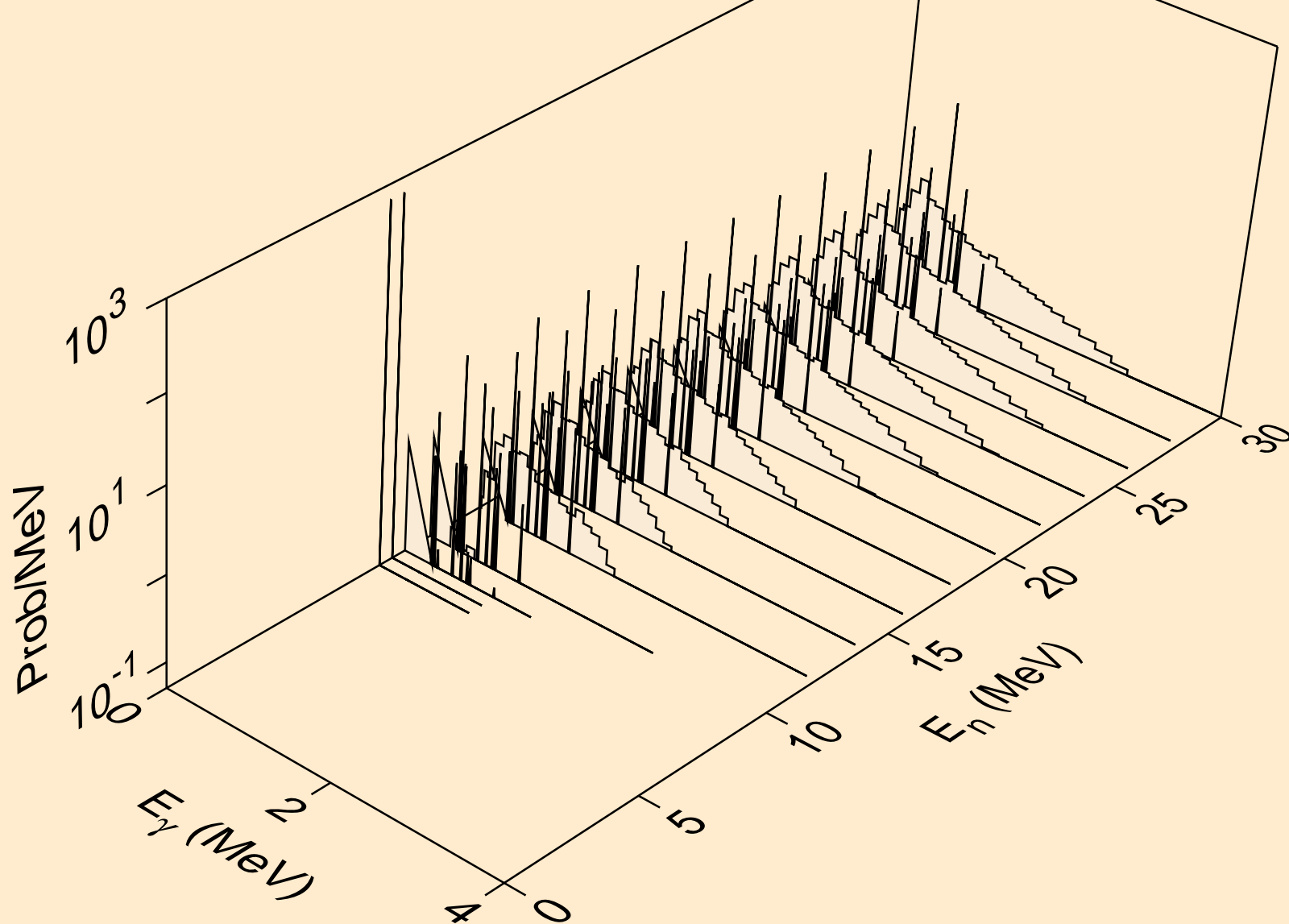

PB203 NEUTRON ACER TENDL-2019 LIBRARY; T=293.16K
Photon emission for (n,he3)

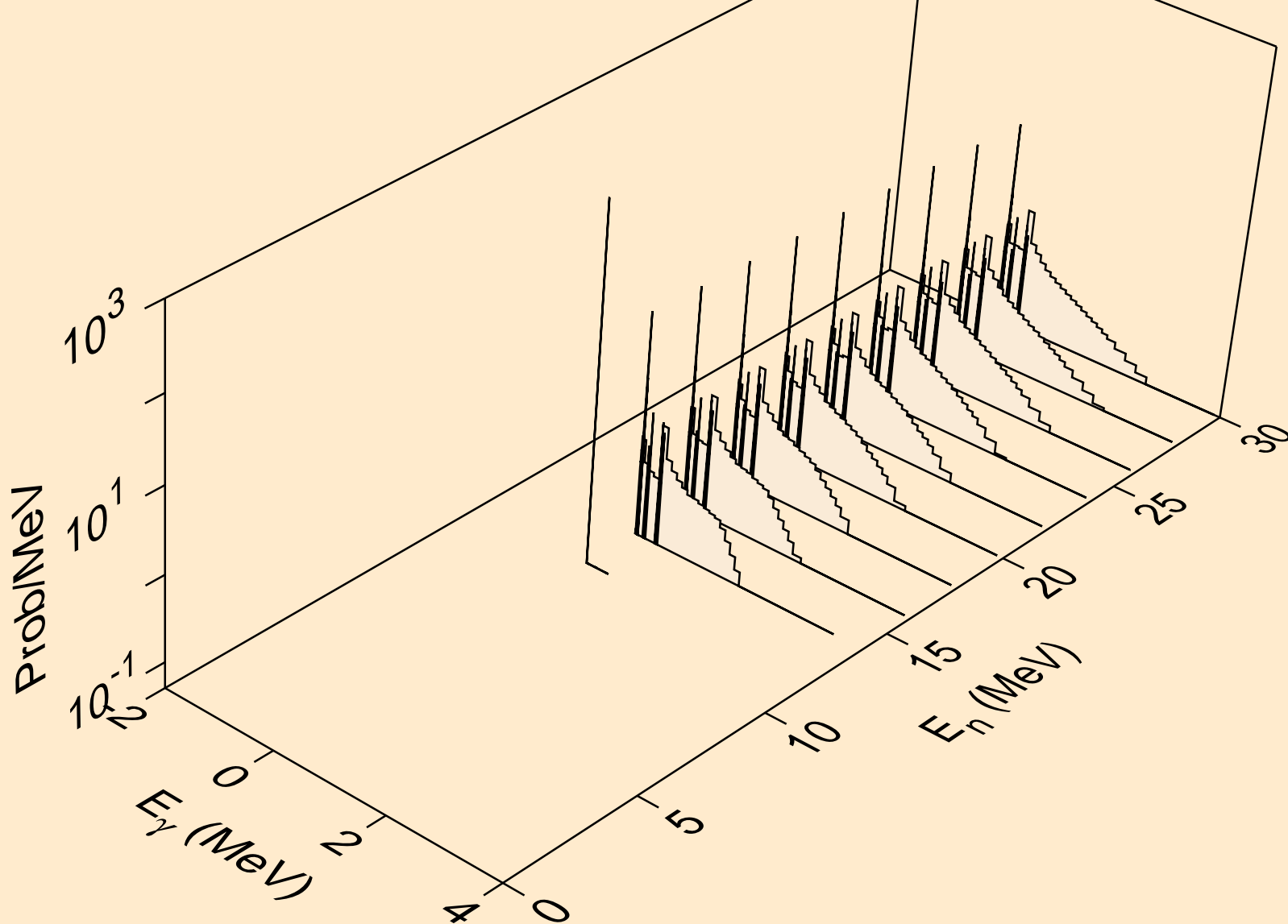

PB203 NEUTRON ACER TENDL-2019 LIBRARY; T=293.16K
Photon emission for (n,a)

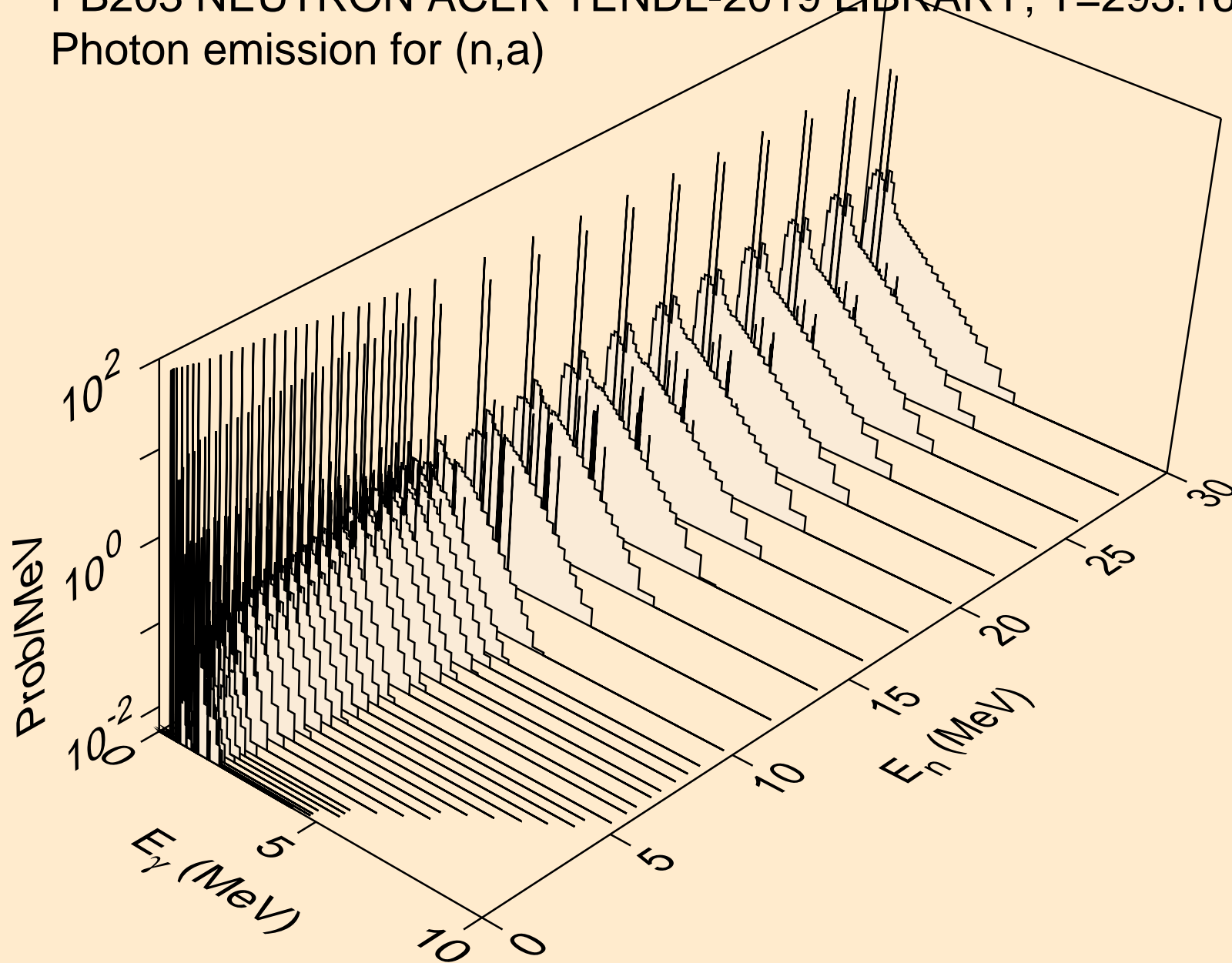

PB203 NEUTRON ACER TENDL-2019 LIBRARY; T=293.16K
Photon emission for (n,2p)

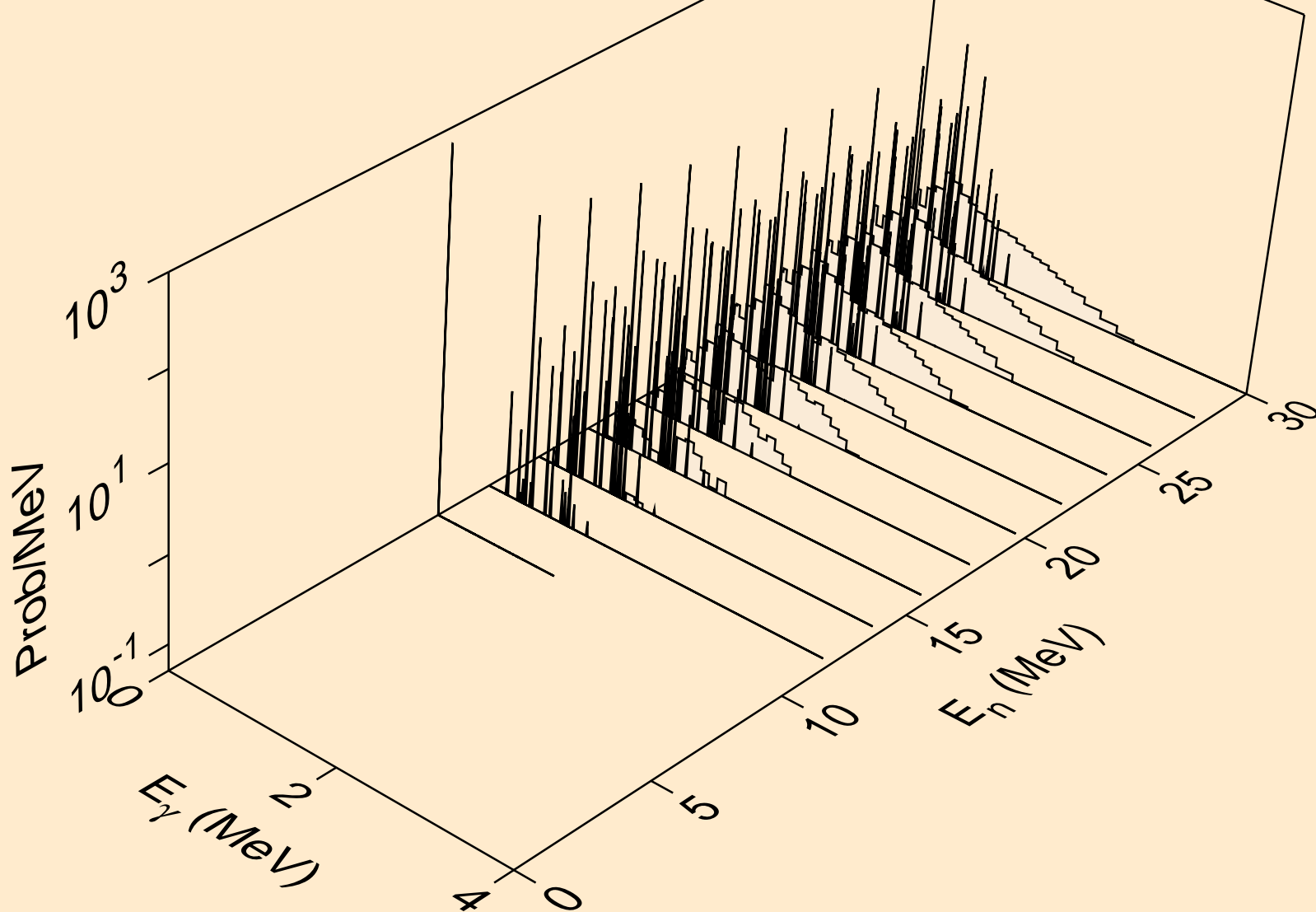

PB203 NEUTRON ACER TENDL-2019 LIBRARY; T=293.16K
Photon emission for (n,p α)

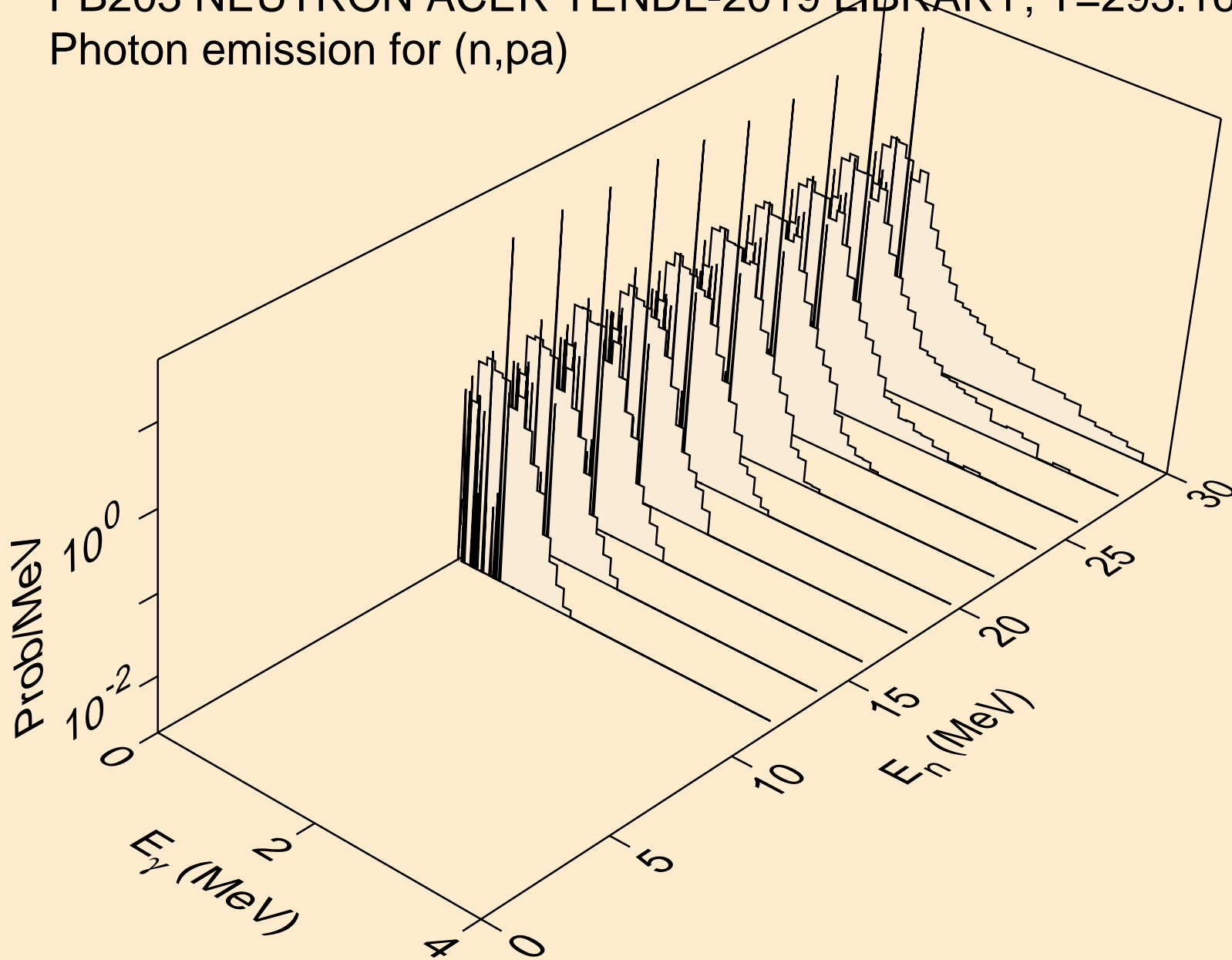

PB203 NEUTRON ACER TENDL-2019 LIBRARY; T=293.16K
Photon emission for (n,pd)

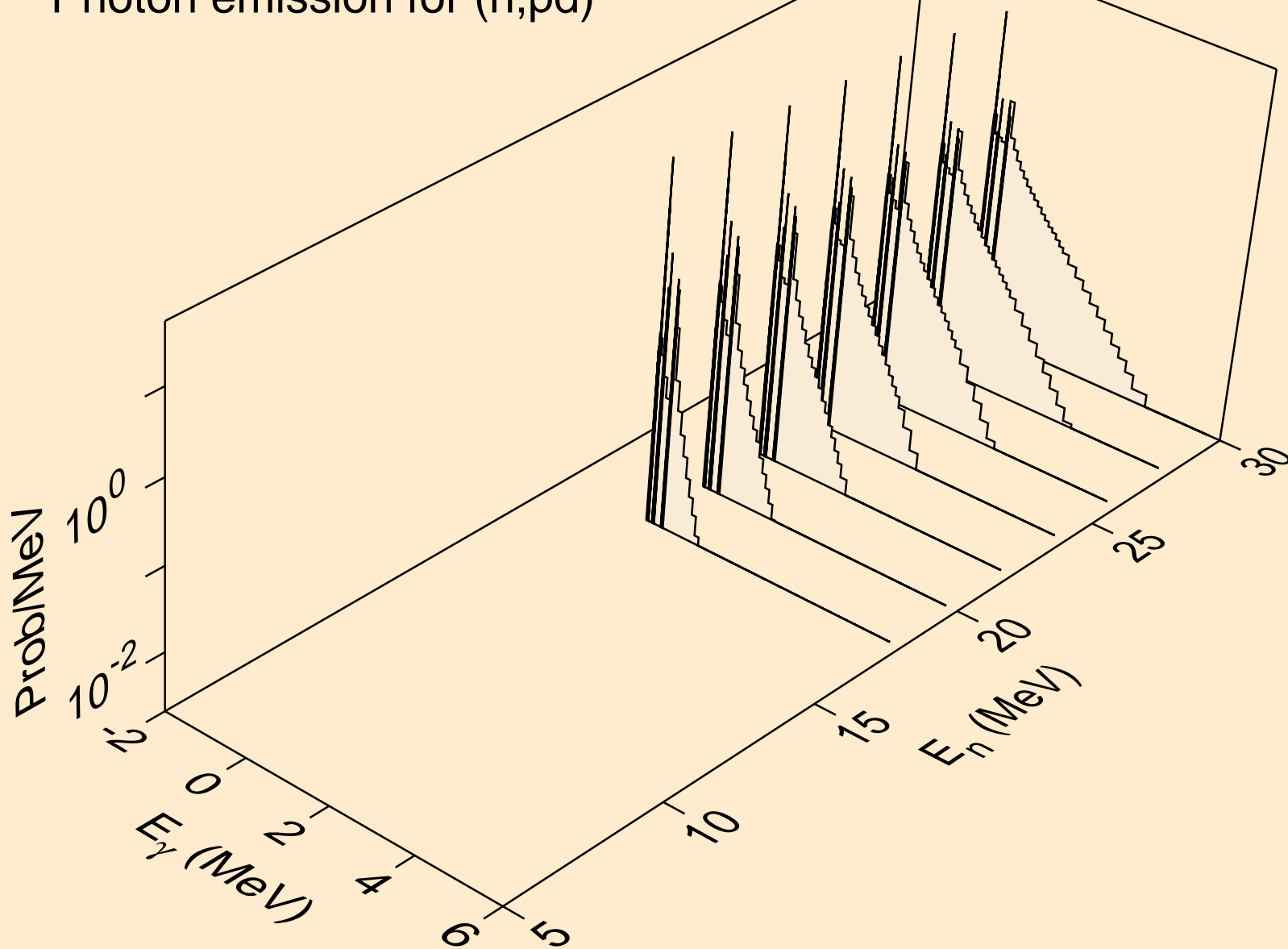

PB203 NEUTRON ACER TENDL-2019 LIBRARY; T=293.16K
Photon emission for (n,pt)

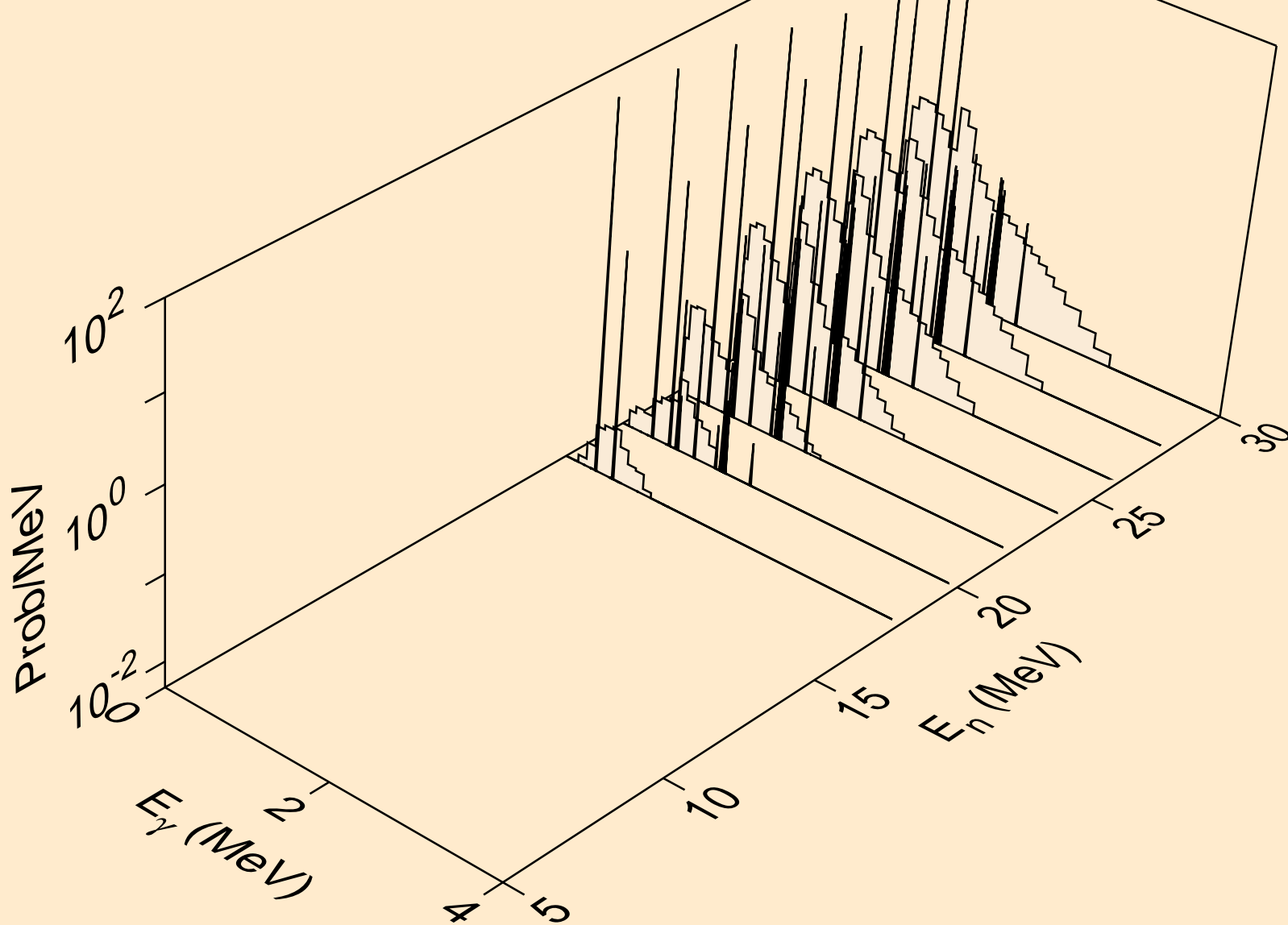

PB203 NEUTRON ACER TENDL-2019 LIBRARY; T=293.16K
thermal capture photon spectrum

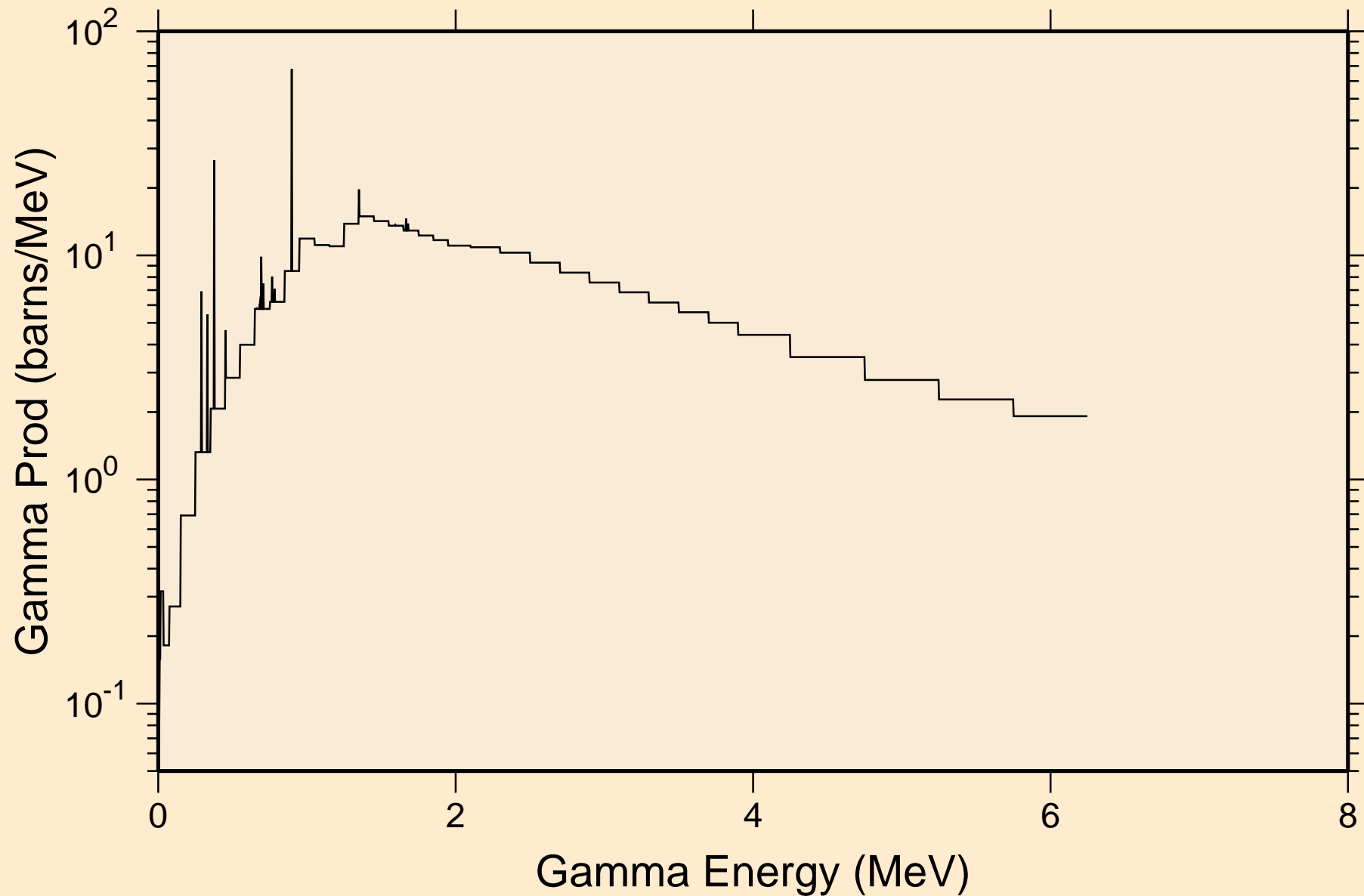

PB203 NEUTRON ACER TENDL-2019 LIBRARY; T=293.16K
14 MeV photon spectrum

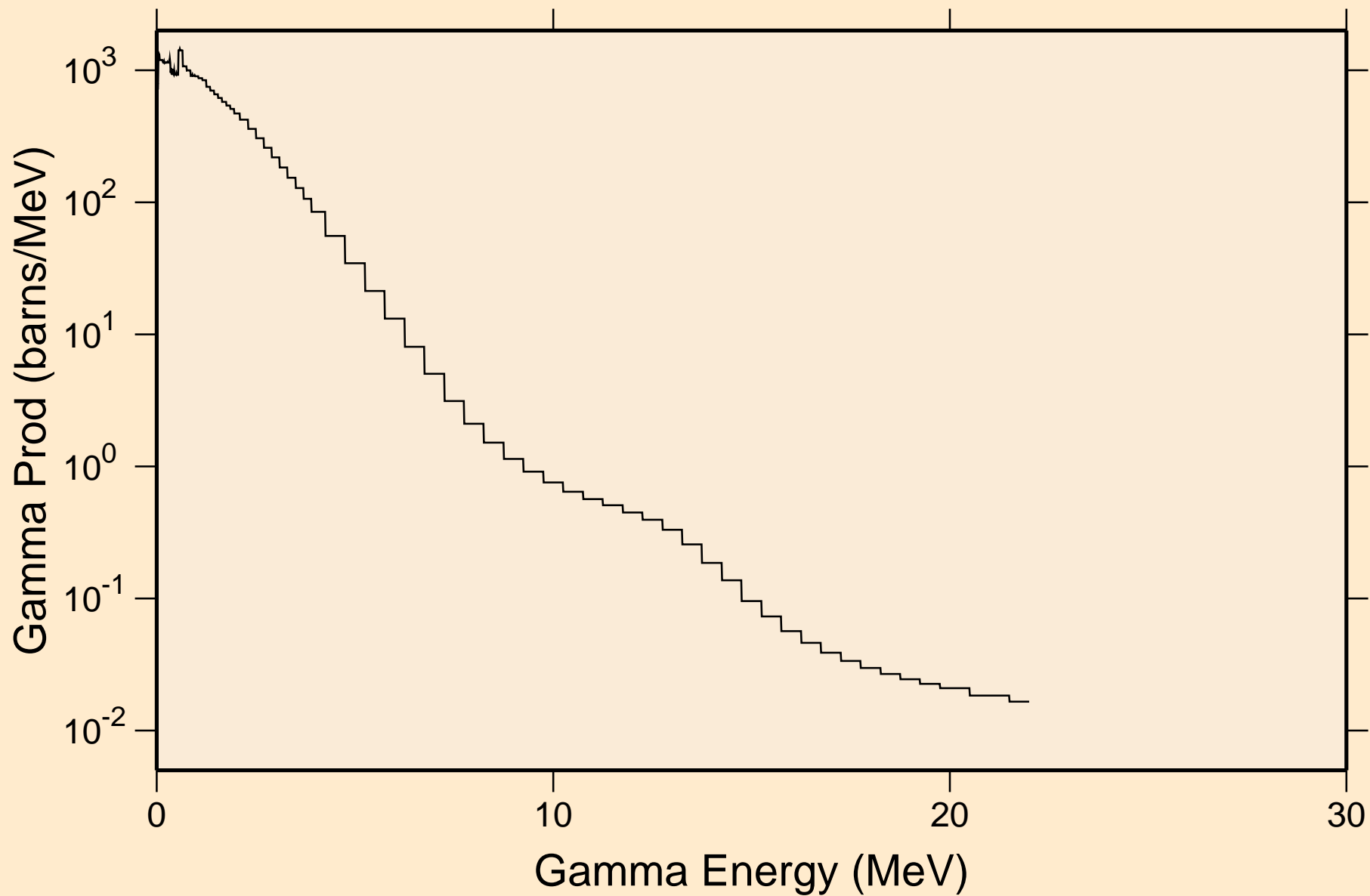

PB203 NEUTRON ACER TENDL-2019 LIBRARY; T=293.16K
Particle heating contributions

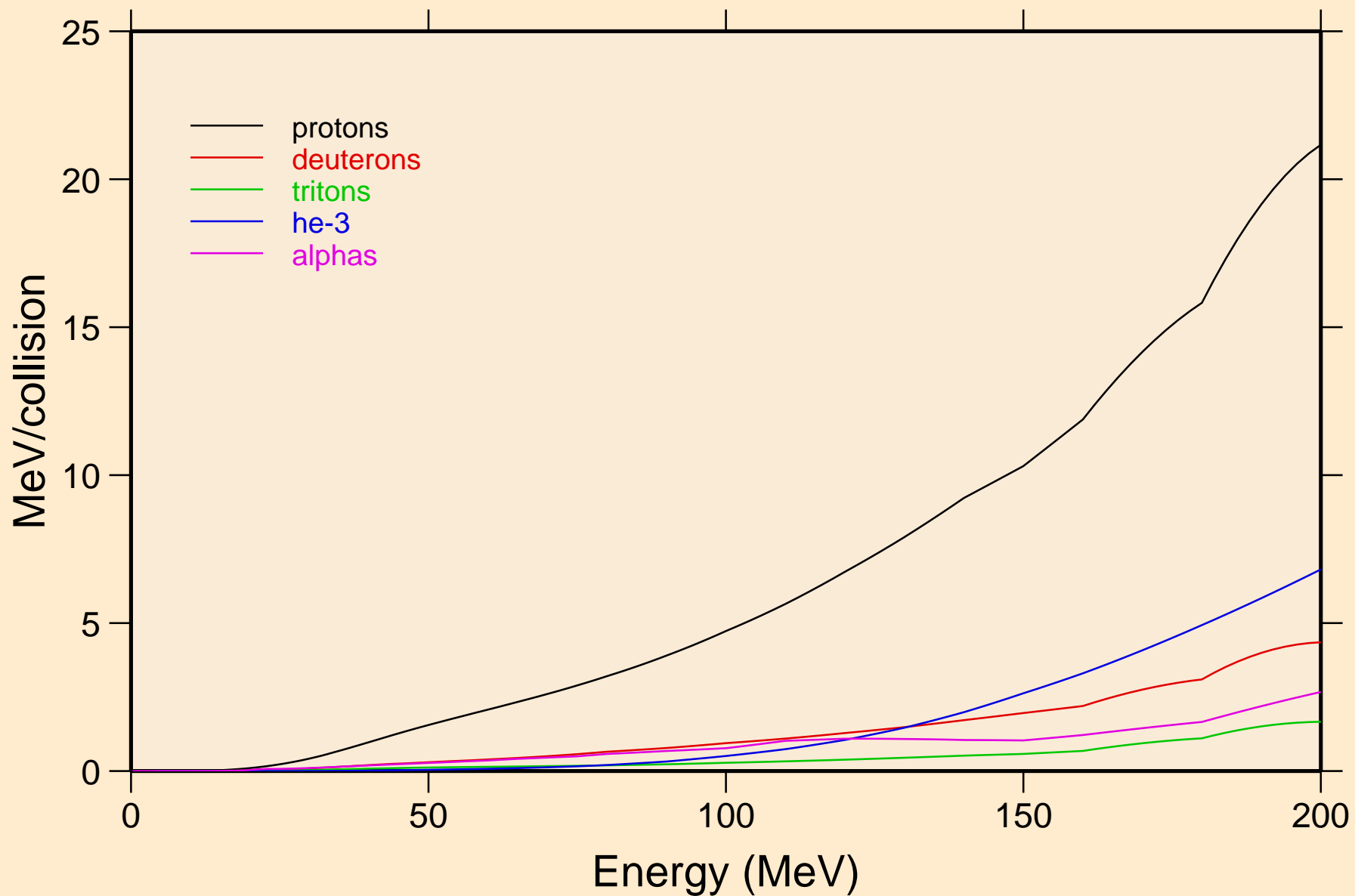

PB203 NEUTRON ACER TENDL-2019 LIBRARY; T=293.16K
Recoil Heating

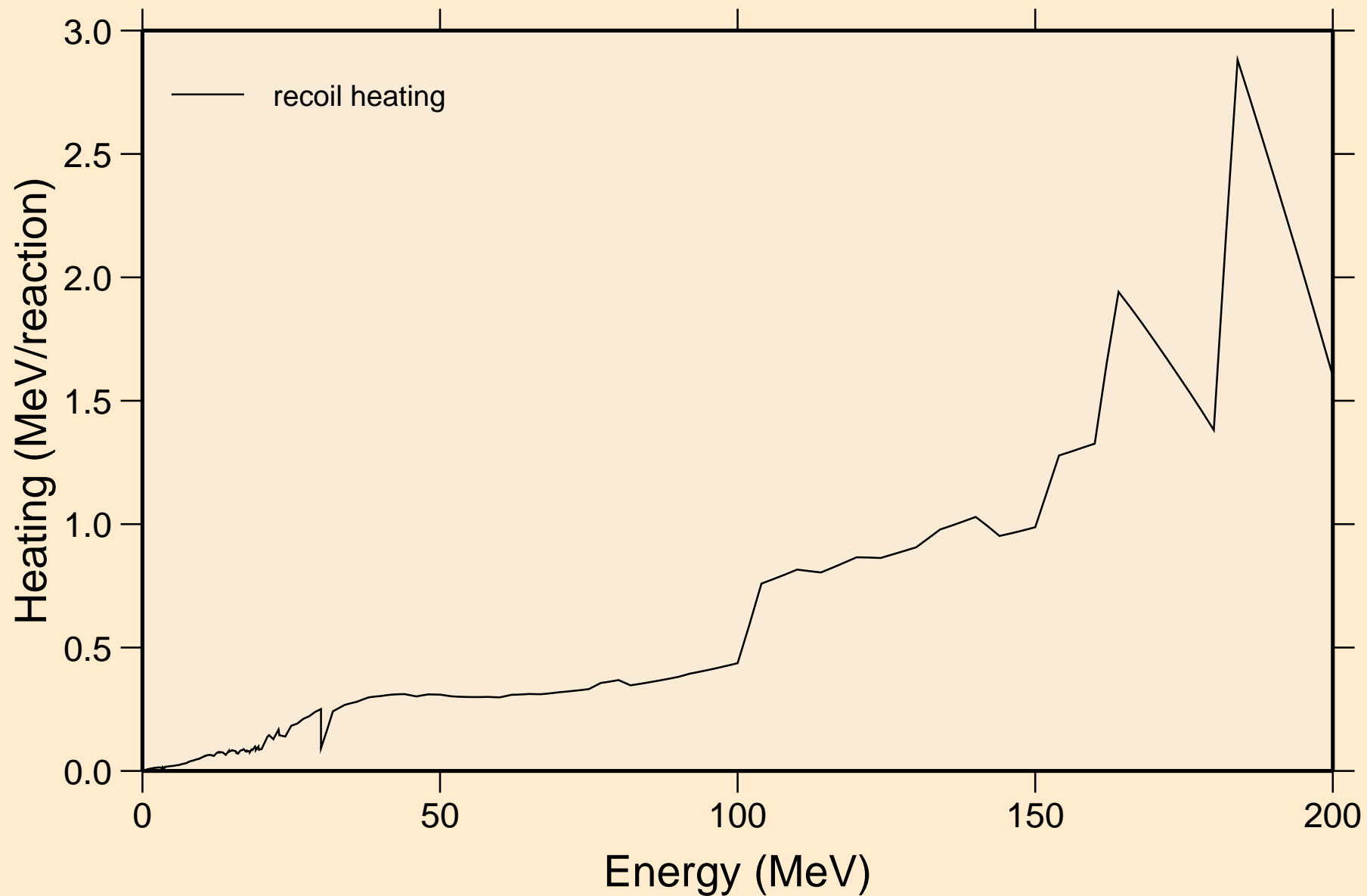

PB203 NEUTRON ACER TENDL-2019 LIBRARY; T=293.16K
Particle production cross sections

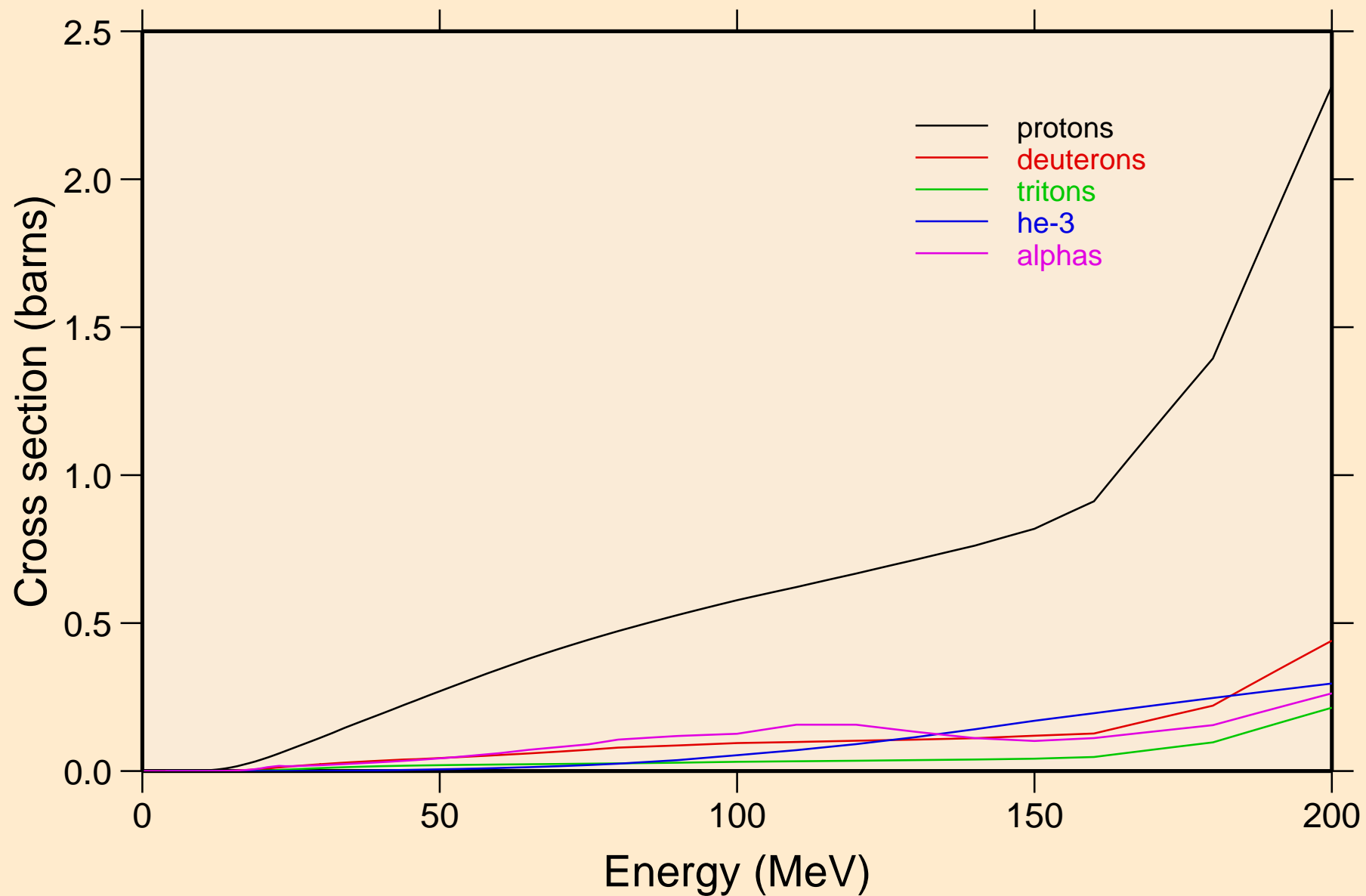

PB203 NEUTRON ACER TENDL-2019 LIBRARY; T=293.16K
protons from (n,x)

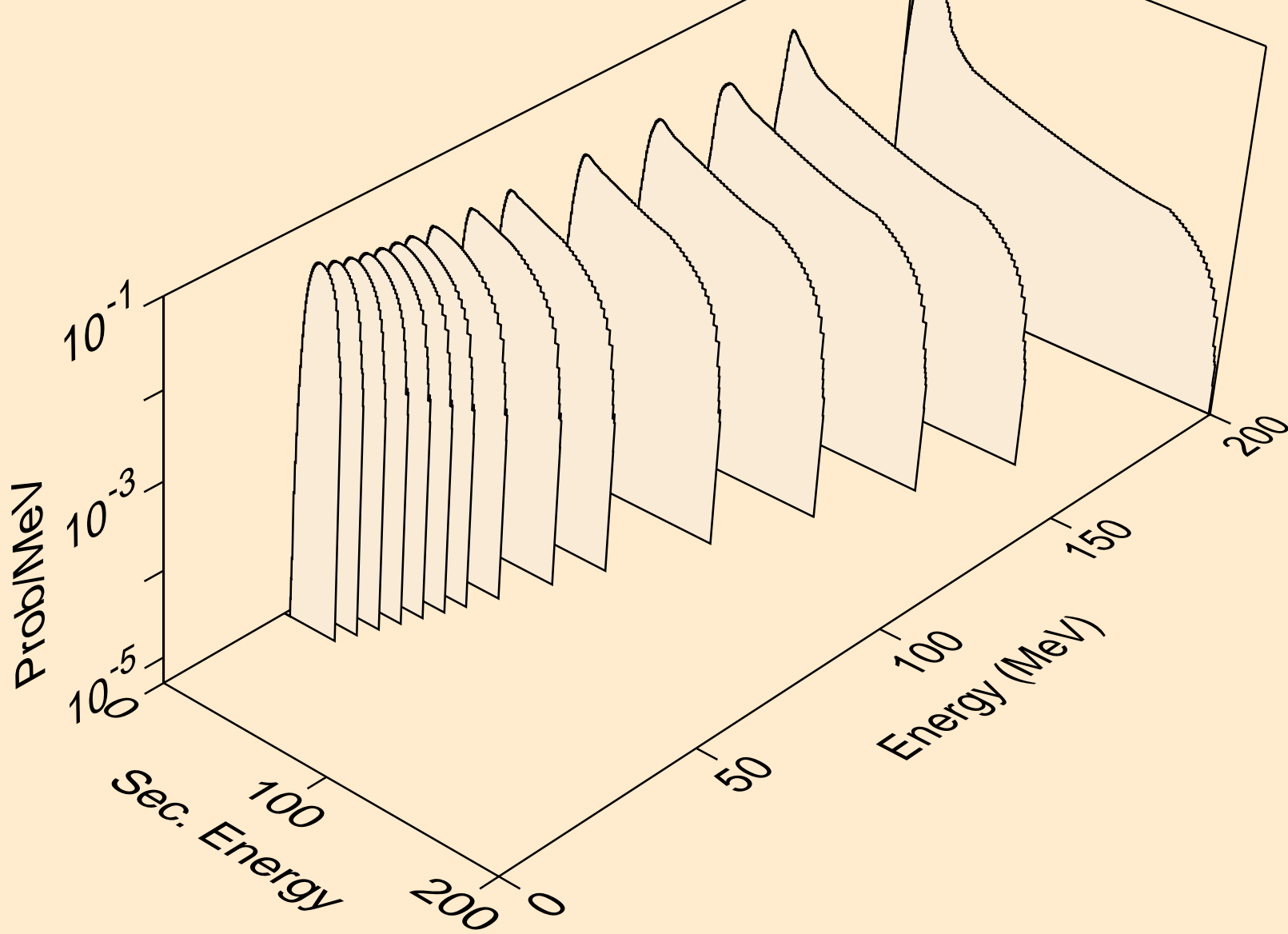

PB203 NEUTRON ACER TENDL-2019 LIBRARY; T=293.16K
protons from (n,n*)p

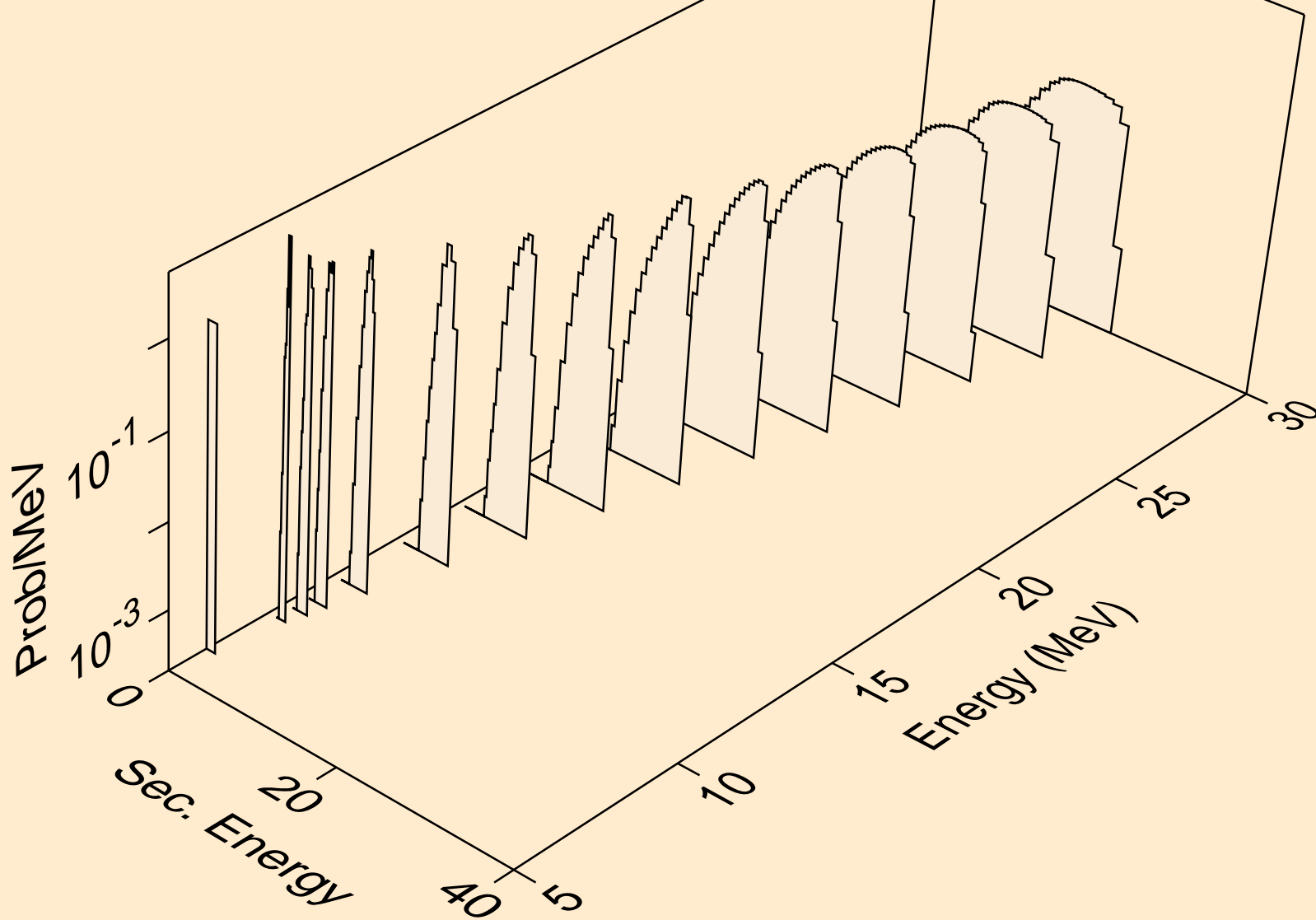

PB203 NEUTRON ACER TENDL-2019 LIBRARY; T=293.16K
protons from (n,2np)

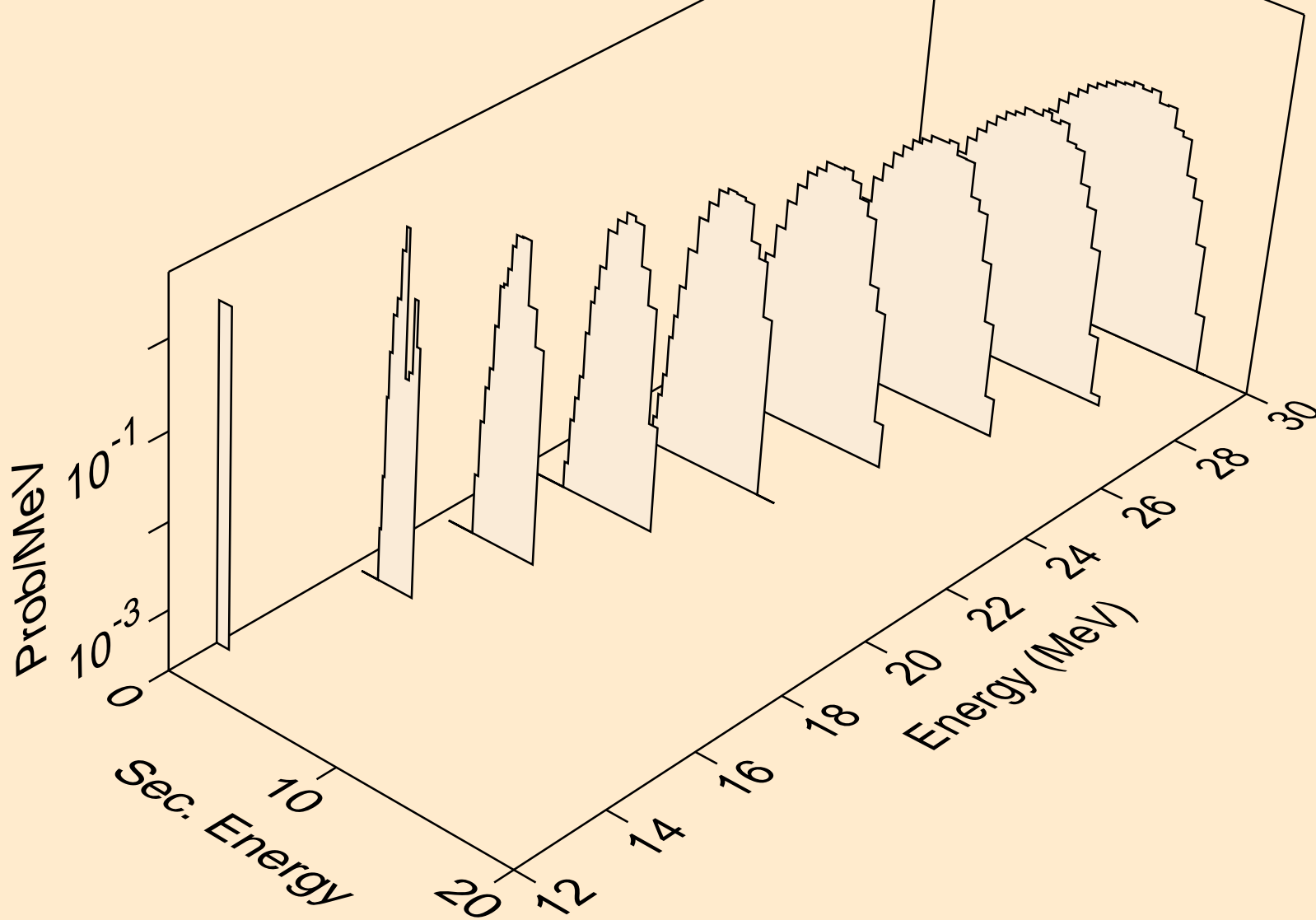

PB203 NEUTRON ACER TENDL-2019 LIBRARY; T=293.16K
protons from (n,3np)

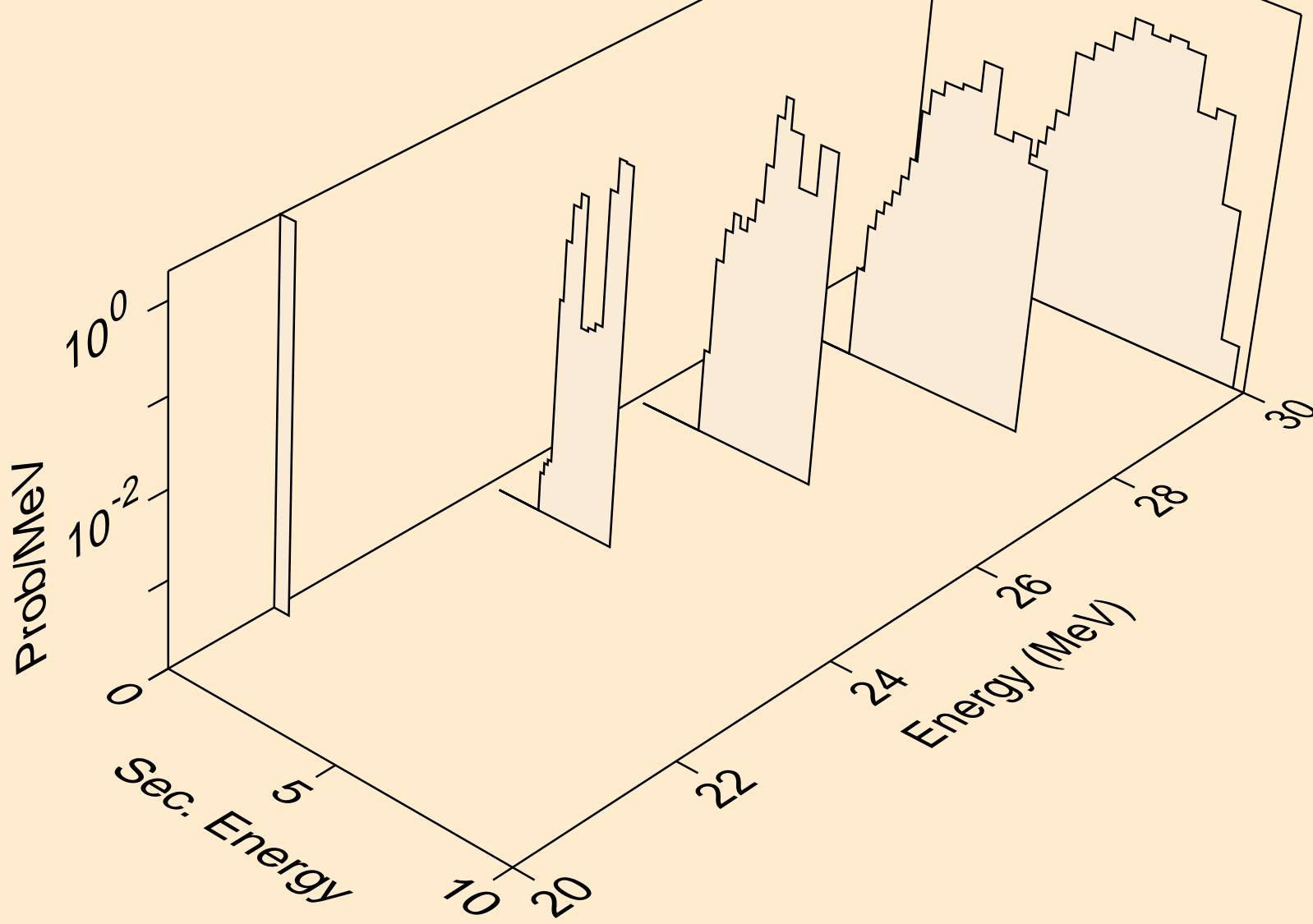

PB203 NEUTRON ACER TENDL-2019 LIBRARY; T=293.16K
protons from (n,2np)

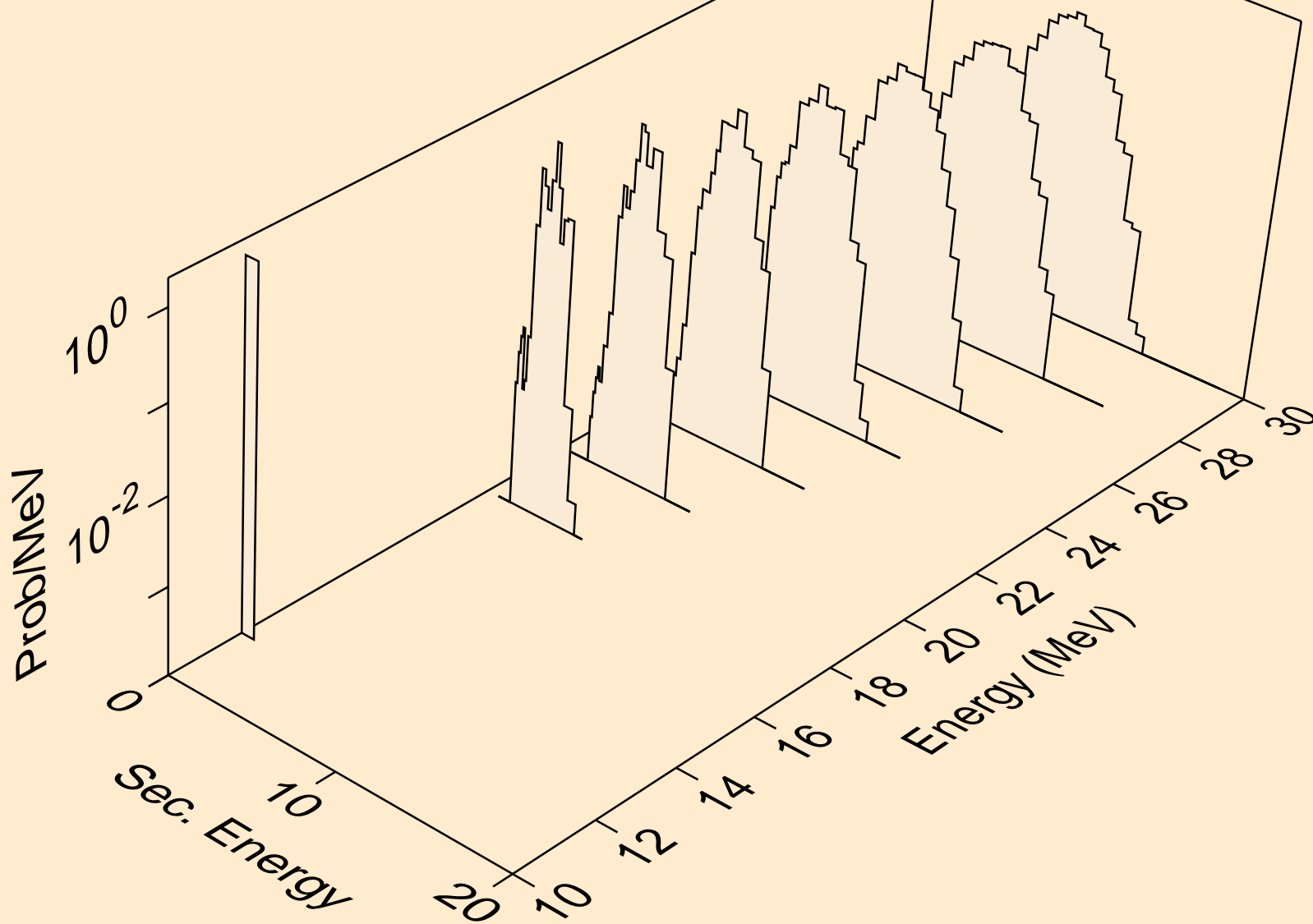

PB203 NEUTRON ACER TENDL-2019 LIBRARY; T=293.16K
protons from (n,npa)

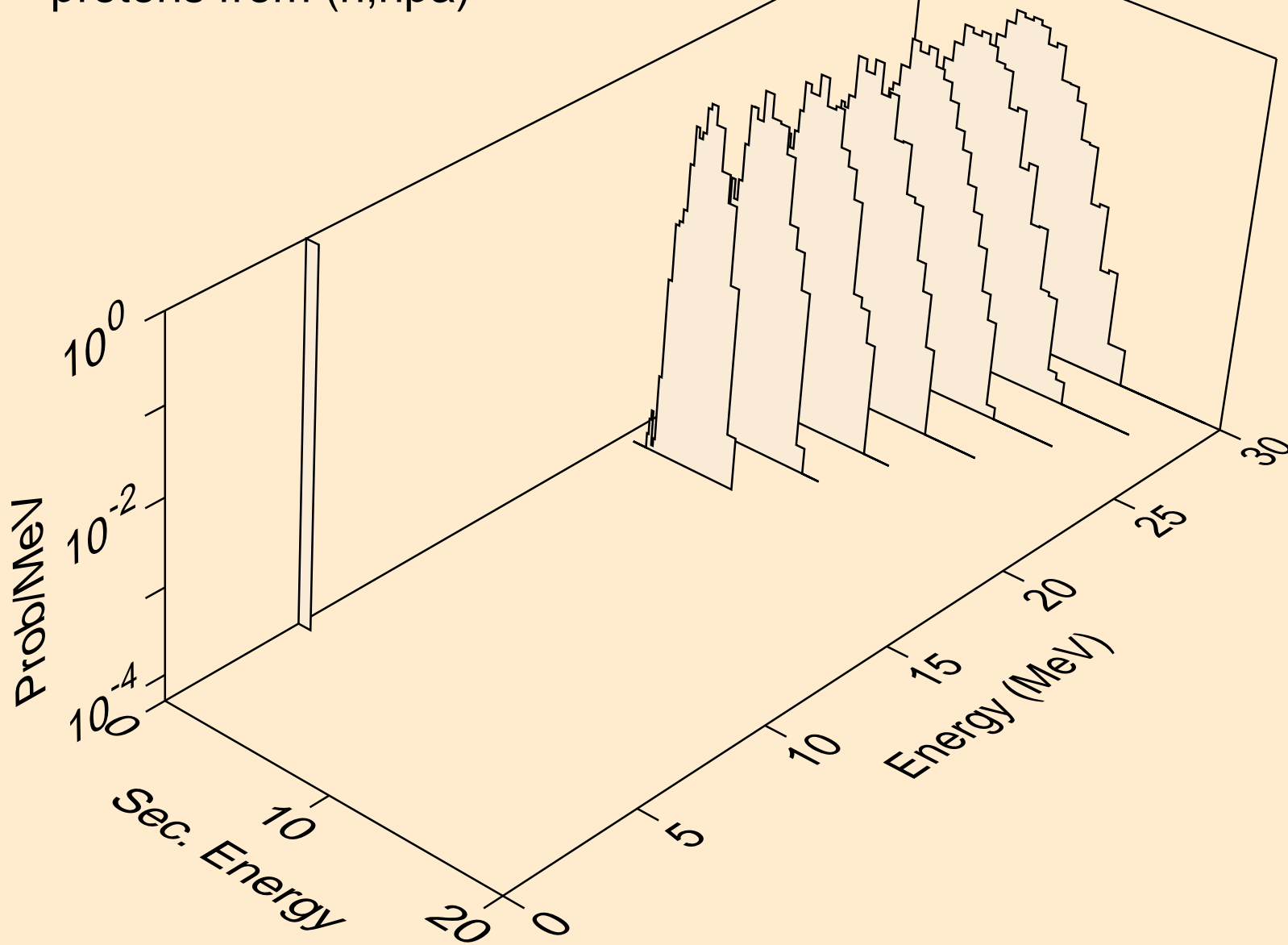

PB203 NEUTRON ACER TENDL-2019 LIBRARY; T=293.16K
protons from (n,p)

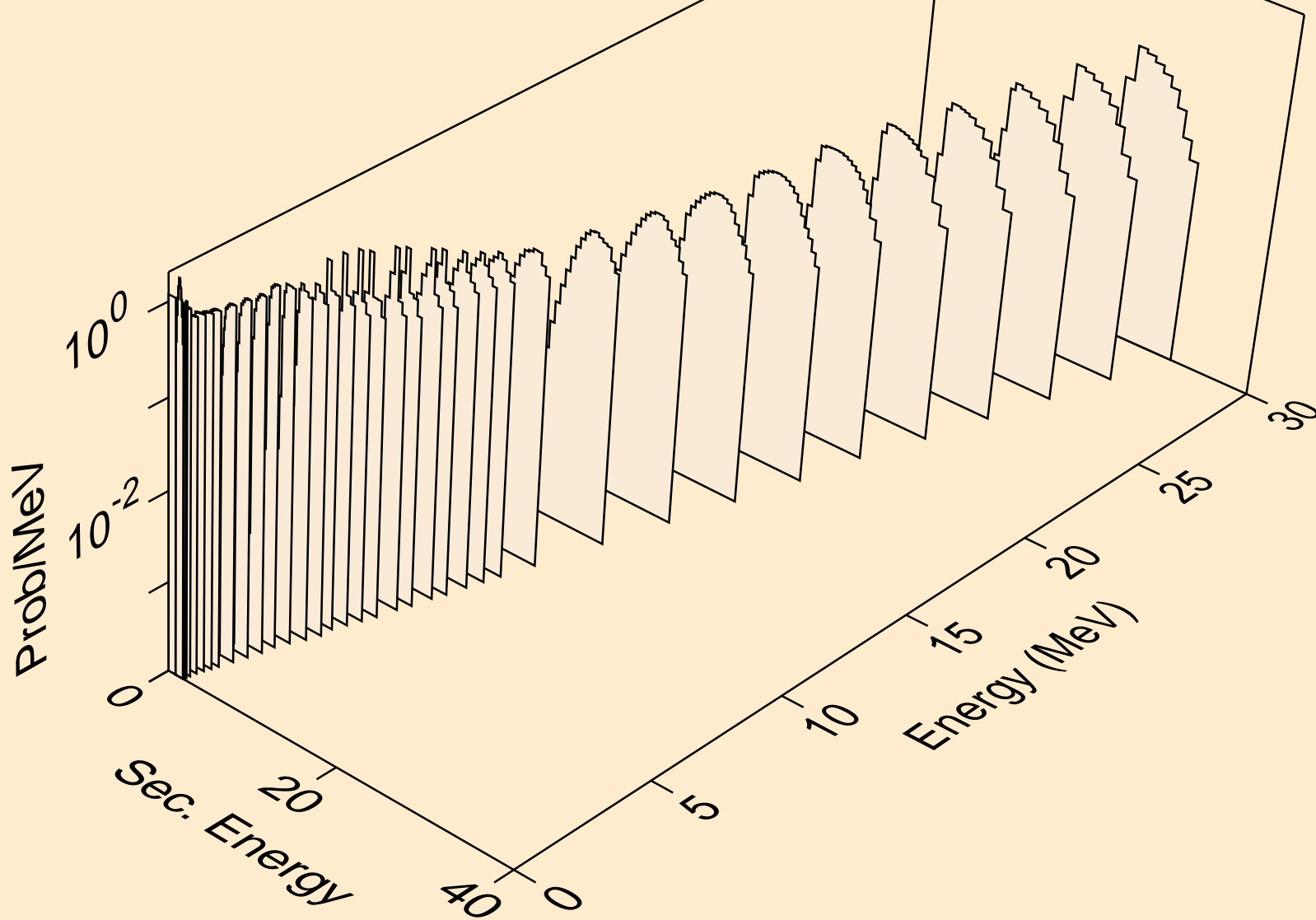

PB203 NEUTRON ACER TENDL-2019 LIBRARY; T=293.16K
protons from (n,2p)

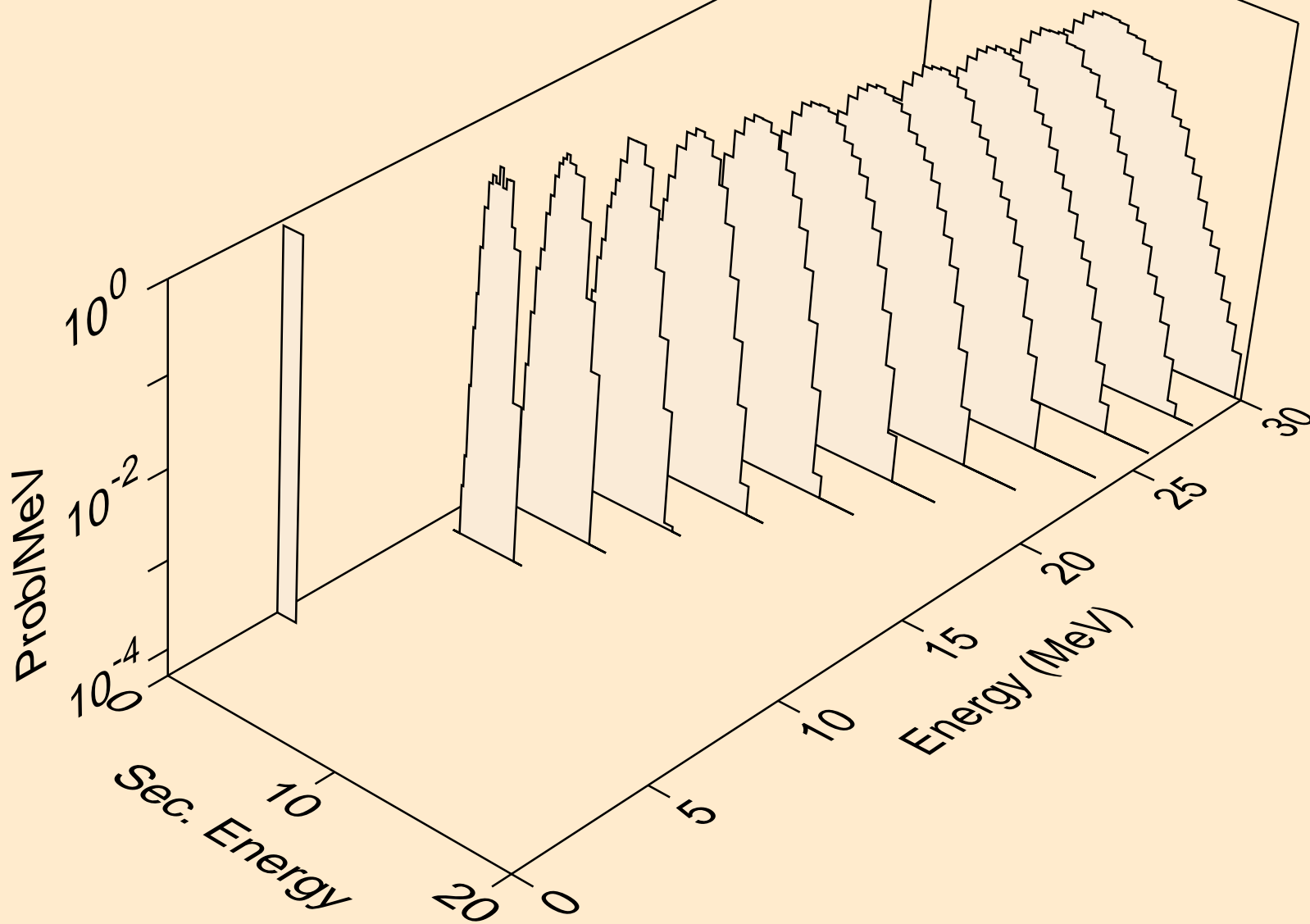

PB203 NEUTRON ACER TENDL-2019 LIBRARY; T=293.16K
protons from (n,p)

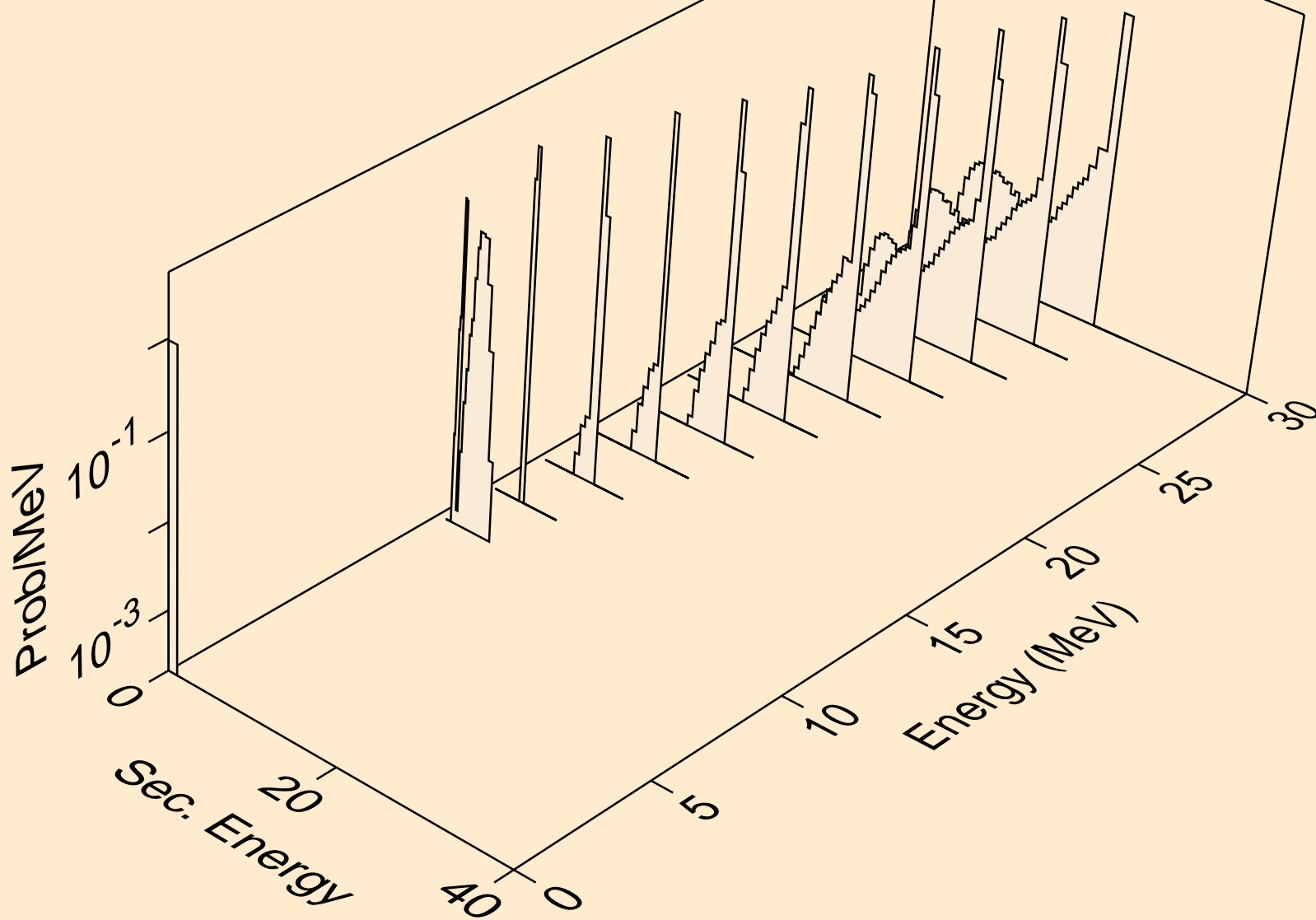

PB203 NEUTRON ACER TENDL-2019 LIBRARY; T=293.16K
protons from (n,pd)

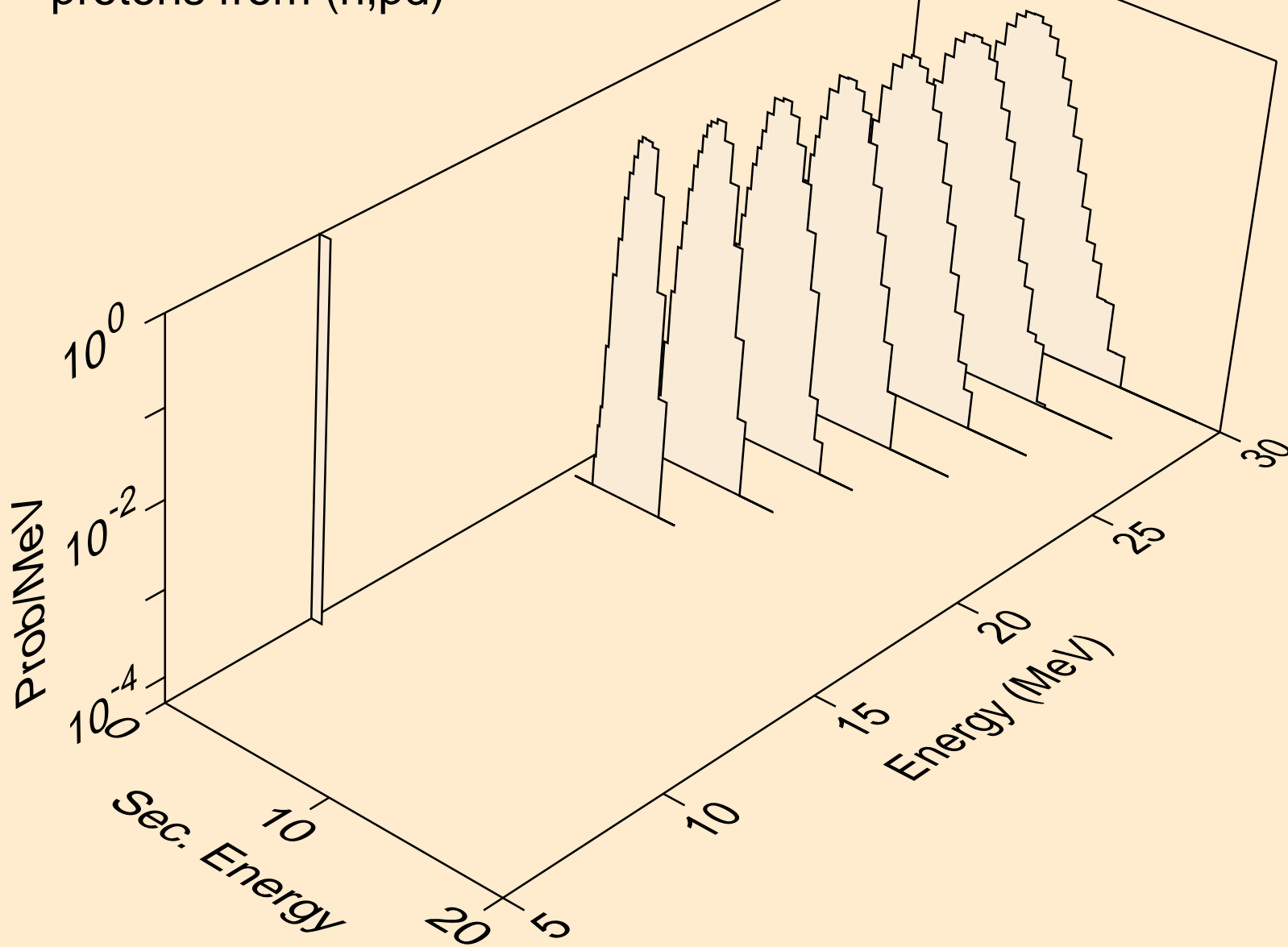

PB203 NEUTRON ACER TENDL-2019 LIBRARY; T=293.16K
protons from (n,pt)

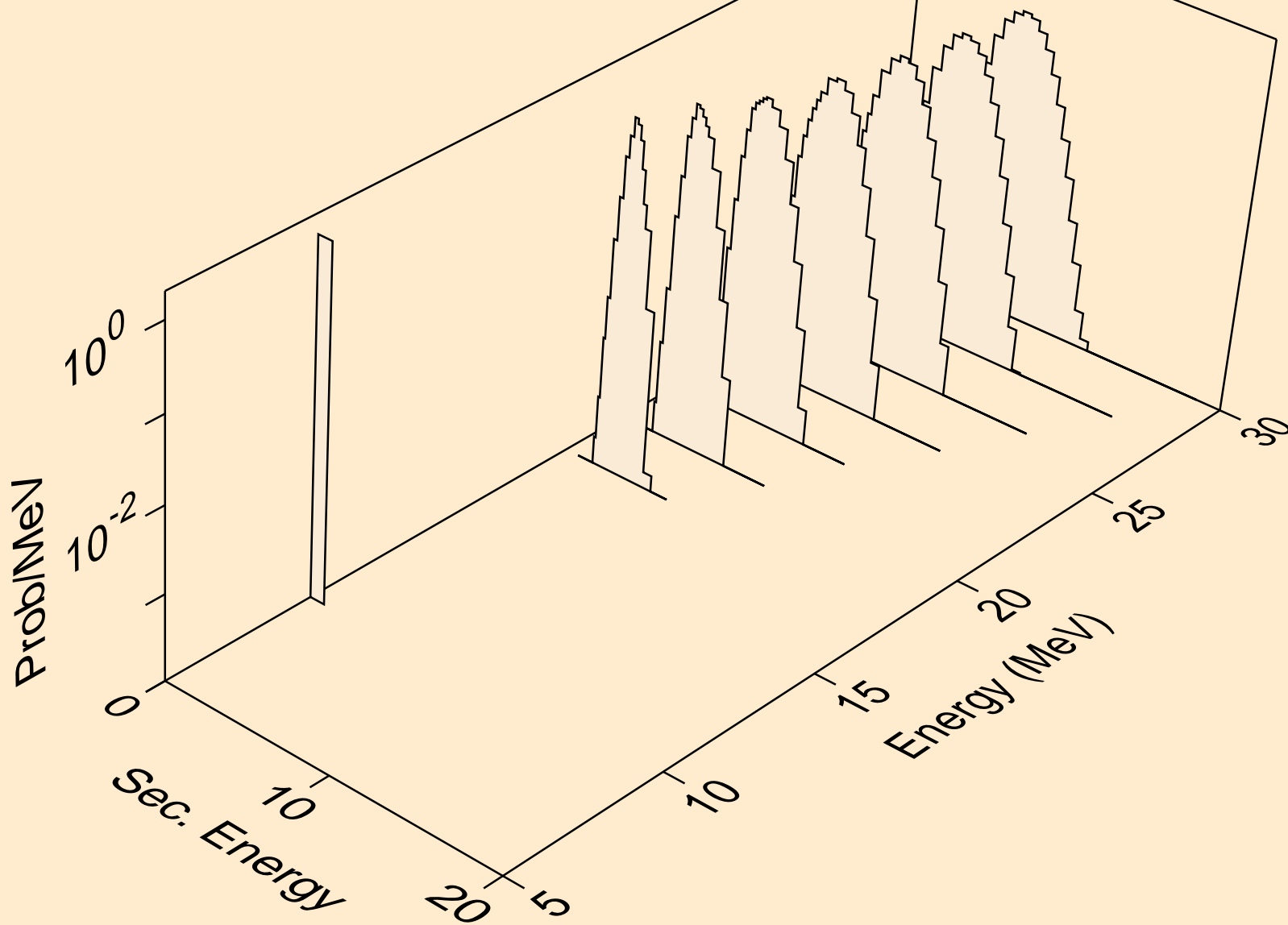

PB203 NEUTRON ACER TENDL-2019 LIBRARY; T=293.16K
deuterons from (n,x)

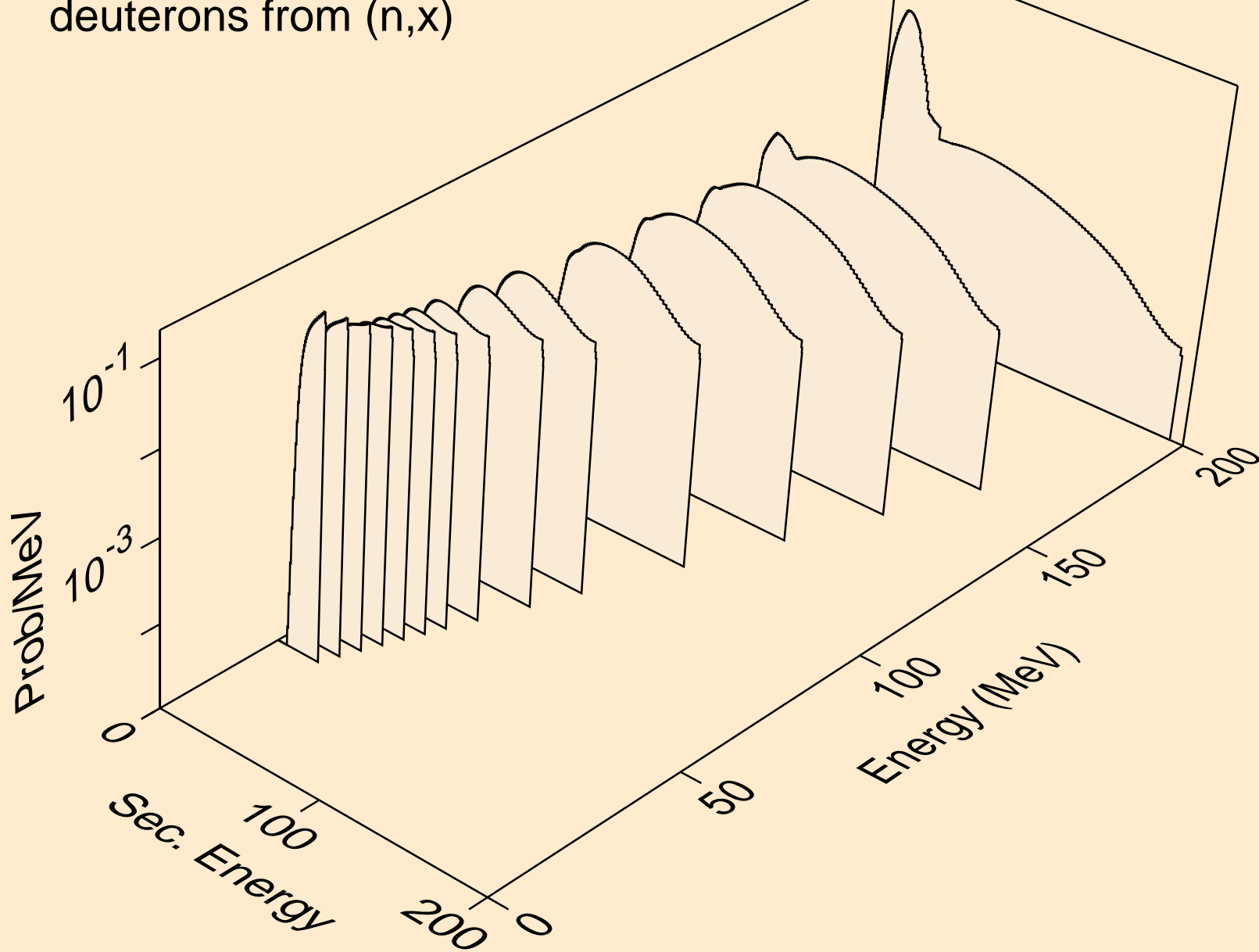

PB203 NEUTRON ACER TENDL-2019 LIBRARY; T=293.16K
deuterons from (n,2nd)

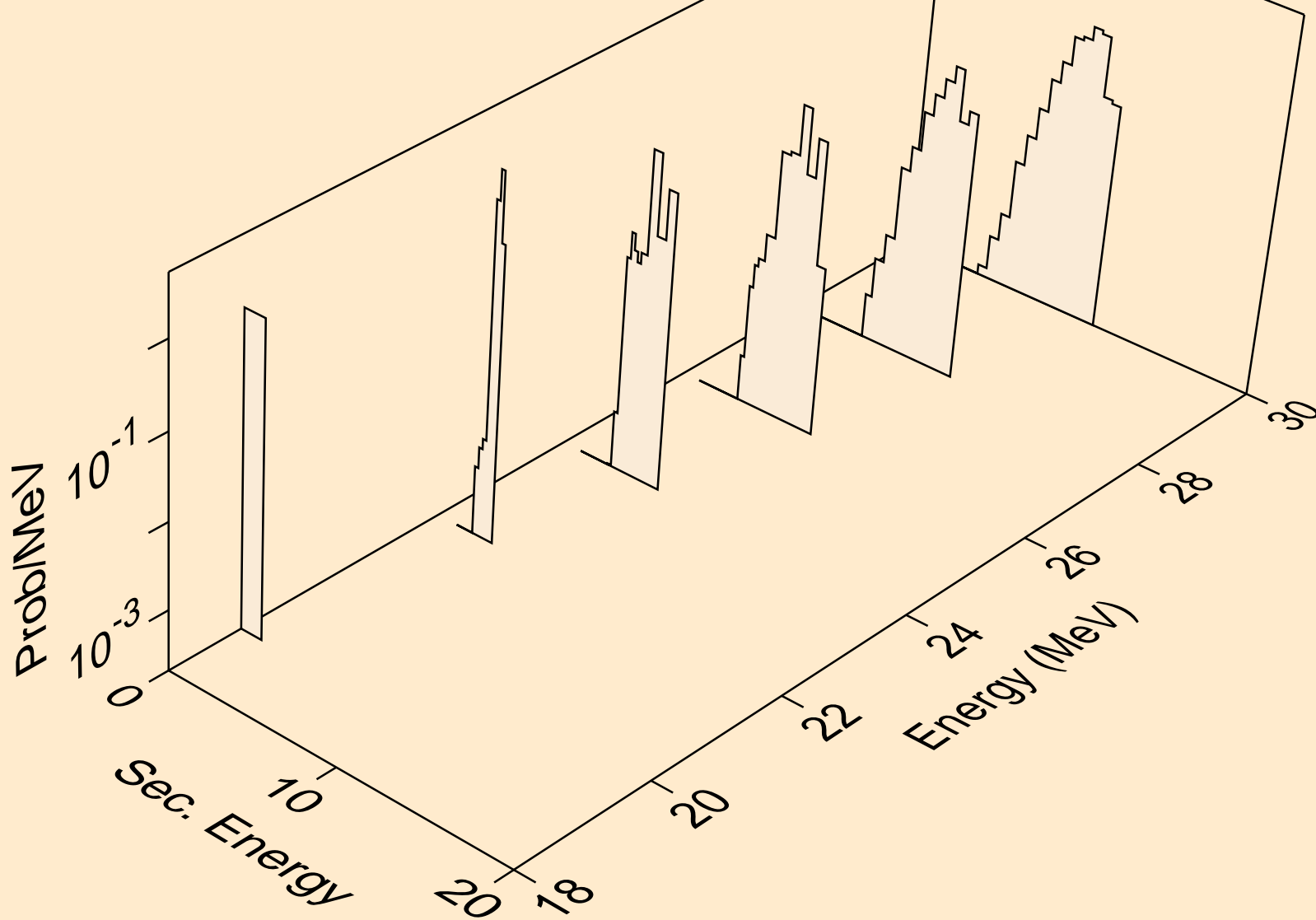

PB203 NEUTRON ACER TENDL-2019 LIBRARY; T=293.16K
deuterons from (n,n*)d

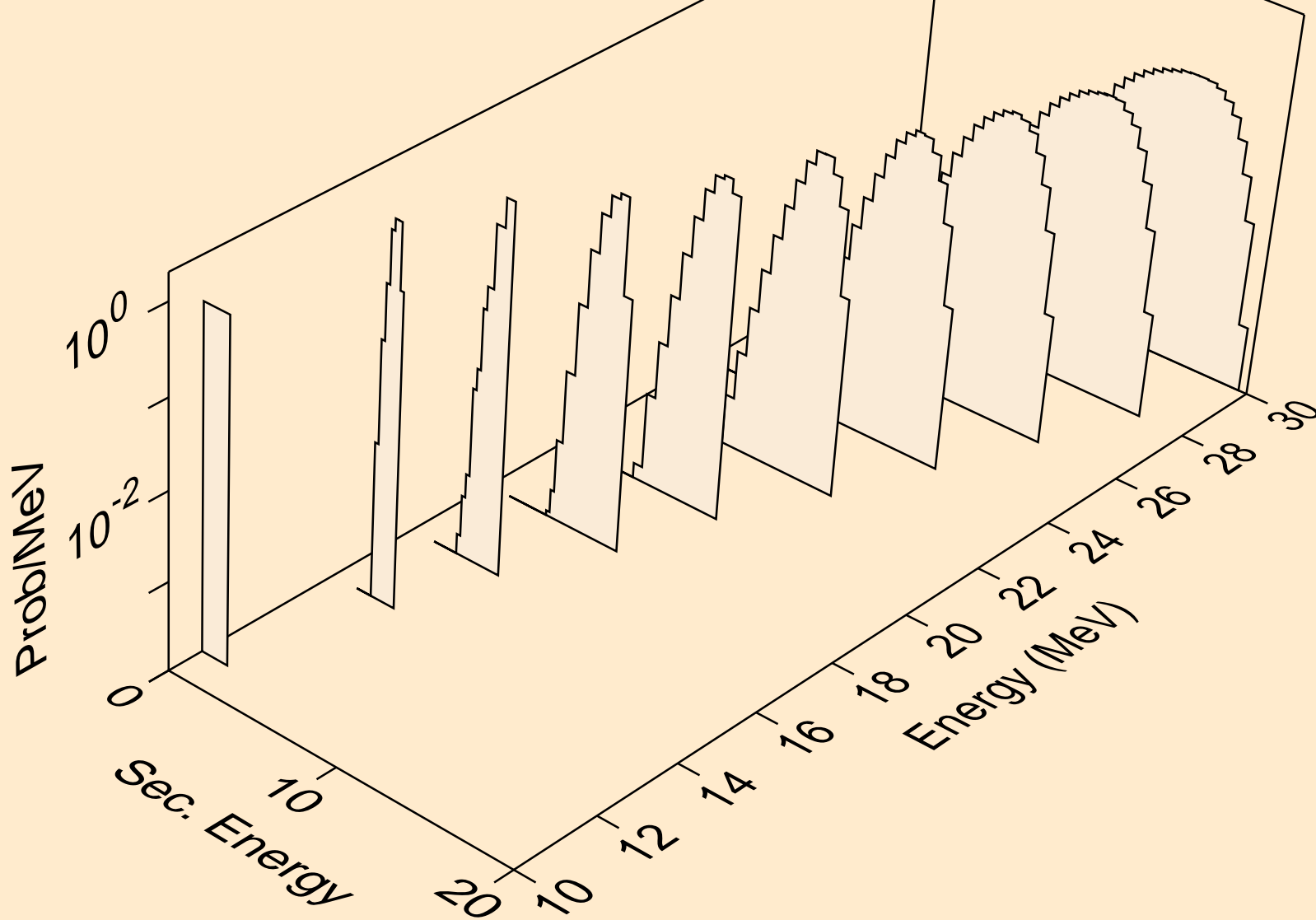

PB203 NEUTRON ACER TENDL-2019 LIBRARY; T=293.16K
deuterons from (n,d)

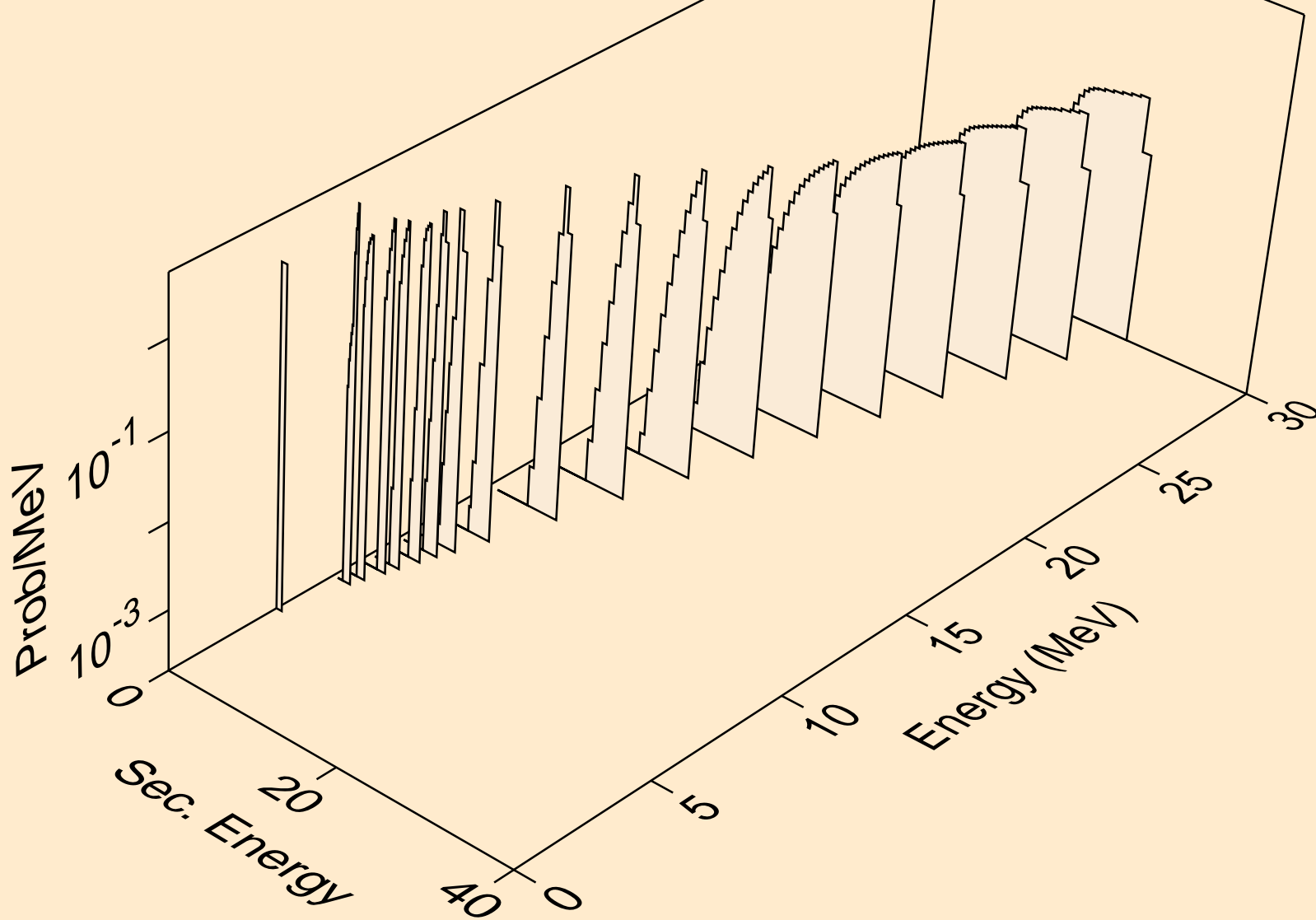

PB203 NEUTRON ACER TENDL-2019 LIBRARY; T=293.16K
deuterons from (n,pd)

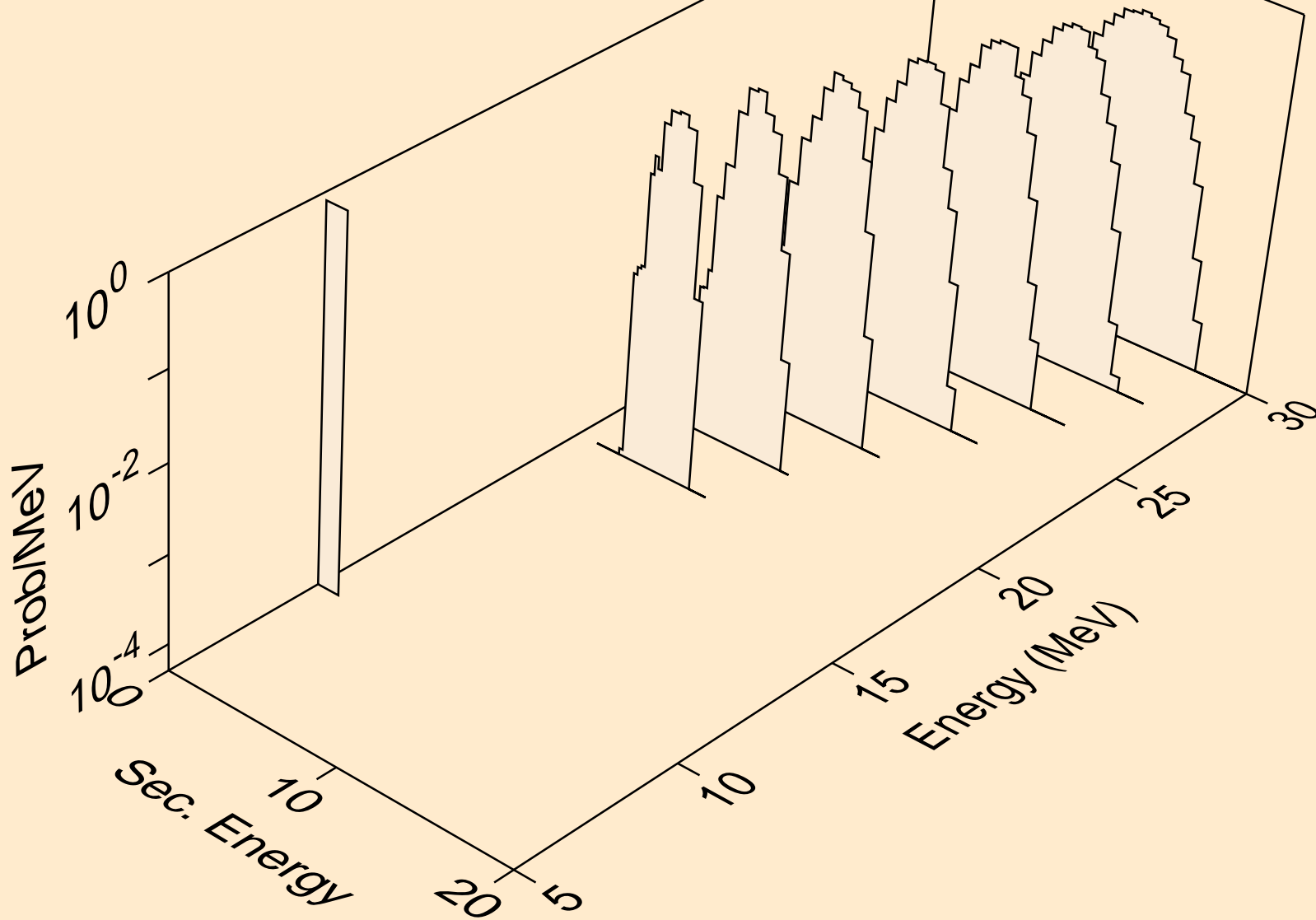

PB203 NEUTRON ACER TENDL-2019 LIBRARY; T=293.16K
tritons from (n,x)

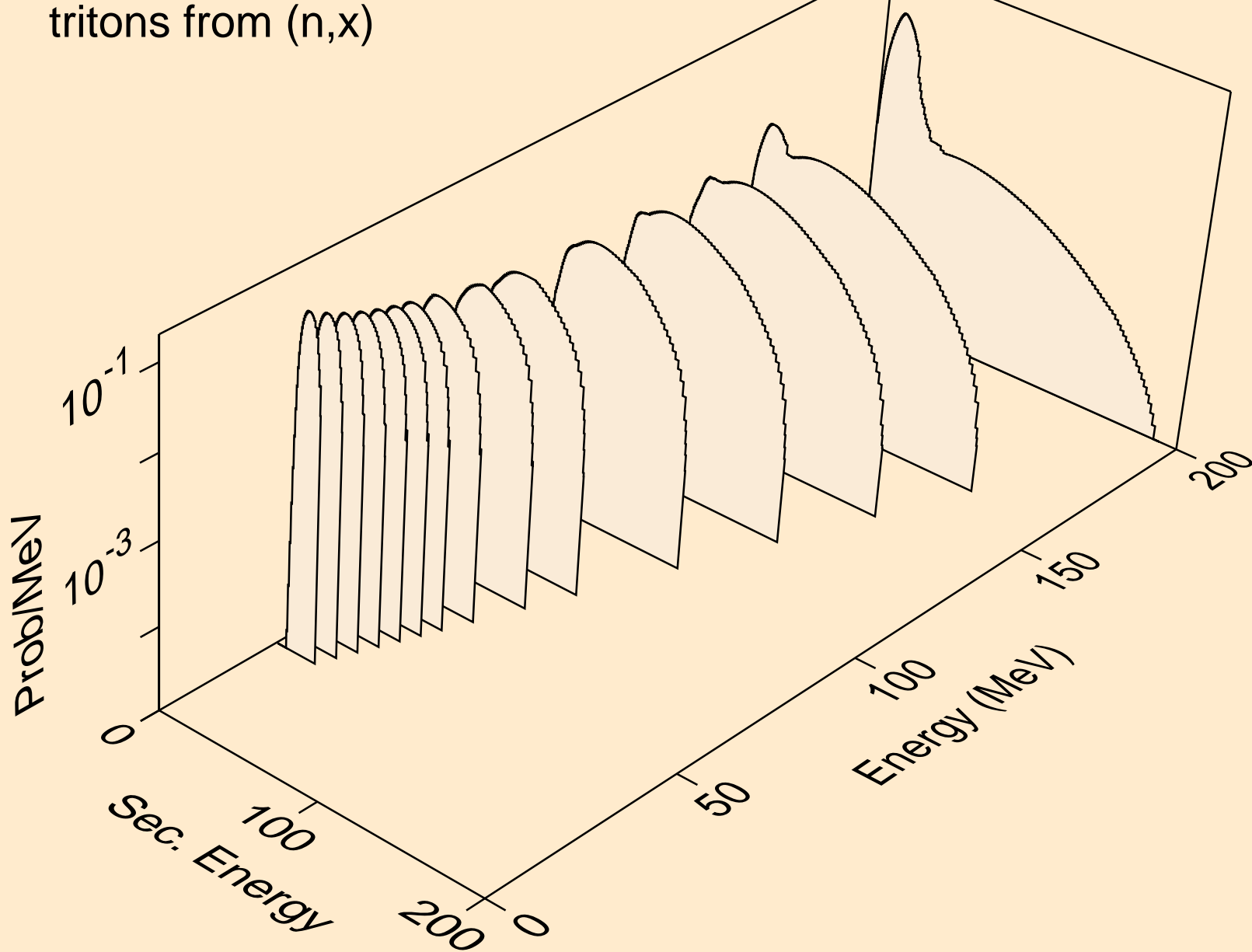

PB203 NEUTRON ACER TENDL-2019 LIBRARY; T=293.16K
tritons from (n,n*)t

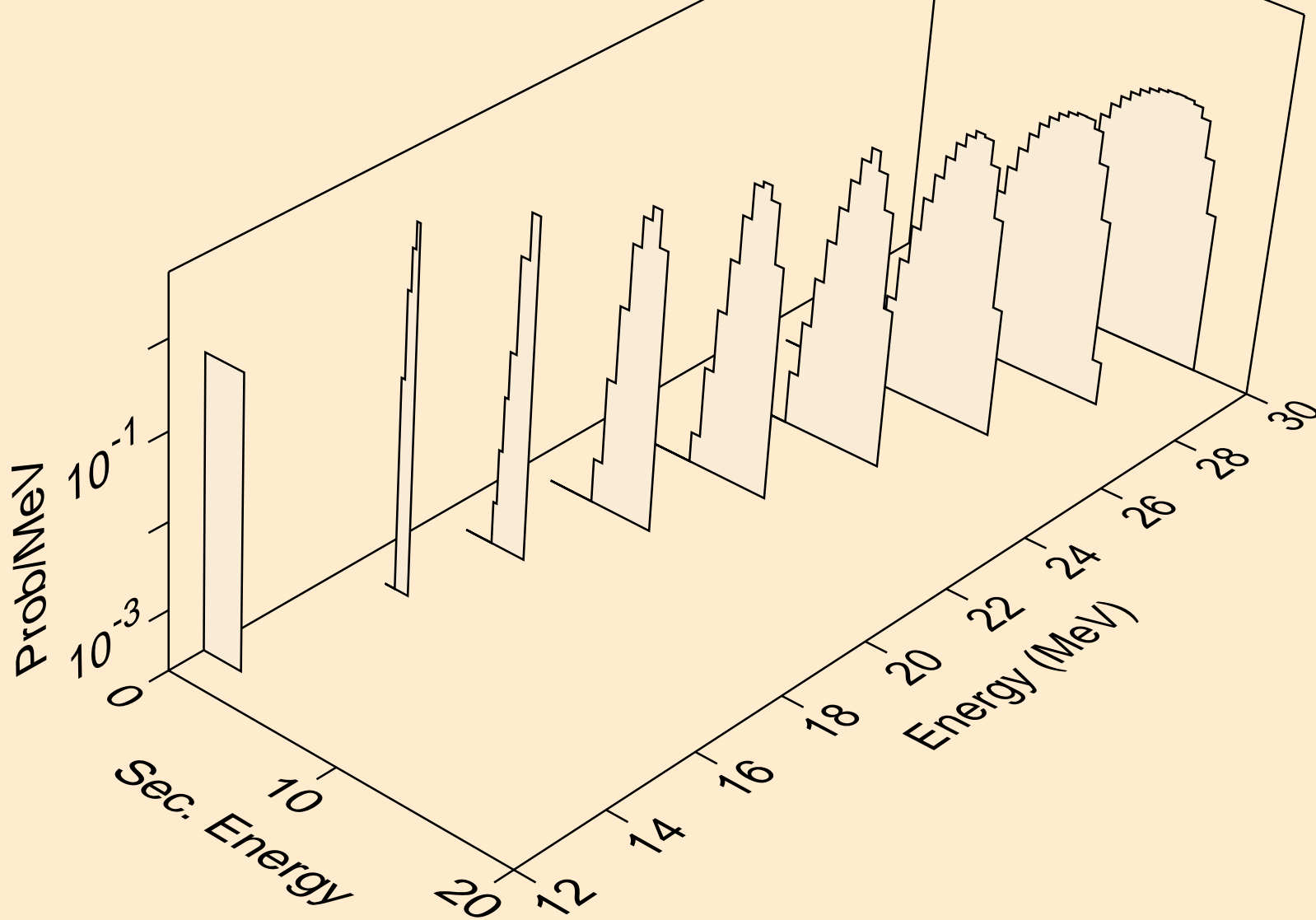

PB203 NEUTRON ACER TENDL-2019 LIBRARY; T=293.16K
tritons from (n,t)

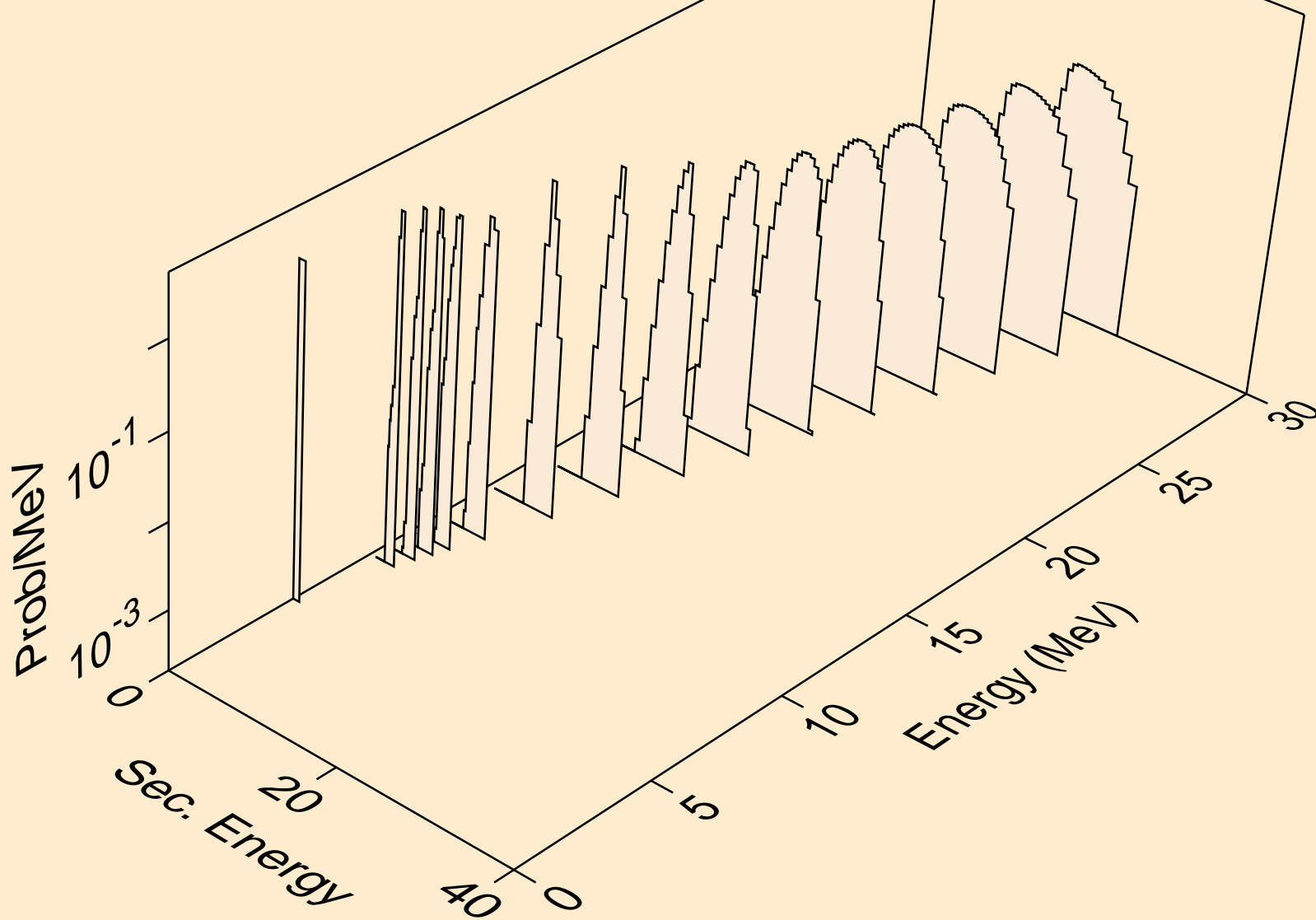

PB203 NEUTRON ACER TENDL-2019 LIBRARY; T=293.16K
tritons from (n,pt)

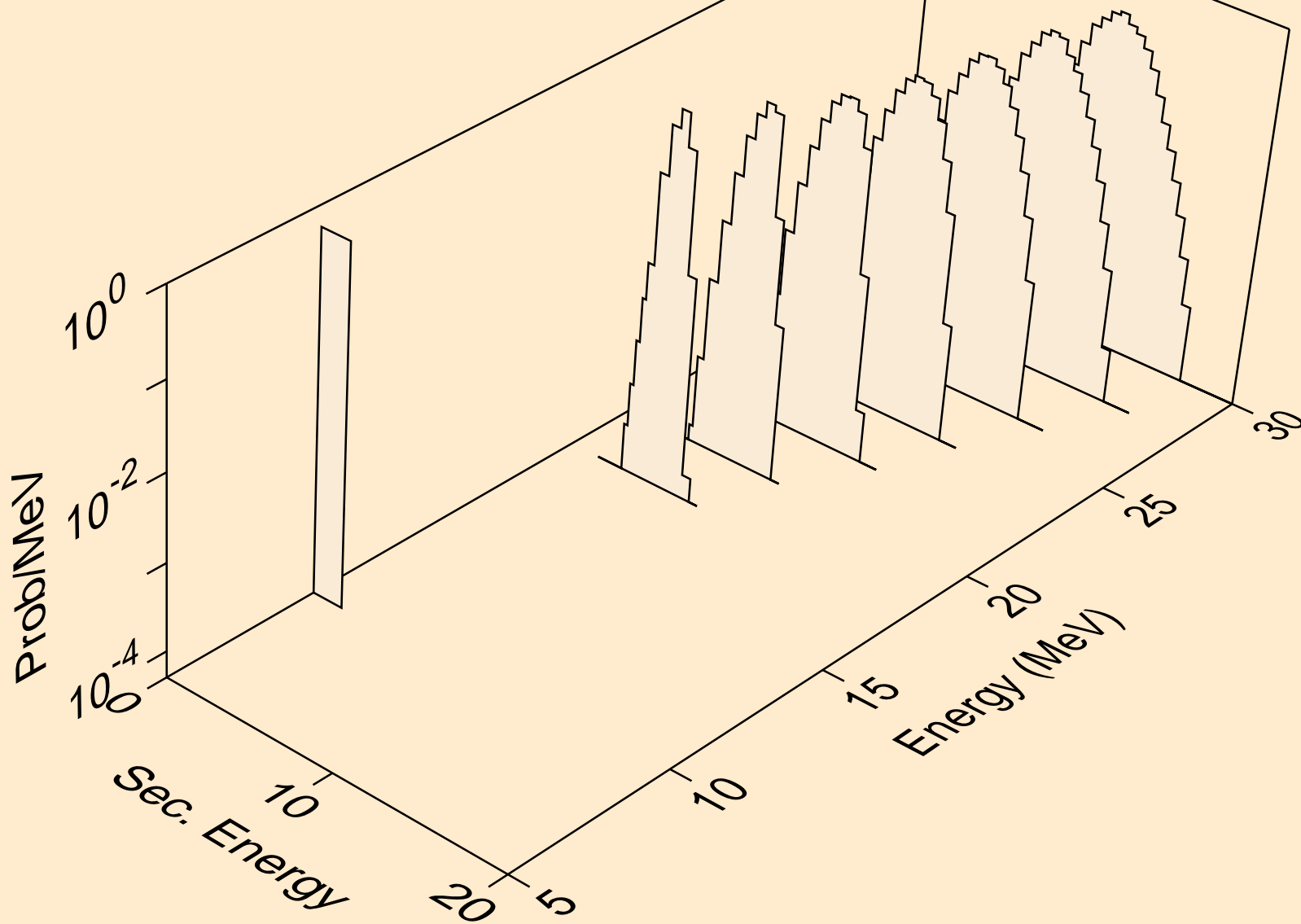

PB203 NEUTRON ACER TENDL-2019 LIBRARY; T=293.16K
he3s from (n,x)

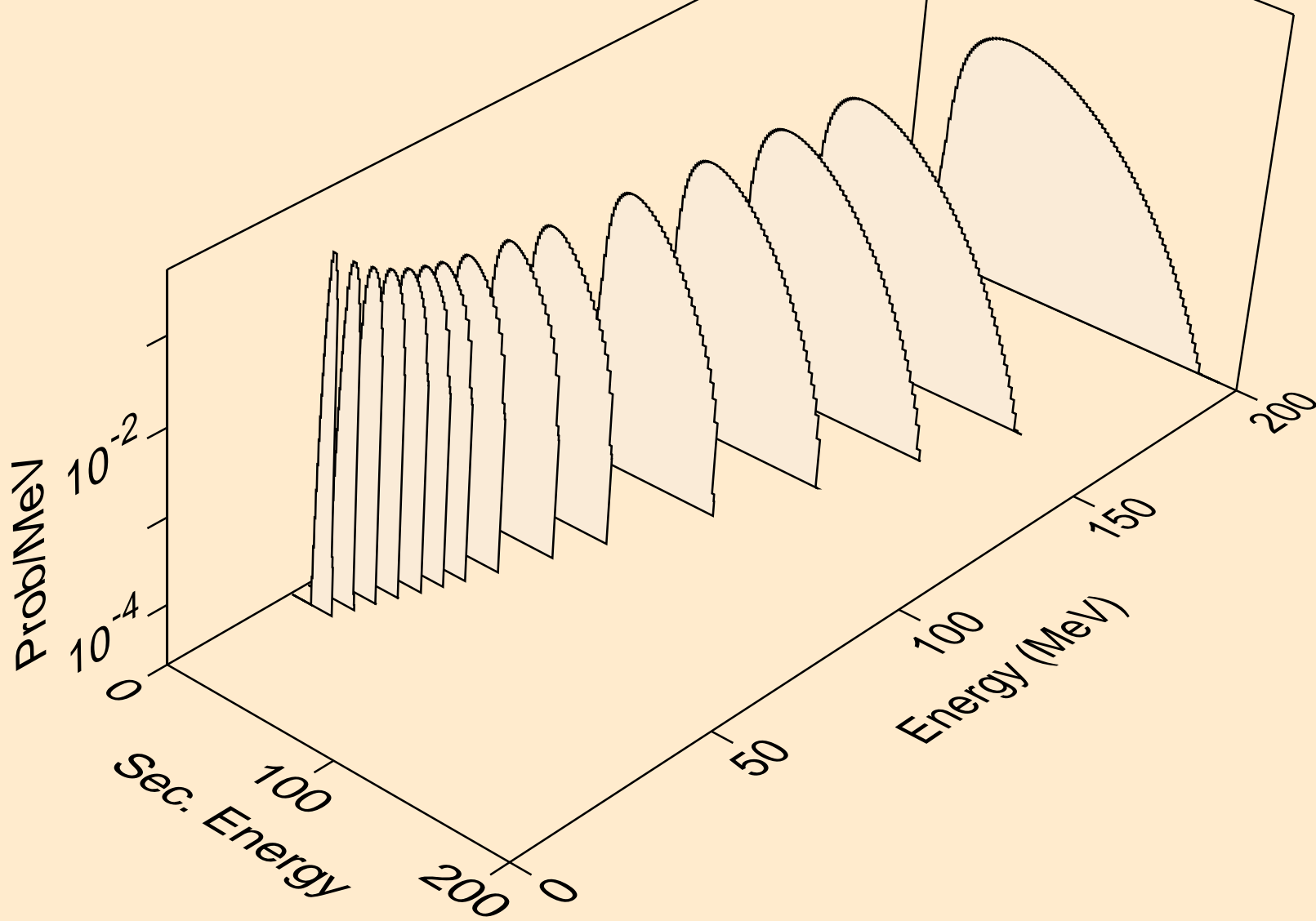

PB203 NEUTRON ACER TENDL-2019 LIBRARY; T=293.16K
he3s from (n,n*)he3

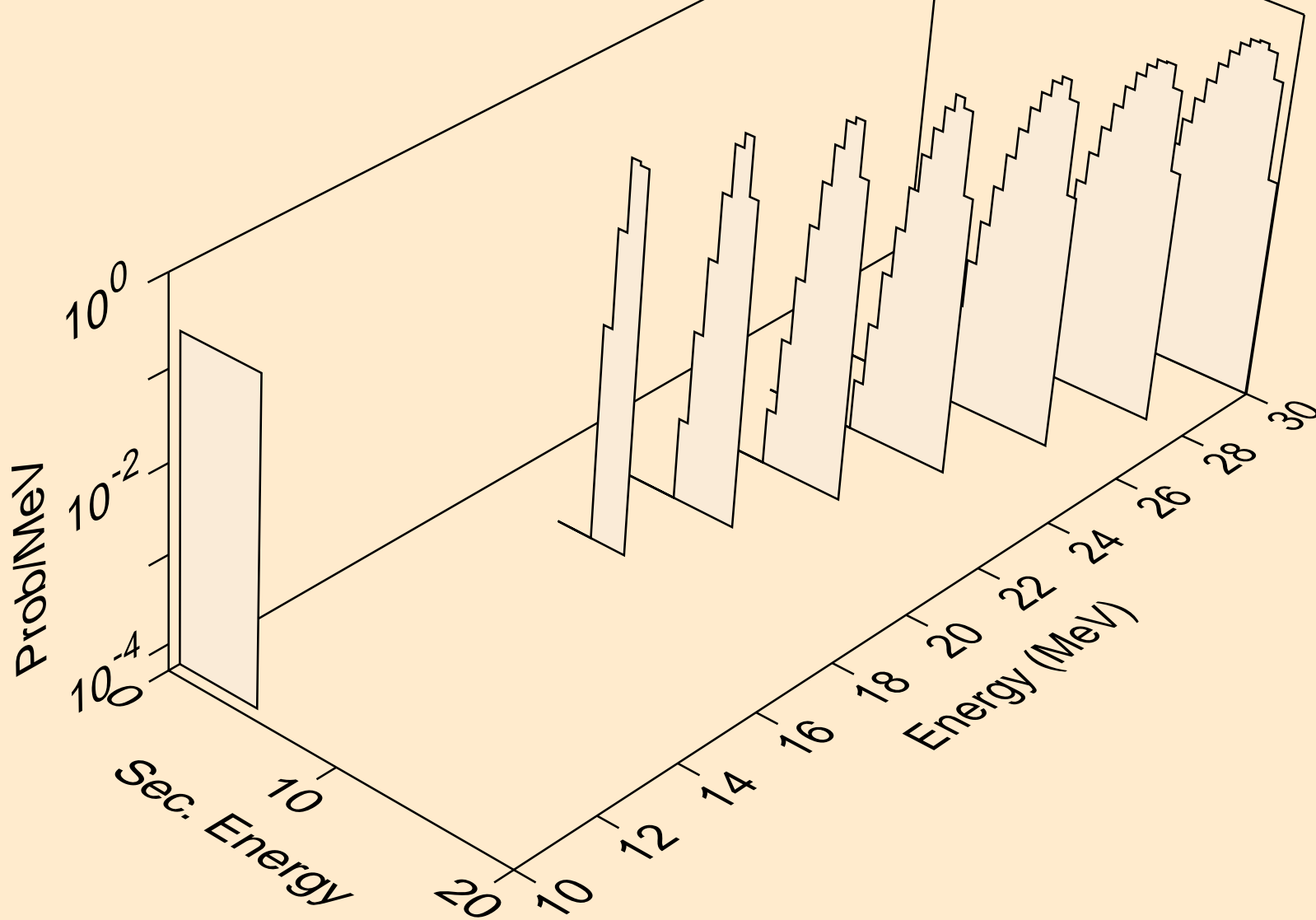

PB203 NEUTRON ACER TENDL-2019 LIBRARY; T=293.16K
he3s from (n,he3)

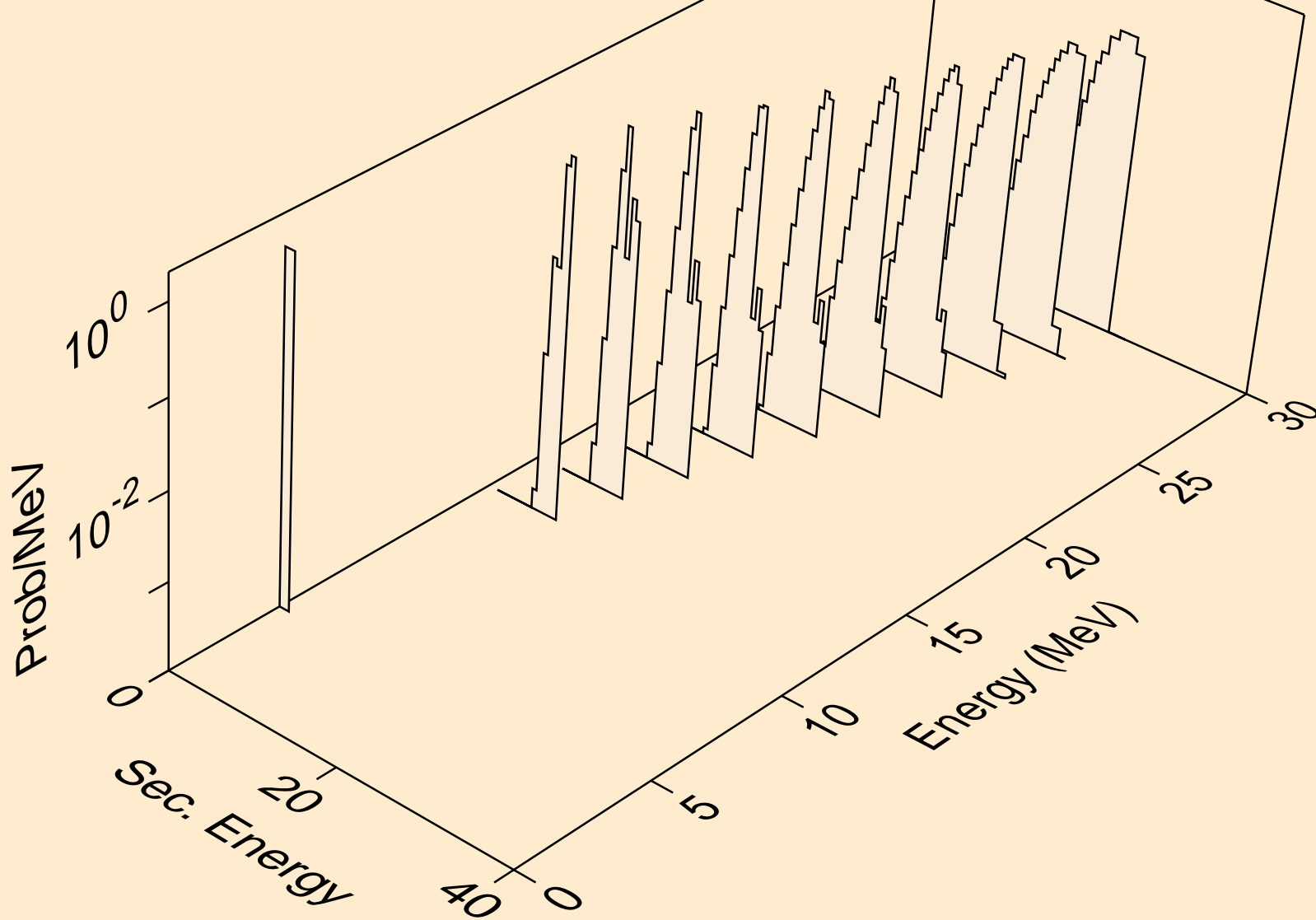

PB203 NEUTRON ACER TENDL-2019 LIBRARY; T=293.16K
alphas from (n,x)

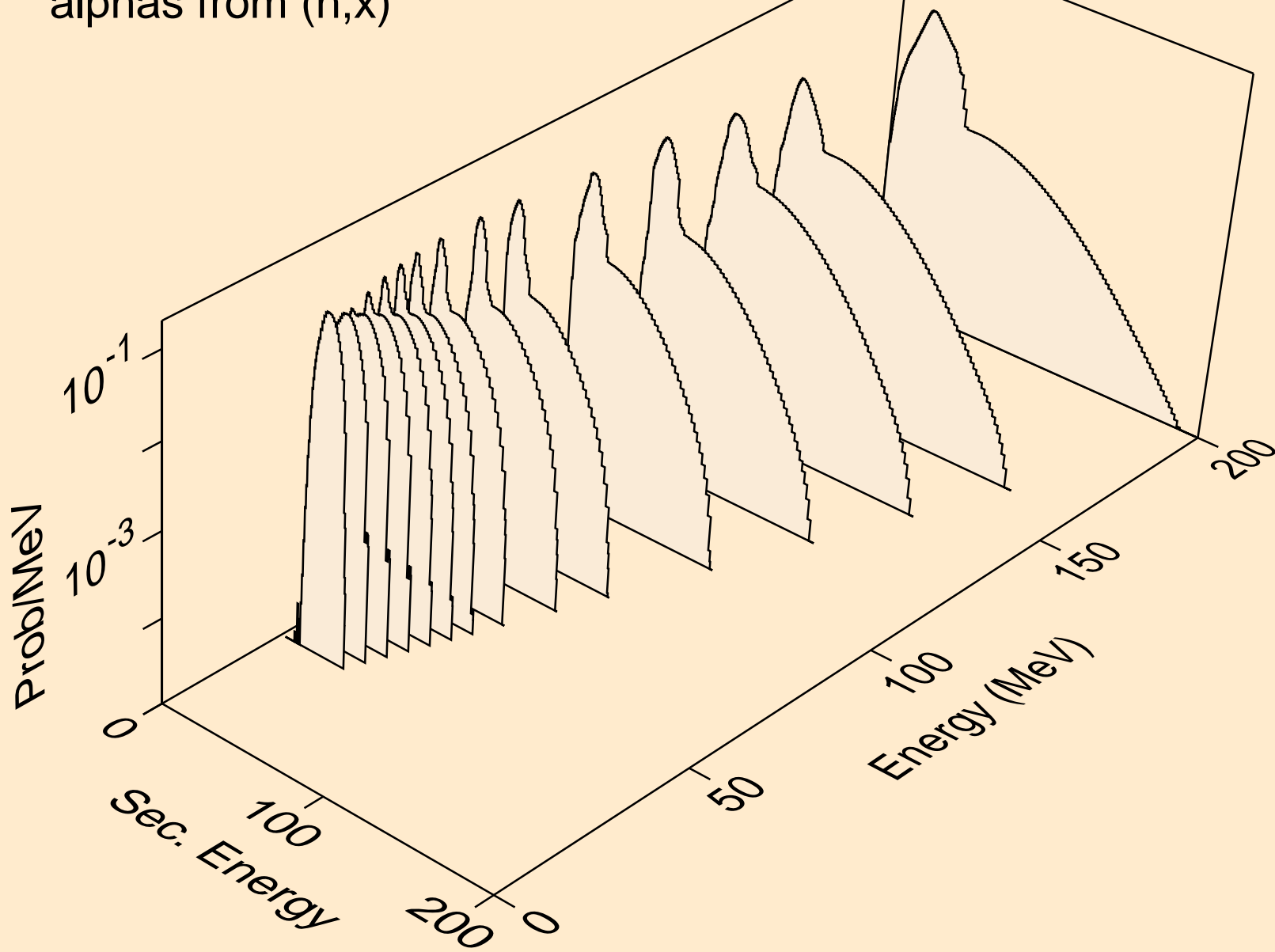

PB203 NEUTRON ACER TENDL-2019 LIBRARY; T=293.16K
alphas from (n,n*)a

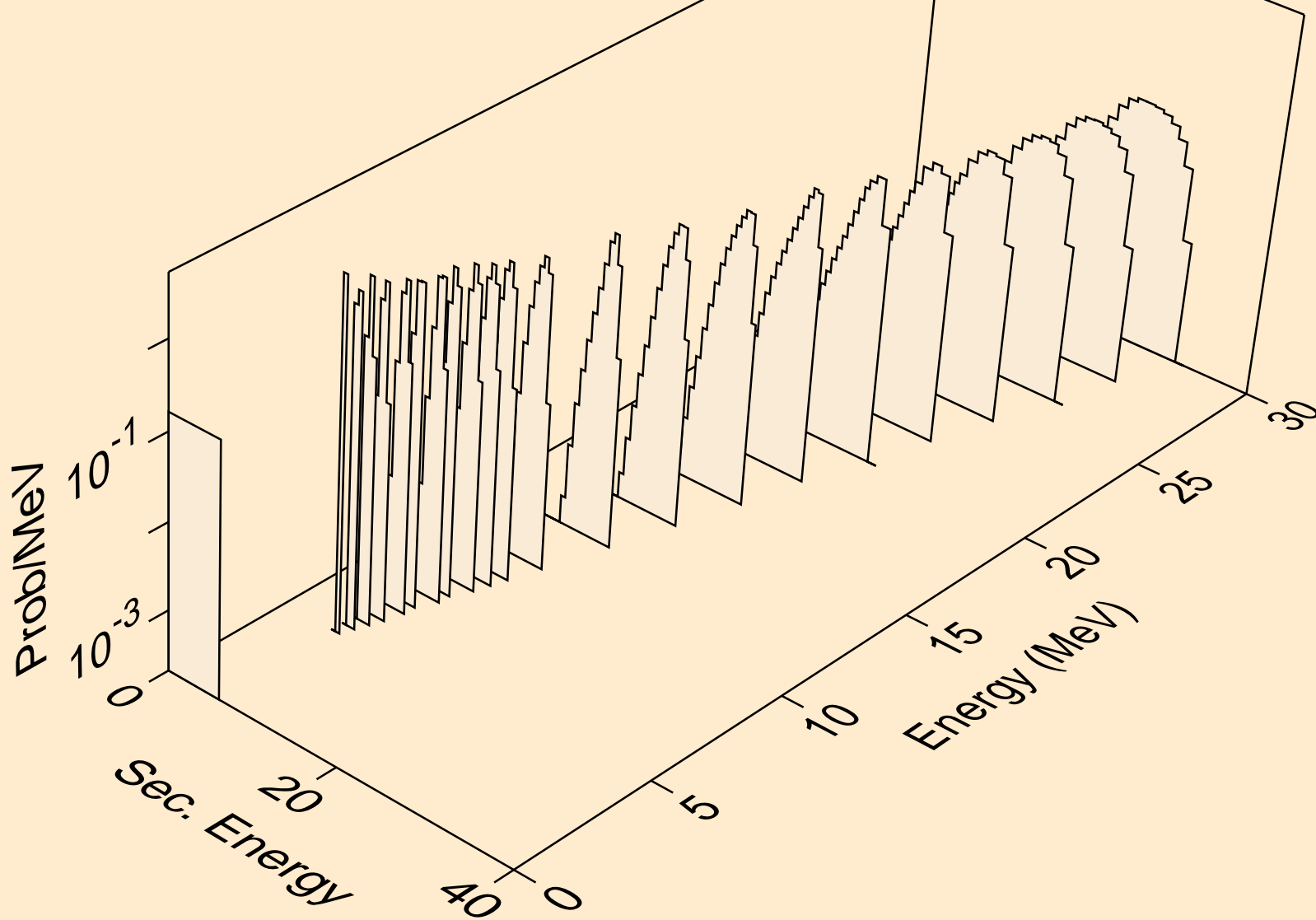

PB203 NEUTRON ACER TENDL-2019 LIBRARY; T=293.16K
alphas from (n,2n)a

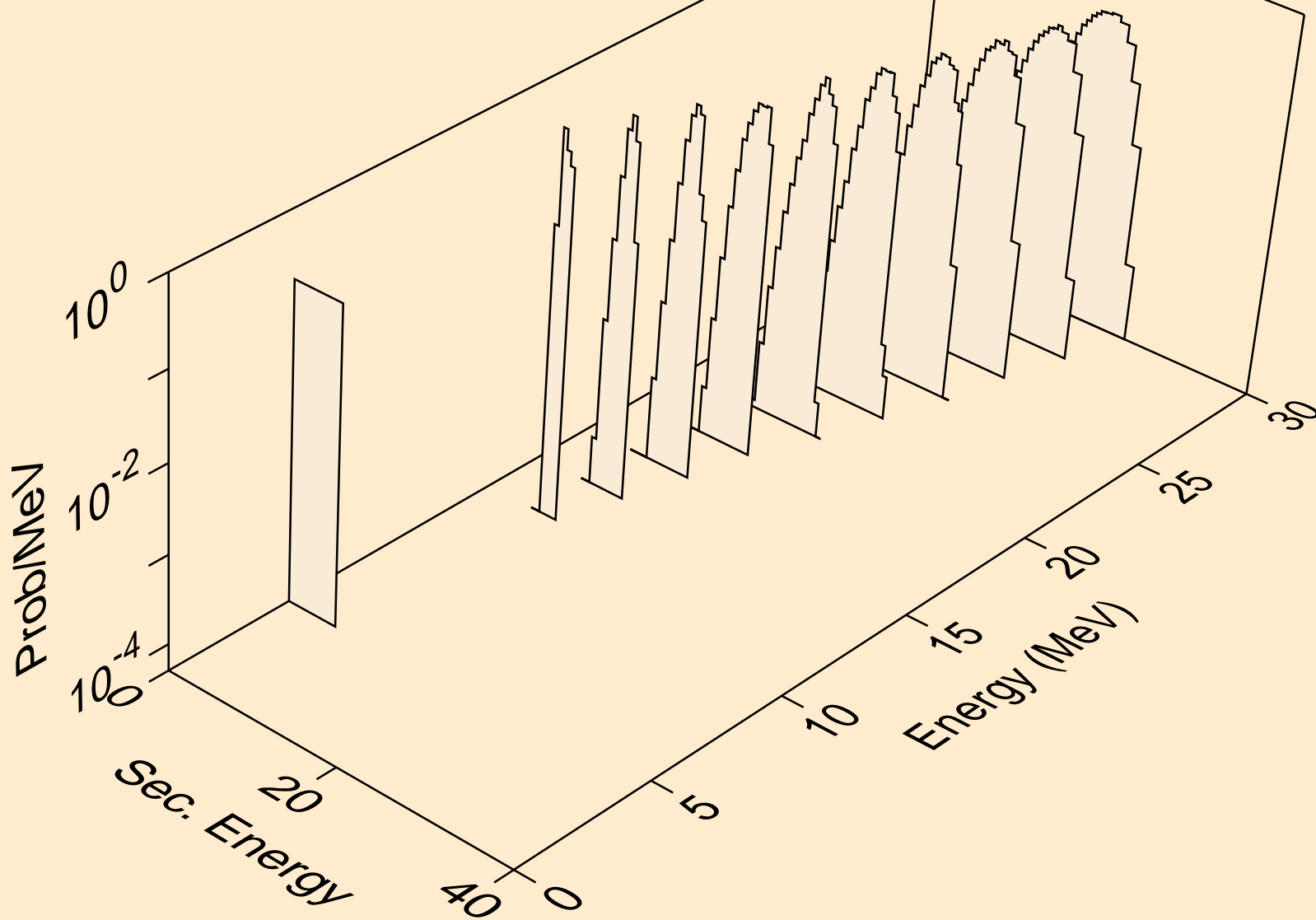

PB203 NEUTRON ACER TENDL-2019 LIBRARY; T=293.16K
alphas from (n,3n)a

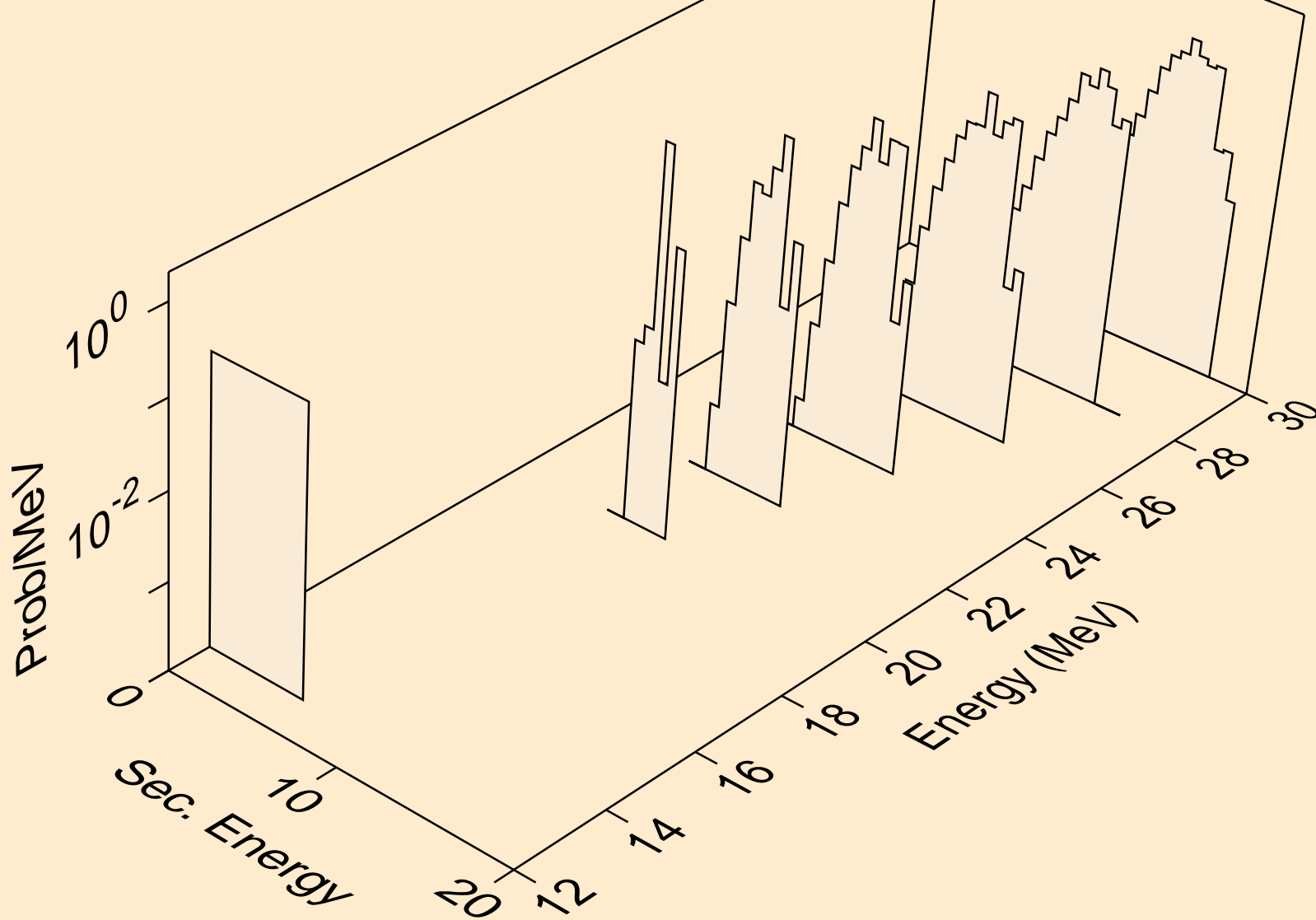

PB203 NEUTRON ACER TENDL-2019 LIBRARY; T=293.16K
alphas from (n,npa)

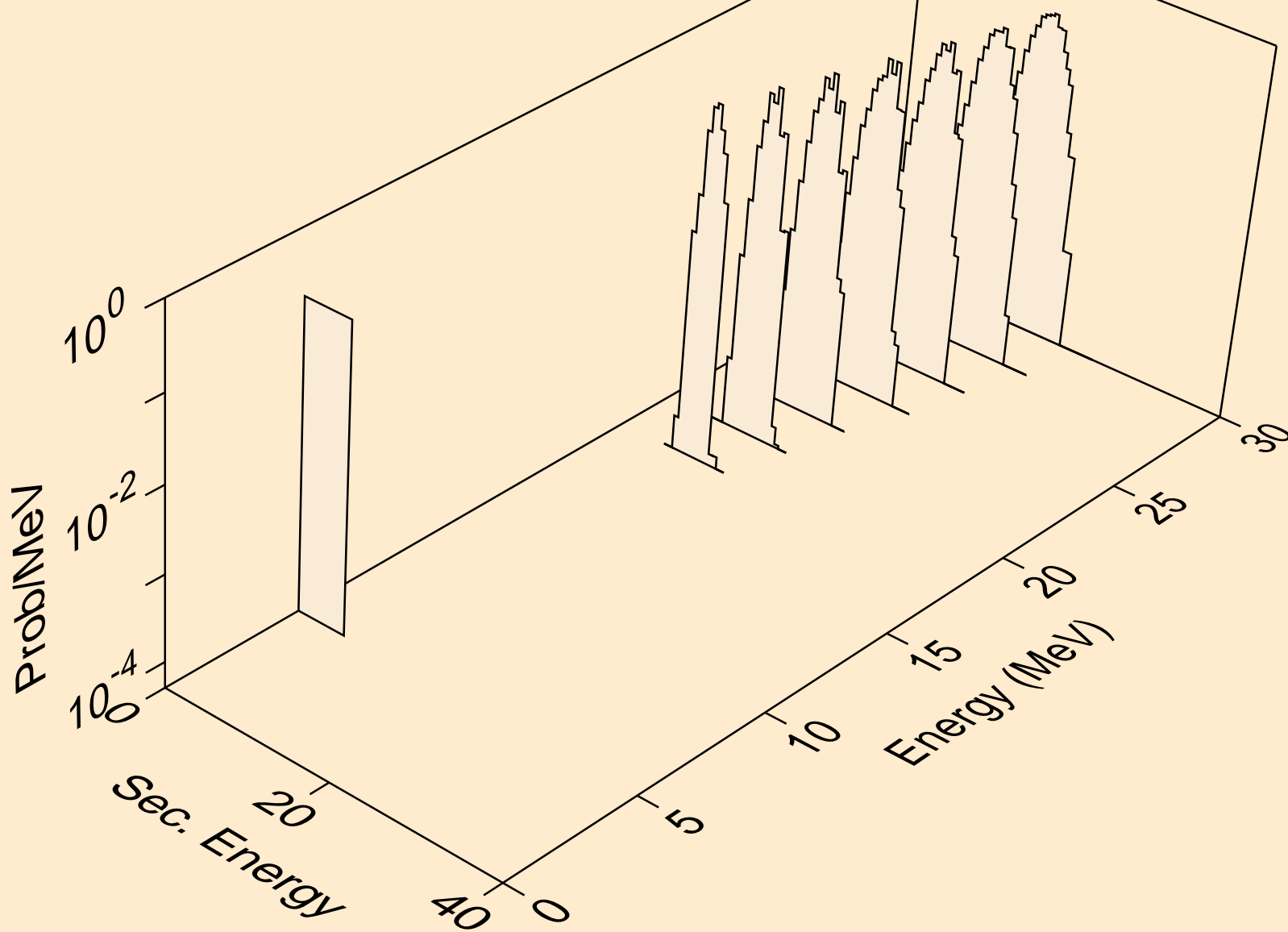

PB203 NEUTRON ACER TENDL-2019 LIBRARY; T=293.16K
alphas from (n,a)

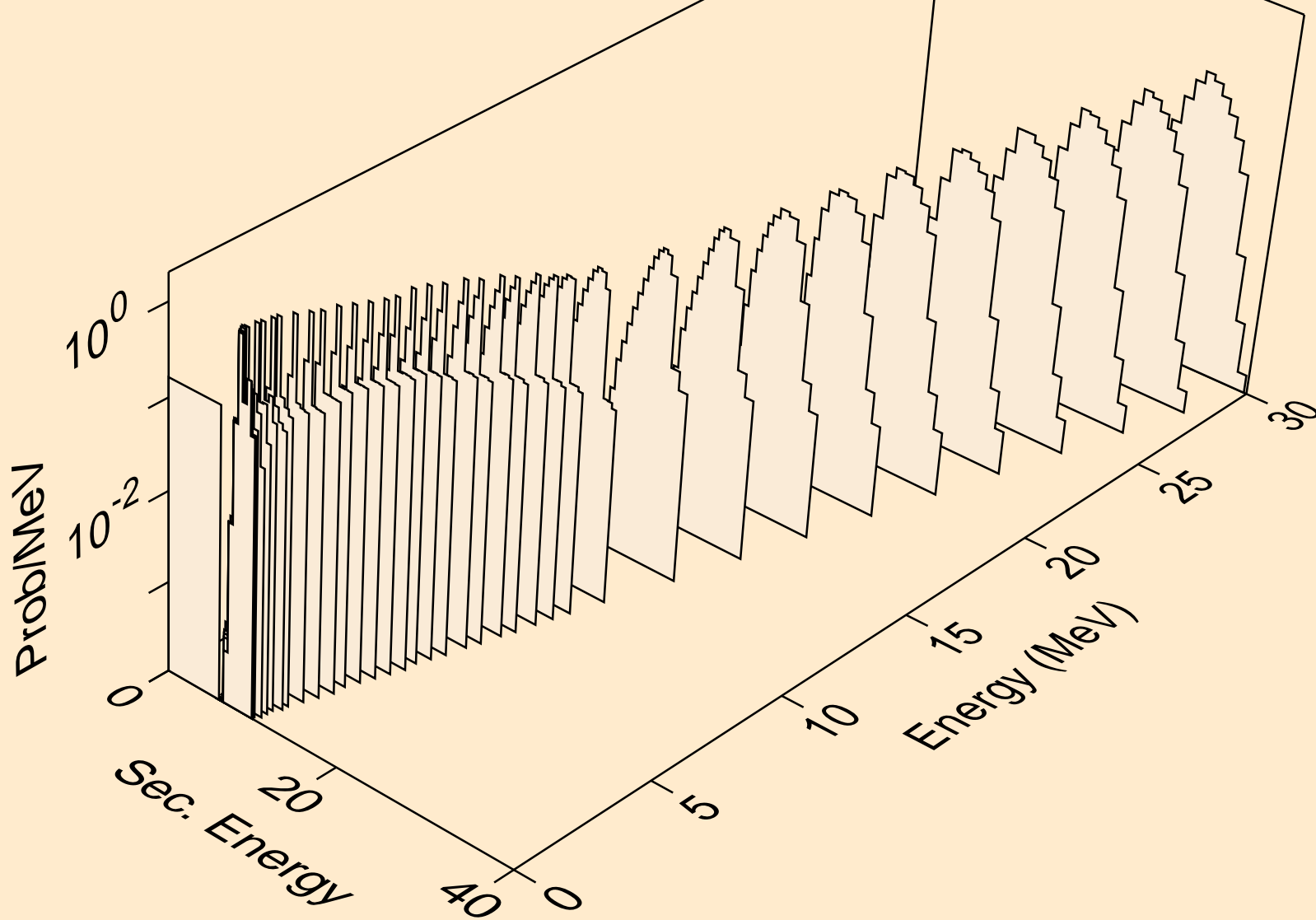

PB203 NEUTRON ACER TENDL-2019 LIBRARY; T=293.16K
alphas from (n,pa)

