

PD099 NEUTRON ACER TENDL-2019 LIBRARY; T=293.16K
Principal cross sections

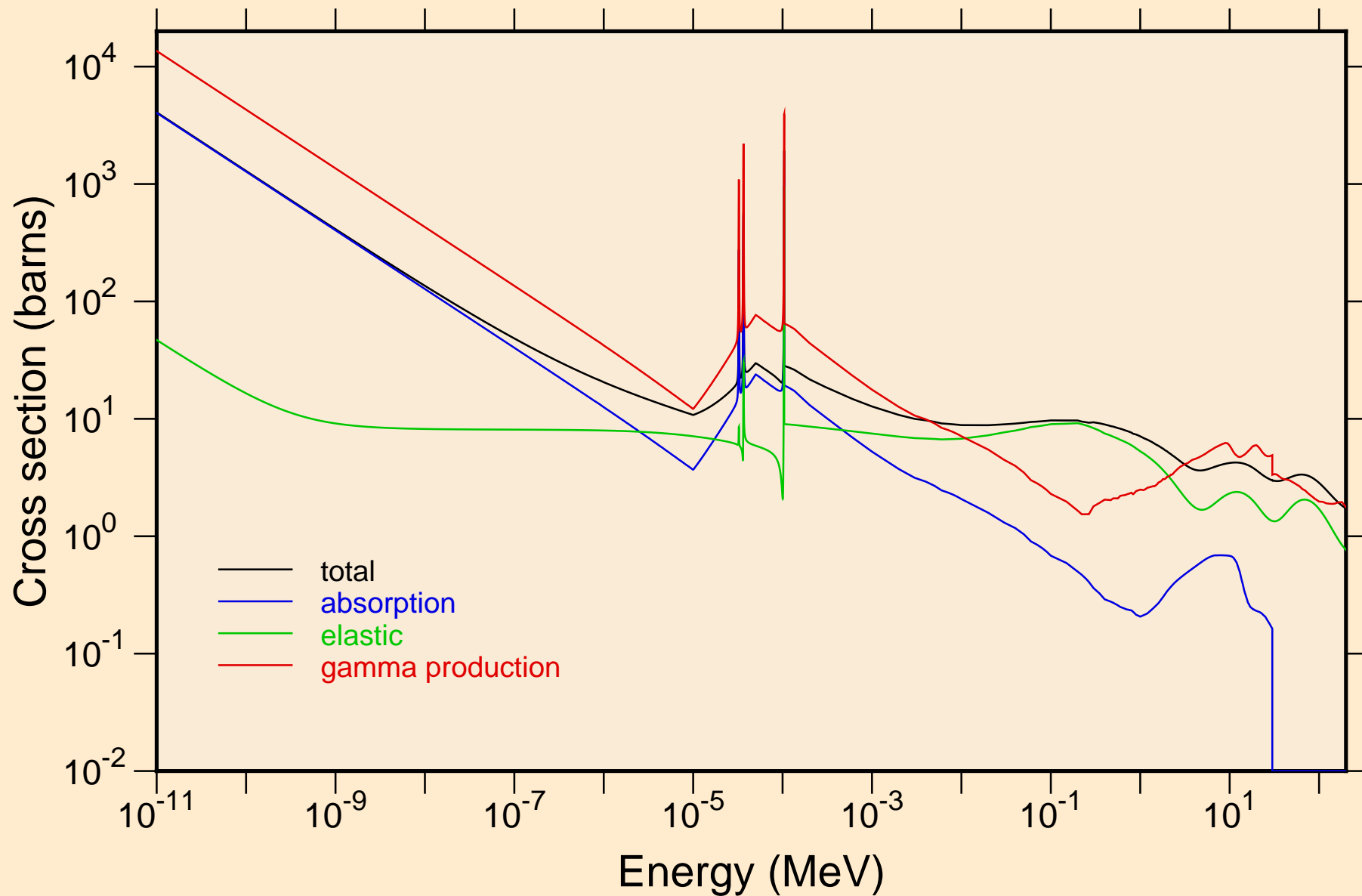

PD099 NEUTRON ACER TENDL-2019 LIBRARY; T=293.16K
resonance total cross section

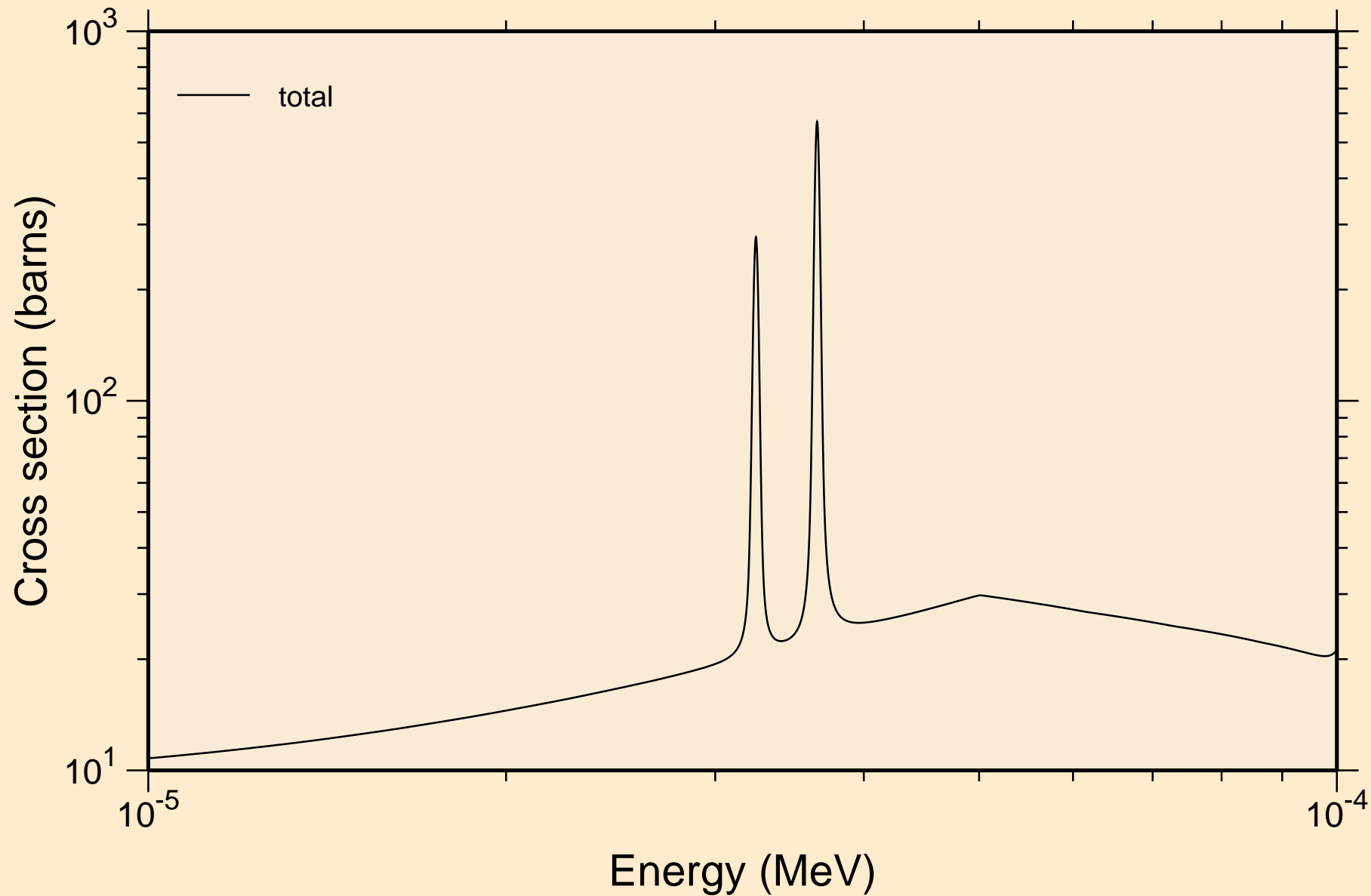

PD099 NEUTRON ACER TENDL-2019 LIBRARY; T=293.16K
resonance total cross section

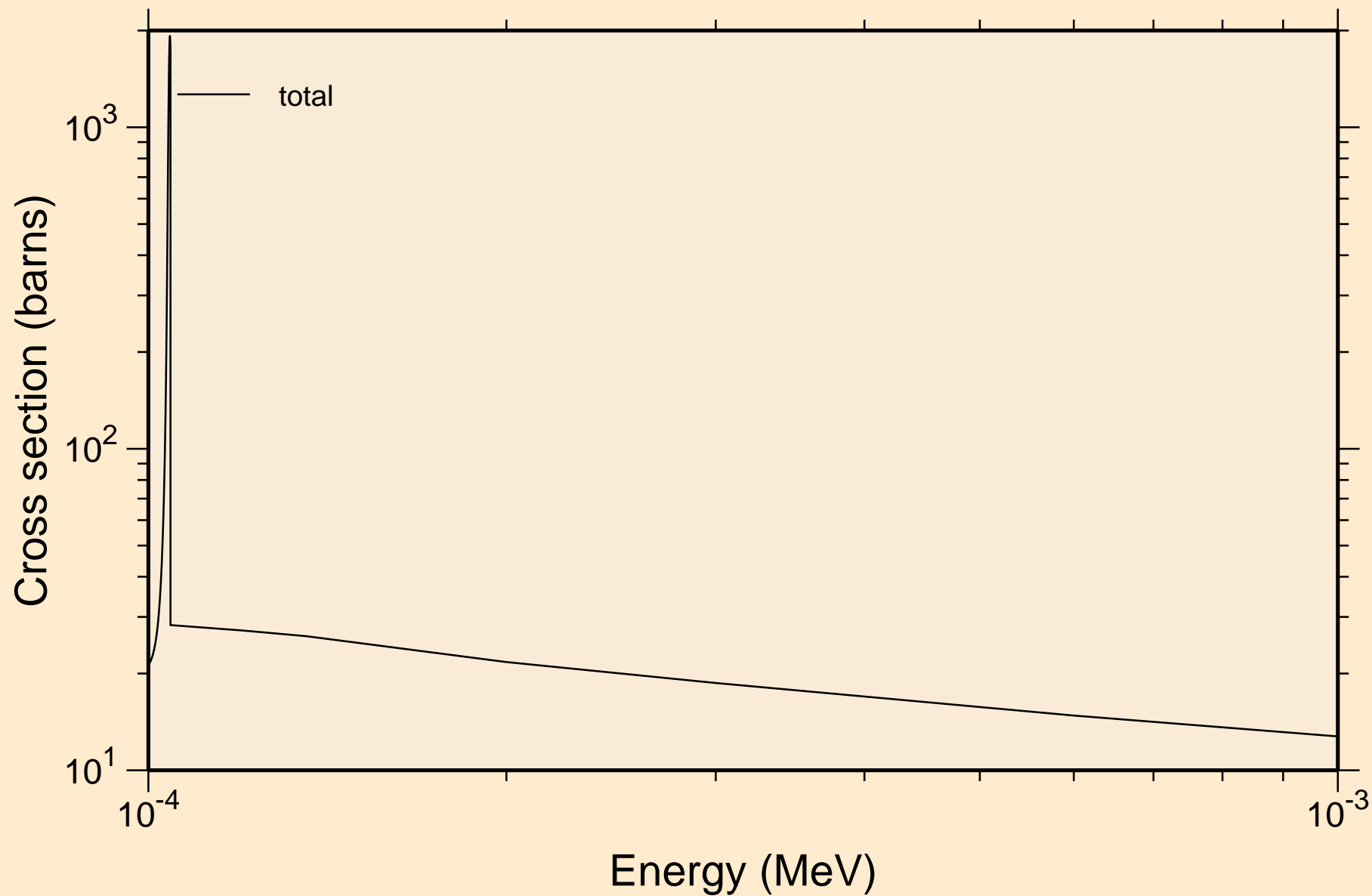

PD099 NEUTRON ACER TENDL-2019 LIBRARY; T=293.16K
resonance total cross section

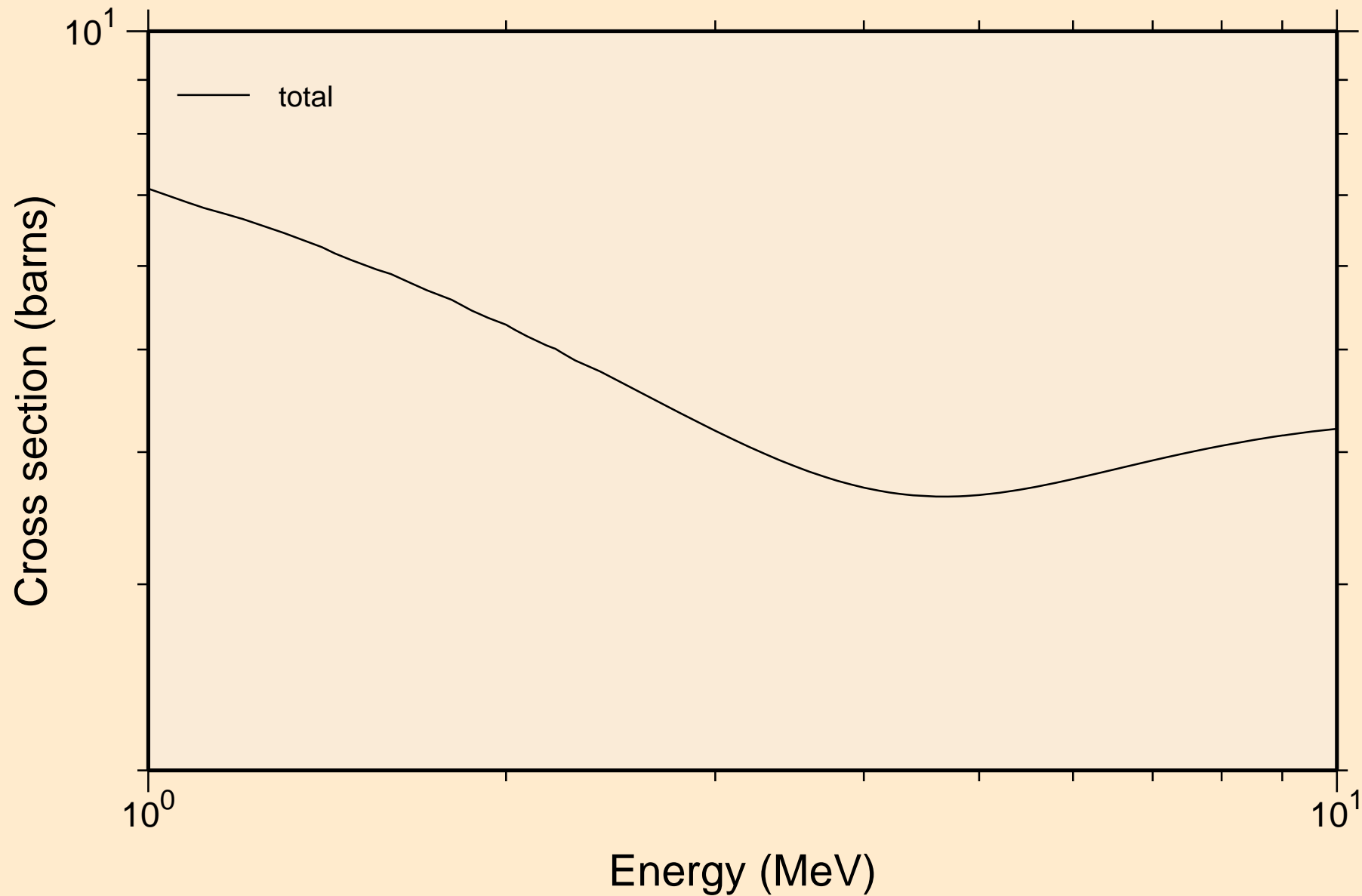

PD099 NEUTRON ACER TENDL-2019 LIBRARY; T=293.16K
resonance absorption cross sections

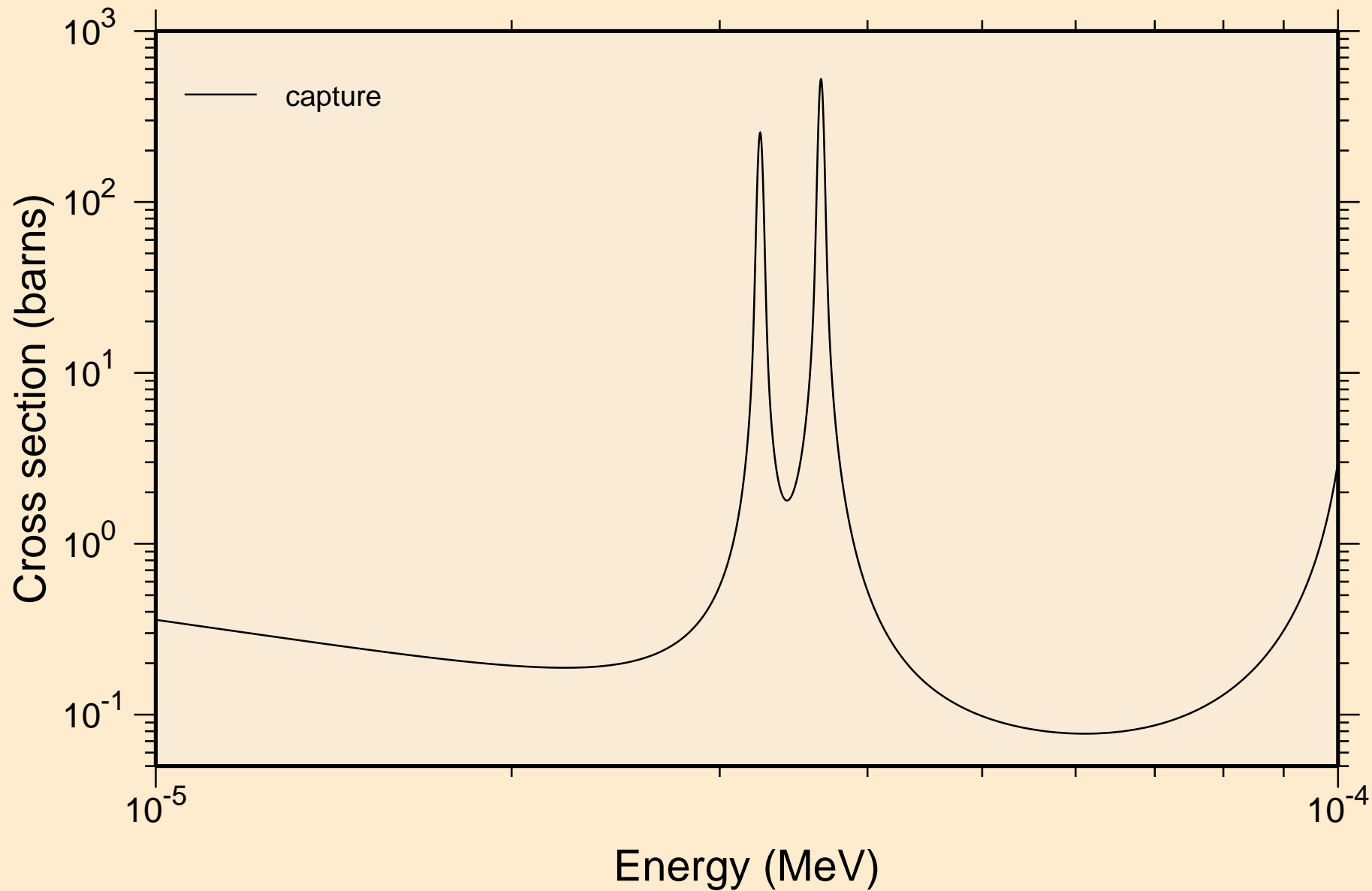

PD099 NEUTRON ACER TENDL-2019 LIBRARY; T=293.16K
resonance absorption cross sections

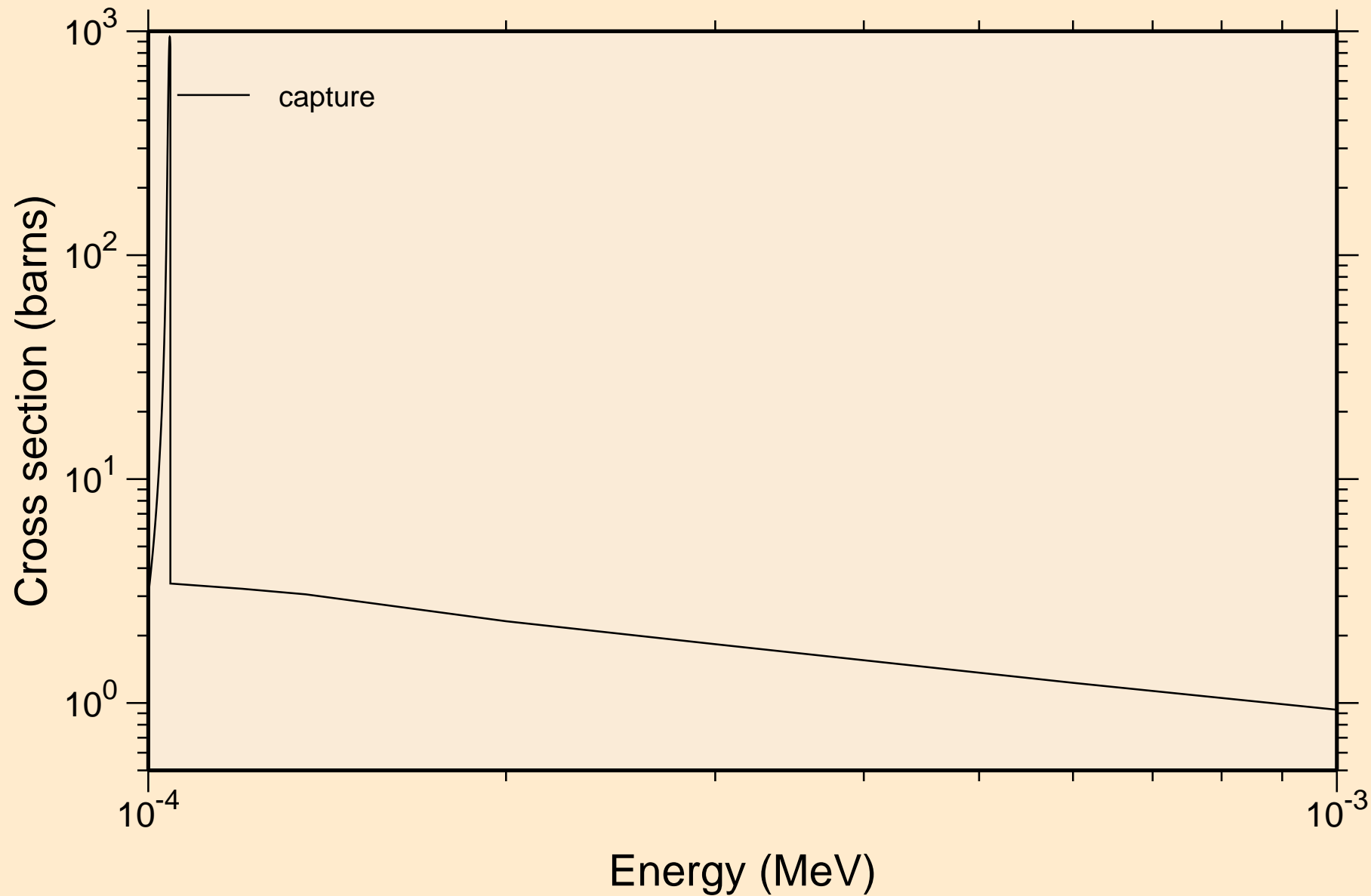

PD099 NEUTRON ACER TENDL-2019 LIBRARY; T=293.16K
resonance absorption cross sections

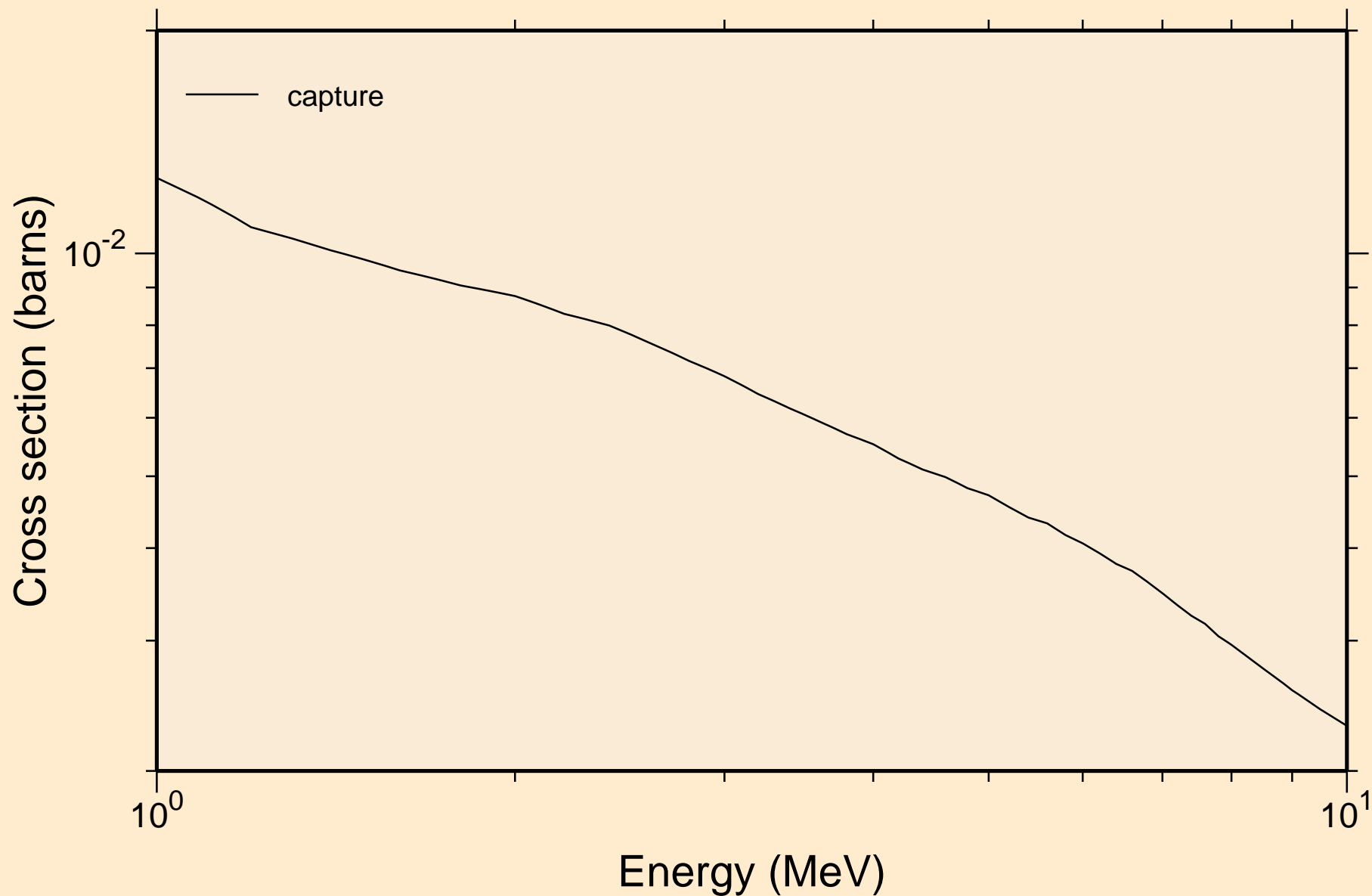

PD099 NEUTRON ACER TENDL-2019 LIBRARY; T=293.16K
Heating

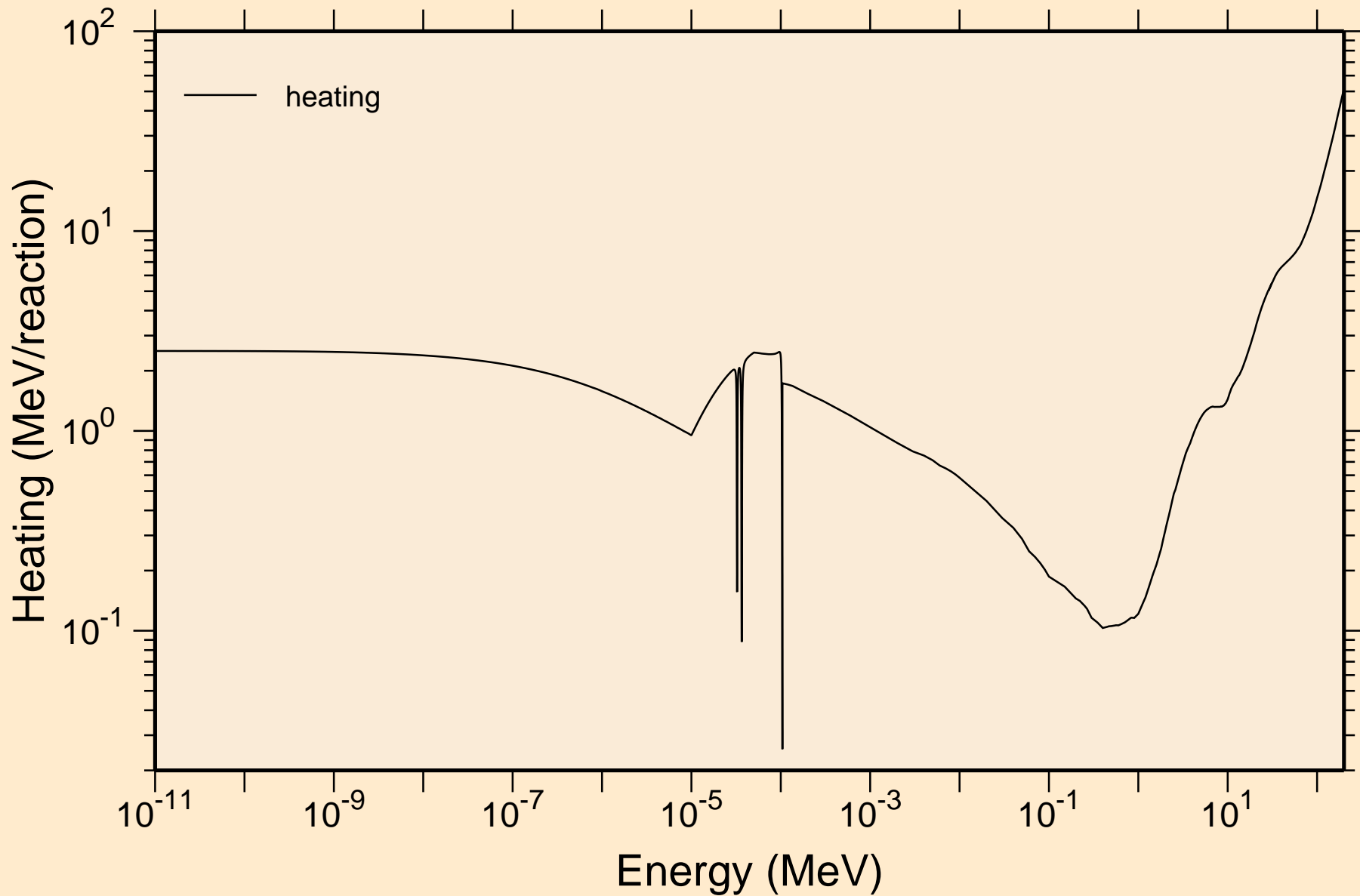

PD099 NEUTRON ACER TENDL-2019 LIBRARY; T=293.16K
Damage

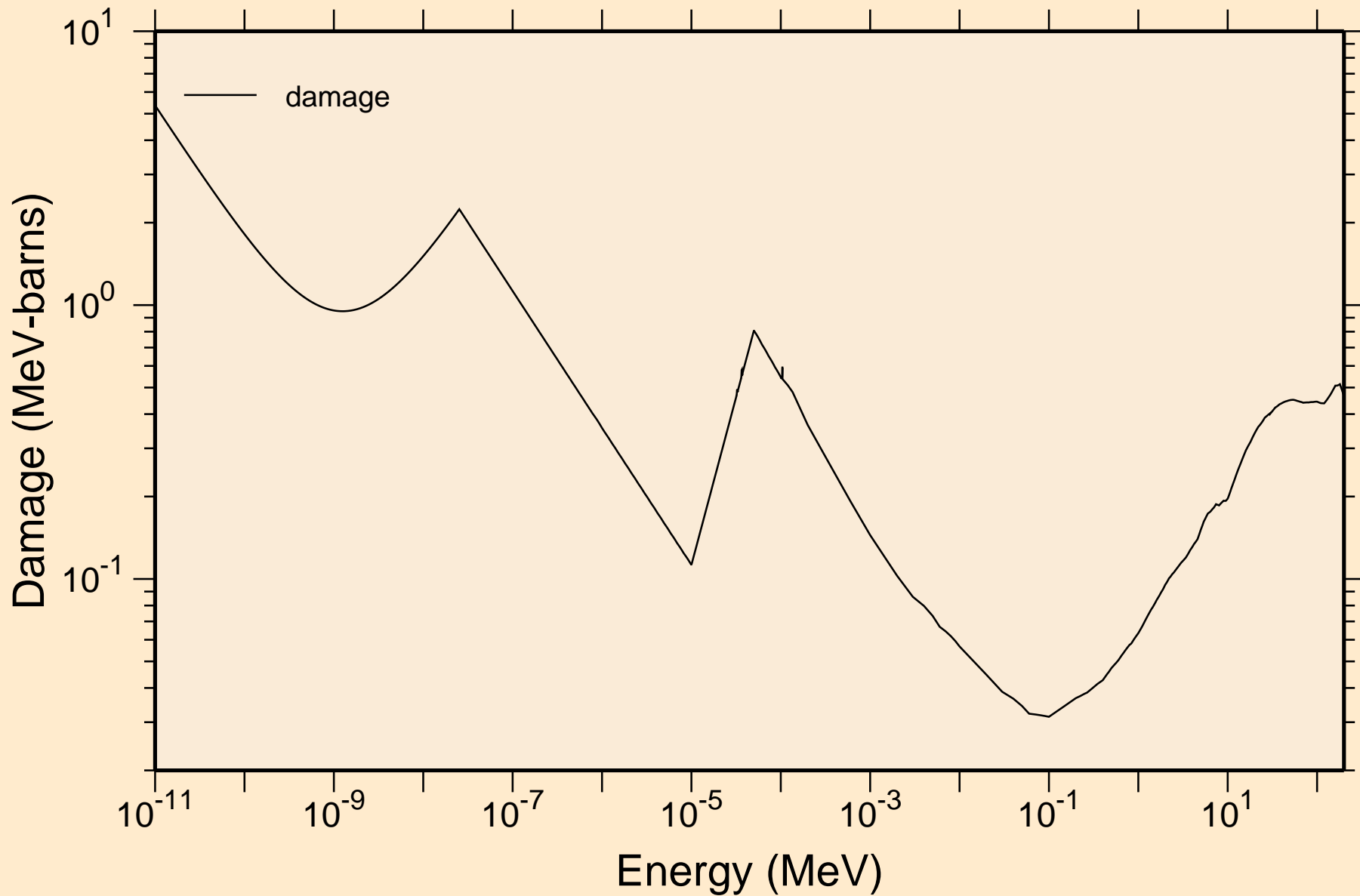

PD099 NEUTRON ACER TENDL-2019 LIBRARY; T=293.16K
Non-threshold reactions

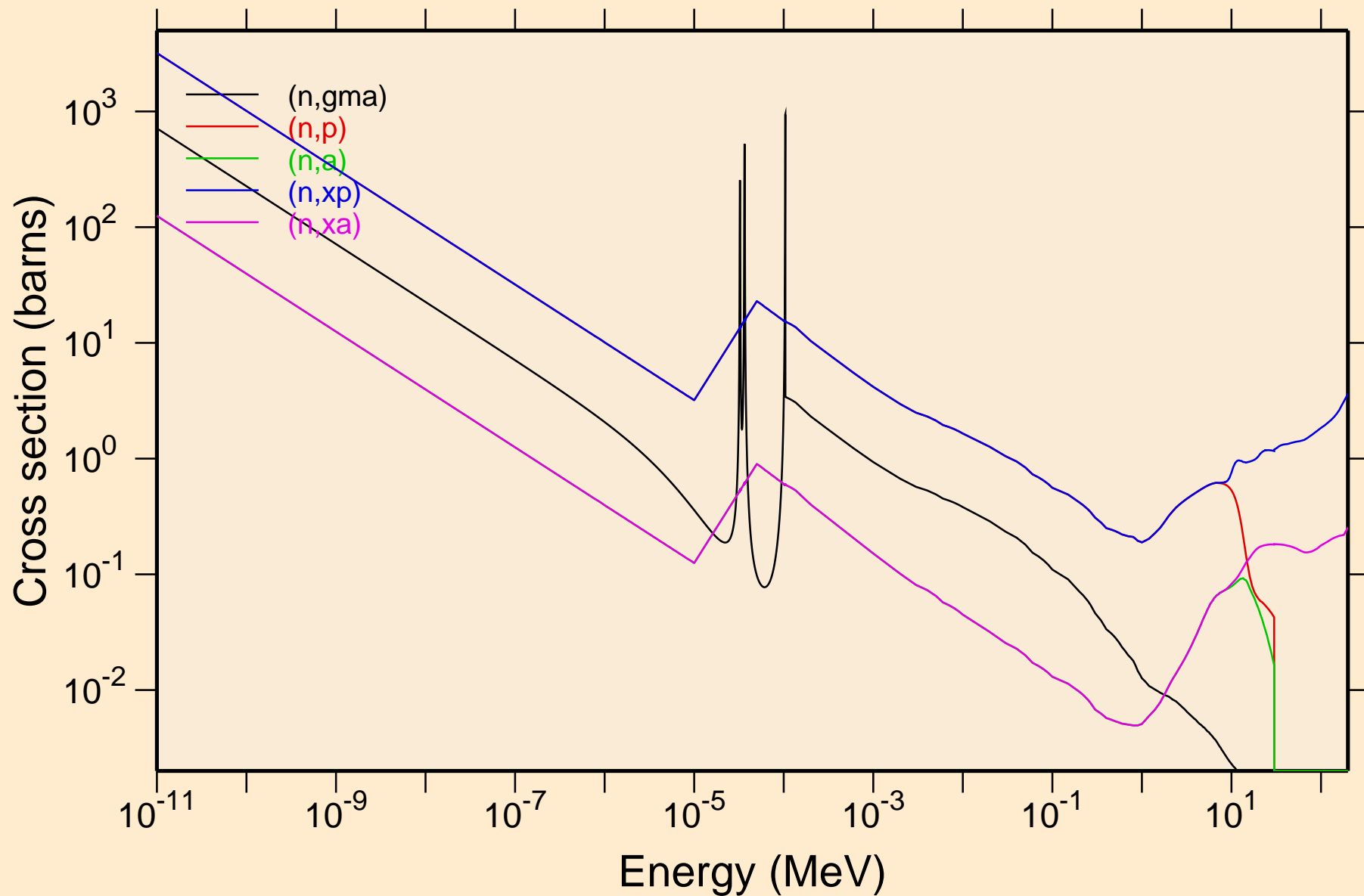

PD099 NEUTRON ACER TENDL-2019 LIBRARY; T=293.16K
Principal cross sections

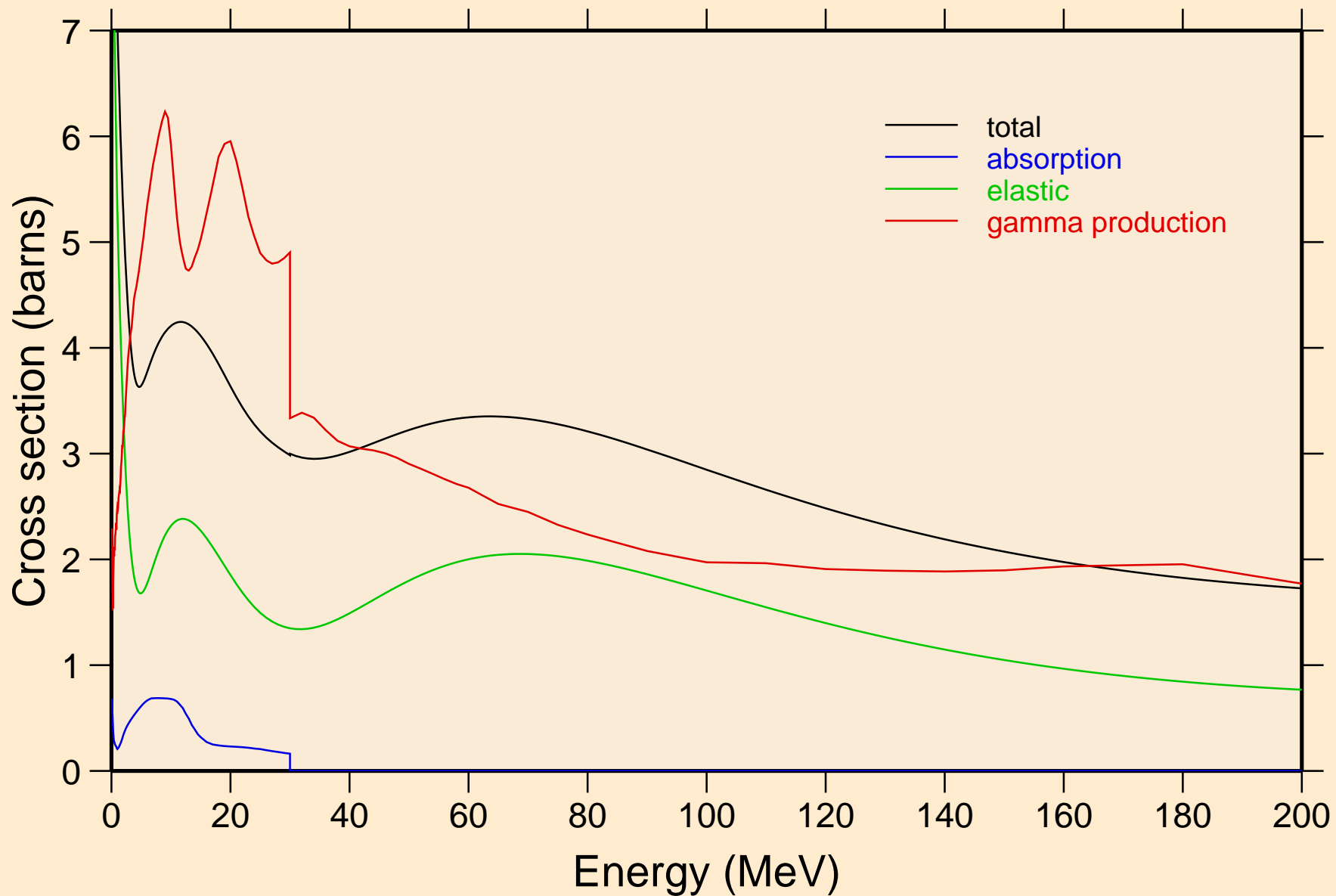

PD099 NEUTRON ACER TENDL-2019 LIBRARY; T=293.16K
Heating

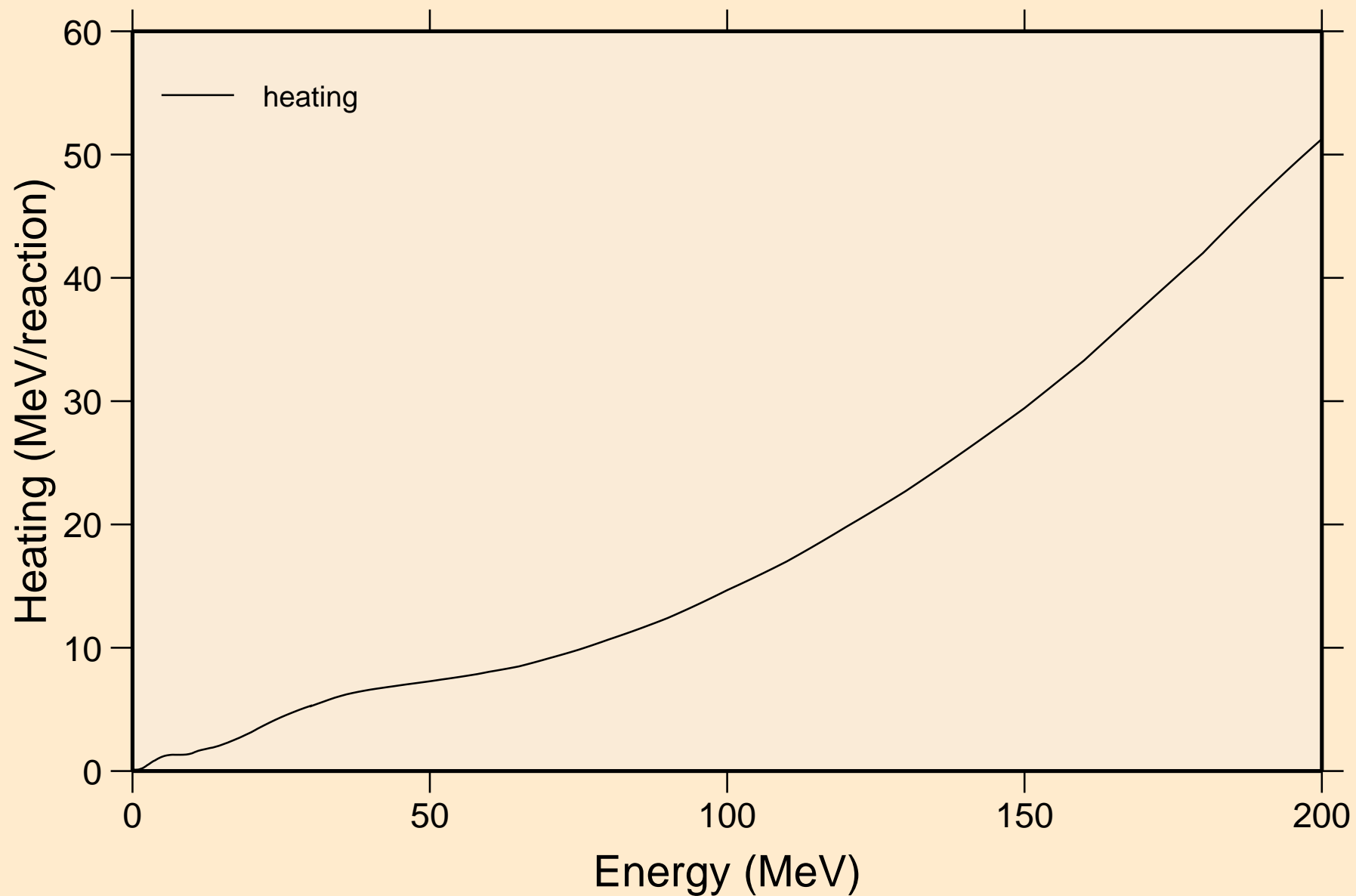

PD099 NEUTRON ACER TENDL-2019 LIBRARY; T=293.16K
Damage

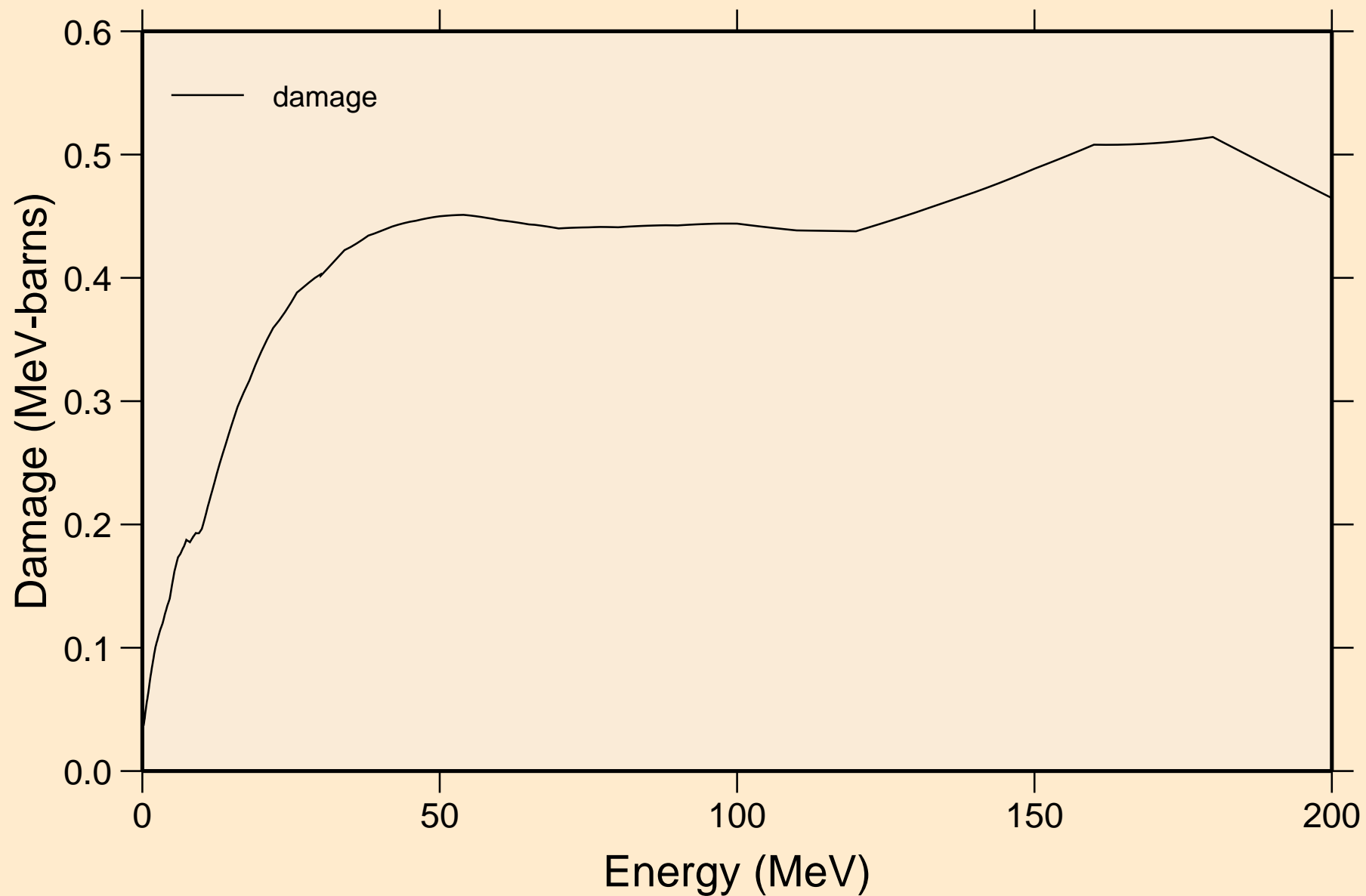

PD099 NEUTRON ACER TENDL-2019 LIBRARY; T=293.16K
Non-threshold reactions

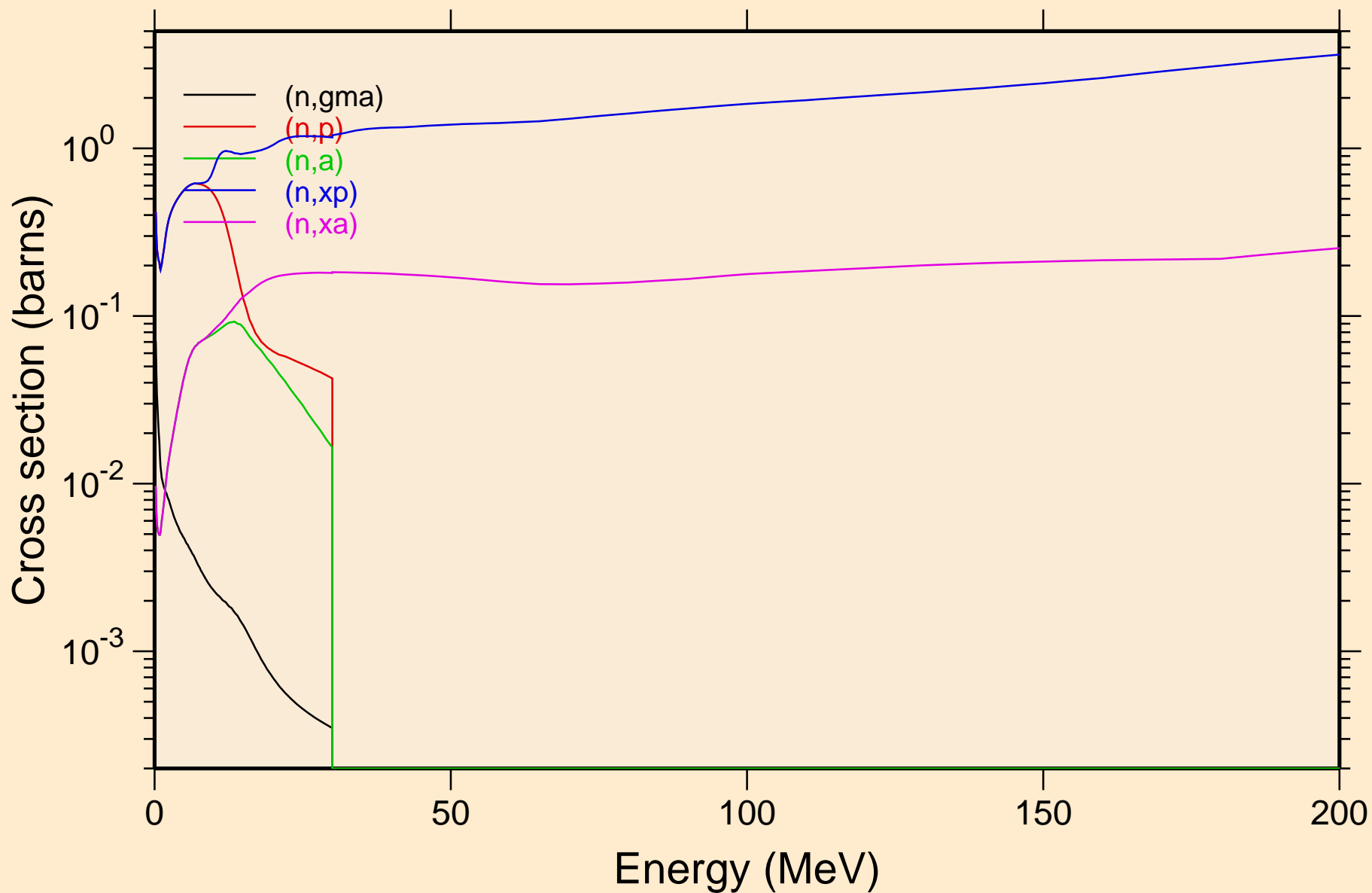

PD099 NEUTRON ACER TENDL-2019 LIBRARY; T=293.16K
Inelastic levels

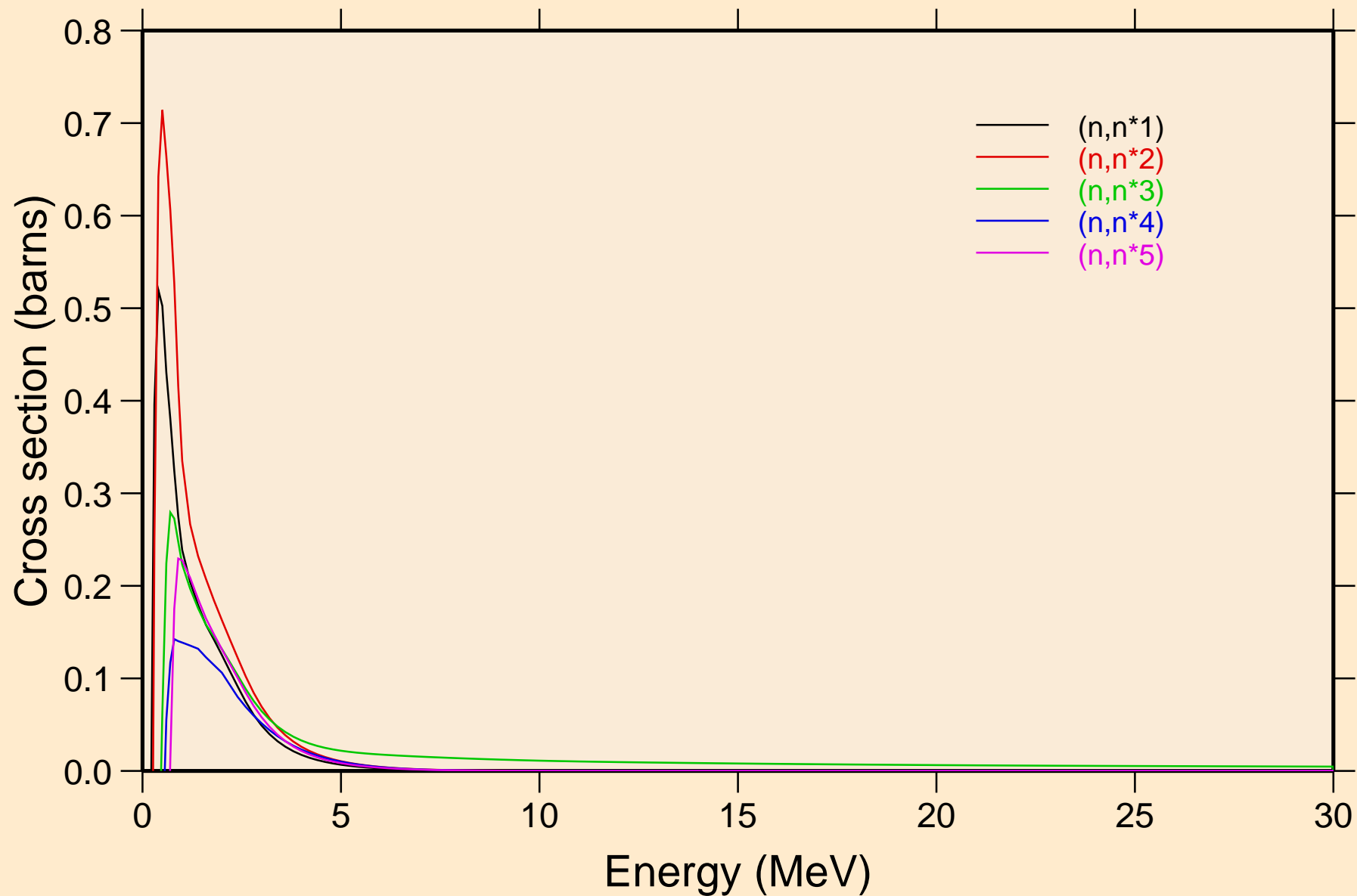

PD099 NEUTRON ACER TENDL-2019 LIBRARY; T=293.16K
Inelastic levels

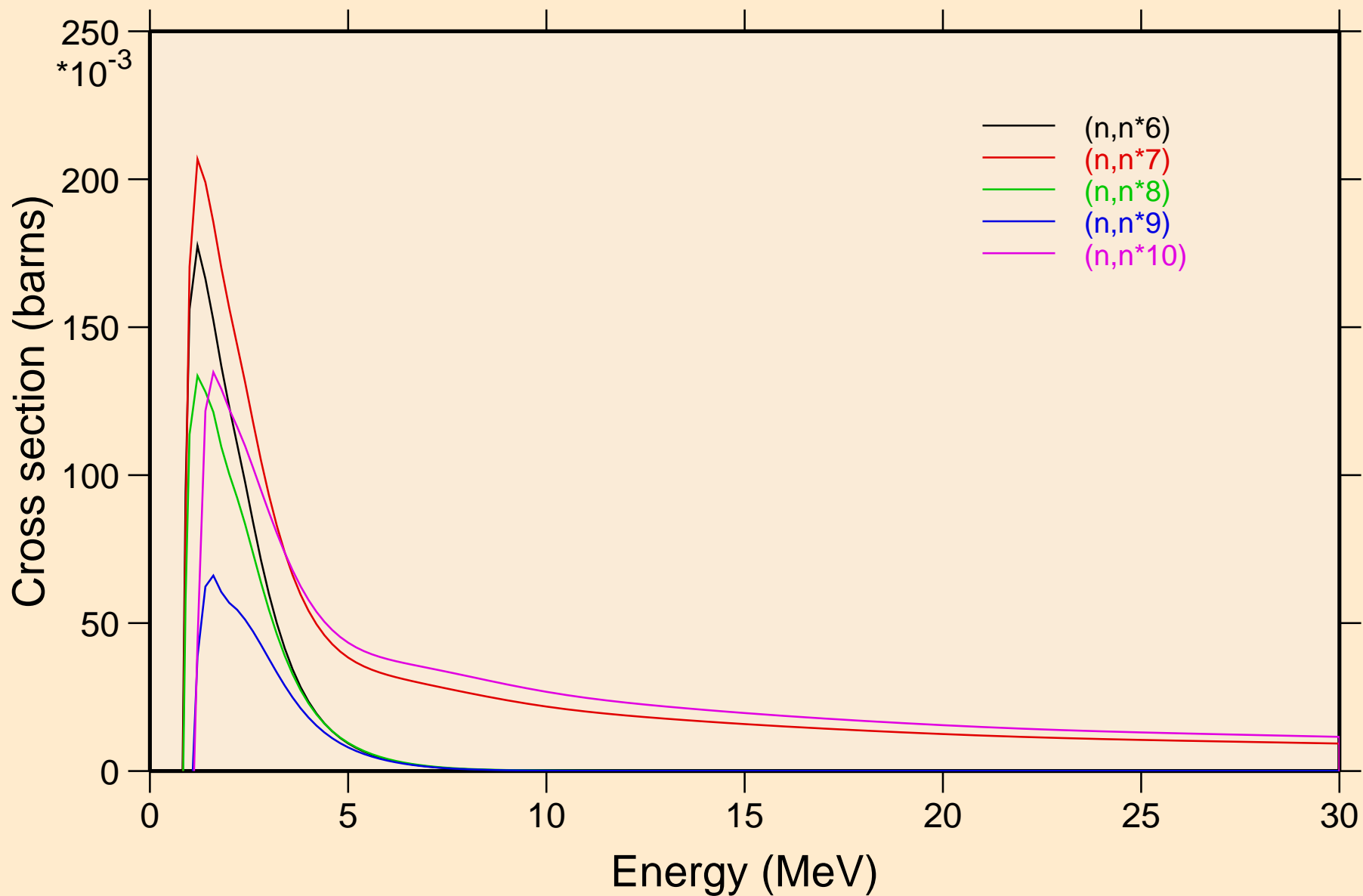

PD099 NEUTRON ACER TENDL-2019 LIBRARY; T=293.16K
Inelastic levels

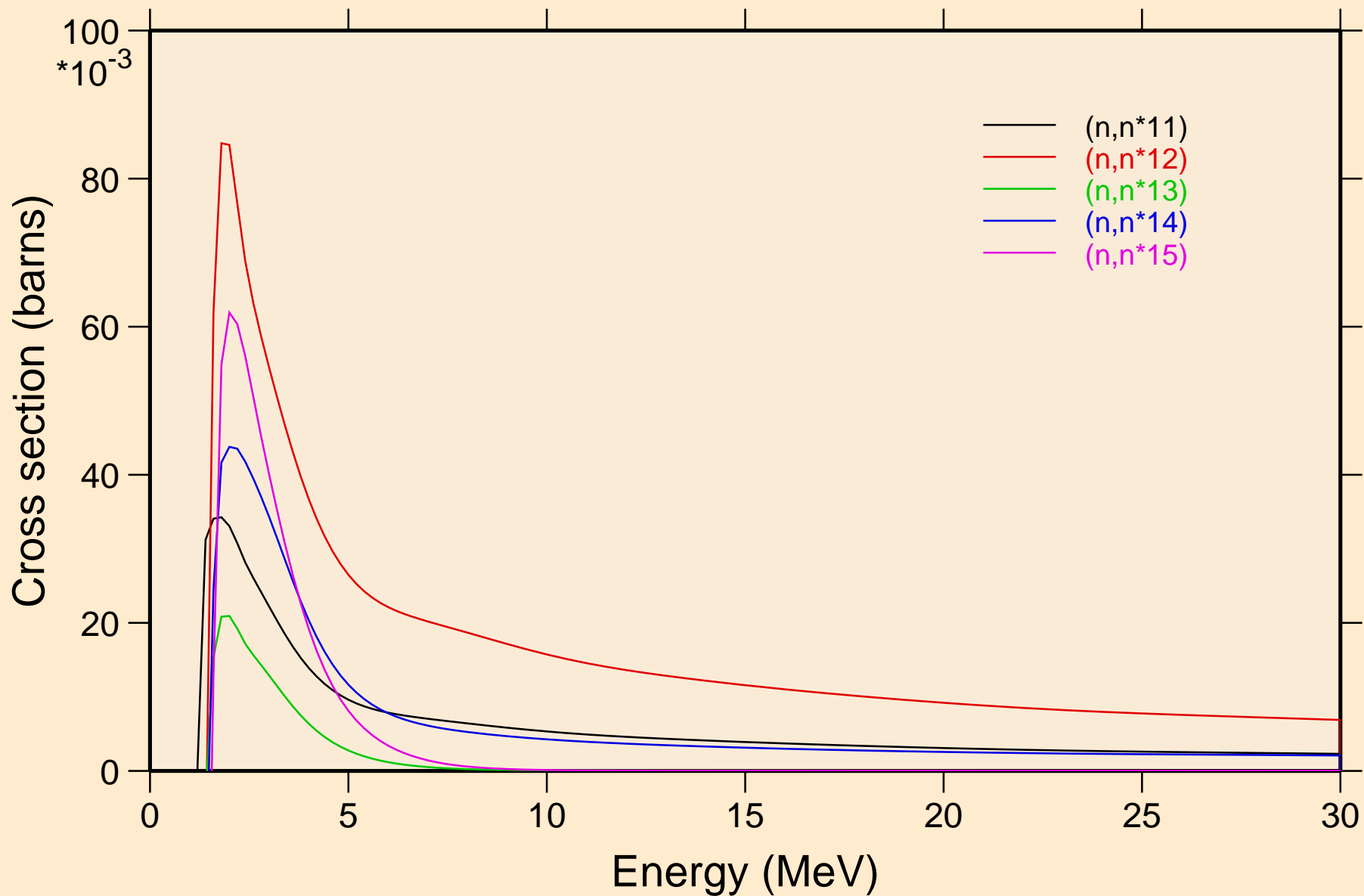

PD099 NEUTRON ACER TENDL-2019 LIBRARY; T=293.16K
Inelastic levels

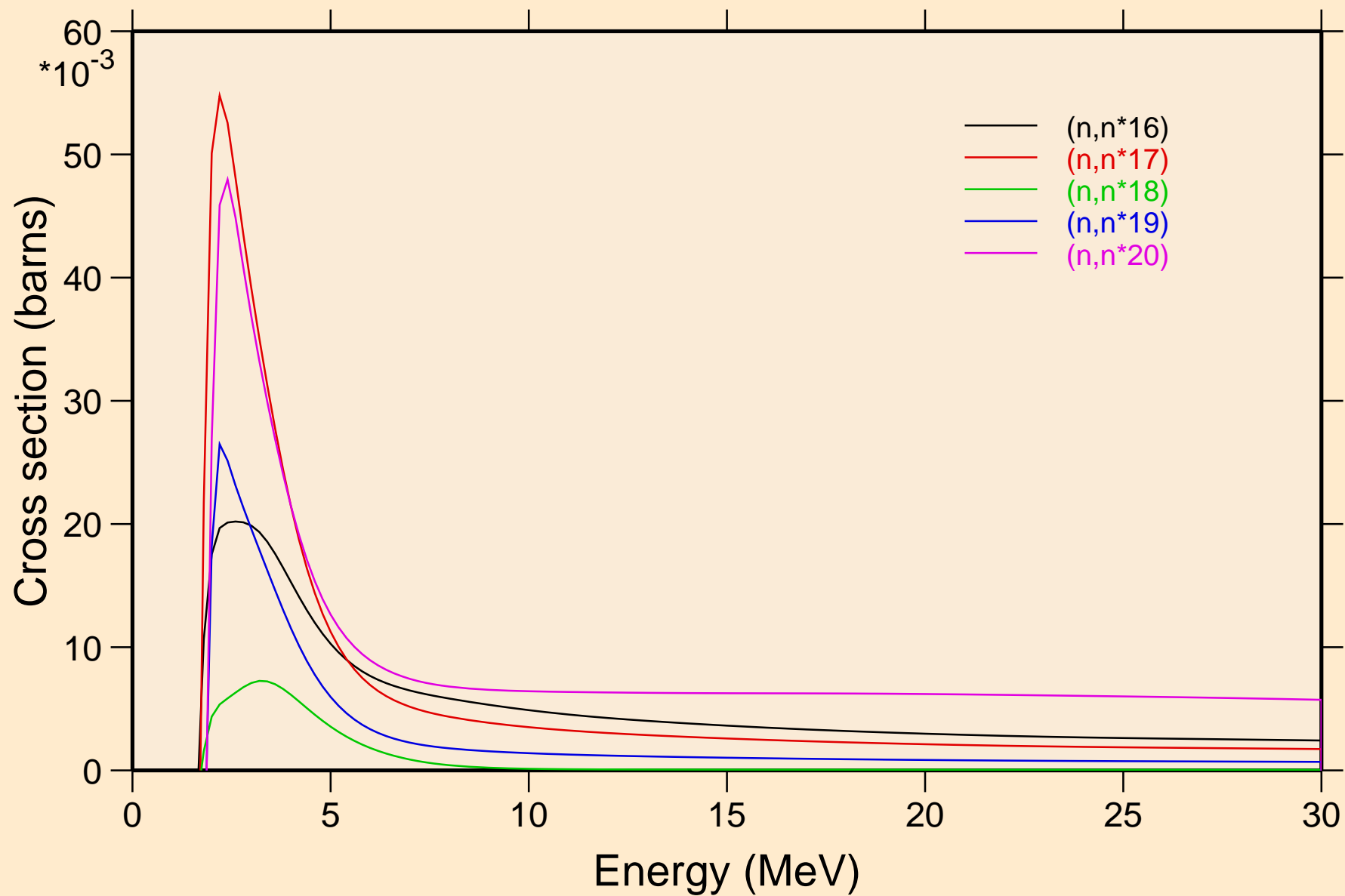

PD099 NEUTRON ACER TENDL-2019 LIBRARY; T=293.16K
Inelastic levels

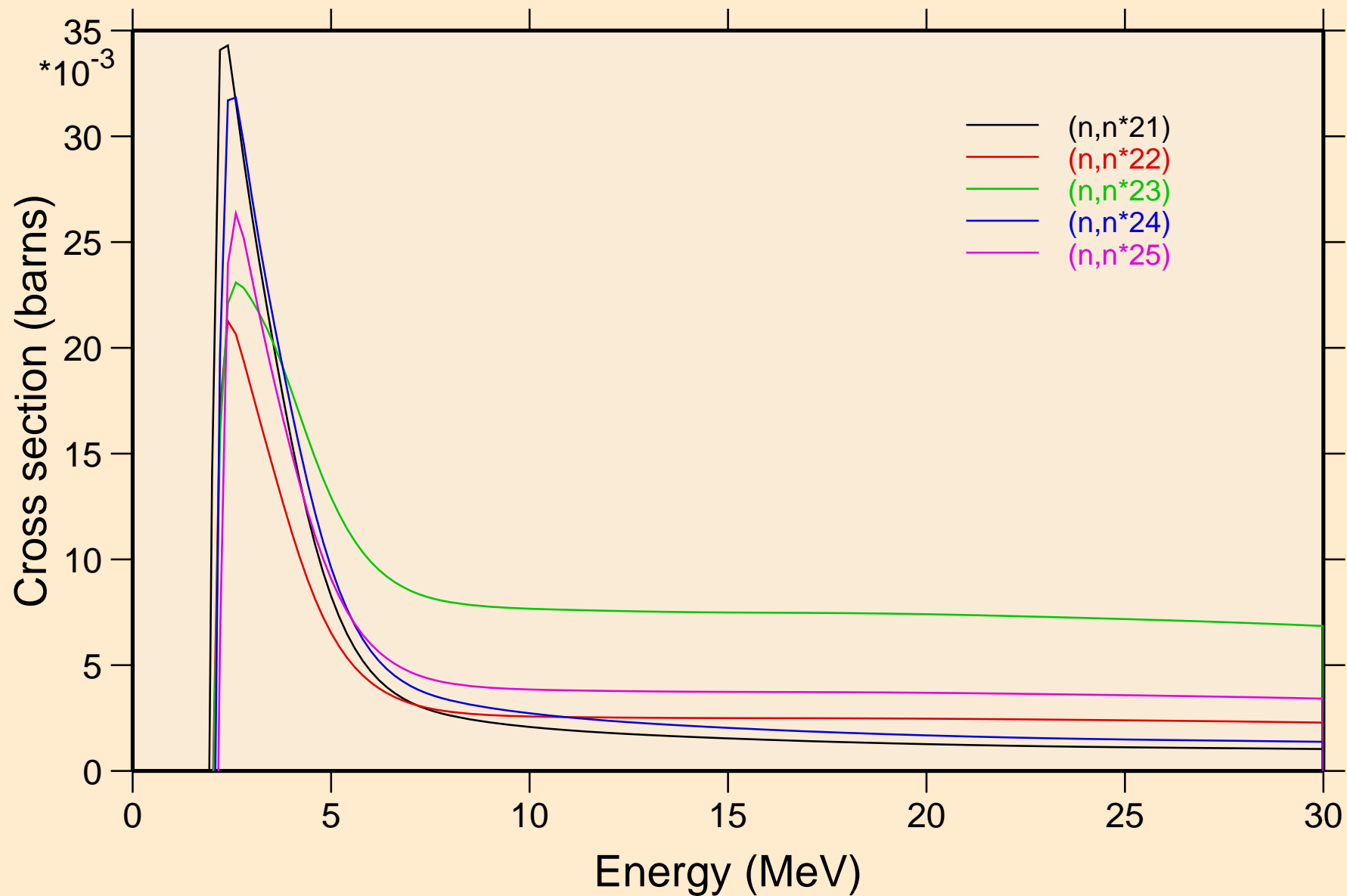

PD099 NEUTRON ACER TENDL-2019 LIBRARY; T=293.16K
Inelastic levels

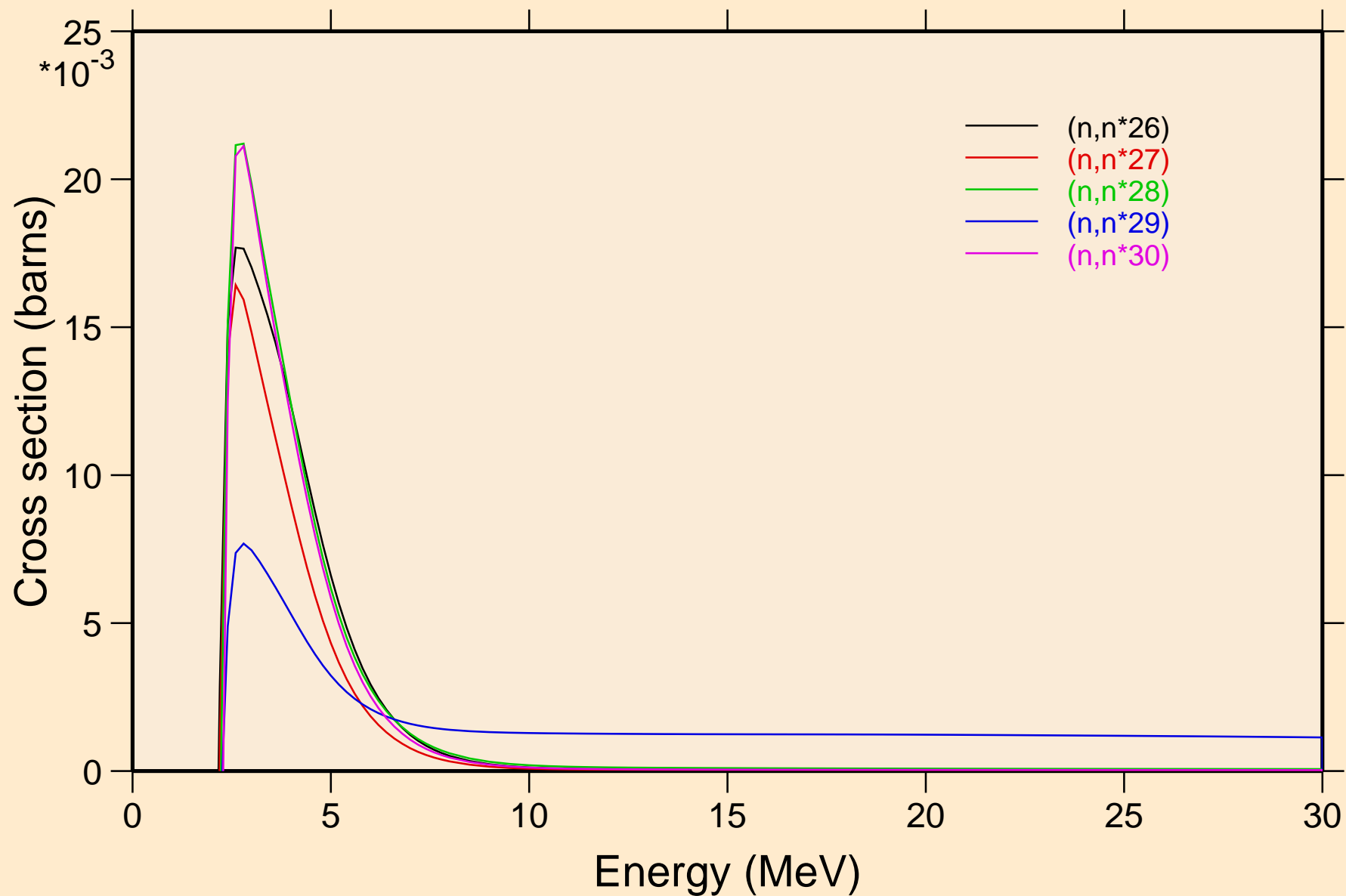

PD099 NEUTRON ACER TENDL-2019 LIBRARY; T=293.16K
Threshold reactions

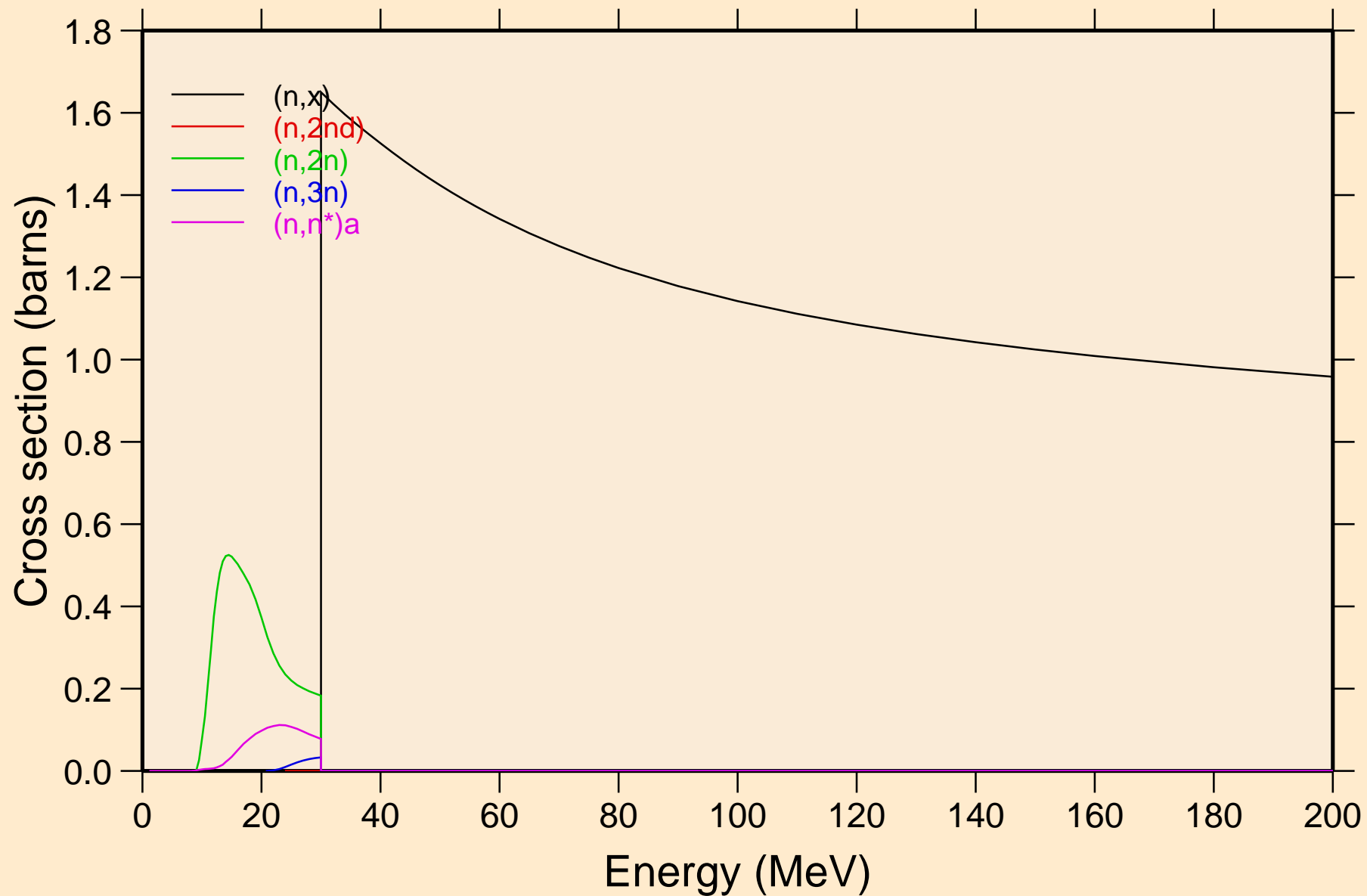

PD099 NEUTRON ACER TENDL-2019 LIBRARY; T=293.16K
Threshold reactions

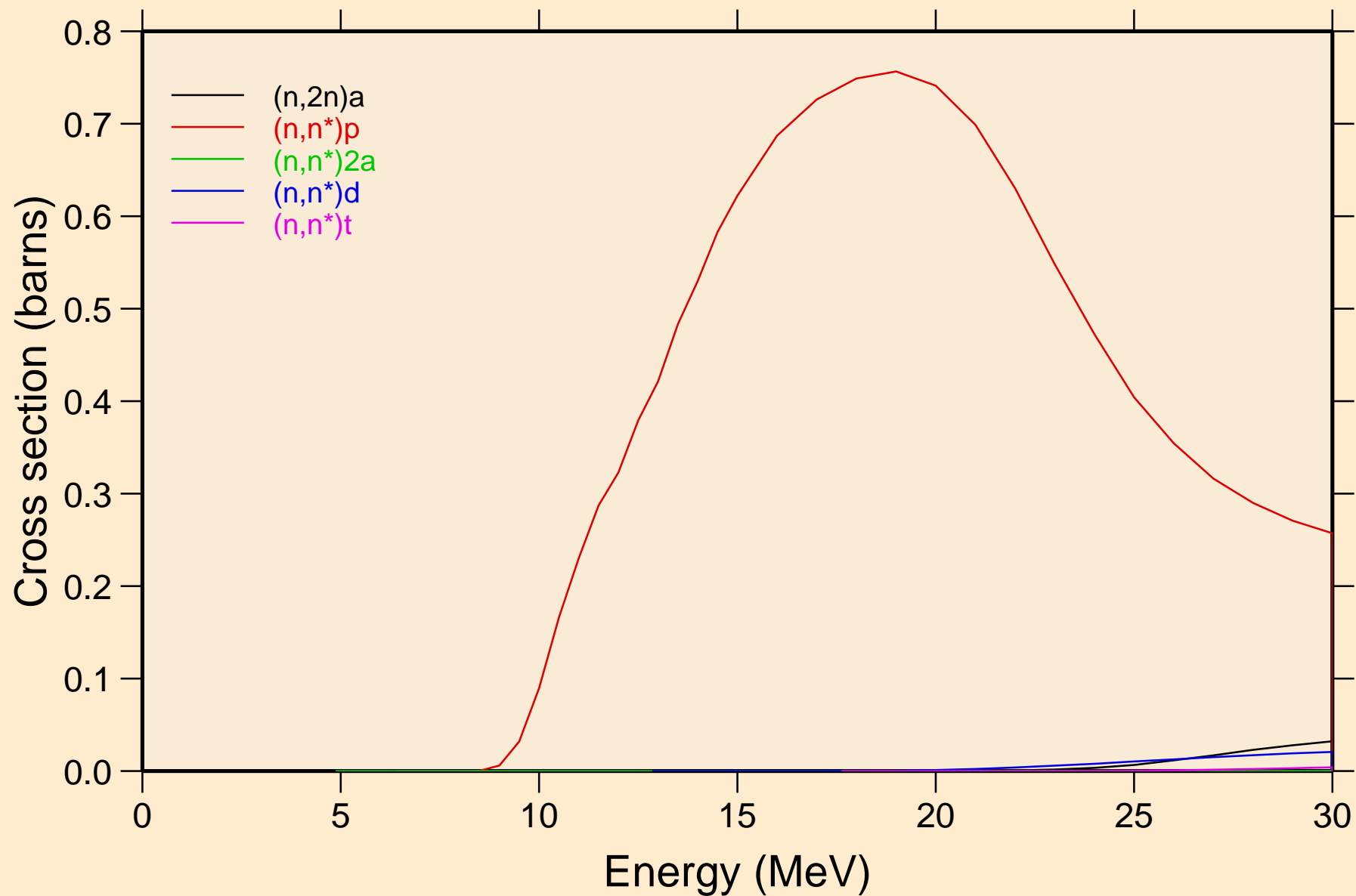

PD099 NEUTRON ACER TENDL-2019 LIBRARY; T=293.16K
Threshold reactions

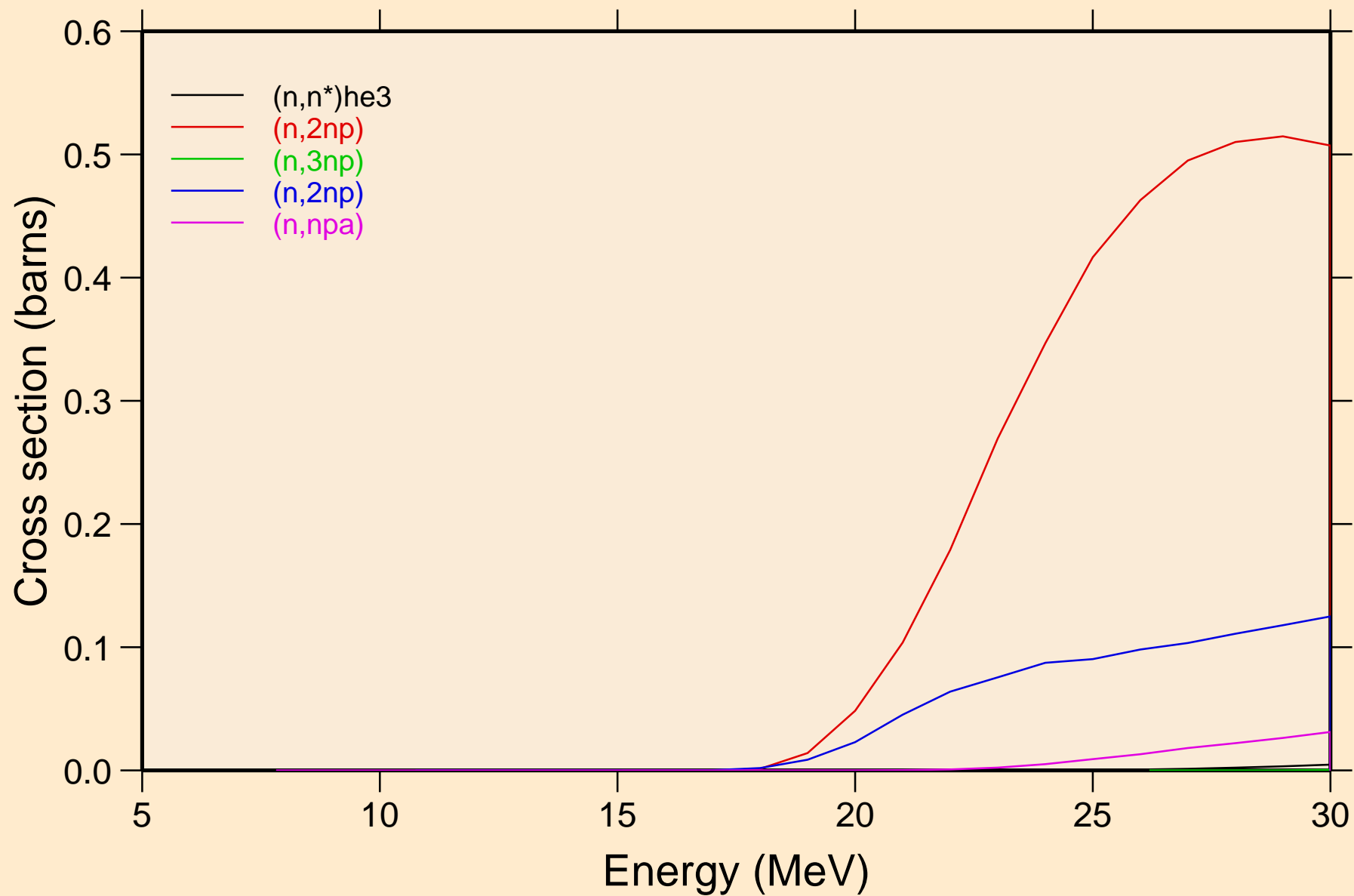

PD099 NEUTRON ACER TENDL-2019 LIBRARY; T=293.16K
Threshold reactions

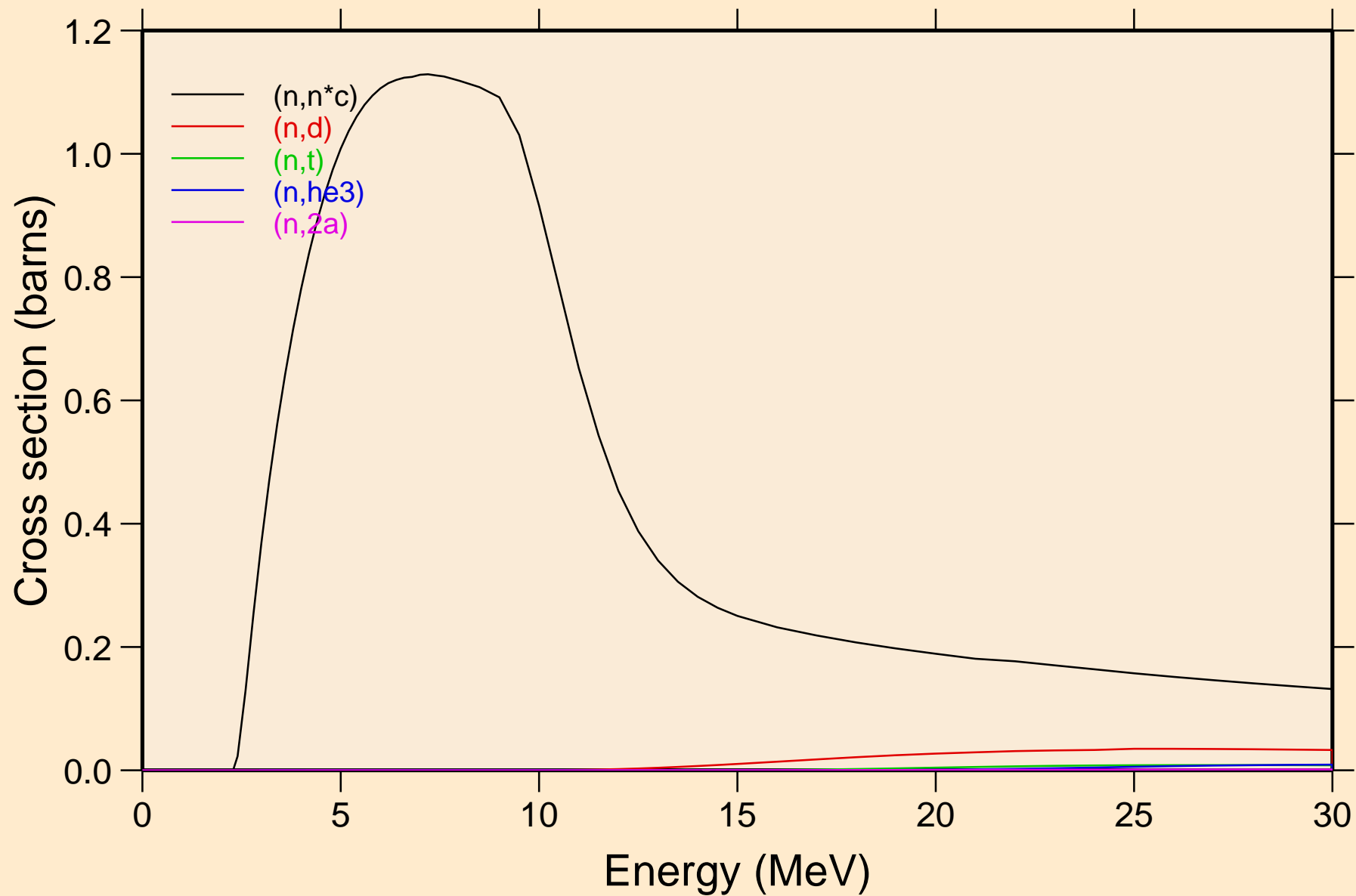

PD099 NEUTRON ACER TENDL-2019 LIBRARY; T=293.16K
Threshold reactions

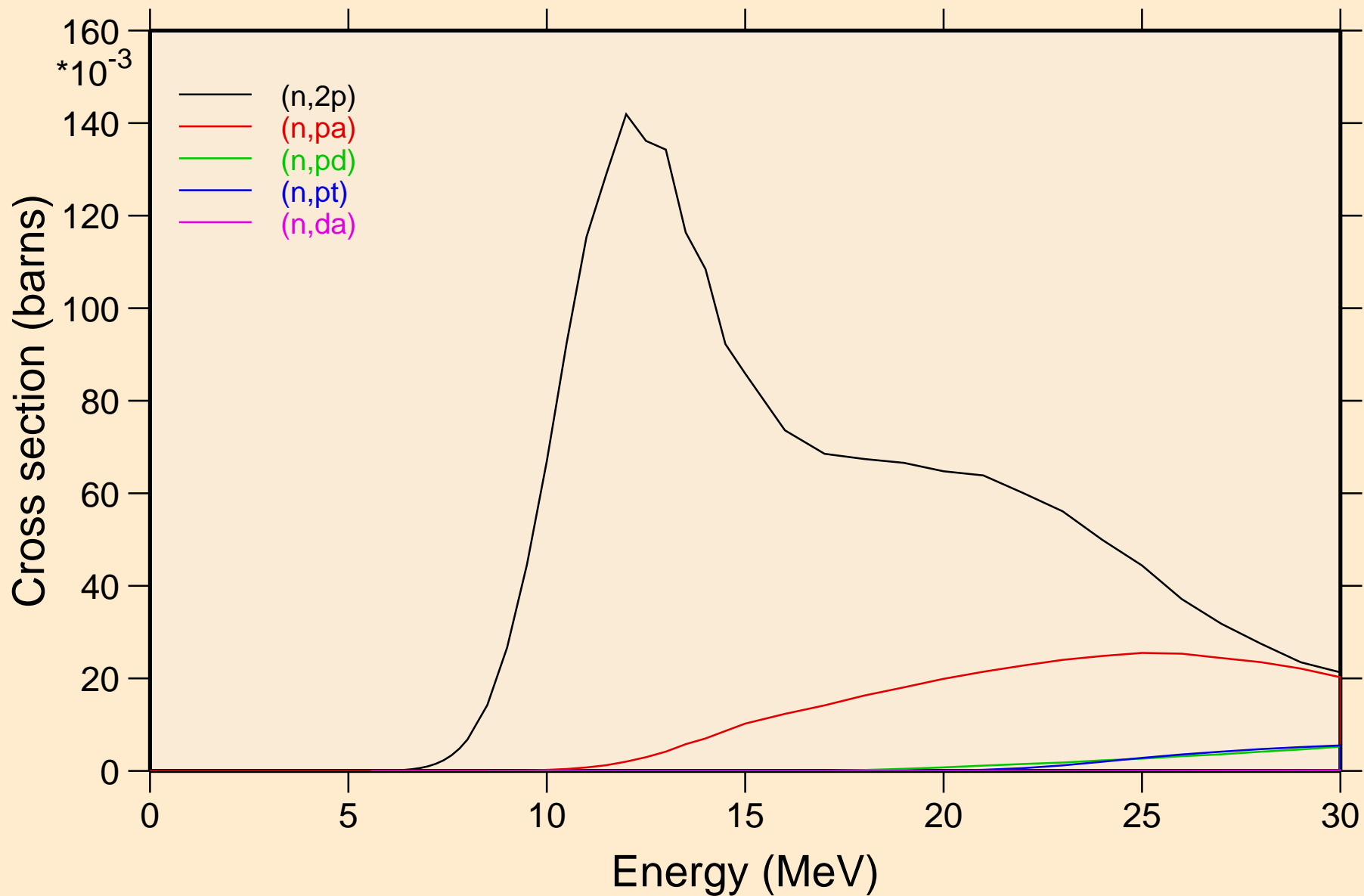

PD099 NEUTRON ACER TENDL-2019 LIBRARY; T=293.16K
Threshold reactions

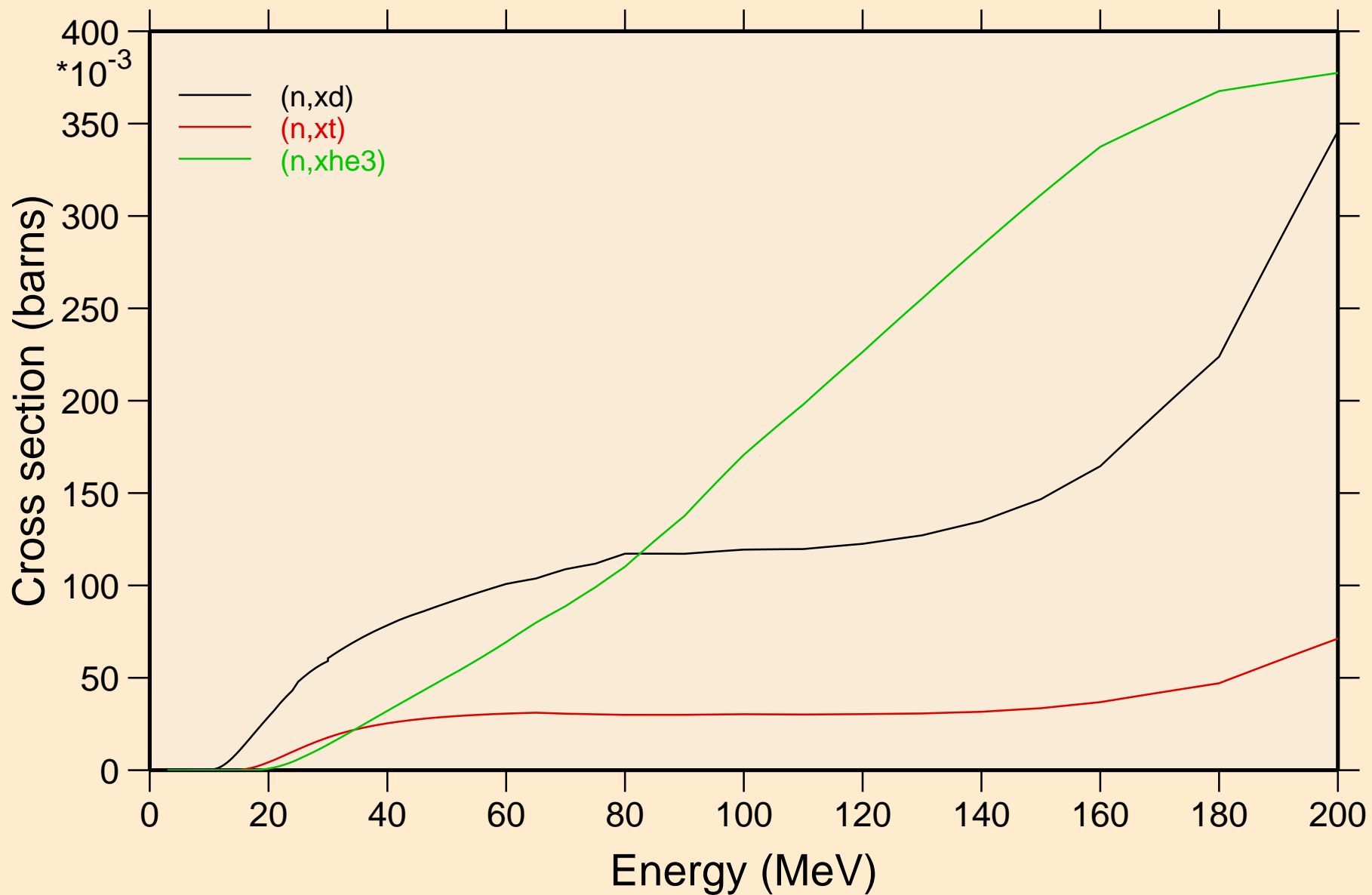

PD099 NEUTRON ACER TENDL-2019 LIBRARY; T=293.16K
angular distribution for elastic

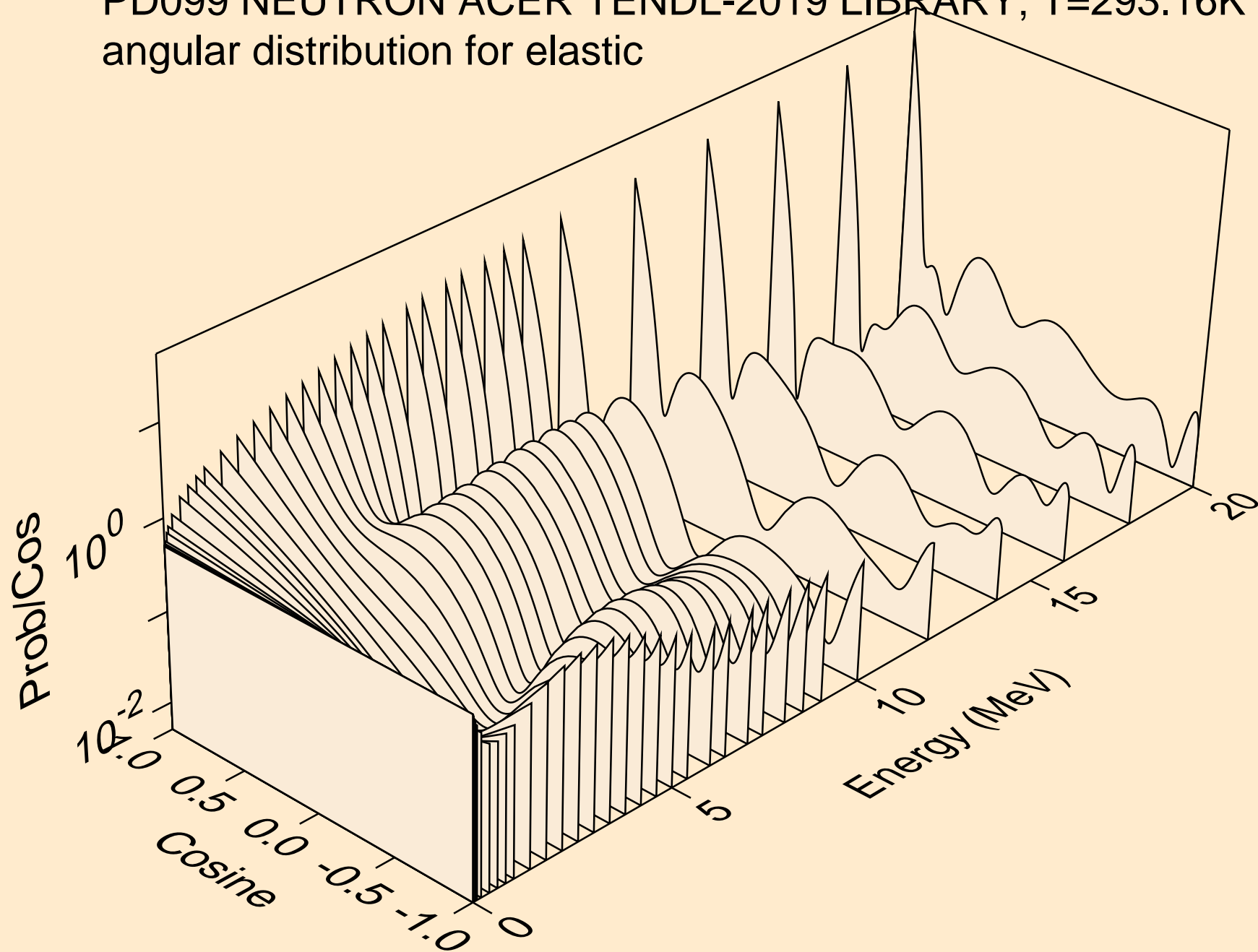

PD099 NEUTRON ACER TENDL-2019 LIBRARY; T=293.16K
angular distribution for elastic

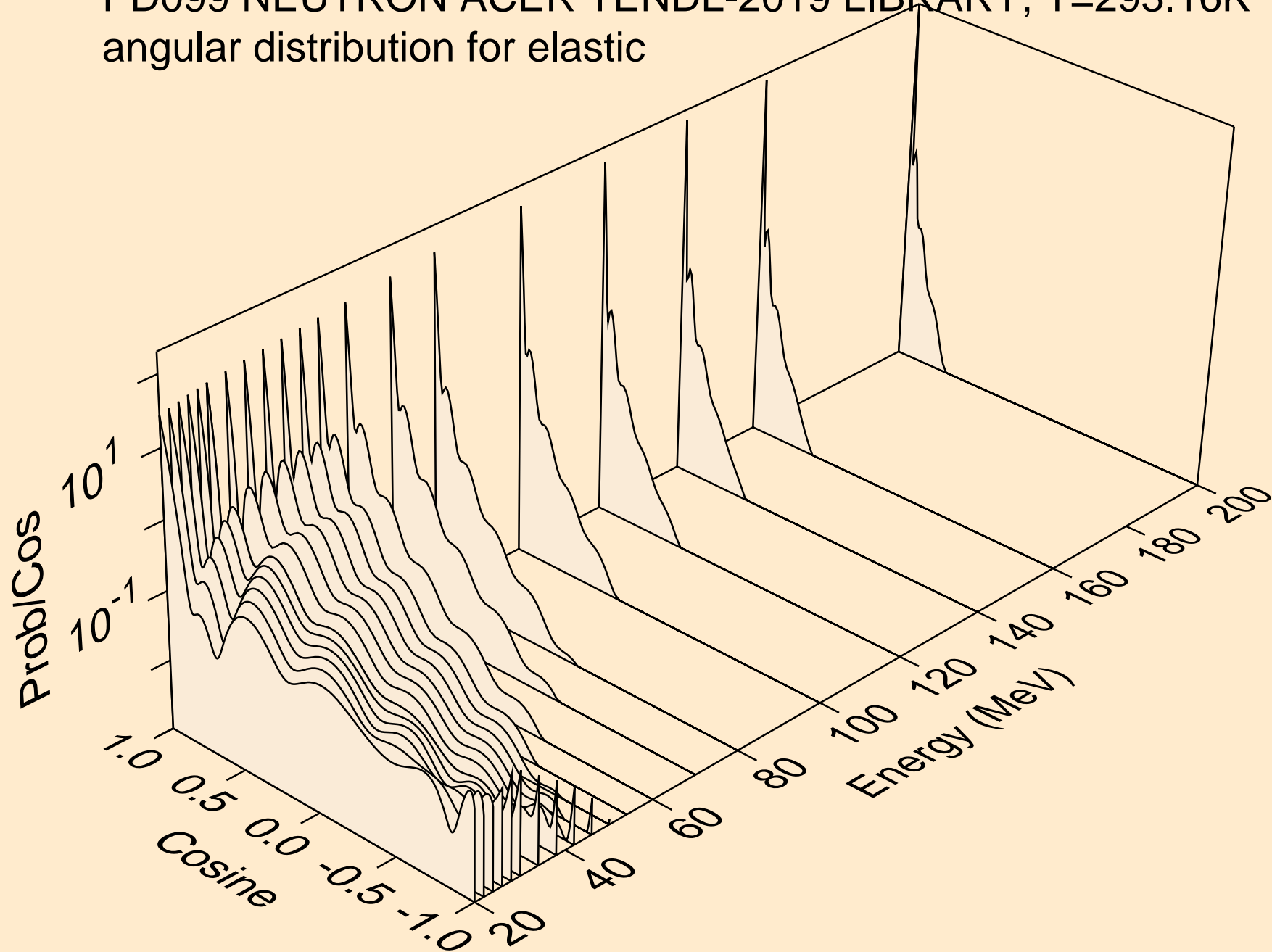

PD099 NEUTRON ACER TENDL-2019 LIBRARY; T=293.16K
angular distribution for (n,n*1)

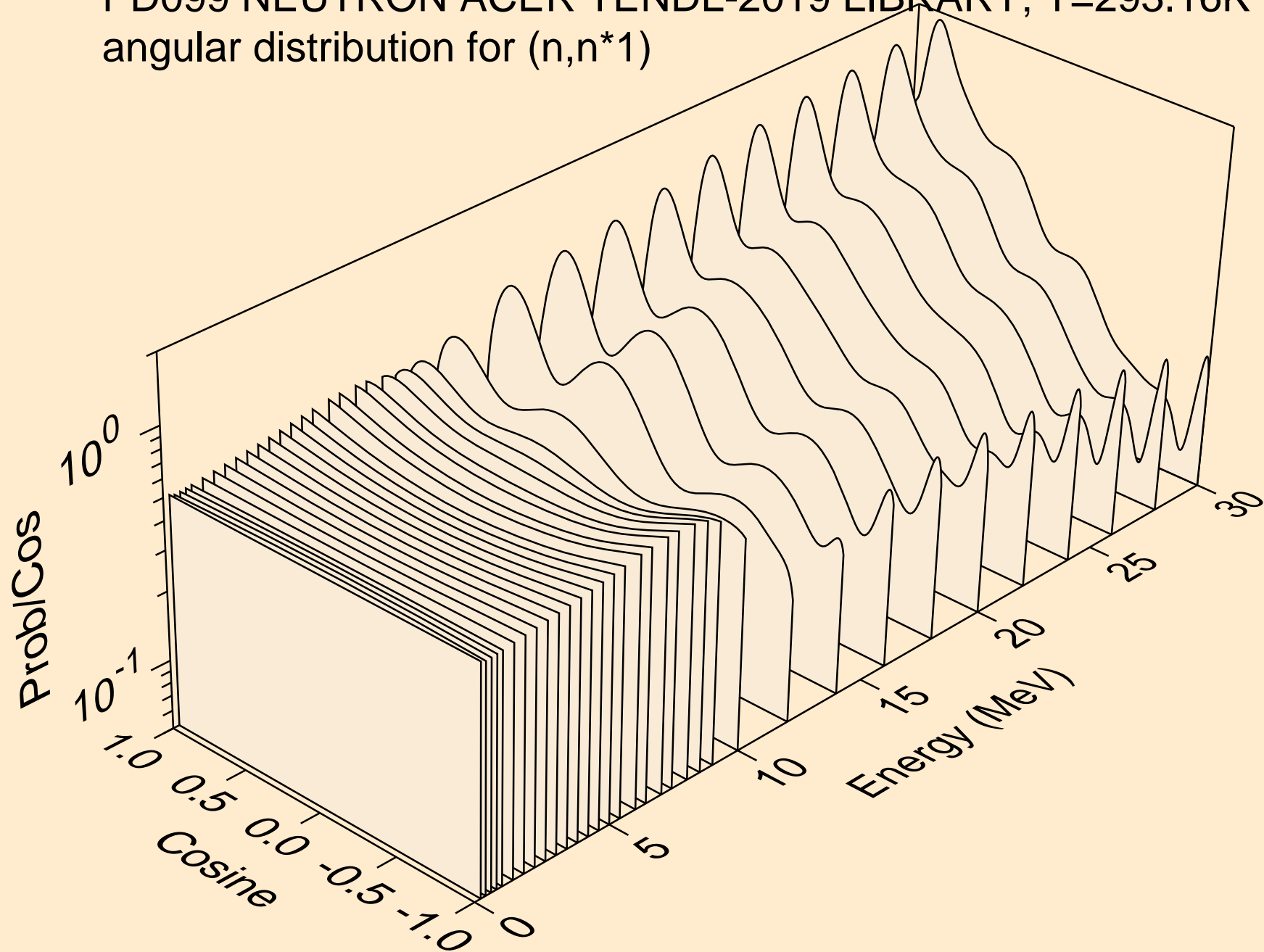

PD099 NEUTRON ACER TENDL-2019 LIBRARY; T=293.16K
angular distribution for (n,n*2)

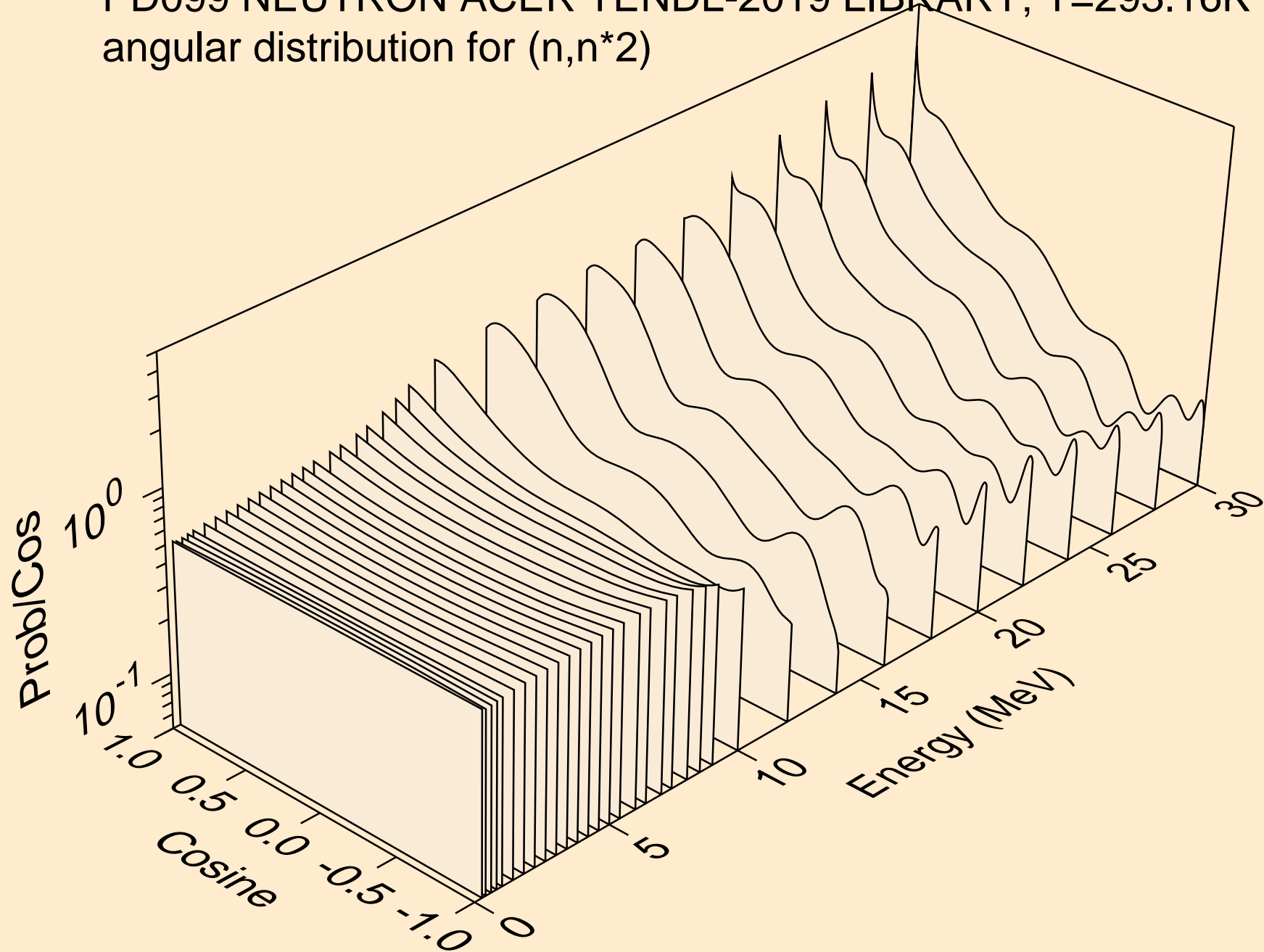

PD099 NEUTRON ACER TENDL-2019 LIBRARY; T=293.16K
angular distribution for (n,n*3)

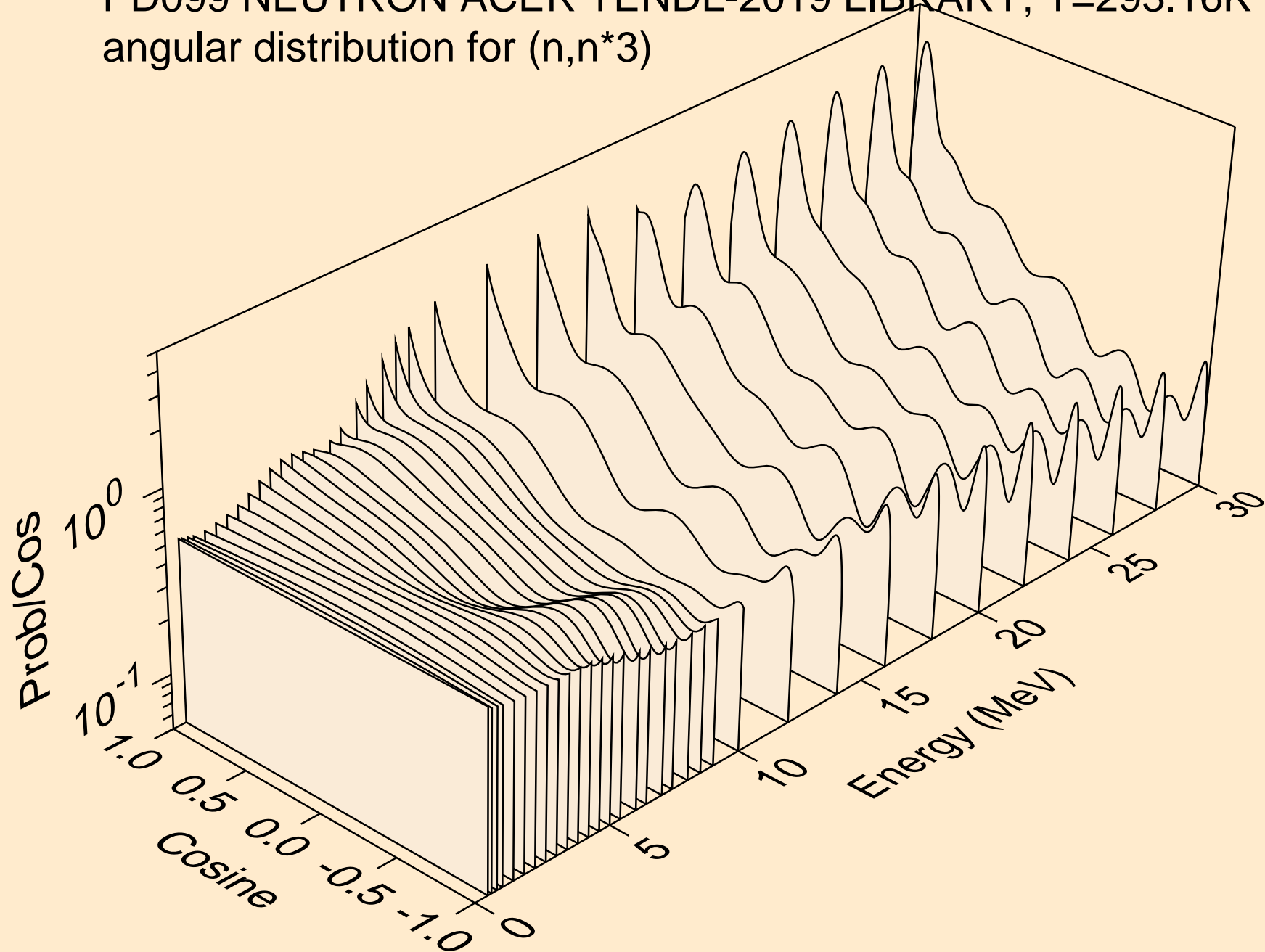

PD099 NEUTRON ACER TENDL-2019 LIBRARY; T=293.16K
angular distribution for (n,n*4)

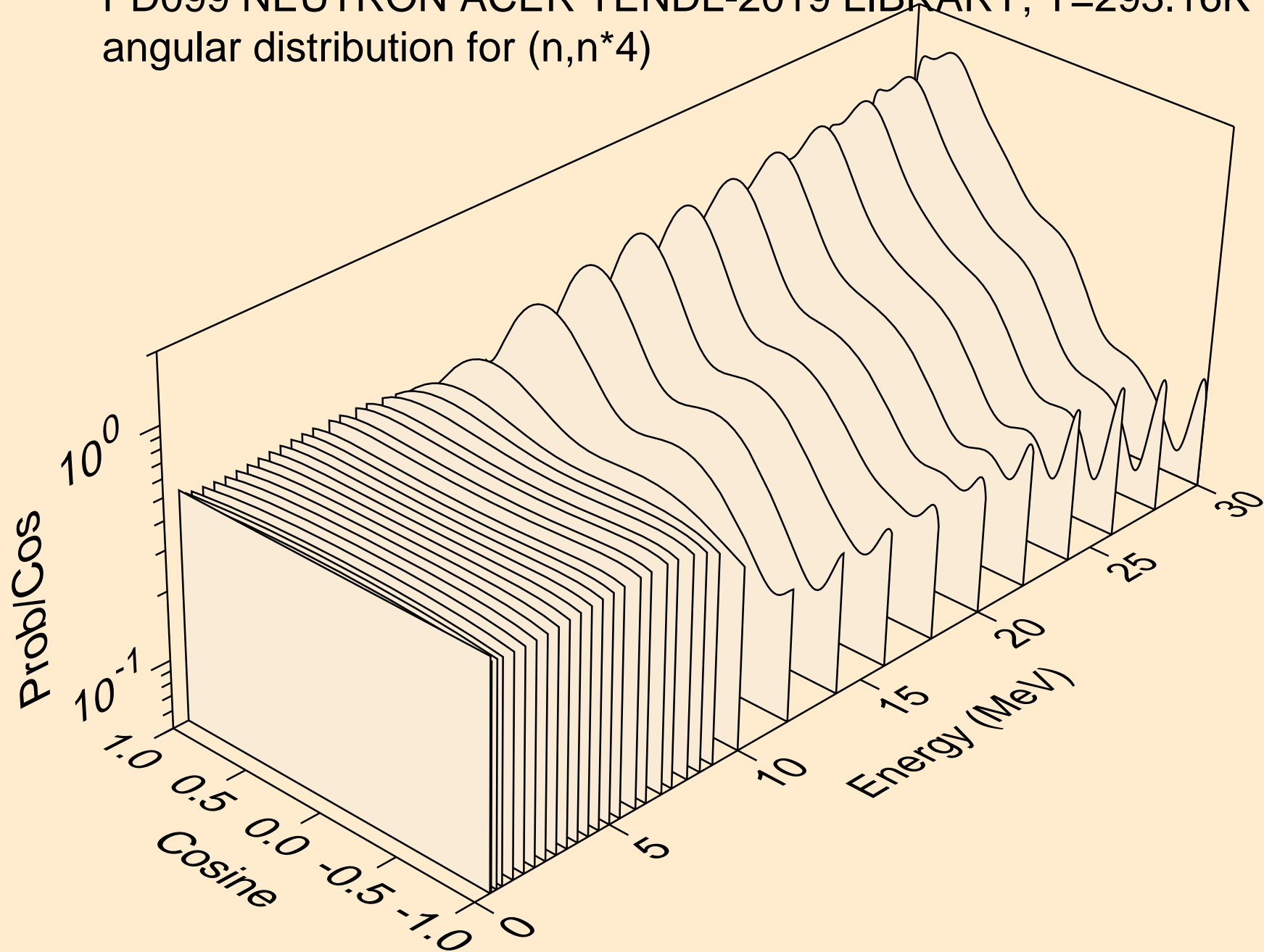

PD099 NEUTRON ACER TENDL-2019 LIBRARY; T=293.16K
angular distribution for (n,n*5)

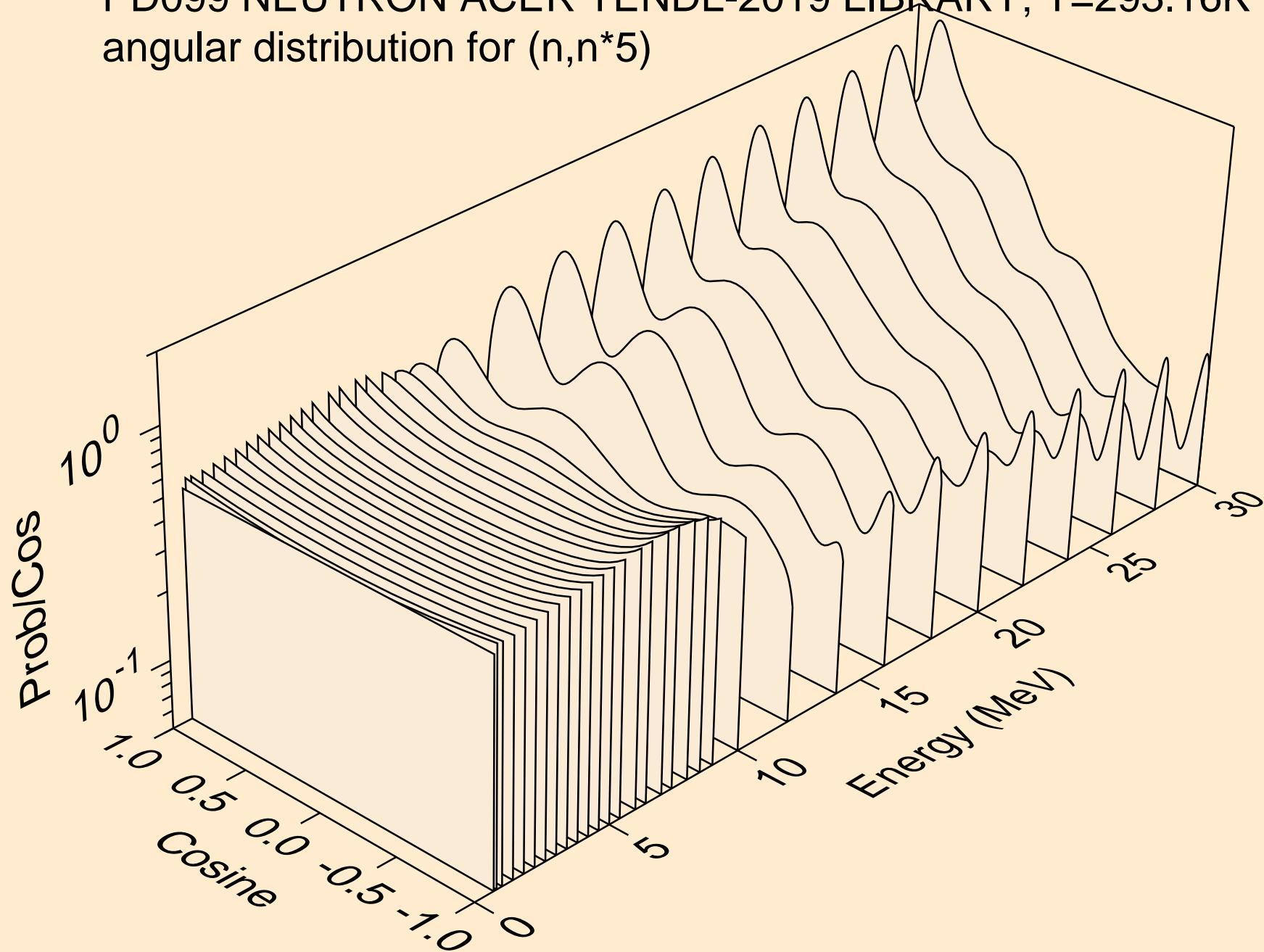

PD099 NEUTRON ACER TENDL-2019 LIBRARY; T=293.16K
angular distribution for (n,n*6)

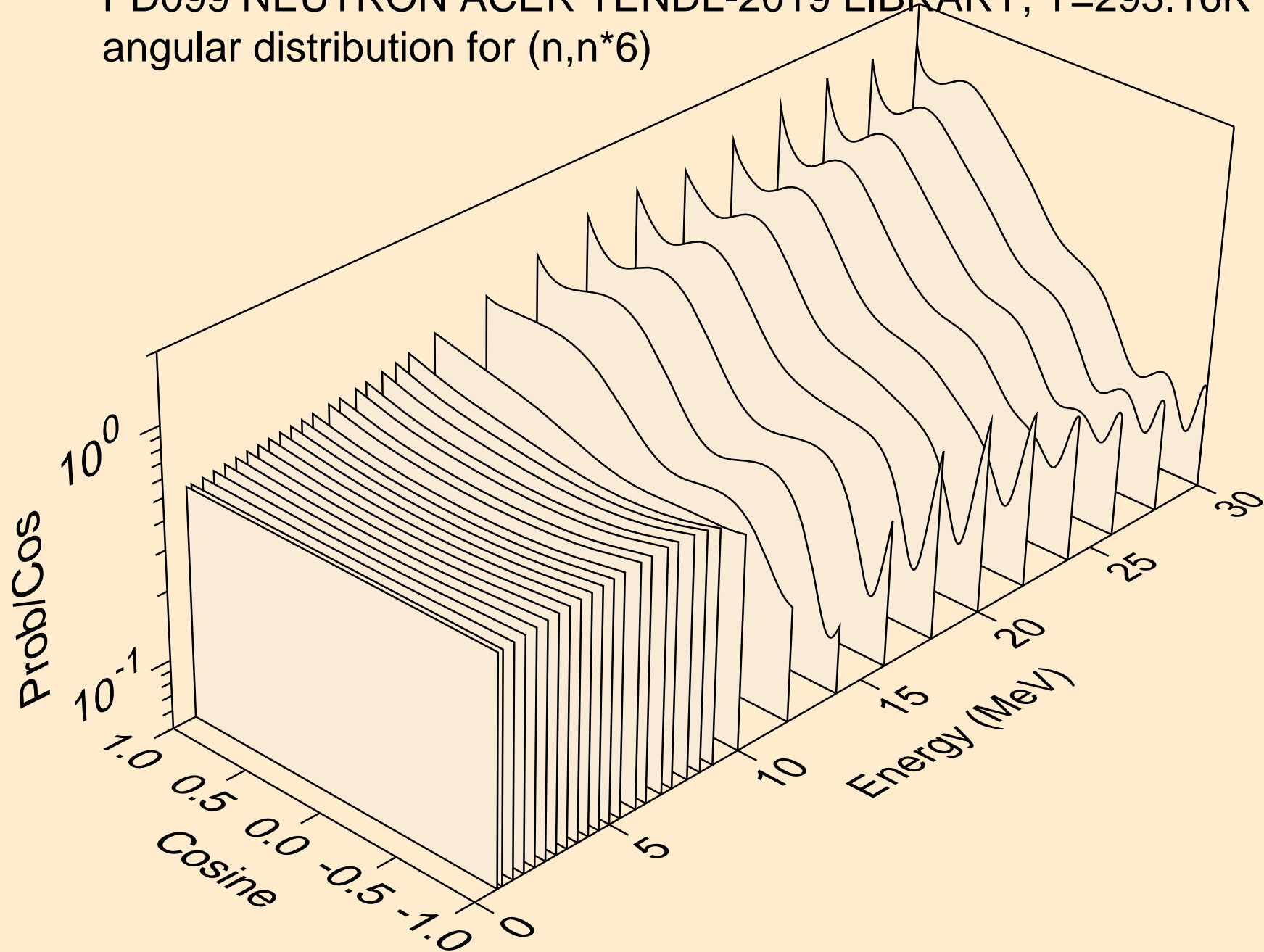

PD099 NEUTRON ACER TENDL-2019 LIBRARY; T=293.16K
angular distribution for (n,n*7)

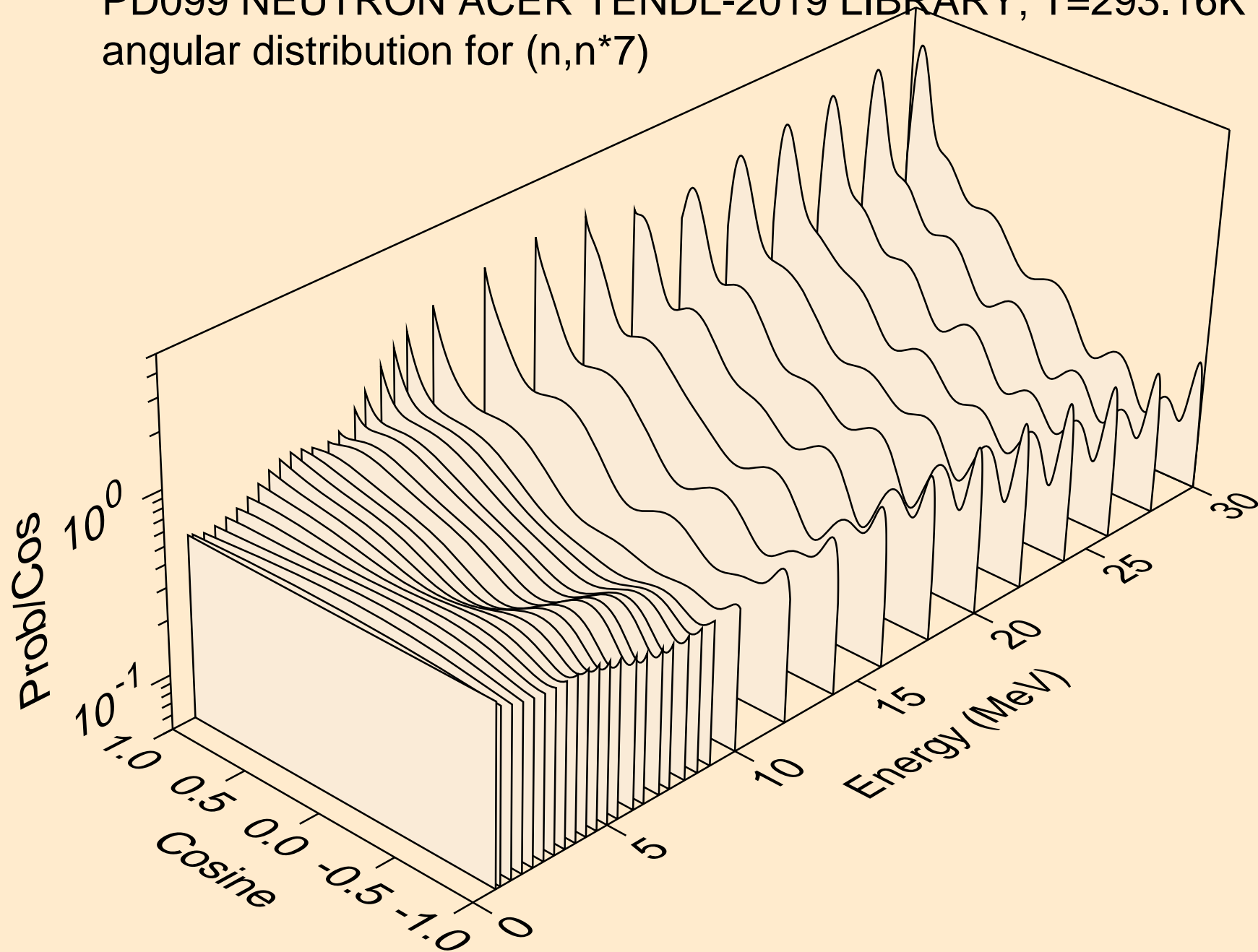

PD099 NEUTRON ACER TENDL-2019 LIBRARY; T=293.16K
angular distribution for (n,n*8)

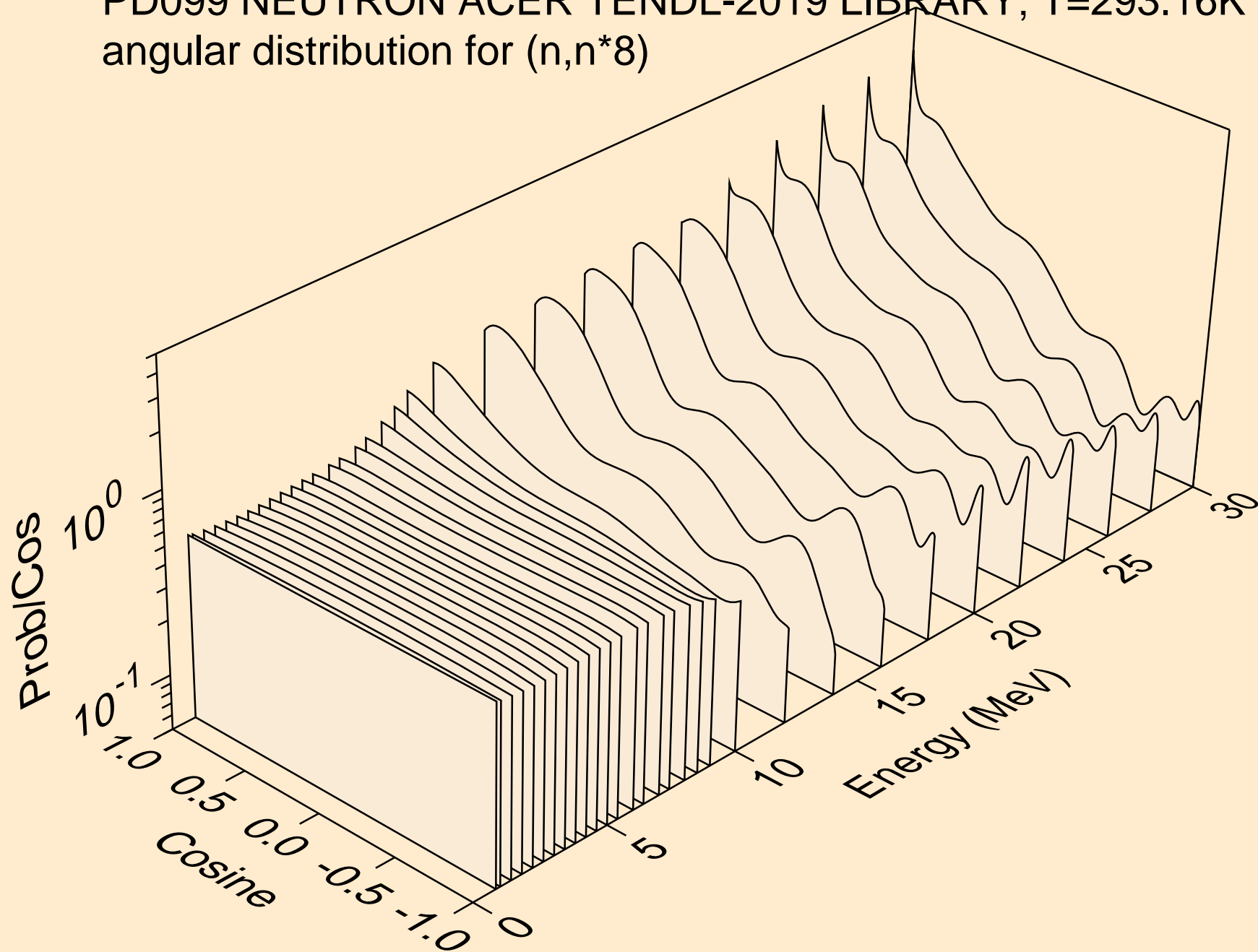

PD099 NEUTRON ACER TENDL-2019 LIBRARY; T=293.16K
angular distribution for (n,n*9)

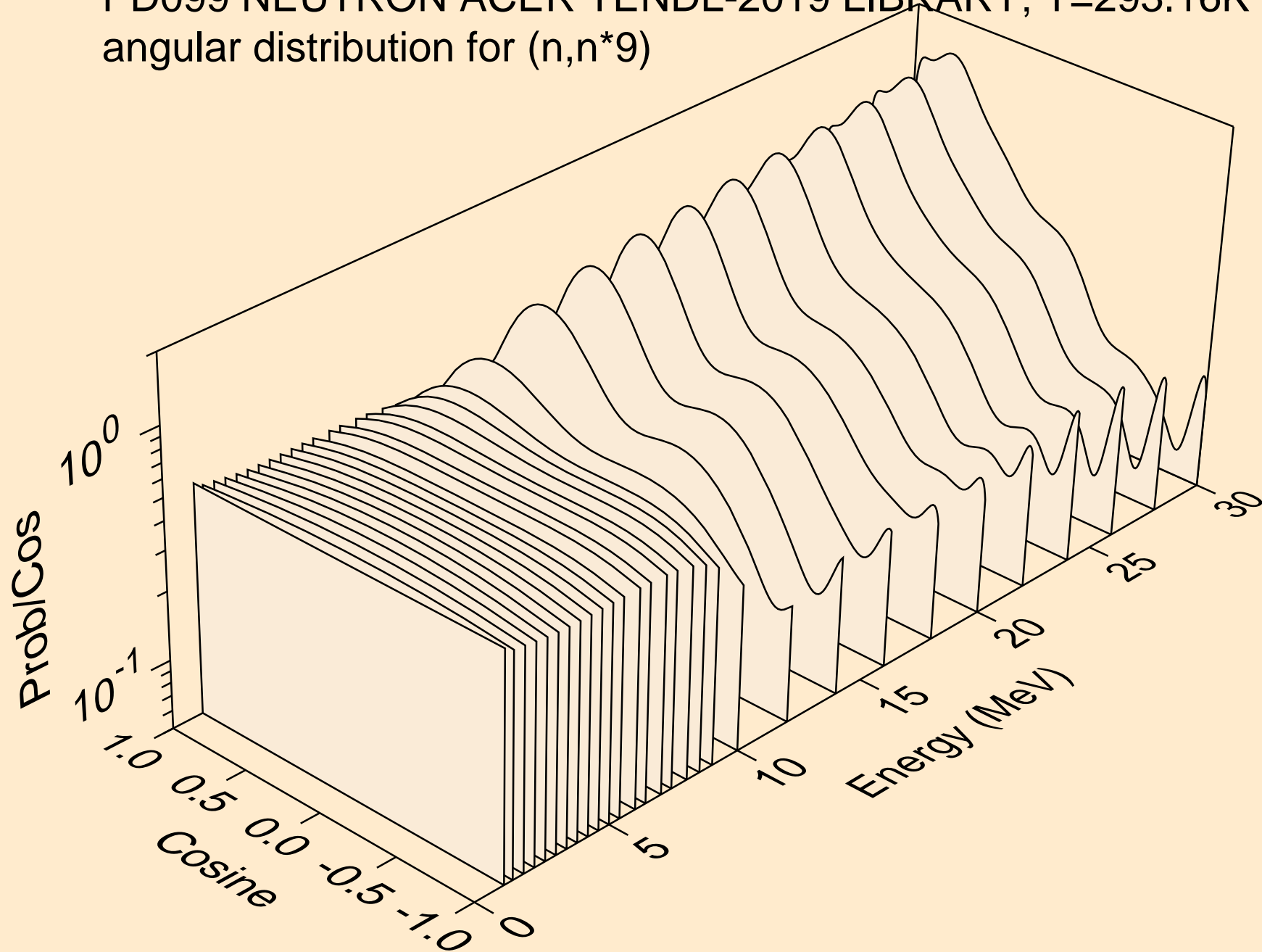

PD099 NEUTRON ACER TENDL-2019 LIBRARY; T=293.16K
angular distribution for (n,n*10)

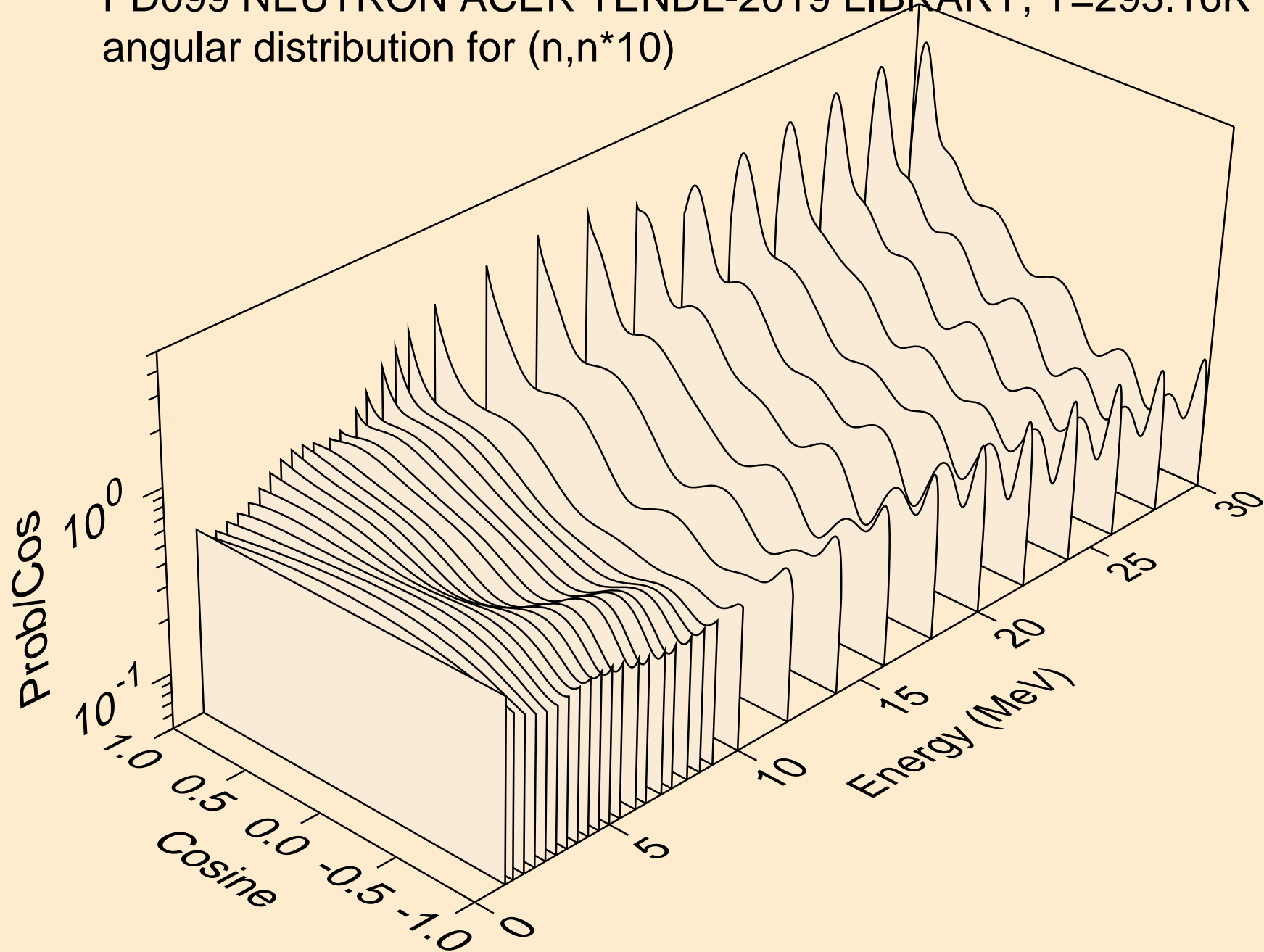

PD099 NEUTRON ACER TENDL-2019 LIBRARY; T=293.16K
angular distribution for (n,n*11)

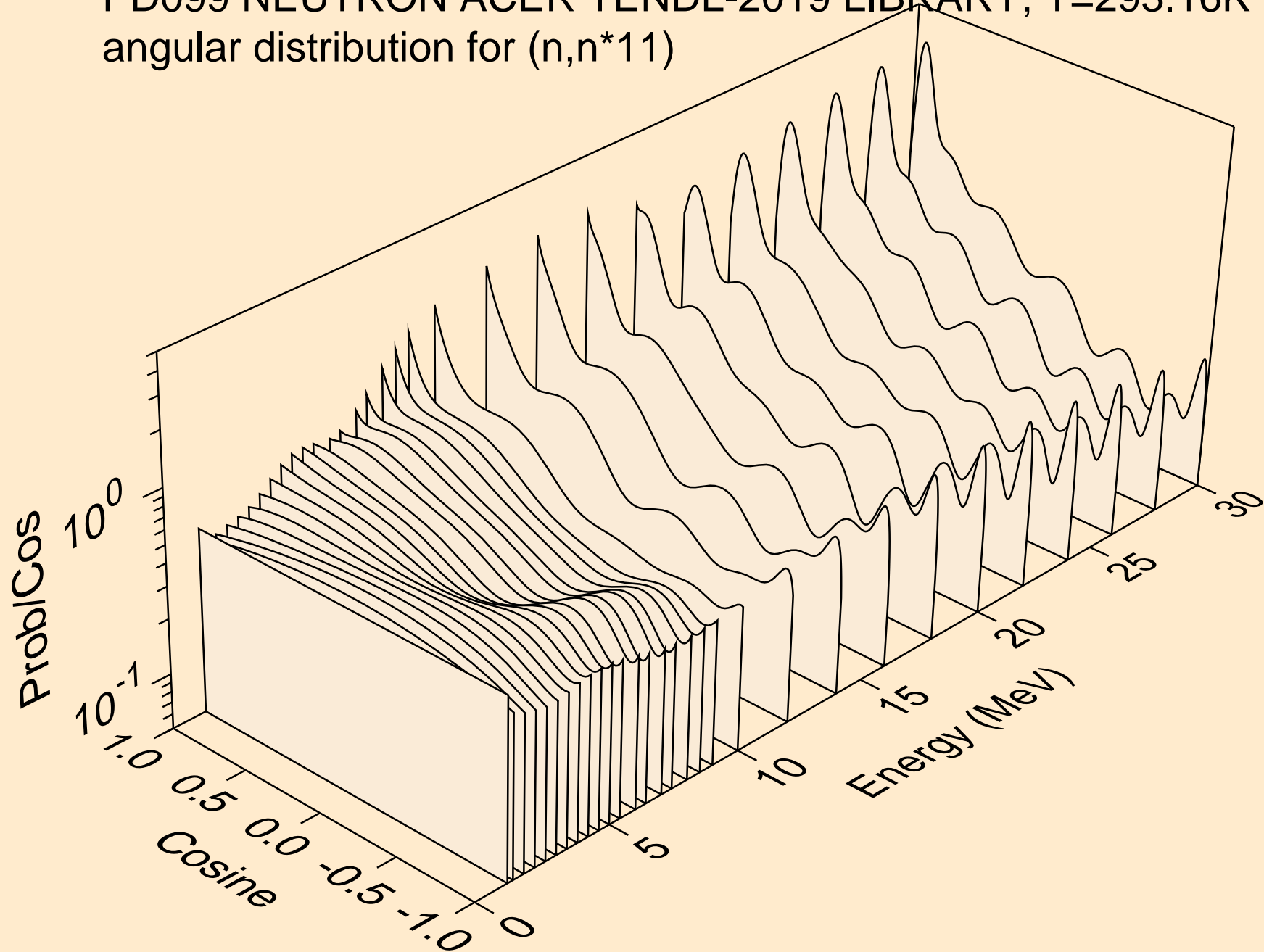

PD099 NEUTRON ACER TENDL-2019 LIBRARY; T=293.16K
angular distribution for (n,n*12)

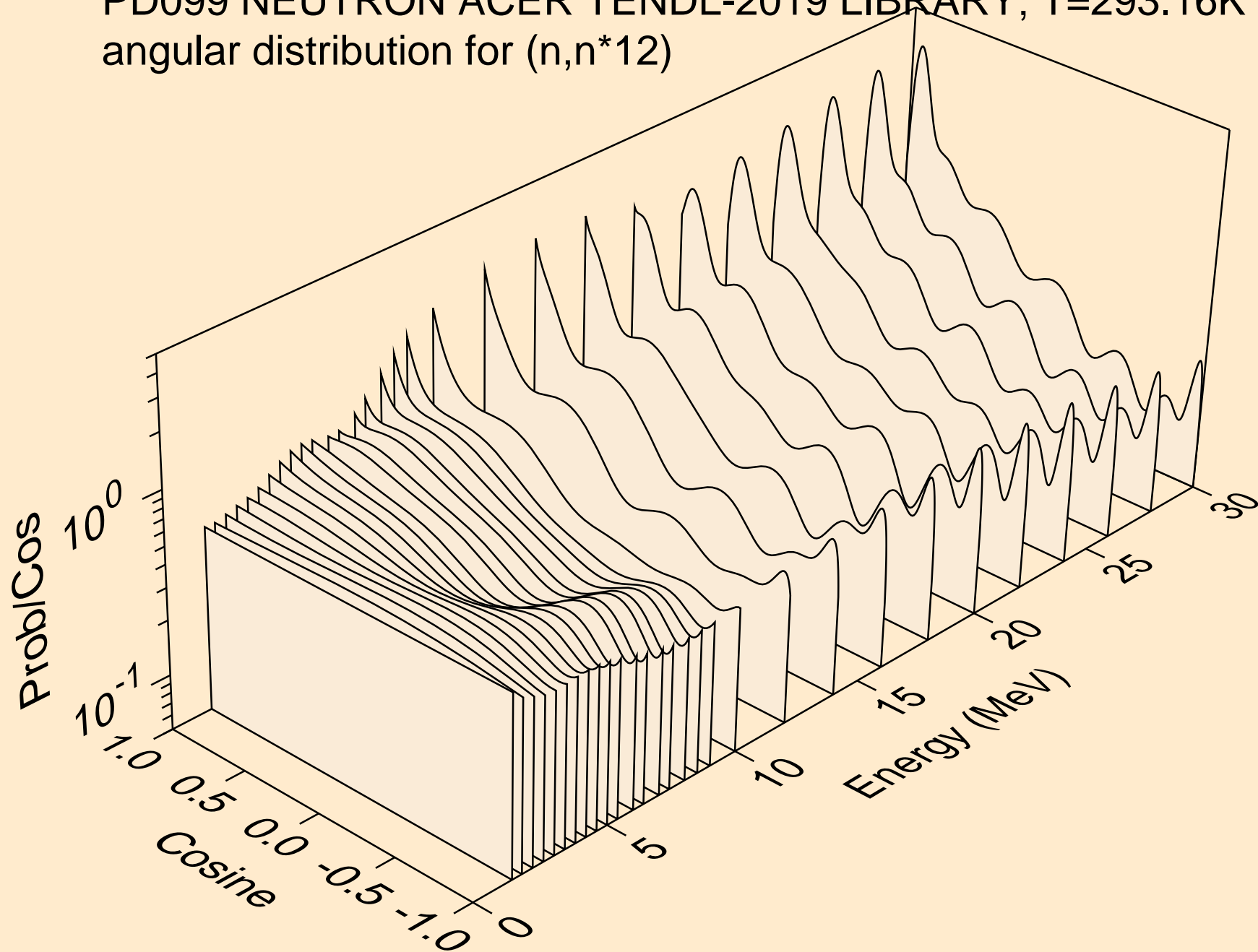

PD099 NEUTRON ACER TENDL-2019 LIBRARY; T=293.16K
angular distribution for (n,n*13)

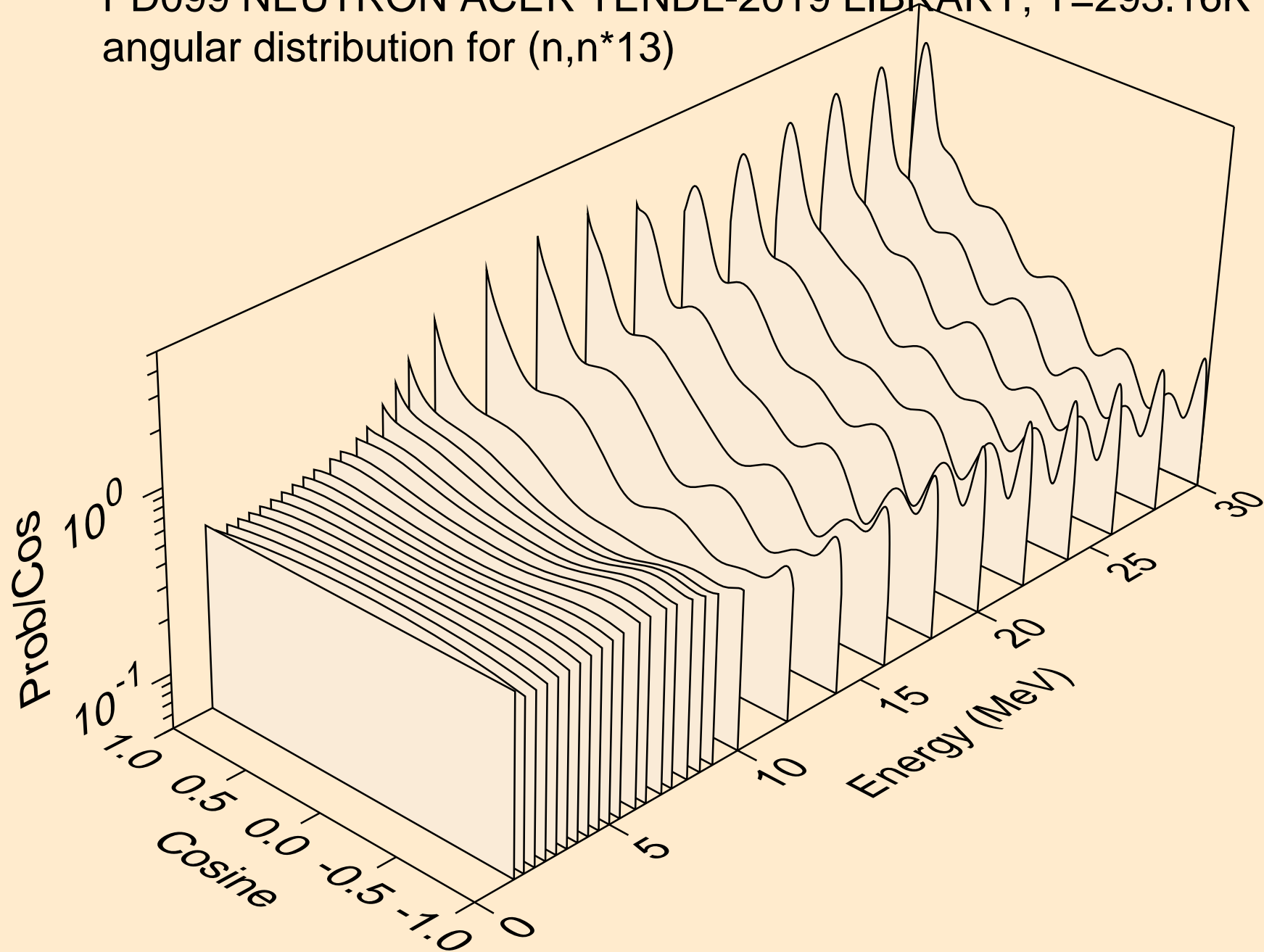

PD099 NEUTRON ACER TENDL-2019 LIBRARY; T=293.16K
angular distribution for (n,n*14)

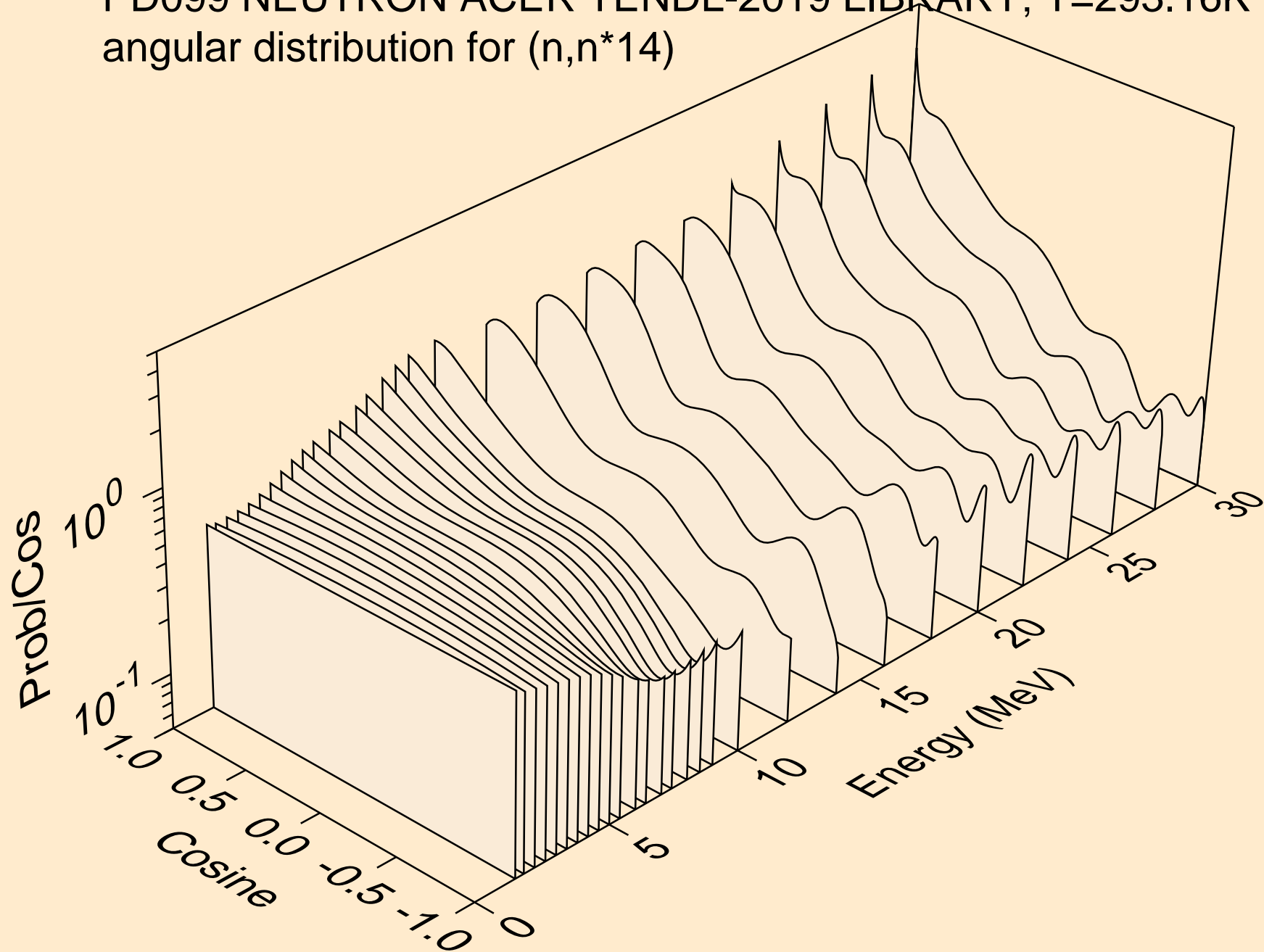

PD099 NEUTRON ACER TENDL-2019 LIBRARY; T=293.16K
angular distribution for (n,n*15)

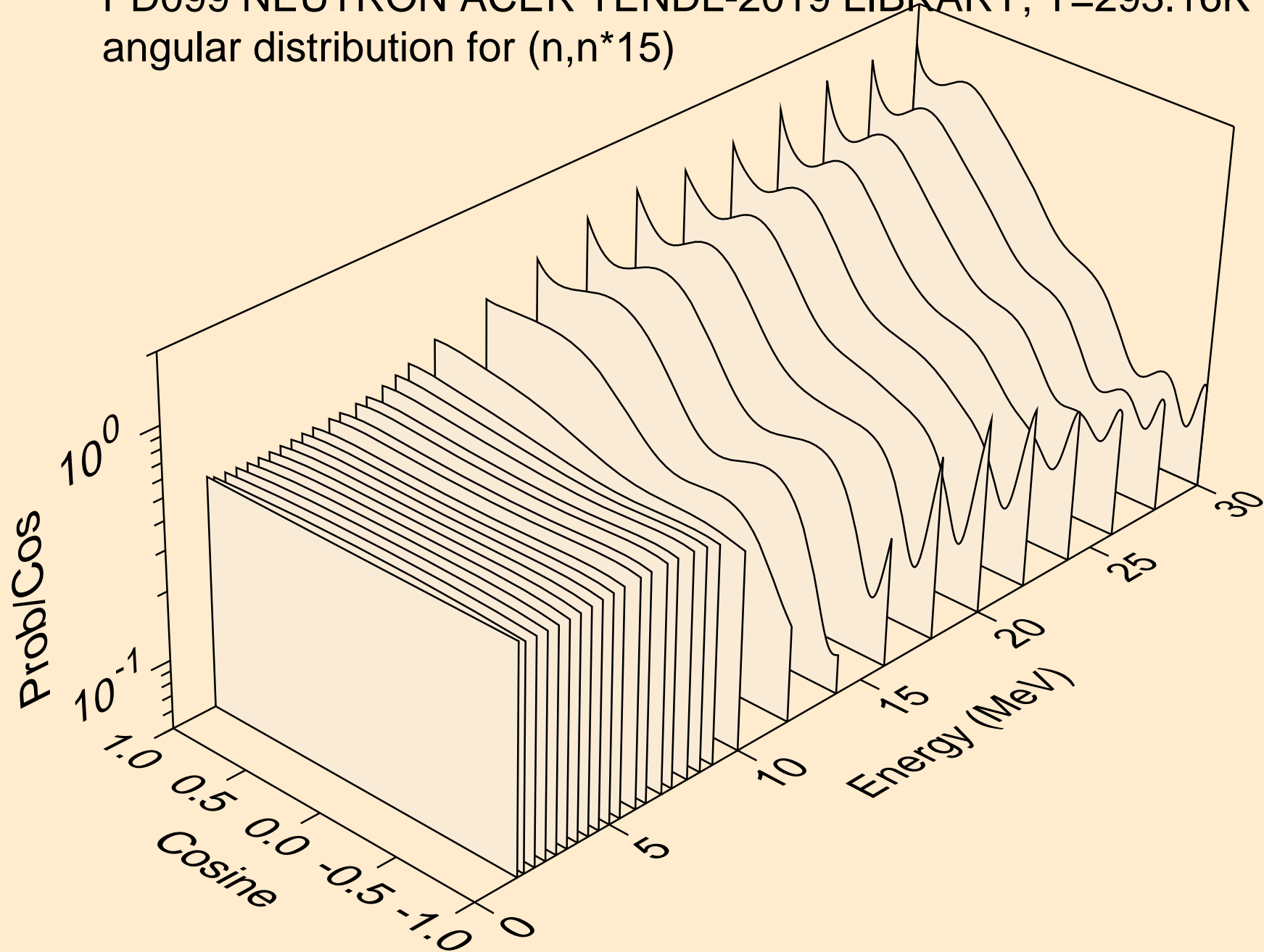

PD099 NEUTRON ACER TENDL-2019 LIBRARY; T=293.16K
angular distribution for (n,n*16)

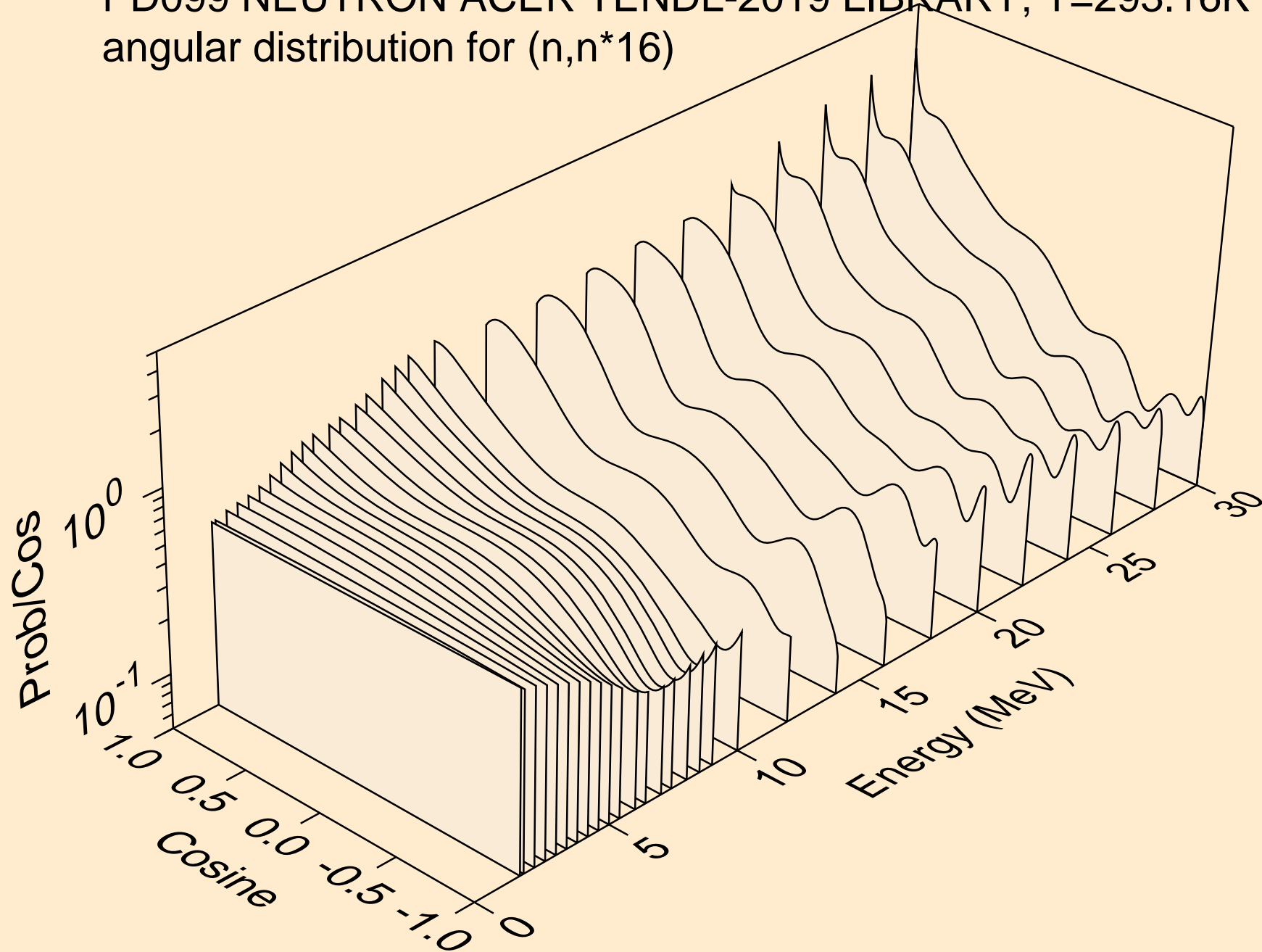

PD099 NEUTRON ACER TENDL-2019 LIBRARY; T=293.16K
angular distribution for (n,n*17)

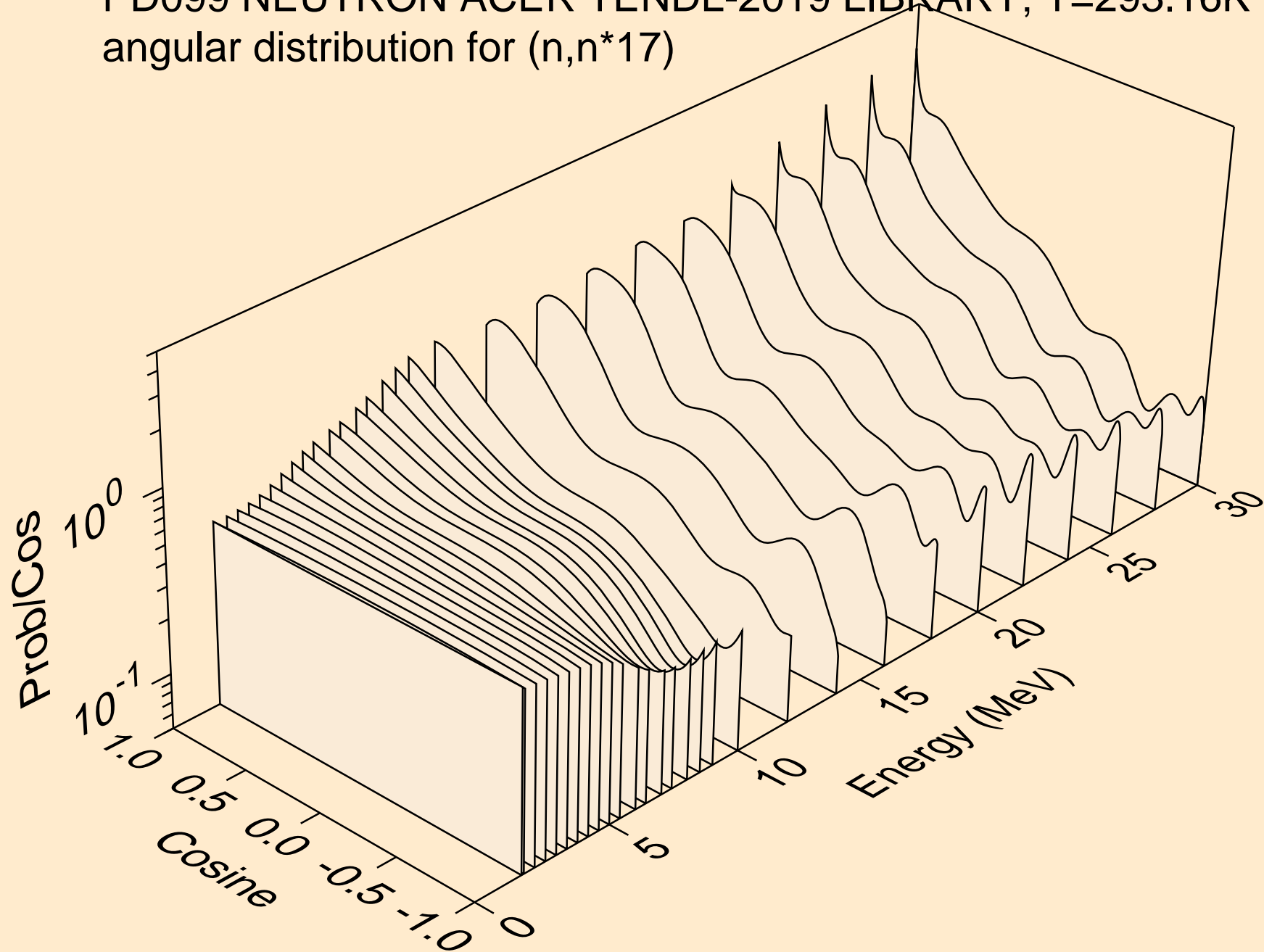

PD099 NEUTRON ACER TENDL-2019 LIBRARY; T=293.16K
angular distribution for (n,n*18)

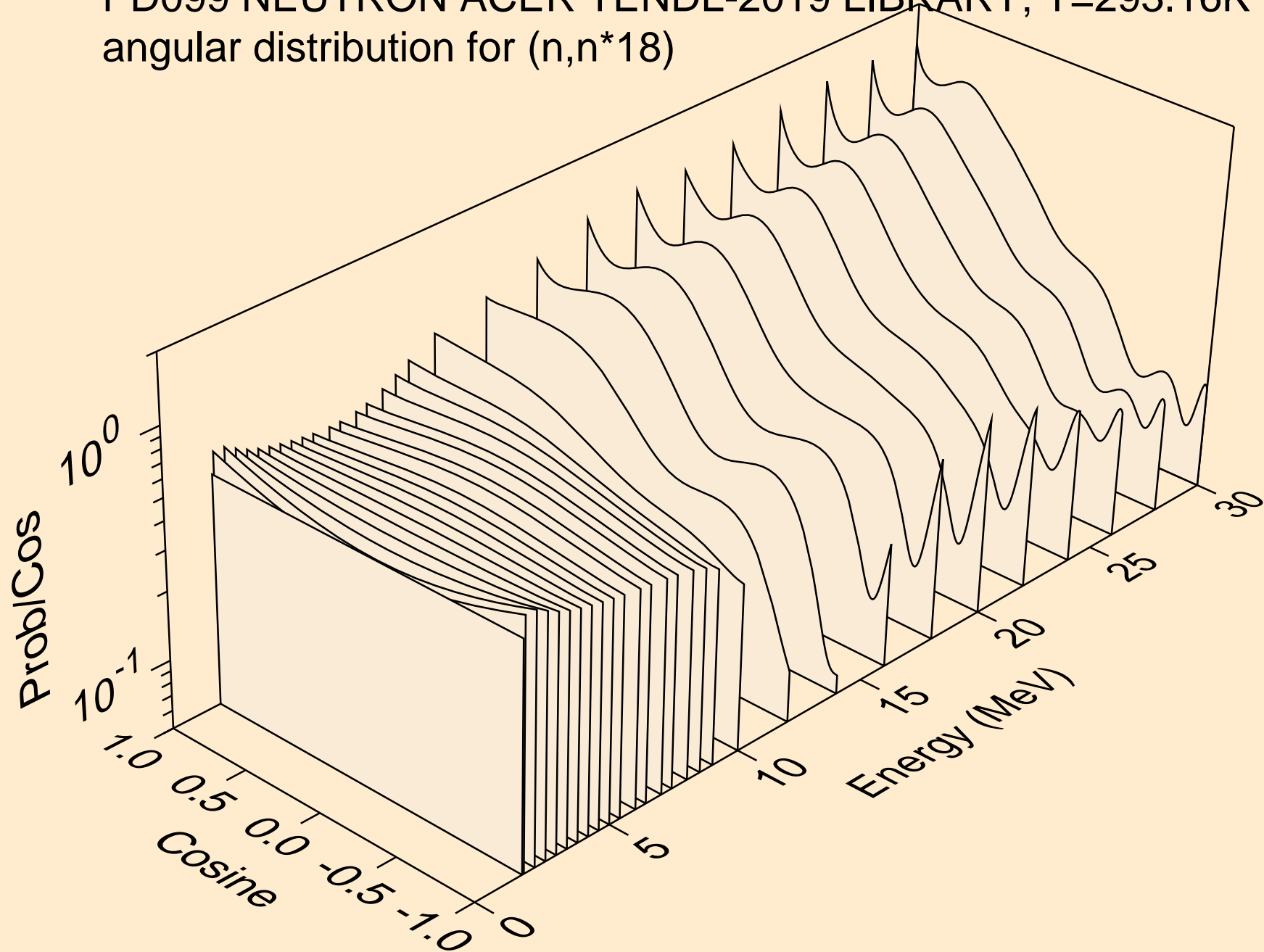

PD099 NEUTRON ACER TENDL-2019 LIBRARY; T=293.16K
angular distribution for (n,n*19)

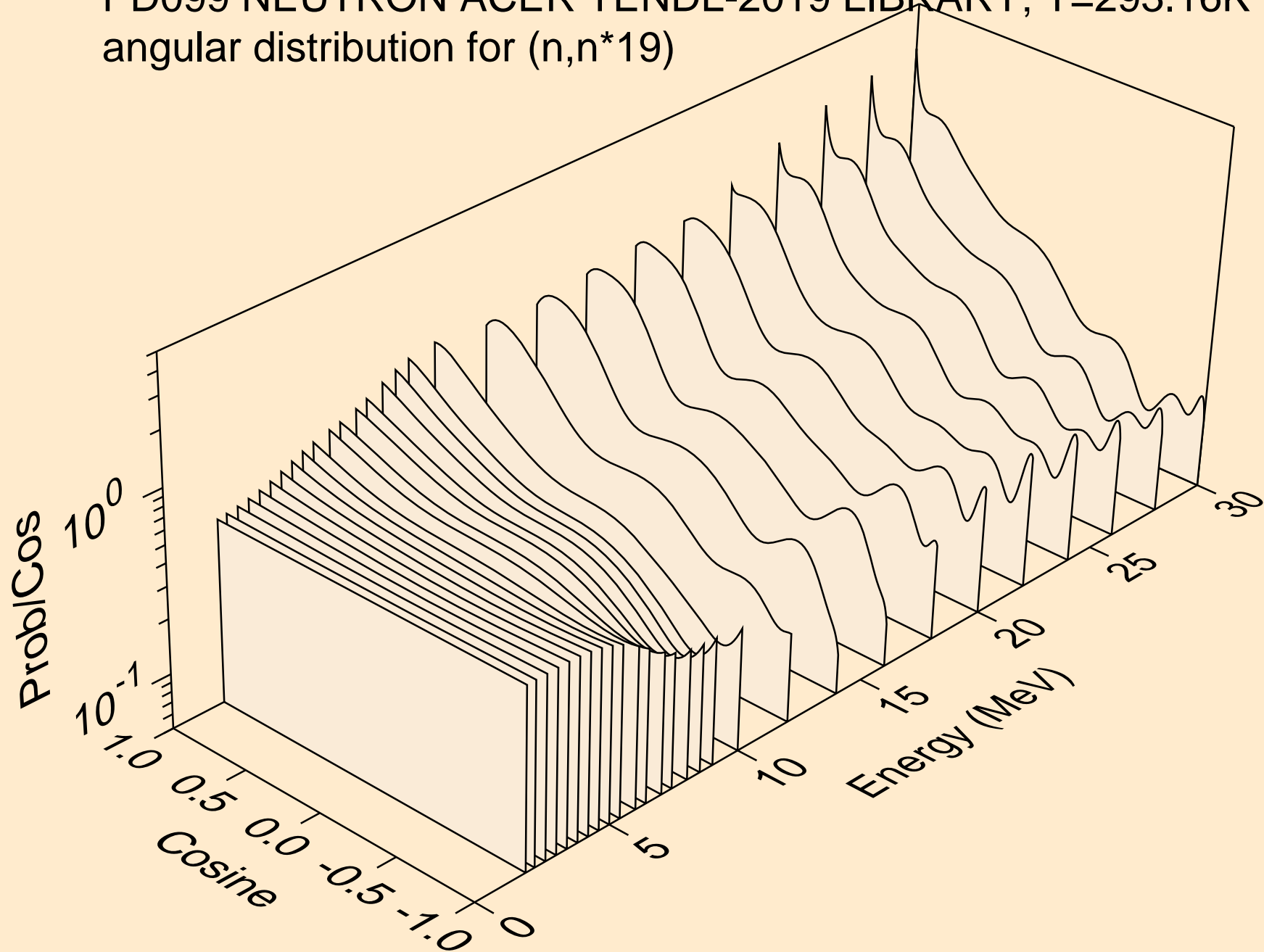

PD099 NEUTRON ACER TENDL-2019 LIBRARY; T=293.16K
angular distribution for (n,n*20)

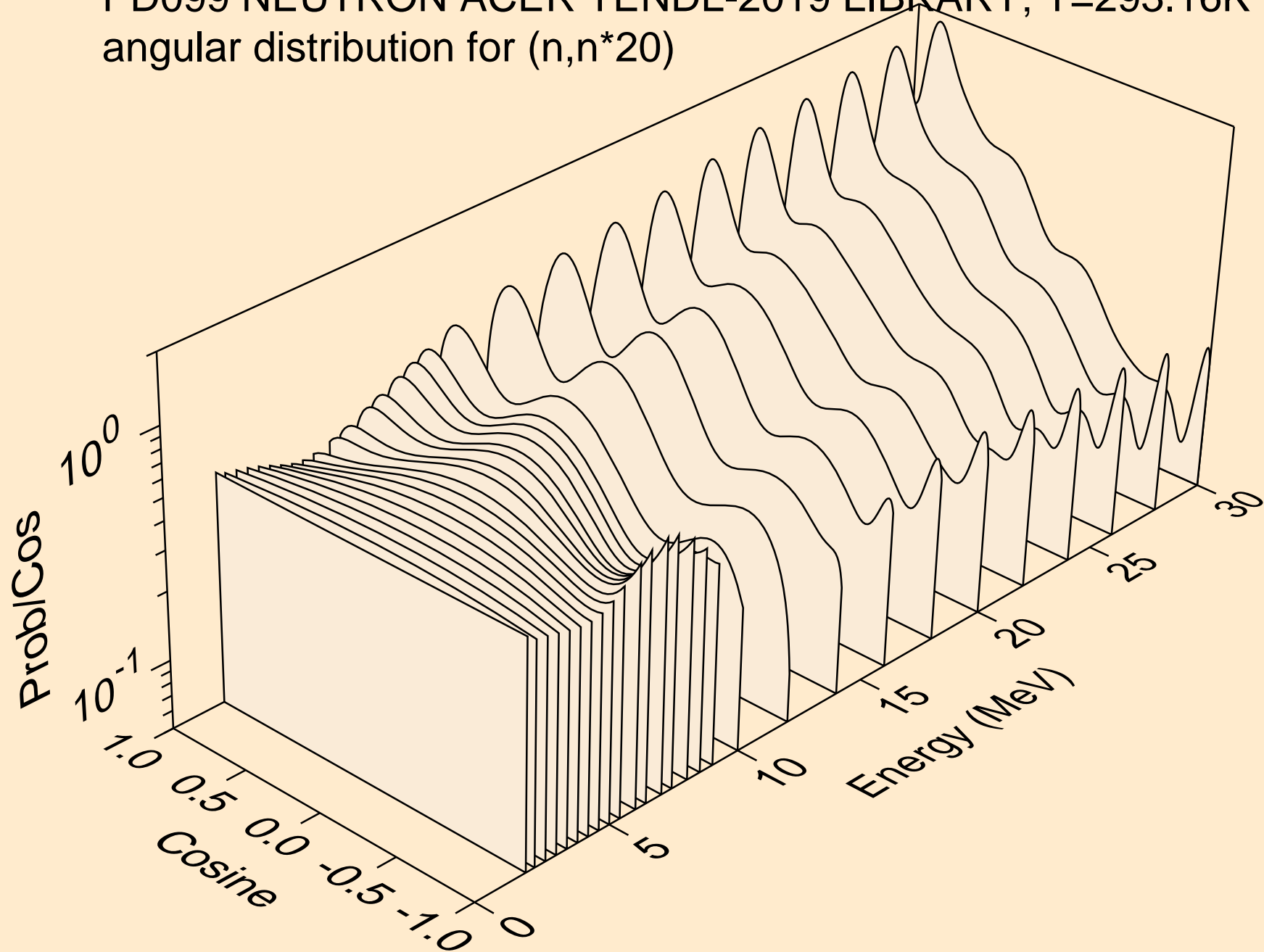

PD099 NEUTRON ACER TENDL-2019 LIBRARY; T=293.16K
angular distribution for (n,n*21)

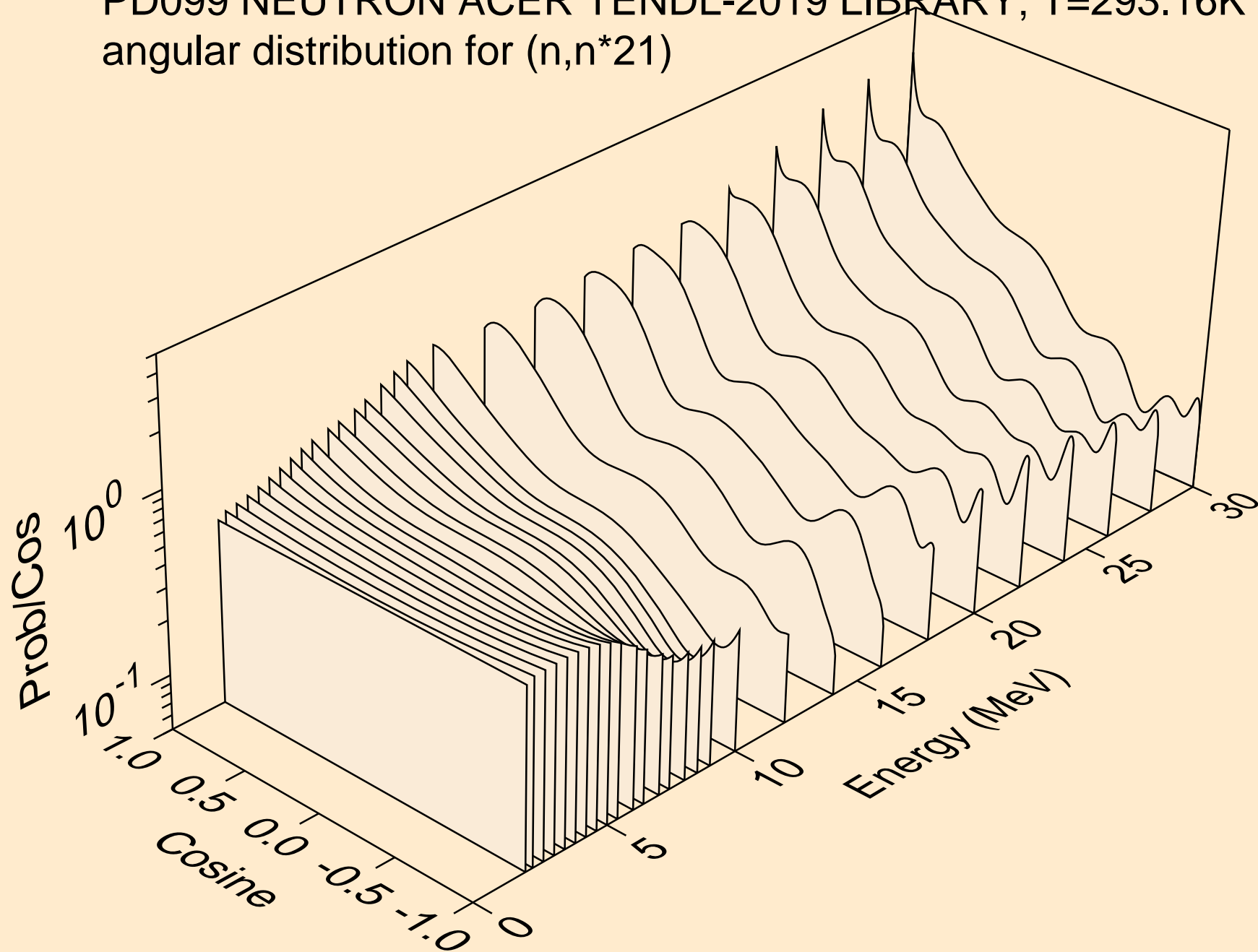

PD099 NEUTRON ACER TENDL-2019 LIBRARY; T=293.16K
angular distribution for (n,n*22)

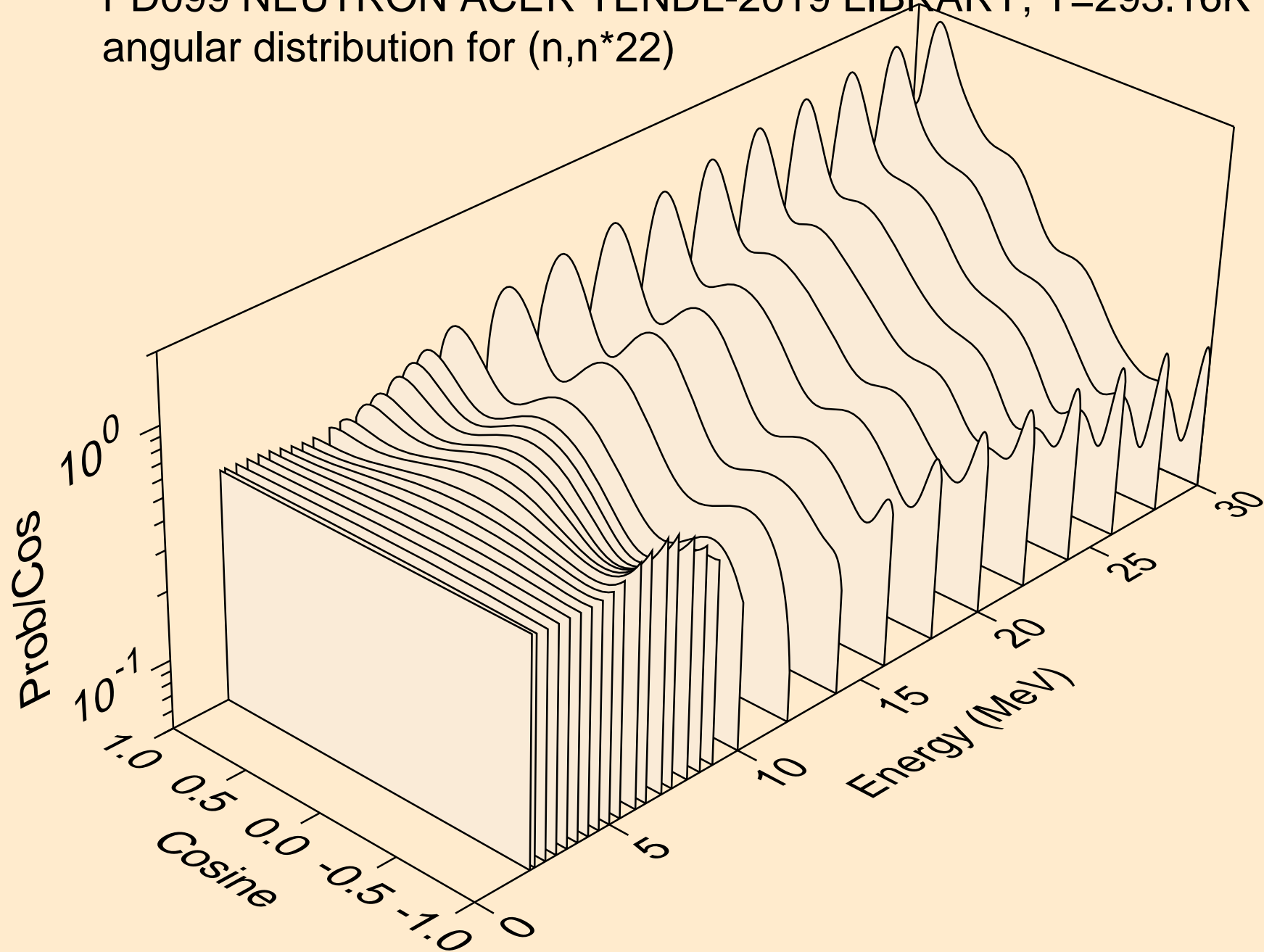

PD099 NEUTRON ACER TENDL-2019 LIBRARY; T=293.16K
angular distribution for (n,n*23)

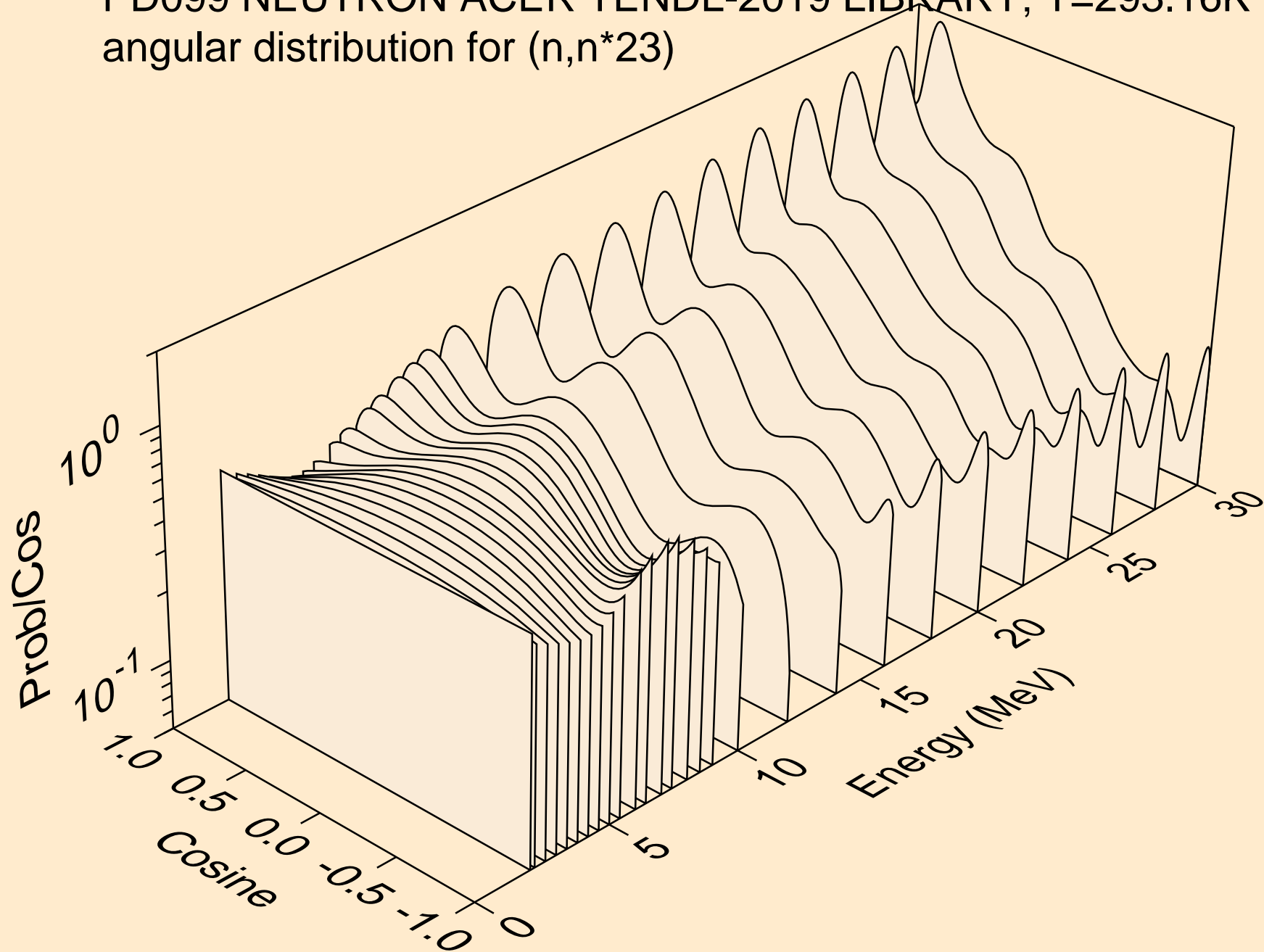

PD099 NEUTRON ACER TENDL-2019 LIBRARY; T=293.16K
angular distribution for (n,n*24)

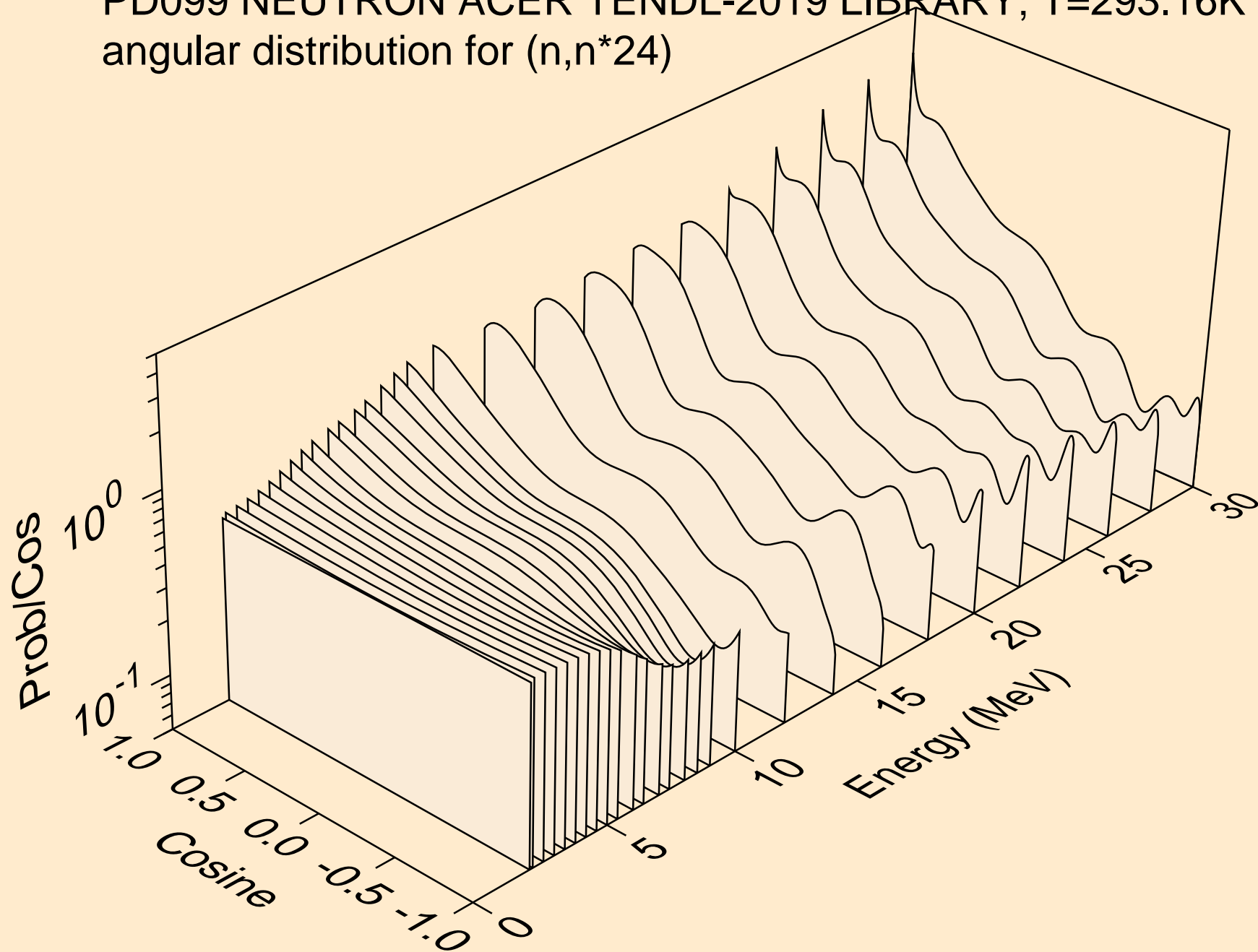

PD099 NEUTRON ACER TENDL-2019 LIBRARY; T=293.16K
angular distribution for (n,n*25)

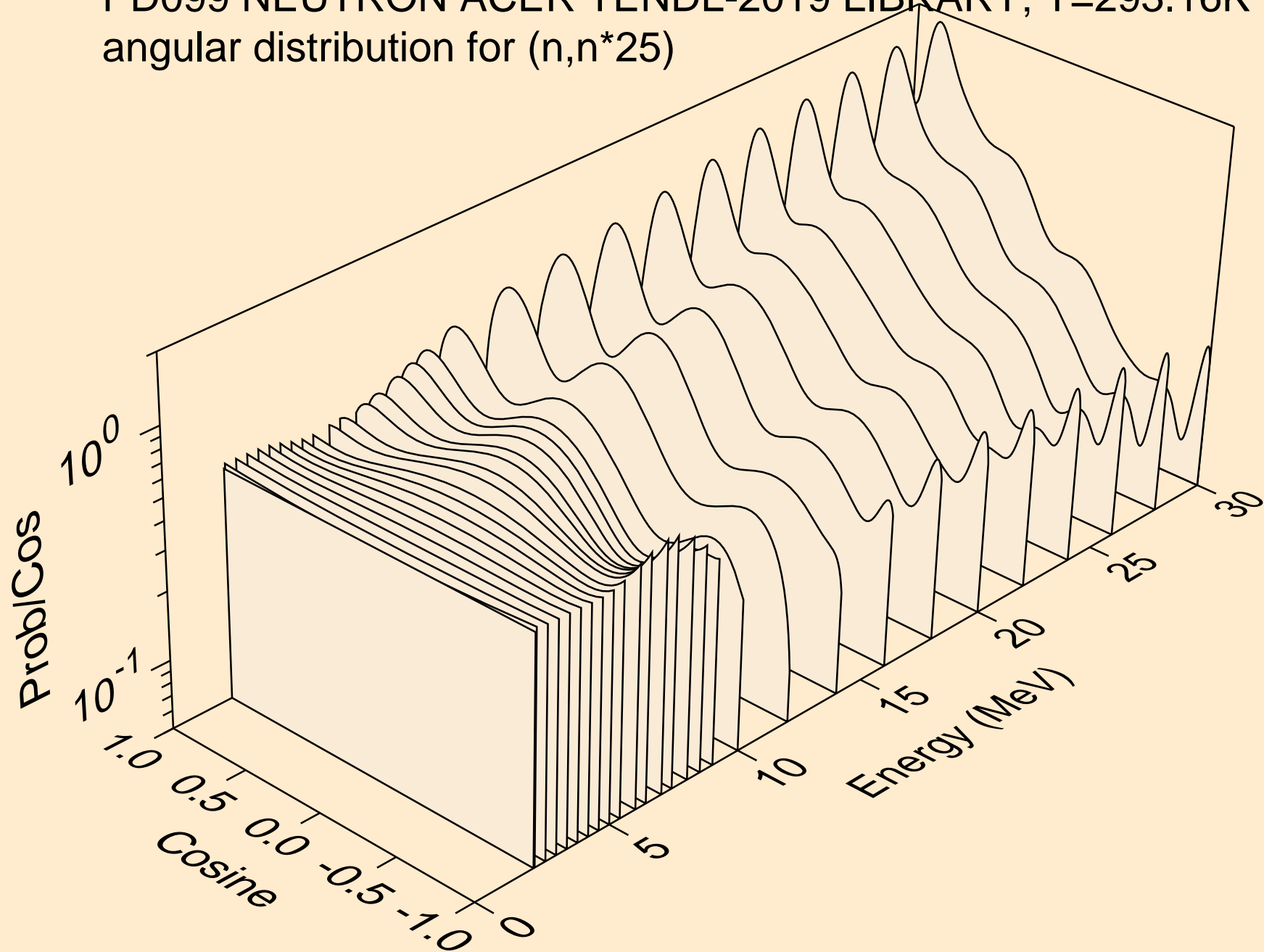

PD099 NEUTRON ACER TENDL-2019 LIBRARY; T=293.16K
angular distribution for (n,n*26)

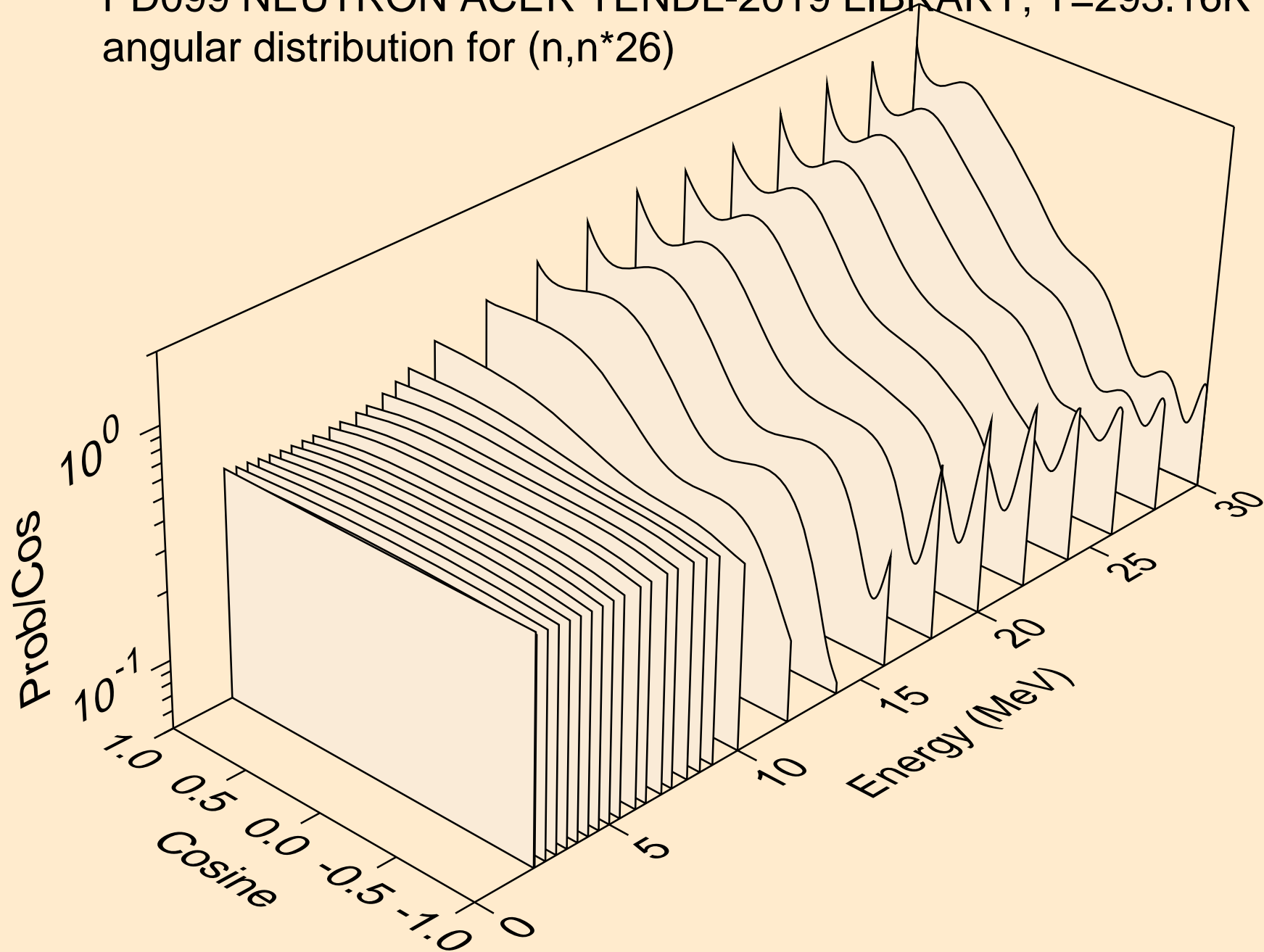

PD099 NEUTRON ACER TENDL-2019 LIBRARY; T=293.16K
angular distribution for (n,n*27)

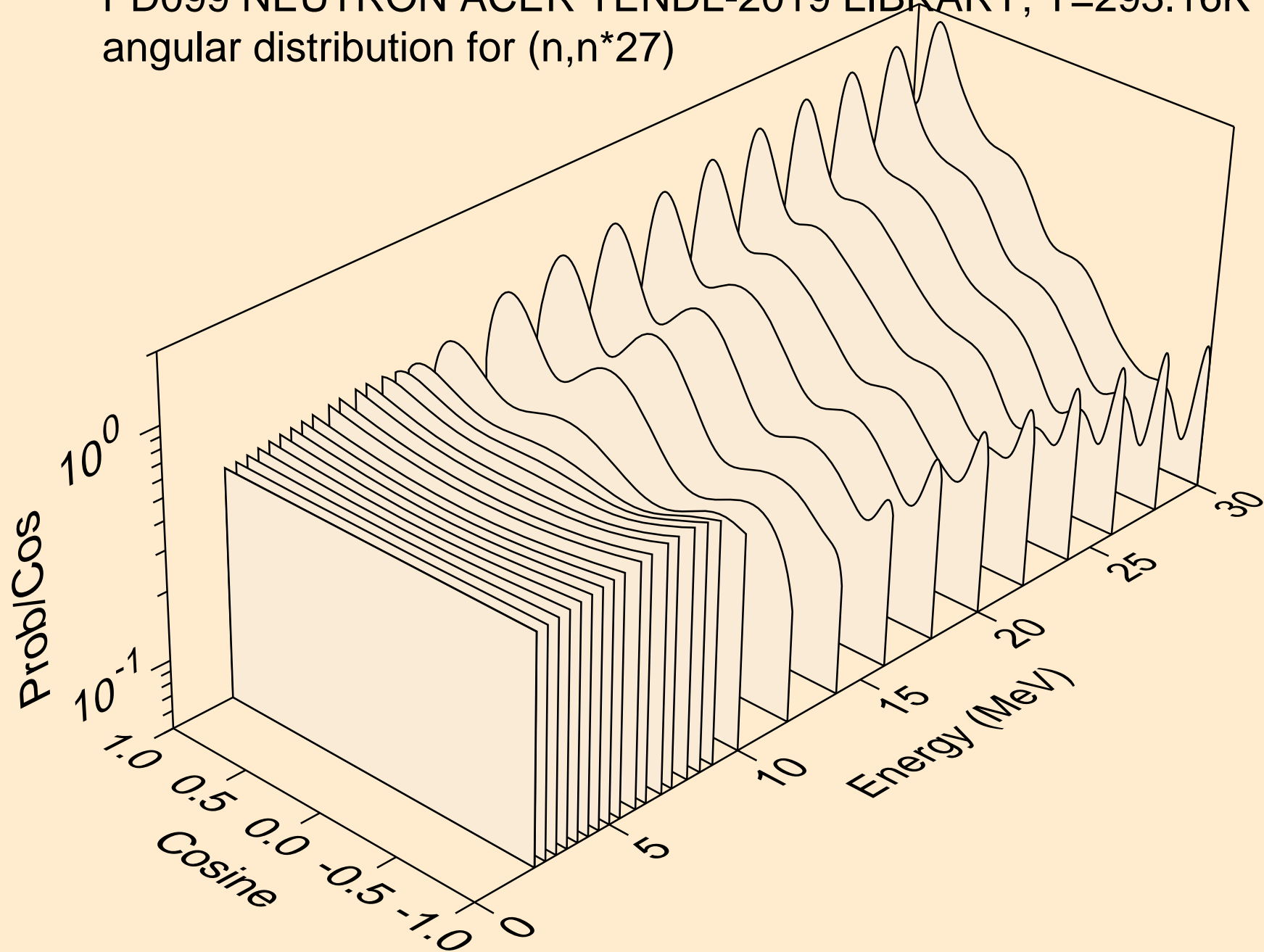

PD099 NEUTRON ACER TENDL-2019 LIBRARY; T=293.16K
angular distribution for (n,n*28)

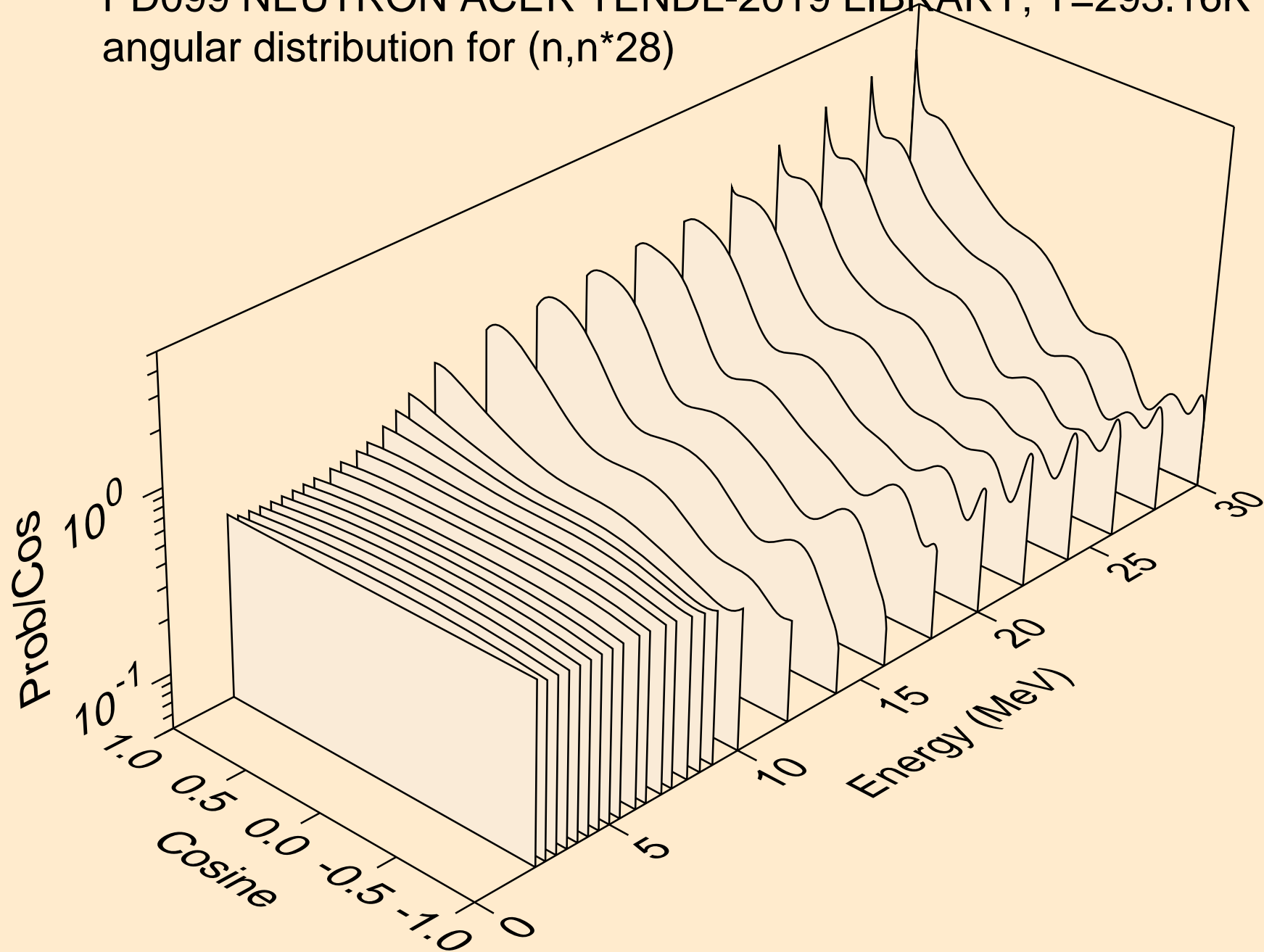

PD099 NEUTRON ACER TENDL-2019 LIBRARY; T=293.16K
angular distribution for (n,n*29)

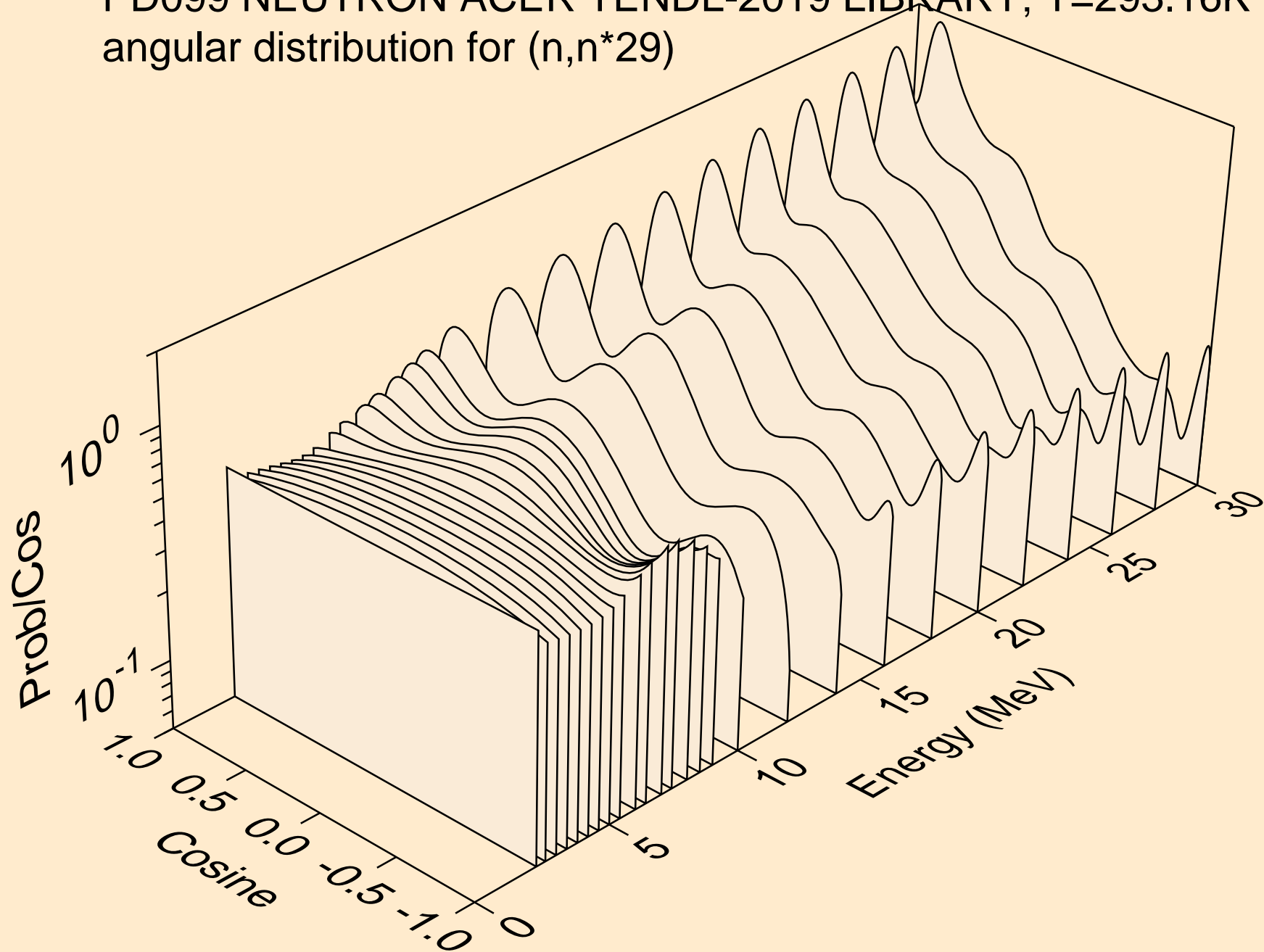

PD099 NEUTRON ACER TENDL-2019 LIBRARY; T=293.16K
angular distribution for (n,n*30)

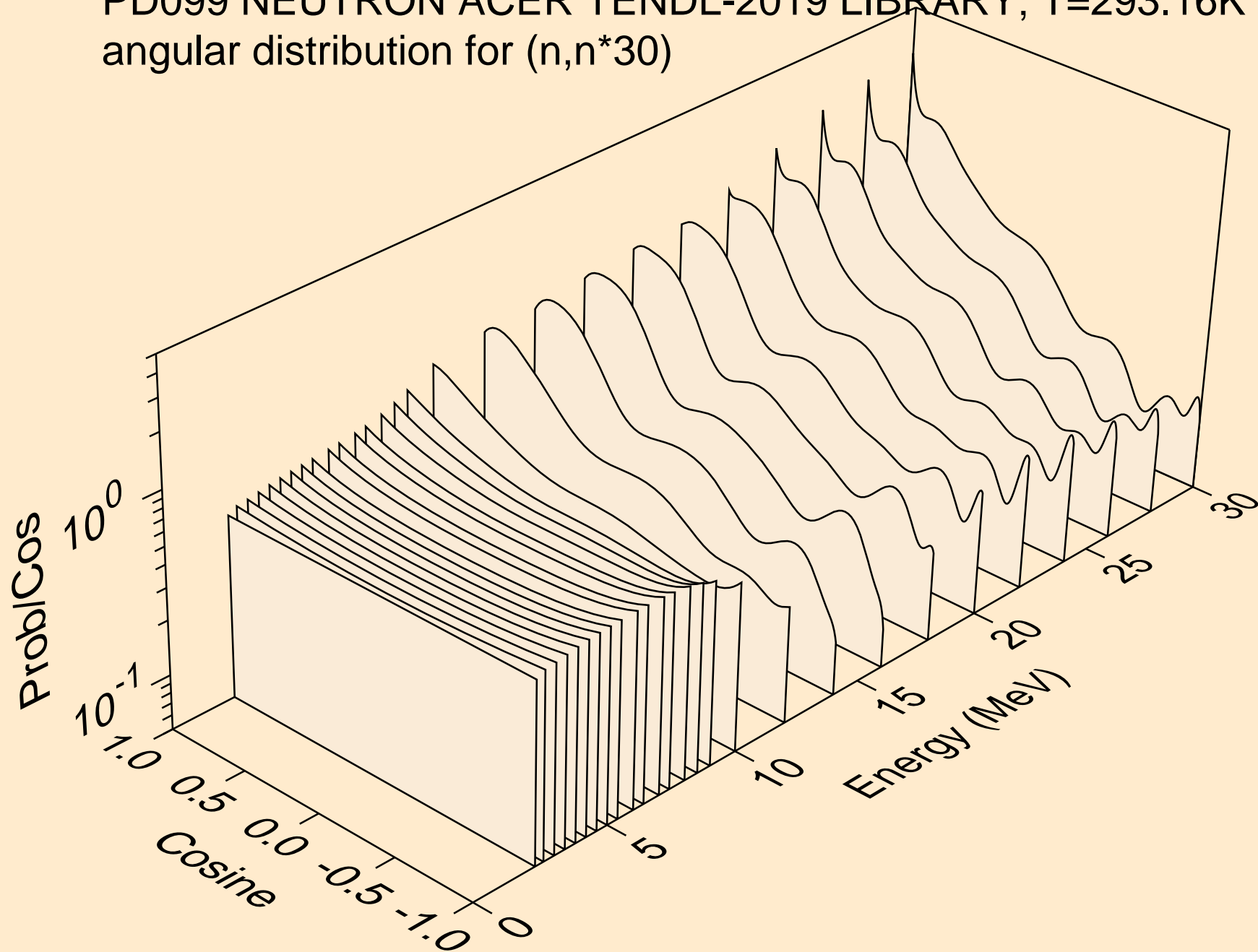

PD099 NEUTRON ACER TENDL-2019 LIBRARY; T=293.16K
Neutron emission for (n,x)

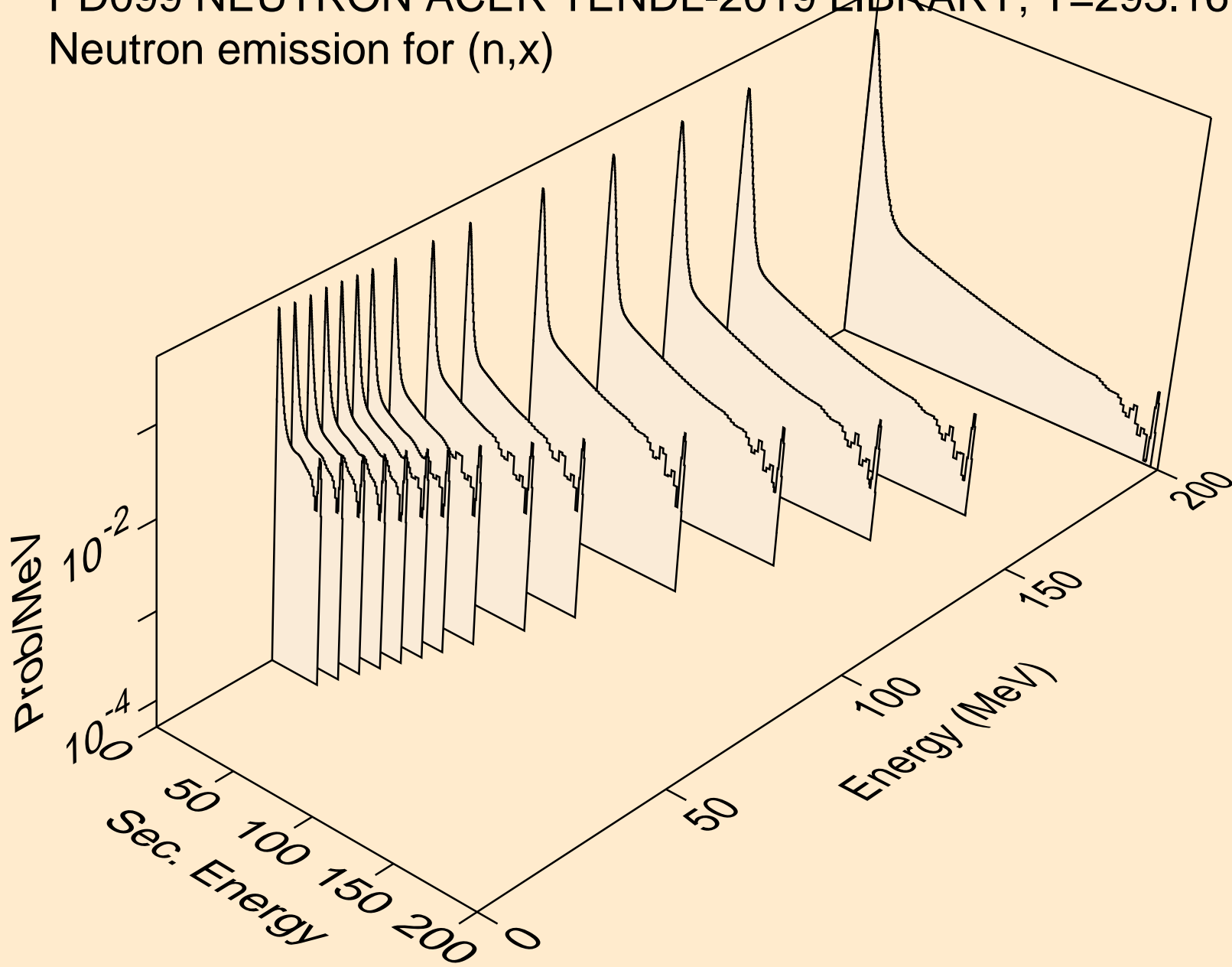

PD099 NEUTRON ACER TENDL-2019 LIBRARY; T=293.16K
Neutron emission for (n,2nd)

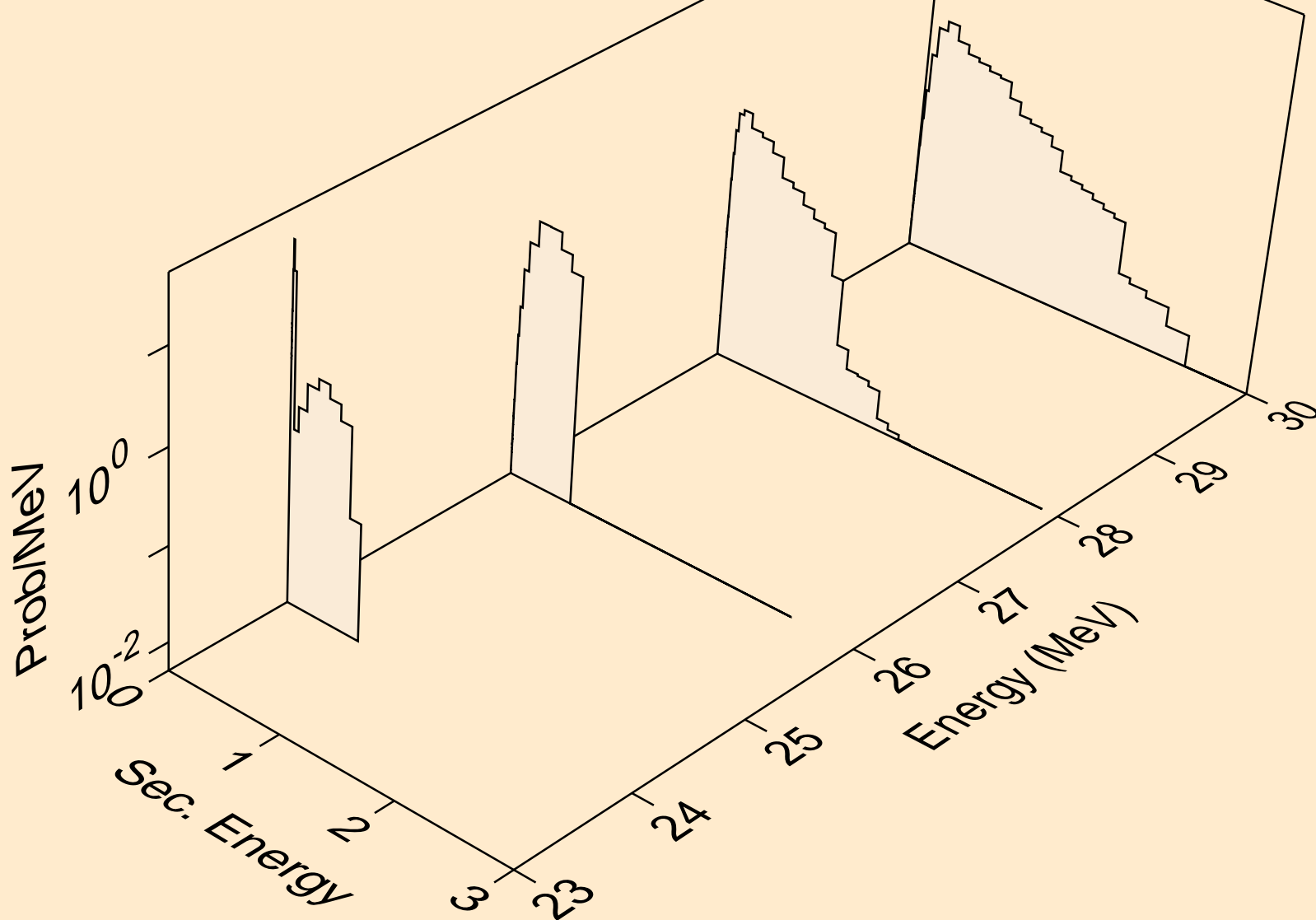

PD099 NEUTRON ACER TENDL-2019 LIBRARY; T=293.16K
Neutron emission for (n,2n)

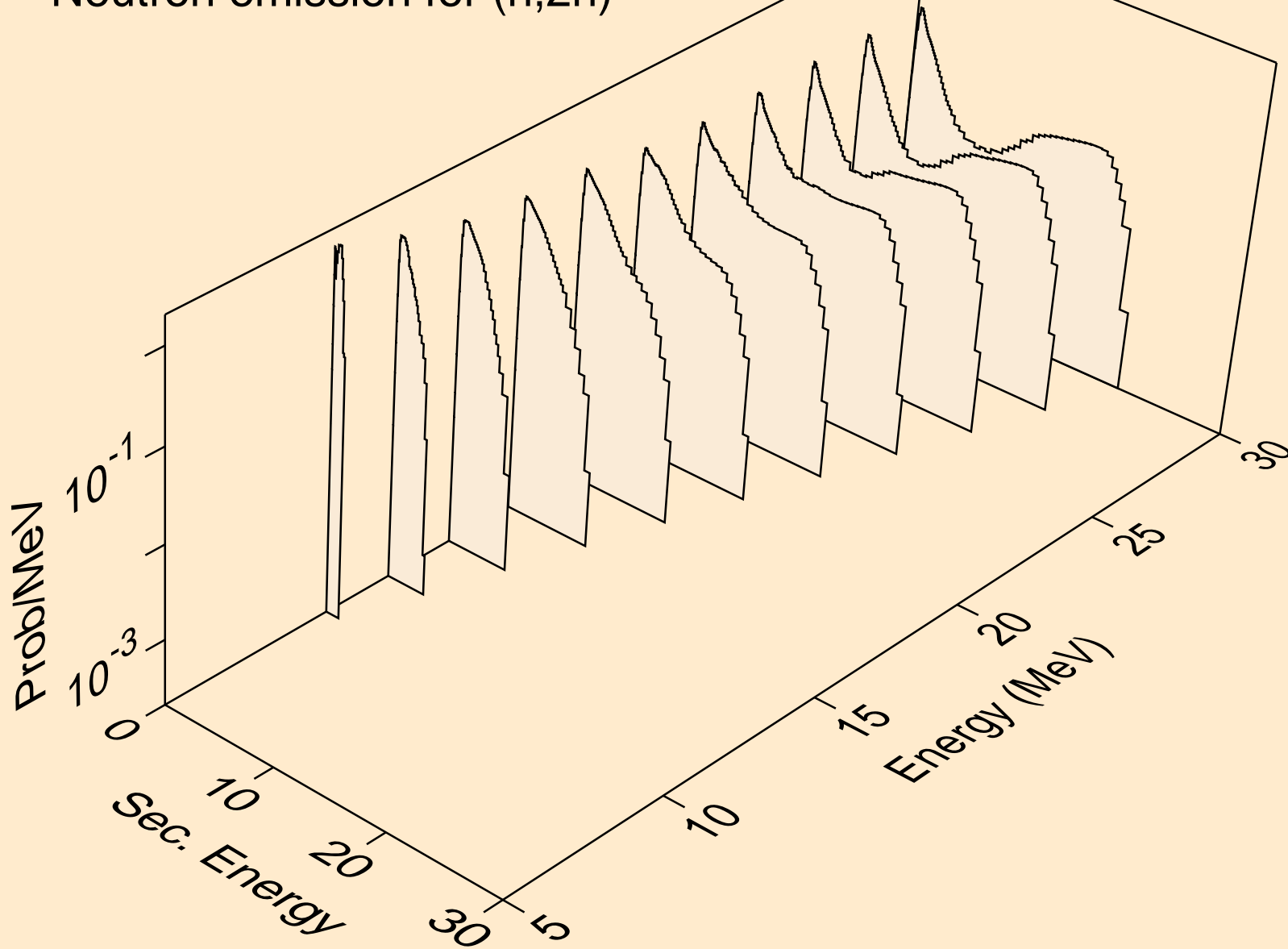

PD099 NEUTRON ACER TENDL-2019 LIBRARY; T=293.16K
Neutron emission for (n,3n)

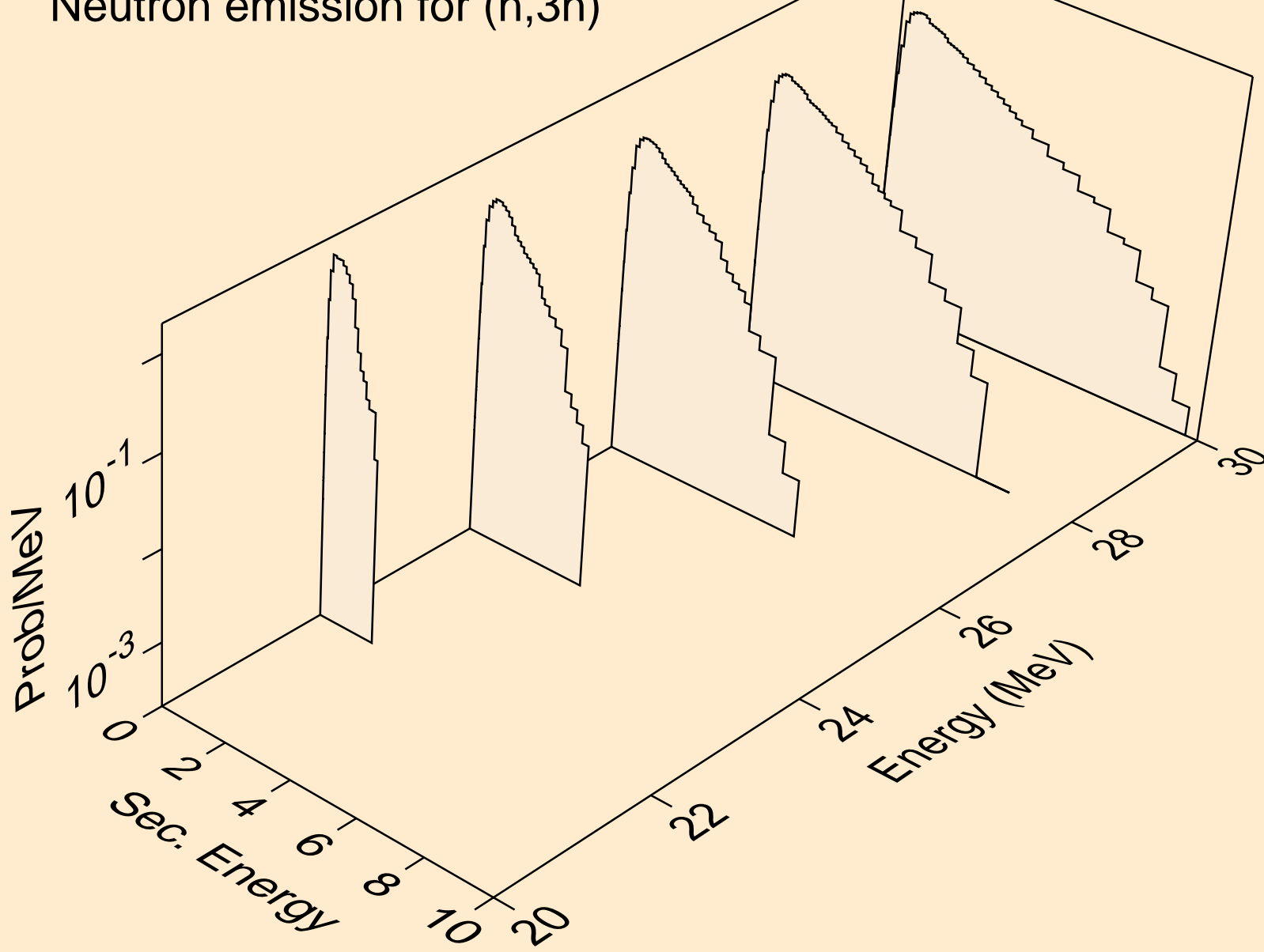

PD099 NEUTRON ACER TENDL-2019 LIBRARY; T=293.16K
Neutron emission for (n,n*)a

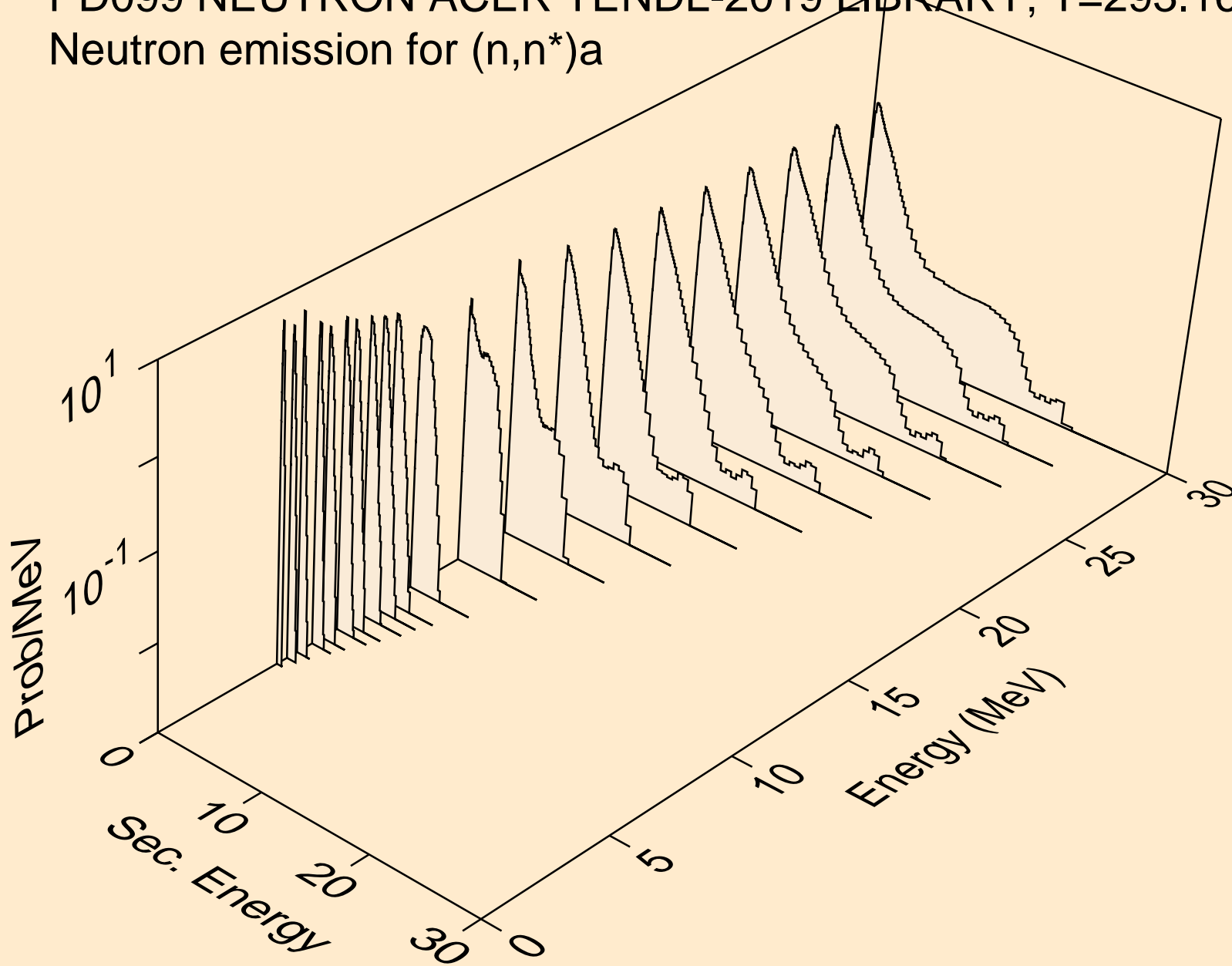

PD099 NEUTRON ACER TENDL-2019 LIBRARY; T=293.16K
Neutron emission for (n,2n)a

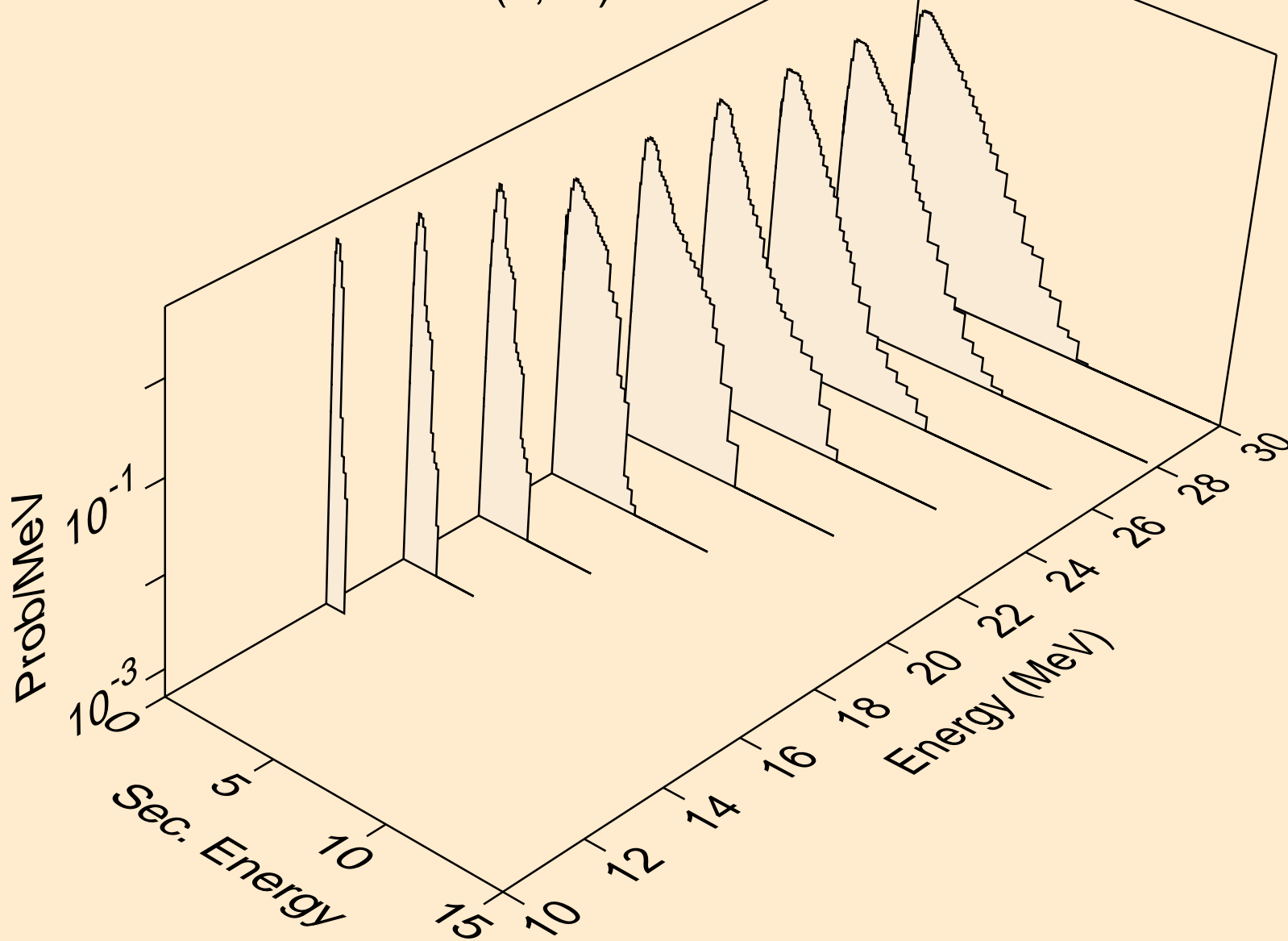

PD099 NEUTRON ACER TENDL-2019 LIBRARY; T=293.16K
Neutron emission for (n,n*)p

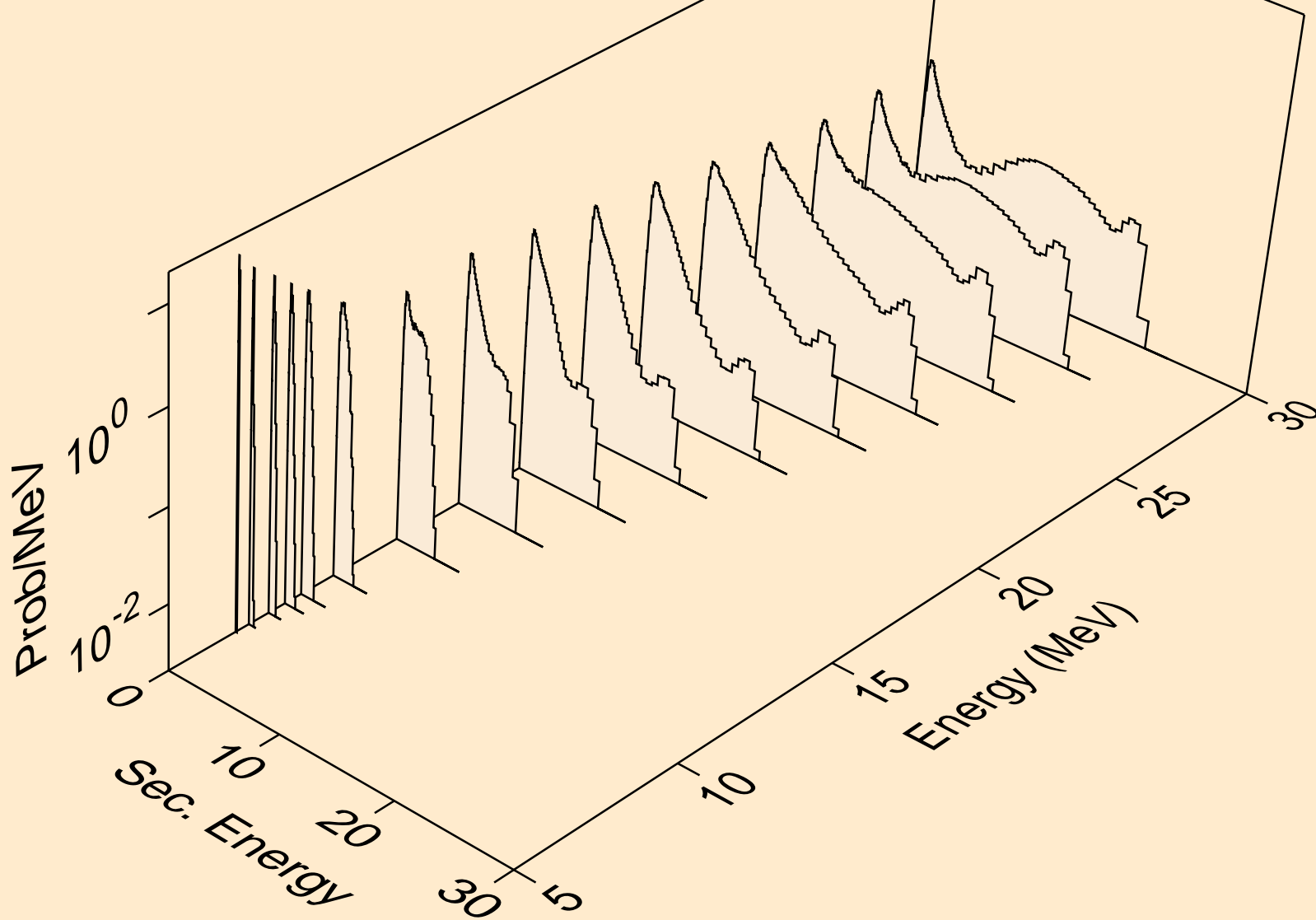

PD099 NEUTRON ACER TENDL-2019 LIBRARY; T=293.16K
Neutron emission for (n,n*)2a

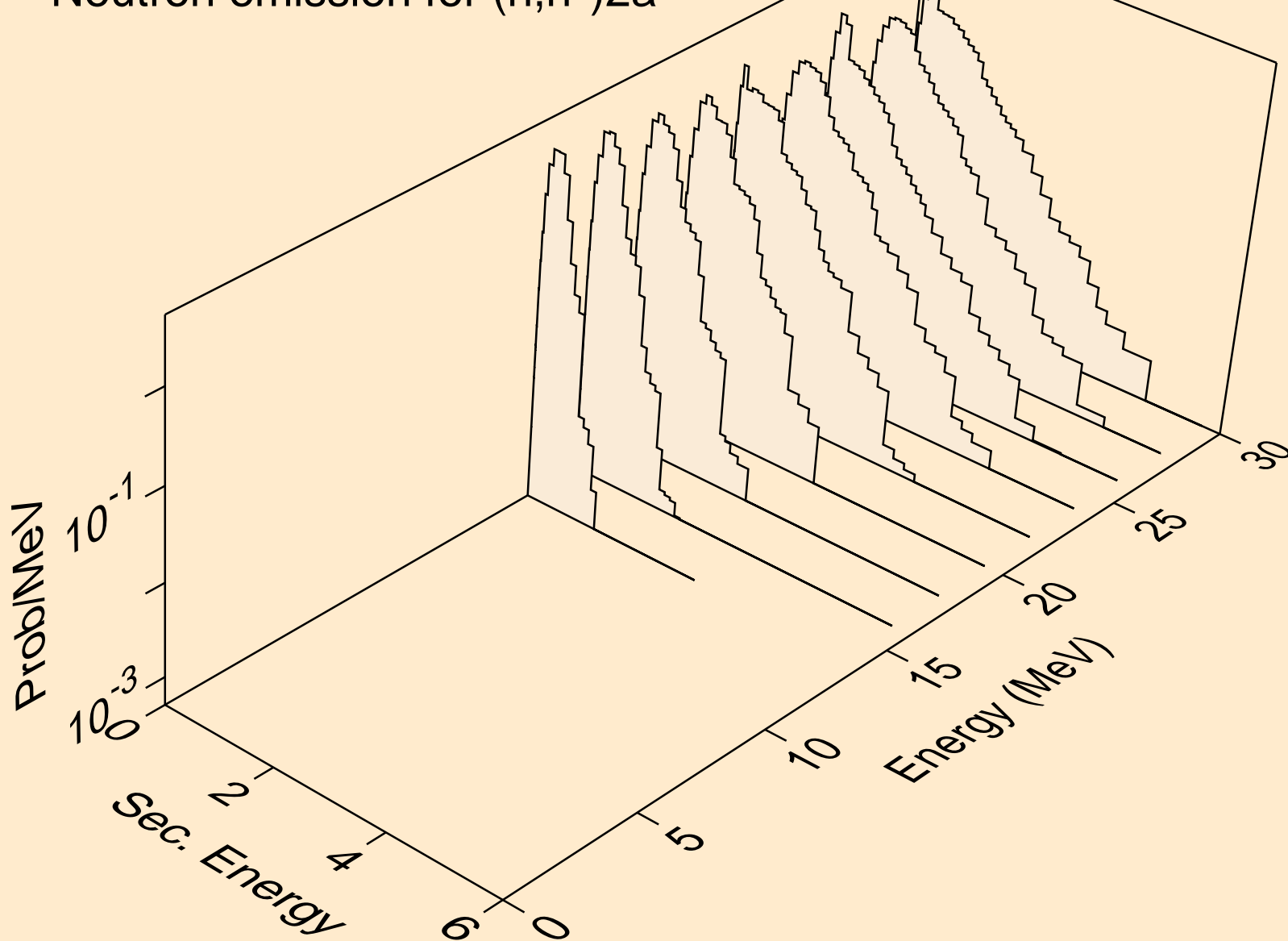

PD099 NEUTRON ACER TENDL-2019 LIBRARY; T=293.16K
Neutron emission for (n,n*)d

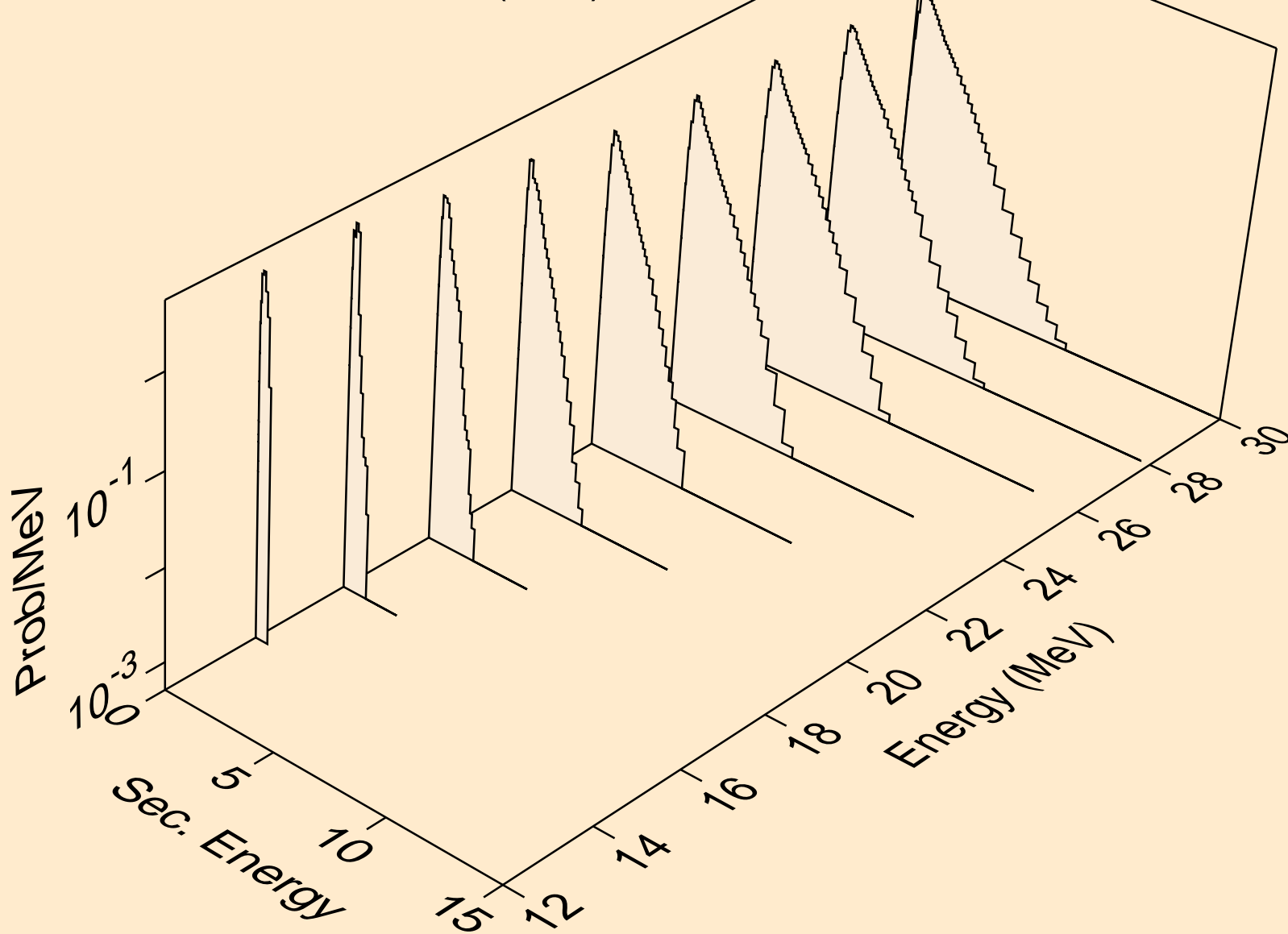

PD099 NEUTRON ACER TENDL-2019 LIBRARY; T=293.16K
Neutron emission for (n,n*)t

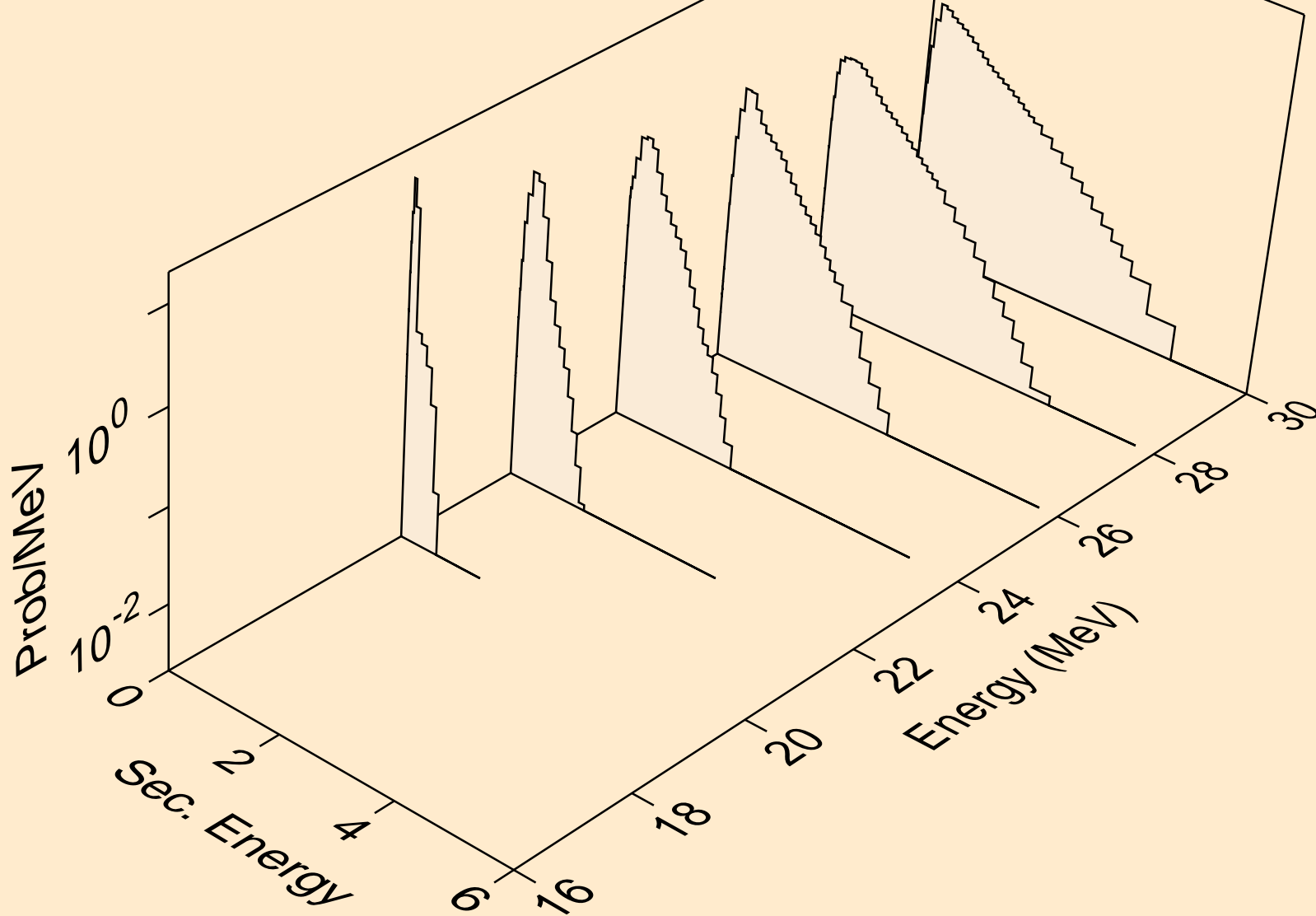

PD099 NEUTRON ACER TENDL-2019 LIBRARY; T=293.16K
Neutron emission for (n,n*)he3

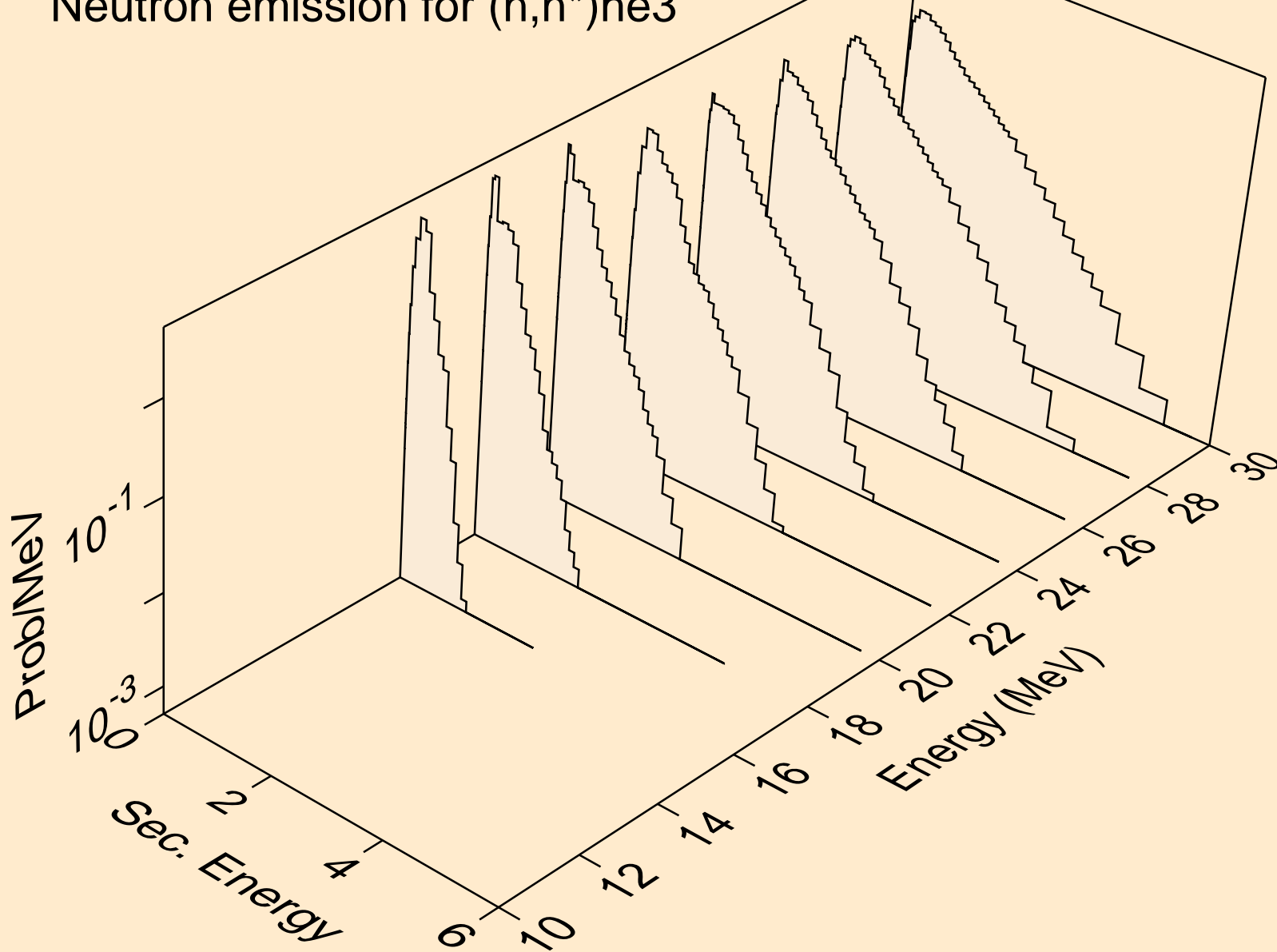

PD099 NEUTRON ACER TENDL-2019 LIBRARY; T=293.16K
Neutron emission for (n,2np)

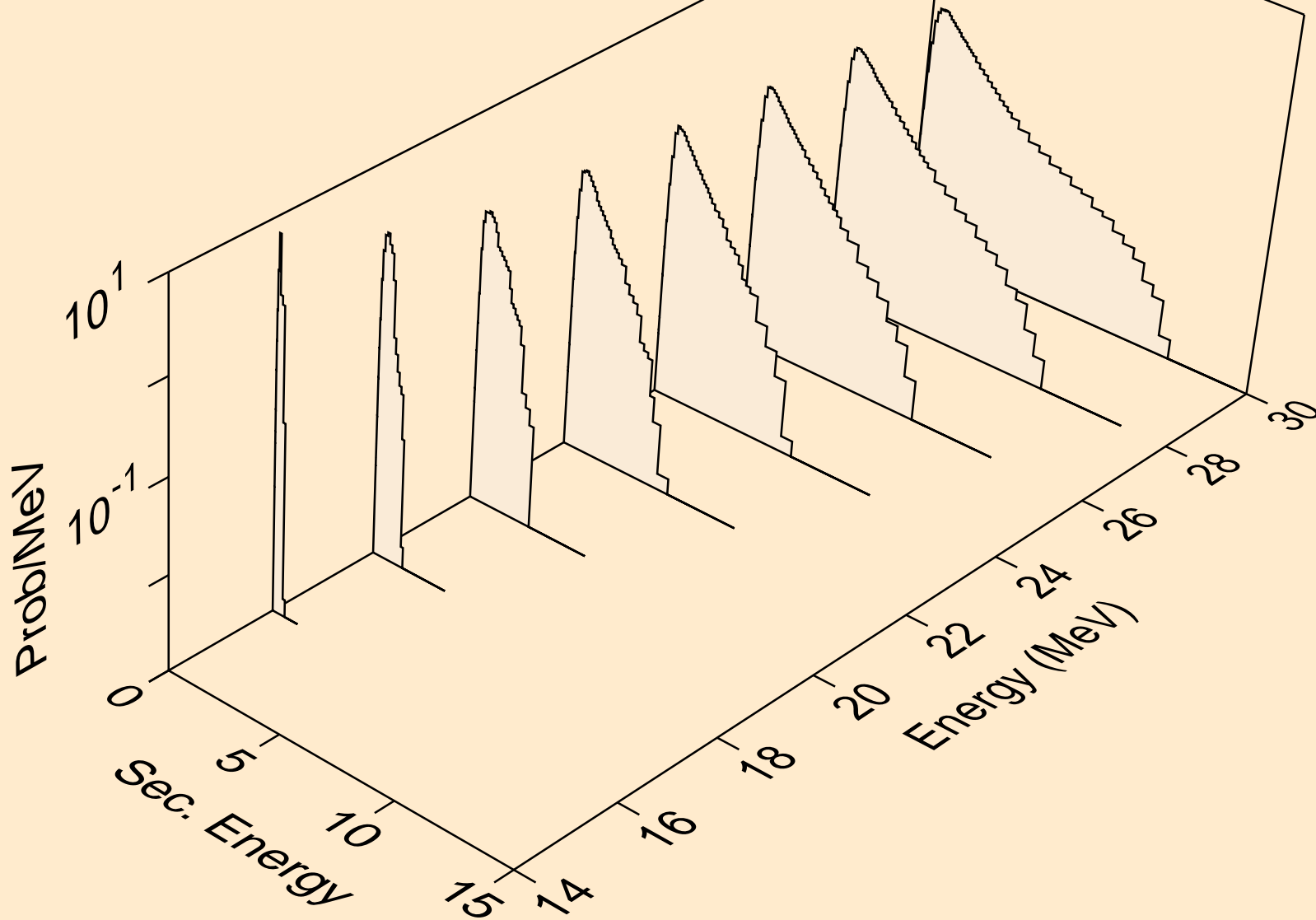

PD099 NEUTRON ACER TENDL-2019 LIBRARY; T=293.16K
Neutron emission for (n,3np)

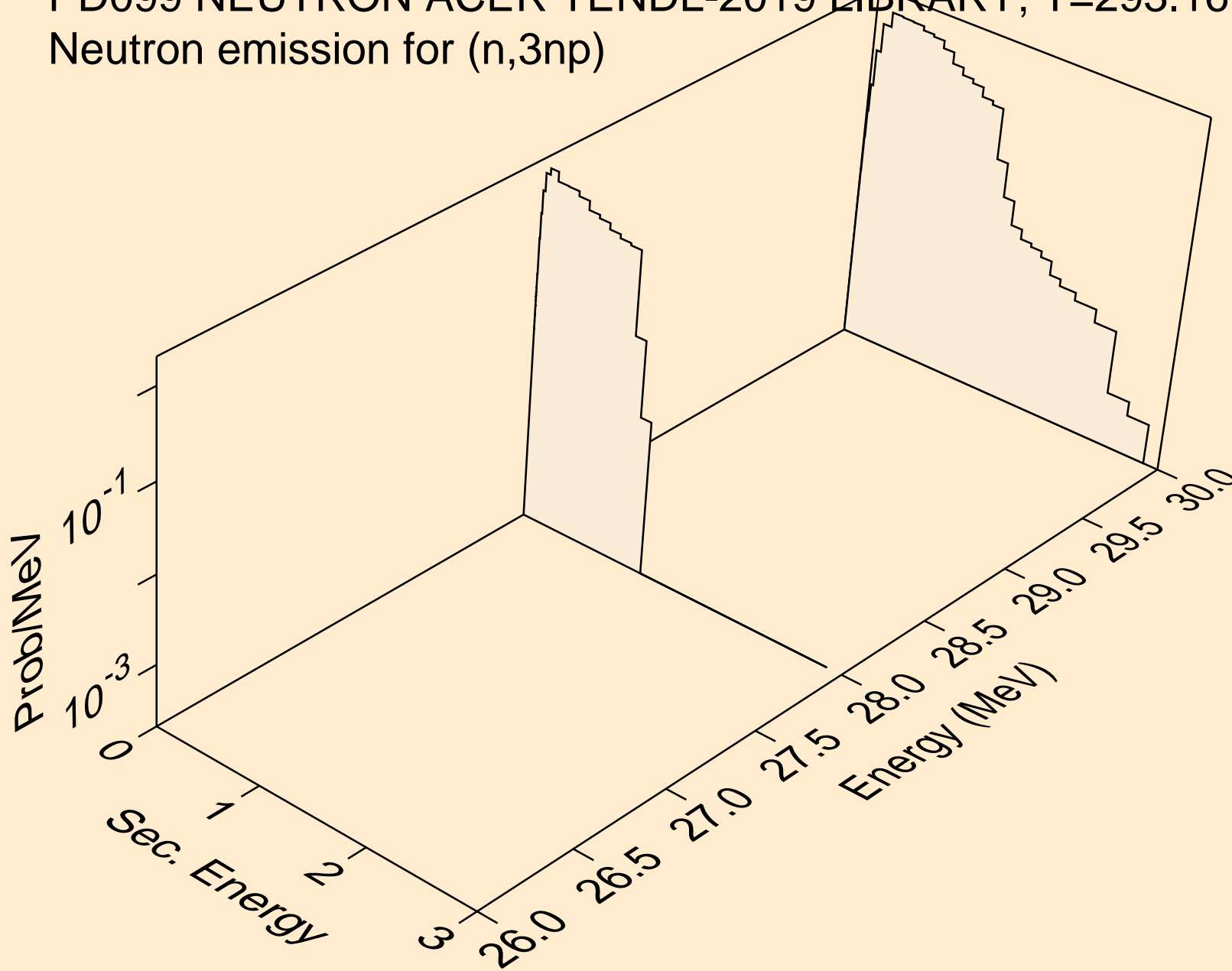

PD099 NEUTRON ACER TENDL-2019 LIBRARY; T=293.16K
Neutron emission for (n,2np)

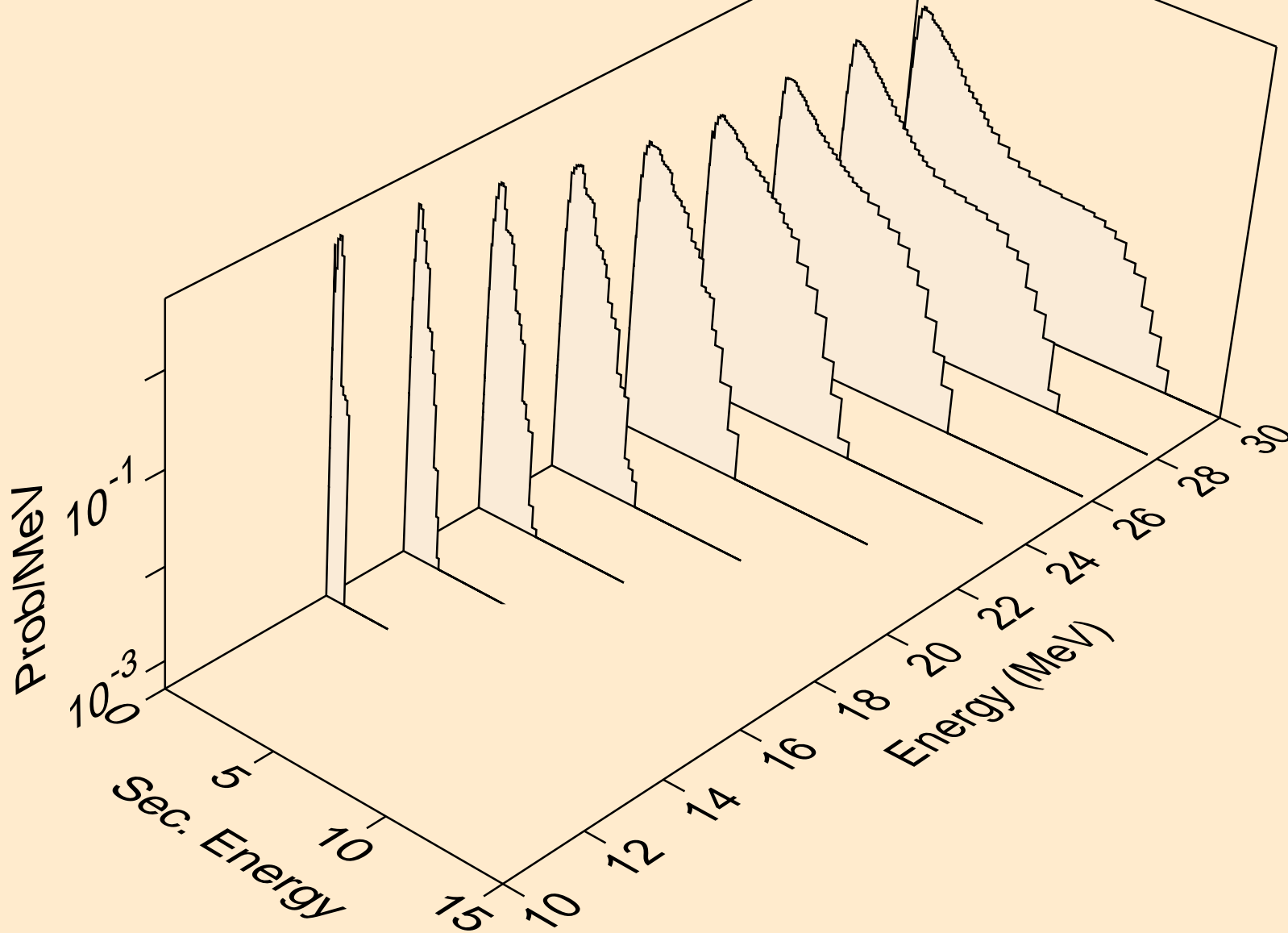

PD099 NEUTRON ACER TENDL-2019 LIBRARY; T=293.16K
Neutron emission for (n,npa)

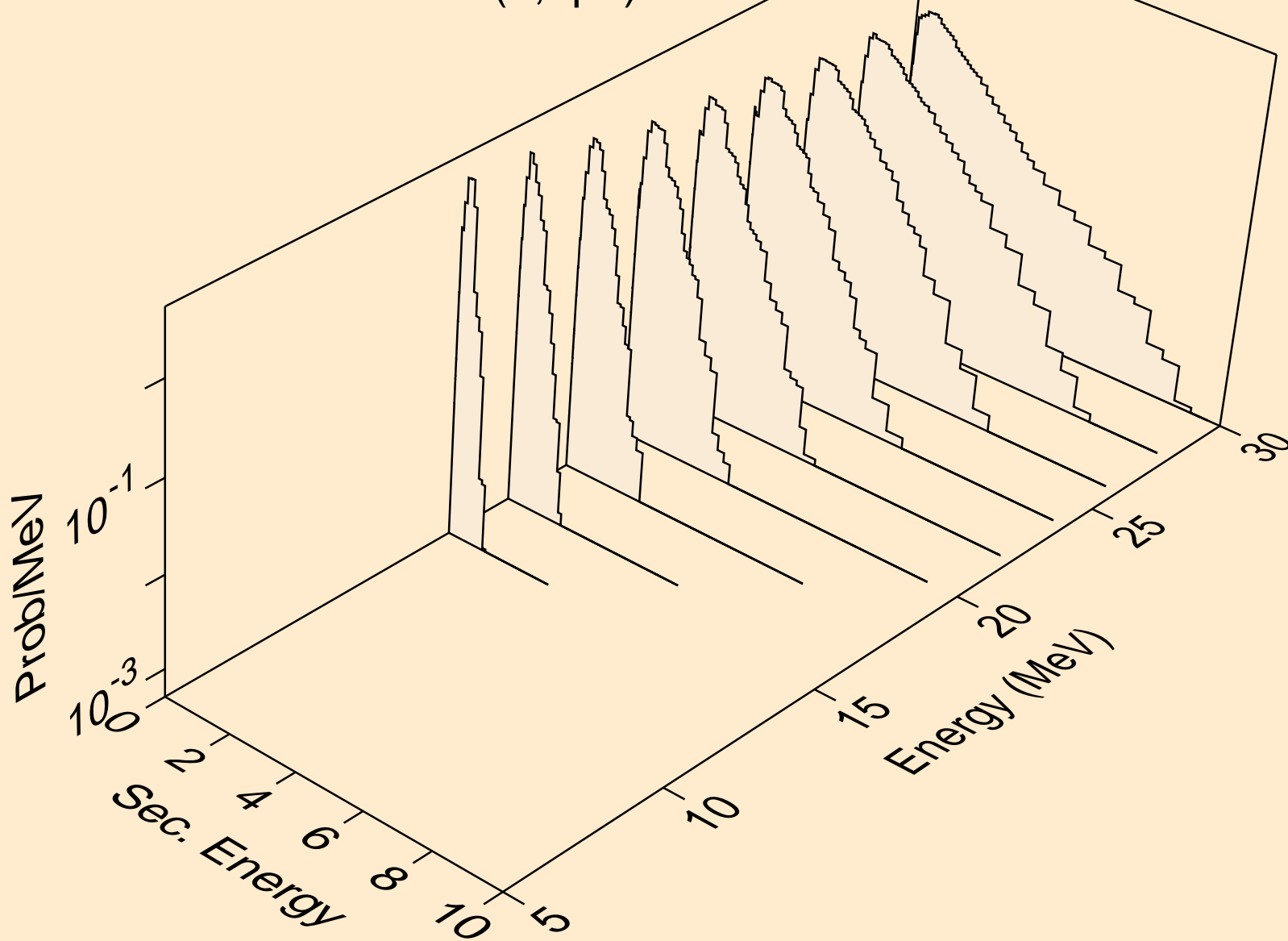

PD099 NEUTRON ACER TENDL-2019 LIBRARY; T=293.16K
Neutron emission for (n,n*c)

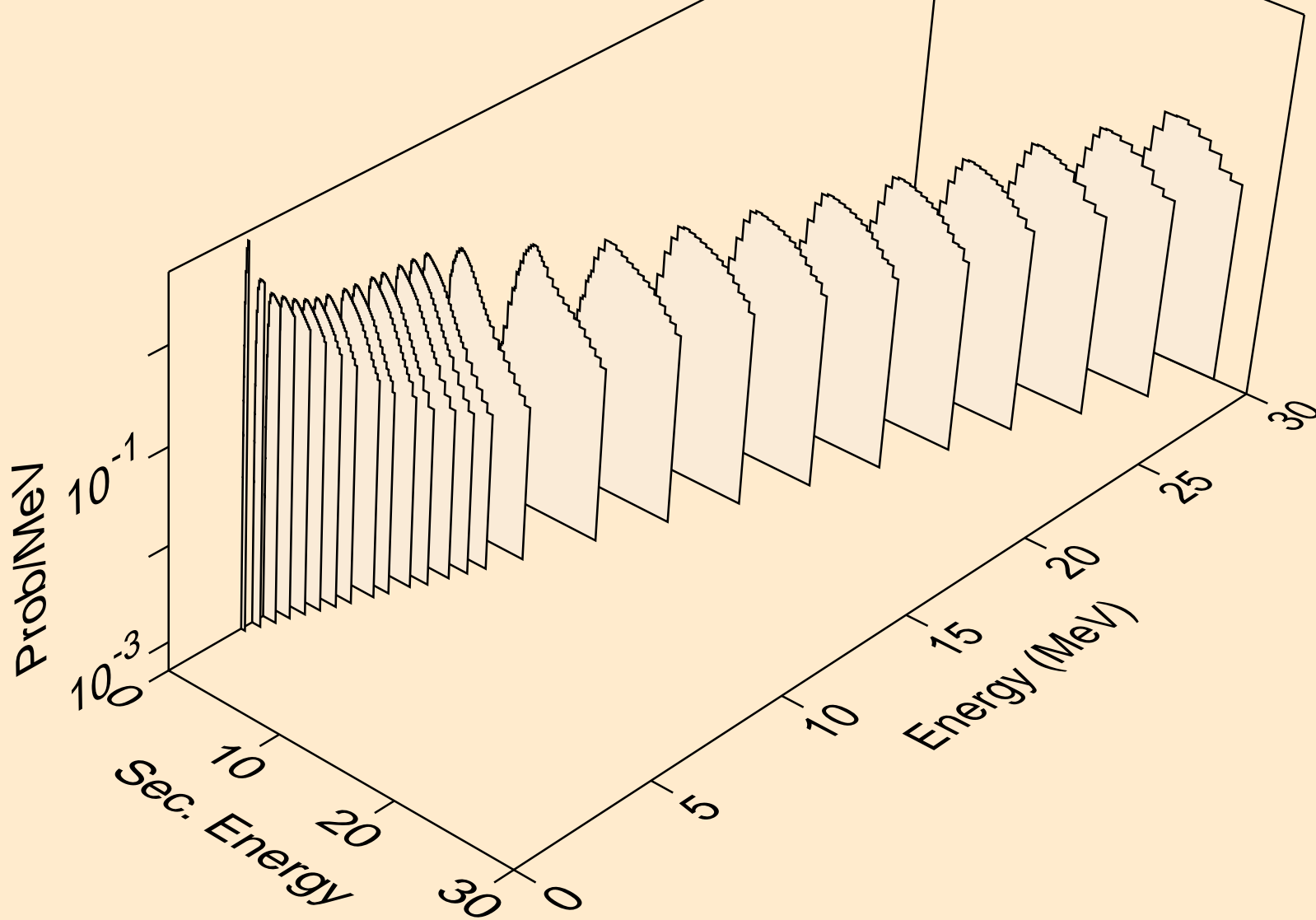

PD099 NEUTRON ACER TENDL-2019 LIBRARY; T=293.16K
Photon emission for (n,x)

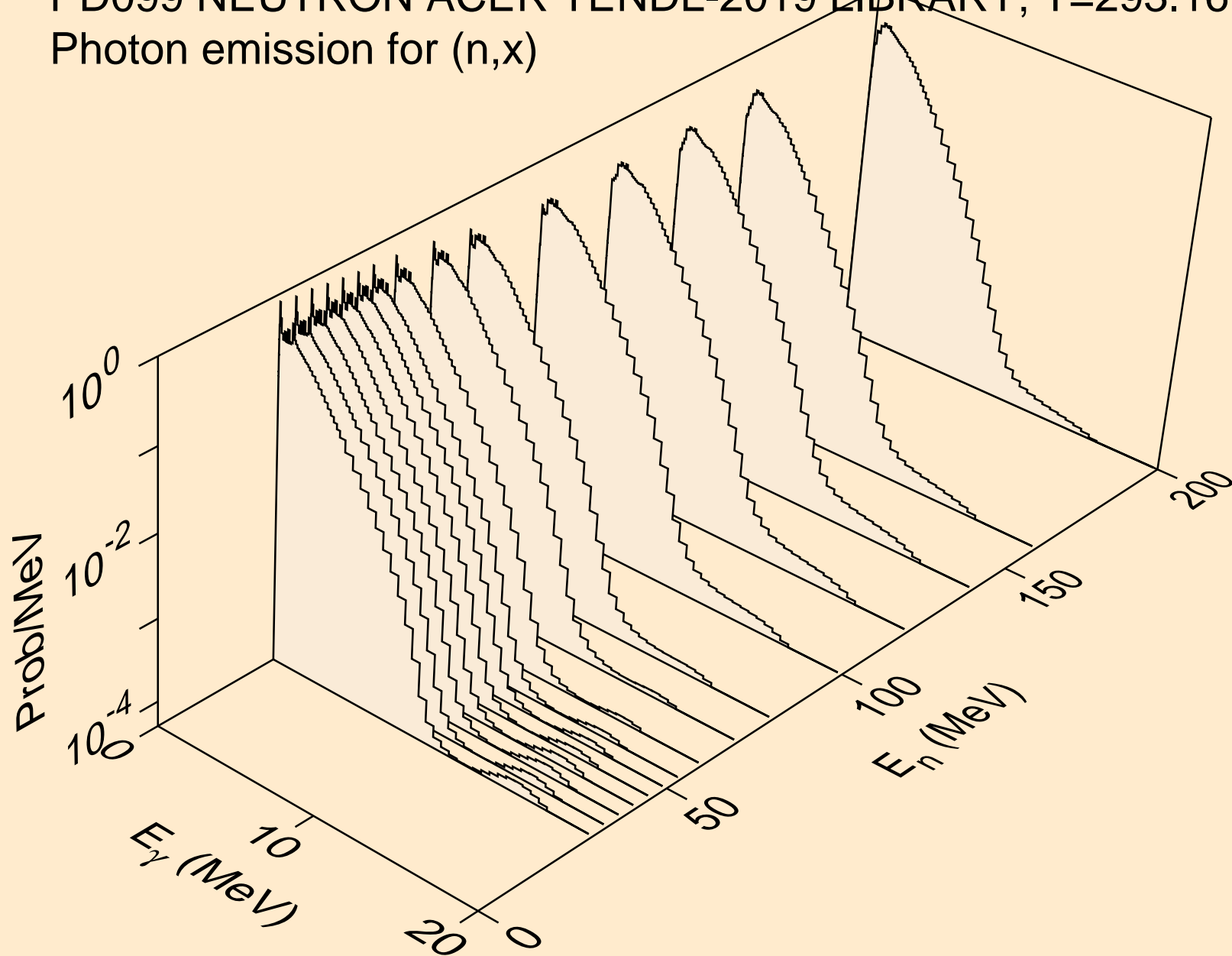

PD099 NEUTRON ACER TENDL-2019 LIBRARY; T=293.16K
Photon emission for (n,2nd)

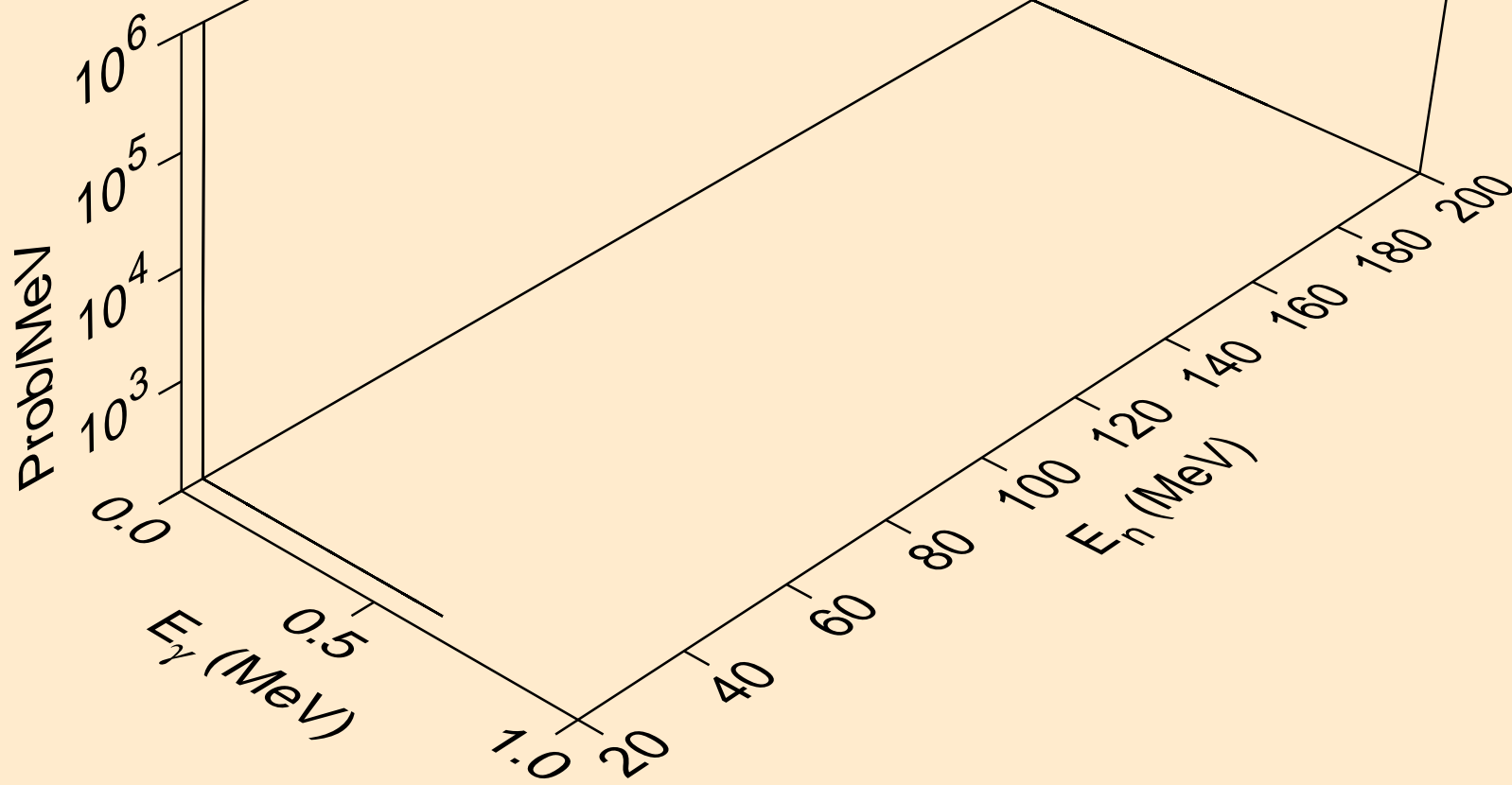

PD099 NEUTRON ACER TENDL-2019 LIBRARY; T=293.16K
Photon emission for (n,2n)

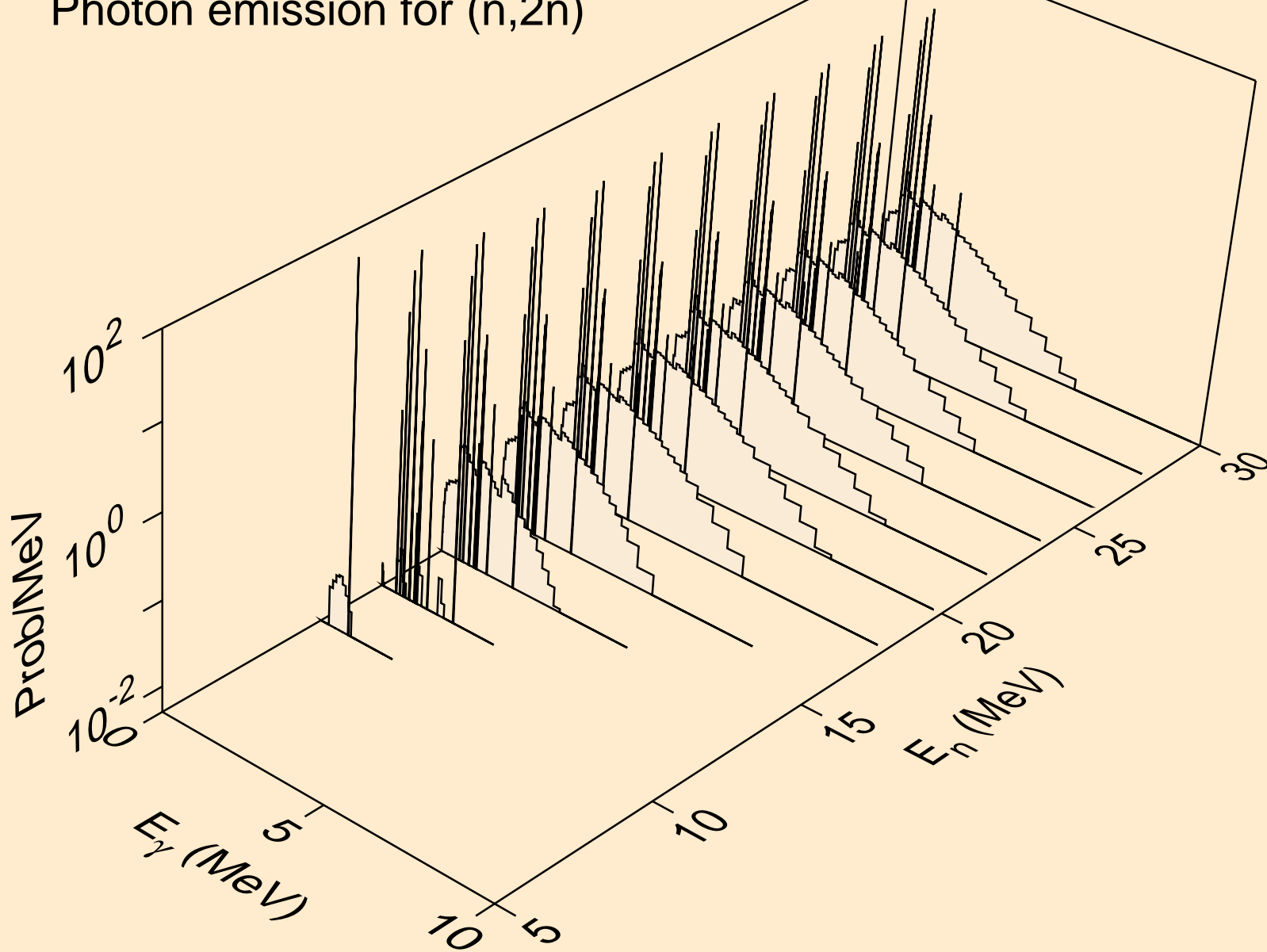

PD099 NEUTRON ACER TENDL-2019 LIBRARY; T=293.16K
Photon emission for (n,3n)

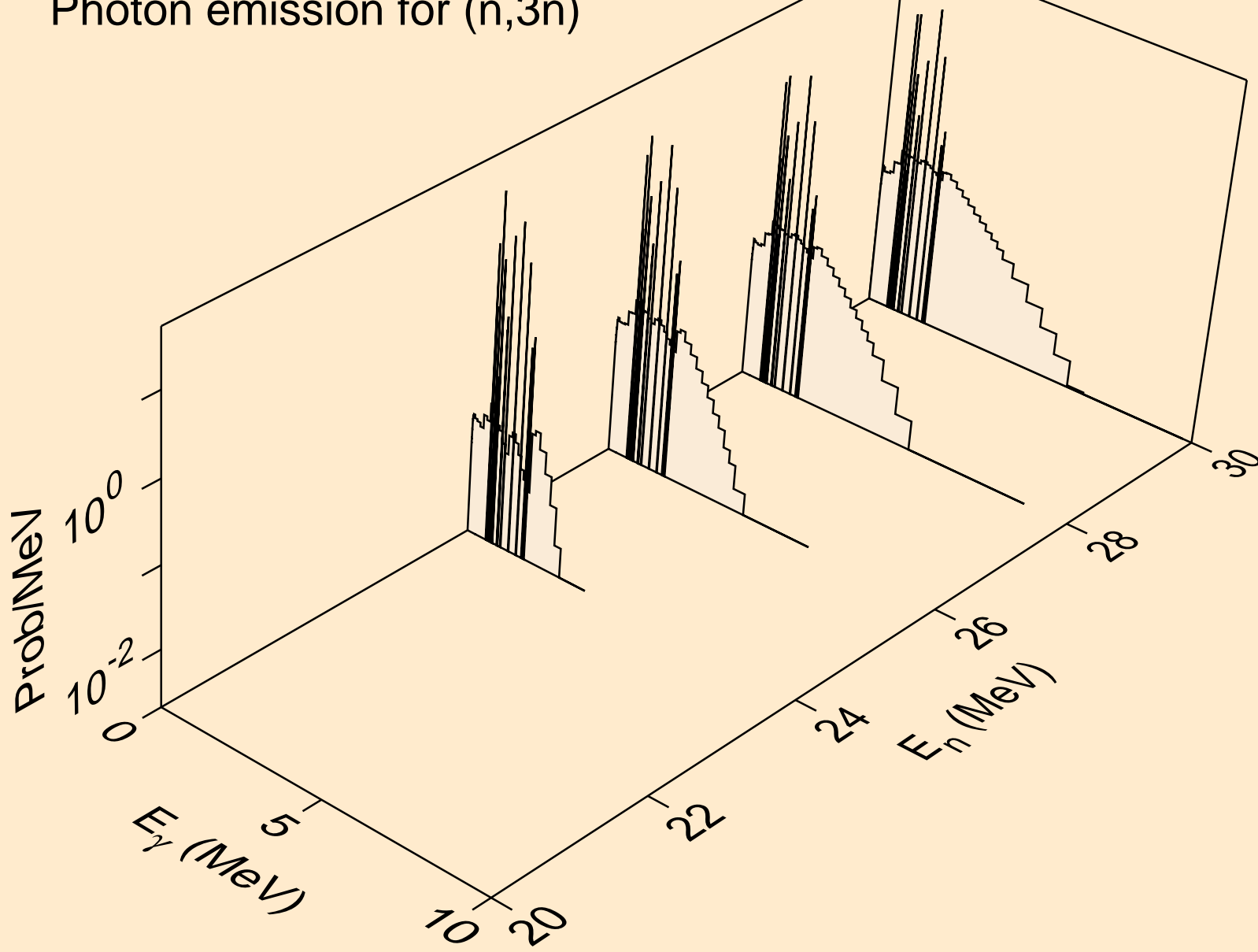

PD099 NEUTRON ACER TENDL-2019 LIBRARY; T=293.16K
Photon emission for (n,n*)a

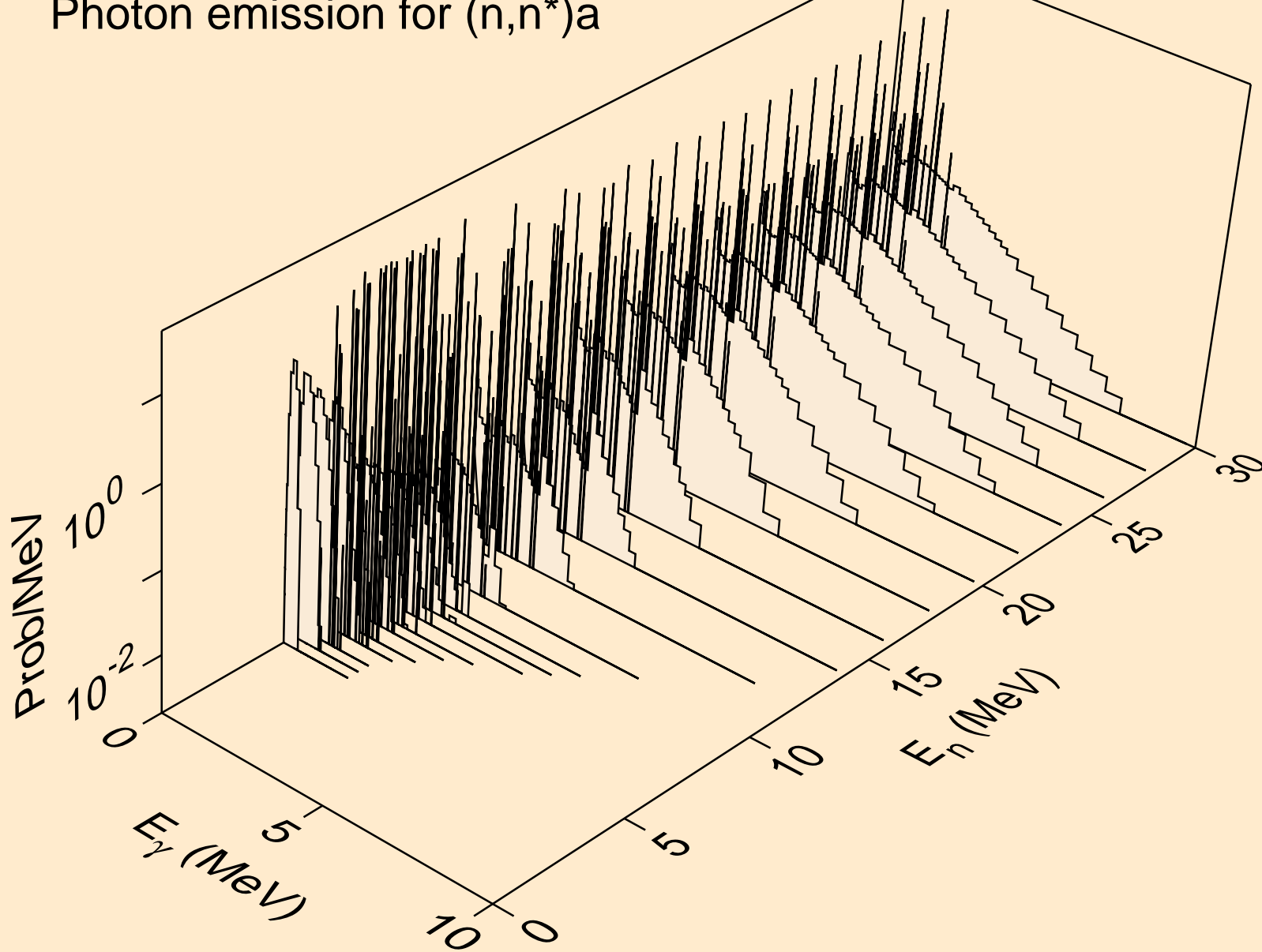

PD099 NEUTRON ACER TENDL-2019 LIBRARY; T=293.16K
Photon emission for (n,2n)a

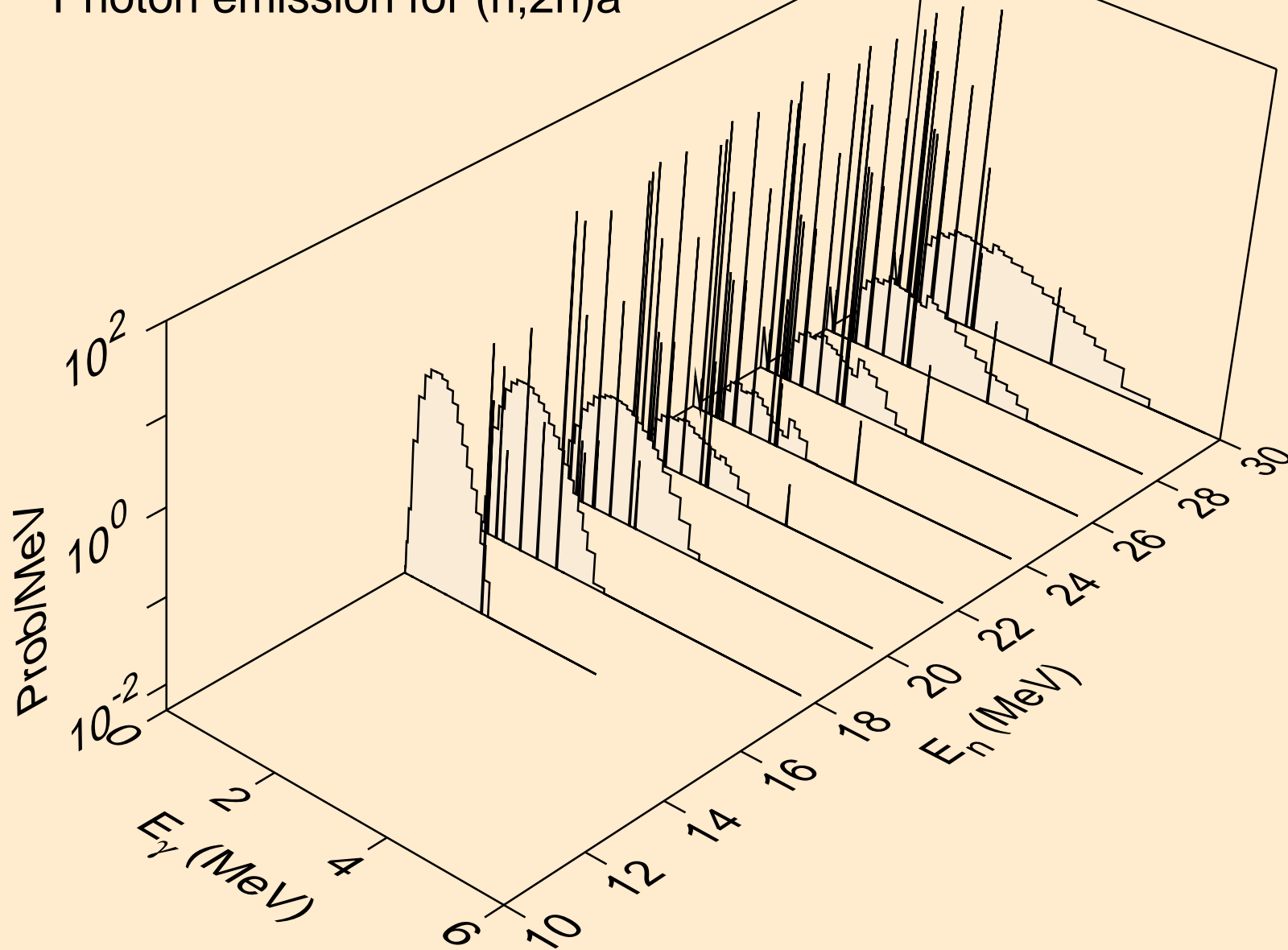

PD099 NEUTRON ACER TENDL-2019 LIBRARY; T=293.16K
Photon emission for (n,n*)p

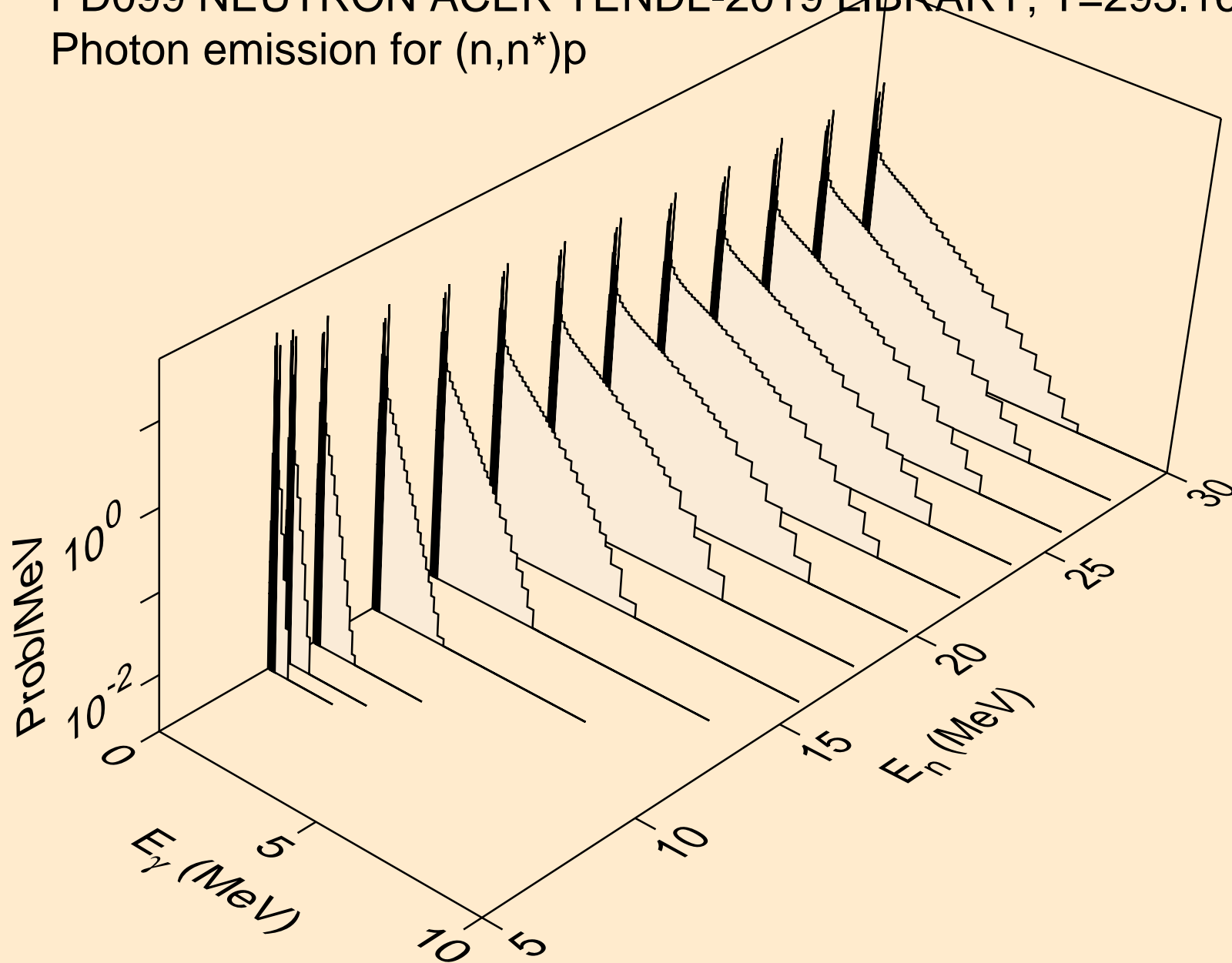

PD099 NEUTRON ACER TENDL-2019 LIBRARY; T=293.16K
Photon emission for (n,n*)2a

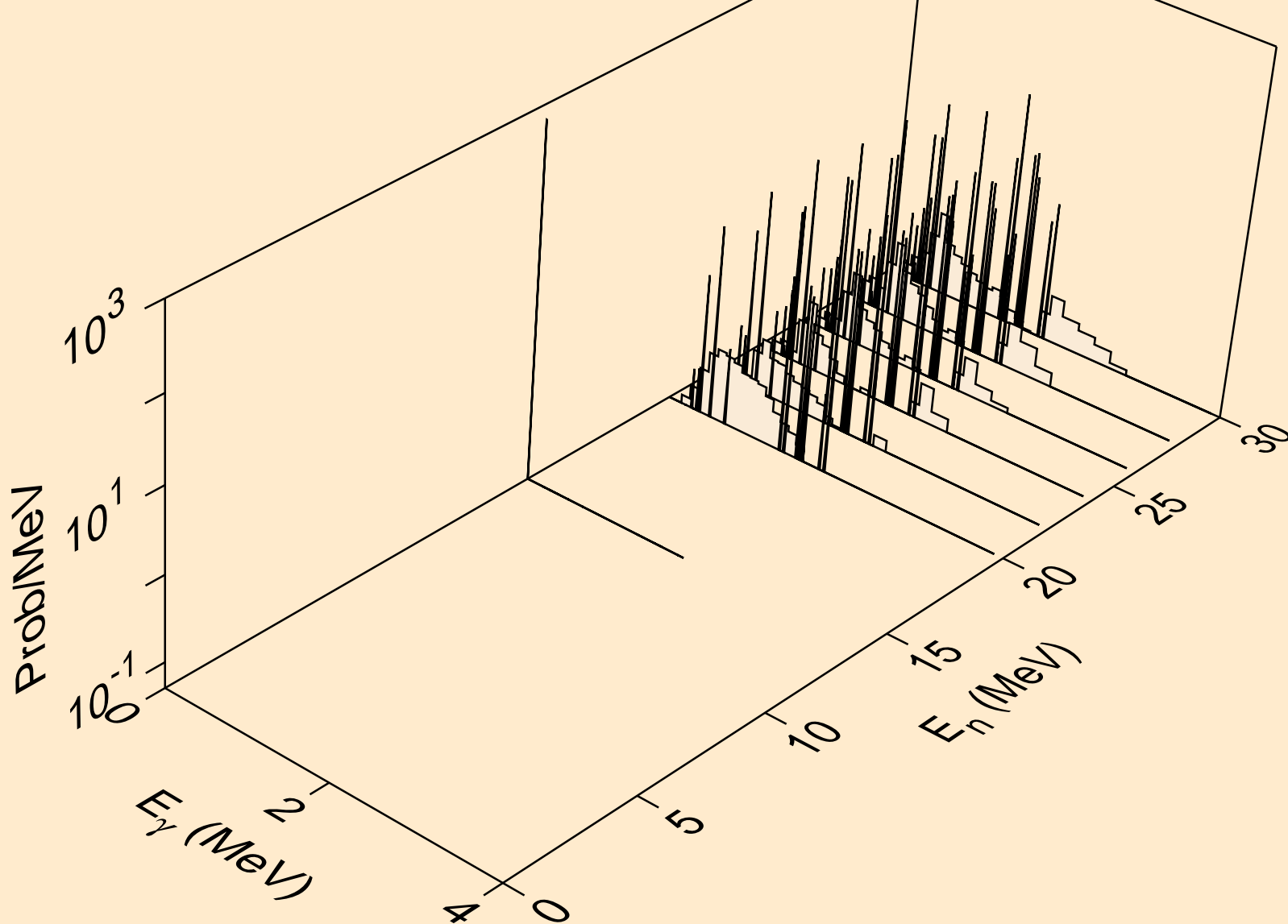

PD099 NEUTRON ACER TENDL-2019 LIBRARY; T=293.16K
Photon emission for (n,n*)d

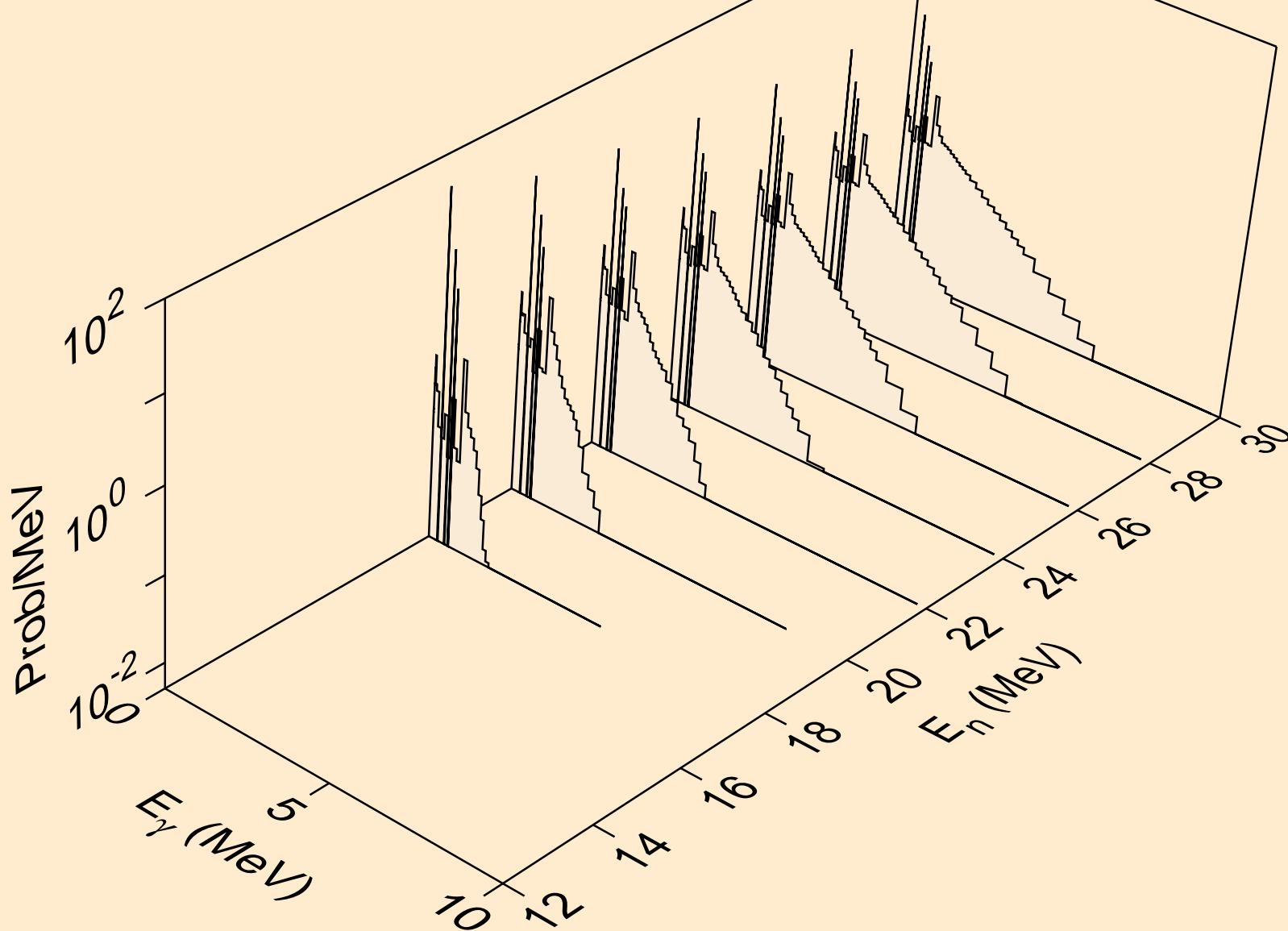

PD099 NEUTRON ACER TENDL-2019 LIBRARY; T=293.16K
Photon emission for (n,n*)t

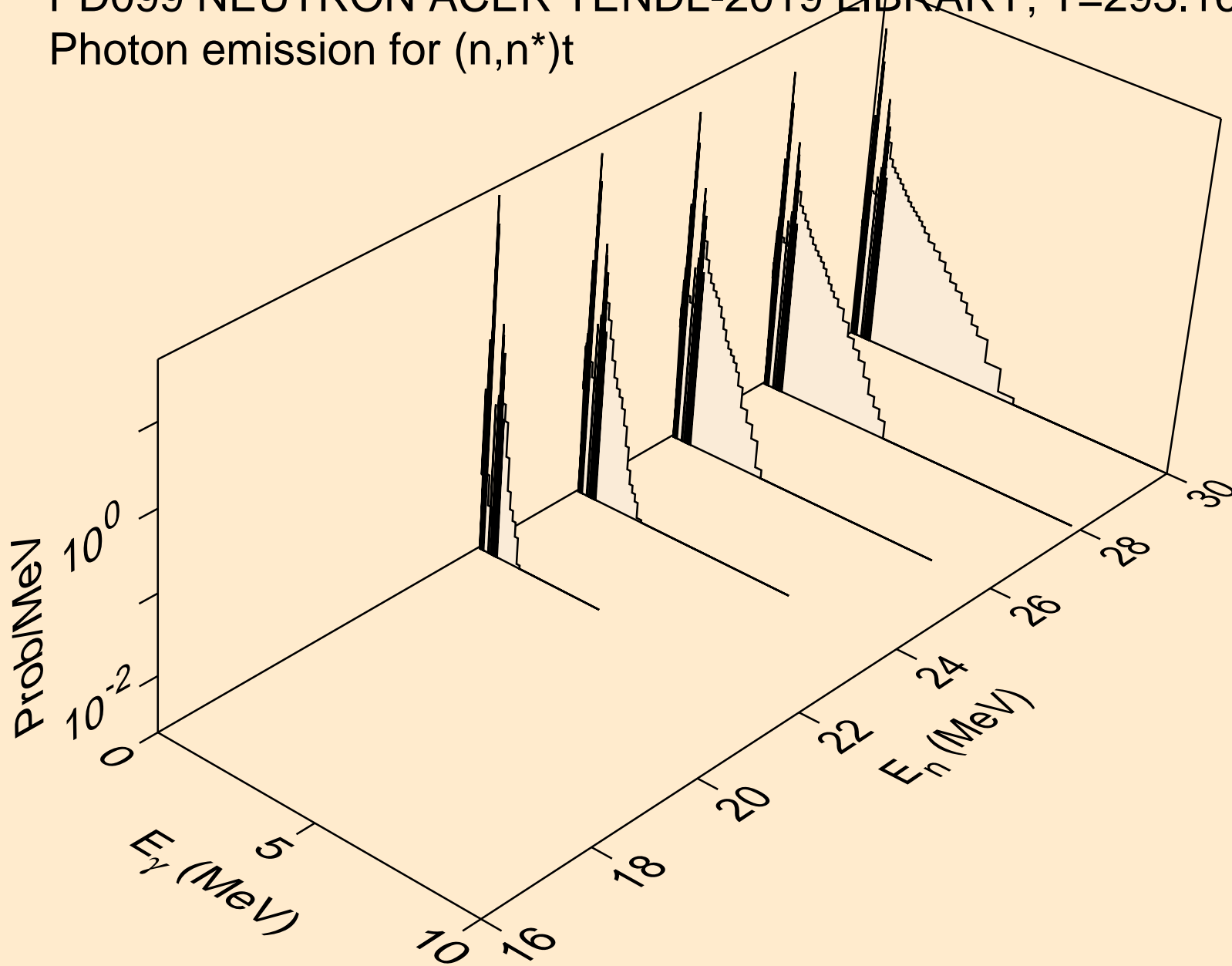

PD099 NEUTRON ACER TENDL-2019 LIBRARY; T=293.16K
Photon emission for (n,n*)he3

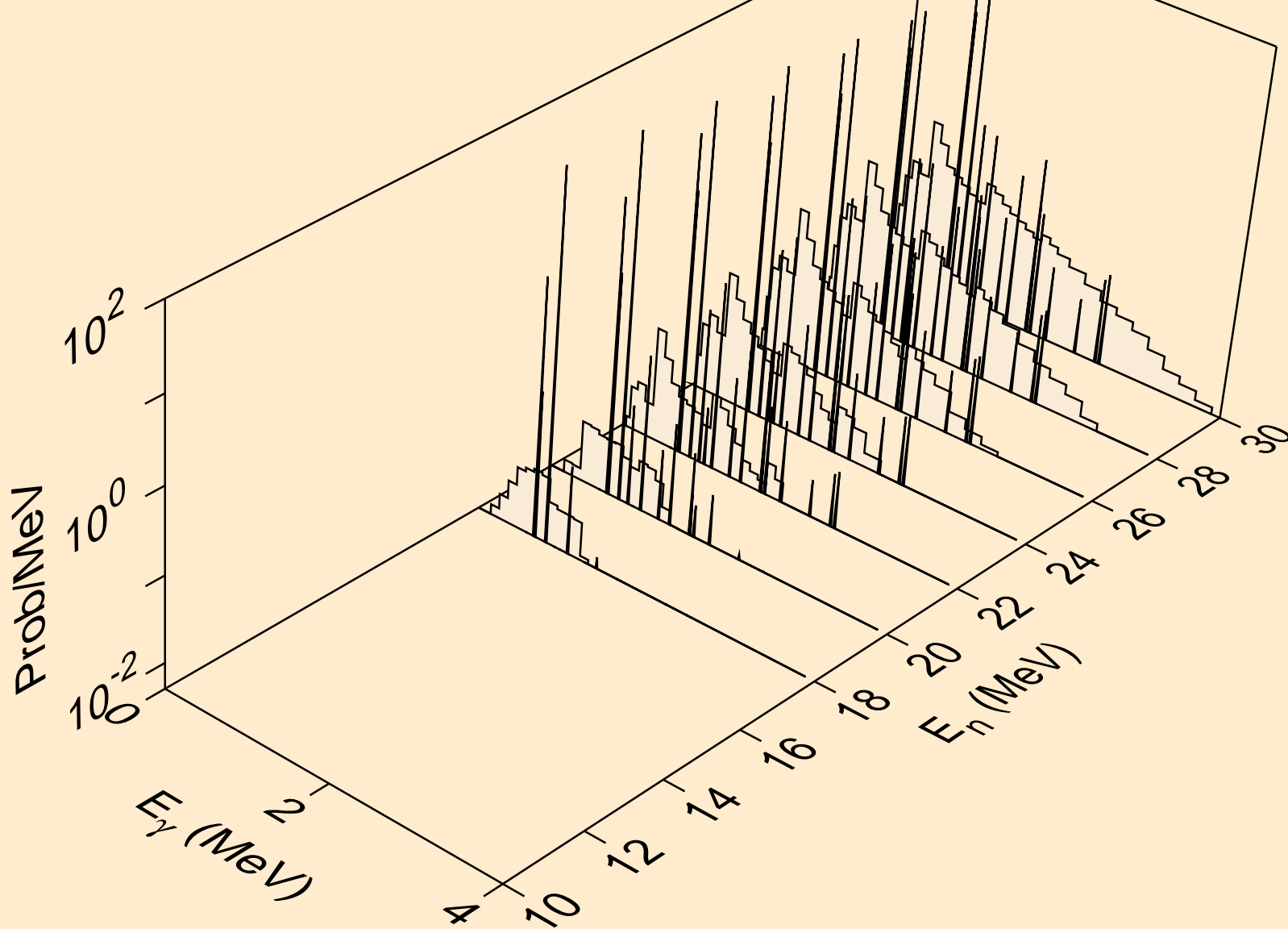

PD099 NEUTRON ACER TENDL-2019 LIBRARY; T=293.16K
Photon emission for (n,2np)

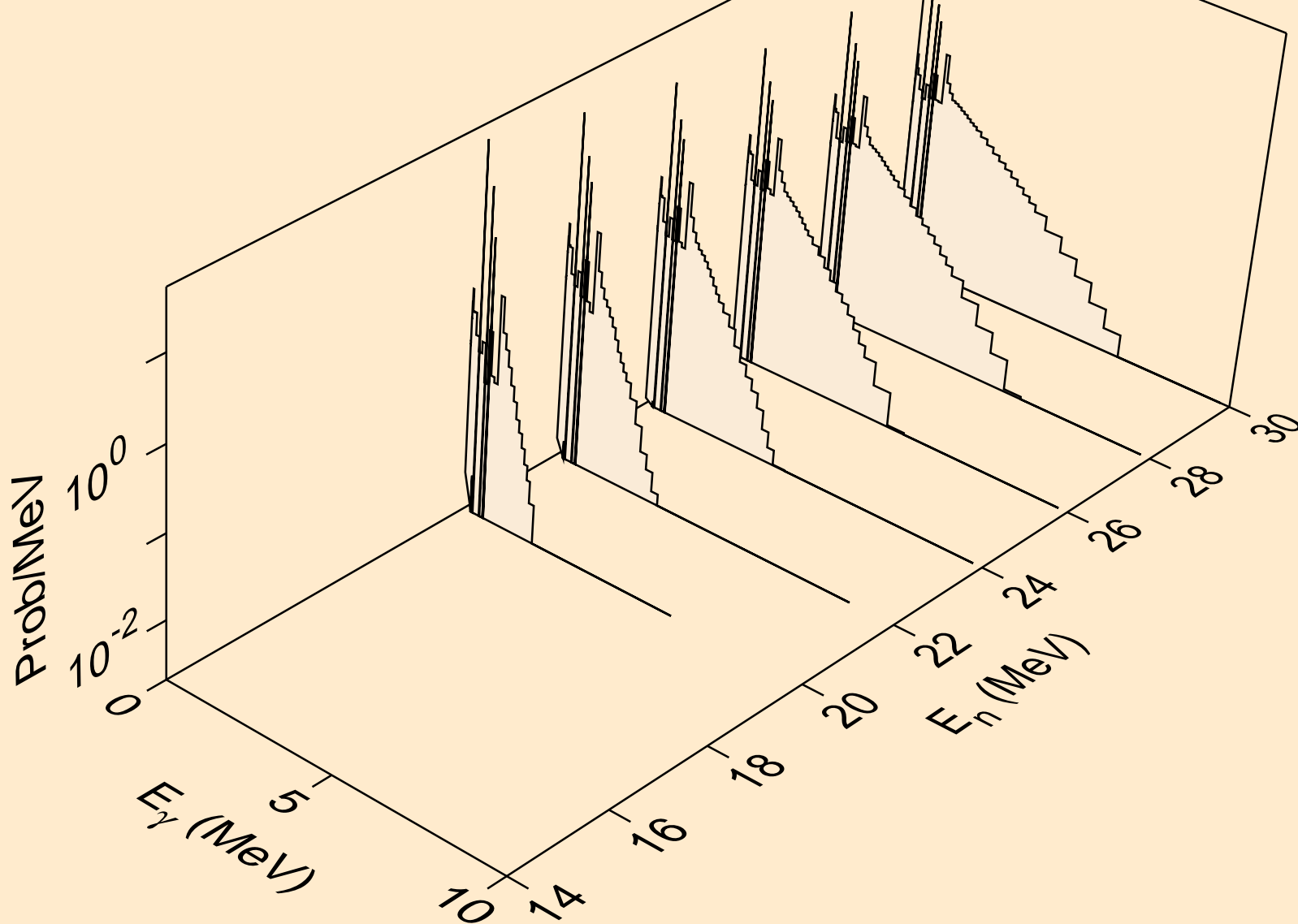

PD099 NEUTRON ACER TENDL-2019 LIBRARY; T=293.16K
Photon emission for (n,3np)

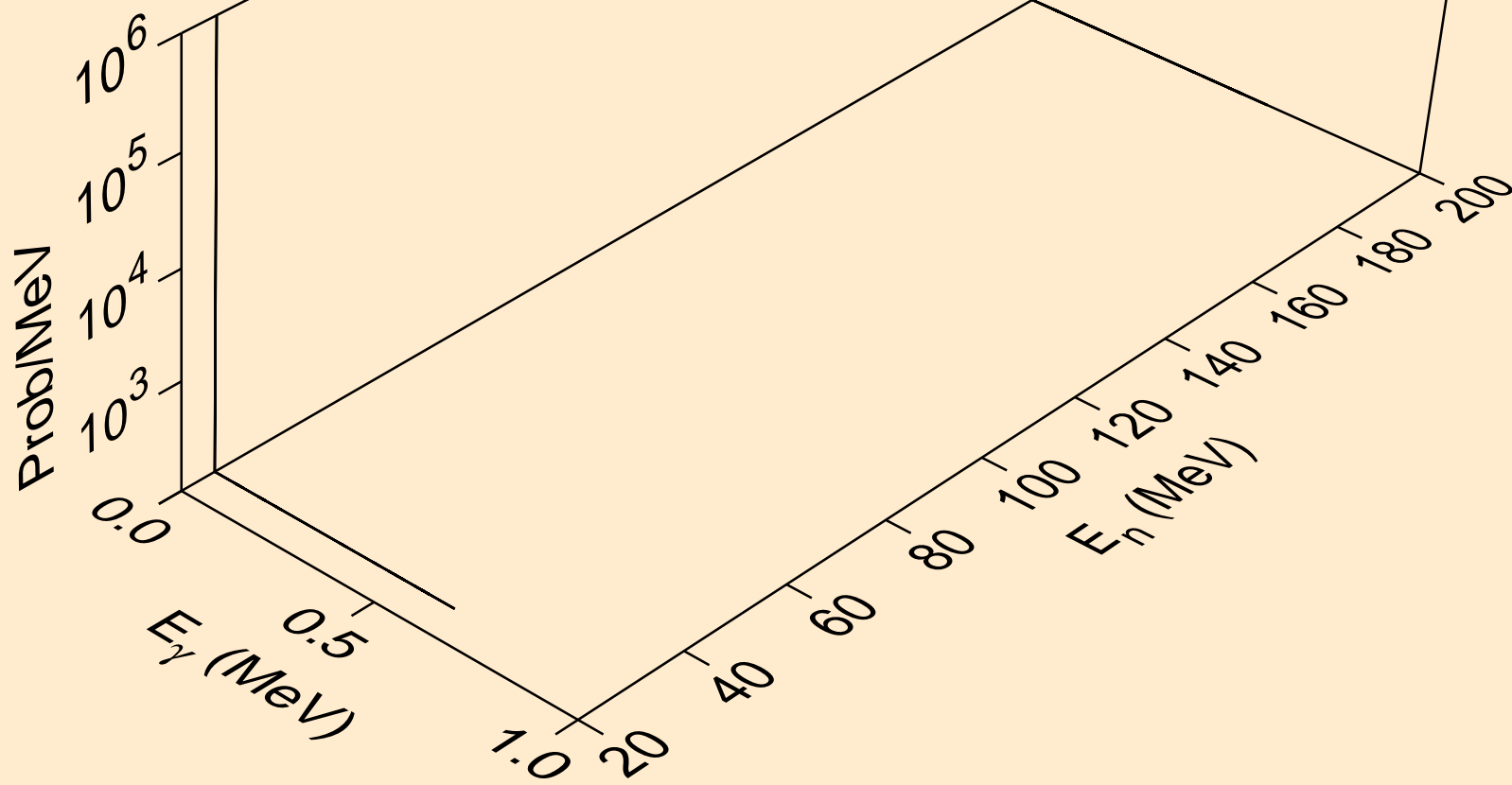

PD099 NEUTRON ACER TENDL-2019 LIBRARY; T=293.16K
Photon emission for (n,2np)

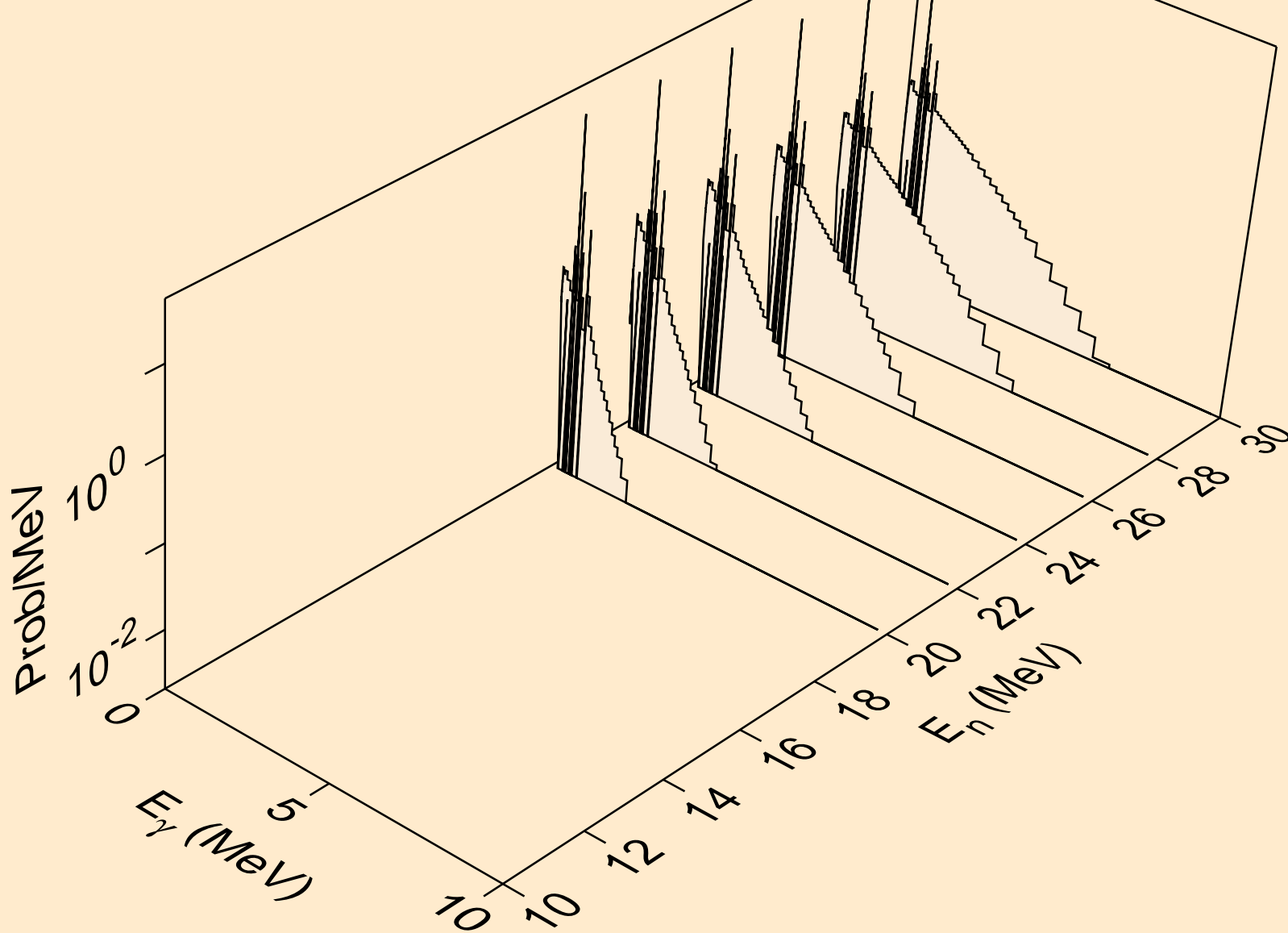

PD099 NEUTRON ACER TENDL-2019 LIBRARY; T=293.16K
Photon emission for (n,npa)

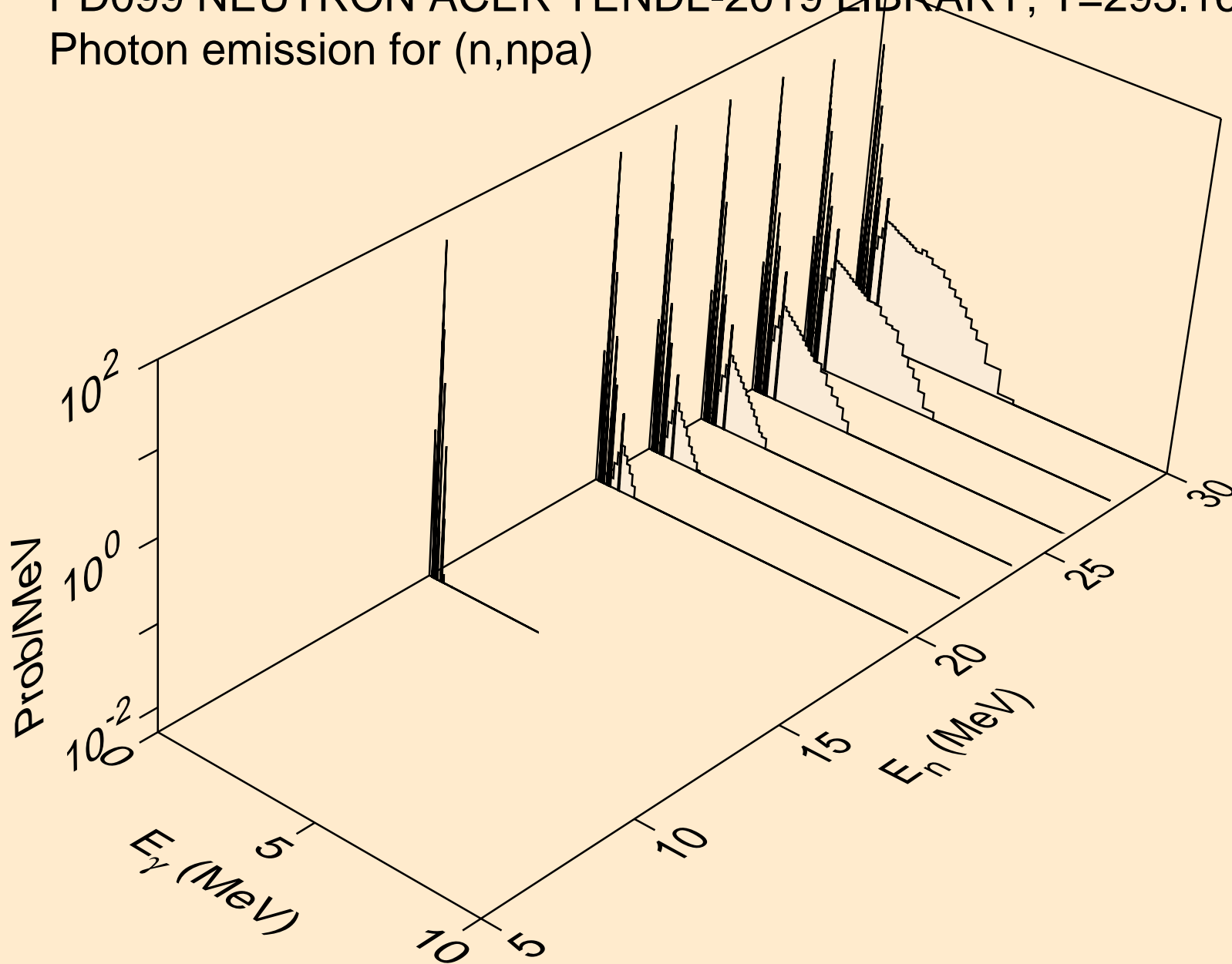

PD099 NEUTRON ACER TENDL-2019 LIBRARY; T=293.16K
Photon emission for (n,n*c)

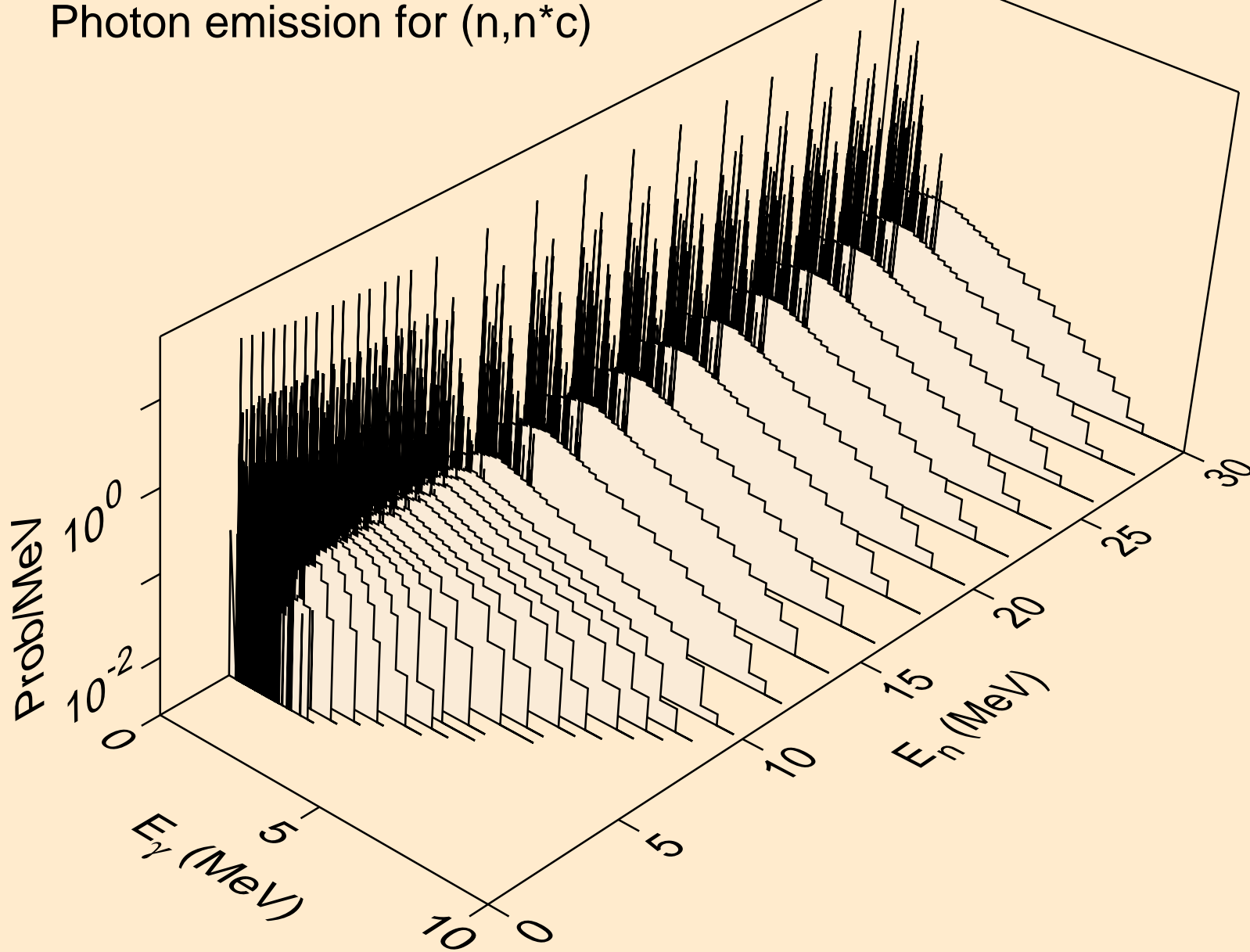

PD099 NEUTRON ACER TENDL-2019 LIBRARY; T=293.16K
Photon emission for (n,gma)

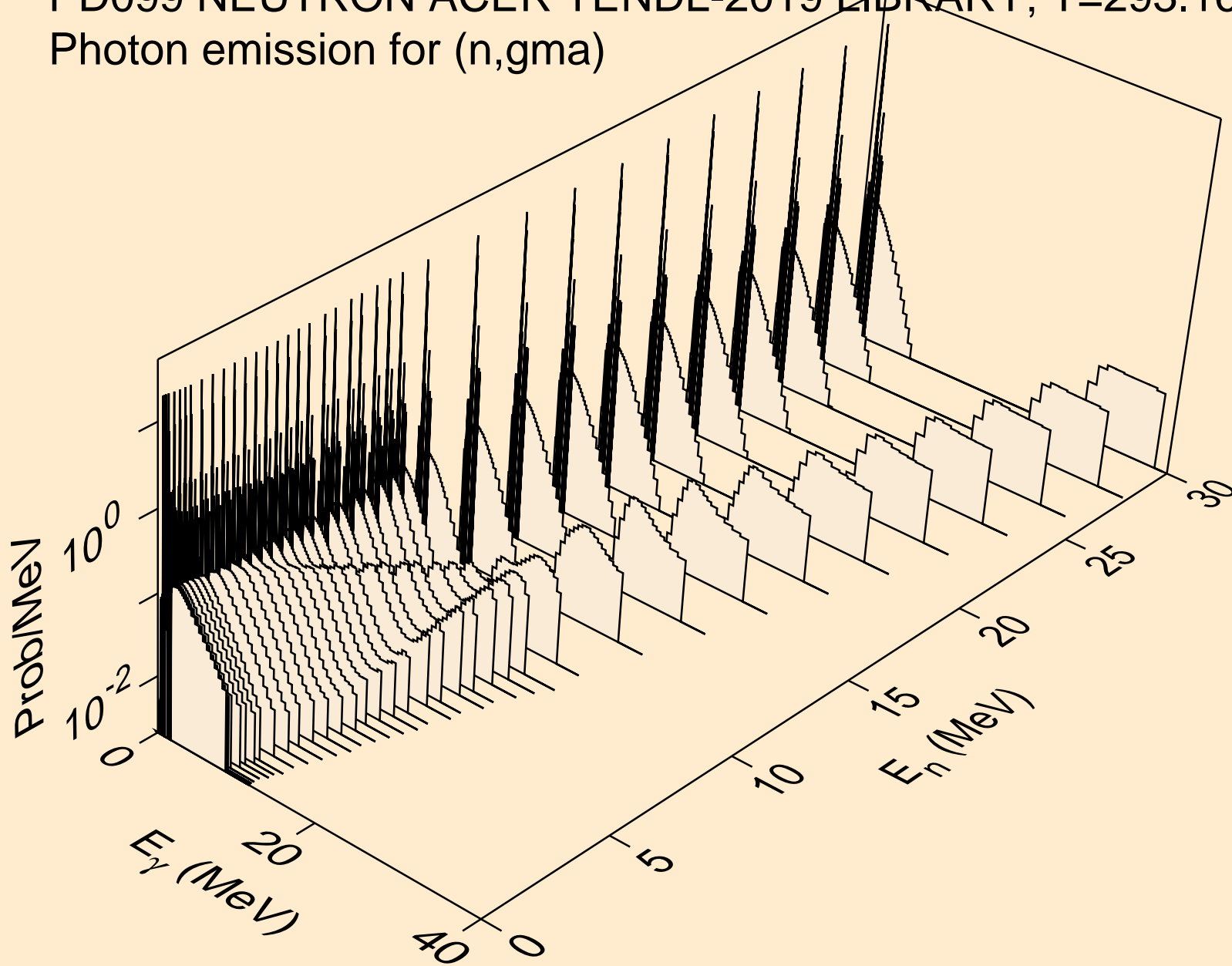

PD099 NEUTRON ACER TENDL-2019 LIBRARY; T=293.16K
Photon emission for (n,p)

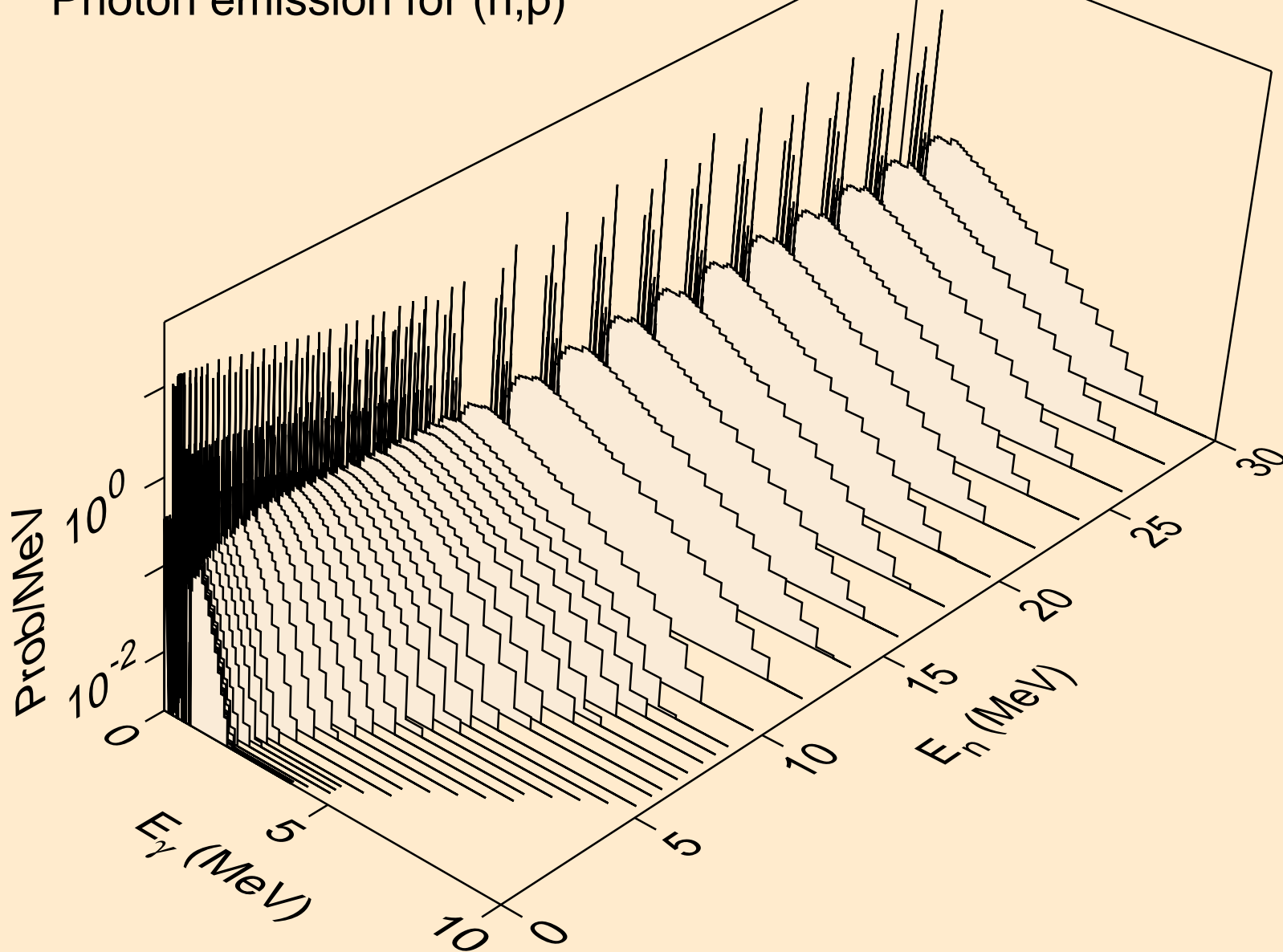

PD099 NEUTRON ACER TENDL-2019 LIBRARY; T=293.16K
Photon emission for (n,d)

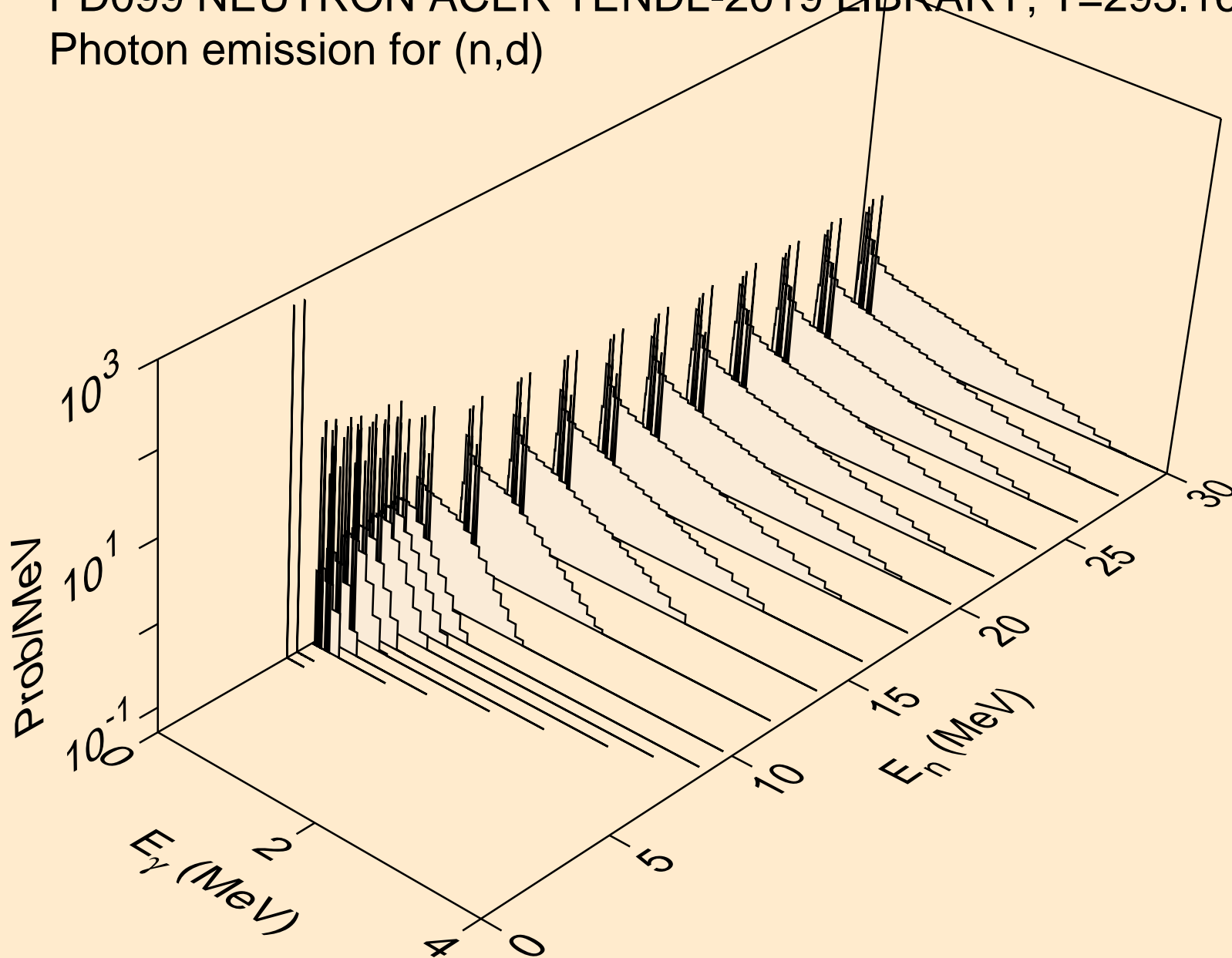

PD099 NEUTRON ACER TENDL-2019 LIBRARY; T=293.16K
Photon emission for (n,t)

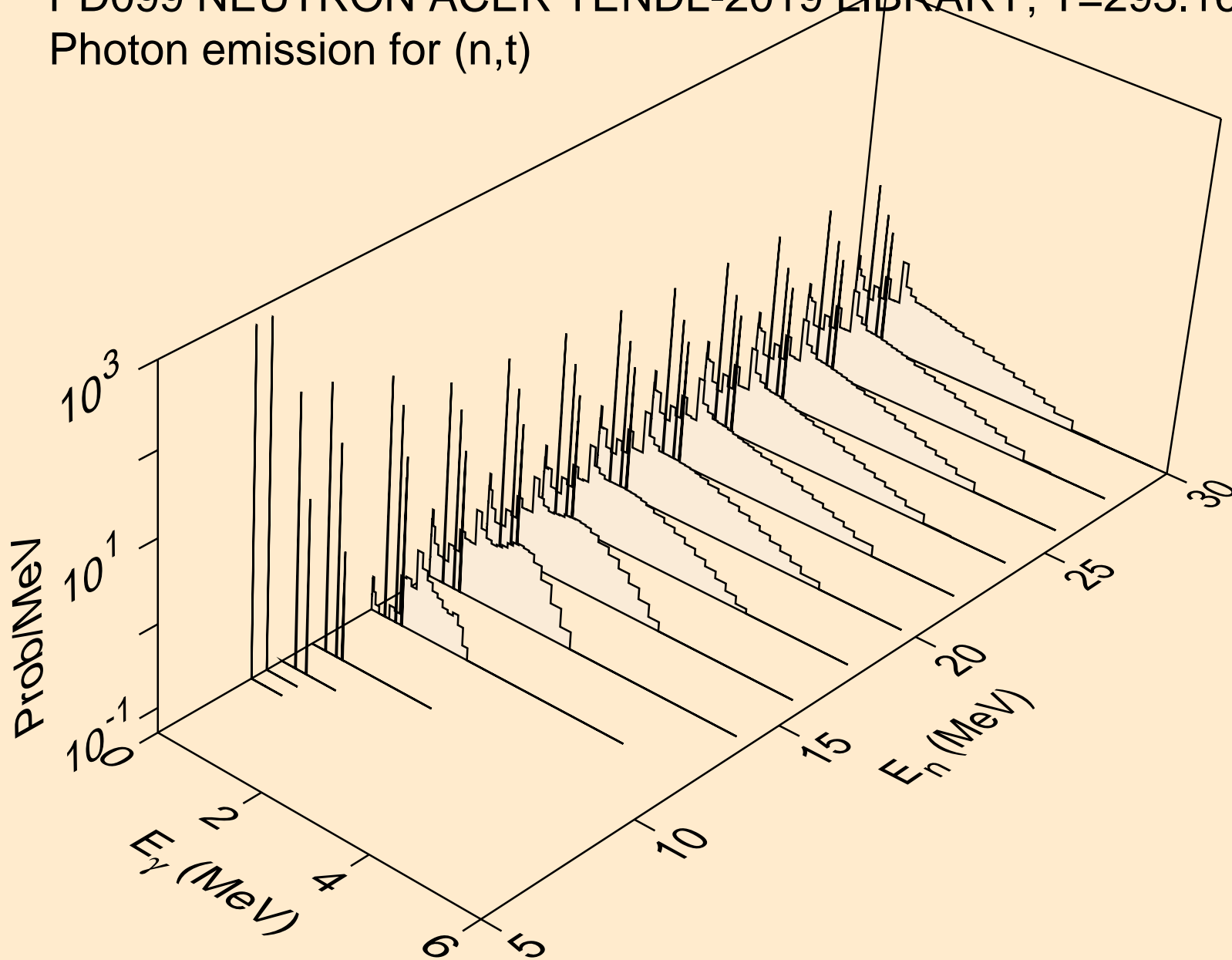

PD099 NEUTRON ACER TENDL-2019 LIBRARY; T=293.16K
Photon emission for (n,he3)

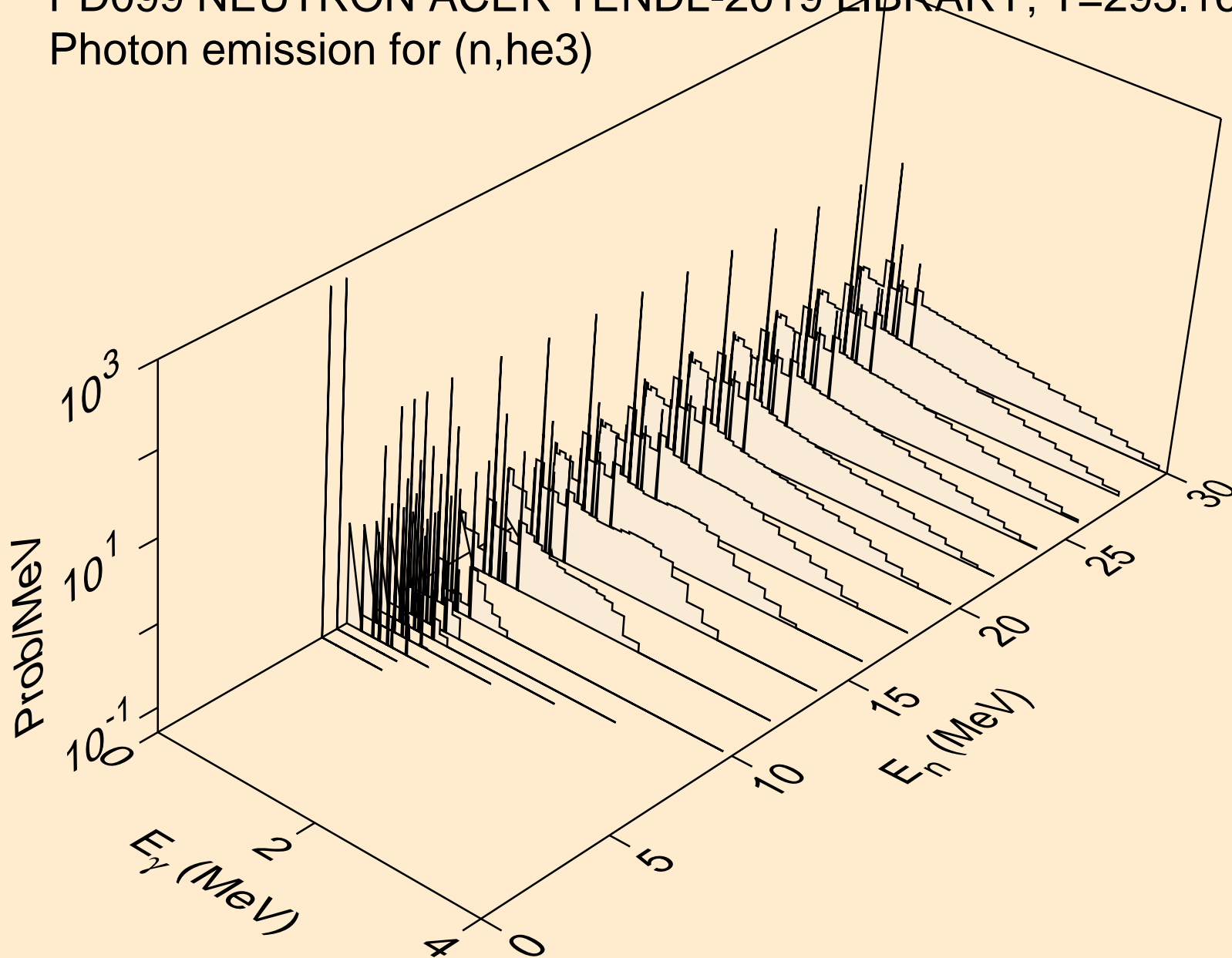

PD099 NEUTRON ACER TENDL-2019 LIBRARY; T=293.16K
Photon emission for (n,a)

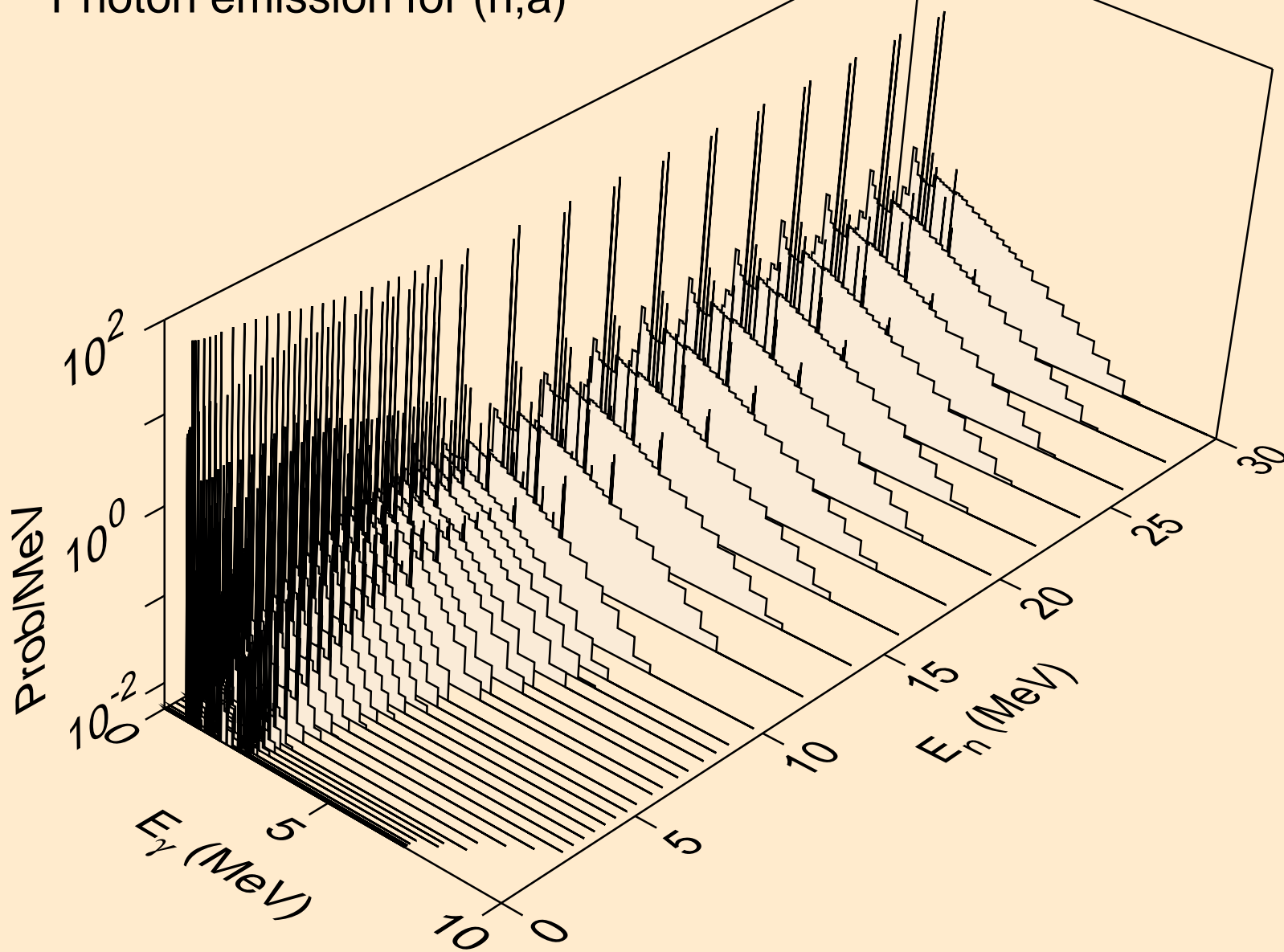

PD099 NEUTRON ACER TENDL-2019 LIBRARY; T=293.16K
Photon emission for (n,2a)

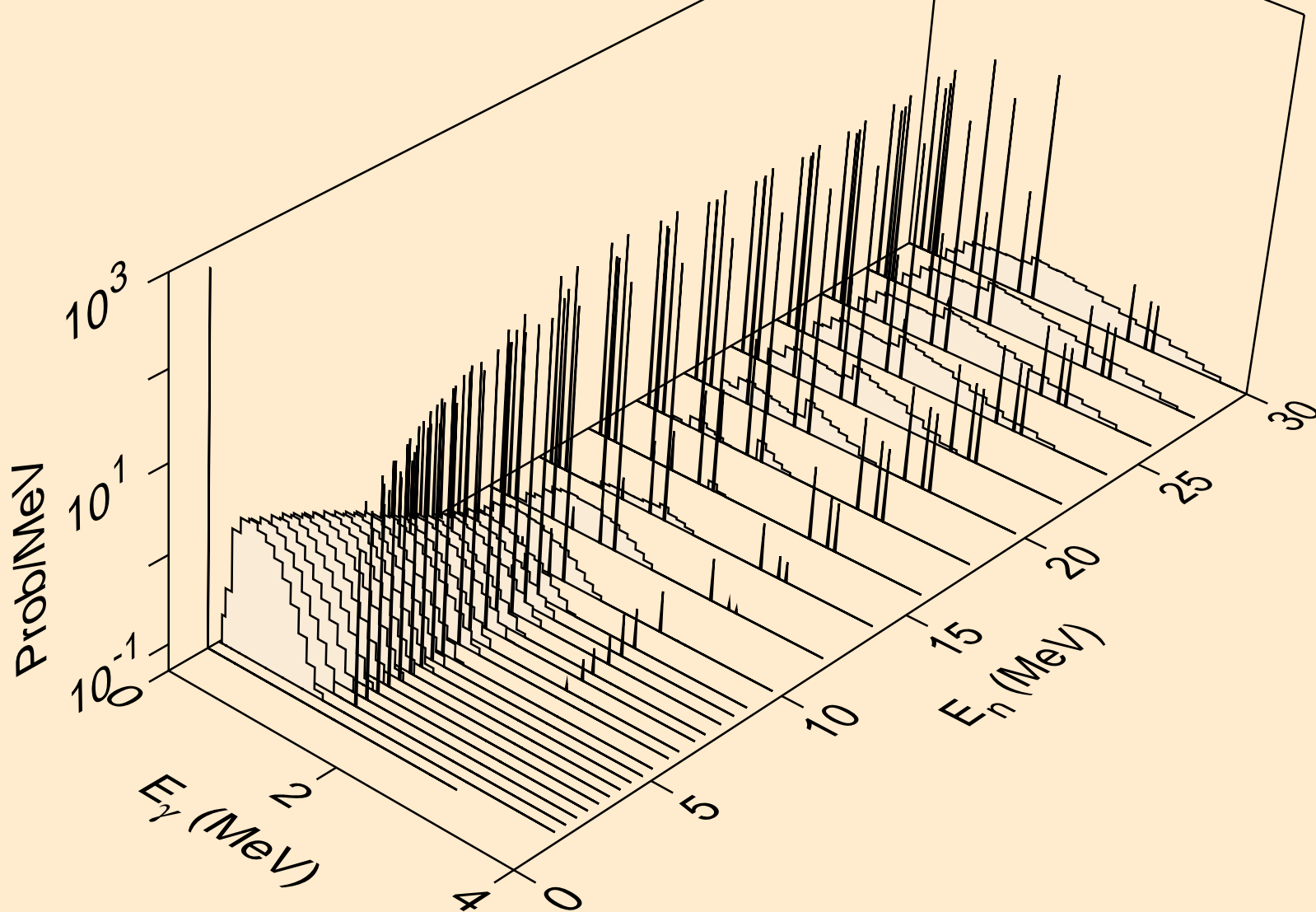

PD099 NEUTRON ACER TENDL-2019 LIBRARY; T=293.16K
Photon emission for (n,2p)

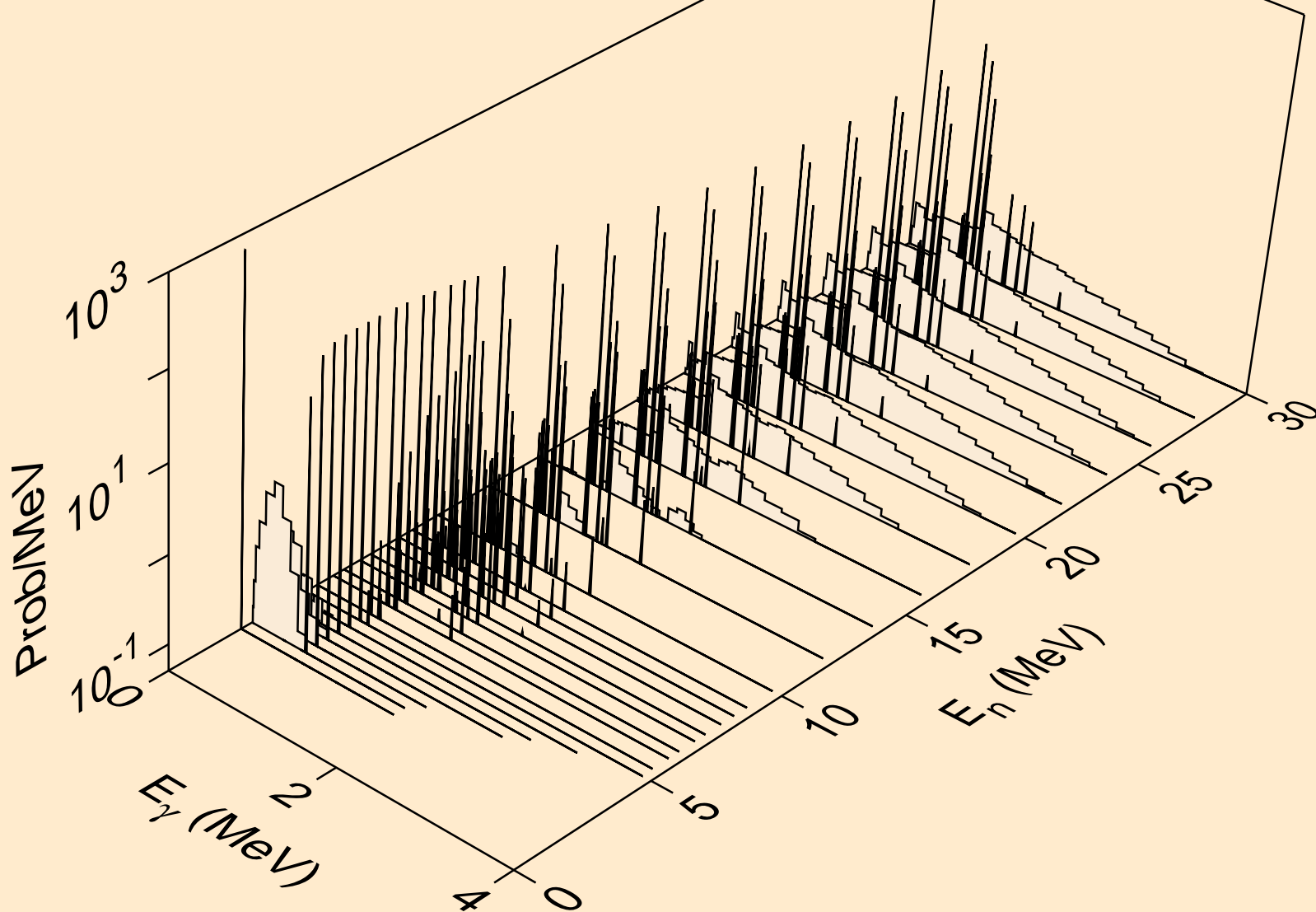

PD099 NEUTRON ACER TENDL-2019 LIBRARY; T=293.16K
Photon emission for (n,p α)

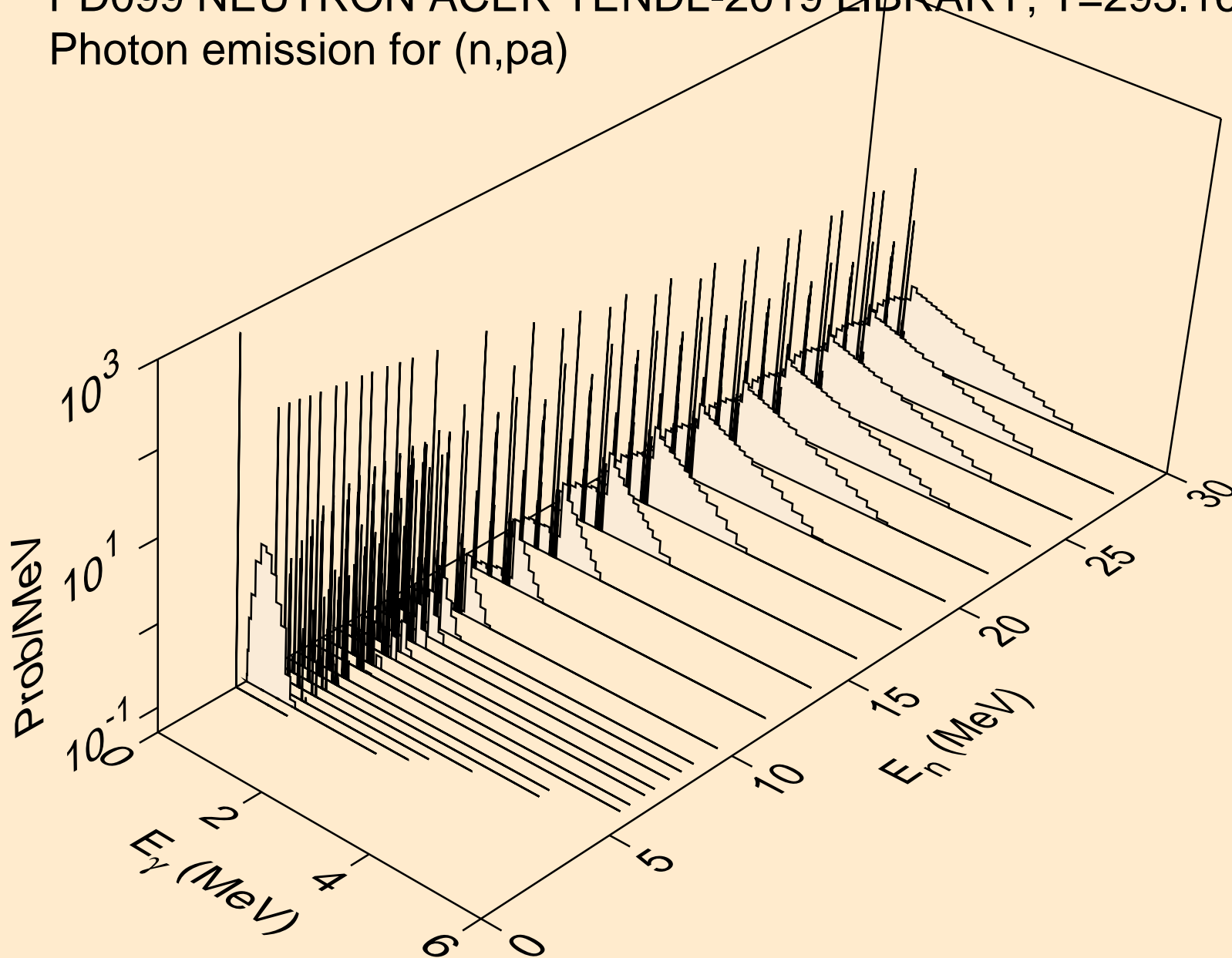

PD099 NEUTRON ACER TENDL-2019 LIBRARY; T=293.16K
Photon emission for (n,pd)

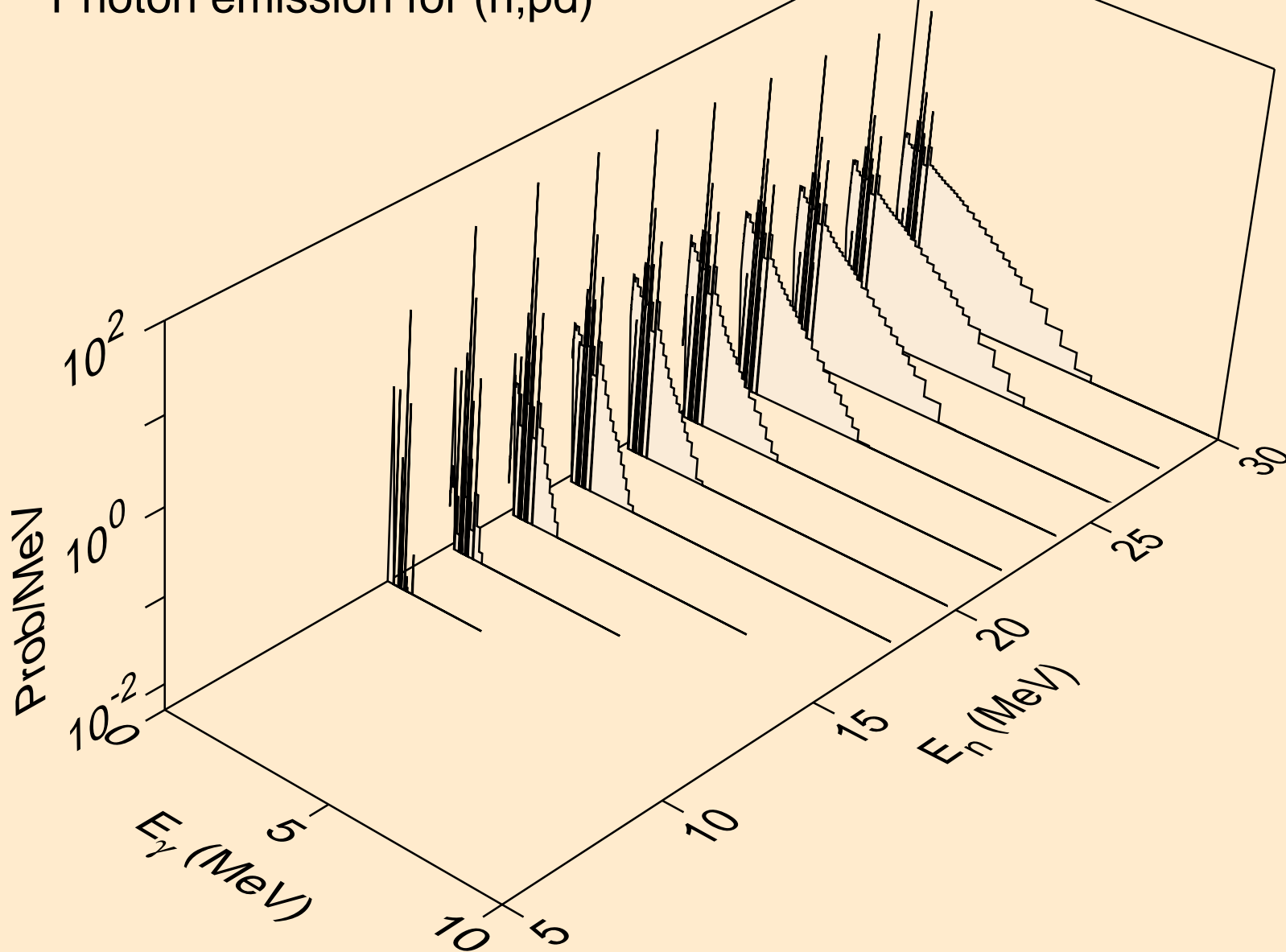

PD099 NEUTRON ACER TENDL-2019 LIBRARY; T=293.16K
Photon emission for (n,pt)

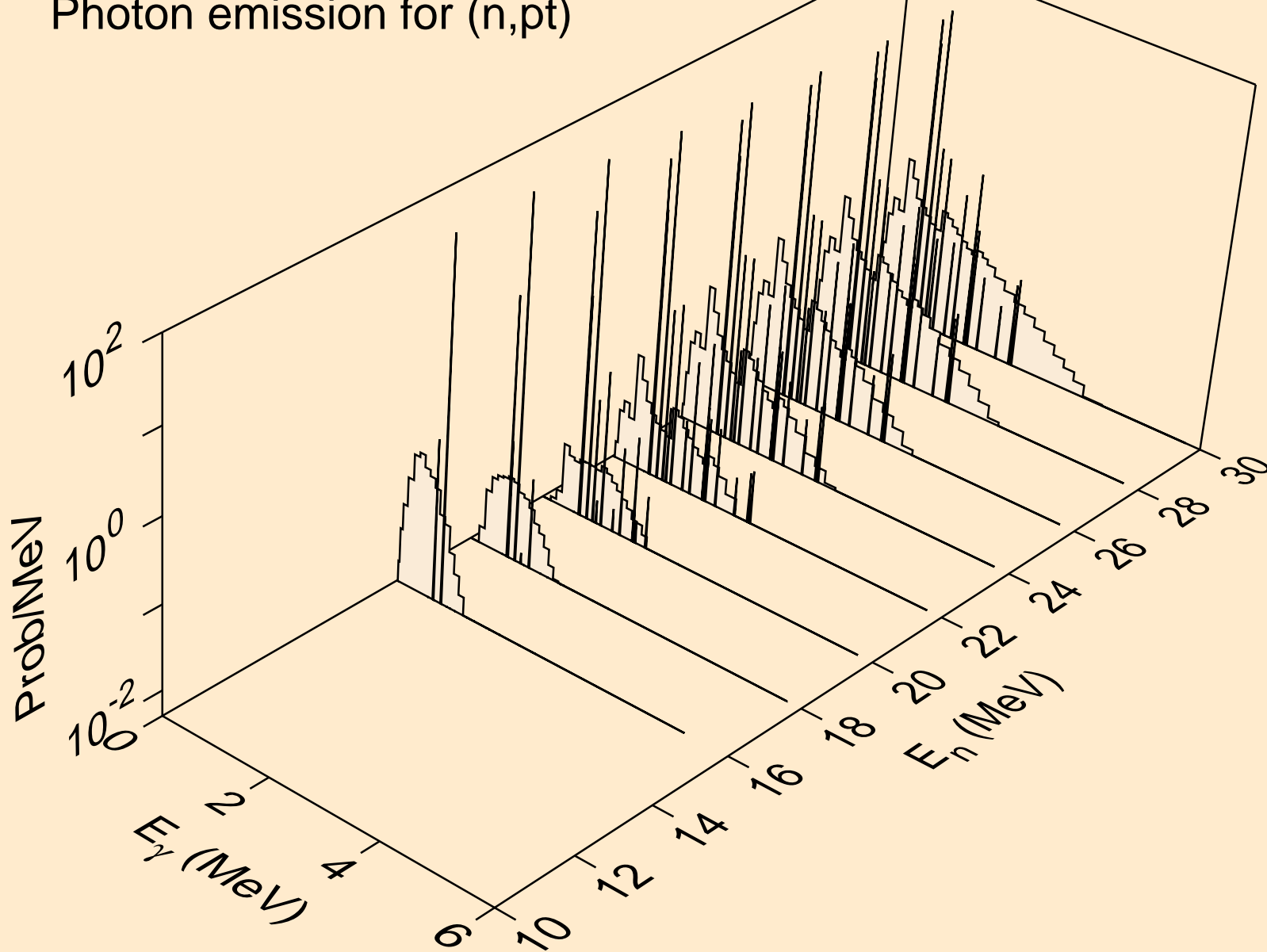

PD099 NEUTRON ACER TENDL-2019 LIBRARY; T=293.16K
Photon emission for (n,da)

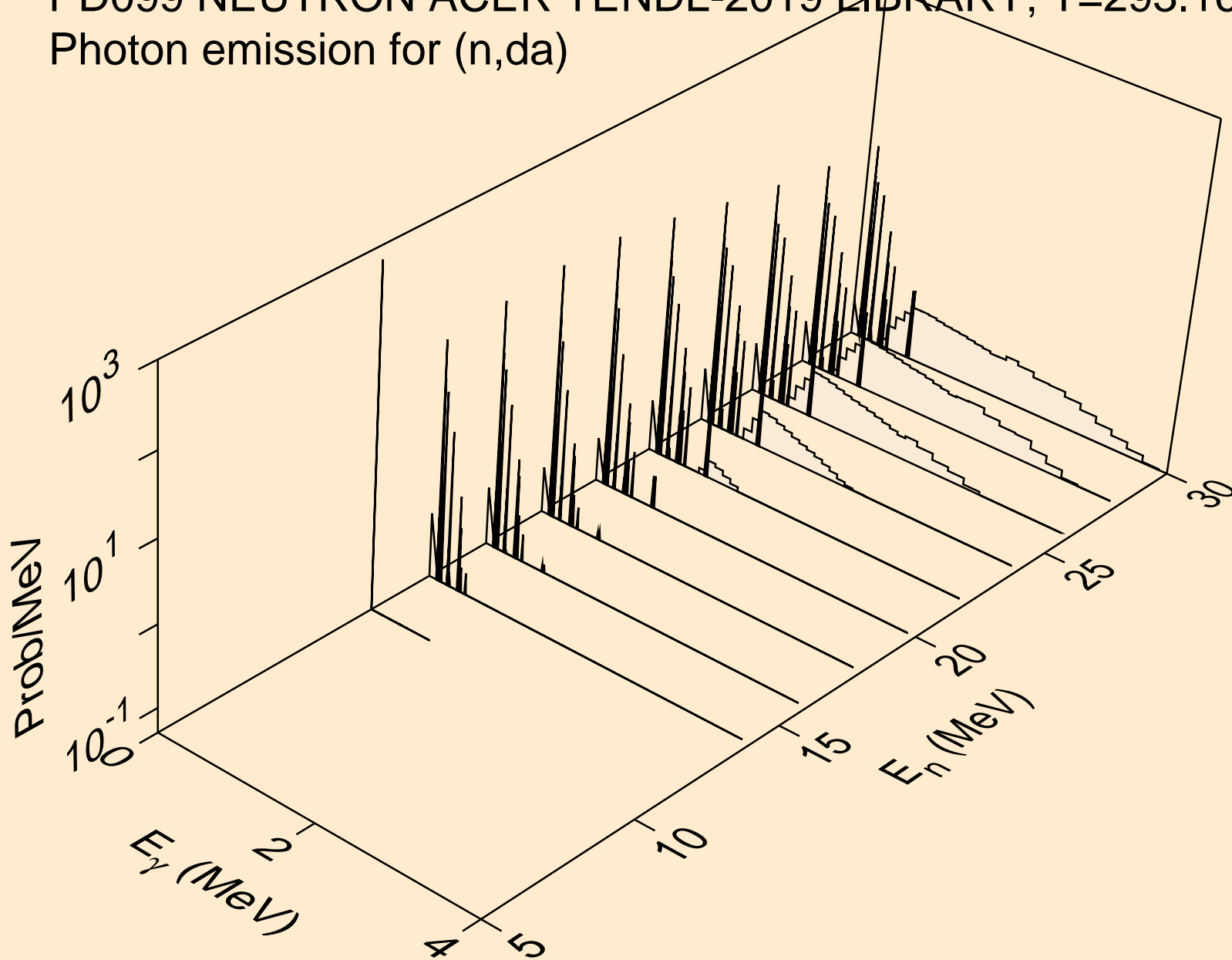

PD099 NEUTRON ACER TENDL-2019 LIBRARY; T=293.16K
thermal capture photon spectrum

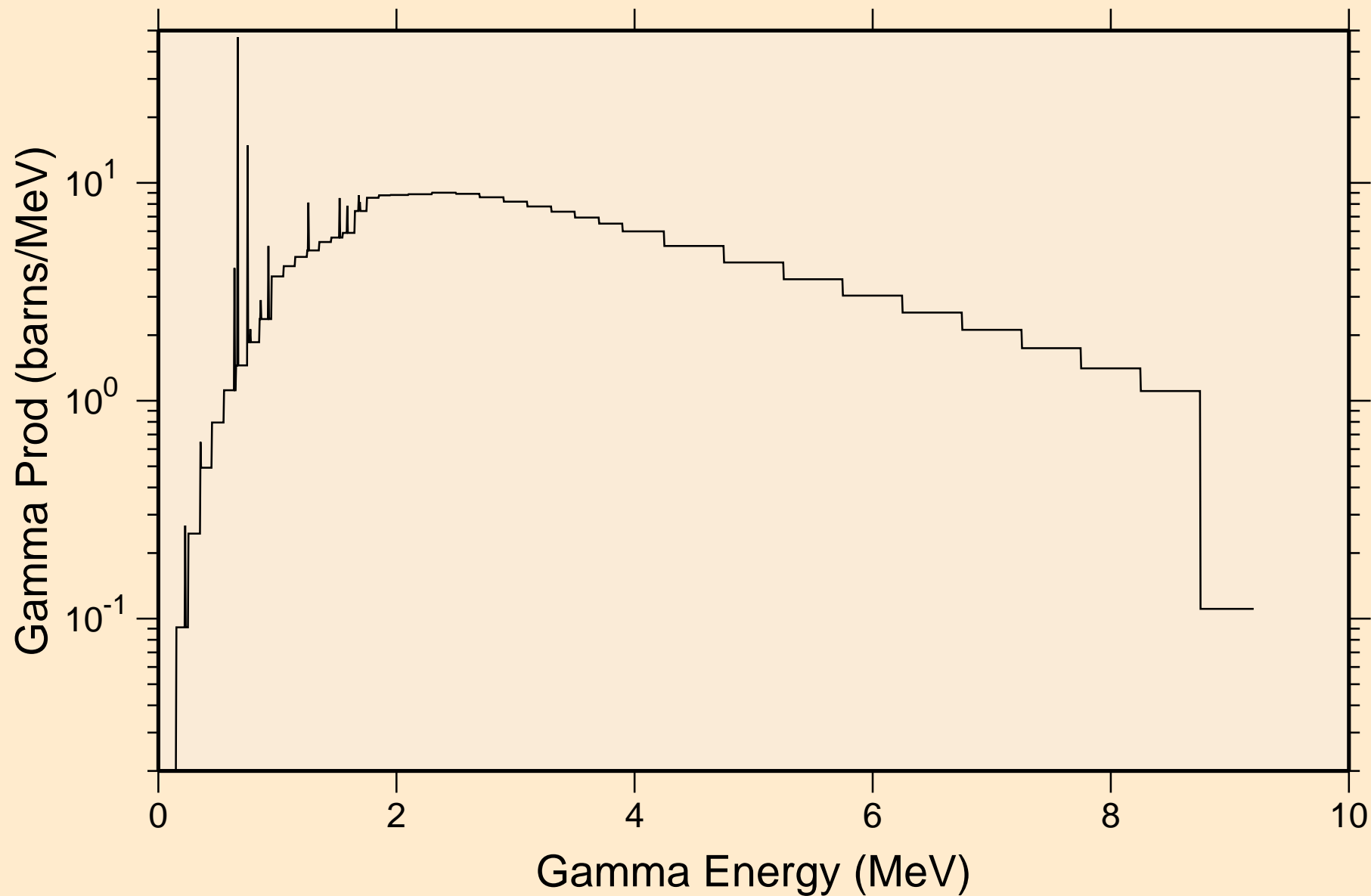

PD099 NEUTRON ACER TENDL-2019 LIBRARY; T=293.16K
14 MeV photon spectrum

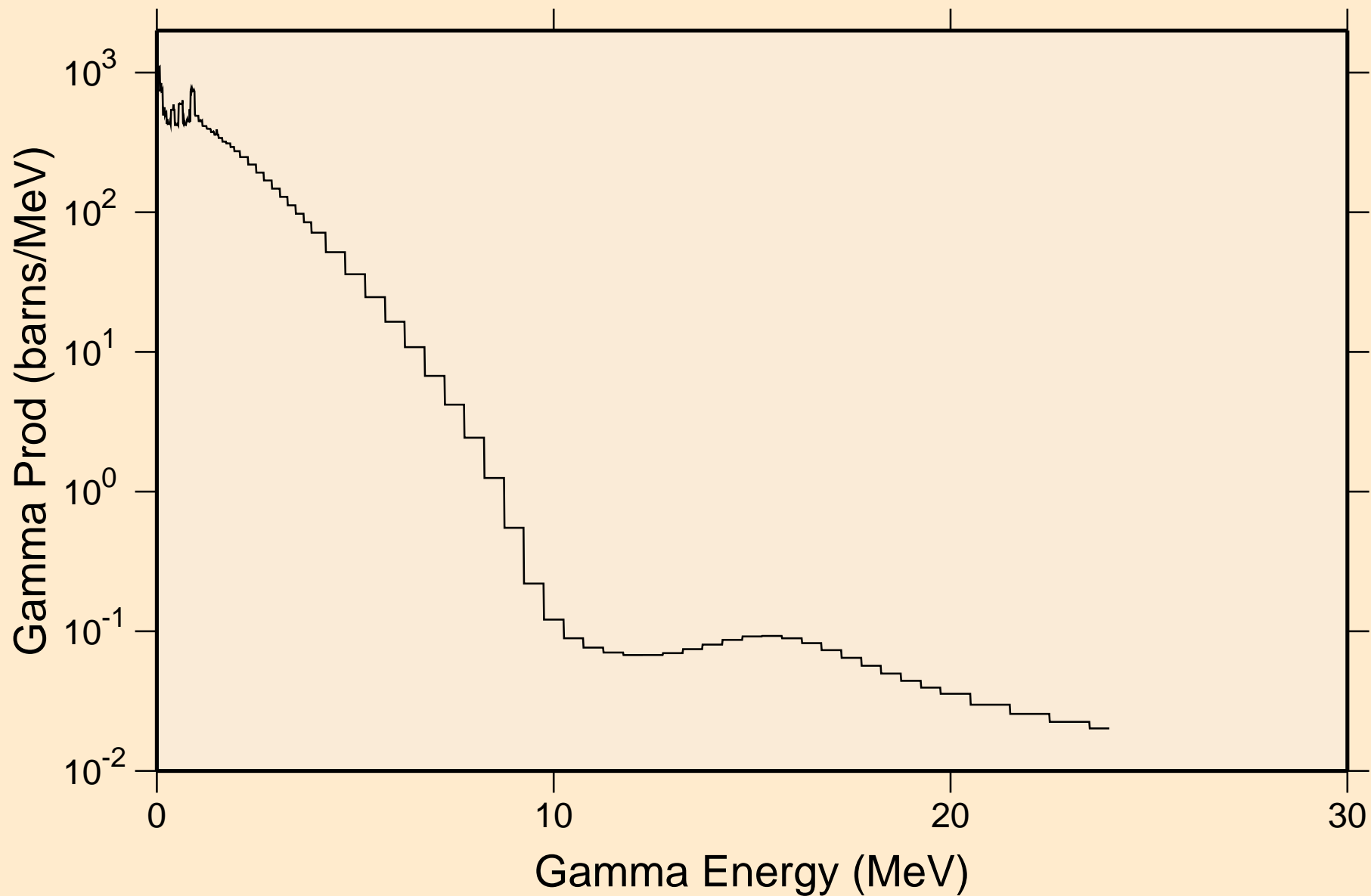

PD099 NEUTRON ACER TENDL-2019 LIBRARY; T=293.16K
Particle heating contributions

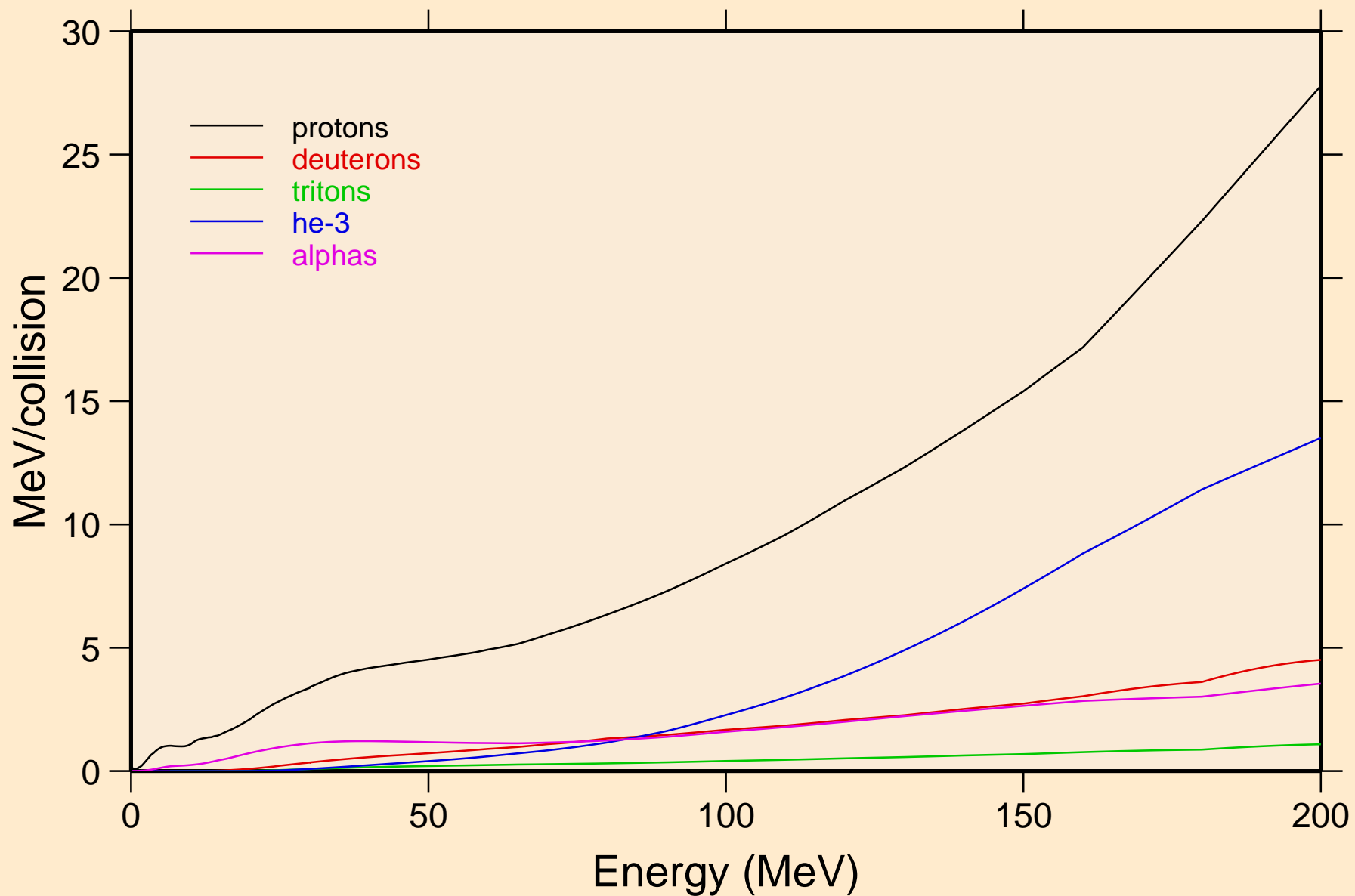

PD099 NEUTRON ACER TENDL-2019 LIBRARY; T=293.16K
Recoil Heating

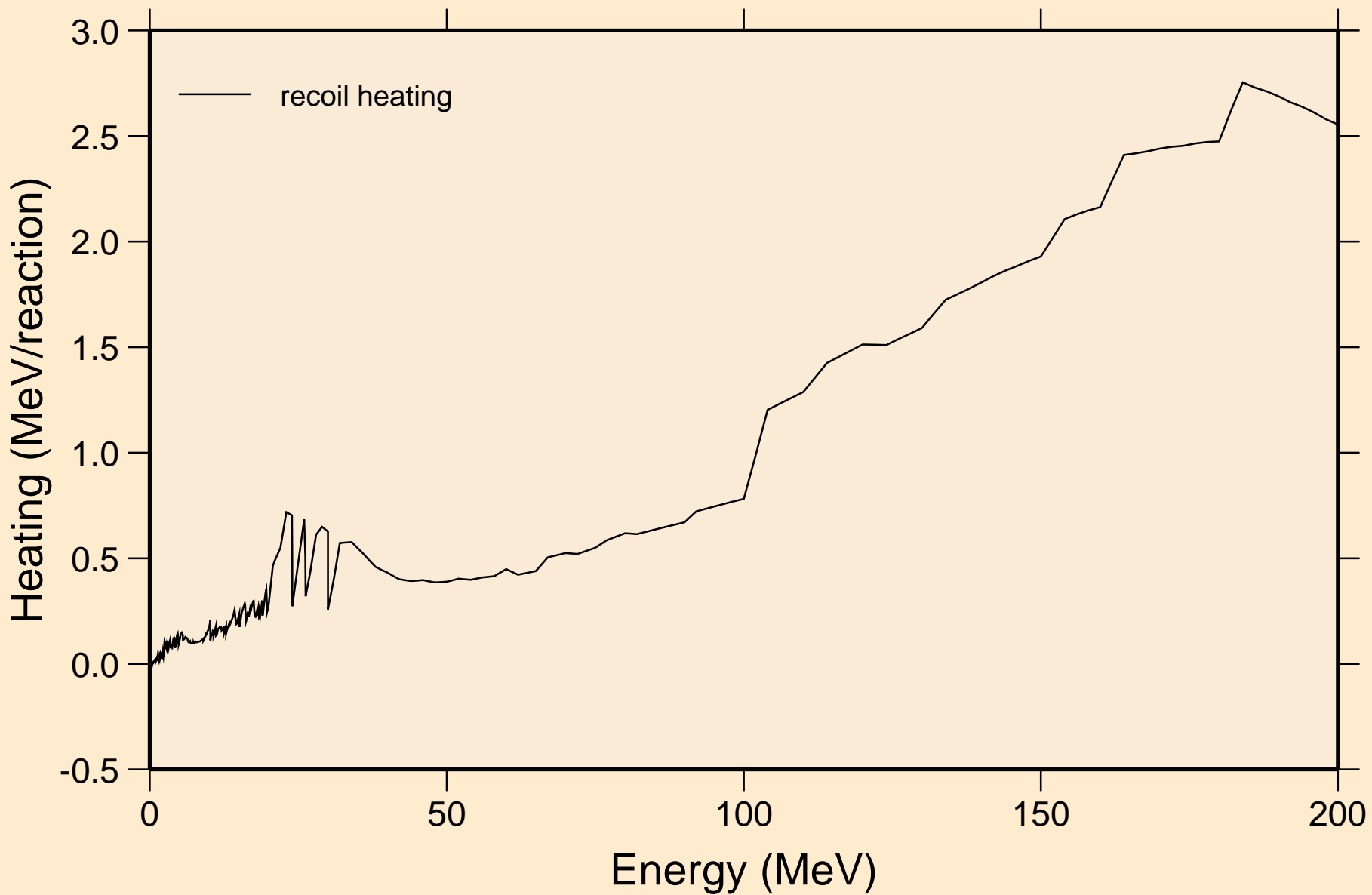

PD099 NEUTRON ACER TENDL-2019 LIBRARY; T=293.16K
Particle production cross sections

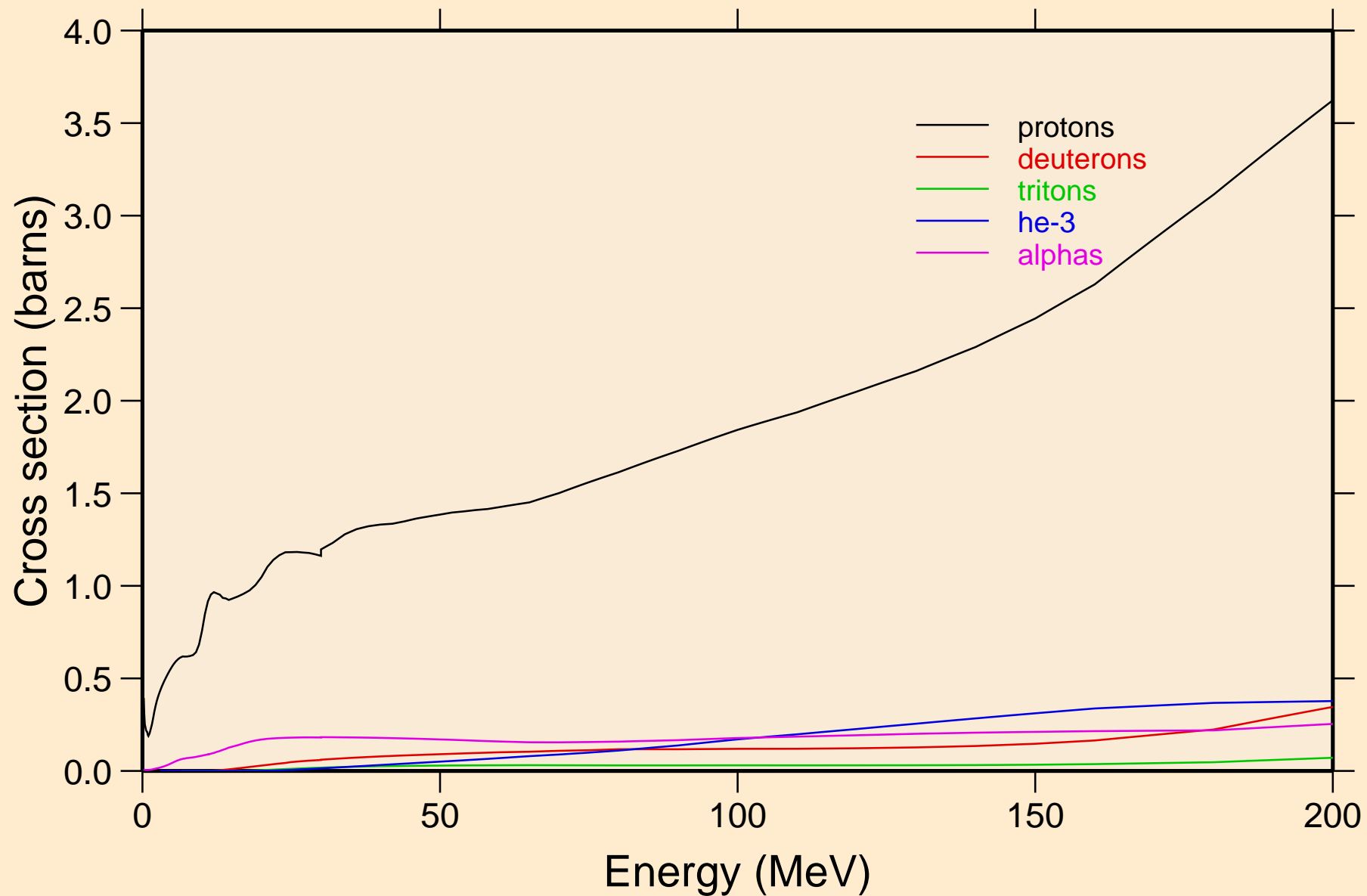

PD099 NEUTRON ACER TENDL-2019 LIBRARY; T=293.16K
protons from (n,x)

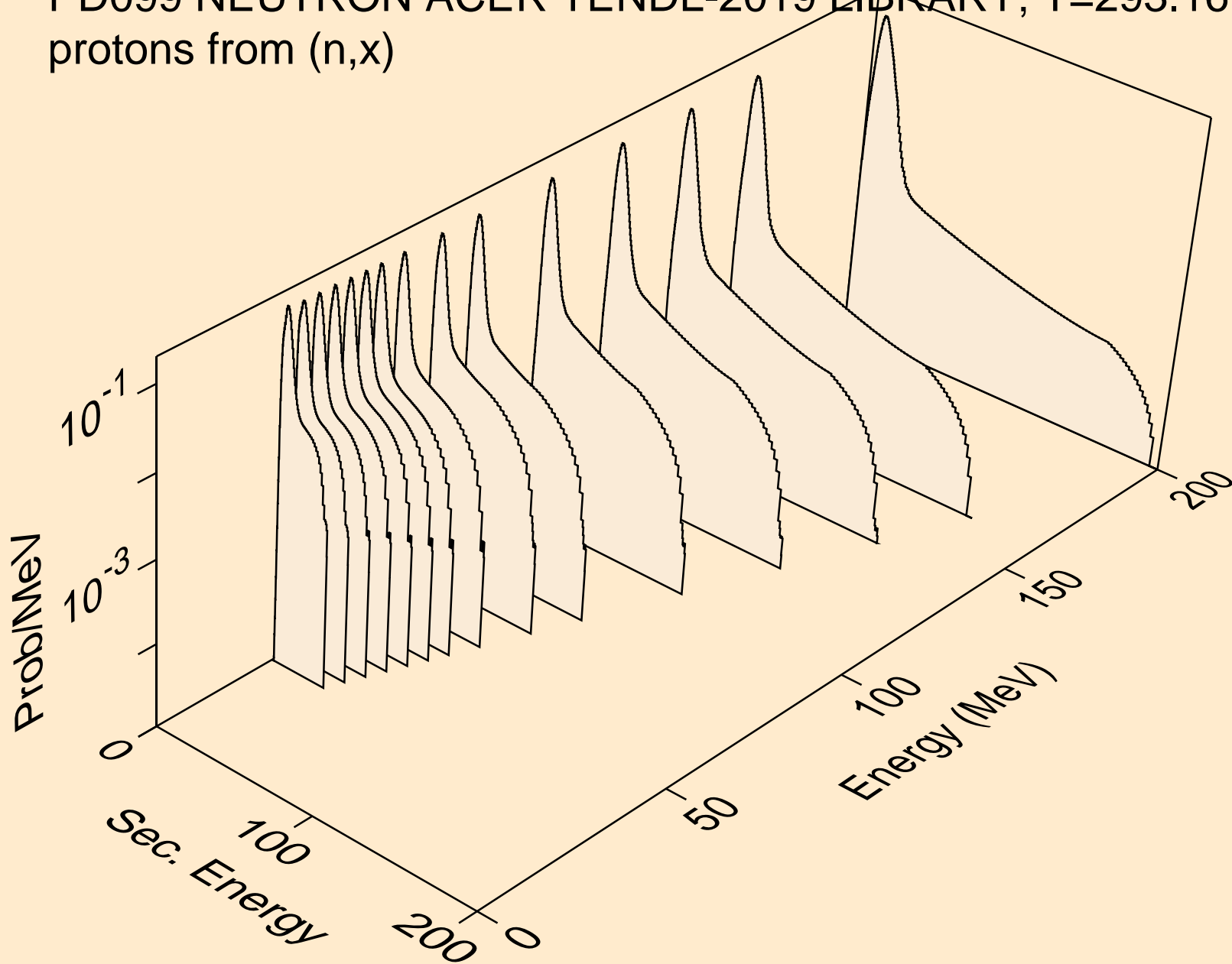

PD099 NEUTRON ACER TENDL-2019 LIBRARY; T=293.16K
protons from (n,n*)p

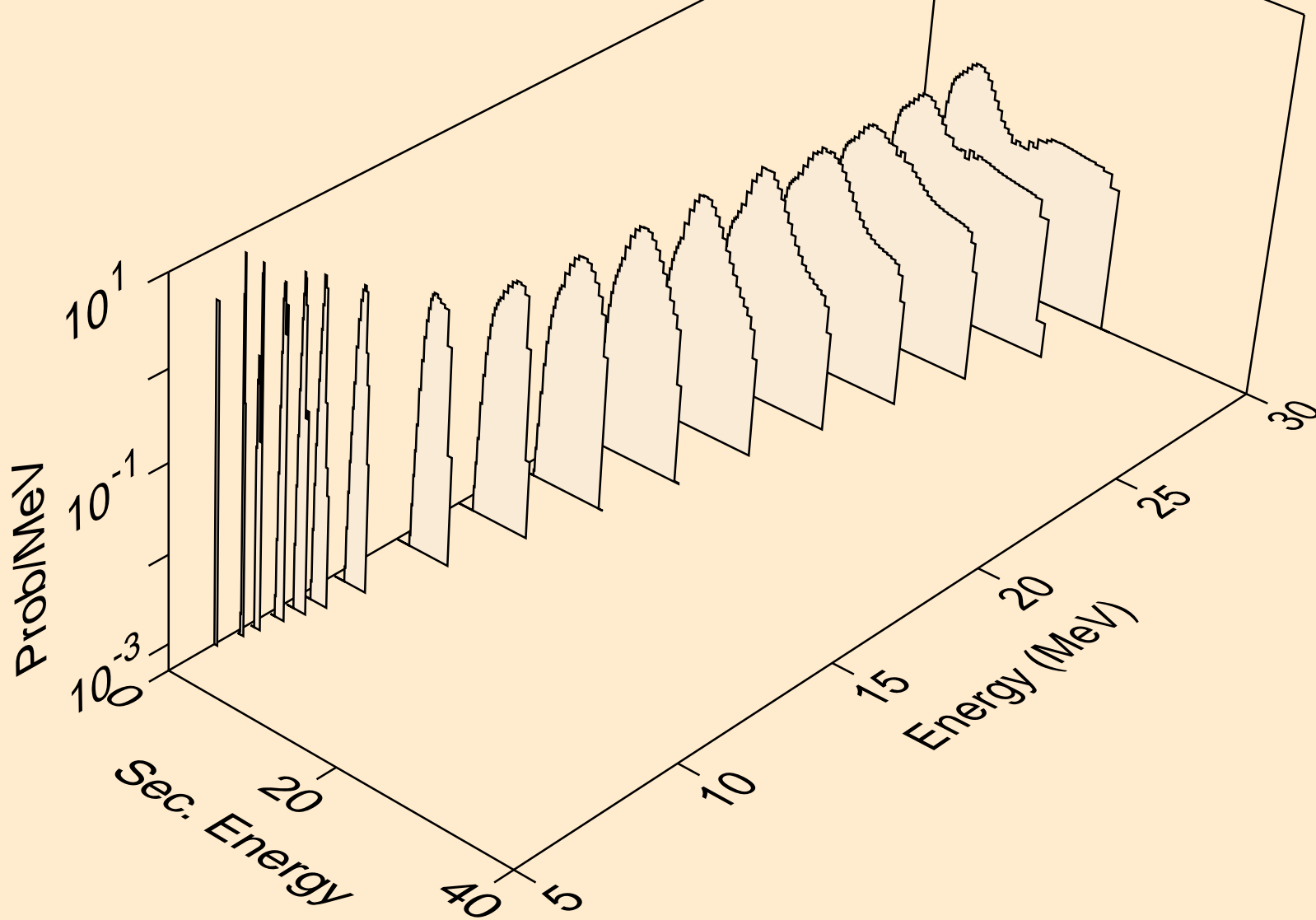

PD099 NEUTRON ACER TENDL-2019 LIBRARY; T=293.16K
protons from (n,2np)

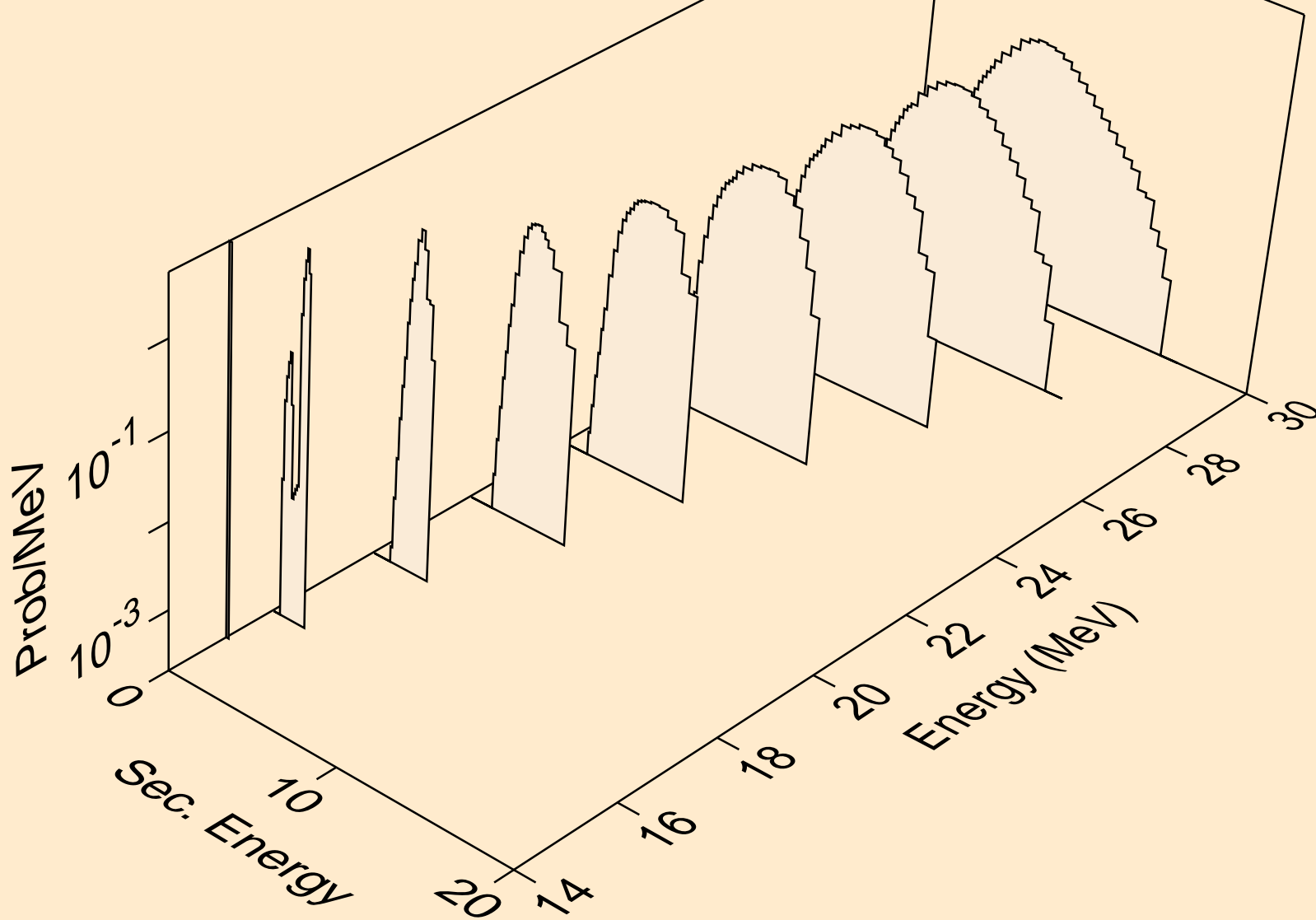

PD099 NEUTRON ACER TENDL-2019 LIBRARY; T=293.16K
protons from (n,3np)

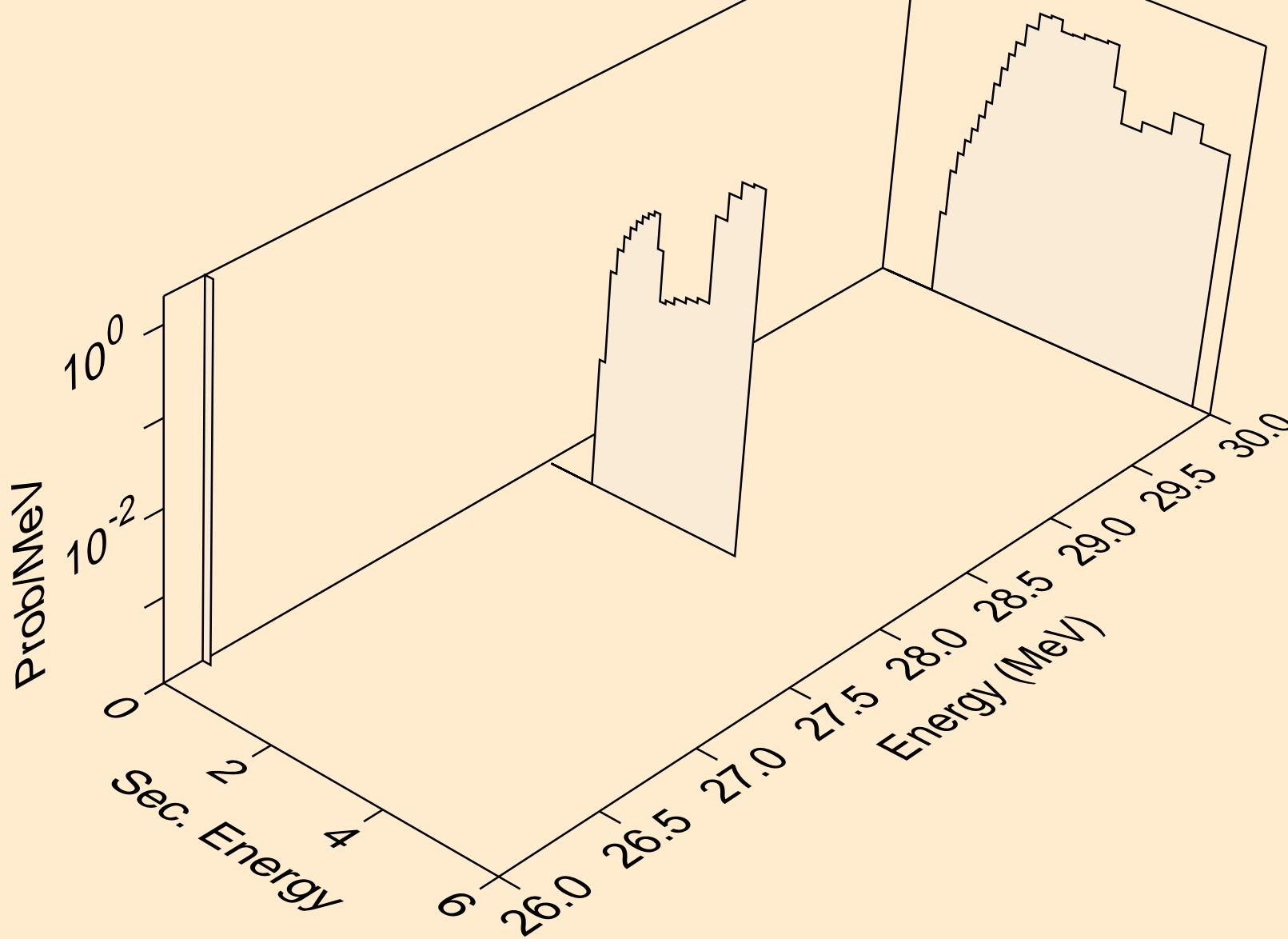

PD099 NEUTRON ACER TENDL-2019 LIBRARY; T=293.16K
protons from (n,2np)

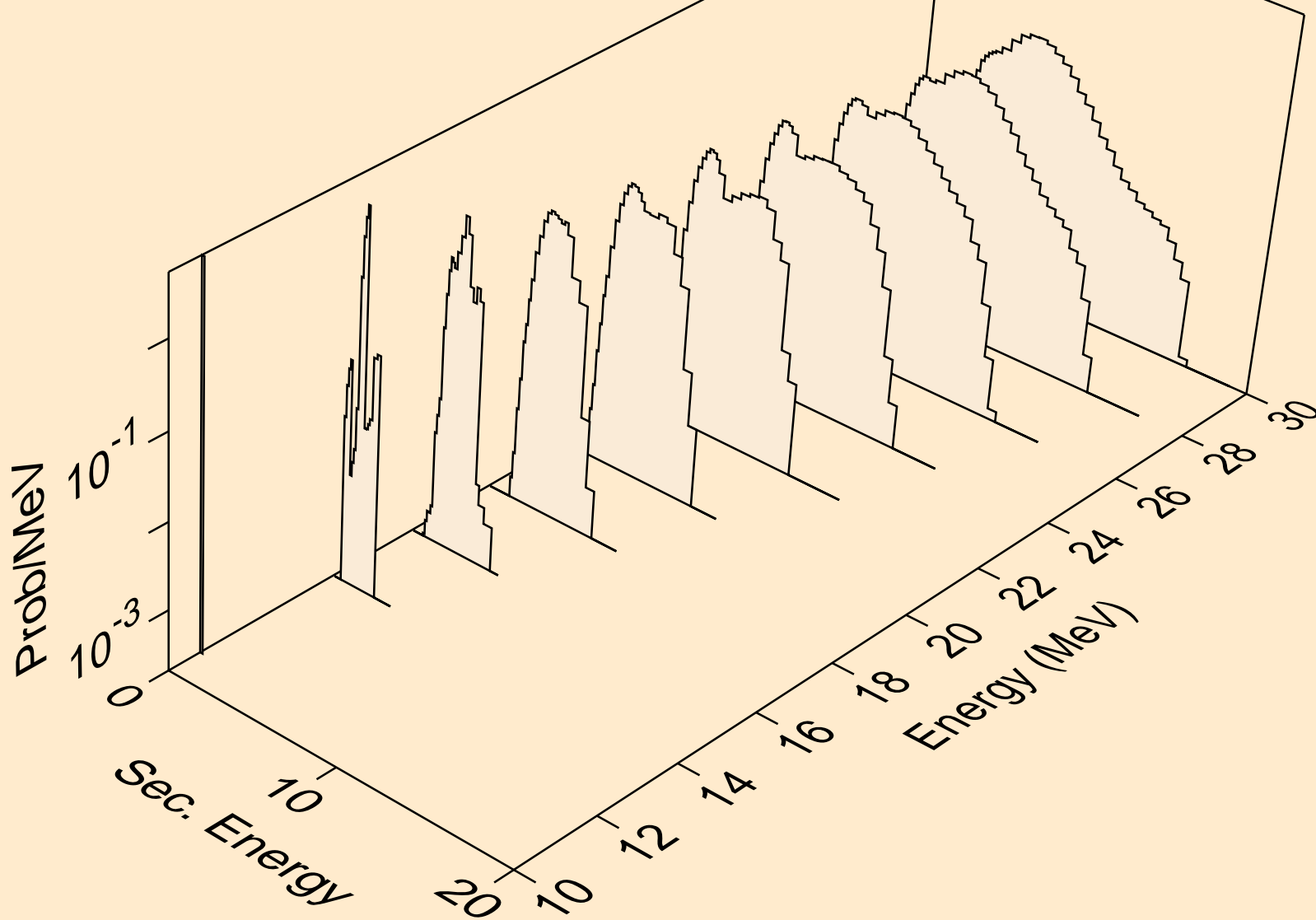

PD099 NEUTRON ACER TENDL-2019 LIBRARY; T=293.16K
protons from (n,npa)

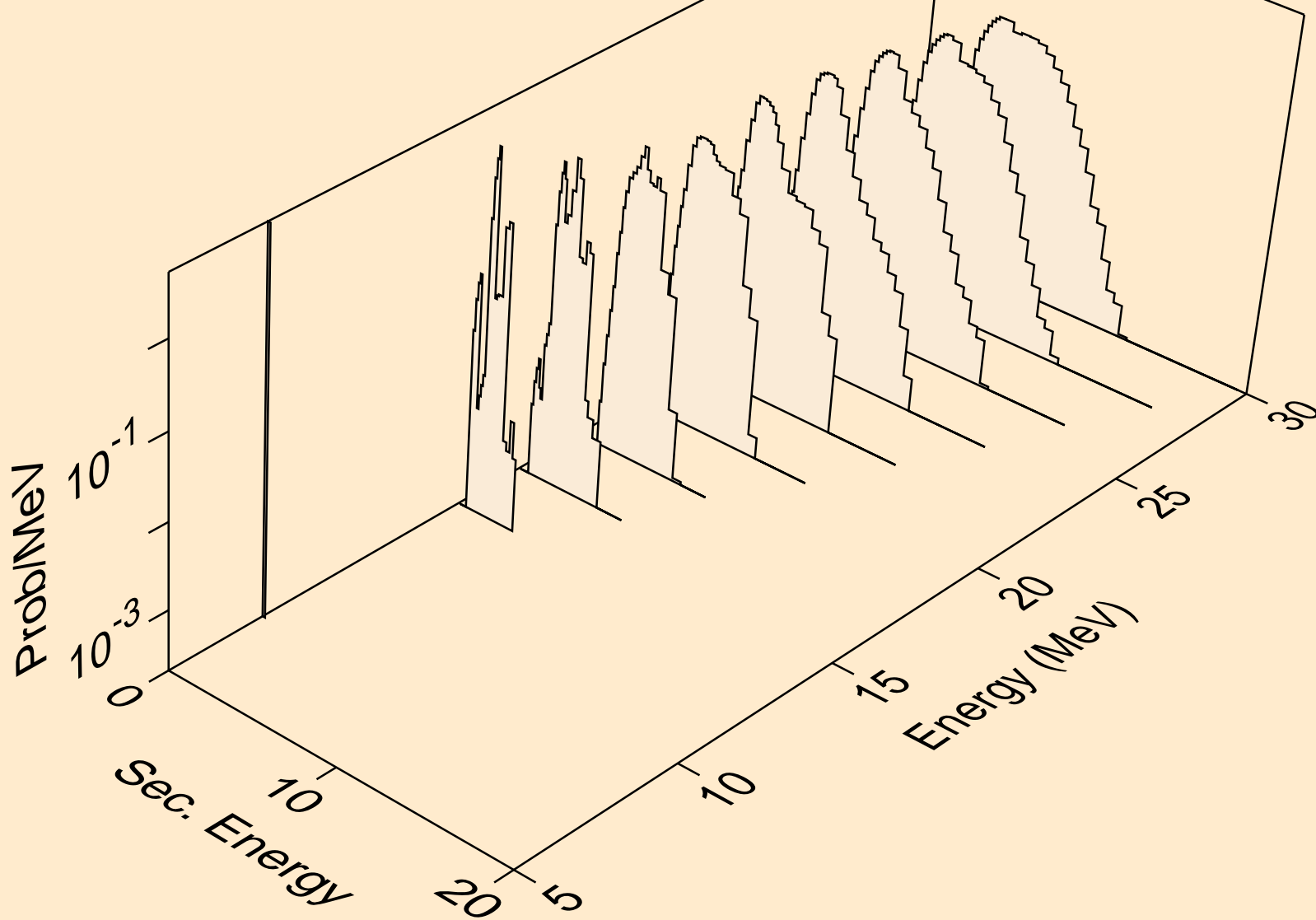

PD099 NEUTRON ACER TENDL-2019 LIBRARY; T=293.16K
protons from (n,p)

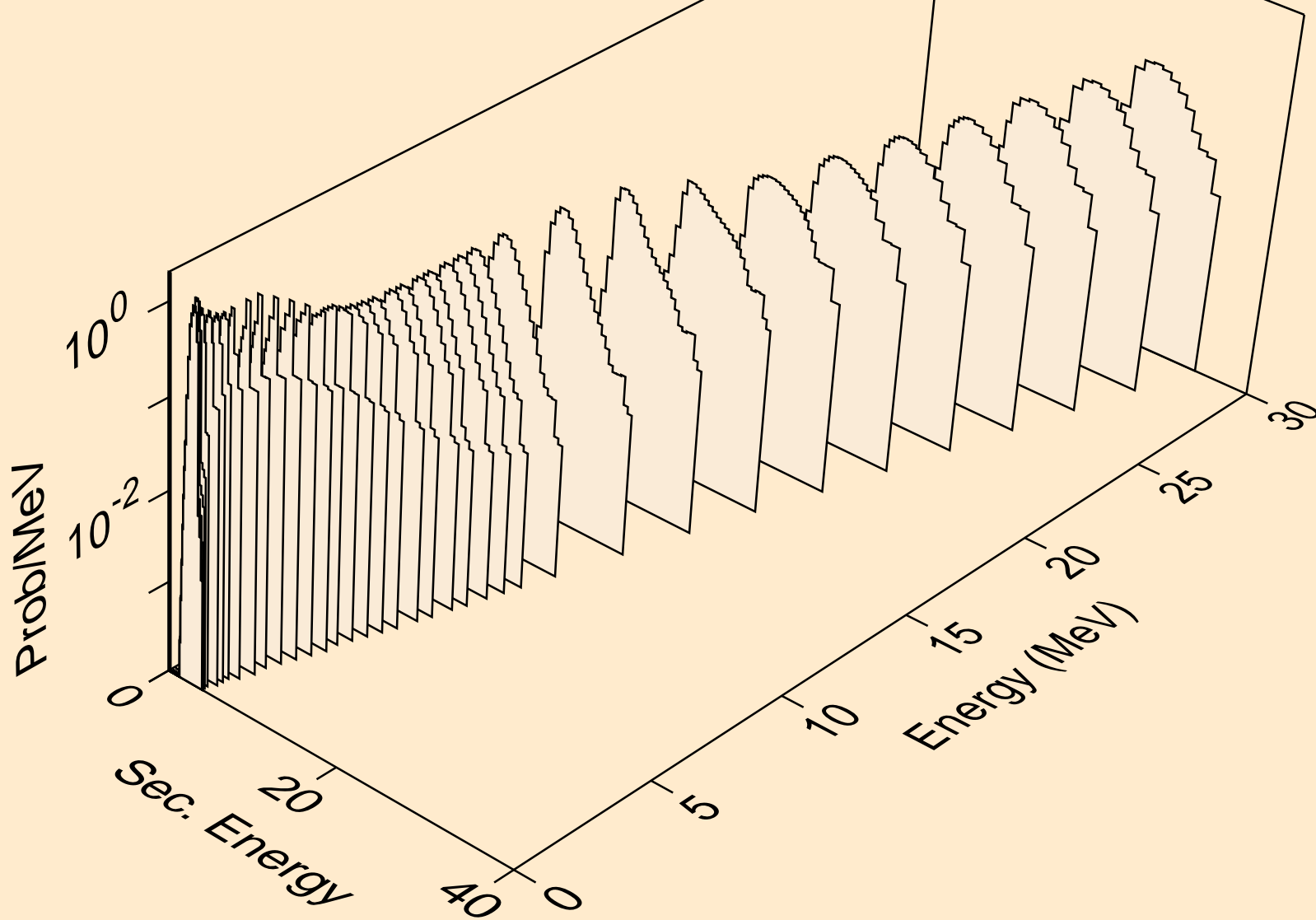

PD099 NEUTRON ACER TENDL-2019 LIBRARY; T=293.16K
protons from (n,2p)

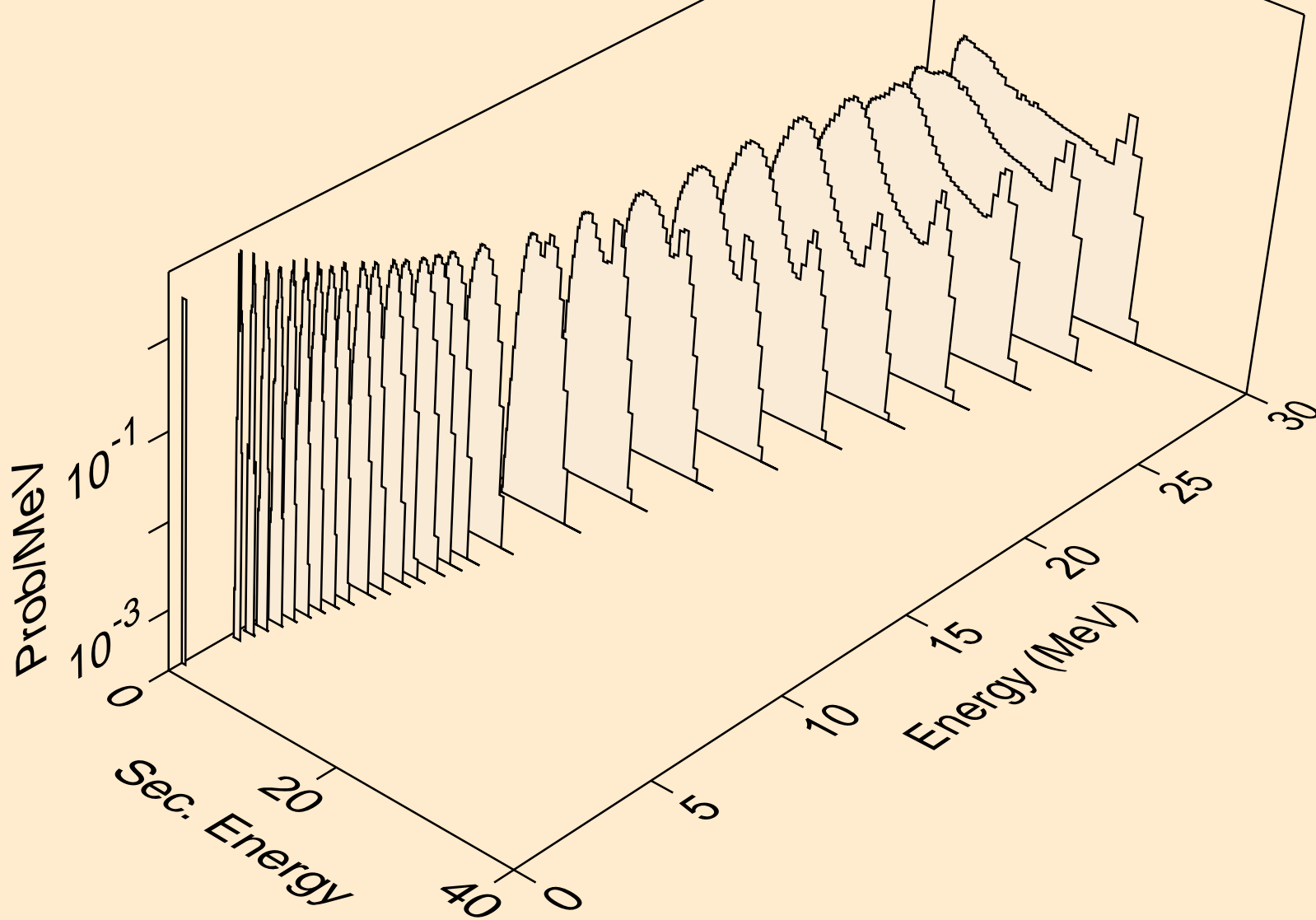

PD099 NEUTRON ACER TENDL-2019 LIBRARY; T=293.16K
protons from (n,p)

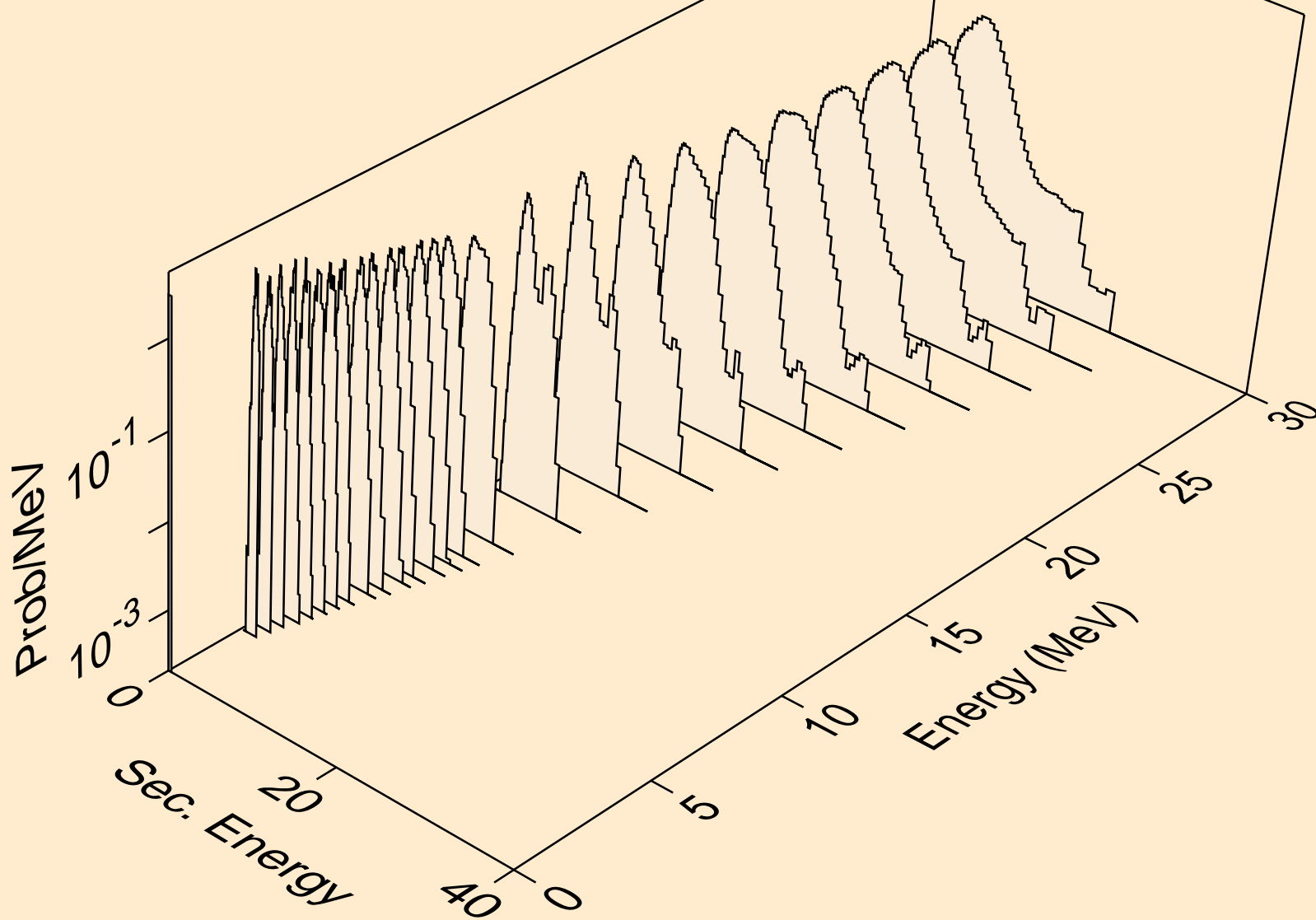

PD099 NEUTRON ACER TENDL-2019 LIBRARY; T=293.16K
protons from (n,pd)

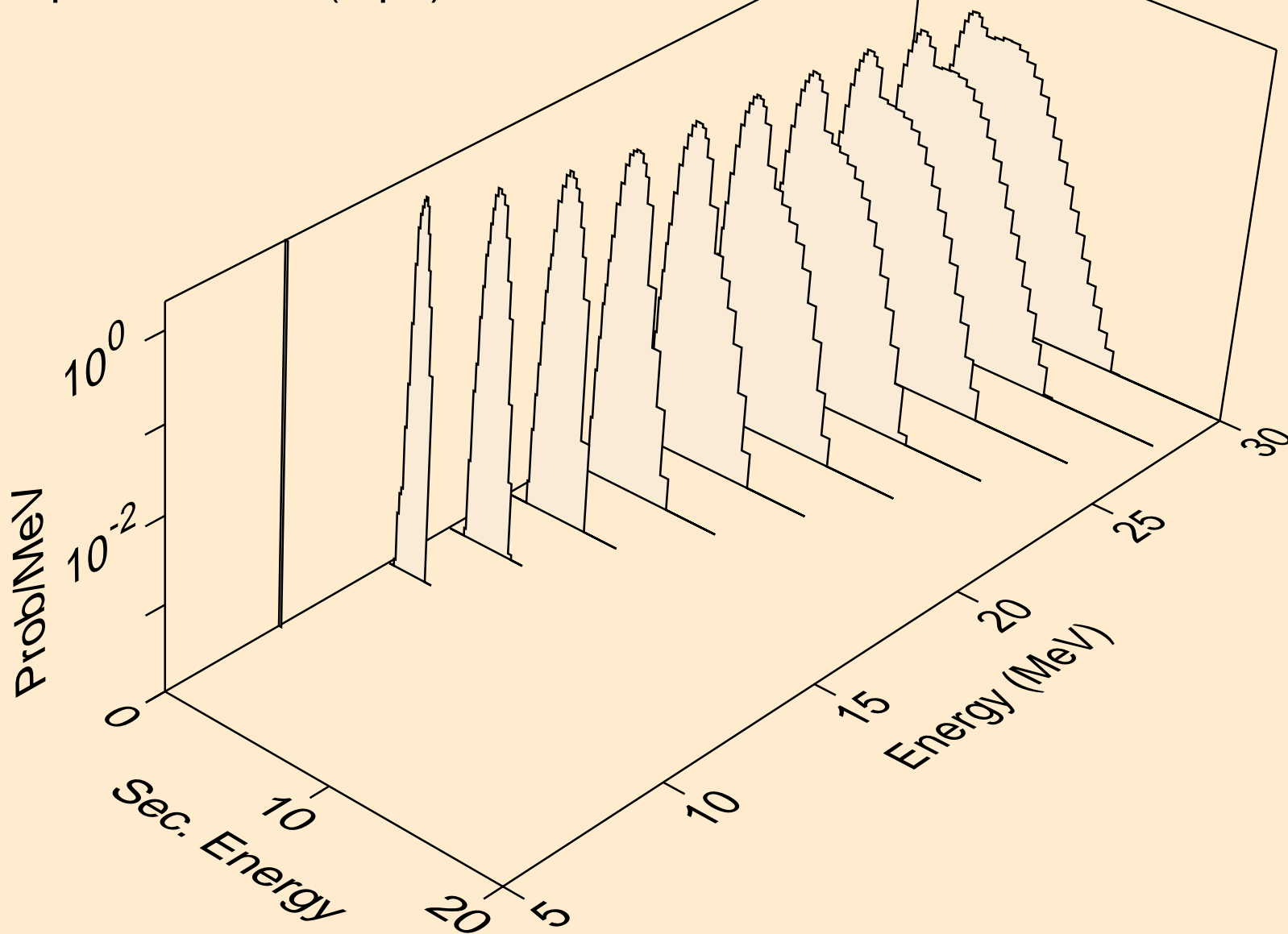

PD099 NEUTRON ACER TENDL-2019 LIBRARY; T=293.16K
protons from (n,pt)

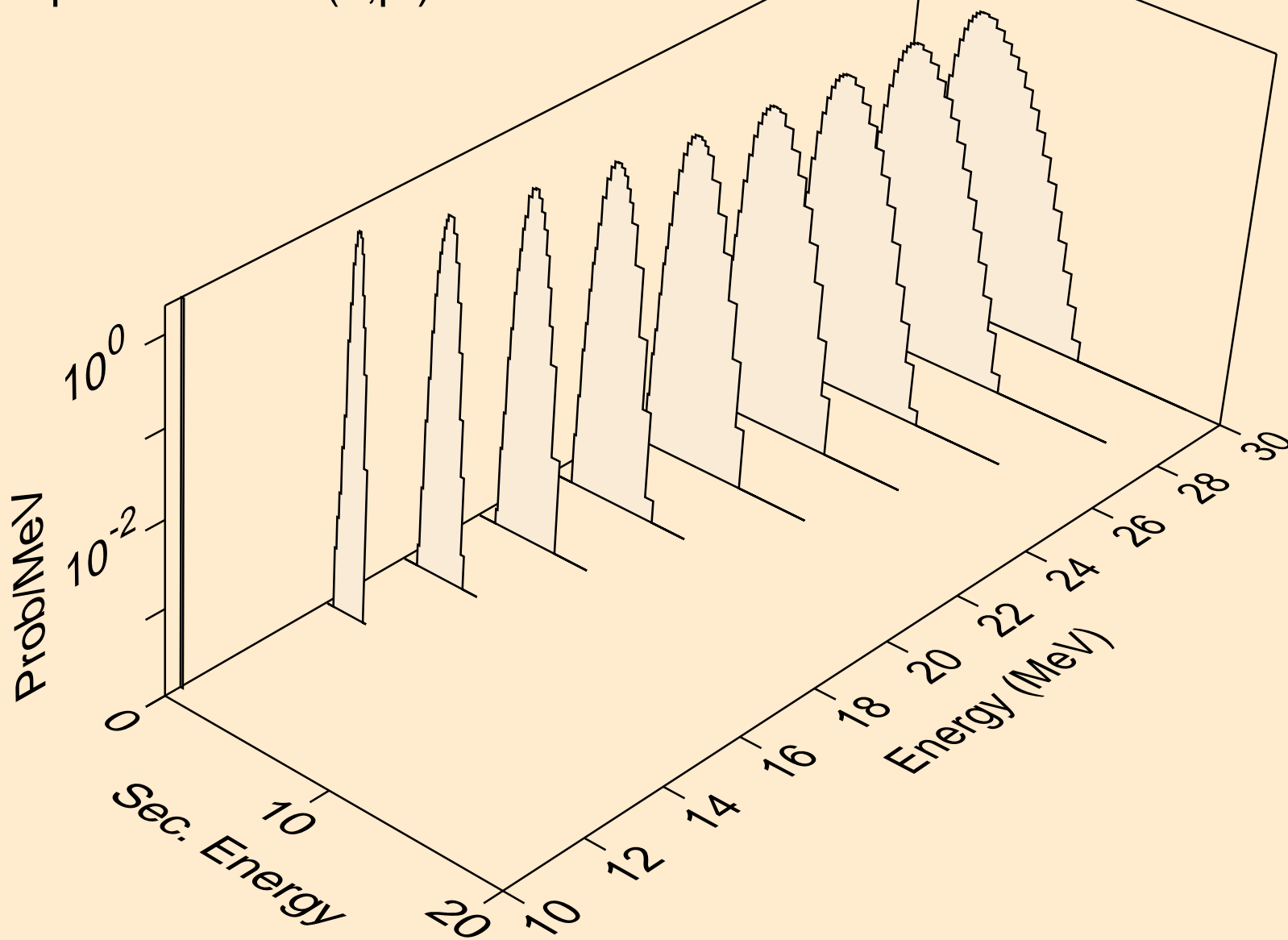

PD099 NEUTRON ACER TENDL-2019 LIBRARY; T=293.16K
deuterons from (n,x)

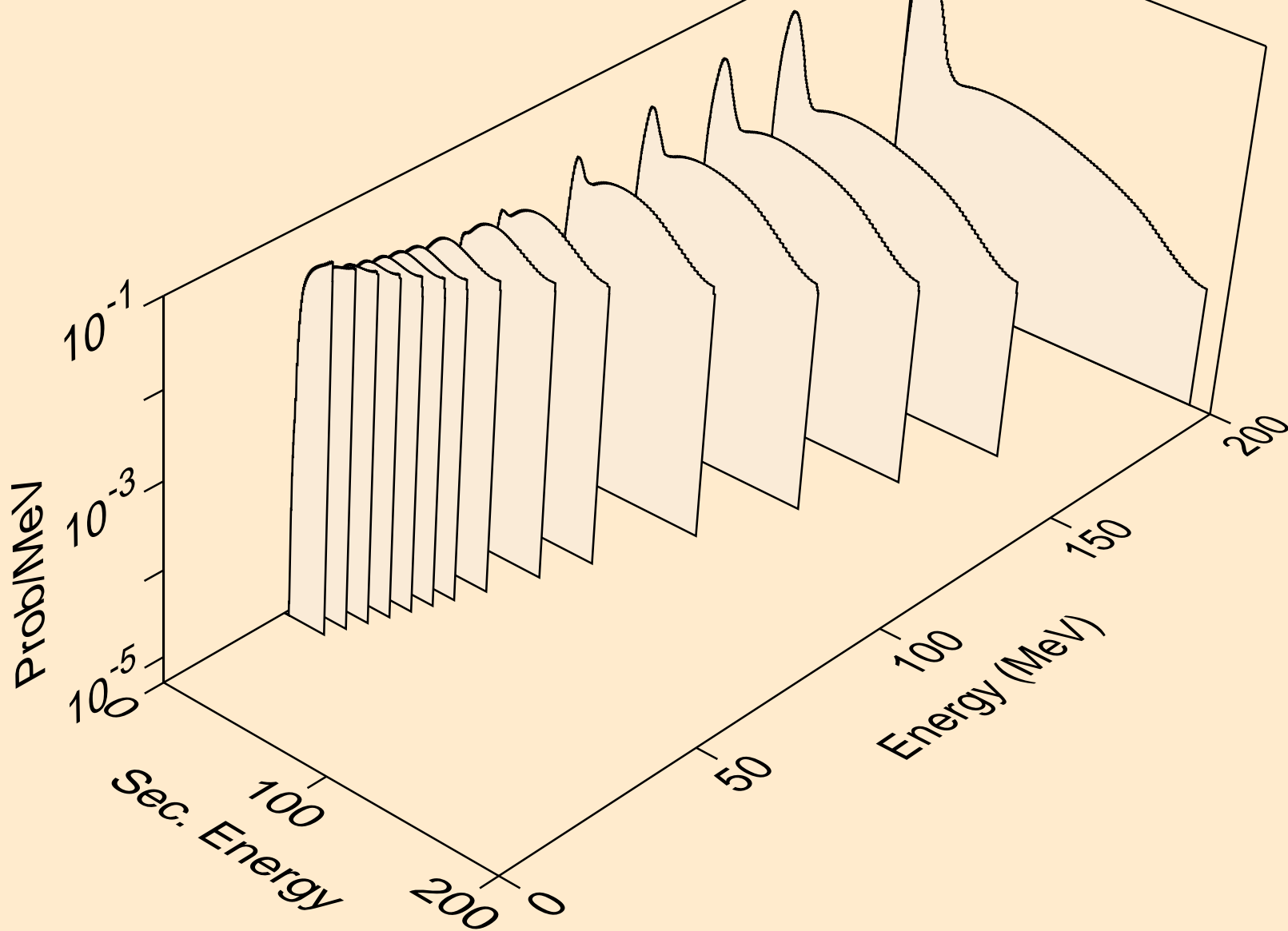

PD099 NEUTRON ACER TENDL-2019 LIBRARY; T=293.16K
deuterons from (n,2nd)

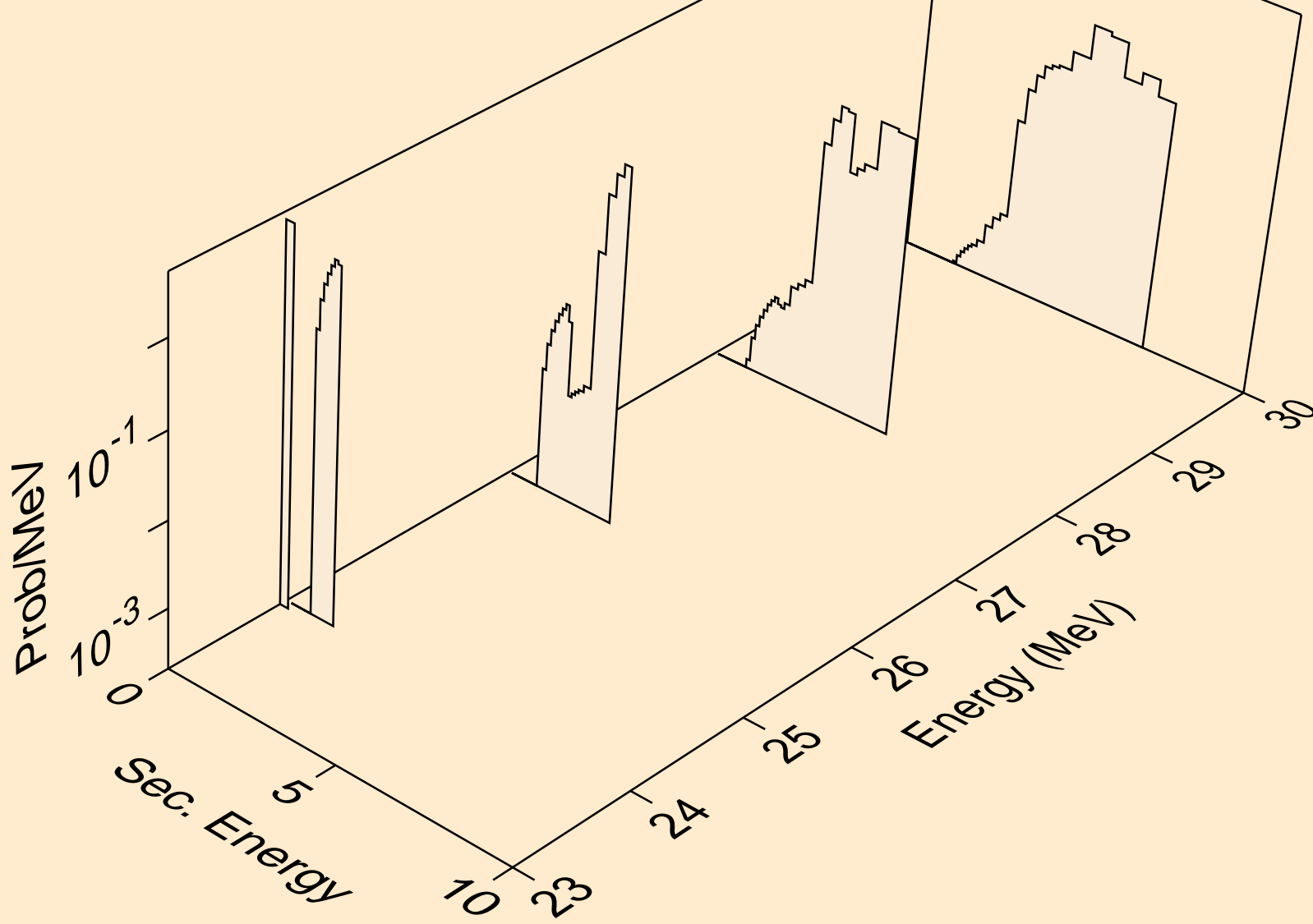

PD099 NEUTRON ACER TENDL-2019 LIBRARY; T=293.16K
deuterons from (n,n*)d

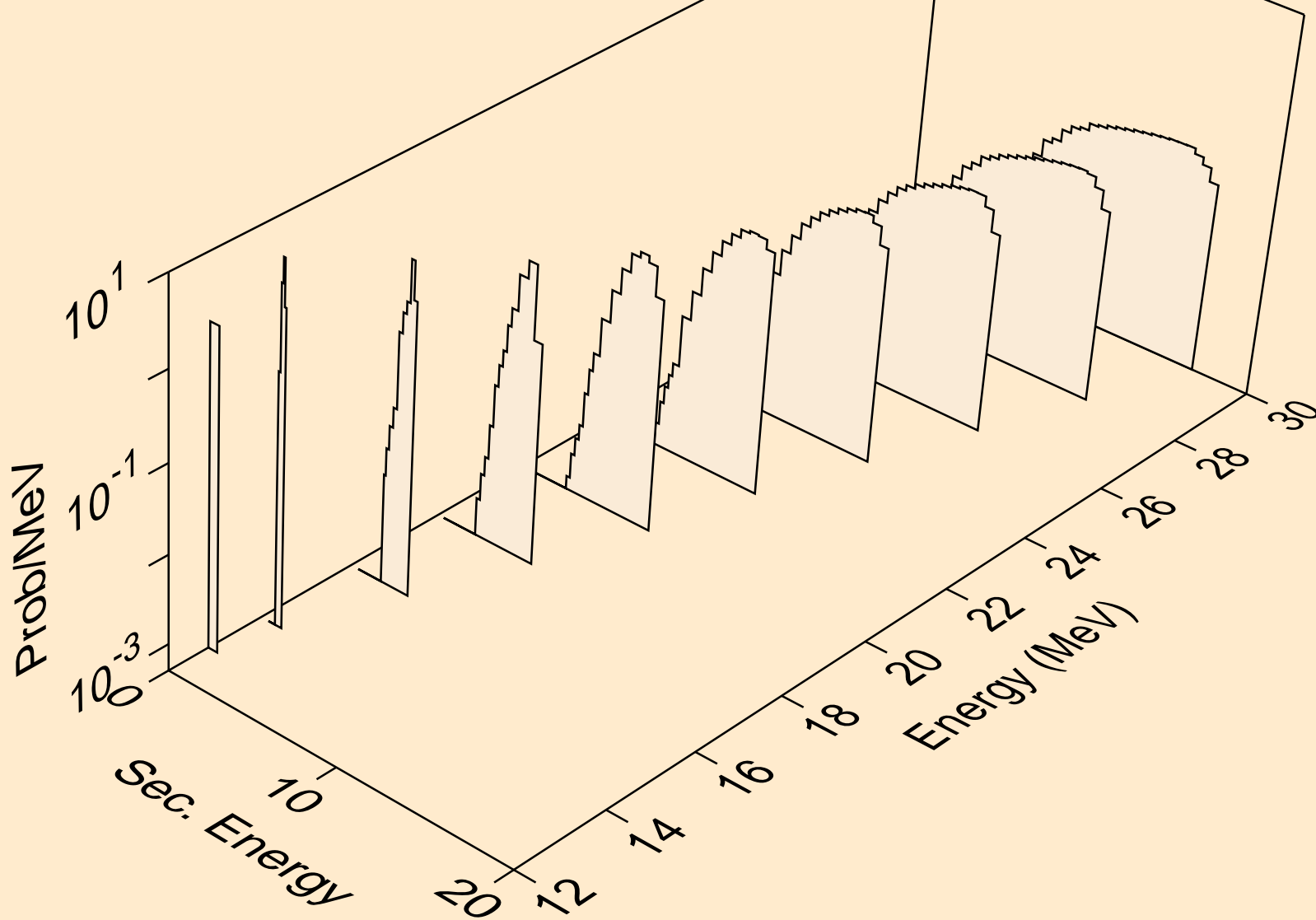

PD099 NEUTRON ACER TENDL-2019 LIBRARY; T=293.16K
deuterons from (n,d)

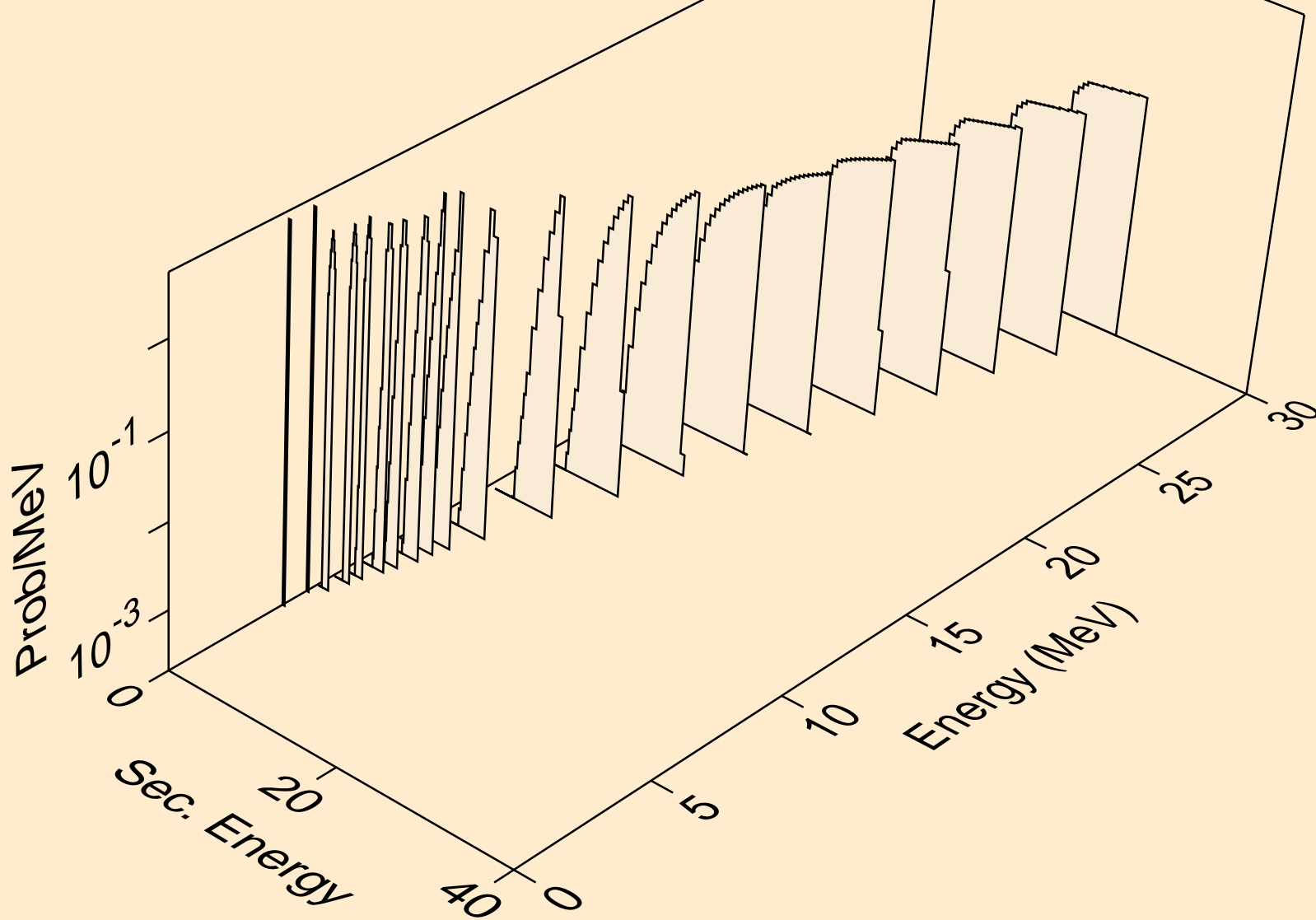

PD099 NEUTRON ACER TENDL-2019 LIBRARY; T=293.16K
deuterons from (n,pd)

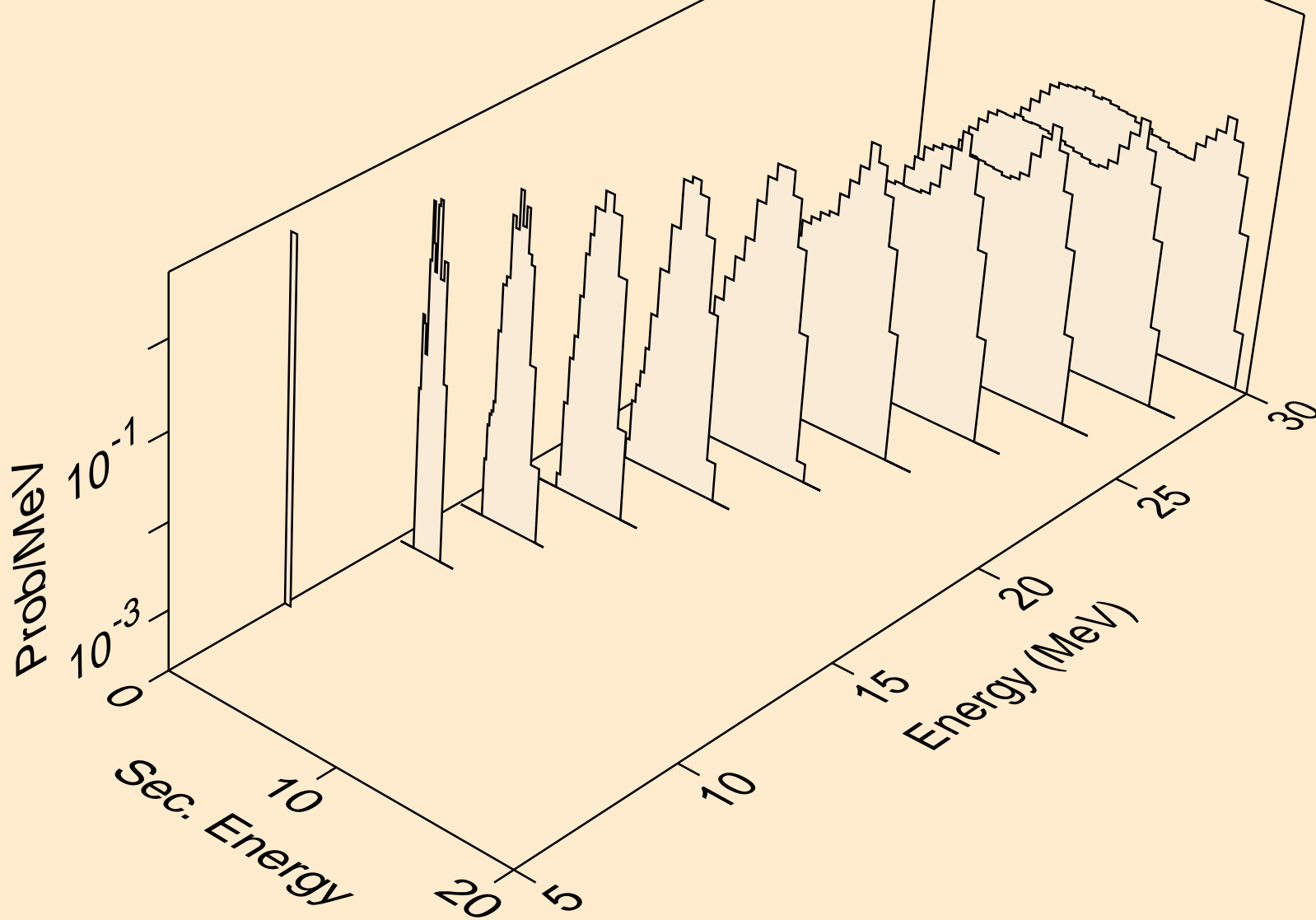

PD099 NEUTRON ACER TENDL-2019 LIBRARY; T=293.16K
deuterons from (n,da)

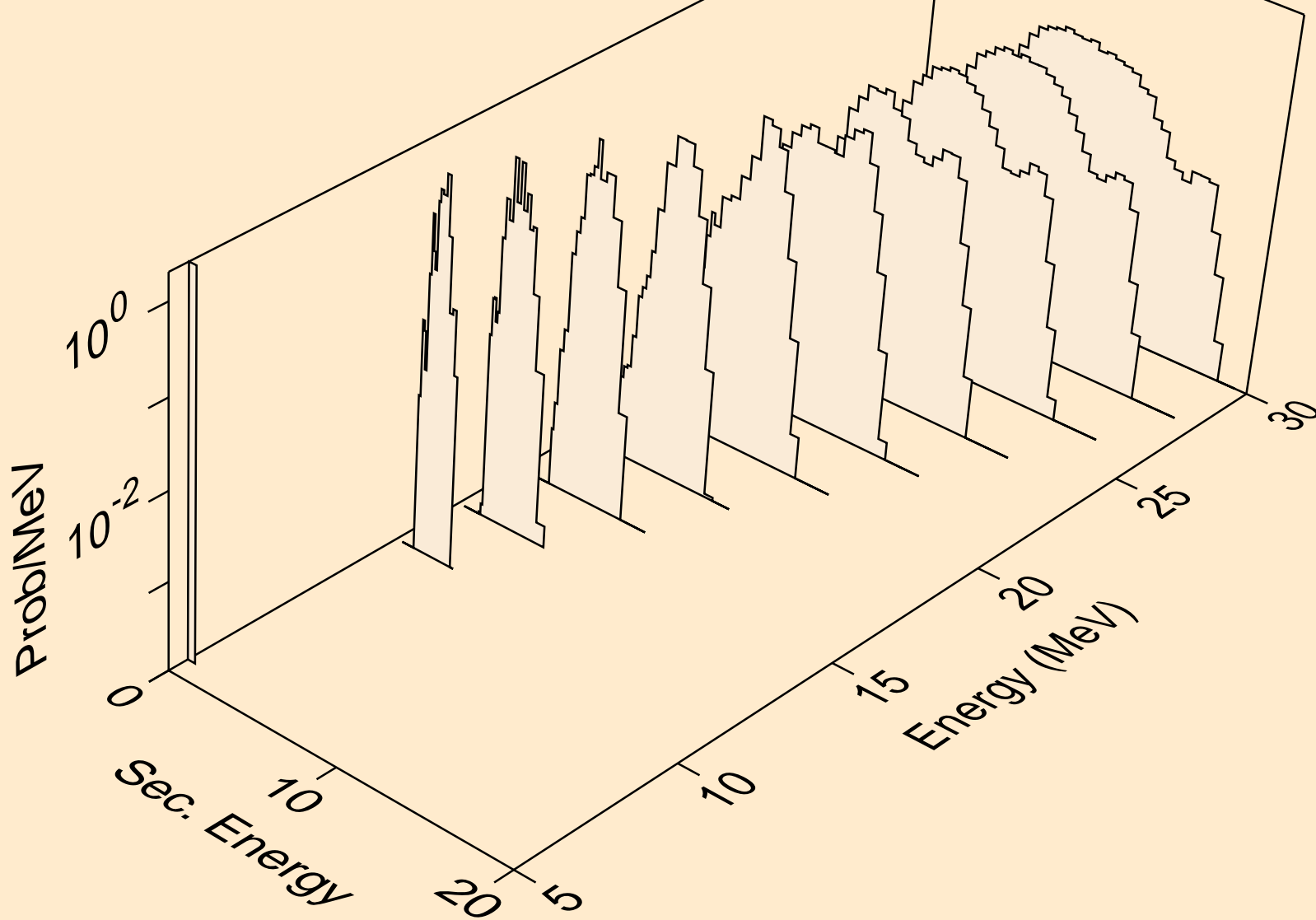

PD099 NEUTRON ACER TENDL-2019 LIBRARY; T=293.16K
tritons from (n,x)

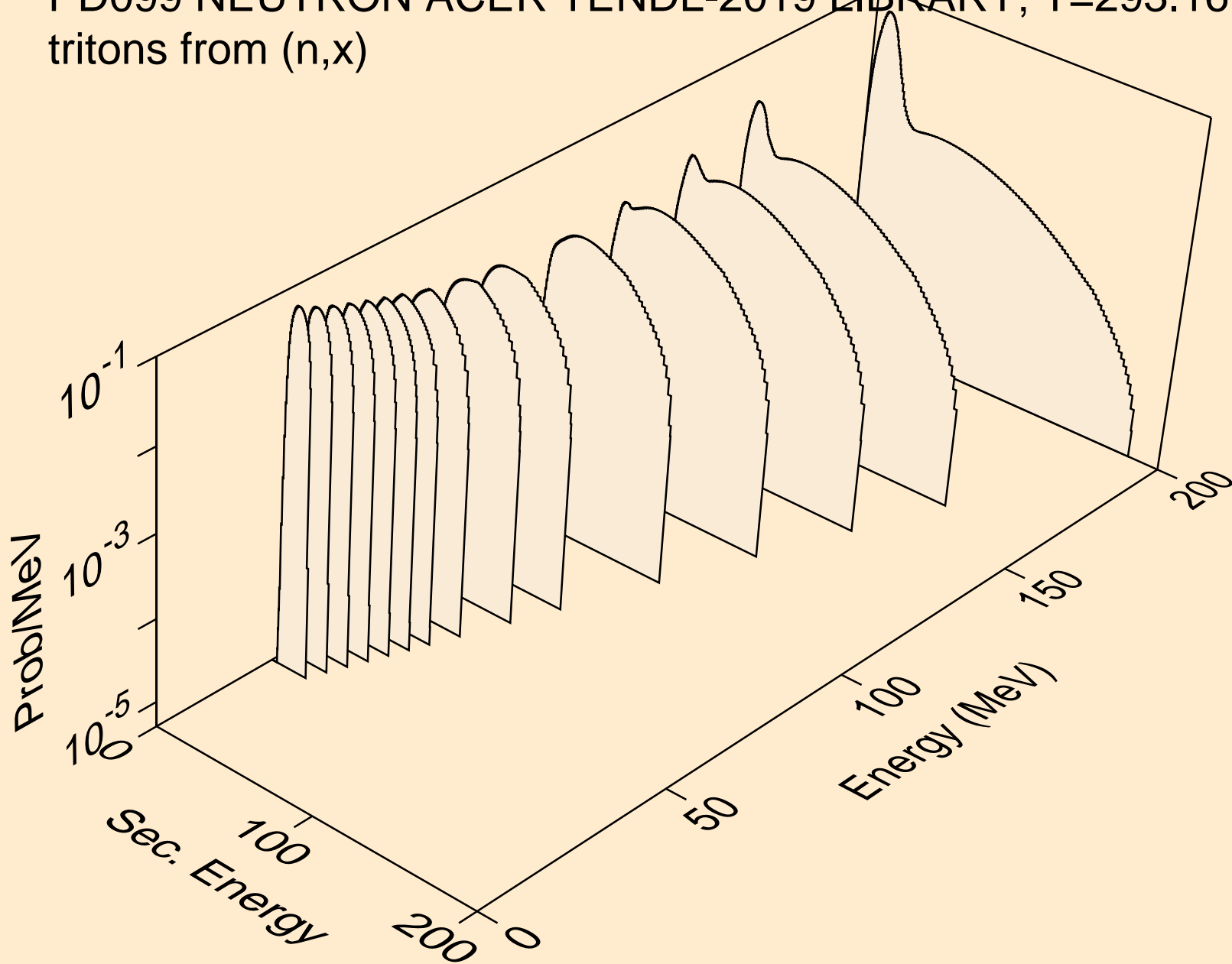

PD099 NEUTRON ACER TENDL-2019 LIBRARY; T=293.16K
tritons from (n,n*)t

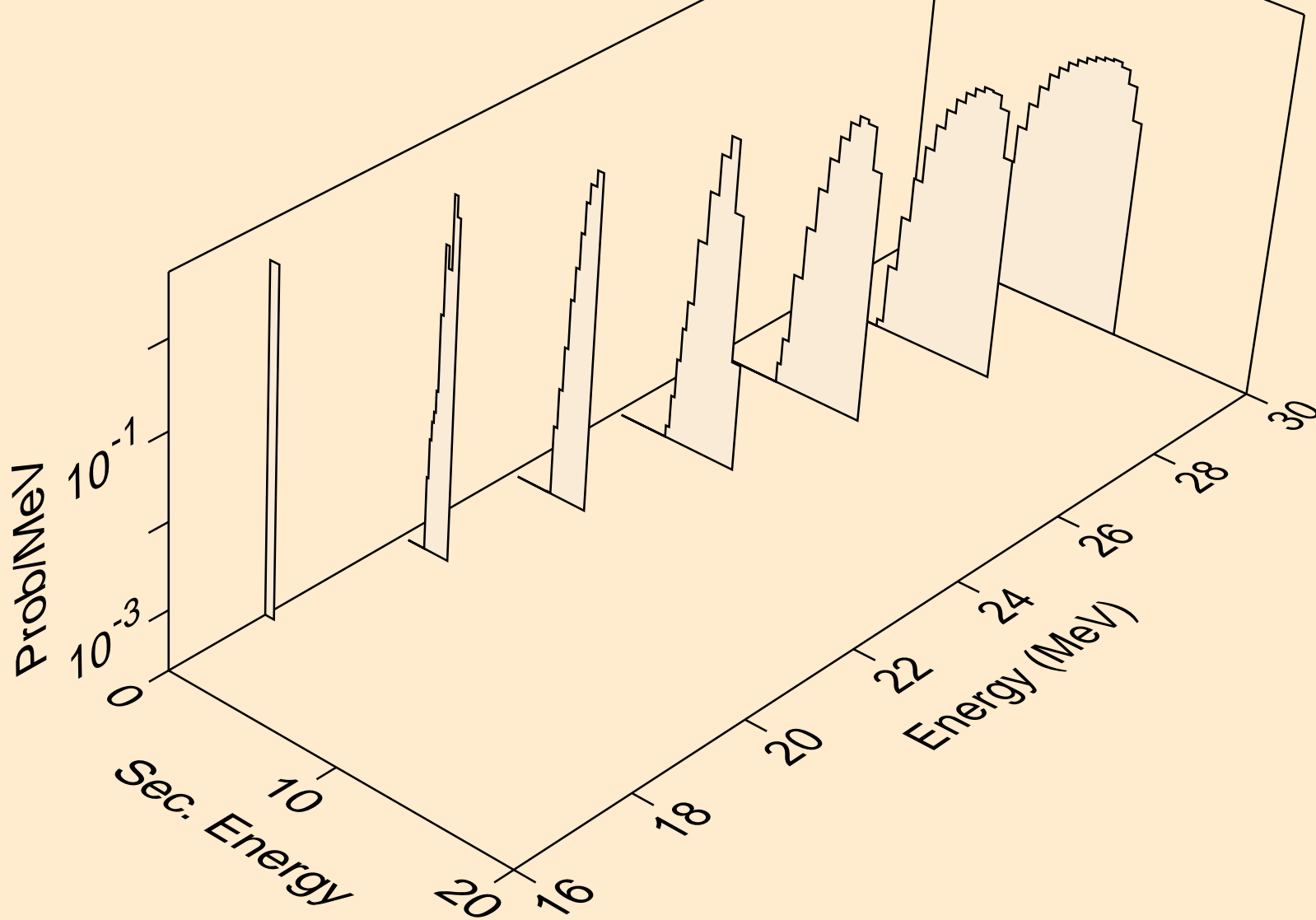

PD099 NEUTRON ACER TENDL-2019 LIBRARY; T=293.16K
tritons from (n,t)

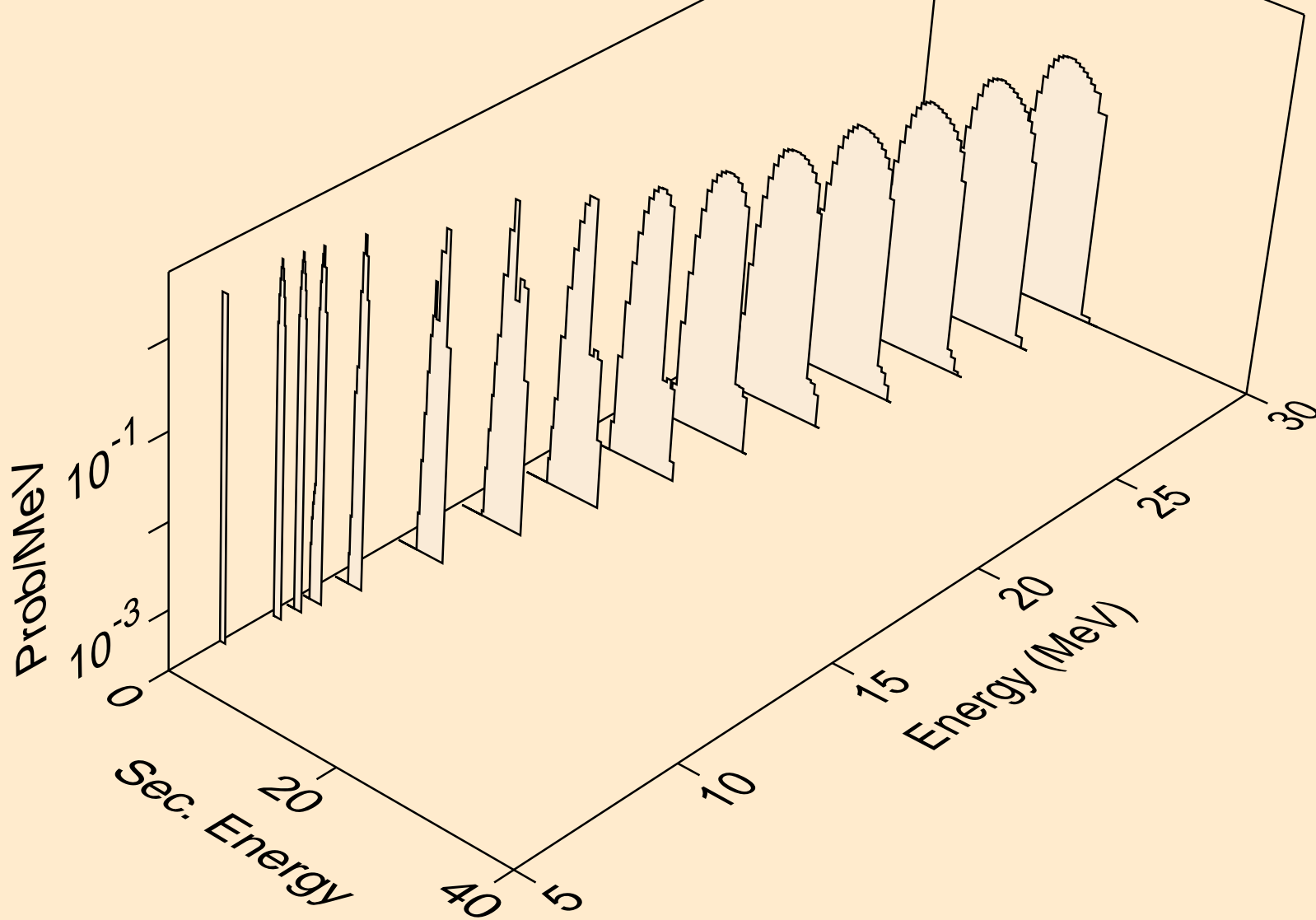

PD099 NEUTRON ACER TENDL-2019 LIBRARY; T=293.16K
tritons from (n,pt)

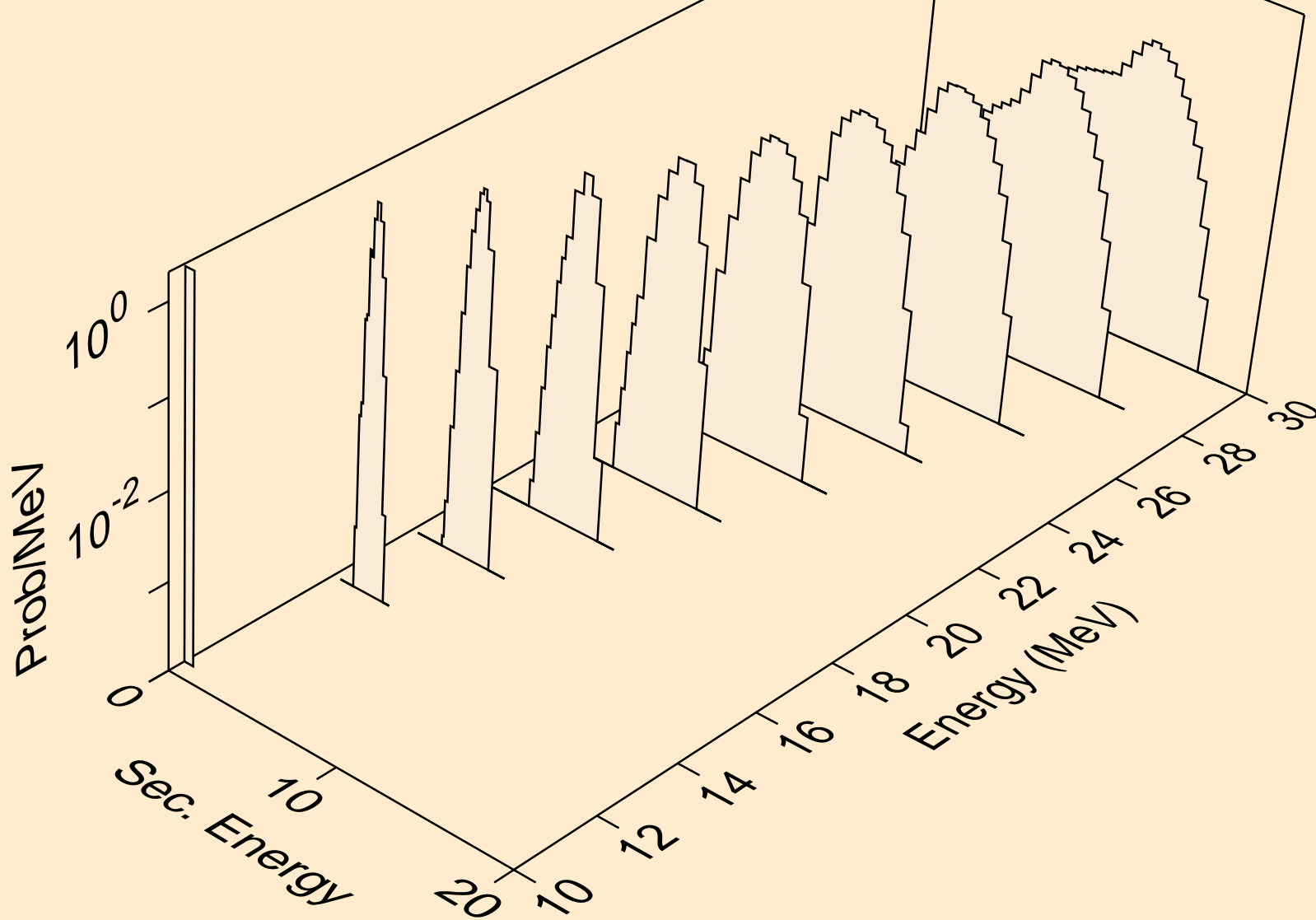

PD099 NEUTRON ACER TENDL-2019 LIBRARY; T=293.16K
he3s from (n,x)

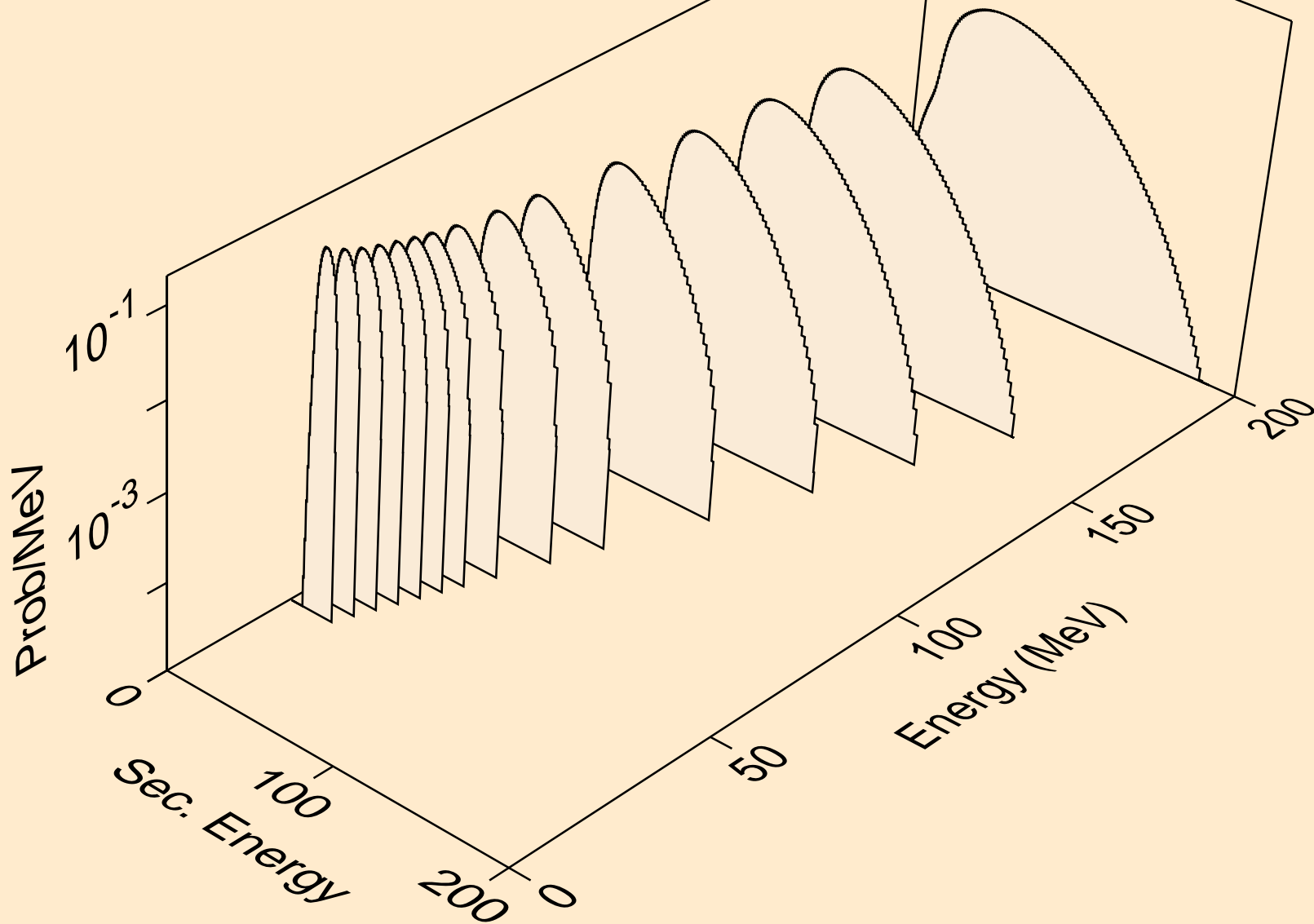

PD099 NEUTRON ACER TENDL-2019 LIBRARY; T=293.16K
he3s from (n,n*)he3

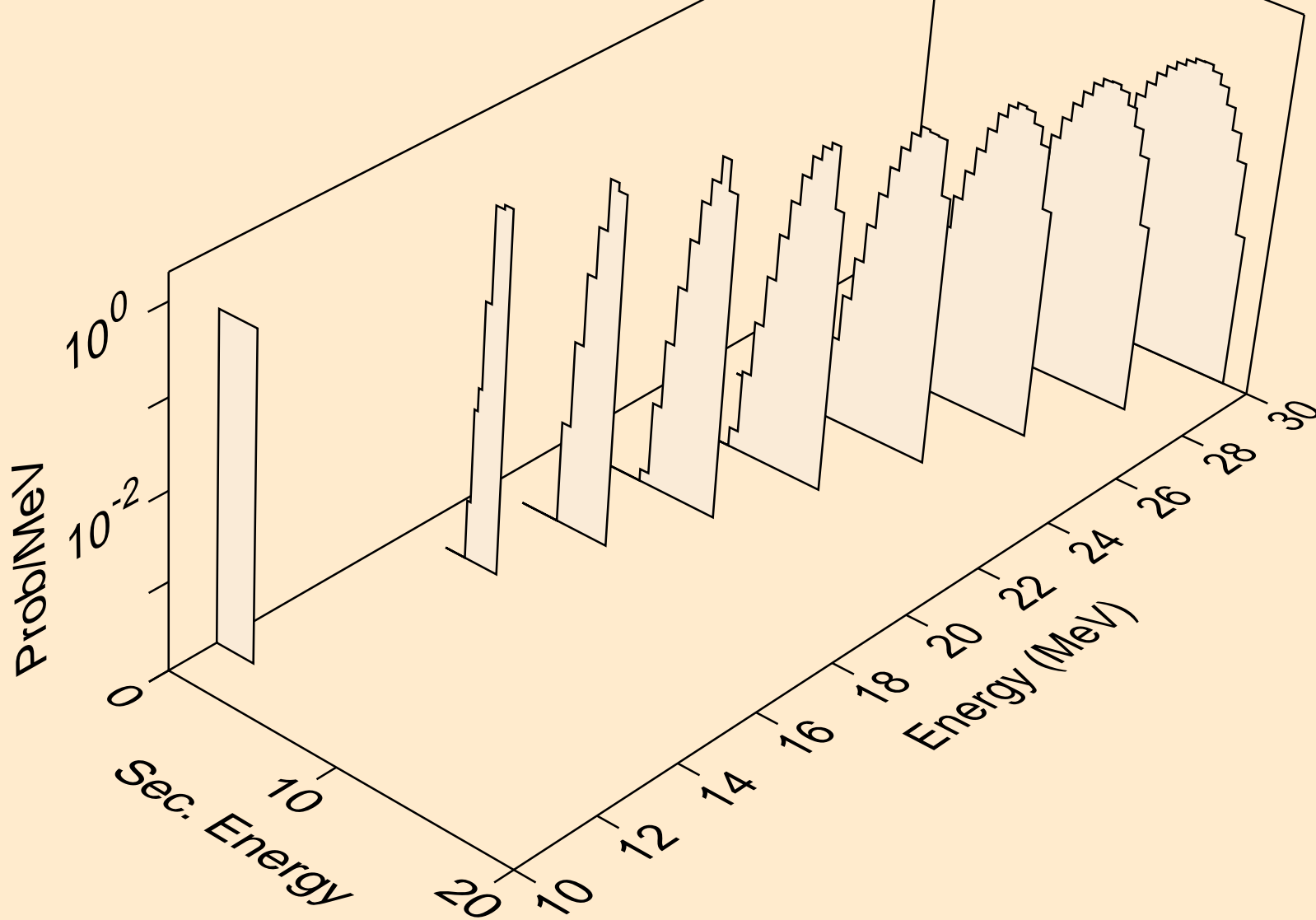

PD099 NEUTRON ACER TENDL-2019 LIBRARY; T=293.16K
he3s from (n,he3)

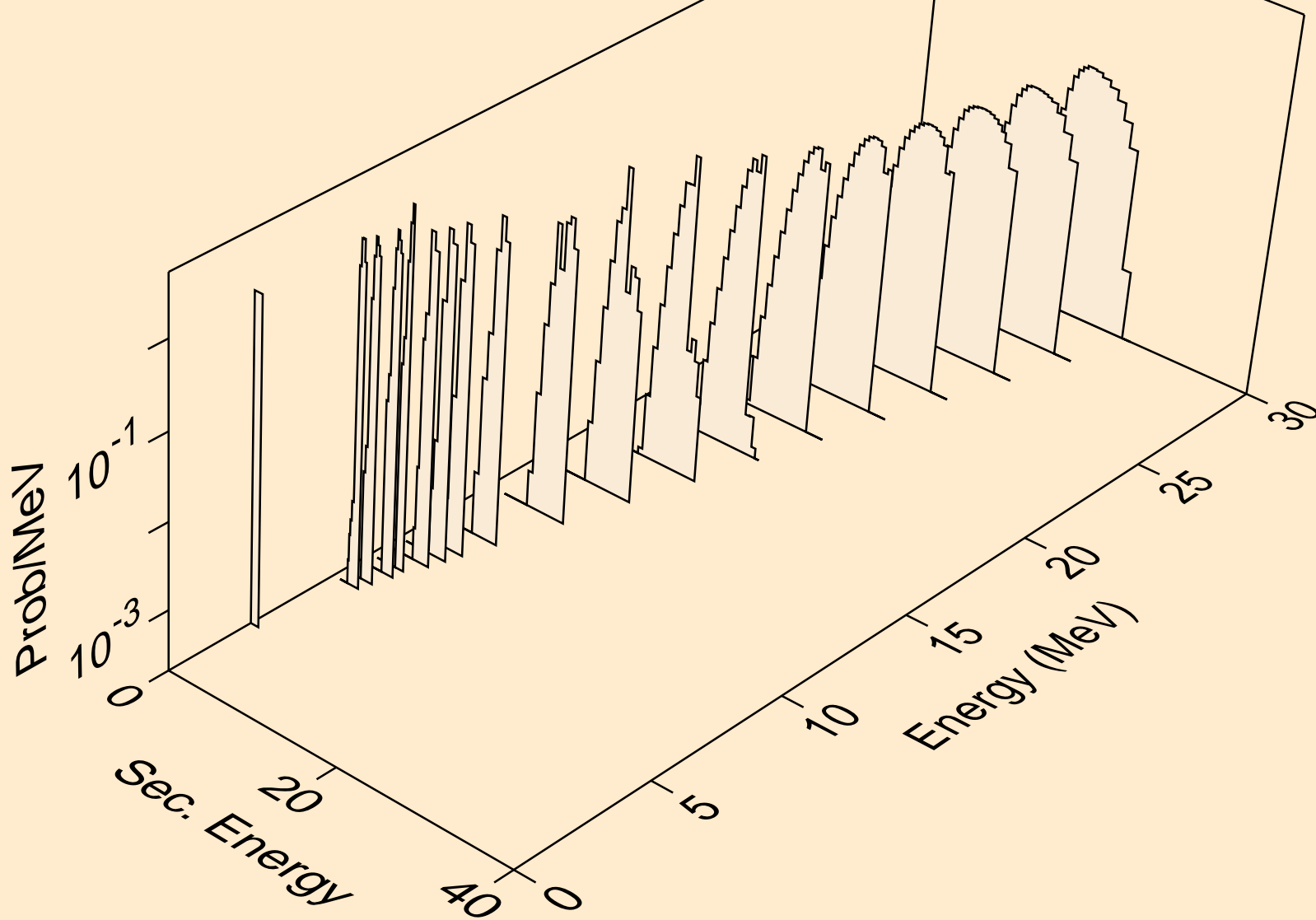

PD099 NEUTRON ACER TENDL-2019 LIBRARY; T=293.16K
alphas from (n,x)

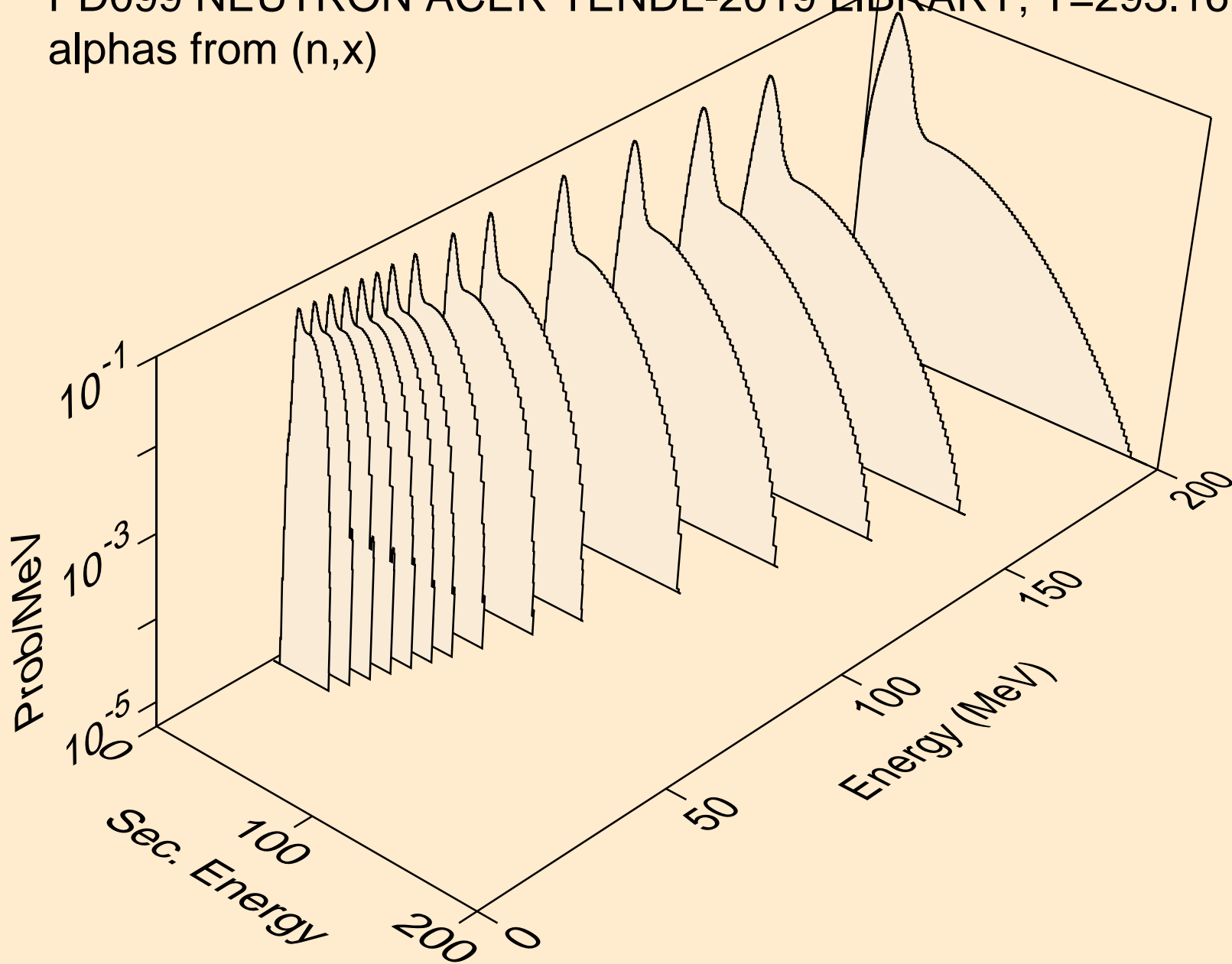

PD099 NEUTRON ACER TENDL-2019 LIBRARY; T=293.16K
alphas from (n,n*)a

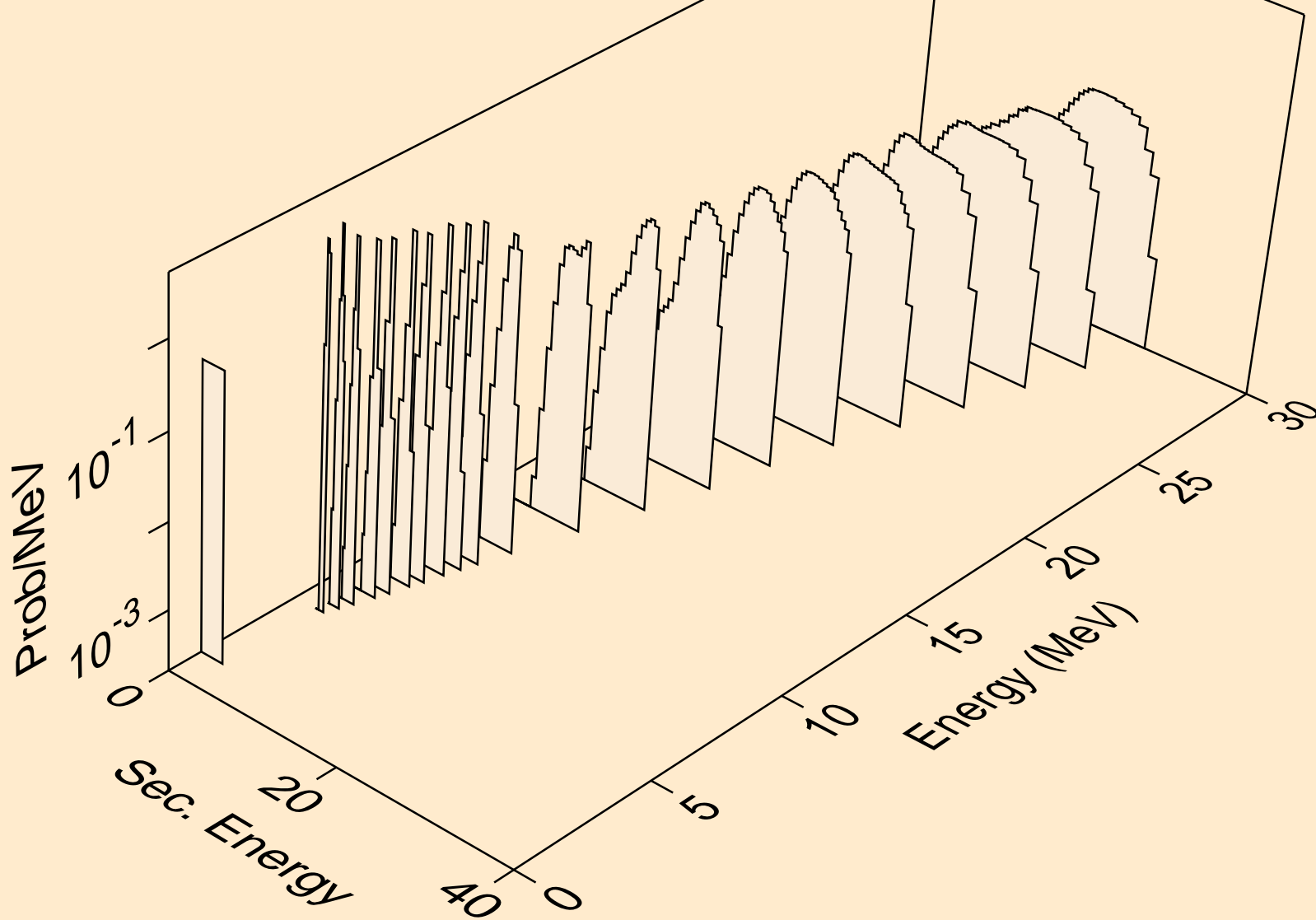

PD099 NEUTRON ACER TENDL-2019 LIBRARY; T=293.16K
alphas from (n,2n)a

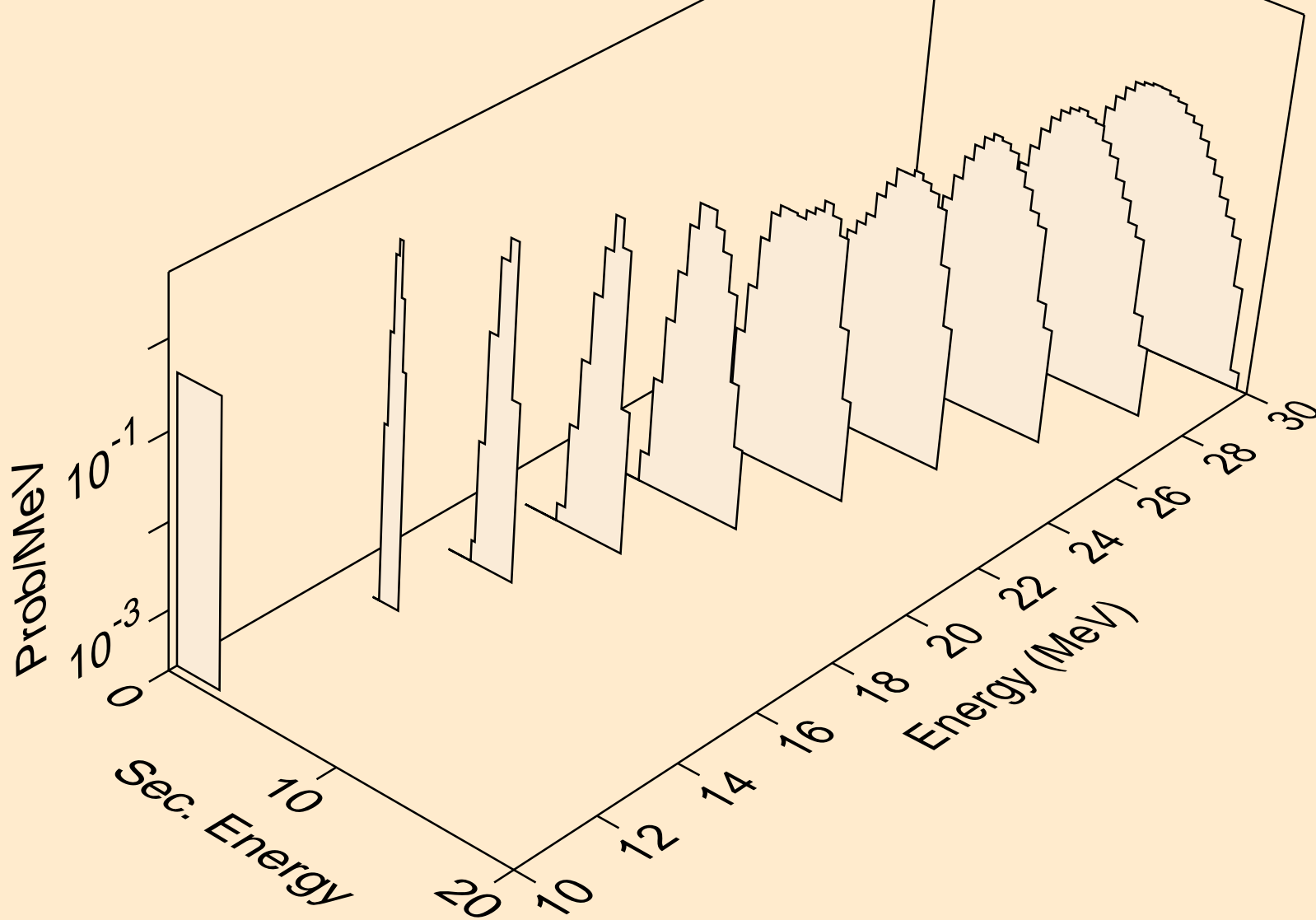

PD099 NEUTRON ACER TENDL-2019 LIBRARY; T=293.16K
alphas from (n,n*)2a

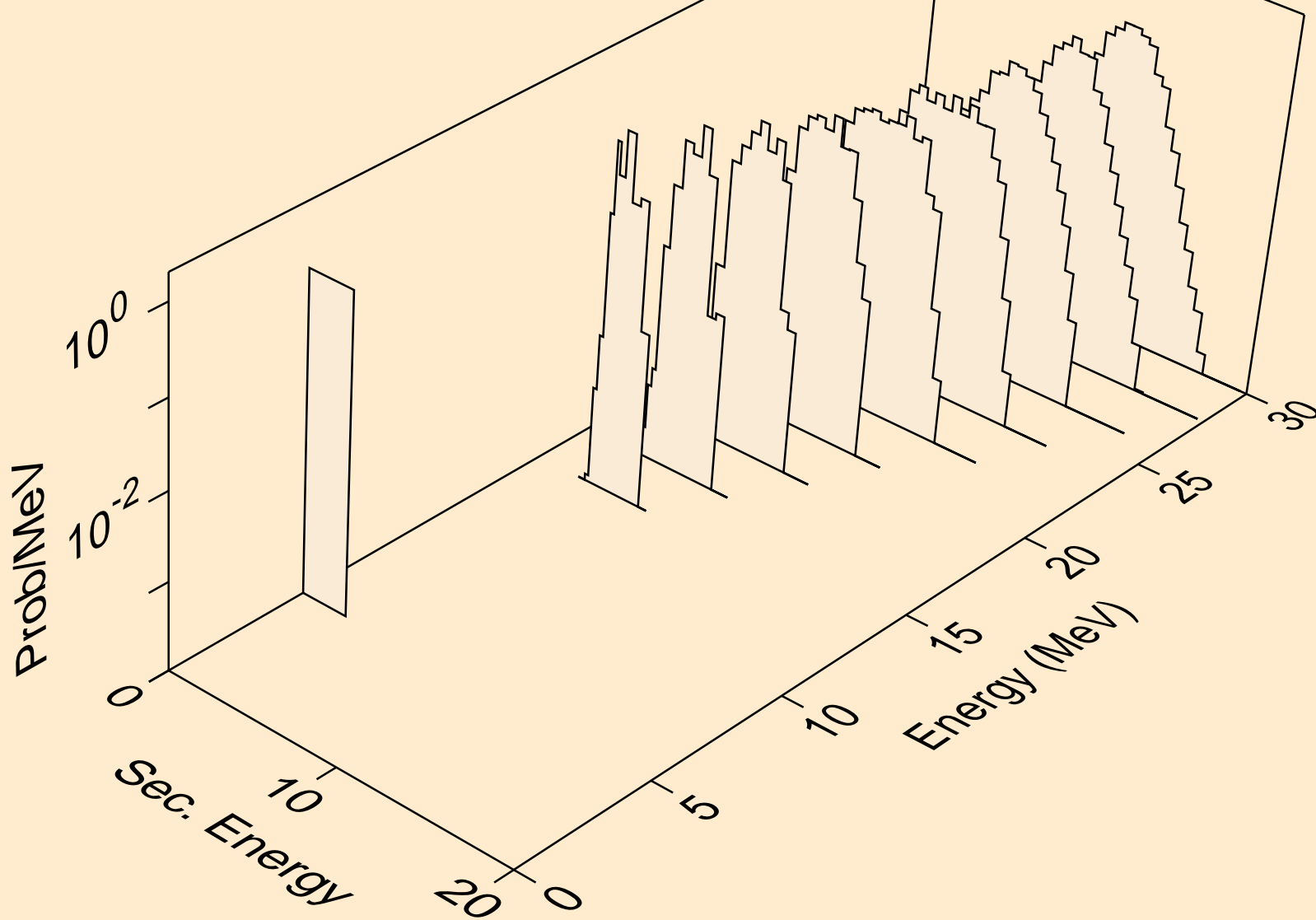

PD099 NEUTRON ACER TENDL-2019 LIBRARY; T=293.16K
alphas from (n,npa)

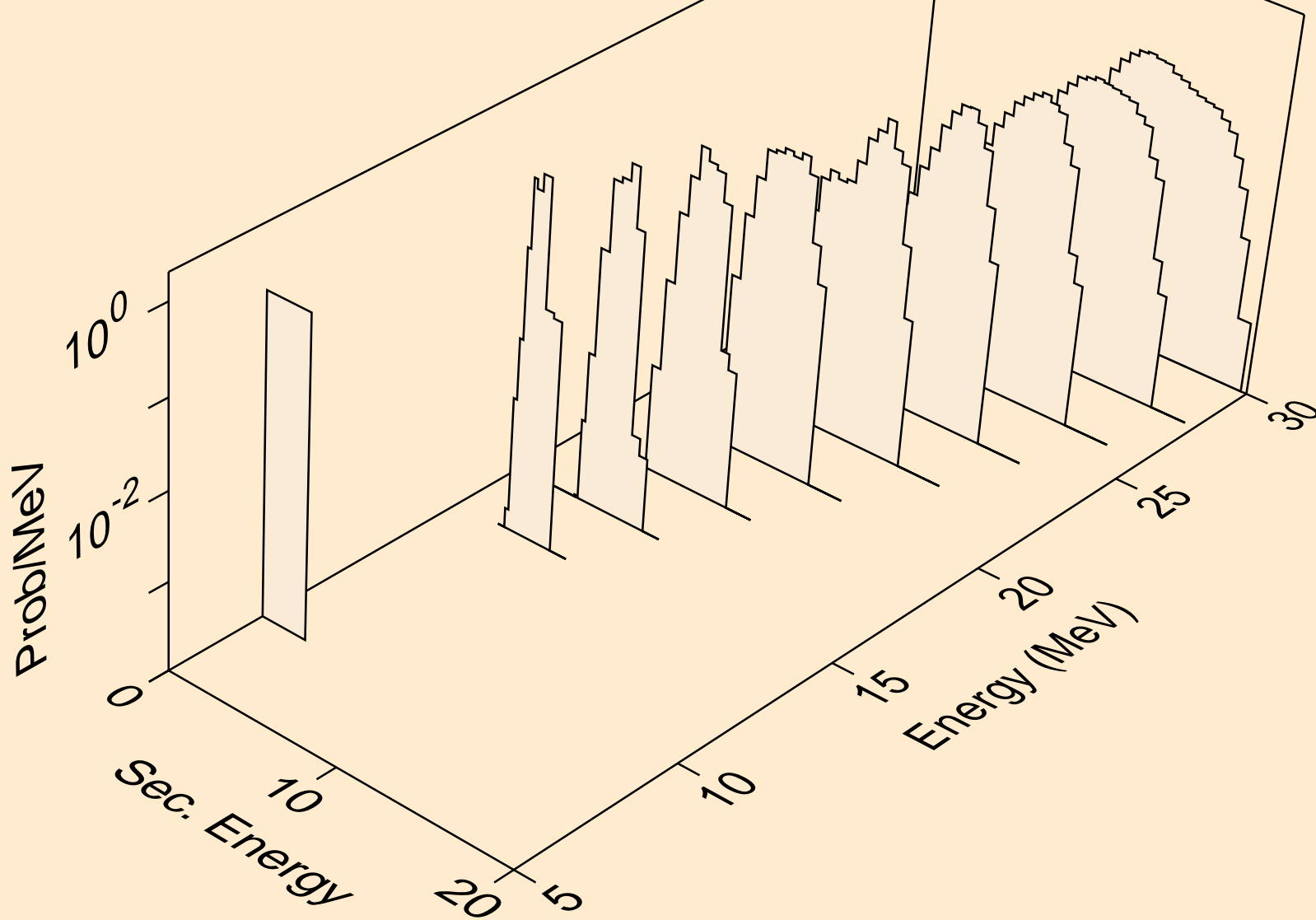

PD099 NEUTRON ACER TENDL-2019 LIBRARY; T=293.16K
alphas from (n,a)

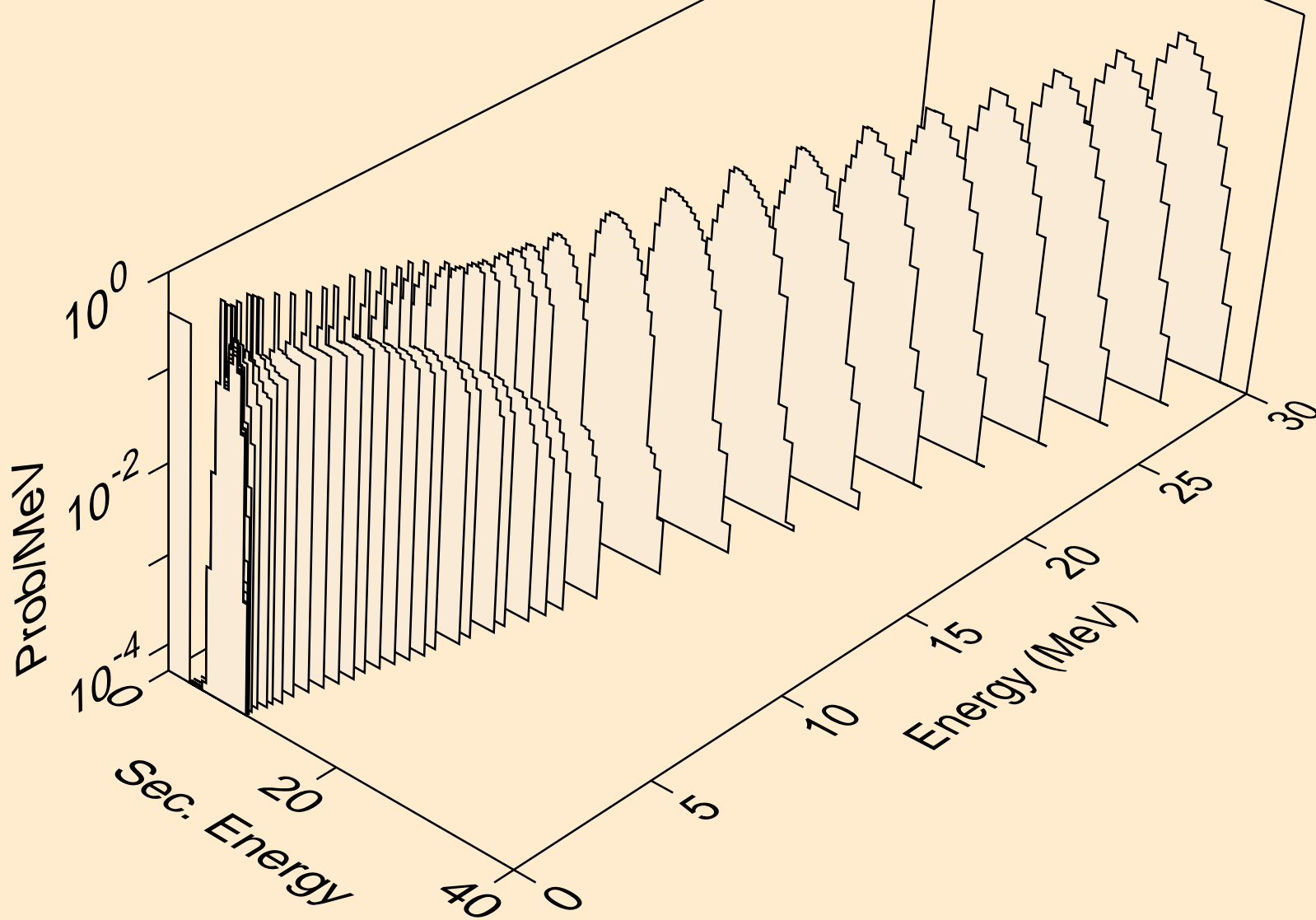

PD099 NEUTRON ACER TENDL-2019 LIBRARY; T=293.16K
alphas from (n,2a)

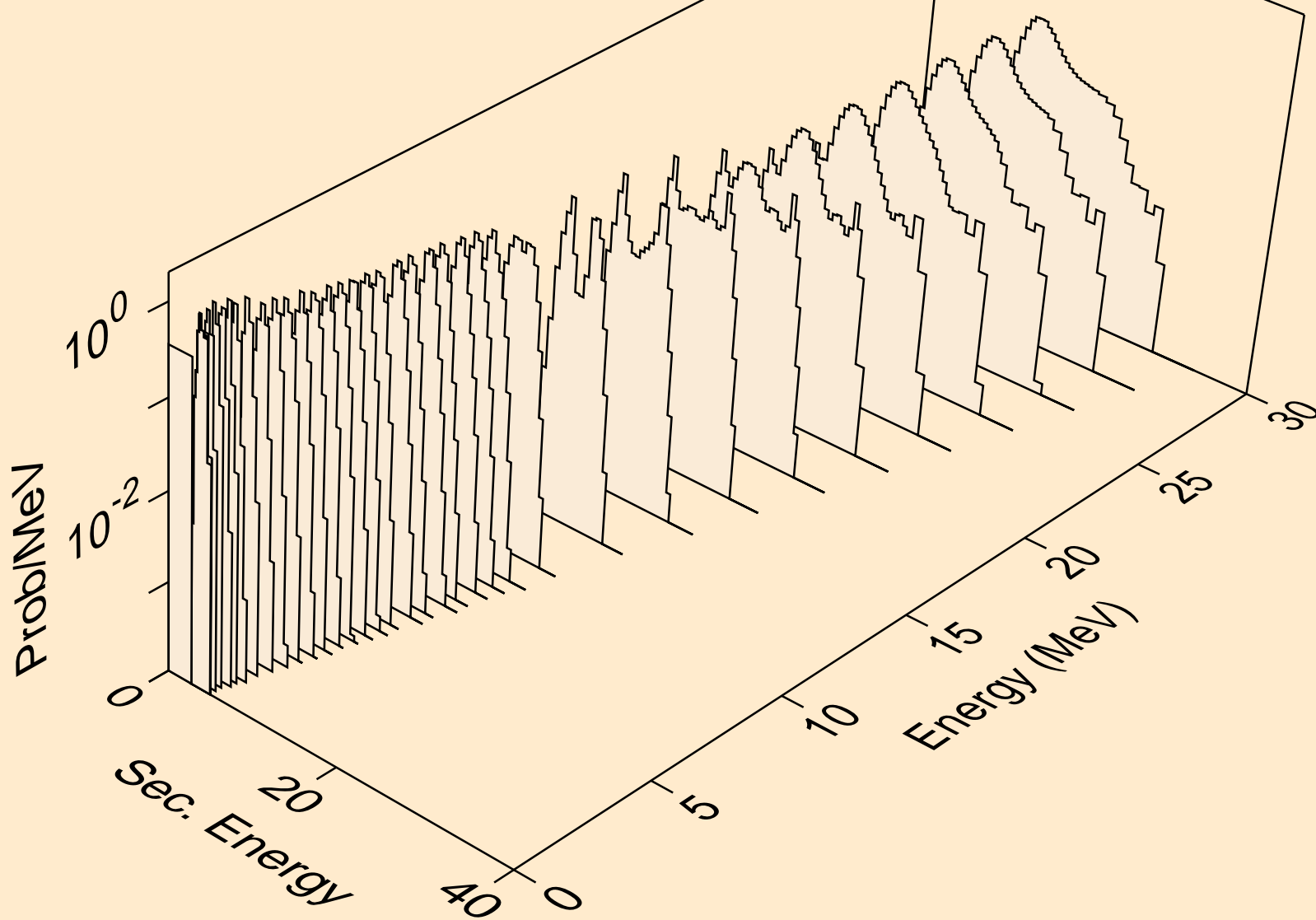

PD099 NEUTRON ACER TENDL-2019 LIBRARY; T=293.16K
alphas from (n,pa)

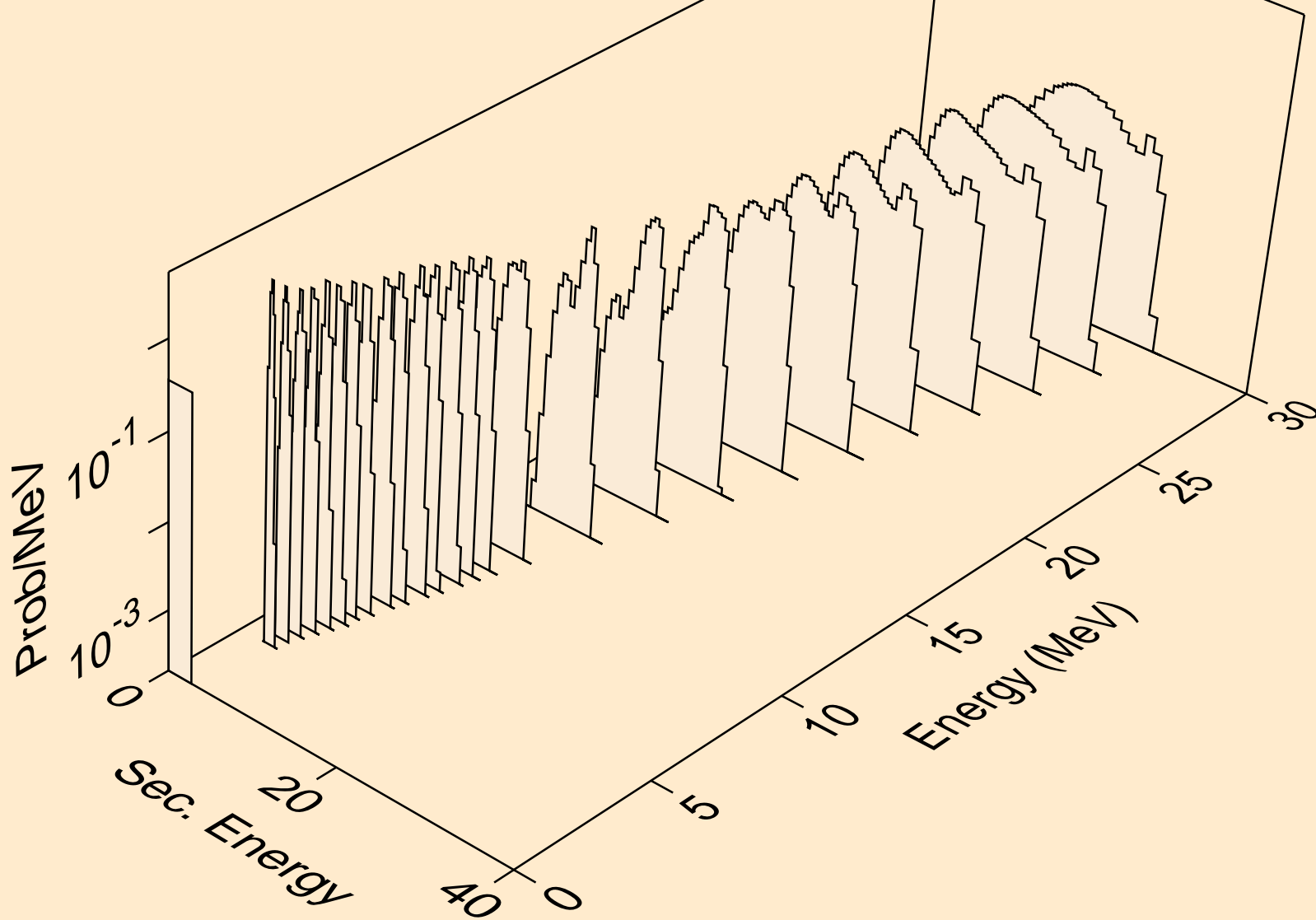

PD099 NEUTRON ACER TENDL-2019 LIBRARY; T=293.16K
alphas from (n,da)

