

PO195M NEUTRON ACER TENDL-2019 LIBRARY; T=293.16K
Principal cross sections

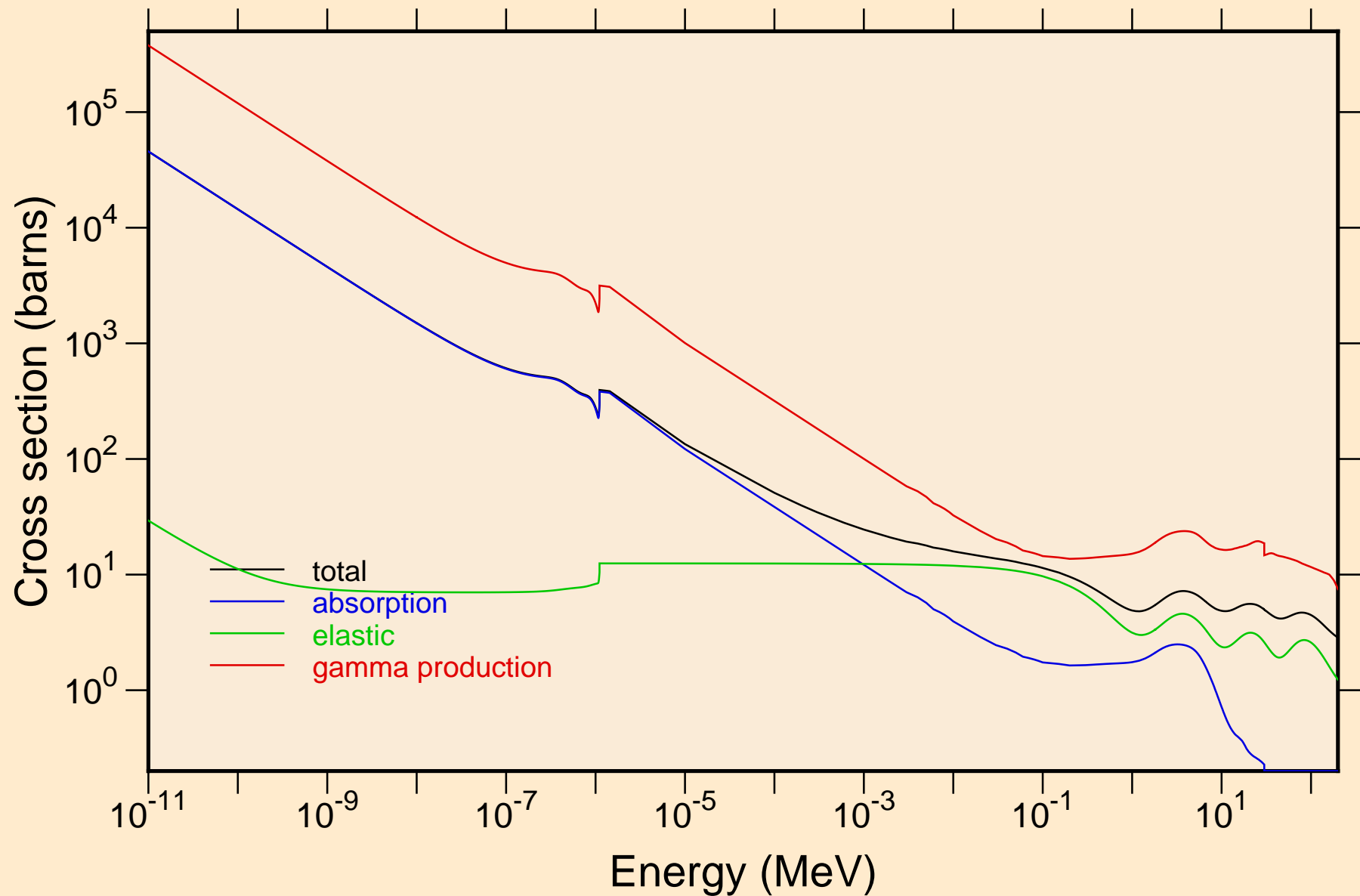

PO195M NEUTRON ACER TENDL-2019 LIBRARY; T=293.16K
Heating

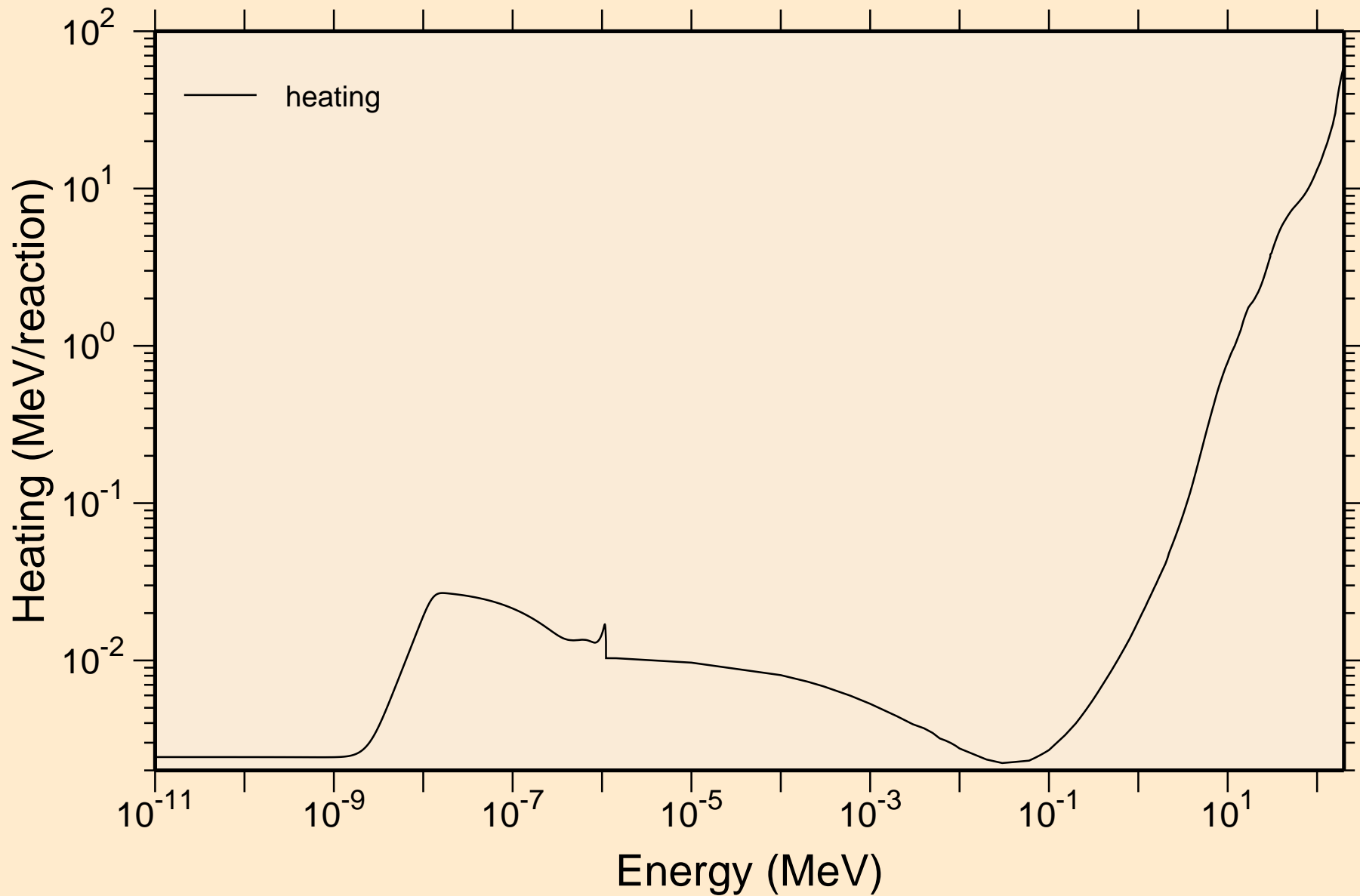

PO195M NEUTRON ACER TENDL-2019 LIBRARY; T=293.16K
Damage

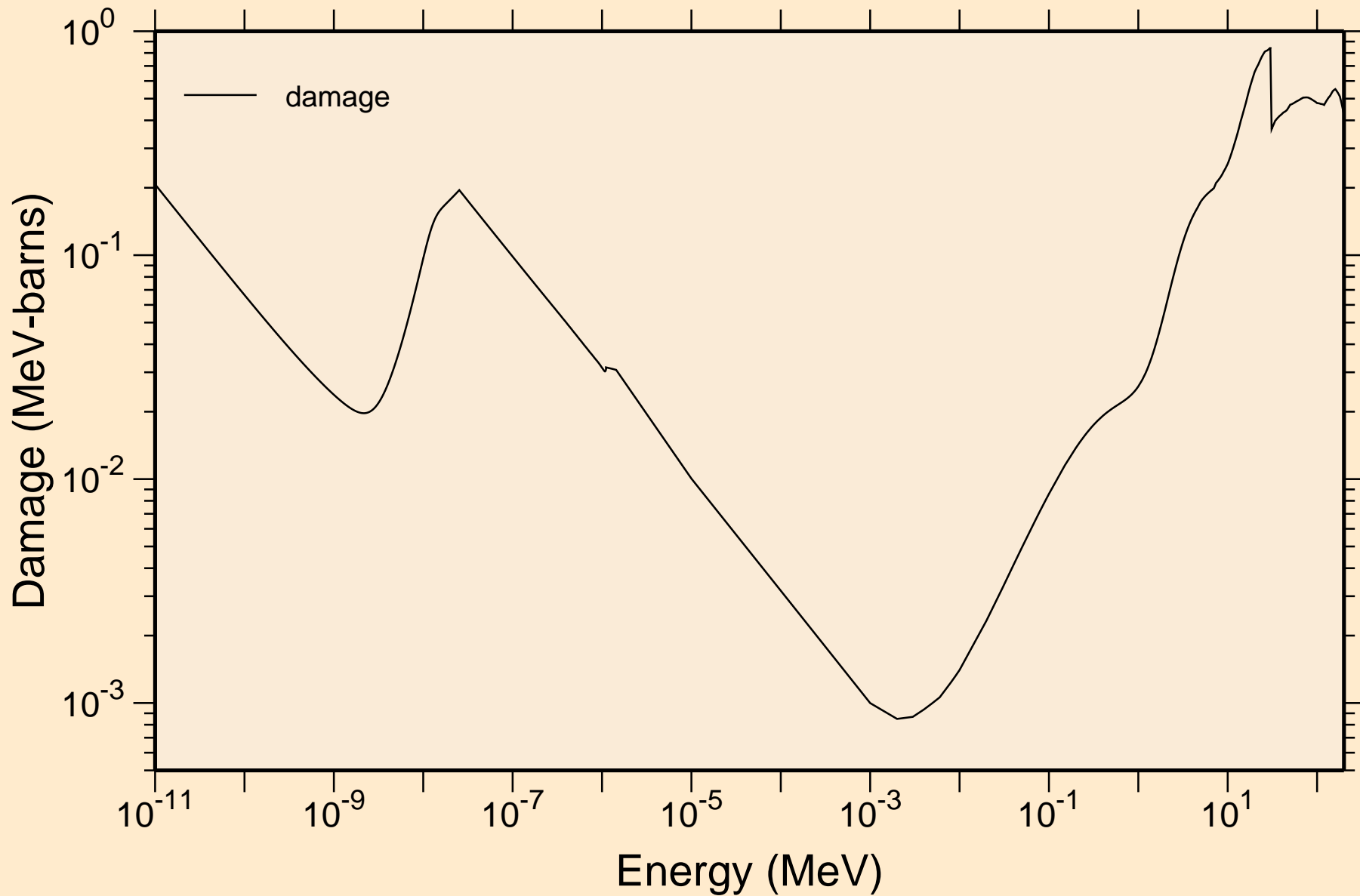

PO195M NEUTRON ACER TENDL-2019 LIBRARY; T=293.16K
Non-threshold reactions

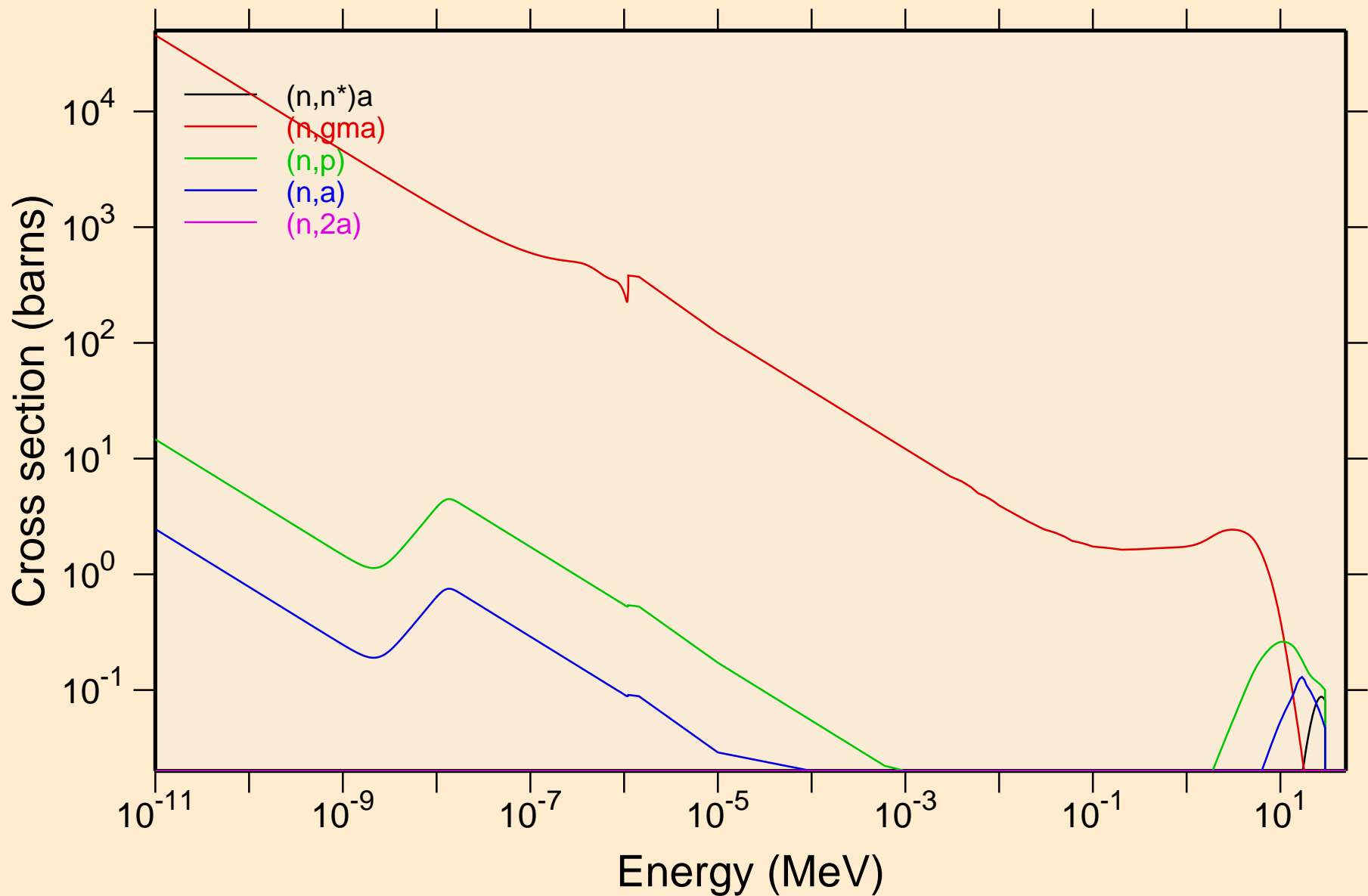

PO195M NEUTRON ACER TENDL-2019 LIBRARY; T=293.16K
Non-threshold reactions

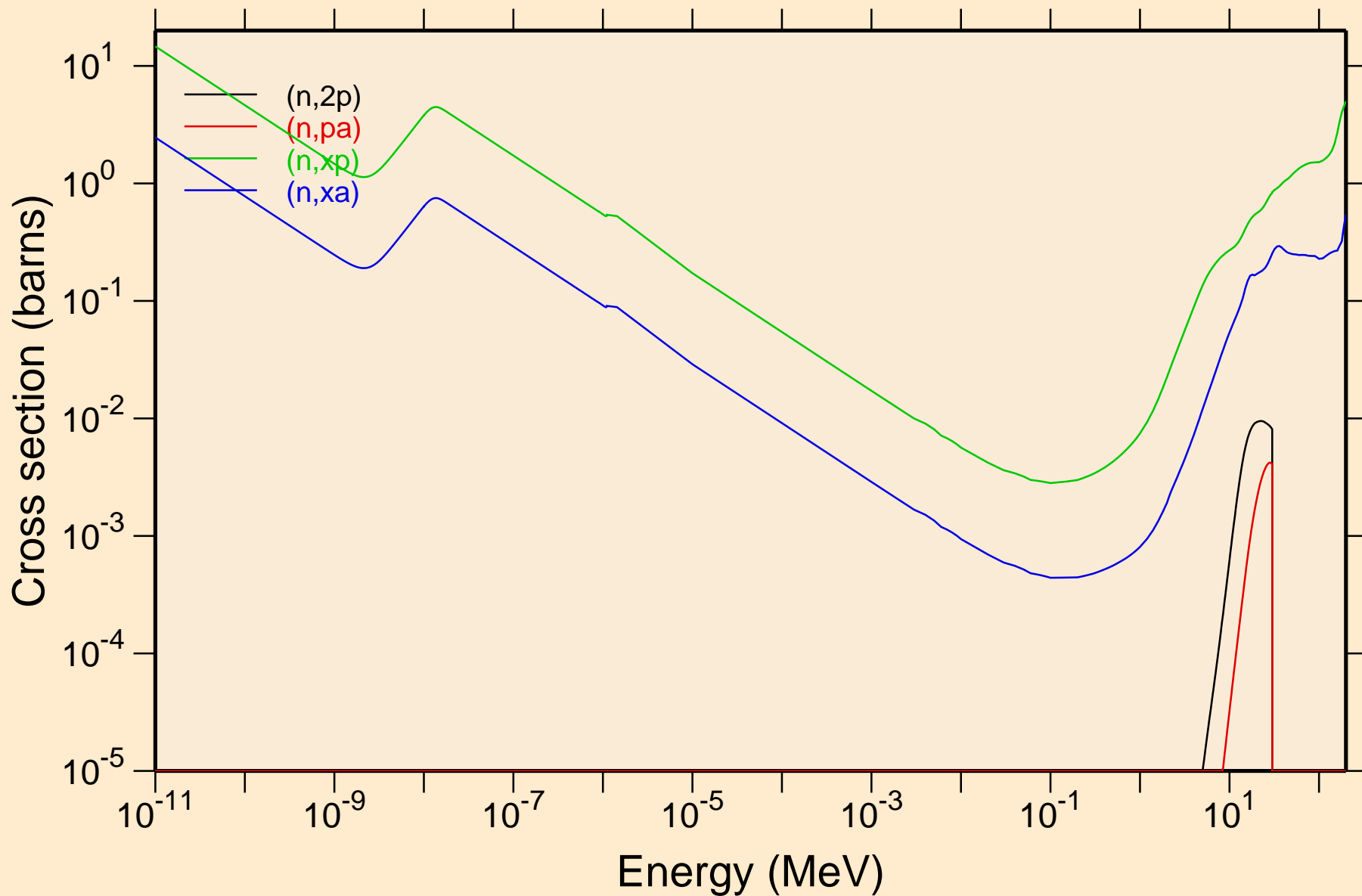

PO195M NEUTRON ACER TENDL-2019 LIBRARY; T=293.16K
Principal cross sections

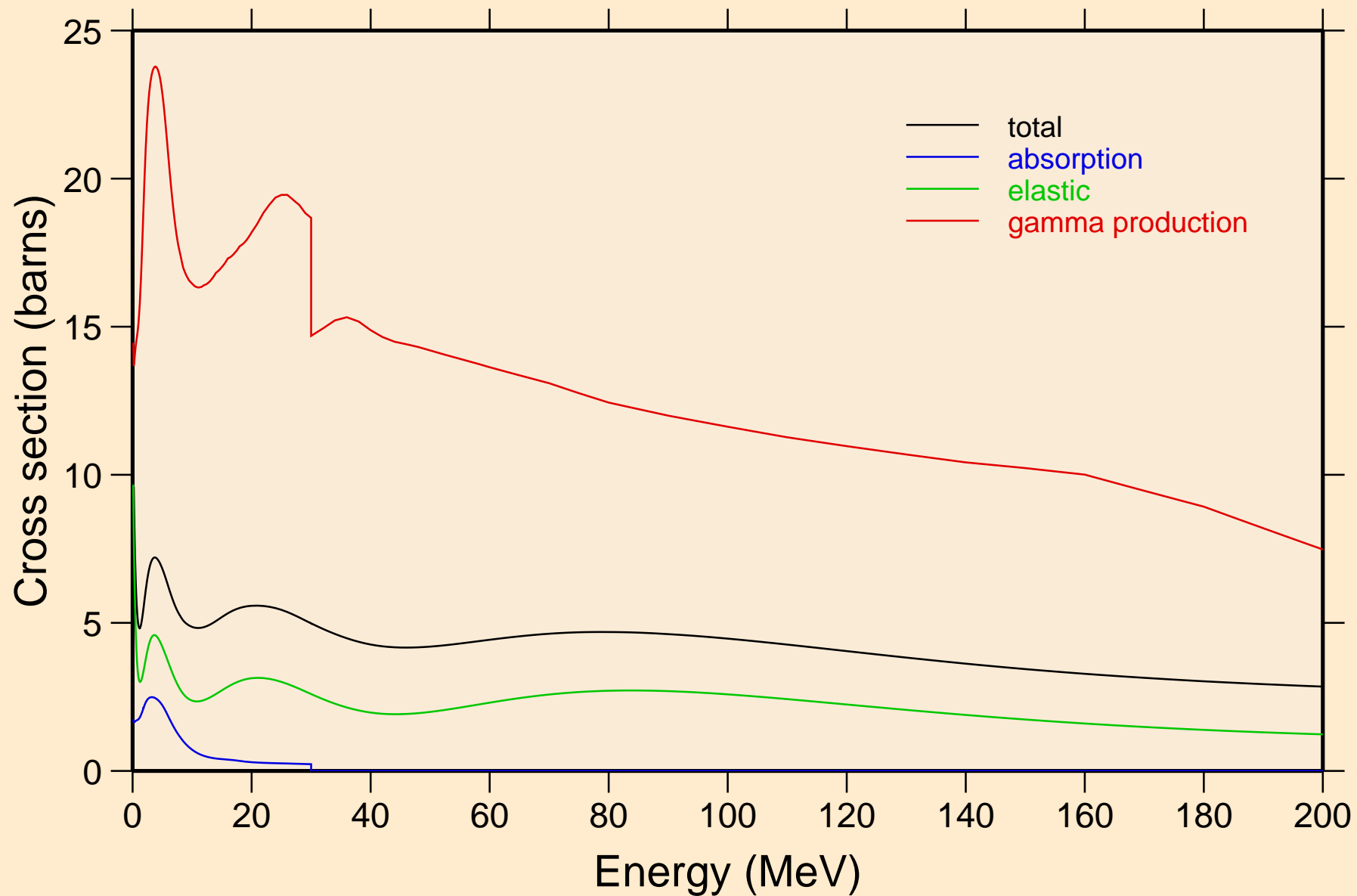

PO195M NEUTRON ACER TENDL-2019 LIBRARY; T=293.16K
Heating

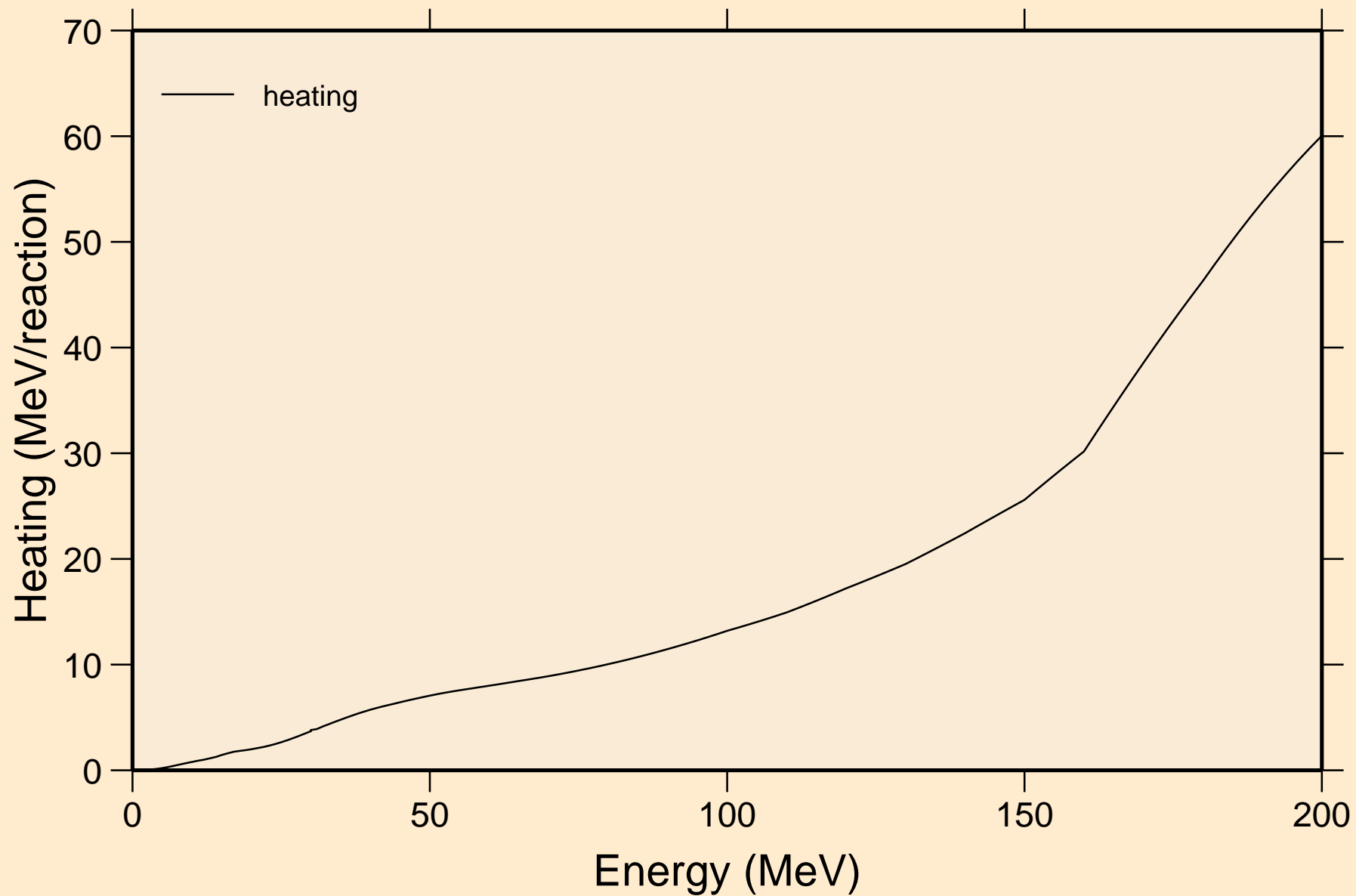

PO195M NEUTRON ACER TENDL-2019 LIBRARY; T=293.16K
Damage

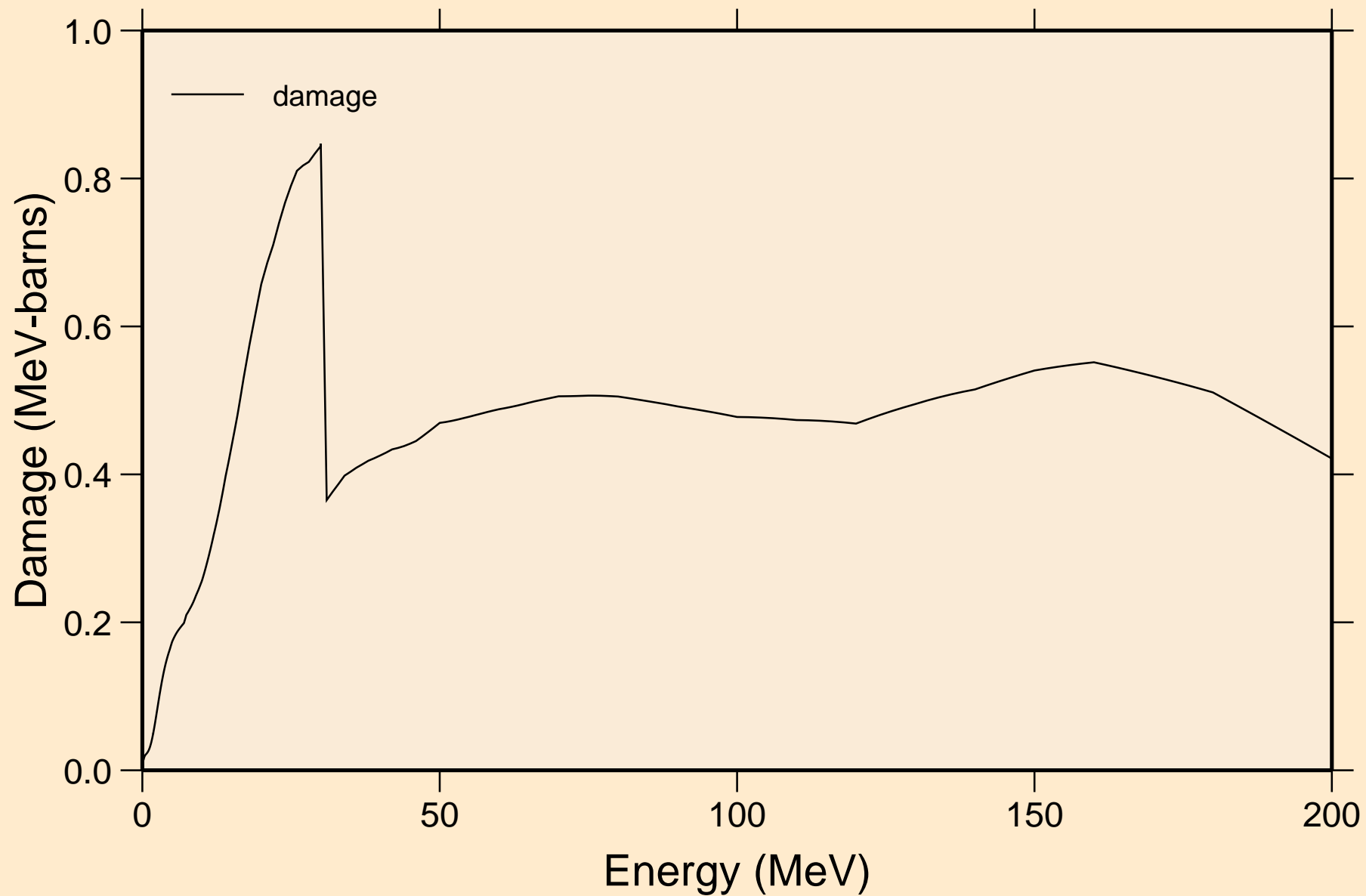

PO195M NEUTRON ACER TENDL-2019 LIBRARY; T=293.16K
Non-threshold reactions

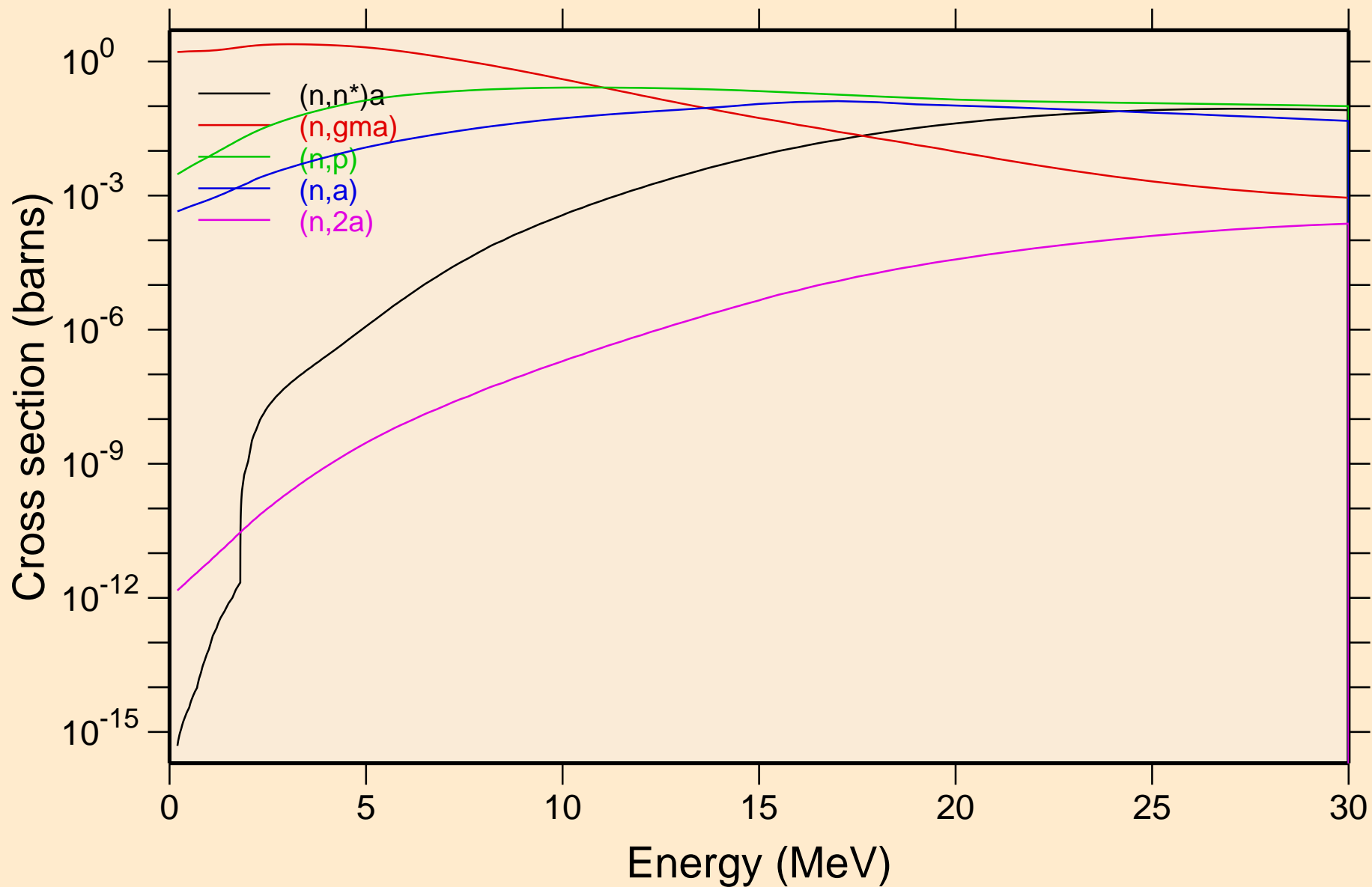

PO195M NEUTRON ACER TENDL-2019 LIBRARY; T=293.16K
Non-threshold reactions

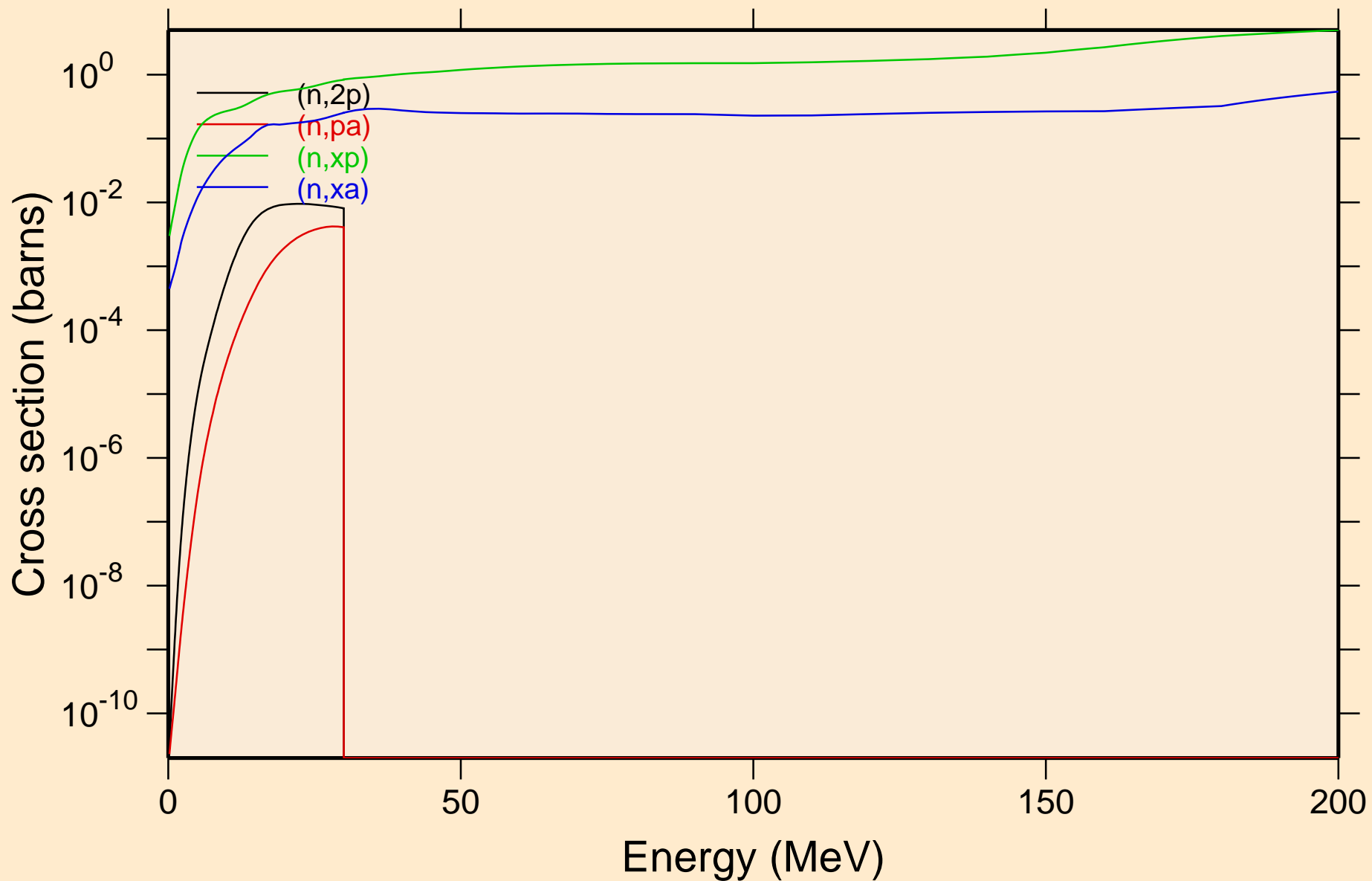

PO195M NEUTRON ACER TENDL-2019 LIBRARY; T=293.16K
Inelastic levels

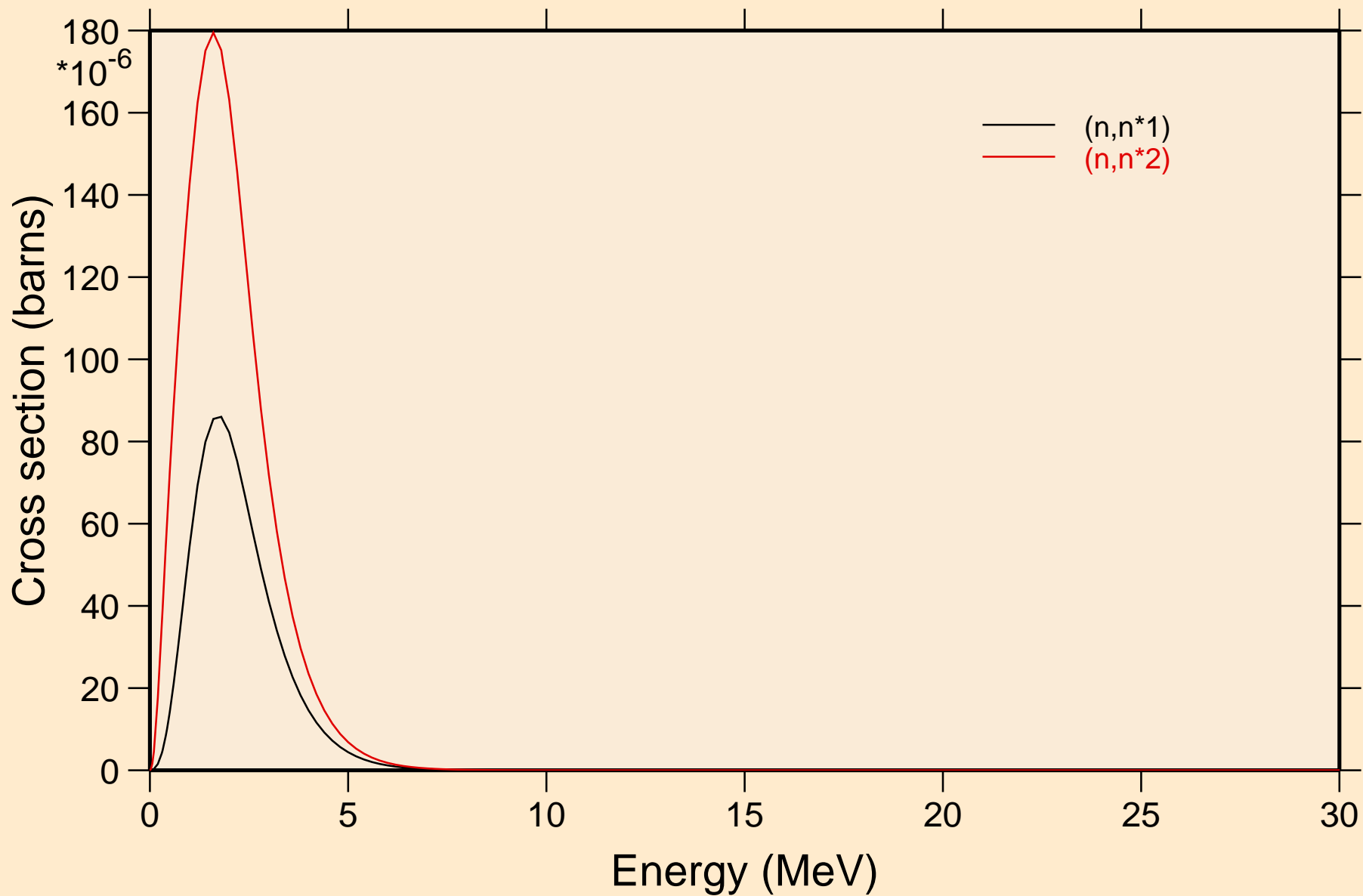

PO195M NEUTRON ACER TENDL-2019 LIBRARY; T=293.16K
Threshold reactions

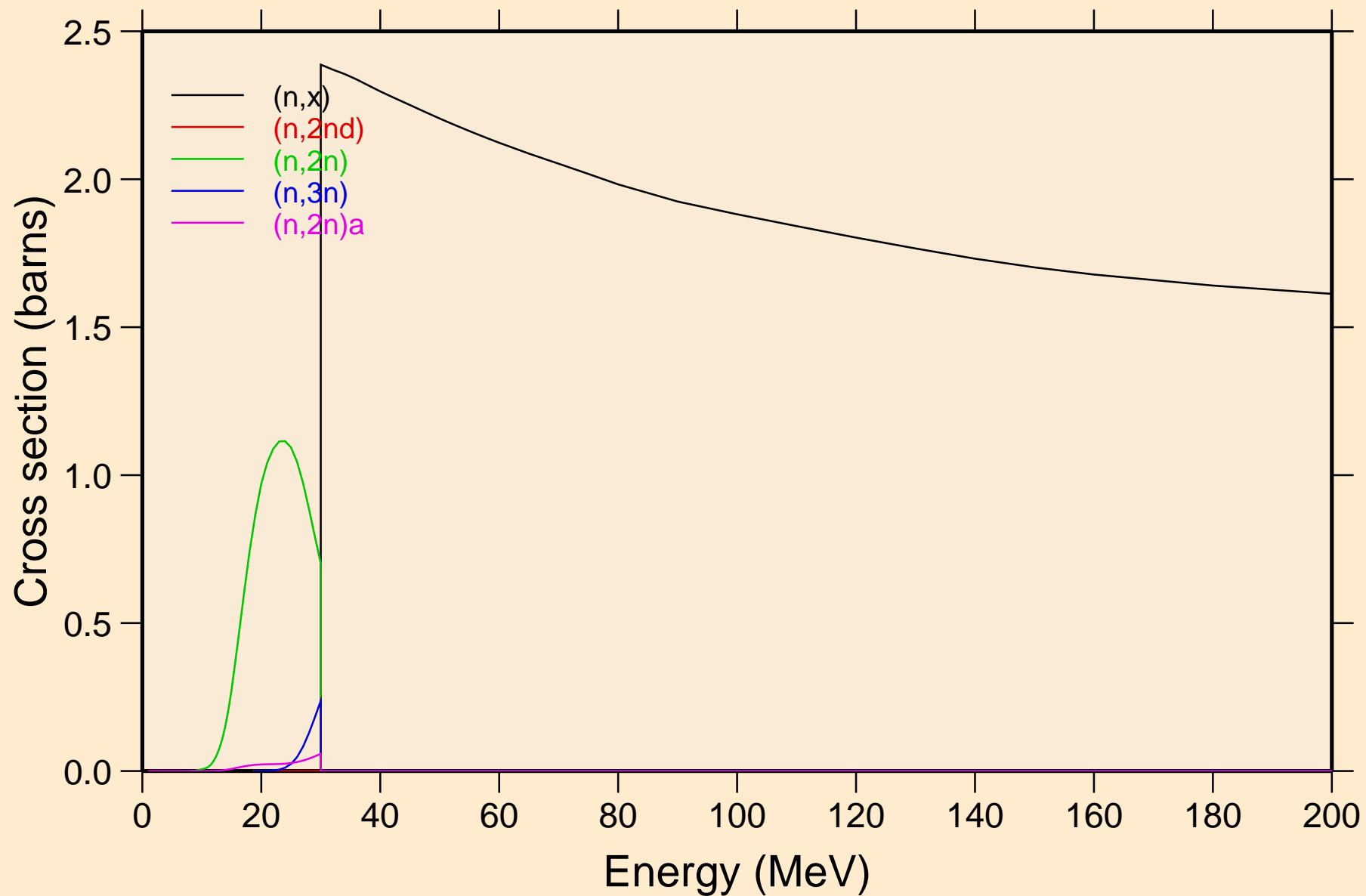

PO195M NEUTRON ACER TENDL-2019 LIBRARY; T=293.16K
Threshold reactions

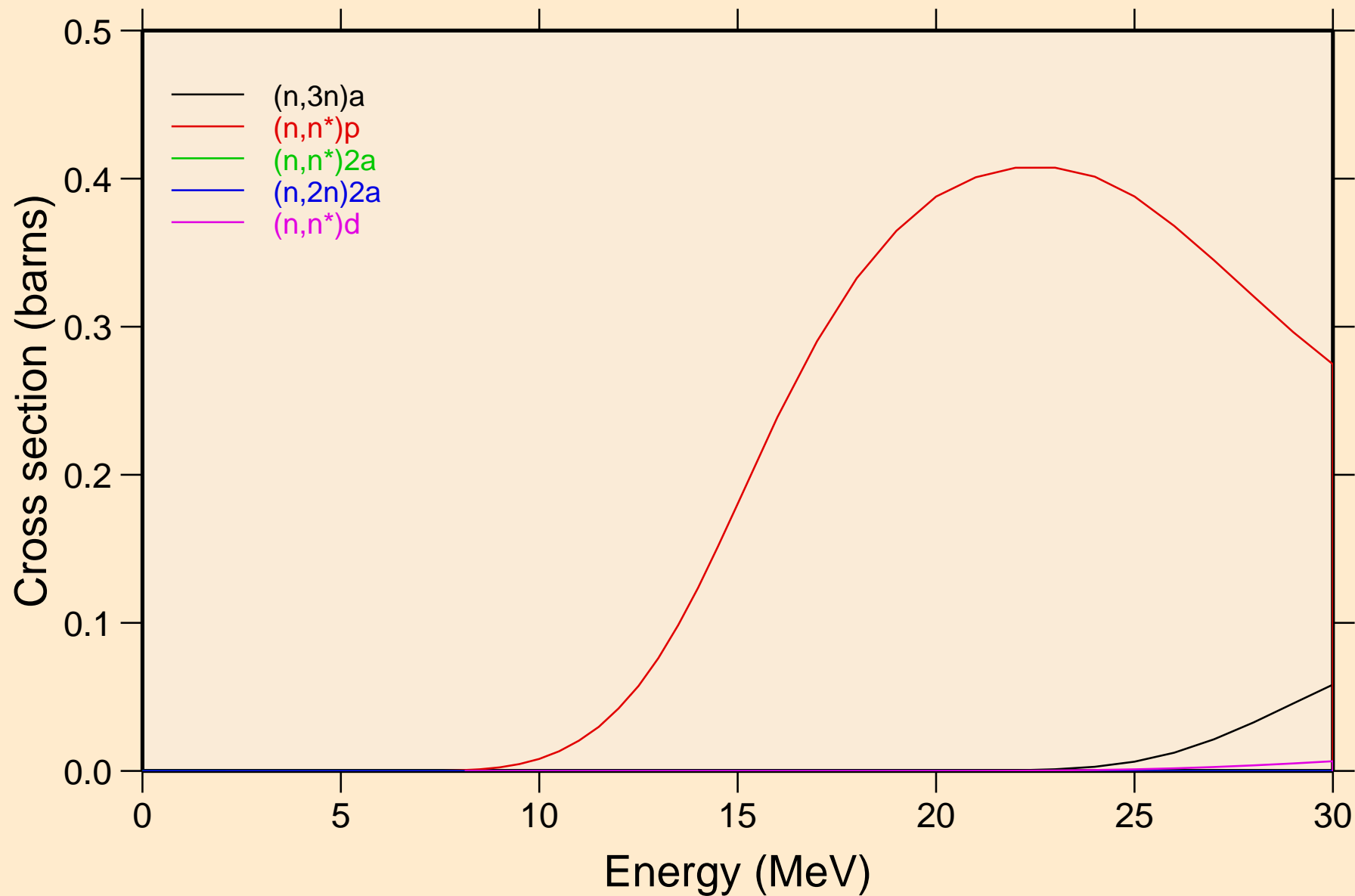

PO195M NEUTRON ACER TENDL-2019 LIBRARY; T=293.16K
Threshold reactions

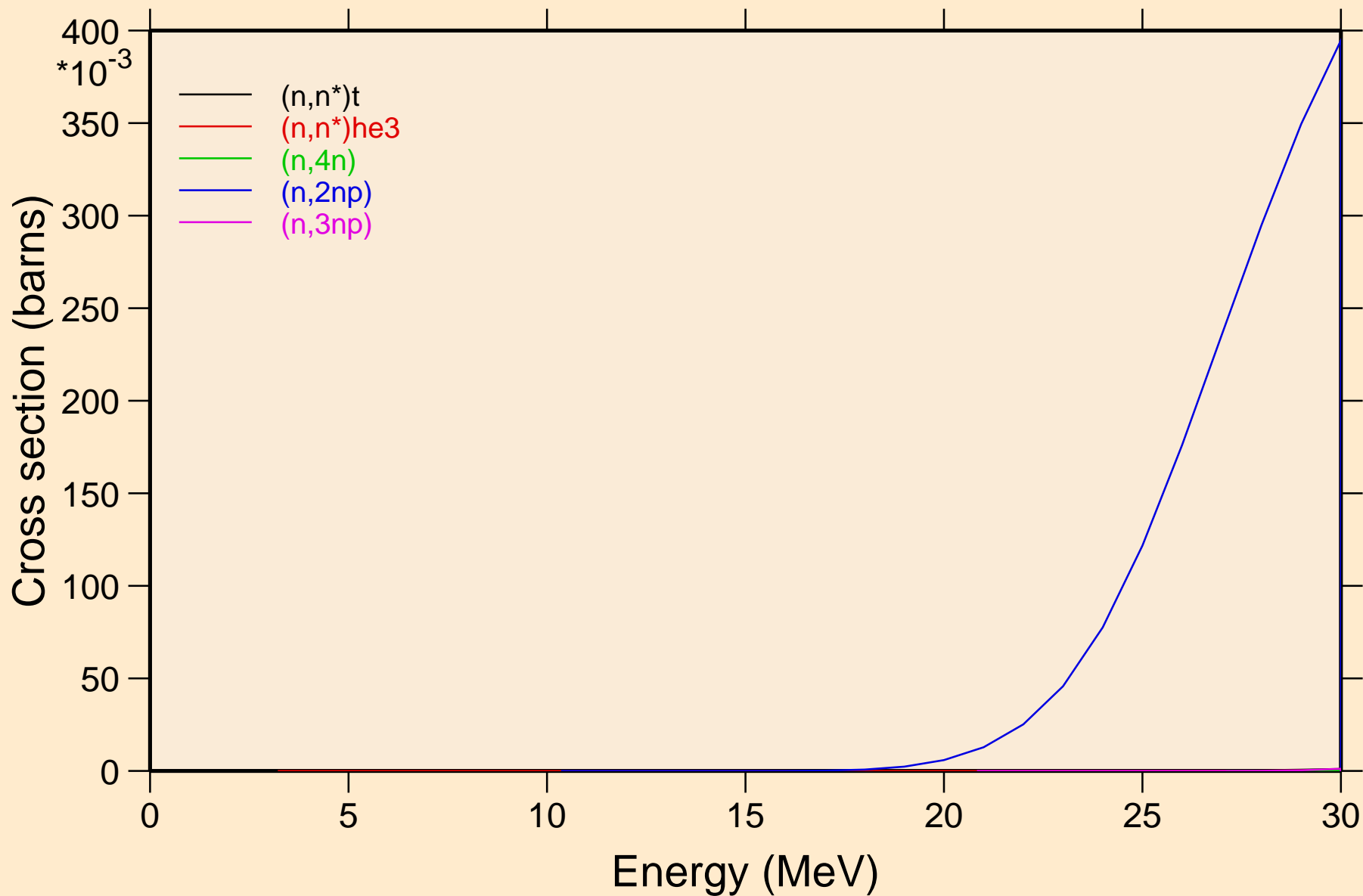

PO195M NEUTRON ACER TENDL-2019 LIBRARY; T=293.16K
Threshold reactions

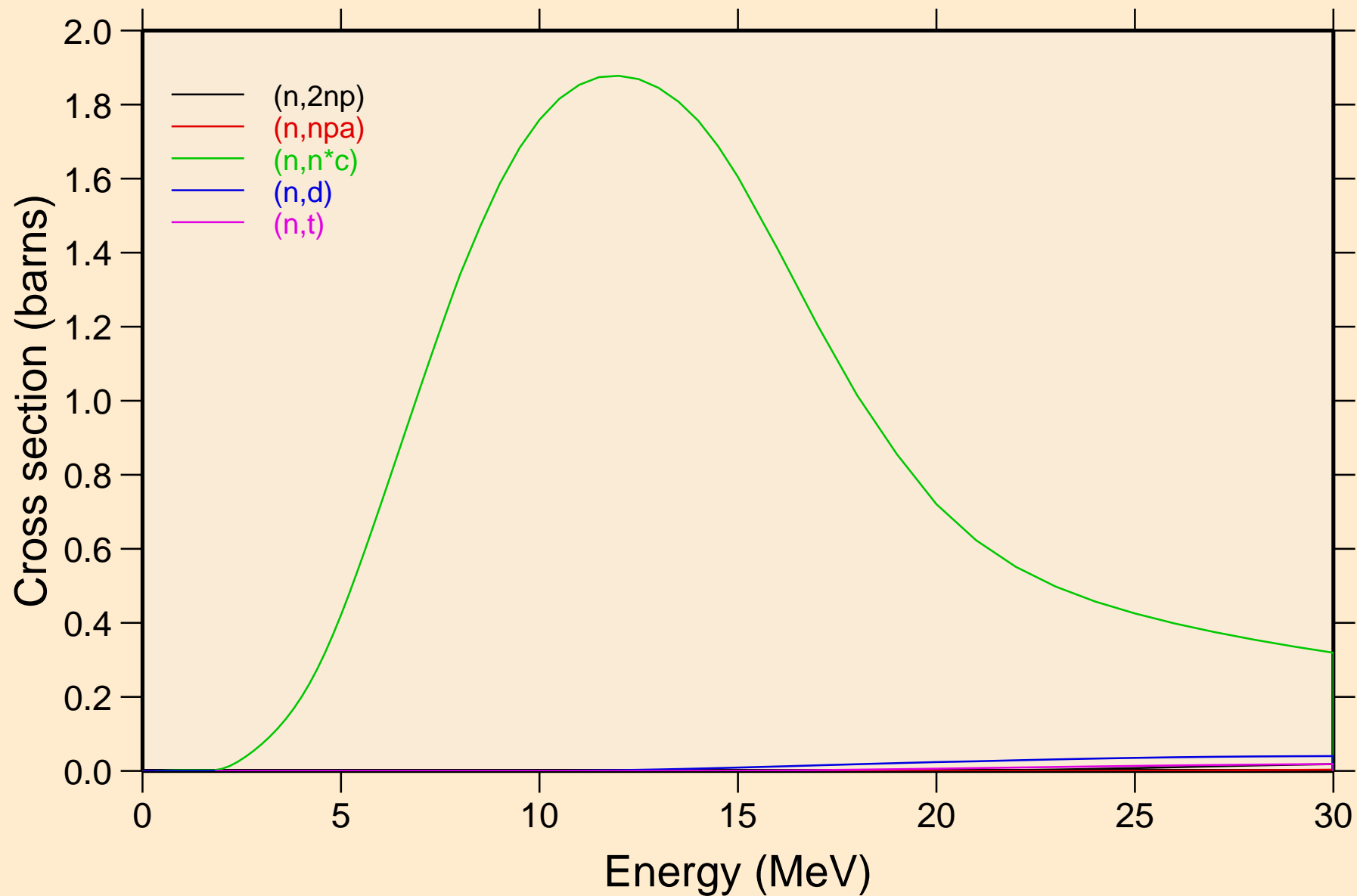

PO195M NEUTRON ACER TENDL-2019 LIBRARY; T=293.16K
Threshold reactions

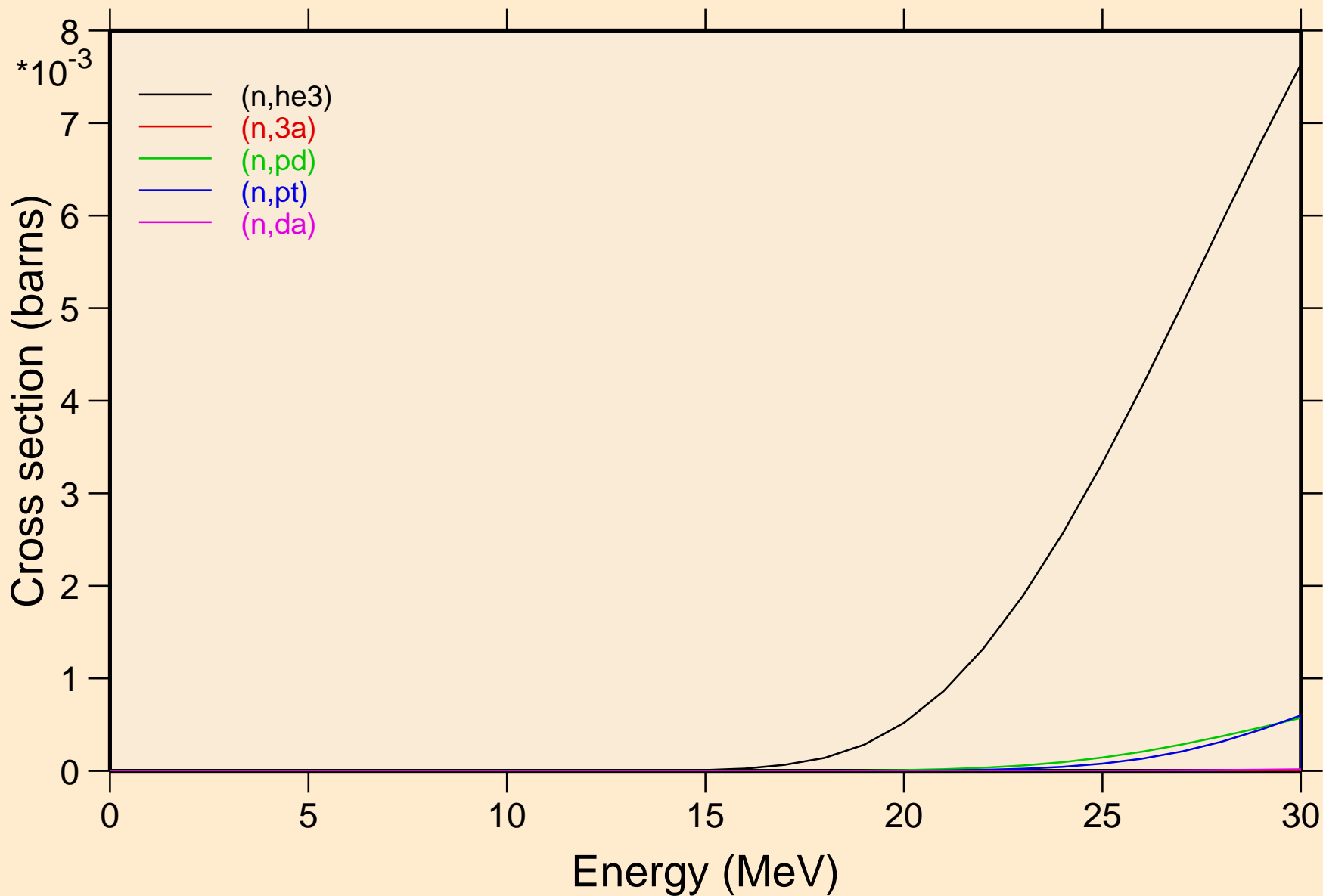

PO195M NEUTRON ACER TENDL-2019 LIBRARY; T=293.16K
Threshold reactions

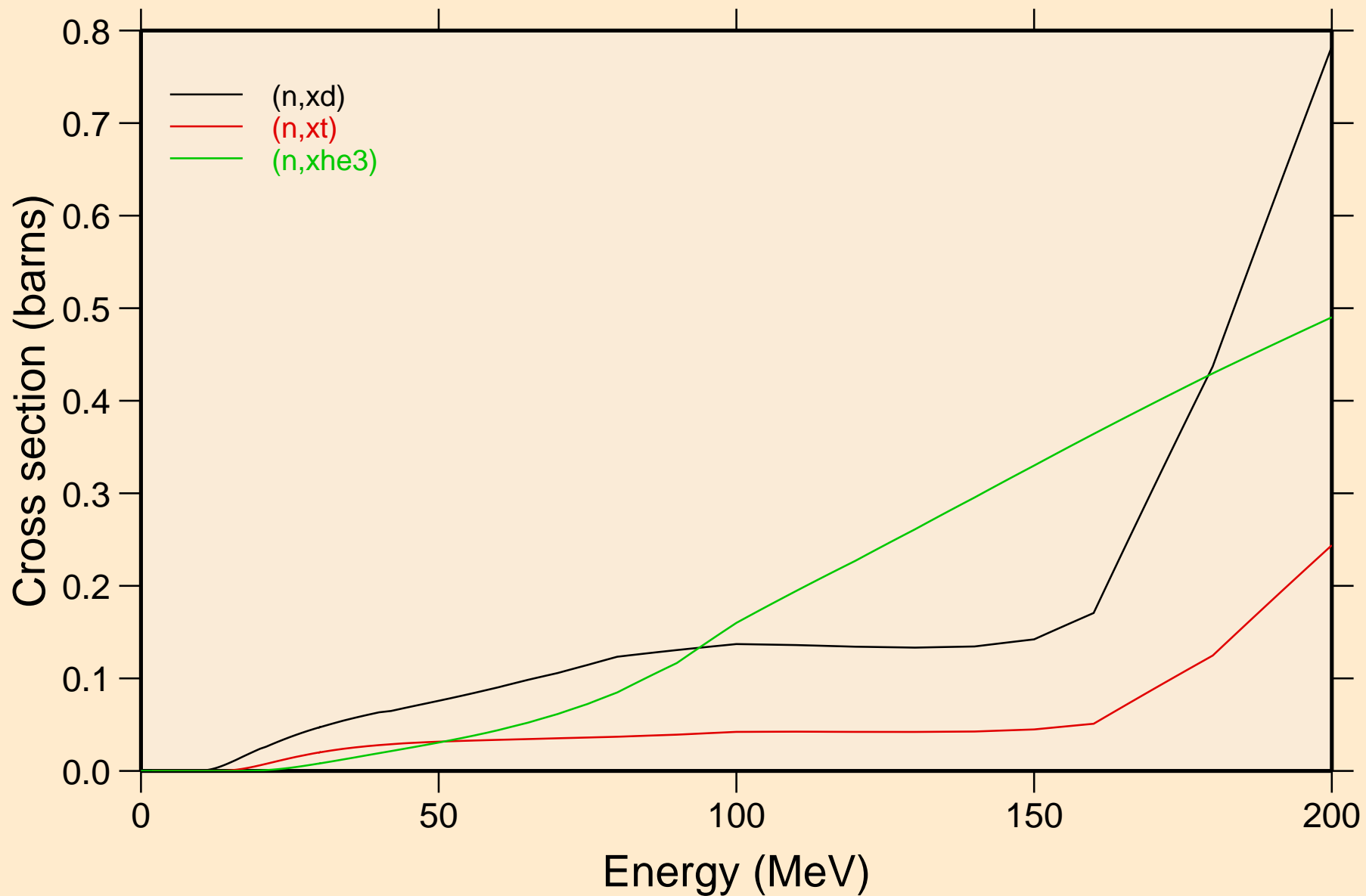

PO195M NEUTRON ACER TENDL-2019 LIBRARY; T=293.16K
angular distribution for elastic

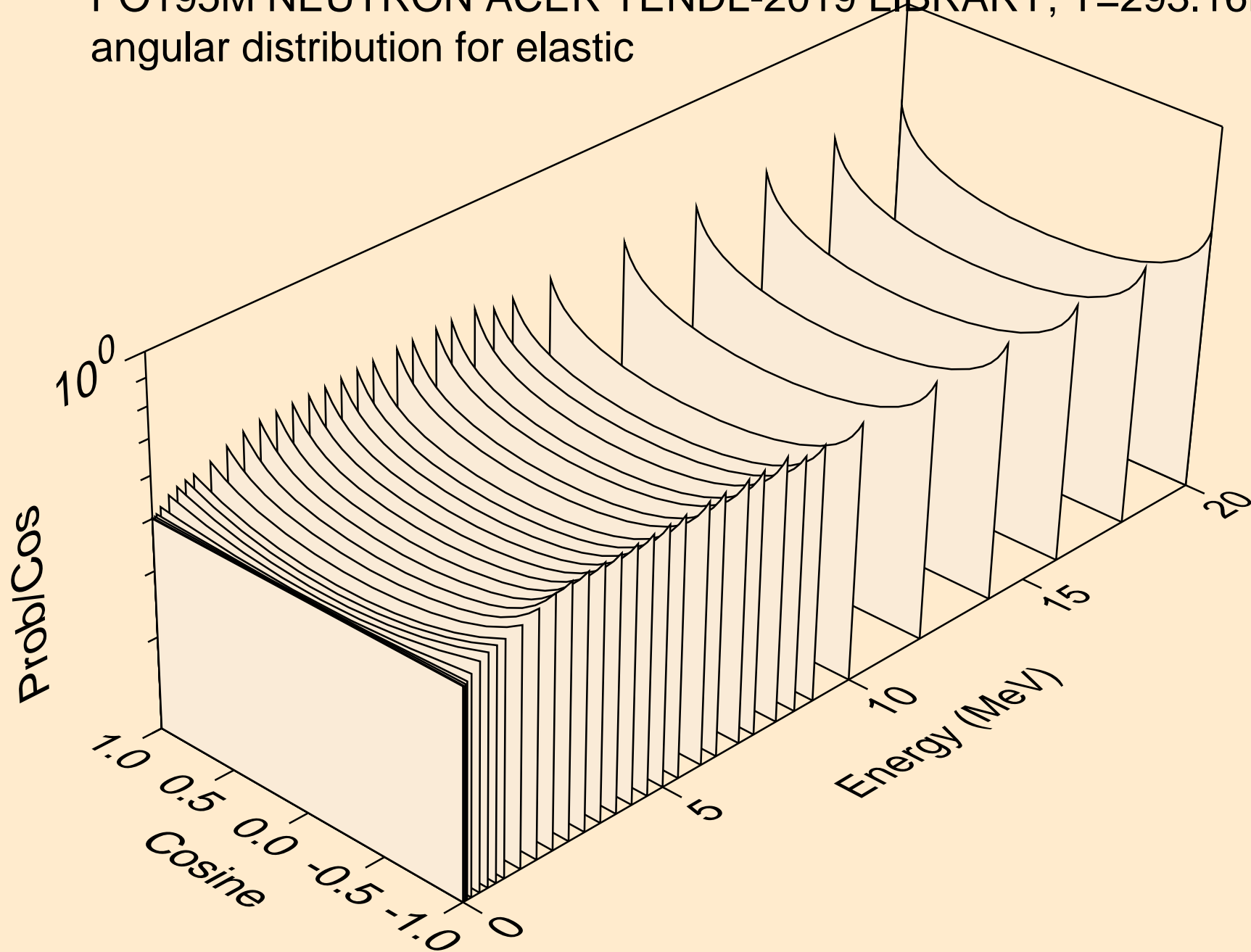

PO195M NEUTRON ACER TENDL-2019 LIBRARY; T=293.16K
angular distribution for elastic

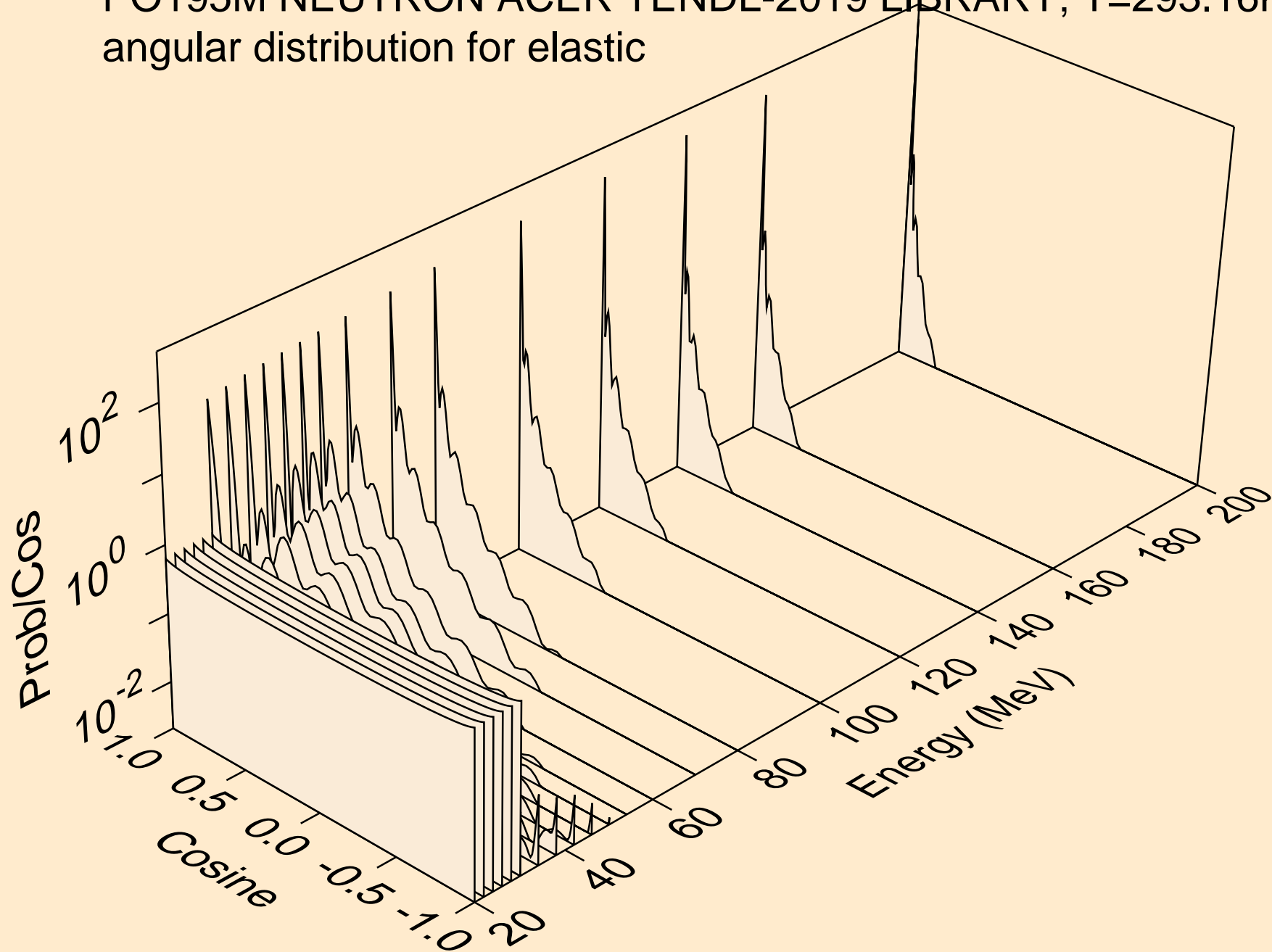

PO195M NEUTRON ACER TENDL-2019 LIBRARY; T=293.16K
angular distribution for (n,n*1)

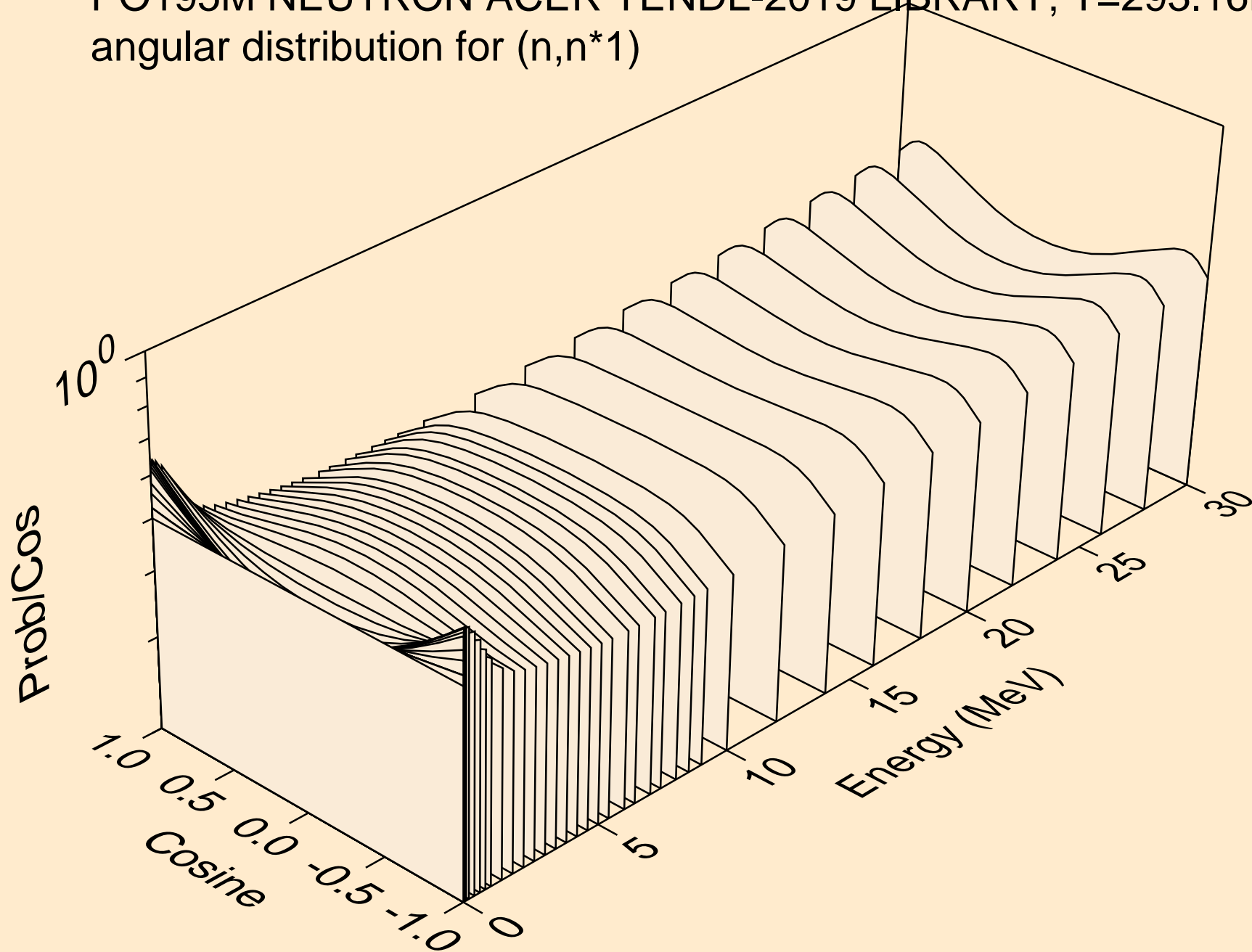

PO195M NEUTRON ACER TENDL-2019 LIBRARY; T=293.16K
angular distribution for (n,n*2)

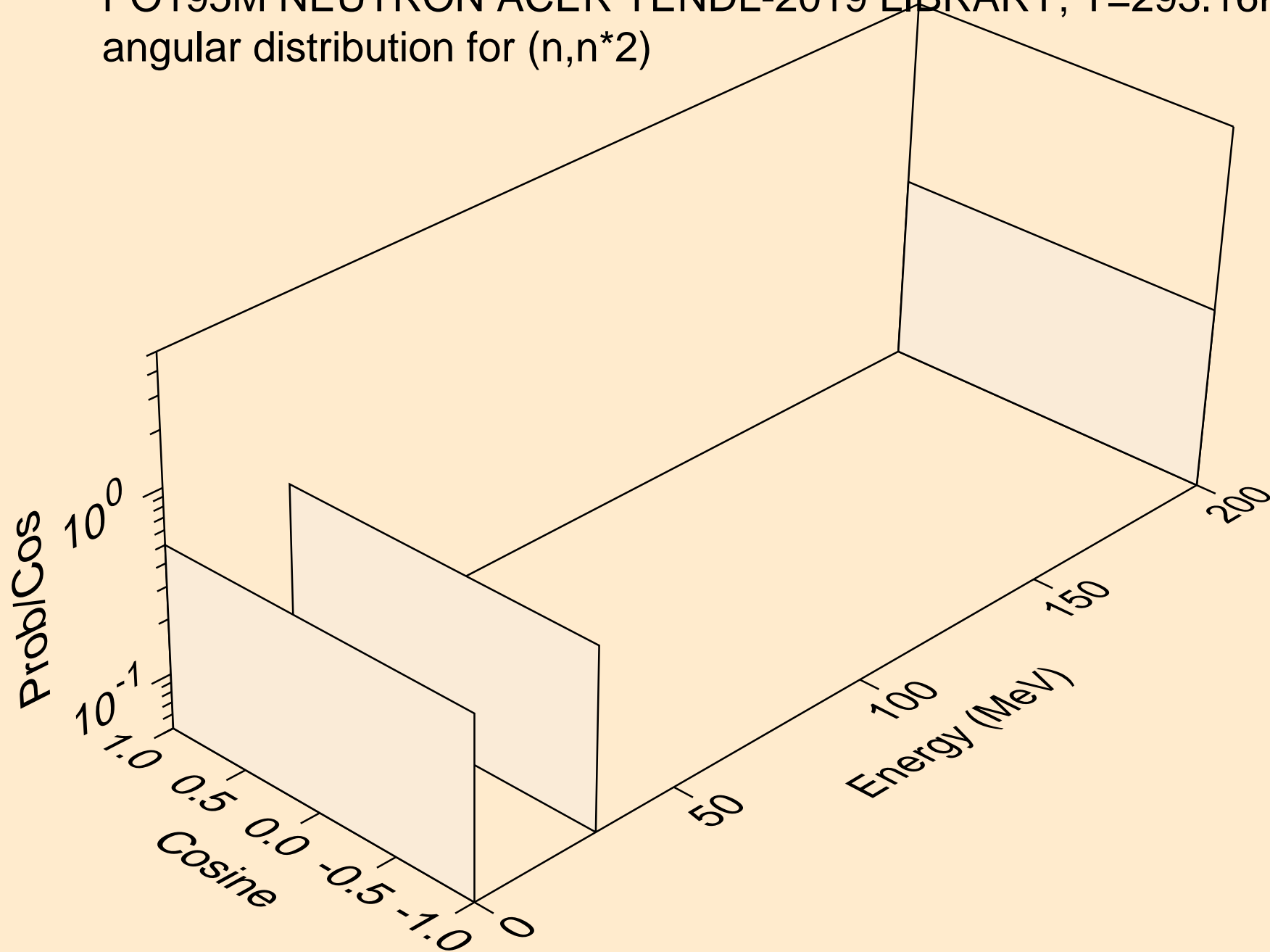

PO195M NEUTRON ACER TENDL-2019 LIBRARY; T=293.16K
Neutron emission for (n,x)

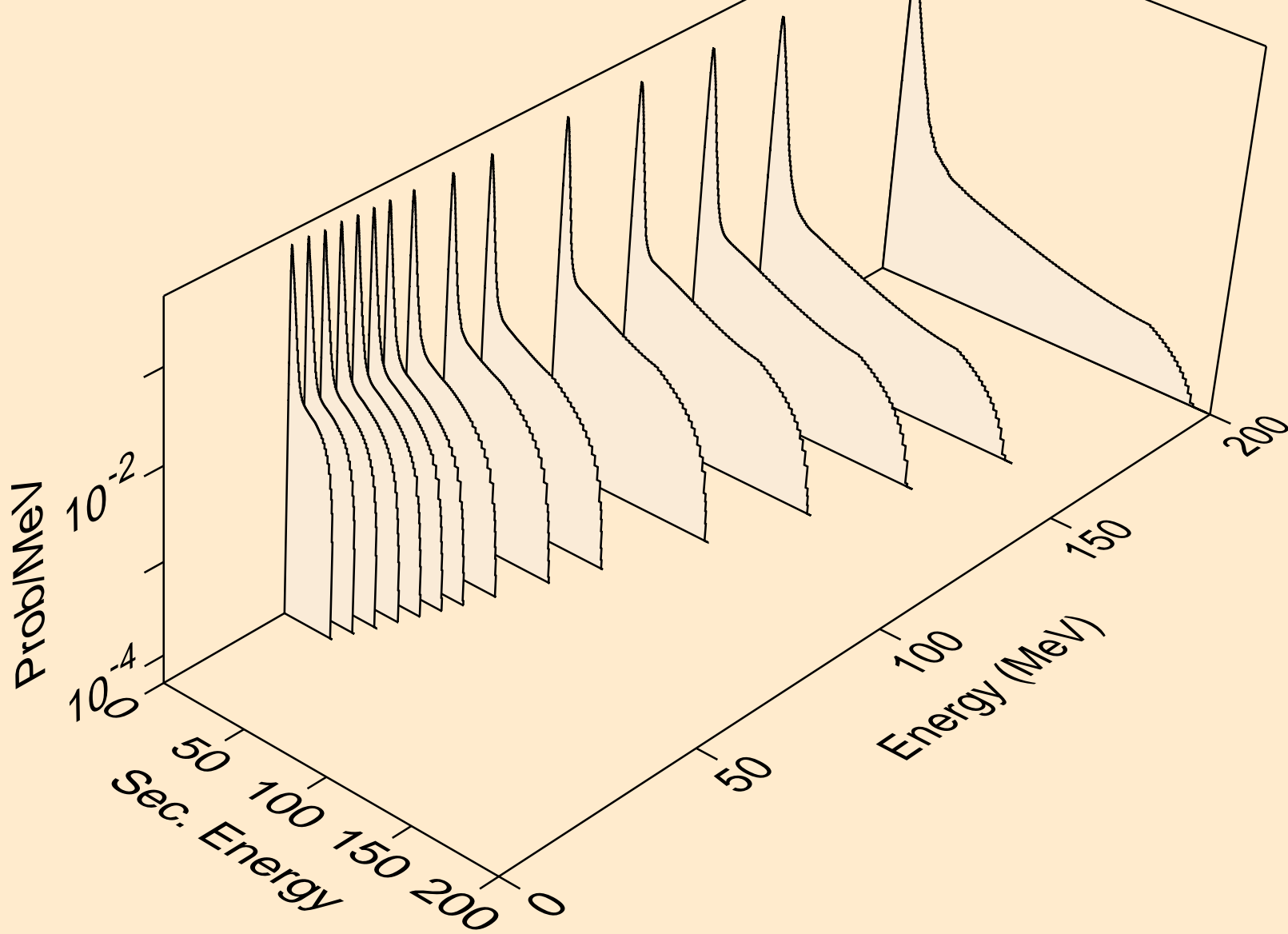

PO195M NEUTRON ACER TENDL-2019 LIBRARY; T=293.16K
Neutron emission for (n,2nd)

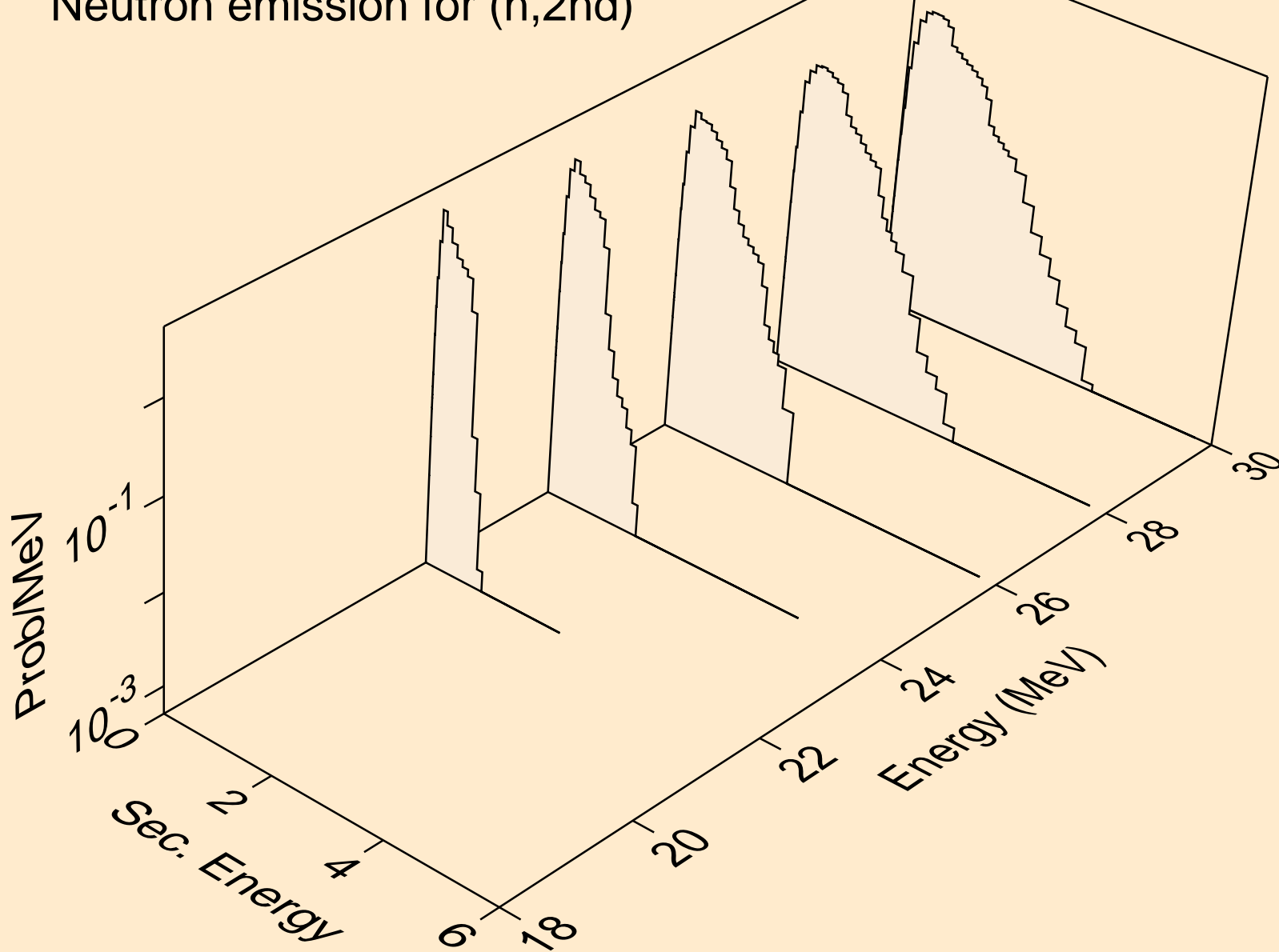

PO195M NEUTRON ACER TENDL-2019 LIBRARY; T=293.16K
Neutron emission for (n,2n)

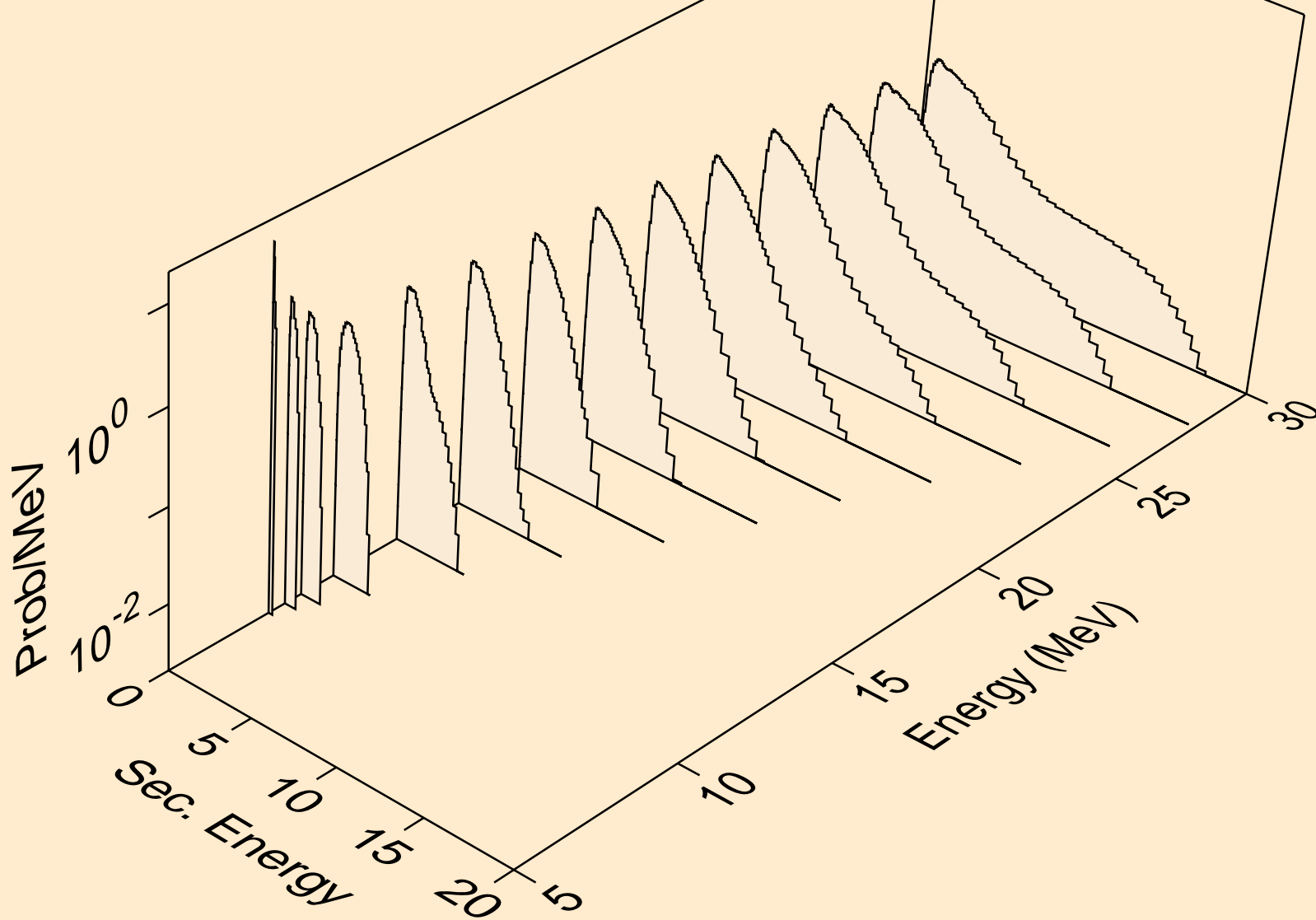

PO195M NEUTRON ACER TENDL-2019 LIBRARY; T=293.16K
Neutron emission for (n,3n)

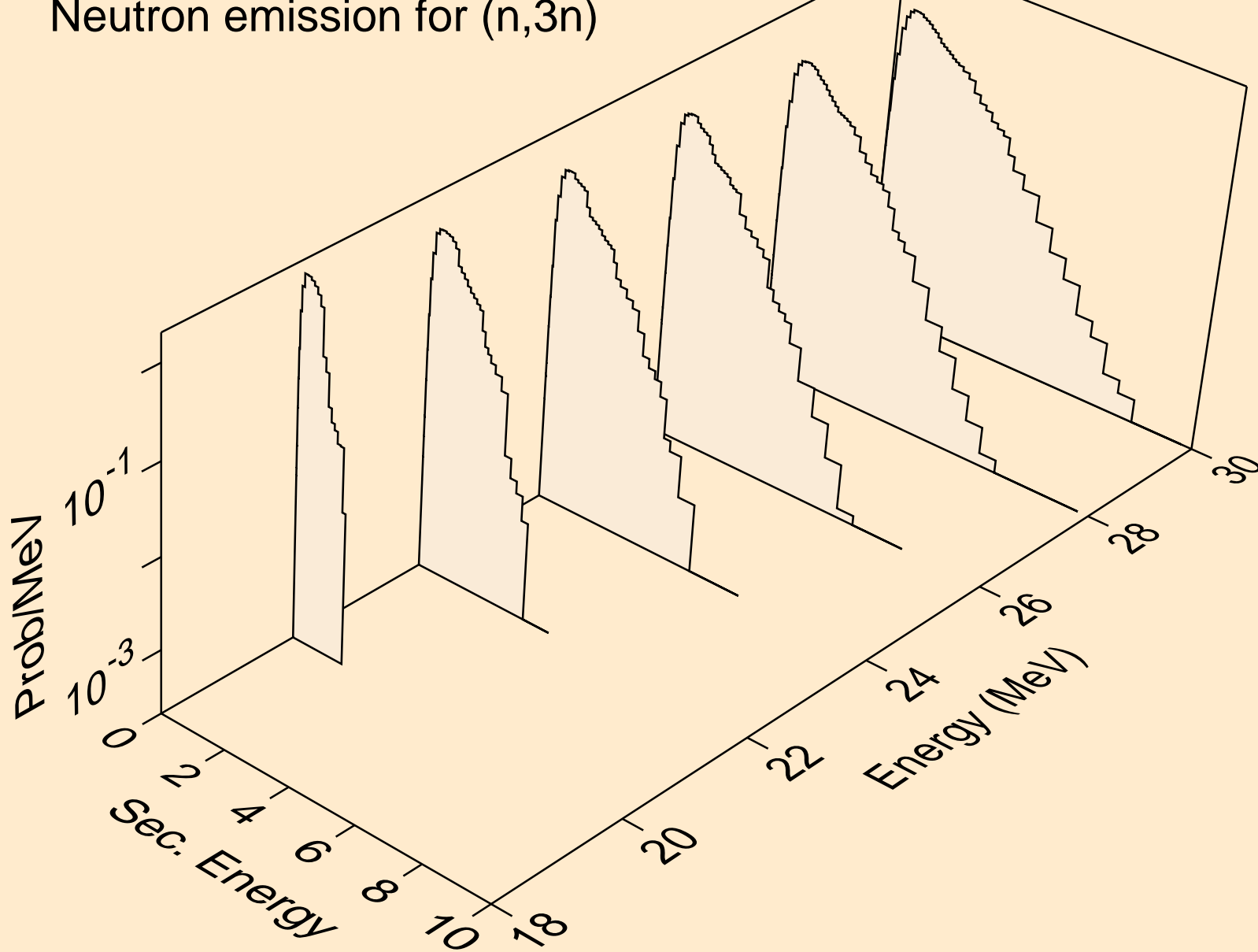

PO195M NEUTRON ACER TENDL-2019 LIBRARY; T=293.16K
Neutron emission for (n,n*)a

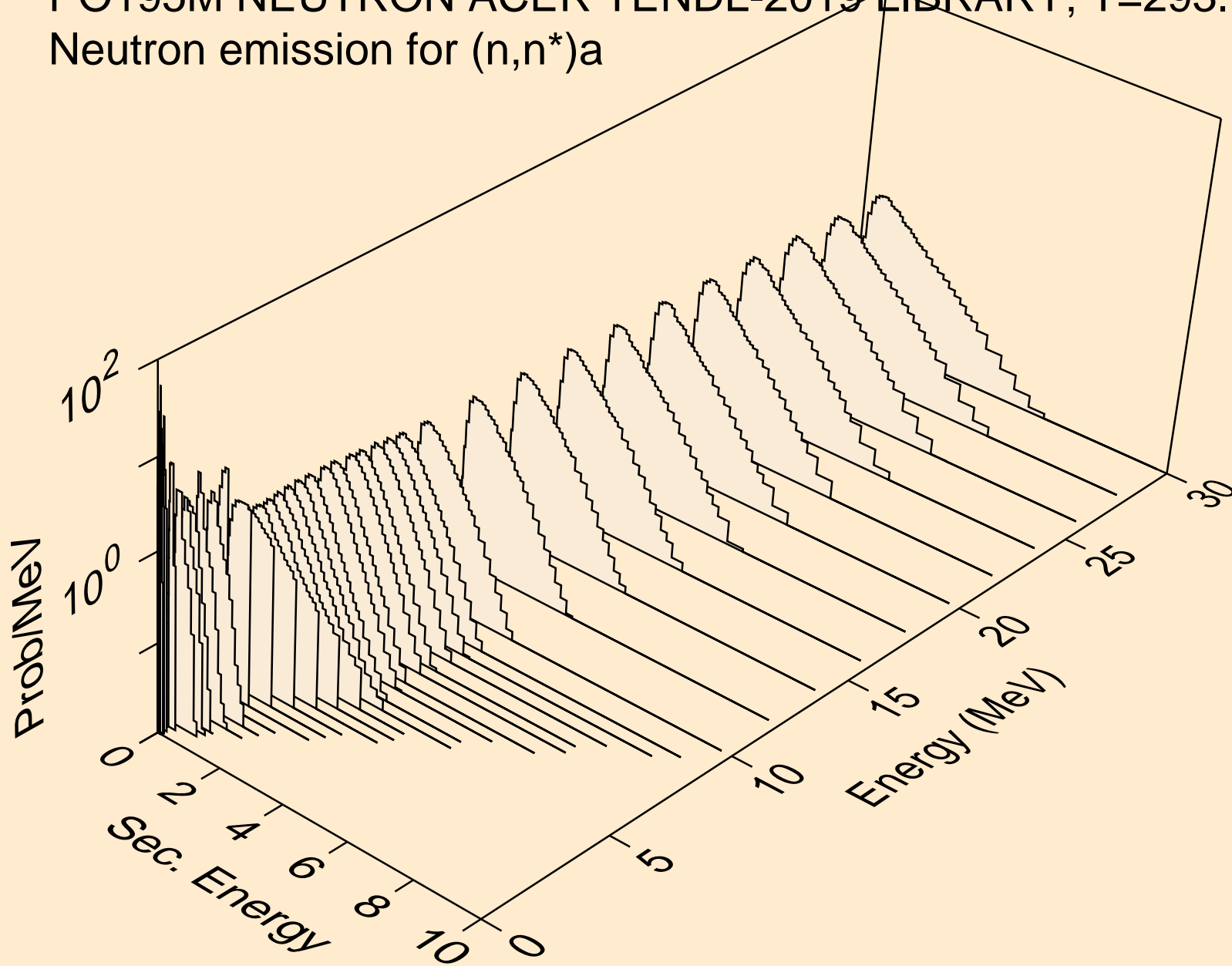

PO195M NEUTRON ACER TENDL-2019 LIBRARY; T=293.16K
Neutron emission for (n,2n)a

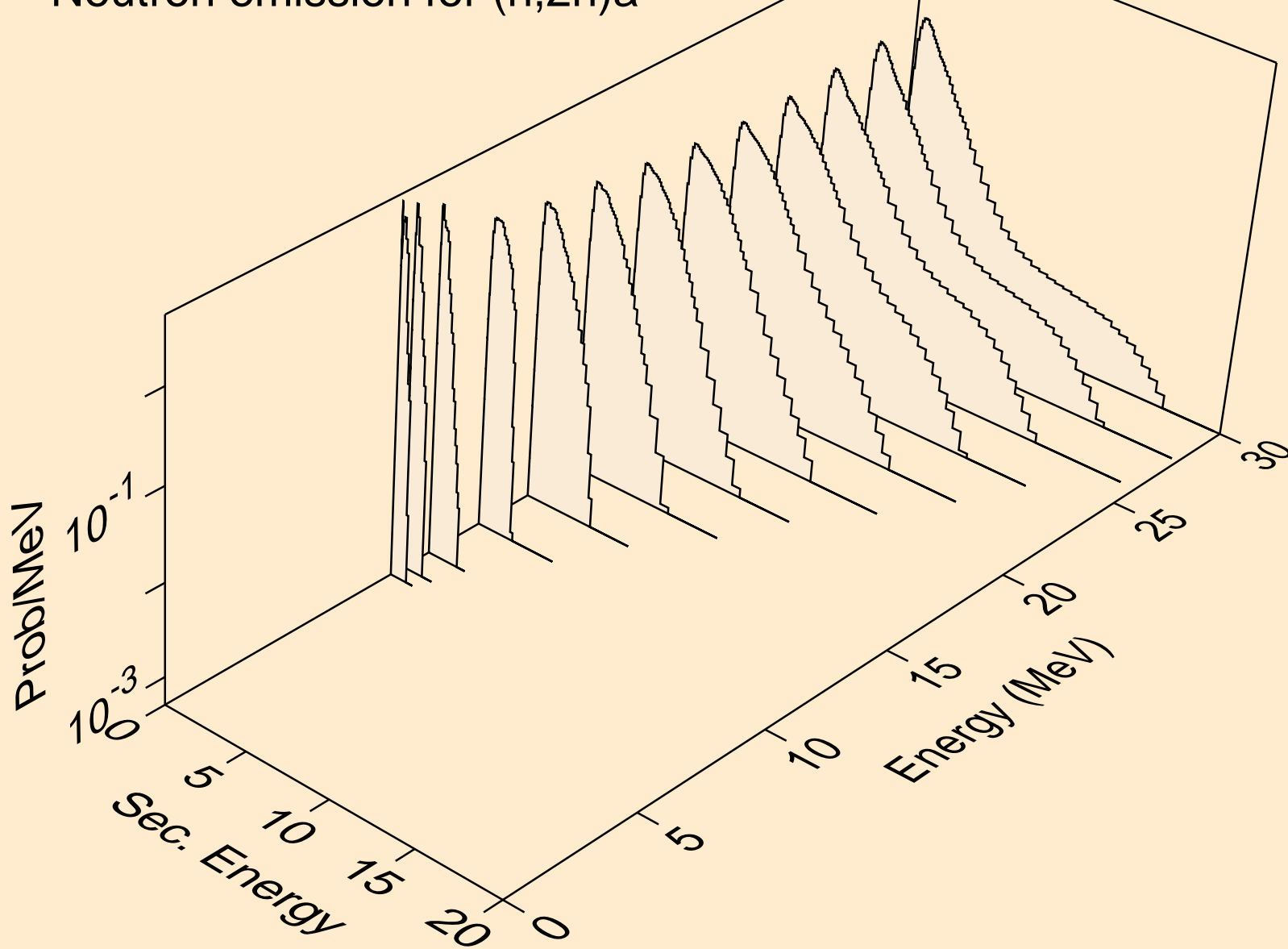

PO195M NEUTRON ACER TENDL-2019 LIBRARY; T=293.16K
Neutron emission for (n,3n)a

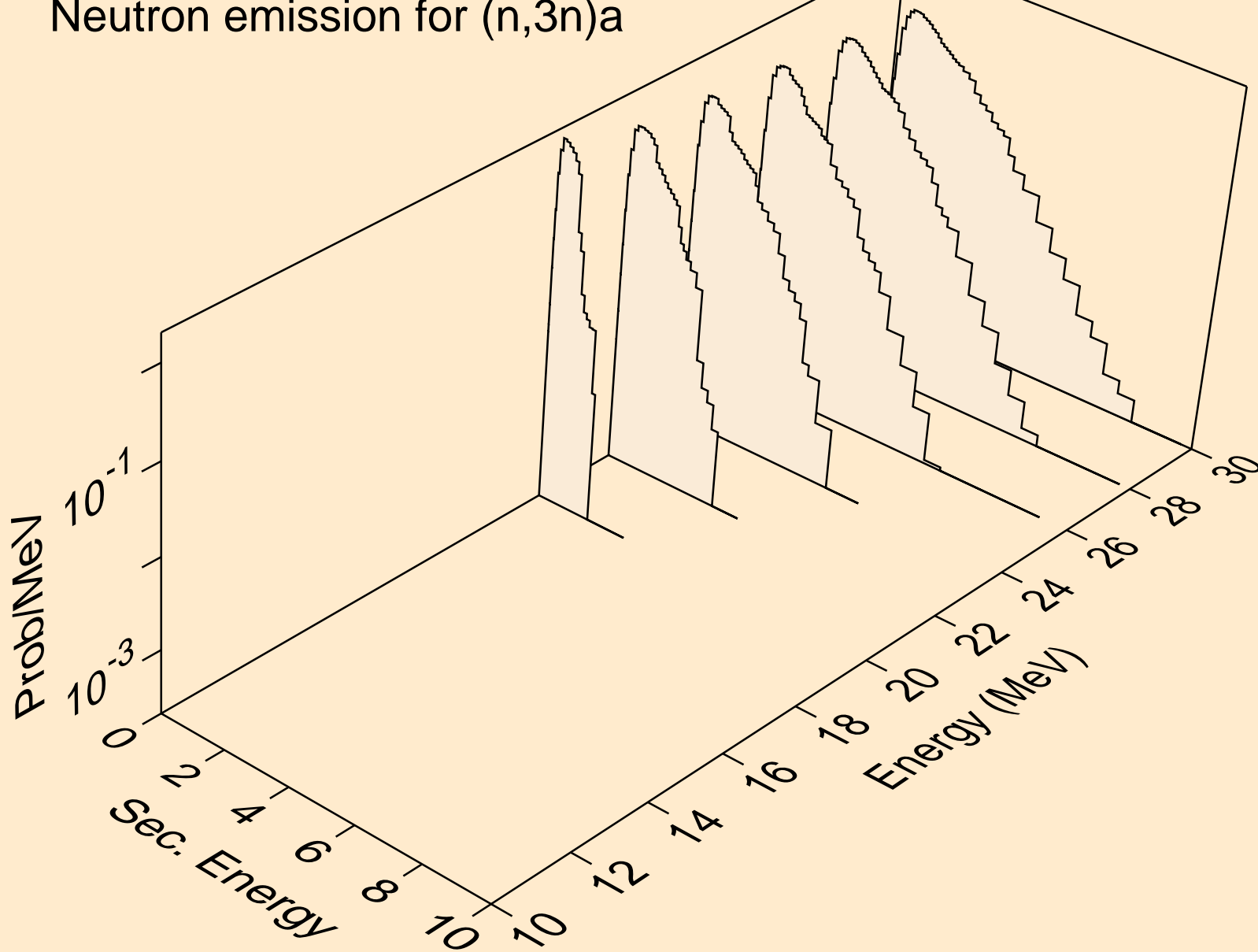

PO195M NEUTRON ACER TENDL-2019 LIBRARY; T=293.16K
Neutron emission for (n,n*)p

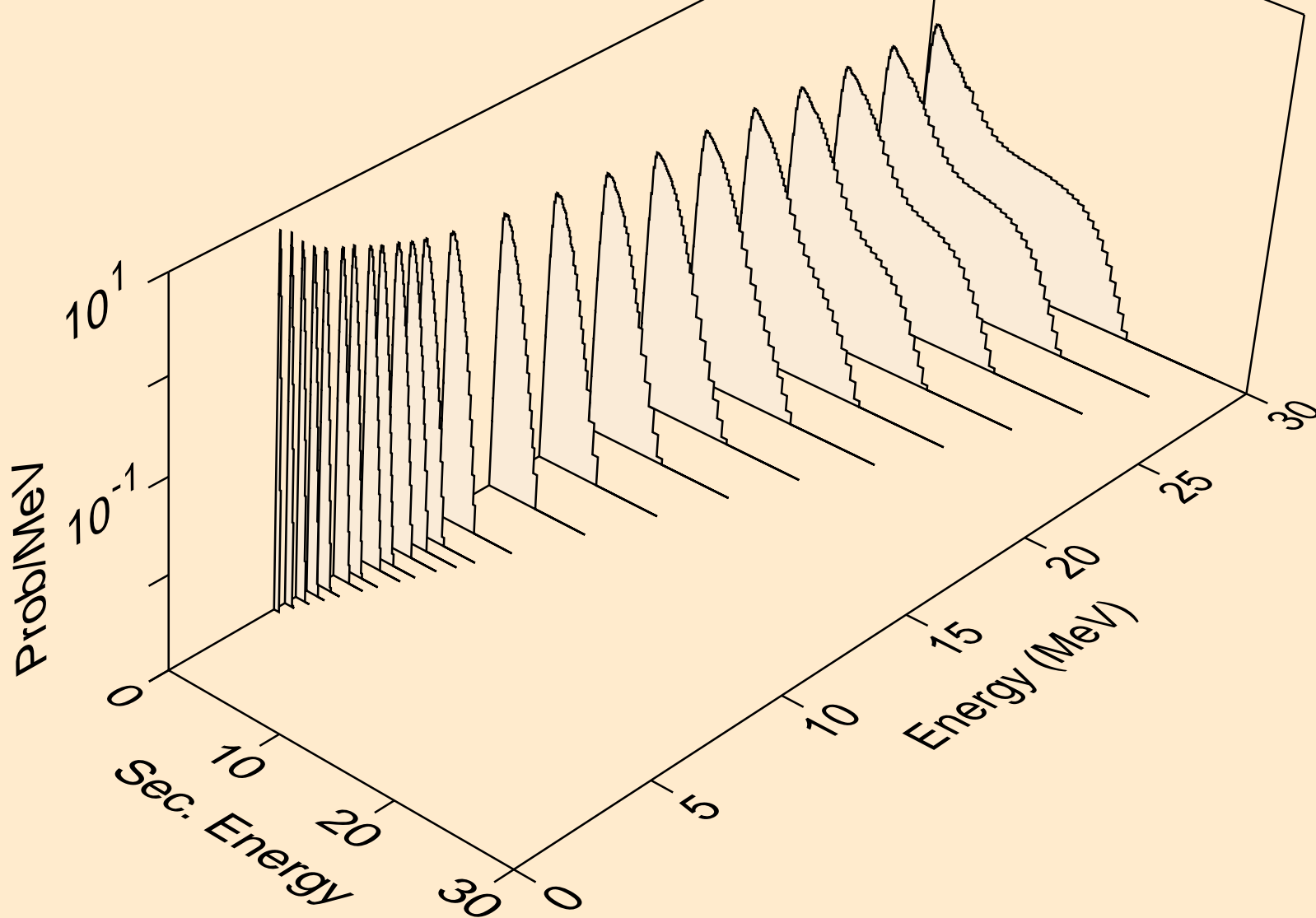

PO195M NEUTRON ACER TENDL-2019 LIBRARY; T=293.16K
Neutron emission for (n,n*)2a

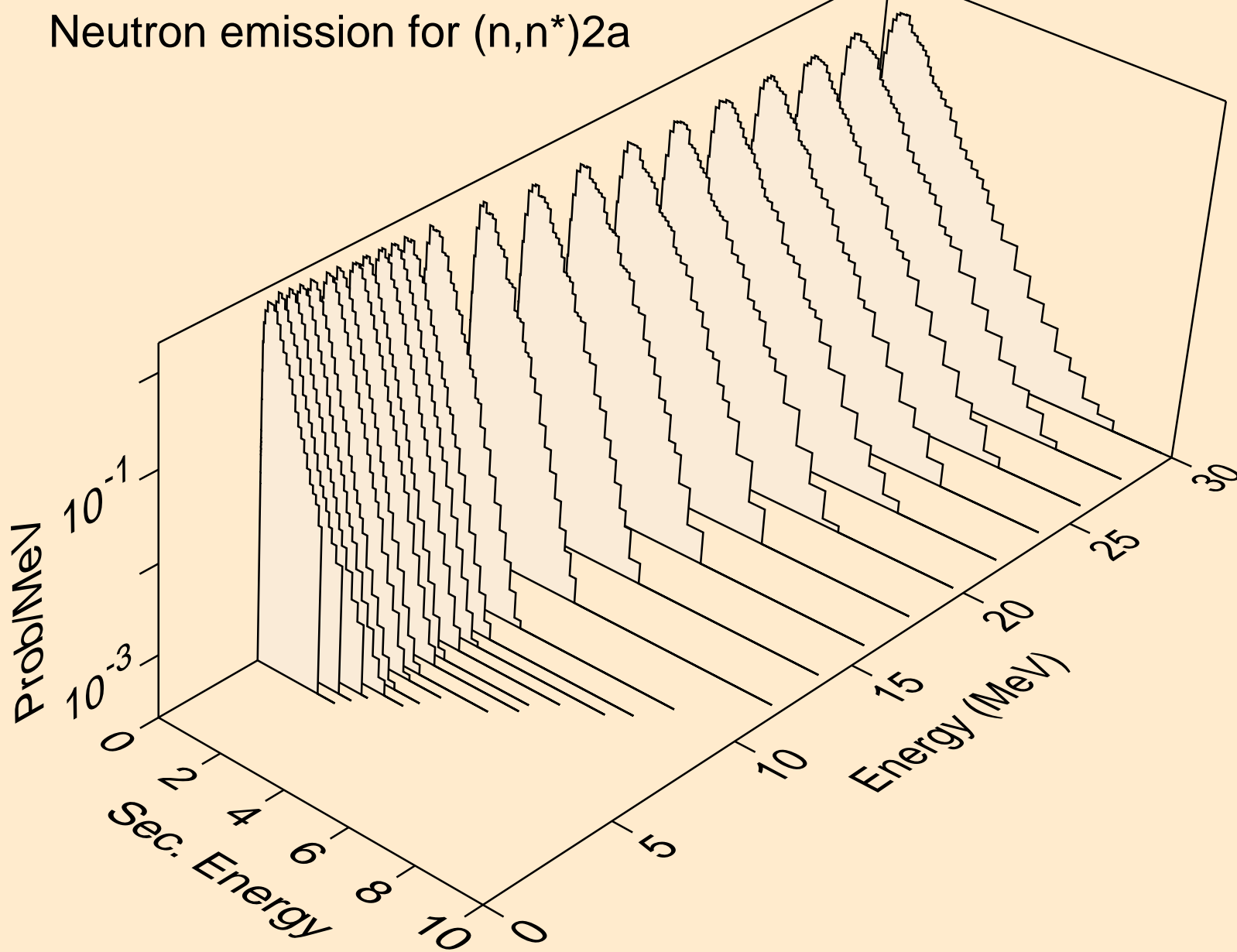

PO195M NEUTRON ACER TENDL-2019 LIBRARY; T=293.16K
Neutron emission for (n,2n)2a

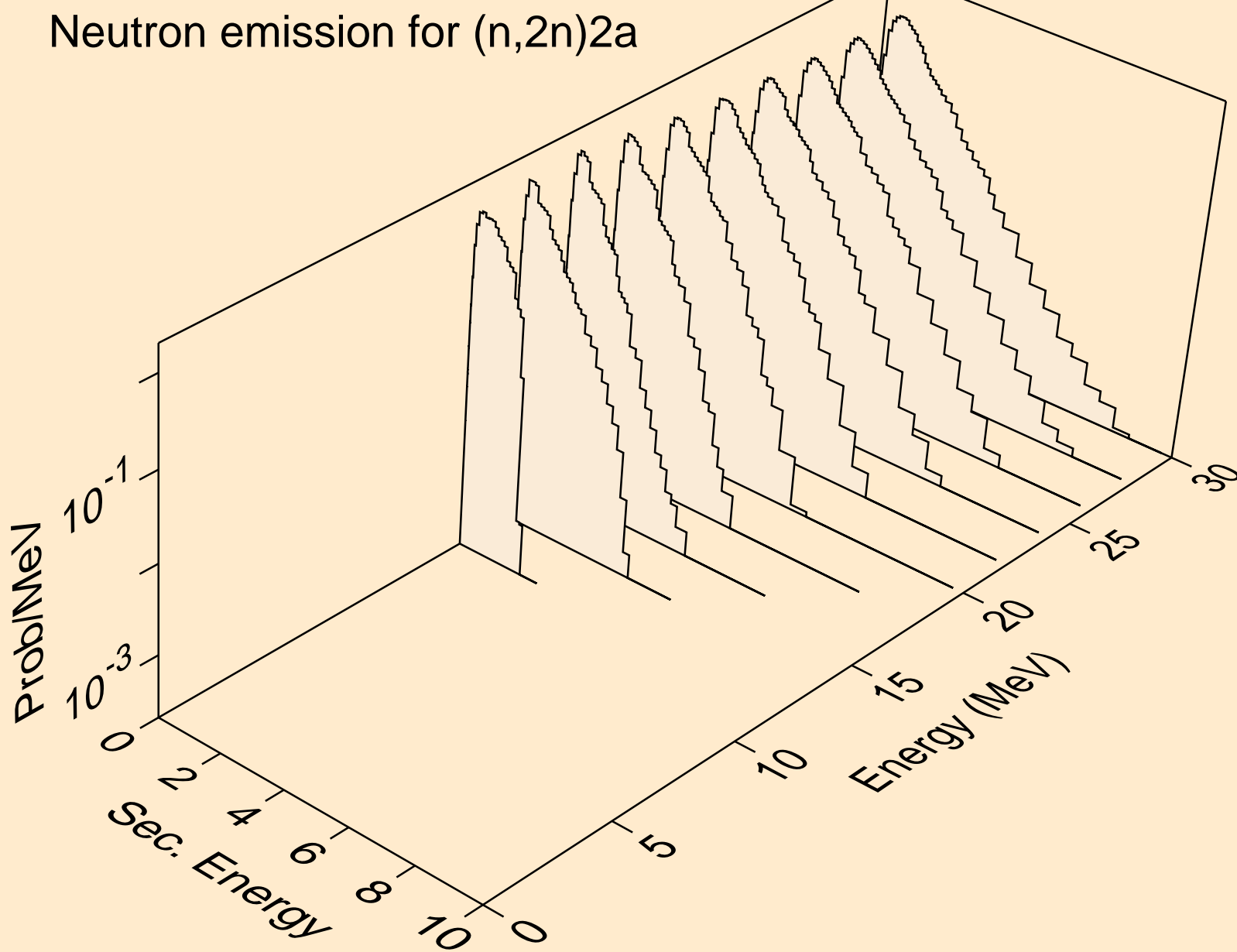

PO195M NEUTRON ACER TENDL-2019 LIBRARY; T=293.16K
Neutron emission for (n,n*)d

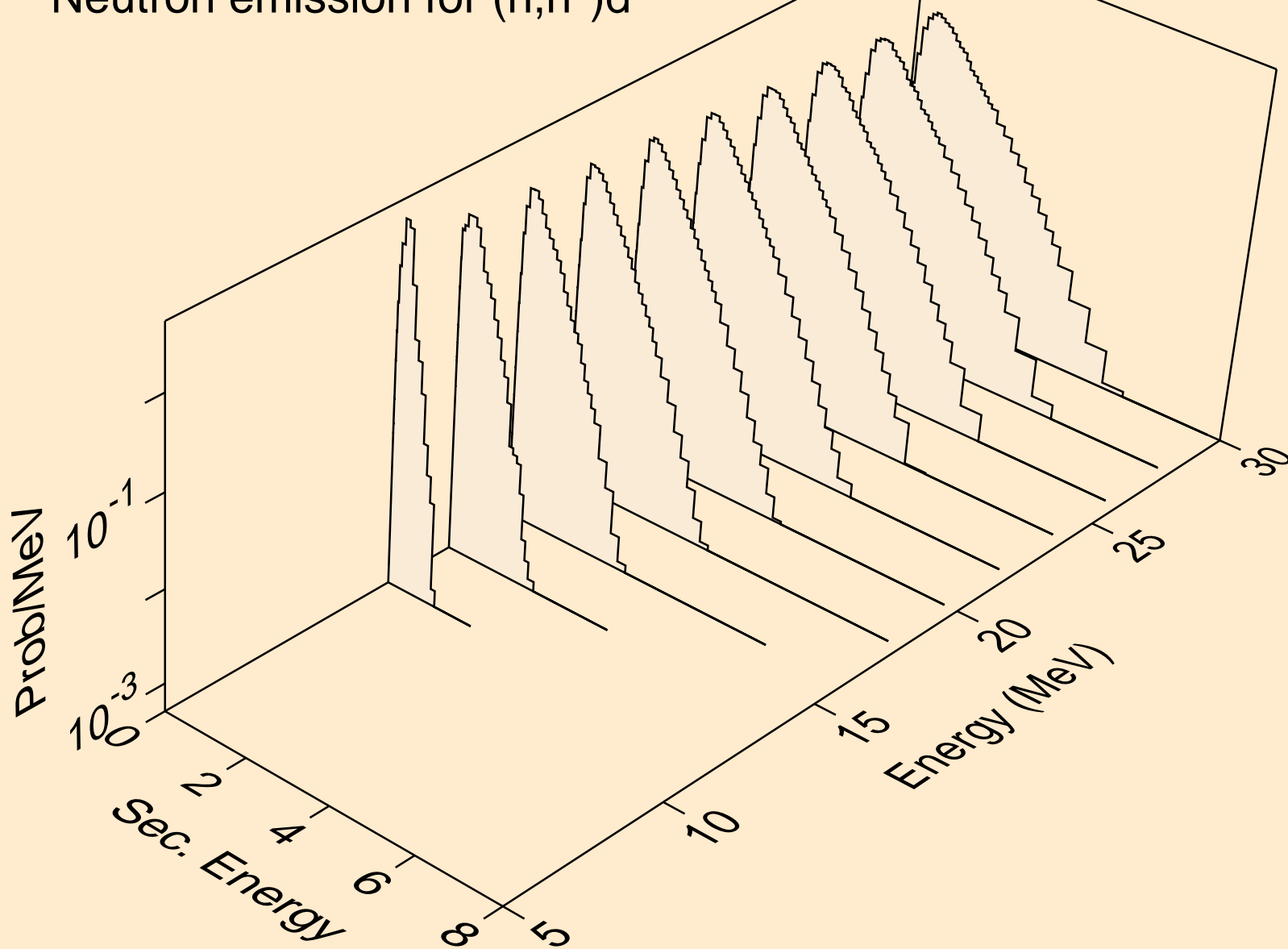

PO195M NEUTRON ACER TENDL-2019 LIBRARY; T=293.16K
Neutron emission for (n,n*)t

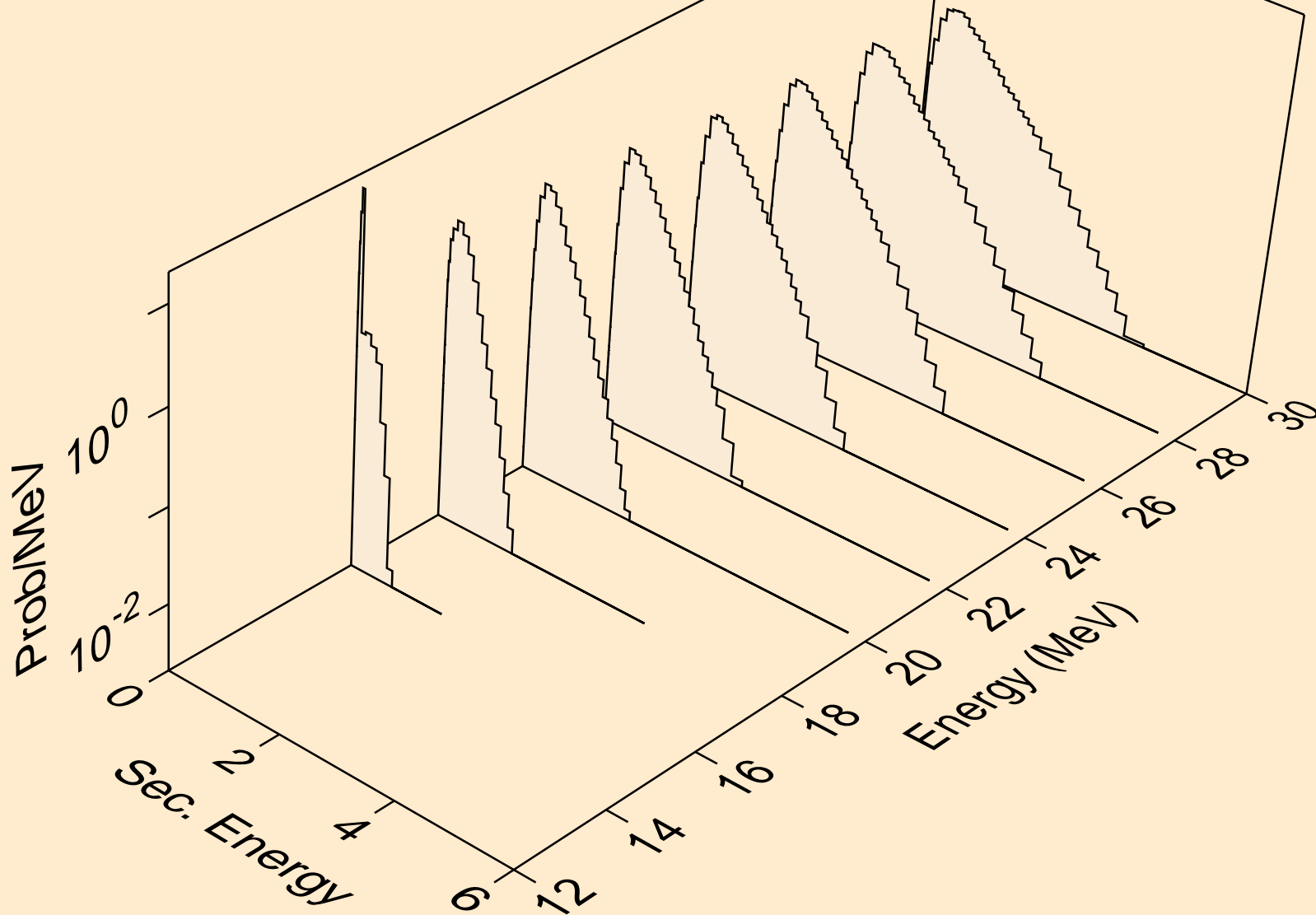

PO195M NEUTRON ACER TENDL-2019 LIBRARY; T=293.16K
Neutron emission for (n,n*)he3

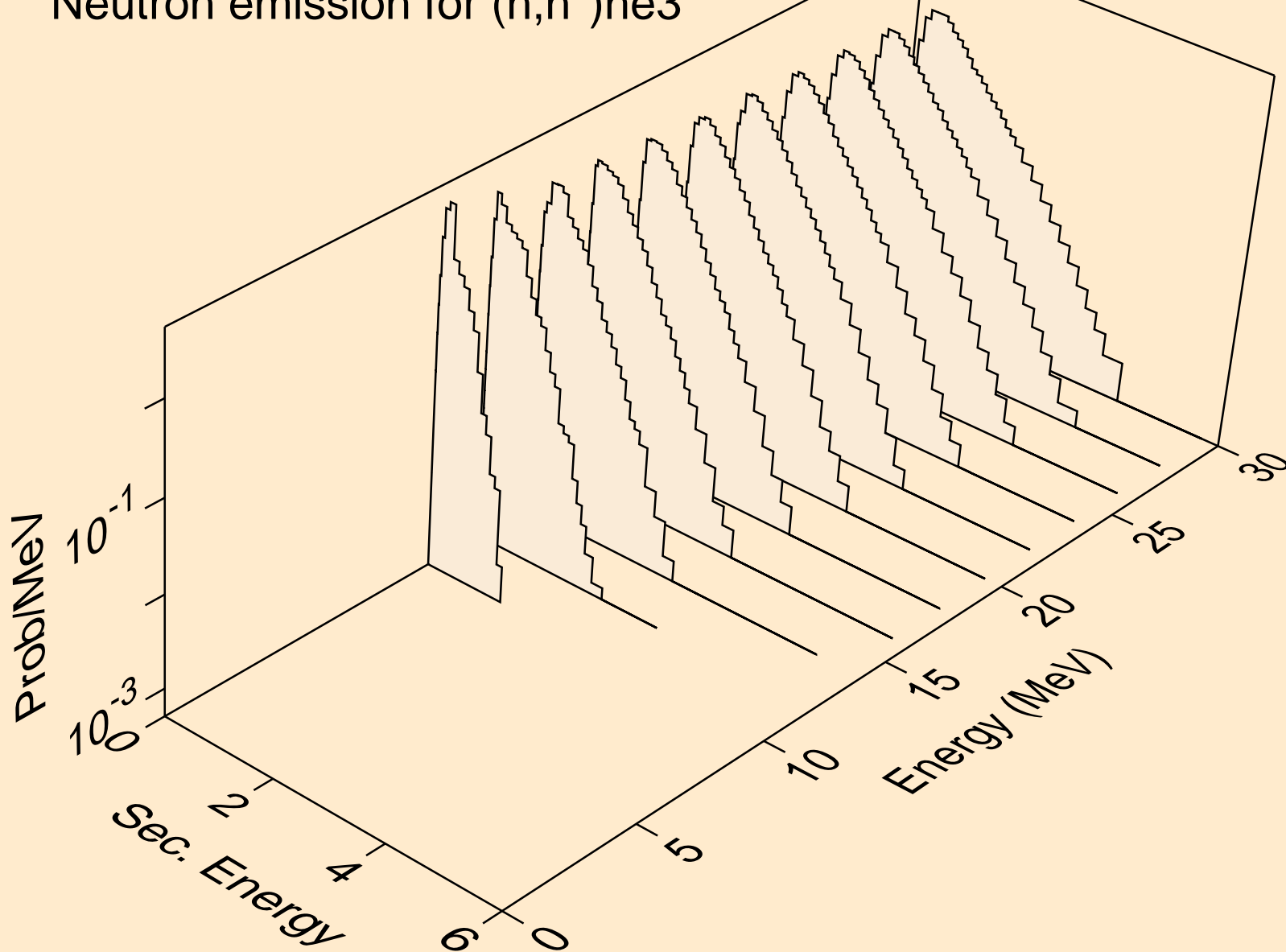

PO195M NEUTRON ACER TENDL-2019 LIBRARY; T=293.16K
Neutron emission for (n,4n)

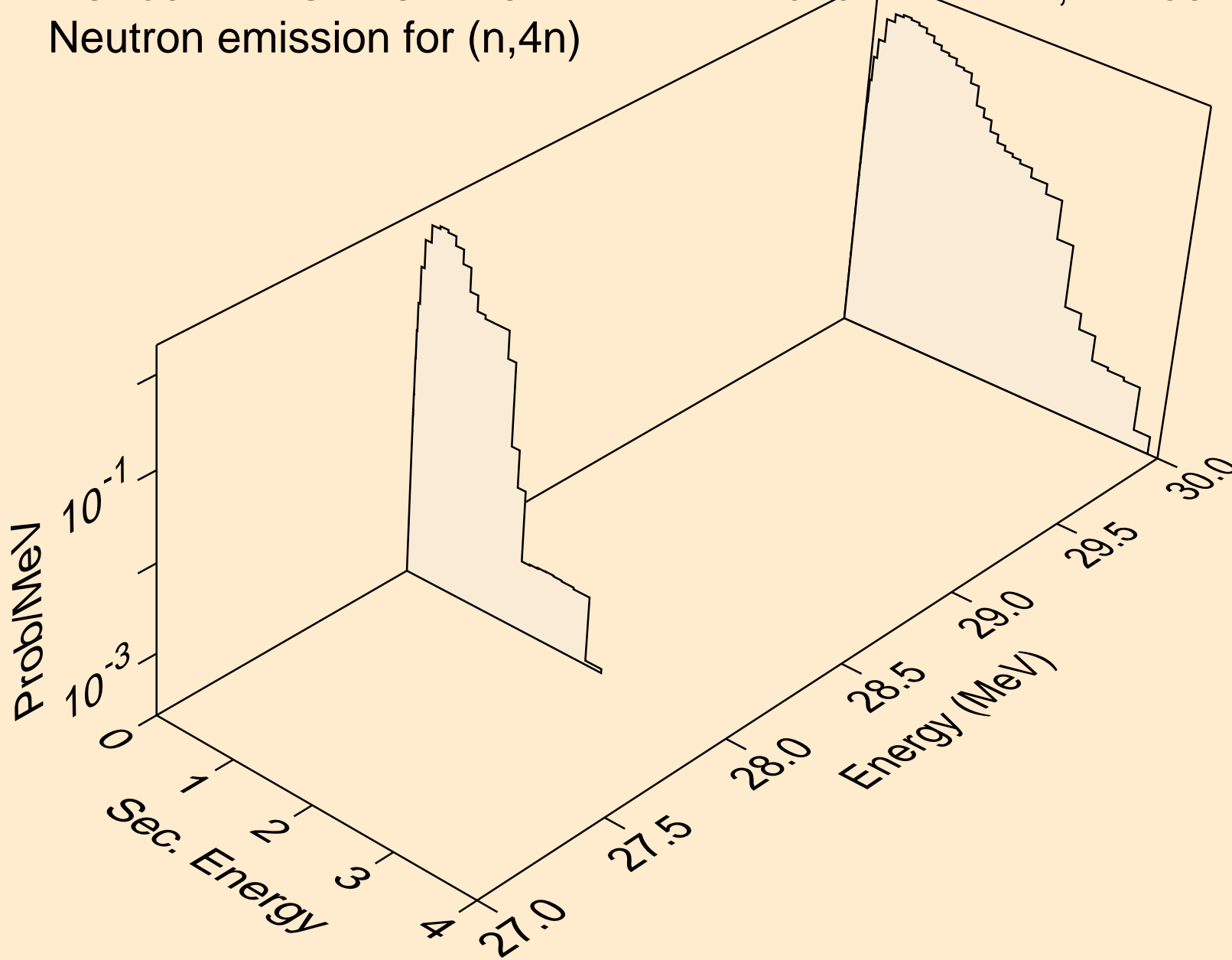

PO195M NEUTRON ACER TENDL-2019 LIBRARY; T=293.16K
Neutron emission for (n,2np)

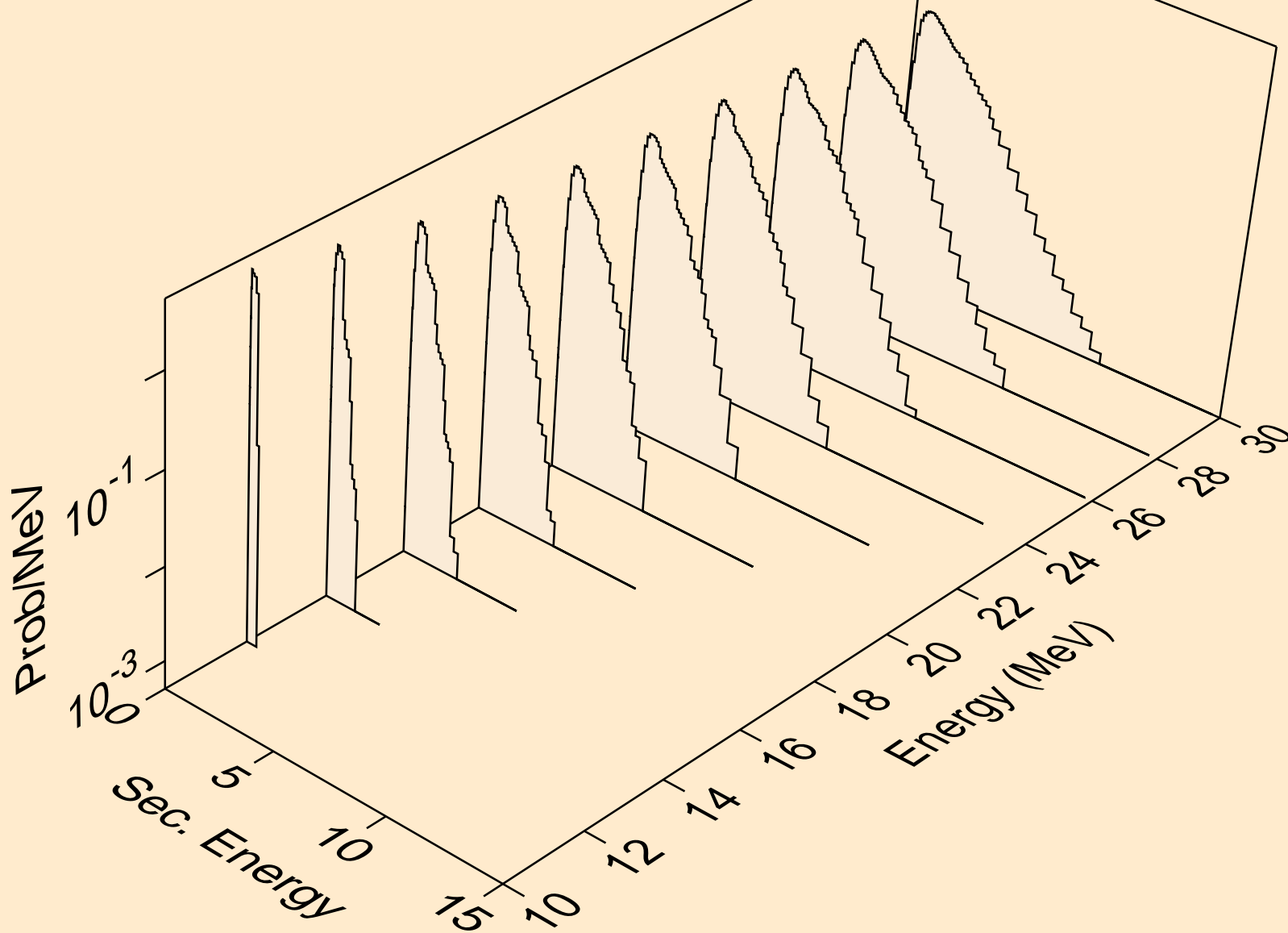

PO195M NEUTRON ACER TENDL-2019 LIBRARY; T=293.16K
Neutron emission for (n,3np)

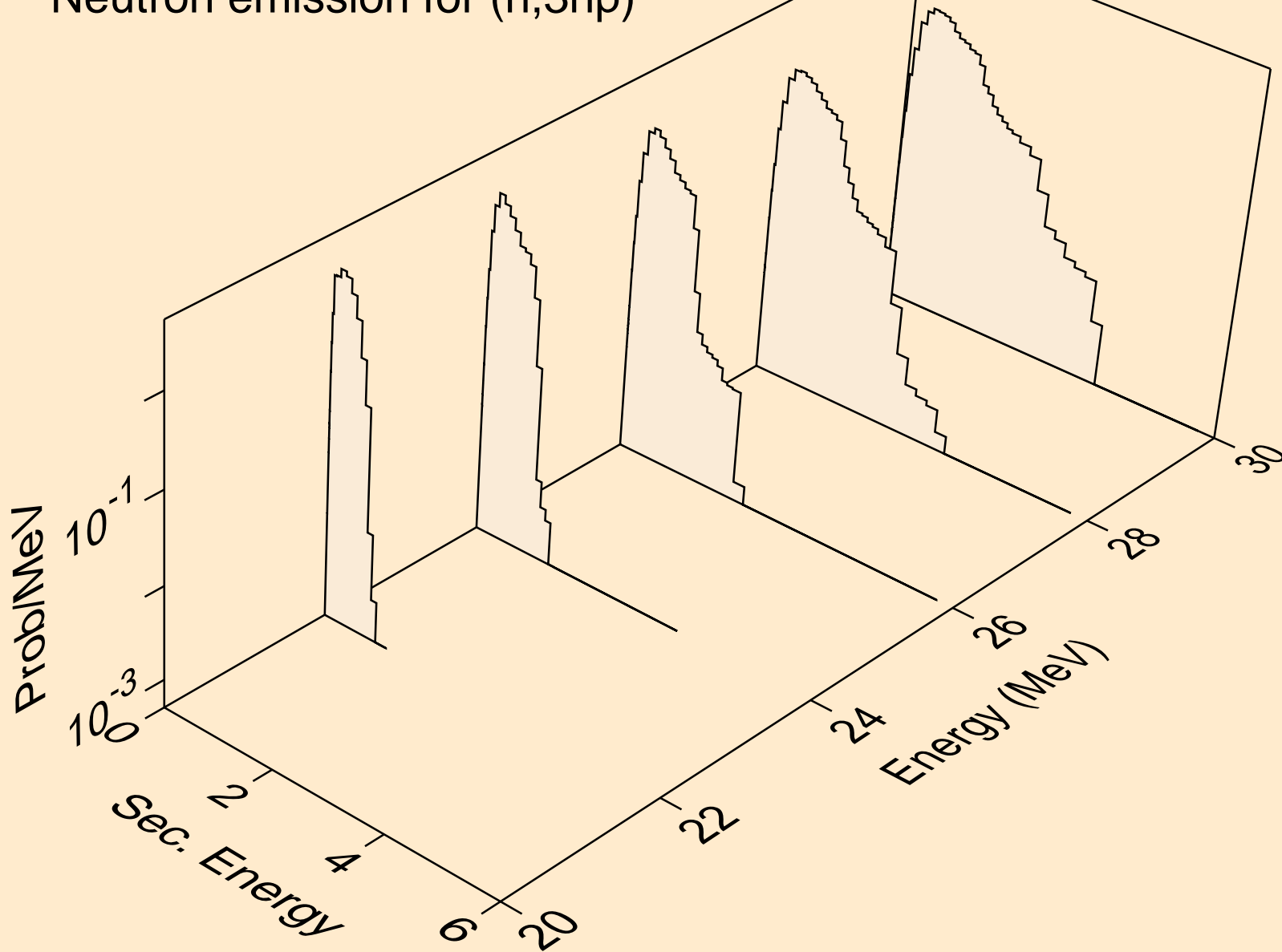

PO195M NEUTRON ACER TENDL-2019 LIBRARY; T=293.16K
Neutron emission for (n,2np)

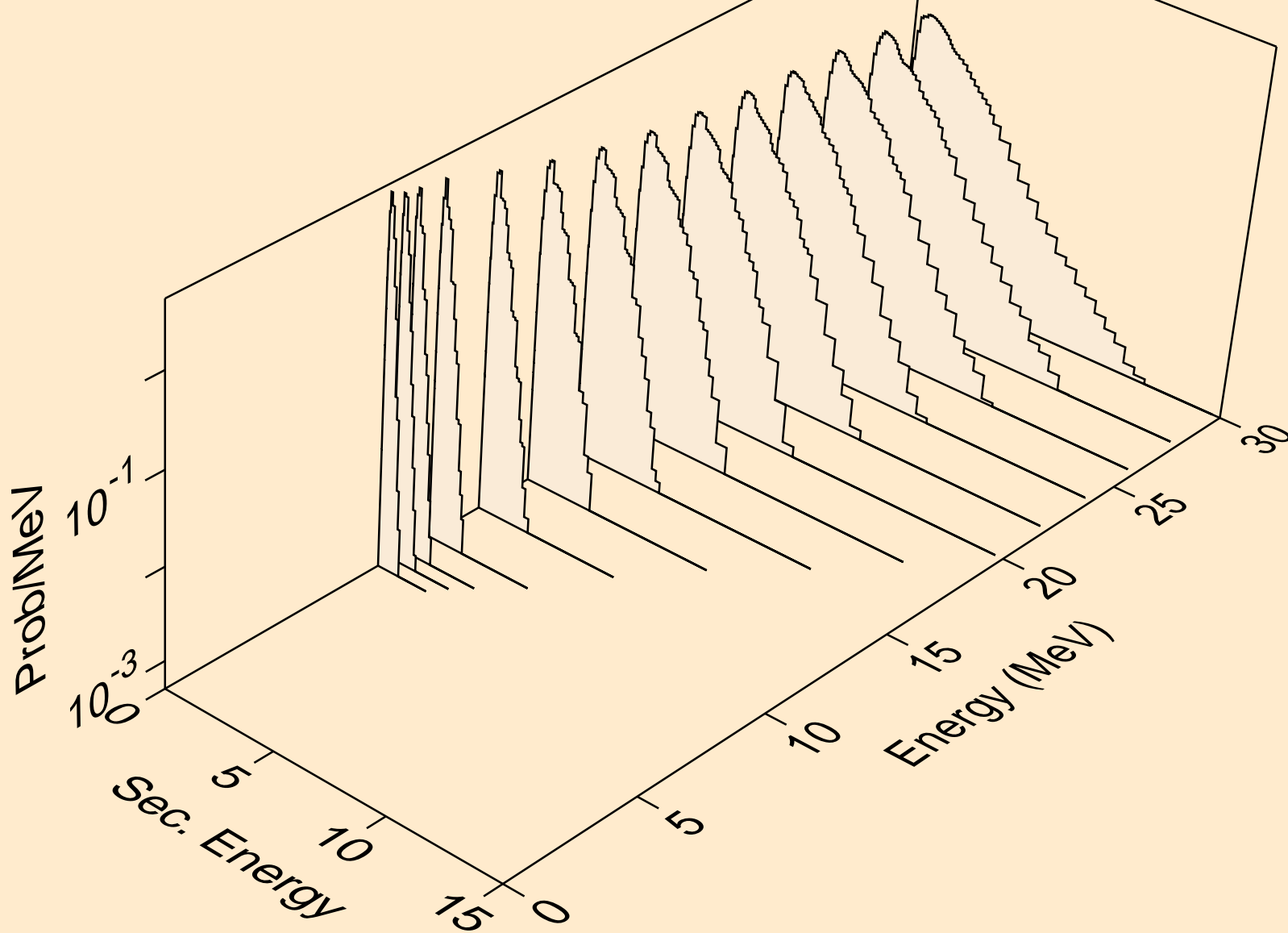

PO195M NEUTRON ACER TENDL-2019 LIBRARY; T=293.16K
Neutron emission for (n,npa)

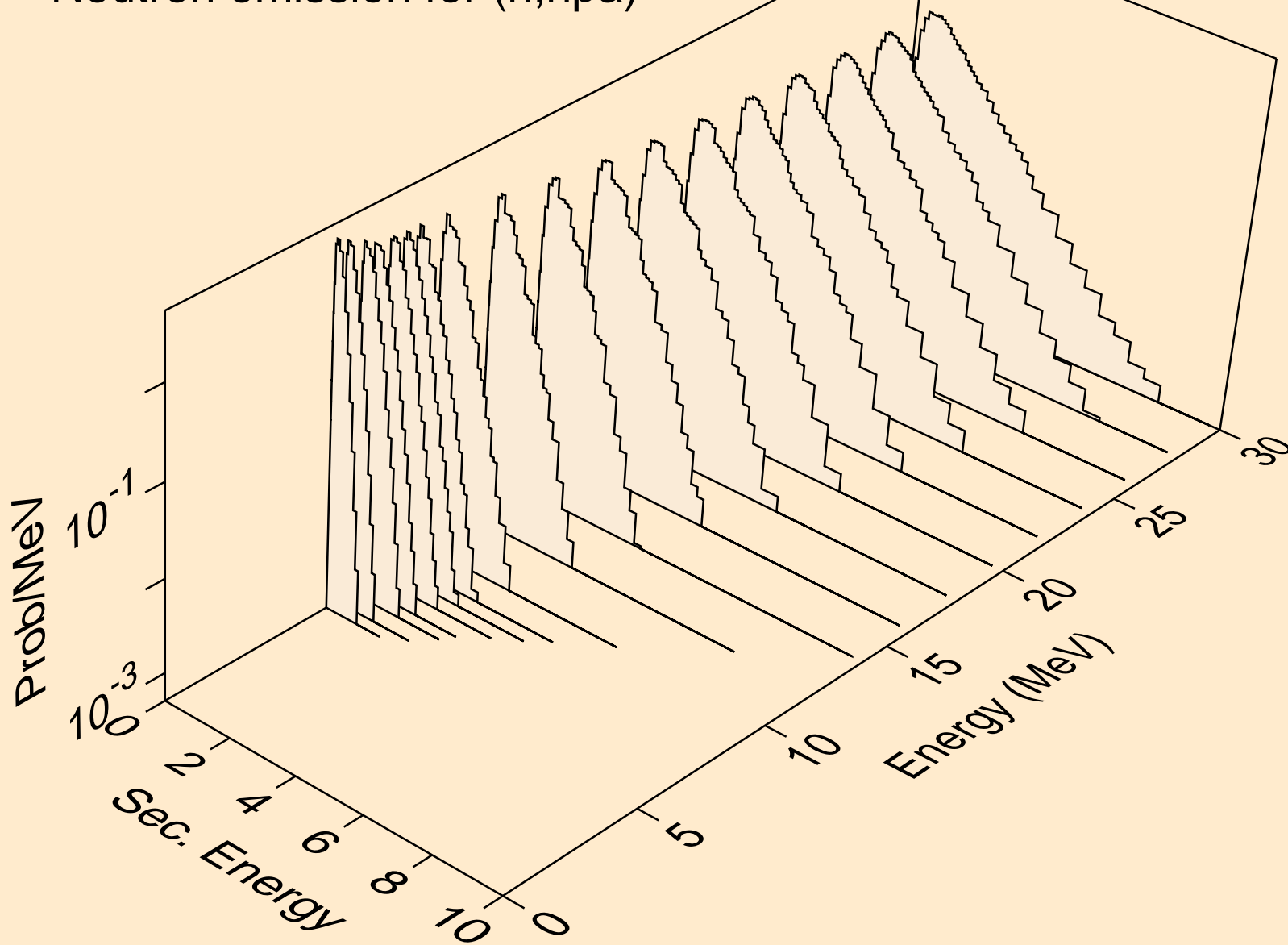

PO195M NEUTRON ACER TENDL-2019 LIBRARY; T=293.16K
Neutron emission for (n,n*c)

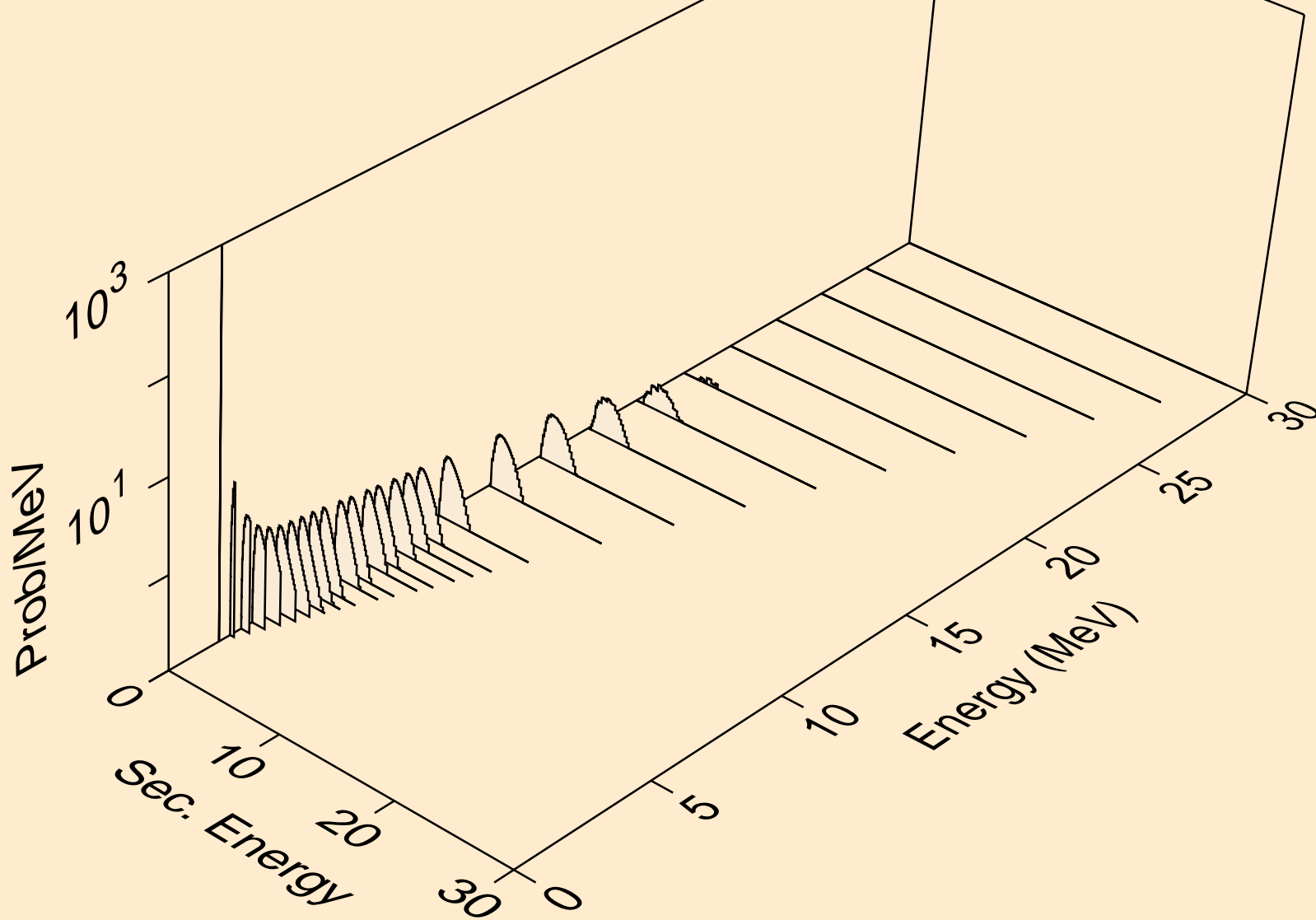

PO195M NEUTRON ACER TENDL-2019 LIBRARY; T=293.16K
Photon emission for (n,x)

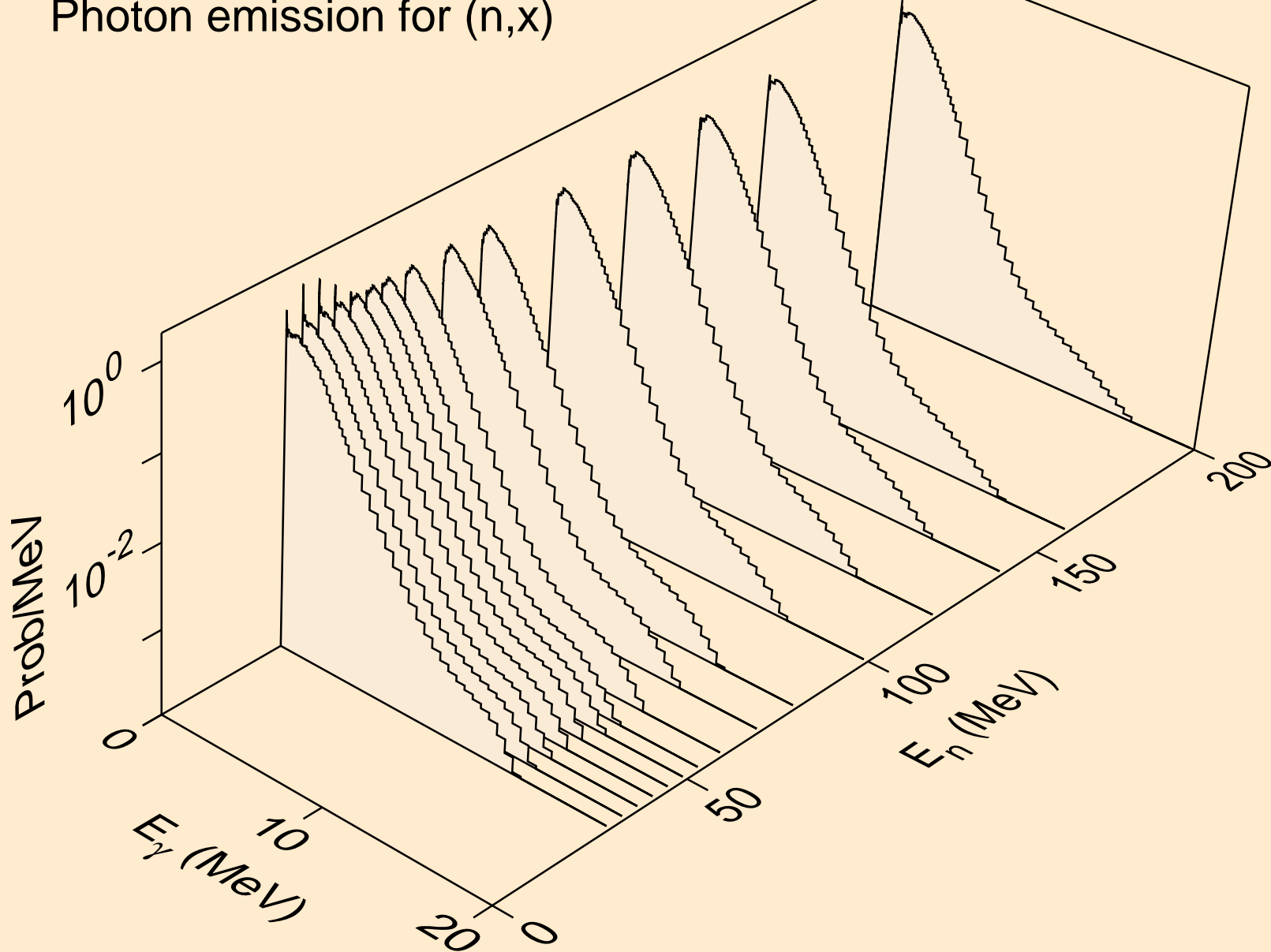

PO195M NEUTRON ACER TENDL-2019 LIBRARY; T=293.16K
Photon emission for (n,2nd)

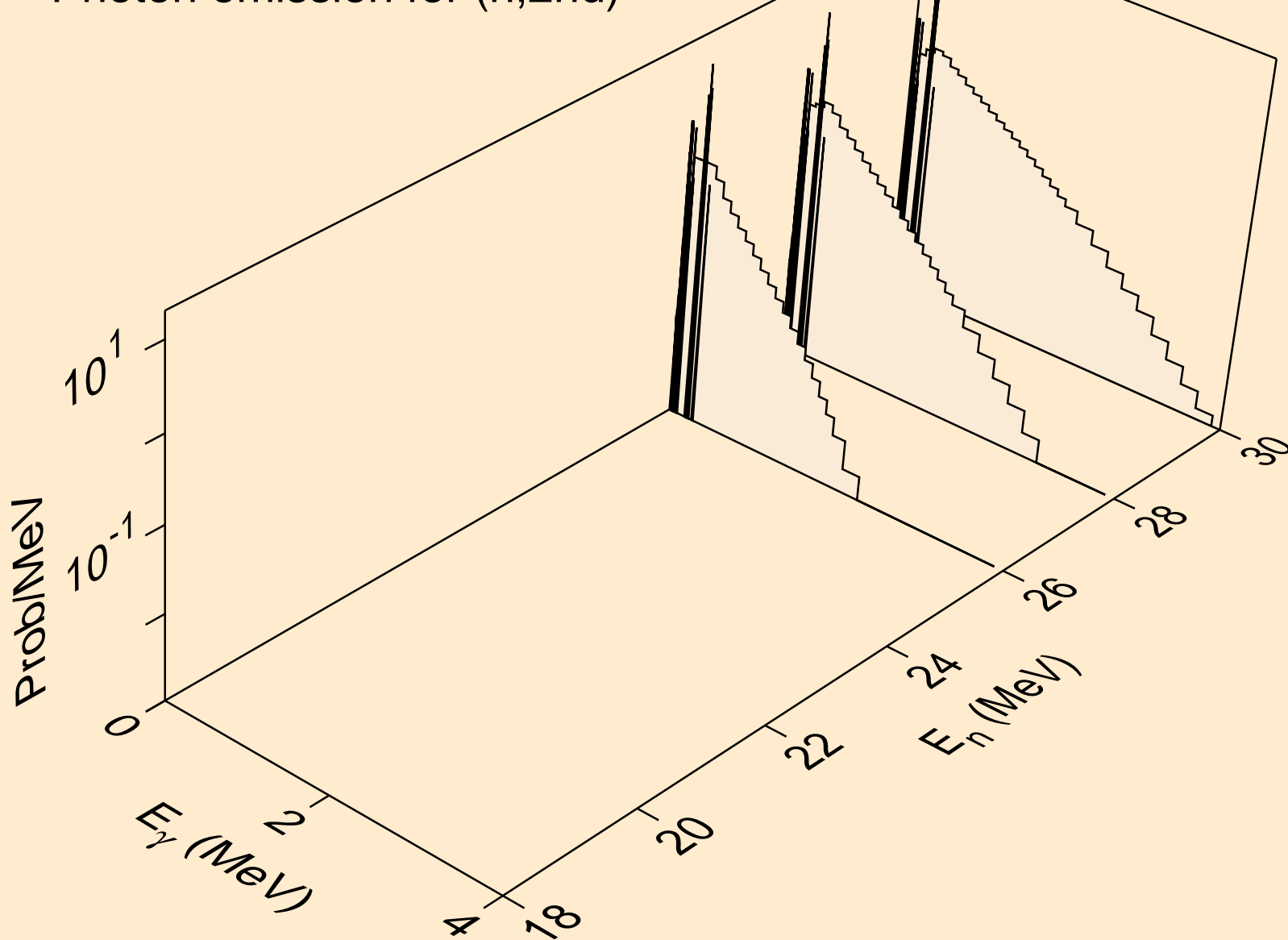

PO195M NEUTRON ACER TENDL-2019 LIBRARY; T=293.16K
Photon emission for (n,2n)

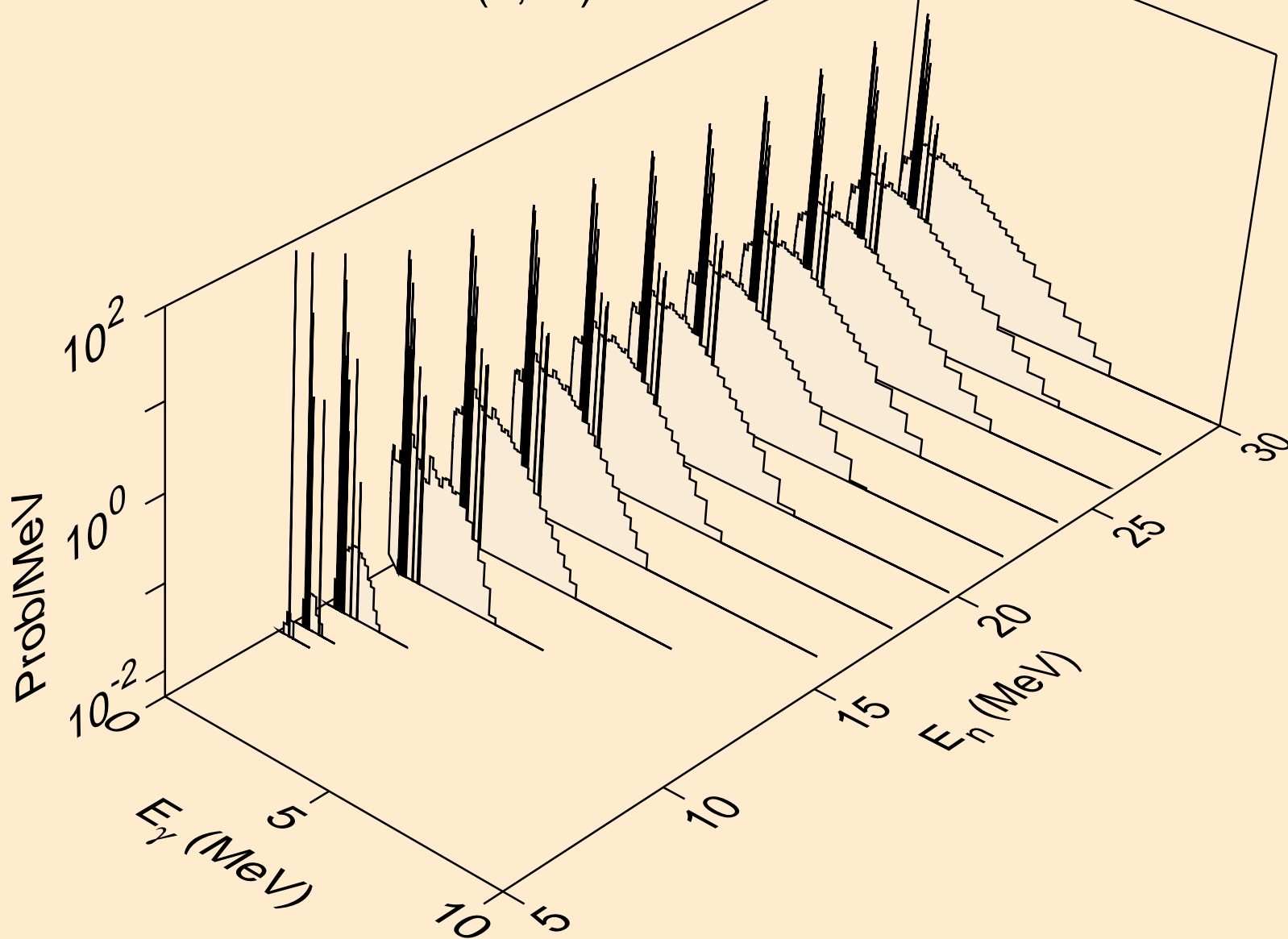

PO195M NEUTRON ACER TENDL-2019 LIBRARY; T=293.16K
Photon emission for (n,3n)

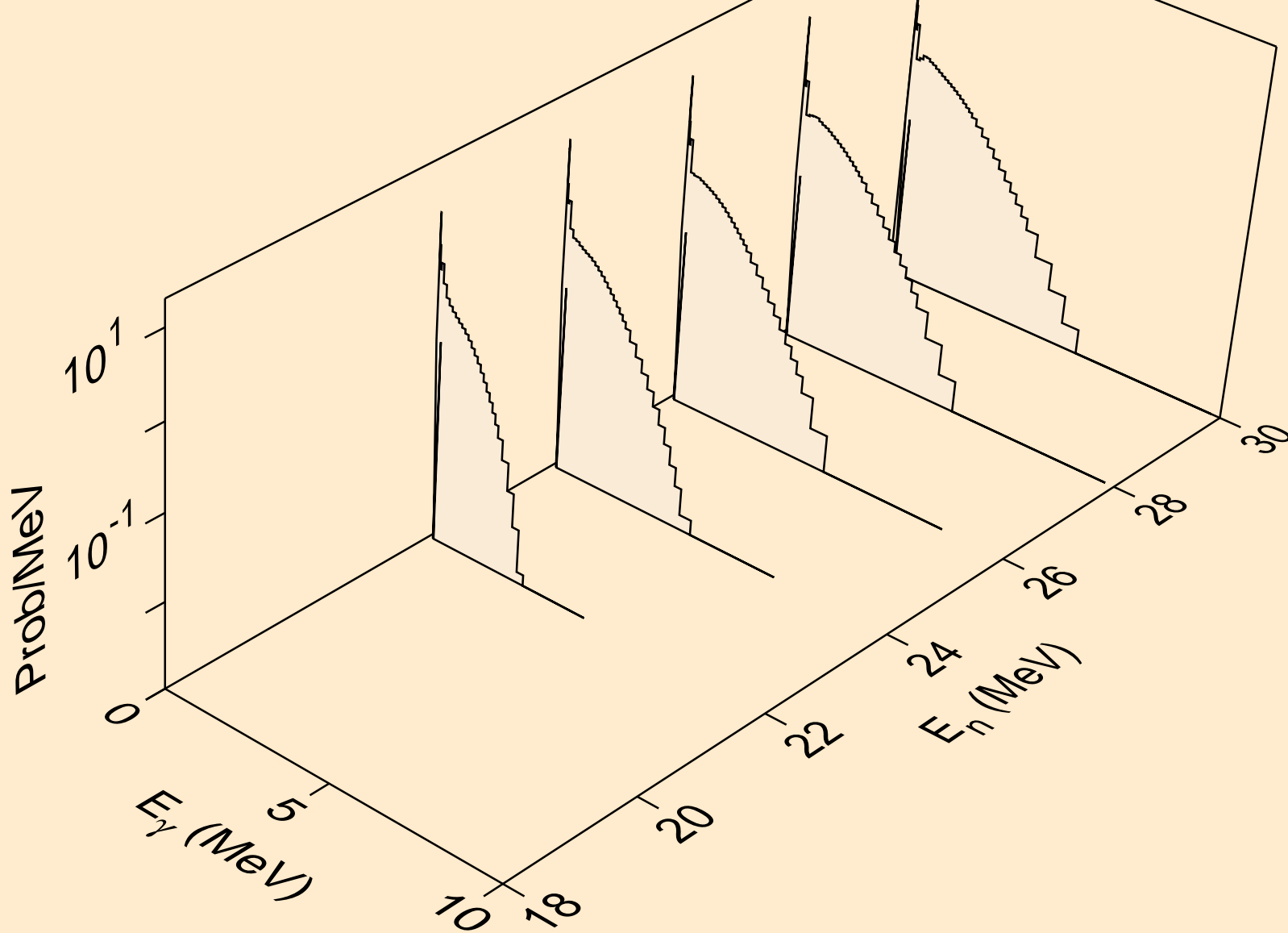

PO195M NEUTRON ACER TENDL-2019 LIBRARY; T=293.16K
Photon emission for (n,n*)a

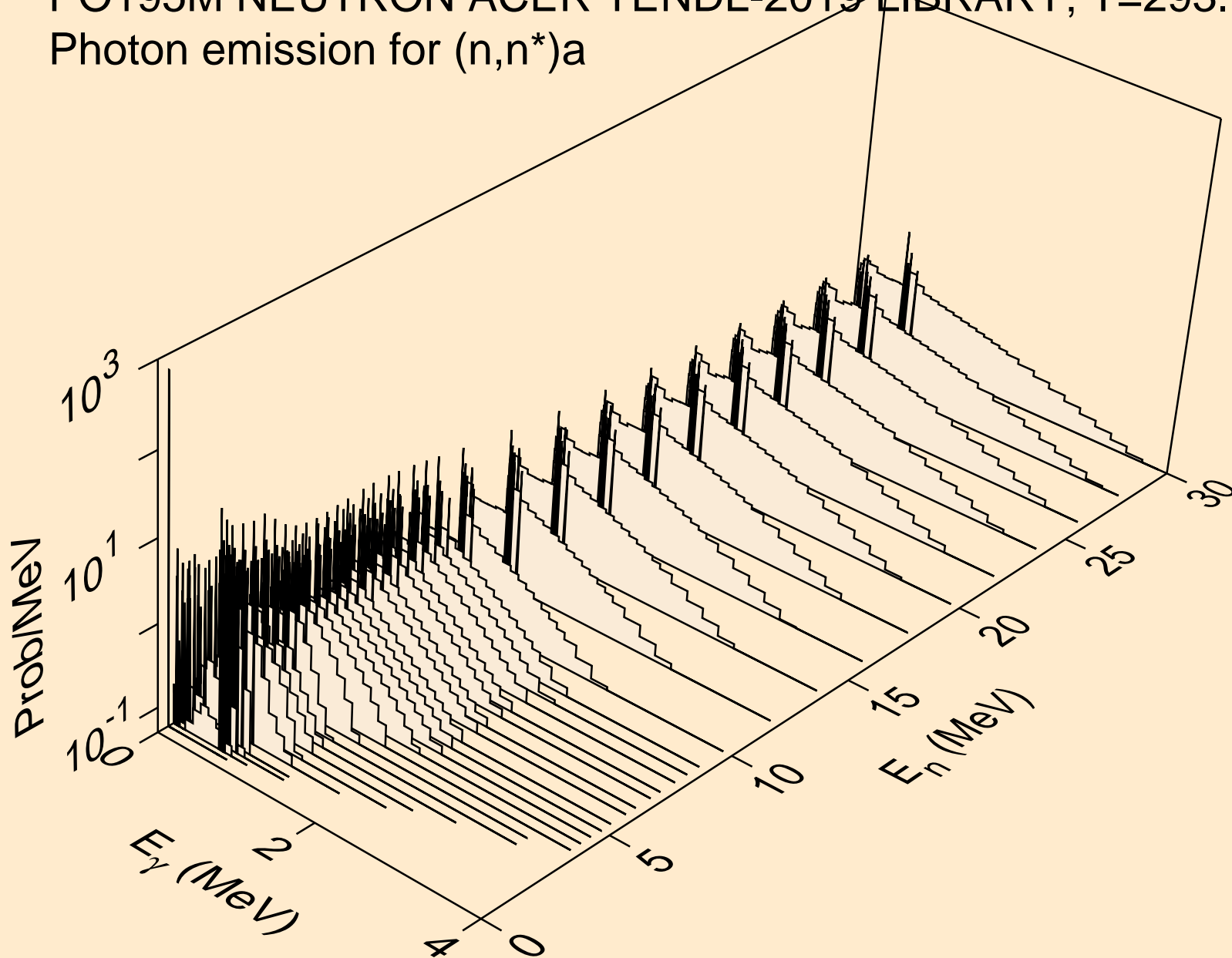

PO195M NEUTRON ACER TENDL-2019 LIBRARY; T=293.16K
Photon emission for (n,2n)a

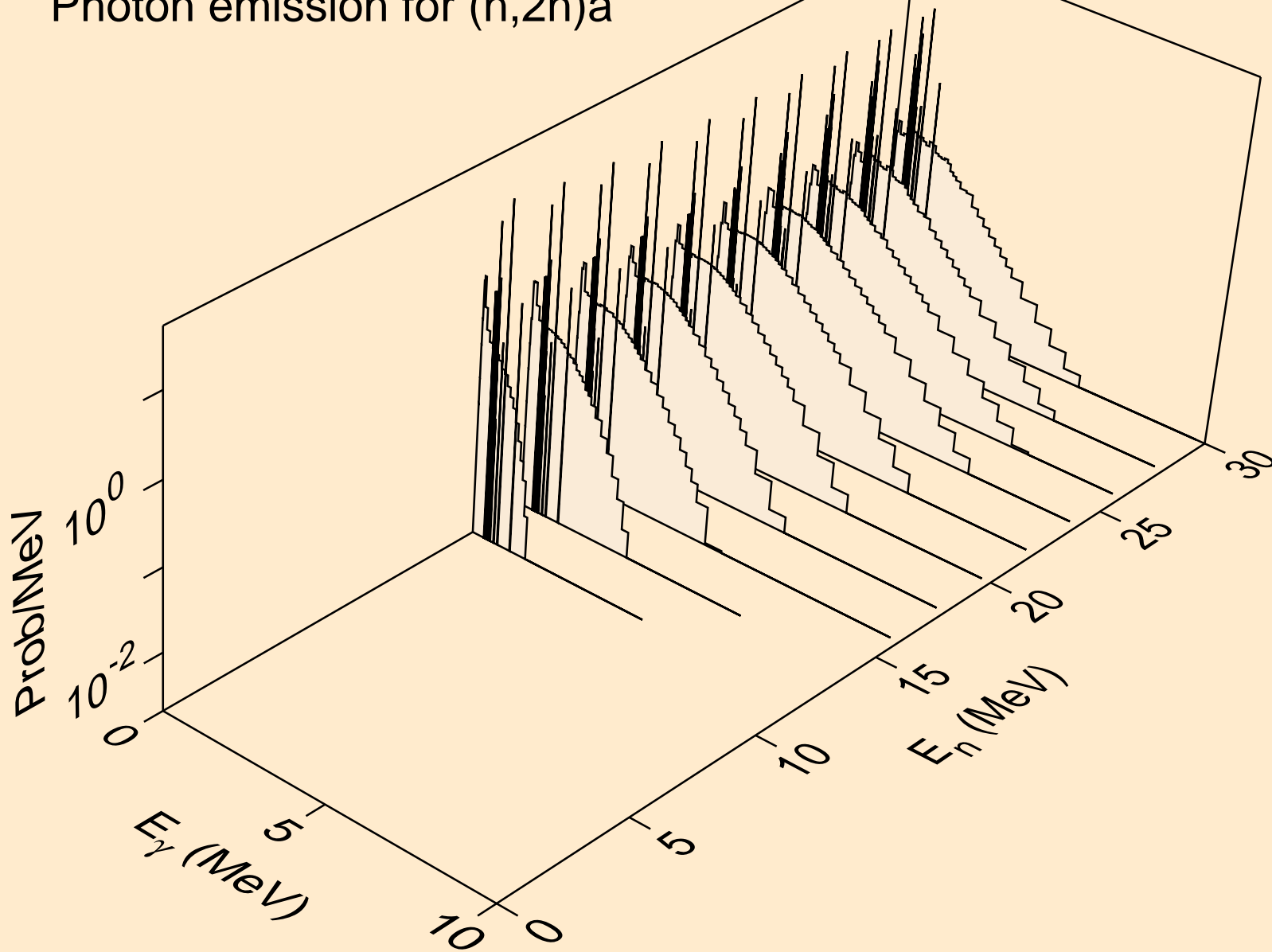

PO195M NEUTRON ACER TENDL-2019 LIBRARY; T=293.16K
Photon emission for (n,3n)a

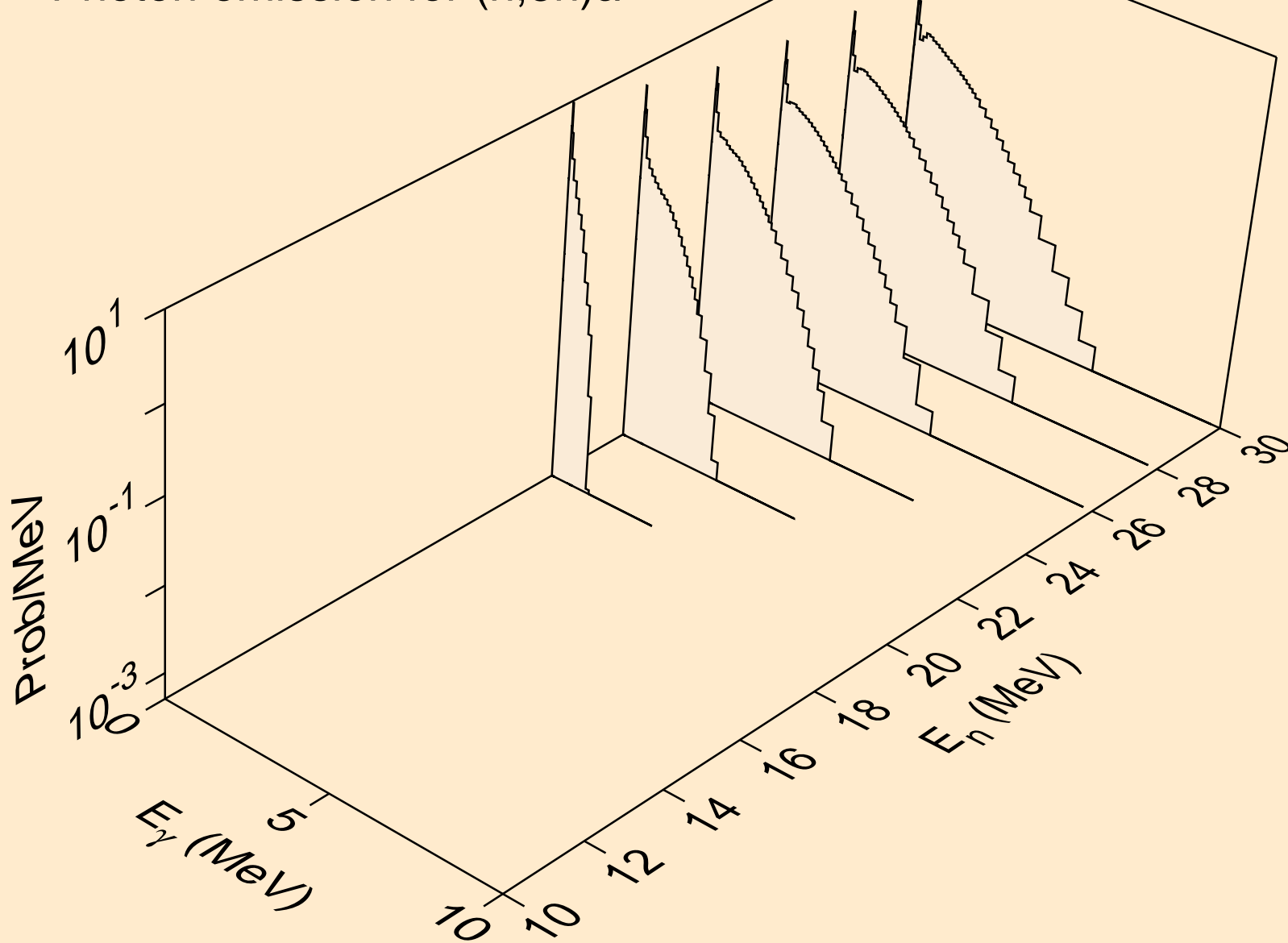

PO195M NEUTRON ACER TENDL-2019 LIBRARY; T=293.16K
Photon emission for (n,n*)p

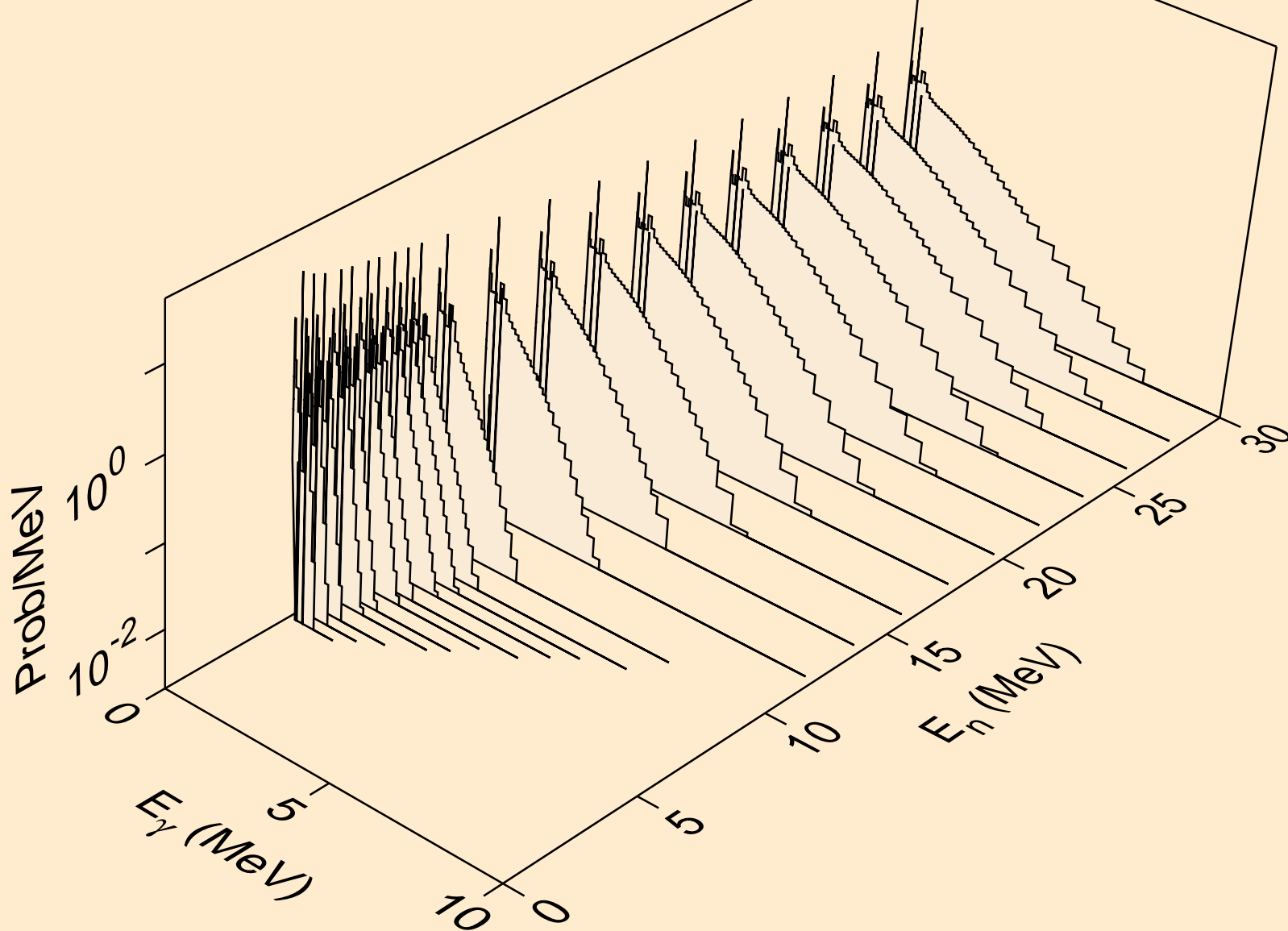

PO195M NEUTRON ACER TENDL-2019 LIBRARY; T=293.16K
Photon emission for (n,n*)2a

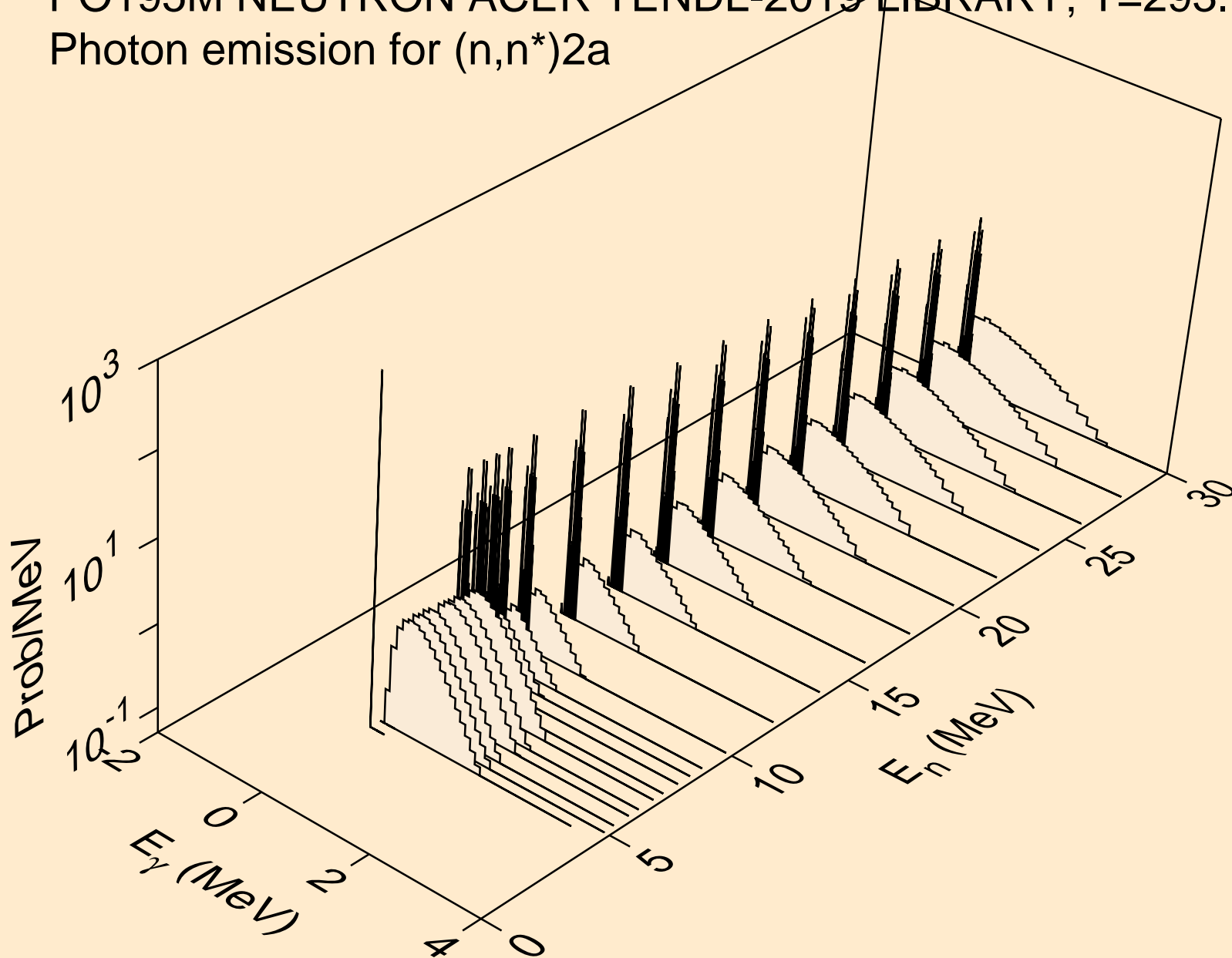

PO195M NEUTRON ACER TENDL-2019 LIBRARY; T=293.16K
Photon emission for (n,2n)2a

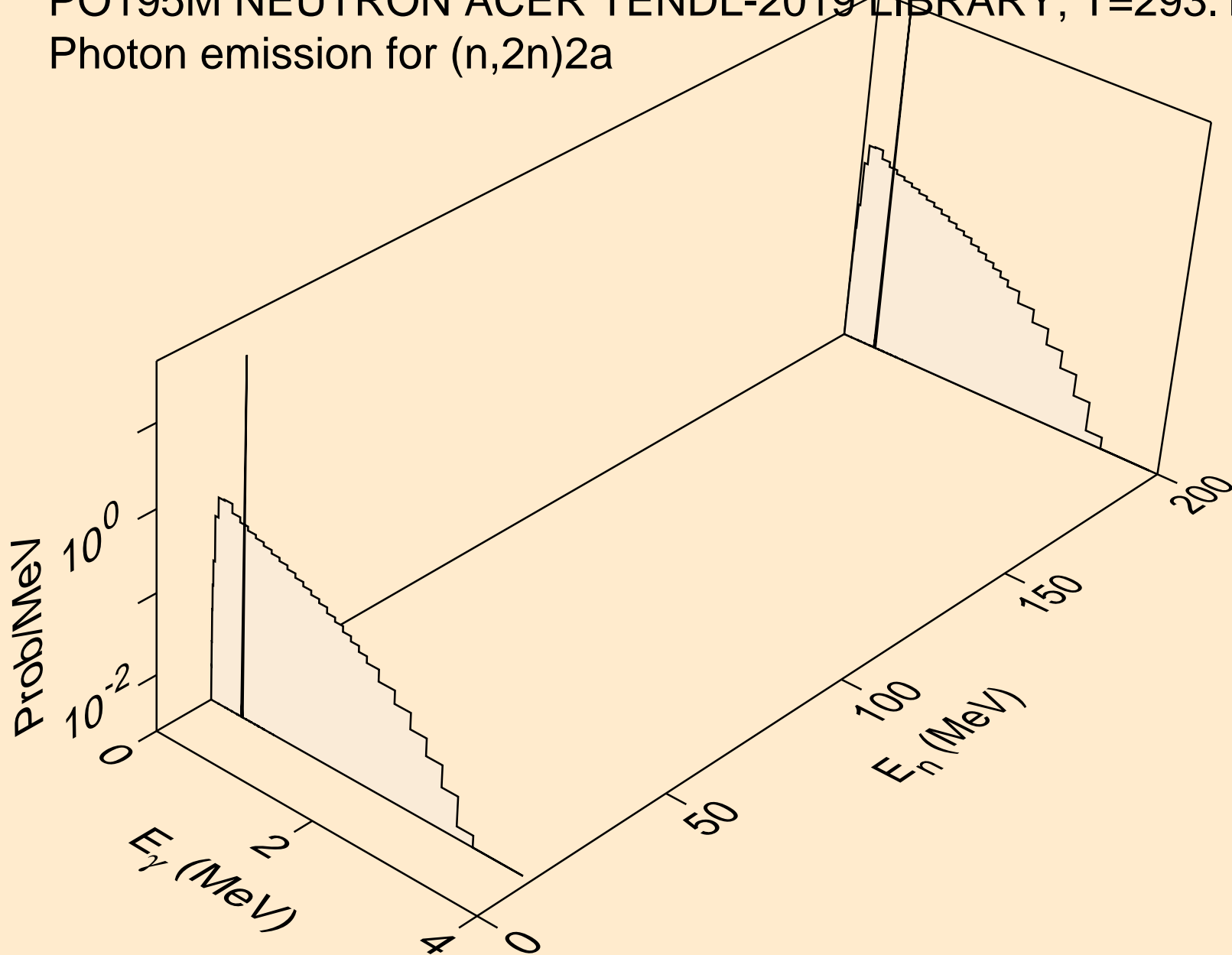

PO195M NEUTRON ACER TENDL-2019 LIBRARY; T=293.16K
Photon emission for (n,n*)d

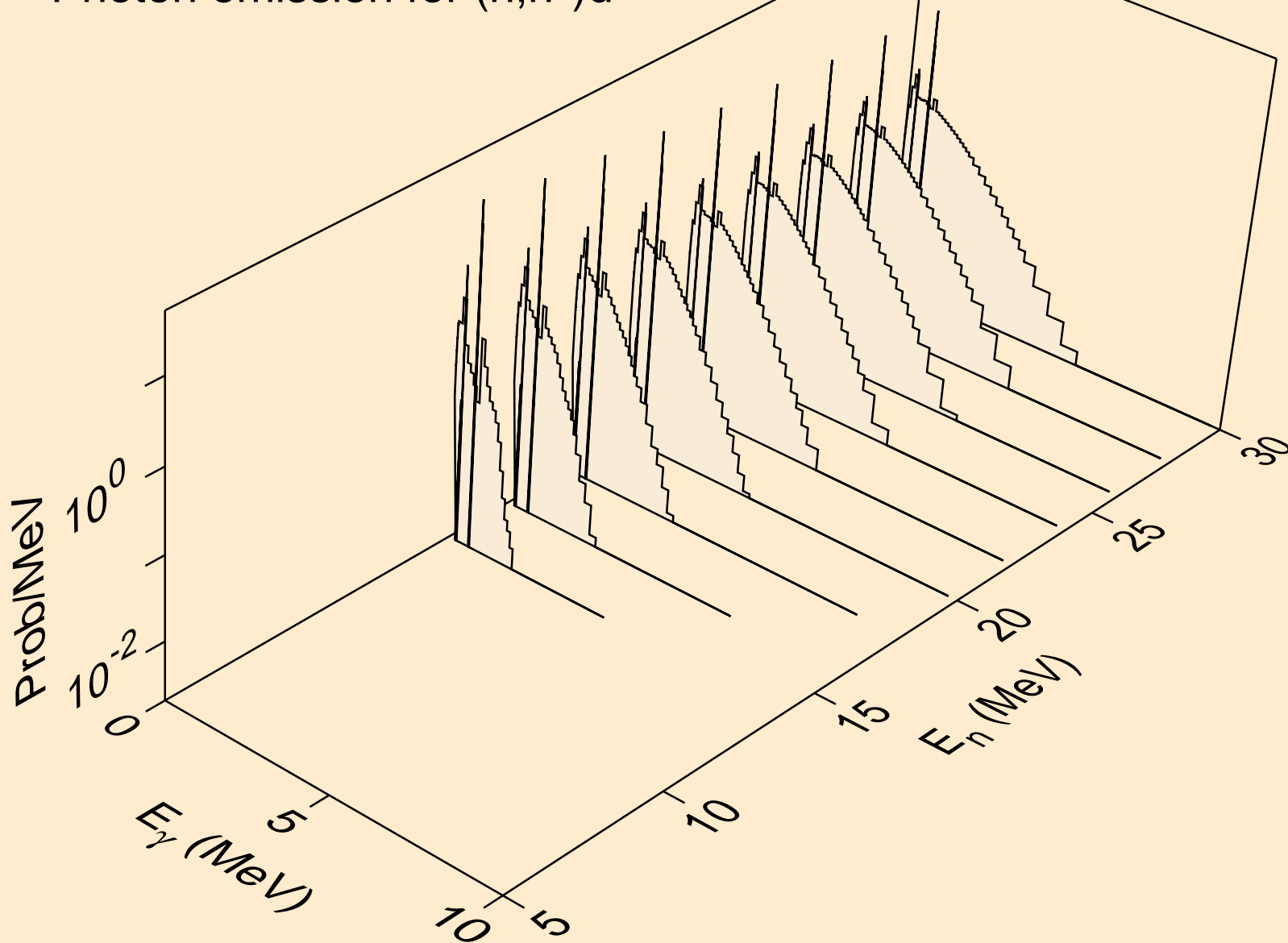

PO195M NEUTRON ACER TENDL-2019 LIBRARY; T=293.16K
Photon emission for (n,n*)t

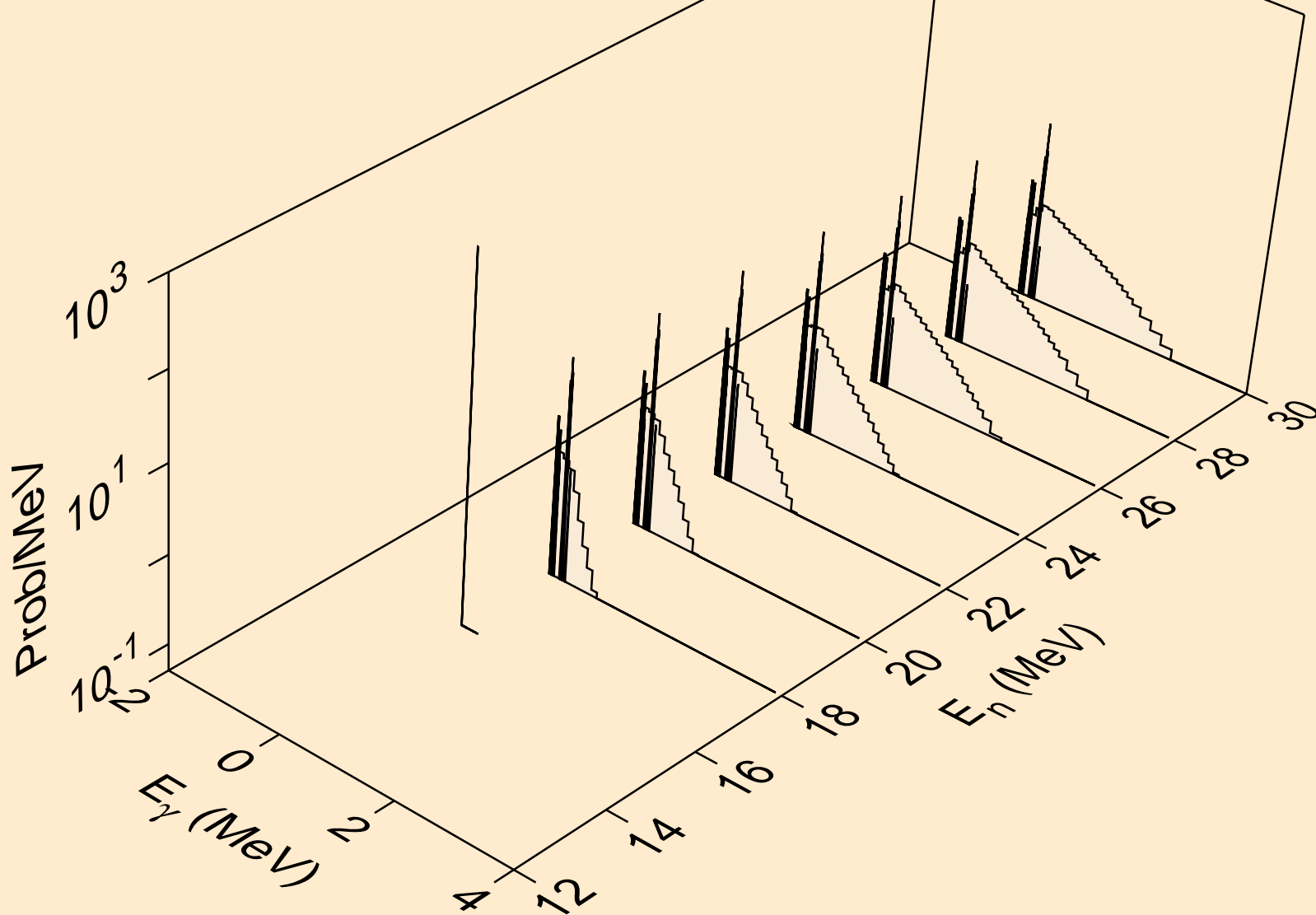

PO195M NEUTRON ACER TENDL-2019 LIBRARY; T=293.16K
Photon emission for (n,n*)he3

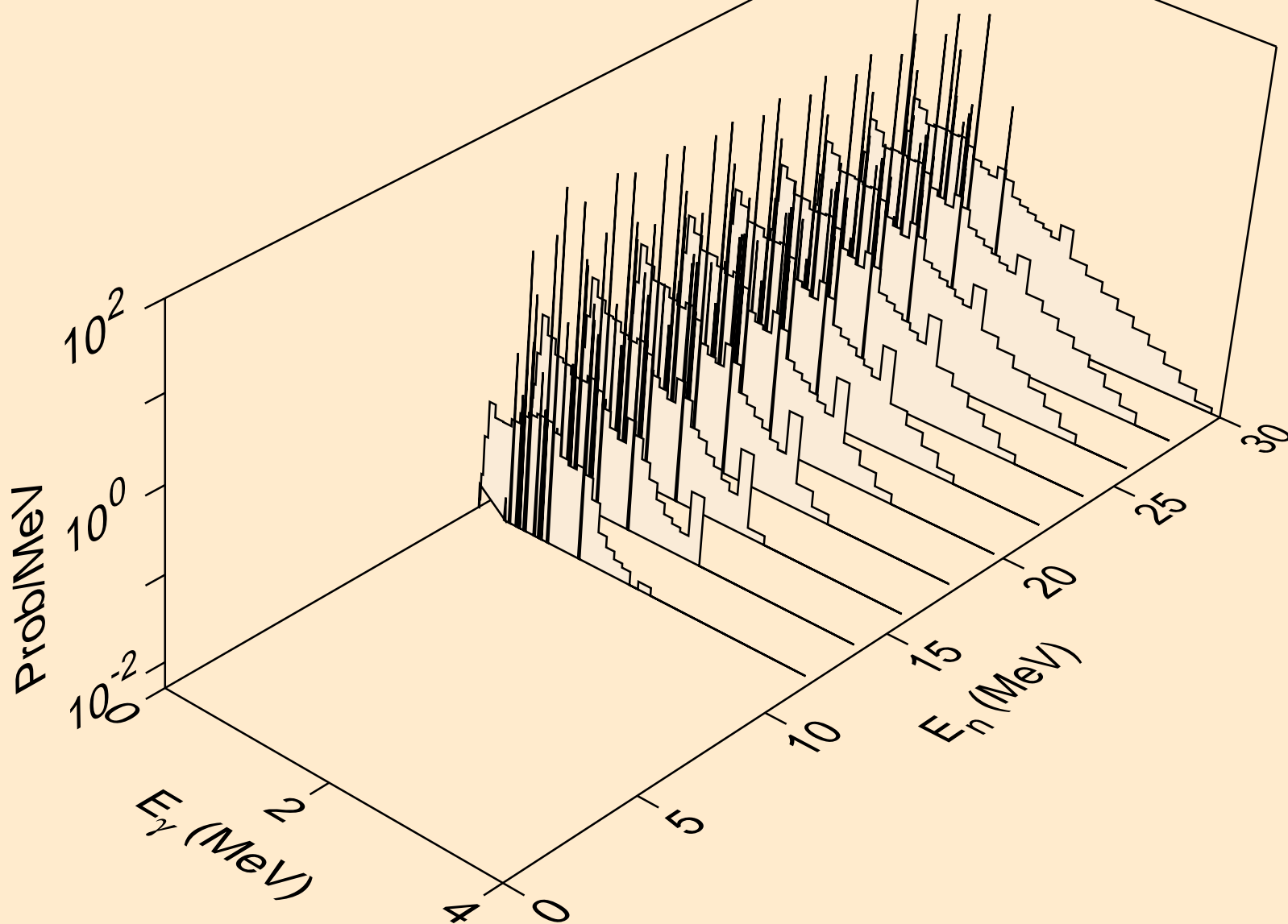

PO195M NEUTRON ACER TENDL-2019 LIBRARY; T=293.16K
Photon emission for (n,4n)

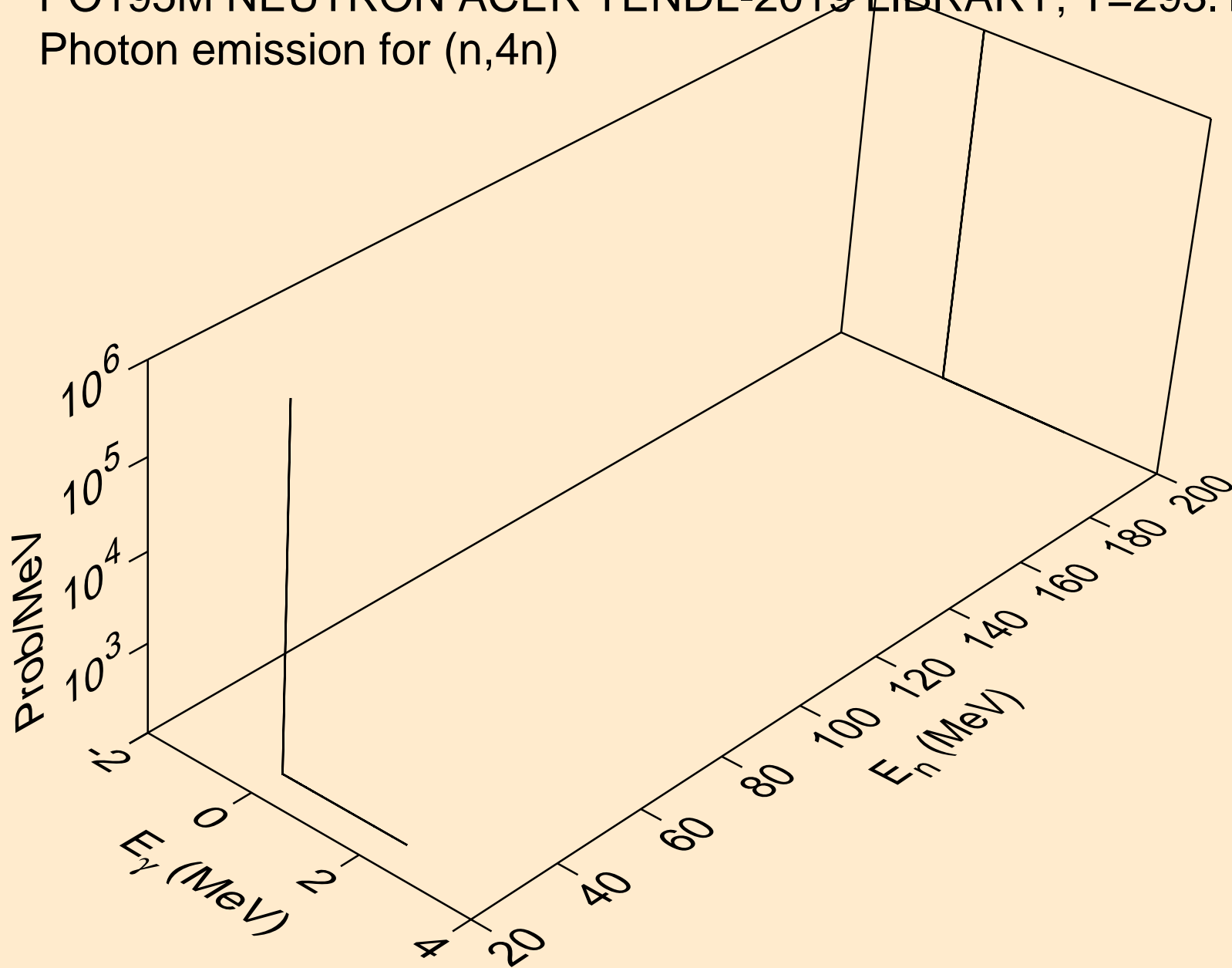

PO195M NEUTRON ACER TENDL-2019 LIBRARY; T=293.16K
Photon emission for (n,2np)

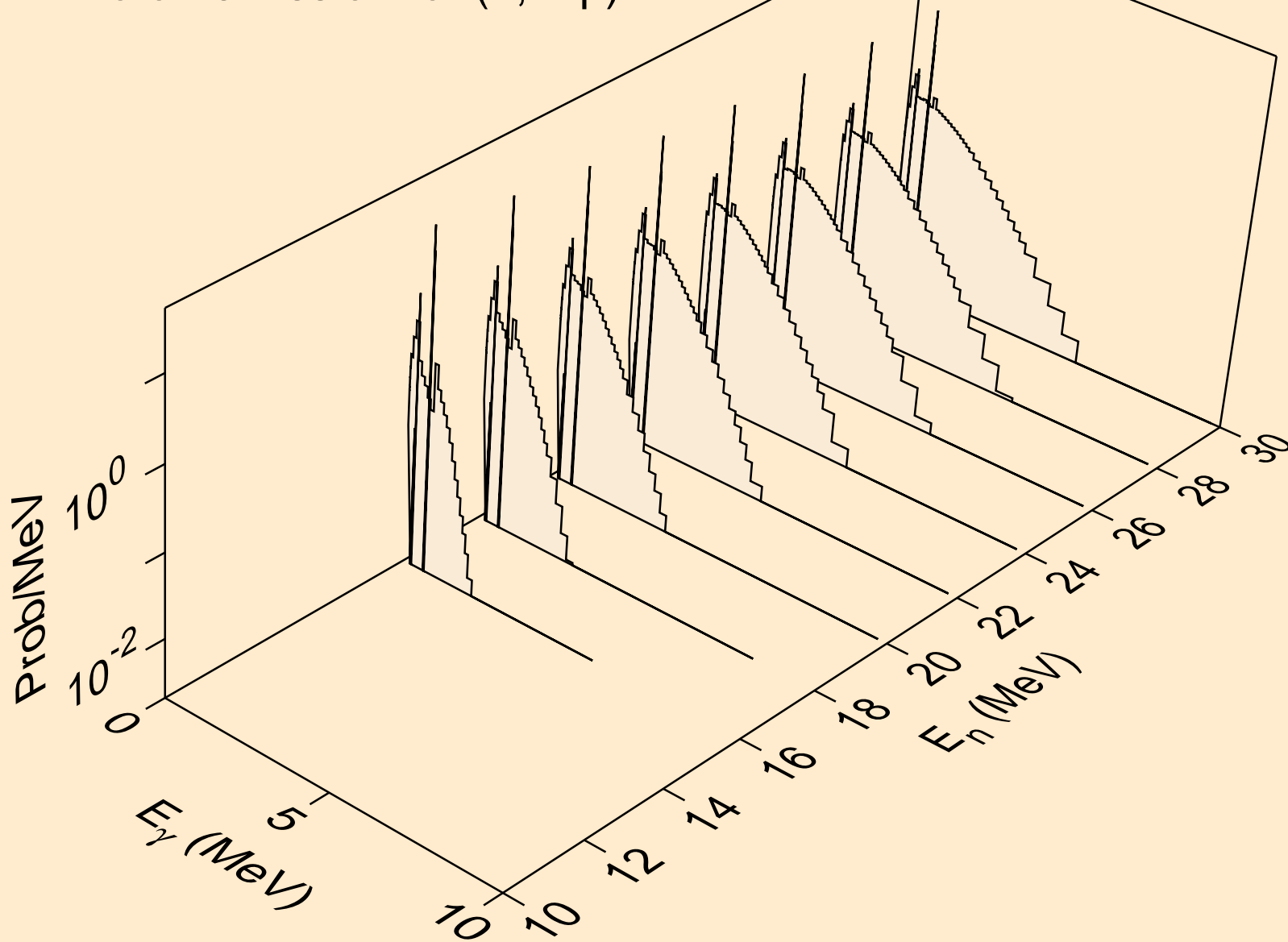

PO195M NEUTRON ACER TENDL-2019 LIBRARY; T=293.16K
Photon emission for (n,3np)

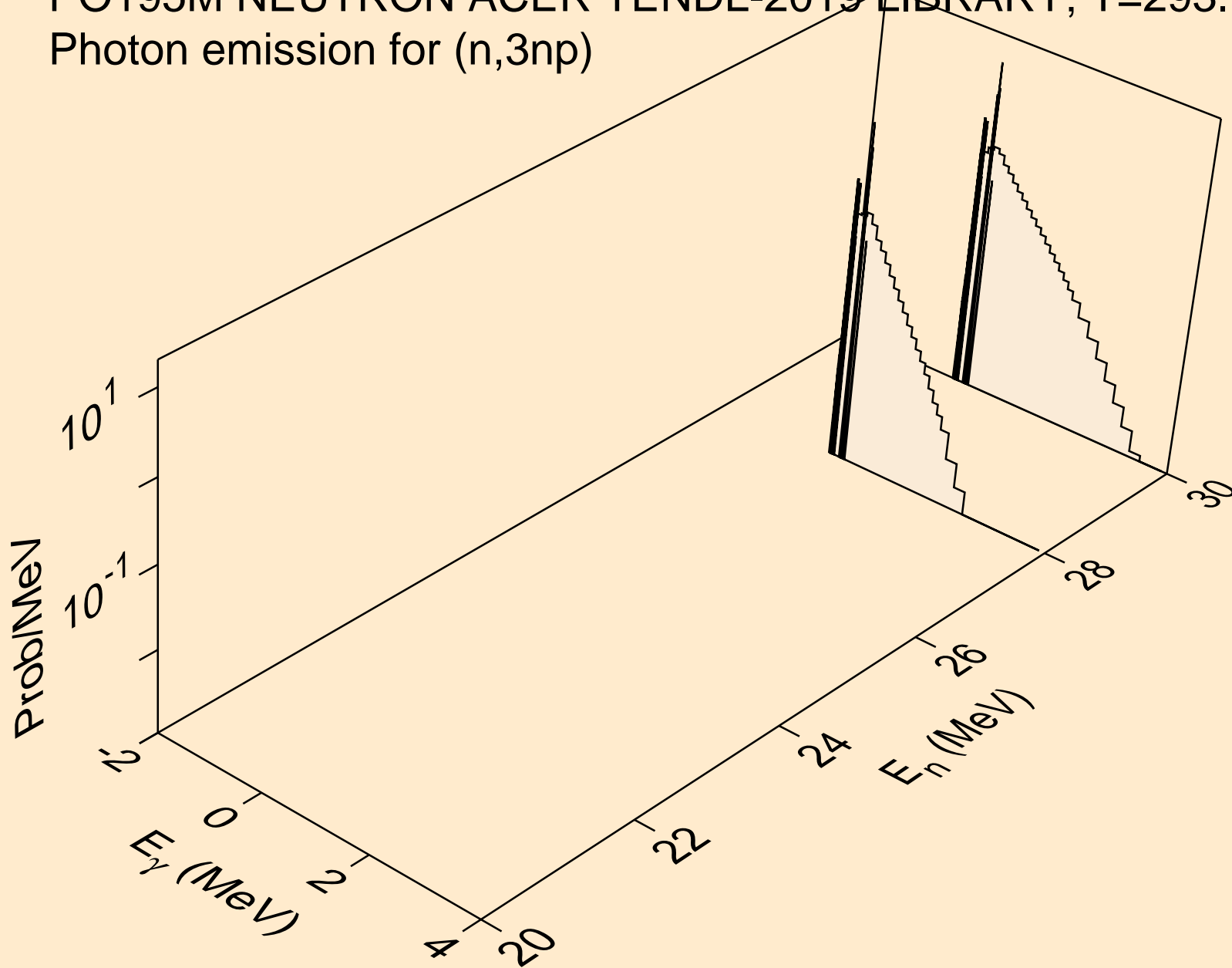

PO195M NEUTRON ACER TENDL-2019 LIBRARY; T=293.16K
Photon emission for (n,2np)

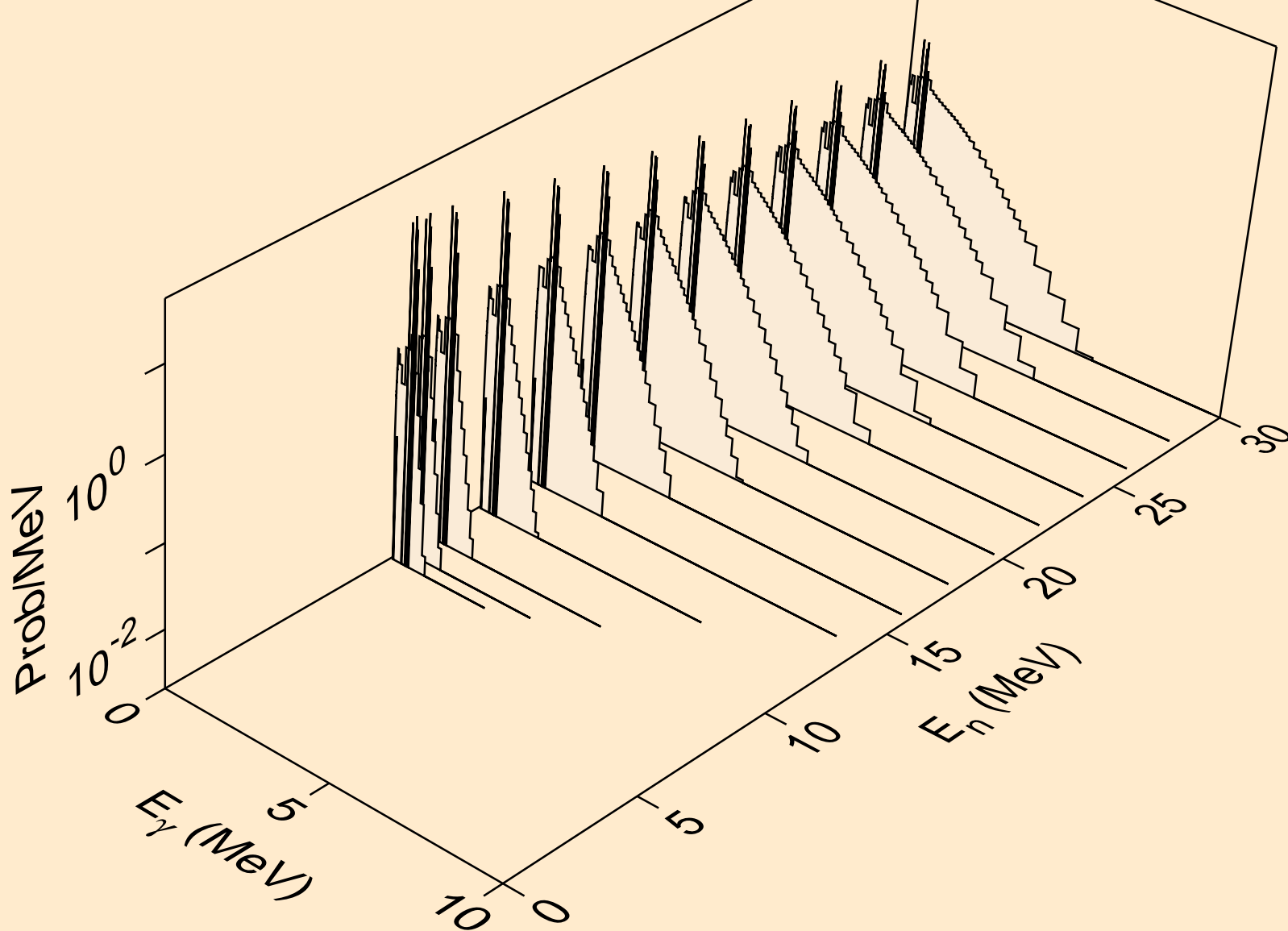

PO195M NEUTRON ACER TENDL-2019 LIBRARY; T=293.16K
Photon emission for (n,npa)

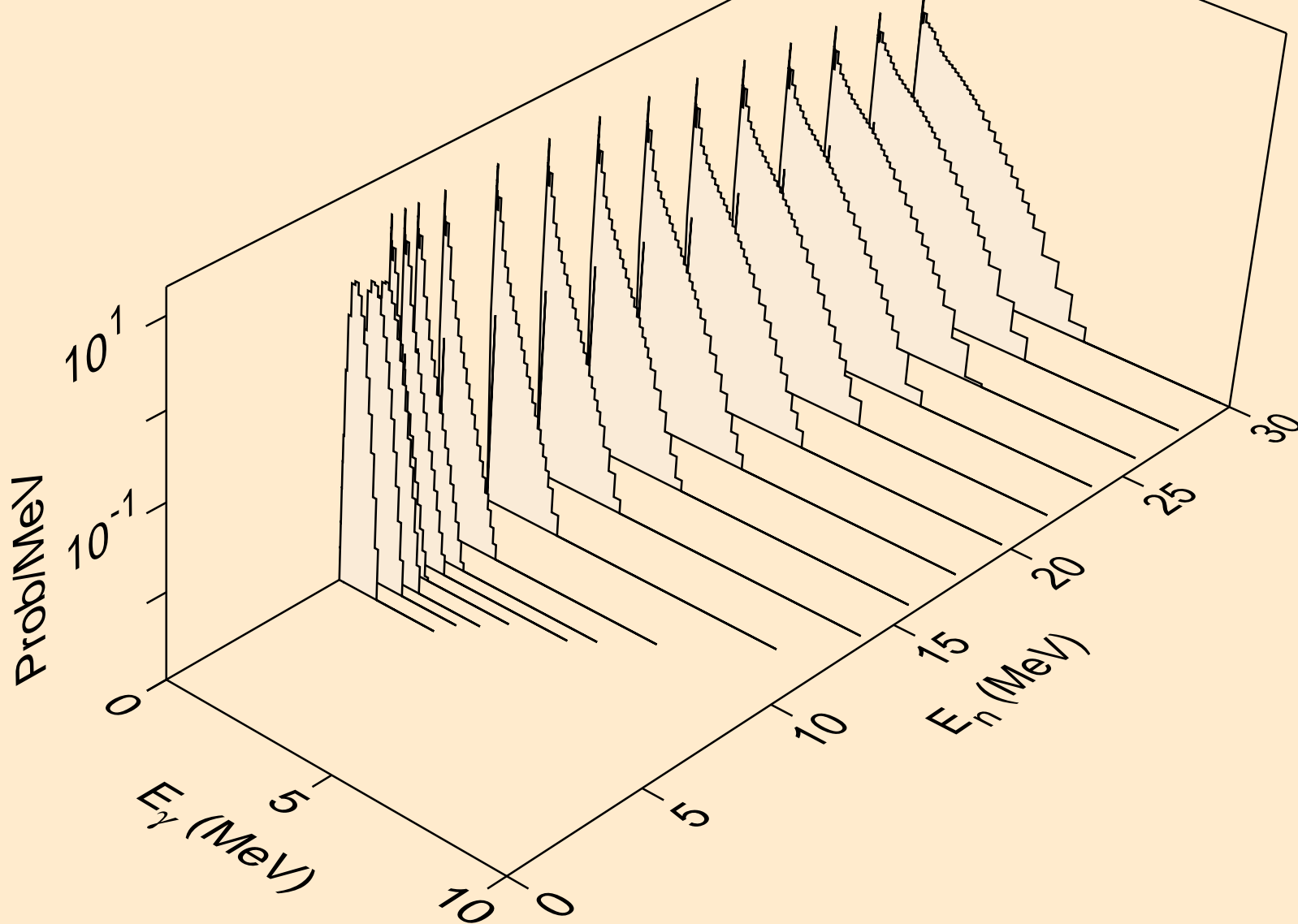

PO195M NEUTRON ACER TENDL-2019 LIBRARY; T=293.16K
Photon emission for (n,n*1)

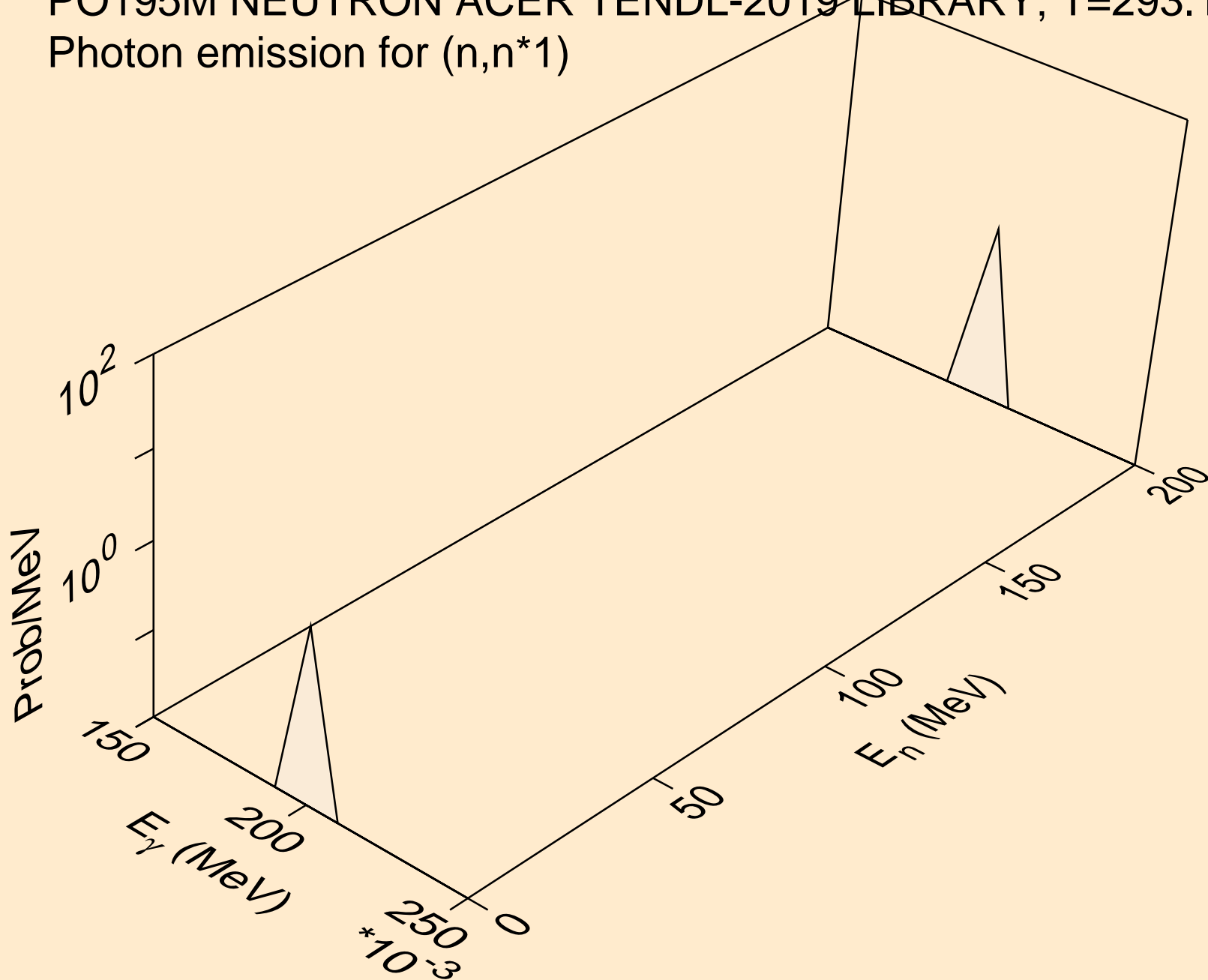

PO195M NEUTRON ACER TENDL-2019 LIBRARY; T=293.16K
Photon emission for (n,n*c)

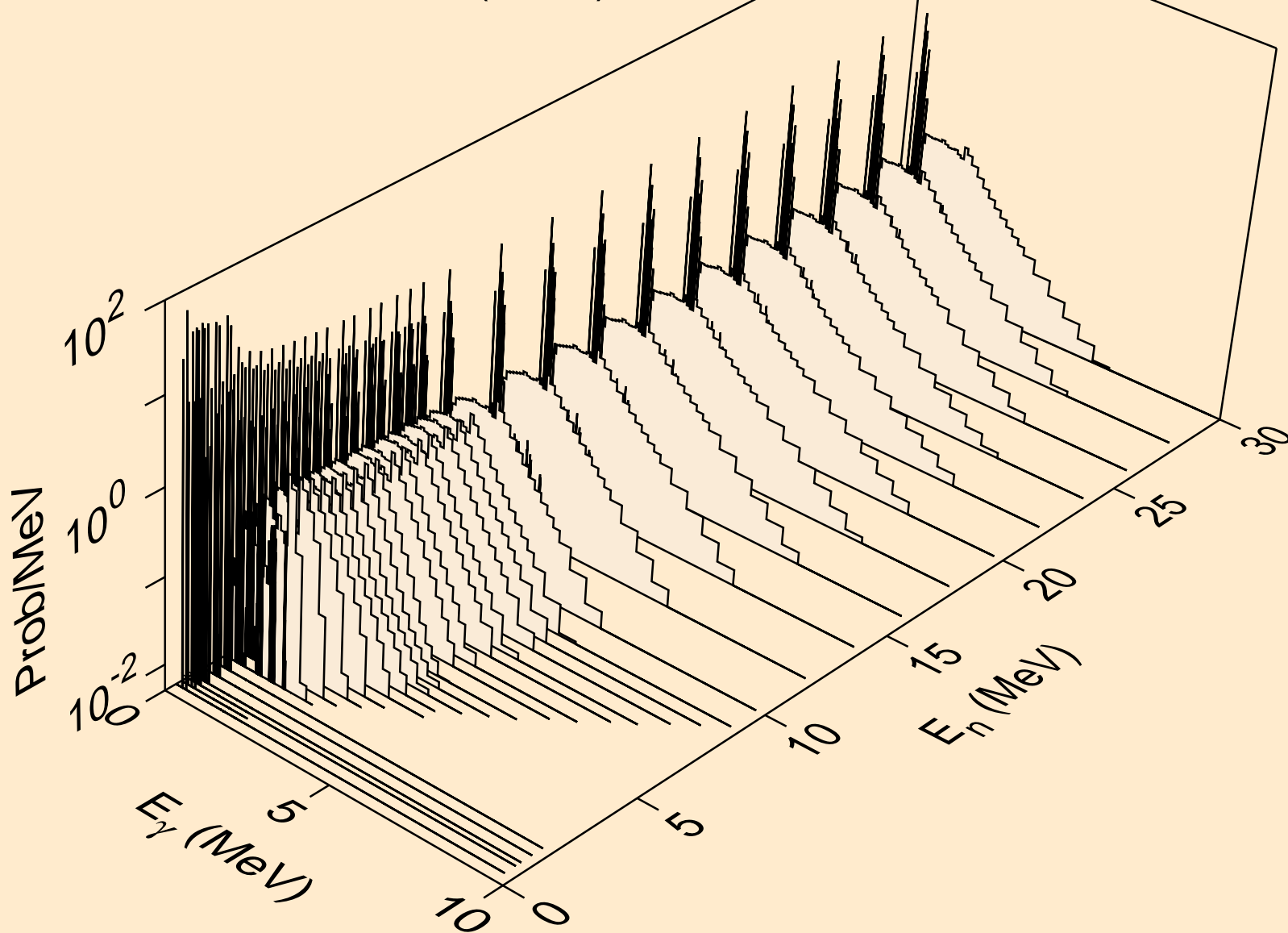

PO195M NEUTRON ACER TENDL-2019 LIBRARY; T=293.16K
Photon emission for (n,gma)

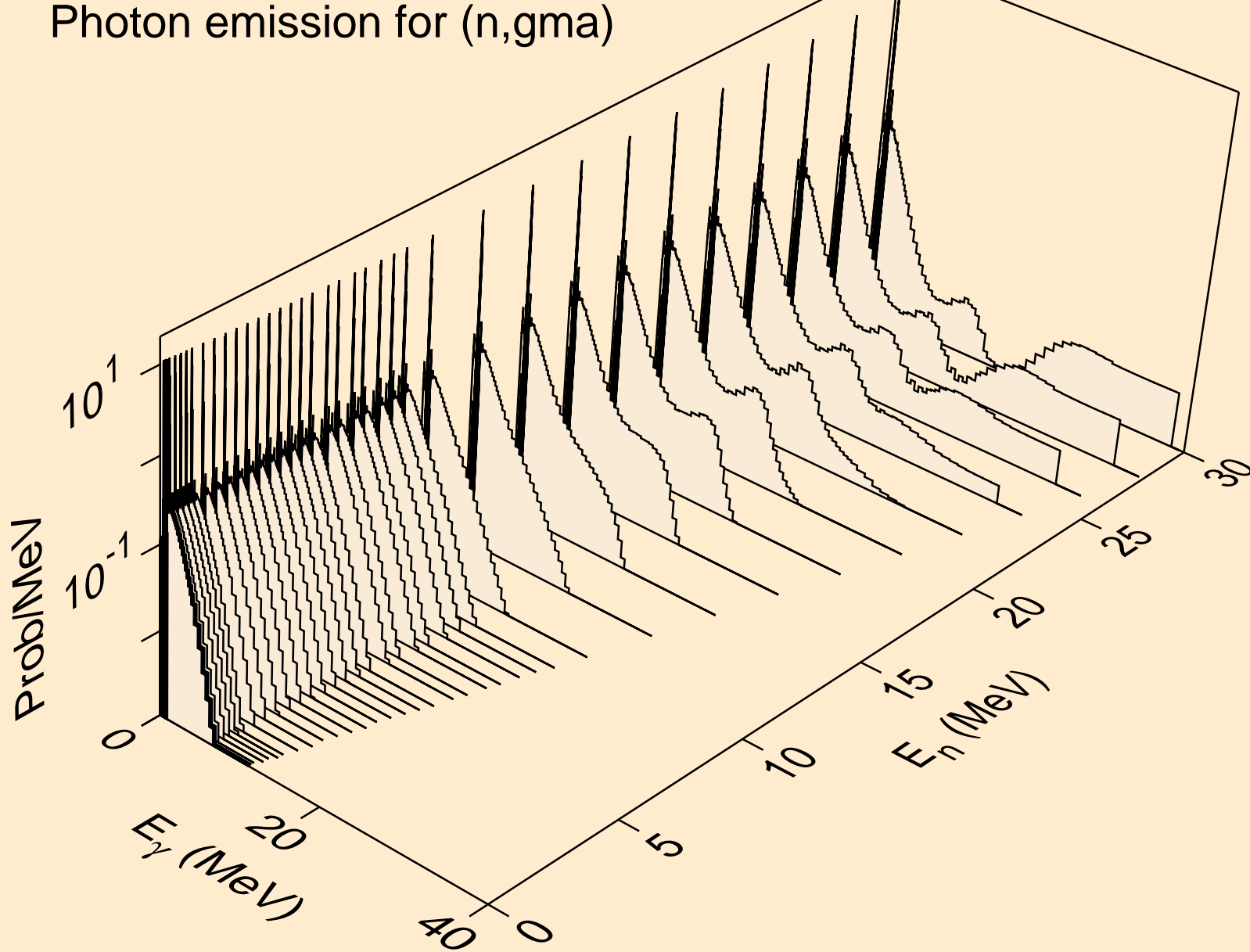

PO195M NEUTRON ACER TENDL-2019 LIBRARY; T=293.16K
Photon emission for (n,p)

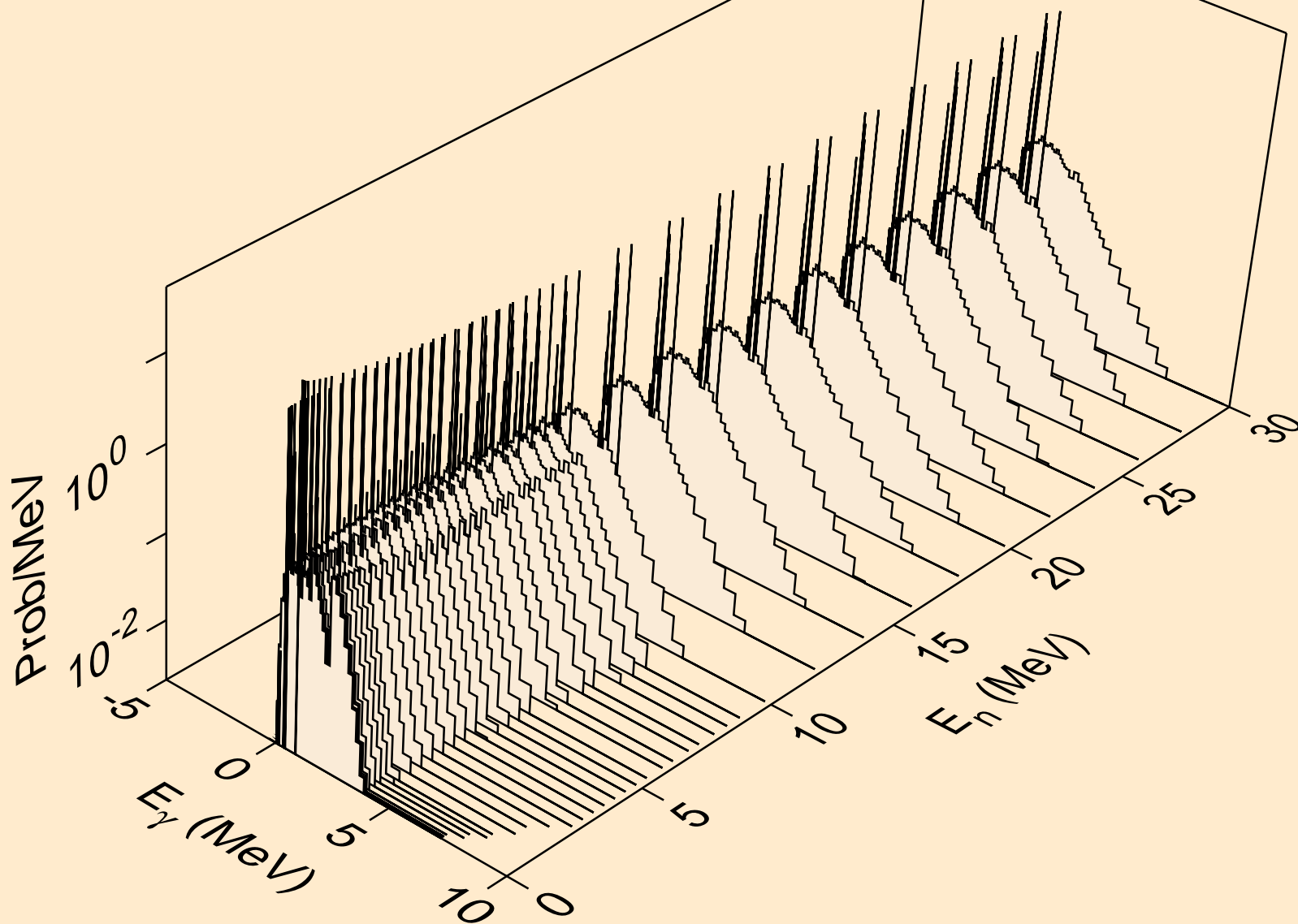

PO195M NEUTRON ACER TENDL-2019 LIBRARY; T=293.16K
Photon emission for (n,d)

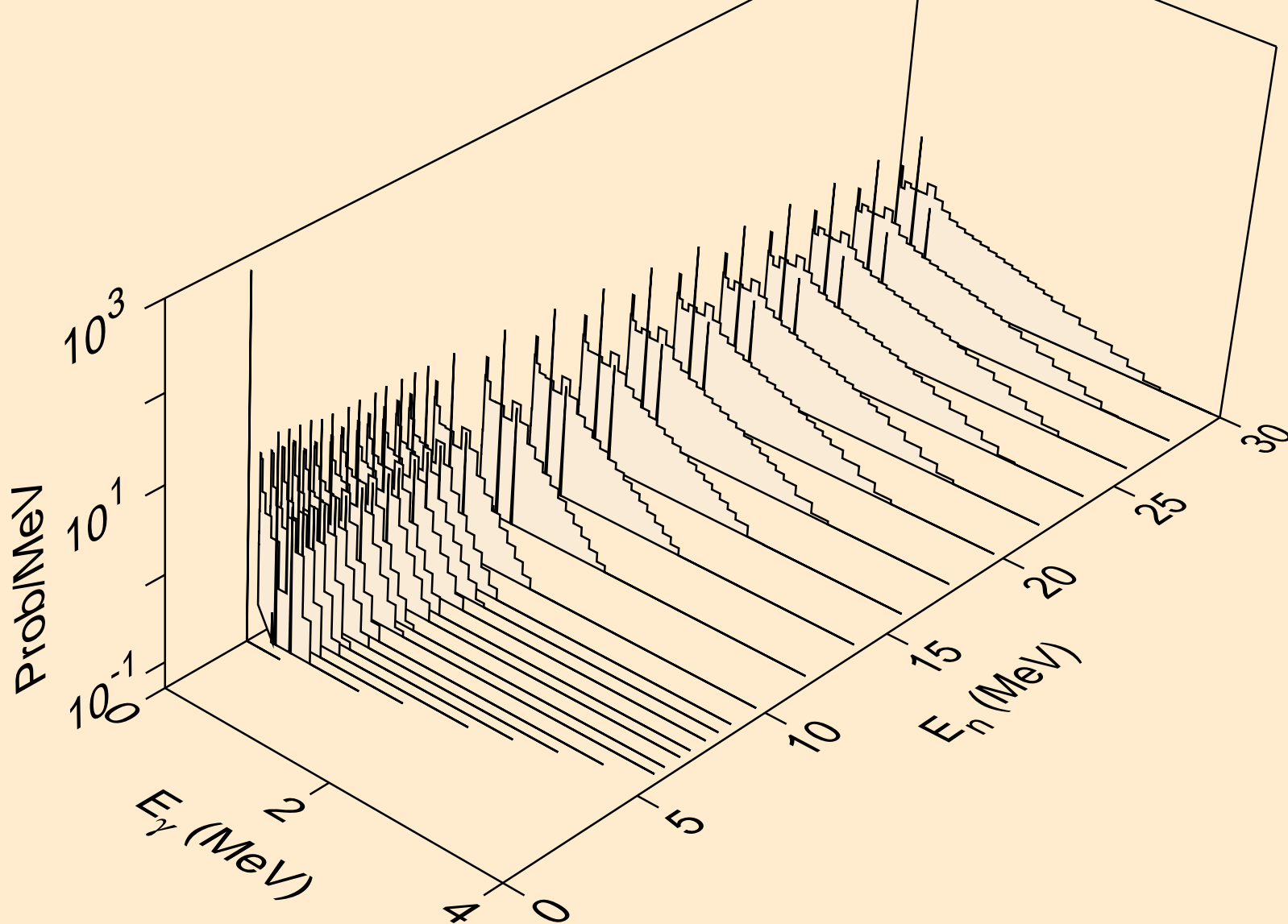

PO195M NEUTRON ACER TENDL-2019 LIBRARY; T=293.16K
Photon emission for (n,t)

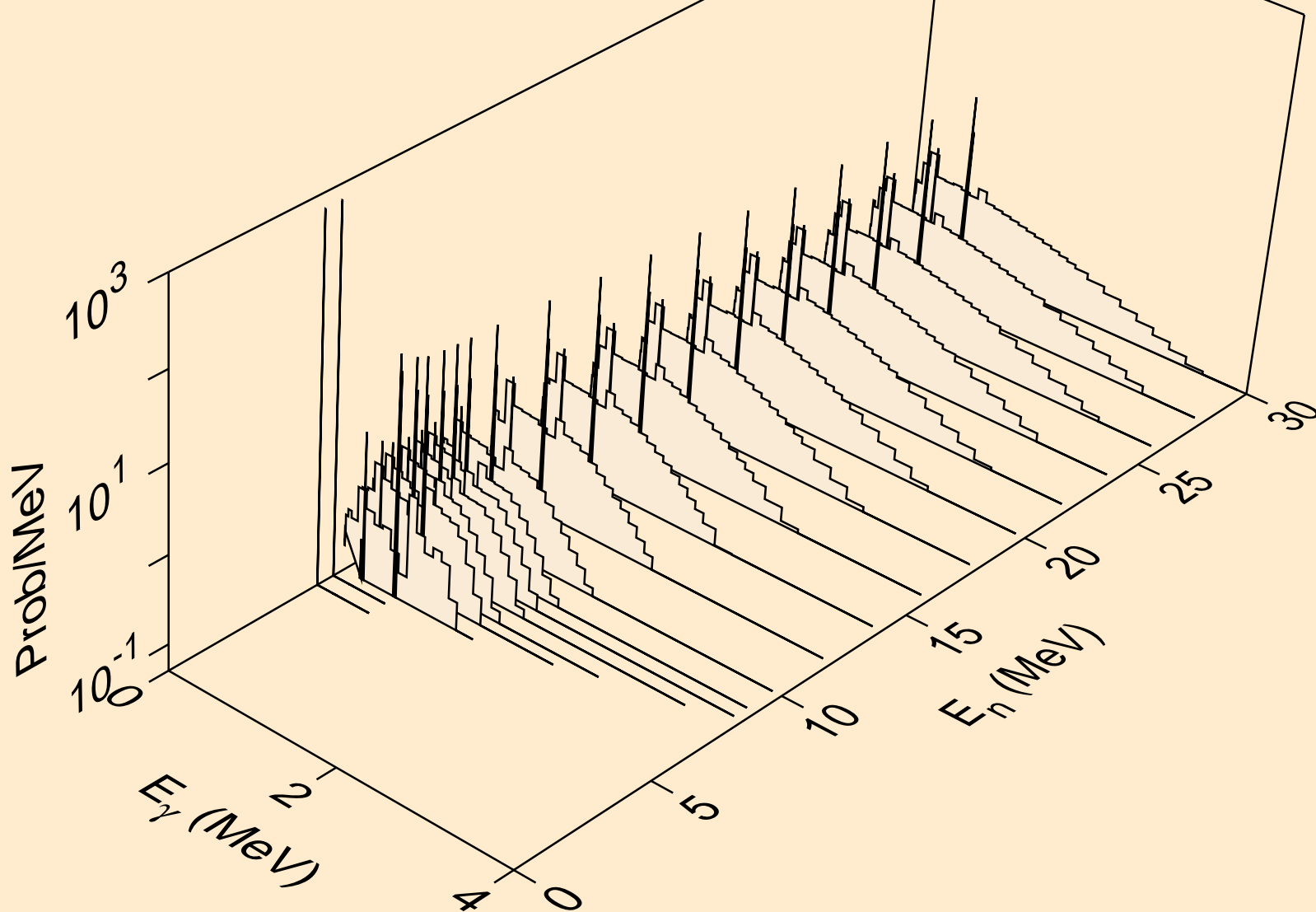

PO195M NEUTRON ACER TENDL-2019 LIBRARY; T=293.16K
Photon emission for (n,he3)

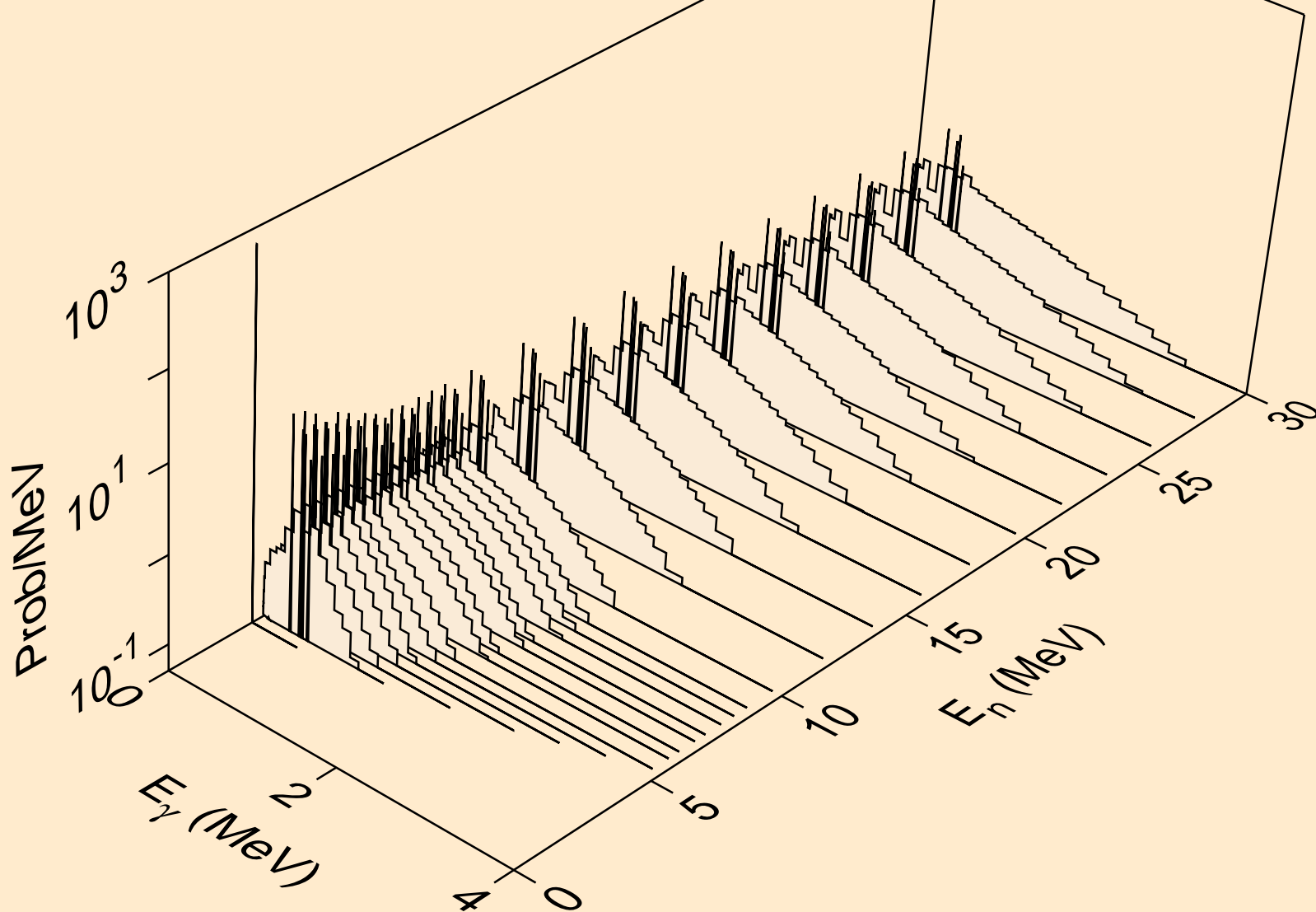

PO195M NEUTRON ACER TENDL-2019 LIBRARY; T=293.16K
Photon emission for (n,a)

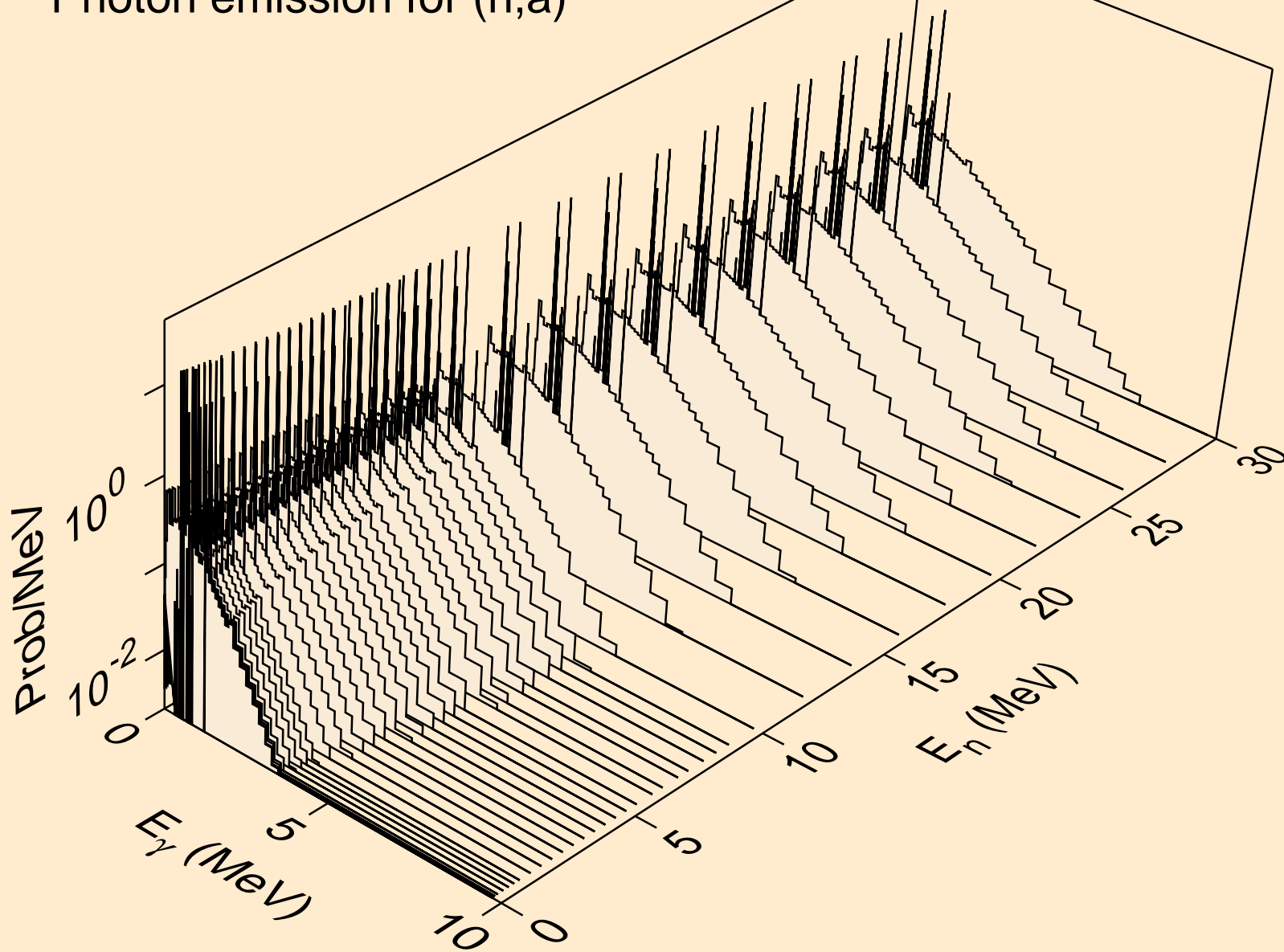

PO195M NEUTRON ACER TENDL-2019 LIBRARY; T=293.16K
Photon emission for (n,2a)

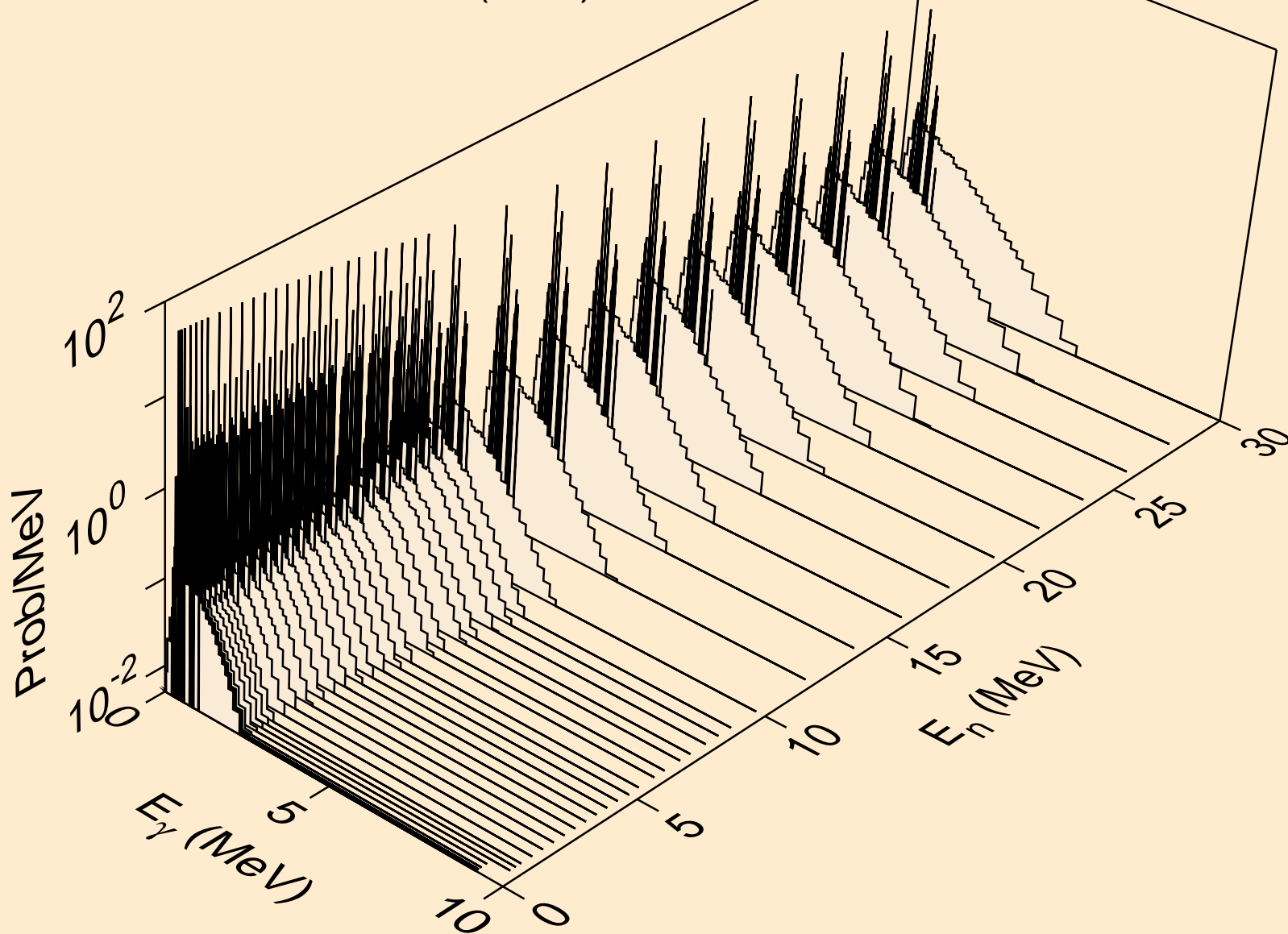

PO195M NEUTRON ACER TENDL-2019 LIBRARY; T=293.16K
Photon emission for (n,3a)

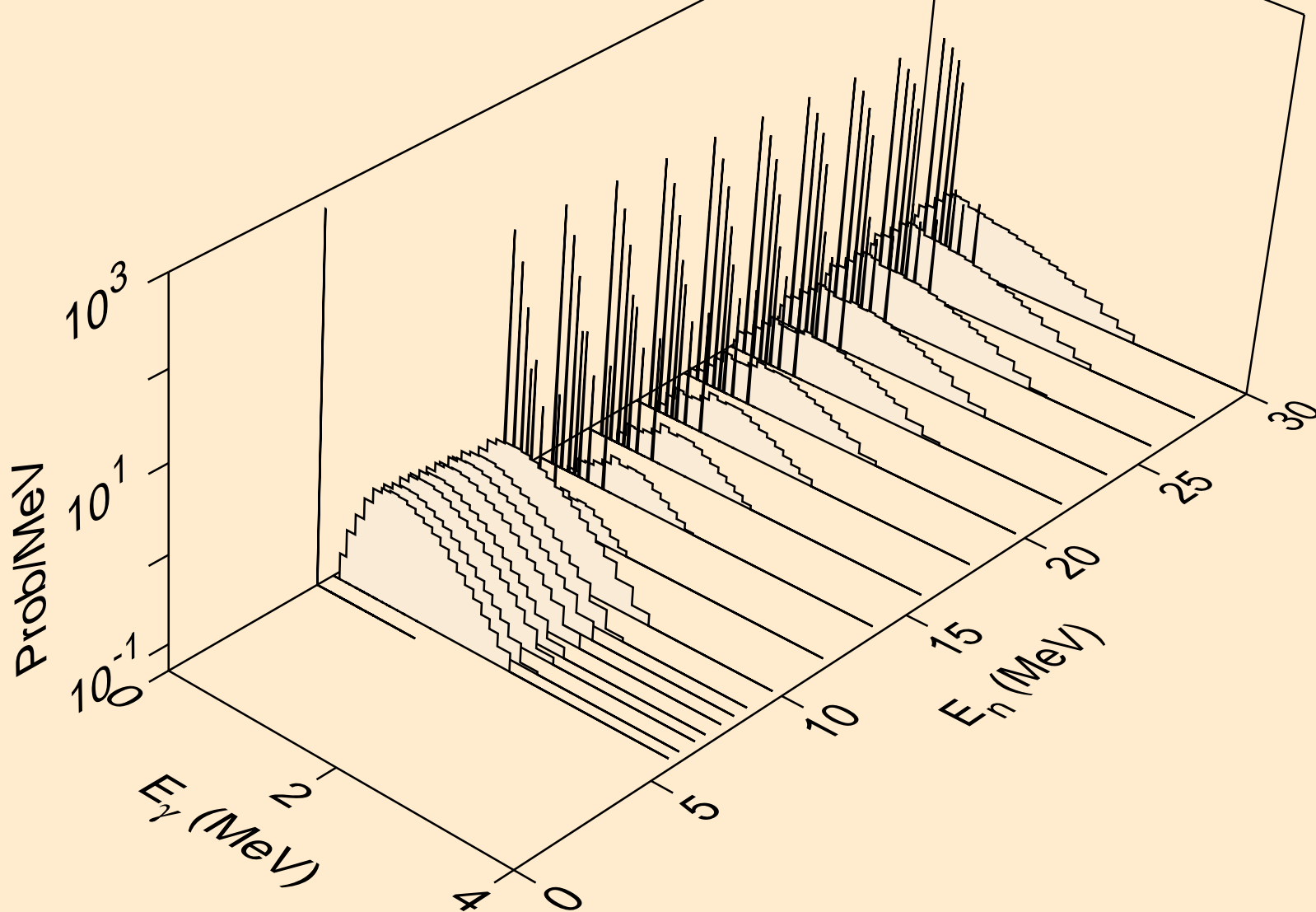

PO195M NEUTRON ACER TENDL-2019 LIBRARY; T=293.16K
Photon emission for (n,2p)

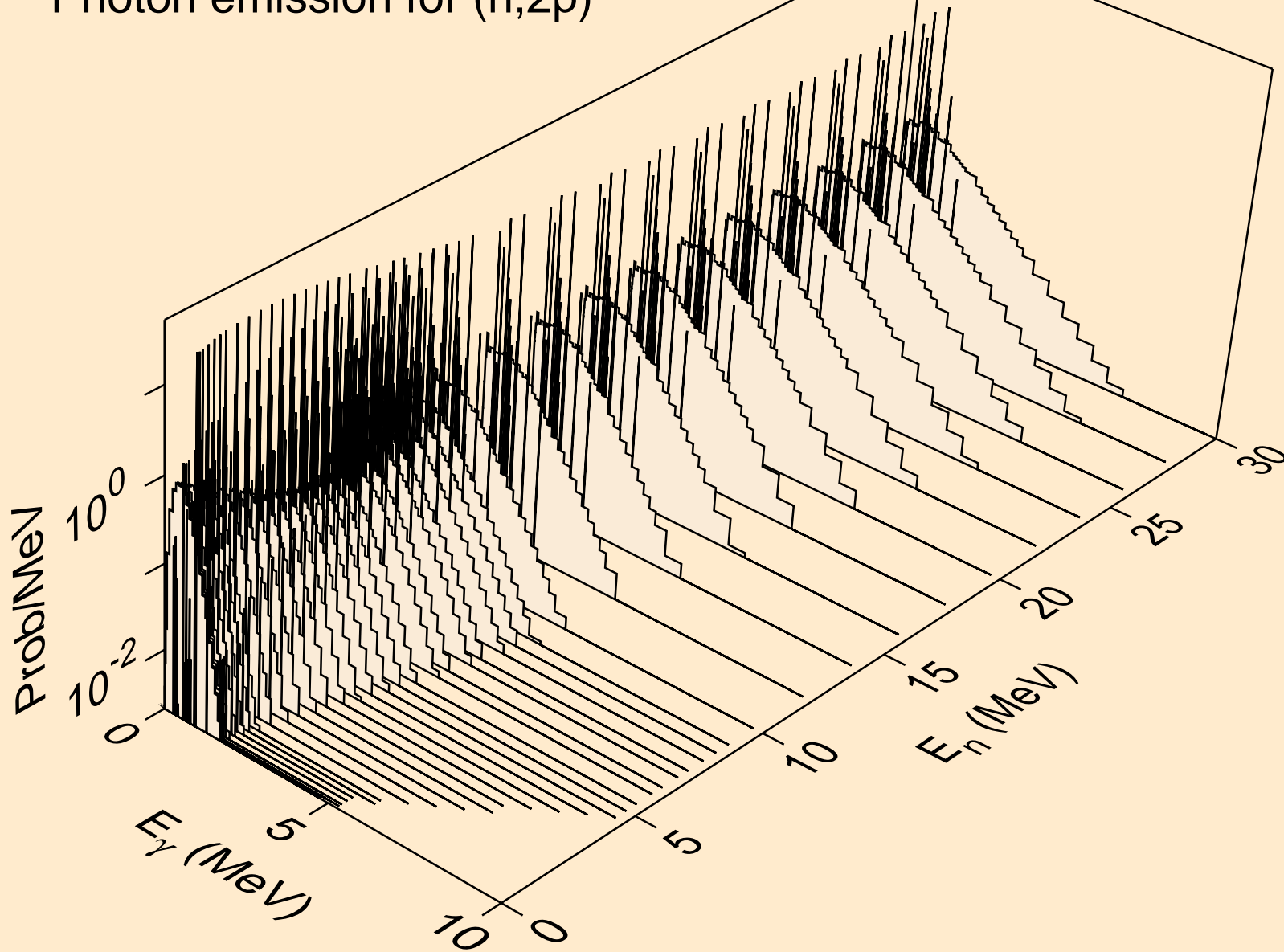

PO195M NEUTRON ACER TENDL-2019 LIBRARY; T=293.16K
Photon emission for (n,p α)

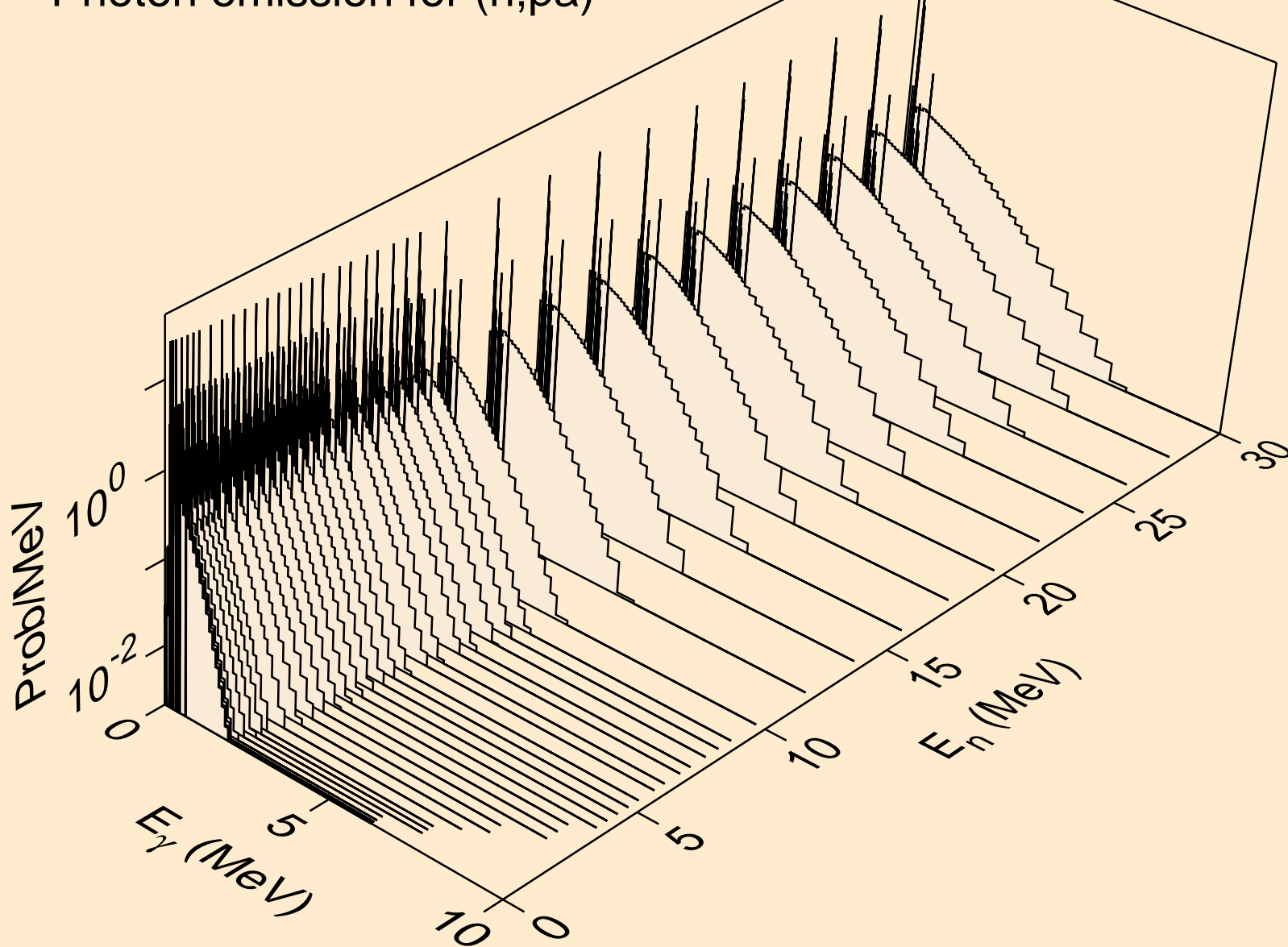

PO195M NEUTRON ACER TENDL-2019 LIBRARY; T=293.16K
Photon emission for (n,pd)

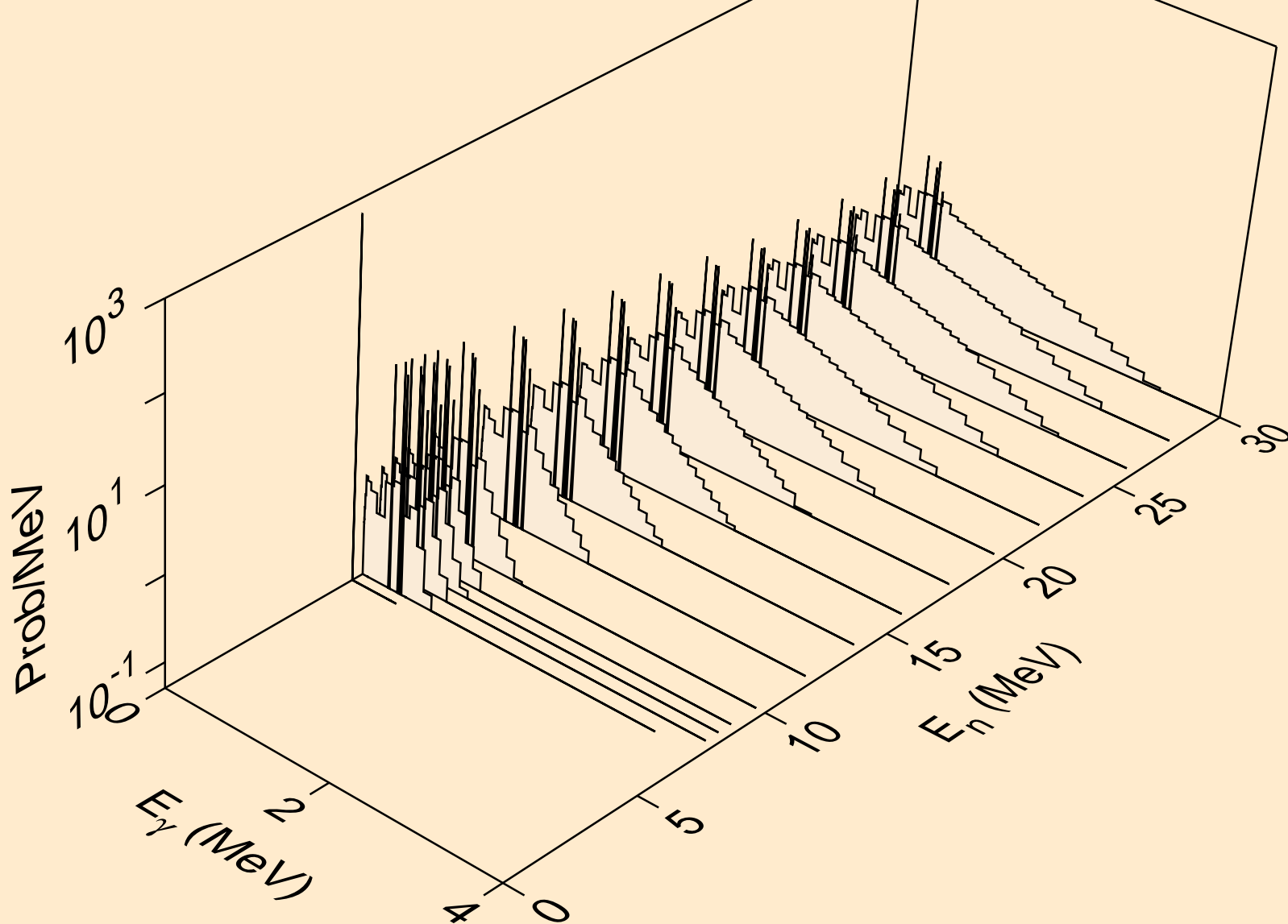

PO195M NEUTRON ACER TENDL-2019 LIBRARY; T=293.16K
Photon emission for (n,pt)

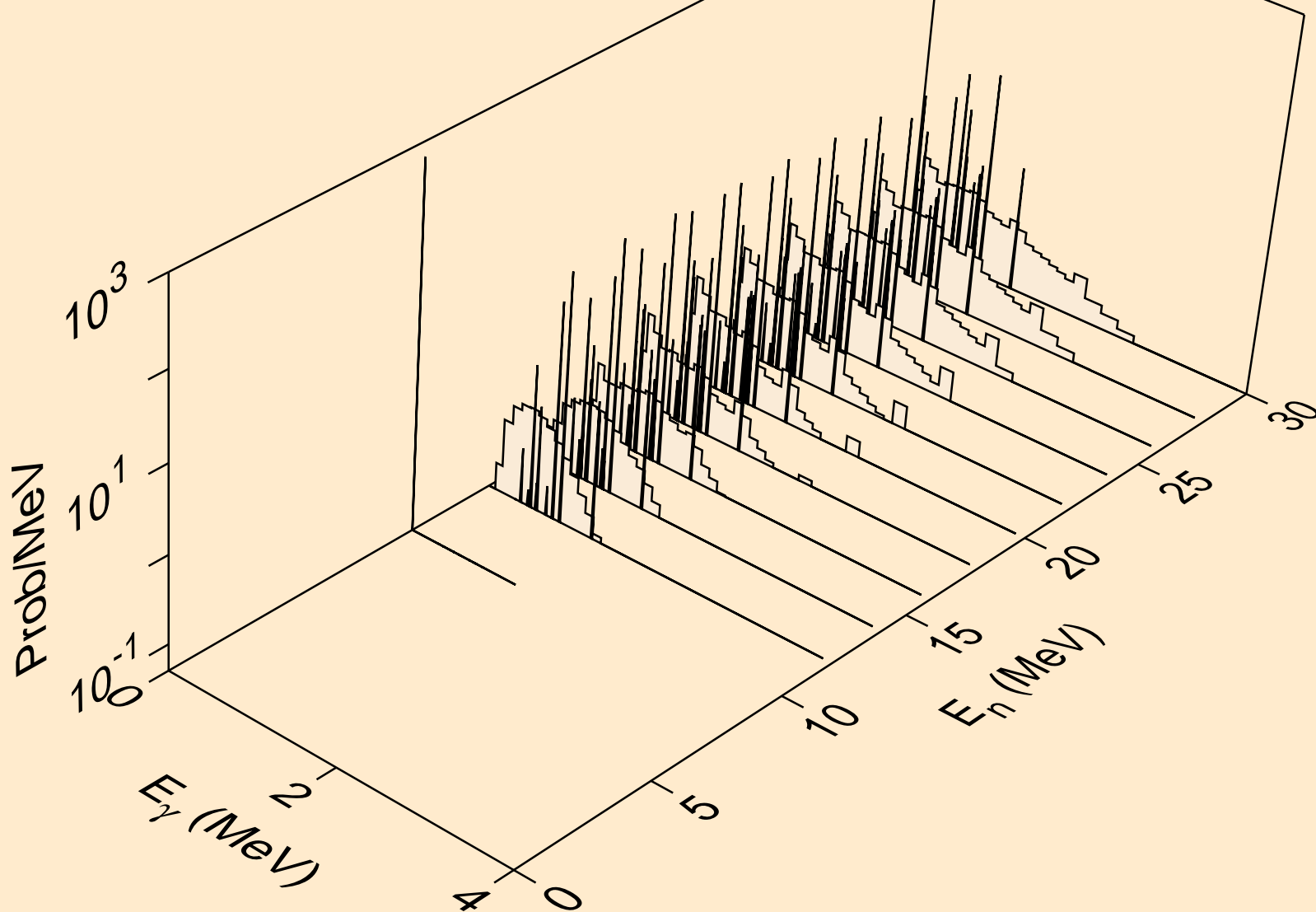

PO195M NEUTRON ACER TENDL-2019 LIBRARY; T=293.16K
Photon emission for (n,da)

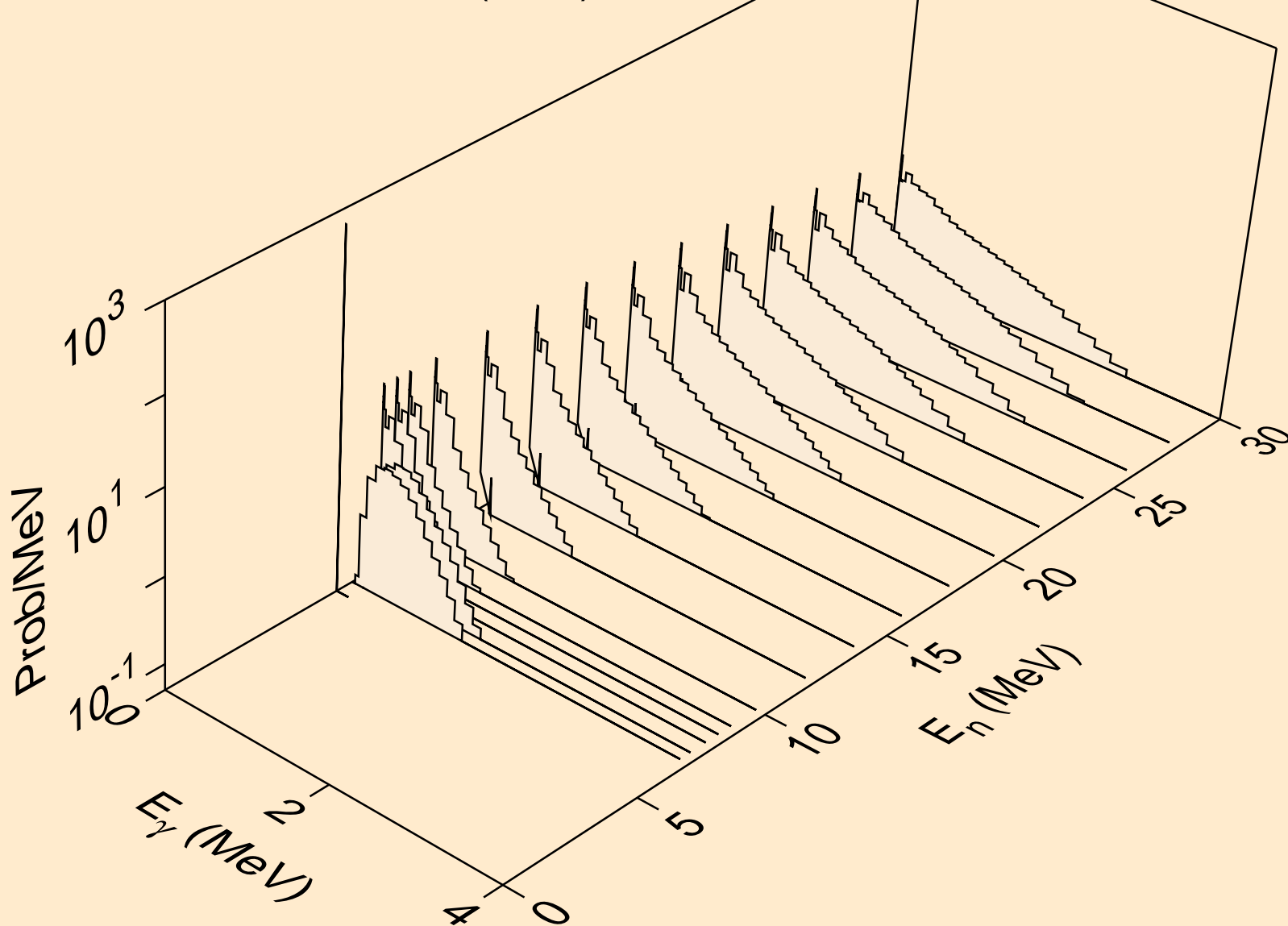

PO195M NEUTRON ACER TENDL-2019 LIBRARY; T=293.16K
thermal capture photon spectrum

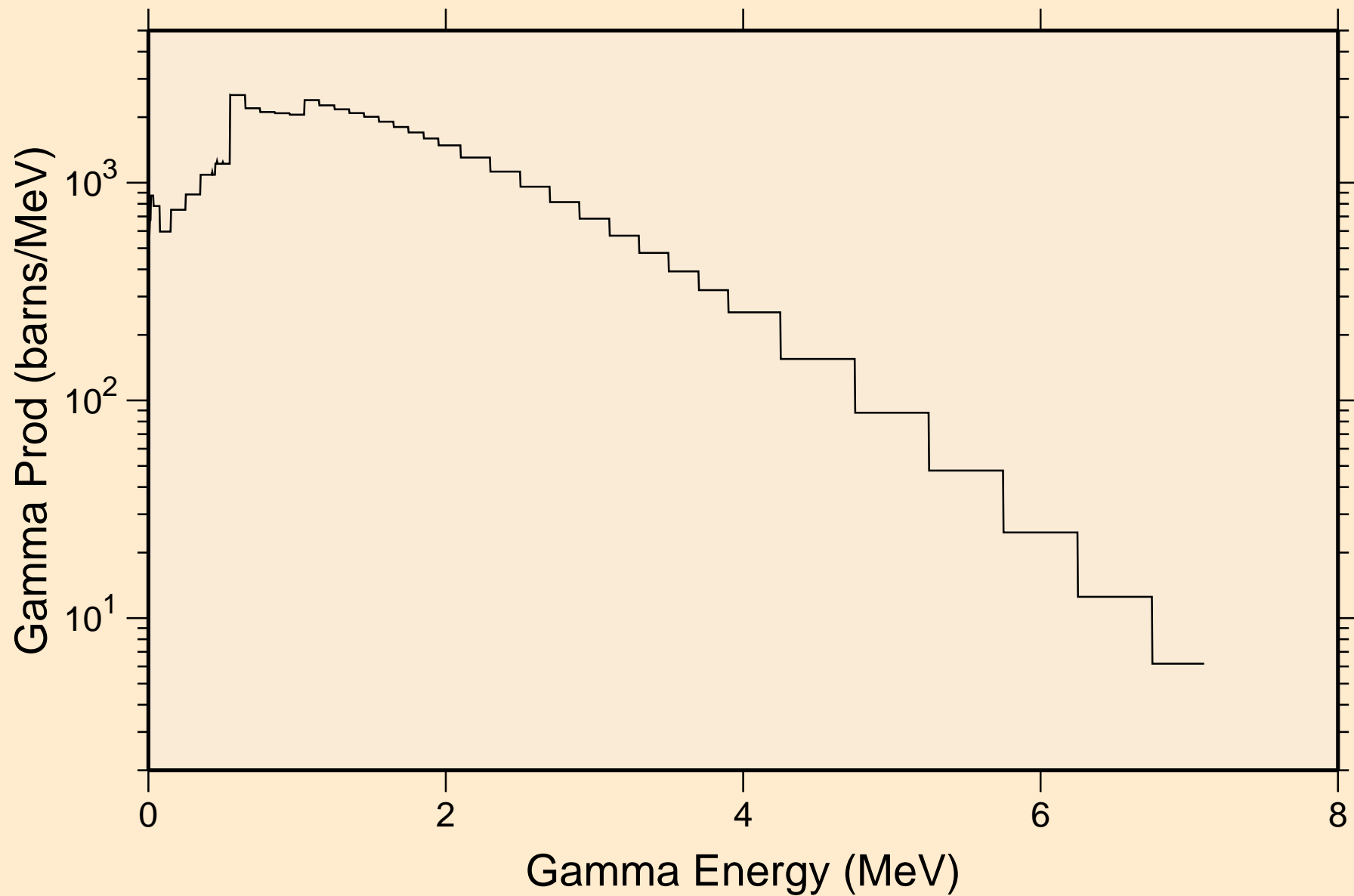

PO195M NEUTRON ACER TENDL-2019 LIBRARY; T=293.16K
14 MeV photon spectrum

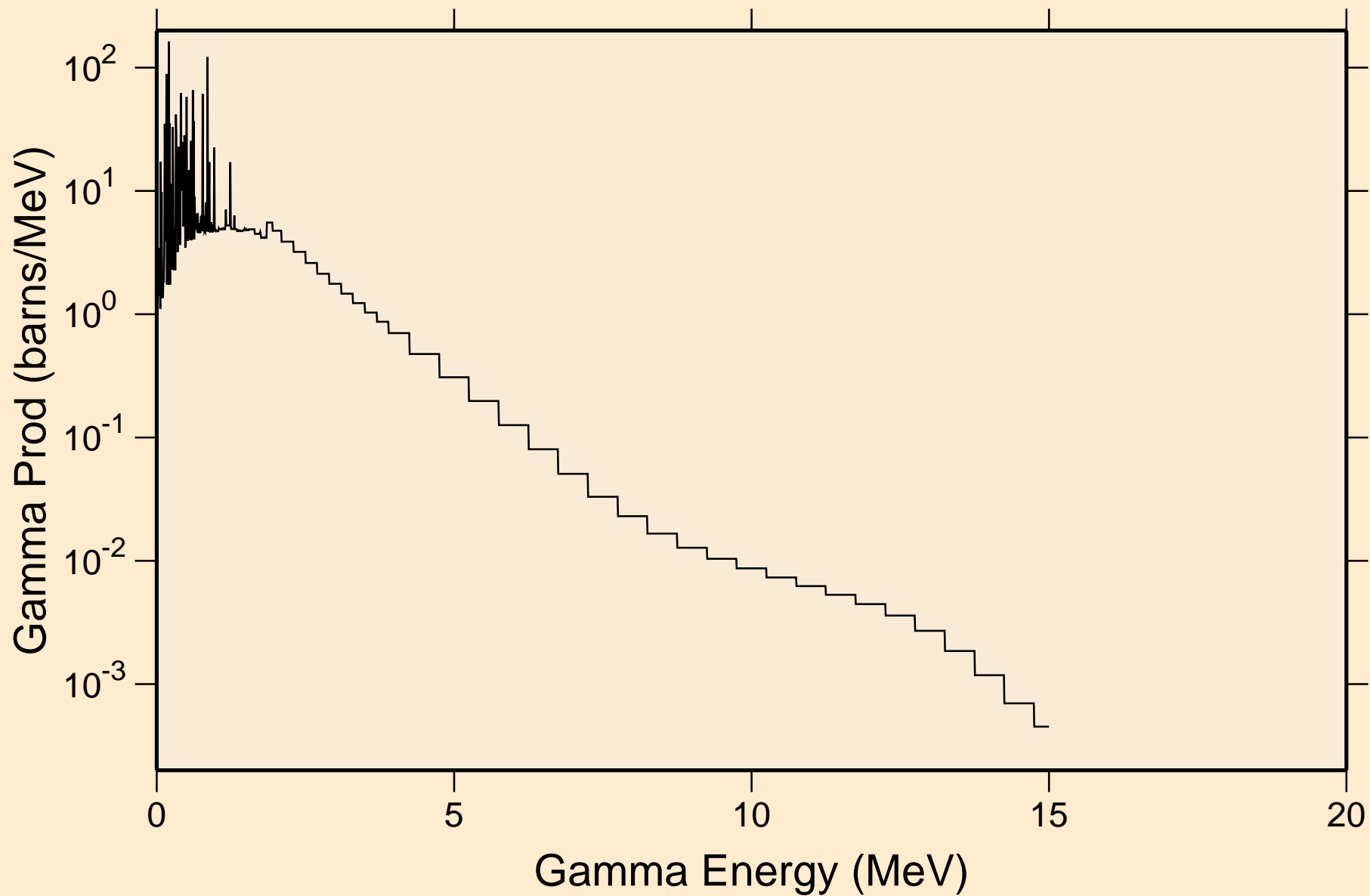

PO195M NEUTRON ACER TENDL-2019 LIBRARY; T=293.16K
Particle heating contributions

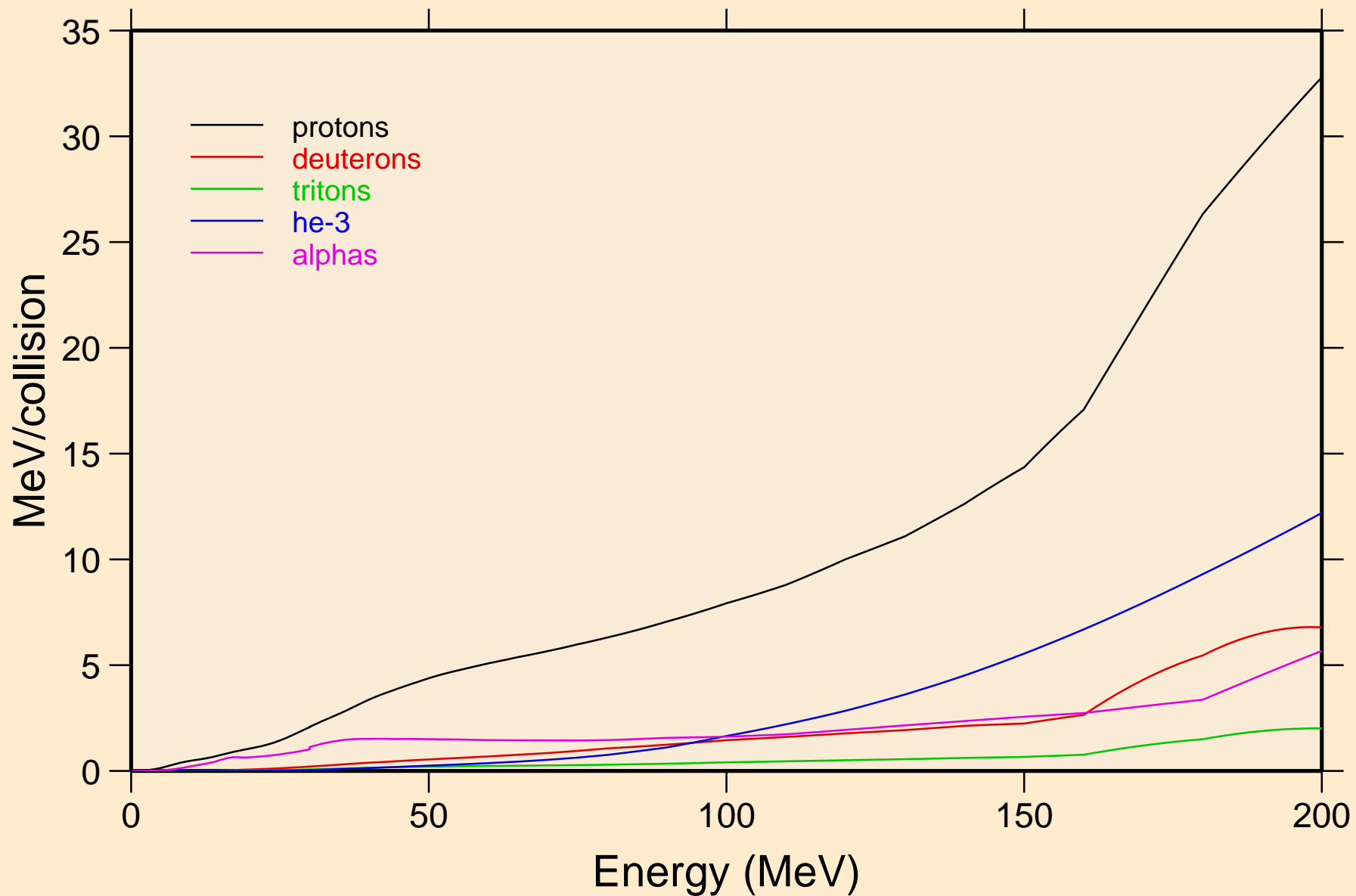

PO195M NEUTRON ACER TENDL-2019 LIBRARY; T=293.16K
Recoil Heating

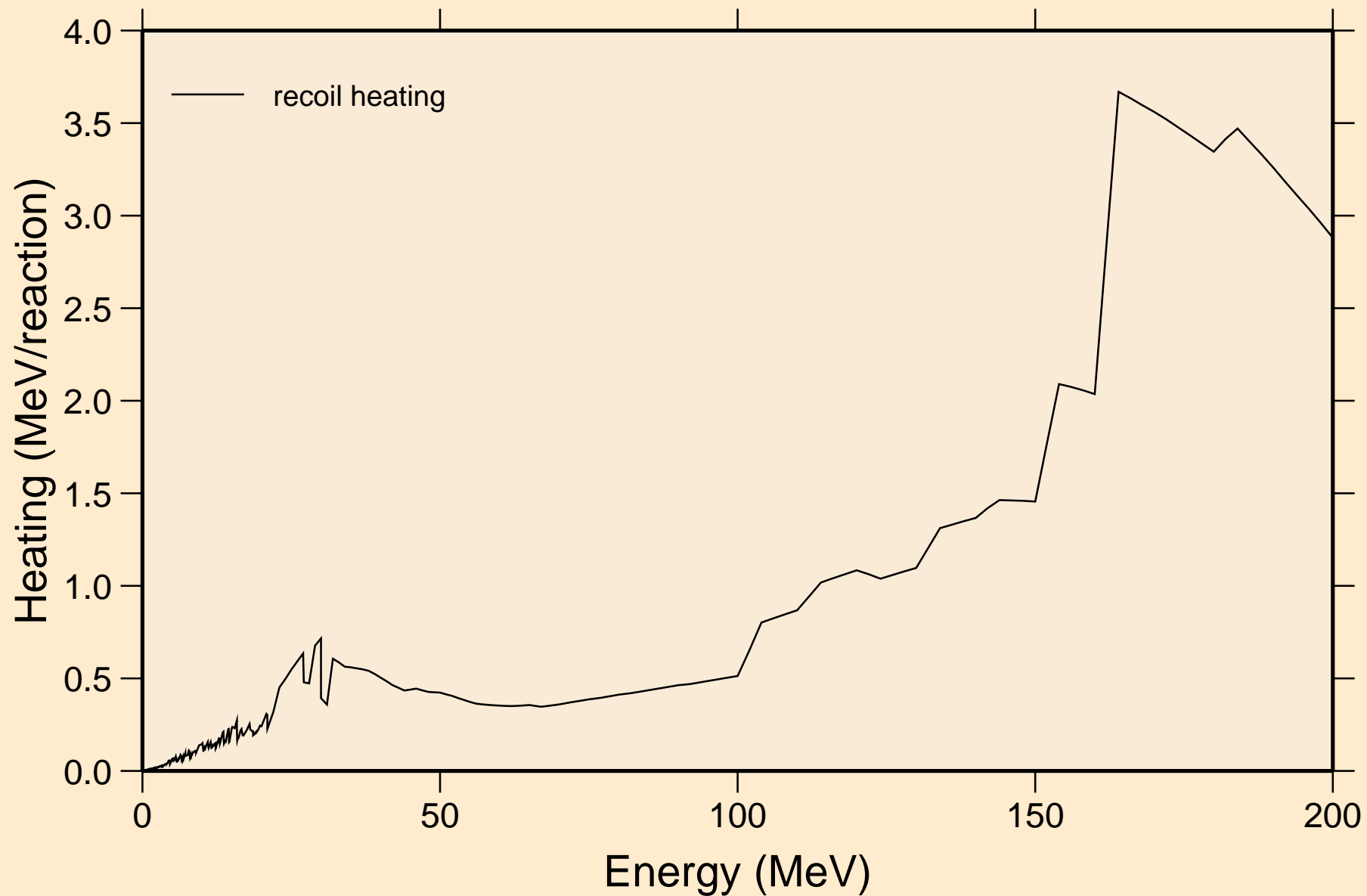

PO195M NEUTRON ACER TENDL-2019 LIBRARY; T=293.16K
Particle production cross sections

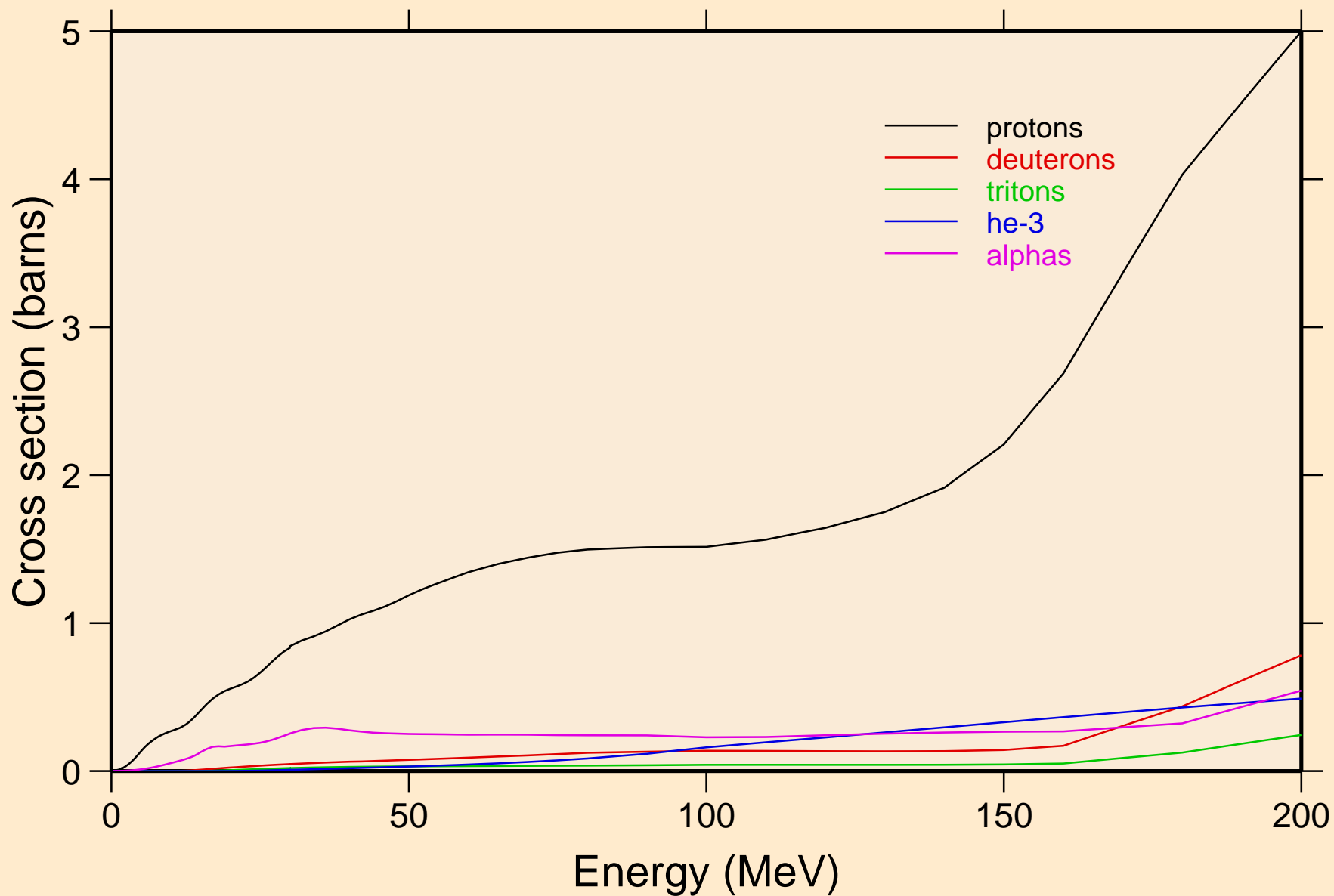

PO195M NEUTRON ACER TENDL-2019 LIBRARY; T=293.16K
protons from (n,x)

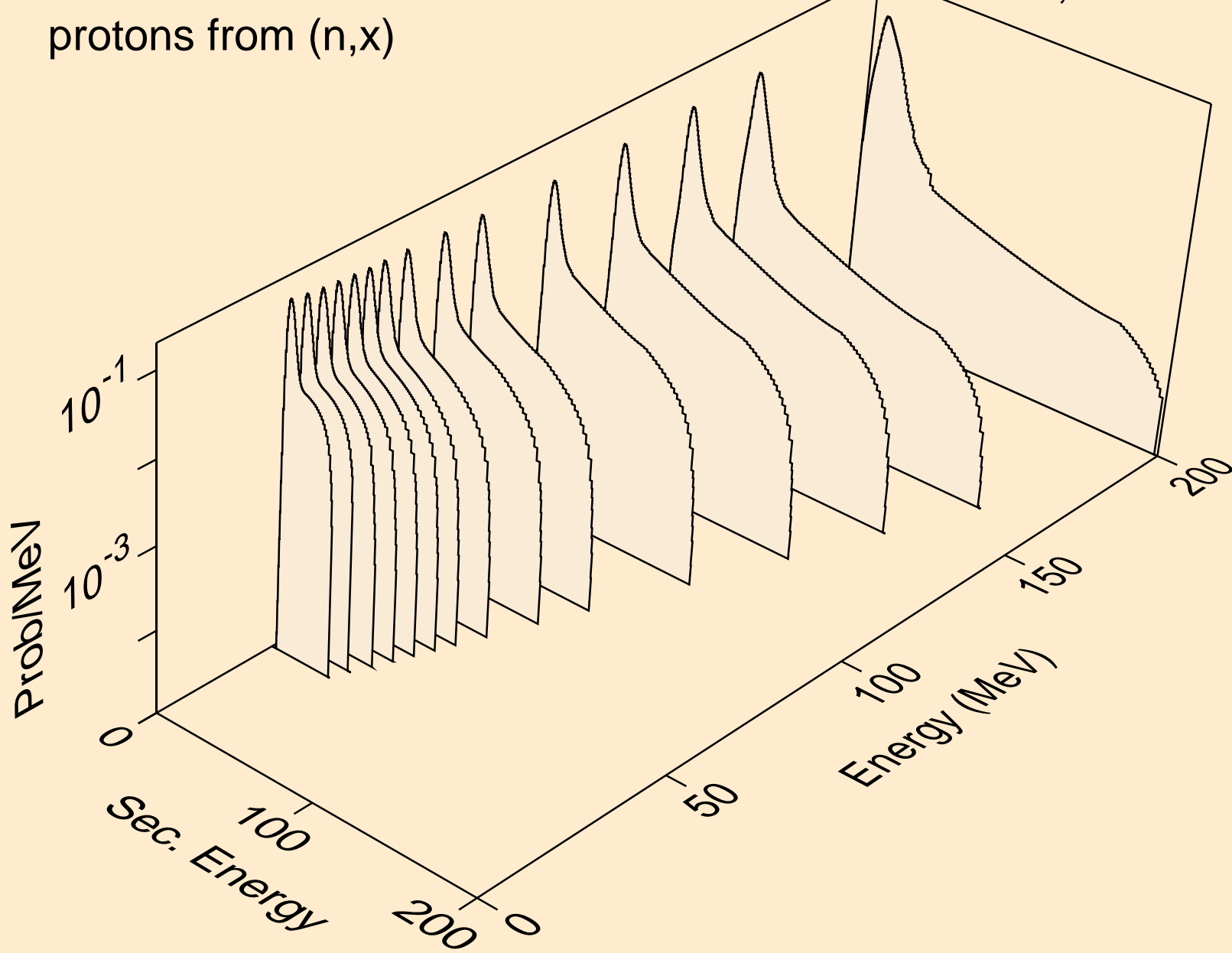

PO195M NEUTRON ACER TENDL-2019 LIBRARY; T=293.16K
protons from (n,n*)p

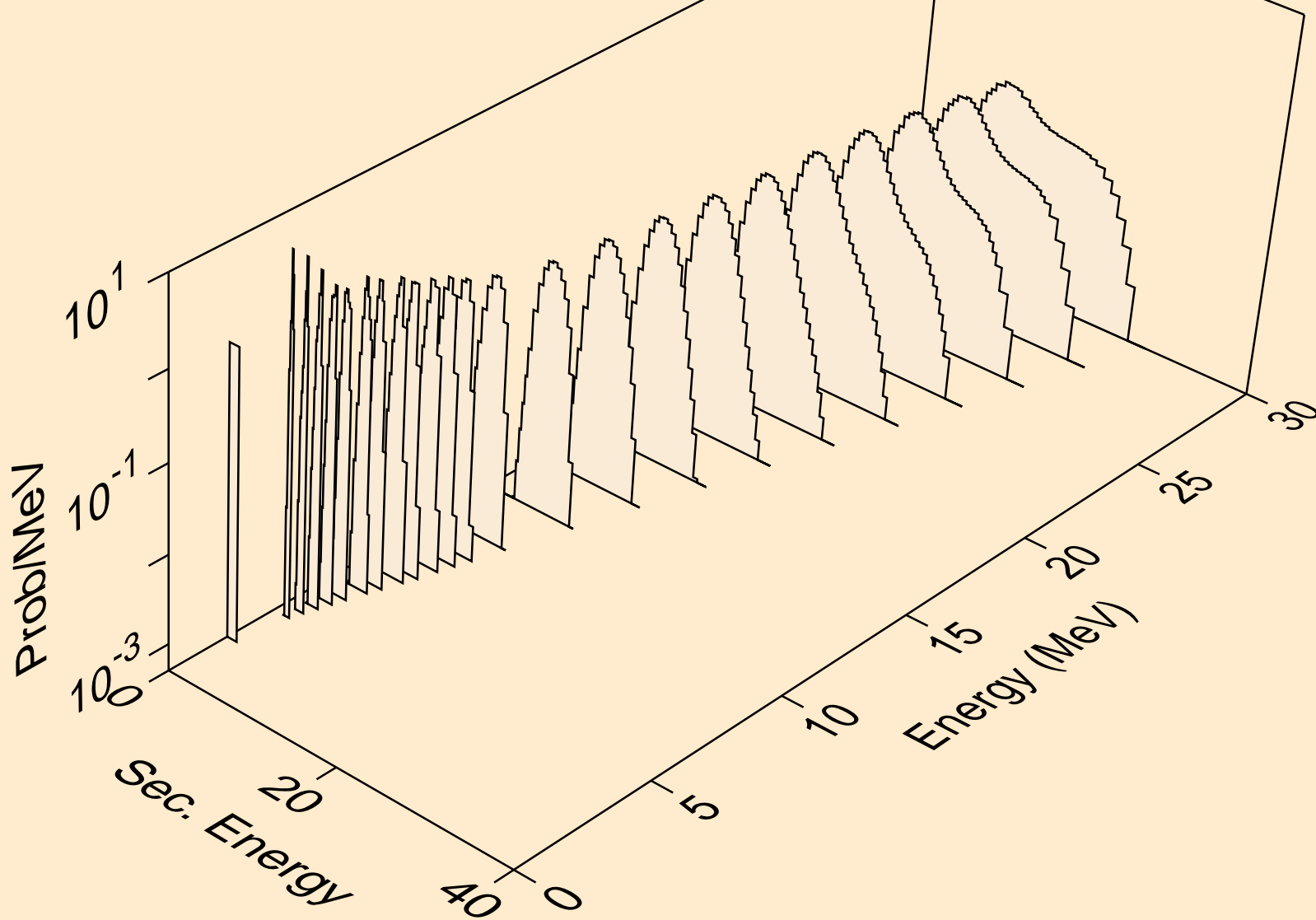

PO195M NEUTRON ACER TENDL-2019 LIBRARY; T=293.16K
protons from (n,2np)

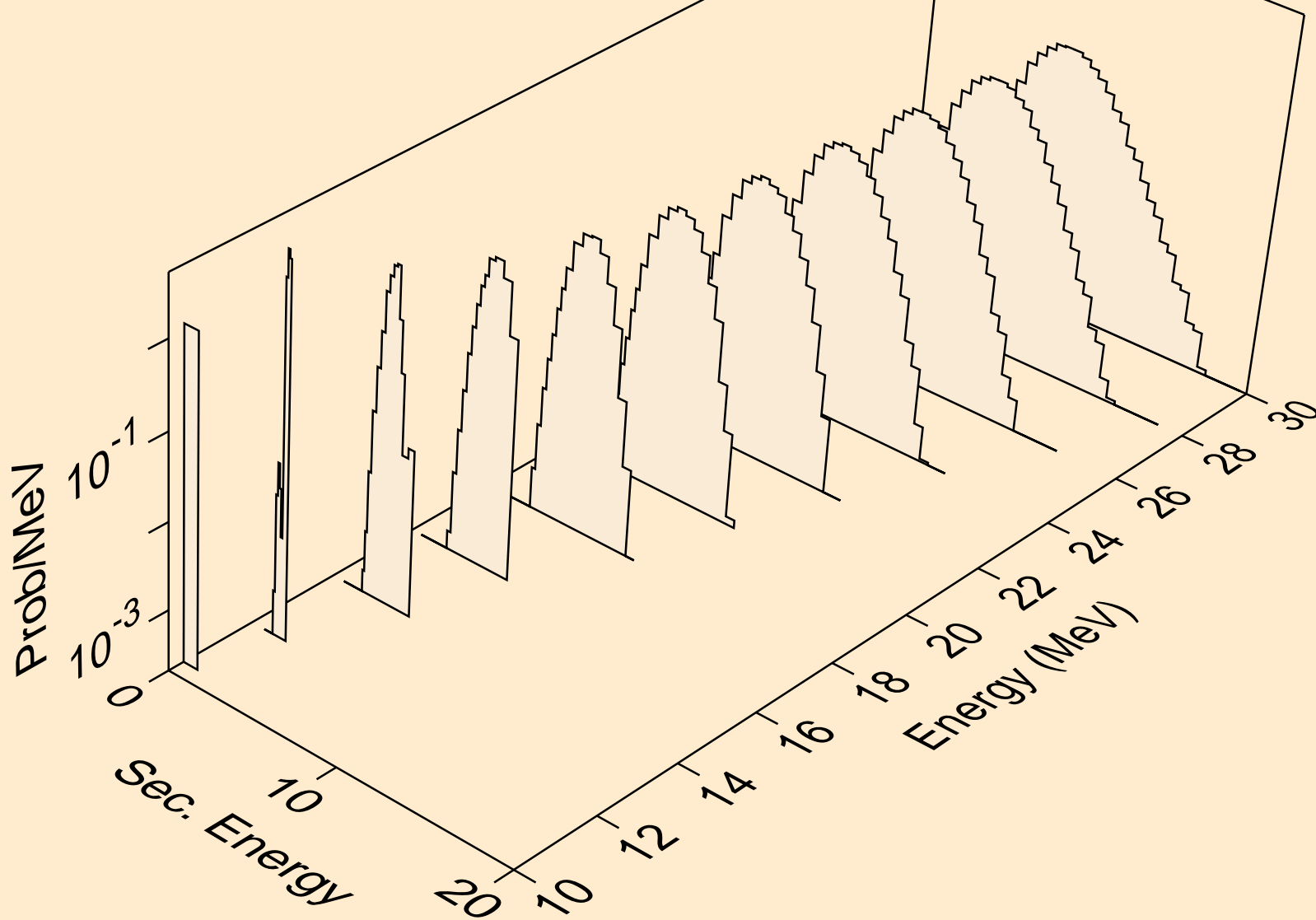

PO195M NEUTRON ACER TENDL-2019 LIBRARY; T=293.16K
protons from (n,3np)

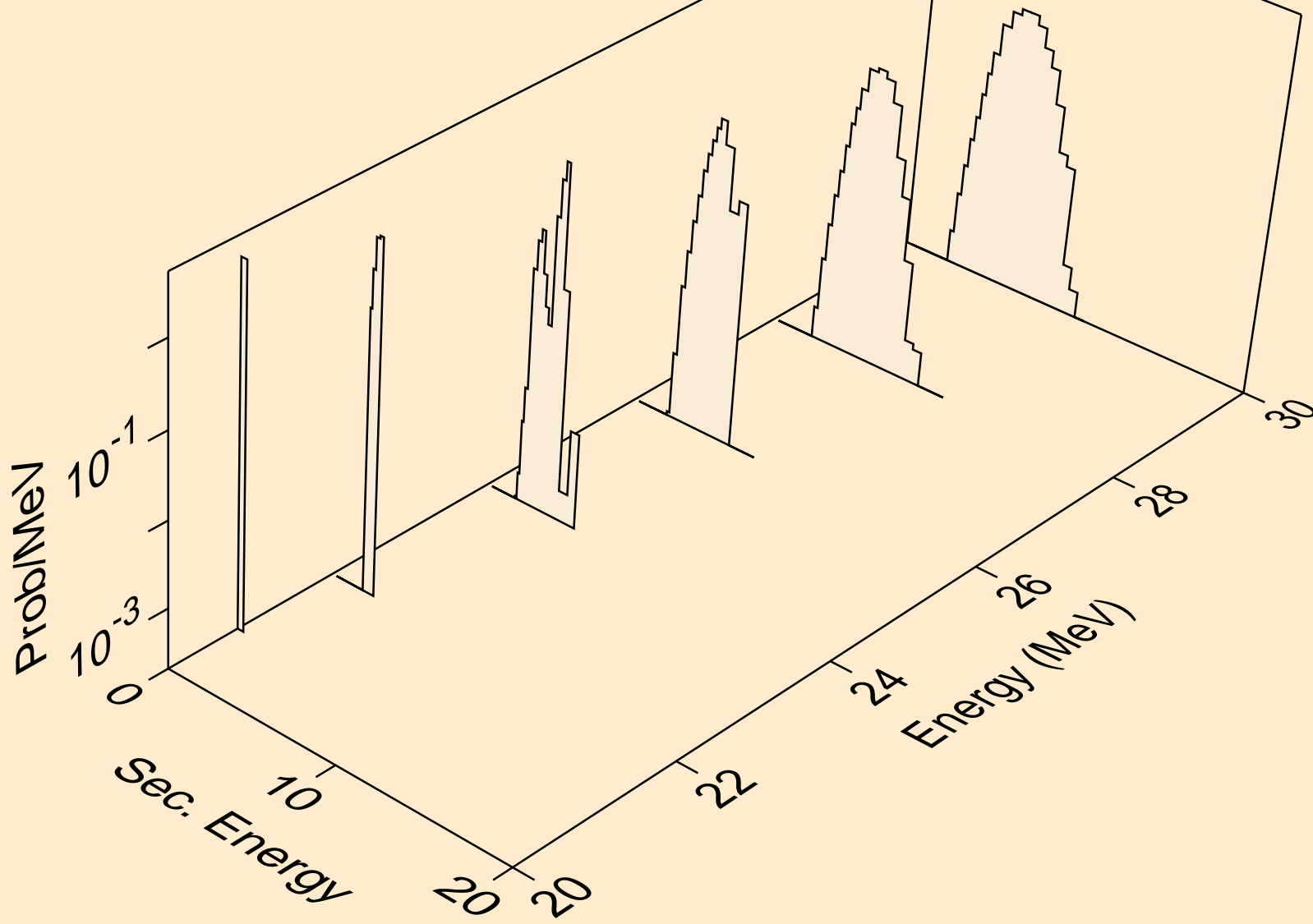

PO195M NEUTRON ACER TENDL-2019 LIBRARY; T=293.16K
protons from (n,2np)

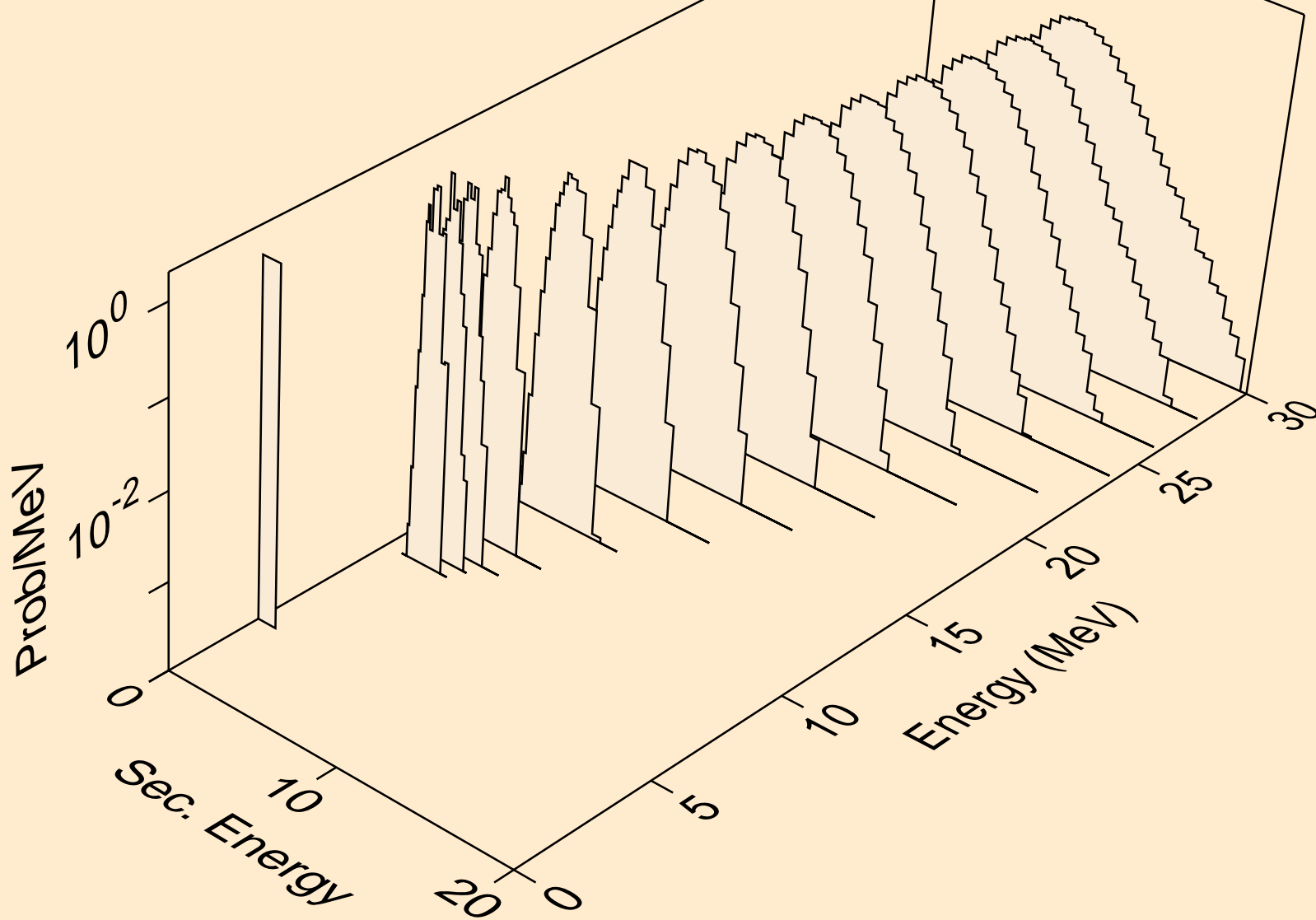

PO195M NEUTRON ACER TENDL-2019 LIBRARY; T=293.16K
protons from (n,npa)

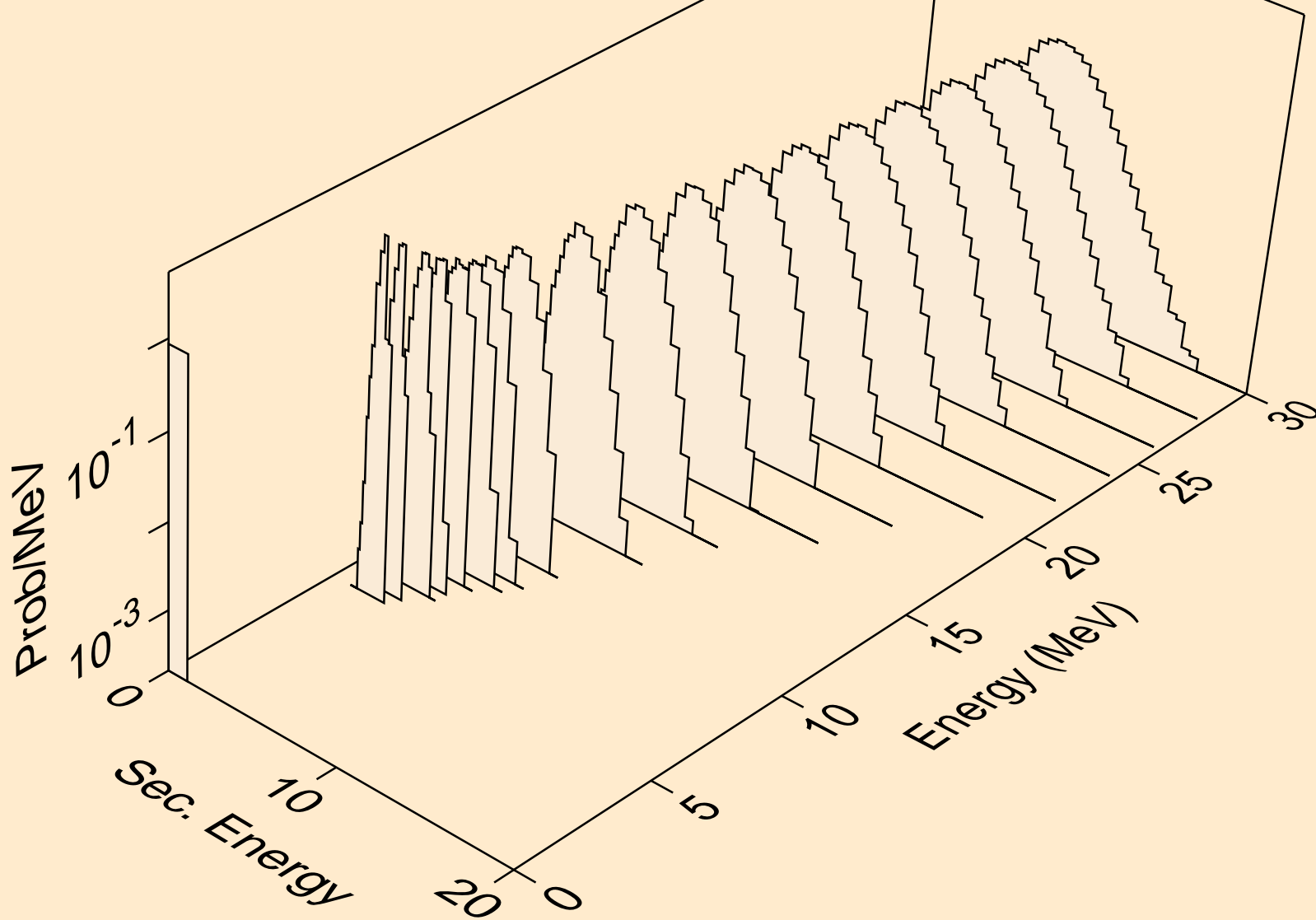

PO195M NEUTRON ACER TENDL-2019 LIBRARY; T=293.16K
protons from (n,p)

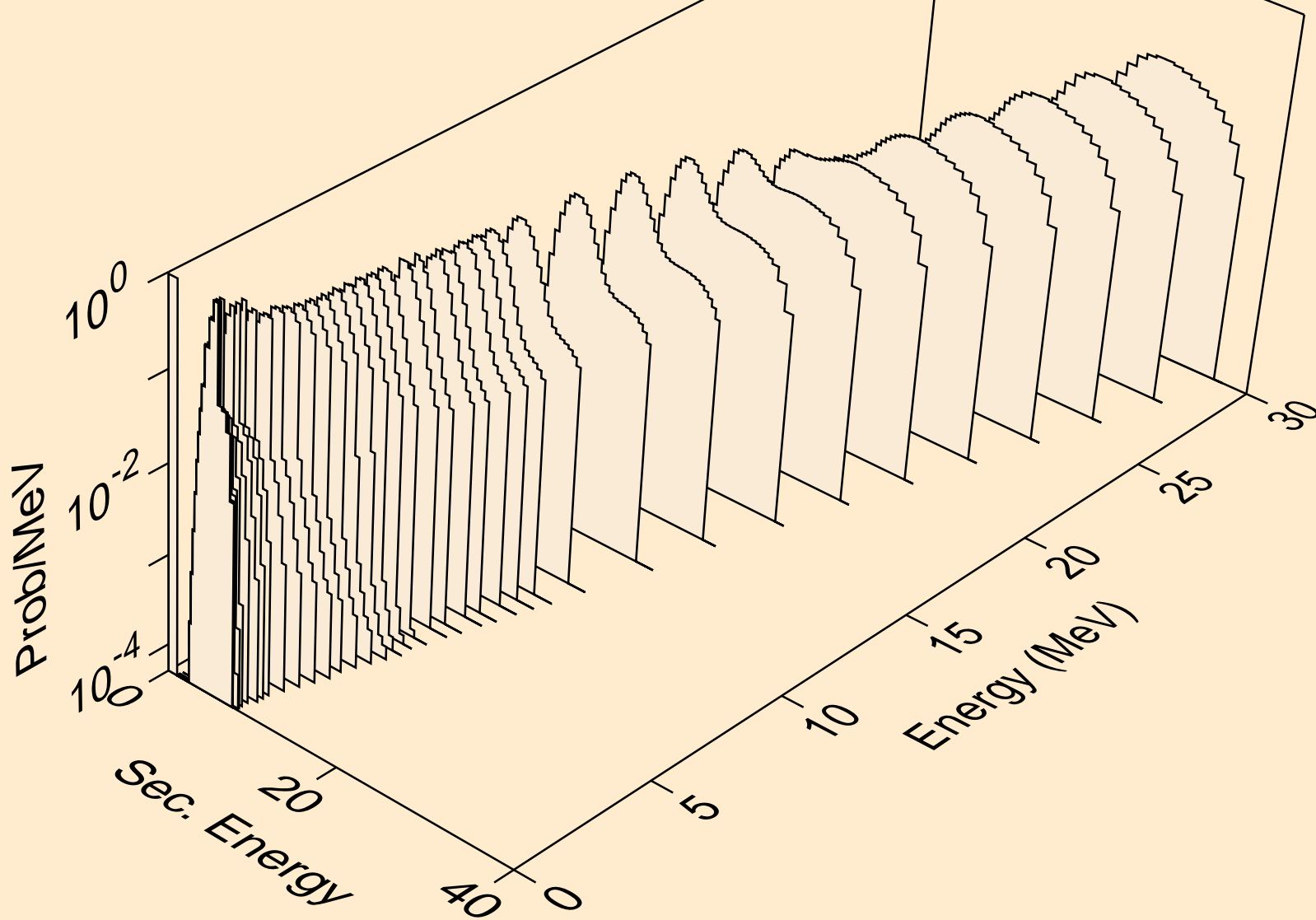

PO195M NEUTRON ACER TENDL-2019 LIBRARY; T=293.16K
protons from (n,2p)

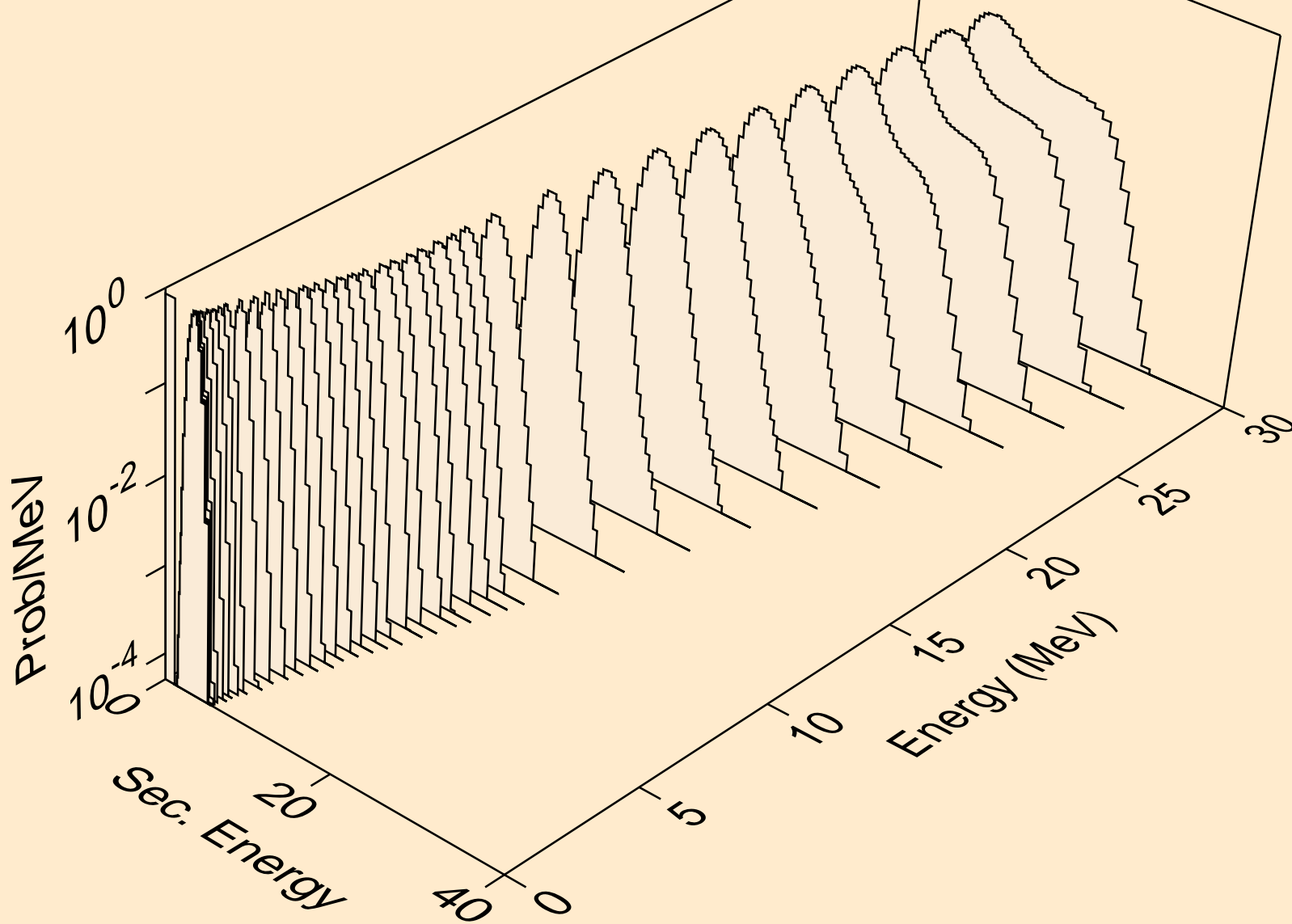

PO195M NEUTRON ACER TENDL-2019 LIBRARY; T=293.16K
protons from (n,p)

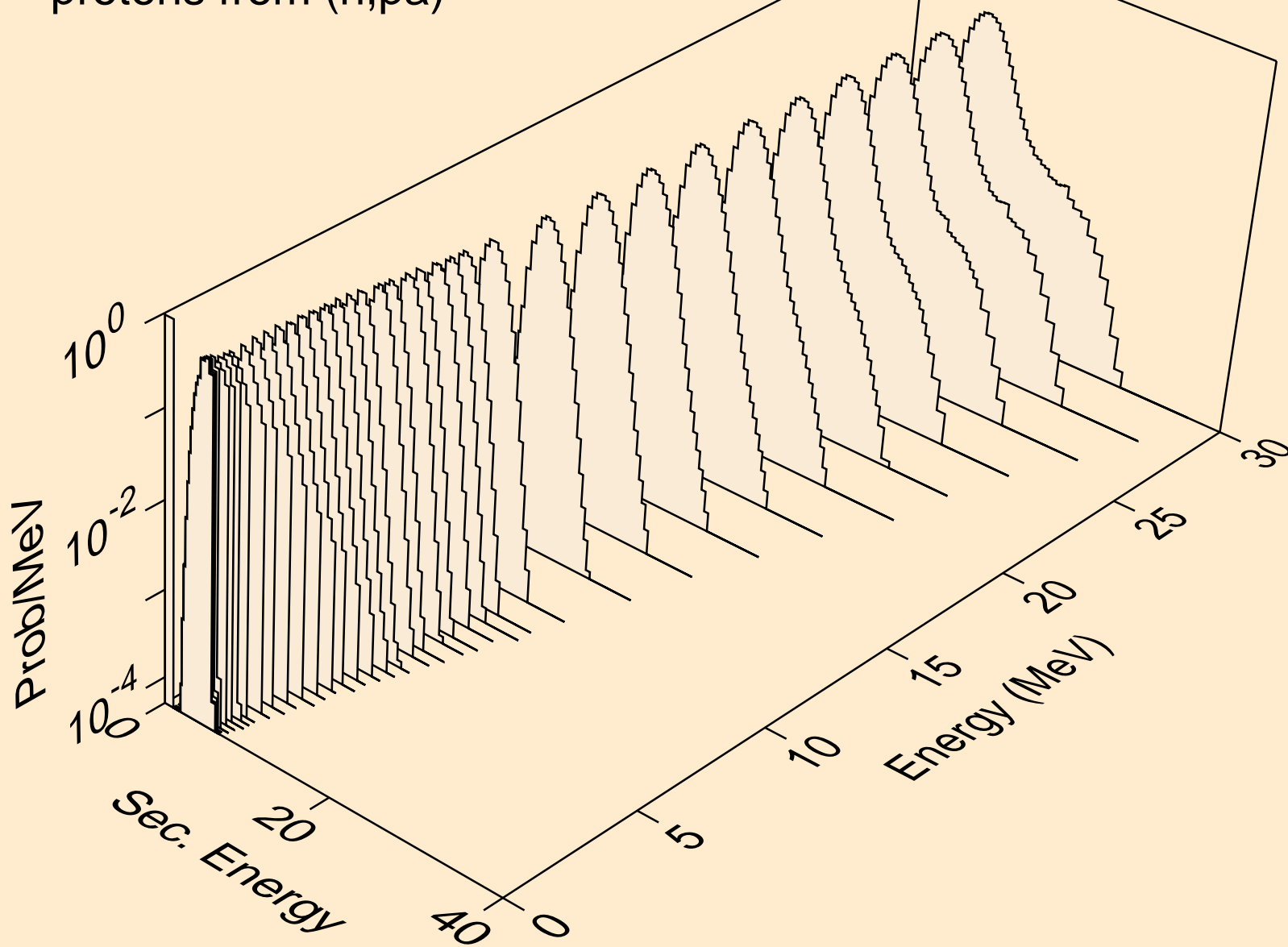

PO195M NEUTRON ACER TENDL-2019 LIBRARY; T=293.16K
protons from (n,pd)

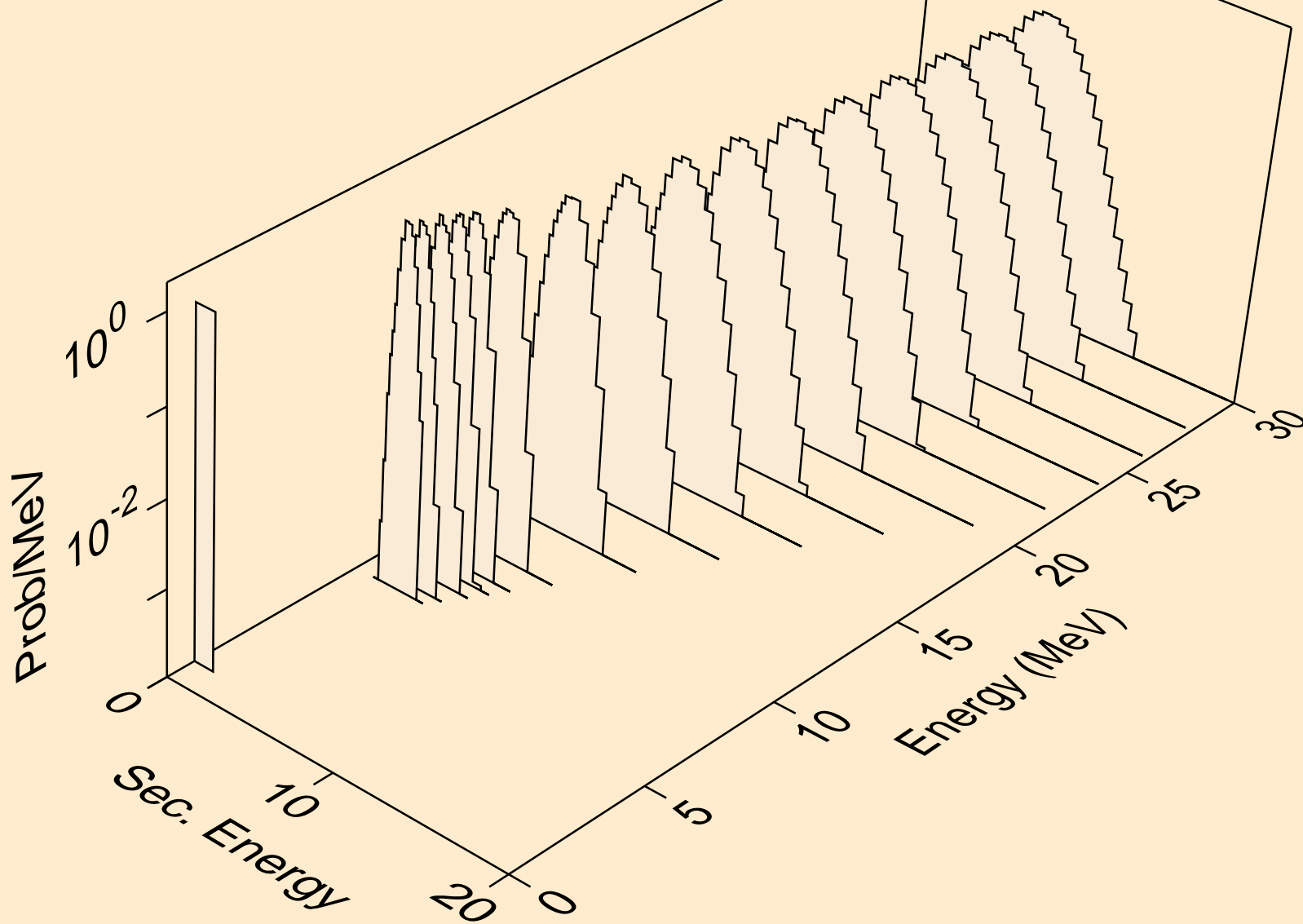

PO195M NEUTRON ACER TENDL-2019 LIBRARY; T=293.16K
protons from (n,pt)

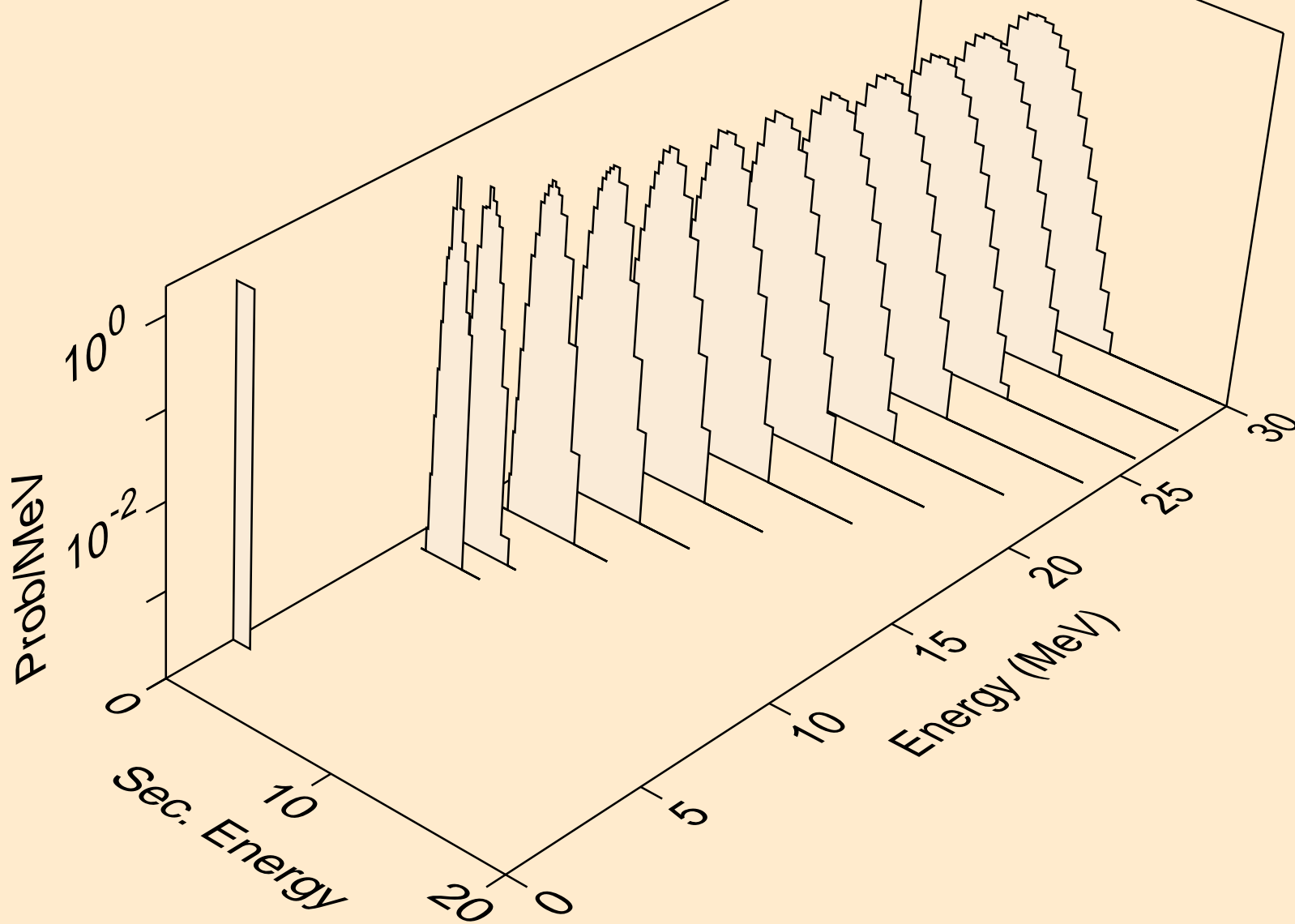

PO195M NEUTRON ACER TENDL-2019 LIBRARY; T=293.16K
deuterons from (n,x)

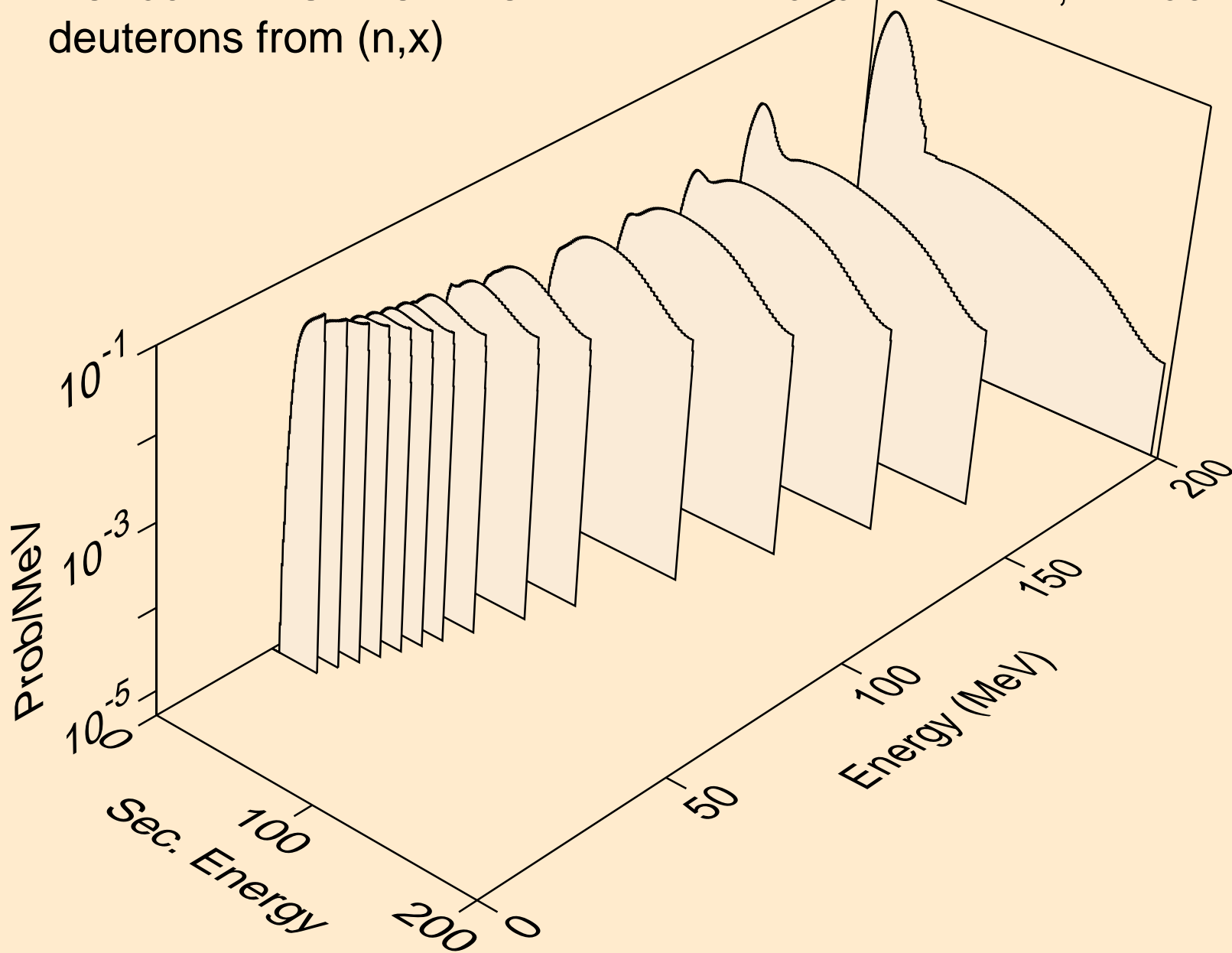

PO195M NEUTRON ACER TENDL-2019 LIBRARY; T=293.16K
deuterons from (n,2nd)

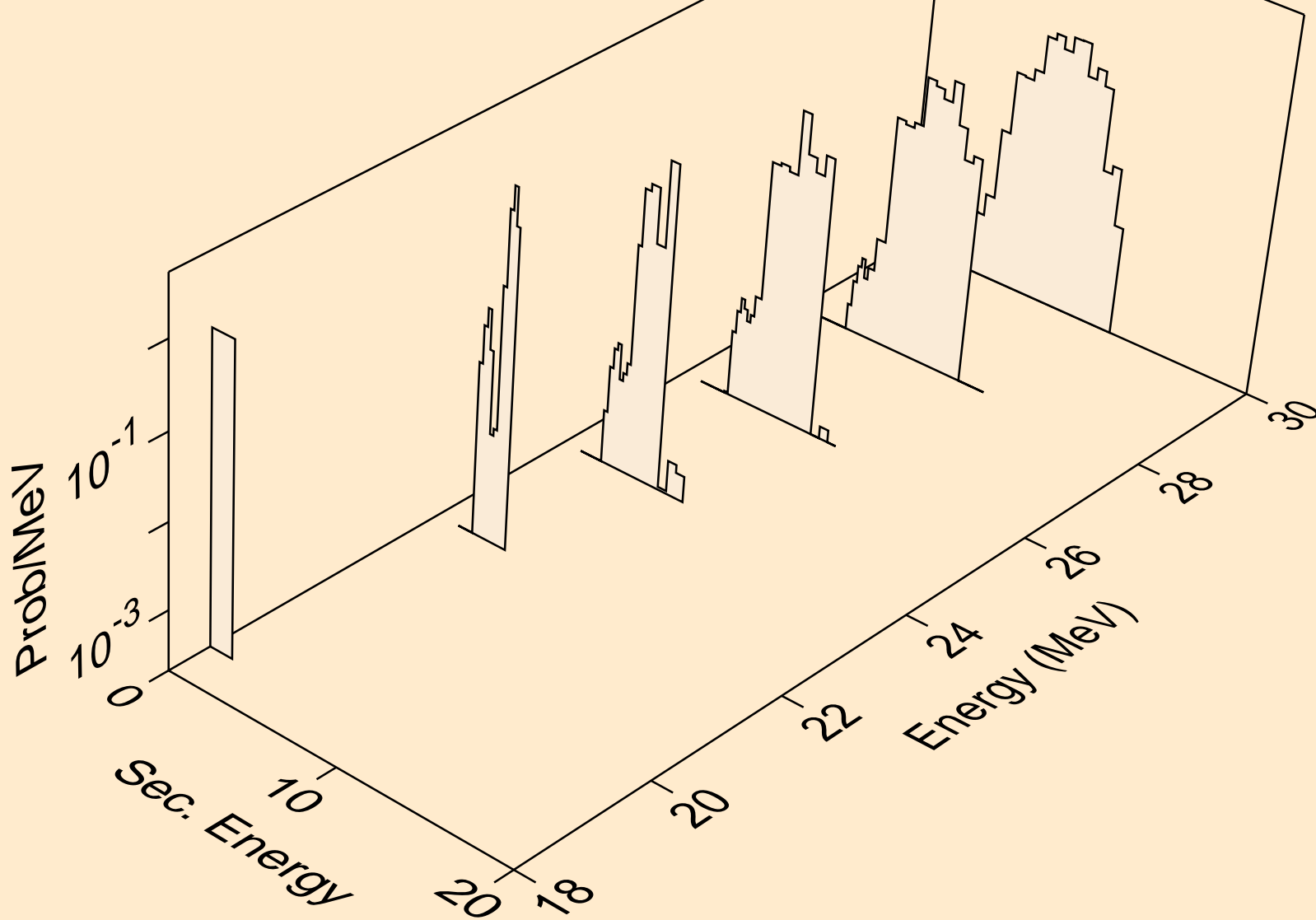

PO195M NEUTRON ACER TENDL-2019 LIBRARY; T=293.16K
deuterons from (n,n*)d

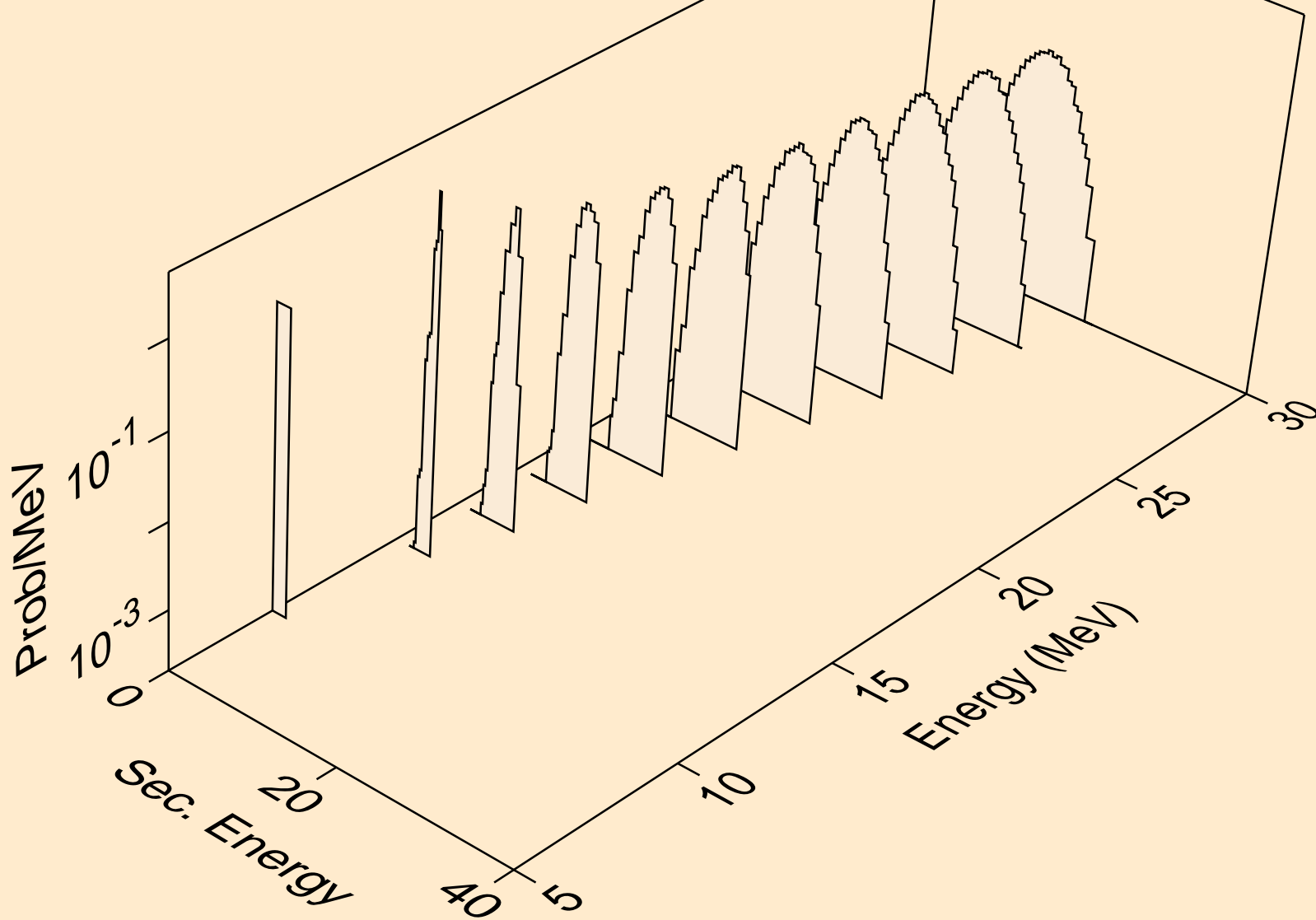

PO195M NEUTRON ACER TENDL-2019 LIBRARY; T=293.16K
deuterons from (n,d)

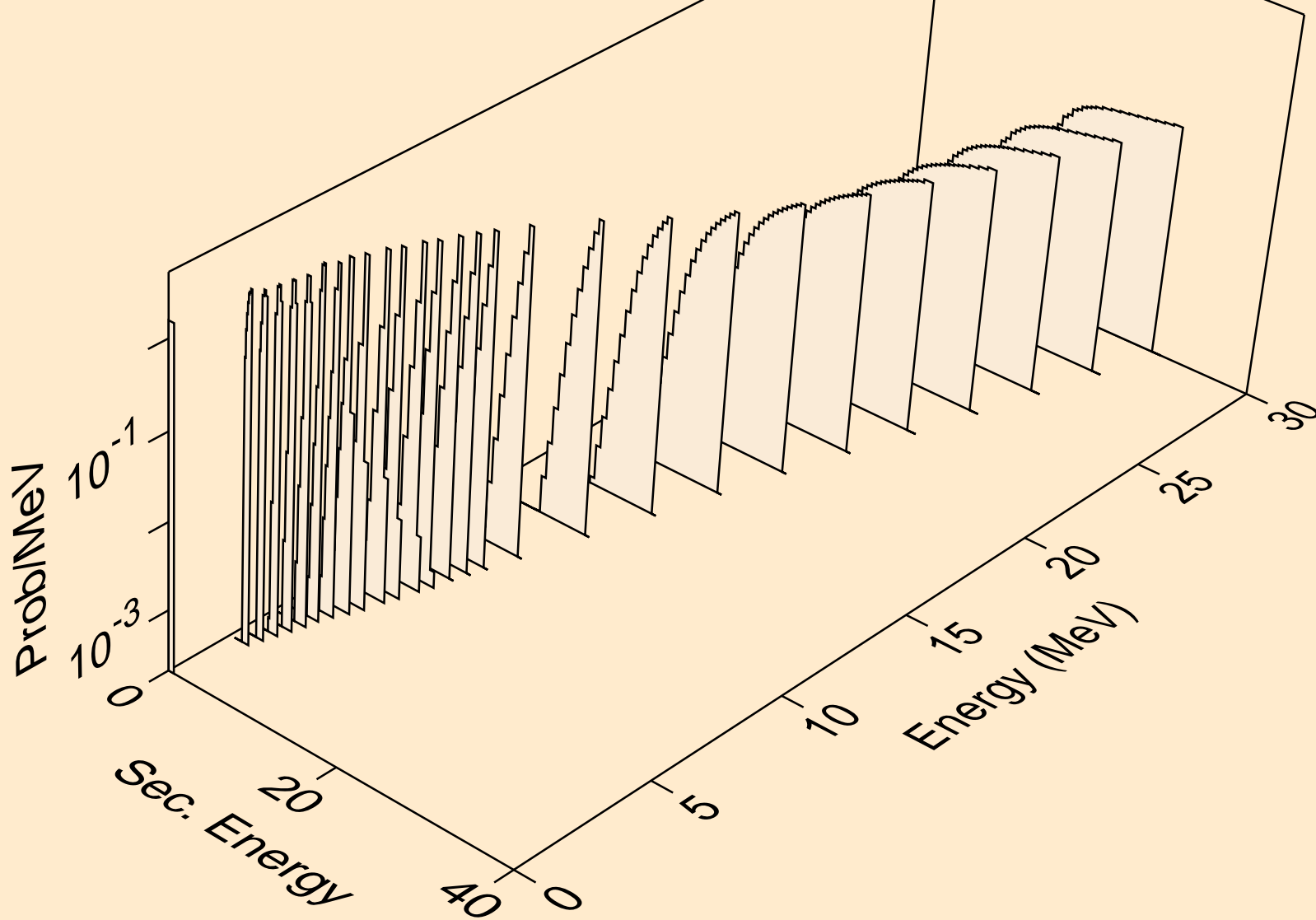

PO195M NEUTRON ACER TENDL-2019 LIBRARY; T=293.16K
deuterons from (n,pd)

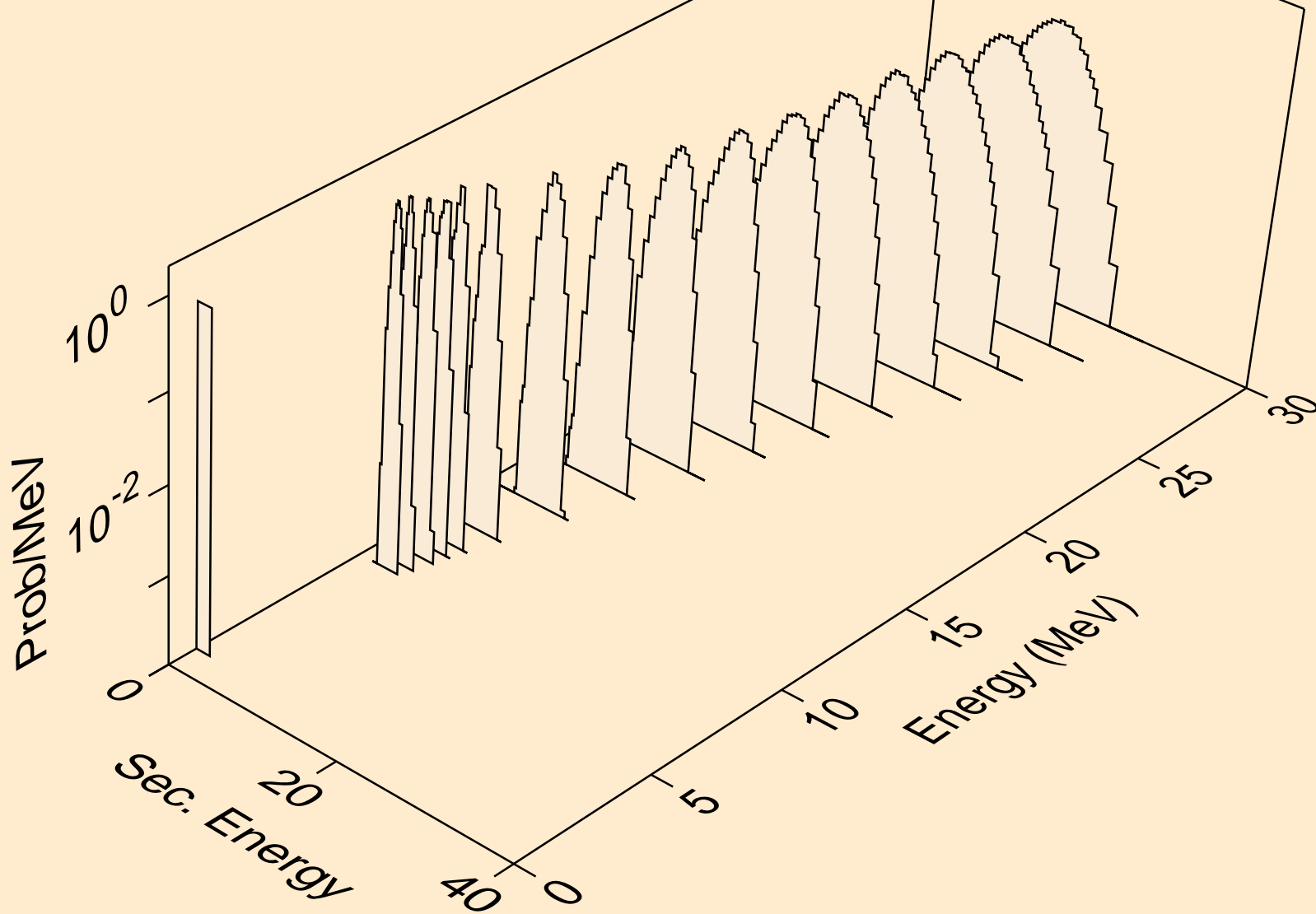

PO195M NEUTRON ACER TENDL-2019 LIBRARY; T=293.16K
deuterons from (n,da)

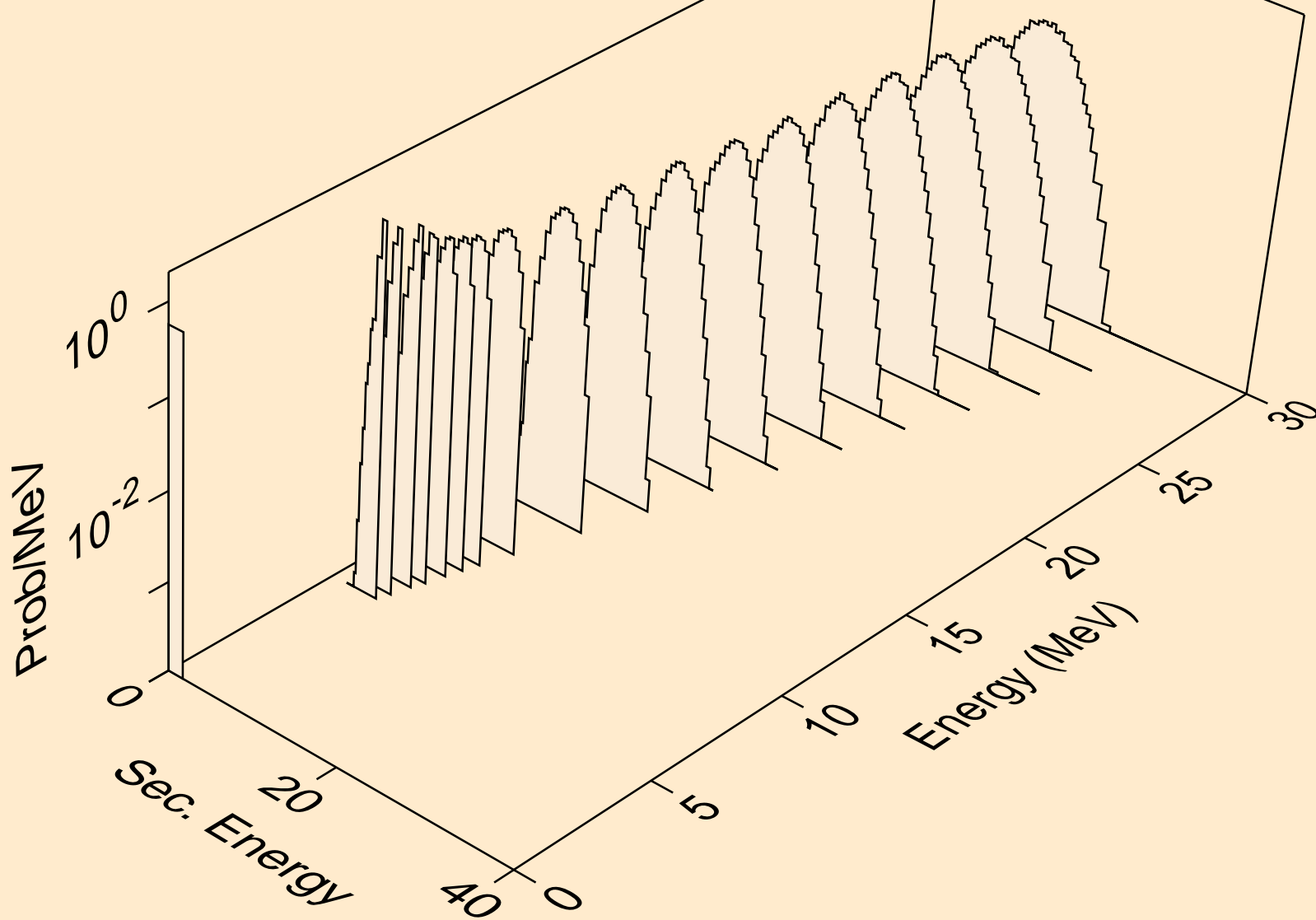

PO195M NEUTRON ACER TENDL-2019 LIBRARY; T=293.16K
tritons from (n,x)

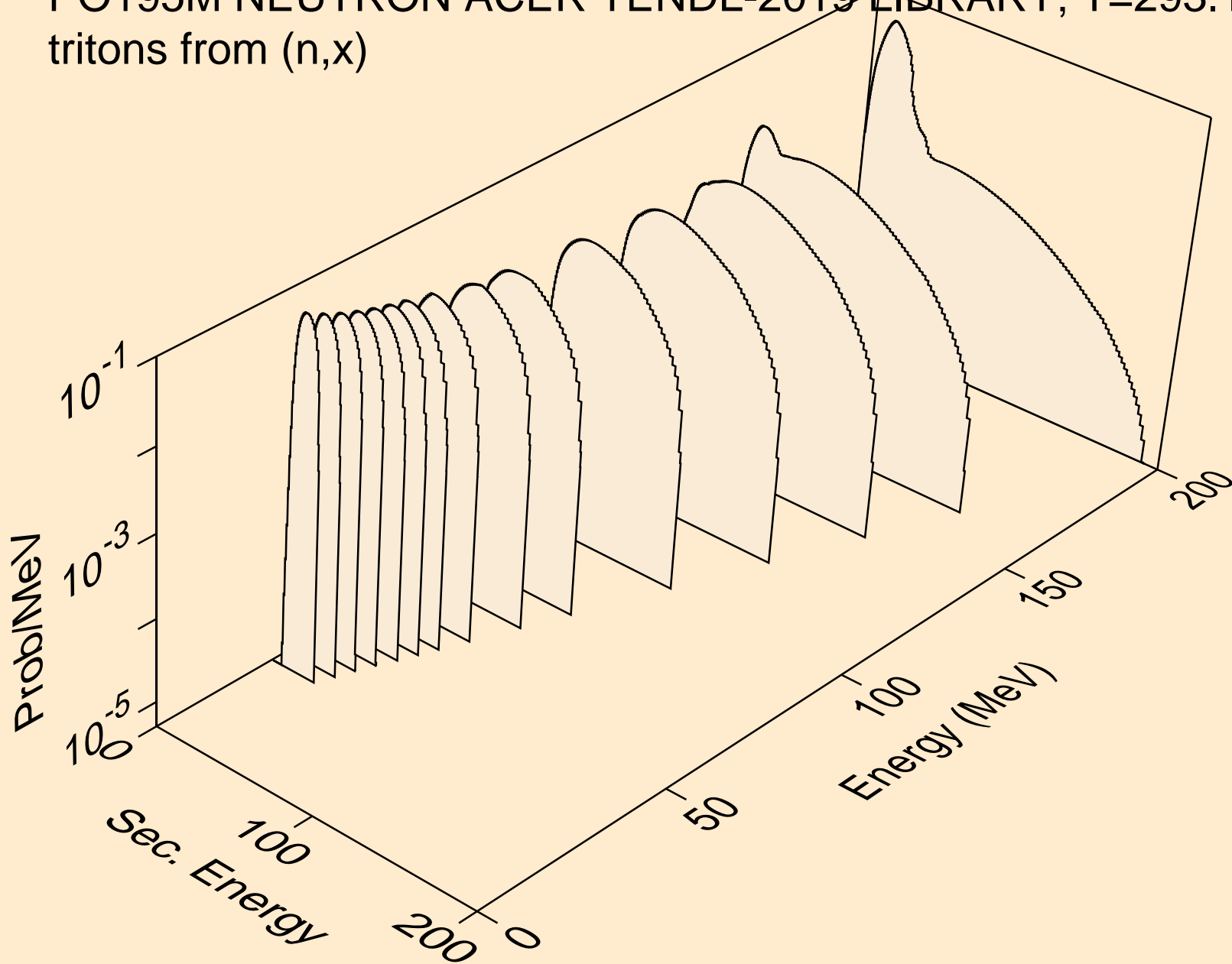

PO195M NEUTRON ACER TENDL-2019 LIBRARY; T=293.16K
tritons from (n,n*)t

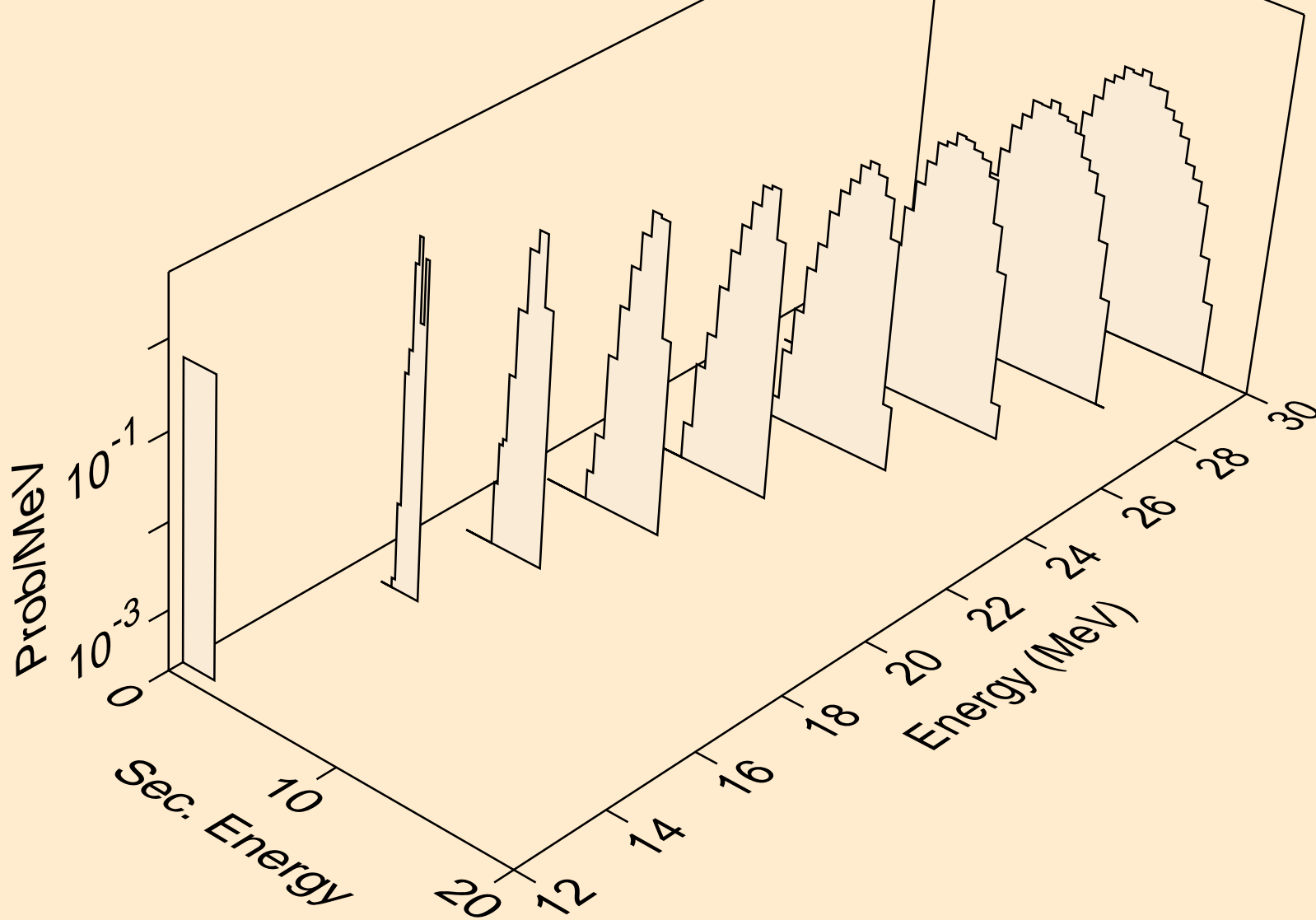

PO195M NEUTRON ACER TENDL-2019 LIBRARY; T=293.16K
tritons from (n,t)

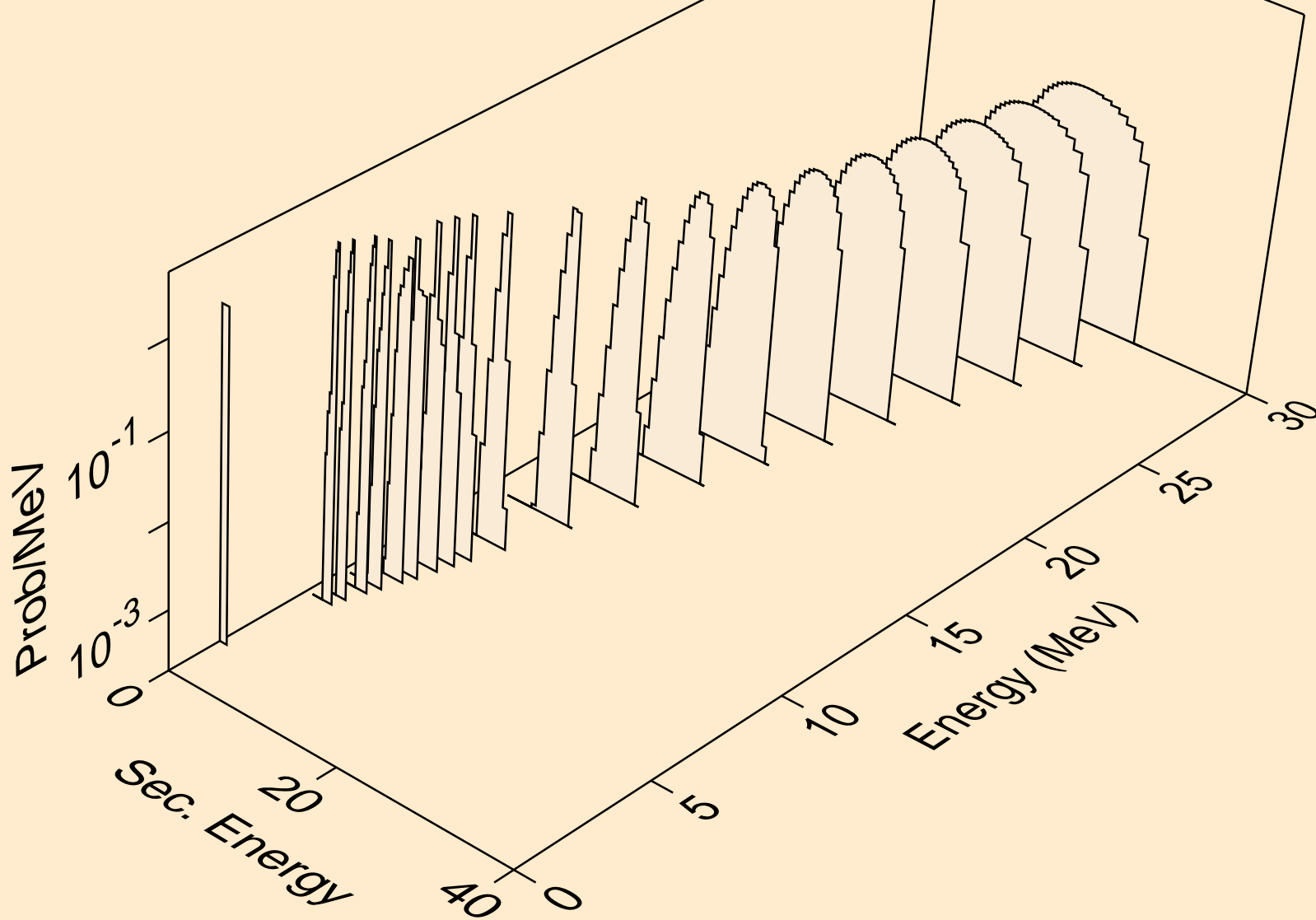

PO195M NEUTRON ACER TENDL-2019 LIBRARY; T=293.16K
tritons from (n,pt)

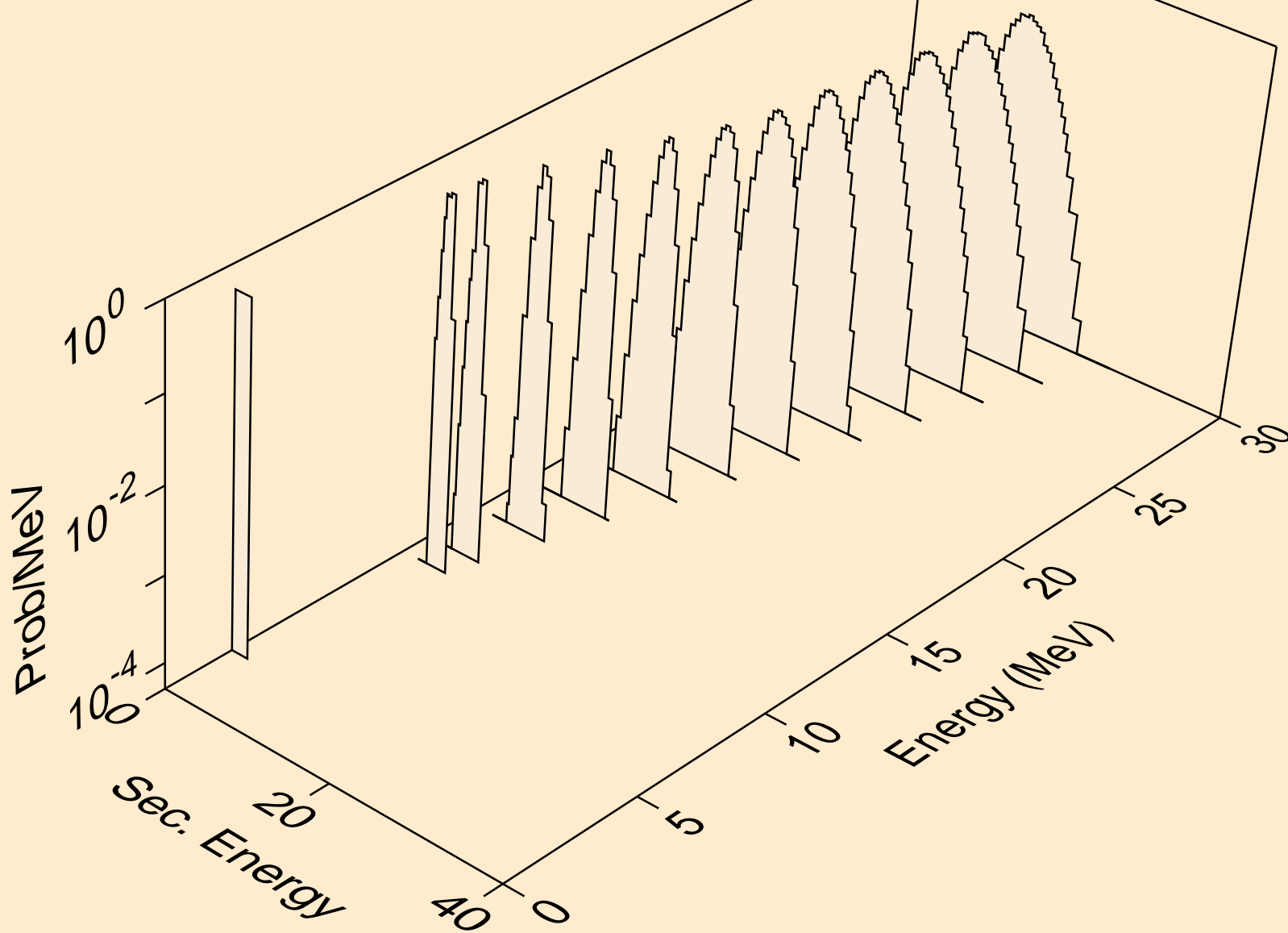

PO195M NEUTRON ACER TENDL-2019 LIBRARY; T=293.16K
he3s from (n,x)

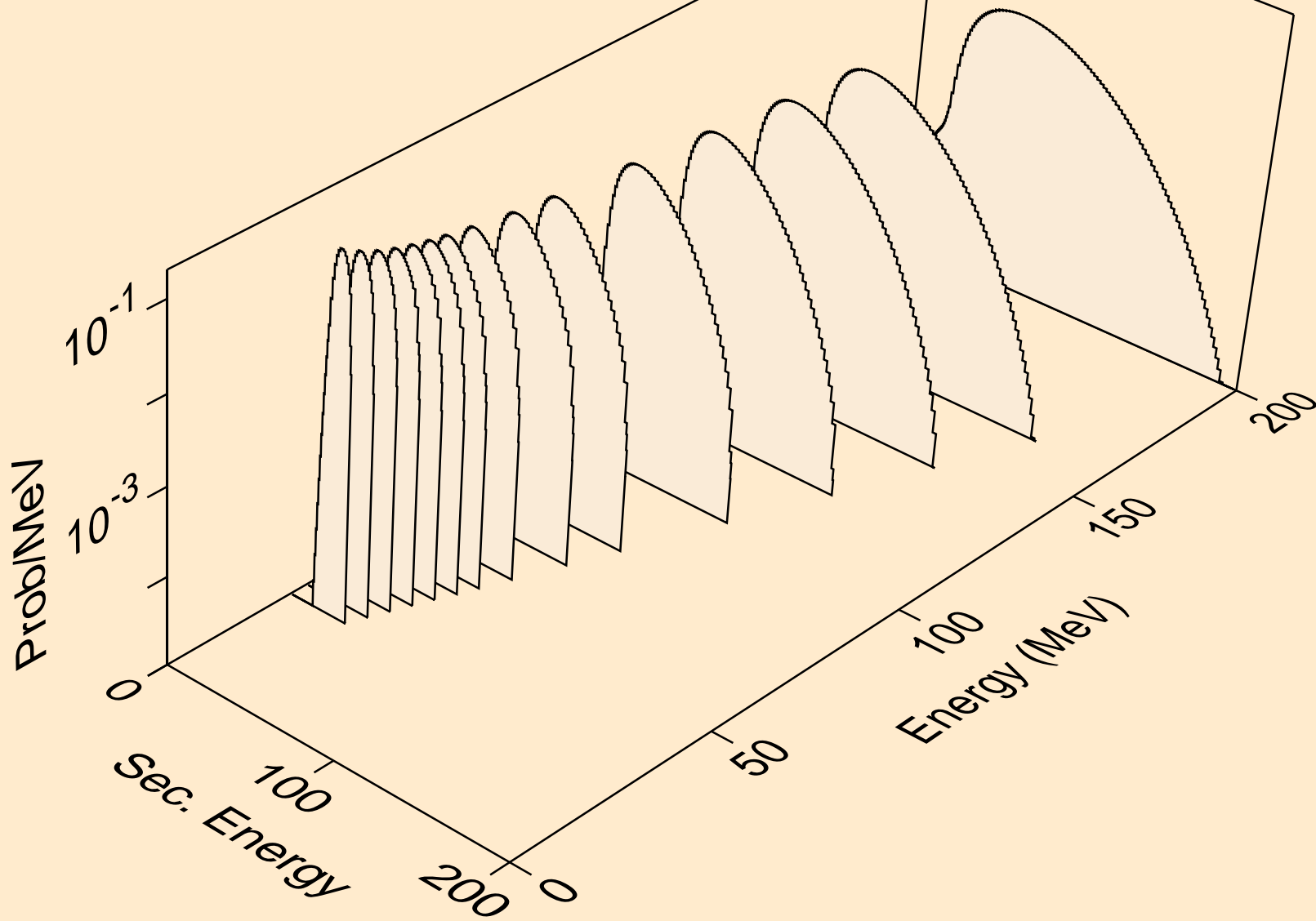

PO195M NEUTRON ACER TENDL-2019 LIBRARY; T=293.16K
he3s from (n,n*)he3

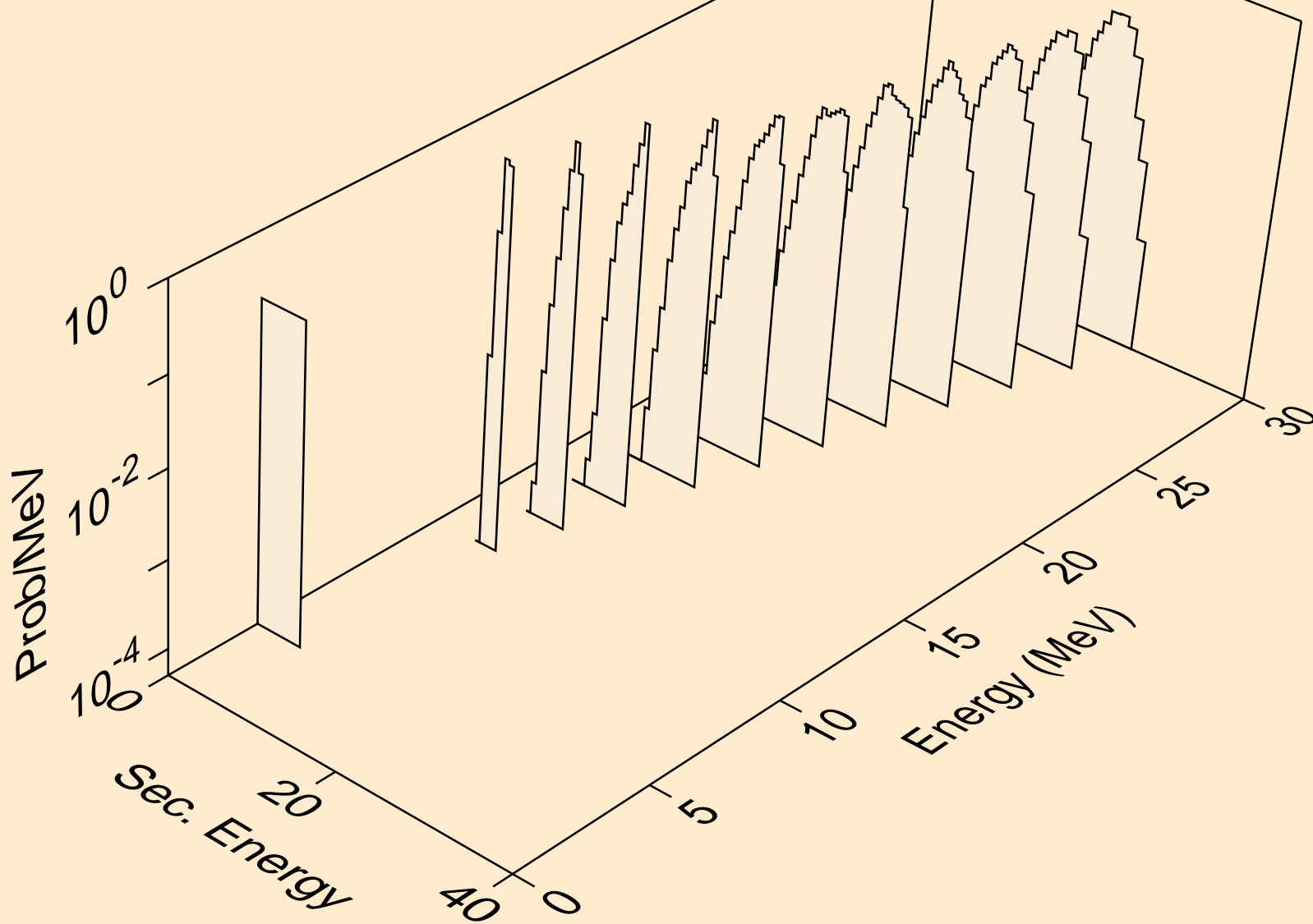

PO195M NEUTRON ACER TENDL-2019 LIBRARY; T=293.16K
he3s from (n,he3)

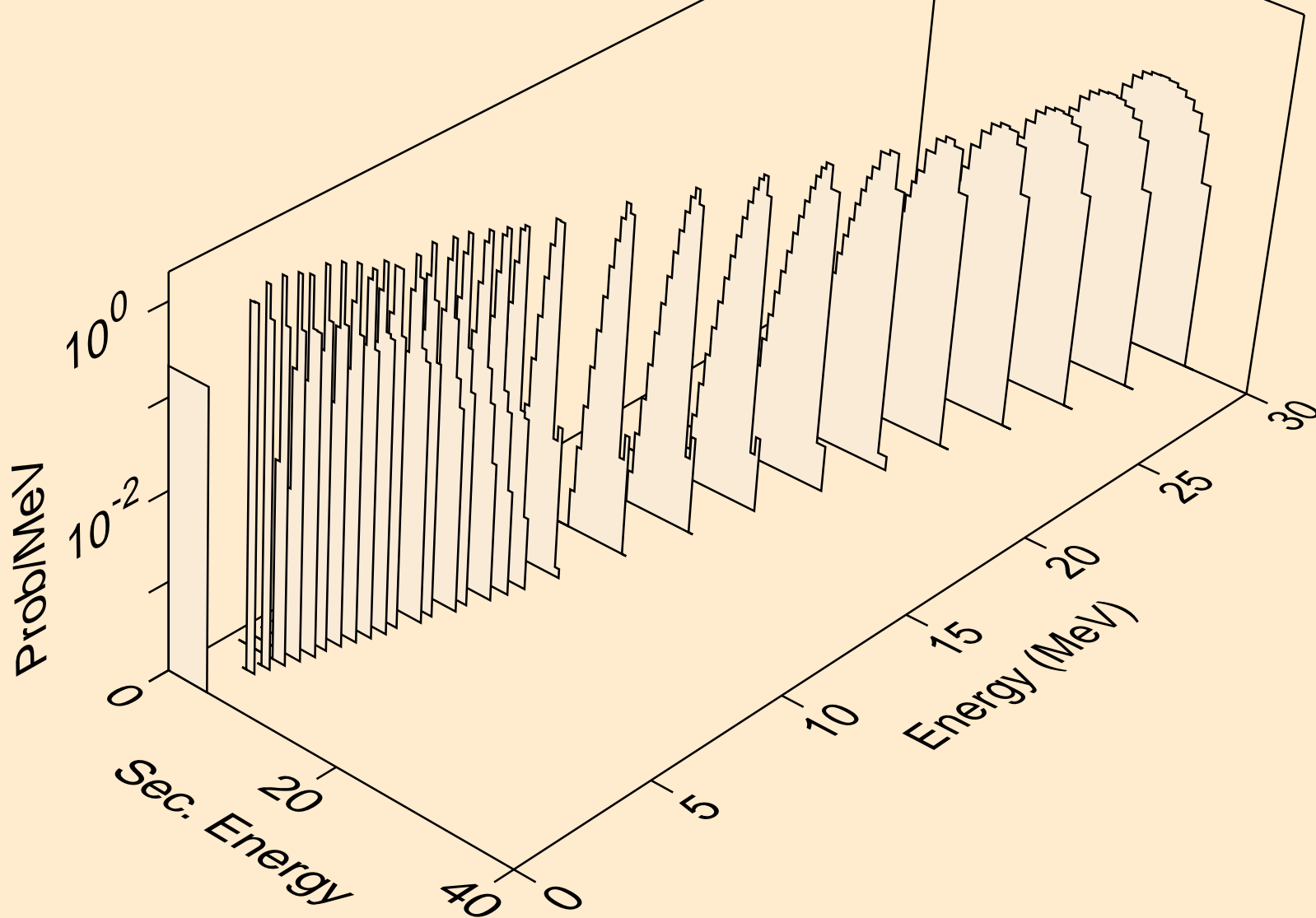

PO195M NEUTRON ACER TENDL-2019 LIBRARY; T=293.16K
alphas from (n,x)

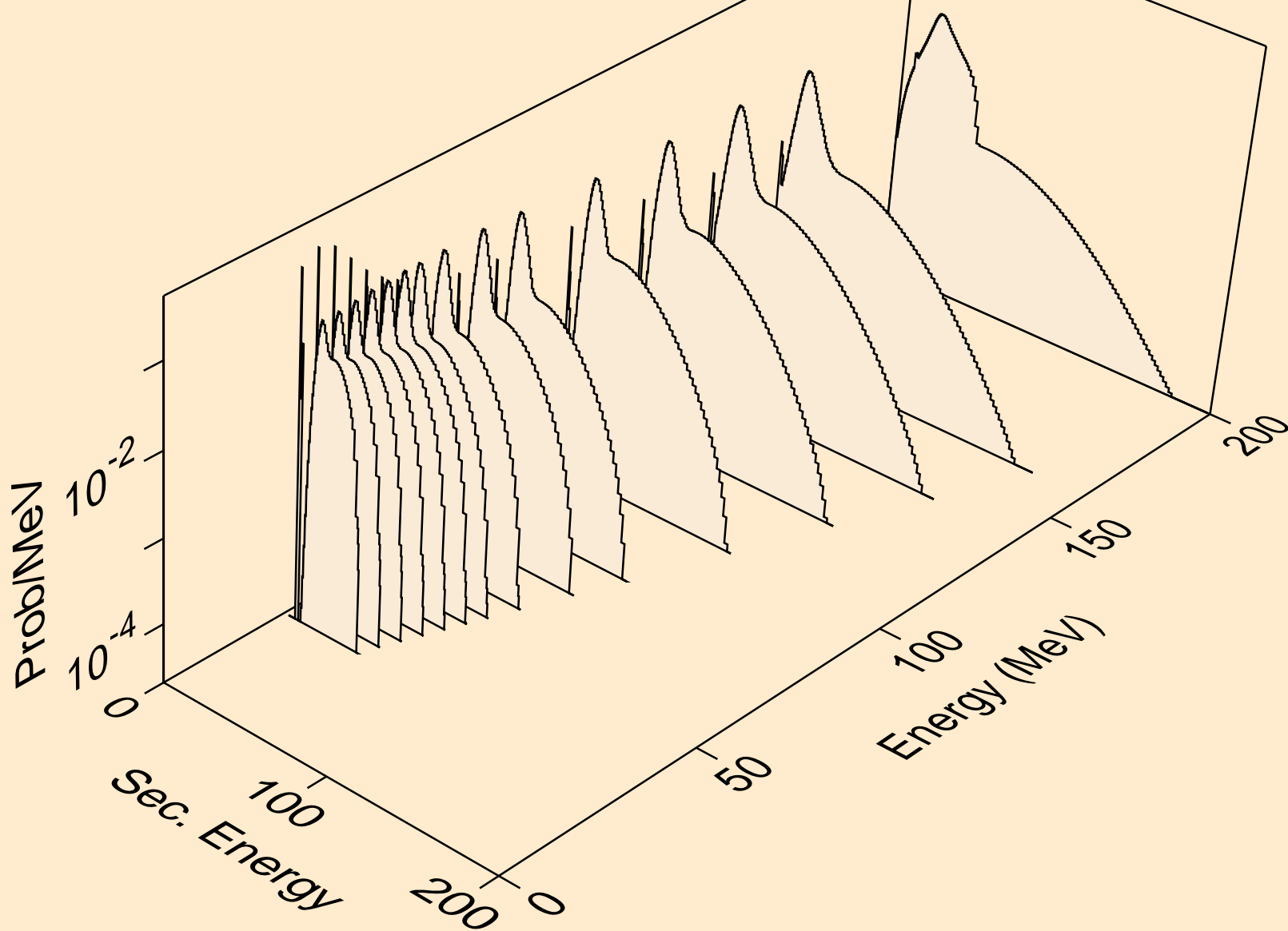

PO195M NEUTRON ACER TENDL-2019 LIBRARY; T=293.16K
alphas from (n,n*)a

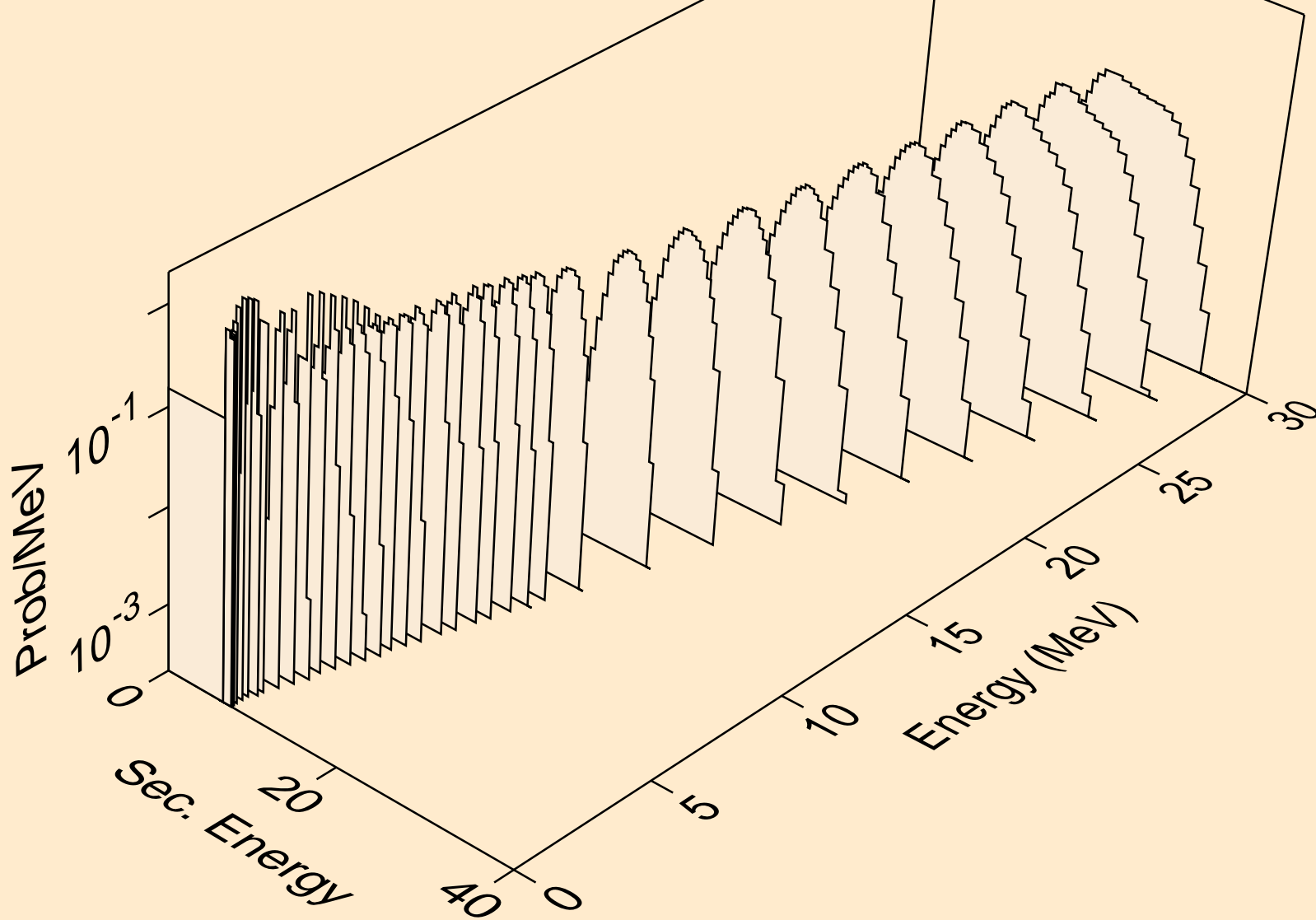

PO195M NEUTRON ACER TENDL-2019 LIBRARY; T=293.16K
alphas from (n,2n)a

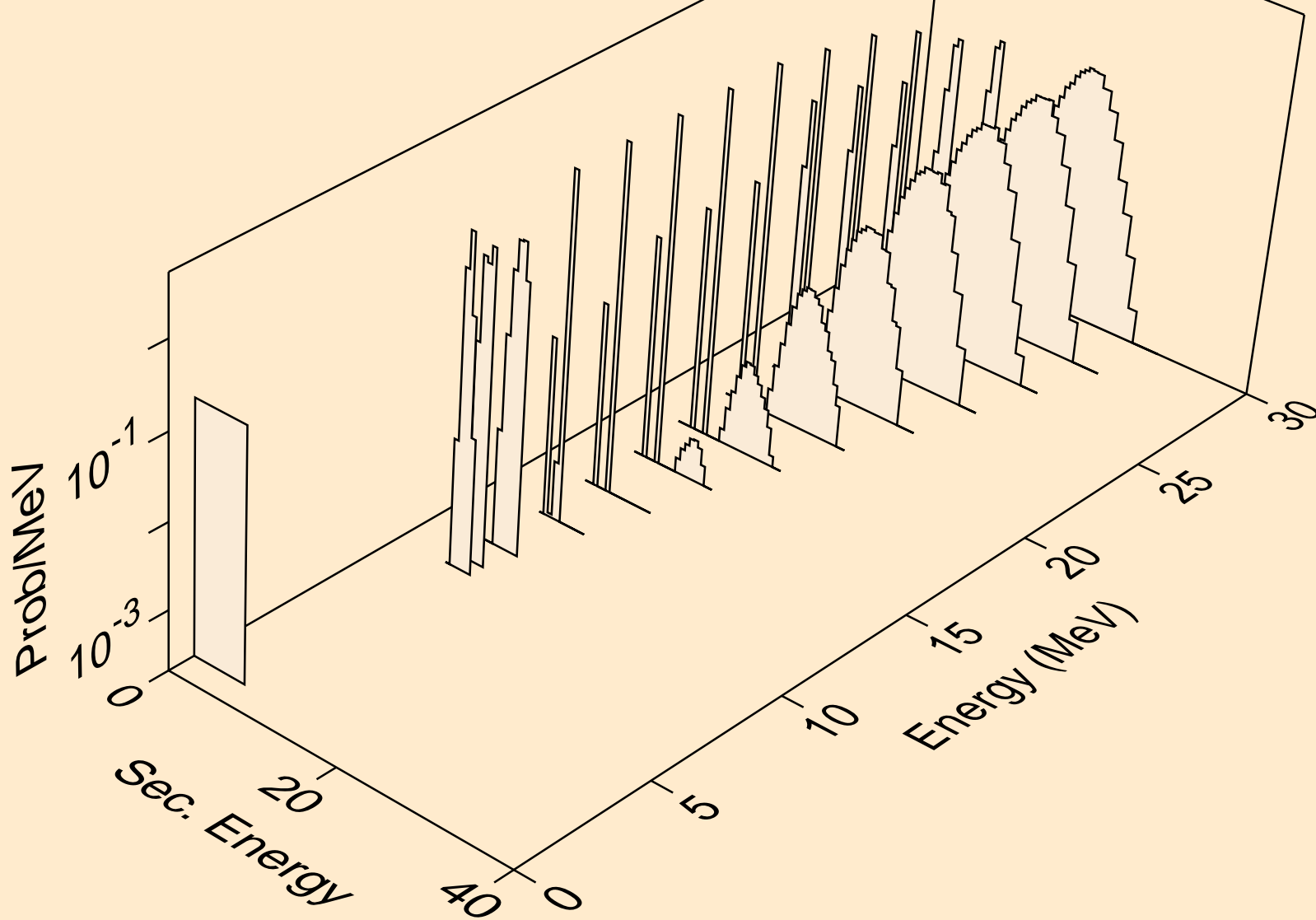

PO195M NEUTRON ACER TENDL-2019 LIBRARY; T=293.16K
alphas from (n,3n)a

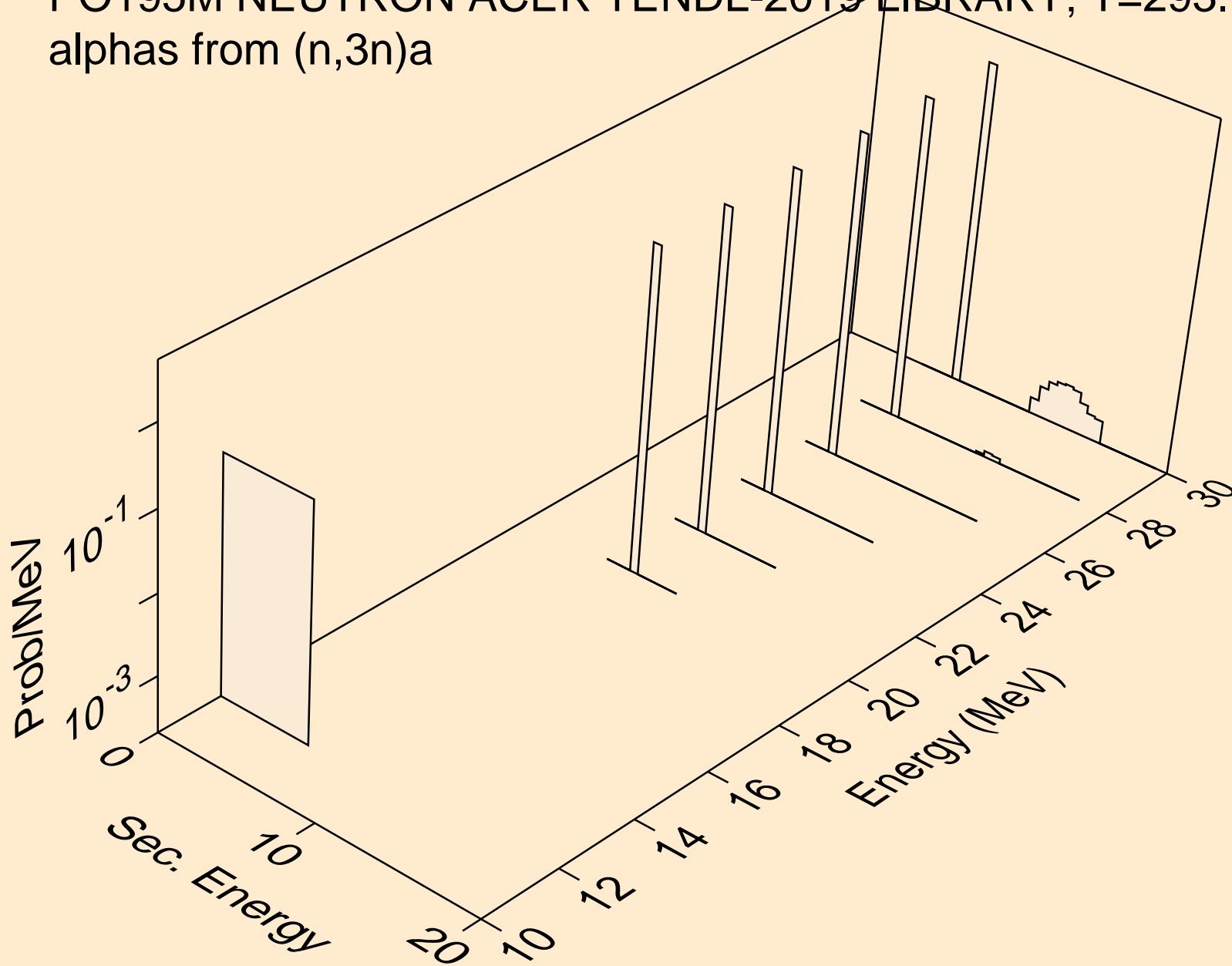

PO195M NEUTRON ACER TENDL-2019 LIBRARY; T=293.16K
alphas from (n,n*)2a

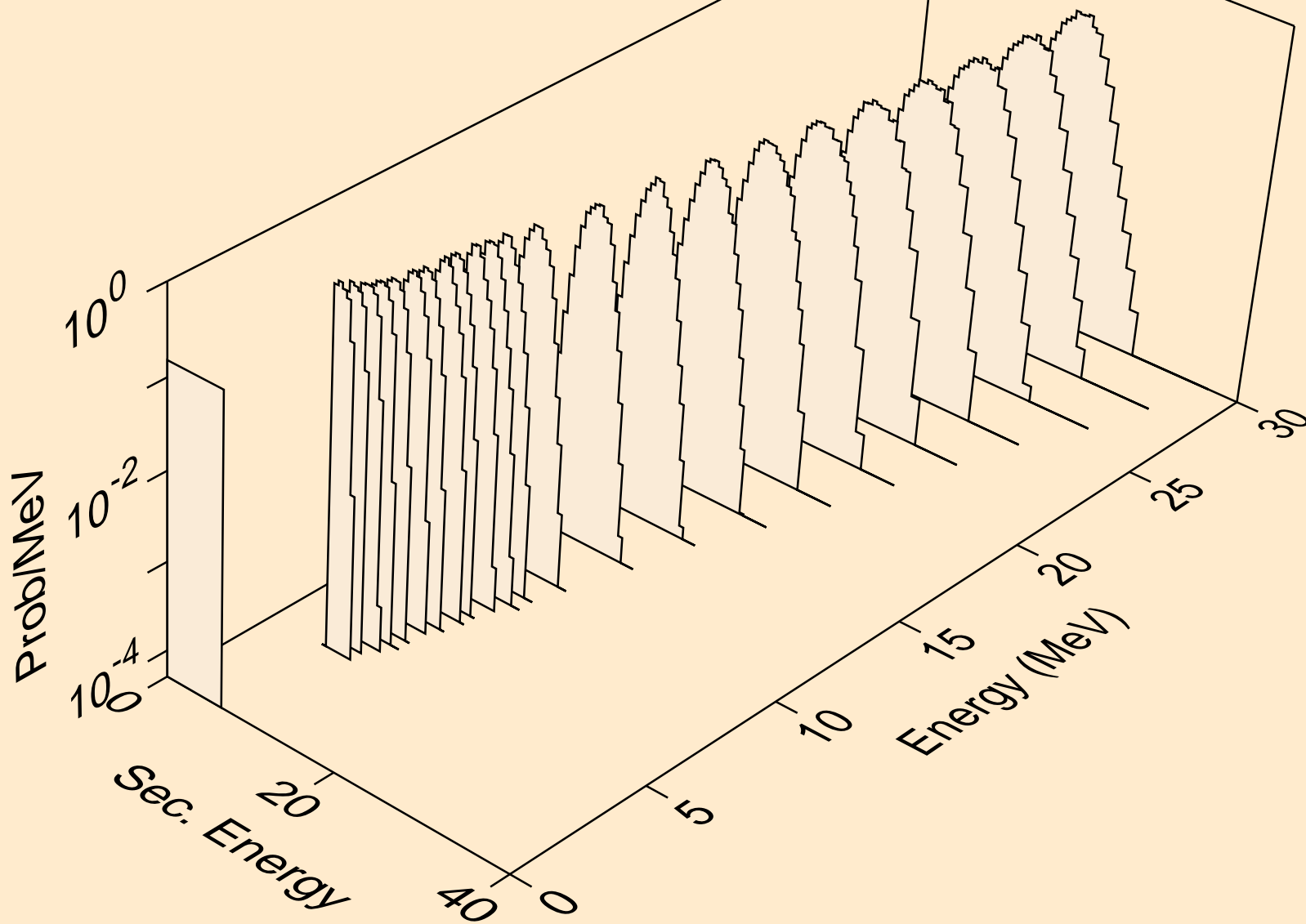

PO195M NEUTRON ACER TENDL-2019 LIBRARY; T=293.16K
alphas from (n,2n)2a

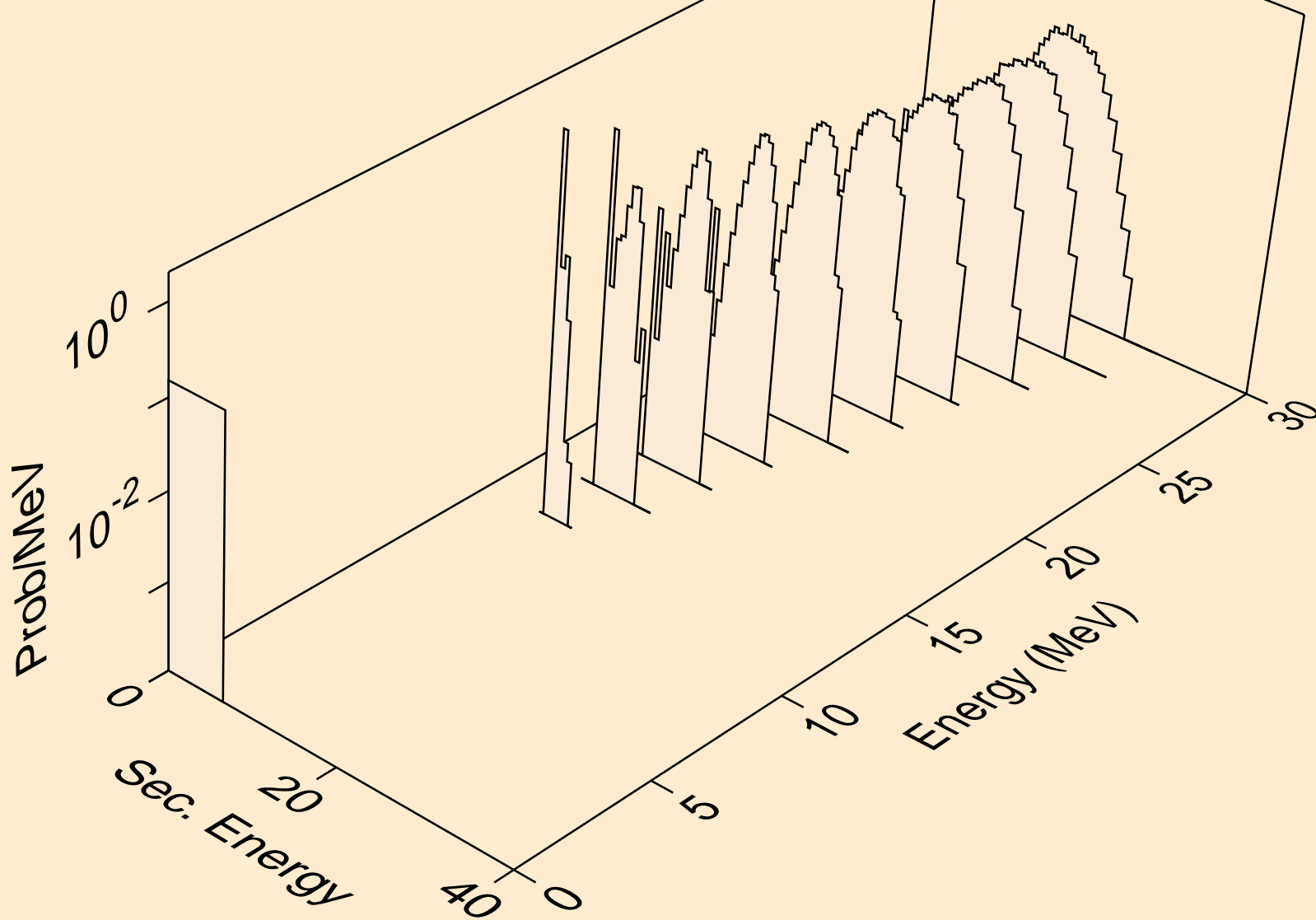

PO195M NEUTRON ACER TENDL-2019 LIBRARY; T=293.16K
alphas from (n,npa)

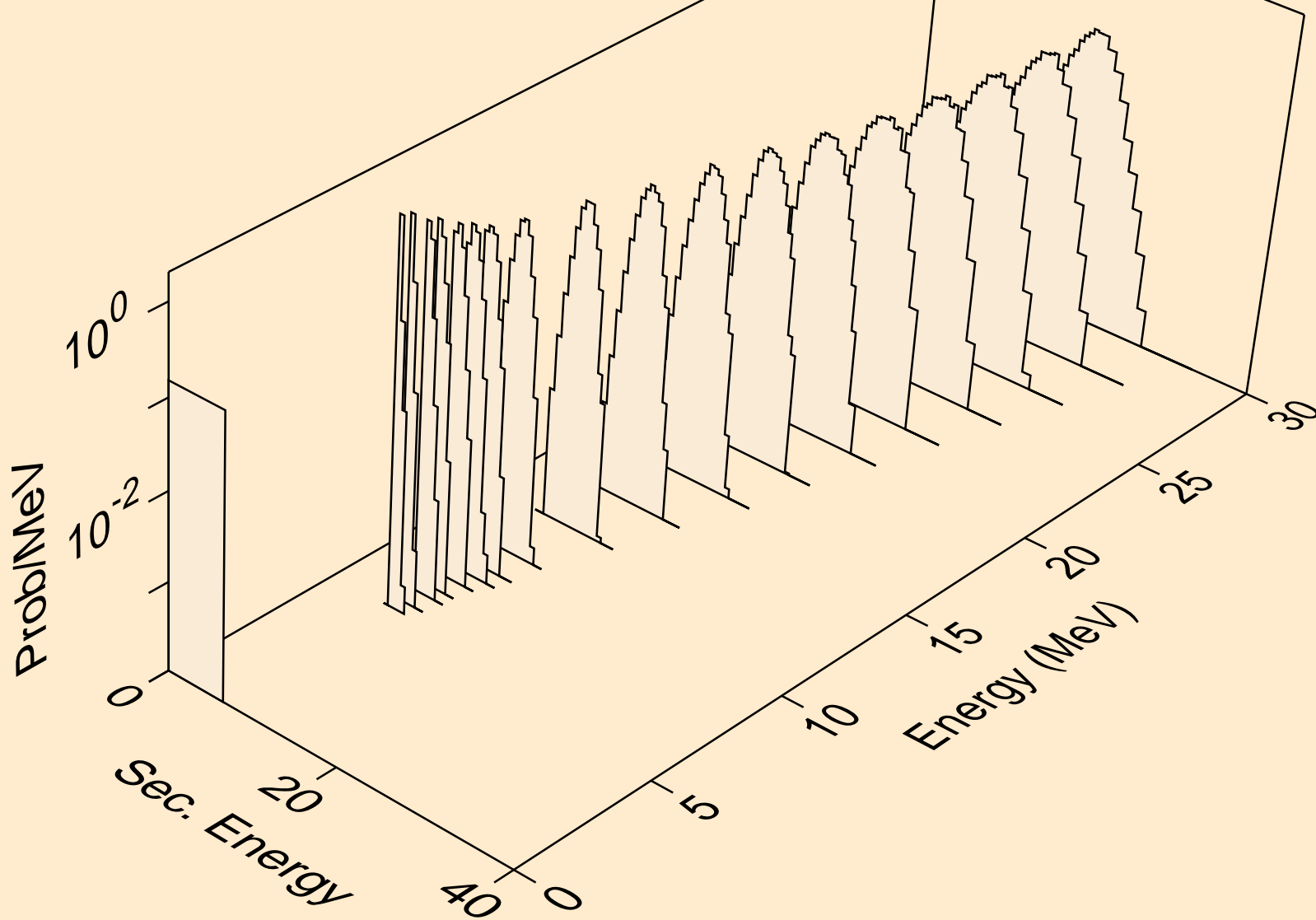

PO195M NEUTRON ACER TENDL-2019 LIBRARY; T=293.16K
alphas from (n,a)

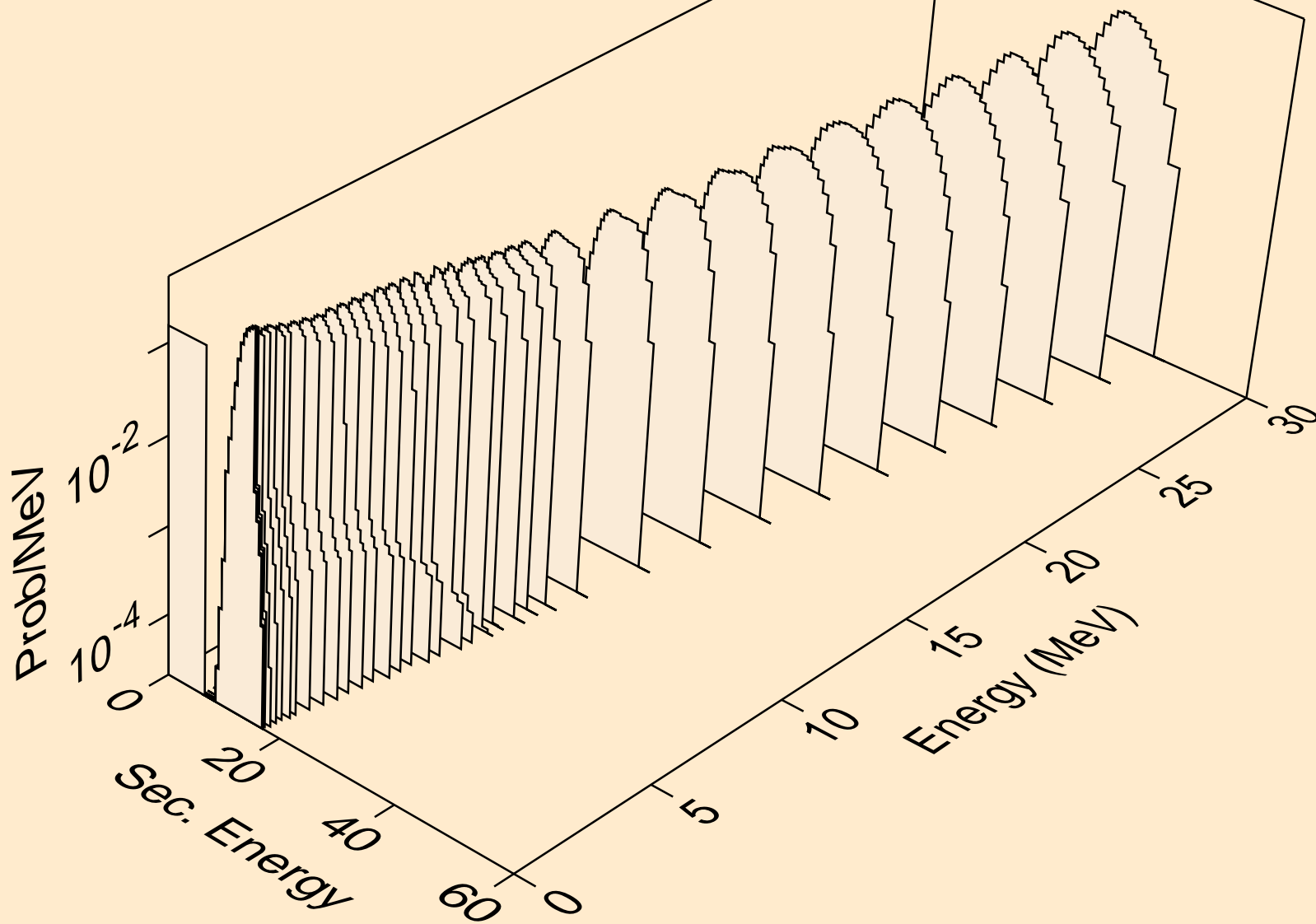

PO195M NEUTRON ACER TENDL-2019 LIBRARY; T=293.16K
alphas from (n,2a)

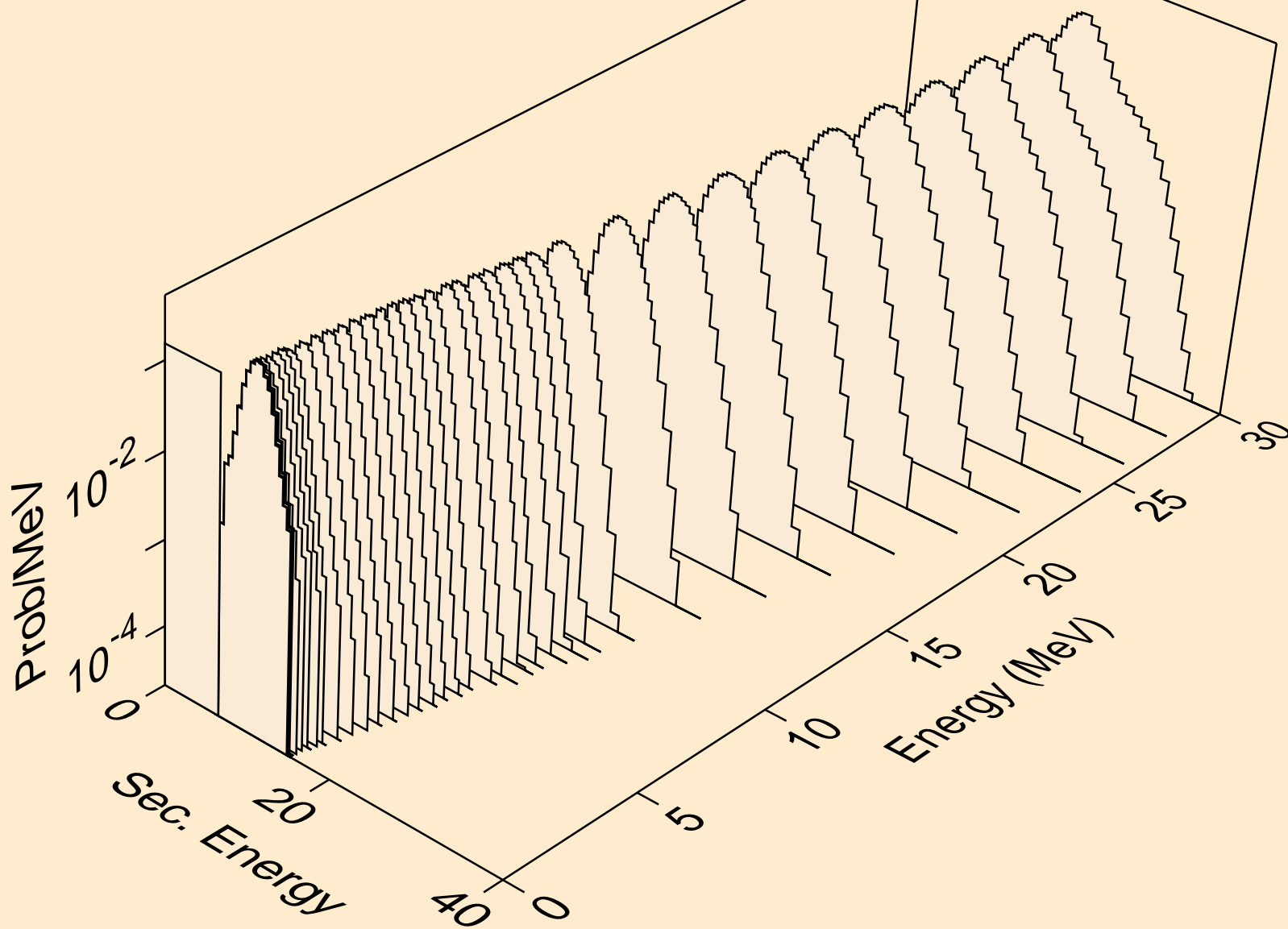

PO195M NEUTRON ACER TENDL-2019 LIBRARY; T=293.16K
alphas from (n,3a)

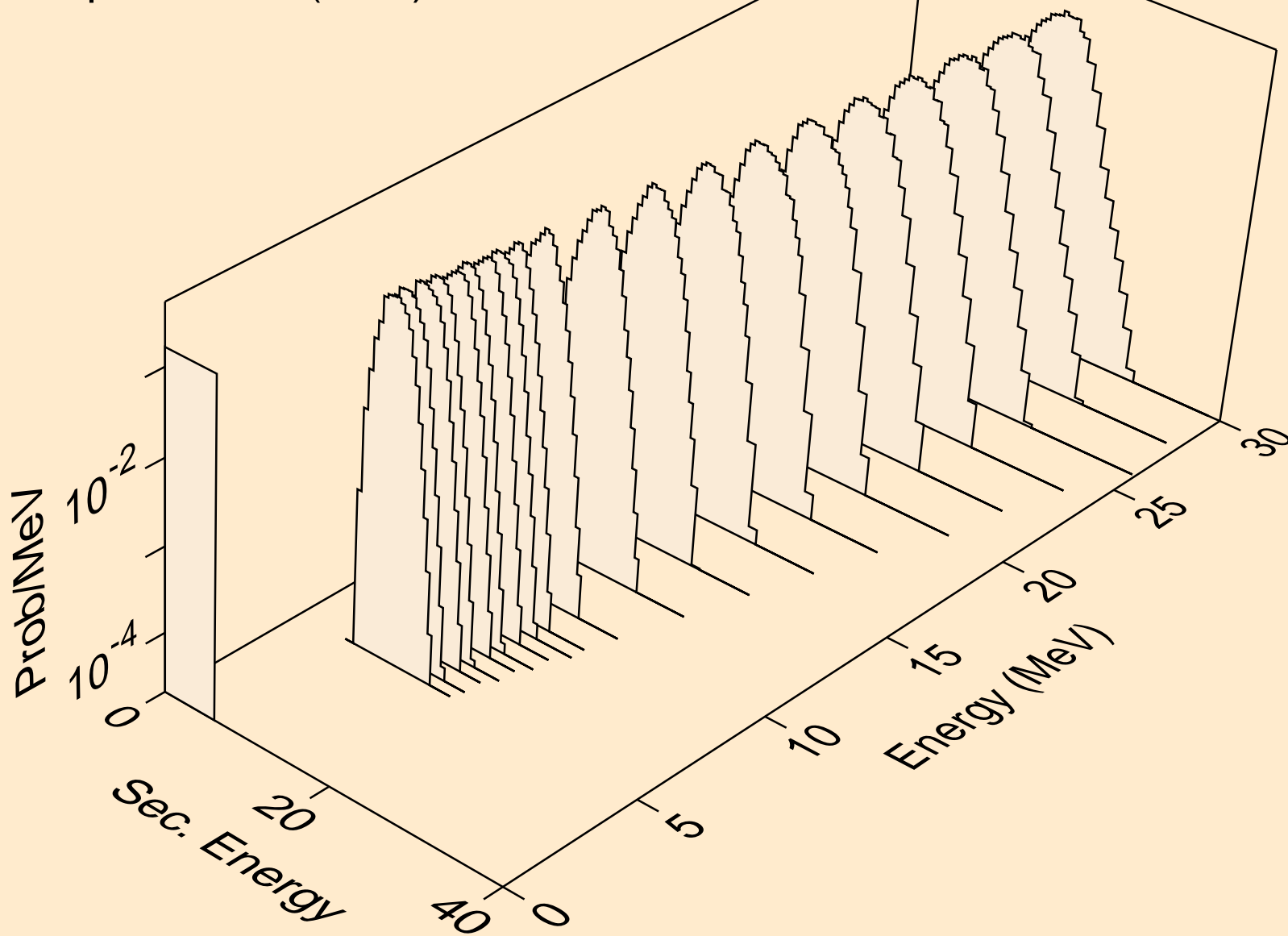

PO195M NEUTRON ACER TENDL-2019 LIBRARY; T=293.16K
alphas from (n,pa)

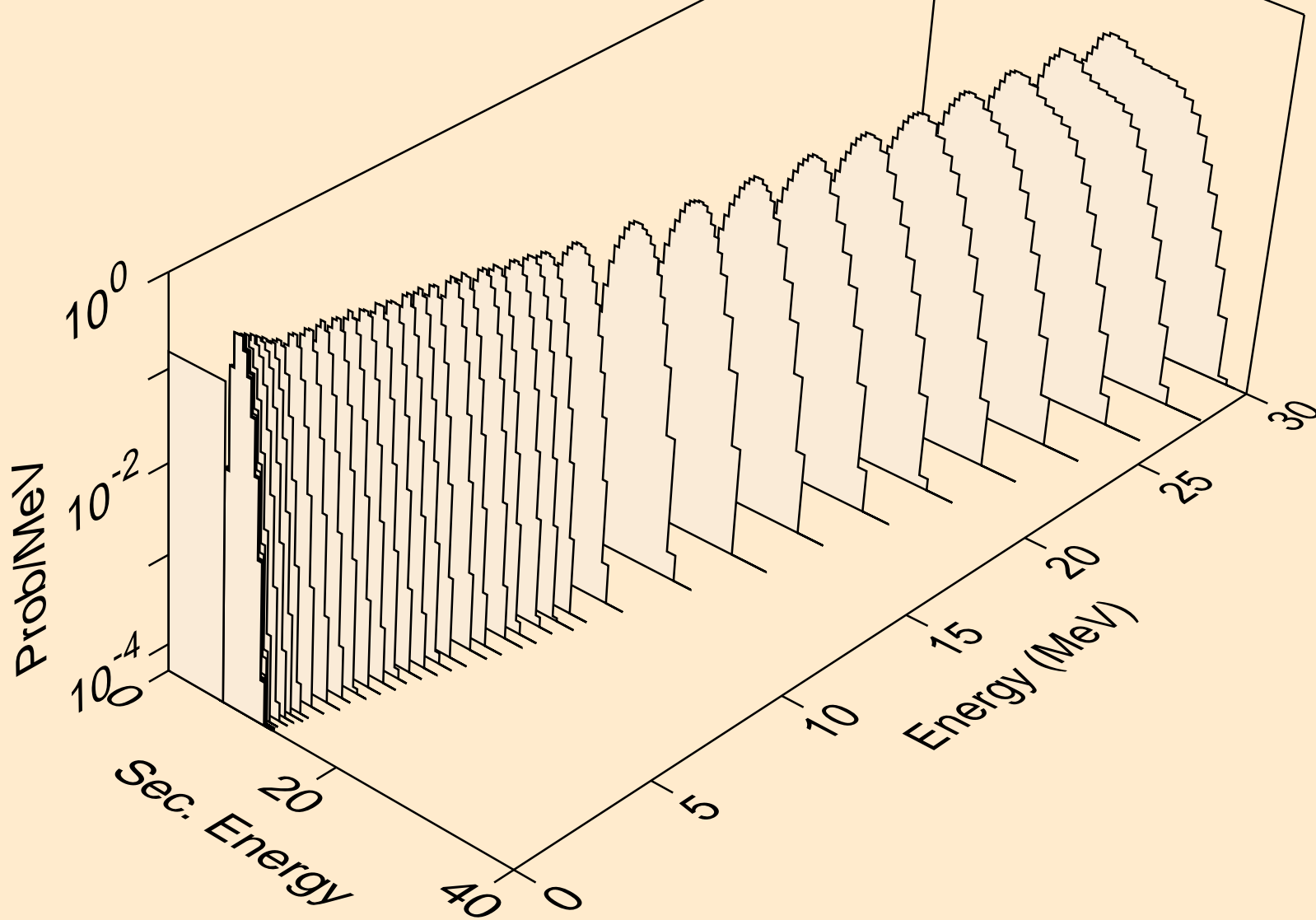

PO195M NEUTRON ACER TENDL-2019 LIBRARY; T=293.16K
alphas from (n,da)

