

PO201M NEUTRON ACER TENDL-2019 LIBRARY; T=293.16K  
Principal cross sections

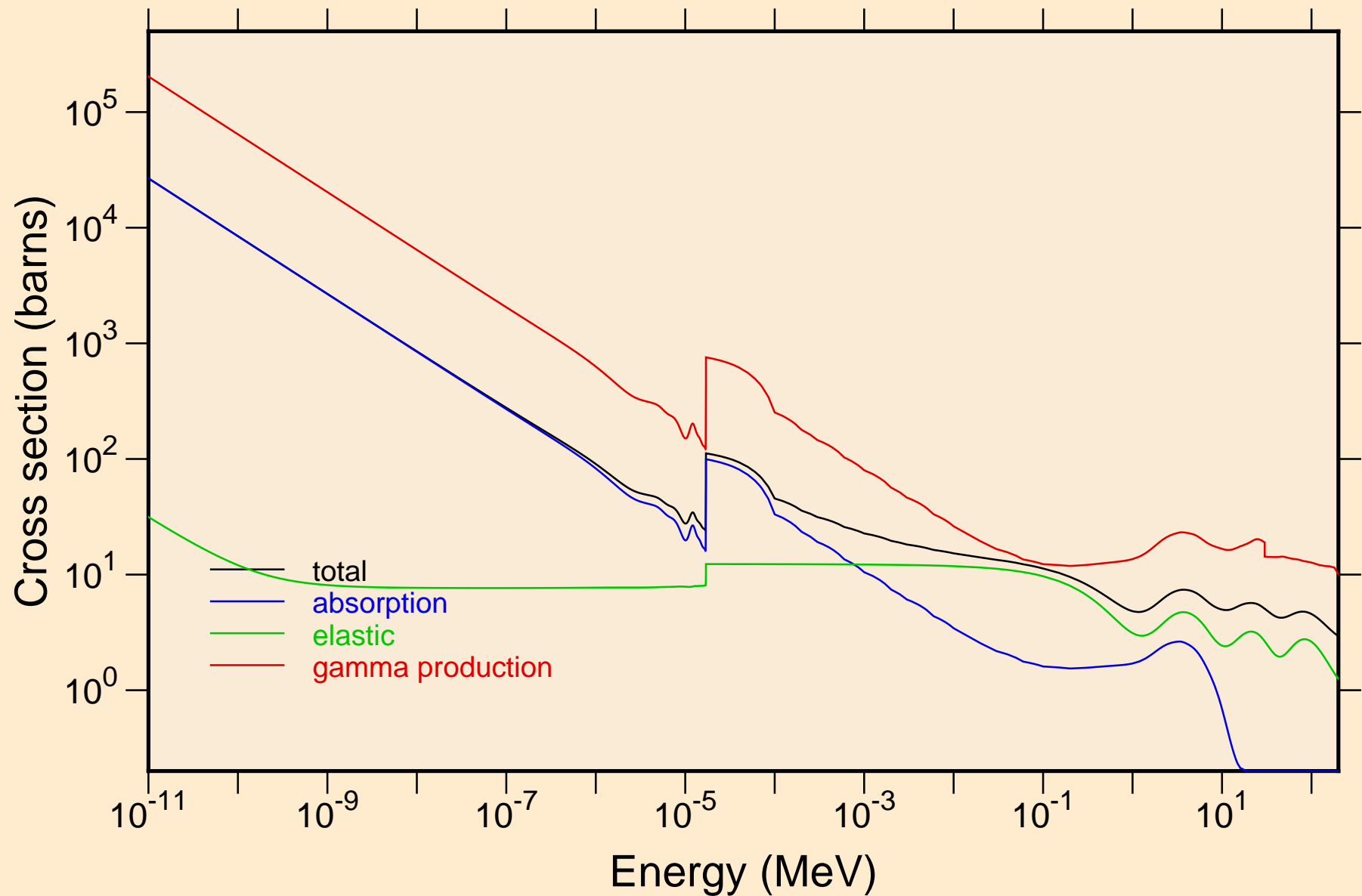

PO201M NEUTRON ACER TENDL-2019 LIBRARY; T=293.16K  
Heating

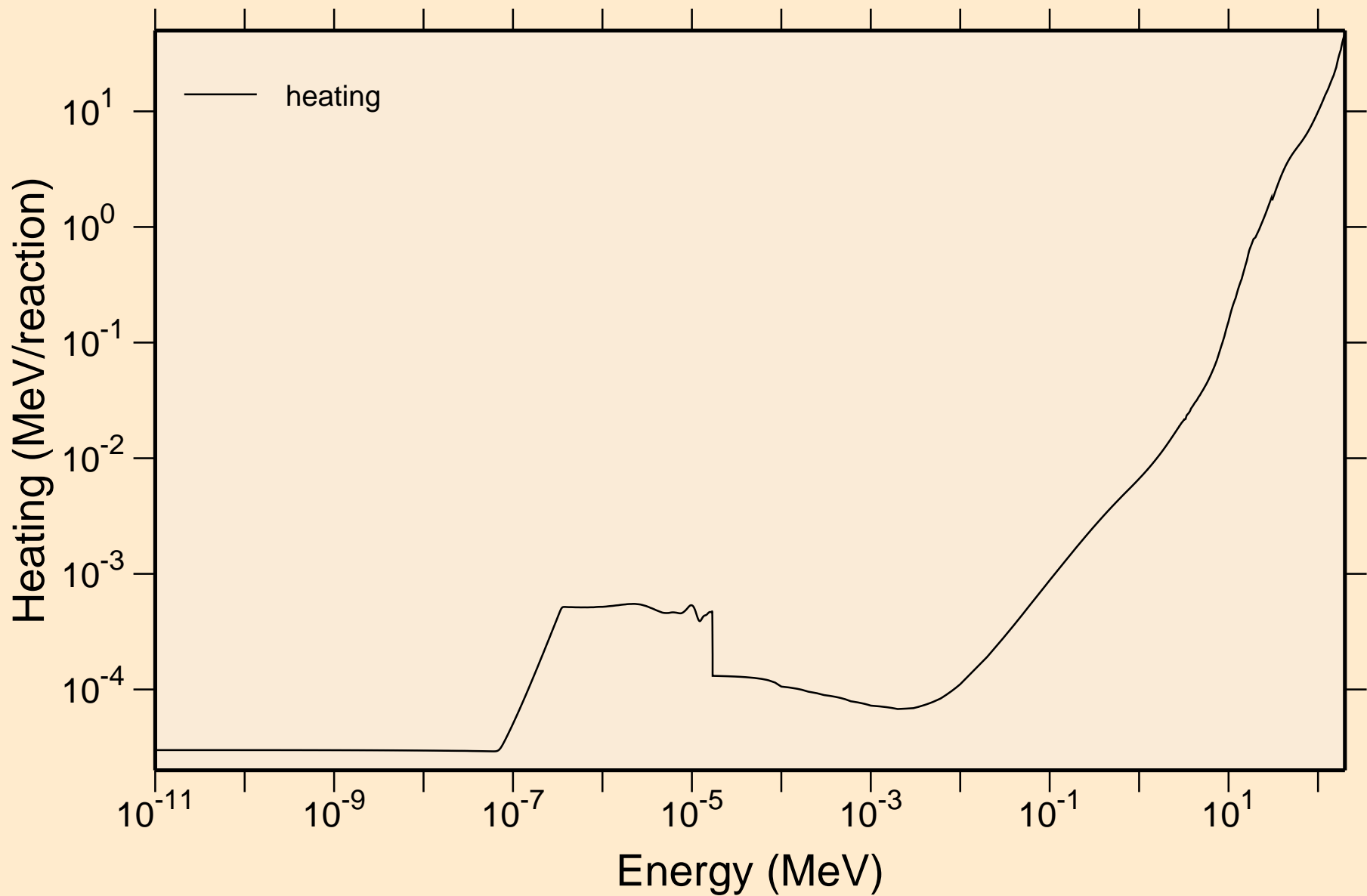

PO201M NEUTRON ACER TENDL-2019 LIBRARY; T=293.16K  
Damage

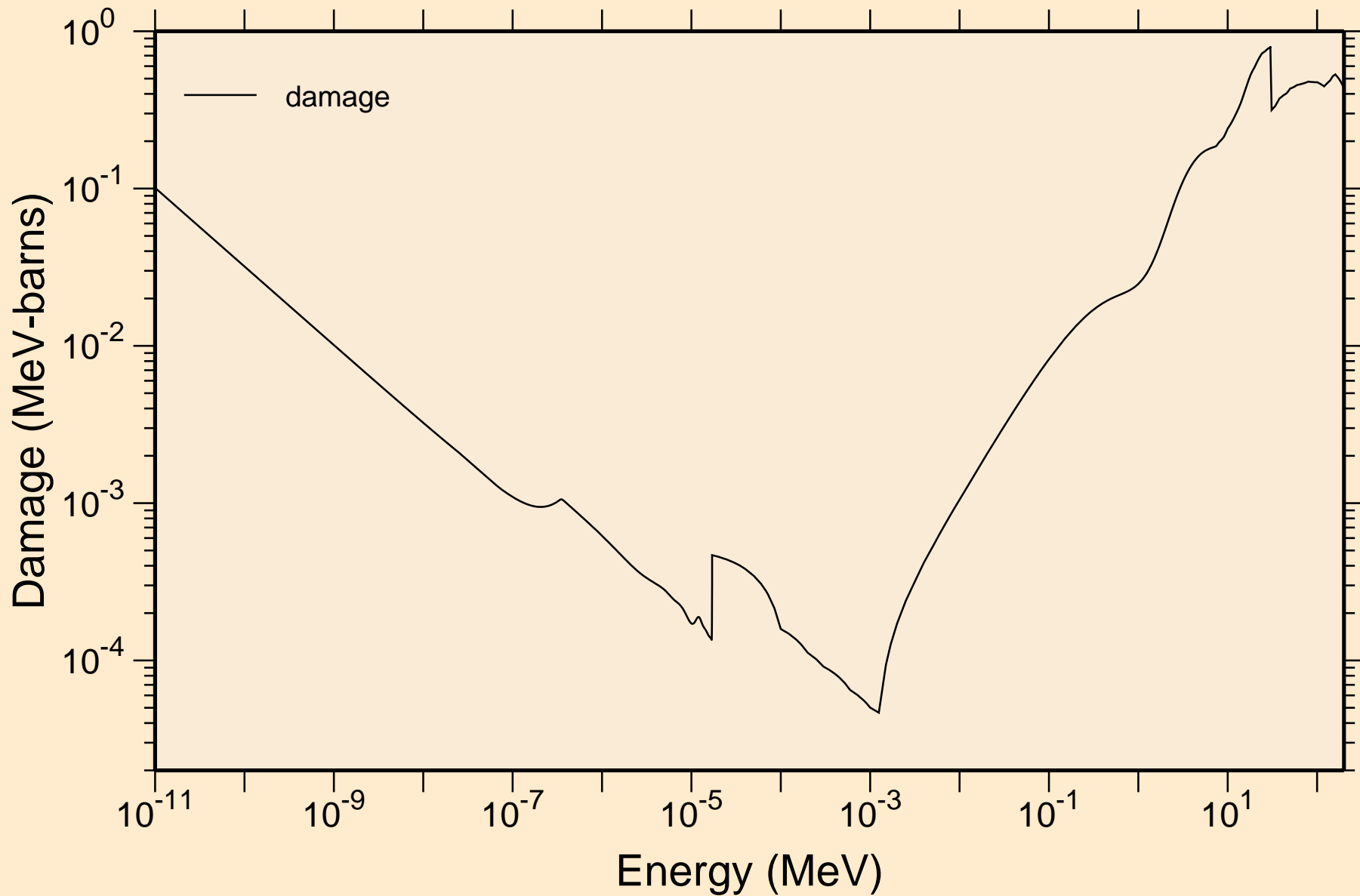

PO201M NEUTRON ACER TENDL-2019 LIBRARY; T=293.16K  
Non-threshold reactions

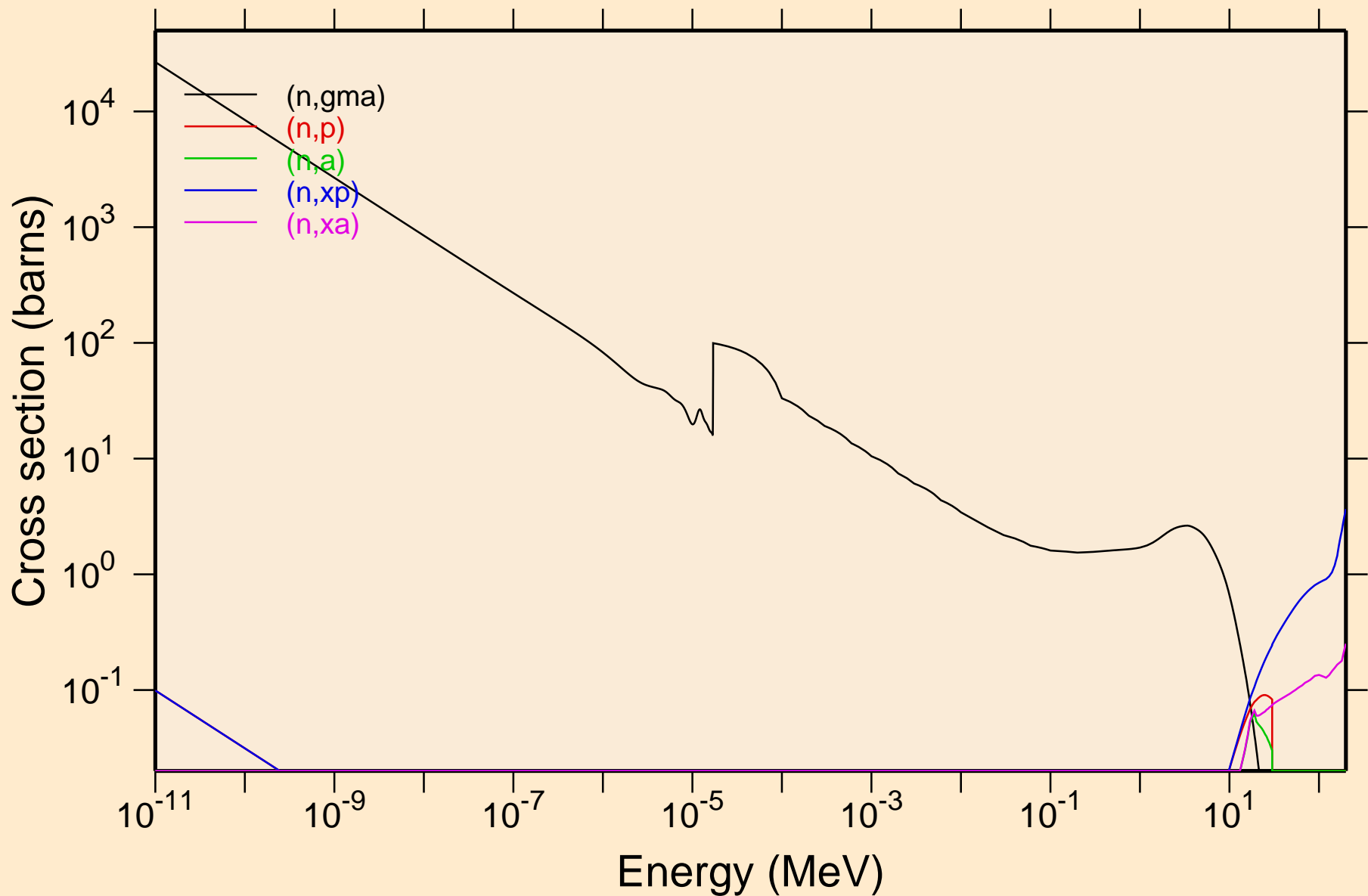

PO201M NEUTRON ACER TENDL-2019 LIBRARY; T=293.16K  
Principal cross sections

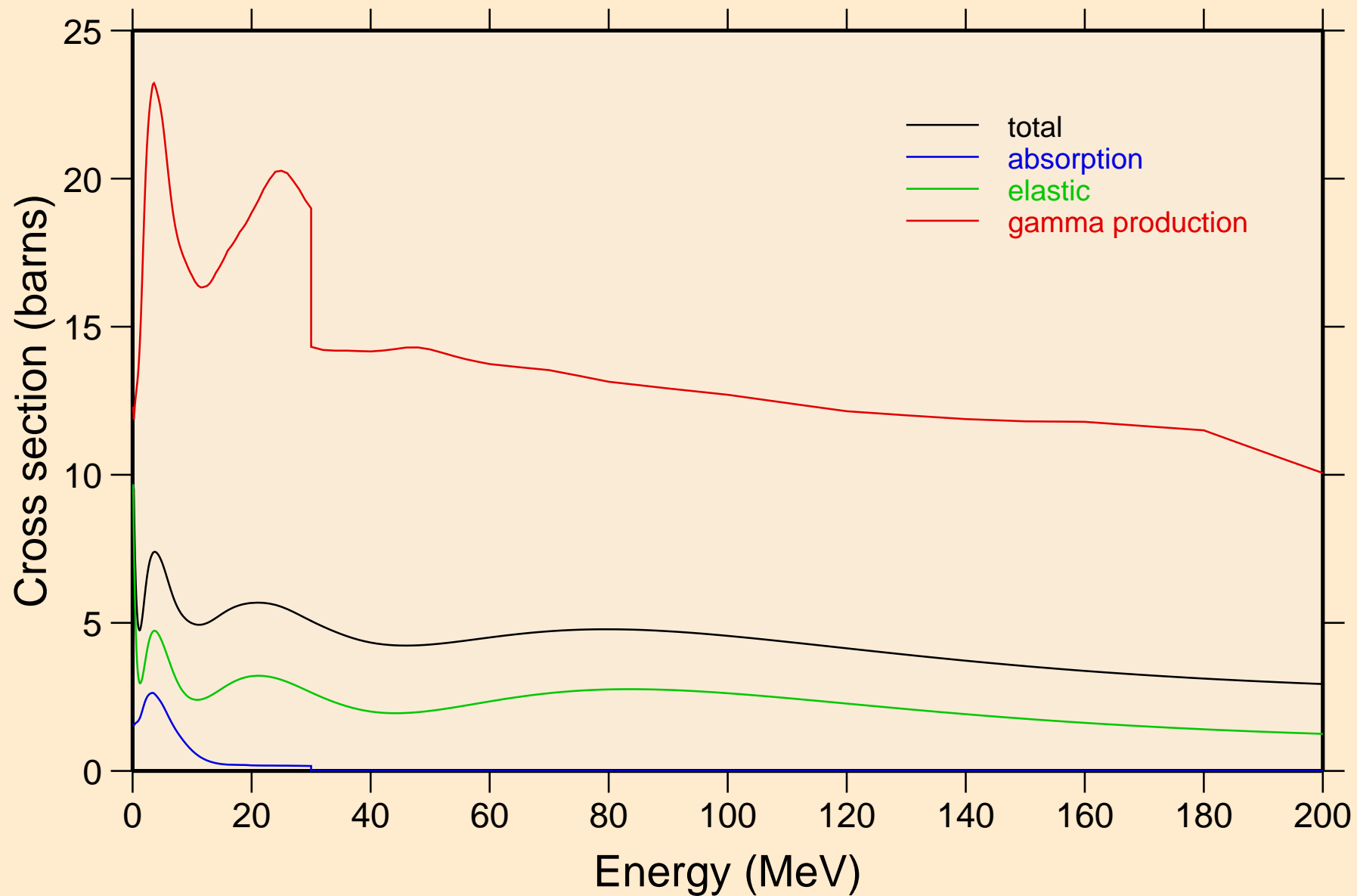

PO201M NEUTRON ACER TENDL-2019 LIBRARY; T=293.16K  
Heating

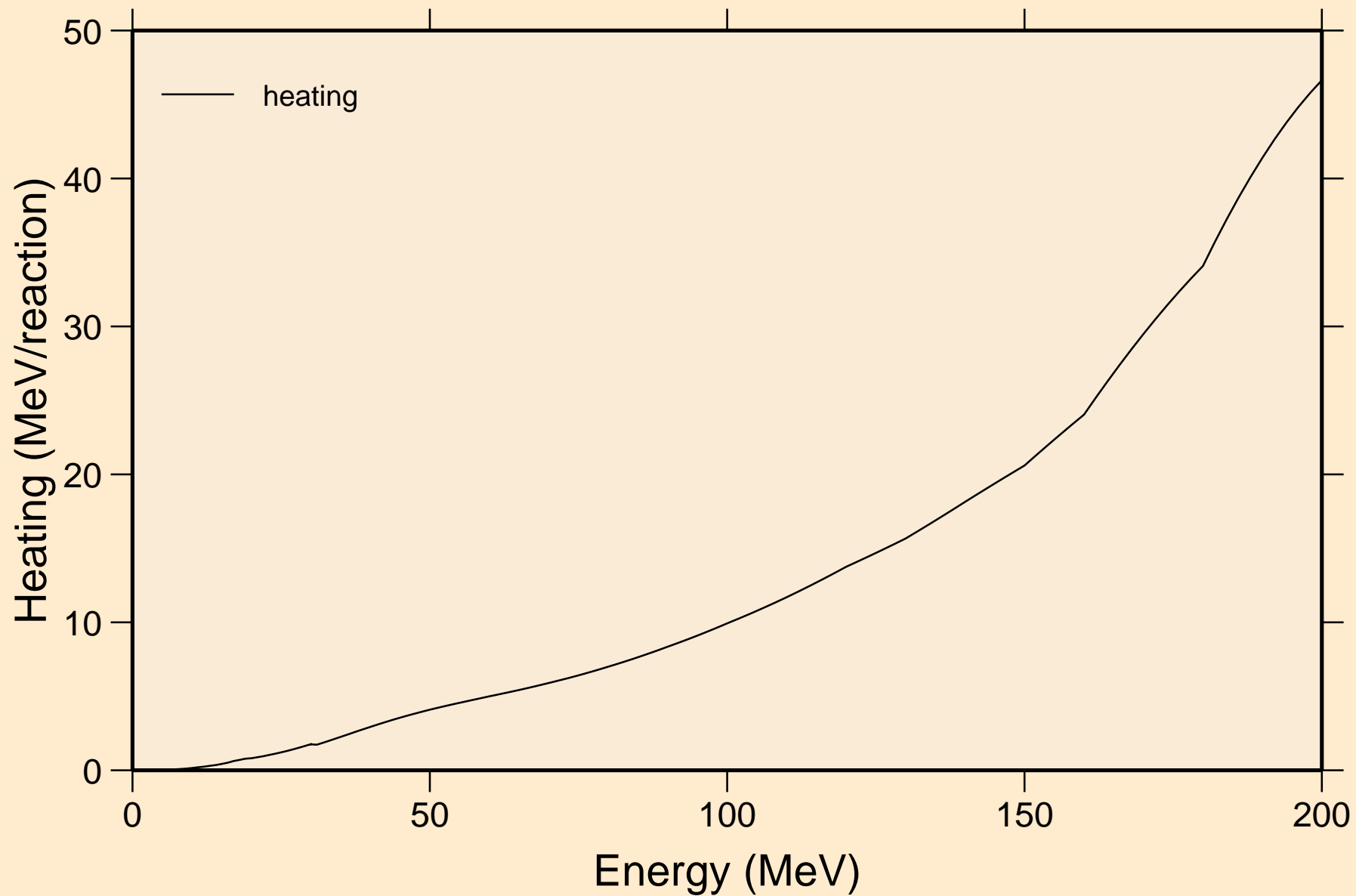

PO201M NEUTRON ACER TENDL-2019 LIBRARY; T=293.16K  
Damage

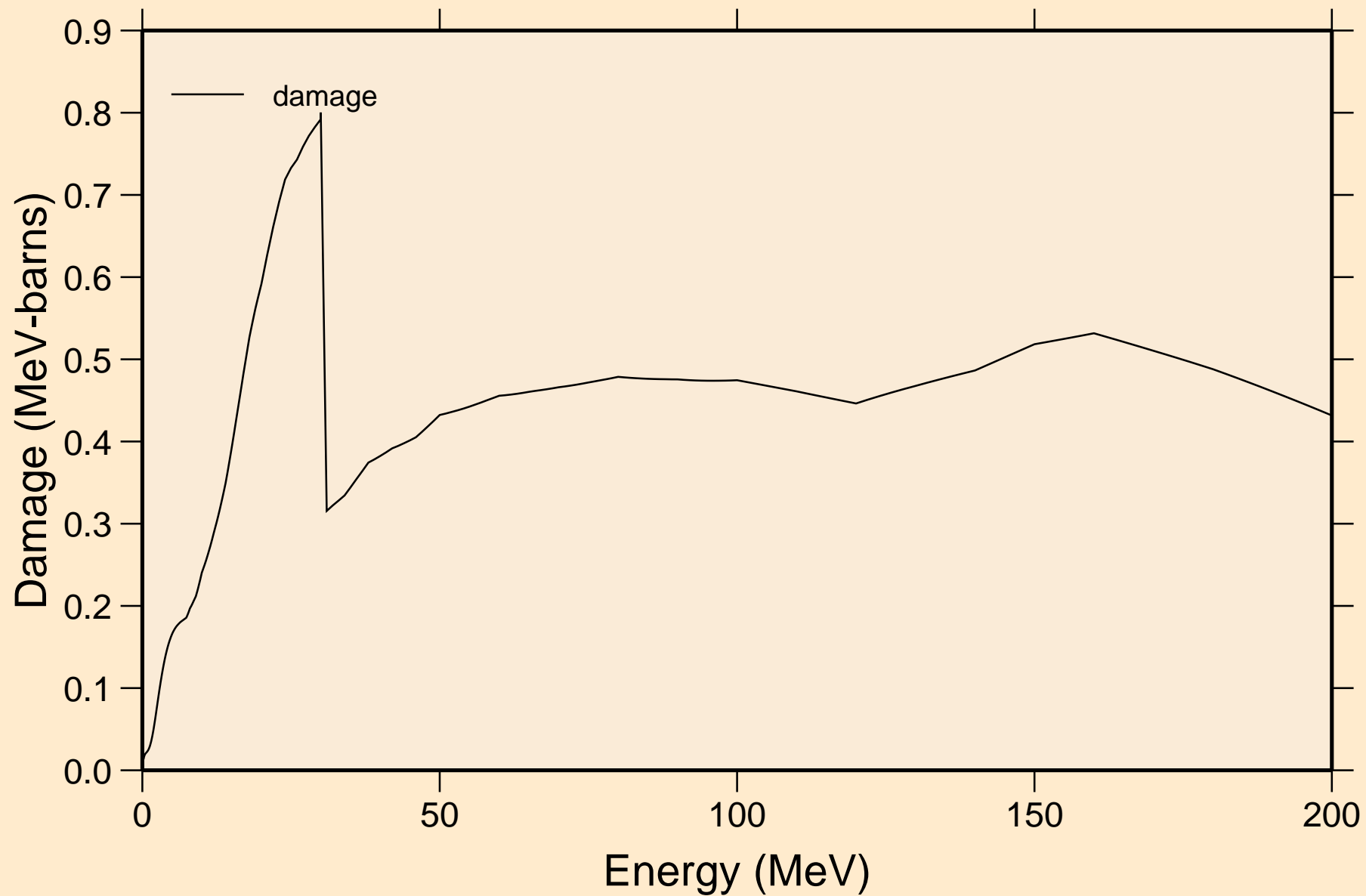

PO201M NEUTRON ACER TENDL-2019 LIBRARY; T=293.16K  
Non-threshold reactions

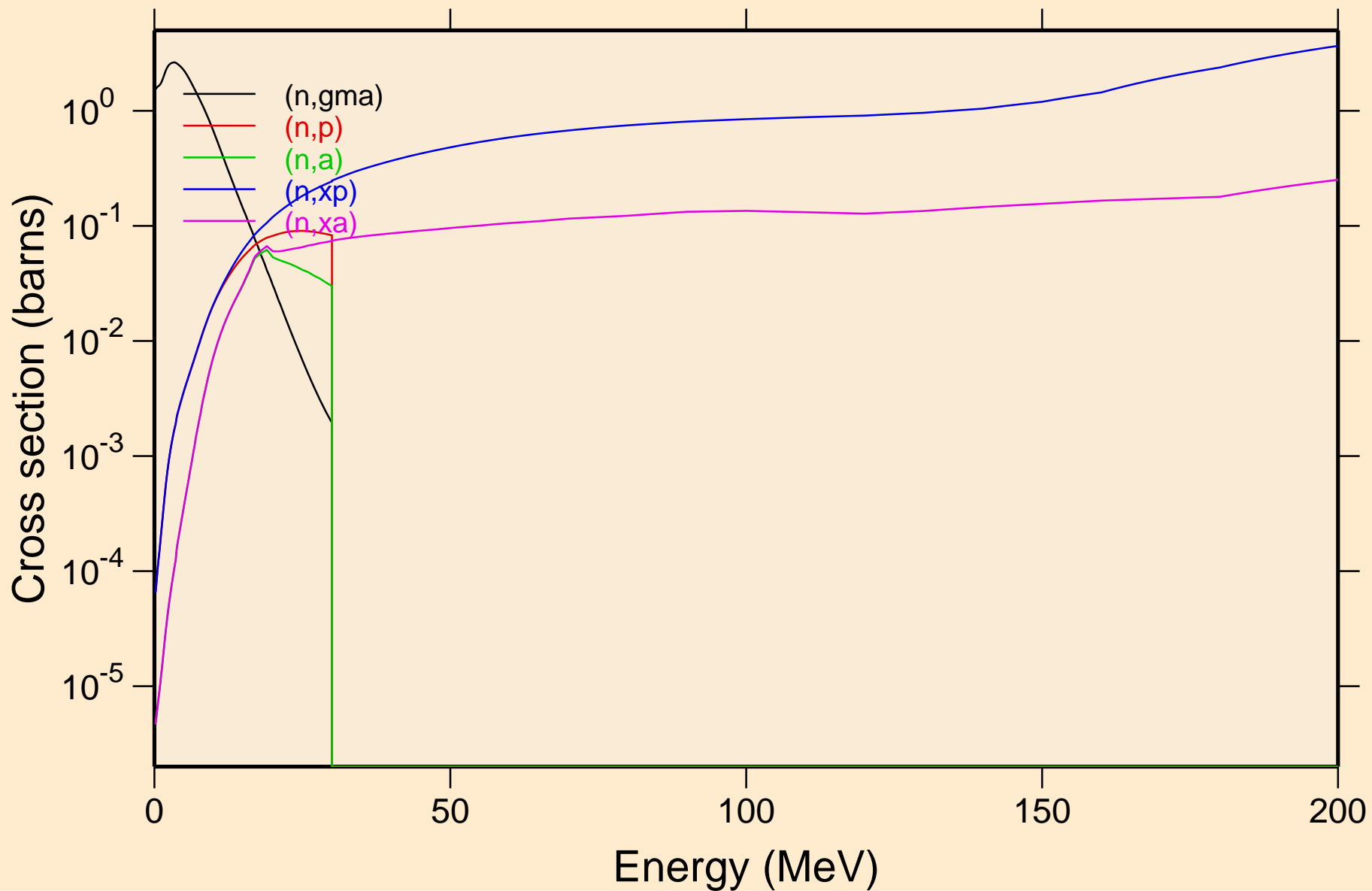



PO201M NEUTRON ACER TENDL-2019 LIBRARY; T=293.16K  
Inelastic levels

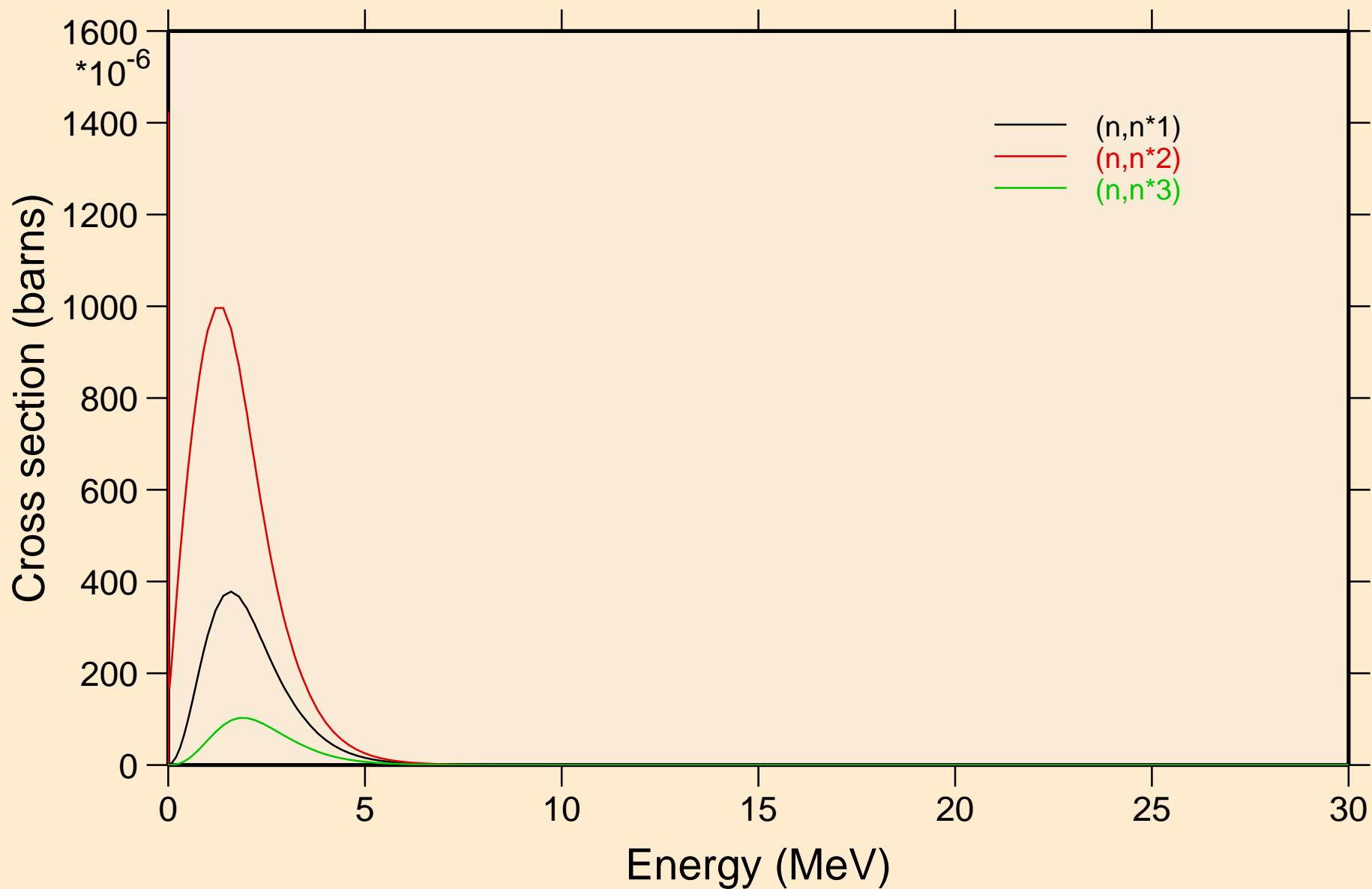

PO201M NEUTRON ACER TENDL-2019 LIBRARY; T=293.16K  
Threshold reactions

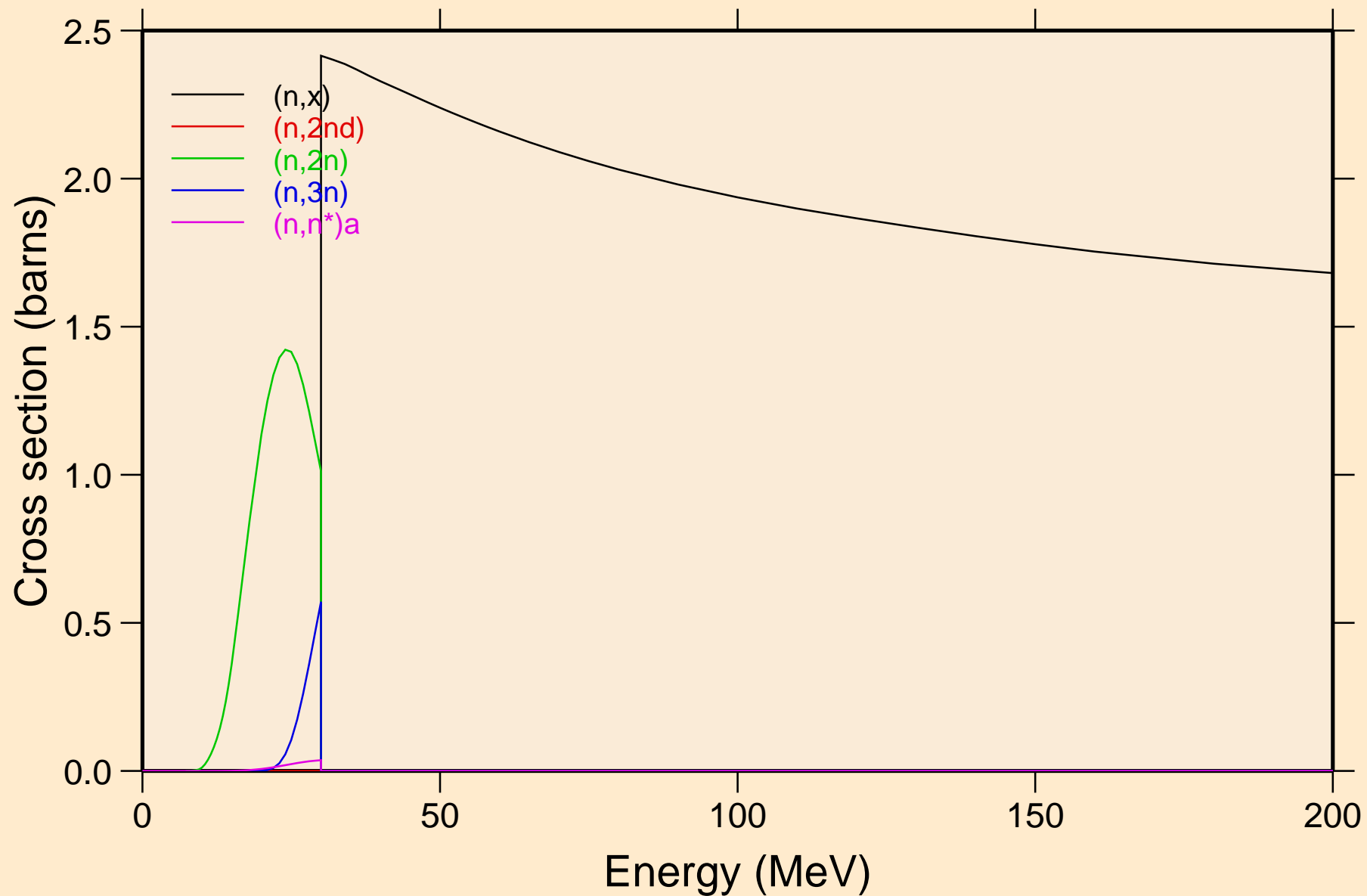

PO201M NEUTRON ACER TENDL-2019 LIBRARY; T=293.16K  
Threshold reactions

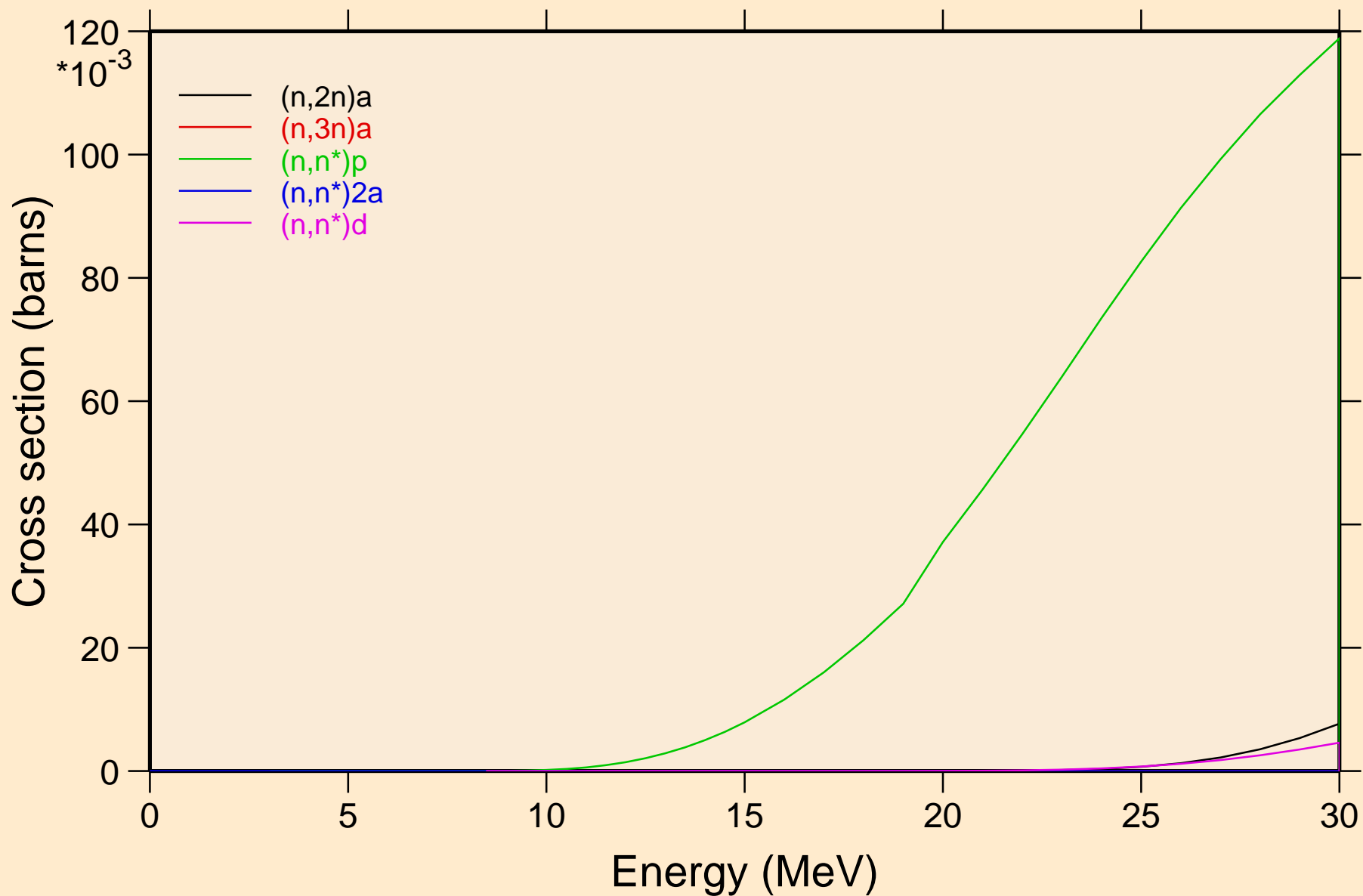

PO201M NEUTRON ACER TENDL-2019 LIBRARY; T=293.16K  
Threshold reactions

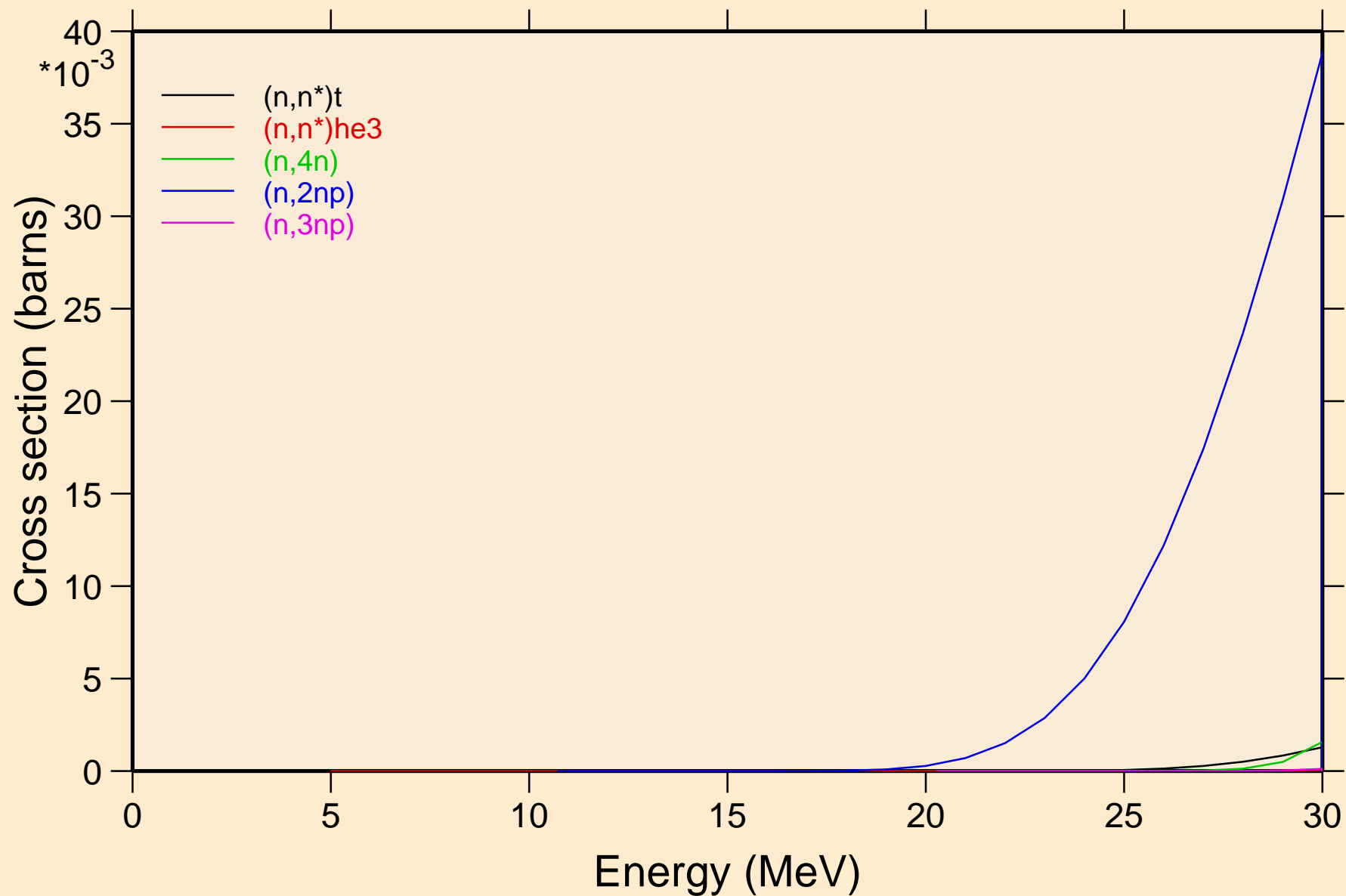

PO201M NEUTRON ACER TENDL-2019 LIBRARY; T=293.16K  
Threshold reactions

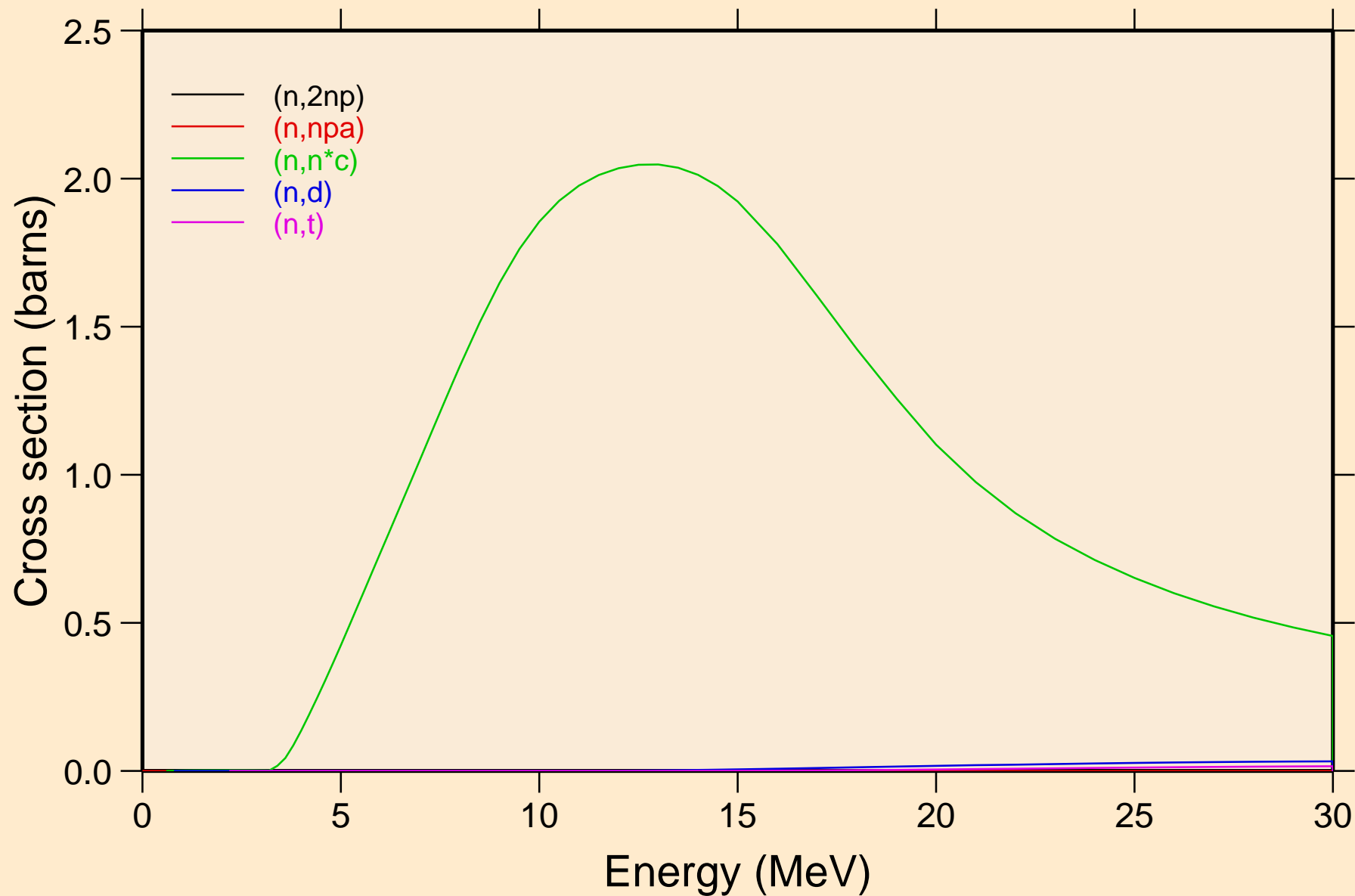

PO201M NEUTRON ACER TENDL-2019 LIBRARY; T=293.16K  
Threshold reactions

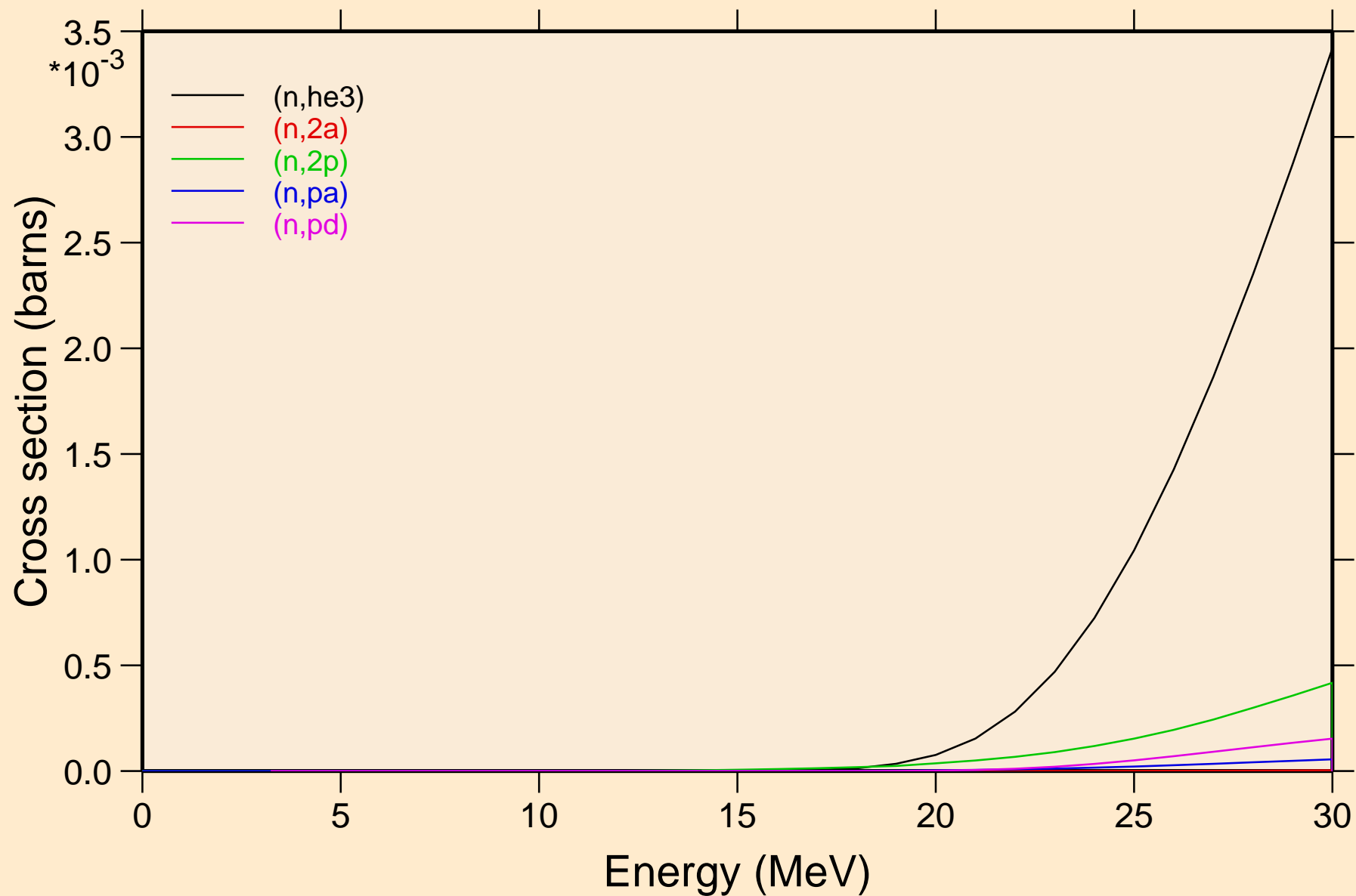

PO201M NEUTRON ACER TENDL-2019 LIBRARY; T=293.16K  
Threshold reactions

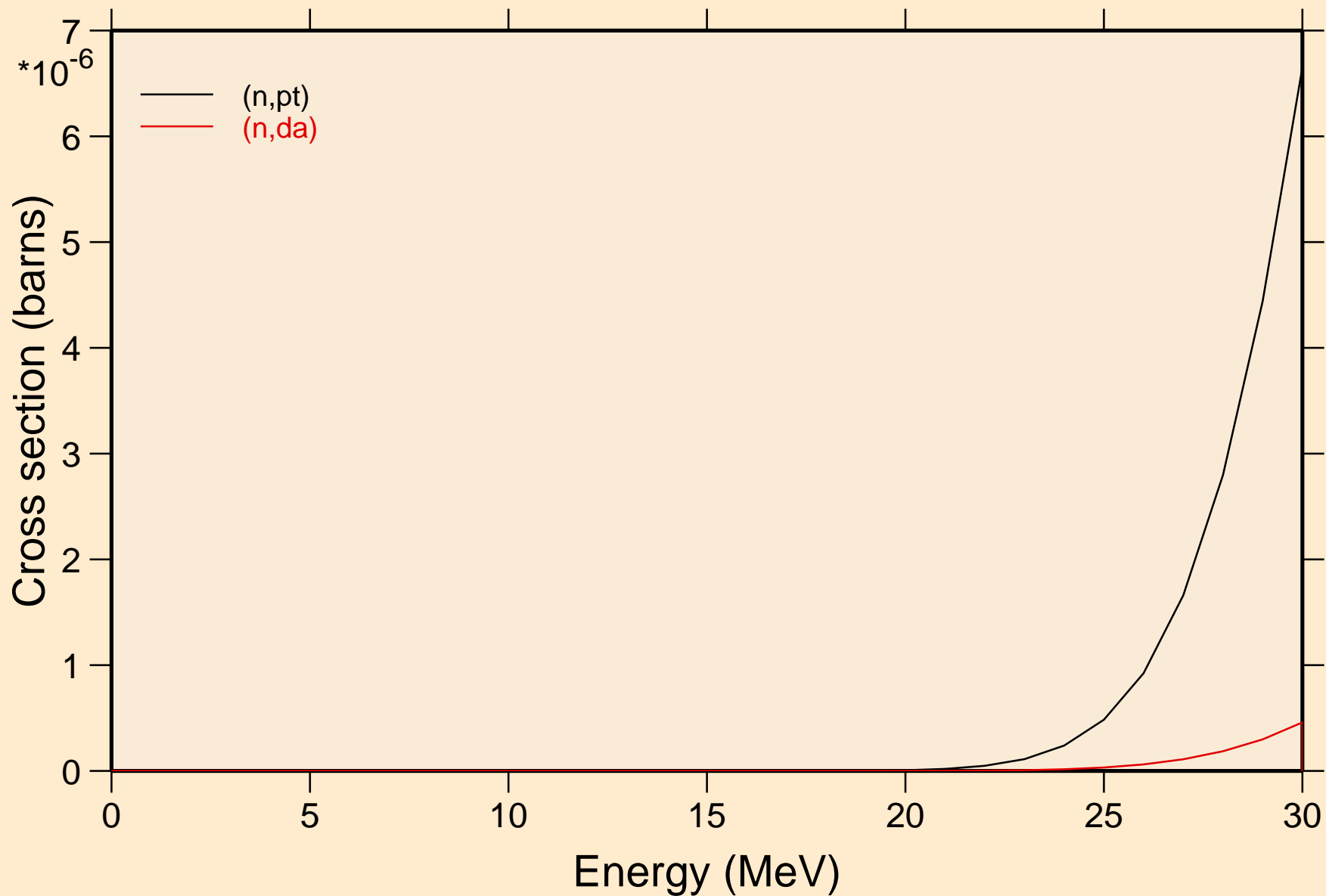

PO201M NEUTRON ACER TENDL-2019 LIBRARY; T=293.16K  
Threshold reactions

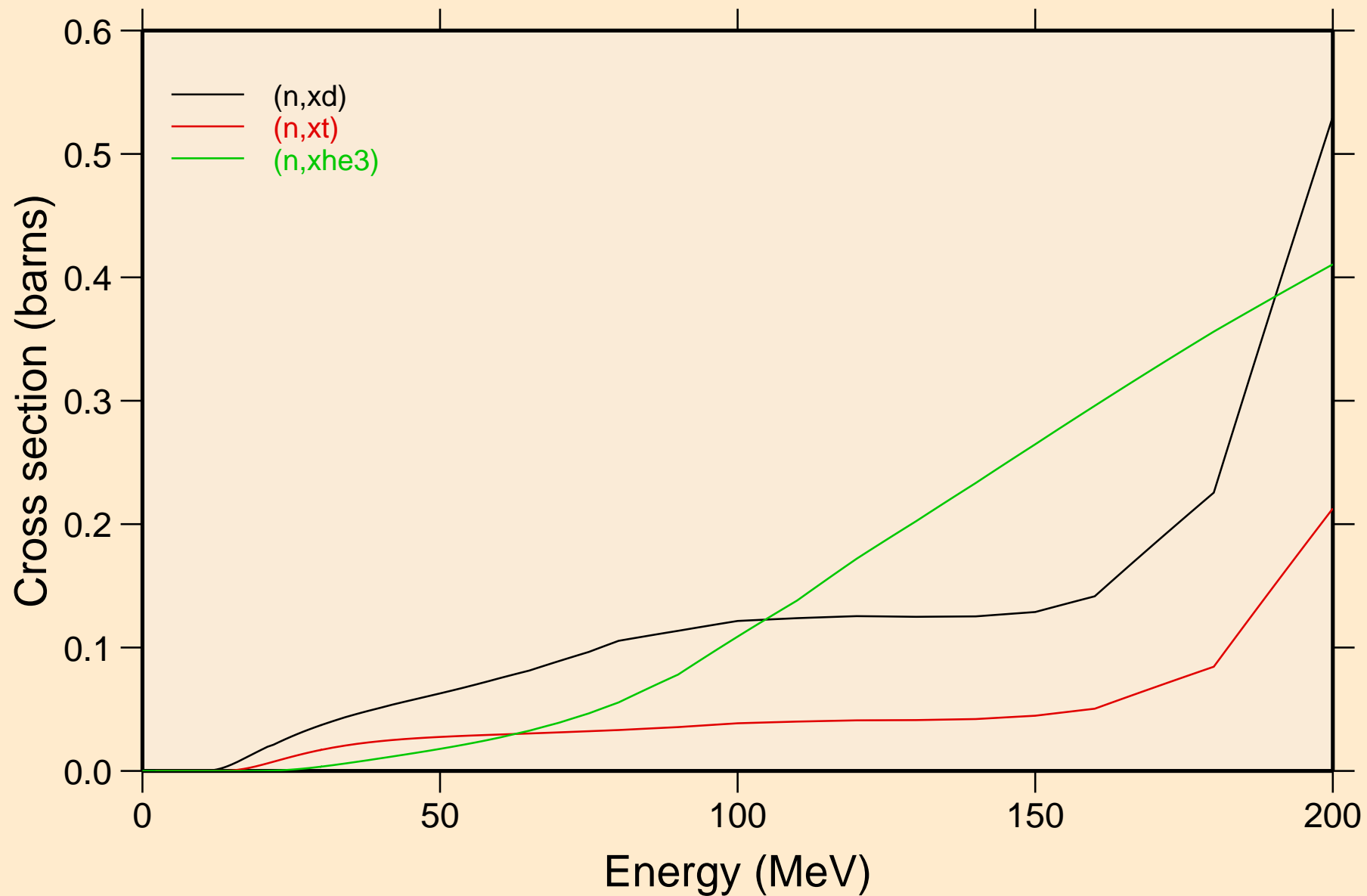



PO201M NEUTRON ACER TENDL-2019 LIBRARY; T=293.16K  
angular distribution for elastic

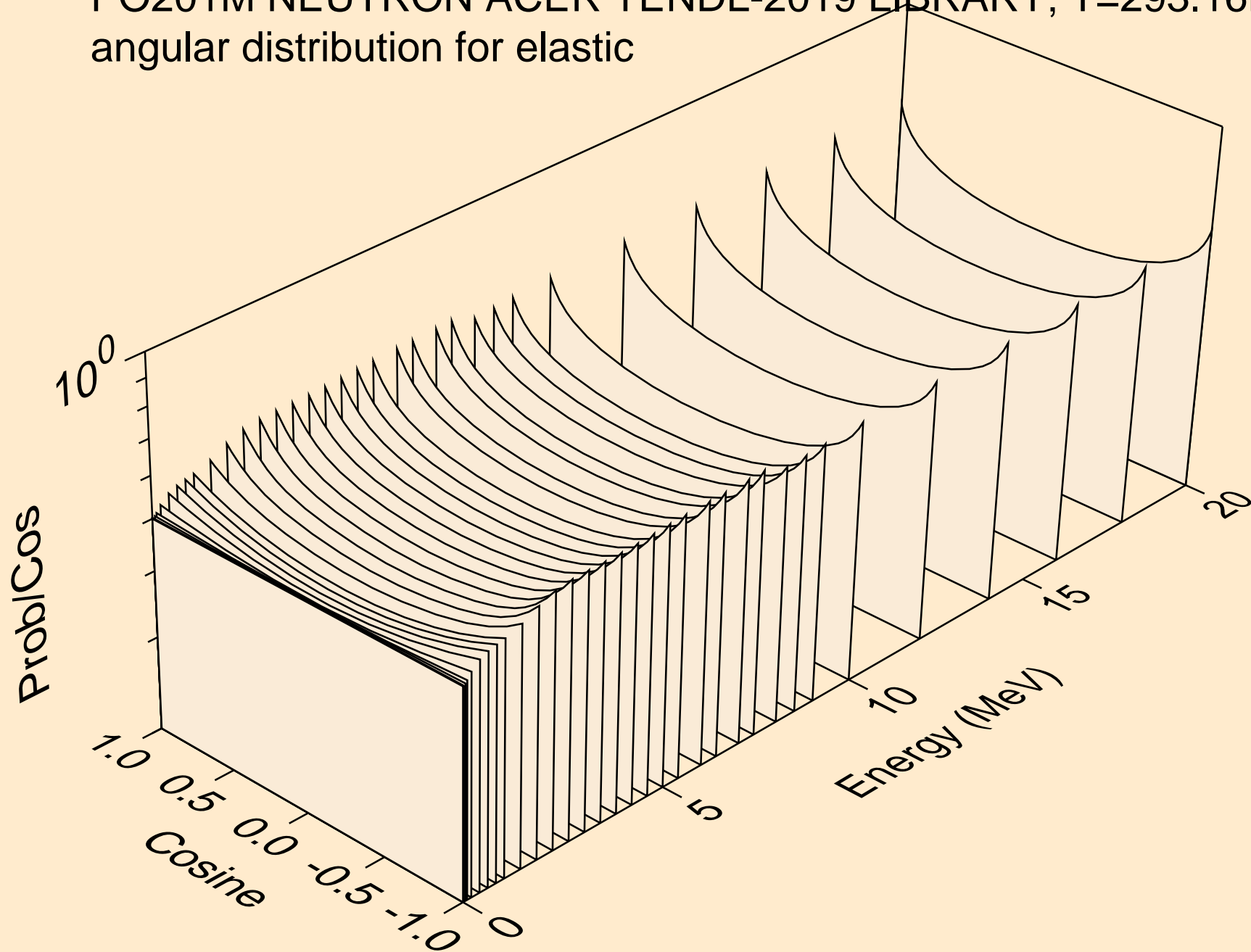

PO201M NEUTRON ACER TENDL-2019 LIBRARY; T=293.16K  
angular distribution for elastic

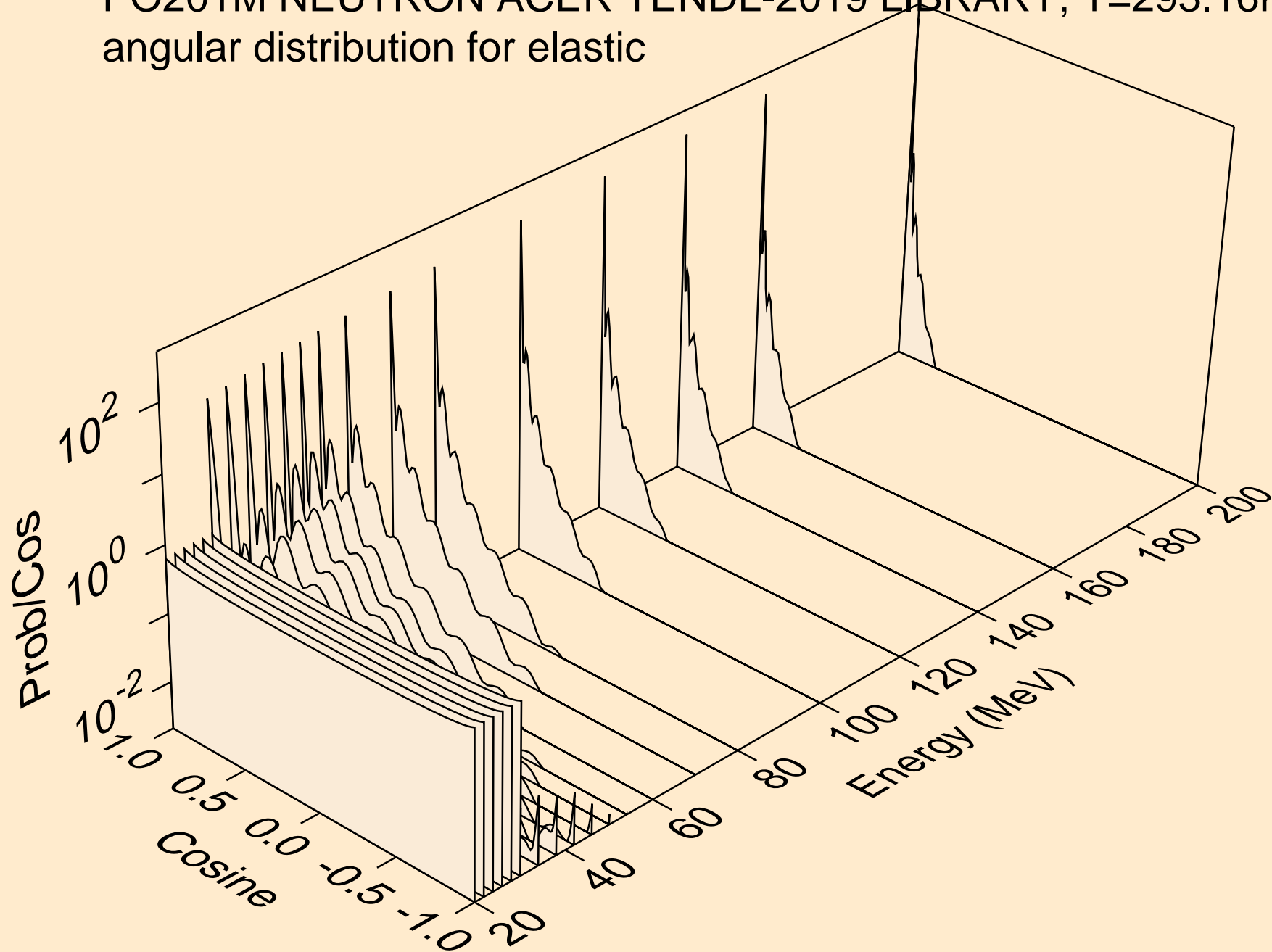

PO201M NEUTRON ACER TENDL-2019 LIBRARY; T=293.16K  
angular distribution for (n,n\*1)

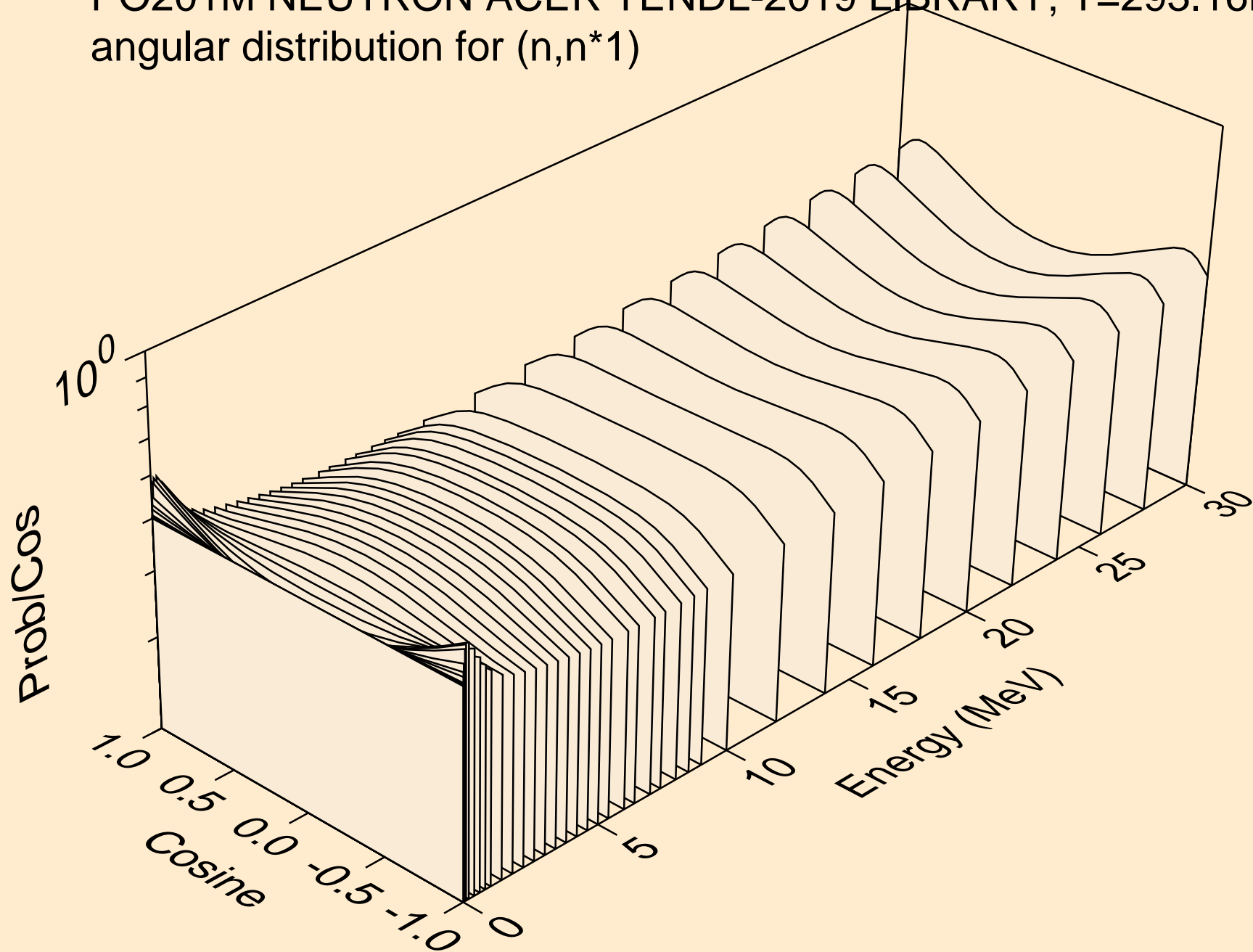

PO201M NEUTRON ACER TENDL-2019 LIBRARY; T=293.16K  
angular distribution for (n,n\*2)

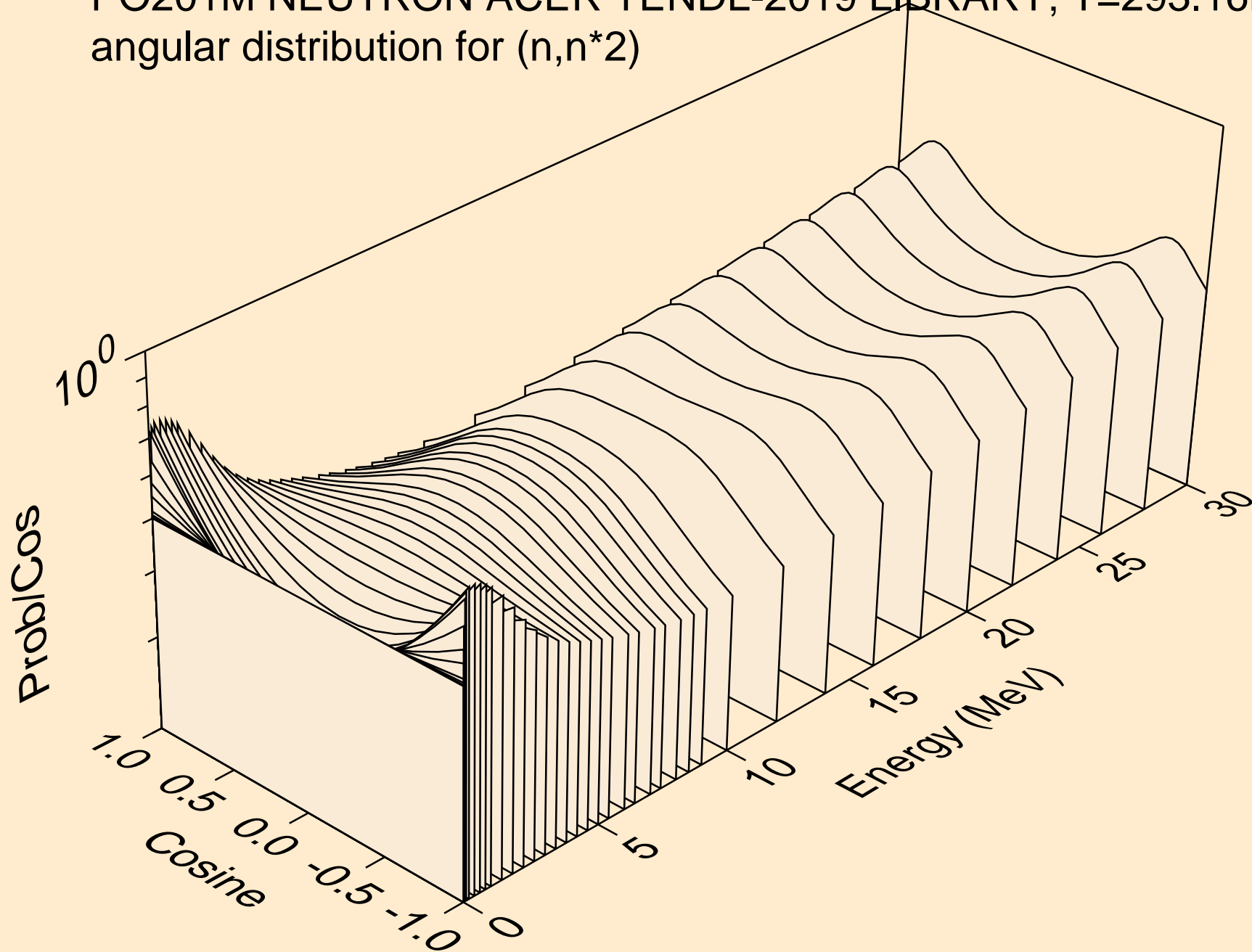

PO201M NEUTRON ACER TENDL-2019 LIBRARY; T=293.16K  
angular distribution for (n,n\*3)

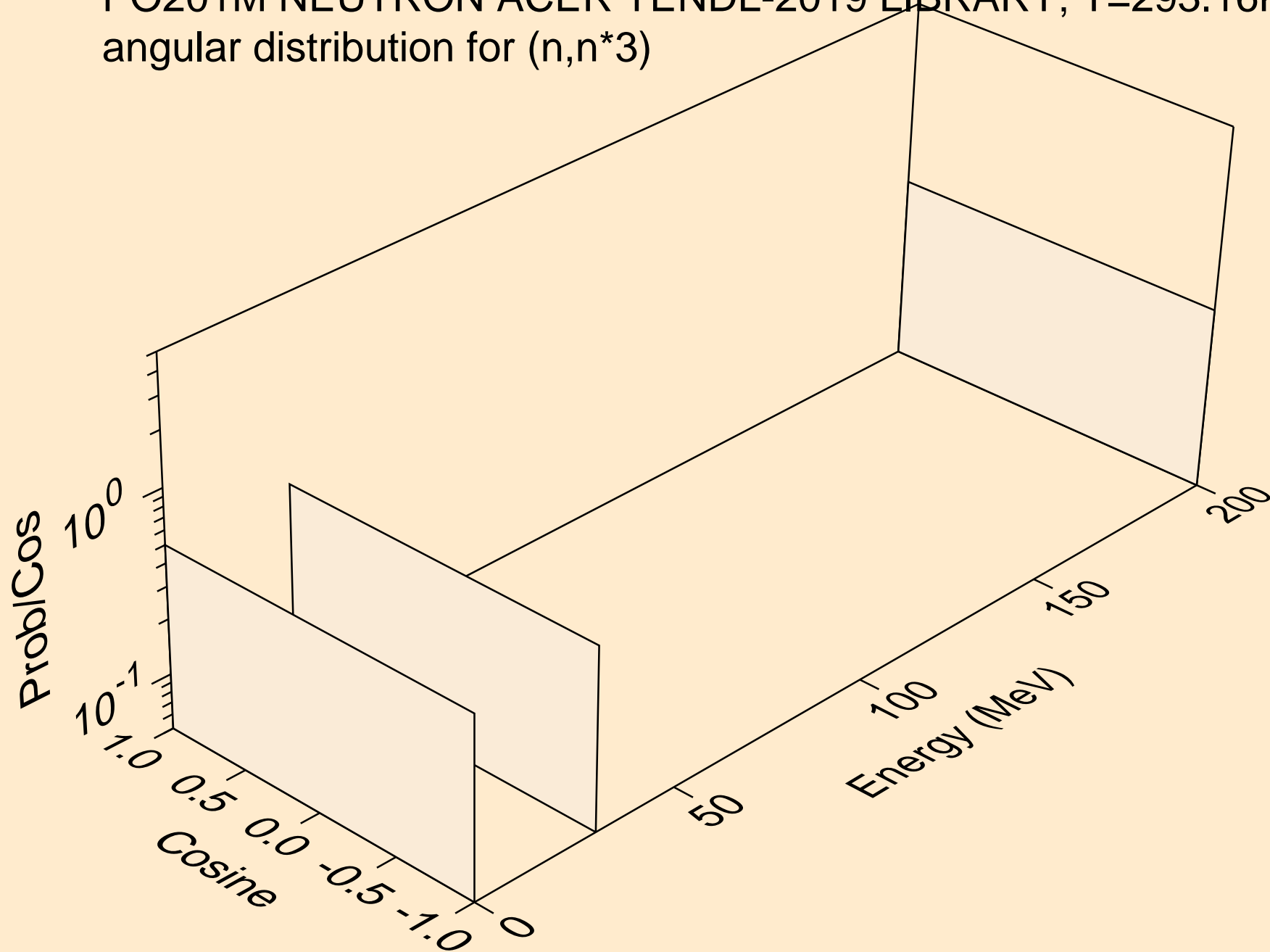

PO201M NEUTRON ACER TENDL-2019 LIBRARY; T=293.16K  
Neutron emission for (n,x)

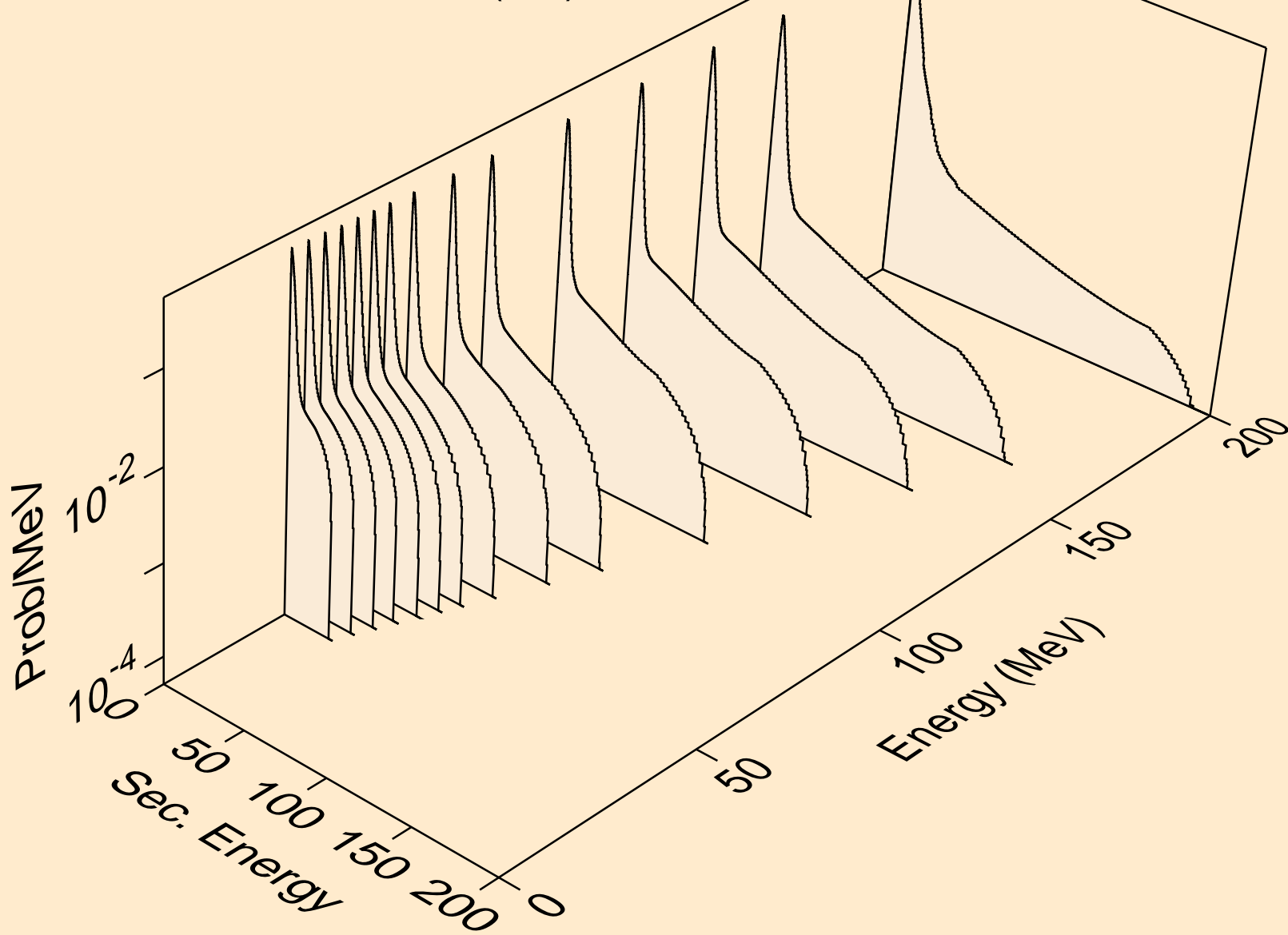

PO201M NEUTRON ACER TENDL-2019 LIBRARY; T=293.16K  
Neutron emission for (n,2nd)

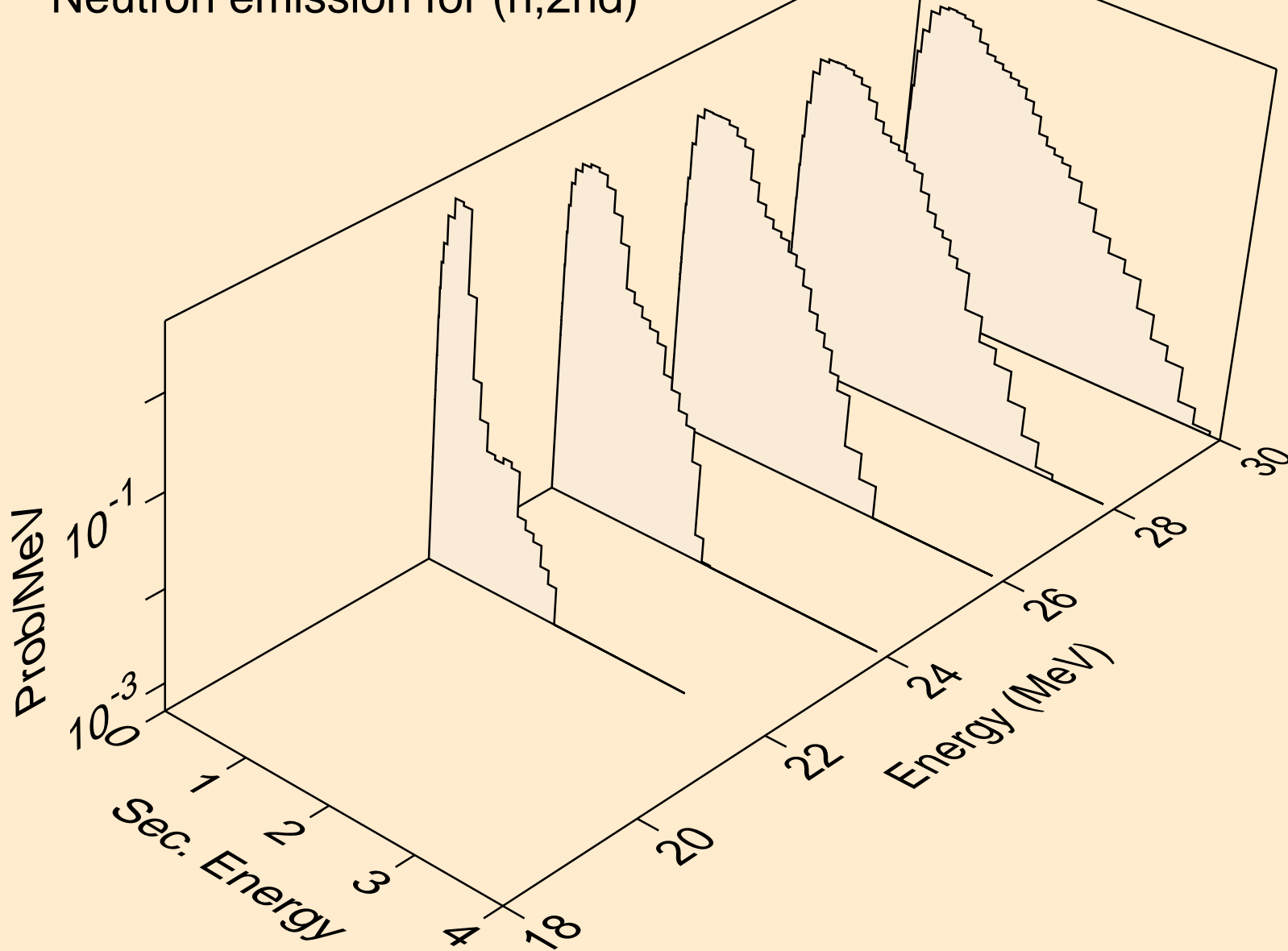

PO201M NEUTRON ACER TENDL-2019 LIBRARY; T=293.16K  
Neutron emission for (n,2n)

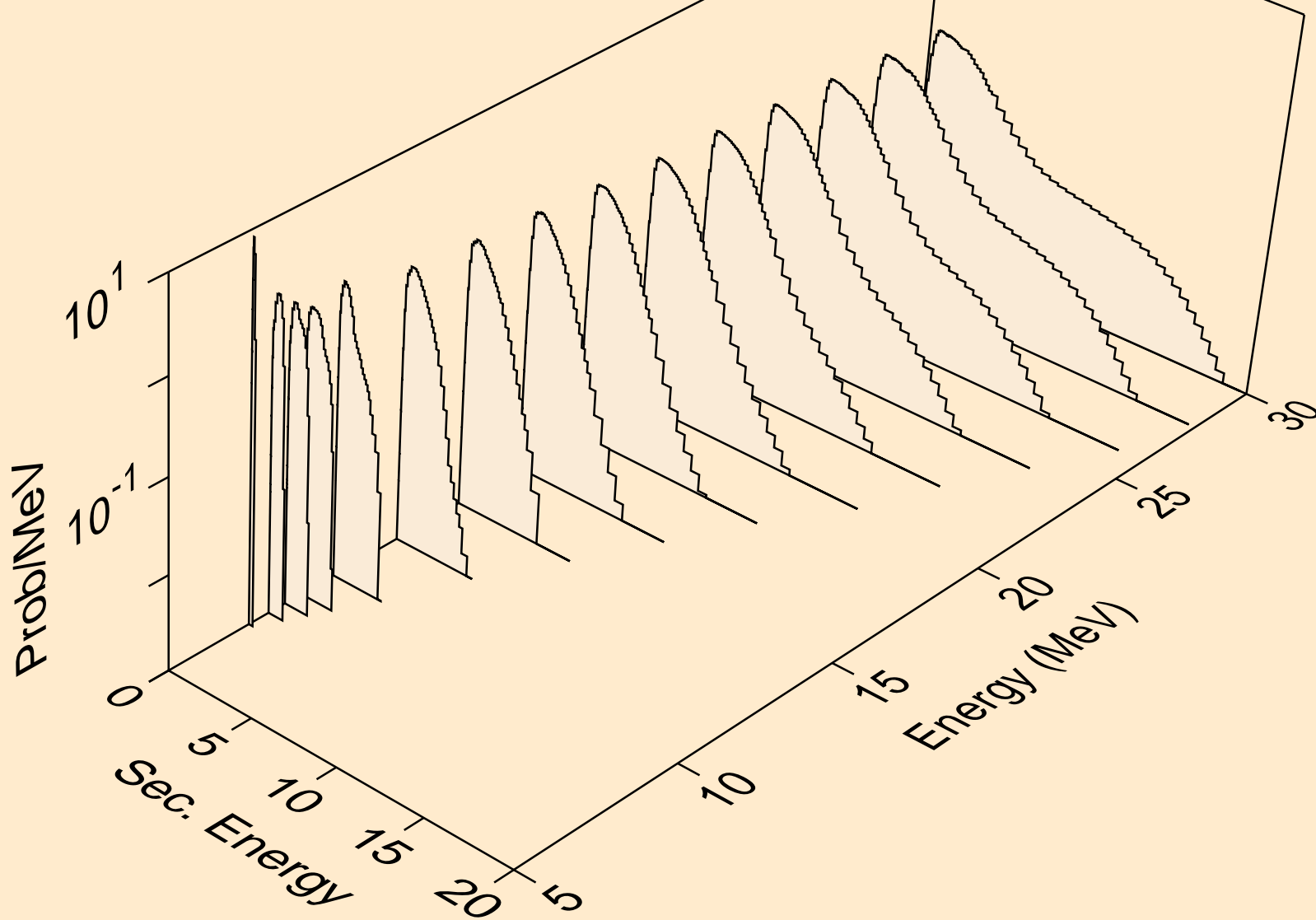



PO201M NEUTRON ACER TENDL-2019 LIBRARY; T=293.16K  
Neutron emission for (n,3n)

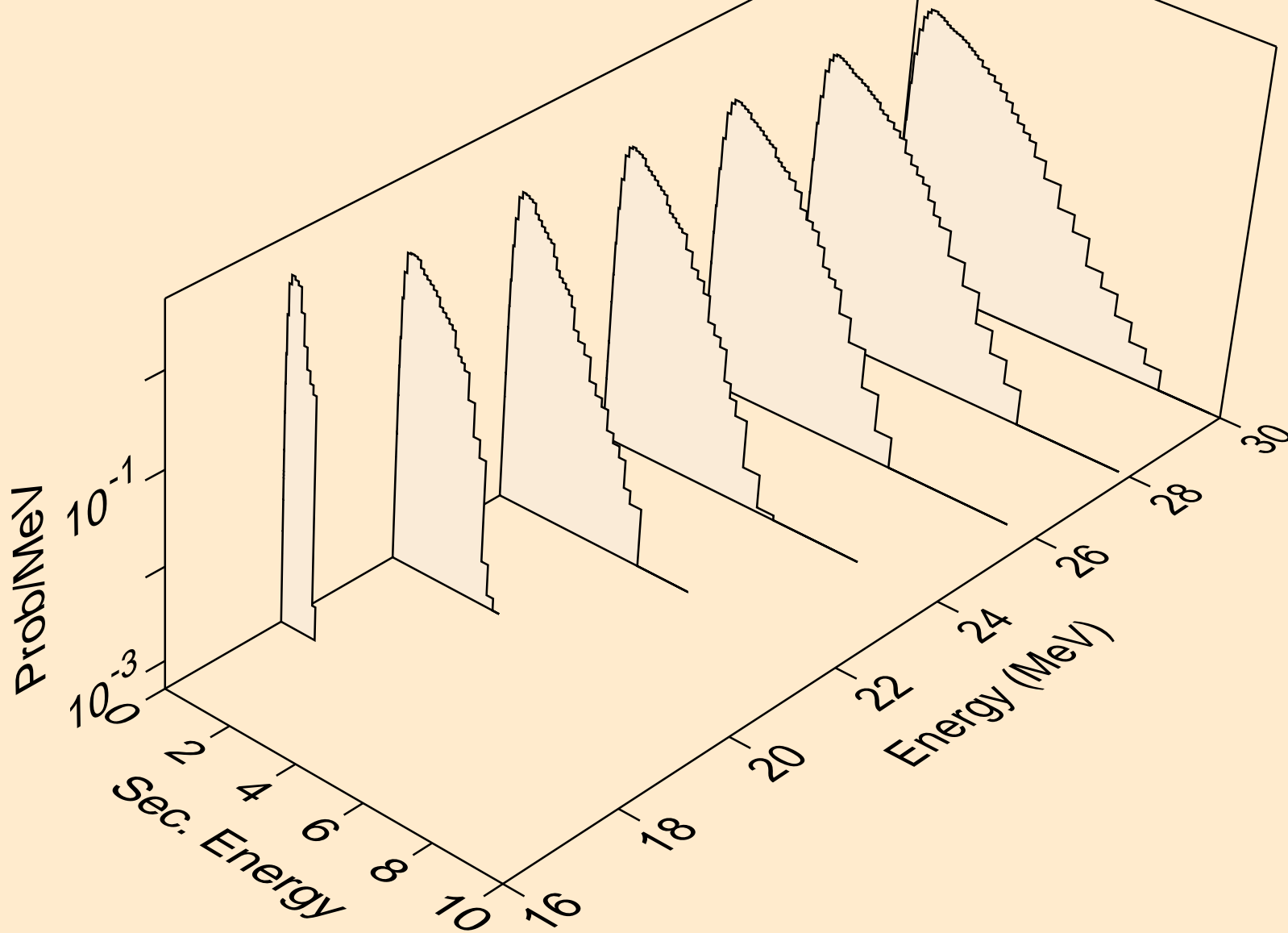

PO201M NEUTRON ACER TENDL-2019 LIBRARY; T=293.16K  
Neutron emission for (n,n\*)a

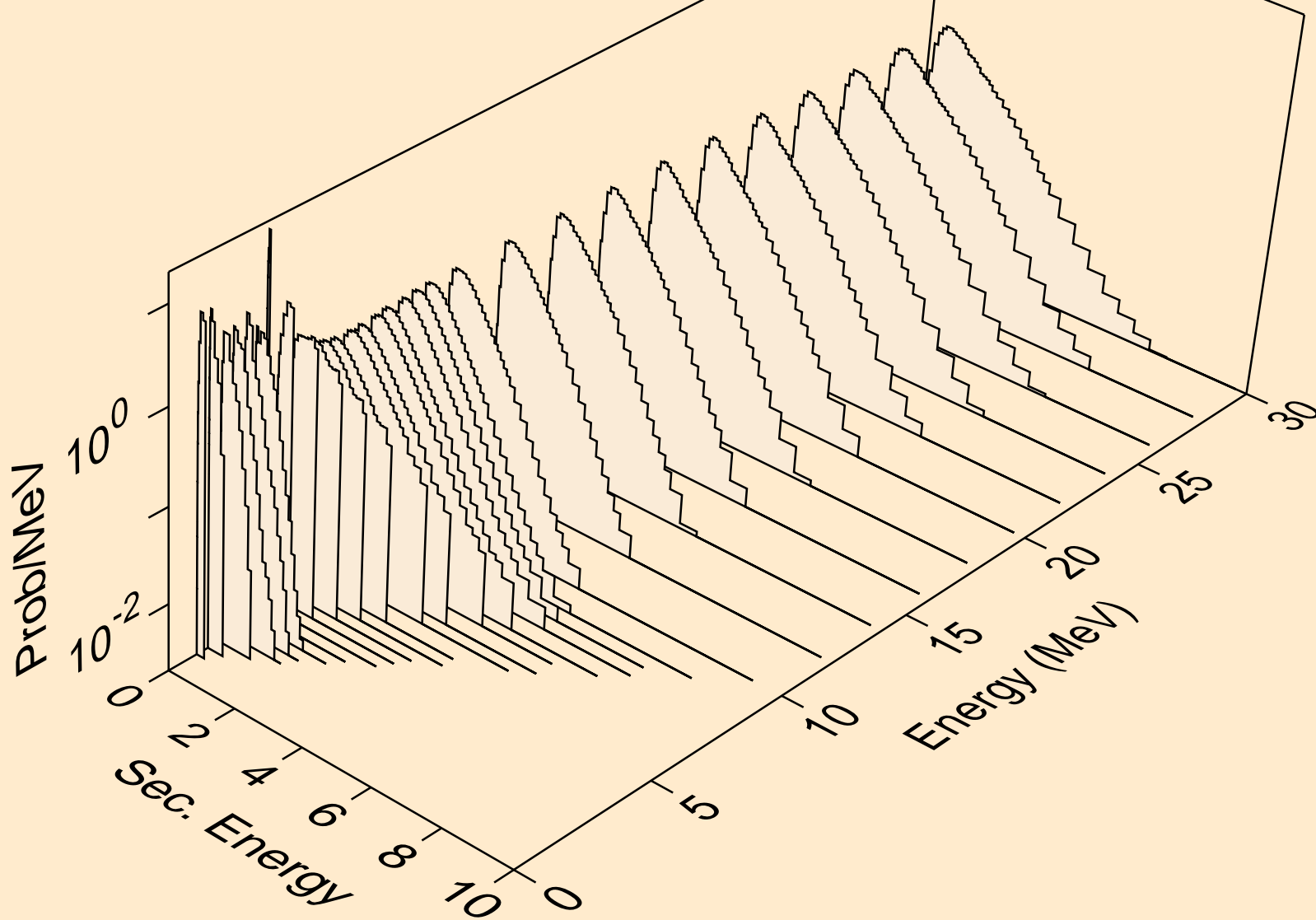

PO201M NEUTRON ACER TENDL-2019 LIBRARY; T=293.16K  
Neutron emission for (n,2n)a

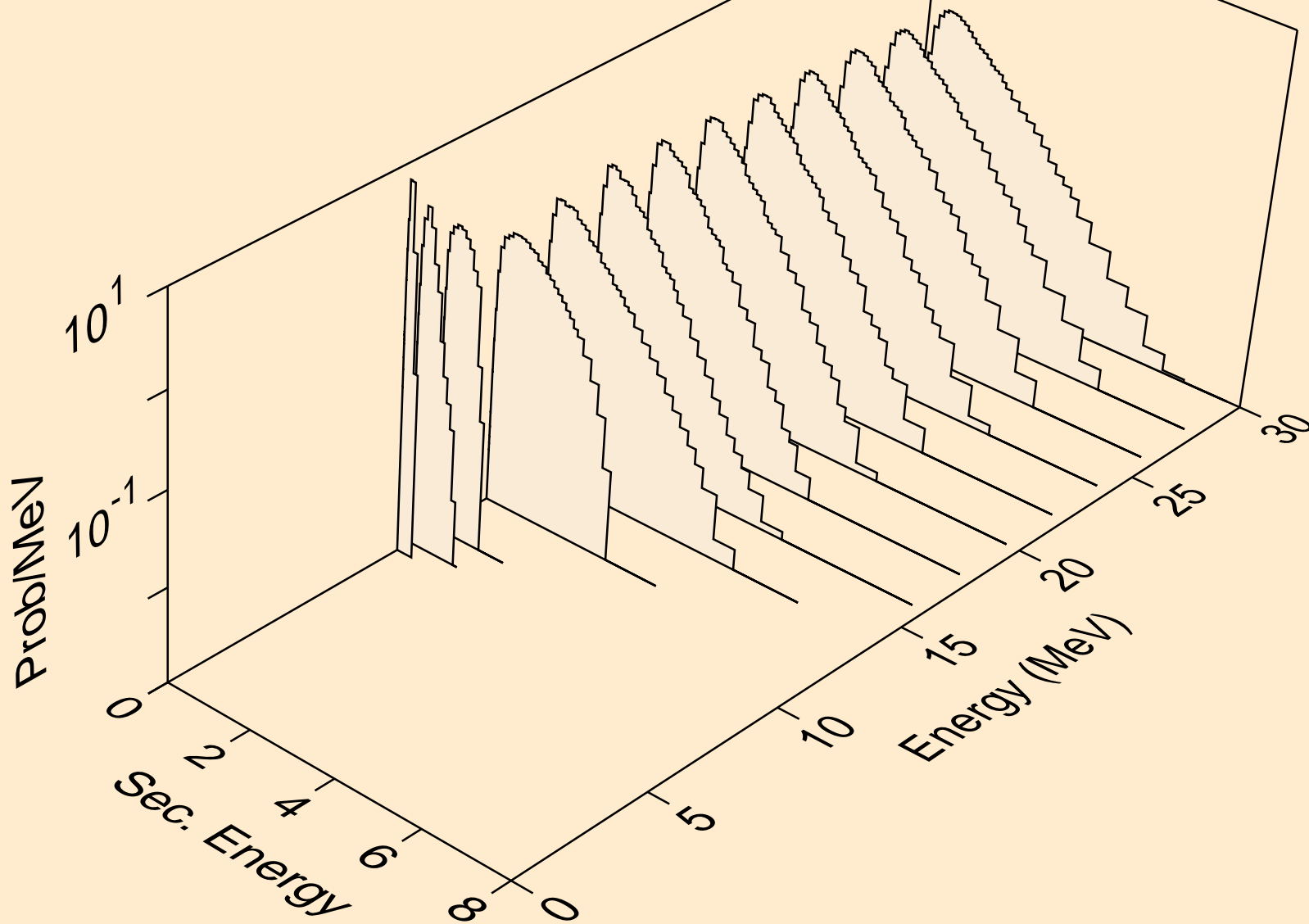

PO201M NEUTRON ACER TENDL-2019 LIBRARY; T=293.16K  
Neutron emission for (n,3n)a

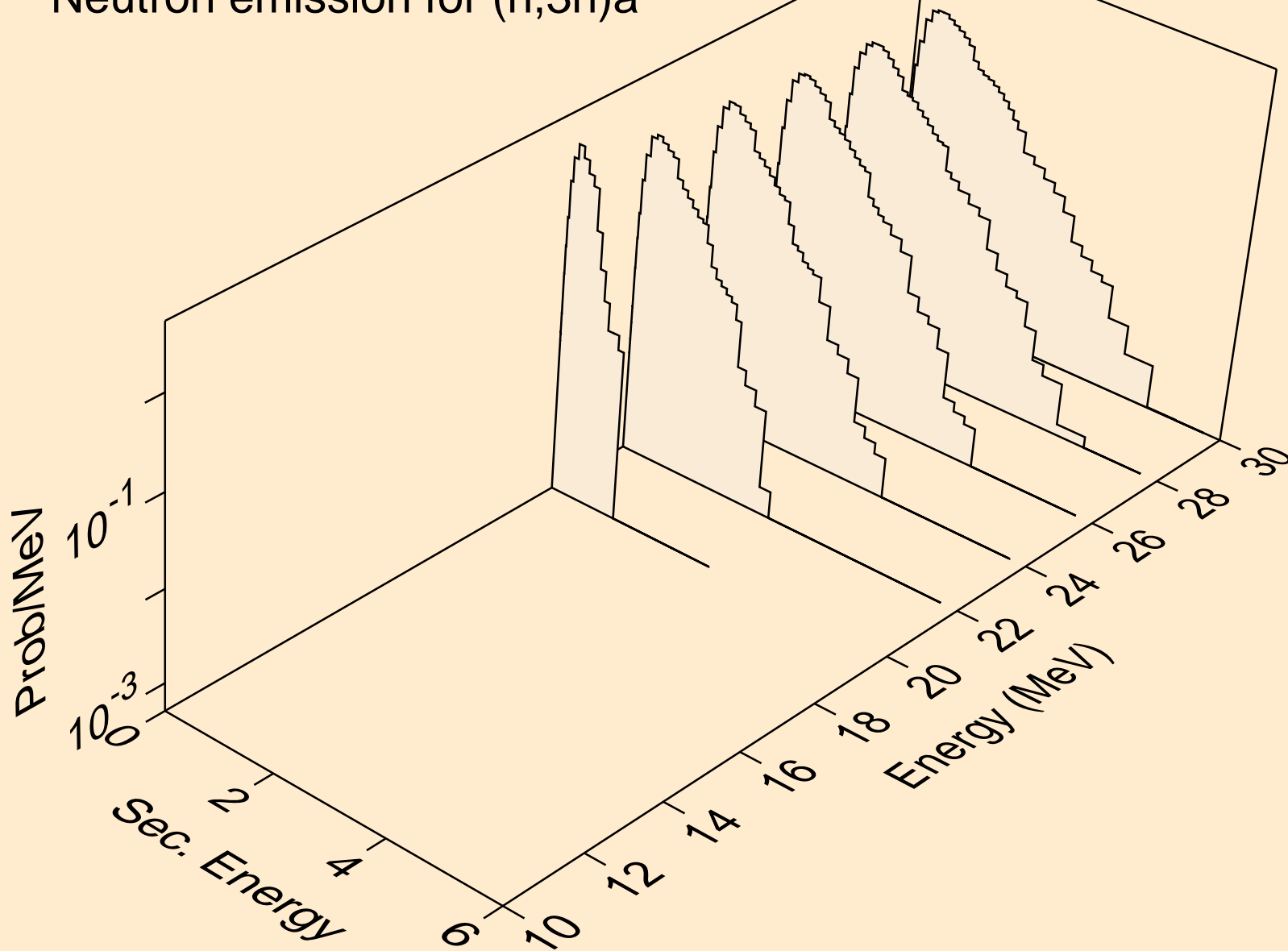

PO201M NEUTRON ACER TENDL-2019 LIBRARY; T=293.16K  
Neutron emission for (n,n\*)p

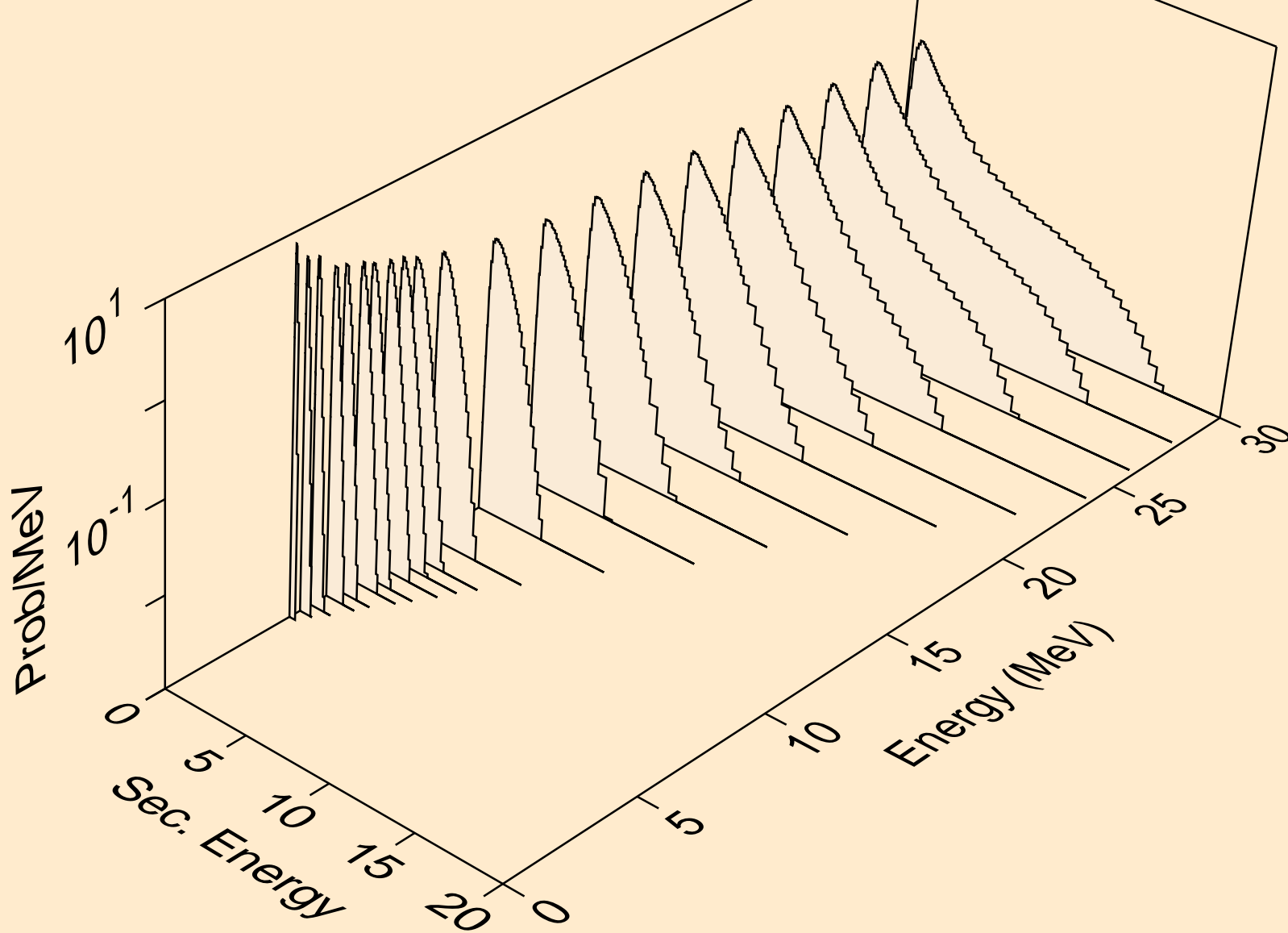

PO201M NEUTRON ACER TENDL-2019 LIBRARY; T=293.16K  
Neutron emission for (n,n\*)2a

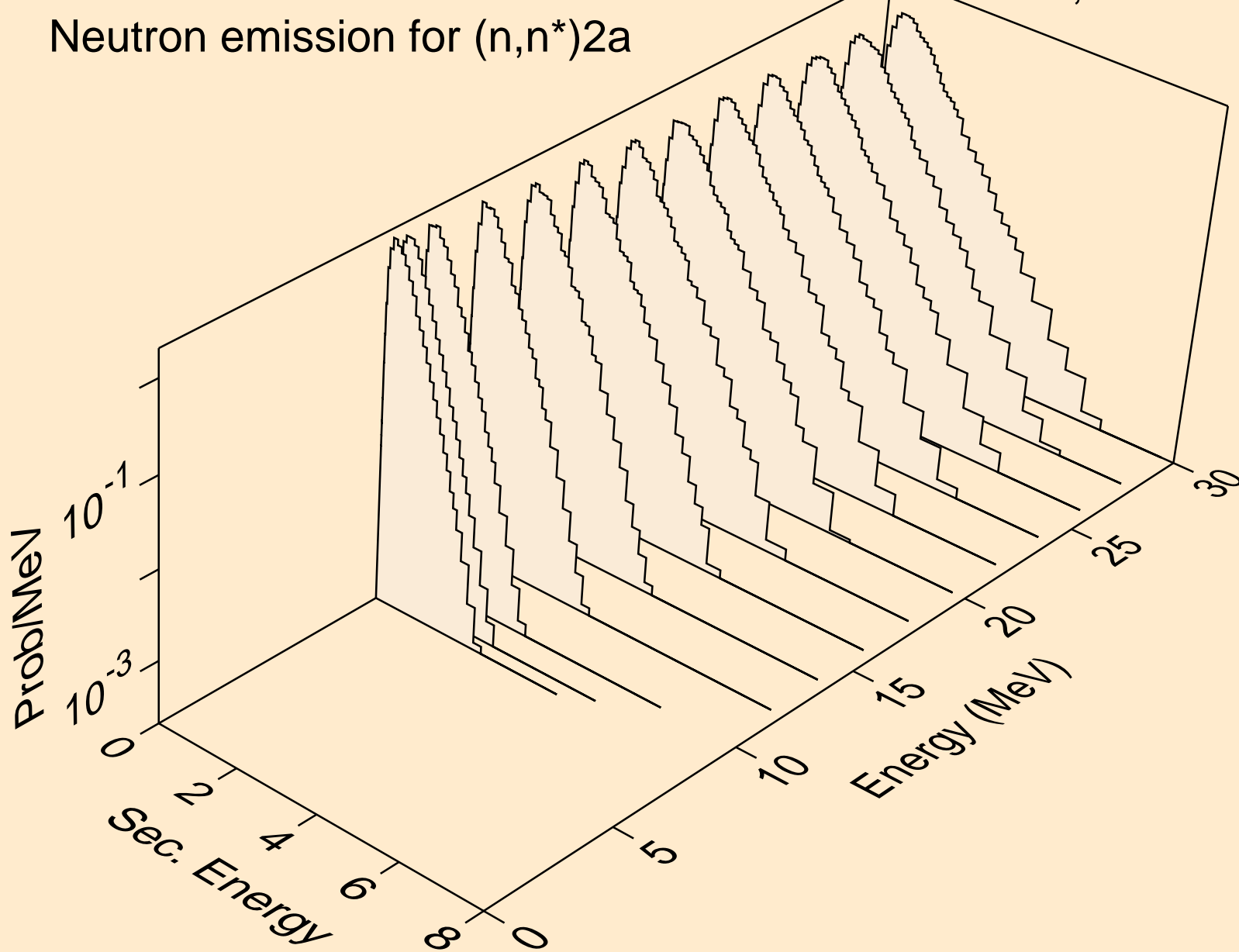

PO201M NEUTRON ACER TENDL-2019 LIBRARY; T=293.16K  
Neutron emission for (n,n\*)d

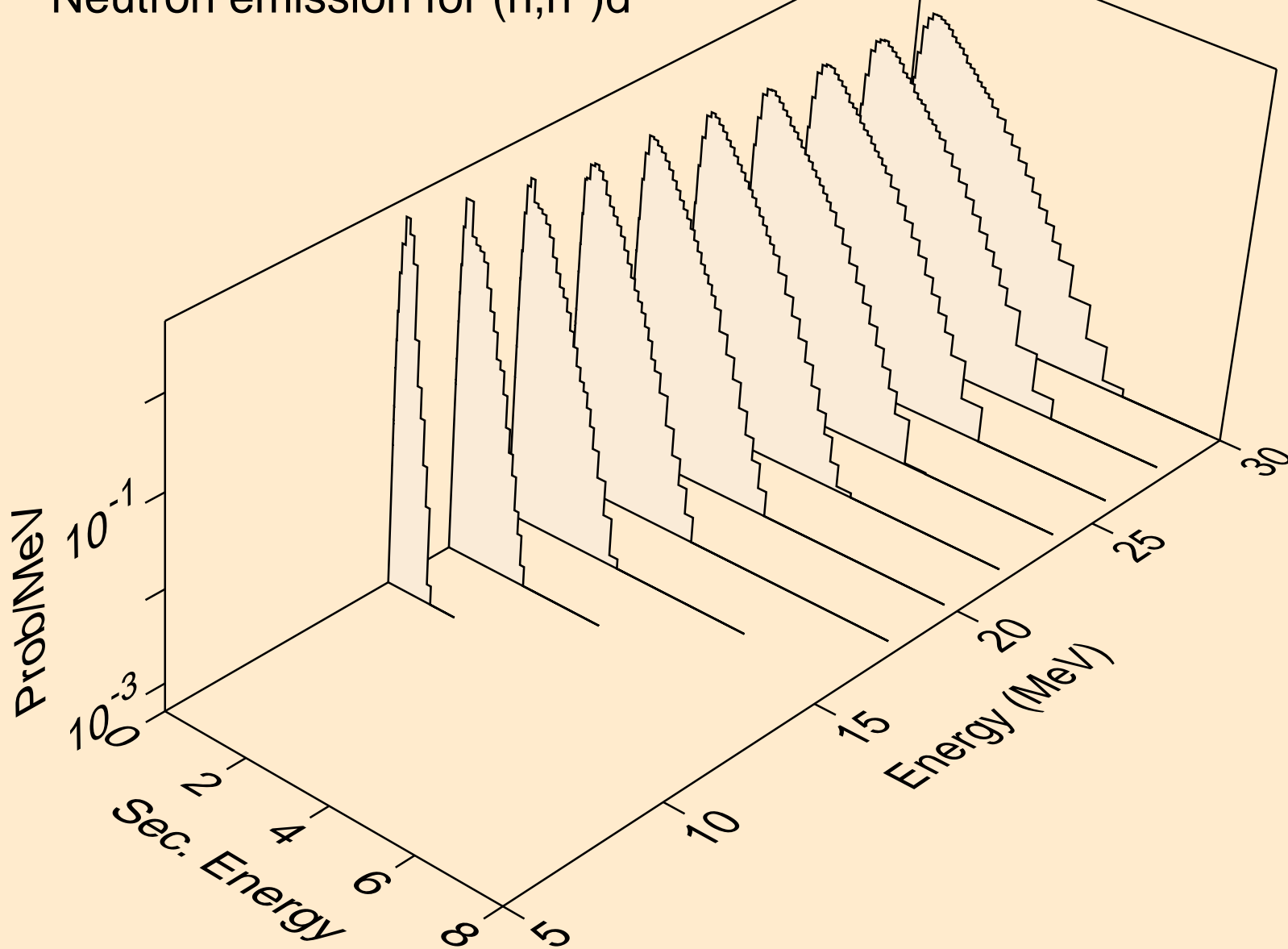

PO201M NEUTRON ACER TENDL-2019 LIBRARY; T=293.16K  
Neutron emission for (n,n\*)t

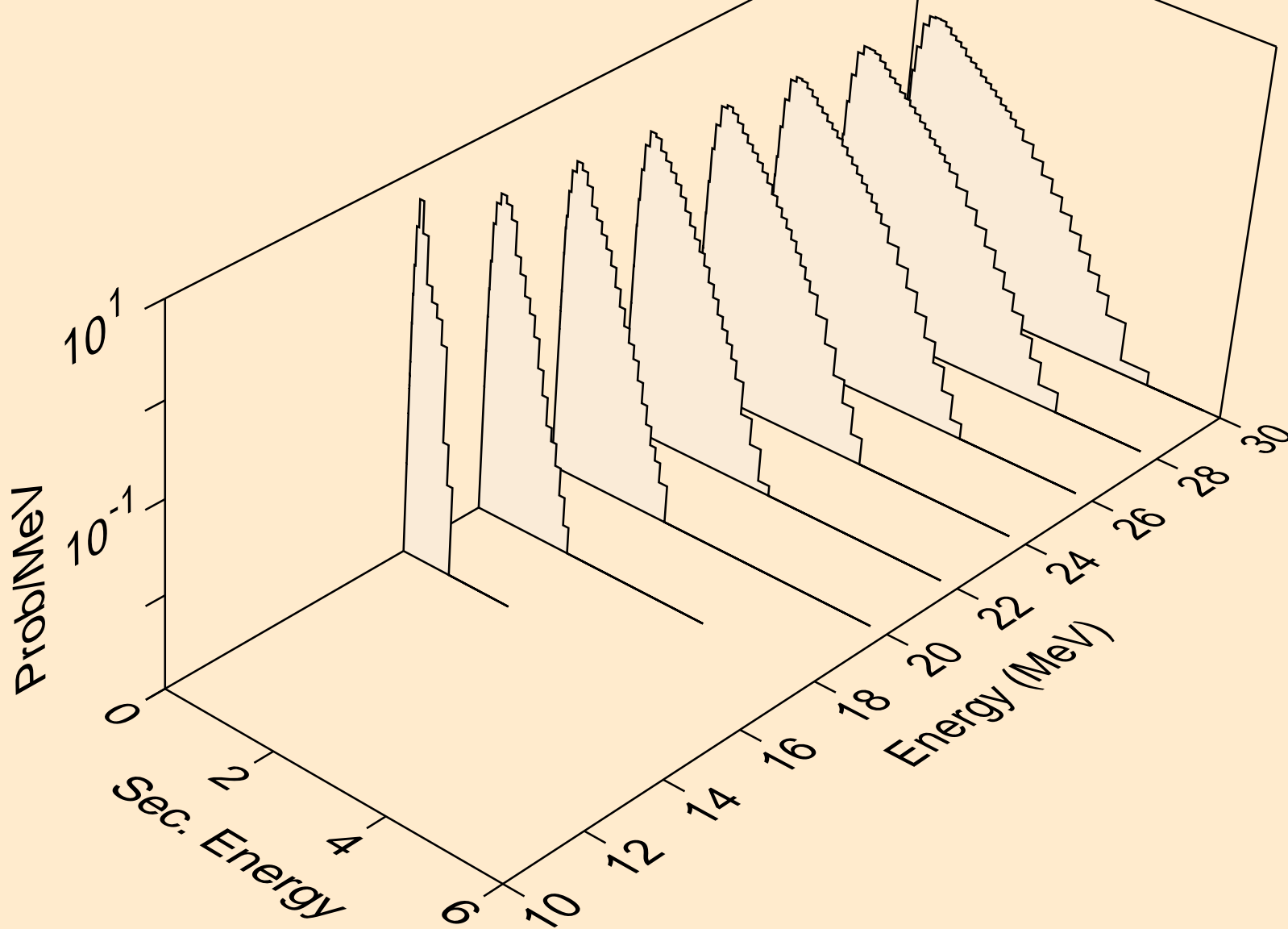



PO201M NEUTRON ACER TENDL-2019 LIBRARY; T=293.16K  
Neutron emission for (n,n\*)he3

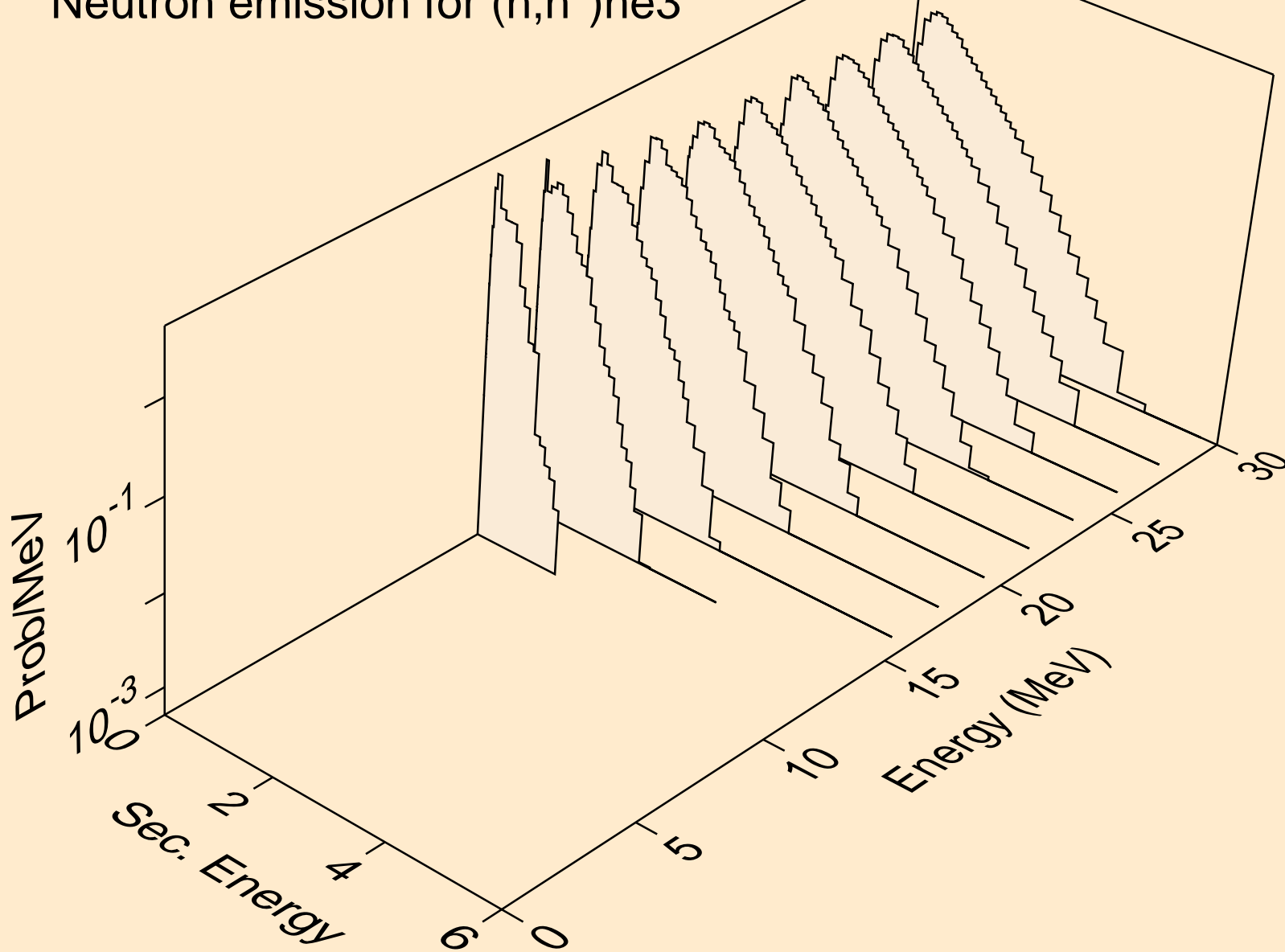

PO201M NEUTRON ACER TENDL-2019 LIBRARY; T=293.16K  
Neutron emission for (n,4n)

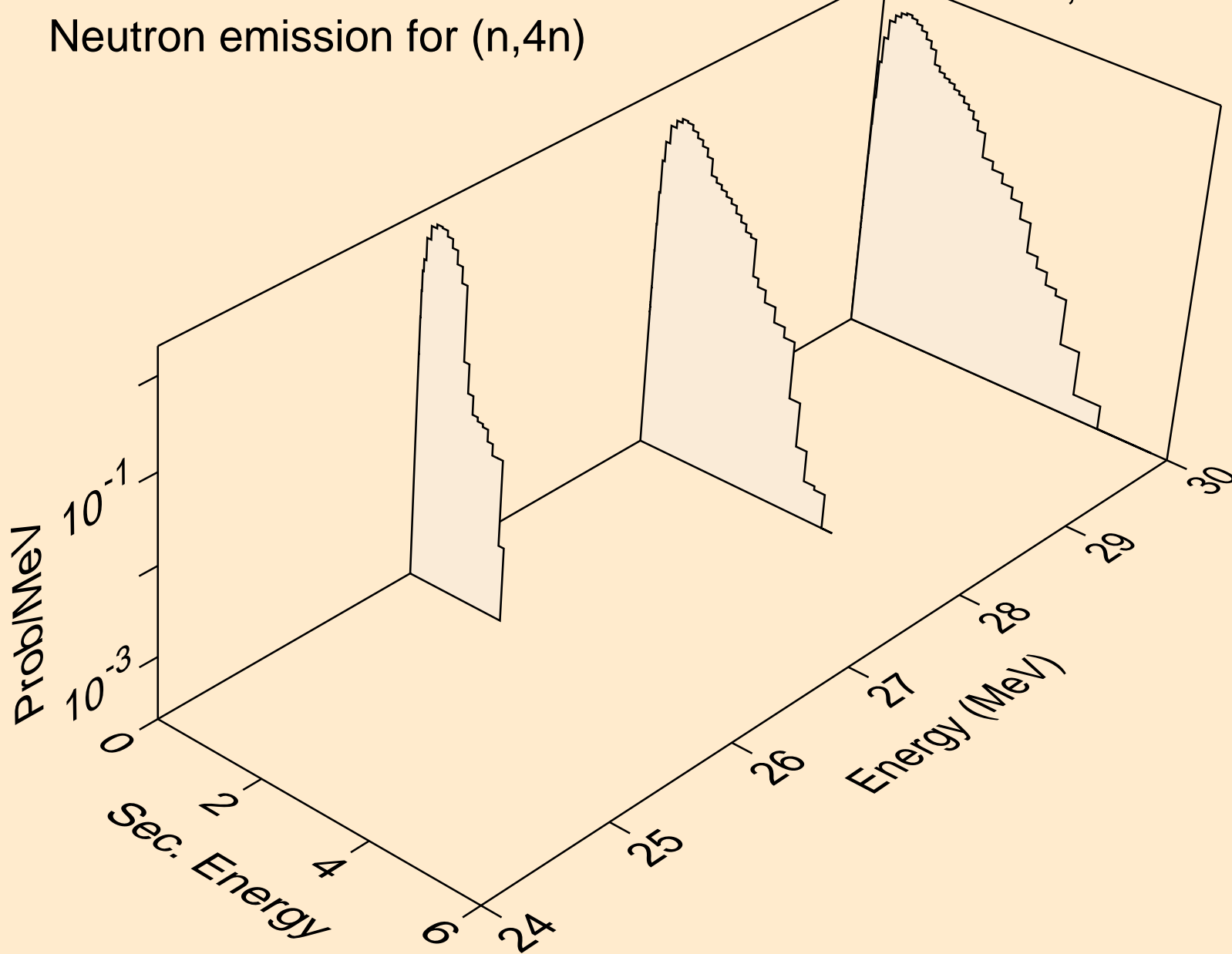

PO201M NEUTRON ACER TENDL-2019 LIBRARY; T=293.16K  
Neutron emission for (n,2np)

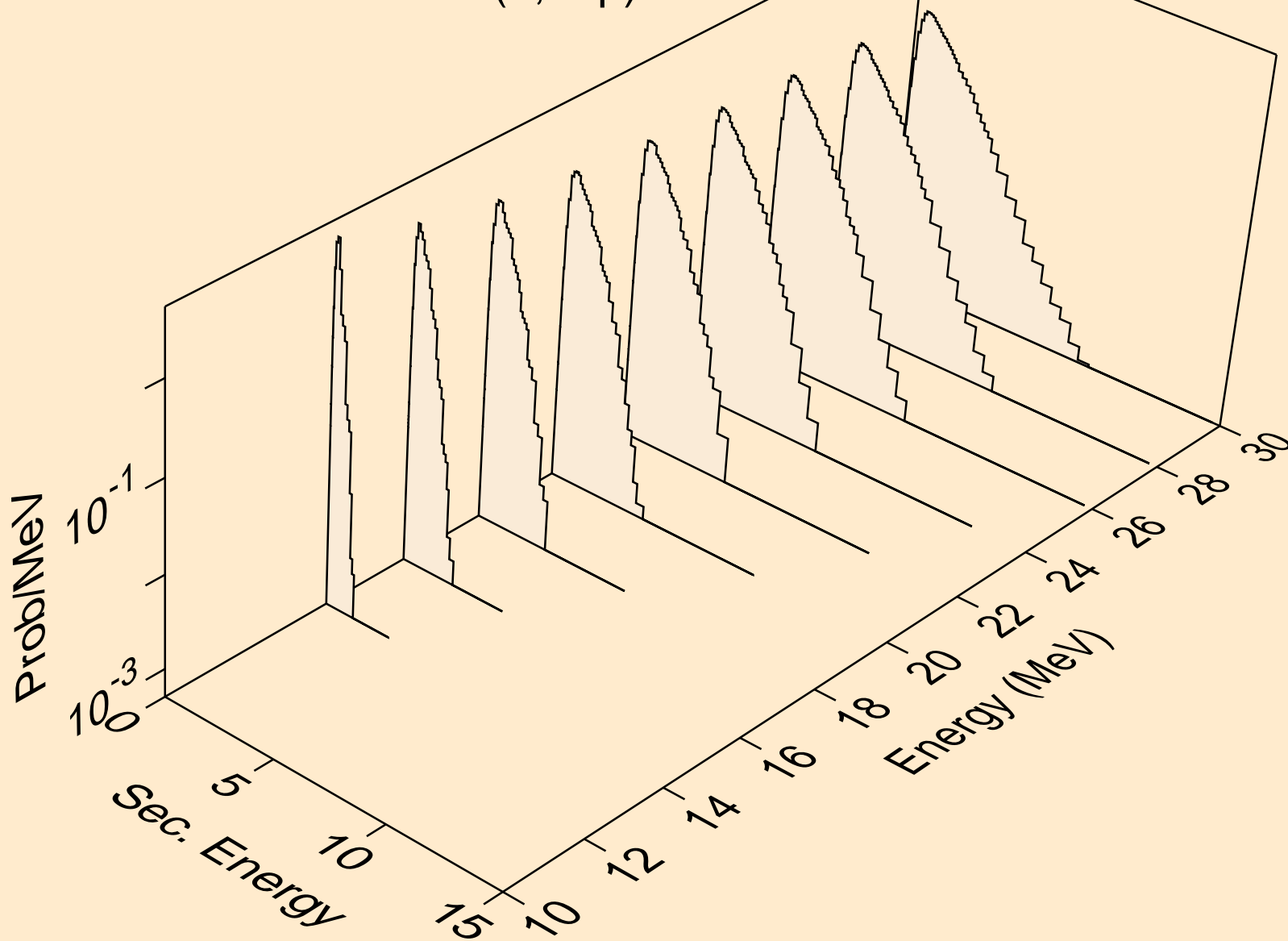

PO201M NEUTRON ACER TENDL-2019 LIBRARY; T=293.16K  
Neutron emission for (n,3np)

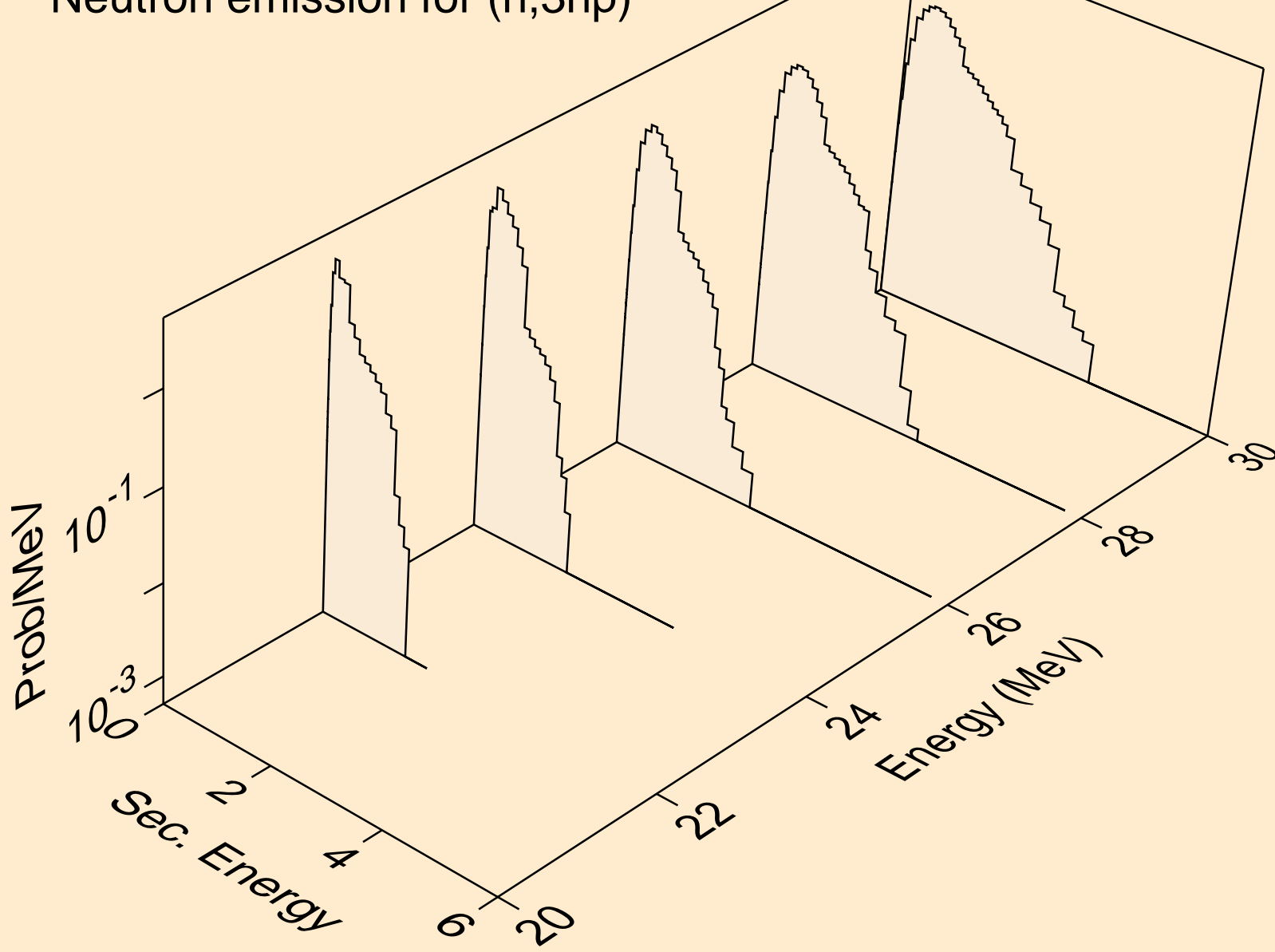

PO201M NEUTRON ACER TENDL-2019 LIBRARY; T=293.16K  
Neutron emission for (n,2np)

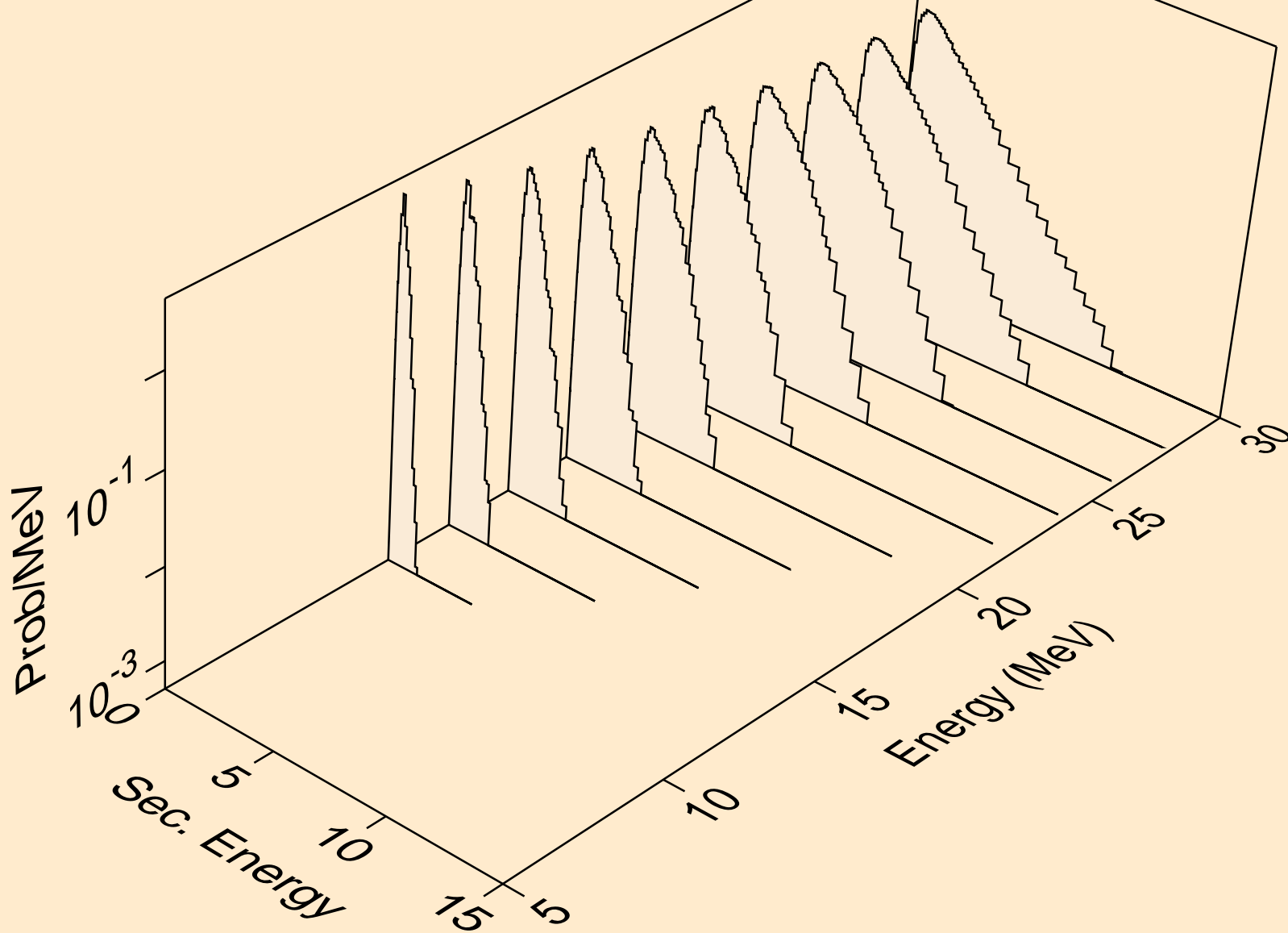

PO201M NEUTRON ACER TENDL-2019 LIBRARY; T=293.16K  
Neutron emission for (n,npa)

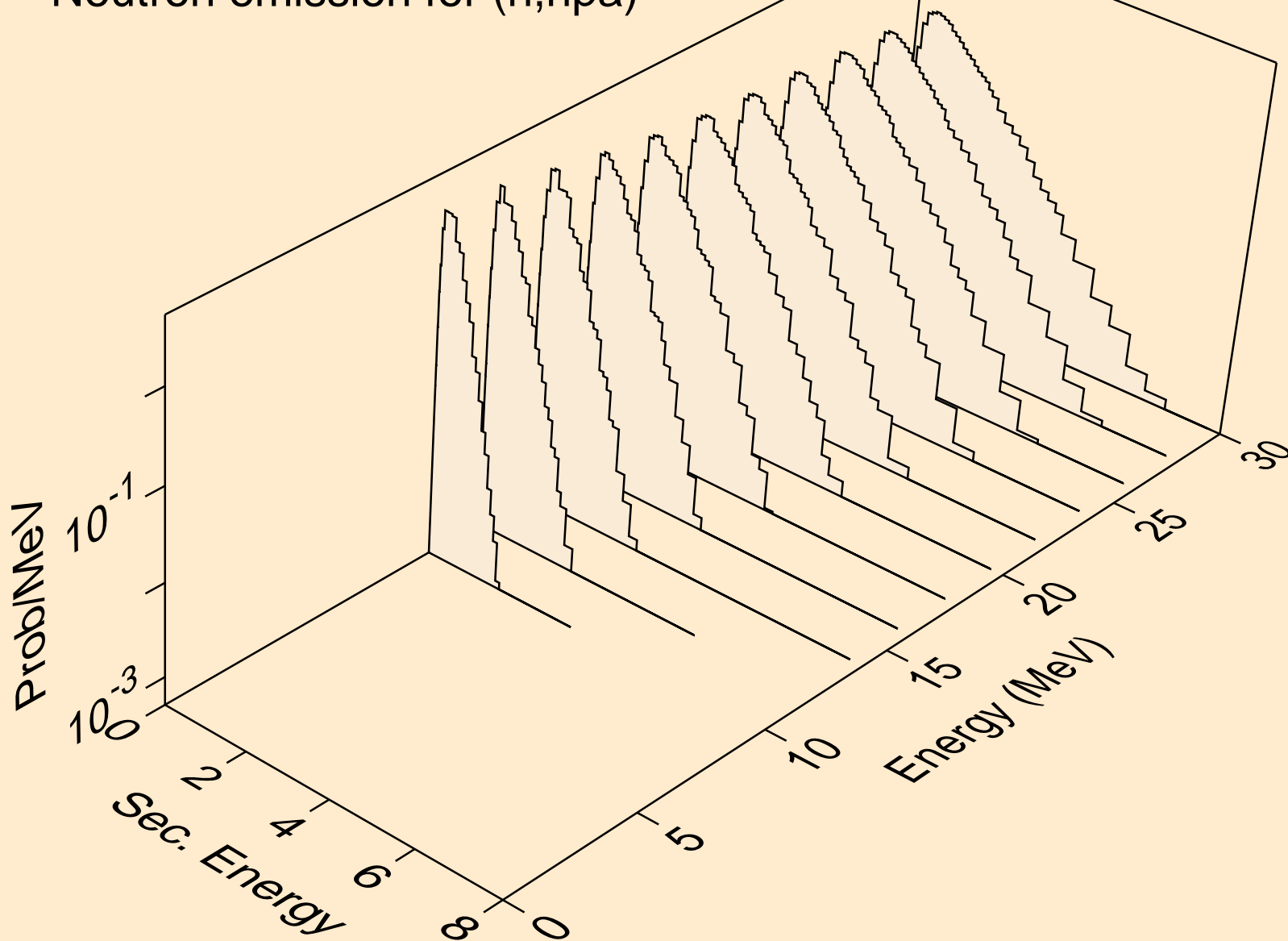

PO201M NEUTRON ACER TENDL-2019 LIBRARY; T=293.16K  
Neutron emission for (n,n\*c)

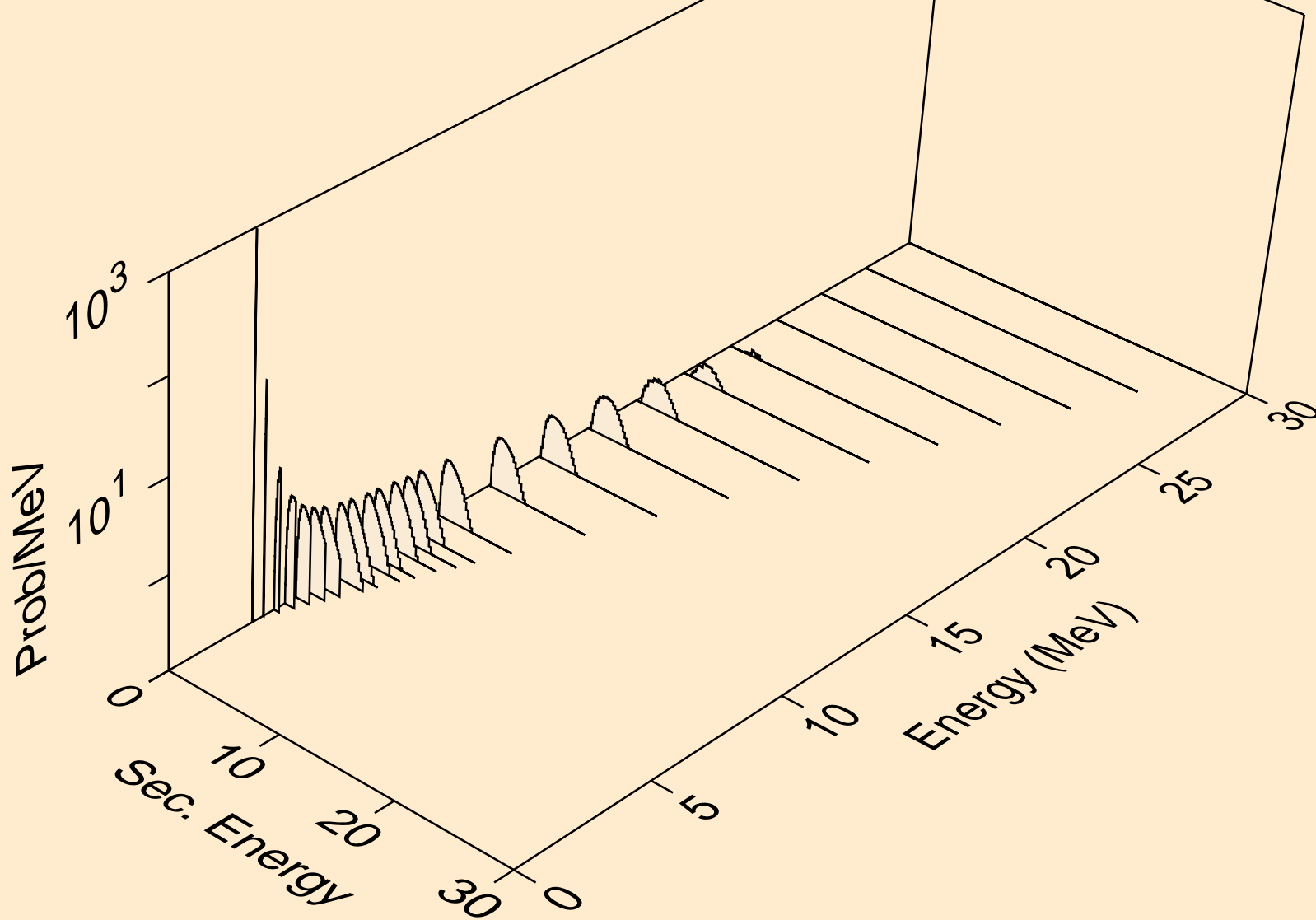

PO201M NEUTRON ACER TENDL-2019 LIBRARY; T=293.16K  
Photon emission for (n,x)

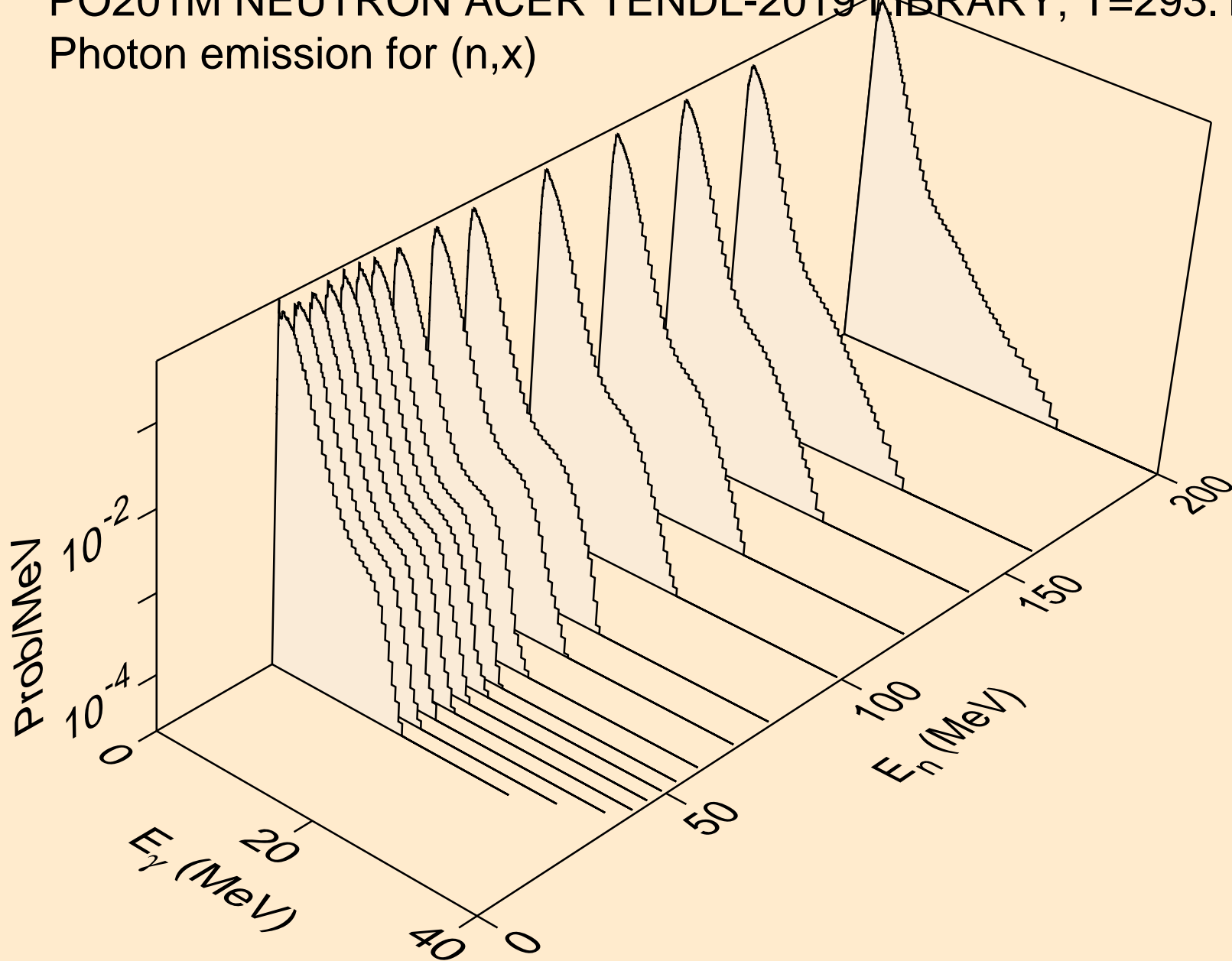



PO201M NEUTRON ACER TENDL-2019 LIBRARY; T=293.16K  
Photon emission for (n,2nd)

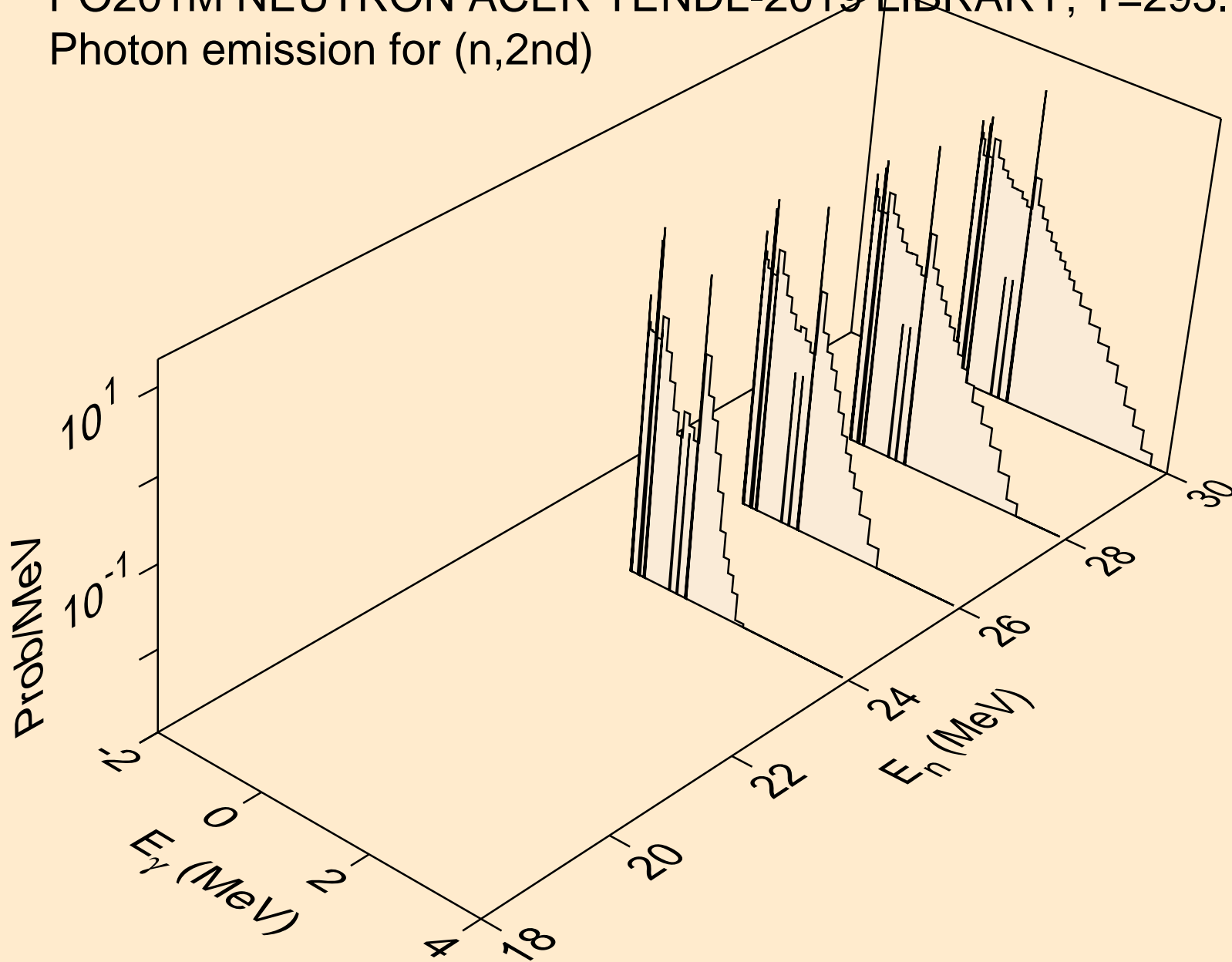

PO201M NEUTRON ACER TENDL-2019 LIBRARY; T=293.16K  
Photon emission for (n,2n)

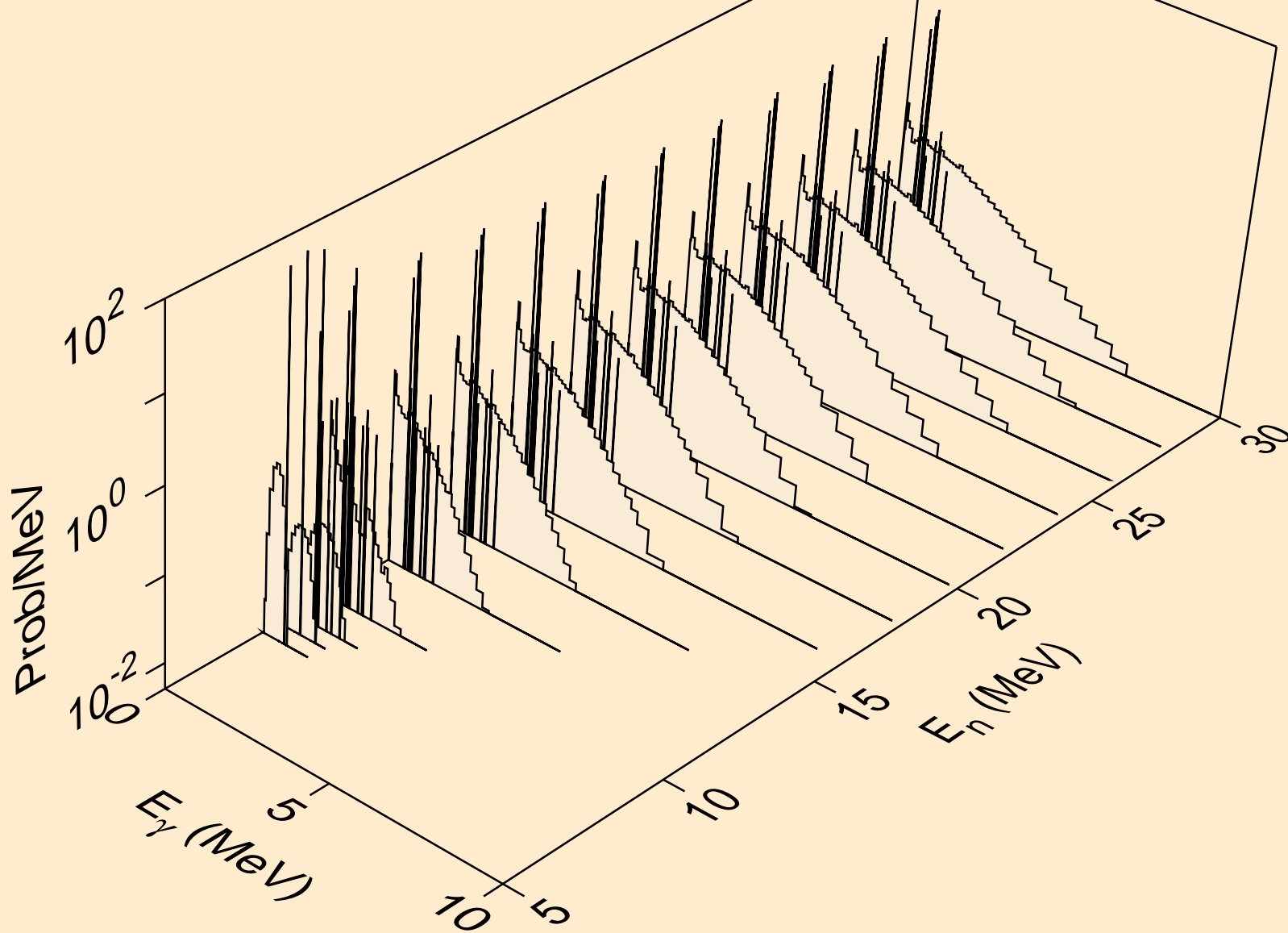

PO201M NEUTRON ACER TENDL-2019 LIBRARY; T=293.16K  
Photon emission for (n,3n)

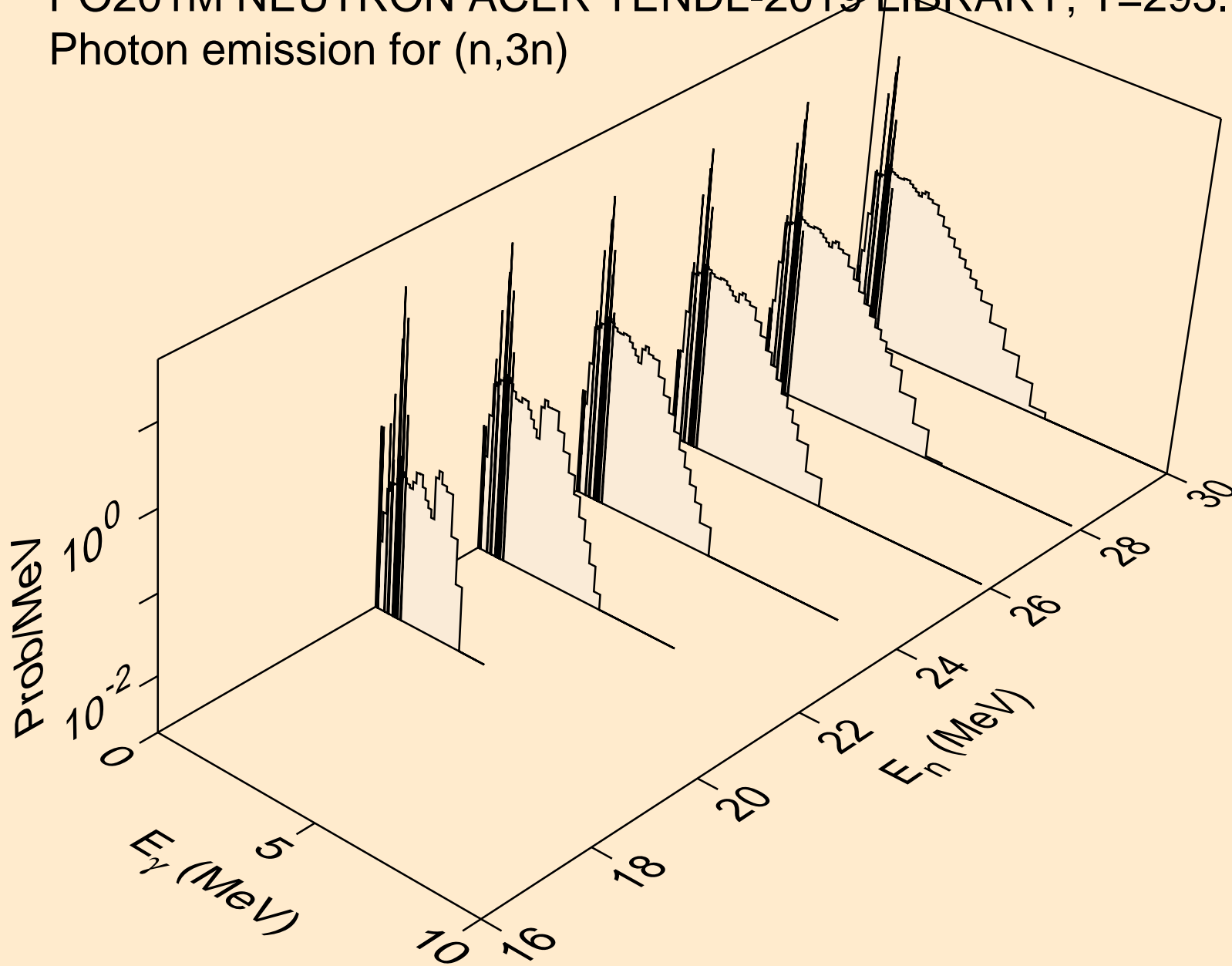

PO201M NEUTRON ACER TENDL-2019 LIBRARY; T=293.16K  
Photon emission for (n,n\*)a

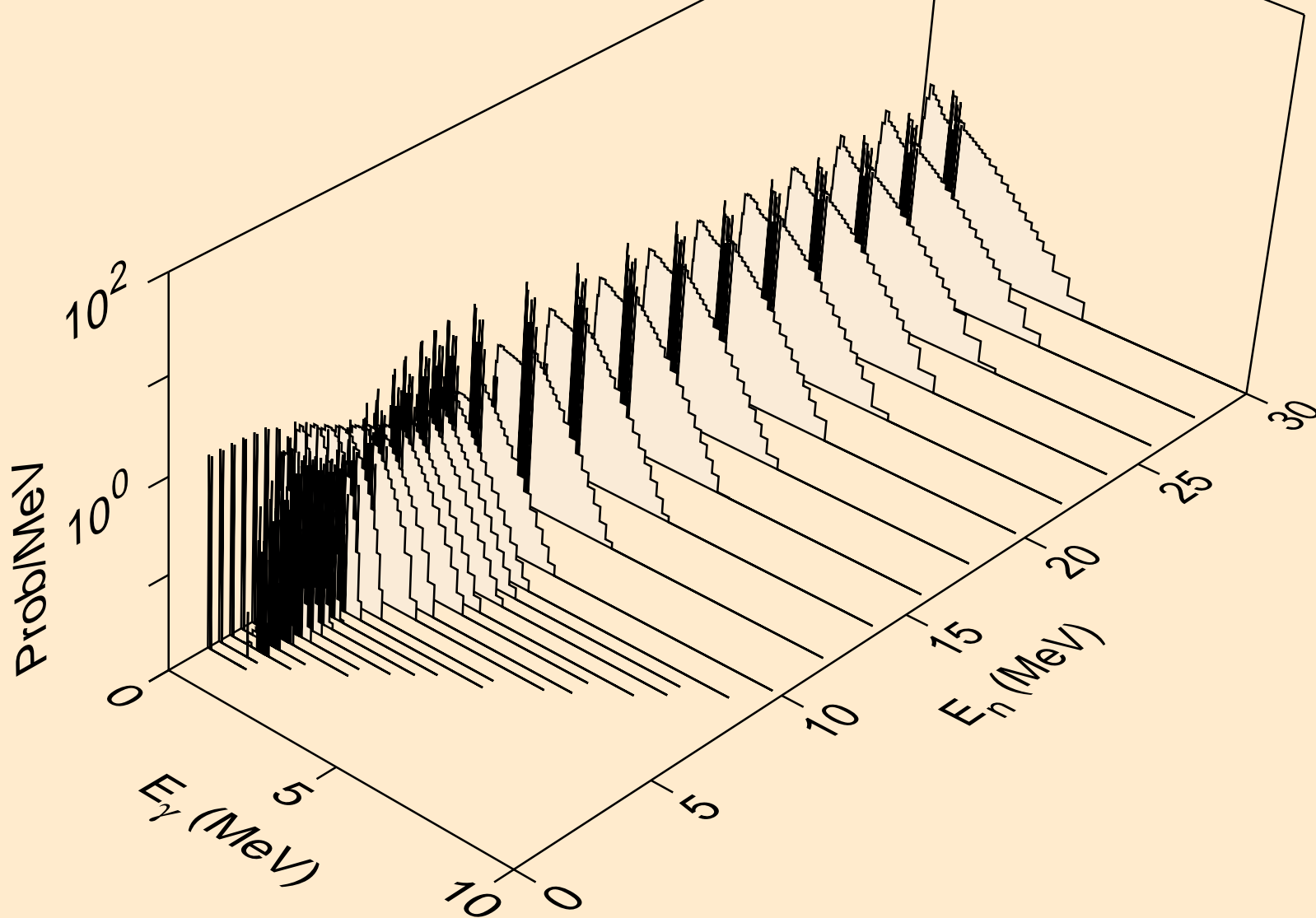

PO201M NEUTRON ACER TENDL-2019 LIBRARY; T=293.16K  
Photon emission for (n,2n)a

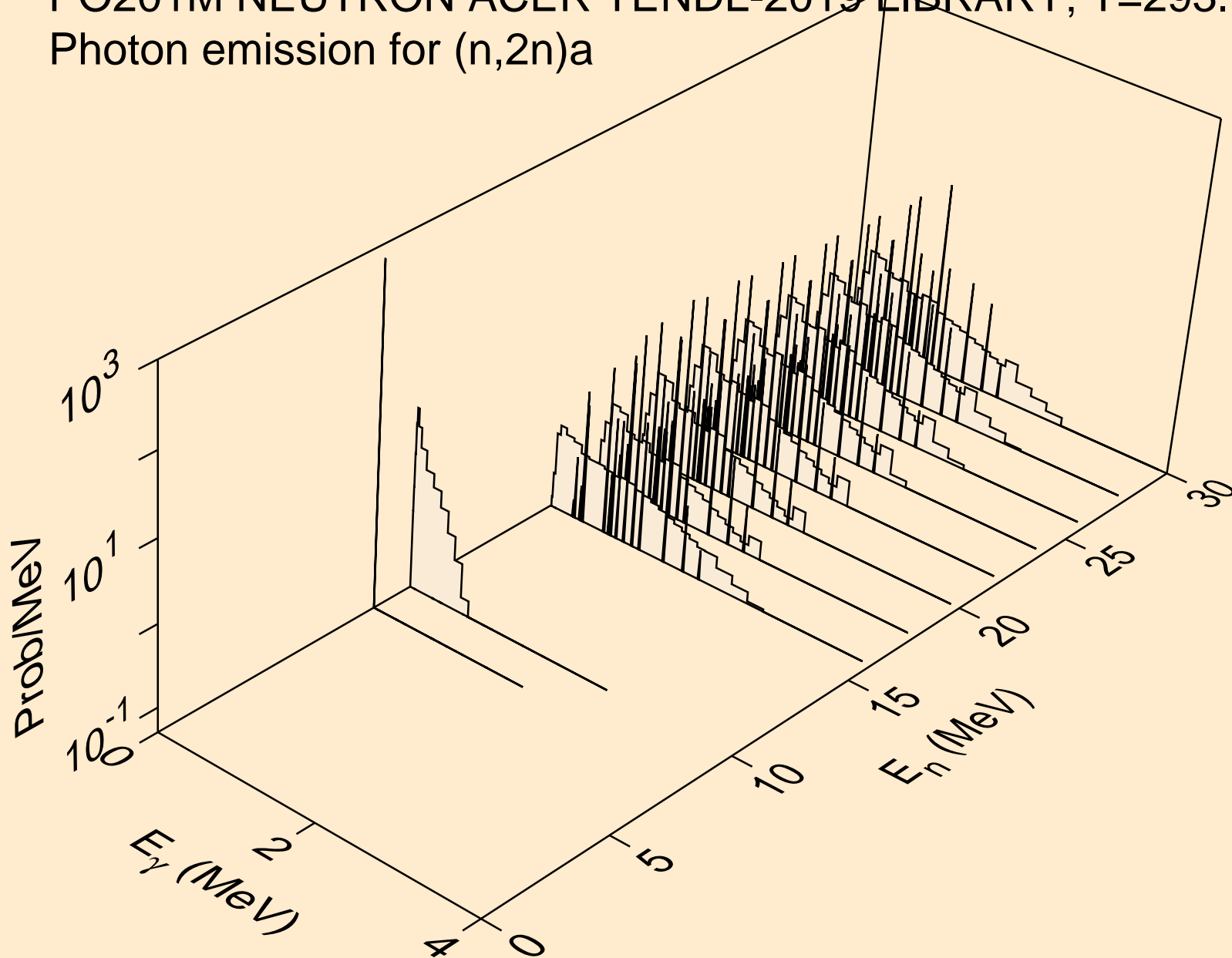

PO201M NEUTRON ACER TENDL-2019 LIBRARY; T=293.16K  
Photon emission for (n,3n)a

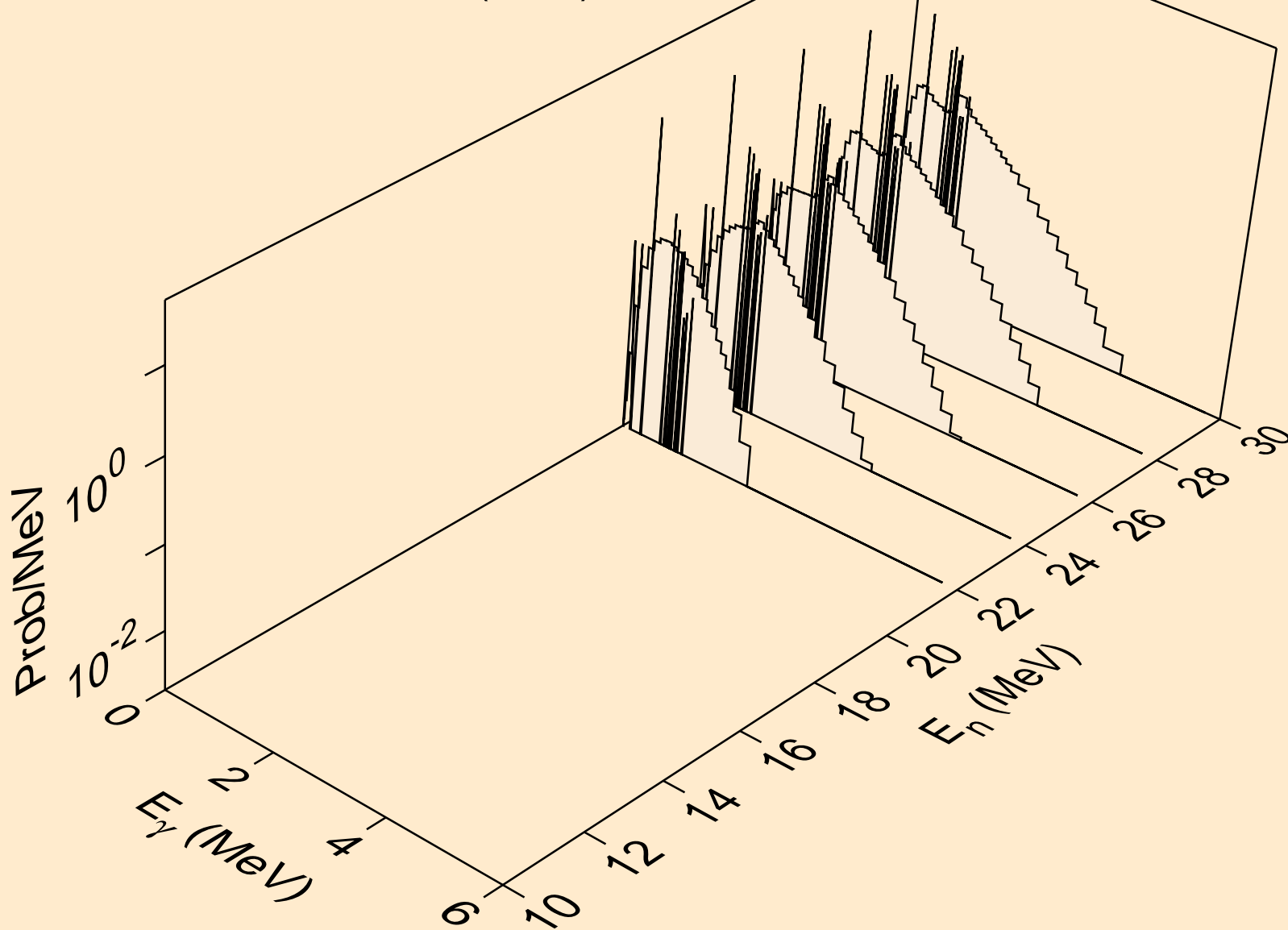

PO201M NEUTRON ACER TENDL-2019 LIBRARY; T=293.16K  
Photon emission for (n,n\*)p

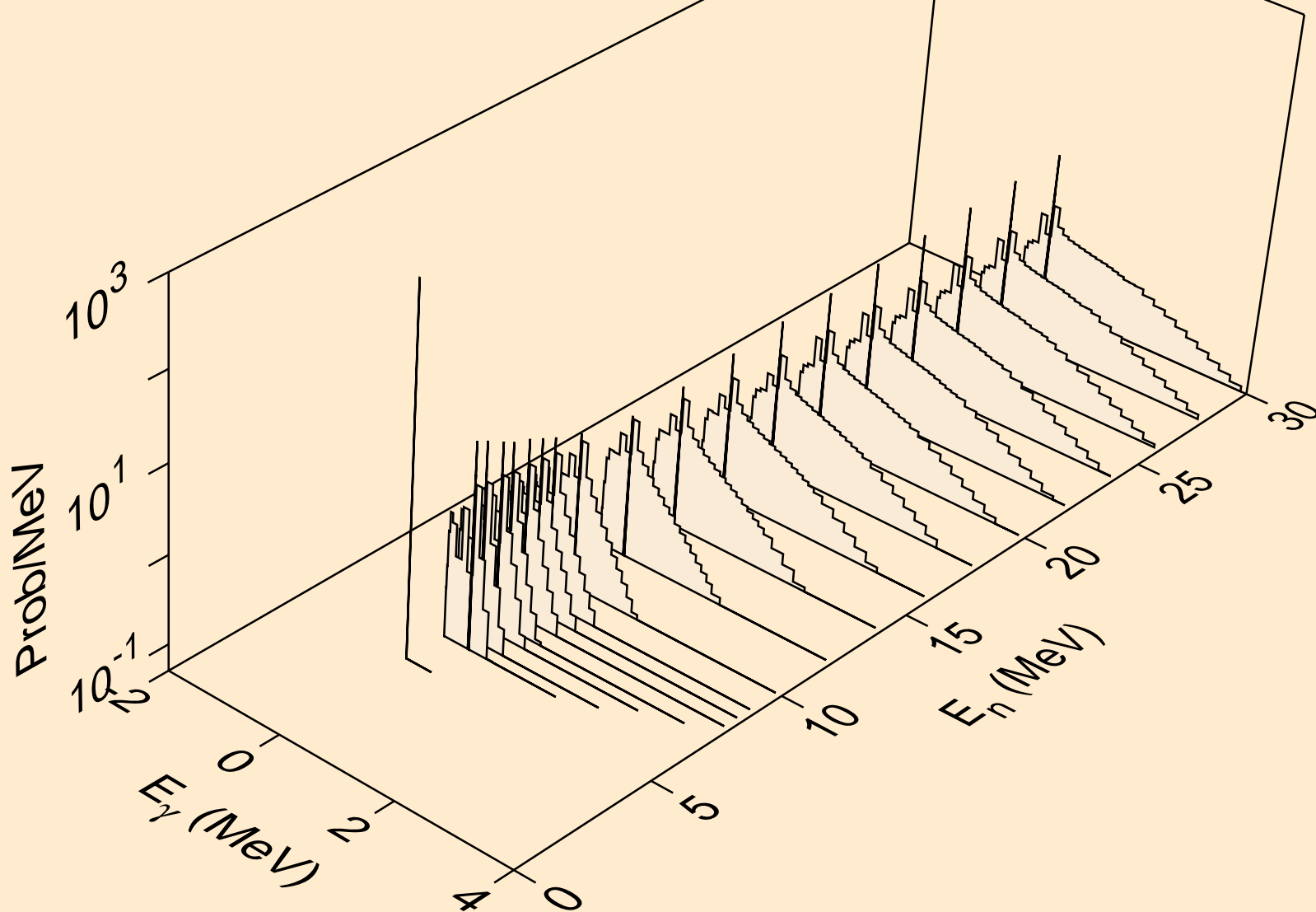

PO201M NEUTRON ACER TENDL-2019 LIBRARY; T=293.16K  
Photon emission for (n,n\*)2a

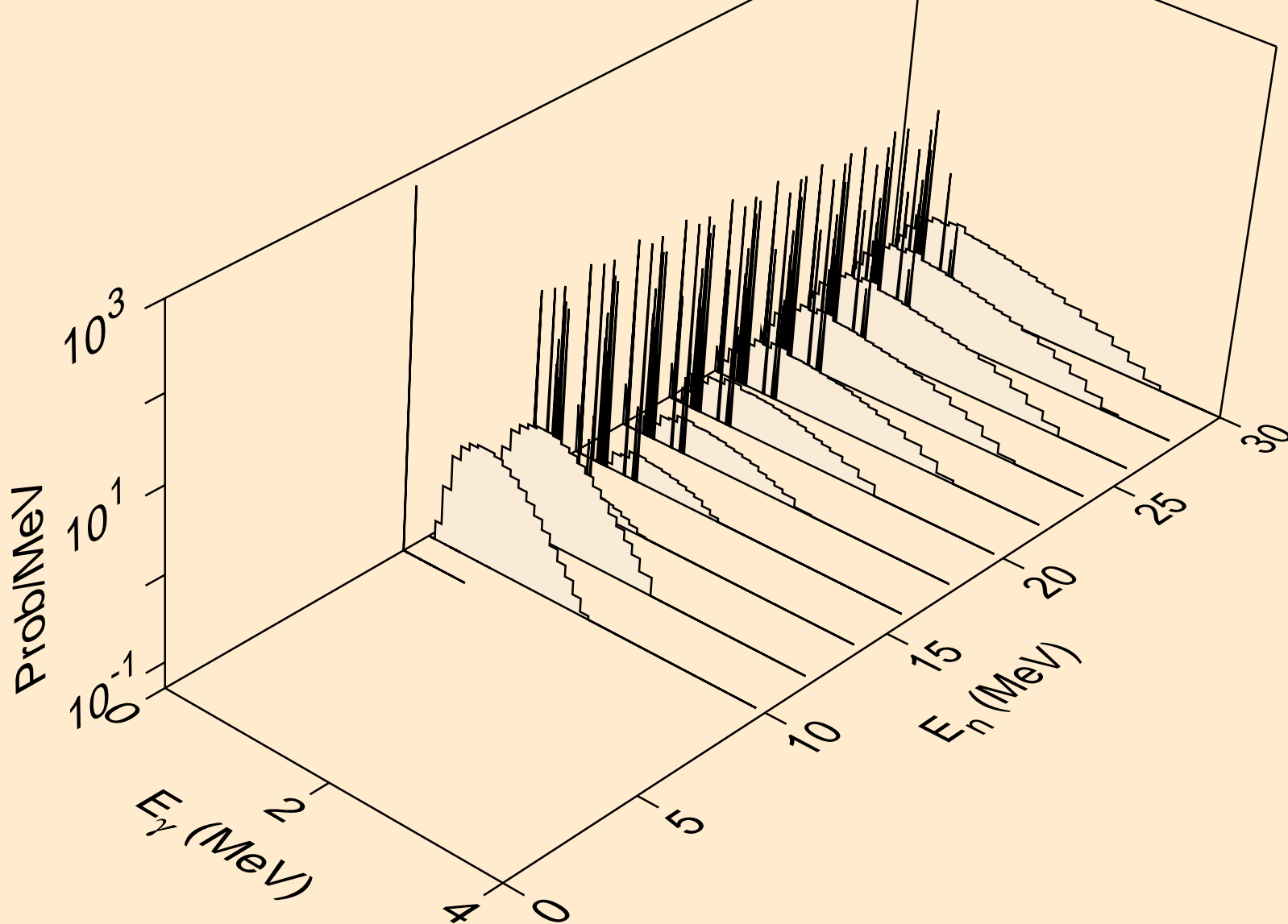



PO201M NEUTRON ACER TENDL-2019 LIBRARY; T=293.16K  
Photon emission for (n,n\*)d

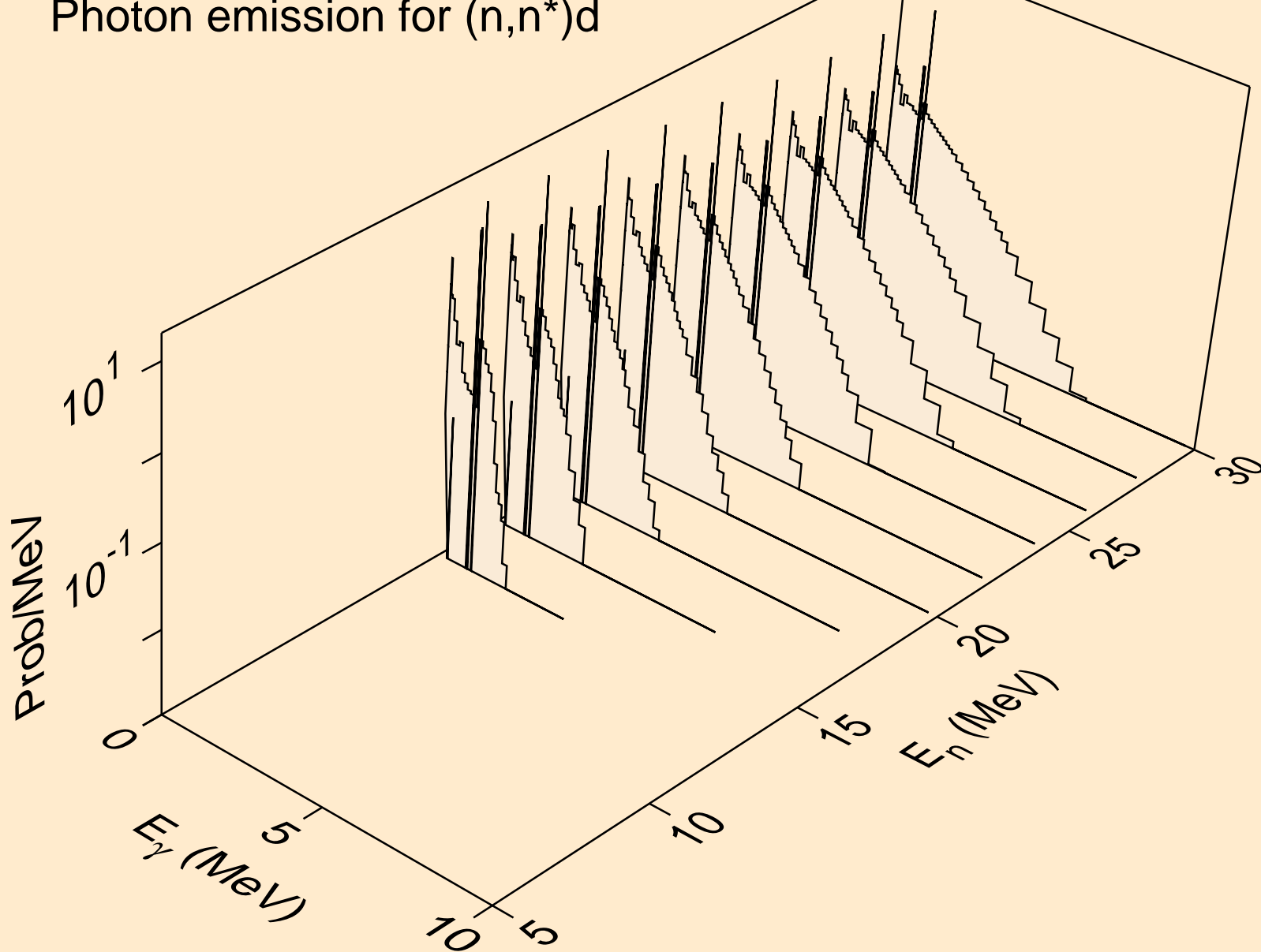

PO201M NEUTRON ACER TENDL-2019 LIBRARY; T=293.16K  
Photon emission for (n,n\*)t

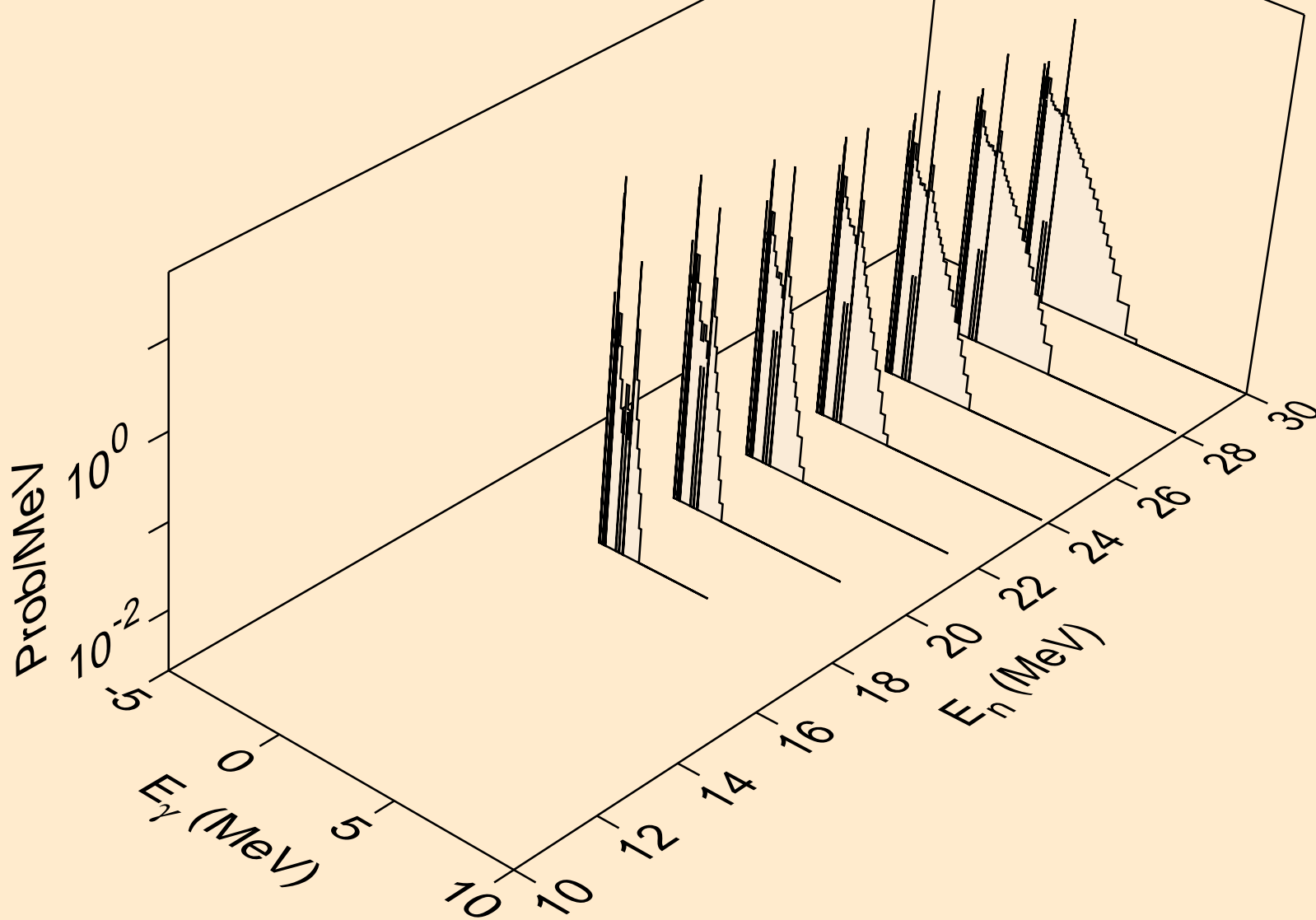

PO201M NEUTRON ACER TENDL-2019 LIBRARY; T=293.16K  
Photon emission for (n,n\*)he3

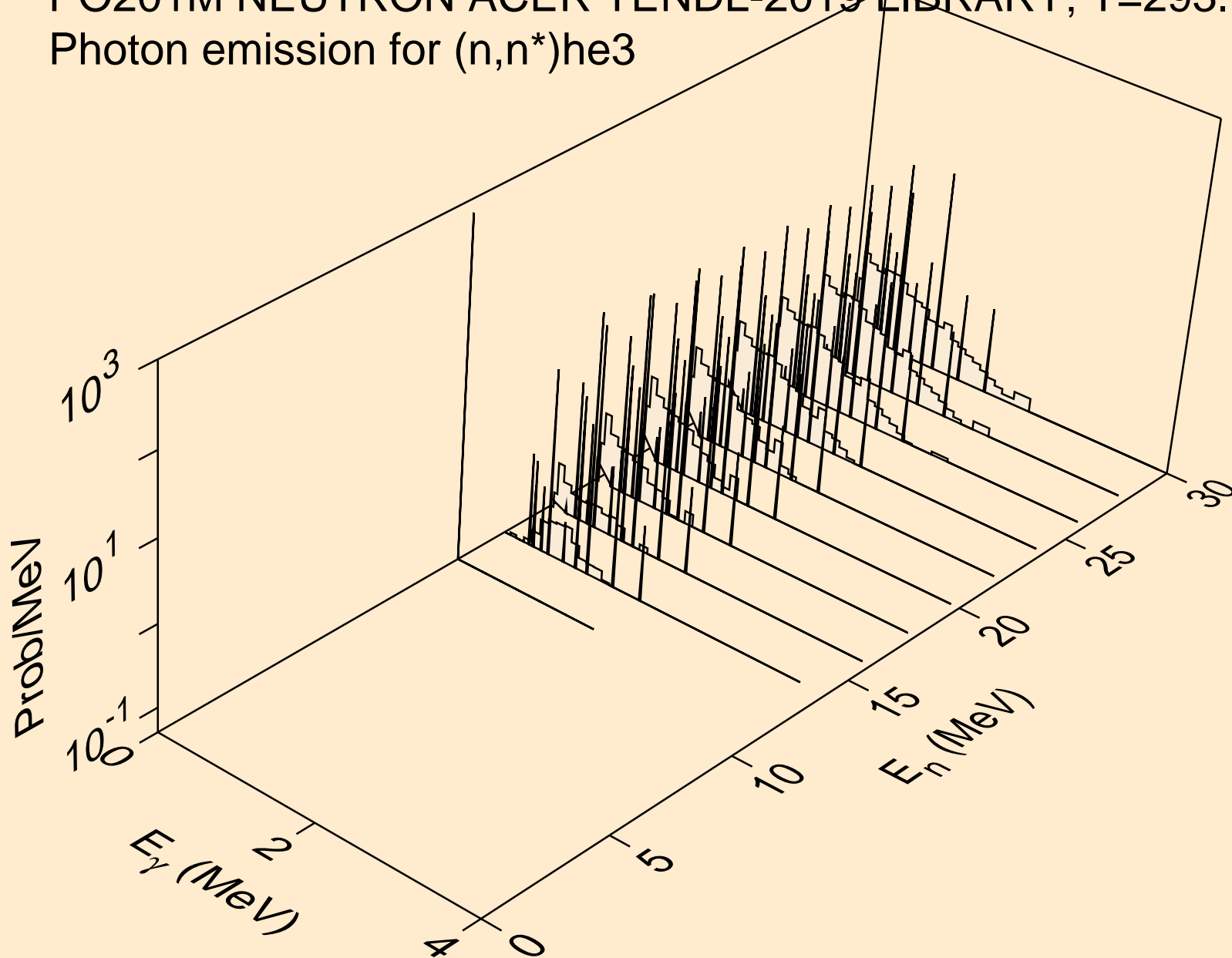

PO201M NEUTRON ACER TENDL-2019 LIBRARY; T=293.16K  
Photon emission for (n,4n)

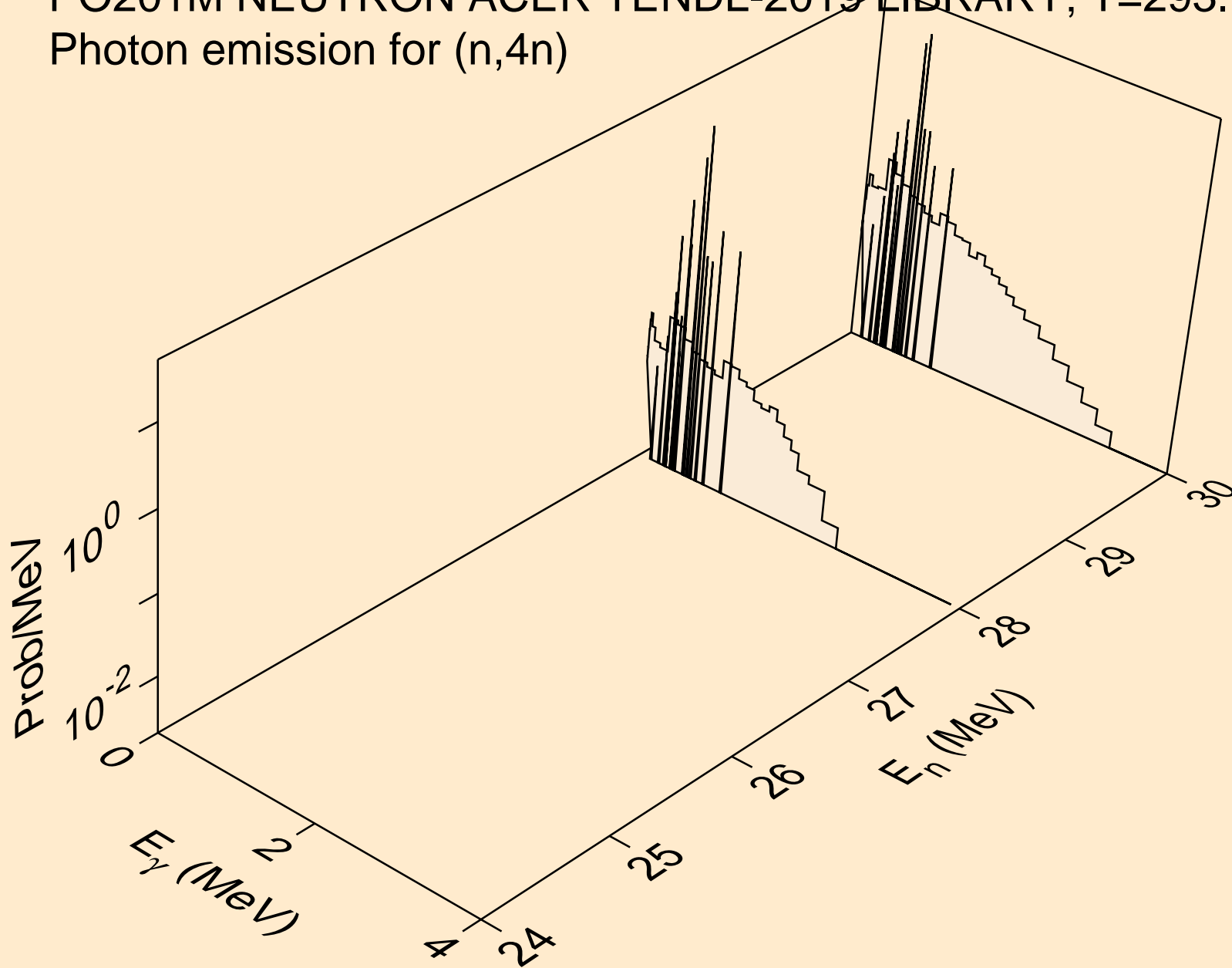

PO201M NEUTRON ACER TENDL-2019 LIBRARY; T=293.16K  
Photon emission for (n,2np)

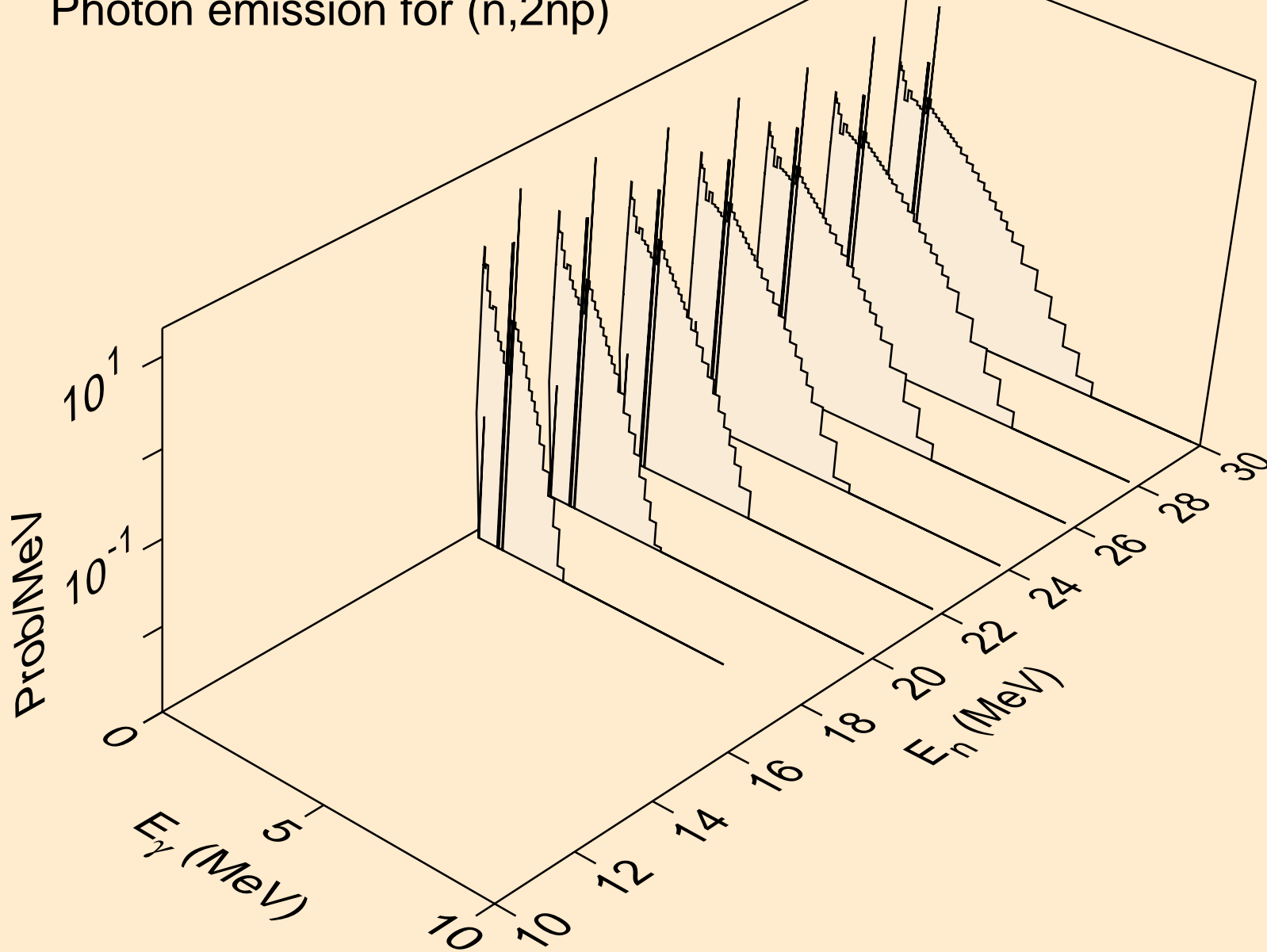

PO201M NEUTRON ACER TENDL-2019 LIBRARY; T=293.16K  
Photon emission for (n,3np)

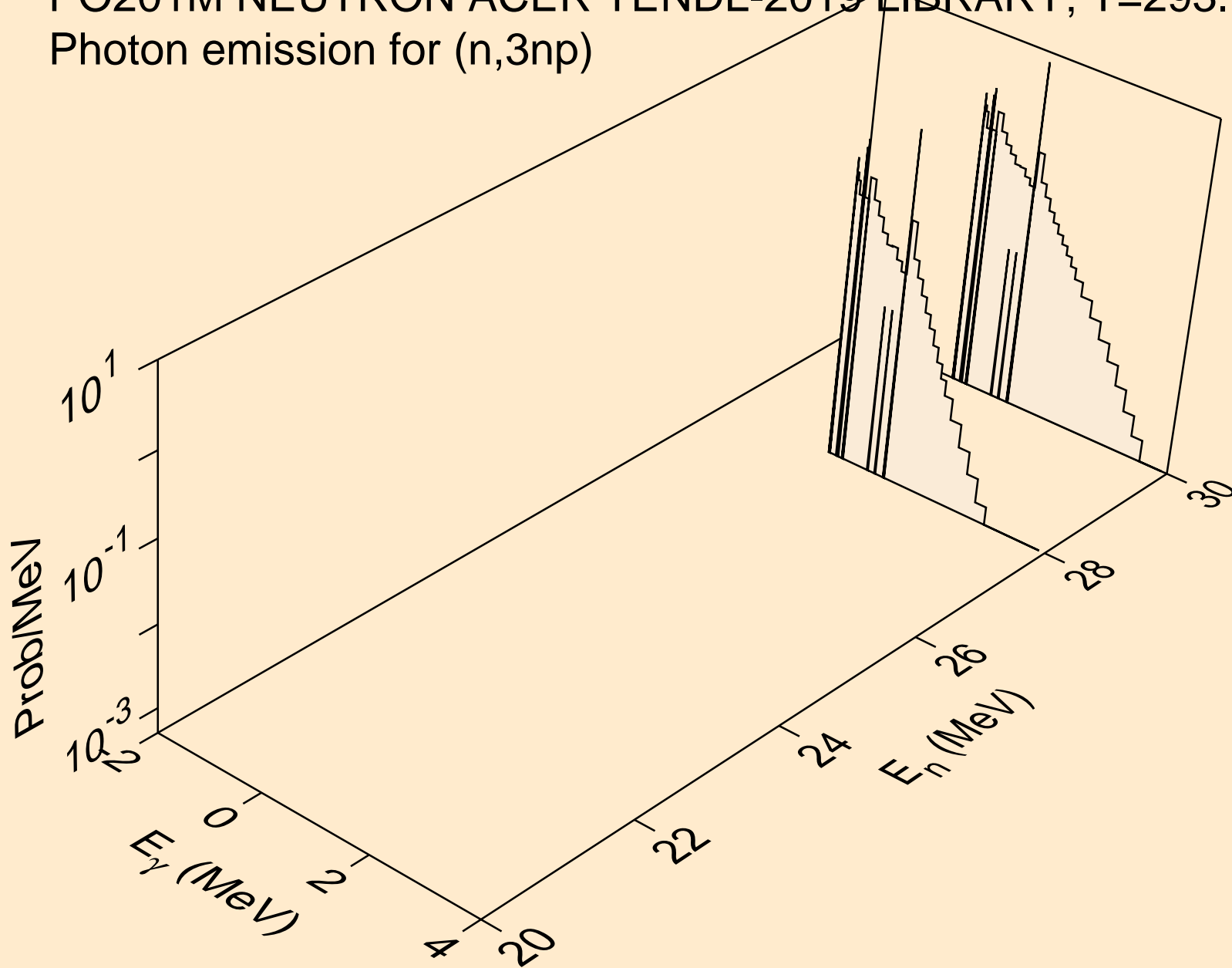

PO201M NEUTRON ACER TENDL-2019 LIBRARY; T=293.16K  
Photon emission for (n,2np)

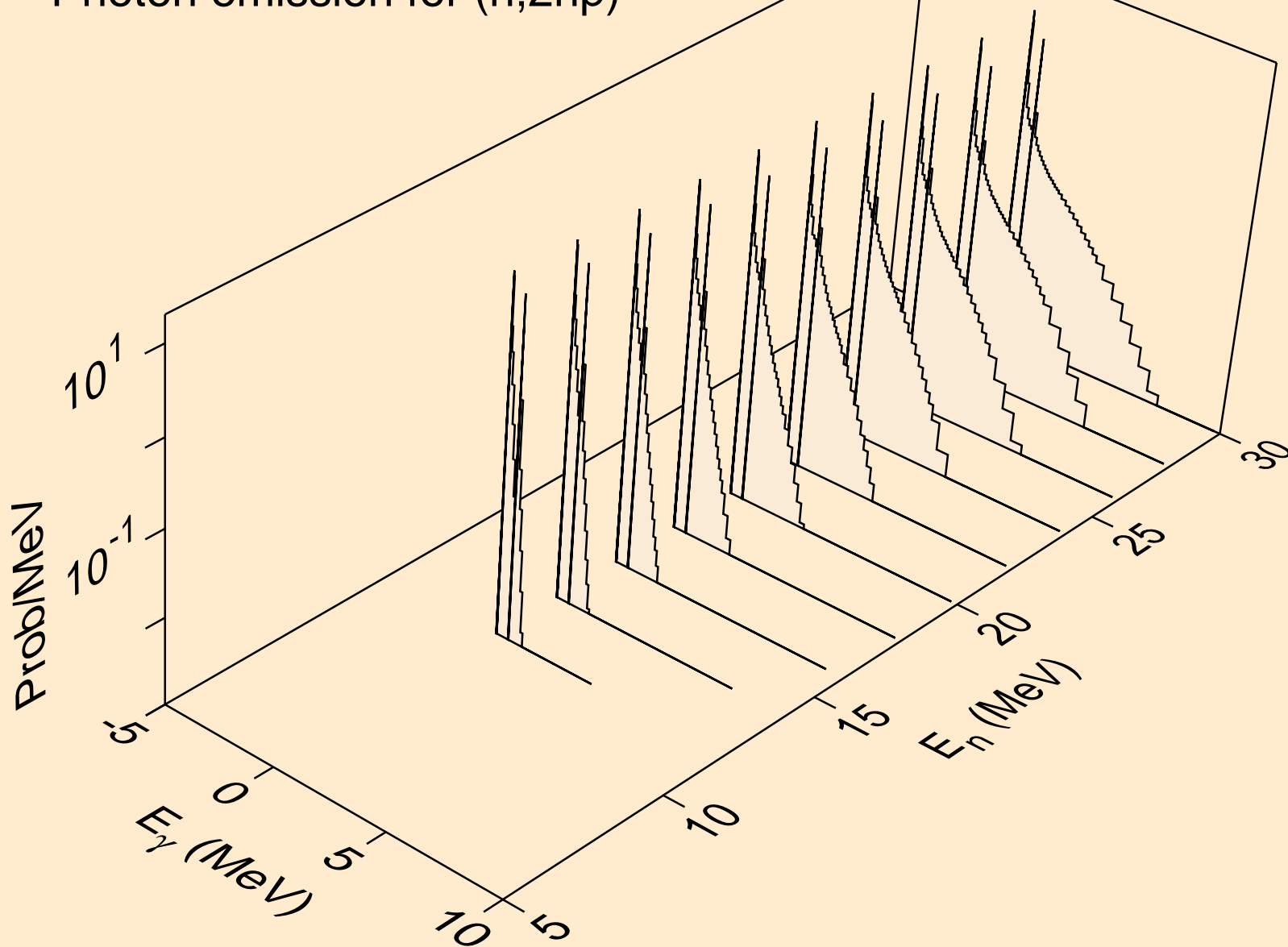

PO201M NEUTRON ACER TENDL-2019 LIBRARY; T=293.16K  
Photon emission for (n,npa)

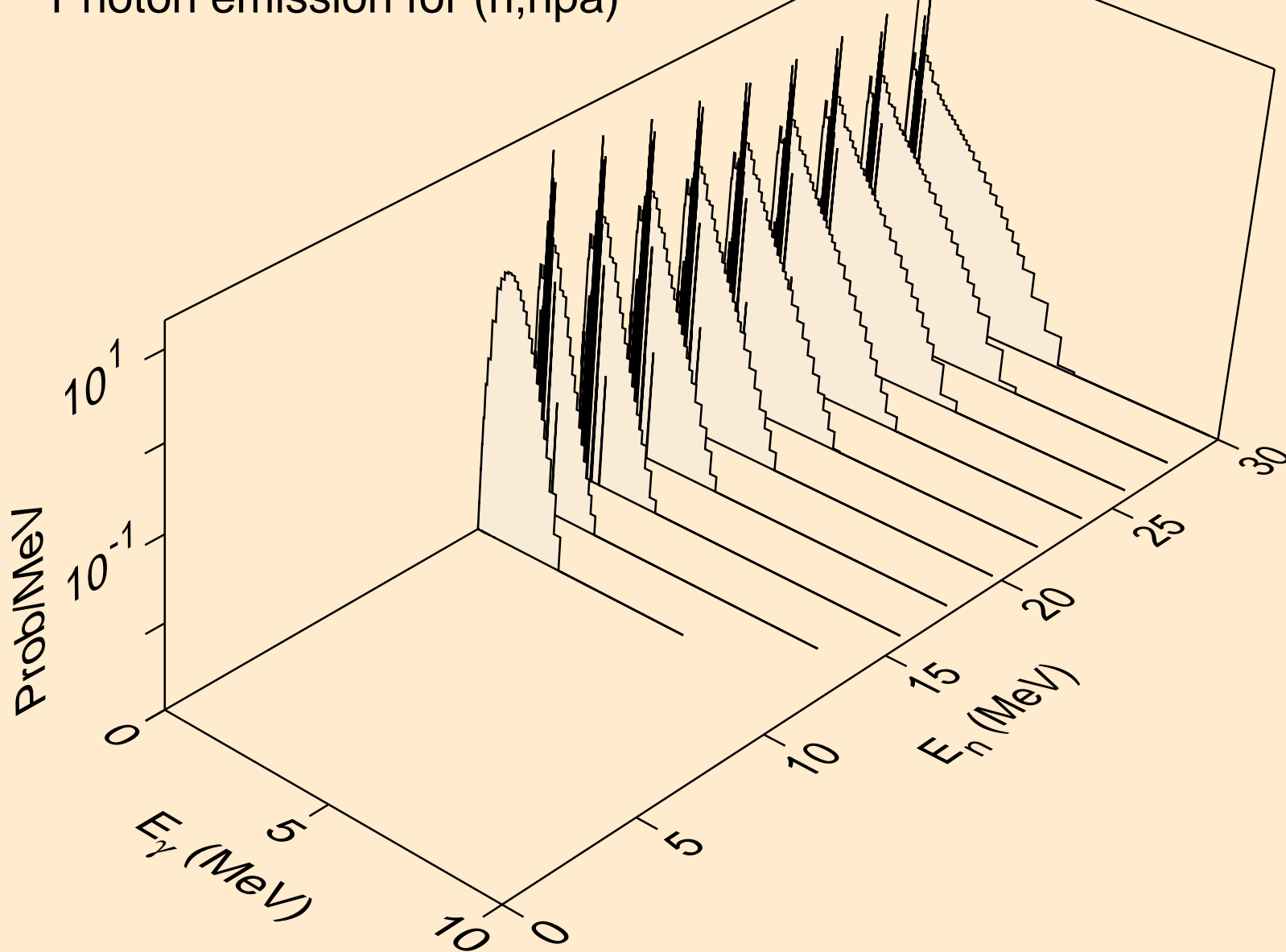



PO201M NEUTRON ACER TENDL-2019 LIBRARY; T=293.16K  
Photon emission for (n,n\*1)

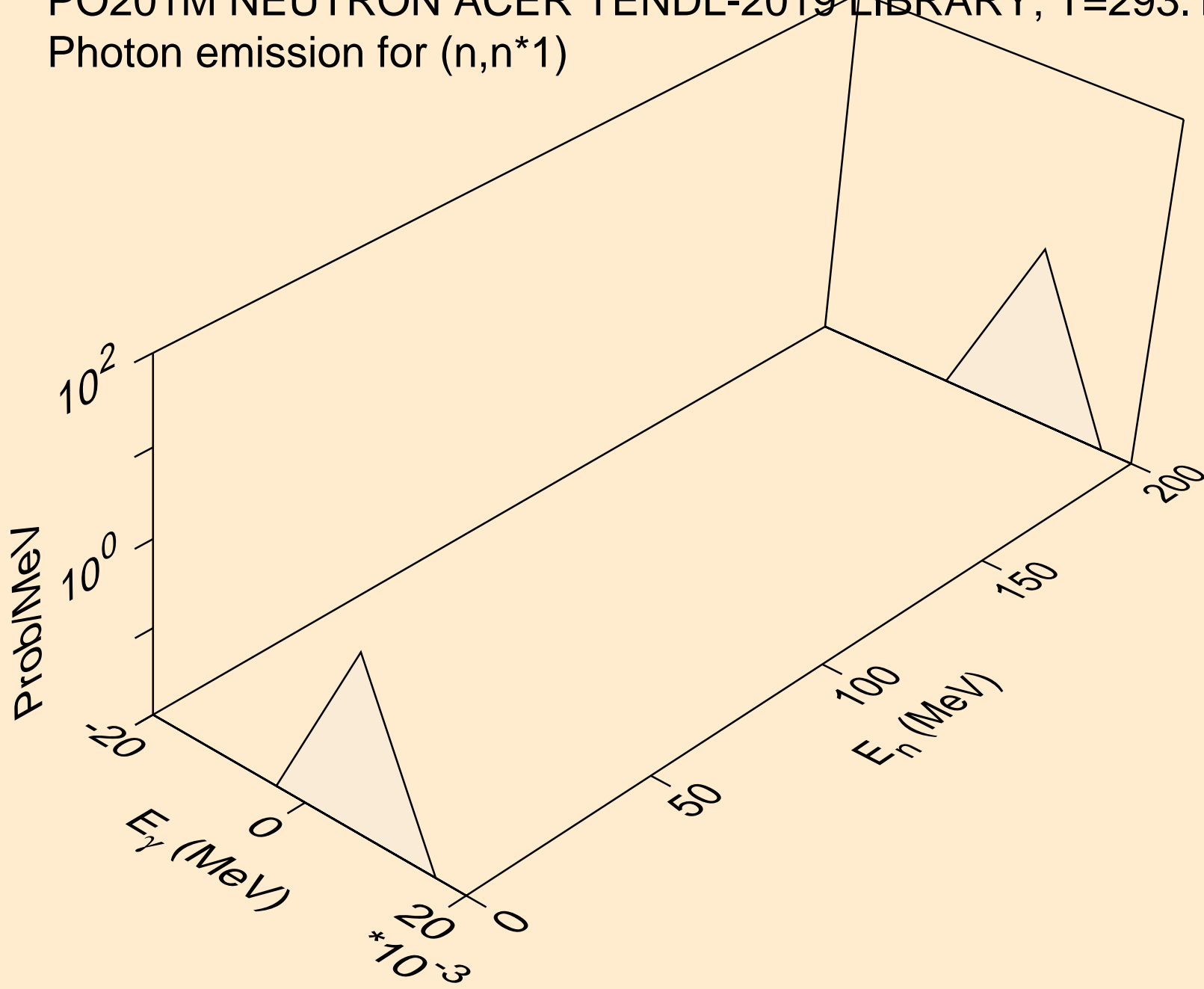

PO201M NEUTRON ACER TENDL-2019 LIBRARY; T=293.16K  
Photon emission for (n,n\*2)

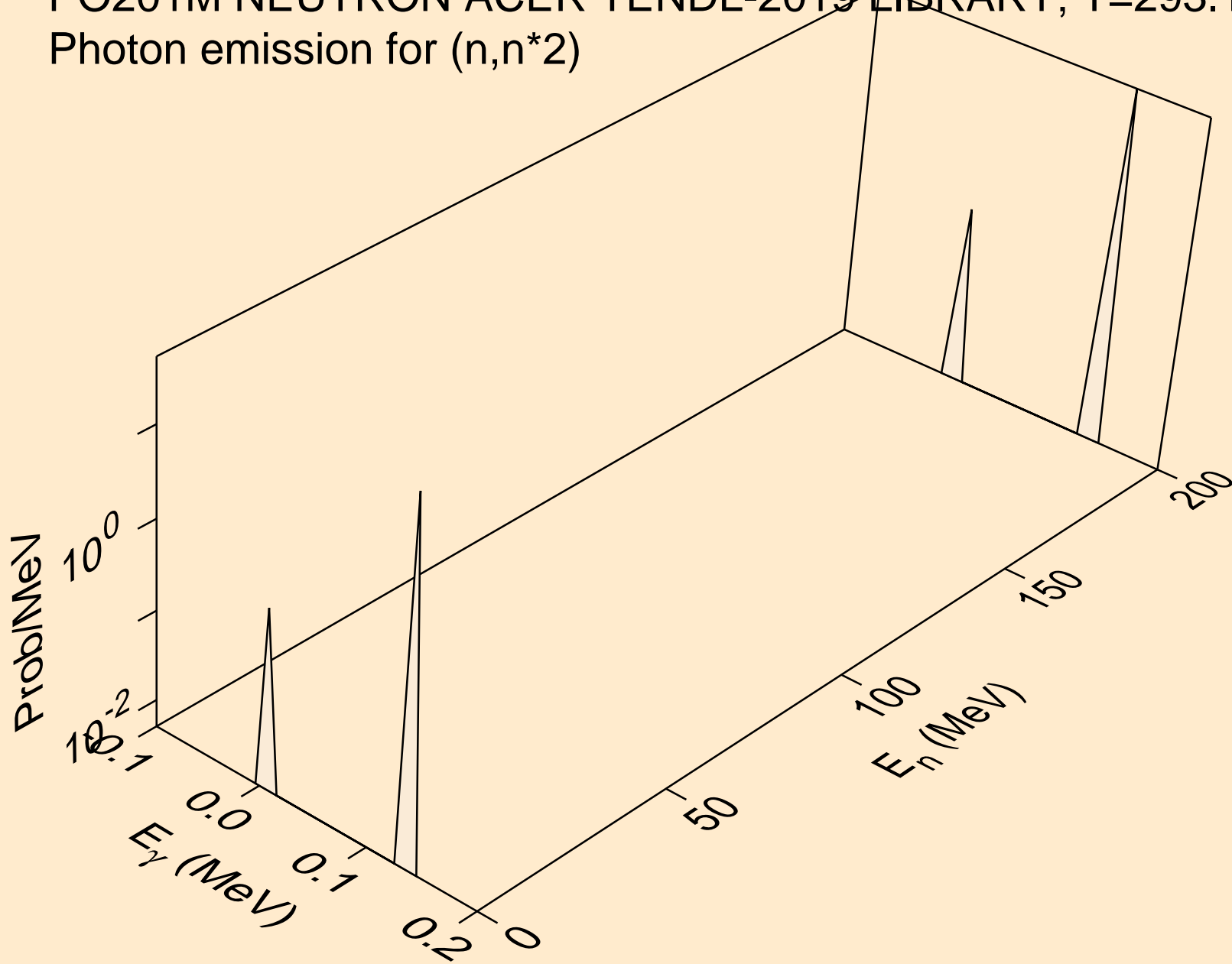

PO201M NEUTRON ACER TENDL-2019 LIBRARY; T=293.16K  
Photon emission for (n,n\*c)

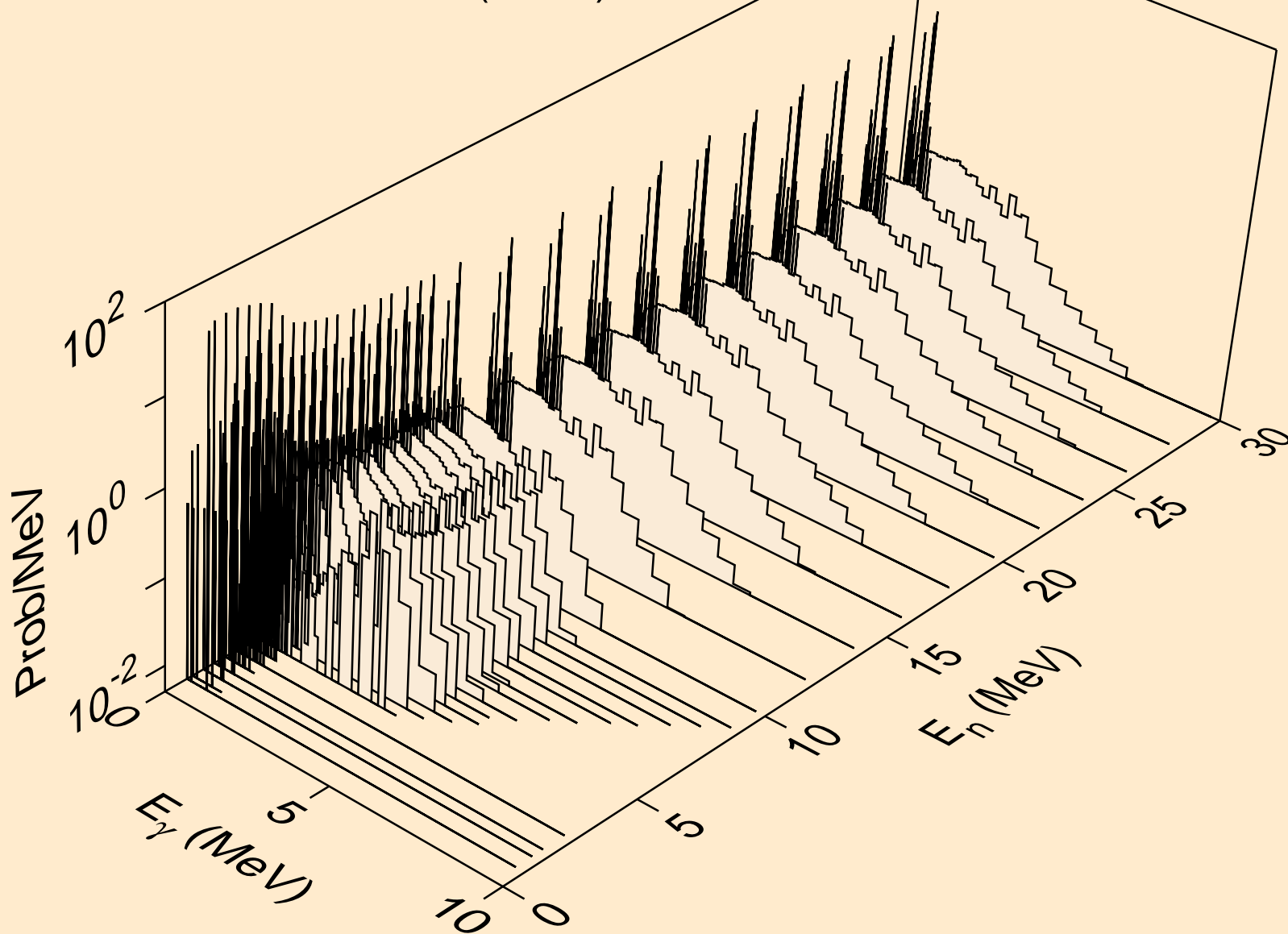

PO201M NEUTRON ACER TENDL-2019 LIBRARY; T=293.16K  
Photon emission for (n,gma)

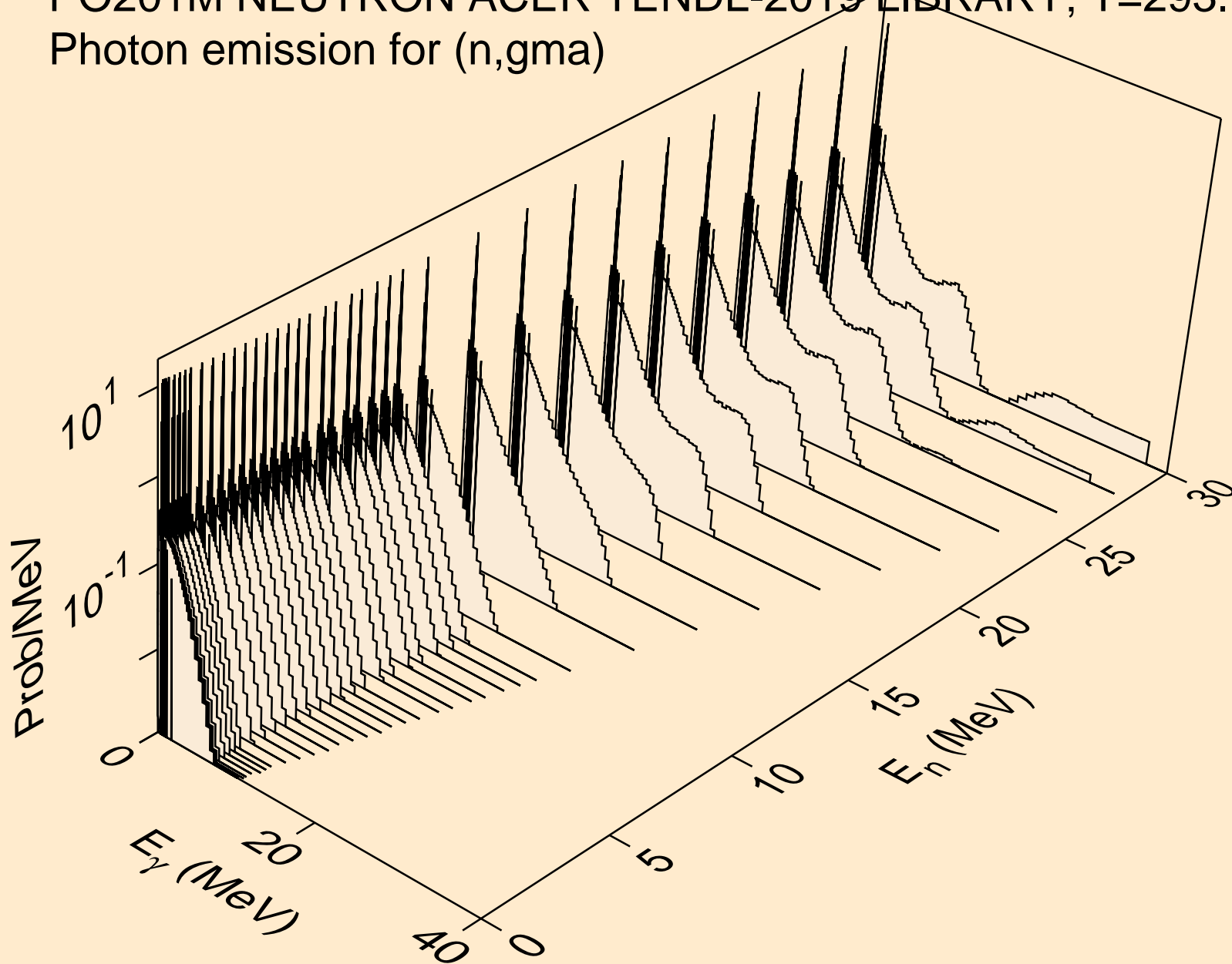

PO201M NEUTRON ACER TENDL-2019 LIBRARY; T=293.16K  
Photon emission for (n,p)

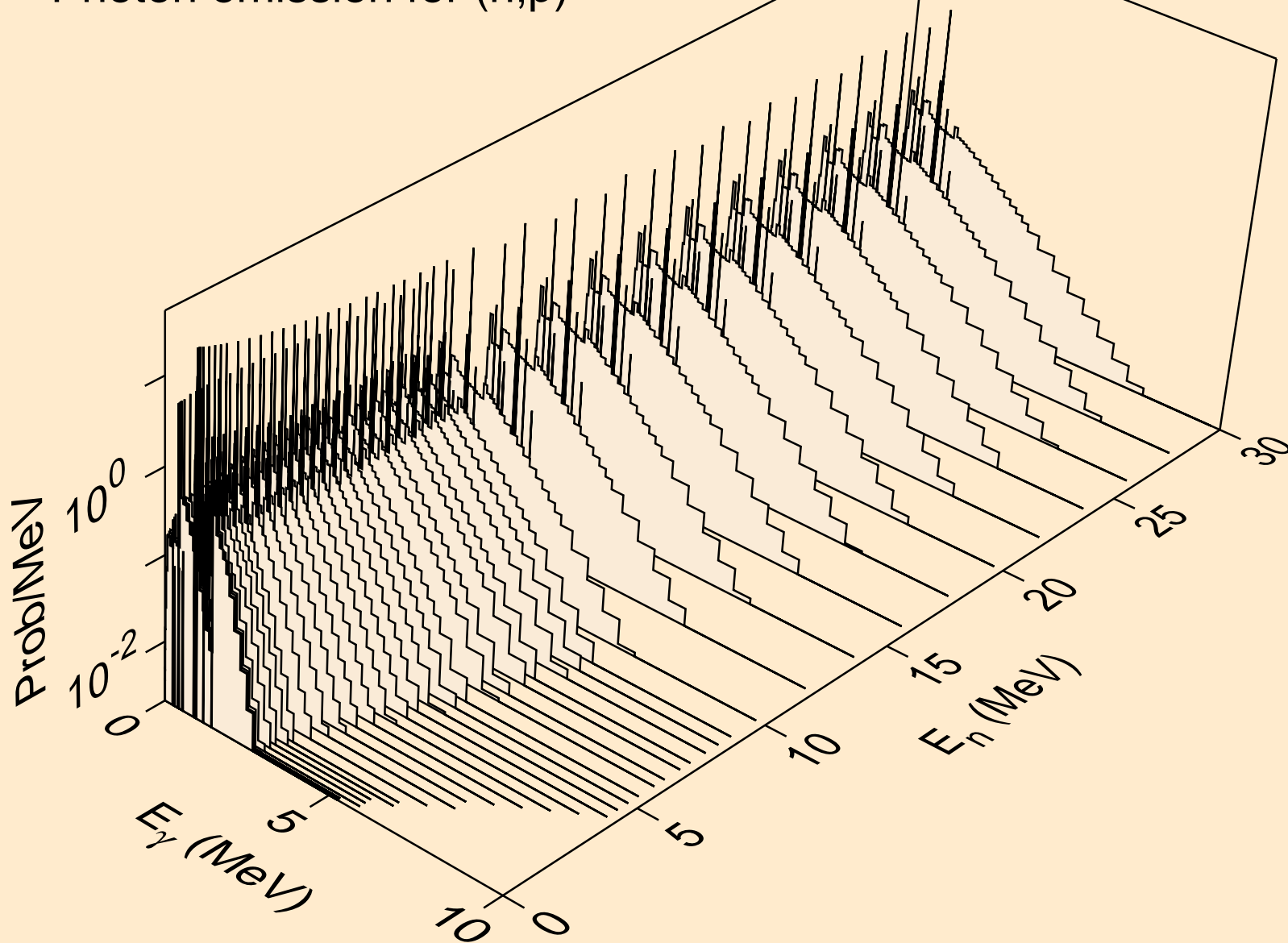

PO201M NEUTRON ACER TENDL-2019 LIBRARY; T=293.16K  
Photon emission for (n,d)

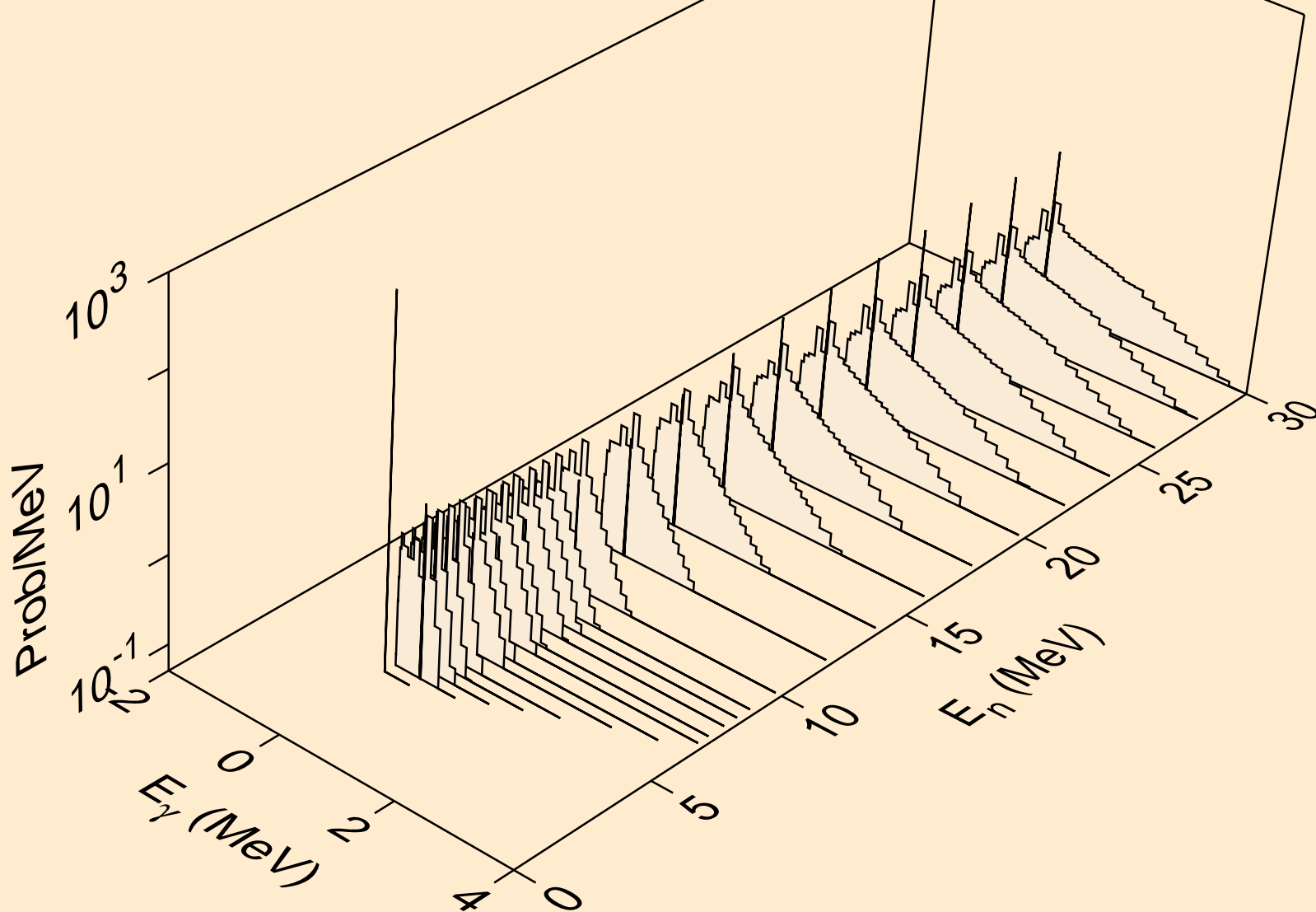

PO201M NEUTRON ACER TENDL-2019 LIBRARY; T=293.16K  
Photon emission for (n,t)

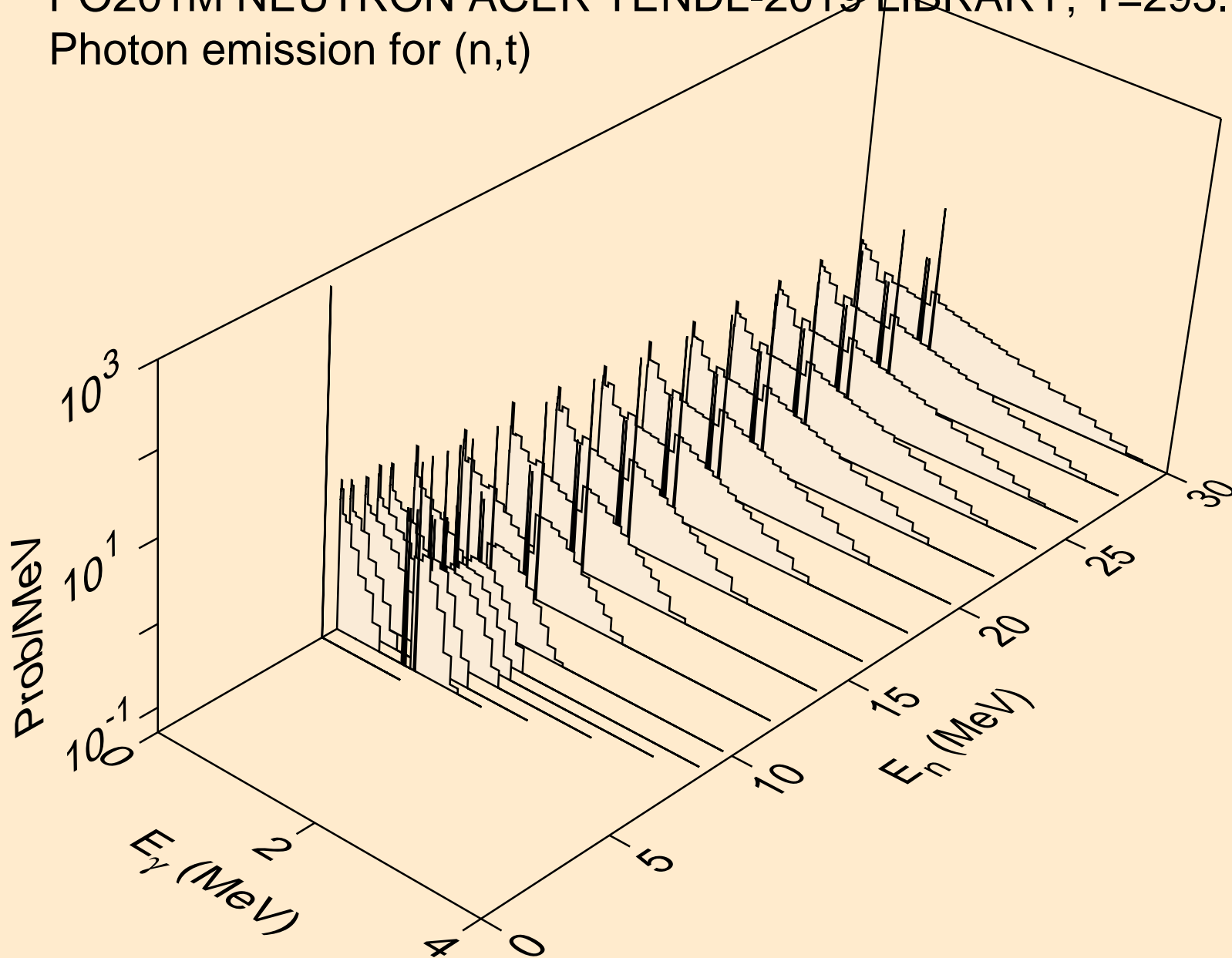

PO201M NEUTRON ACER TENDL-2019 LIBRARY; T=293.16K  
Photon emission for (n,he3)

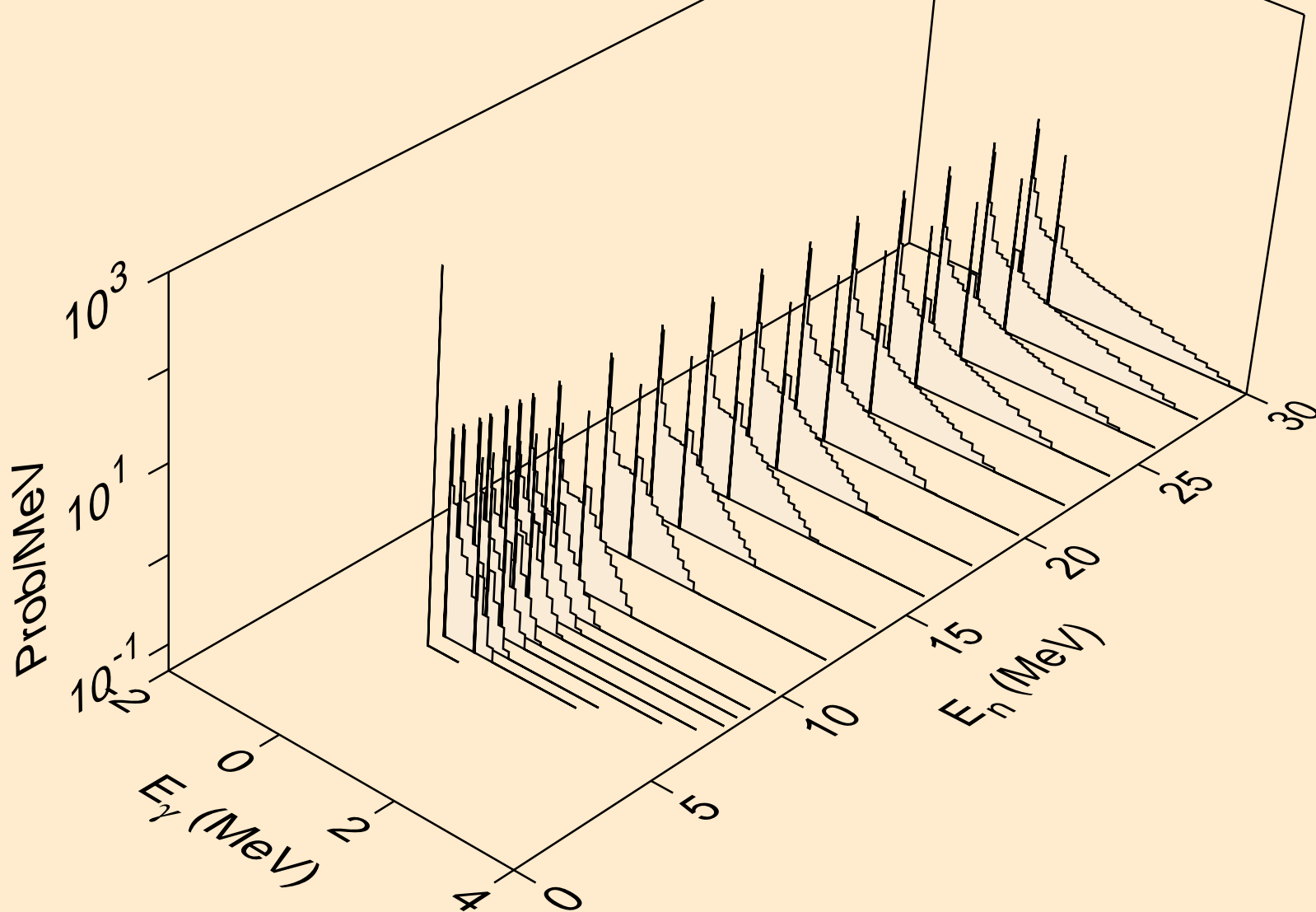



PO201M NEUTRON ACER TENDL-2019 LIBRARY; T=293.16K  
Photon emission for (n,a)

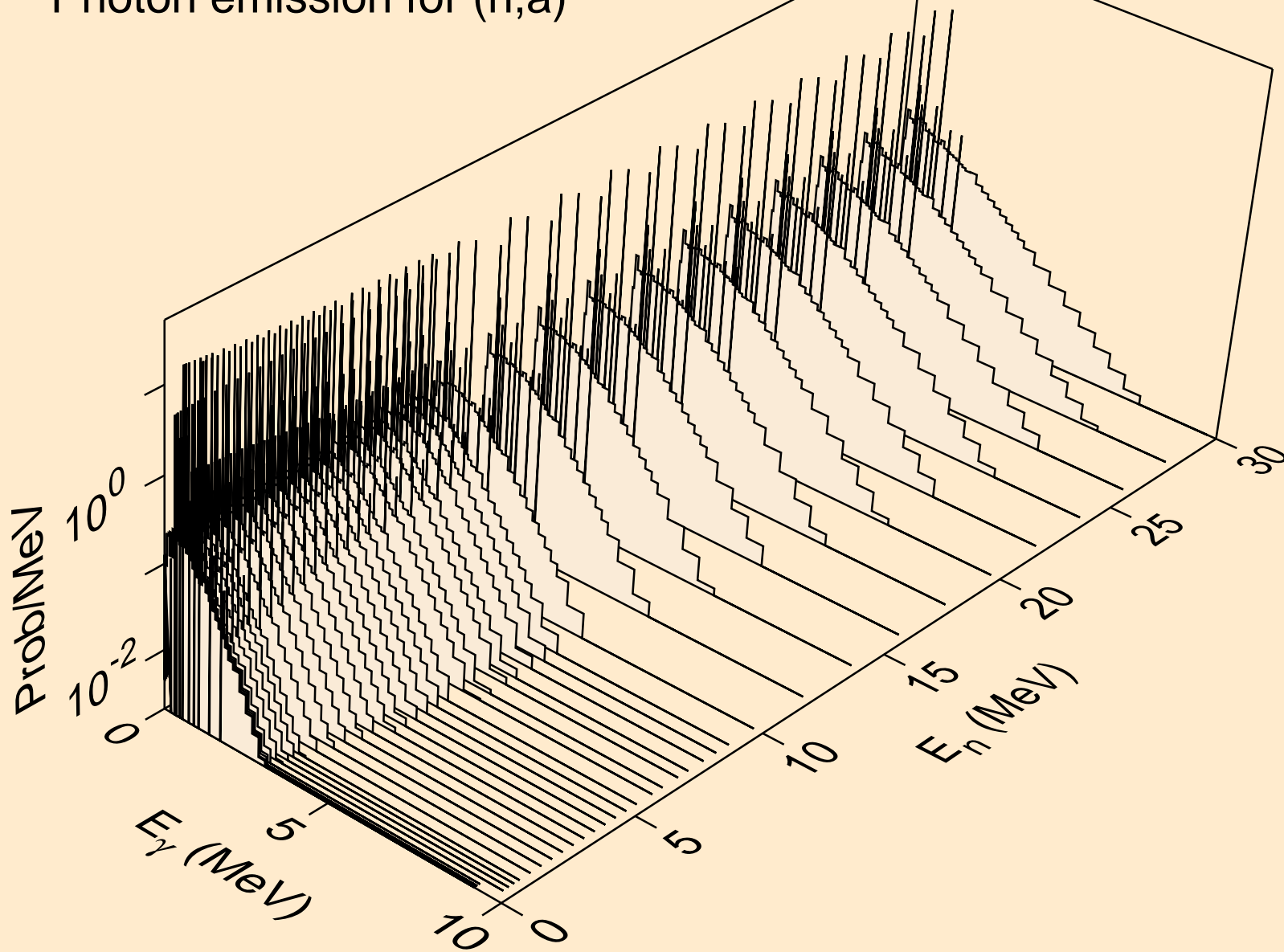

PO201M NEUTRON ACER TENDL-2019 LIBRARY; T=293.16K  
Photon emission for (n,2a)

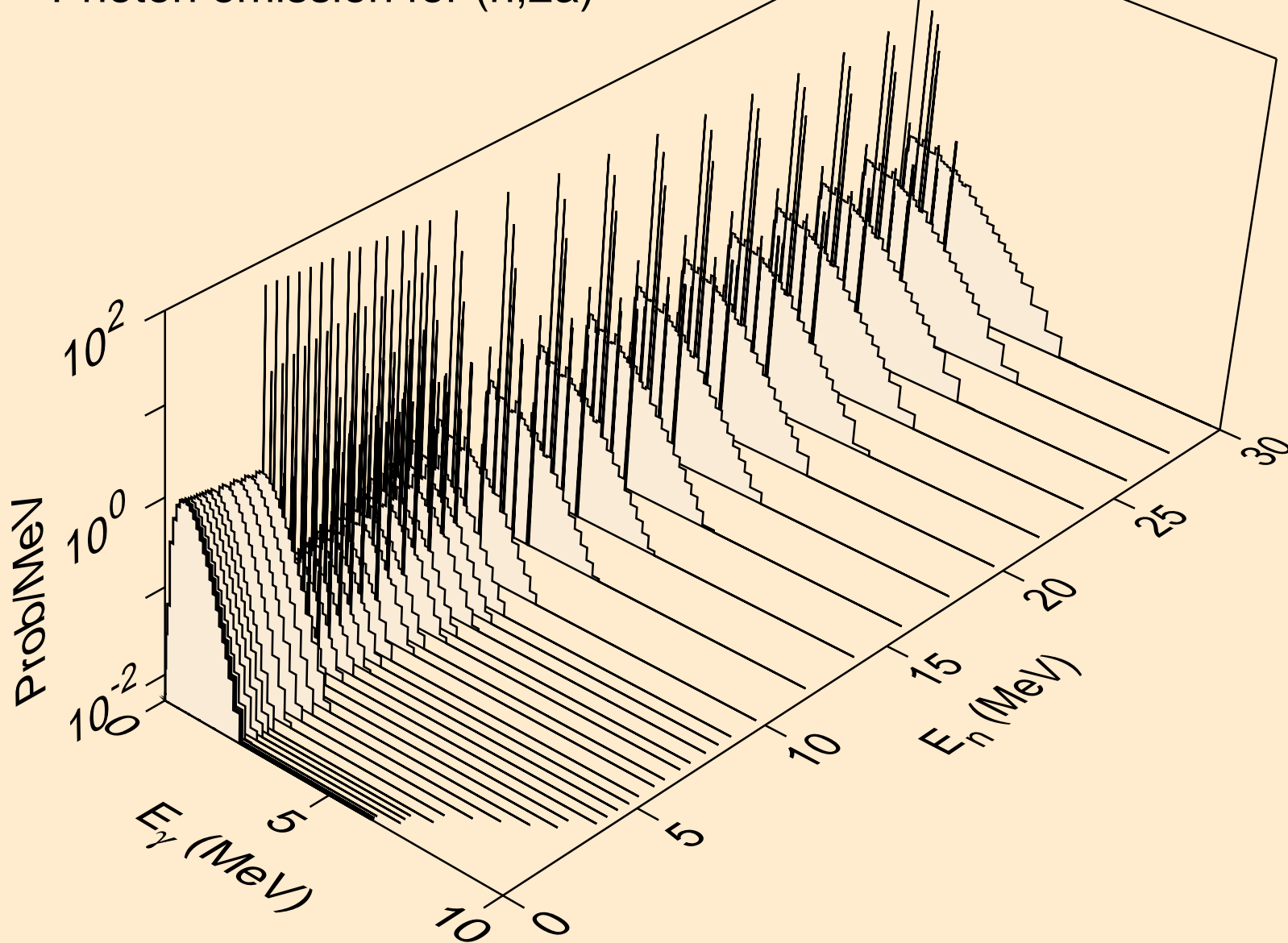

PO201M NEUTRON ACER TENDL-2019 LIBRARY; T=293.16K  
Photon emission for (n,2p)

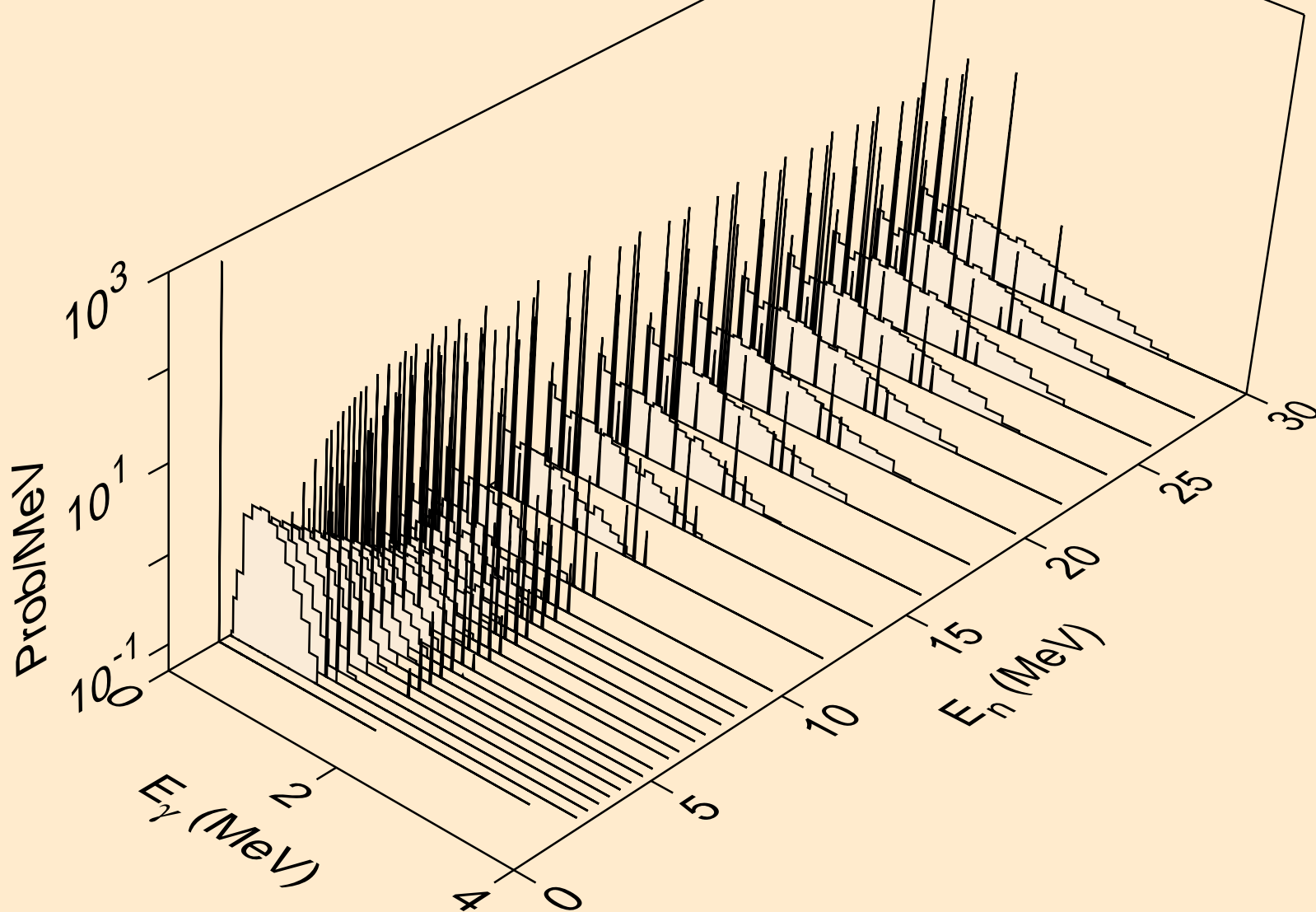

PO201M NEUTRON ACER TENDL-2019 LIBRARY; T=293.16K  
Photon emission for (n,p)

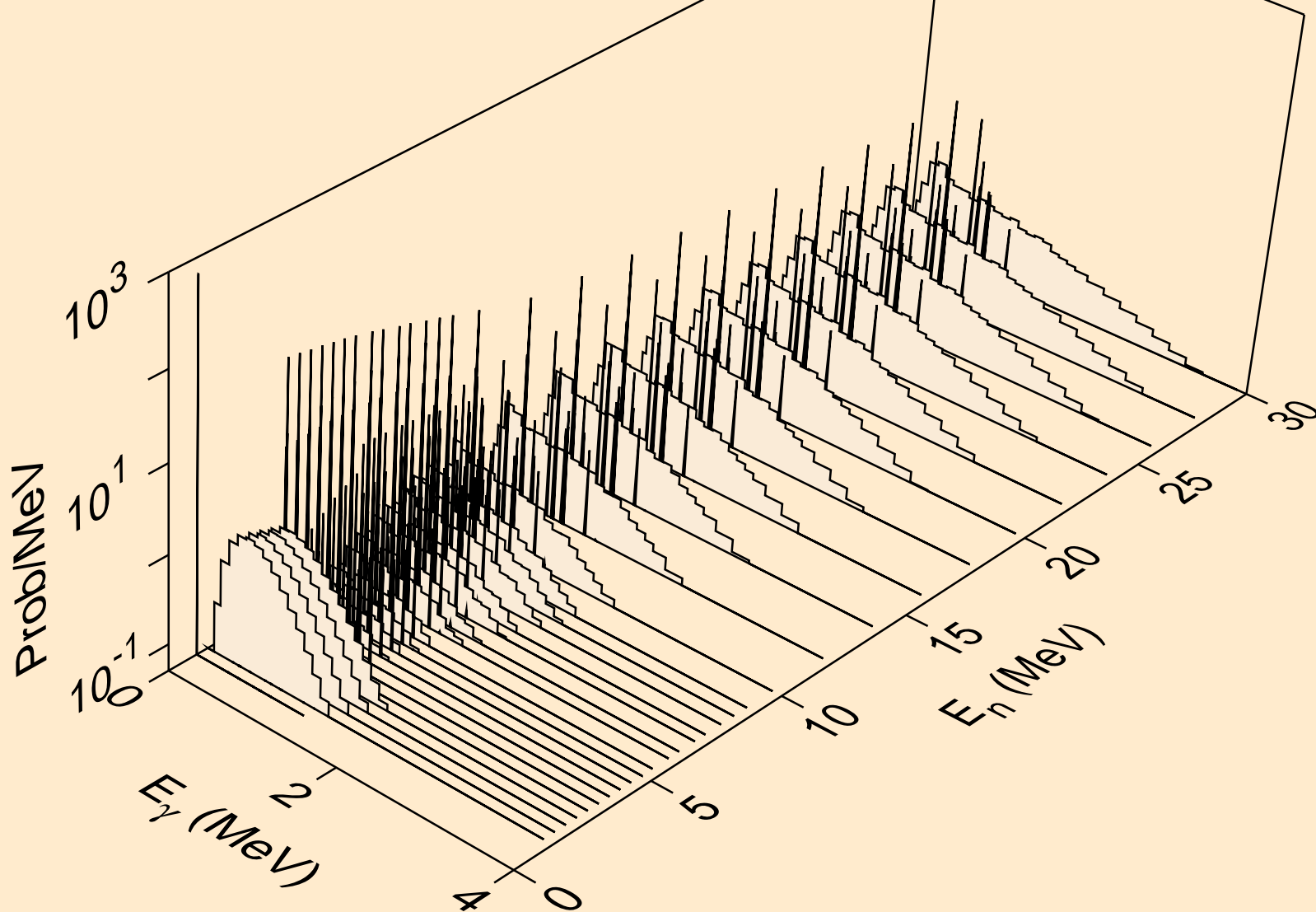

PO201M NEUTRON ACER TENDL-2019 LIBRARY; T=293.16K  
Photon emission for (n,pd)

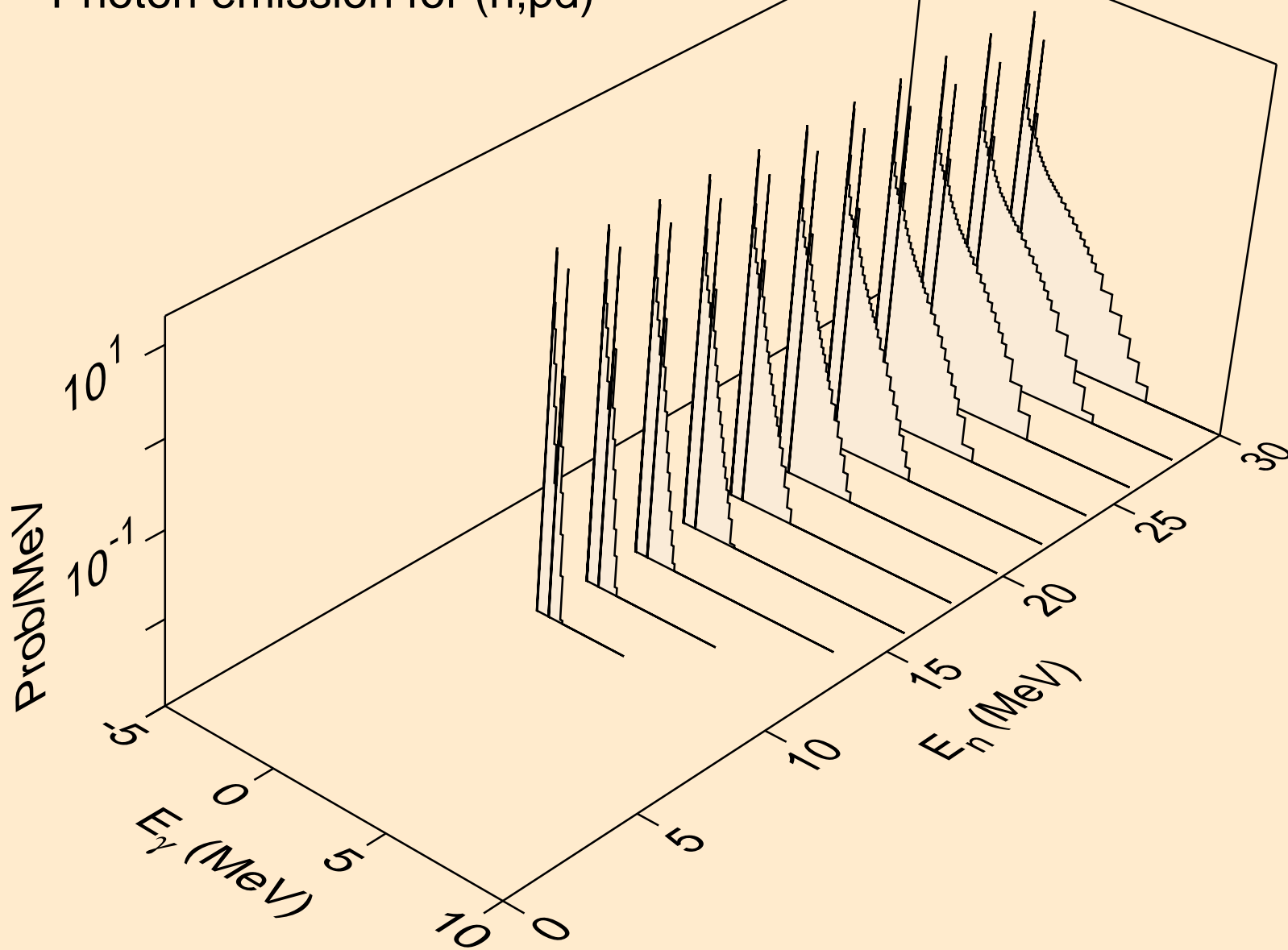

PO201M NEUTRON ACER TENDL-2019 LIBRARY; T=293.16K  
Photon emission for (n,pt)

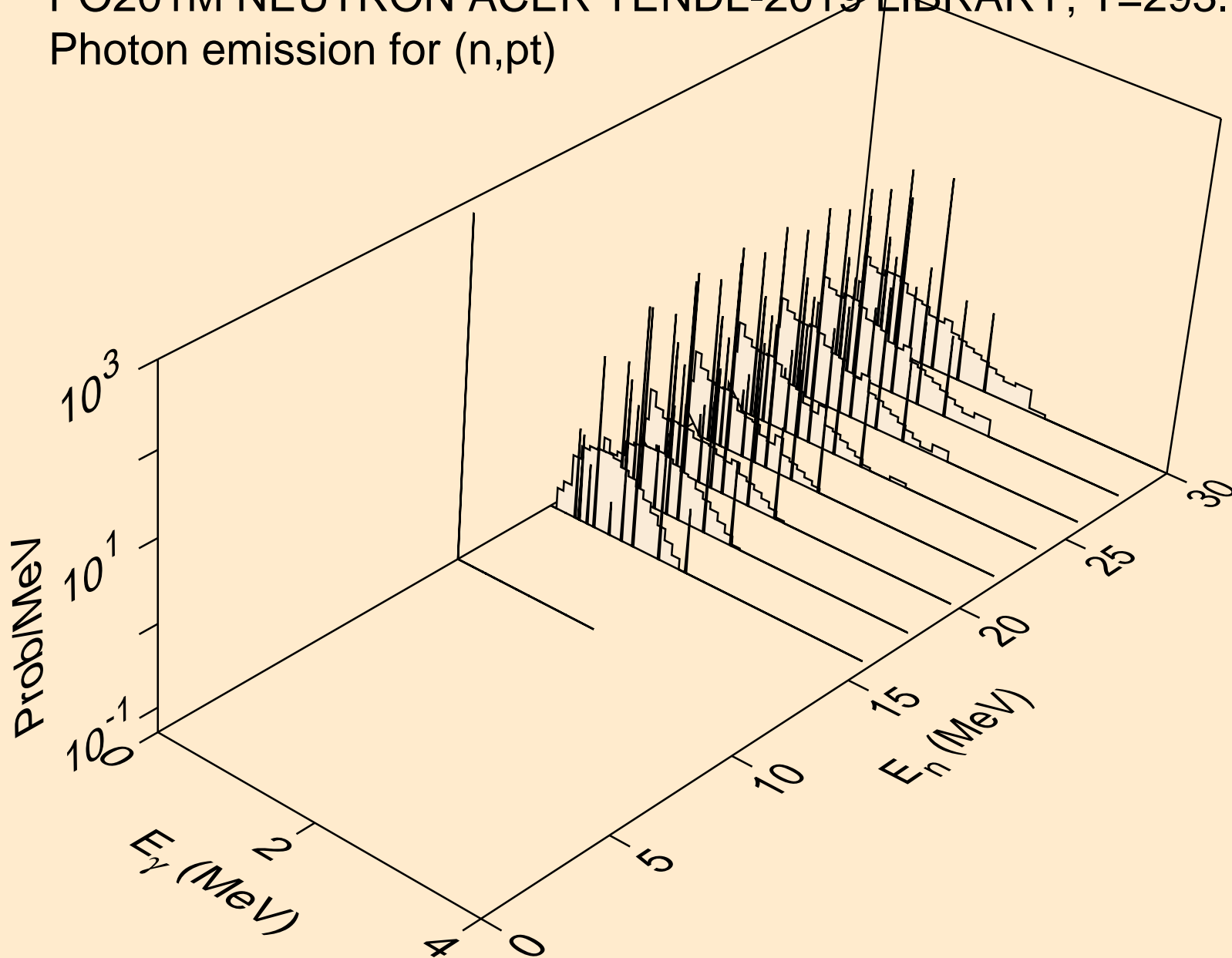

PO201M NEUTRON ACER TENDL-2019 LIBRARY; T=293.16K  
Photon emission for (n,da)

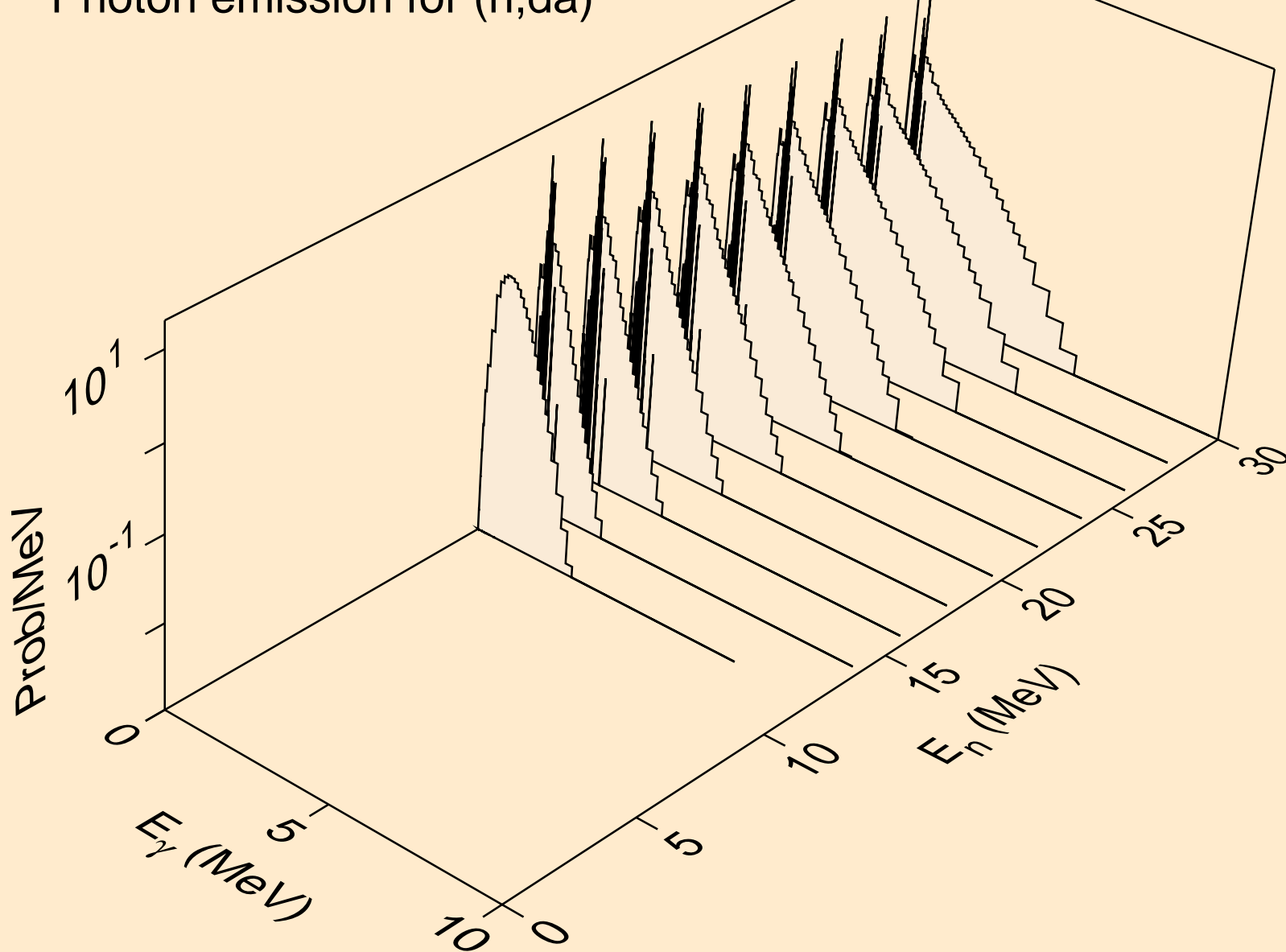

PO201M NEUTRON ACER TENDL-2019 LIBRARY; T=293.16K  
thermal capture photon spectrum

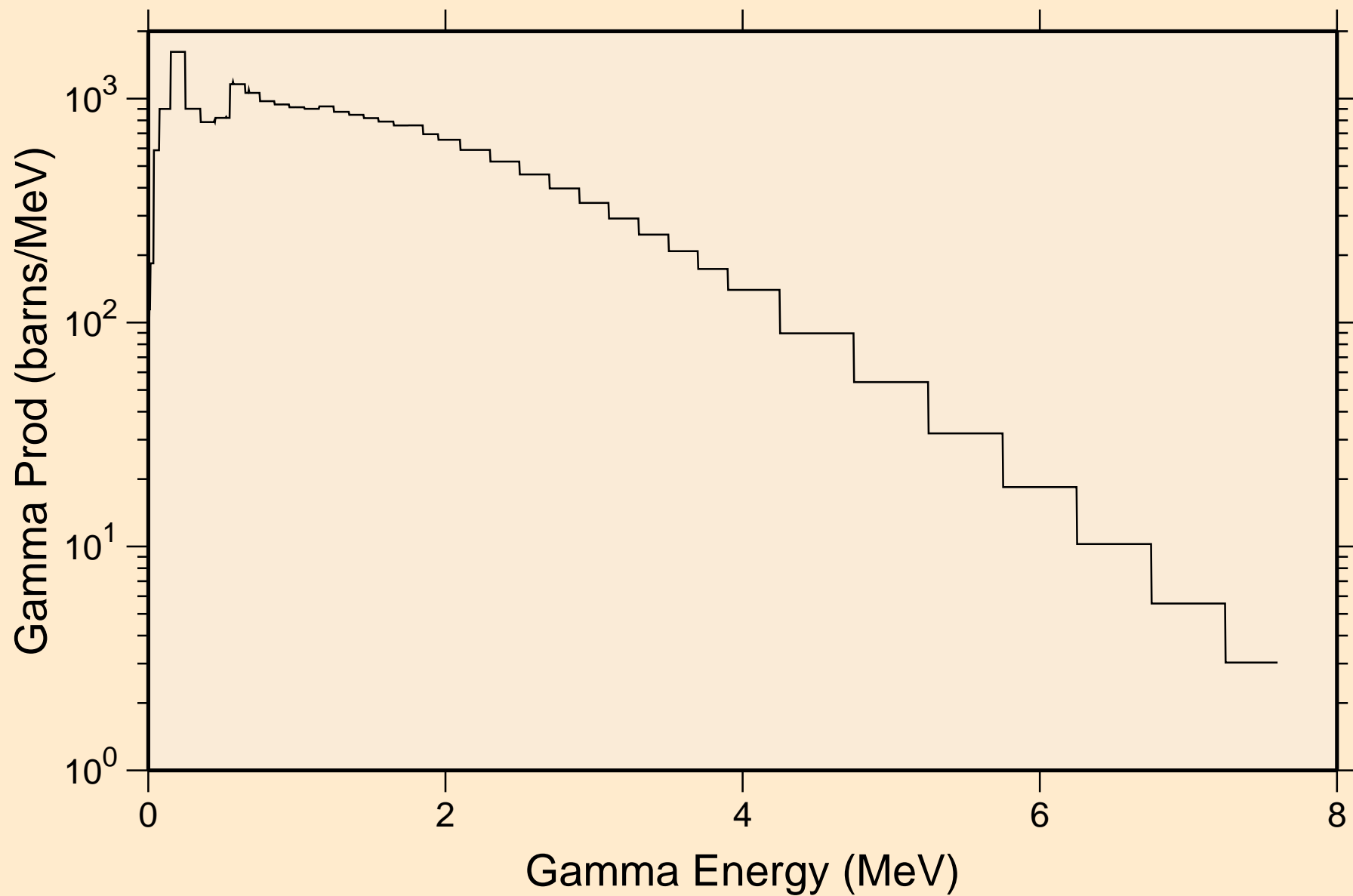



PO201M NEUTRON ACER TENDL-2019 LIBRARY; T=293.16K  
14 MeV photon spectrum

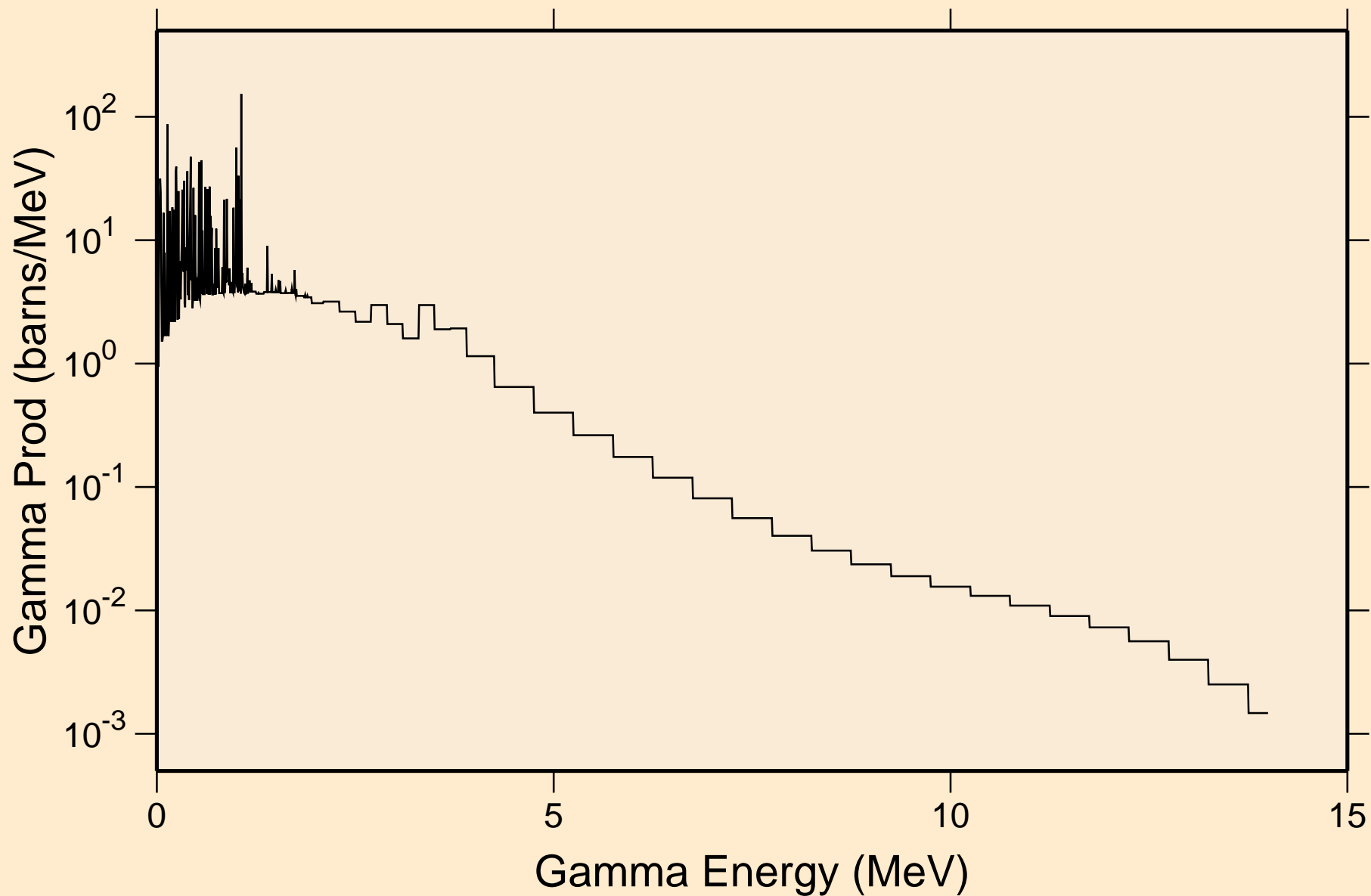

PO201M NEUTRON ACER TENDL-2019 LIBRARY; T=293.16K  
Particle heating contributions

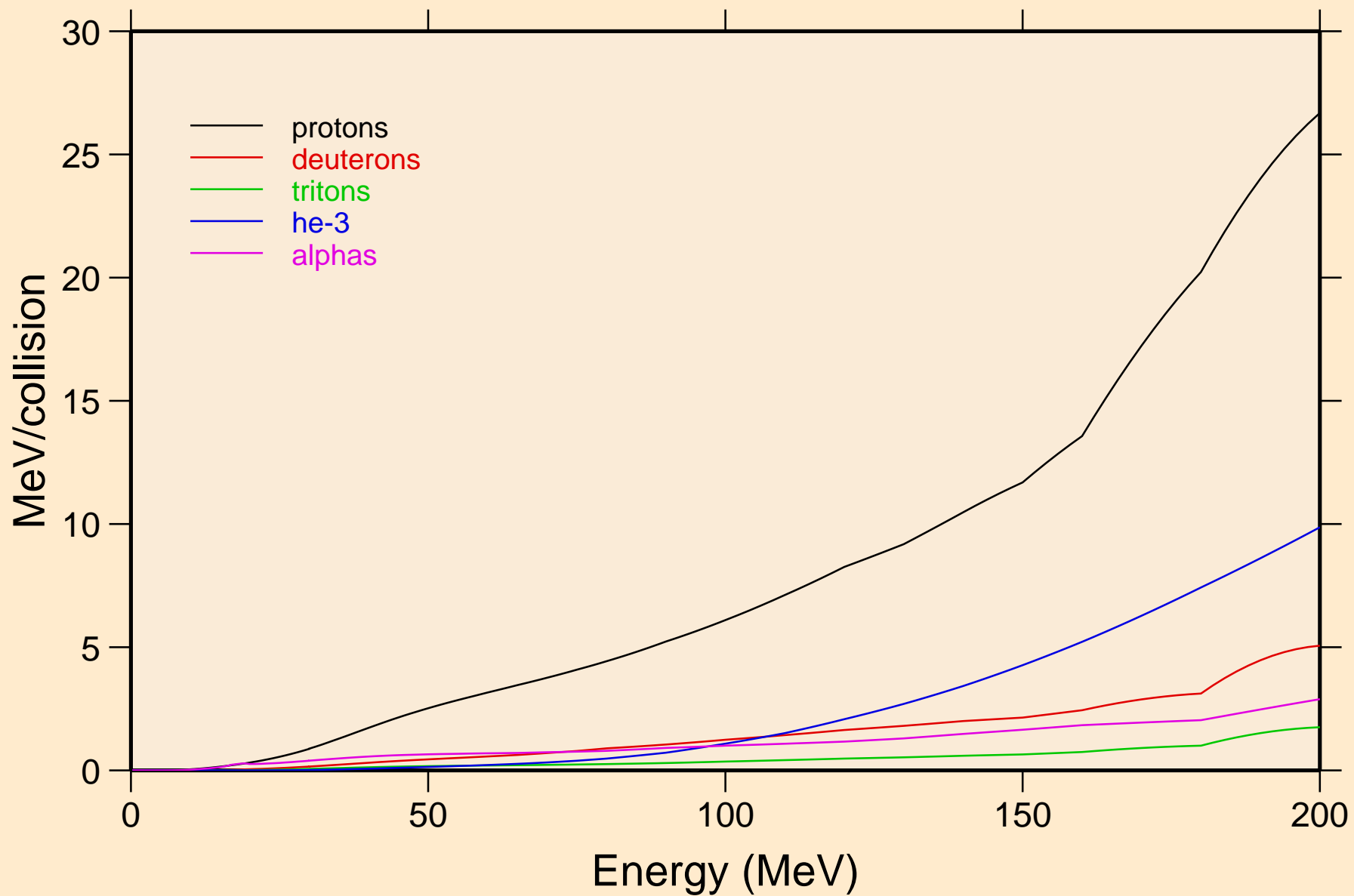

PO201M NEUTRON ACER TENDL-2019 LIBRARY; T=293.16K  
Recoil Heating

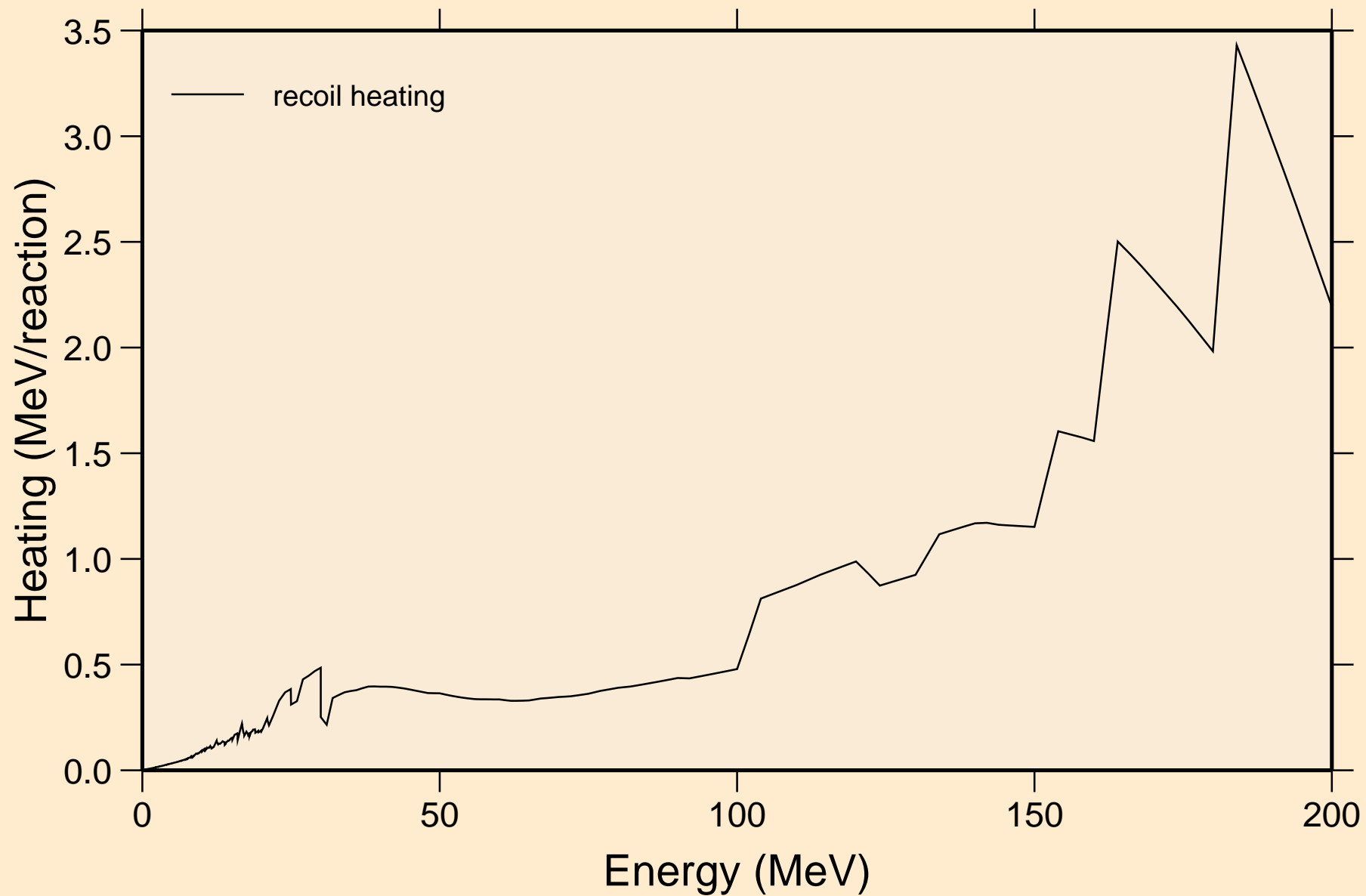

PO201M NEUTRON ACER TENDL-2019 LIBRARY; T=293.16K  
Particle production cross sections

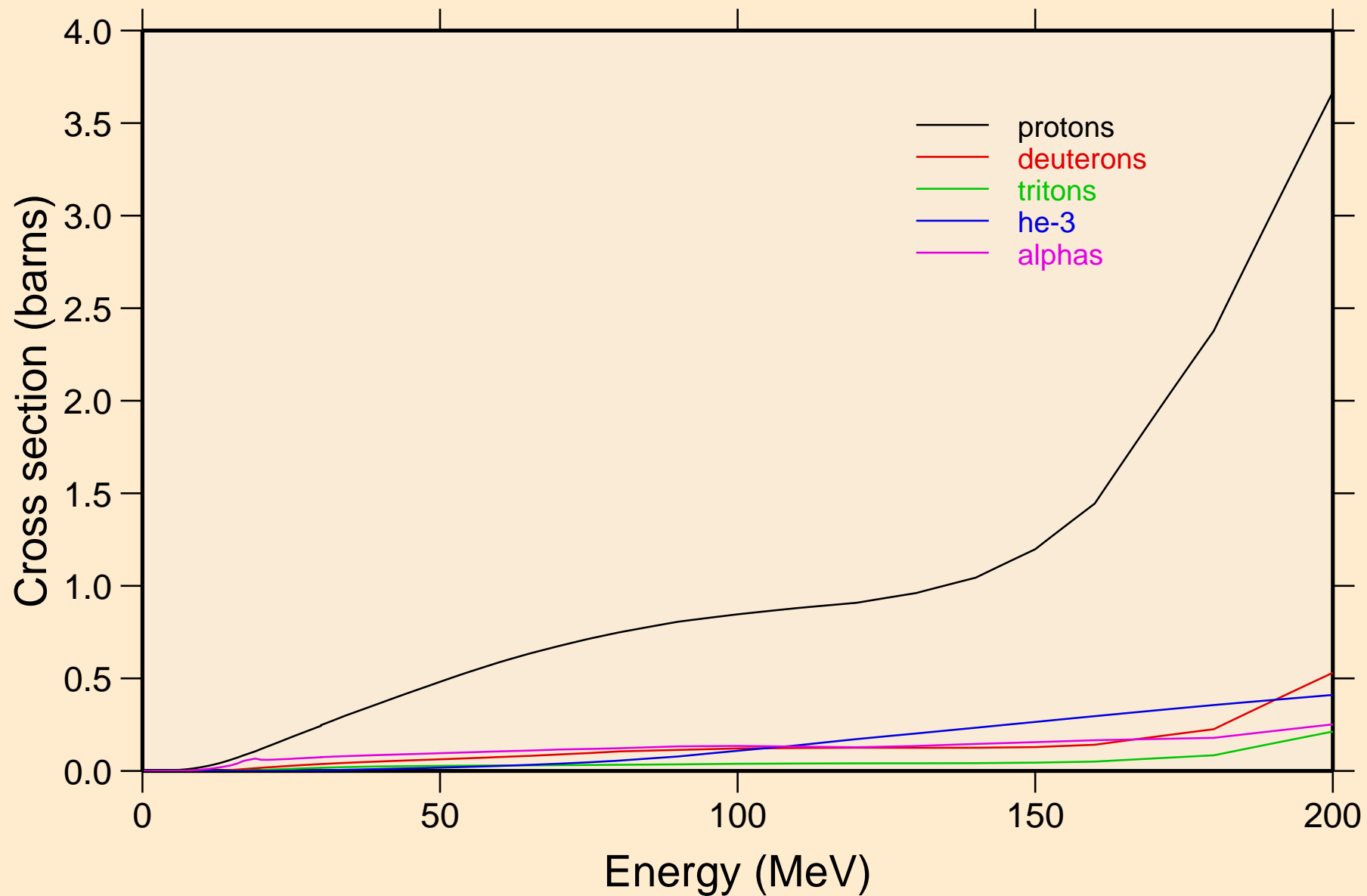

PO201M NEUTRON ACER TENDL-2019 LIBRARY; T=293.16K  
protons from (n,x)

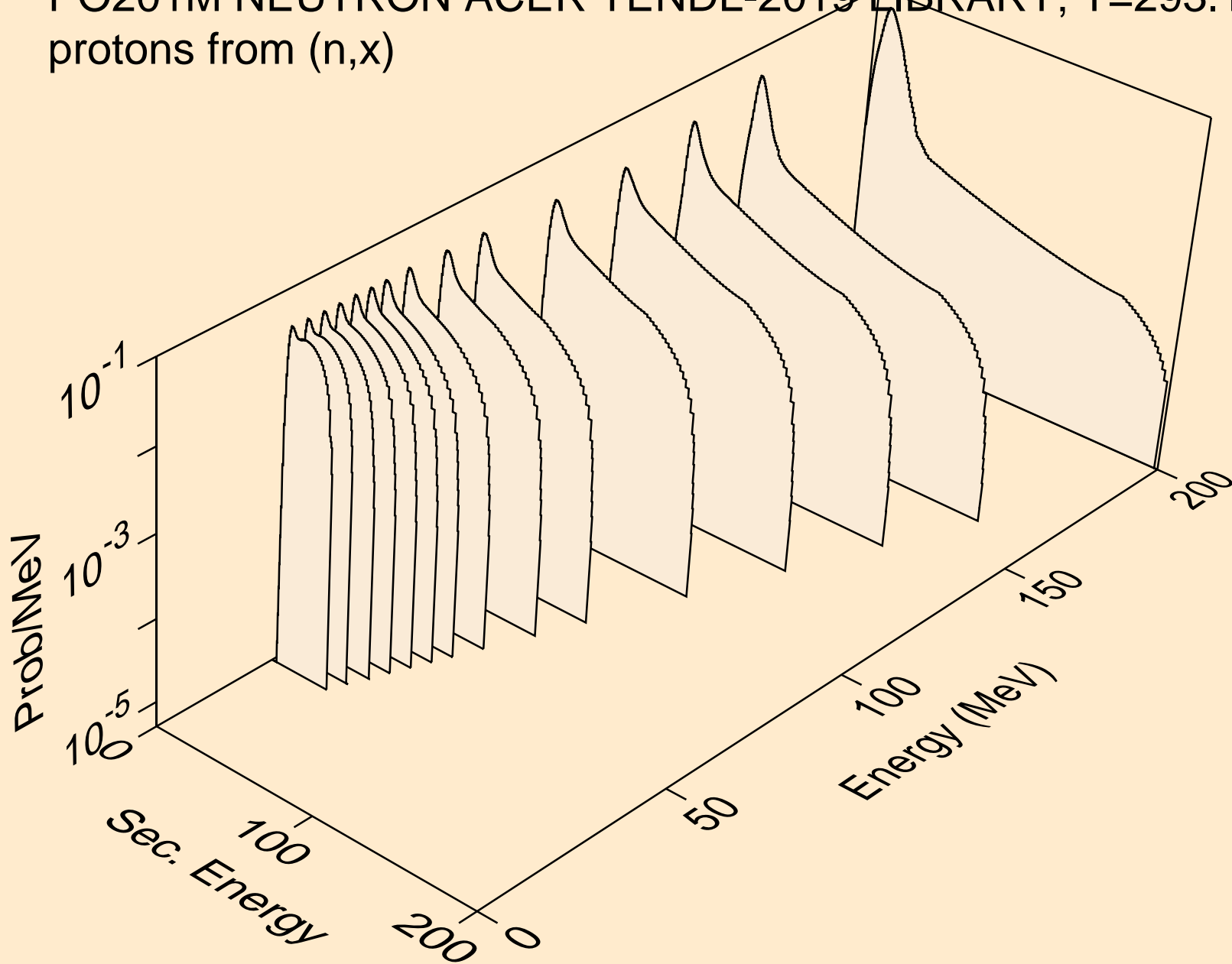

PO201M NEUTRON ACER TENDL-2019 LIBRARY; T=293.16K  
protons from (n,n\*)p

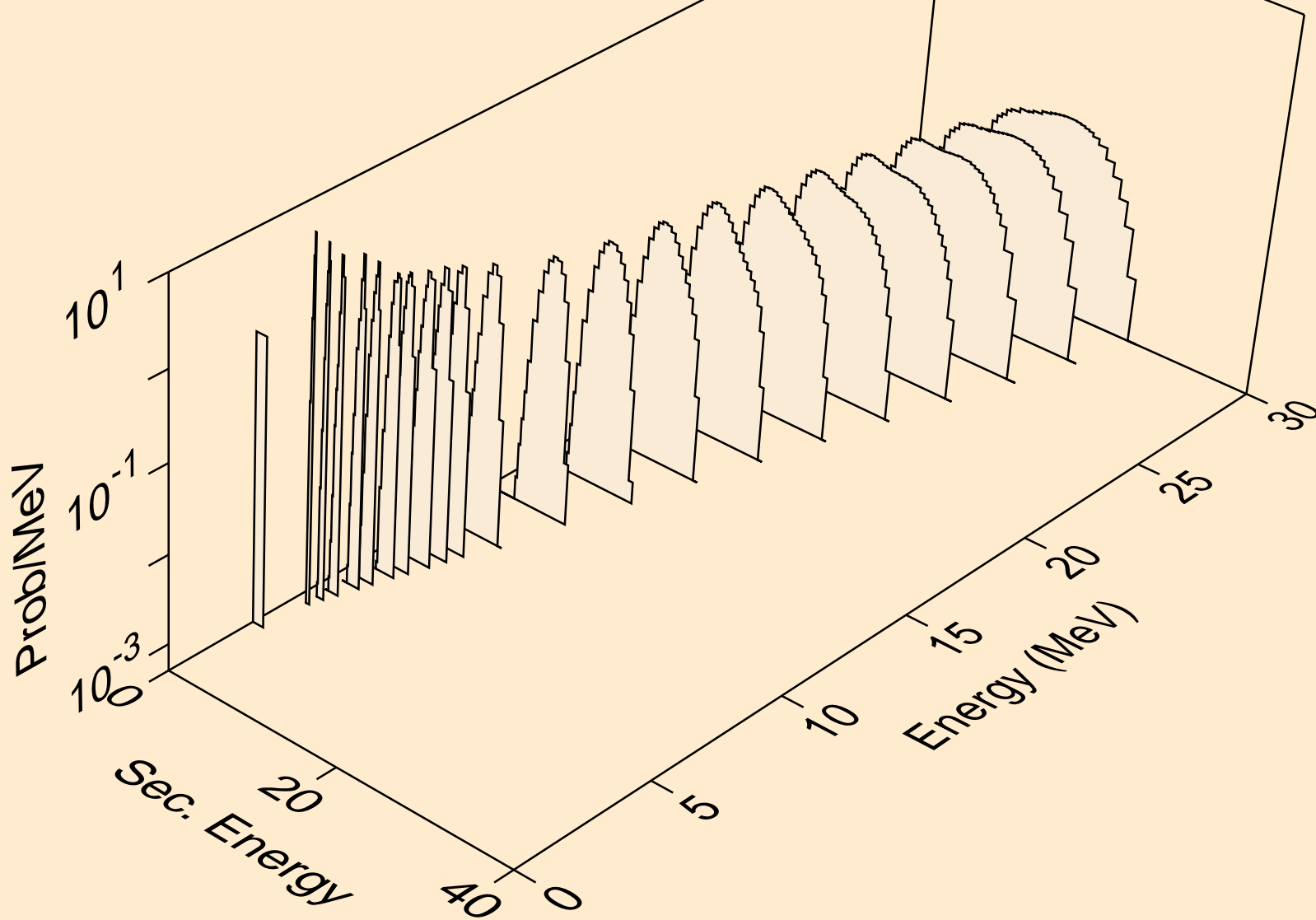

PO201M NEUTRON ACER TENDL-2019 LIBRARY; T=293.16K  
protons from (n,2np)

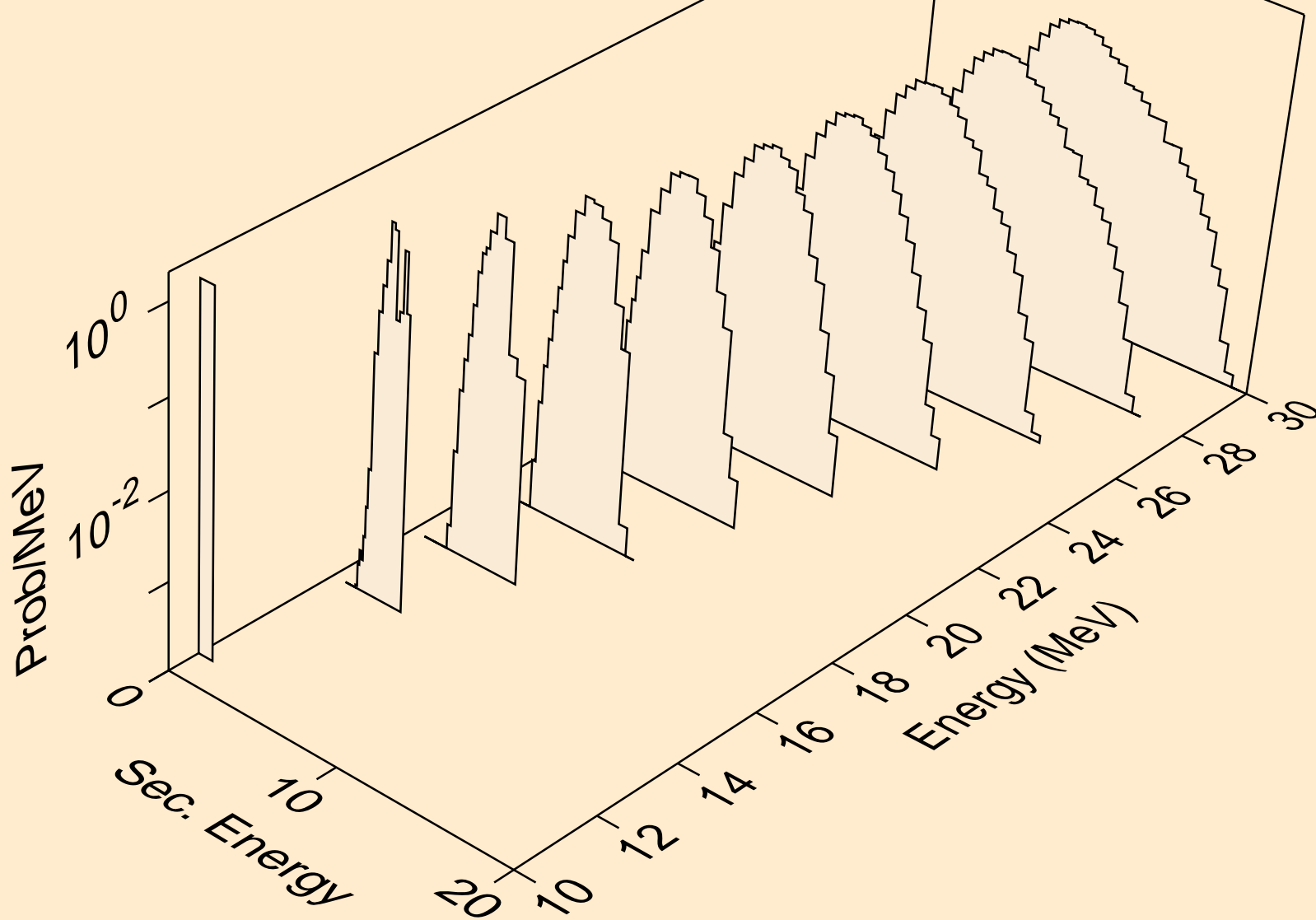

PO201M NEUTRON ACER TENDL-2019 LIBRARY; T=293.16K  
protons from (n,3np)

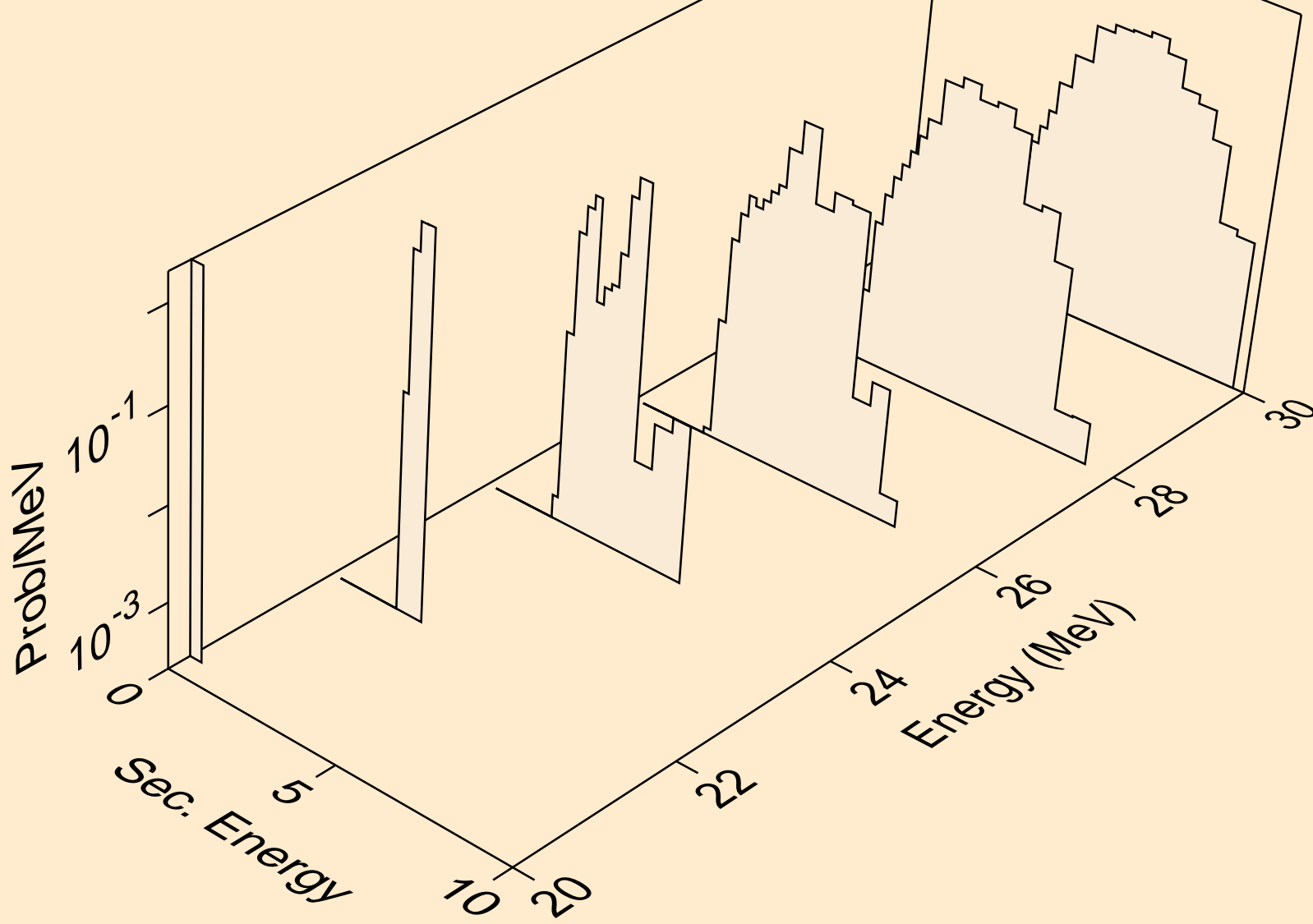



PO201M NEUTRON ACER TENDL-2019 LIBRARY; T=293.16K  
protons from (n,2np)

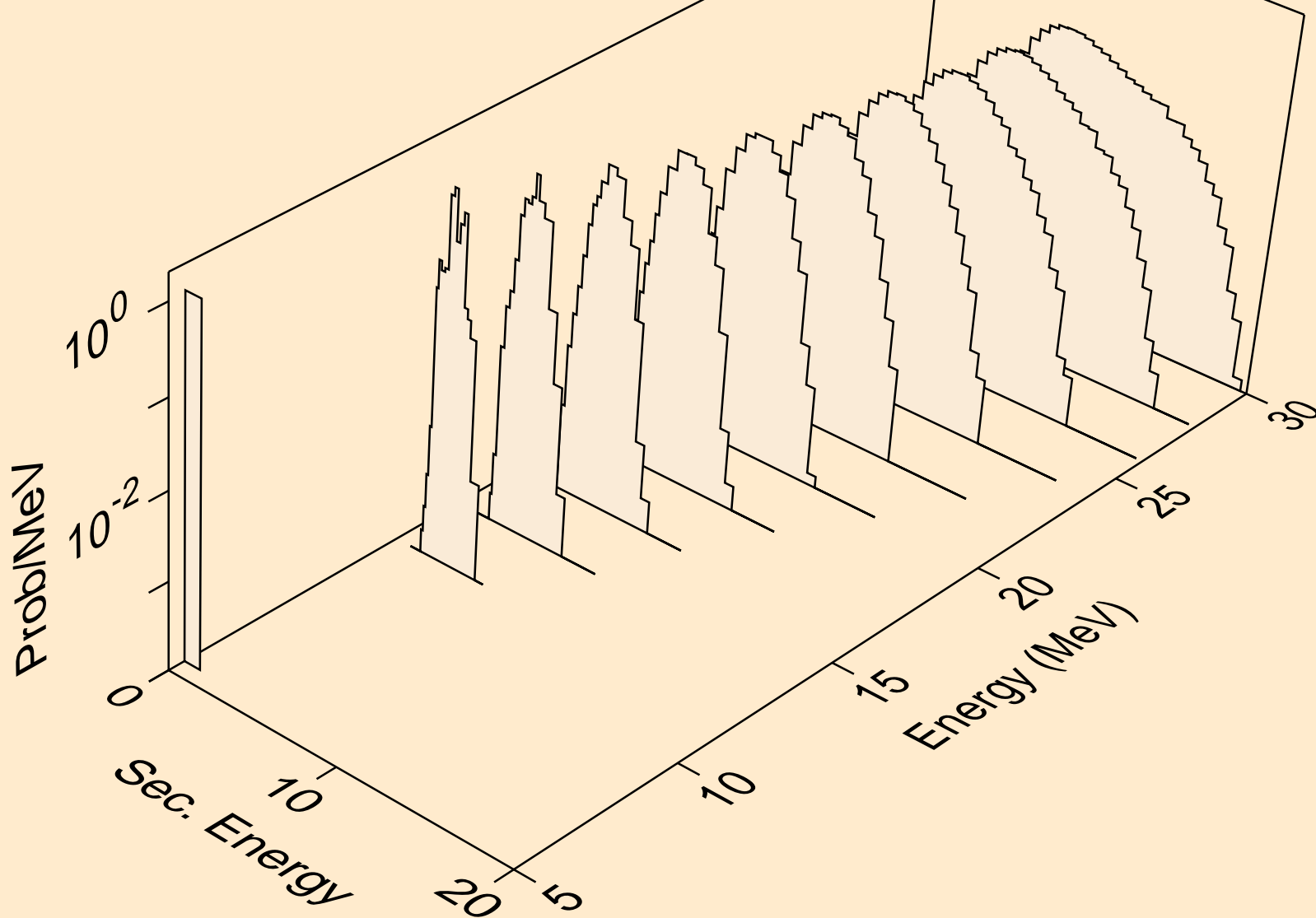

PO201M NEUTRON ACER TENDL-2019 LIBRARY; T=293.16K  
protons from (n,npa)

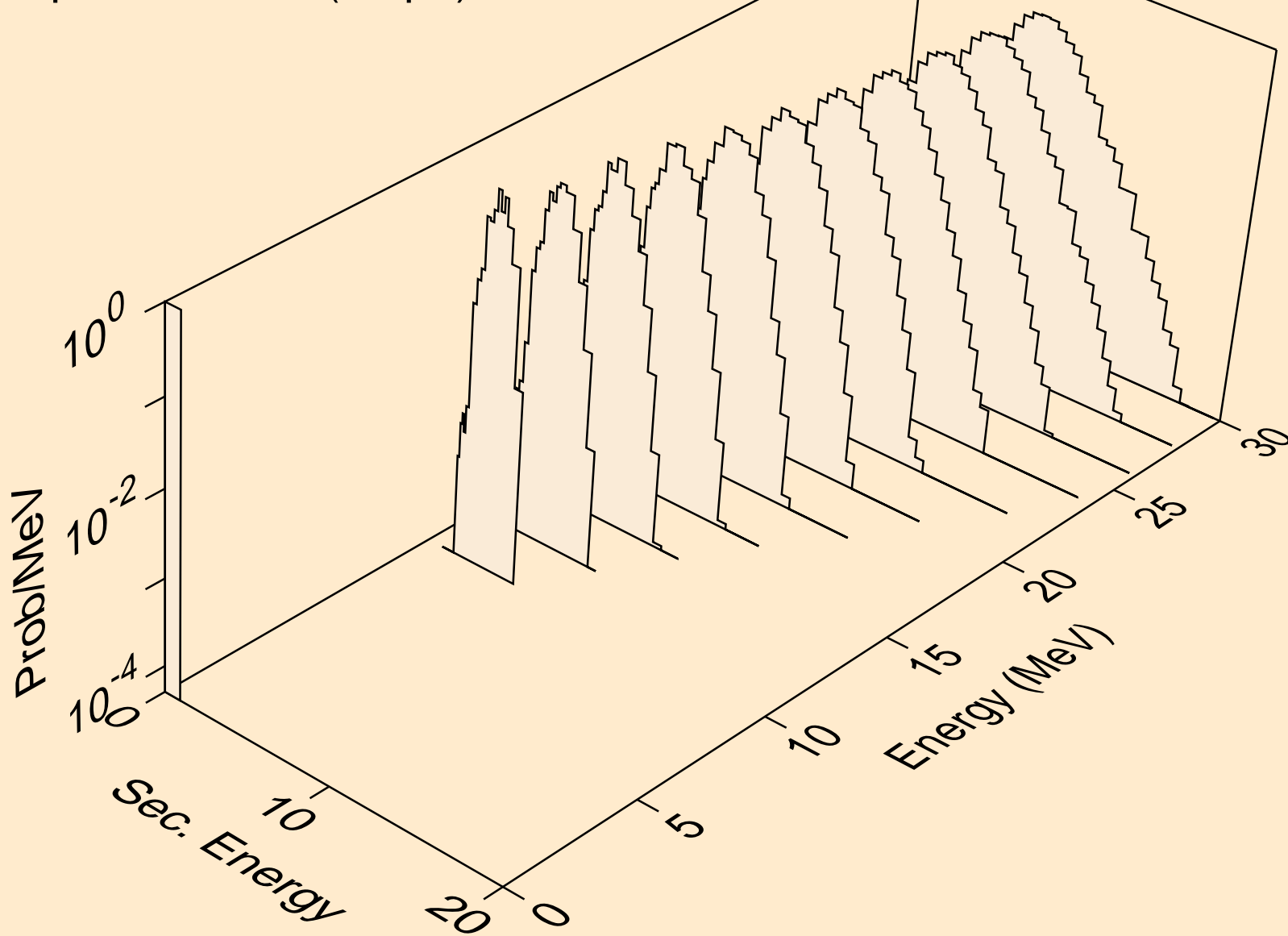

PO201M NEUTRON ACER TENDL-2019 LIBRARY; T=293.16K  
protons from (n,p)

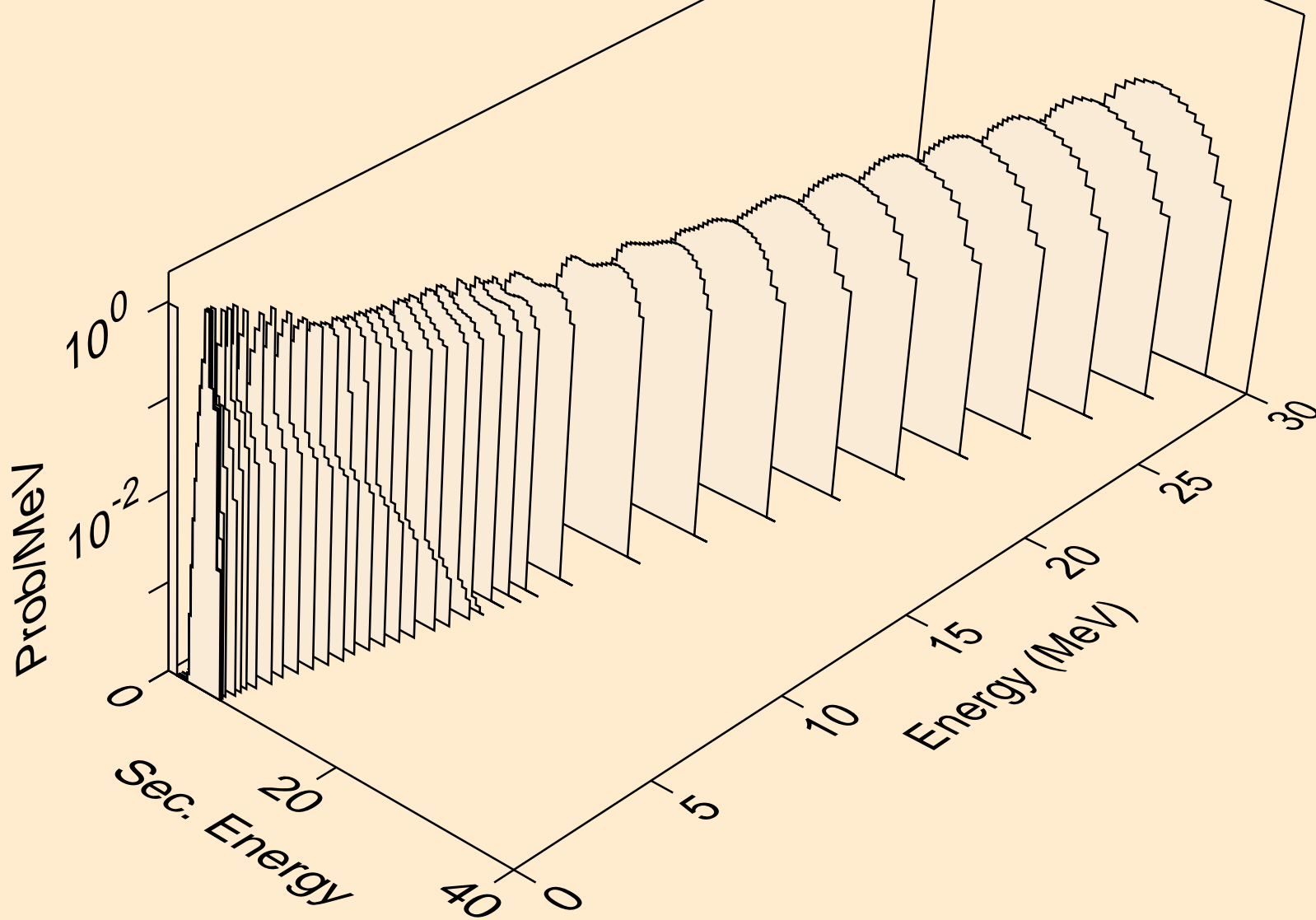

PO201M NEUTRON ACER TENDL-2019 LIBRARY; T=293.16K  
protons from (n,2p)

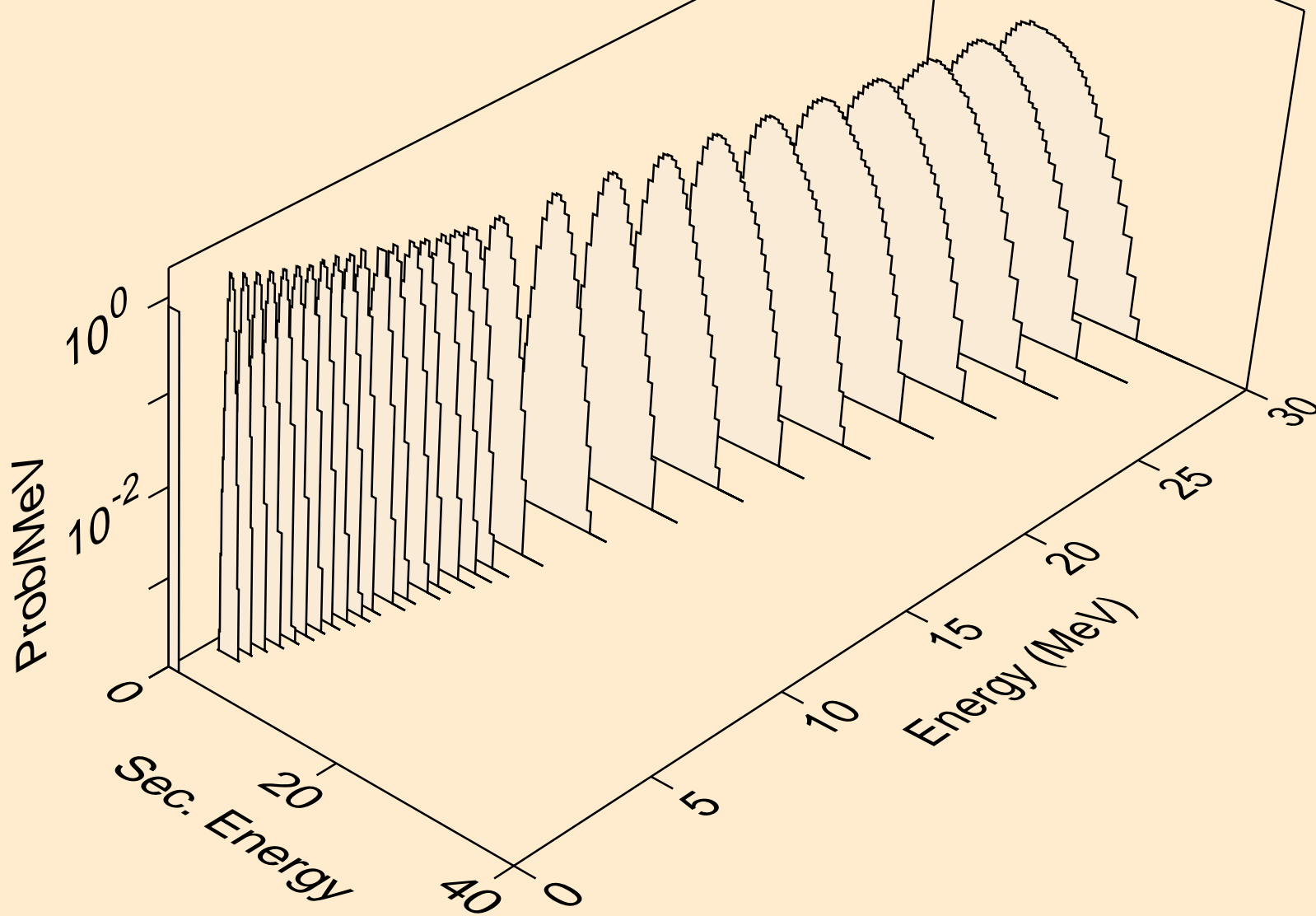

PO201M NEUTRON ACER TENDL-2019 LIBRARY; T=293.16K  
protons from (n,p)

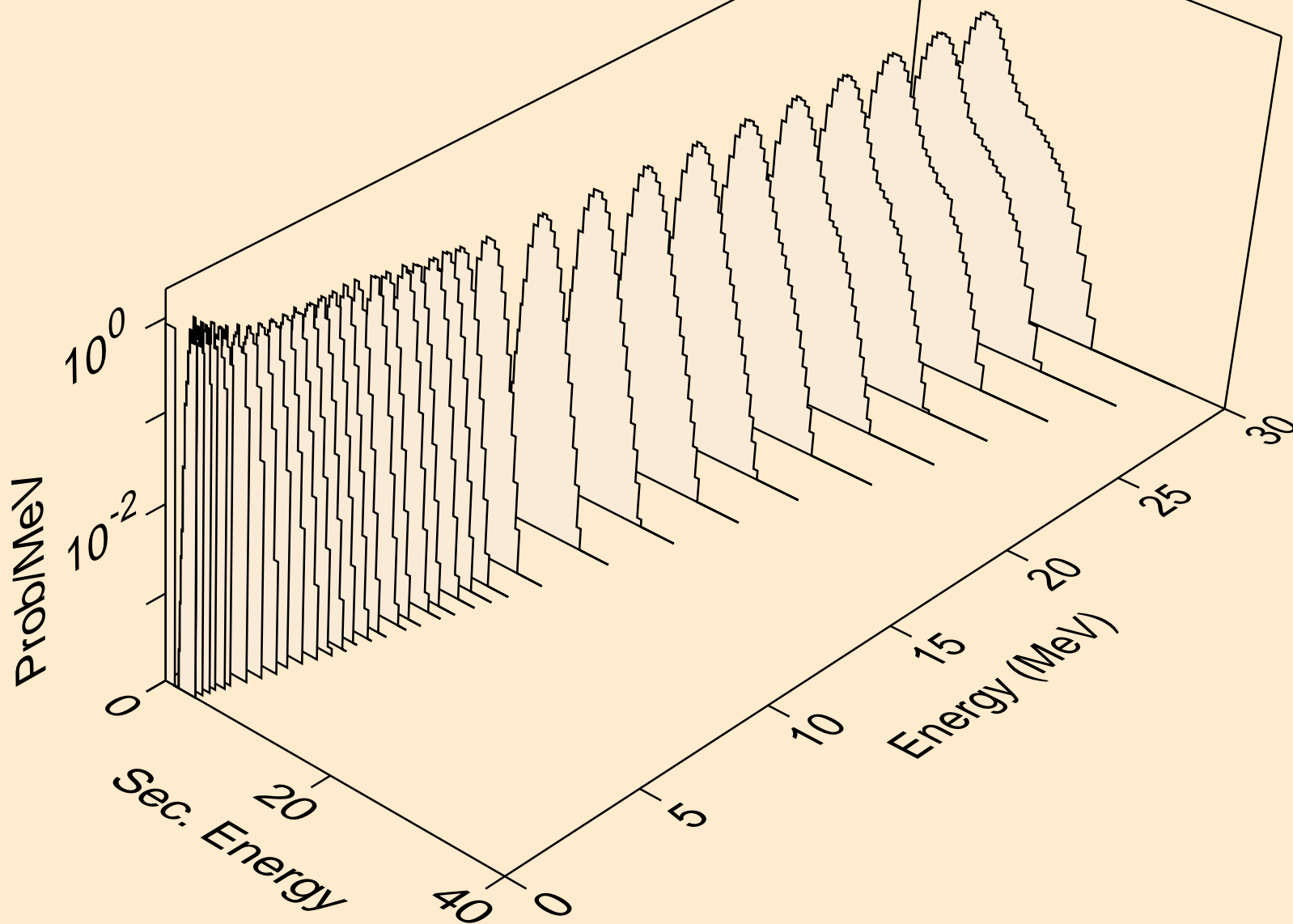

PO201M NEUTRON ACER TENDL-2019 LIBRARY; T=293.16K  
protons from (n,pd)

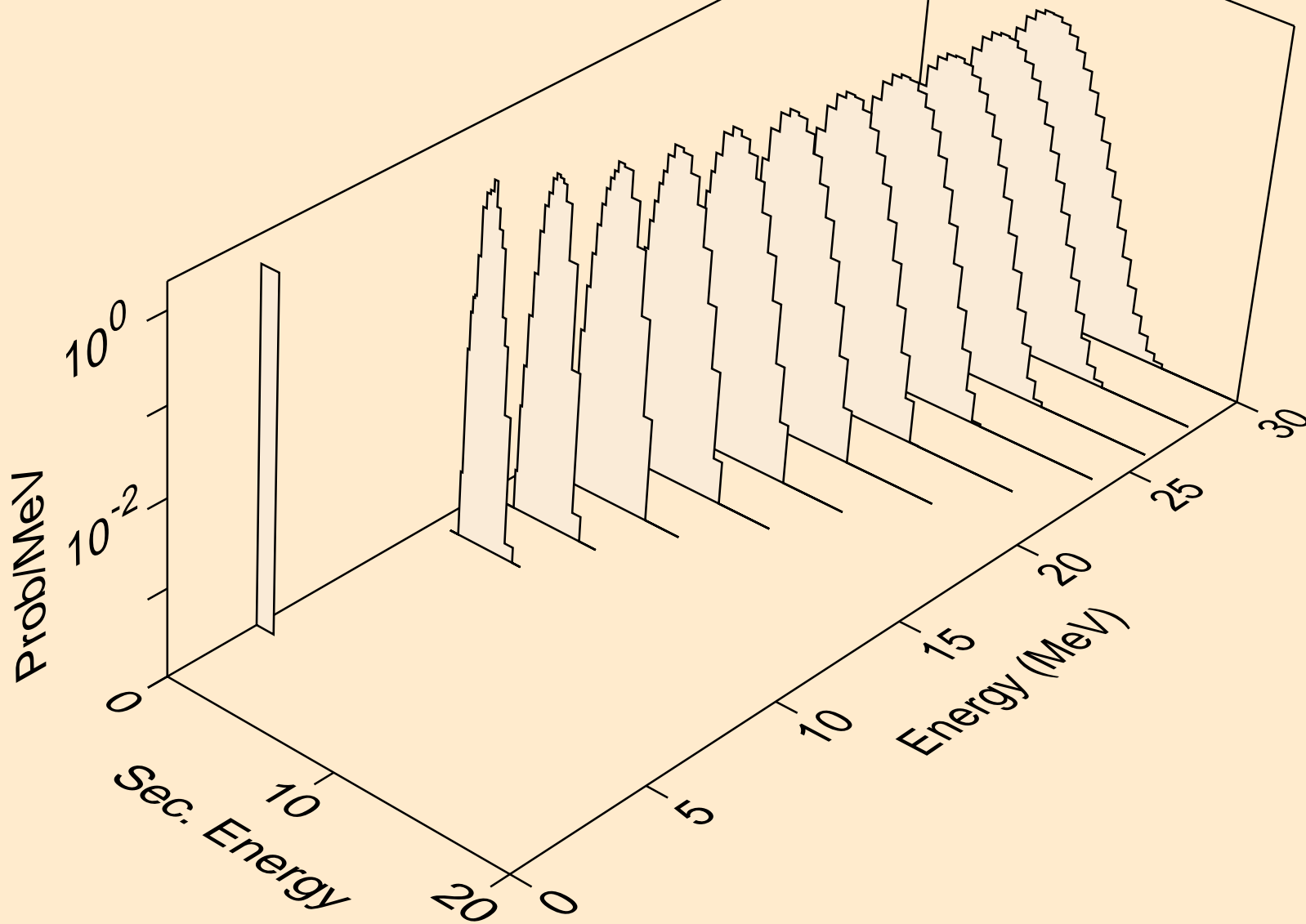

PO201M NEUTRON ACER TENDL-2019 LIBRARY; T=293.16K  
protons from (n,pt)

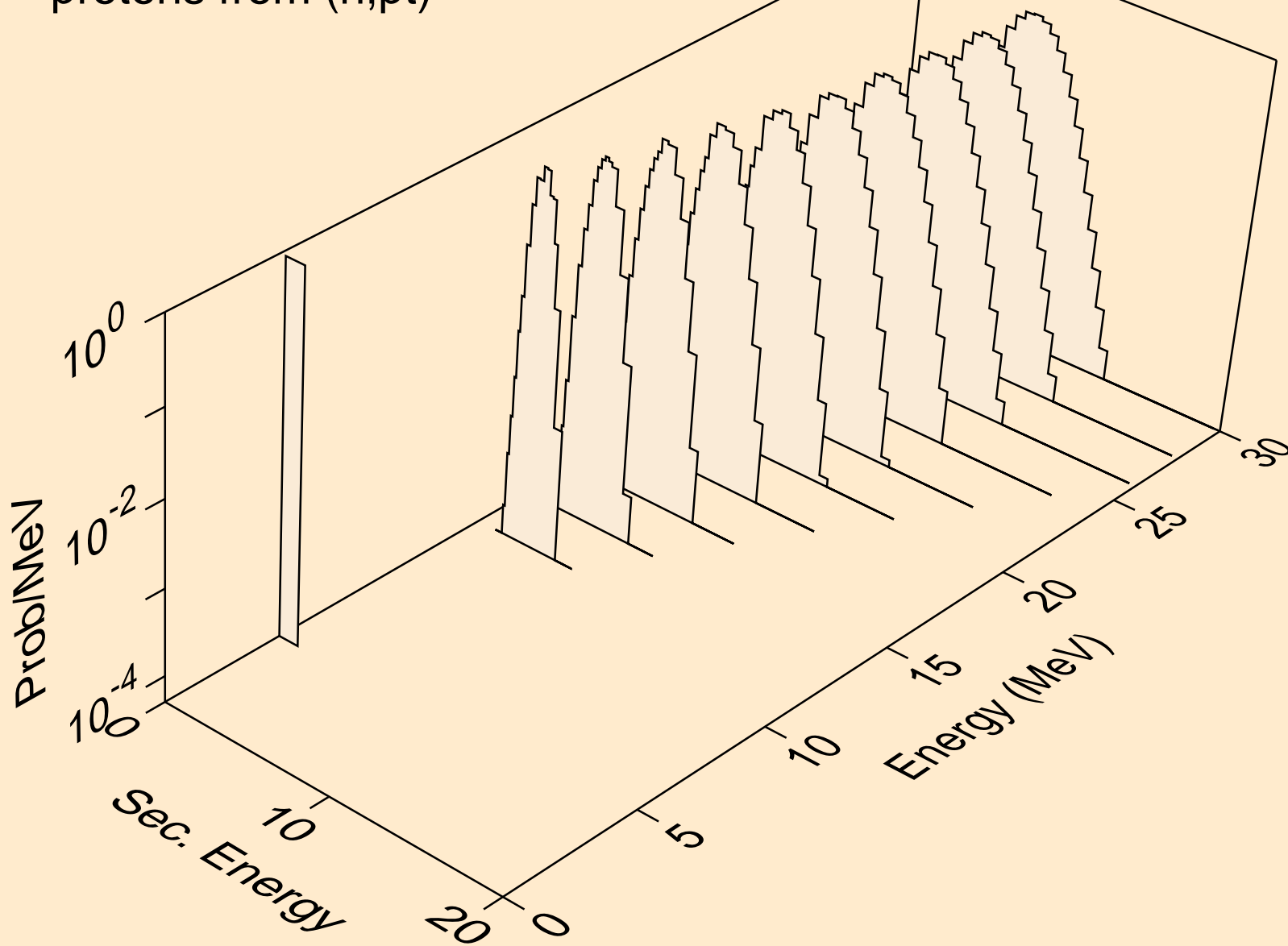

PO201M NEUTRON ACER TENDL-2019 LIBRARY; T=293.16K  
deuterons from (n,x)

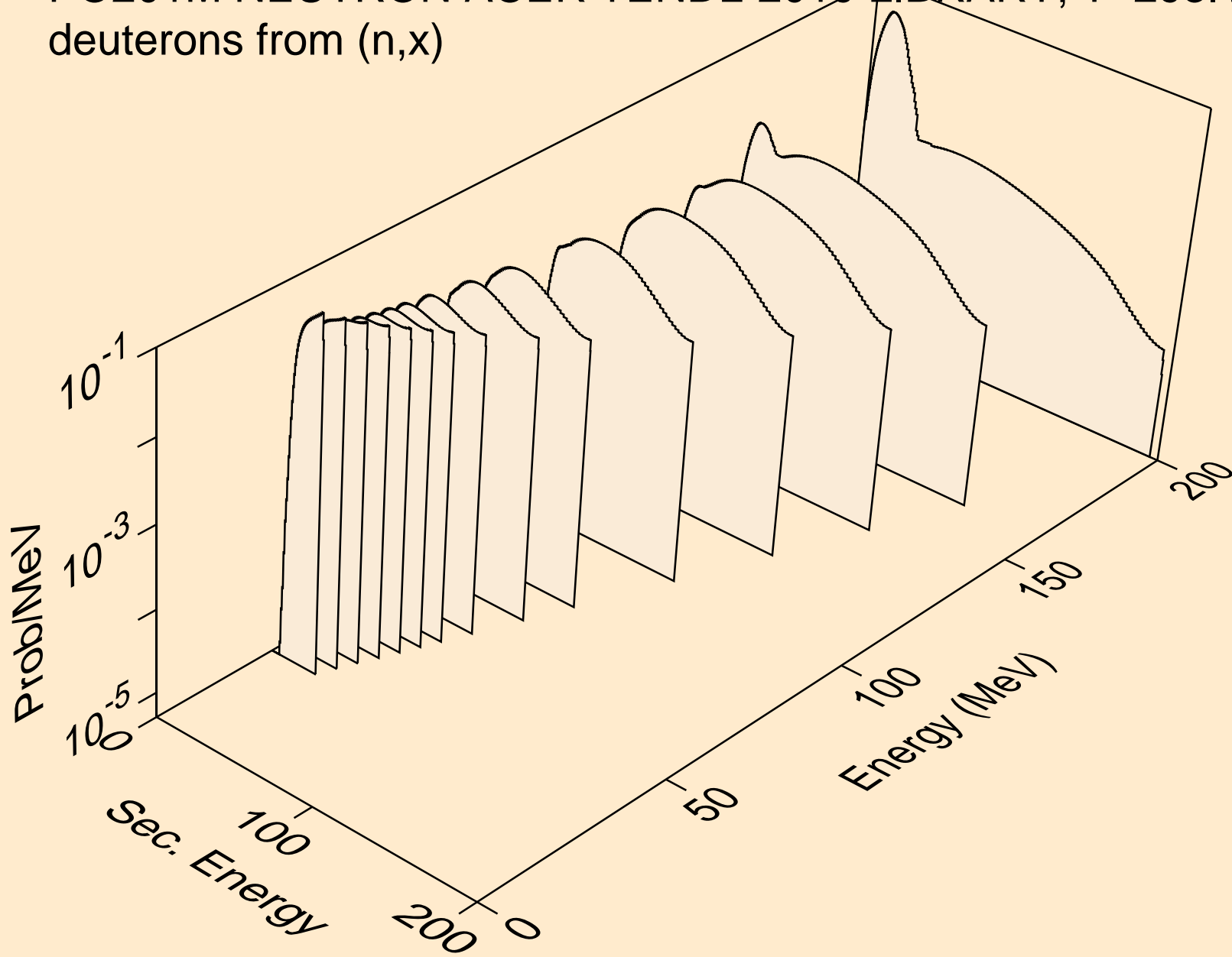



PO201M NEUTRON ACER TENDL-2019 LIBRARY; T=293.16K  
deuterons from (n,2nd)

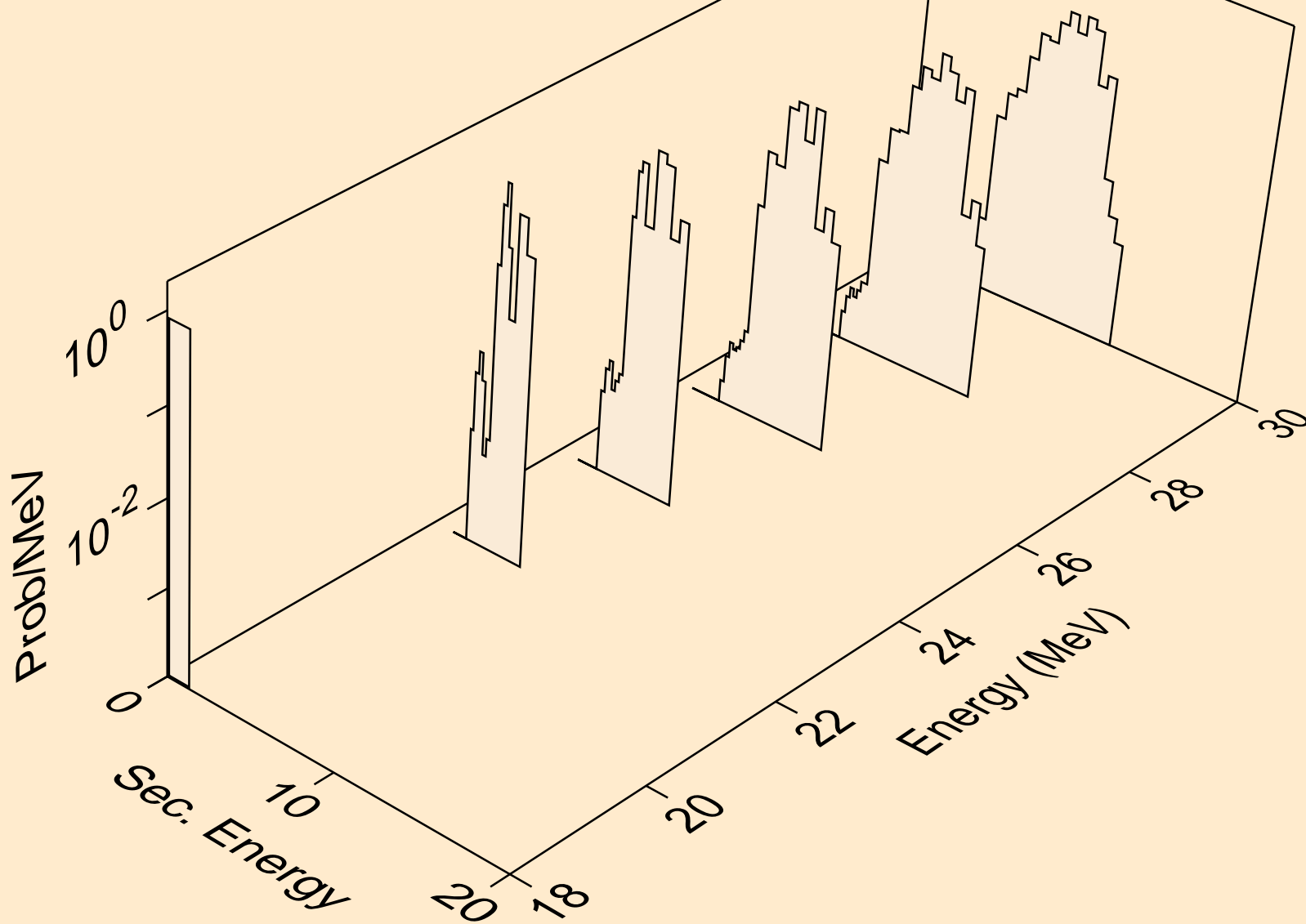

PO201M NEUTRON ACER TENDL-2019 LIBRARY; T=293.16K  
deuterons from (n,n\*)d

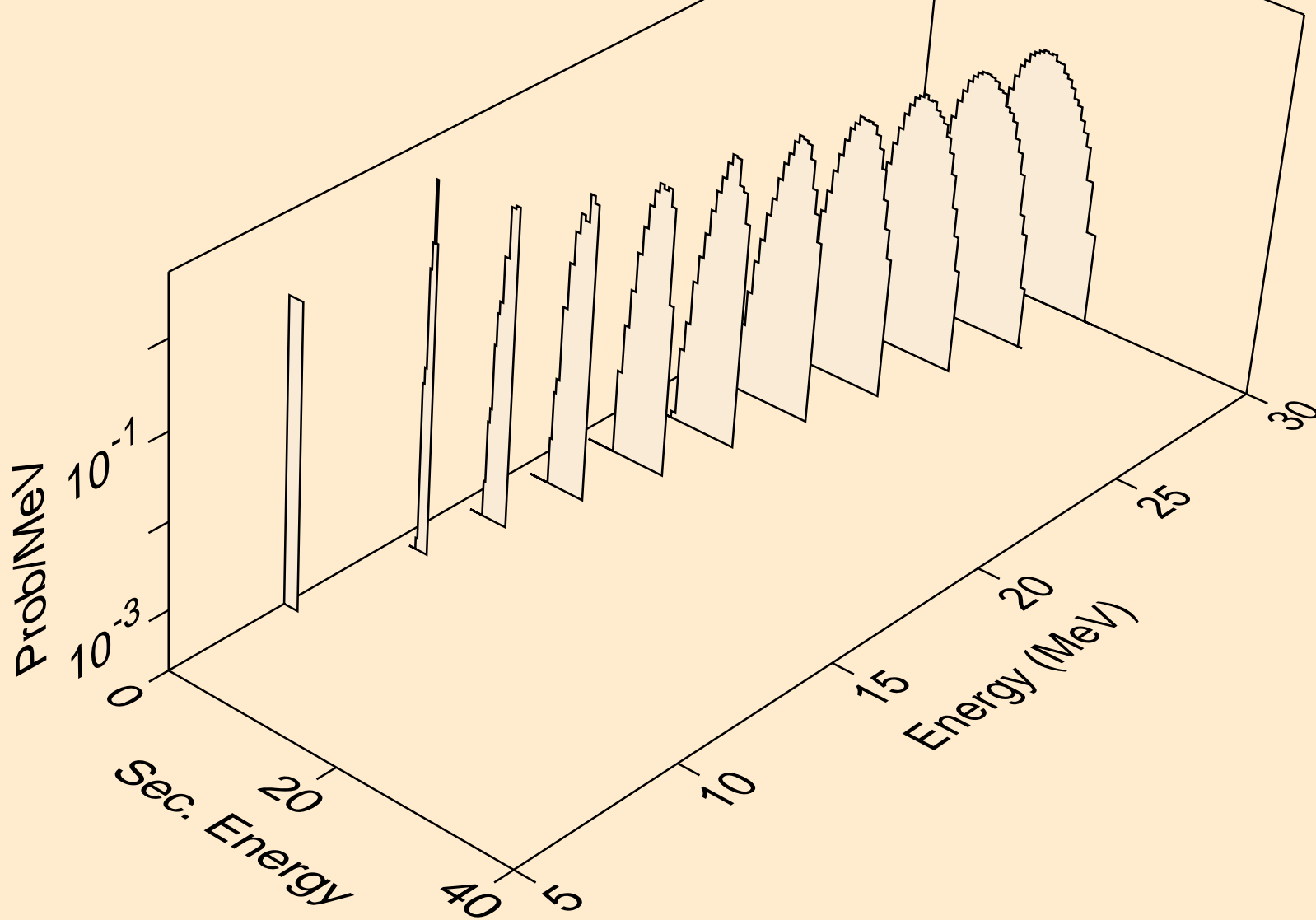

PO201M NEUTRON ACER TENDL-2019 LIBRARY; T=293.16K  
deuterons from (n,d)

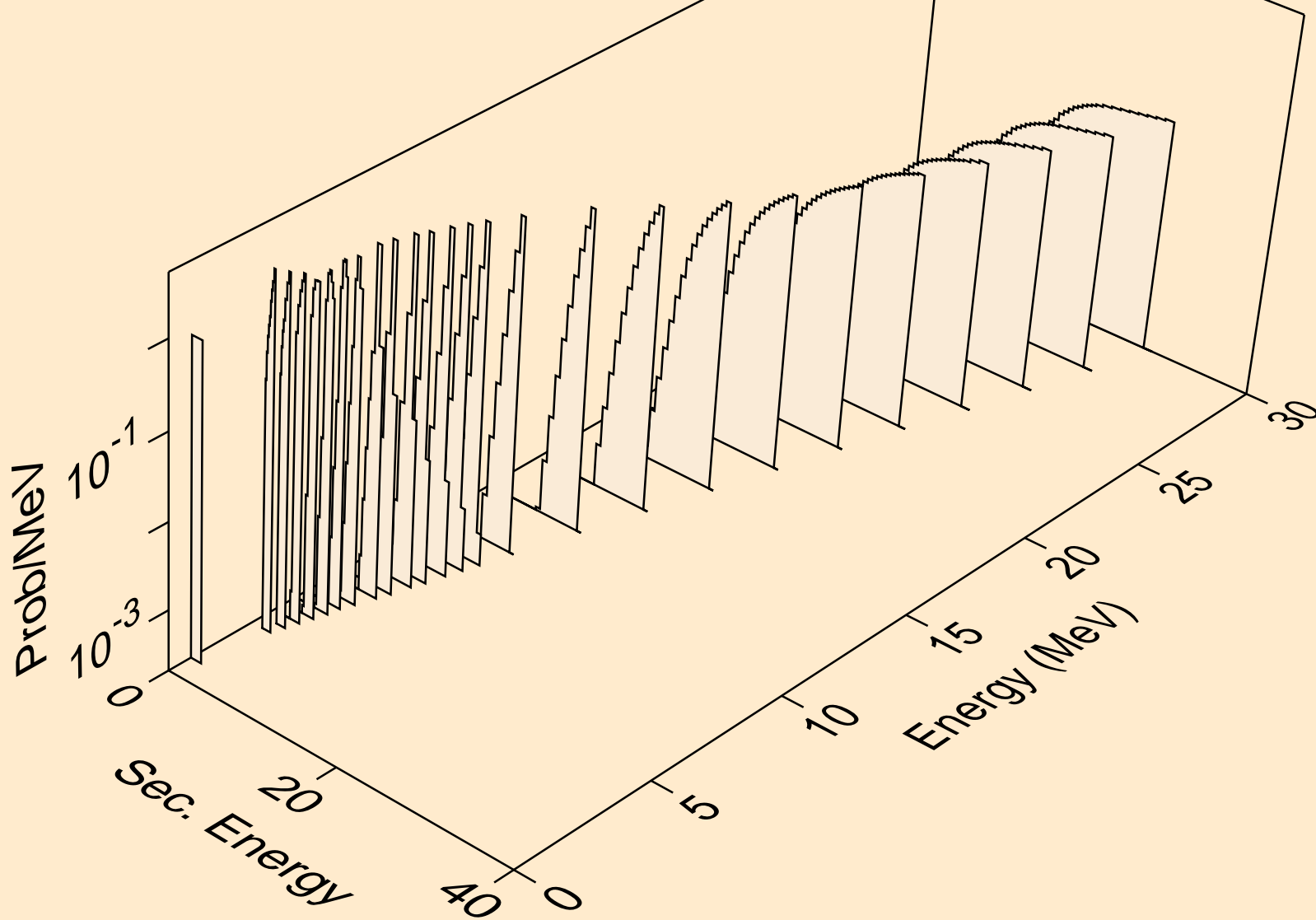

PO201M NEUTRON ACER TENDL-2019 LIBRARY; T=293.16K  
deuterons from (n,pd)

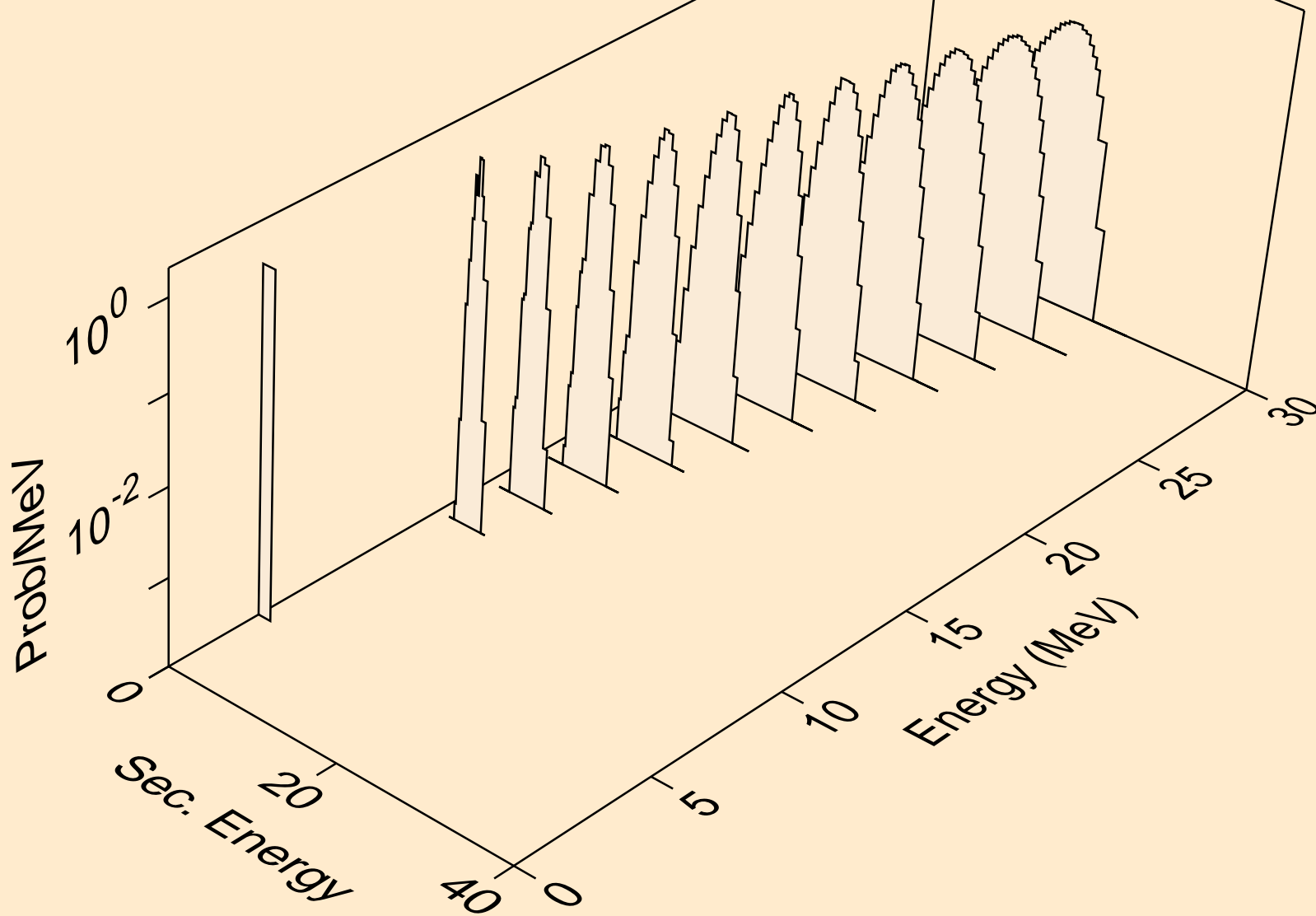

PO201M NEUTRON ACER TENDL-2019 LIBRARY; T=293.16K  
deuterons from (n,da)

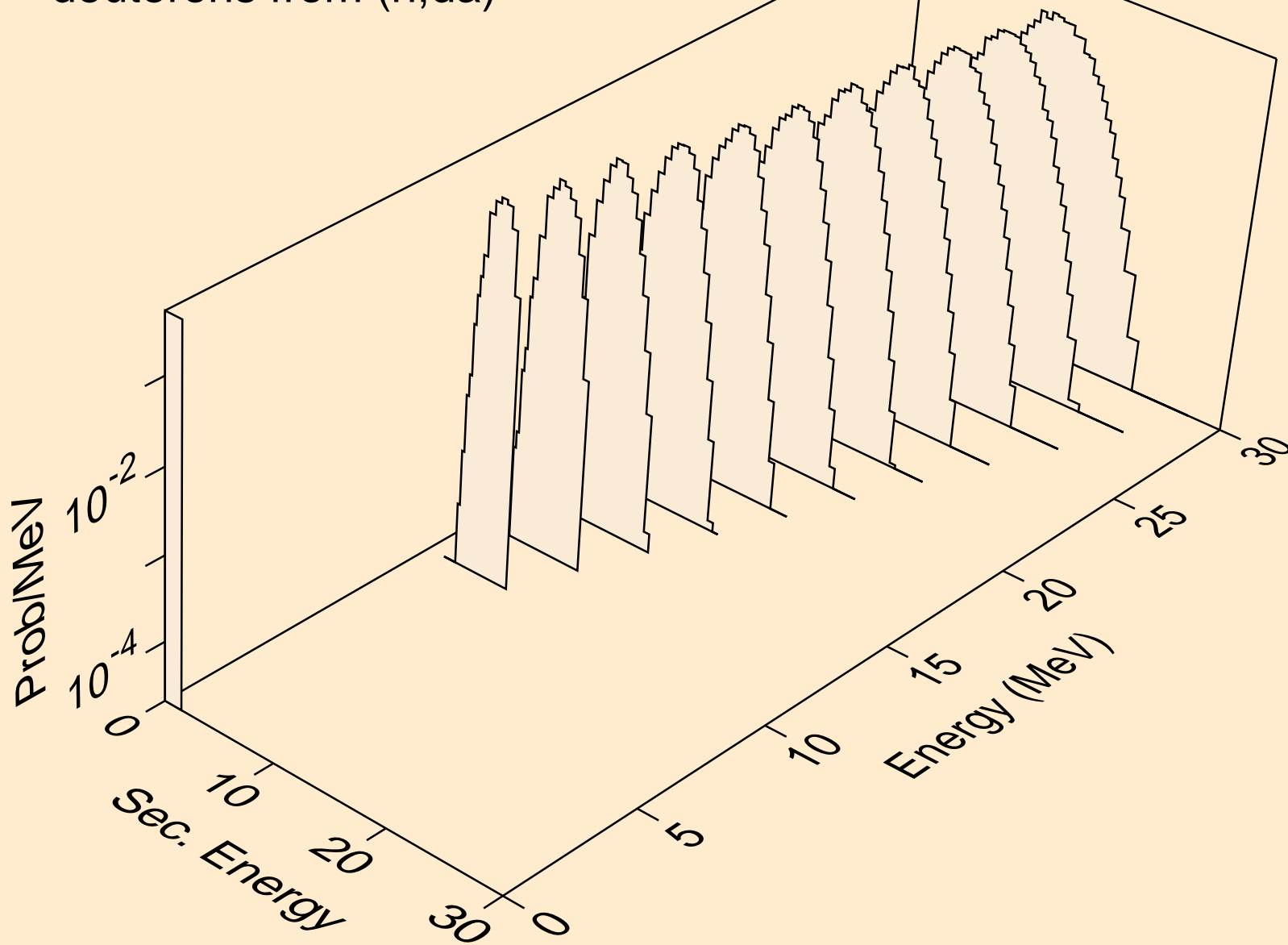

PO201M NEUTRON ACER TENDL-2019 LIBRARY; T=293.16K  
tritons from (n,x)

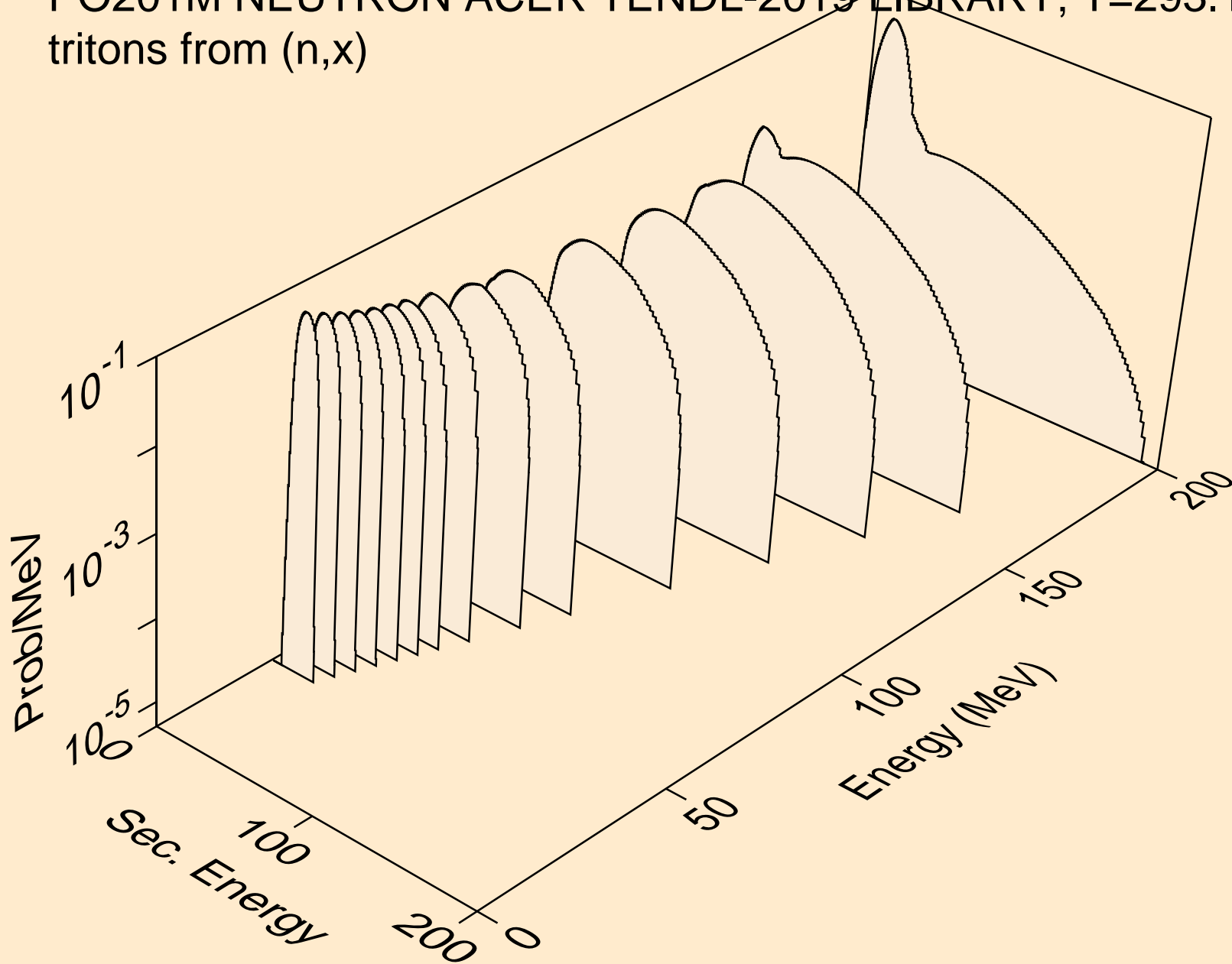

PO201M NEUTRON ACER TENDL-2019 LIBRARY; T=293.16K  
tritons from (n,n\*)t

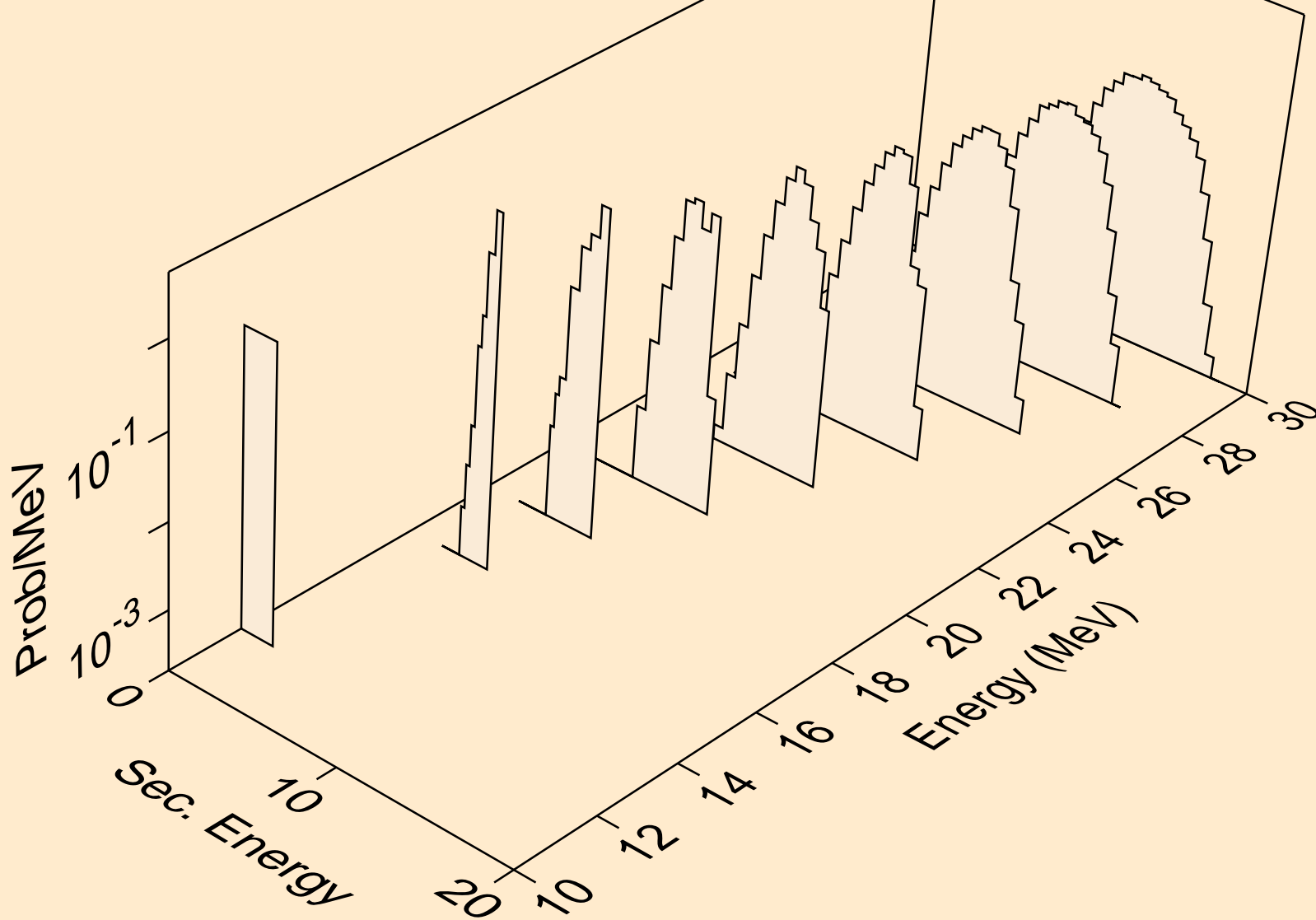

PO201M NEUTRON ACER TENDL-2019 LIBRARY; T=293.16K  
tritons from (n,t)

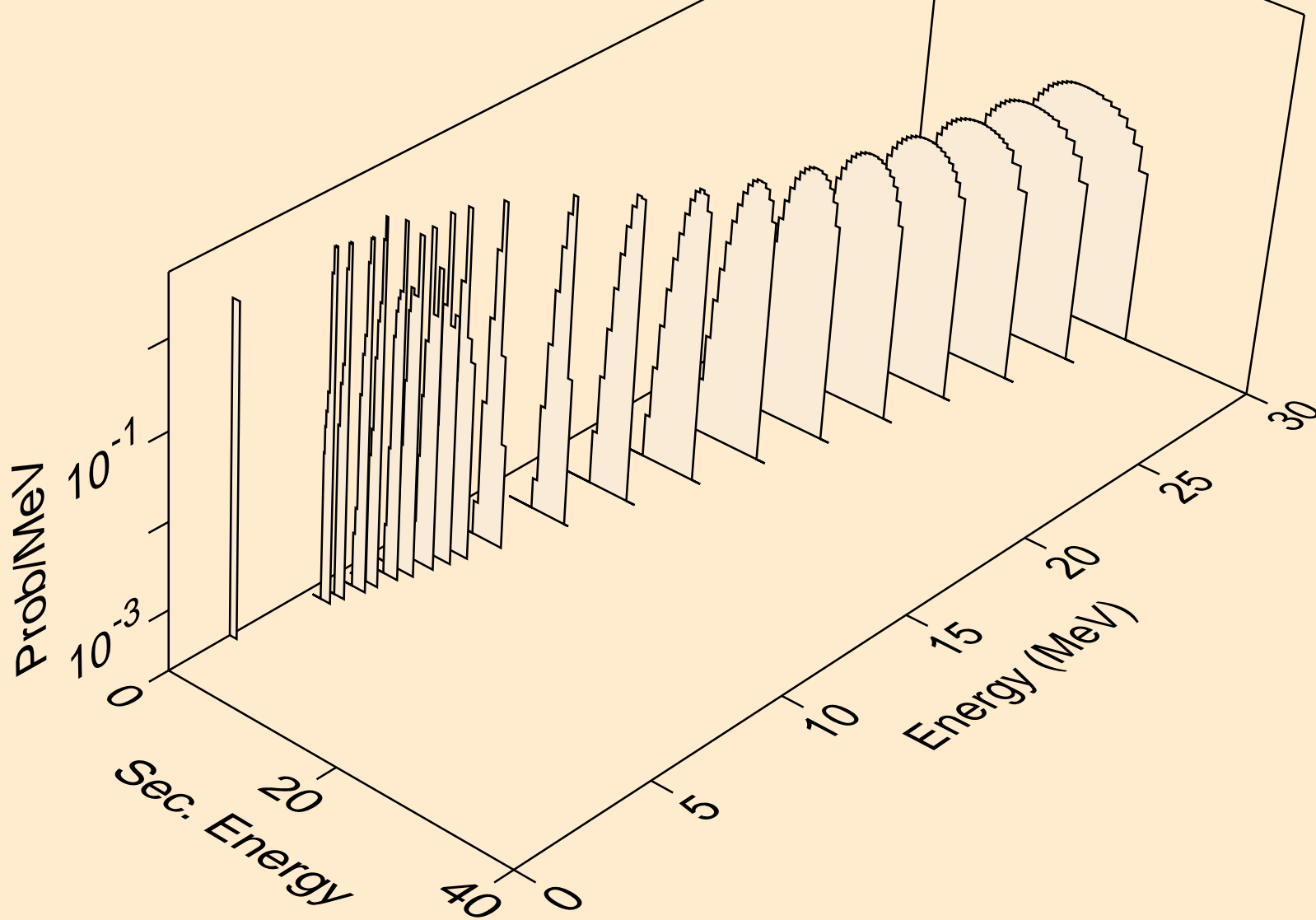



PO201M NEUTRON ACER TENDL-2019 LIBRARY; T=293.16K  
tritons from (n,pt)

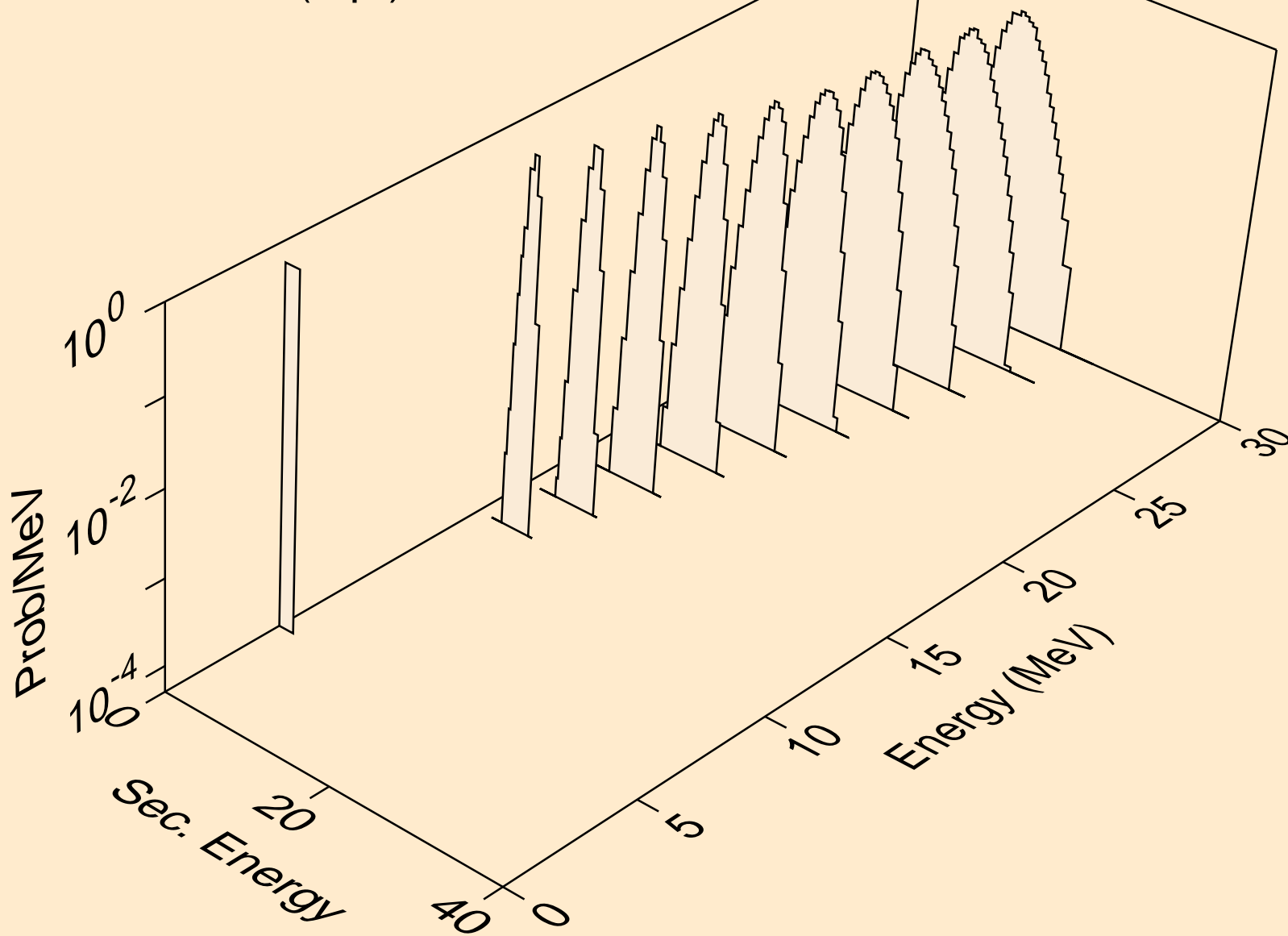

PO201M NEUTRON ACER TENDL-2019 LIBRARY; T=293.16K  
he3s from (n,x)

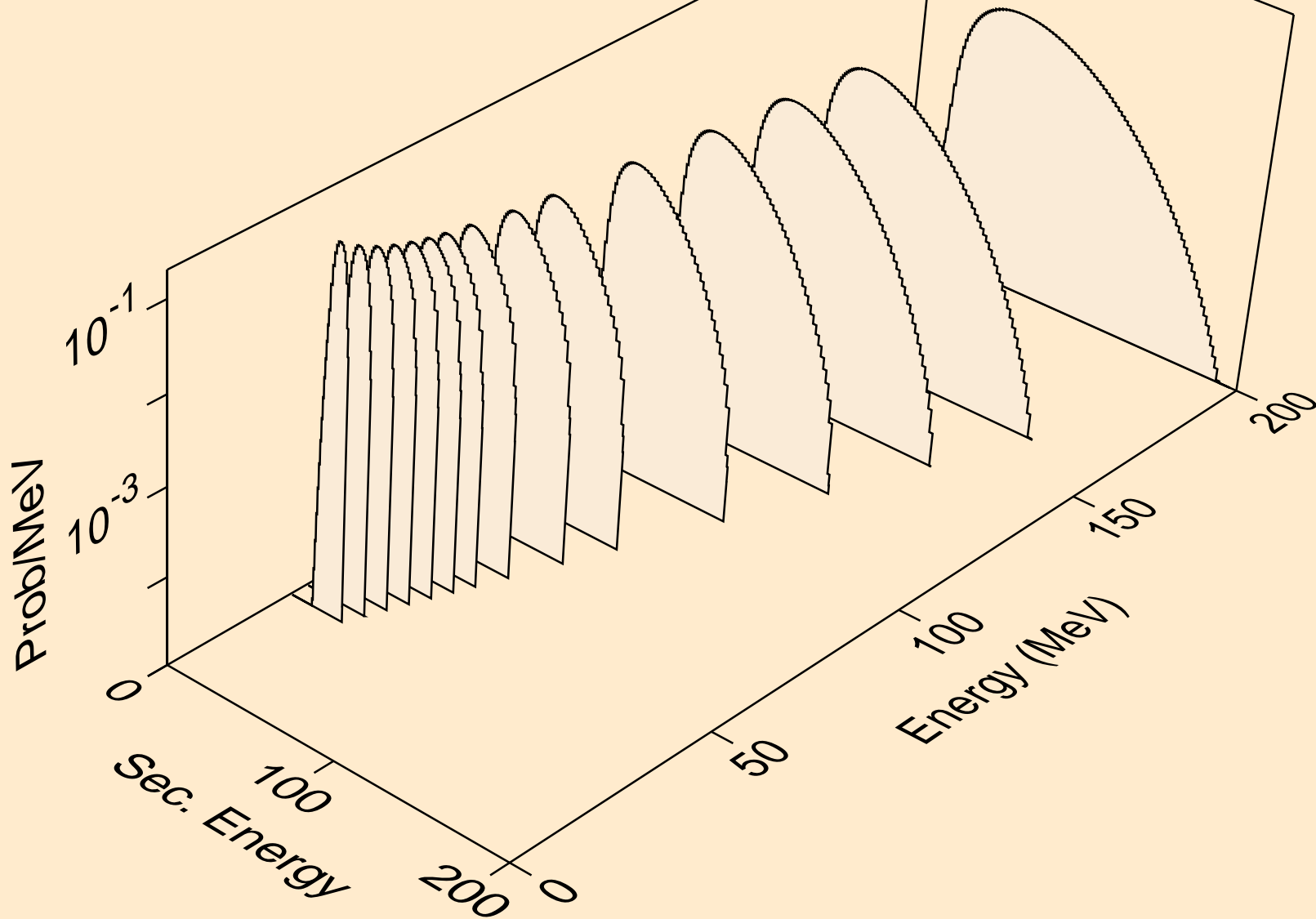

PO201M NEUTRON ACER TENDL-2019 LIBRARY; T=293.16K  
he3s from (n,n\*)he3

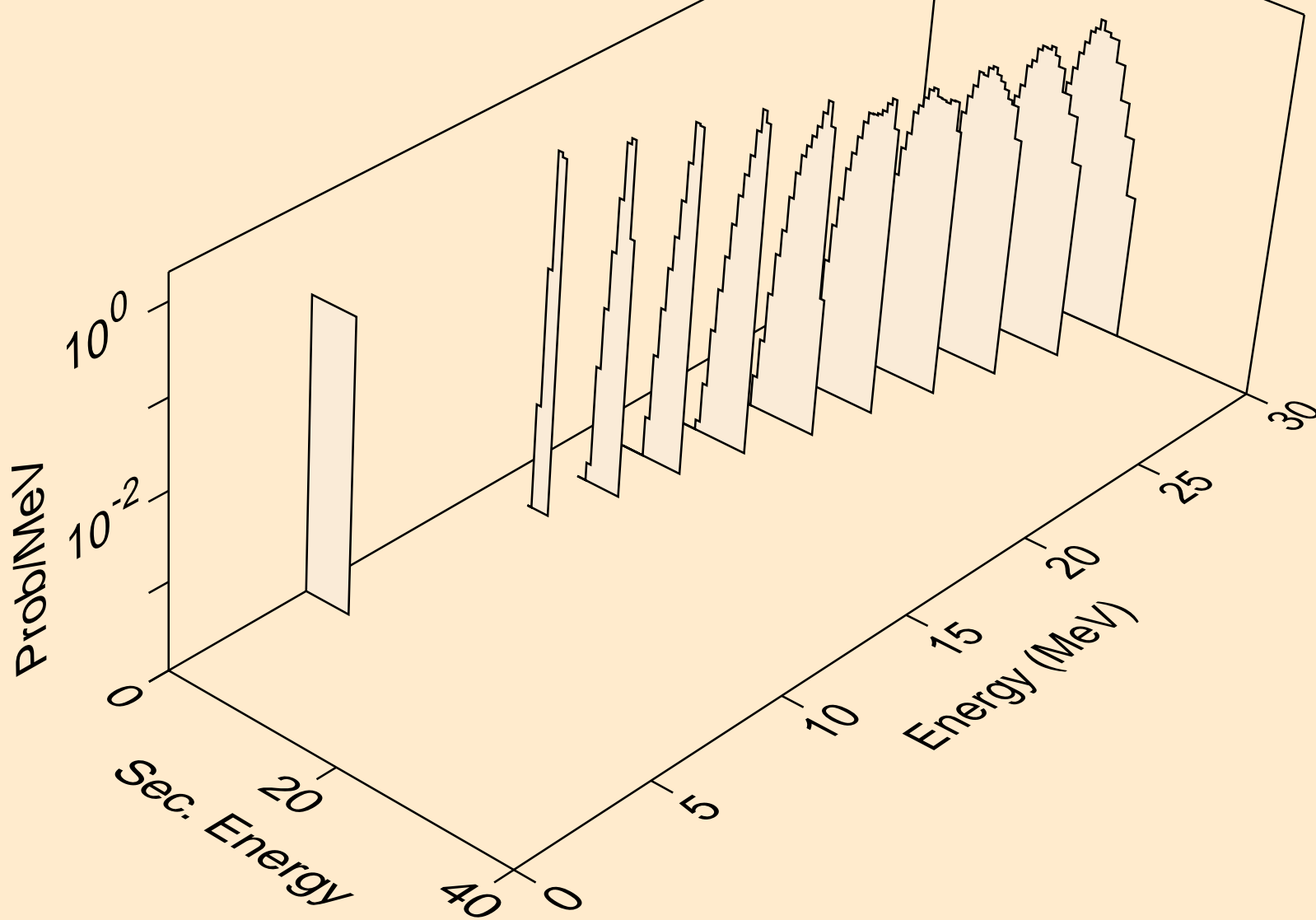

PO201M NEUTRON ACER TENDL-2019 LIBRARY; T=293.16K  
he3s from (n,he3)

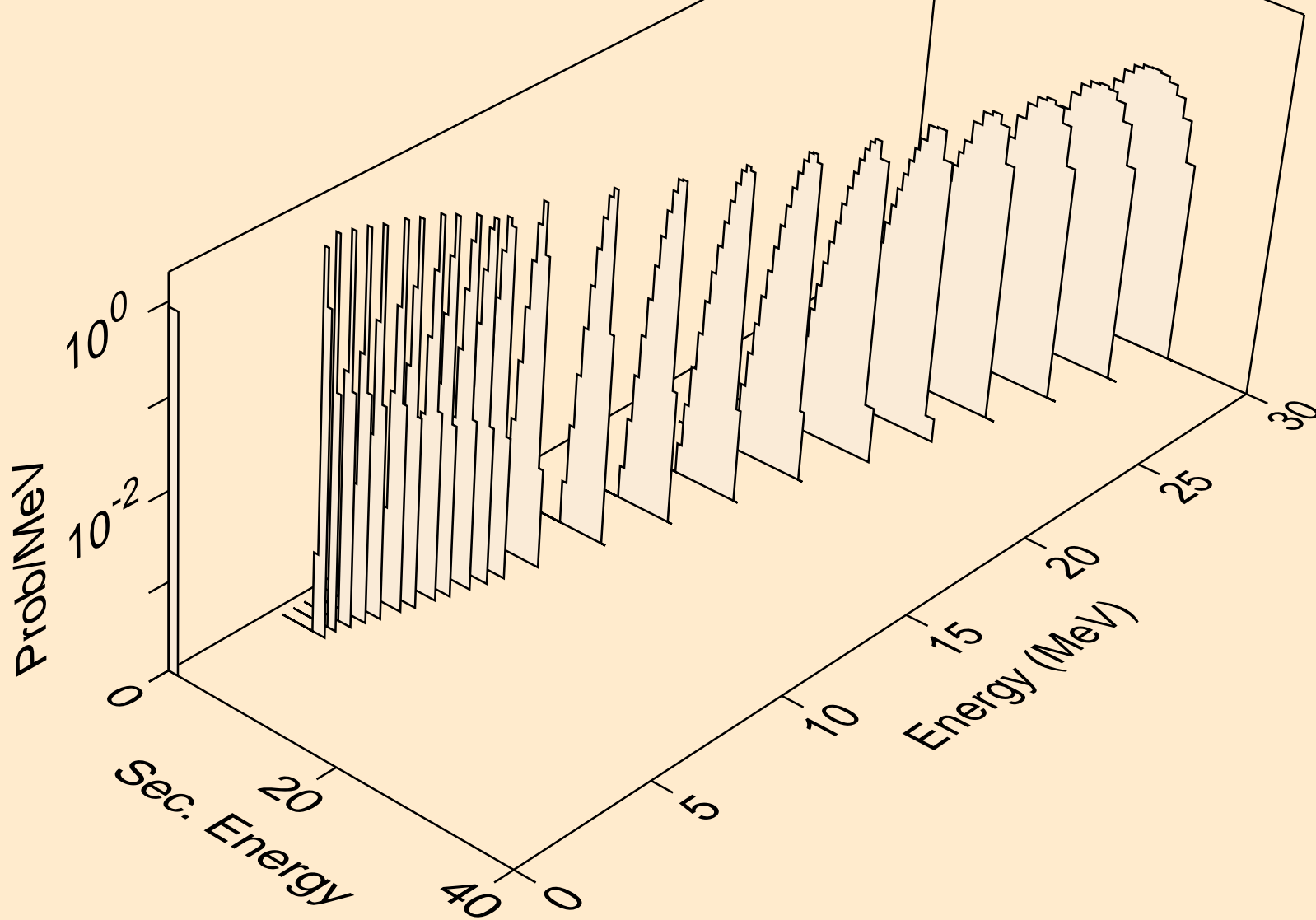

PO201M NEUTRON ACER TENDL-2019 LIBRARY; T=293.16K  
alphas from (n,x)

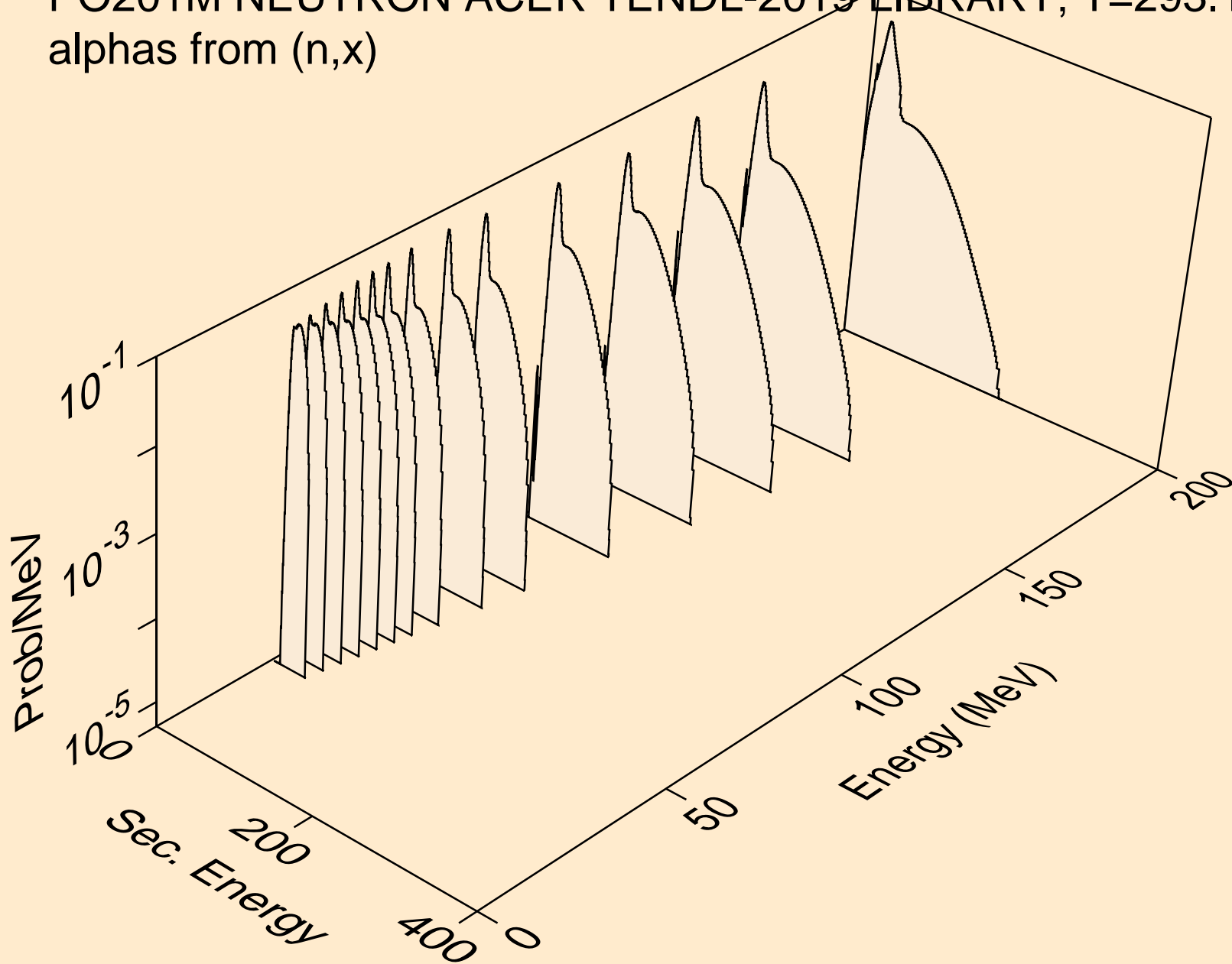

PO201M NEUTRON ACER TENDL-2019 LIBRARY; T=293.16K  
alphas from (n,n\*)a

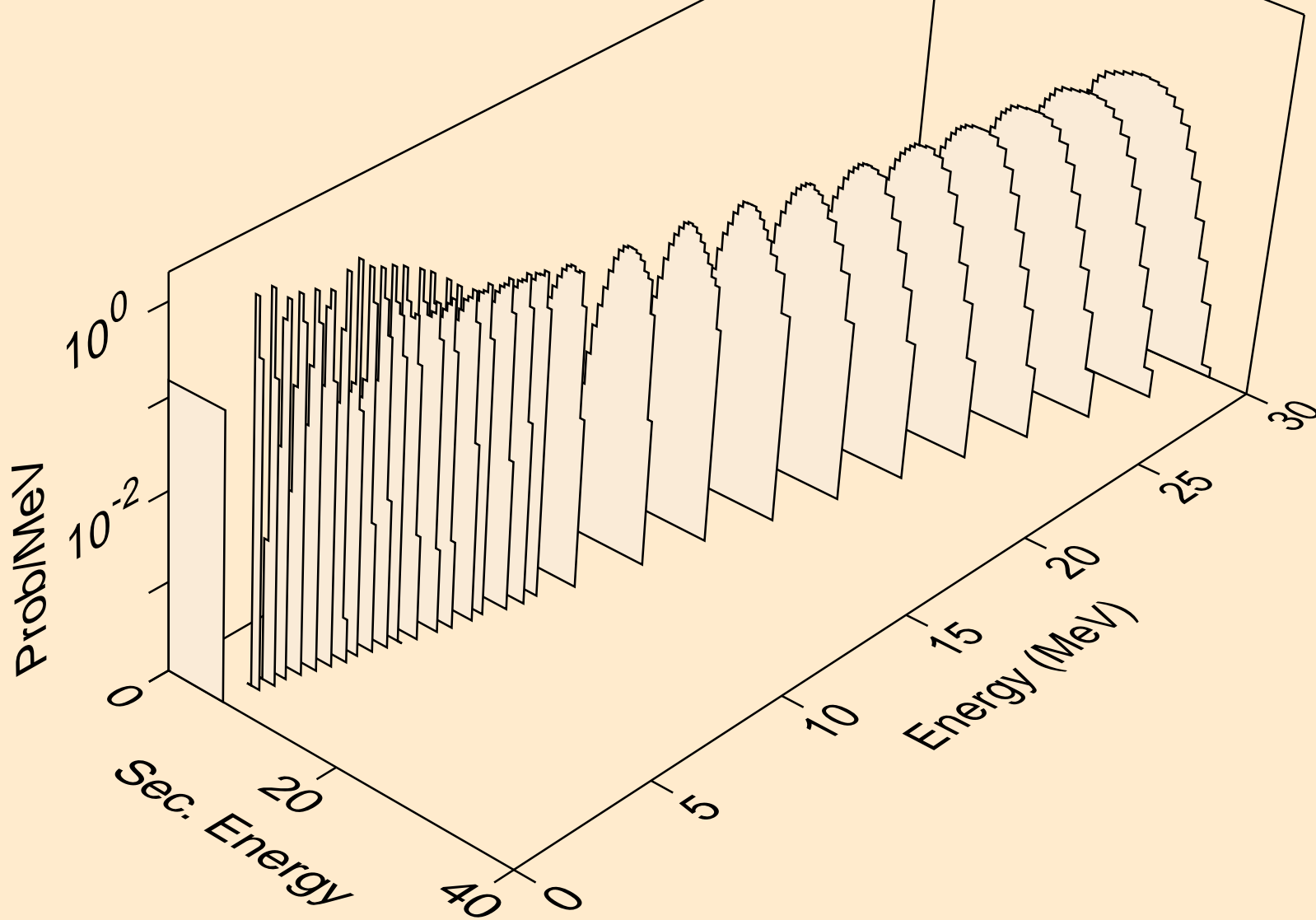

PO201M NEUTRON ACER TENDL-2019 LIBRARY; T=293.16K  
alphas from (n,2n)a

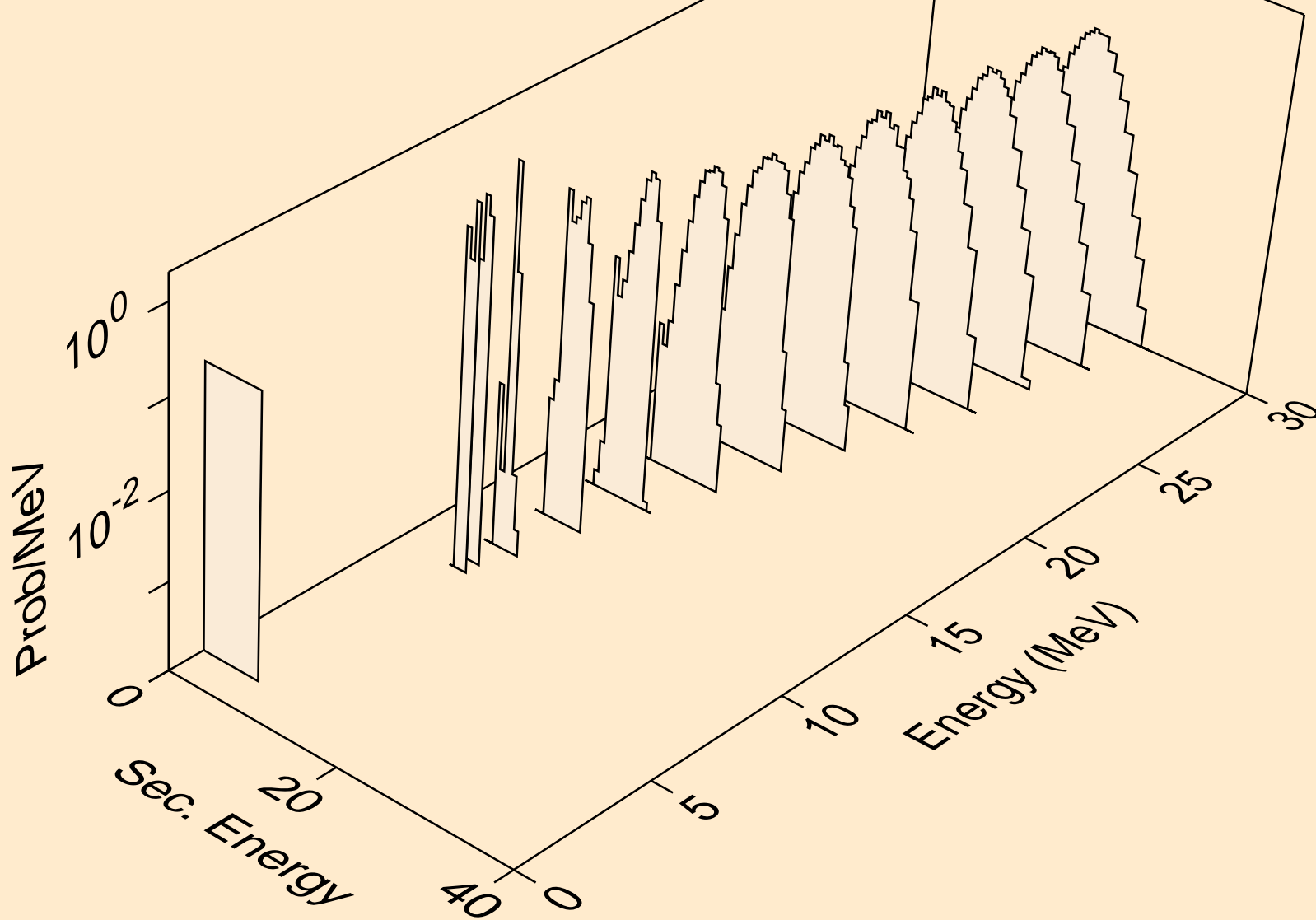

PO201M NEUTRON ACER TENDL-2019 LIBRARY; T=293.16K  
alphas from (n,3n)a

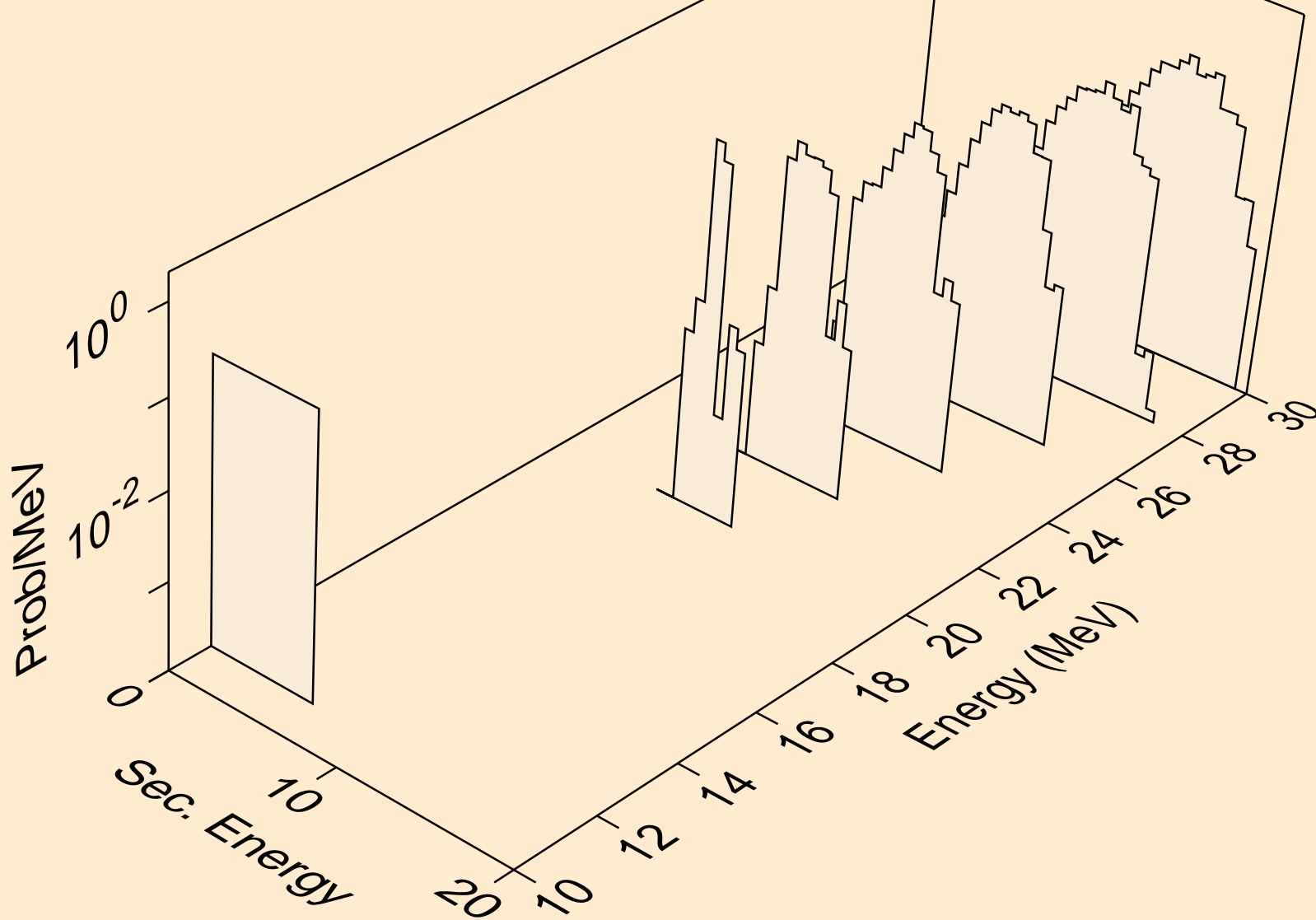



PO201M NEUTRON ACER TENDL-2019 LIBRARY; T=293.16K  
alphas from (n,n\*)2a

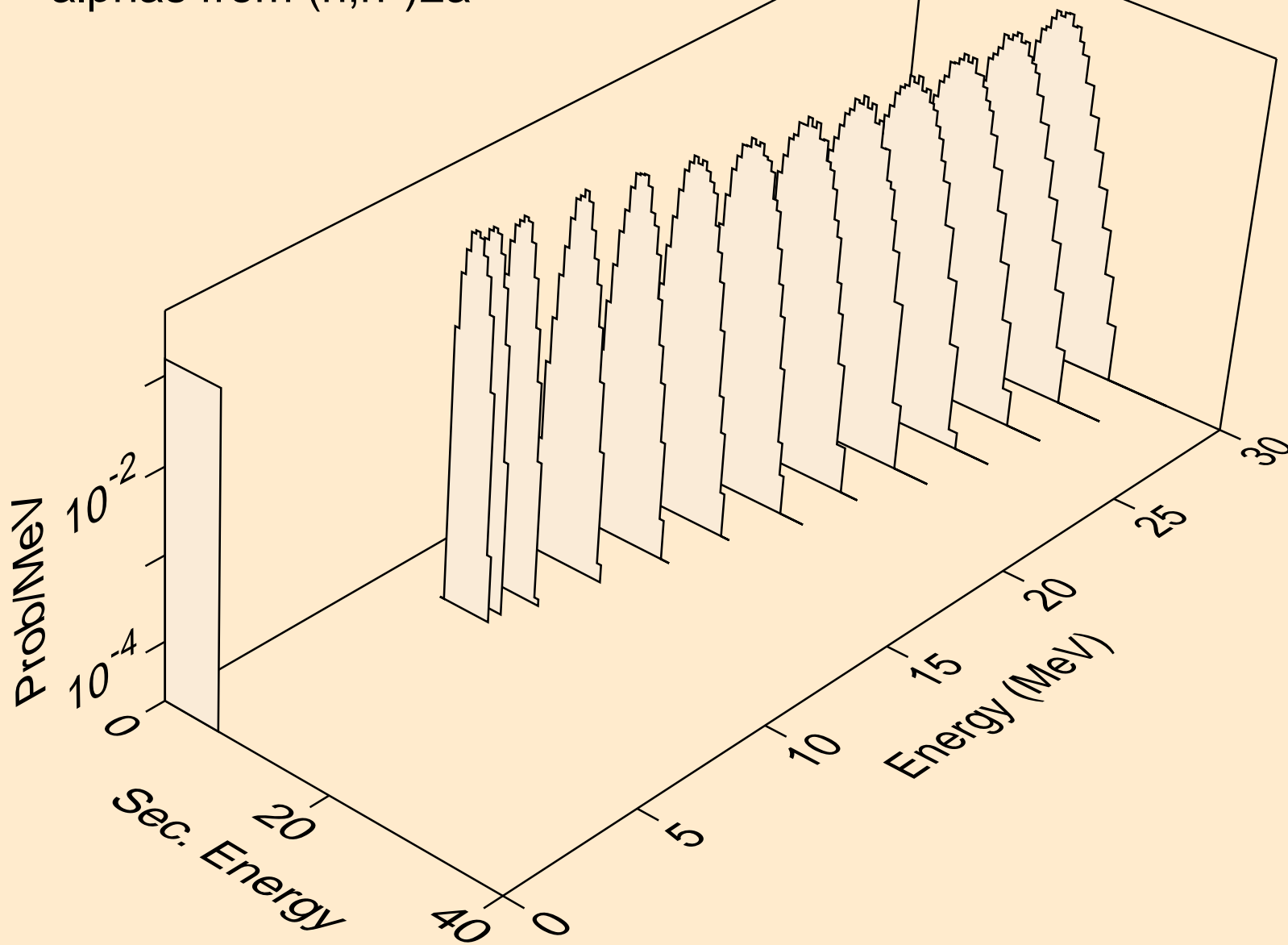

PO201M NEUTRON ACER TENDL-2019 LIBRARY; T=293.16K  
alphas from (n,npa)

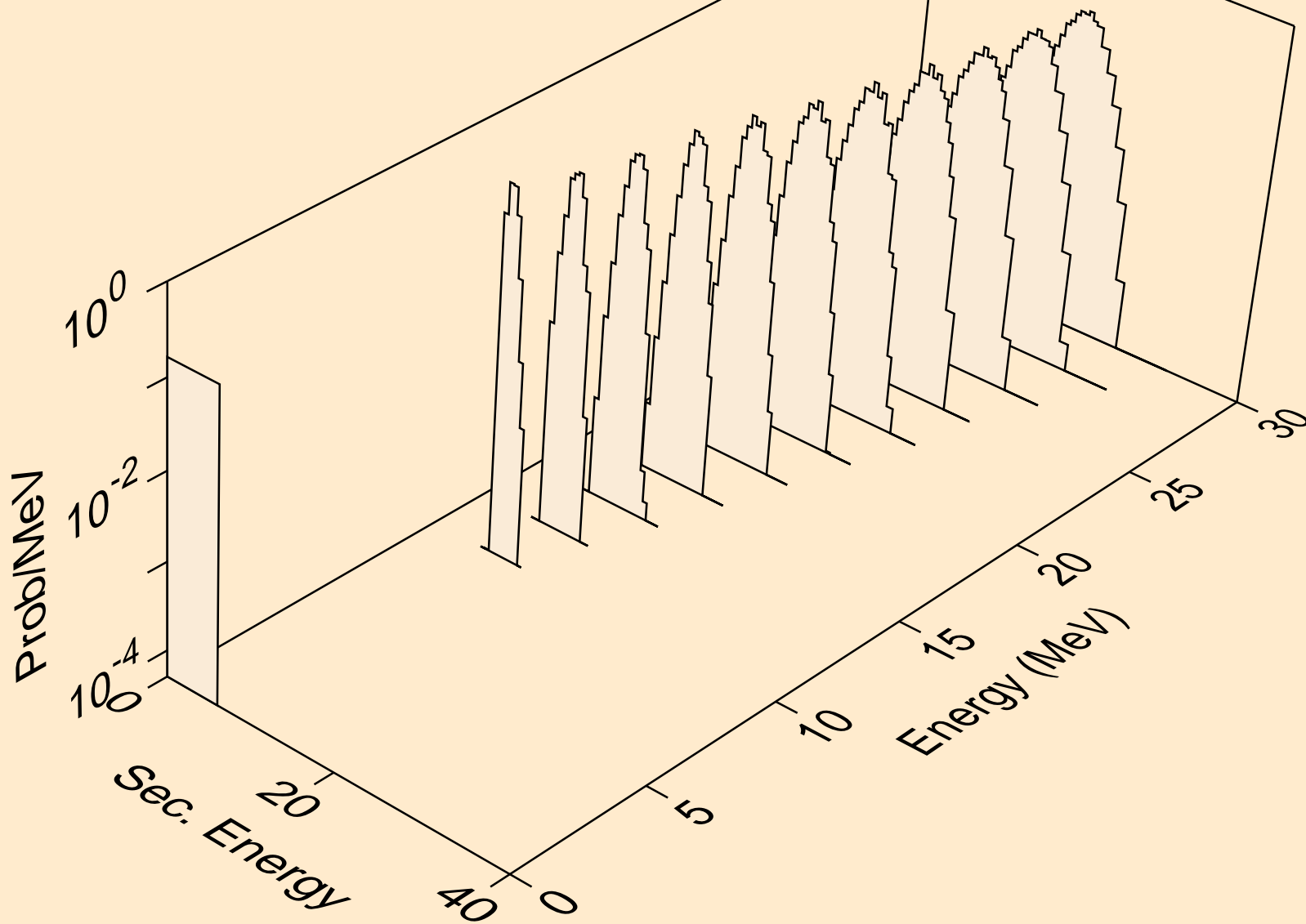

PO201M NEUTRON ACER TENDL-2019 LIBRARY; T=293.16K  
alphas from (n,a)

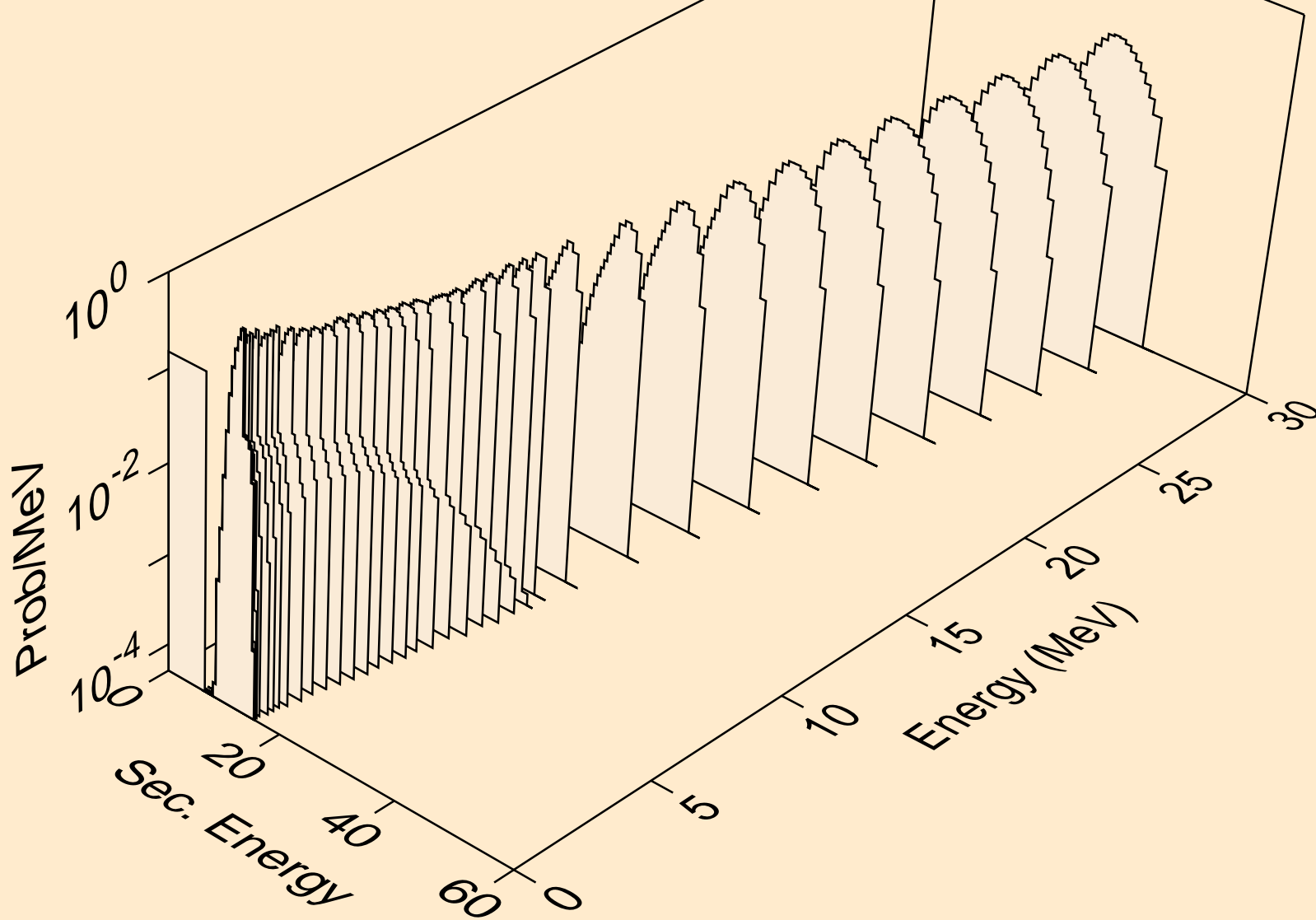

PO201M NEUTRON ACER TENDL-2019 LIBRARY; T=293.16K  
alphas from (n,2a)

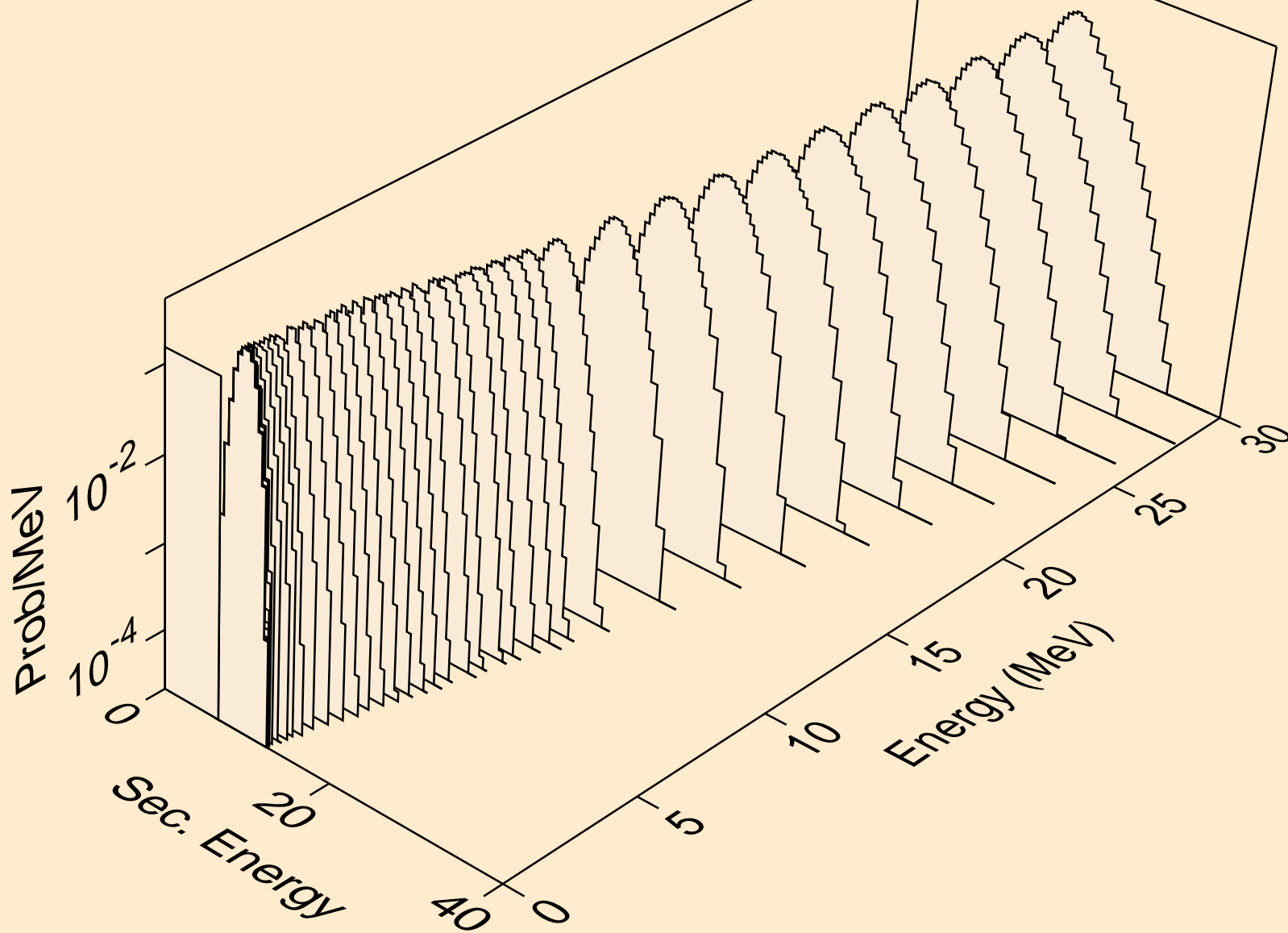

PO201M NEUTRON ACER TENDL-2019 LIBRARY; T=293.16K  
alphas from (n,pa)

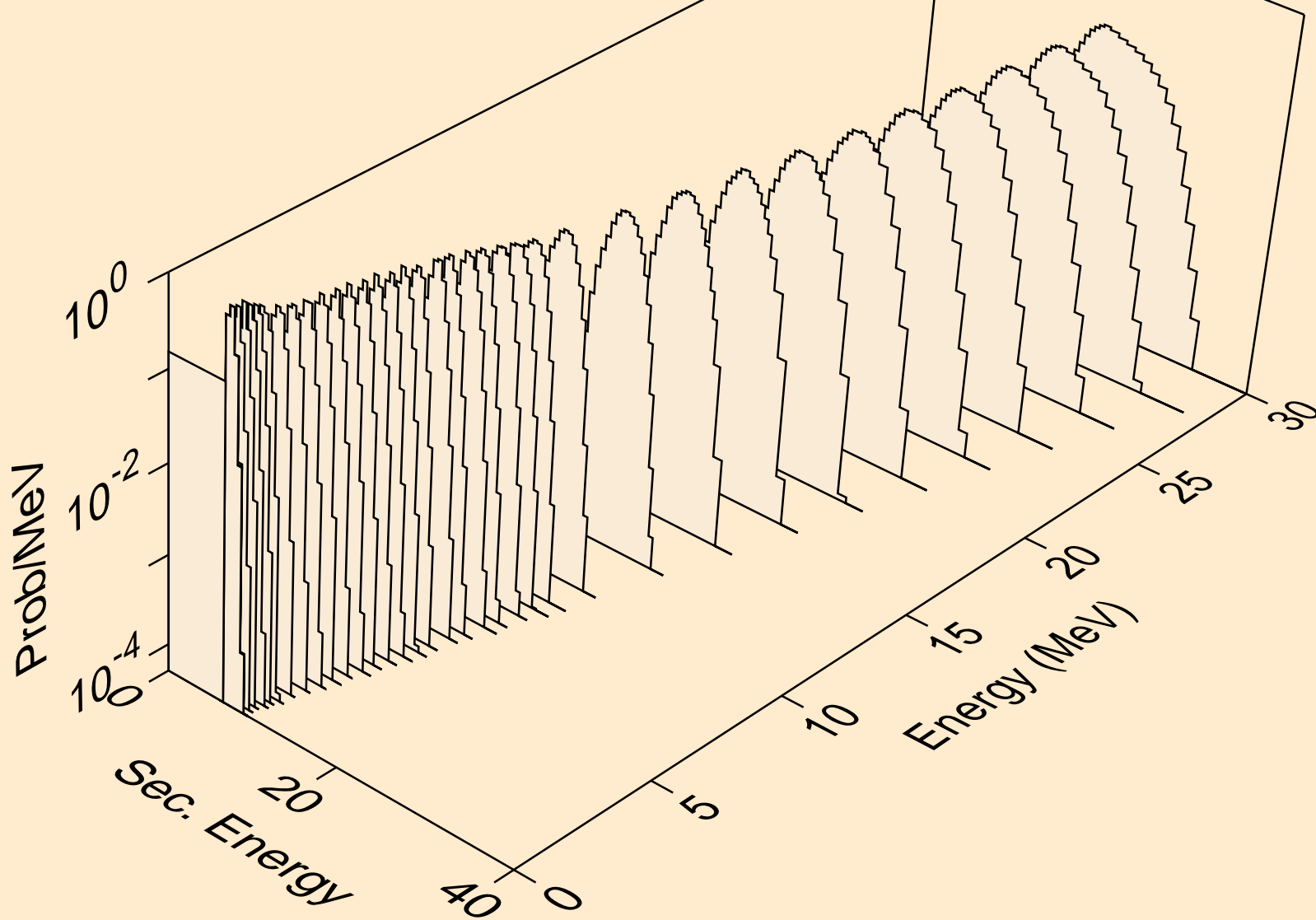

PO201M NEUTRON ACER TENDL-2019 LIBRARY; T=293.16K  
alphas from (n,da)

