

PO211M NEUTRON ACER TENDL-2019 LIBRARY; T=293.16K
Principal cross sections

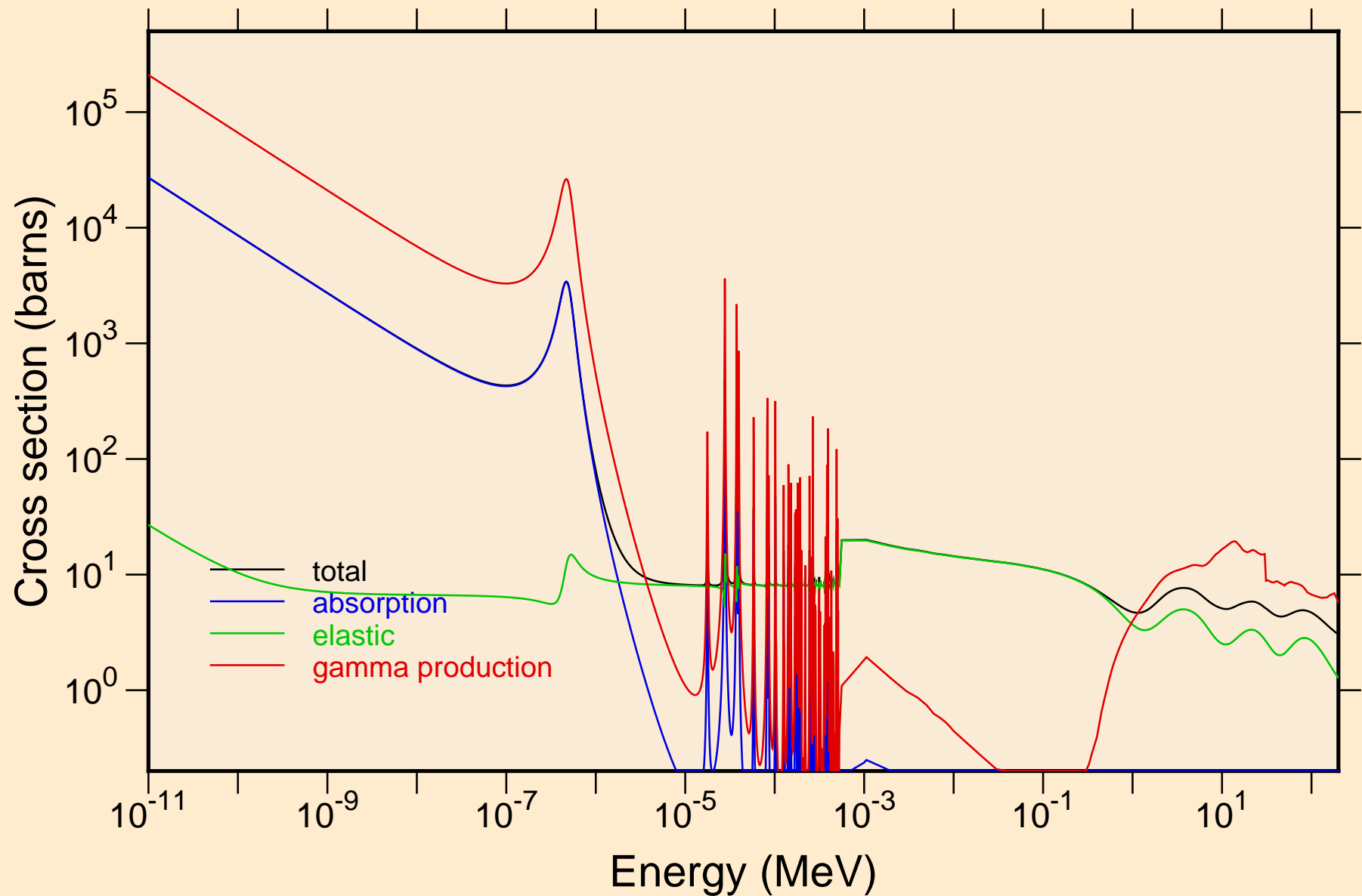

PO211M NEUTRON ACER TENDL-2019 LIBRARY; T=293.16K
resonance total cross section

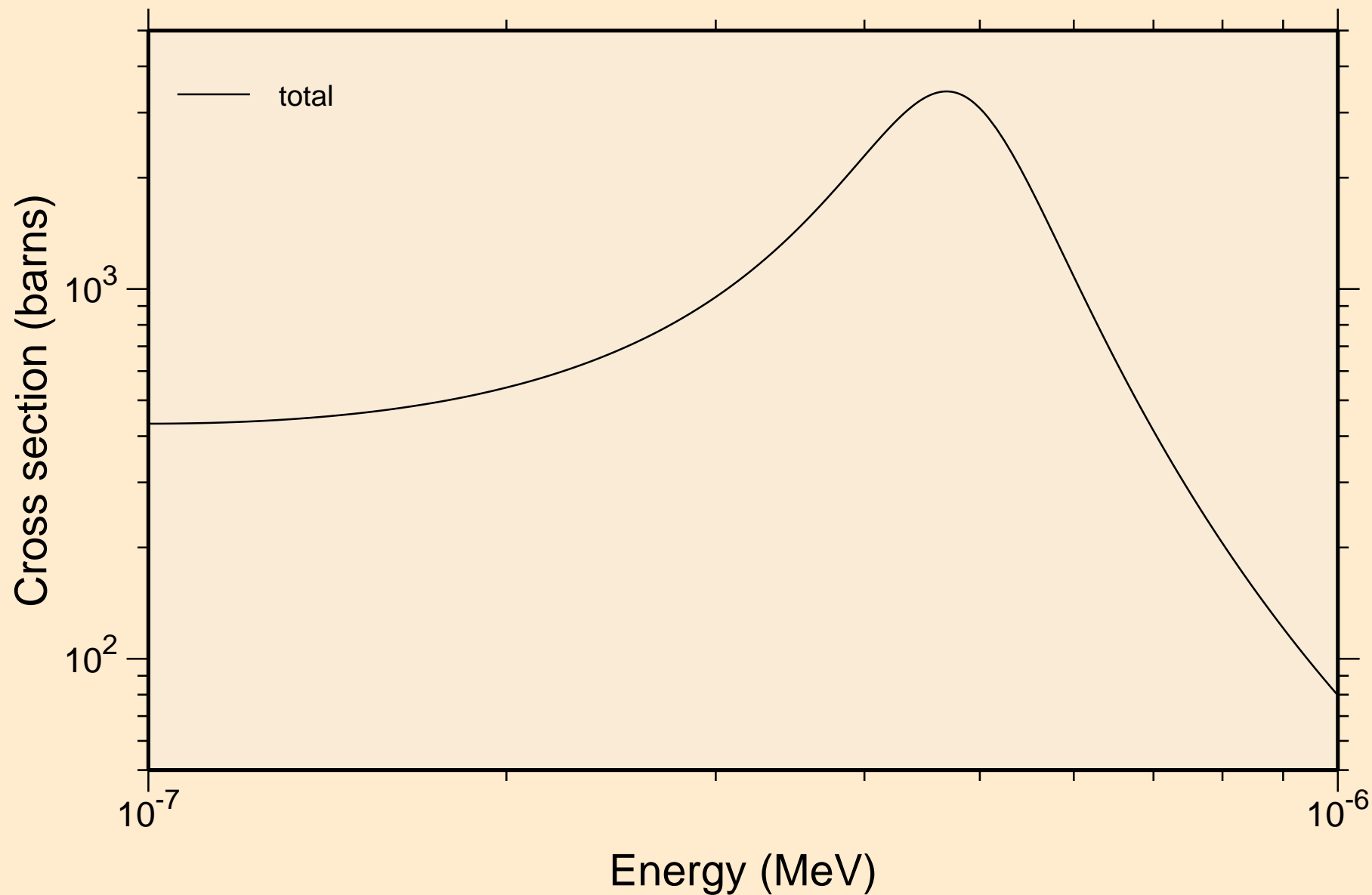

PO211M NEUTRON ACER TENDL-2019 LIBRARY; T=293.16K
resonance total cross section

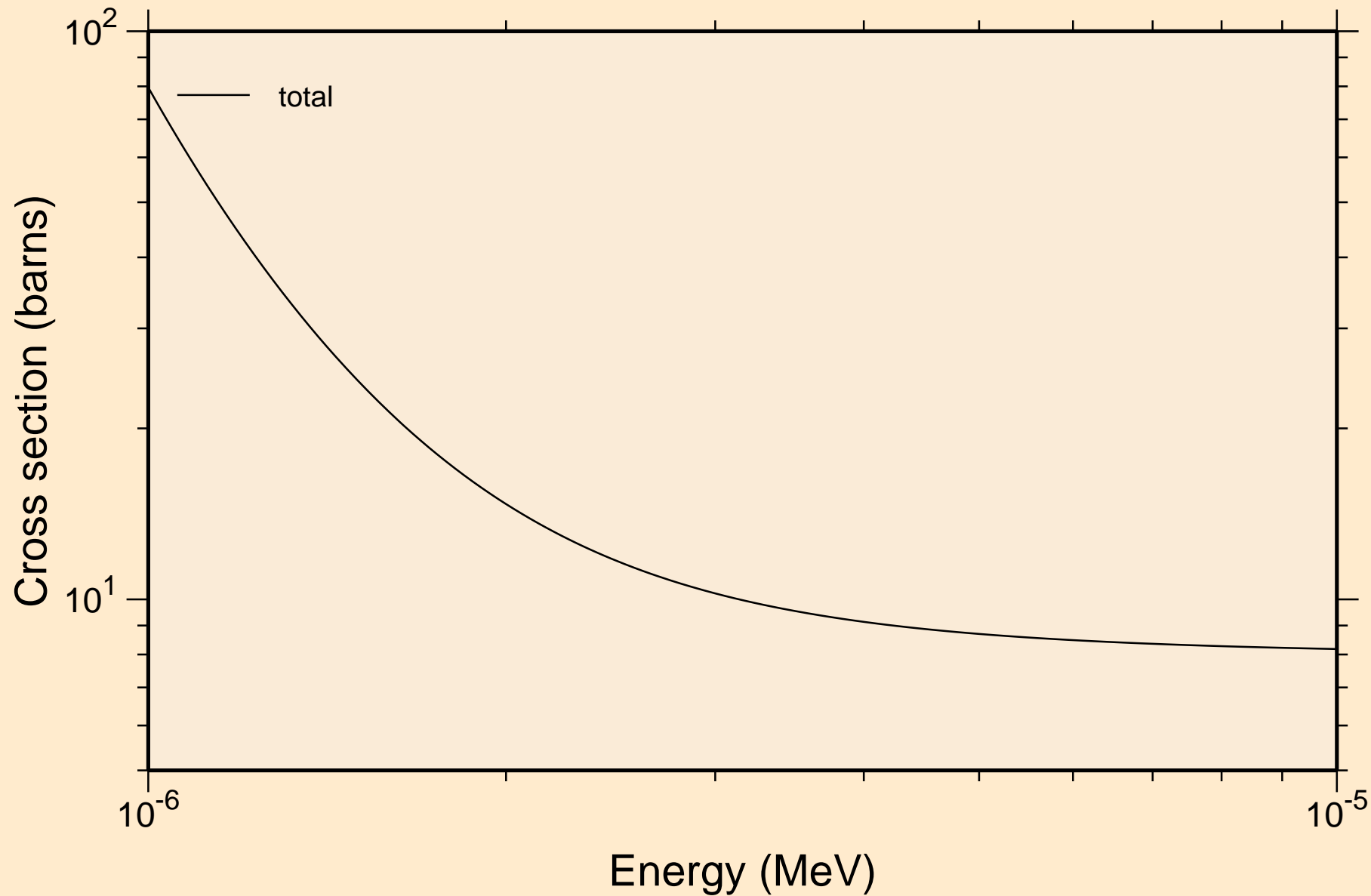

PO211M NEUTRON ACER TENDL-2019 LIBRARY; T=293.16K
resonance total cross section

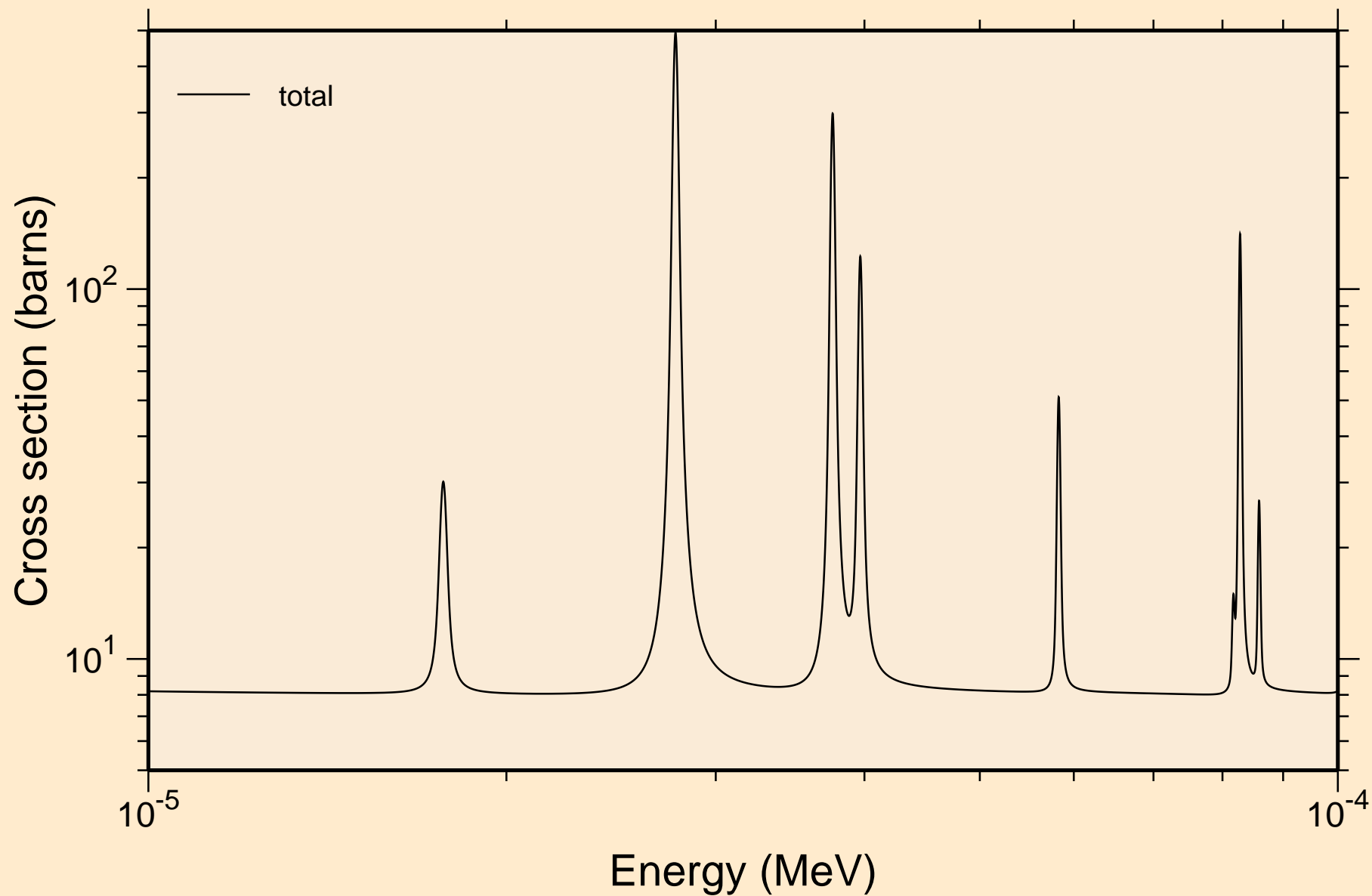

PO211M NEUTRON ACER TENDL-2019 LIBRARY; T=293.16K
resonance total cross section

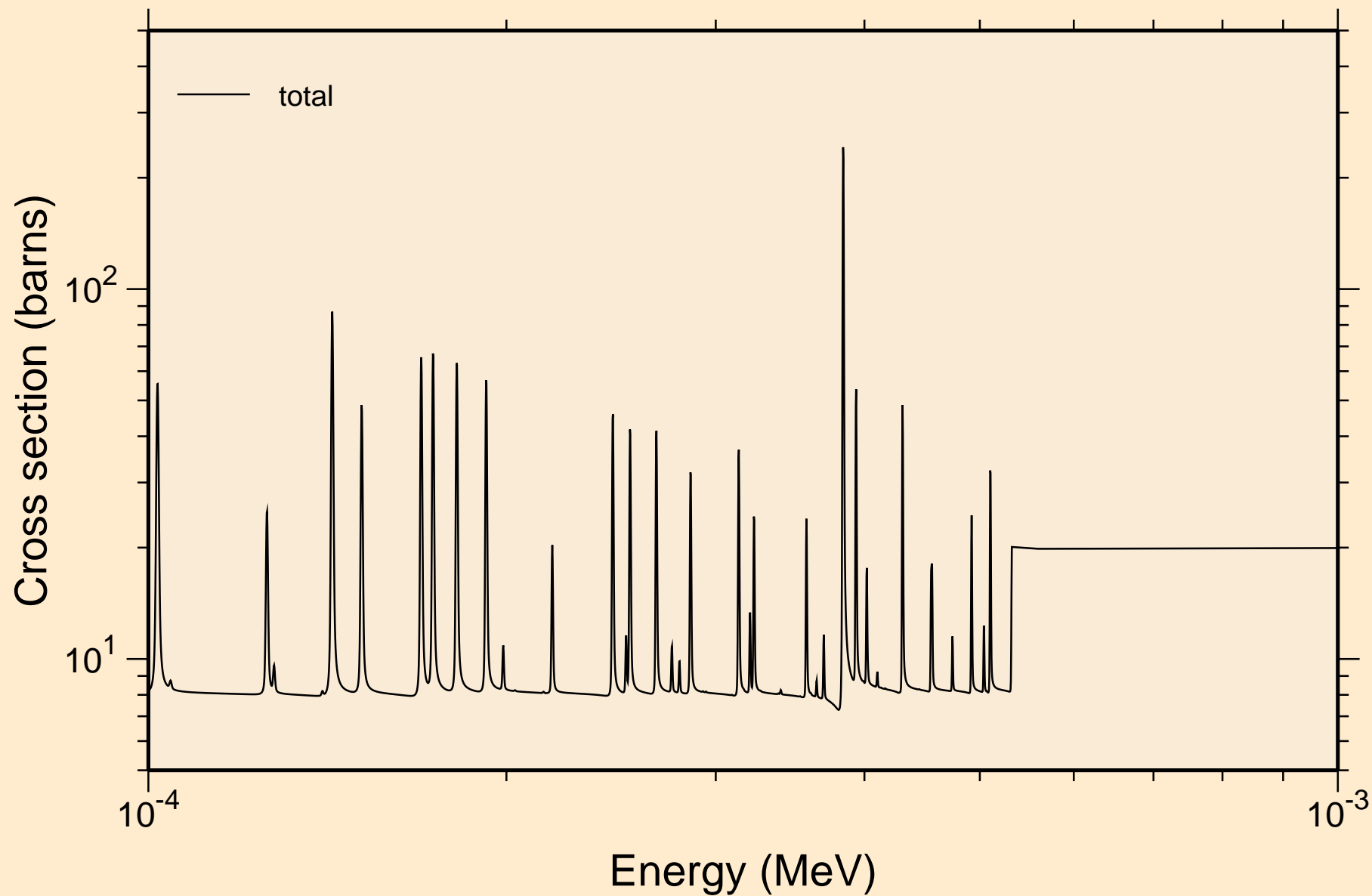

PO211M NEUTRON ACER TENDL-2019 LIBRARY; T=293.16K
resonance total cross section

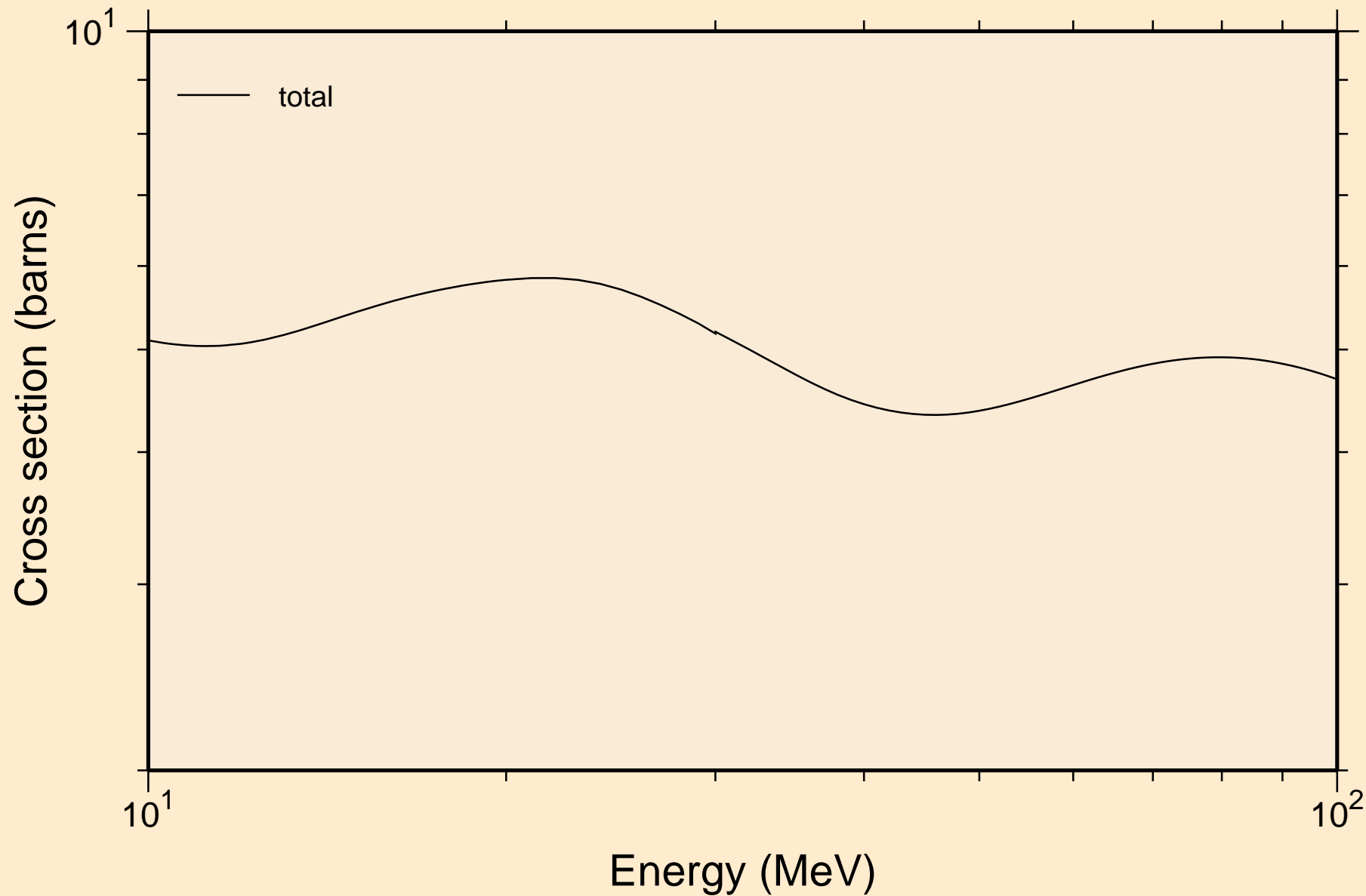

PO211M NEUTRON ACER TENDL-2019 LIBRARY; T=293.16K
resonance absorption cross sections

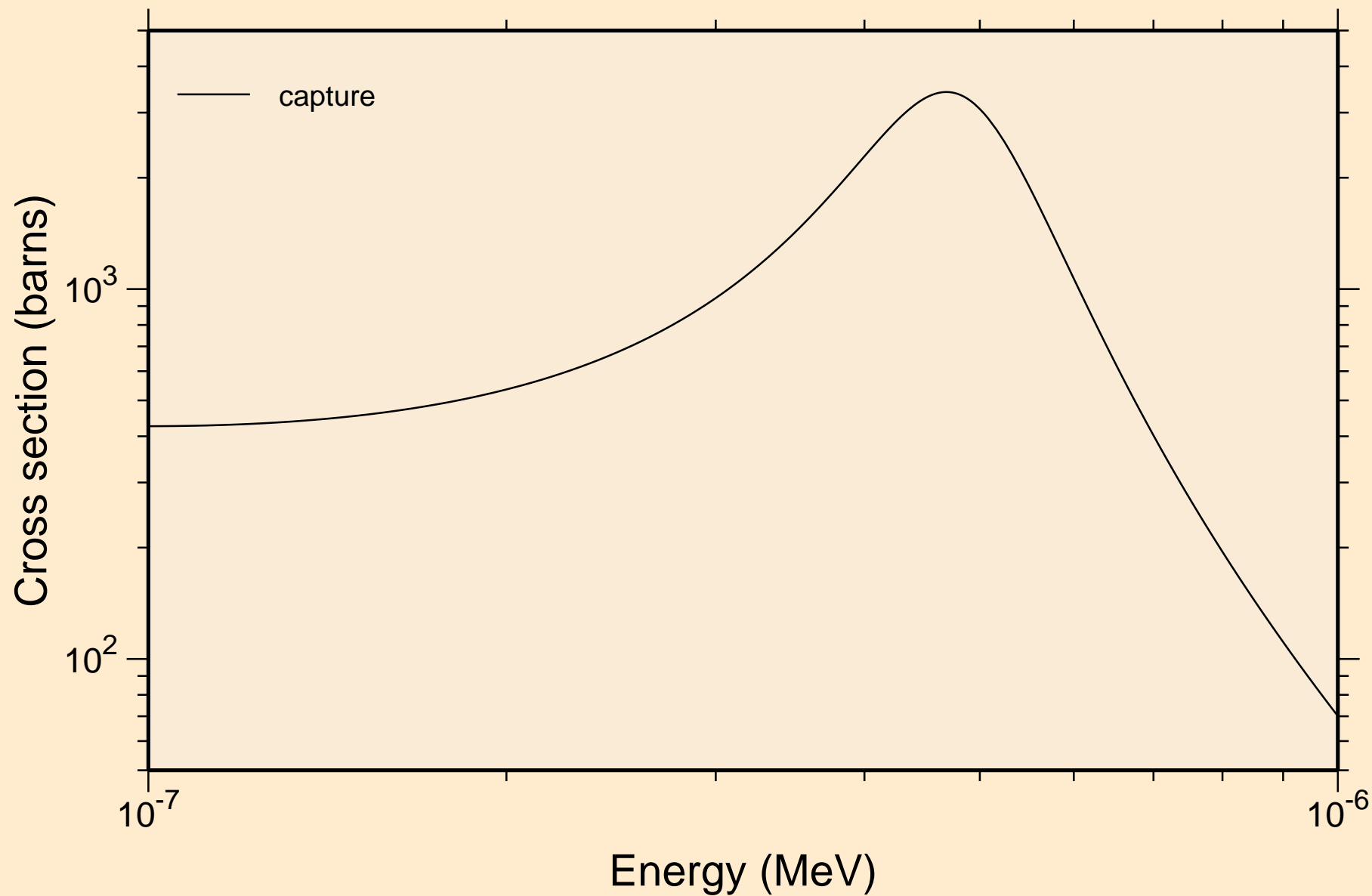

PO211M NEUTRON ACER TENDL-2019 LIBRARY; T=293.16K
resonance absorption cross sections

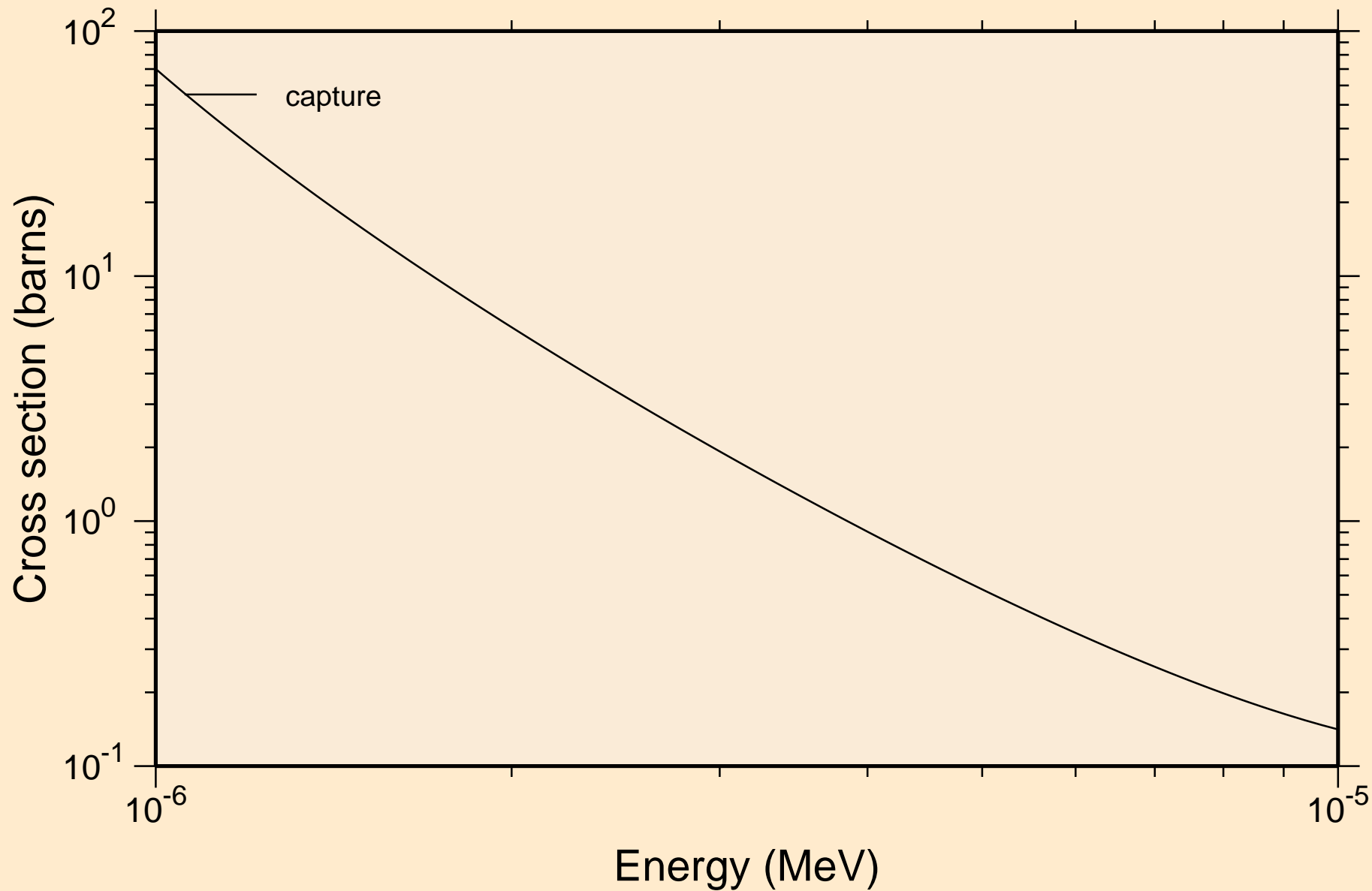

PO211M NEUTRON ACER TENDL-2019 LIBRARY; T=293.16K
resonance absorption cross sections

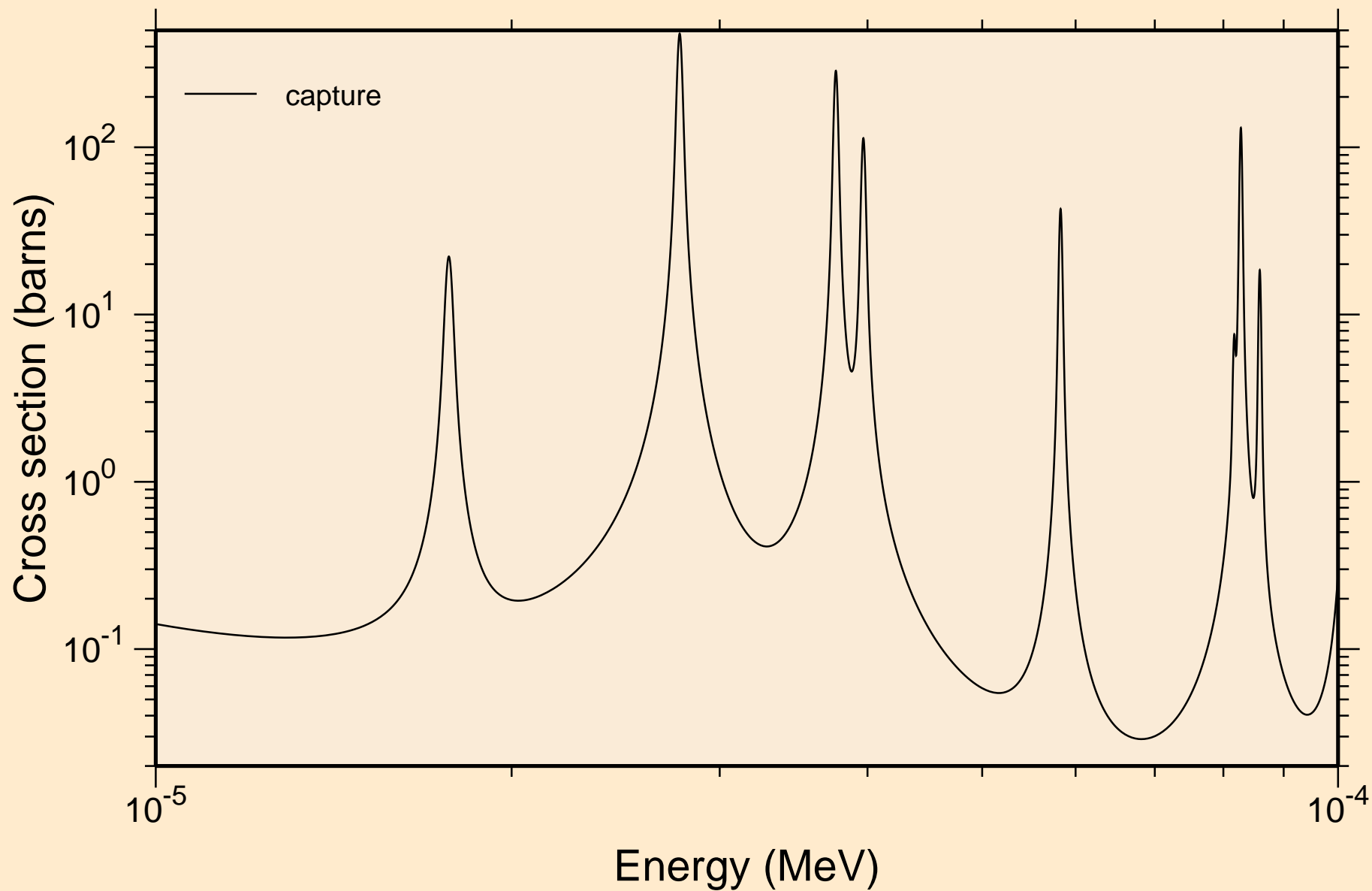

PO211M NEUTRON ACER TENDL-2019 LIBRARY; T=293.16K
resonance absorption cross sections

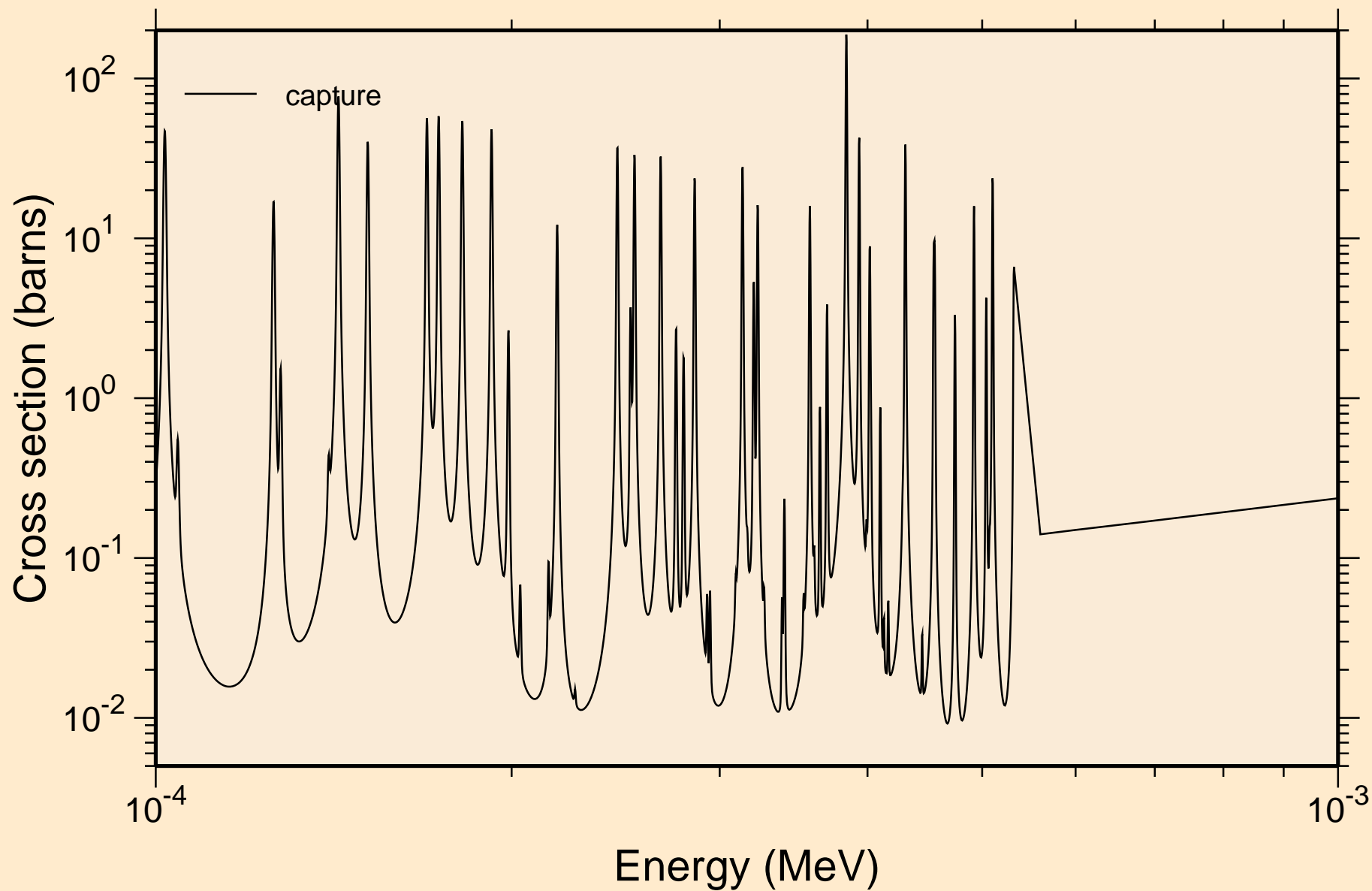

PO211M NEUTRON ACER TENDL-2019 LIBRARY; T=293.16K
resonance absorption cross sections

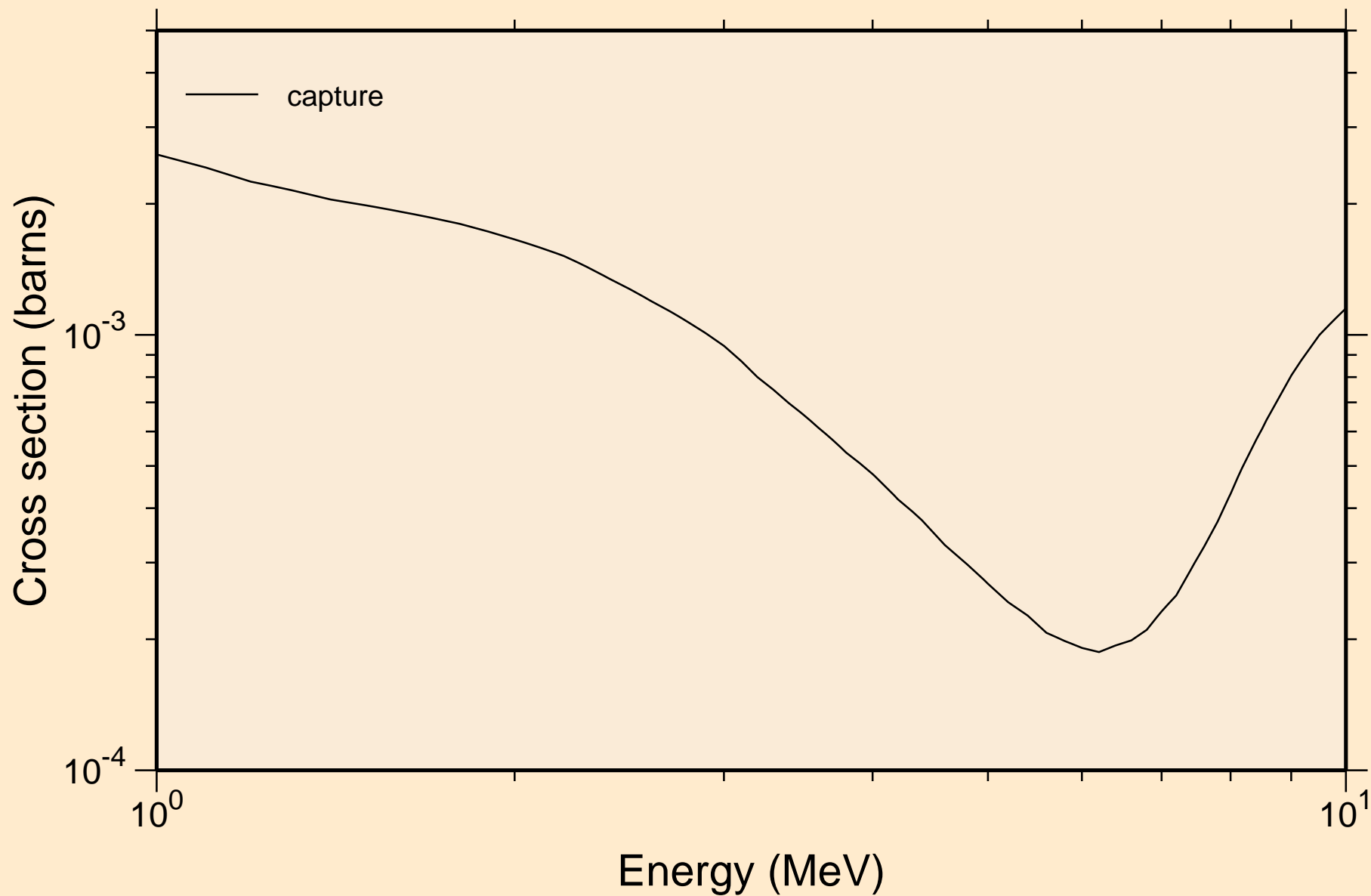

PO211M NEUTRON ACER TENDL-2019 LIBRARY; T=293.16K
Heating

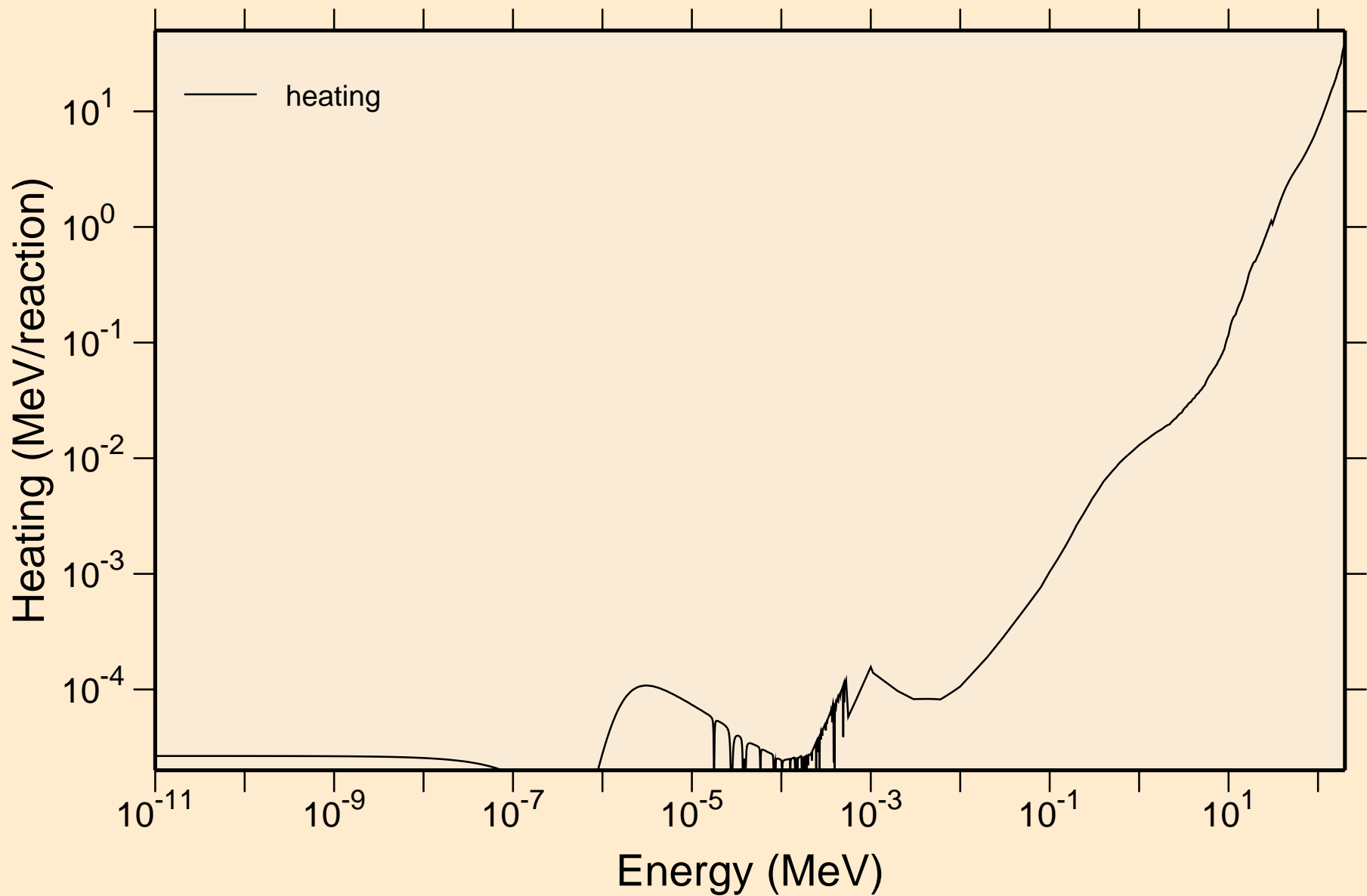

PO211M NEUTRON ACER TENDL-2019 LIBRARY; T=293.16K
Damage

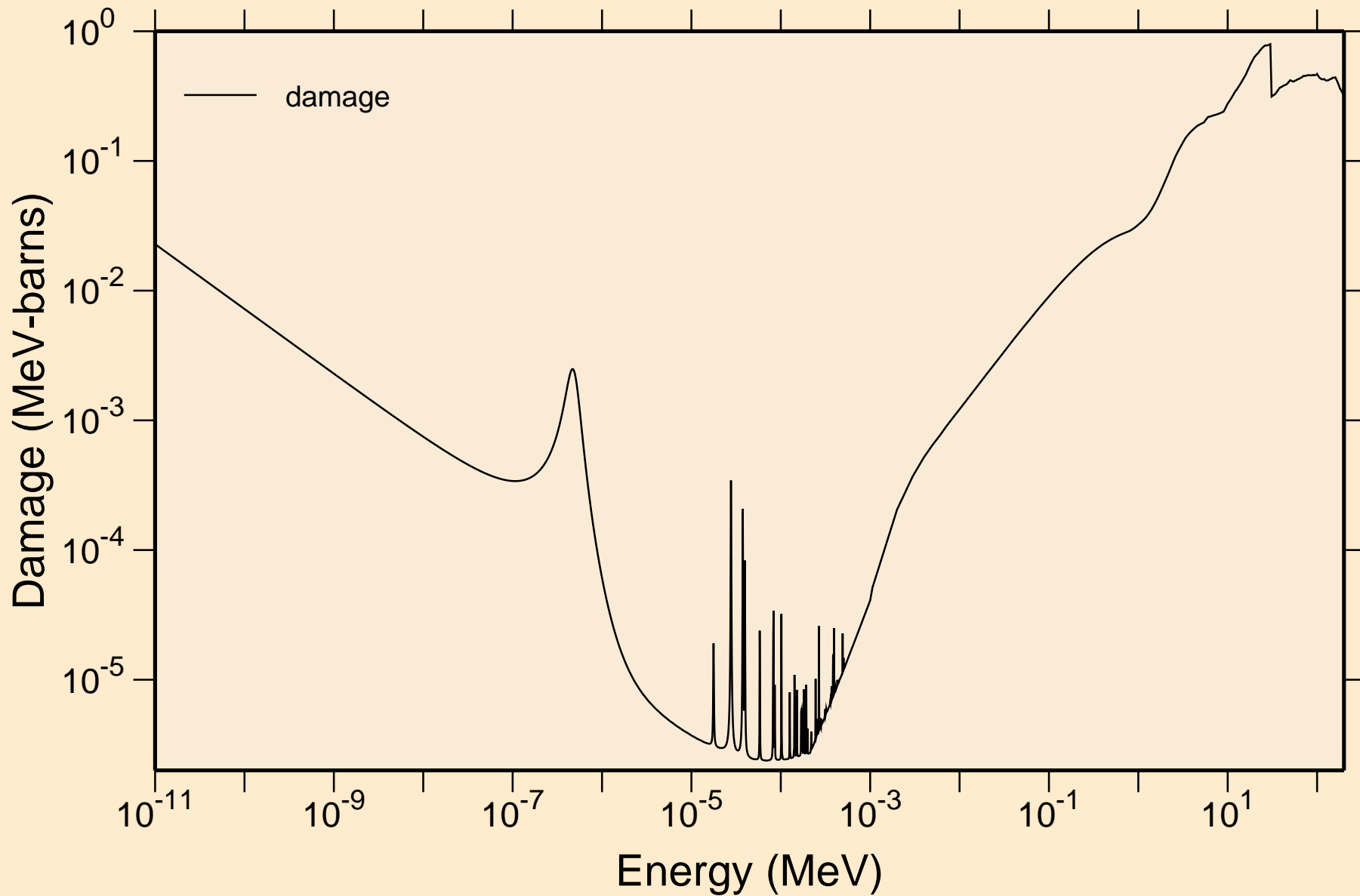

PO211M NEUTRON ACER TENDL-2019 LIBRARY; T=293.16K
Non-threshold reactions

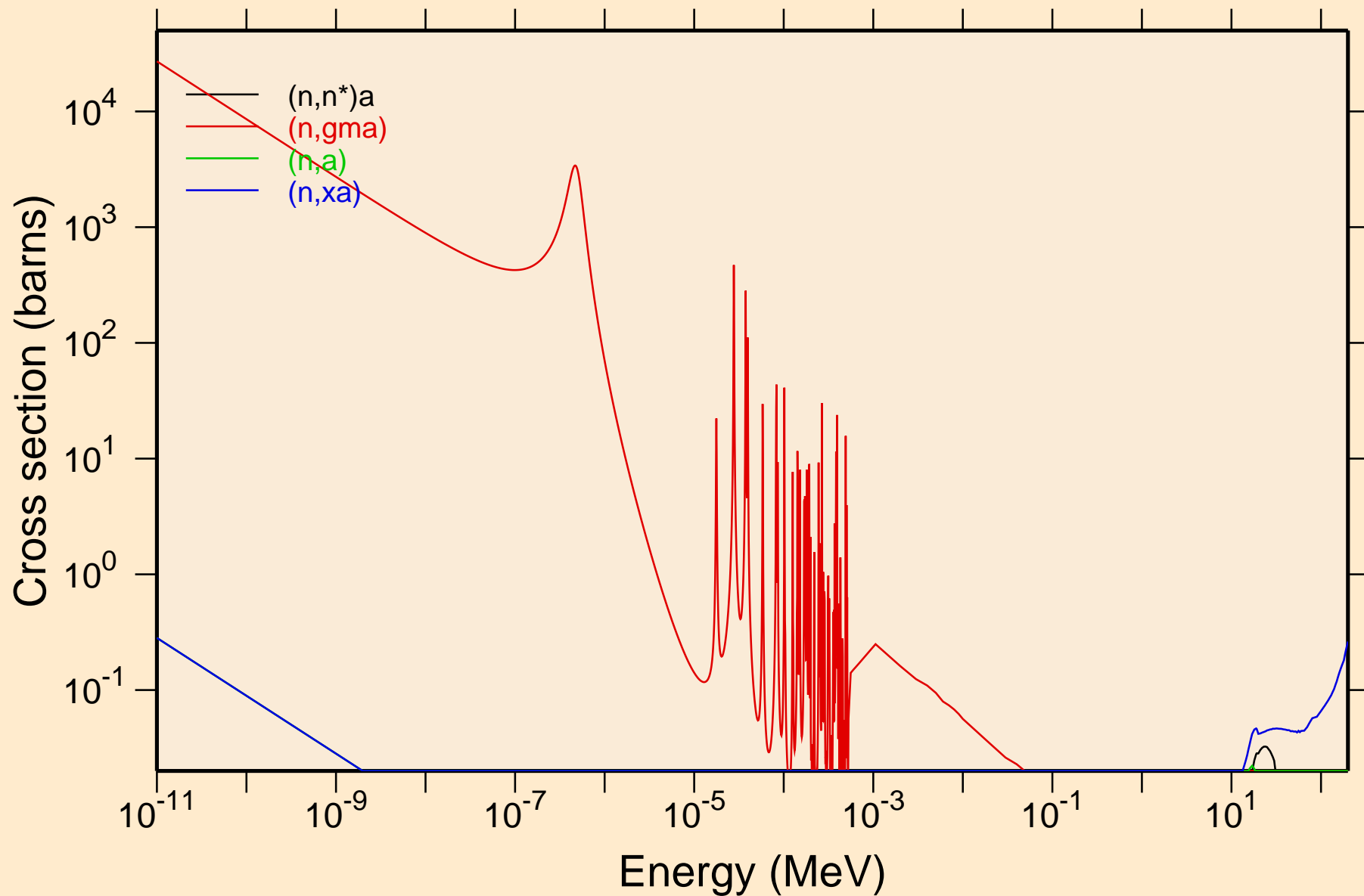

PO211M NEUTRON ACER TENDL-2019 LIBRARY; T=293.16K
Principal cross sections

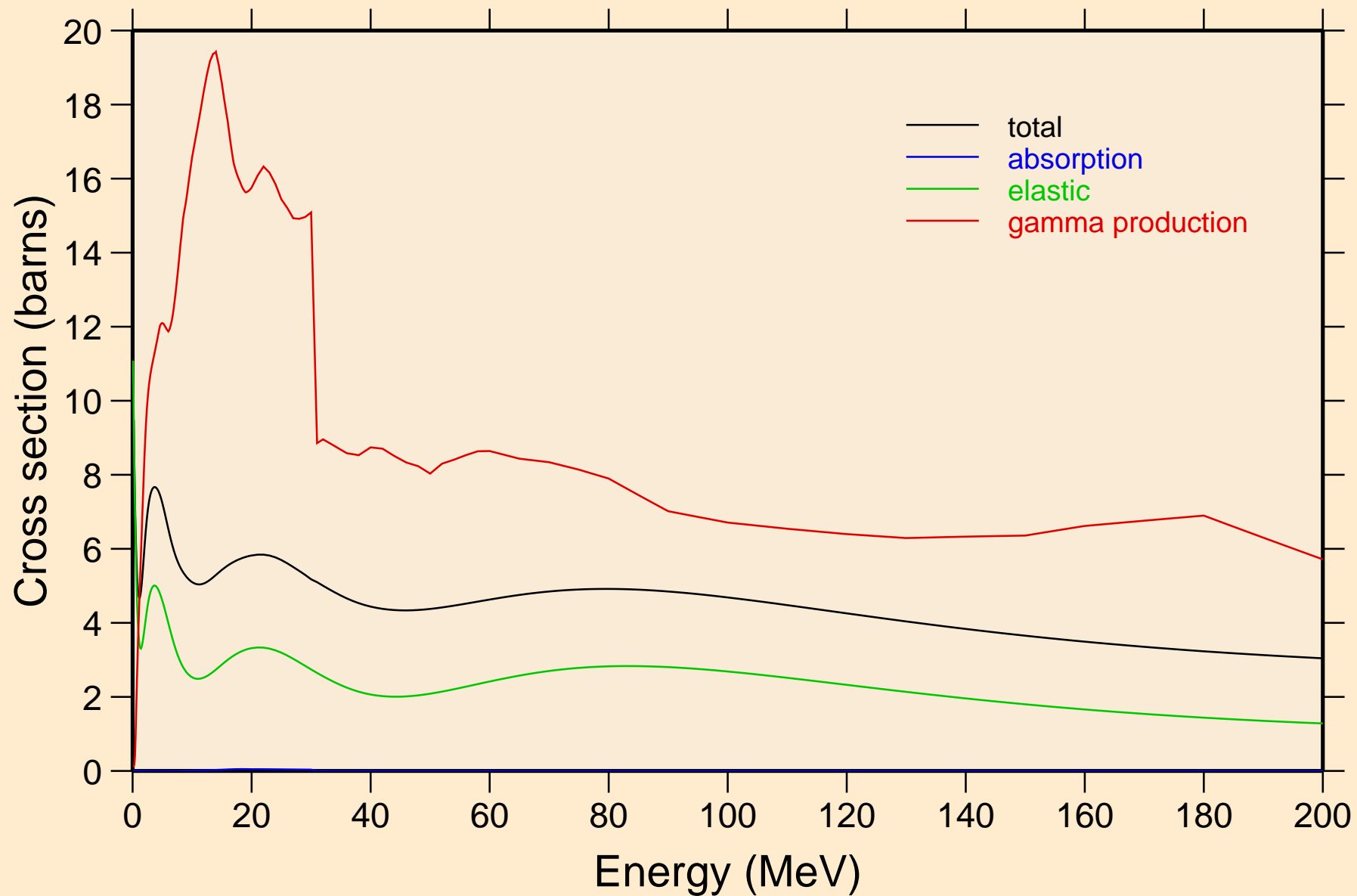

PO211M NEUTRON ACER TENDL-2019 LIBRARY; T=293.16K
Heating

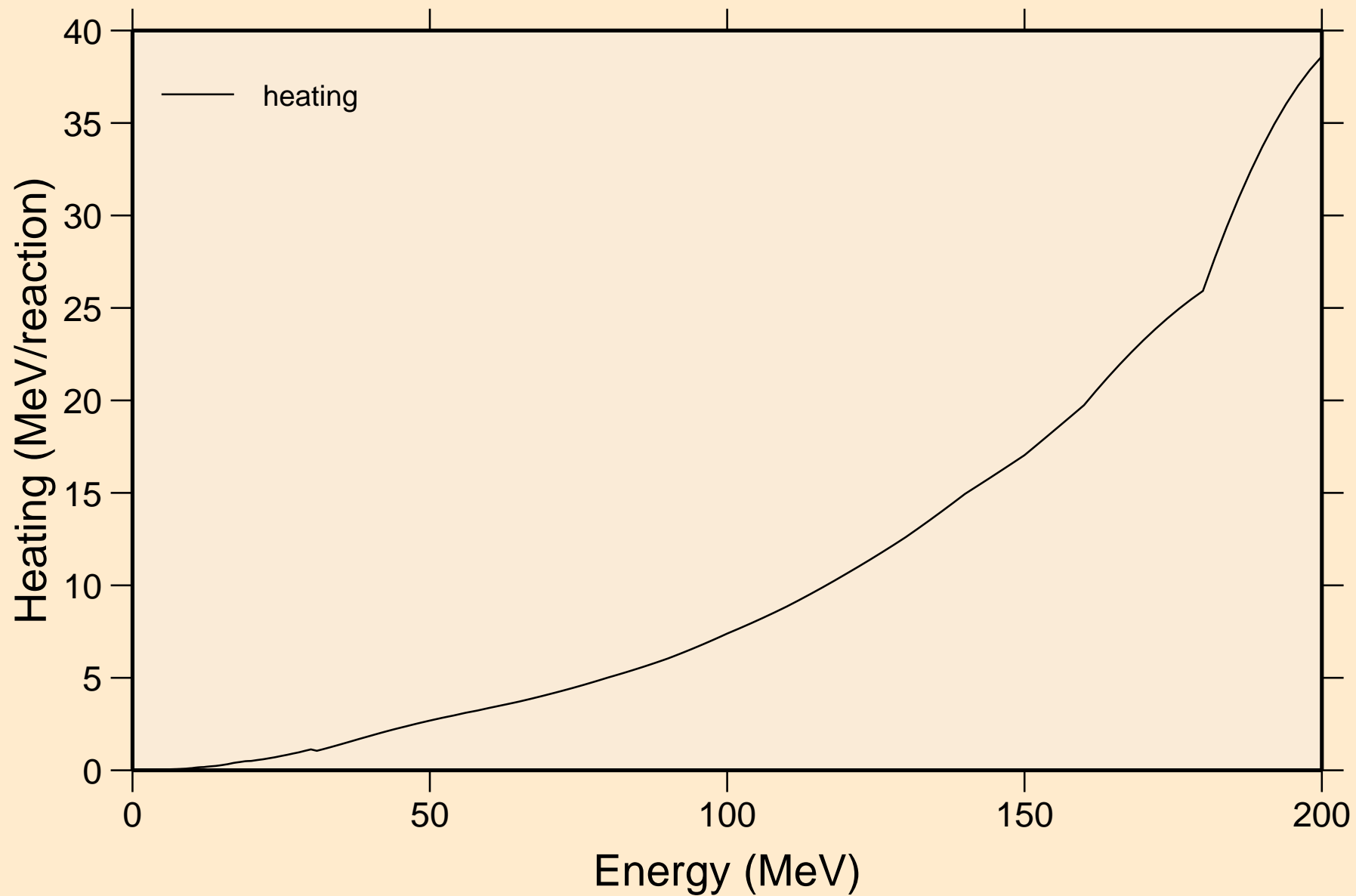

PO211M NEUTRON ACER TENDL-2019 LIBRARY; T=293.16K
Damage

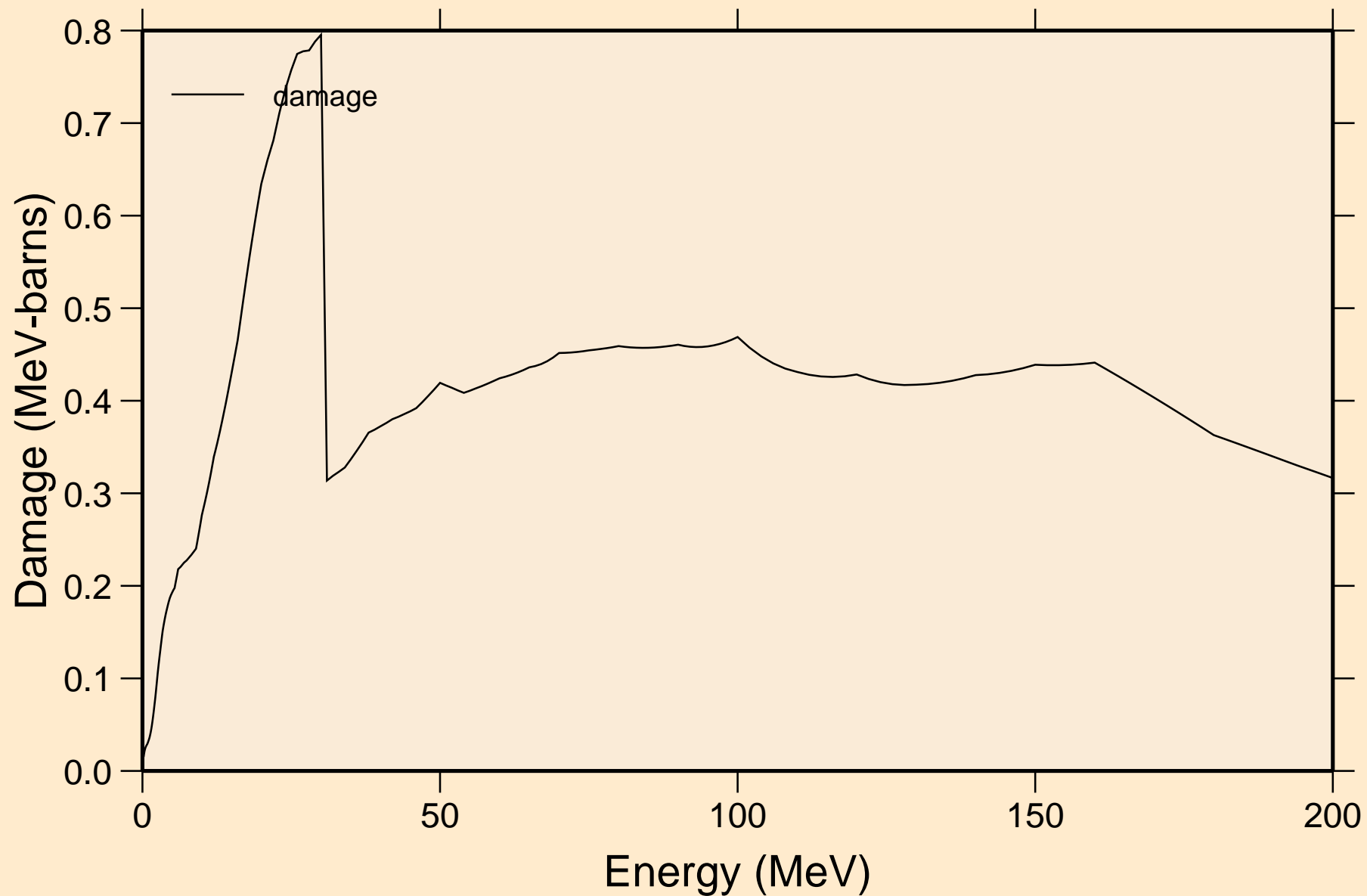

PO211M NEUTRON ACER TENDL-2019 LIBRARY; T=293.16K
Non-threshold reactions

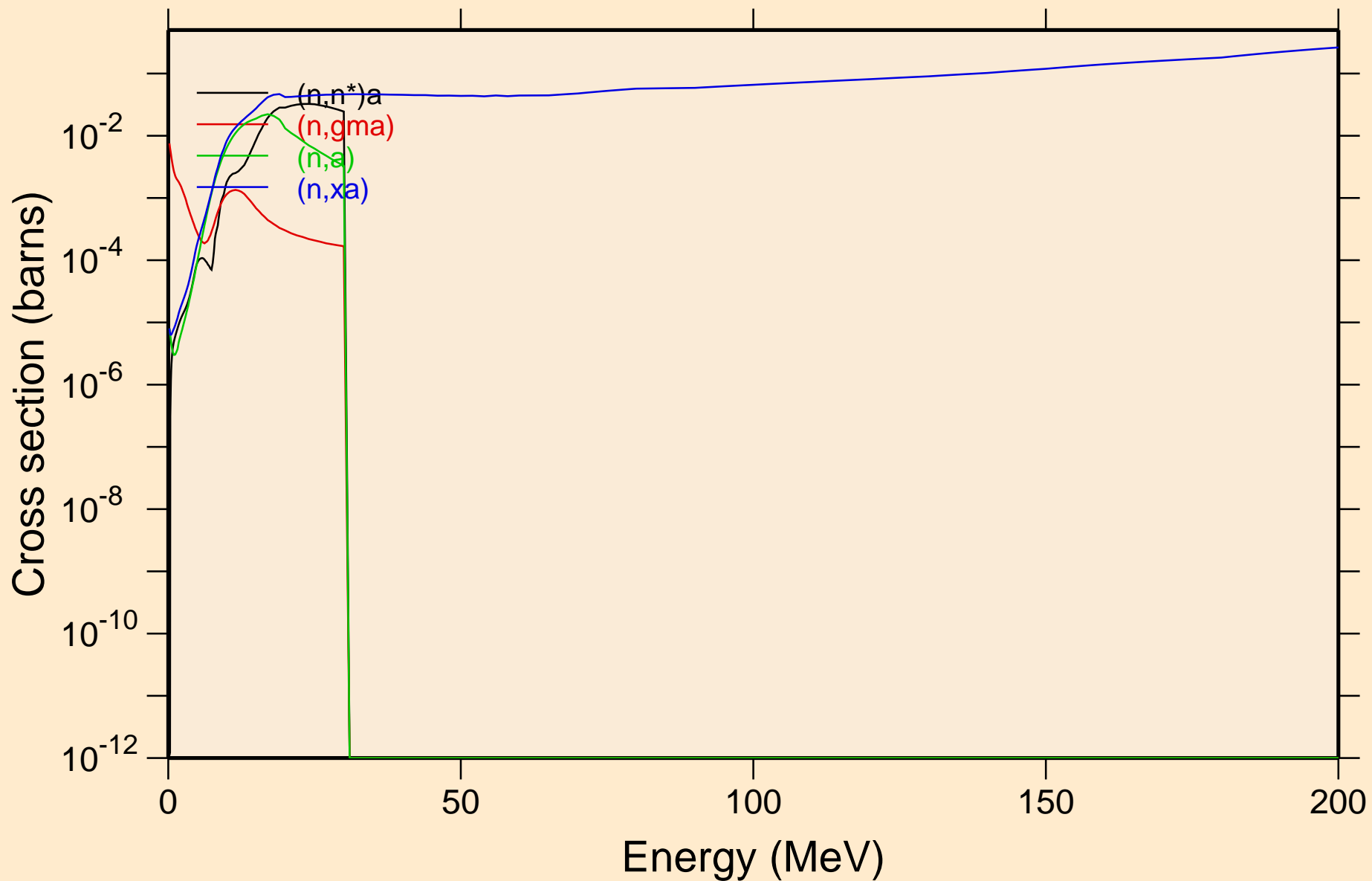

PO211M NEUTRON ACER TENDL-2019 LIBRARY; T=293.16K
Inelastic levels

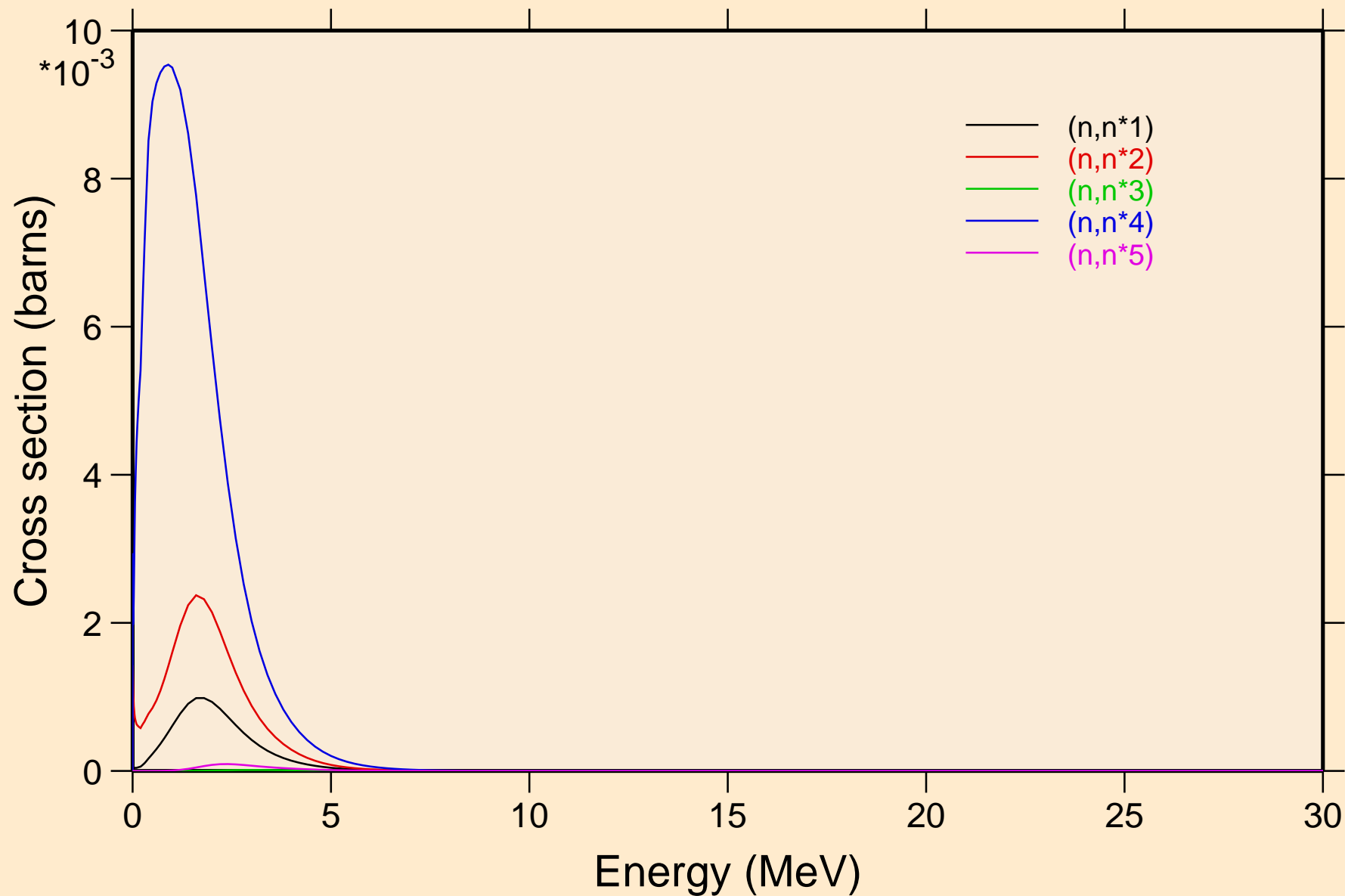

PO211M NEUTRON ACER TENDL-2019 LIBRARY; T=293.16K
Inelastic levels

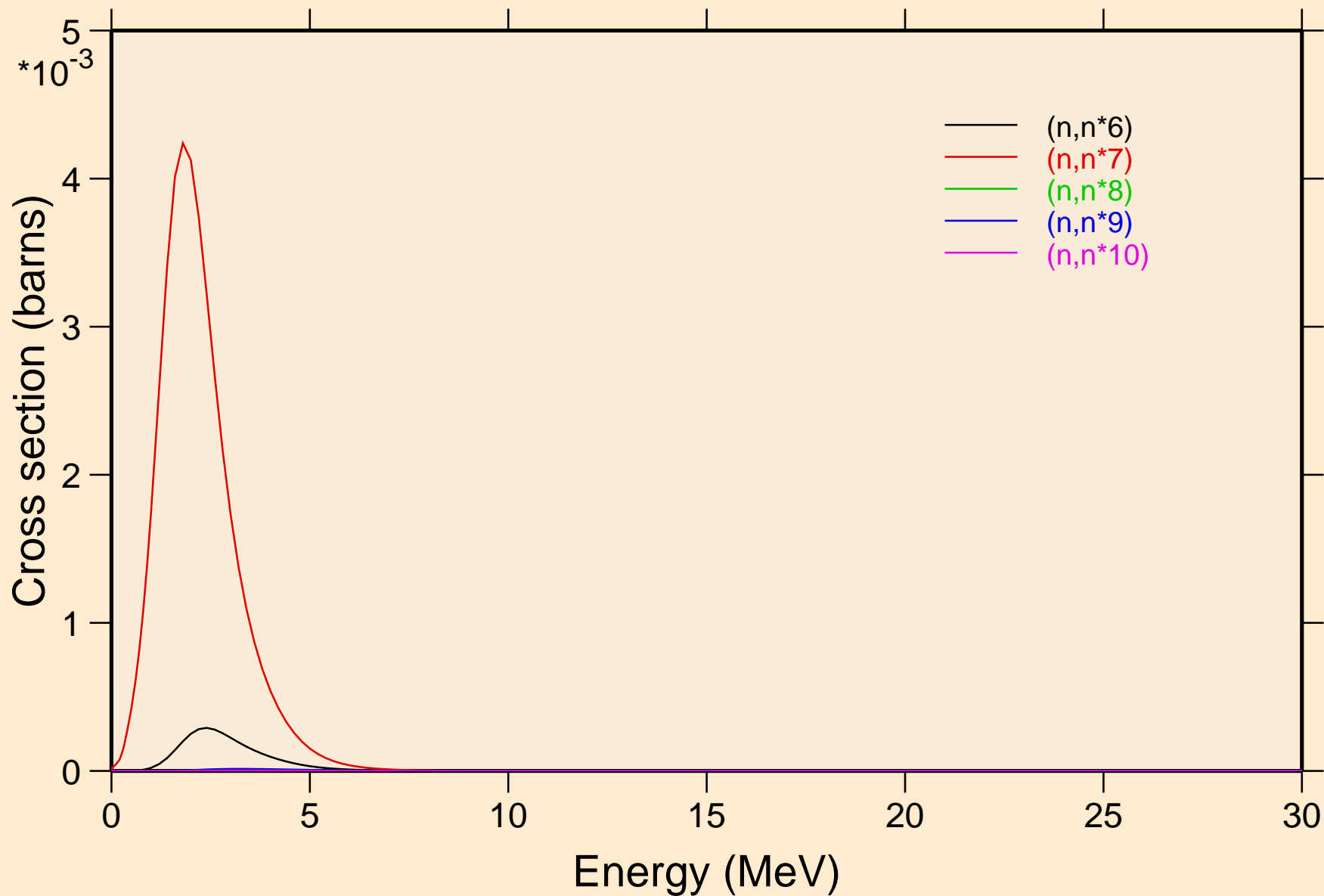

PO211M NEUTRON ACER TENDL-2019 LIBRARY; T=293.16K
Inelastic levels

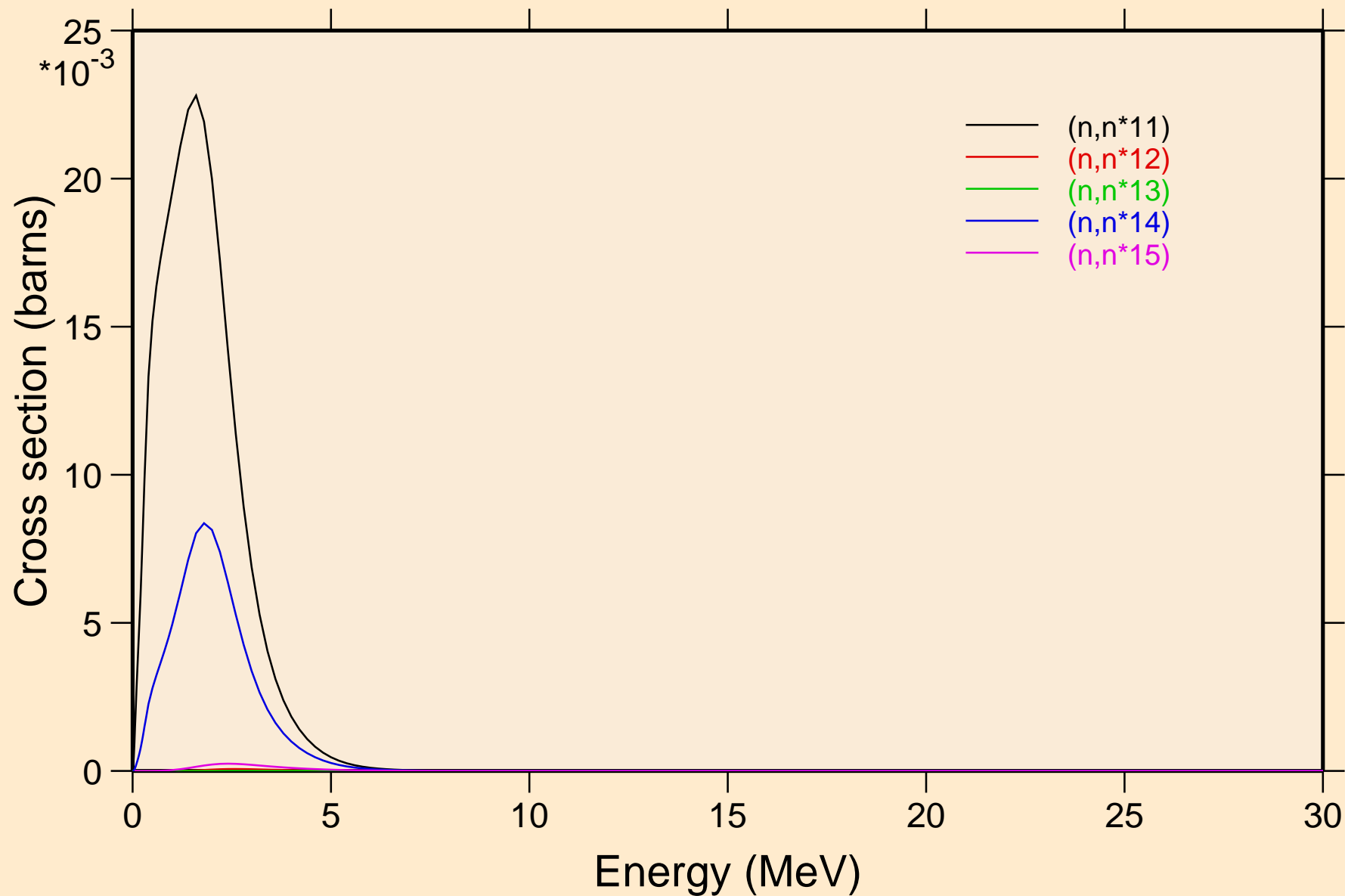

PO211M NEUTRON ACER TENDL-2019 LIBRARY; T=293.16K
Inelastic levels

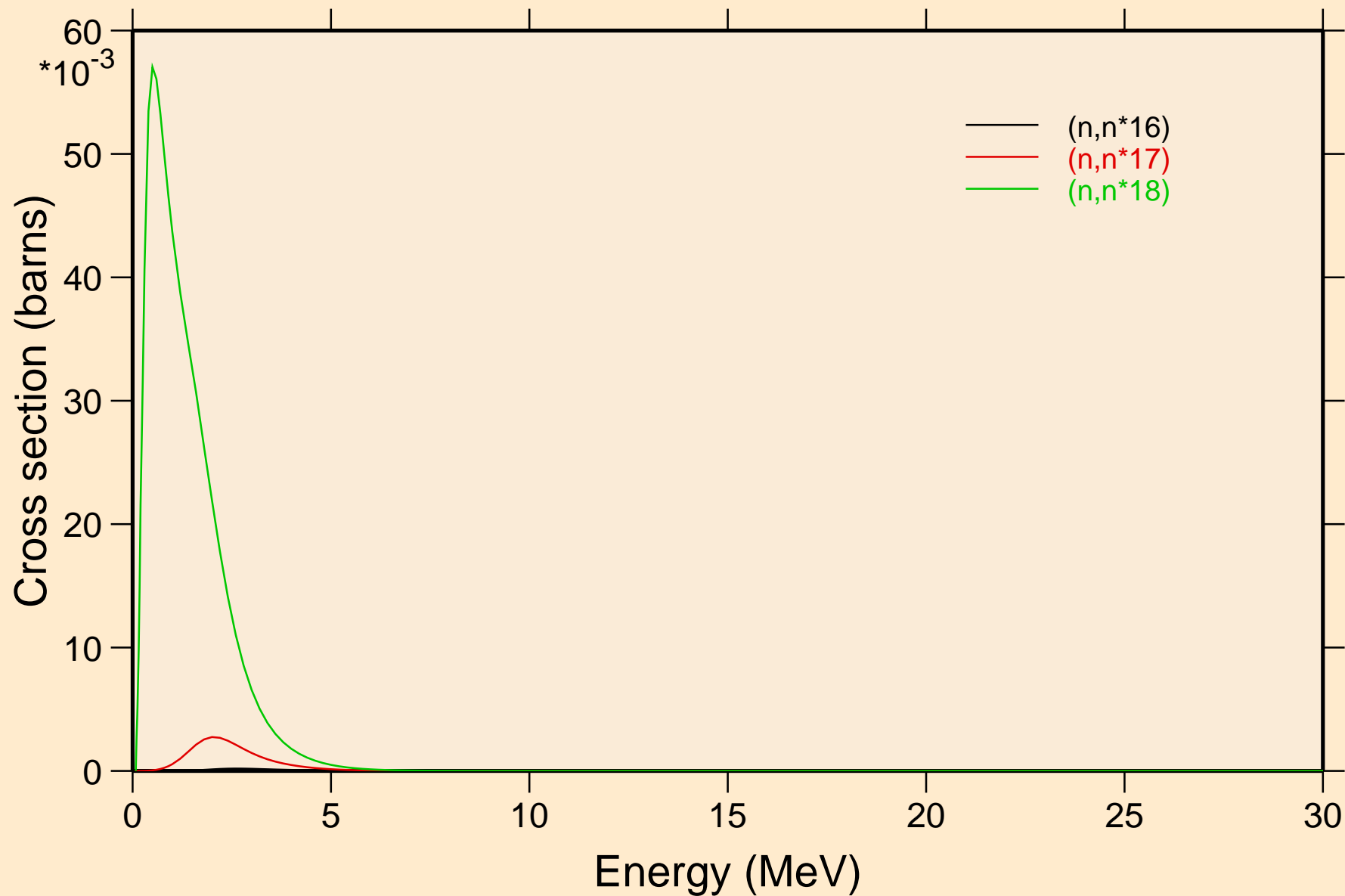

PO211M NEUTRON ACER TENDL-2019 LIBRARY; T=293.16K
Threshold reactions

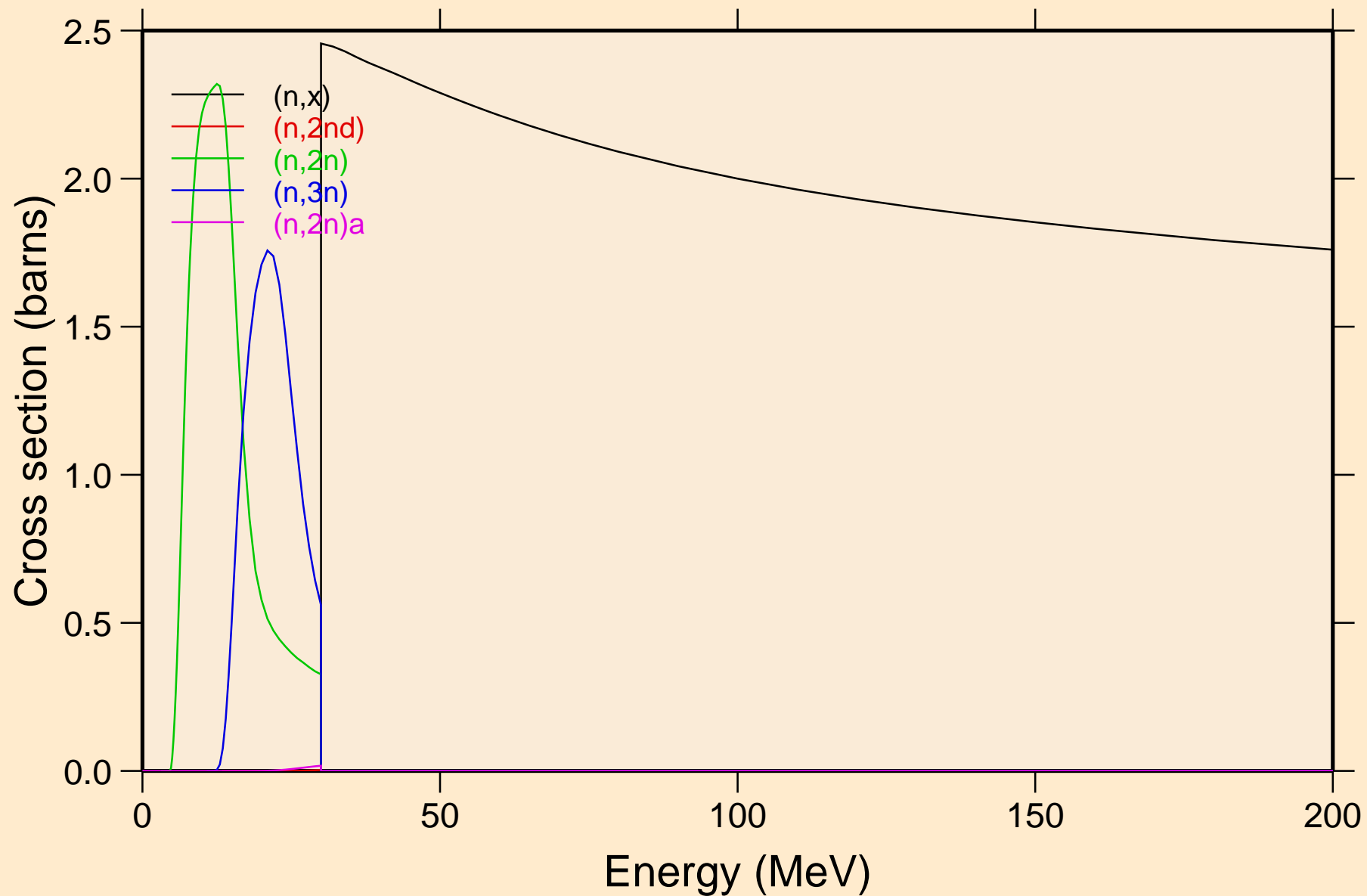

PO211M NEUTRON ACER TENDL-2019 LIBRARY; T=293.16K
Threshold reactions

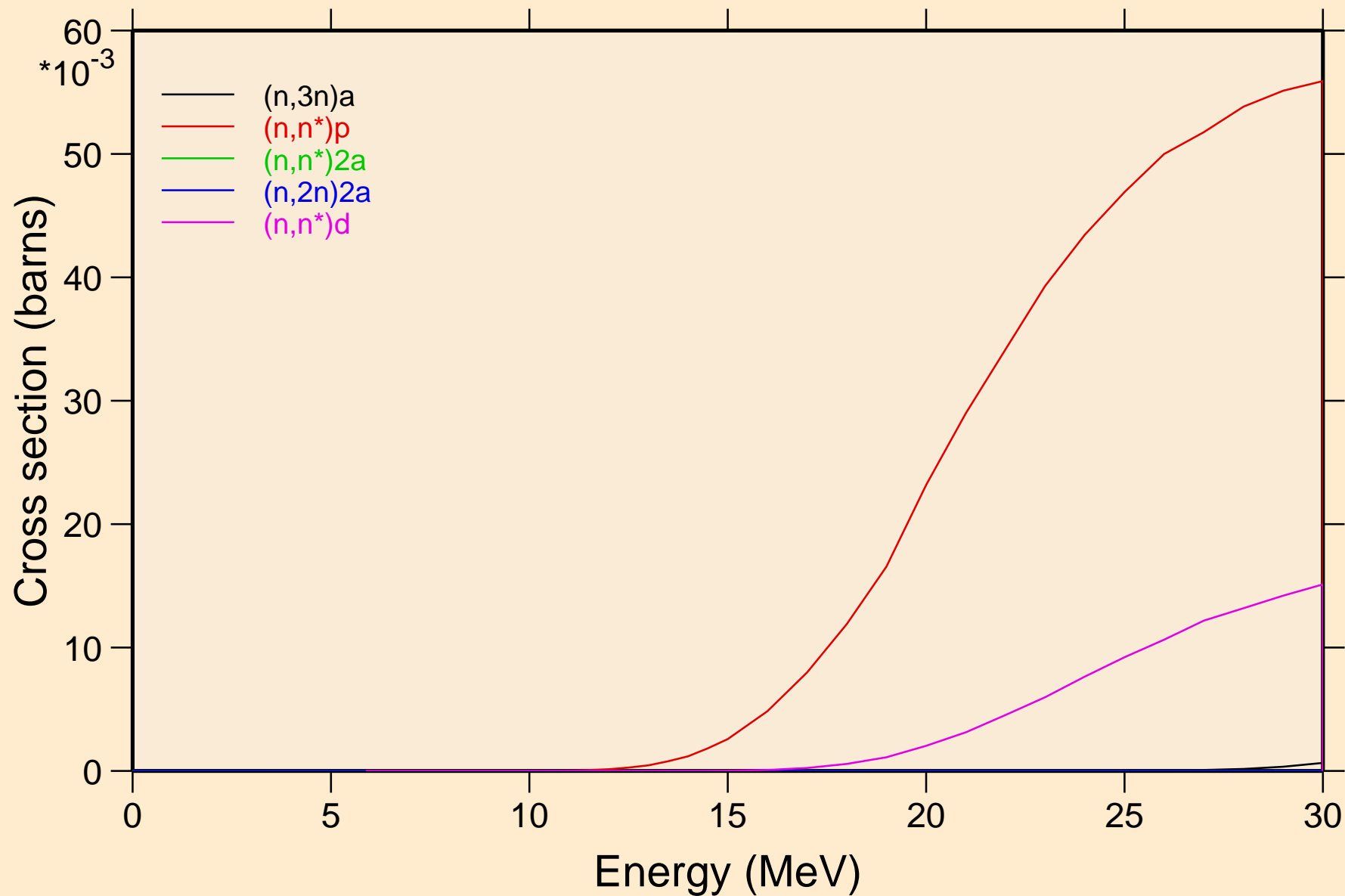

PO211M NEUTRON ACER TENDL-2019 LIBRARY; T=293.16K
Threshold reactions

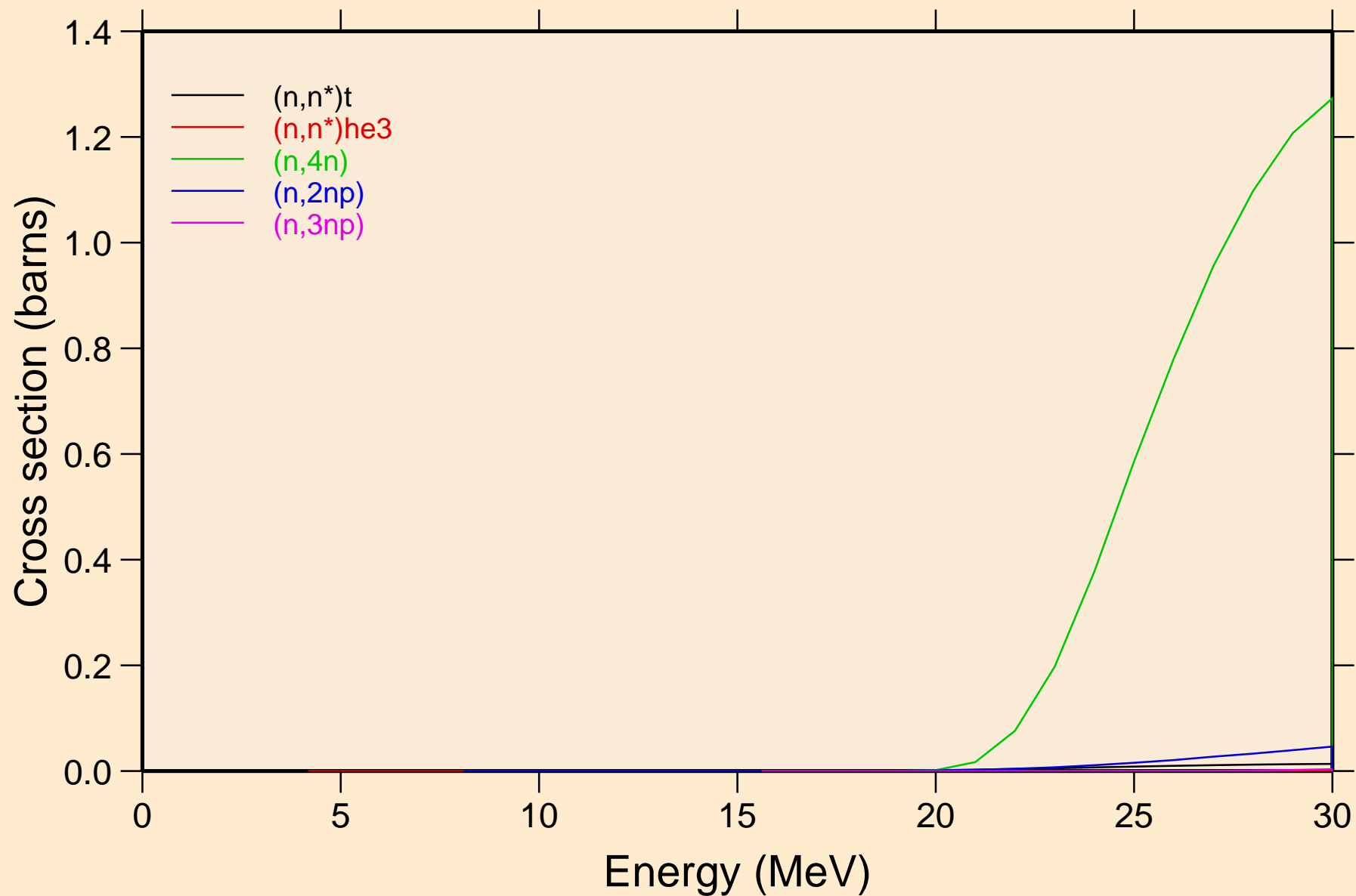

PO211M NEUTRON ACER TENDL-2019 LIBRARY; T=293.16K
Threshold reactions

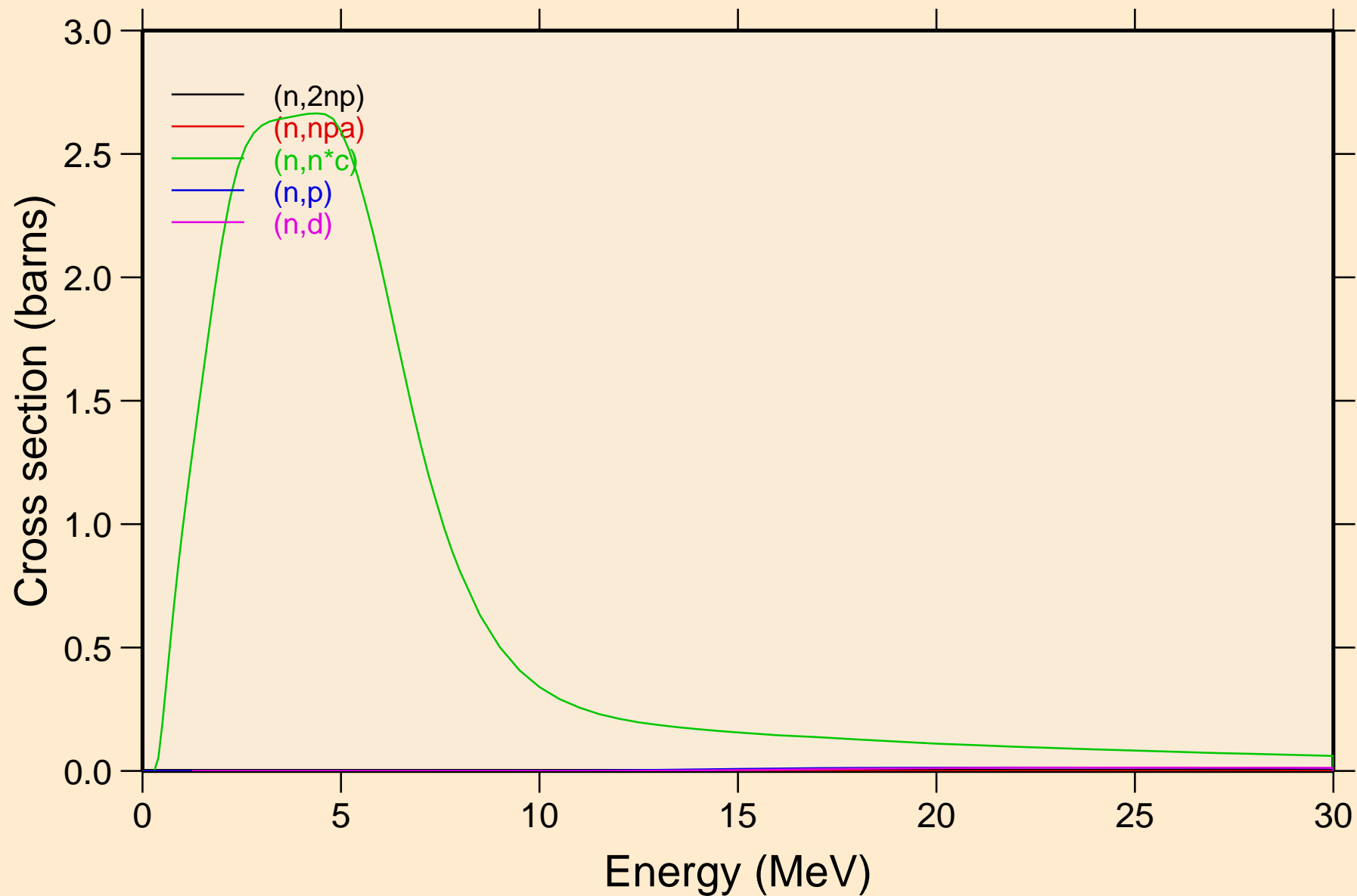

PO211M NEUTRON ACER TENDL-2019 LIBRARY; T=293.16K
Threshold reactions

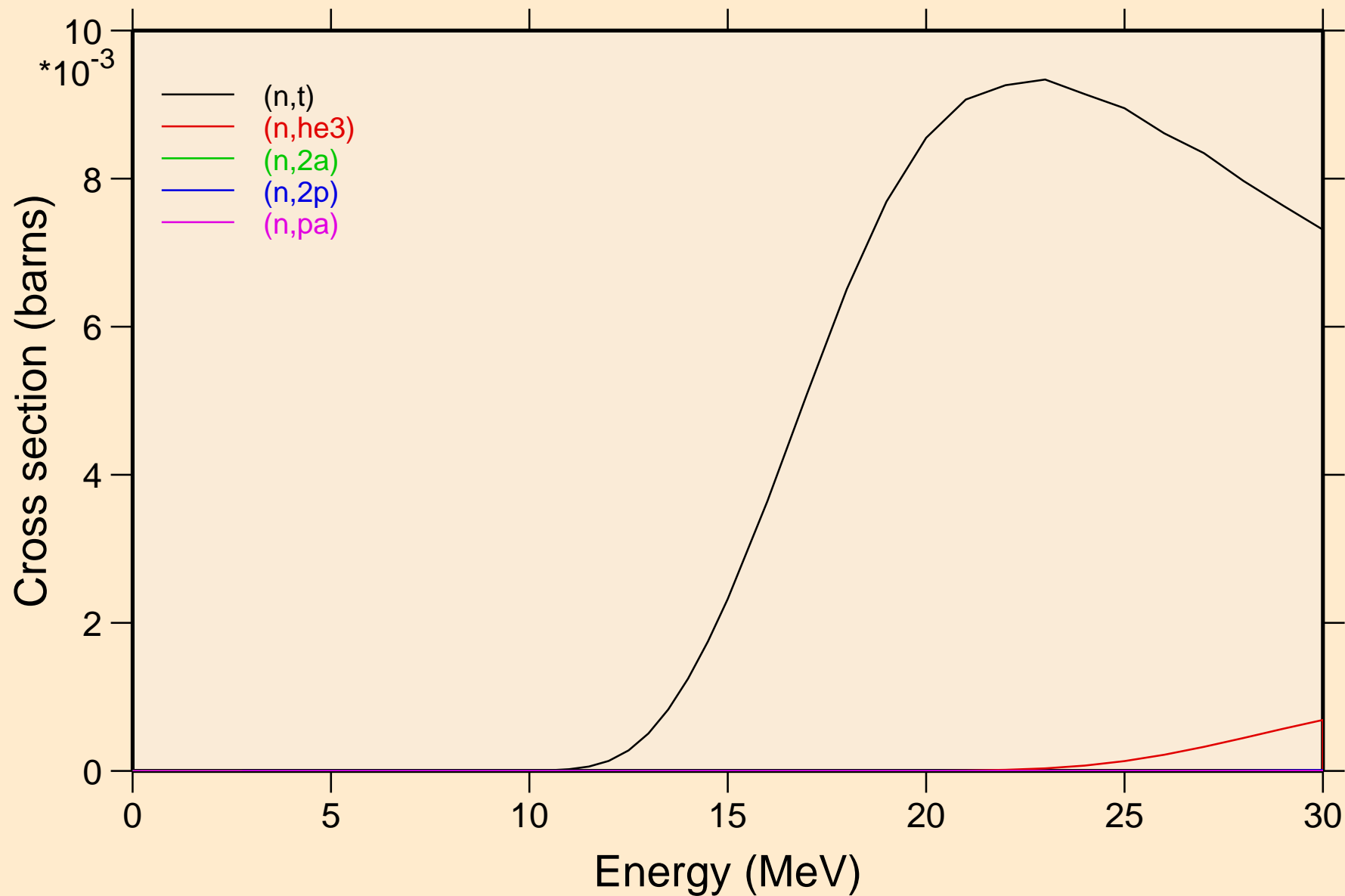

PO211M NEUTRON ACER TENDL-2019 LIBRARY; T=293.16K
Threshold reactions

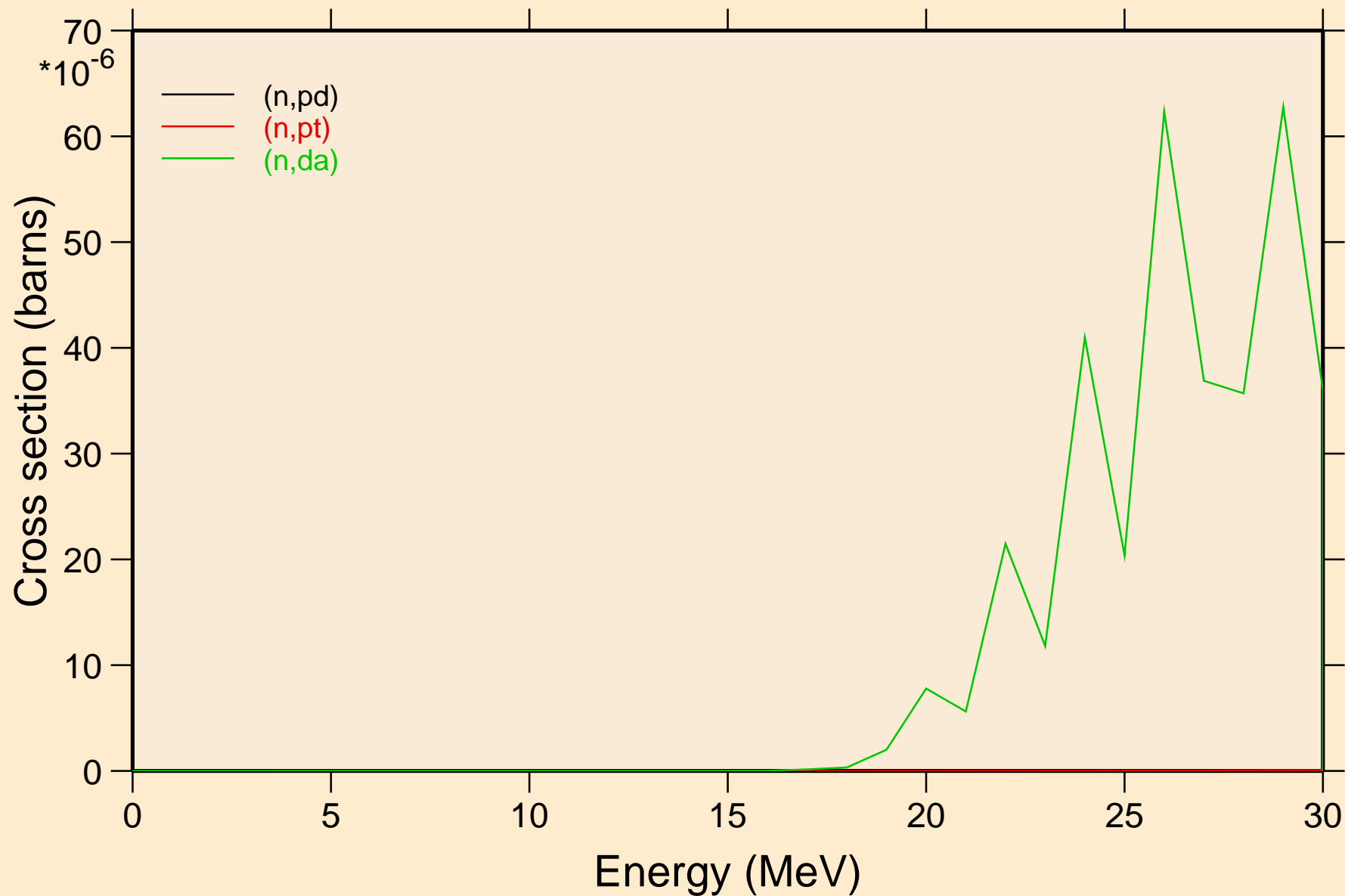

PO211M NEUTRON ACER TENDL-2019 LIBRARY; T=293.16K
Threshold reactions

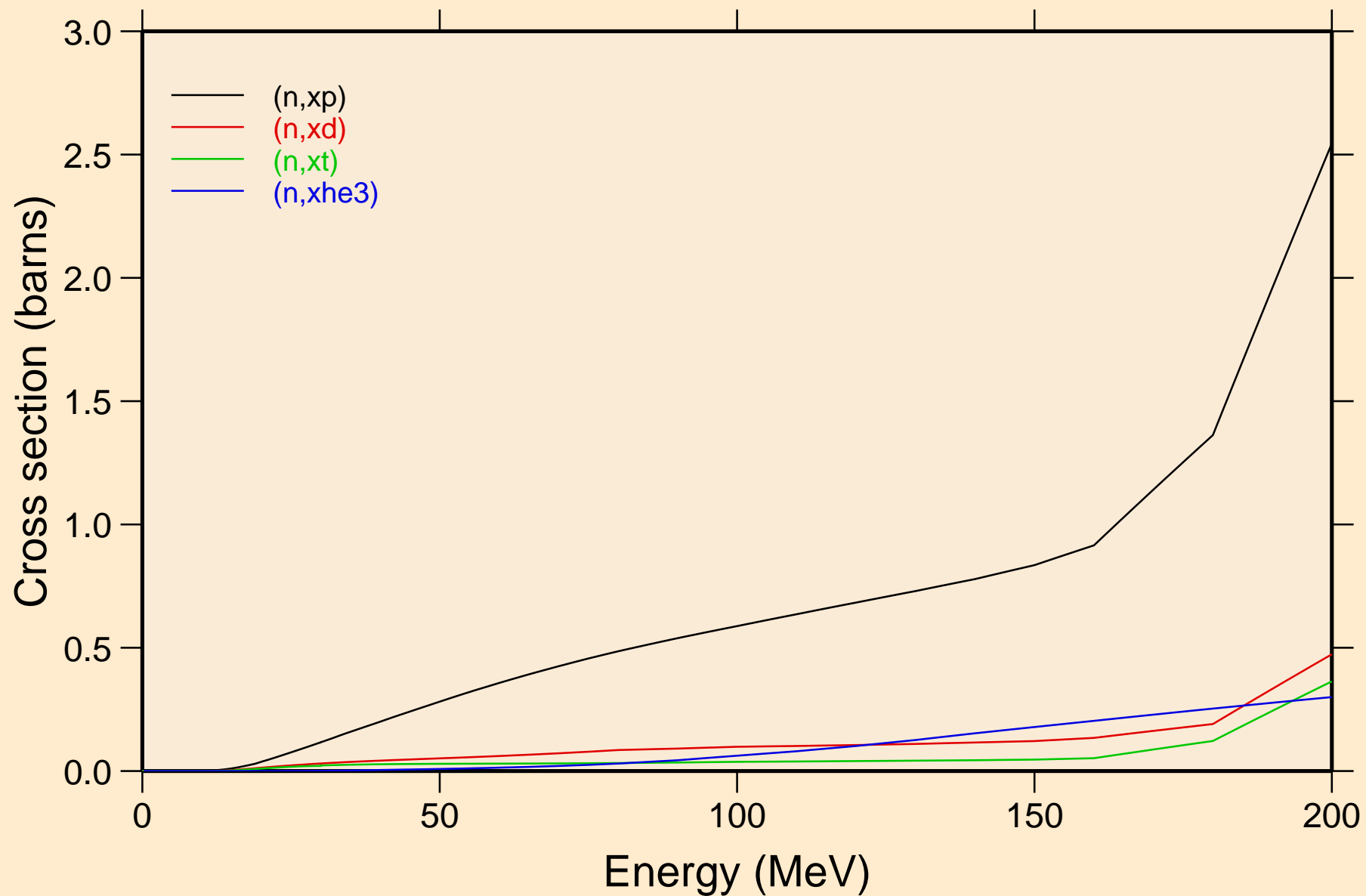

PO211M NEUTRON ACER TENDL-2019 LIBRARY; T=293.16K
angular distribution for elastic

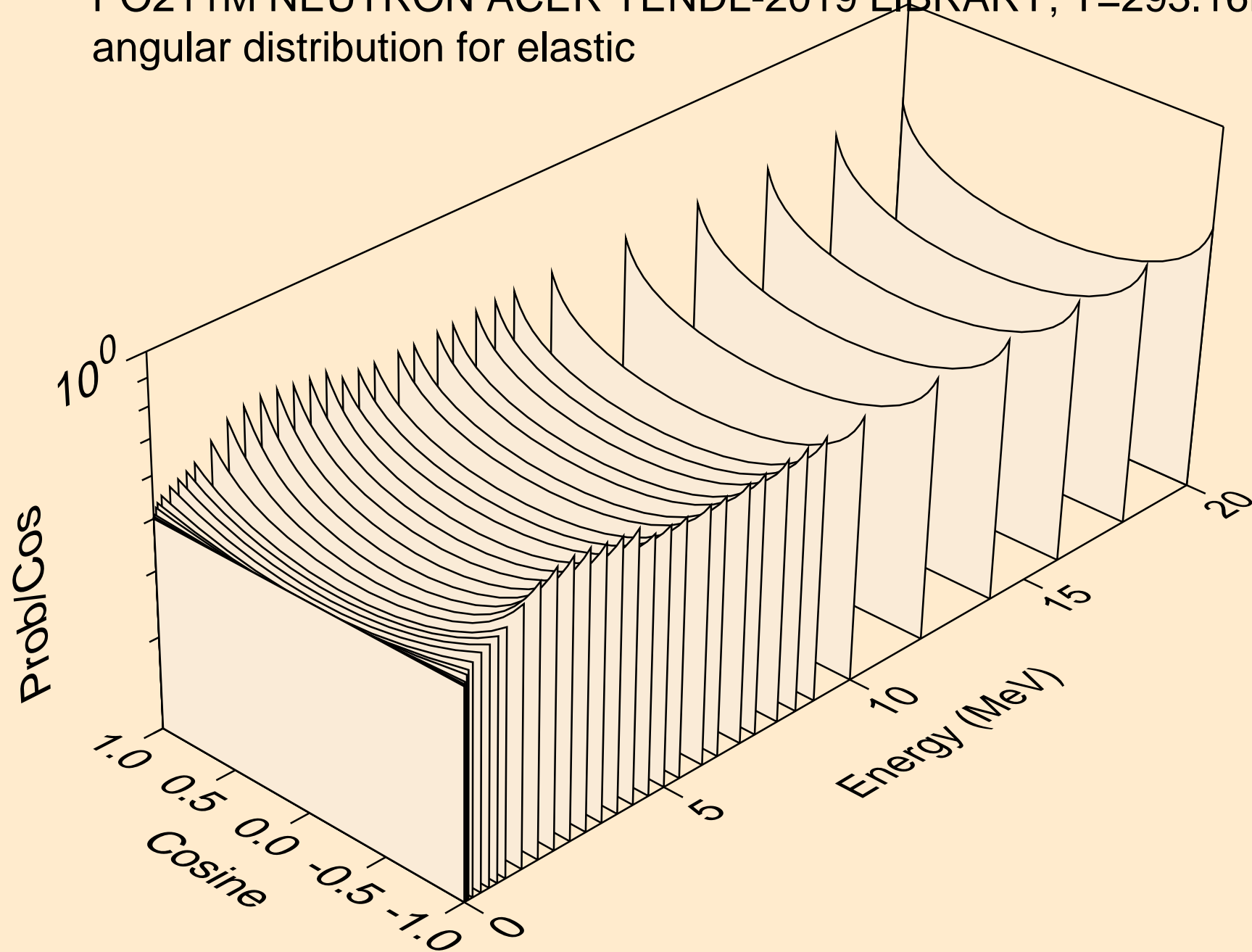

PO211M NEUTRON ACER TENDL-2019 LIBRARY; T=293.16K
angular distribution for elastic

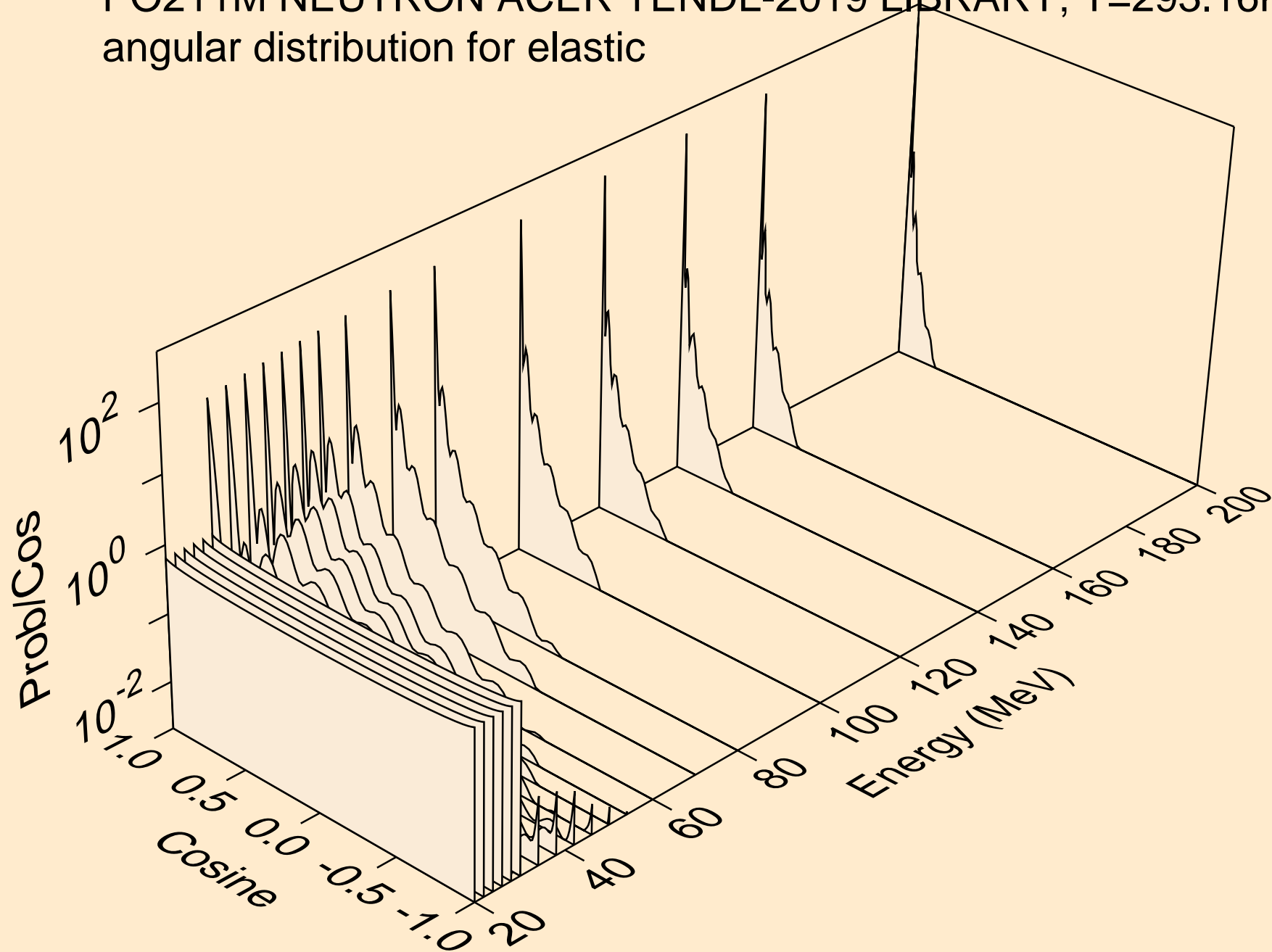

PO211M NEUTRON ACER TENDL-2019 LIBRARY; T=293.16K
angular distribution for (n,n*1)

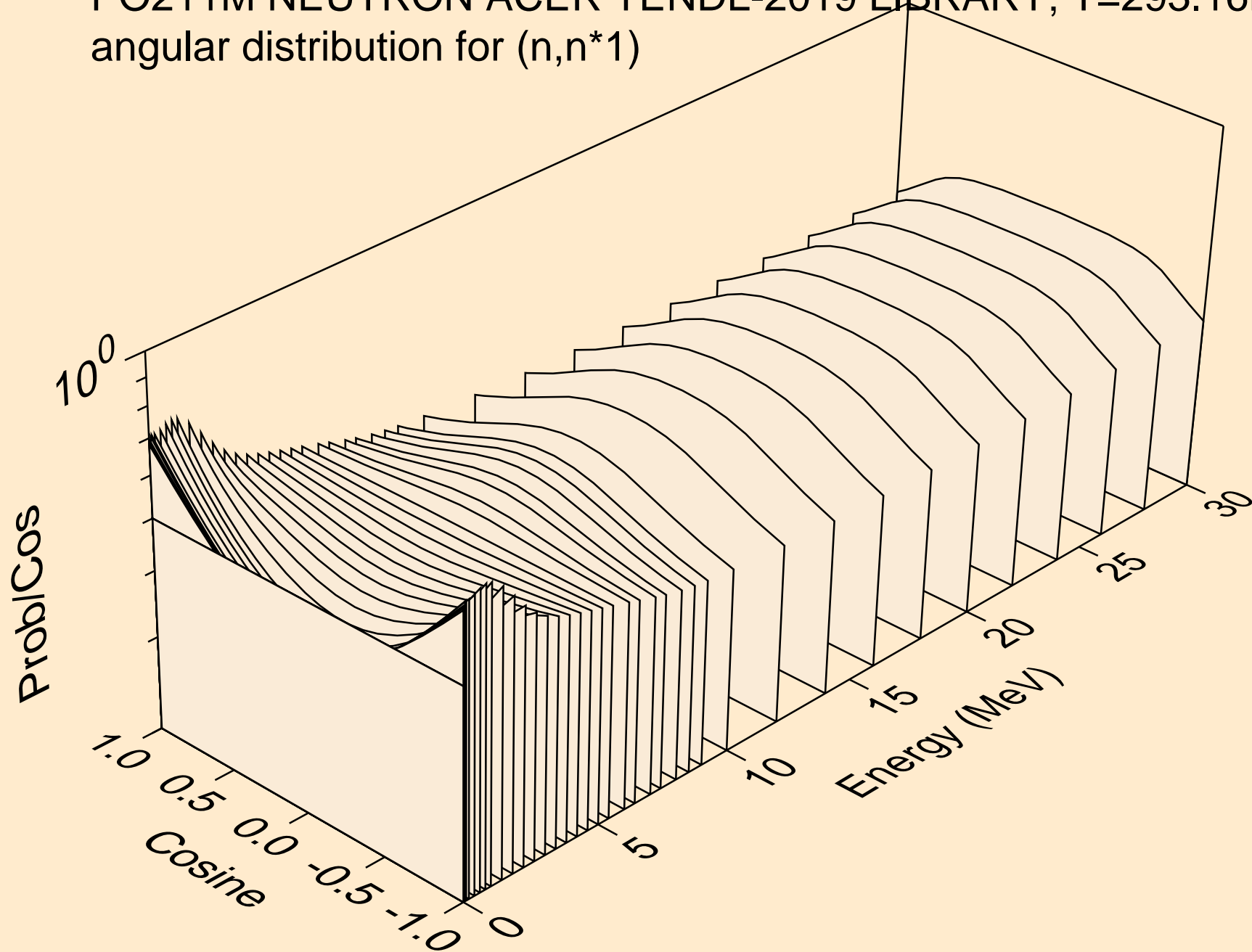

PO211M NEUTRON ACER TENDL-2019 LIBRARY; T=293.16K
angular distribution for (n,n*2)

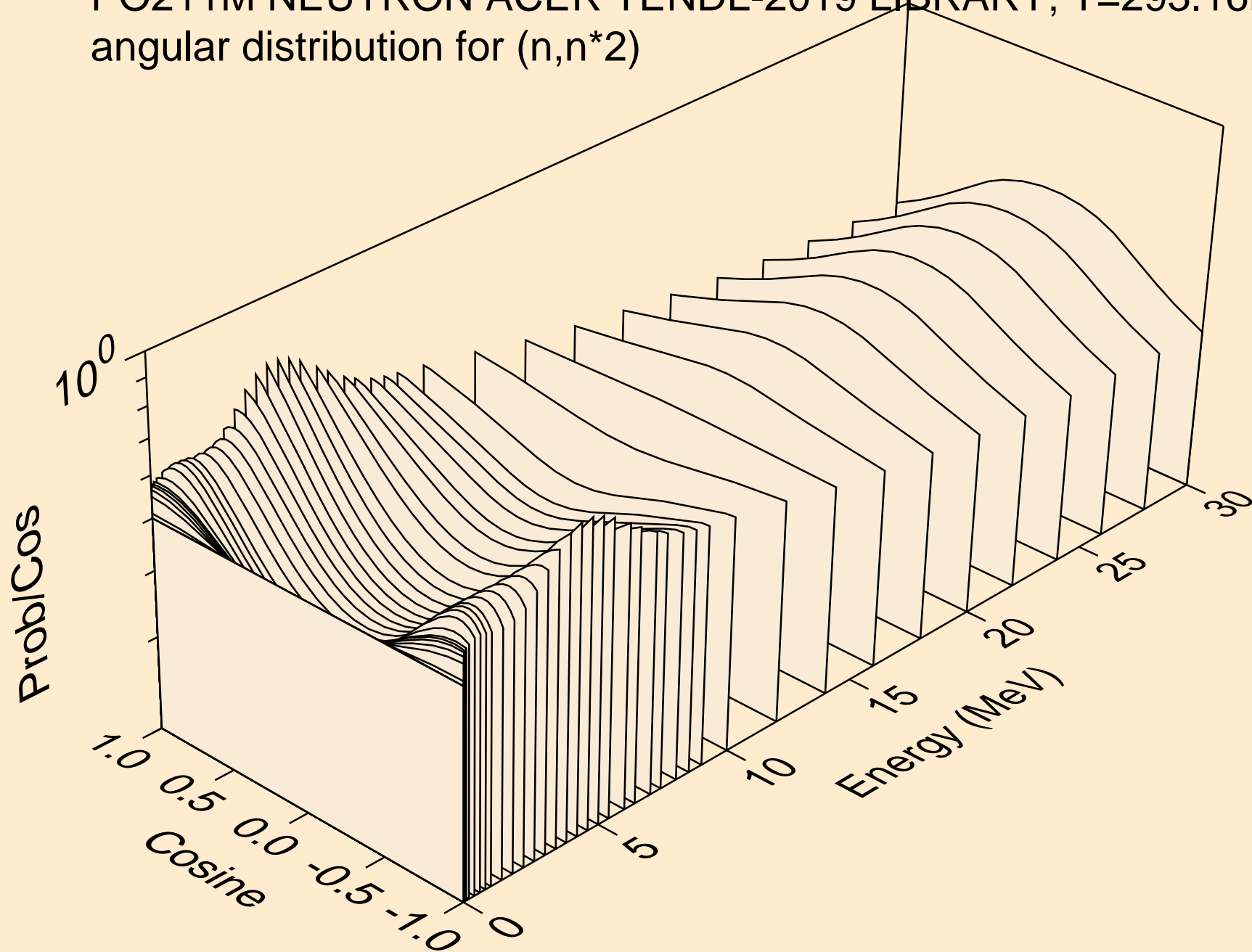

PO211M NEUTRON ACER TENDL-2019 LIBRARY; T=293.16K
angular distribution for (n,n*3)

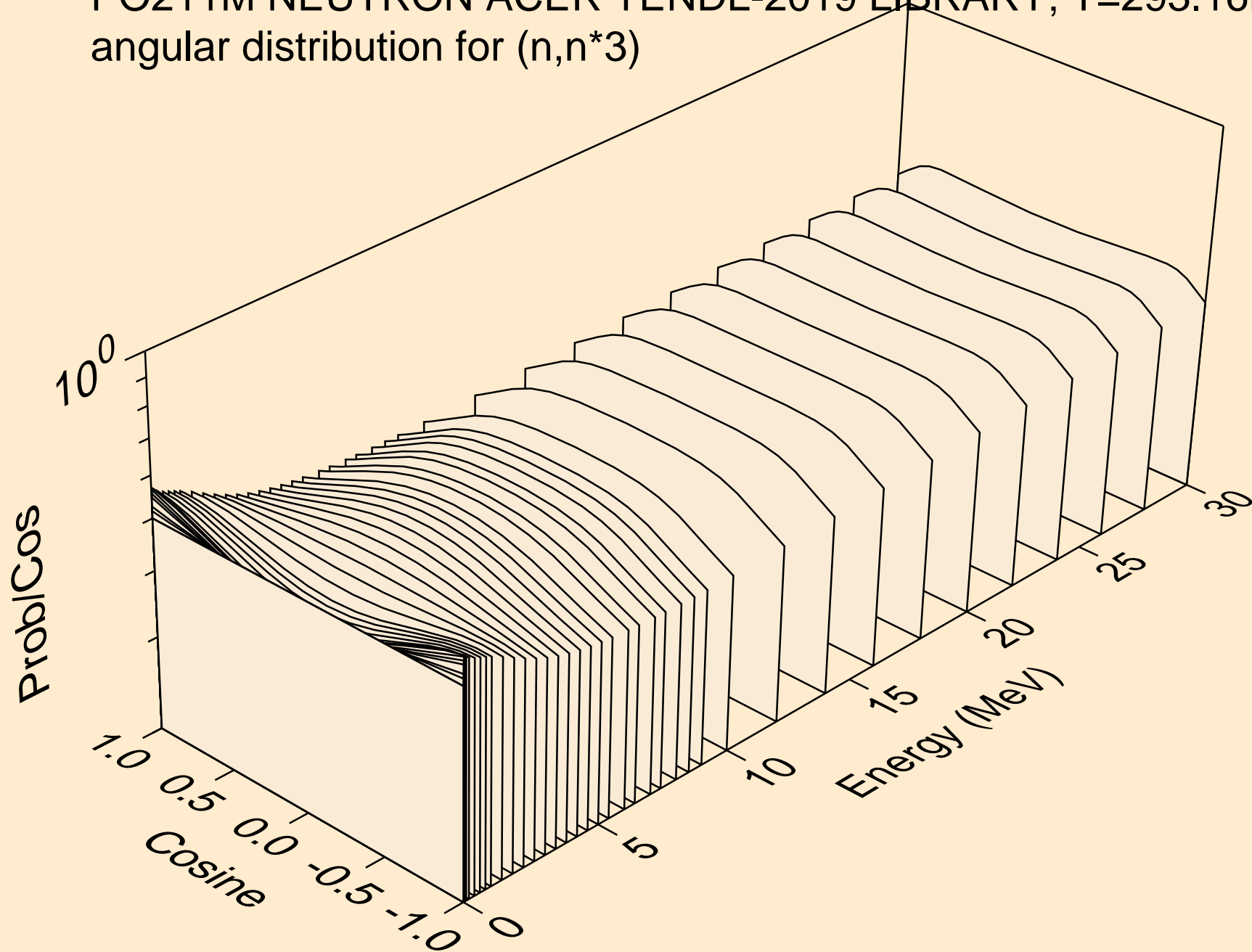

PO211M NEUTRON ACER TENDL-2019 LIBRARY; T=293.16K
angular distribution for (n,n*4)

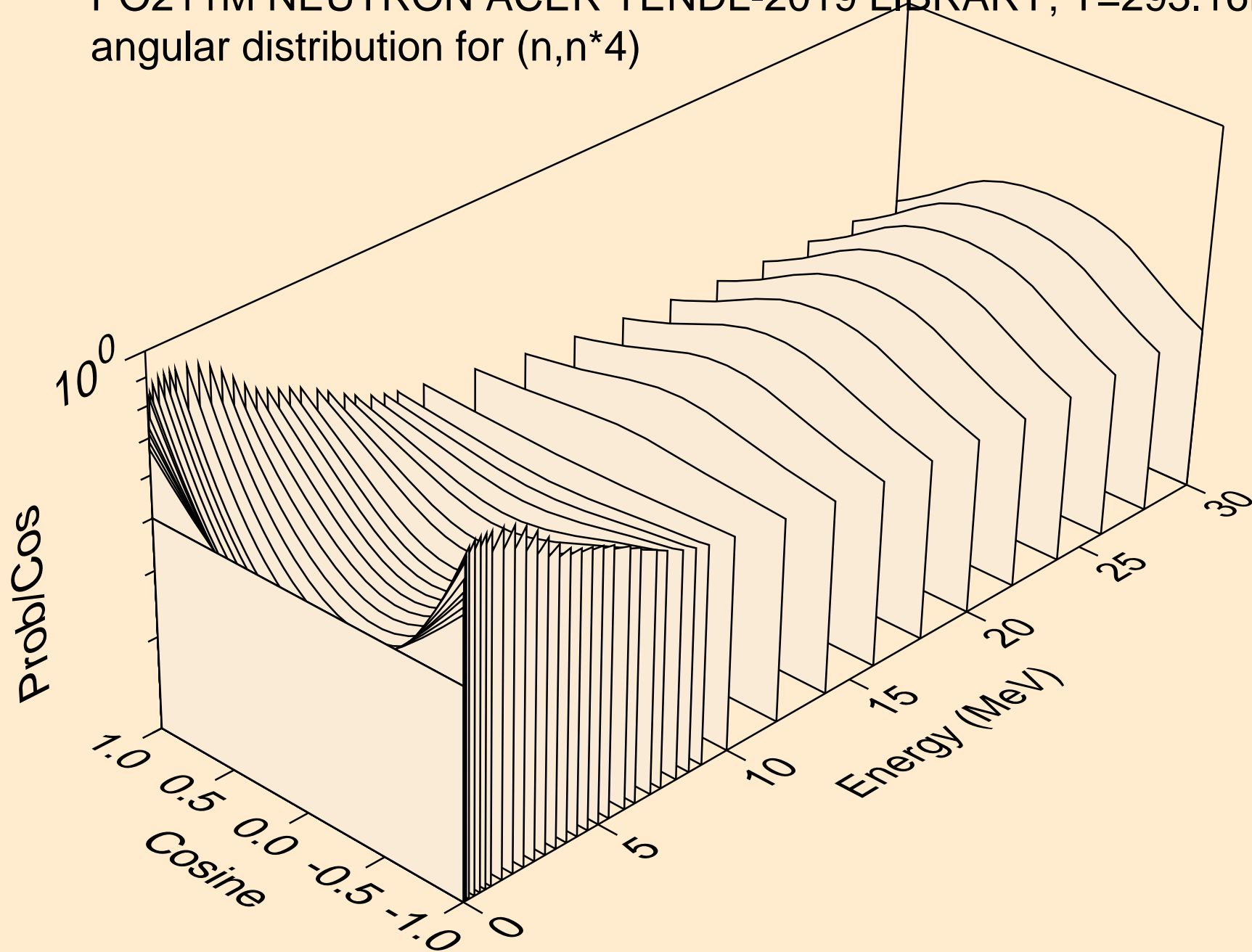

PO211M NEUTRON ACER TENDL-2019 LIBRARY; T=293.16K
angular distribution for (n,n*5)

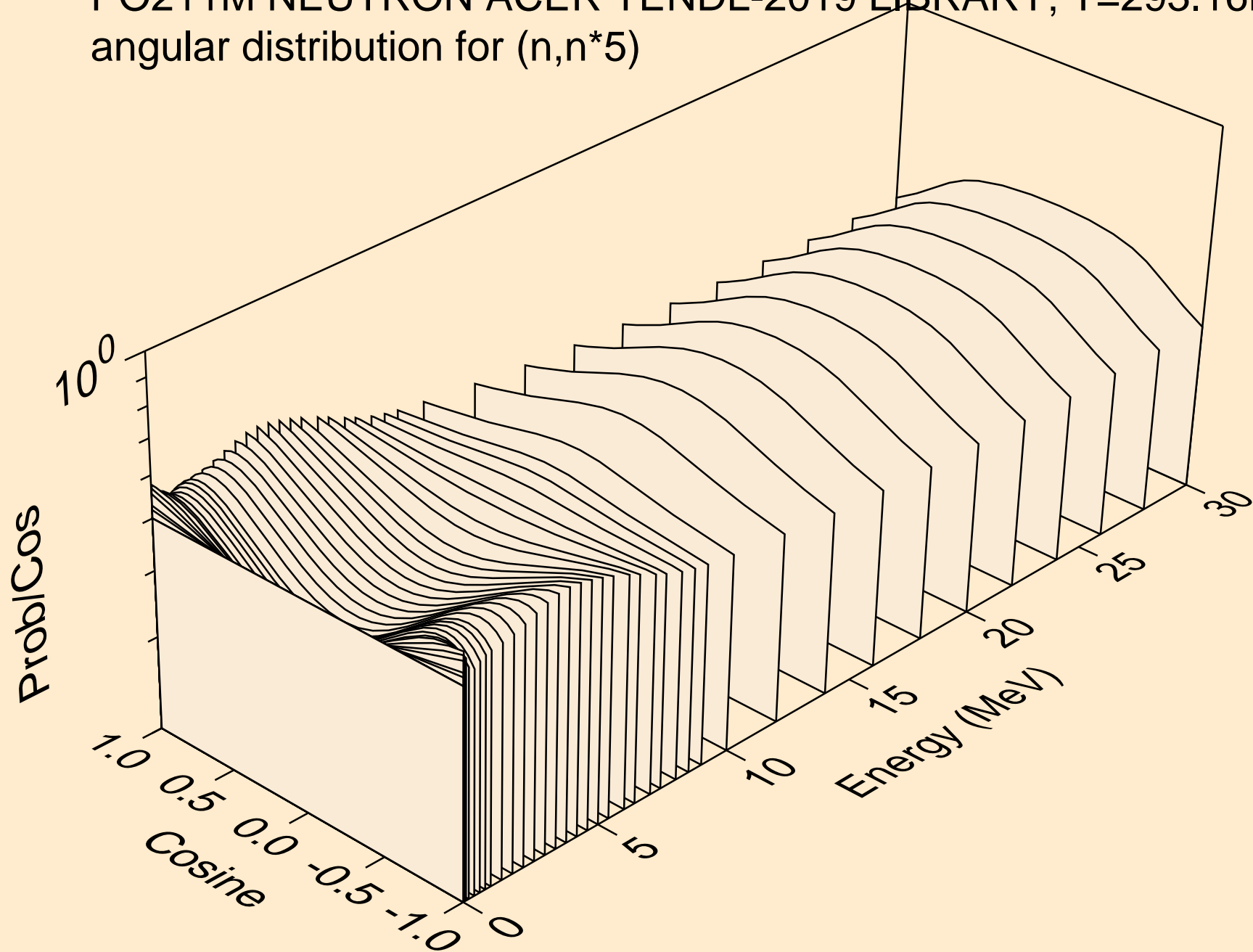

PO211M NEUTRON ACER TENDL-2019 LIBRARY; T=293.16K
angular distribution for (n,n*6)

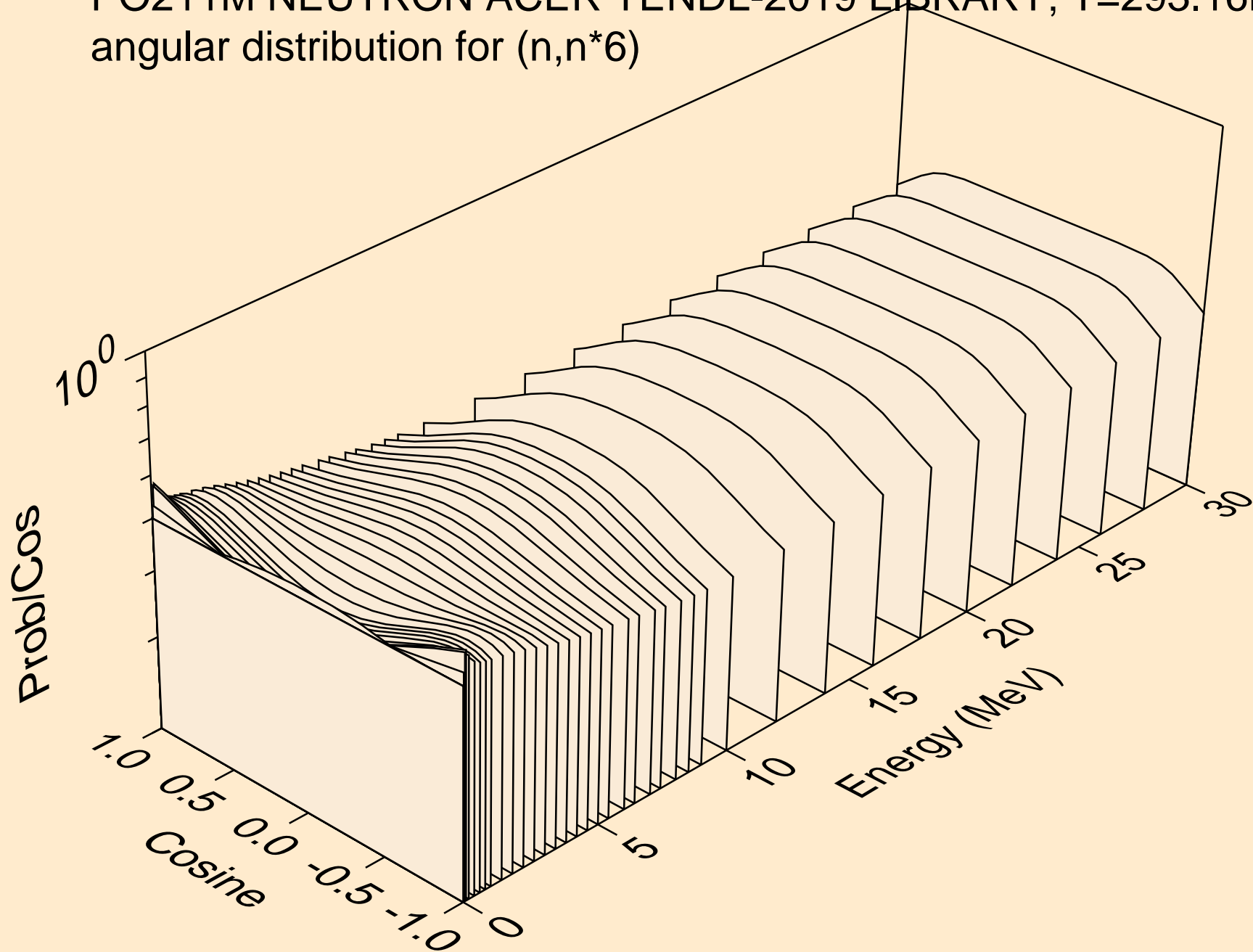

PO211M NEUTRON ACER TENDL-2019 LIBRARY; T=293.16K
angular distribution for (n,n*7)

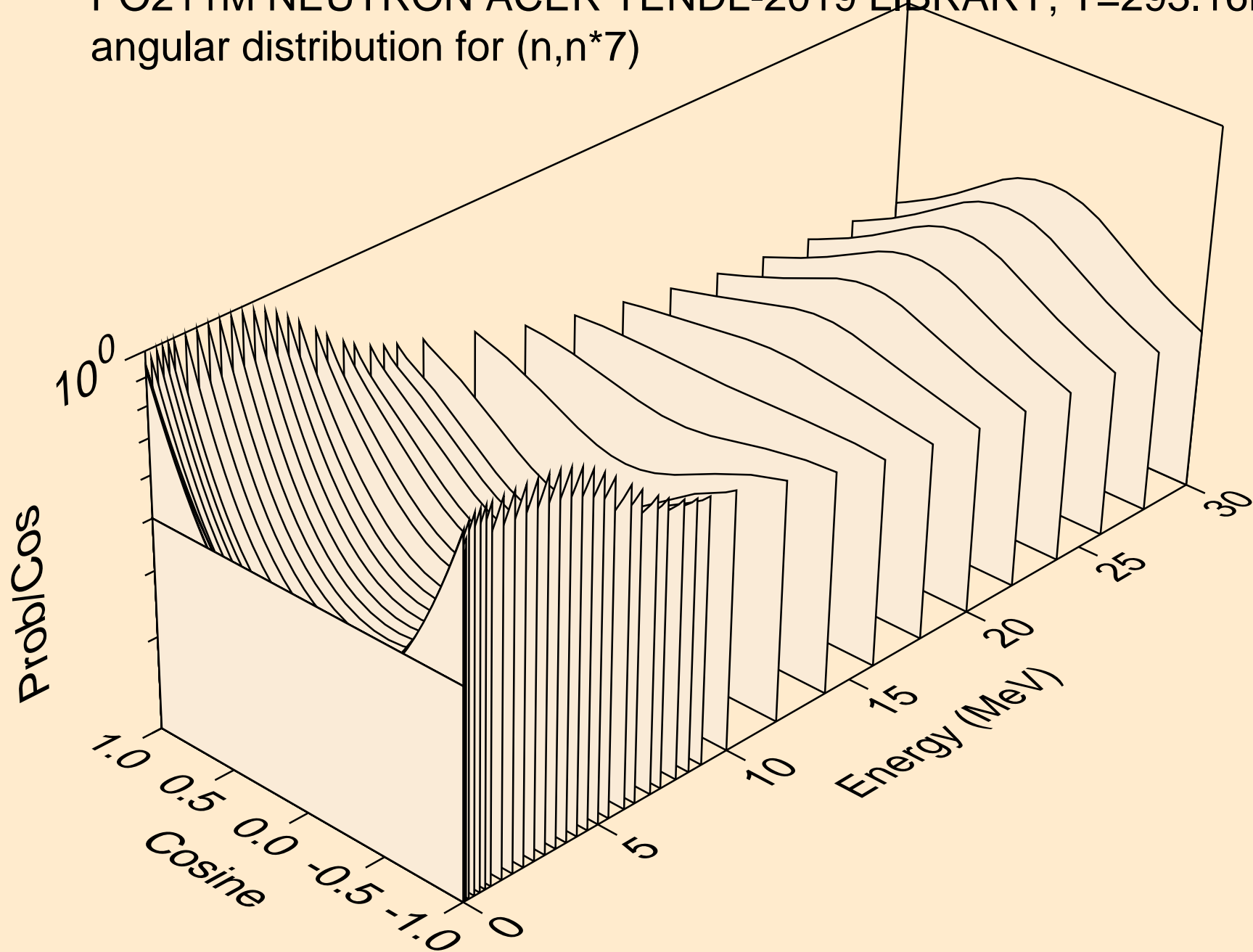

PO211M NEUTRON ACER TENDL-2019 LIBRARY; T=293.16K
angular distribution for (n,n*8)

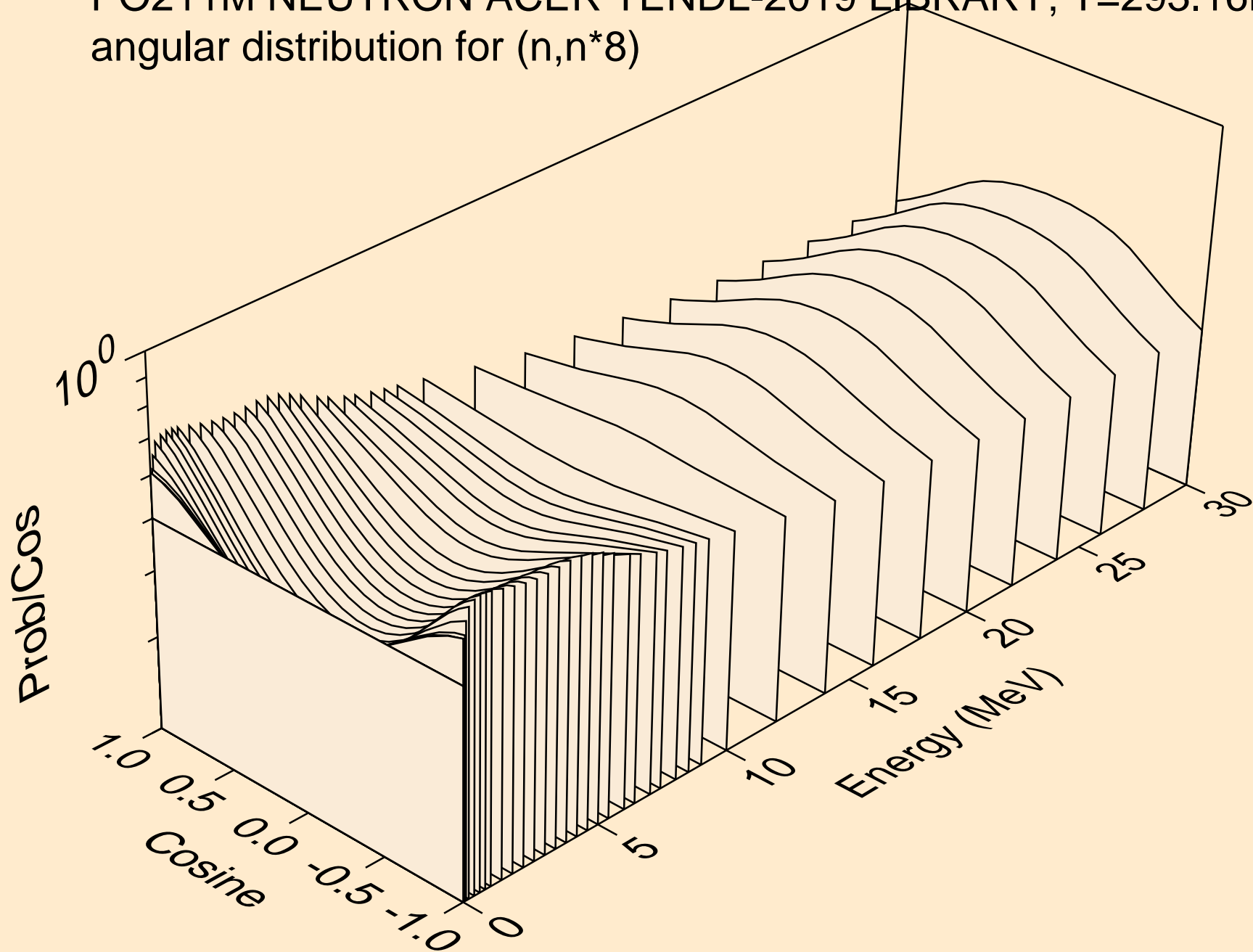

PO211M NEUTRON ACER TENDL-2019 LIBRARY; T=293.16K
angular distribution for (n,n*9)

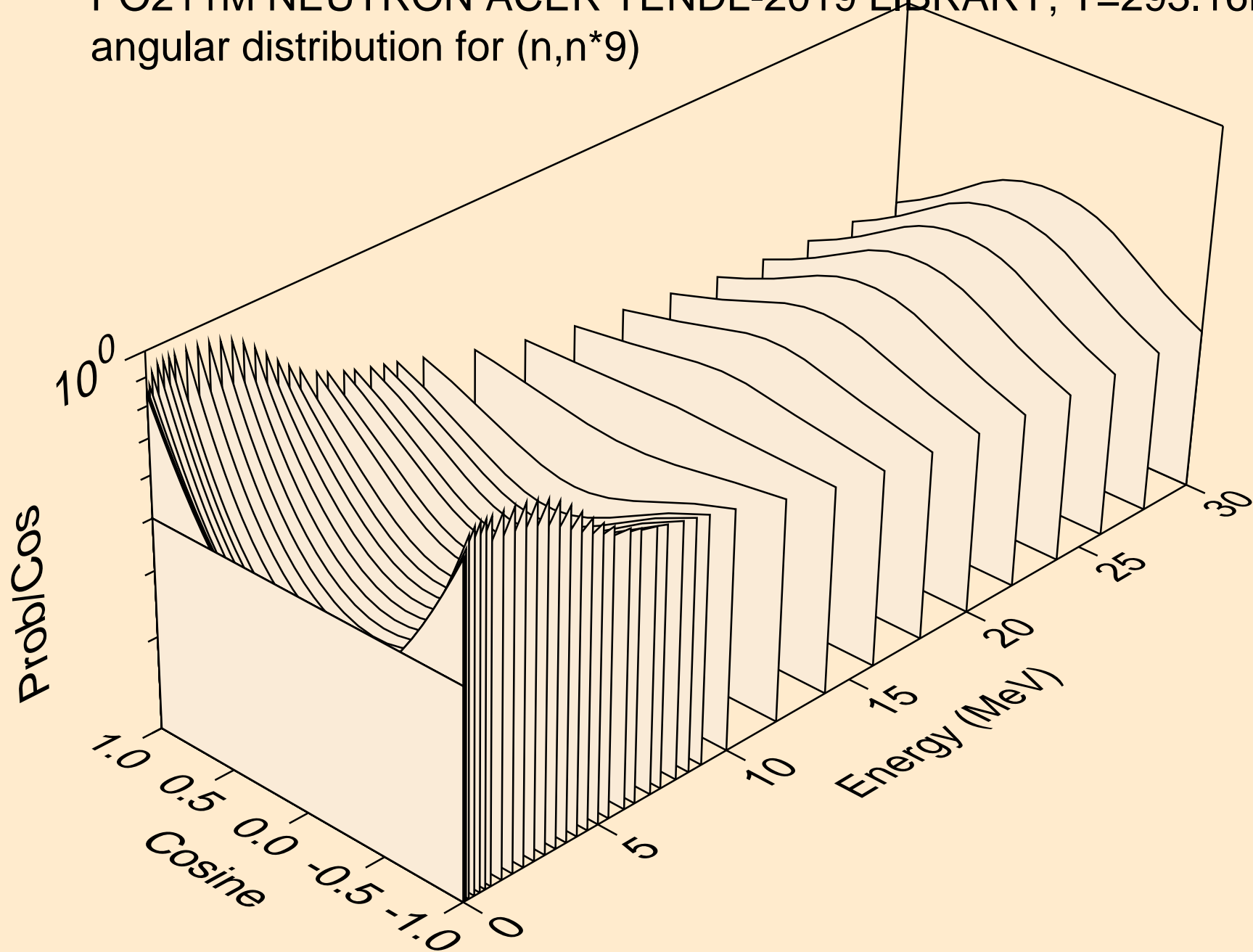

PO211M NEUTRON ACER TENDL-2019 LIBRARY; T=293.16K
angular distribution for (n,n*10)

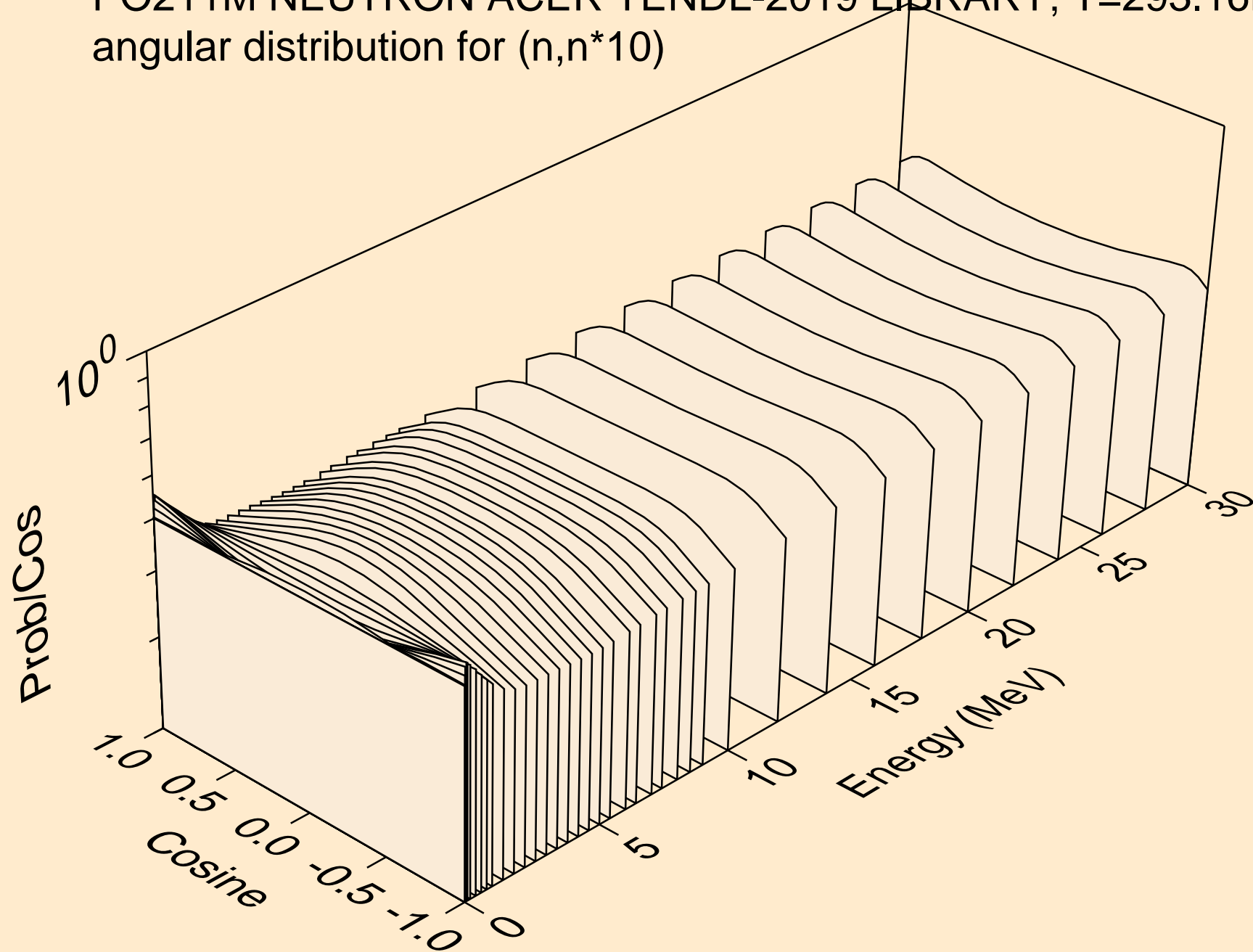

PO211M NEUTRON ACER TENDL-2019 LIBRARY; T=293.16K
angular distribution for (n,n*11)

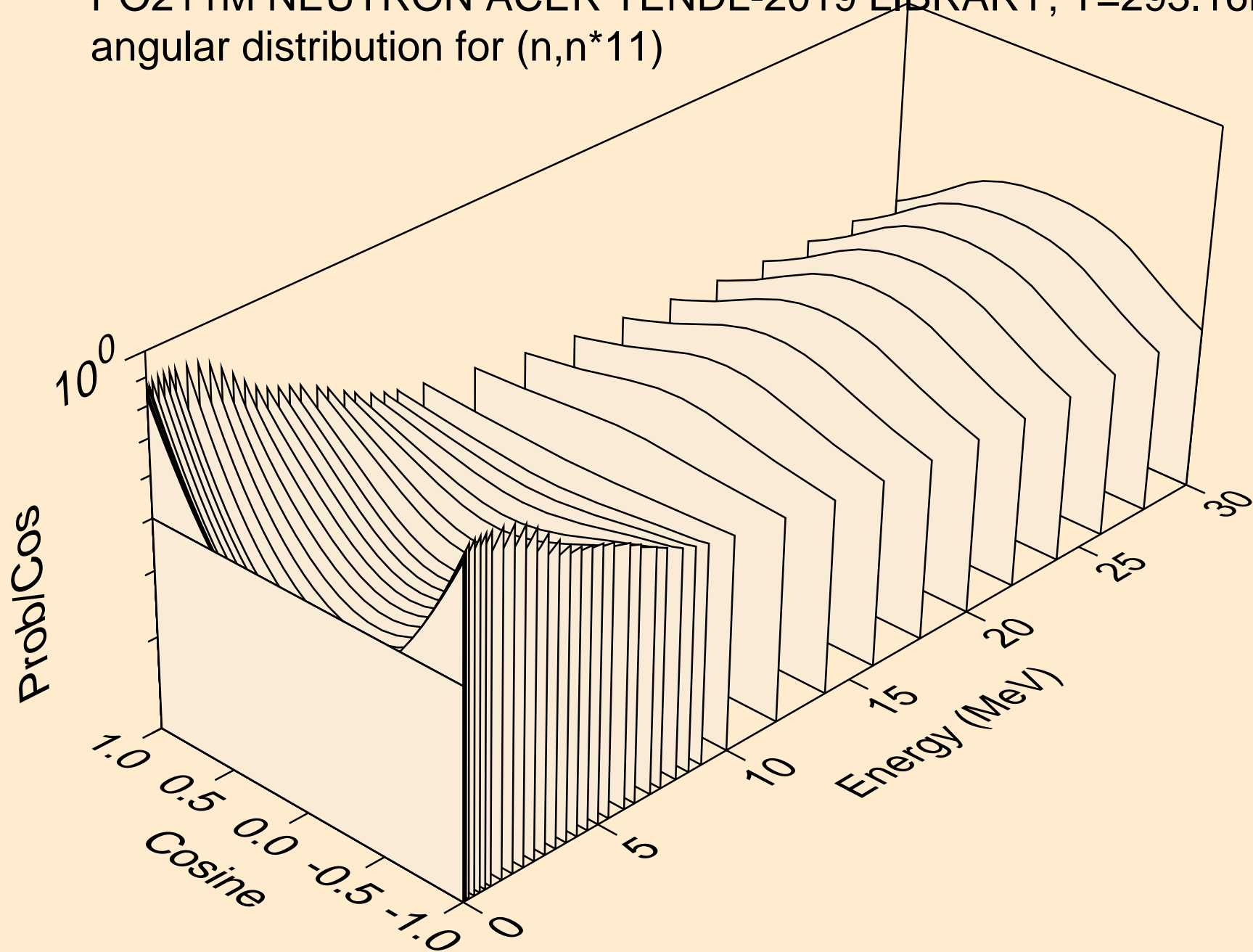

PO211M NEUTRON ACER TENDL-2019 LIBRARY; T=293.16K
angular distribution for (n,n*12)

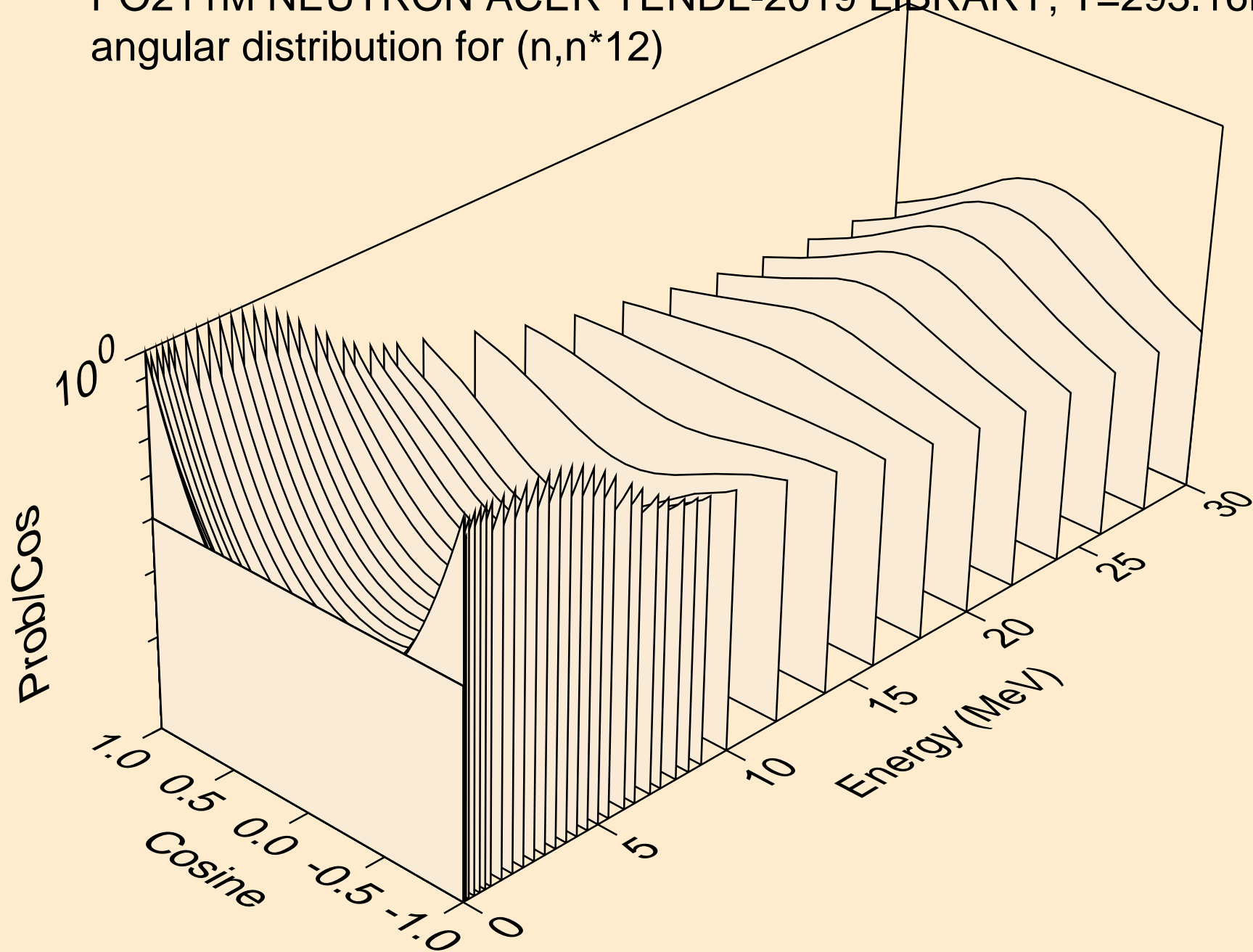

PO211M NEUTRON ACER TENDL-2019 LIBRARY; T=293.16K
angular distribution for (n,n*13)

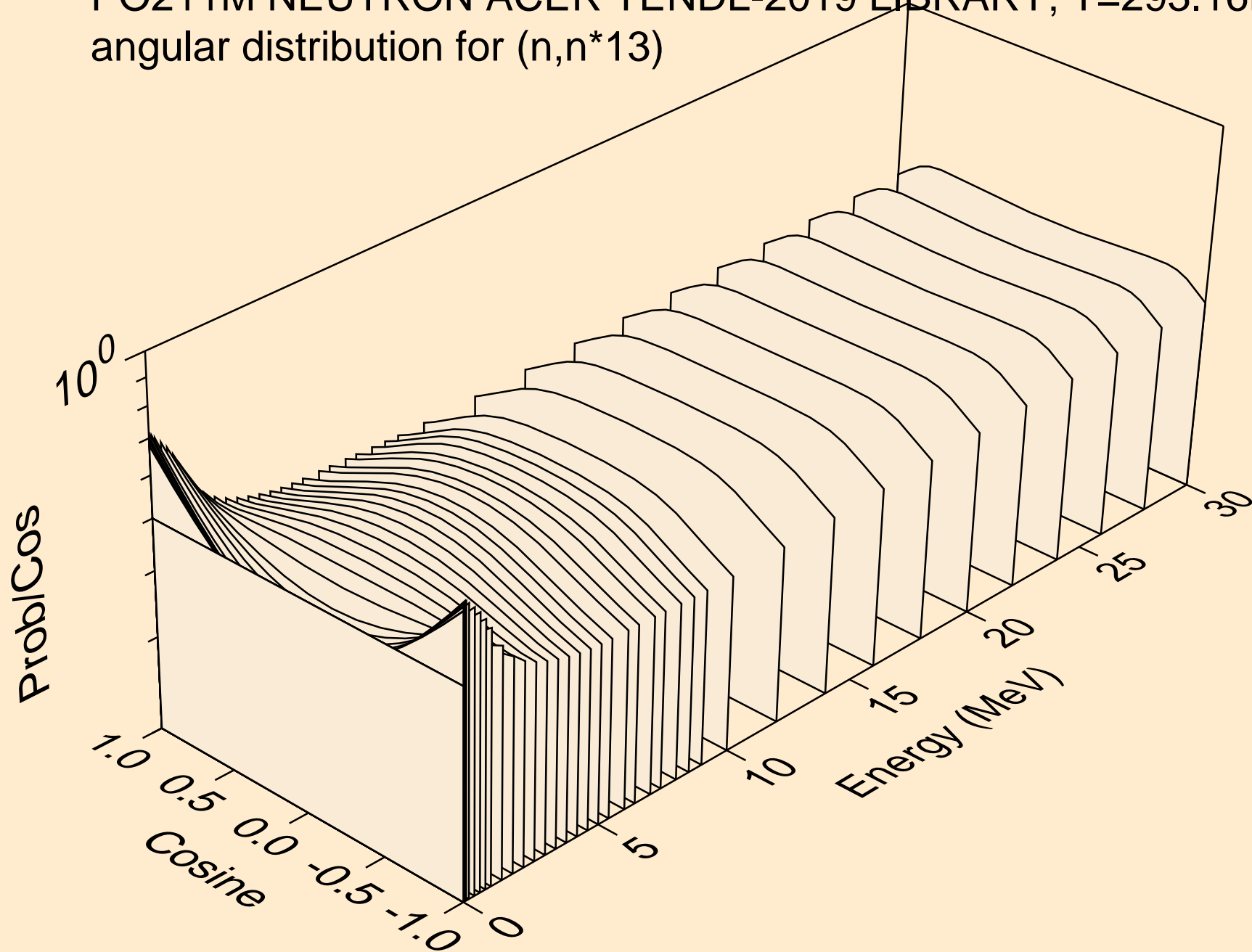

PO211M NEUTRON ACER TENDL-2019 LIBRARY; T=293.16K
angular distribution for (n,n*14)

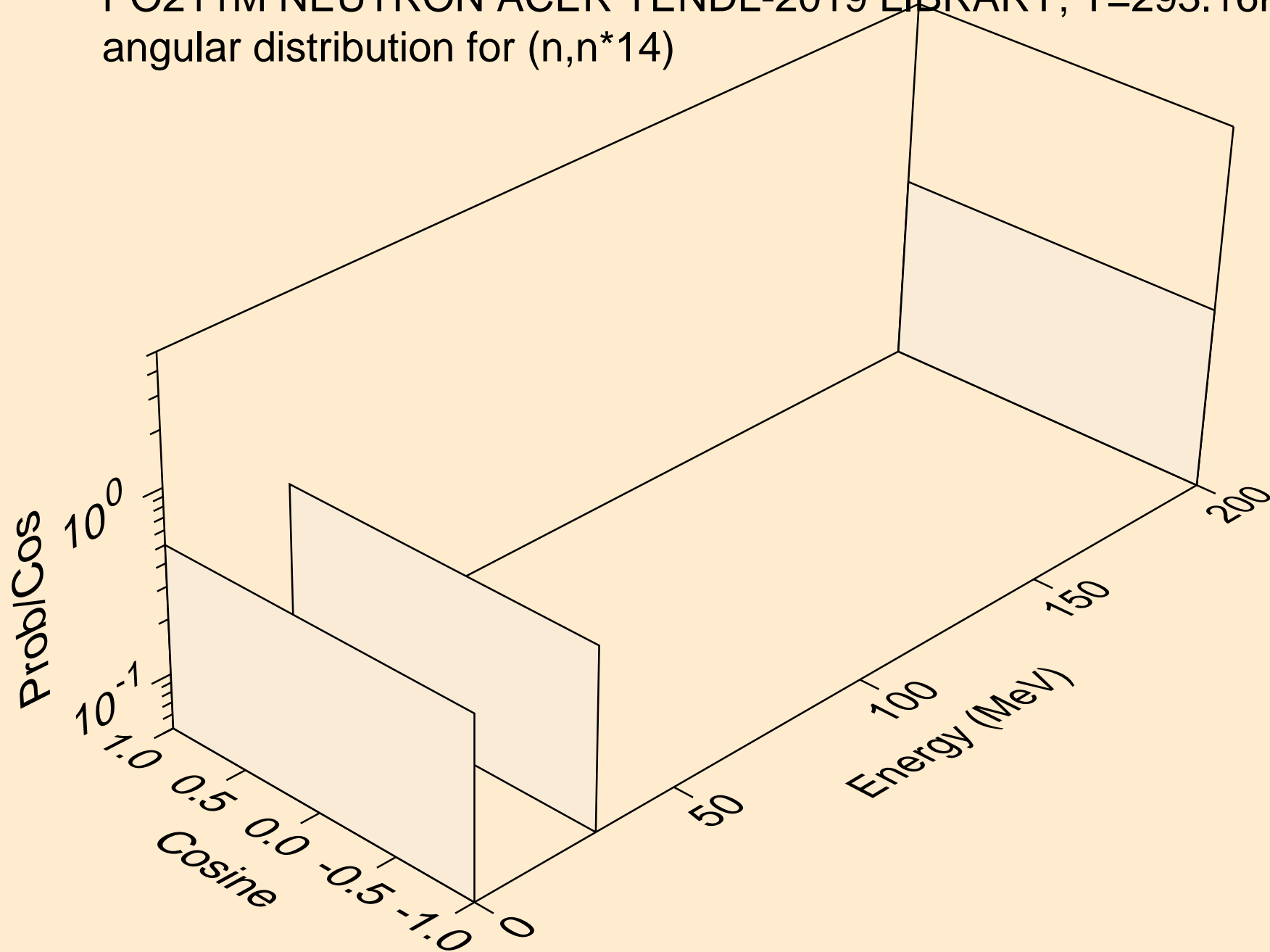

PO211M NEUTRON ACER TENDL-2019 LIBRARY; T=293.16K
angular distribution for (n,n*15)

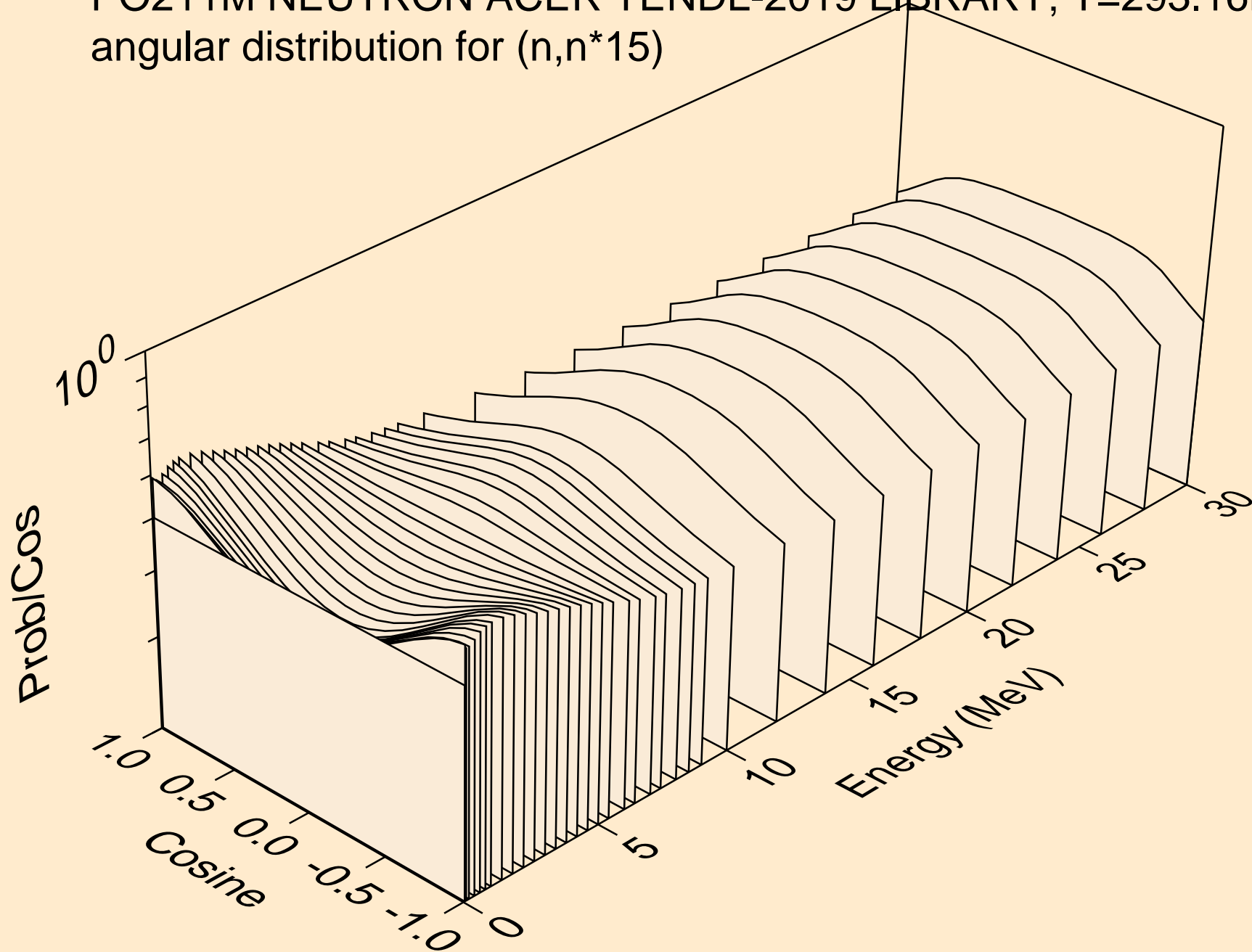

PO211M NEUTRON ACER TENDL-2019 LIBRARY; T=293.16K
angular distribution for (n,n*16)

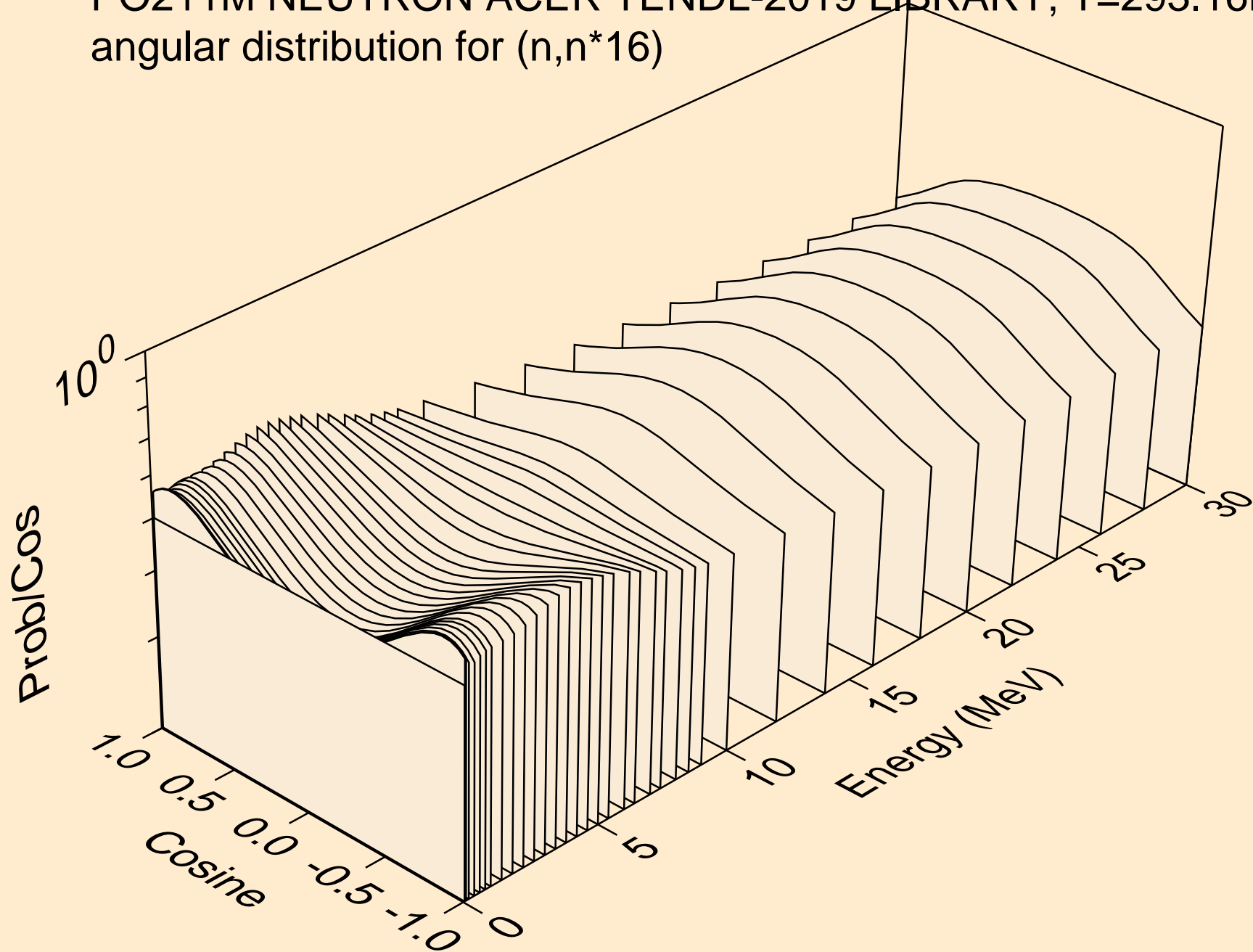

PO211M NEUTRON ACER TENDL-2019 LIBRARY; T=293.16K
angular distribution for (n,n*17)

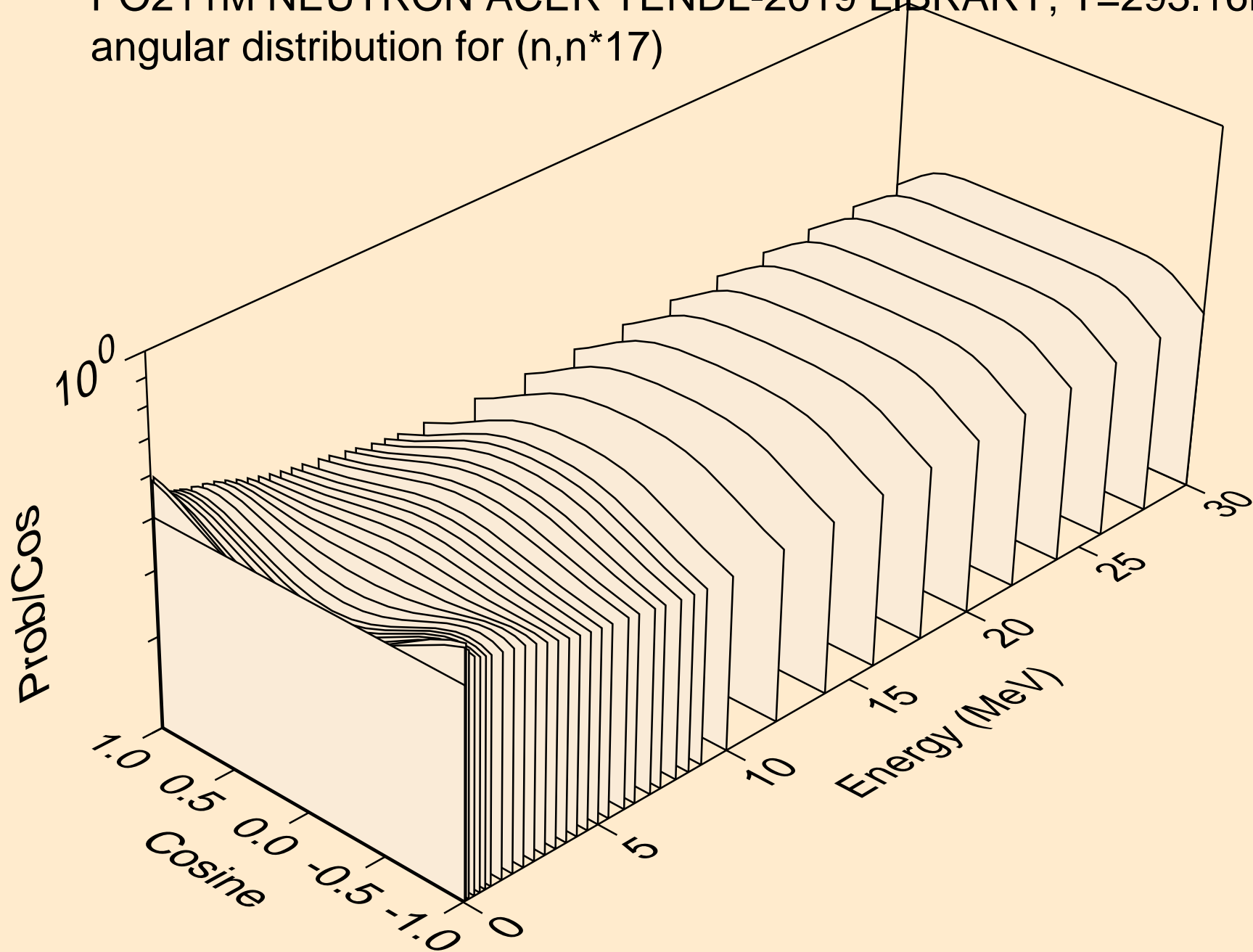

PO211M NEUTRON ACER TENDL-2019 LIBRARY; T=293.16K
angular distribution for (n,n*18)

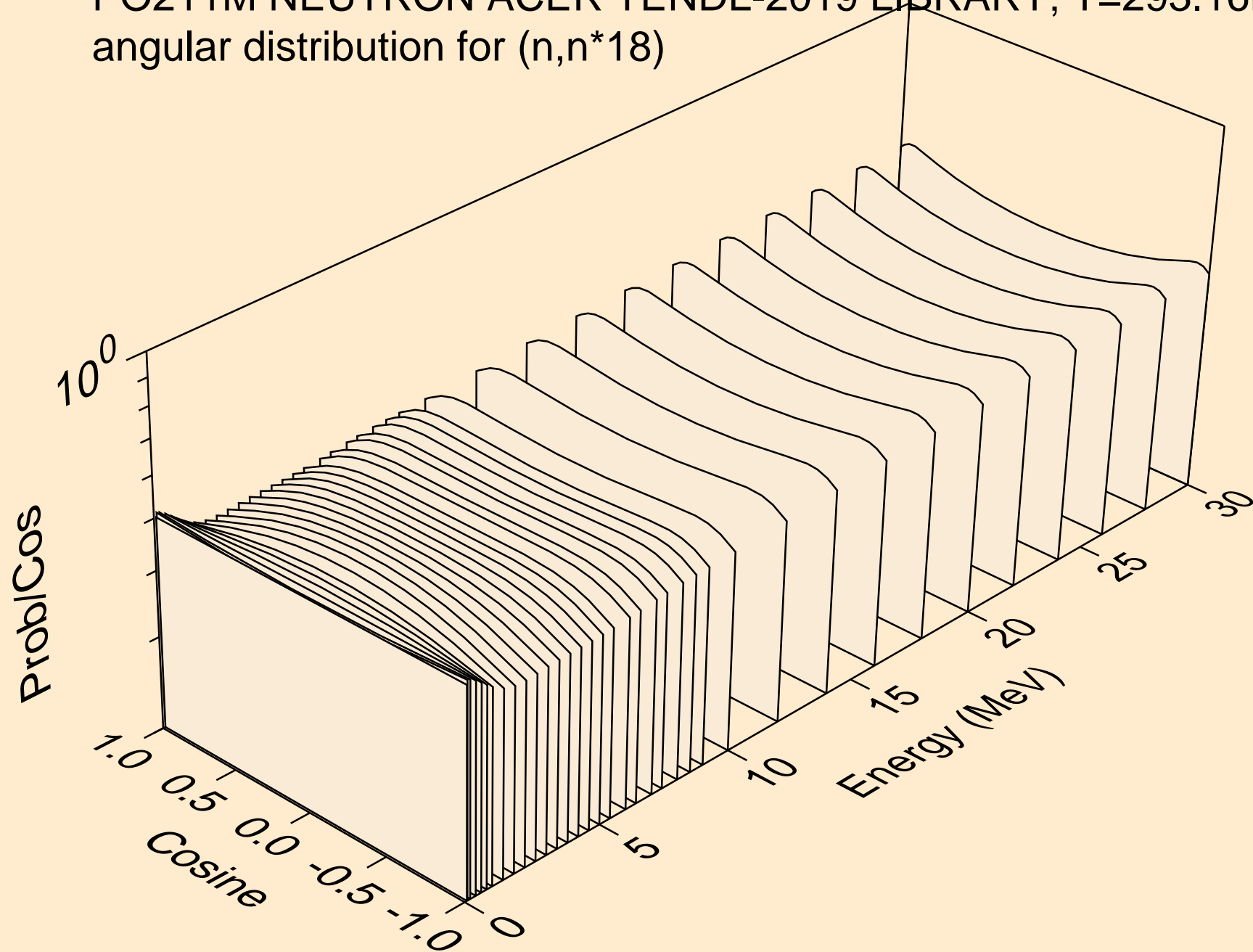

PO211M NEUTRON ACER TENDL-2019 LIBRARY; T=293.16K
Neutron emission for (n,x)

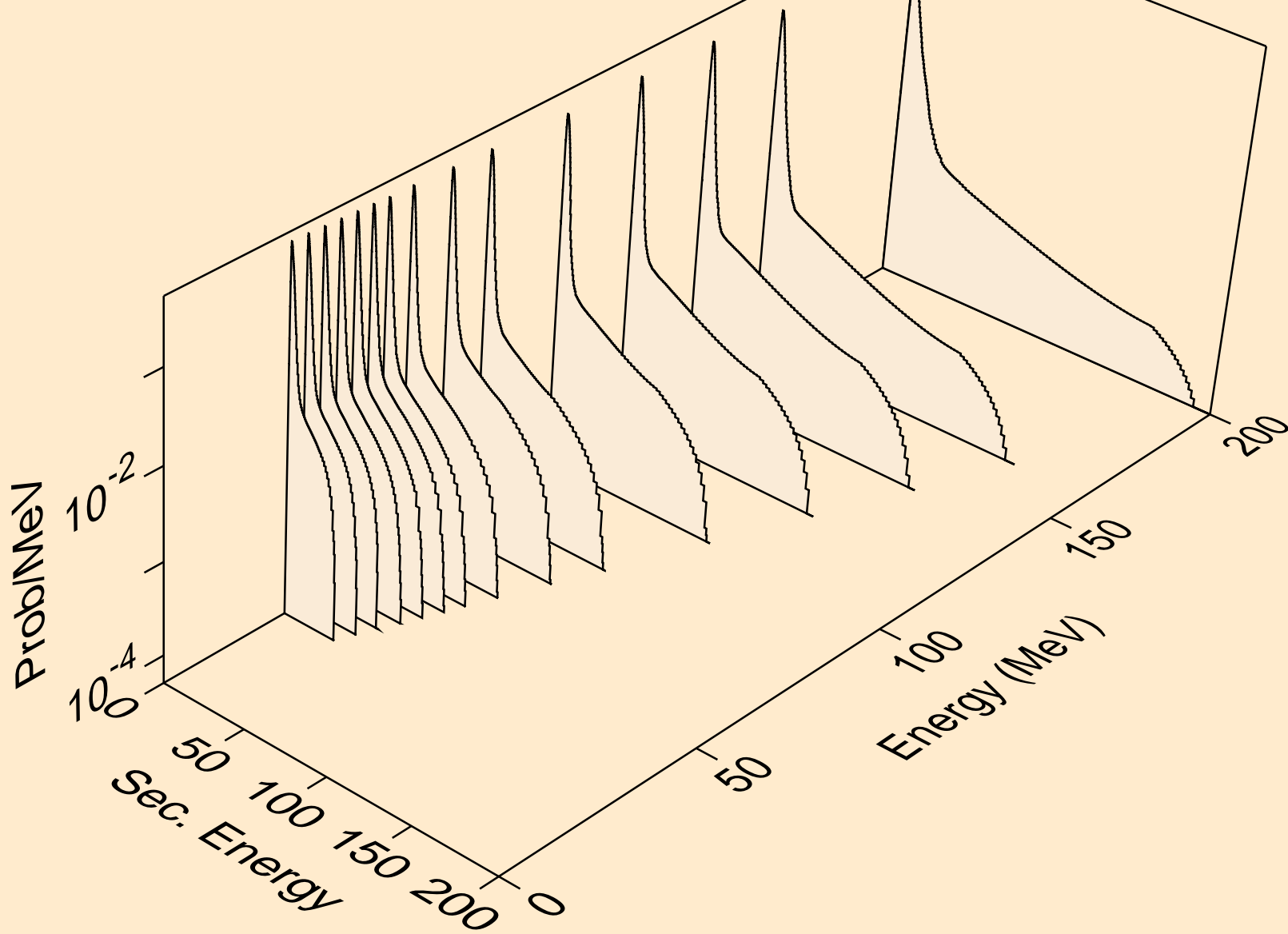

PO211M NEUTRON ACER TENDL-2019 LIBRARY; T=293.16K
Neutron emission for (n,2nd)

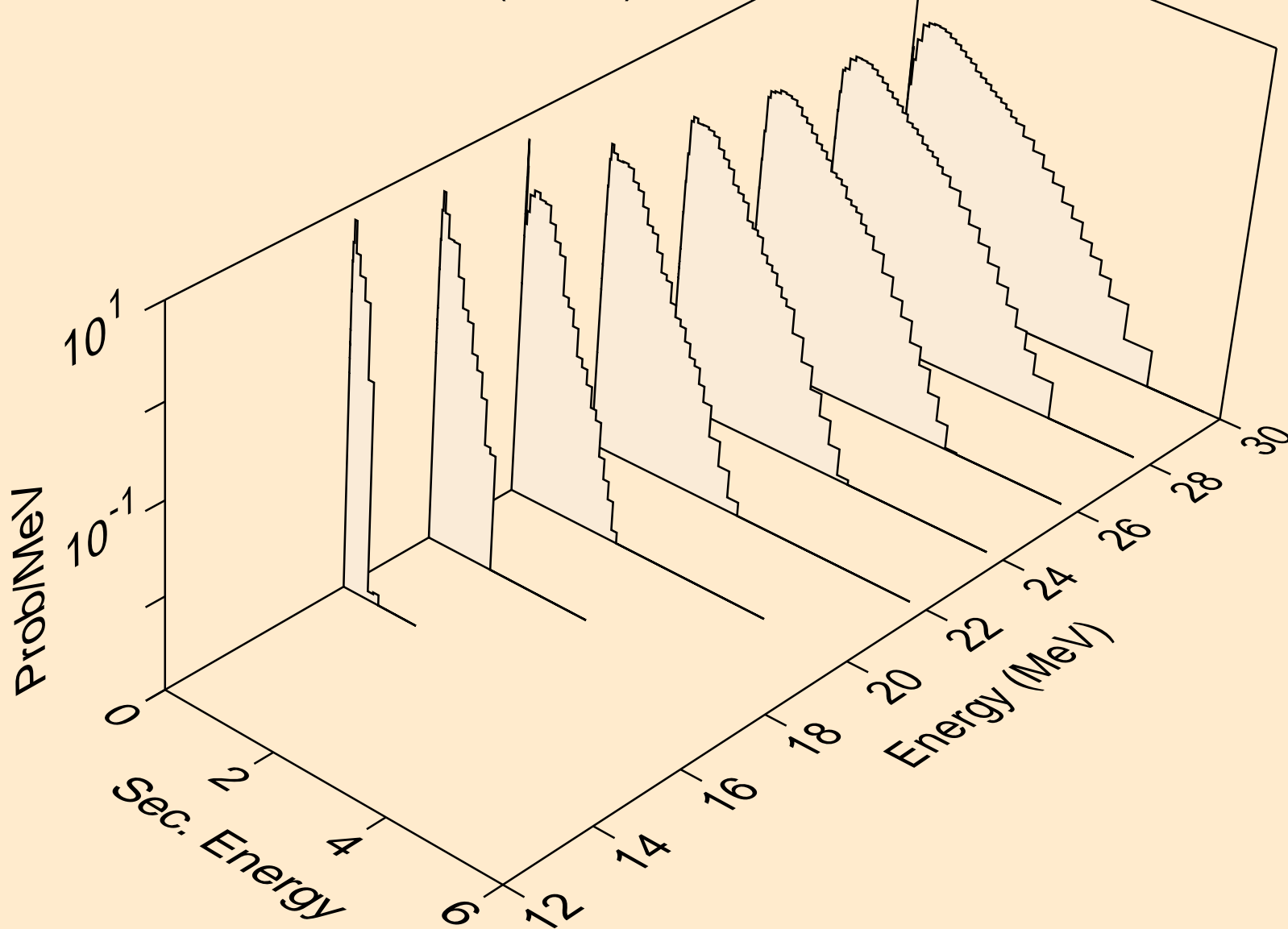

PO211M NEUTRON ACER TENDL-2019 LIBRARY; T=293.16K
Neutron emission for (n,2n)

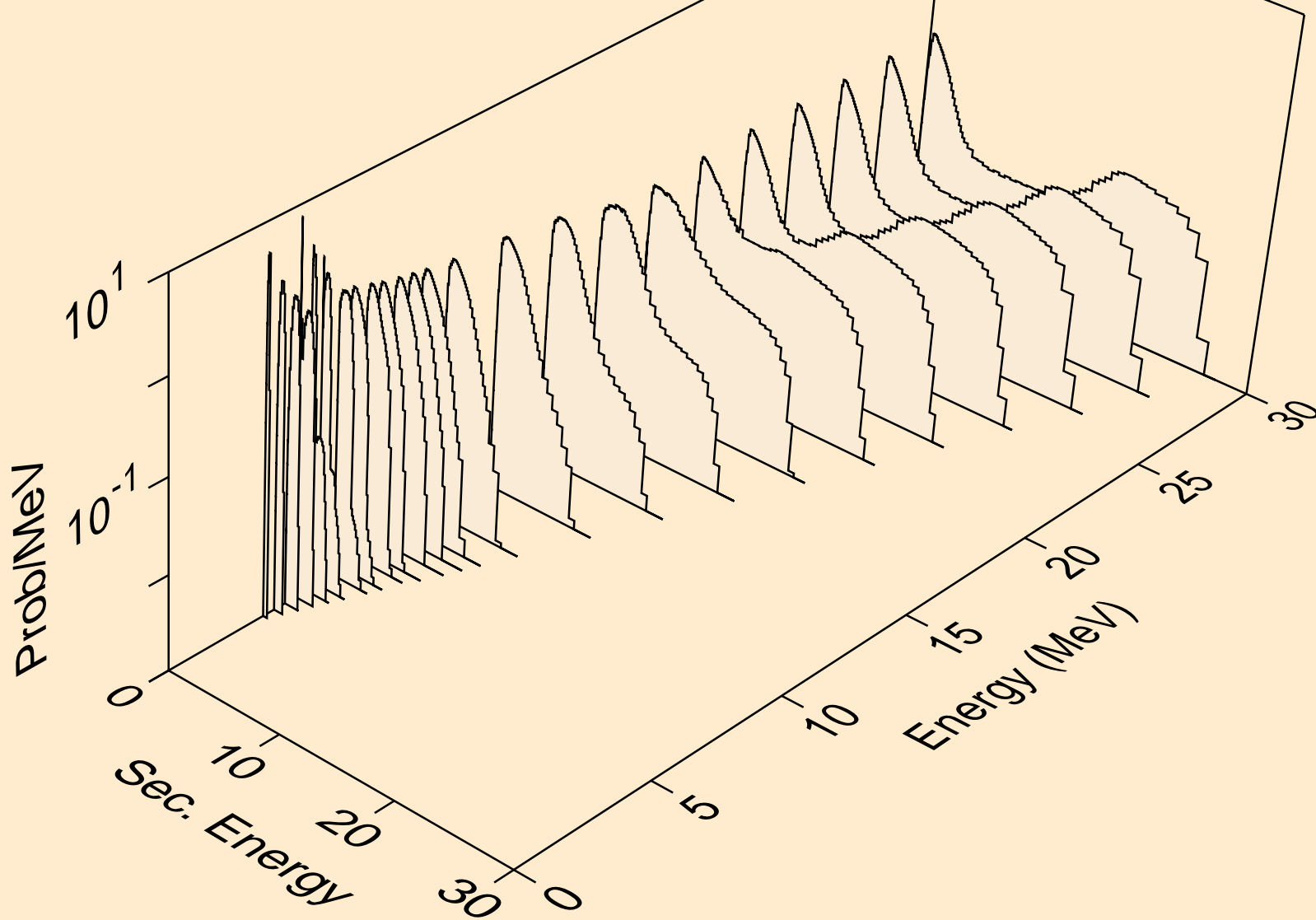

PO211M NEUTRON ACER TENDL-2019 LIBRARY; T=293.16K
Neutron emission for (n,3n)

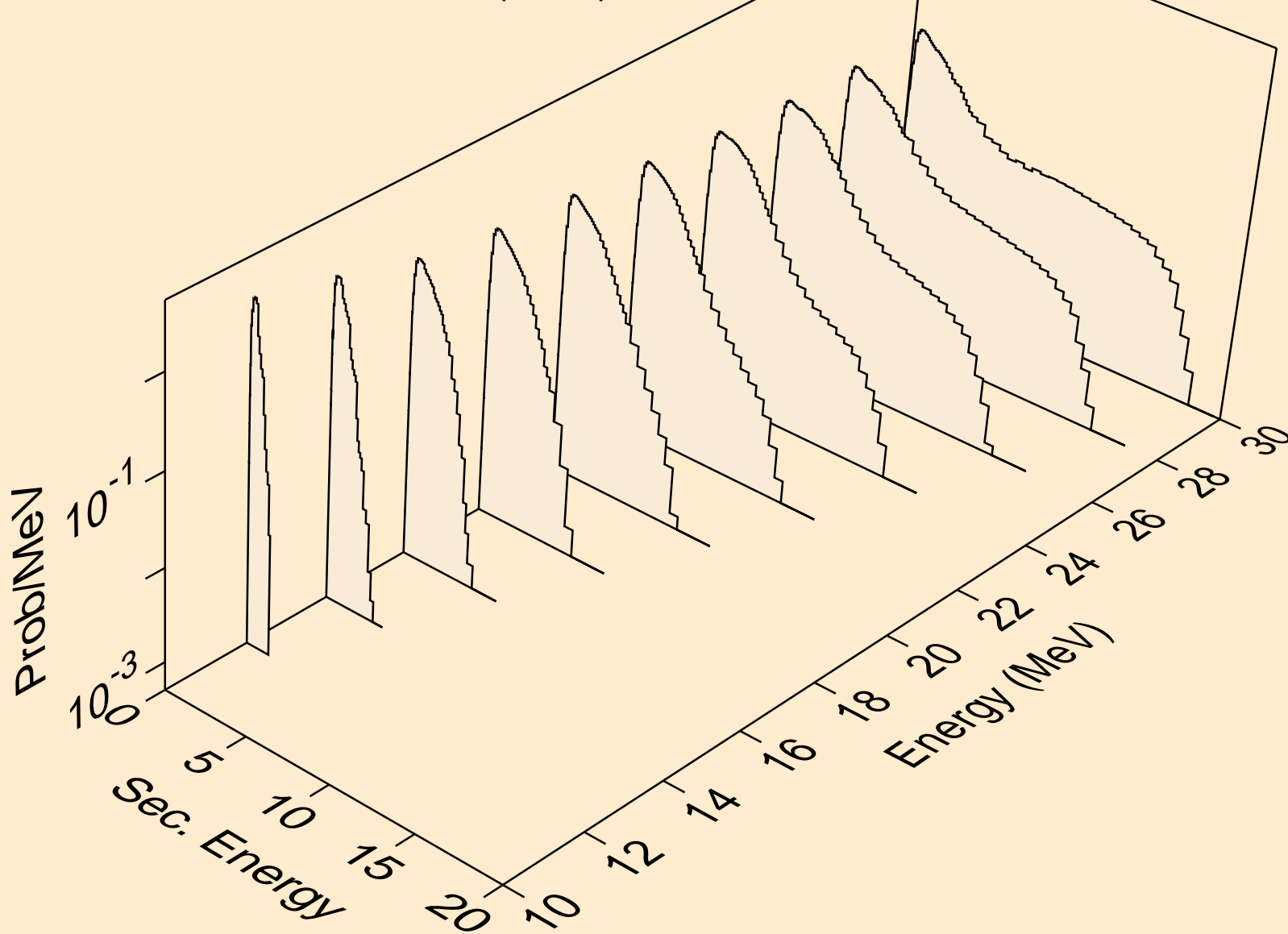

PO211M NEUTRON ACER TENDL-2019 LIBRARY; T=293.16K
Neutron emission for (n,n*)a

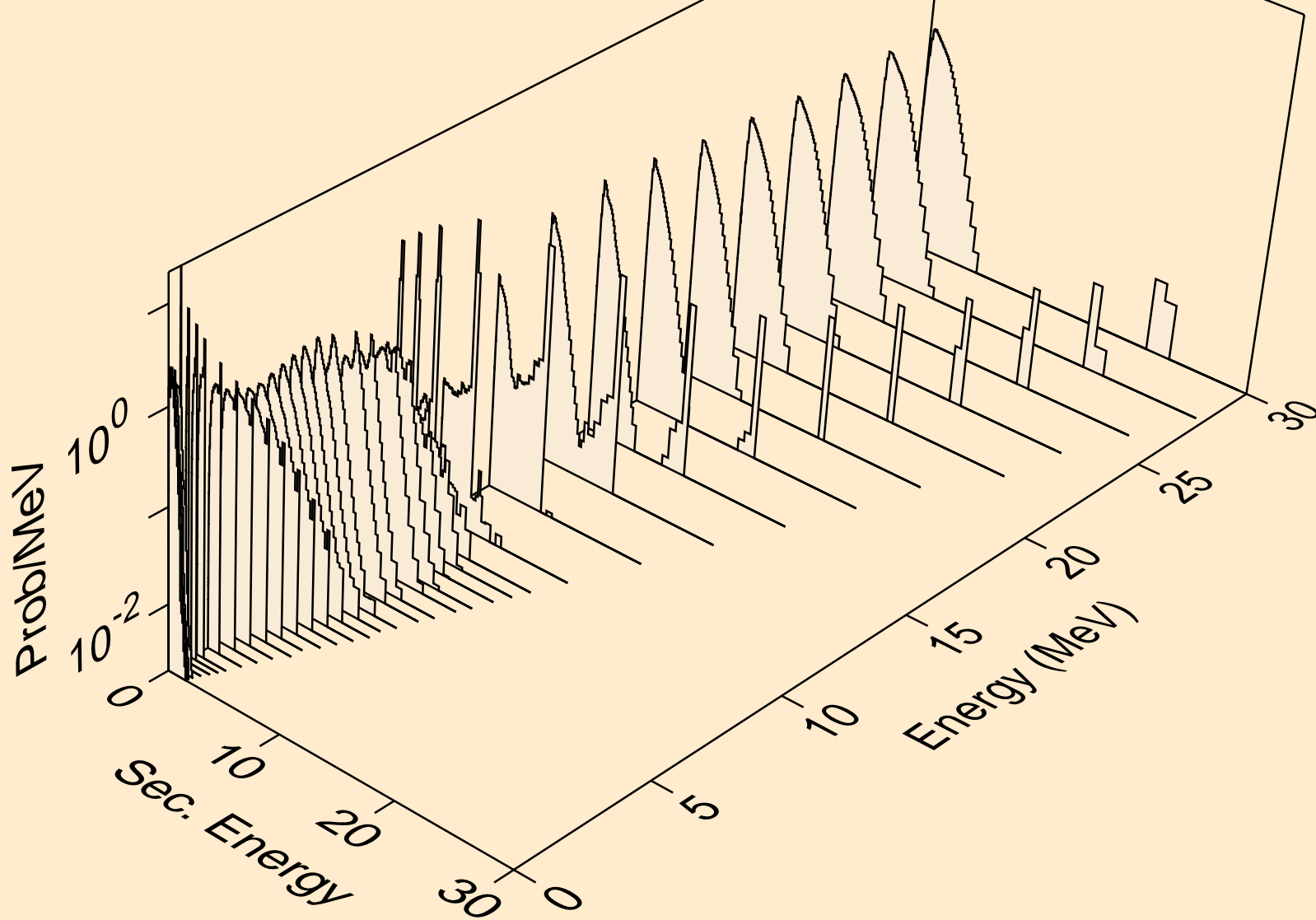

PO211M NEUTRON ACER TENDL-2019 LIBRARY; T=293.16K
Neutron emission for (n,2n)a

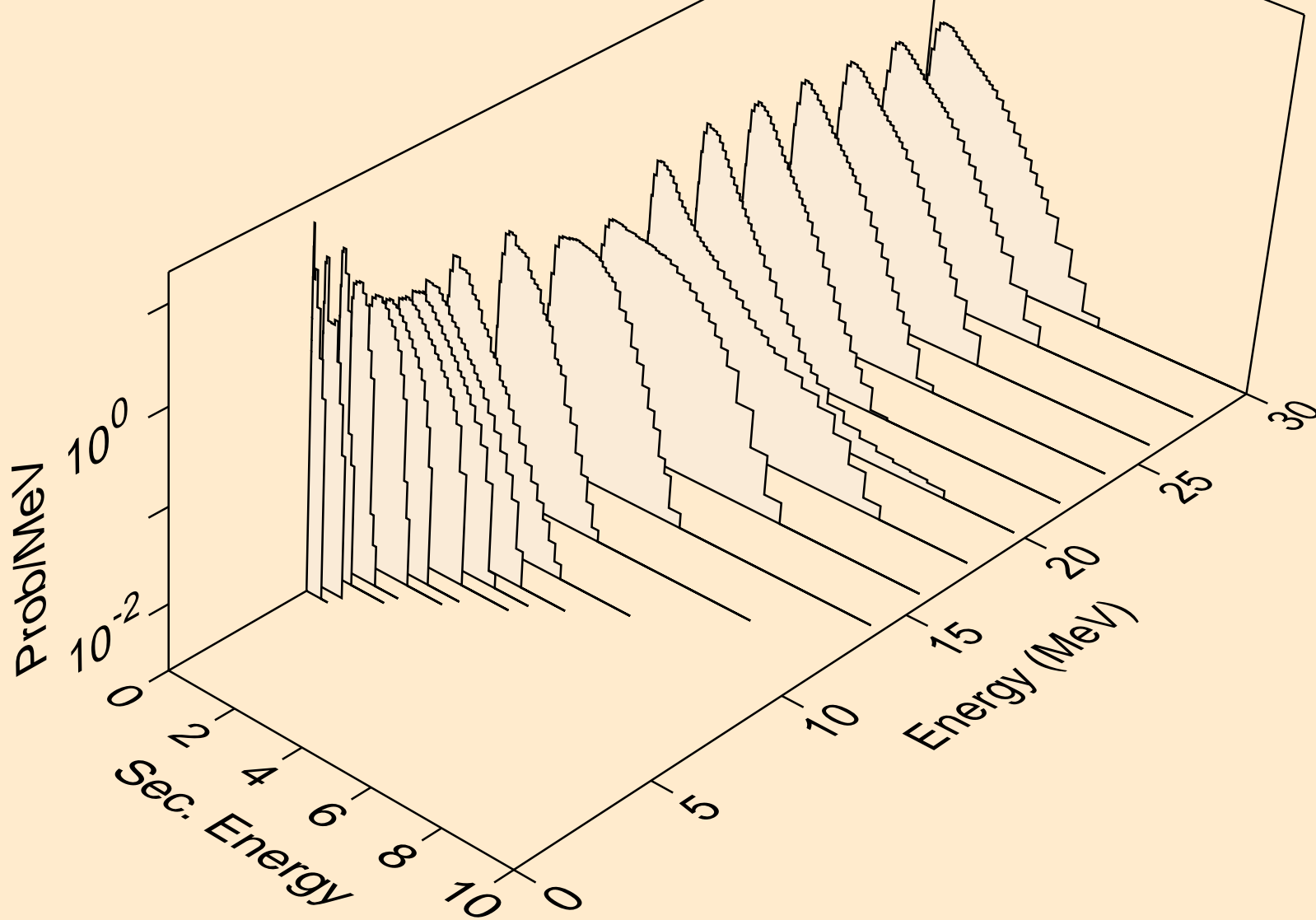

PO211M NEUTRON ACER TENDL-2019 LIBRARY; T=293.16K
Neutron emission for (n,3n)a

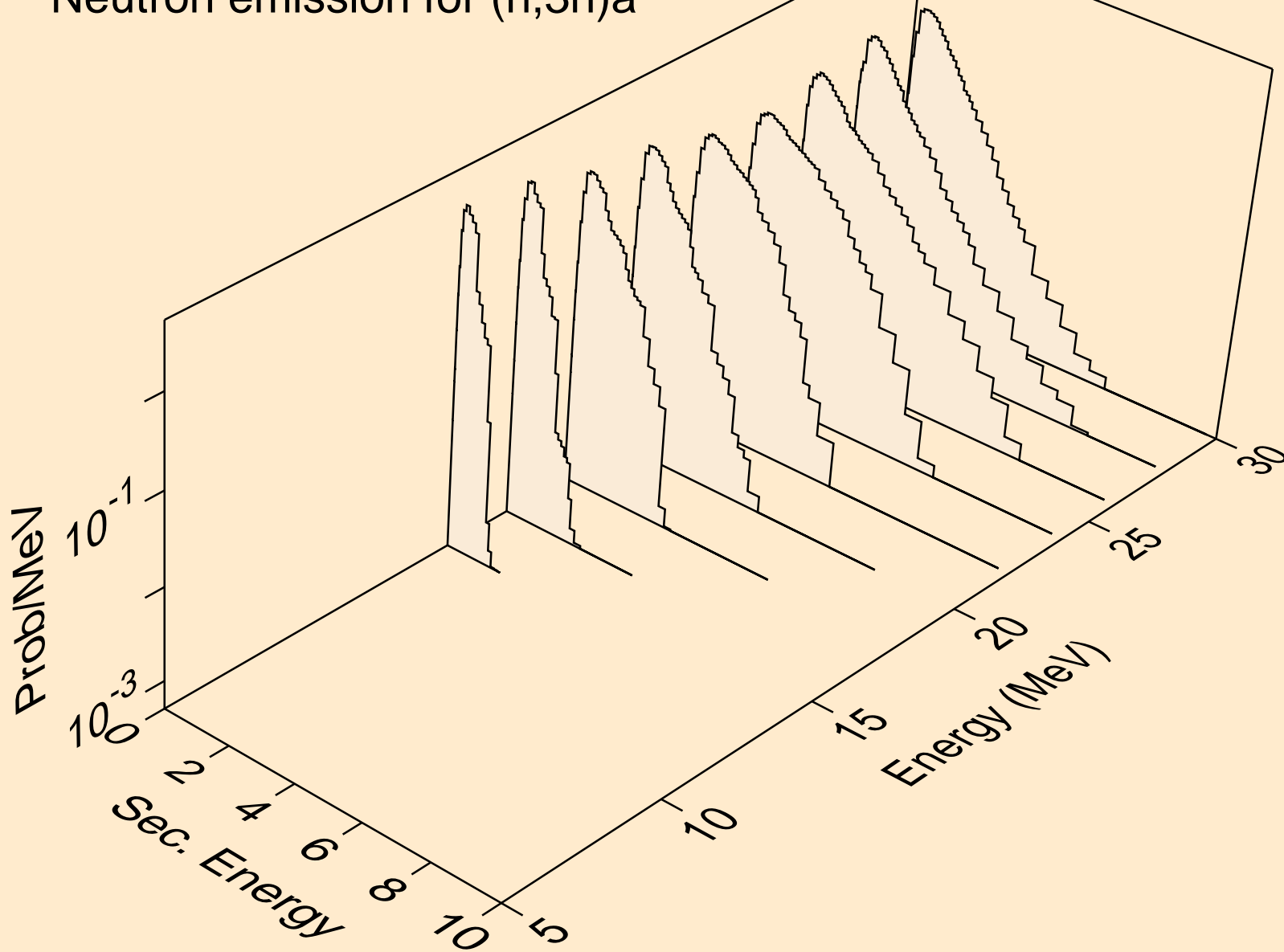

PO211M NEUTRON ACER TENDL-2019 LIBRARY; T=293.16K
Neutron emission for (n,n*)p

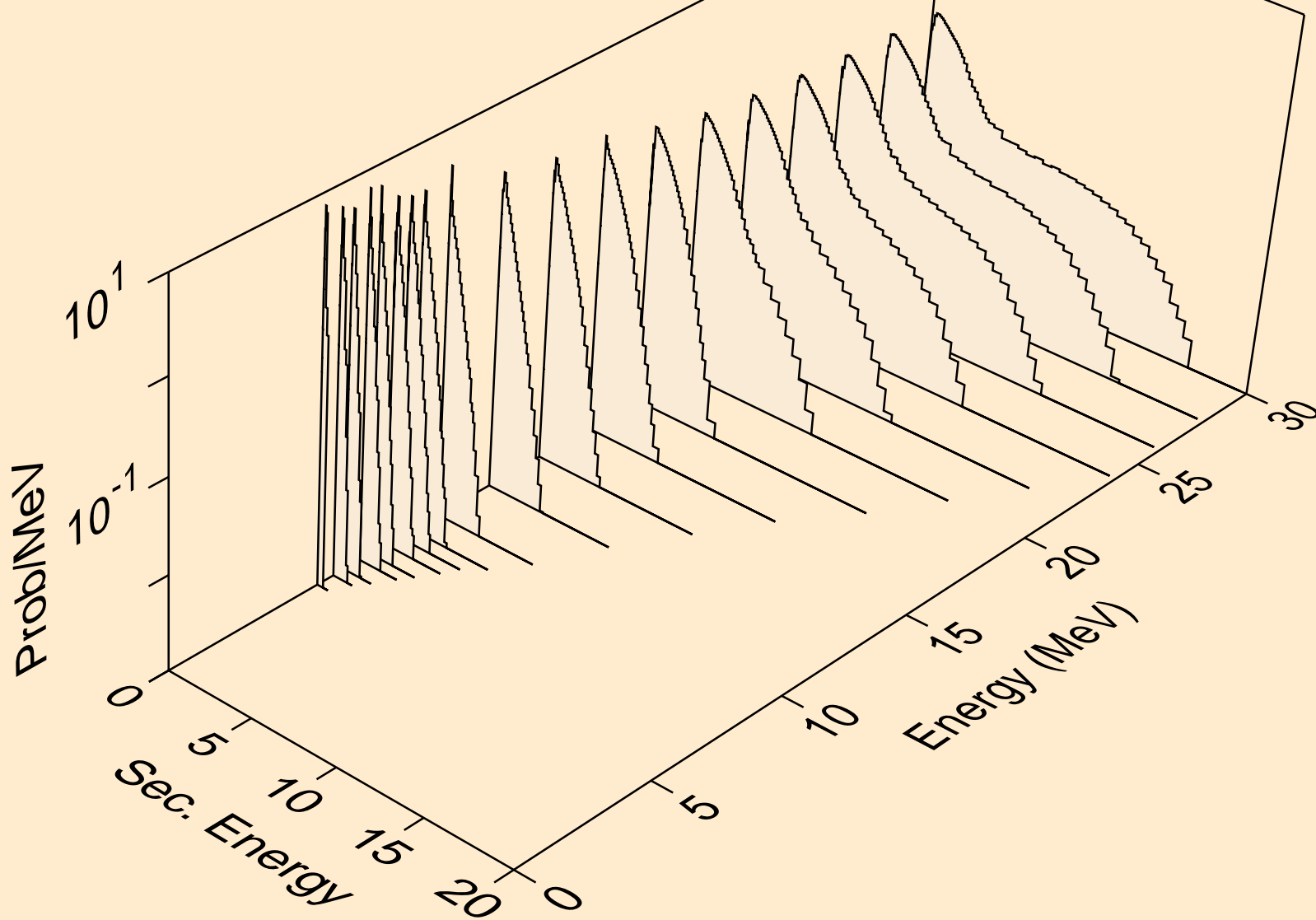

PO211M NEUTRON ACER TENDL-2019 LIBRARY; T=293.16K
Neutron emission for (n,n*)2a

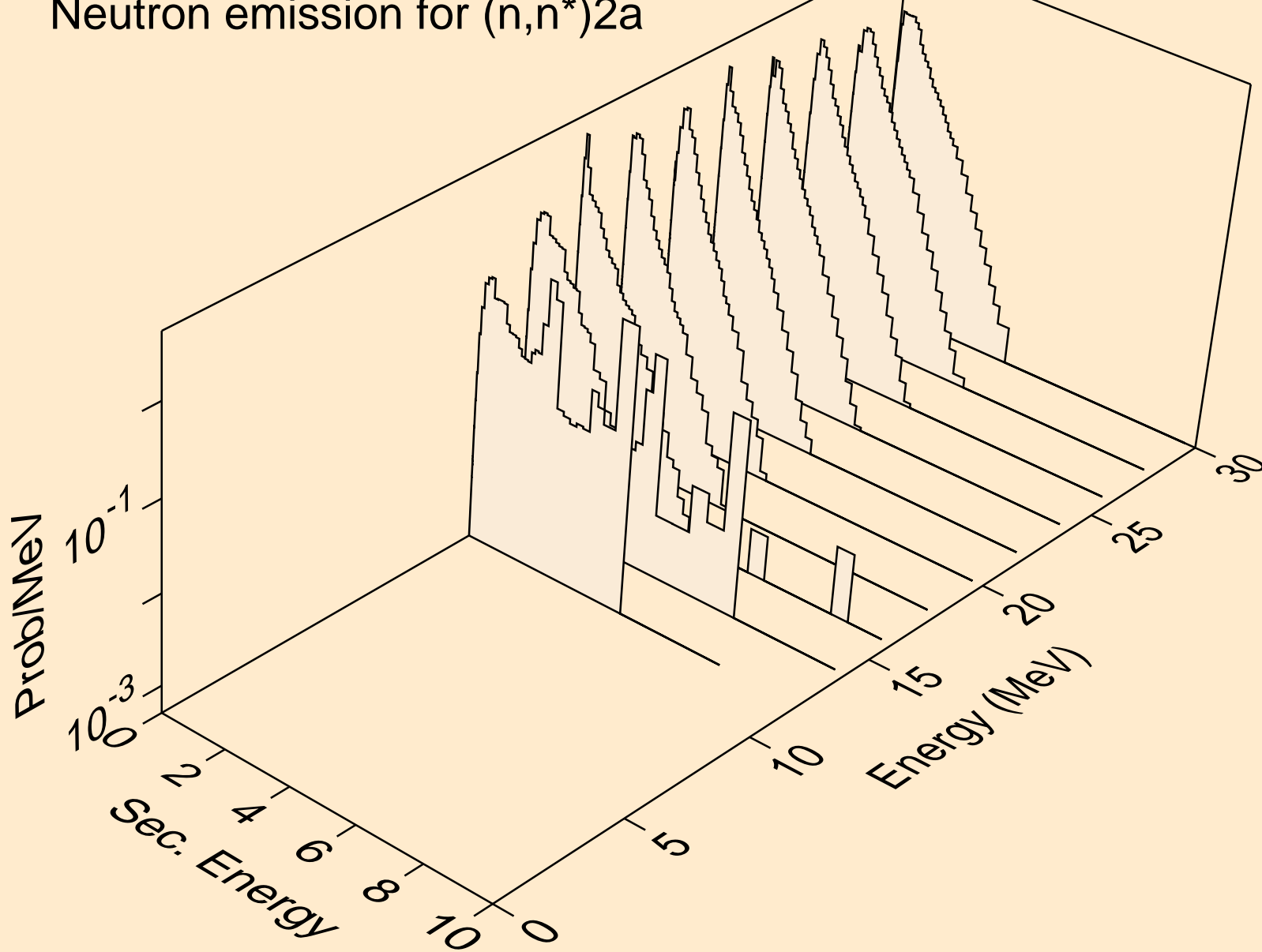

PO211M NEUTRON ACER TENDL-2019 LIBRARY; T=293.16K
Neutron emission for (n,2n)2a

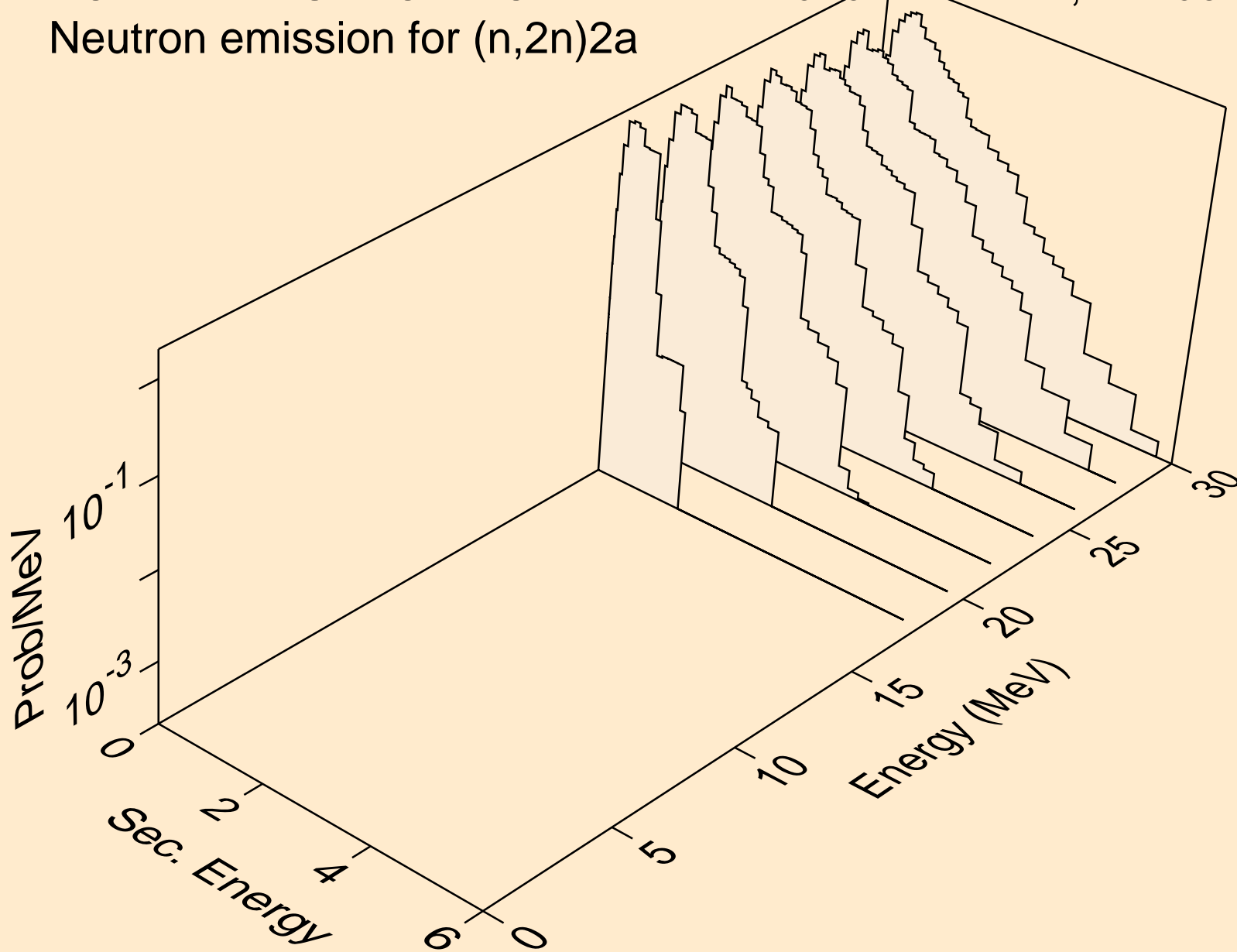

PO211M NEUTRON ACER TENDL-2019 LIBRARY; T=293.16K
Neutron emission for (n,n*)d

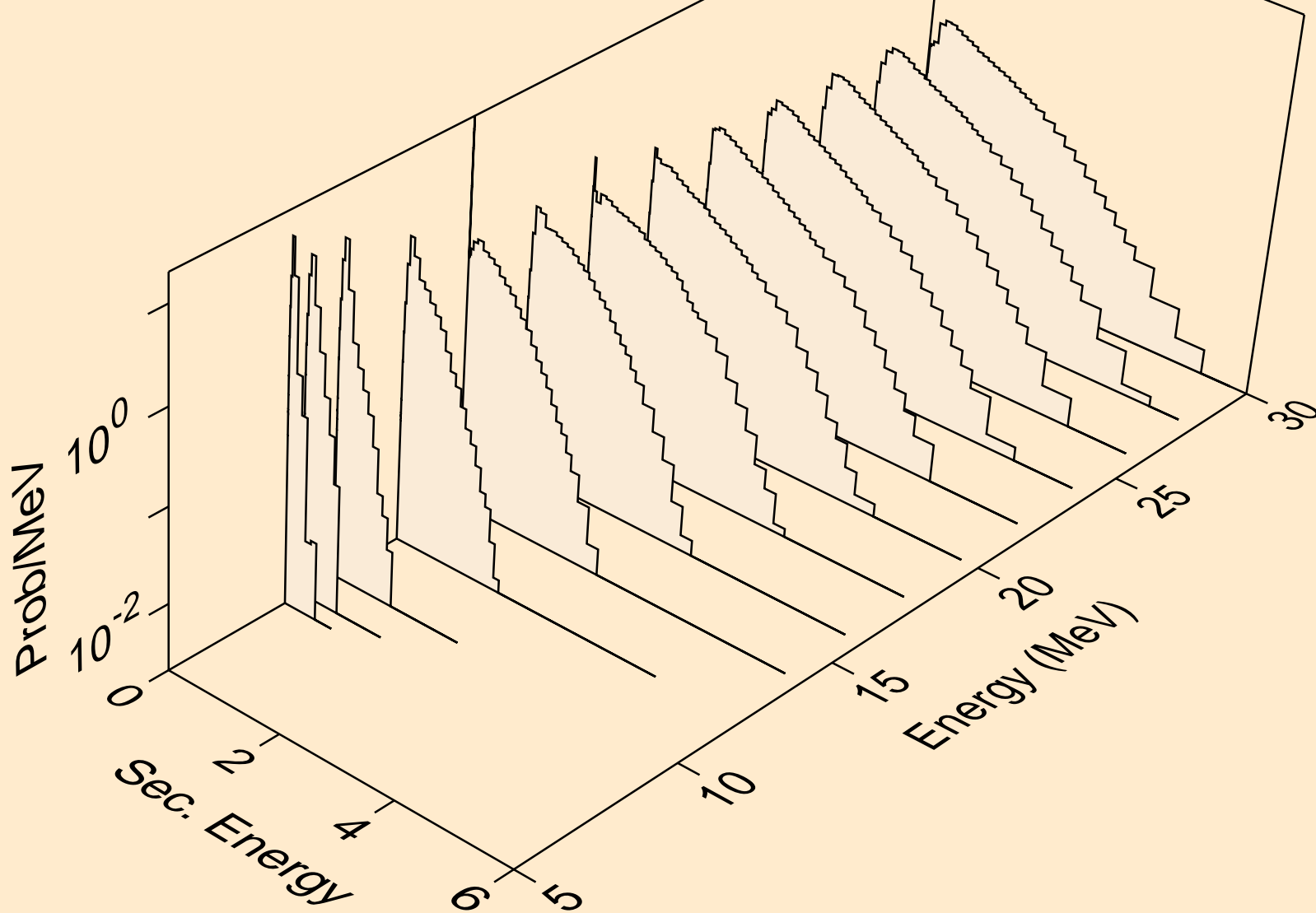

PO211M NEUTRON ACER TENDL-2019 LIBRARY; T=293.16K
Neutron emission for (n,n*)t

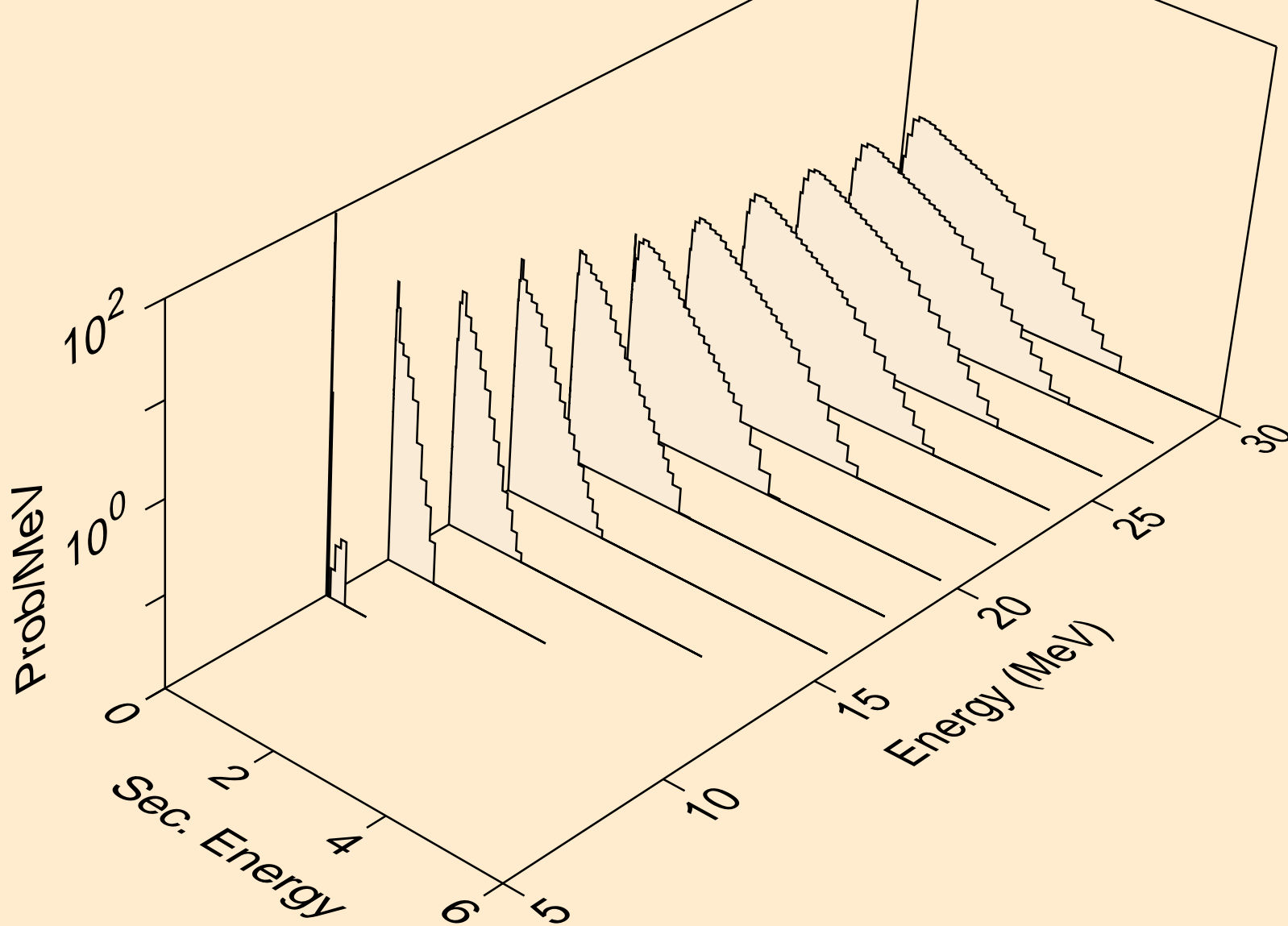

PO211M NEUTRON ACER TENDL-2019 LIBRARY; T=293.16K
Neutron emission for (n,n*)he3

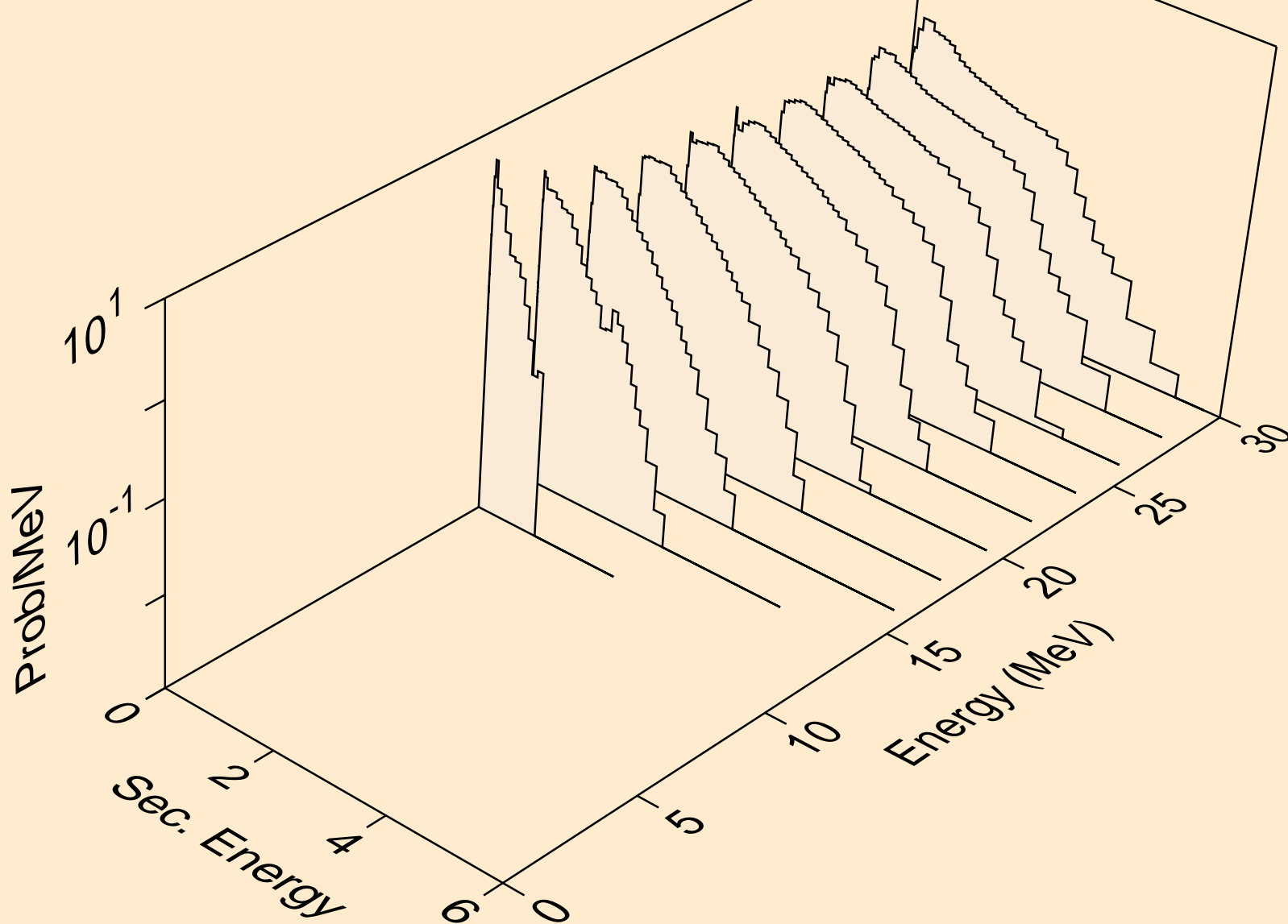

PO211M NEUTRON ACER TENDL-2019 LIBRARY; T=293.16K
Neutron emission for (n,4n)

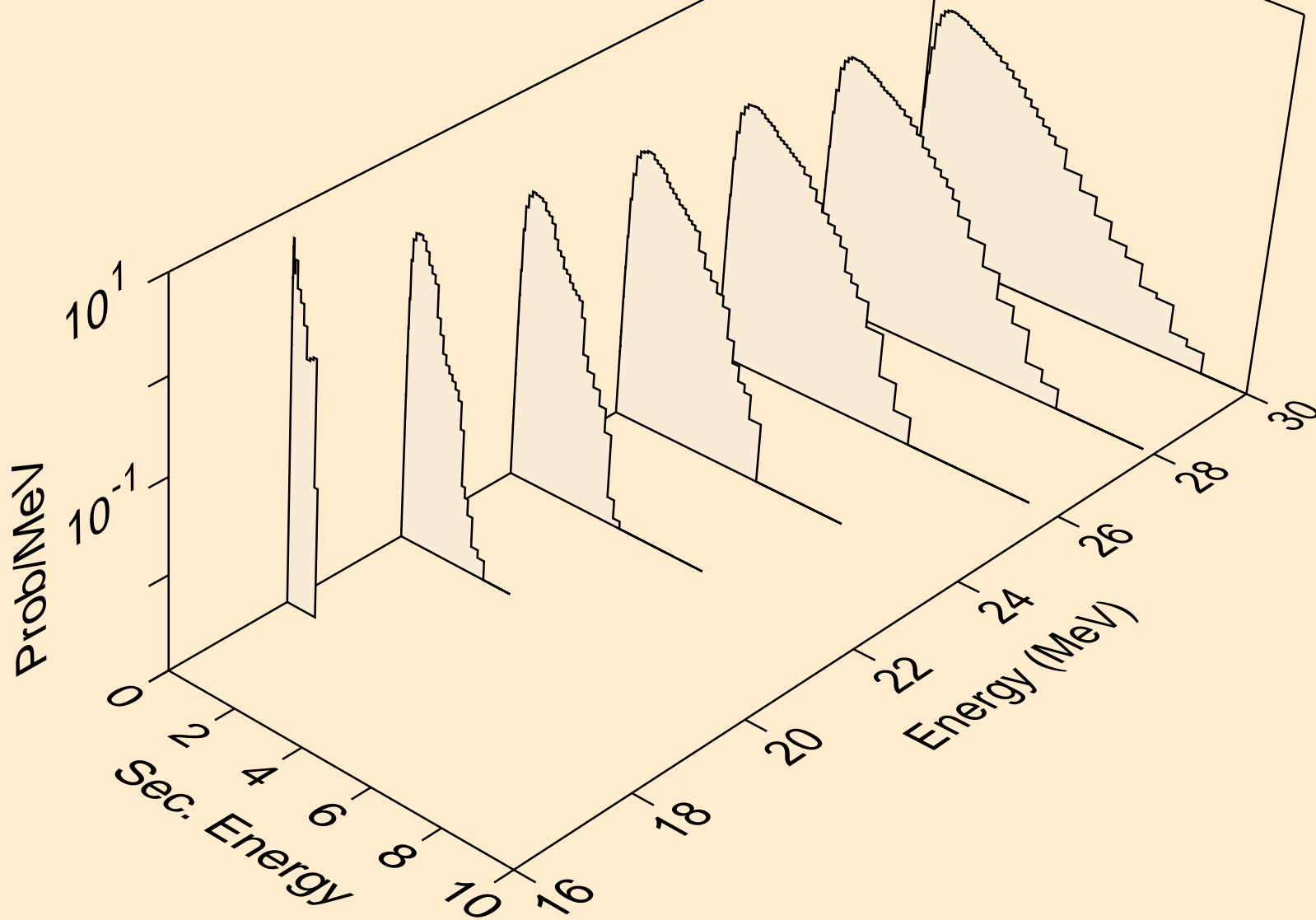

PO211M NEUTRON ACER TENDL-2019 LIBRARY; T=293.16K
Neutron emission for (n,2np)

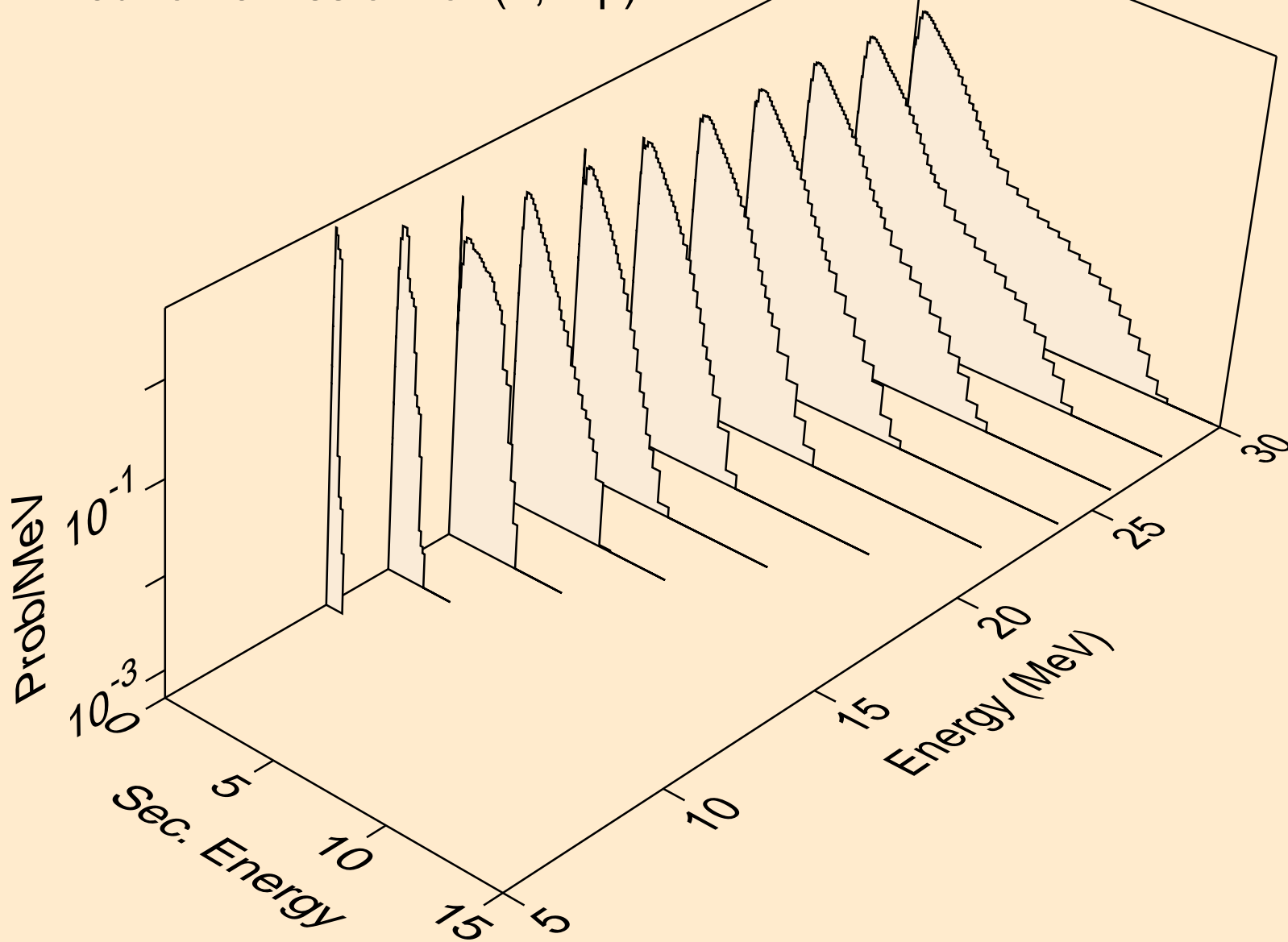

PO211M NEUTRON ACER TENDL-2019 LIBRARY; T=293.16K
Neutron emission for (n,3np)

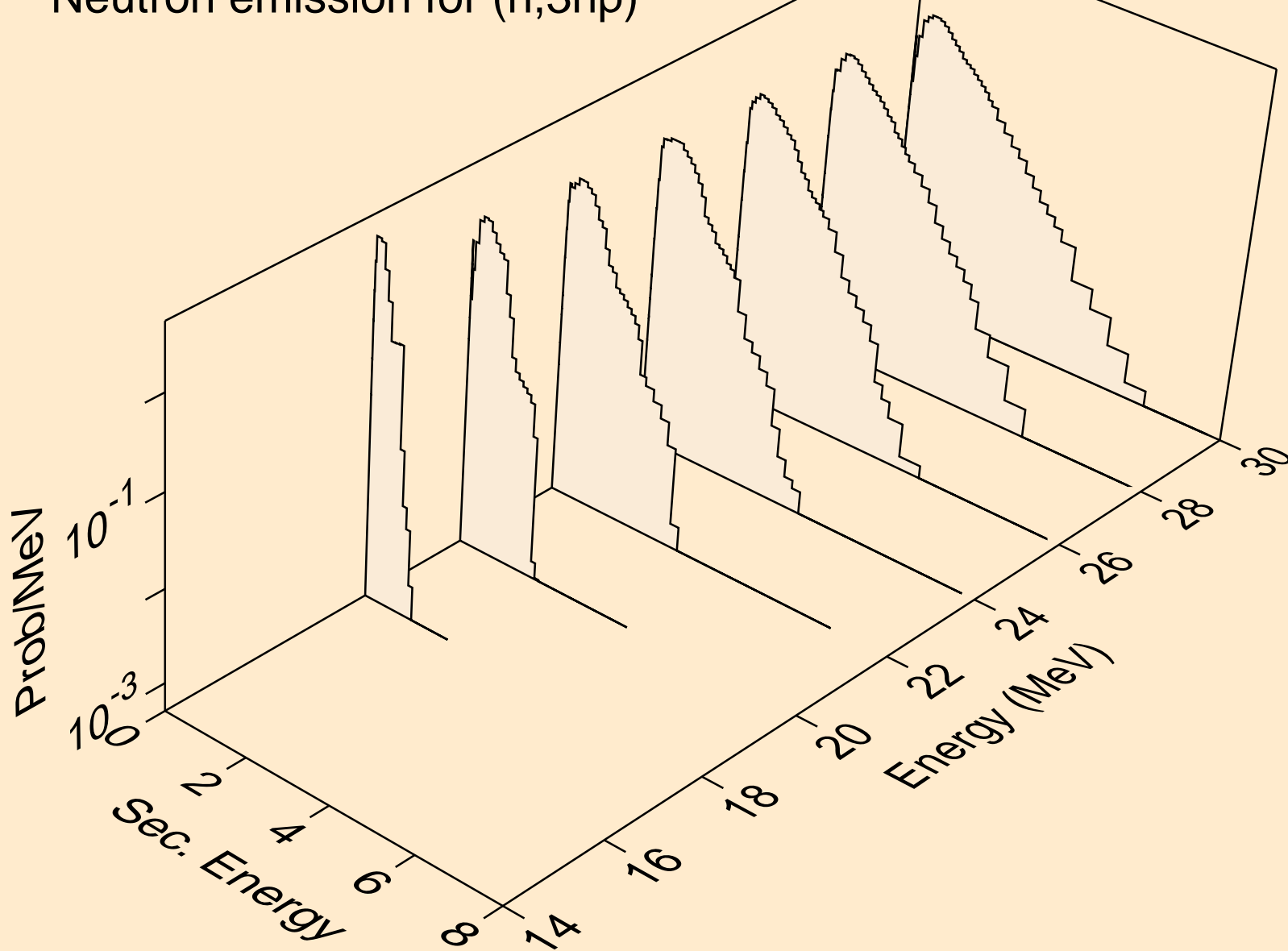

PO211M NEUTRON ACER TENDL-2019 LIBRARY; T=293.16K
Neutron emission for (n,2np)

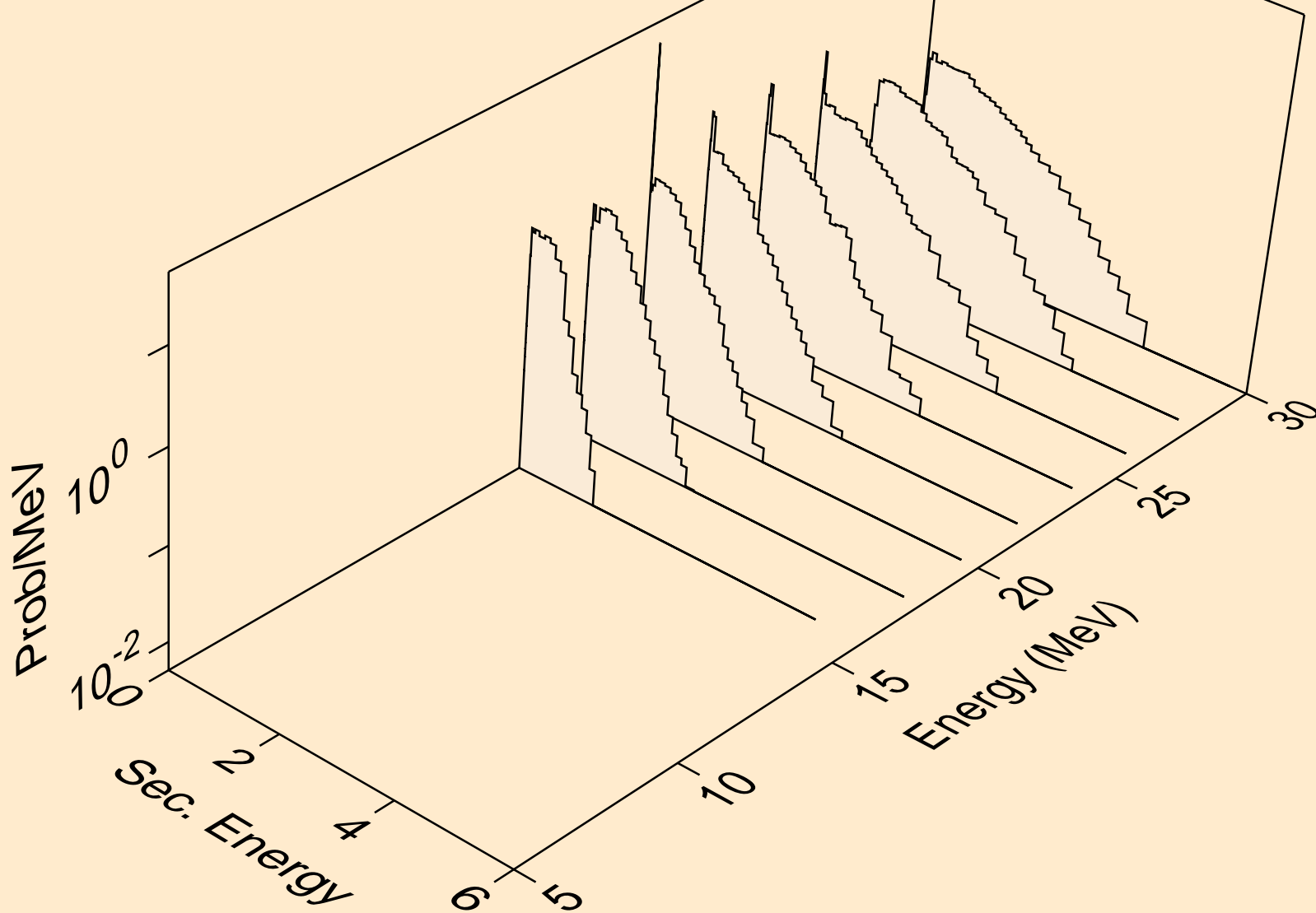

PO211M NEUTRON ACER TENDL-2019 LIBRARY; T=293.16K
Neutron emission for (n,npa)

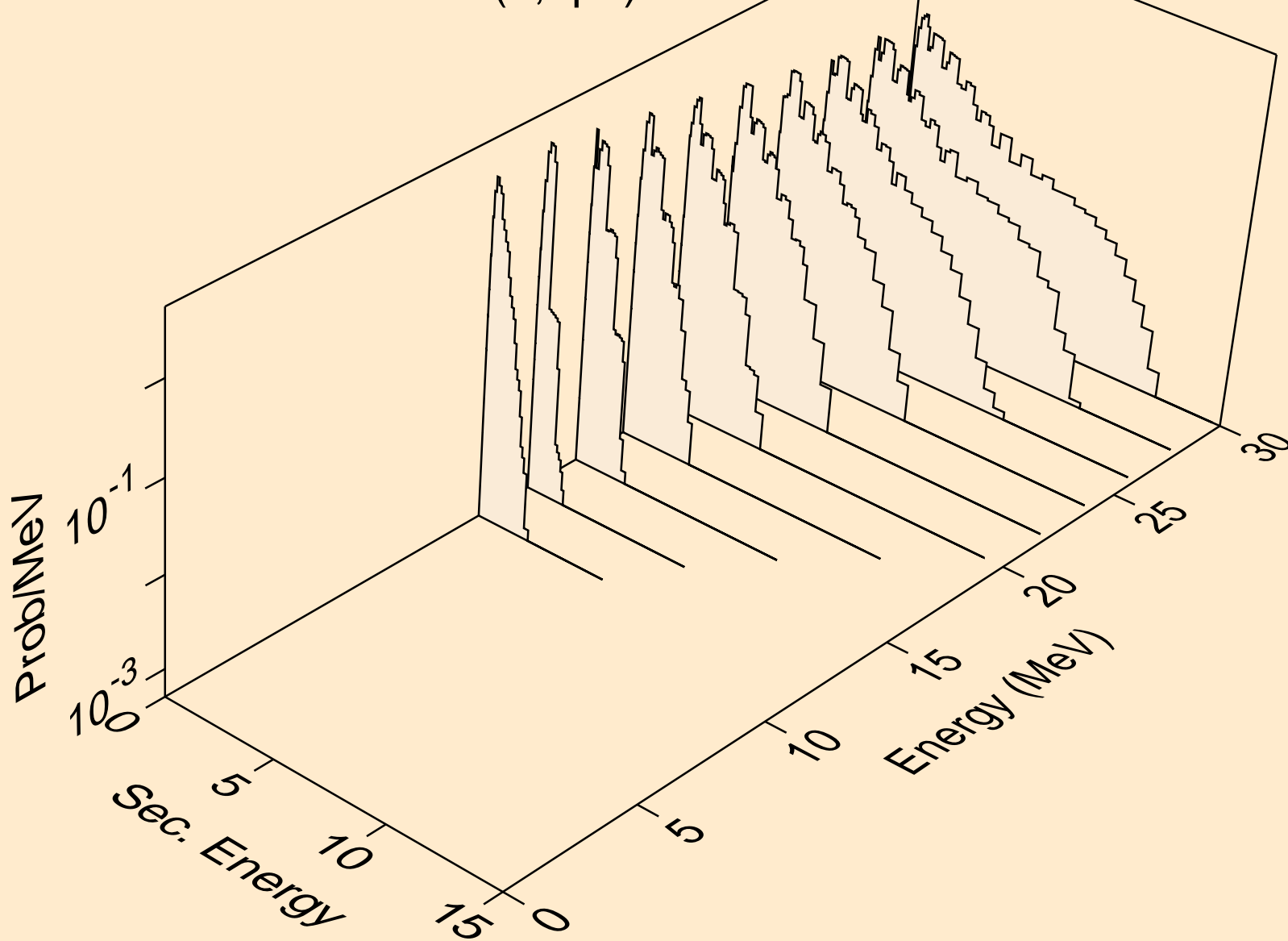

PO211M NEUTRON ACER TENDL-2019 LIBRARY; T=293.16K
Neutron emission for (n,n*c)

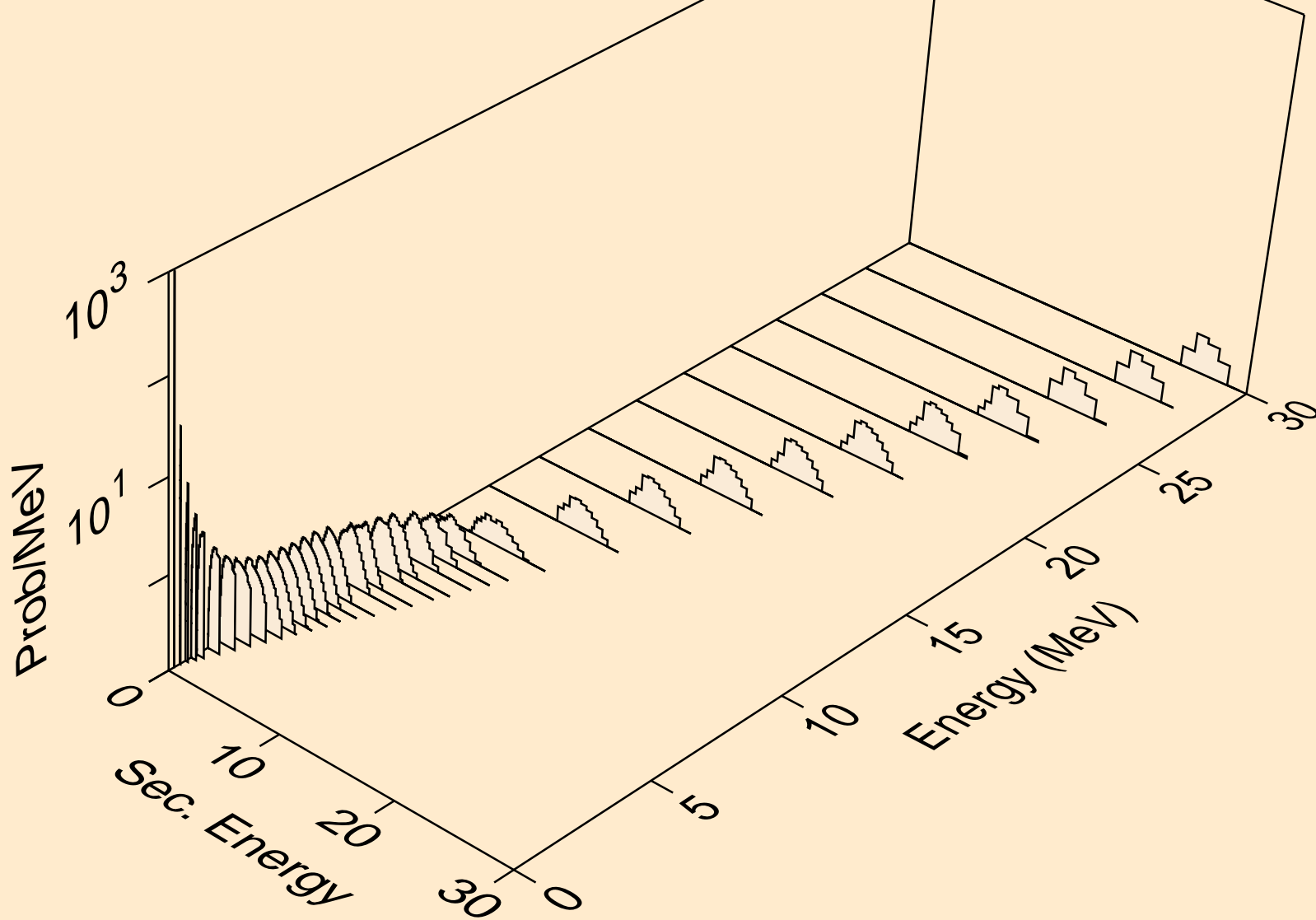

PO211M NEUTRON ACER TENDL-2019 LIBRARY; T=293.16K
Photon emission for (n,x)

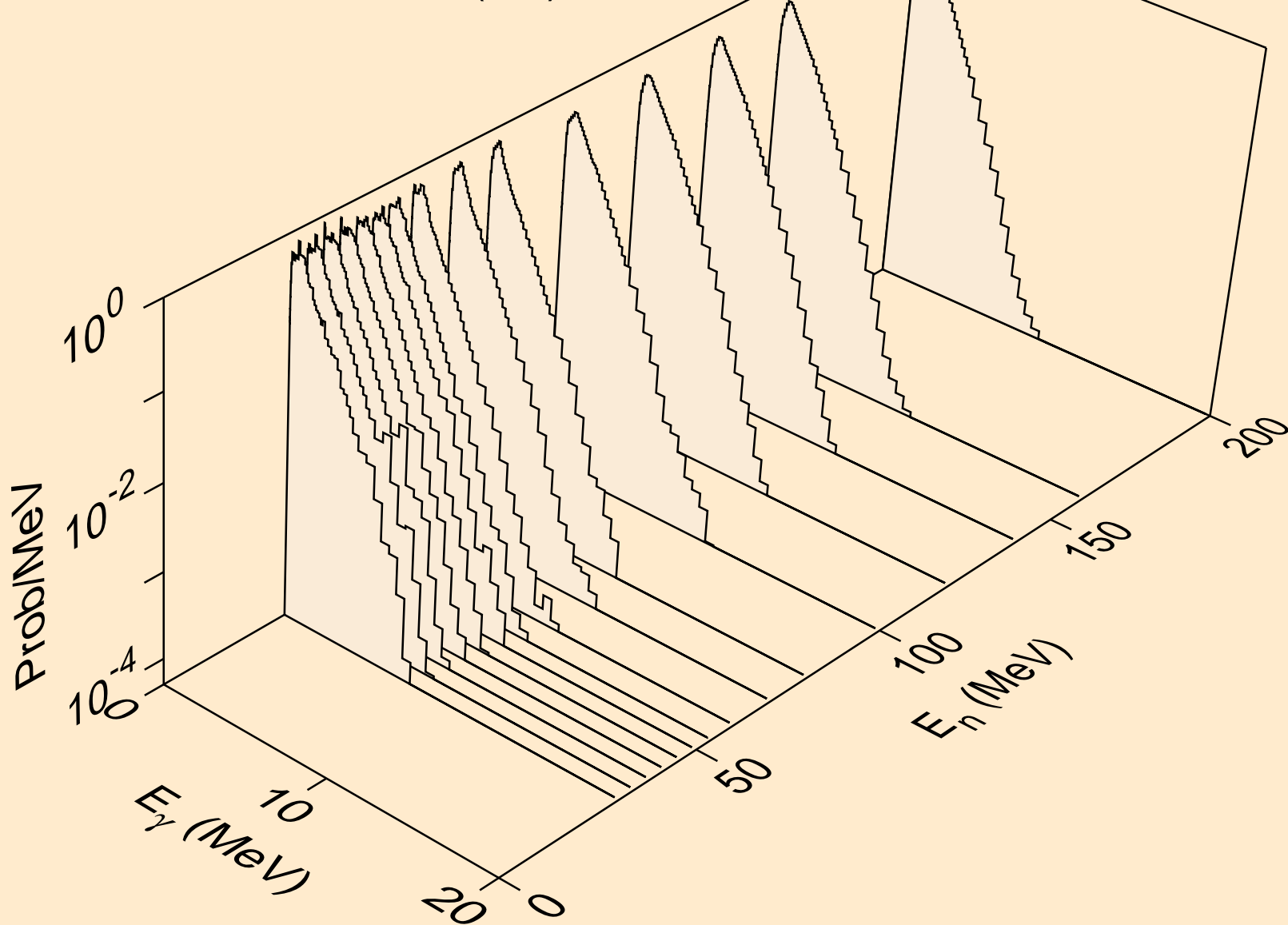

PO211M NEUTRON ACER TENDL-2019 LIBRARY; T=293.16K
Photon emission for (n,2nd)

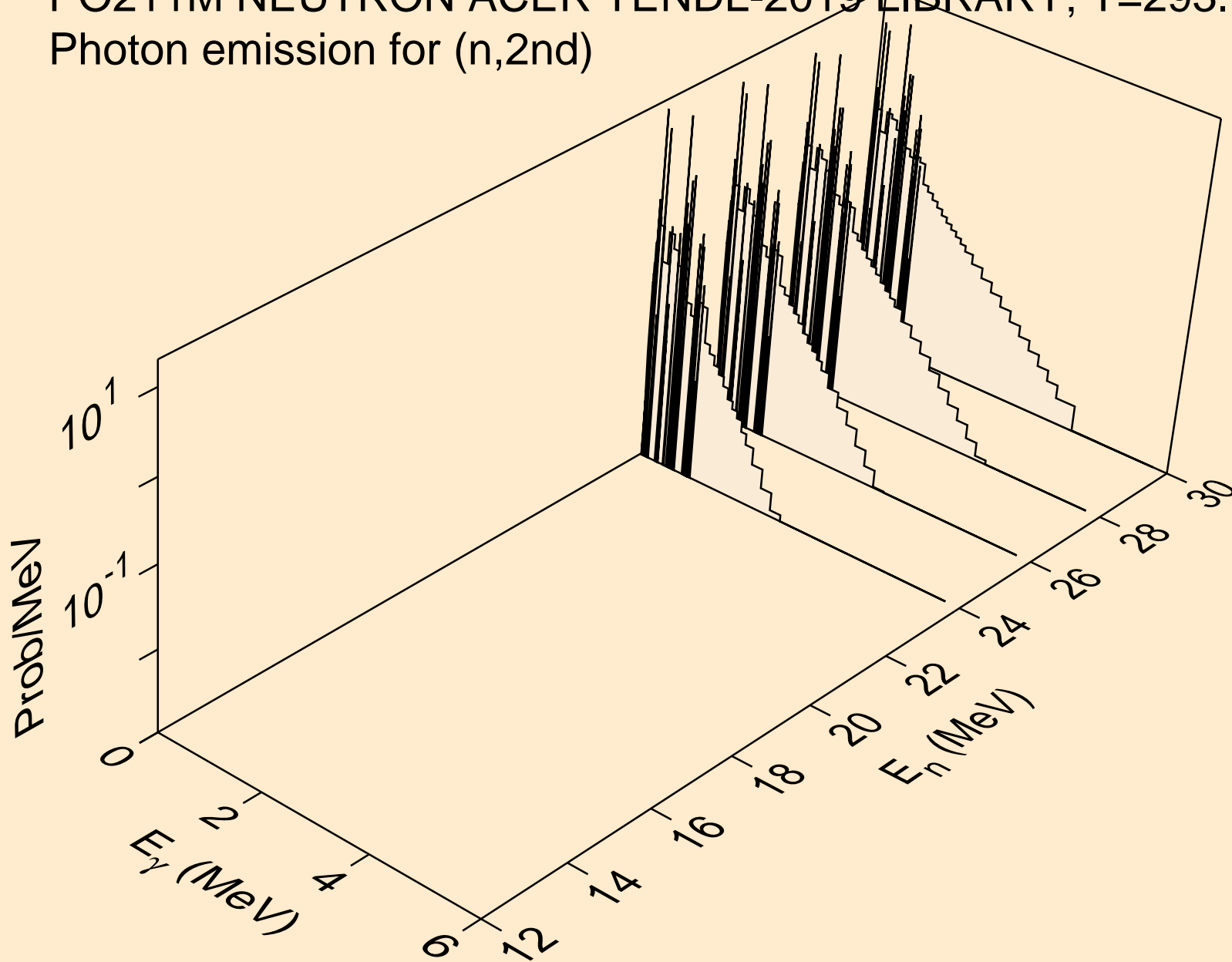

PO211M NEUTRON ACER TENDL-2019 LIBRARY; T=293.16K
Photon emission for (n,2n)

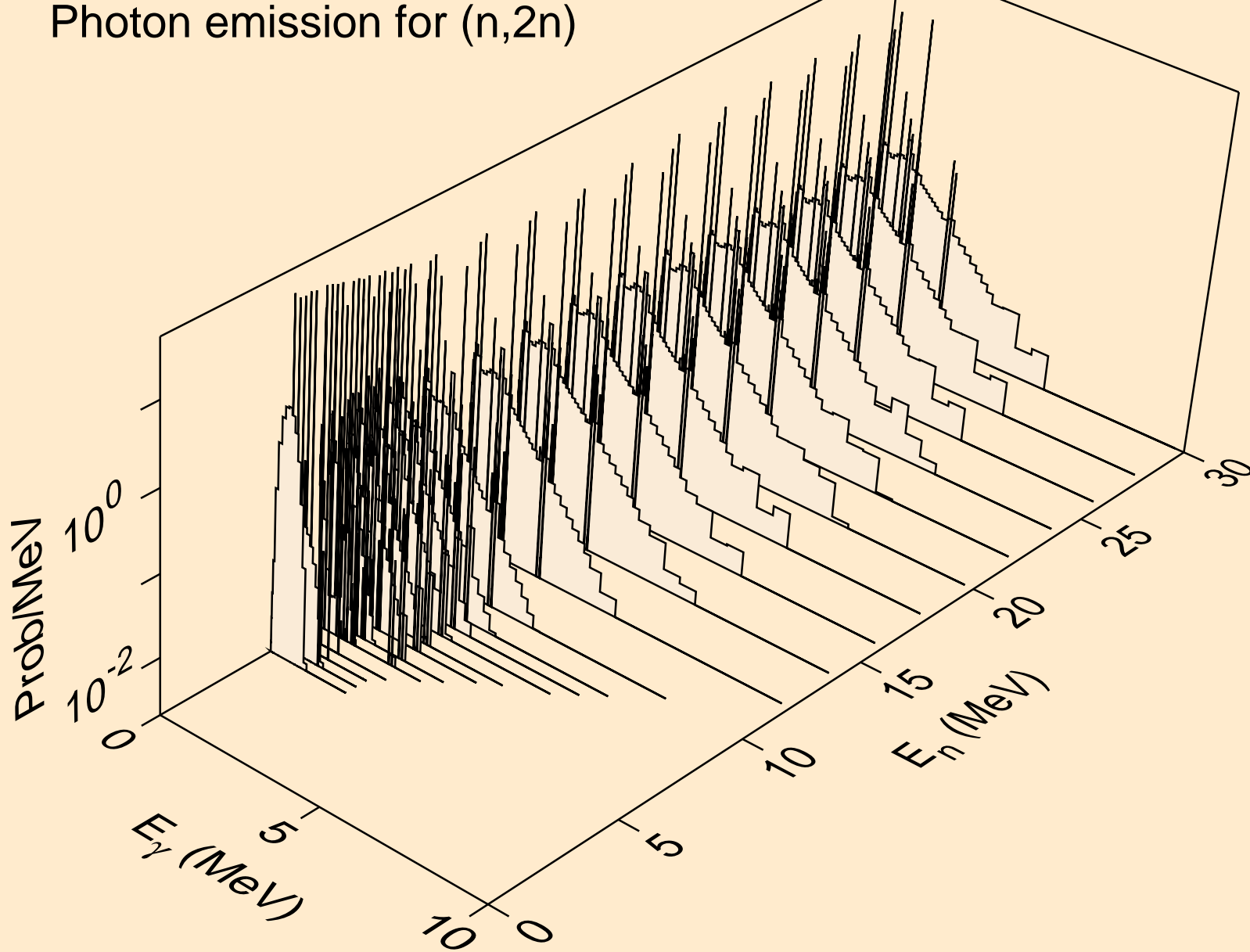

PO211M NEUTRON ACER TENDL-2019 LIBRARY; T=293.16K
Photon emission for (n,3n)

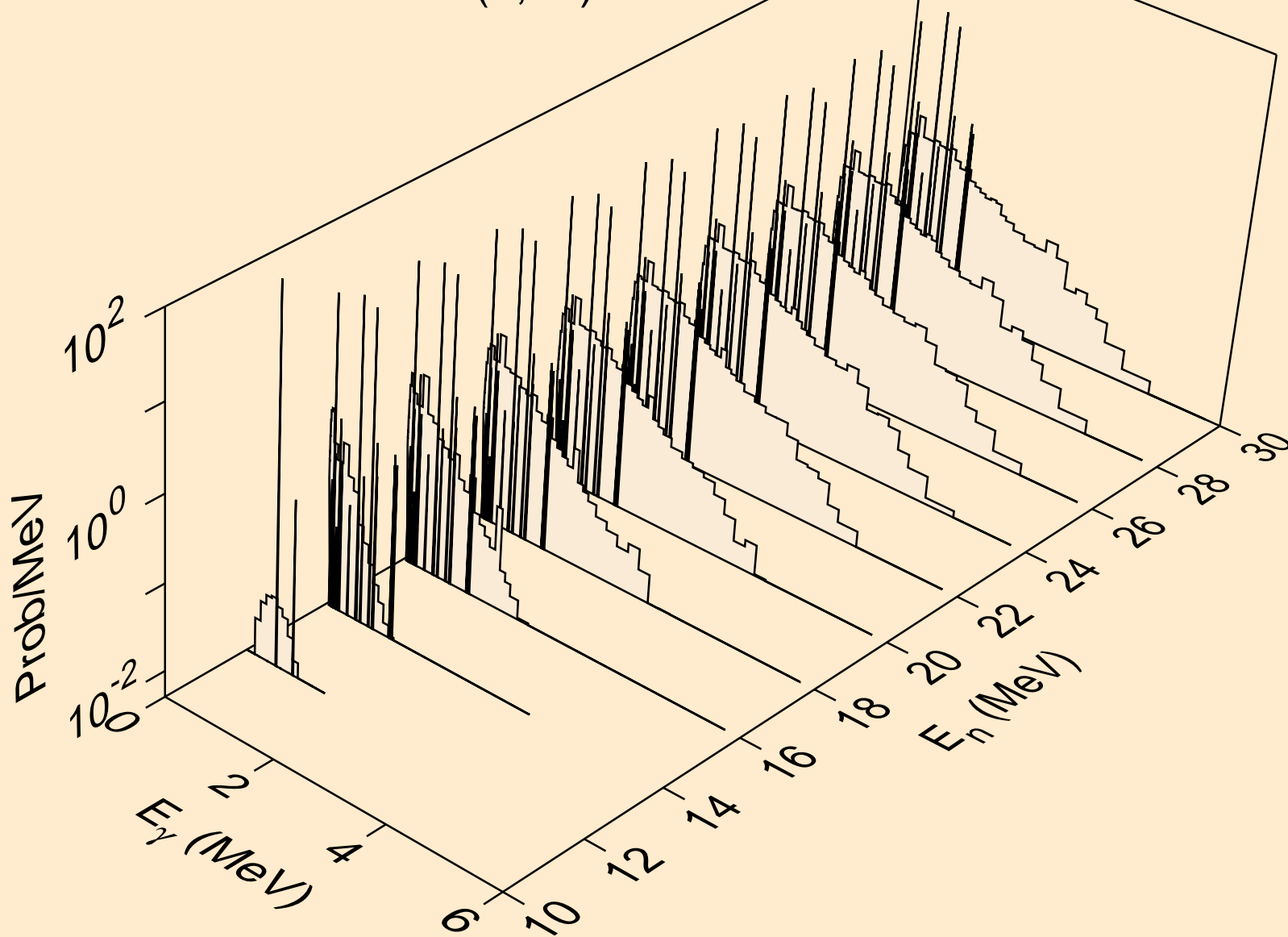

PO211M NEUTRON ACER TENDL-2019 LIBRARY; T=293.16K
Photon emission for (n,n*)a

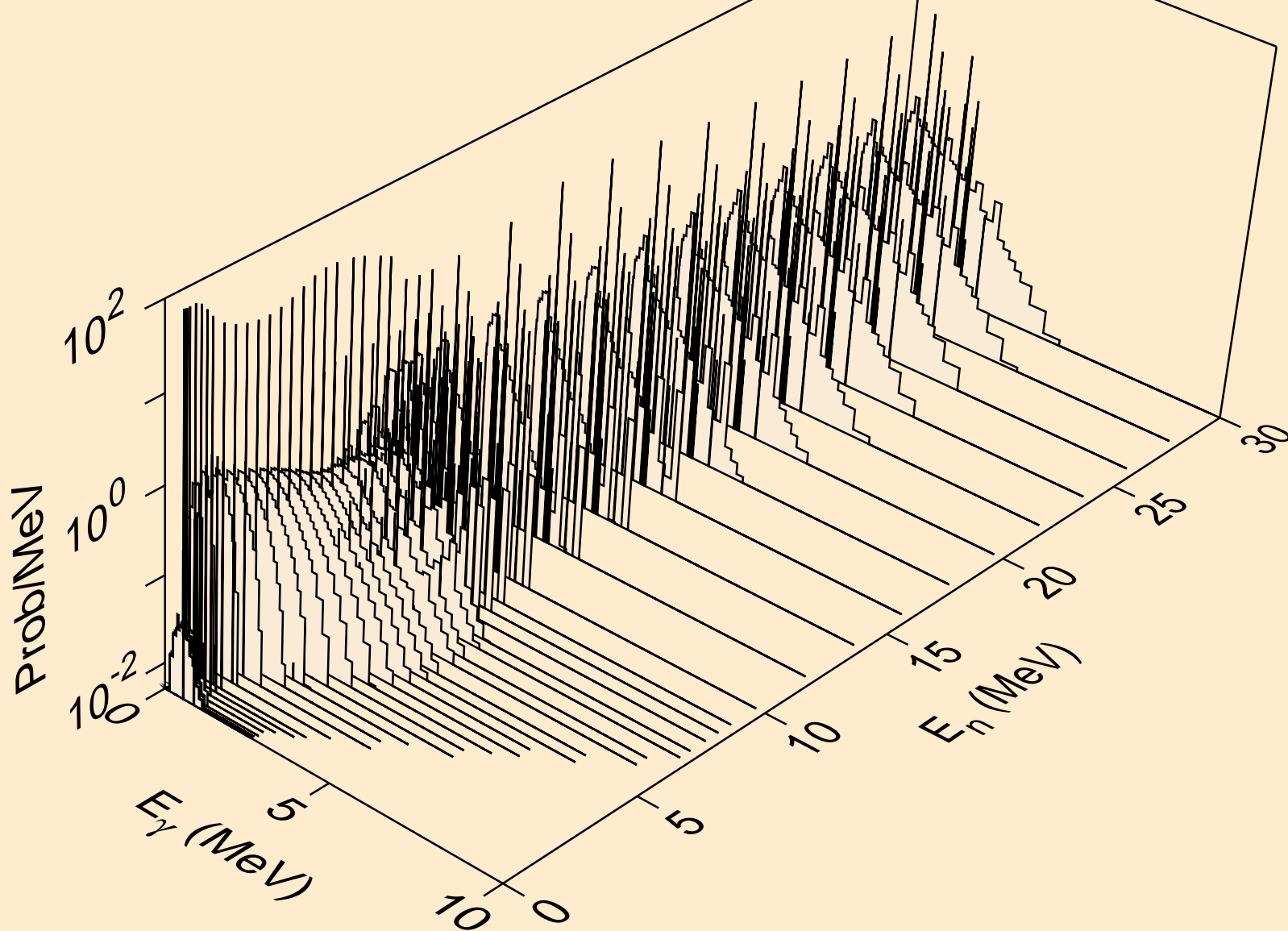

PO211M NEUTRON ACER TENDL-2019 LIBRARY; T=293.16K
Photon emission for (n,2n)a

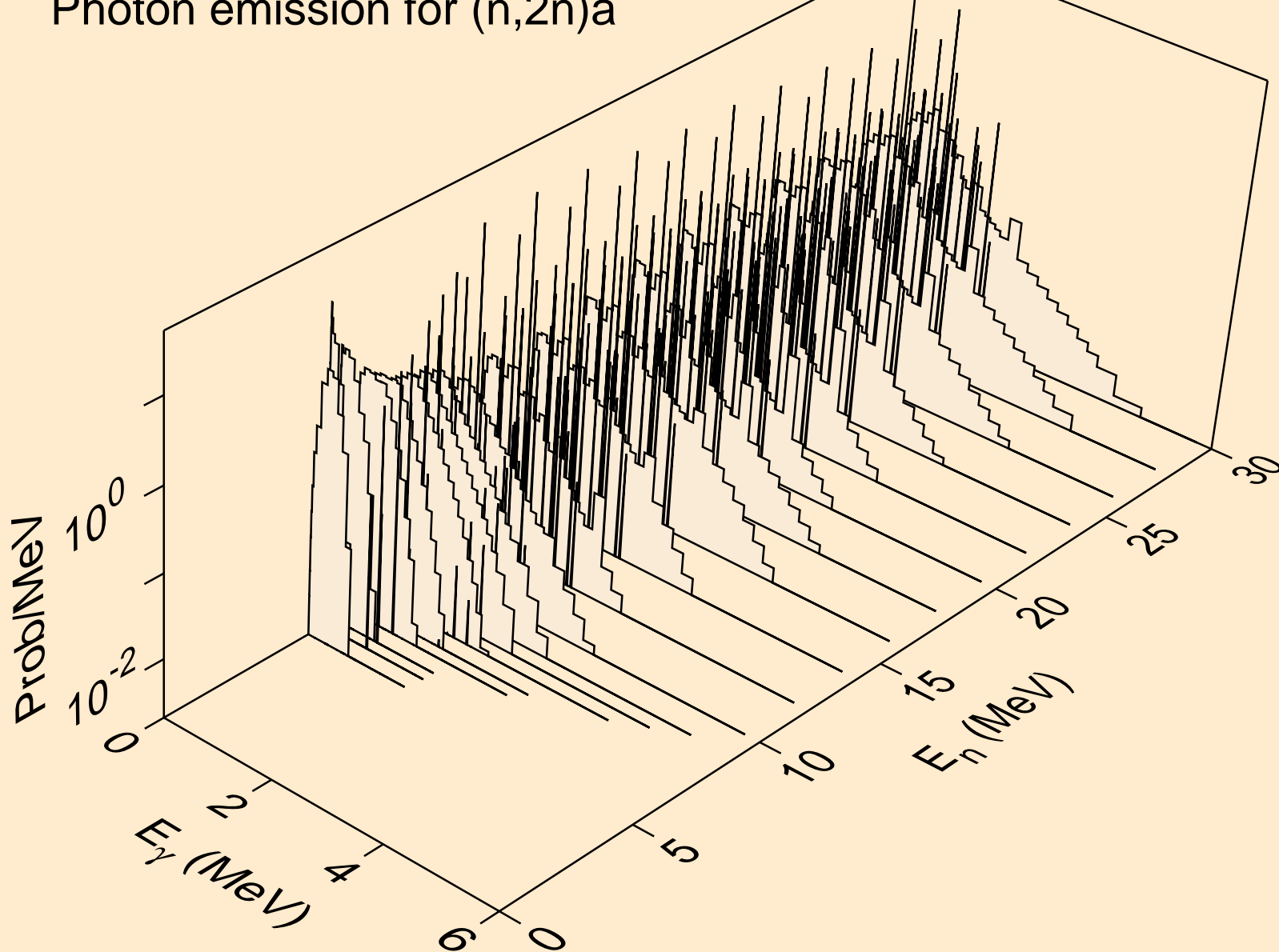

PO211M NEUTRON ACER TENDL-2019 LIBRARY; T=293.16K
Photon emission for (n,3n)a

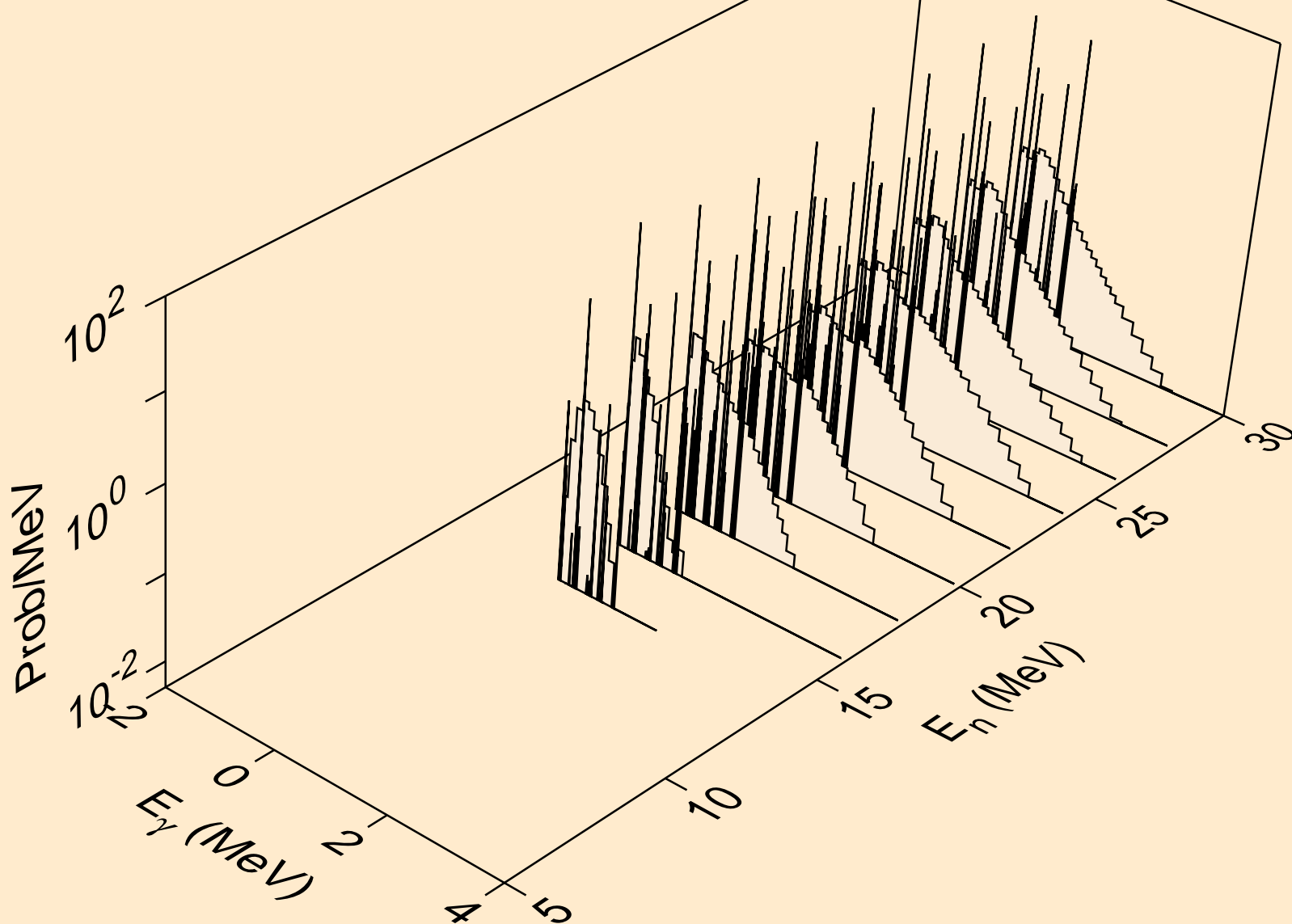

PO211M NEUTRON ACER TENDL-2019 LIBRARY; T=293.16K
Photon emission for (n,n*)p

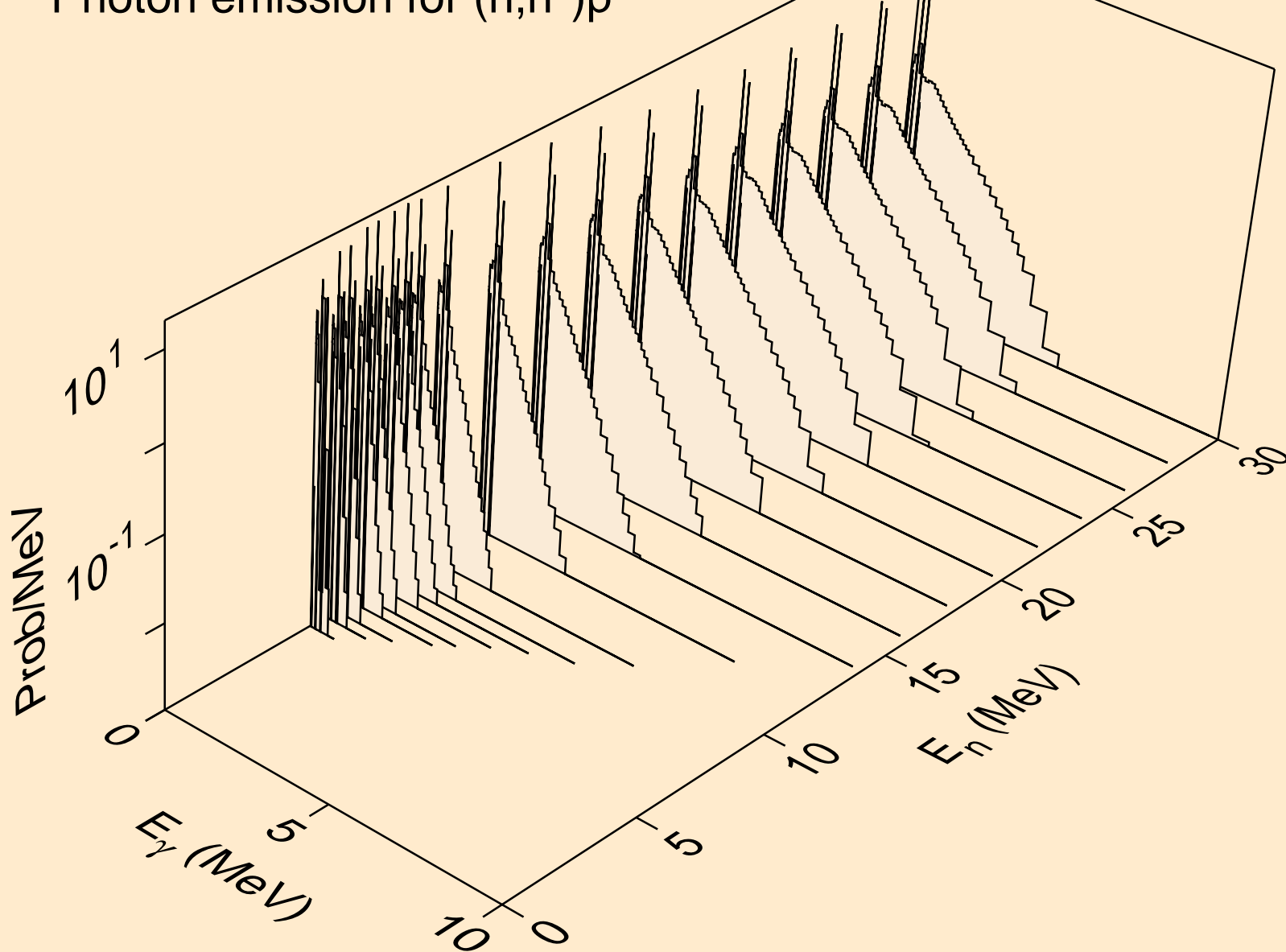

PO211M NEUTRON ACER TENDL-2019 LIBRARY; T=293.16K
Photon emission for (n,n*)2a

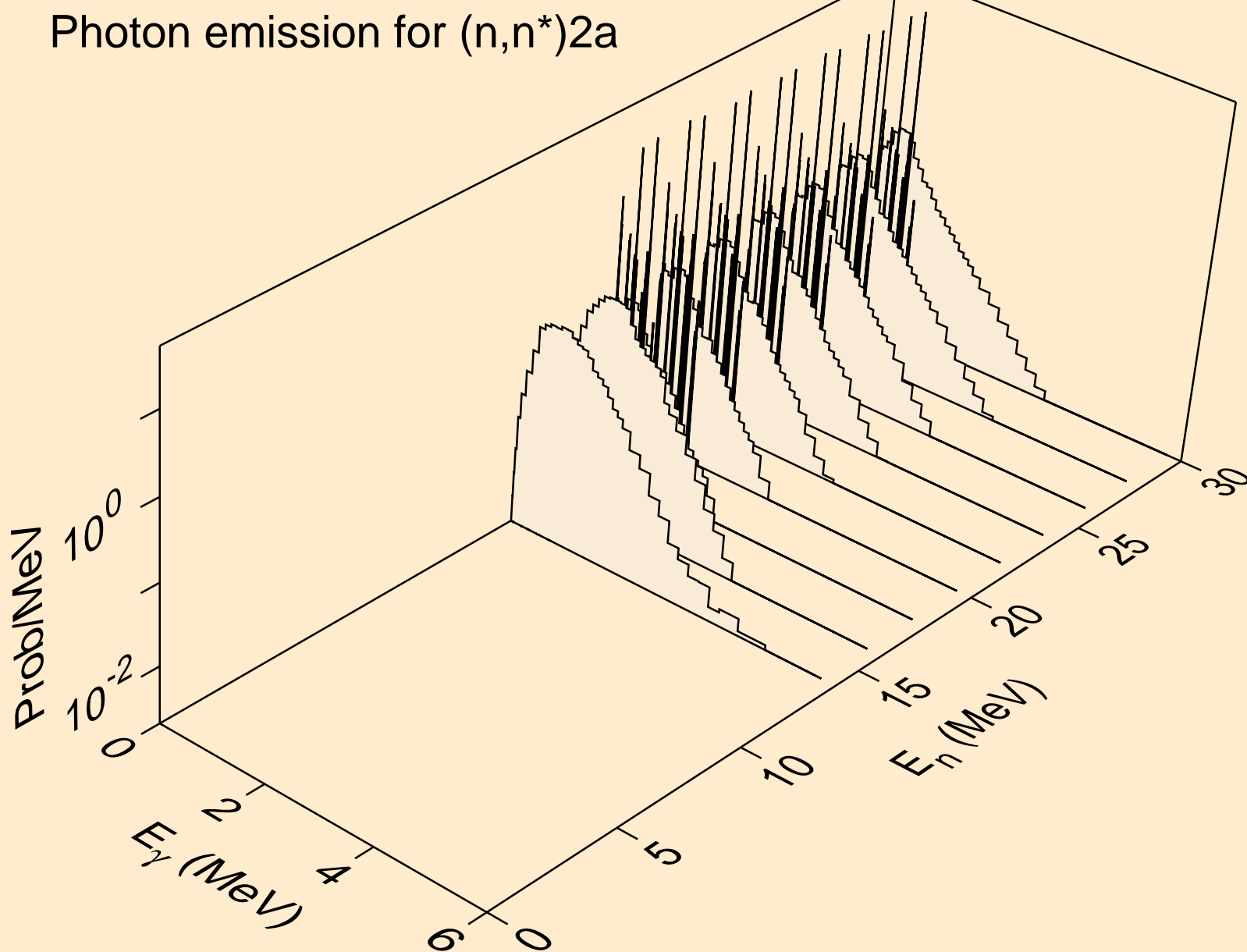

PO211M NEUTRON ACER TENDL-2019 LIBRARY; T=293.16K
Photon emission for (n,2n)2a

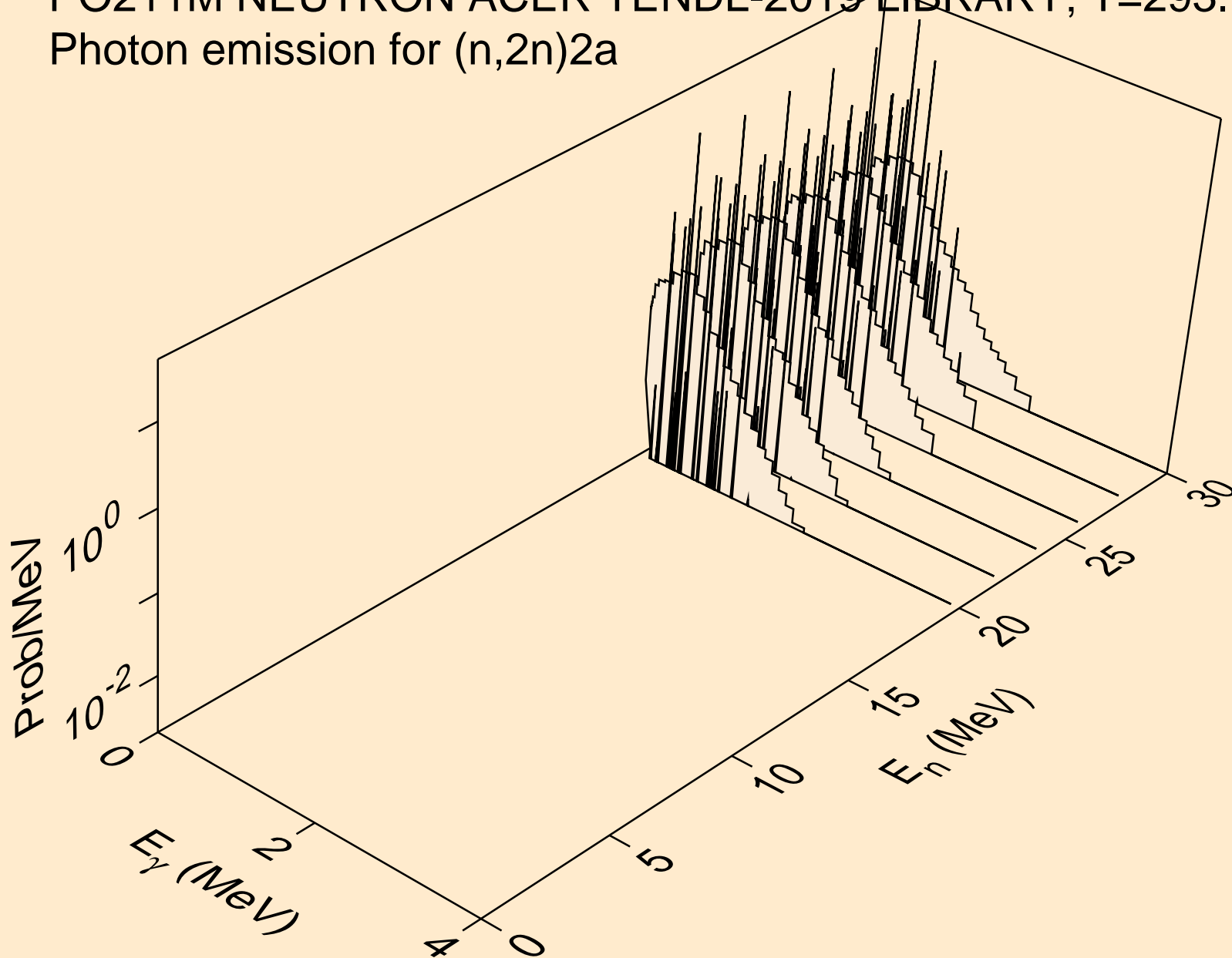

PO211M NEUTRON ACER TENDL-2019 LIBRARY; T=293.16K
Photon emission for (n,n*)d

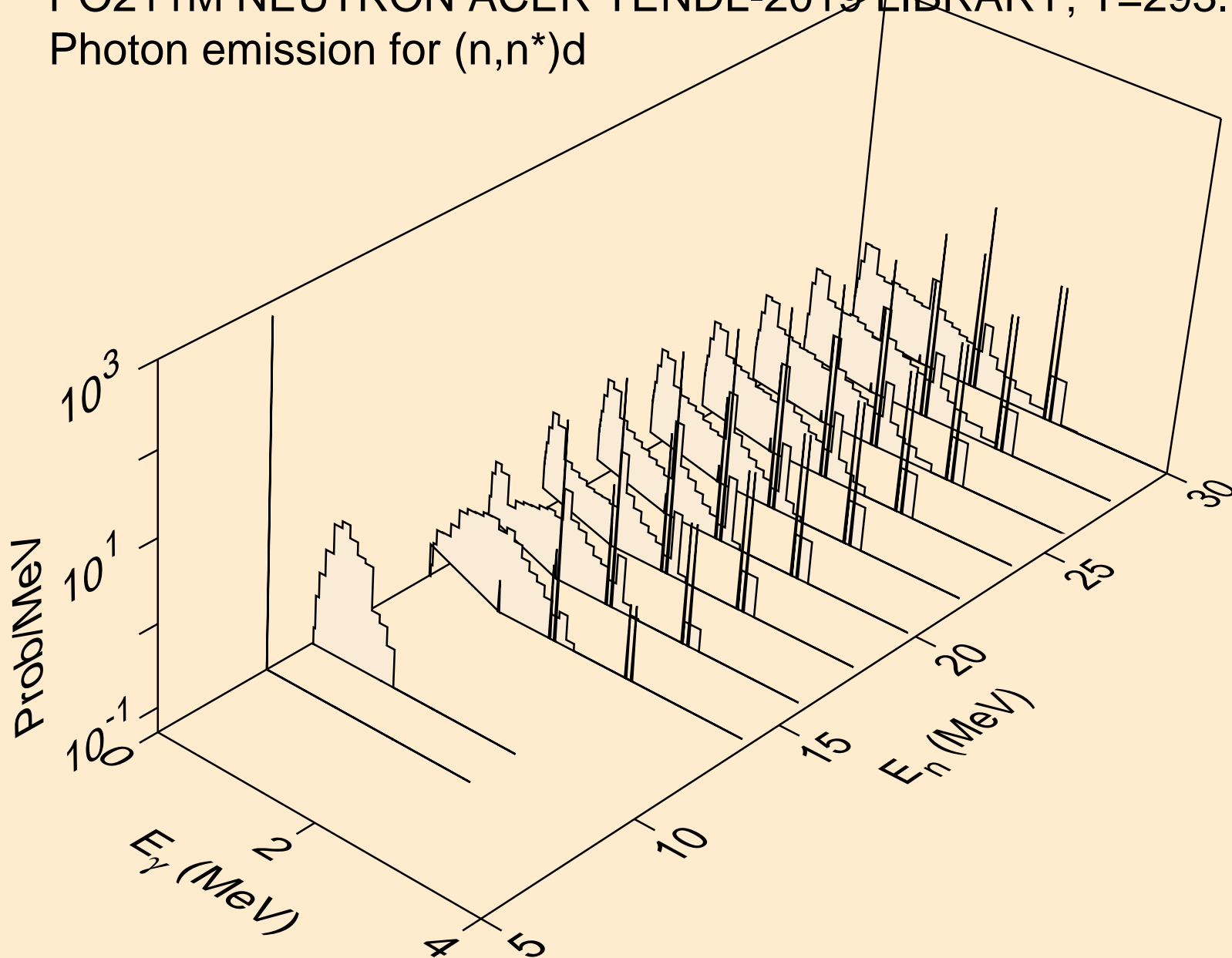

PO211M NEUTRON ACER TENDL-2019 LIBRARY; T=293.16K
Photon emission for (n,n*)t

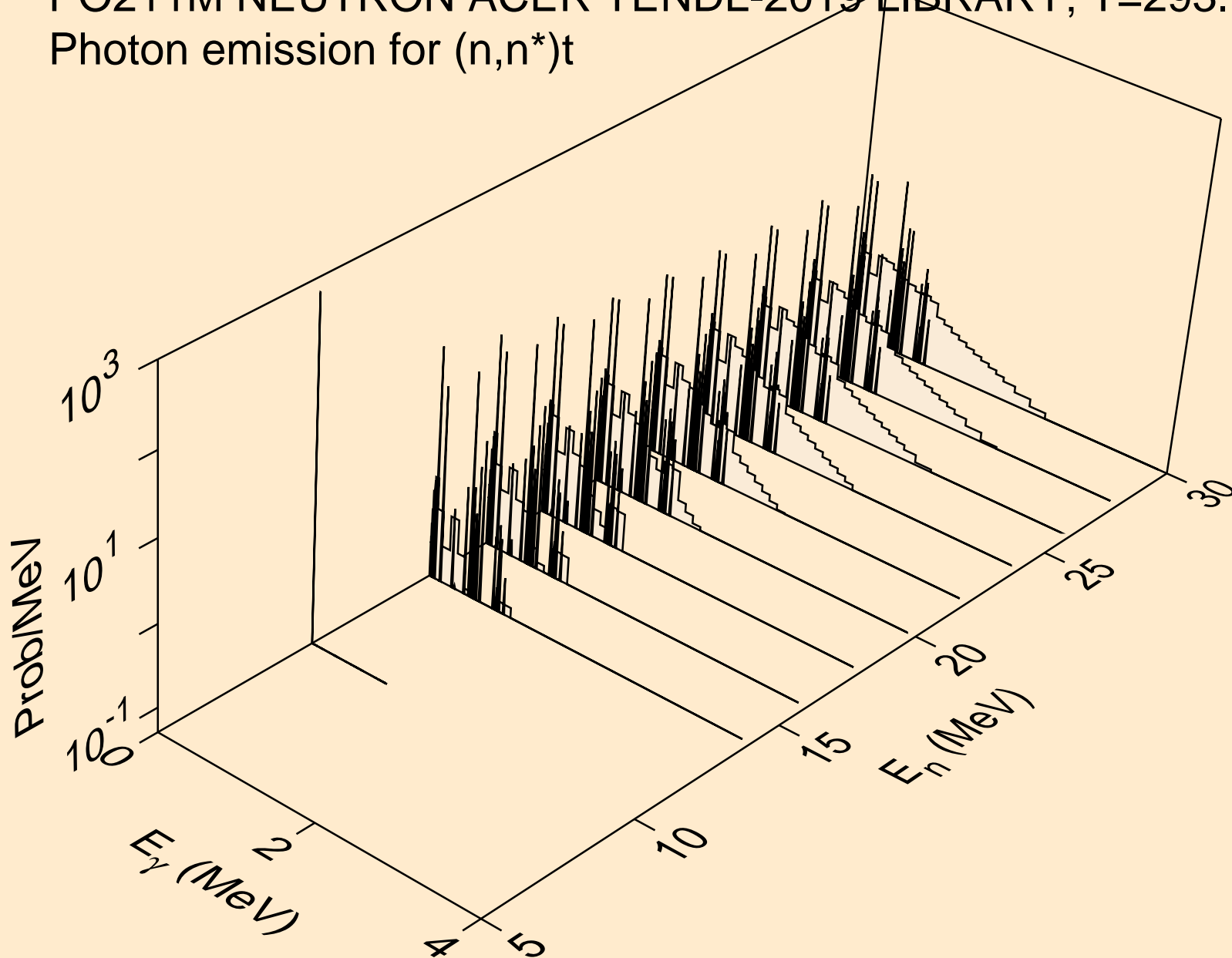

PO211M NEUTRON ACER TENDL-2019 LIBRARY; T=293.16K
Photon emission for (n,n*)he3

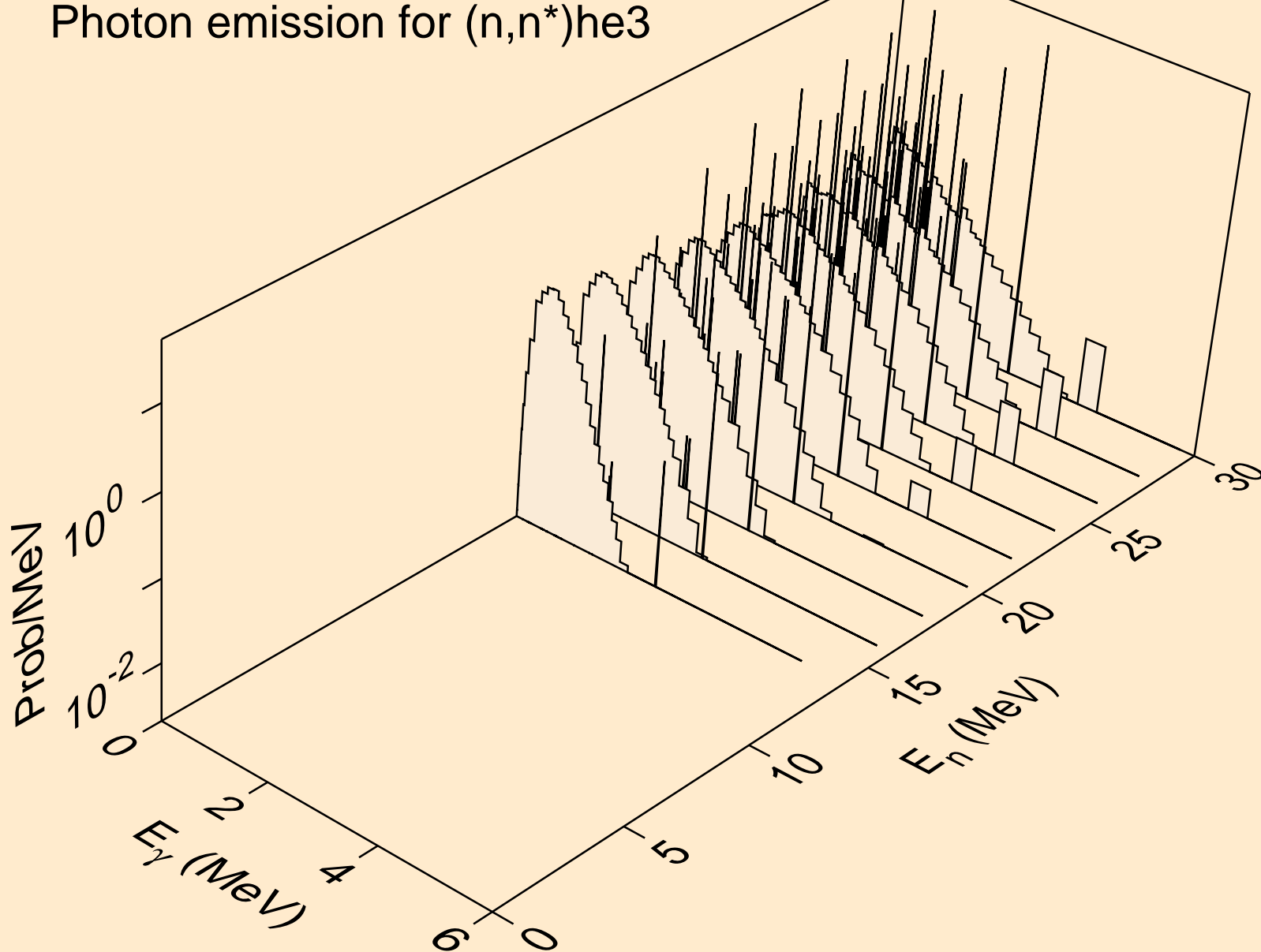

PO211M NEUTRON ACER TENDL-2019 LIBRARY; T=293.16K
Photon emission for (n,4n)

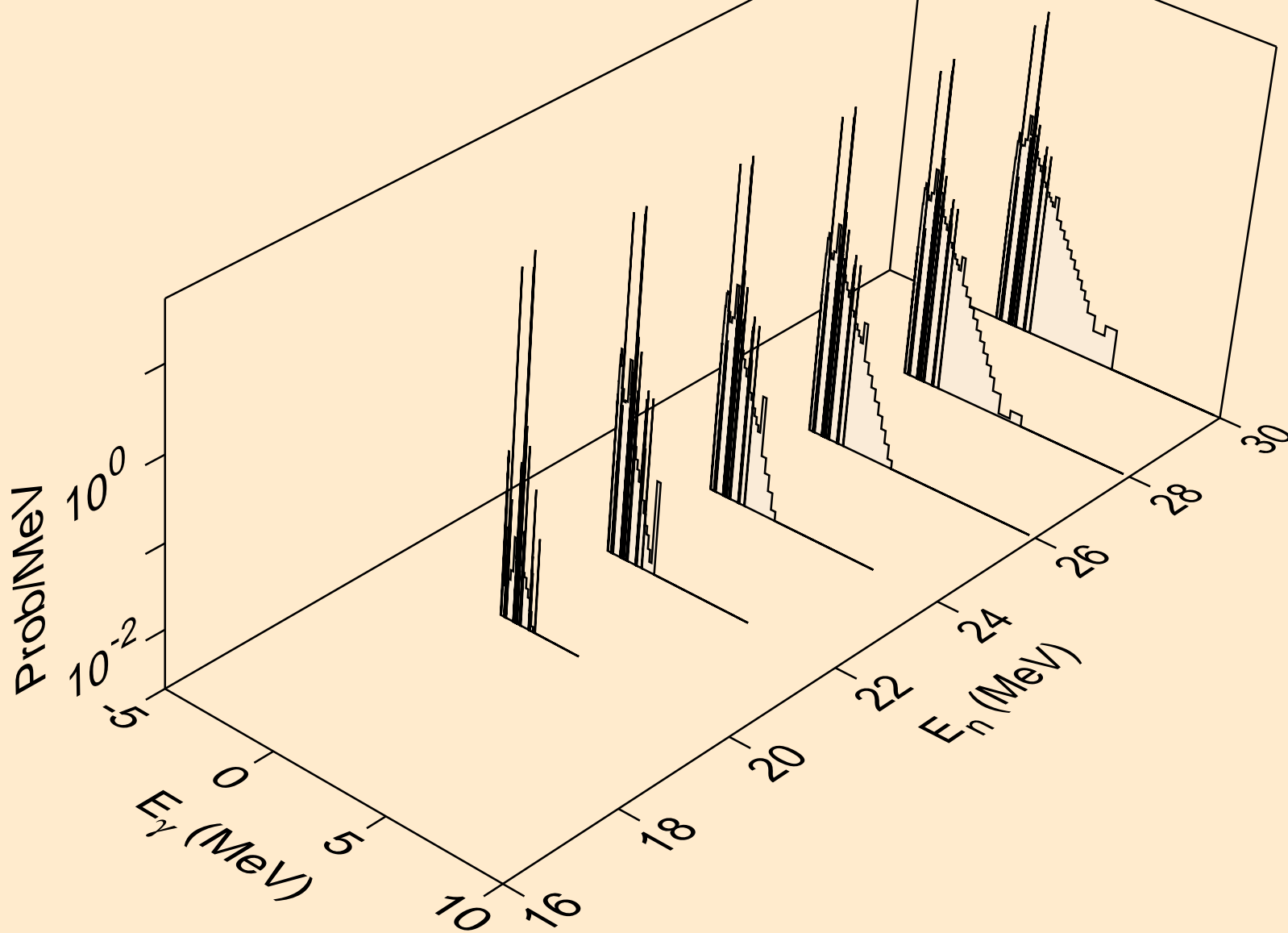

PO211M NEUTRON ACER TENDL-2019 LIBRARY; T=293.16K
Photon emission for (n,2np)

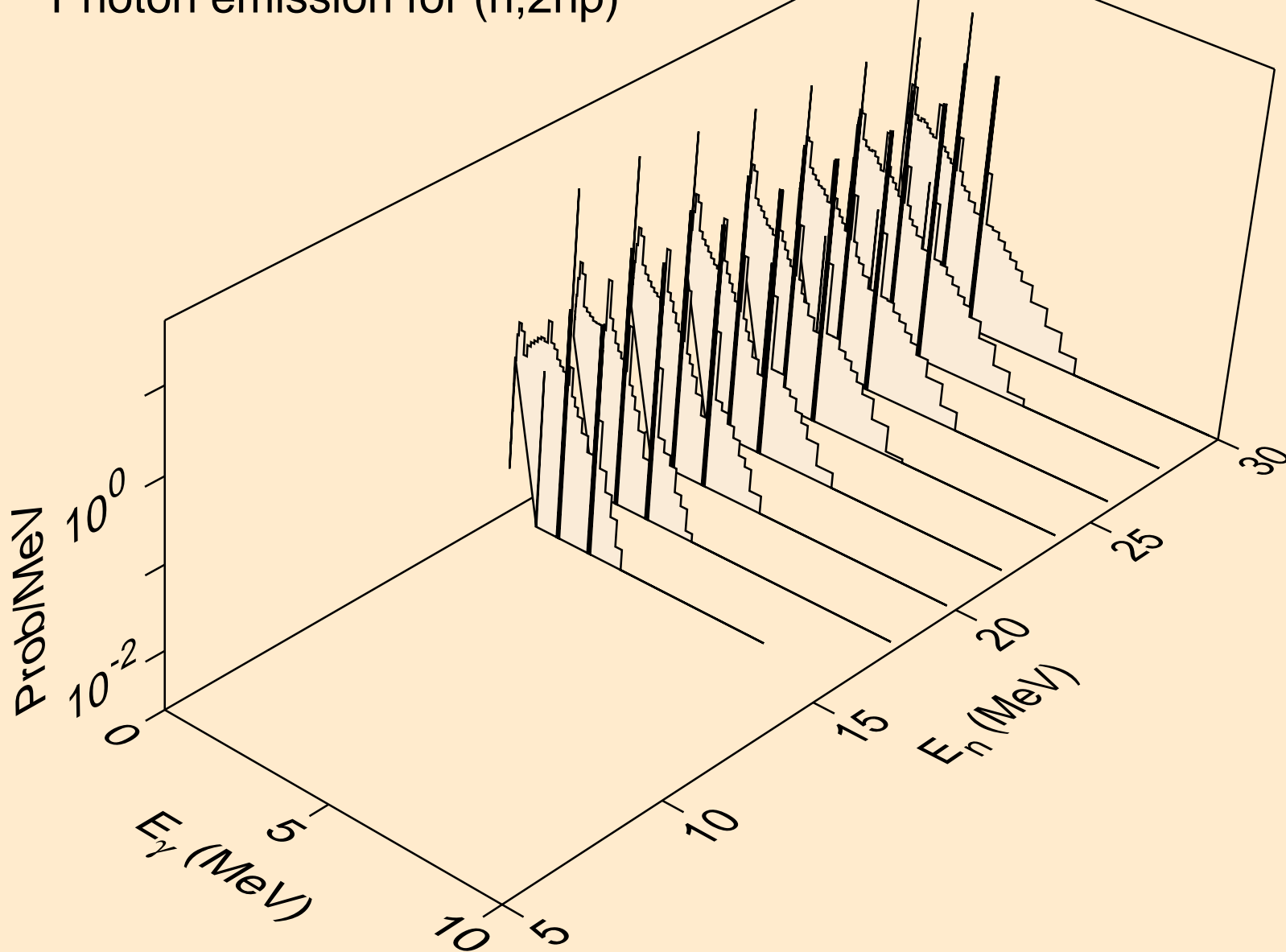

PO211M NEUTRON ACER TENDL-2019 LIBRARY; T=293.16K
Photon emission for (n,3np)

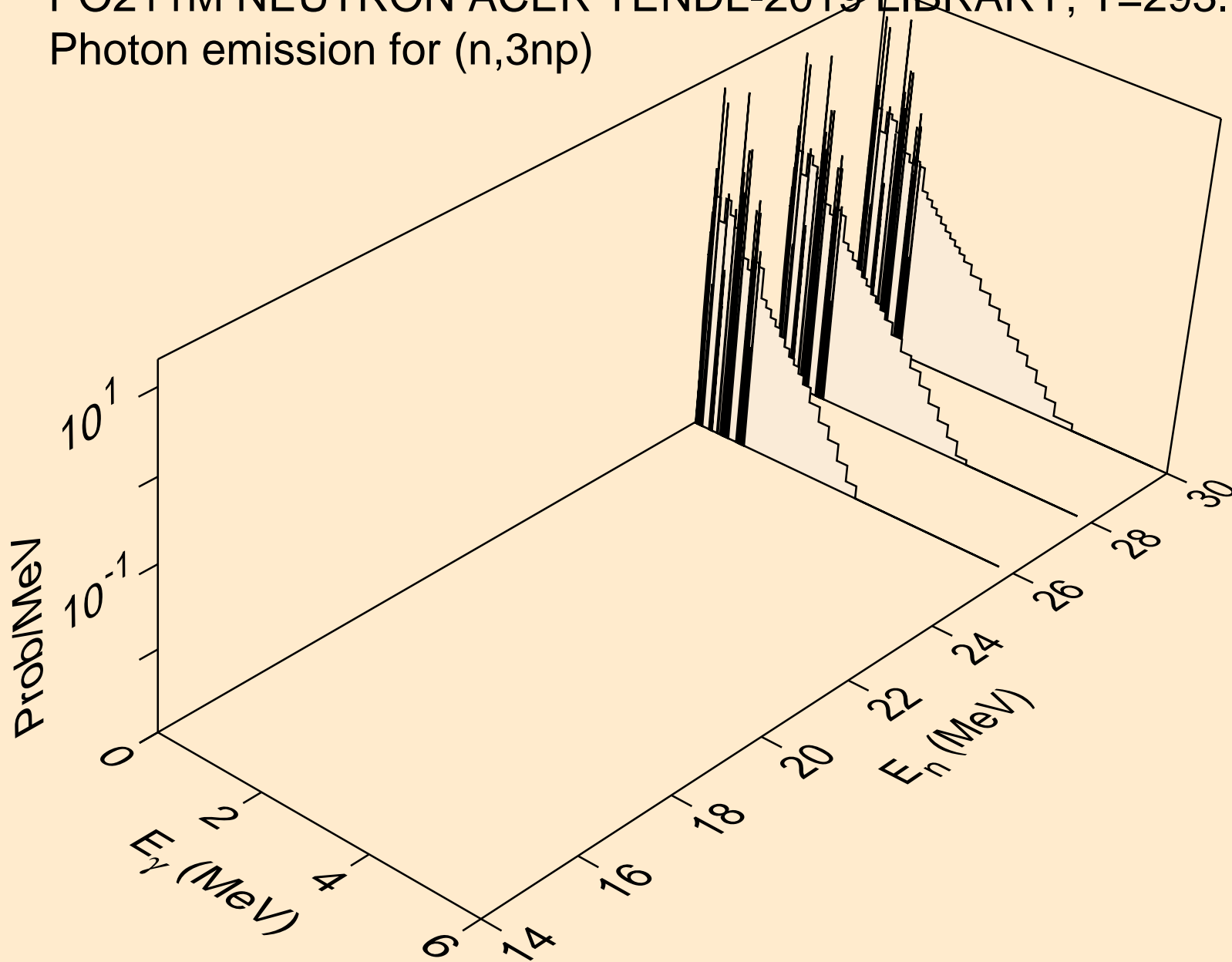

PO211M NEUTRON ACER TENDL-2019 LIBRARY; T=293.16K
Photon emission for (n,2np)

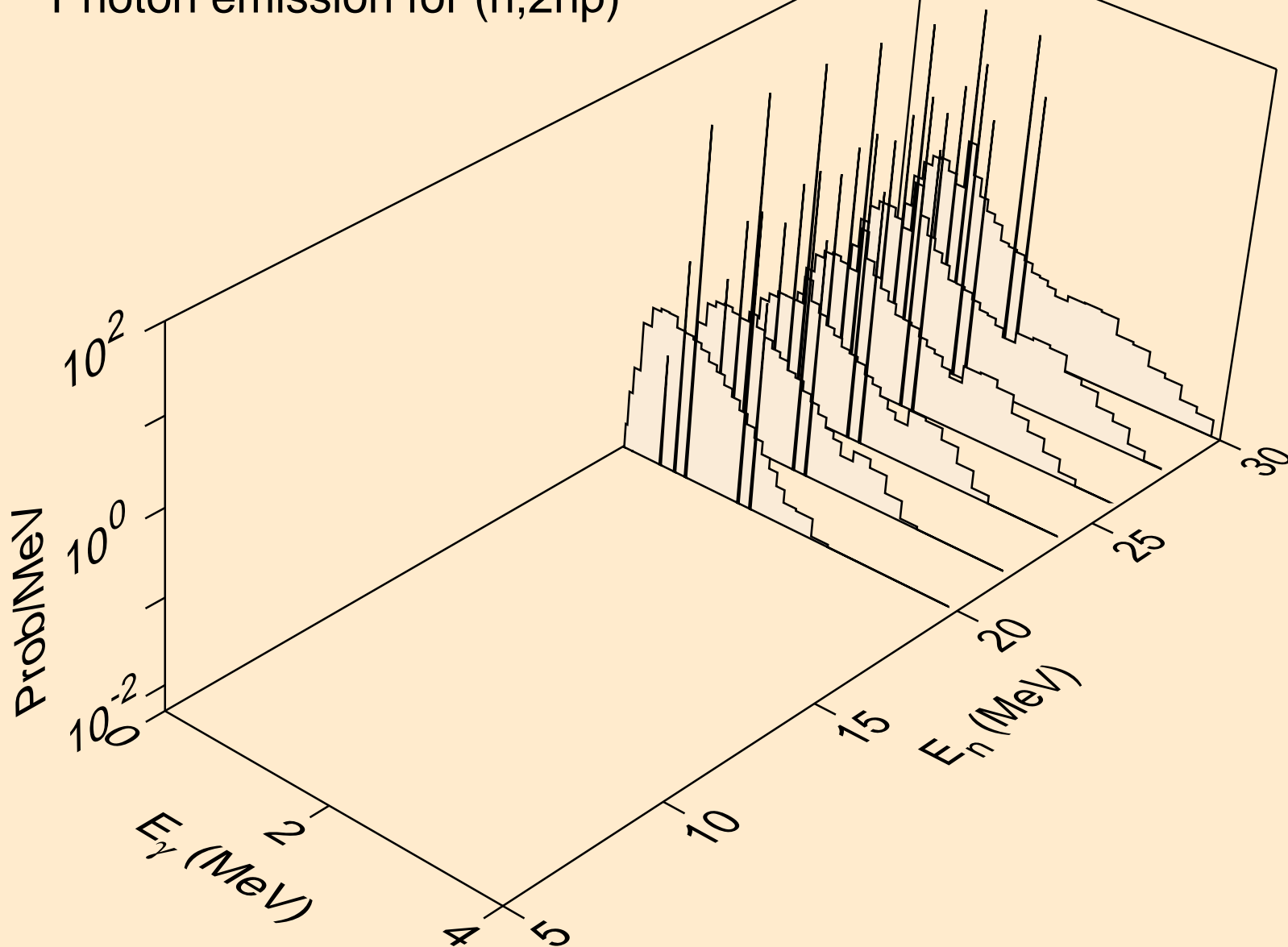

PO211M NEUTRON ACER TENDL-2019 LIBRARY; T=293.16K
Photon emission for (n,npa)

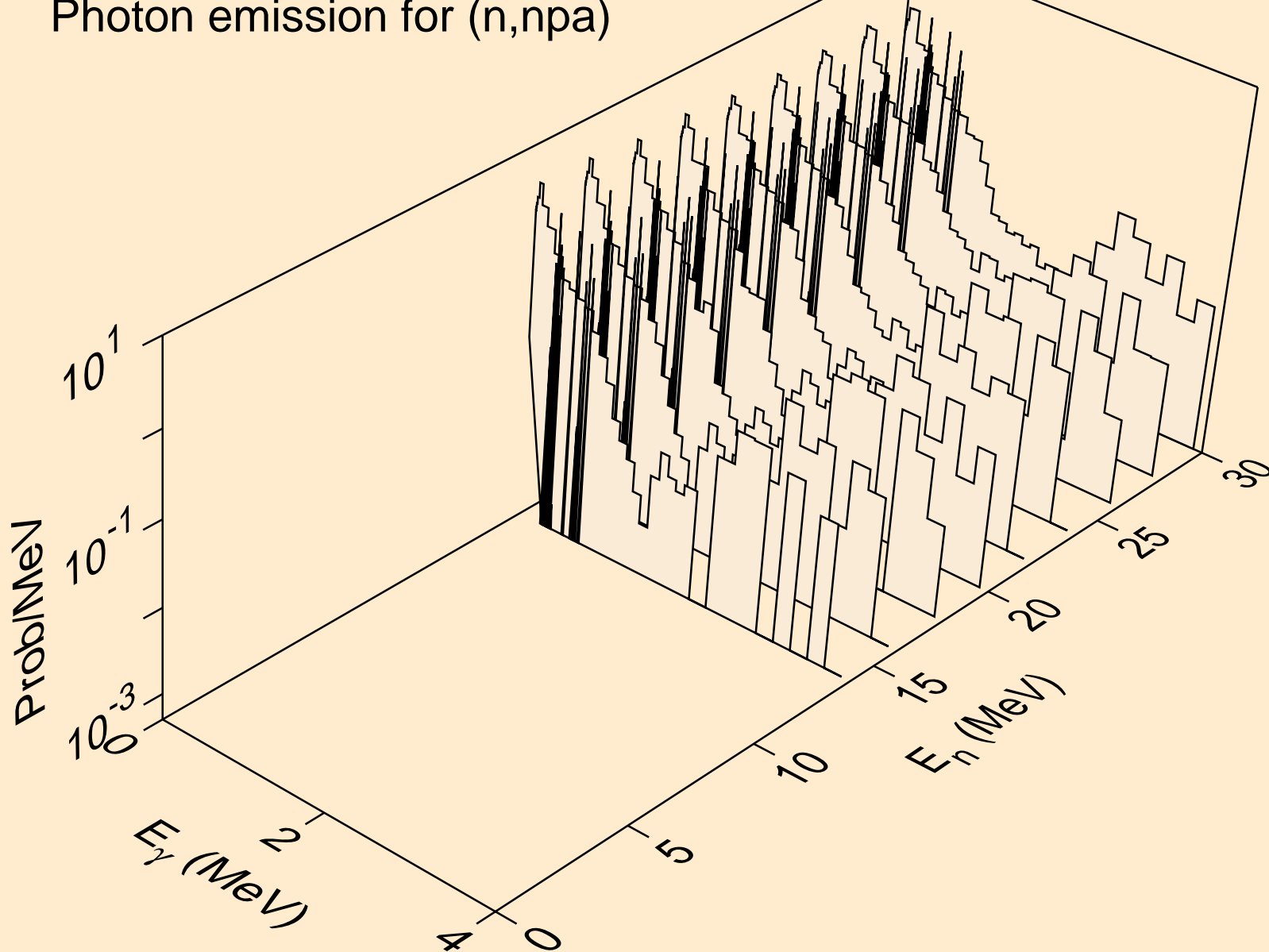

PO211M NEUTRON ACER TENDL-2019 LIBRARY; T=293.16K
Photon emission for (n,n*1)

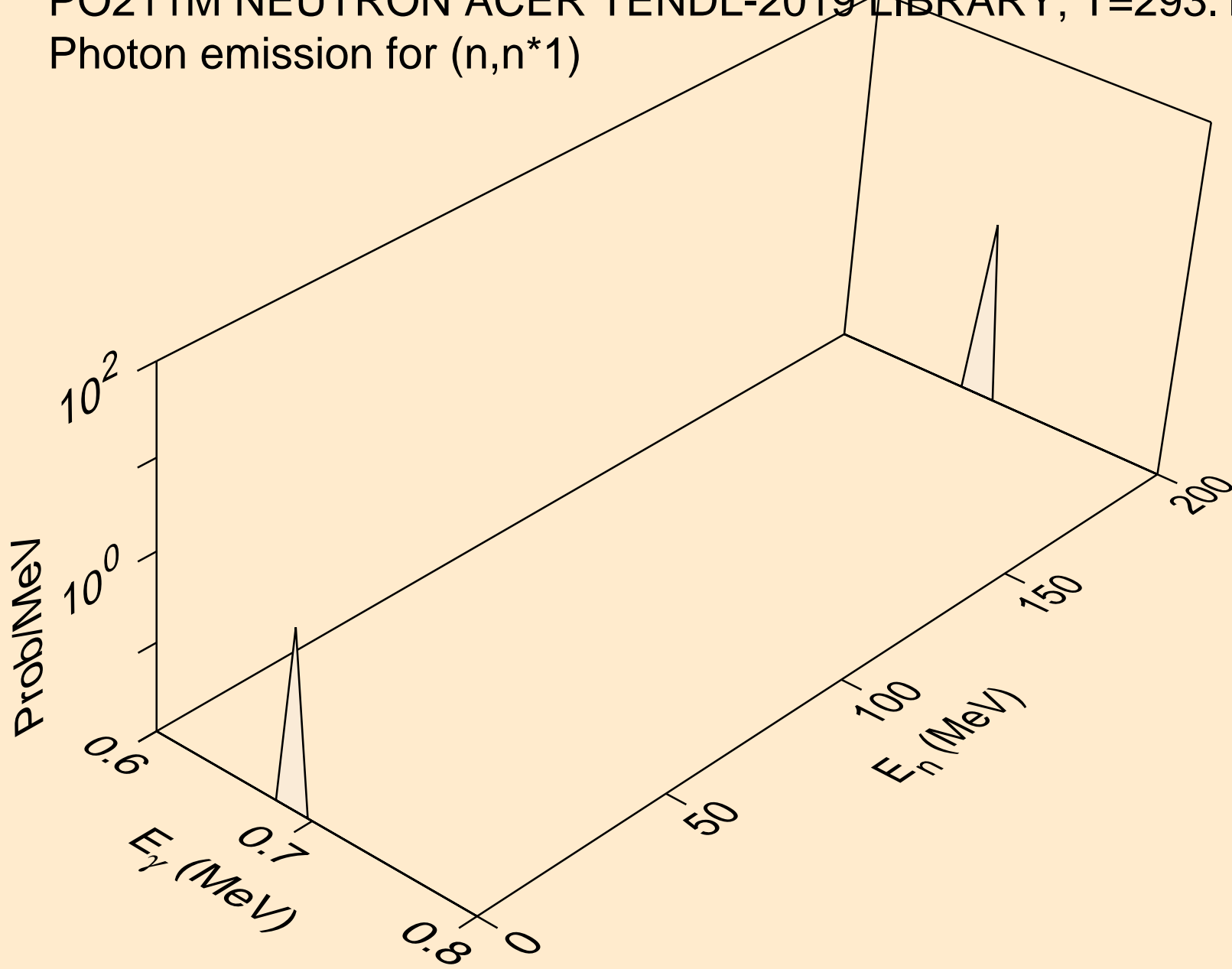

PO211M NEUTRON ACER TENDL-2019 LIBRARY; T=293.16K
Photon emission for (n,n*2)

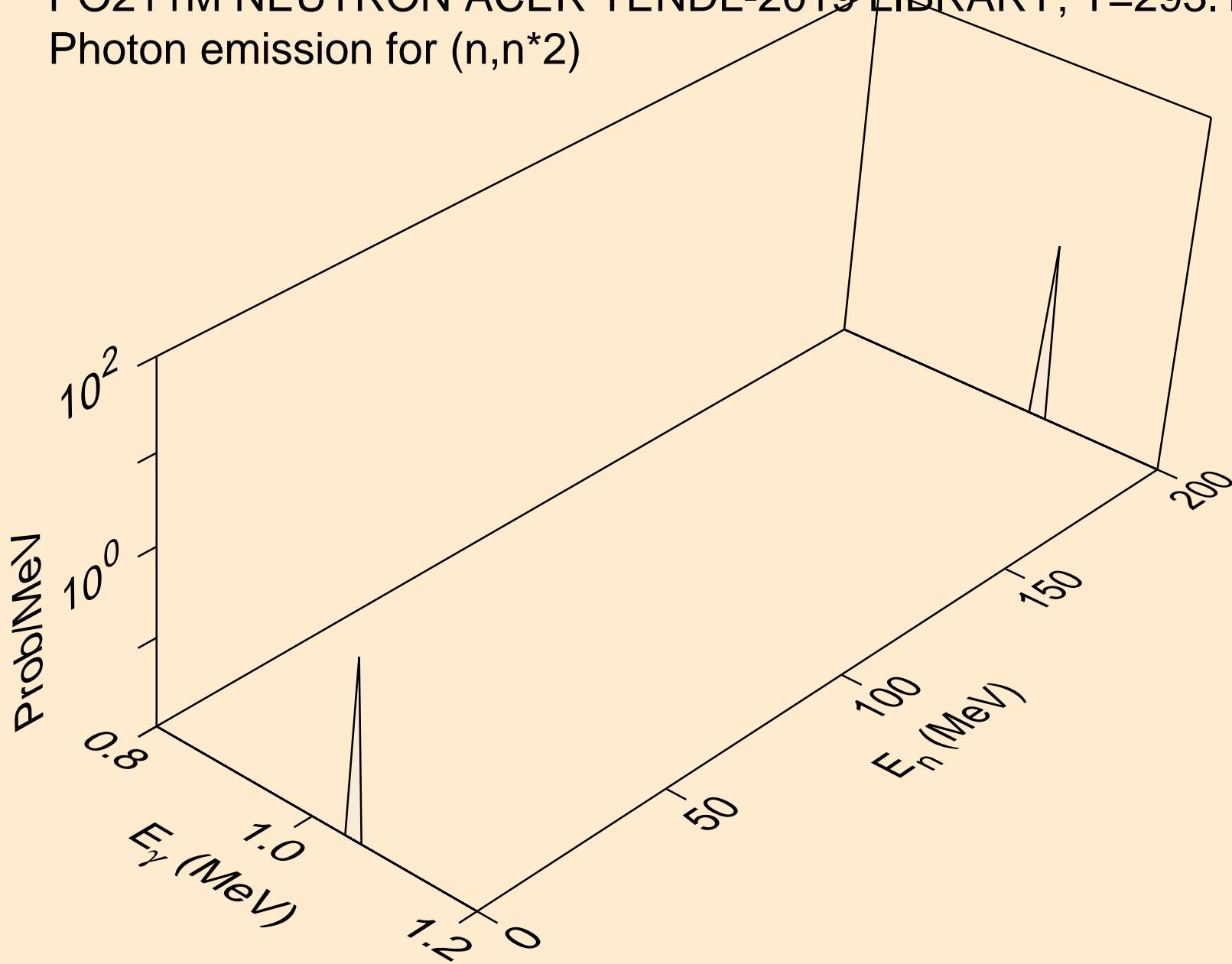

PO211M NEUTRON ACER TENDL-2019 LIBRARY; T=293.16K
Photon emission for (n,n*3)

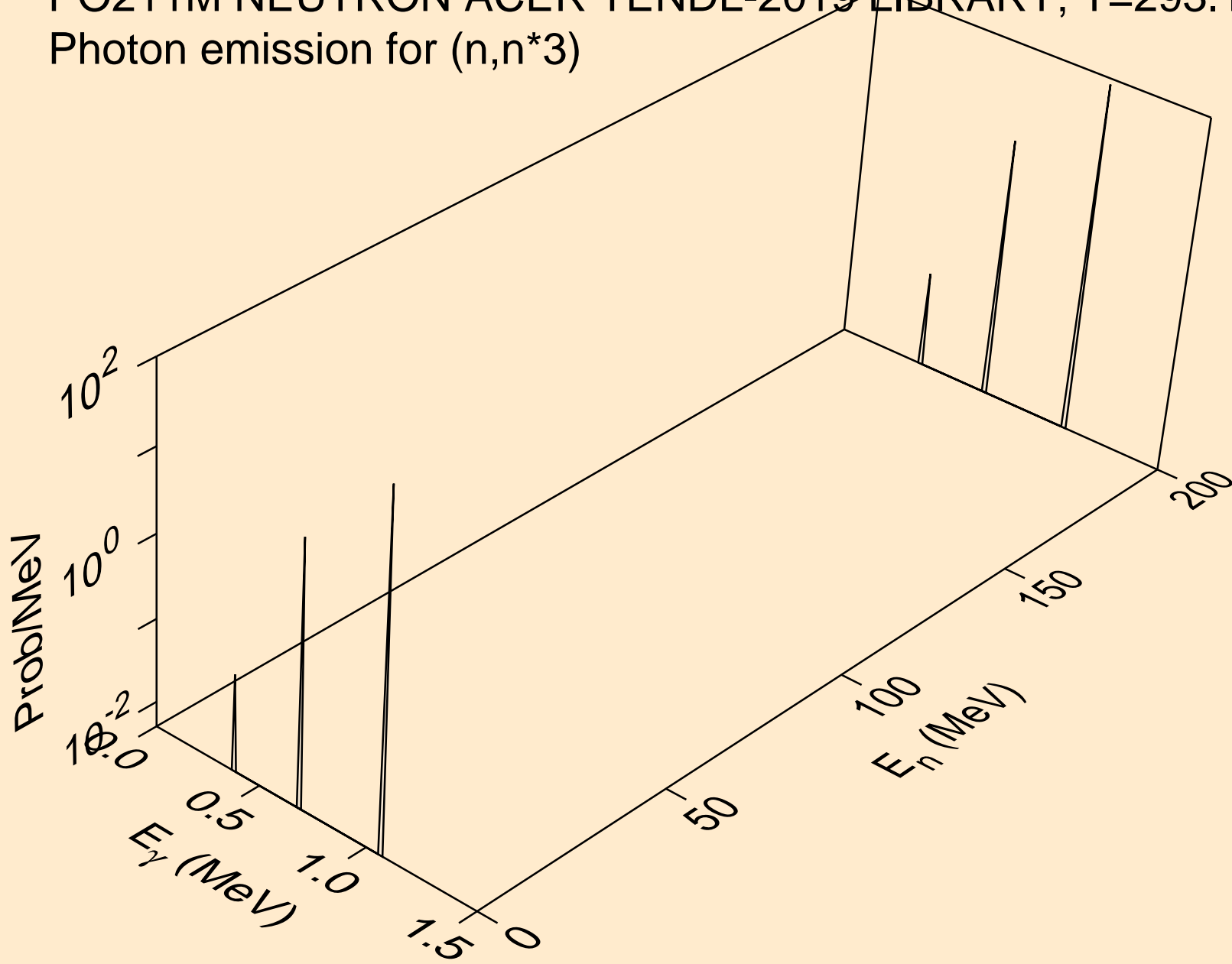

PO211M NEUTRON ACER TENDL-2019 LIBRARY; T=293.16K
Photon emission for (n,n*4)

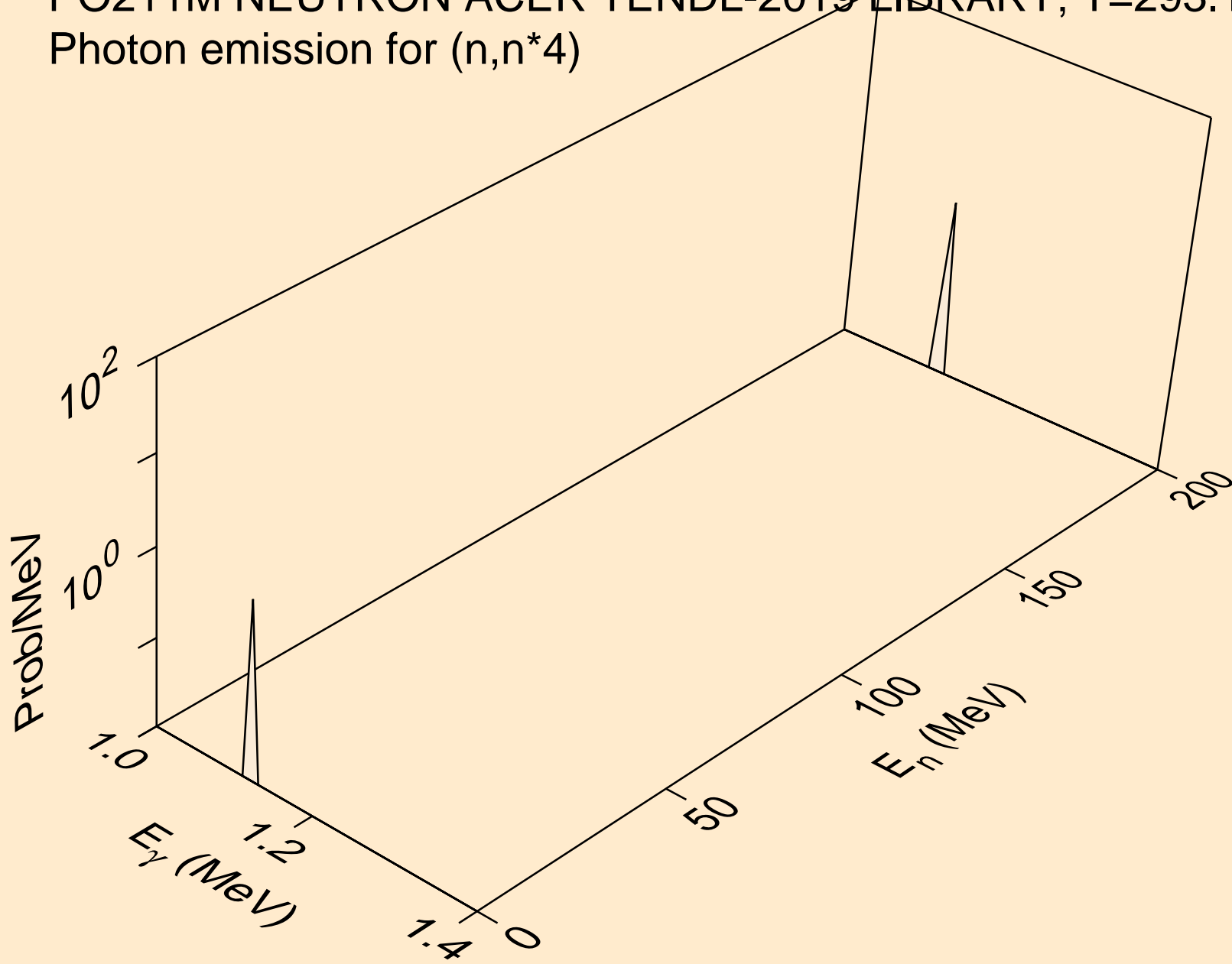

PO211M NEUTRON ACER TENDL-2019 LIBRARY; T=293.16K
Photon emission for (n,n*5)

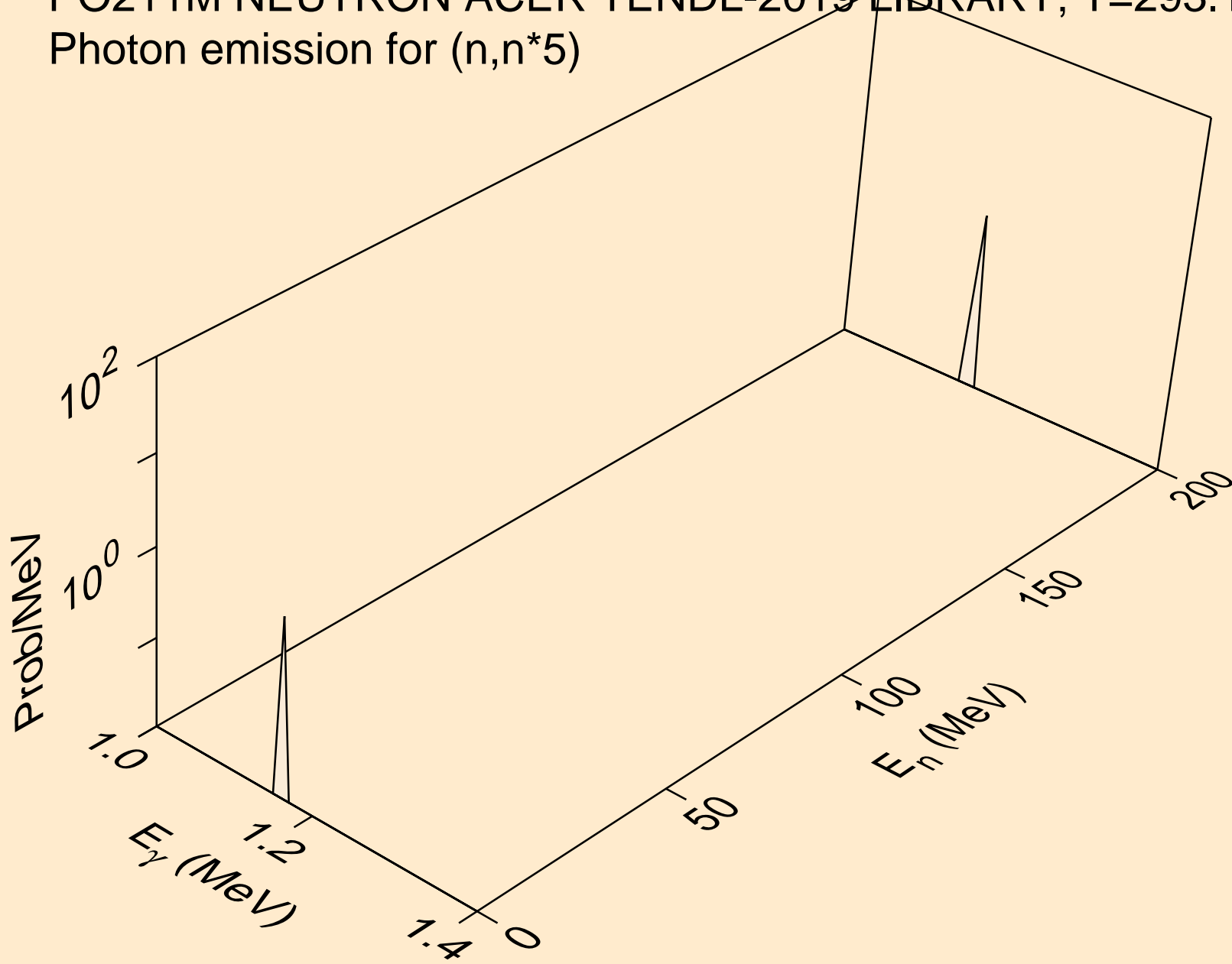

PO211M NEUTRON ACER TENDL-2019 LIBRARY; T=293.16K
Photon emission for (n,n*6)

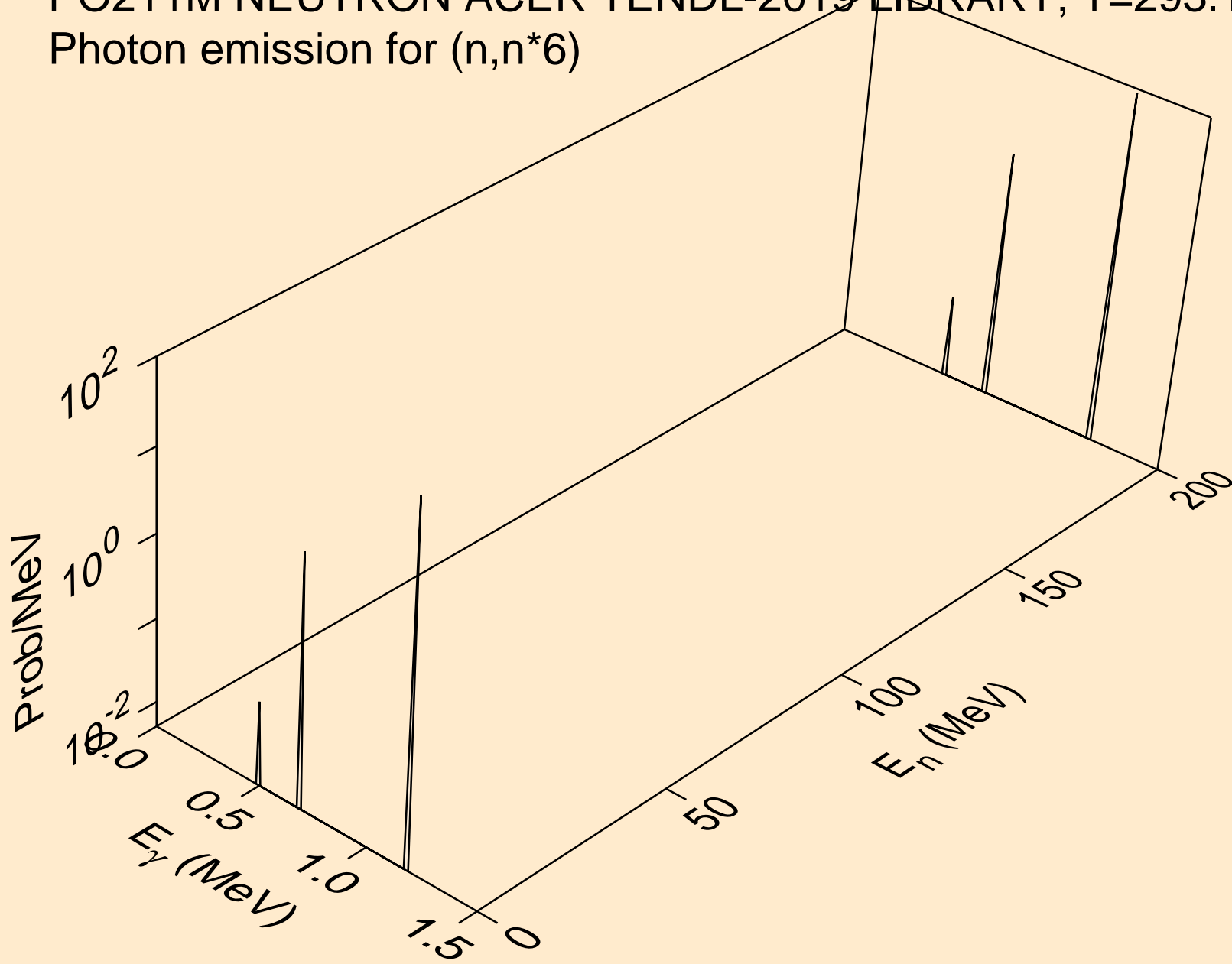

PO211M NEUTRON ACER TENDL-2019 LIBRARY; T=293.16K
Photon emission for (n,n*7)

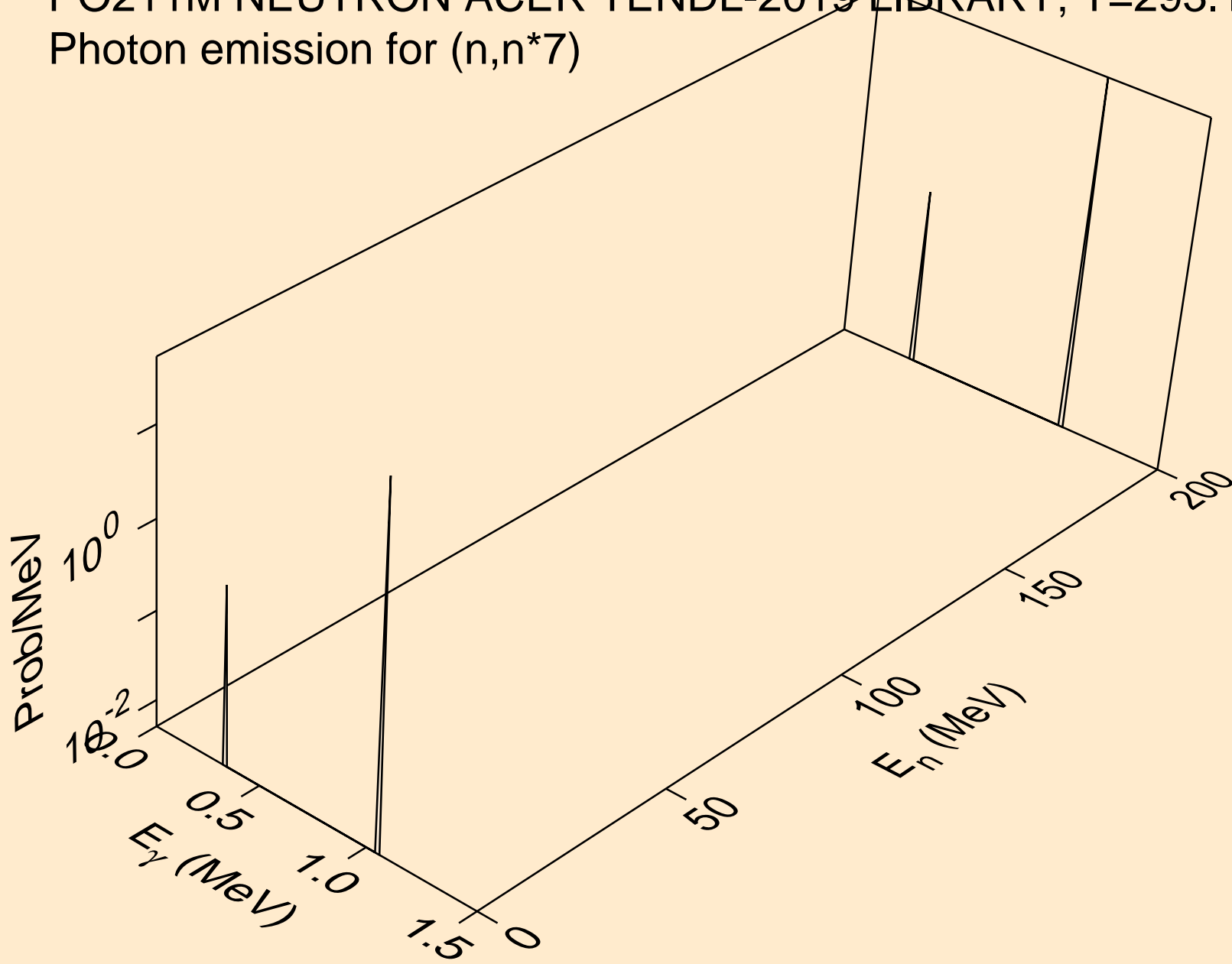

PO211M NEUTRON ACER TENDL-2019 LIBRARY; T=293.16K
Photon emission for (n,n*8)

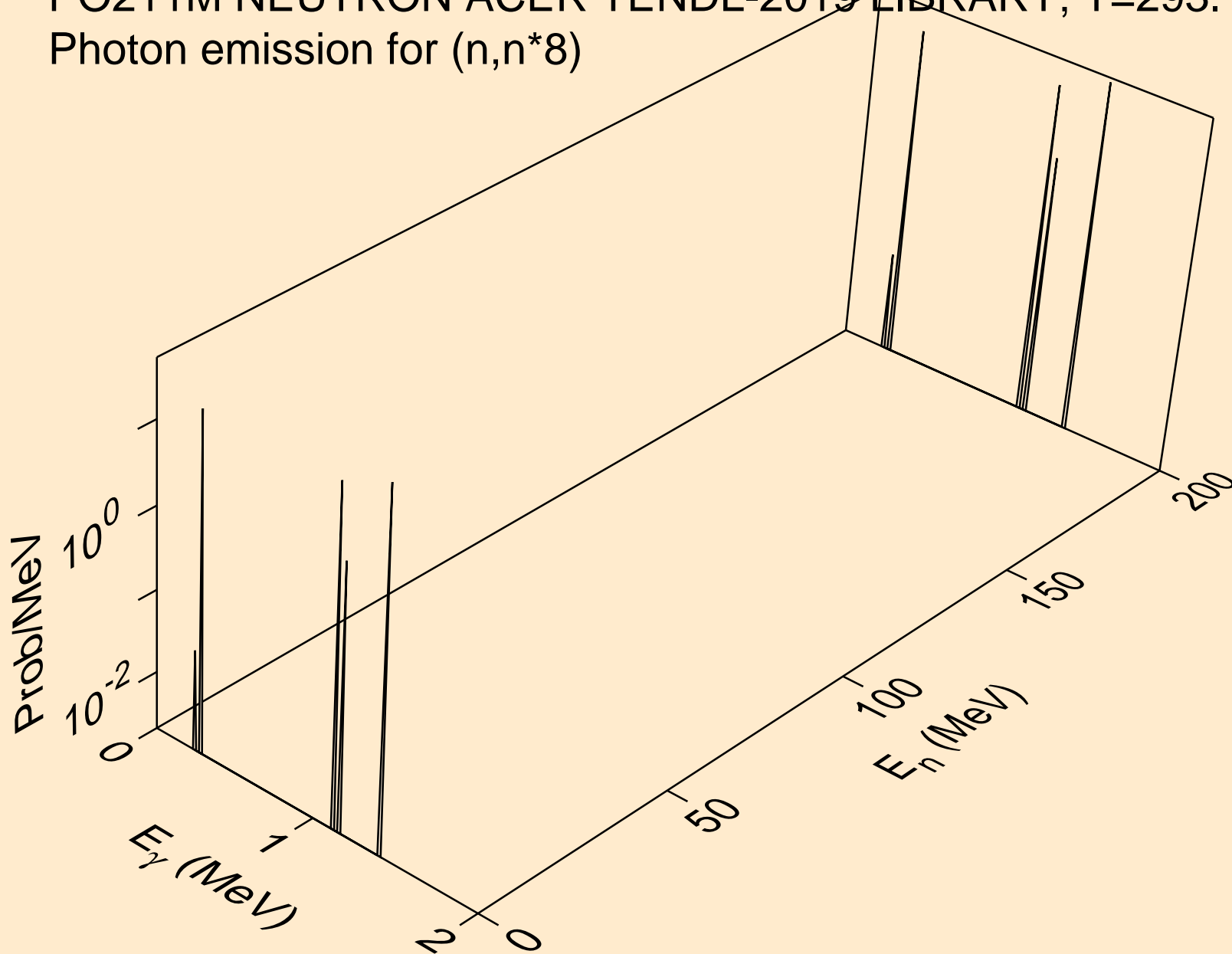

PO211M NEUTRON ACER TENDL-2019 LIBRARY; T=293.16K
Photon emission for (n,n*9)

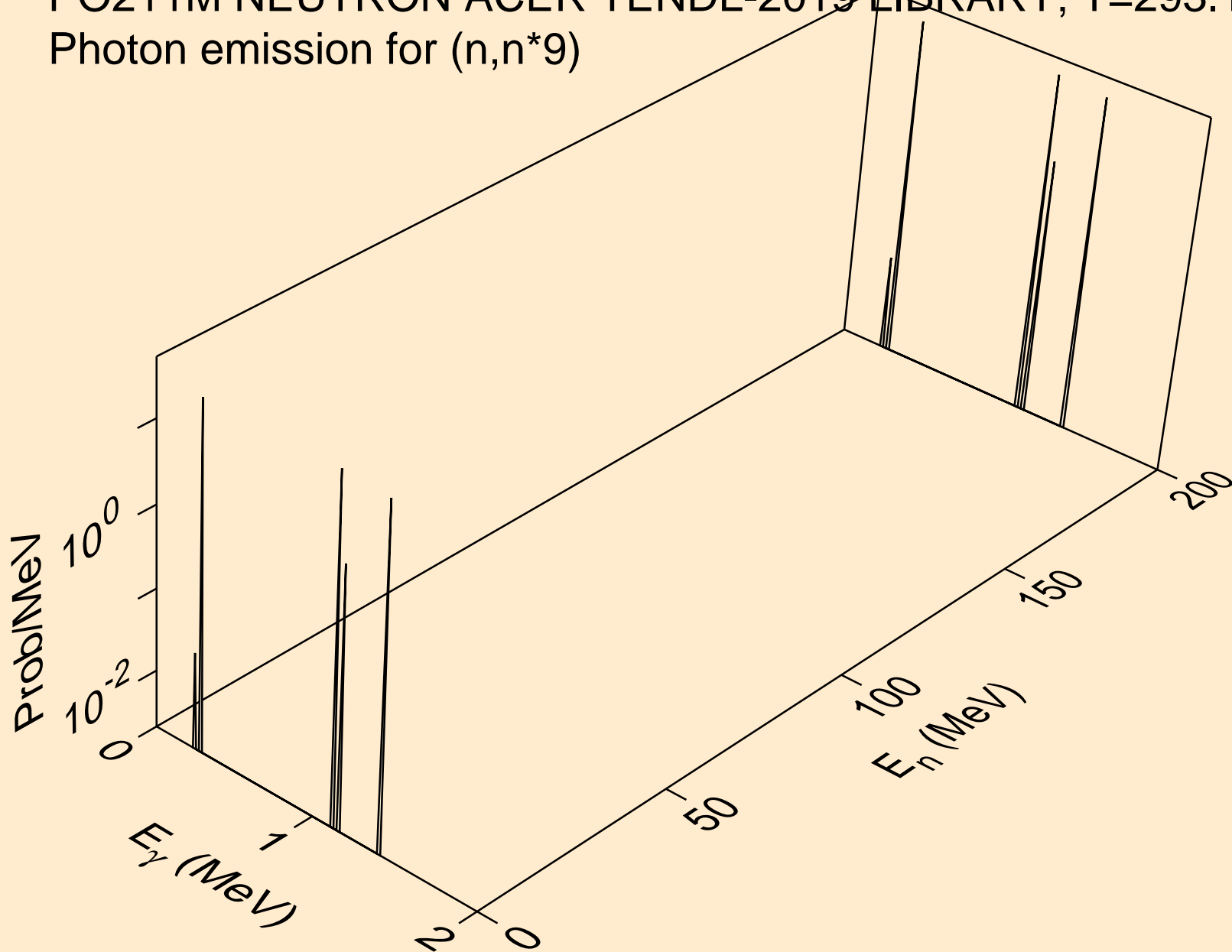

PO211M NEUTRON ACER TENDL-2019 LIBRARY; T=293.16K
Photon emission for (n,n*10)

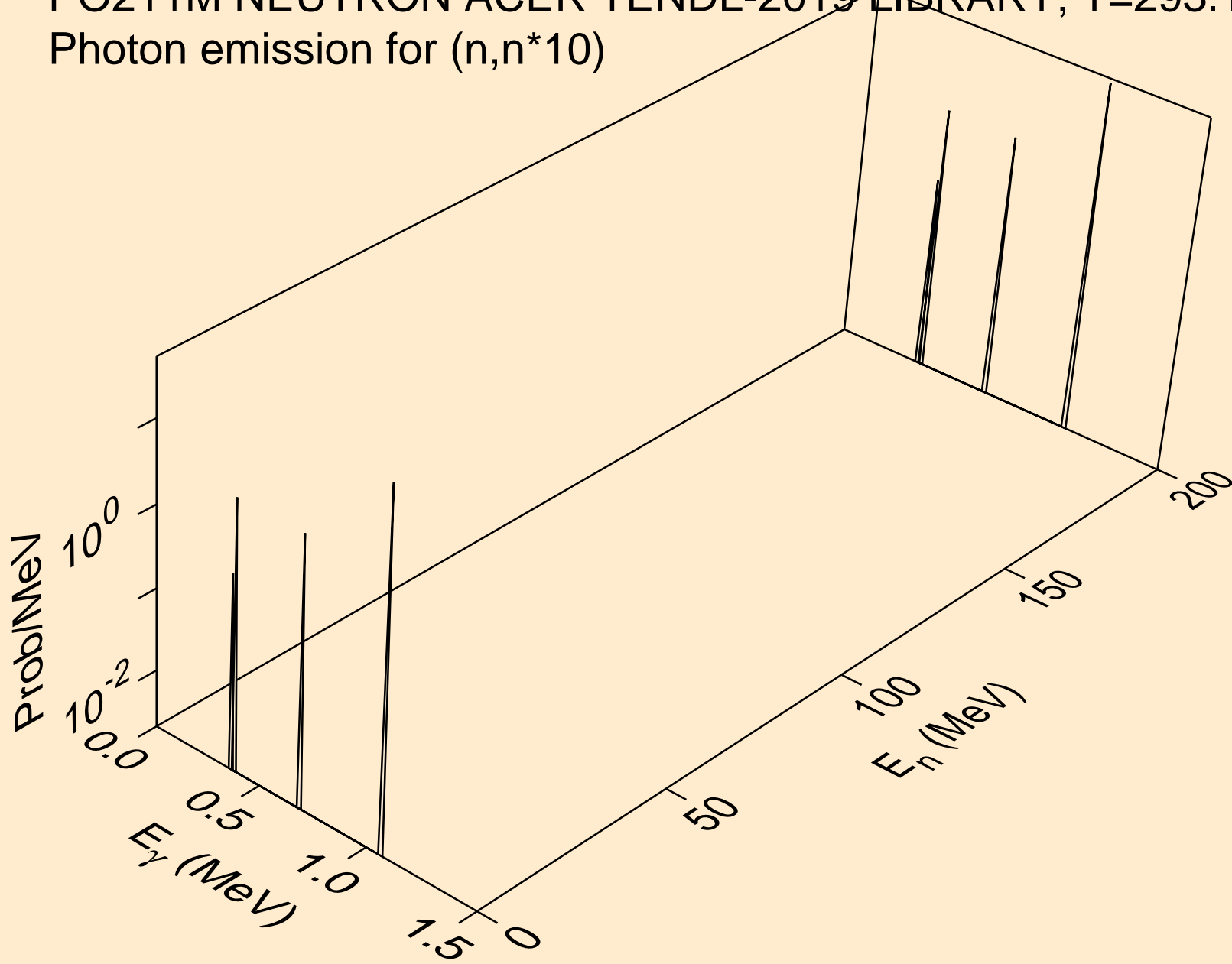

PO211M NEUTRON ACER TENDL-2019 LIBRARY; T=293.16K
Photon emission for (n,n*11)

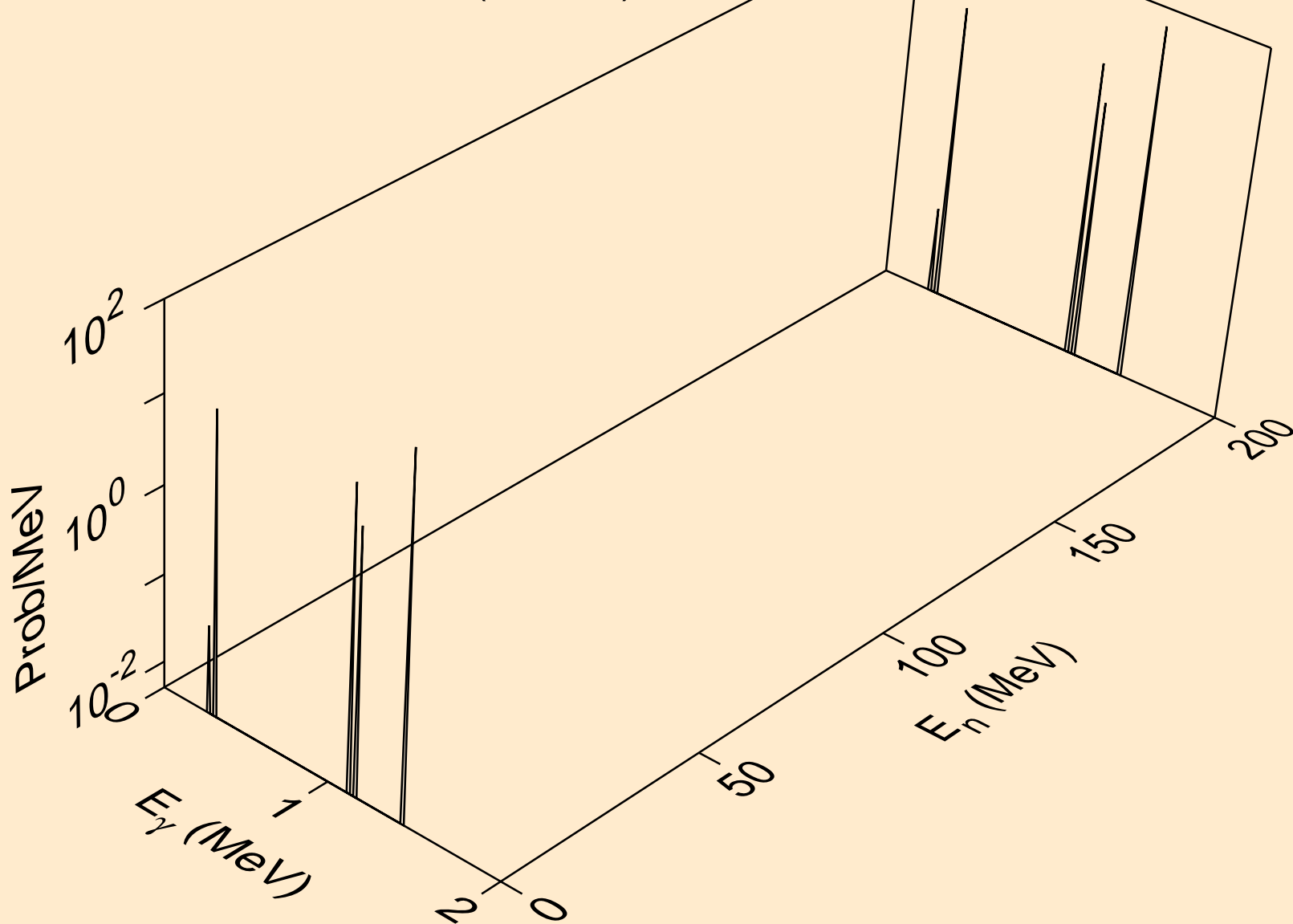

PO211M NEUTRON ACER TENDL-2019 LIBRARY; T=293.16K
Photon emission for (n,n*12)

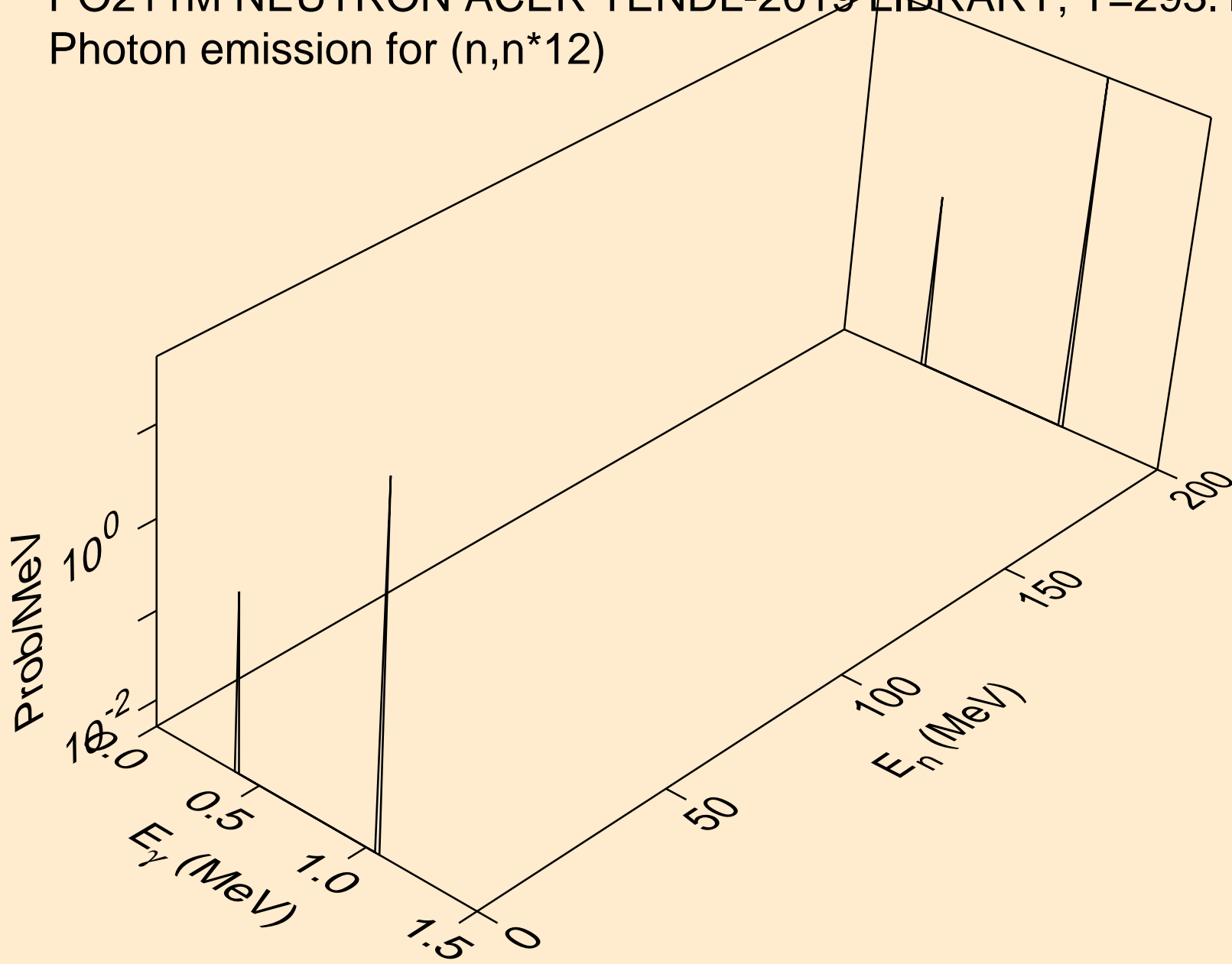

PO211M NEUTRON ACER TENDL-2019 LIBRARY; T=293.16K
Photon emission for (n,n*13)

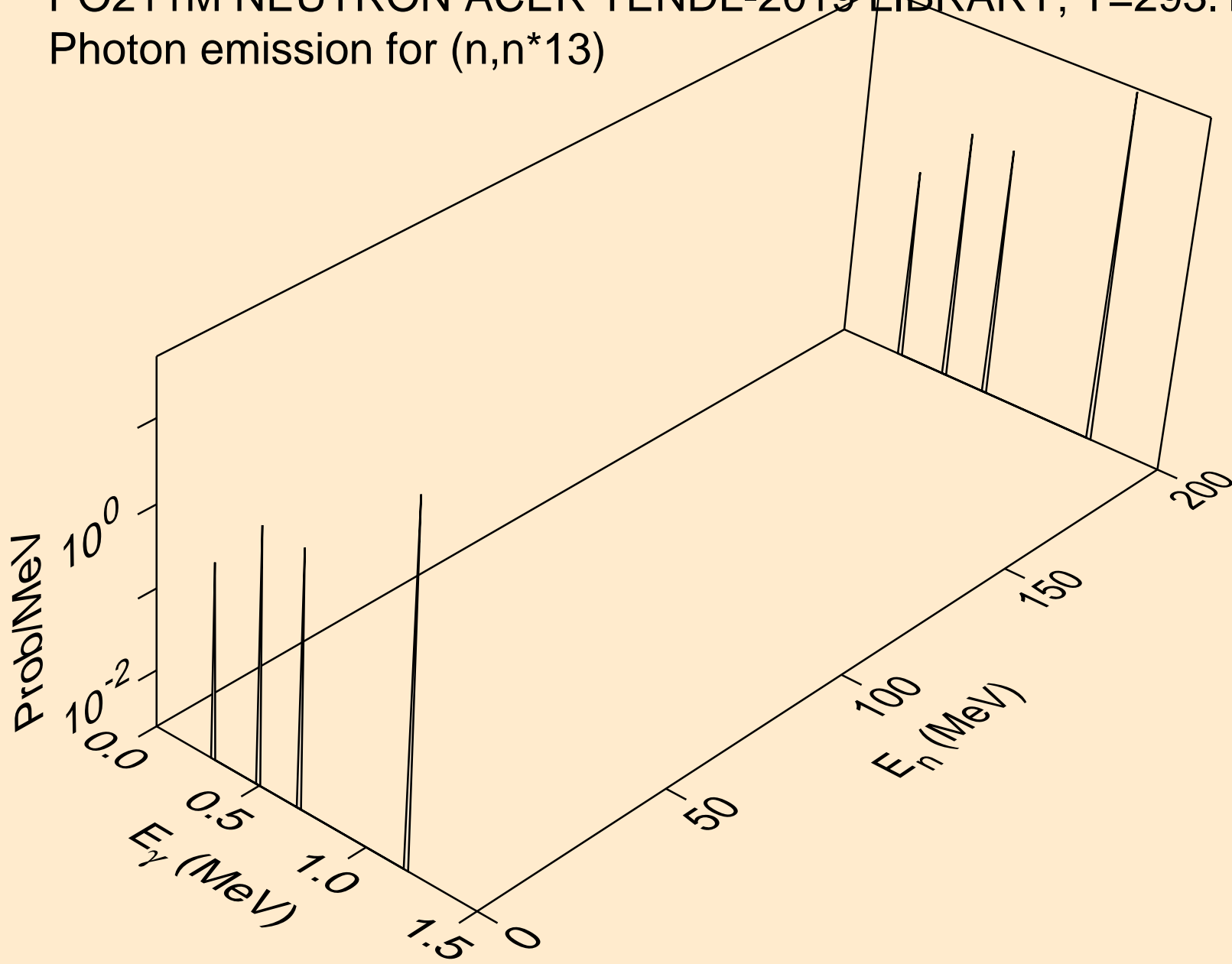

PO211M NEUTRON ACER TENDL-2019 LIBRARY; T=293.16K
Photon emission for (n,n*15)

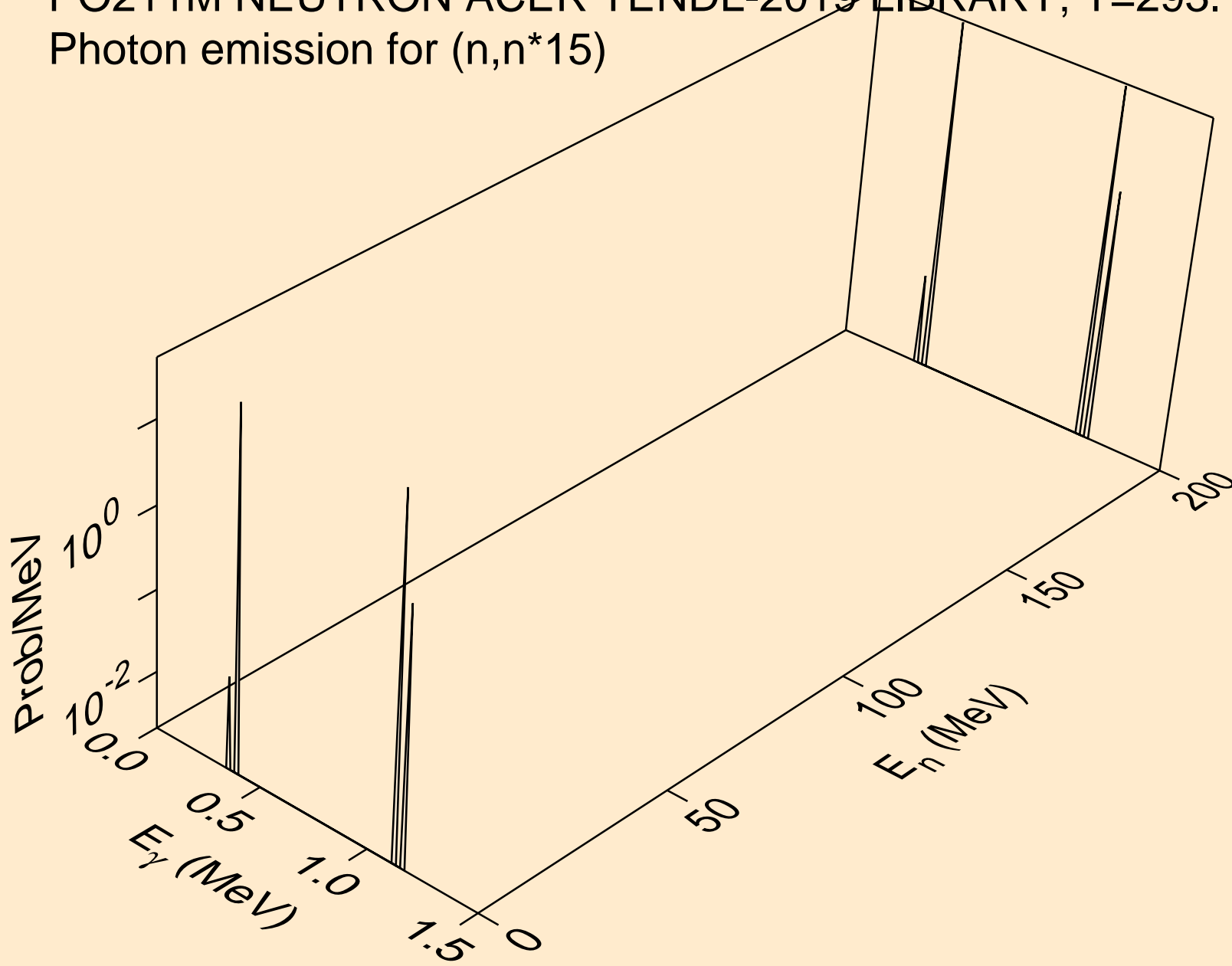

PO211M NEUTRON ACER TENDL-2019 LIBRARY; T=293.16K
Photon emission for (n,n*16)

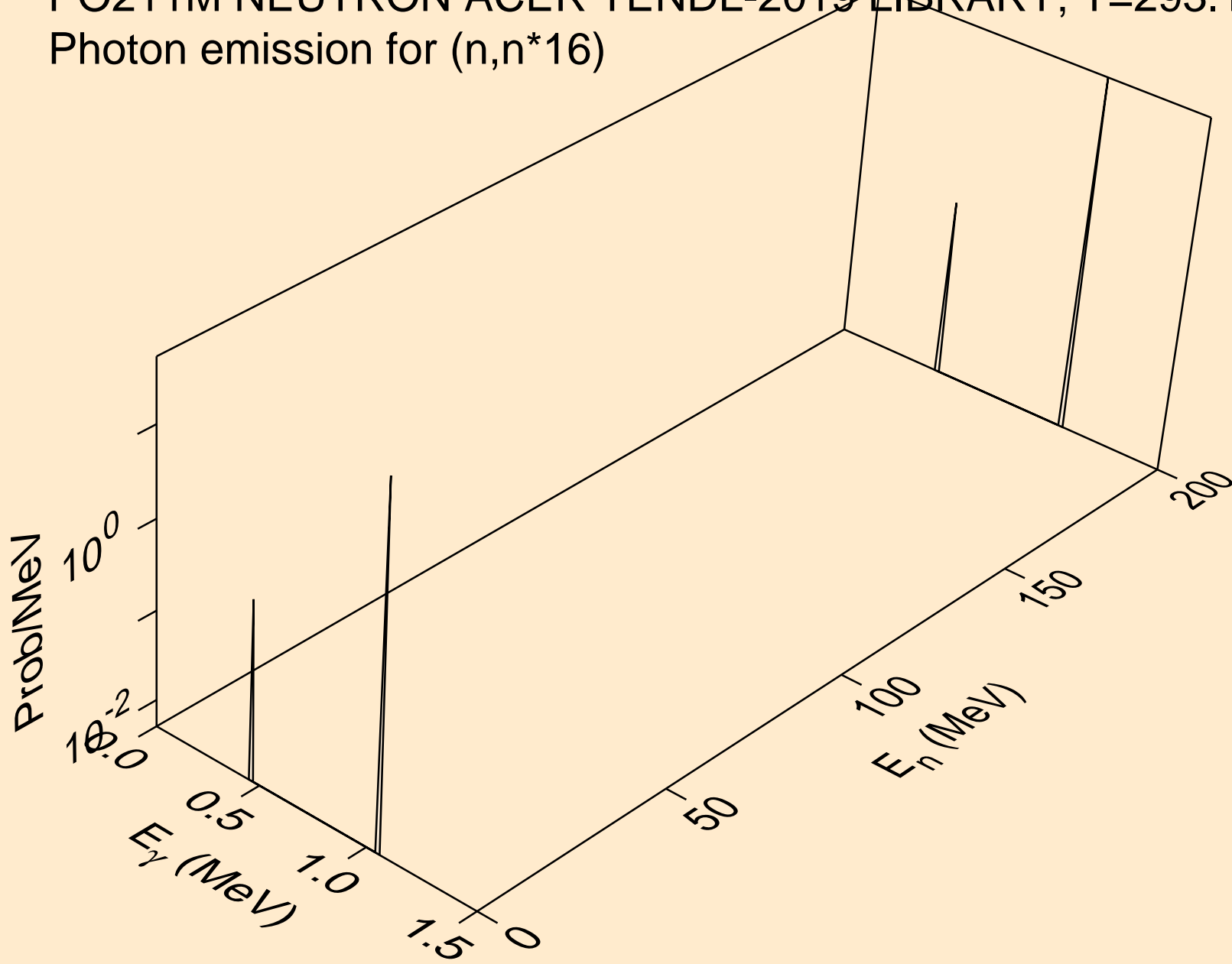

PO211M NEUTRON ACER TENDL-2019 LIBRARY; T=293.16K
Photon emission for (n,n*17)

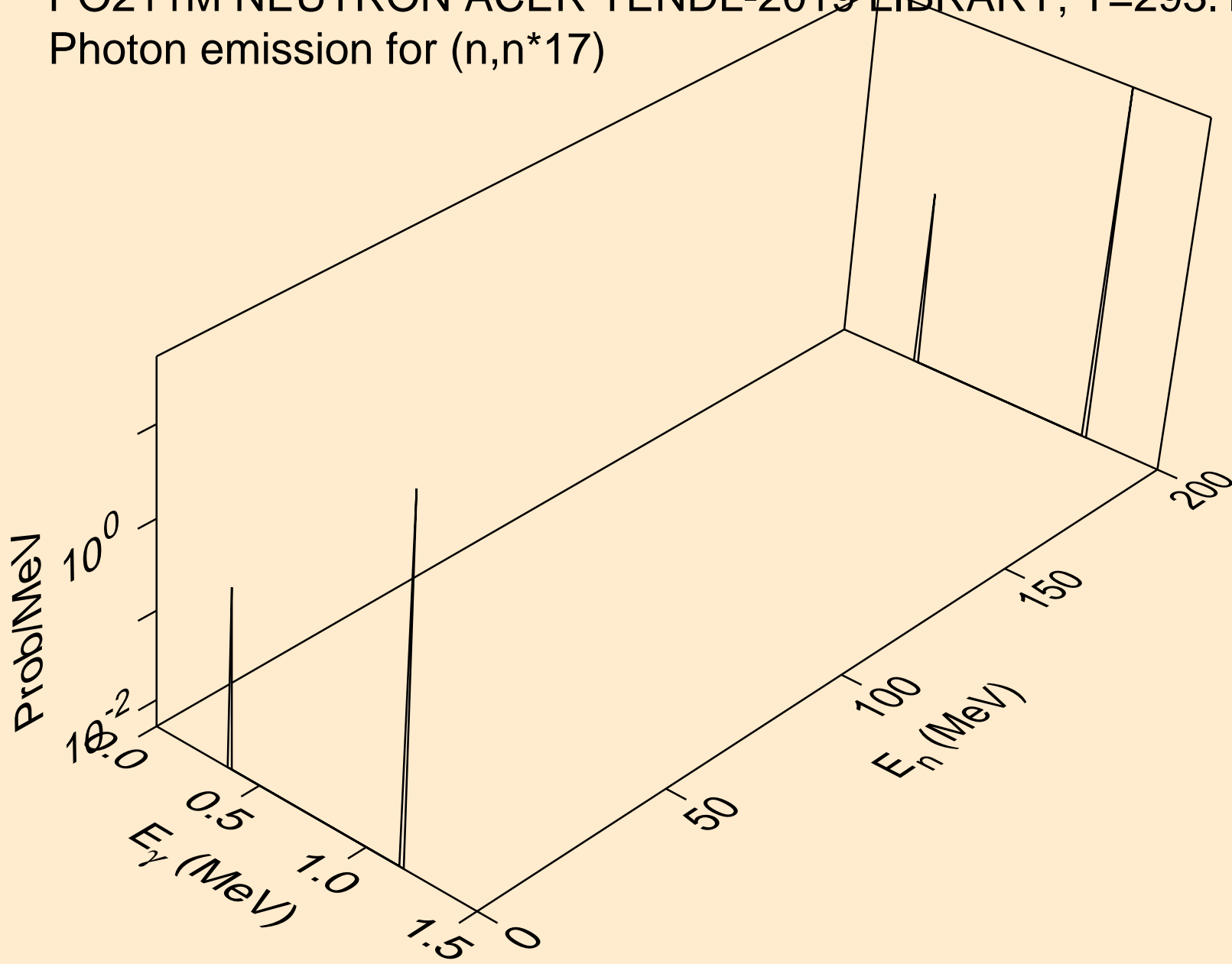

PO211M NEUTRON ACER TENDL-2019 LIBRARY; T=293.16K
Photon emission for (n,n*18)

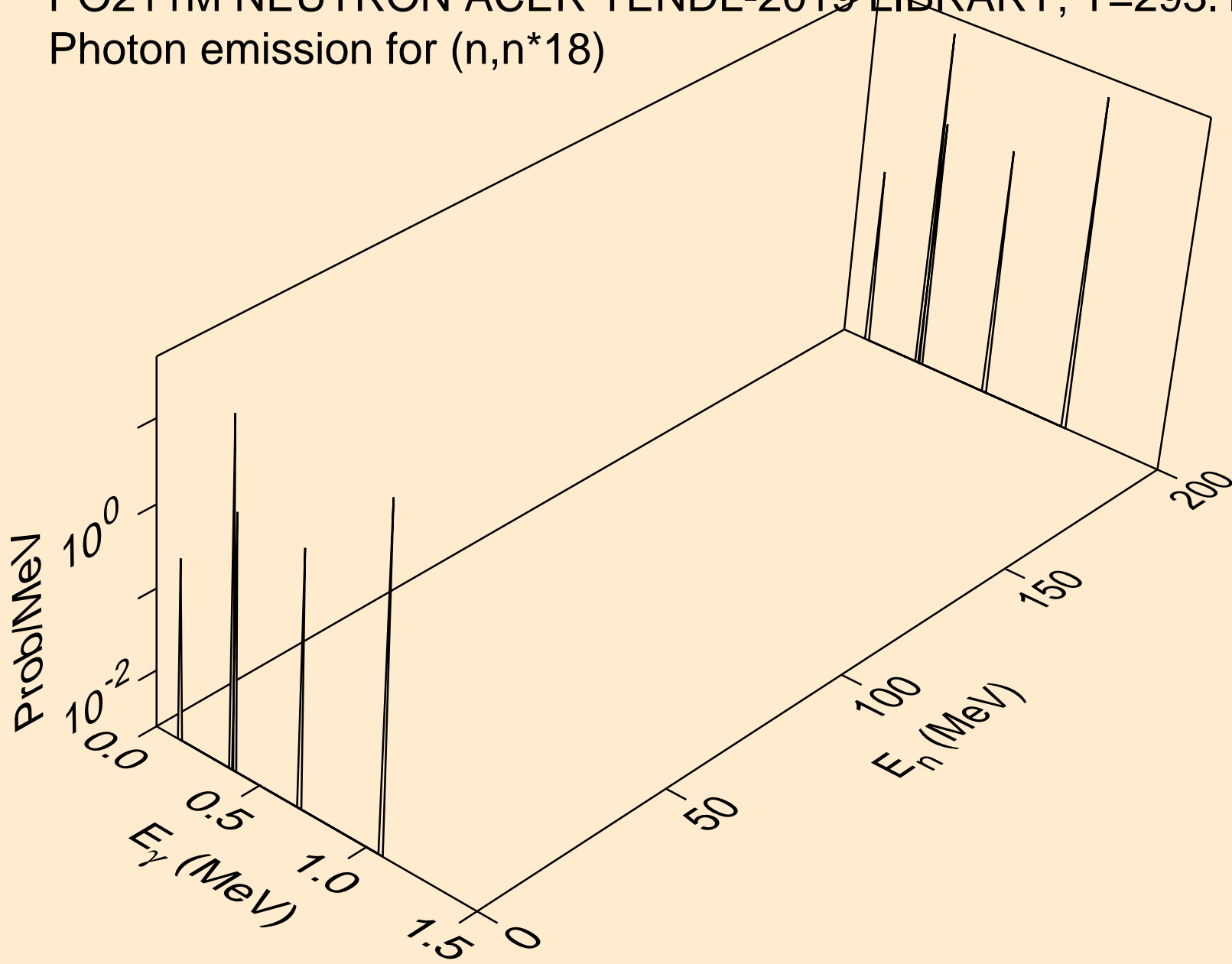

PO211M NEUTRON ACER TENDL-2019 LIBRARY; T=293.16K
Photon emission for (n,n*c)

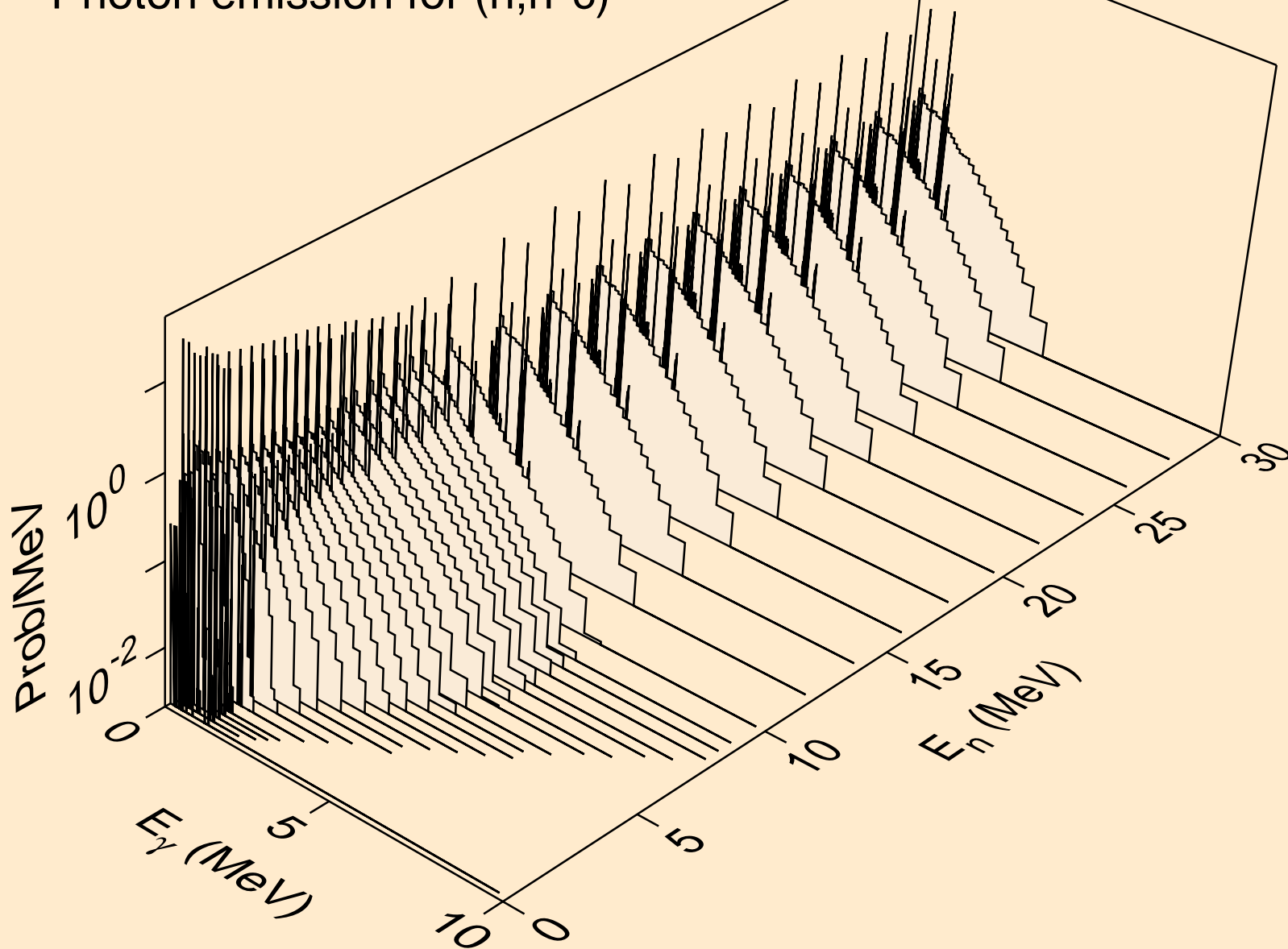

PO211M NEUTRON ACER TENDL-2019 LIBRARY; T=293.16K
Photon emission for (n,gma)

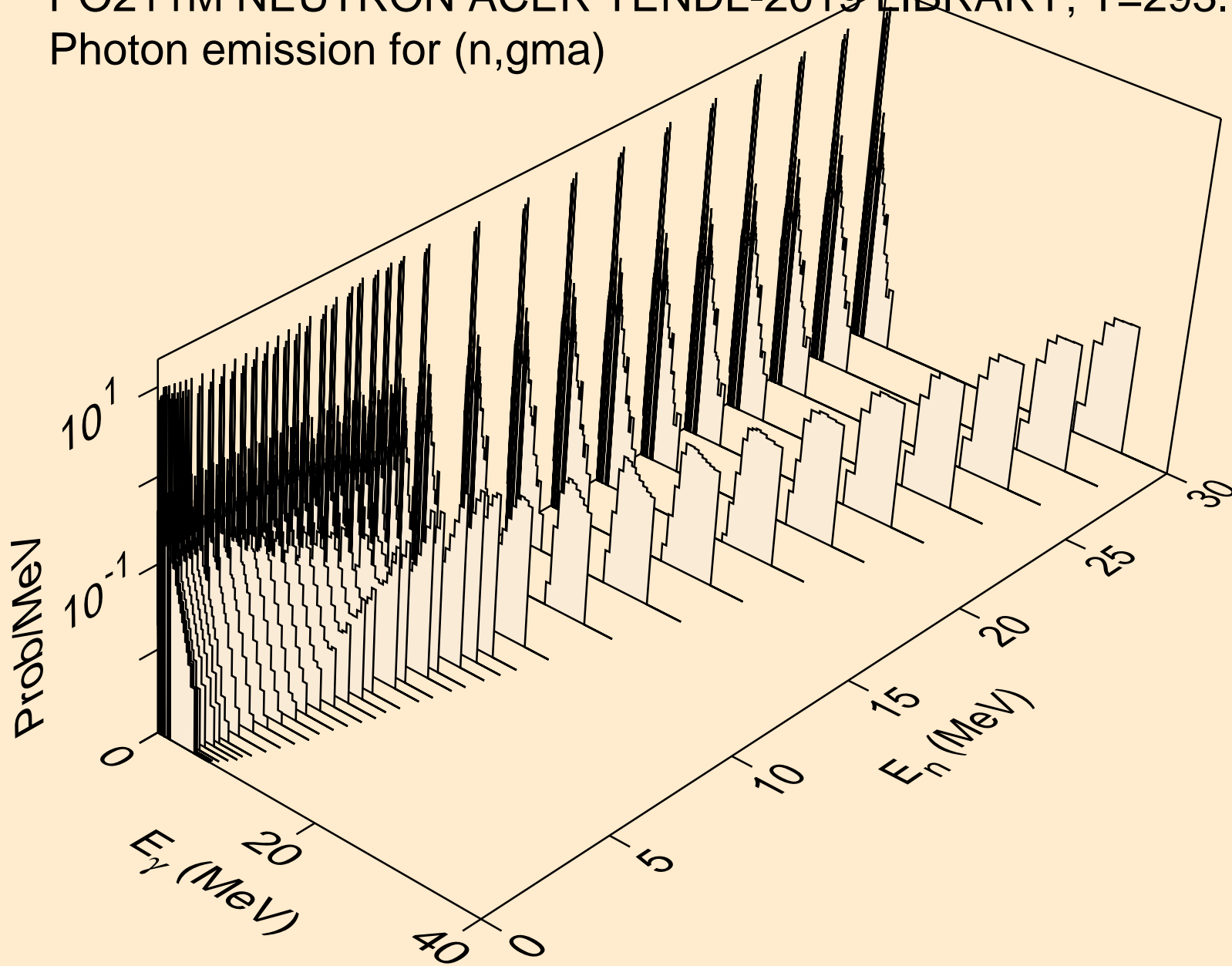

PO211M NEUTRON ACER TENDL-2019 LIBRARY; T=293.16K
Photon emission for (n,p)

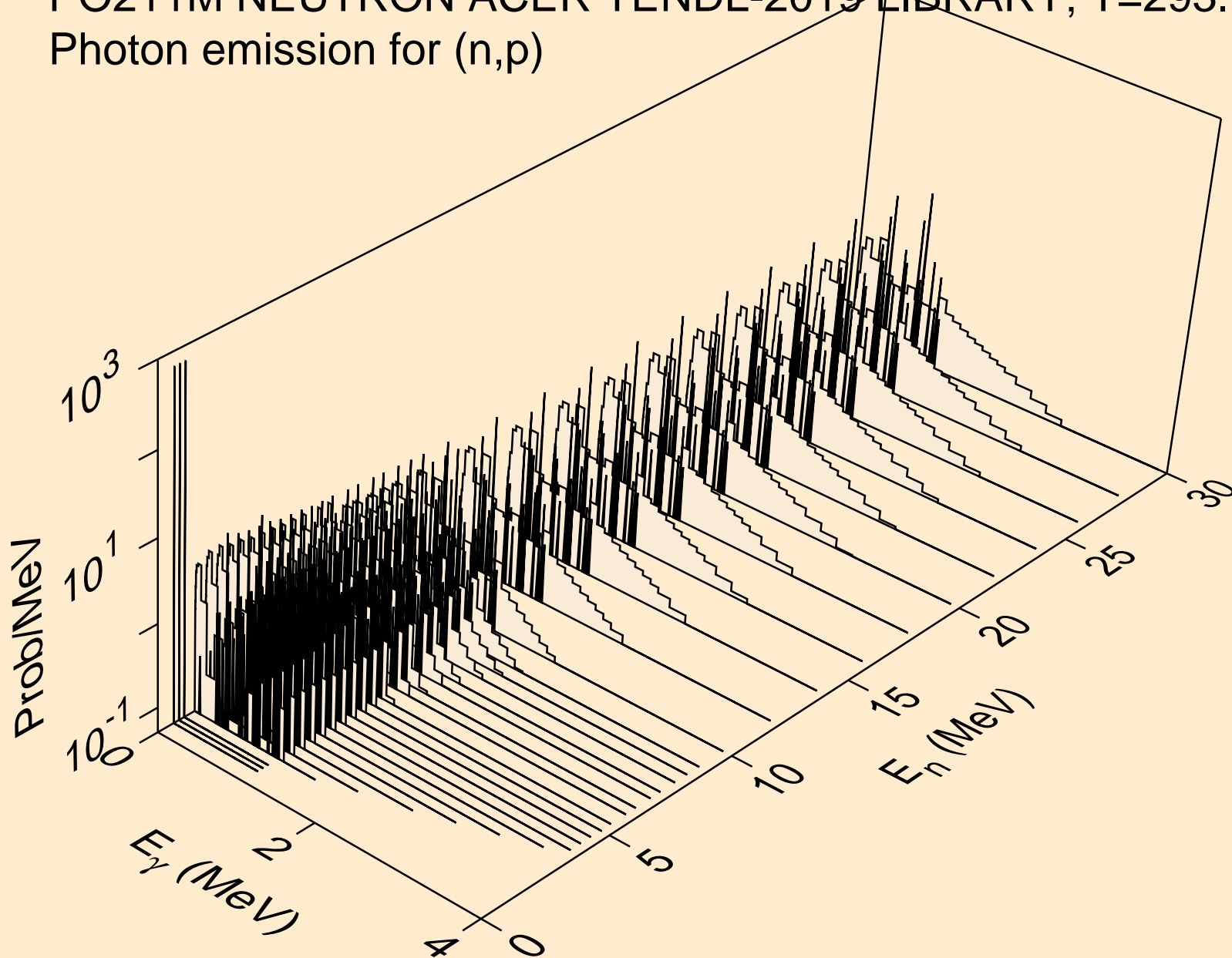

PO211M NEUTRON ACER TENDL-2019 LIBRARY; T=293.16K
Photon emission for (n,d)

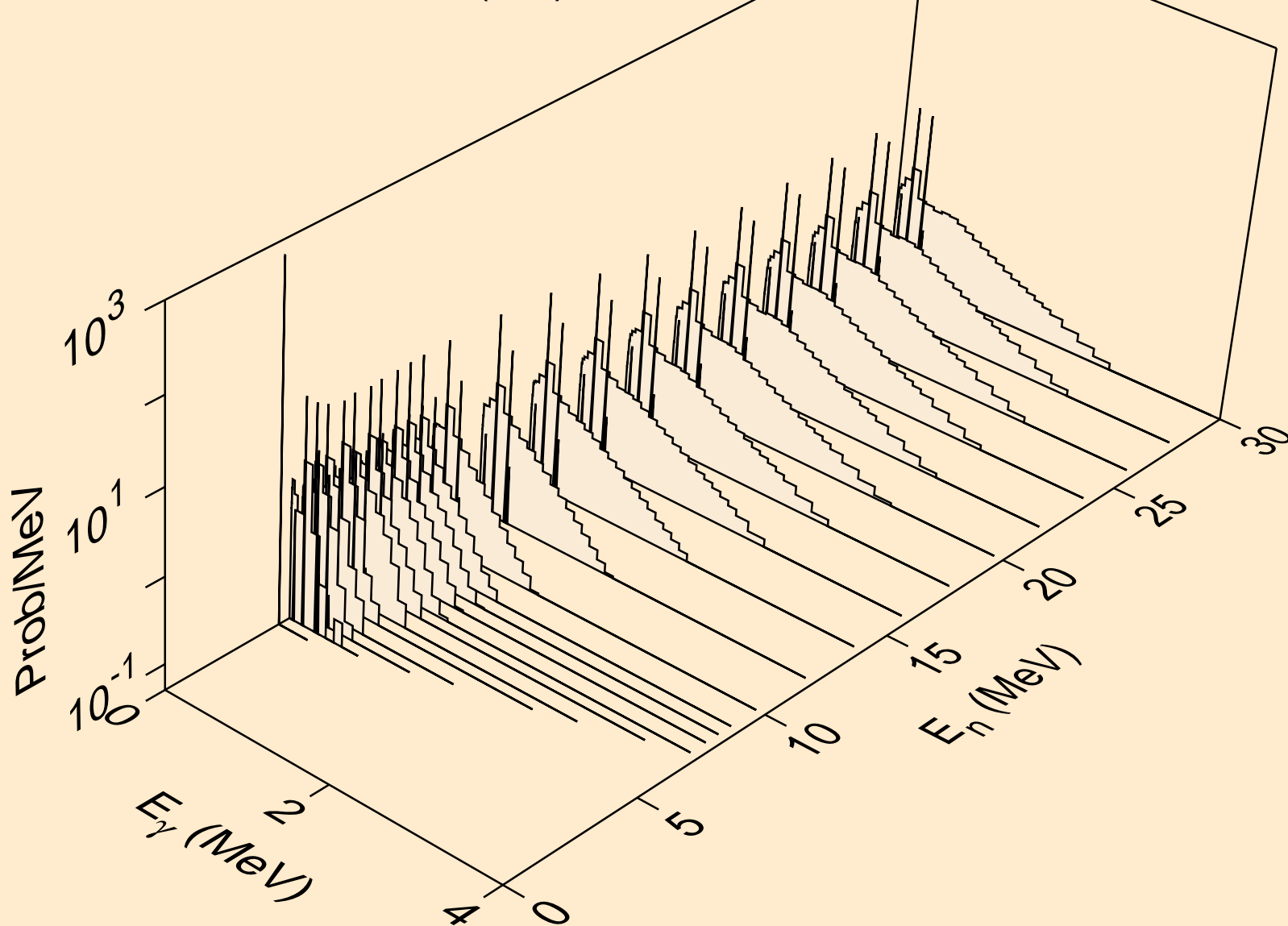

PO211M NEUTRON ACER TENDL-2019 LIBRARY; T=293.16K
Photon emission for (n,t)

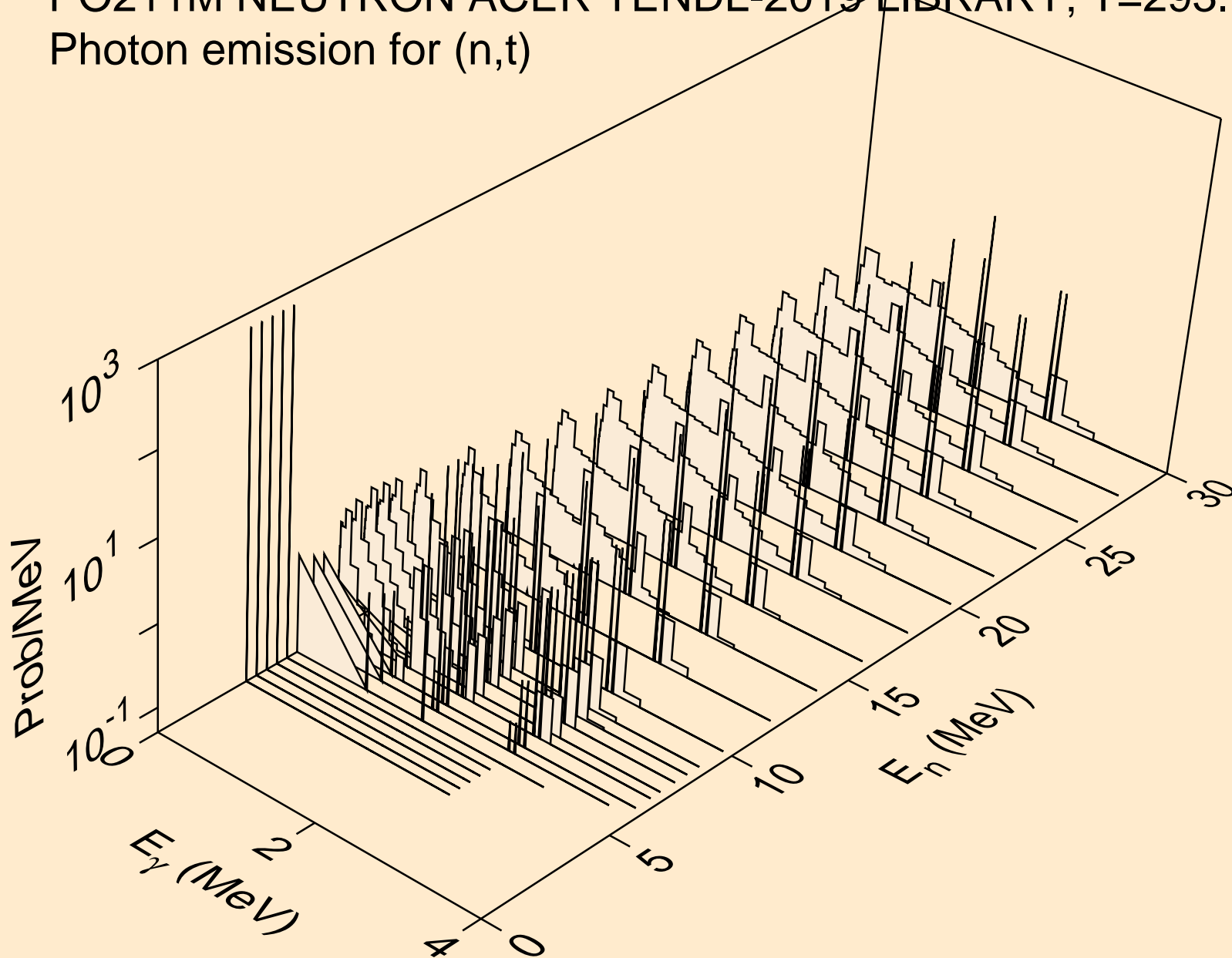

PO211M NEUTRON ACER TENDL-2019 LIBRARY; T=293.16K
Photon emission for (n,he3)

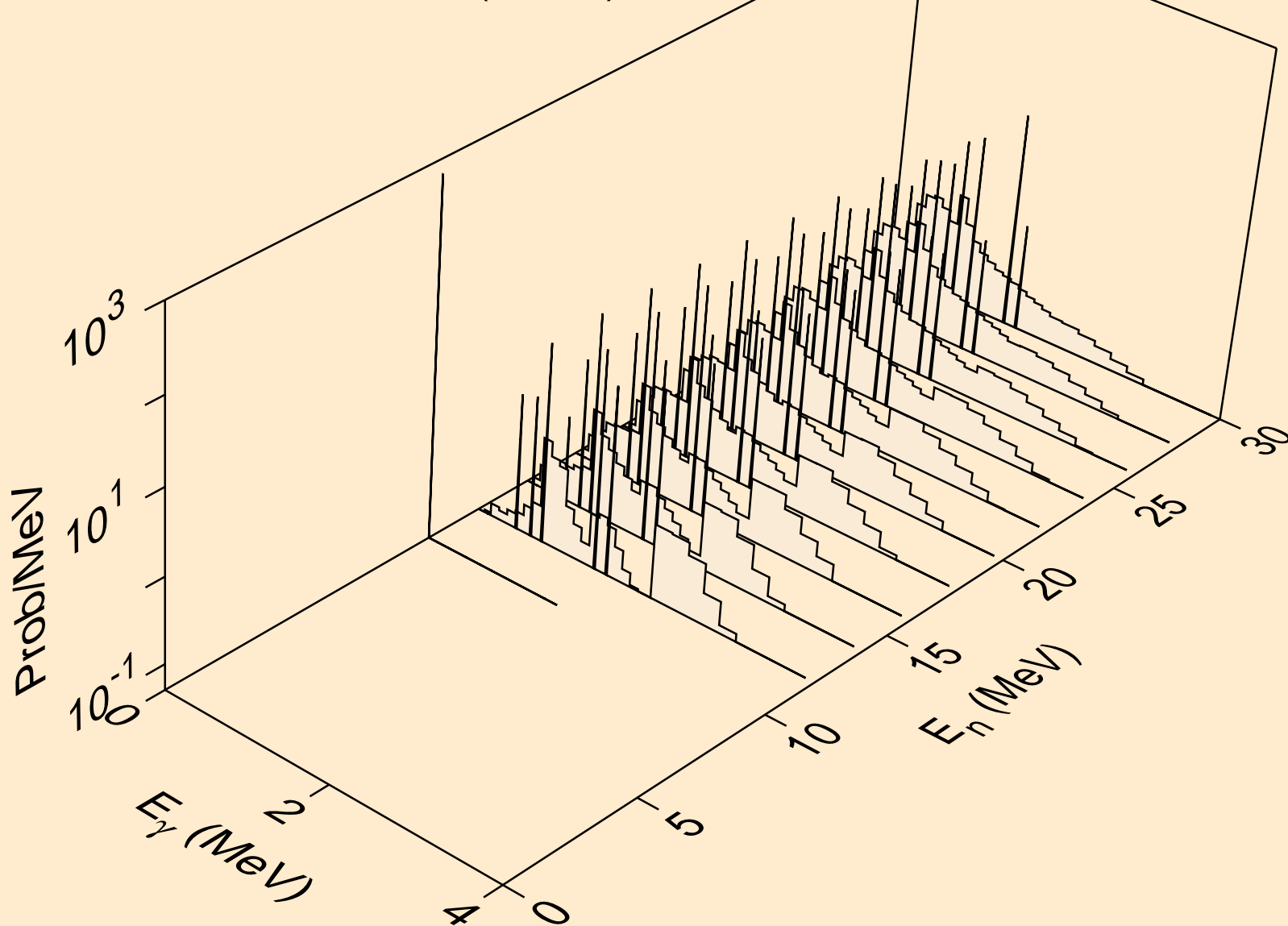

PO211M NEUTRON ACER TENDL-2019 LIBRARY; T=293.16K
Photon emission for (n,a)

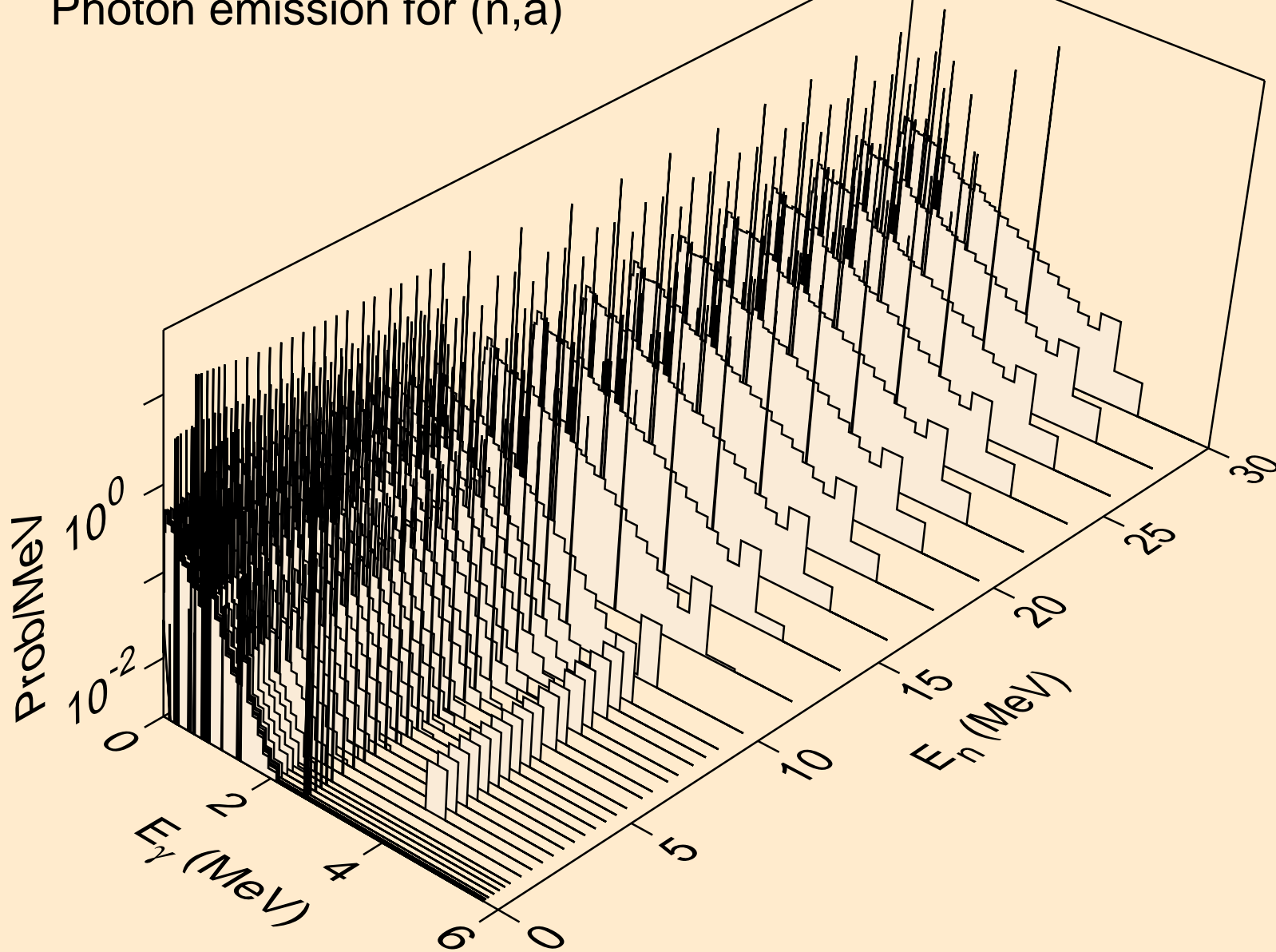

PO211M NEUTRON ACER TENDL-2019 LIBRARY; T=293.16K
Photon emission for (n,2a)

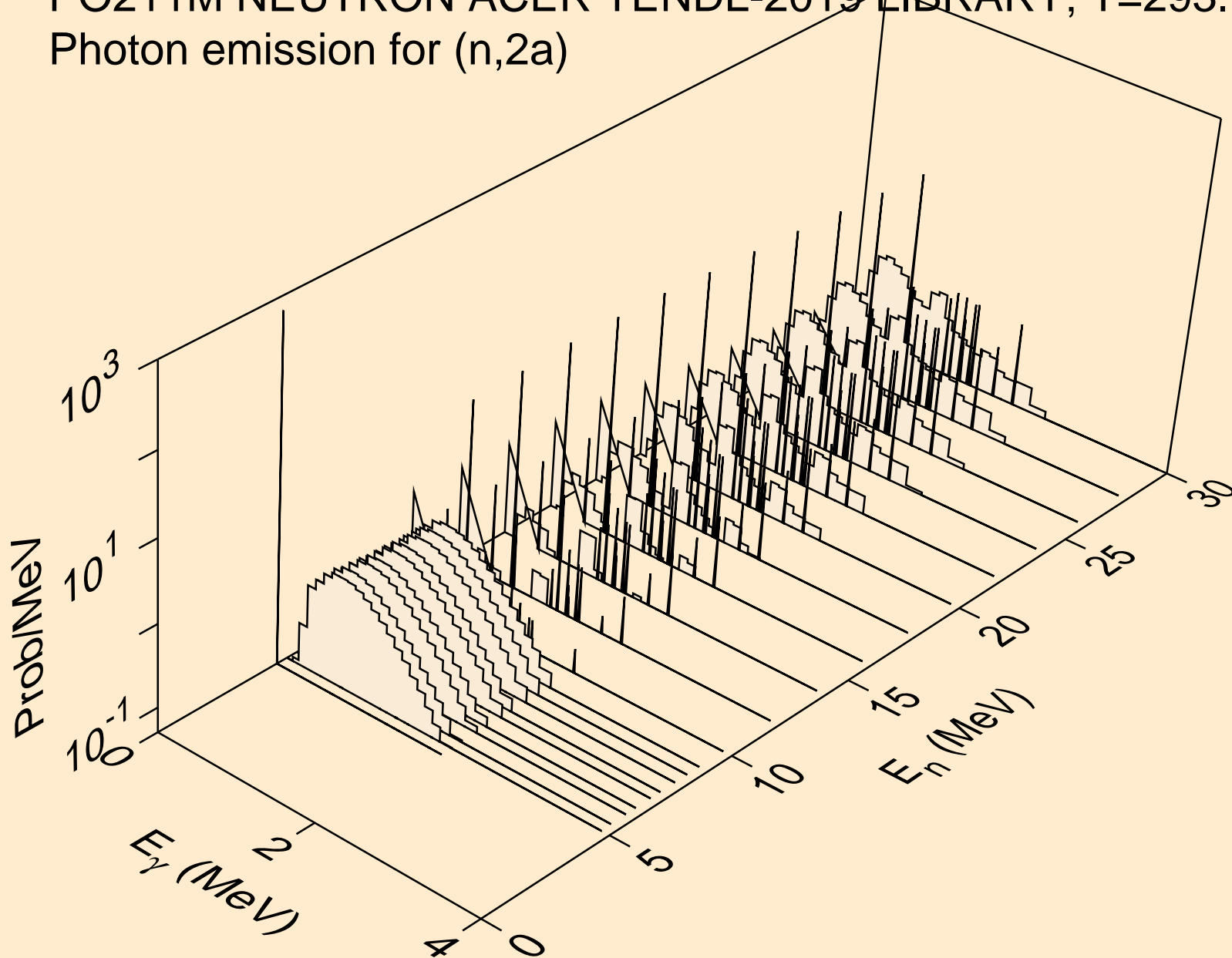

PO211M NEUTRON ACER TENDL-2019 LIBRARY; T=293.16K
Photon emission for (n,2p)

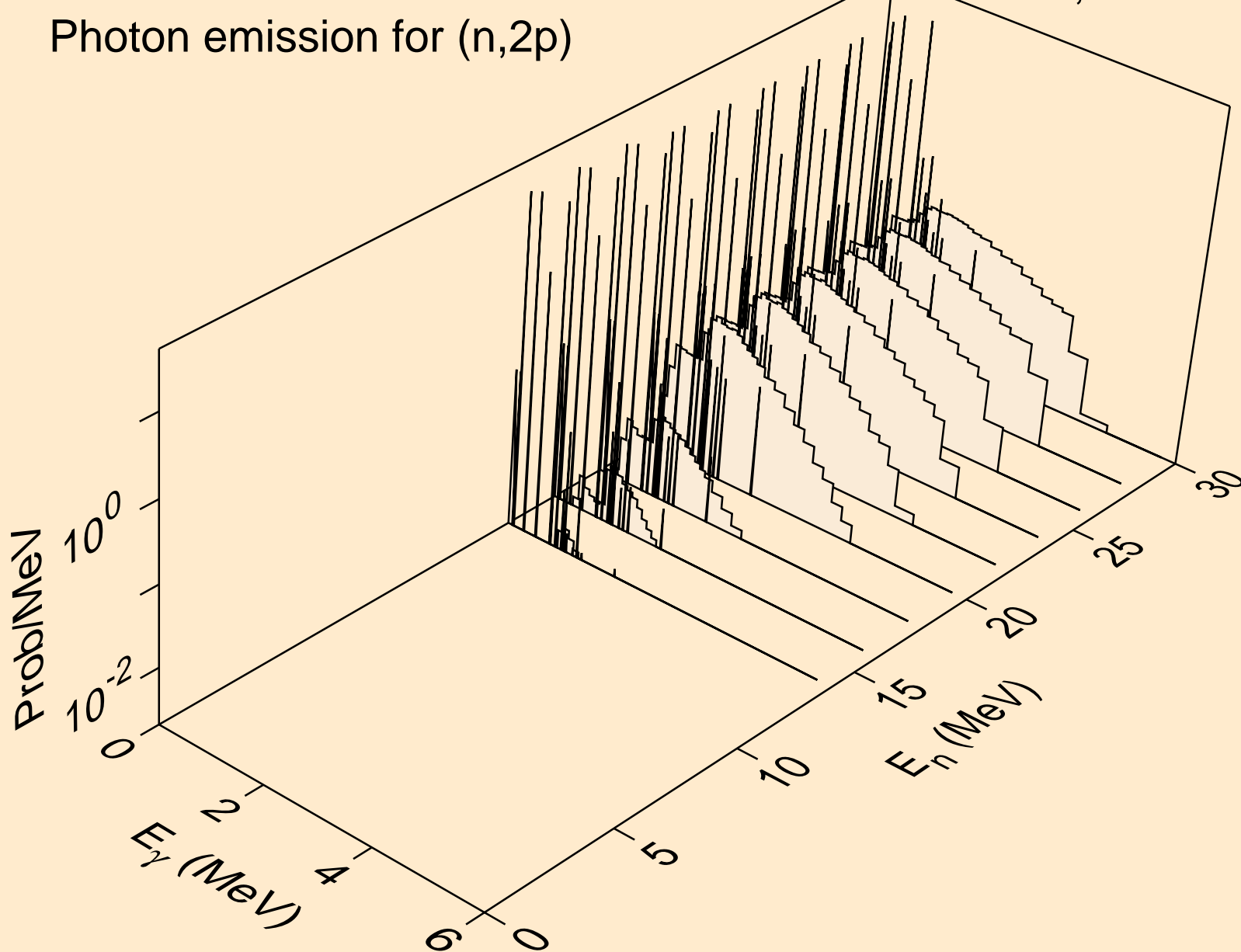

PO211M NEUTRON ACER TENDL-2019 LIBRARY; T=293.16K
Photon emission for (n,p α)

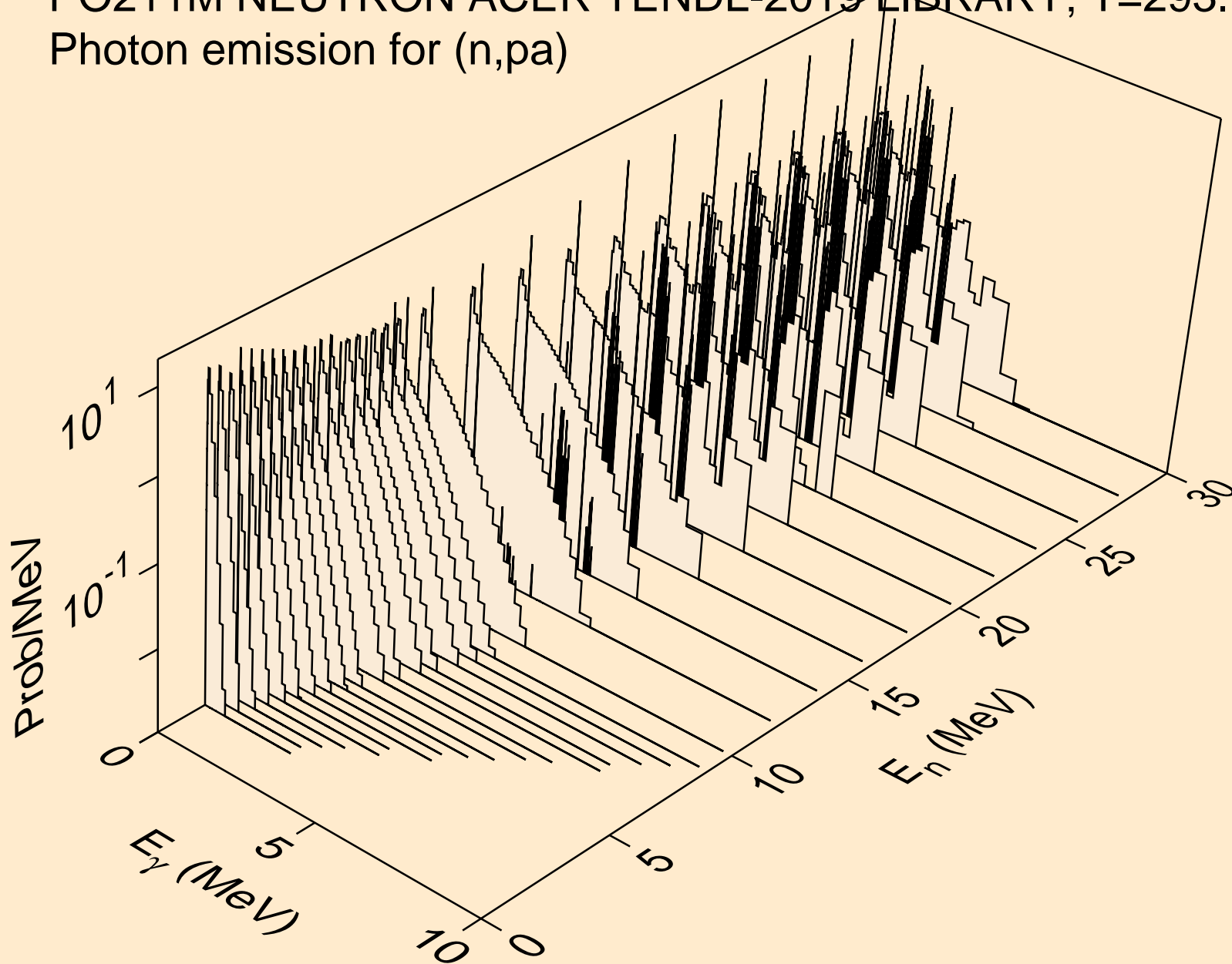

PO211M NEUTRON ACER TENDL-2019 LIBRARY; T=293.16K
Photon emission for (n,pd)

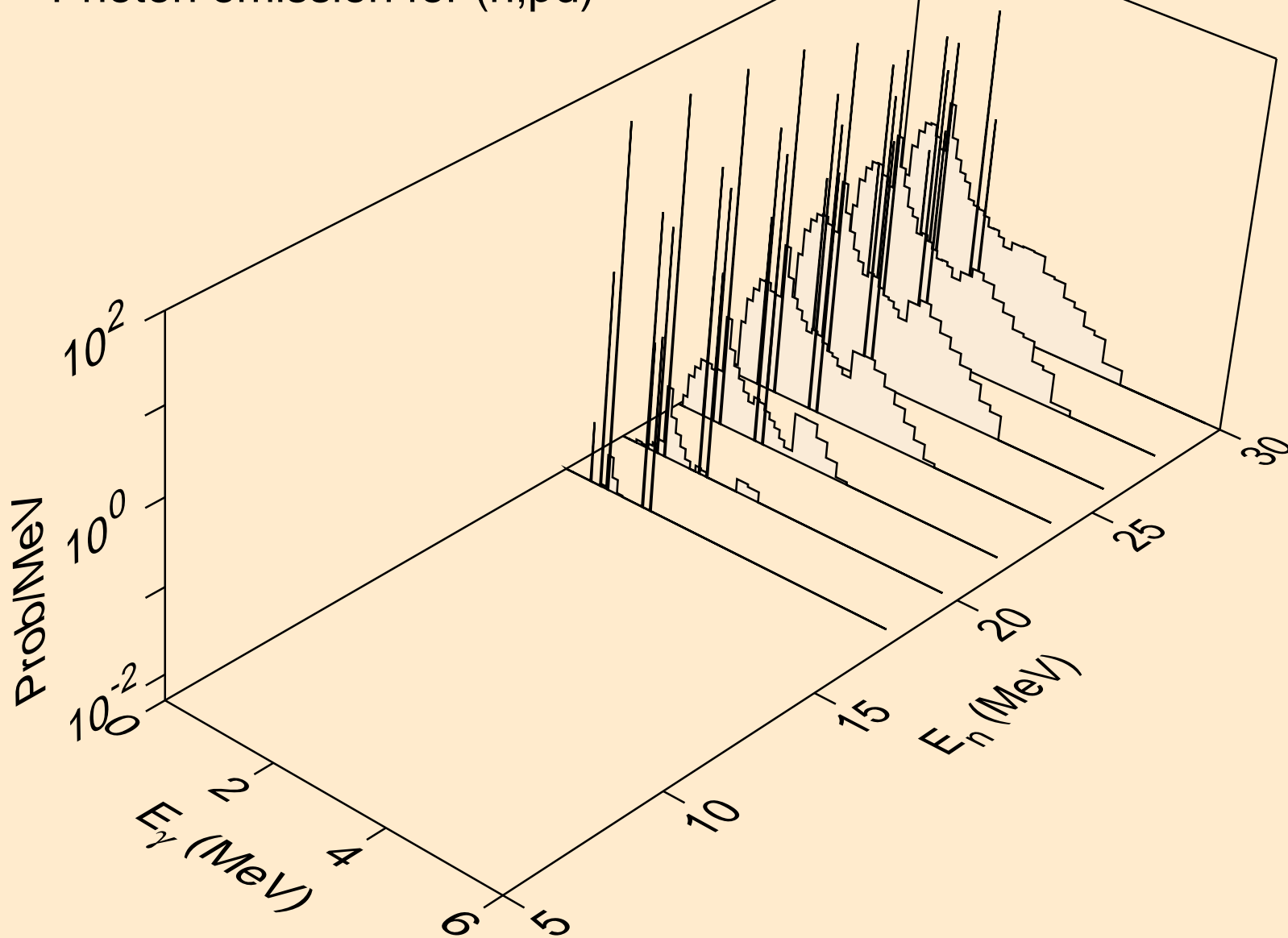

PO211M NEUTRON ACER TENDL-2019 LIBRARY; T=293.16K
Photon emission for (n,pt)

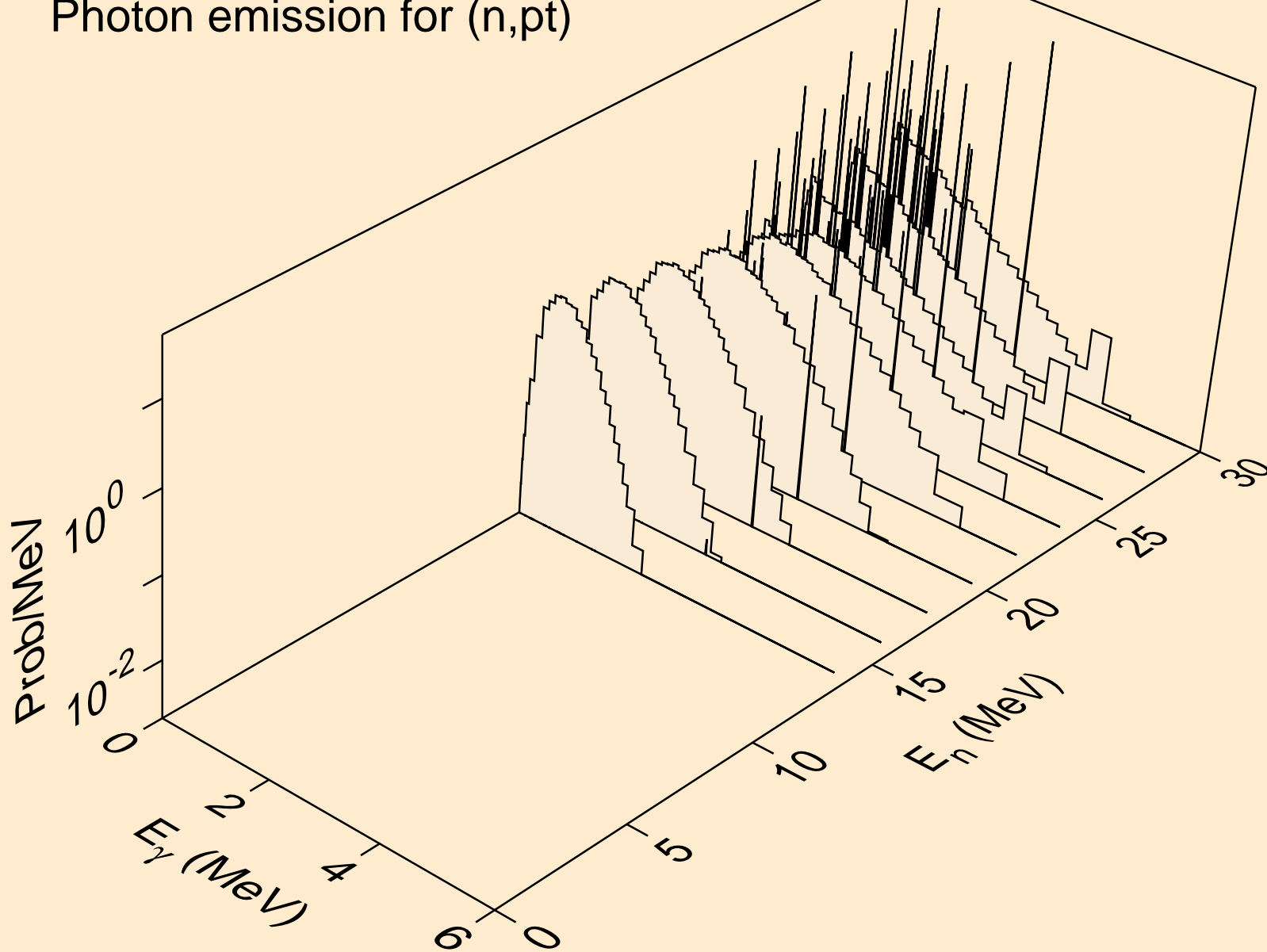

PO211M NEUTRON ACER TENDL-2019 LIBRARY; T=293.16K
Photon emission for (n,da)

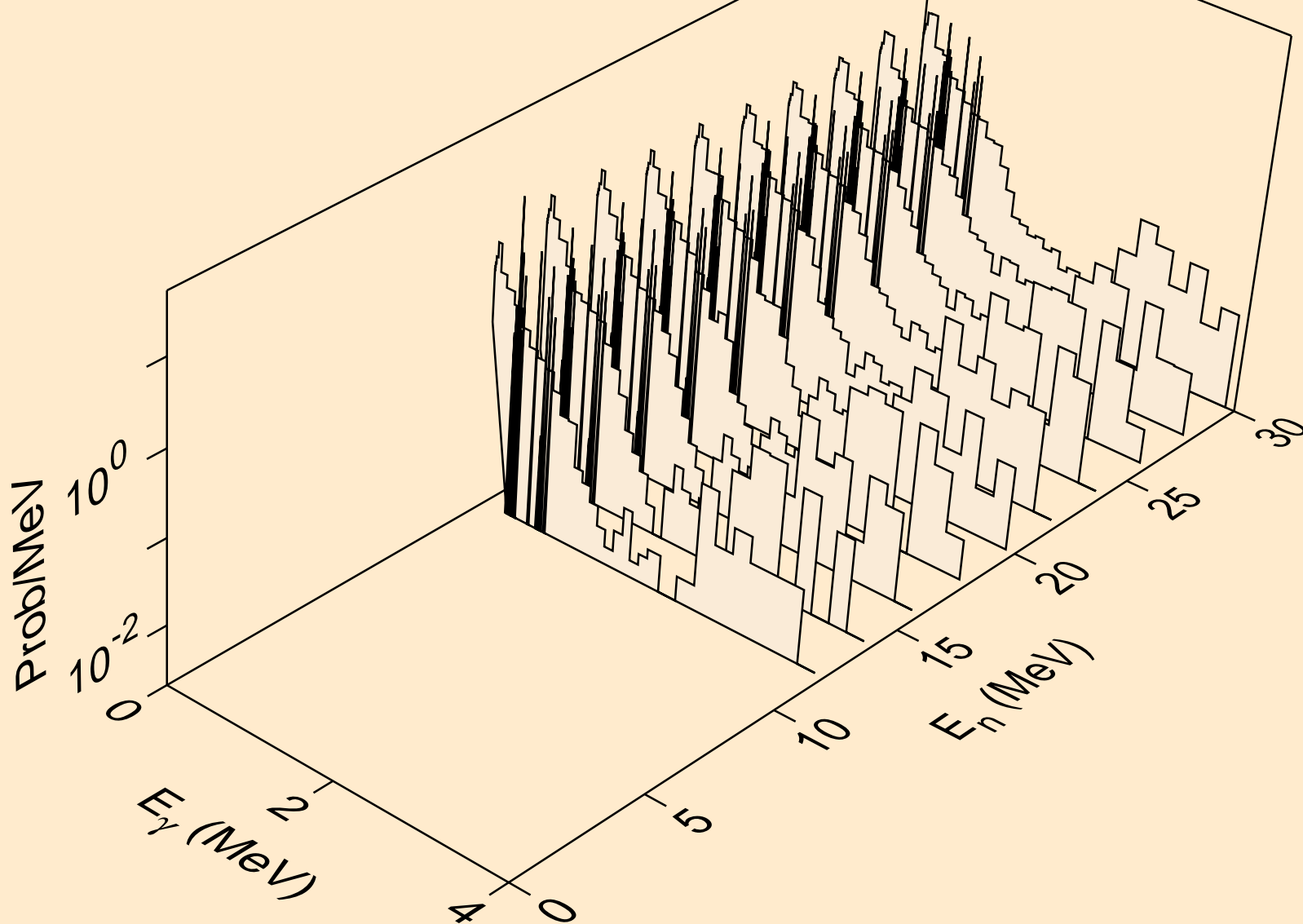

PO211M NEUTRON ACER TENDL-2019 LIBRARY; T=293.16K
thermal capture photon spectrum

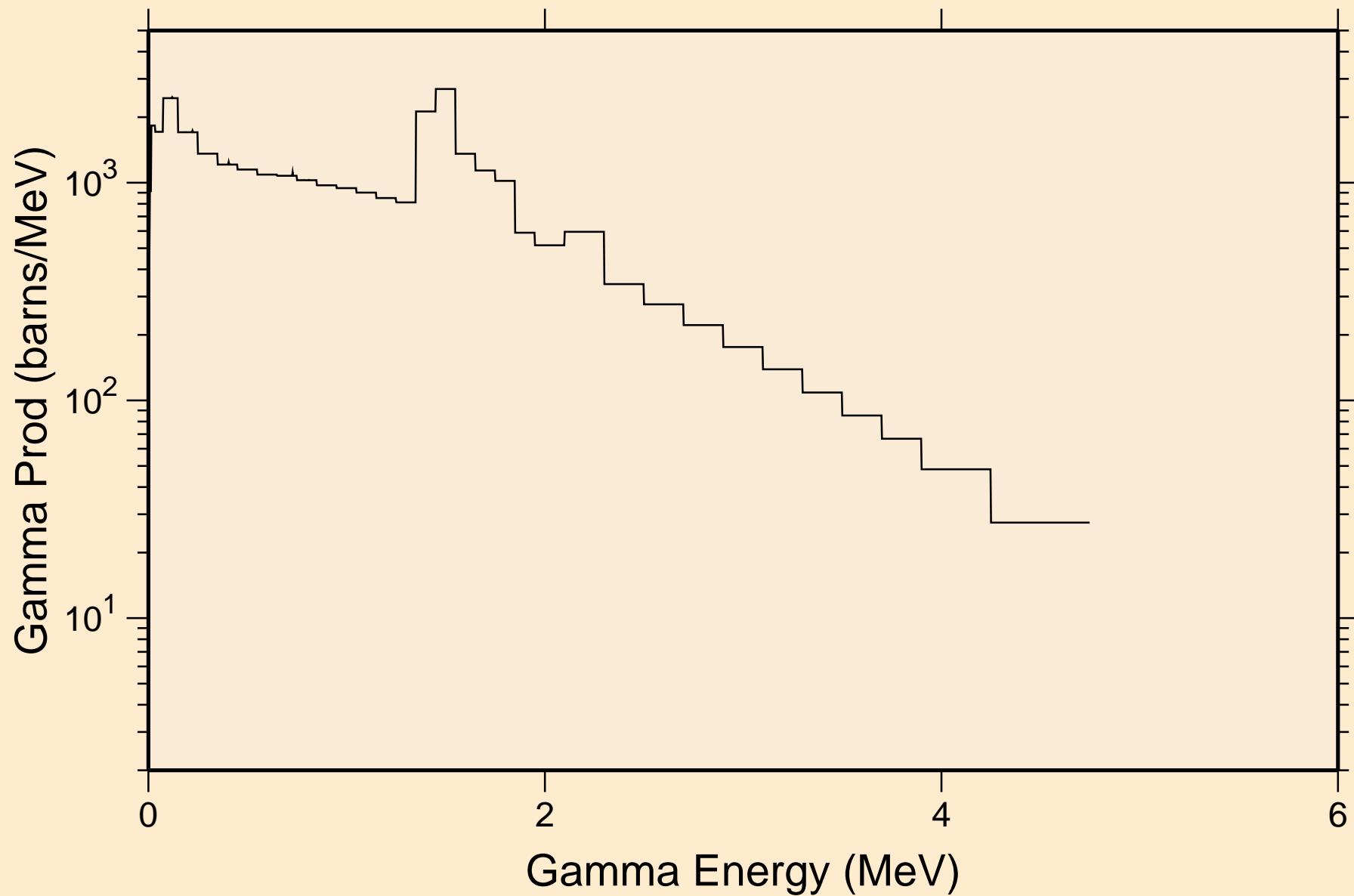

PO211M NEUTRON ACER TENDL-2019 LIBRARY; T=293.16K
14 MeV photon spectrum

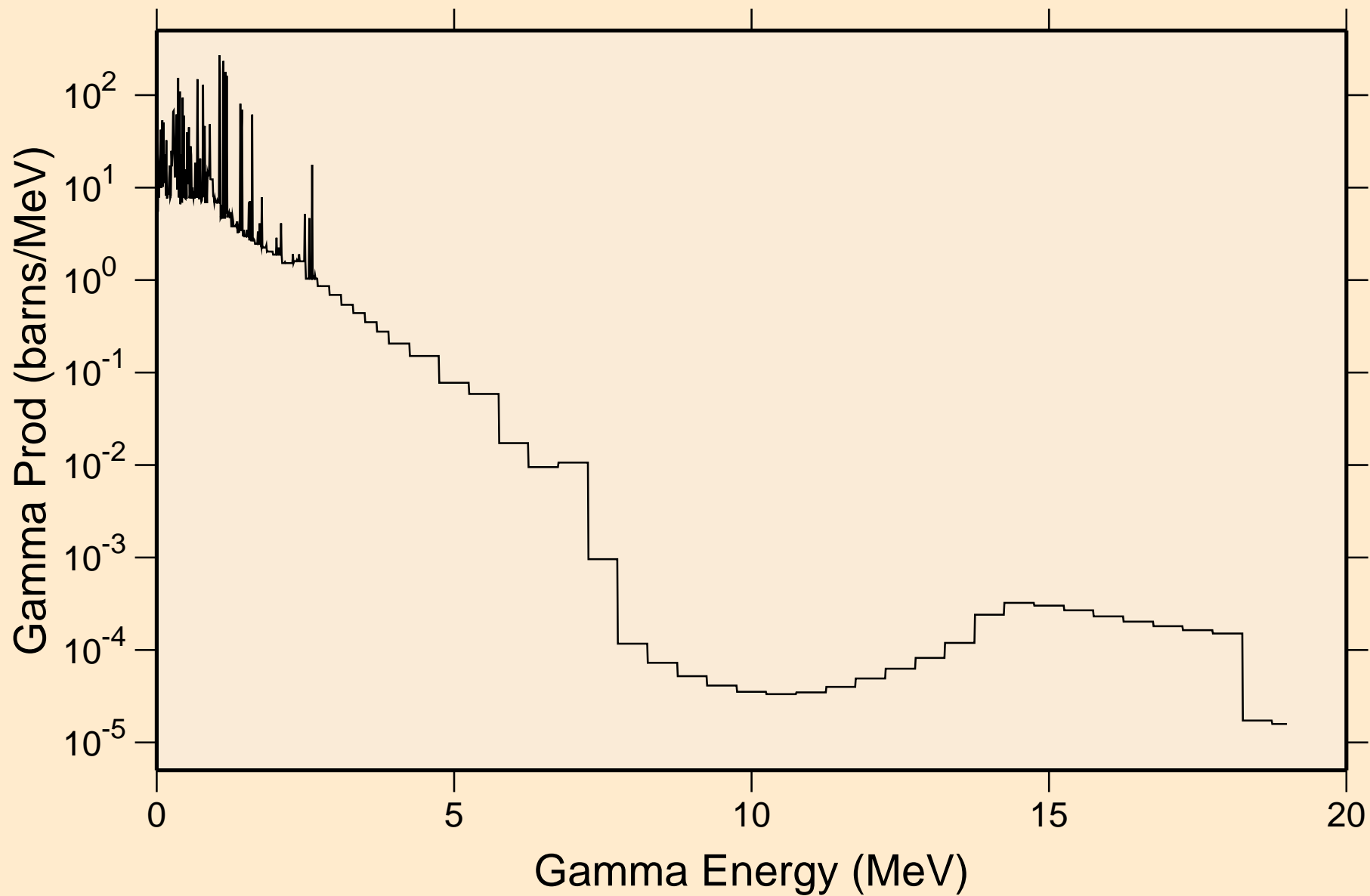

PO211M NEUTRON ACER TENDL-2019 LIBRARY; T=293.16K
Particle heating contributions

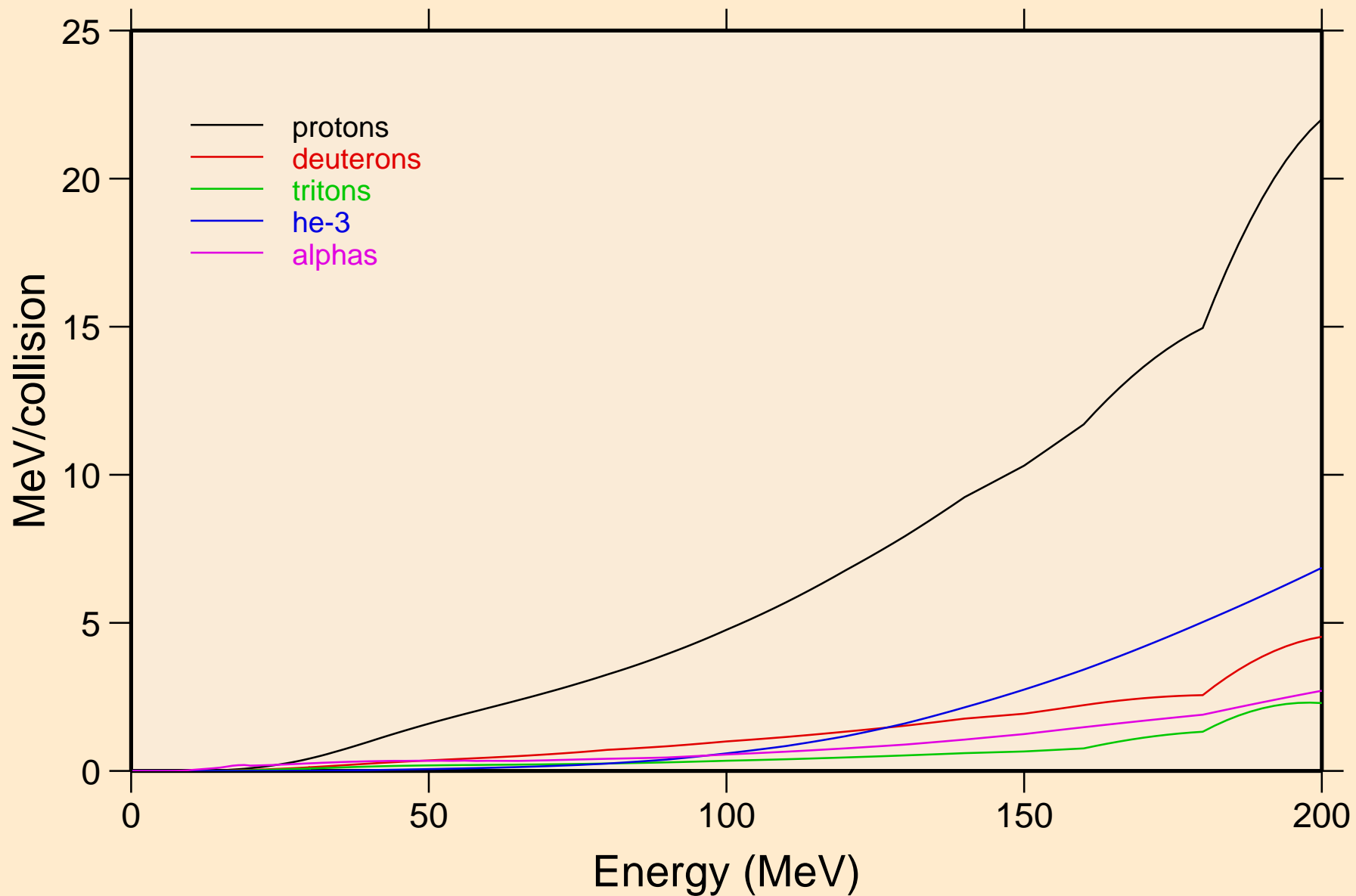

PO211M NEUTRON ACER TENDL-2019 LIBRARY; T=293.16K
Recoil Heating

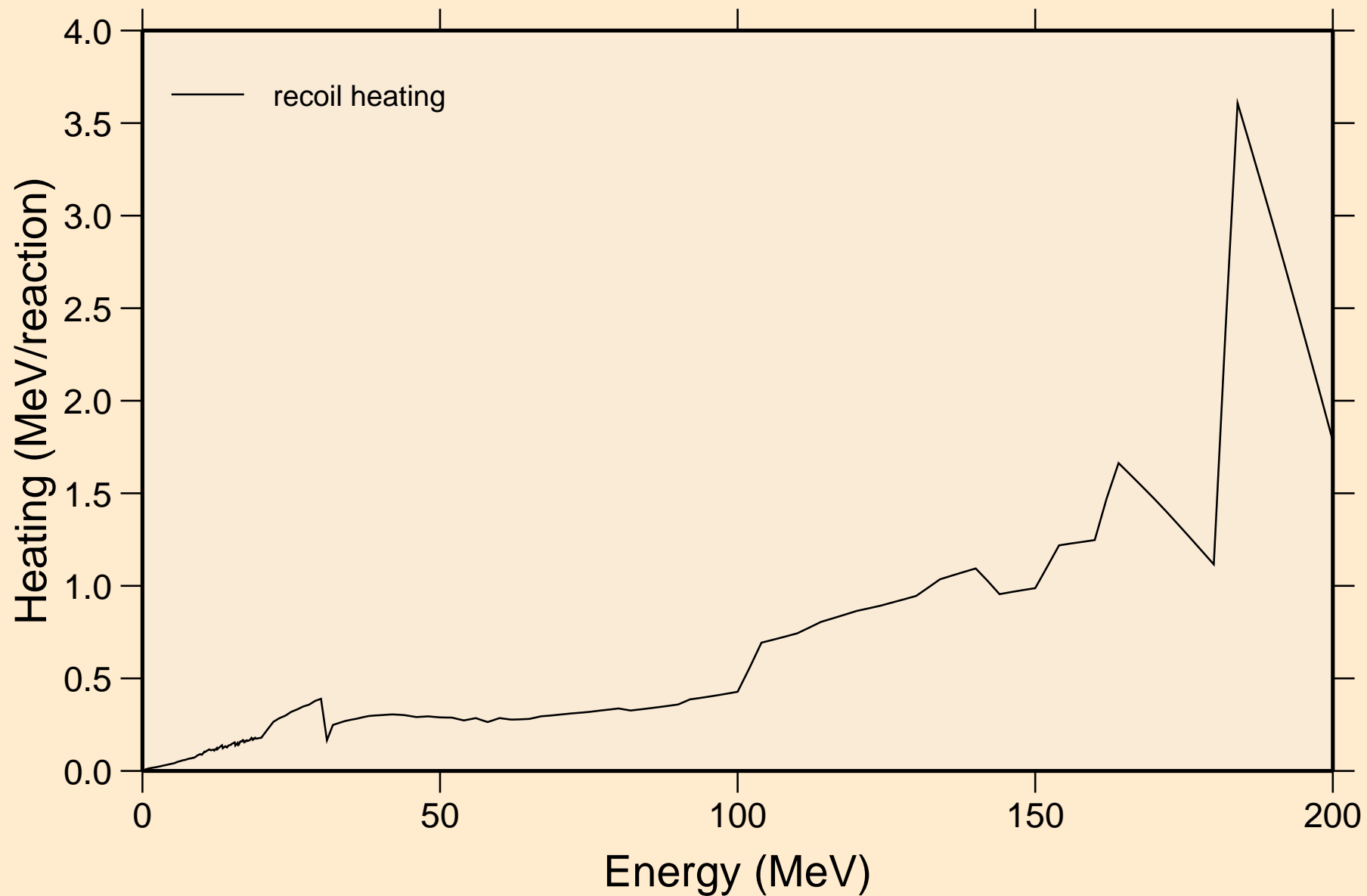

PO211M NEUTRON ACER TENDL-2019 LIBRARY; T=293.16K
Particle production cross sections

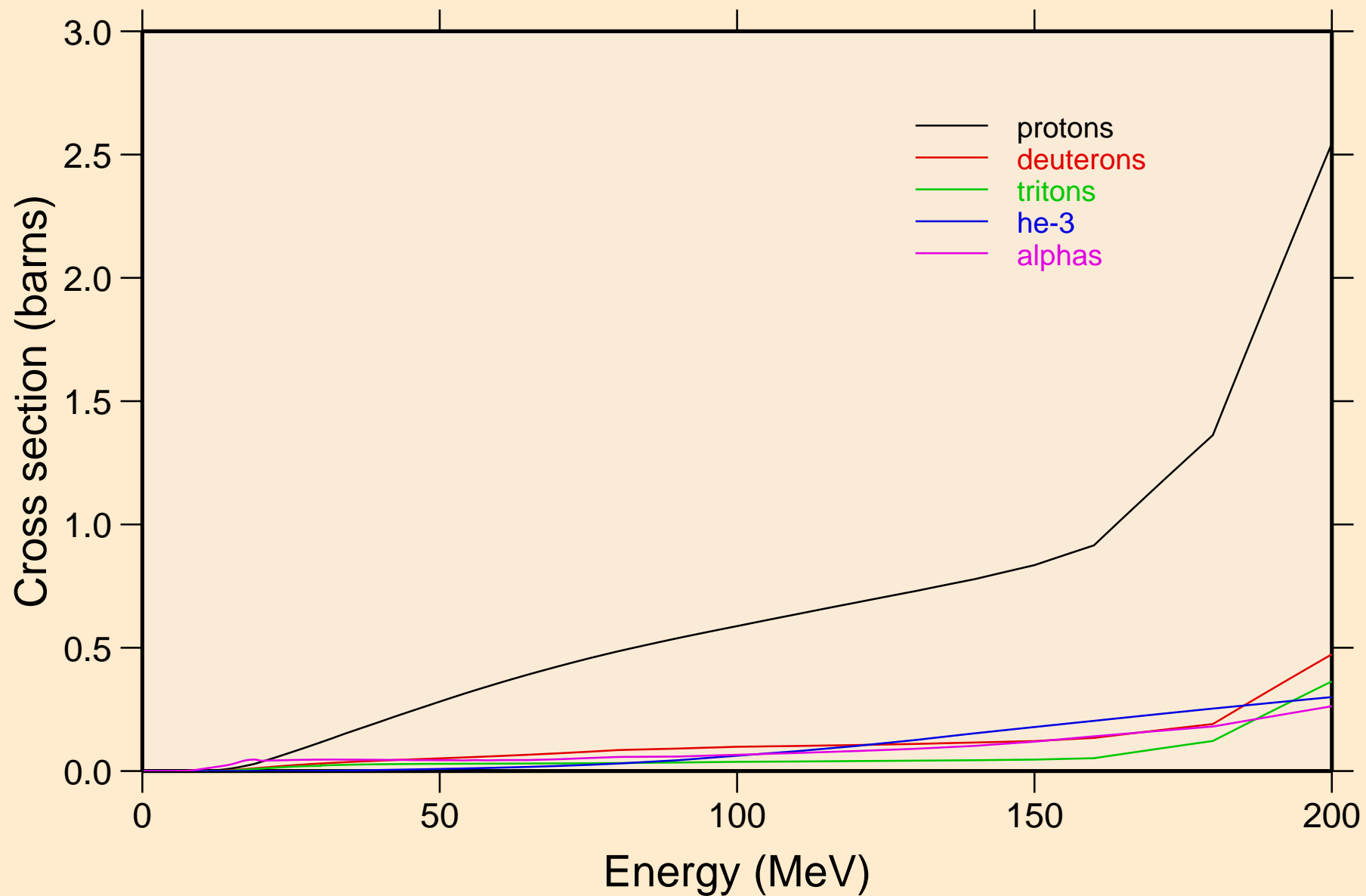

PO211M NEUTRON ACER TENDL-2019 LIBRARY; T=293.16K
protons from (n,x)

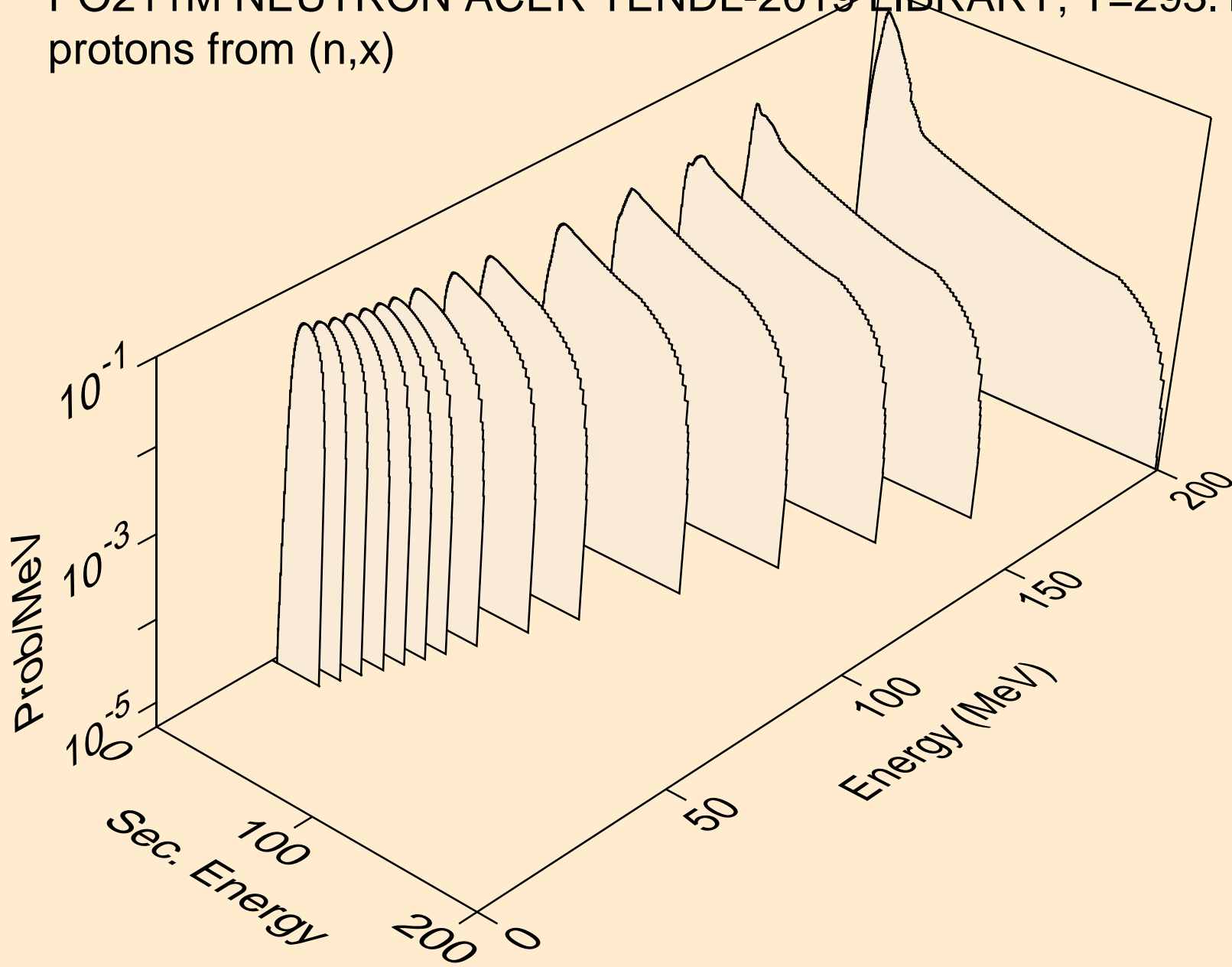

PO211M NEUTRON ACER TENDL-2019 LIBRARY; T=293.16K
protons from (n,n*)p

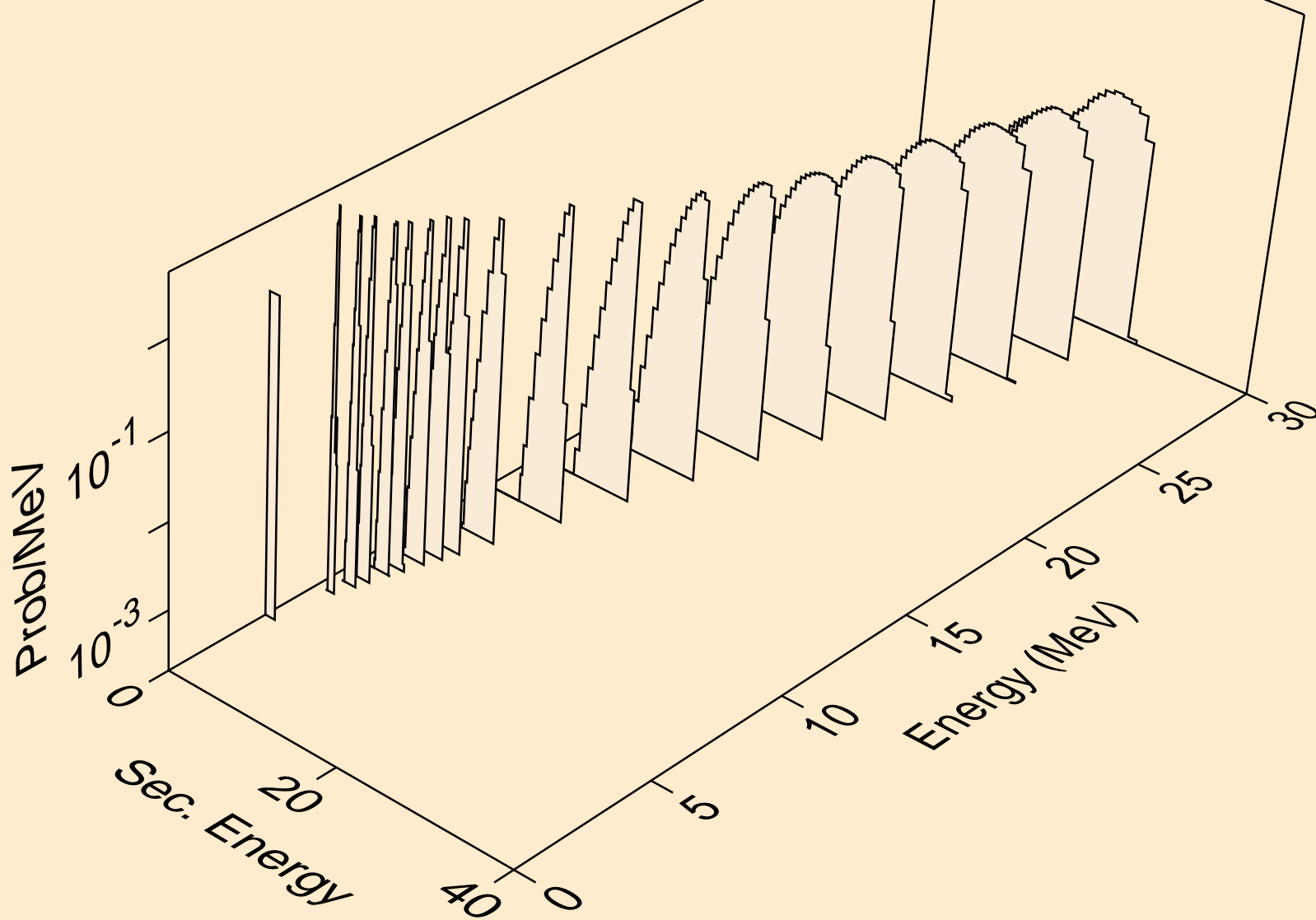

PO211M NEUTRON ACER TENDL-2019 LIBRARY; T=293.16K
protons from (n,2np)

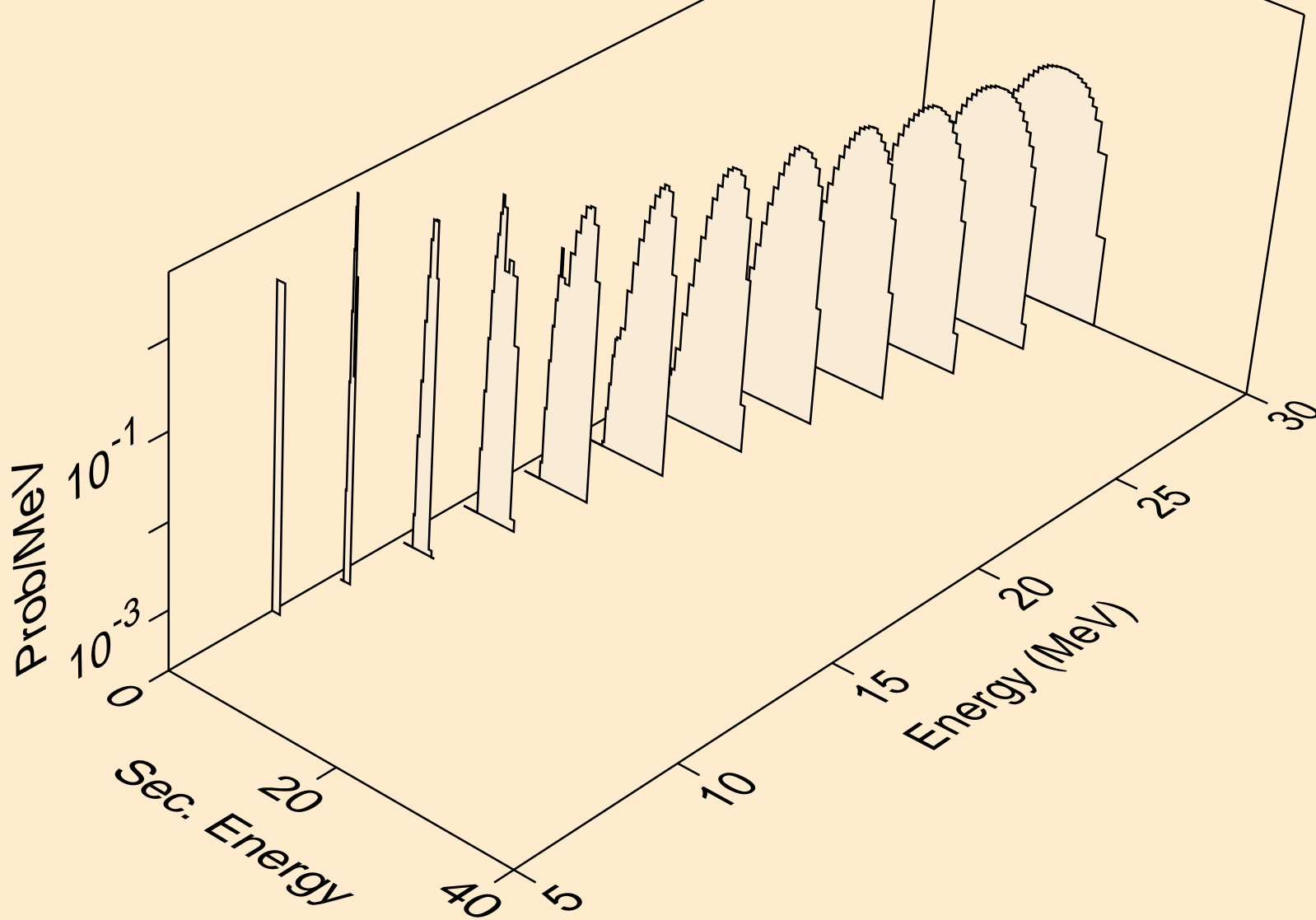

PO211M NEUTRON ACER TENDL-2019 LIBRARY; T=293.16K
protons from (n,3np)

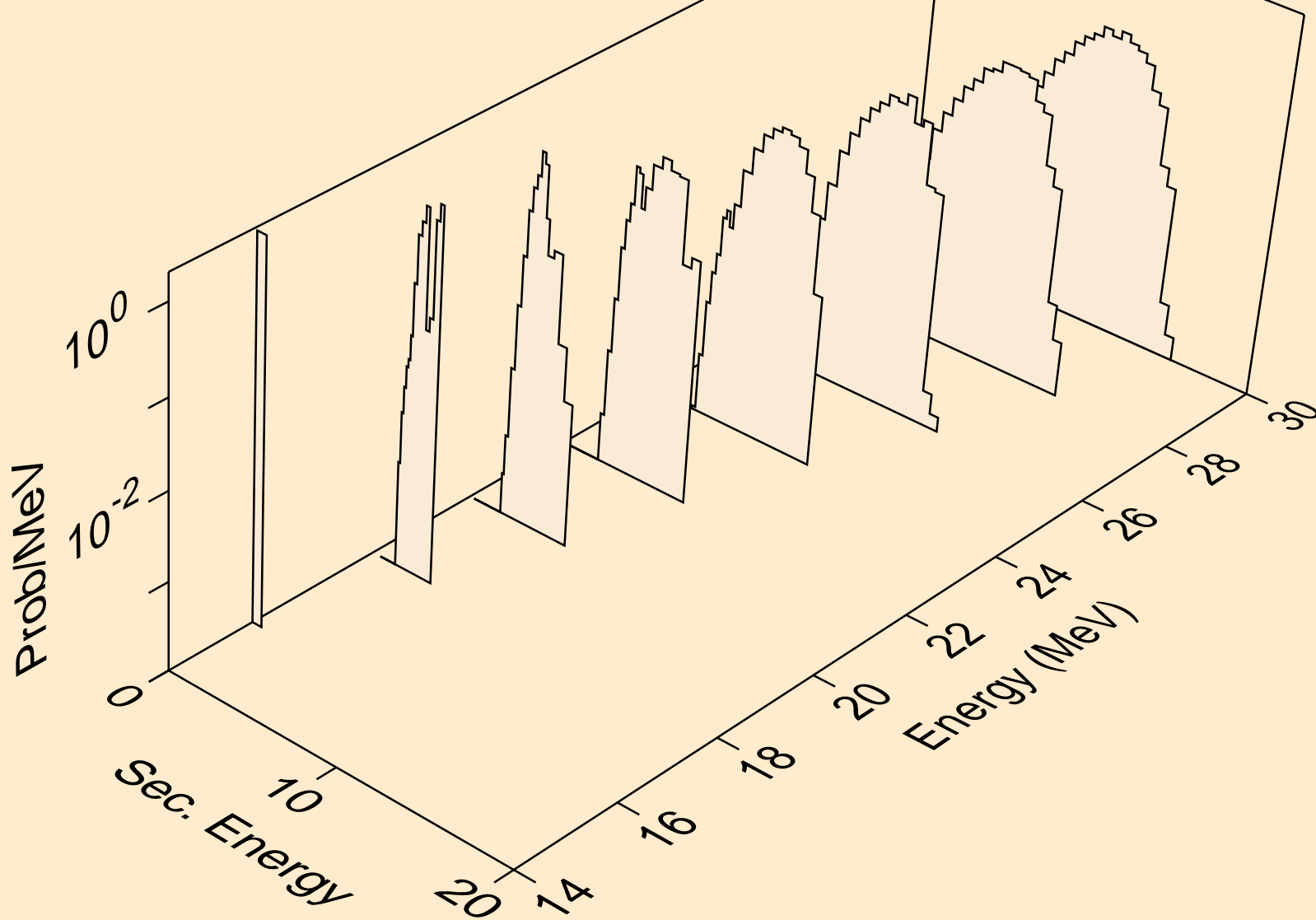

PO211M NEUTRON ACER TENDL-2019 LIBRARY; T=293.16K
protons from (n,2np)

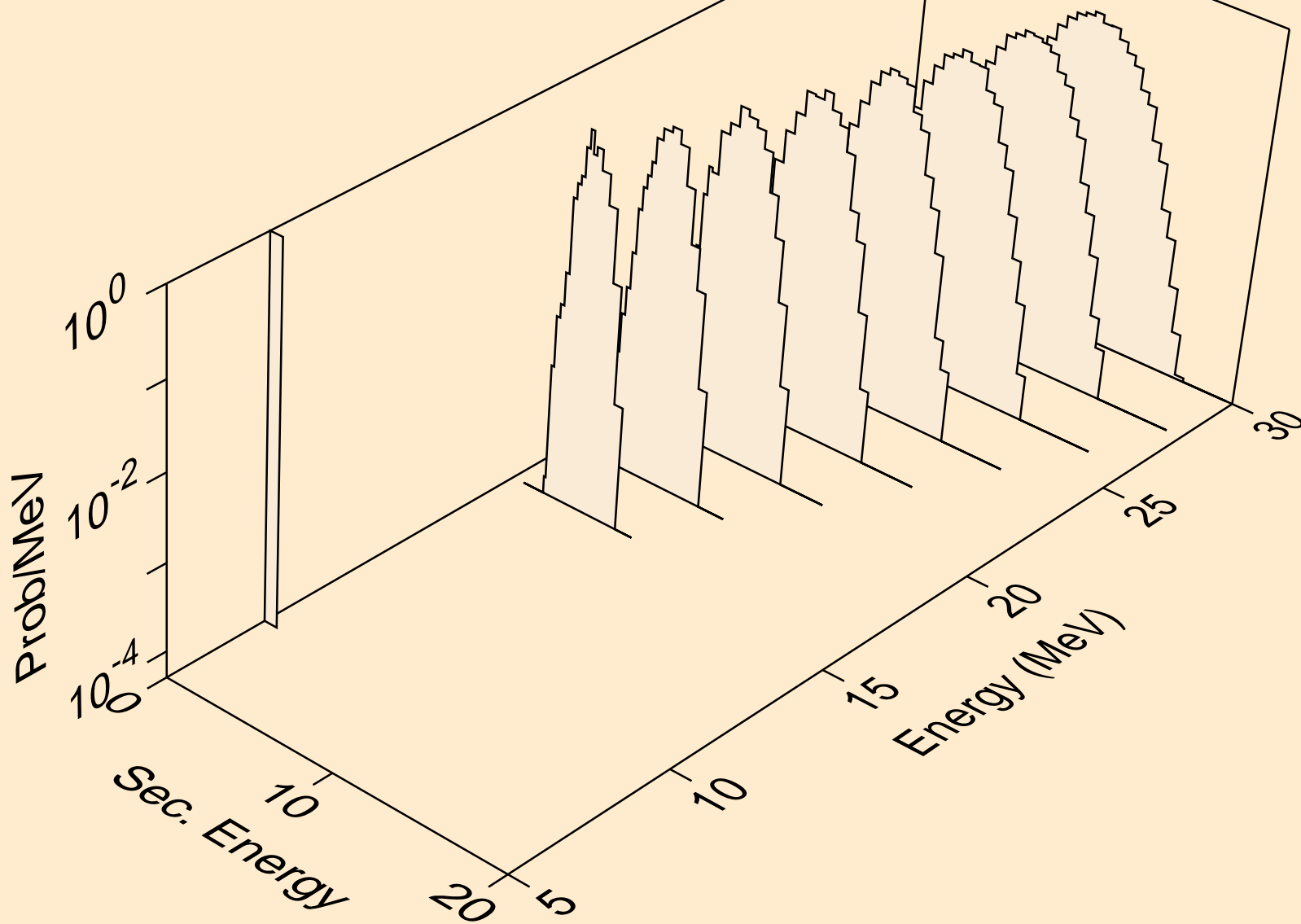

PO211M NEUTRON ACER TENDL-2019 LIBRARY; T=293.16K
protons from (n,npa)

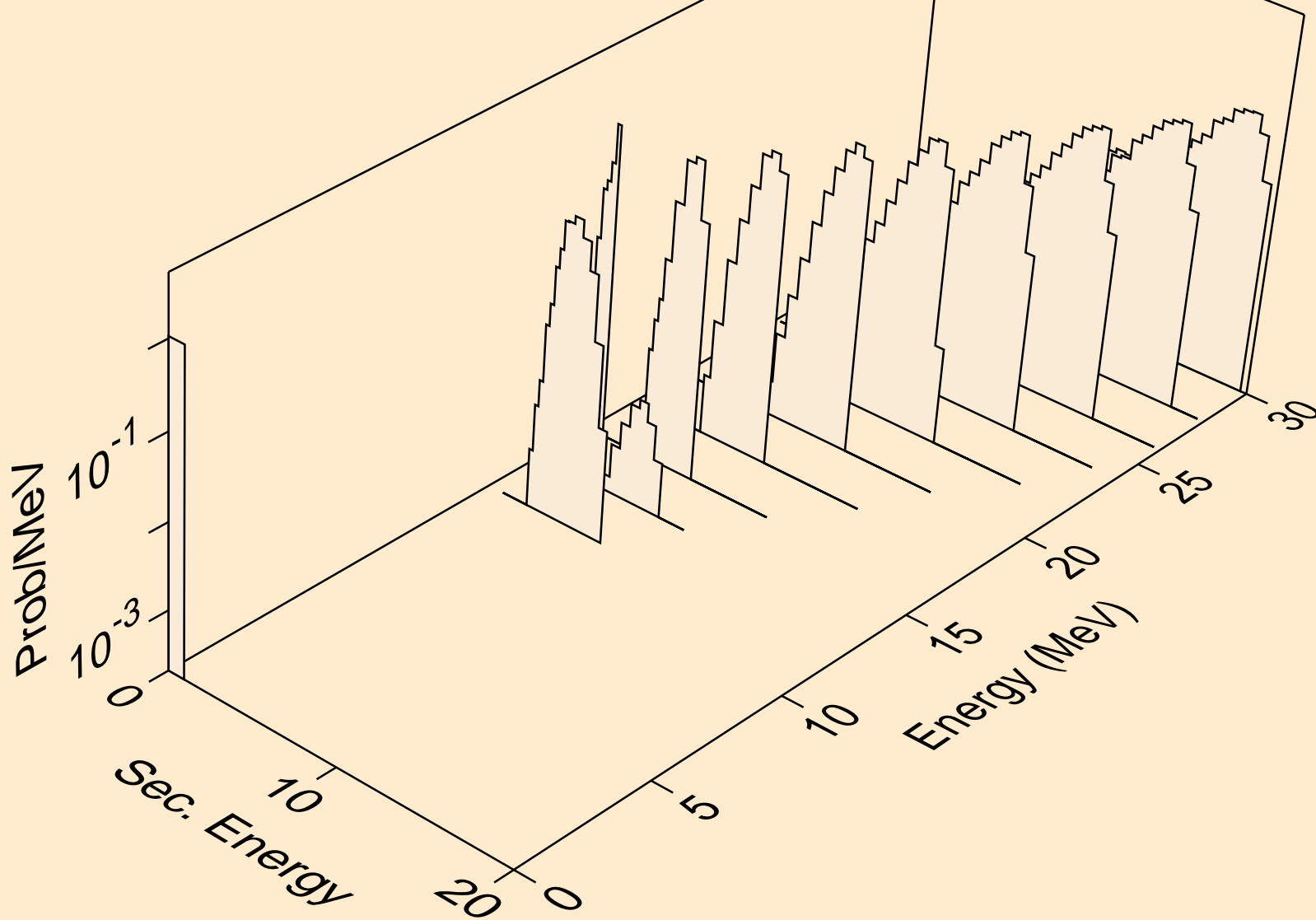

PO211M NEUTRON ACER TENDL-2019 LIBRARY; T=293.16K
protons from (n,p)

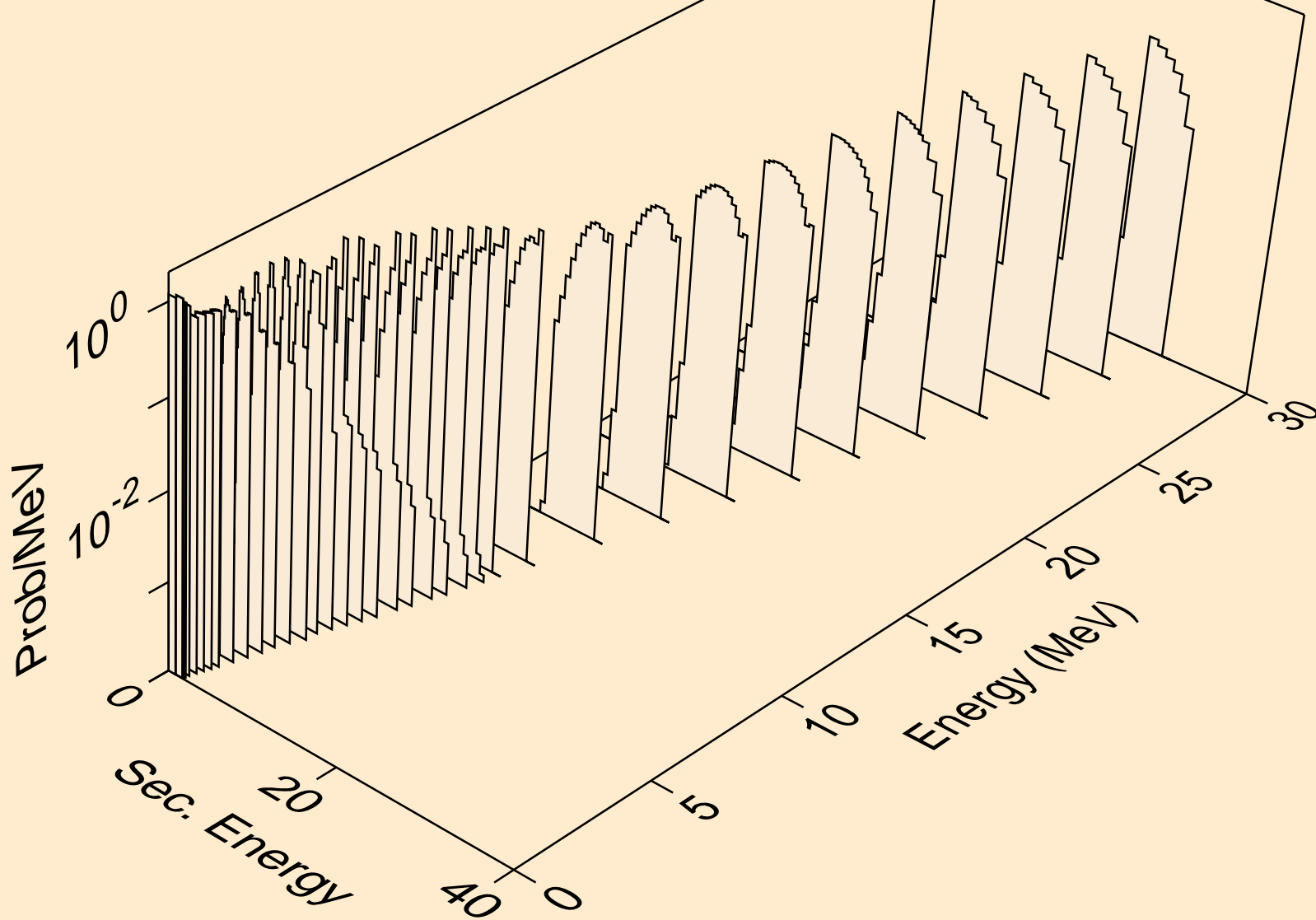

PO211M NEUTRON ACER TENDL-2019 LIBRARY; T=293.16K
protons from (n,2p)

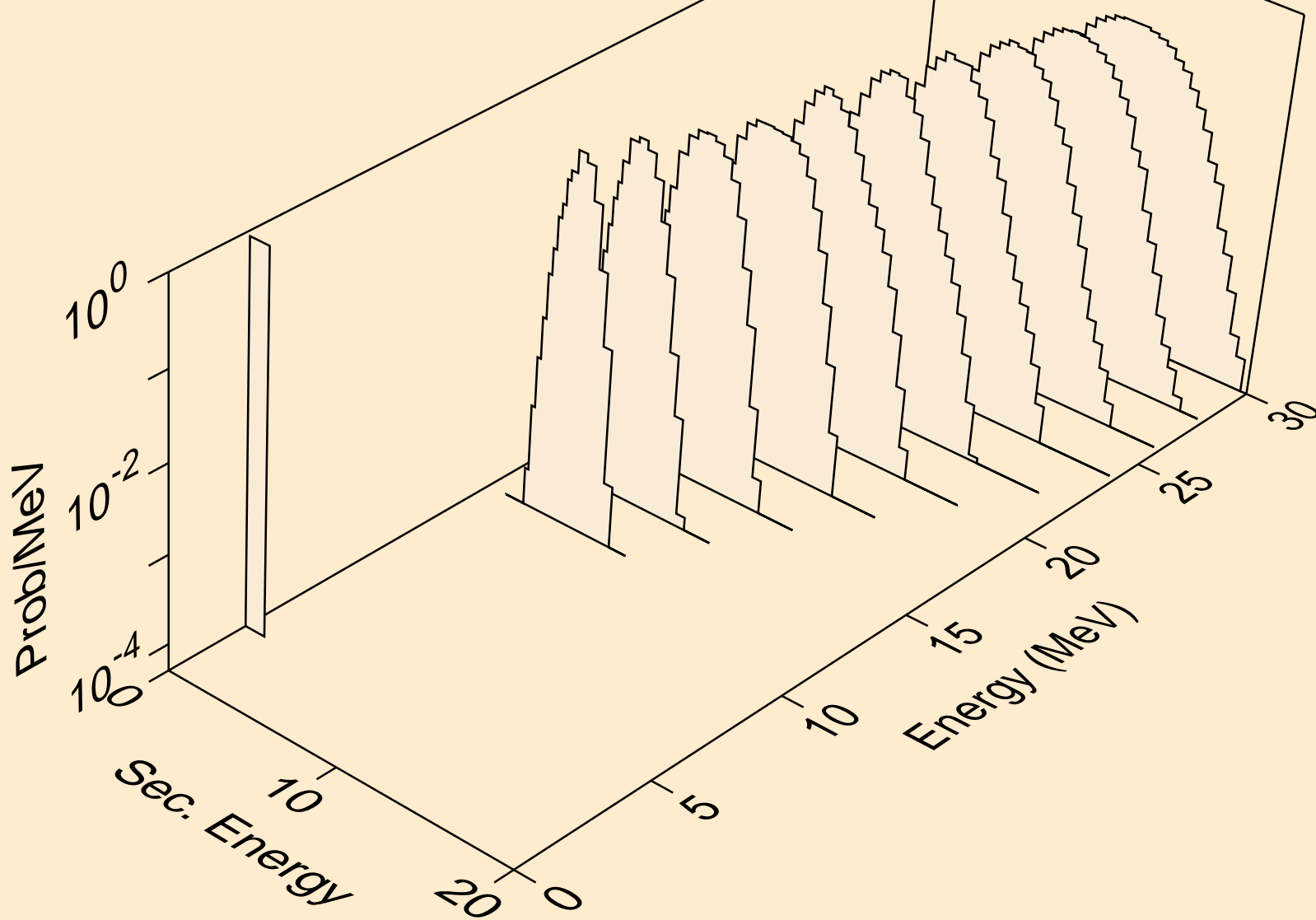

PO211M NEUTRON ACER TENDL-2019 LIBRARY; T=293.16K
protons from (n,p)

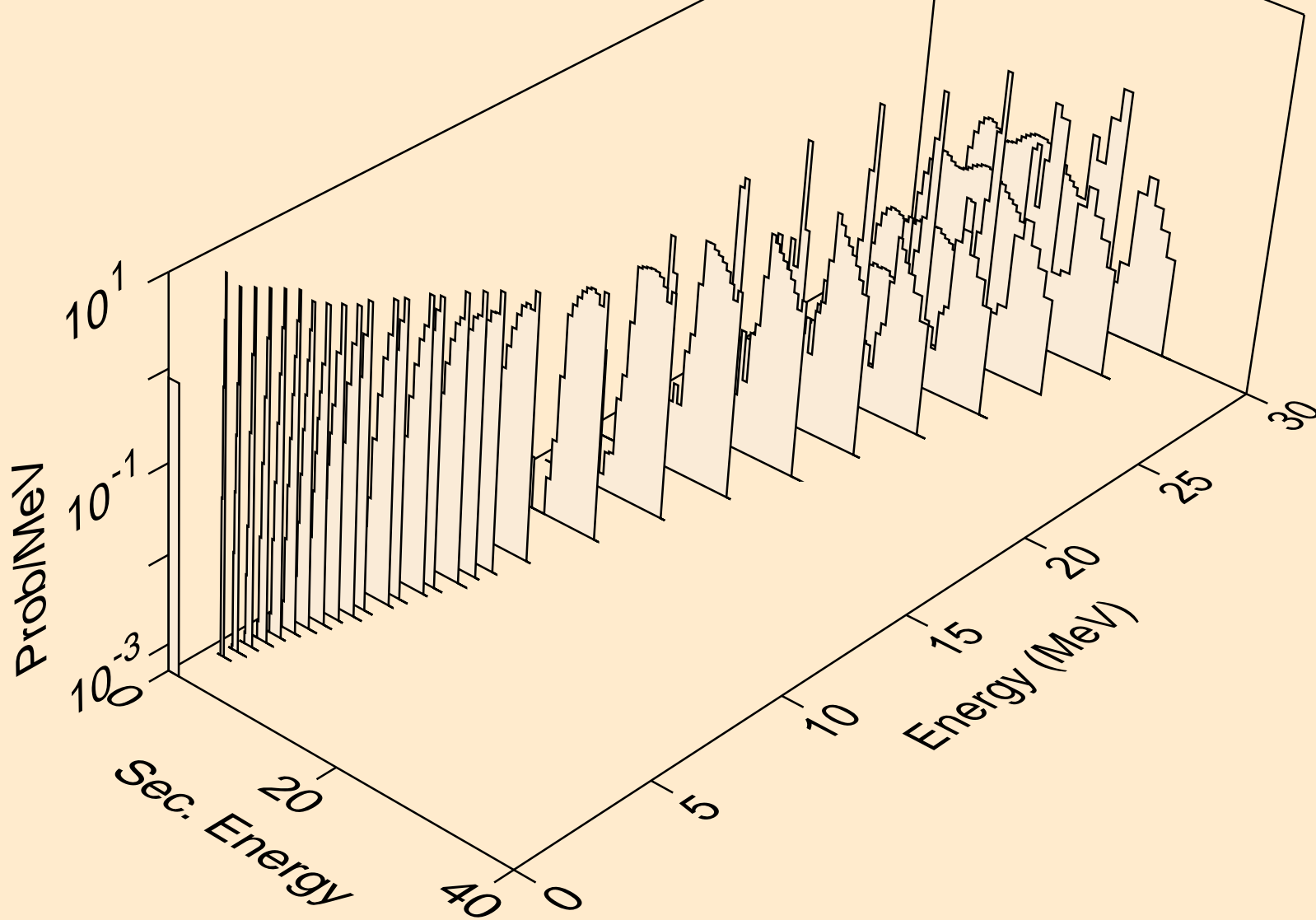

PO211M NEUTRON ACER TENDL-2019 LIBRARY; T=293.16K
protons from (n,pd)

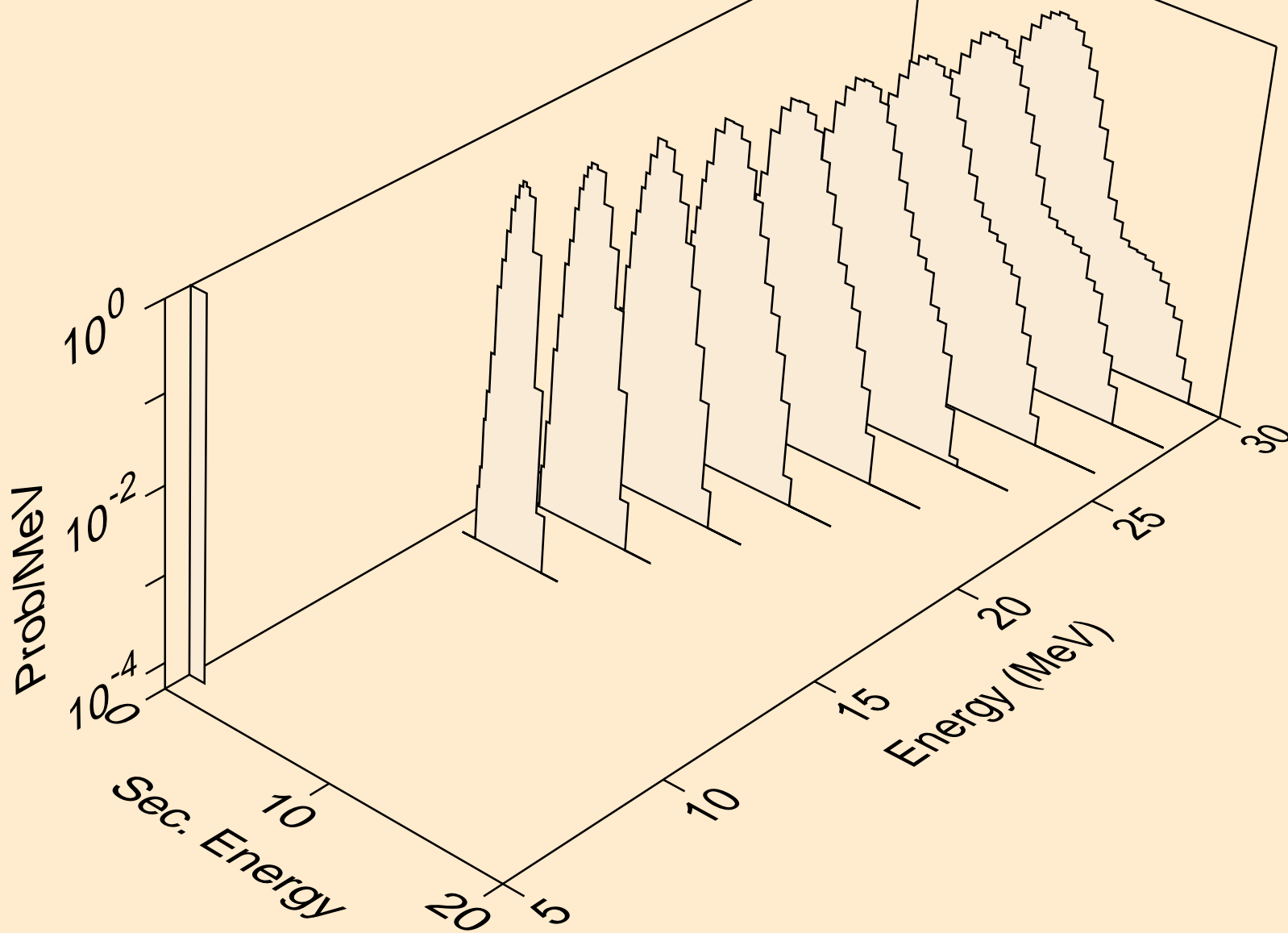

PO211M NEUTRON ACER TENDL-2019 LIBRARY; T=293.16K
protons from (n,pt)

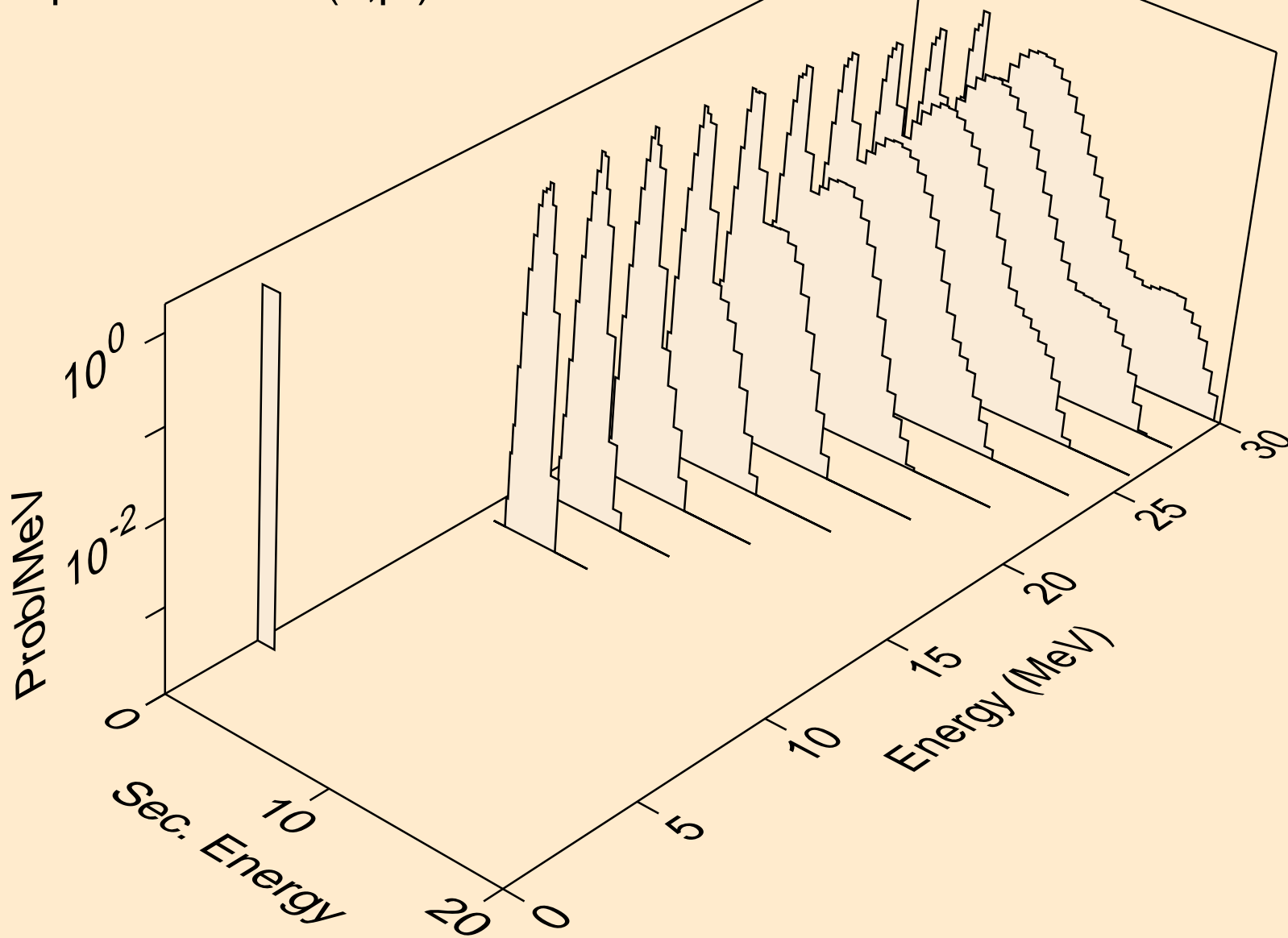

PO211M NEUTRON ACER TENDL-2019 LIBRARY; T=293.16K
deuterons from (n,x)

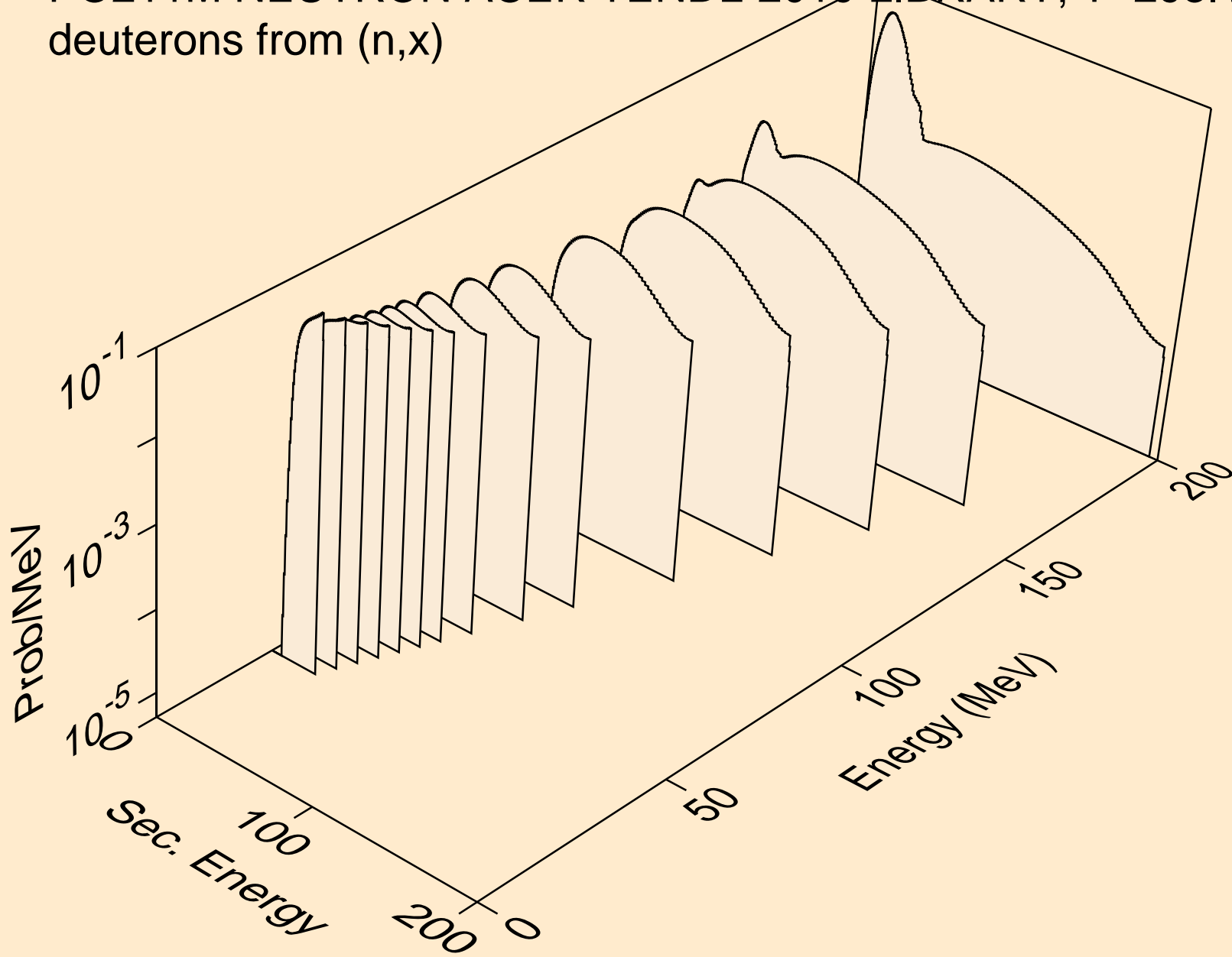

PO211M NEUTRON ACER TENDL-2019 LIBRARY; T=293.16K
deuterons from (n,2nd)

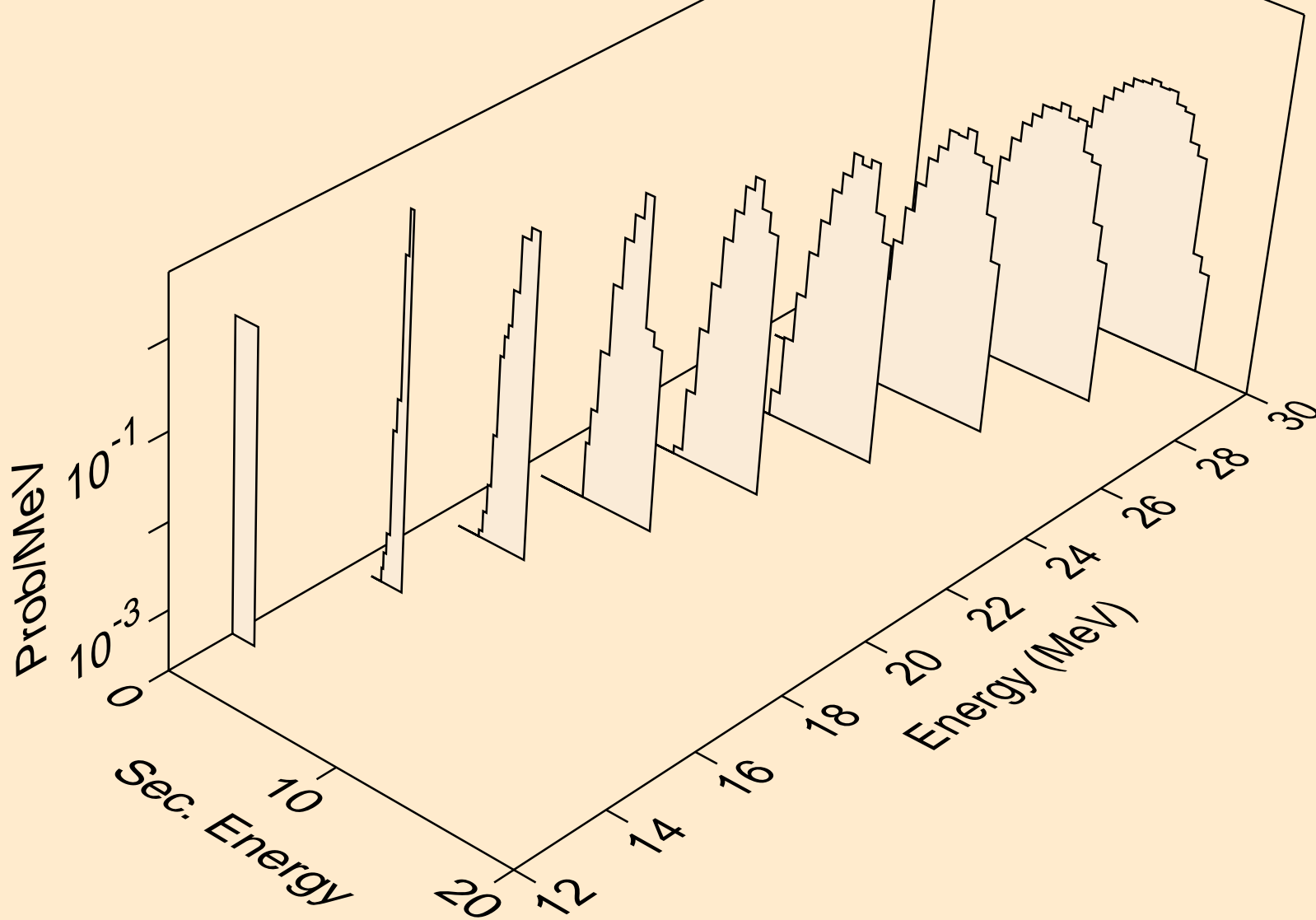

PO211M NEUTRON ACER TENDL-2019 LIBRARY; T=293.16K
deuterons from (n,n*)d

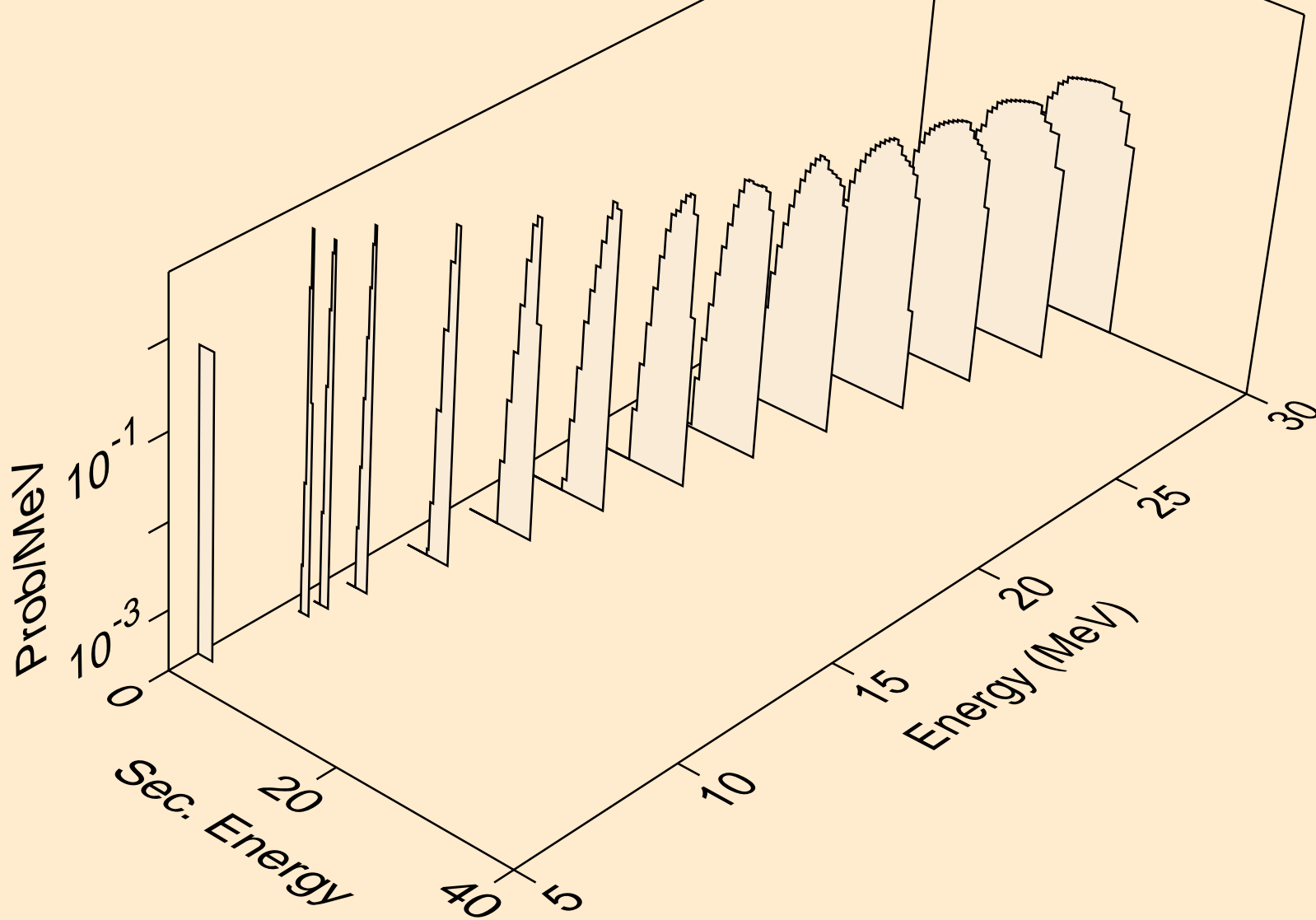

PO211M NEUTRON ACER TENDL-2019 LIBRARY; T=293.16K
deuterons from (n,d)

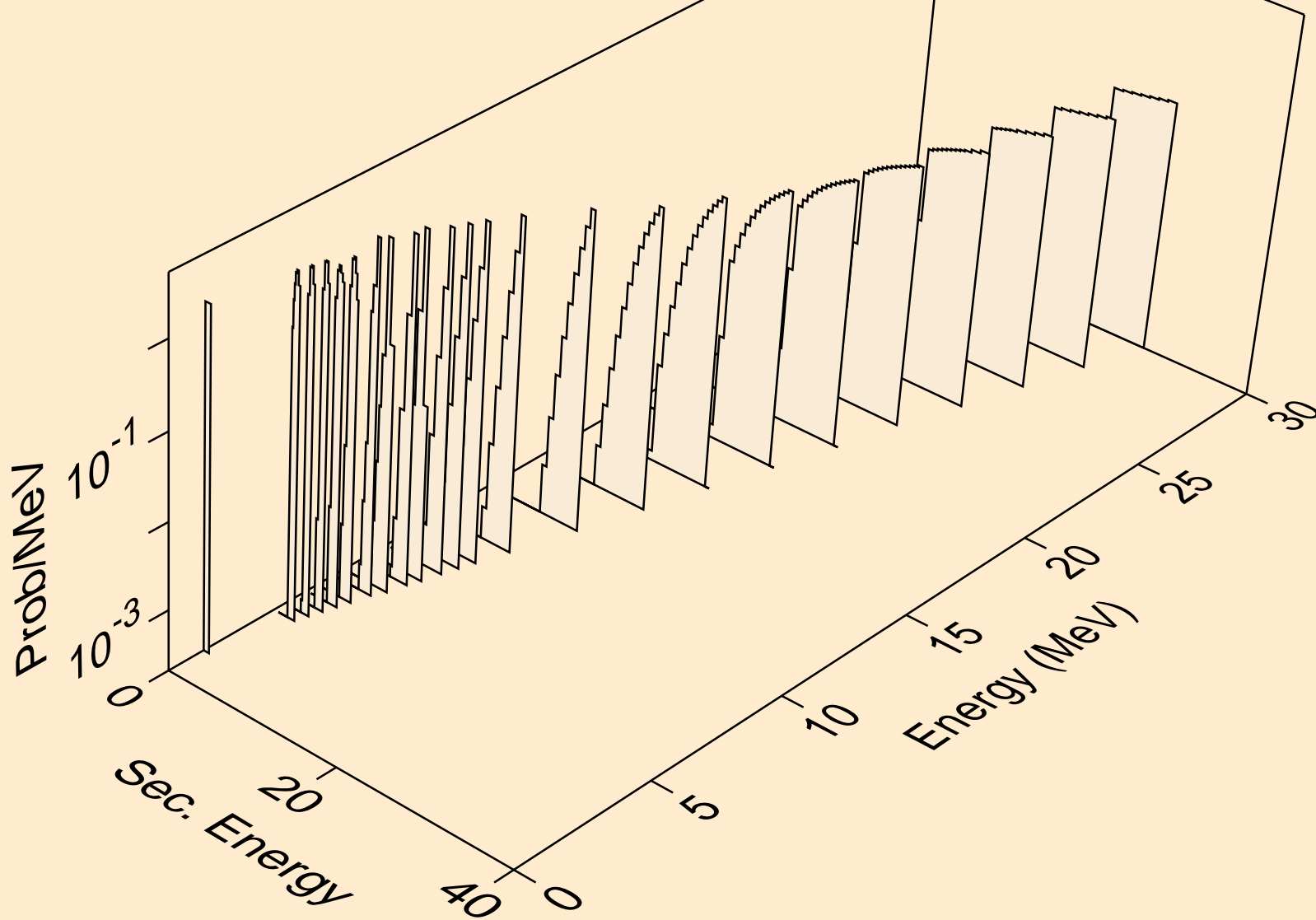

PO211M NEUTRON ACER TENDL-2019 LIBRARY; T=293.16K
deuterons from (n,pd)

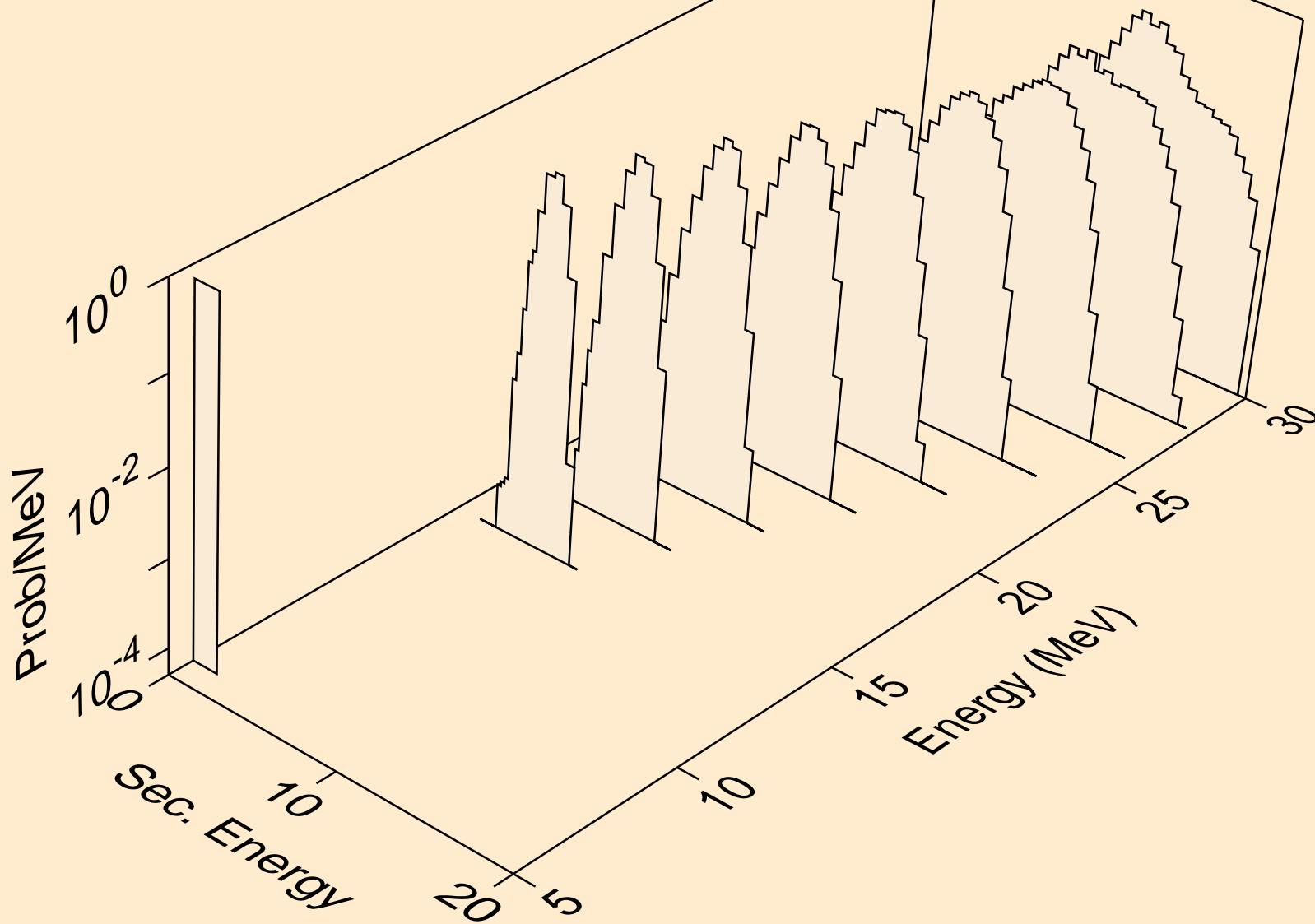

PO211M NEUTRON ACER TENDL-2019 LIBRARY; T=293.16K
deuterons from (n,da)

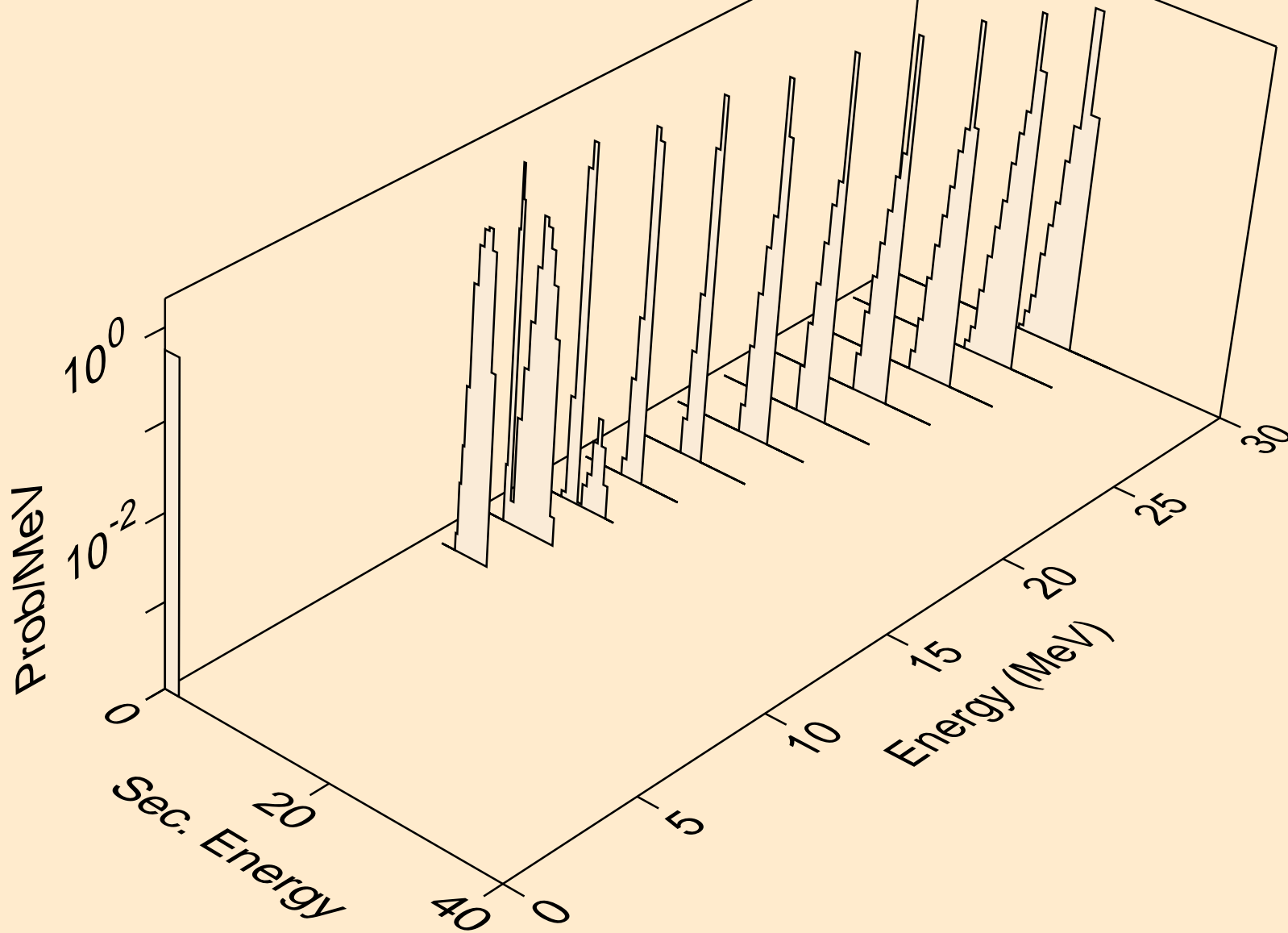

PO211M NEUTRON ACER TENDL-2019 LIBRARY; T=293.16K
tritons from (n,x)

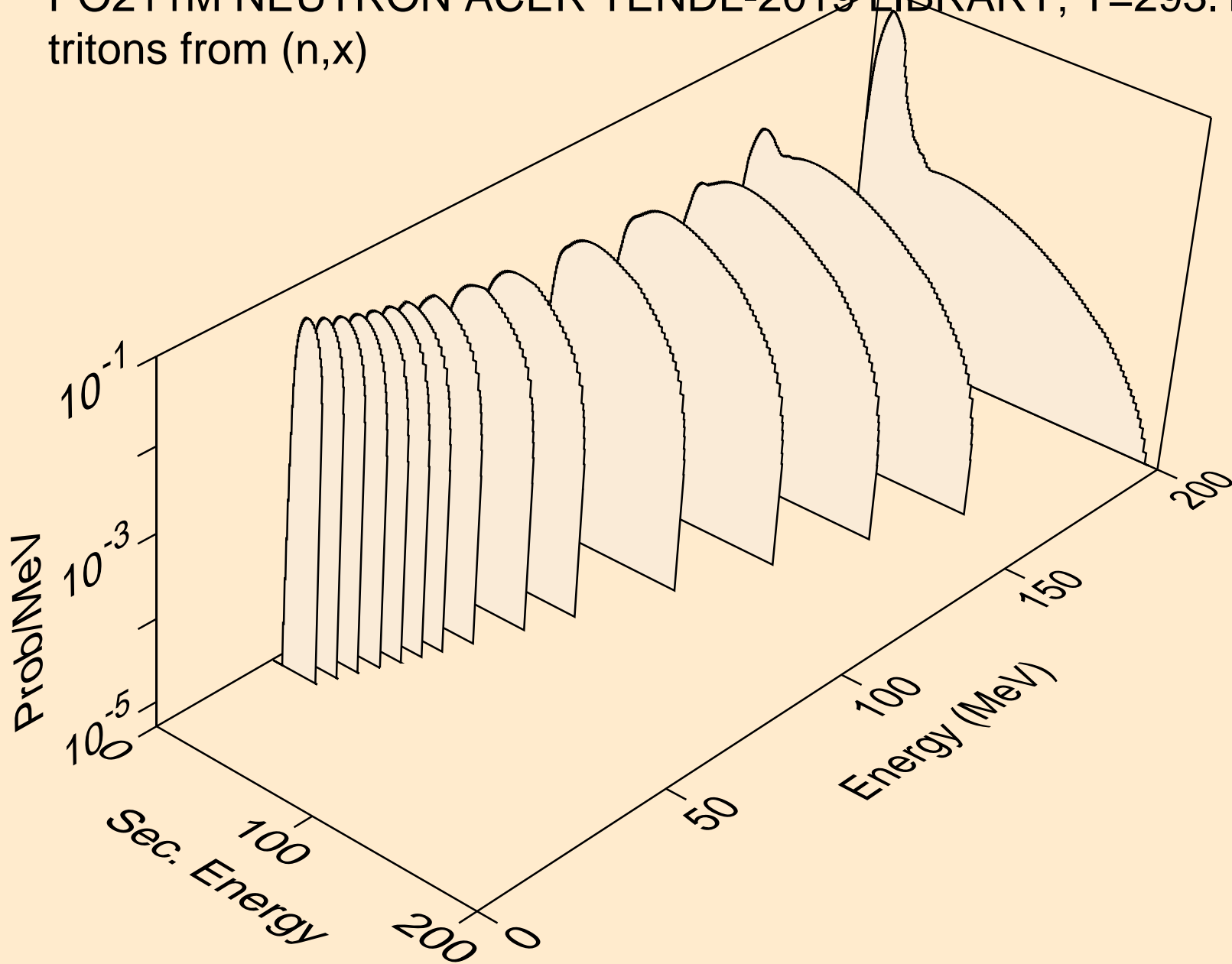

PO211M NEUTRON ACER TENDL-2019 LIBRARY; T=293.16K
tritons from (n,n*)t

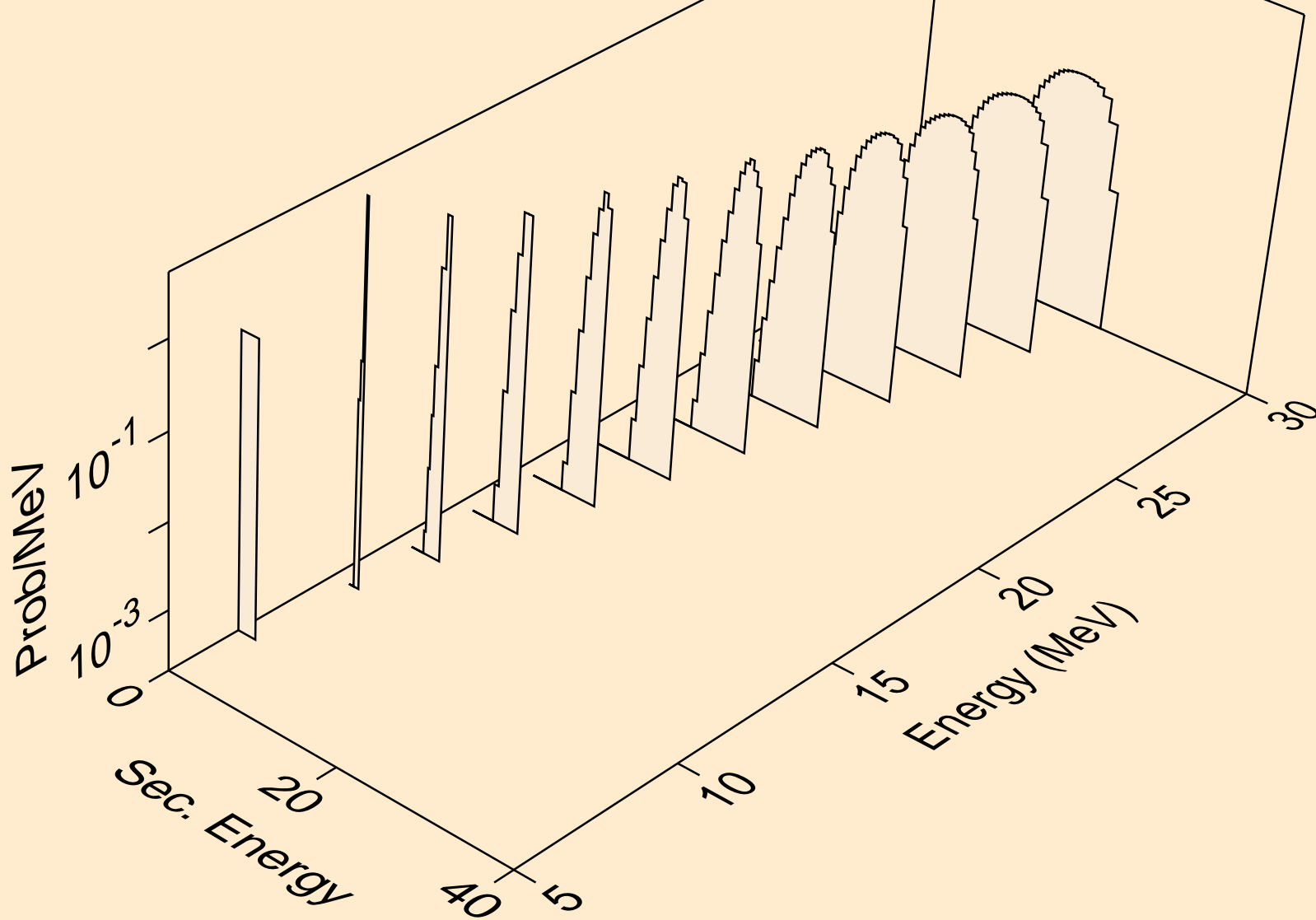

PO211M NEUTRON ACER TENDL-2019 LIBRARY; T=293.16K
tritons from (n,t)

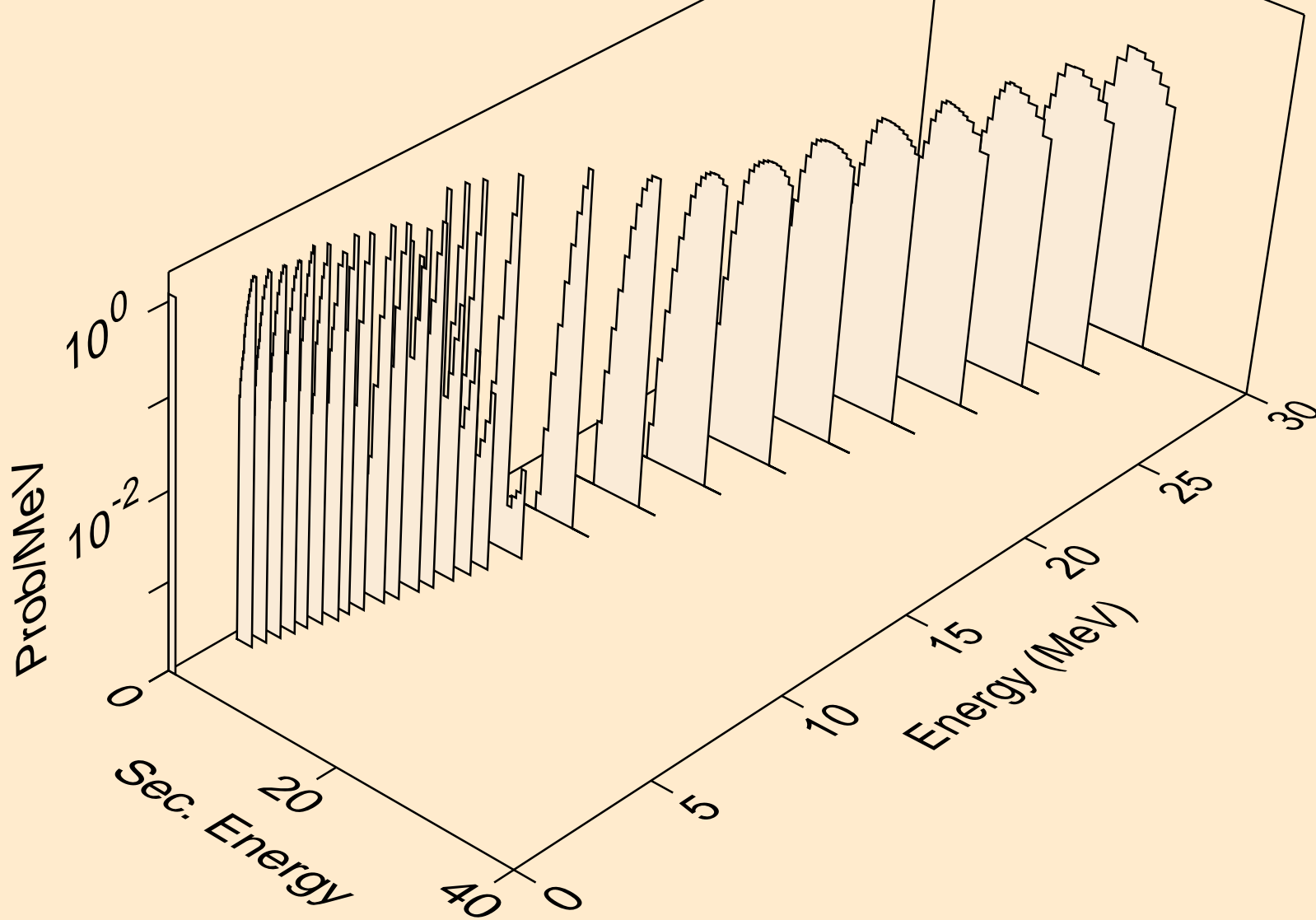

PO211M NEUTRON ACER TENDL-2019 LIBRARY; T=293.16K
tritons from (n,pt)

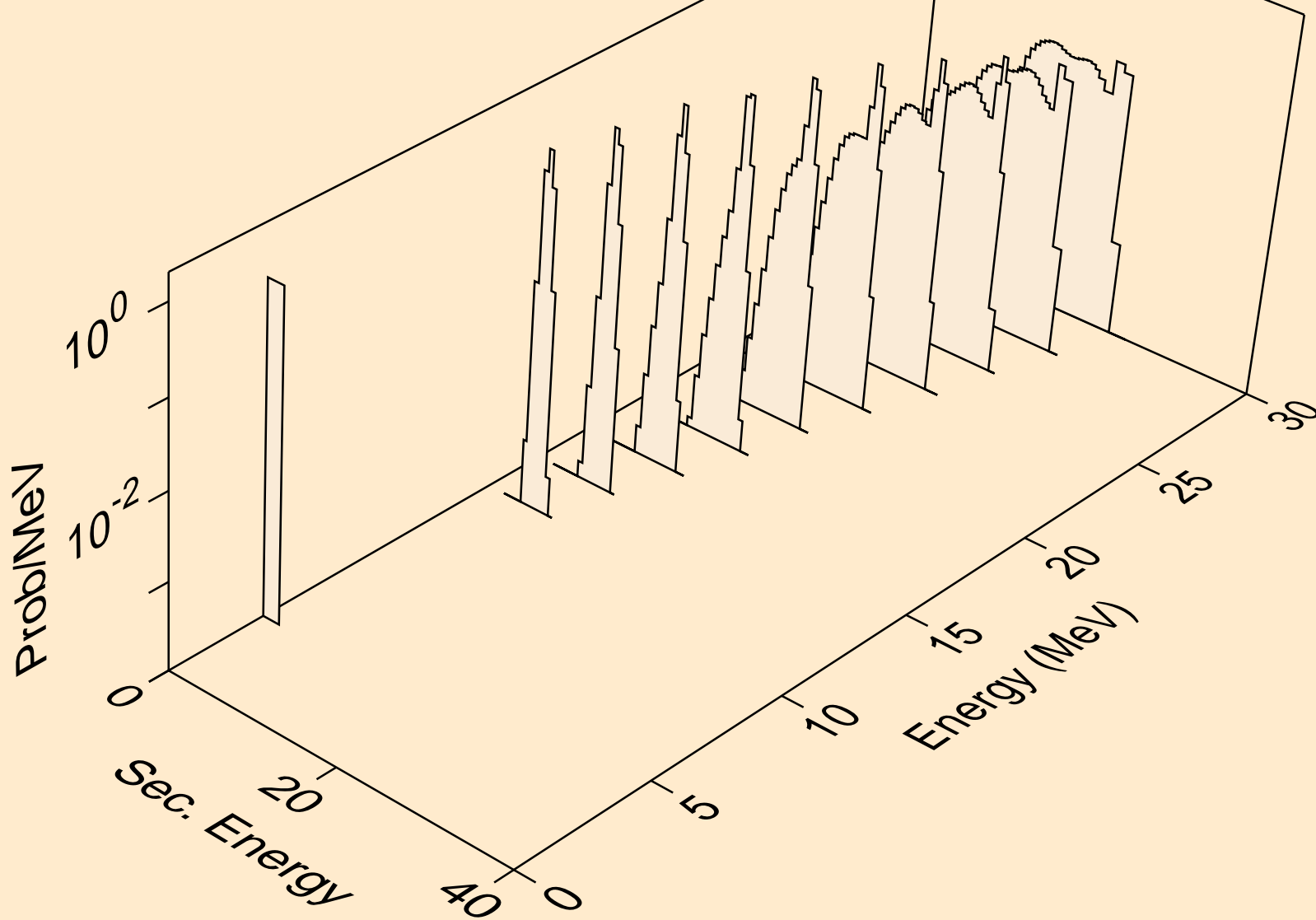

PO211M NEUTRON ACER TENDL-2019 LIBRARY; T=293.16K
he3s from (n,x)

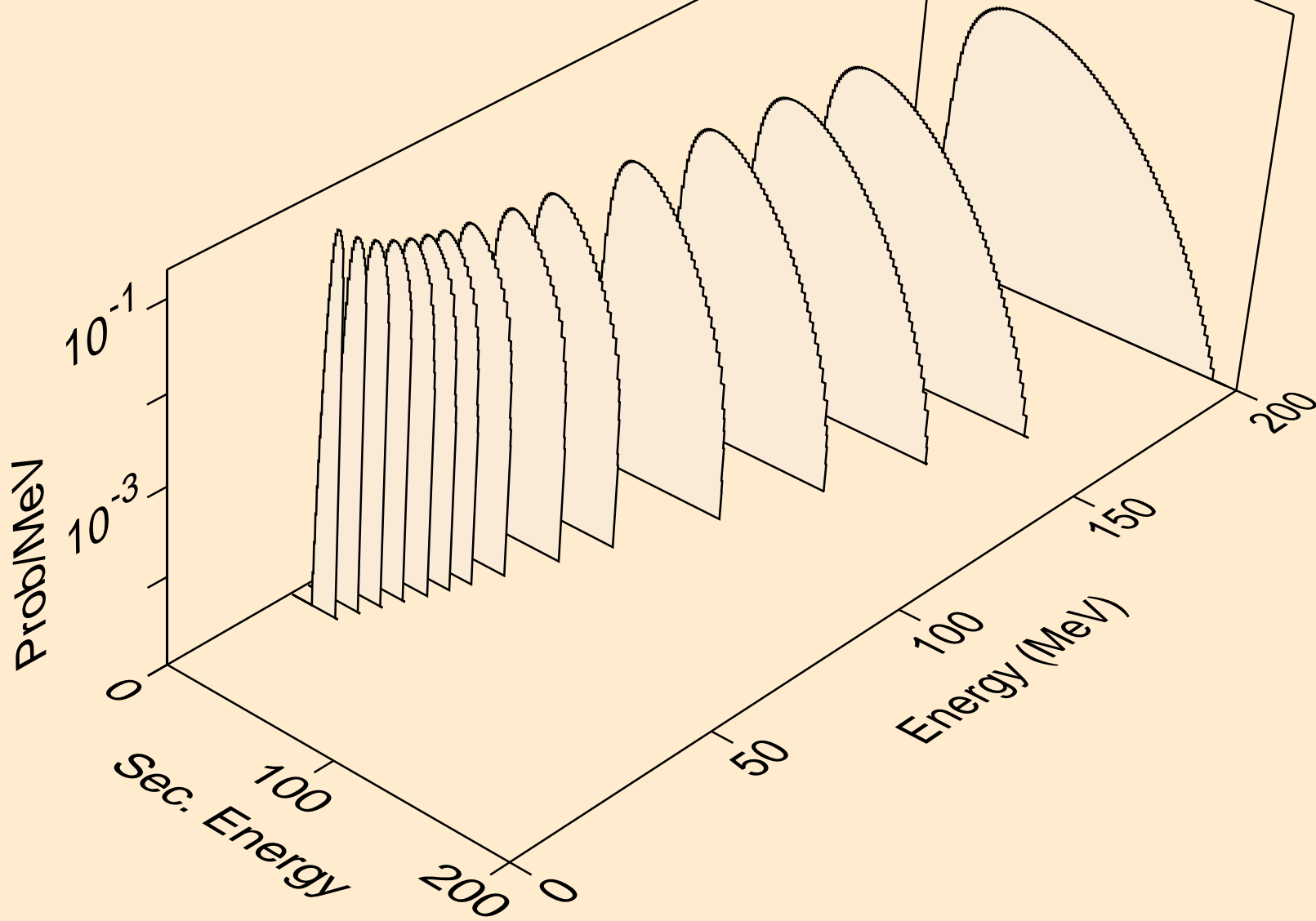

PO211M NEUTRON ACER TENDL-2019 LIBRARY; T=293.16K
he3s from (n,n*)he3

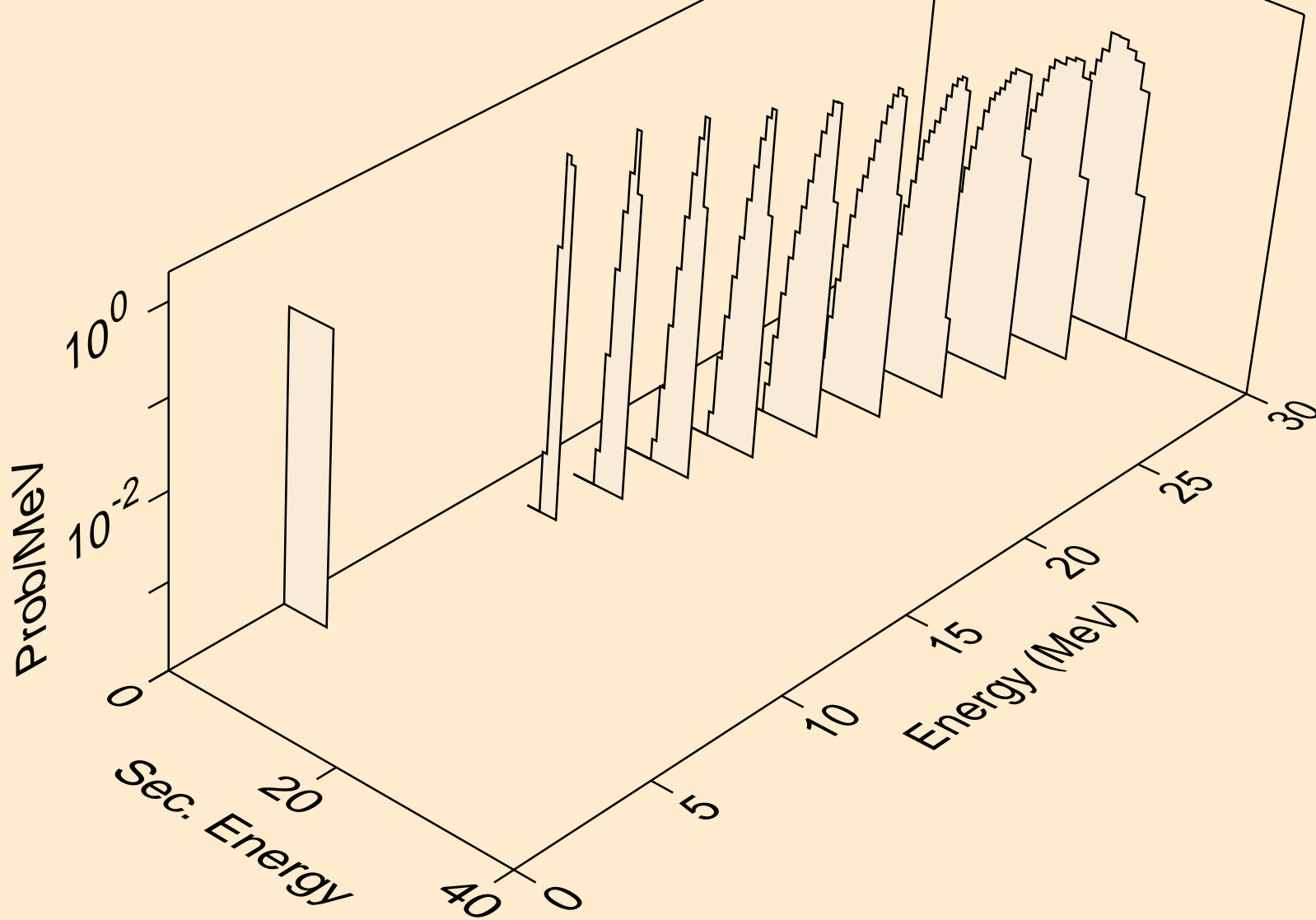

PO211M NEUTRON ACER TENDL-2019 LIBRARY; T=293.16K
he3s from (n,he3)

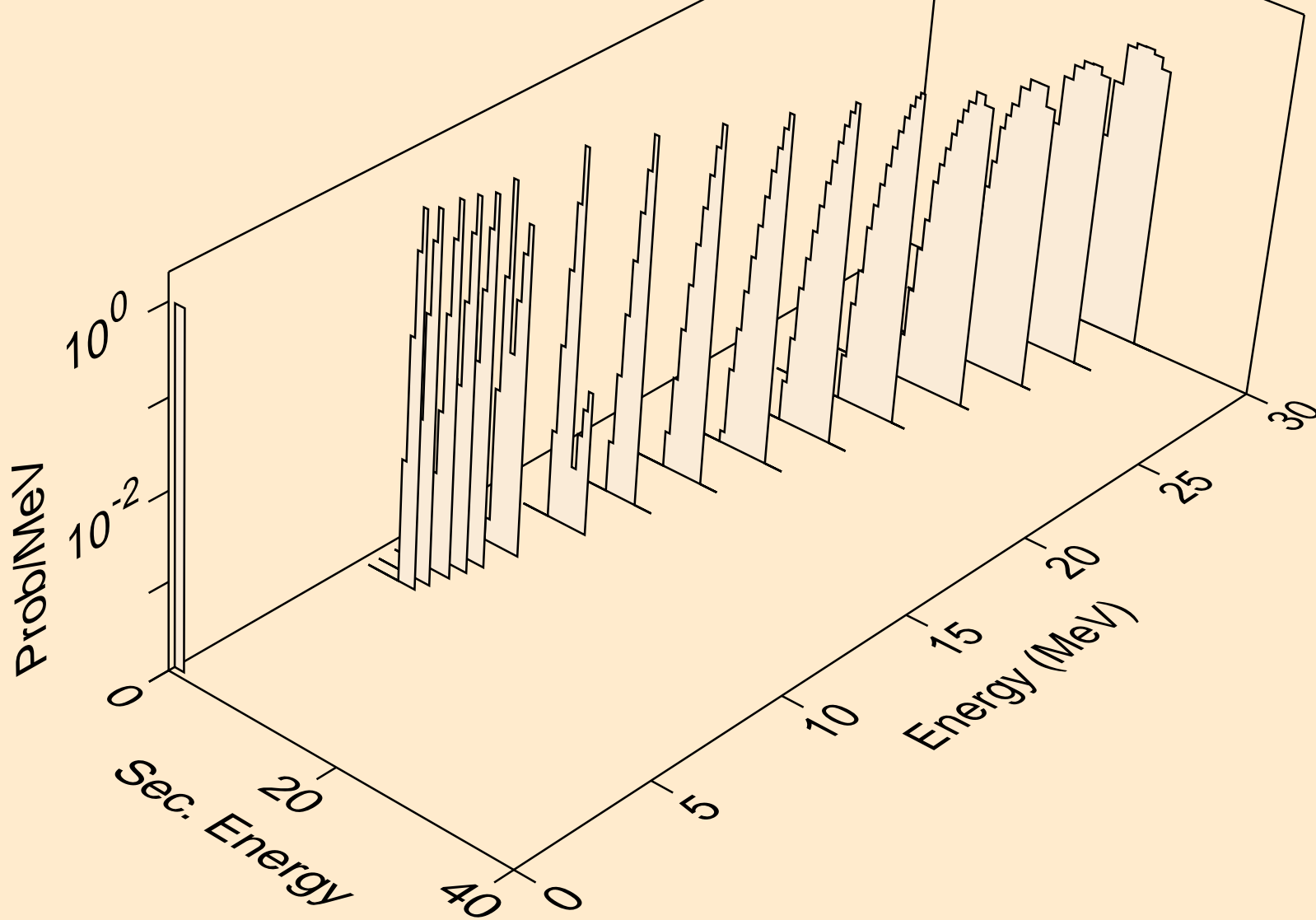

PO211M NEUTRON ACER TENDL-2019 LIBRARY; T=293.16K
alphas from (n,x)

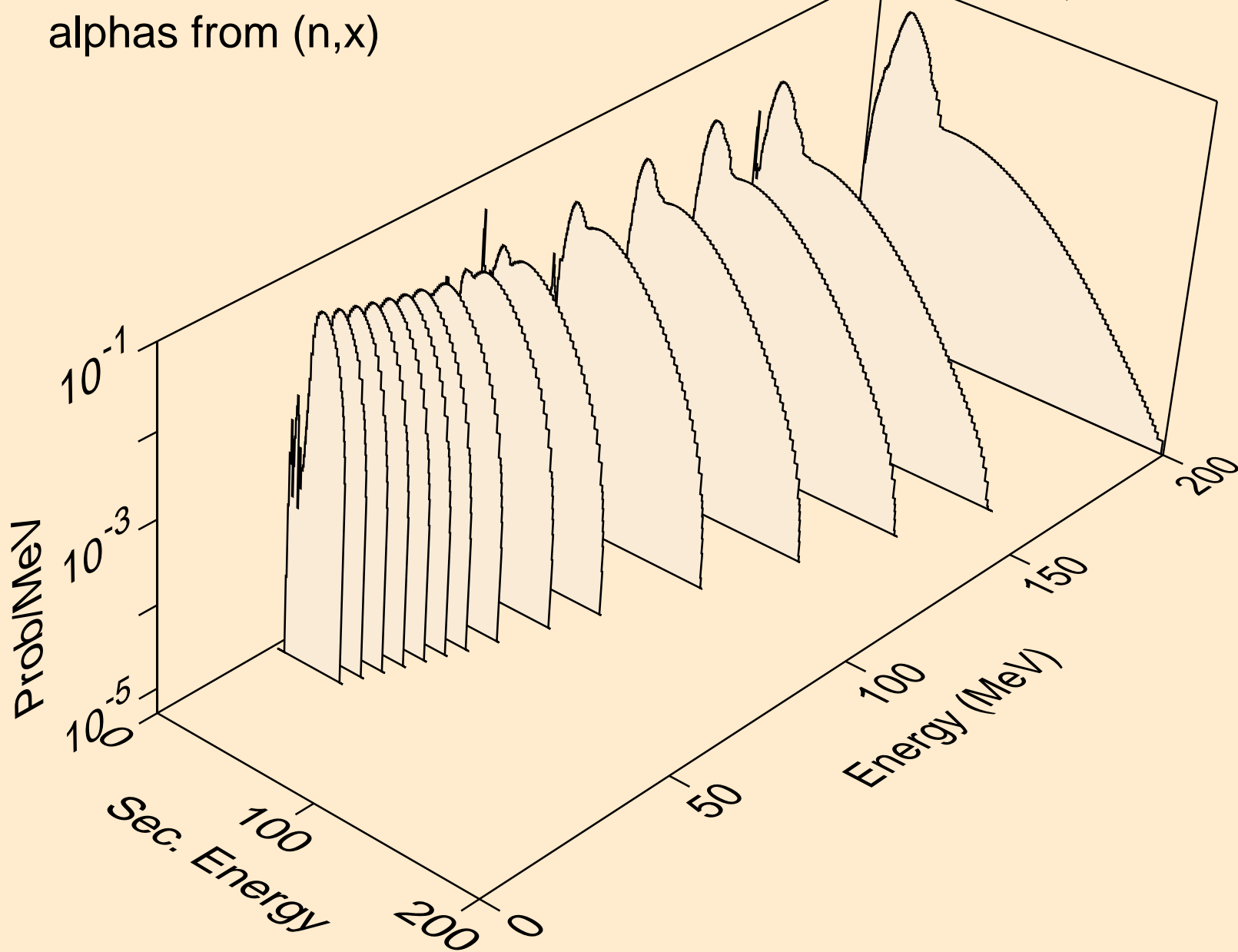

PO211M NEUTRON ACER TENDL-2019 LIBRARY; T=293.16K
alphas from (n,n*)a

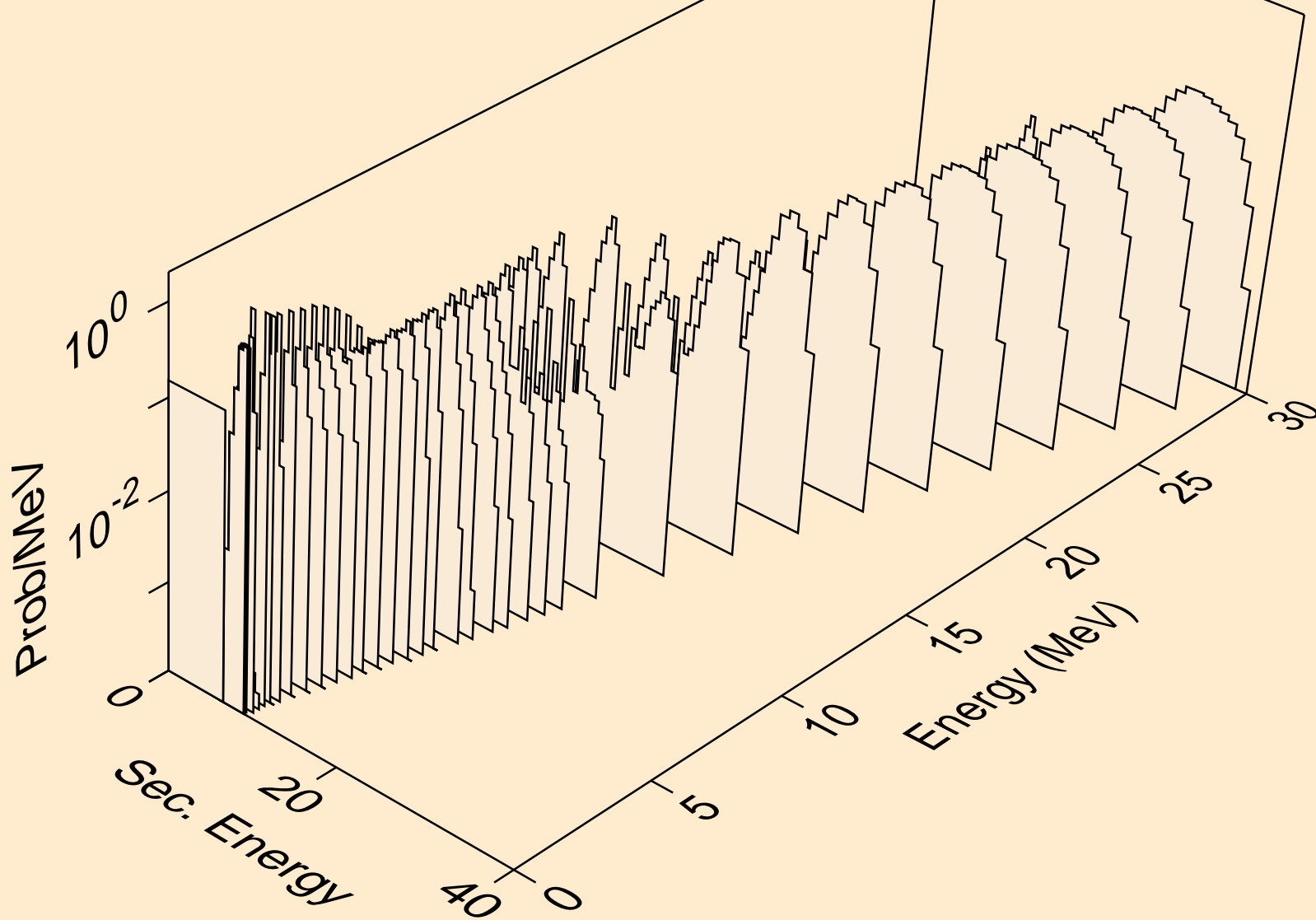

PO211M NEUTRON ACER TENDL-2019 LIBRARY; T=293.16K
alphas from (n,2n)a

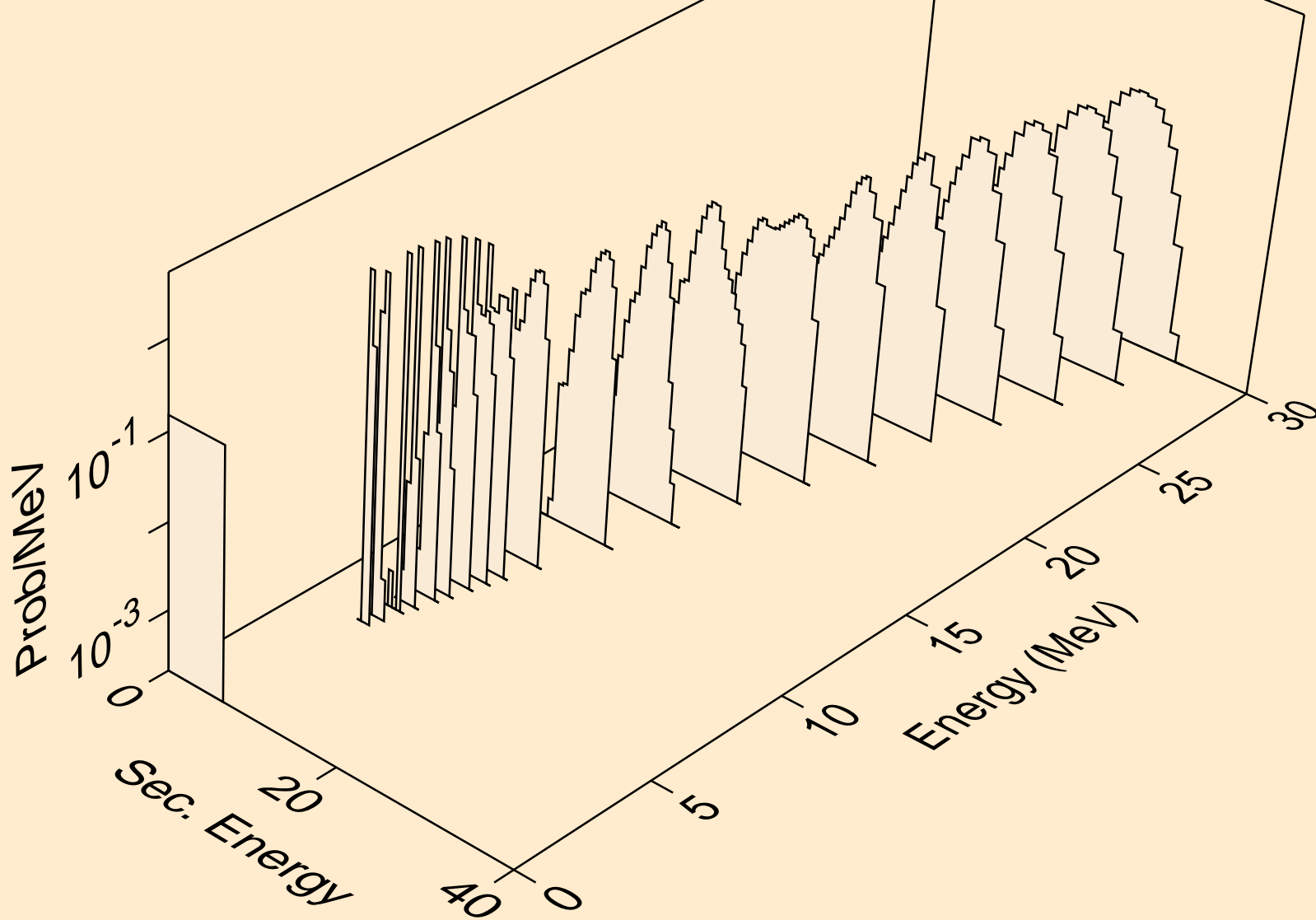

PO211M NEUTRON ACER TENDL-2019 LIBRARY; T=293.16K
alphas from (n,3n)a

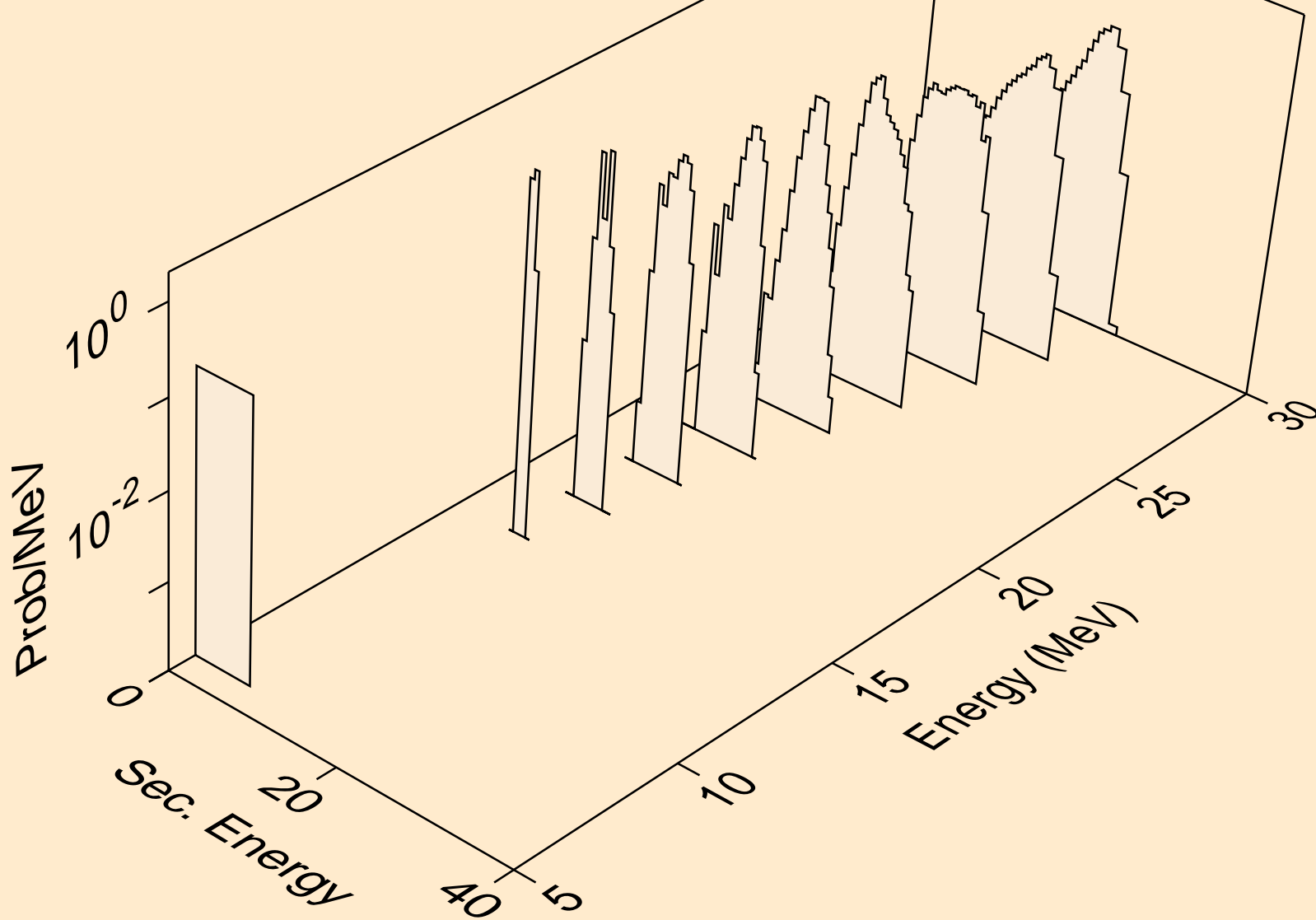

PO211M NEUTRON ACER TENDL-2019 LIBRARY; T=293.16K
alphas from (n,n*)2a

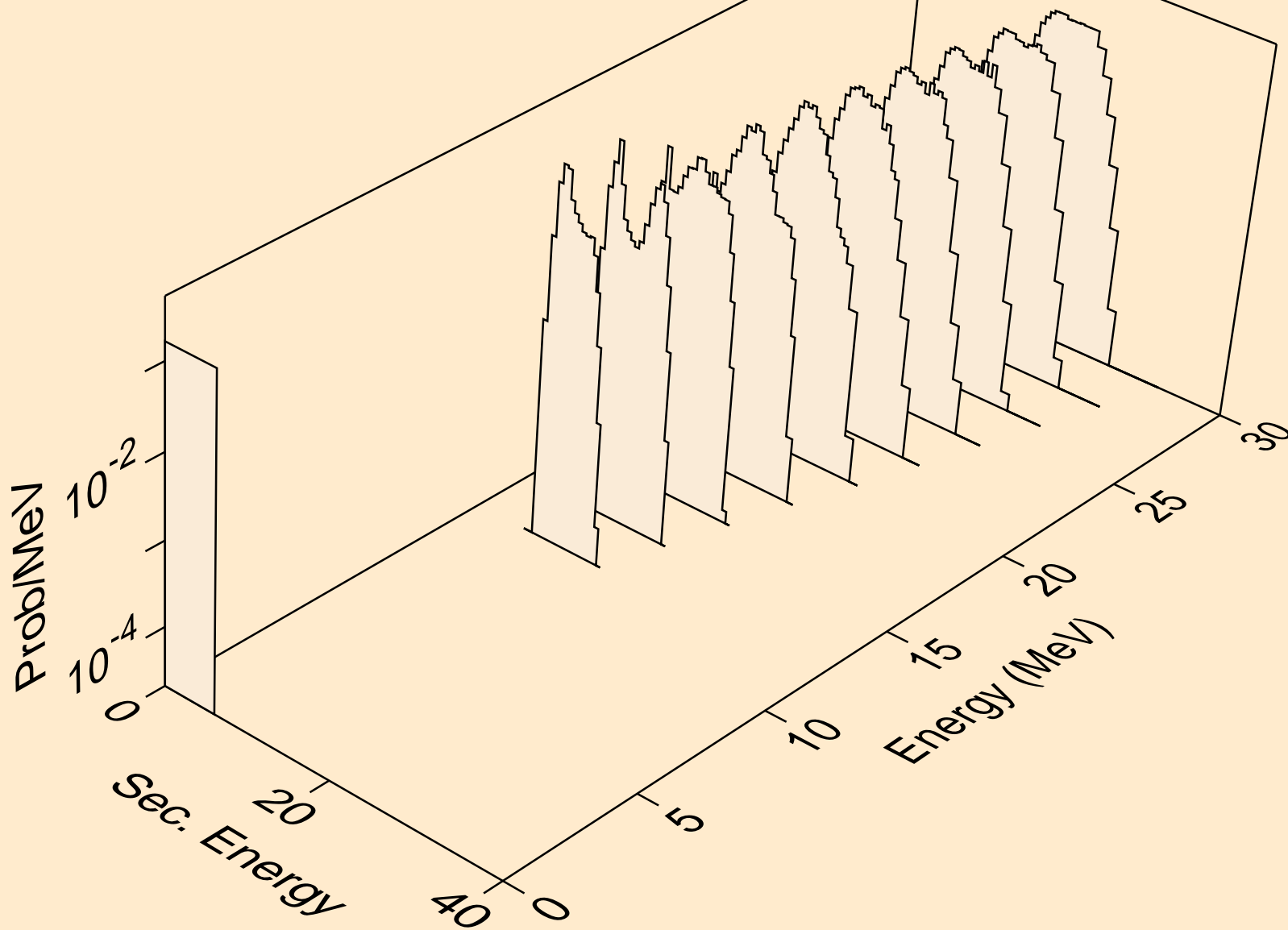

PO211M NEUTRON ACER TENDL-2019 LIBRARY; T=293.16K
alphas from (n,2n)2a

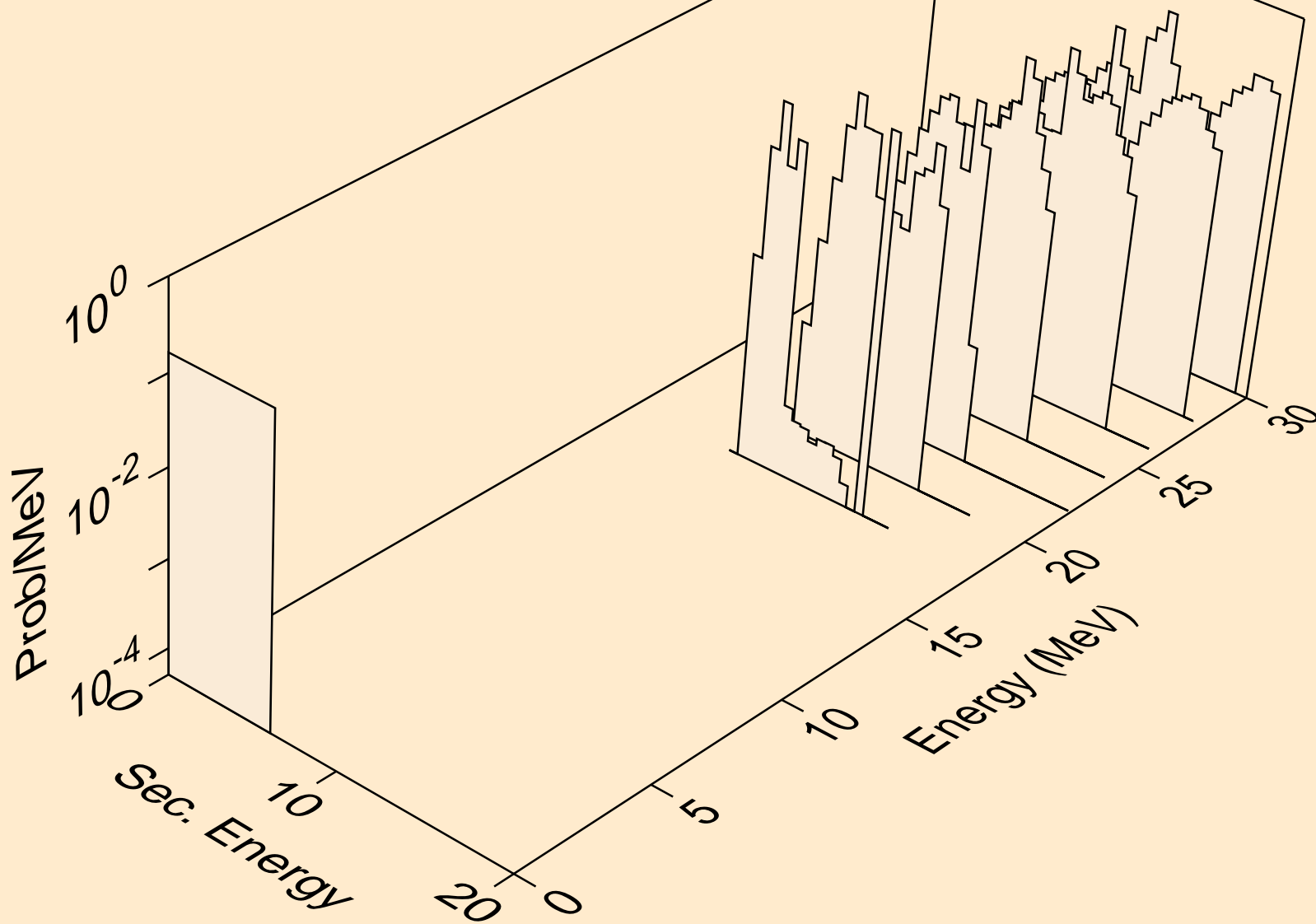

PO211M NEUTRON ACER TENDL-2019 LIBRARY; T=293.16K
alphas from (n,npa)

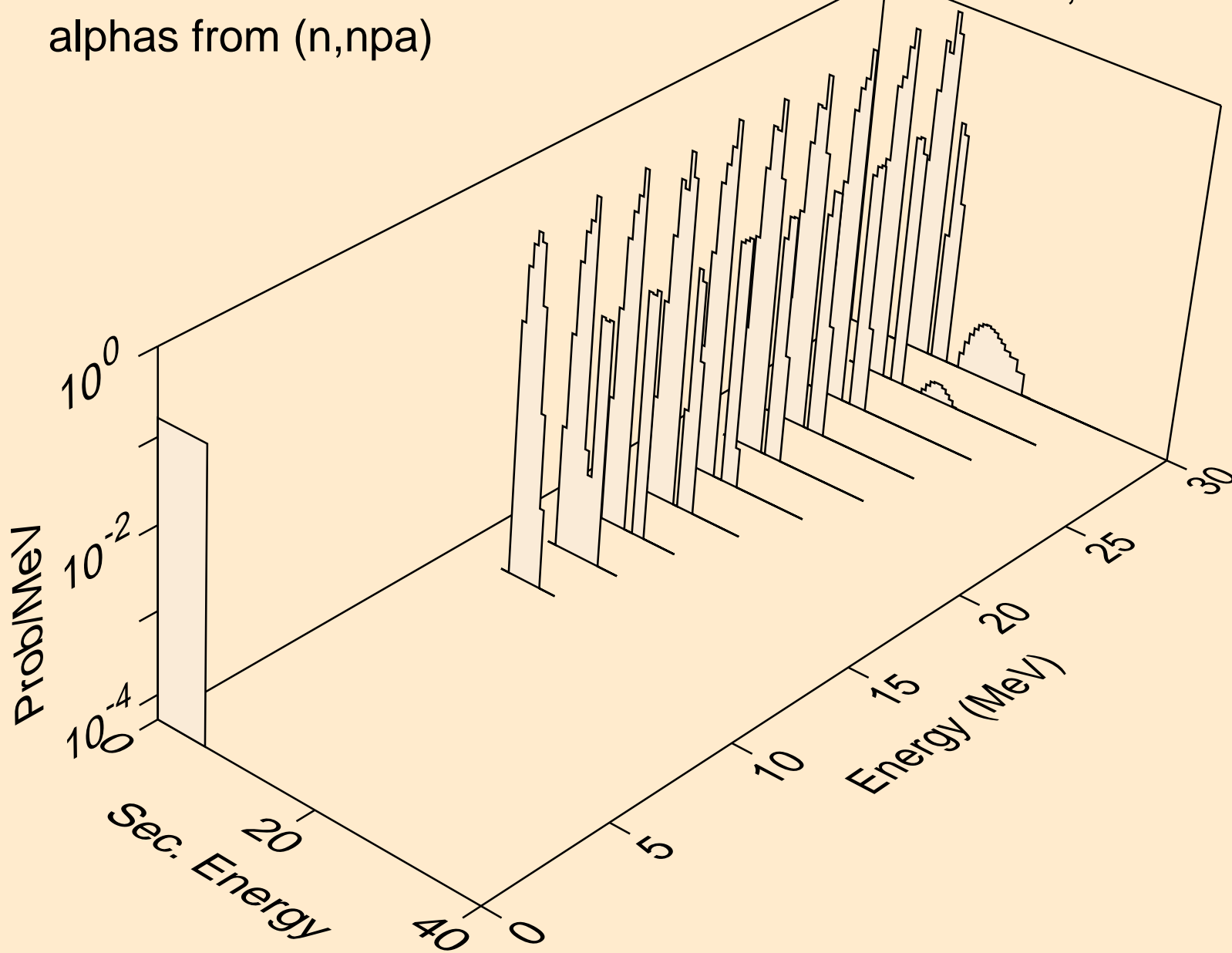

PO211M NEUTRON ACER TENDL-2019 LIBRARY; T=293.16K
alphas from (n,a)

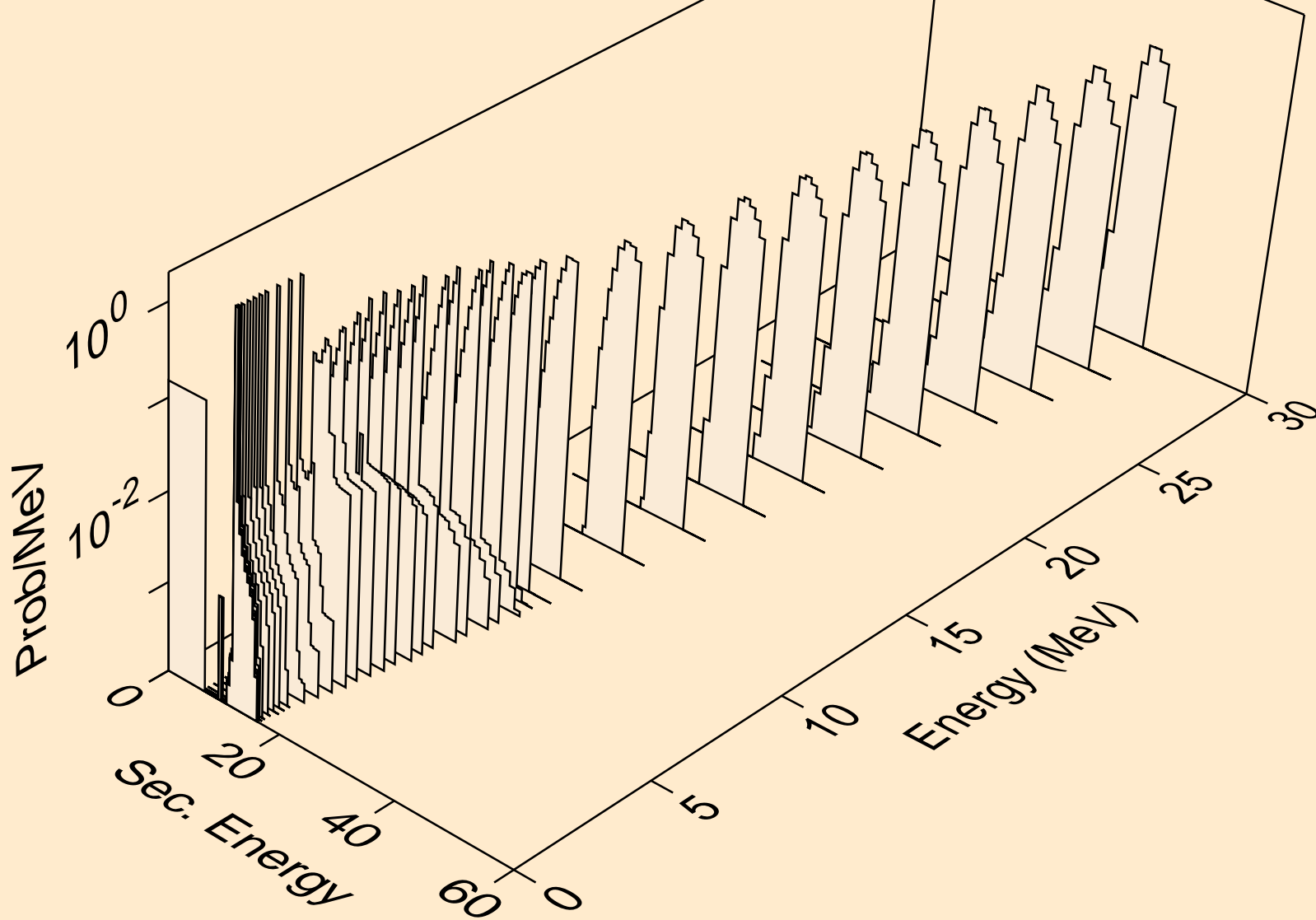

PO211M NEUTRON ACER TENDL-2019 LIBRARY; T=293.16K
alphas from (n,2a)

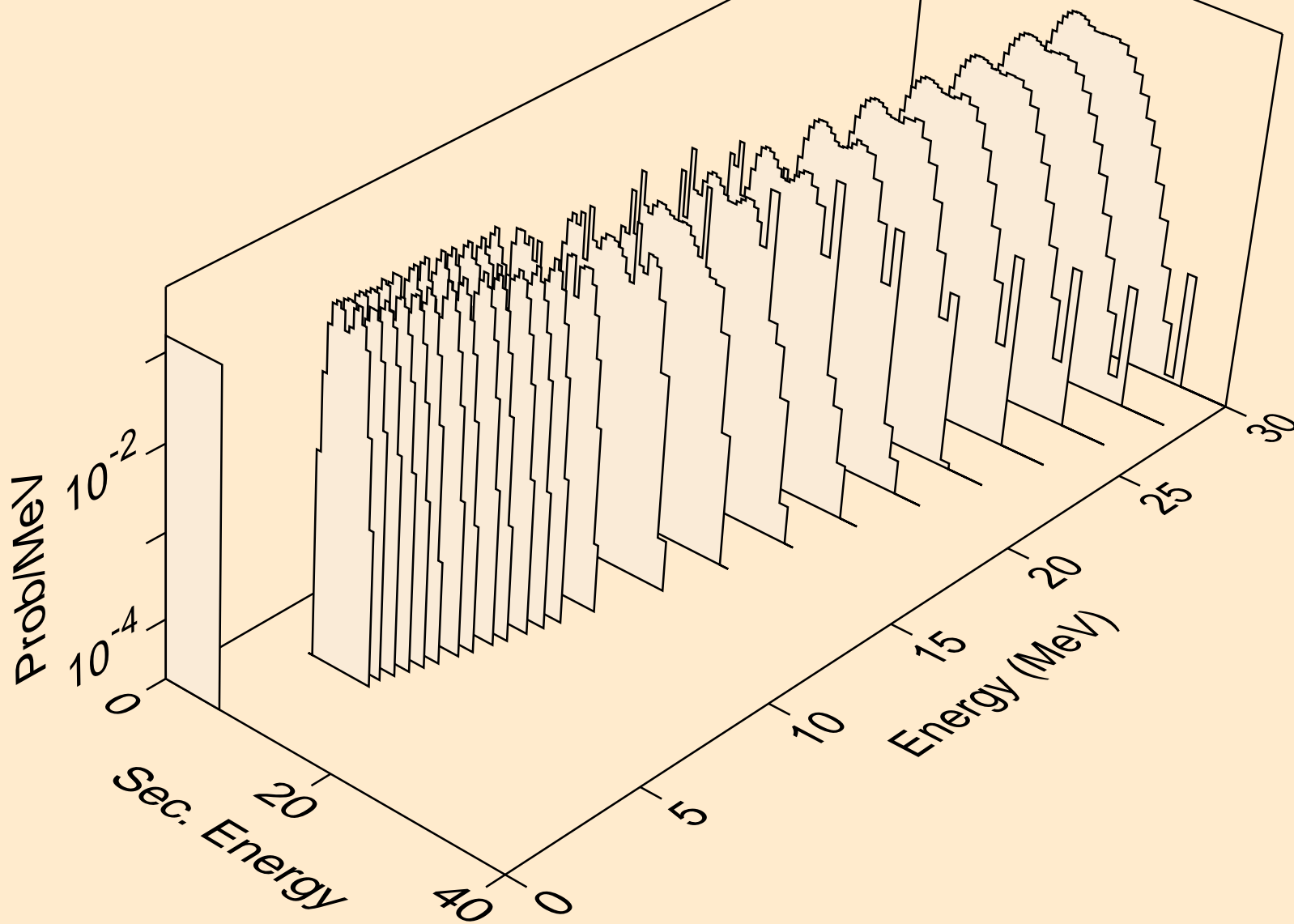

PO211M NEUTRON ACER TENDL-2019 LIBRARY; T=293.16K
alphas from (n,pa)

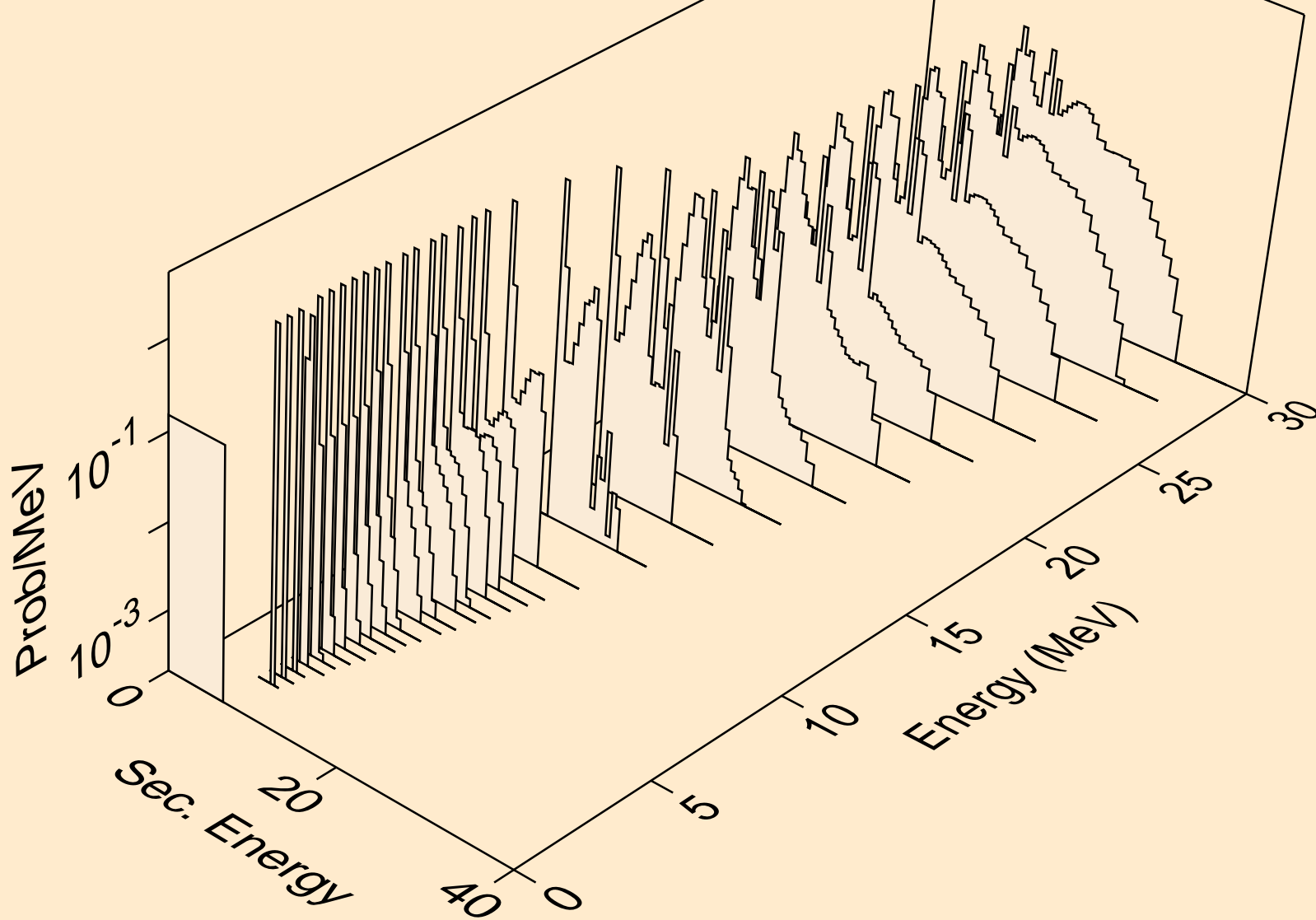

PO211M NEUTRON ACER TENDL-2019 LIBRARY; T=293.16K
alphas from (n,da)

