

PT183 NEUTRON ACER TENDL-2019 LIBRARY; T=293.16K  
Principal cross sections

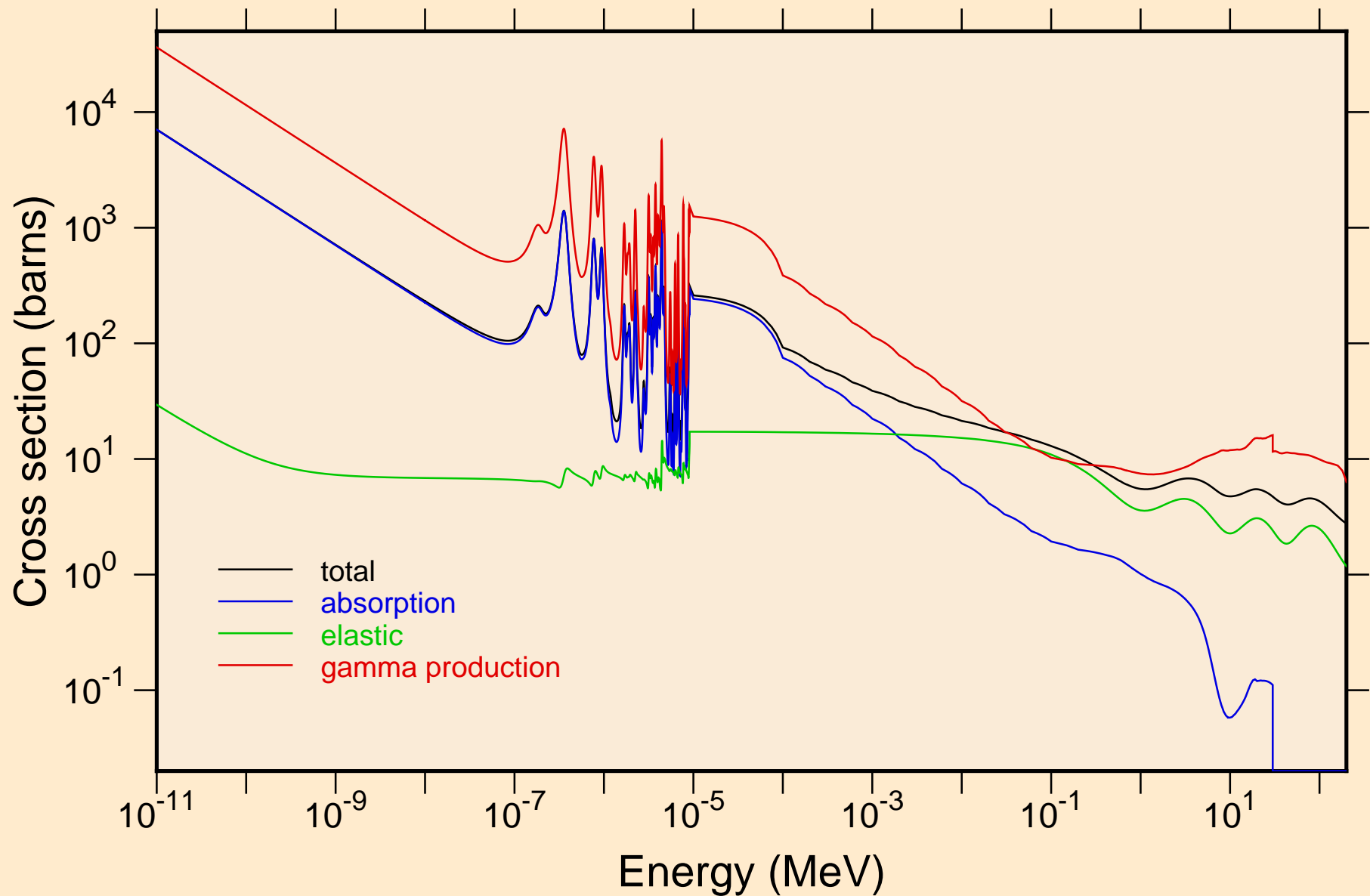

PT183 NEUTRON ACER TENDL-2019 LIBRARY; T=293.16K  
resonance total cross section

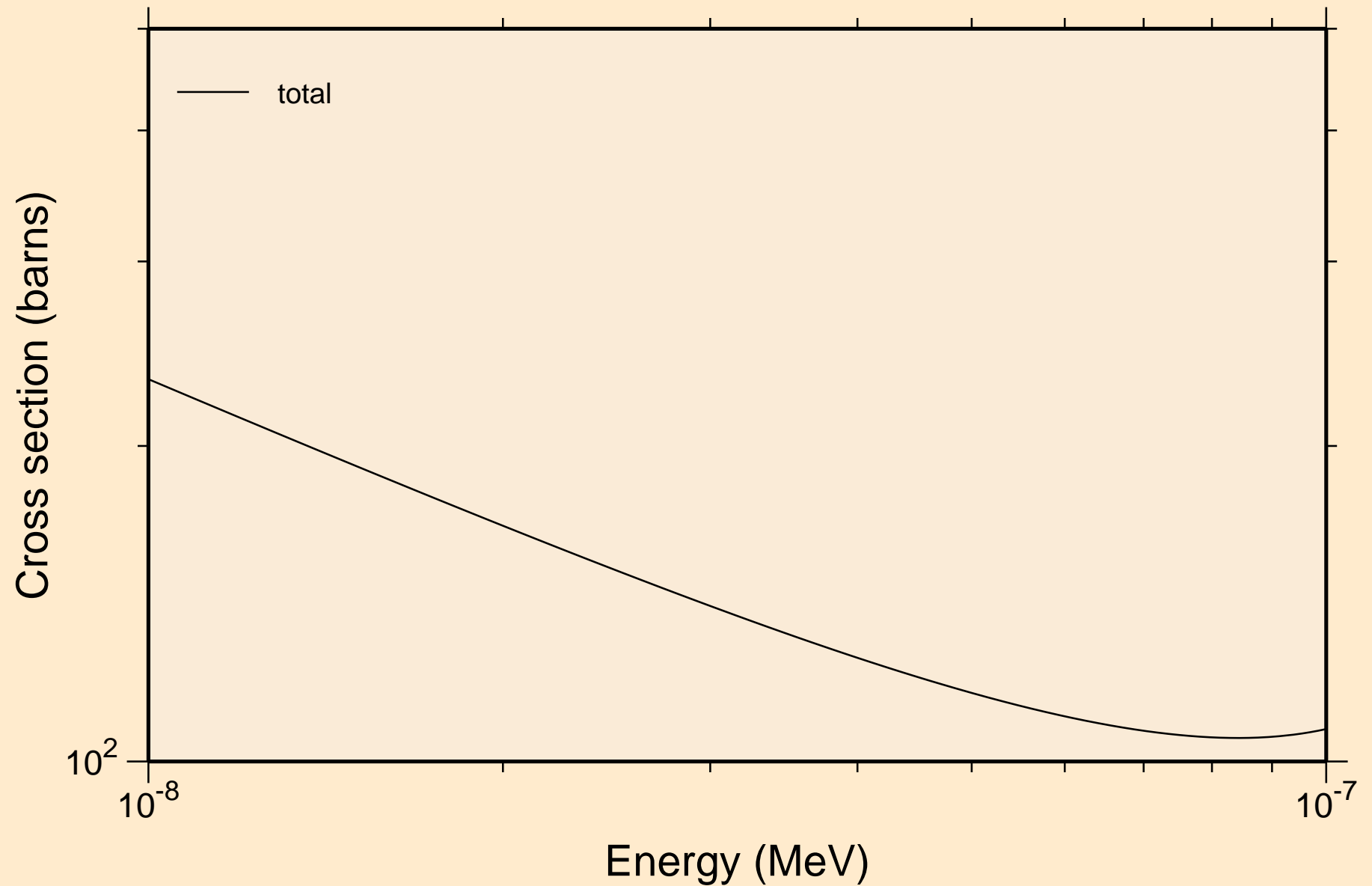

PT183 NEUTRON ACER TENDL-2019 LIBRARY; T=293.16K  
resonance total cross section

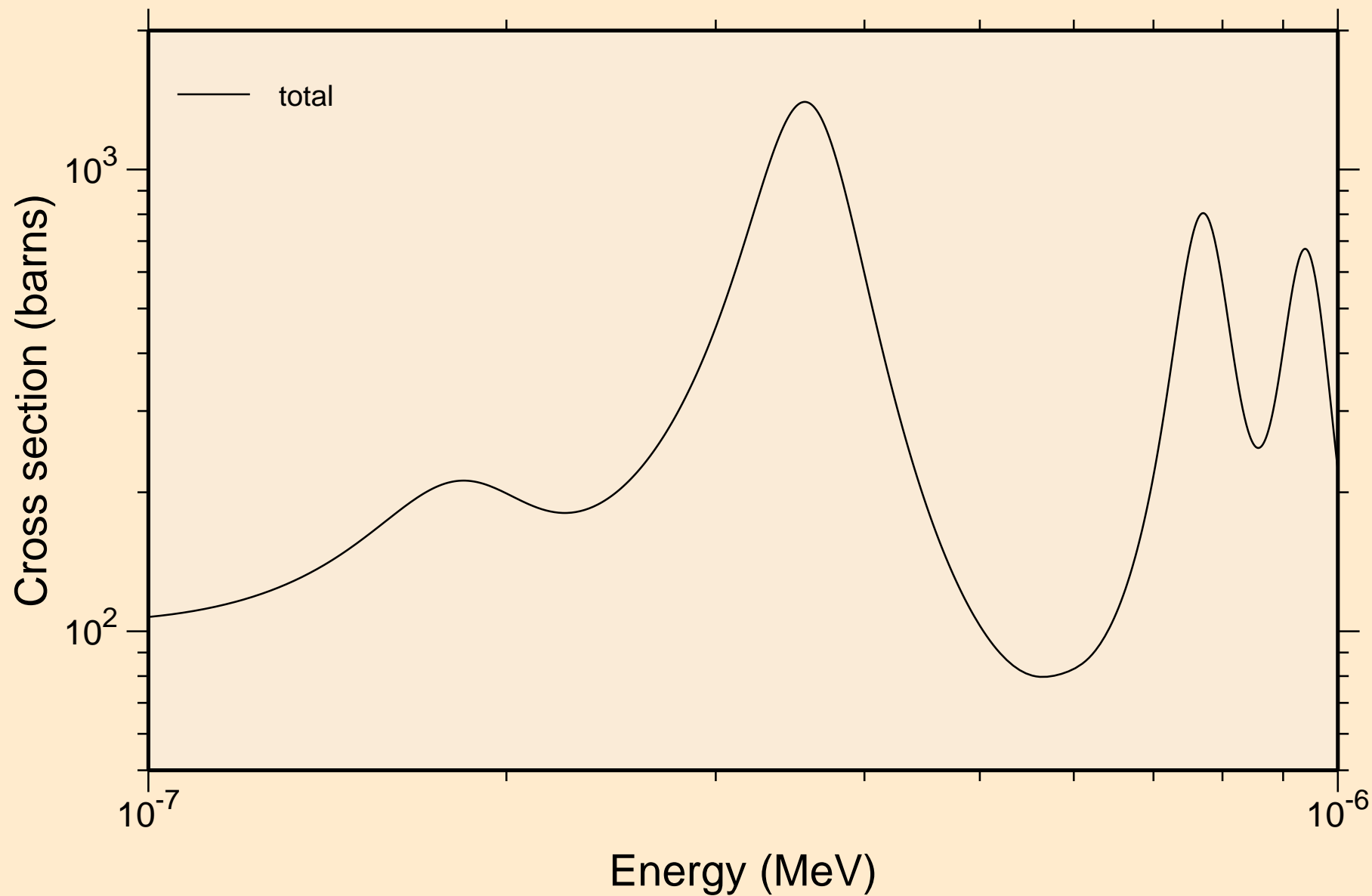

PT183 NEUTRON ACER TENDL-2019 LIBRARY; T=293.16K  
resonance total cross section

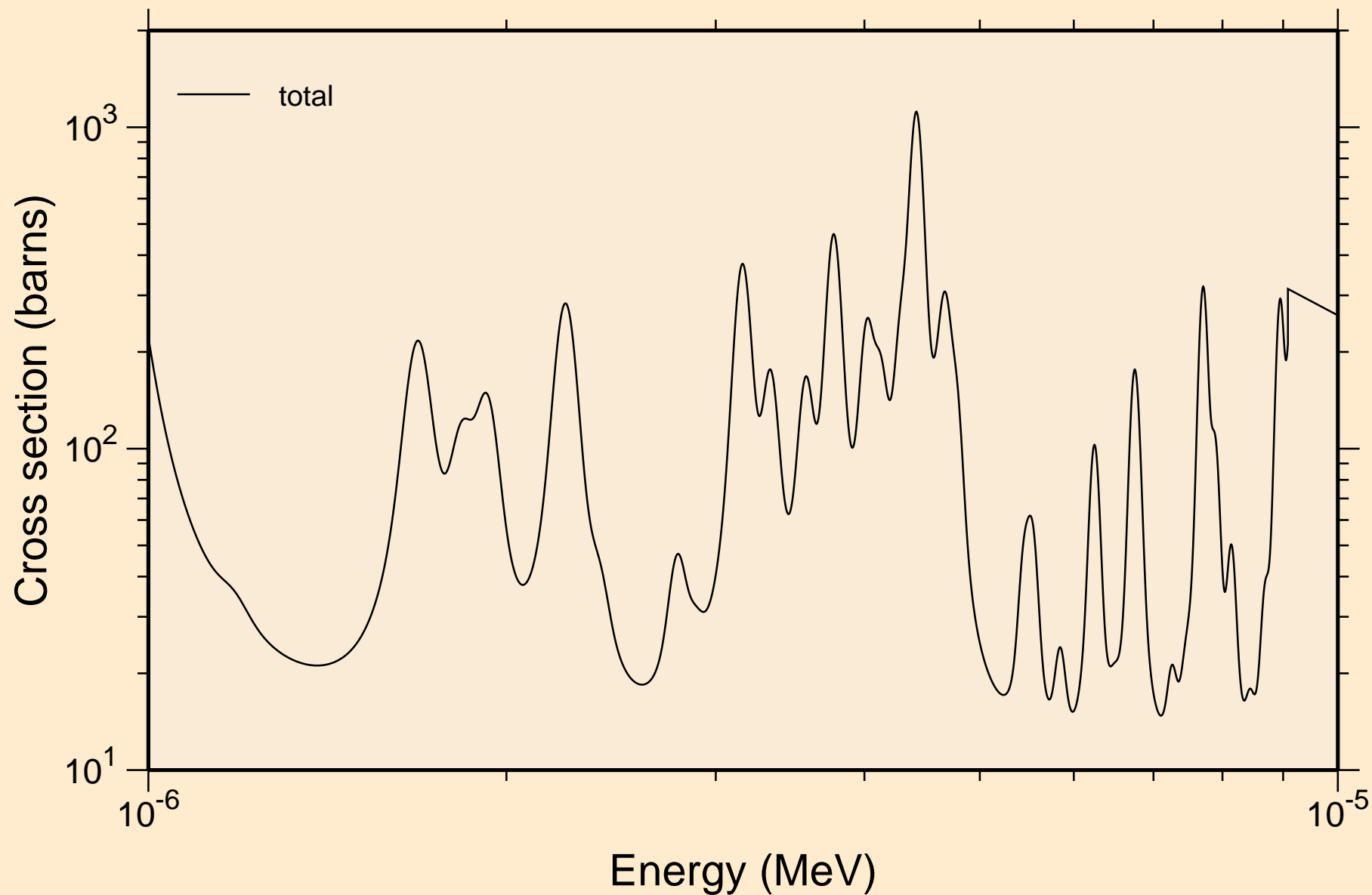

PT183 NEUTRON ACER TENDL-2019 LIBRARY; T=293.16K  
resonance total cross section

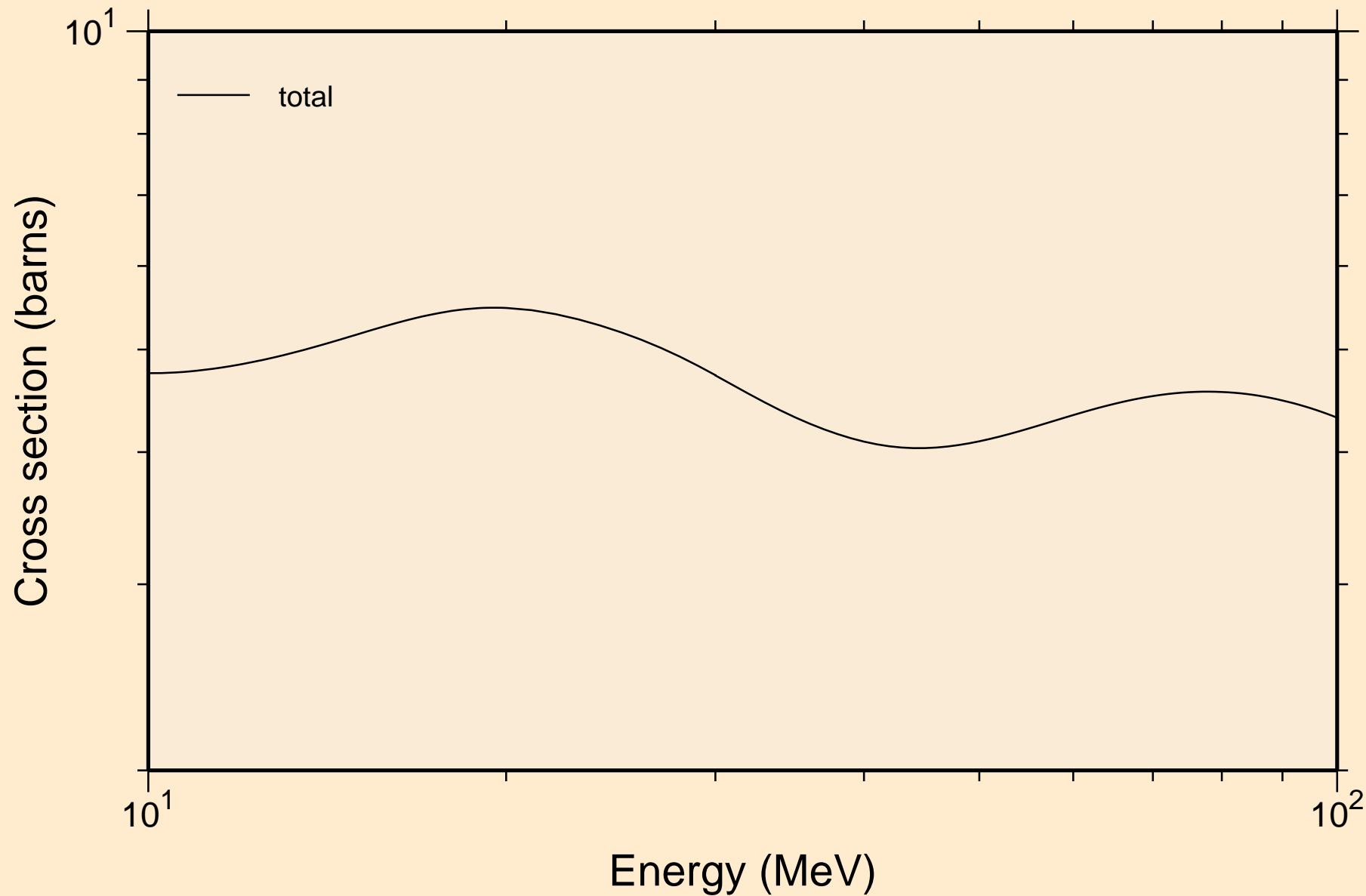

PT183 NEUTRON ACER TENDL-2019 LIBRARY; T=293.16K  
resonance absorption cross sections

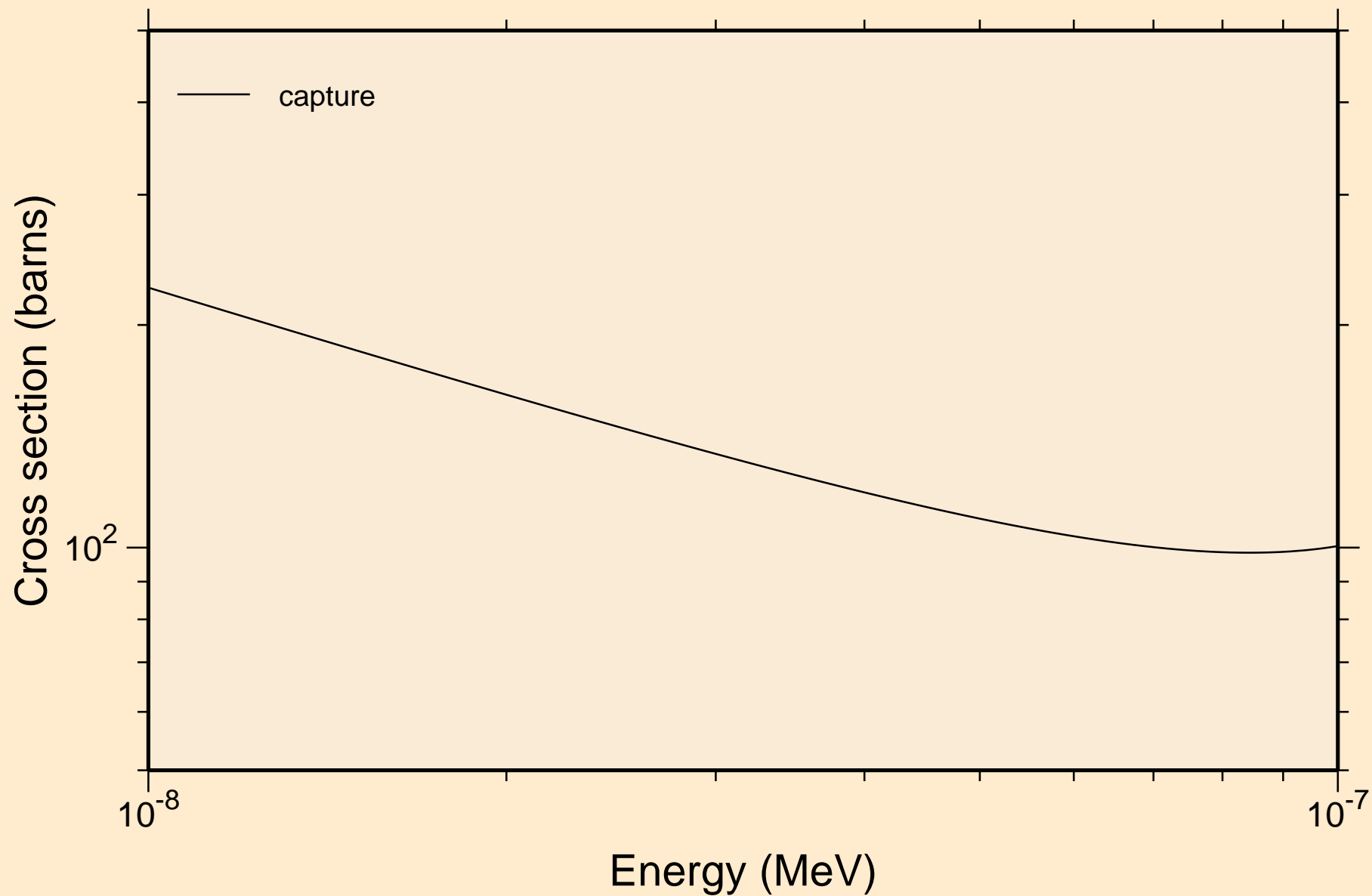

PT183 NEUTRON ACER TENDL-2019 LIBRARY; T=293.16K  
resonance absorption cross sections

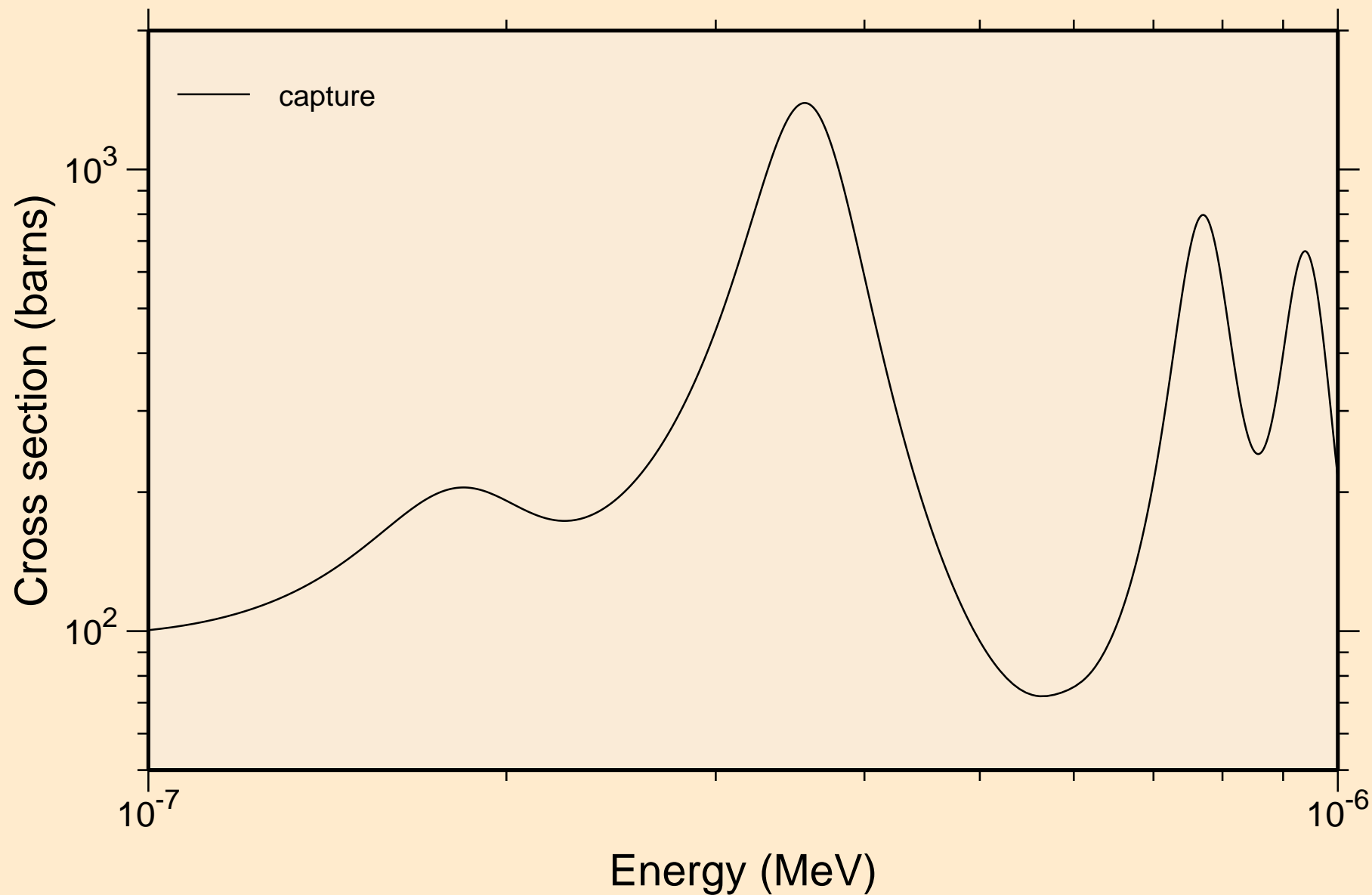

PT183 NEUTRON ACER TENDL-2019 LIBRARY; T=293.16K  
resonance absorption cross sections

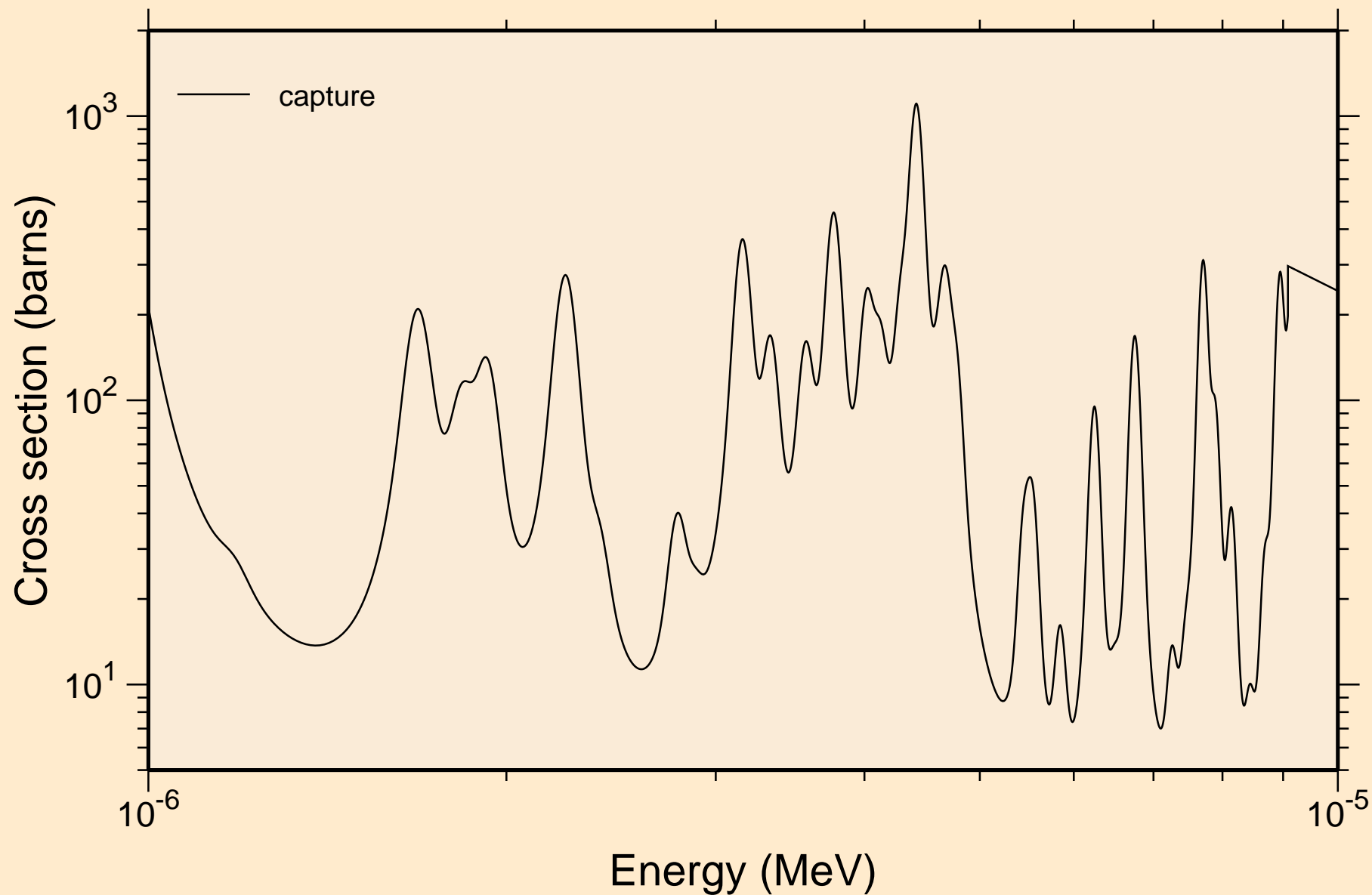



PT183 NEUTRON ACER TENDL-2019 LIBRARY; T=293.16K  
resonance absorption cross sections

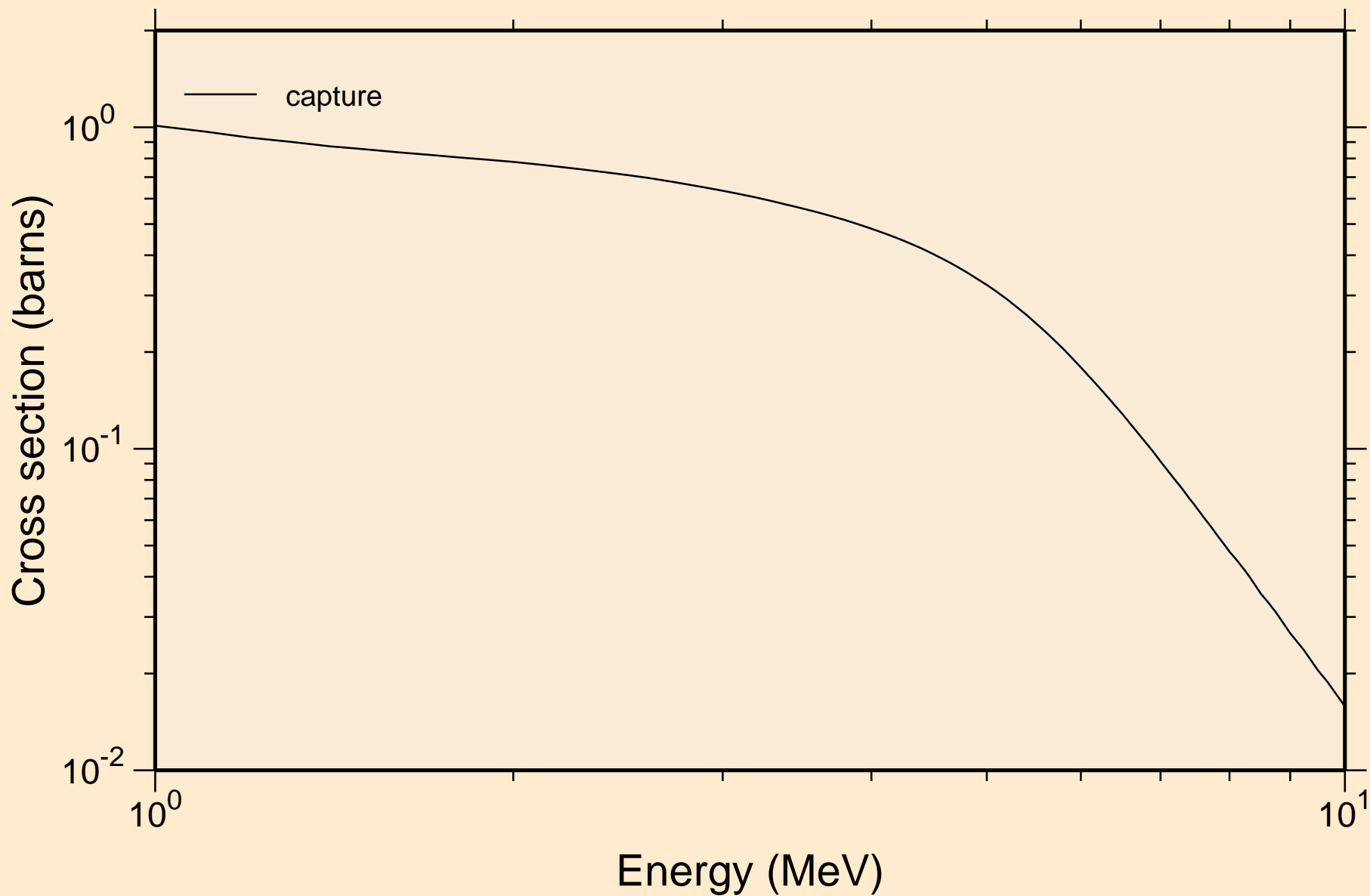

PT183 NEUTRON ACER TENDL-2019 LIBRARY; T=293.16K  
Heating

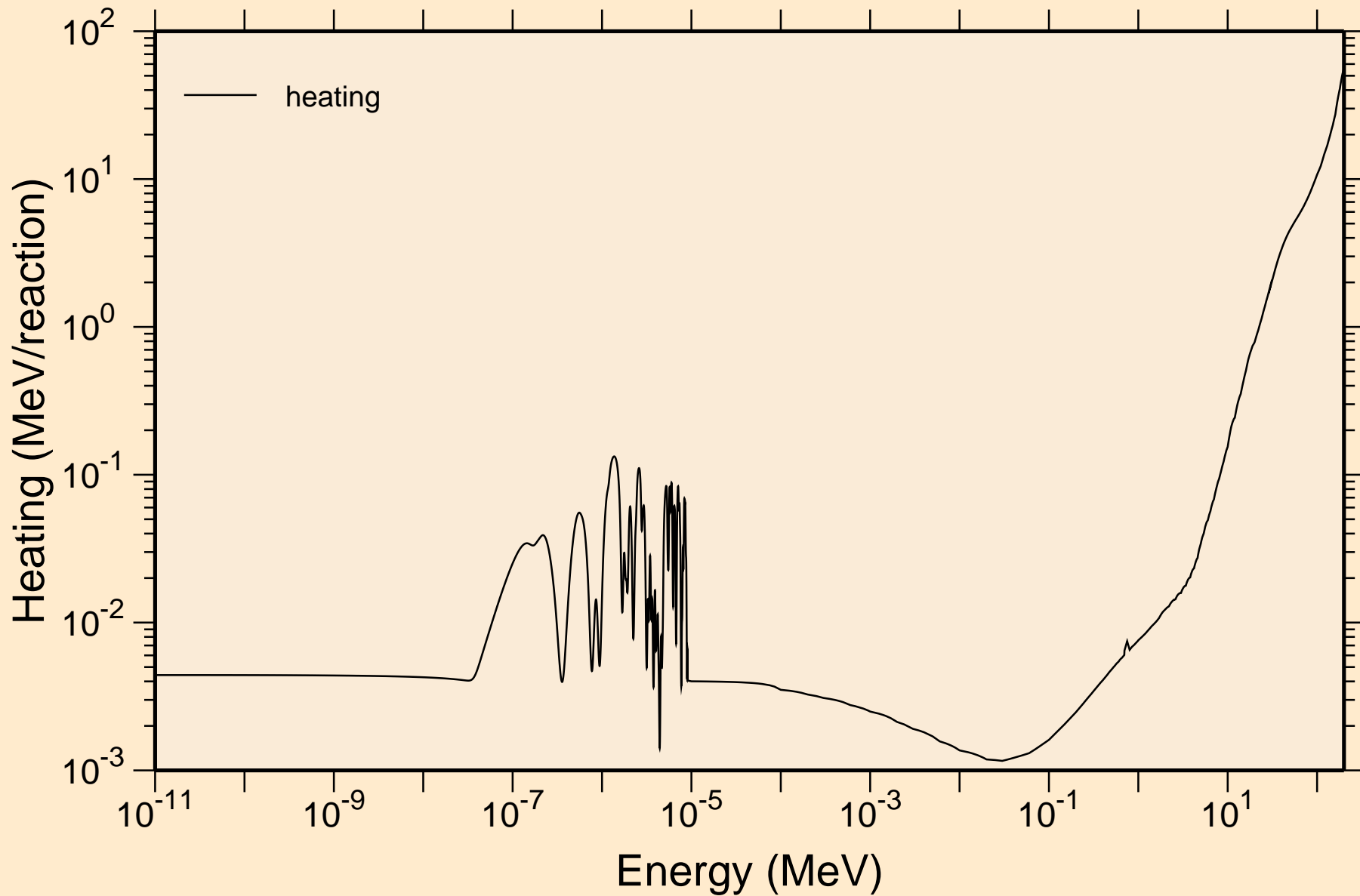

PT183 NEUTRON ACER TENDL-2019 LIBRARY; T=293.16K  
Damage

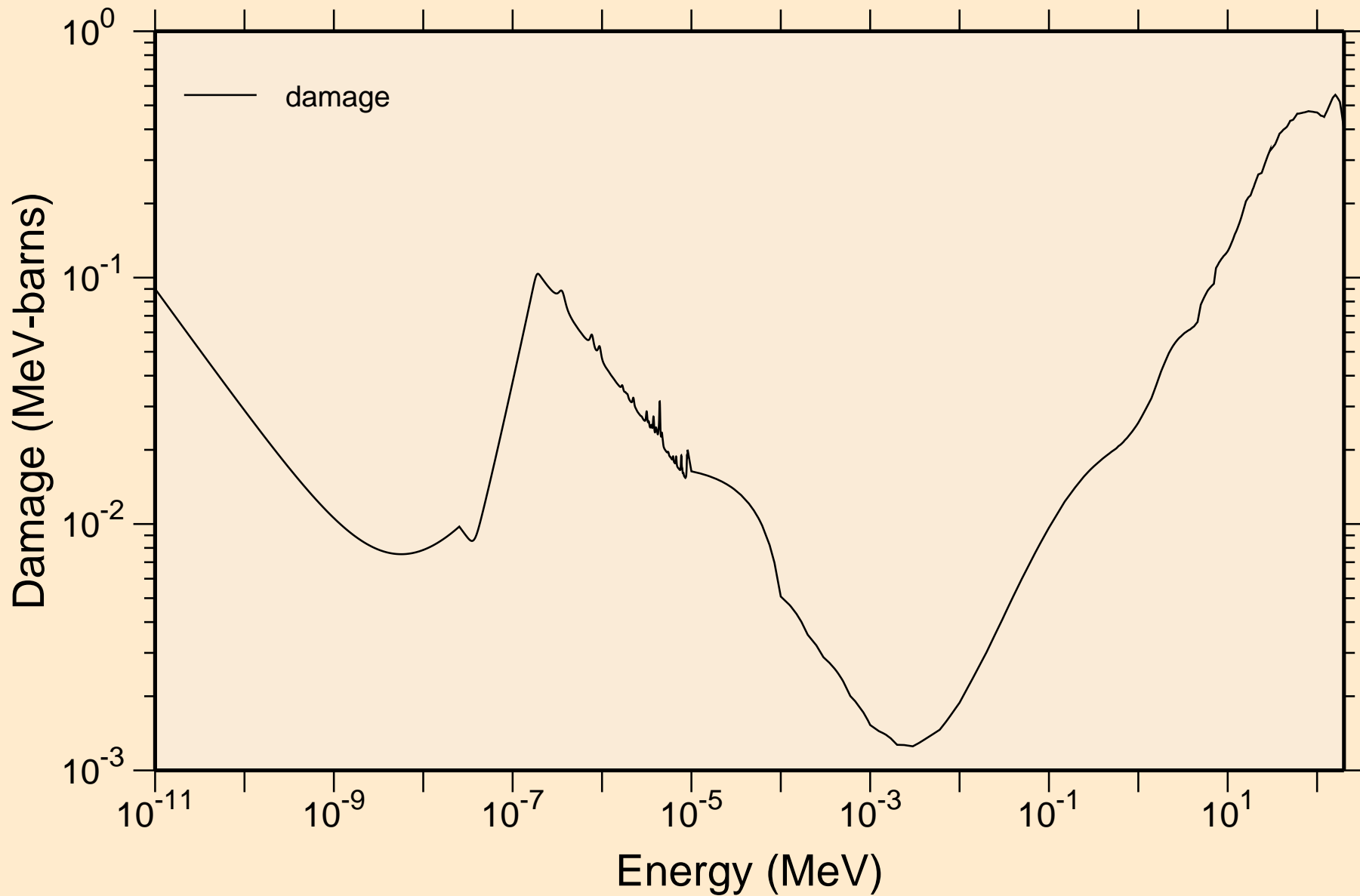

PT183 NEUTRON ACER TENDL-2019 LIBRARY; T=293.16K  
Non-threshold reactions

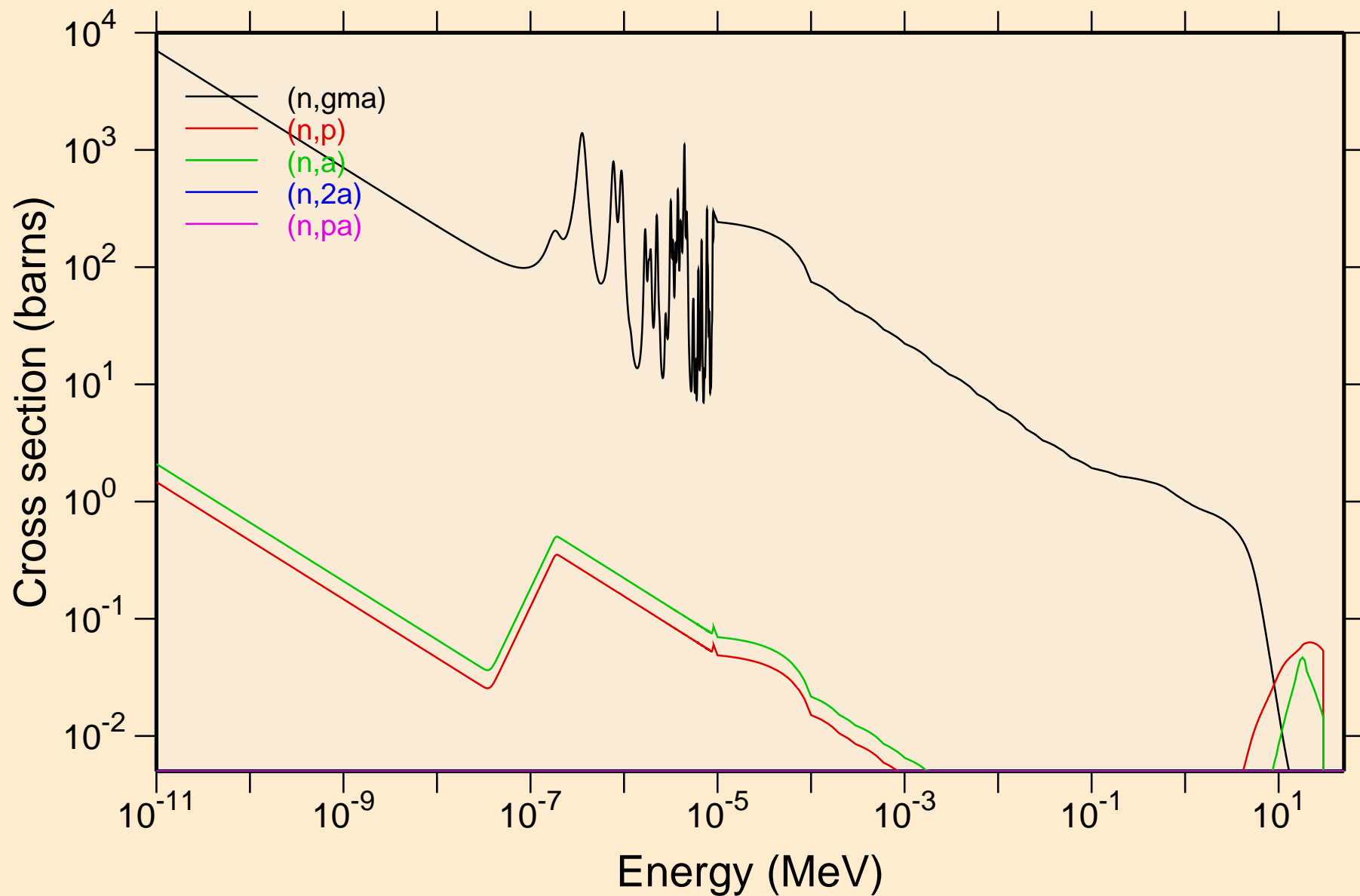

PT183 NEUTRON ACER TENDL-2019 LIBRARY; T=293.16K  
Non-threshold reactions

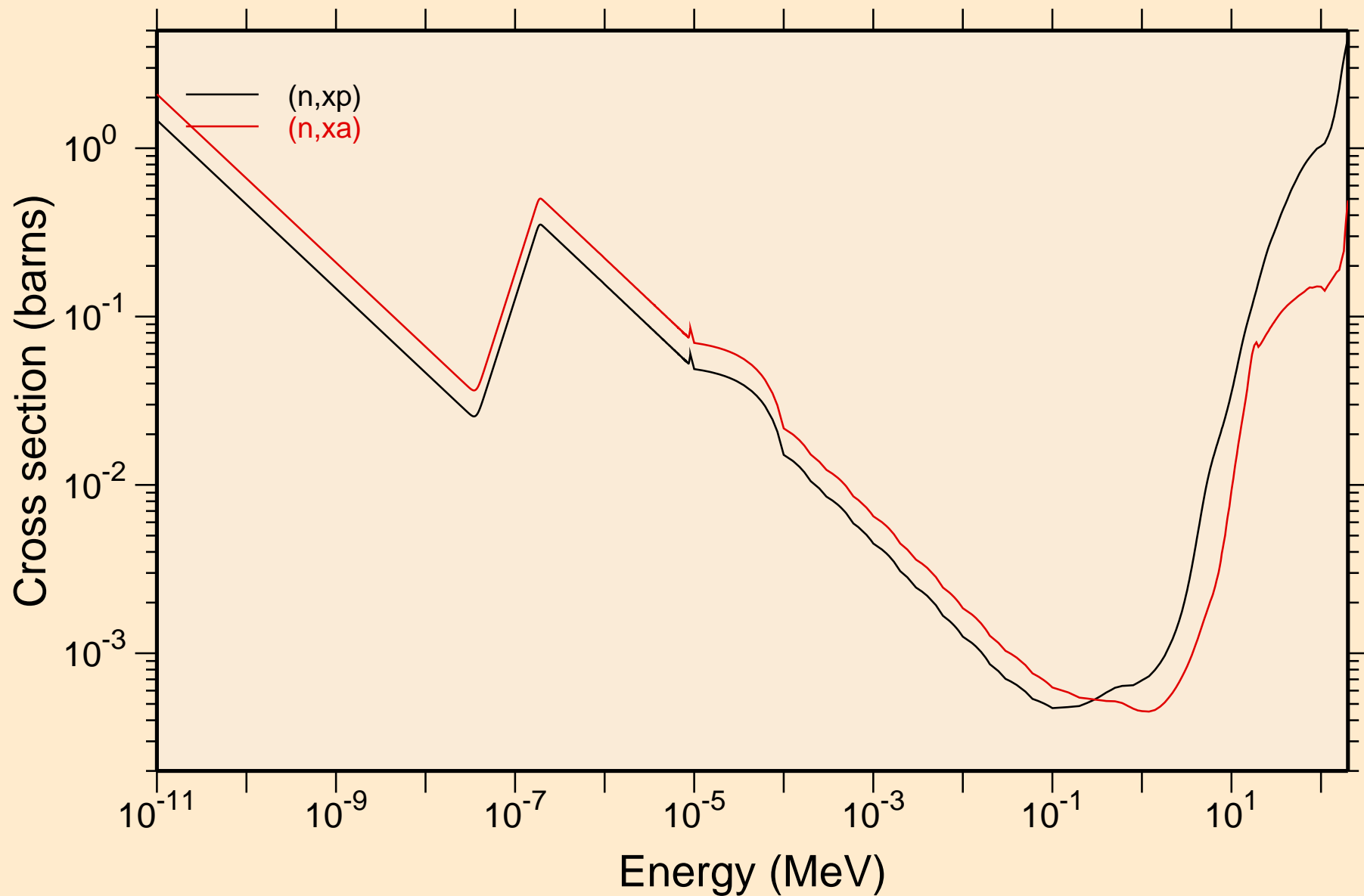

PT183 NEUTRON ACER TENDL-2019 LIBRARY; T=293.16K  
Principal cross sections

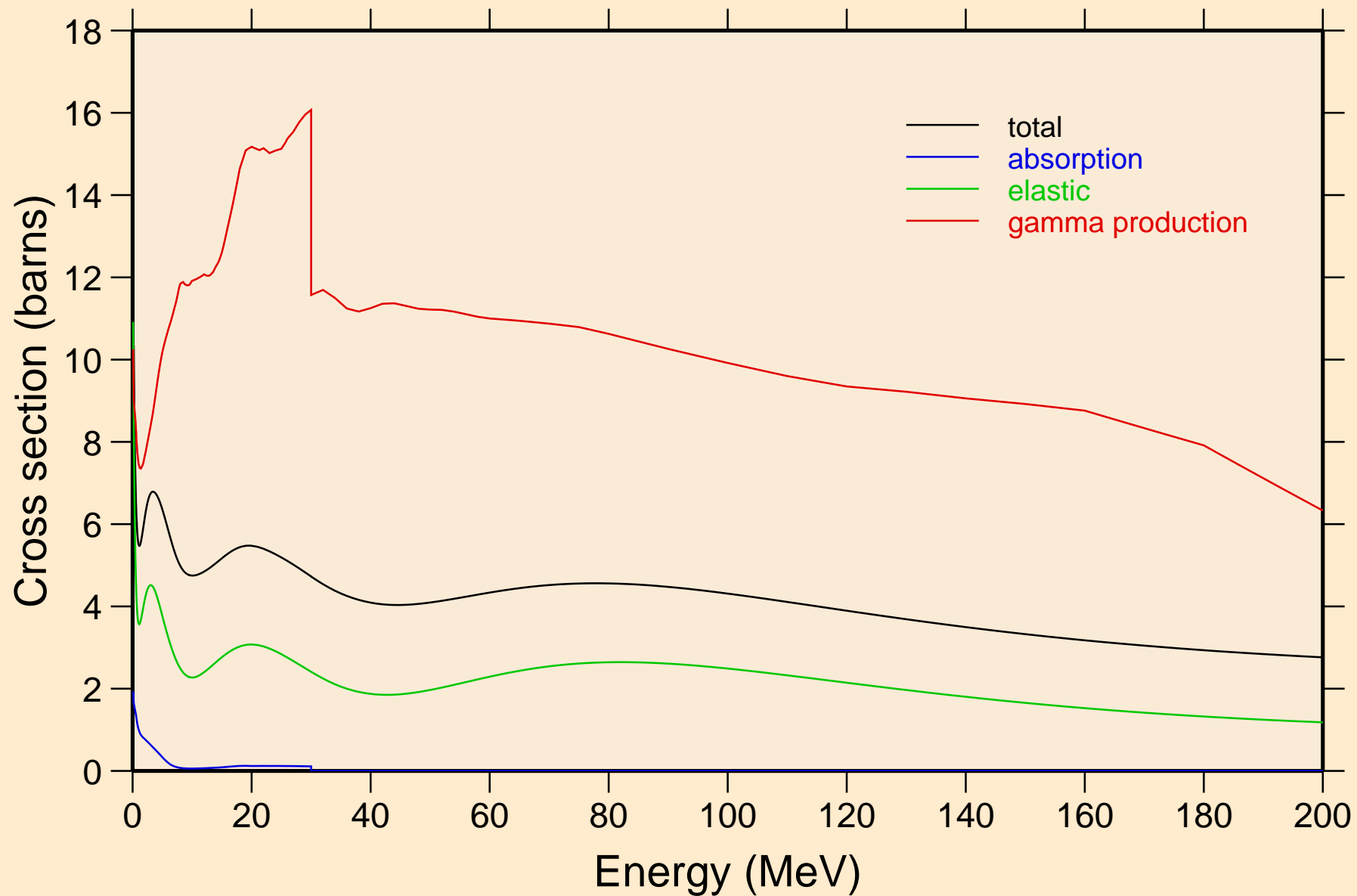

PT183 NEUTRON ACER TENDL-2019 LIBRARY; T=293.16K  
Heating

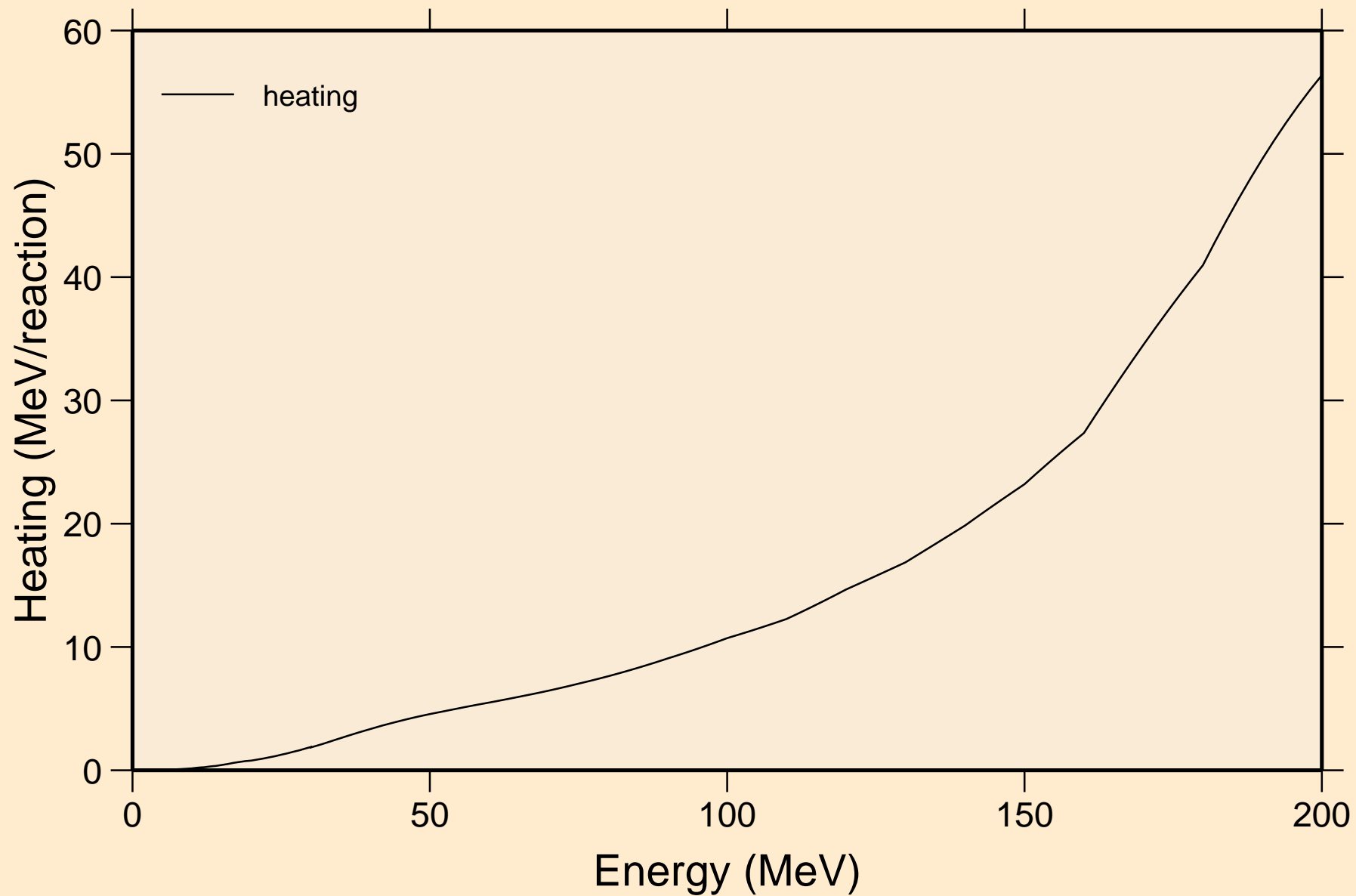

PT183 NEUTRON ACER TENDL-2019 LIBRARY; T=293.16K  
Damage

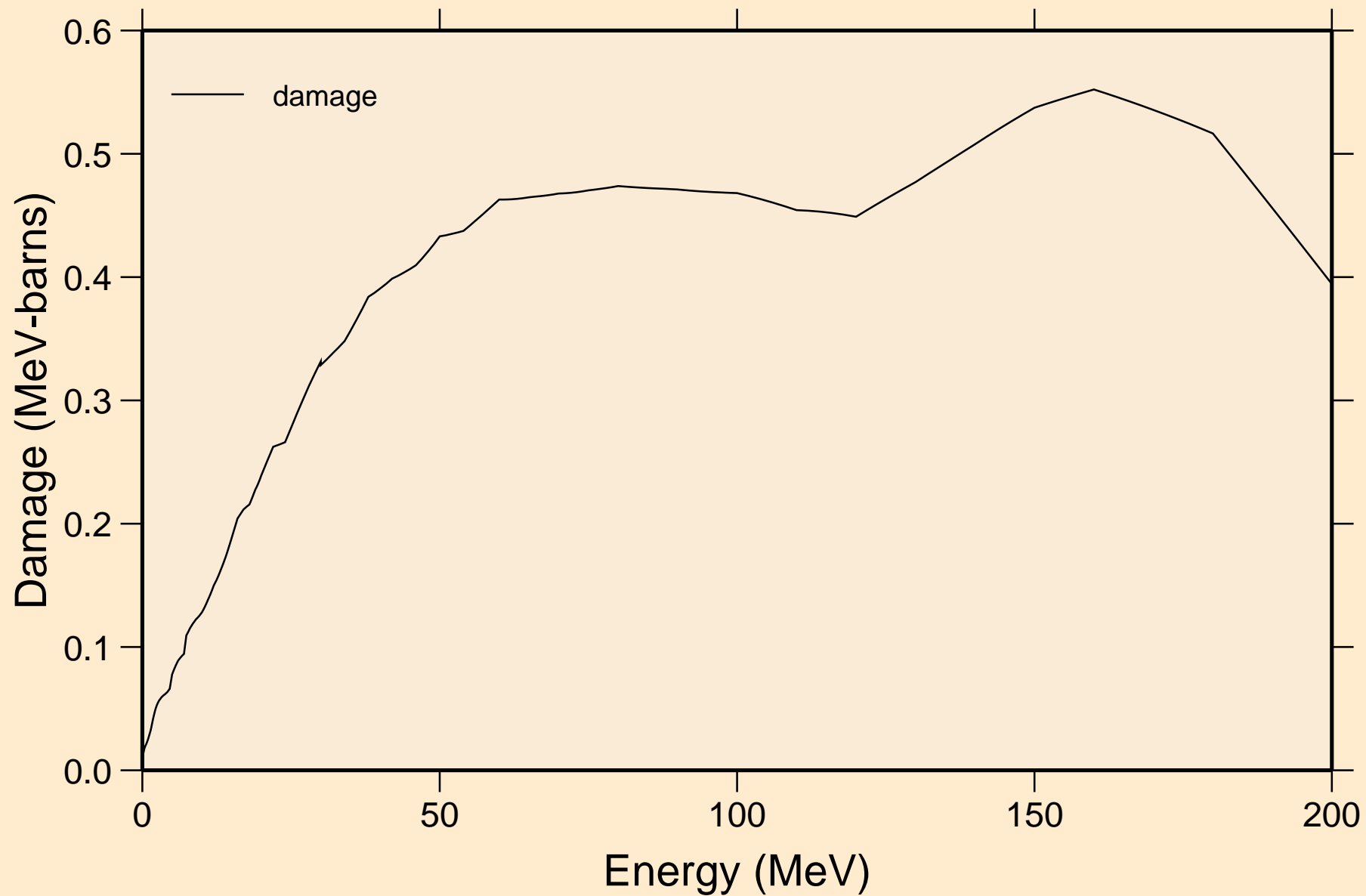



PT183 NEUTRON ACER TENDL-2019 LIBRARY; T=293.16K  
Non-threshold reactions

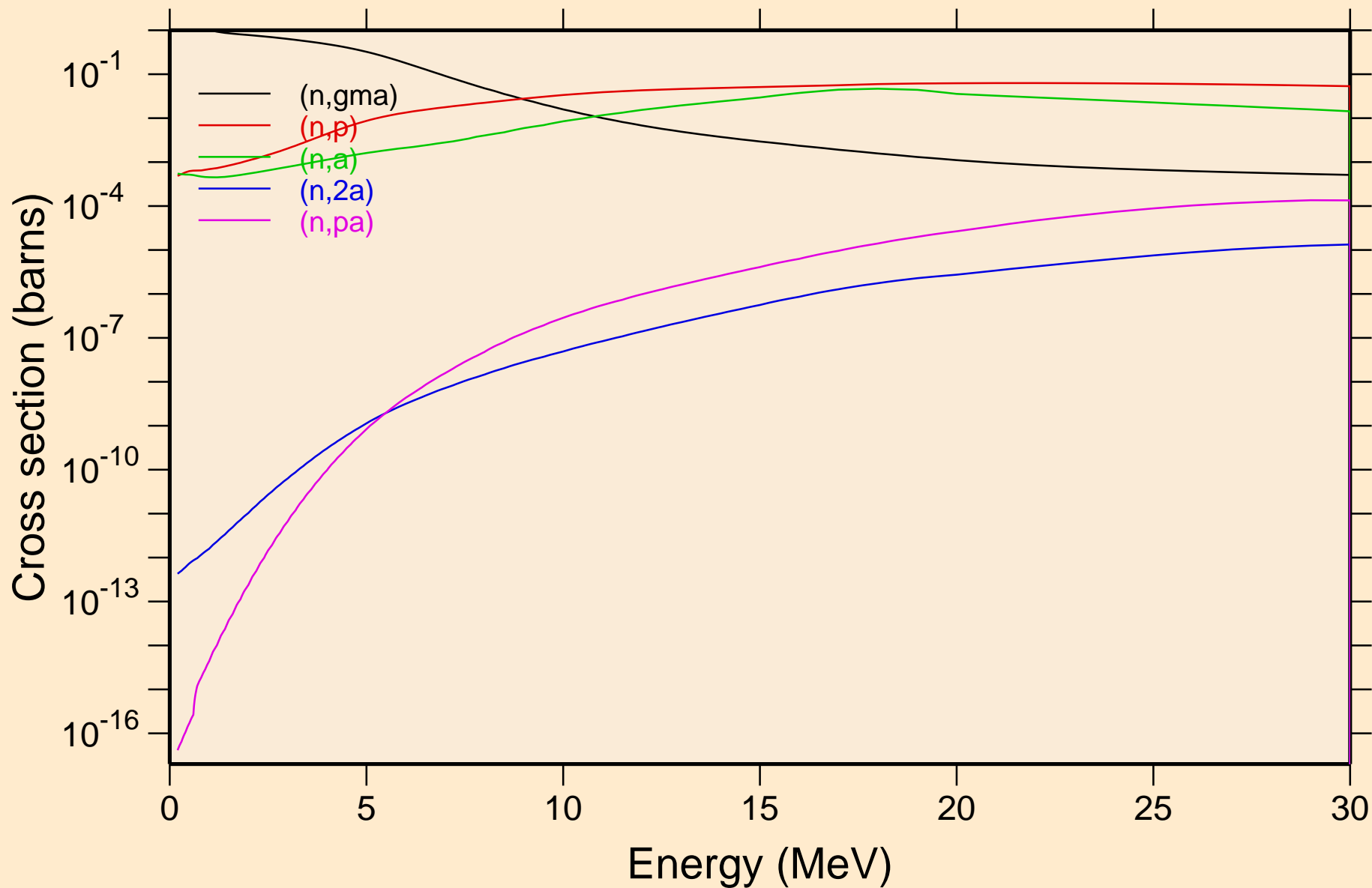

PT183 NEUTRON ACER TENDL-2019 LIBRARY; T=293.16K  
Non-threshold reactions

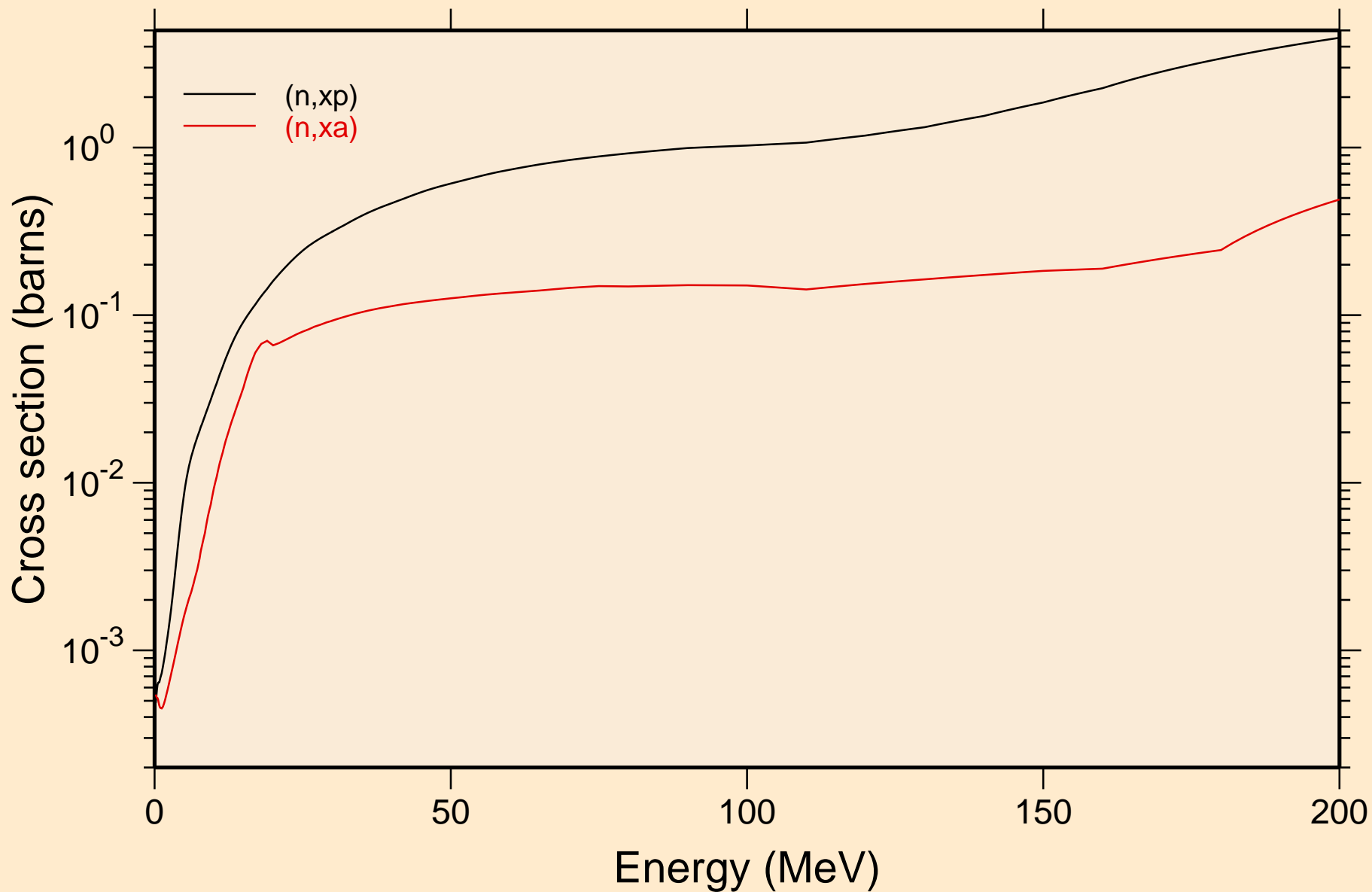

PT183 NEUTRON ACER TENDL-2019 LIBRARY; T=293.16K  
Inelastic levels

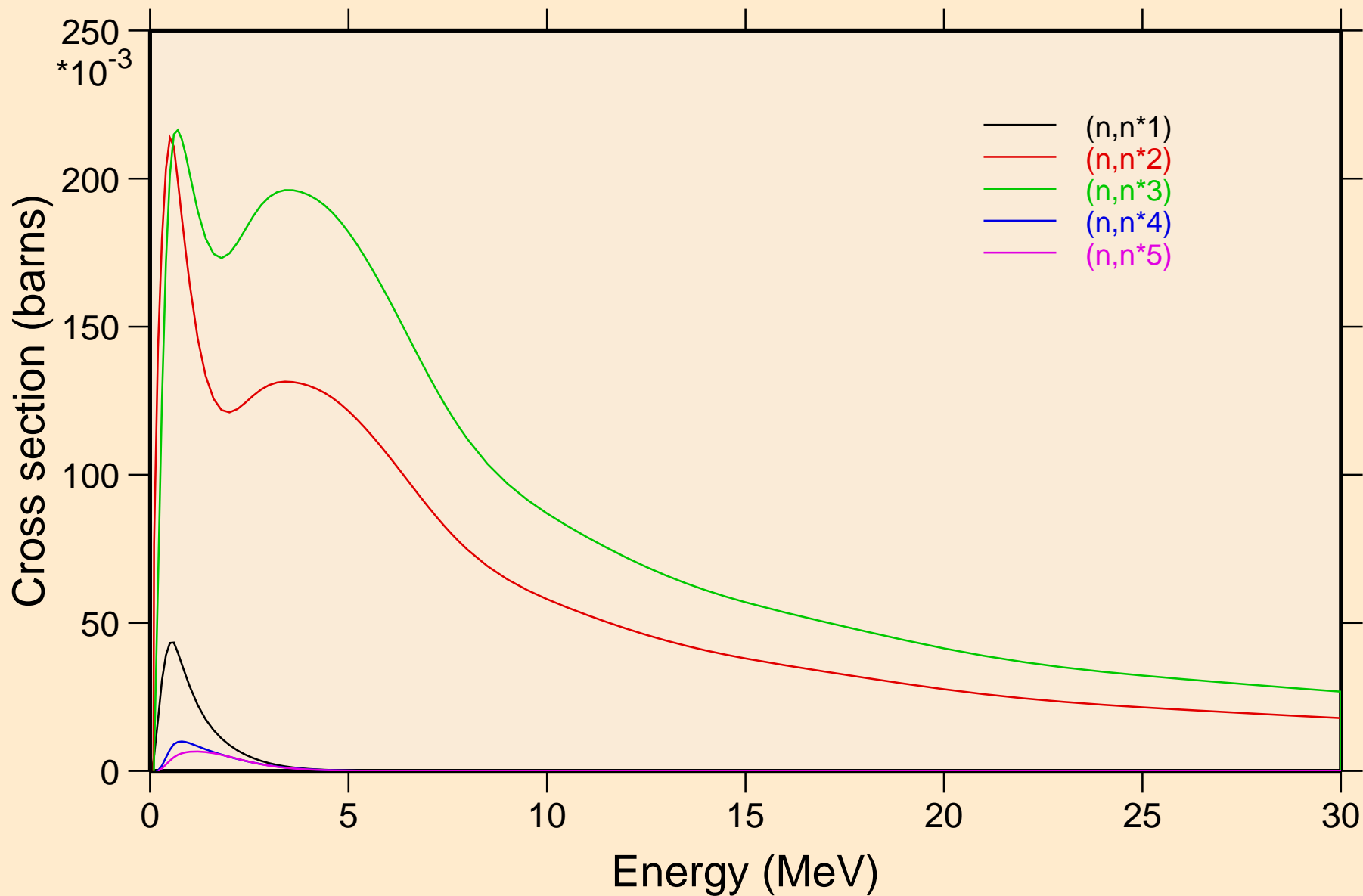

PT183 NEUTRON ACER TENDL-2019 LIBRARY; T=293.16K  
Inelastic levels

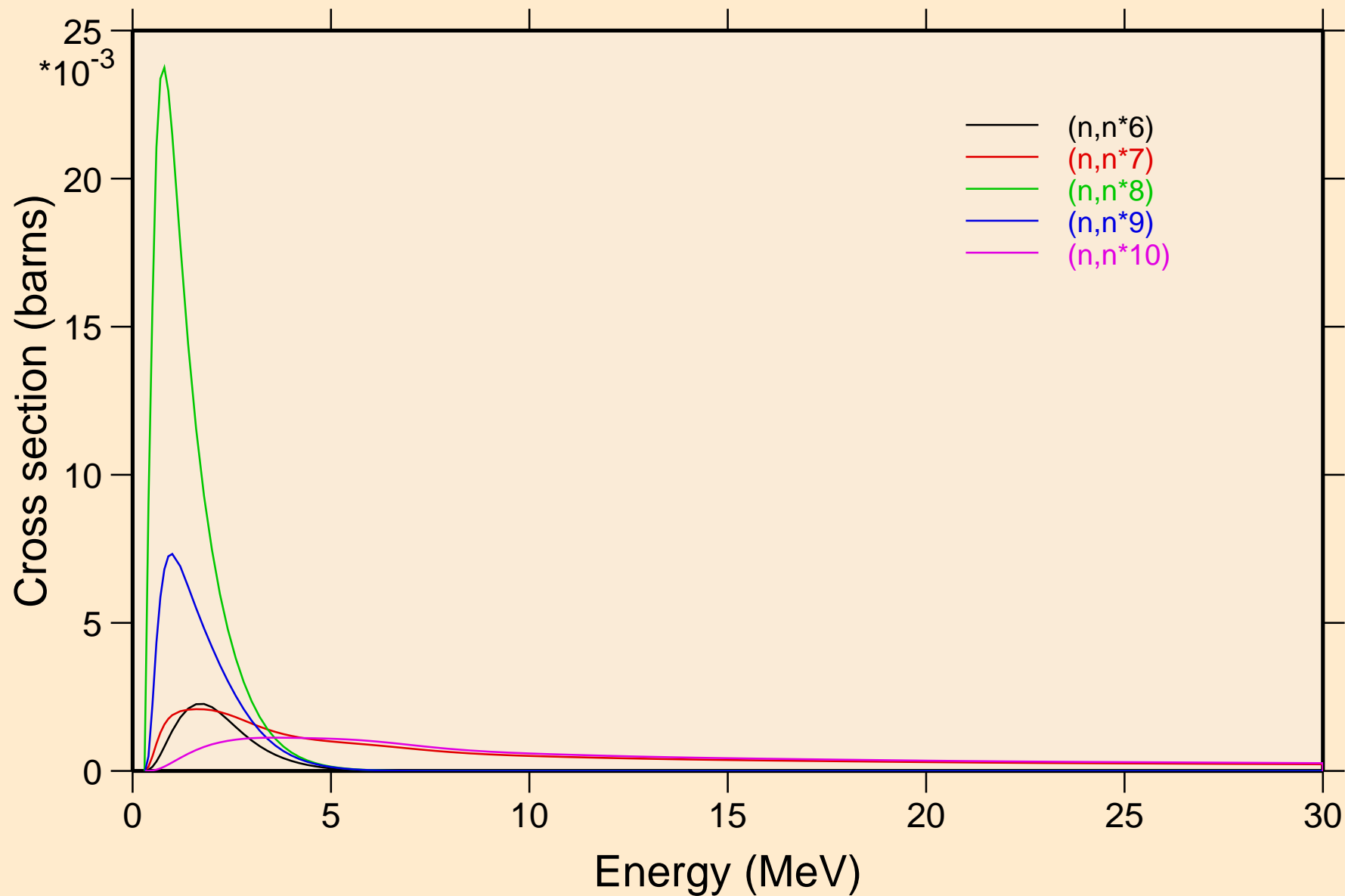

PT183 NEUTRON ACER TENDL-2019 LIBRARY; T=293.16K  
Inelastic levels

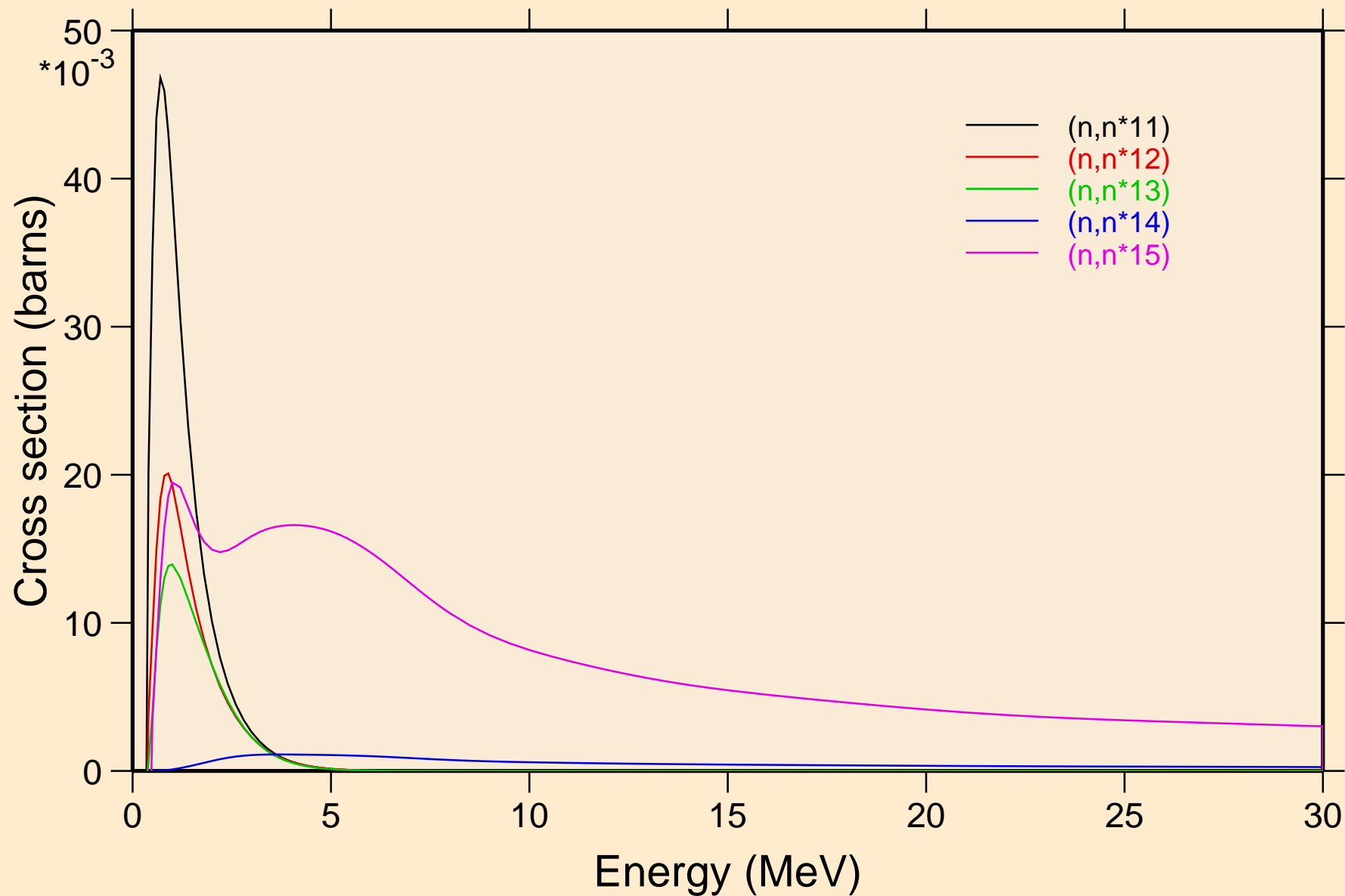

PT183 NEUTRON ACER TENDL-2019 LIBRARY; T=293.16K  
Inelastic levels

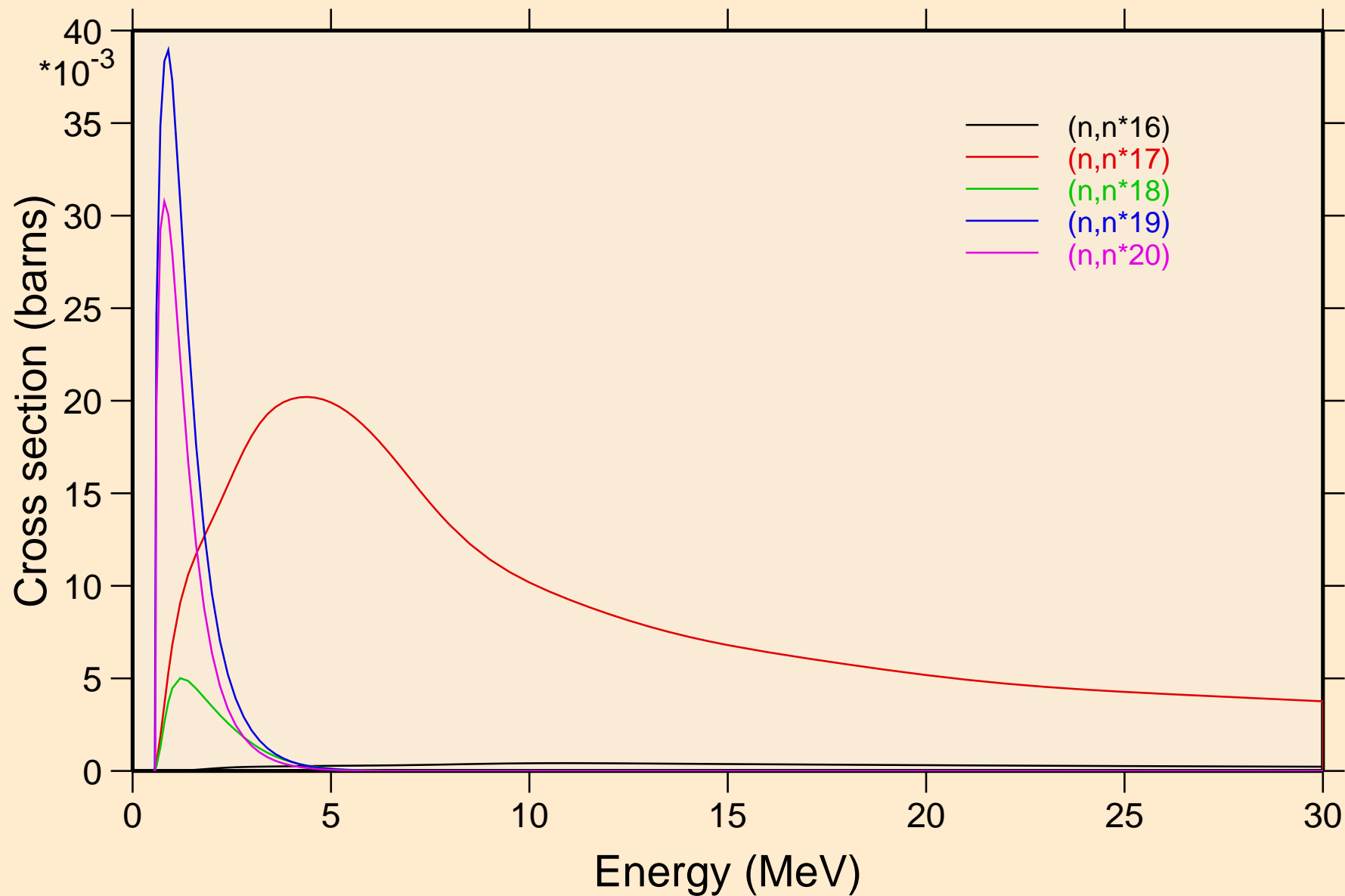

PT183 NEUTRON ACER TENDL-2019 LIBRARY; T=293.16K  
Inelastic levels

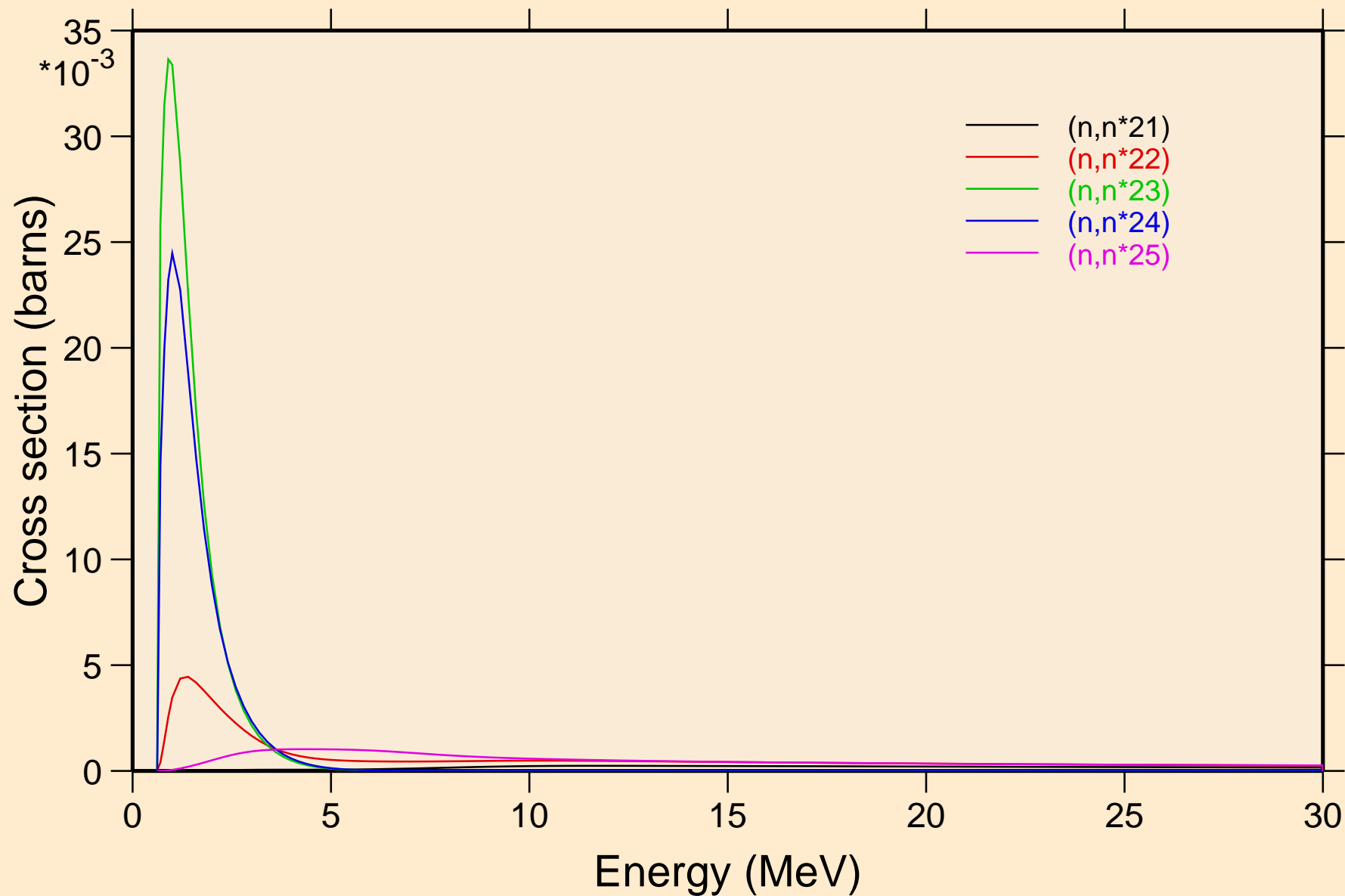

PT183 NEUTRON ACER TENDL-2019 LIBRARY; T=293.16K  
Inelastic levels

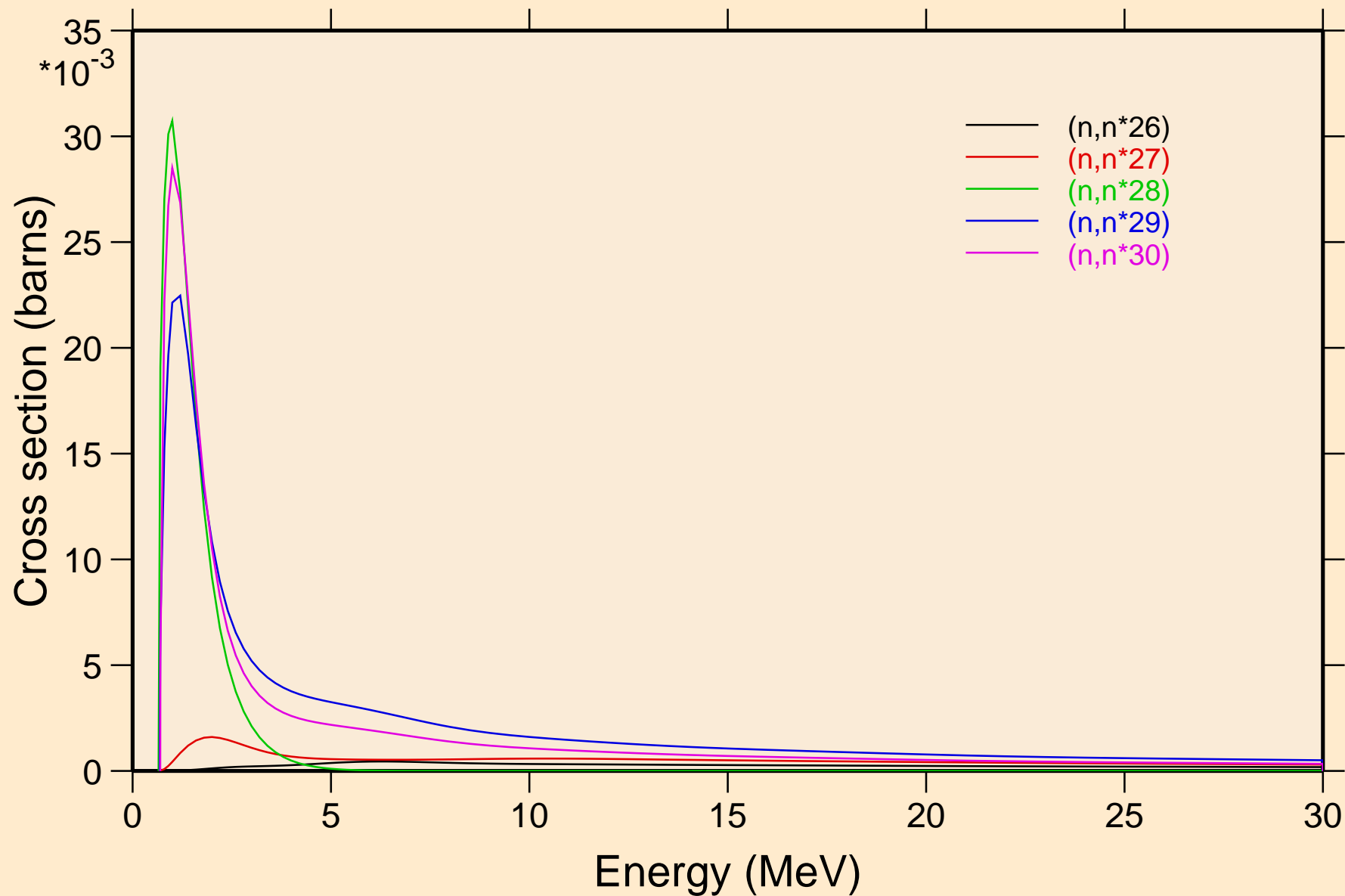



PT183 NEUTRON ACER TENDL-2019 LIBRARY; T=293.16K  
Threshold reactions

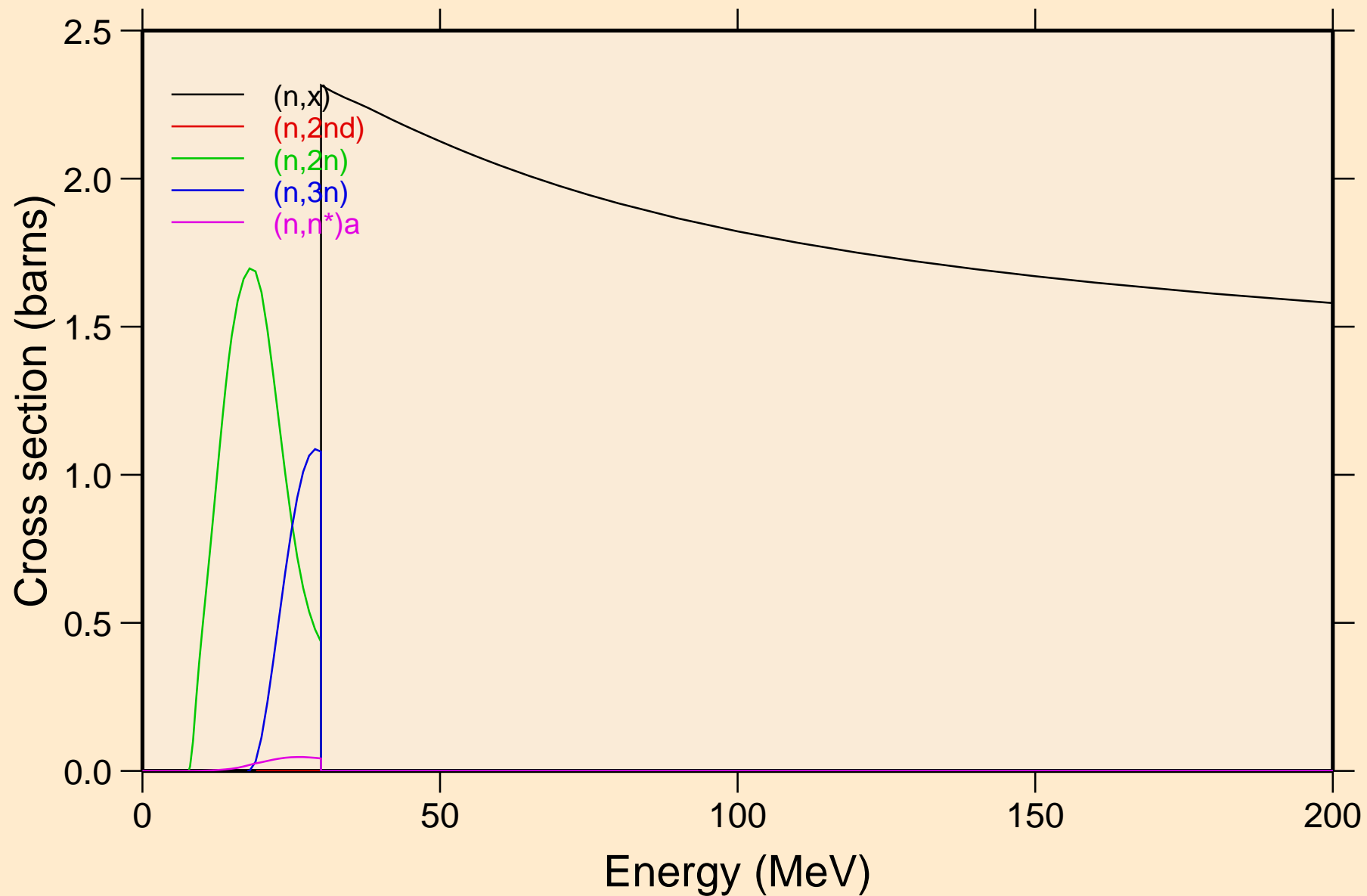

PT183 NEUTRON ACER TENDL-2019 LIBRARY; T=293.16K  
Threshold reactions

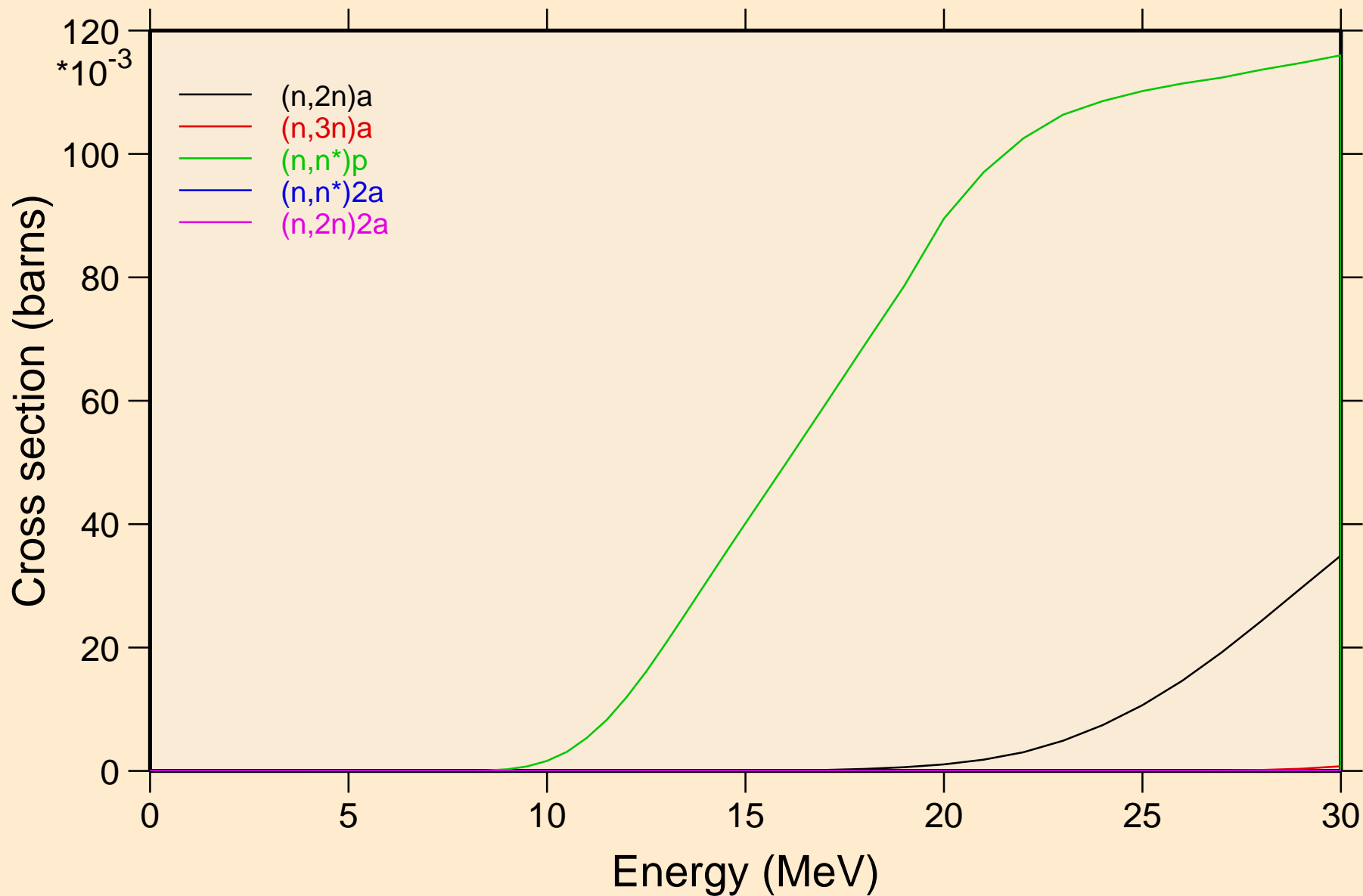

PT183 NEUTRON ACER TENDL-2019 LIBRARY; T=293.16K  
Threshold reactions

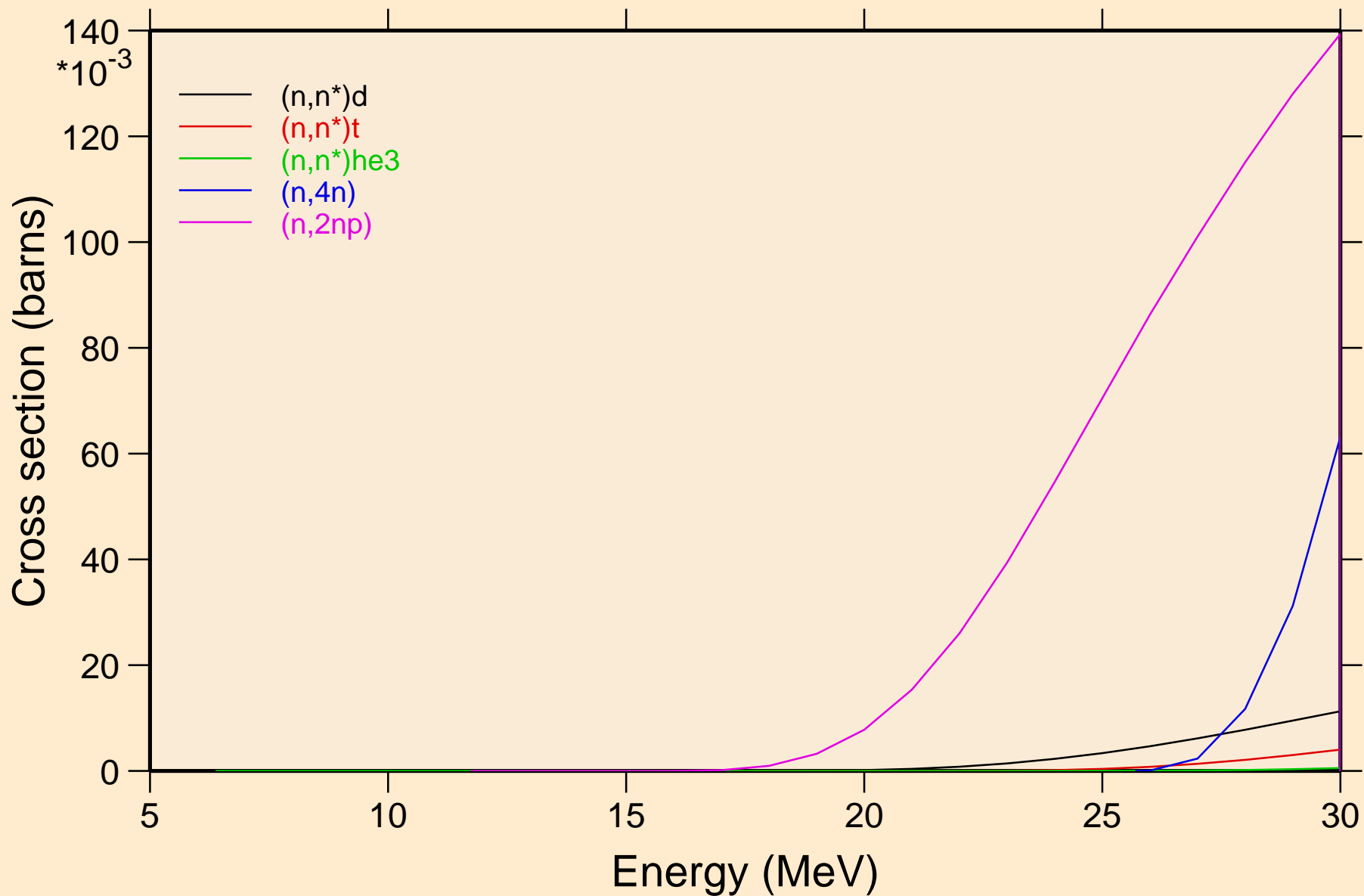

PT183 NEUTRON ACER TENDL-2019 LIBRARY; T=293.16K  
Threshold reactions

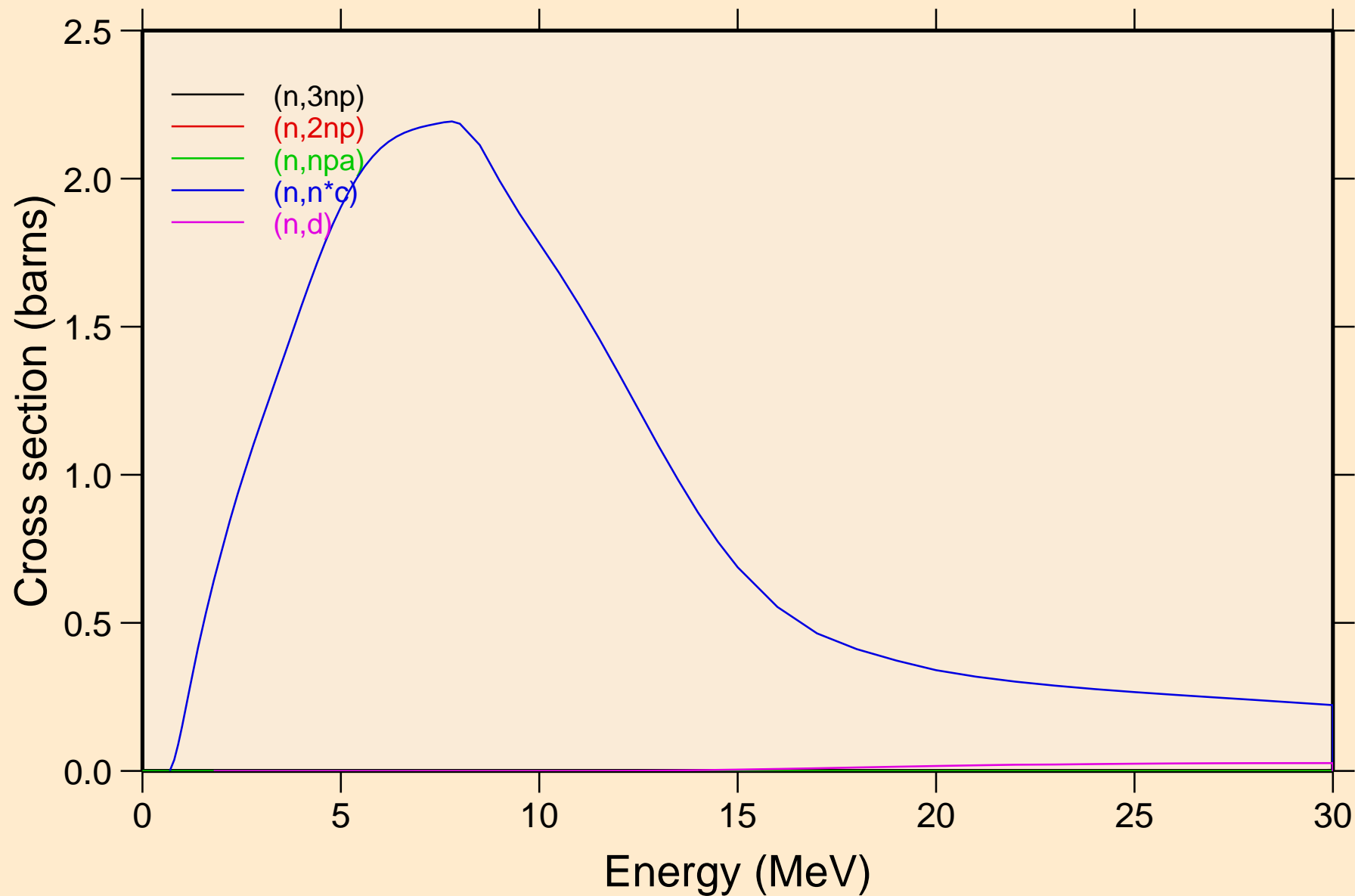

PT183 NEUTRON ACER TENDL-2019 LIBRARY; T=293.16K  
Threshold reactions

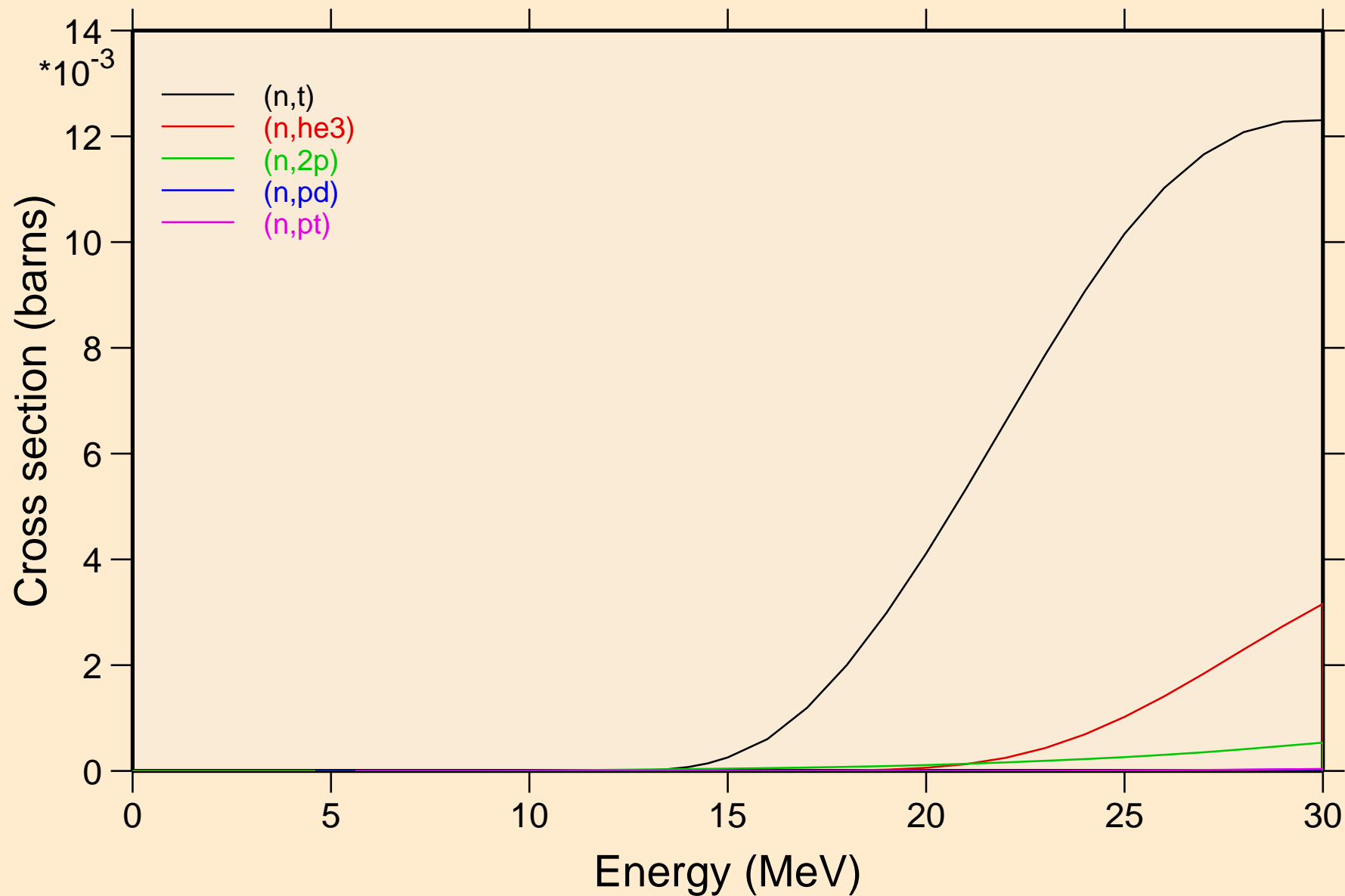

PT183 NEUTRON ACER TENDL-2019 LIBRARY; T=293.16K  
Threshold reactions

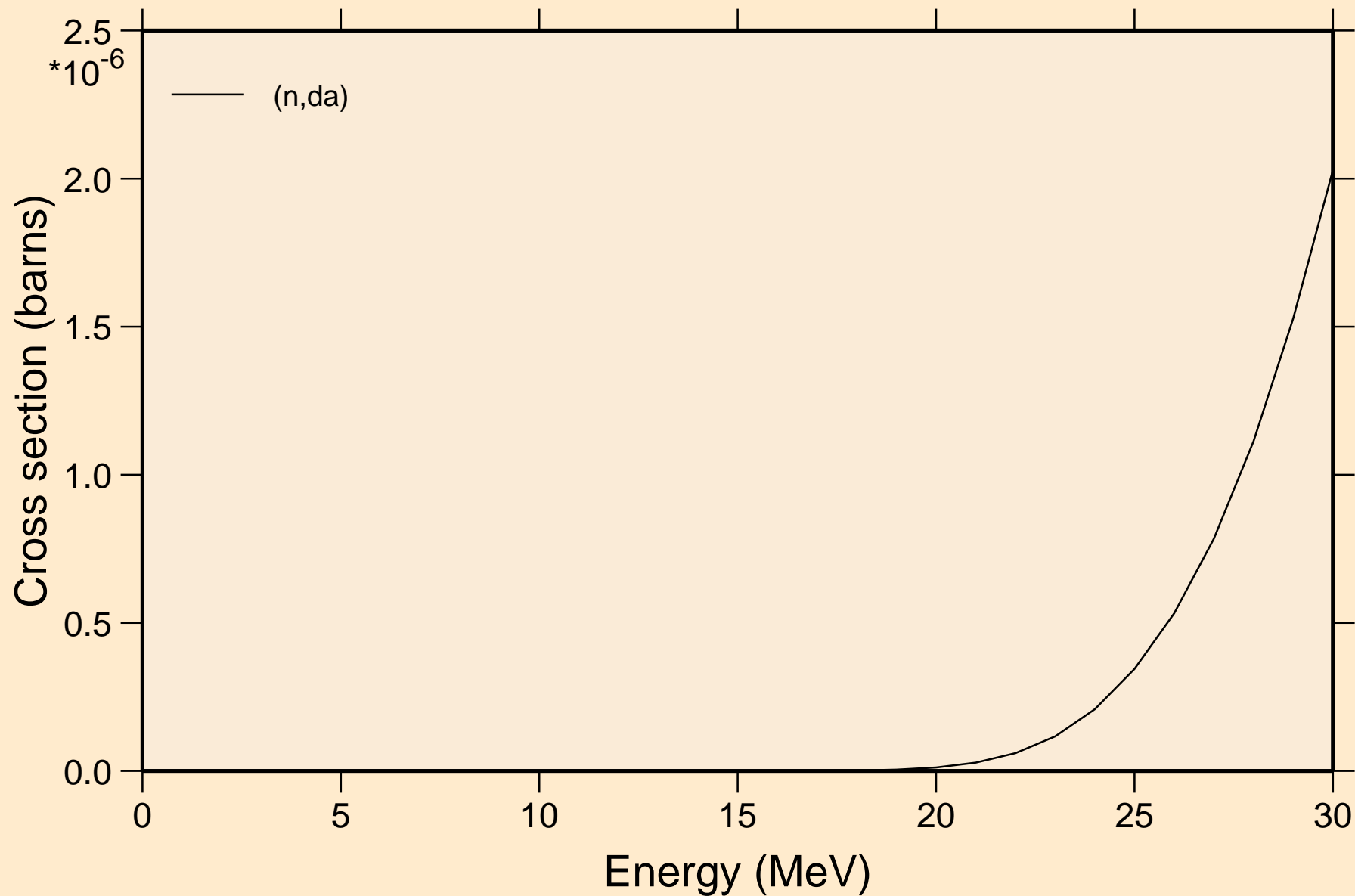

PT183 NEUTRON ACER TENDL-2019 LIBRARY; T=293.16K  
Threshold reactions

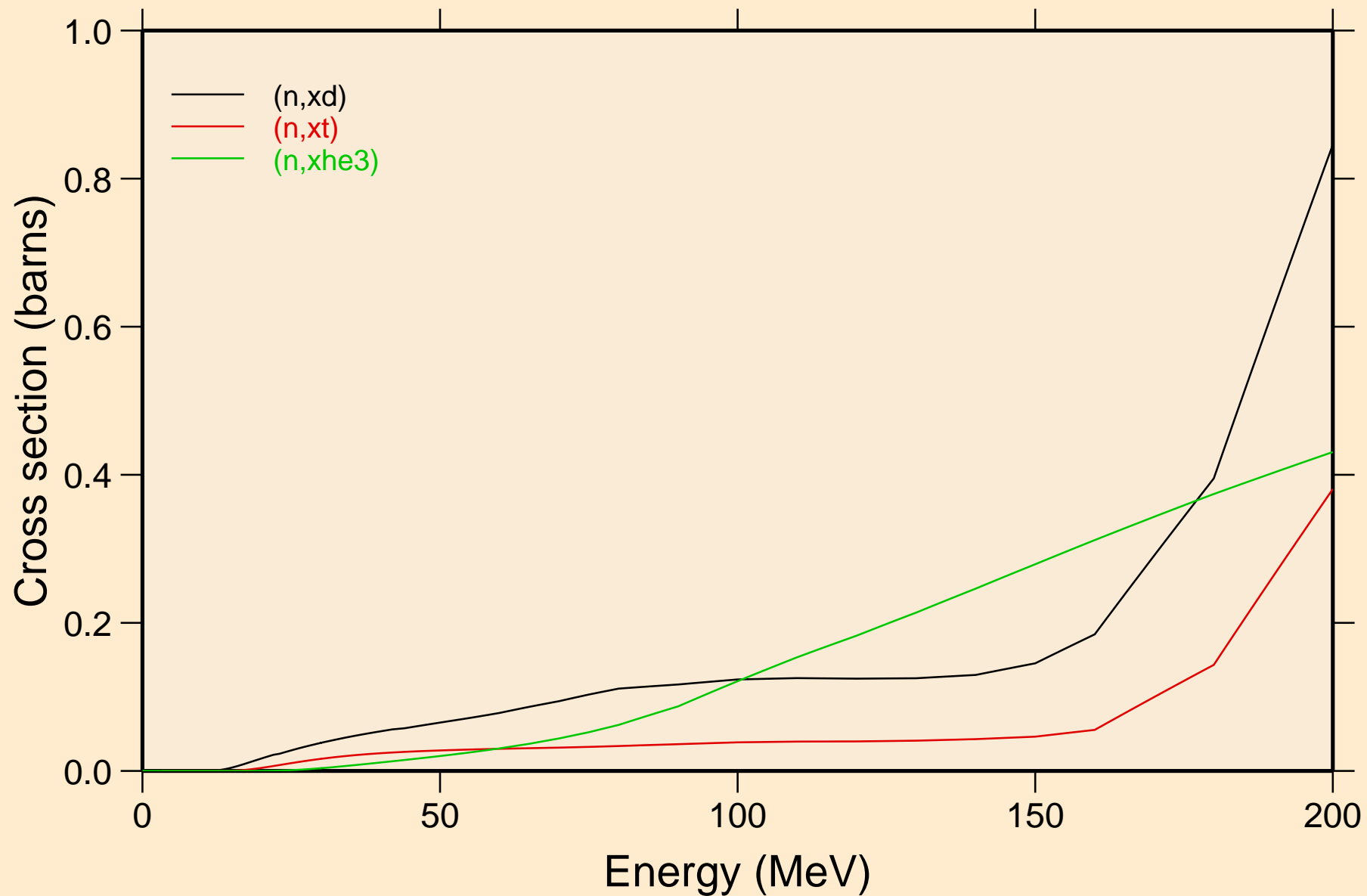

PT183 NEUTRON ACER TENDL-2019 LIBRARY; T=293.16K  
angular distribution for elastic

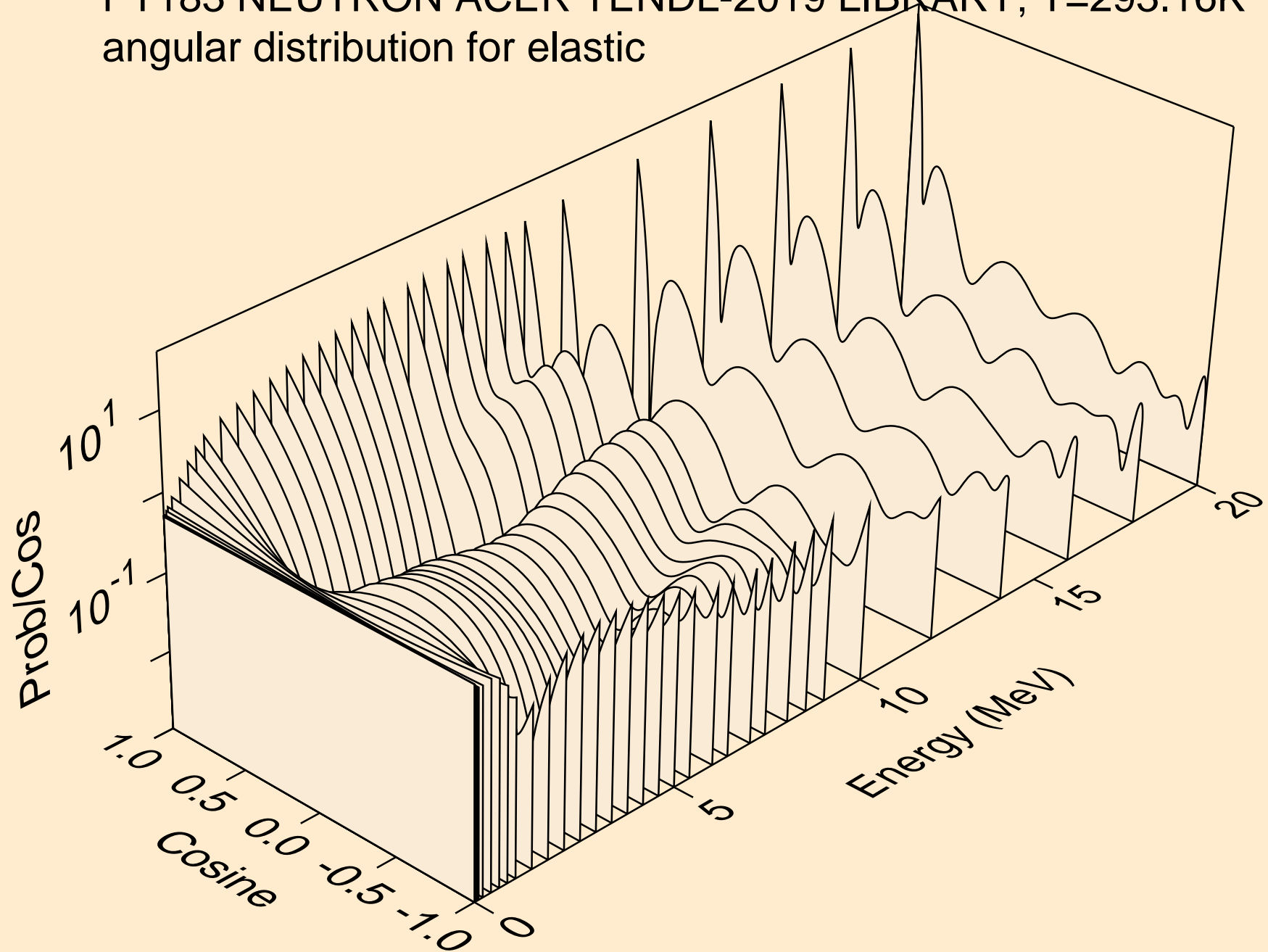



PT183 NEUTRON ACER TENDL-2019 LIBRARY; T=293.16K  
angular distribution for elastic

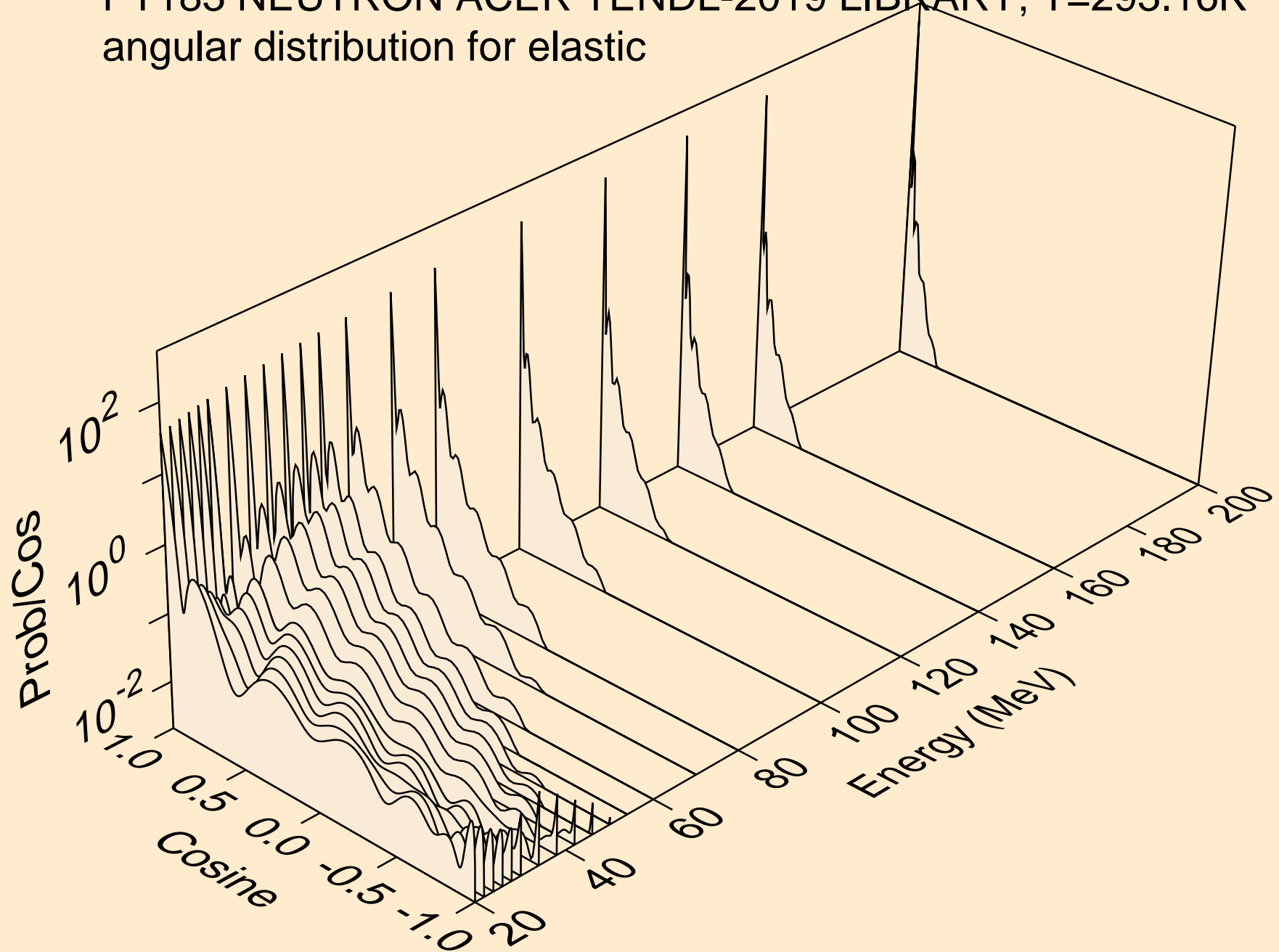

PT183 NEUTRON ACER TENDL-2019 LIBRARY; T=293.16K  
angular distribution for (n,n\*1)

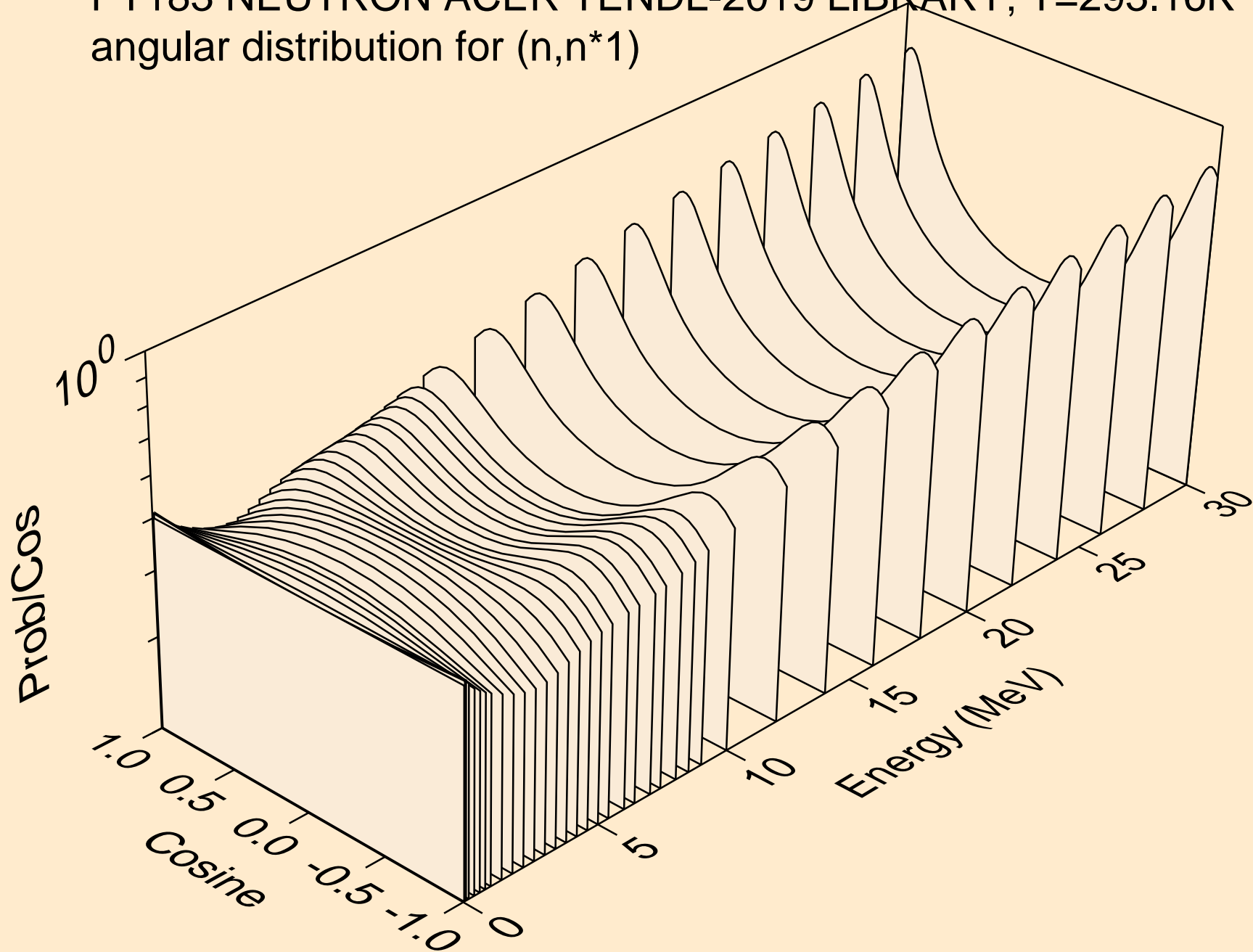

PT183 NEUTRON ACER TENDL-2019 LIBRARY; T=293.16K  
angular distribution for (n,n\*2)

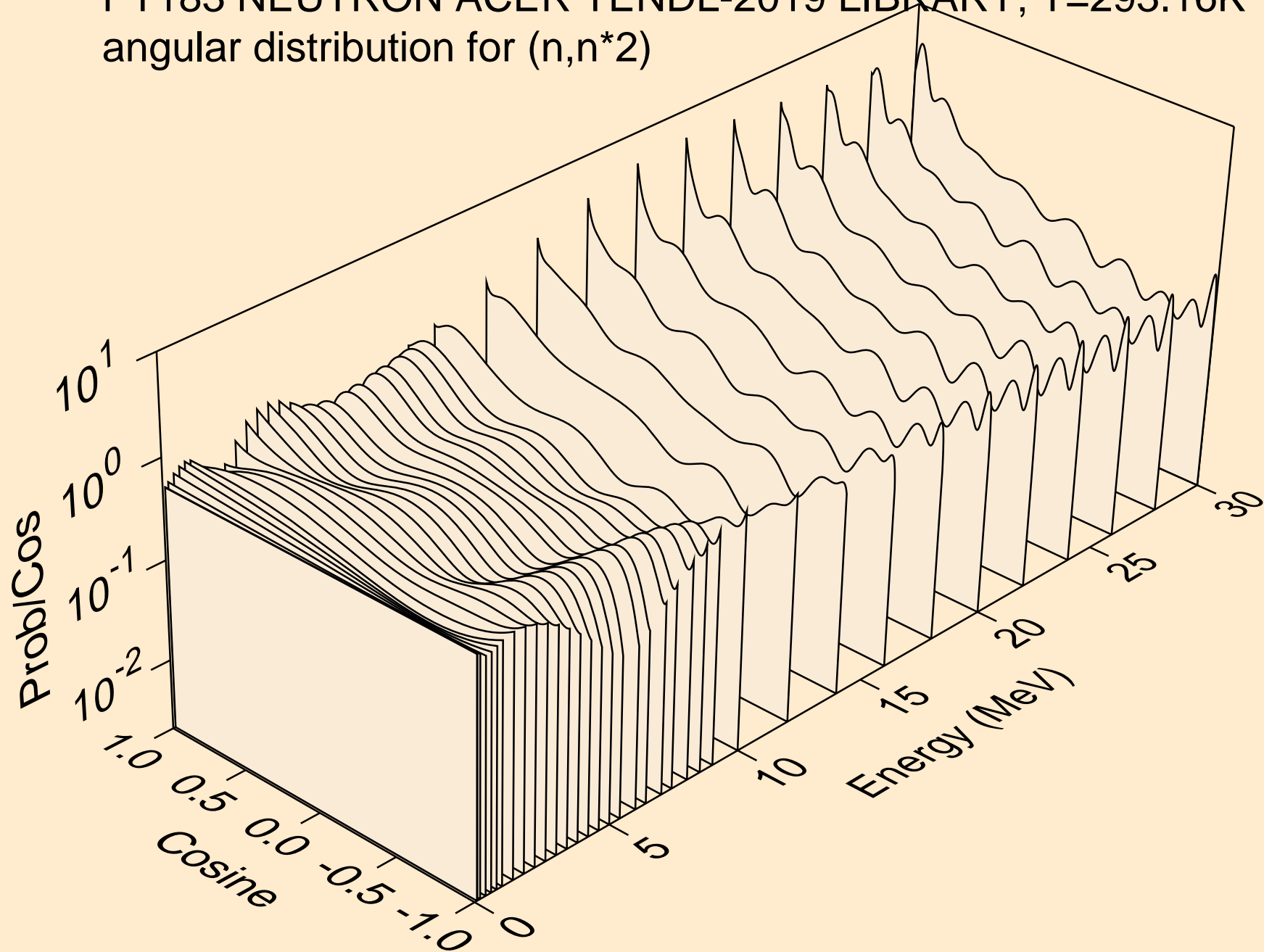

PT183 NEUTRON ACER TENDL-2019 LIBRARY; T=293.16K  
angular distribution for (n,n\*3)

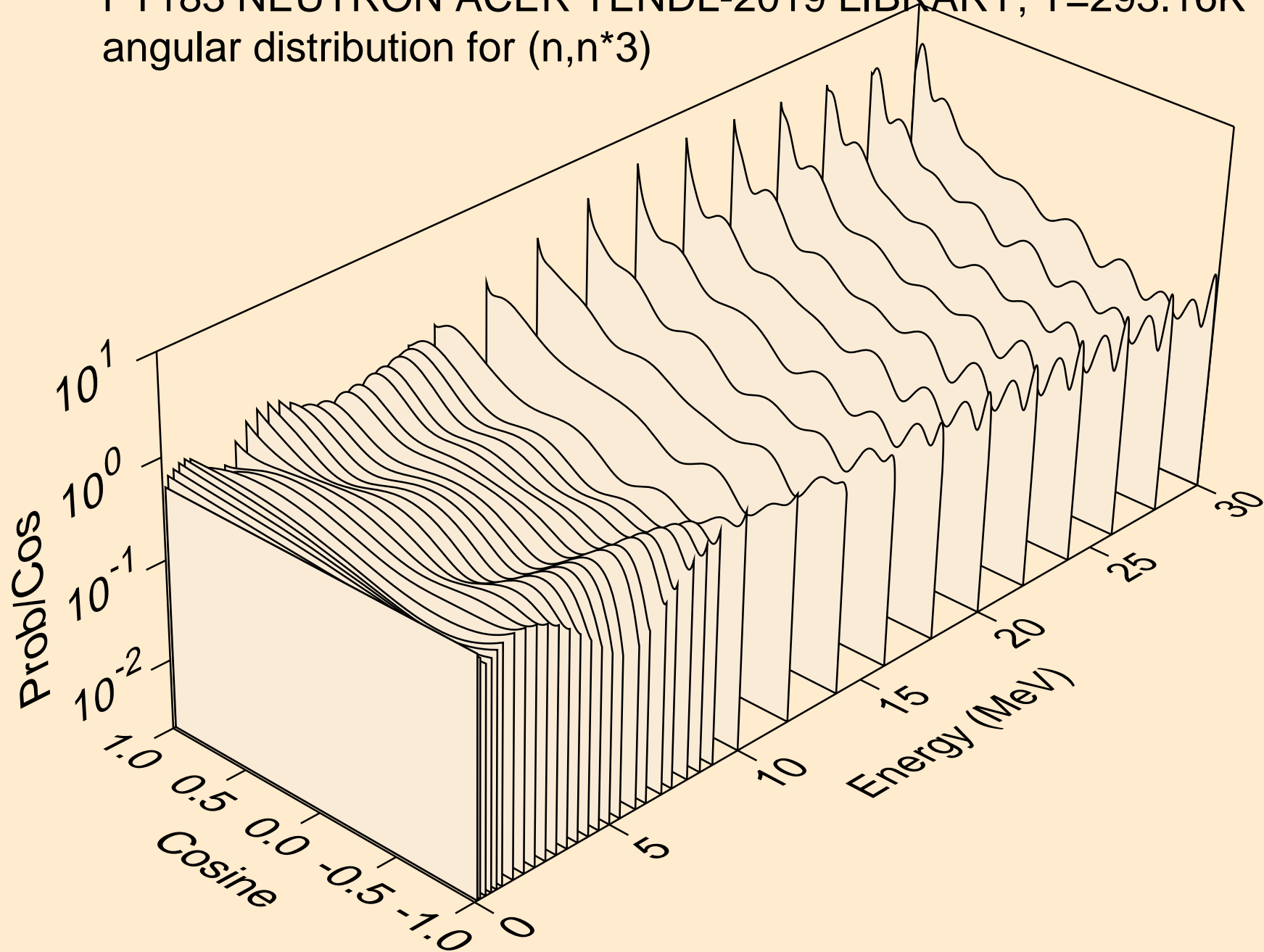

PT183 NEUTRON ACER TENDL-2019 LIBRARY; T=293.16K  
angular distribution for (n,n\*4)

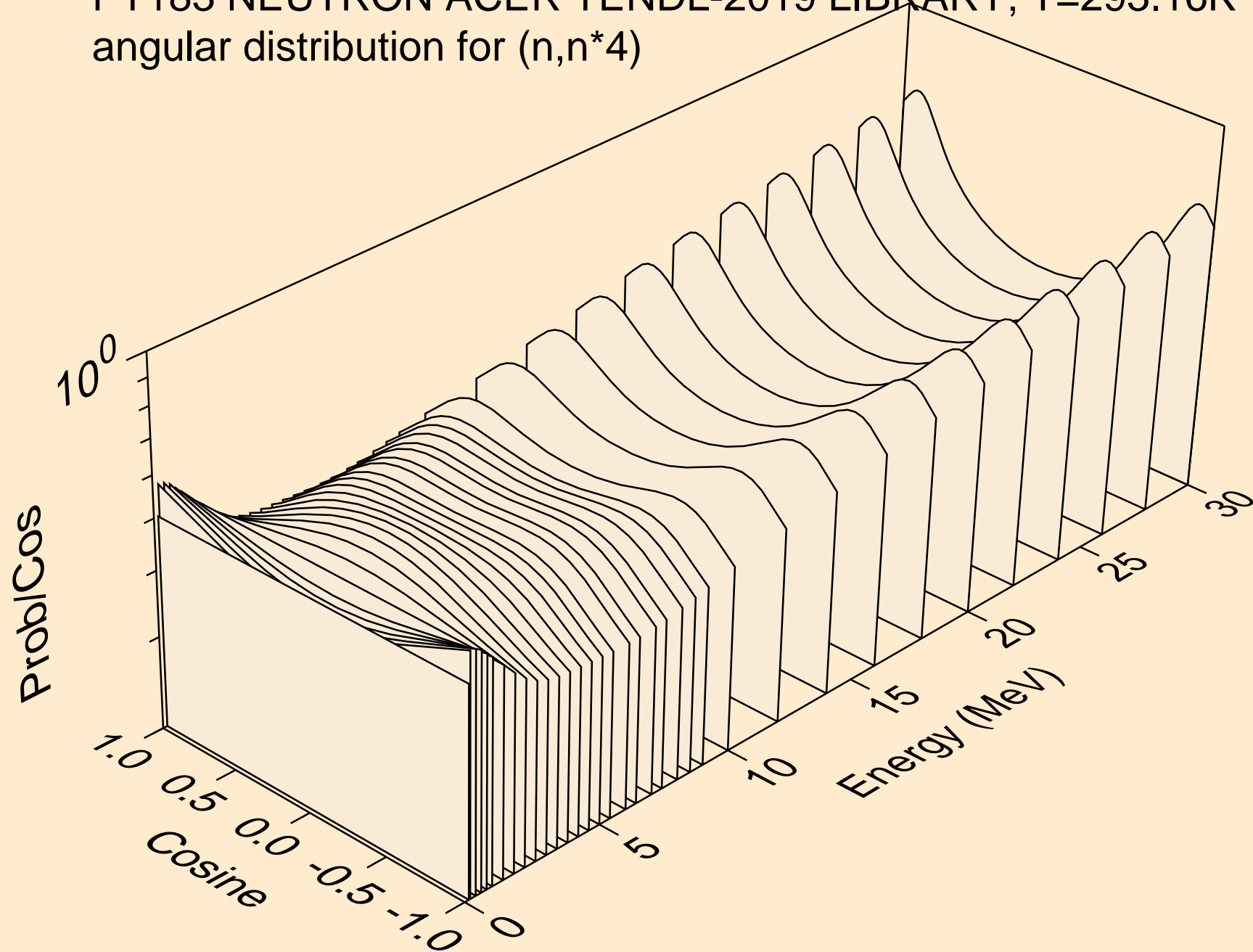

PT183 NEUTRON ACER TENDL-2019 LIBRARY; T=293.16K  
angular distribution for (n,n\*5)

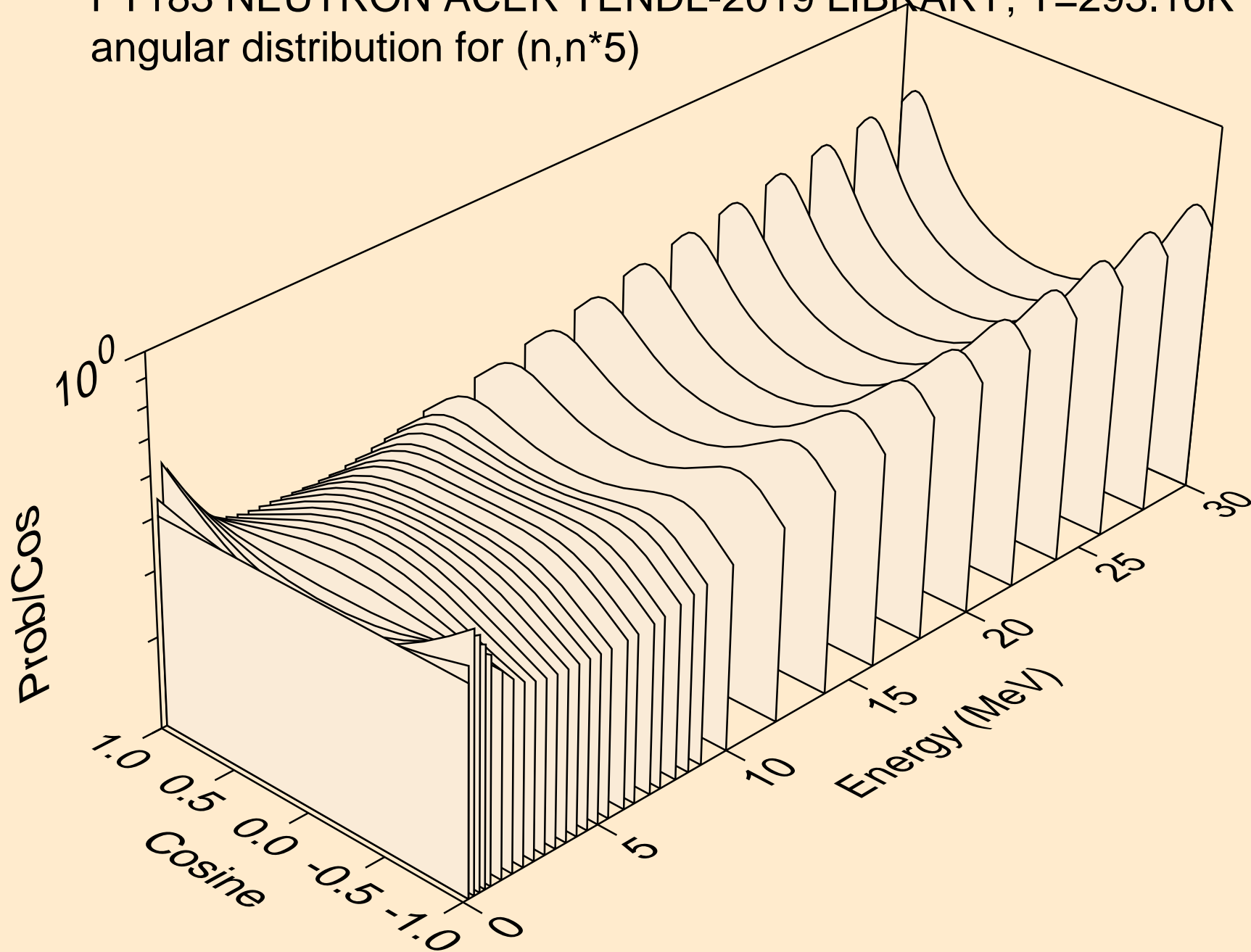

PT183 NEUTRON ACER TENDL-2019 LIBRARY; T=293.16K  
angular distribution for (n,n\*6)

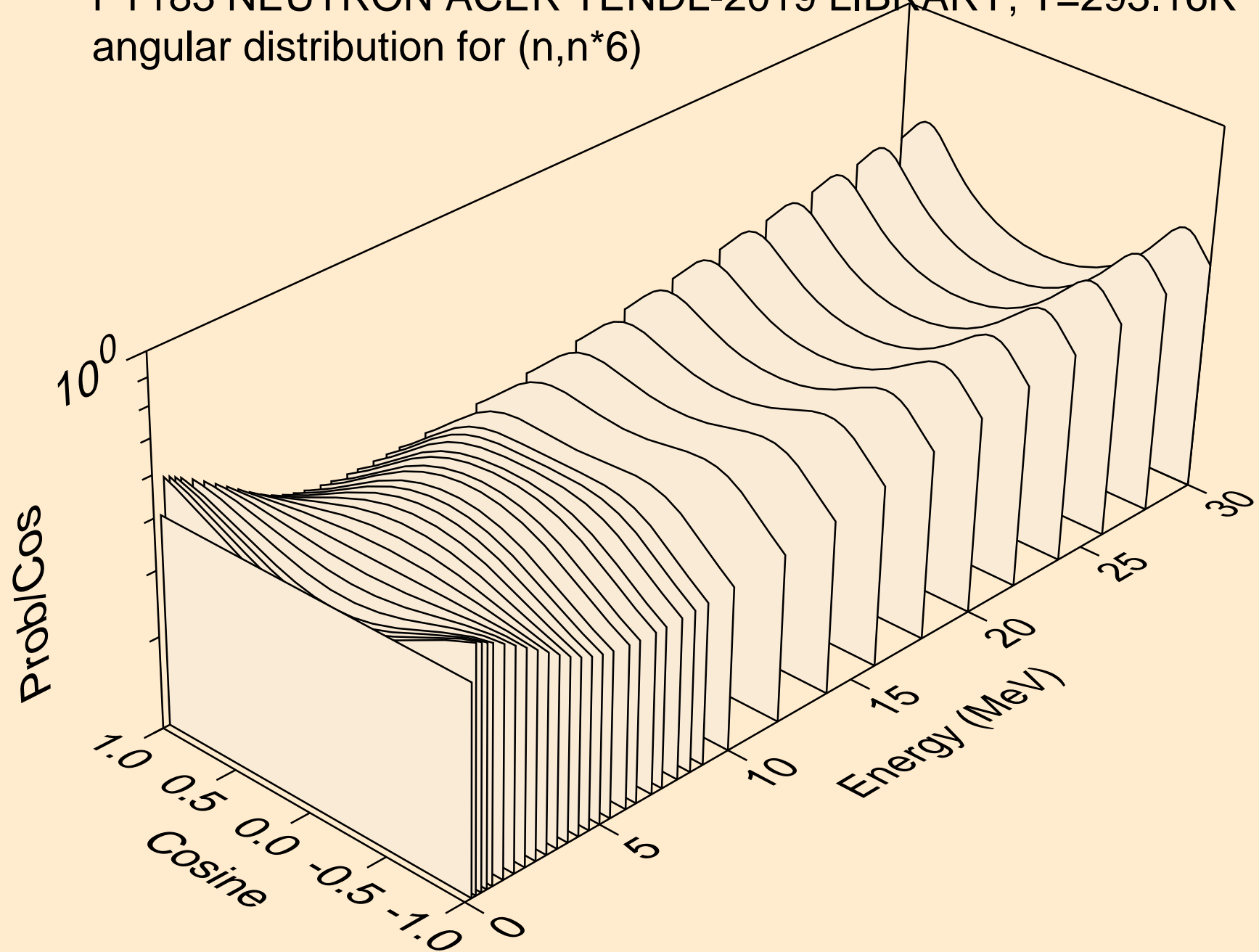

PT183 NEUTRON ACER TENDL-2019 LIBRARY; T=293.16K  
angular distribution for (n,n\*7)

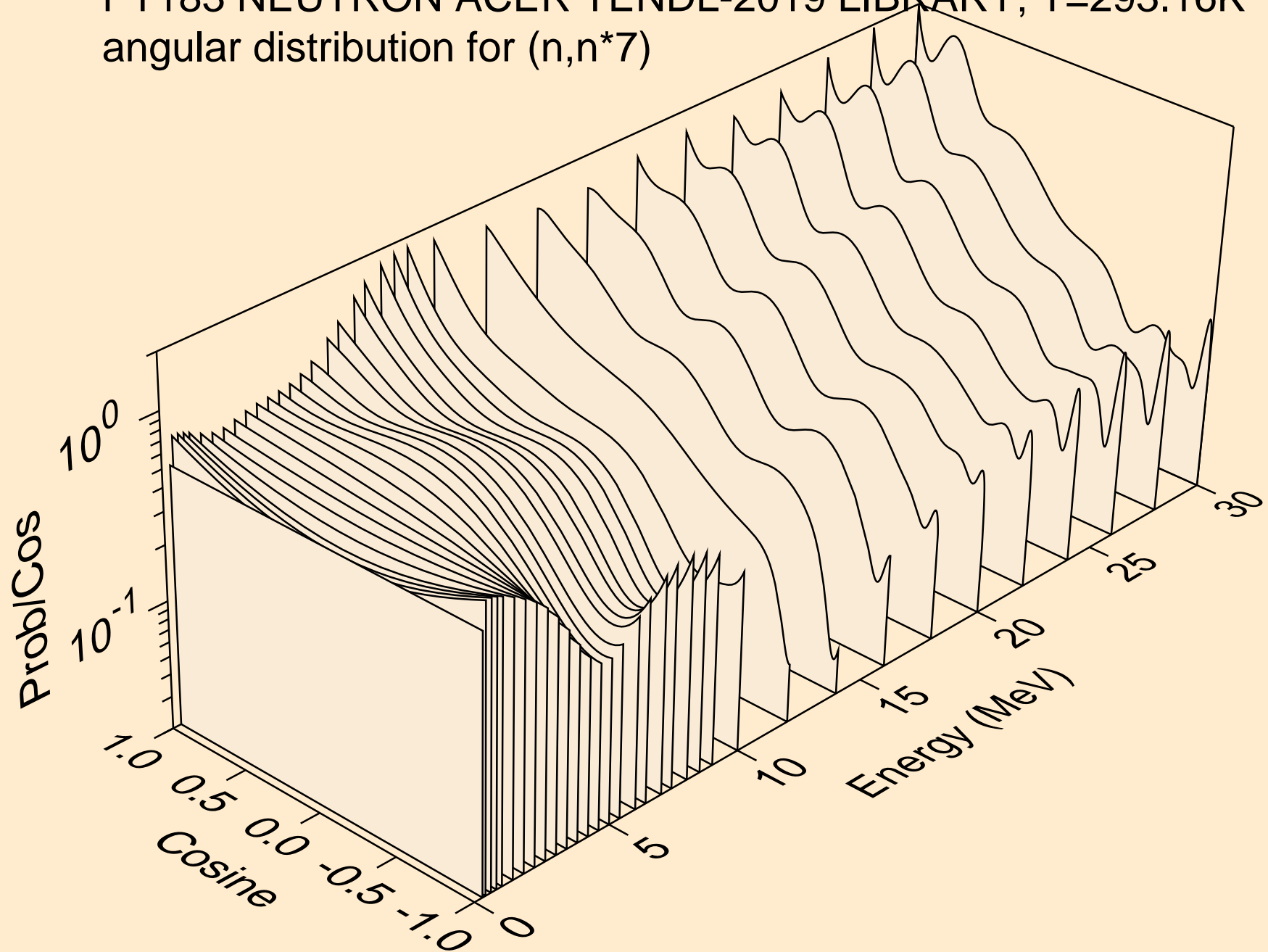



PT183 NEUTRON ACER TENDL-2019 LIBRARY; T=293.16K  
angular distribution for (n,n\*8)

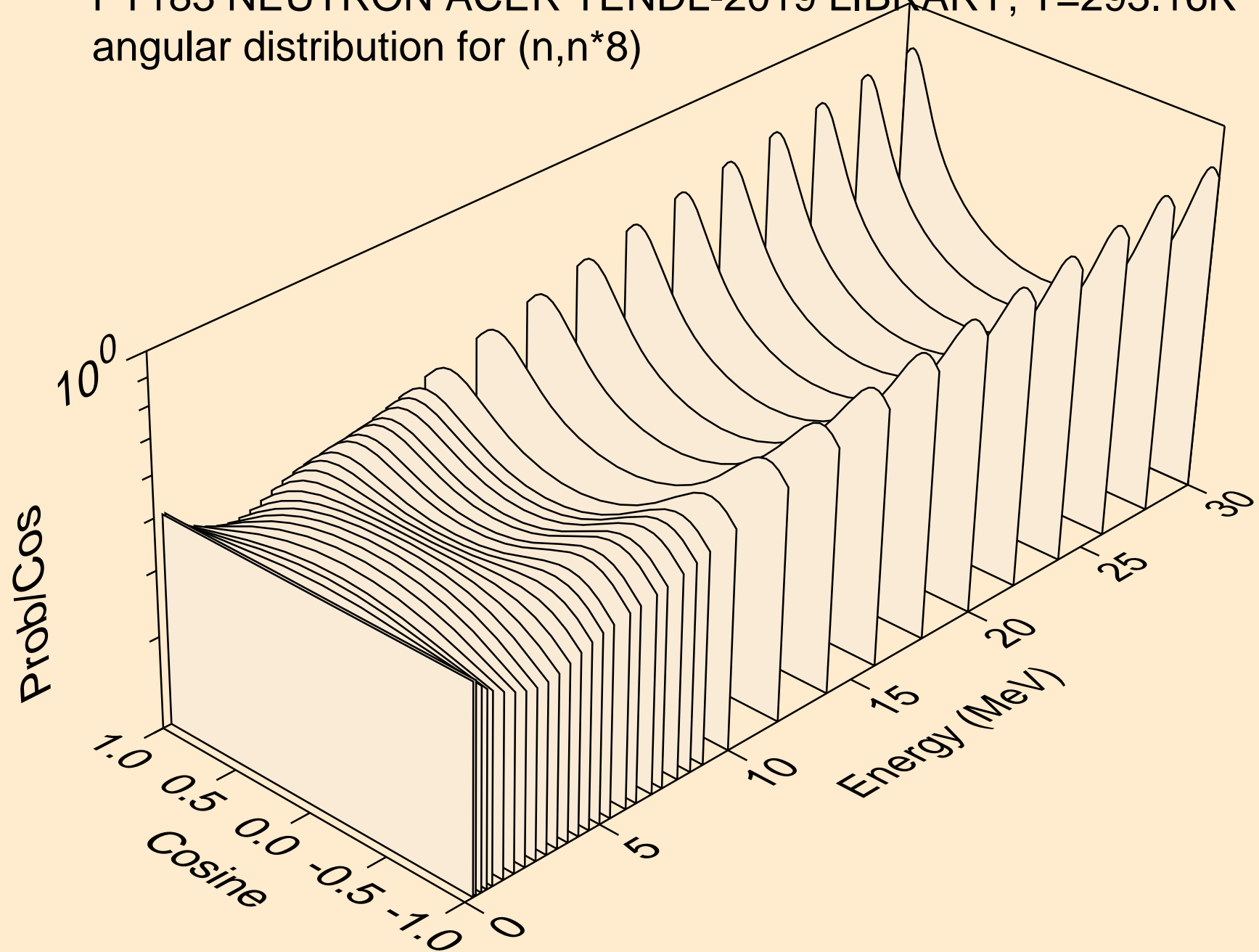

PT183 NEUTRON ACER TENDL-2019 LIBRARY; T=293.16K  
angular distribution for (n,n\*9)

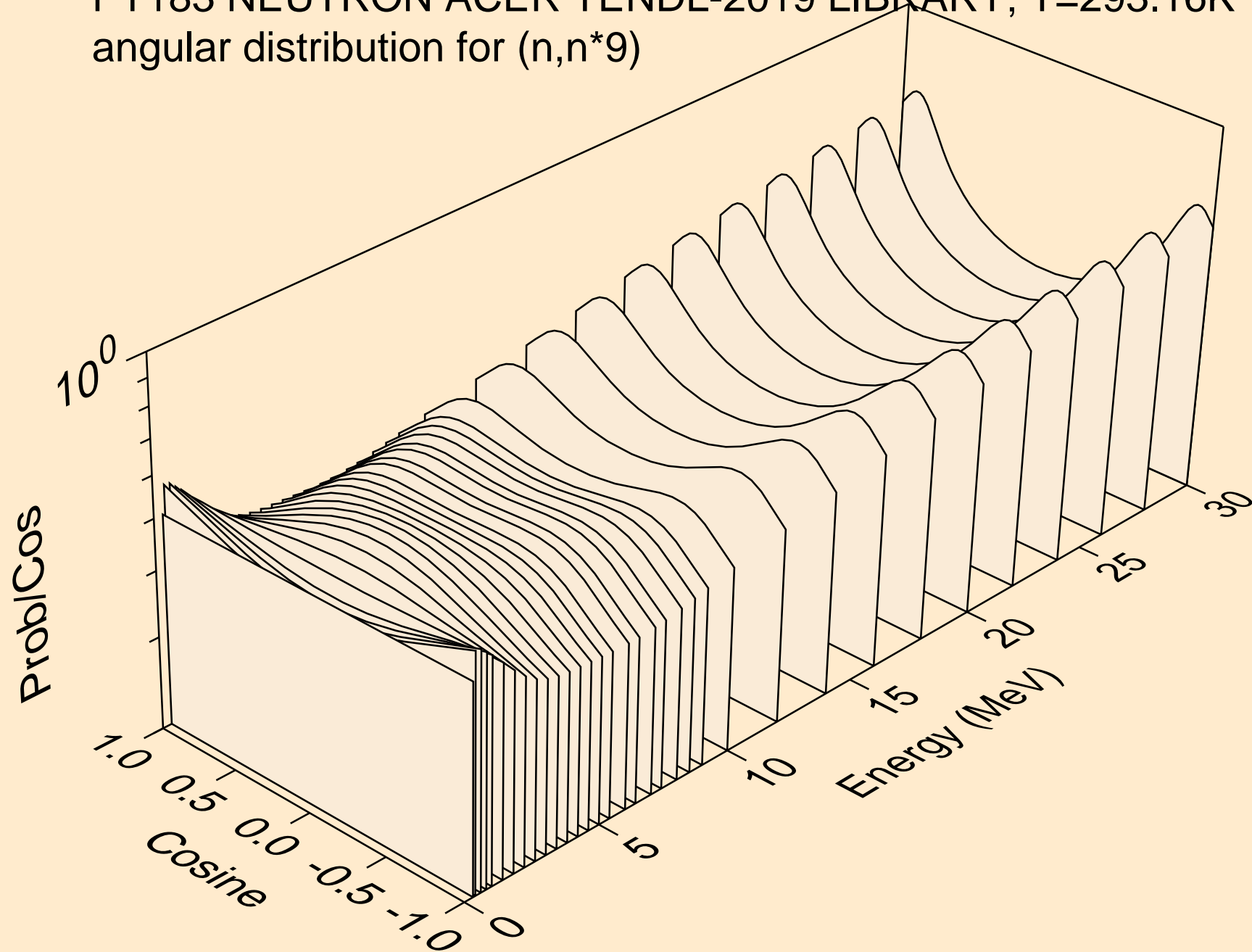

PT183 NEUTRON ACER TENDL-2019 LIBRARY; T=293.16K  
angular distribution for (n,n\*10)

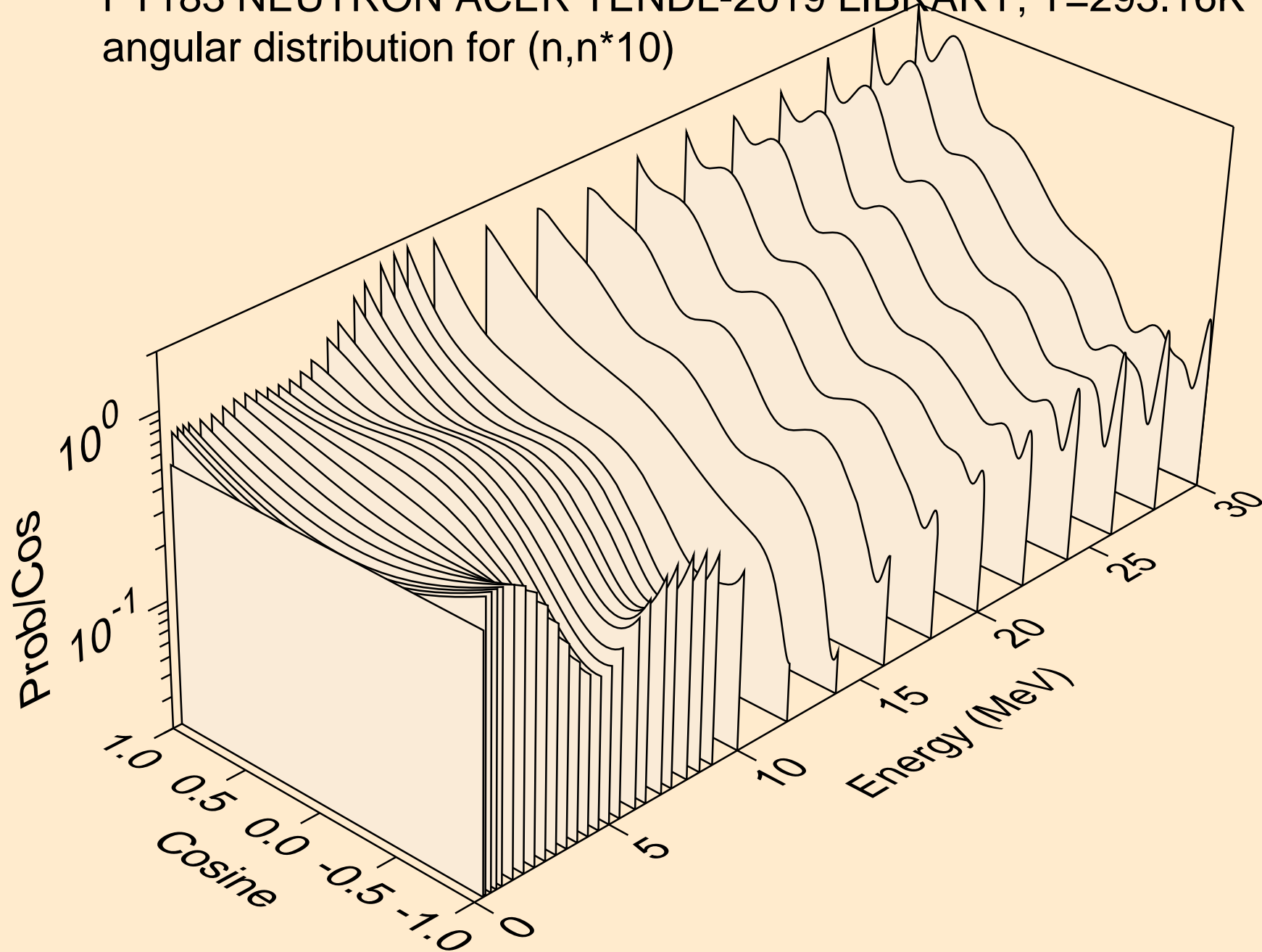

PT183 NEUTRON ACER TENDL-2019 LIBRARY; T=293.16K  
angular distribution for (n,n\*11)

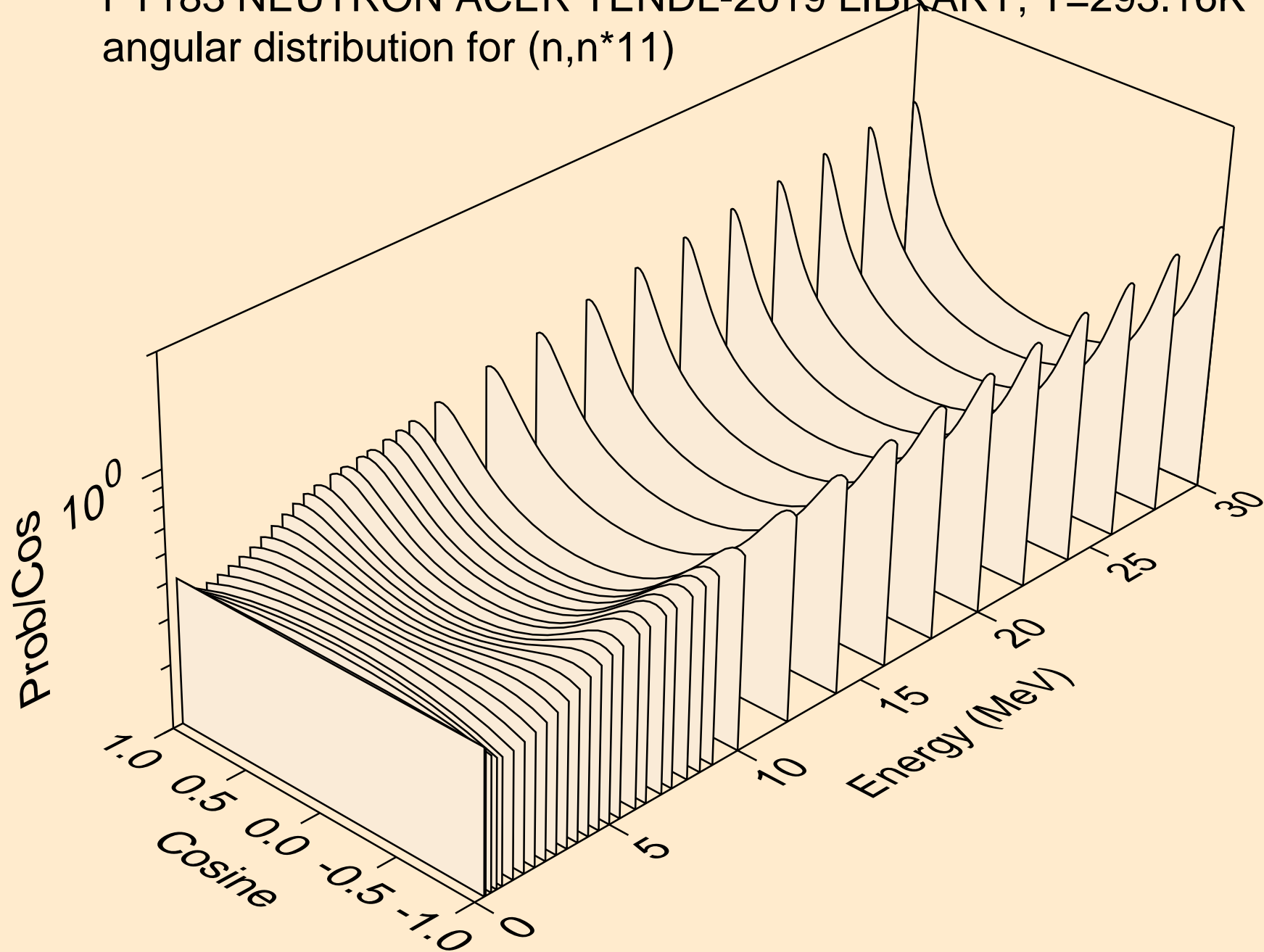

PT183 NEUTRON ACER TENDL-2019 LIBRARY; T=293.16K  
angular distribution for (n,n\*12)

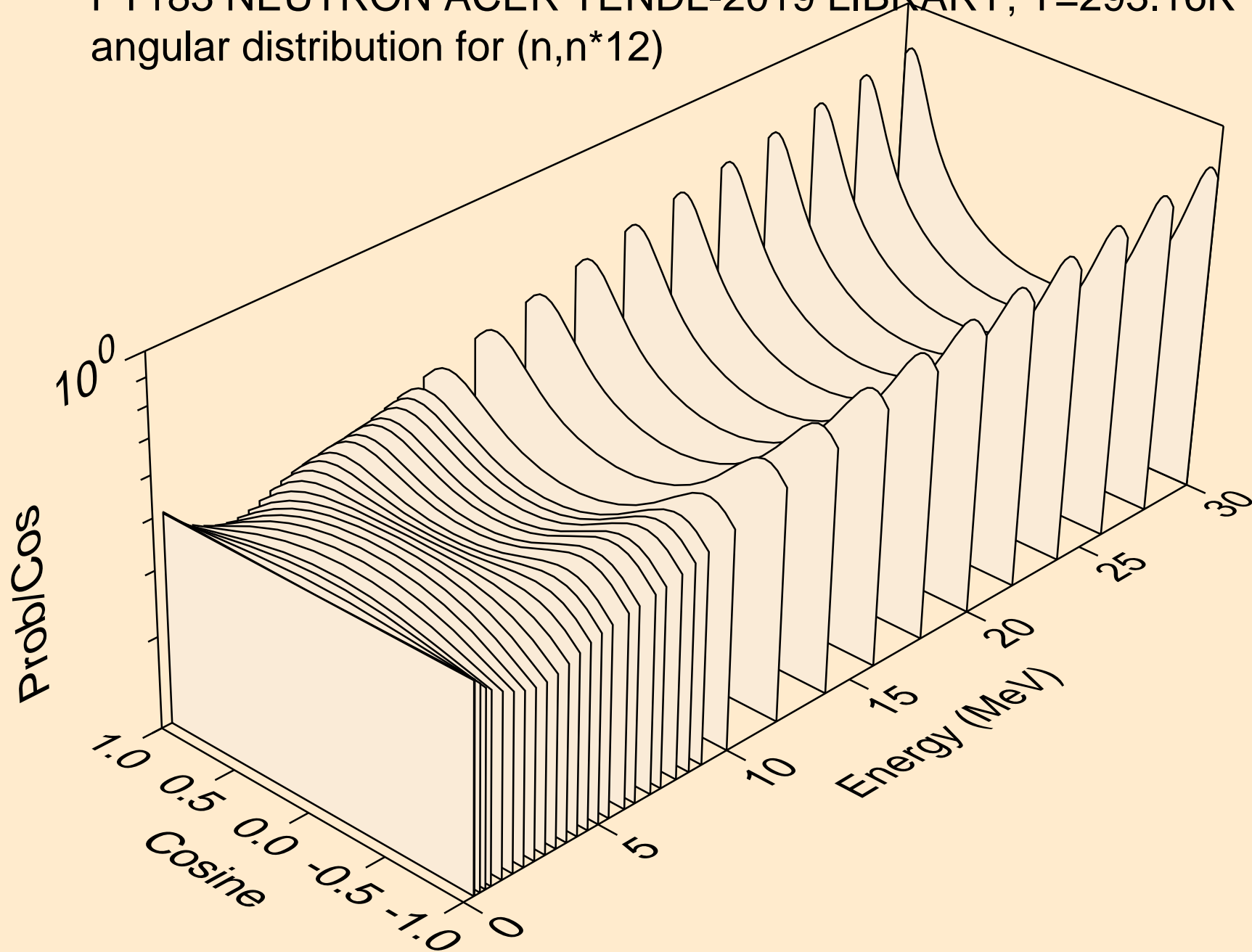

PT183 NEUTRON ACER TENDL-2019 LIBRARY; T=293.16K  
angular distribution for (n,n\*13)

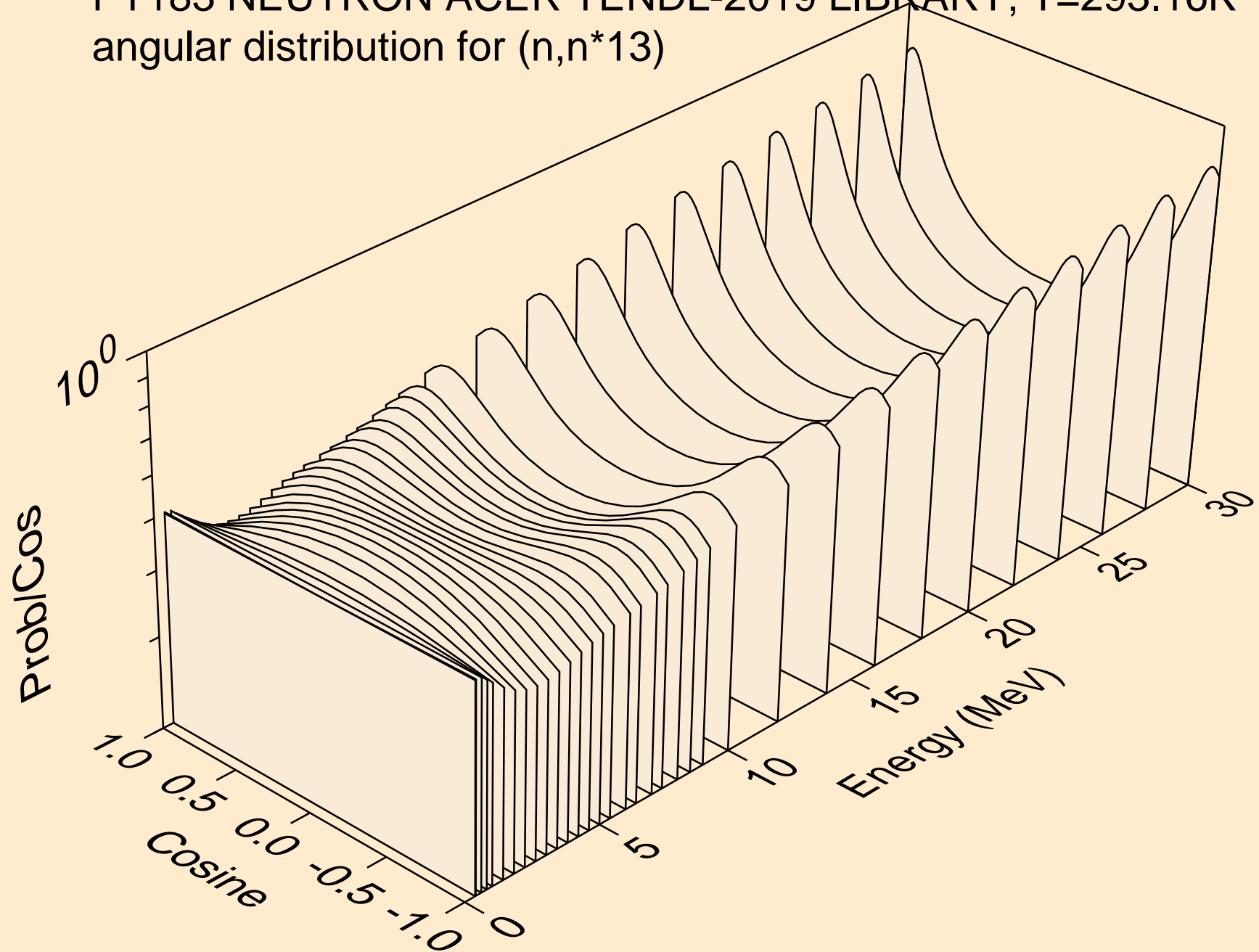

PT183 NEUTRON ACER TENDL-2019 LIBRARY; T=293.16K  
angular distribution for (n,n\*14)

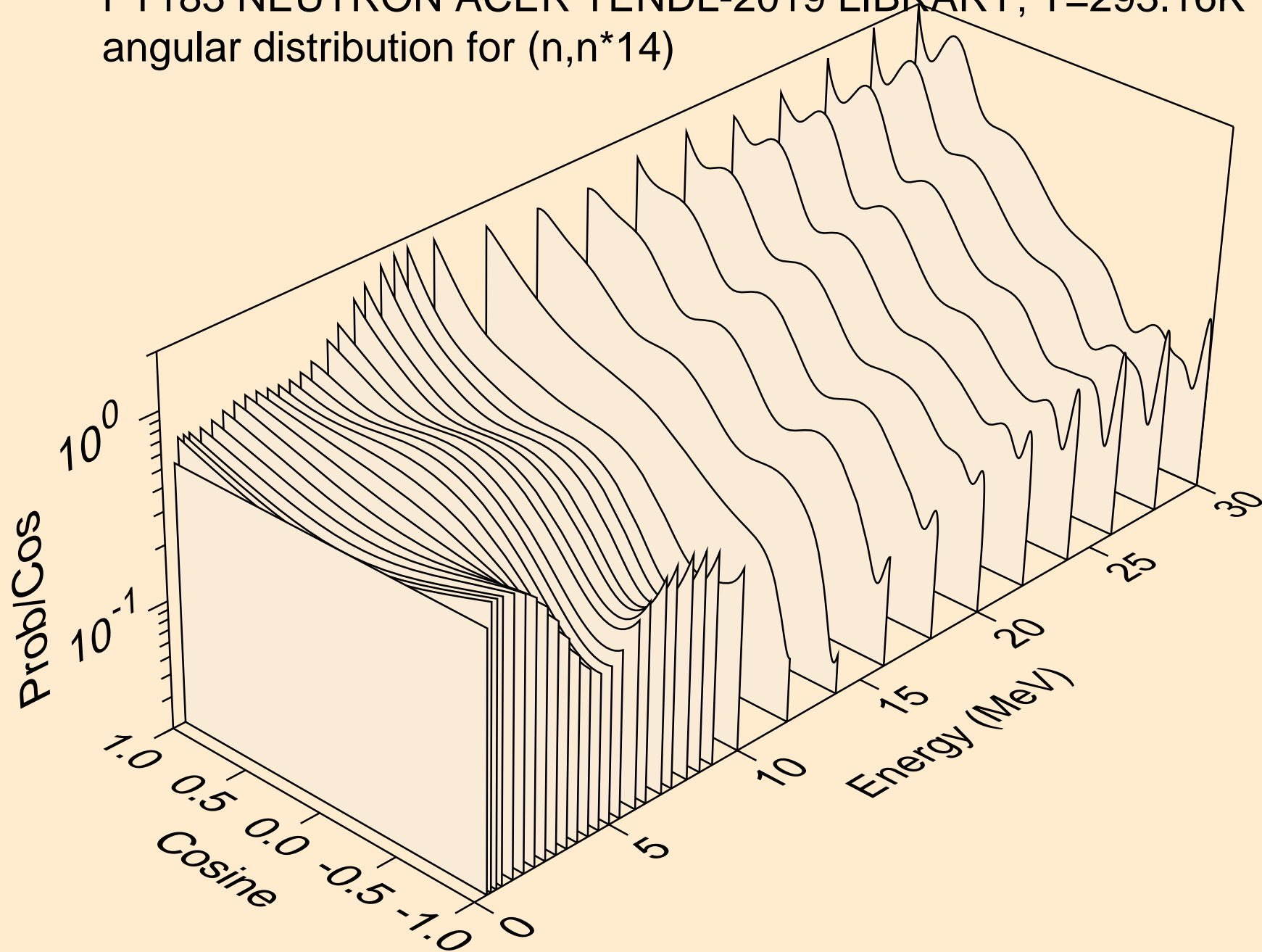

PT183 NEUTRON ACER TENDL-2019 LIBRARY; T=293.16K  
angular distribution for (n,n\*15)

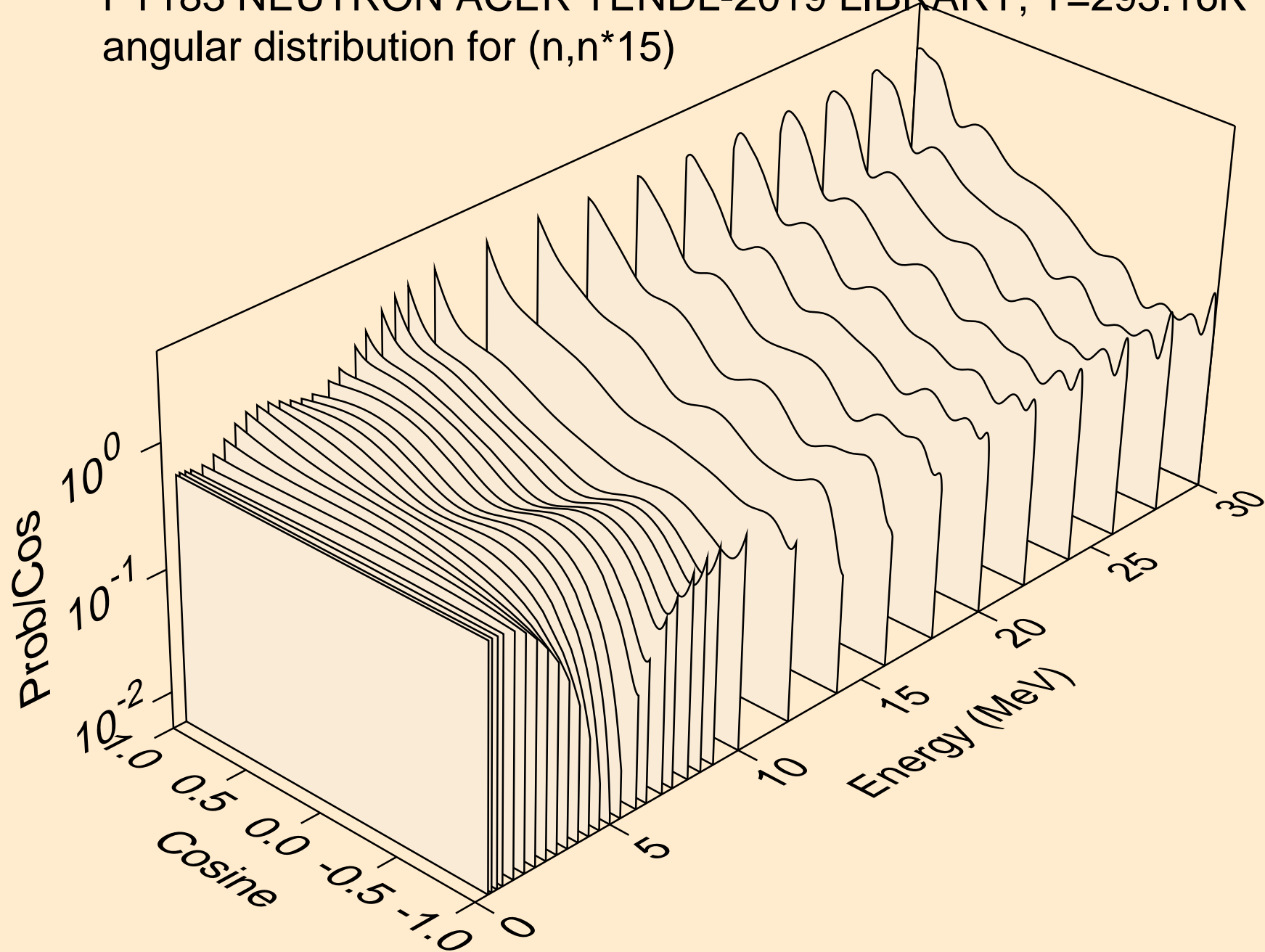



PT183 NEUTRON ACER TENDL-2019 LIBRARY; T=293.16K  
angular distribution for (n,n\*16)

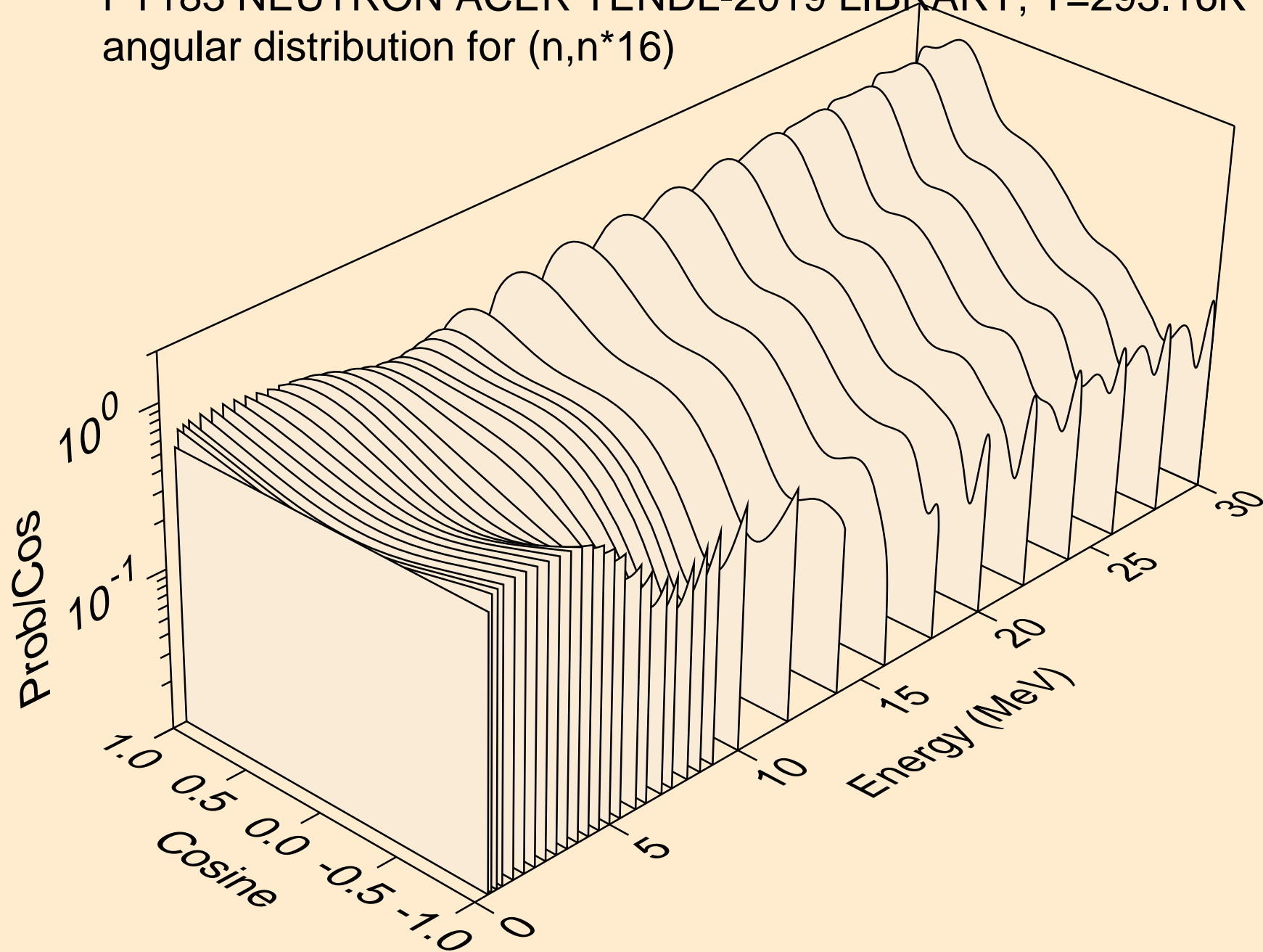

PT183 NEUTRON ACER TENDL-2019 LIBRARY; T=293.16K  
angular distribution for (n,n\*17)

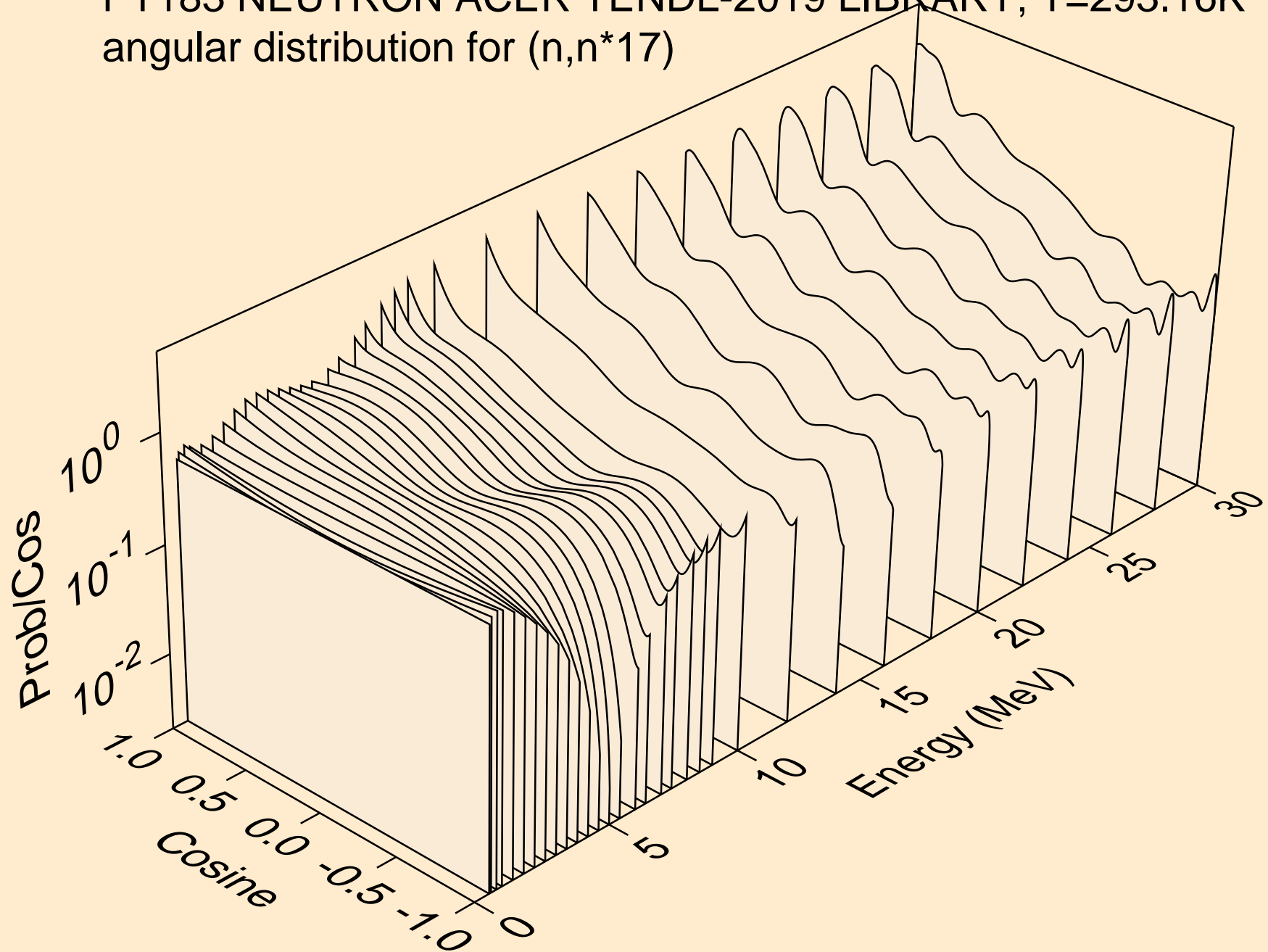

PT183 NEUTRON ACER TENDL-2019 LIBRARY; T=293.16K  
angular distribution for (n,n\*18)

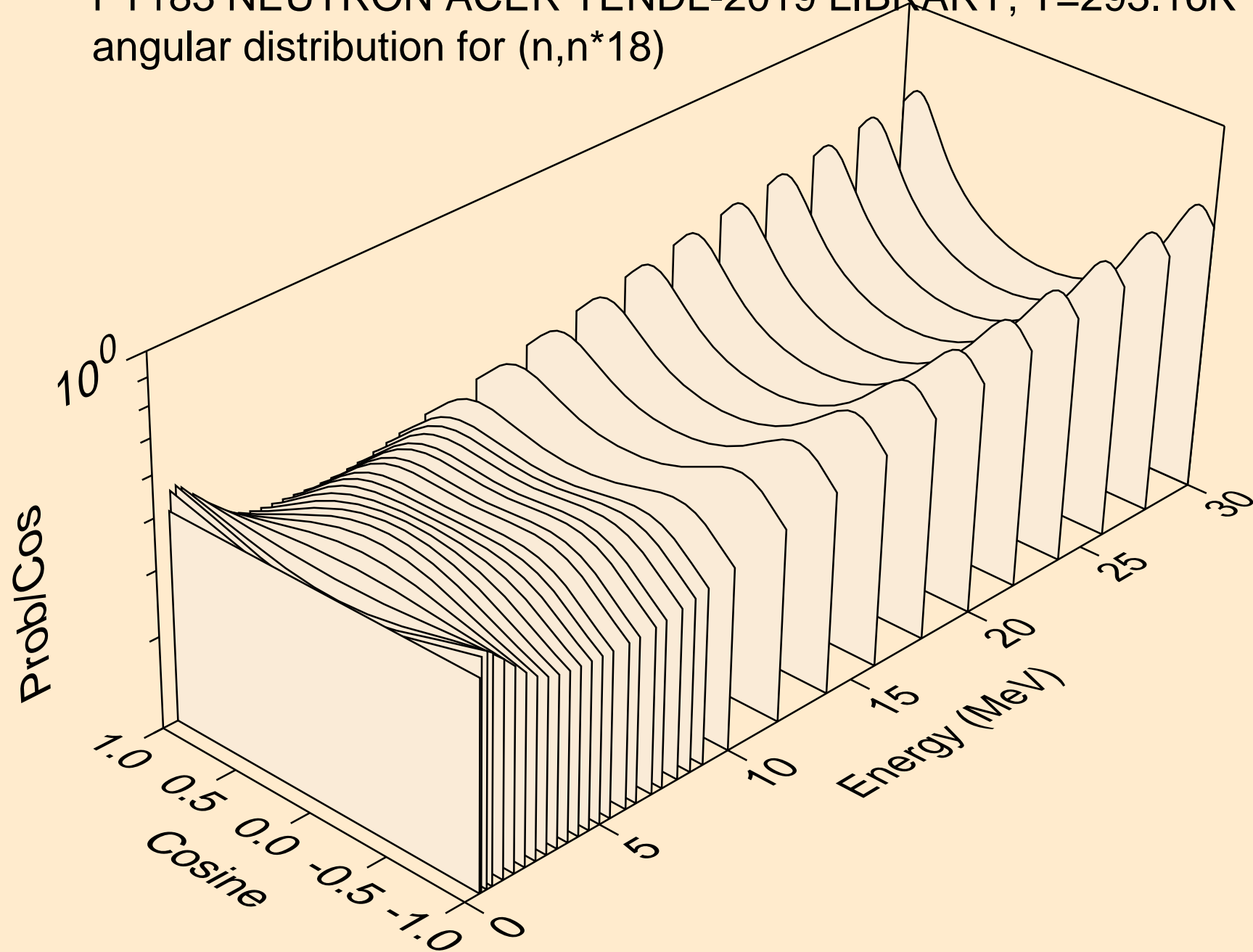

PT183 NEUTRON ACER TENDL-2019 LIBRARY; T=293.16K  
angular distribution for (n,n\*19)

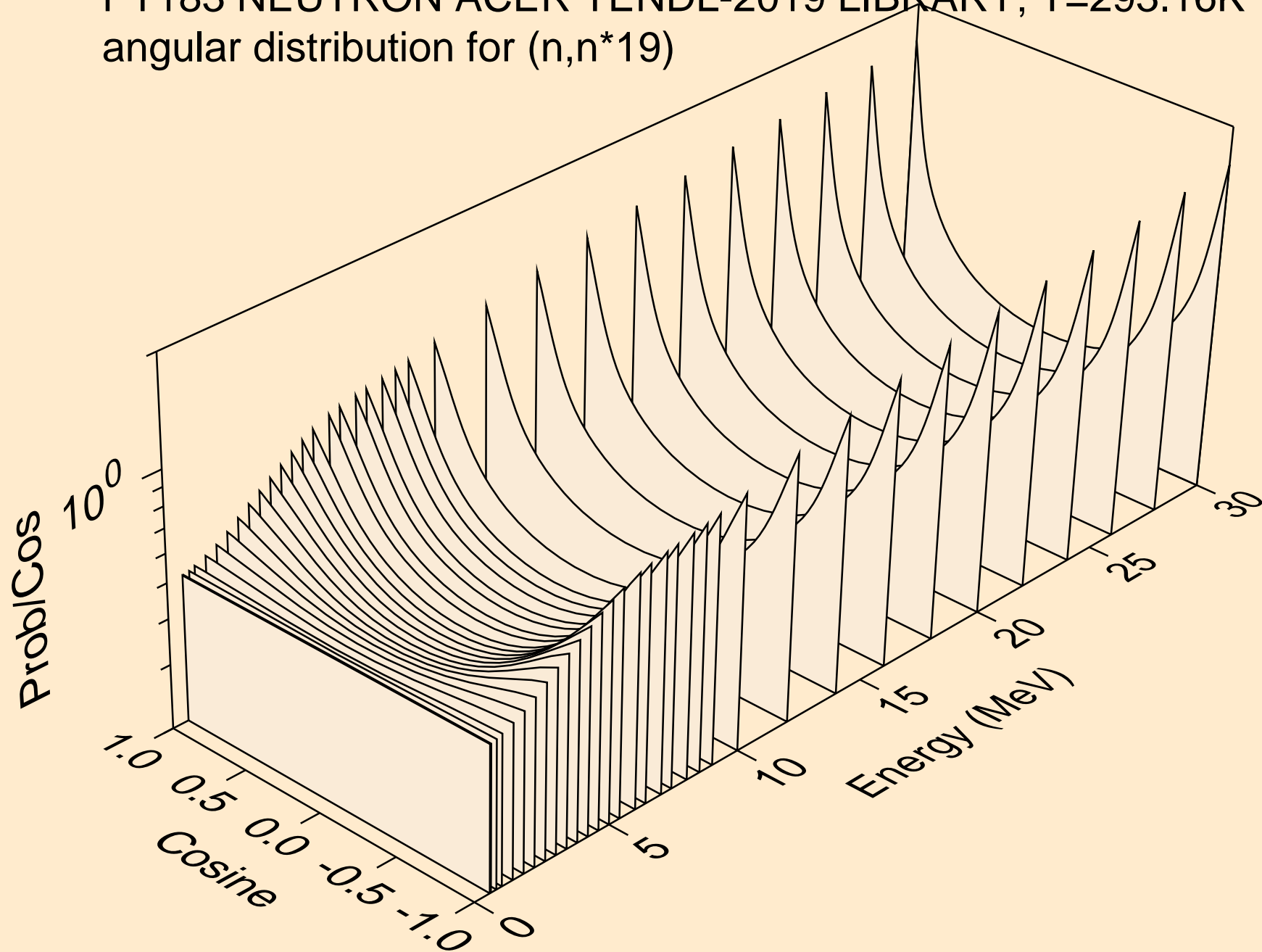

PT183 NEUTRON ACER TENDL-2019 LIBRARY; T=293.16K  
angular distribution for (n,n\*20)

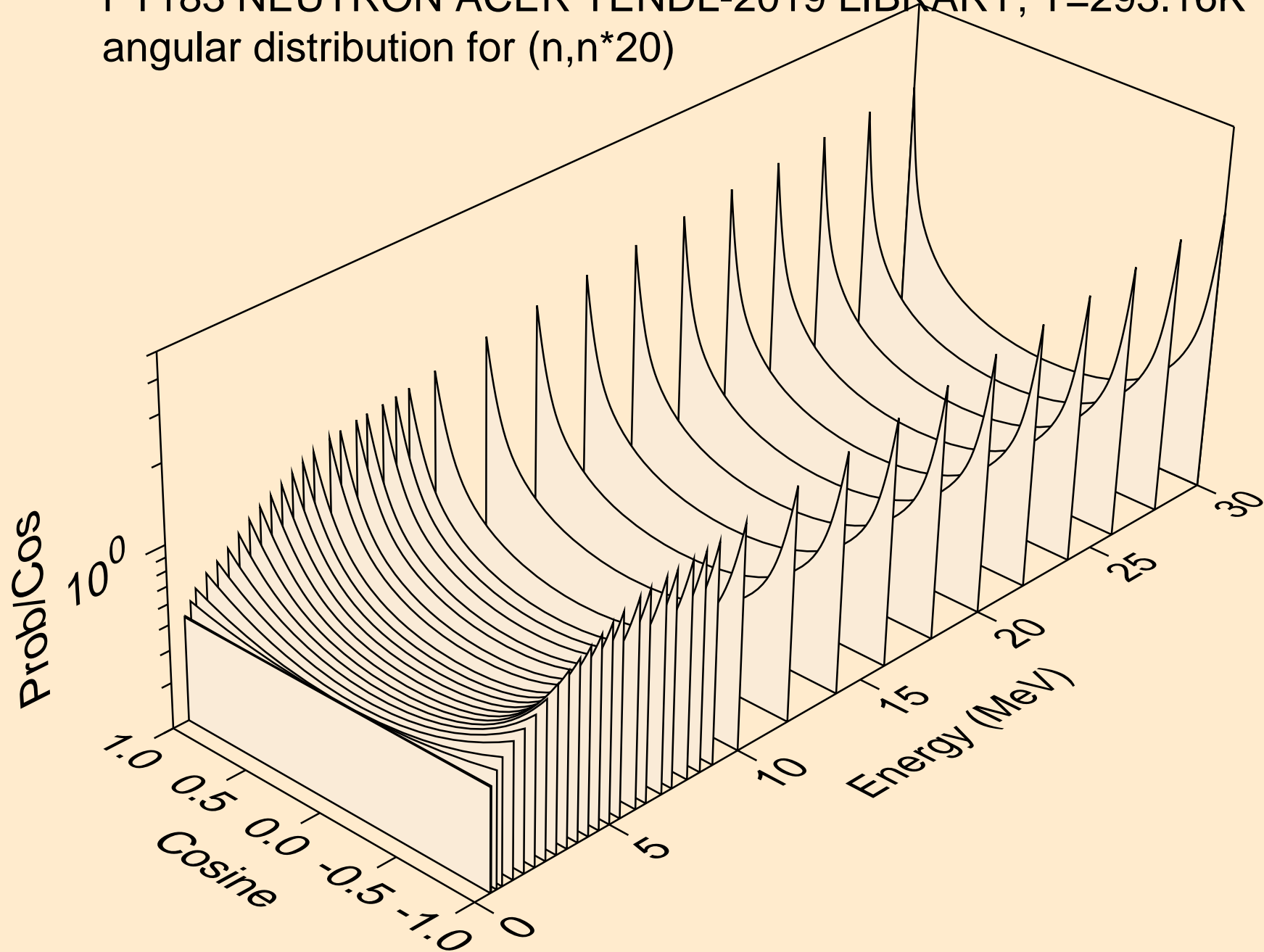

PT183 NEUTRON ACER TENDL-2019 LIBRARY; T=293.16K  
angular distribution for (n,n\*21)

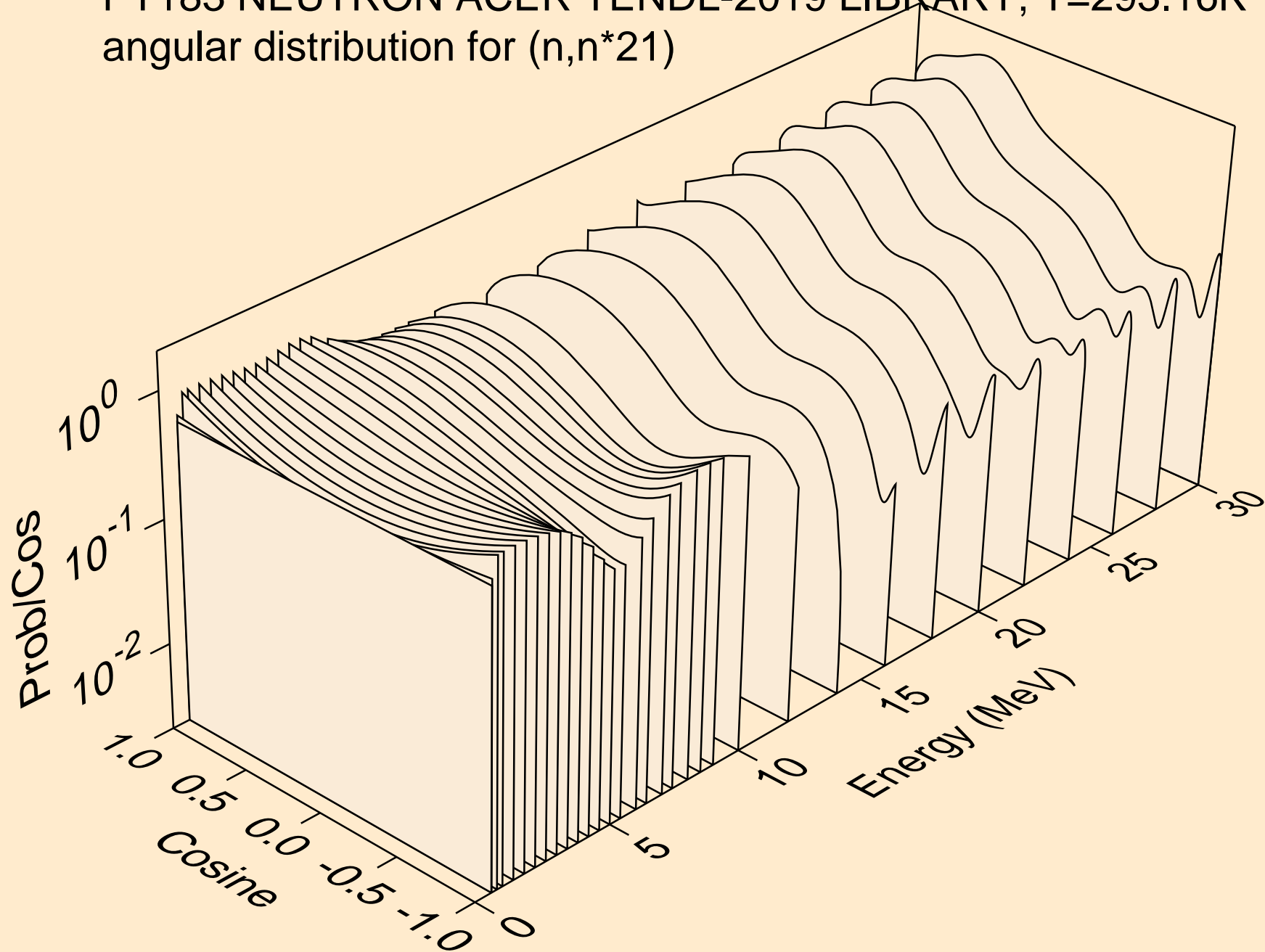

PT183 NEUTRON ACER TENDL-2019 LIBRARY; T=293.16K  
angular distribution for (n,n\*22)

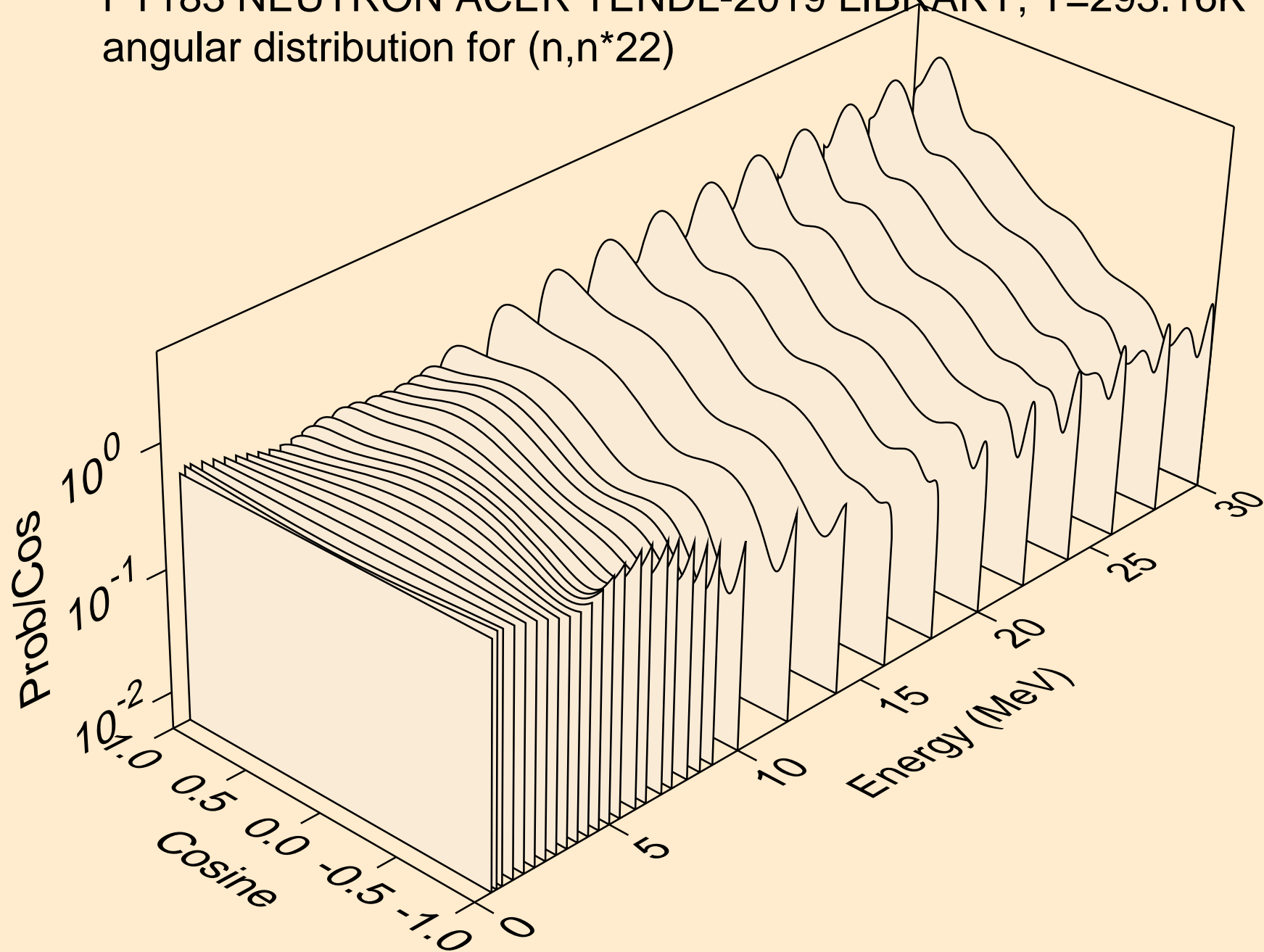

PT183 NEUTRON ACER TENDL-2019 LIBRARY; T=293.16K  
angular distribution for (n,n\*23)

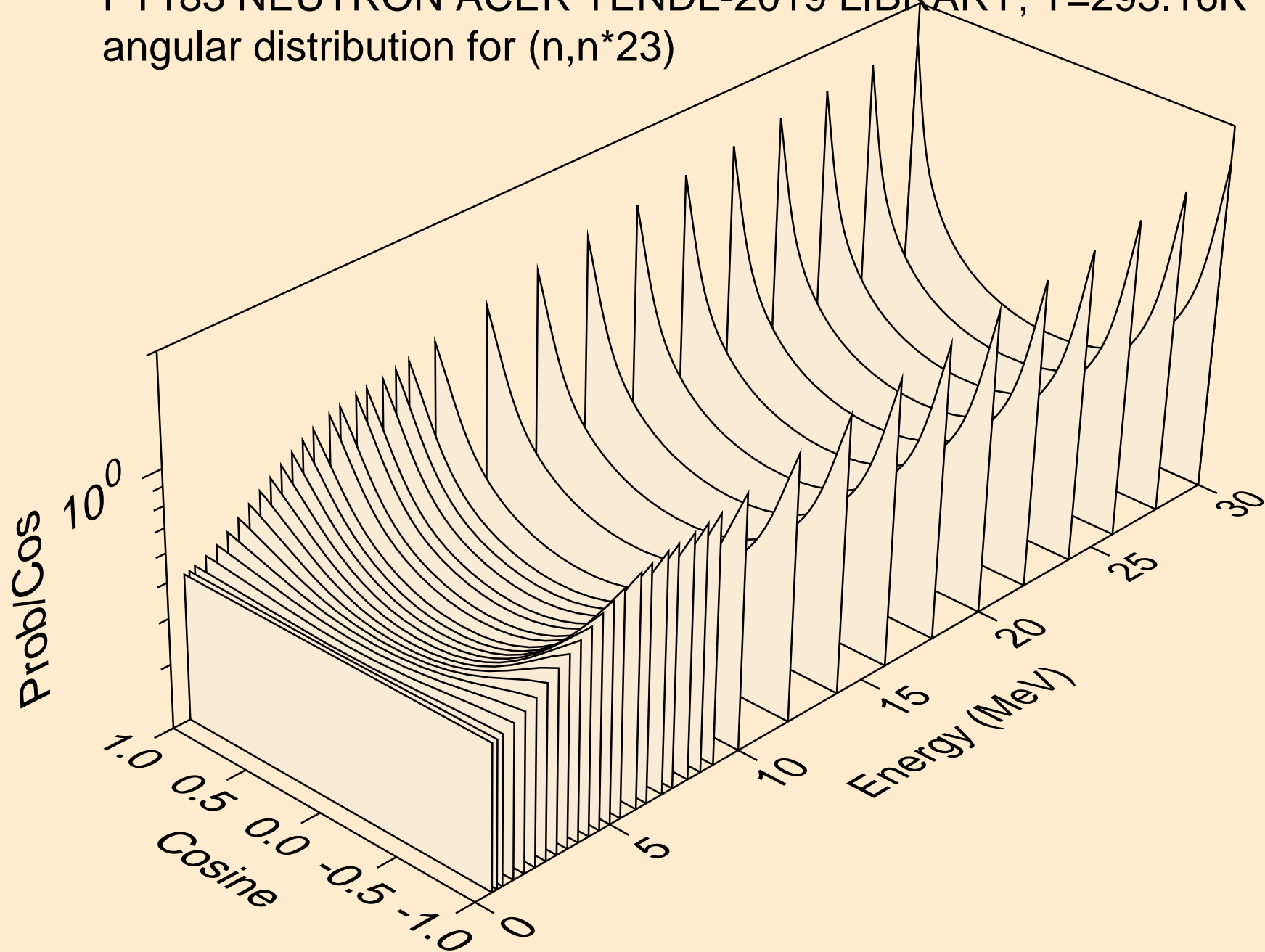



PT183 NEUTRON ACER TENDL-2019 LIBRARY; T=293.16K  
angular distribution for (n,n\*24)

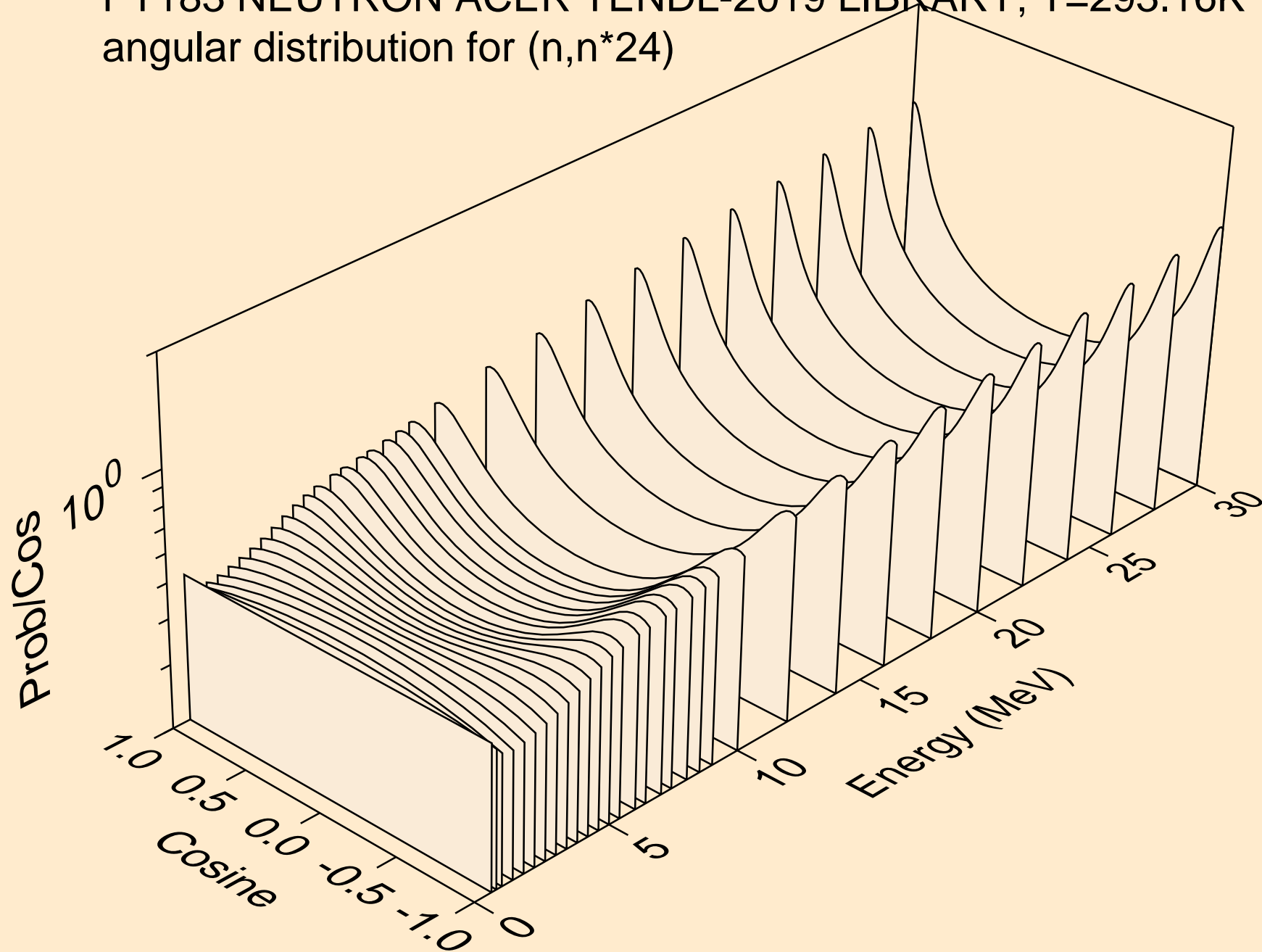

PT183 NEUTRON ACER TENDL-2019 LIBRARY; T=293.16K  
angular distribution for (n,n\*25)

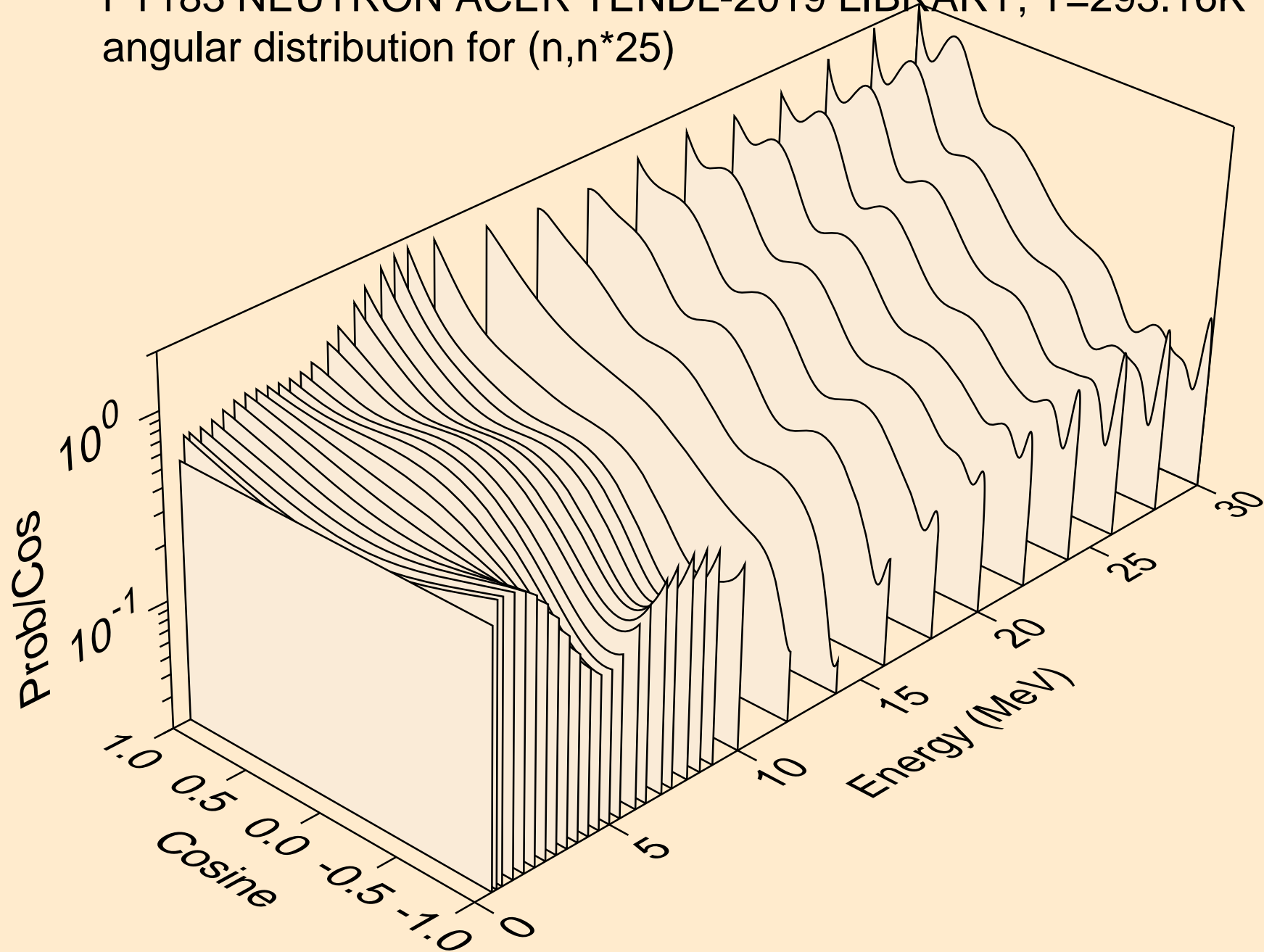

PT183 NEUTRON ACER TENDL-2019 LIBRARY; T=293.16K  
angular distribution for (n,n\*26)

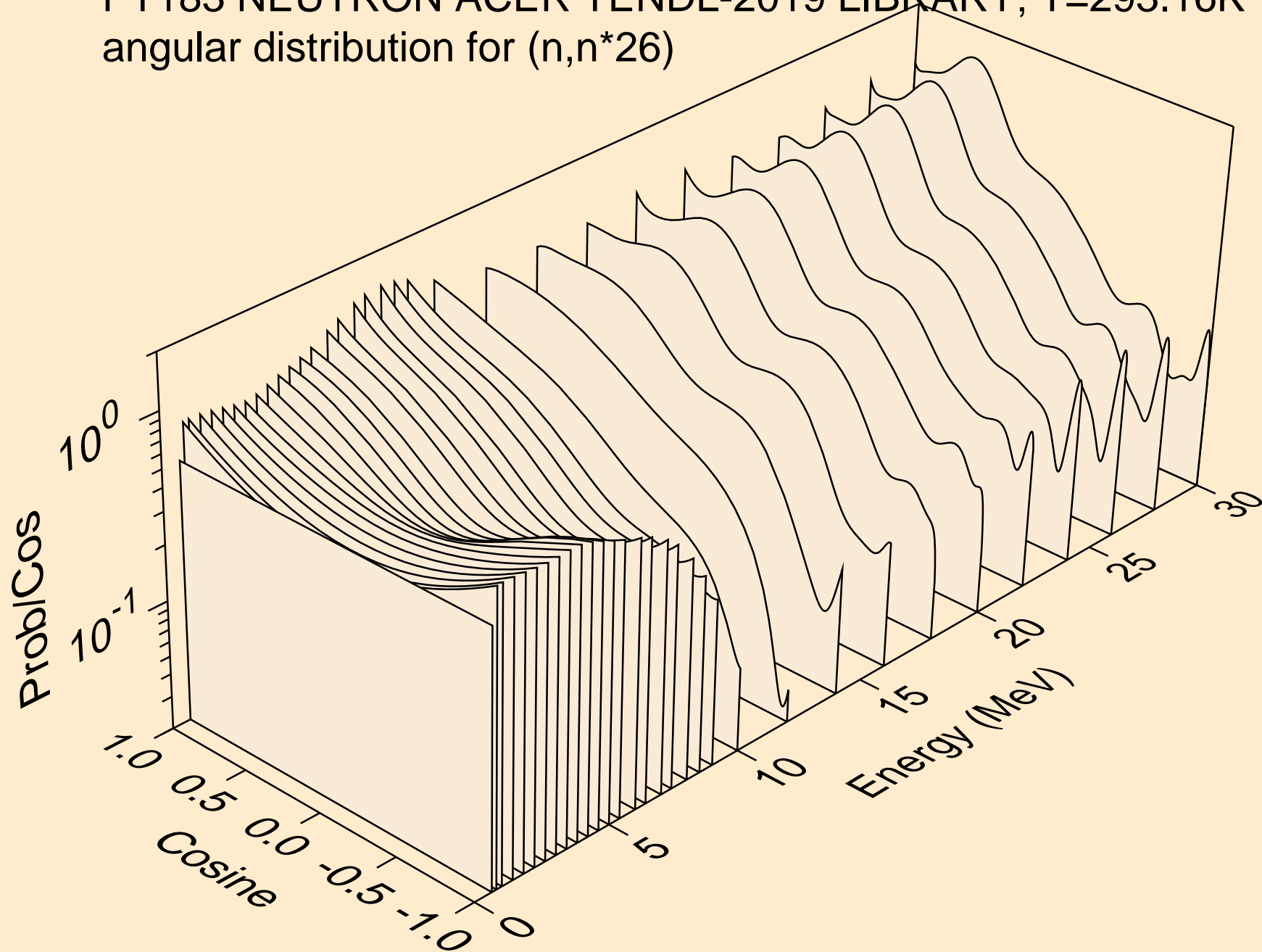

PT183 NEUTRON ACER TENDL-2019 LIBRARY; T=293.16K  
angular distribution for (n,n\*27)

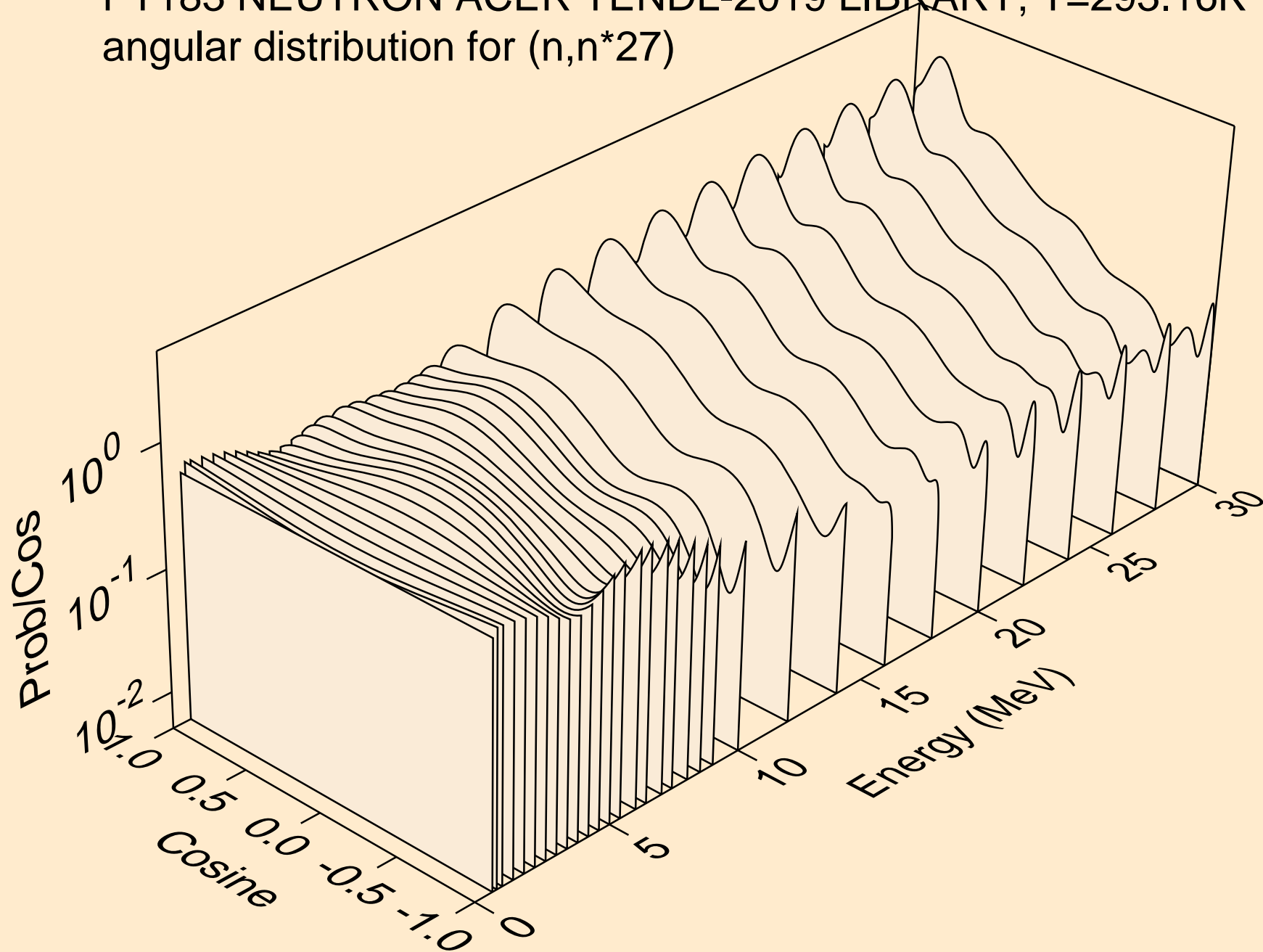

PT183 NEUTRON ACER TENDL-2019 LIBRARY; T=293.16K  
angular distribution for (n,n\*28)

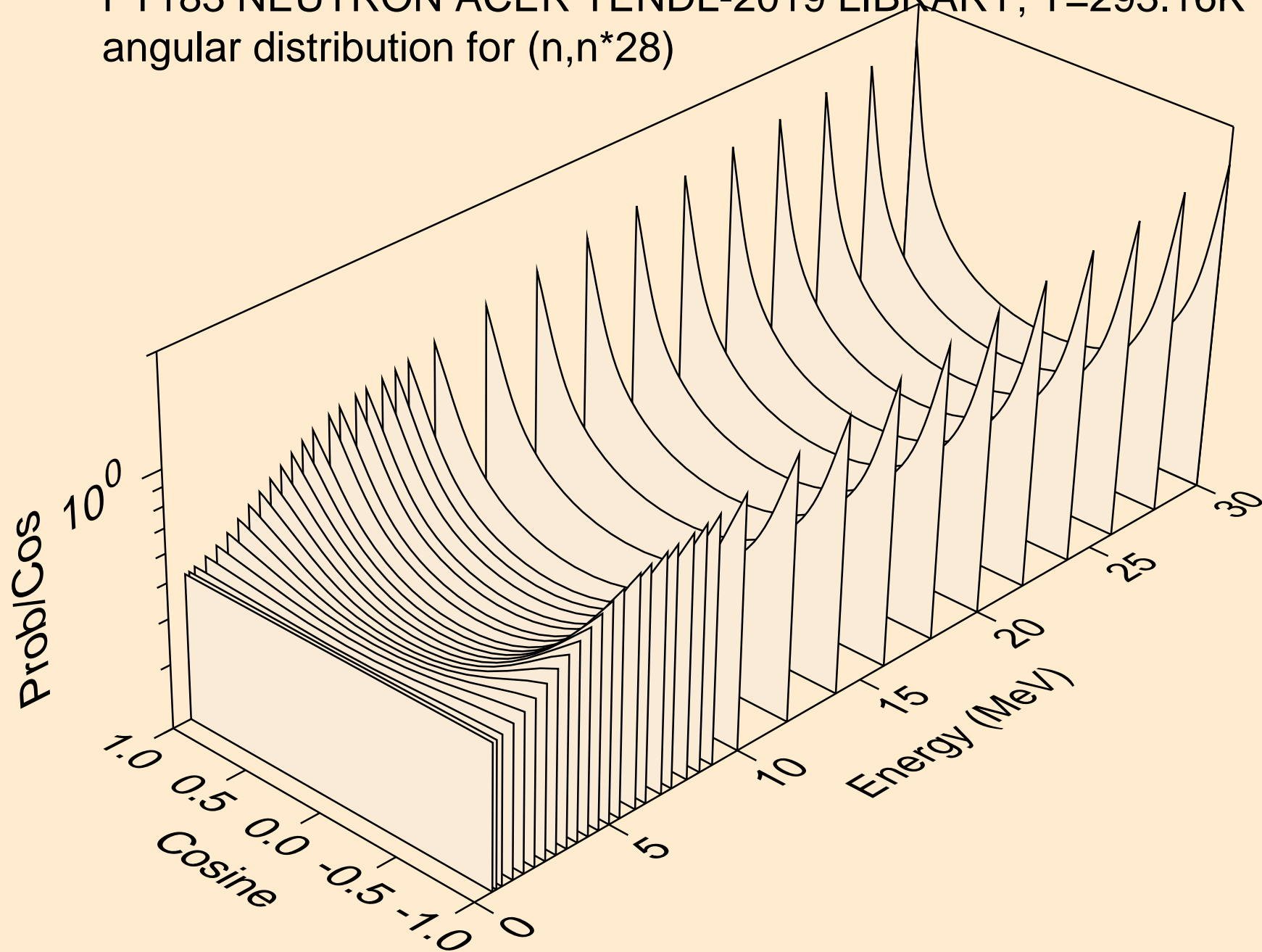

PT183 NEUTRON ACER TENDL-2019 LIBRARY; T=293.16K  
angular distribution for (n,n\*29)

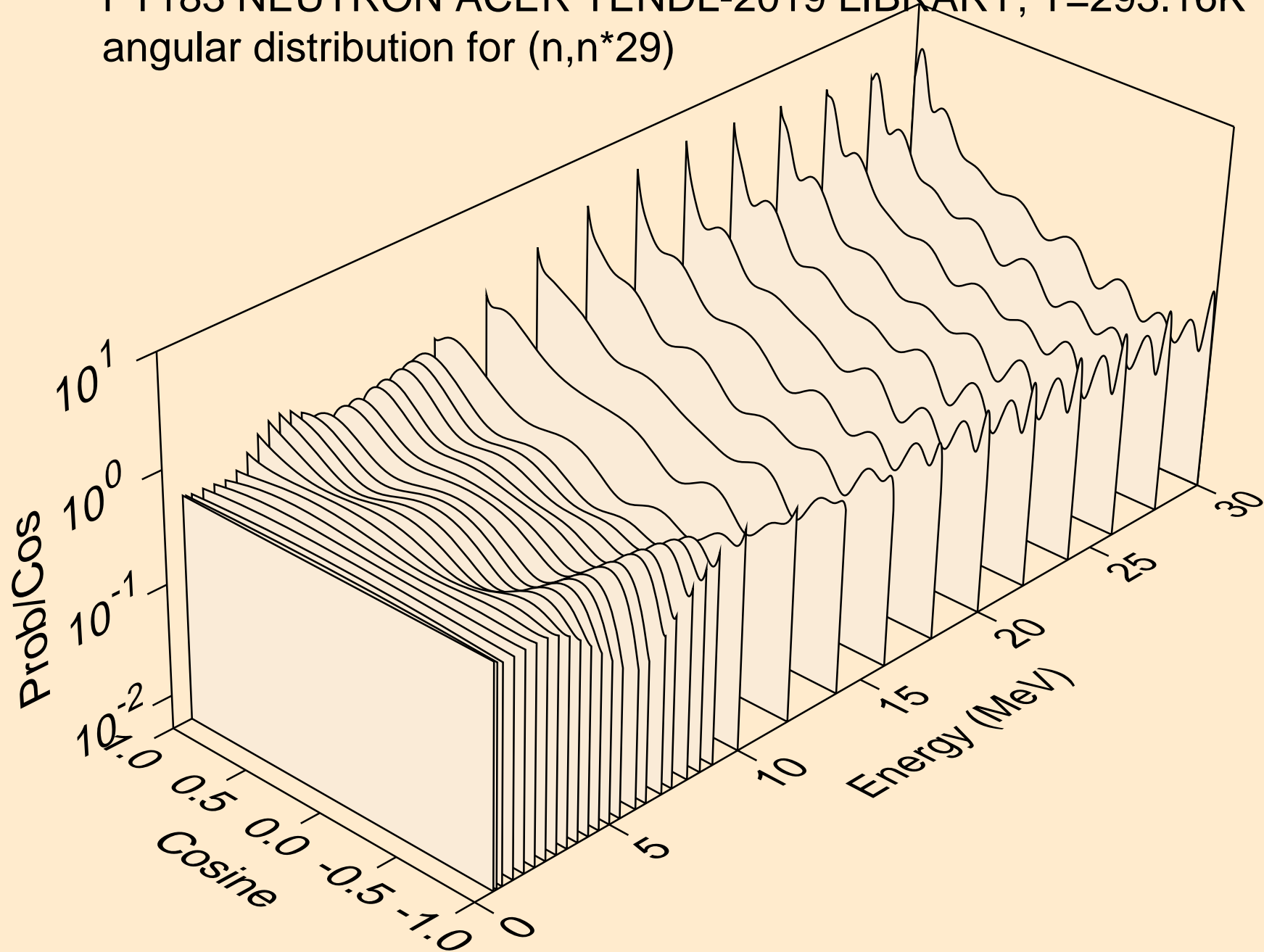

PT183 NEUTRON ACER TENDL-2019 LIBRARY; T=293.16K  
angular distribution for (n,n\*30)

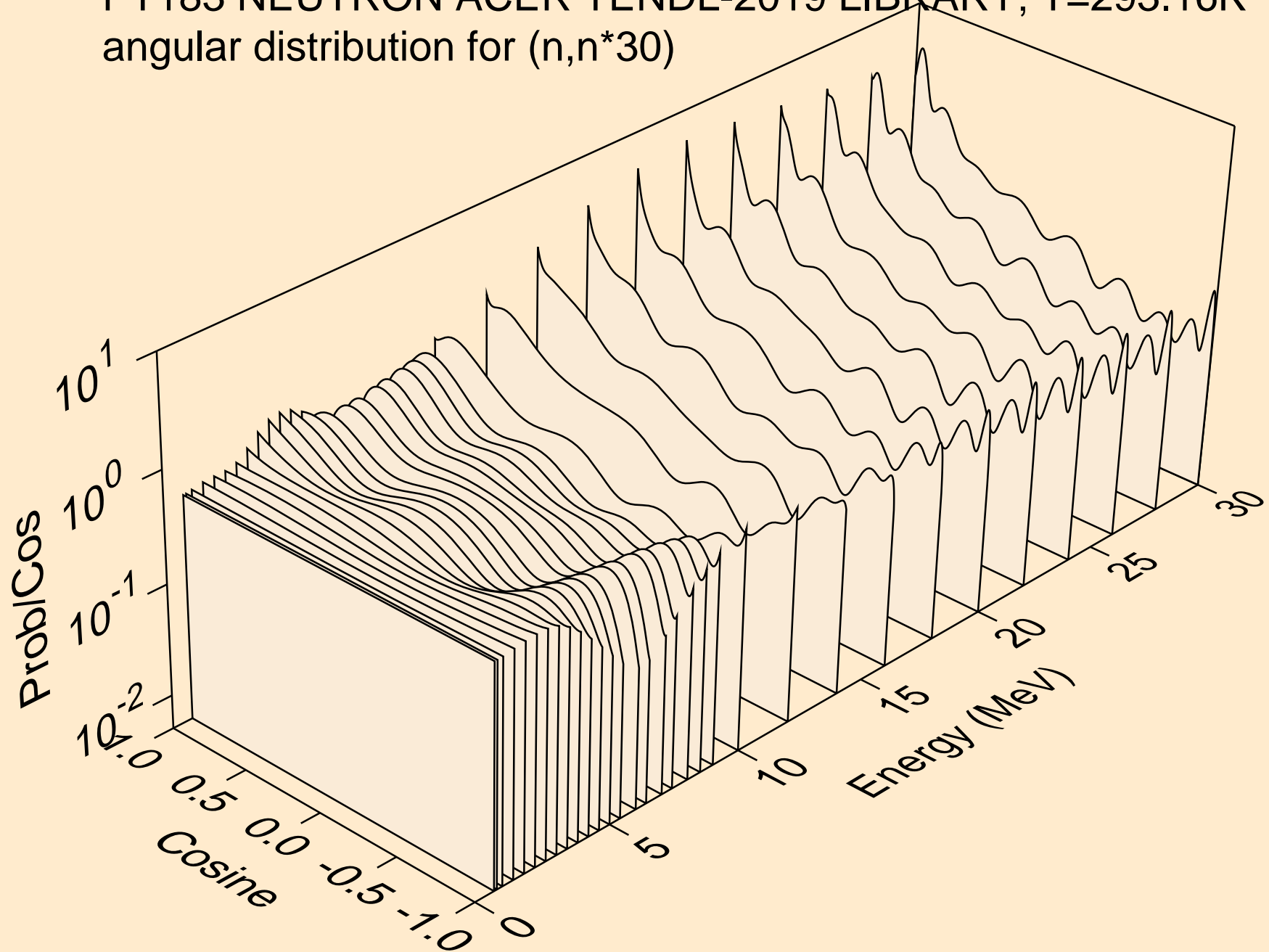

PT183 NEUTRON ACER TENDL-2019 LIBRARY; T=293.16K  
Neutron emission for (n,x)

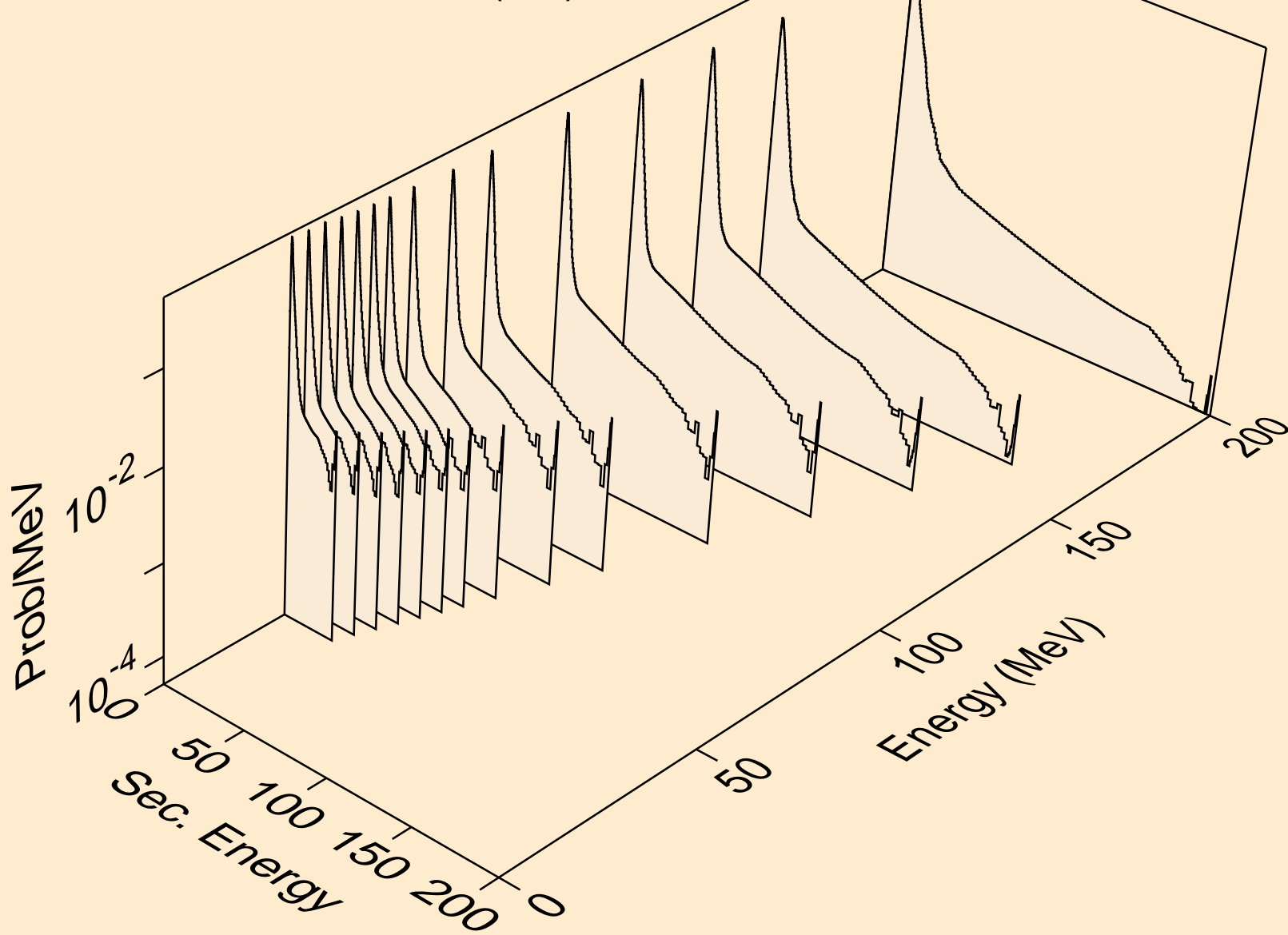



PT183 NEUTRON ACER TENDL-2019 LIBRARY; T=293.16K  
Neutron emission for (n,2nd)

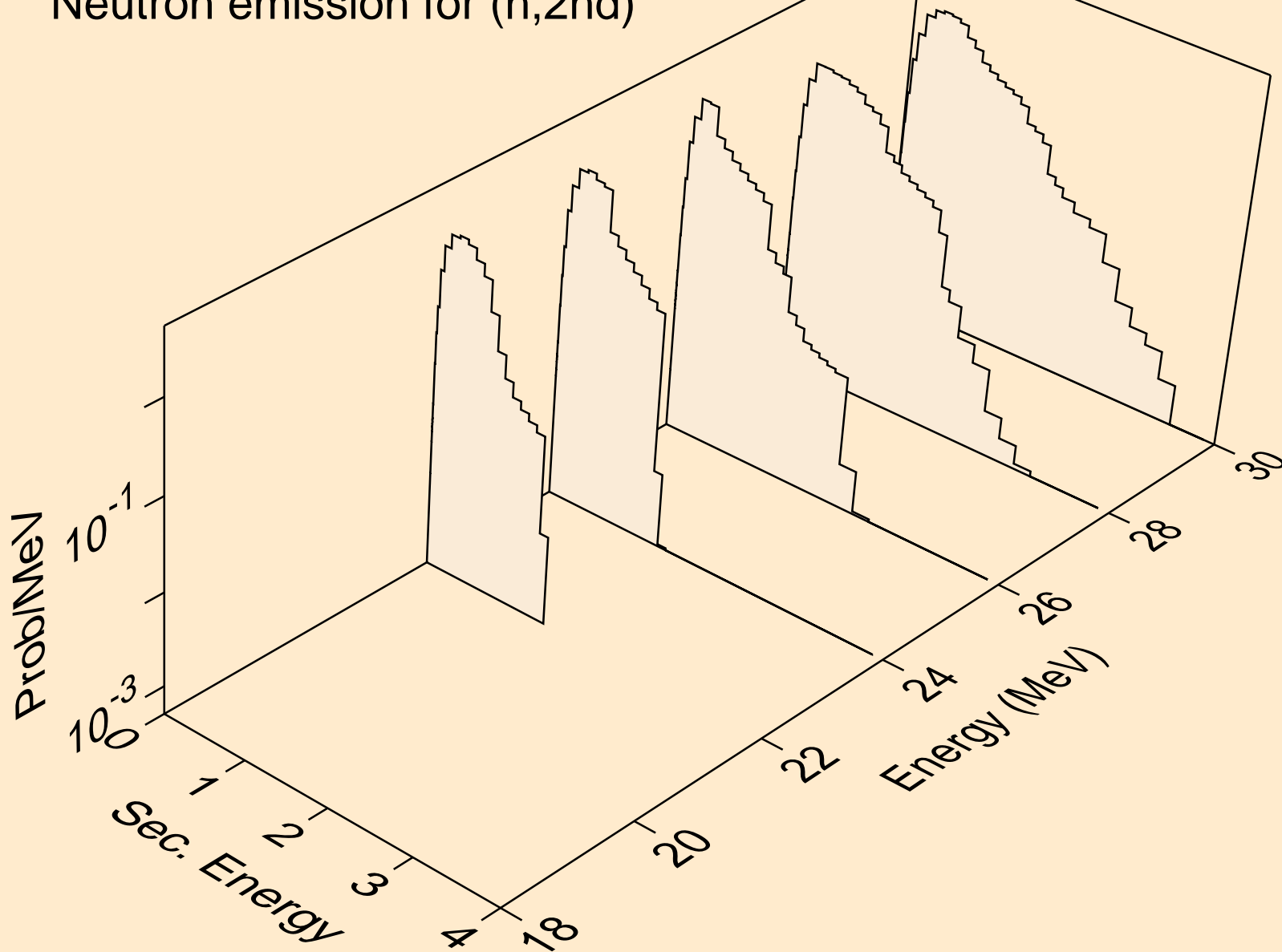

PT183 NEUTRON ACER TENDL-2019 LIBRARY; T=293.16K  
Neutron emission for (n,2n)

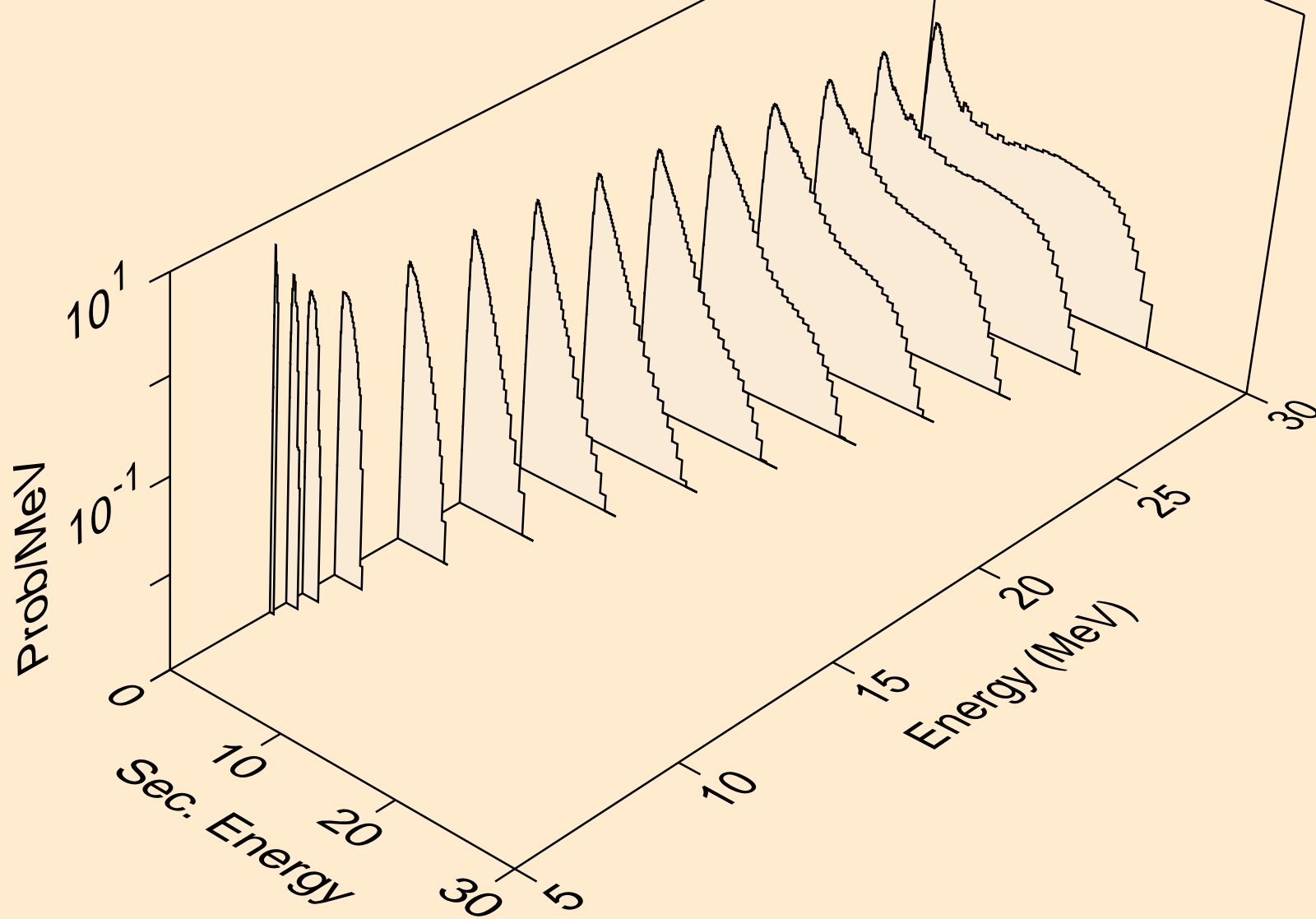

PT183 NEUTRON ACER TENDL-2019 LIBRARY; T=293.16K  
Neutron emission for (n,3n)

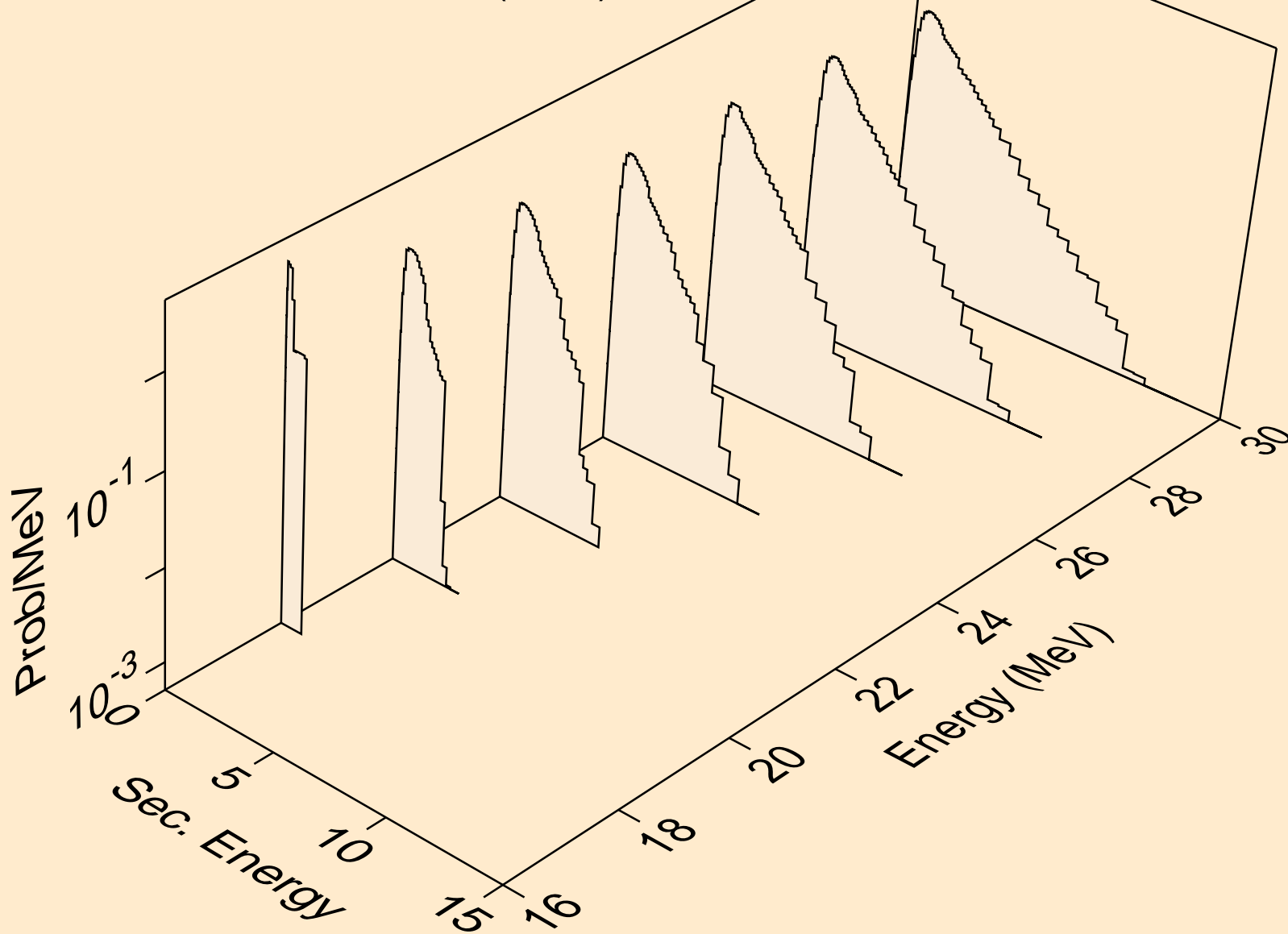

PT183 NEUTRON ACER TENDL-2019 LIBRARY; T=293.16K  
Neutron emission for (n,n\*)a

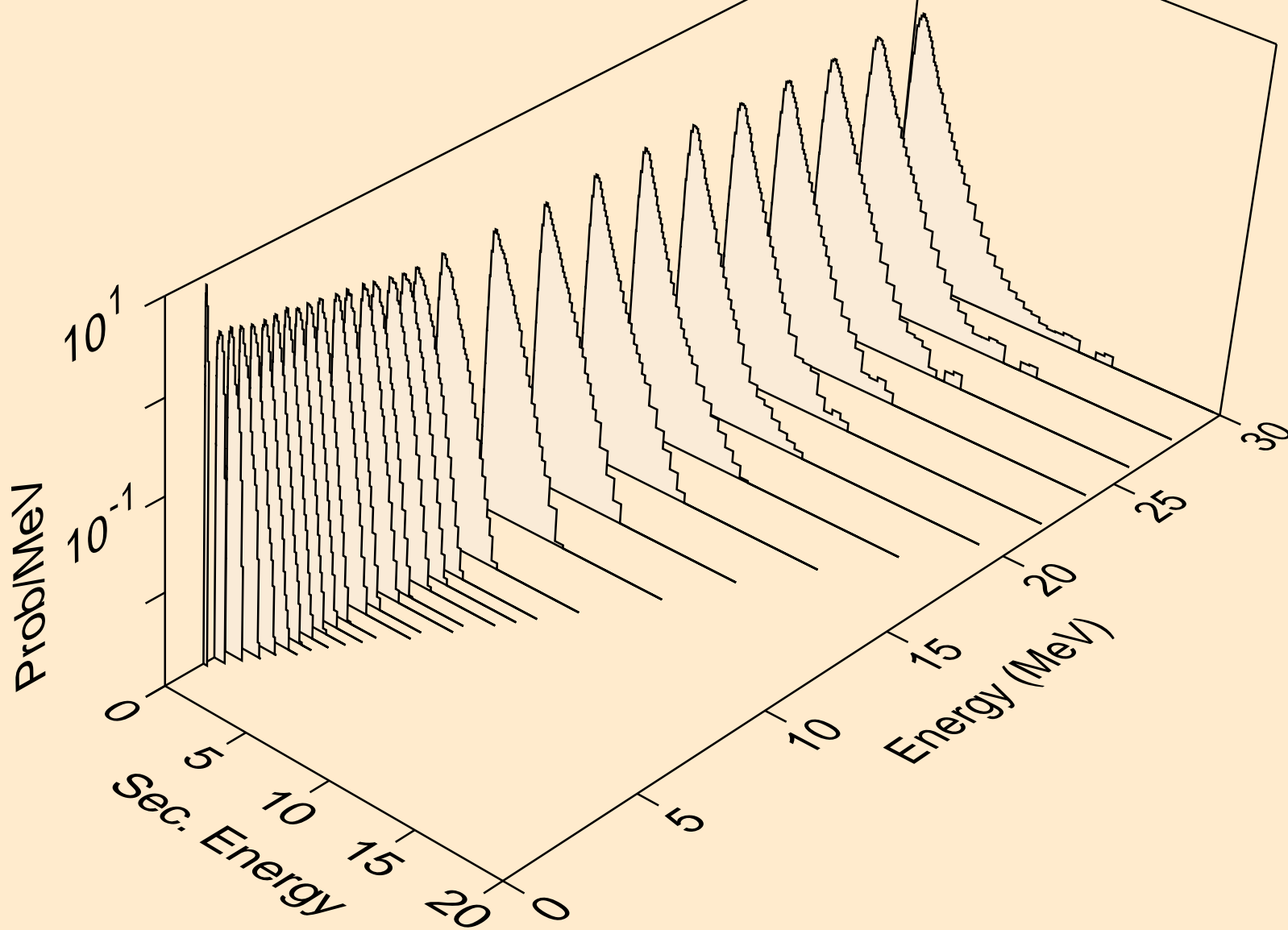

PT183 NEUTRON ACER TENDL-2019 LIBRARY; T=293.16K  
Neutron emission for (n,2n)a

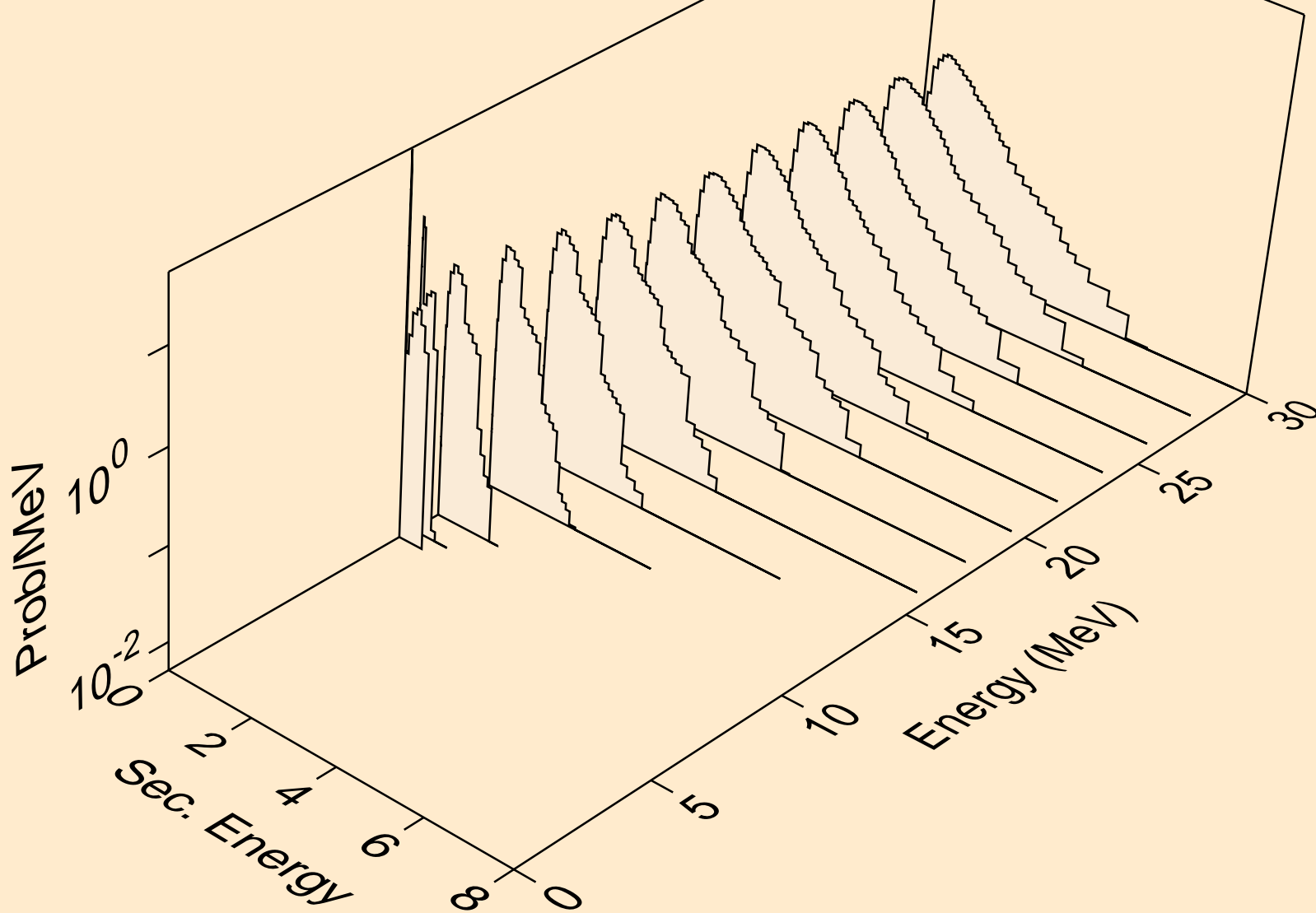

PT183 NEUTRON ACER TENDL-2019 LIBRARY; T=293.16K  
Neutron emission for (n,3n)a

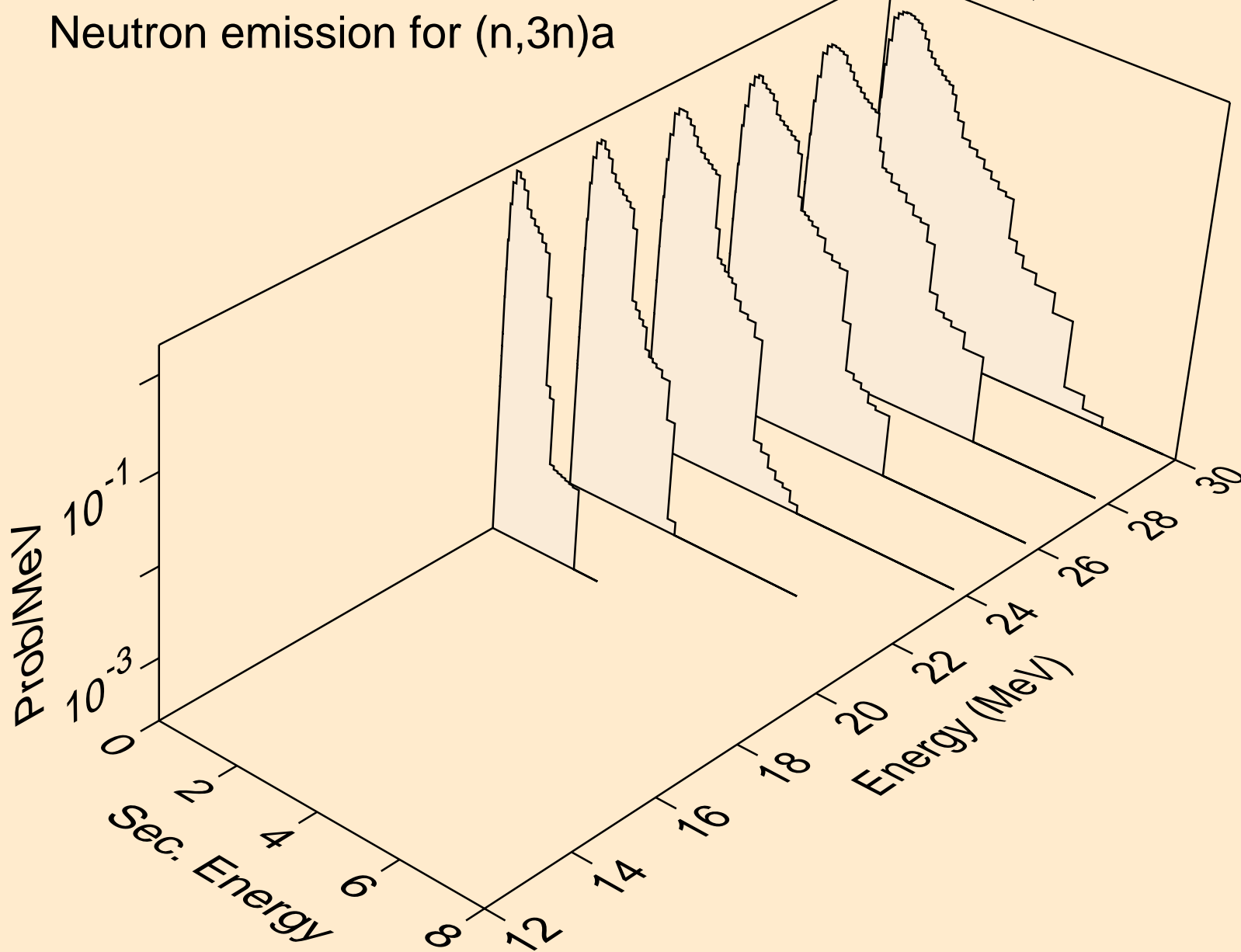

PT183 NEUTRON ACER TENDL-2019 LIBRARY; T=293.16K  
Neutron emission for (n,n\*)p

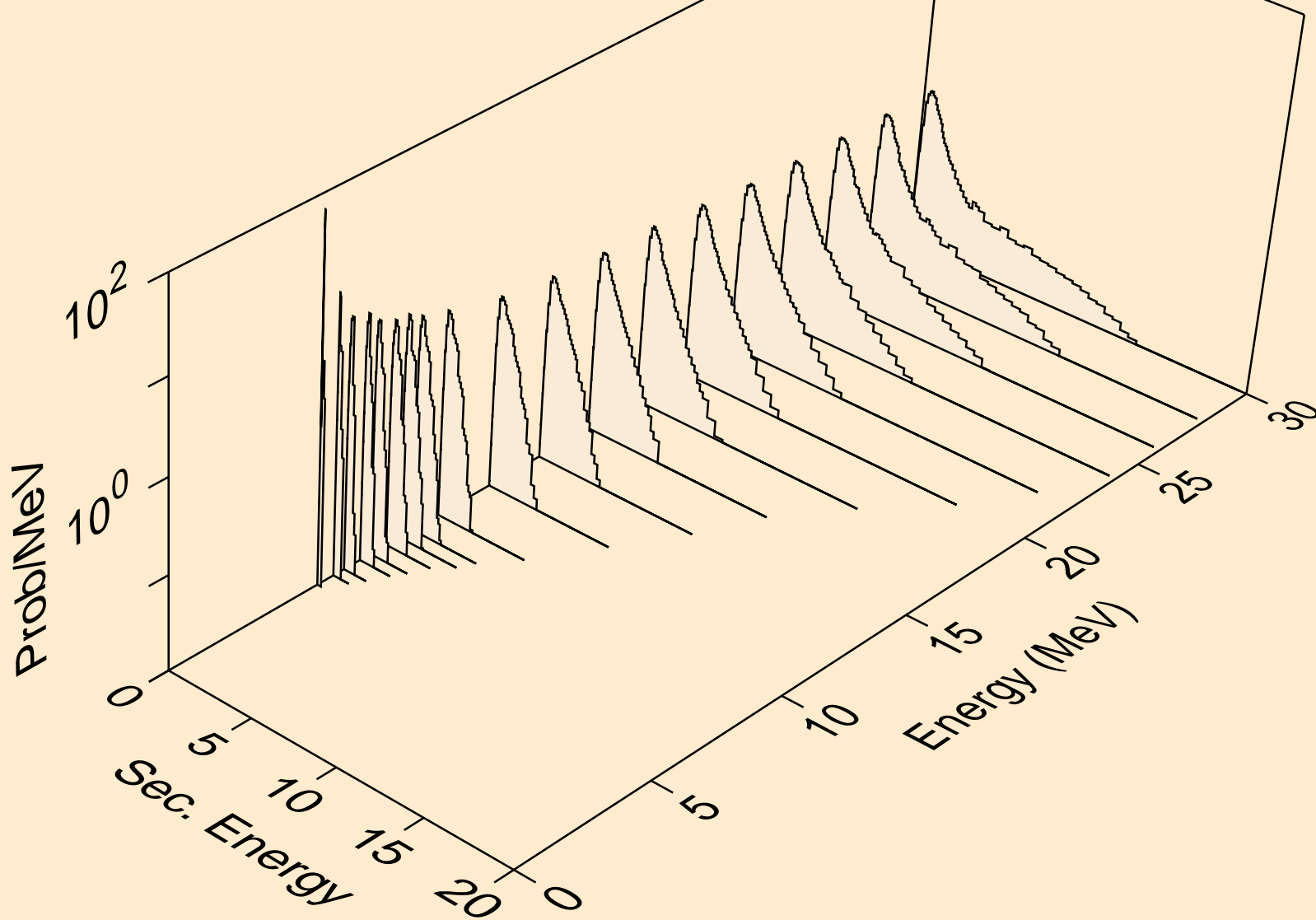

PT183 NEUTRON ACER TENDL-2019 LIBRARY; T=293.16K  
Neutron emission for (n,n\*)2a

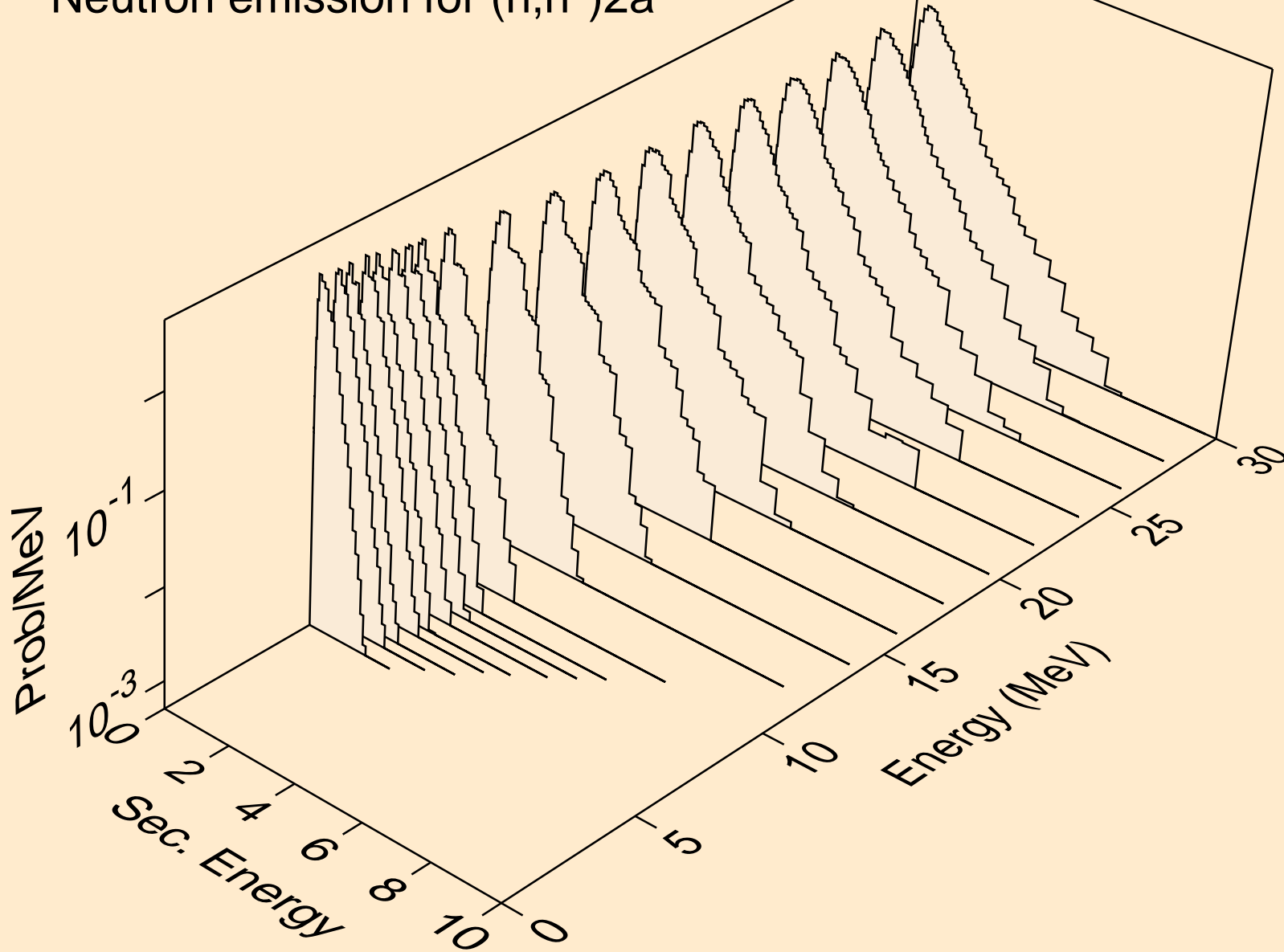



PT183 NEUTRON ACER TENDL-2019 LIBRARY; T=293.16K  
Neutron emission for (n,2n)2a

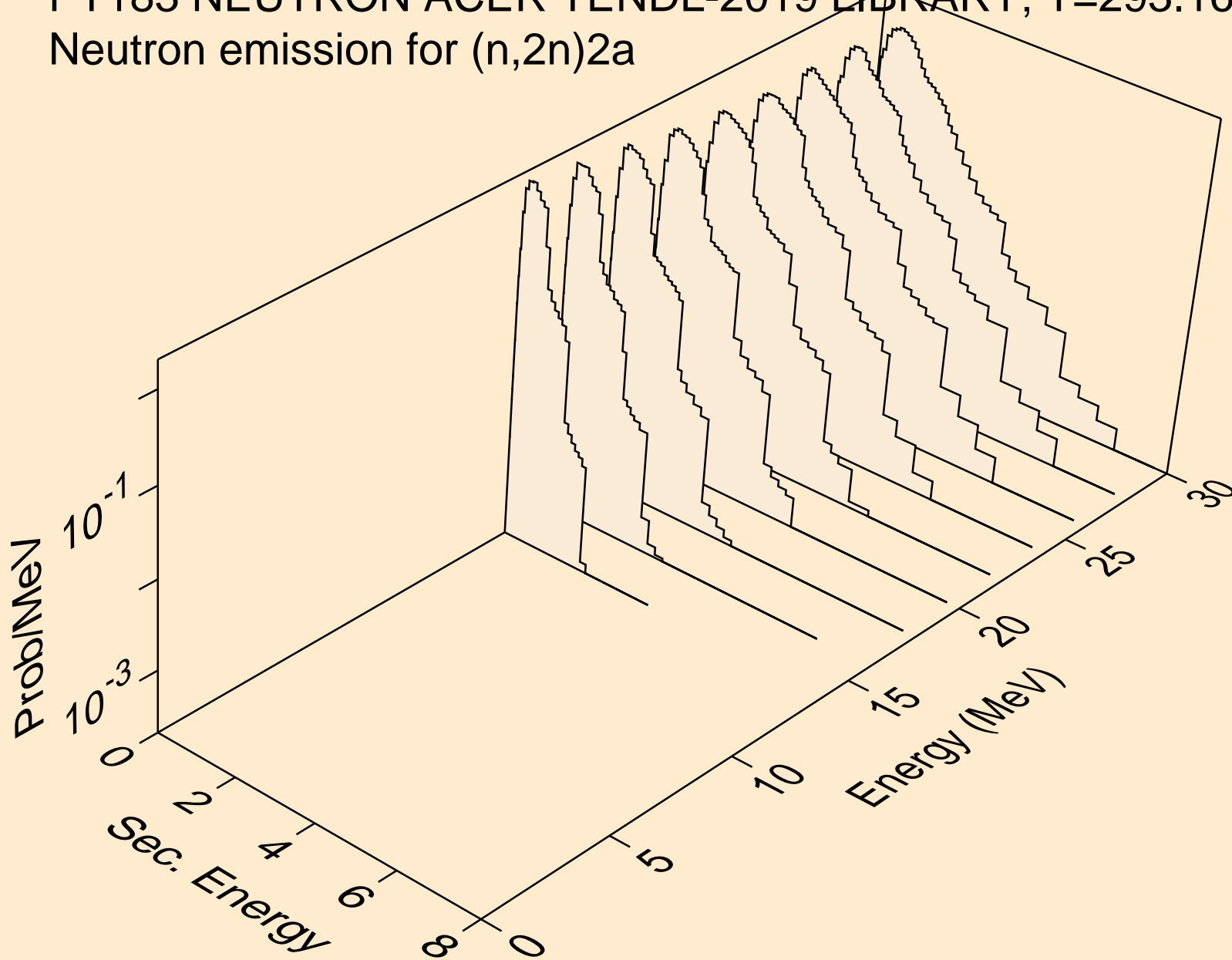

PT183 NEUTRON ACER TENDL-2019 LIBRARY; T=293.16K  
Neutron emission for (n,n\*)d

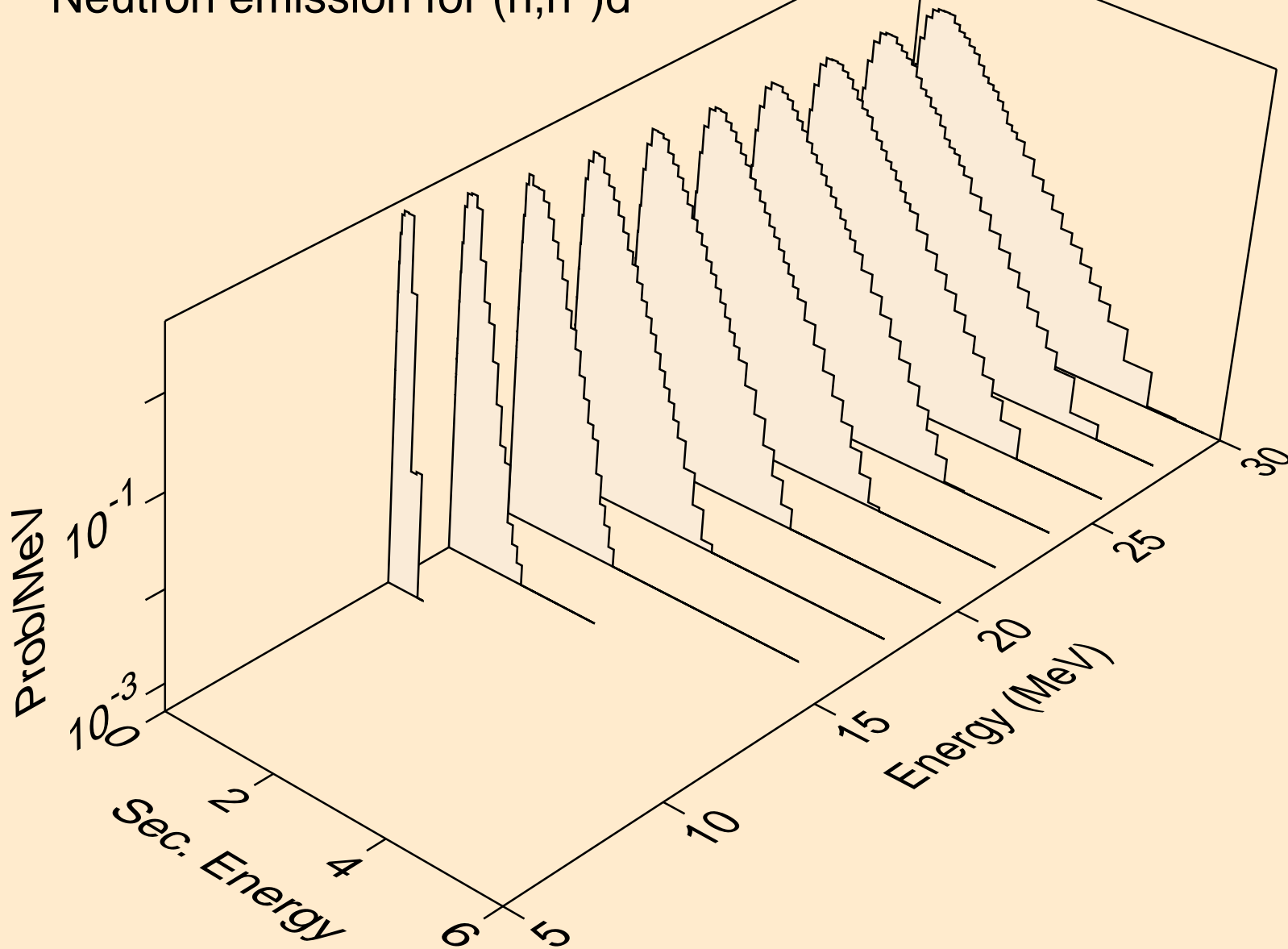

PT183 NEUTRON ACER TENDL-2019 LIBRARY; T=293.16K  
Neutron emission for (n,n\*)t

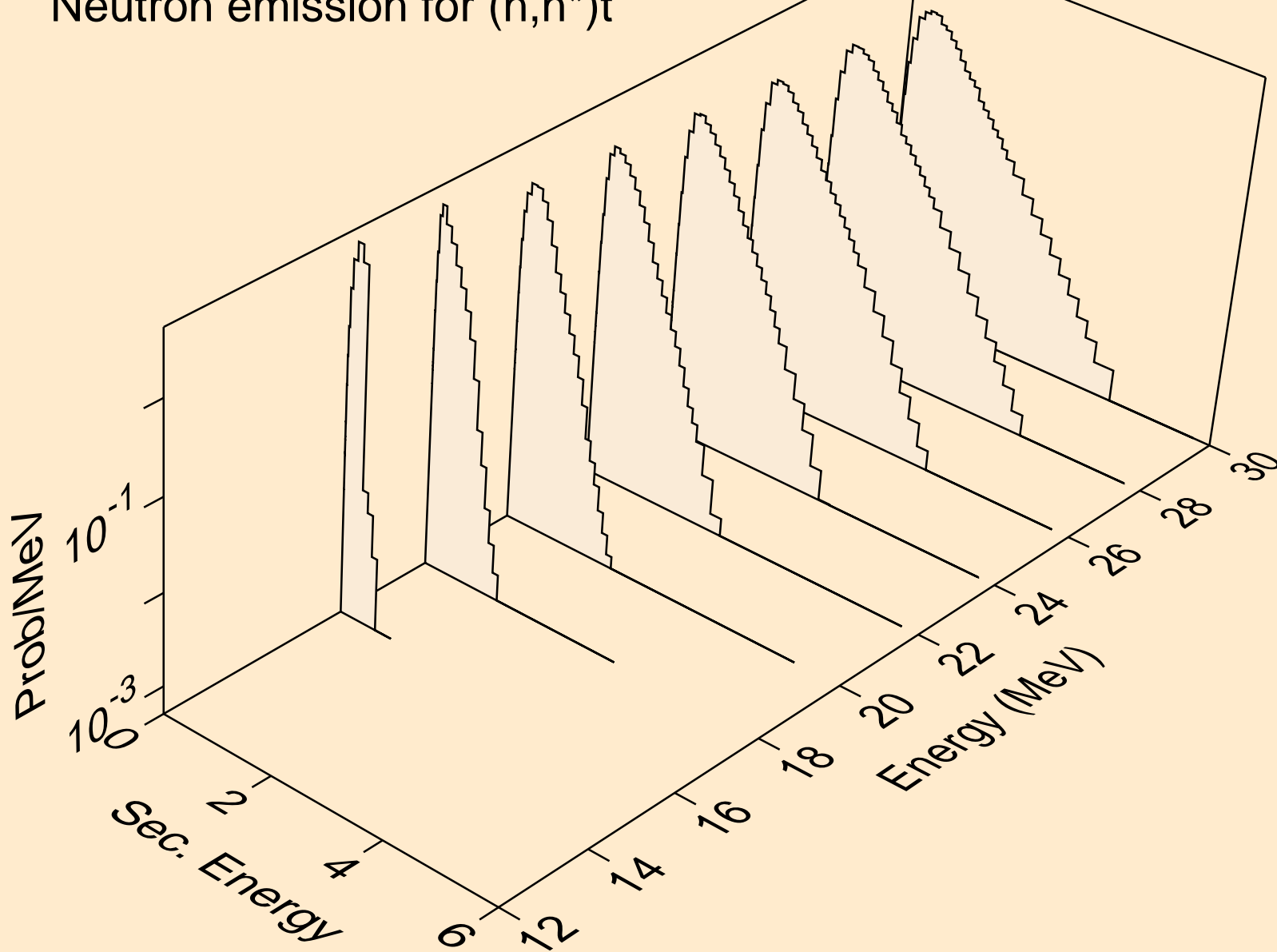

PT183 NEUTRON ACER TENDL-2019 LIBRARY; T=293.16K  
Neutron emission for (n,n\*)he3

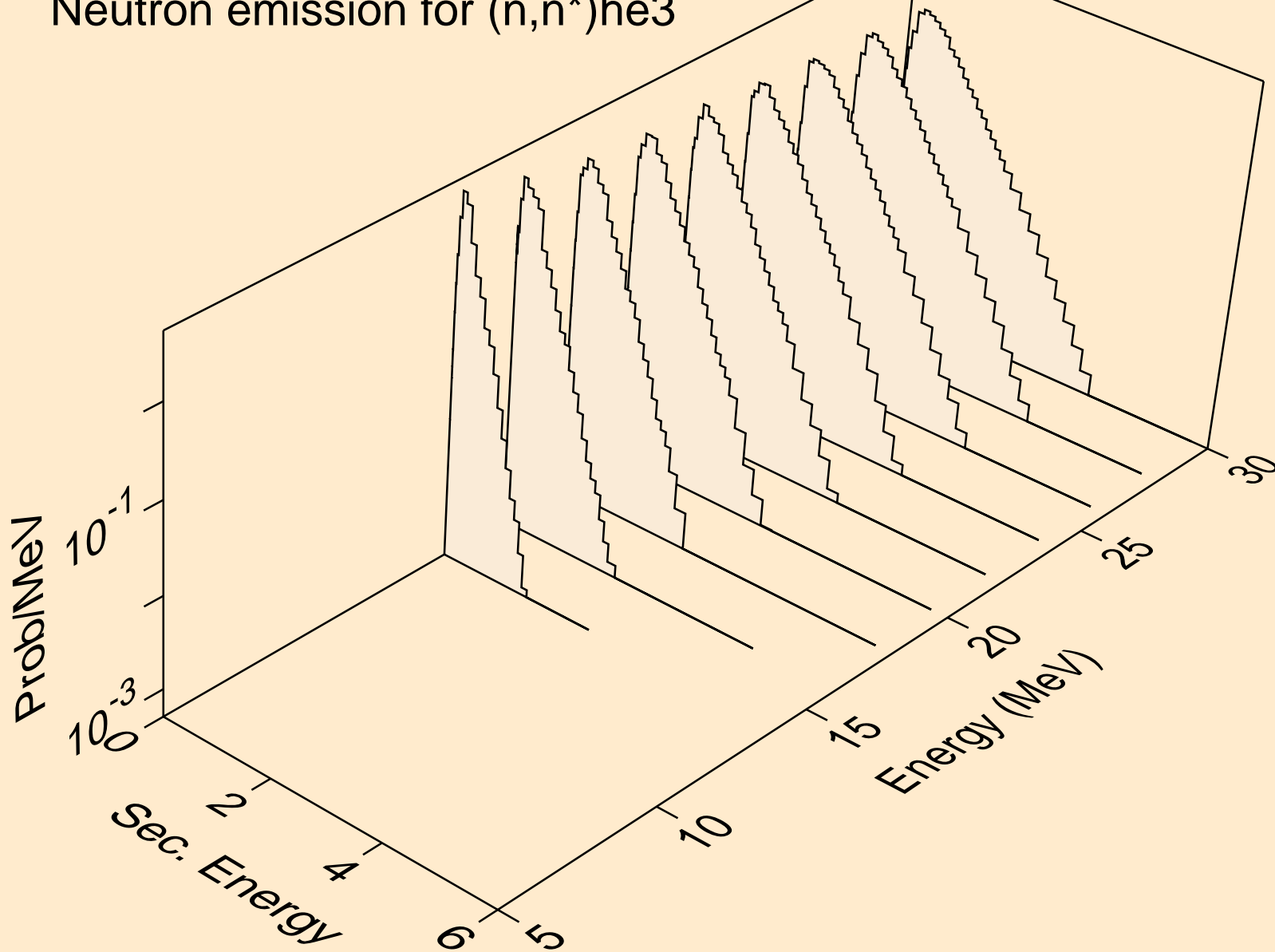

PT183 NEUTRON ACER TENDL-2019 LIBRARY; T=293.16K  
Neutron emission for (n,4n)

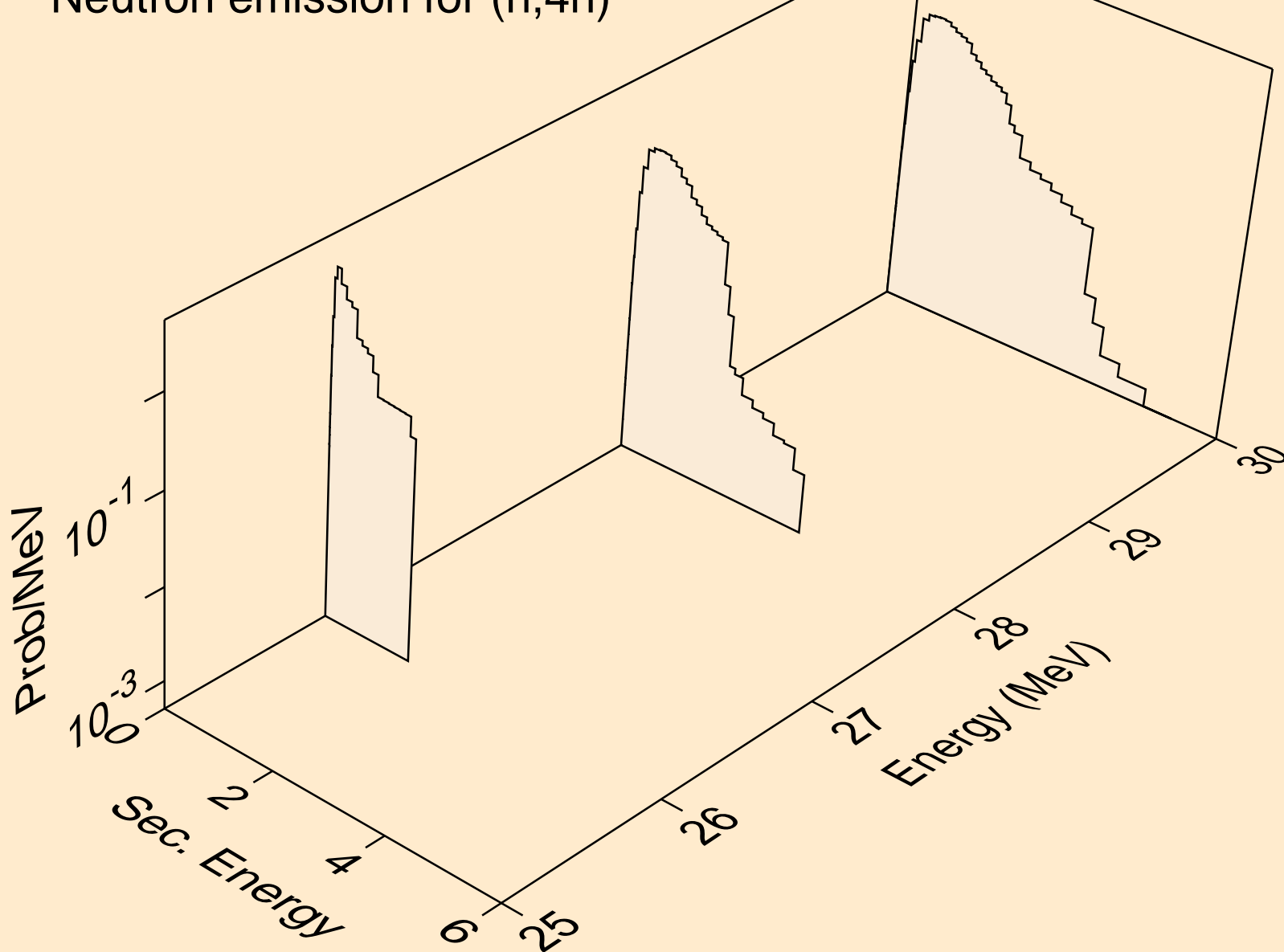

PT183 NEUTRON ACER TENDL-2019 LIBRARY; T=293.16K  
Neutron emission for (n,2np)

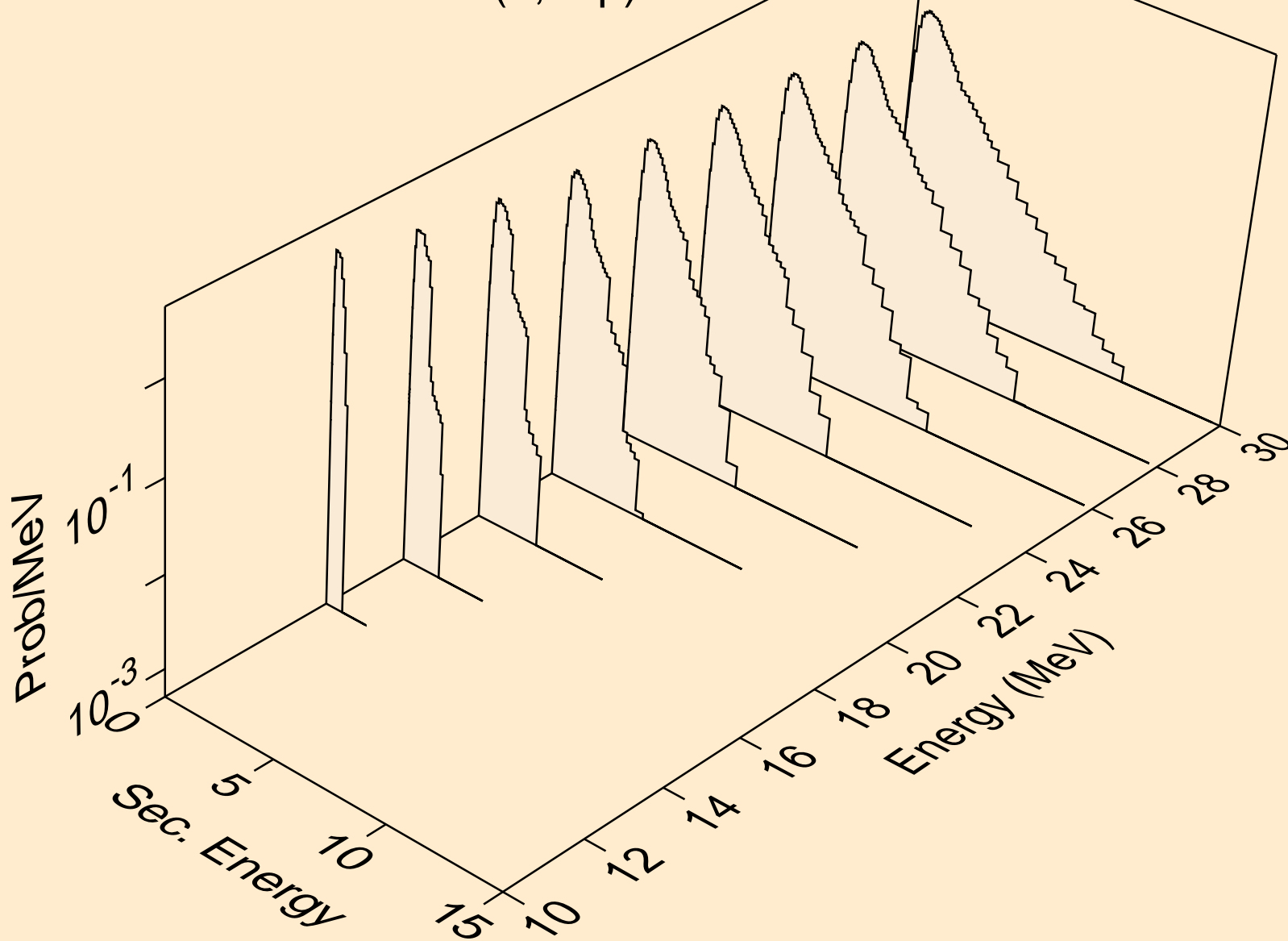

PT183 NEUTRON ACER TENDL-2019 LIBRARY; T=293.16K  
Neutron emission for (n,3np)

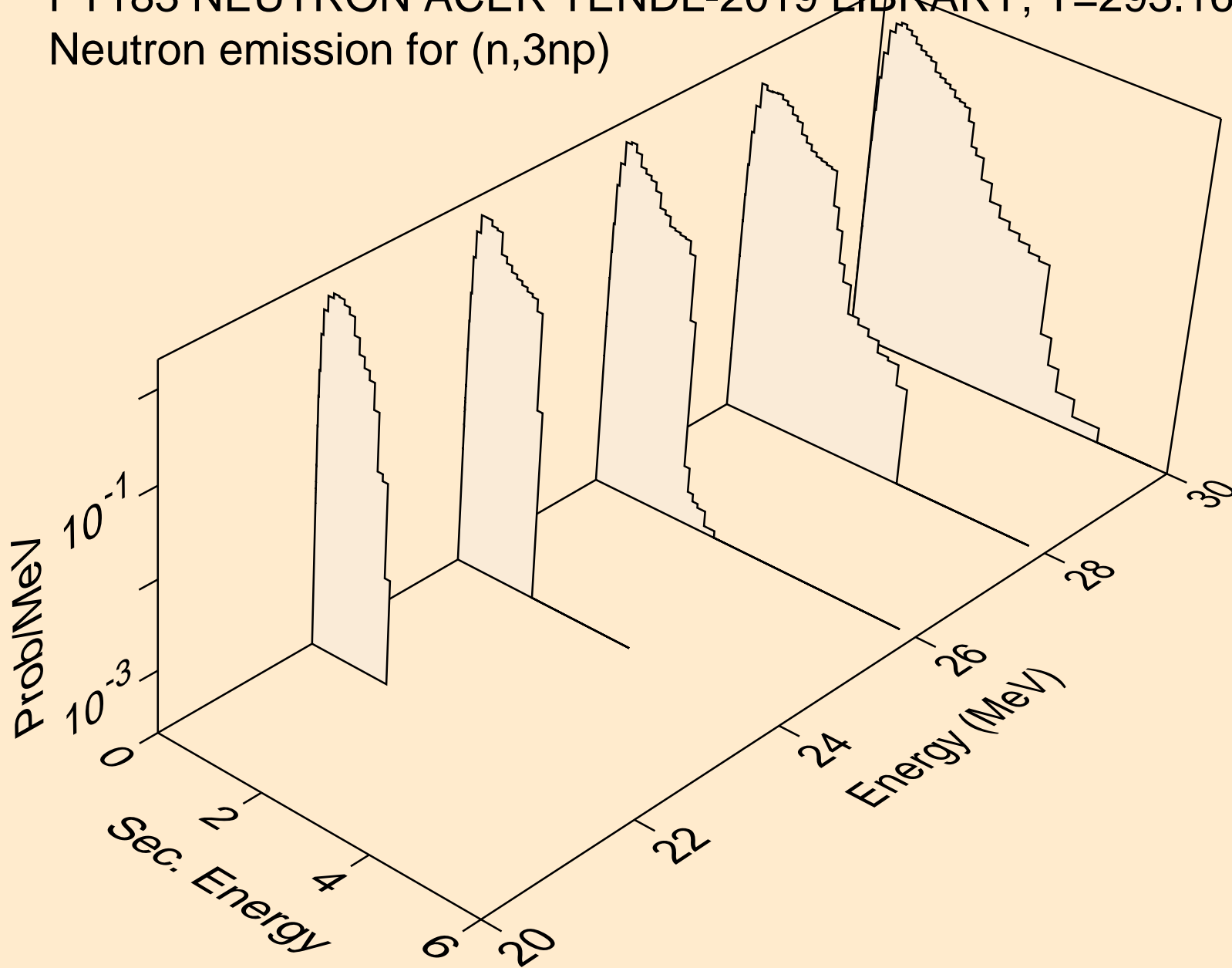

PT183 NEUTRON ACER TENDL-2019 LIBRARY; T=293.16K  
Neutron emission for (n,2np)

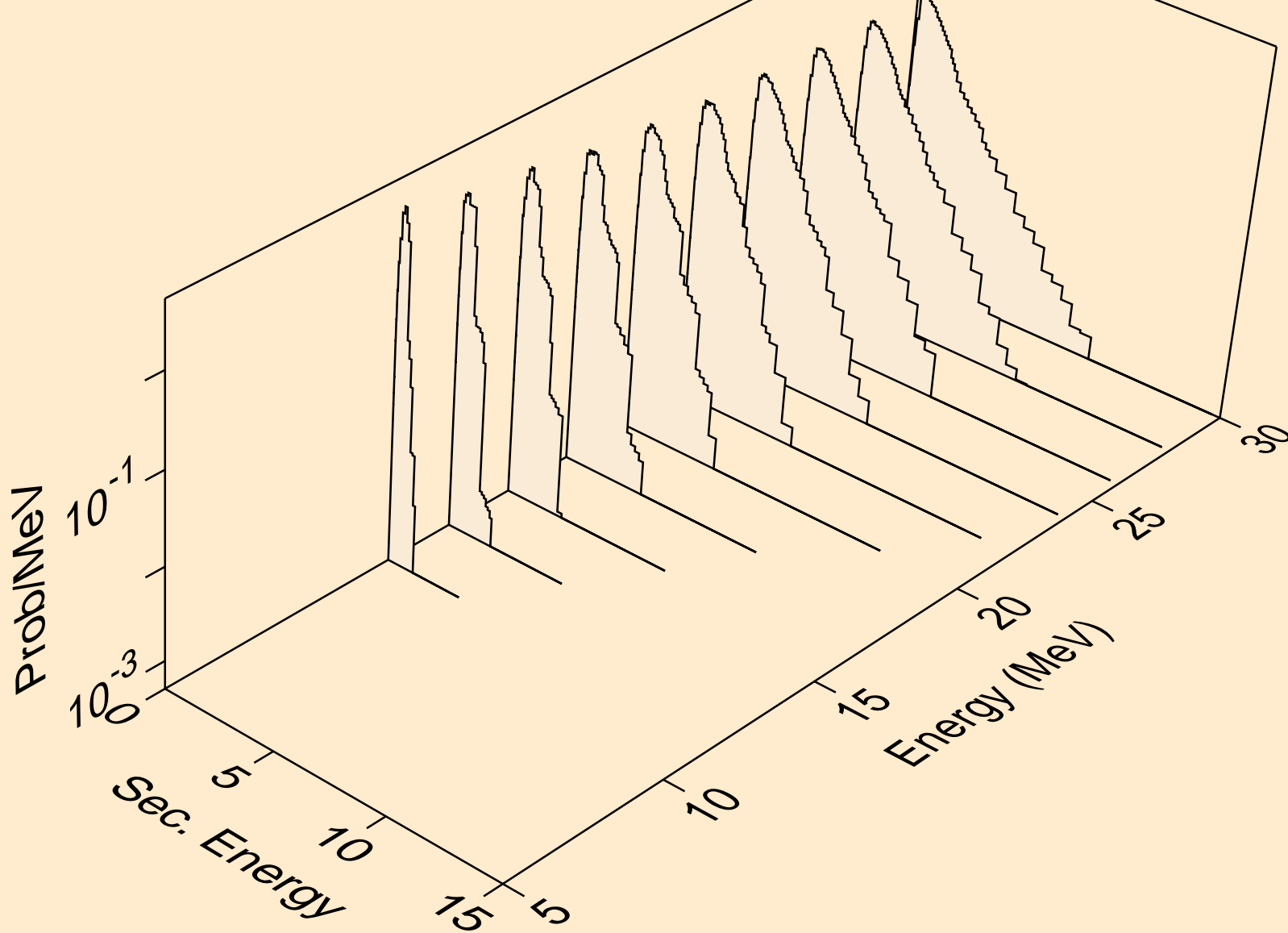



PT183 NEUTRON ACER TENDL-2019 LIBRARY; T=293.16K  
Neutron emission for (n,npa)

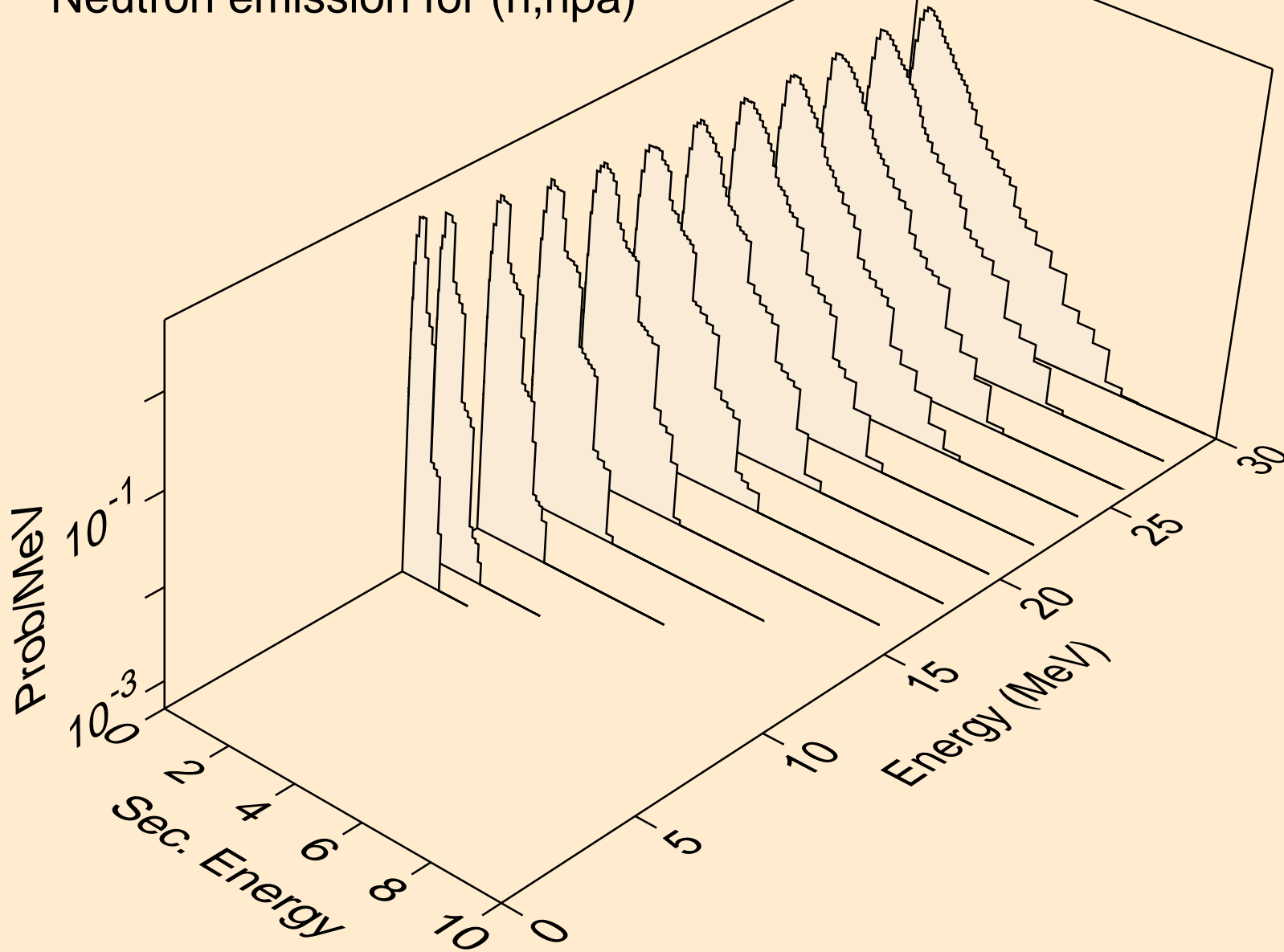

PT183 NEUTRON ACER TENDL-2019 LIBRARY; T=293.16K  
Neutron emission for (n,n\*c)

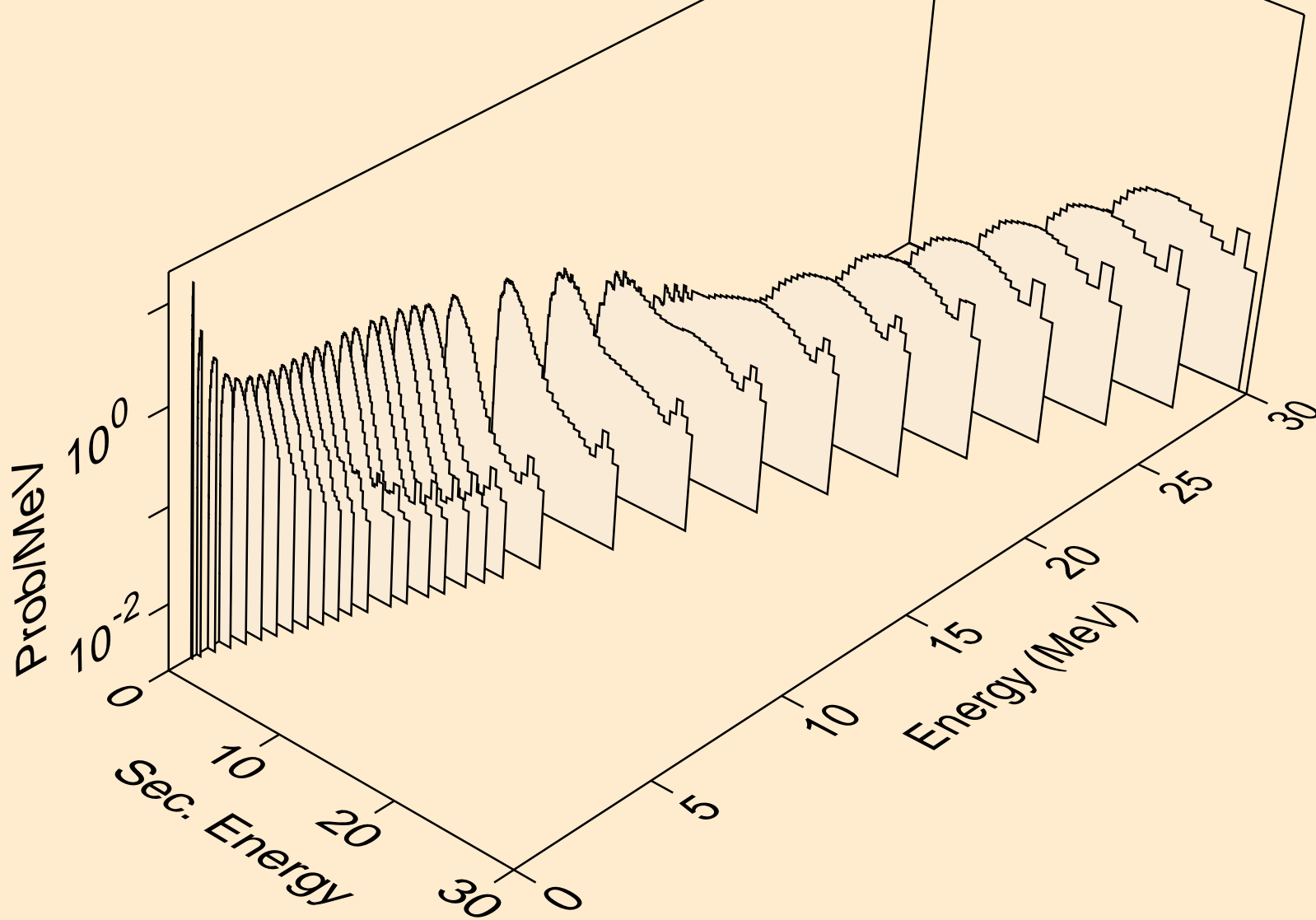

PT183 NEUTRON ACER TENDL-2019 LIBRARY; T=293.16K  
Photon emission for (n,x)

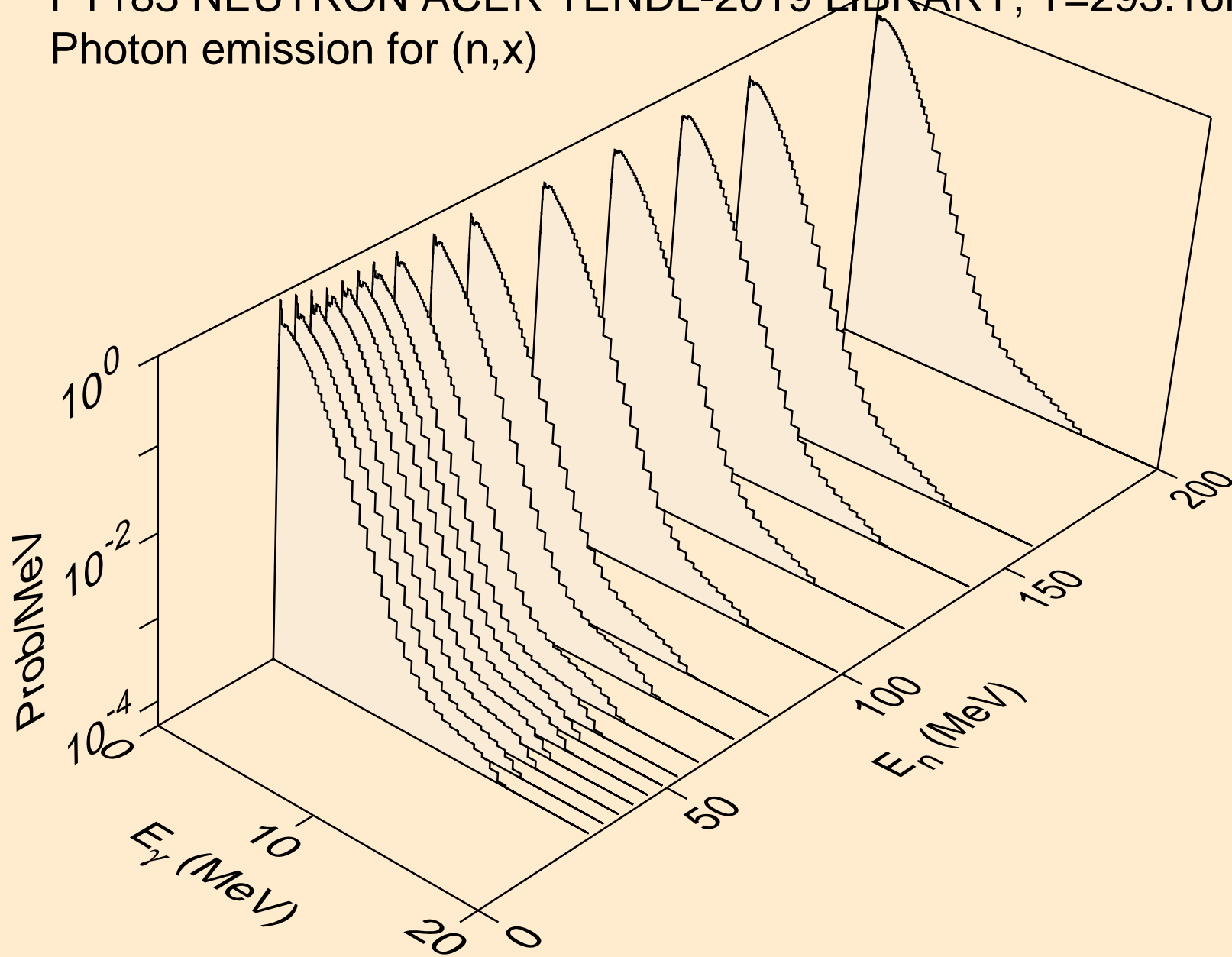

PT183 NEUTRON ACER TENDL-2019 LIBRARY; T=293.16K  
Photon emission for (n,2nd)

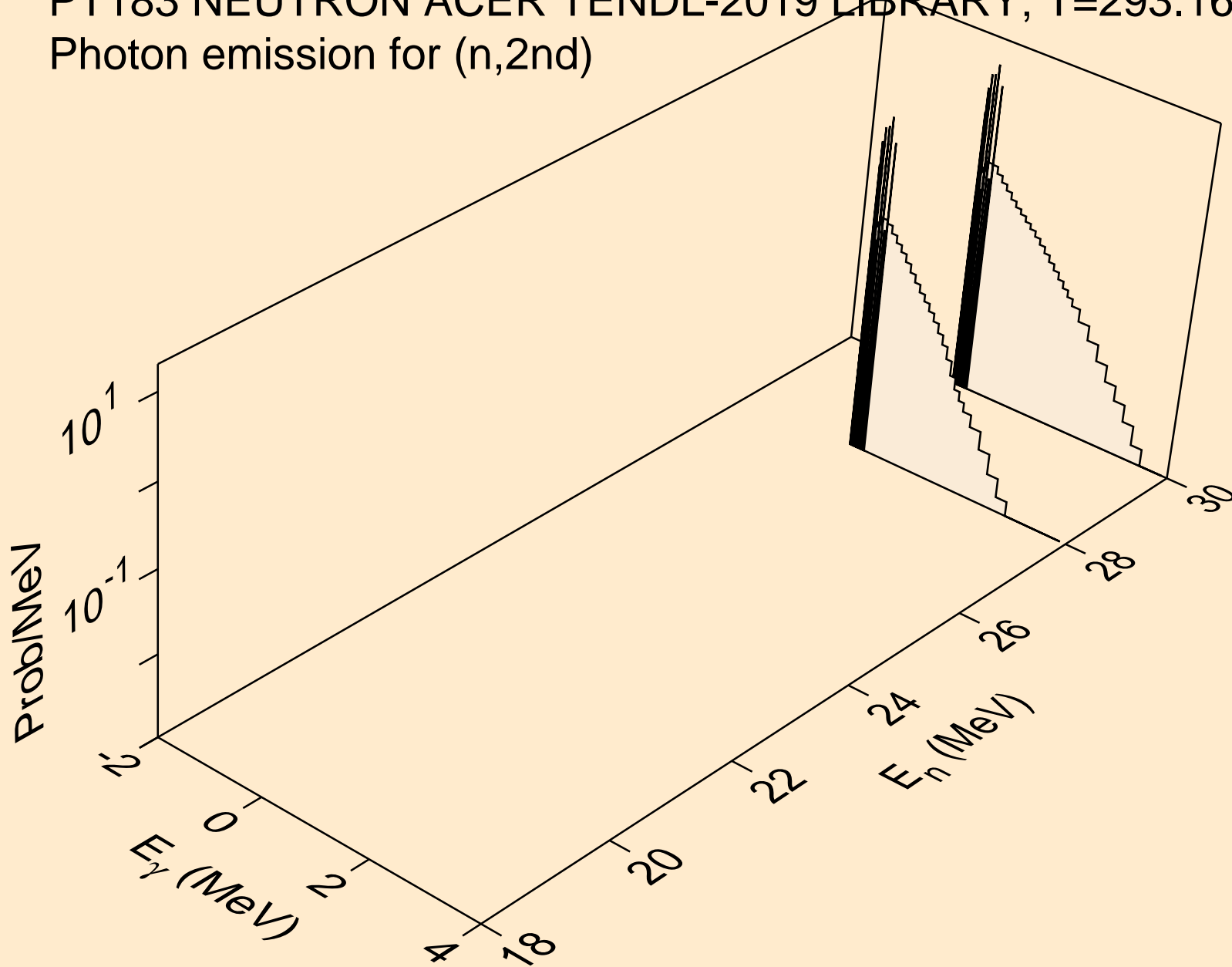

PT183 NEUTRON ACER TENDL-2019 LIBRARY; T=293.16K  
Photon emission for (n,2n)

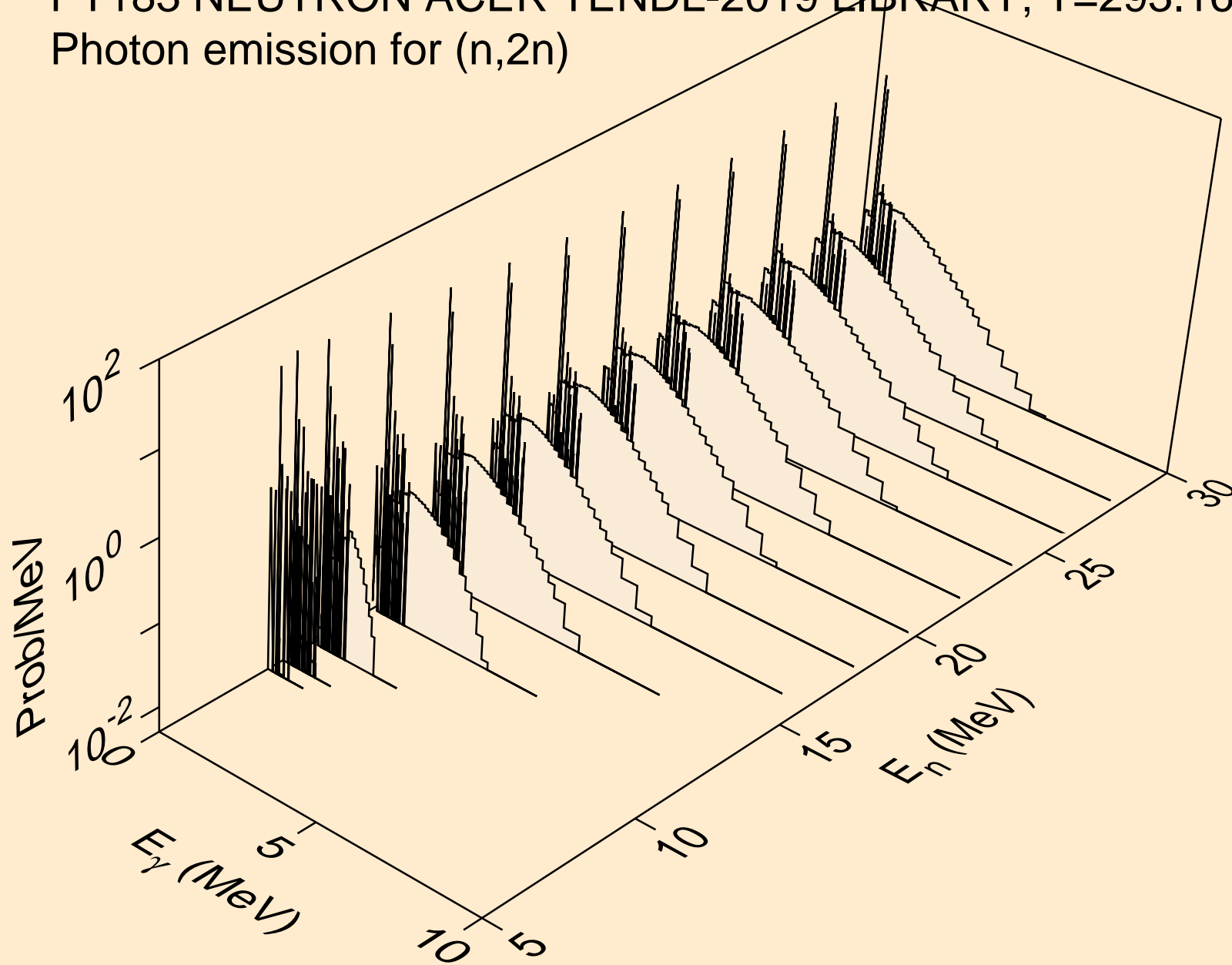

PT183 NEUTRON ACER TENDL-2019 LIBRARY; T=293.16K  
Photon emission for (n,3n)

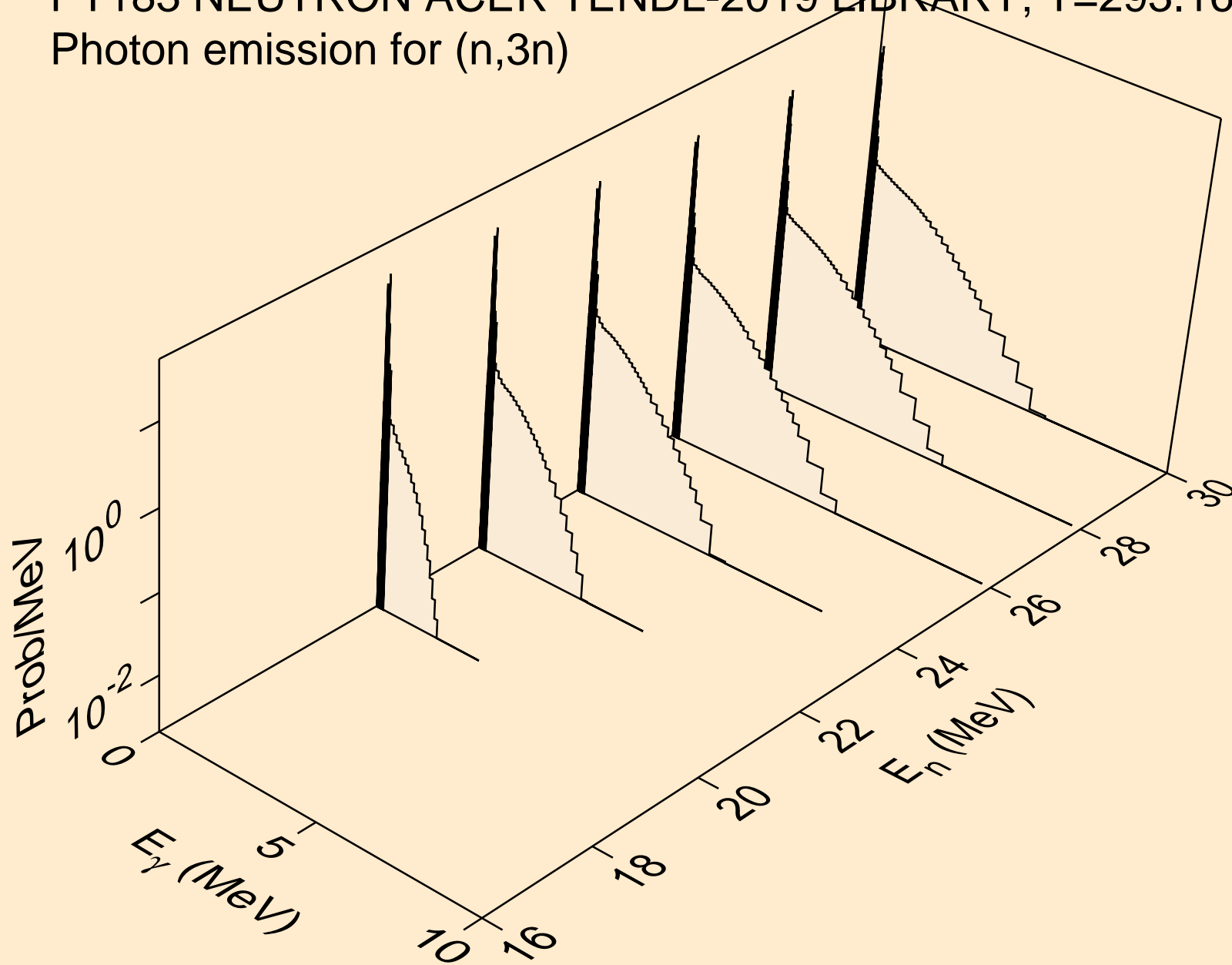

PT183 NEUTRON ACER TENDL-2019 LIBRARY; T=293.16K  
Photon emission for (n,n\*)a

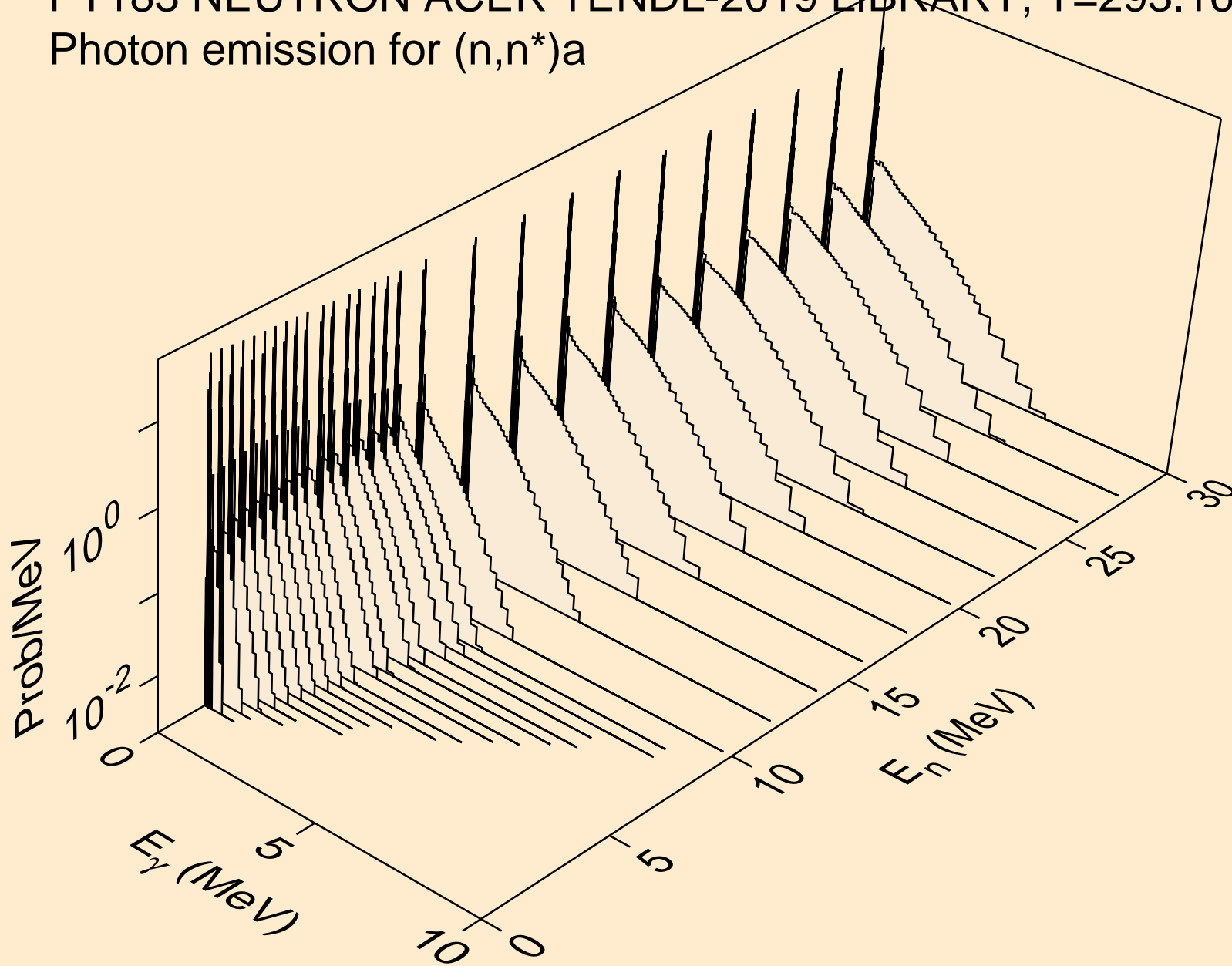

PT183 NEUTRON ACER TENDL-2019 LIBRARY; T=293.16K  
Photon emission for (n,2n)a

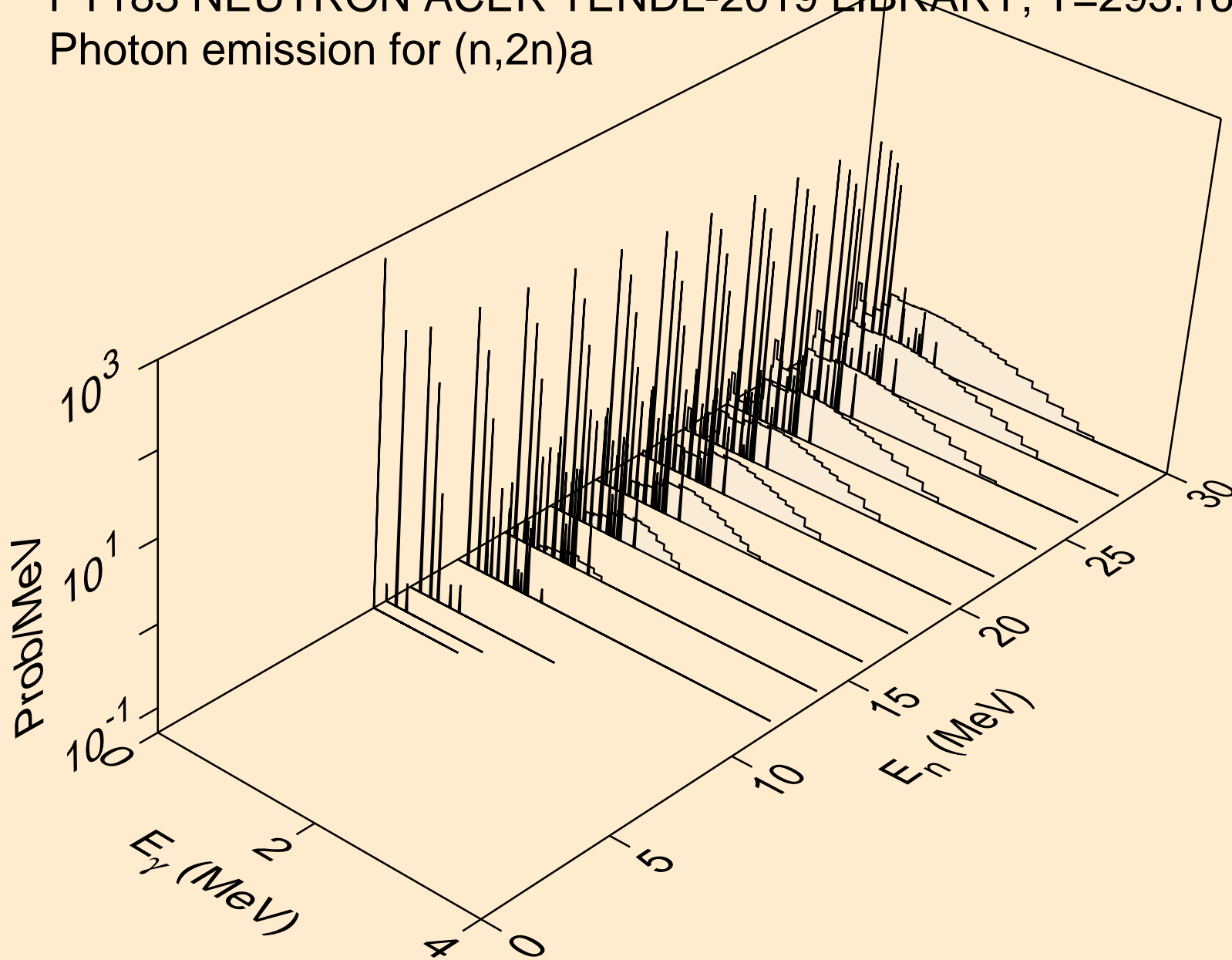



PT183 NEUTRON ACER TENDL-2019 LIBRARY; T=293.16K  
Photon emission for (n,3n)a

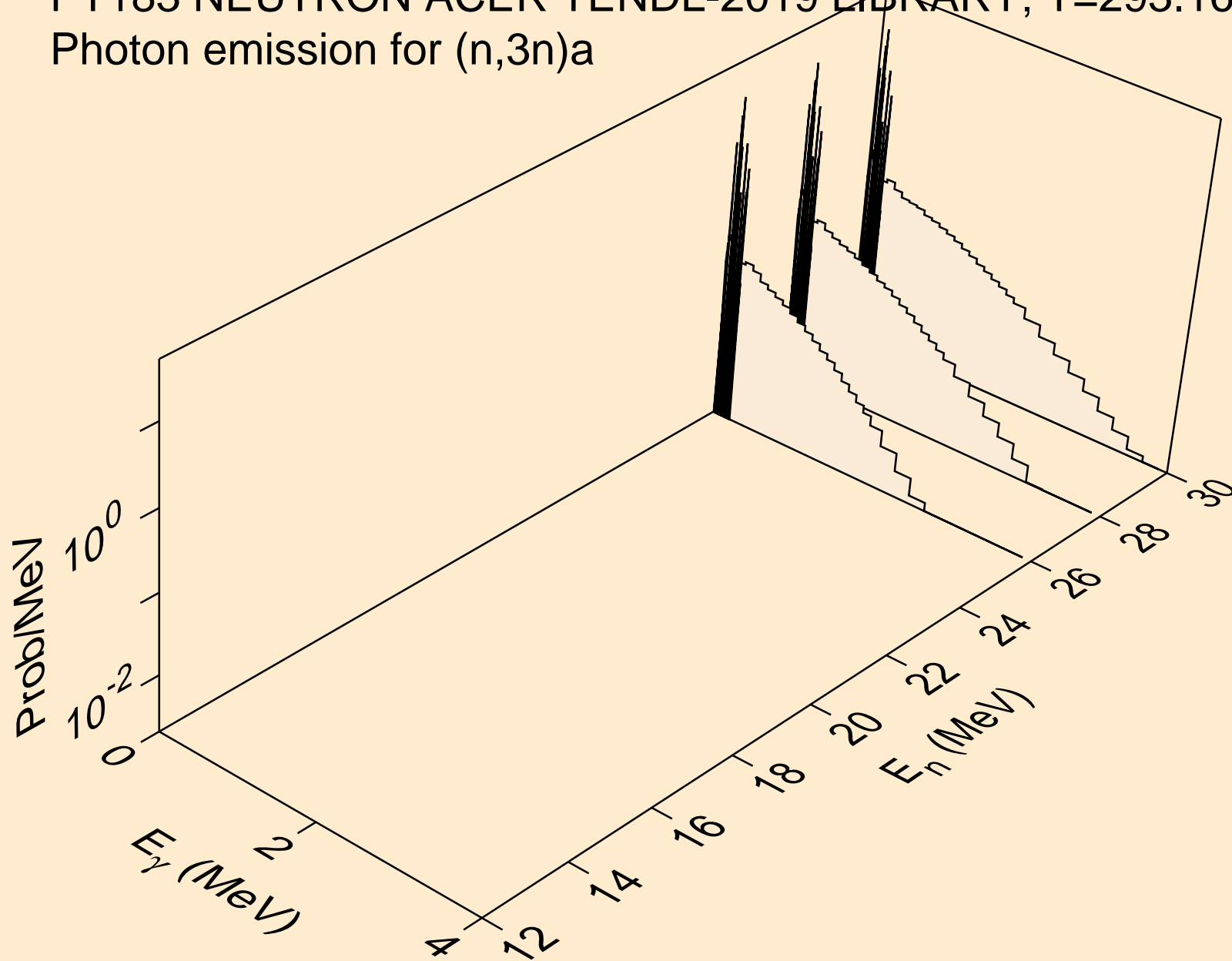

PT183 NEUTRON ACER TENDL-2019 LIBRARY; T=293.16K  
Photon emission for (n,n\*)p

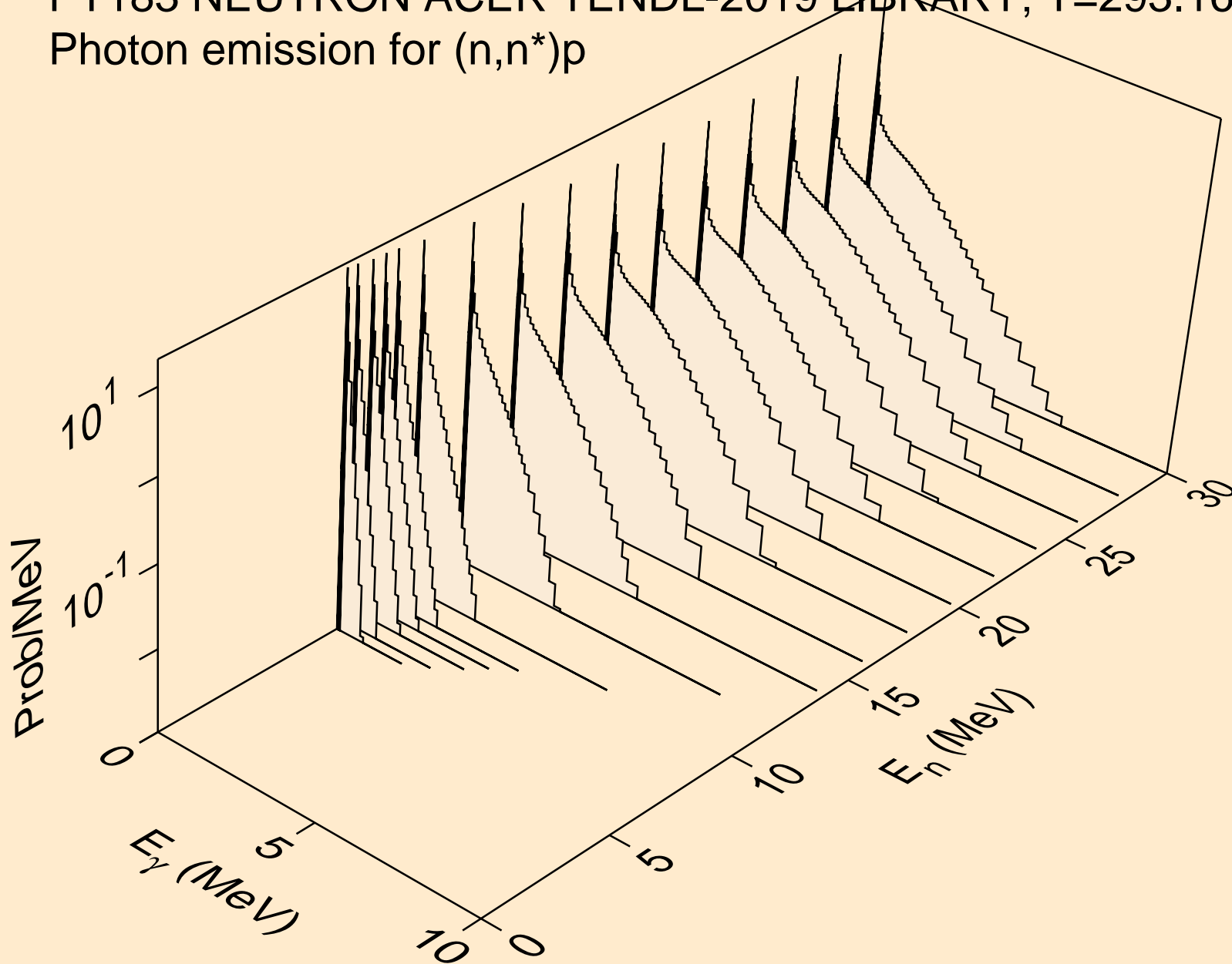

PT183 NEUTRON ACER TENDL-2019 LIBRARY; T=293.16K  
Photon emission for (n,n\*)2a

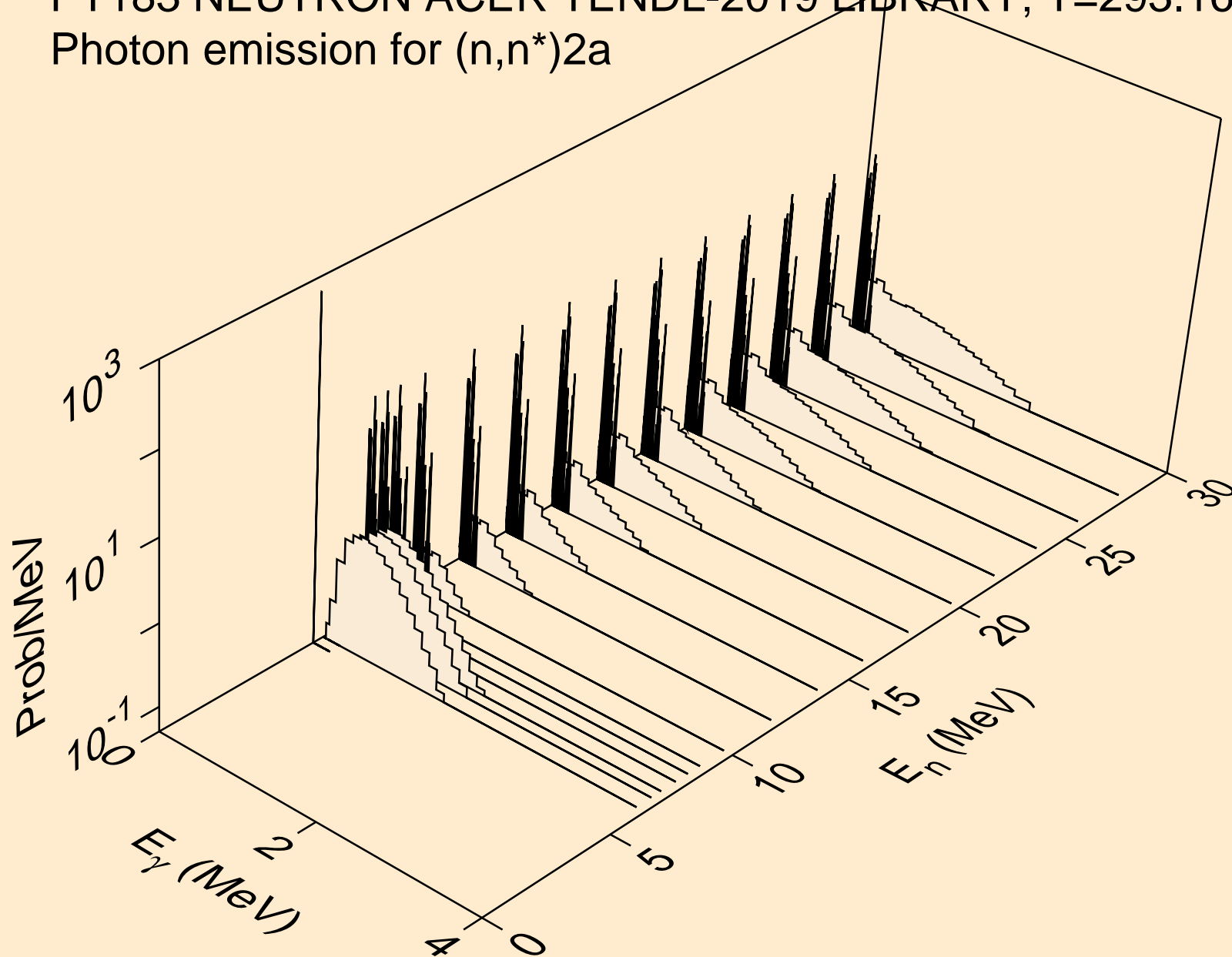

PT183 NEUTRON ACER TENDL-2019 LIBRARY; T=293.16K  
Photon emission for (n,2n)2a

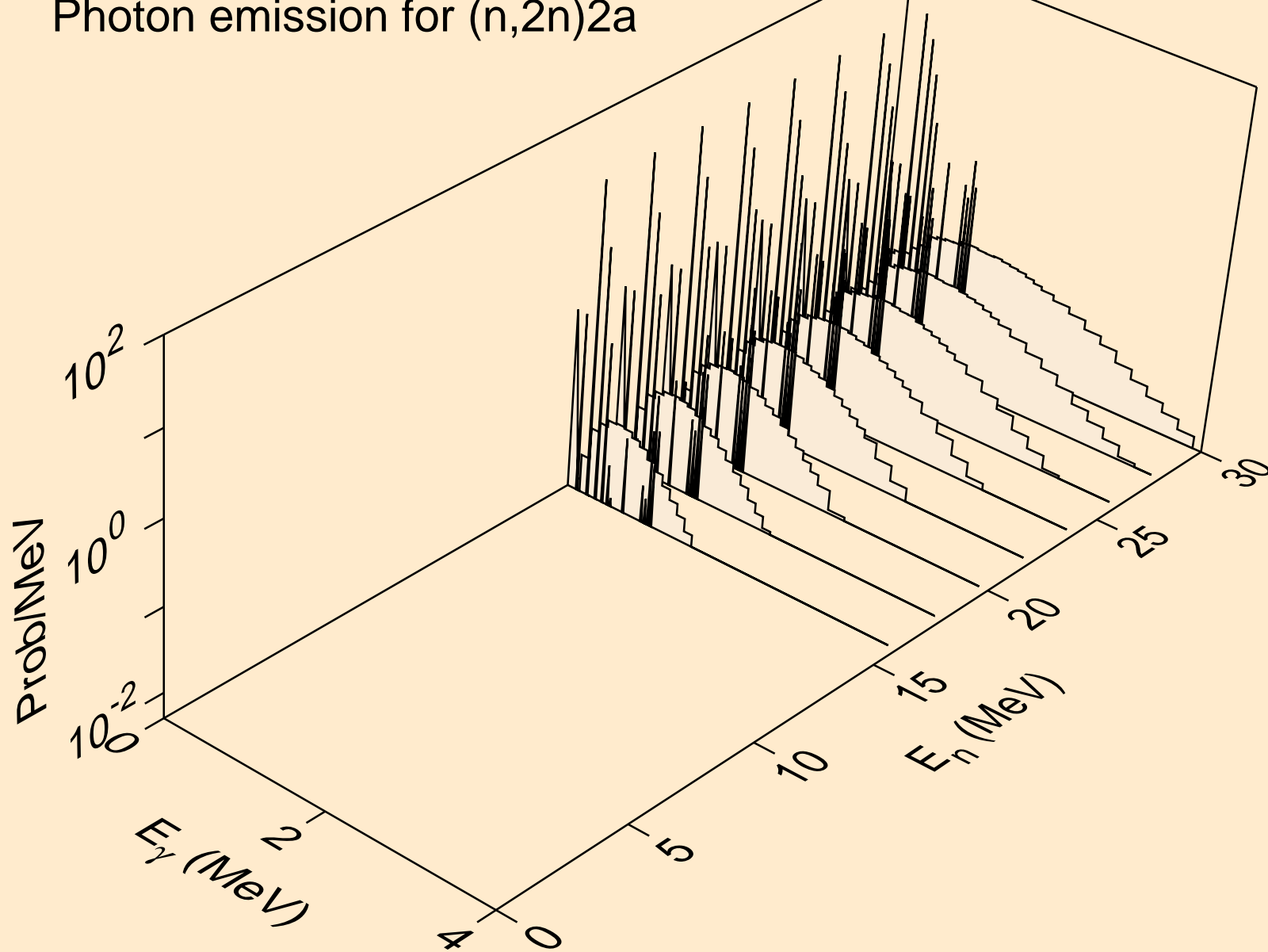

PT183 NEUTRON ACER TENDL-2019 LIBRARY; T=293.16K  
Photon emission for (n,n\*)d

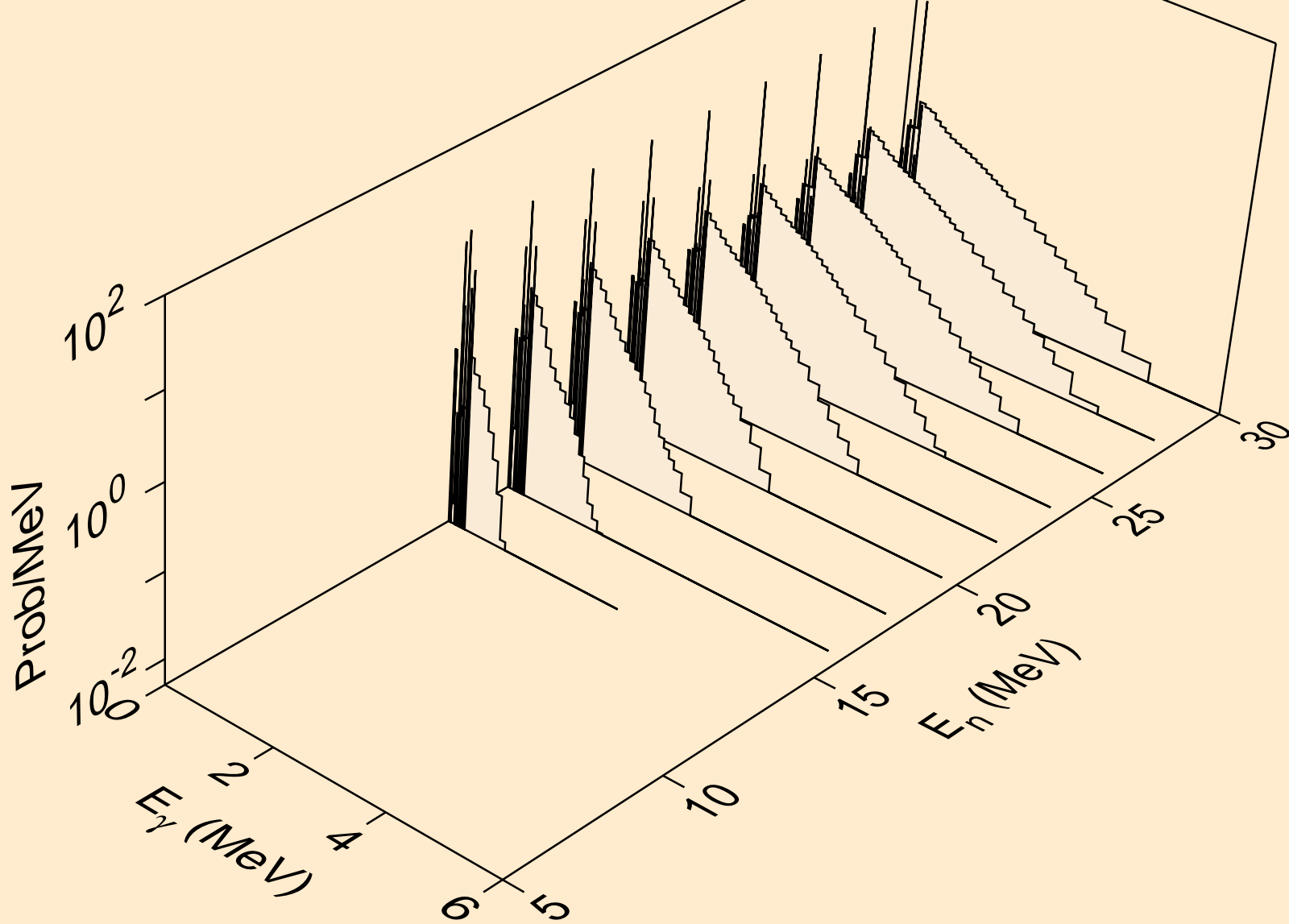

PT183 NEUTRON ACER TENDL-2019 LIBRARY; T=293.16K  
Photon emission for (n,n\*)t

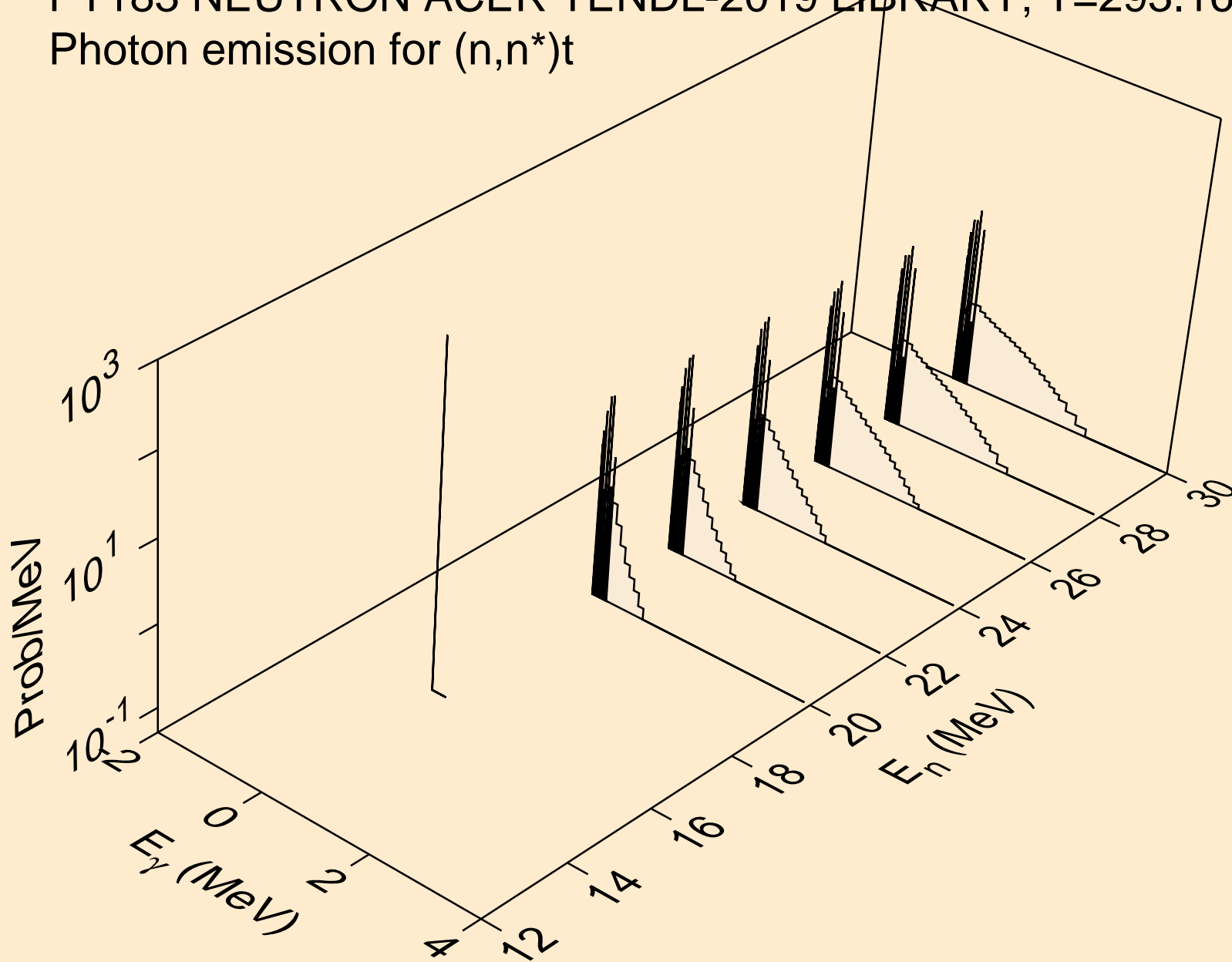

PT183 NEUTRON ACER TENDL-2019 LIBRARY; T=293.16K  
Photon emission for (n,n\*)he3

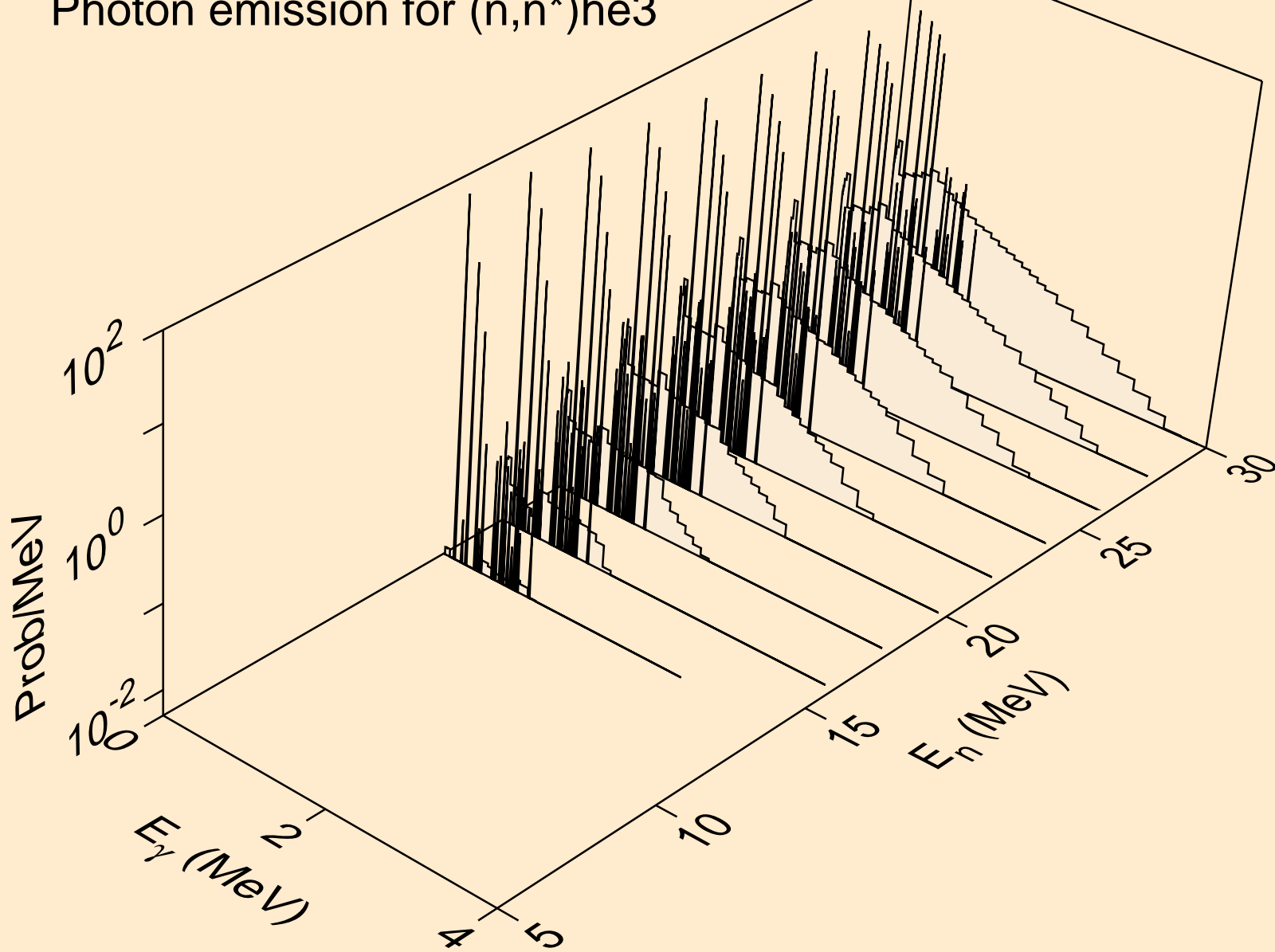

PT183 NEUTRON ACER TENDL-2019 LIBRARY; T=293.16K  
Photon emission for (n,4n)

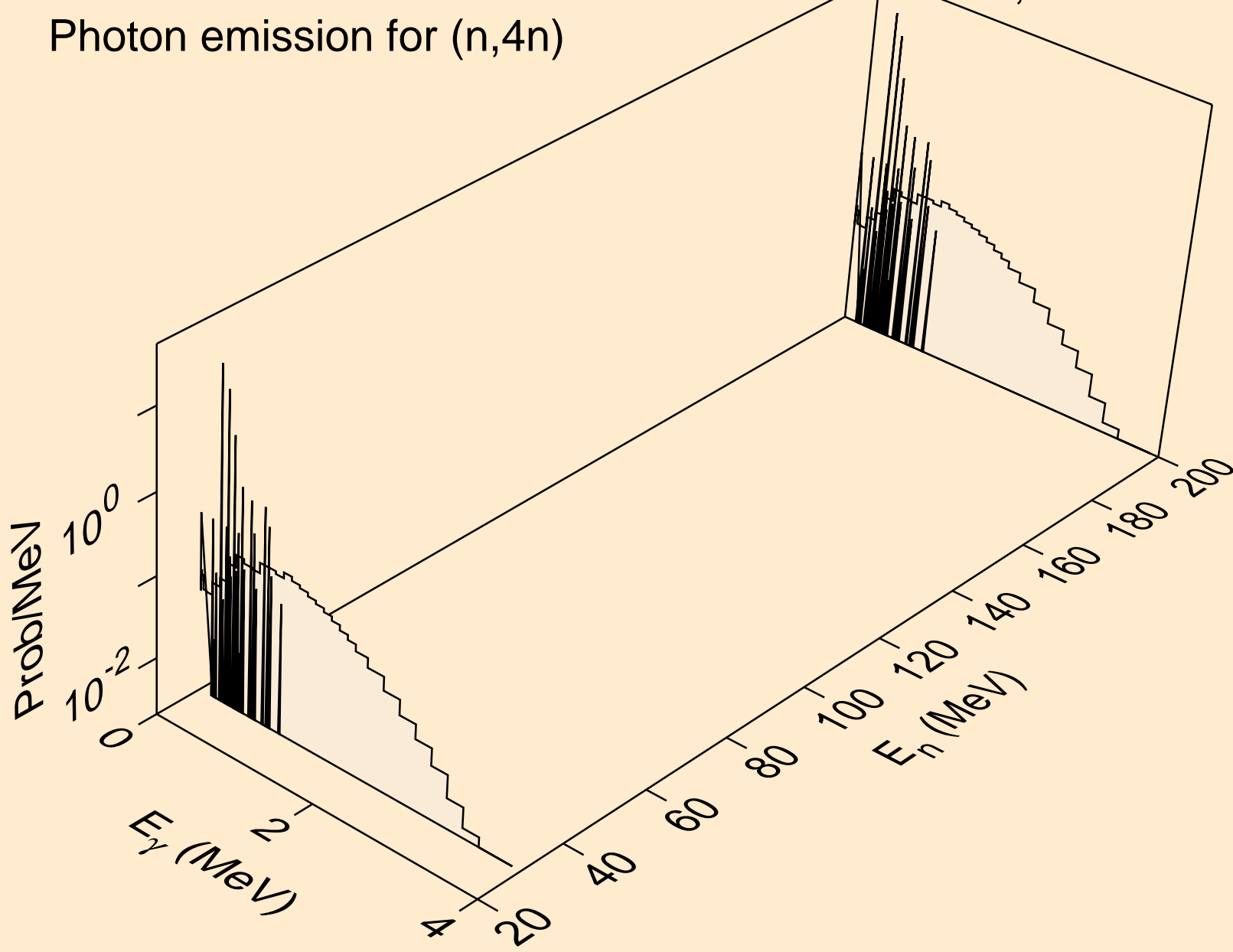



PT183 NEUTRON ACER TENDL-2019 LIBRARY; T=293.16K  
Photon emission for (n,2np)

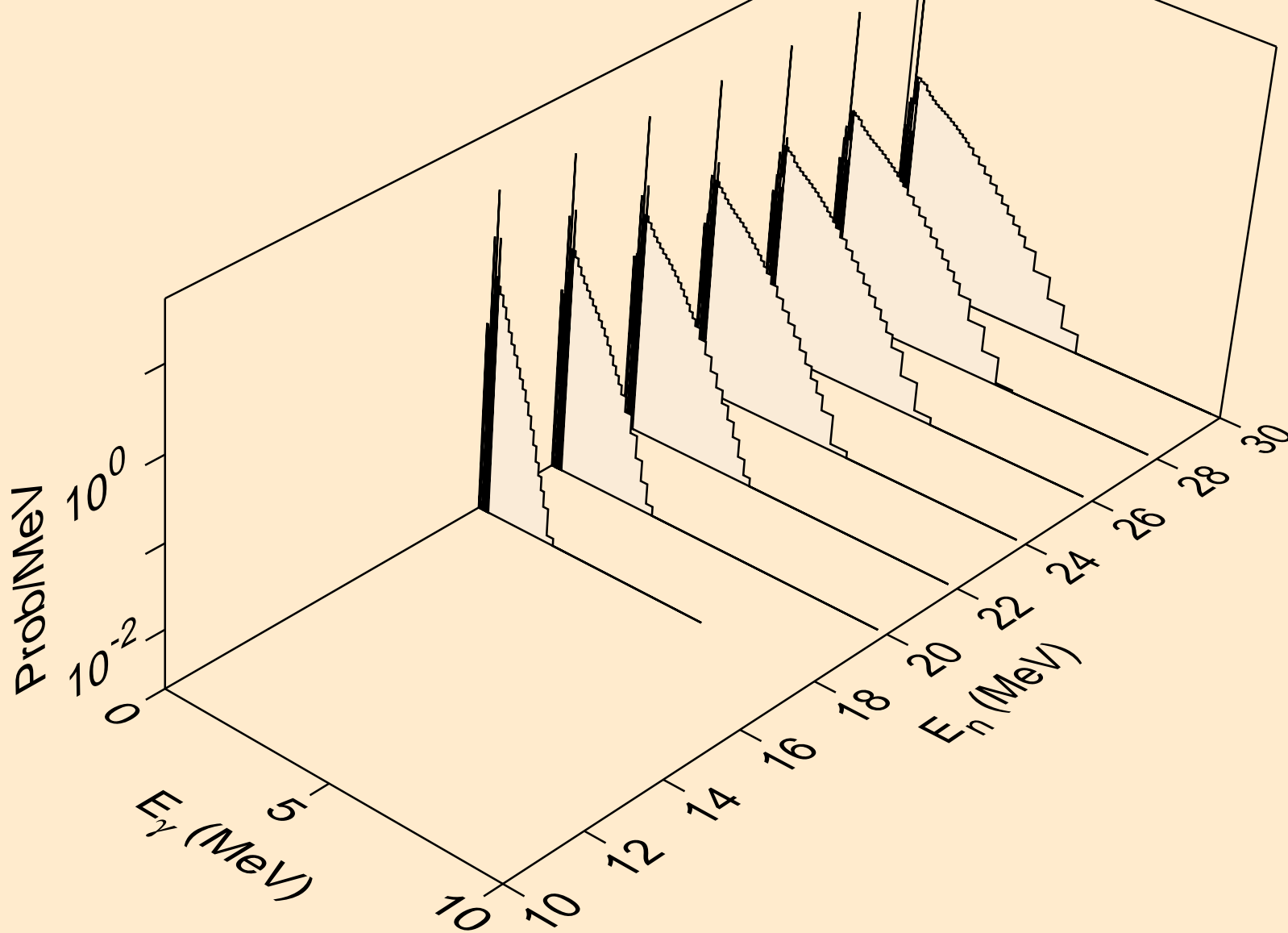

PT183 NEUTRON ACER TENDL-2019 LIBRARY; T=293.16K  
Photon emission for (n,3np)

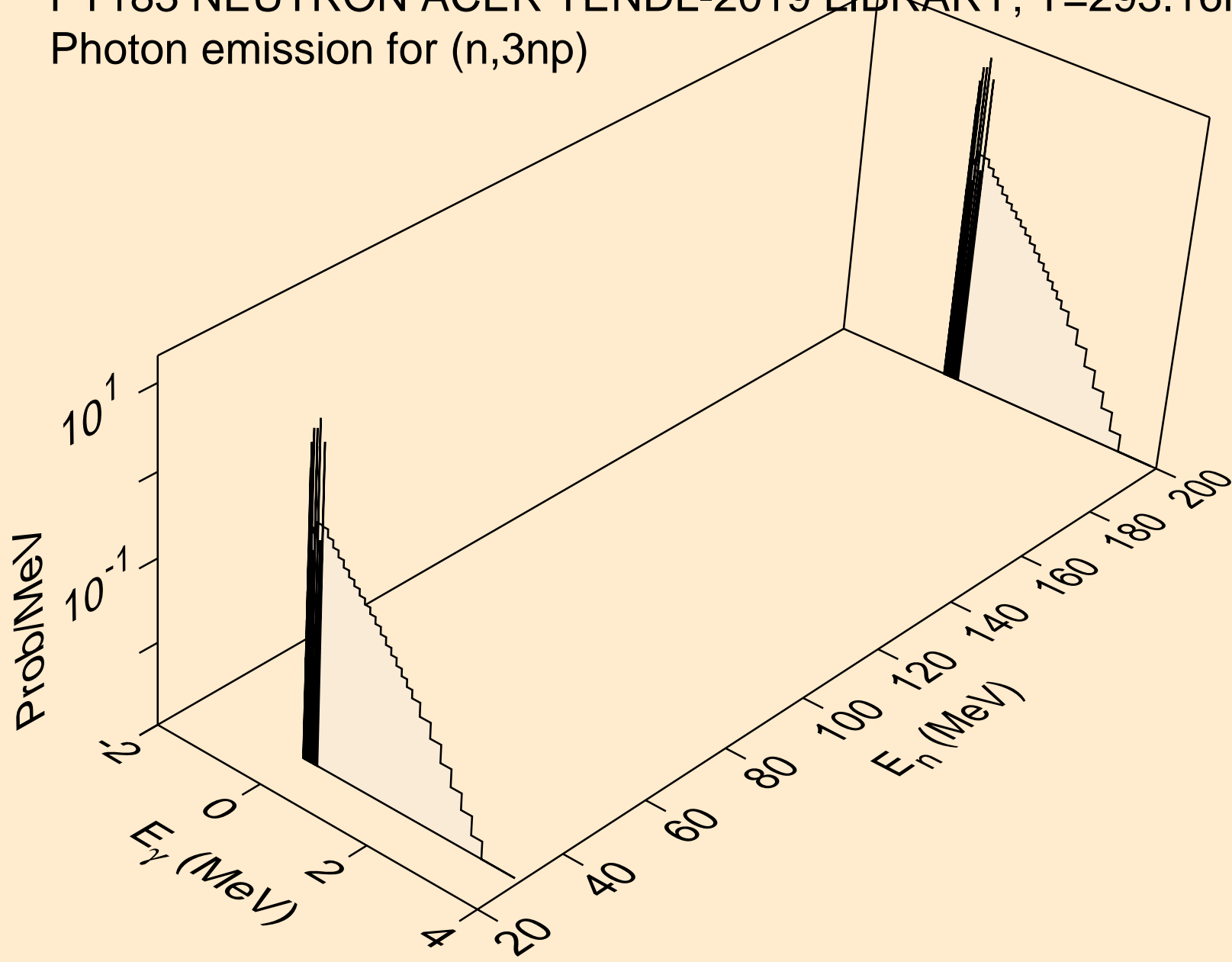

PT183 NEUTRON ACER TENDL-2019 LIBRARY; T=293.16K  
Photon emission for (n,2np)

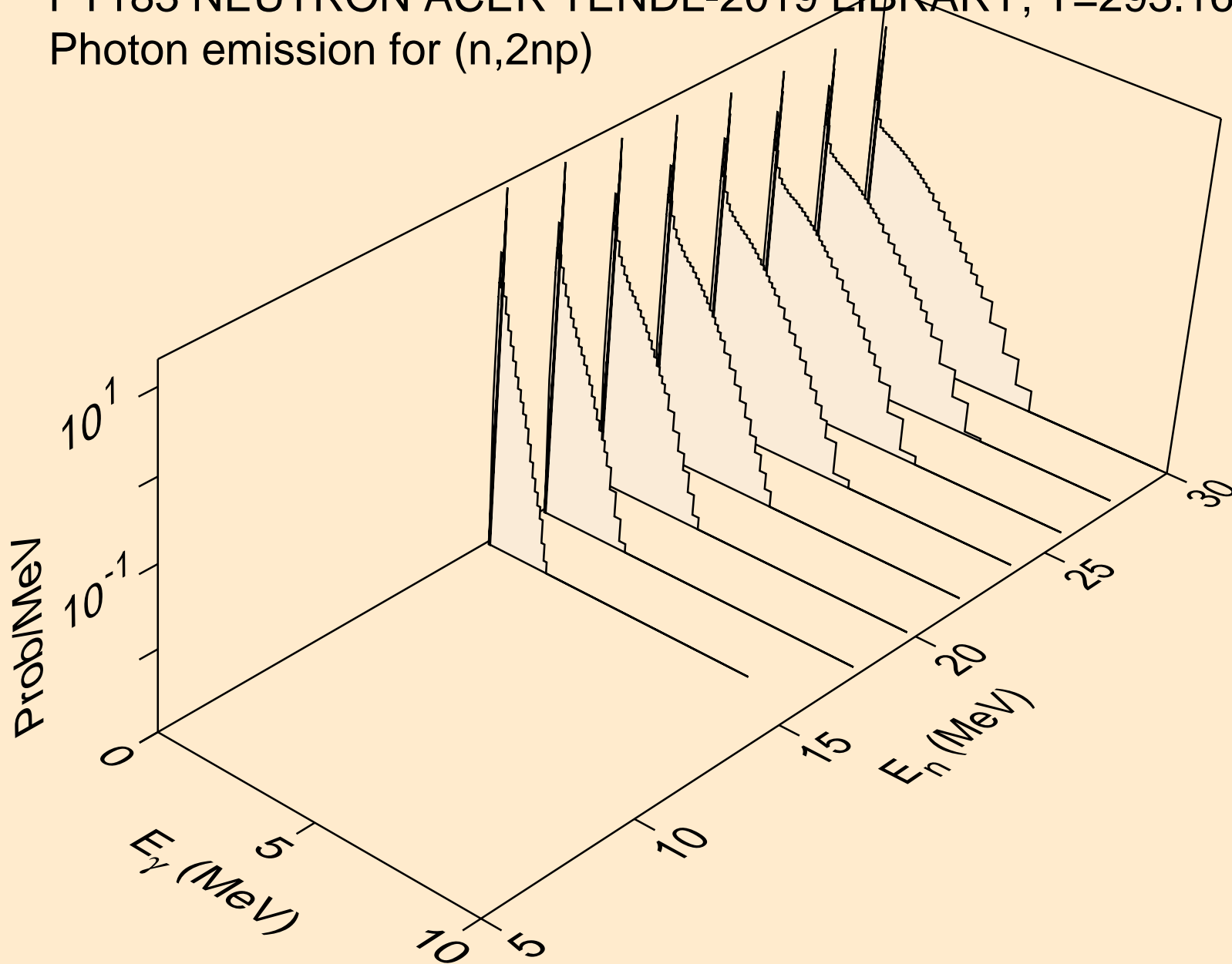

PT183 NEUTRON ACER TENDL-2019 LIBRARY; T=293.16K  
Photon emission for (n,npa)

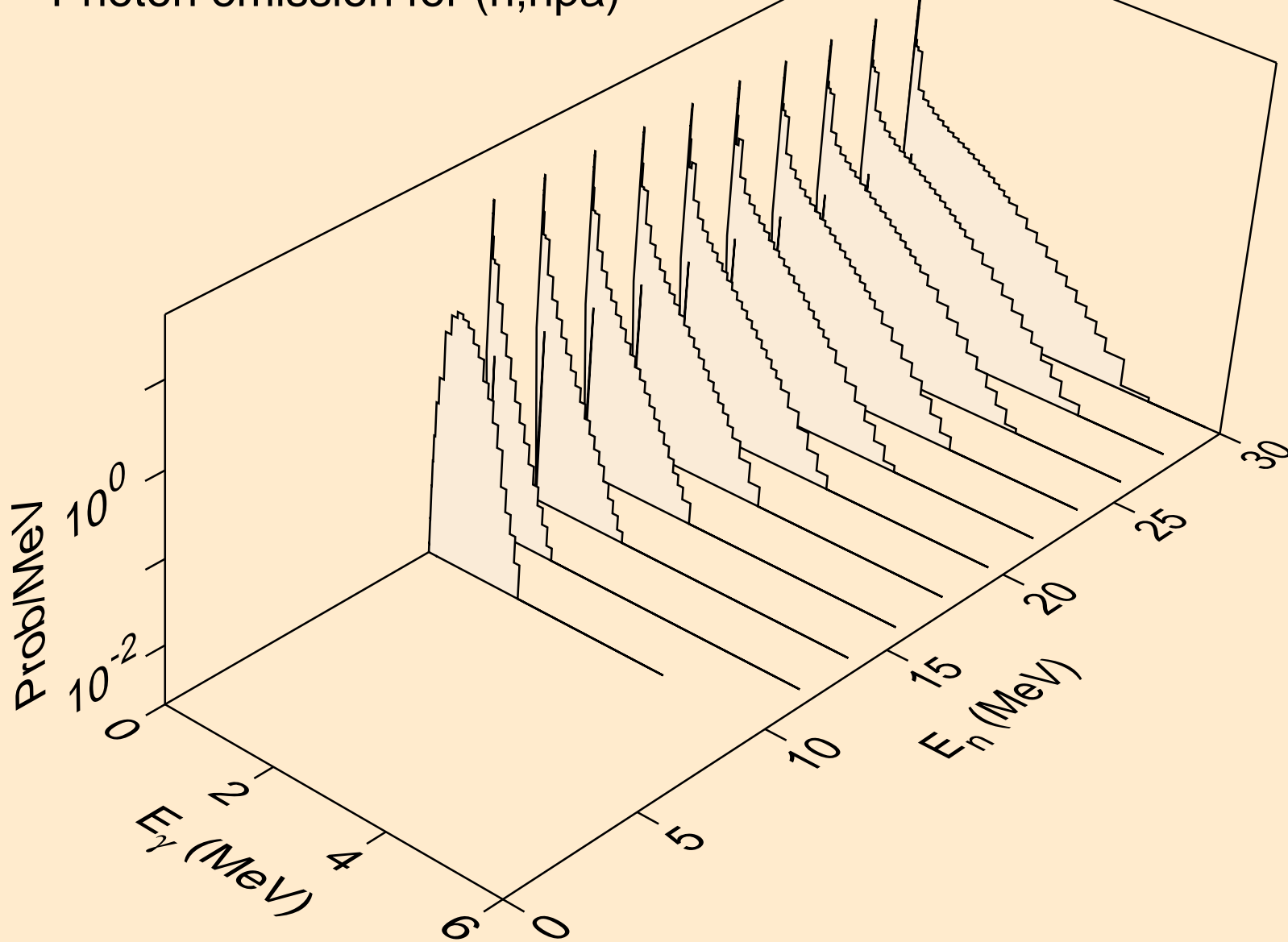

PT183 NEUTRON ACER TENDL-2019 LIBRARY; T=293.16K  
Photon emission for (n,n\*c)

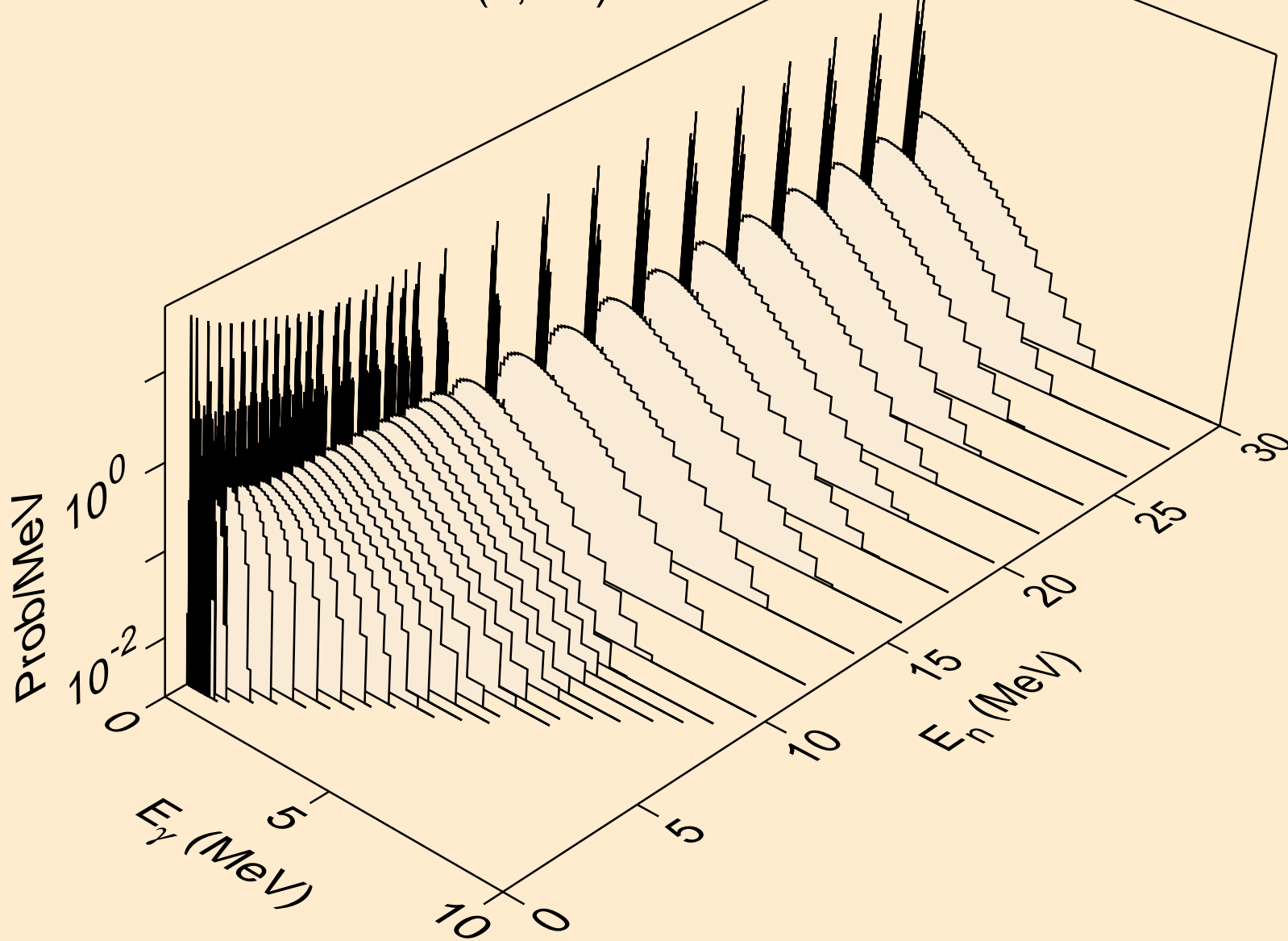

PT183 NEUTRON ACER TENDL-2019 LIBRARY; T=293.16K  
Photon emission for (n,gma)

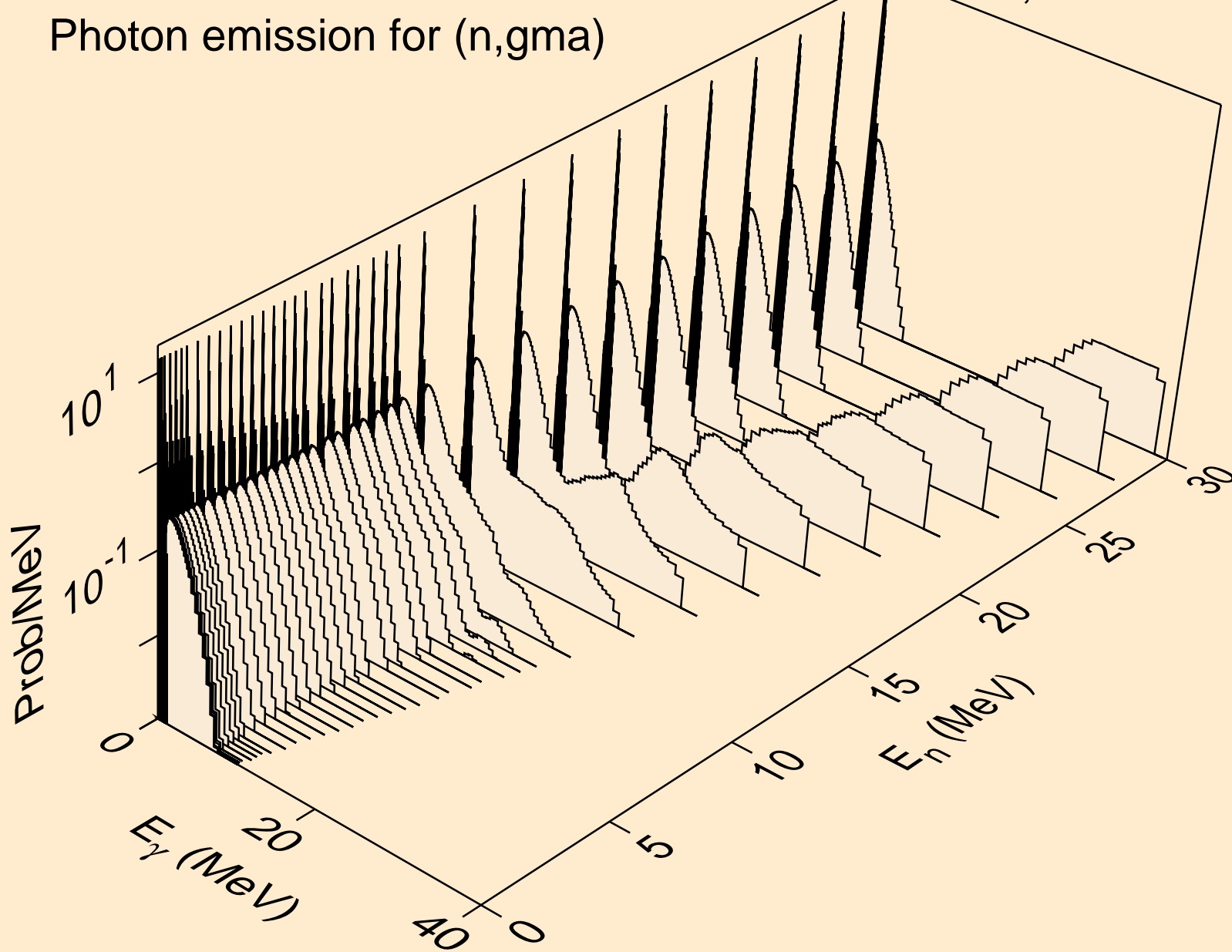

PT183 NEUTRON ACER TENDL-2019 LIBRARY; T=293.16K  
Photon emission for (n,p)

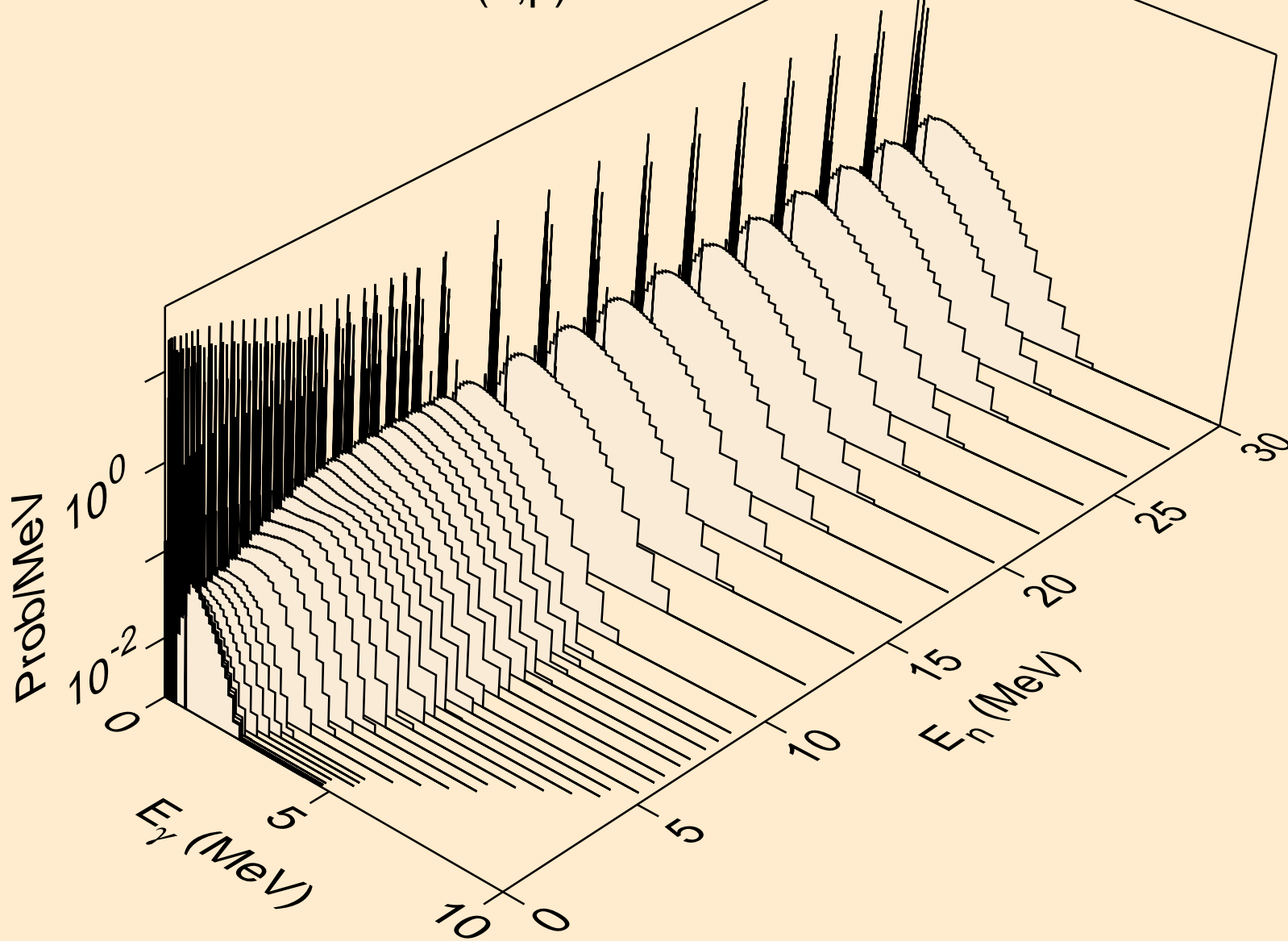

PT183 NEUTRON ACER TENDL-2019 LIBRARY; T=293.16K  
Photon emission for (n,d)

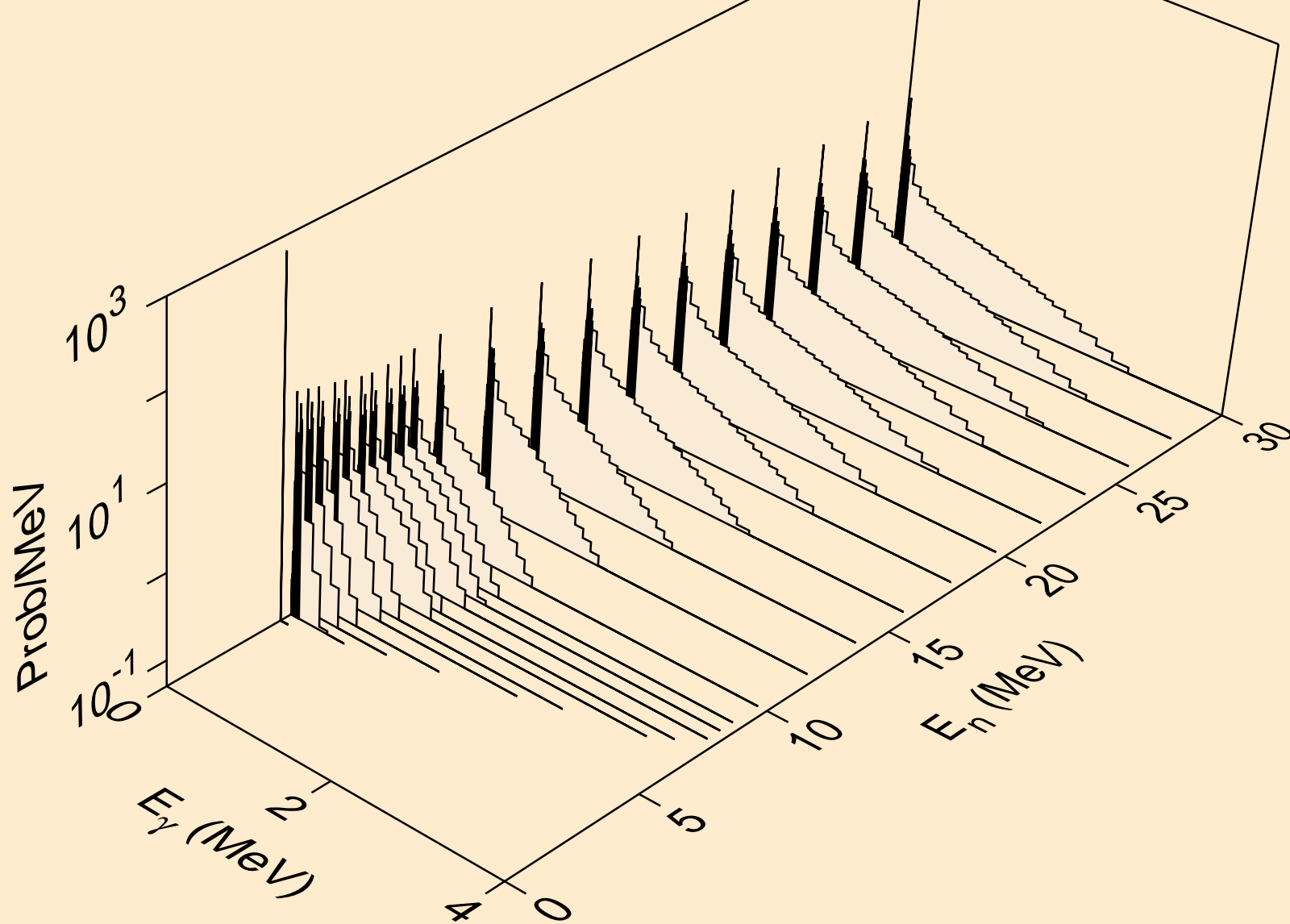



PT183 NEUTRON ACER TENDL-2019 LIBRARY; T=293.16K  
Photon emission for (n,t)

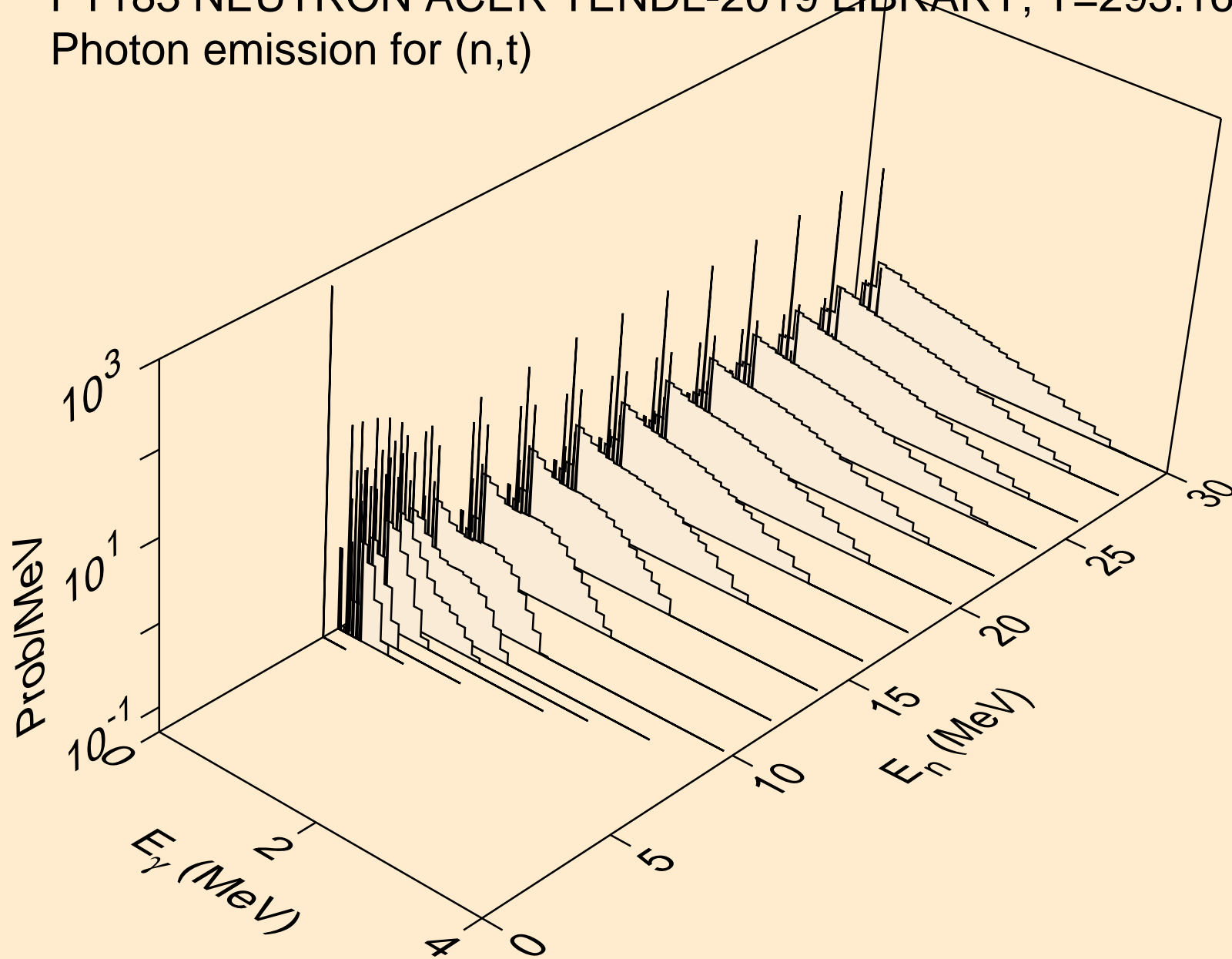

PT183 NEUTRON ACER TENDL-2019 LIBRARY; T=293.16K  
Photon emission for (n,he3)

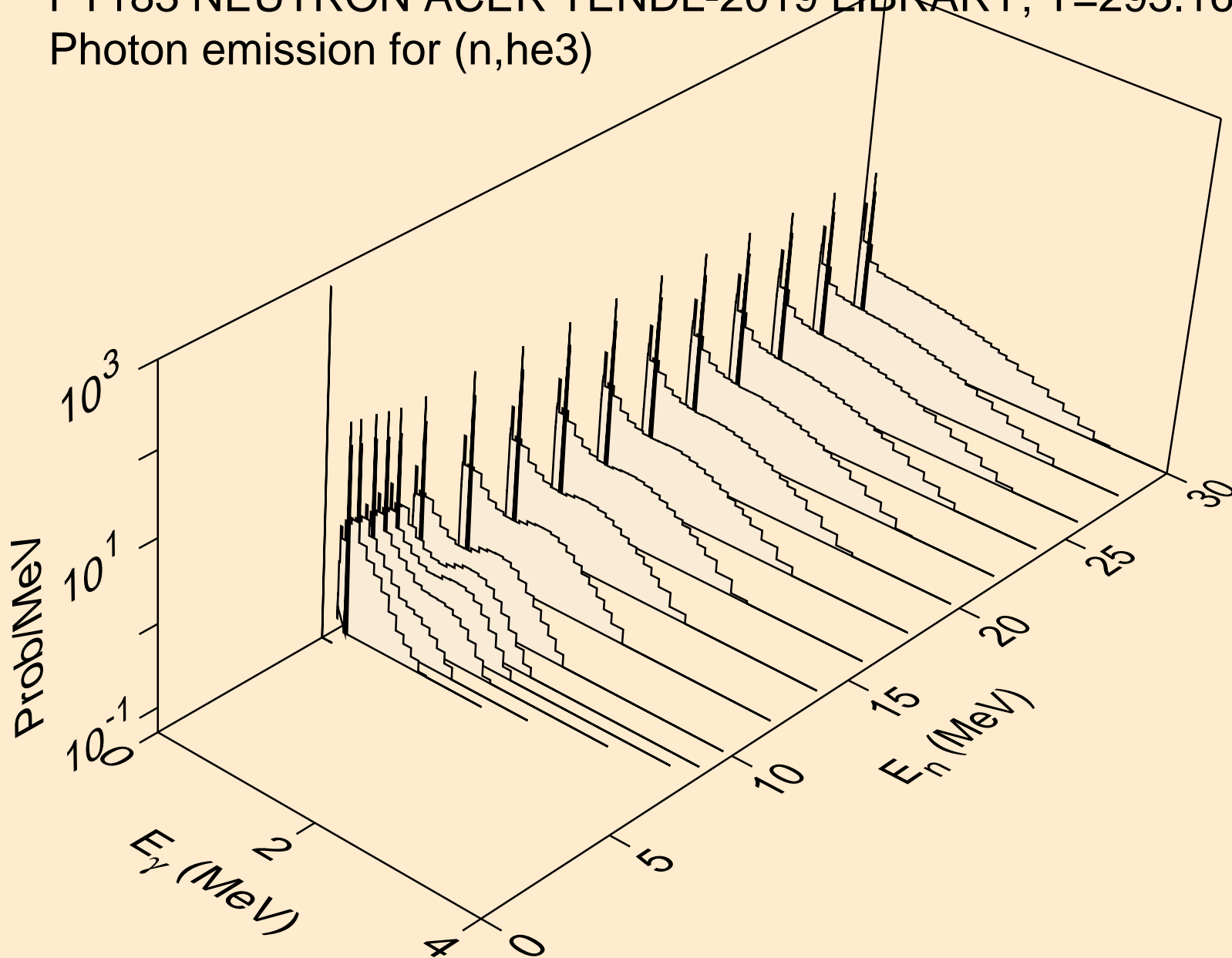

PT183 NEUTRON ACER TENDL-2019 LIBRARY; T=293.16K  
Photon emission for (n,a)

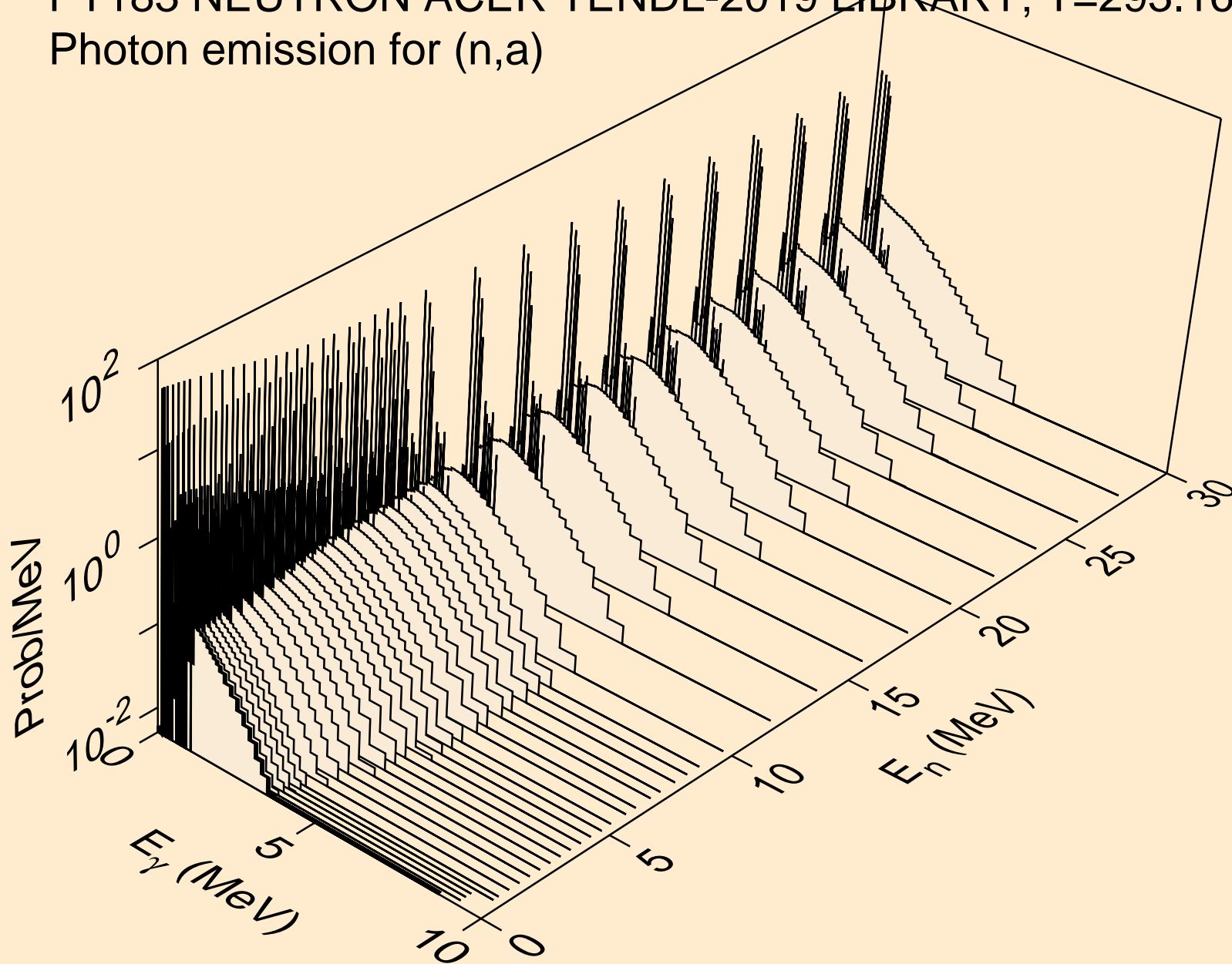

PT183 NEUTRON ACER TENDL-2019 LIBRARY; T=293.16K  
Photon emission for (n,2a)

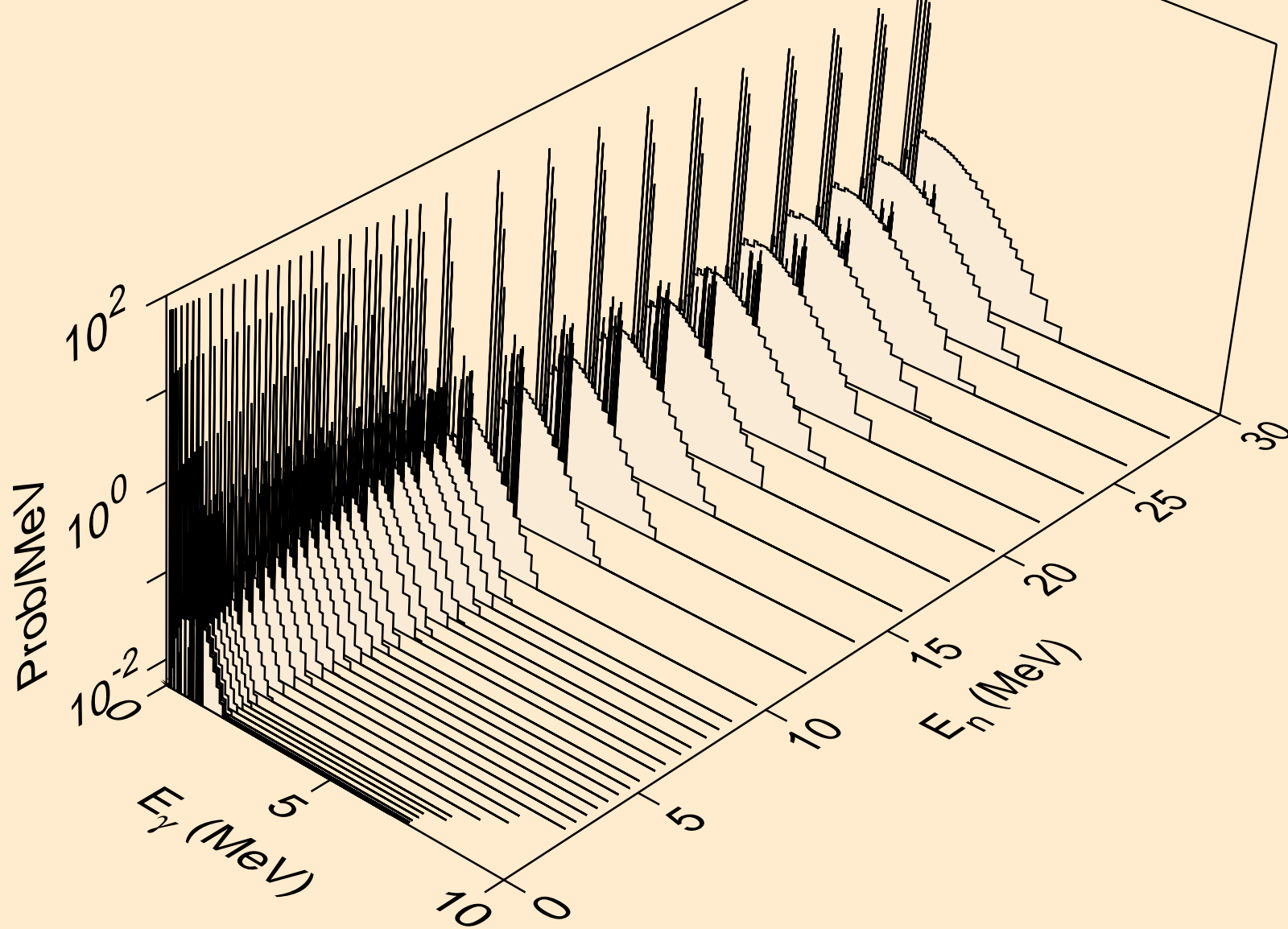

PT183 NEUTRON ACER TENDL-2019 LIBRARY; T=293.16K  
Photon emission for (n,2p)

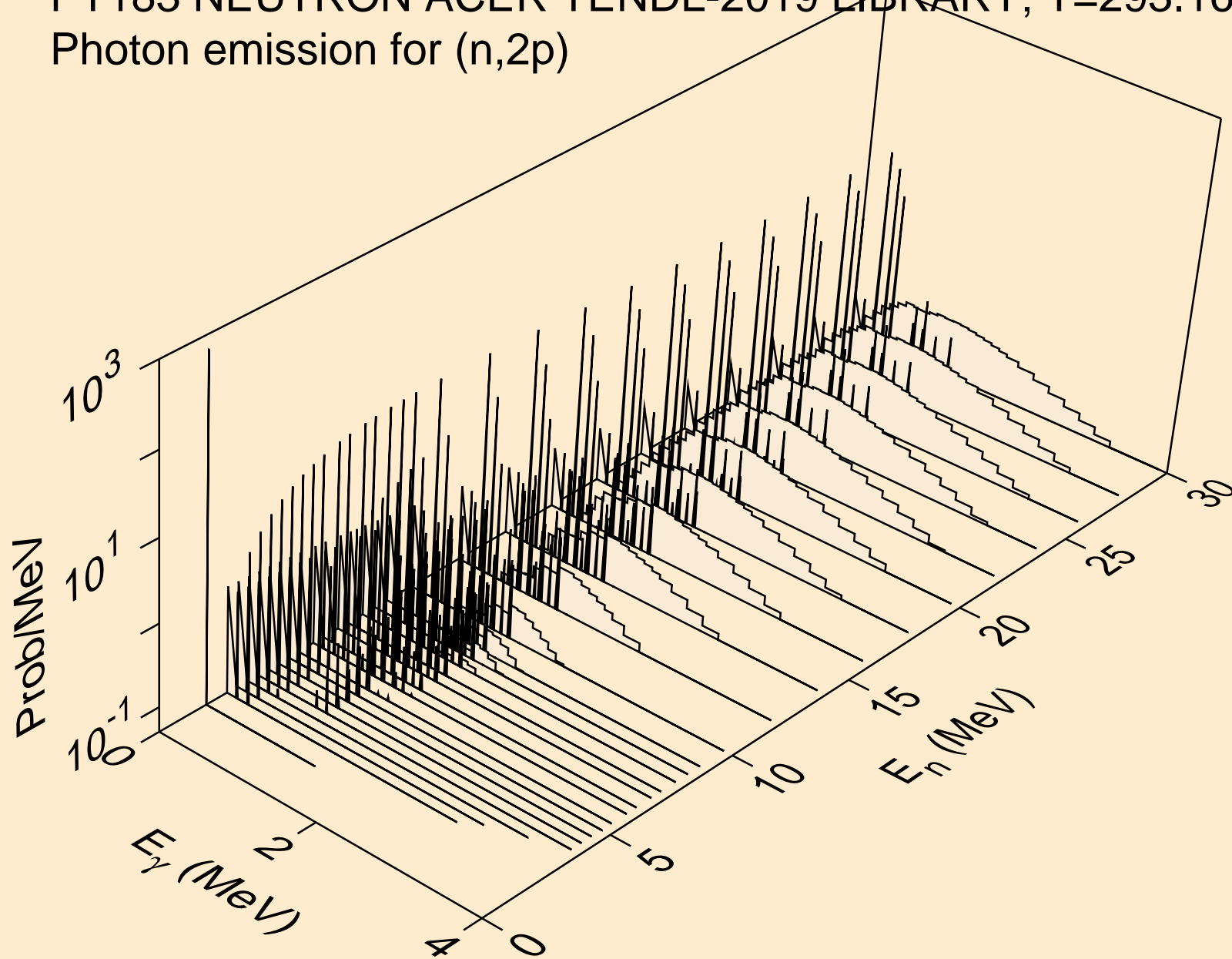

PT183 NEUTRON ACER TENDL-2019 LIBRARY; T=293.16K  
Photon emission for (n,p)

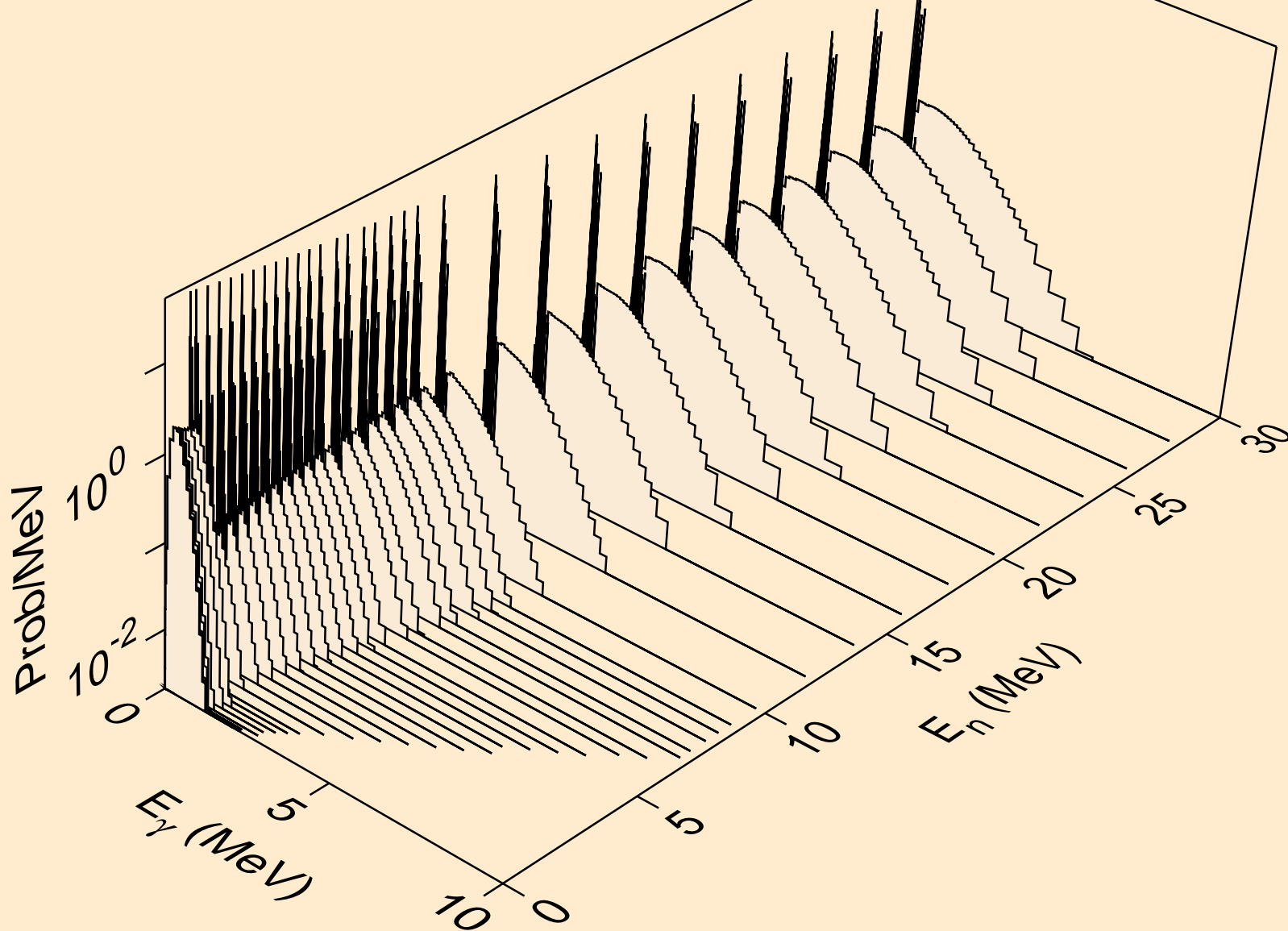

PT183 NEUTRON ACER TENDL-2019 LIBRARY; T=293.16K  
Photon emission for (n,pd)

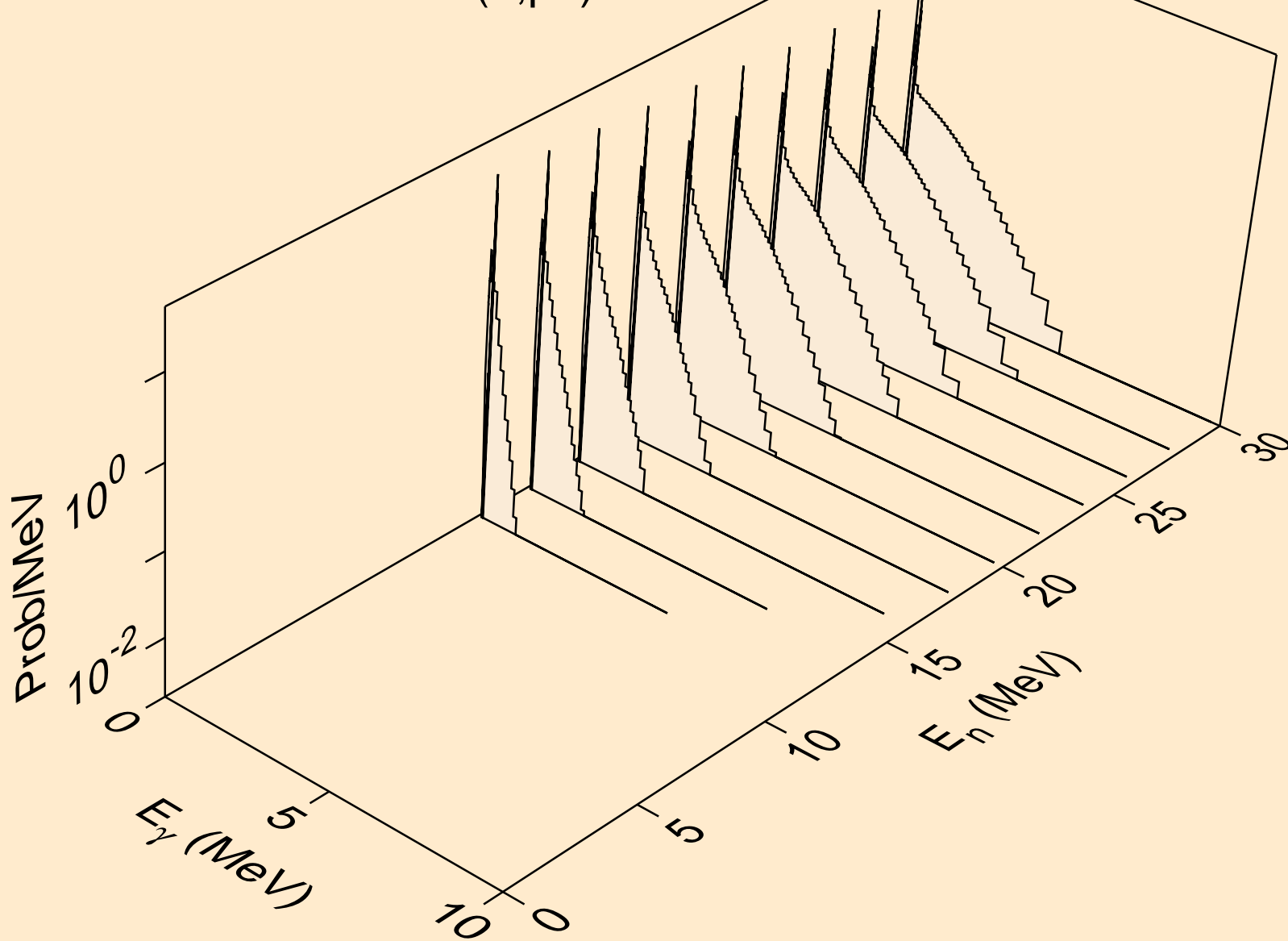

PT183 NEUTRON ACER TENDL-2019 LIBRARY; T=293.16K  
Photon emission for (n,pt)

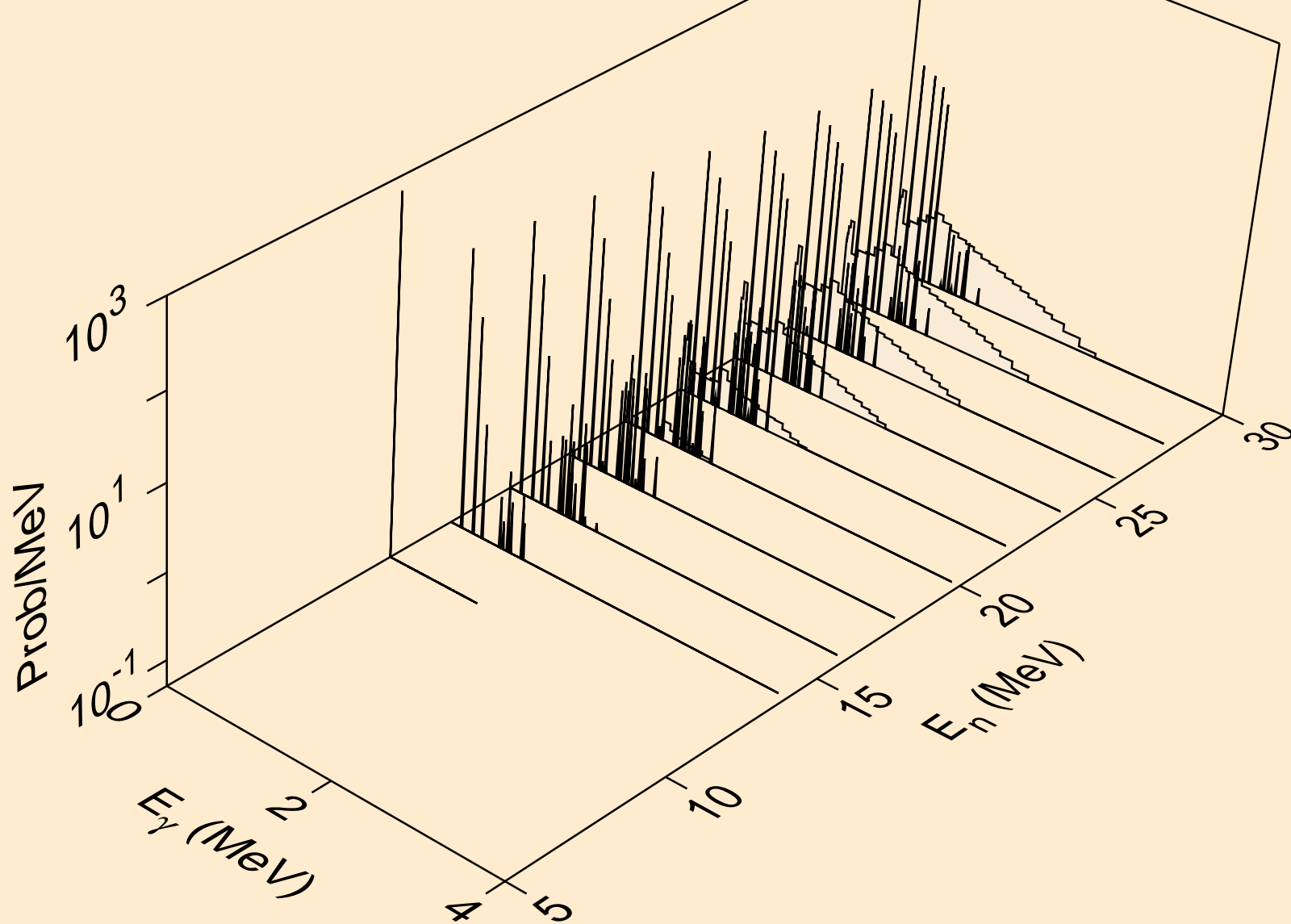



PT183 NEUTRON ACER TENDL-2019 LIBRARY; T=293.16K  
Photon emission for (n,da)

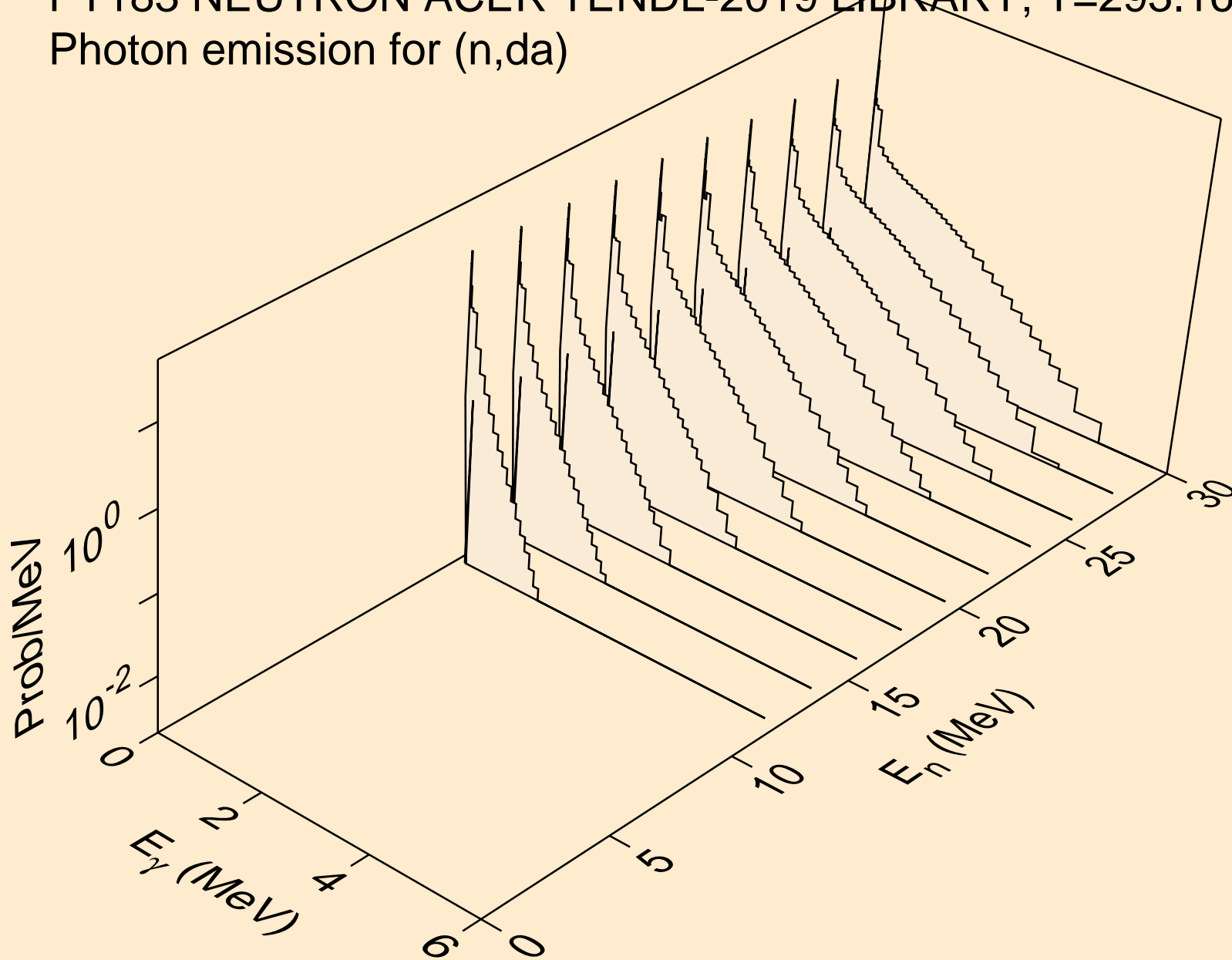

PT183 NEUTRON ACER TENDL-2019 LIBRARY; T=293.16K  
thermal capture photon spectrum

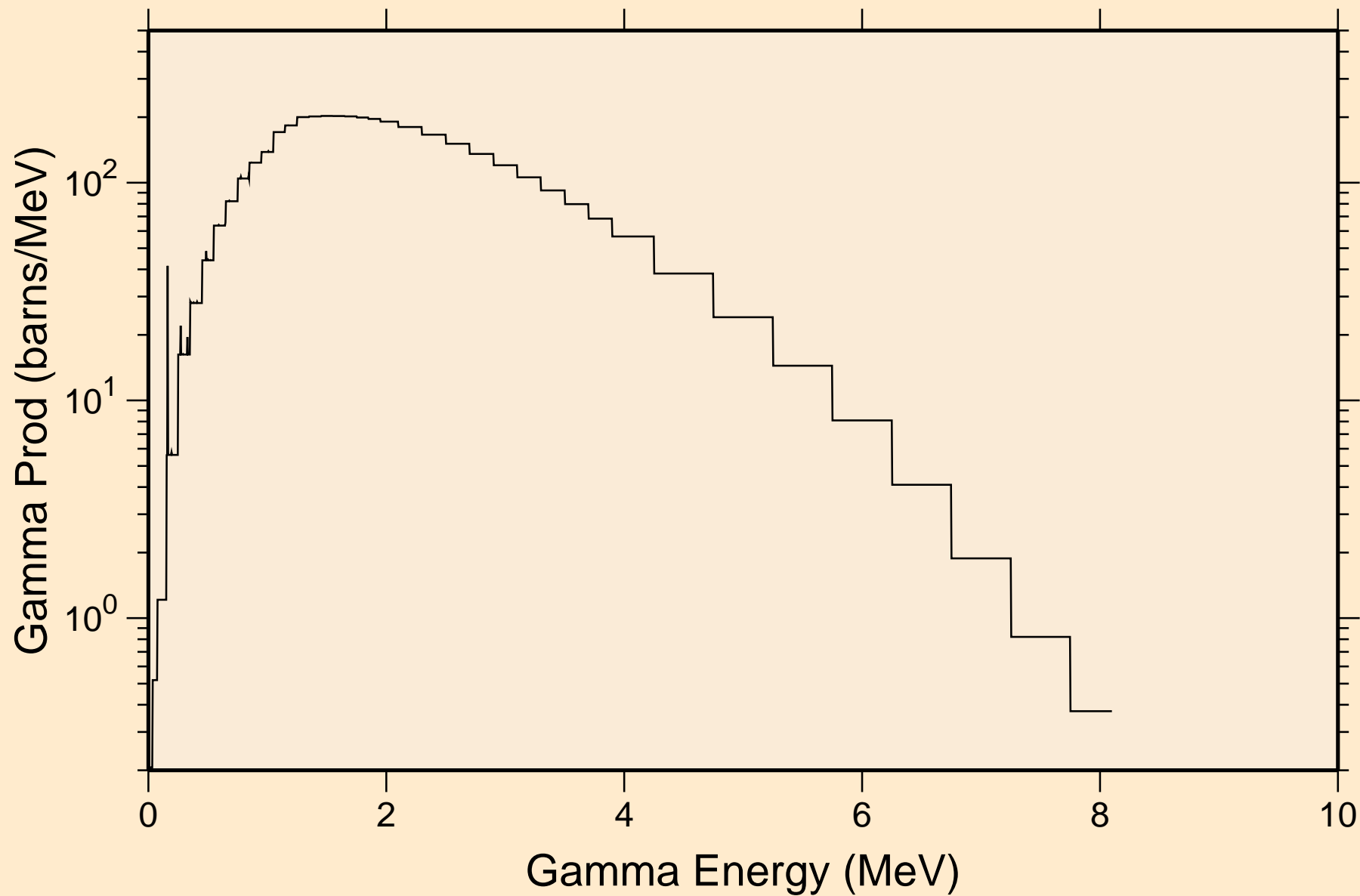

PT183 NEUTRON ACER TENDL-2019 LIBRARY; T=293.16K  
14 MeV photon spectrum

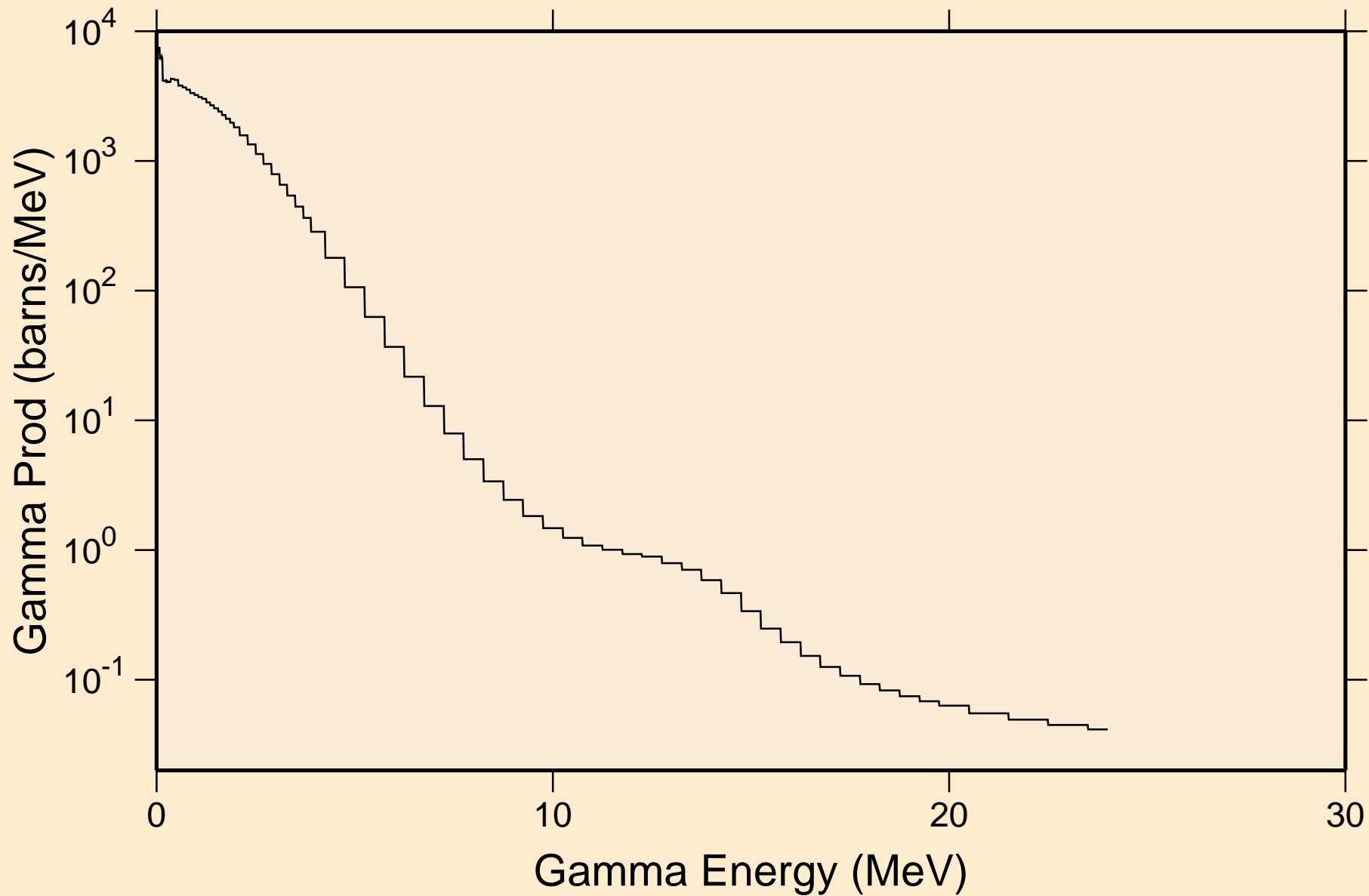

PT183 NEUTRON ACER TENDL-2019 LIBRARY; T=293.16K  
Particle heating contributions

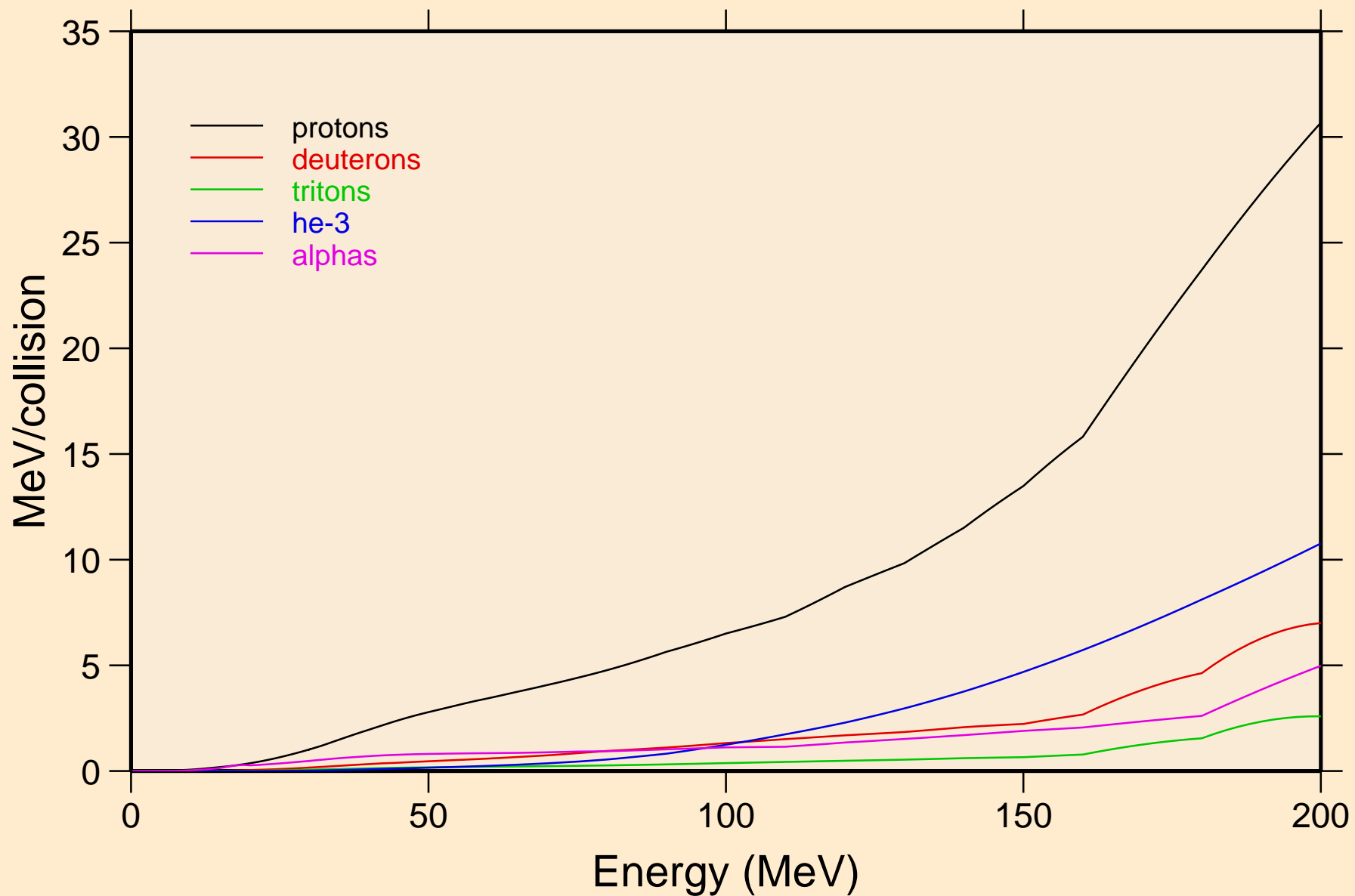

PT183 NEUTRON ACER TENDL-2019 LIBRARY; T=293.16K  
Recoil Heating

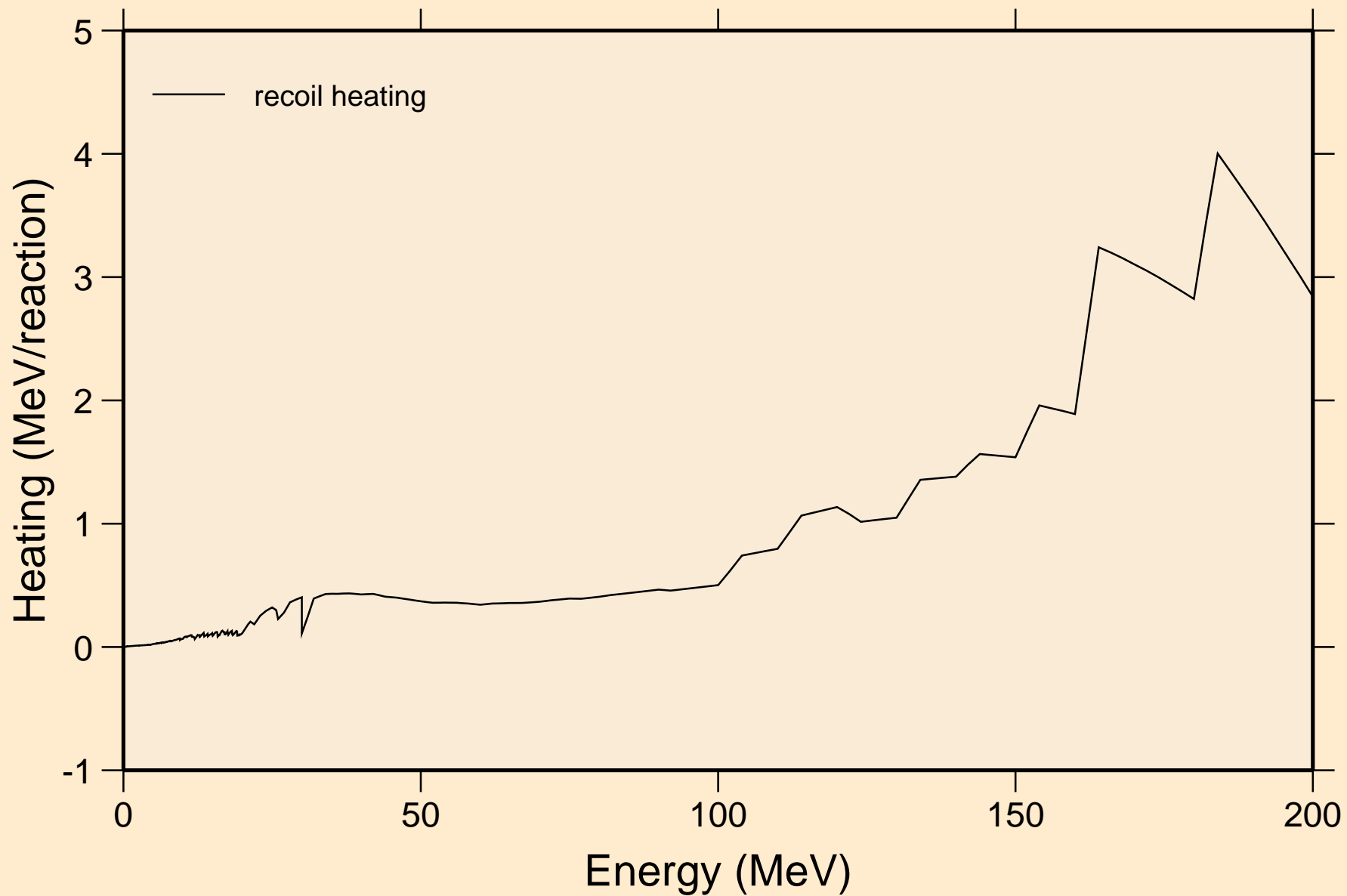

PT183 NEUTRON ACER TENDL-2019 LIBRARY; T=293.16K  
Particle production cross sections

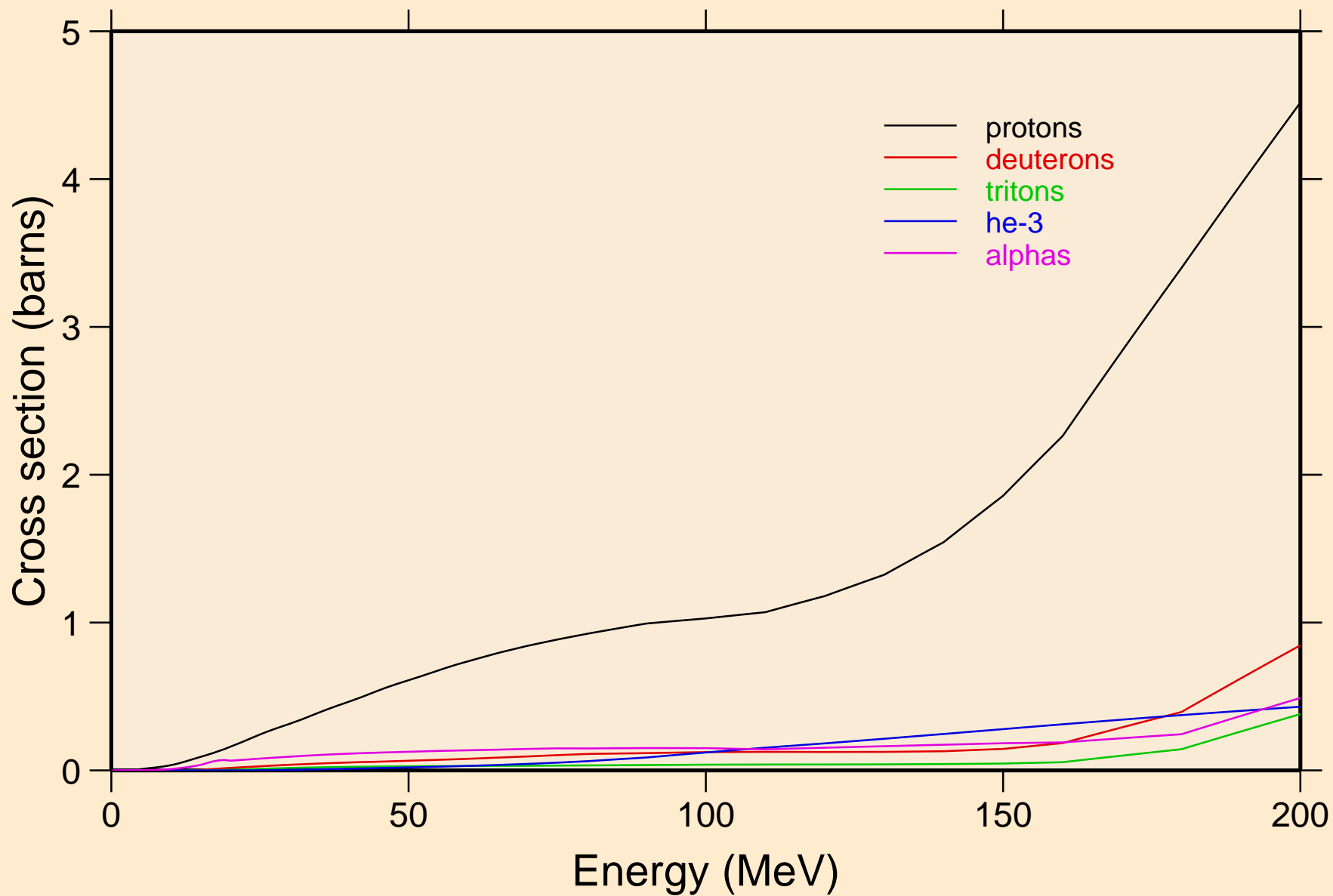

PT183 NEUTRON ACER TENDL-2019 LIBRARY; T=293.16K  
protons from (n,x)

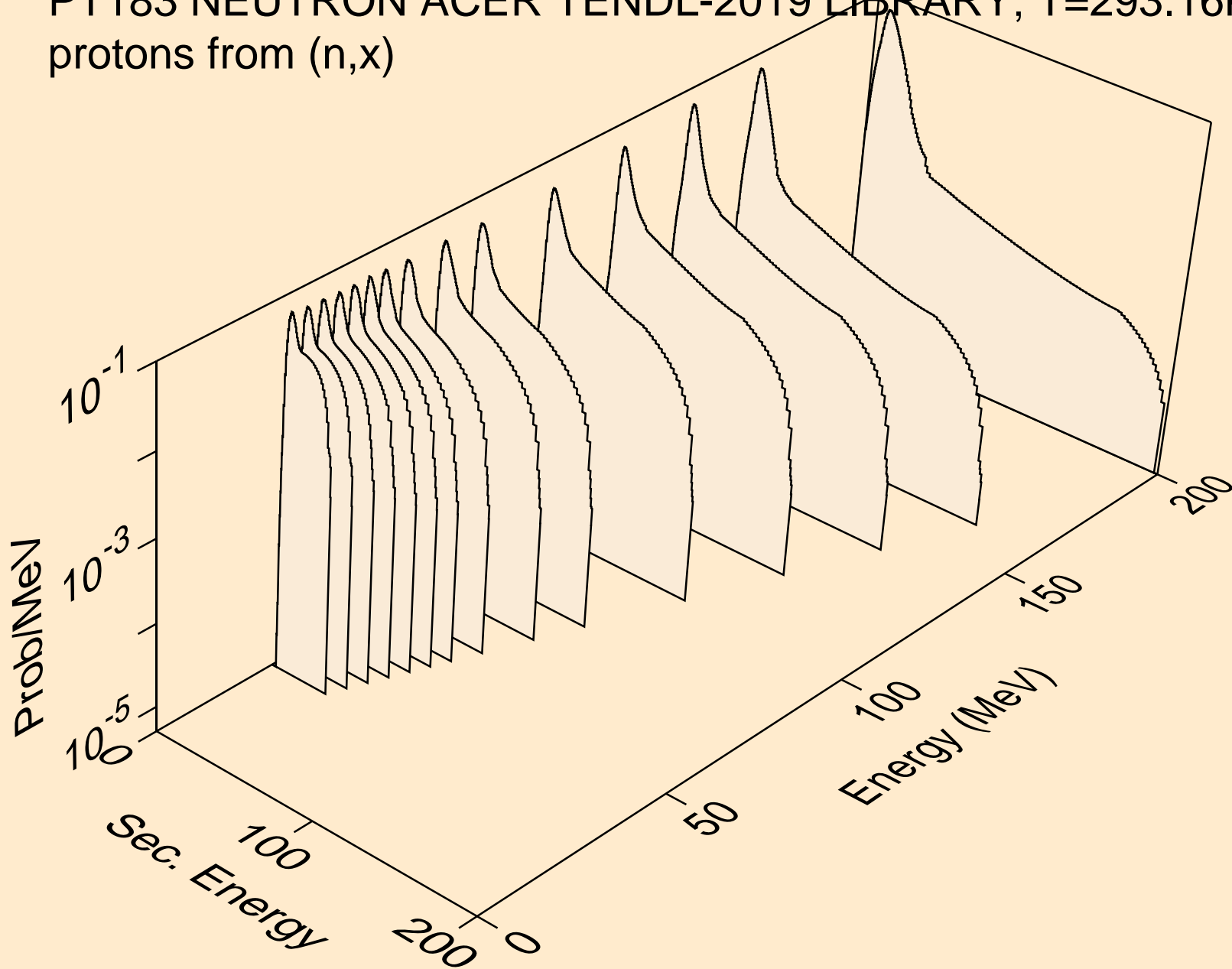

PT183 NEUTRON ACER TENDL-2019 LIBRARY; T=293.16K  
protons from (n,n\*)p

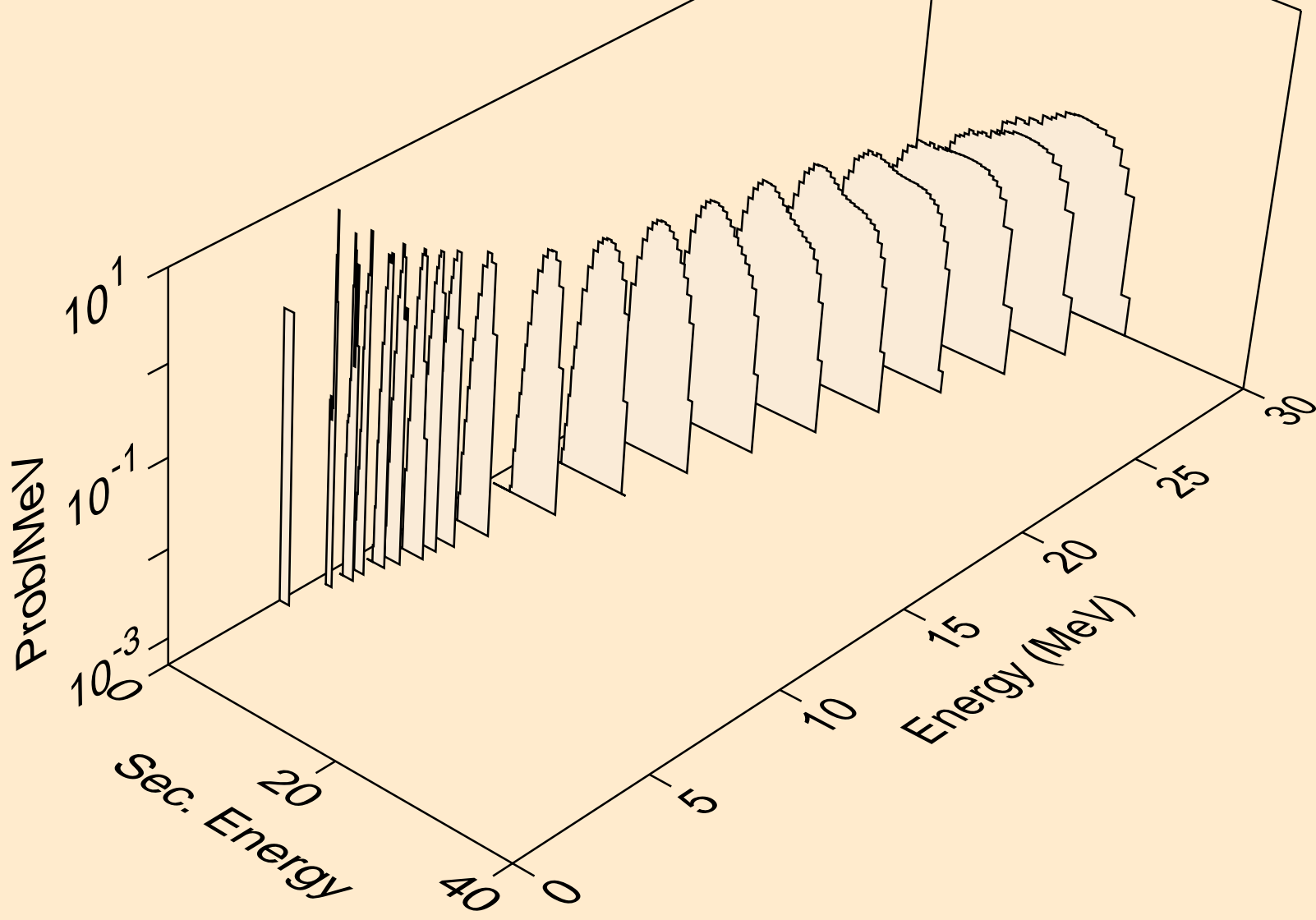



PT183 NEUTRON ACER TENDL-2019 LIBRARY; T=293.16K  
protons from (n,2np)

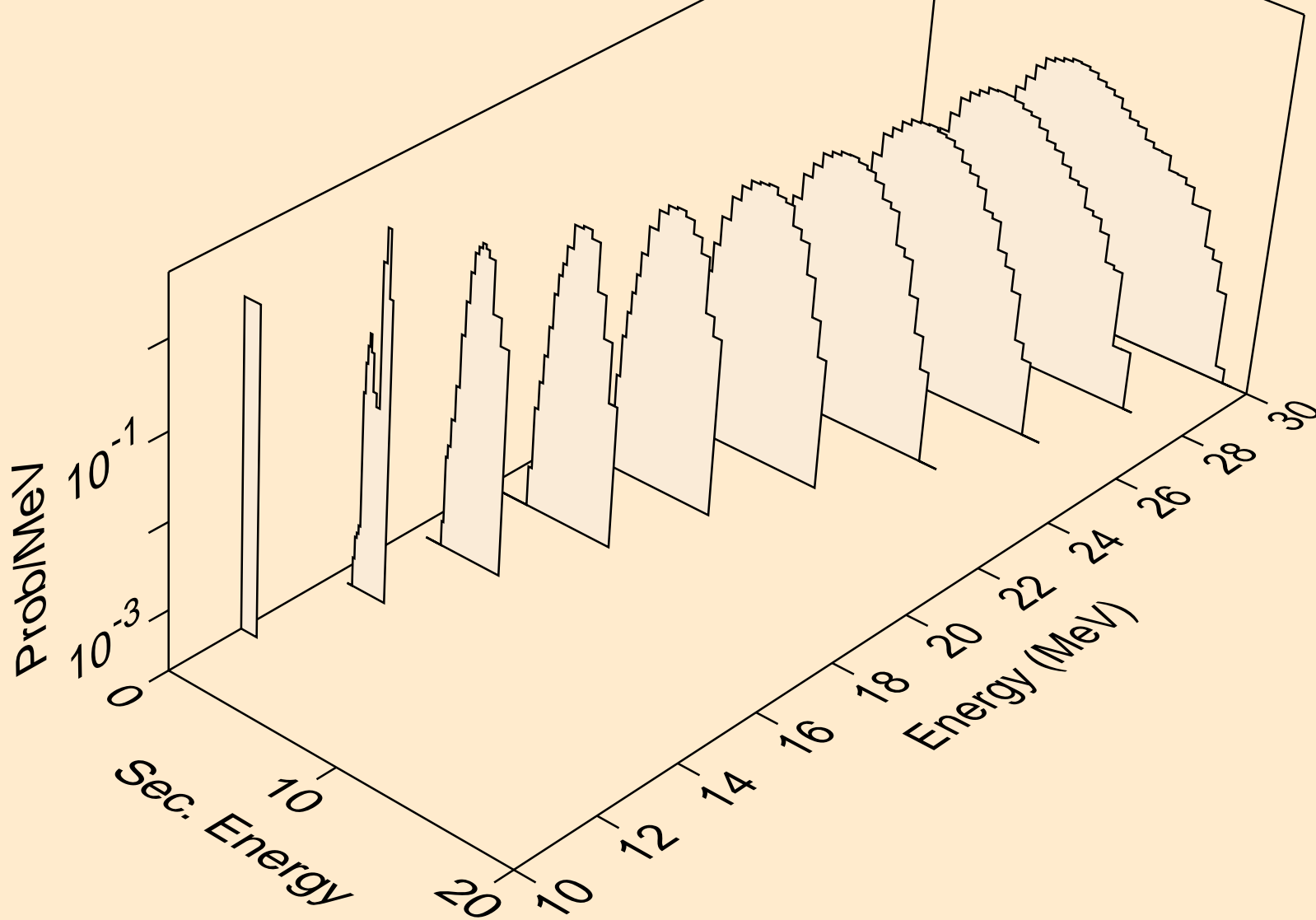

PT183 NEUTRON ACER TENDL-2019 LIBRARY; T=293.16K  
protons from (n,3np)

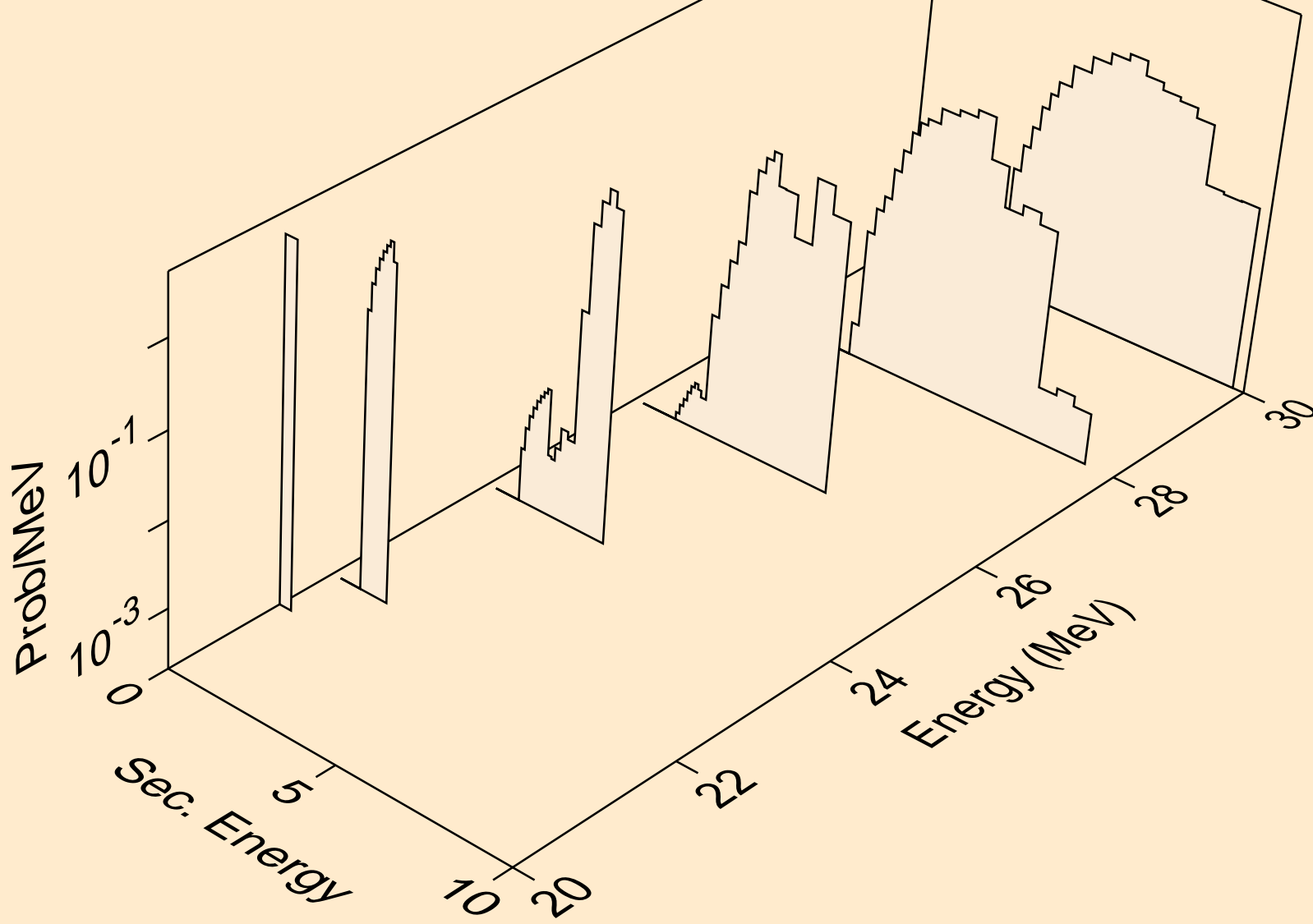

PT183 NEUTRON ACER TENDL-2019 LIBRARY; T=293.16K  
protons from (n,2np)

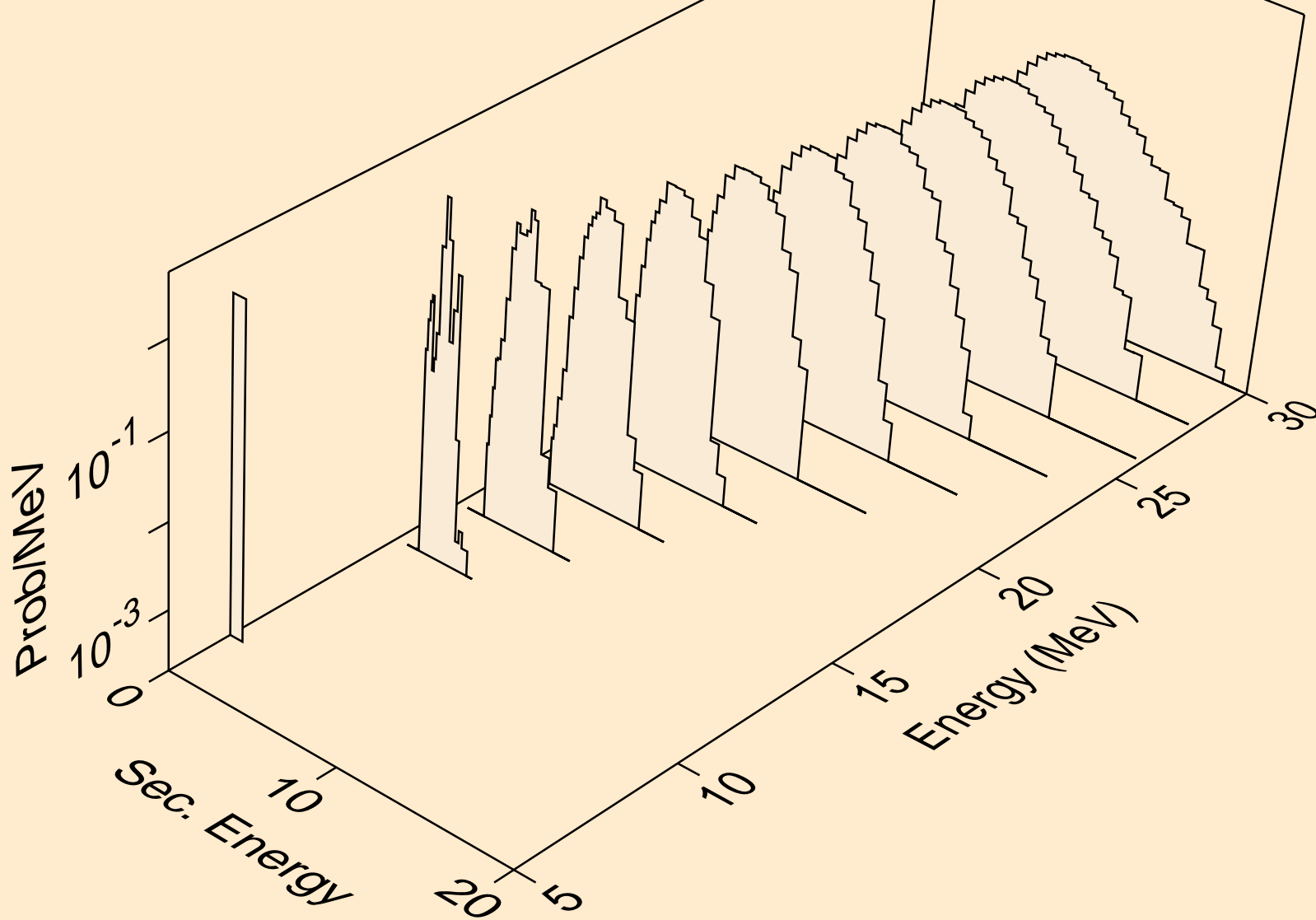

PT183 NEUTRON ACER TENDL-2019 LIBRARY; T=293.16K  
protons from (n,npa)

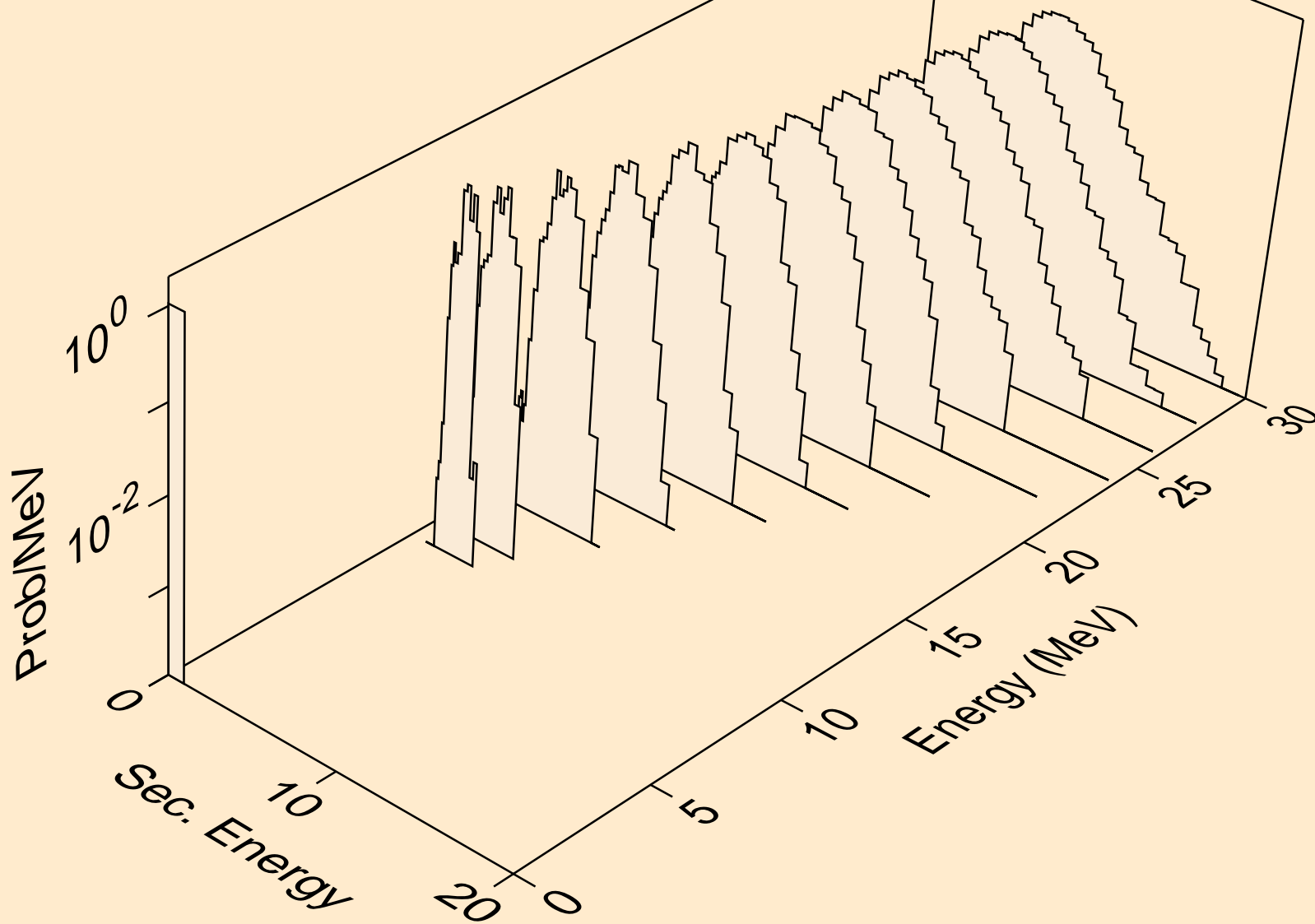

PT183 NEUTRON ACER TENDL-2019 LIBRARY; T=293.16K  
protons from (n,p)

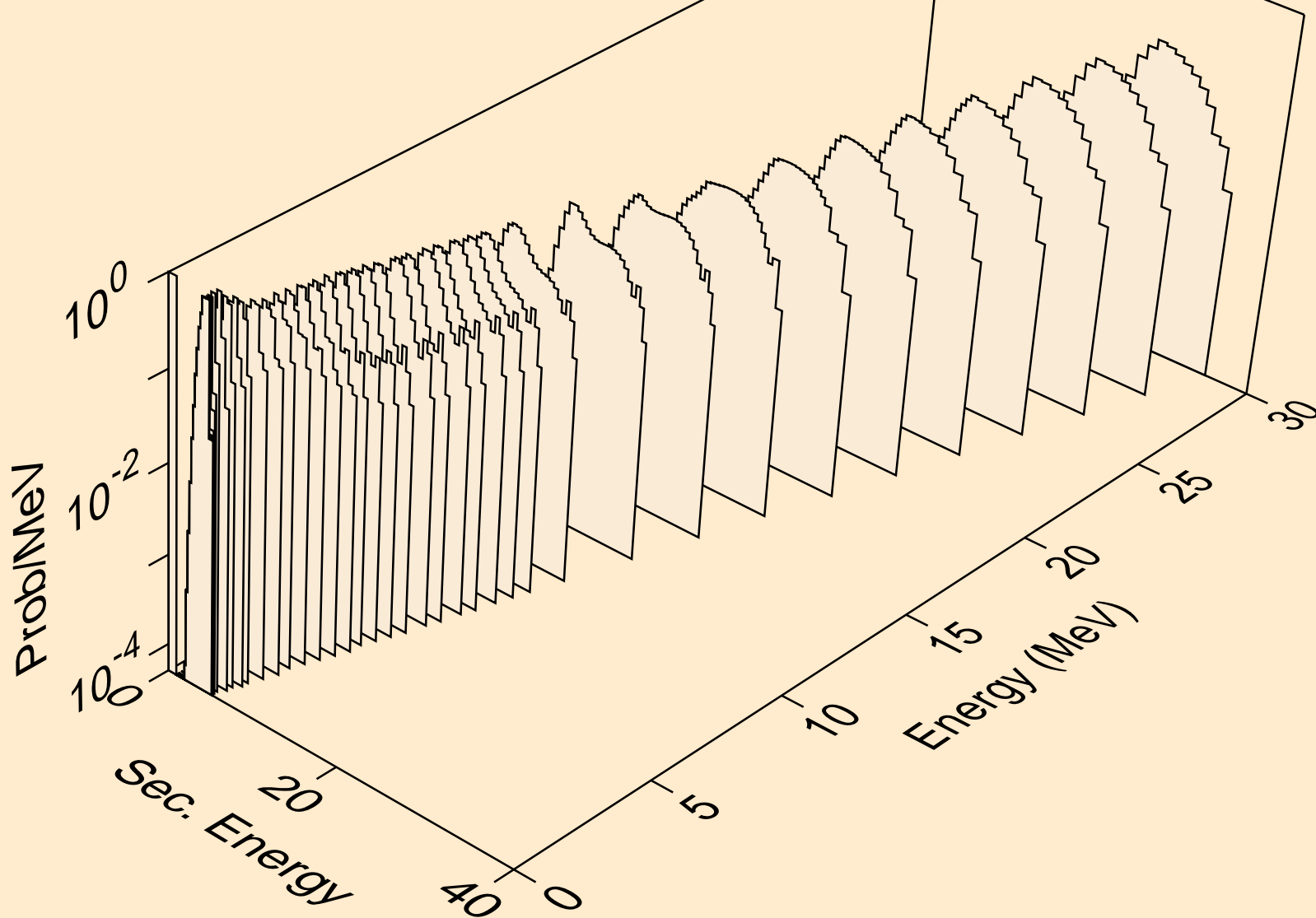

PT183 NEUTRON ACER TENDL-2019 LIBRARY; T=293.16K  
protons from (n,2p)

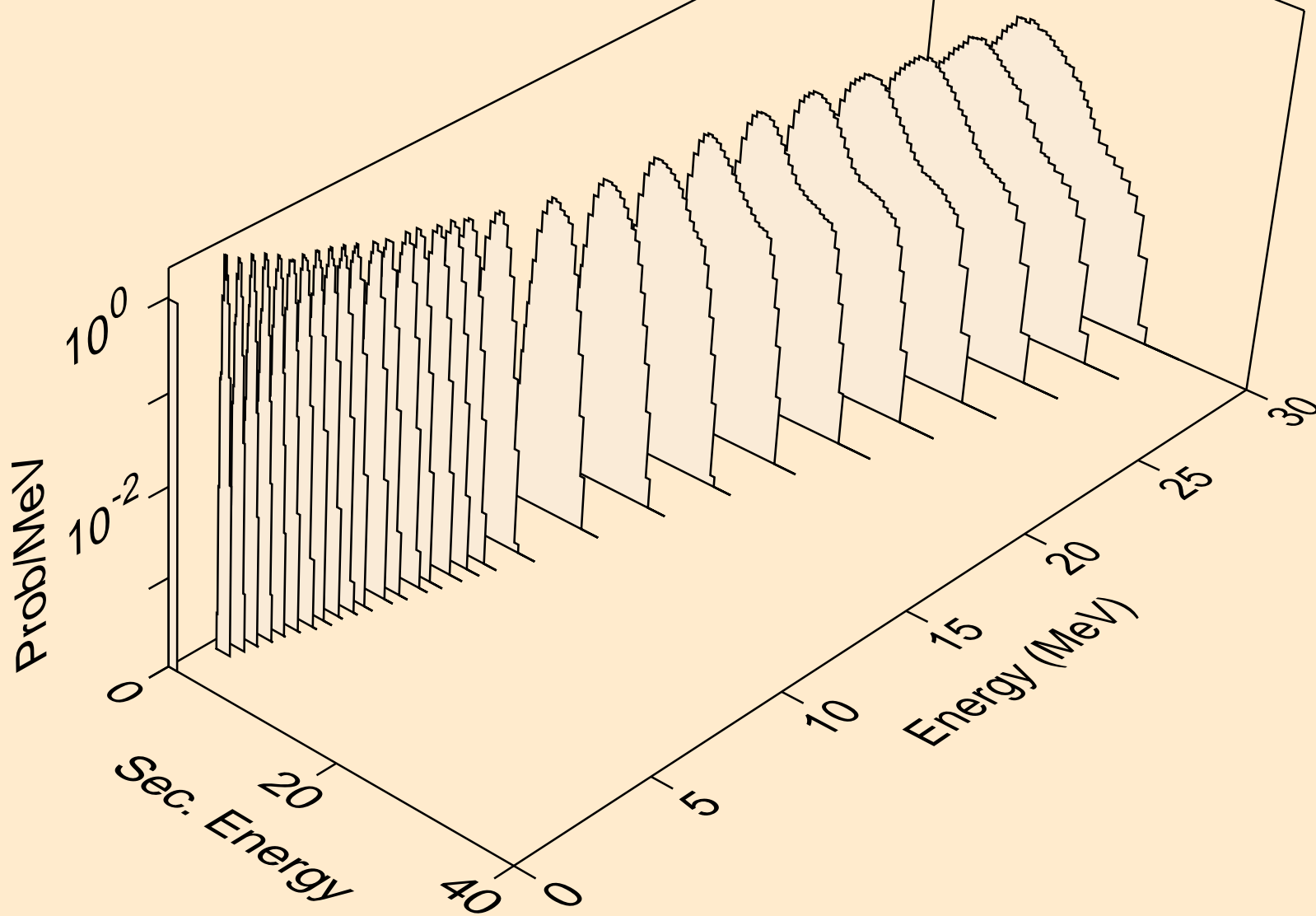

PT183 NEUTRON ACER TENDL-2019 LIBRARY; T=293.16K  
protons from (n,p)

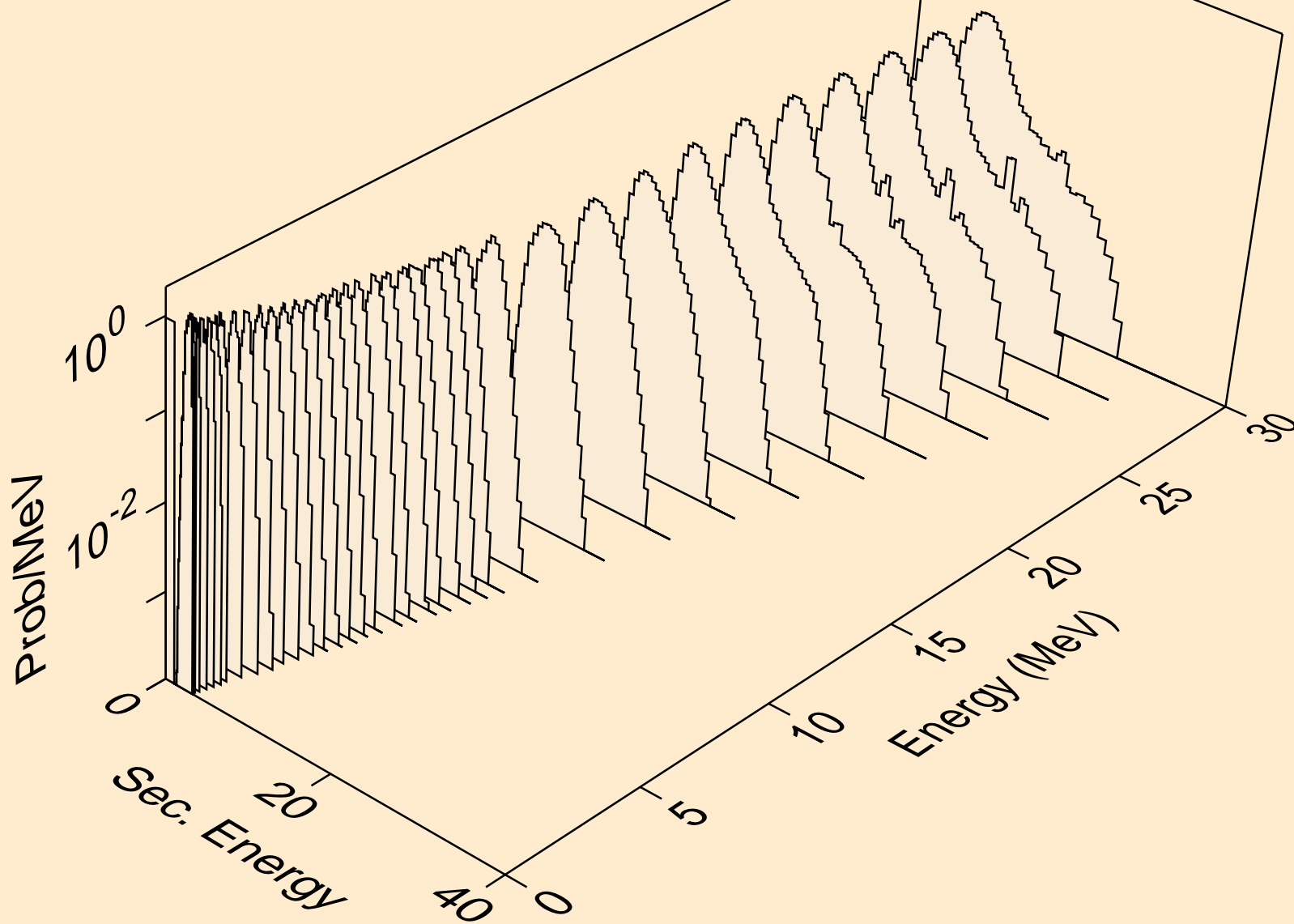

PT183 NEUTRON ACER TENDL-2019 LIBRARY; T=293.16K  
protons from (n,pd)

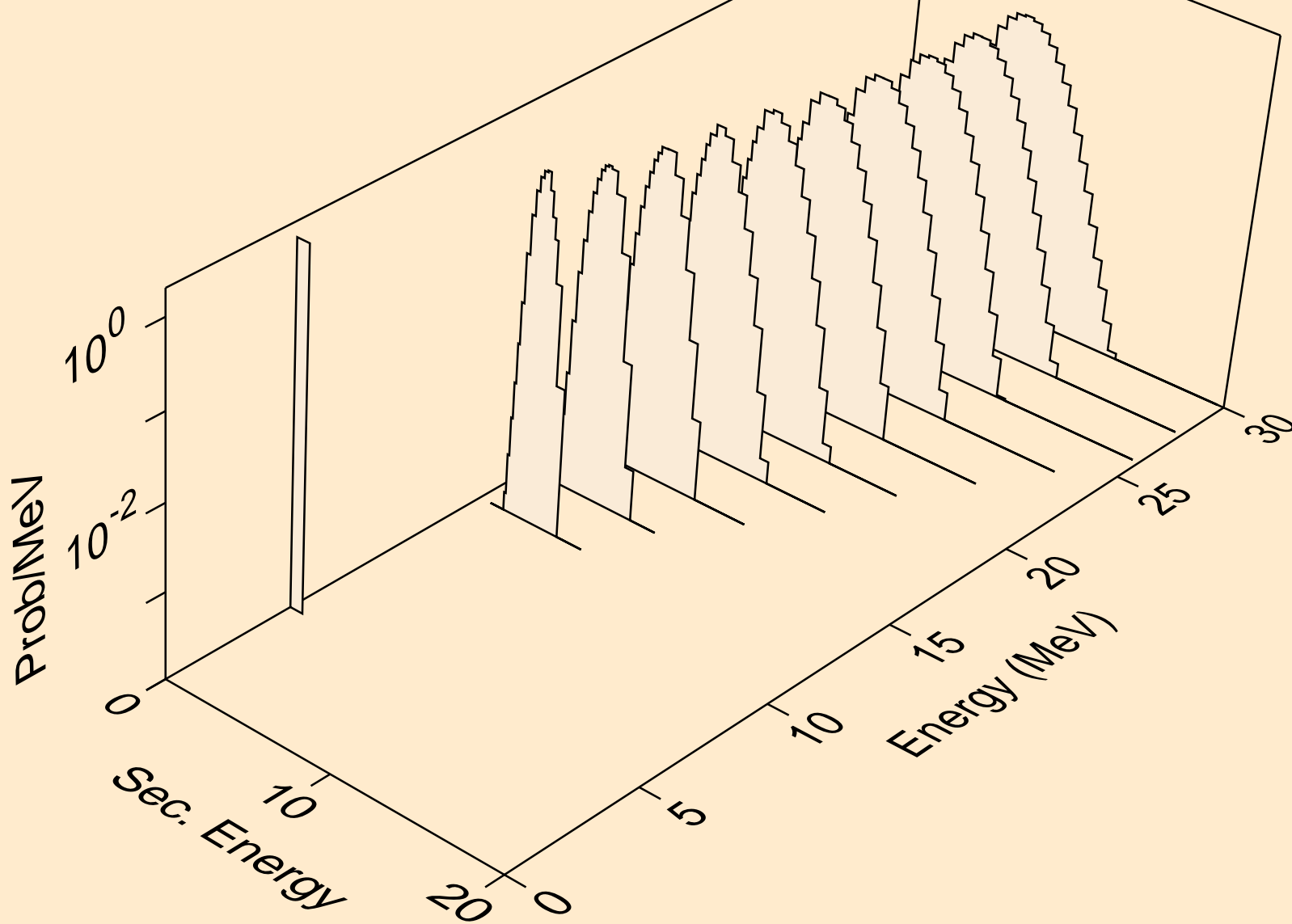



PT183 NEUTRON ACER TENDL-2019 LIBRARY; T=293.16K  
protons from (n,pt)

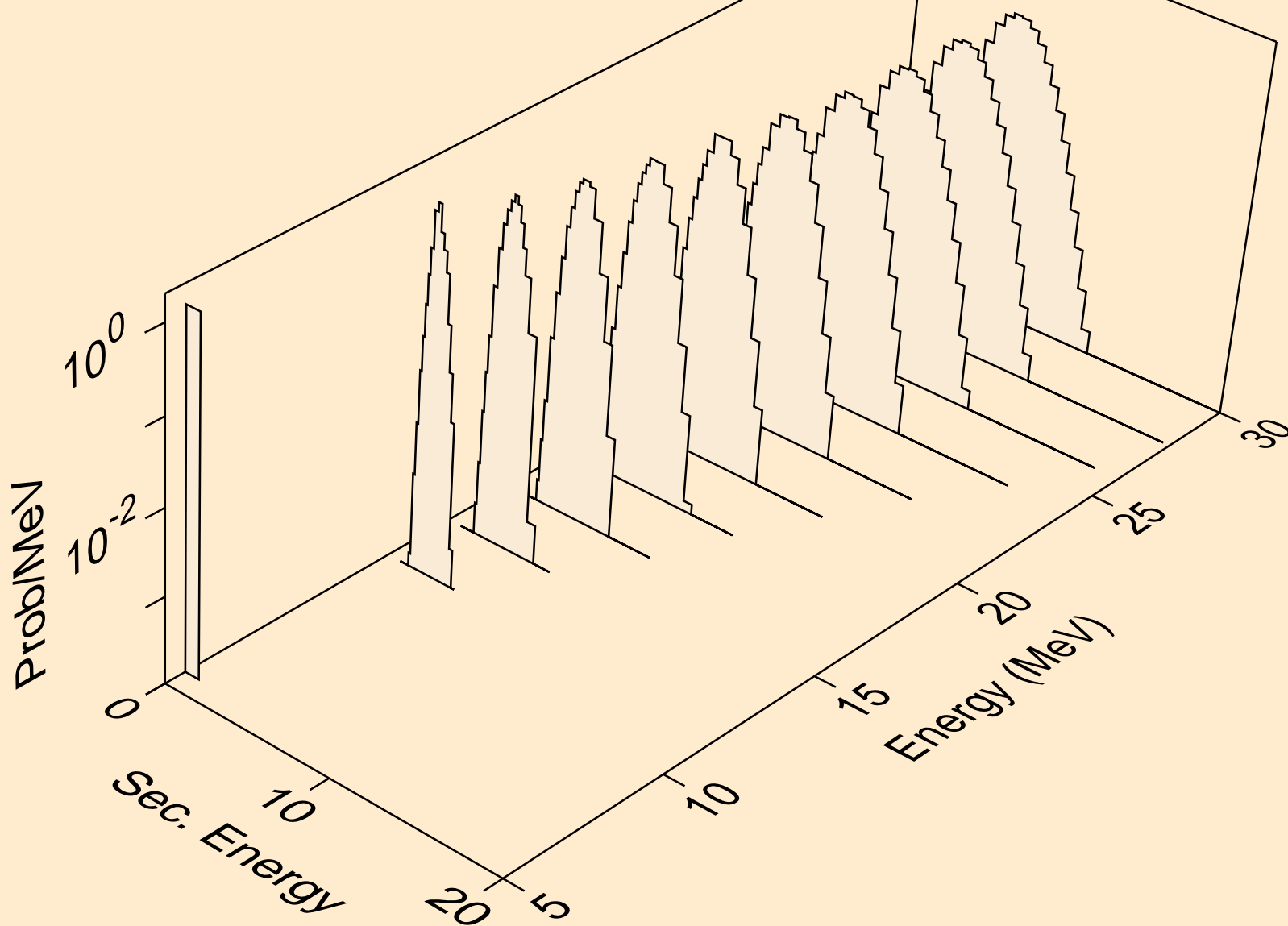

PT183 NEUTRON ACER TENDL-2019 LIBRARY; T=293.16K  
deuterons from (n,x)

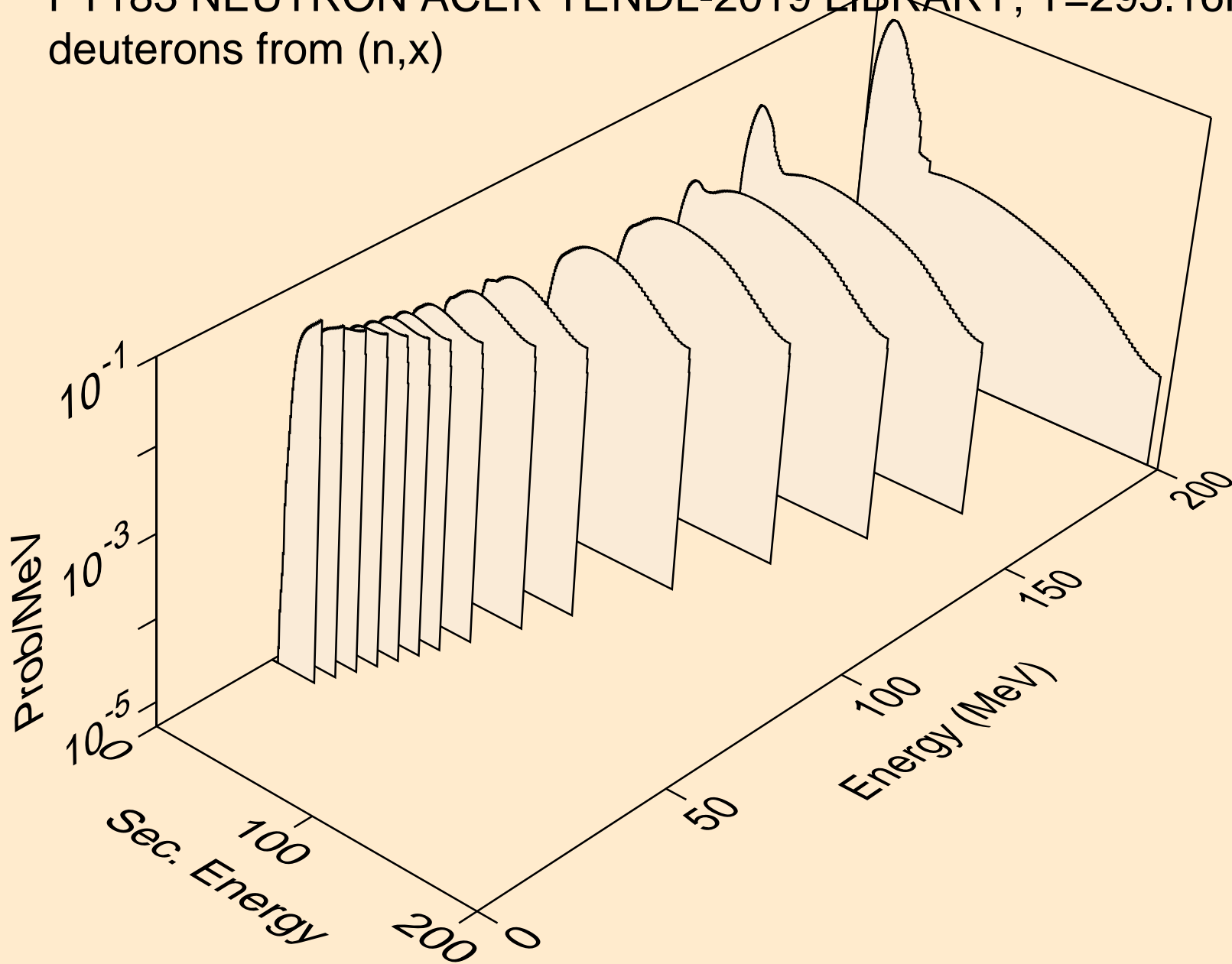

PT183 NEUTRON ACER TENDL-2019 LIBRARY; T=293.16K  
deuterons from (n,2nd)

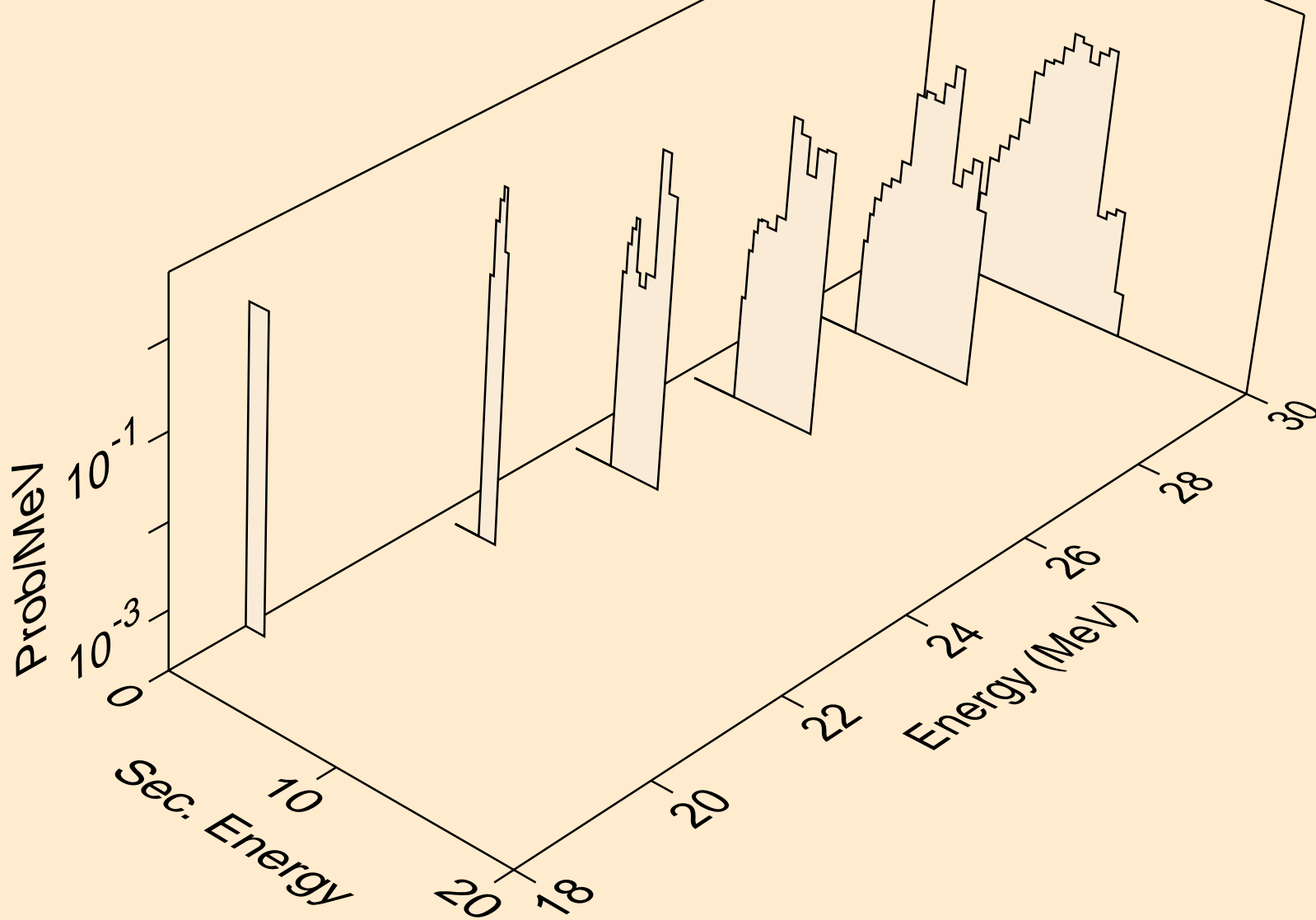

PT183 NEUTRON ACER TENDL-2019 LIBRARY; T=293.16K  
deuterons from (n,n\*)d

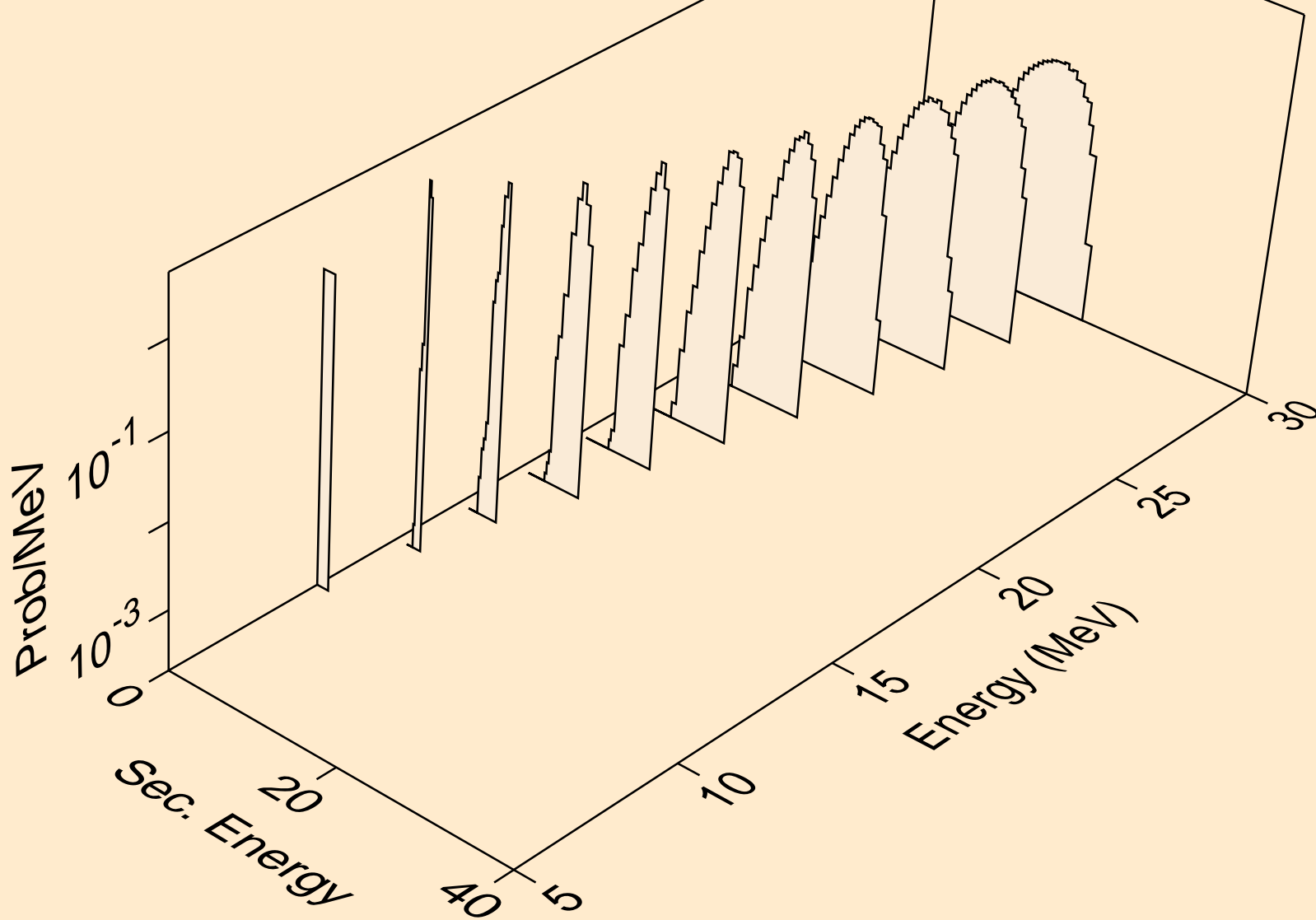

PT183 NEUTRON ACER TENDL-2019 LIBRARY; T=293.16K  
deuterons from (n,d)

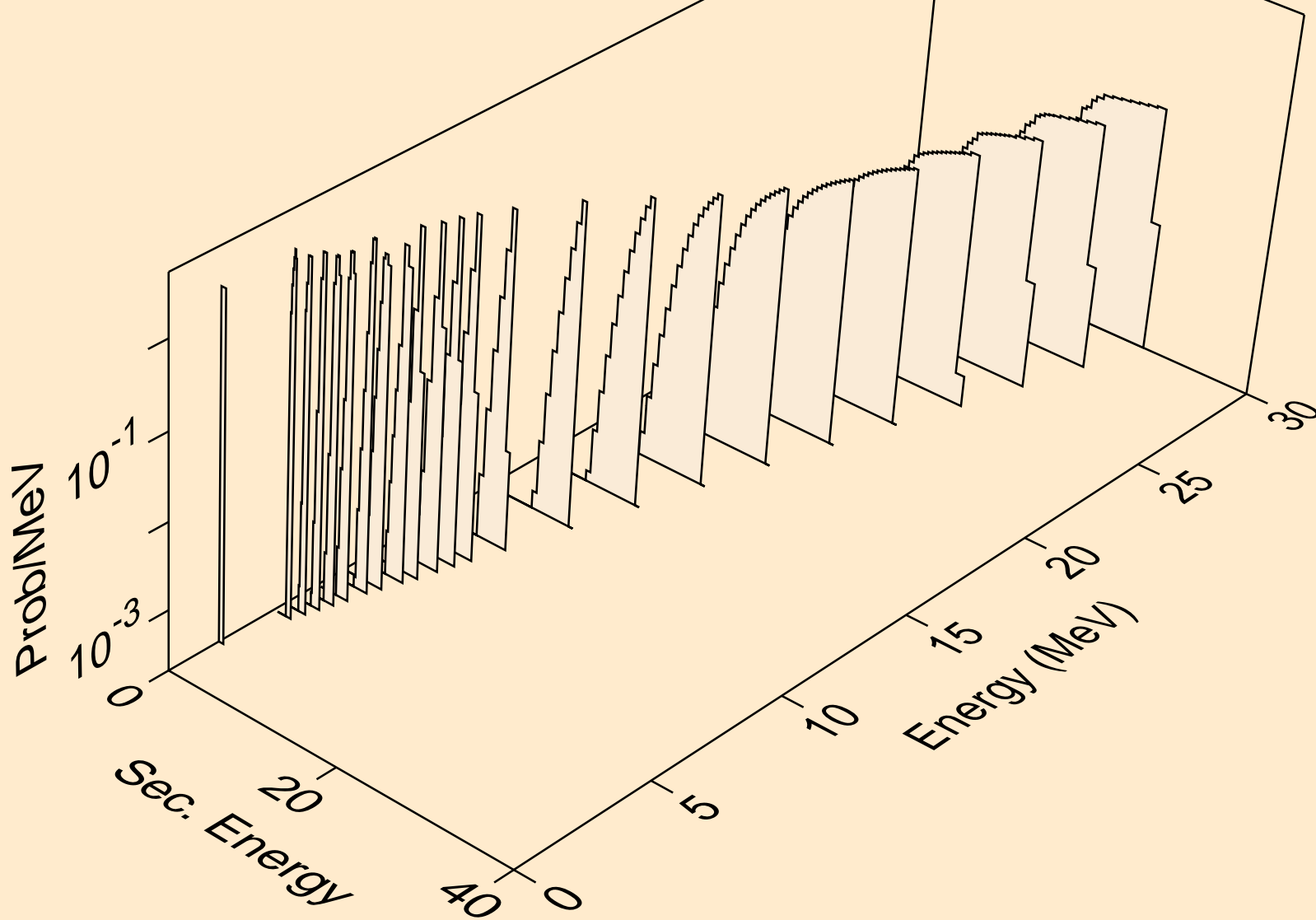

PT183 NEUTRON ACER TENDL-2019 LIBRARY; T=293.16K  
deuterons from (n,pd)

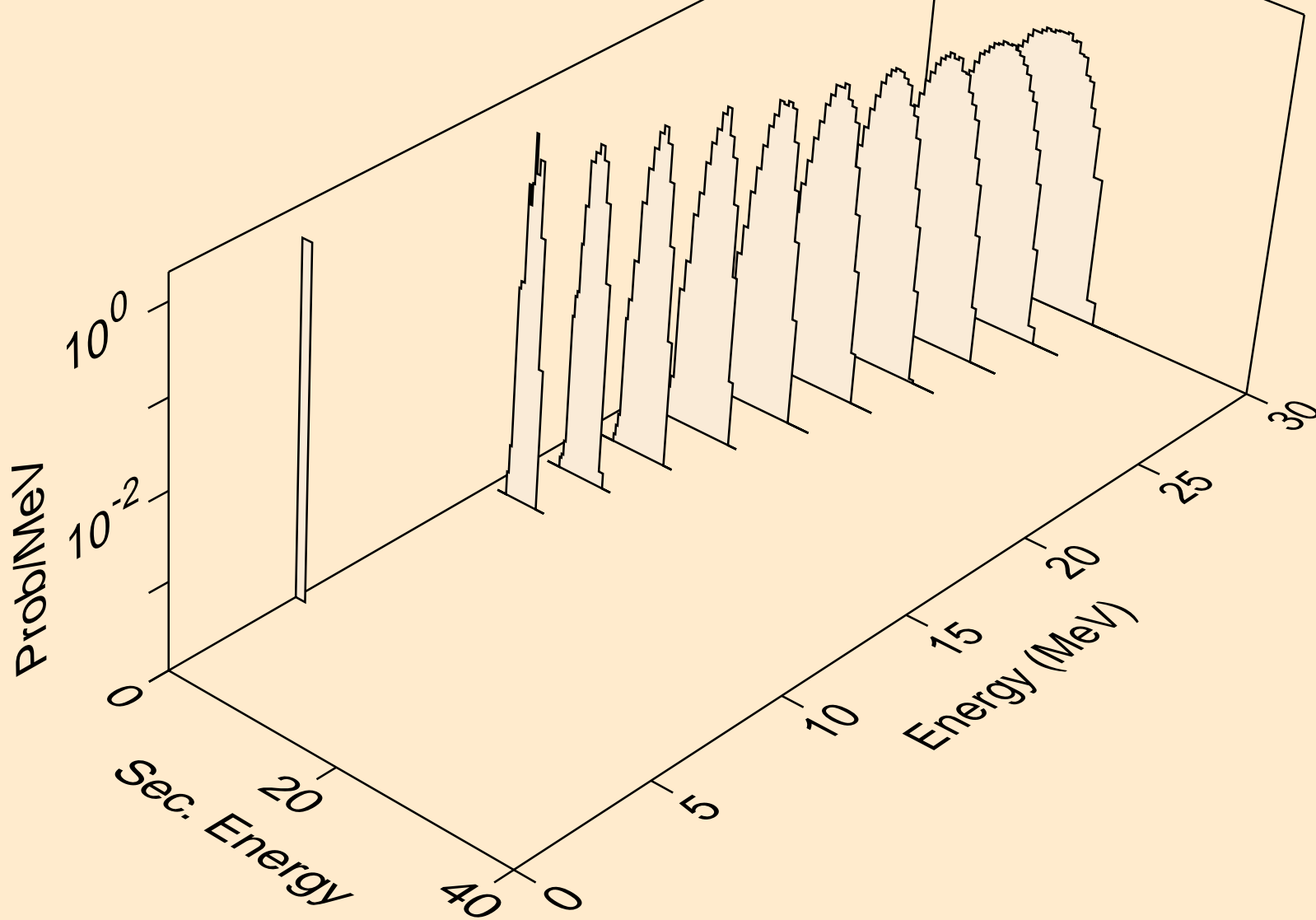

PT183 NEUTRON ACER TENDL-2019 LIBRARY; T=293.16K  
deuterons from (n,da)

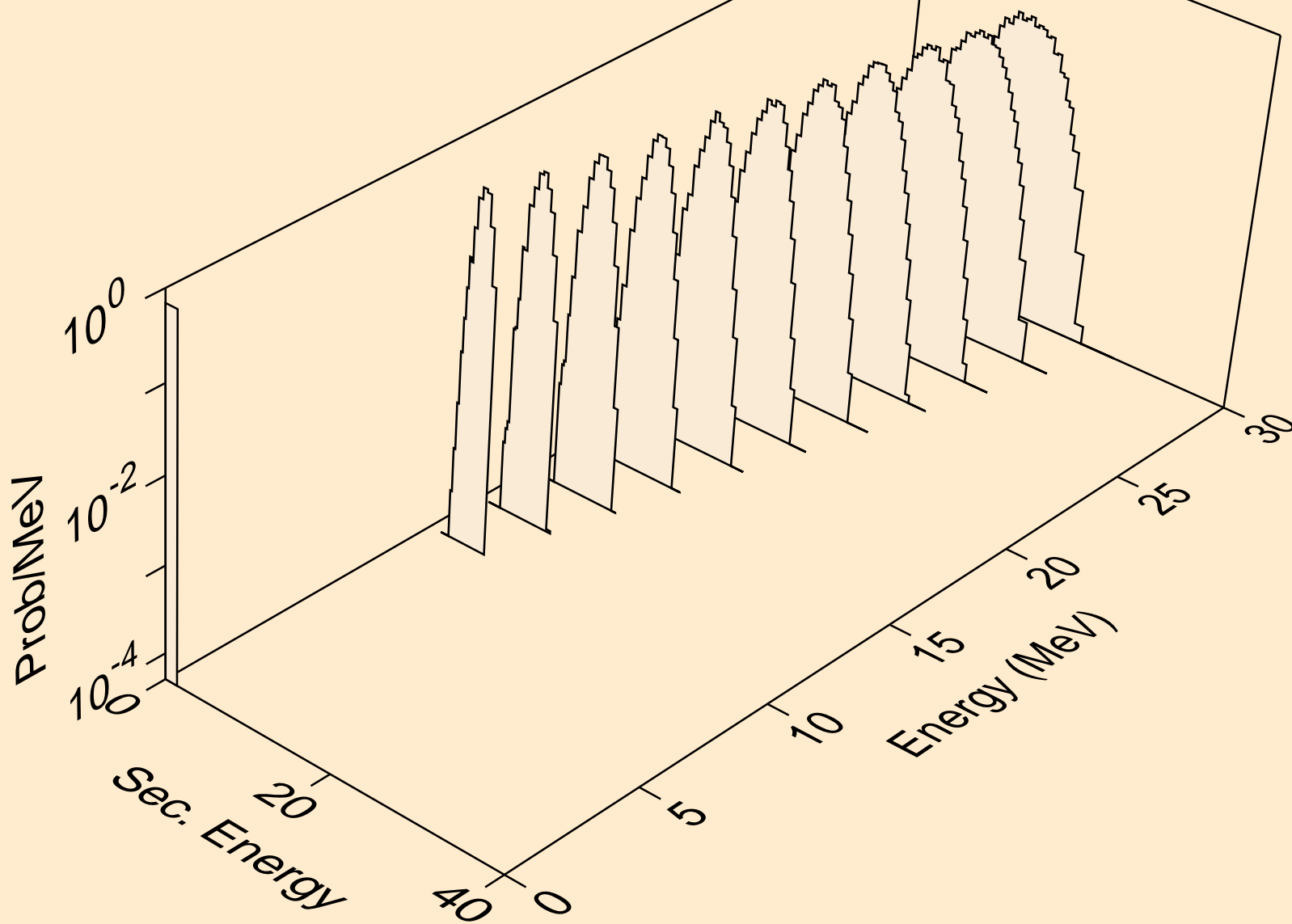

PT183 NEUTRON ACER TENDL-2019 LIBRARY; T=293.16K  
tritons from (n,x)

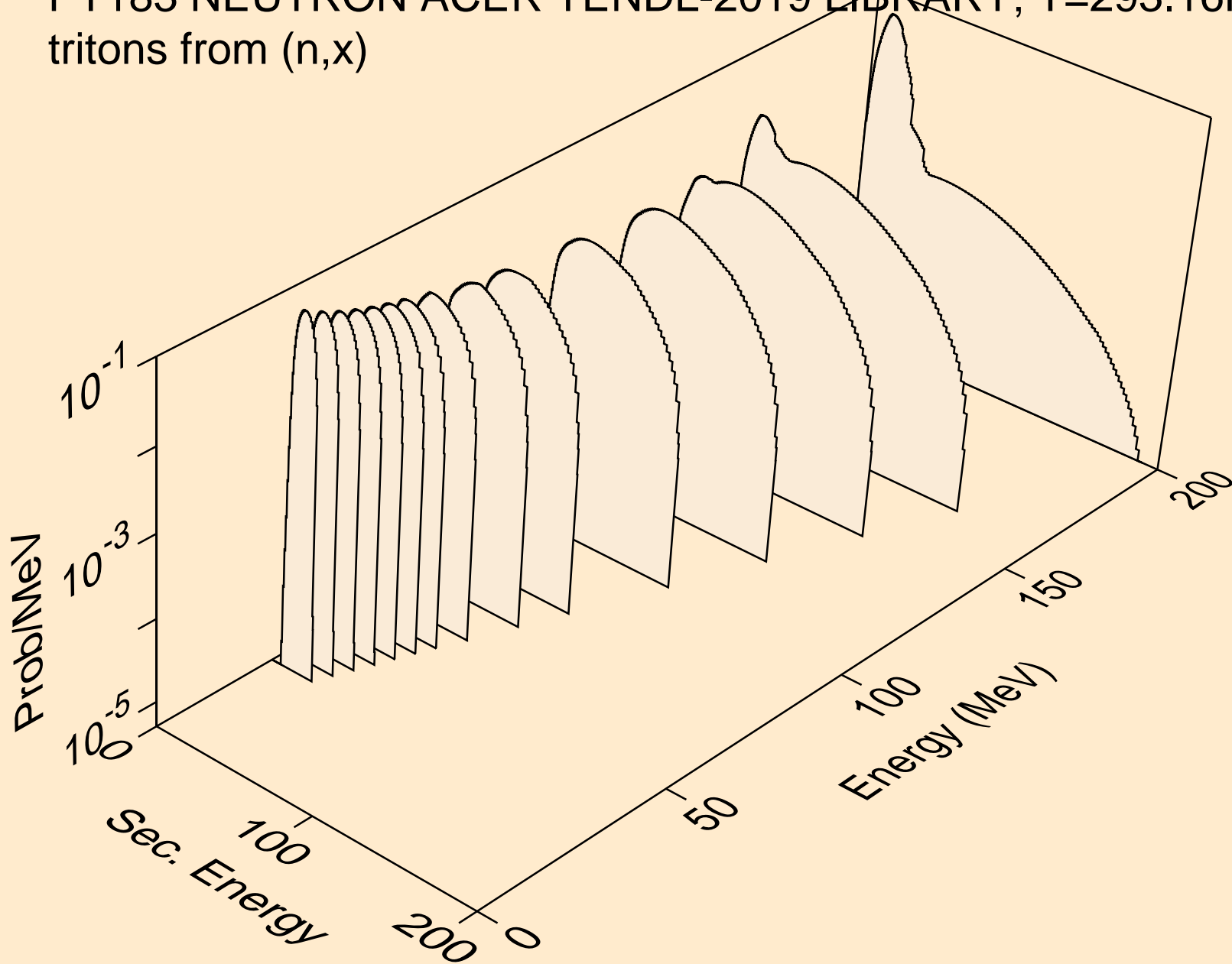



PT183 NEUTRON ACER TENDL-2019 LIBRARY; T=293.16K  
tritons from (n,n\*)t

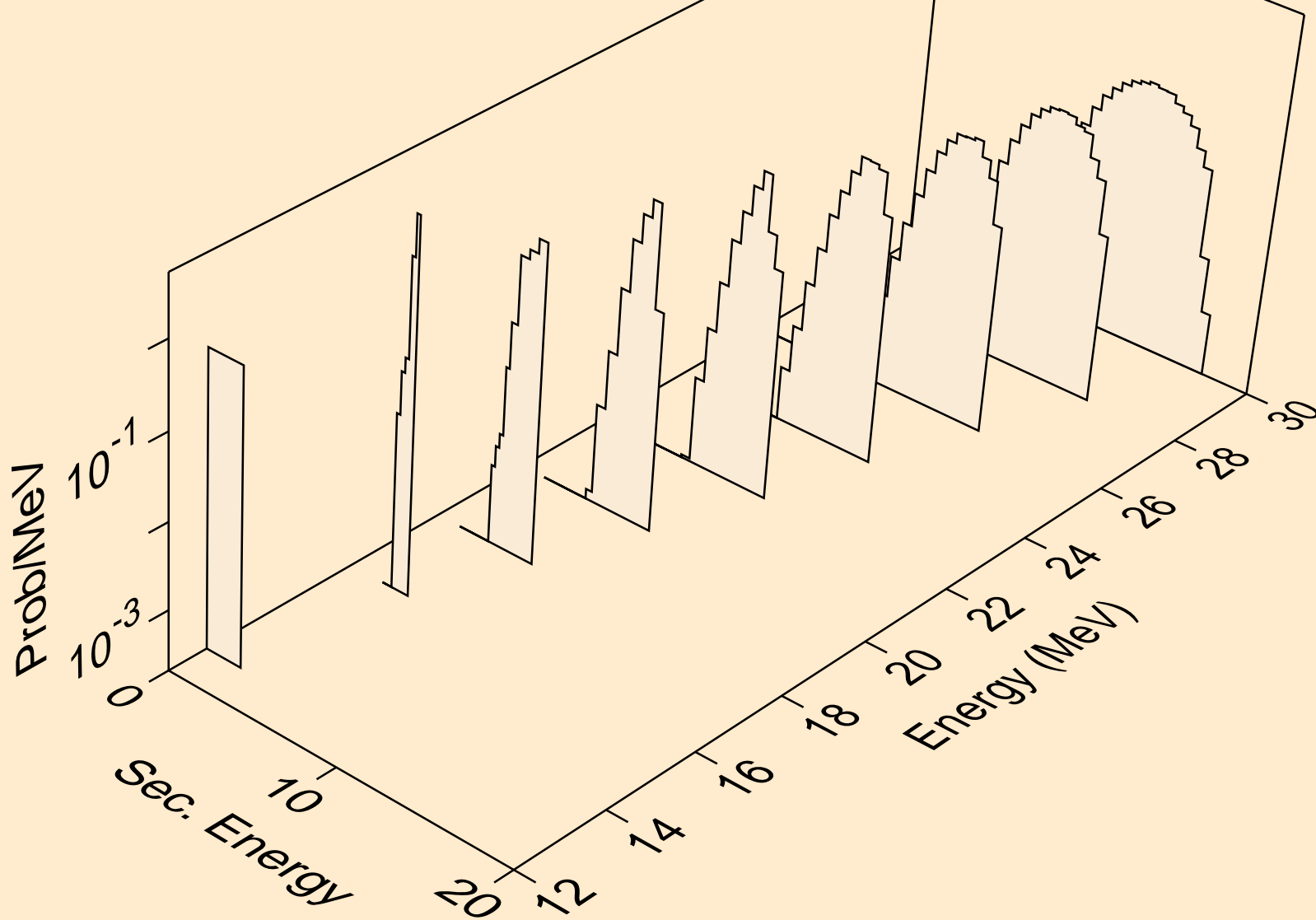

PT183 NEUTRON ACER TENDL-2019 LIBRARY; T=293.16K  
tritons from (n,t)

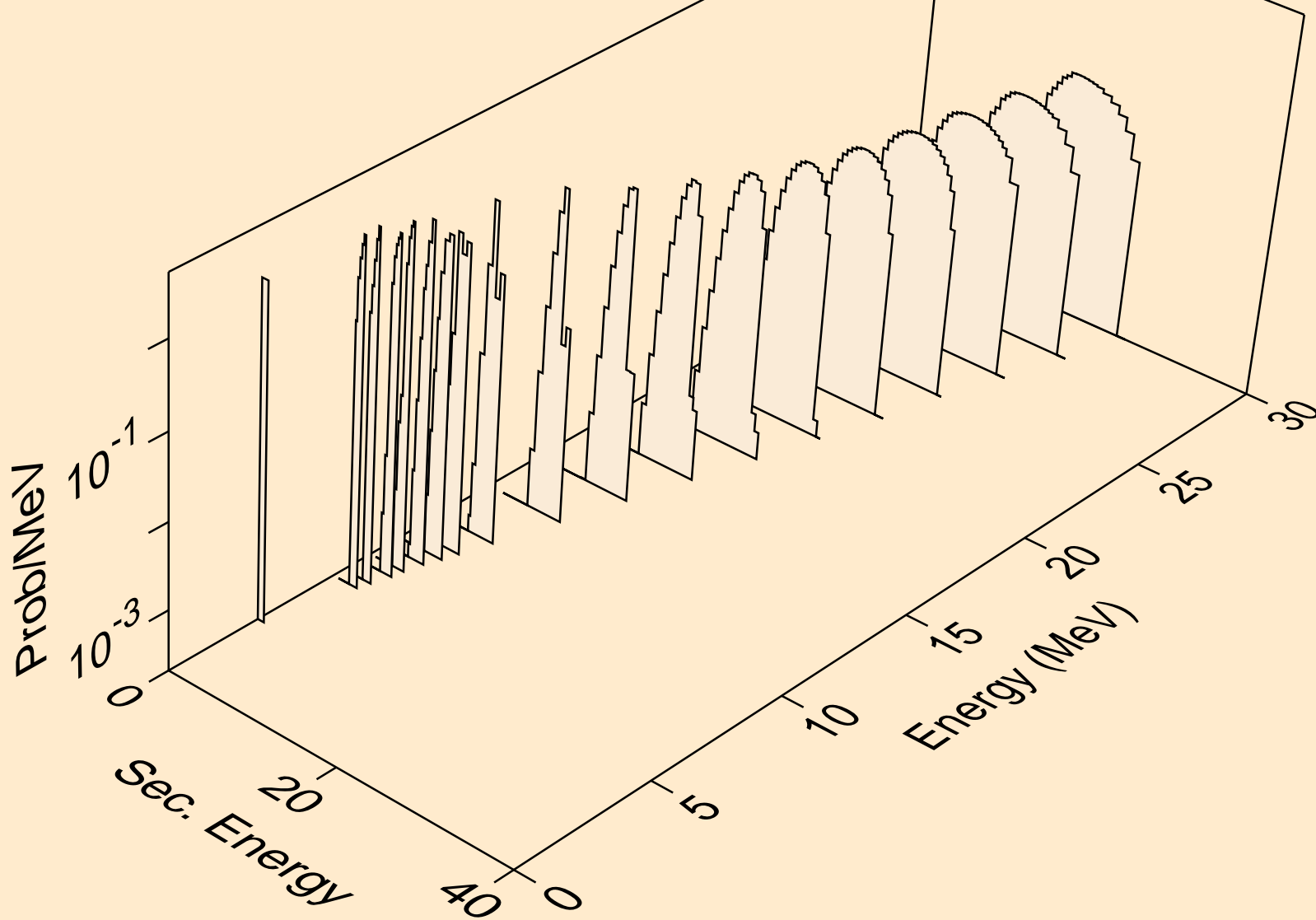

PT183 NEUTRON ACER TENDL-2019 LIBRARY; T=293.16K  
tritons from (n,pt)

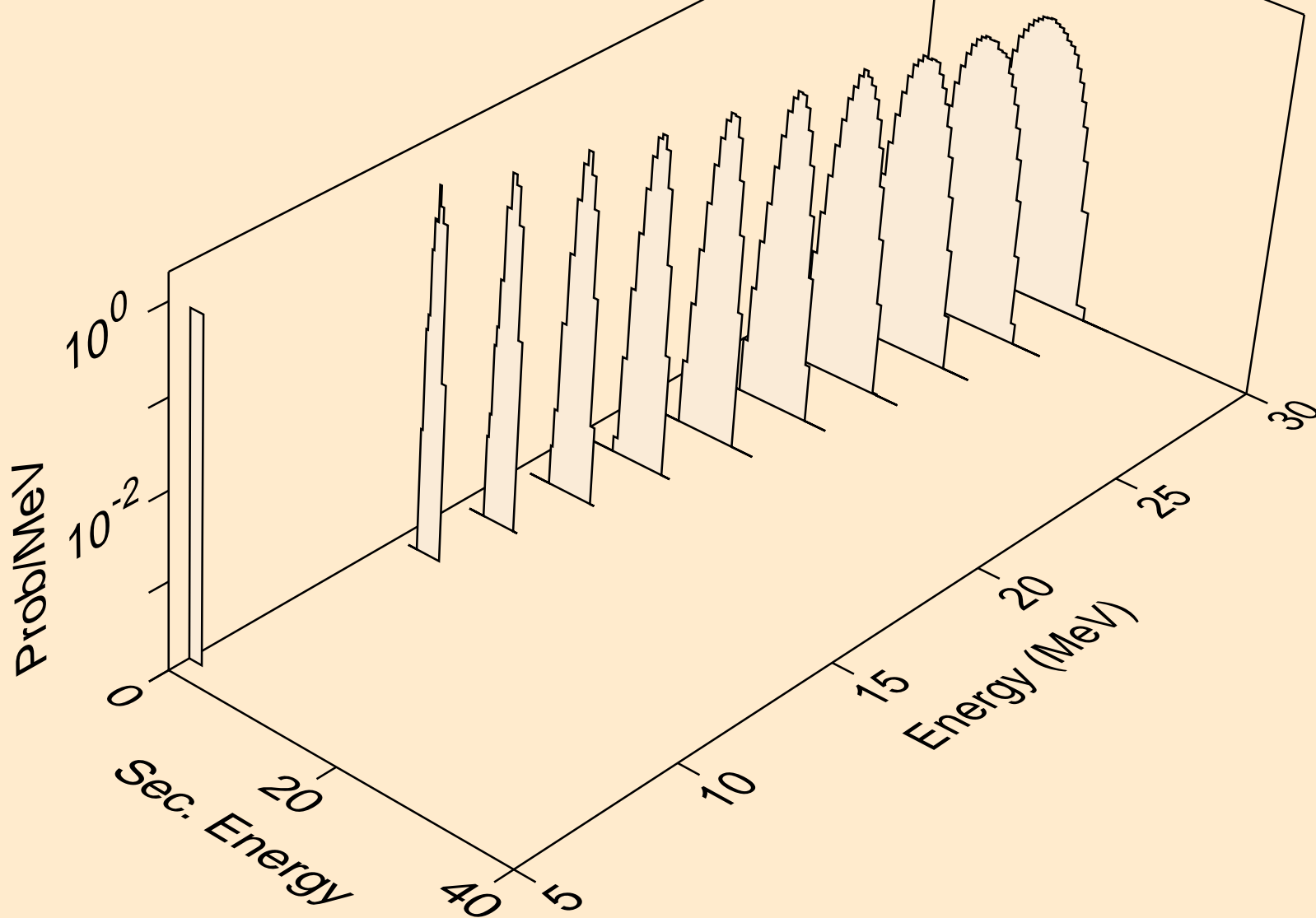

PT183 NEUTRON ACER TENDL-2019 LIBRARY; T=293.16K  
he3s from (n,x)

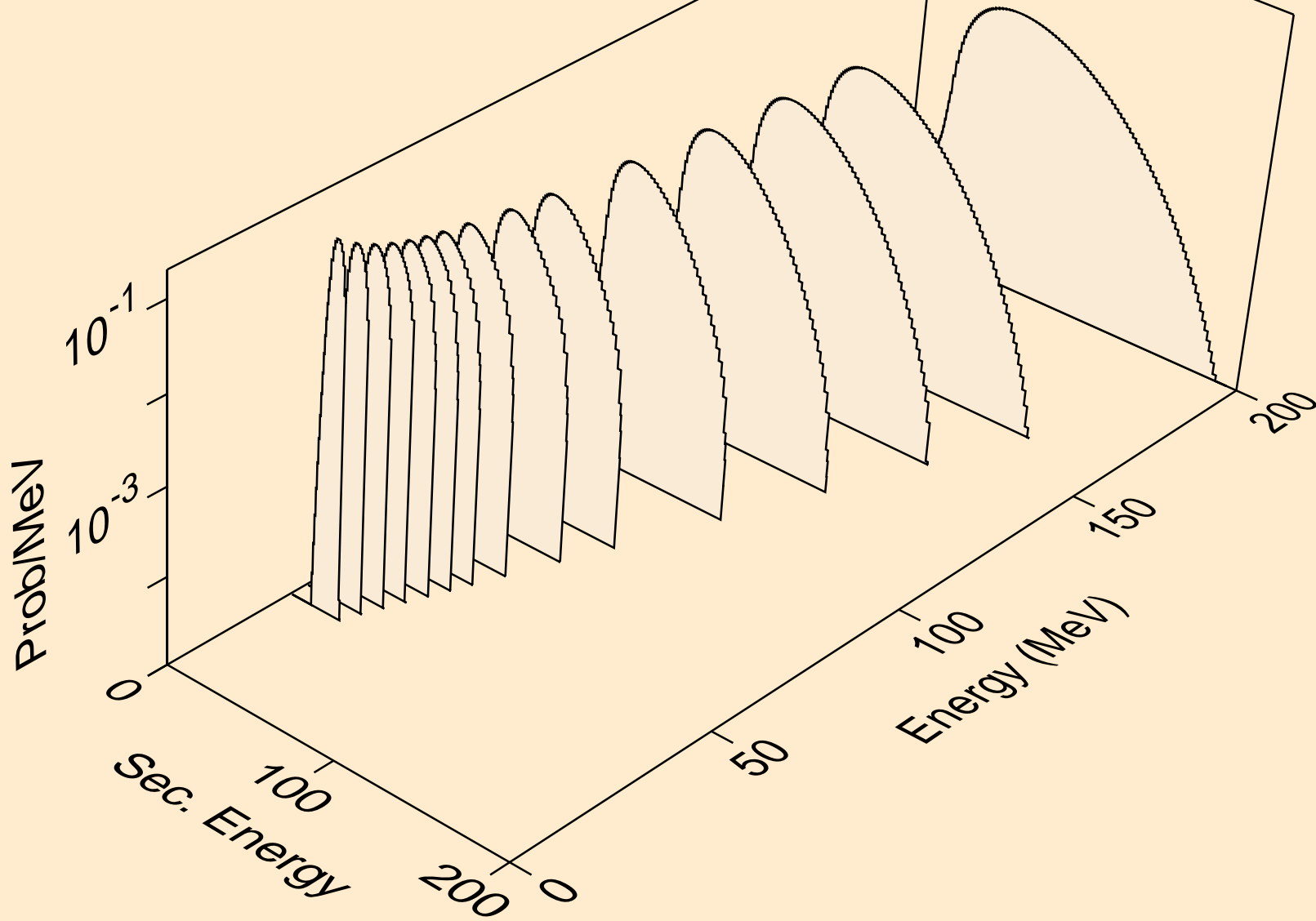

PT183 NEUTRON ACER TENDL-2019 LIBRARY; T=293.16K  
he3s from (n,n\*)he3

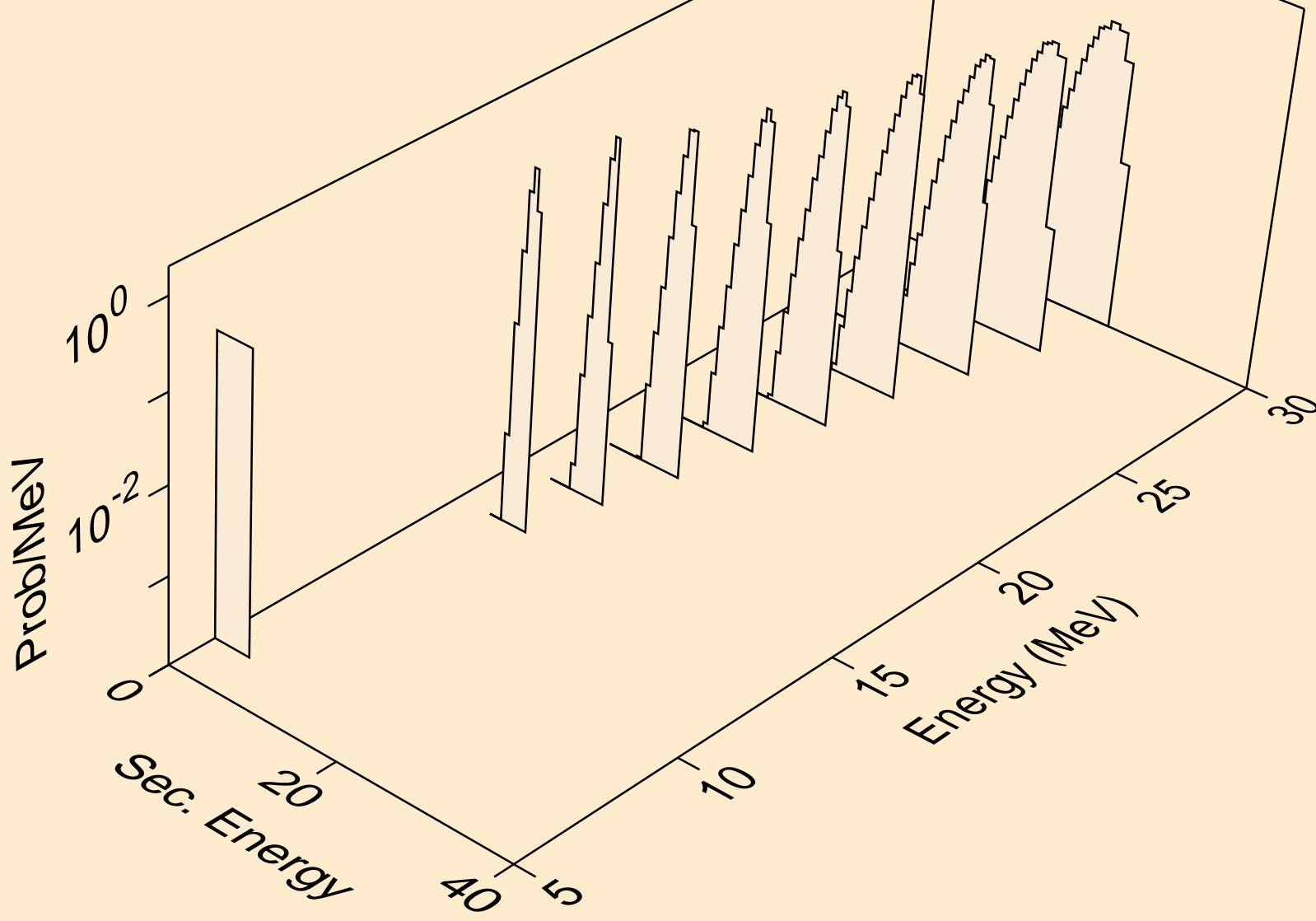

PT183 NEUTRON ACER TENDL-2019 LIBRARY; T=293.16K  
he3s from (n,he3)

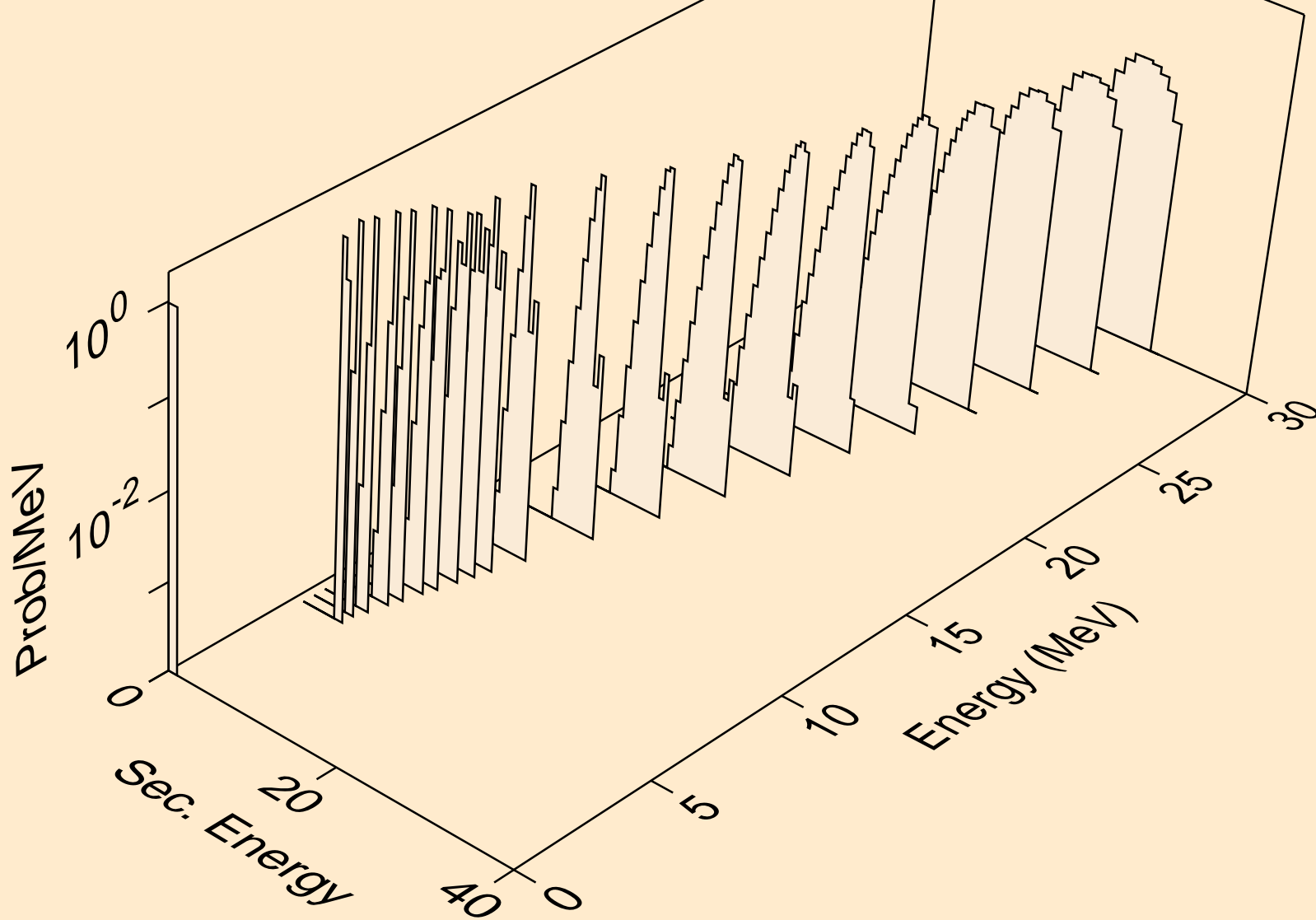

PT183 NEUTRON ACER TENDL-2019 LIBRARY; T=293.16K  
alphas from (n,x)

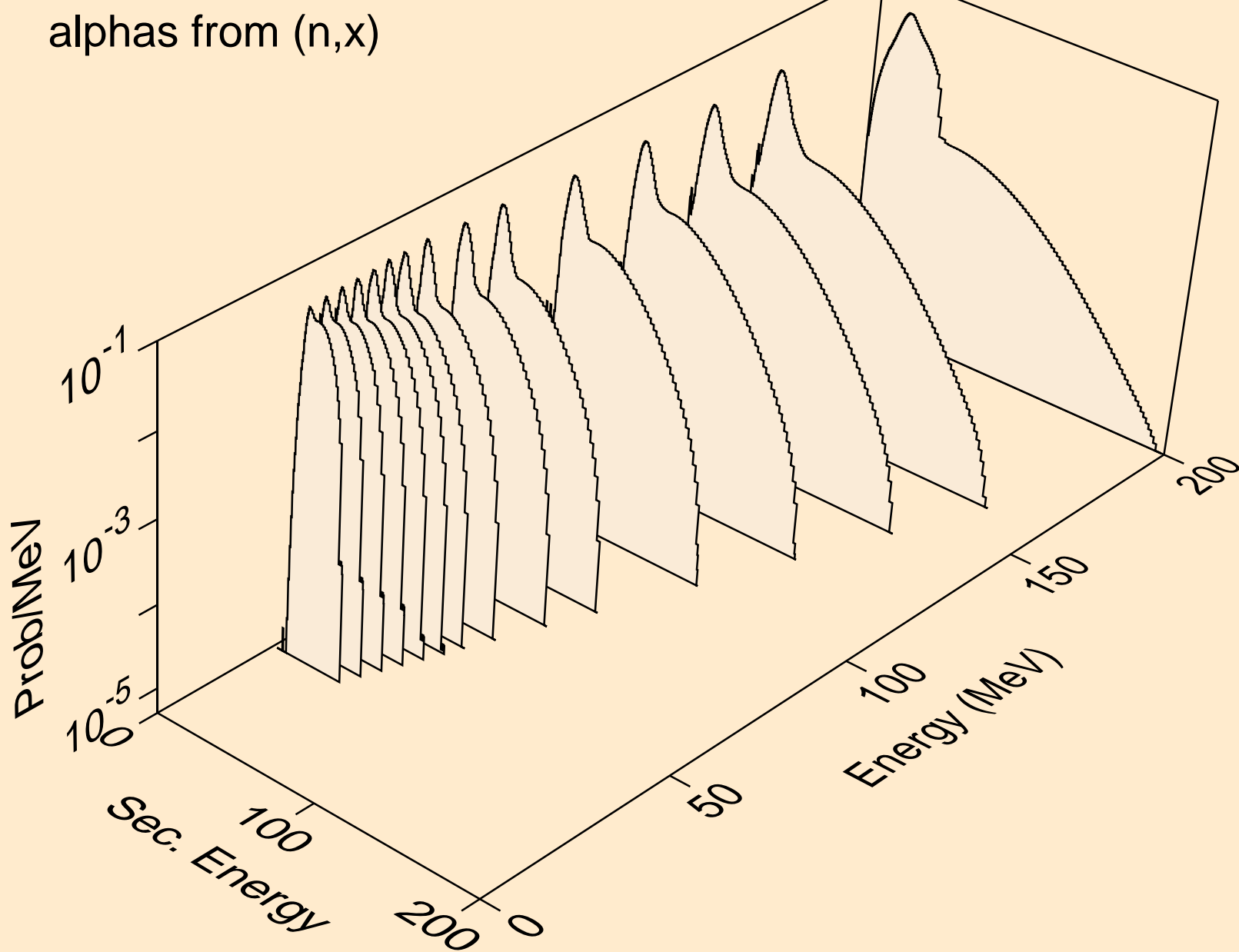

PT183 NEUTRON ACER TENDL-2019 LIBRARY; T=293.16K  
alphas from (n,n\*)a

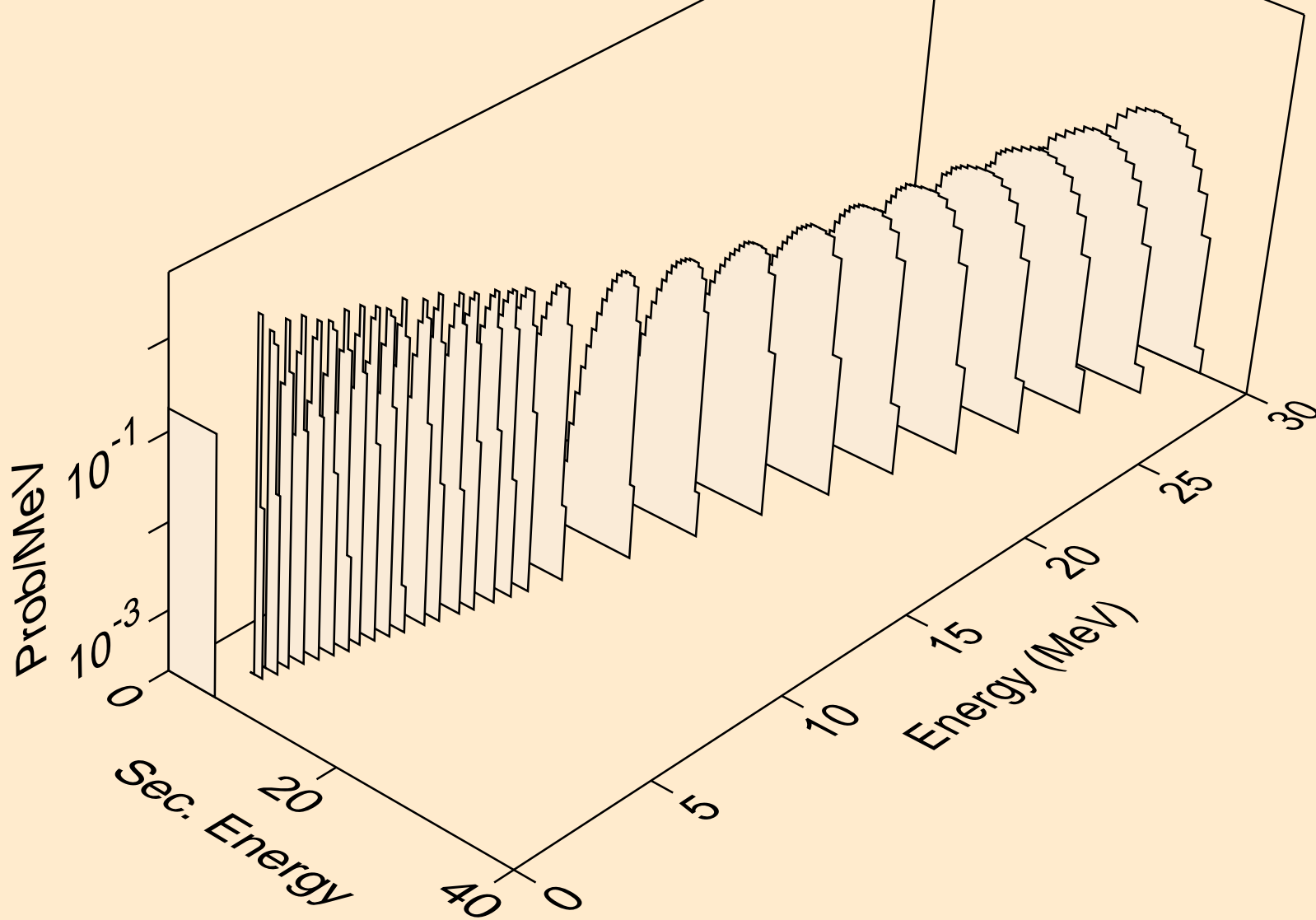



PT183 NEUTRON ACER TENDL-2019 LIBRARY; T=293.16K  
alphas from (n,2n)a

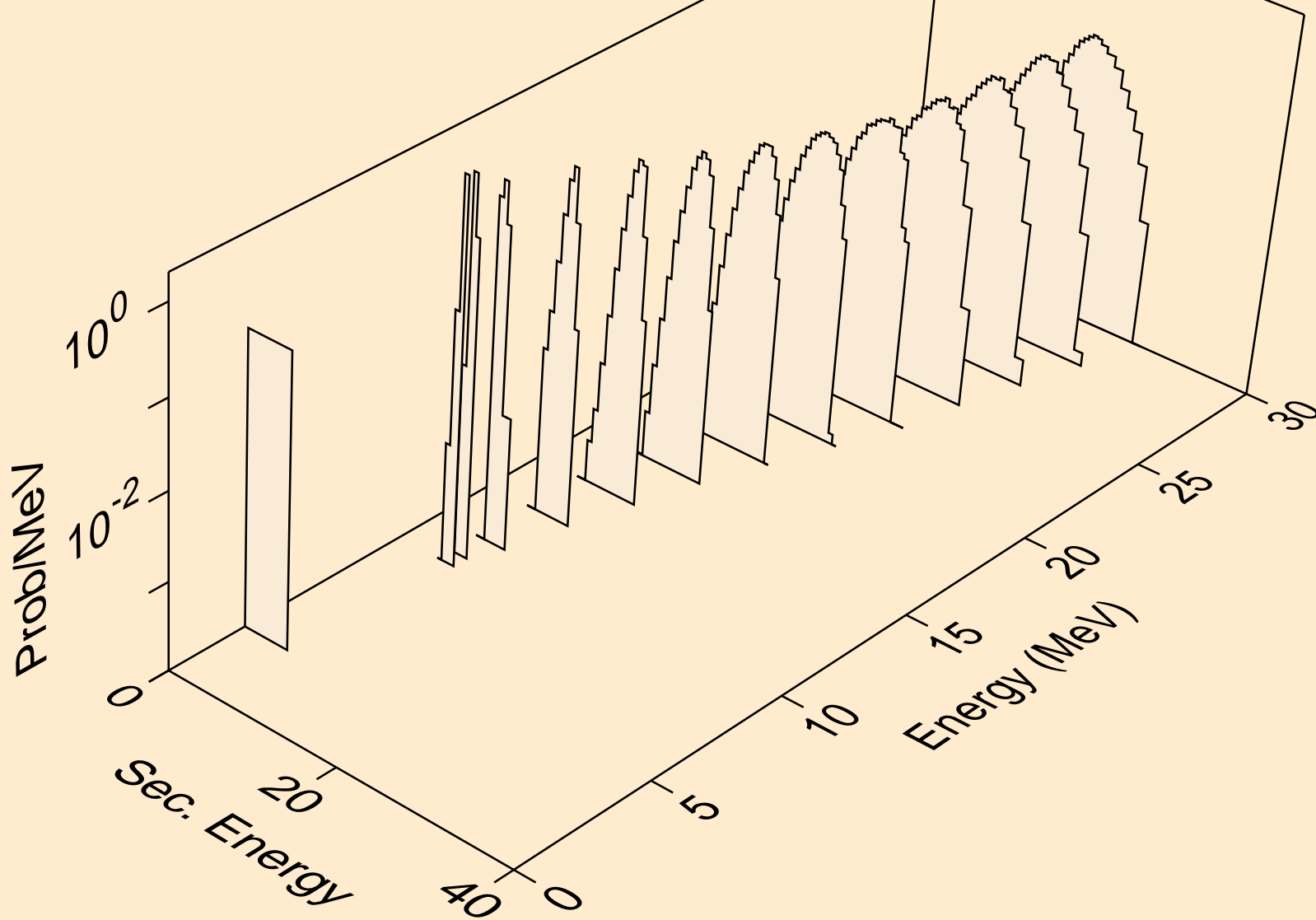

PT183 NEUTRON ACER TENDL-2019 LIBRARY; T=293.16K  
alphas from (n,3n)a

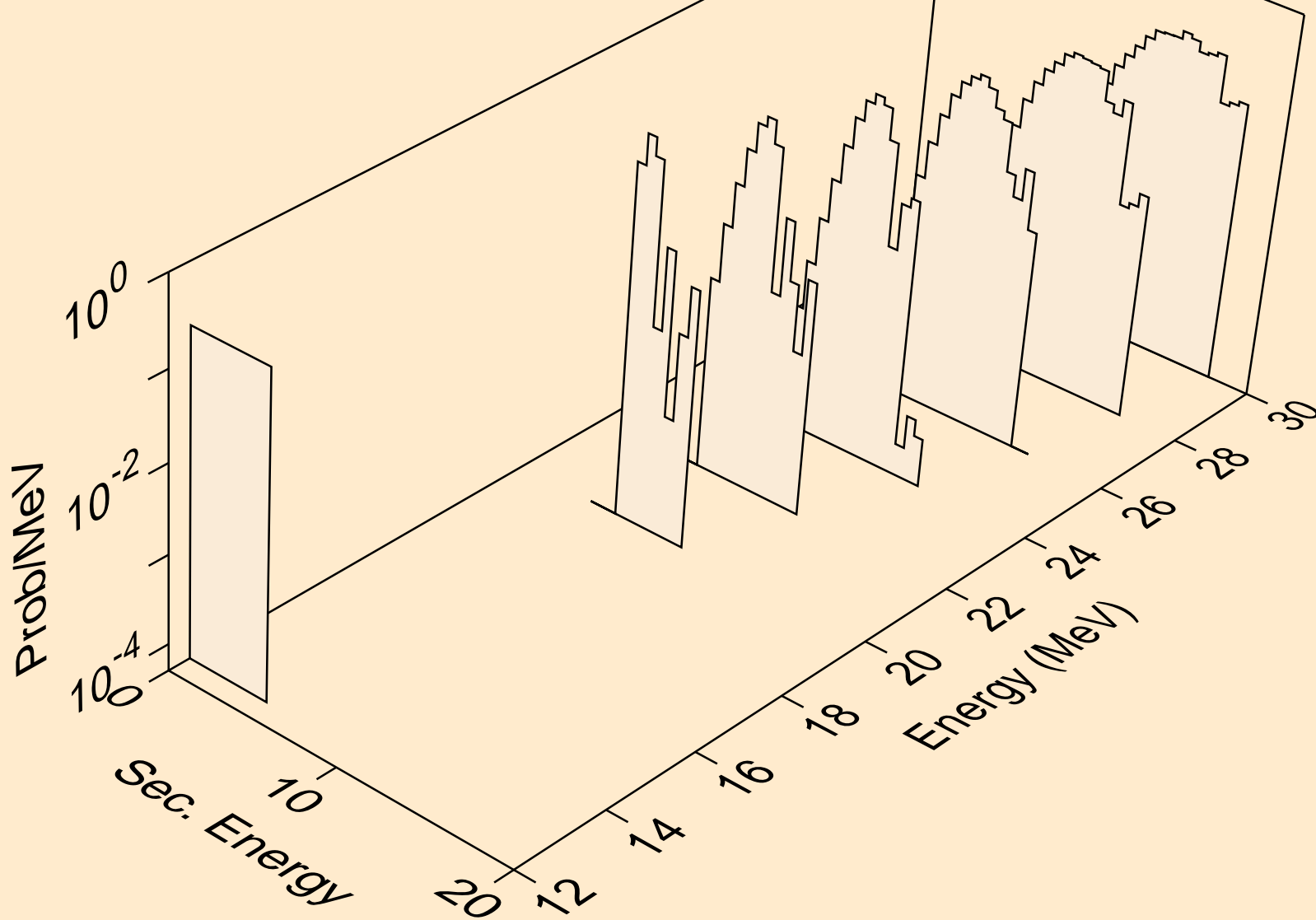

PT183 NEUTRON ACER TENDL-2019 LIBRARY; T=293.16K  
alphas from (n,n\*)2a

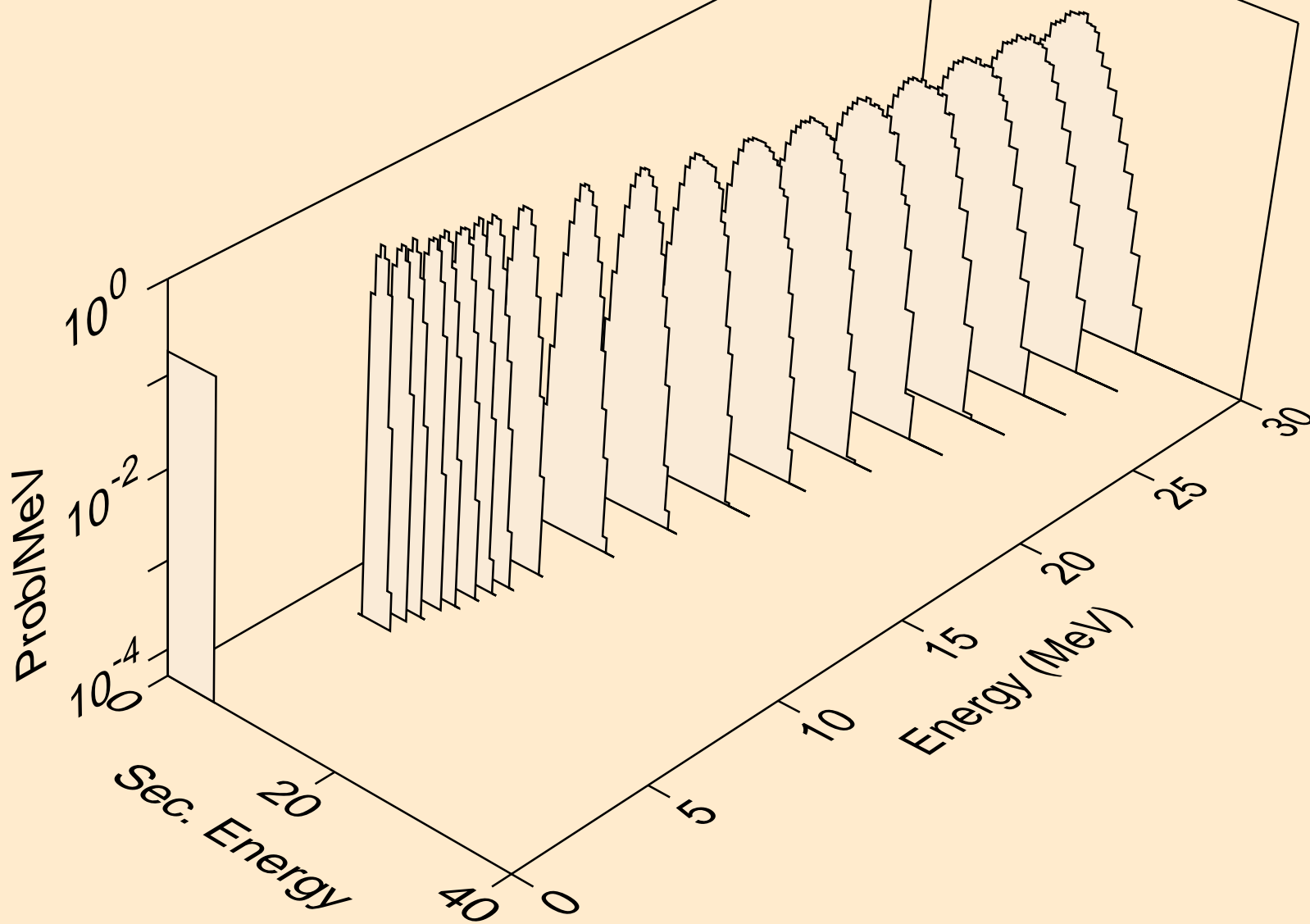

PT183 NEUTRON ACER TENDL-2019 LIBRARY; T=293.16K  
alphas from (n,2n)2a

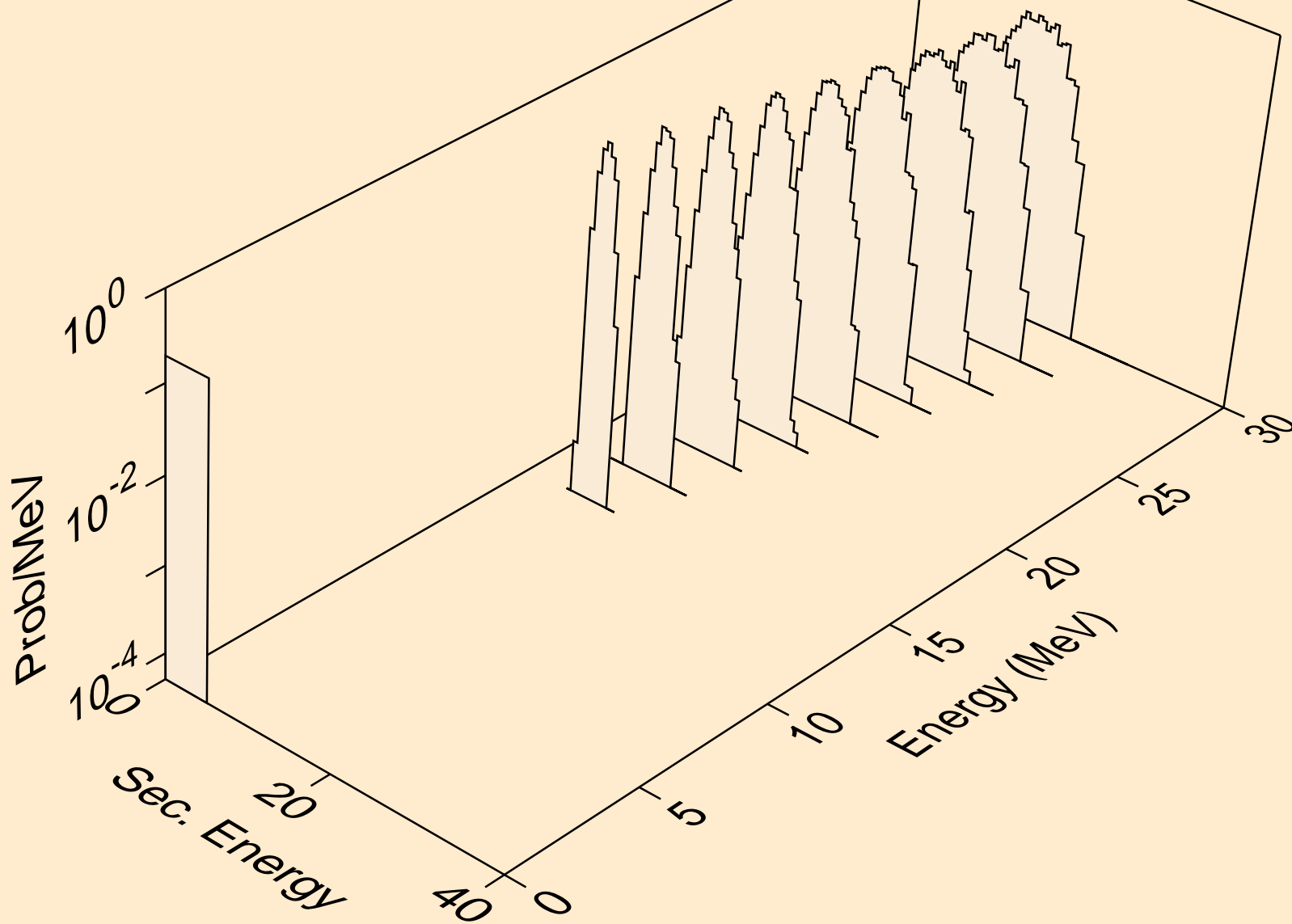

PT183 NEUTRON ACER TENDL-2019 LIBRARY; T=293.16K  
alphas from (n,npa)

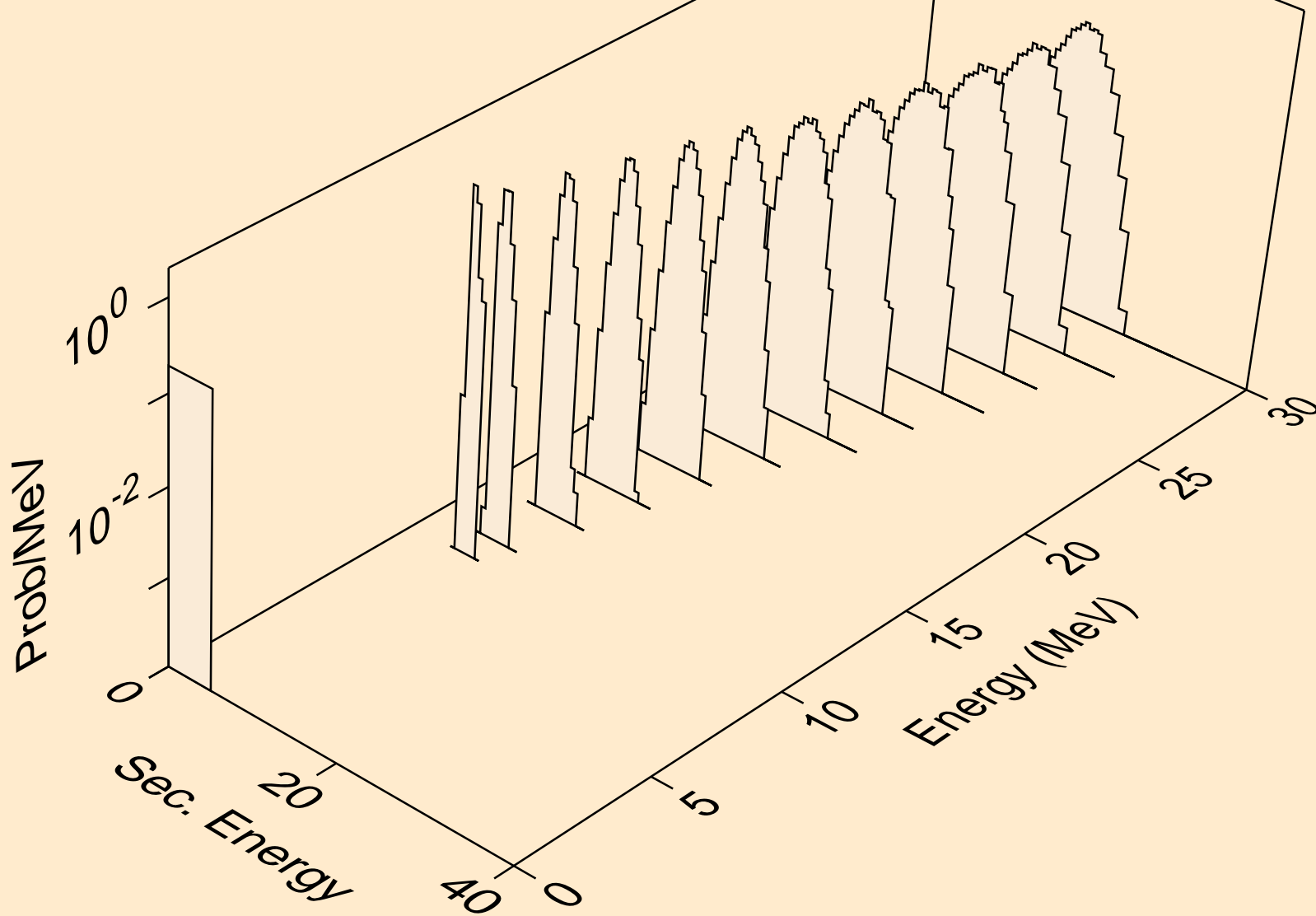

PT183 NEUTRON ACER TENDL-2019 LIBRARY; T=293.16K  
alphas from (n,a)

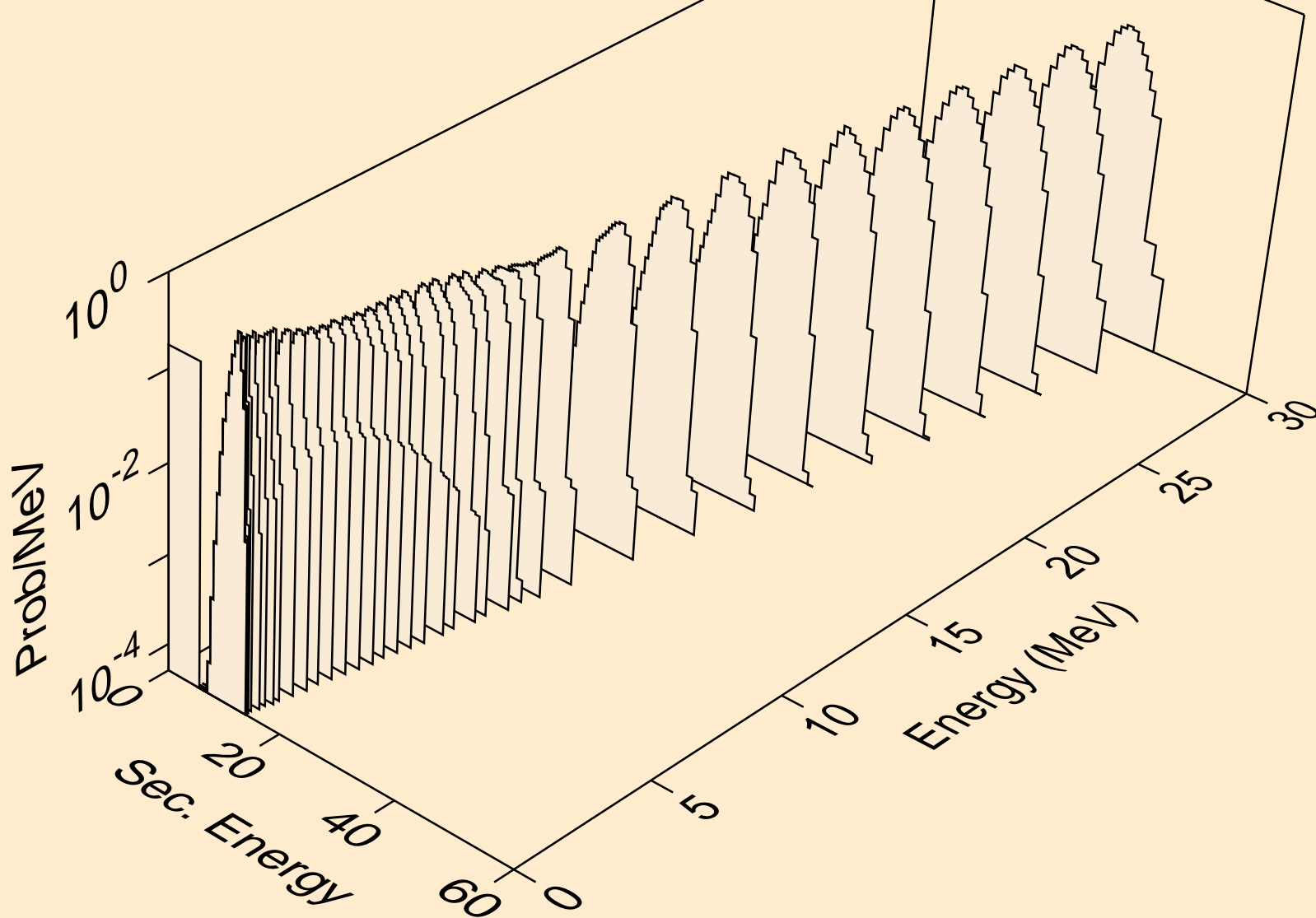

PT183 NEUTRON ACER TENDL-2019 LIBRARY; T=293.16K  
alphas from (n,2a)

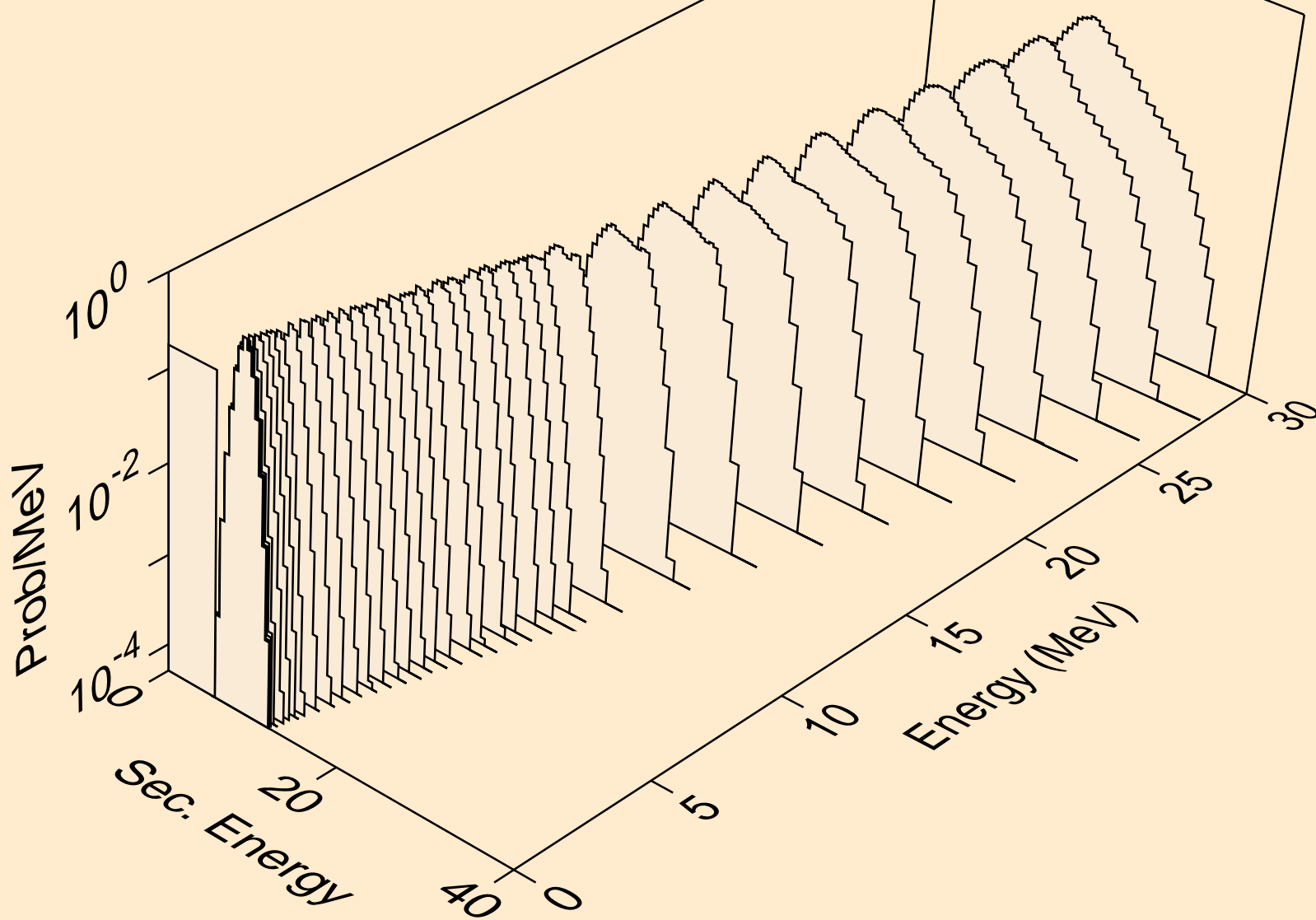

PT183 NEUTRON ACER TENDL-2019 LIBRARY; T=293.16K  
alphas from (n,pa)

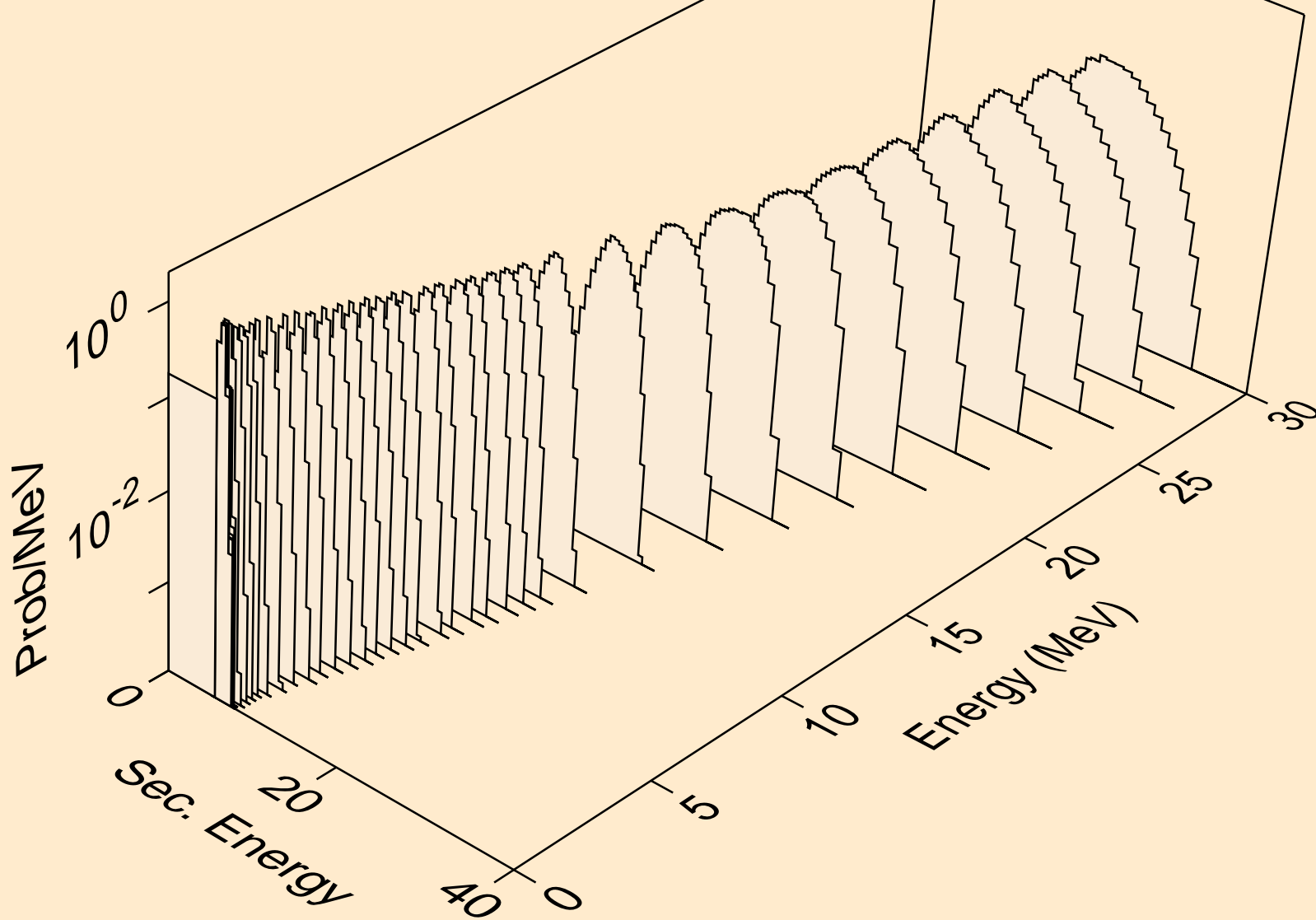



PT183 NEUTRON ACER TENDL-2019 LIBRARY; T=293.16K  
alphas from (n,da)

