

PT185 NEUTRON ACER TENDL-2019 LIBRARY; T=293.16K
Principal cross sections

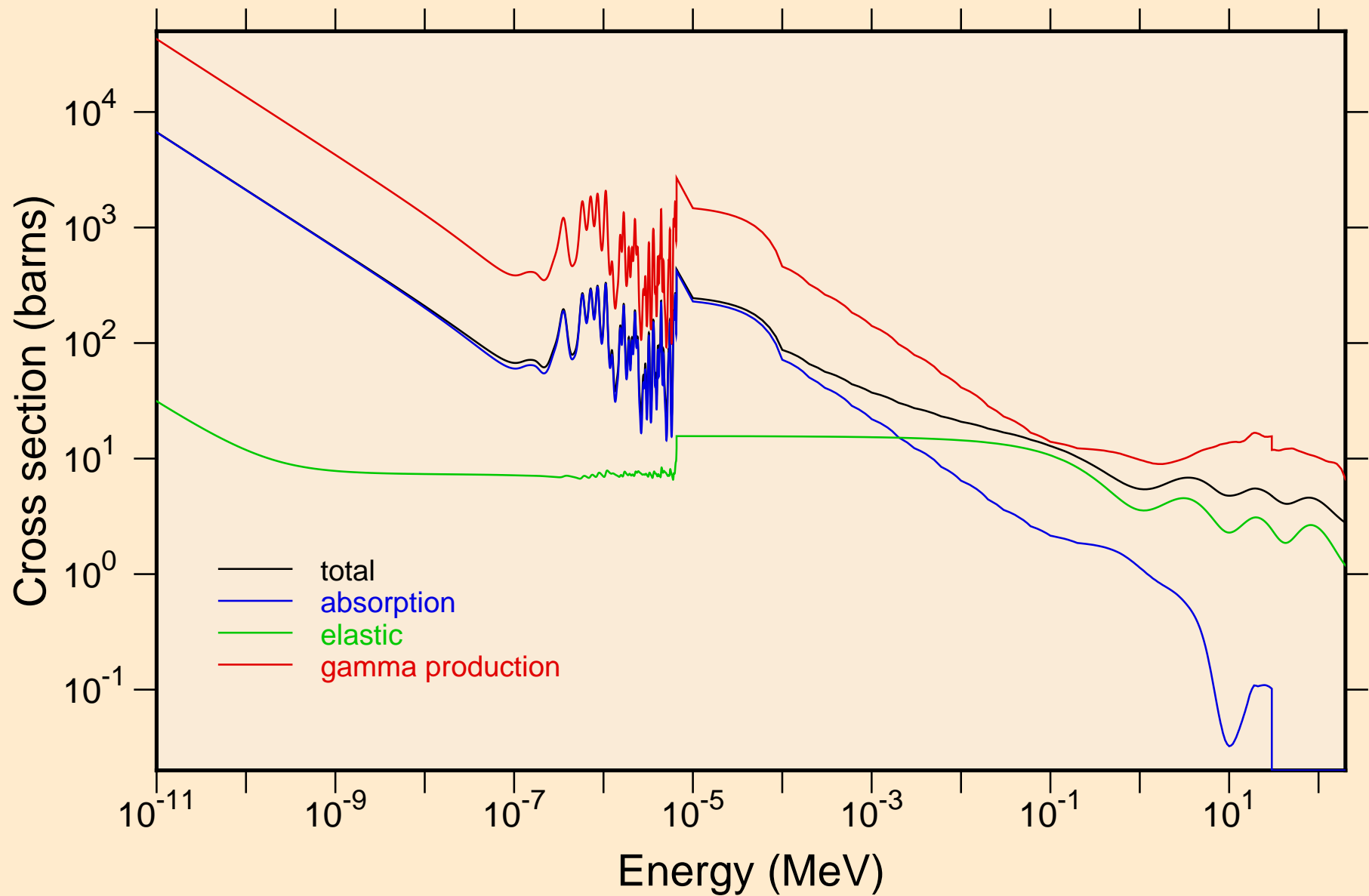

PT185 NEUTRON ACER TENDL-2019 LIBRARY; T=293.16K
resonance total cross section

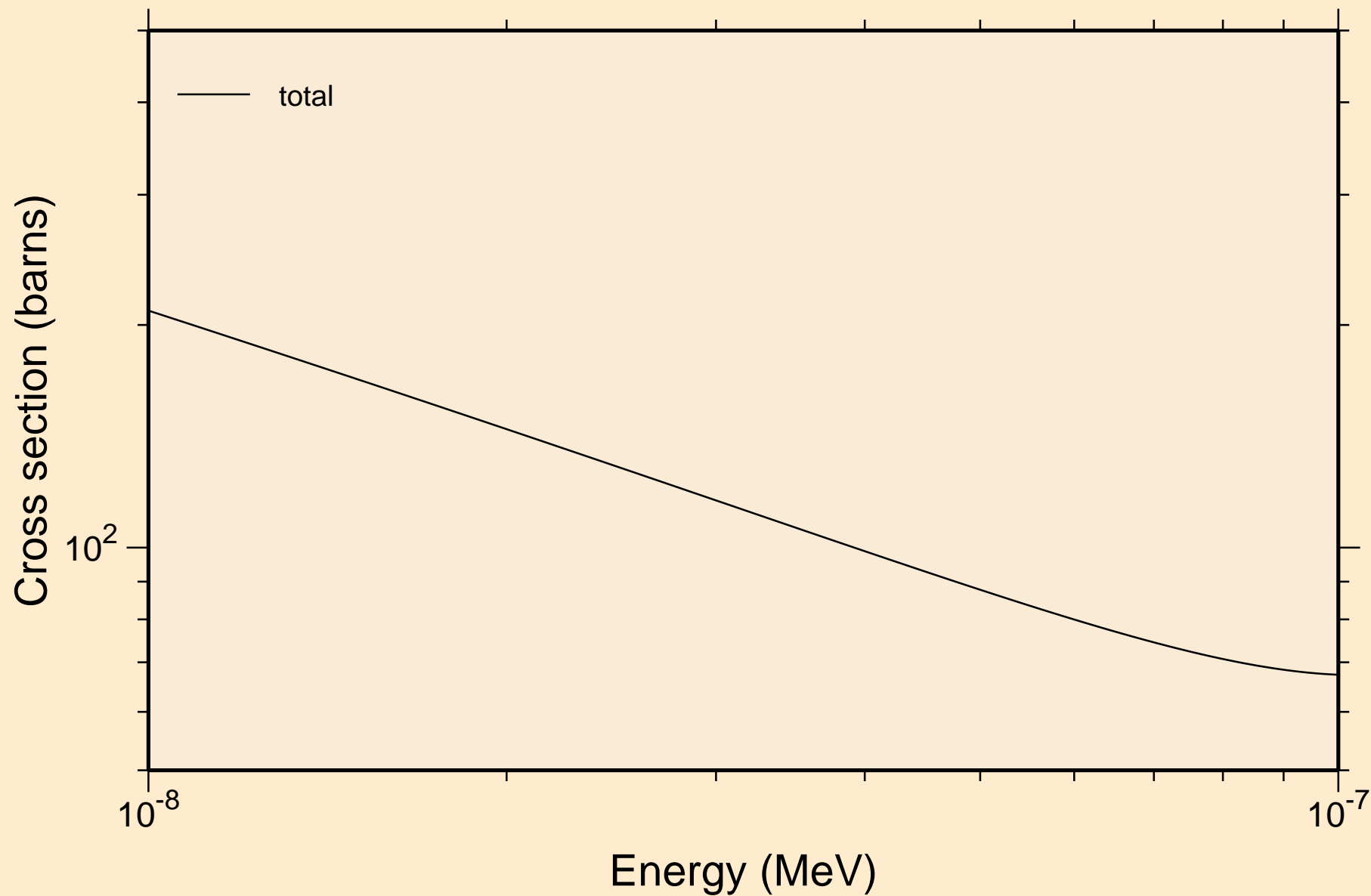

PT185 NEUTRON ACER TENDL-2019 LIBRARY; T=293.16K
resonance total cross section

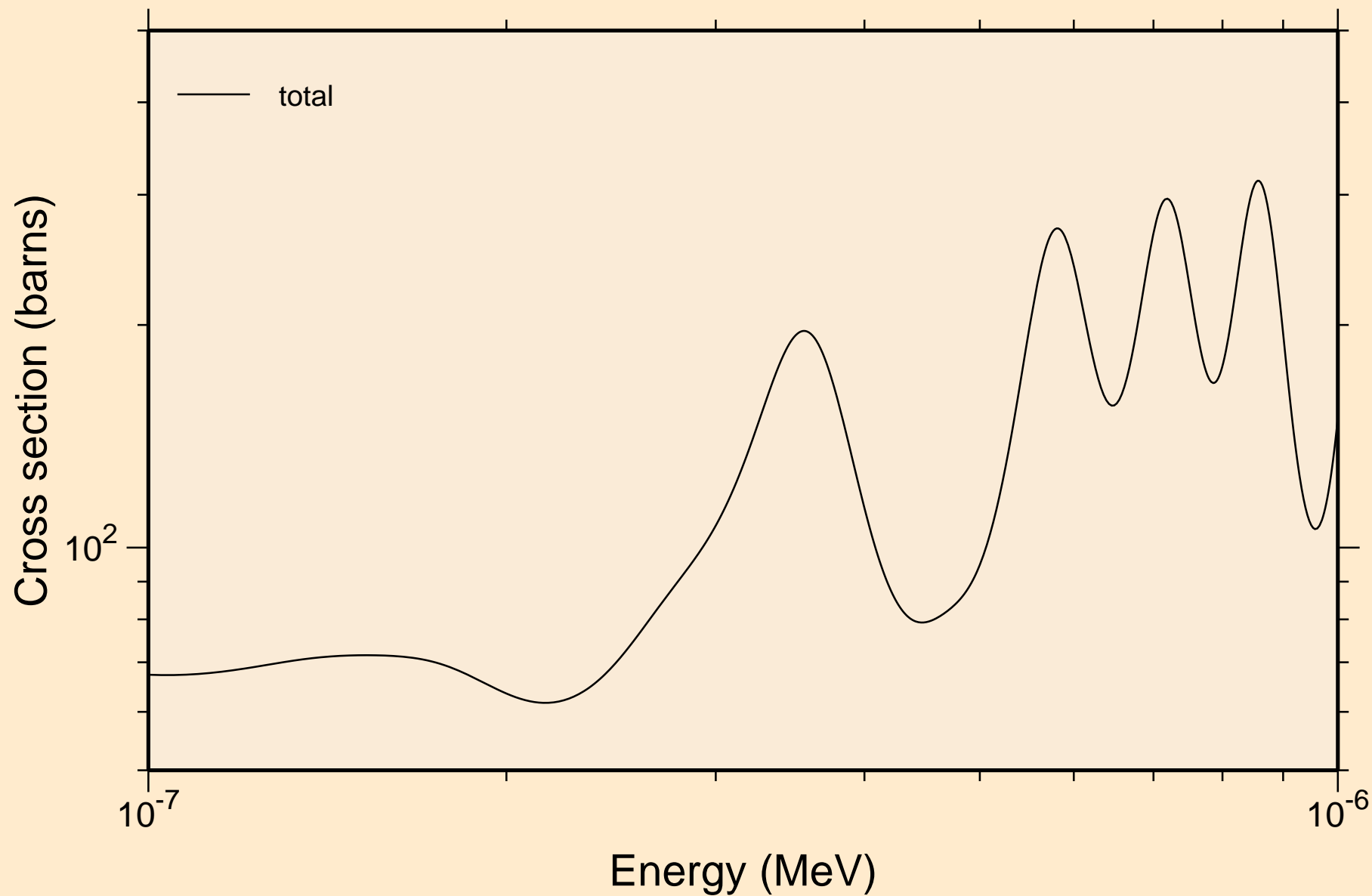

PT185 NEUTRON ACER TENDL-2019 LIBRARY; T=293.16K
resonance total cross section

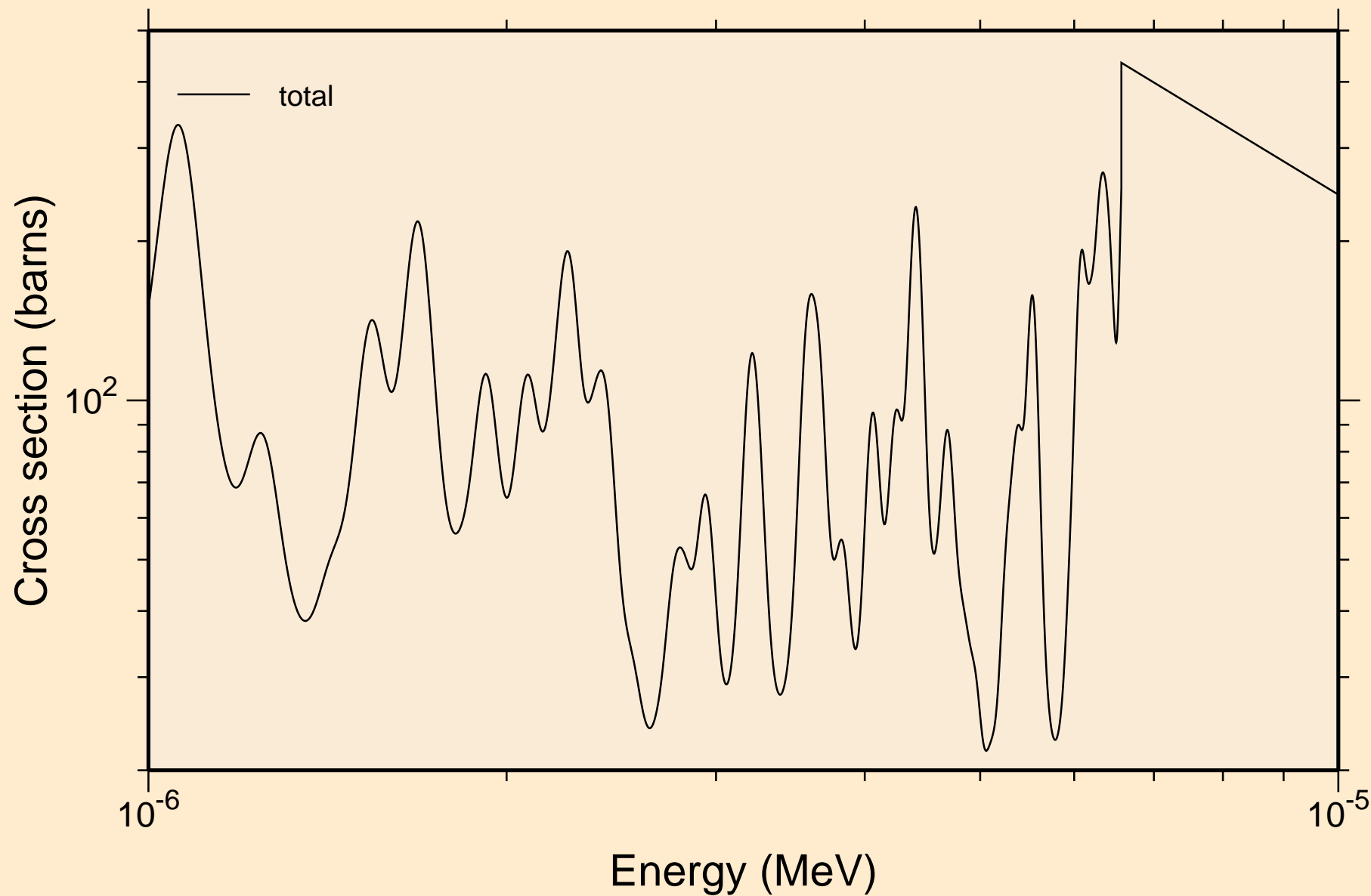

PT185 NEUTRON ACER TENDL-2019 LIBRARY; T=293.16K
resonance total cross section

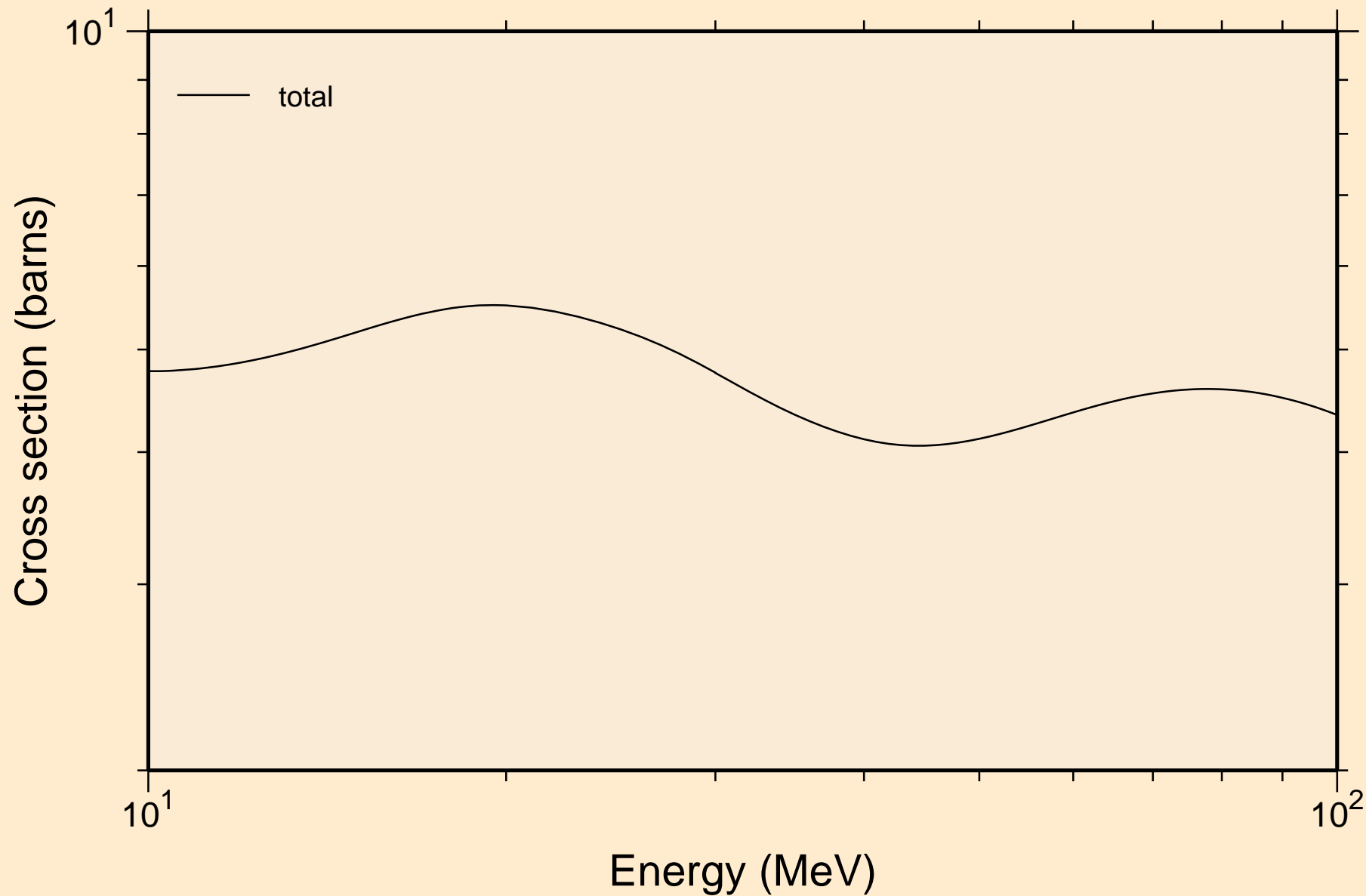

PT185 NEUTRON ACER TENDL-2019 LIBRARY; T=293.16K
resonance absorption cross sections

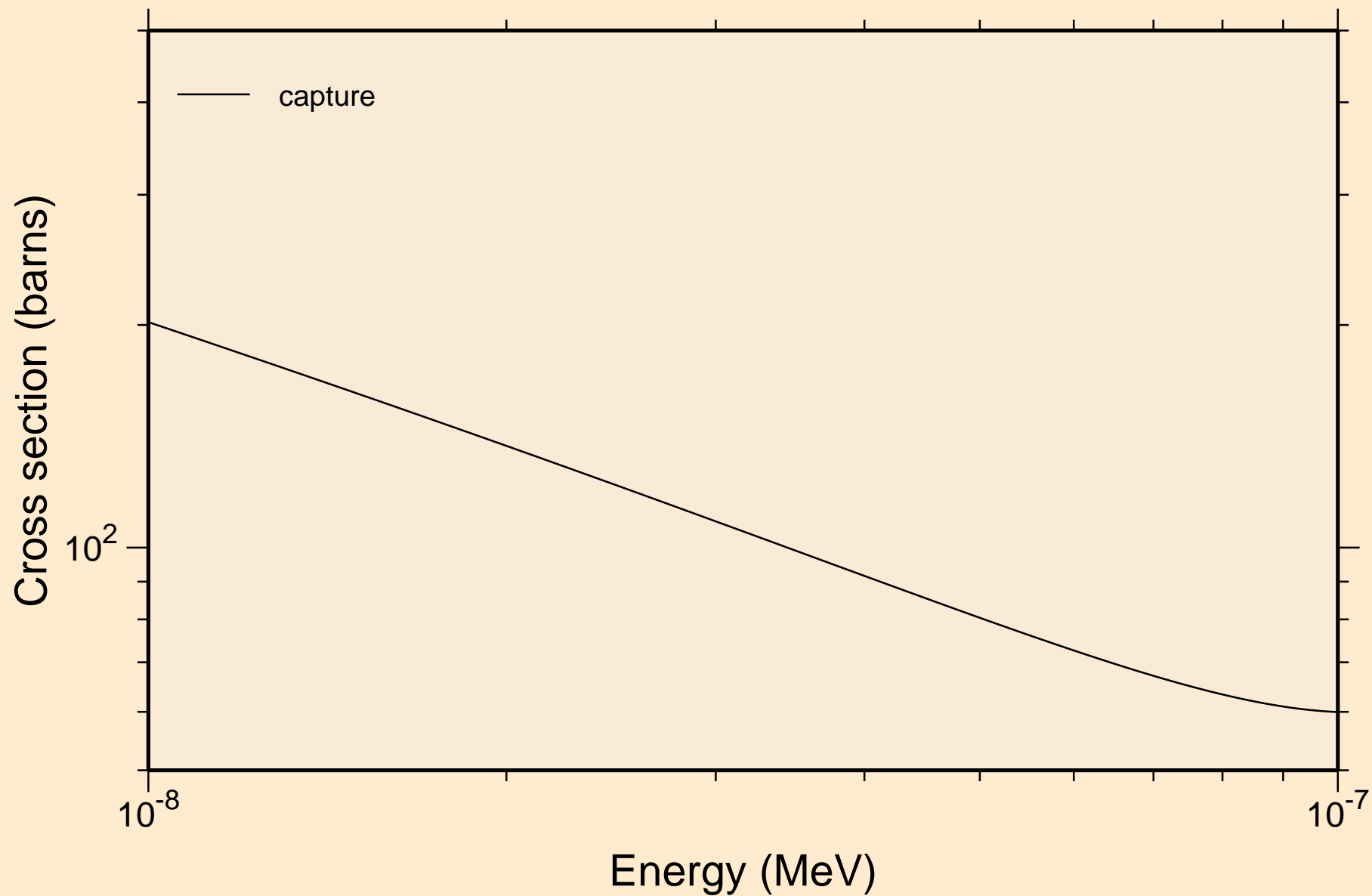

PT185 NEUTRON ACER TENDL-2019 LIBRARY; T=293.16K
resonance absorption cross sections

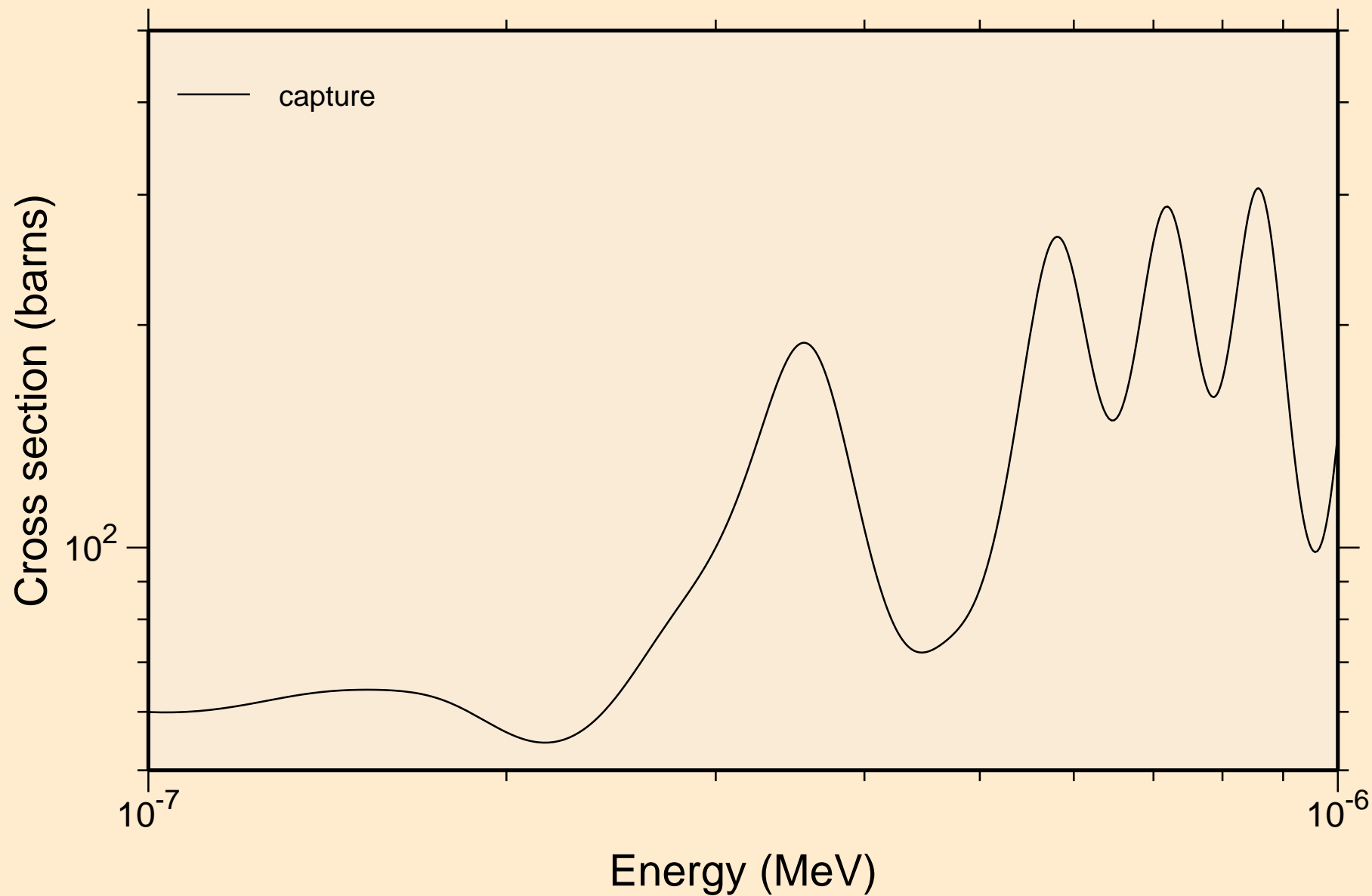

PT185 NEUTRON ACER TENDL-2019 LIBRARY; T=293.16K
resonance absorption cross sections

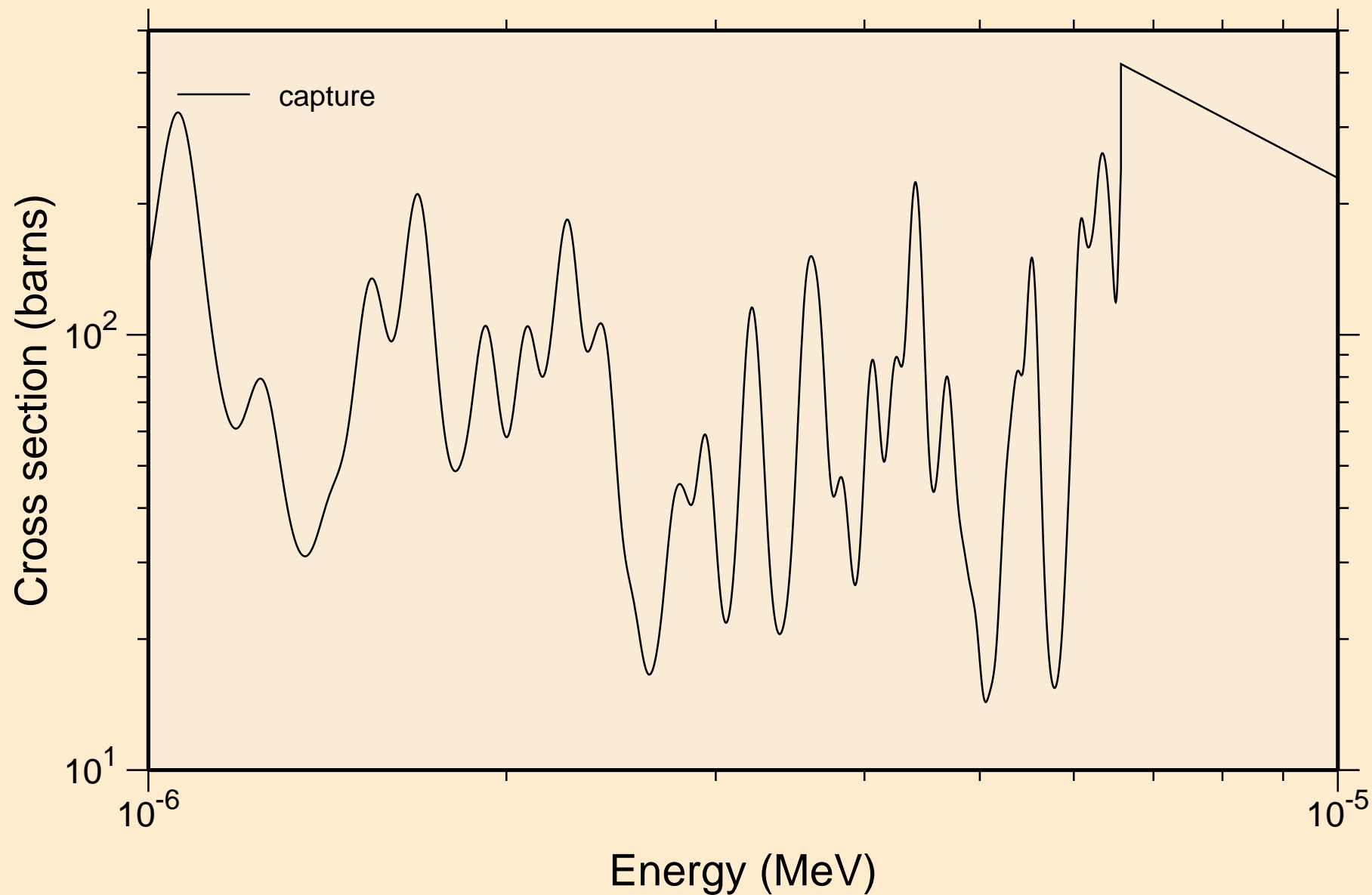

PT185 NEUTRON ACER TENDL-2019 LIBRARY; T=293.16K
resonance absorption cross sections

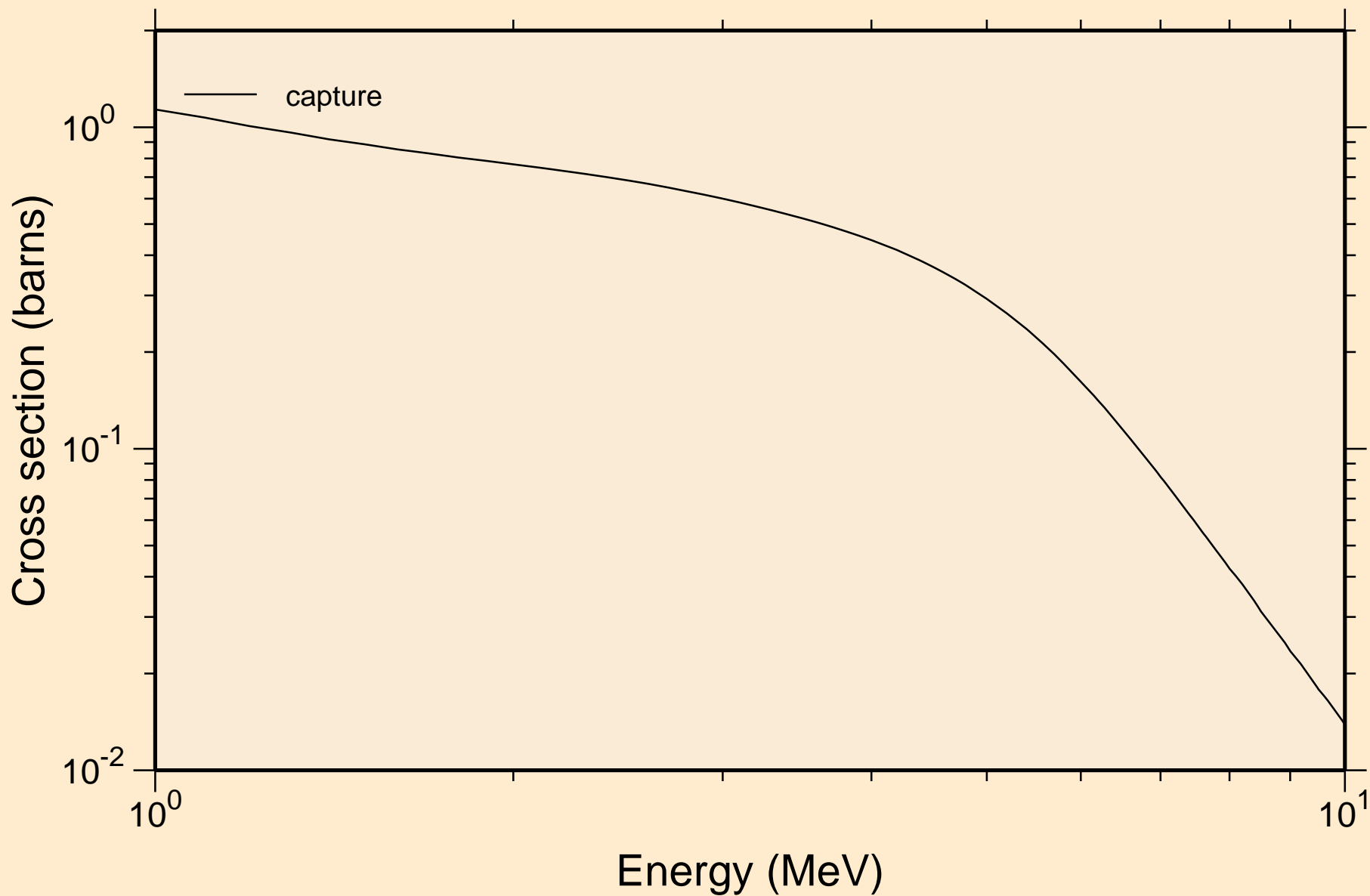

PT185 NEUTRON ACER TENDL-2019 LIBRARY; T=293.16K
Heating

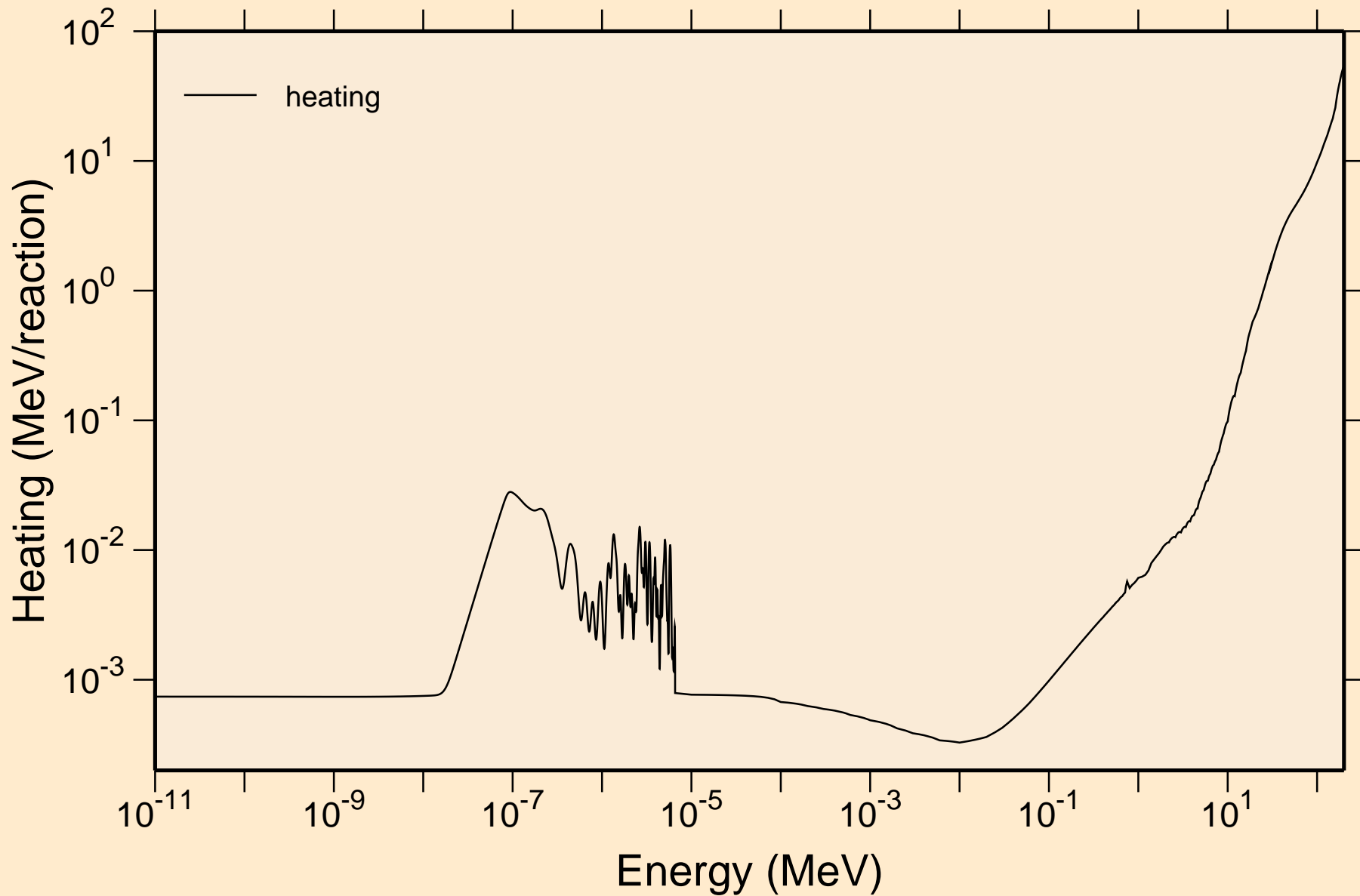

PT185 NEUTRON ACER TENDL-2019 LIBRARY; T=293.16K
Damage

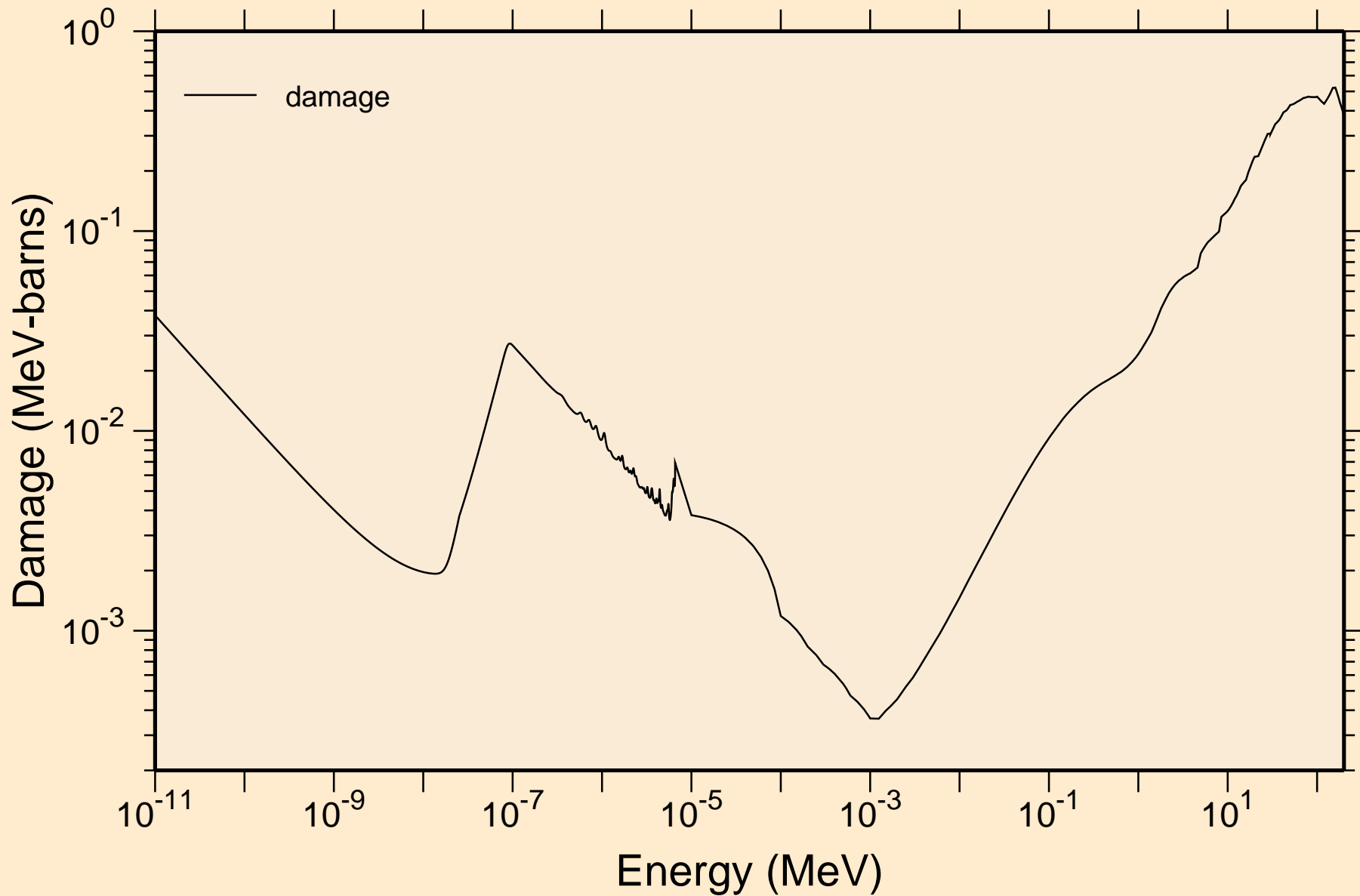

PT185 NEUTRON ACER TENDL-2019 LIBRARY; T=293.16K
Non-threshold reactions

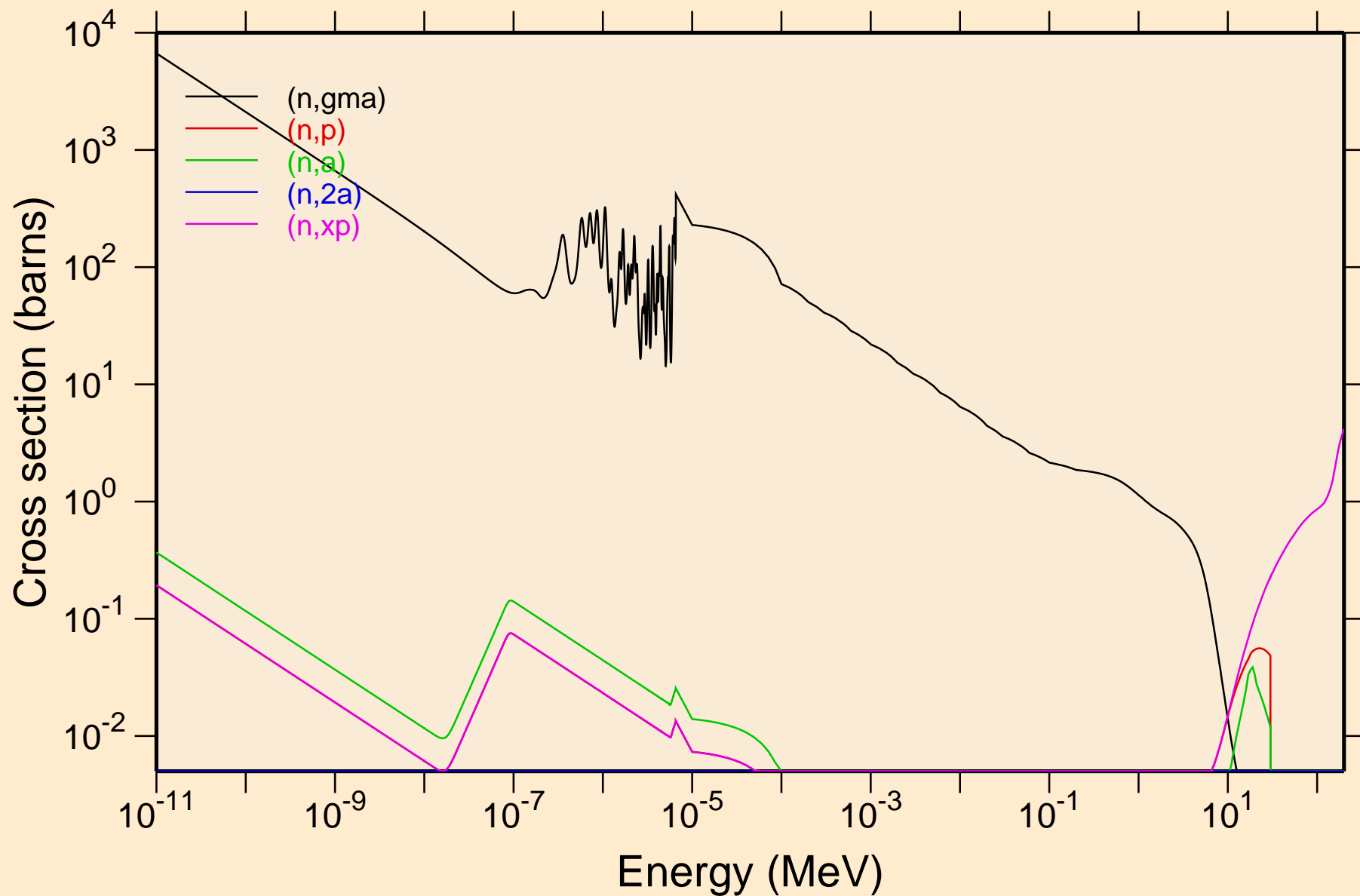

PT185 NEUTRON ACER TENDL-2019 LIBRARY; T=293.16K
Non-threshold reactions

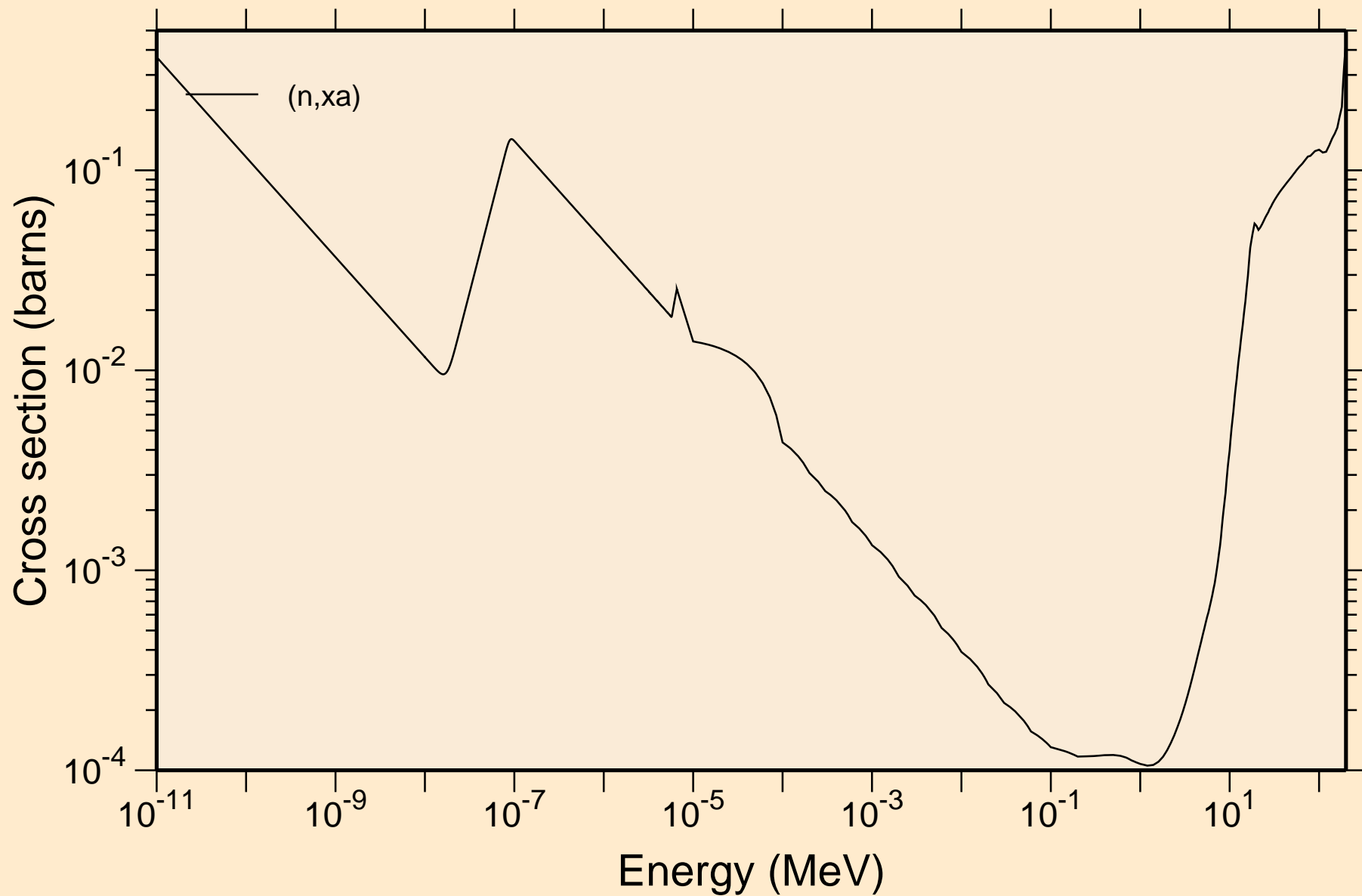

PT185 NEUTRON ACER TENDL-2019 LIBRARY; T=293.16K
Principal cross sections

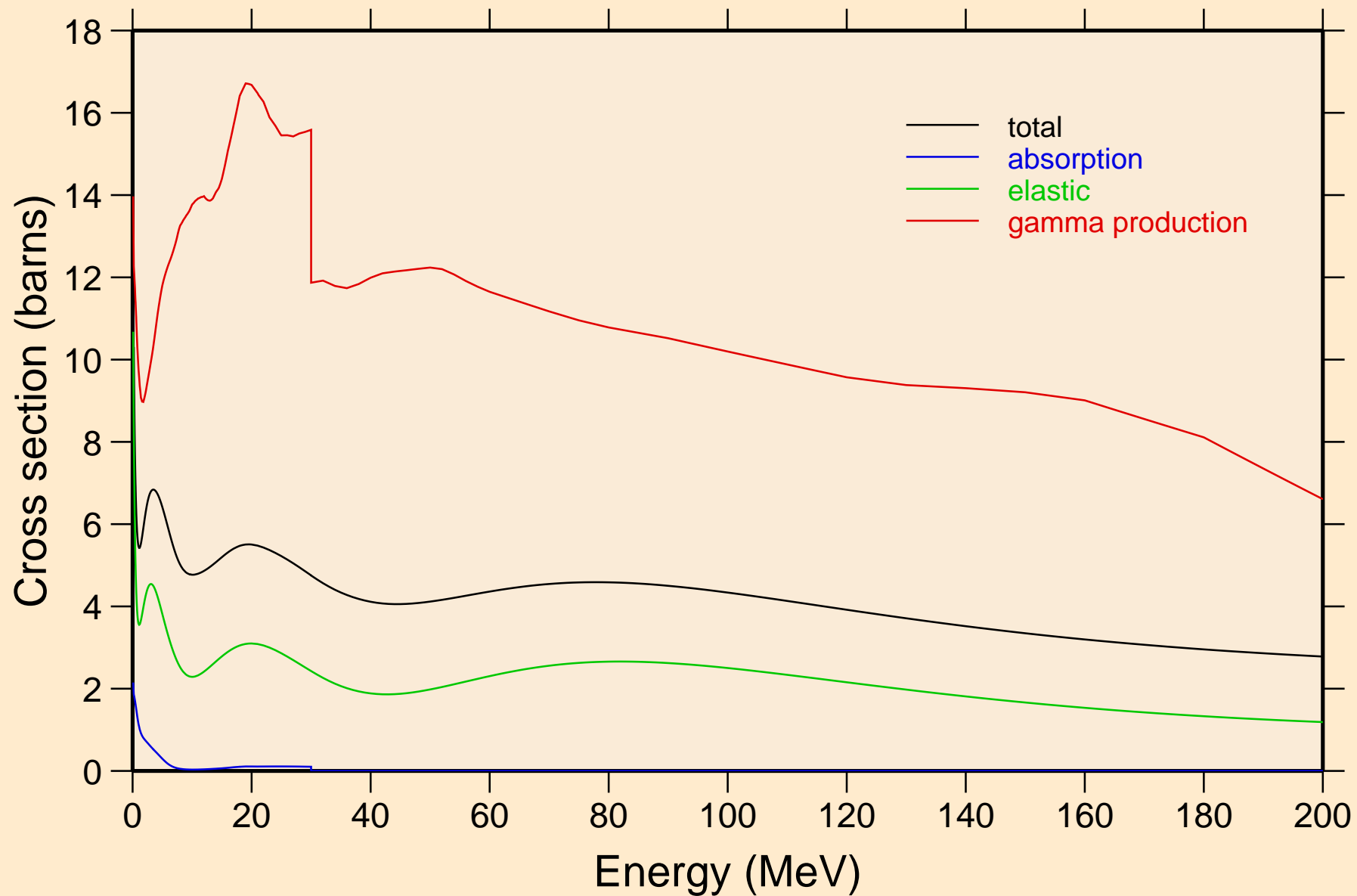

PT185 NEUTRON ACER TENDL-2019 LIBRARY; T=293.16K
Heating

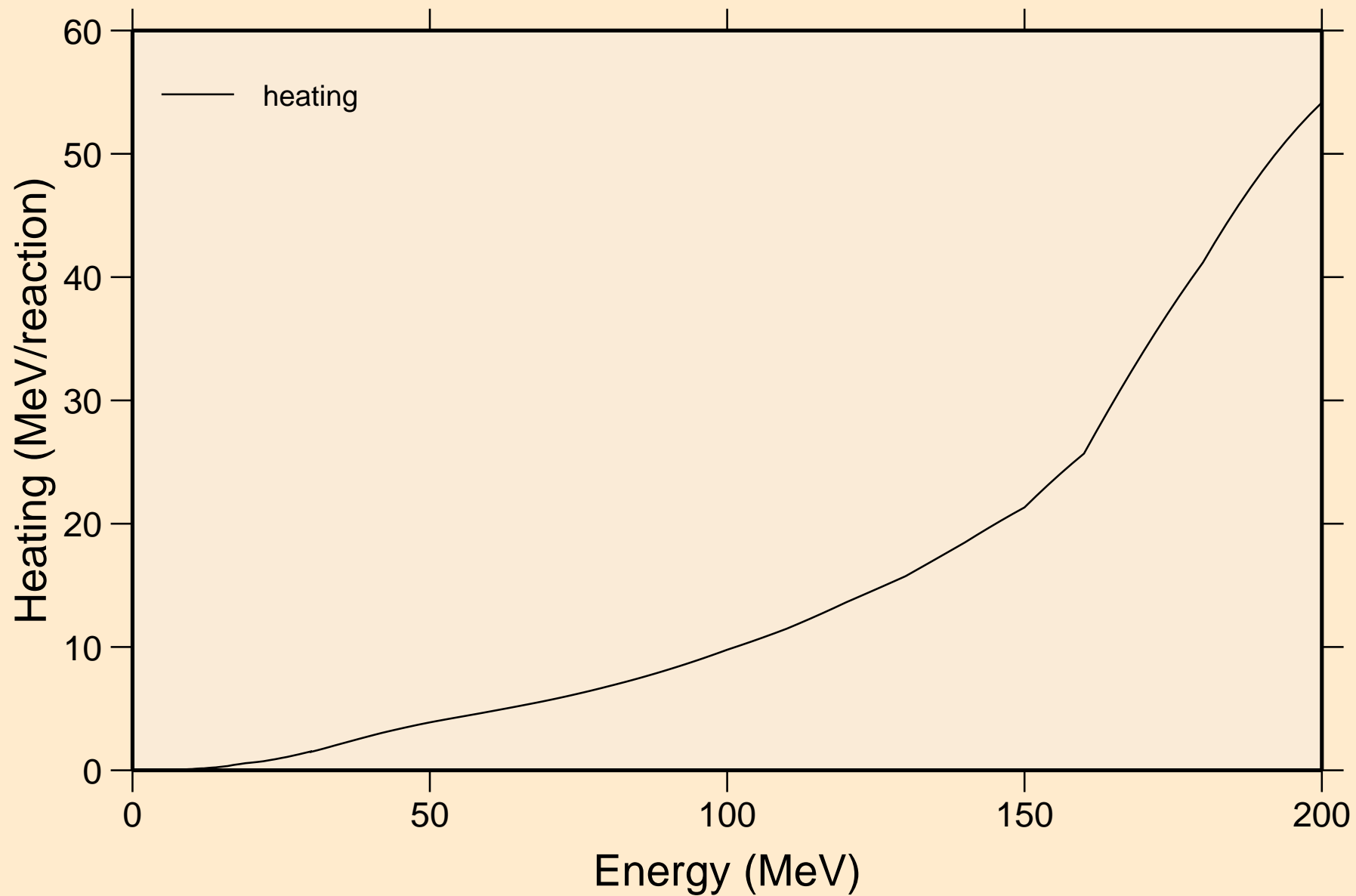

PT185 NEUTRON ACER TENDL-2019 LIBRARY; T=293.16K
Damage

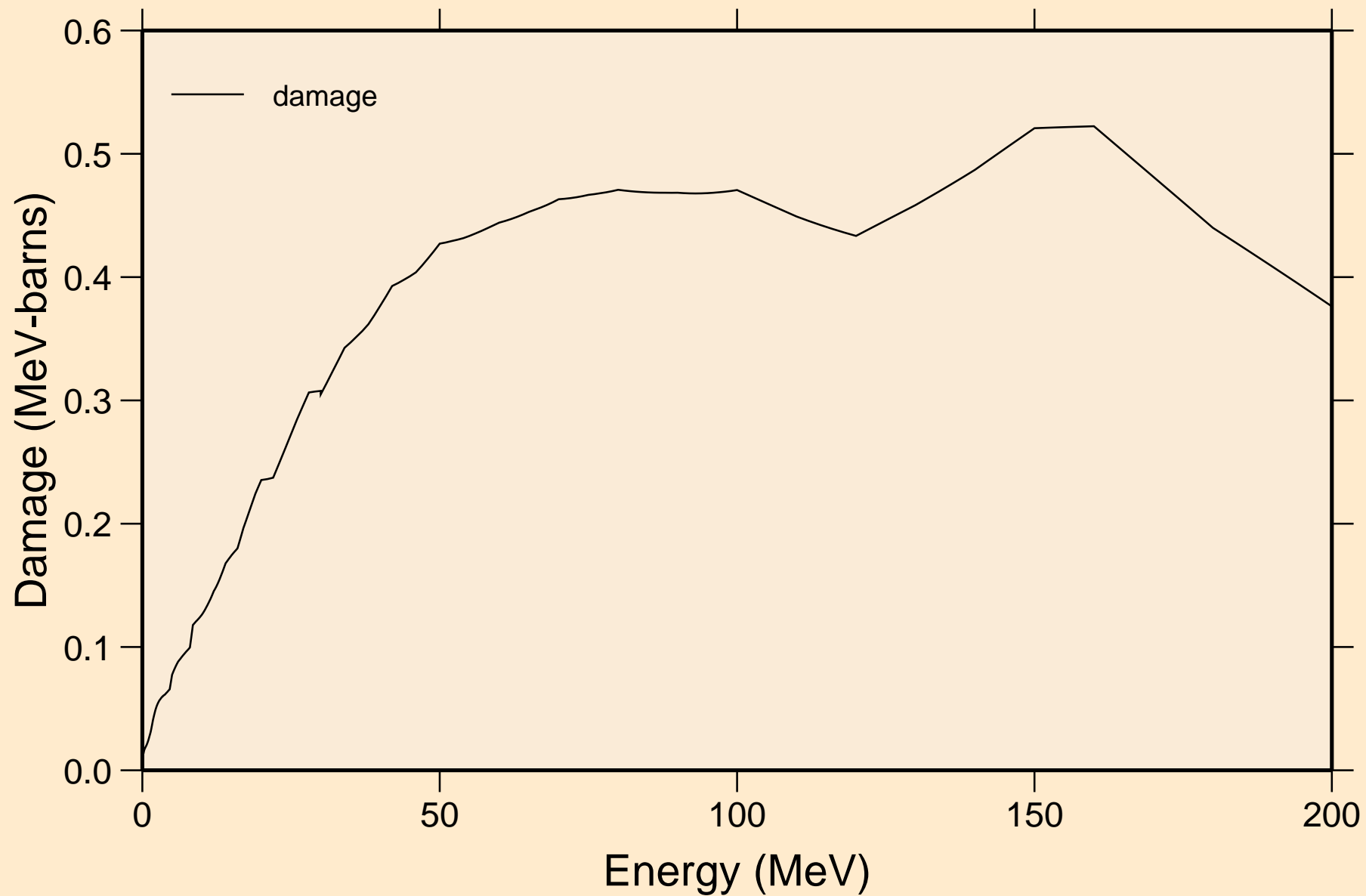

PT185 NEUTRON ACER TENDL-2019 LIBRARY; T=293.16K
Non-threshold reactions

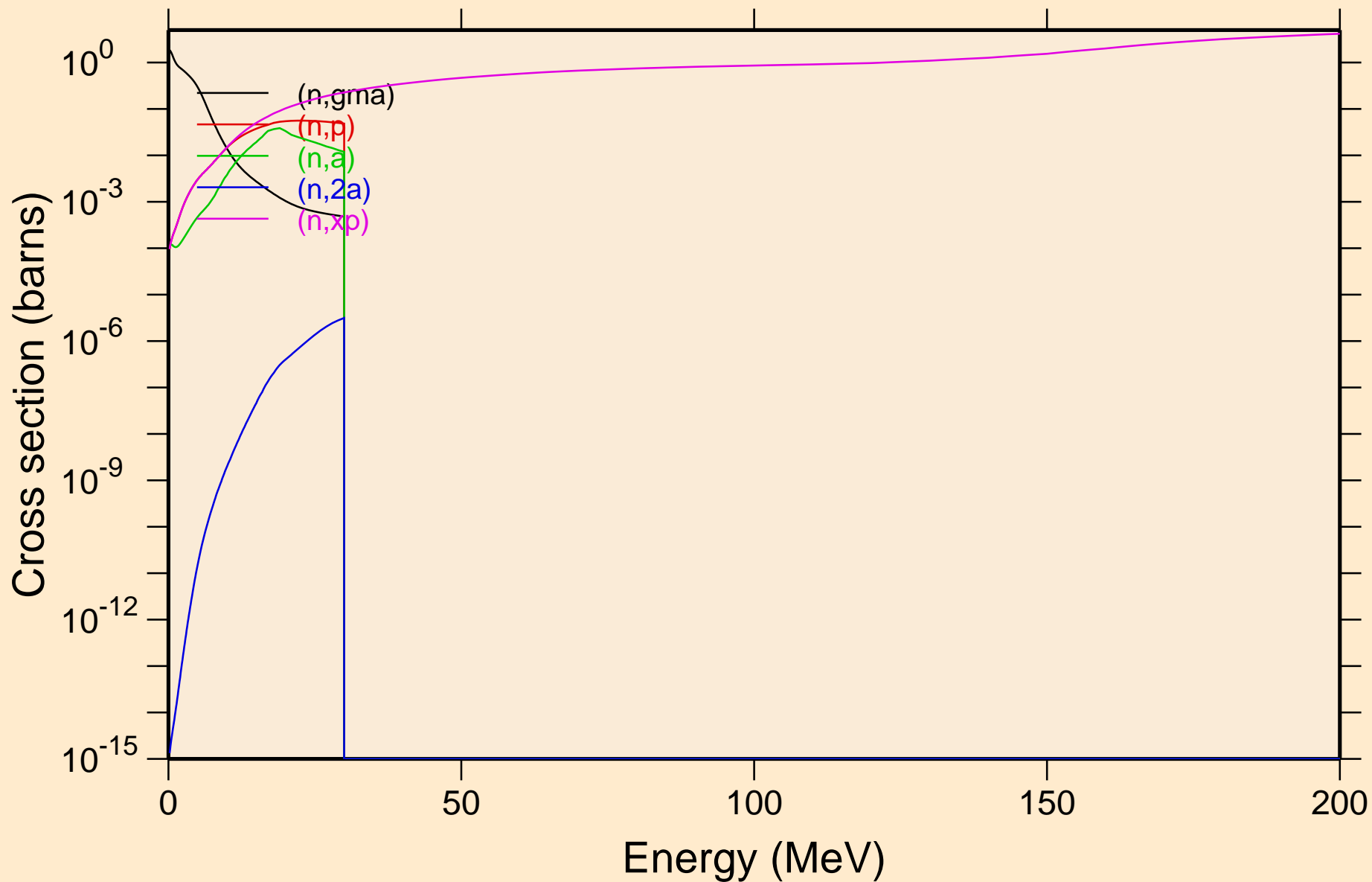

PT185 NEUTRON ACER TENDL-2019 LIBRARY; T=293.16K
Non-threshold reactions

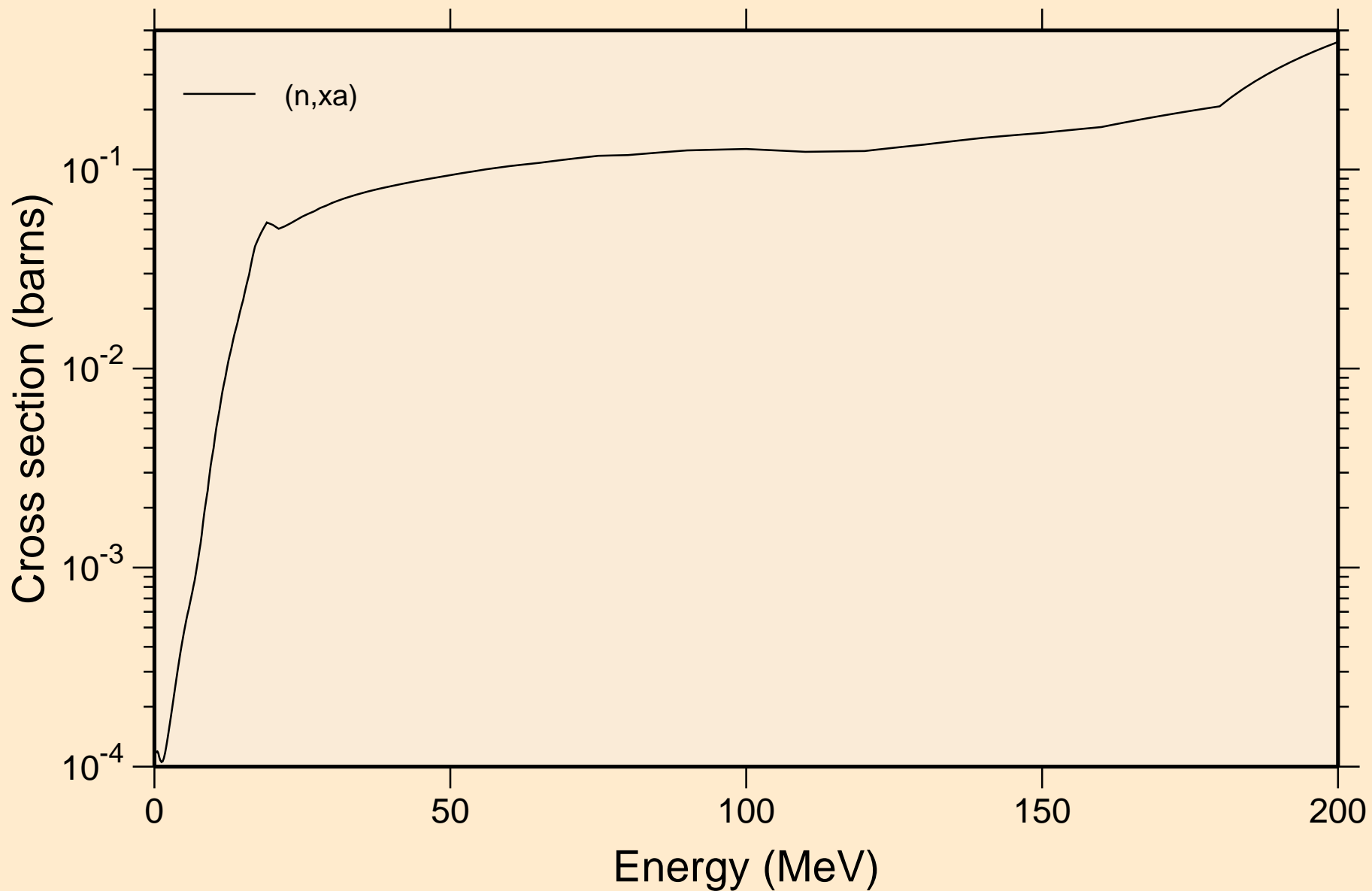

PT185 NEUTRON ACER TENDL-2019 LIBRARY; T=293.16K
Inelastic levels

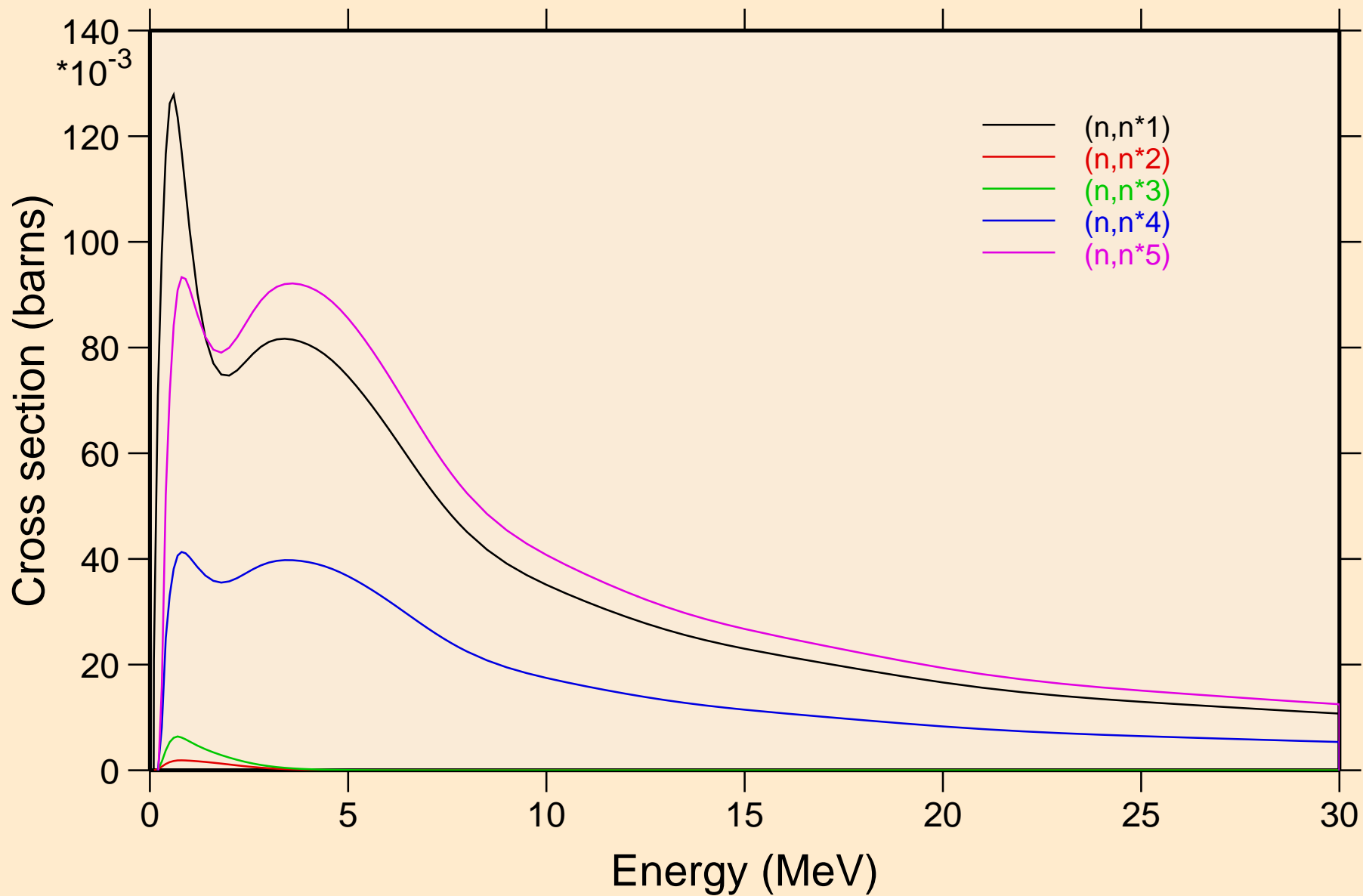

PT185 NEUTRON ACER TENDL-2019 LIBRARY; T=293.16K
Inelastic levels

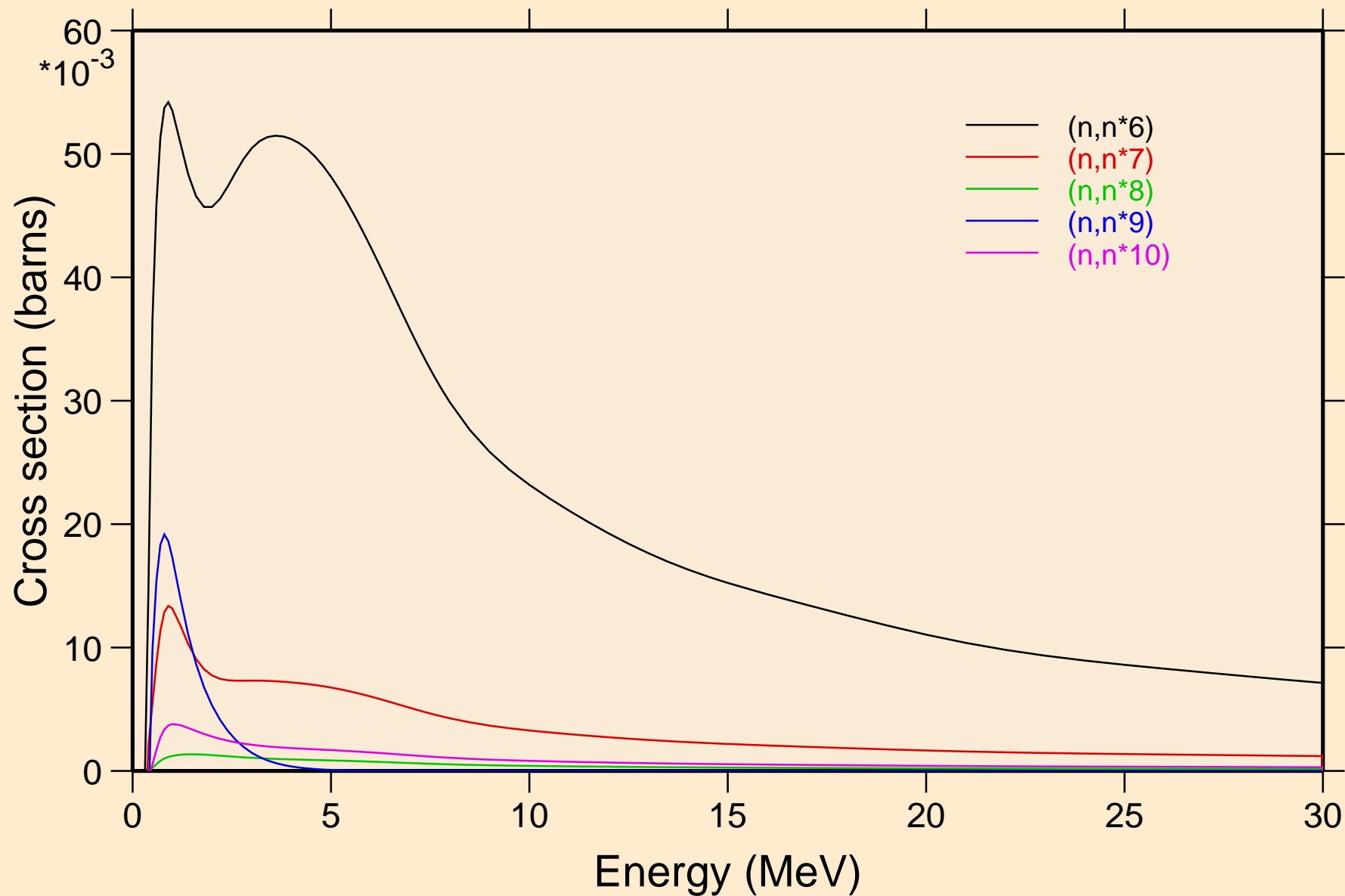

PT185 NEUTRON ACER TENDL-2019 LIBRARY; T=293.16K
Inelastic levels

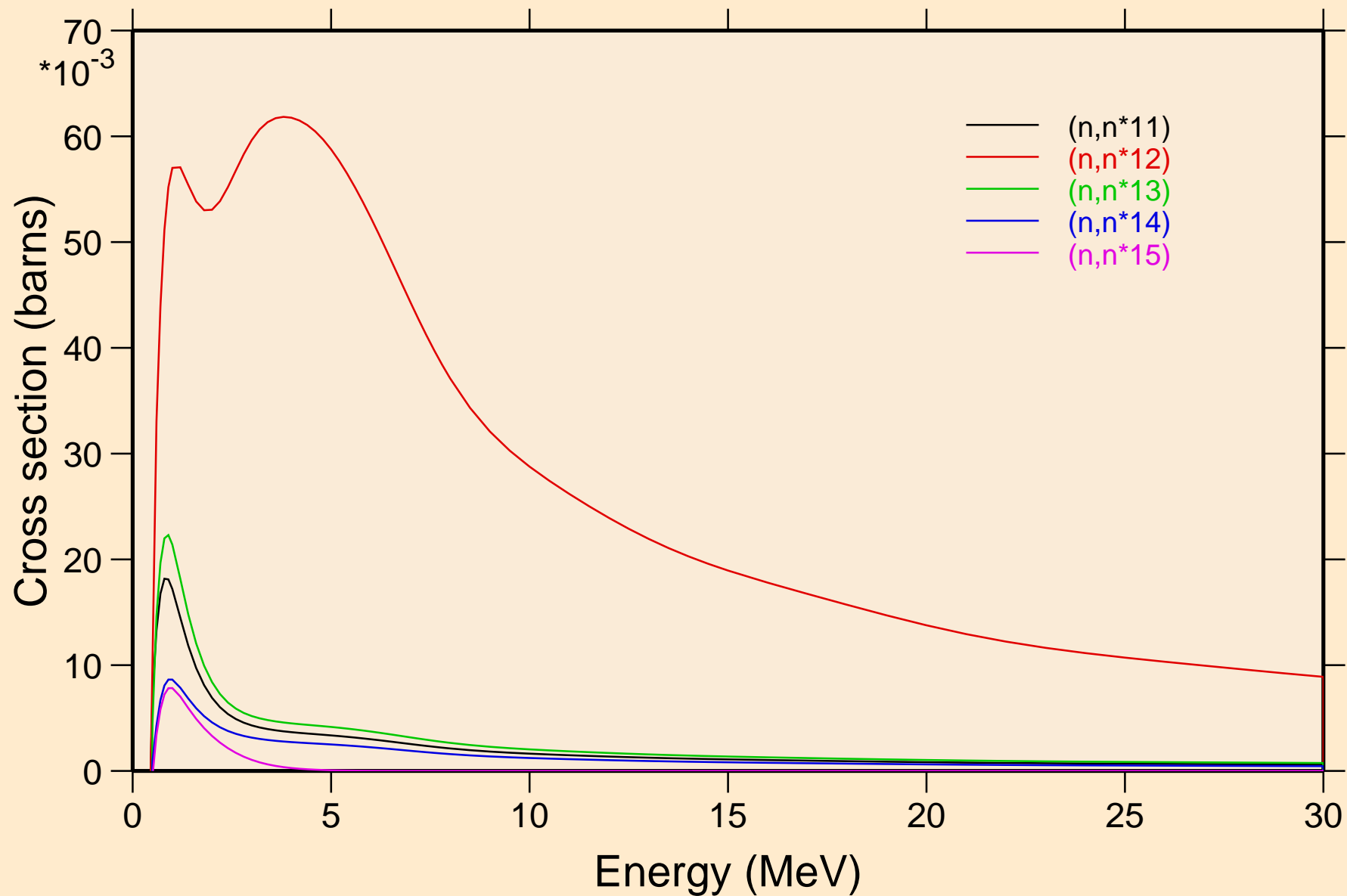

PT185 NEUTRON ACER TENDL-2019 LIBRARY; T=293.16K
Inelastic levels

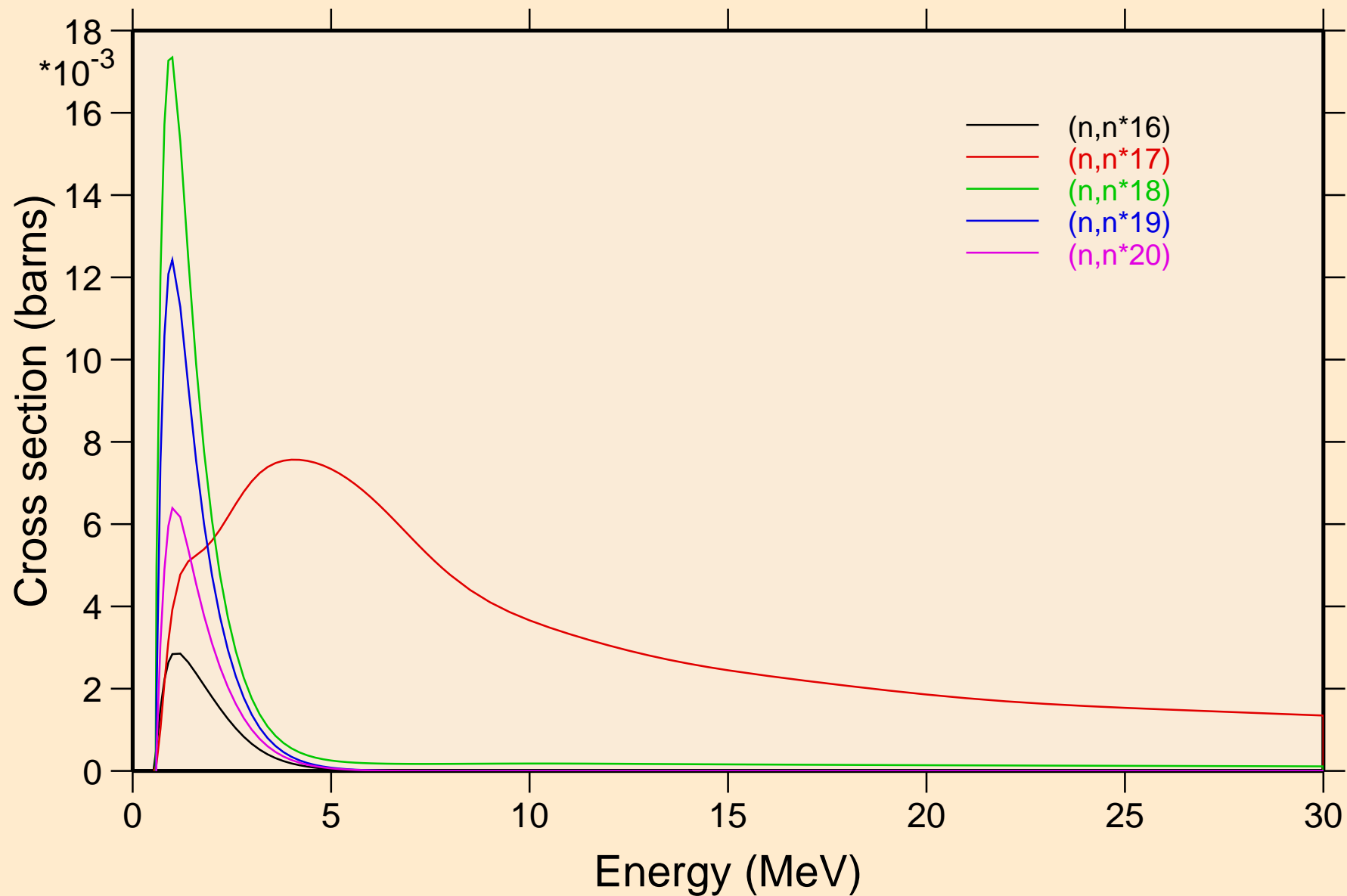

PT185 NEUTRON ACER TENDL-2019 LIBRARY; T=293.16K
Inelastic levels

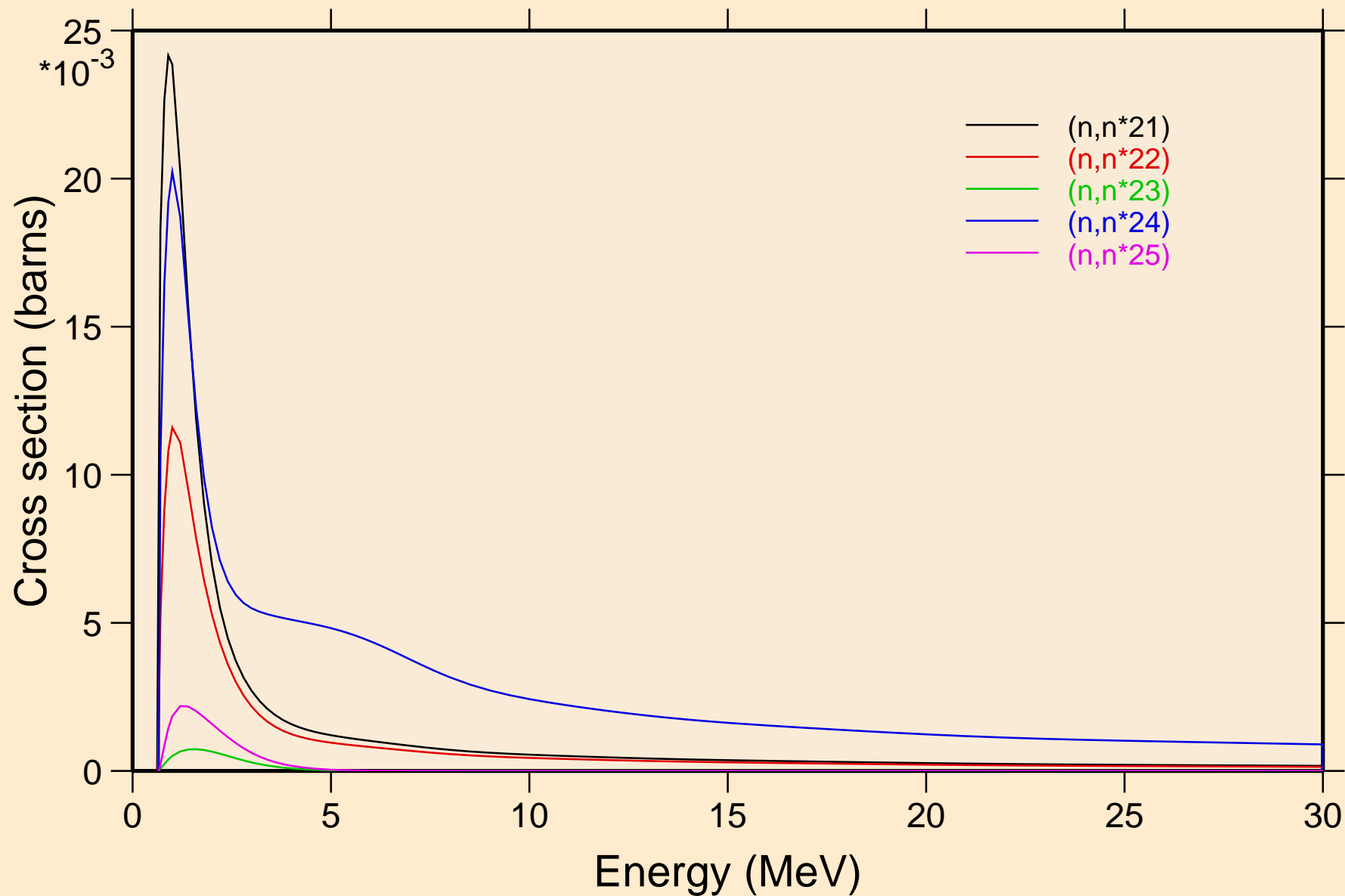

PT185 NEUTRON ACER TENDL-2019 LIBRARY; T=293.16K
Inelastic levels

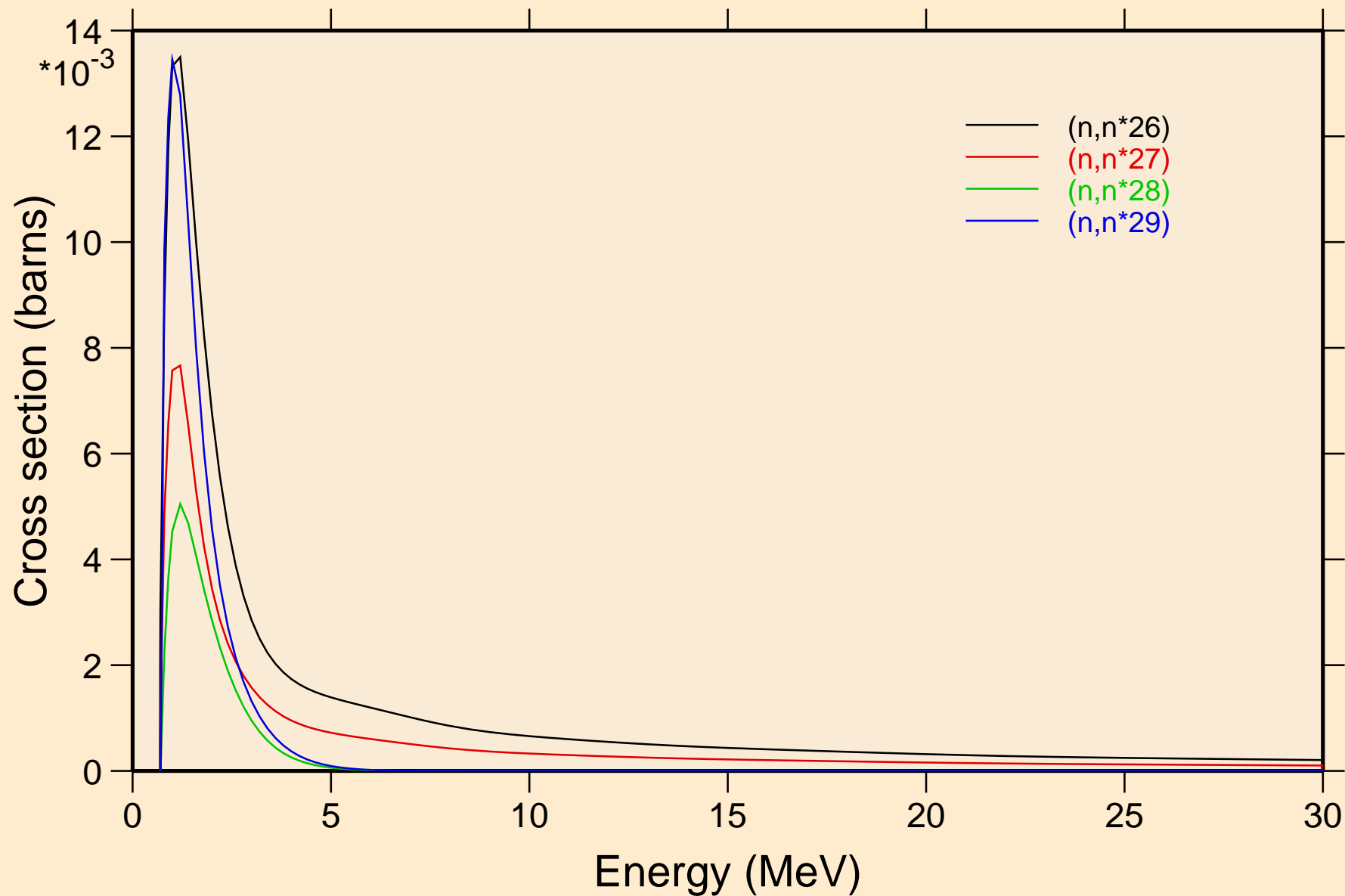

PT185 NEUTRON ACER TENDL-2019 LIBRARY; T=293.16K
Threshold reactions

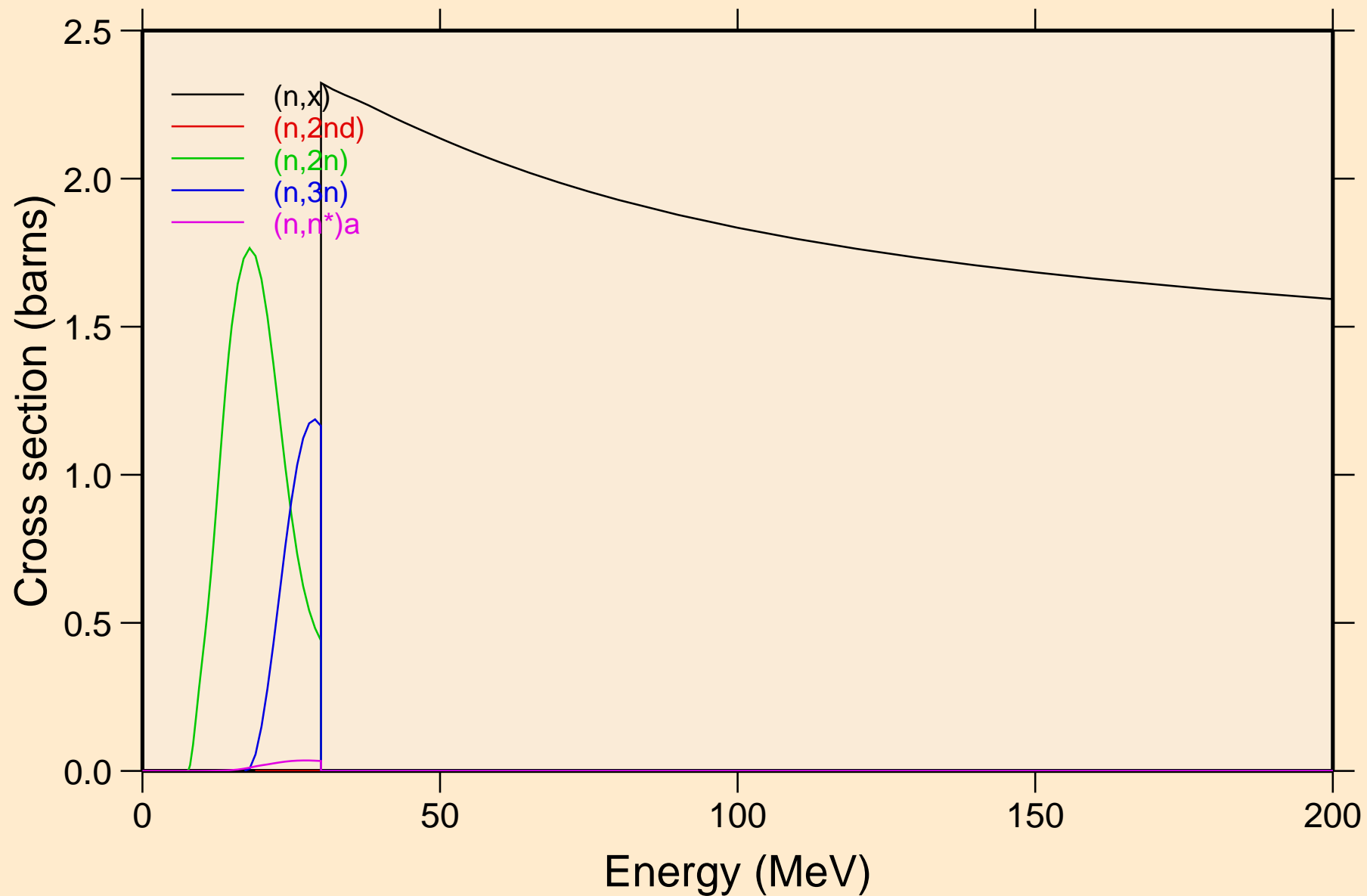

PT185 NEUTRON ACER TENDL-2019 LIBRARY; T=293.16K
Threshold reactions

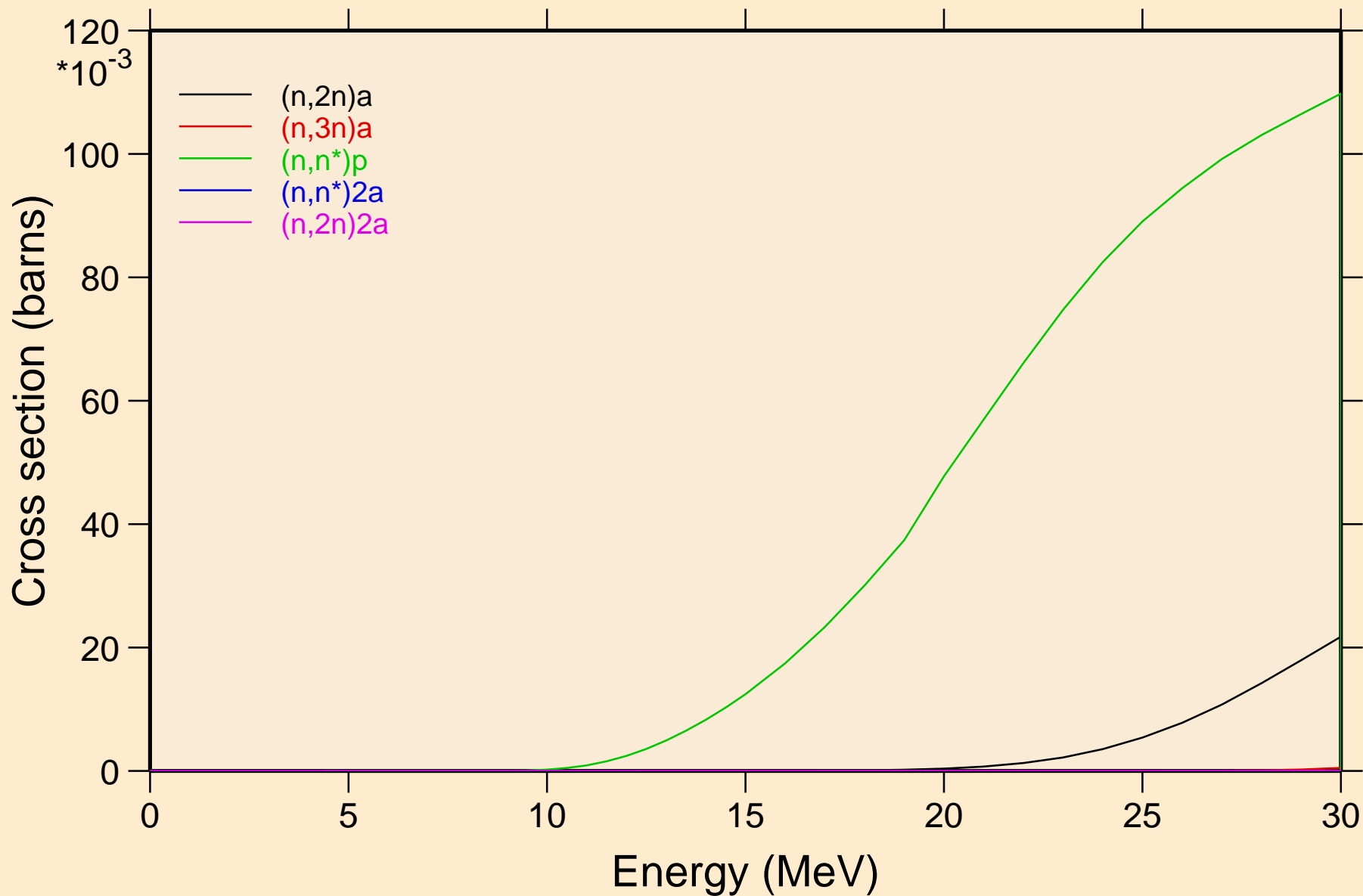

PT185 NEUTRON ACER TENDL-2019 LIBRARY; T=293.16K
Threshold reactions

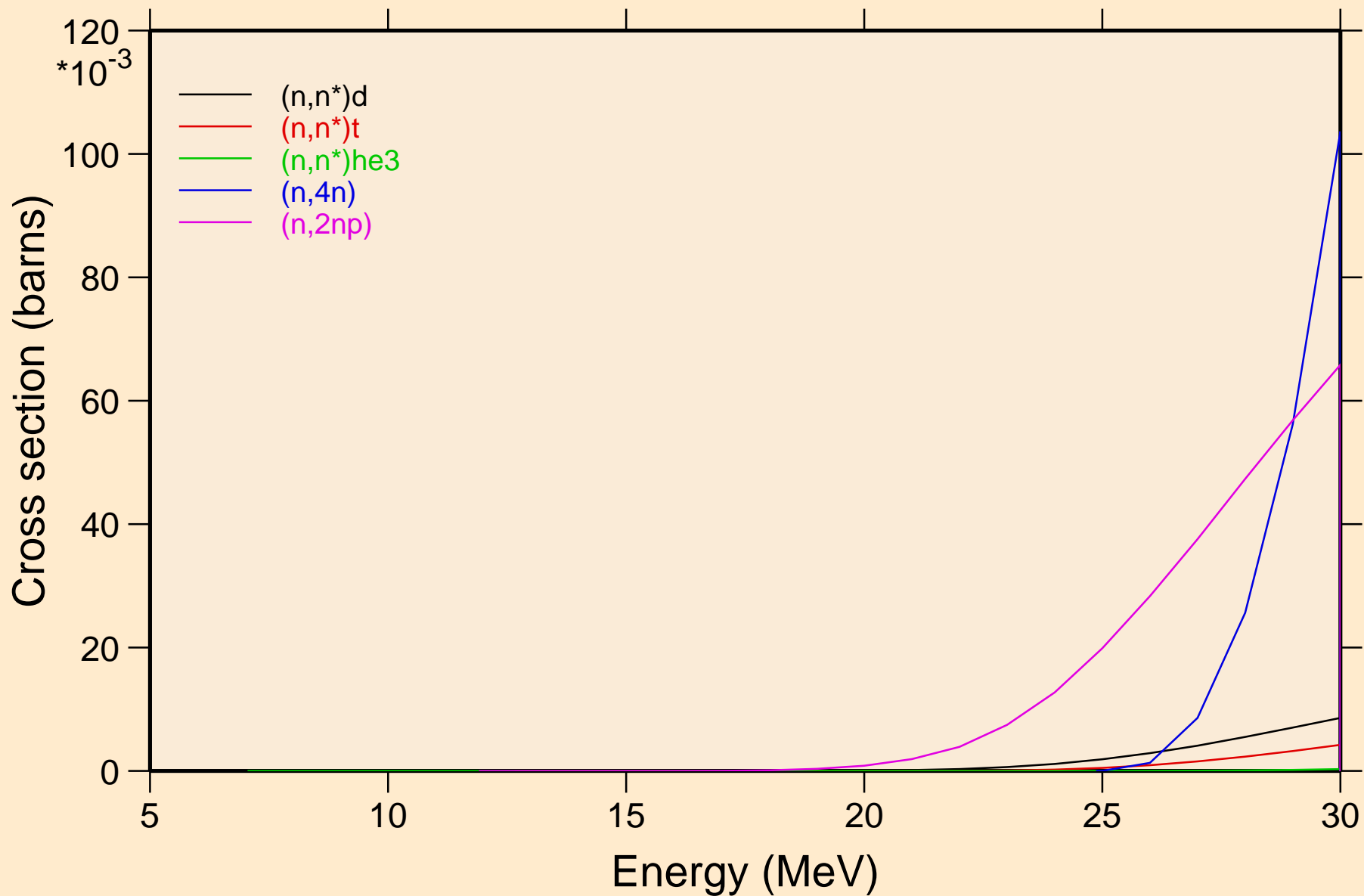

PT185 NEUTRON ACER TENDL-2019 LIBRARY; T=293.16K
Threshold reactions

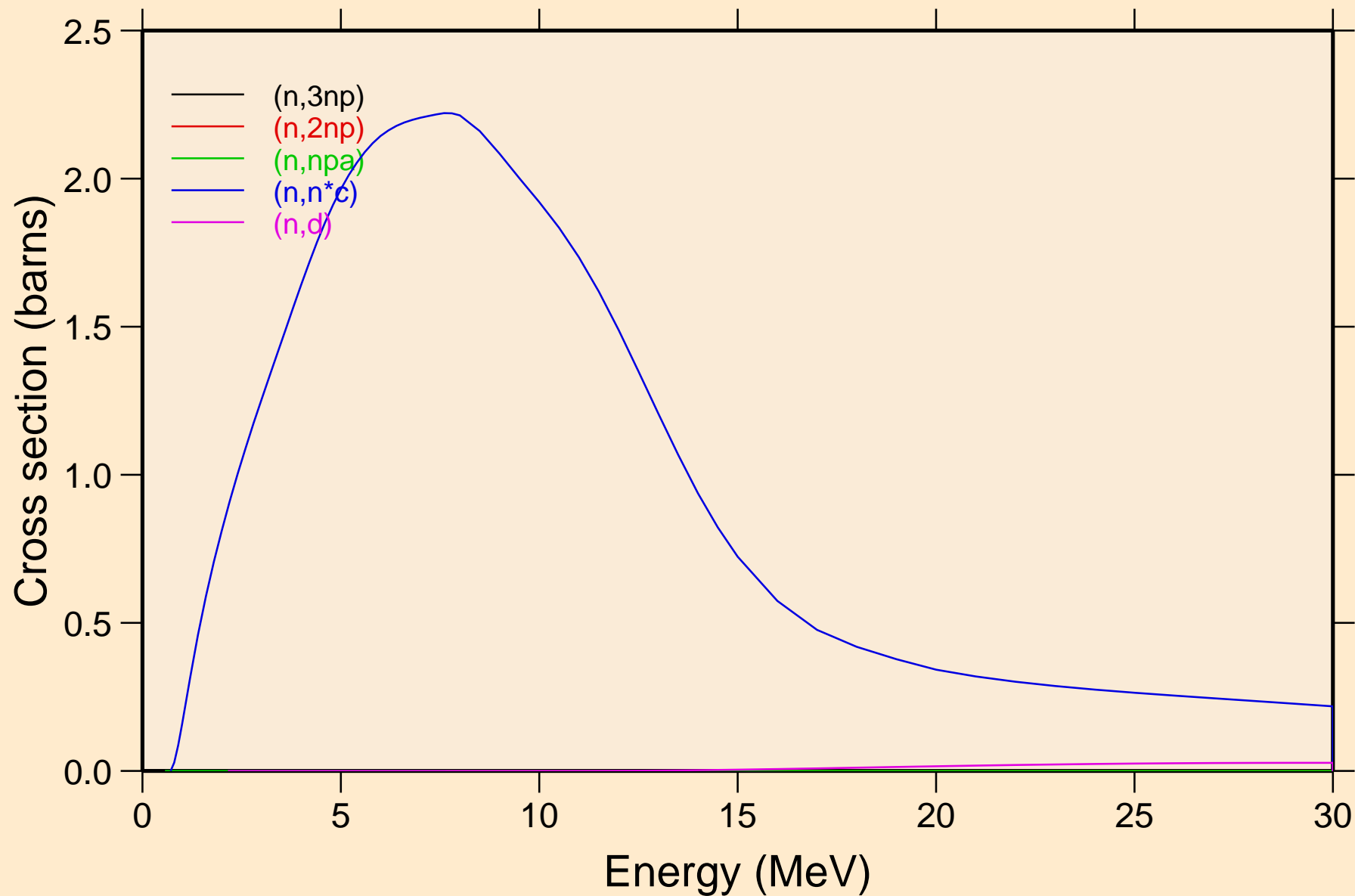

PT185 NEUTRON ACER TENDL-2019 LIBRARY; T=293.16K
Threshold reactions

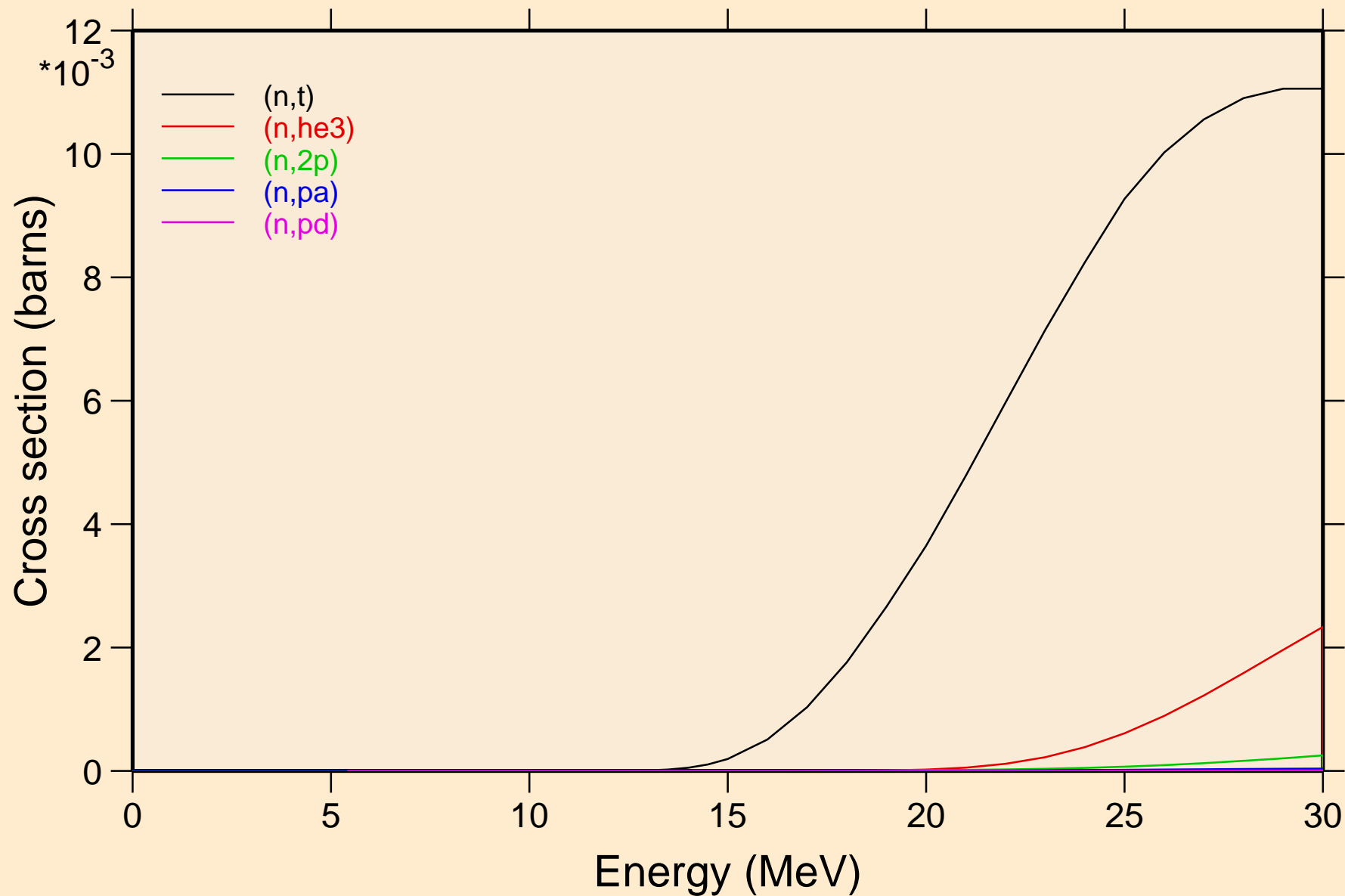

PT185 NEUTRON ACER TENDL-2019 LIBRARY; T=293.16K
Threshold reactions

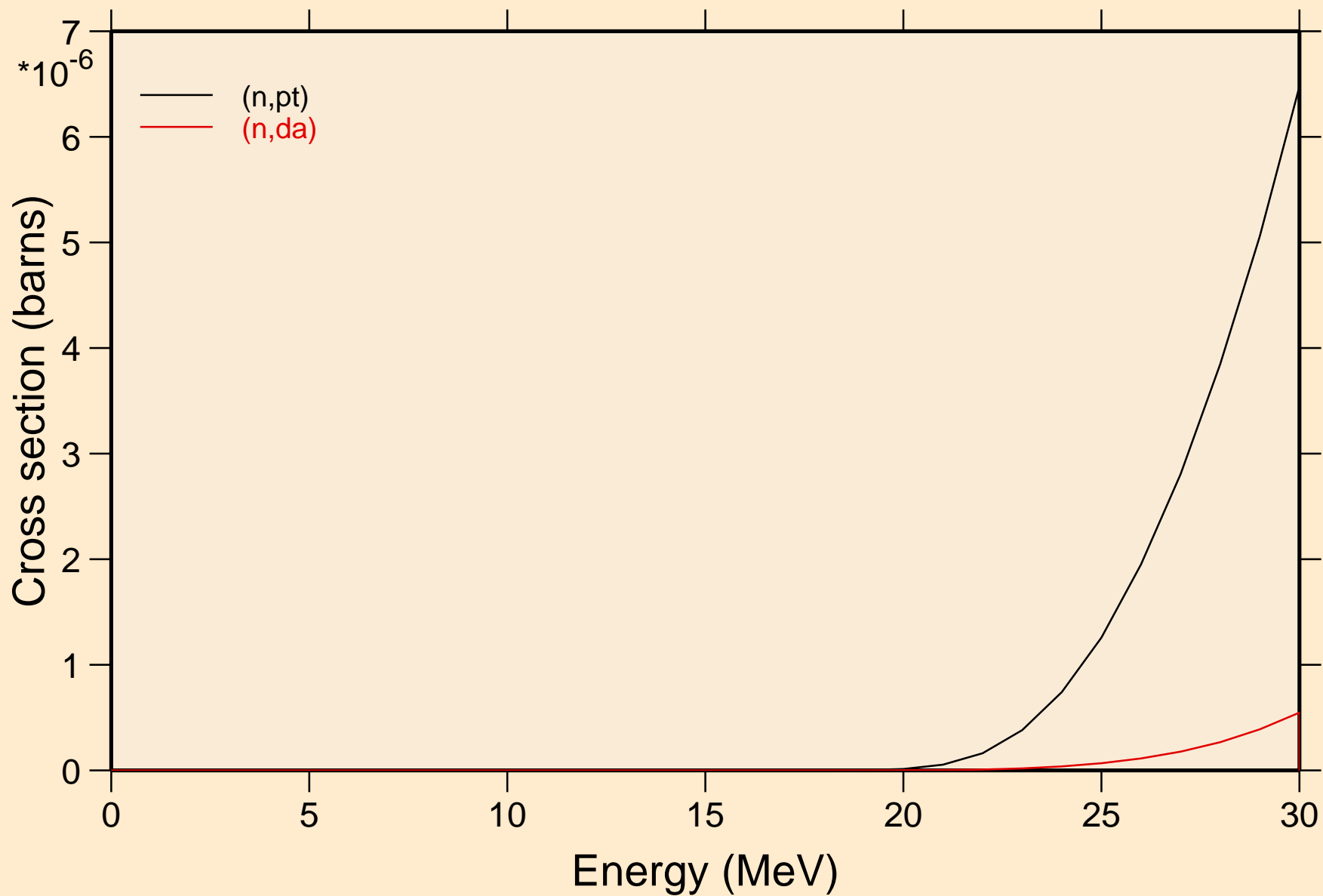

PT185 NEUTRON ACER TENDL-2019 LIBRARY; T=293.16K
Threshold reactions

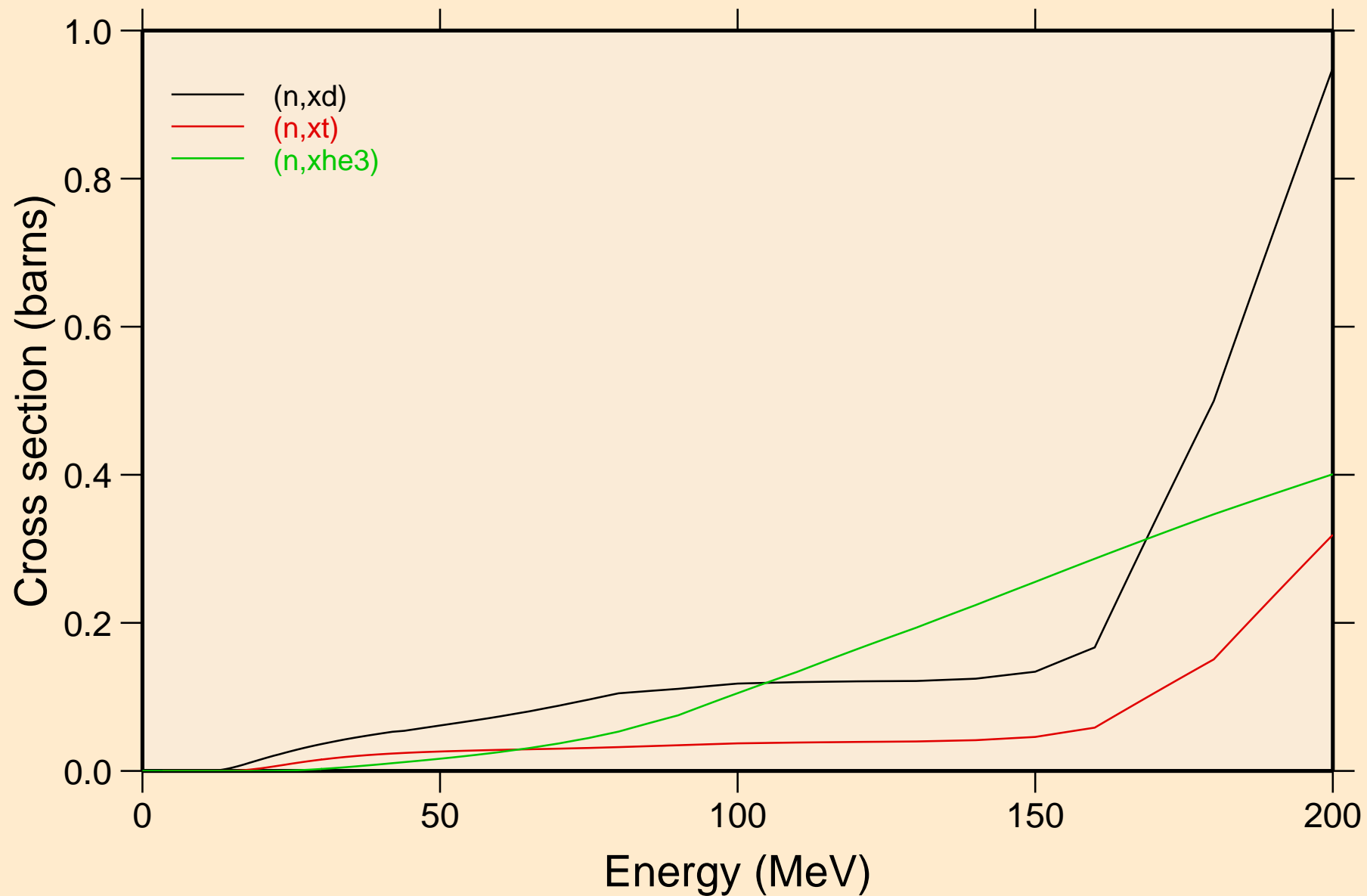

PT185 NEUTRON ACER TENDL-2019 LIBRARY; T=293.16K
angular distribution for elastic

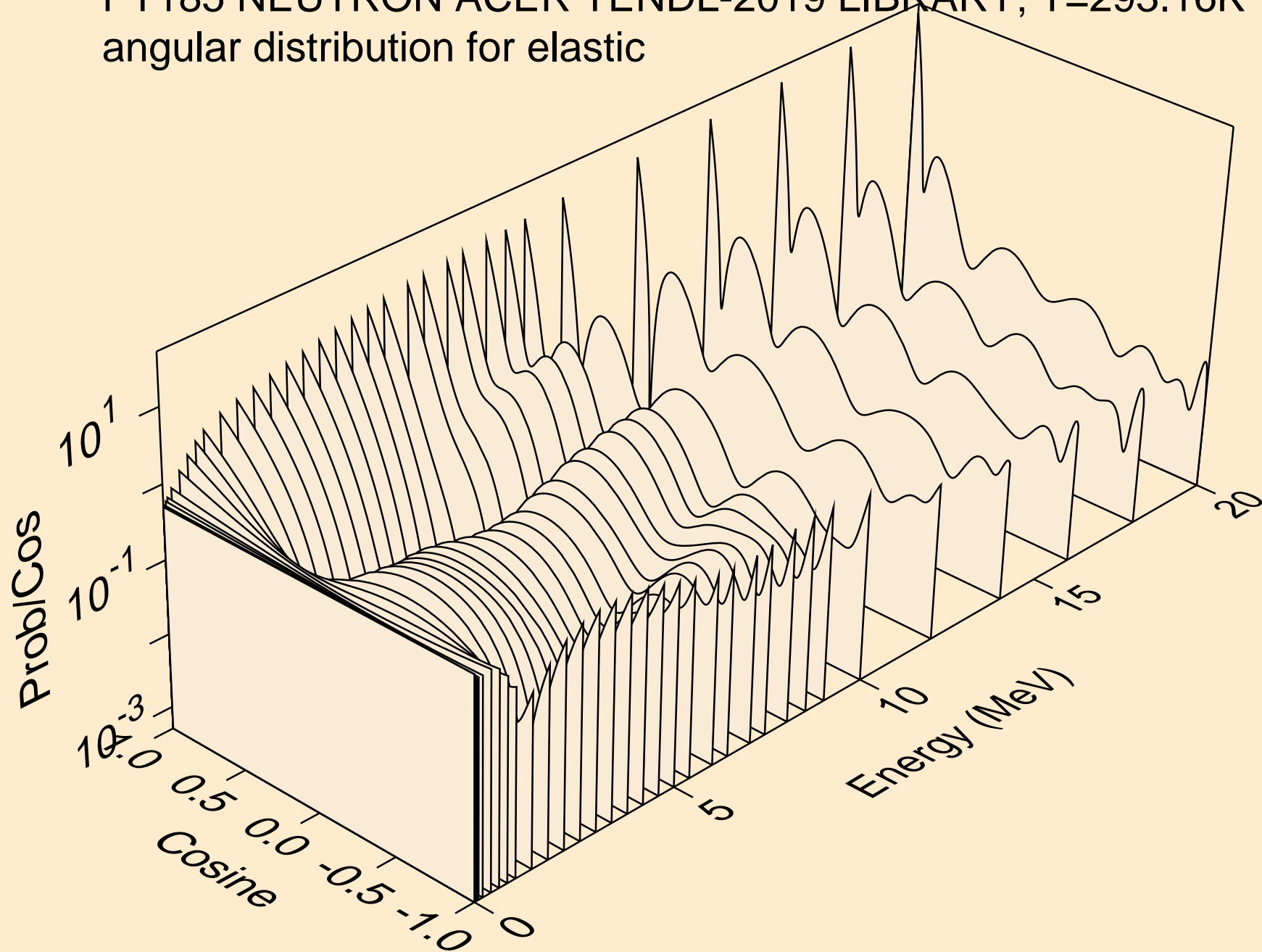

PT185 NEUTRON ACER TENDL-2019 LIBRARY; T=293.16K
angular distribution for elastic

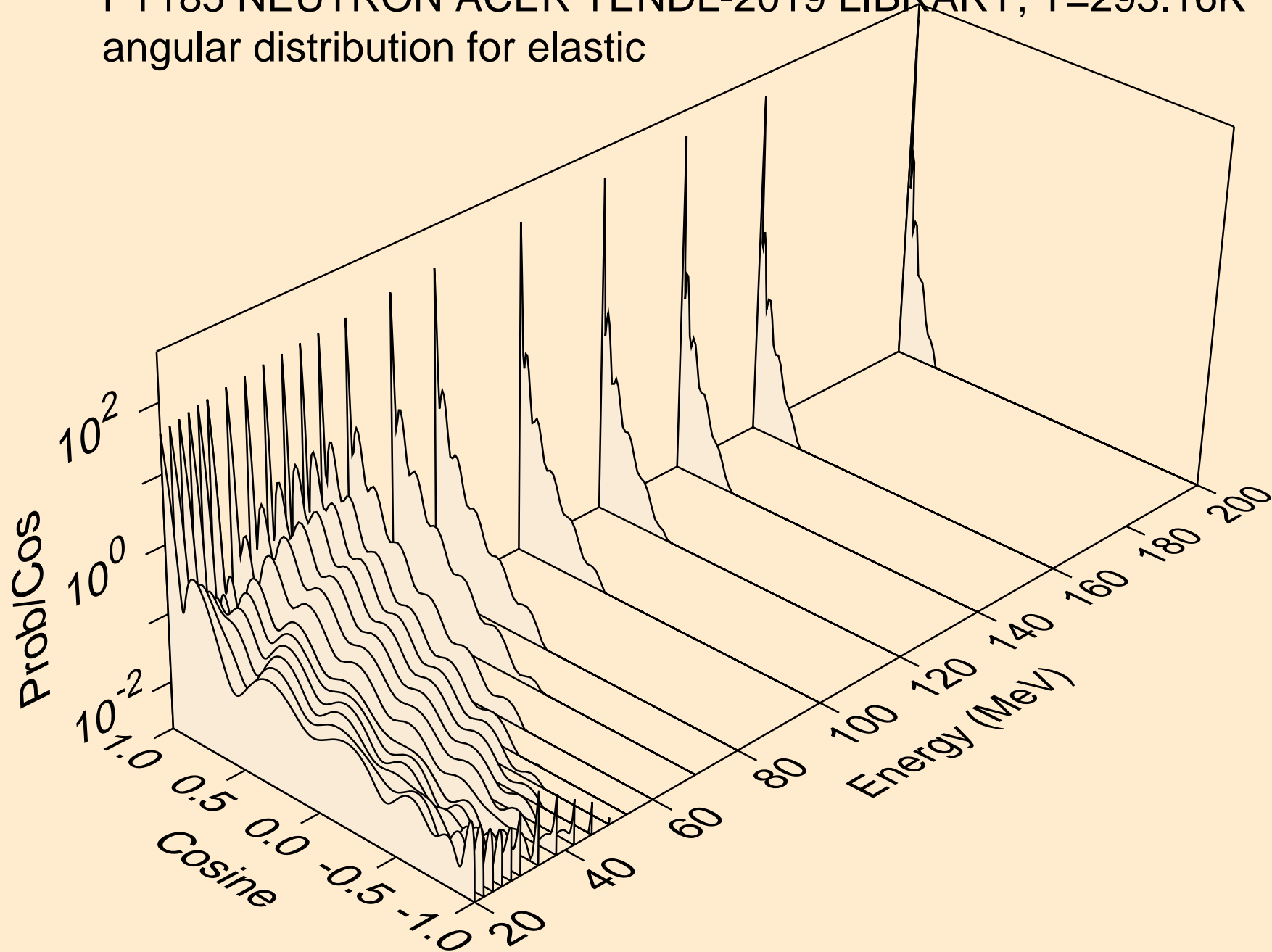

PT185 NEUTRON ACER TENDL-2019 LIBRARY; T=293.16K
angular distribution for (n,n*1)

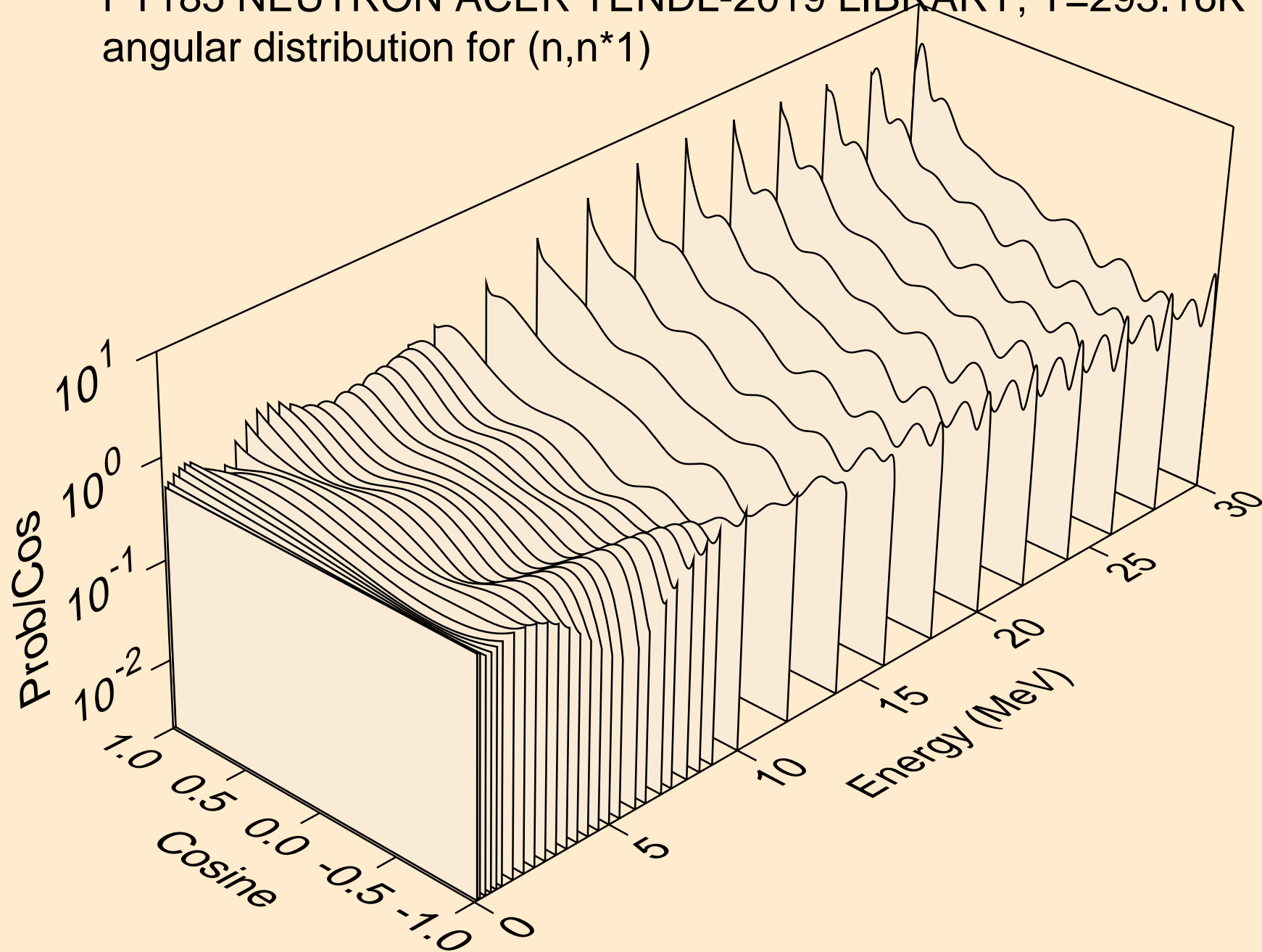

PT185 NEUTRON ACER TENDL-2019 LIBRARY; T=293.16K
angular distribution for (n,n*2)

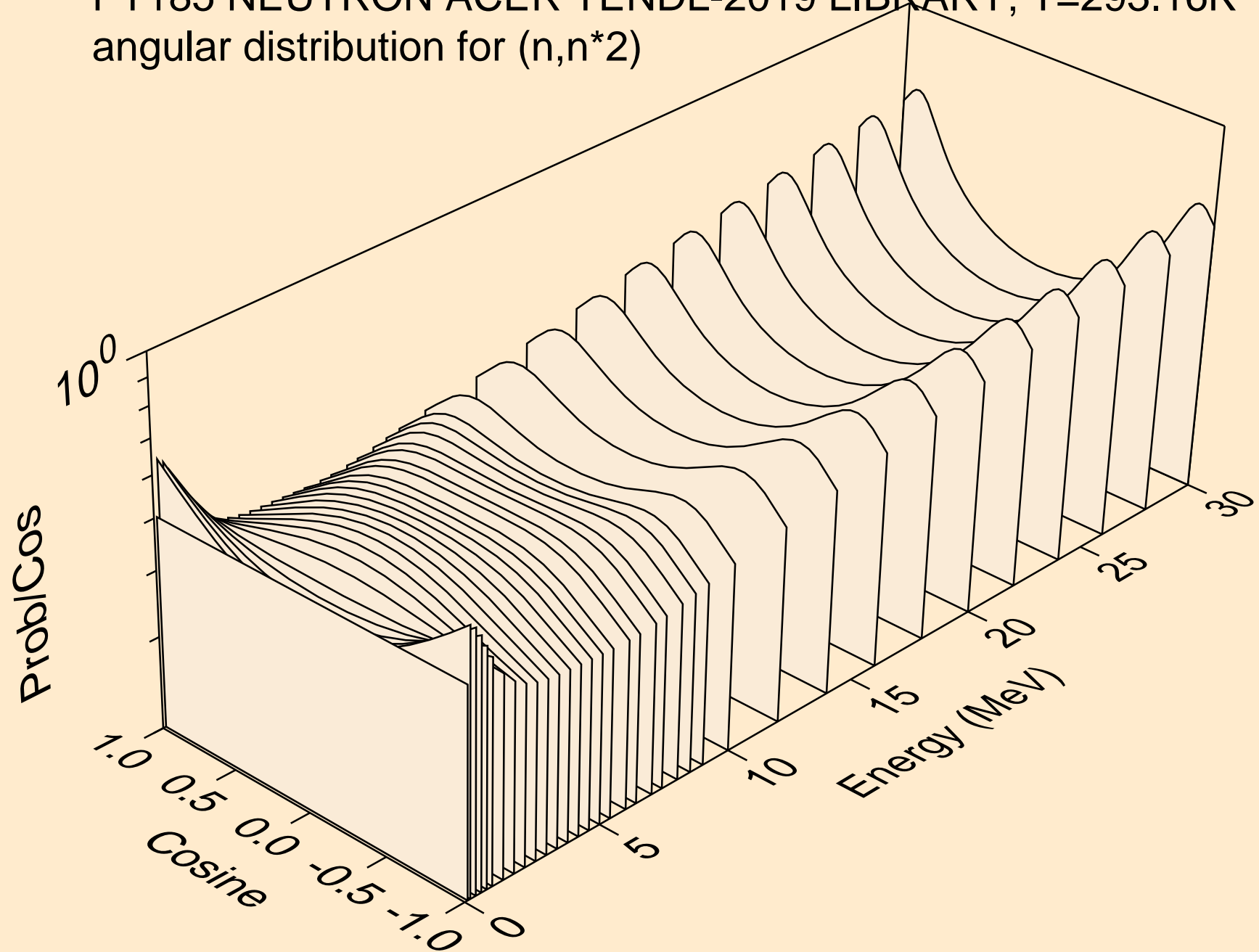

PT185 NEUTRON ACER TENDL-2019 LIBRARY; T=293.16K
angular distribution for (n,n*3)

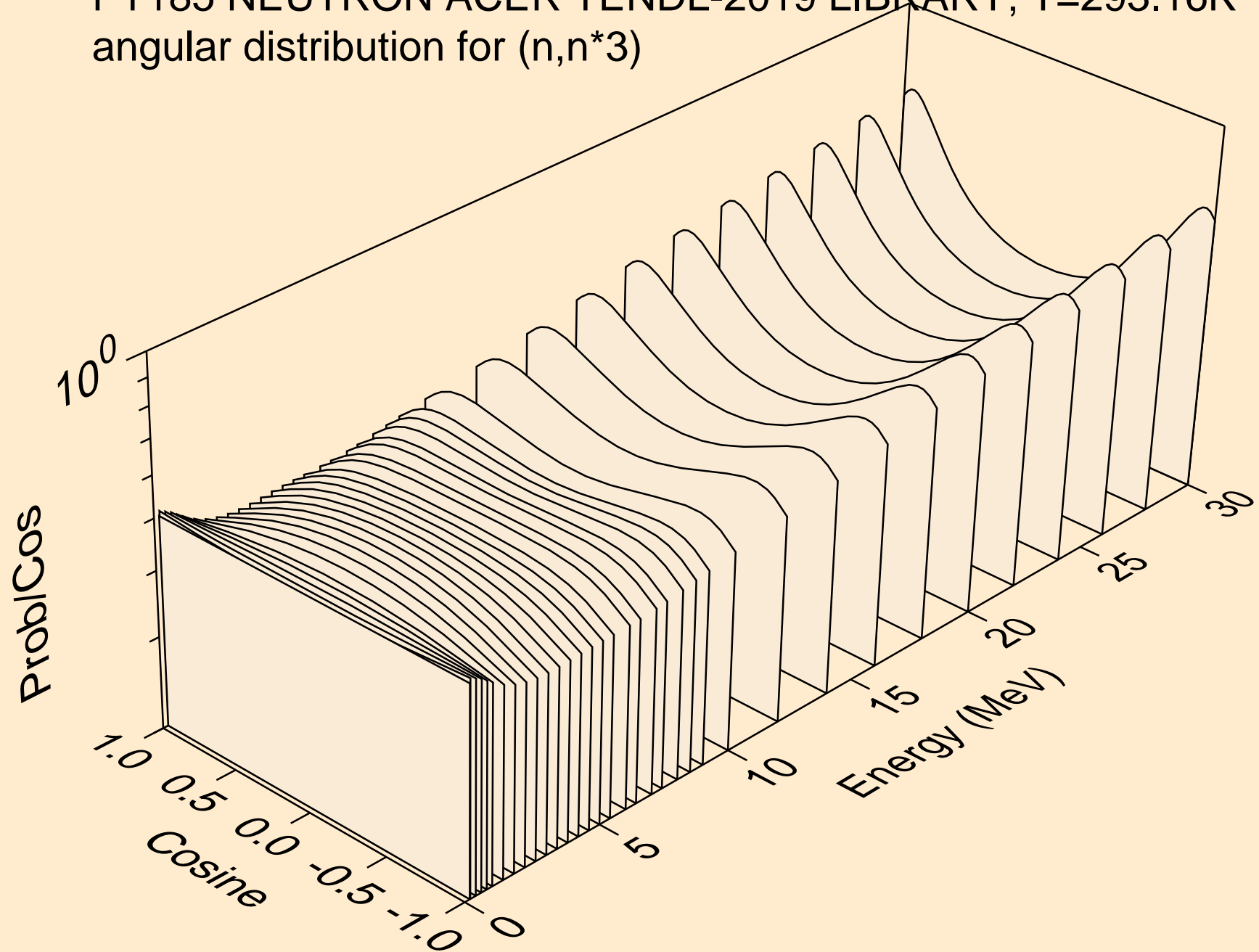

PT185 NEUTRON ACER TENDL-2019 LIBRARY; T=293.16K
angular distribution for (n,n*4)

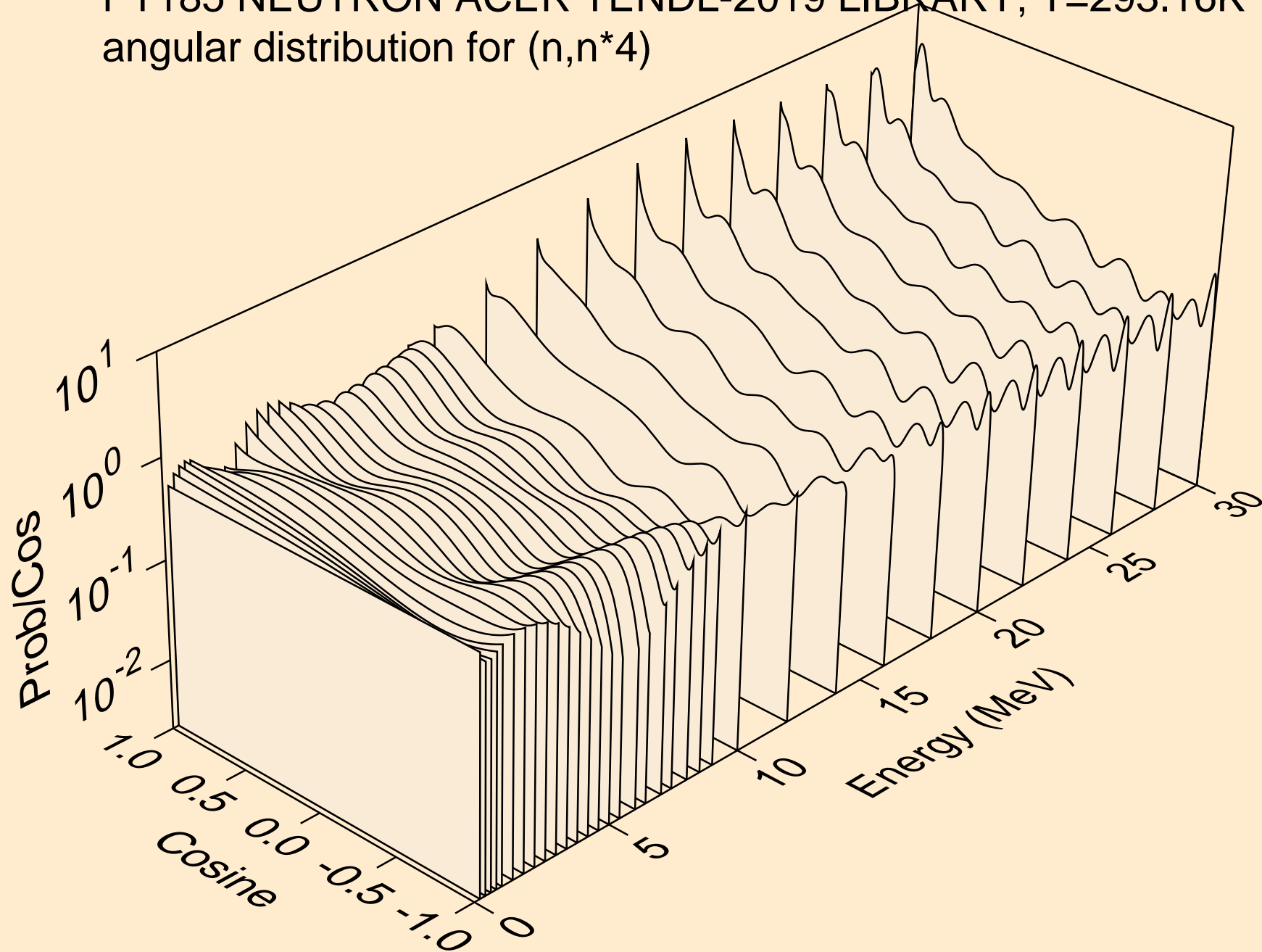

PT185 NEUTRON ACER TENDL-2019 LIBRARY; T=293.16K
angular distribution for (n,n*5)

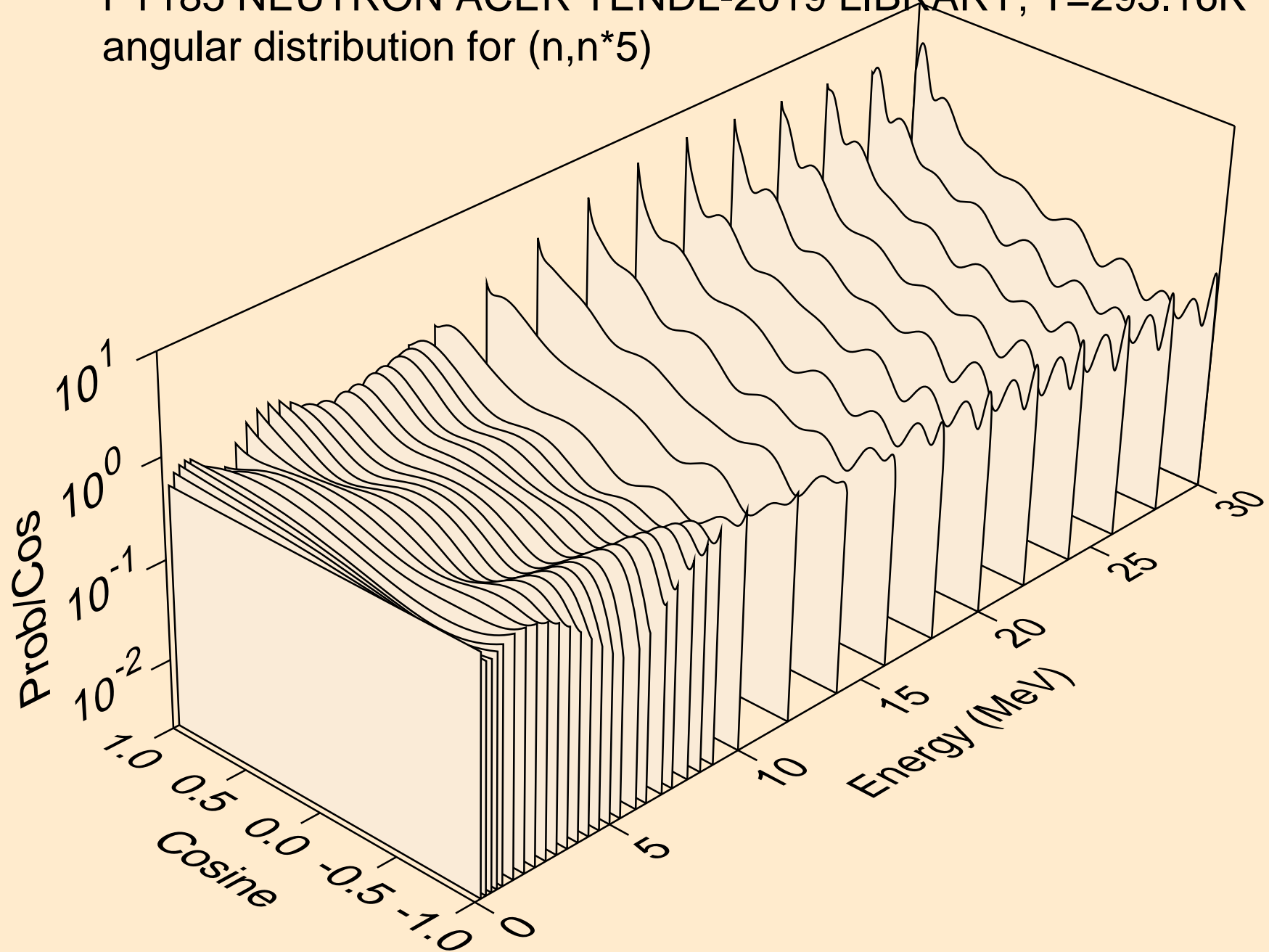

PT185 NEUTRON ACER TENDL-2019 LIBRARY; T=293.16K
angular distribution for (n,n*6)

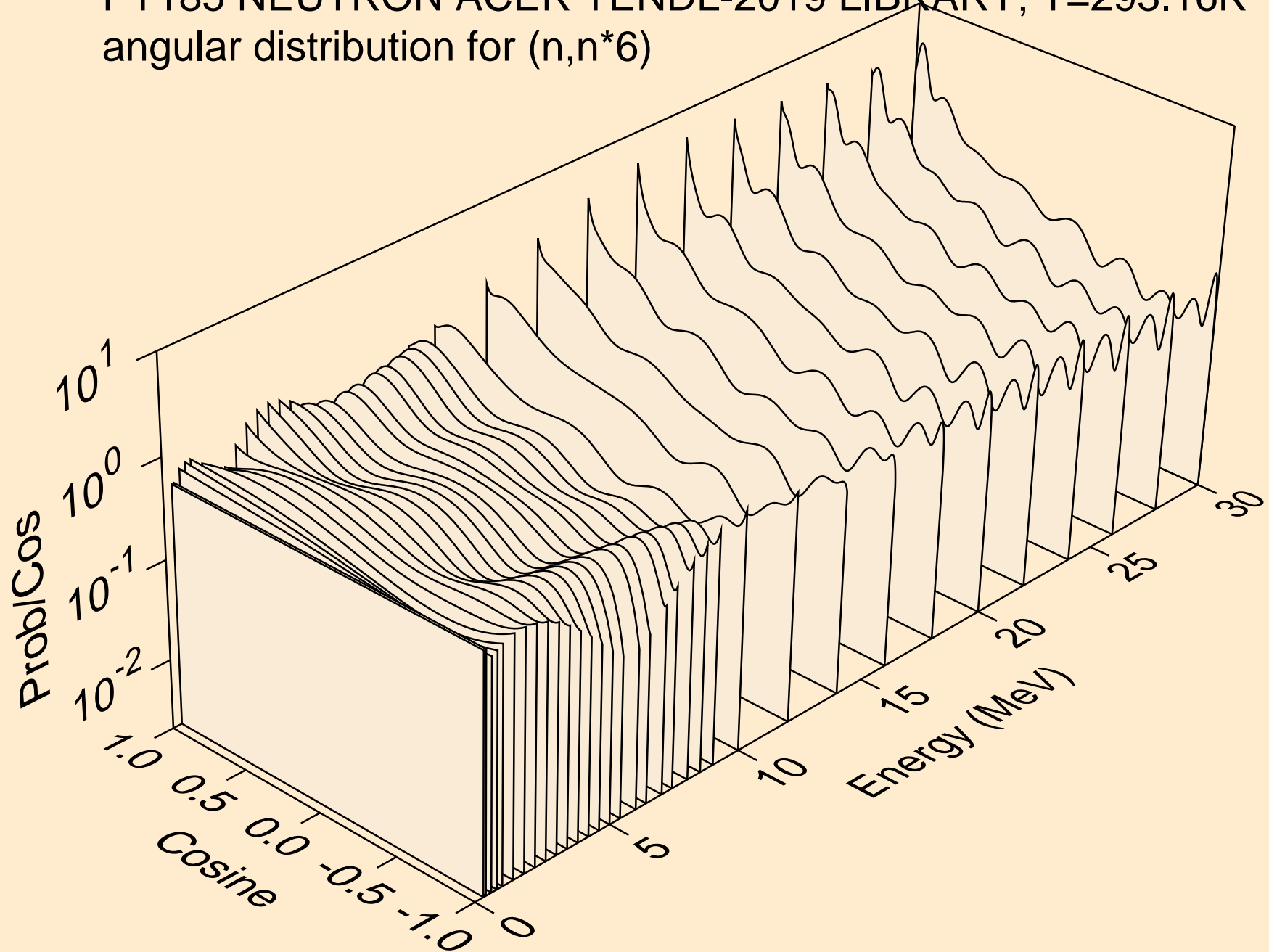

PT185 NEUTRON ACER TENDL-2019 LIBRARY; T=293.16K
angular distribution for (n,n*7)

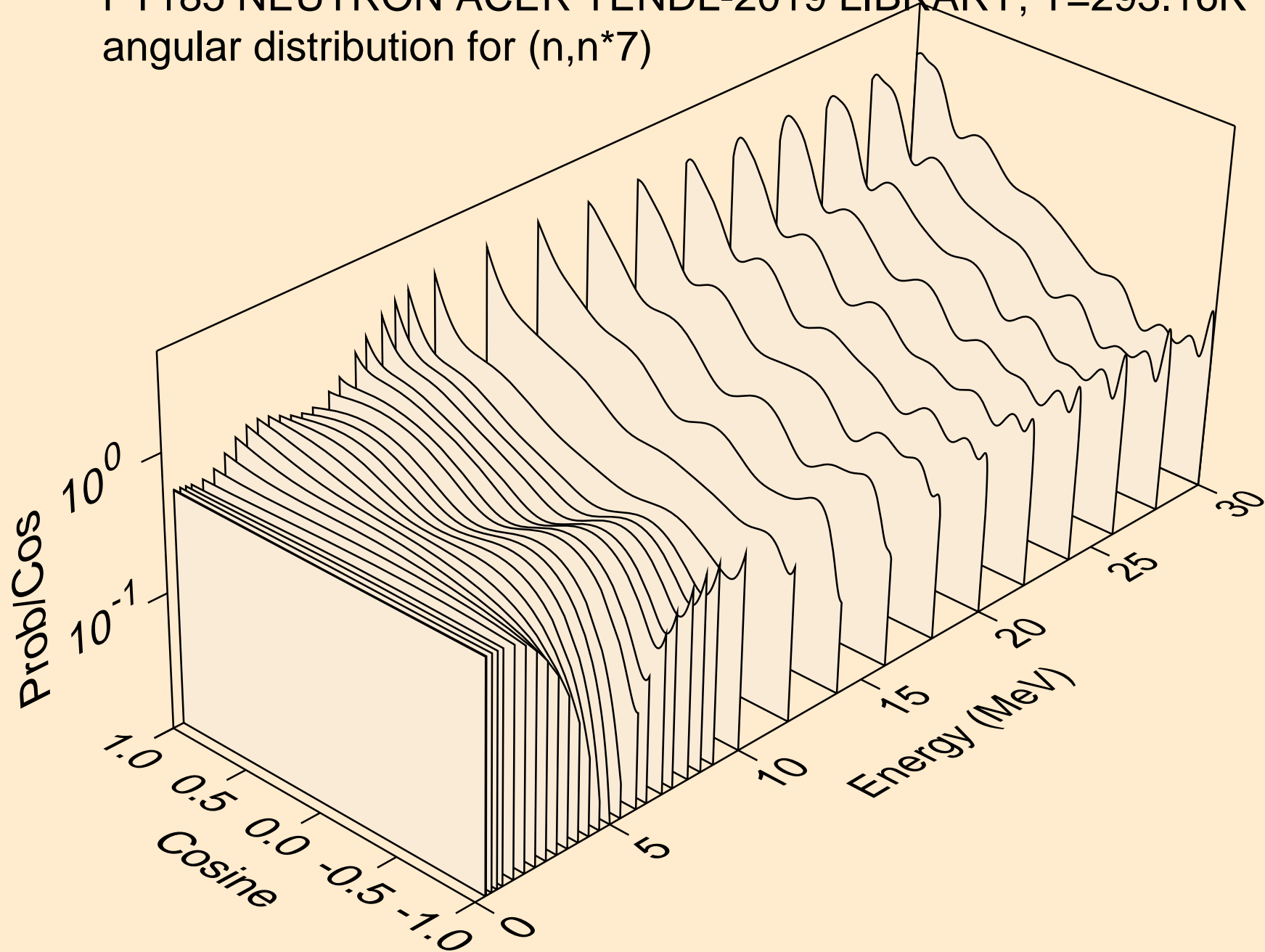

PT185 NEUTRON ACER TENDL-2019 LIBRARY; T=293.16K
angular distribution for (n,n*8)

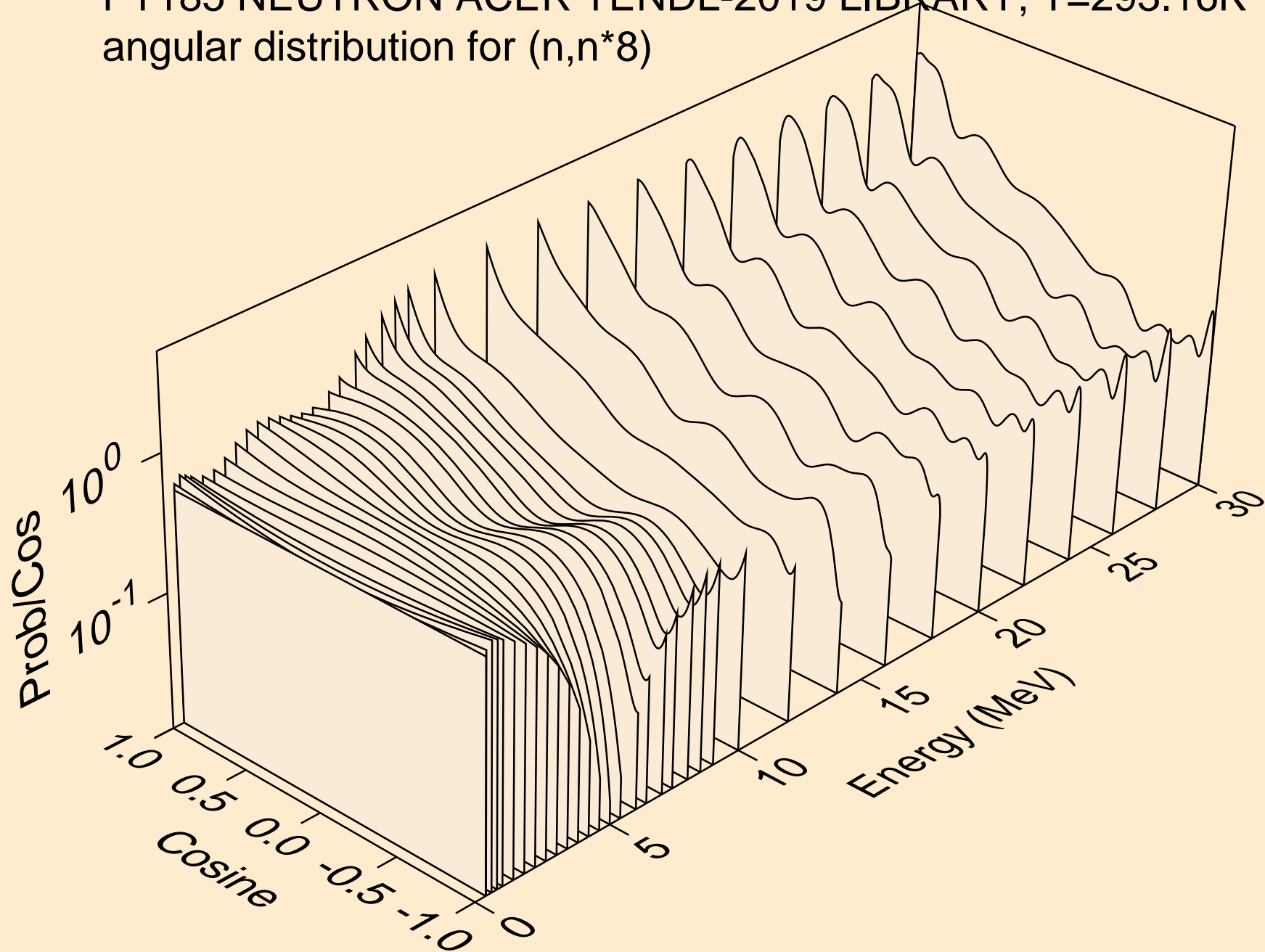

PT185 NEUTRON ACER TENDL-2019 LIBRARY; T=293.16K
angular distribution for (n,n*9)

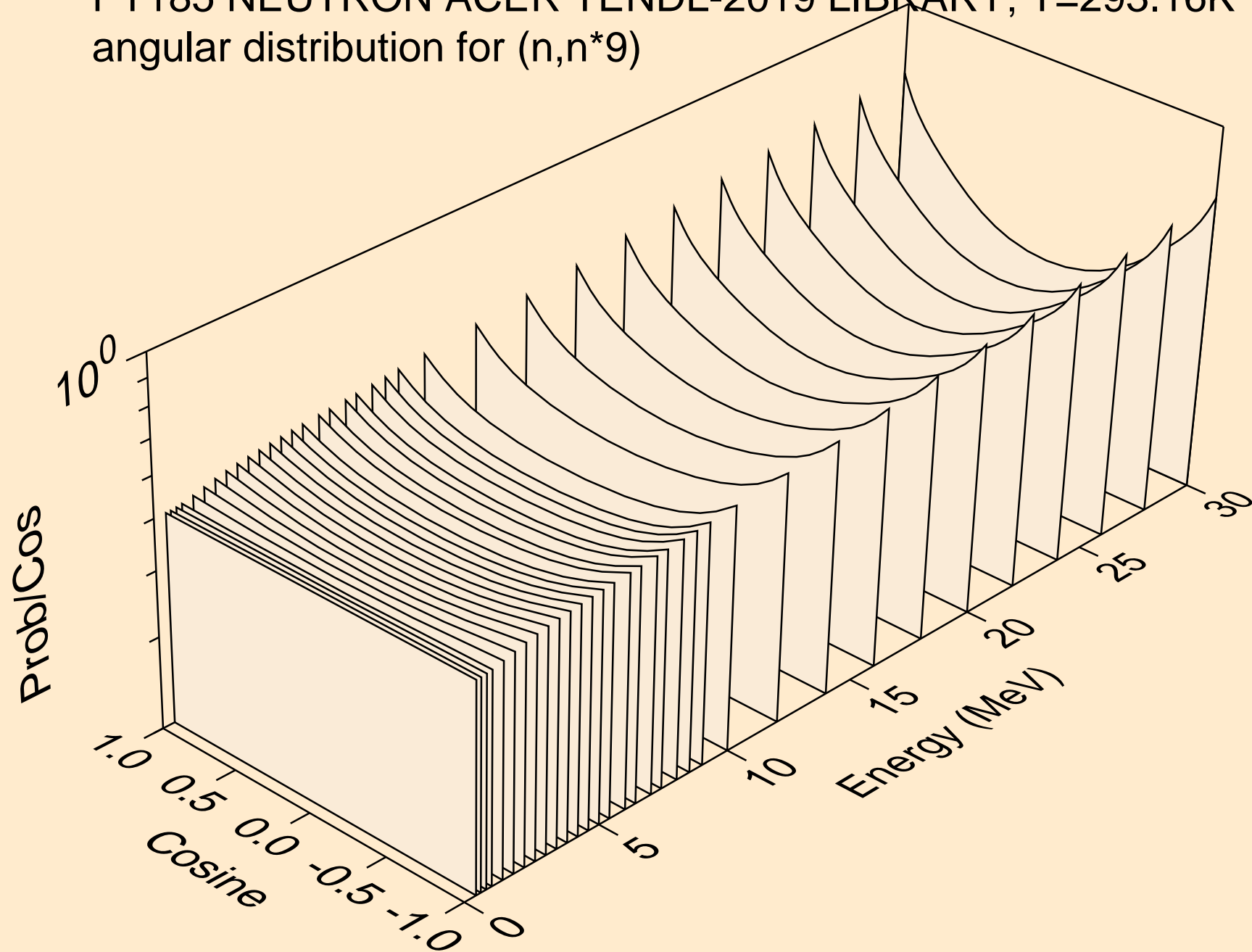

PT185 NEUTRON ACER TENDL-2019 LIBRARY; T=293.16K
angular distribution for (n,n*10)

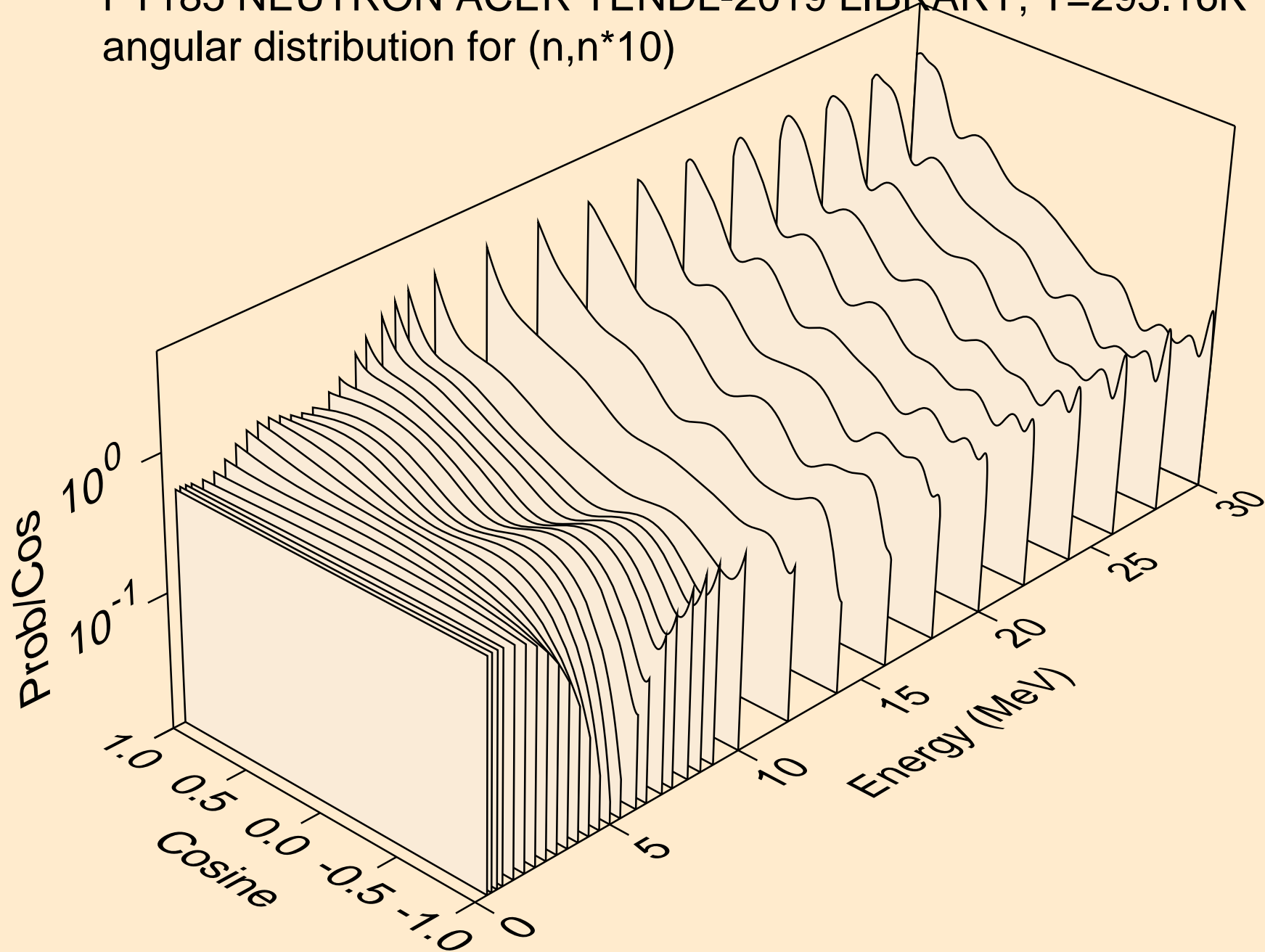

PT185 NEUTRON ACER TENDL-2019 LIBRARY; T=293.16K
angular distribution for (n,n*11)

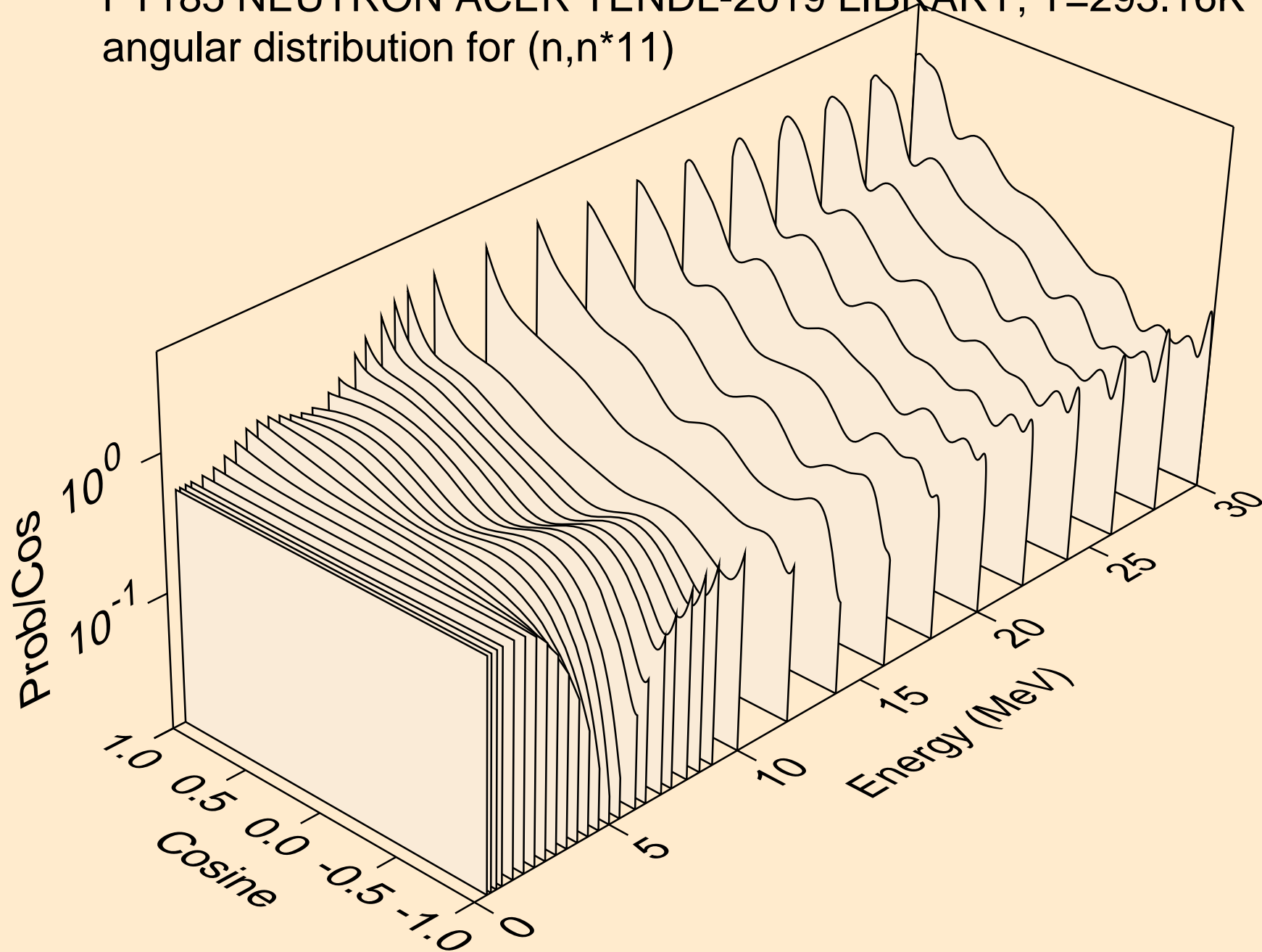

PT185 NEUTRON ACER TENDL-2019 LIBRARY; T=293.16K
angular distribution for (n,n*12)

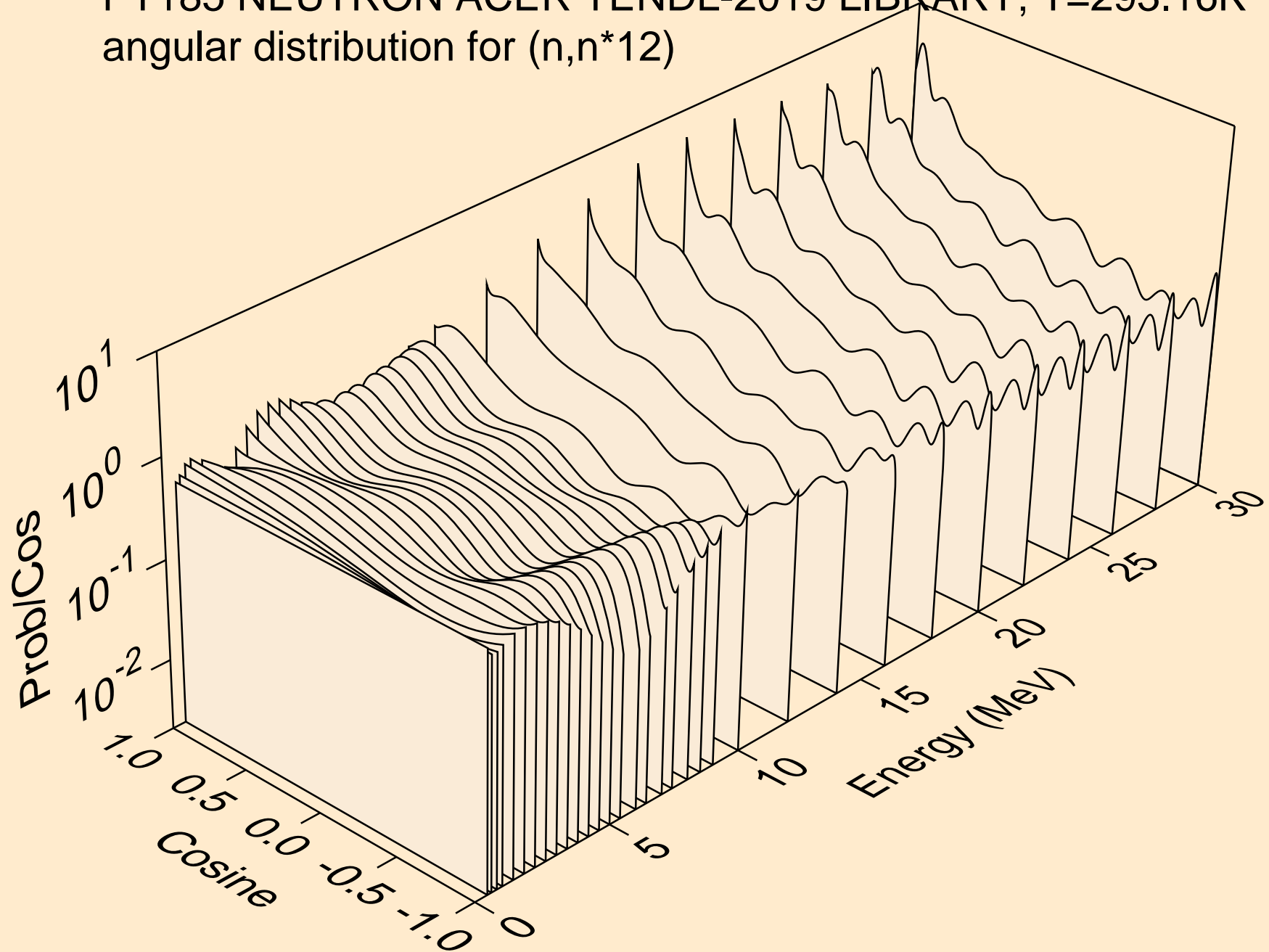

PT185 NEUTRON ACER TENDL-2019 LIBRARY; T=293.16K
angular distribution for (n,n*13)

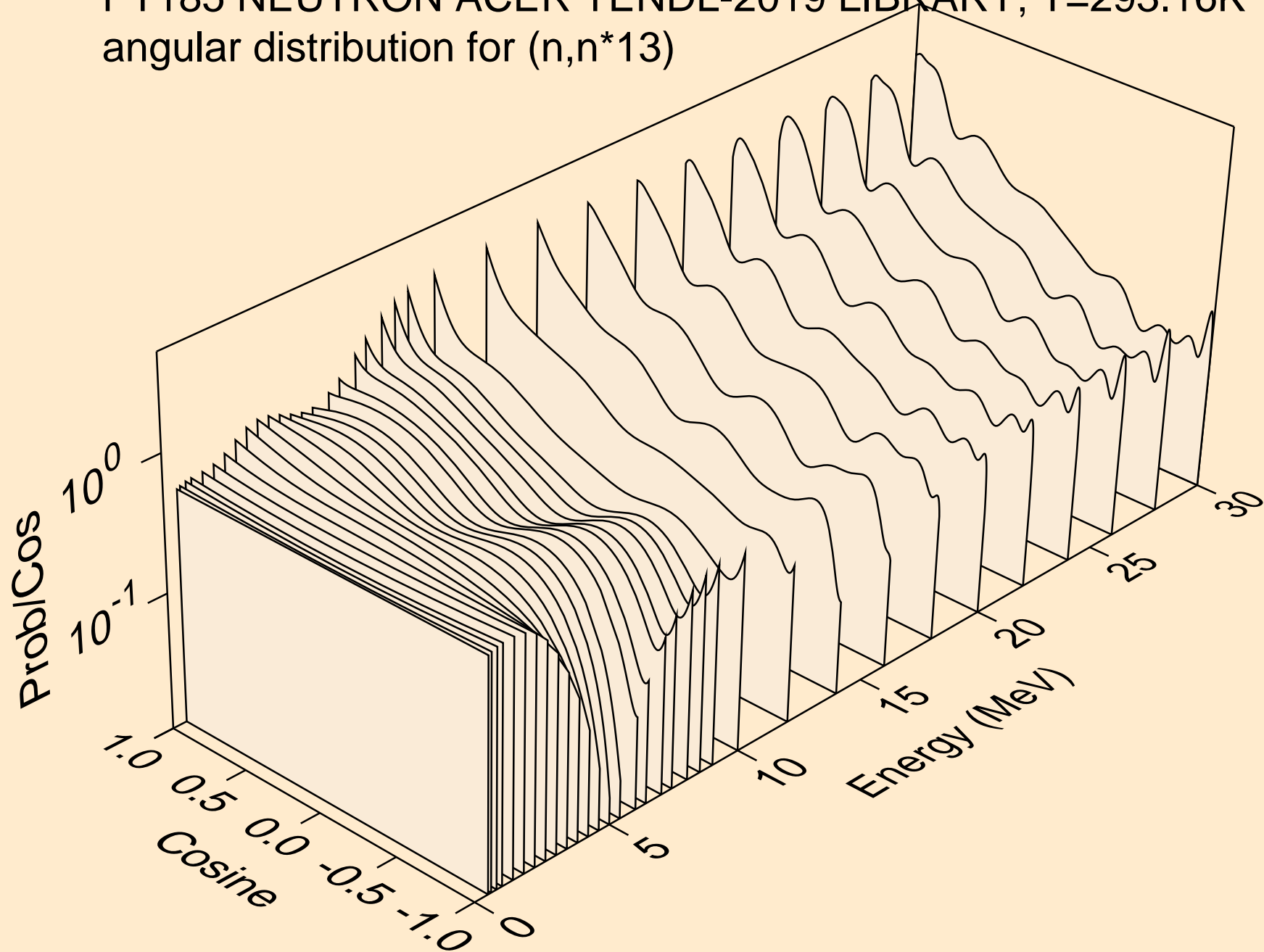

PT185 NEUTRON ACER TENDL-2019 LIBRARY; T=293.16K
angular distribution for (n,n*14)

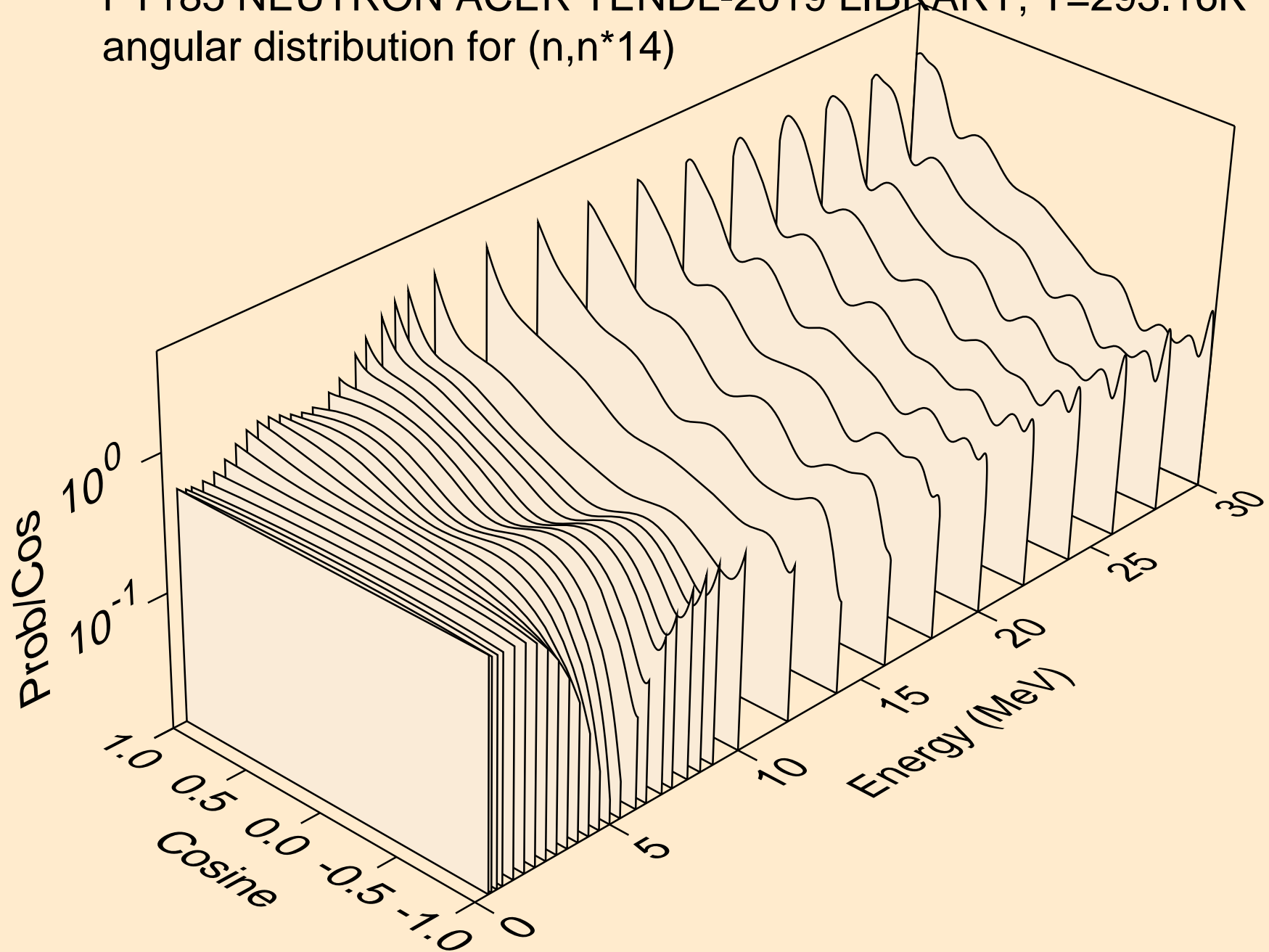

PT185 NEUTRON ACER TENDL-2019 LIBRARY; T=293.16K
angular distribution for (n,n*15)

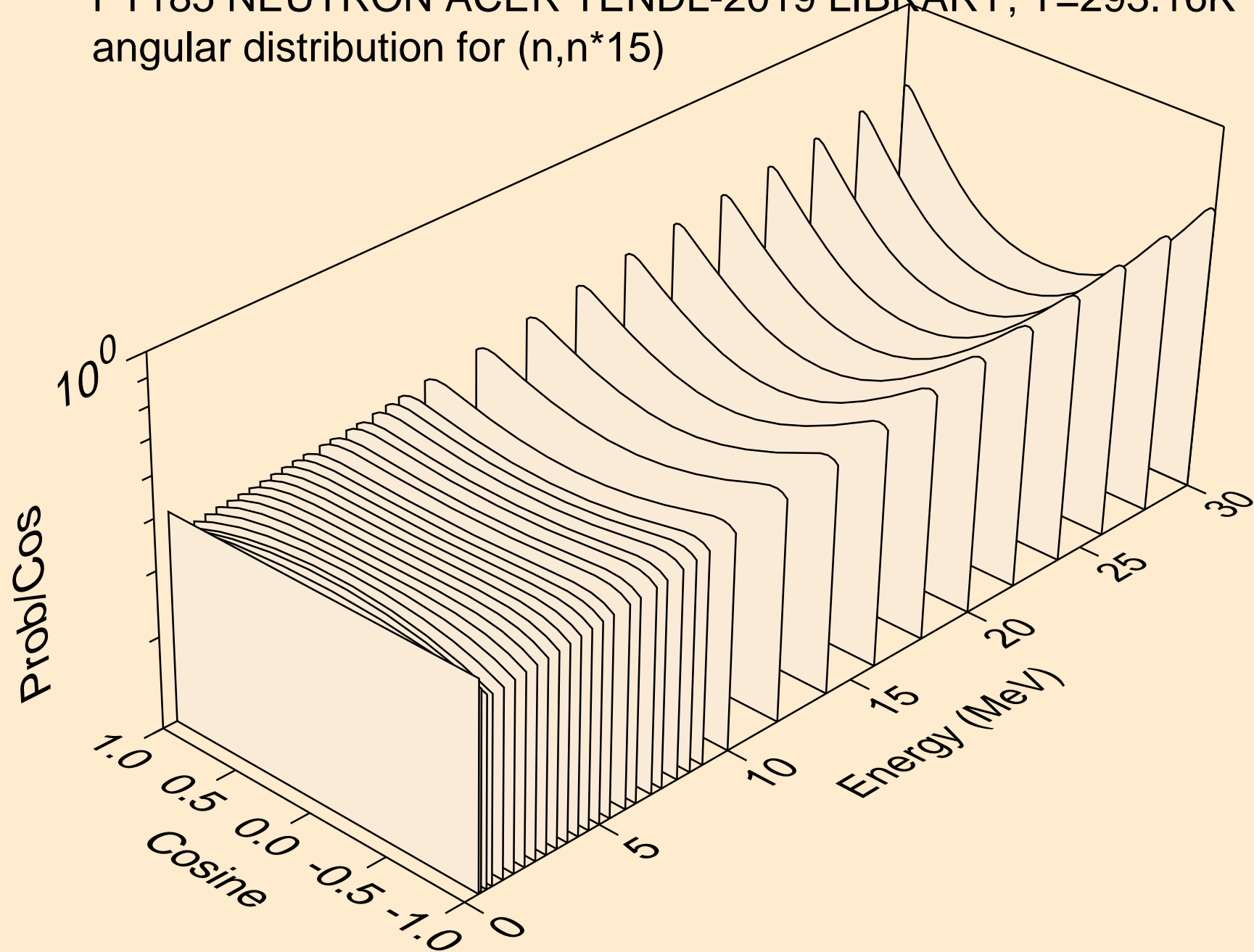

PT185 NEUTRON ACER TENDL-2019 LIBRARY; T=293.16K
angular distribution for (n,n*16)

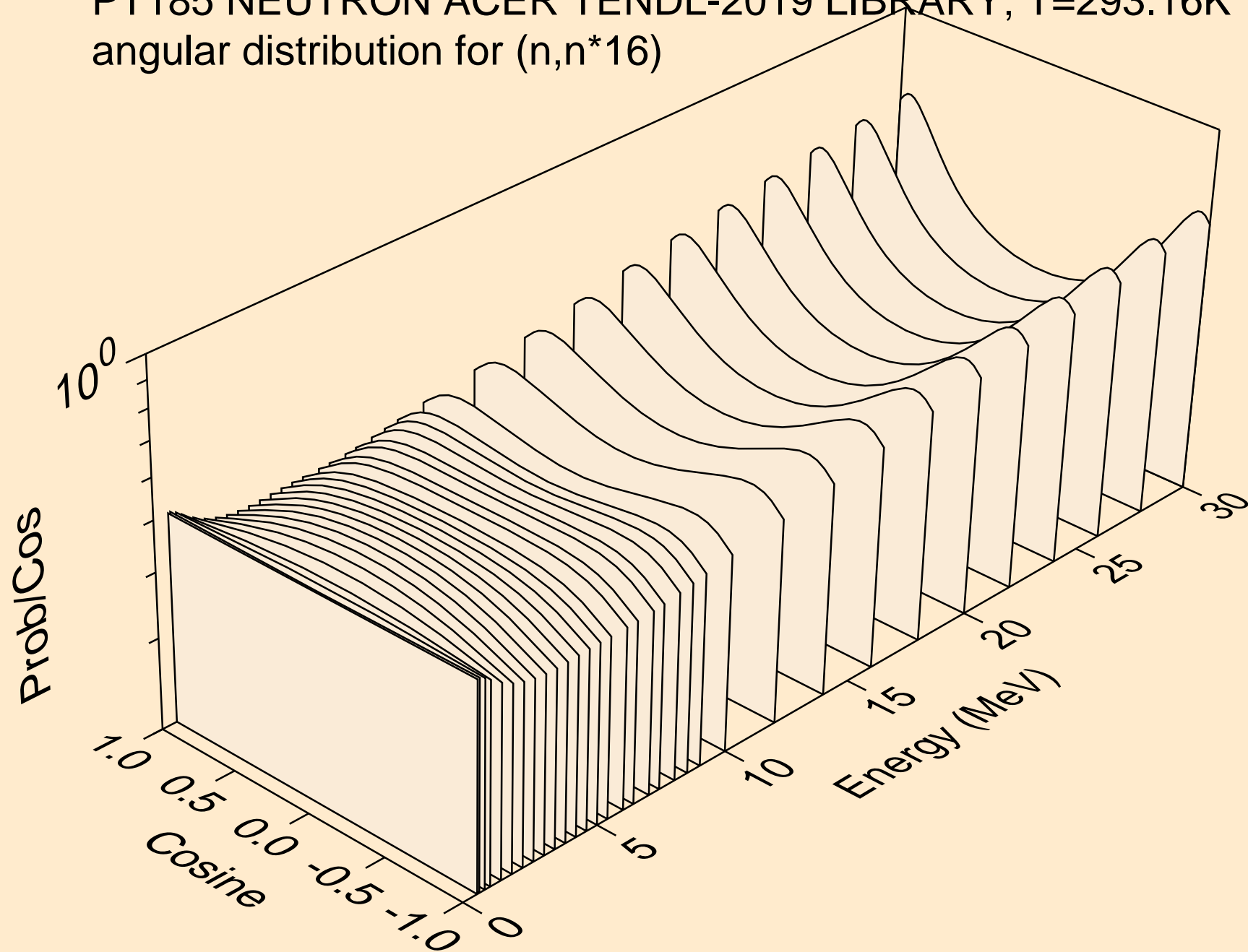

PT185 NEUTRON ACER TENDL-2019 LIBRARY; T=293.16K
angular distribution for (n,n*17)

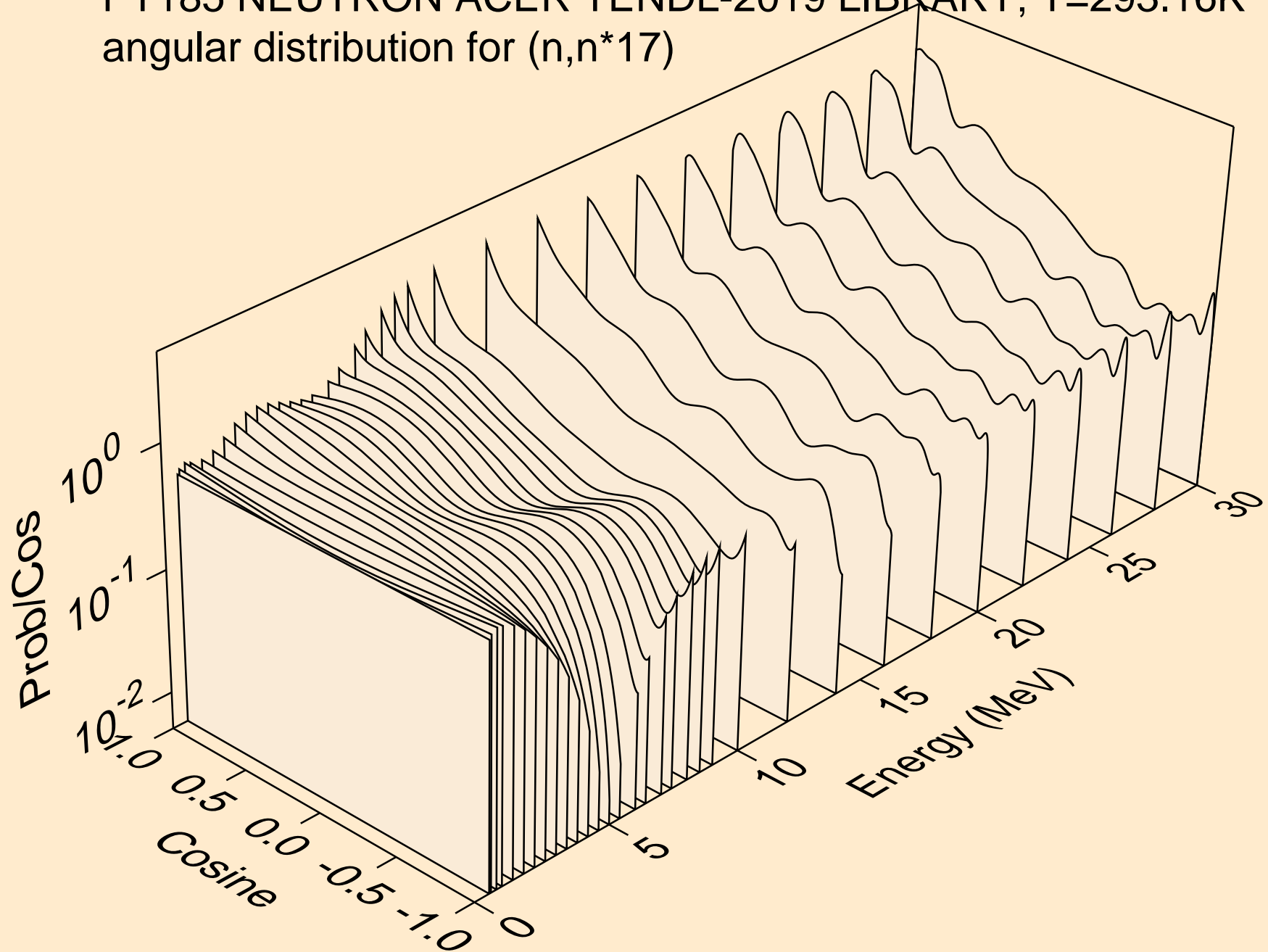

PT185 NEUTRON ACER TENDL-2019 LIBRARY; T=293.16K
angular distribution for (n,n*18)

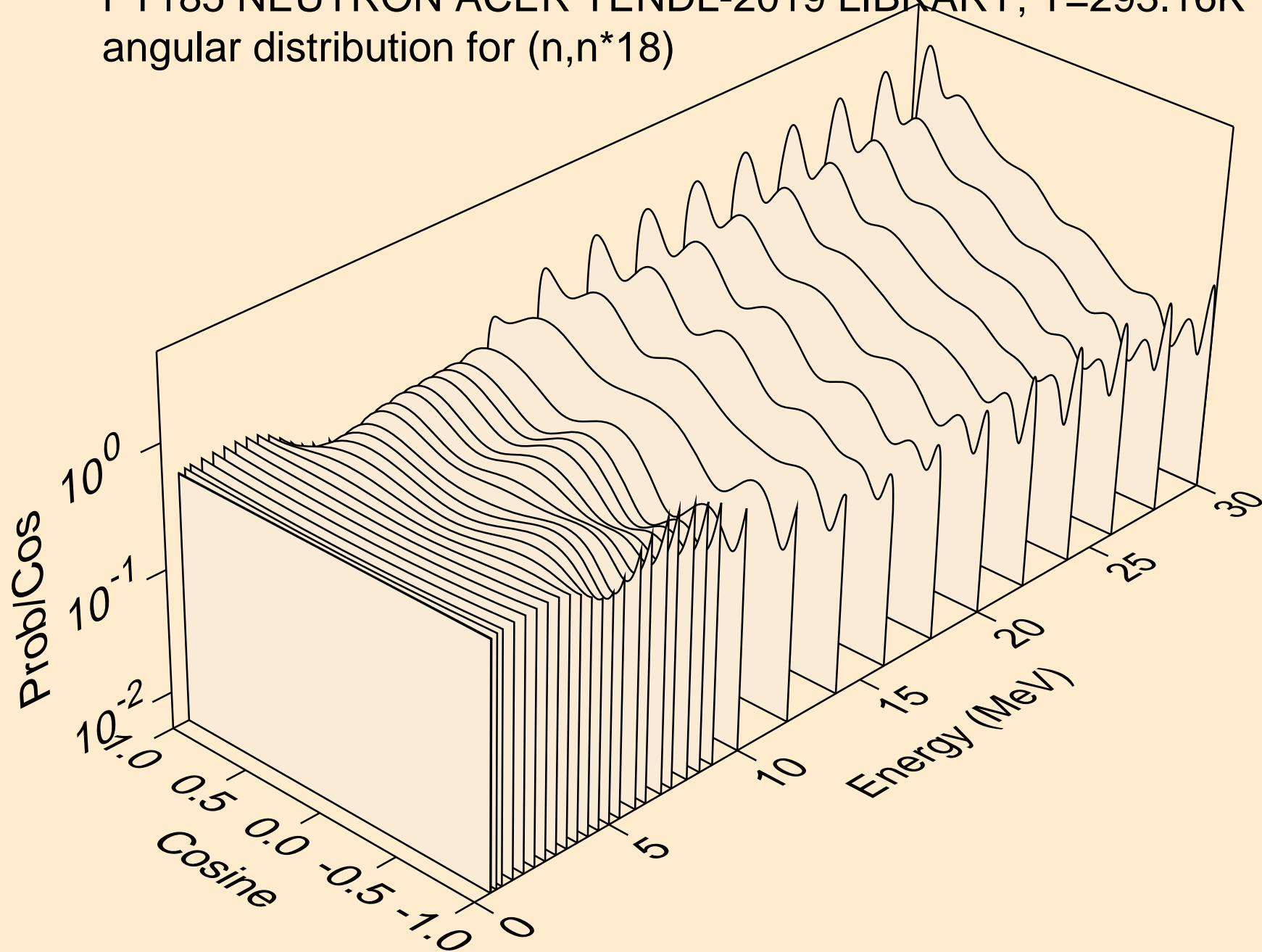

PT185 NEUTRON ACER TENDL-2019 LIBRARY; T=293.16K
angular distribution for (n,n*19)

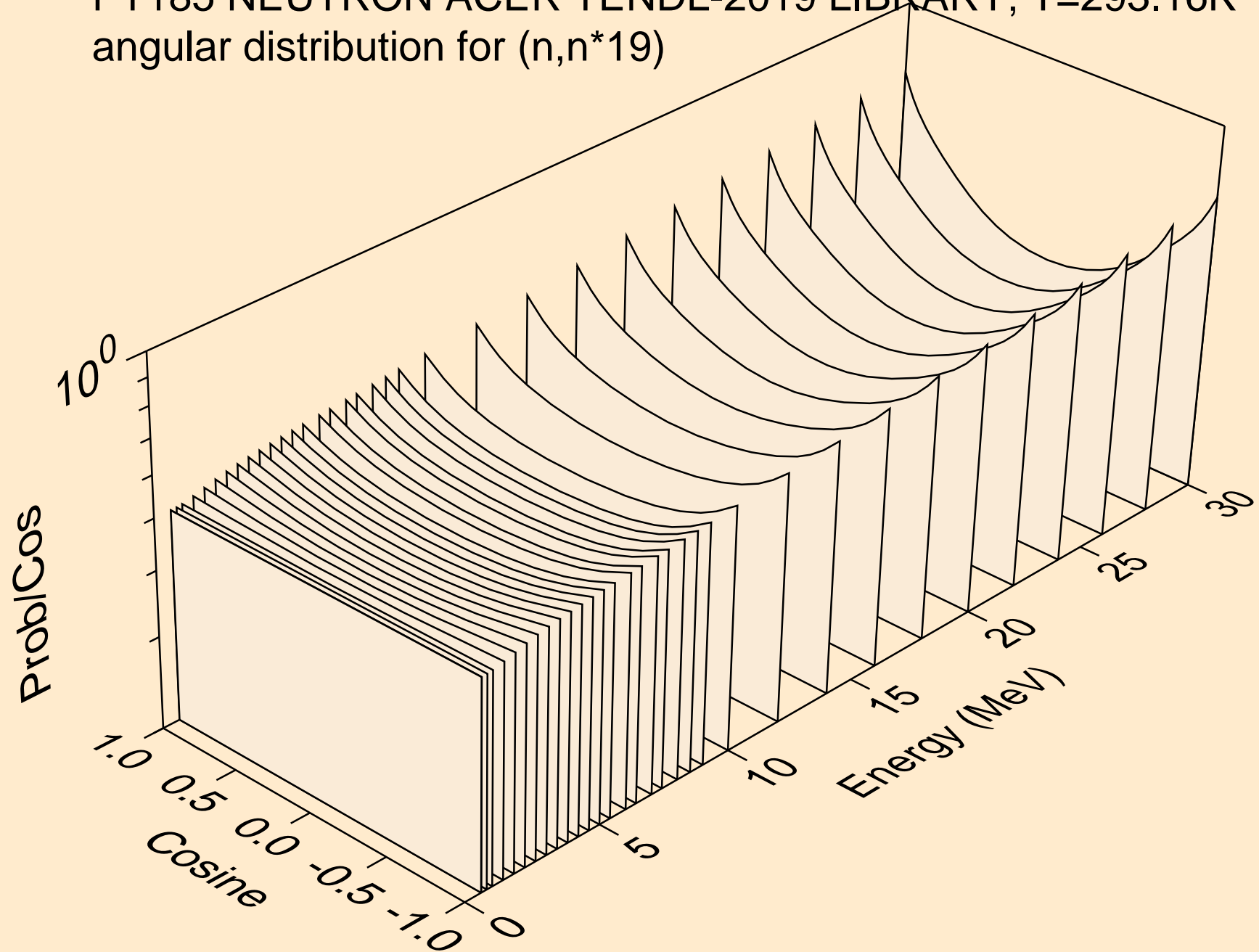

PT185 NEUTRON ACER TENDL-2019 LIBRARY; T=293.16K
angular distribution for (n,n*20)

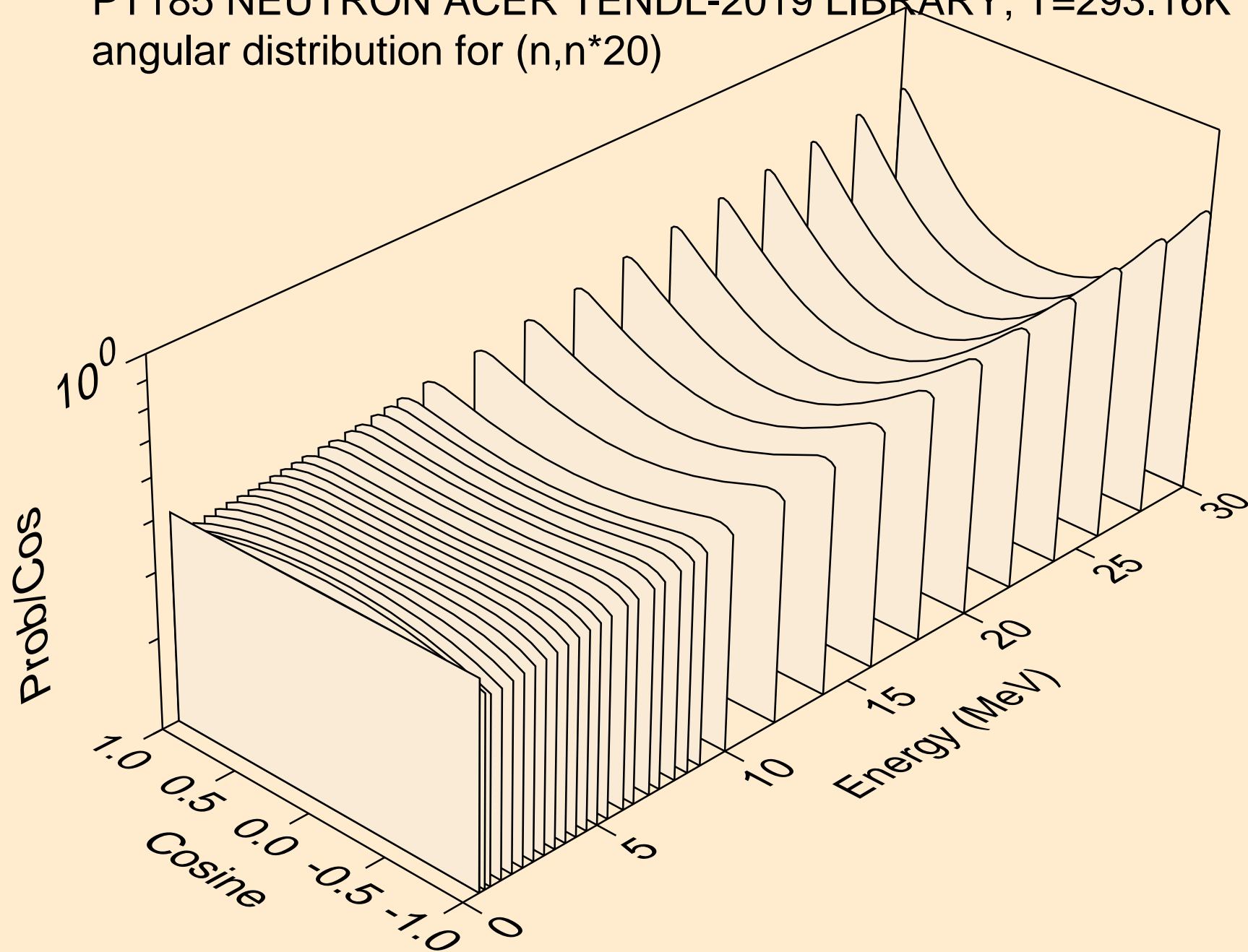

PT185 NEUTRON ACER TENDL-2019 LIBRARY; T=293.16K
angular distribution for (n,n*21)

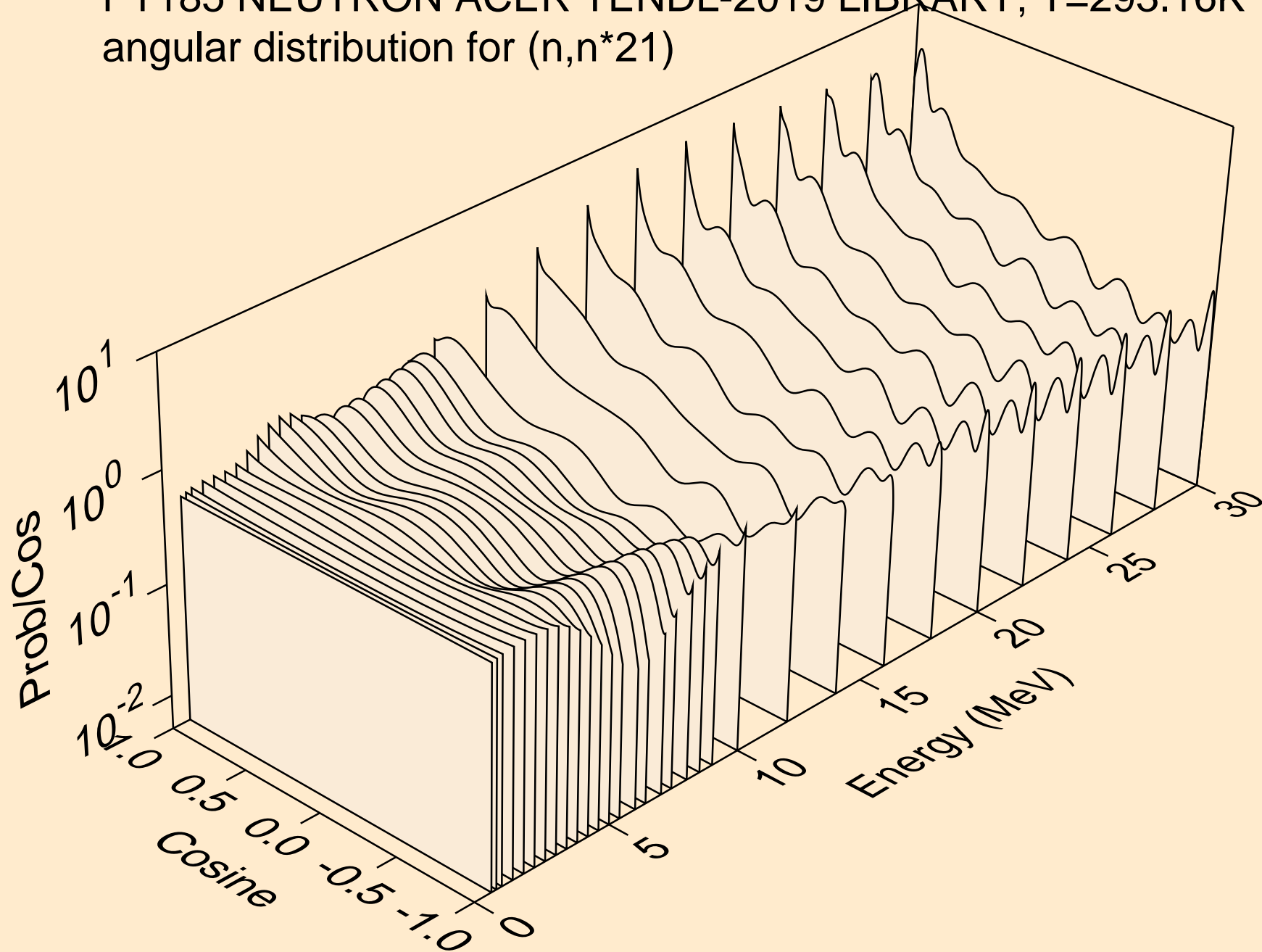

PT185 NEUTRON ACER TENDL-2019 LIBRARY; T=293.16K
angular distribution for (n,n*22)

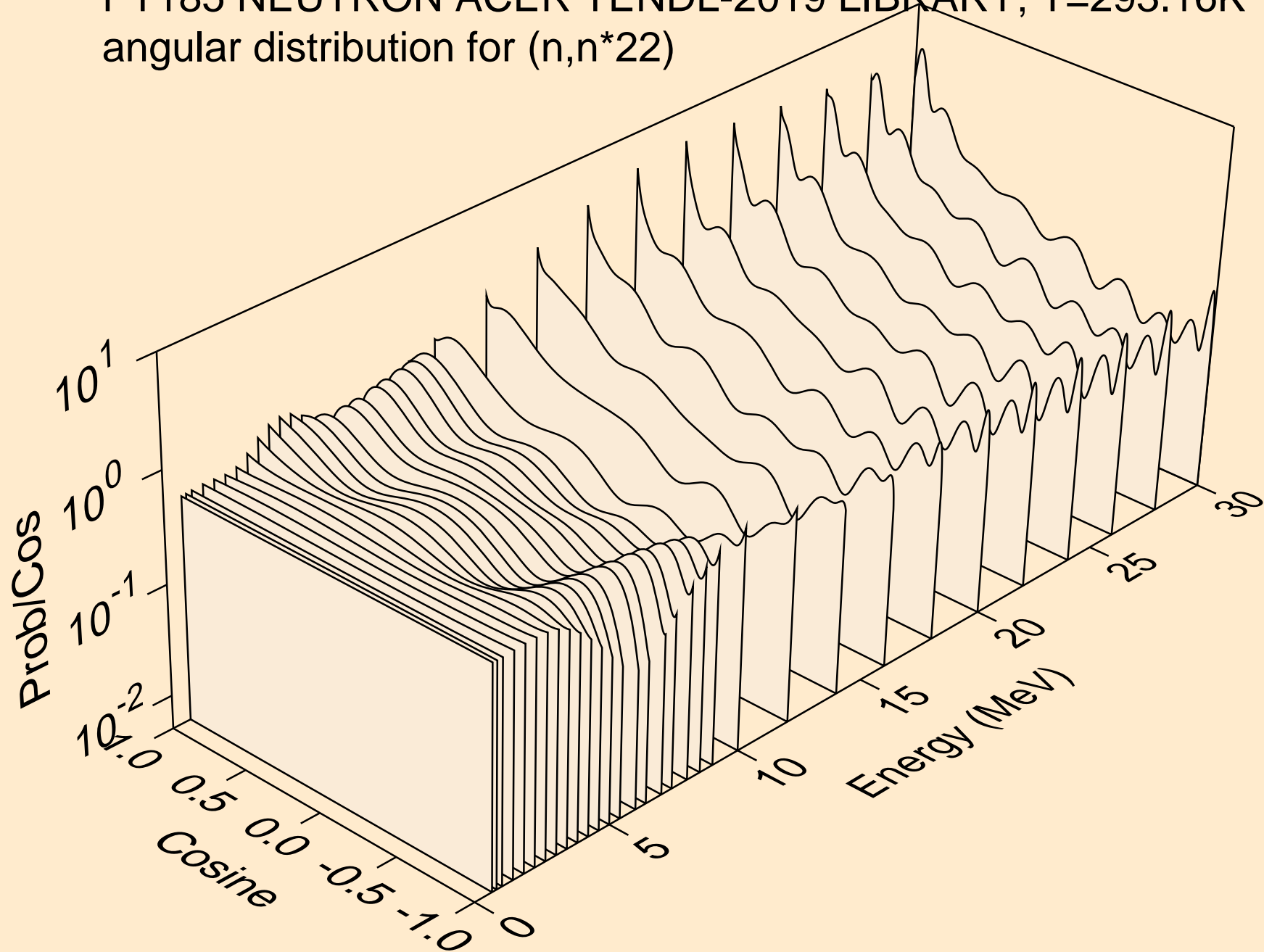

PT185 NEUTRON ACER TENDL-2019 LIBRARY; T=293.16K
angular distribution for (n,n*23)

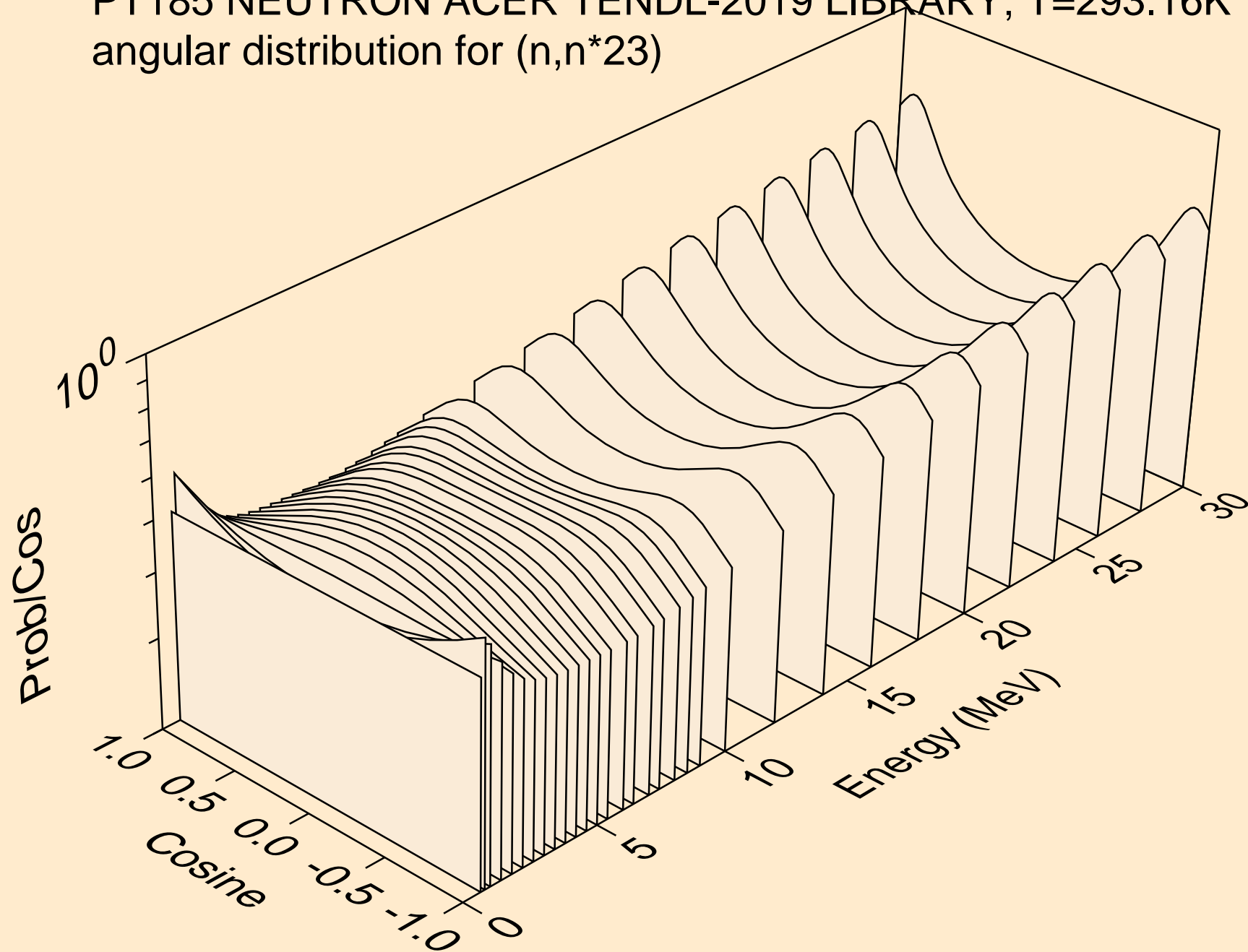

PT185 NEUTRON ACER TENDL-2019 LIBRARY; T=293.16K
angular distribution for (n,n*24)

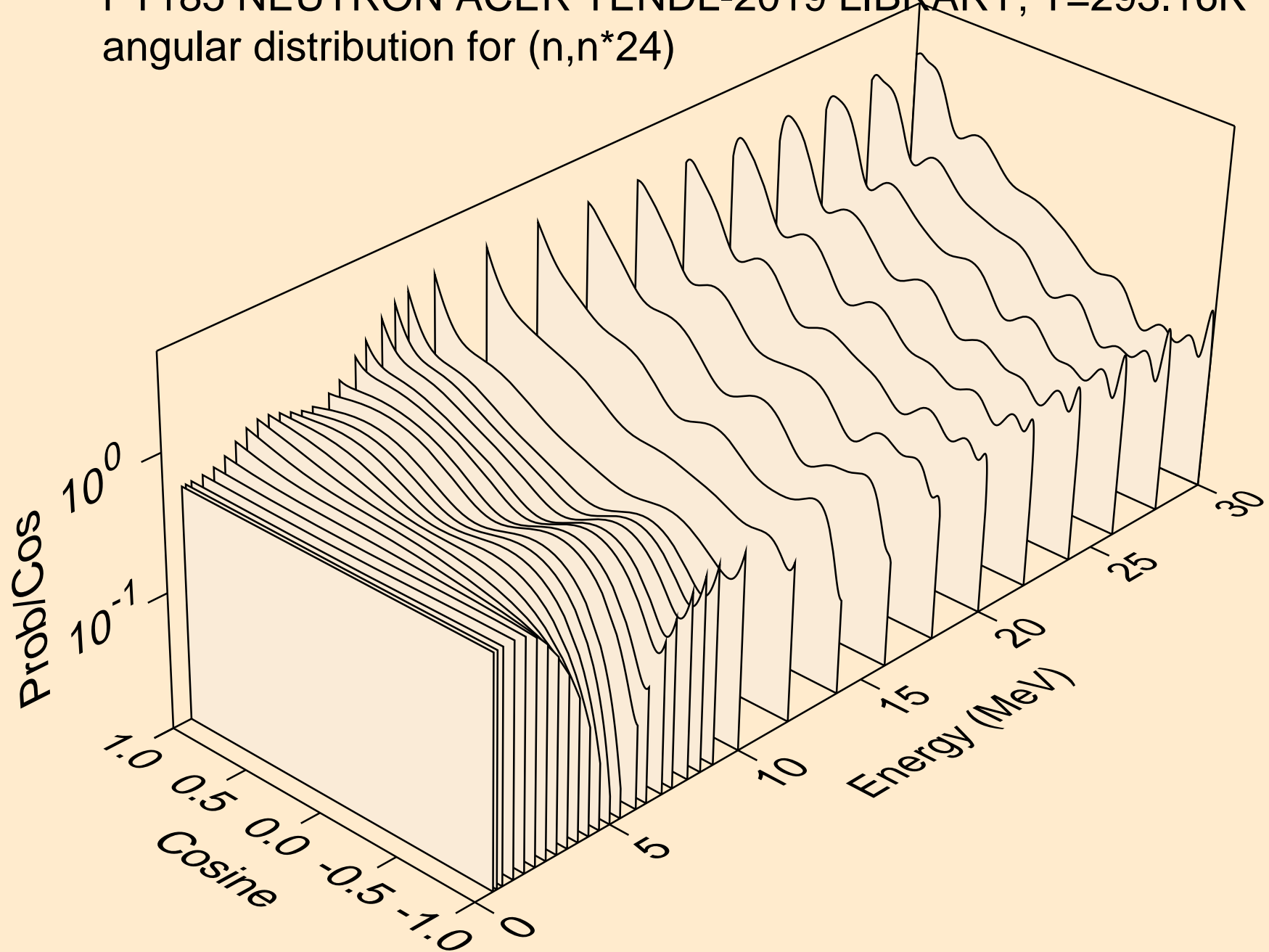

PT185 NEUTRON ACER TENDL-2019 LIBRARY; T=293.16K
angular distribution for (n,n*25)

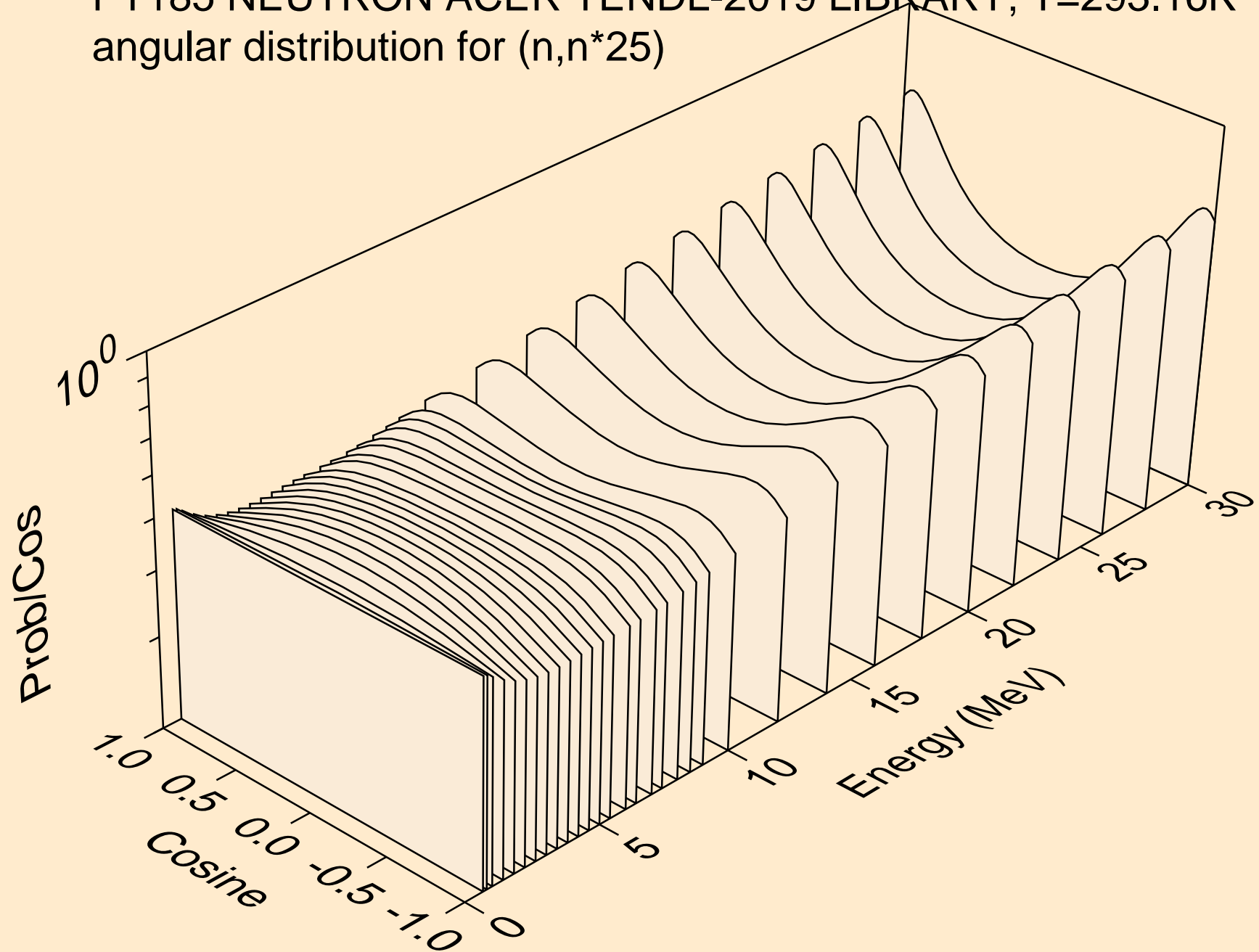

PT185 NEUTRON ACER TENDL-2019 LIBRARY; T=293.16K
angular distribution for (n,n*26)

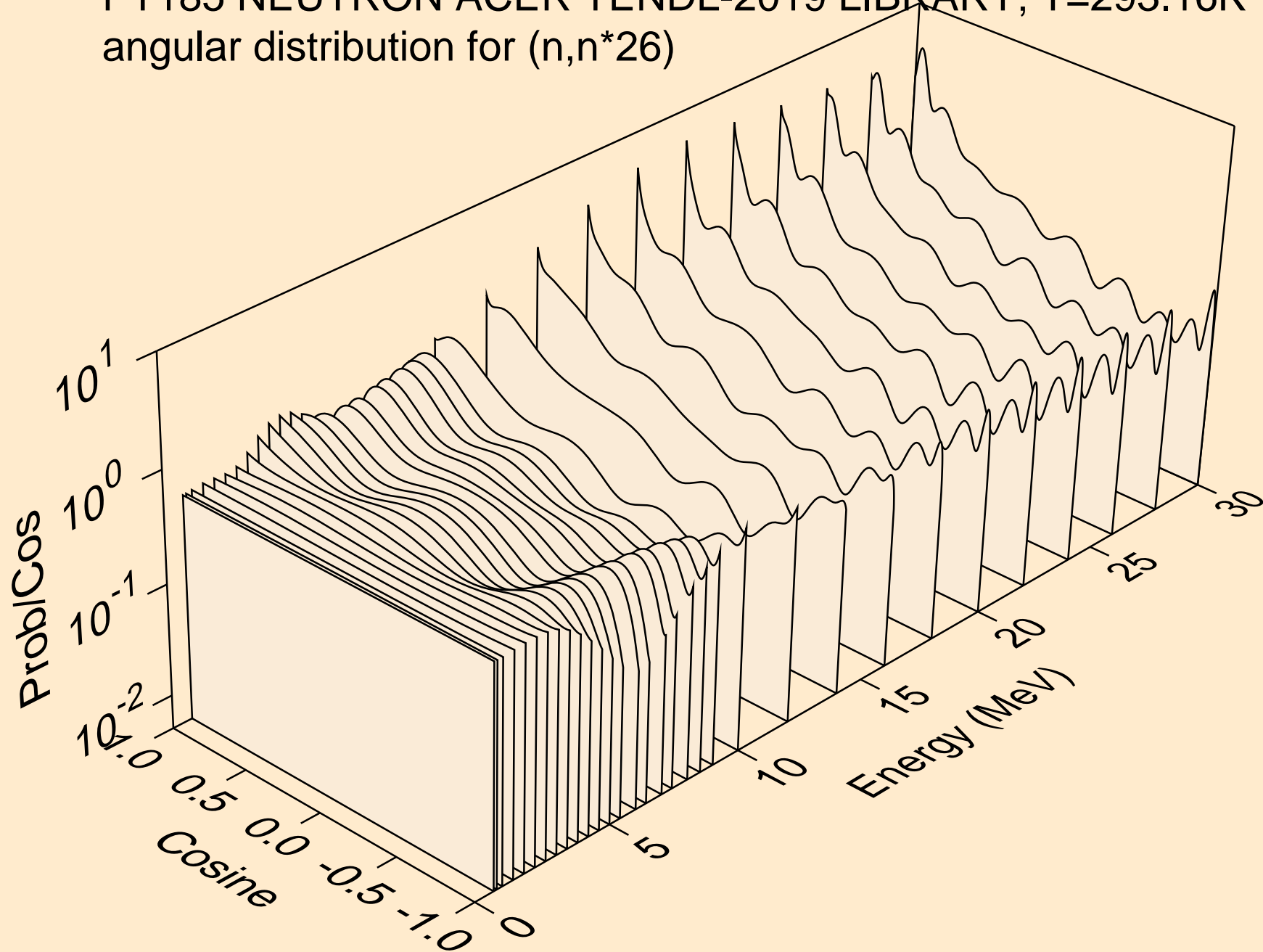

PT185 NEUTRON ACER TENDL-2019 LIBRARY; T=293.16K
angular distribution for (n,n*27)

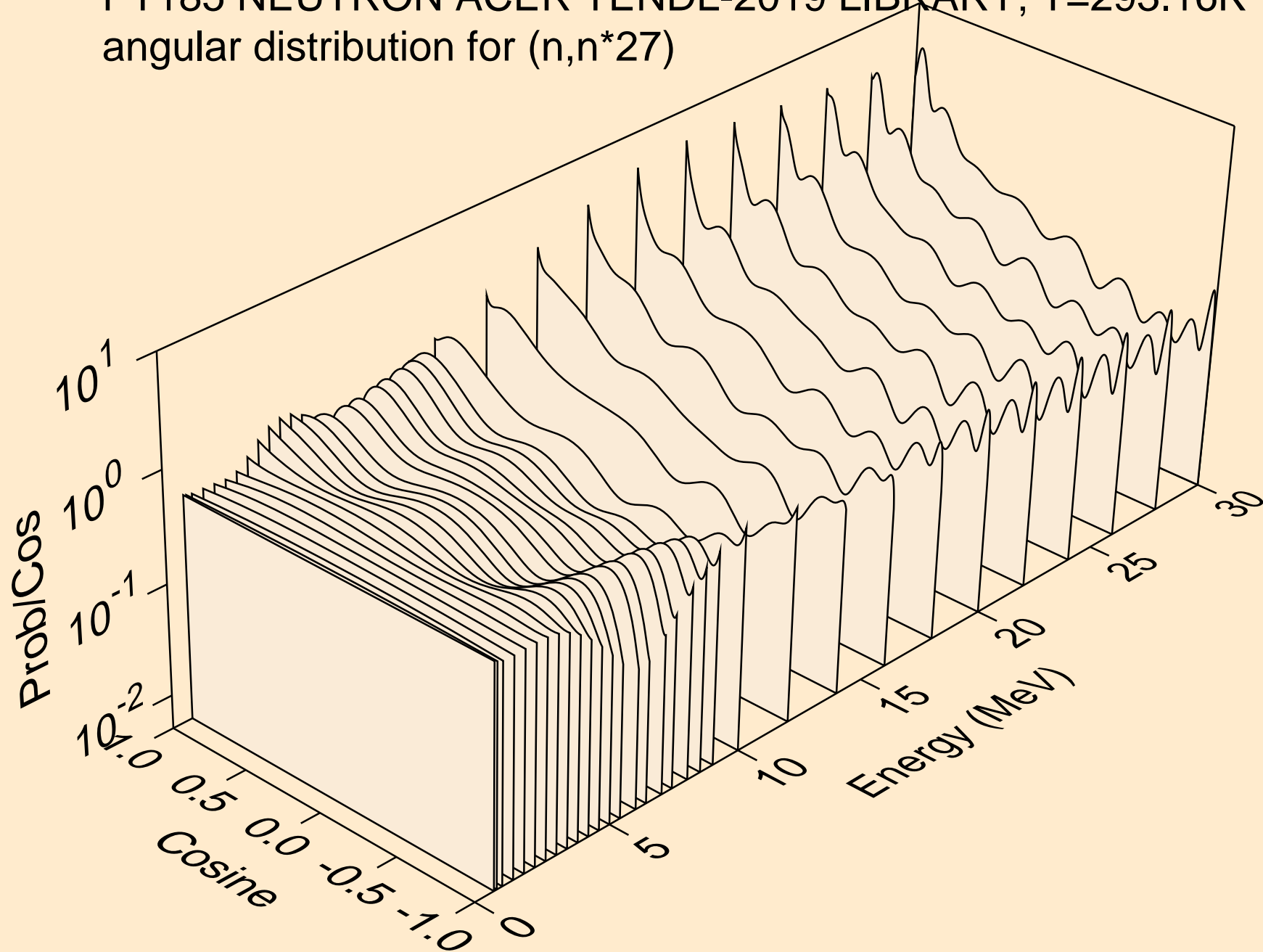

PT185 NEUTRON ACER TENDL-2019 LIBRARY; T=293.16K
angular distribution for (n,n*28)

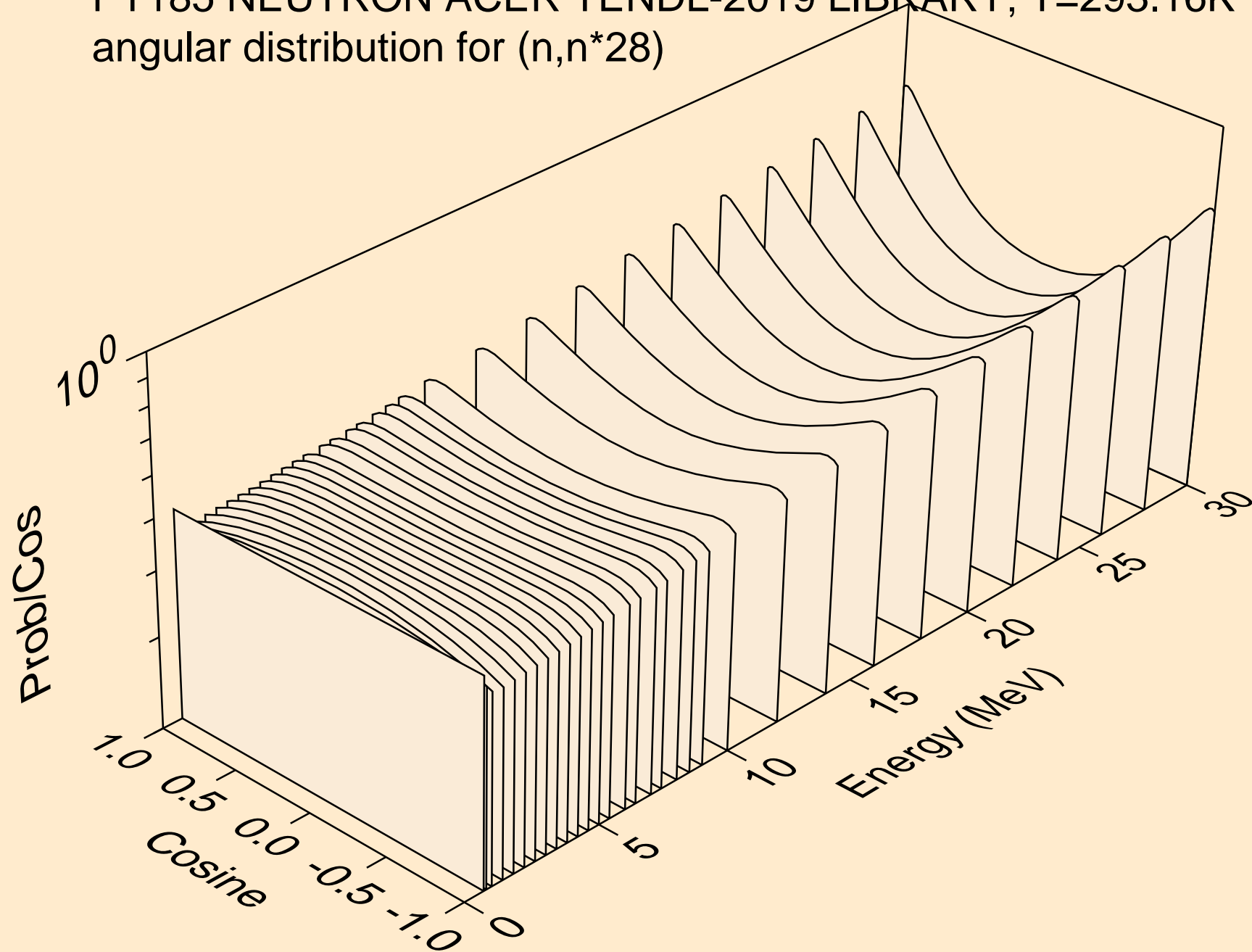

PT185 NEUTRON ACER TENDL-2019 LIBRARY; T=293.16K
angular distribution for (n,n*29)

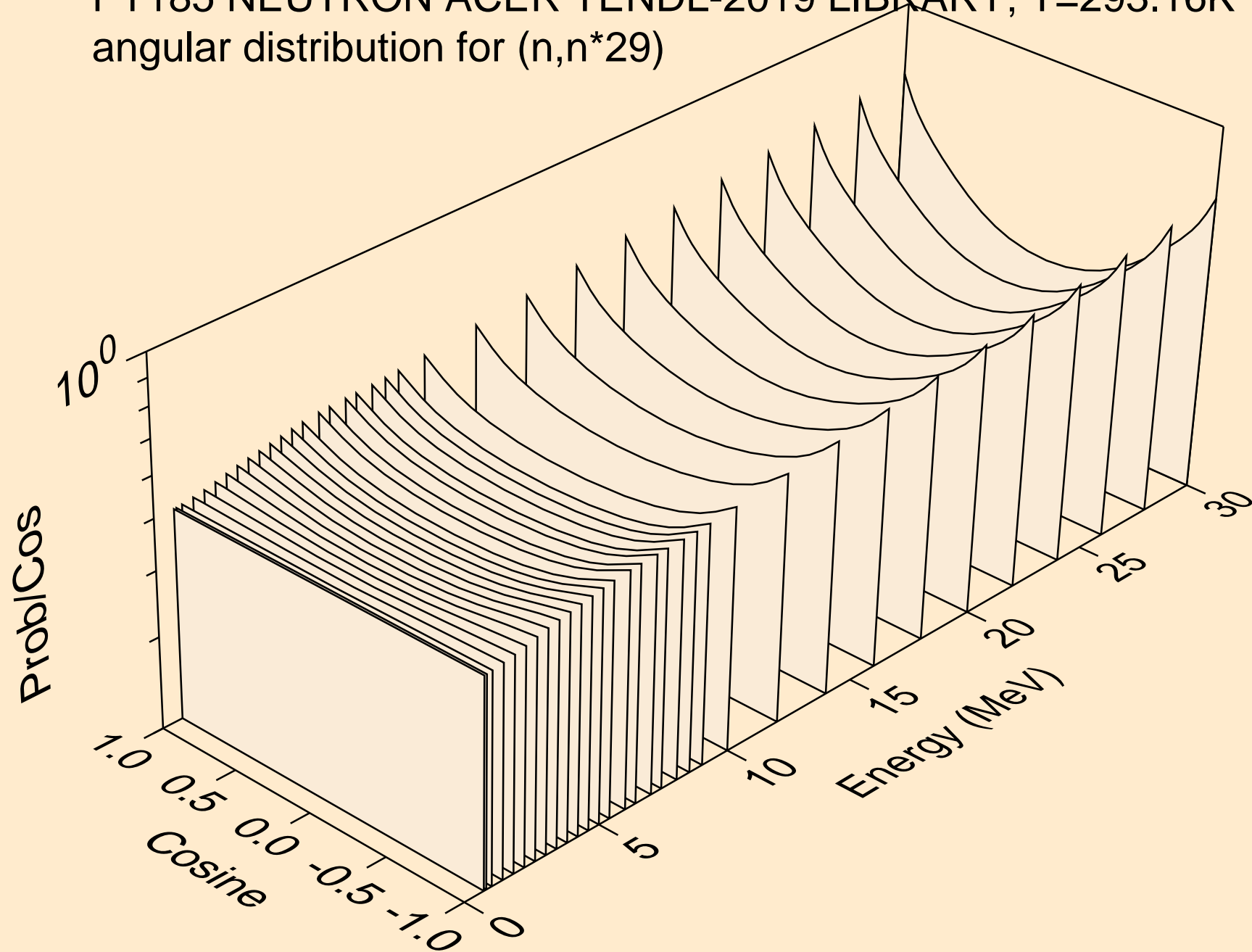

PT185 NEUTRON ACER TENDL-2019 LIBRARY; T=293.16K
Neutron emission for (n,x)

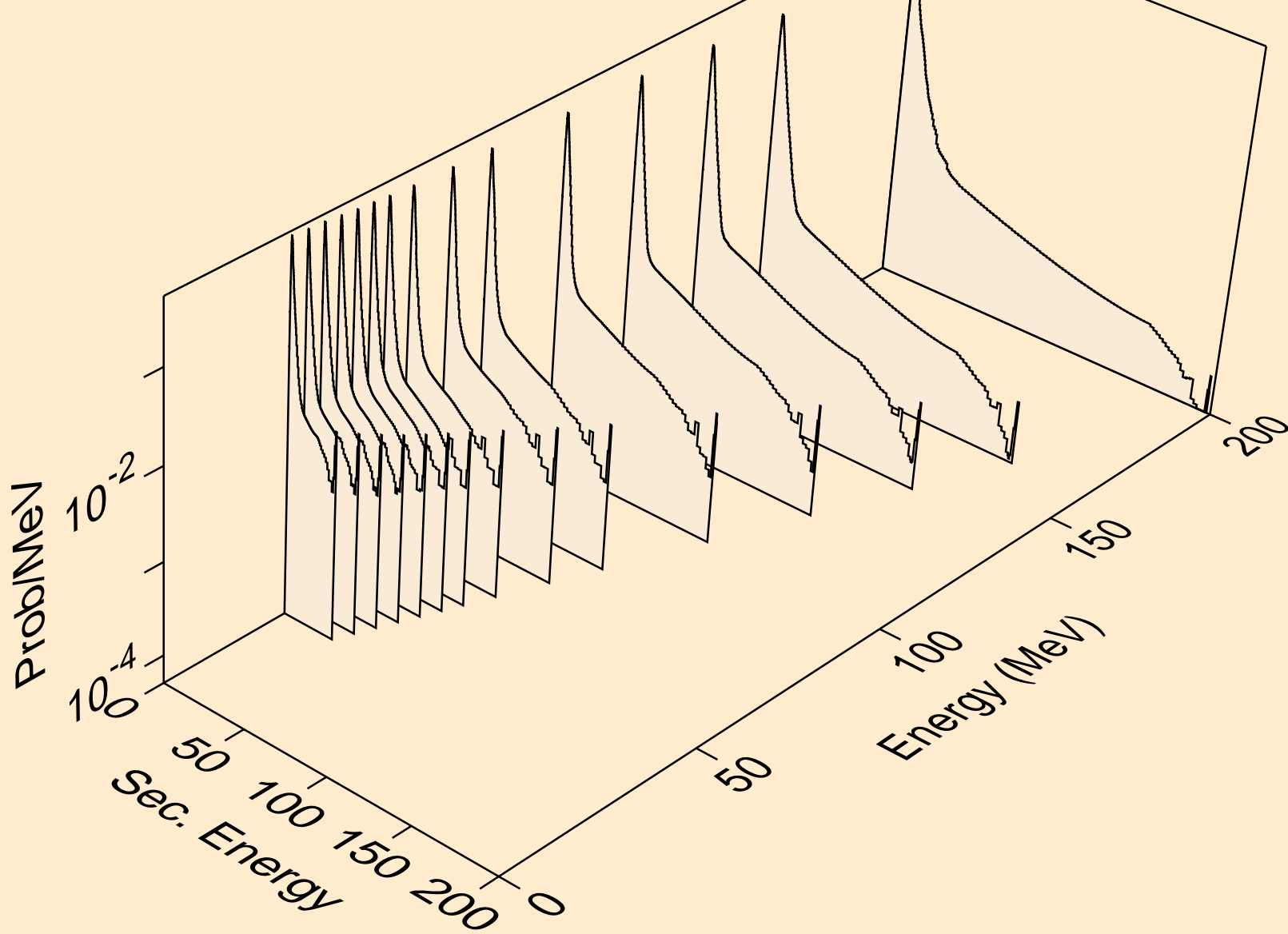

PT185 NEUTRON ACER TENDL-2019 LIBRARY; T=293.16K
Neutron emission for (n,2nd)

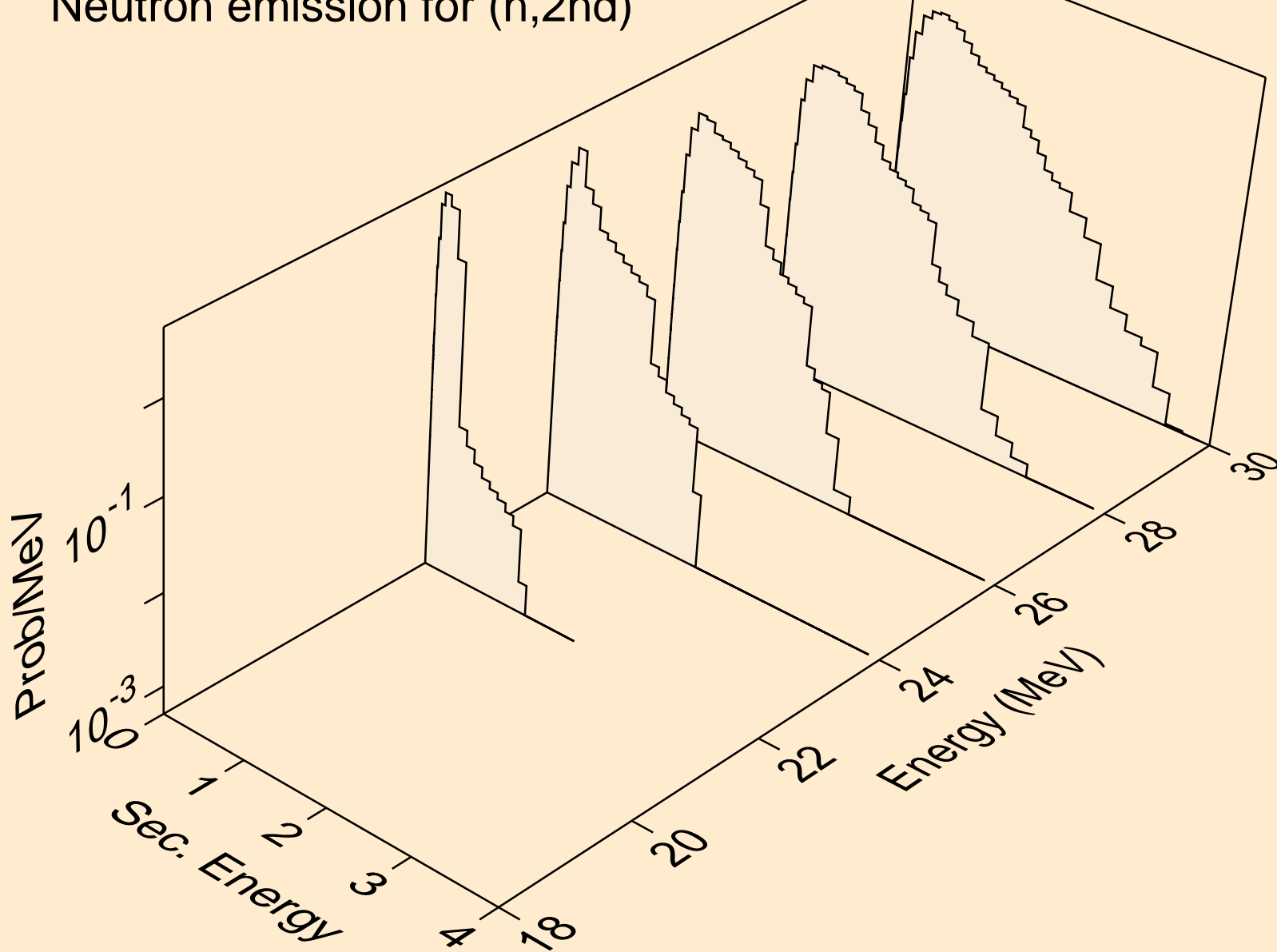

PT185 NEUTRON ACER TENDL-2019 LIBRARY; T=293.16K
Neutron emission for (n,2n)

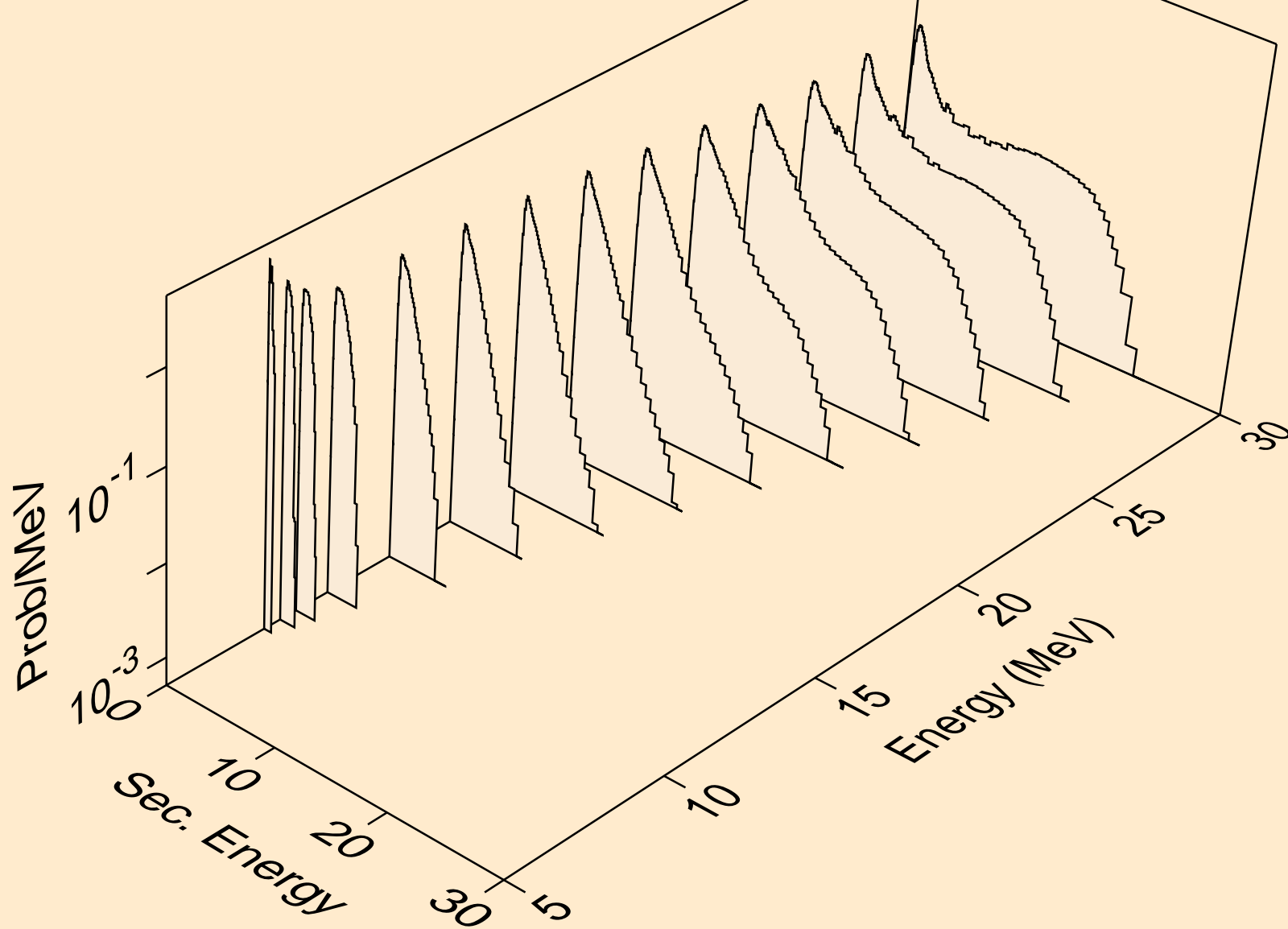

PT185 NEUTRON ACER TENDL-2019 LIBRARY; T=293.16K
Neutron emission for (n,3n)

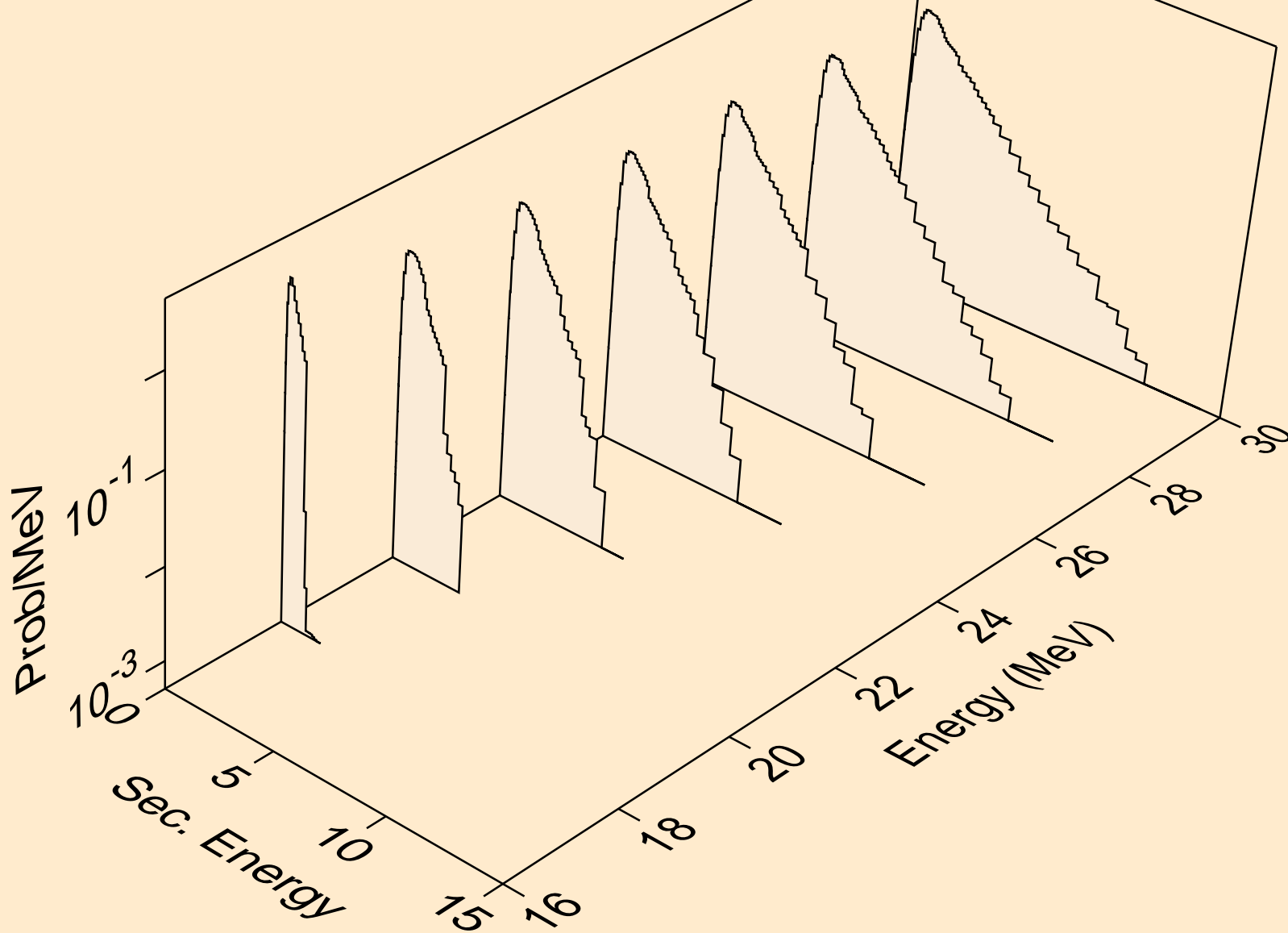

PT185 NEUTRON ACER TENDL-2019 LIBRARY; T=293.16K
Neutron emission for (n,n*)a

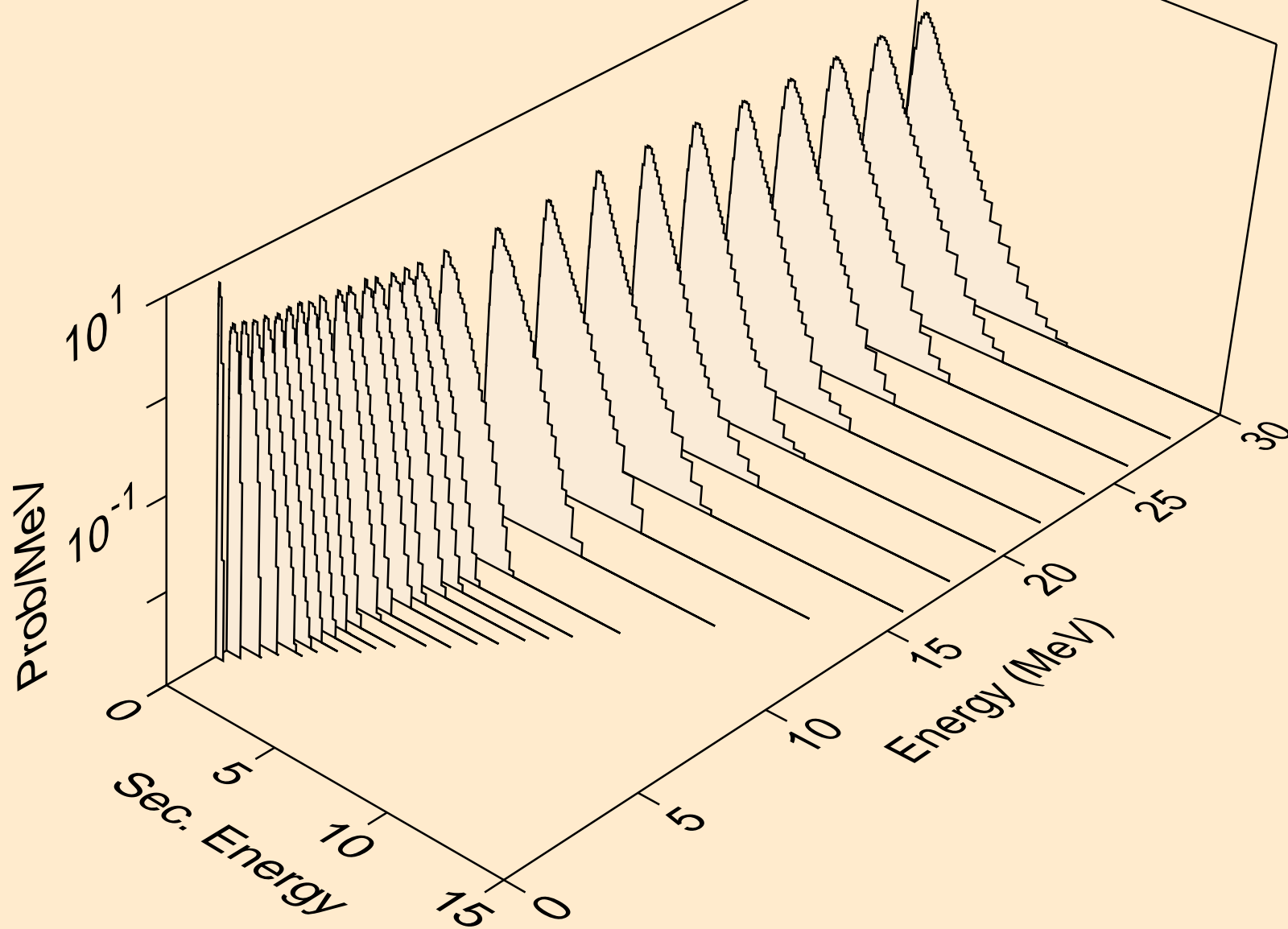

PT185 NEUTRON ACER TENDL-2019 LIBRARY; T=293.16K
Neutron emission for (n,2n)a

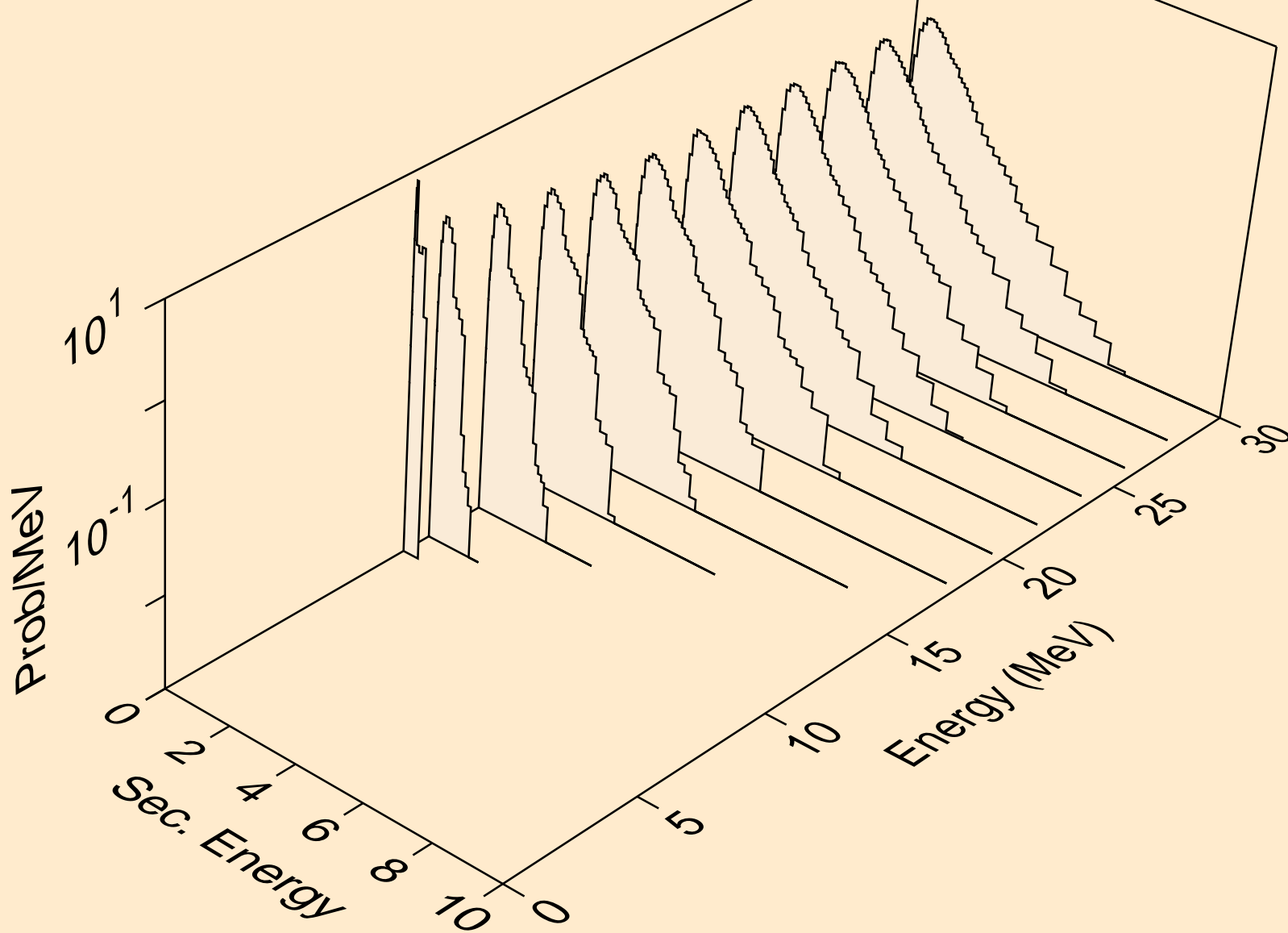

PT185 NEUTRON ACER TENDL-2019 LIBRARY; T=293.16K
Neutron emission for (n,3n)a

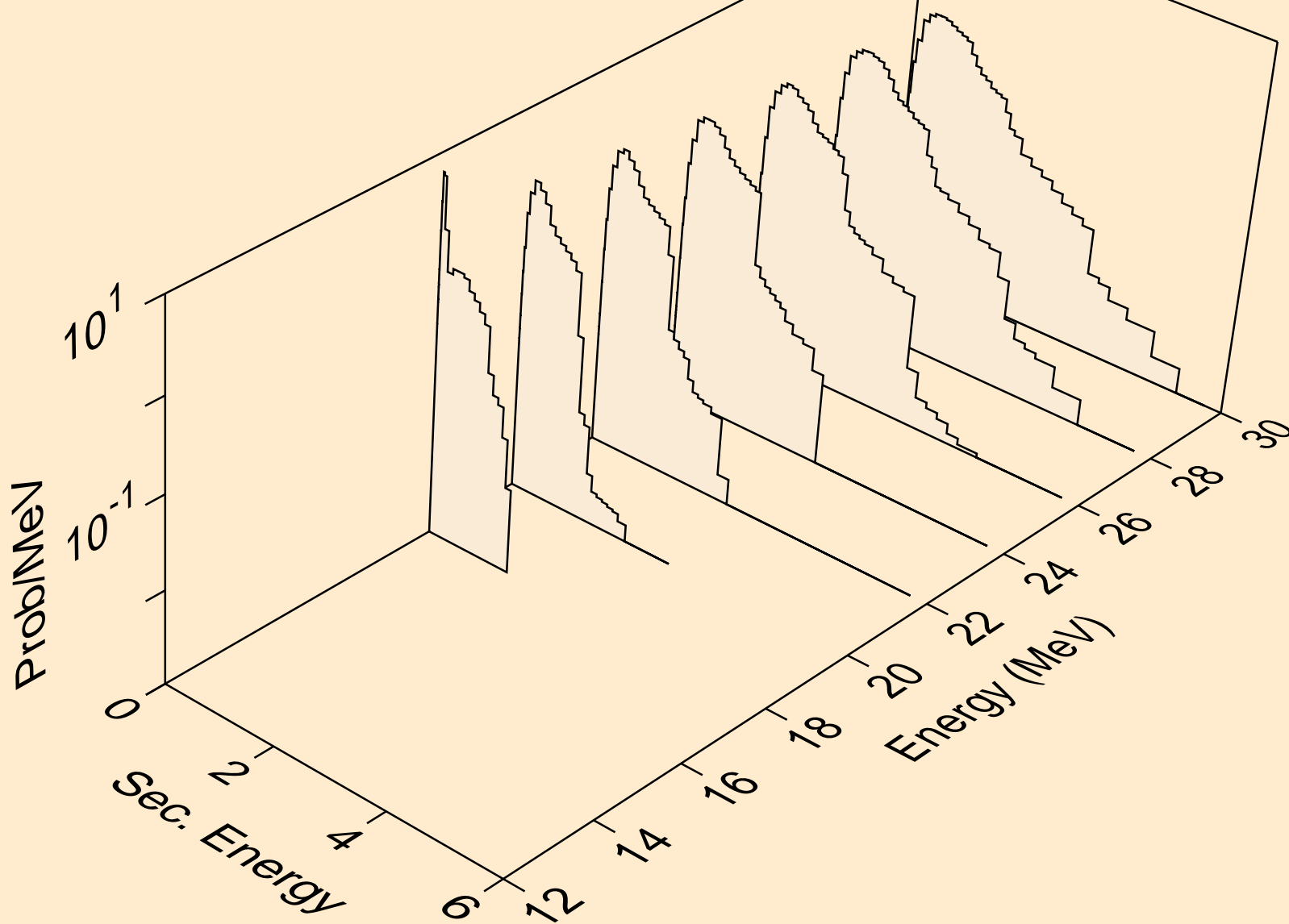

PT185 NEUTRON ACER TENDL-2019 LIBRARY; T=293.16K
Neutron emission for (n,n*)p

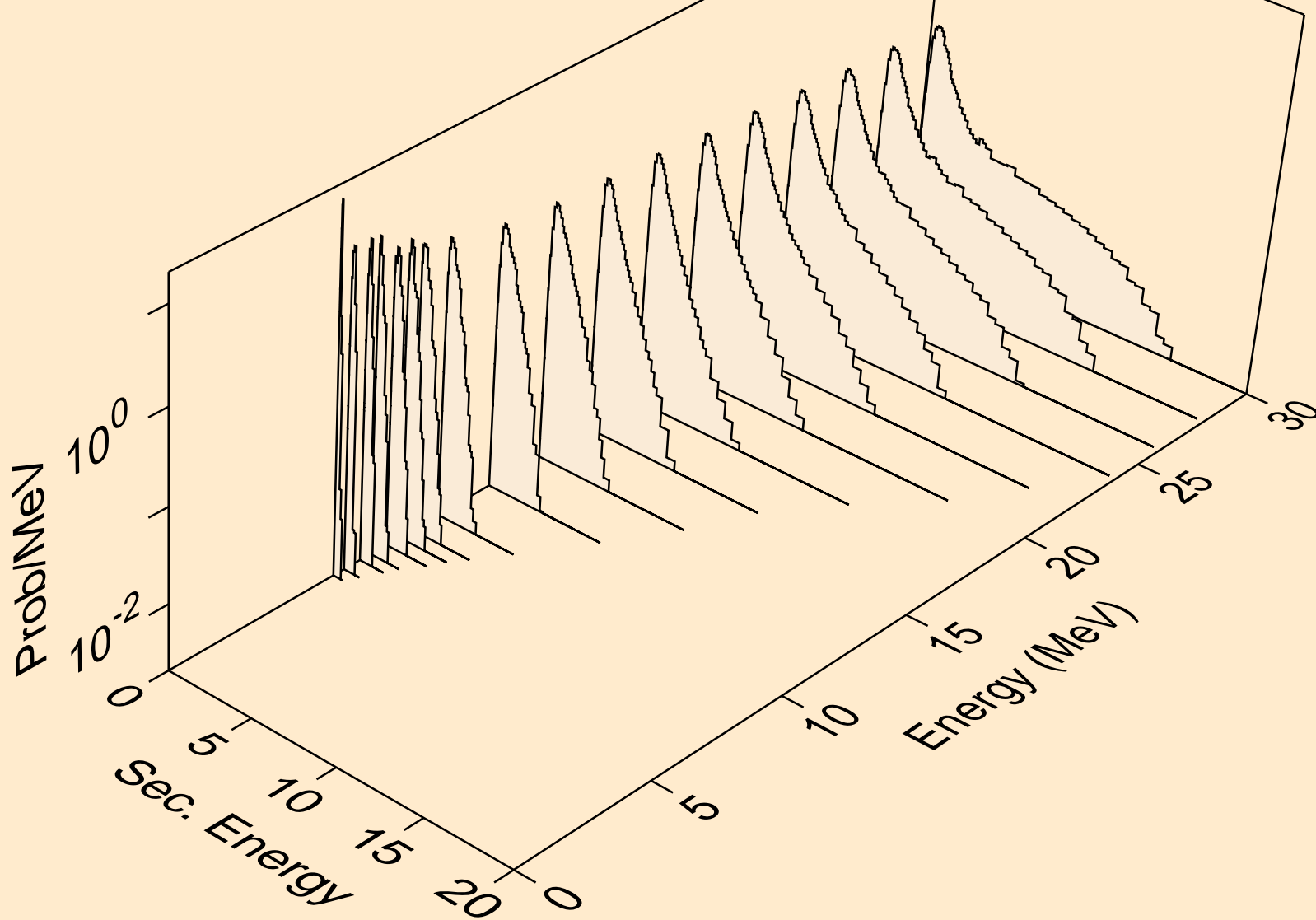

PT185 NEUTRON ACER TENDL-2019 LIBRARY; T=293.16K
Neutron emission for (n,n*)2a

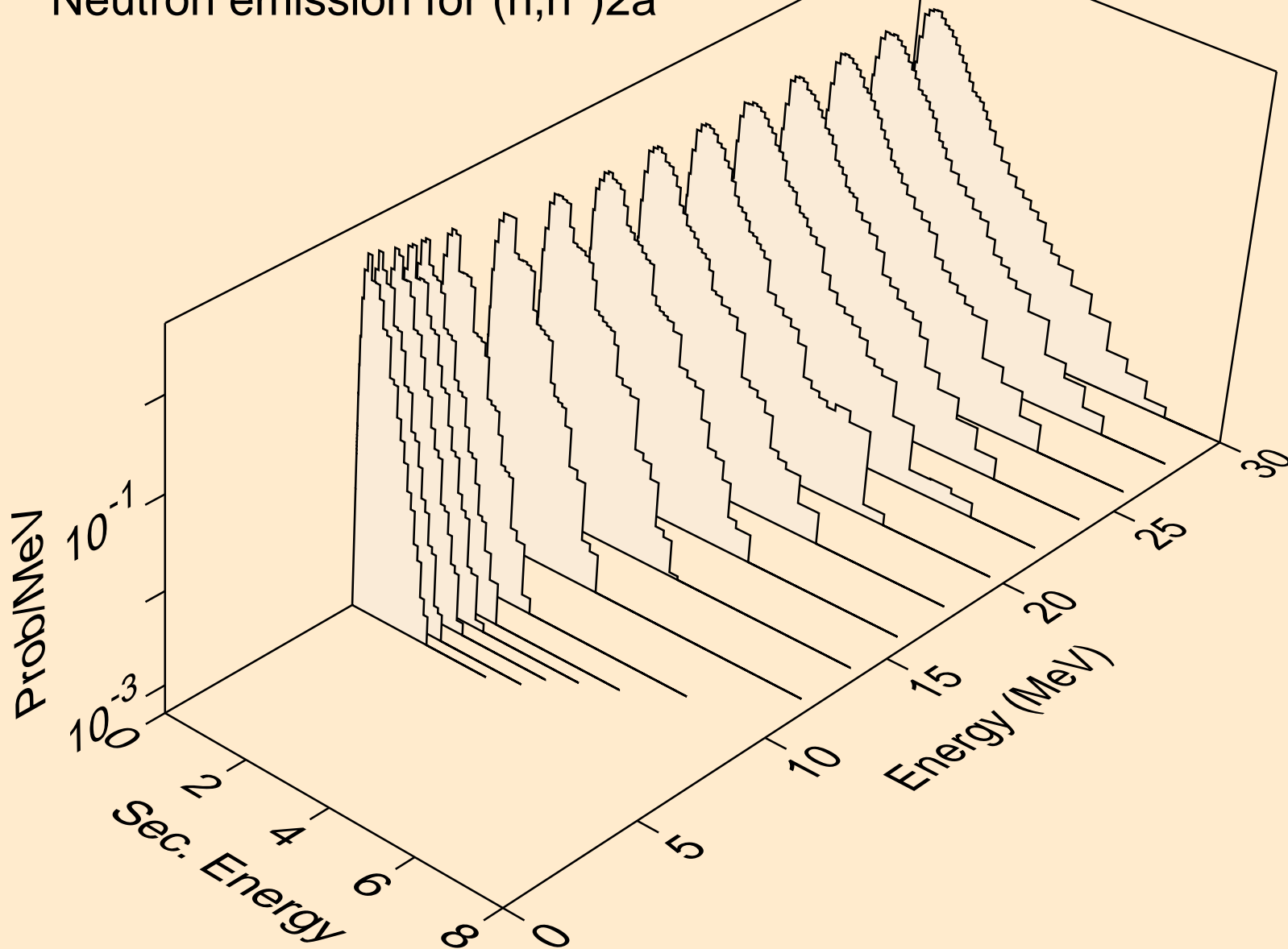

PT185 NEUTRON ACER TENDL-2019 LIBRARY; T=293.16K
Neutron emission for (n,2n)2a

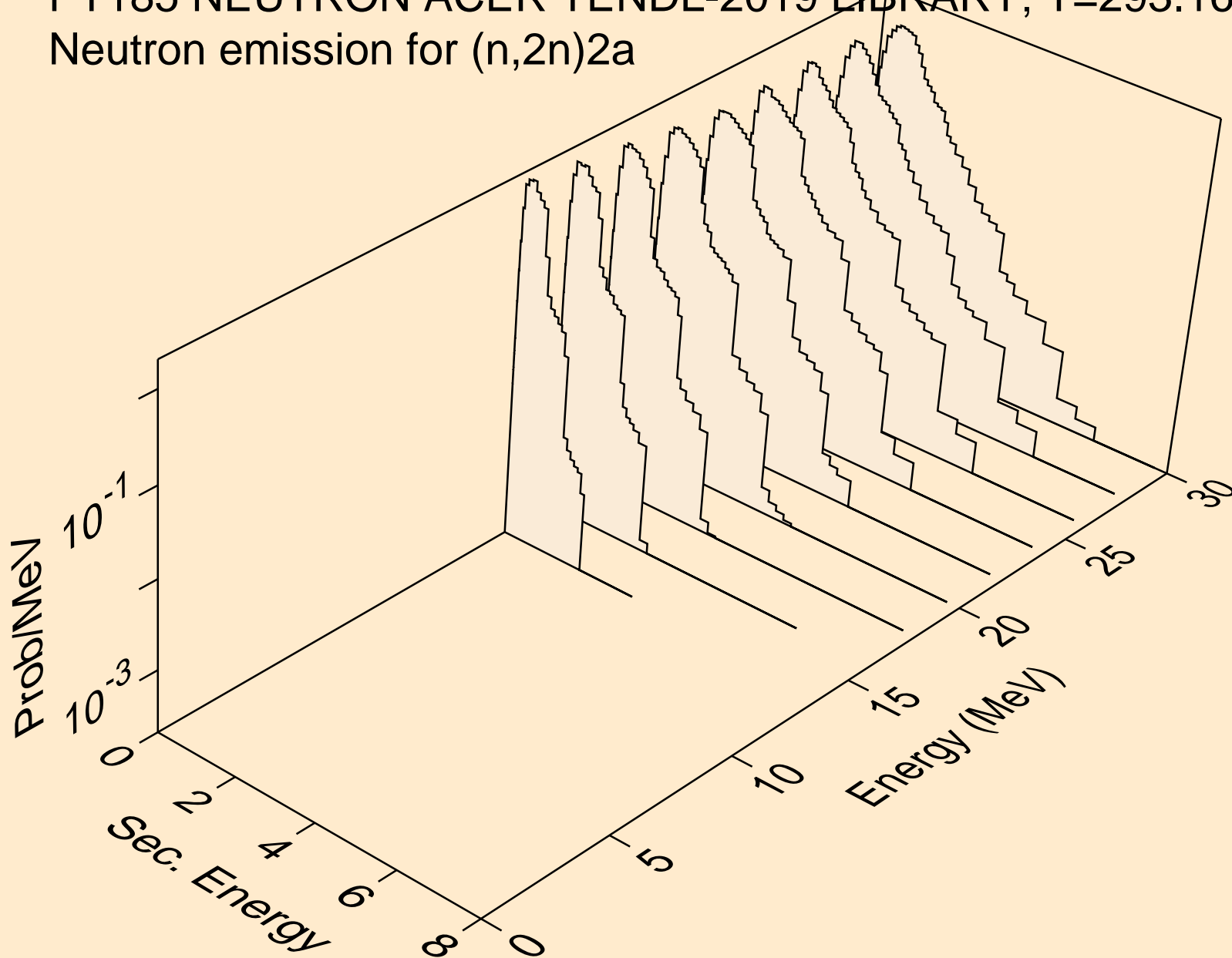

PT185 NEUTRON ACER TENDL-2019 LIBRARY; T=293.16K
Neutron emission for (n,n*)d

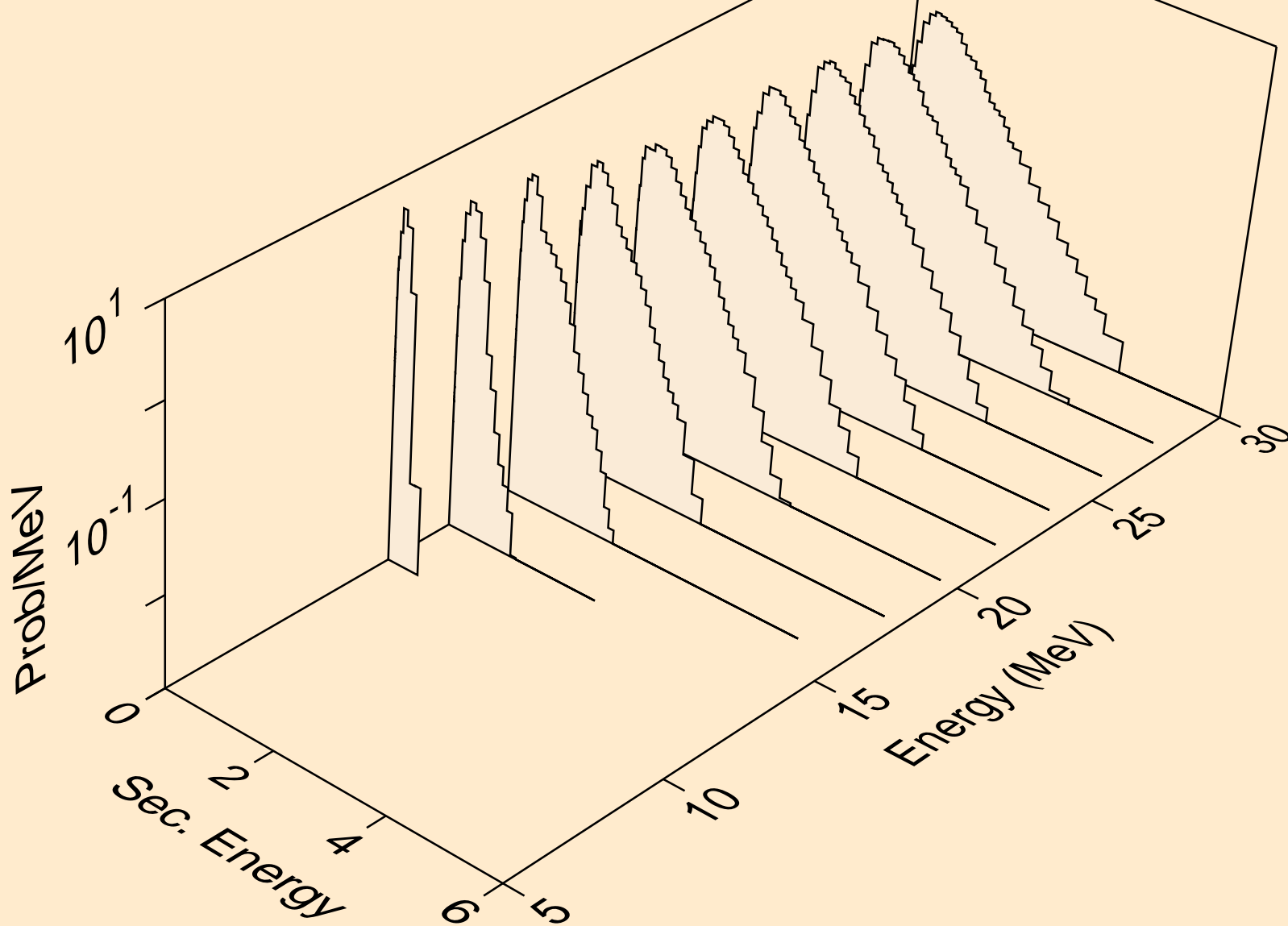

PT185 NEUTRON ACER TENDL-2019 LIBRARY; T=293.16K
Neutron emission for (n,n*)t

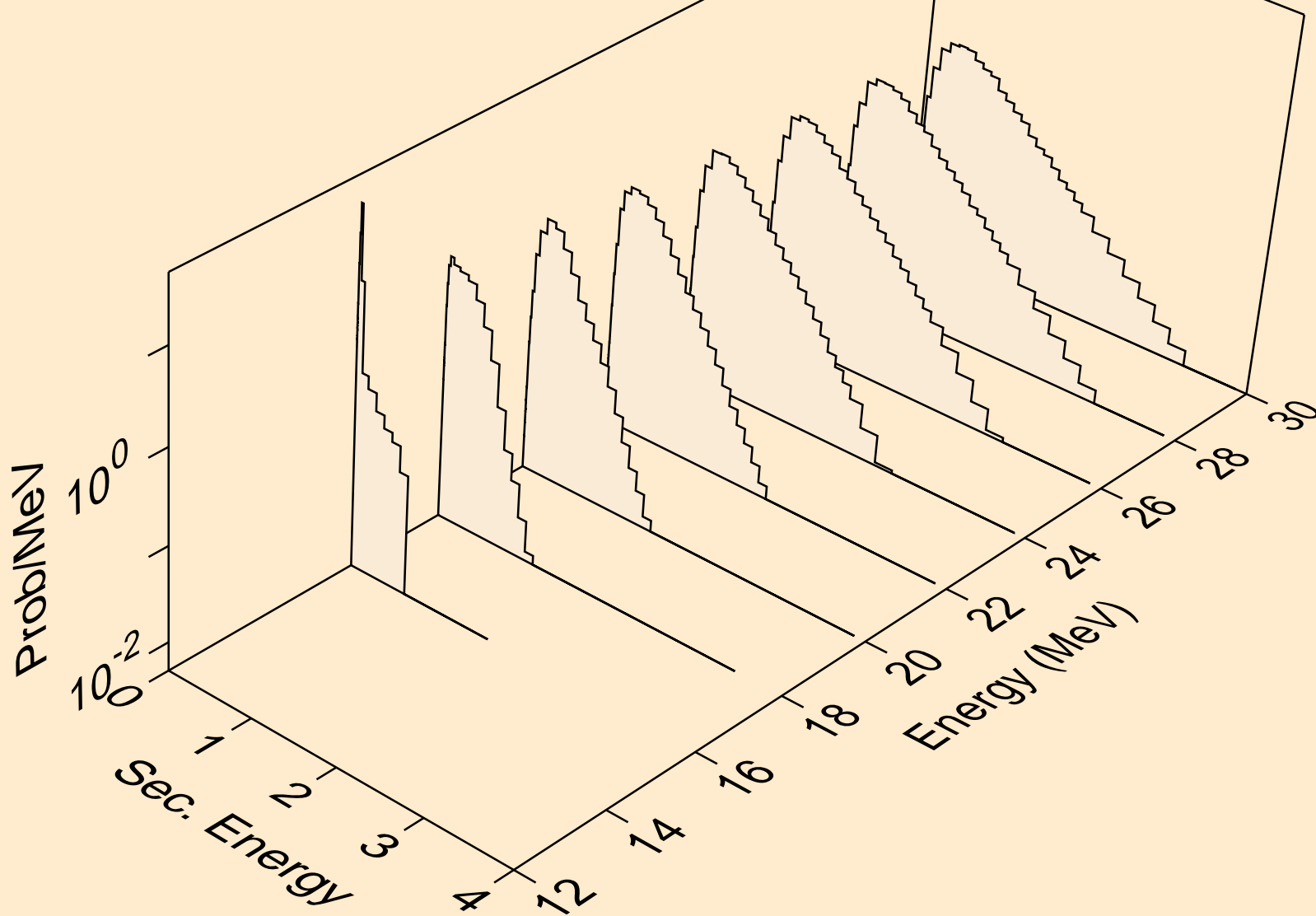

PT185 NEUTRON ACER TENDL-2019 LIBRARY; T=293.16K
Neutron emission for (n,n*)he3

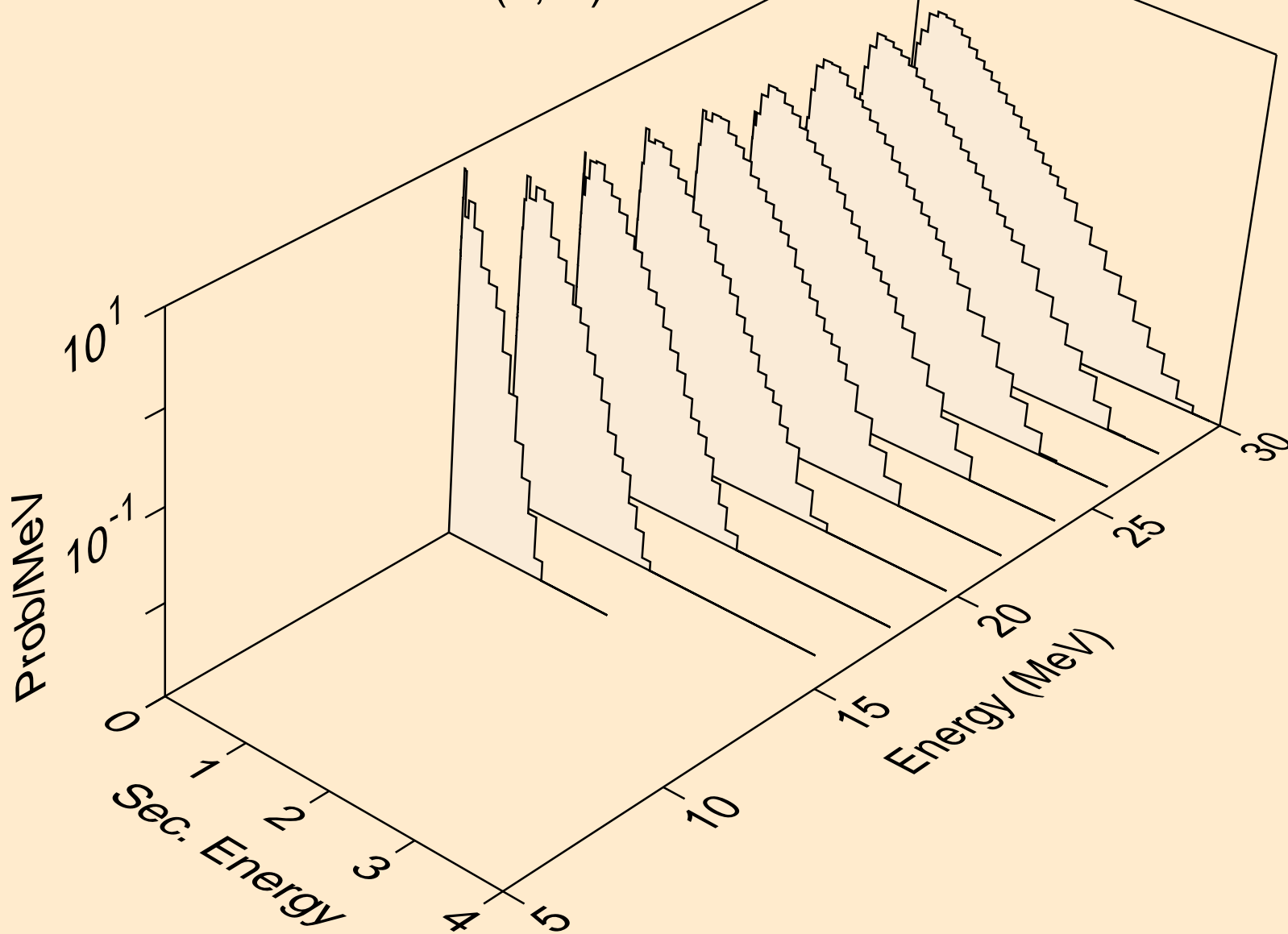

PT185 NEUTRON ACER TENDL-2019 LIBRARY; T=293.16K
Neutron emission for (n,4n)

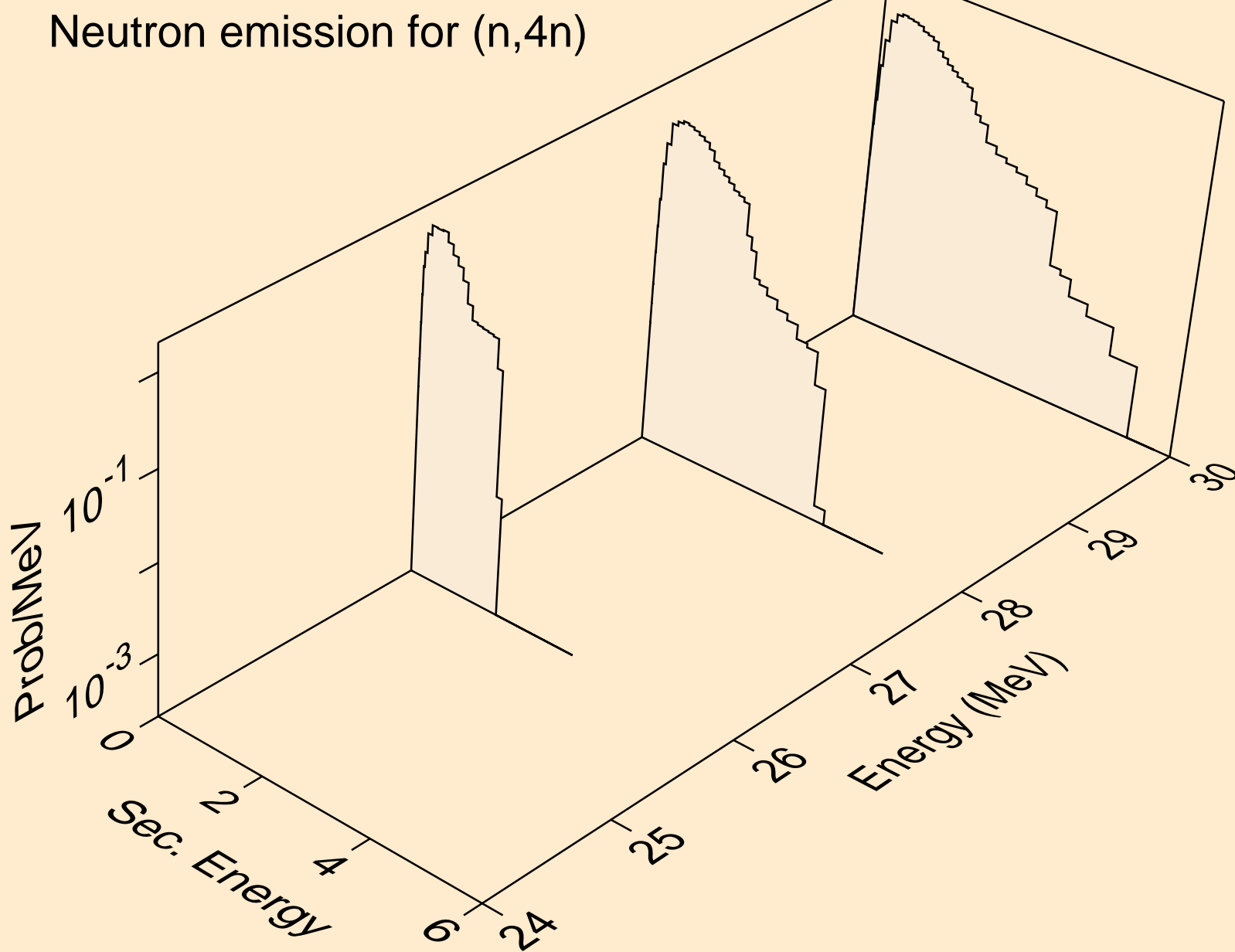

PT185 NEUTRON ACER TENDL-2019 LIBRARY; T=293.16K
Neutron emission for (n,2np)

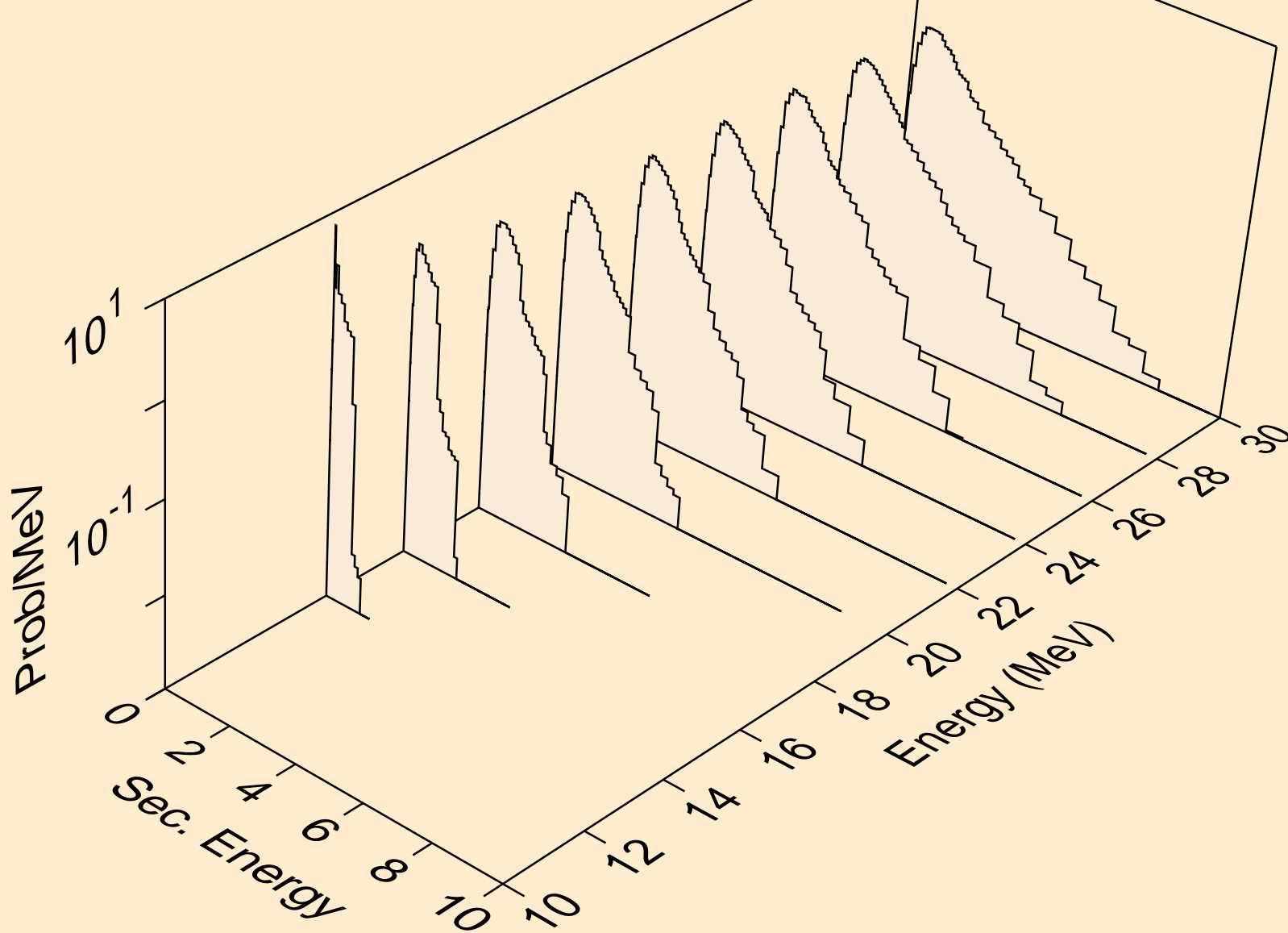

PT185 NEUTRON ACER TENDL-2019 LIBRARY; T=293.16K
Neutron emission for (n,3np)

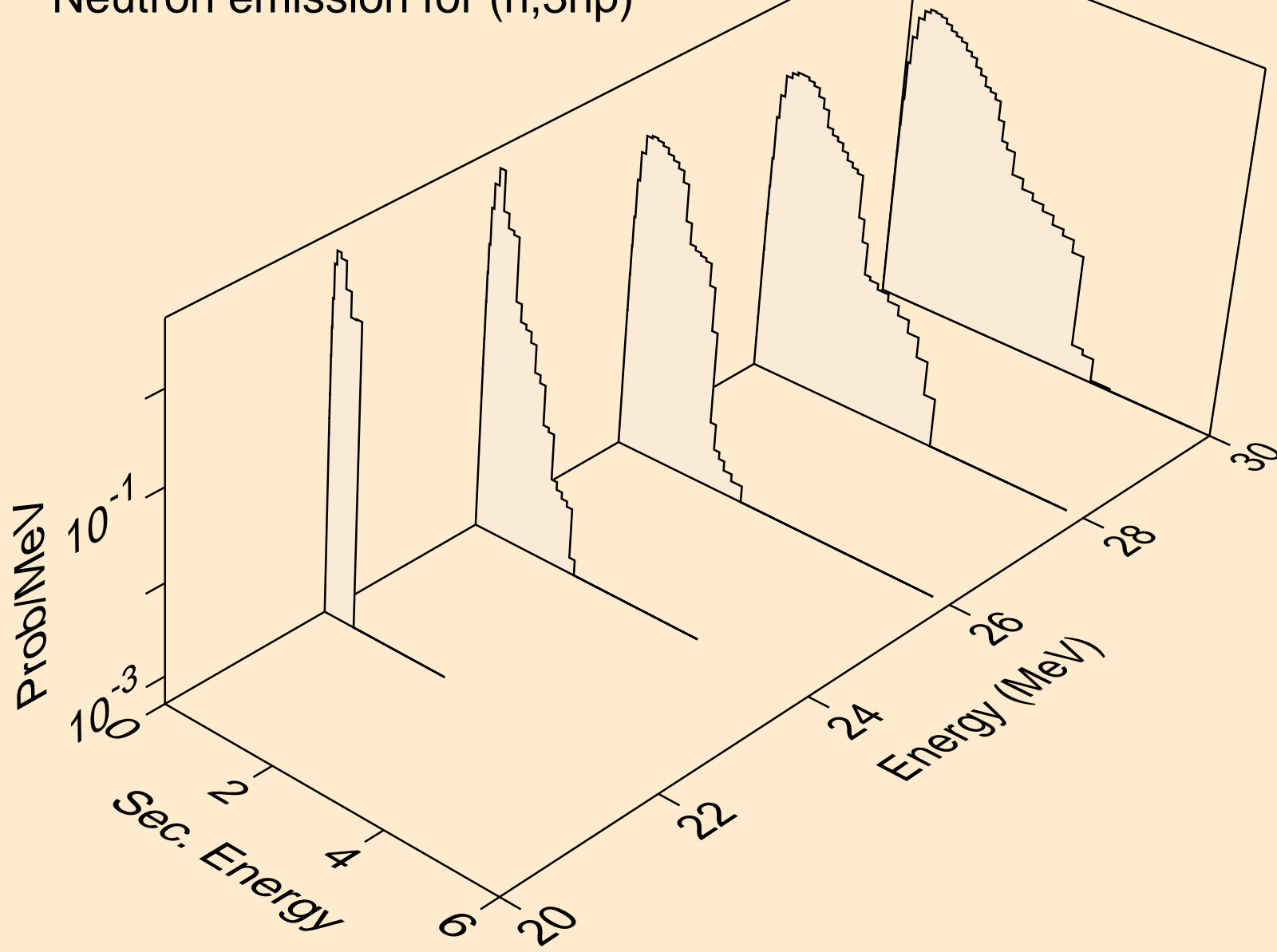

PT185 NEUTRON ACER TENDL-2019 LIBRARY; T=293.16K
Neutron emission for (n,2np)

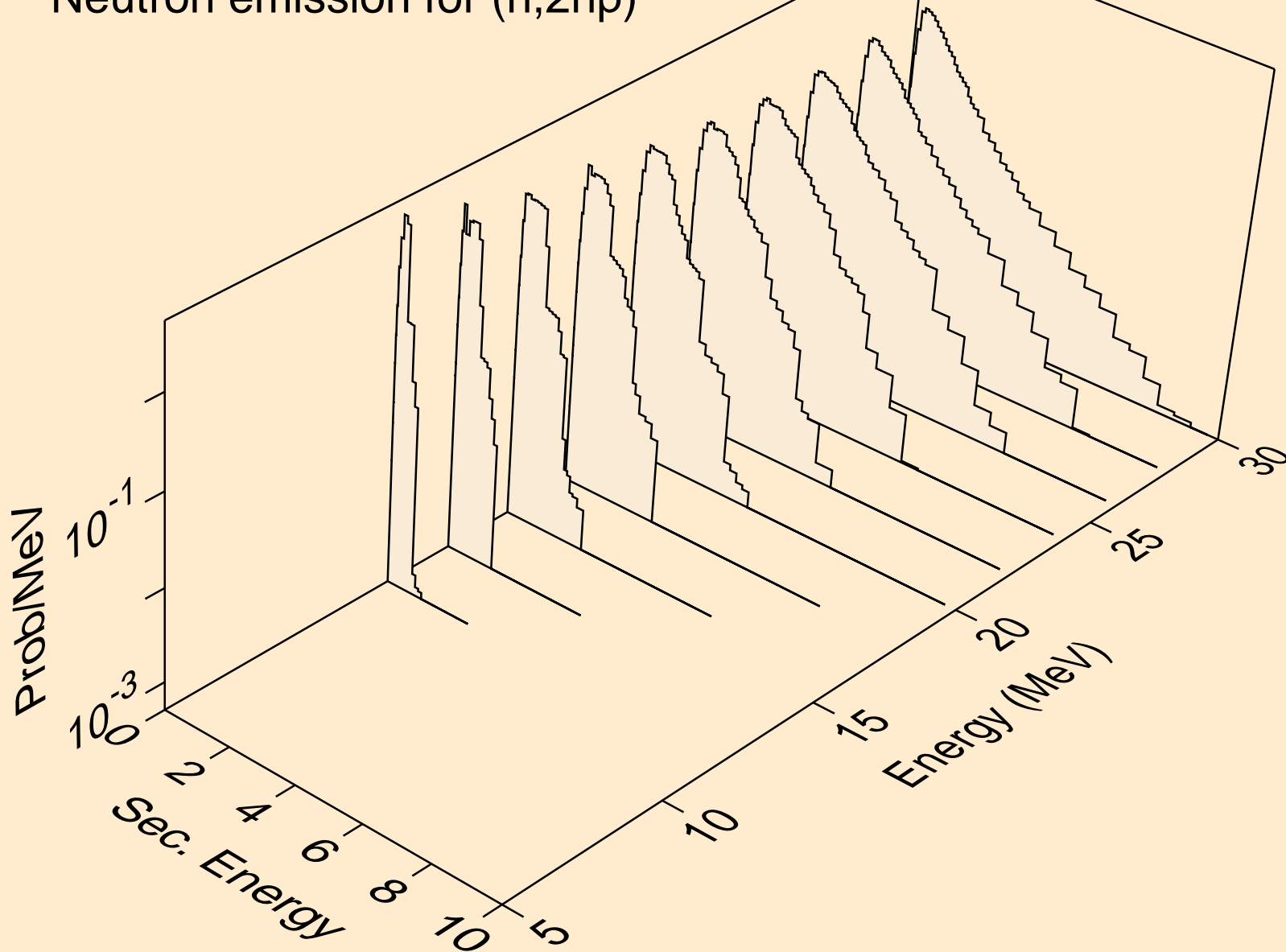

PT185 NEUTRON ACER TENDL-2019 LIBRARY; T=293.16K
Neutron emission for (n,npa)

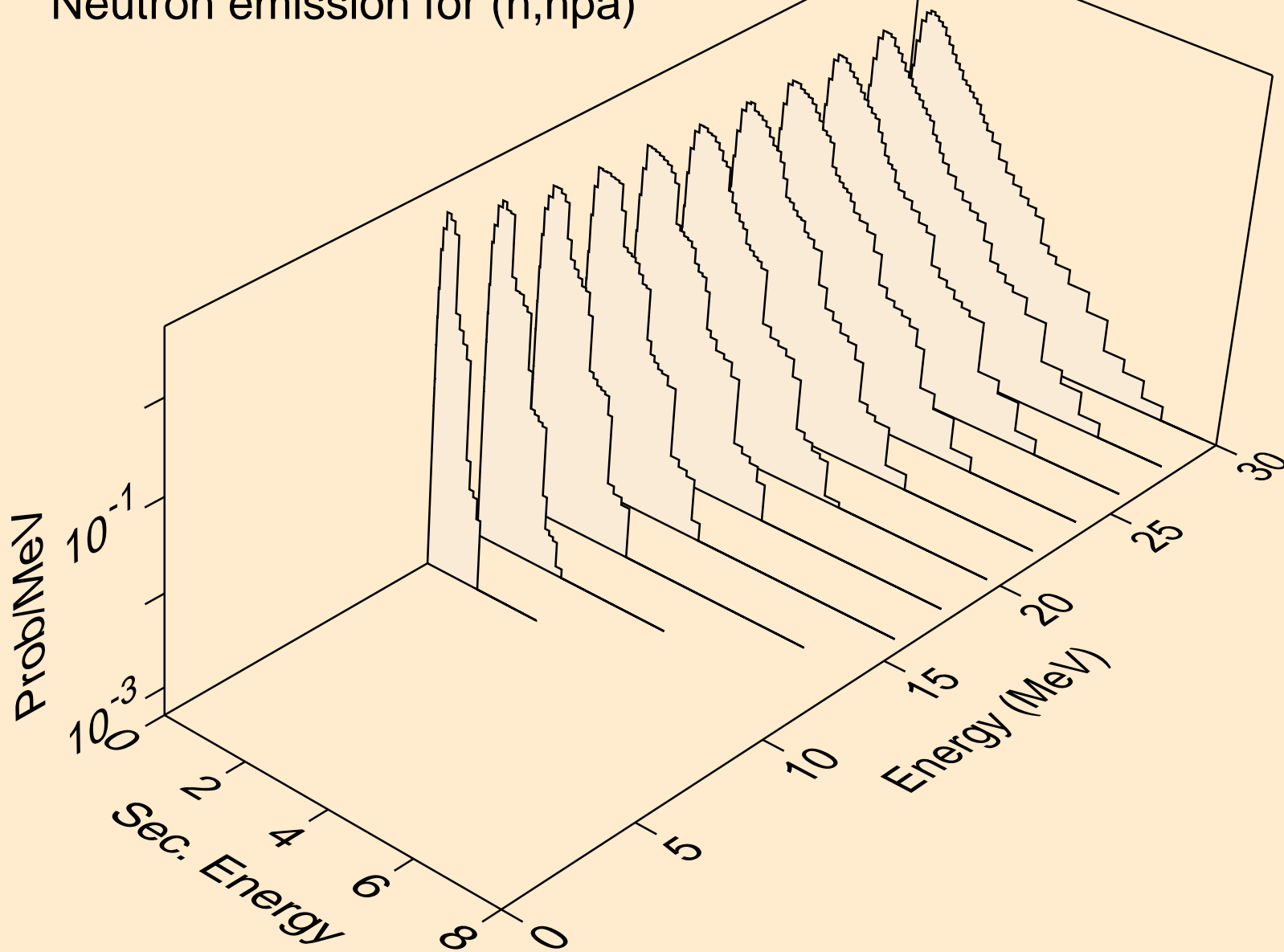

PT185 NEUTRON ACER TENDL-2019 LIBRARY; T=293.16K
Neutron emission for (n,n*c)

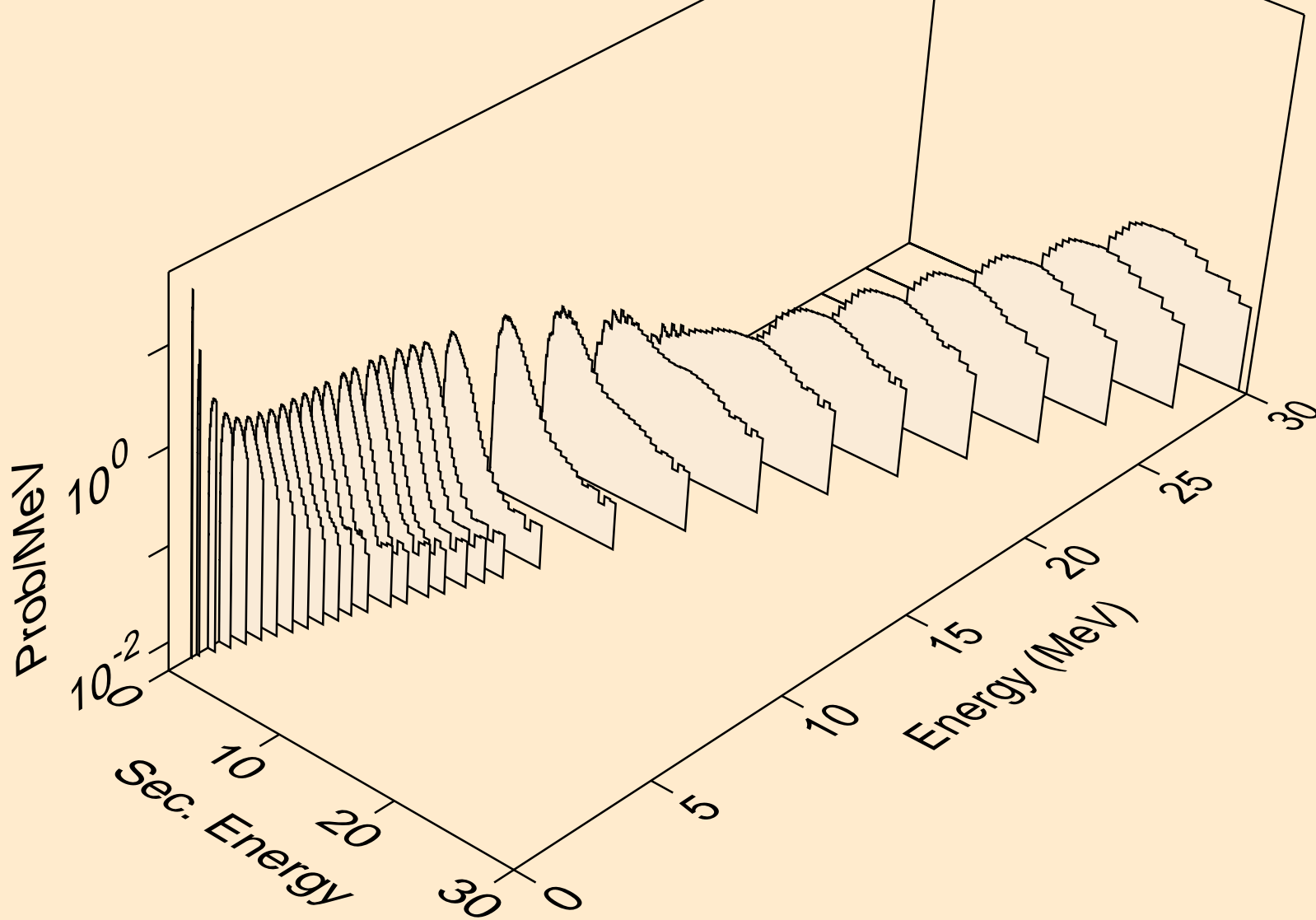

PT185 NEUTRON ACER TENDL-2019 LIBRARY; T=293.16K
Photon emission for (n,x)

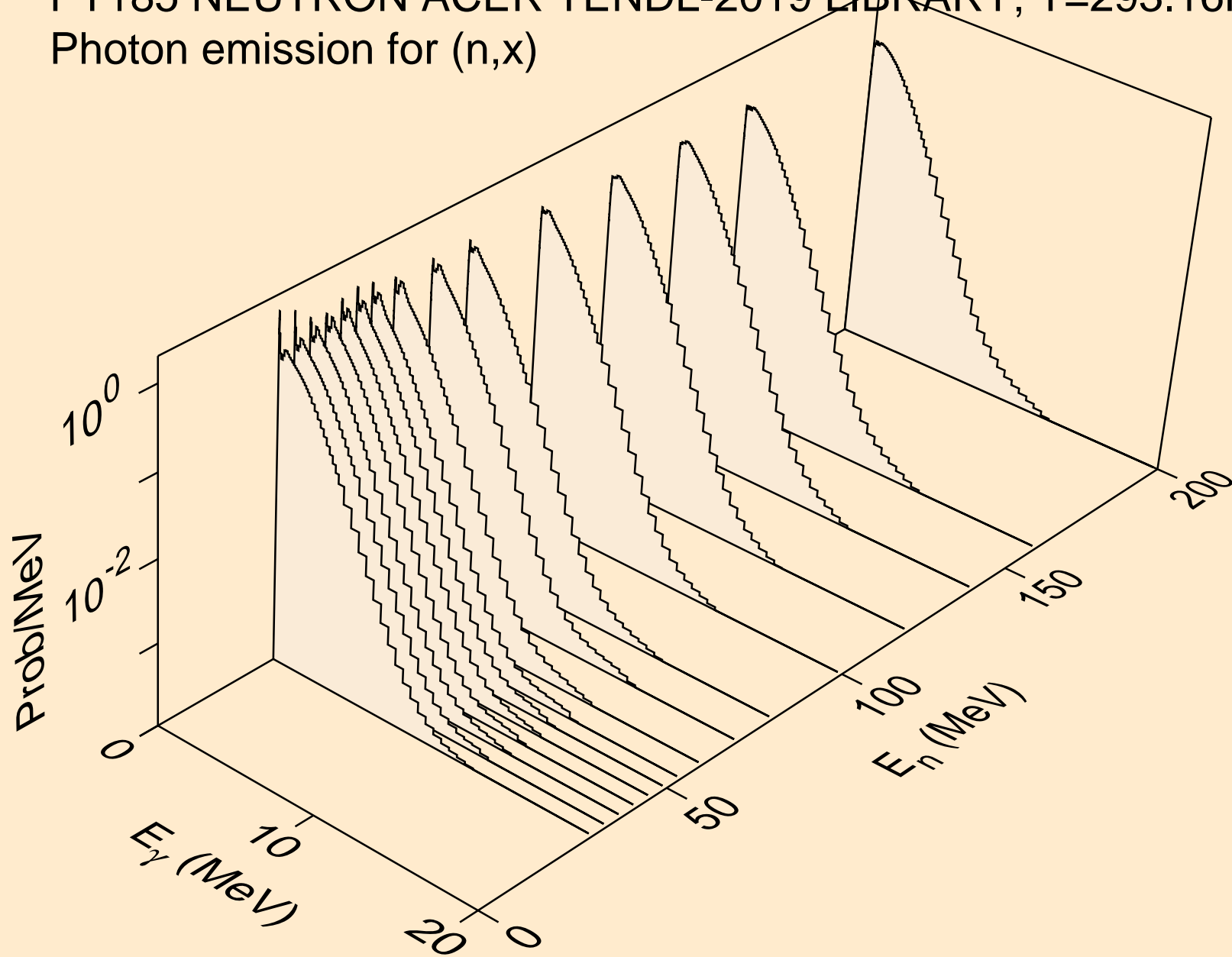

PT185 NEUTRON ACER TENDL-2019 LIBRARY; T=293.16K
Photon emission for (n,2nd)

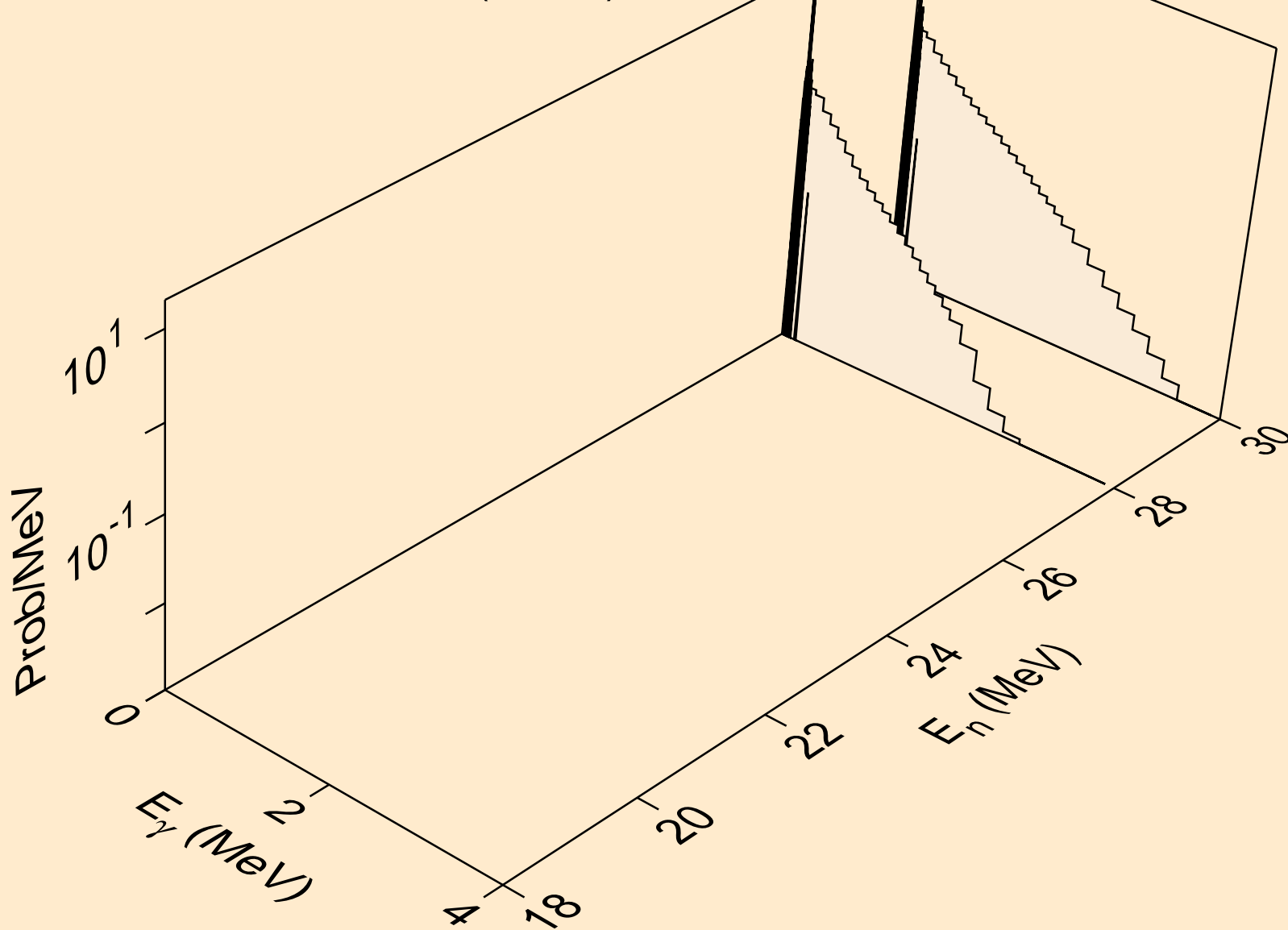

PT185 NEUTRON ACER TENDL-2019 LIBRARY; T=293.16K
Photon emission for (n,2n)

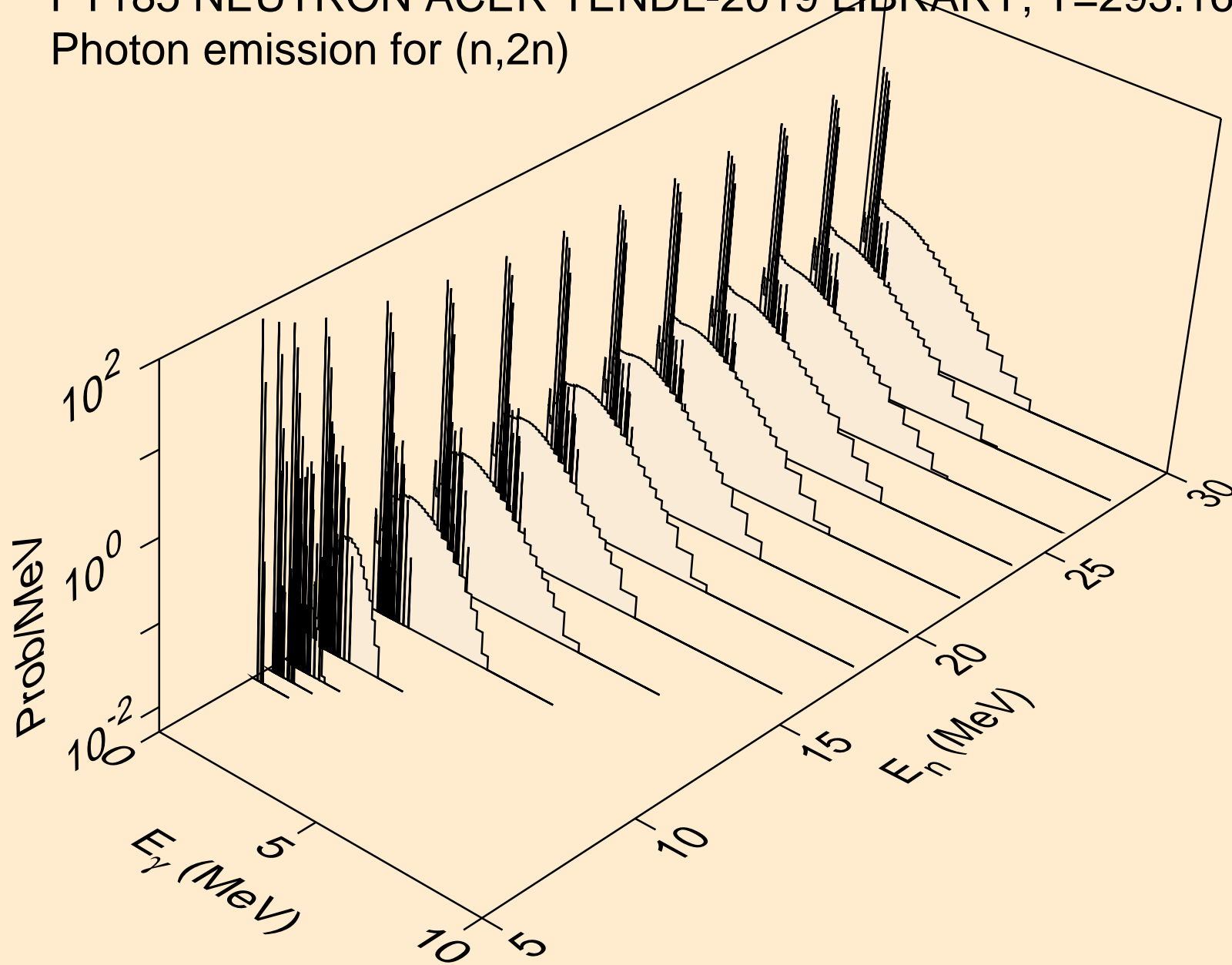

PT185 NEUTRON ACER TENDL-2019 LIBRARY; T=293.16K
Photon emission for (n,3n)

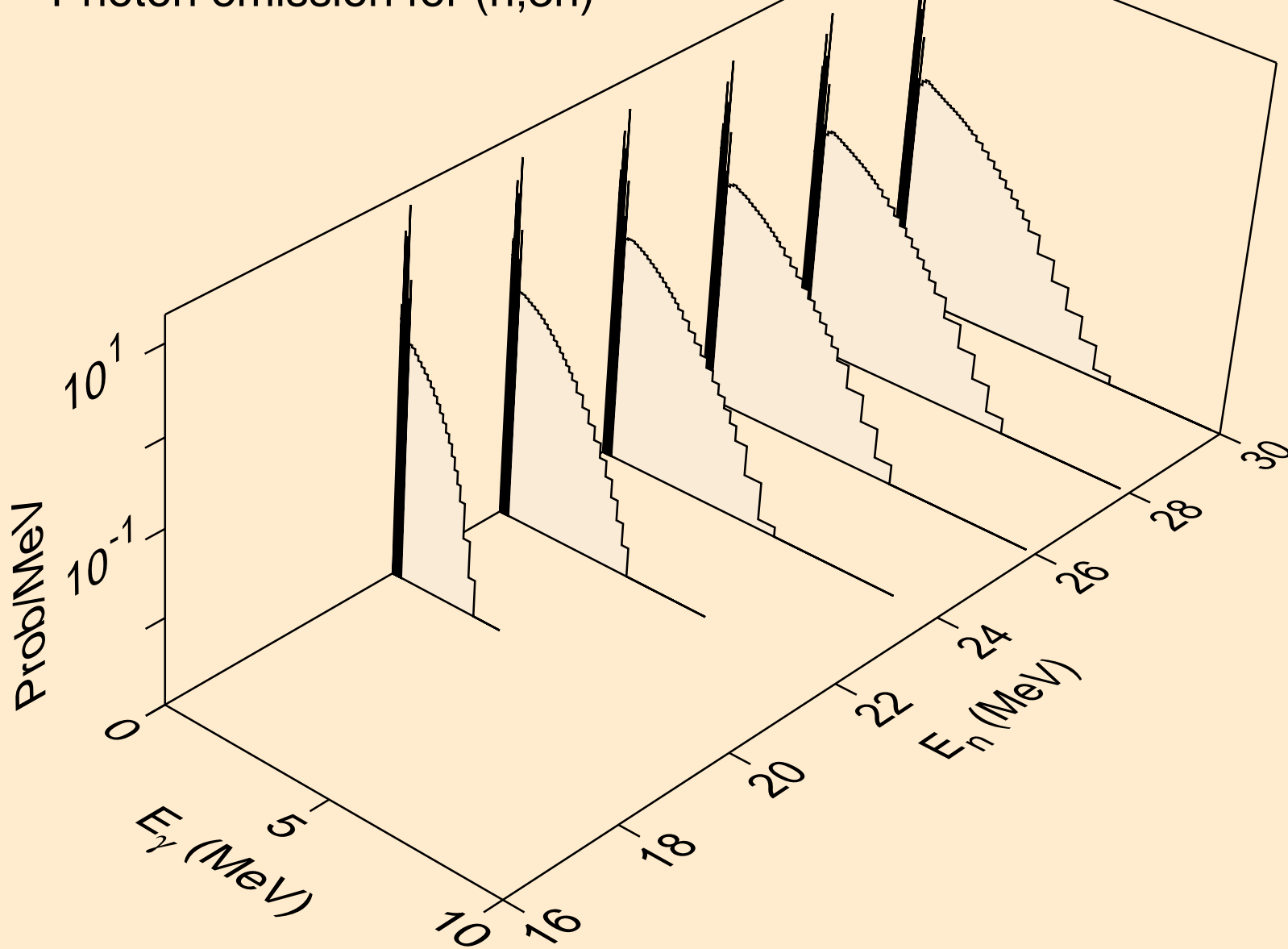

PT185 NEUTRON ACER TENDL-2019 LIBRARY; T=293.16K
Photon emission for (n,n*)a

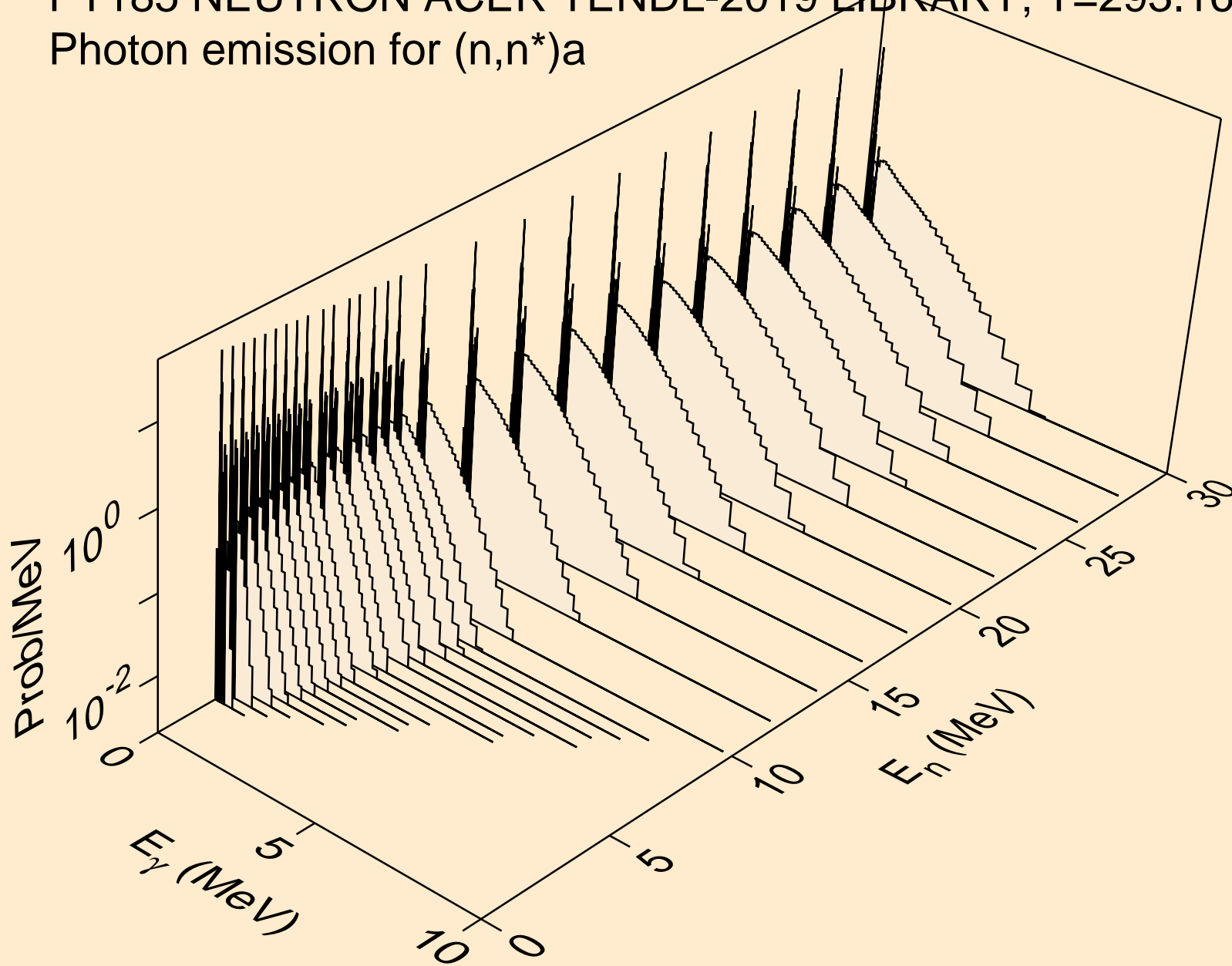

PT185 NEUTRON ACER TENDL-2019 LIBRARY; T=293.16K
Photon emission for (n,2n)a

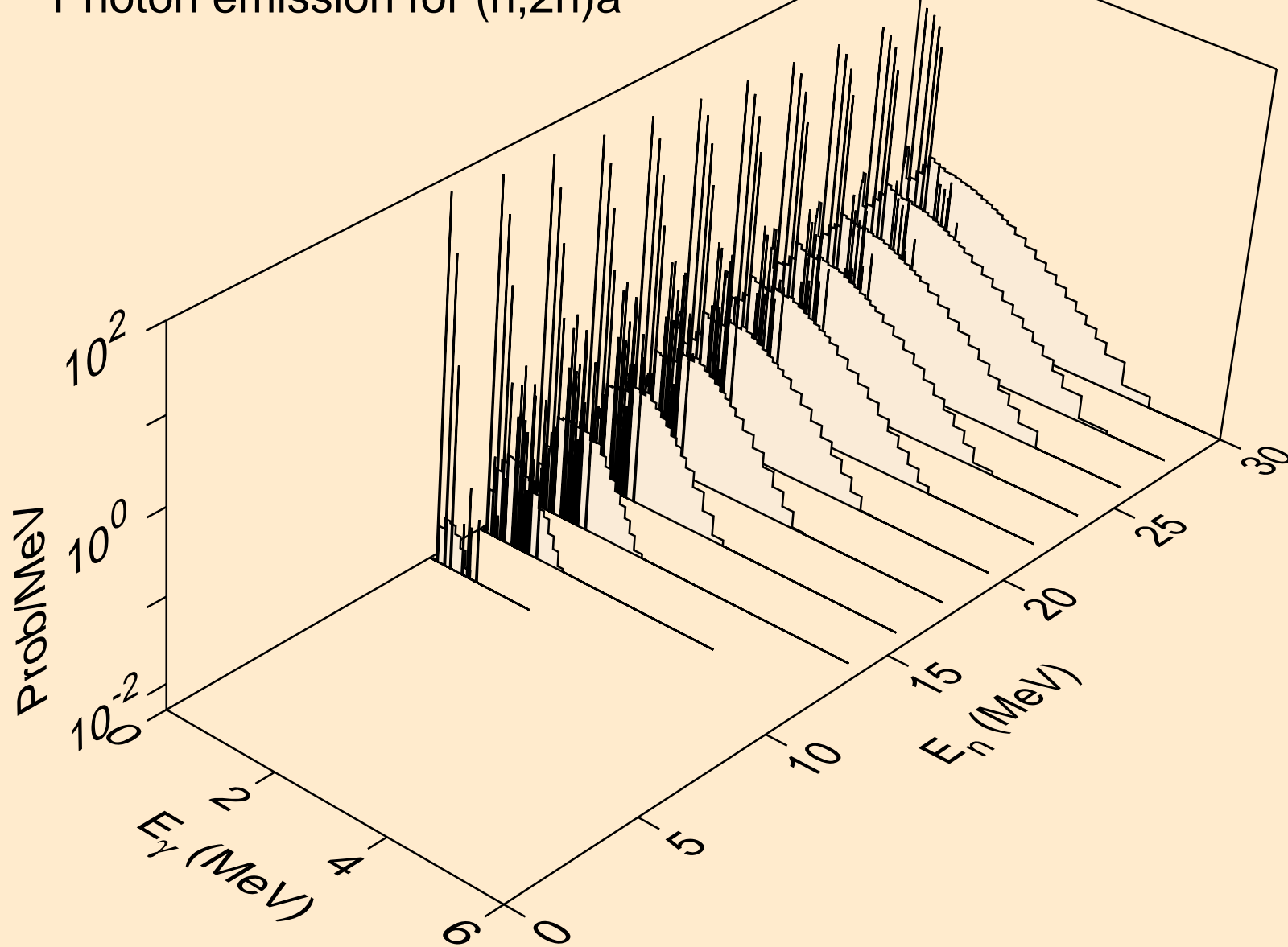

PT185 NEUTRON ACER TENDL-2019 LIBRARY; T=293.16K
Photon emission for (n,3n)a

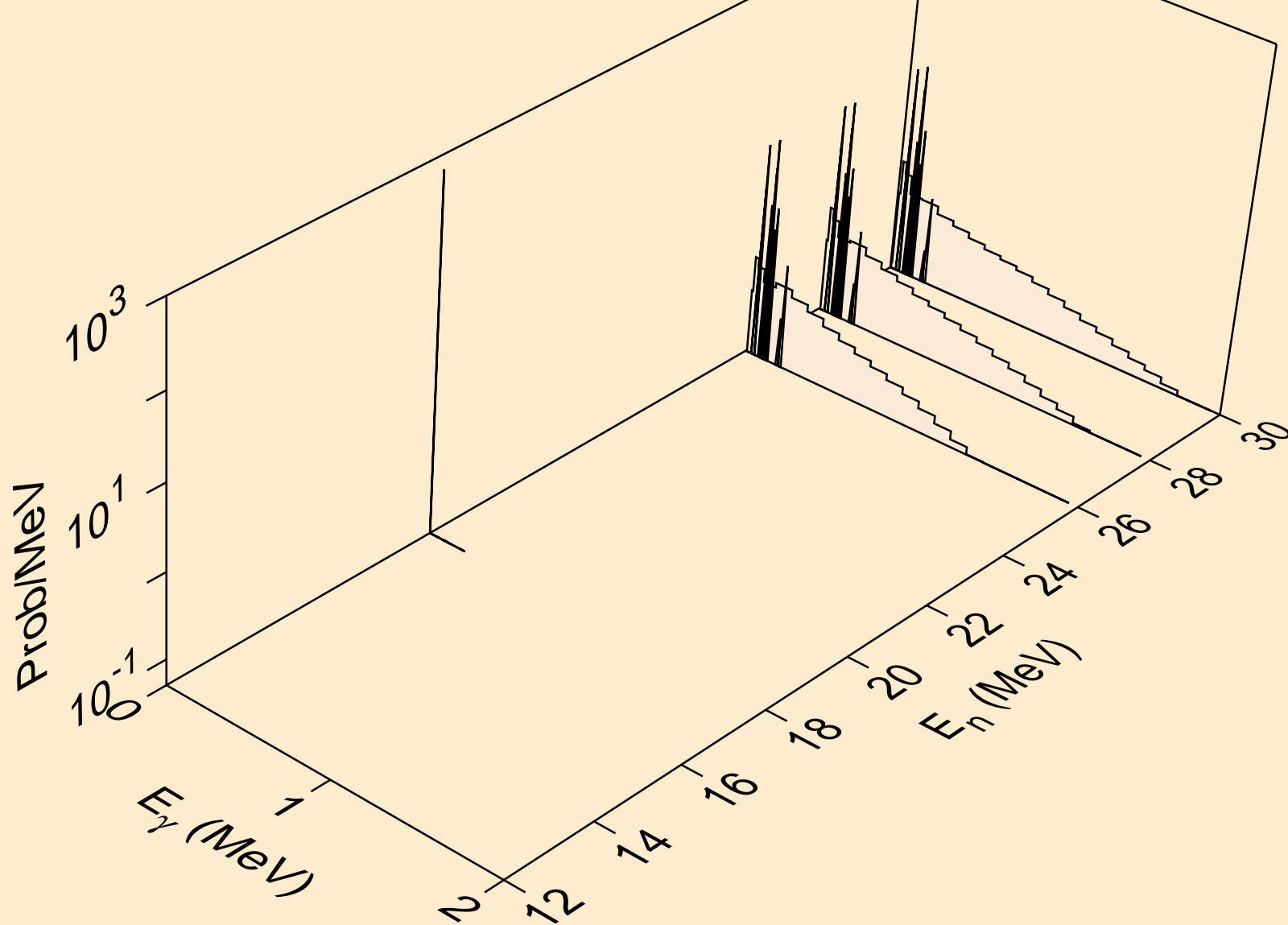

PT185 NEUTRON ACER TENDL-2019 LIBRARY; T=293.16K
Photon emission for (n,n*)p

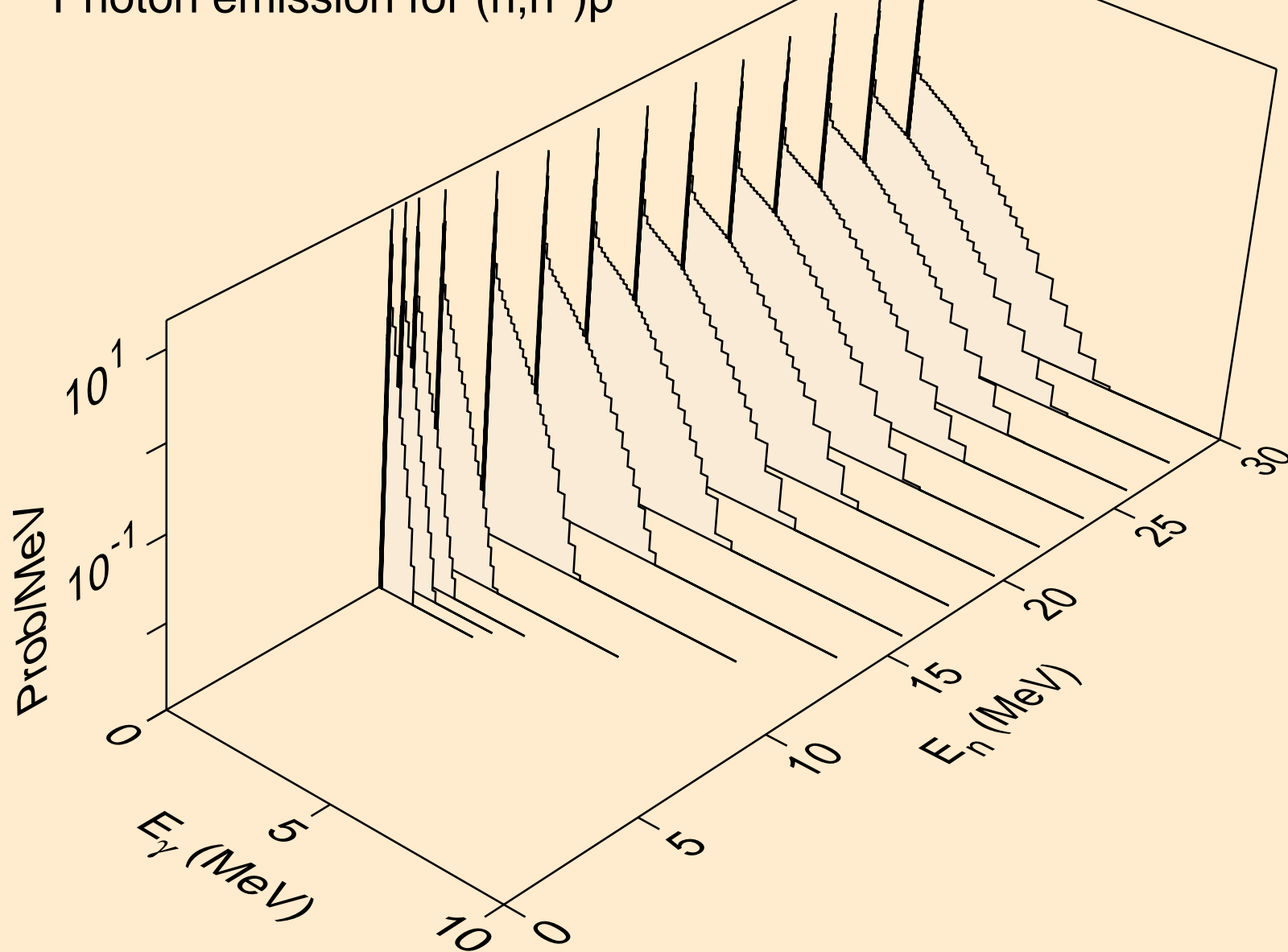

PT185 NEUTRON ACER TENDL-2019 LIBRARY; T=293.16K
Photon emission for (n,n*)2a

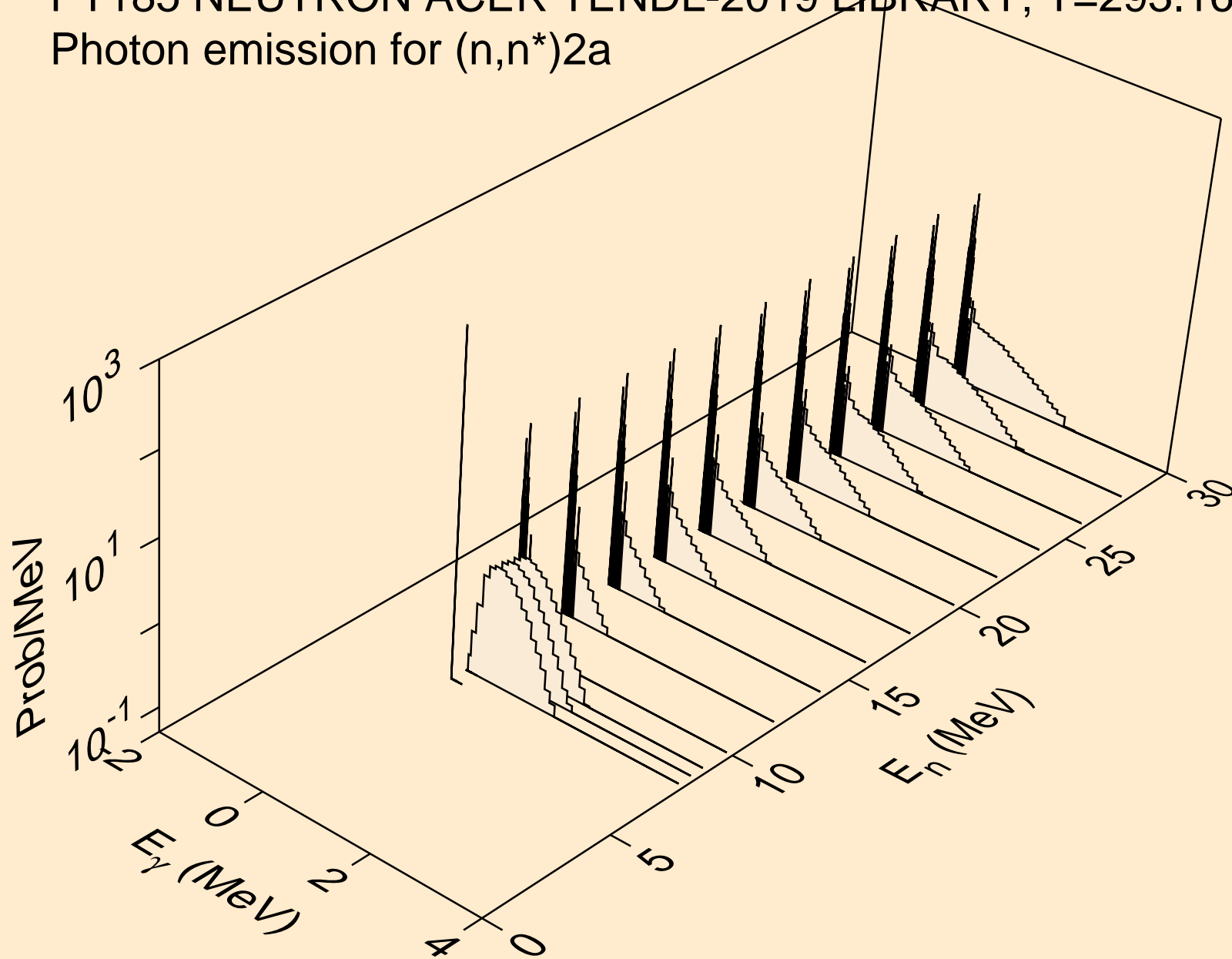

PT185 NEUTRON ACER TENDL-2019 LIBRARY; T=293.16K
Photon emission for (n,2n)2a

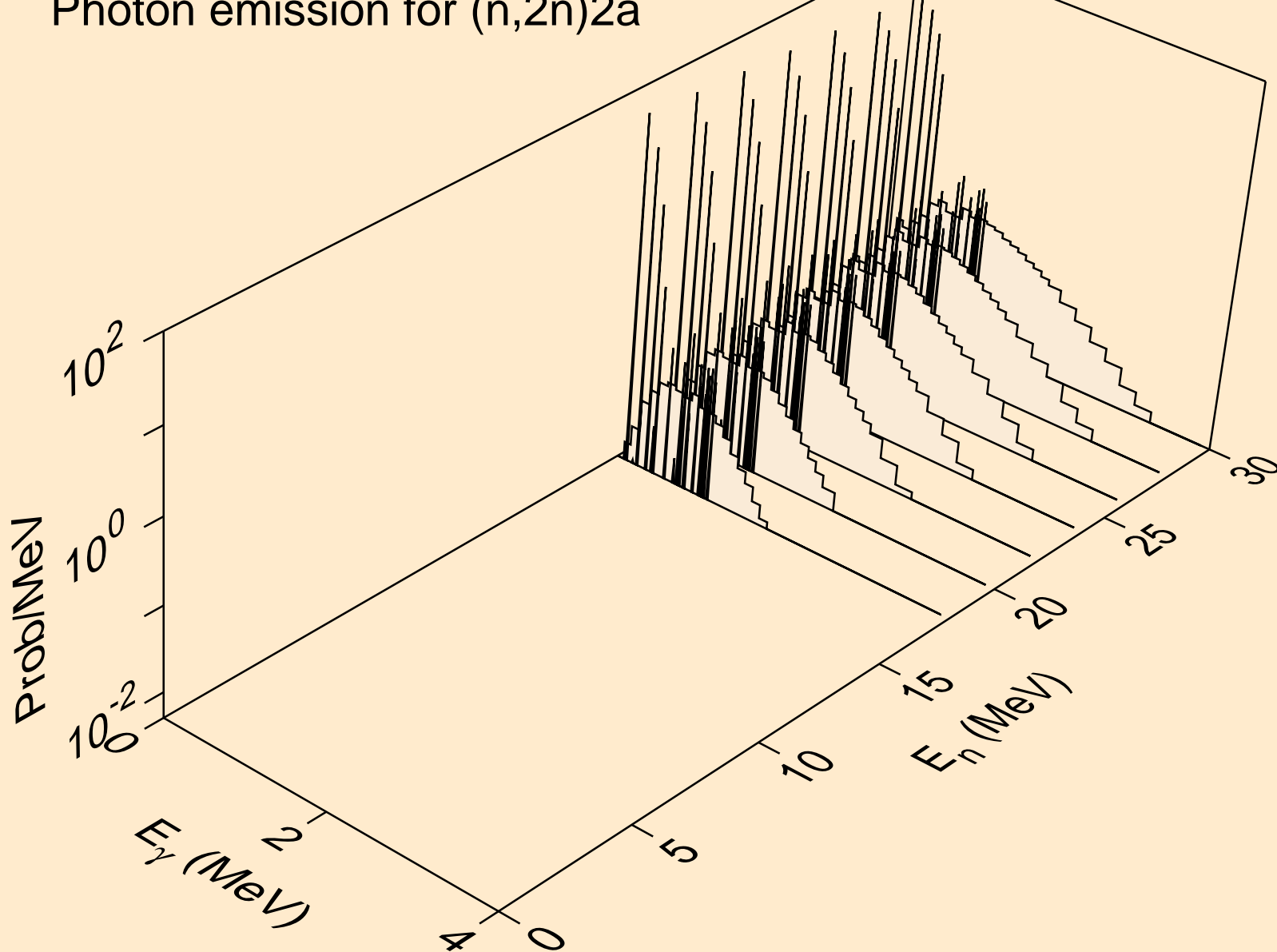

PT185 NEUTRON ACER TENDL-2019 LIBRARY; T=293.16K
Photon emission for (n,n*)d

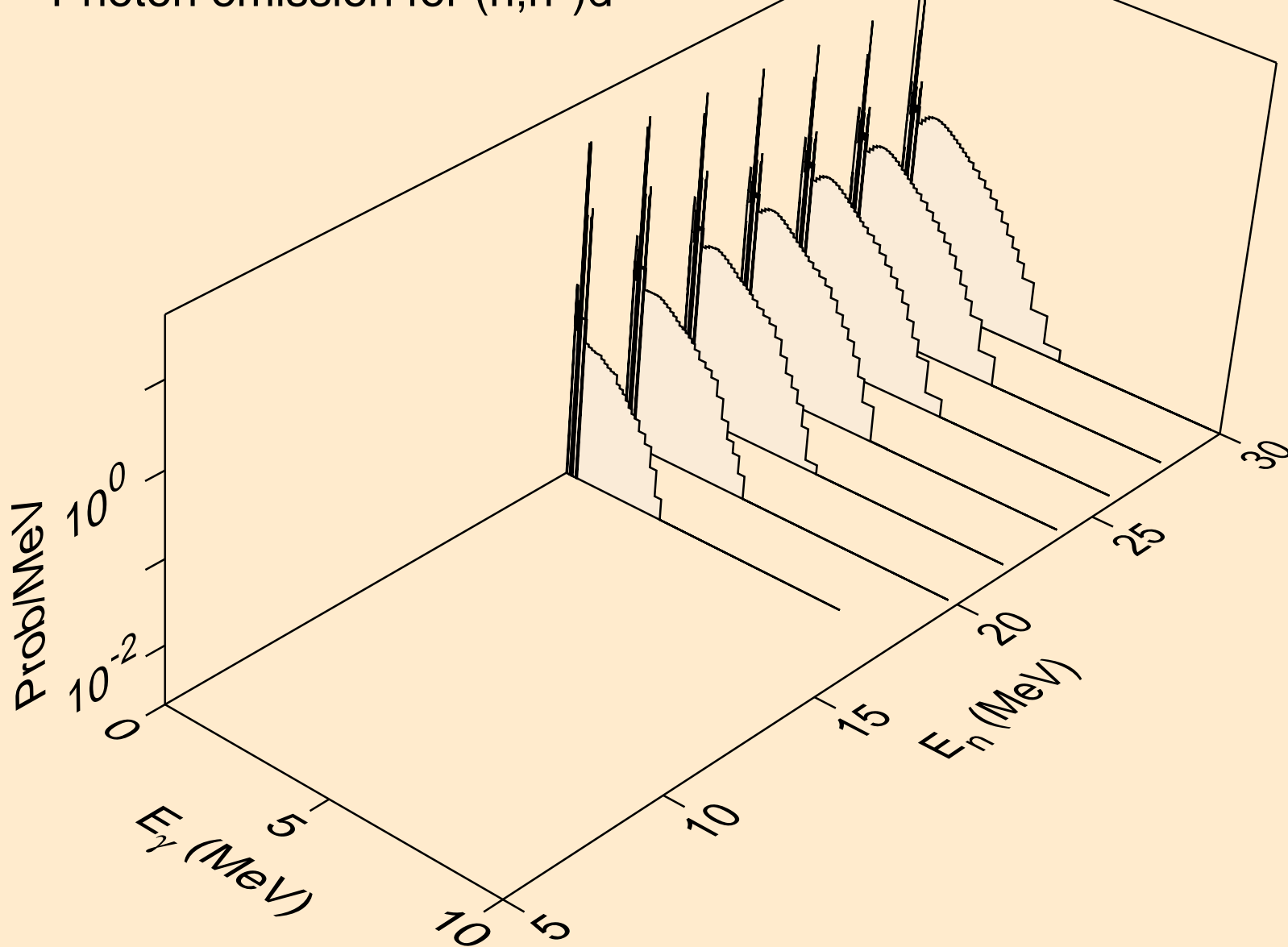

PT185 NEUTRON ACER TENDL-2019 LIBRARY; T=293.16K
Photon emission for (n,n*)t

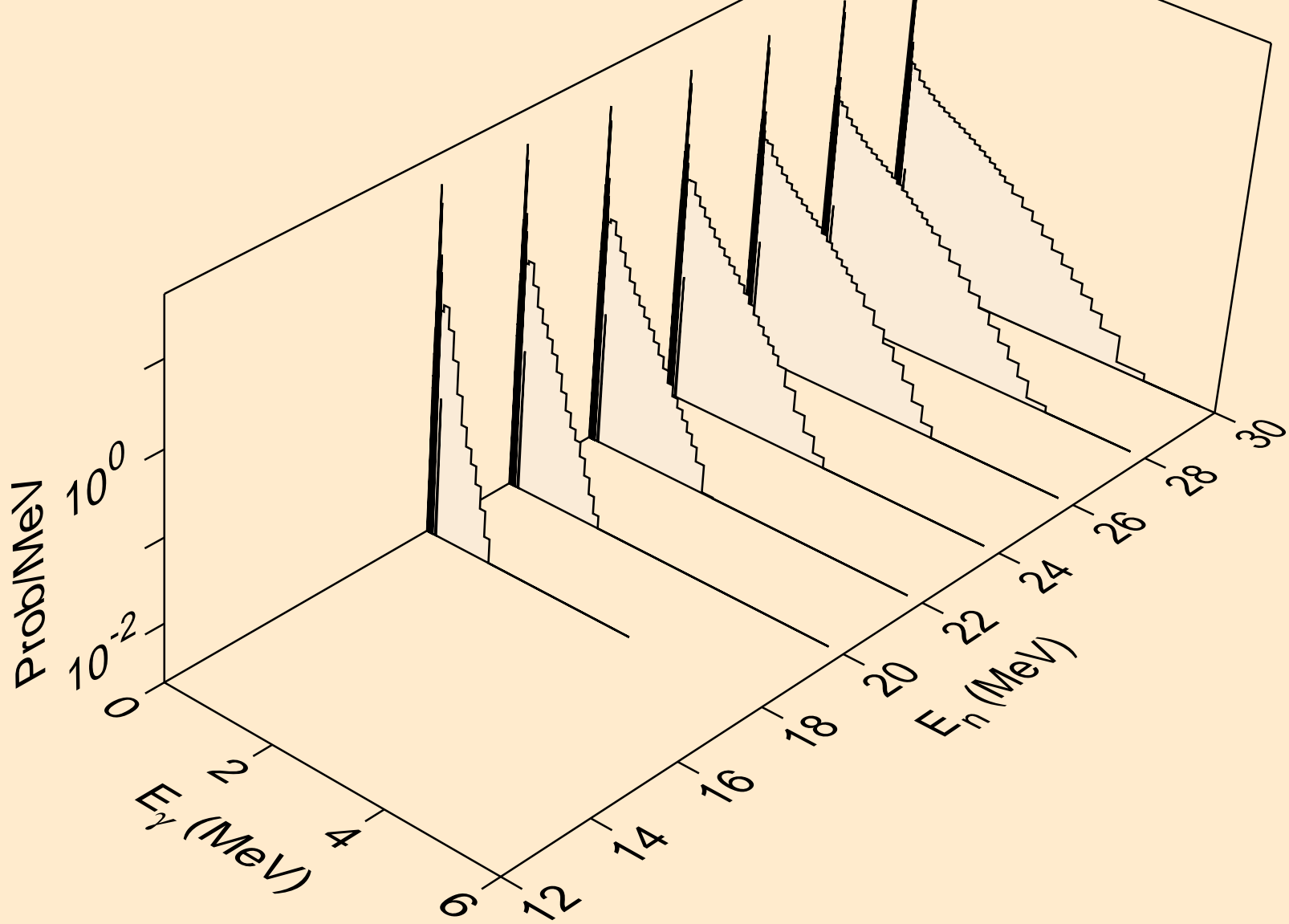

PT185 NEUTRON ACER TENDL-2019 LIBRARY; T=293.16K
Photon emission for (n,n*)he3

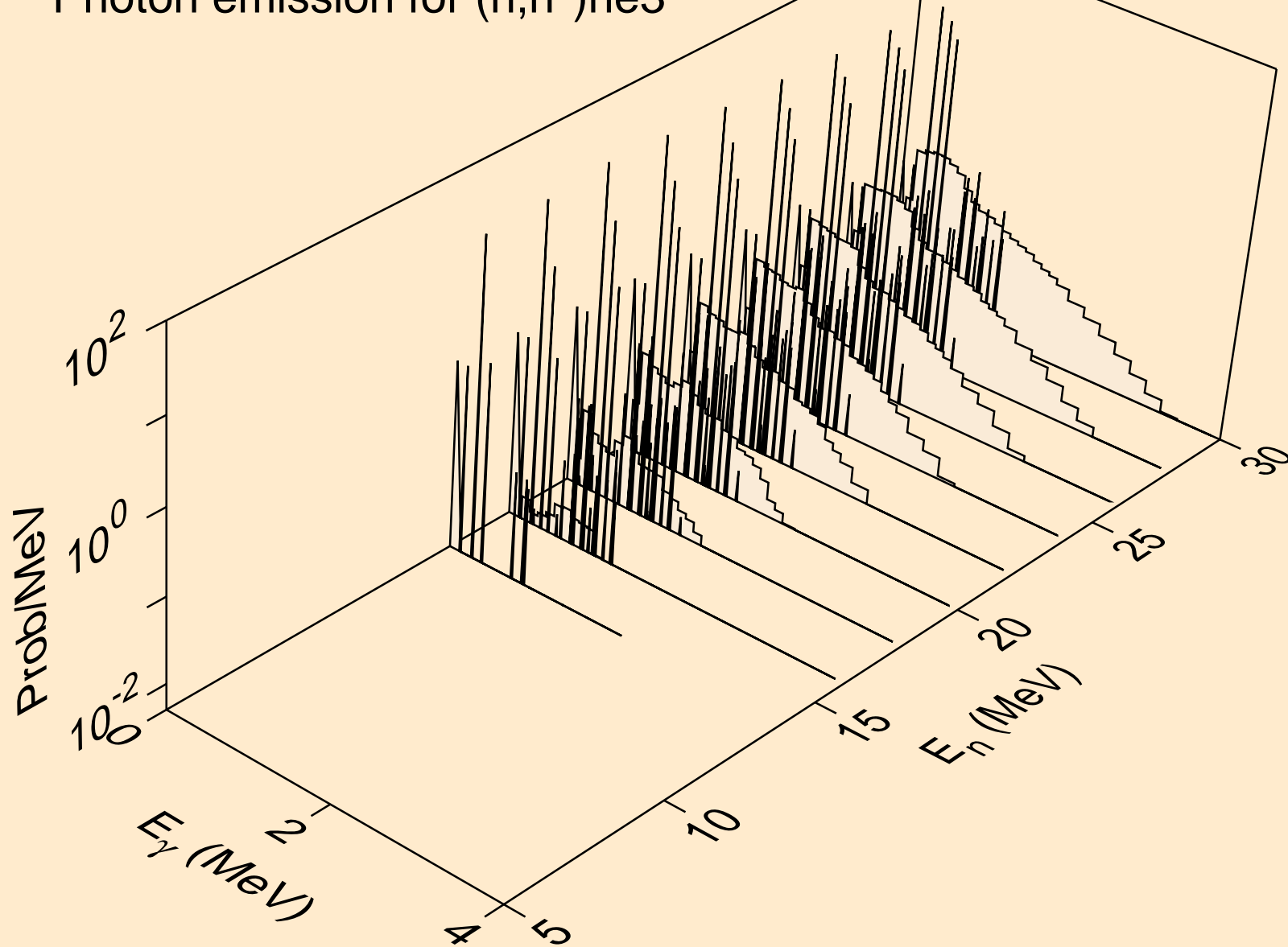

PT185 NEUTRON ACER TENDL-2019 LIBRARY; T=293.16K
Photon emission for (n,4n)

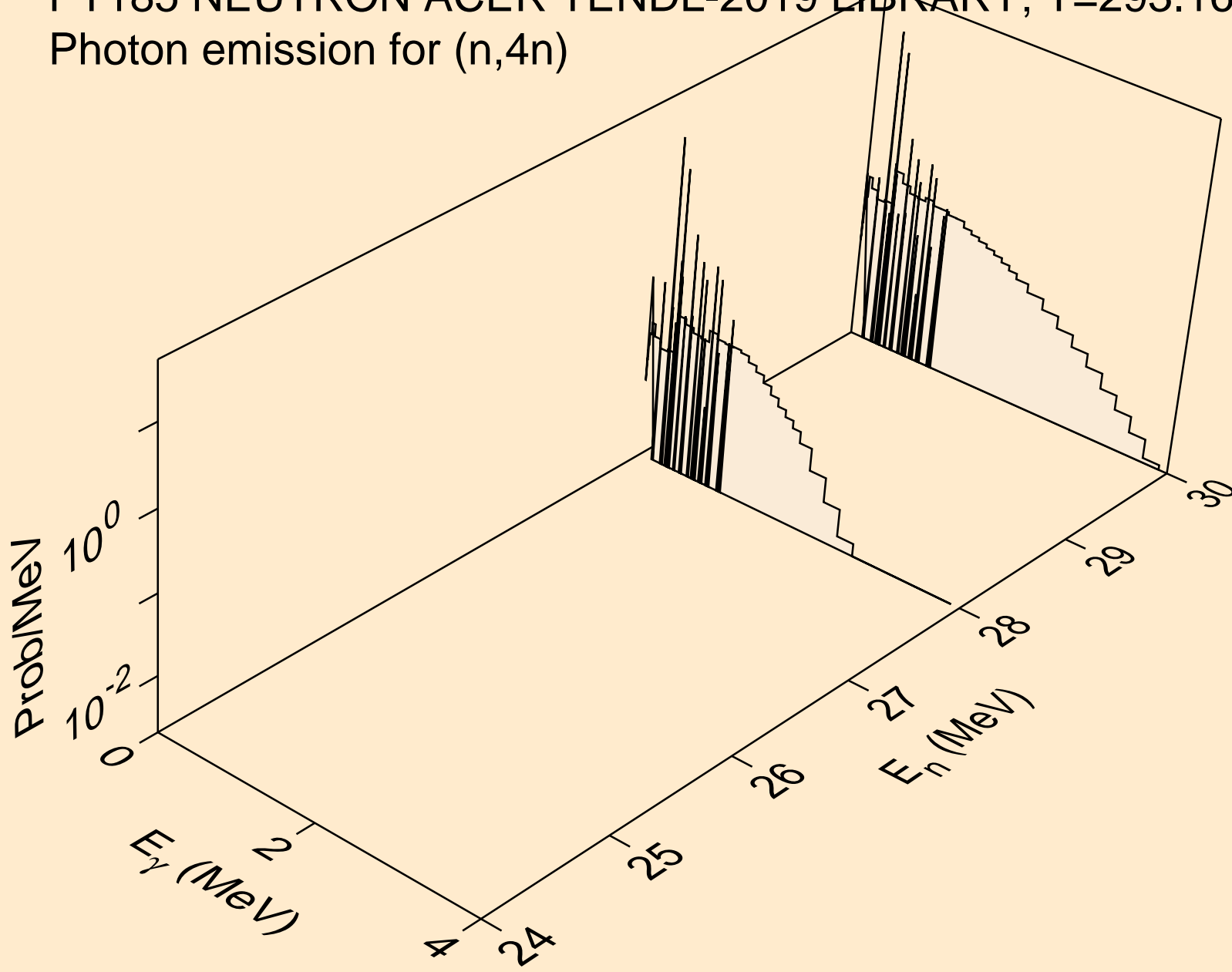

PT185 NEUTRON ACER TENDL-2019 LIBRARY; T=293.16K
Photon emission for (n,2np)

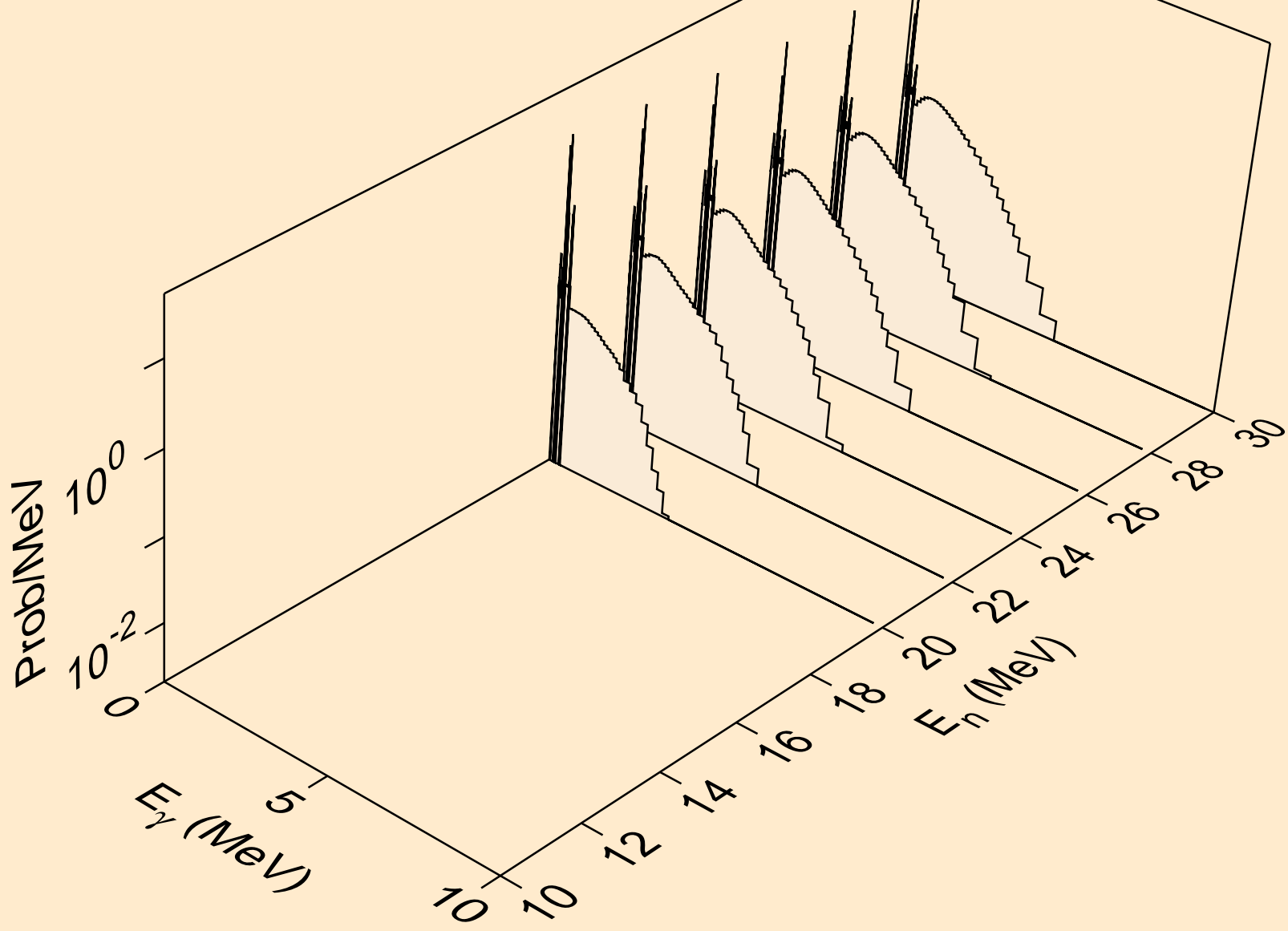

PT185 NEUTRON ACER TENDL-2019 LIBRARY; T=293.16K
Photon emission for (n,3np)

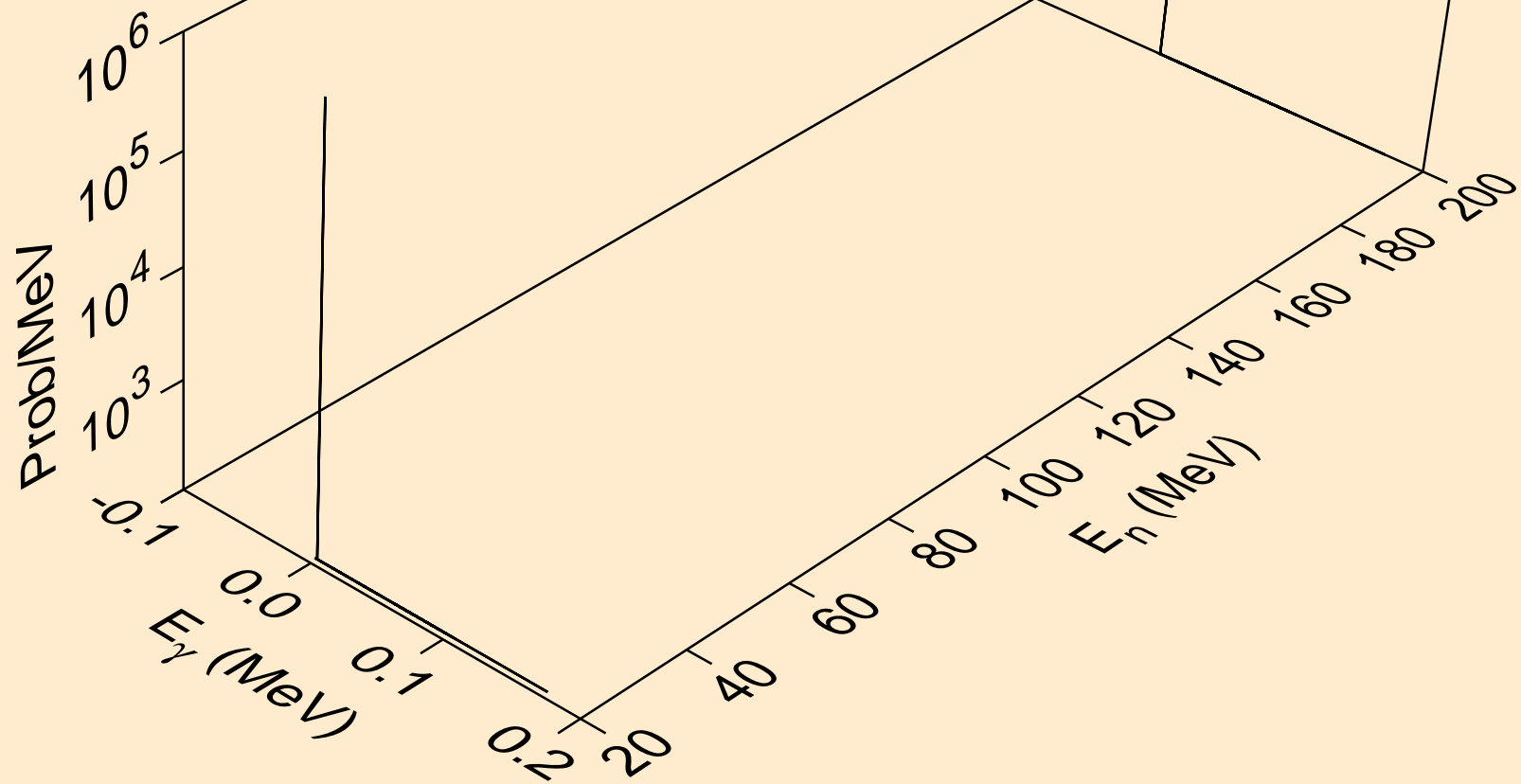

PT185 NEUTRON ACER TENDL-2019 LIBRARY; T=293.16K
Photon emission for (n,2np)

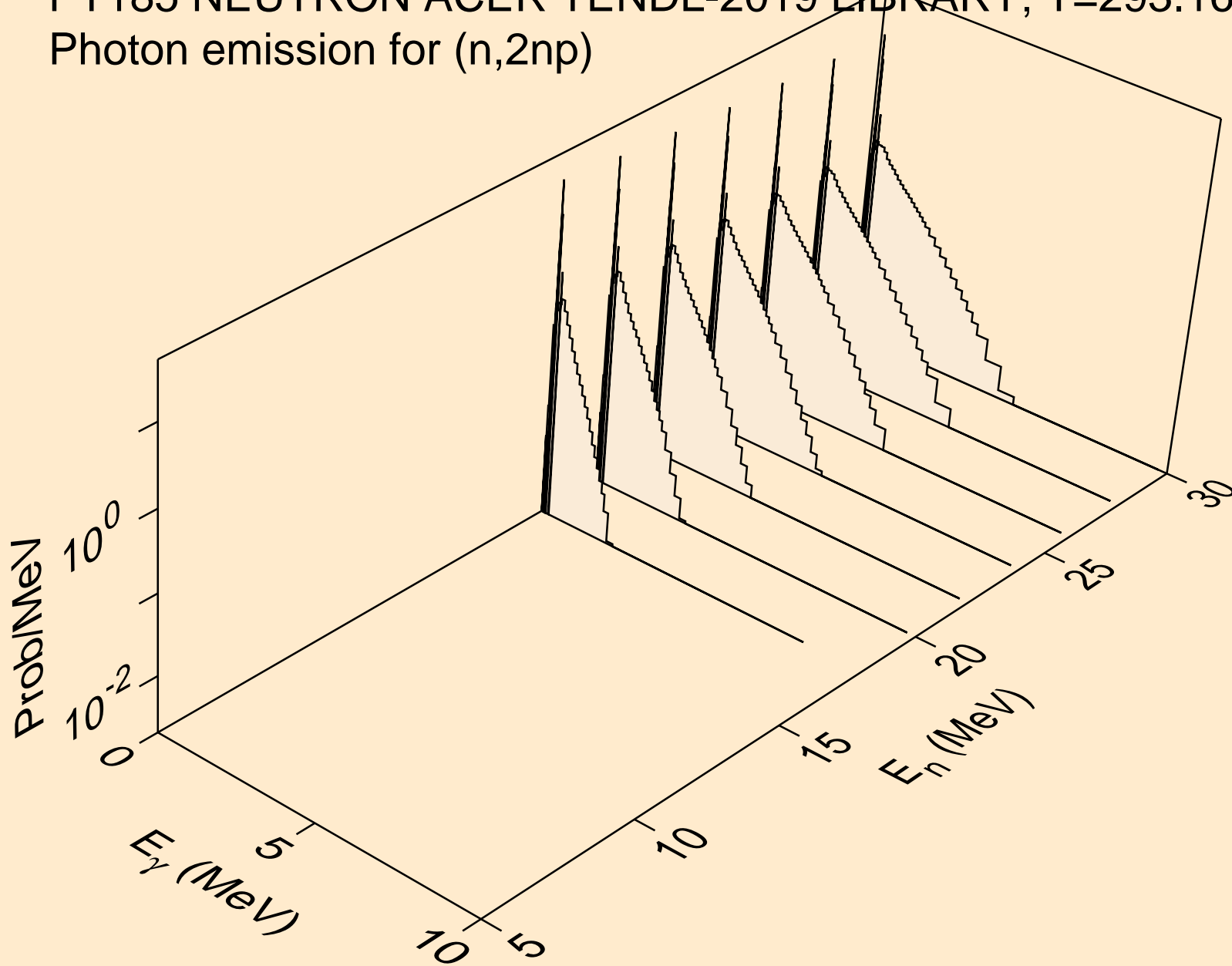

PT185 NEUTRON ACER TENDL-2019 LIBRARY; T=293.16K
Photon emission for (n,npa)

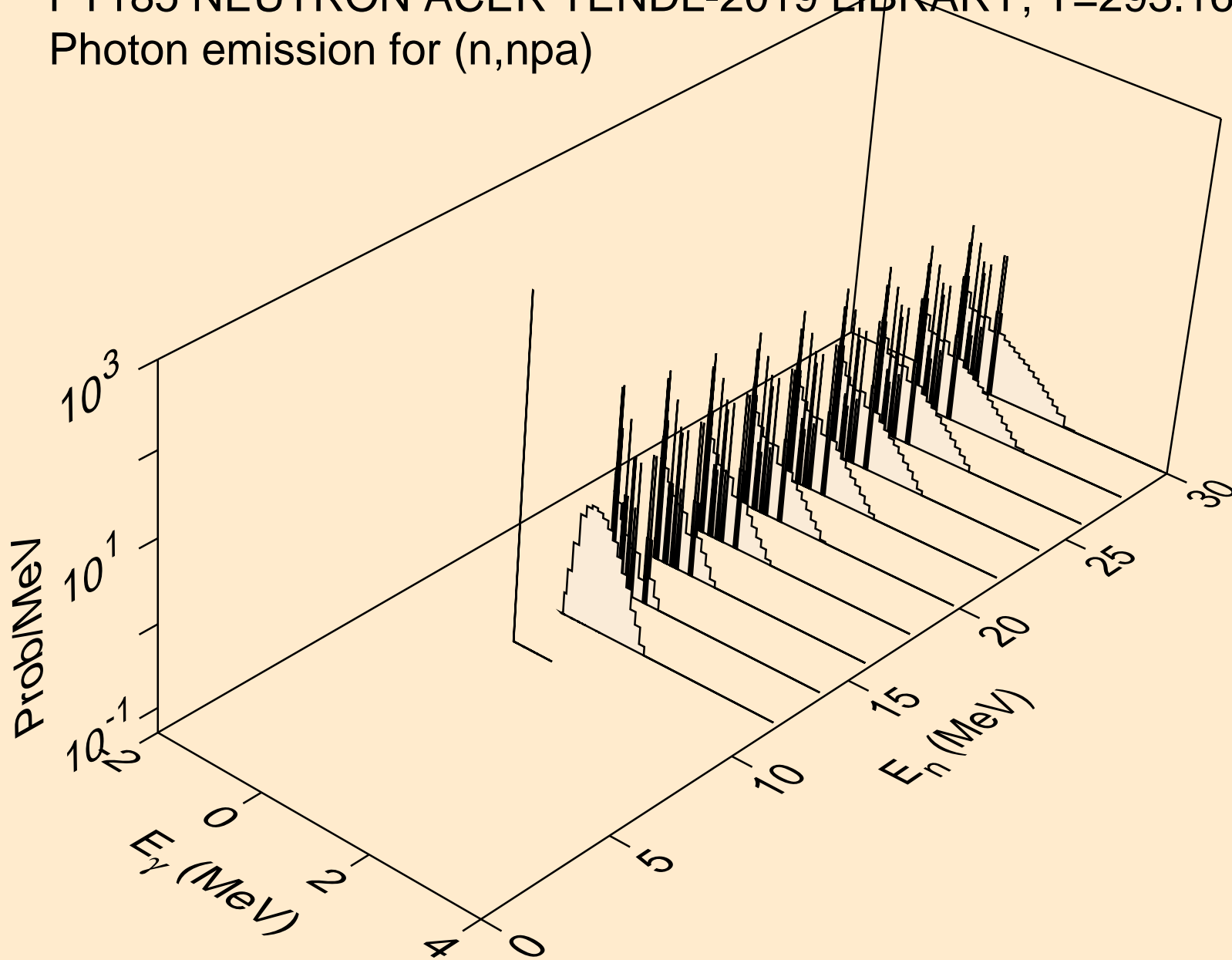

PT185 NEUTRON ACER TENDL-2019 LIBRARY; T=293.16K
Photon emission for (n,n*c)

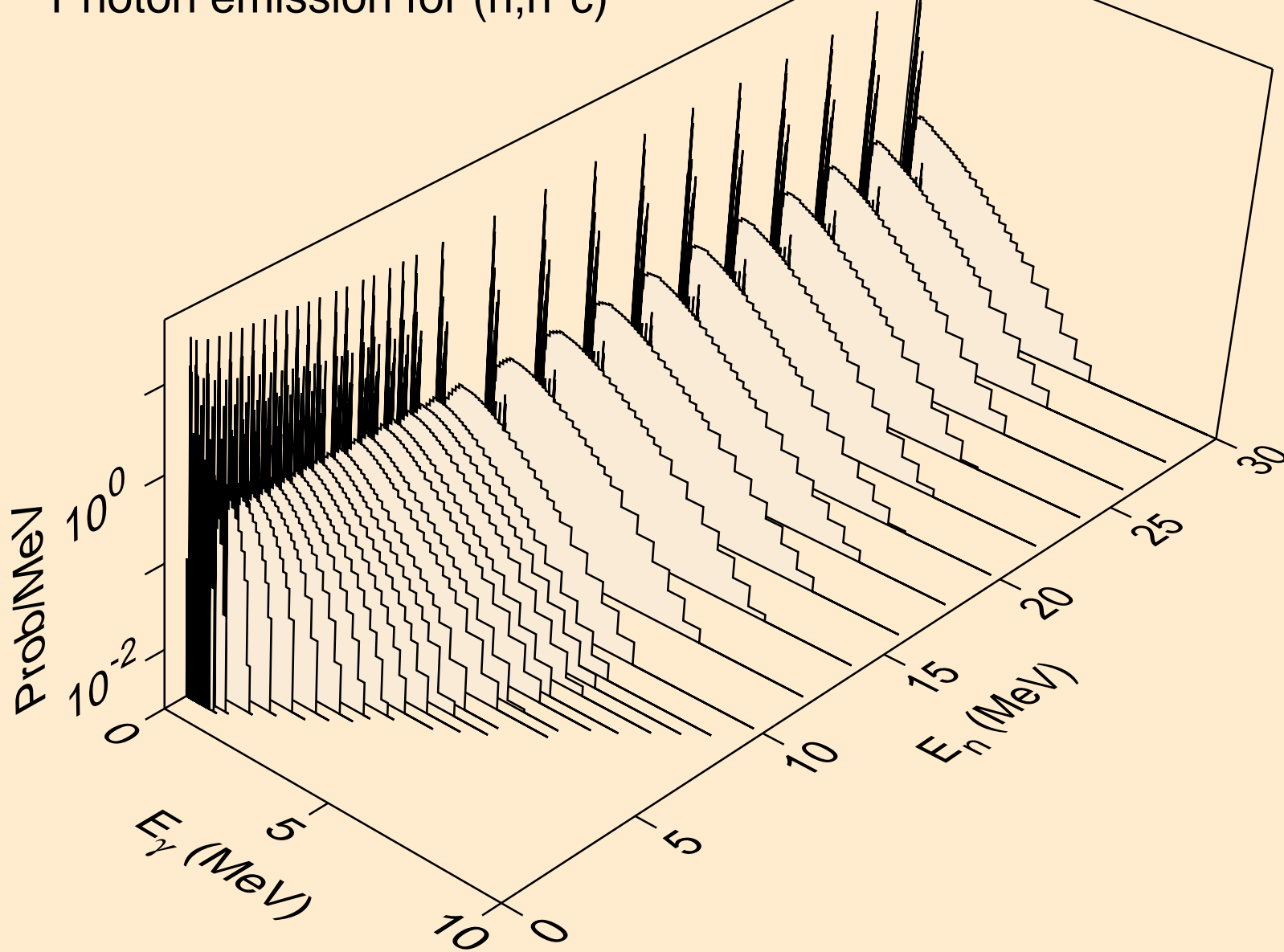

PT185 NEUTRON ACER TENDL-2019 LIBRARY; T=293.16K
Photon emission for (n,gma)

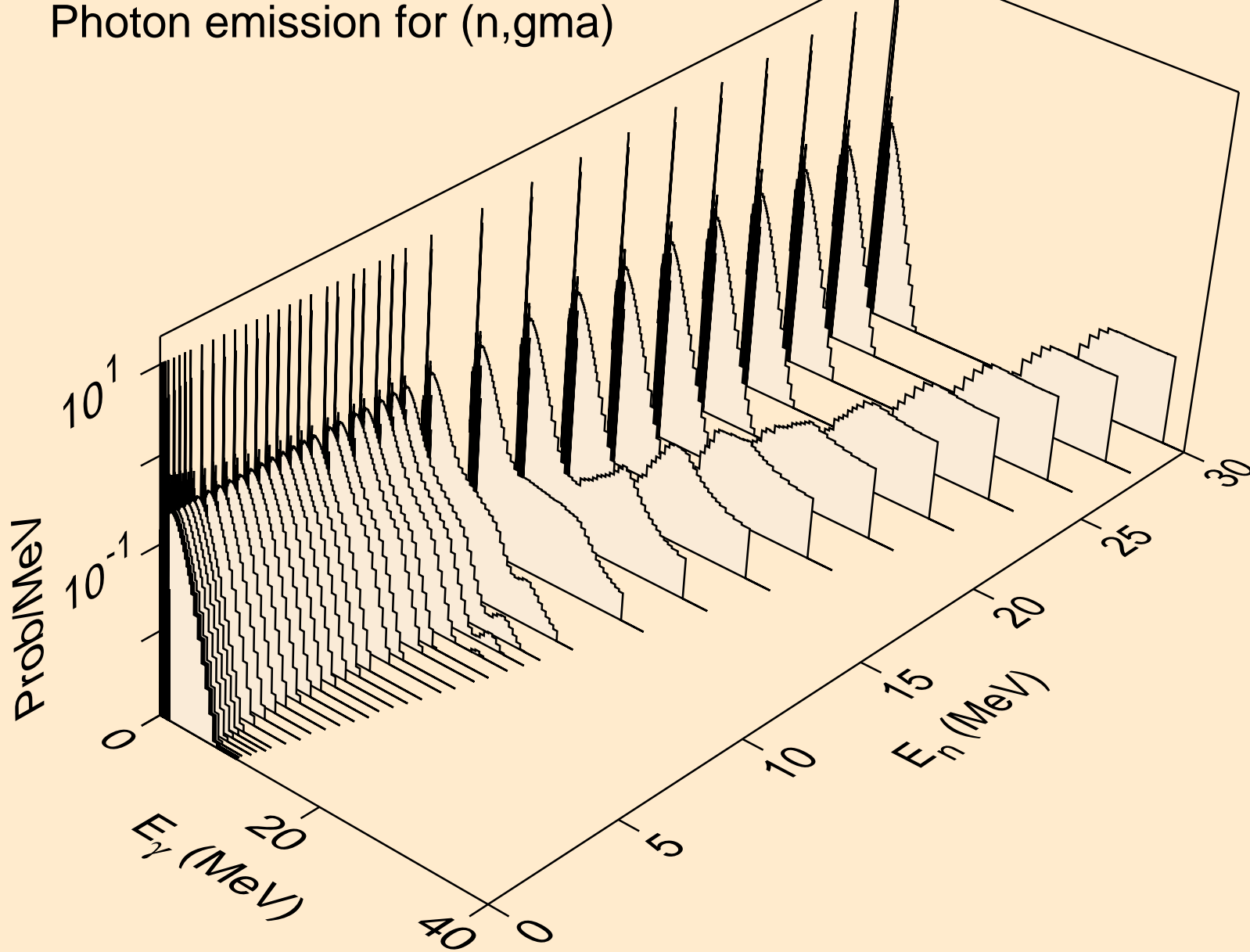

PT185 NEUTRON ACER TENDL-2019 LIBRARY; T=293.16K
Photon emission for (n,p)

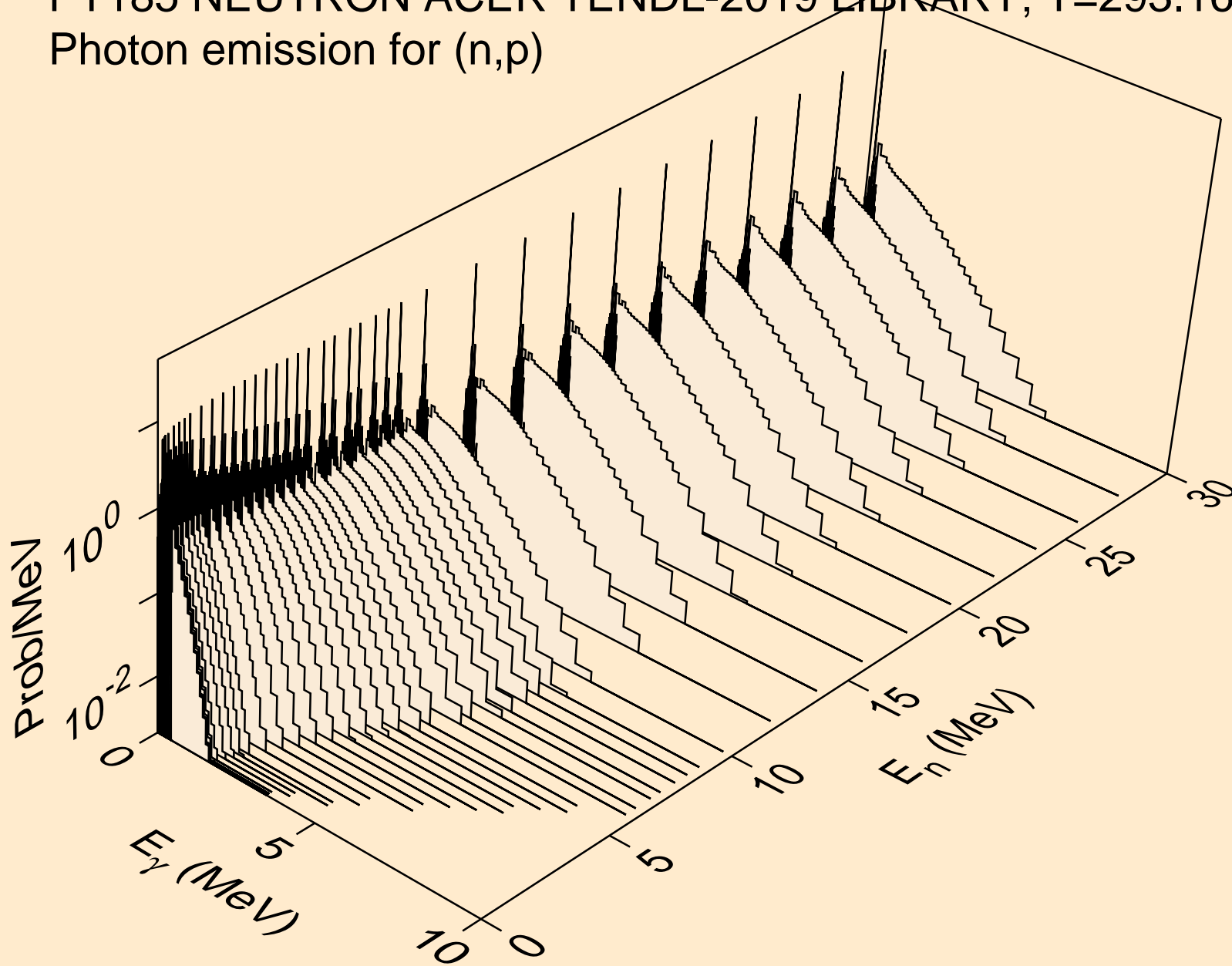

PT185 NEUTRON ACER TENDL-2019 LIBRARY; T=293.16K
Photon emission for (n,d)

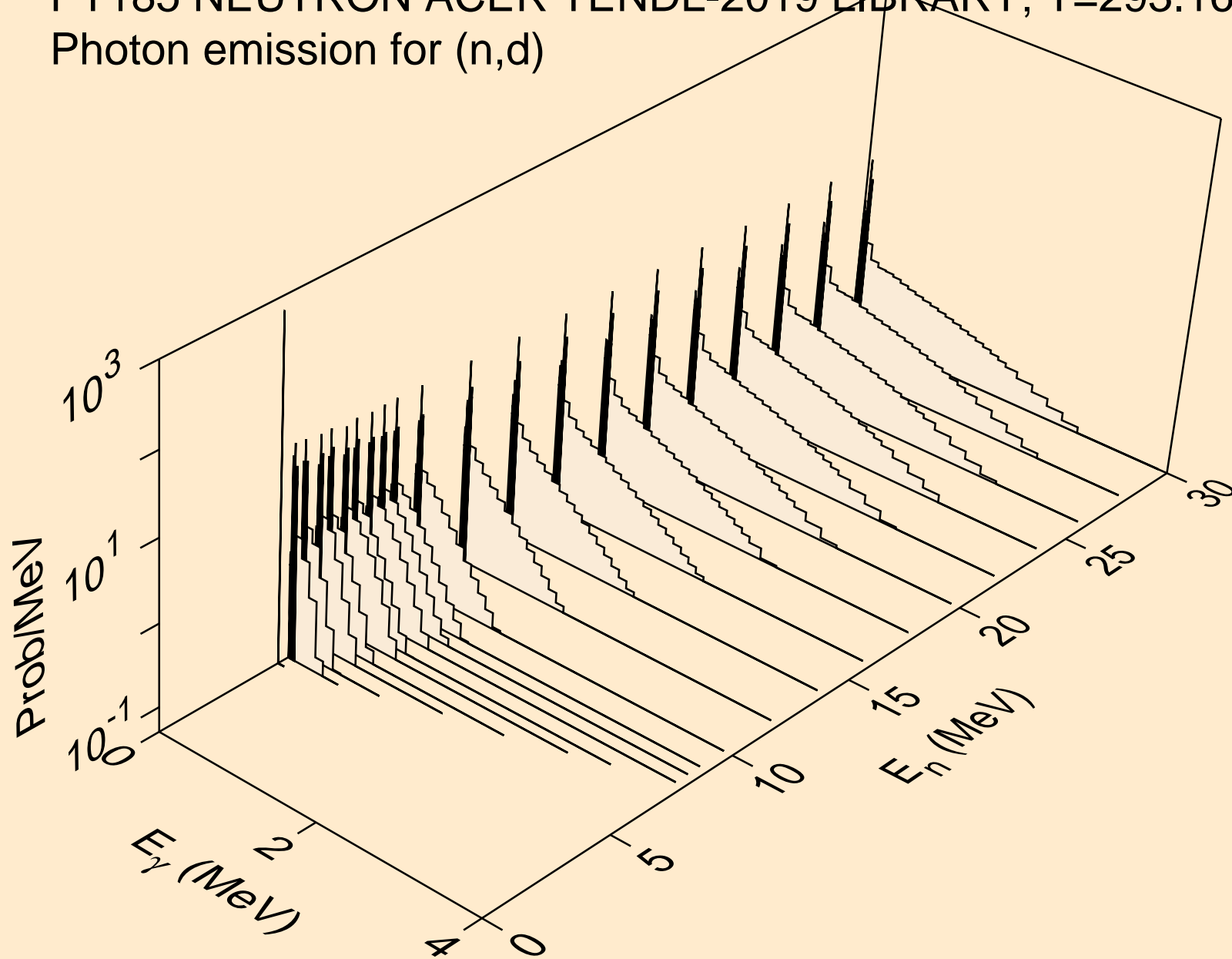

PT185 NEUTRON ACER TENDL-2019 LIBRARY; T=293.16K
Photon emission for (n,t)

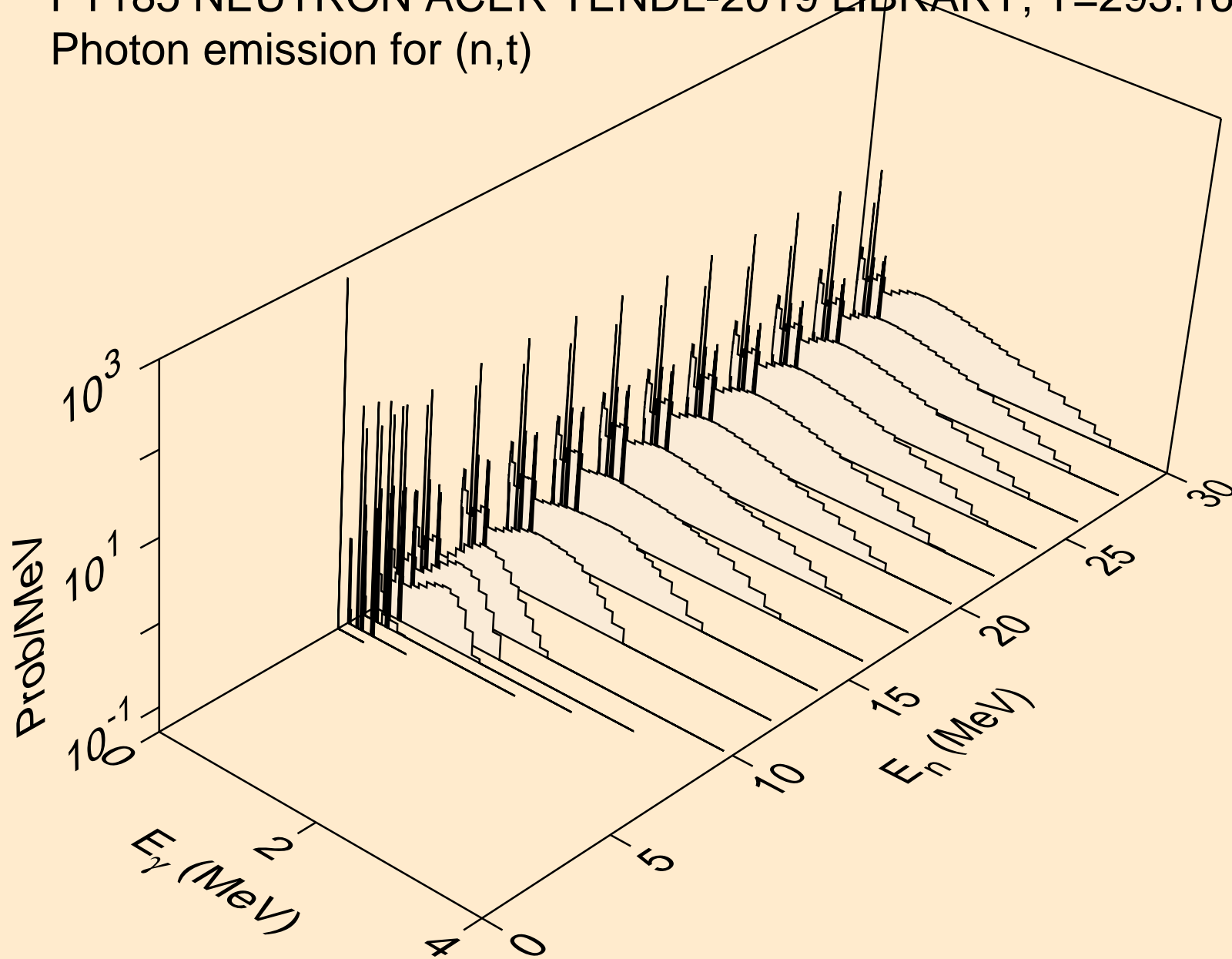

PT185 NEUTRON ACER TENDL-2019 LIBRARY; T=293.16K
Photon emission for (n,he3)

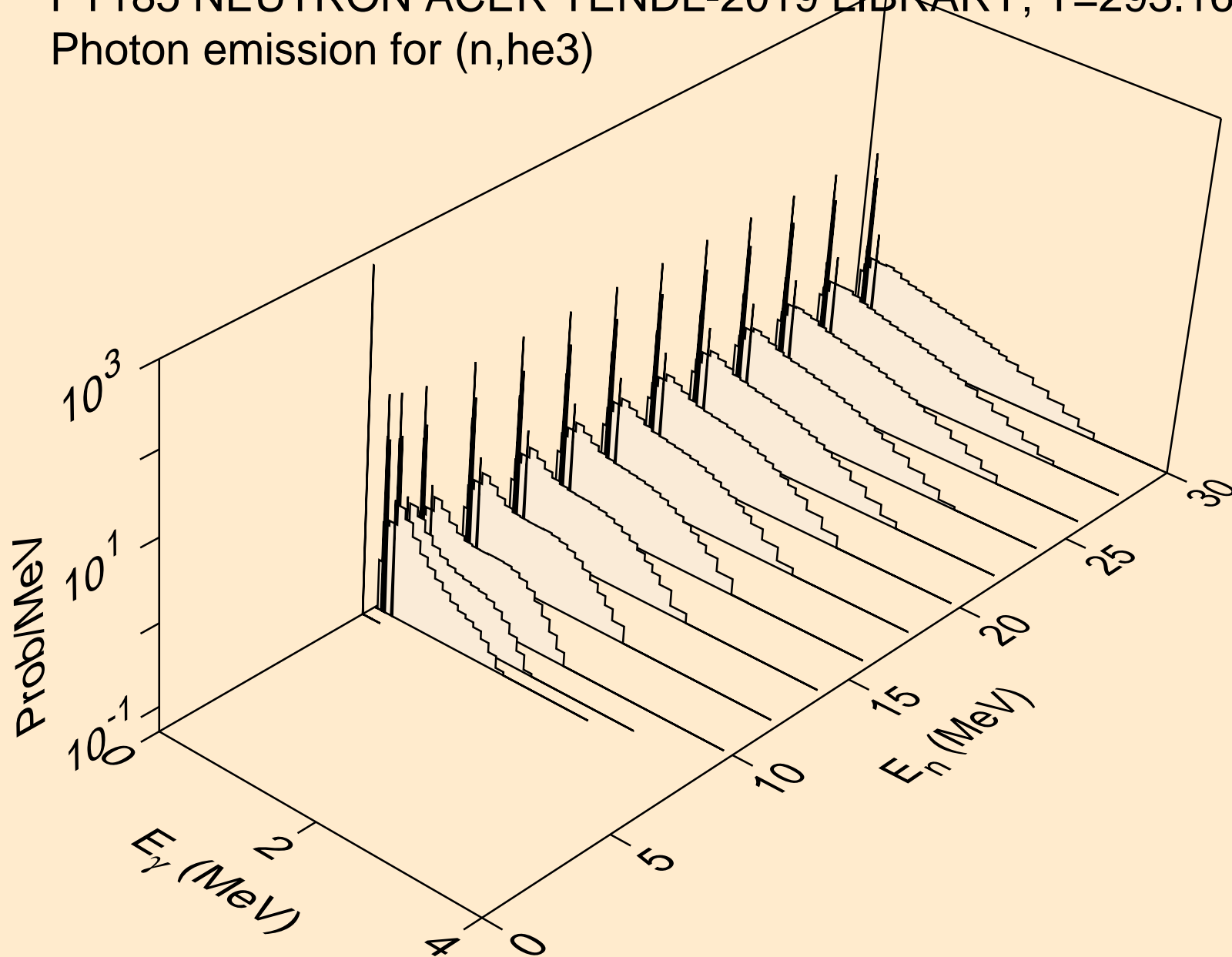

PT185 NEUTRON ACER TENDL-2019 LIBRARY; T=293.16K
Photon emission for (n,a)

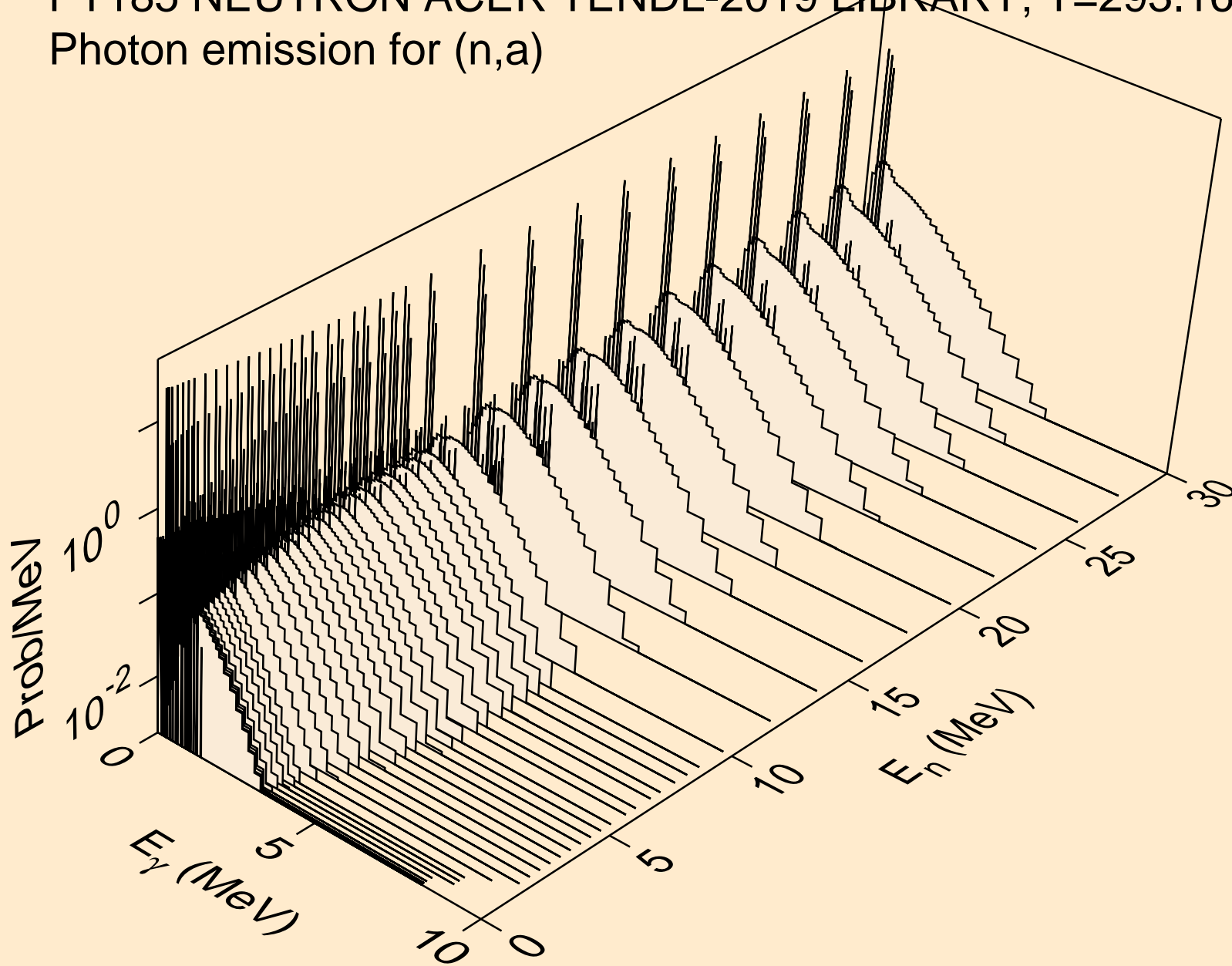

PT185 NEUTRON ACER TENDL-2019 LIBRARY; T=293.16K
Photon emission for (n,2a)

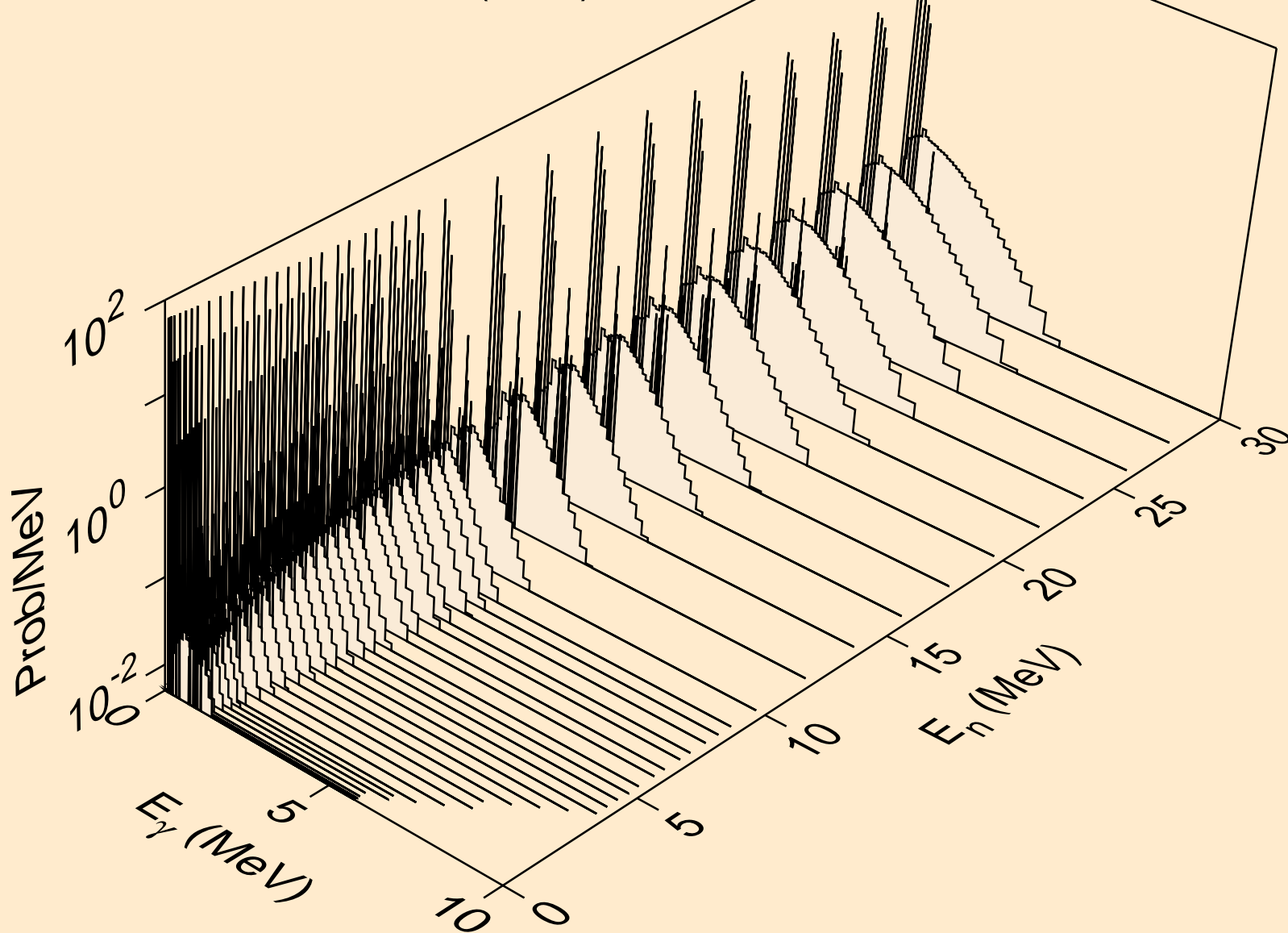

PT185 NEUTRON ACER TENDL-2019 LIBRARY; T=293.16K
Photon emission for (n,2p)

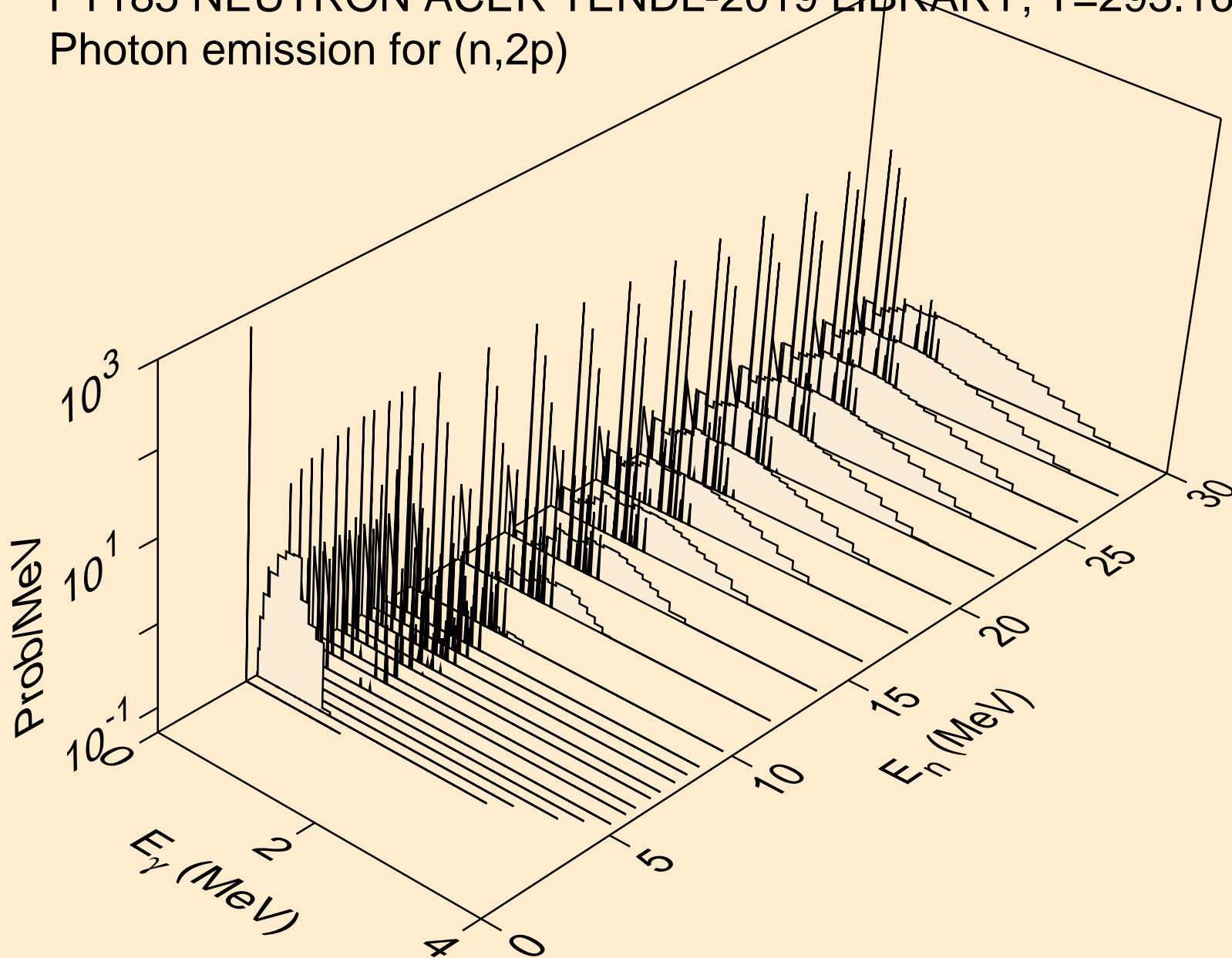

PT185 NEUTRON ACER TENDL-2019 LIBRARY; T=293.16K
Photon emission for (n,p α)

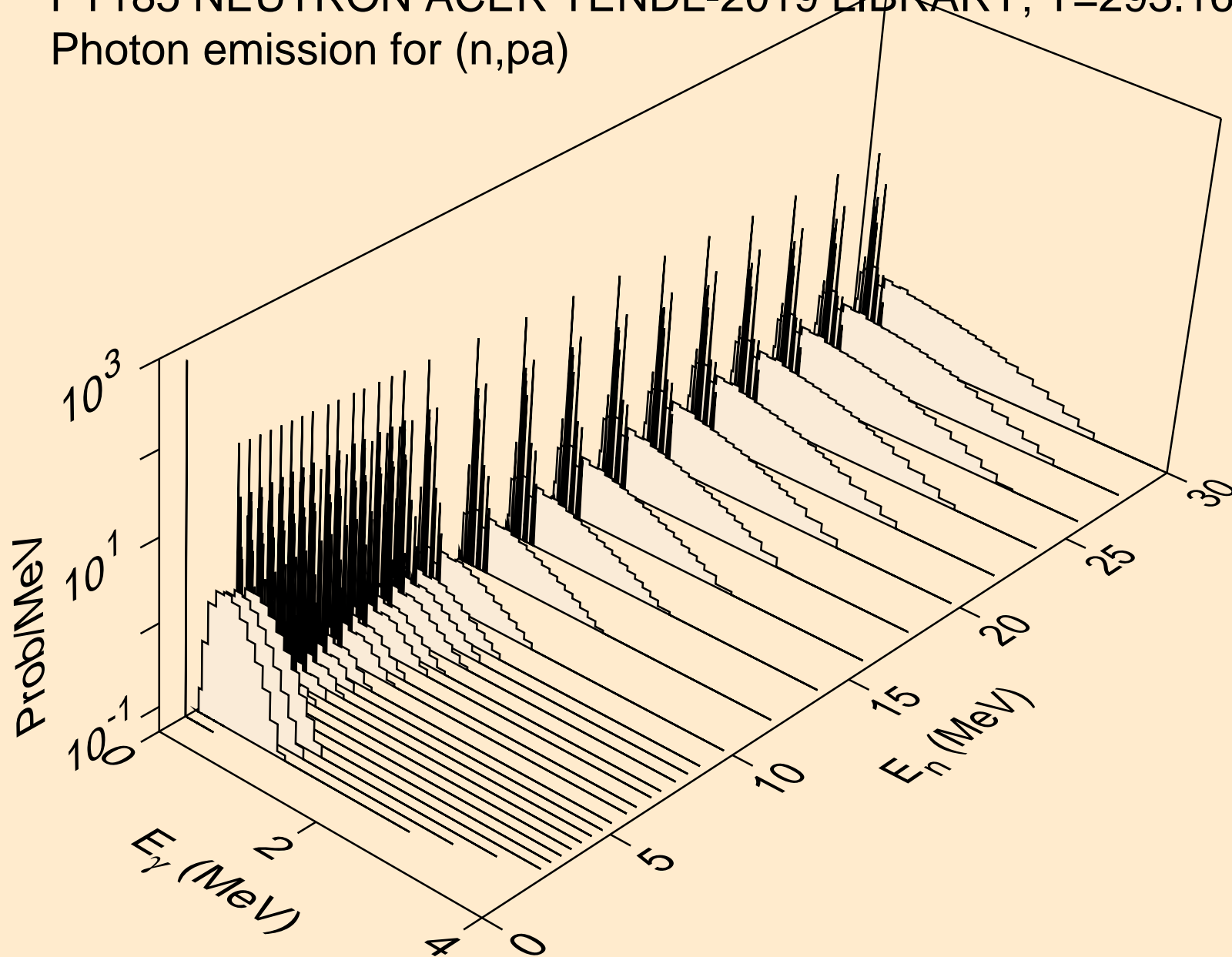

PT185 NEUTRON ACER TENDL-2019 LIBRARY; T=293.16K
Photon emission for (n,pd)

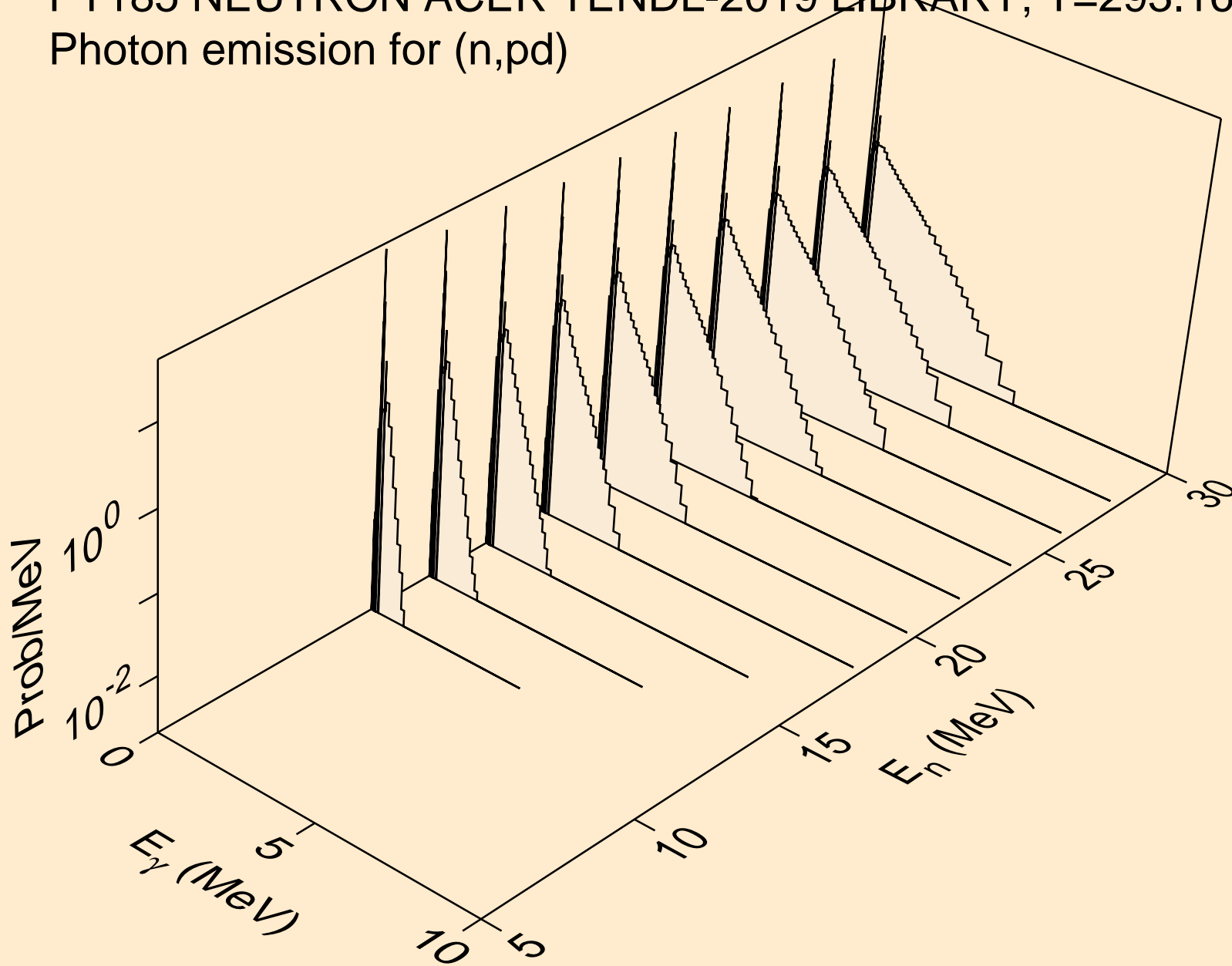

PT185 NEUTRON ACER TENDL-2019 LIBRARY; T=293.16K
Photon emission for (n,pt)

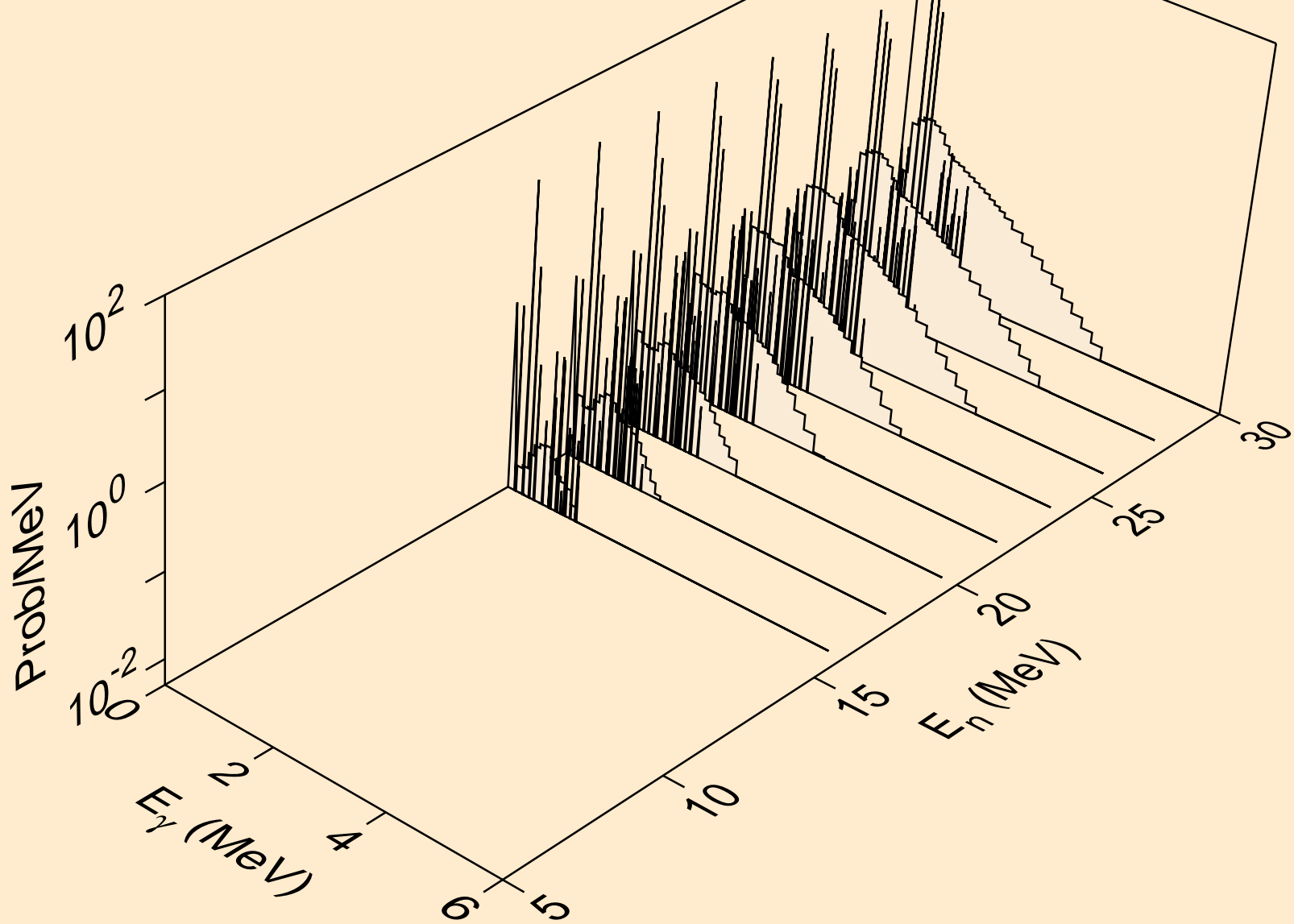

PT185 NEUTRON ACER TENDL-2019 LIBRARY; T=293.16K
Photon emission for (n,da)

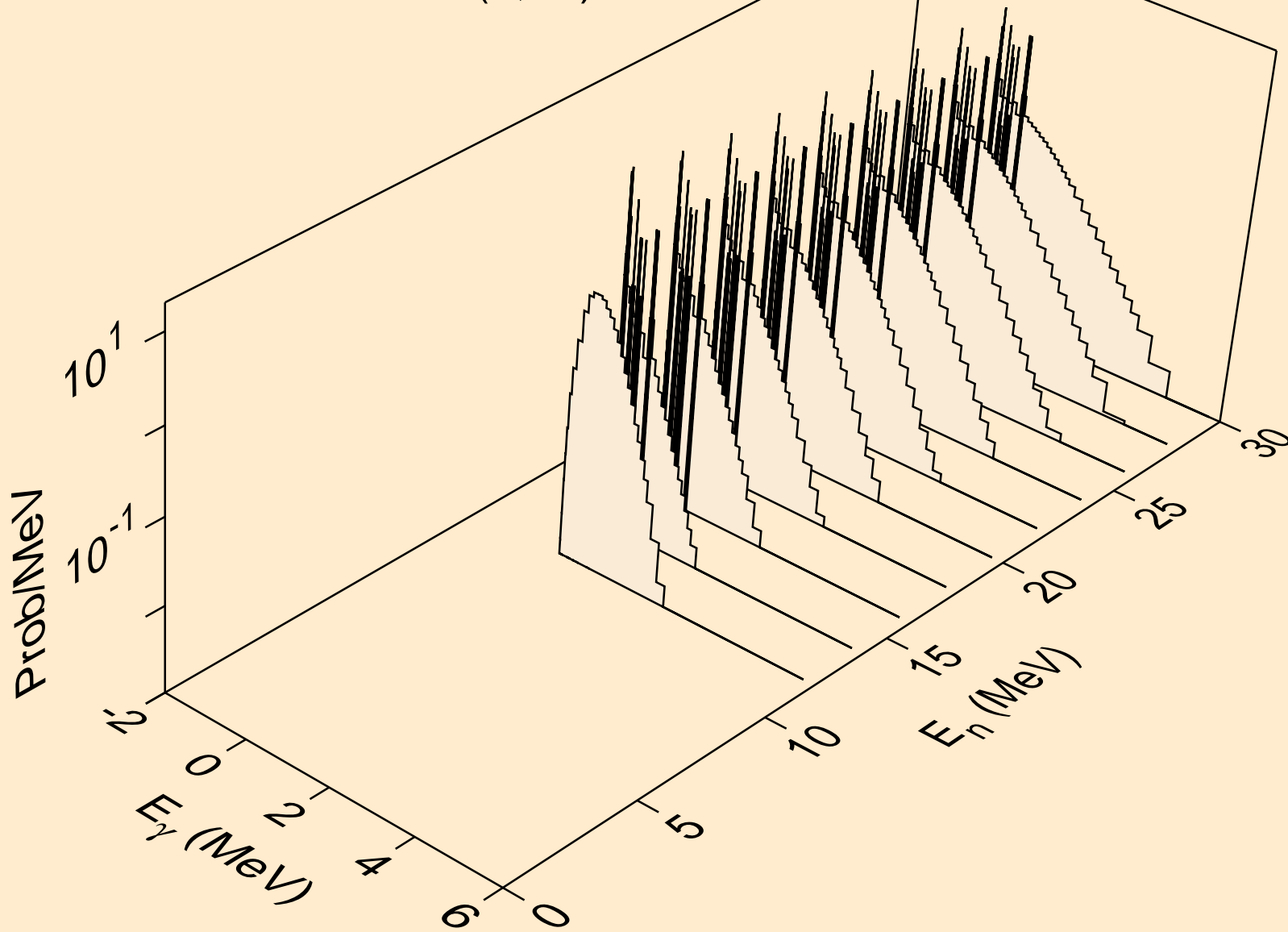

PT185 NEUTRON ACER TENDL-2019 LIBRARY; T=293.16K
thermal capture photon spectrum

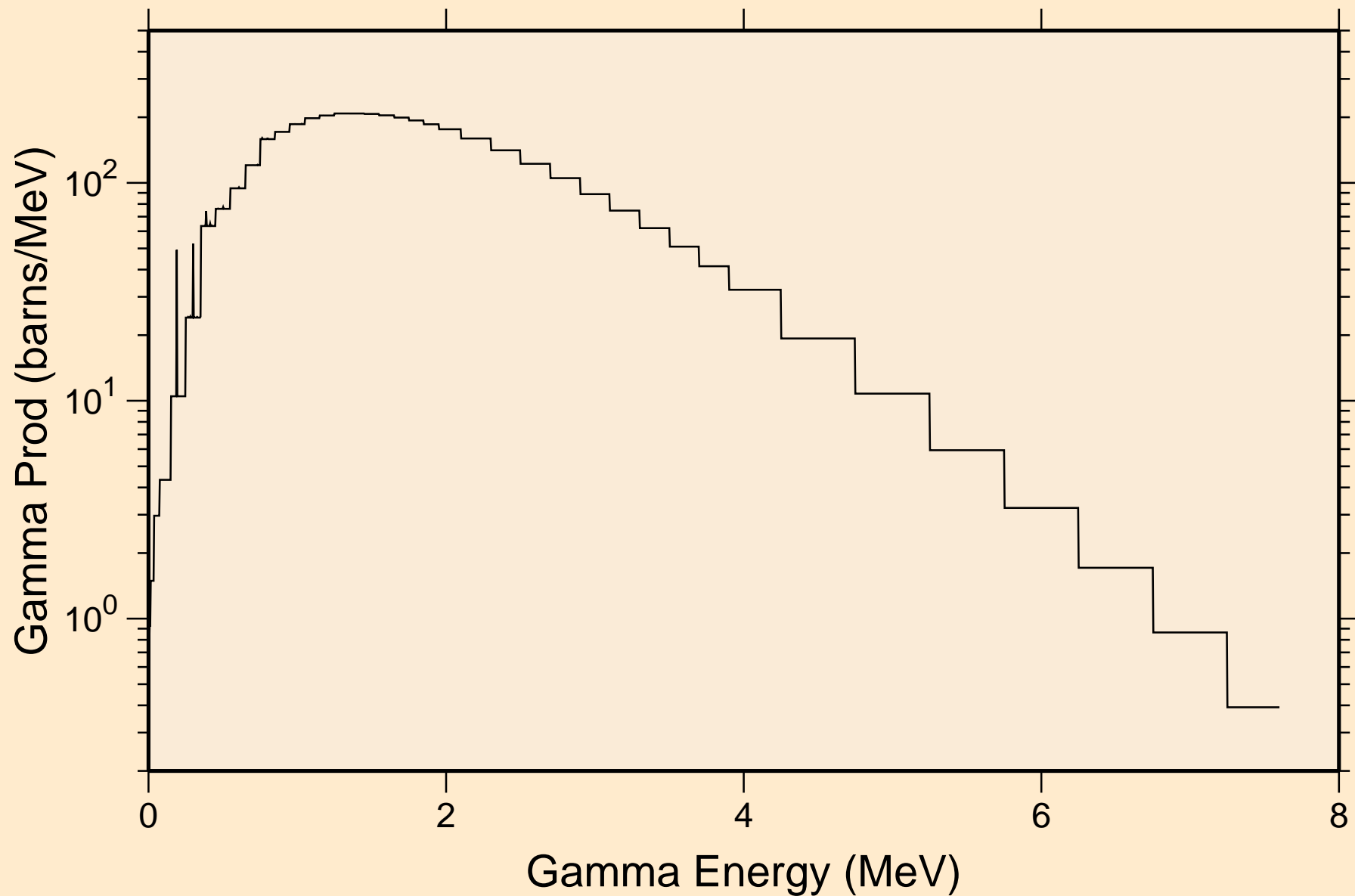

PT185 NEUTRON ACER TENDL-2019 LIBRARY; T=293.16K
14 MeV photon spectrum

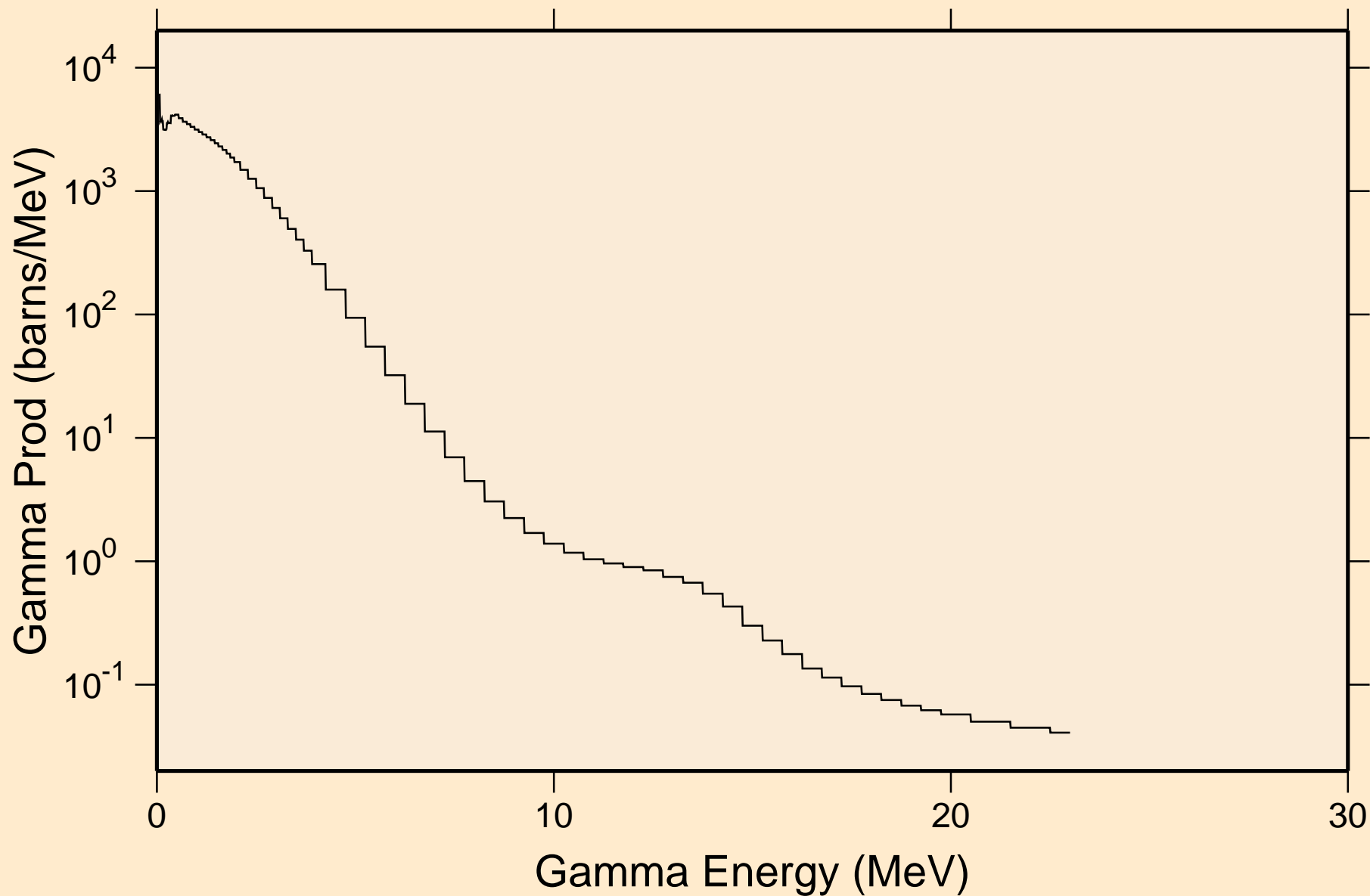

PT185 NEUTRON ACER TENDL-2019 LIBRARY; T=293.16K
Particle heating contributions

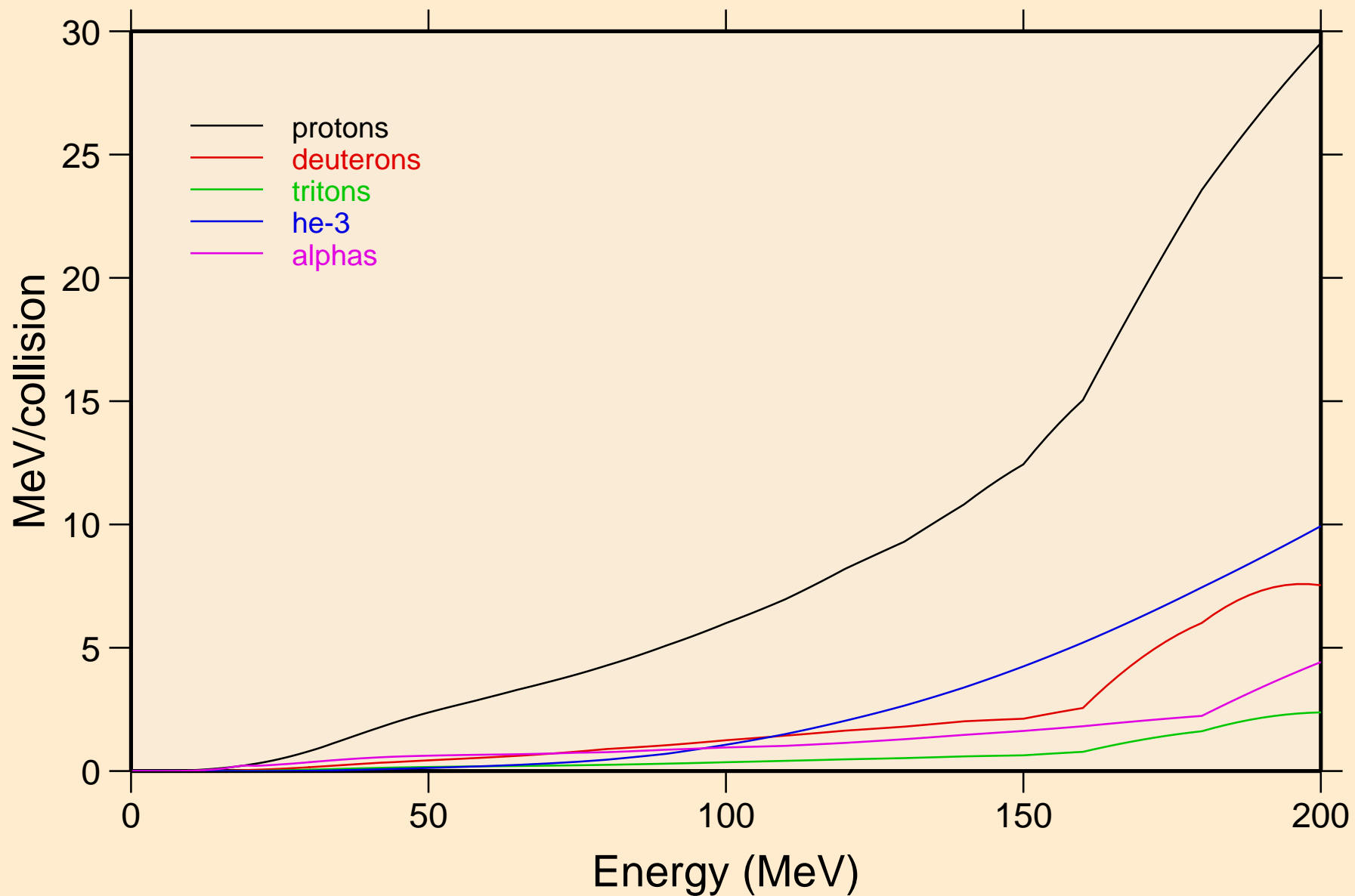

PT185 NEUTRON ACER TENDL-2019 LIBRARY; T=293.16K
Recoil Heating

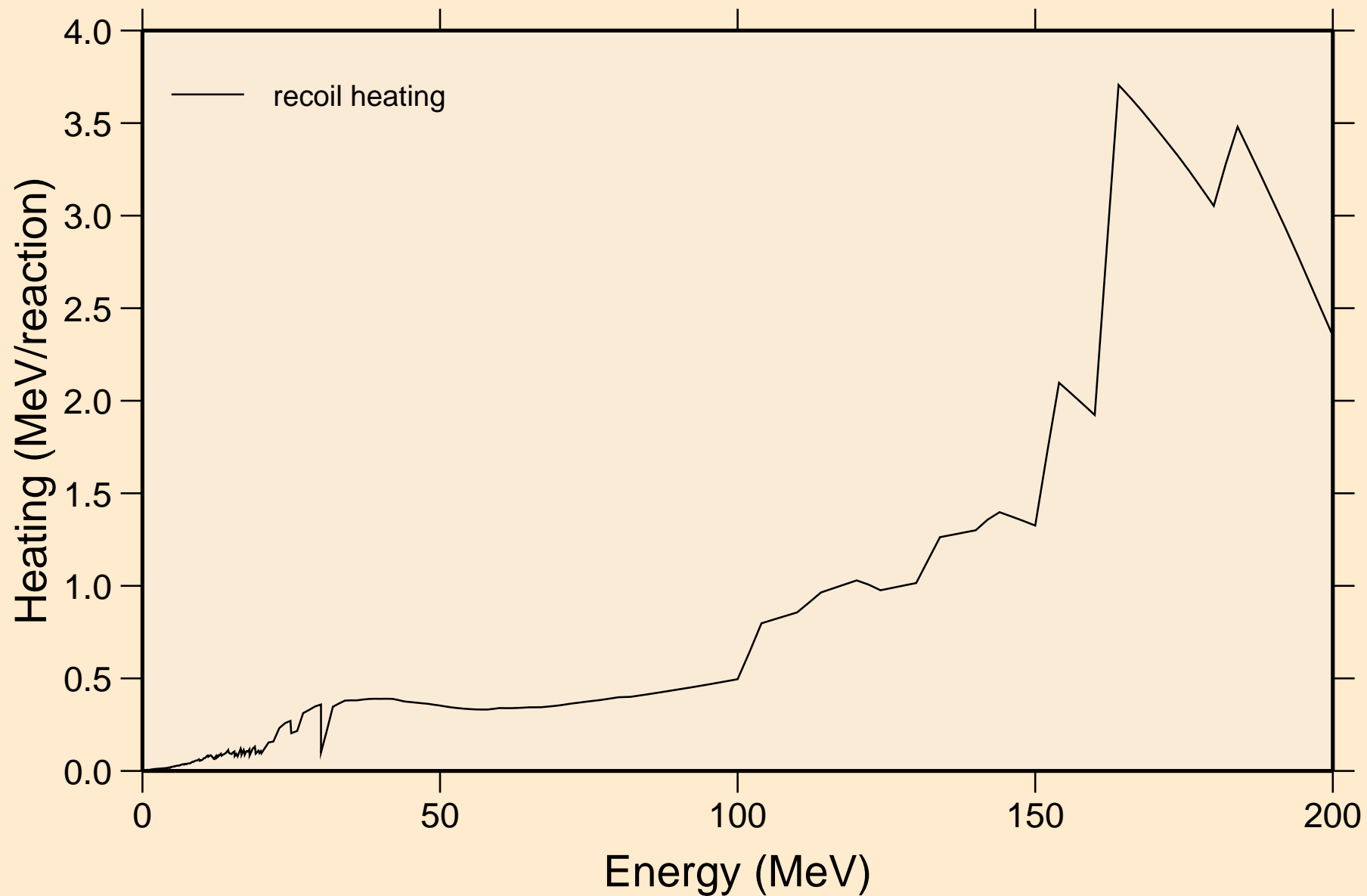

PT185 NEUTRON ACER TENDL-2019 LIBRARY; T=293.16K
Particle production cross sections

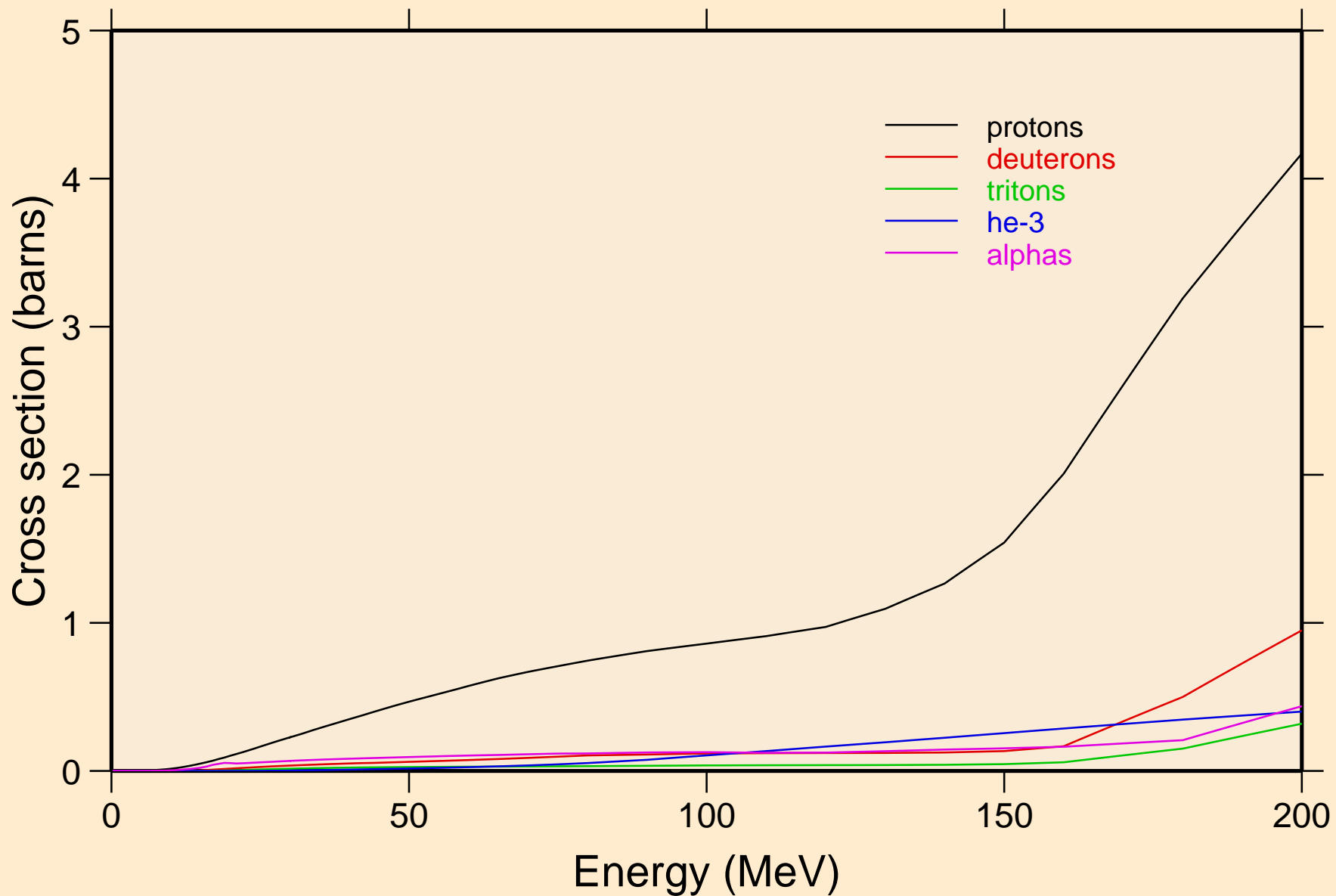

PT185 NEUTRON ACER TENDL-2019 LIBRARY; T=293.16K
protons from (n,x)

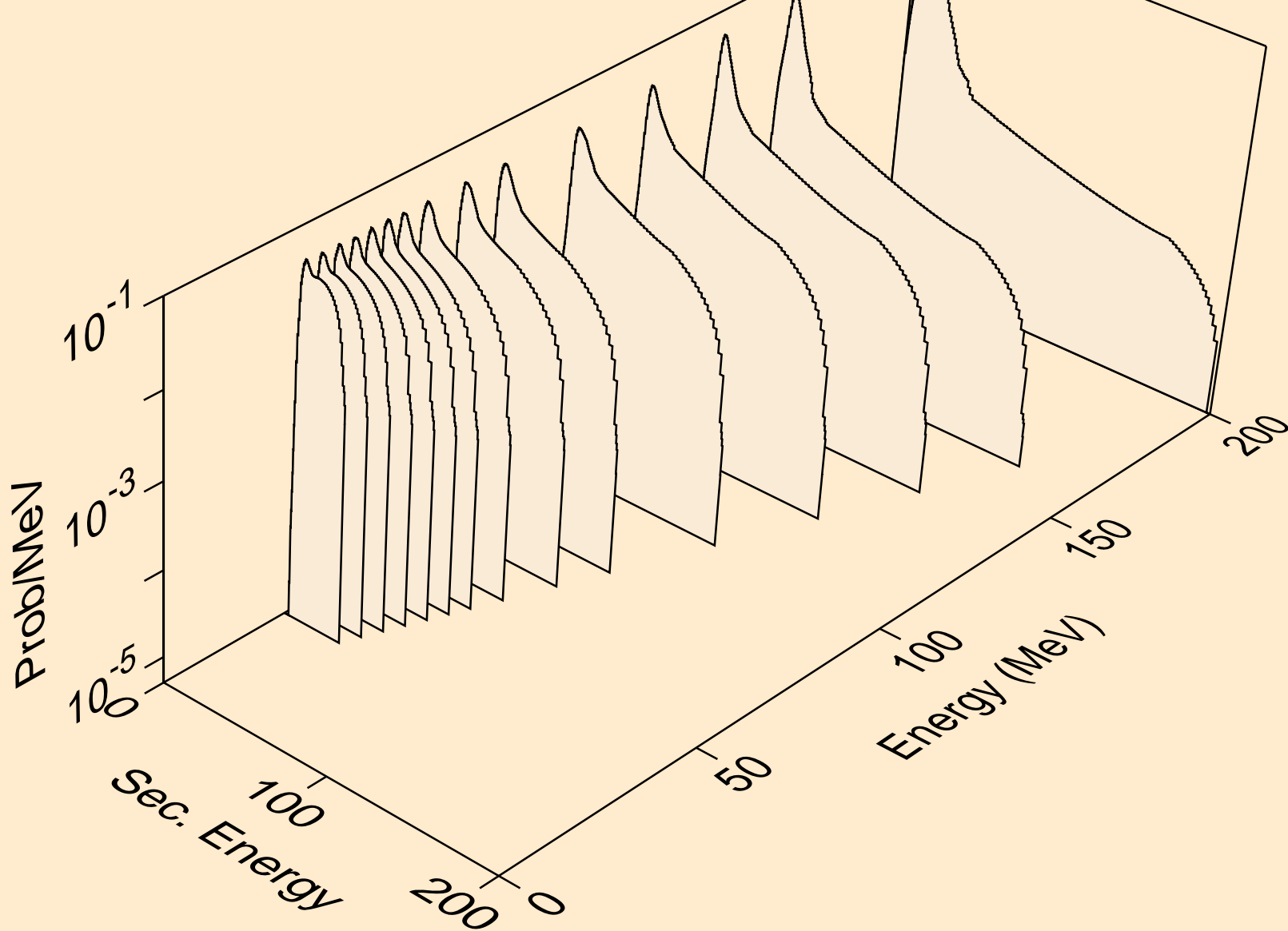

PT185 NEUTRON ACER TENDL-2019 LIBRARY; T=293.16K
protons from (n,n*)p

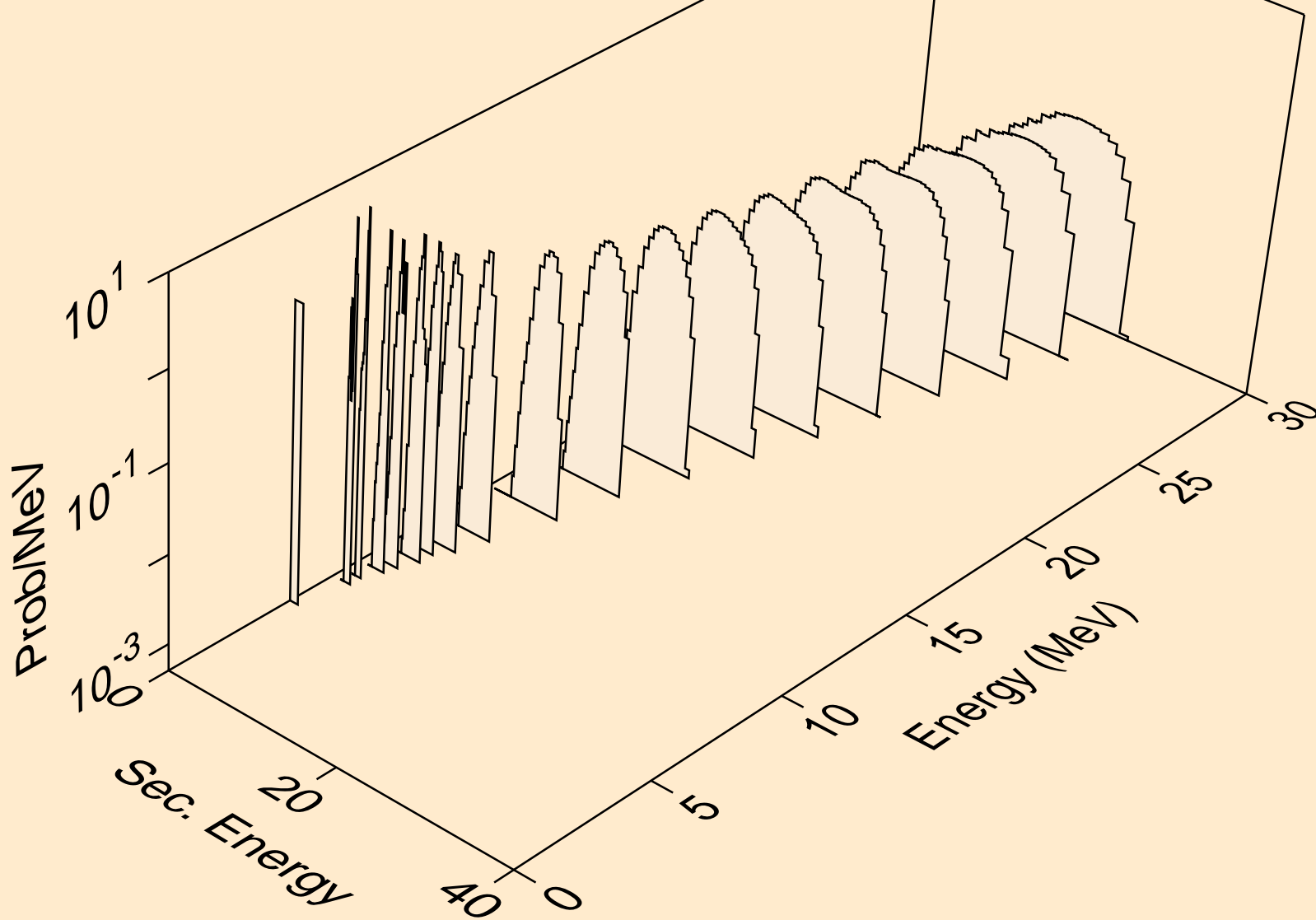

PT185 NEUTRON ACER TENDL-2019 LIBRARY; T=293.16K
protons from (n,2np)

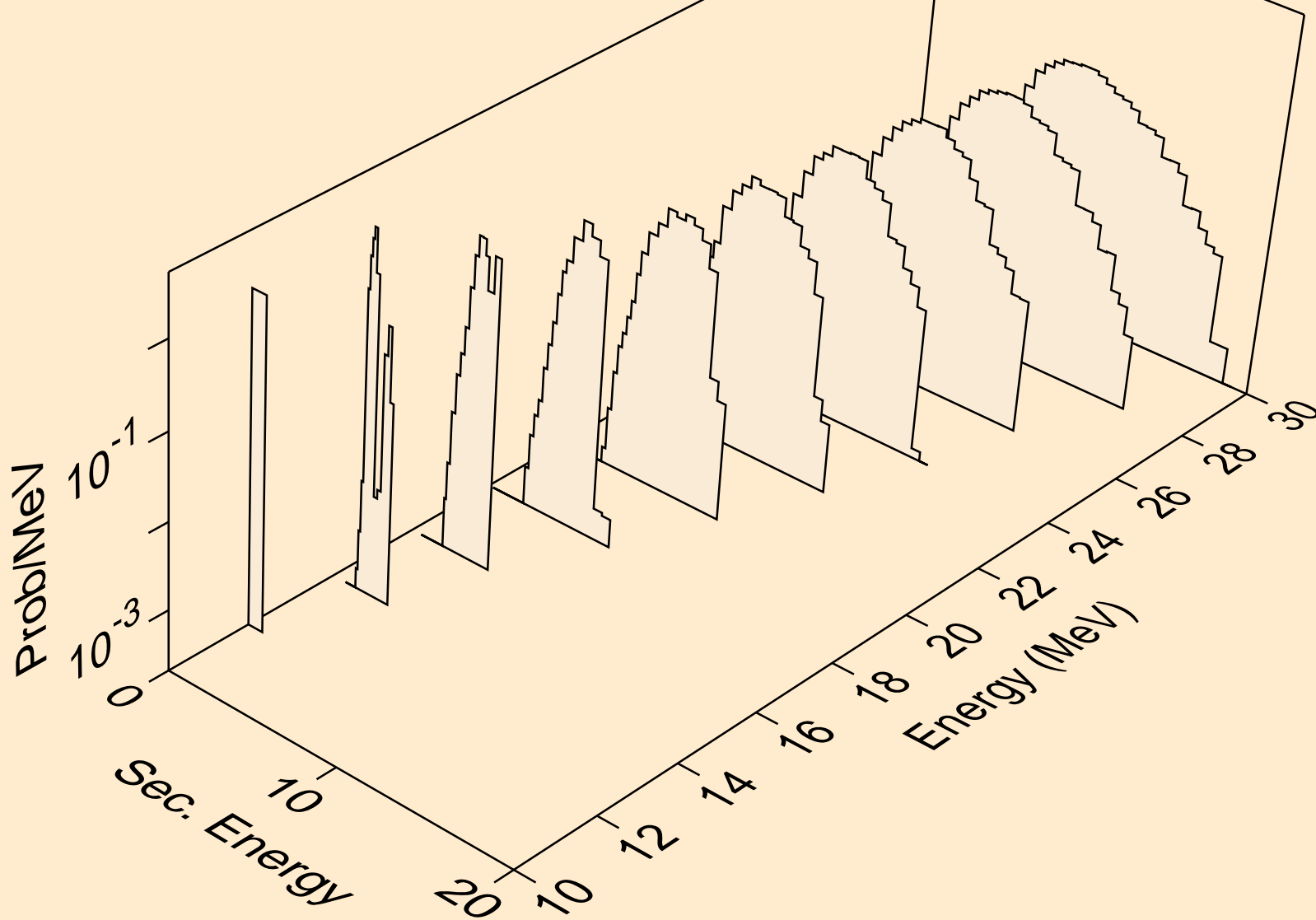

PT185 NEUTRON ACER TENDL-2019 LIBRARY; T=293.16K
protons from (n,3np)

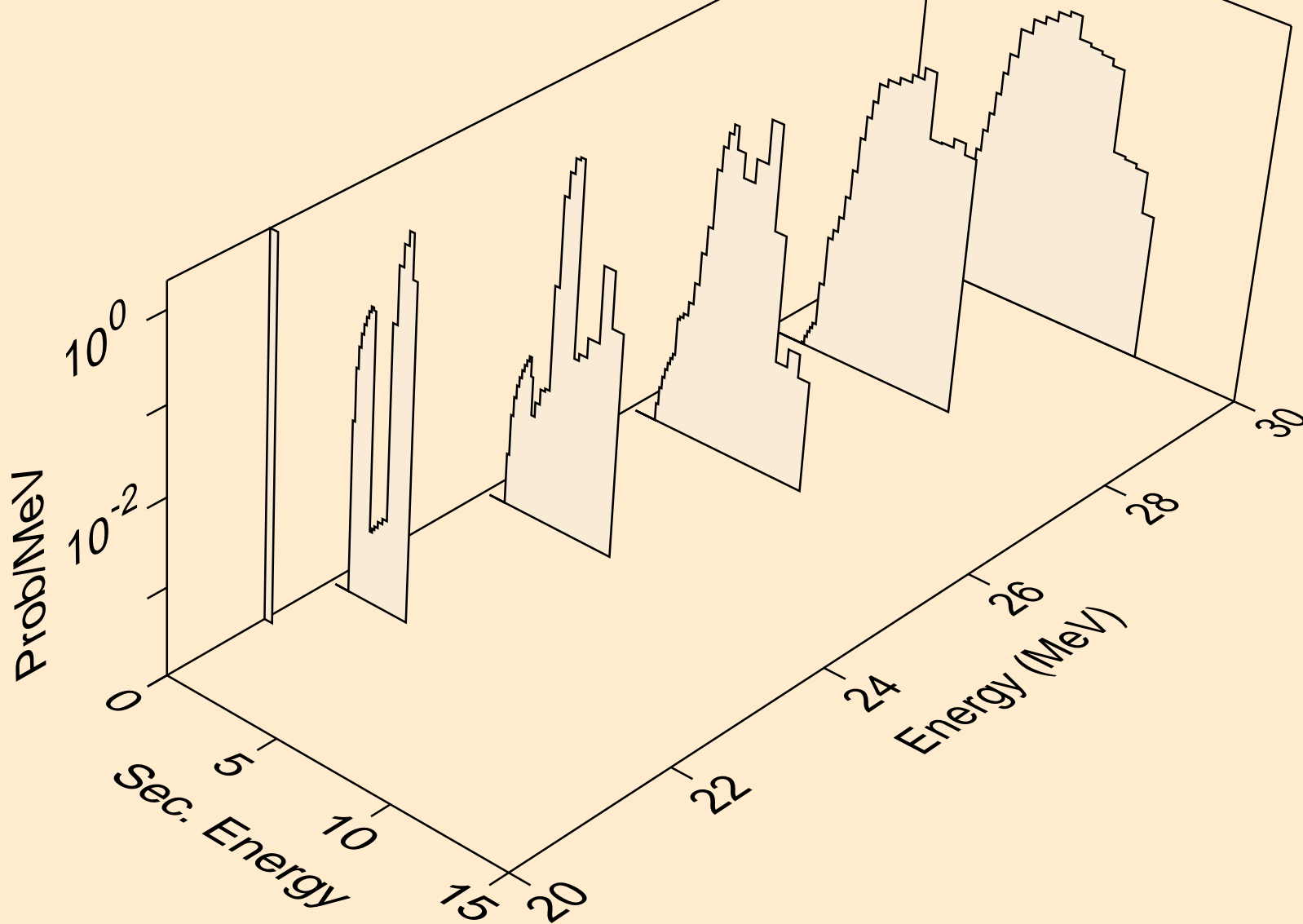

PT185 NEUTRON ACER TENDL-2019 LIBRARY; T=293.16K
protons from (n,2np)

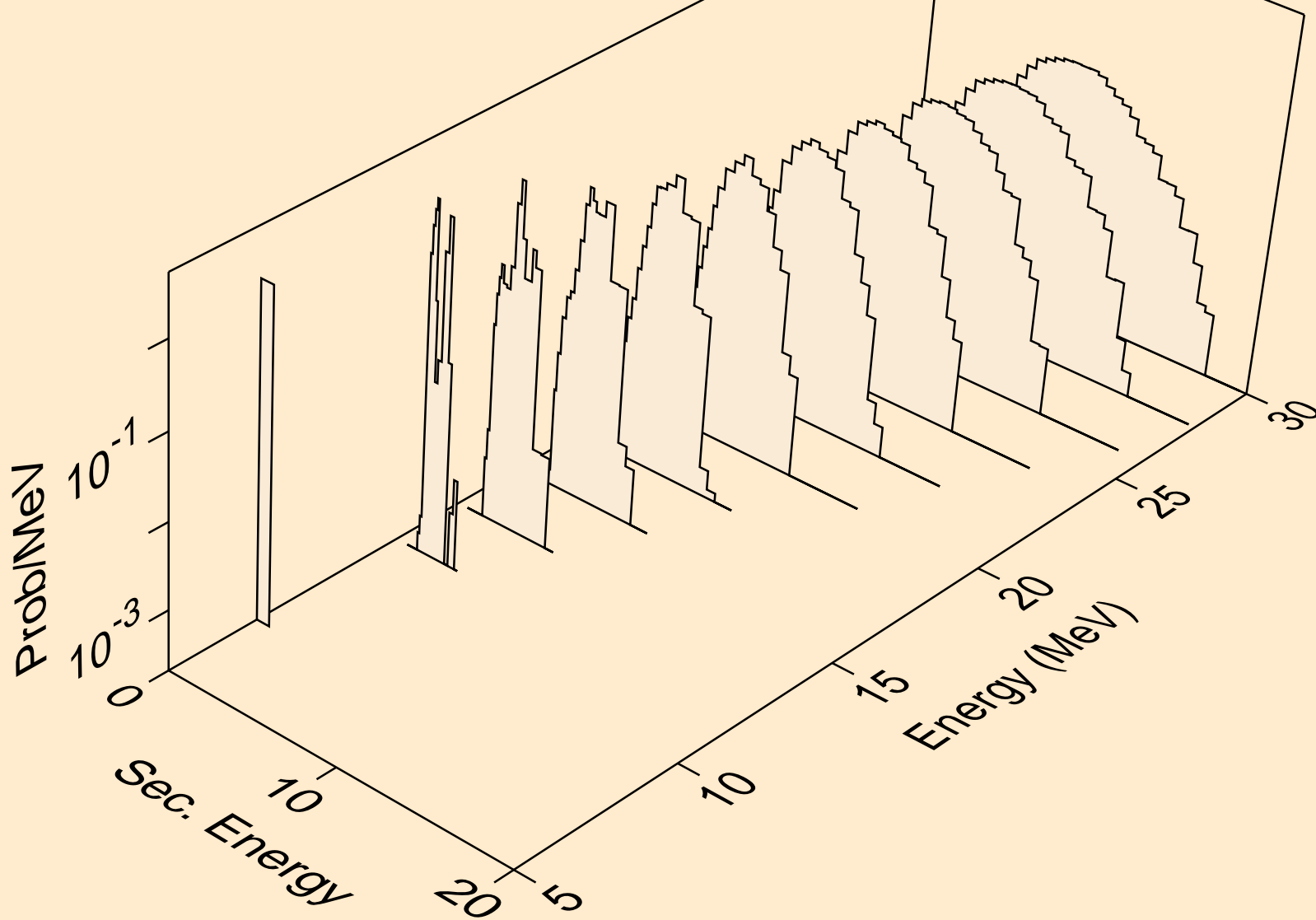

PT185 NEUTRON ACER TENDL-2019 LIBRARY; T=293.16K
protons from (n,npa)

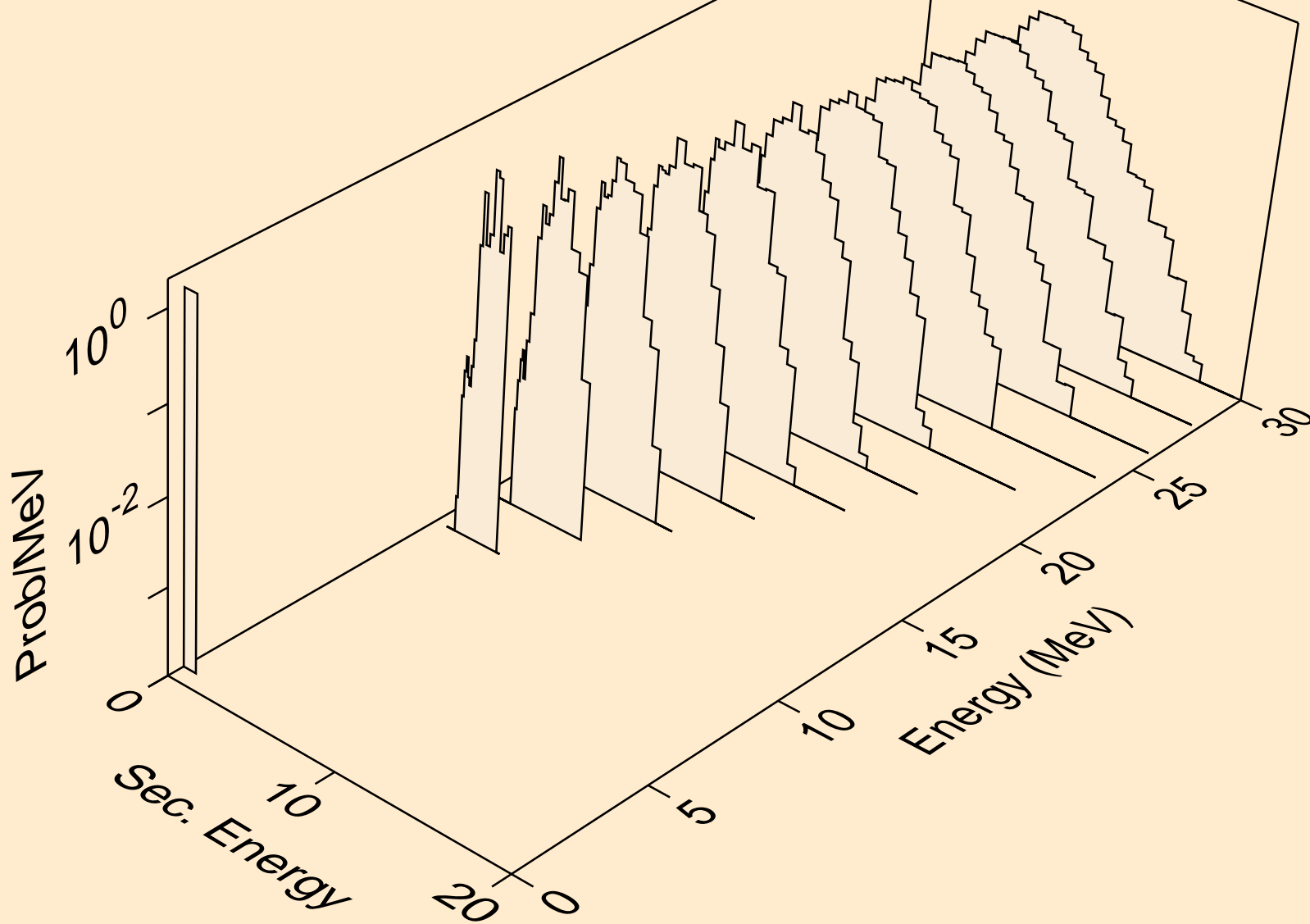

PT185 NEUTRON ACER TENDL-2019 LIBRARY; T=293.16K
protons from (n,p)

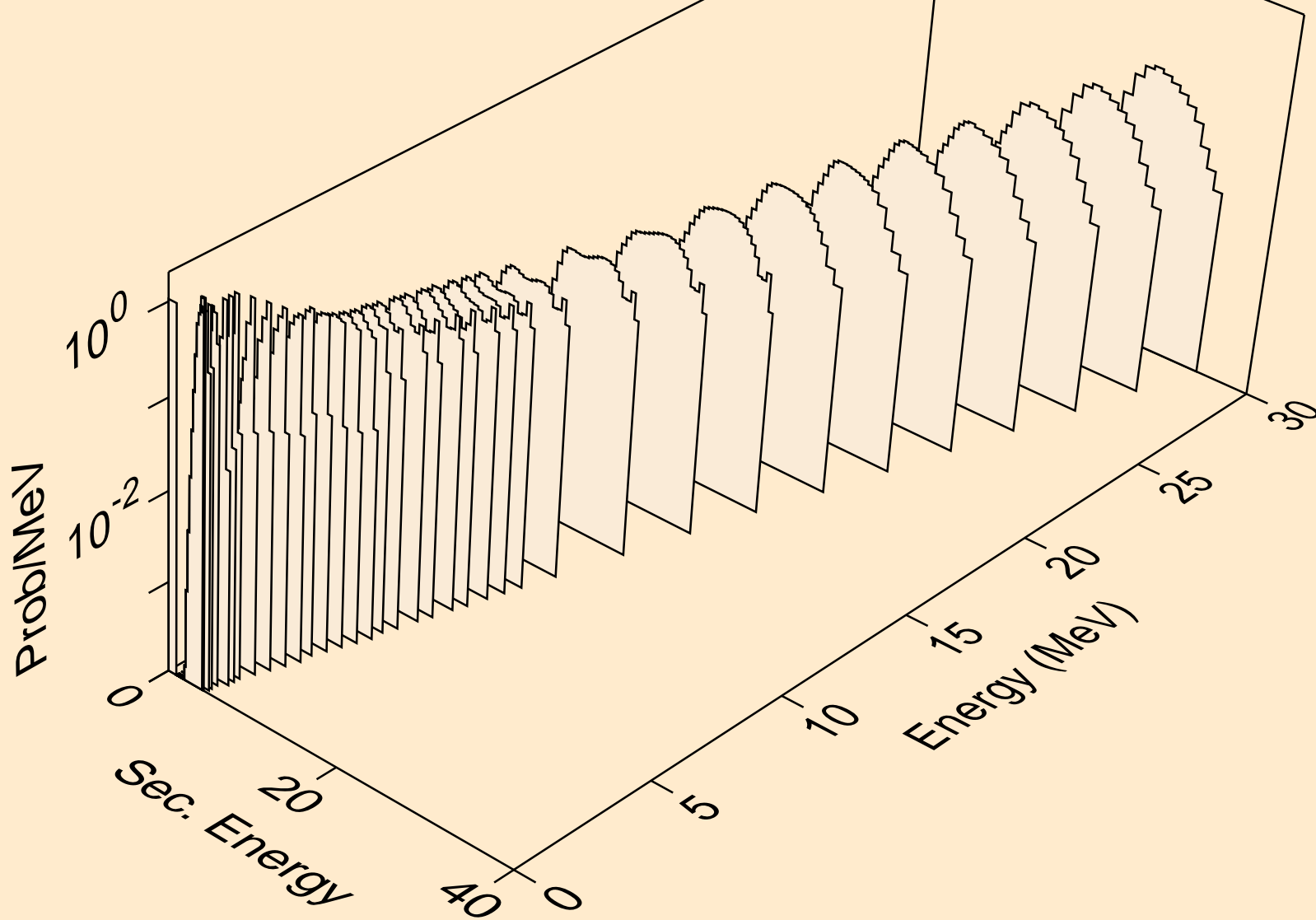

PT185 NEUTRON ACER TENDL-2019 LIBRARY; T=293.16K
protons from (n,2p)

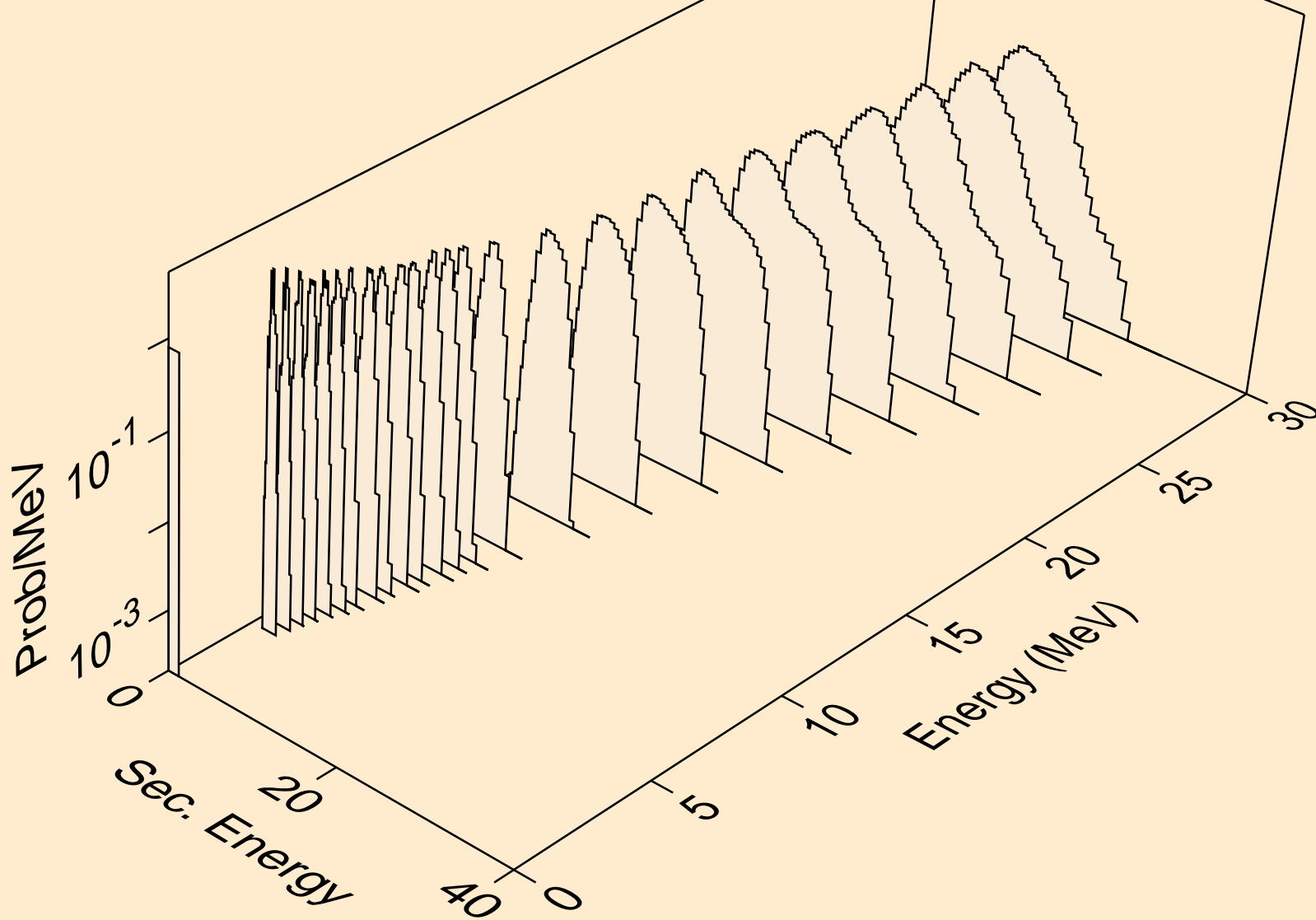

PT185 NEUTRON ACER TENDL-2019 LIBRARY; T=293.16K
protons from (n,p)

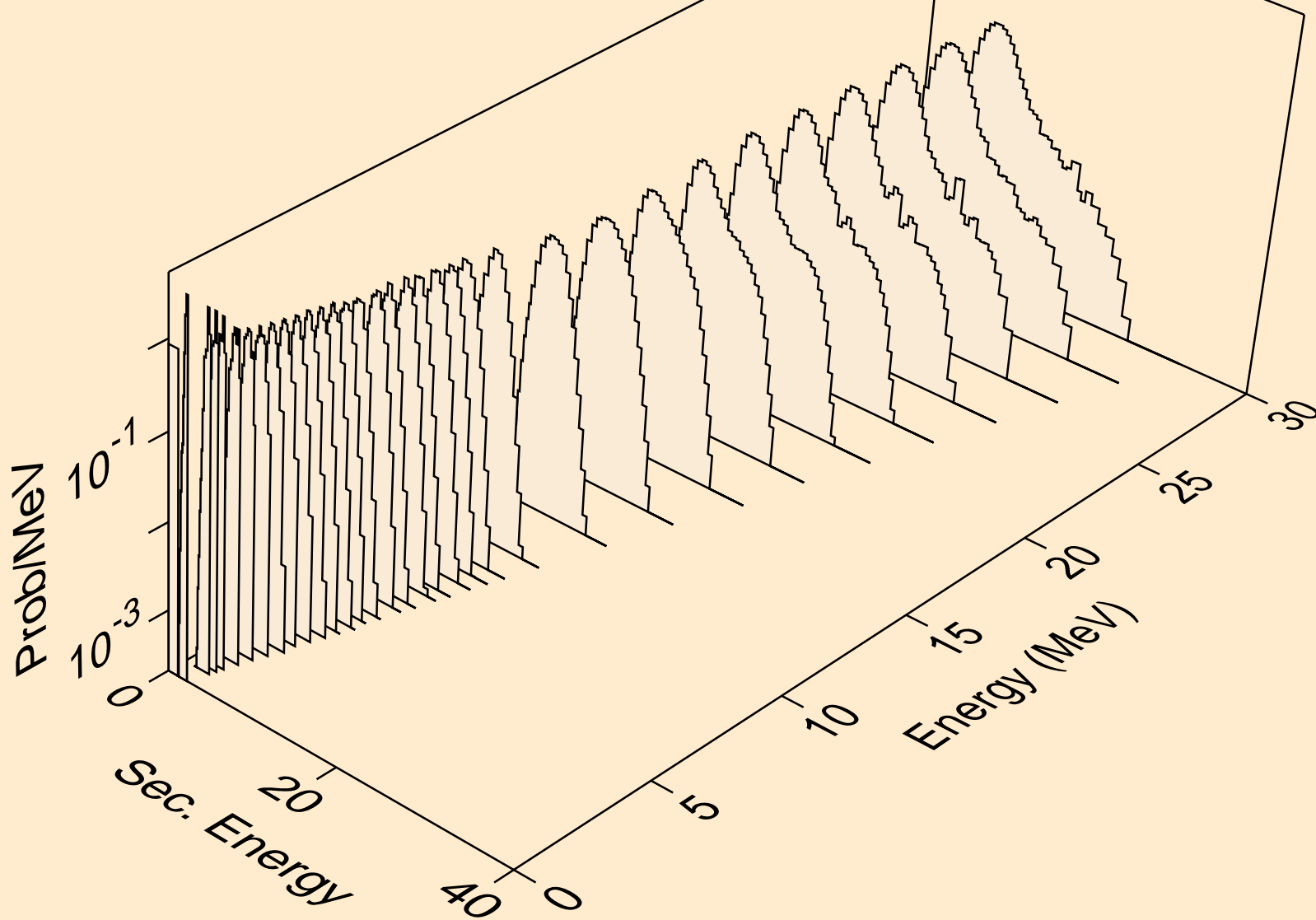

PT185 NEUTRON ACER TENDL-2019 LIBRARY; T=293.16K
protons from (n,pd)

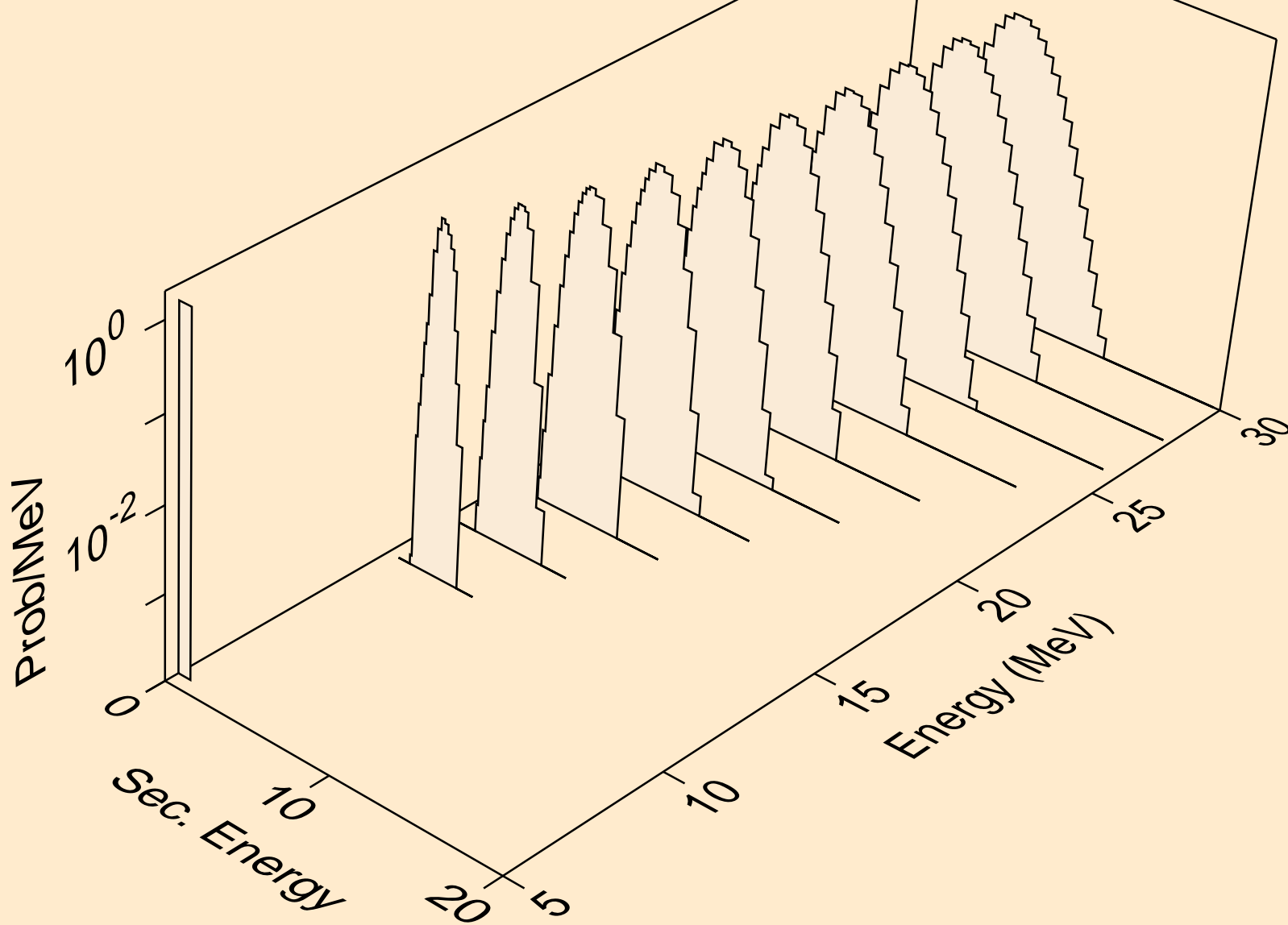

PT185 NEUTRON ACER TENDL-2019 LIBRARY; T=293.16K
protons from (n,pt)

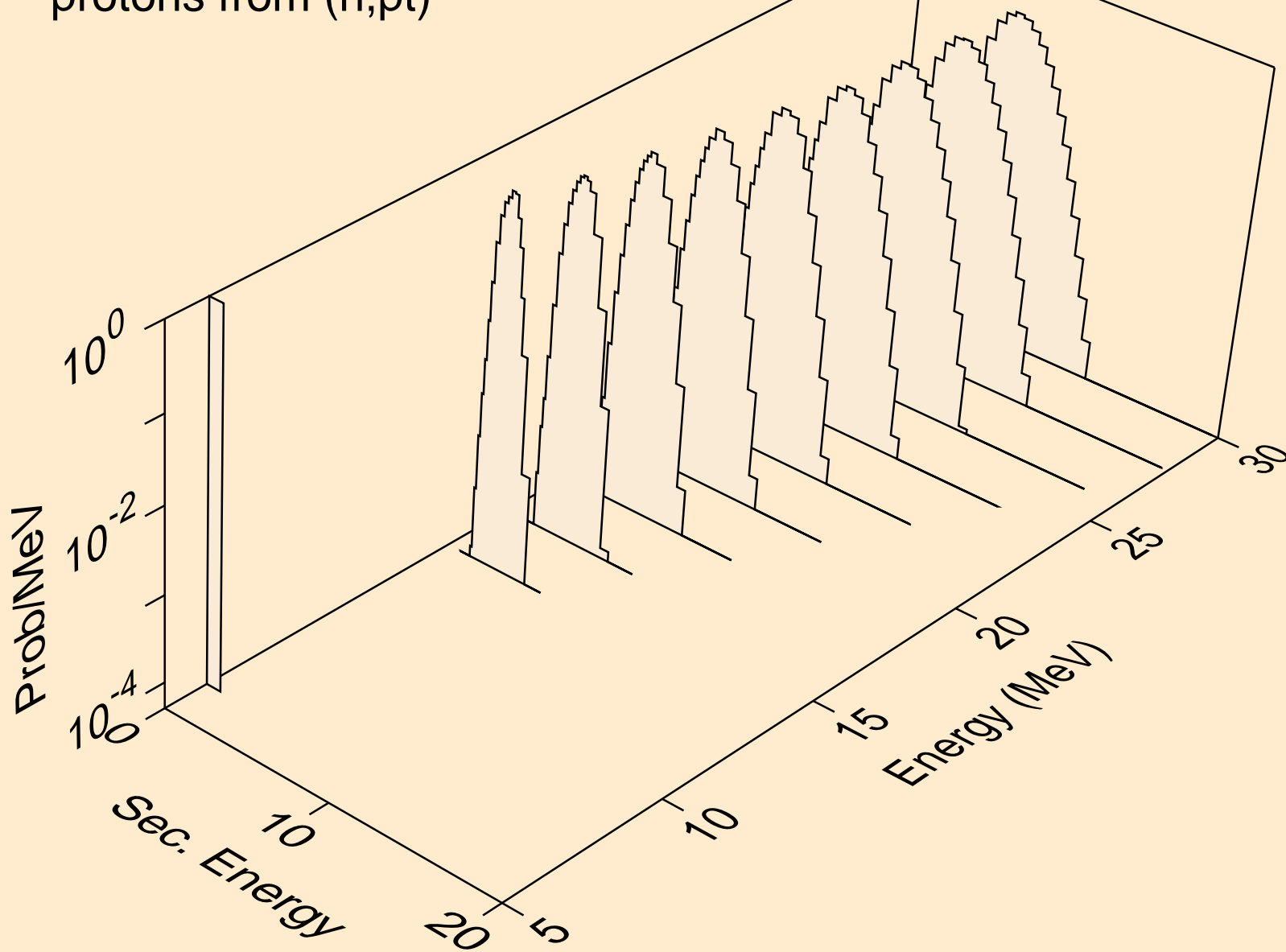

PT185 NEUTRON ACER TENDL-2019 LIBRARY; T=293.16K
deuterons from (n,x)

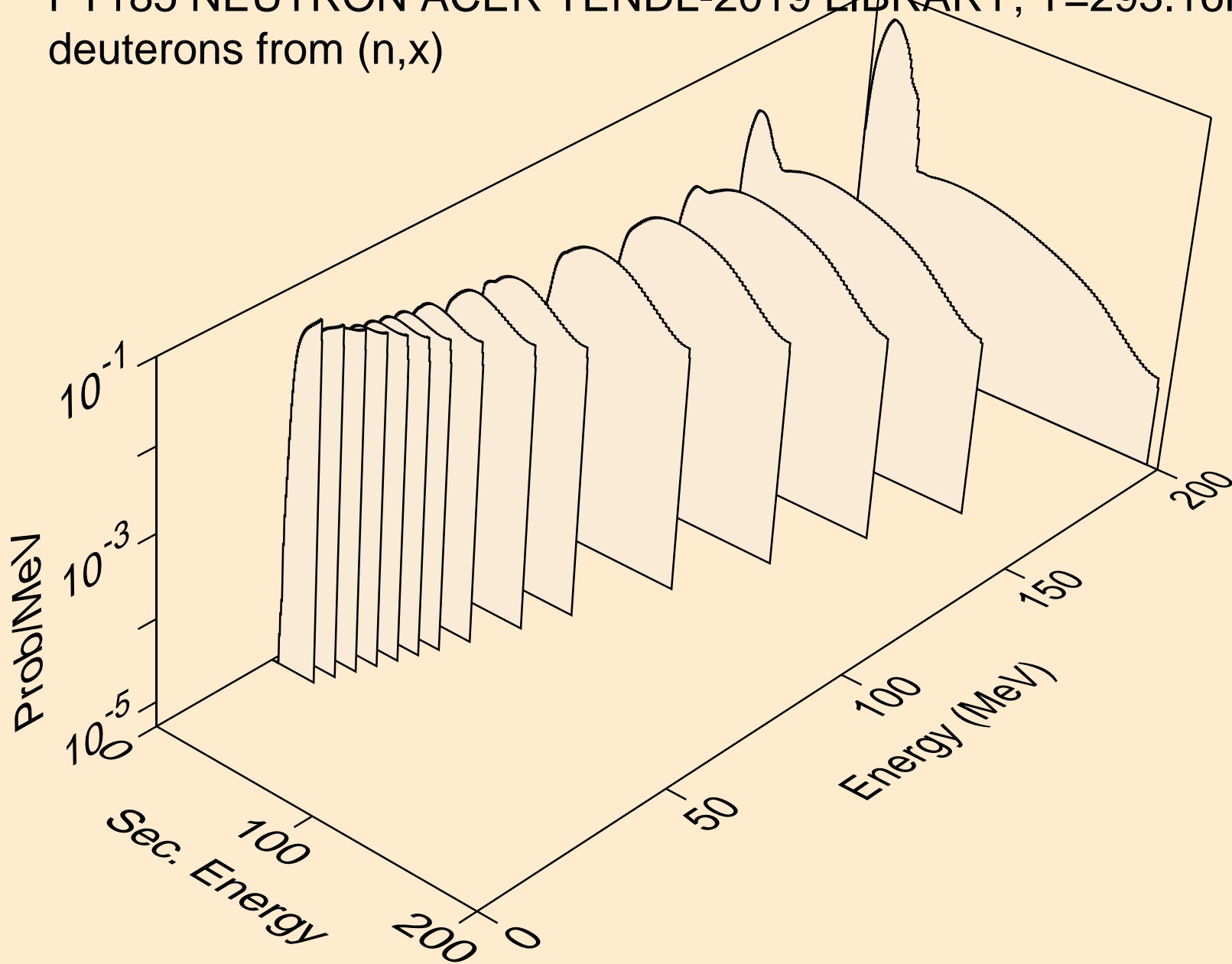

PT185 NEUTRON ACER TENDL-2019 LIBRARY; T=293.16K
deuterons from (n,2nd)

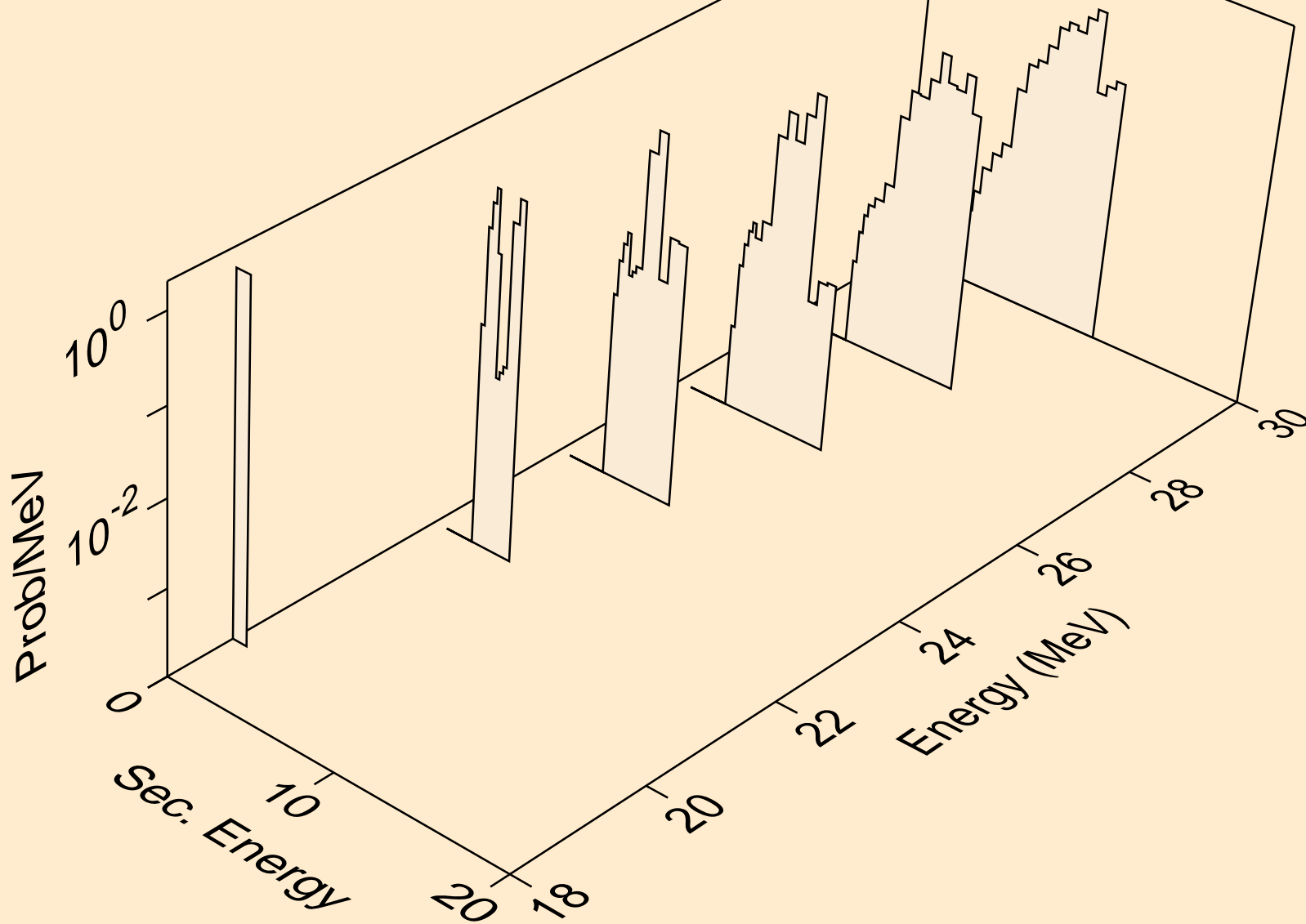

PT185 NEUTRON ACER TENDL-2019 LIBRARY; T=293.16K
deuterons from (n,n*)d

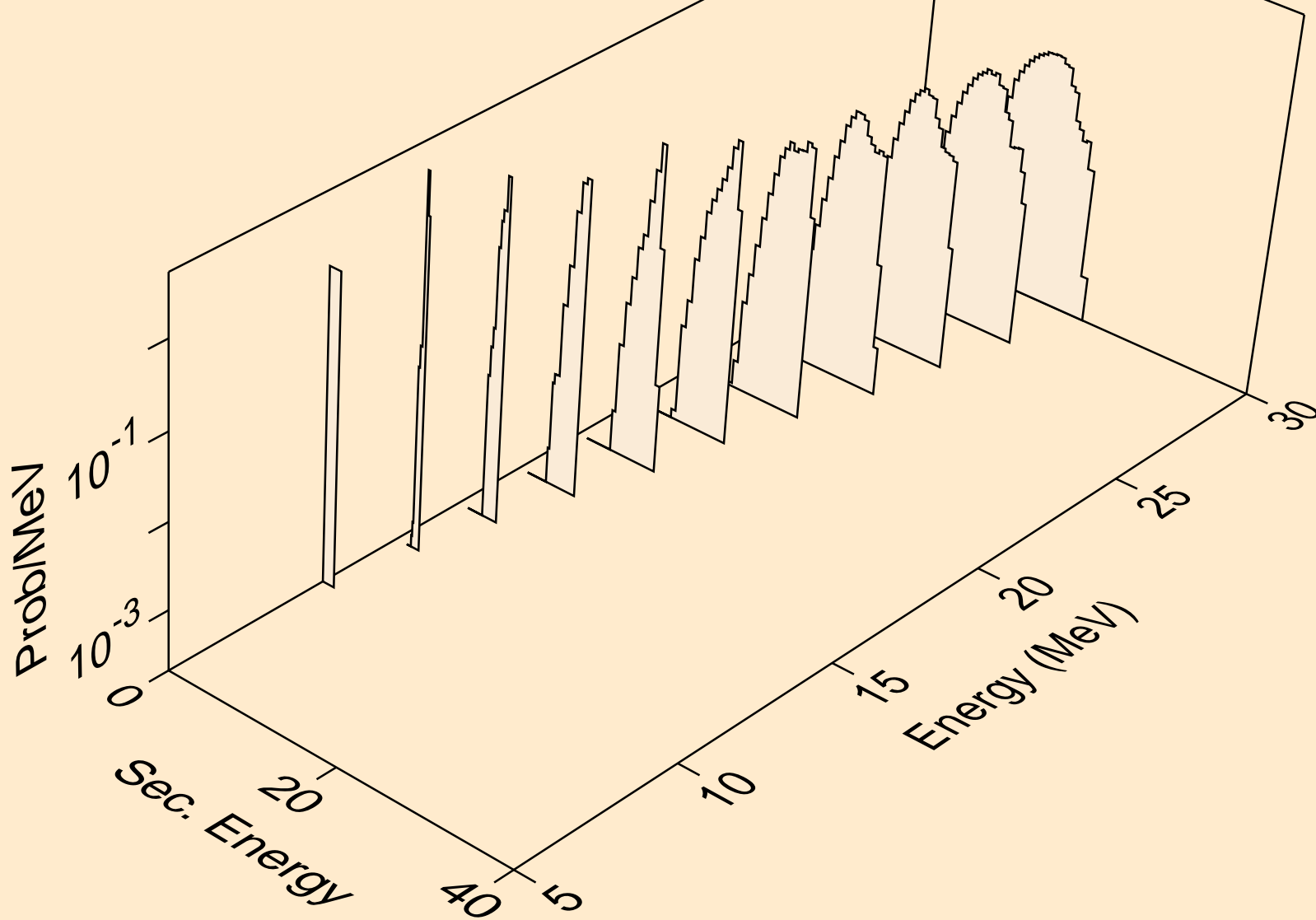

PT185 NEUTRON ACER TENDL-2019 LIBRARY; T=293.16K
deuterons from (n,d)

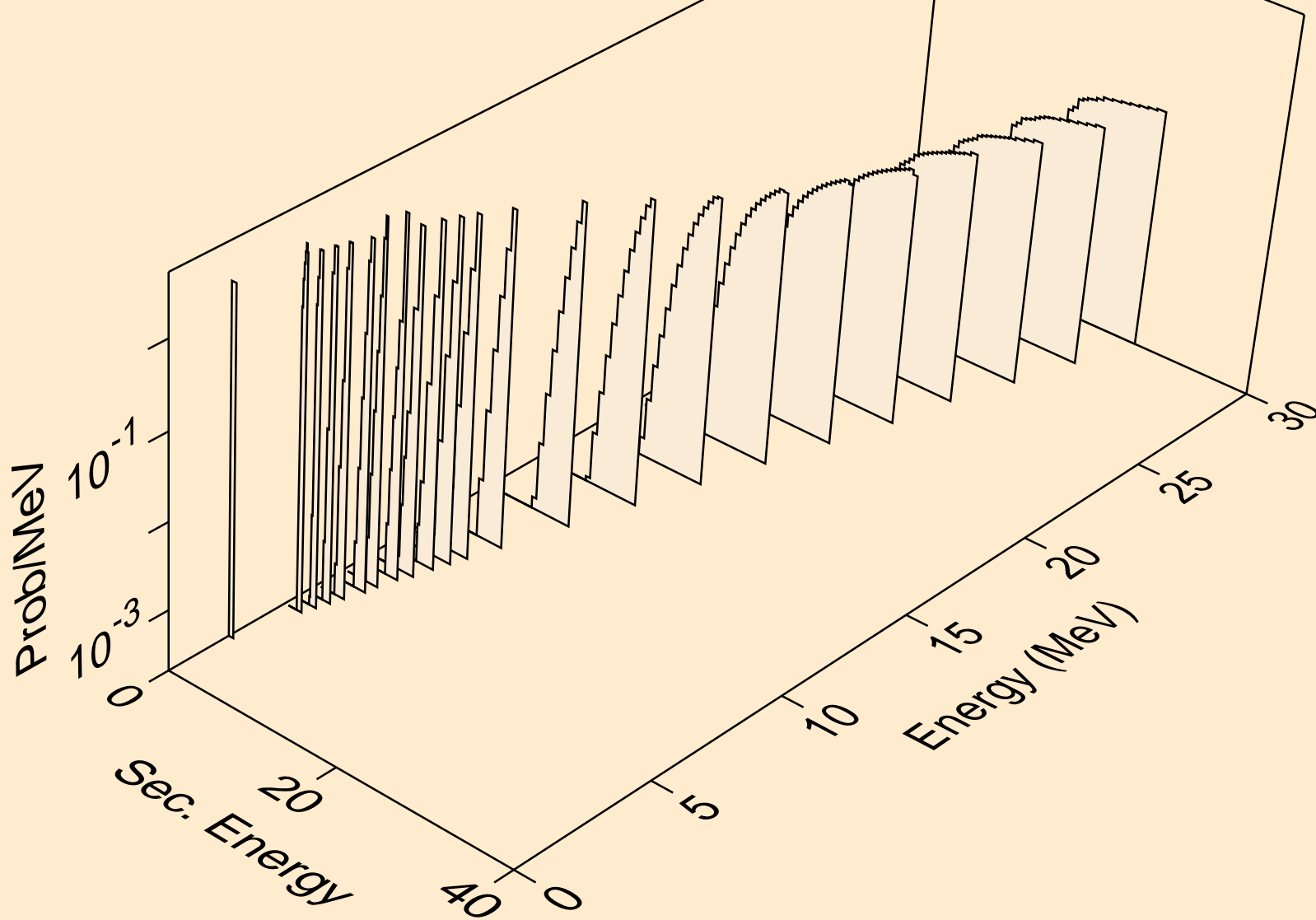

PT185 NEUTRON ACER TENDL-2019 LIBRARY; T=293.16K
deuterons from (n,pd)

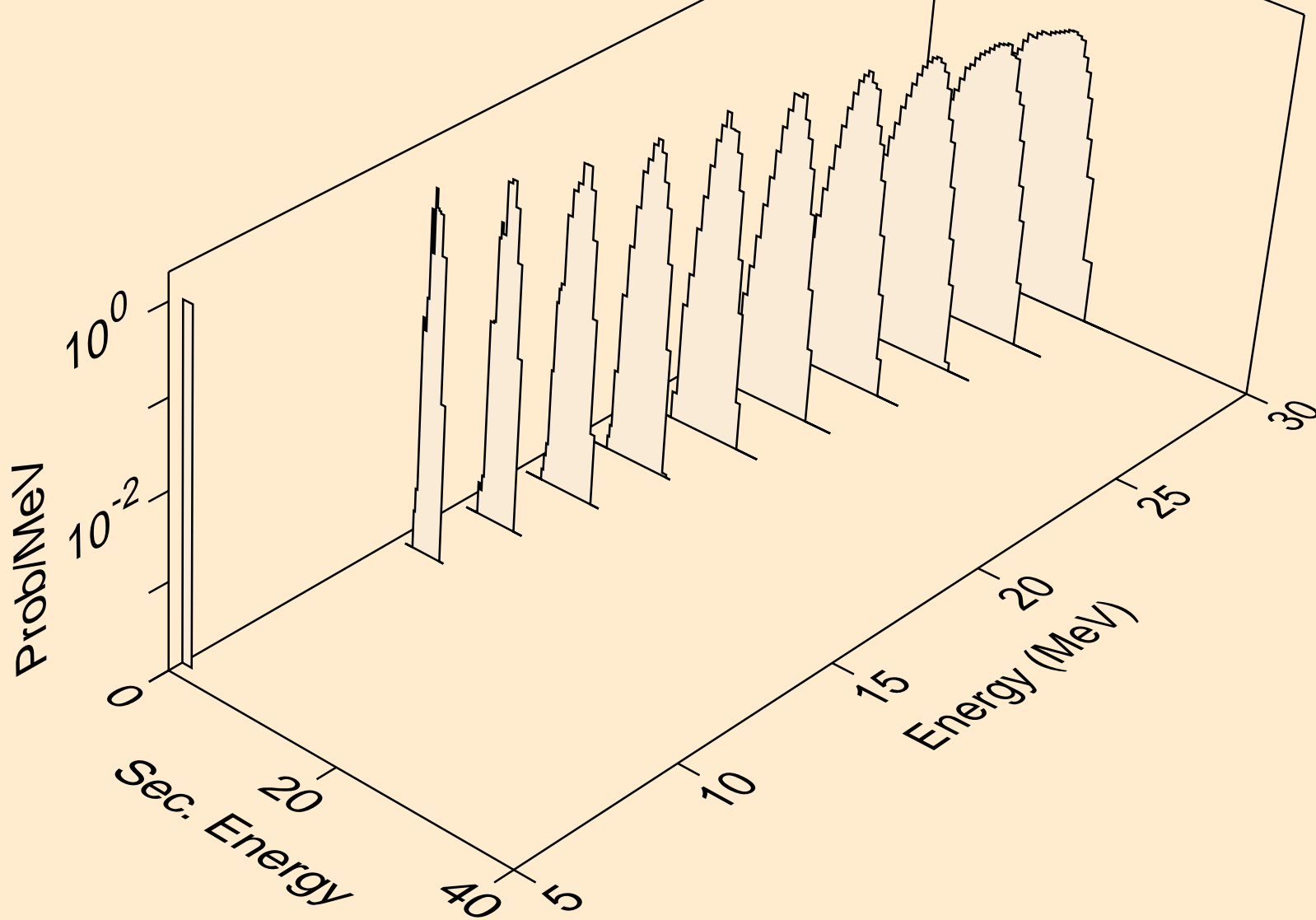

PT185 NEUTRON ACER TENDL-2019 LIBRARY; T=293.16K
deuterons from (n,da)

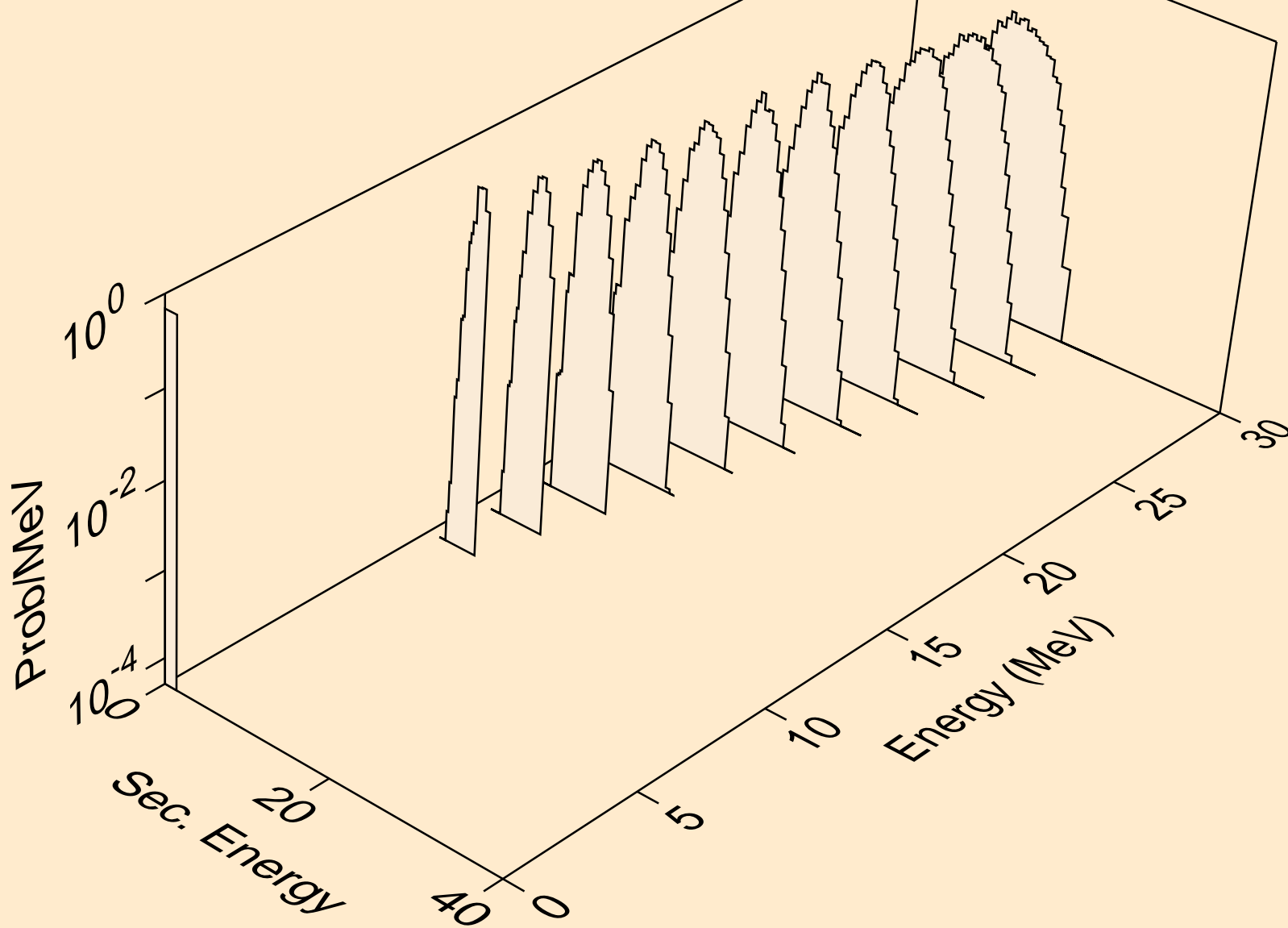

PT185 NEUTRON ACER TENDL-2019 LIBRARY; T=293.16K
tritons from (n,x)

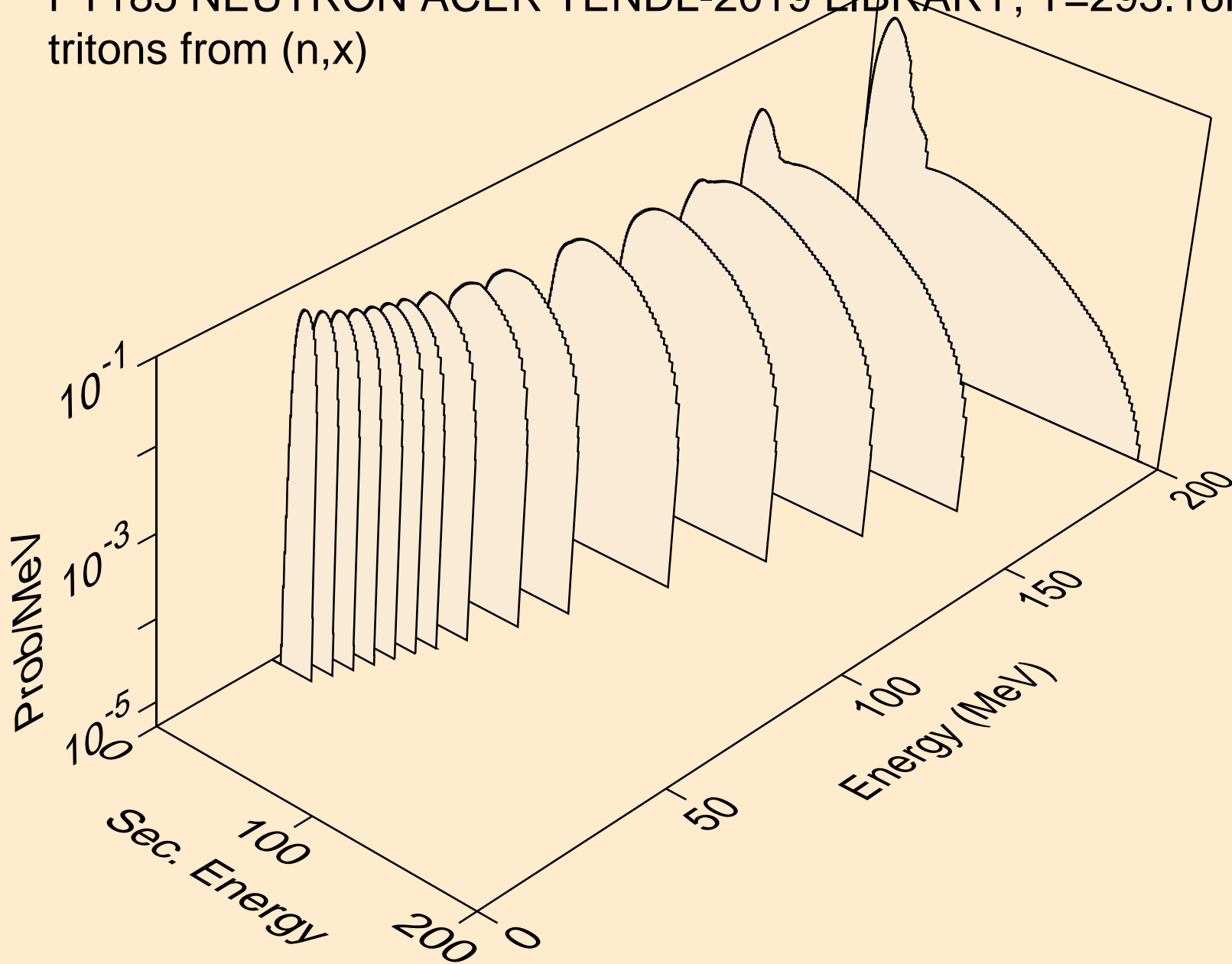

PT185 NEUTRON ACER TENDL-2019 LIBRARY; T=293.16K
tritons from (n,n*)t

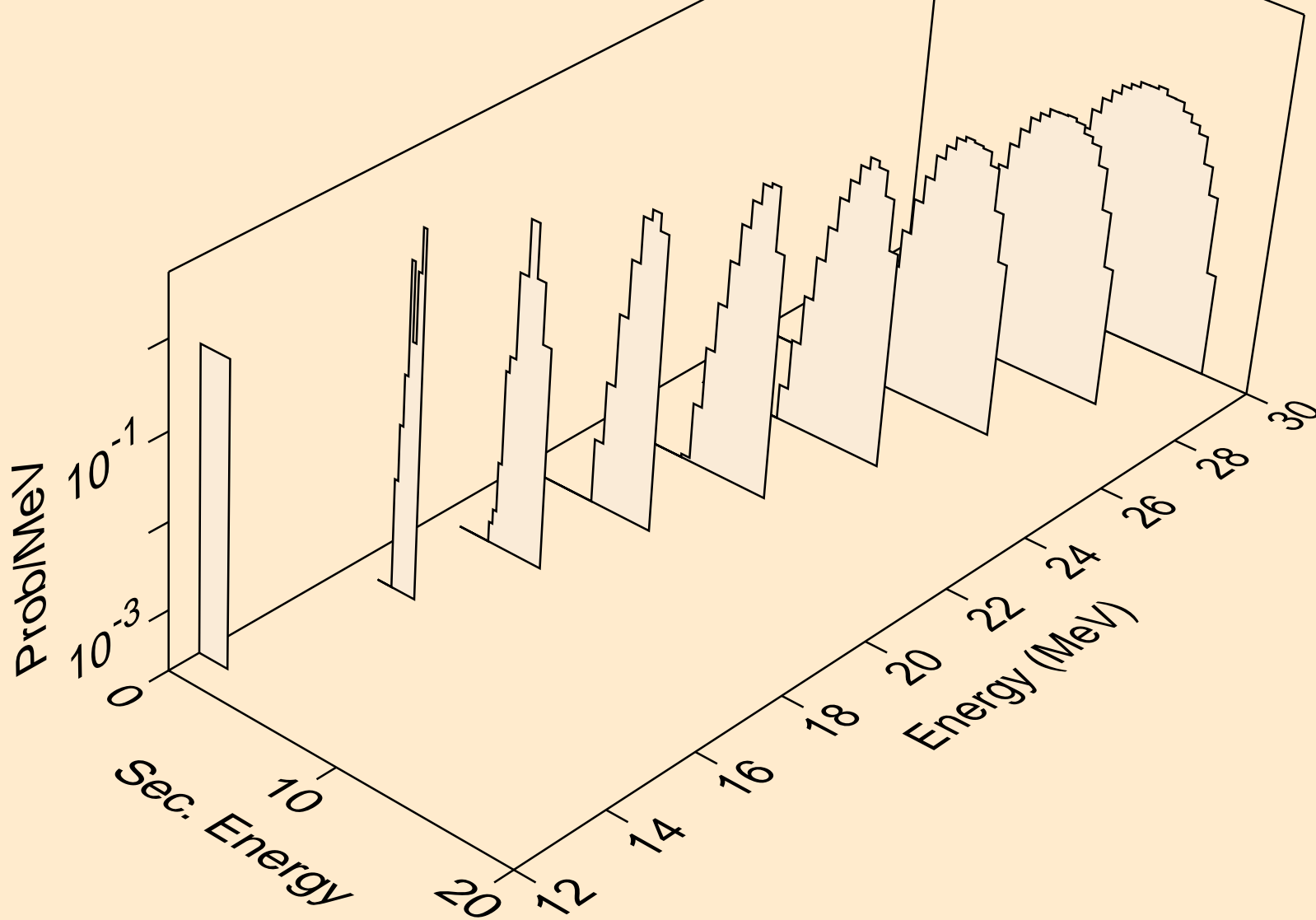

PT185 NEUTRON ACER TENDL-2019 LIBRARY; T=293.16K
tritons from (n,t)

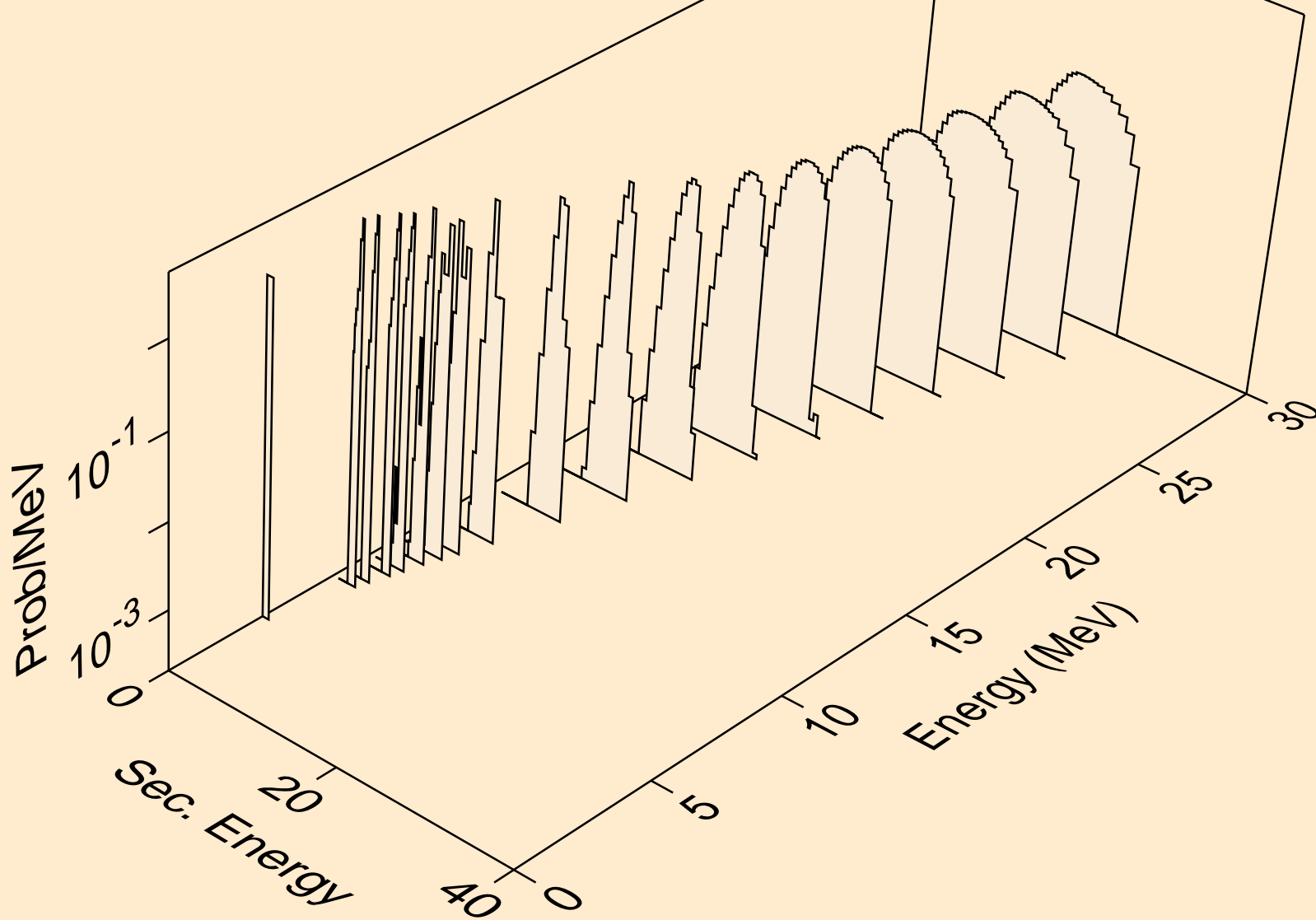

PT185 NEUTRON ACER TENDL-2019 LIBRARY; T=293.16K
tritons from (n,pt)

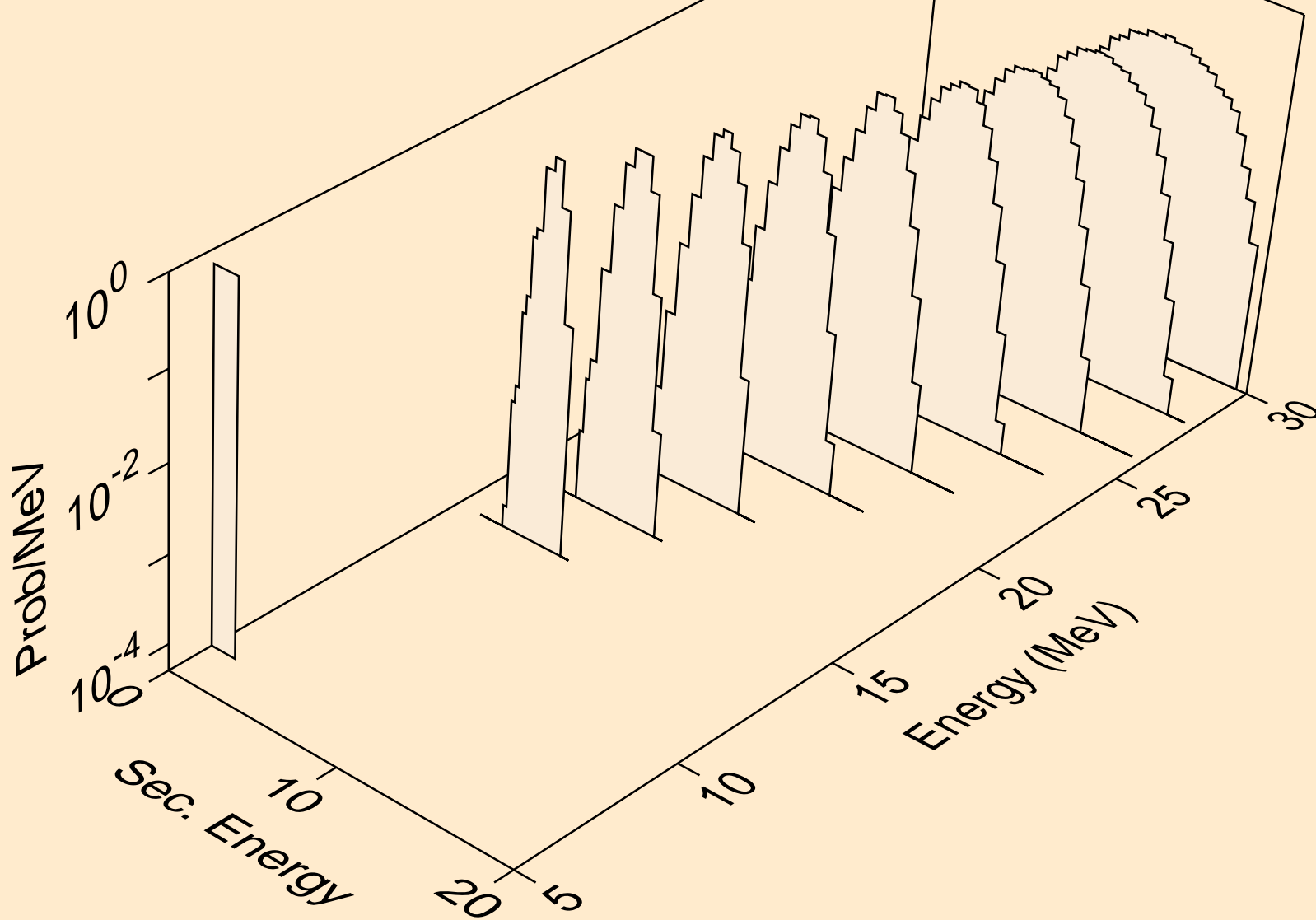

PT185 NEUTRON ACER TENDL-2019 LIBRARY; T=293.16K
he3s from (n,x)

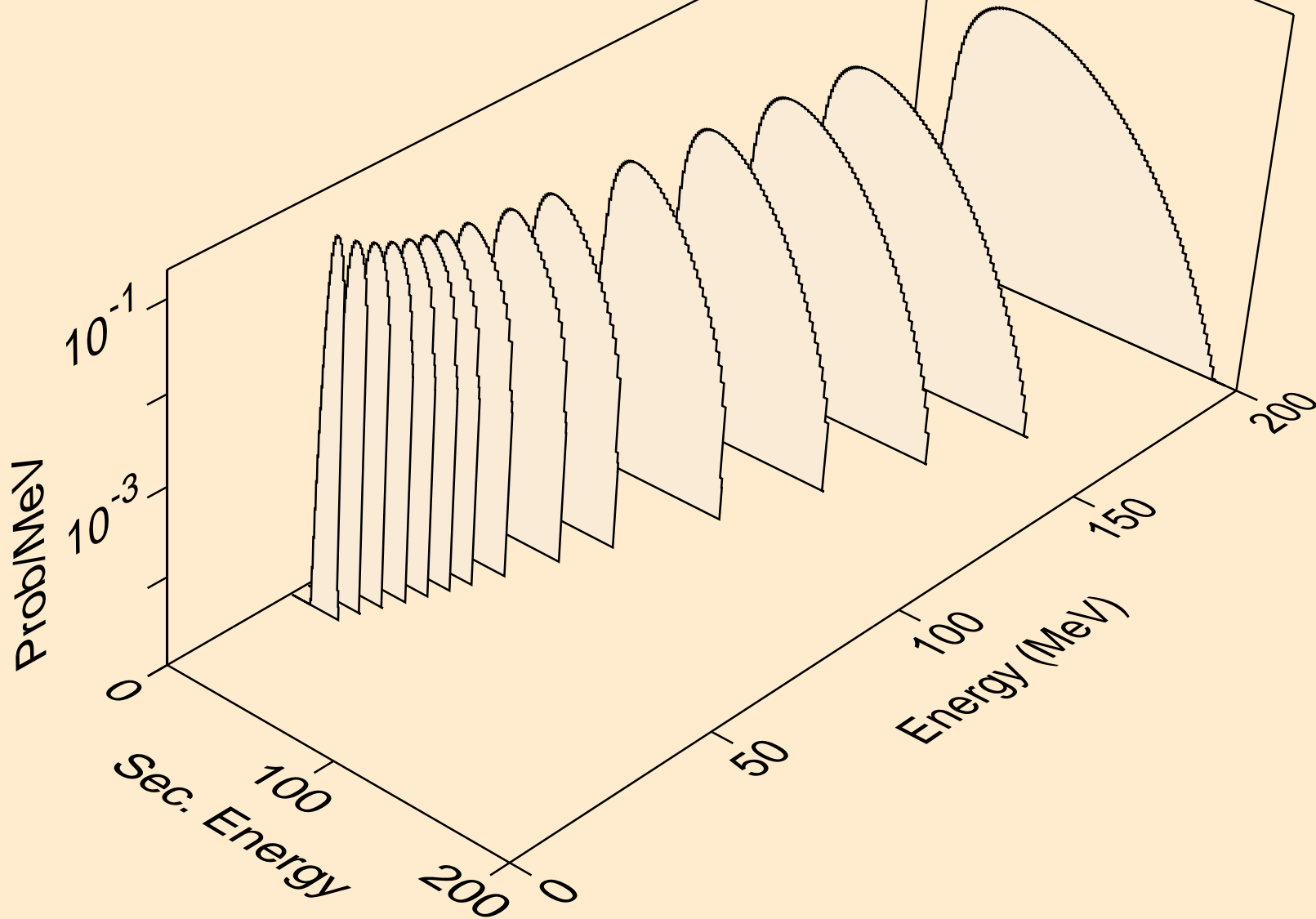

PT185 NEUTRON ACER TENDL-2019 LIBRARY; T=293.16K
he3s from (n,n*)he3

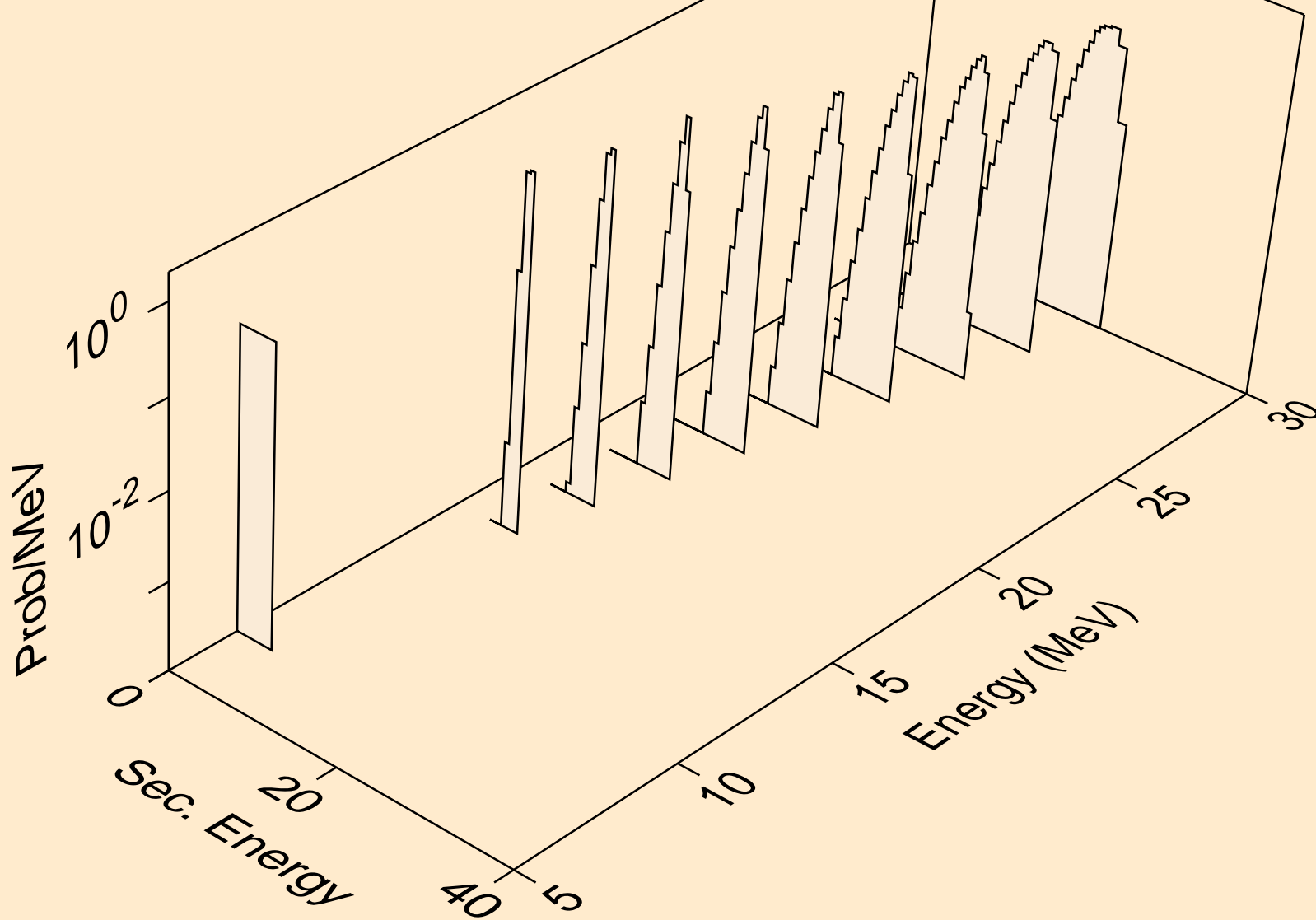

PT185 NEUTRON ACER TENDL-2019 LIBRARY; T=293.16K
he3s from (n,he3)

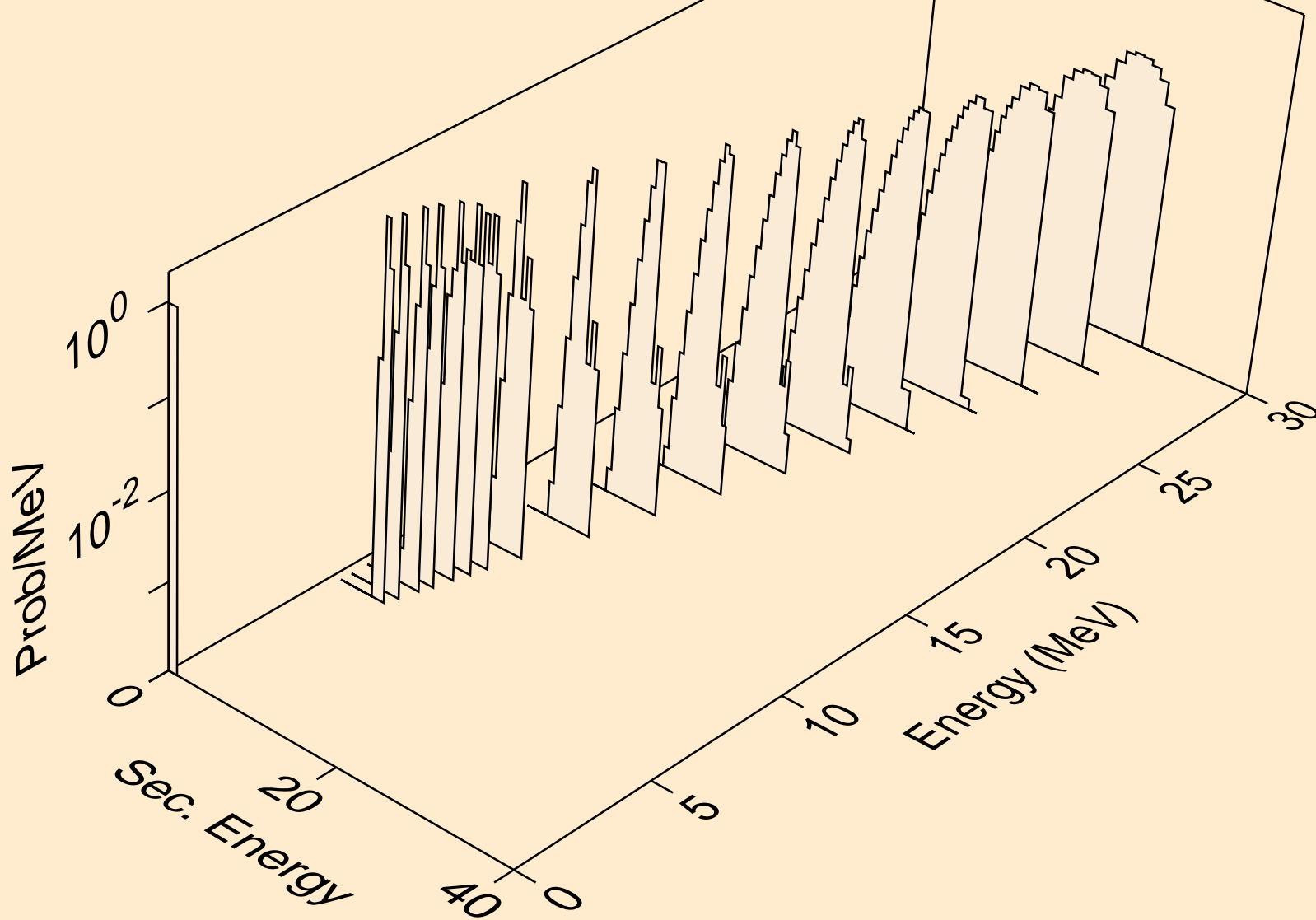

PT185 NEUTRON ACER TENDL-2019 LIBRARY; T=293.16K
alphas from (n,x)

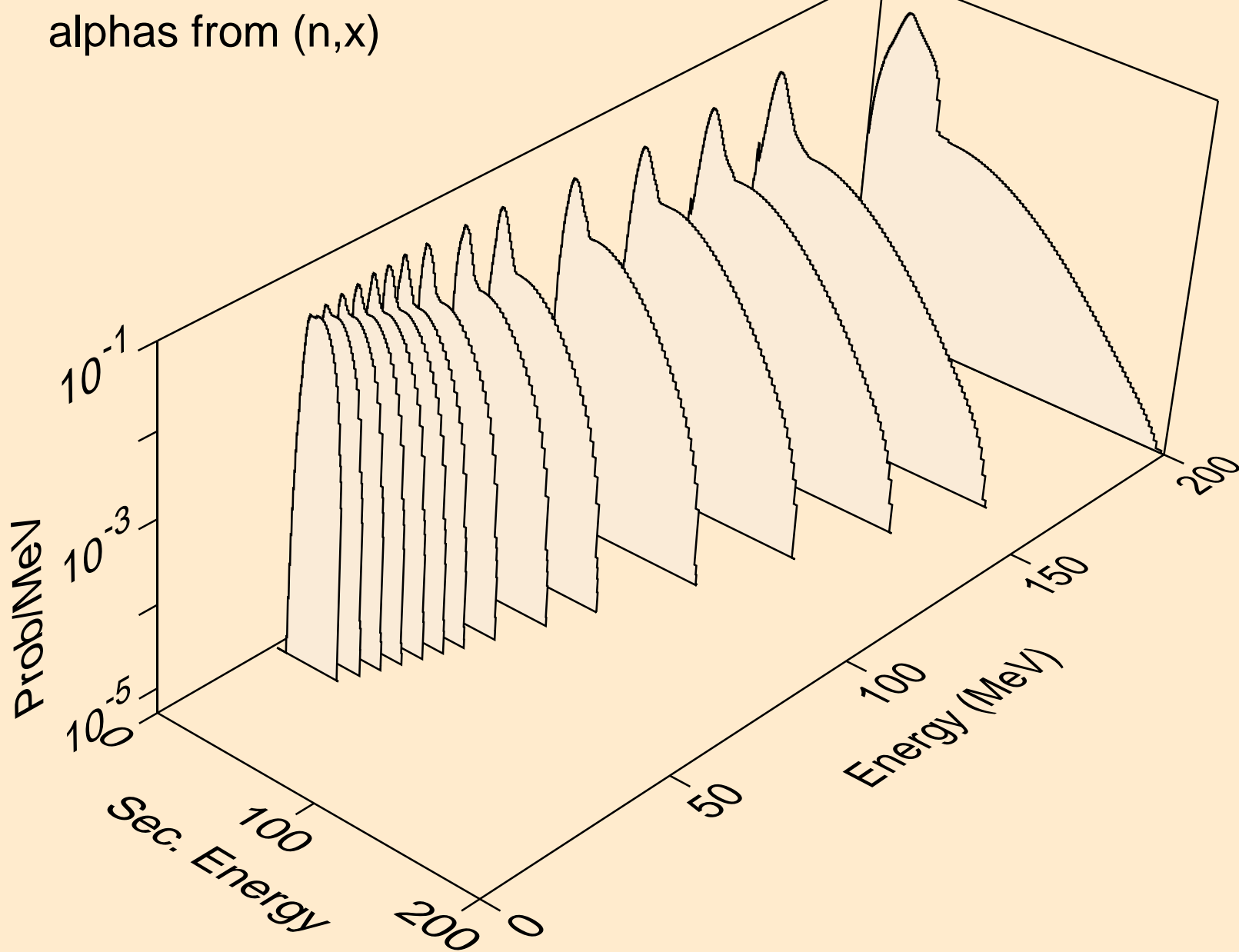

PT185 NEUTRON ACER TENDL-2019 LIBRARY; T=293.16K
alphas from (n,n*)a

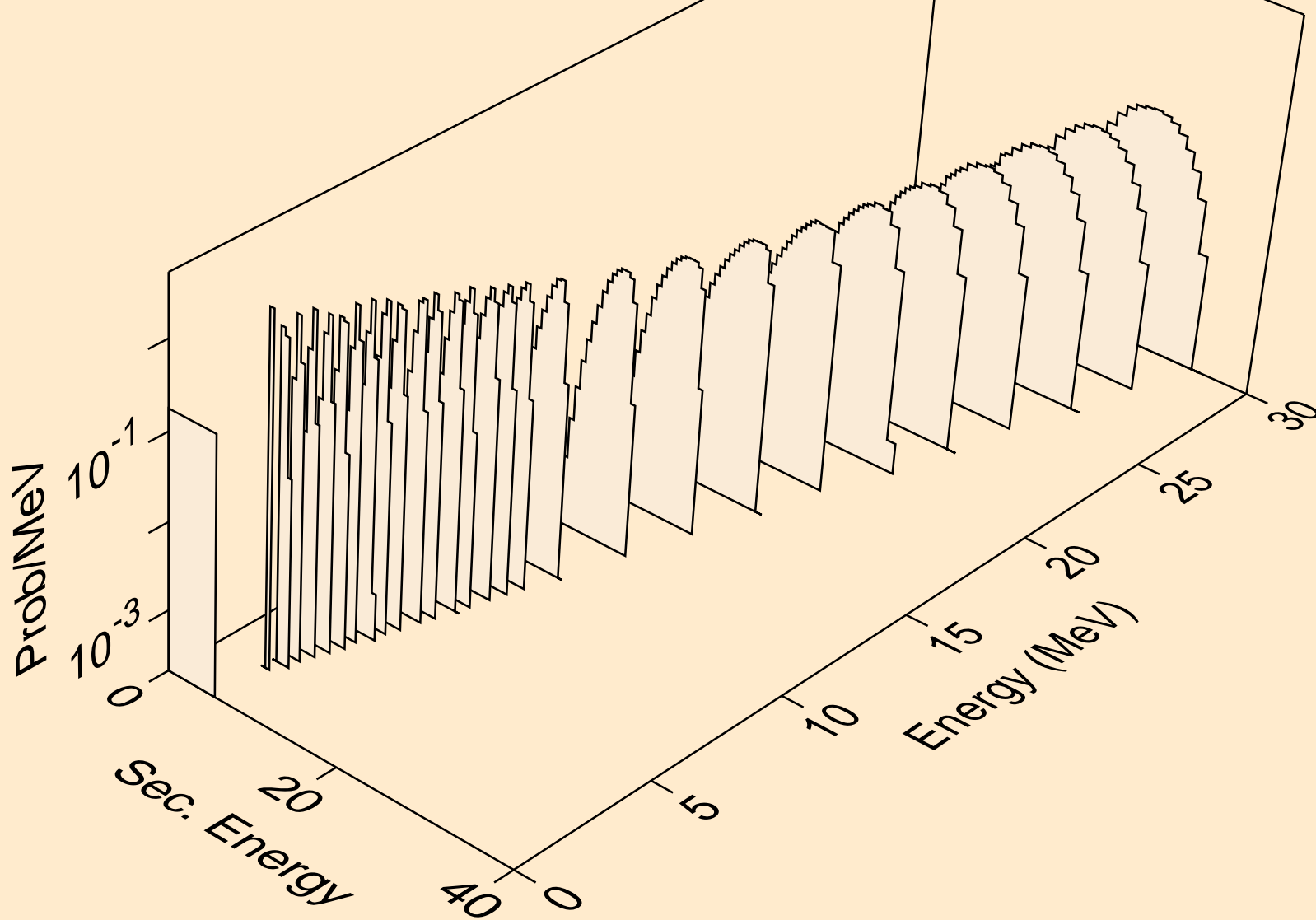

PT185 NEUTRON ACER TENDL-2019 LIBRARY; T=293.16K
alphas from (n,2n)a

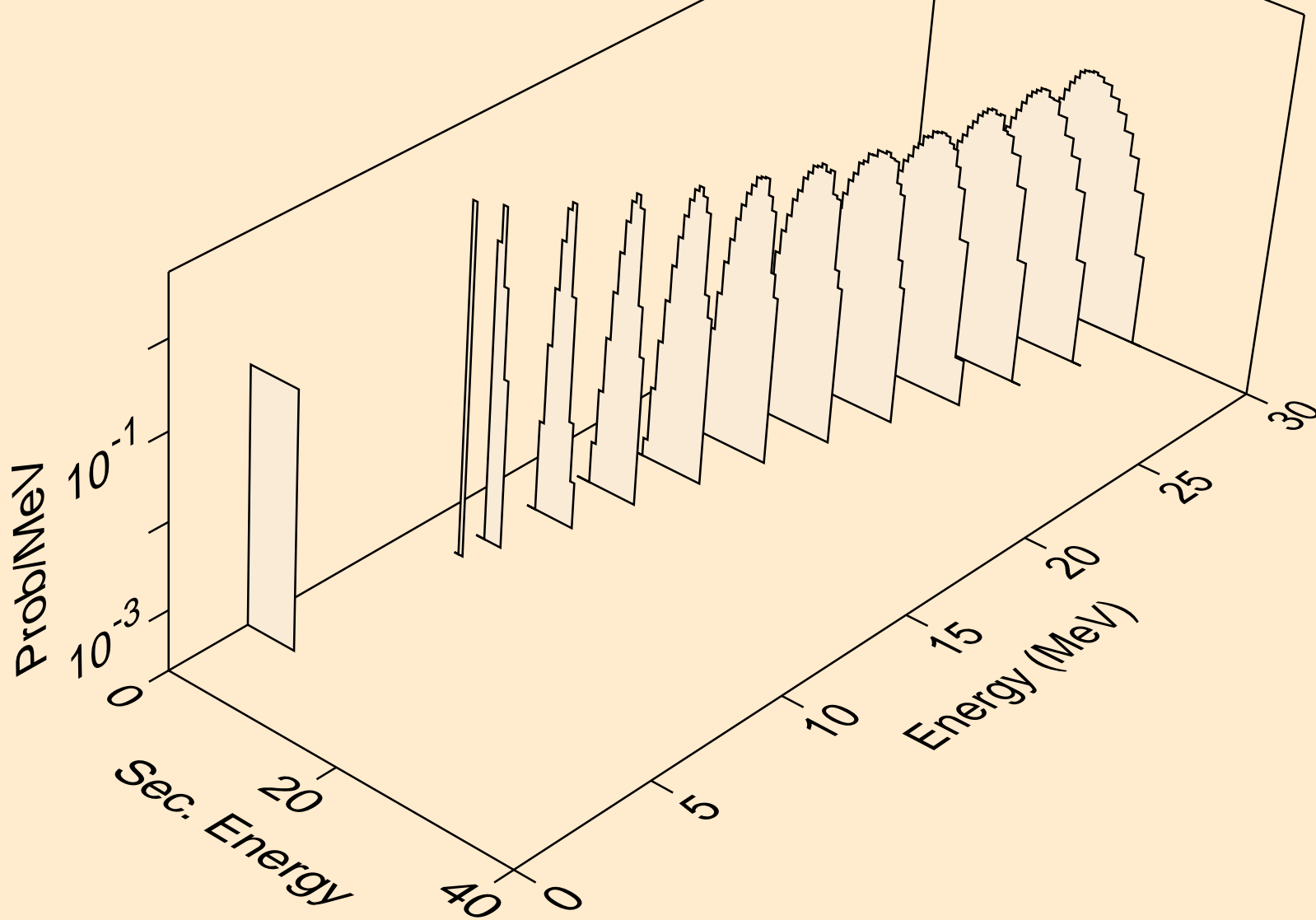

PT185 NEUTRON ACER TENDL-2019 LIBRARY; T=293.16K
alphas from (n,3n)a

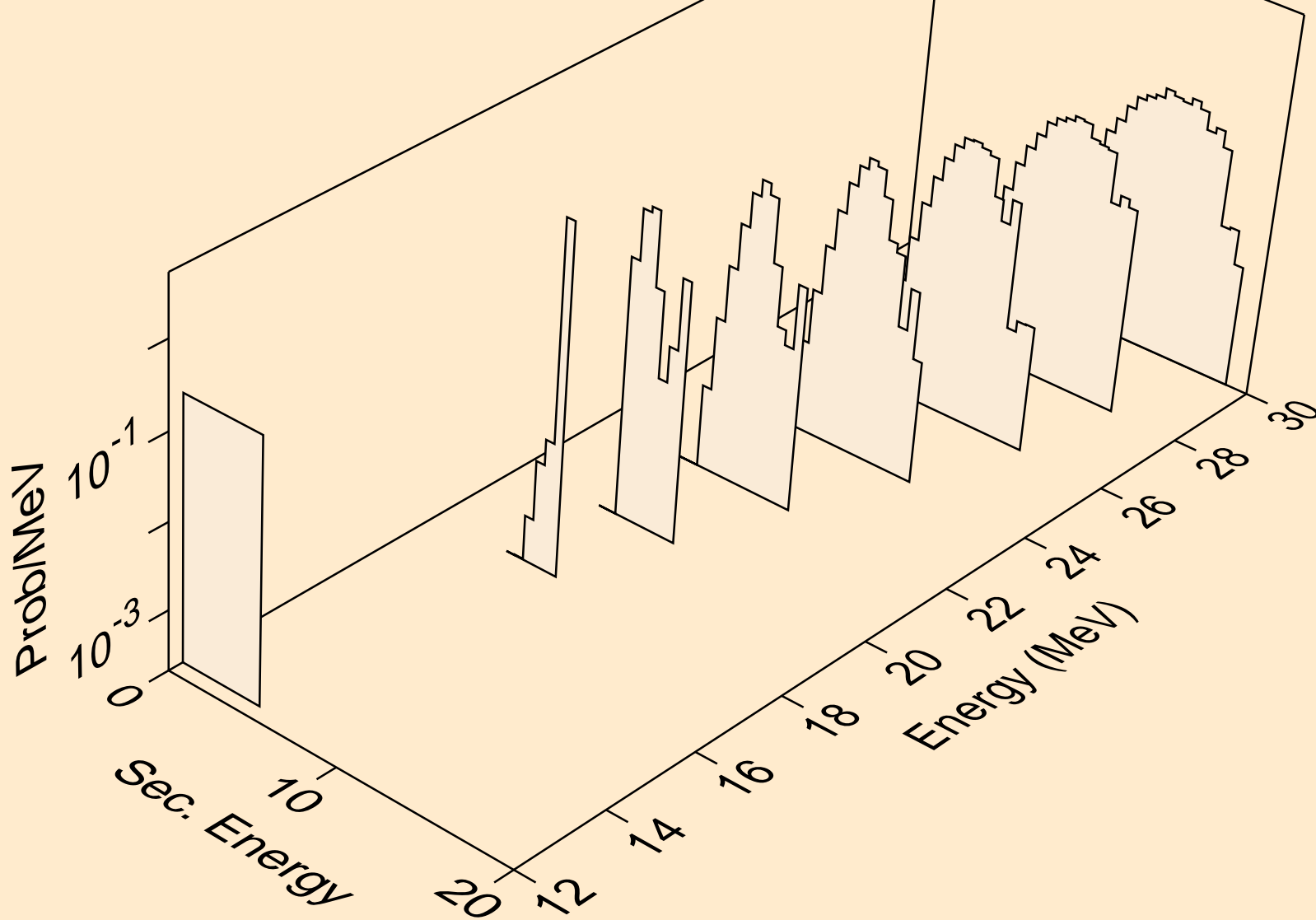

PT185 NEUTRON ACER TENDL-2019 LIBRARY; T=293.16K
alphas from (n,n*)2a

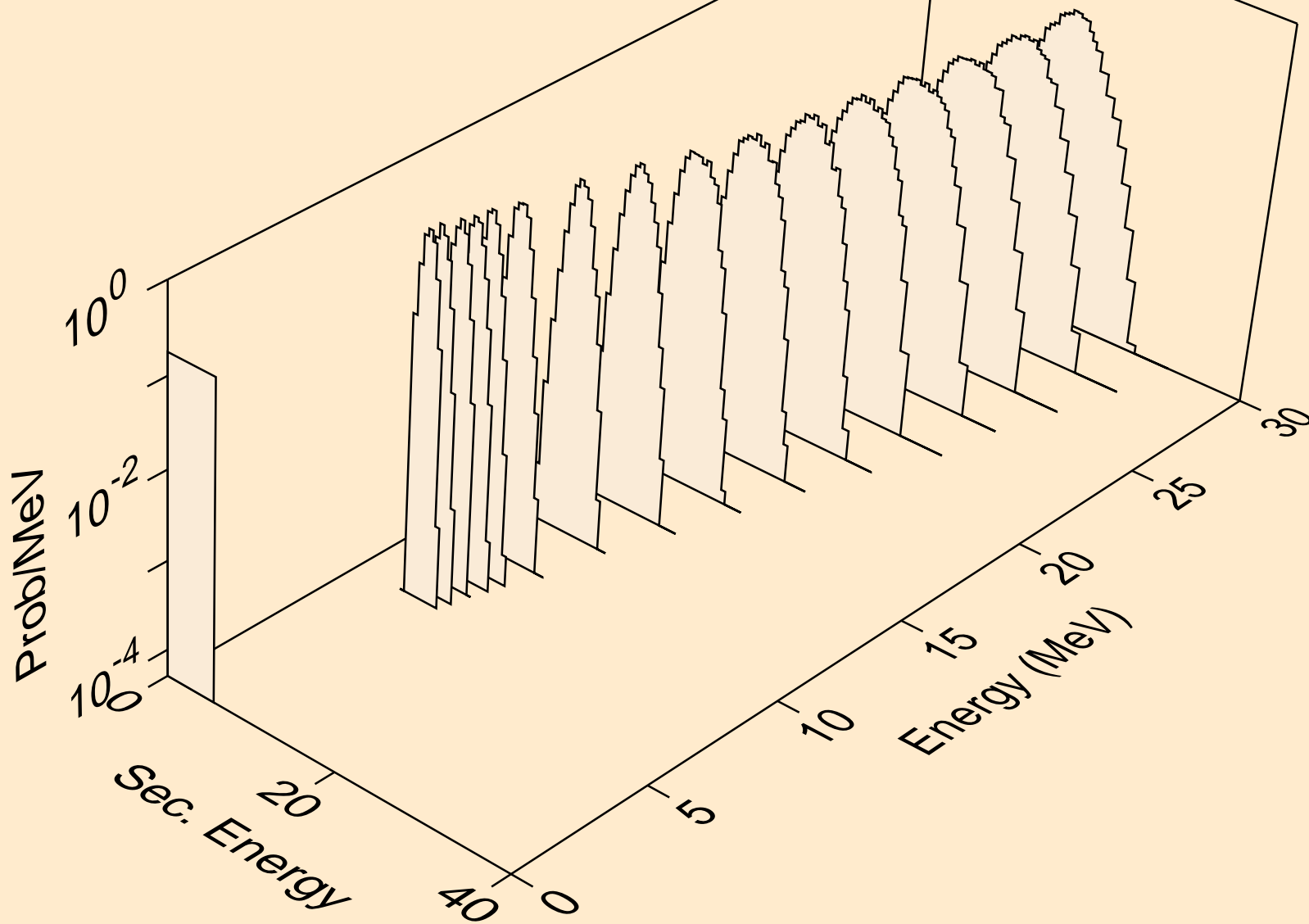

PT185 NEUTRON ACER TENDL-2019 LIBRARY; T=293.16K
alphas from (n,2n)2a

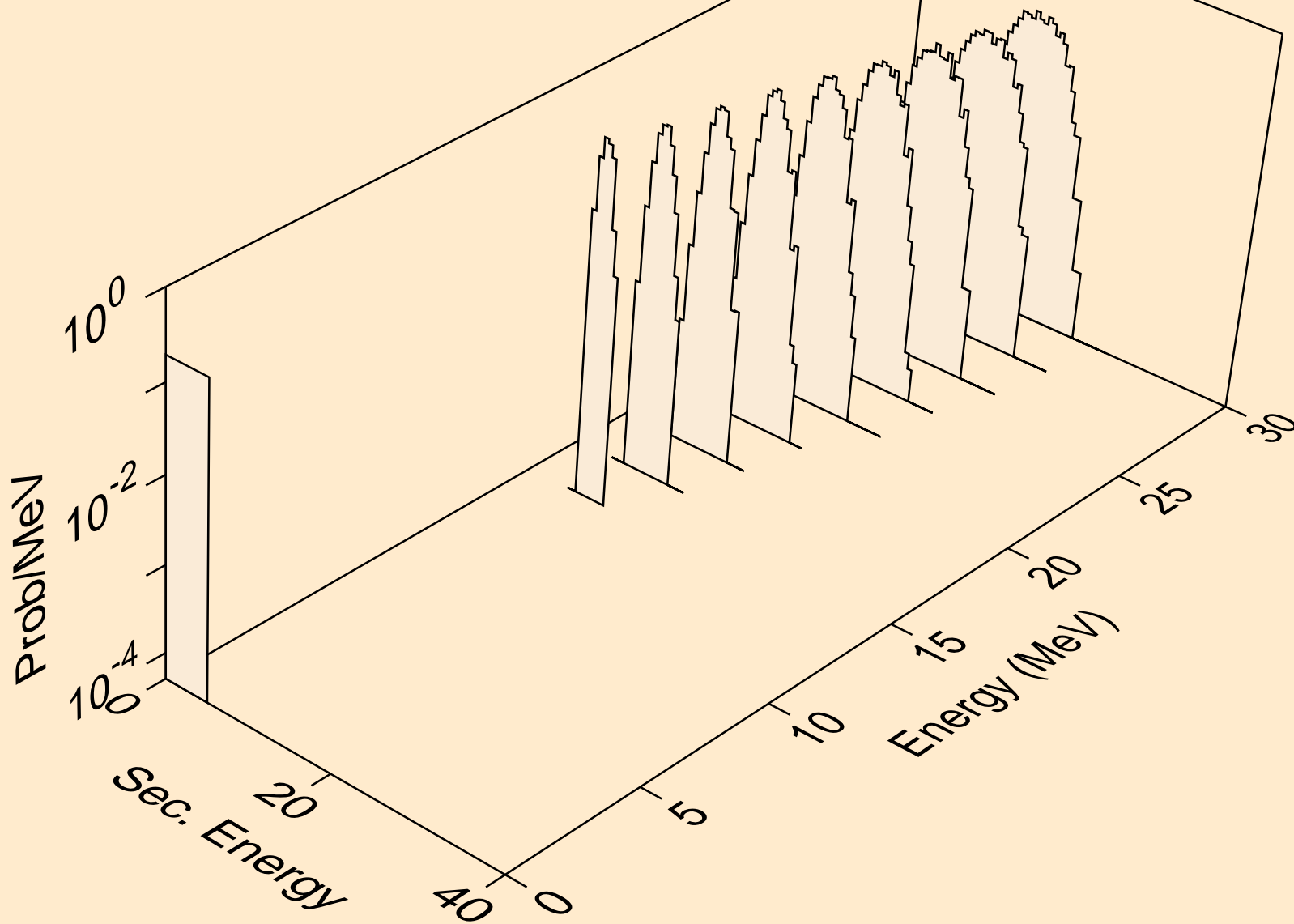

PT185 NEUTRON ACER TENDL-2019 LIBRARY; T=293.16K
alphas from (n,npa)

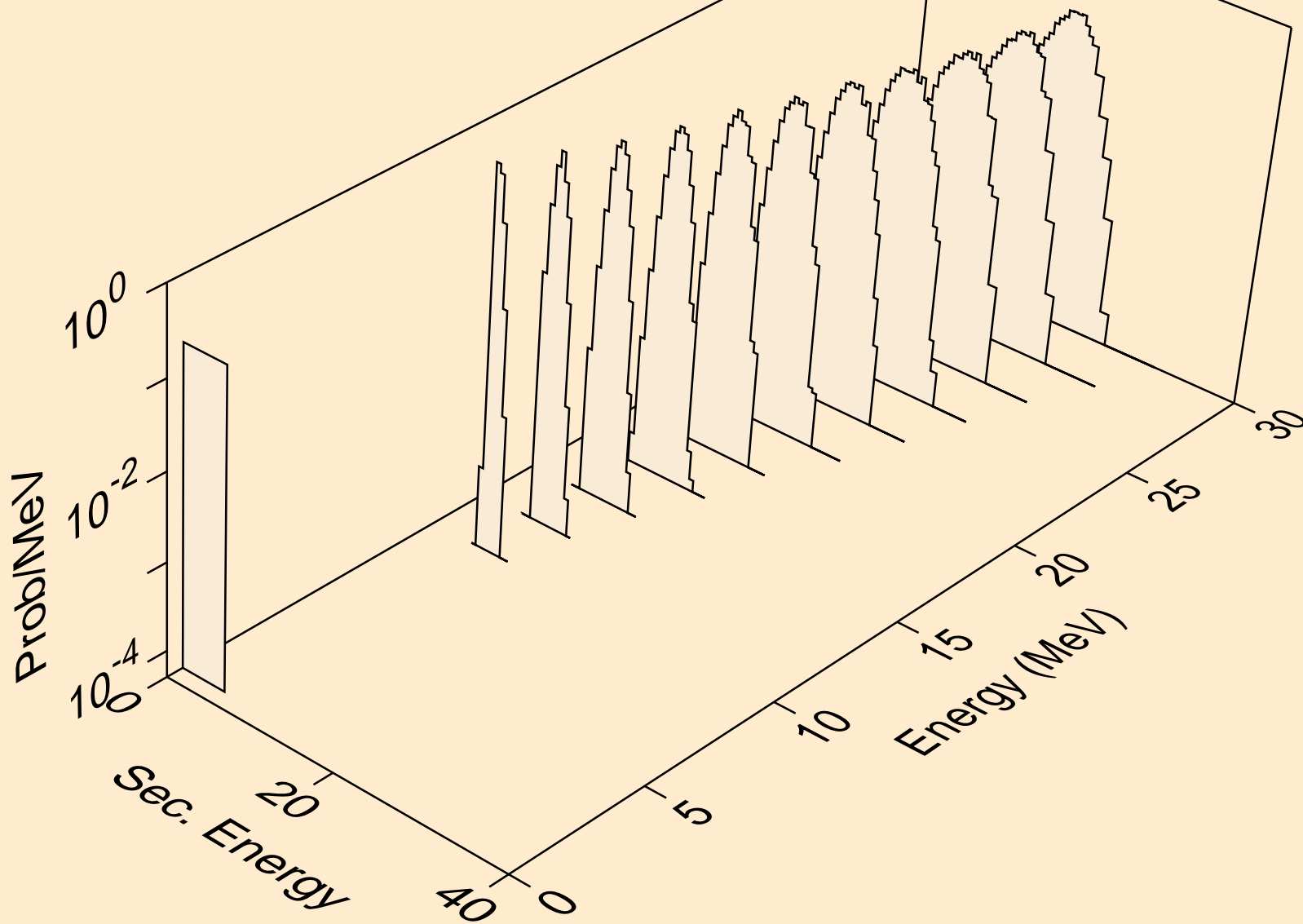

PT185 NEUTRON ACER TENDL-2019 LIBRARY; T=293.16K
alphas from (n,a)

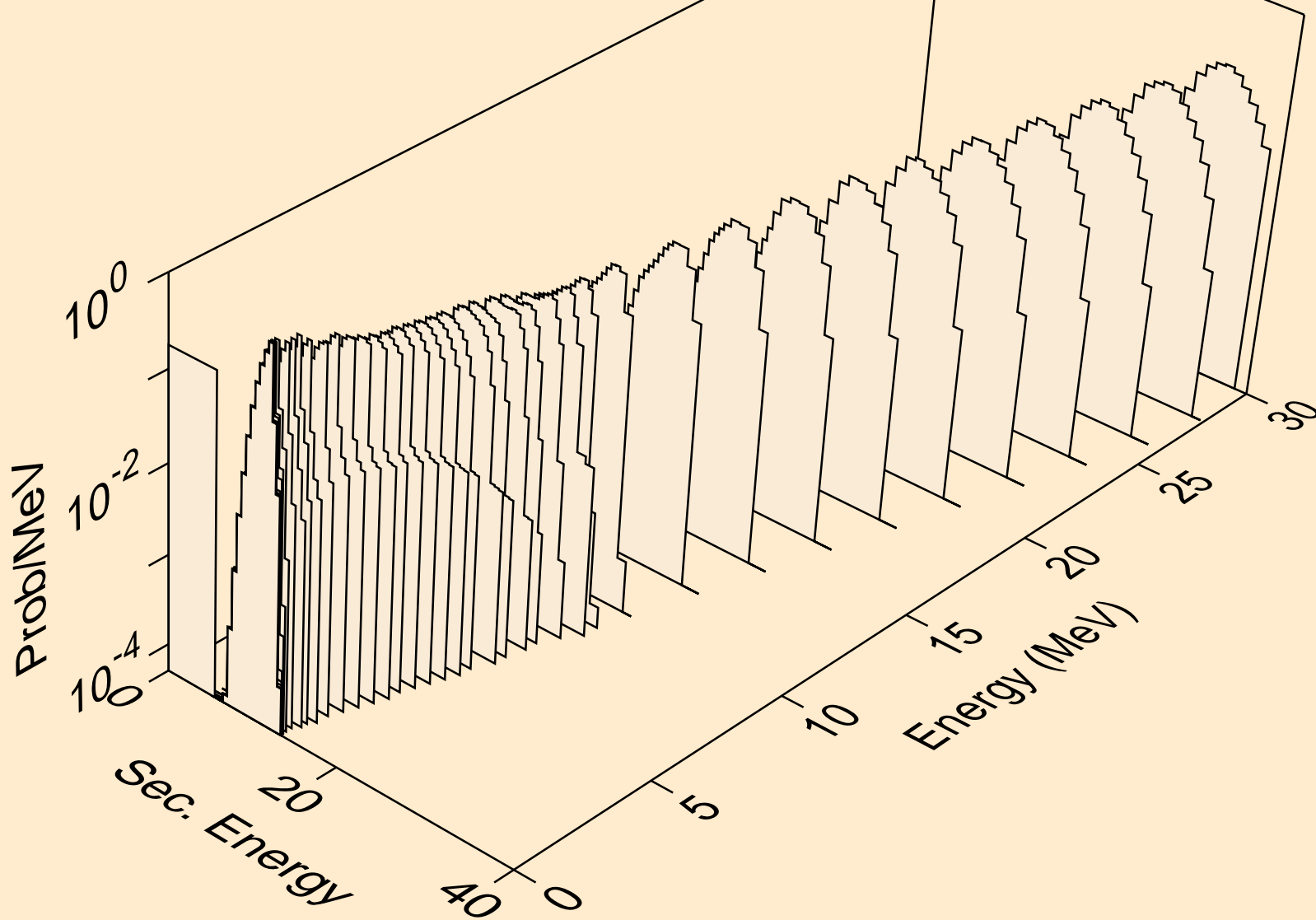

PT185 NEUTRON ACER TENDL-2019 LIBRARY; T=293.16K
alphas from (n,2a)

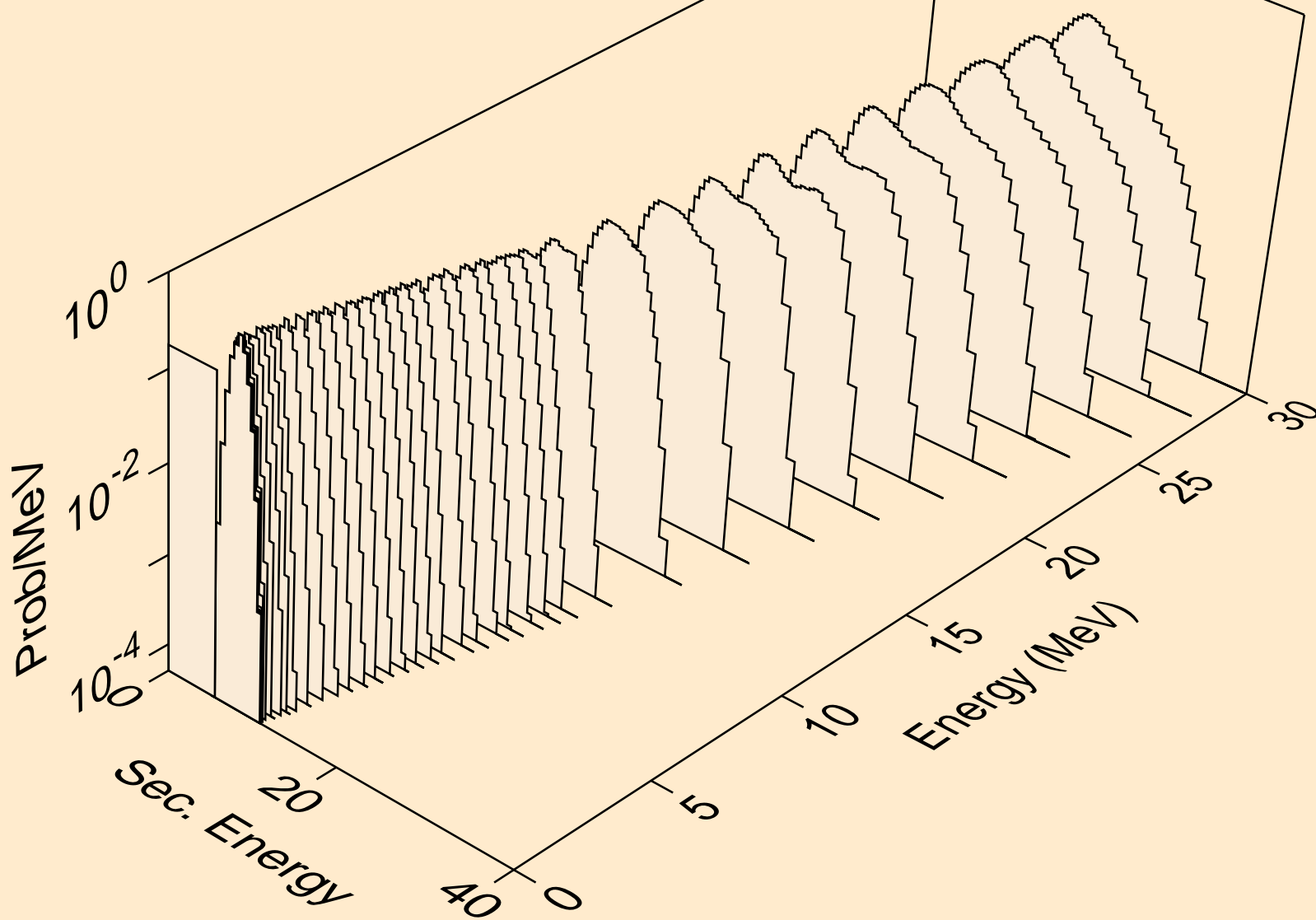

PT185 NEUTRON ACER TENDL-2019 LIBRARY; T=293.16K
alphas from (n,pa)

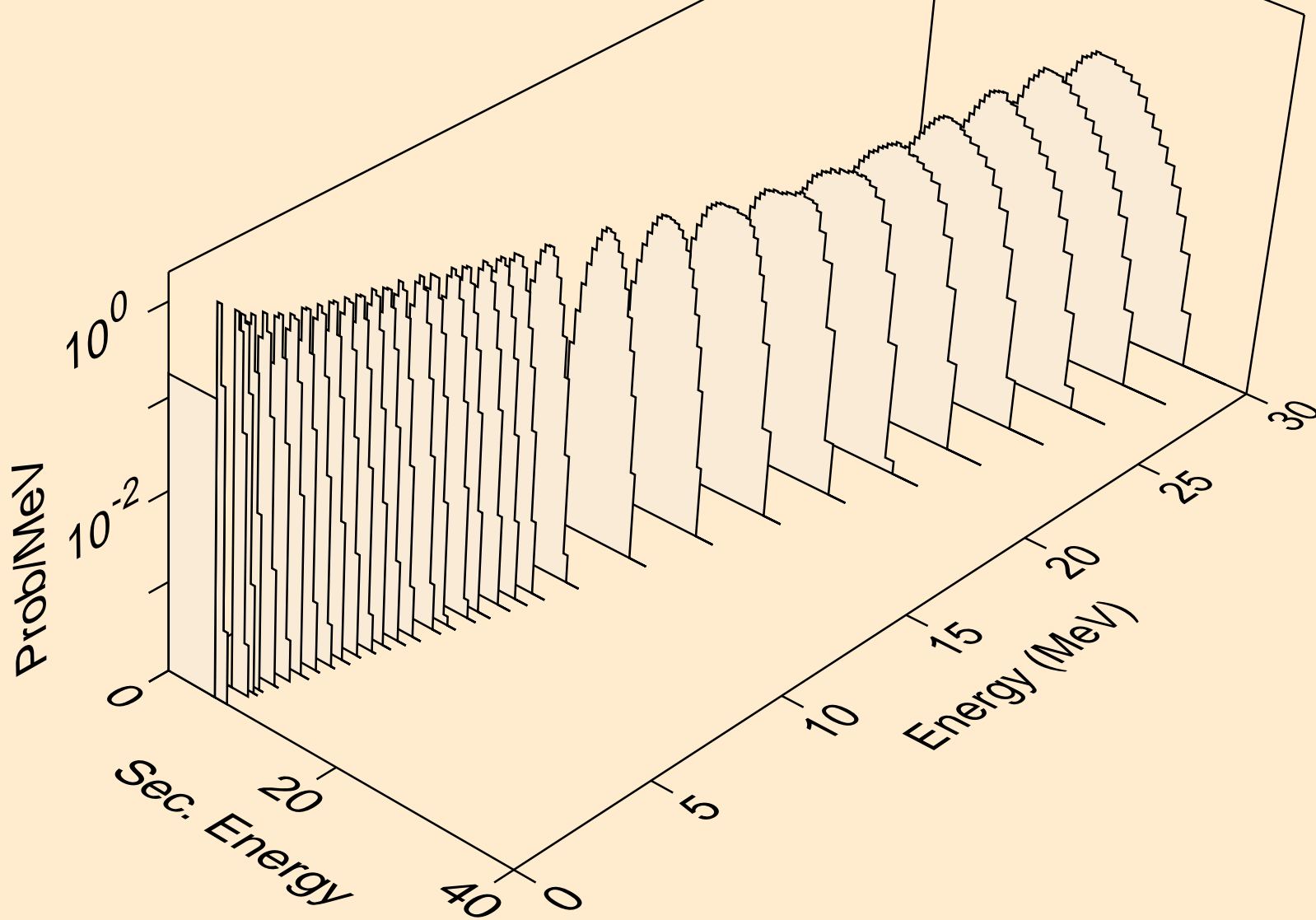

PT185 NEUTRON ACER TENDL-2019 LIBRARY; T=293.16K
alphas from (n,da)

