

PT188 NEUTRON ACER TENDL-2019 LIBRARY; T=293.16K
Principal cross sections

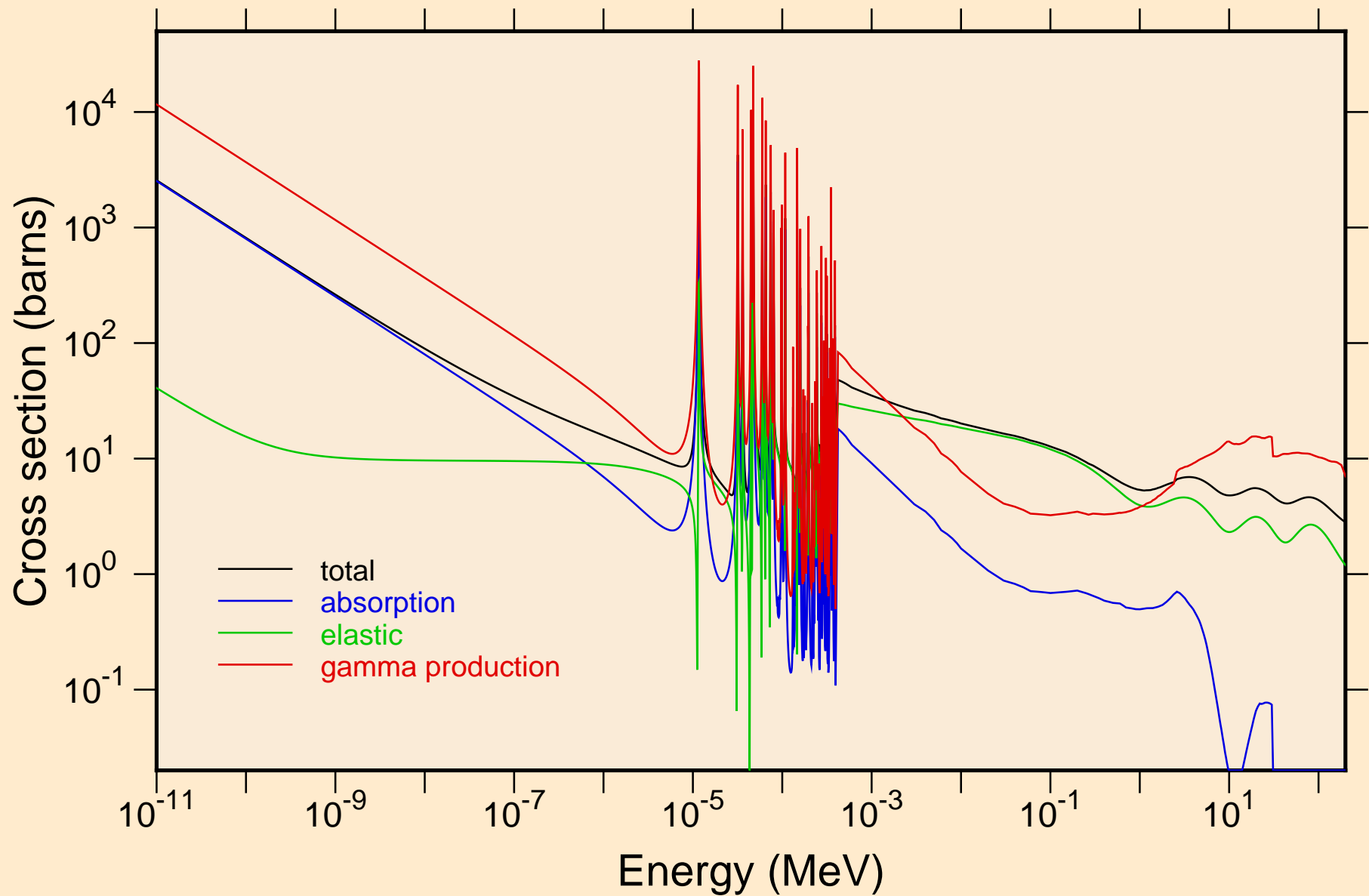

PT188 NEUTRON ACER TENDL-2019 LIBRARY; T=293.16K
resonance total cross section

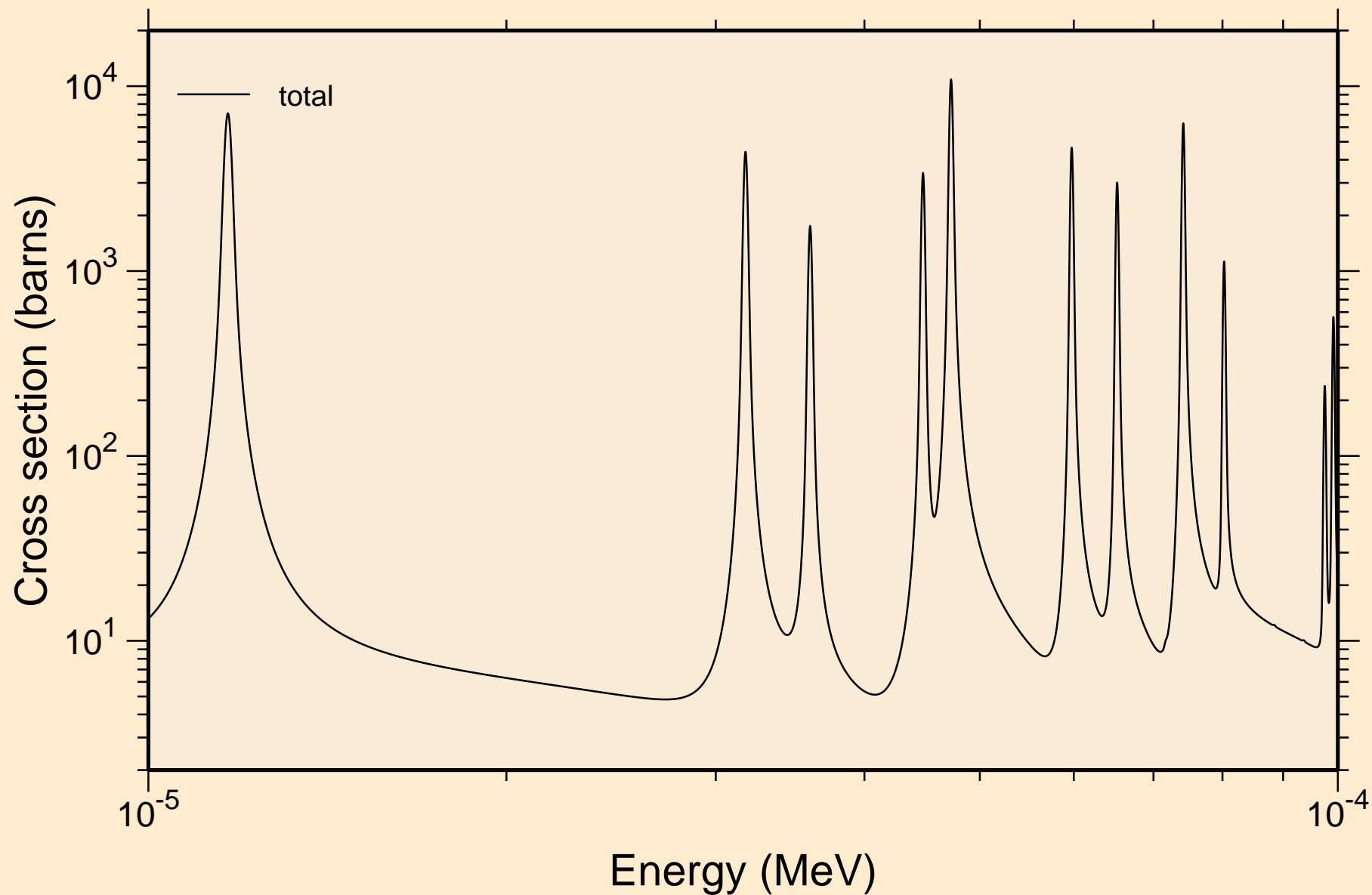

PT188 NEUTRON ACER TENDL-2019 LIBRARY; T=293.16K
resonance total cross section

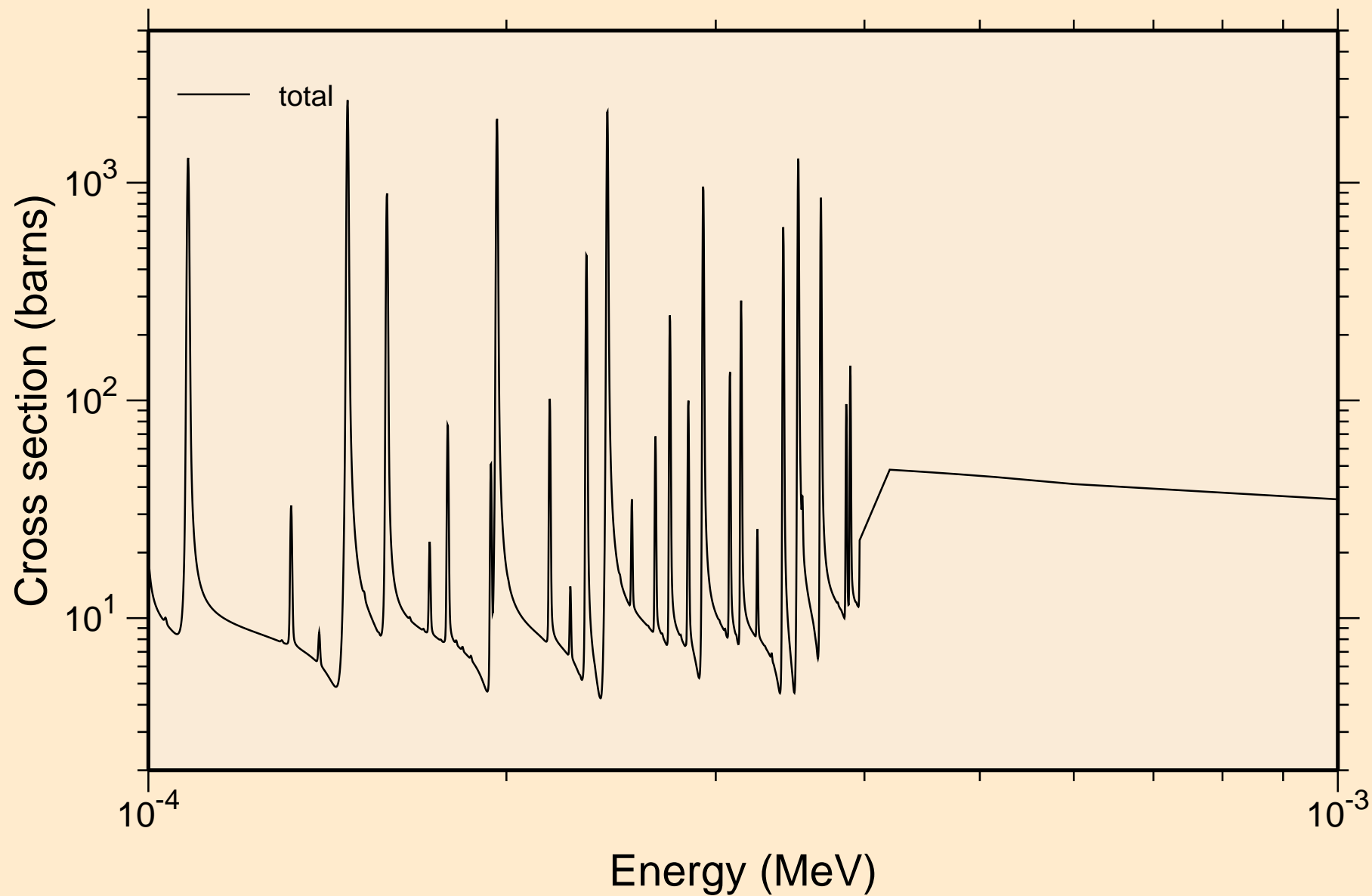

PT188 NEUTRON ACER TENDL-2019 LIBRARY; T=293.16K
resonance total cross section

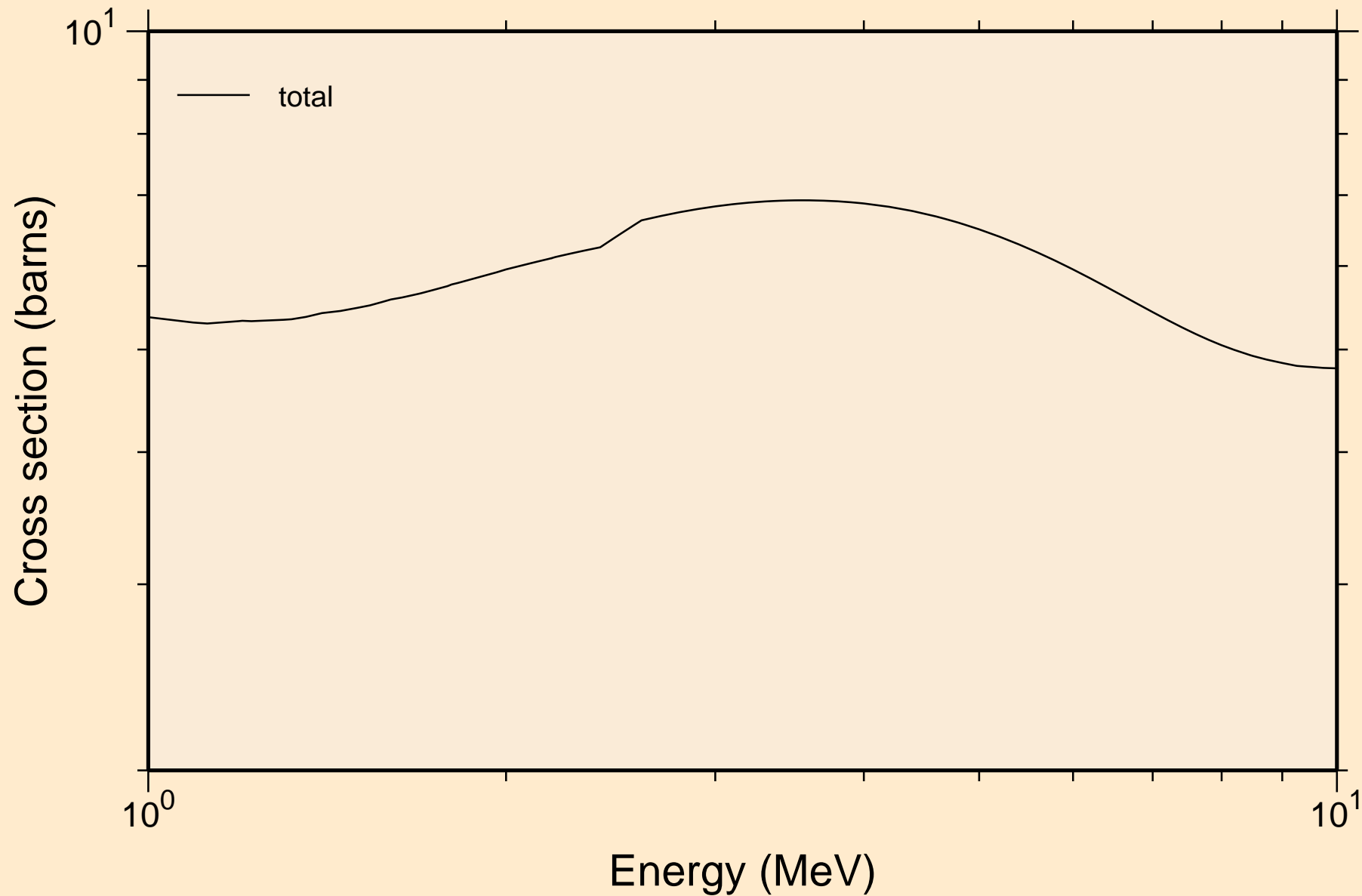

PT188 NEUTRON ACER TENDL-2019 LIBRARY; T=293.16K
resonance absorption cross sections

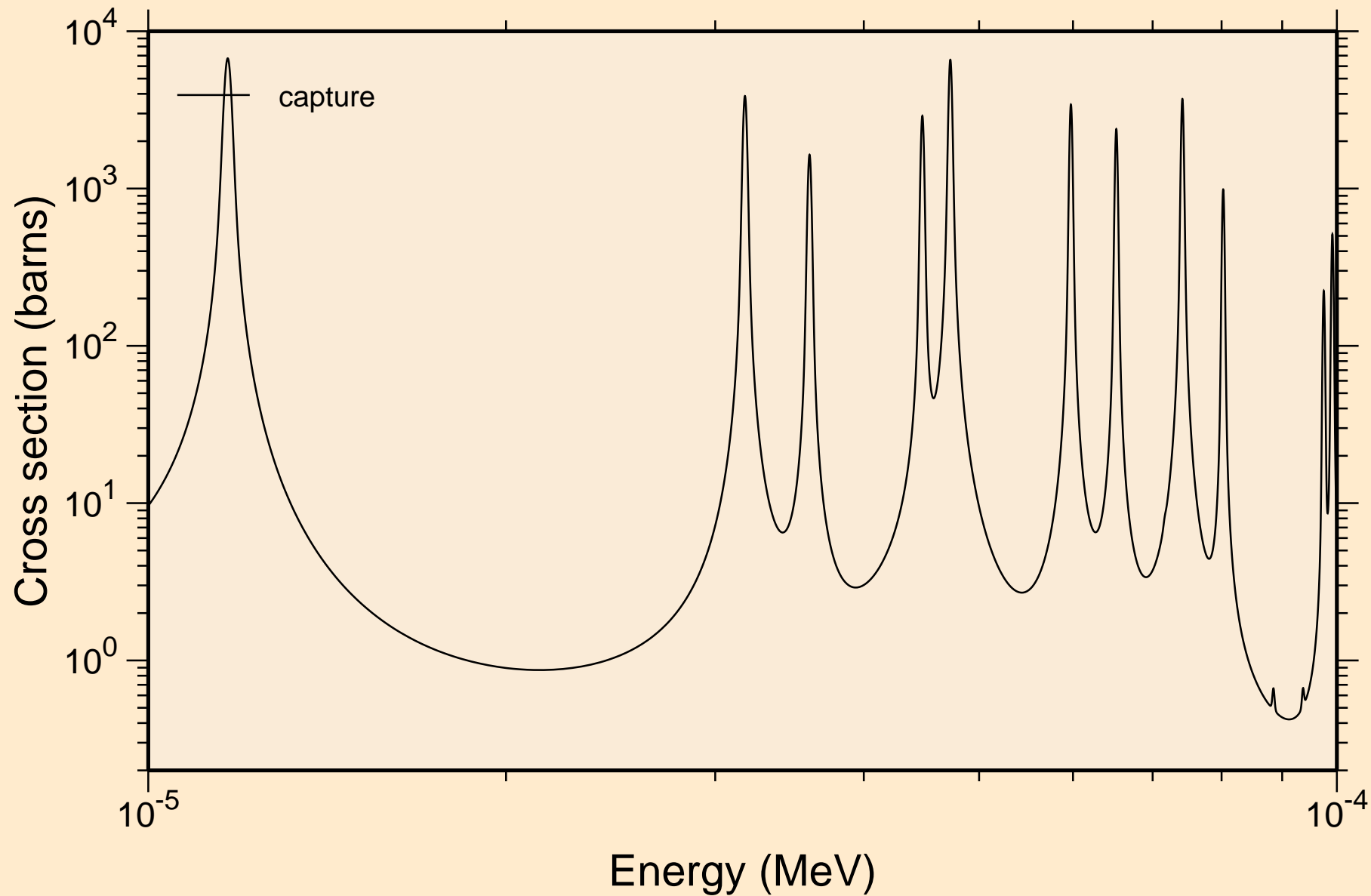

PT188 NEUTRON ACER TENDL-2019 LIBRARY; T=293.16K
resonance absorption cross sections

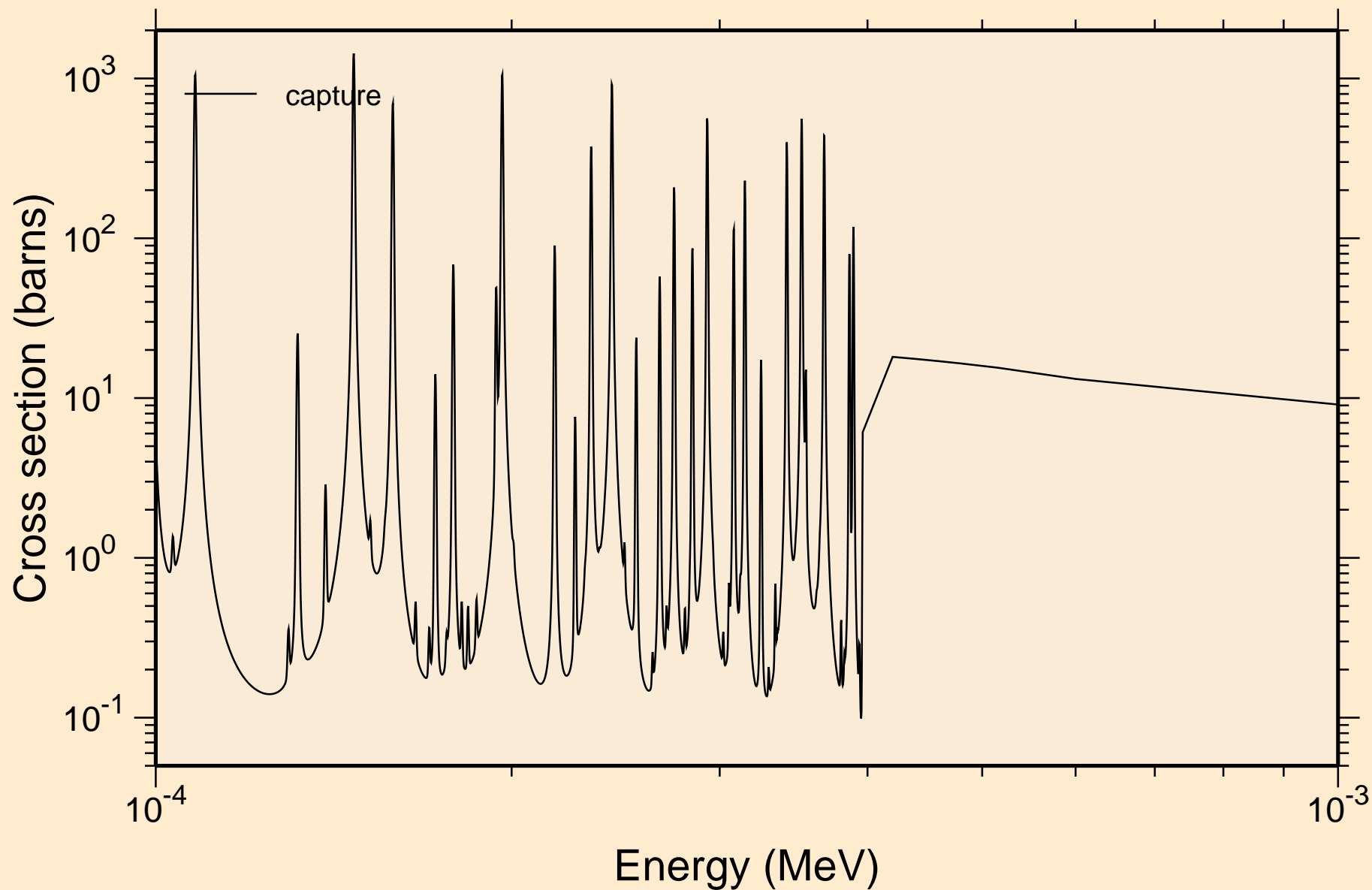

PT188 NEUTRON ACER TENDL-2019 LIBRARY; T=293.16K
resonance absorption cross sections

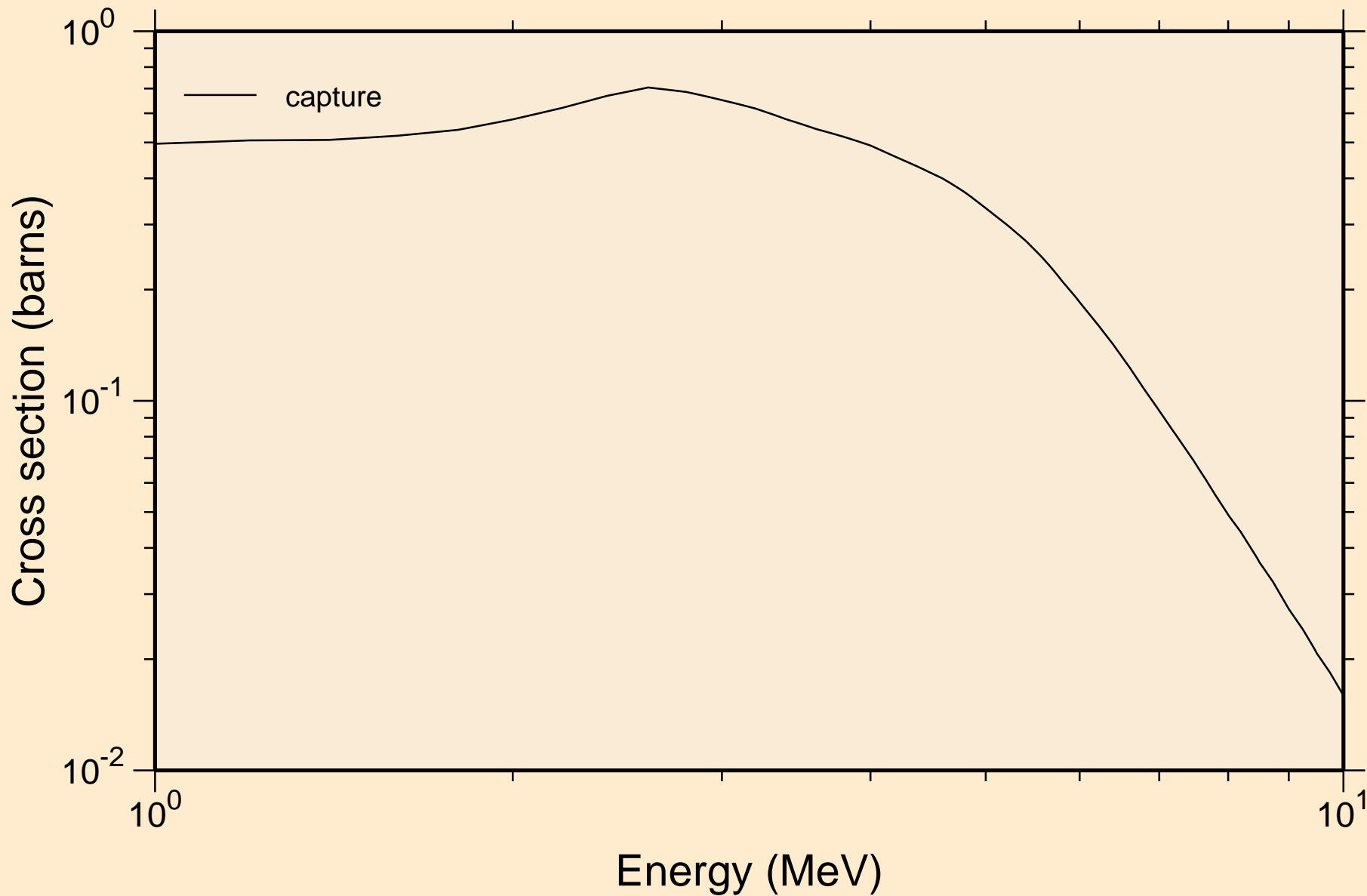

PT188 NEUTRON ACER TENDL-2019 LIBRARY; T=293.16K
Heating

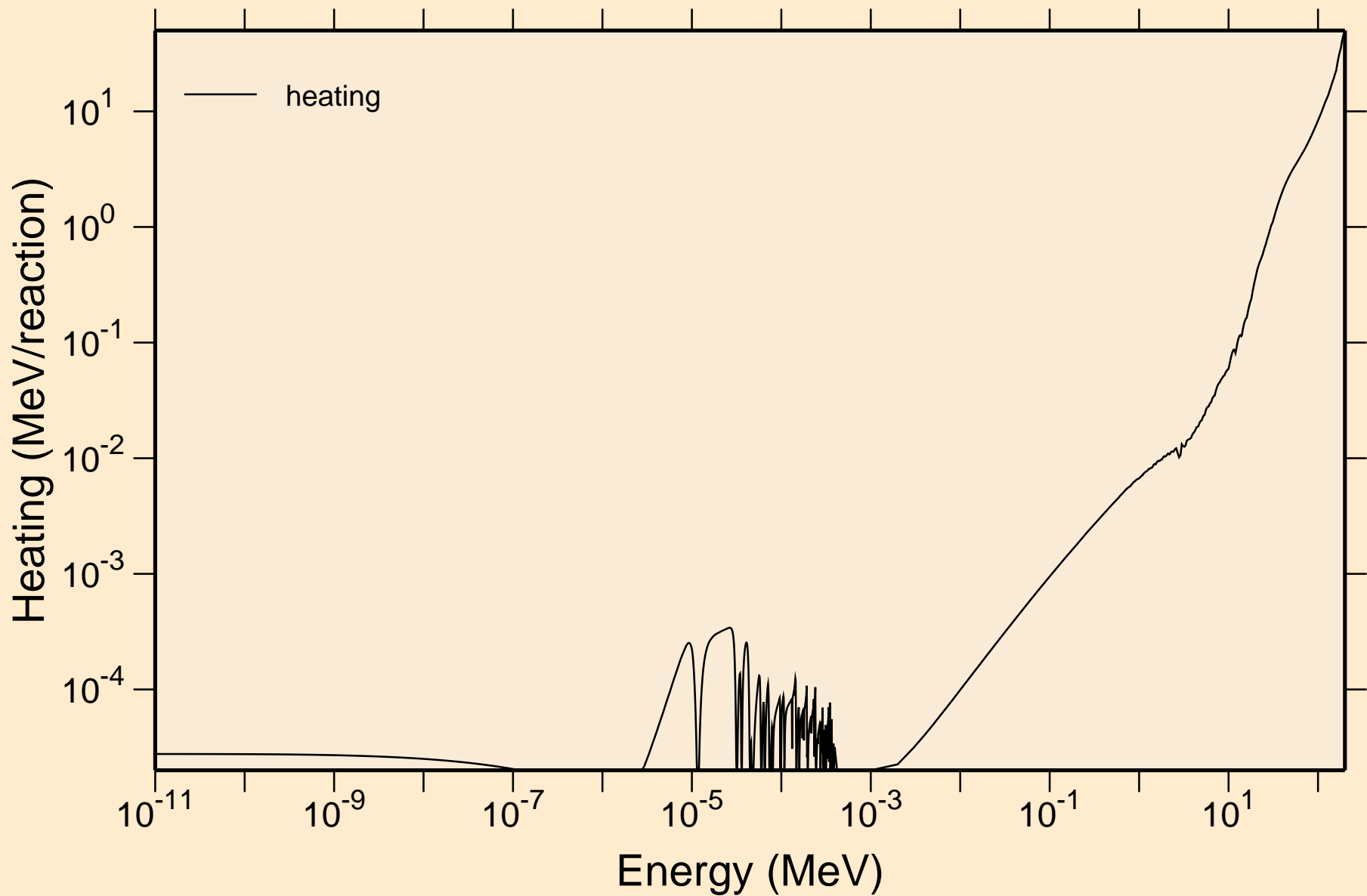

PT188 NEUTRON ACER TENDL-2019 LIBRARY; T=293.16K
Damage

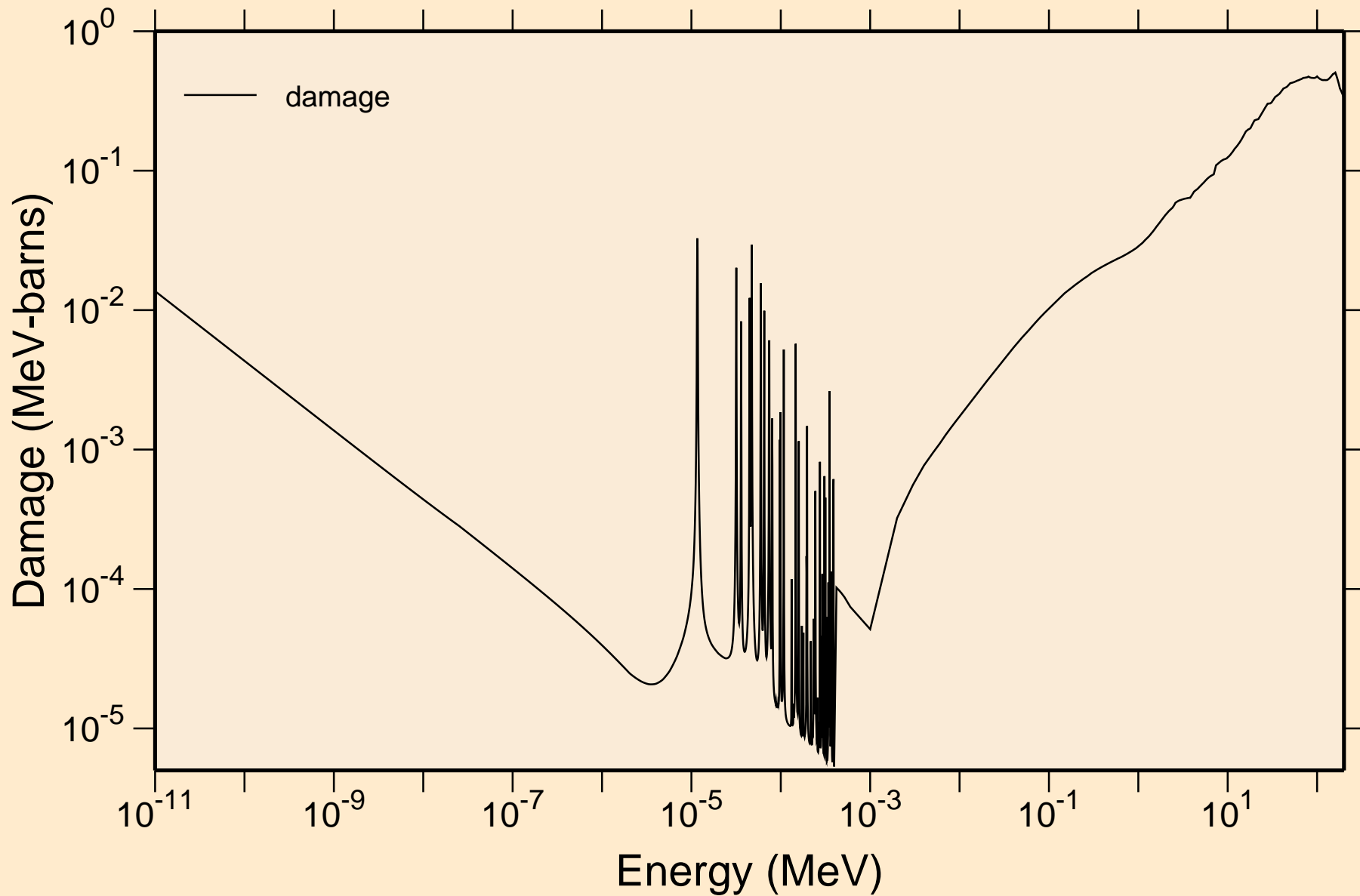

PT188 NEUTRON ACER TENDL-2019 LIBRARY; T=293.16K
Non-threshold reactions

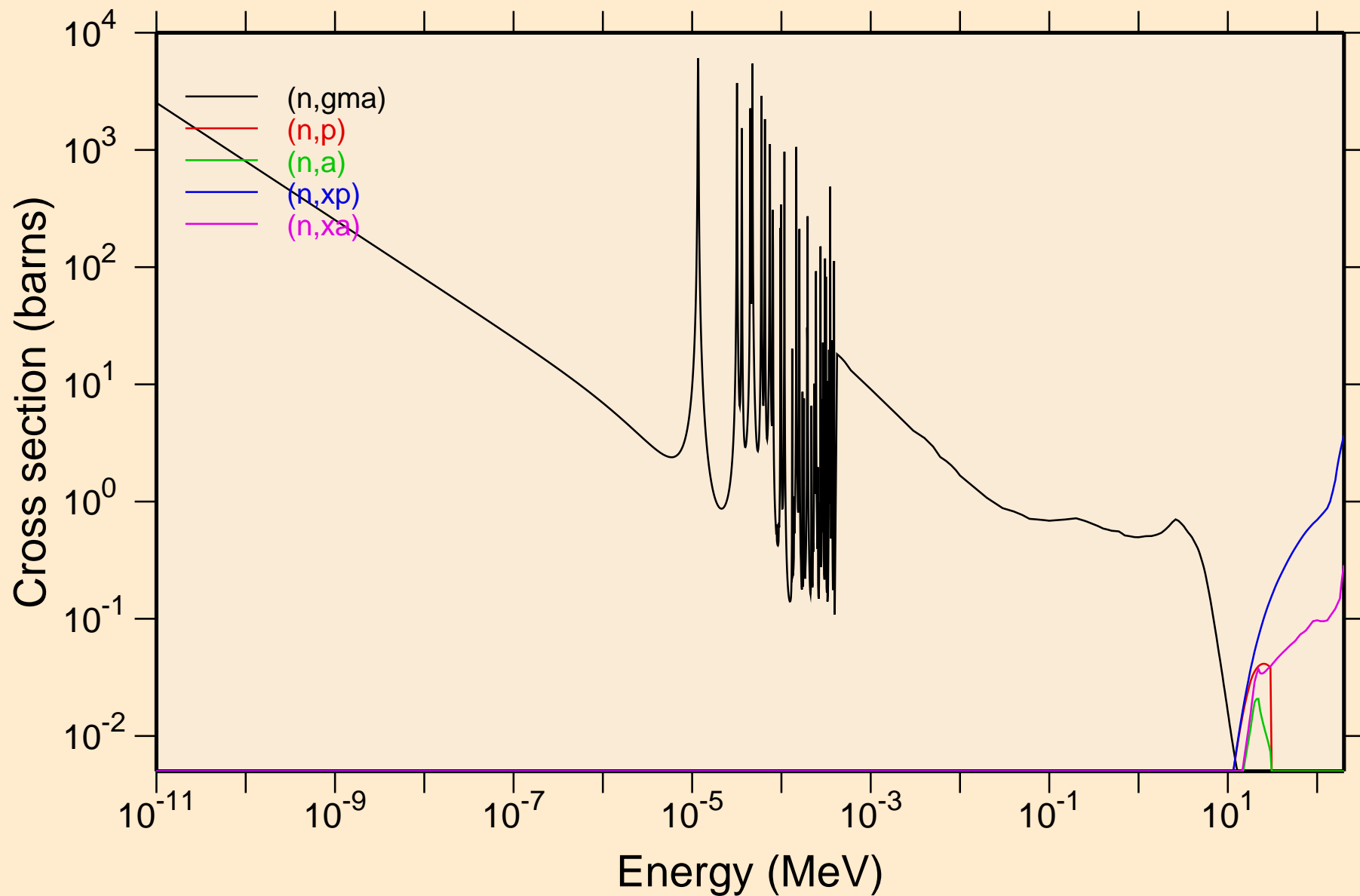

PT188 NEUTRON ACER TENDL-2019 LIBRARY; T=293.16K
Principal cross sections

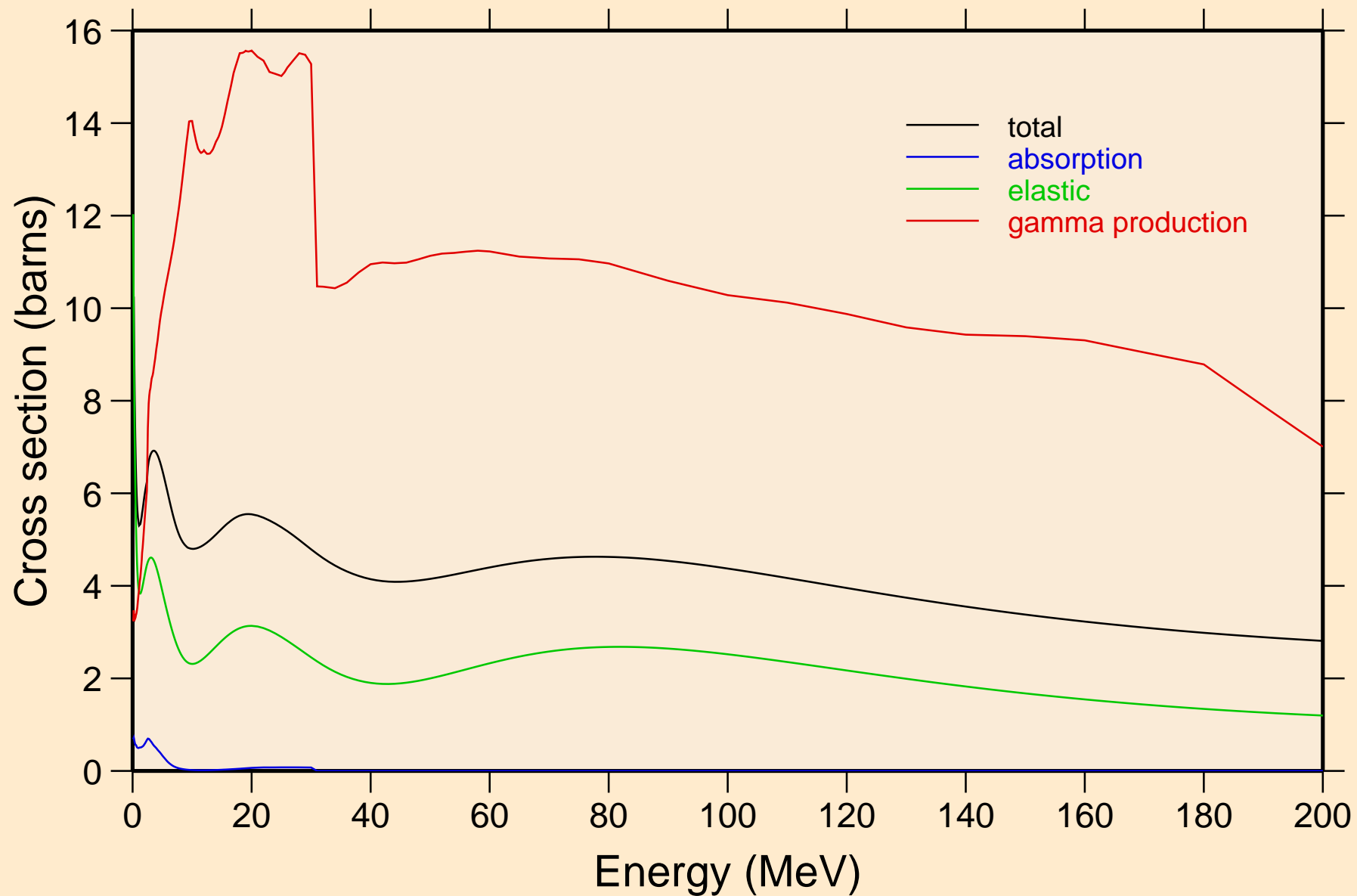

PT188 NEUTRON ACER TENDL-2019 LIBRARY; T=293.16K
Heating

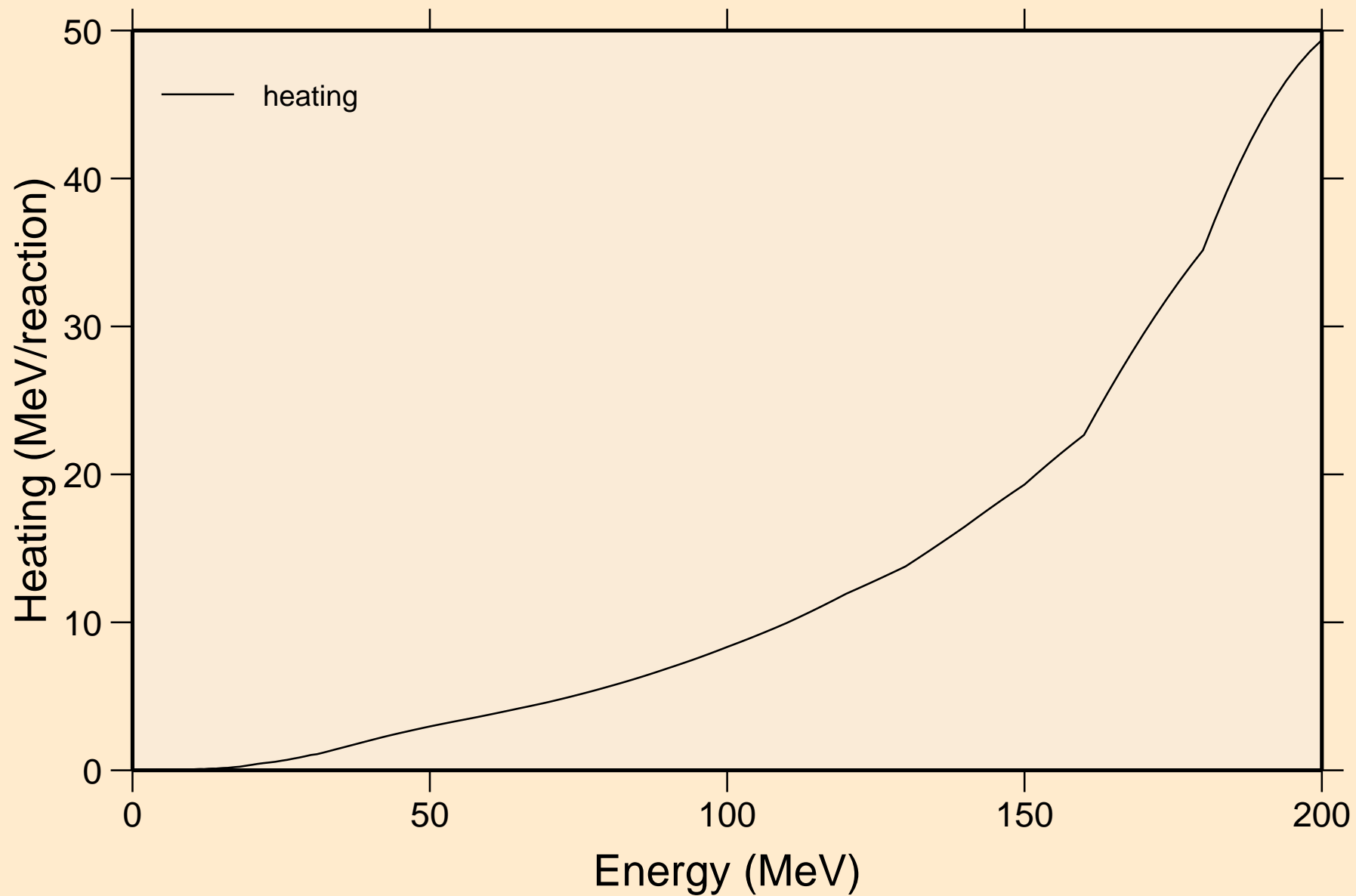

PT188 NEUTRON ACER TENDL-2019 LIBRARY; T=293.16K
Damage

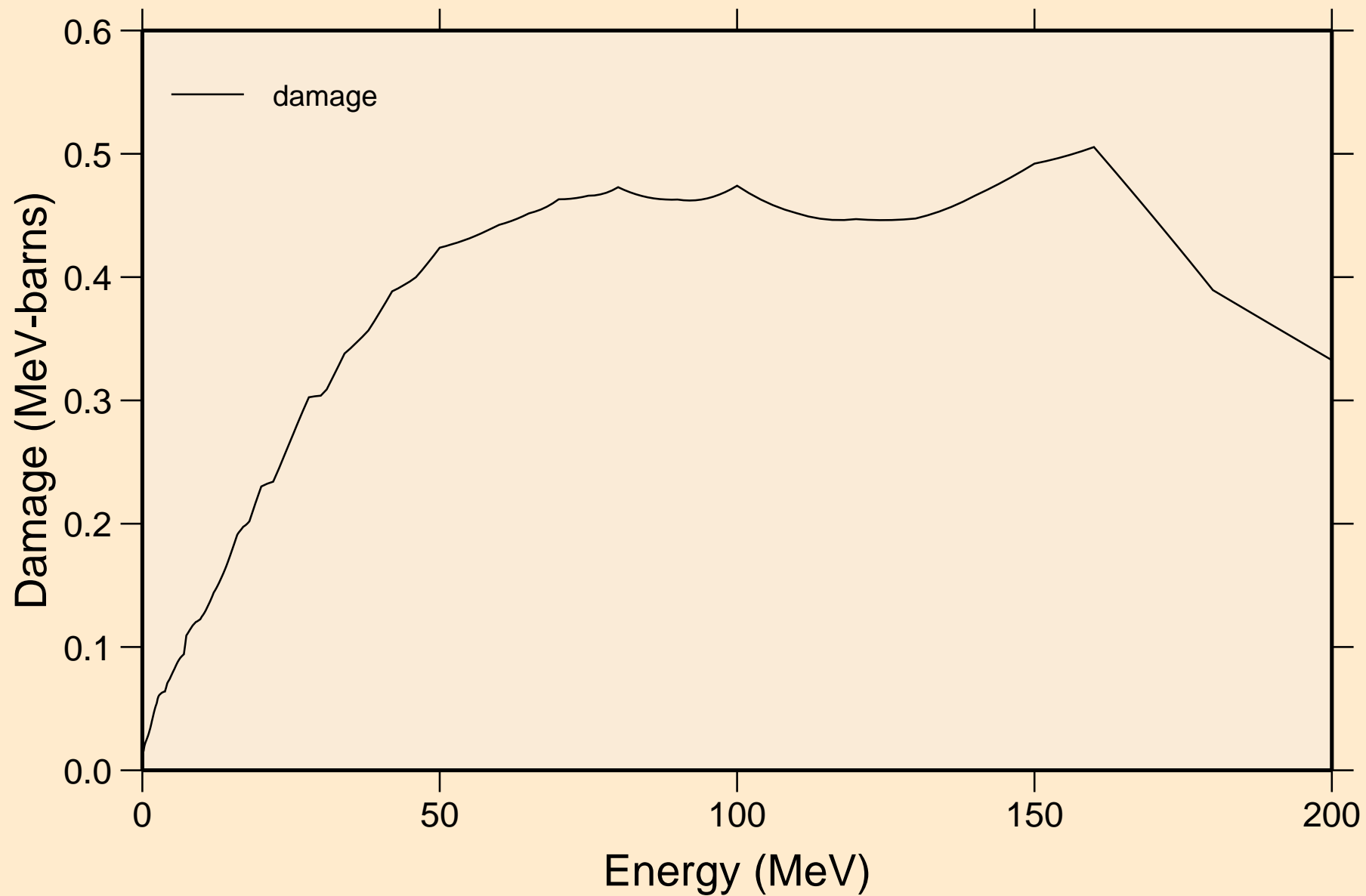

PT188 NEUTRON ACER TENDL-2019 LIBRARY; T=293.16K
Non-threshold reactions

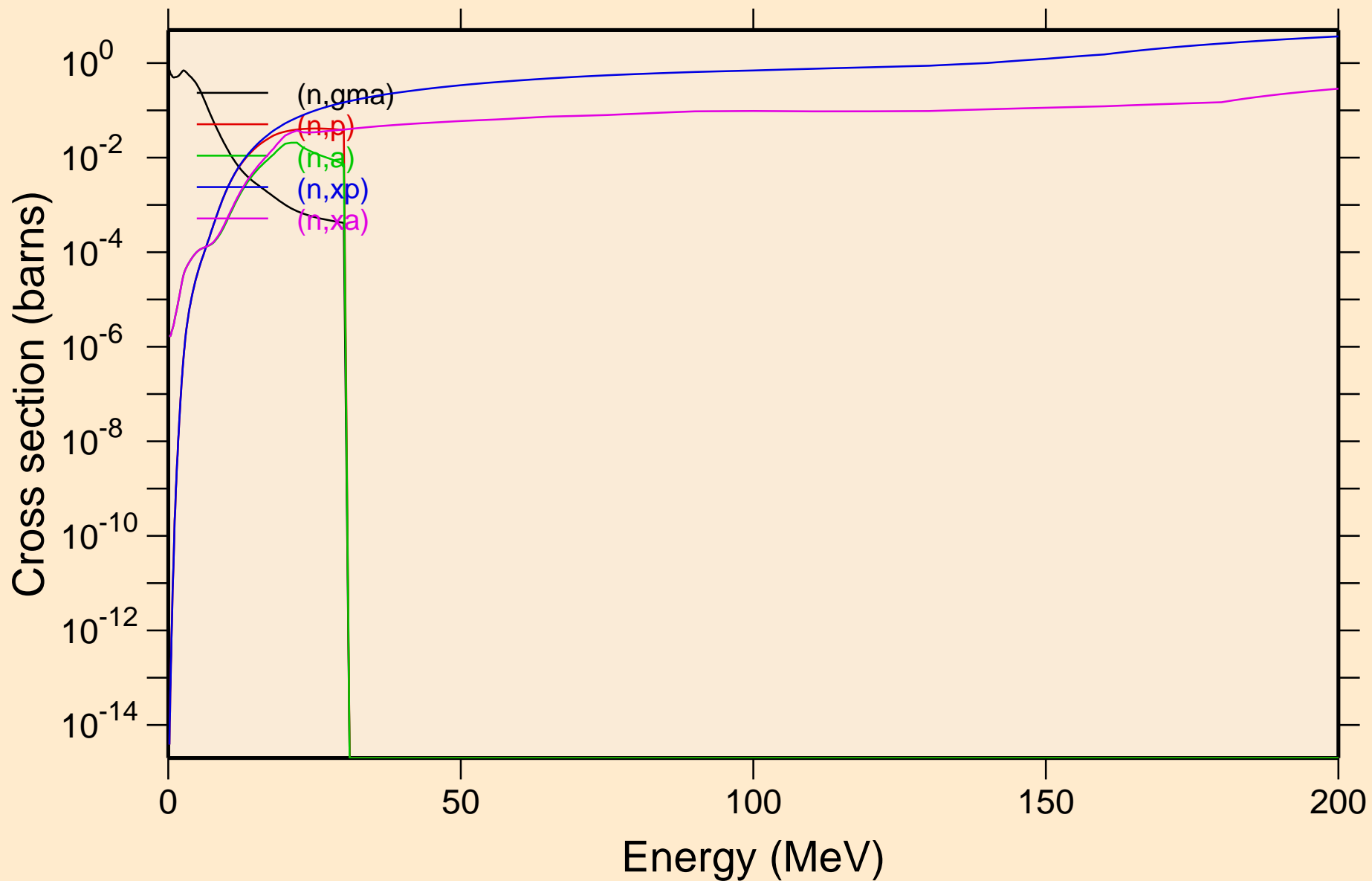

PT188 NEUTRON ACER TENDL-2019 LIBRARY; T=293.16K
Inelastic levels

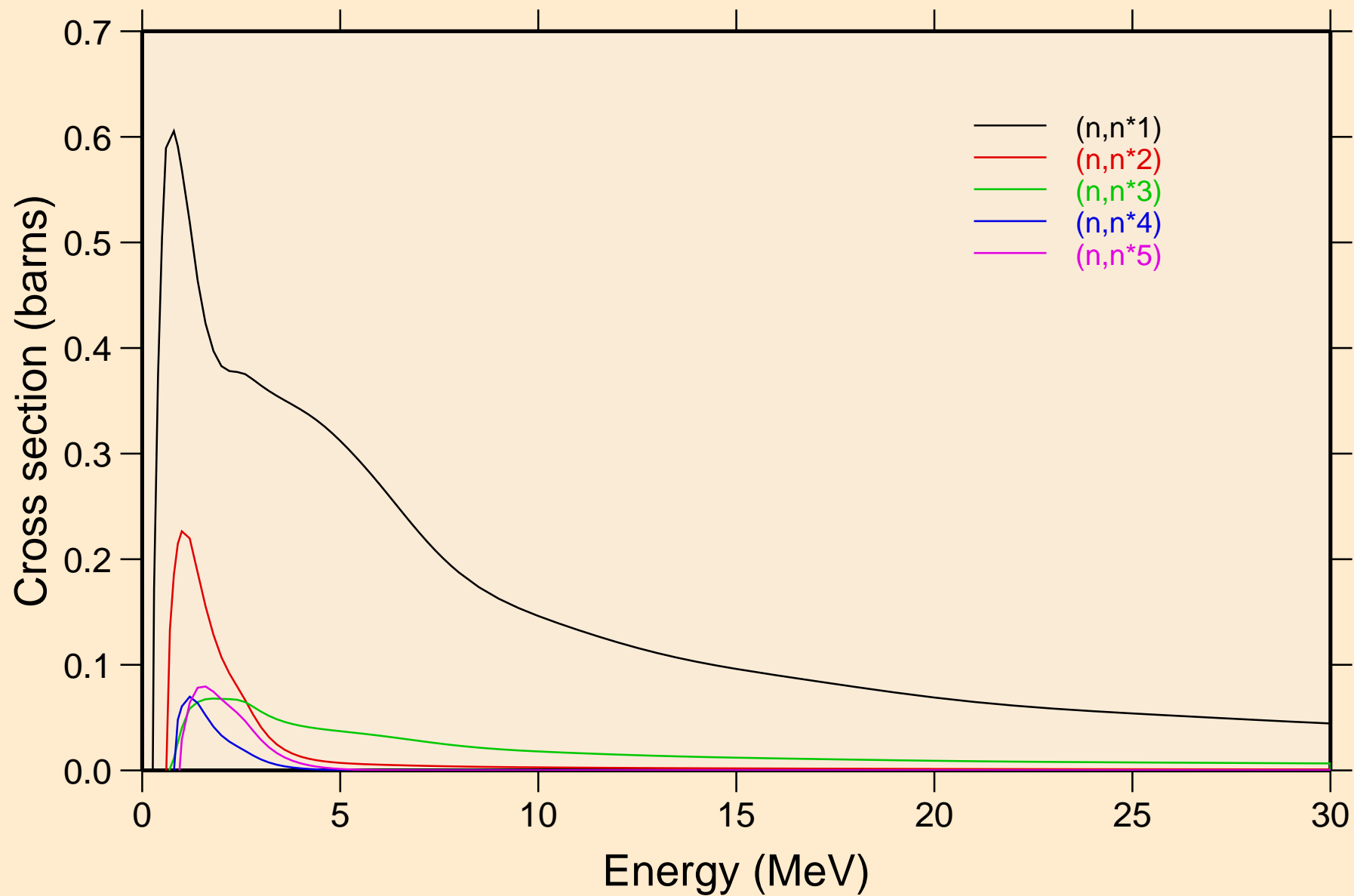

PT188 NEUTRON ACER TENDL-2019 LIBRARY; T=293.16K
Inelastic levels

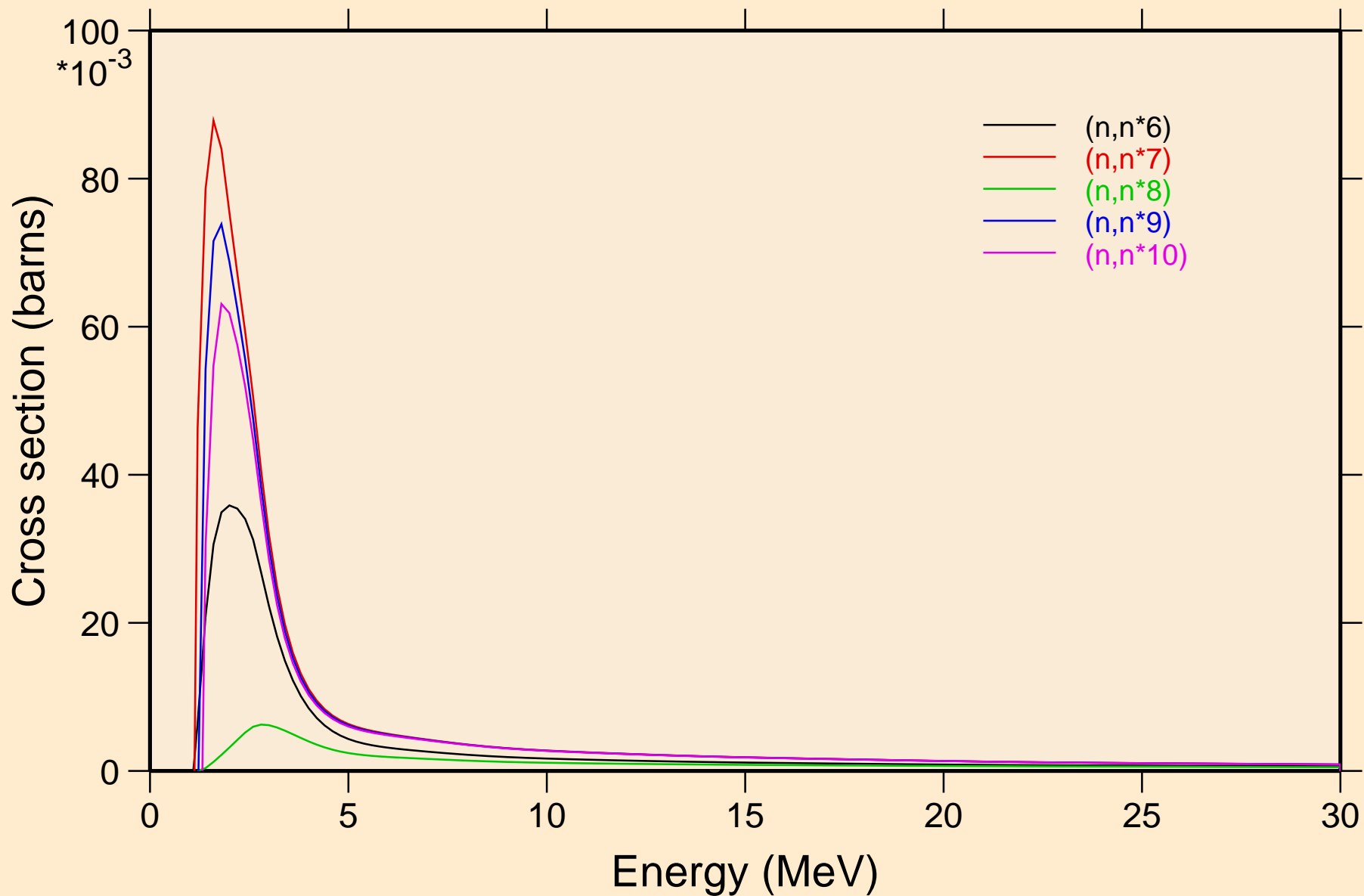

PT188 NEUTRON ACER TENDL-2019 LIBRARY; T=293.16K
Inelastic levels

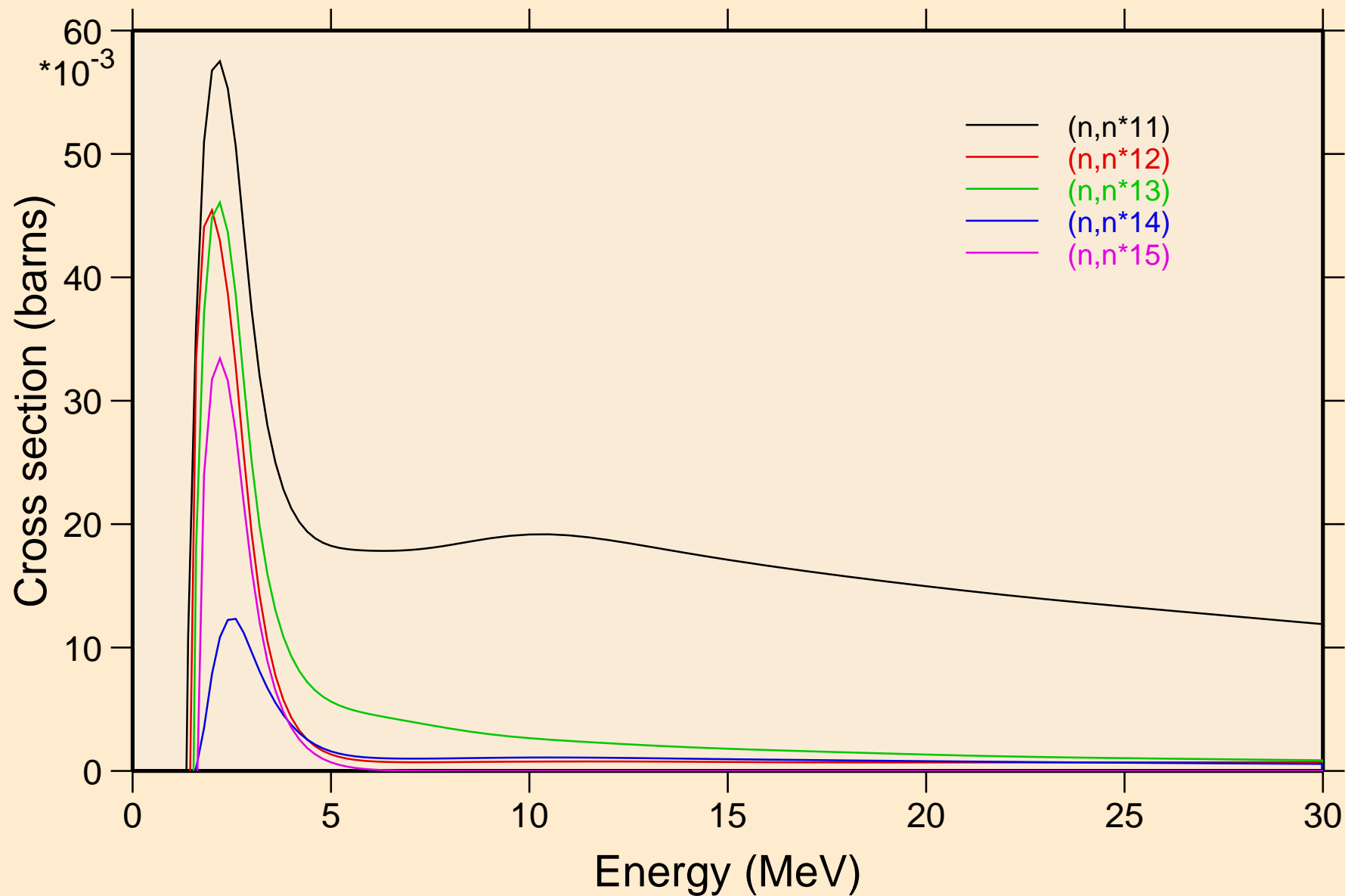

PT188 NEUTRON ACER TENDL-2019 LIBRARY; T=293.16K
Inelastic levels

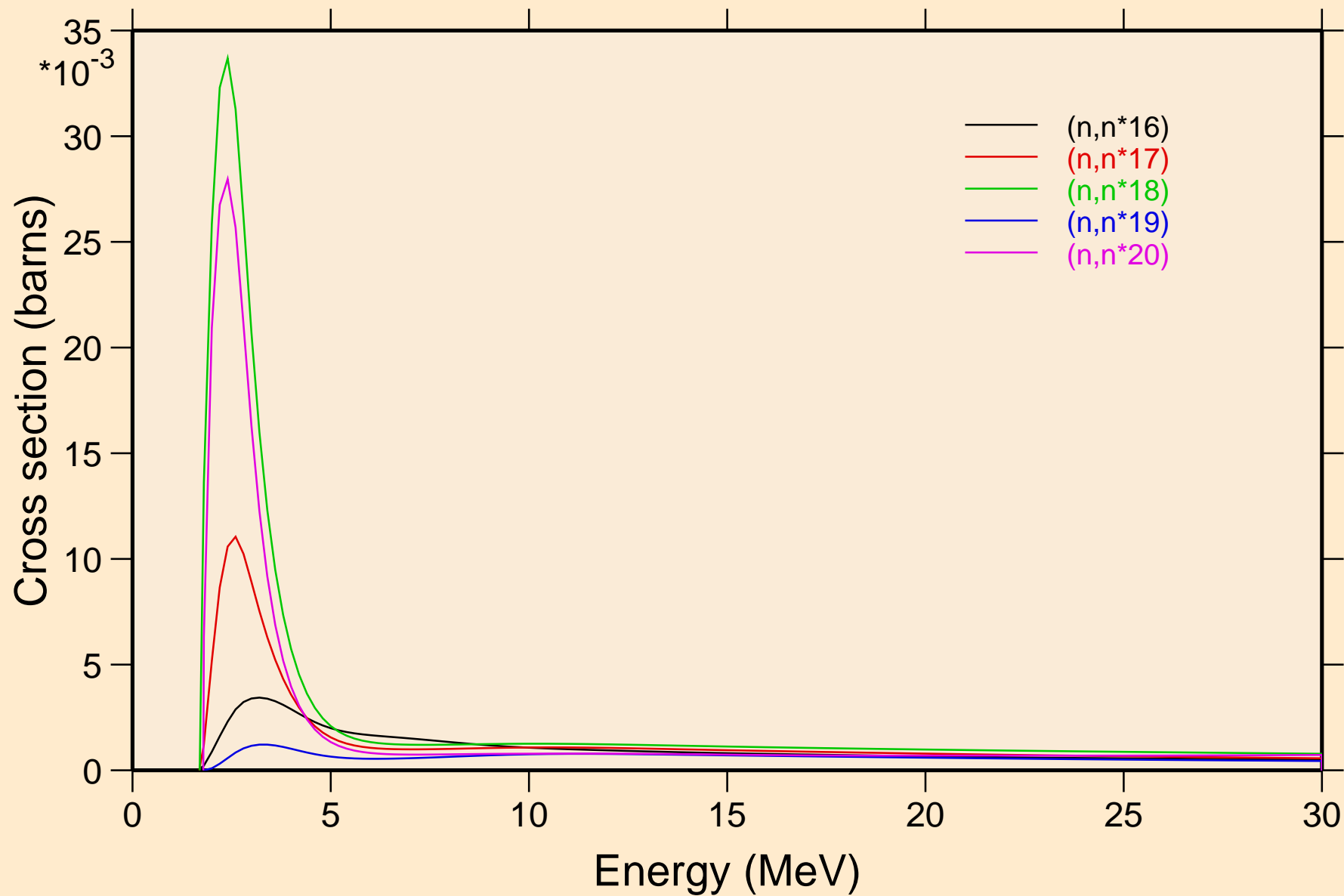

PT188 NEUTRON ACER TENDL-2019 LIBRARY; T=293.16K
Inelastic levels

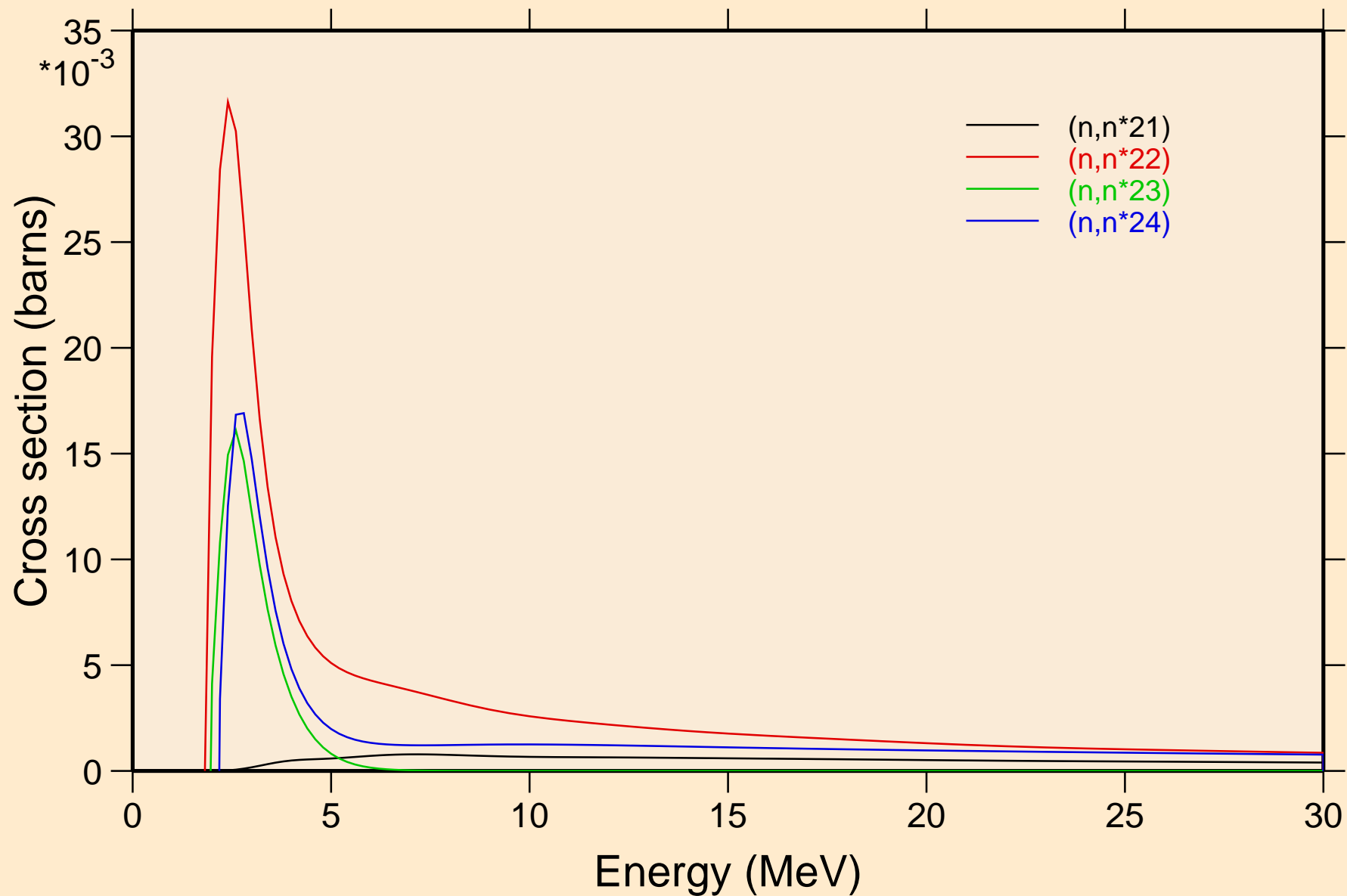

PT188 NEUTRON ACER TENDL-2019 LIBRARY; T=293.16K
Threshold reactions

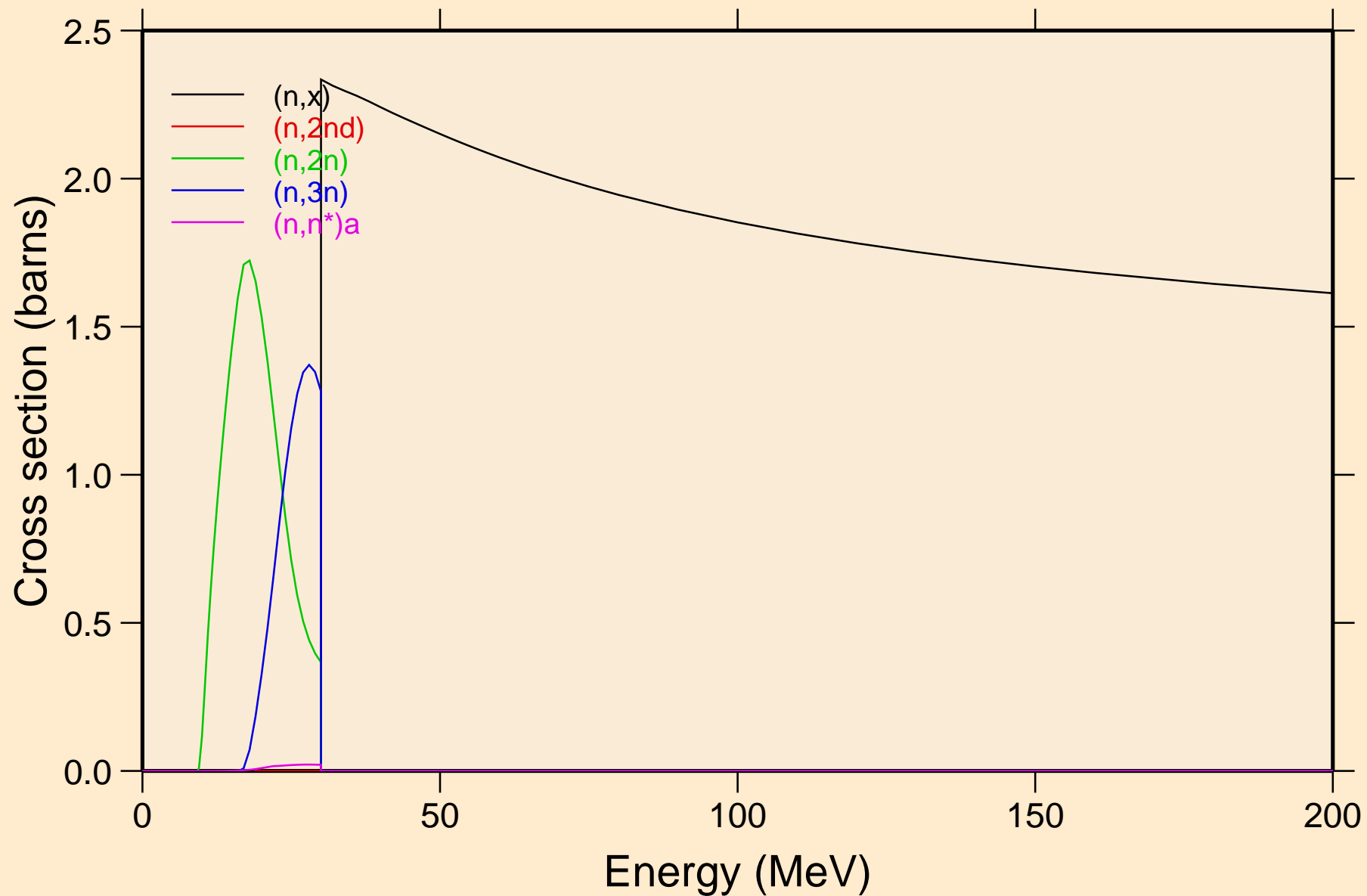

PT188 NEUTRON ACER TENDL-2019 LIBRARY; T=293.16K
Threshold reactions

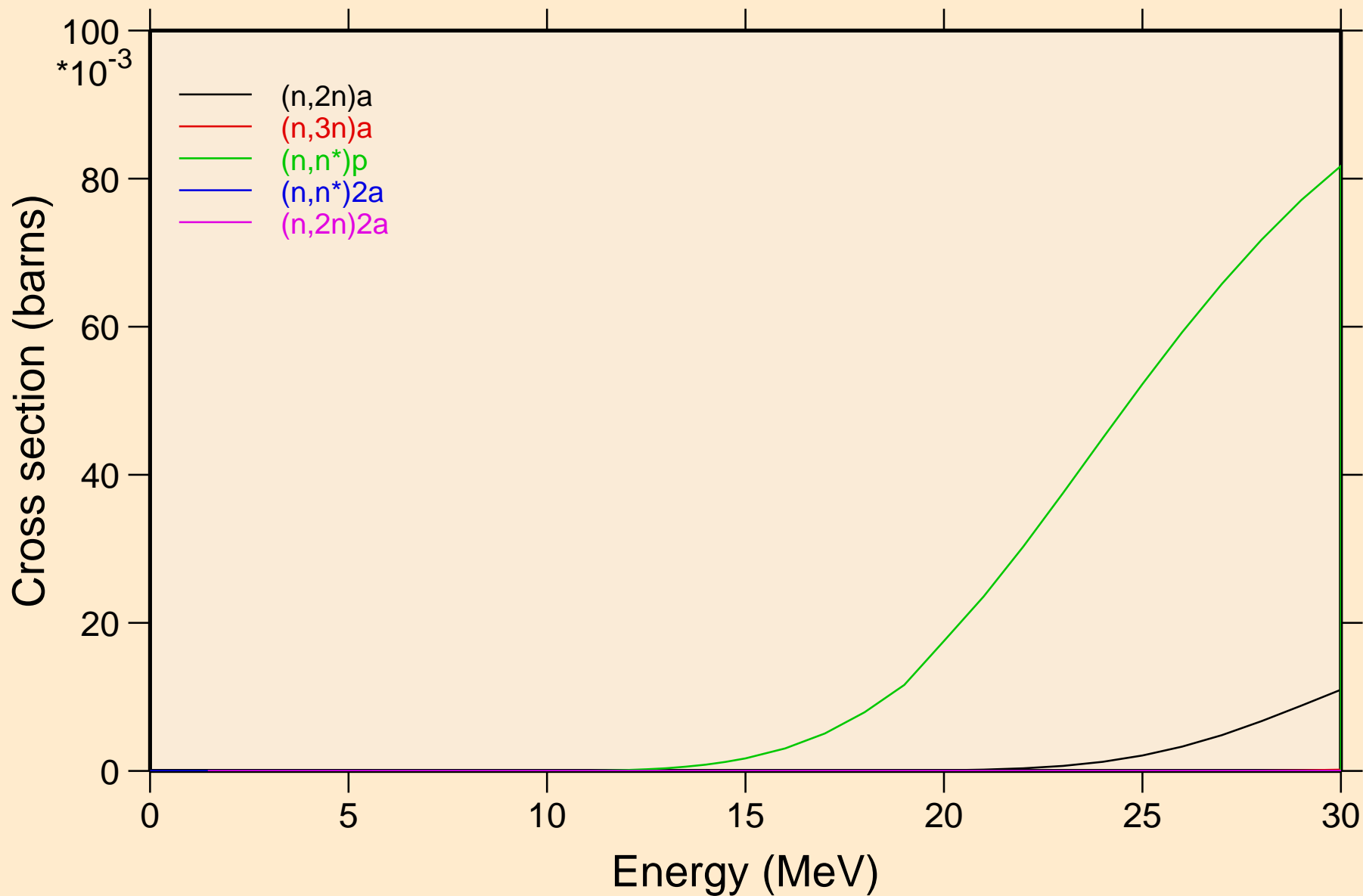

PT188 NEUTRON ACER TENDL-2019 LIBRARY; T=293.16K
Threshold reactions

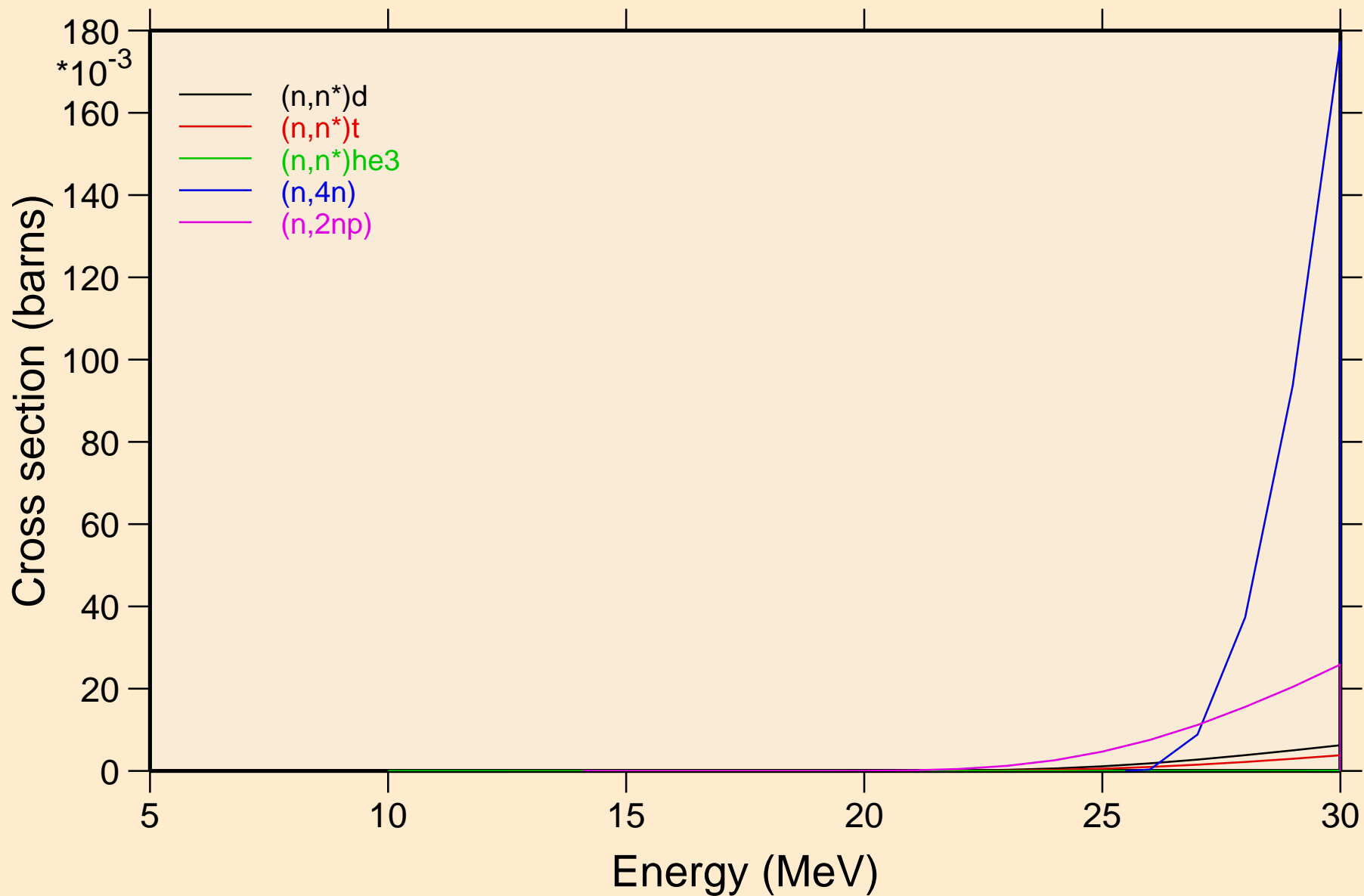

PT188 NEUTRON ACER TENDL-2019 LIBRARY; T=293.16K
Threshold reactions

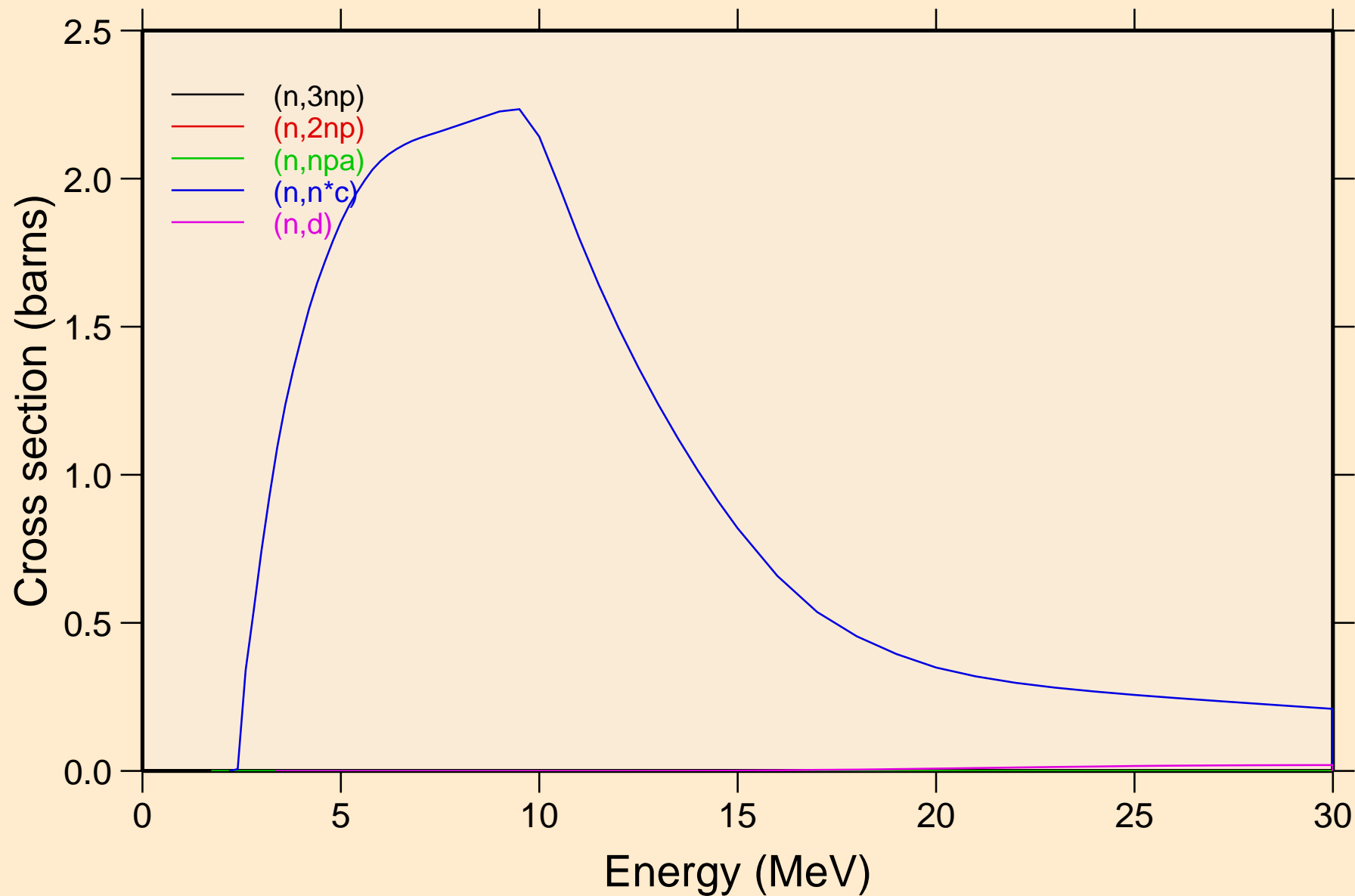

PT188 NEUTRON ACER TENDL-2019 LIBRARY; T=293.16K
Threshold reactions

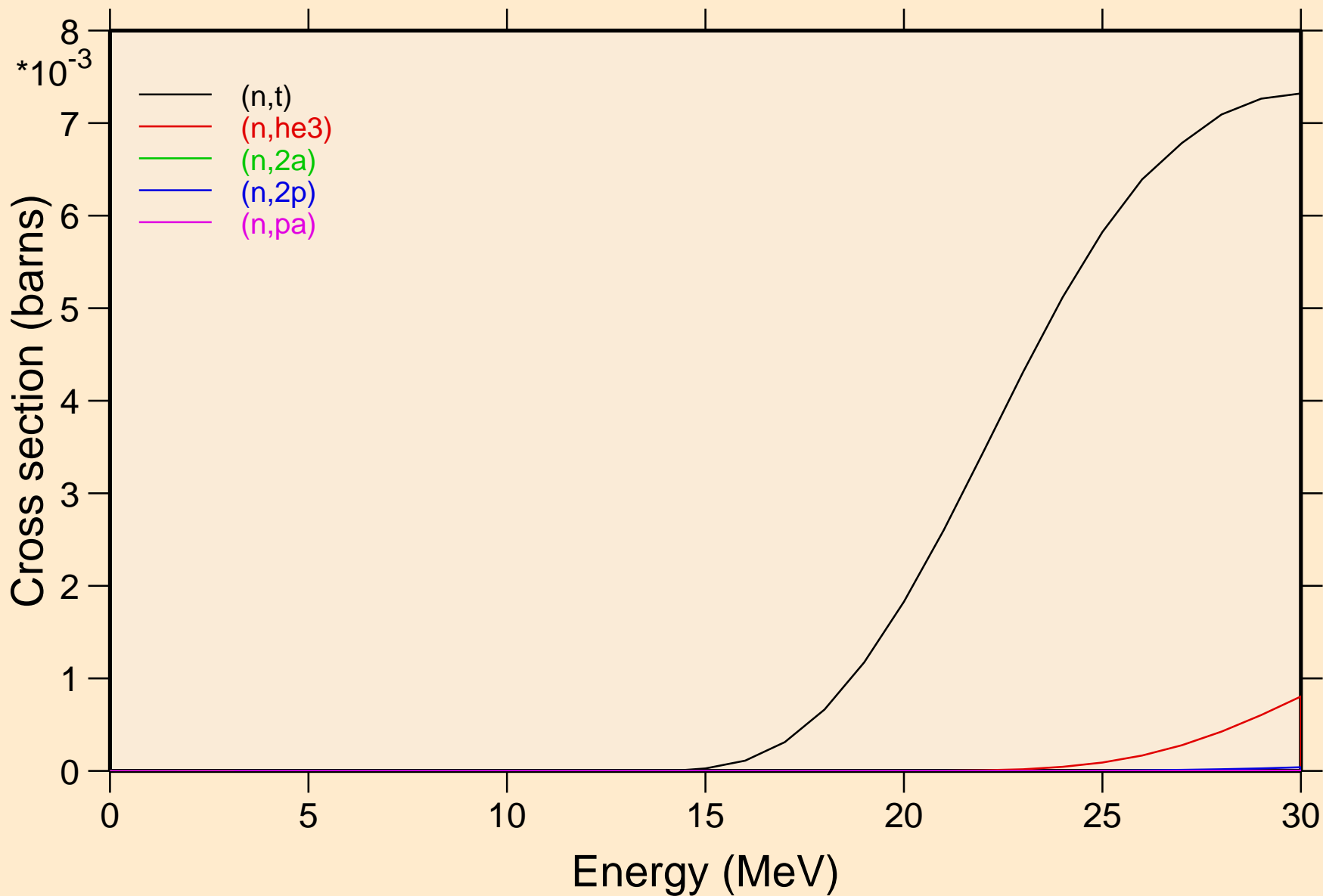

PT188 NEUTRON ACER TENDL-2019 LIBRARY; T=293.16K
Threshold reactions

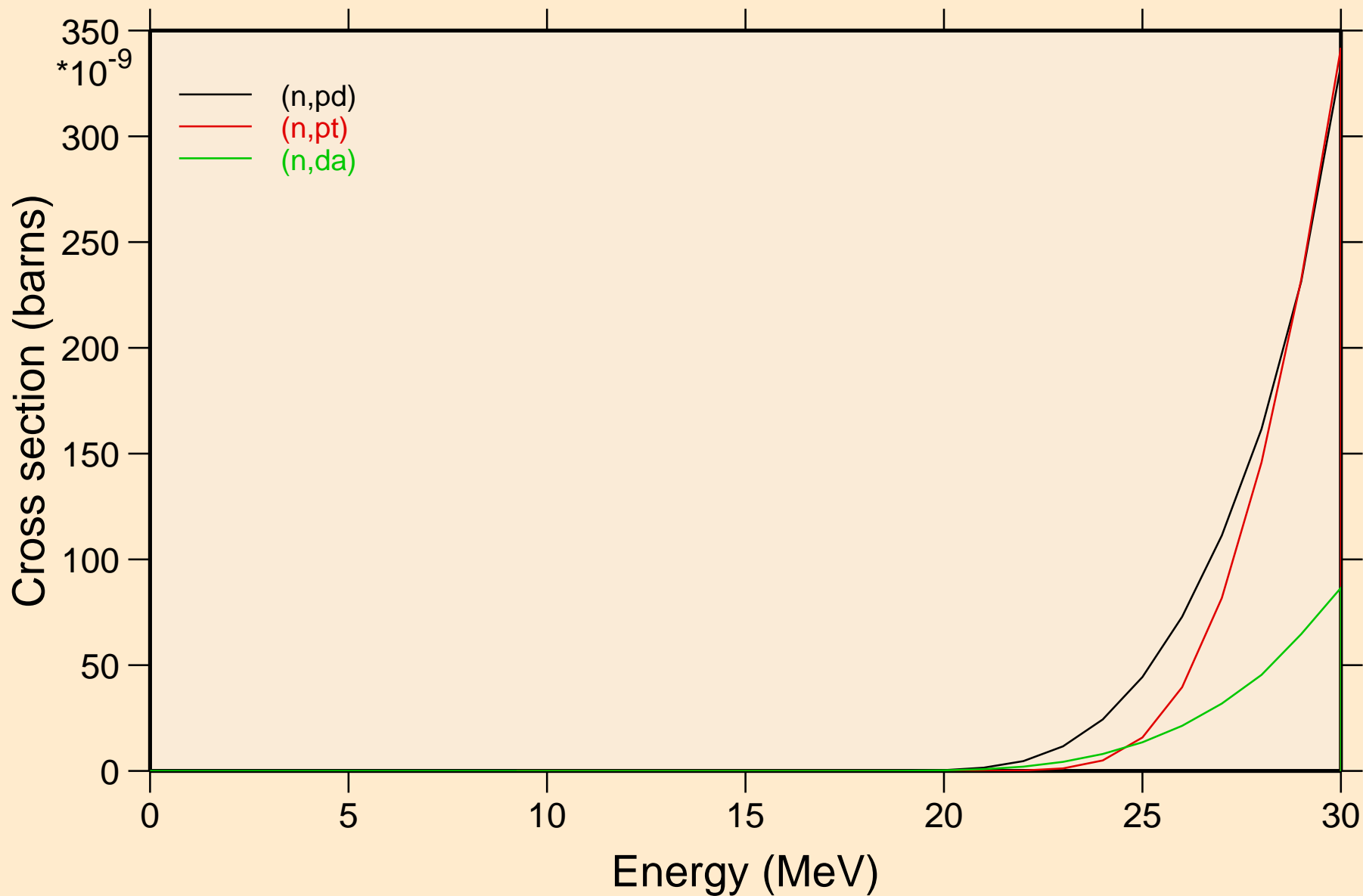

PT188 NEUTRON ACER TENDL-2019 LIBRARY; T=293.16K
Threshold reactions

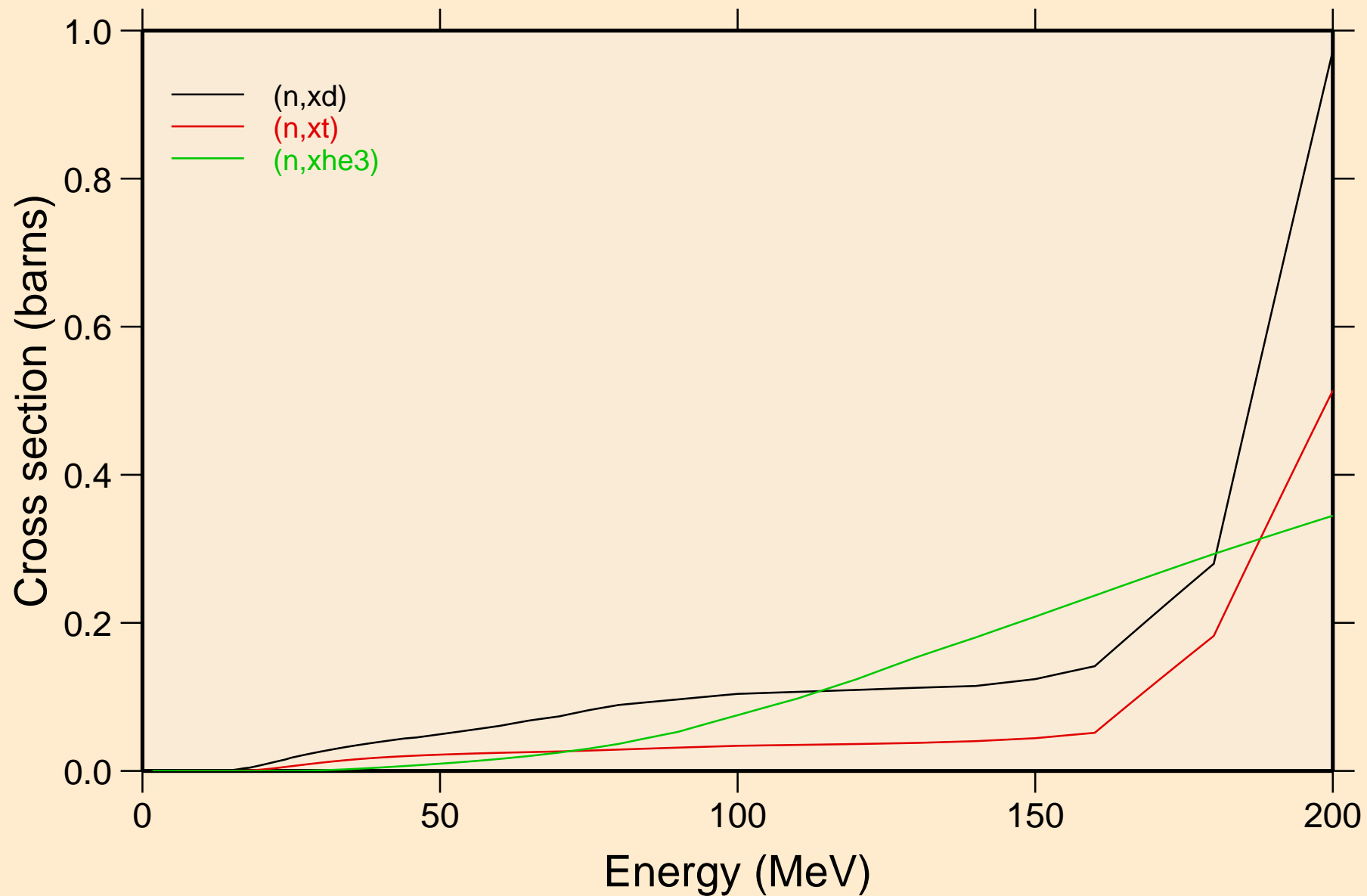

PT188 NEUTRON ACER TENDL-2019 LIBRARY; T=293.16K
angular distribution for elastic

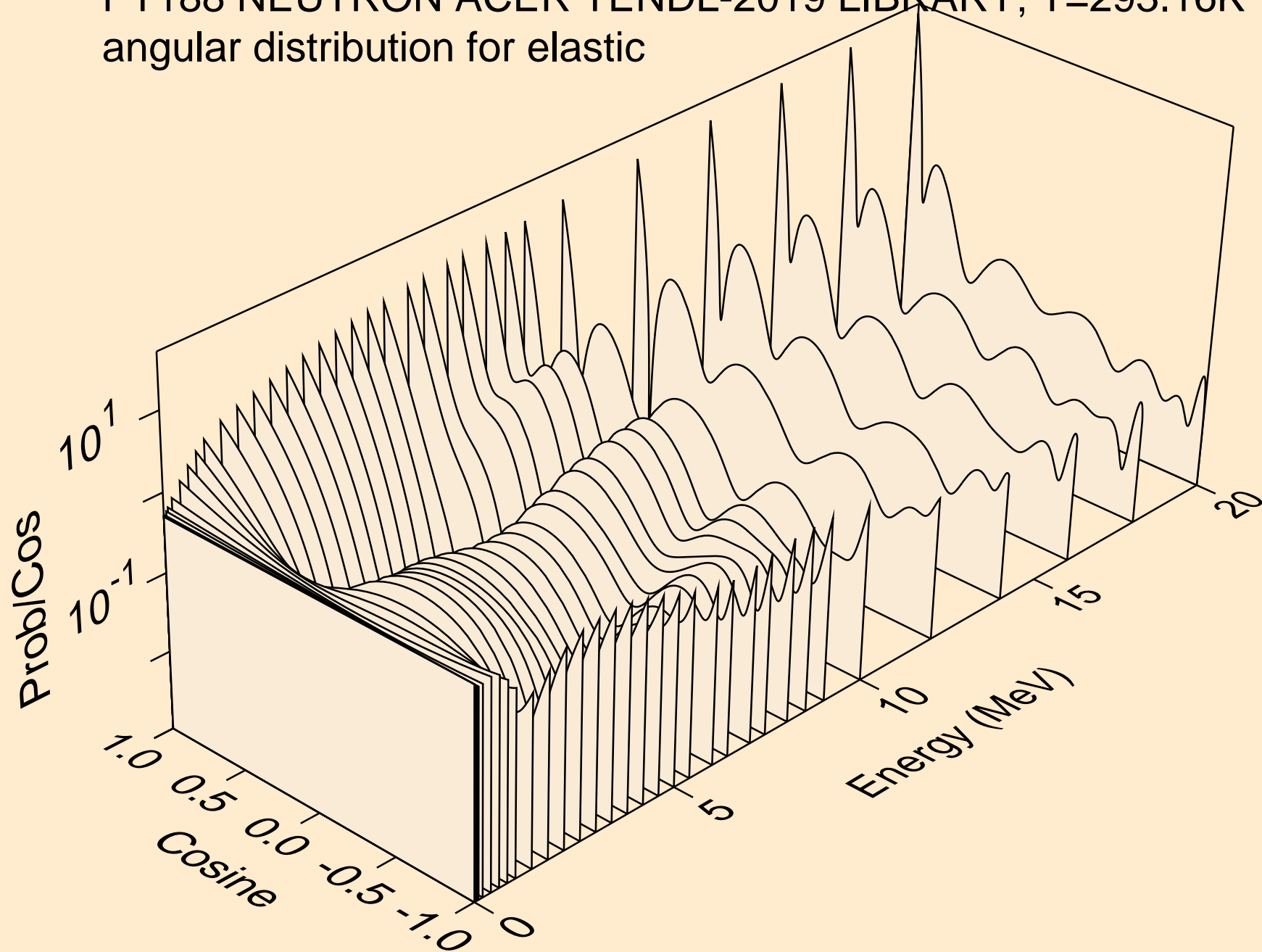

PT188 NEUTRON ACER TENDL-2019 LIBRARY; T=293.16K
angular distribution for elastic

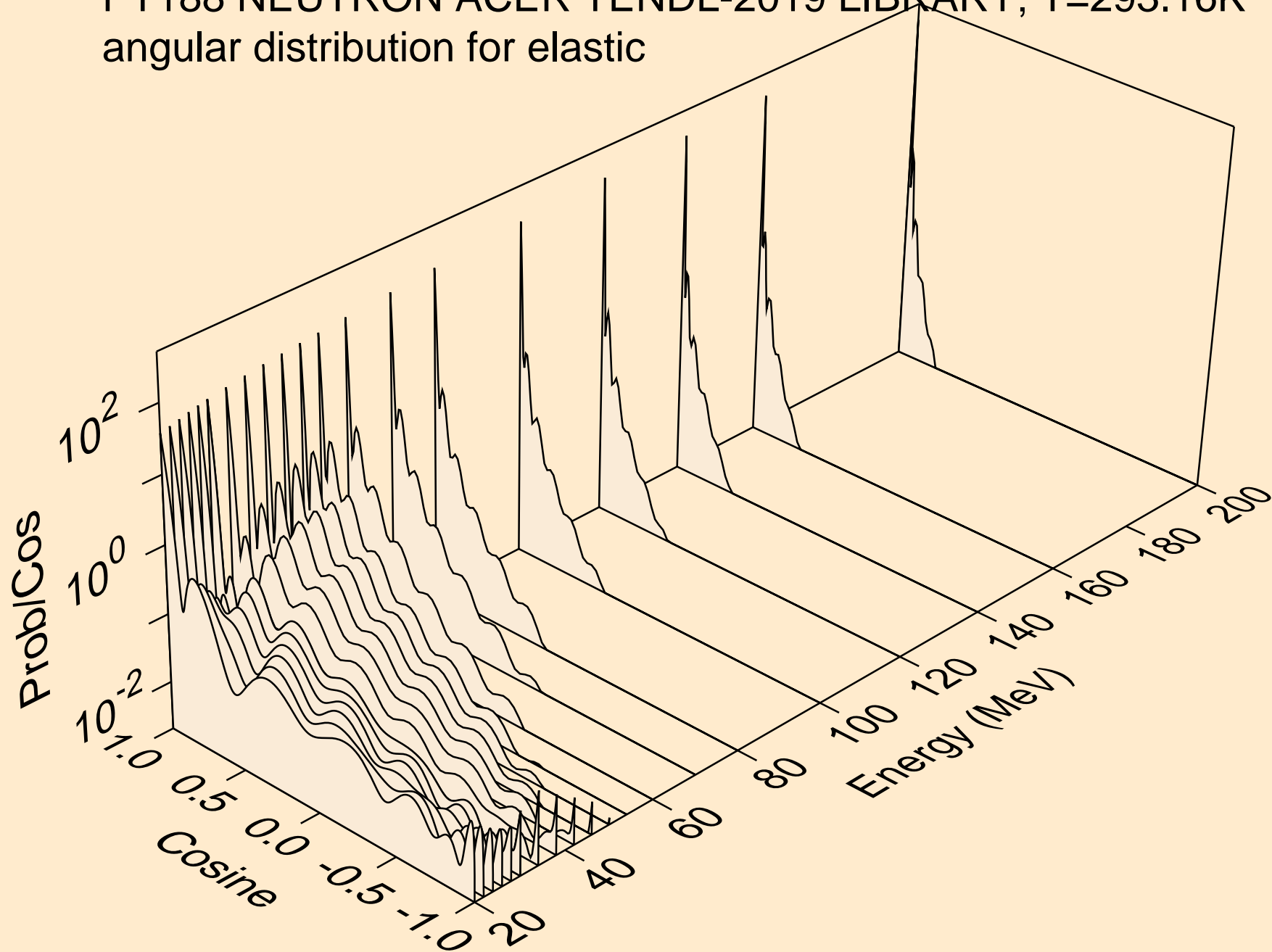

PT188 NEUTRON ACER TENDL-2019 LIBRARY; T=293.16K
angular distribution for (n,n*1)

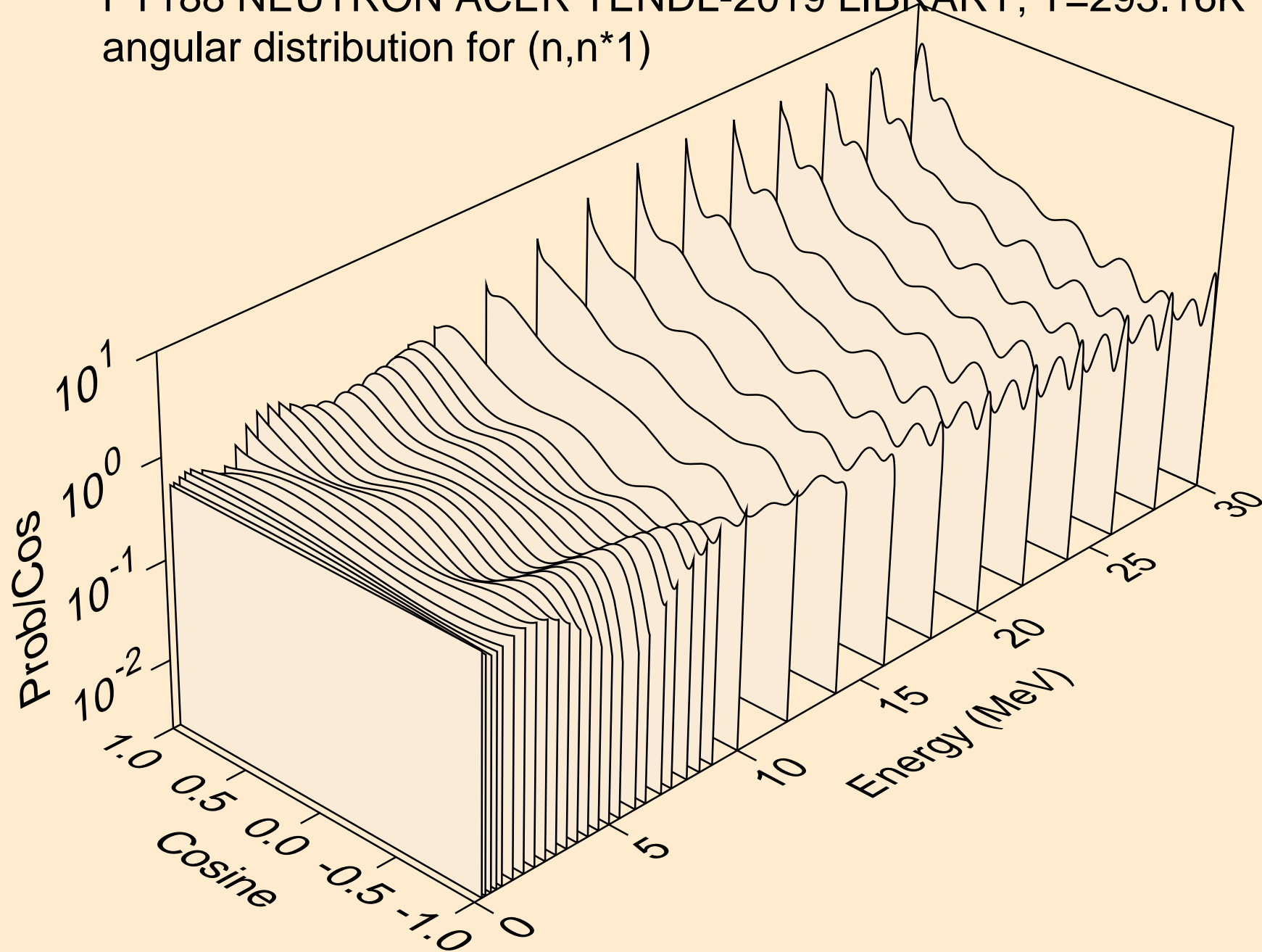

PT188 NEUTRON ACER TENDL-2019 LIBRARY; T=293.16K
angular distribution for (n,n*2)

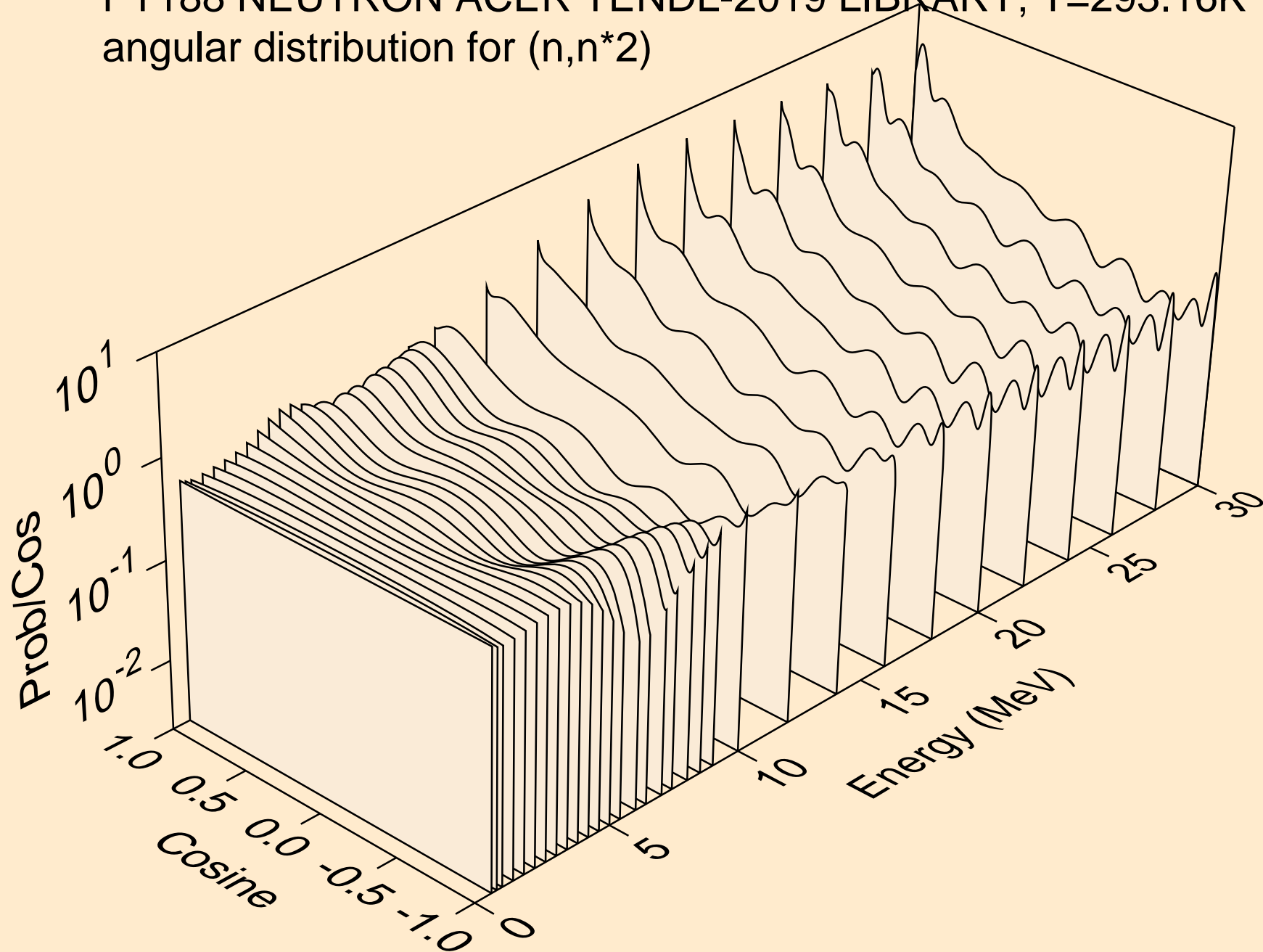

PT188 NEUTRON ACER TENDL-2019 LIBRARY; T=293.16K
angular distribution for (n,n*3)

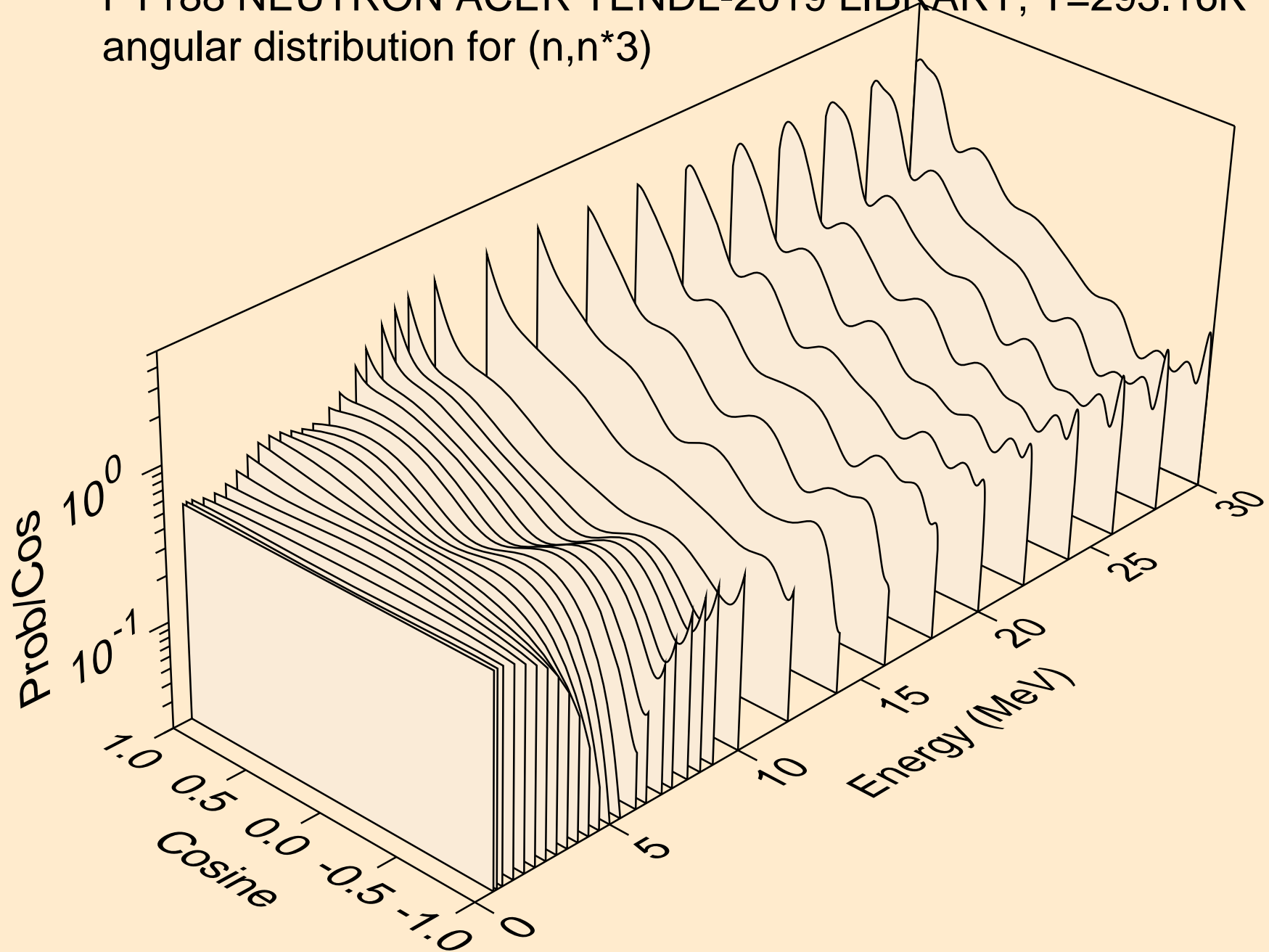

PT188 NEUTRON ACER TENDL-2019 LIBRARY; T=293.16K
angular distribution for (n,n*4)

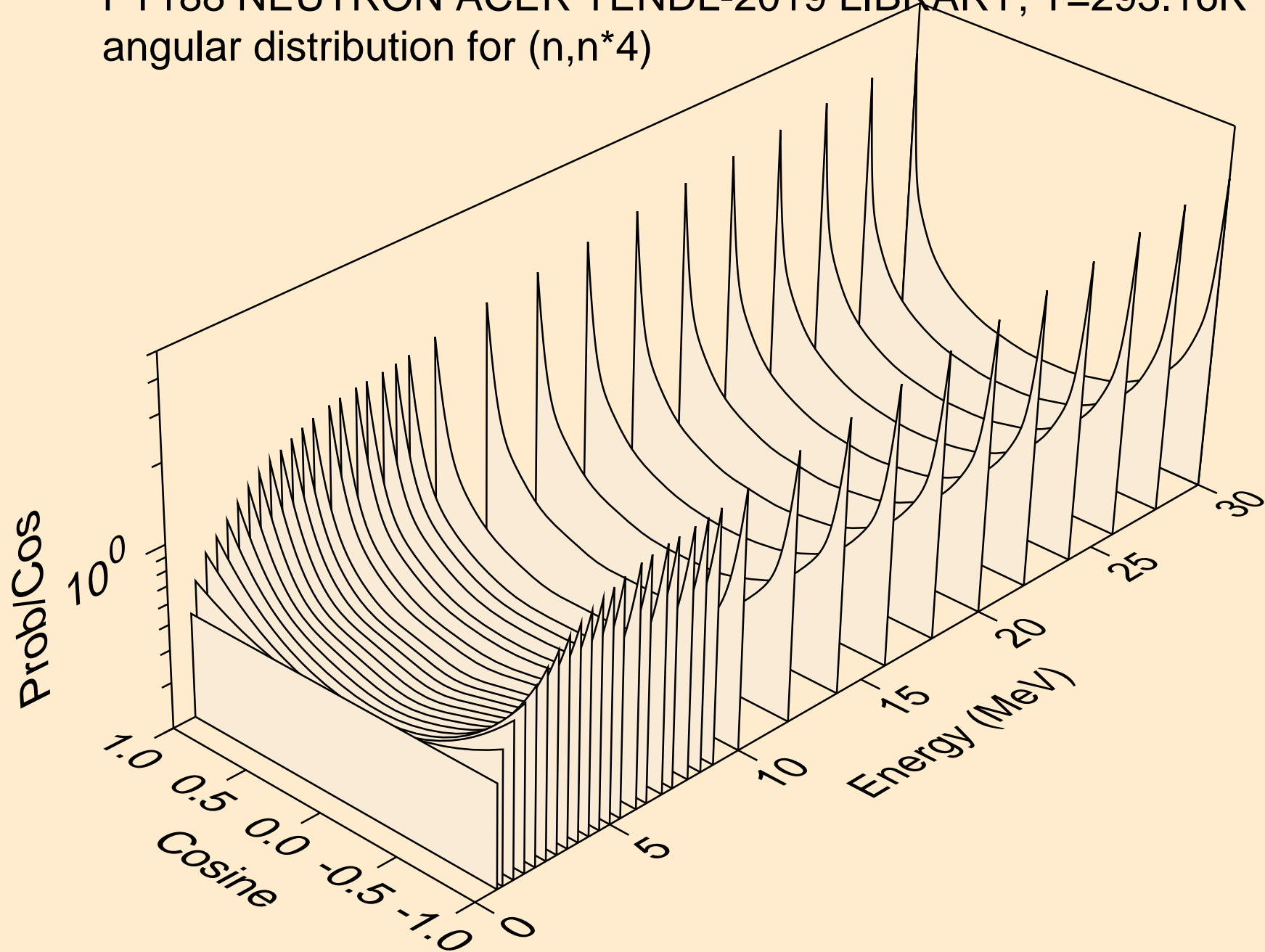

PT188 NEUTRON ACER TENDL-2019 LIBRARY; T=293.16K
angular distribution for (n,n*5)

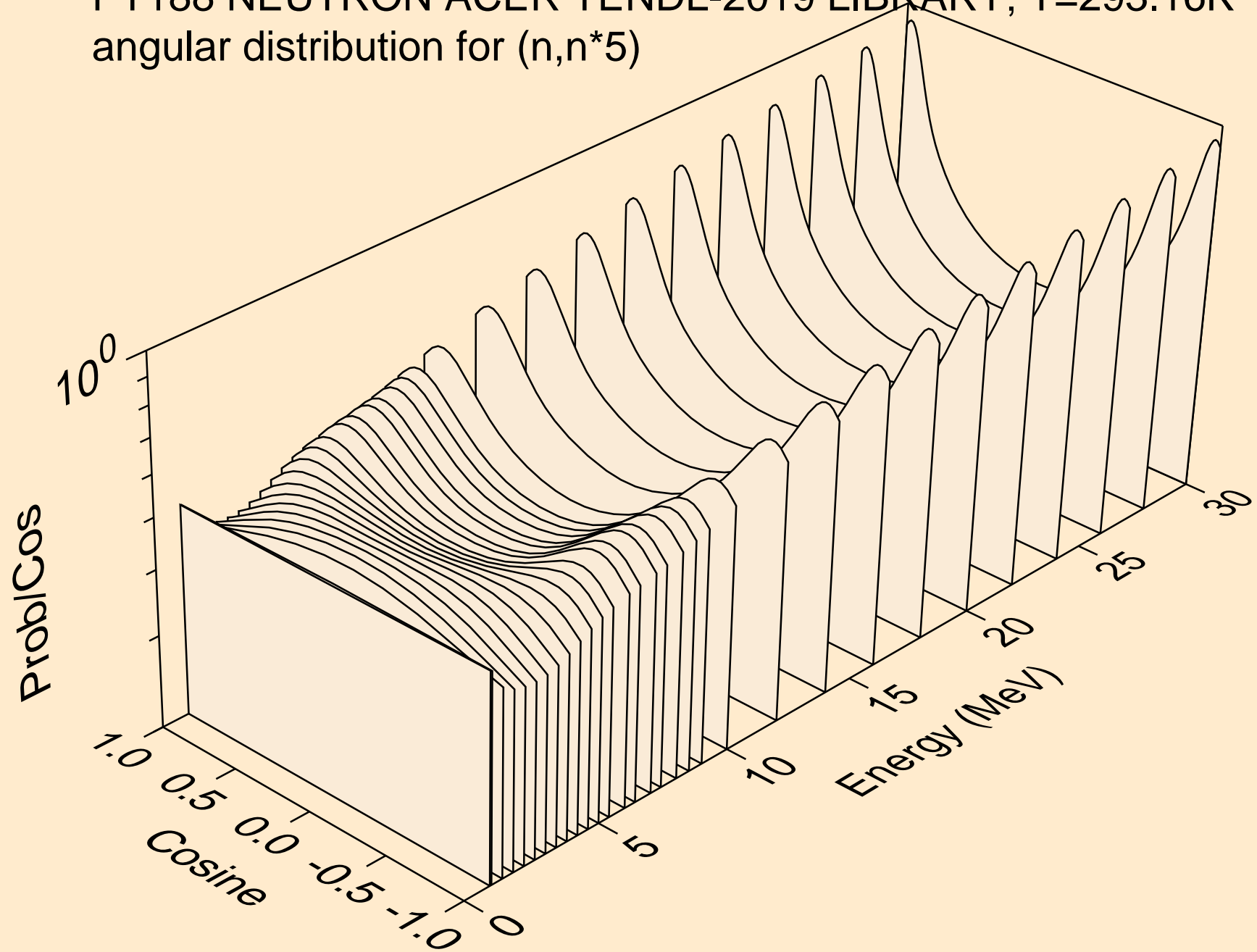

PT188 NEUTRON ACER TENDL-2019 LIBRARY; T=293.16K
angular distribution for (n,n*6)

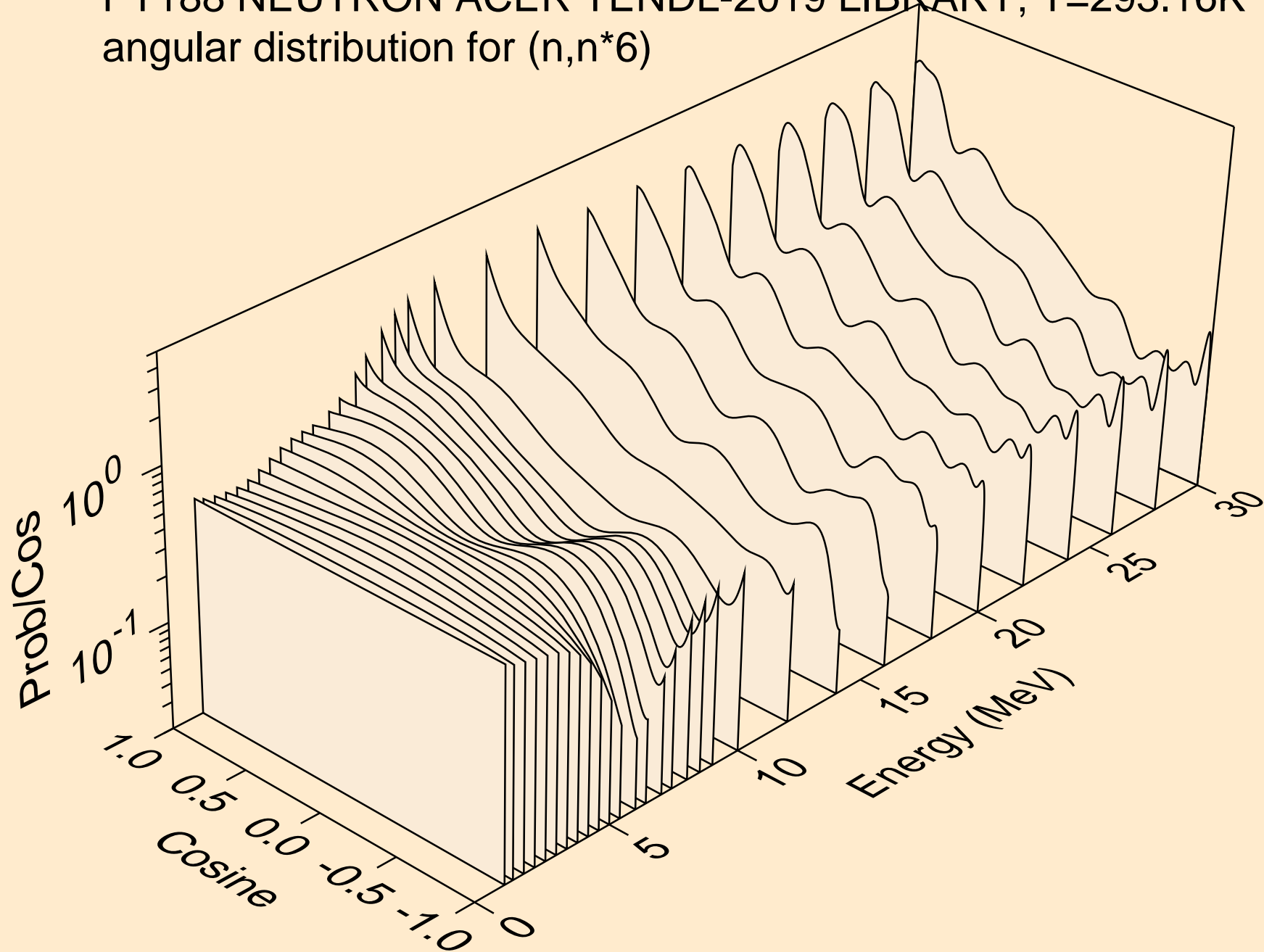

PT188 NEUTRON ACER TENDL-2019 LIBRARY; T=293.16K
angular distribution for (n,n*7)

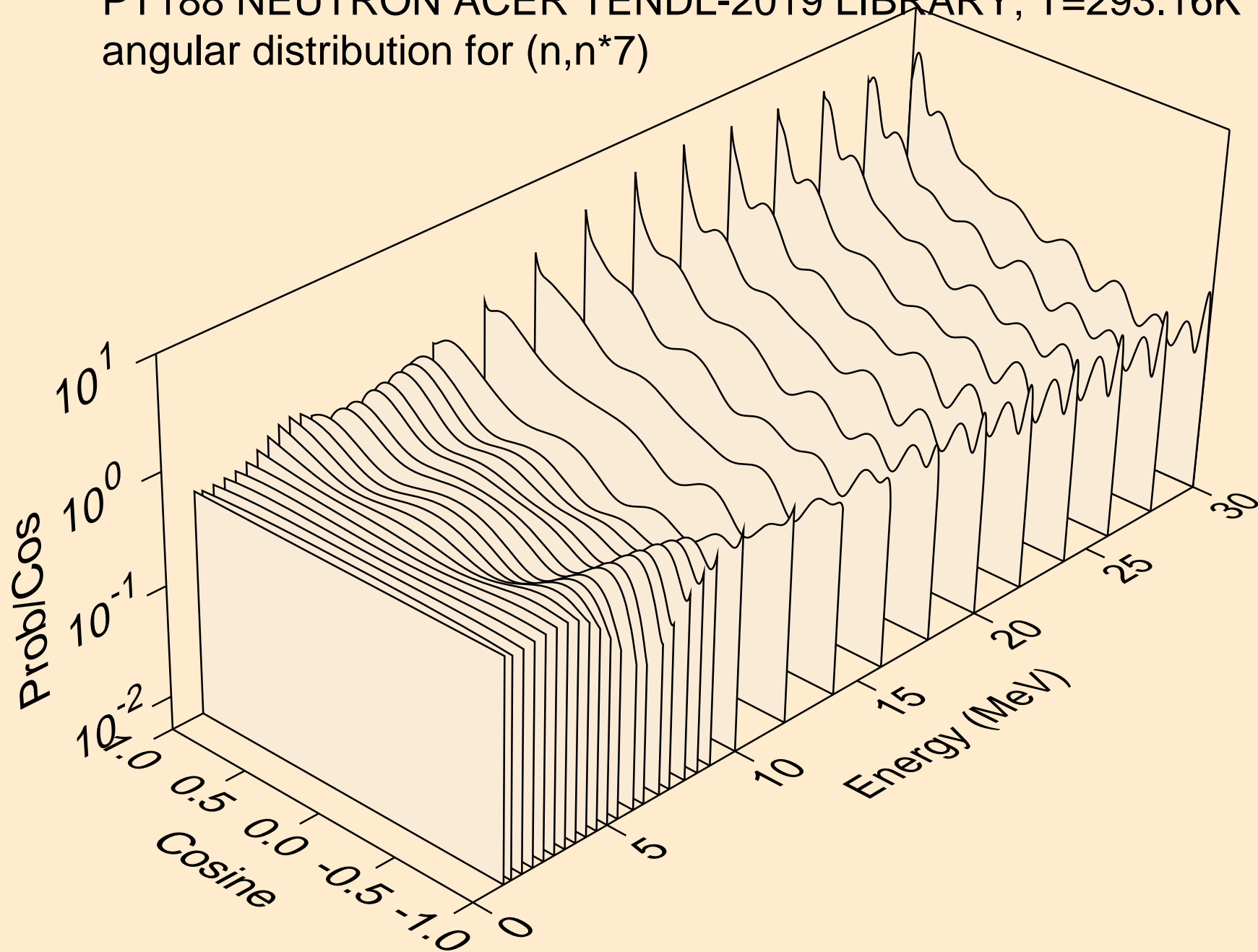

PT188 NEUTRON ACER TENDL-2019 LIBRARY; T=293.16K
angular distribution for (n,n*8)

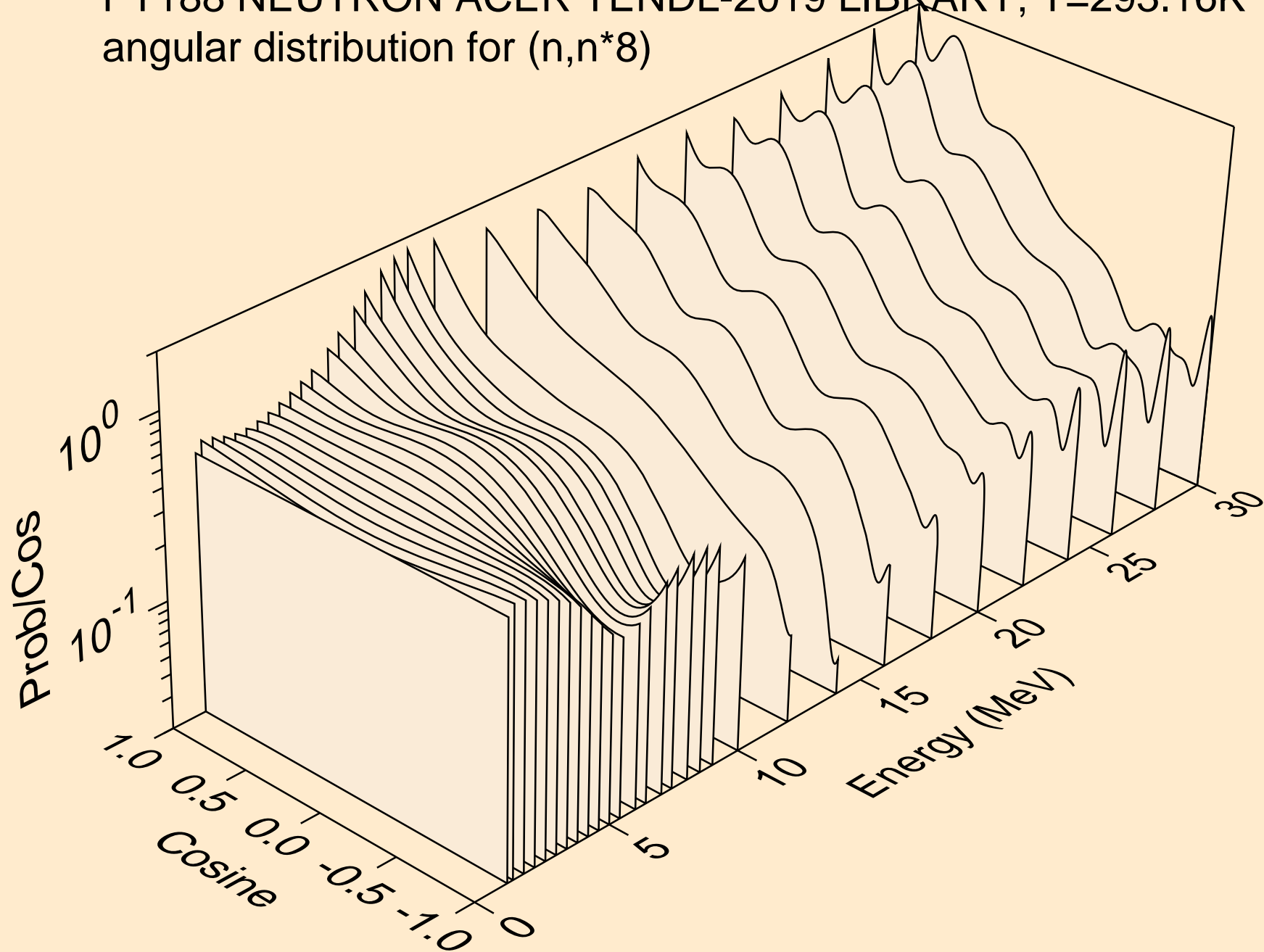

PT188 NEUTRON ACER TENDL-2019 LIBRARY; T=293.16K
angular distribution for (n,n*9)

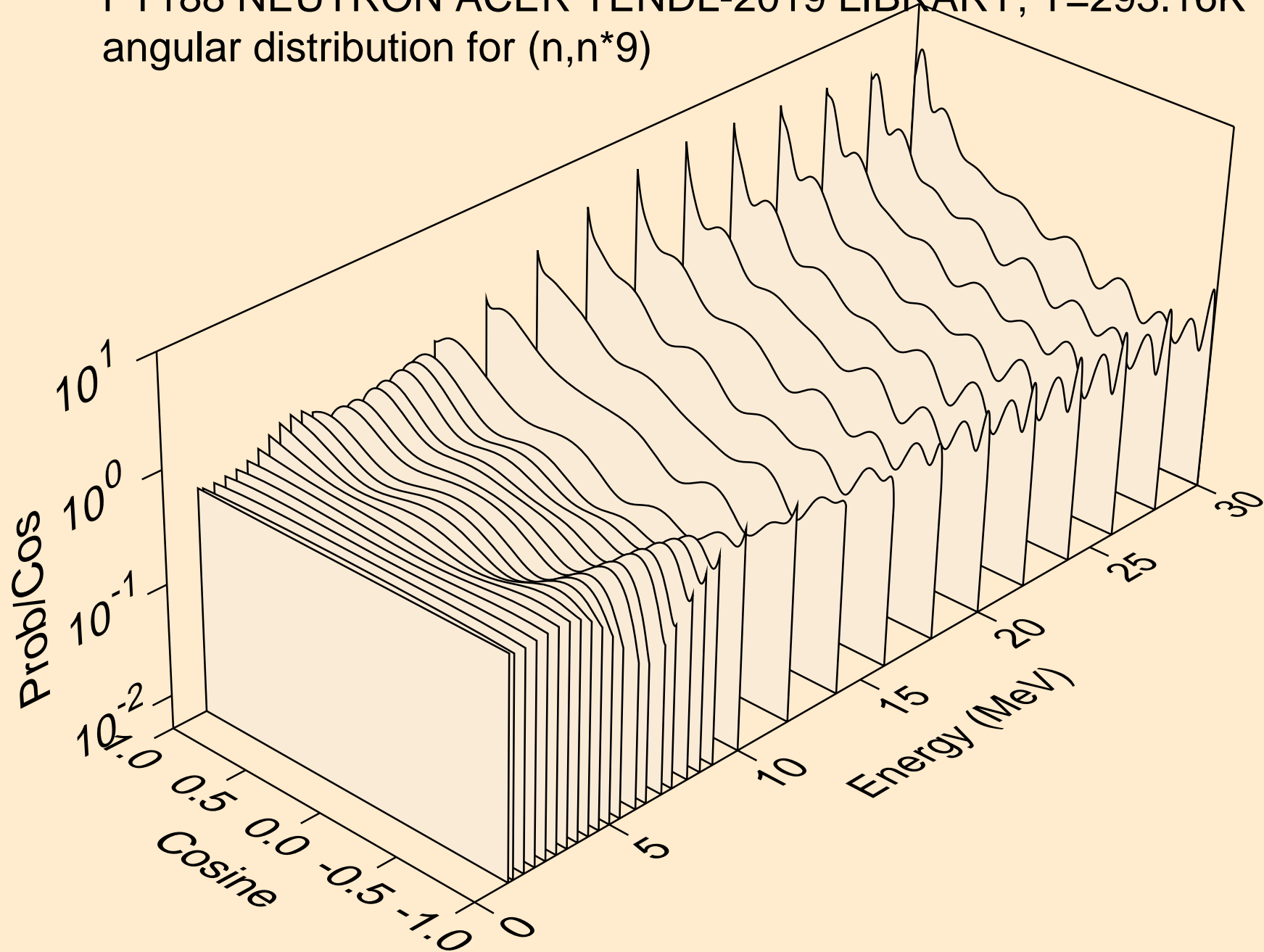

PT188 NEUTRON ACER TENDL-2019 LIBRARY; T=293.16K
angular distribution for (n,n*10)

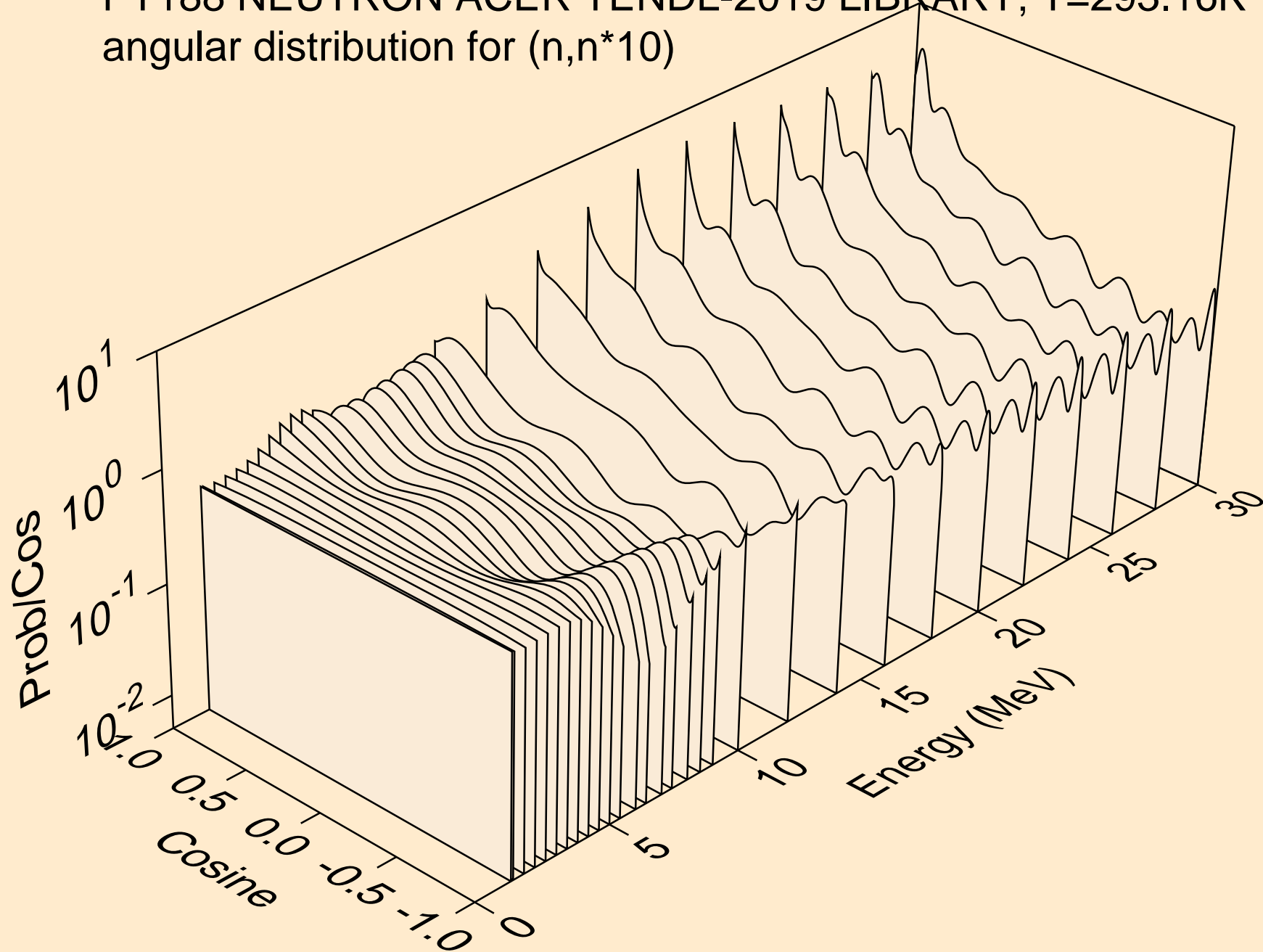

PT188 NEUTRON ACER TENDL-2019 LIBRARY; T=293.16K
angular distribution for (n,n*11)

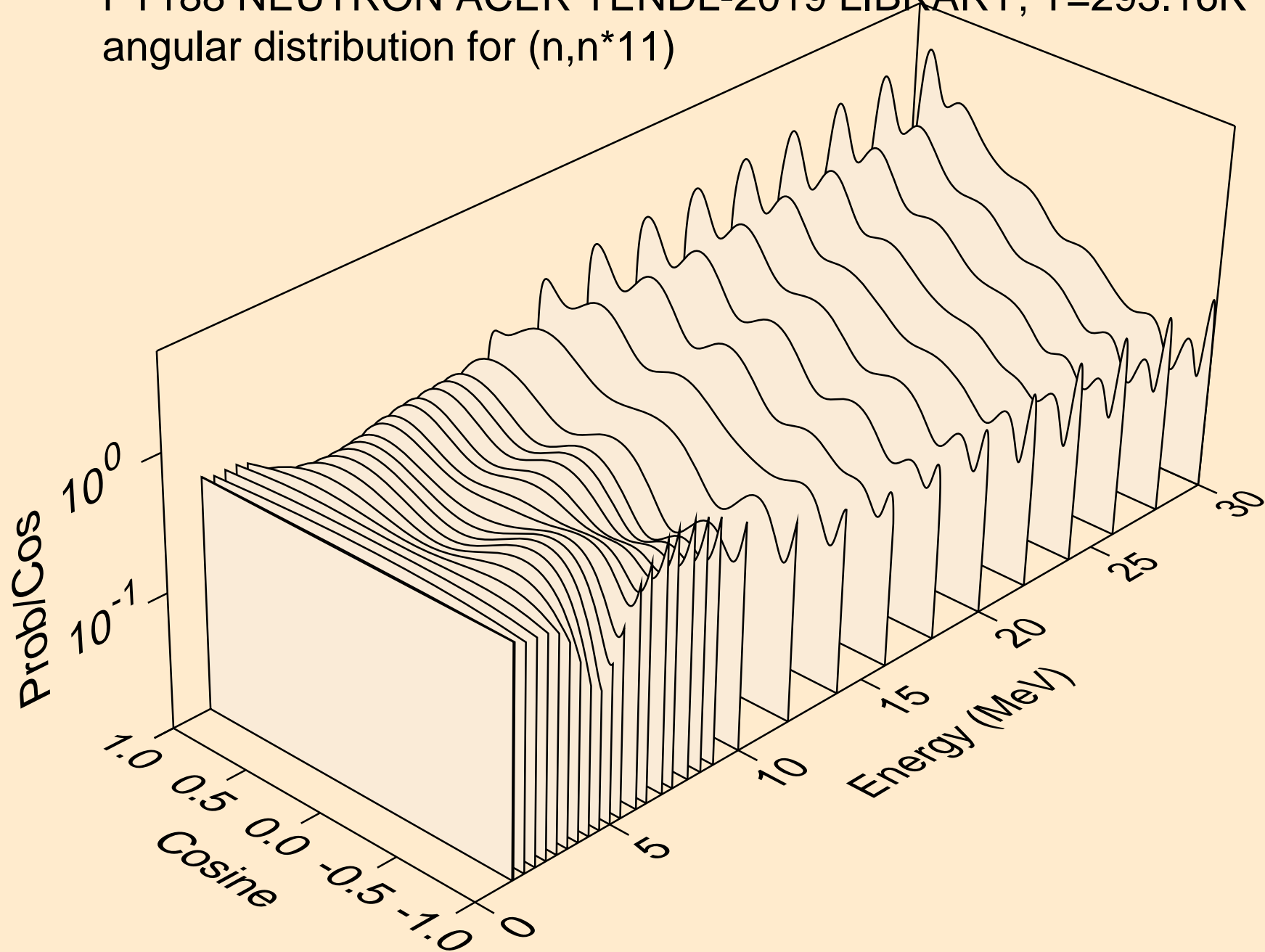

PT188 NEUTRON ACER TENDL-2019 LIBRARY; T=293.16K
angular distribution for (n,n*12)

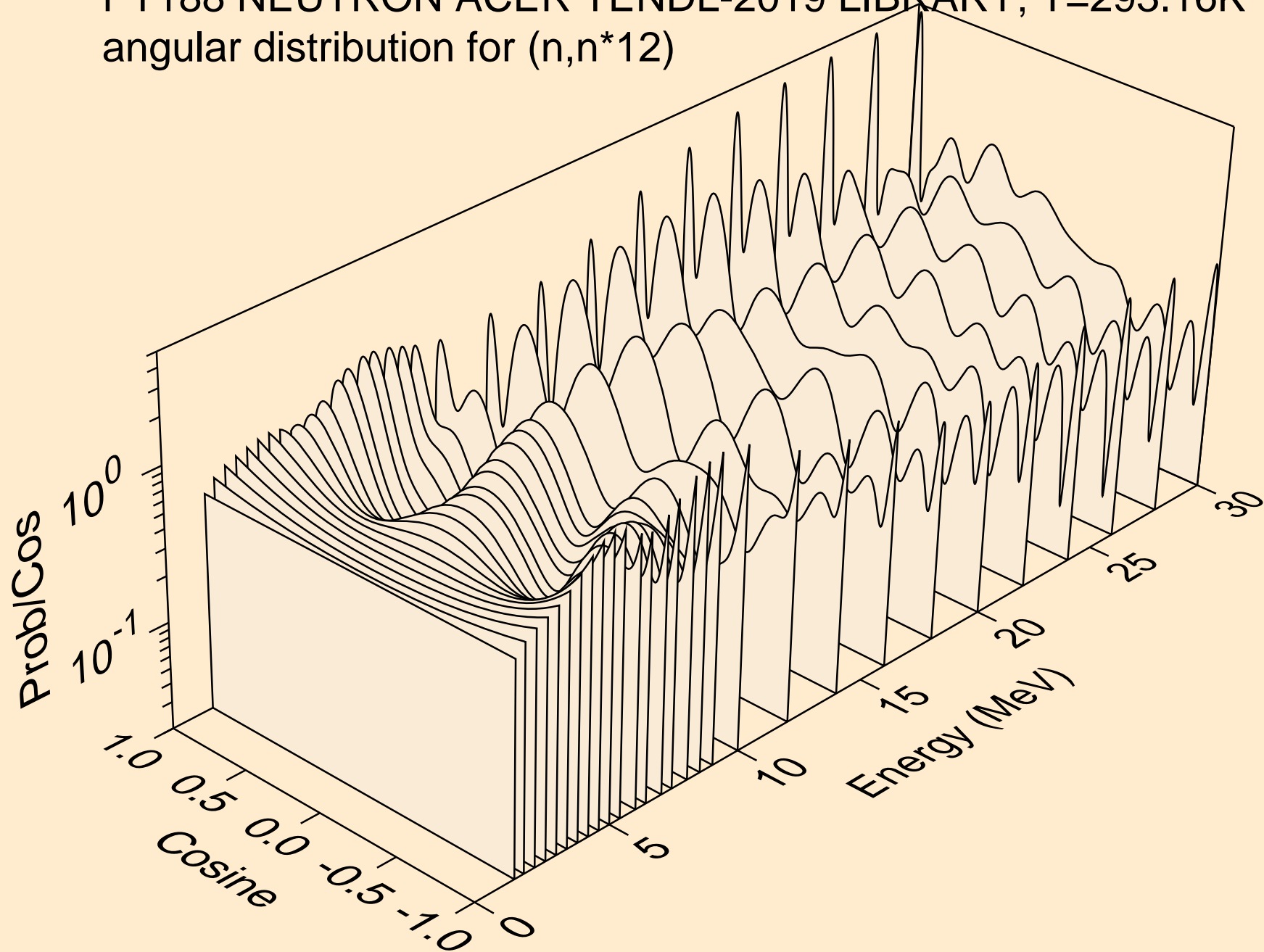

PT188 NEUTRON ACER TENDL-2019 LIBRARY; T=293.16K
angular distribution for (n,n*13)

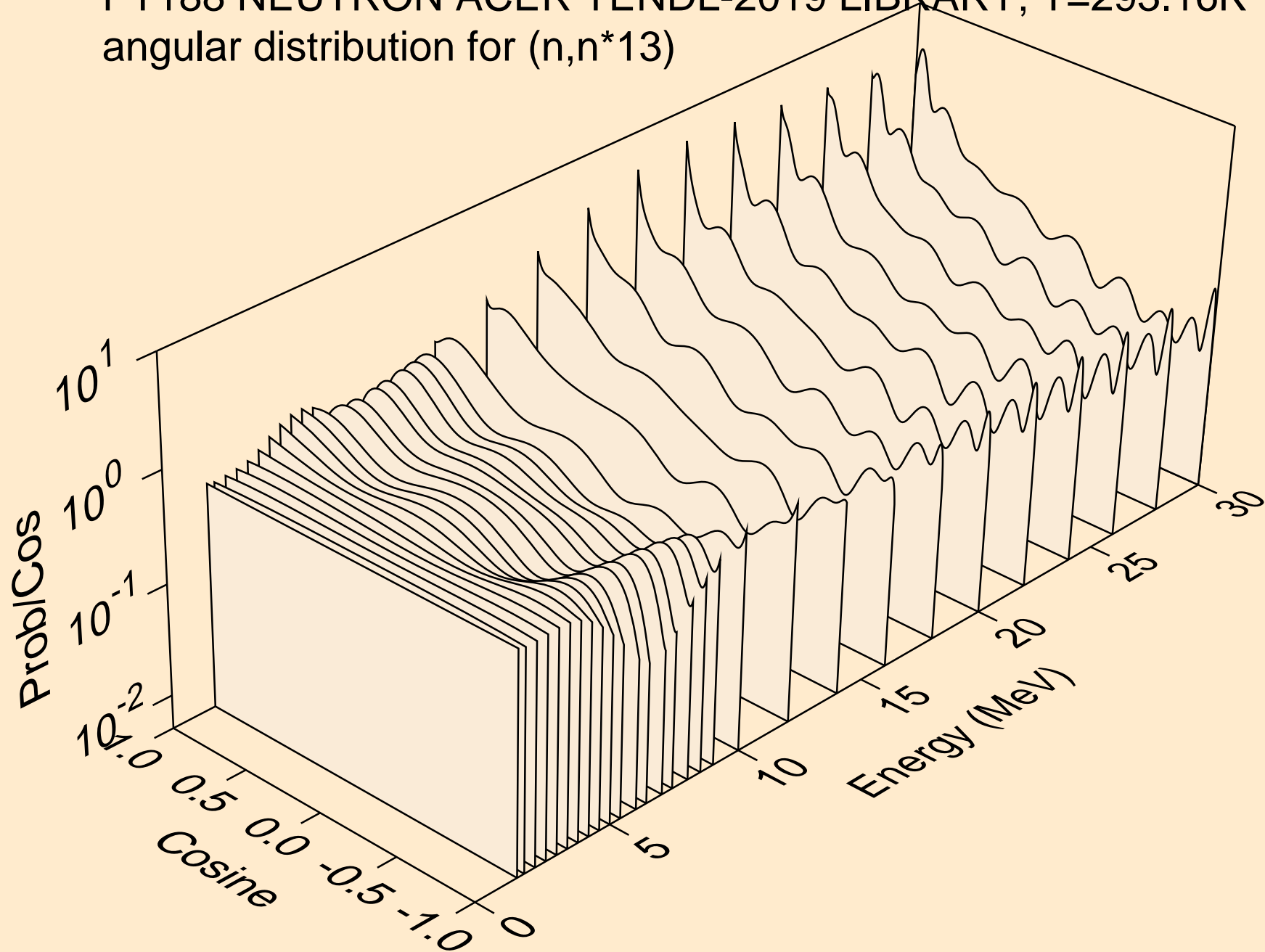

PT188 NEUTRON ACER TENDL-2019 LIBRARY; T=293.16K
angular distribution for (n,n*14)

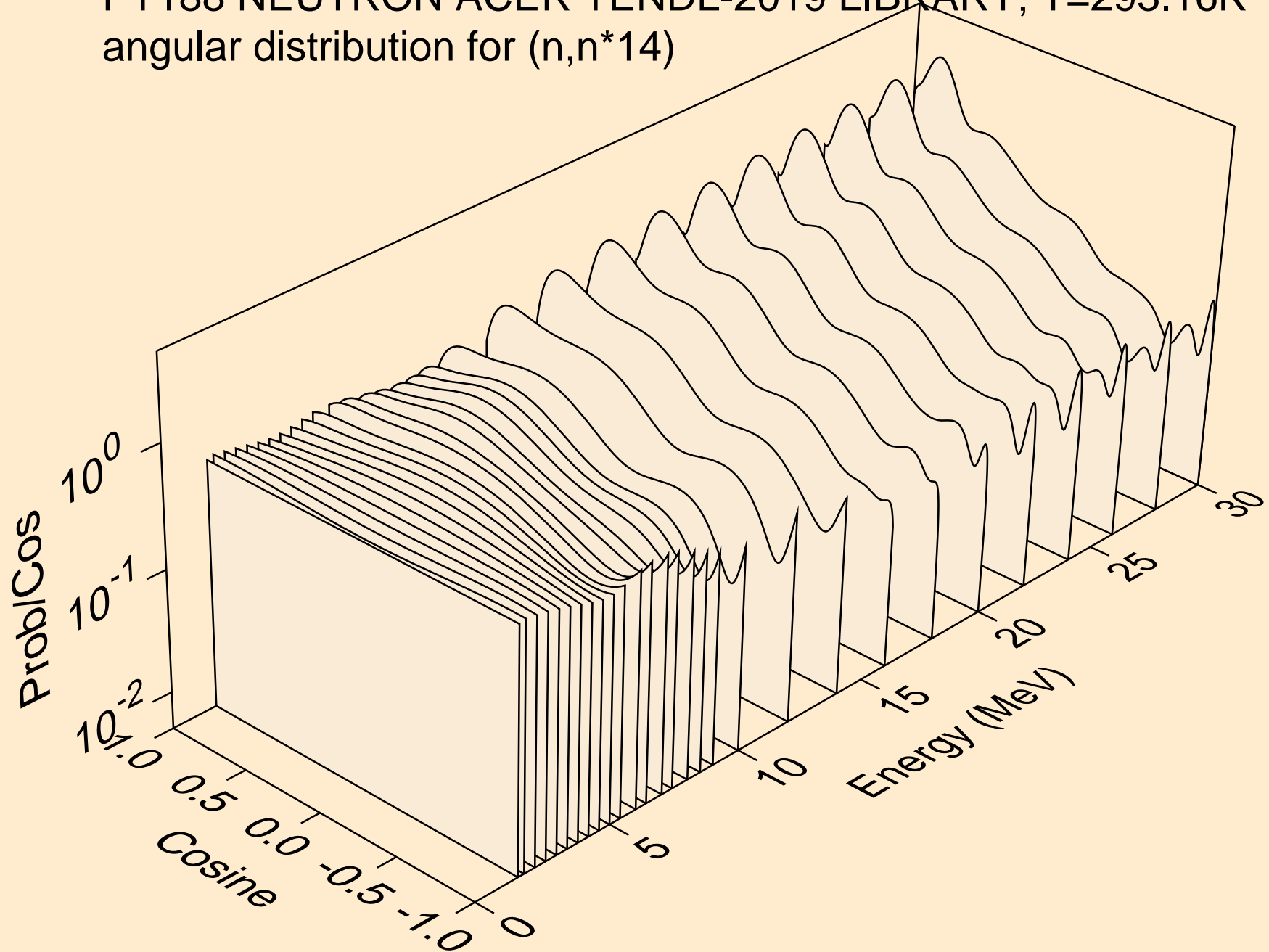

PT188 NEUTRON ACER TENDL-2019 LIBRARY; T=293.16K
angular distribution for (n,n*15)

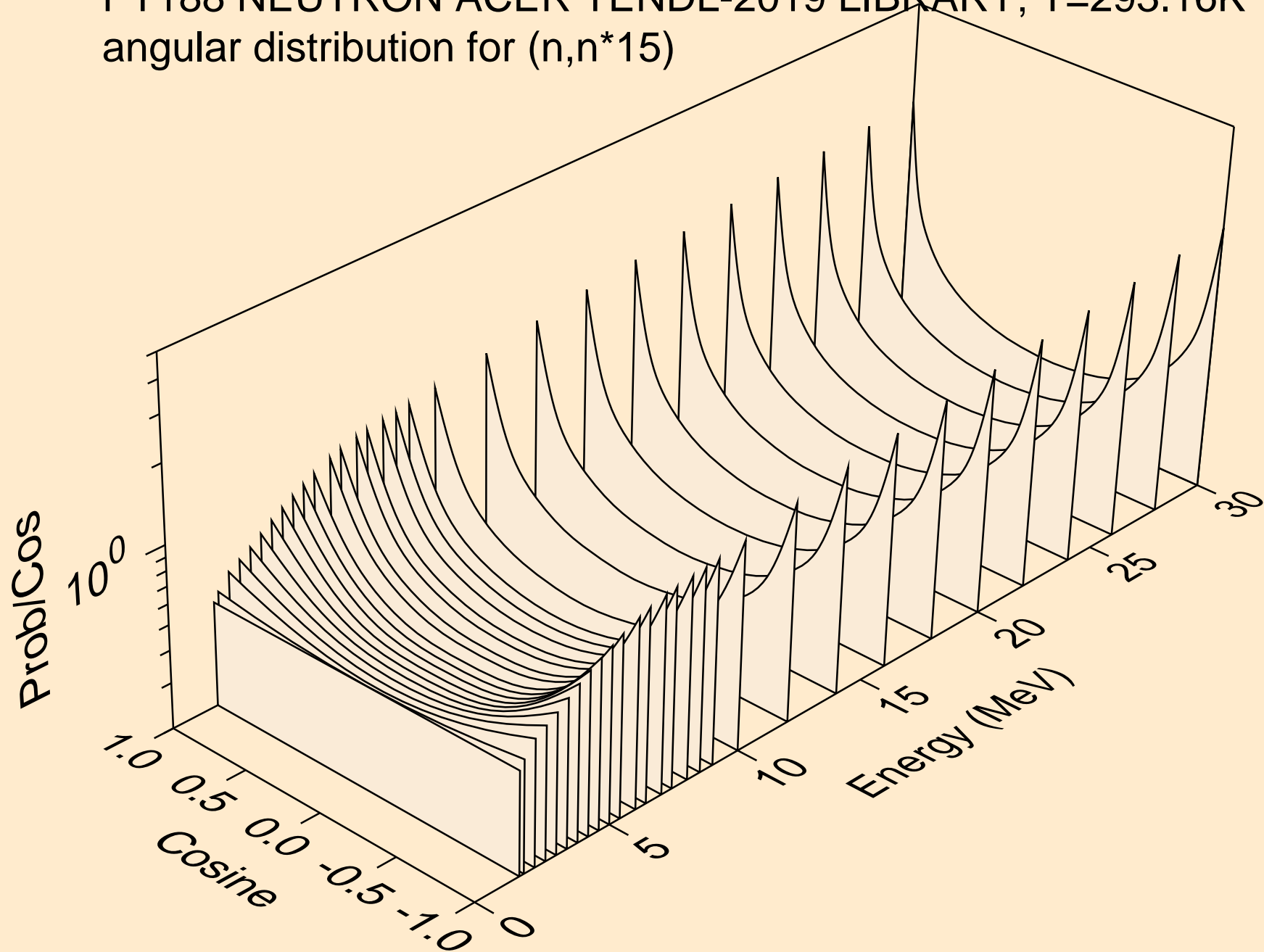

PT188 NEUTRON ACER TENDL-2019 LIBRARY; T=293.16K
angular distribution for (n,n*16)

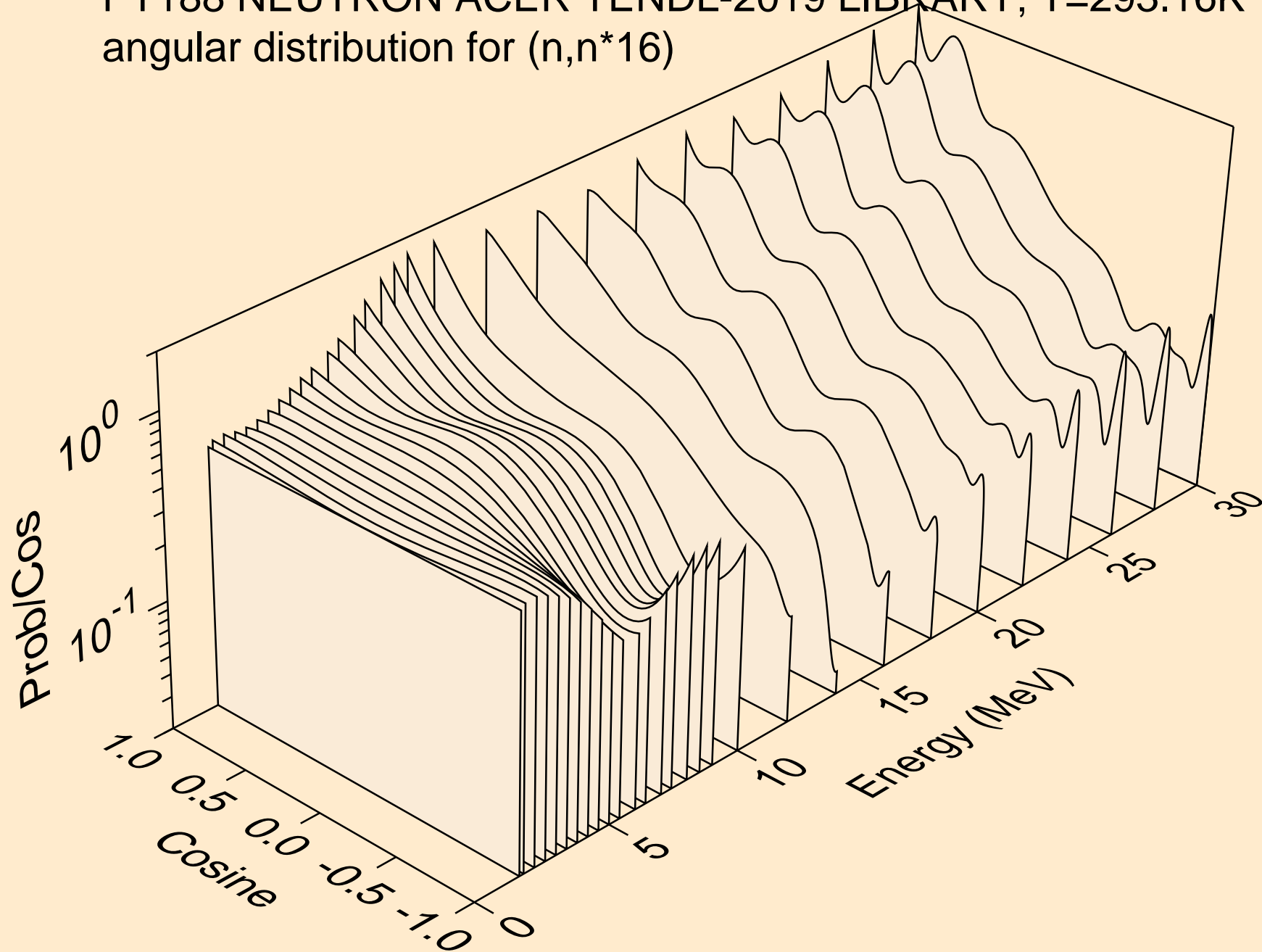

PT188 NEUTRON ACER TENDL-2019 LIBRARY; T=293.16K
angular distribution for (n,n*17)

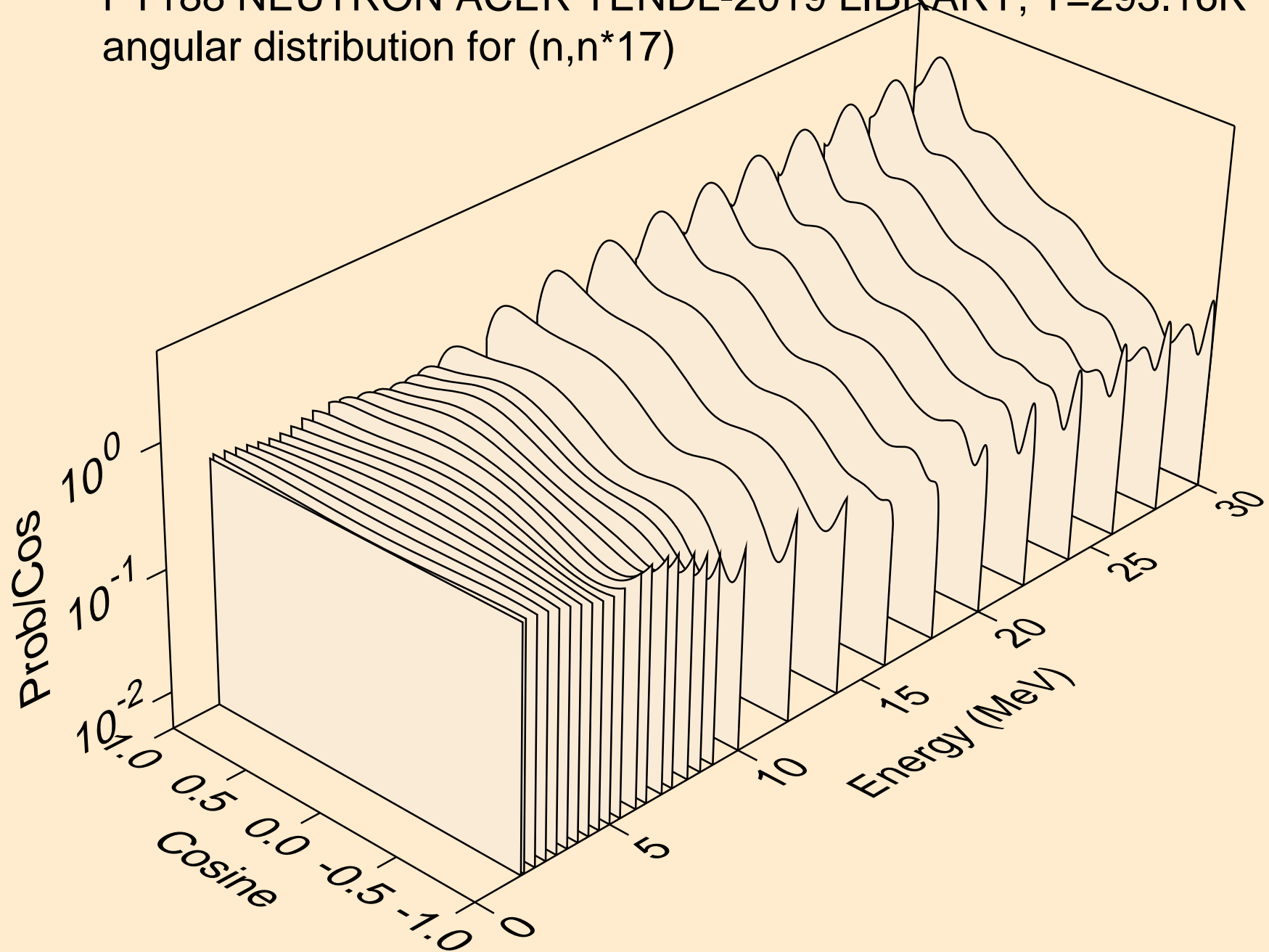

PT188 NEUTRON ACER TENDL-2019 LIBRARY; T=293.16K
angular distribution for (n,n*18)

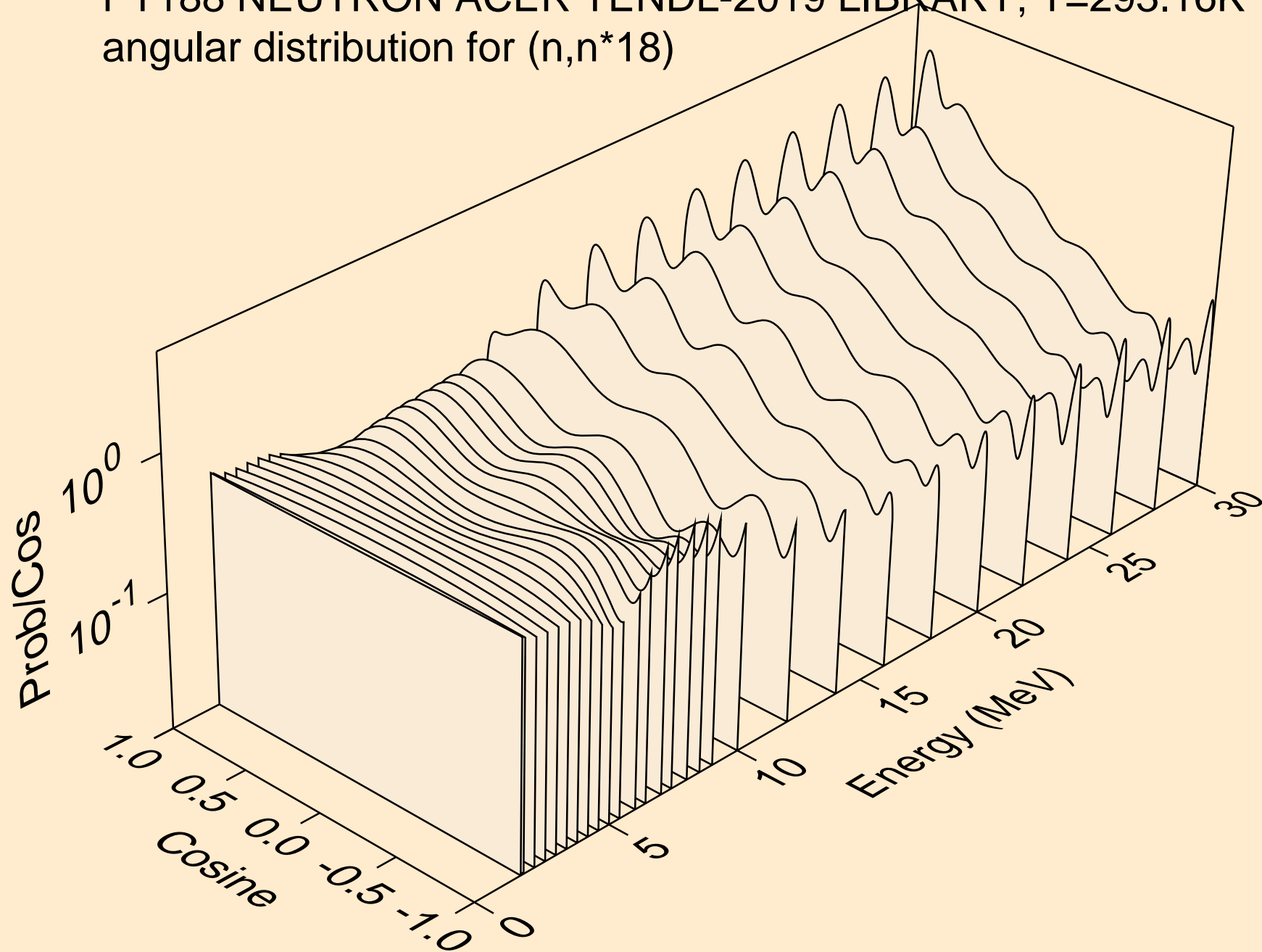

PT188 NEUTRON ACER TENDL-2019 LIBRARY; T=293.16K
angular distribution for (n,n*19)

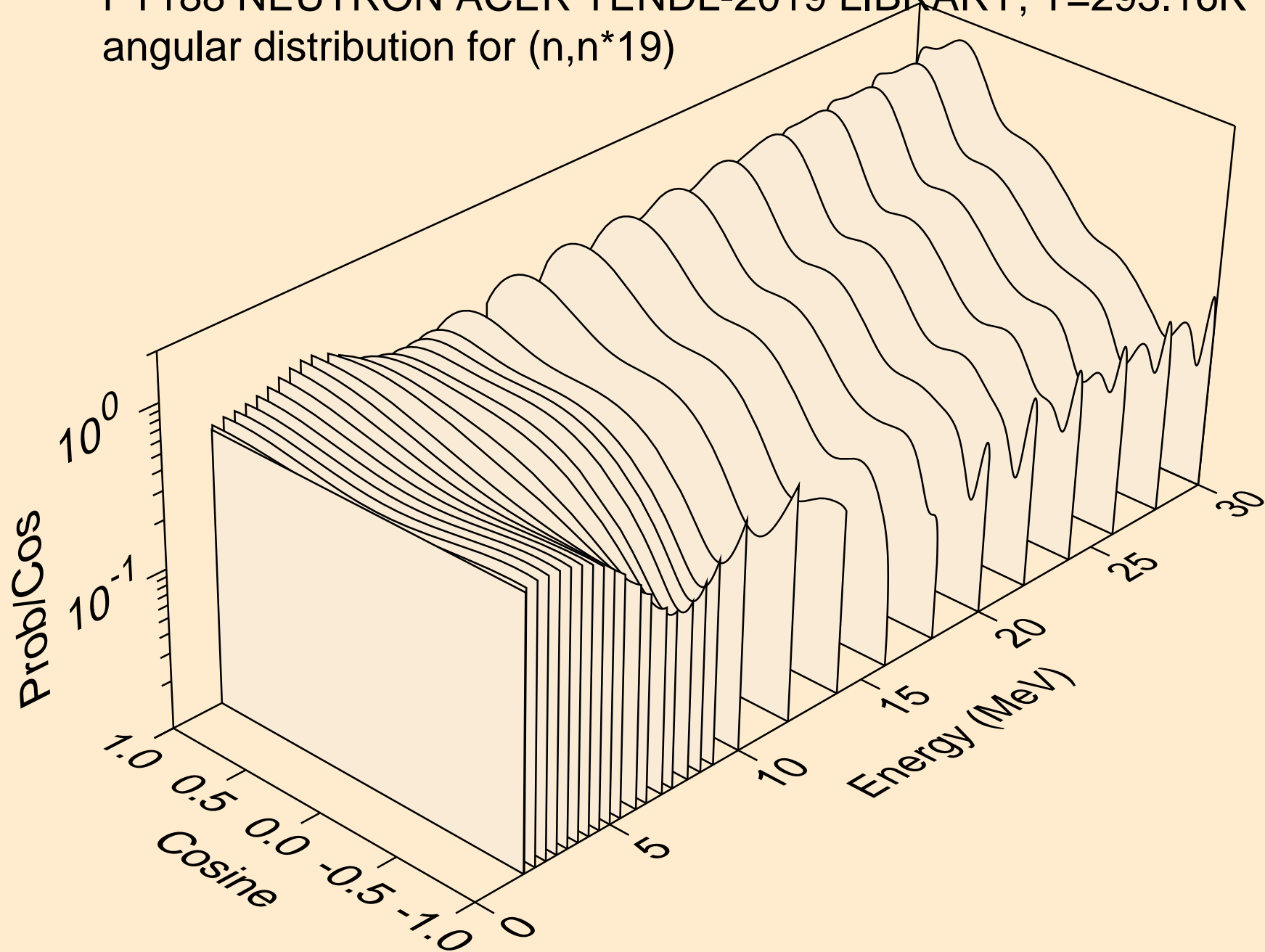

PT188 NEUTRON ACER TENDL-2019 LIBRARY; T=293.16K
angular distribution for (n,n*20)

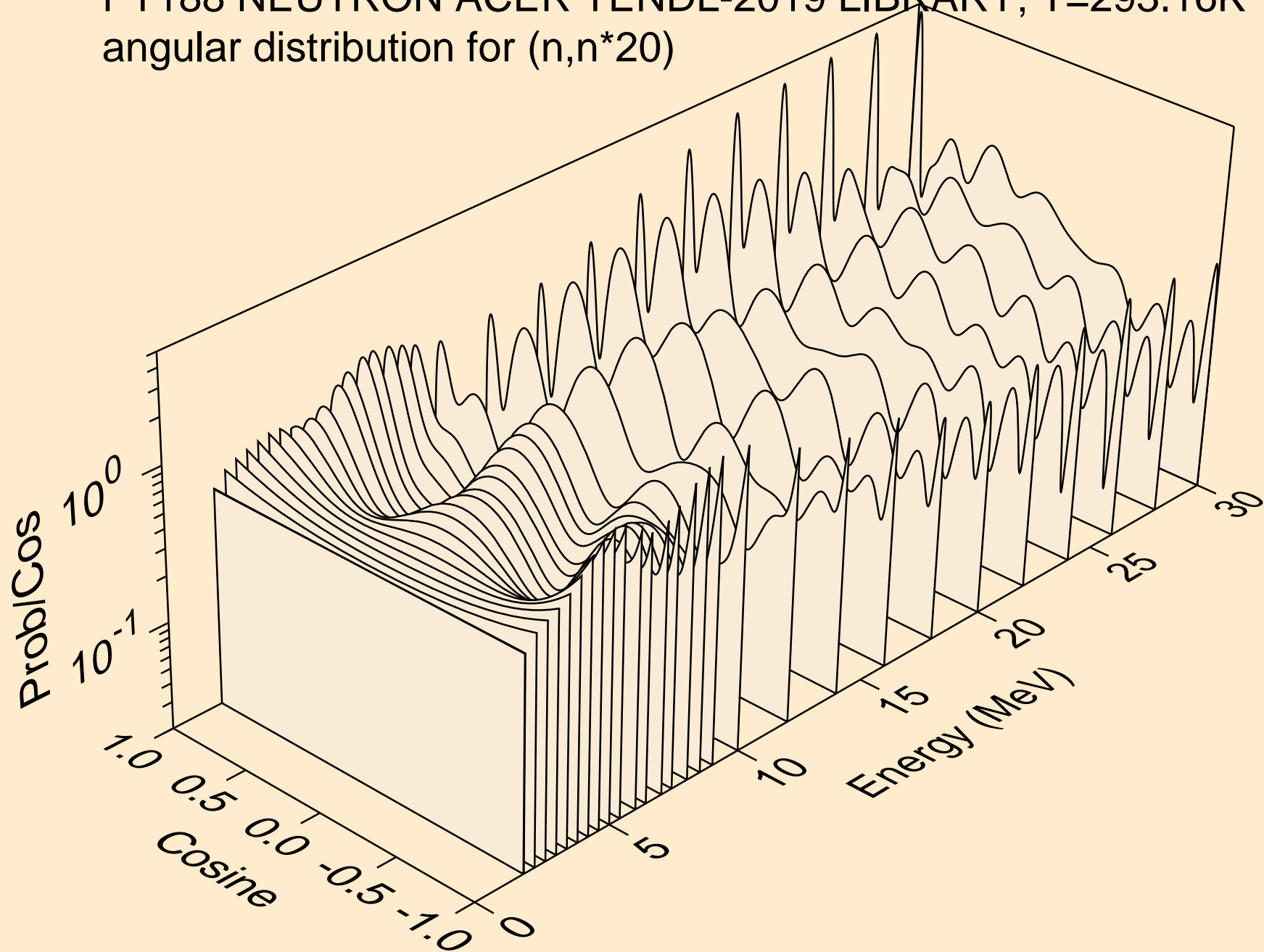

PT188 NEUTRON ACER TENDL-2019 LIBRARY; T=293.16K
angular distribution for (n,n*21)

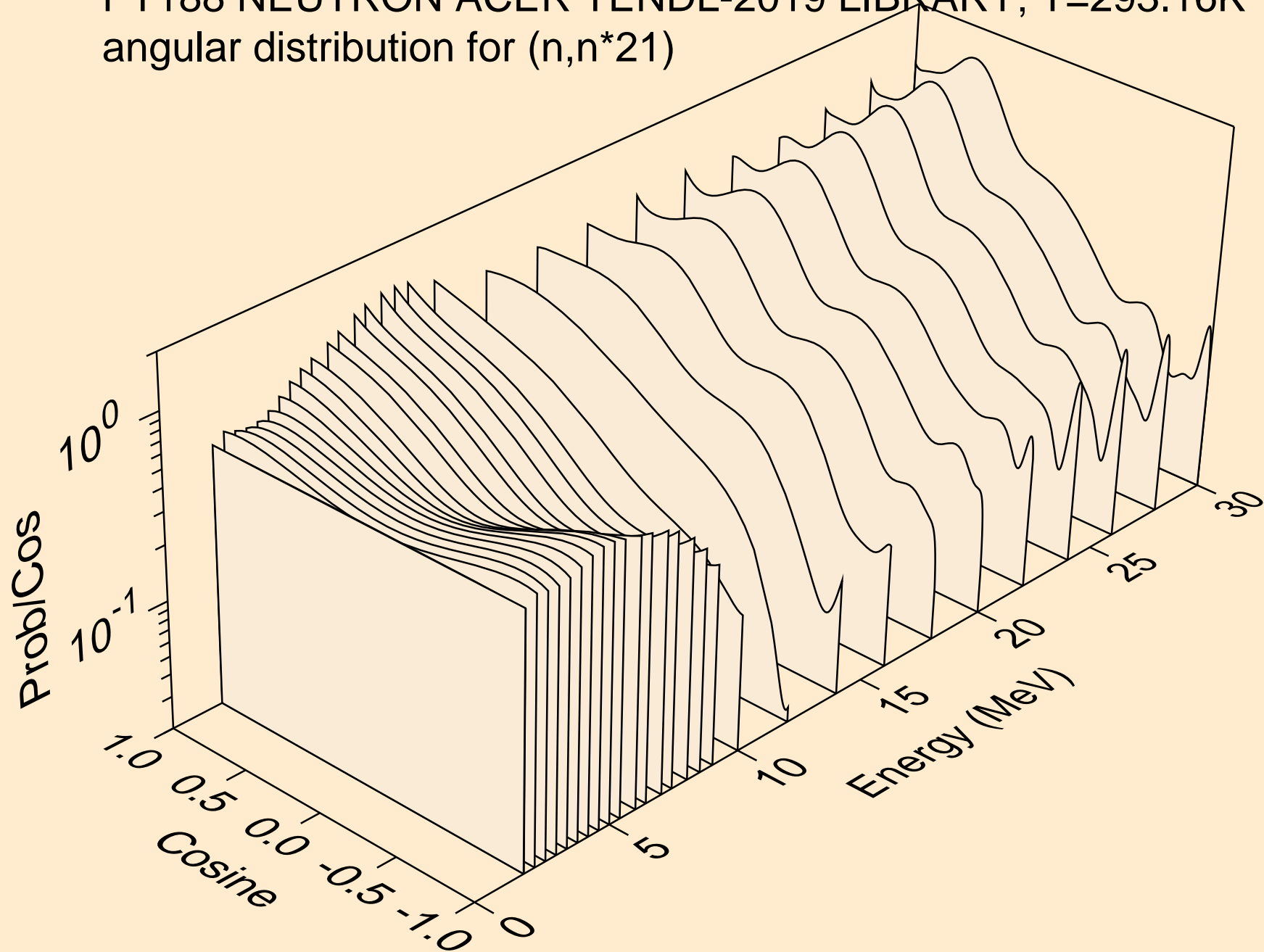

PT188 NEUTRON ACER TENDL-2019 LIBRARY; T=293.16K
angular distribution for (n,n*22)

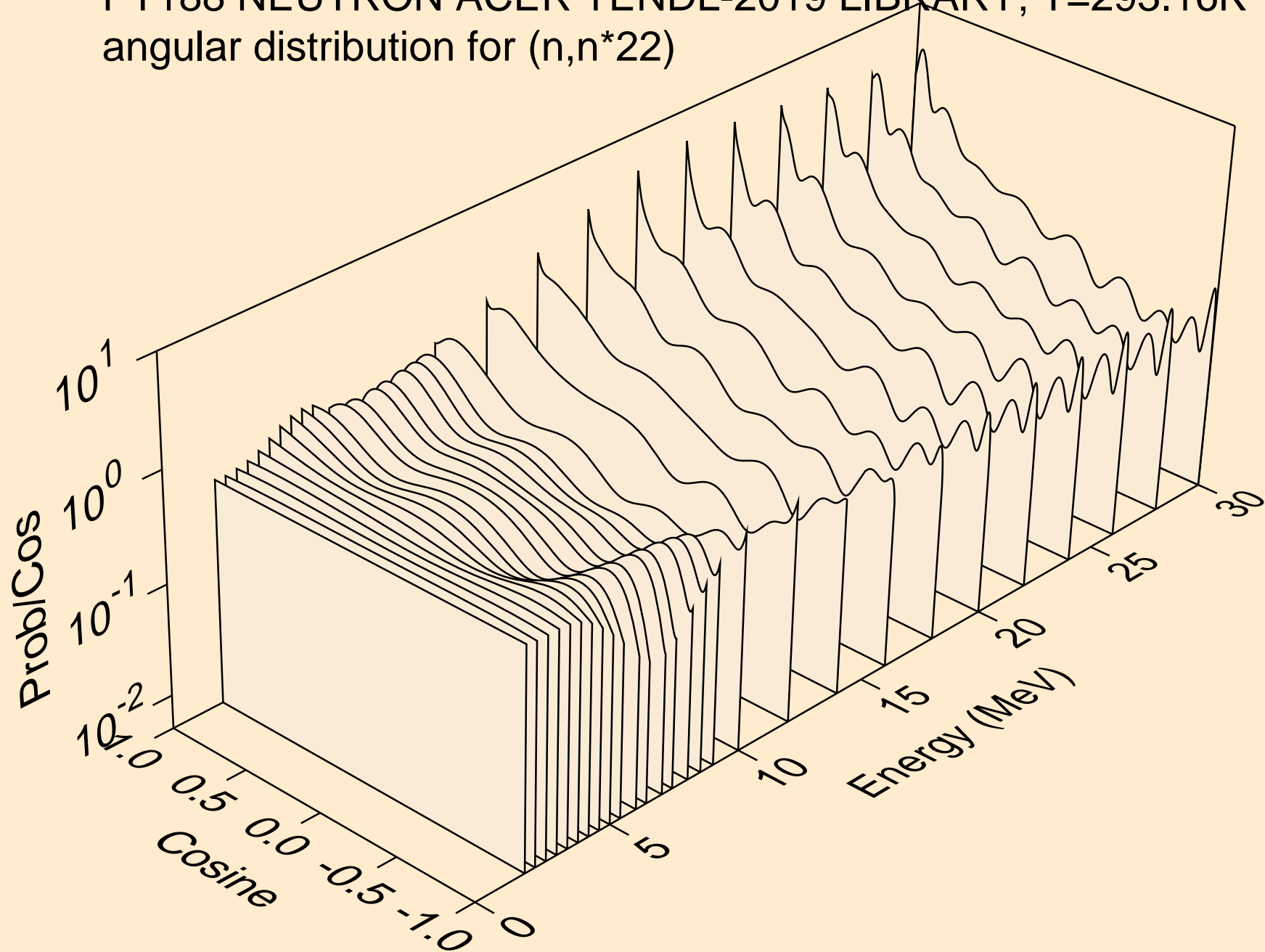

PT188 NEUTRON ACER TENDL-2019 LIBRARY; T=293.16K
angular distribution for (n,n*23)

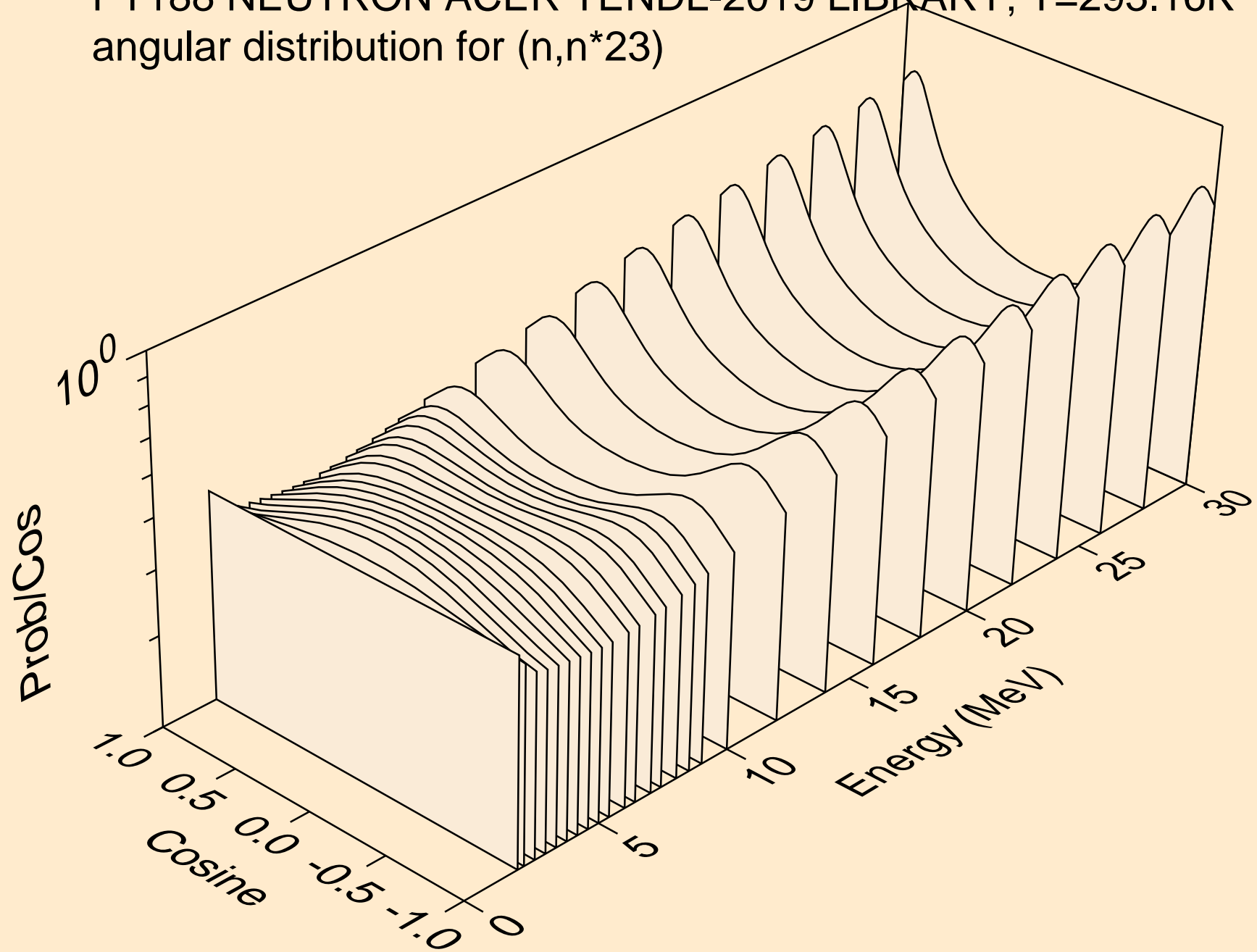

PT188 NEUTRON ACER TENDL-2019 LIBRARY; T=293.16K
angular distribution for (n,n*24)

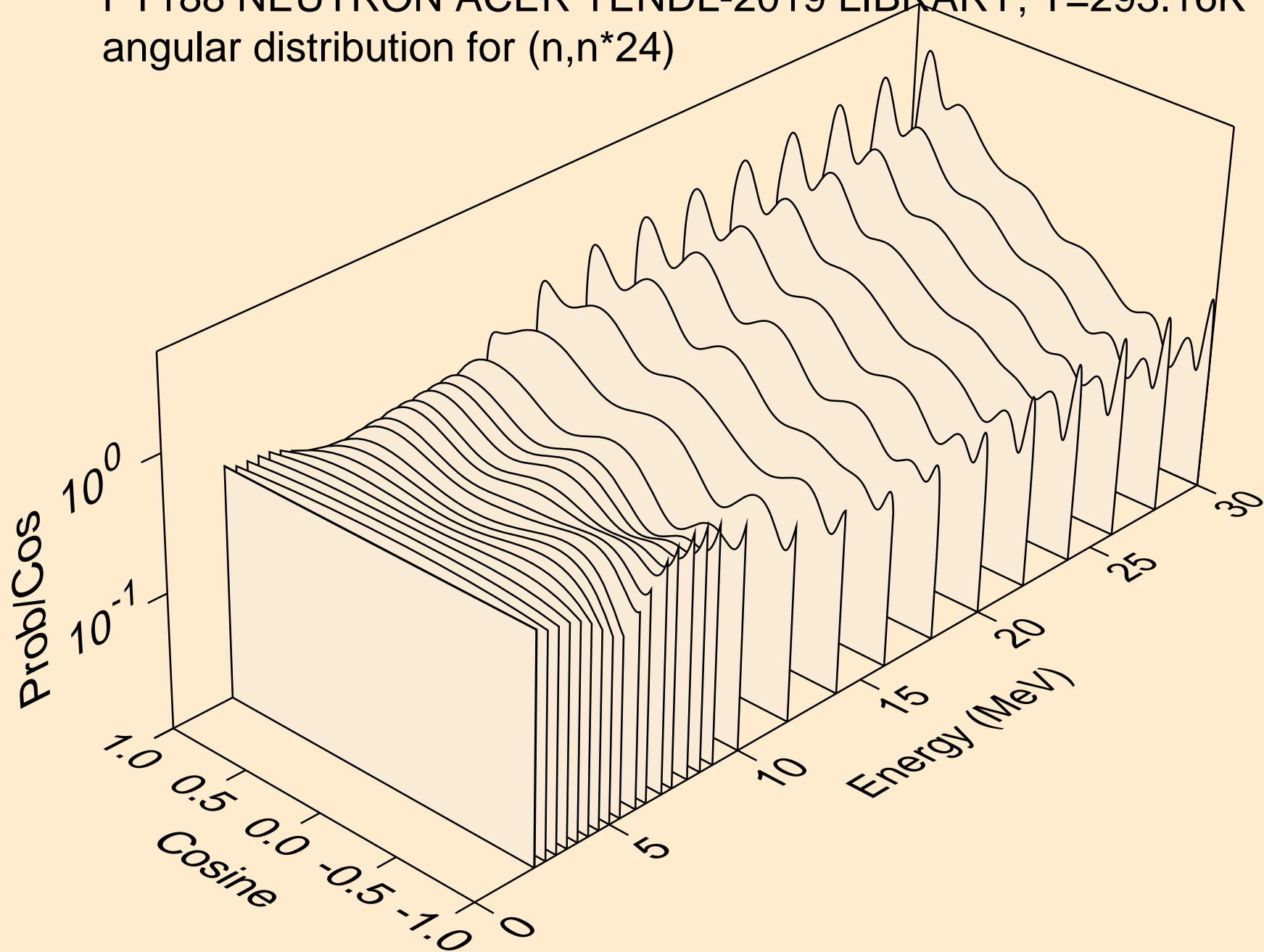

PT188 NEUTRON ACER TENDL-2019 LIBRARY; T=293.16K
Neutron emission for (n,x)

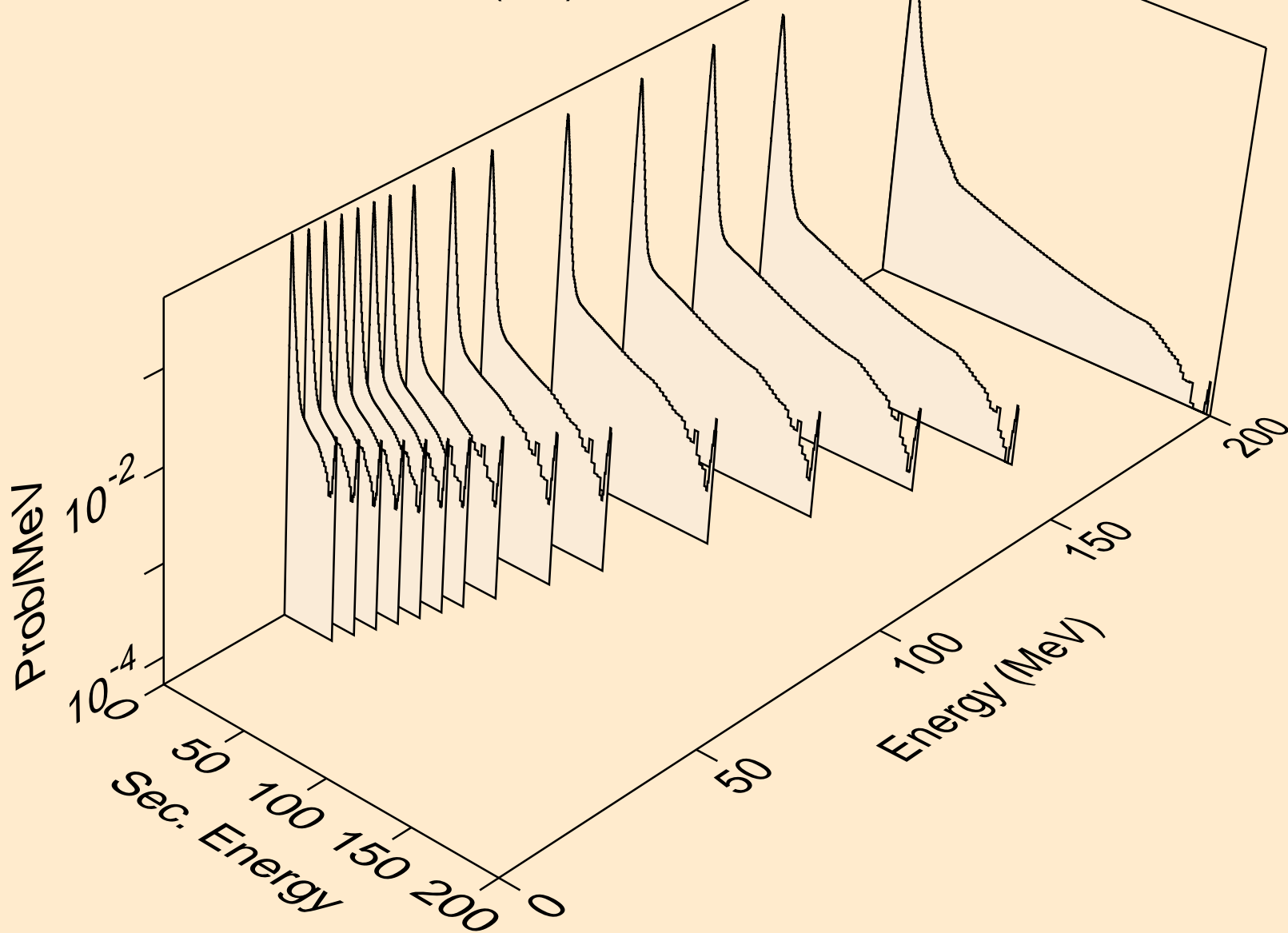

PT188 NEUTRON ACER TENDL-2019 LIBRARY; T=293.16K
Neutron emission for (n,2nd)

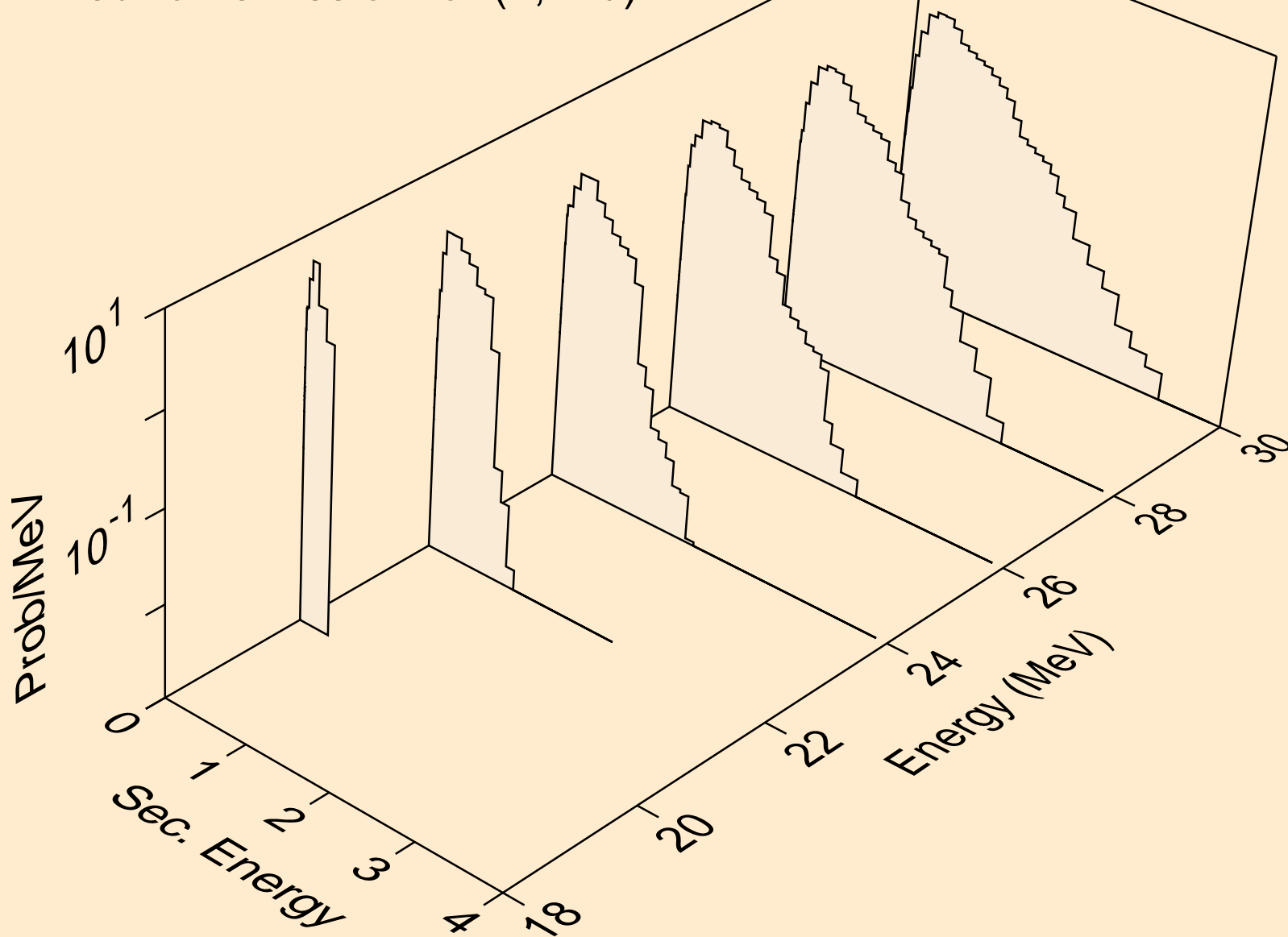

PT188 NEUTRON ACER TENDL-2019 LIBRARY; T=293.16K
Neutron emission for (n,2n)

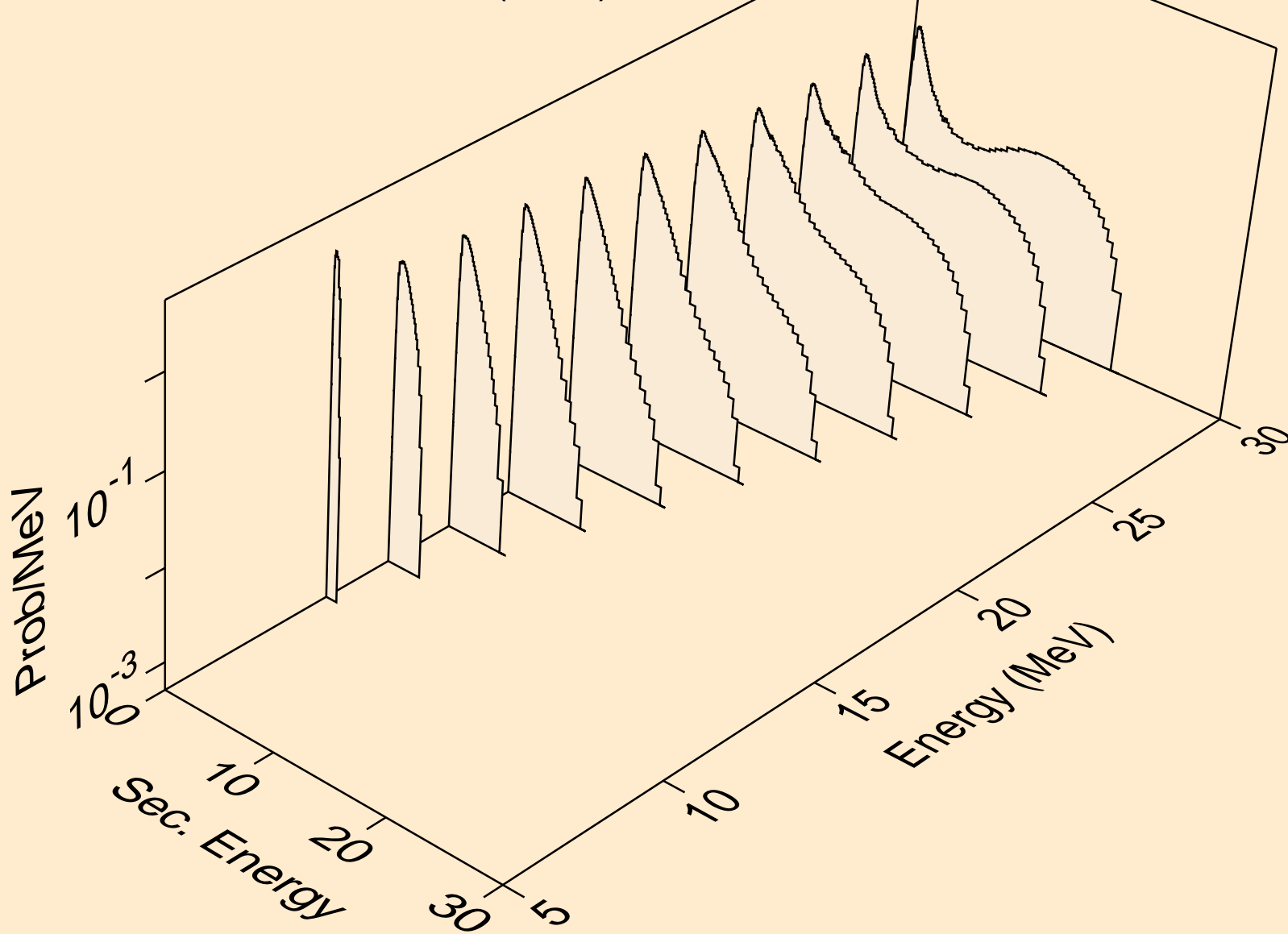

PT188 NEUTRON ACER TENDL-2019 LIBRARY; T=293.16K
Neutron emission for (n,3n)

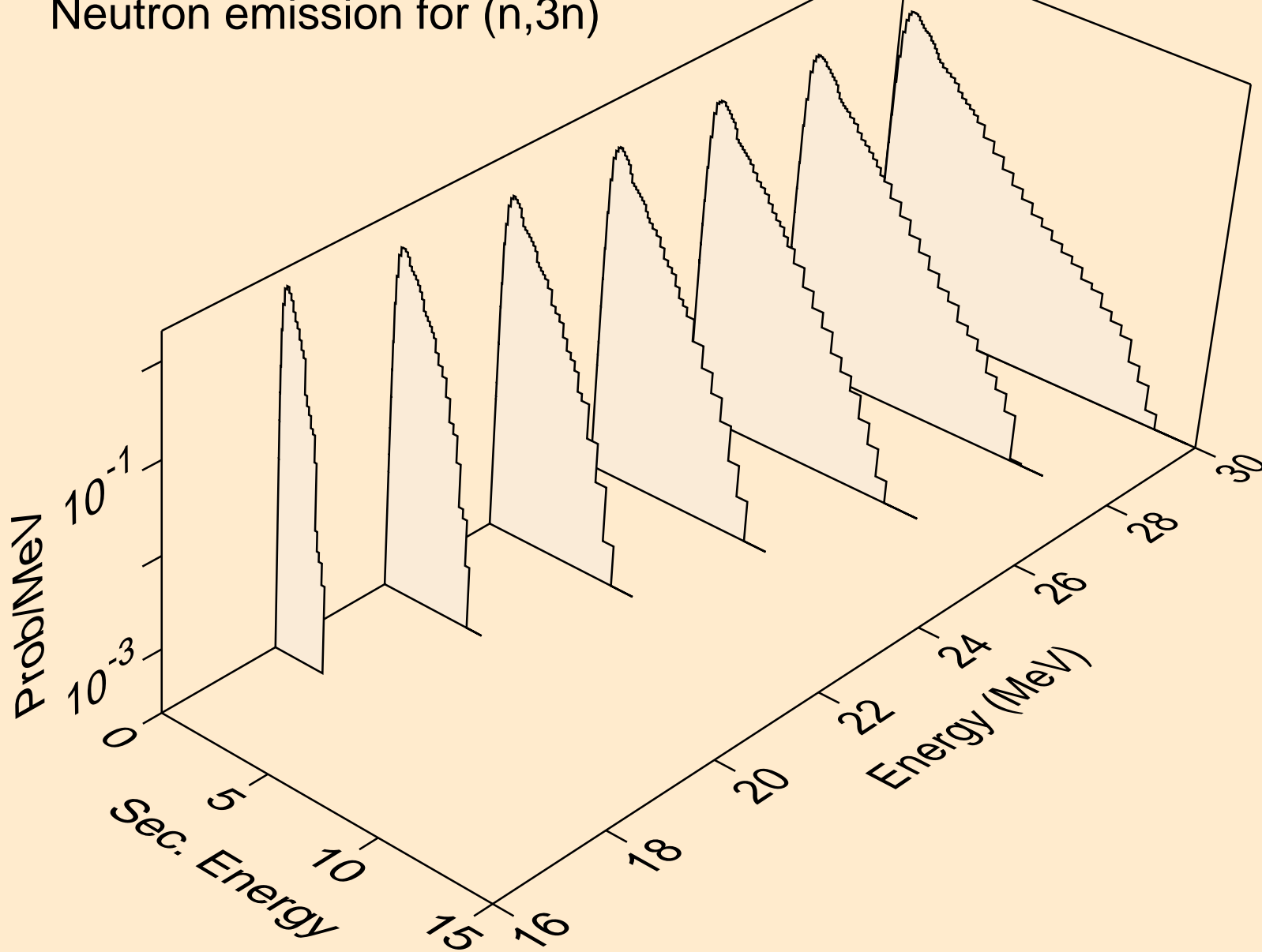

PT188 NEUTRON ACER TENDL-2019 LIBRARY; T=293.16K
Neutron emission for (n,n*)a

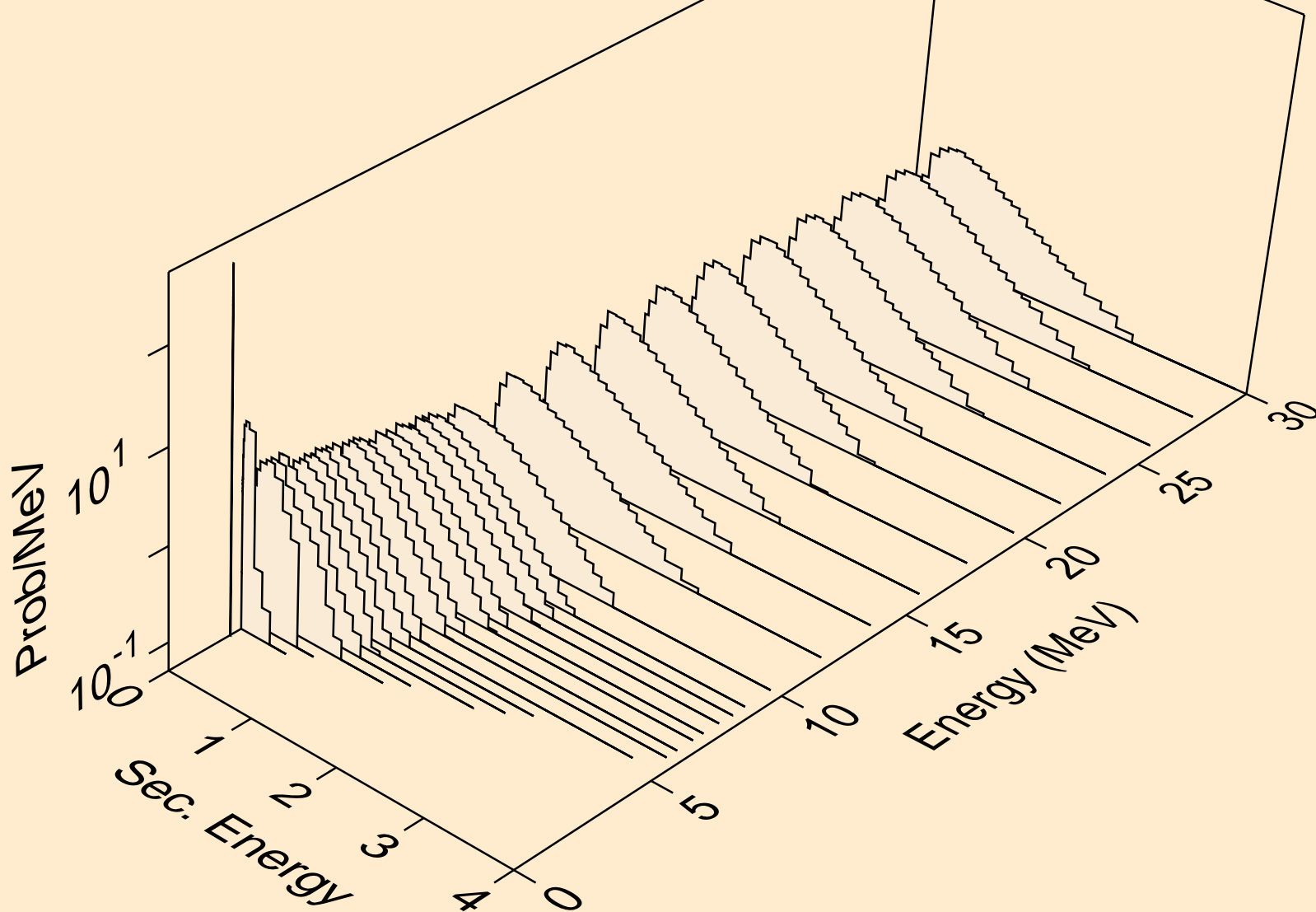

PT188 NEUTRON ACER TENDL-2019 LIBRARY; T=293.16K
Neutron emission for (n,2n)a

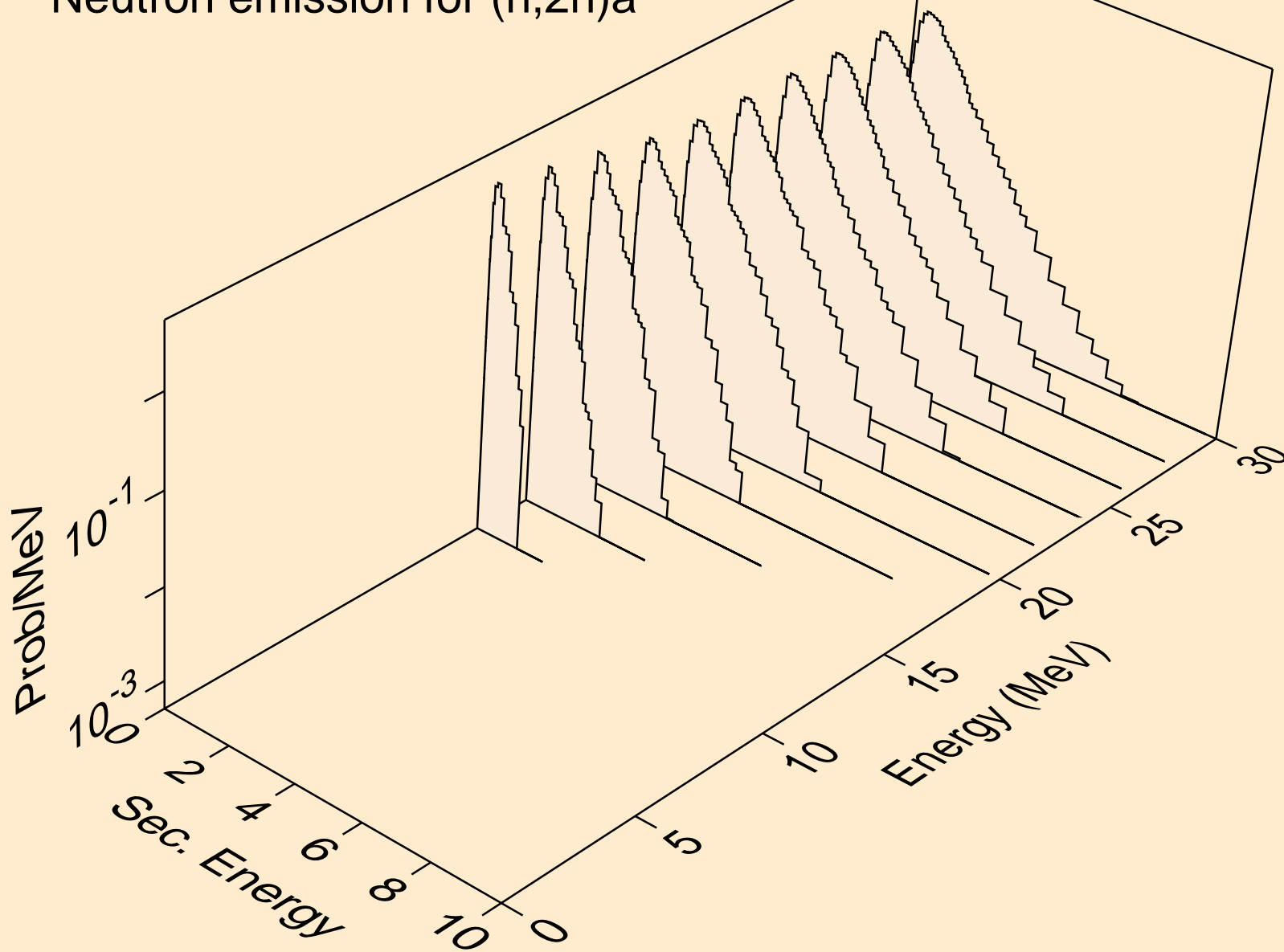

PT188 NEUTRON ACER TENDL-2019 LIBRARY; T=293.16K
Neutron emission for (n,3n)a

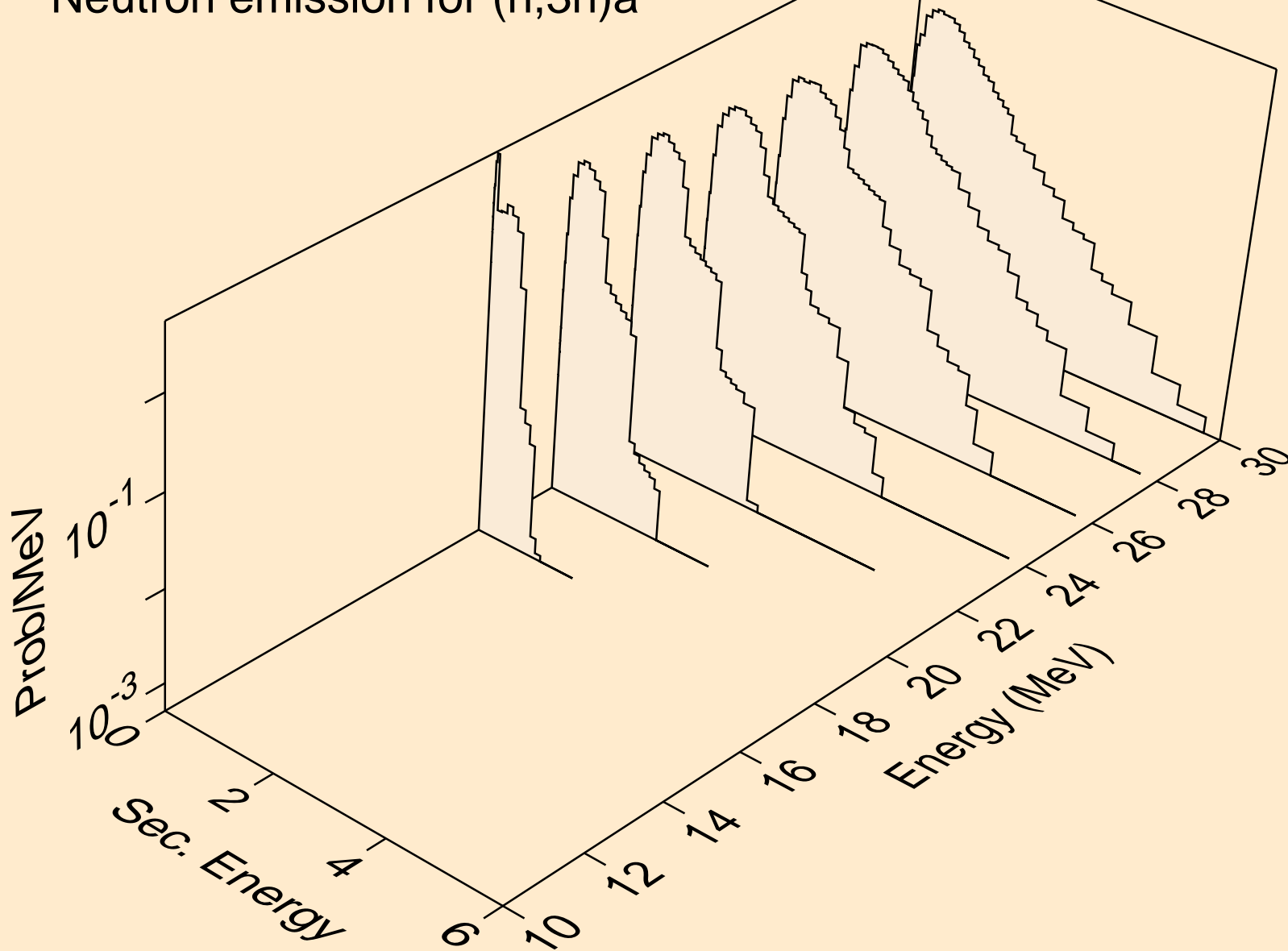

PT188 NEUTRON ACER TENDL-2019 LIBRARY; T=293.16K
Neutron emission for (n,n*)p

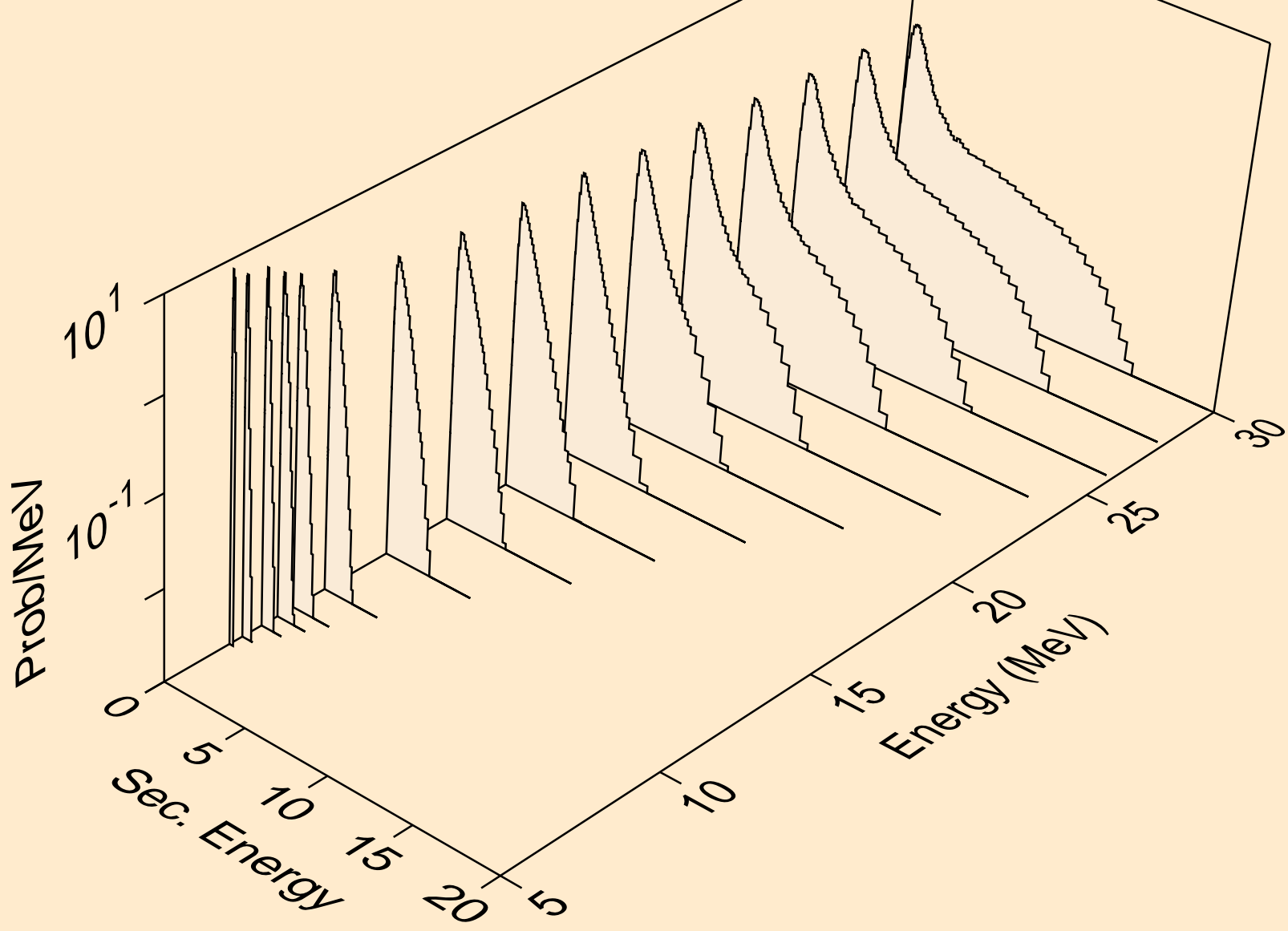

PT188 NEUTRON ACER TENDL-2019 LIBRARY; T=293.16K
Neutron emission for (n,n*)2a

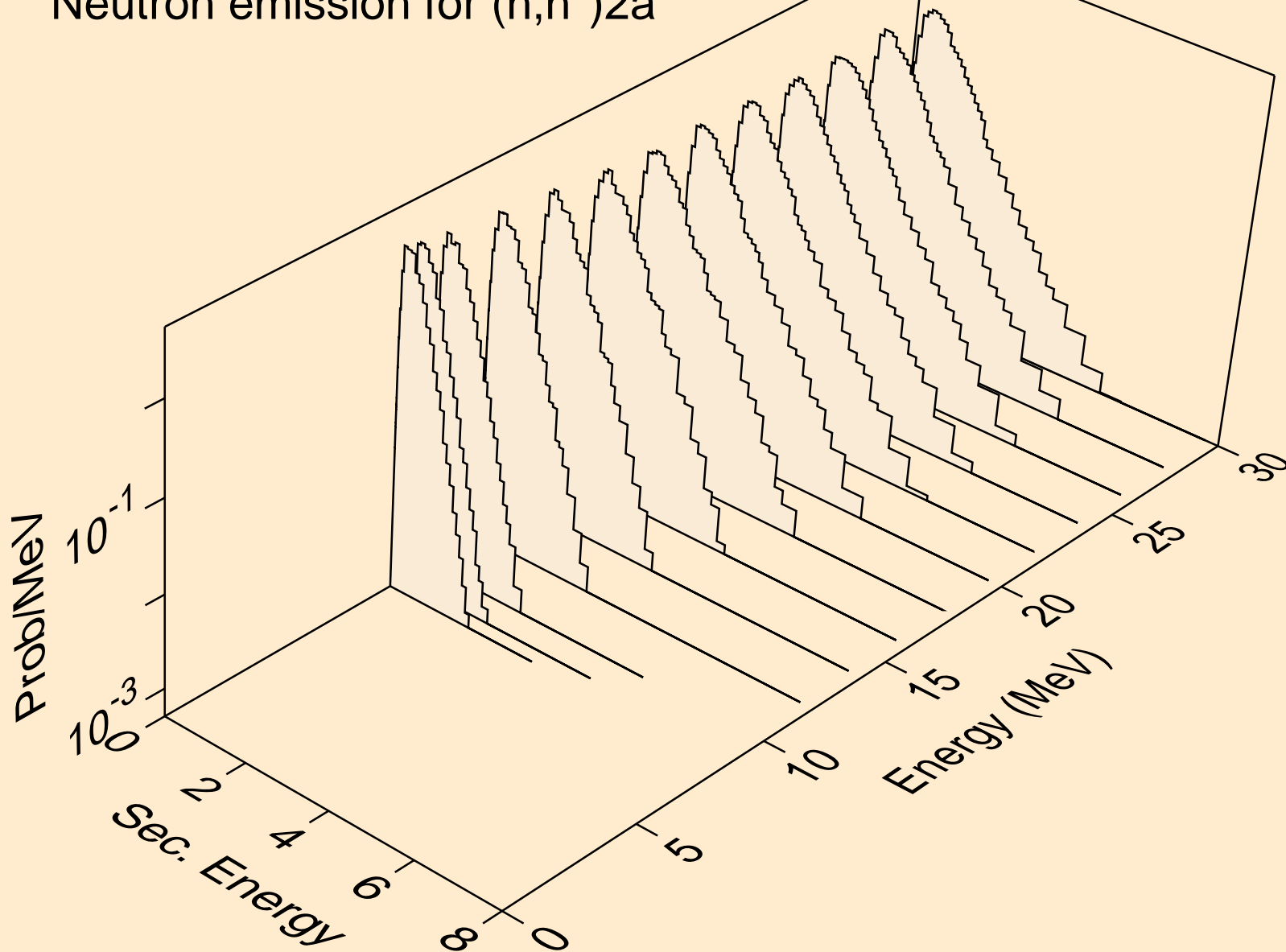

PT188 NEUTRON ACER TENDL-2019 LIBRARY; T=293.16K
Neutron emission for (n,2n)2a

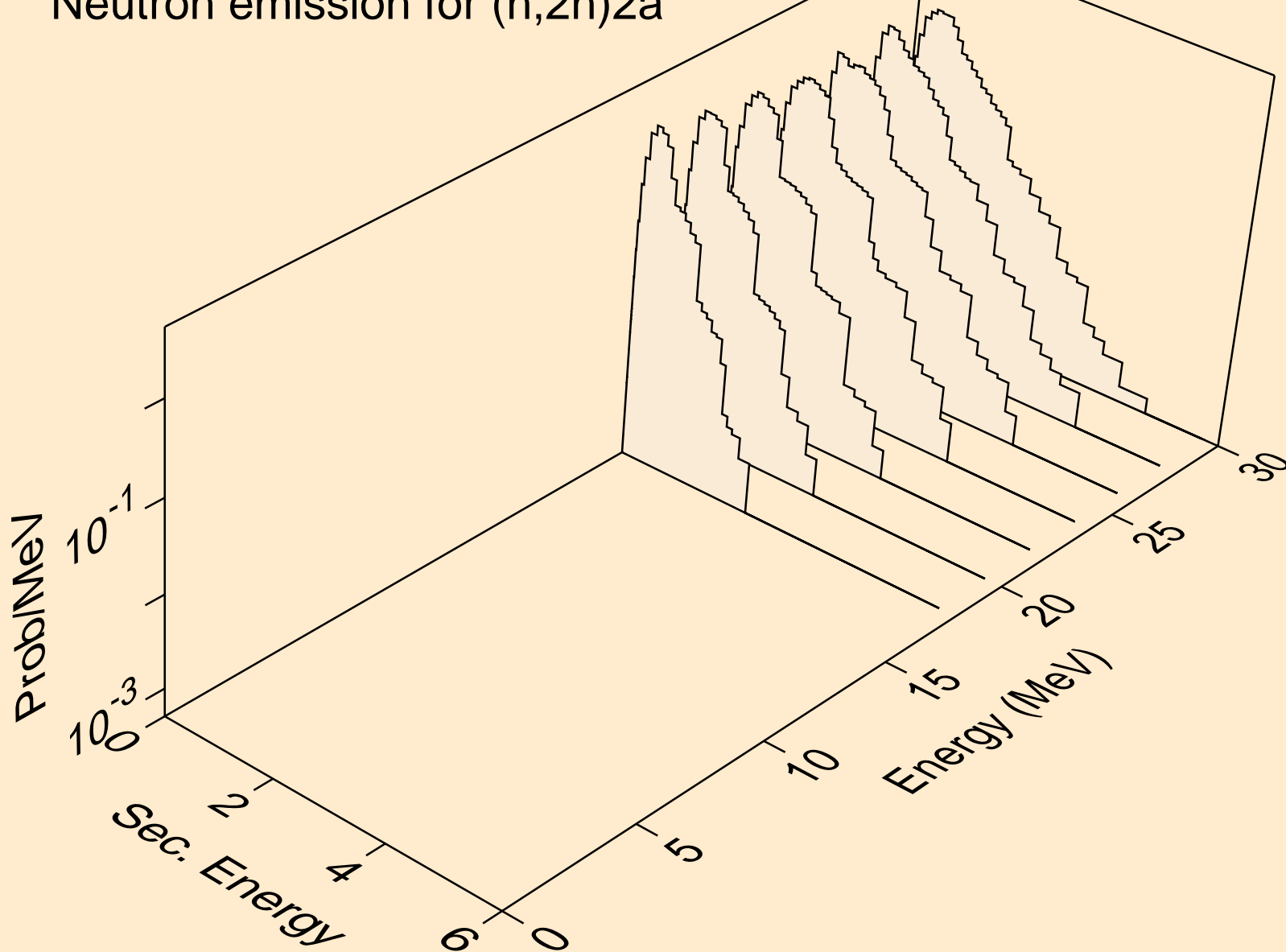

PT188 NEUTRON ACER TENDL-2019 LIBRARY; T=293.16K
Neutron emission for (n,n*)d

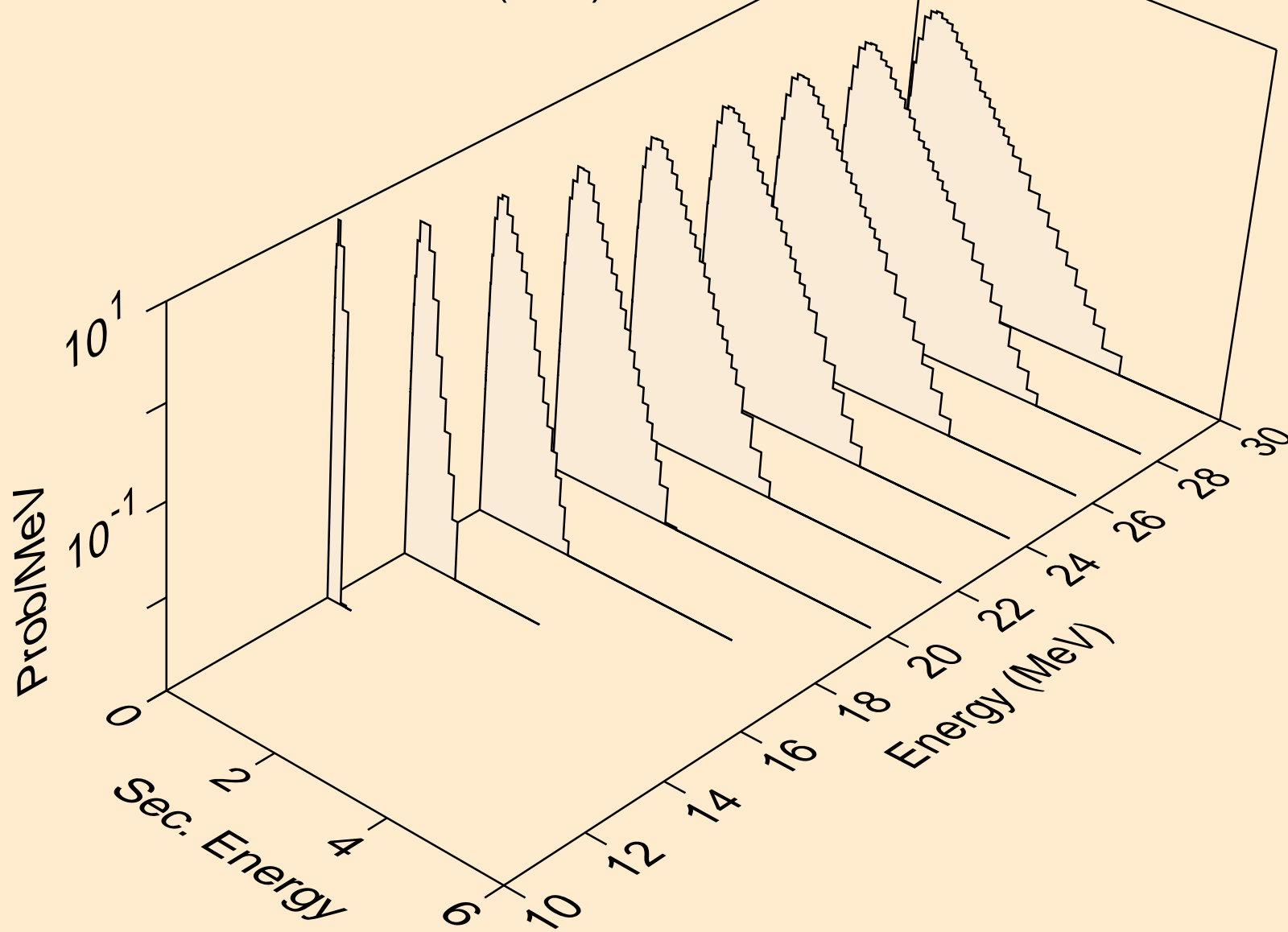

PT188 NEUTRON ACER TENDL-2019 LIBRARY; T=293.16K
Neutron emission for (n,n*)t

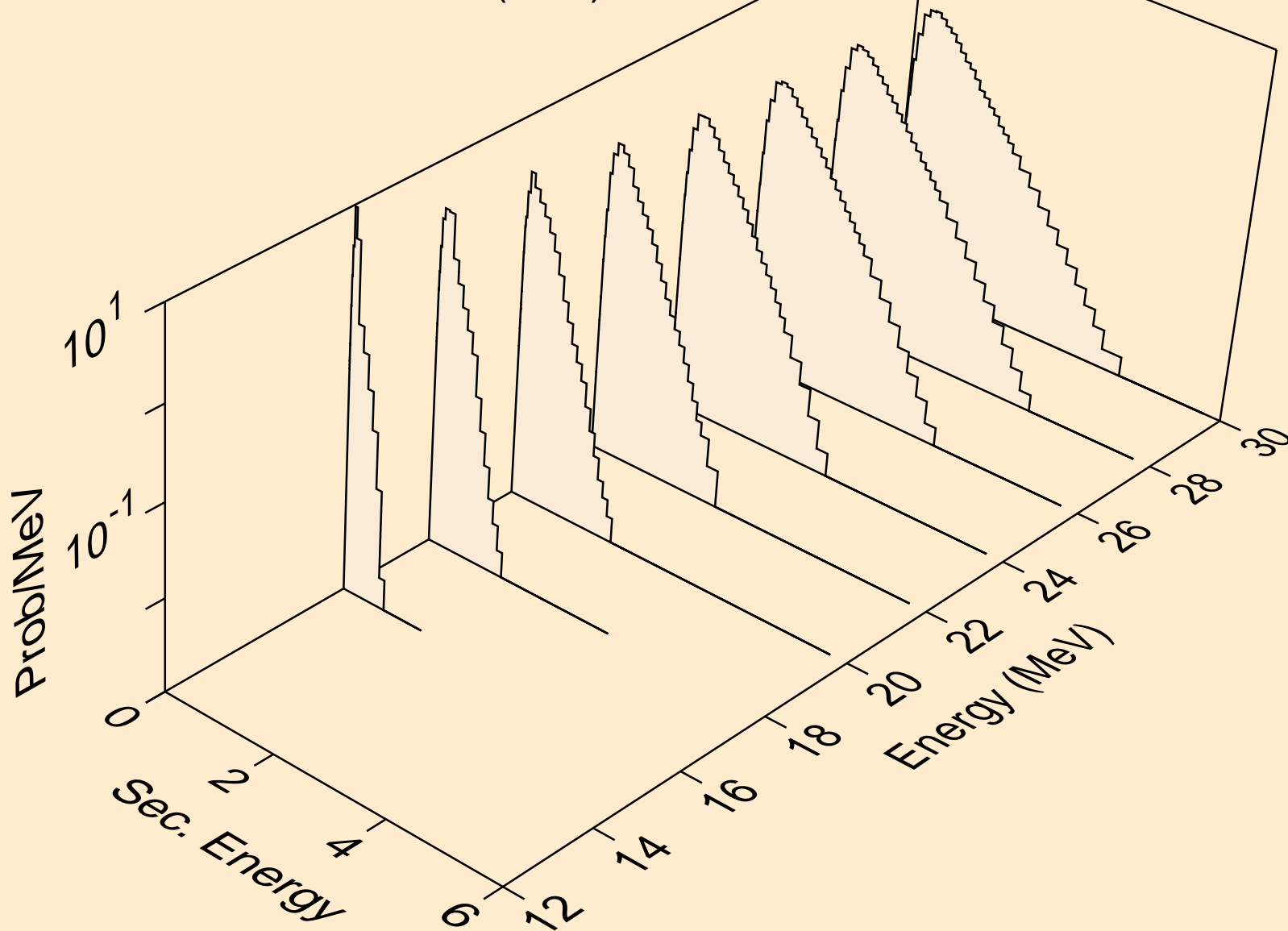

PT188 NEUTRON ACER TENDL-2019 LIBRARY; T=293.16K
Neutron emission for (n,n*)he3

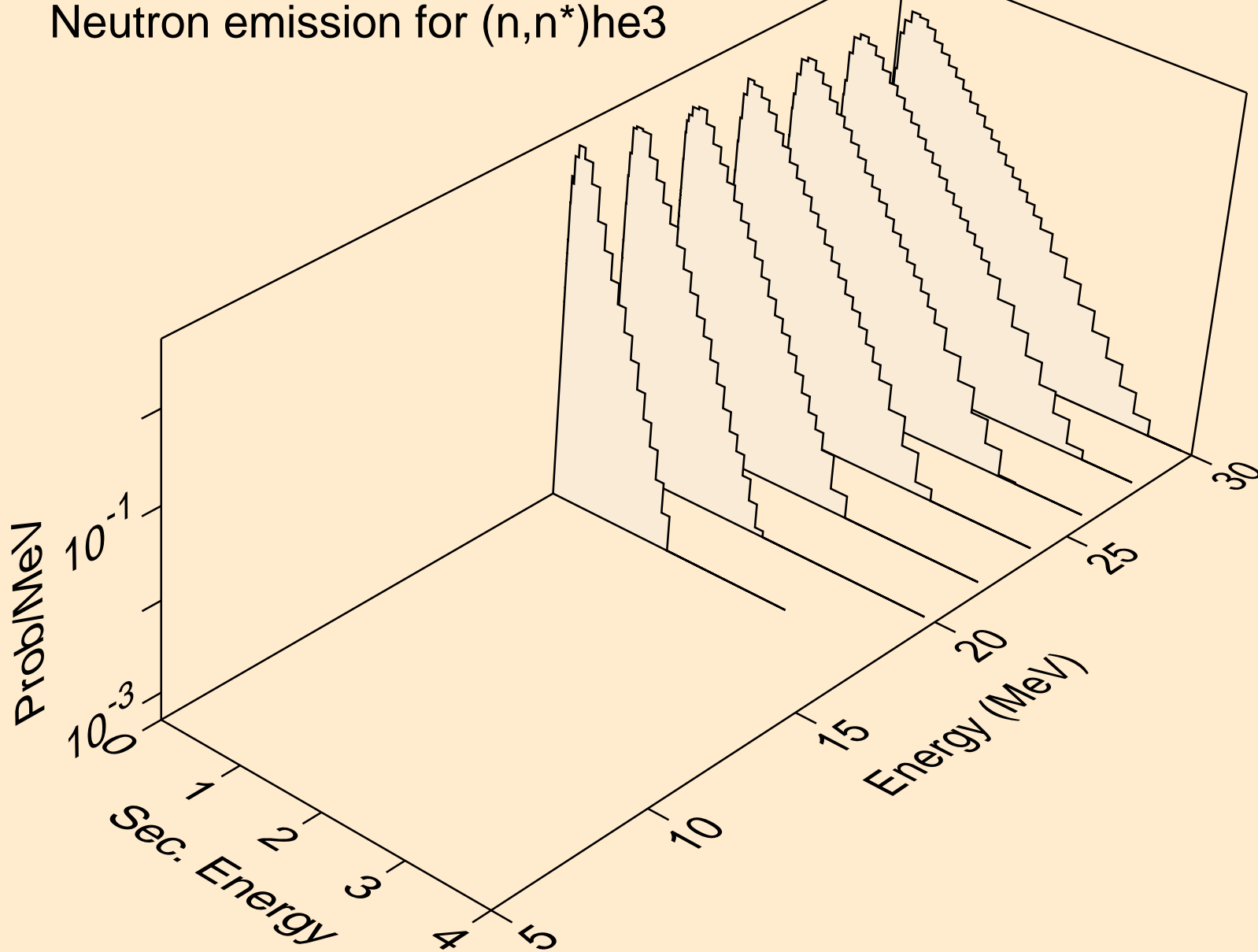

PT188 NEUTRON ACER TENDL-2019 LIBRARY; T=293.16K
Neutron emission for (n,4n)

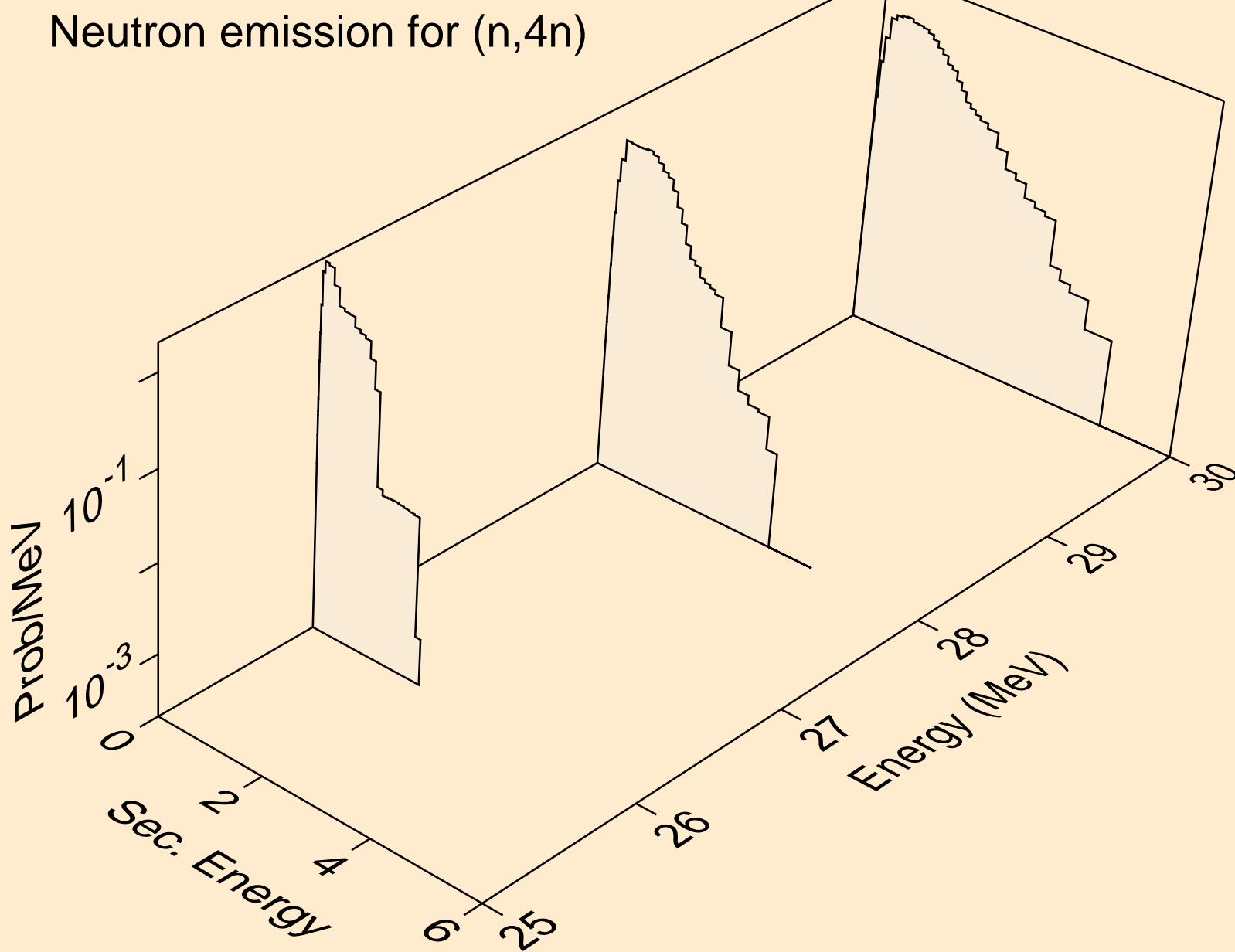

PT188 NEUTRON ACER TENDL-2019 LIBRARY; T=293.16K
Neutron emission for (n,2np)

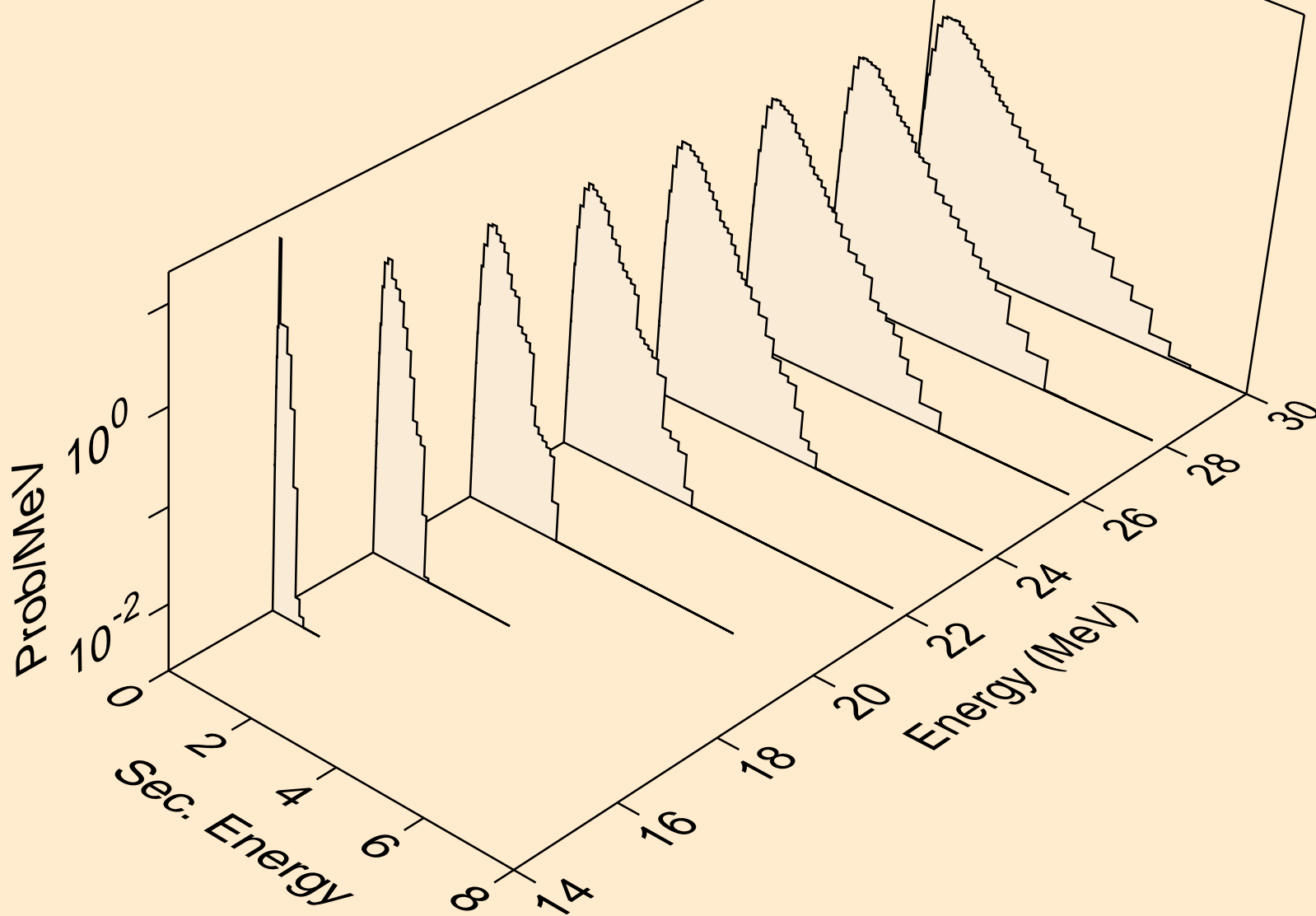

PT188 NEUTRON ACER TENDL-2019 LIBRARY; T=293.16K
Neutron emission for (n,3np)

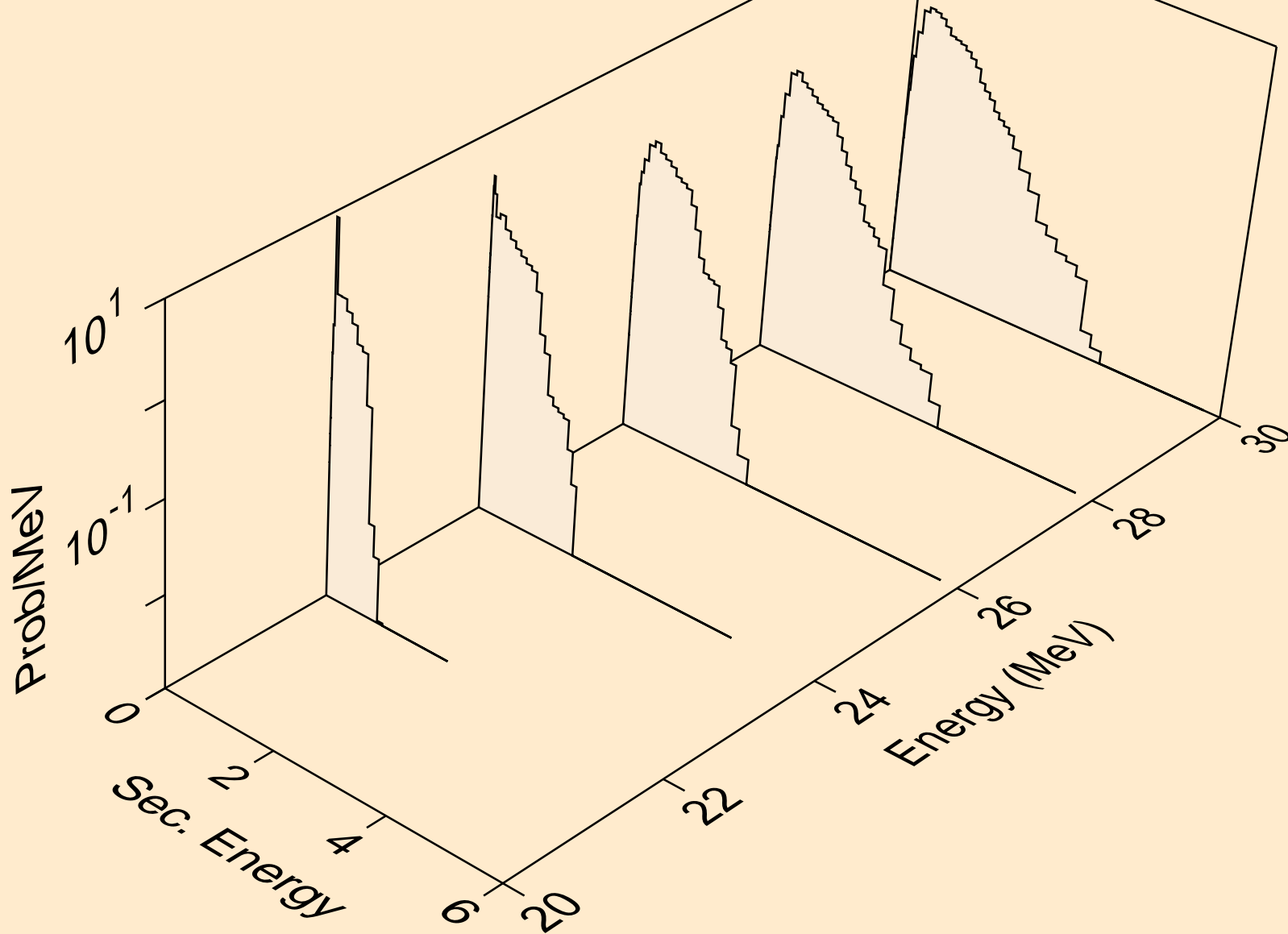

PT188 NEUTRON ACER TENDL-2019 LIBRARY; T=293.16K
Neutron emission for (n,2np)

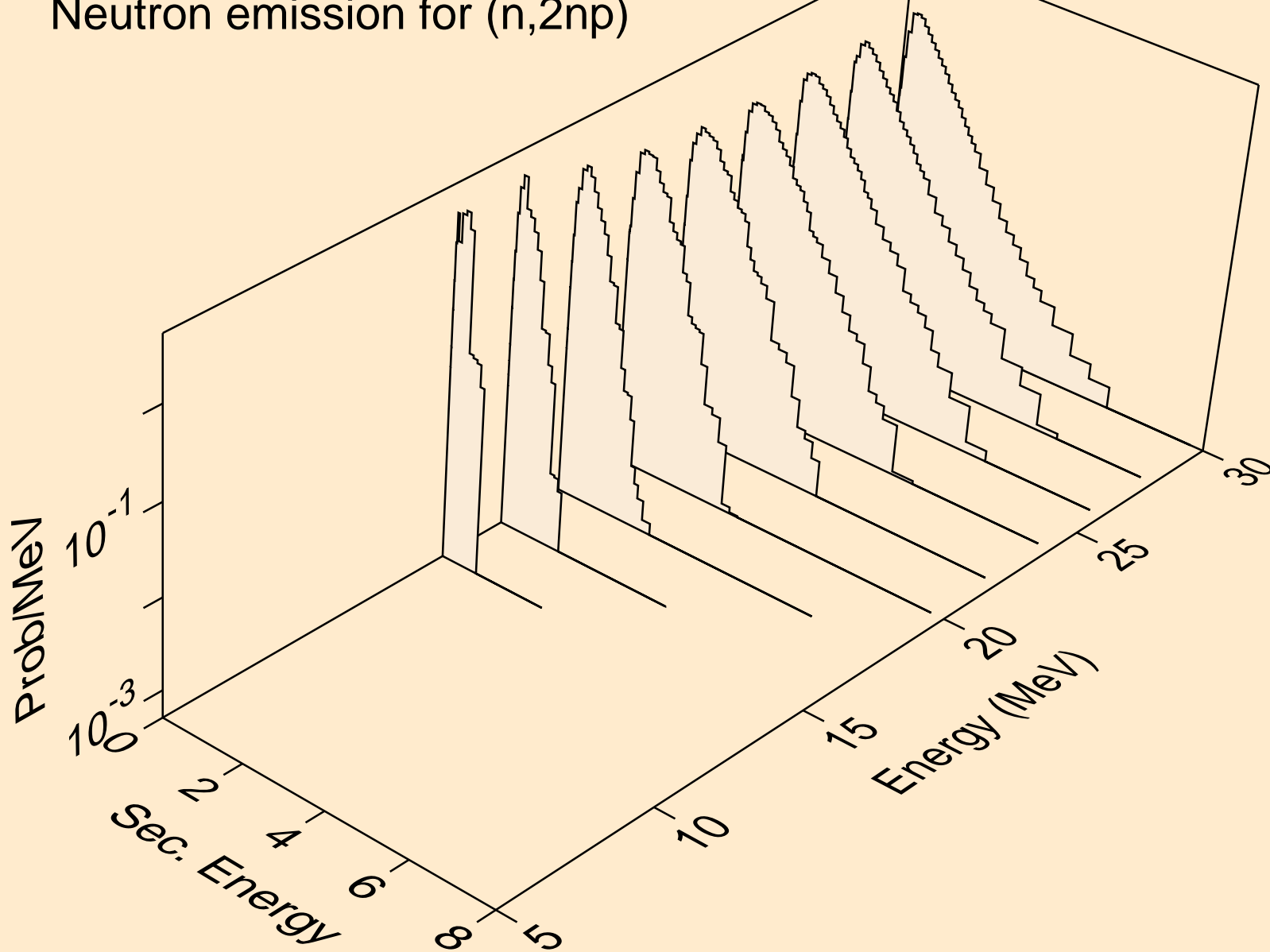

PT188 NEUTRON ACER TENDL-2019 LIBRARY; T=293.16K
Neutron emission for (n,npa)

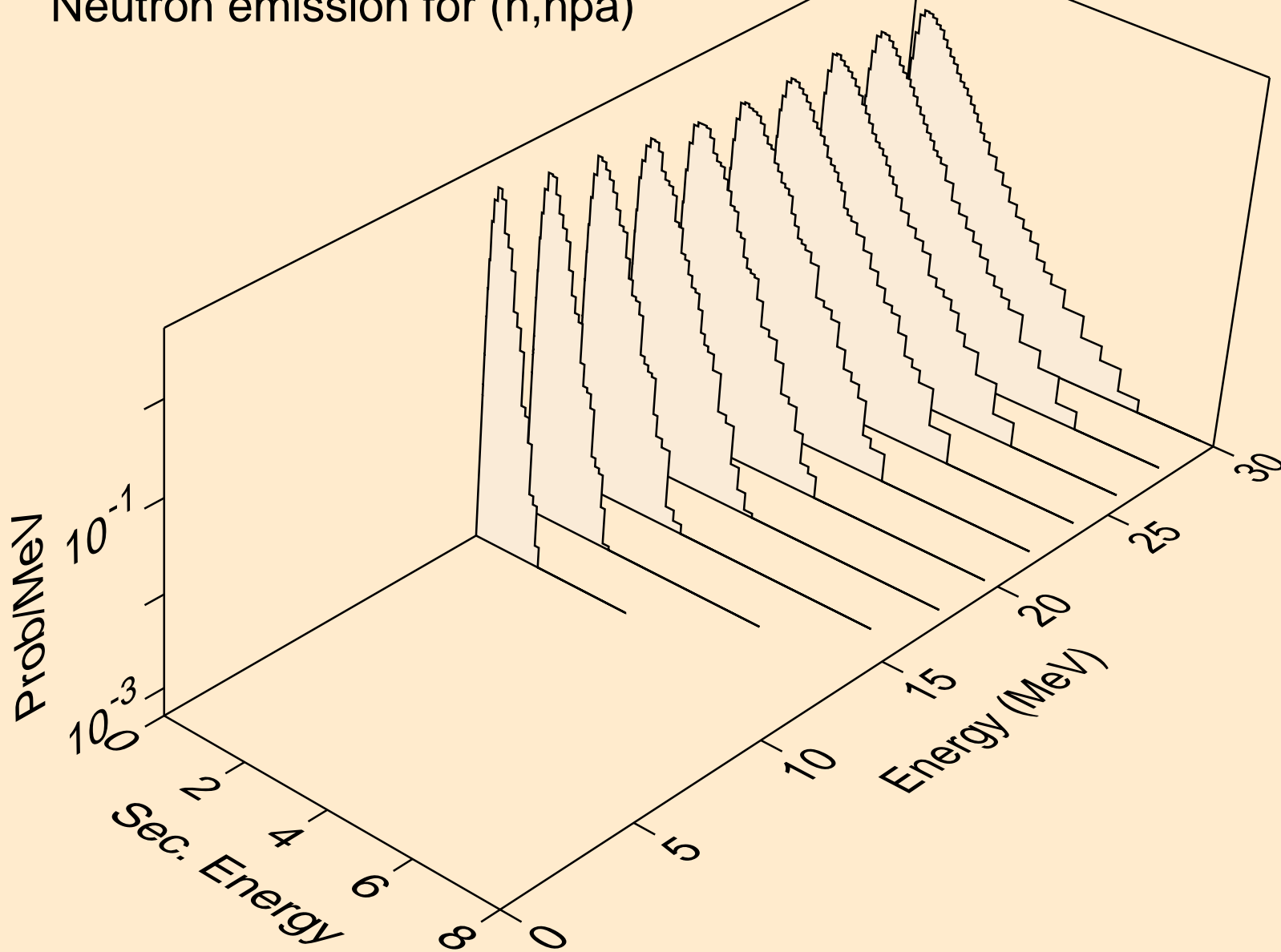

PT188 NEUTRON ACER TENDL-2019 LIBRARY; T=293.16K
Neutron emission for (n,n*c)

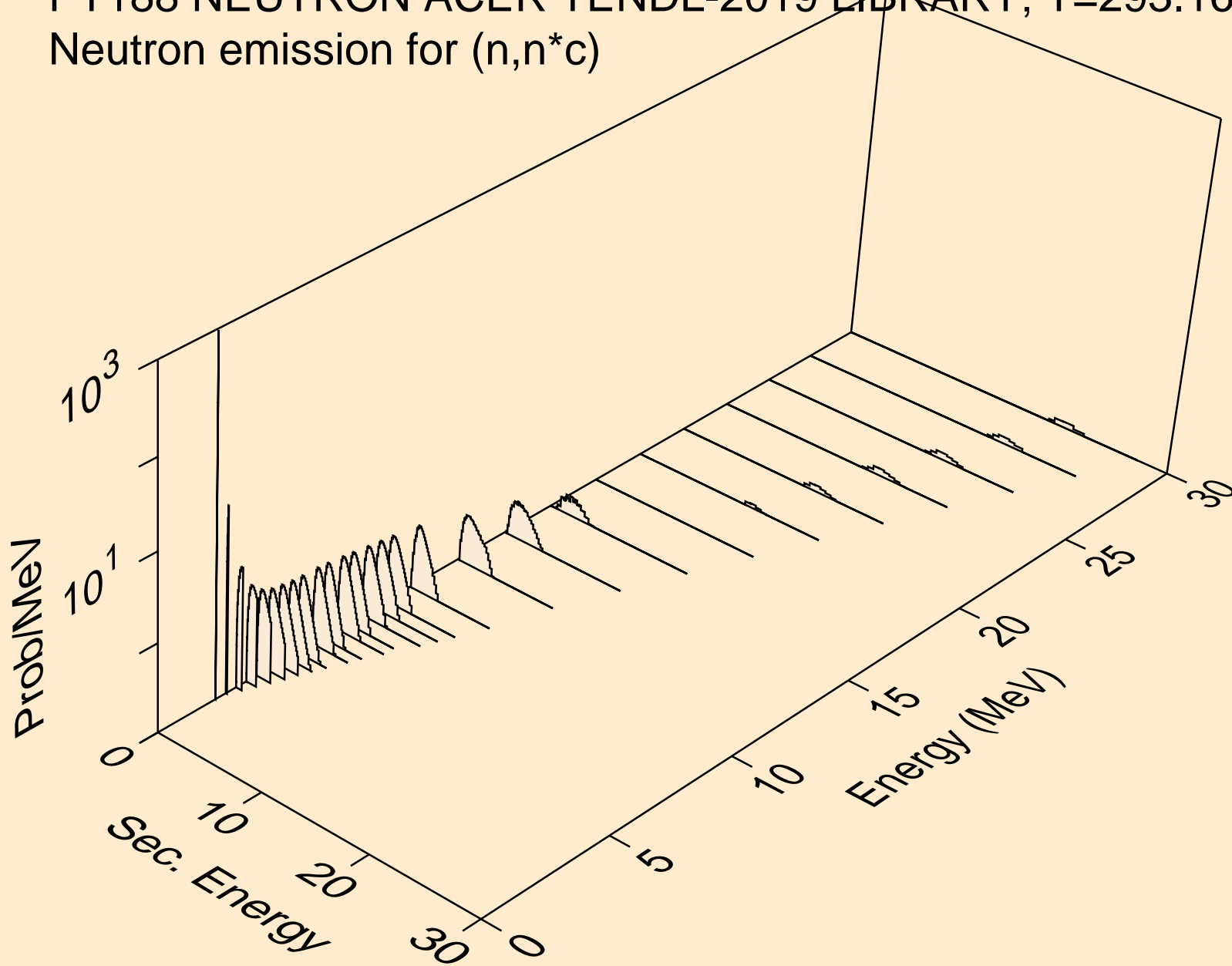

PT188 NEUTRON ACER TENDL-2019 LIBRARY; T=293.16K
Photon emission for (n,x)

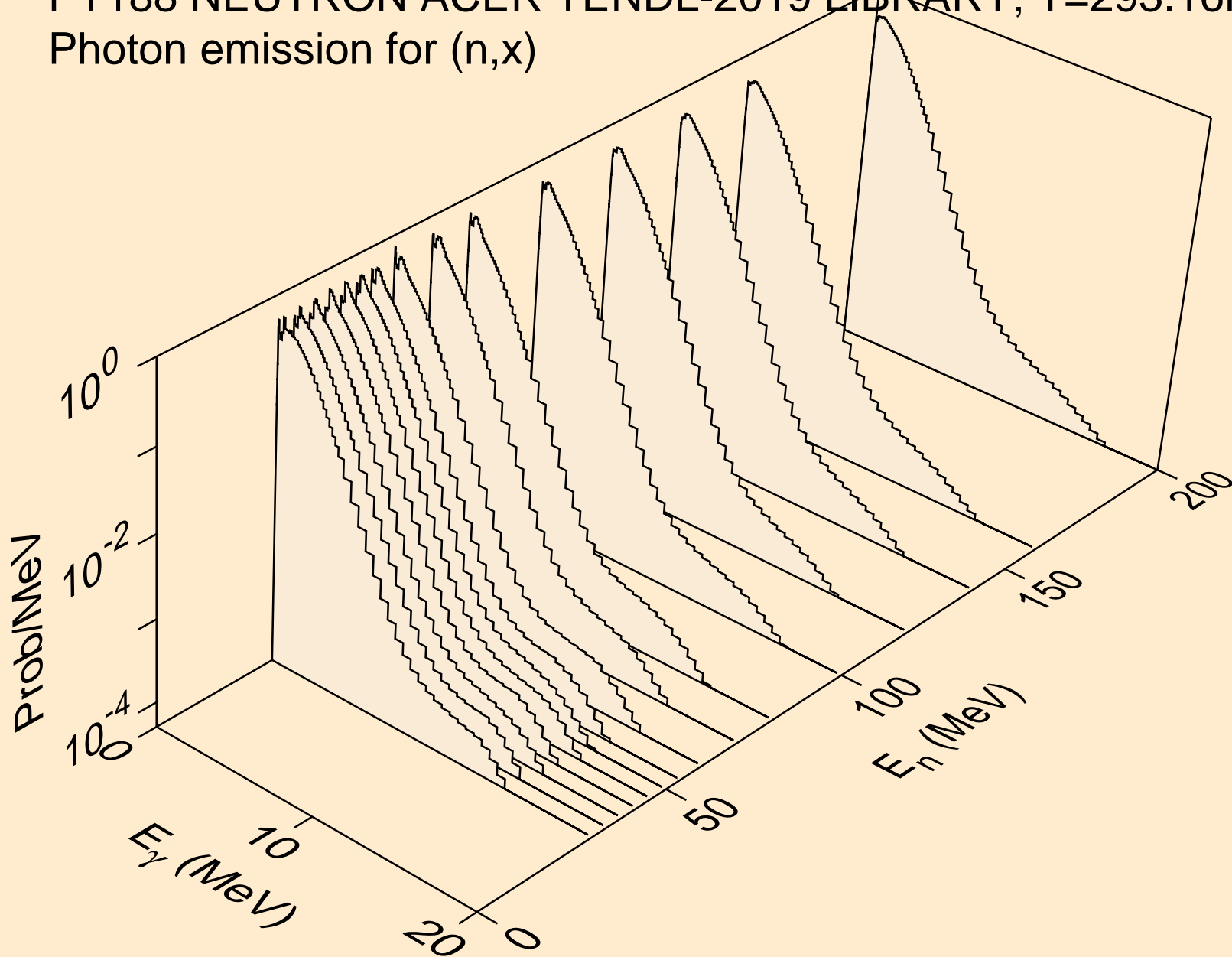

PT188 NEUTRON ACER TENDL-2019 LIBRARY; T=293.16K
Photon emission for (n,2nd)

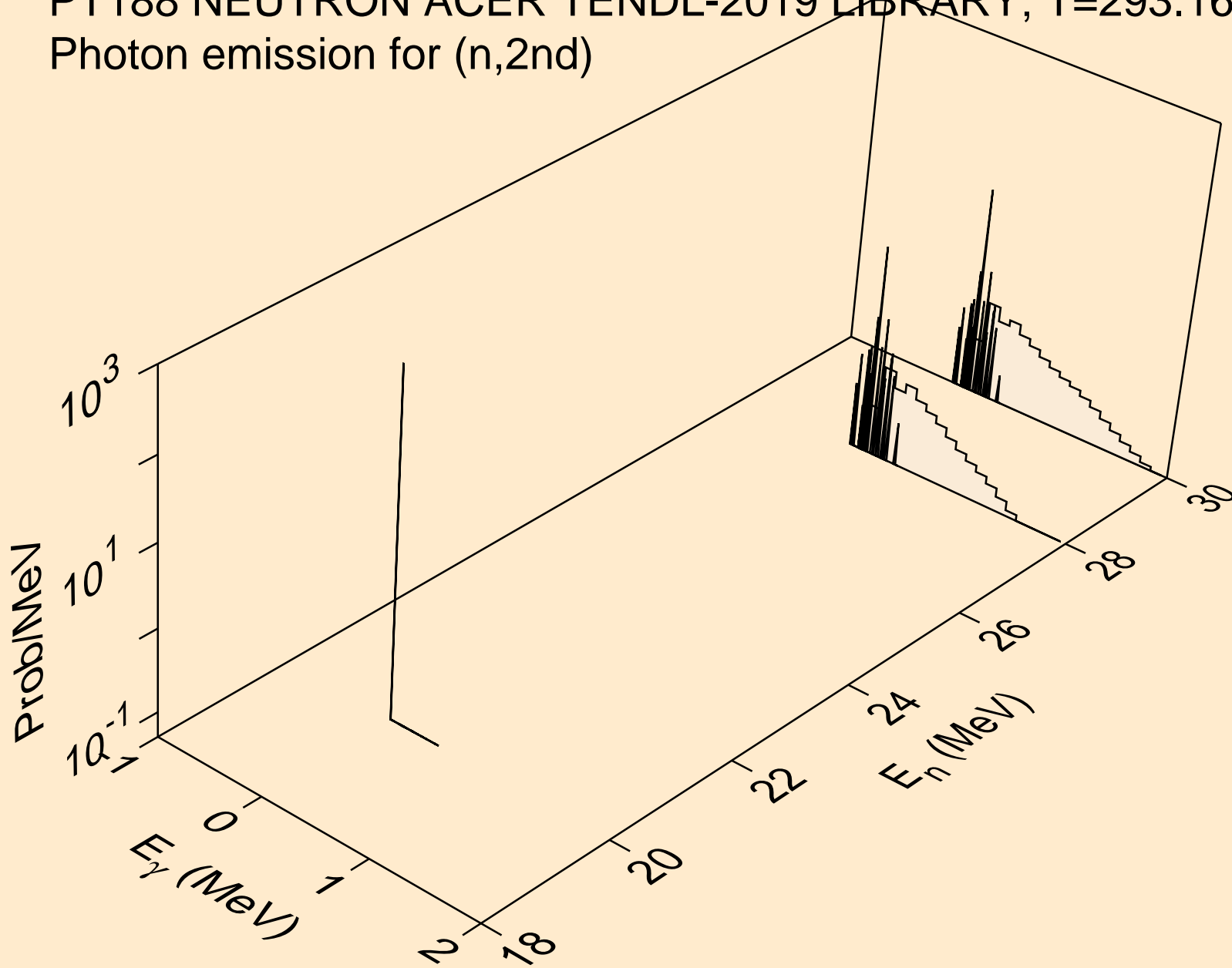

PT188 NEUTRON ACER TENDL-2019 LIBRARY; T=293.16K
Photon emission for (n,2n)

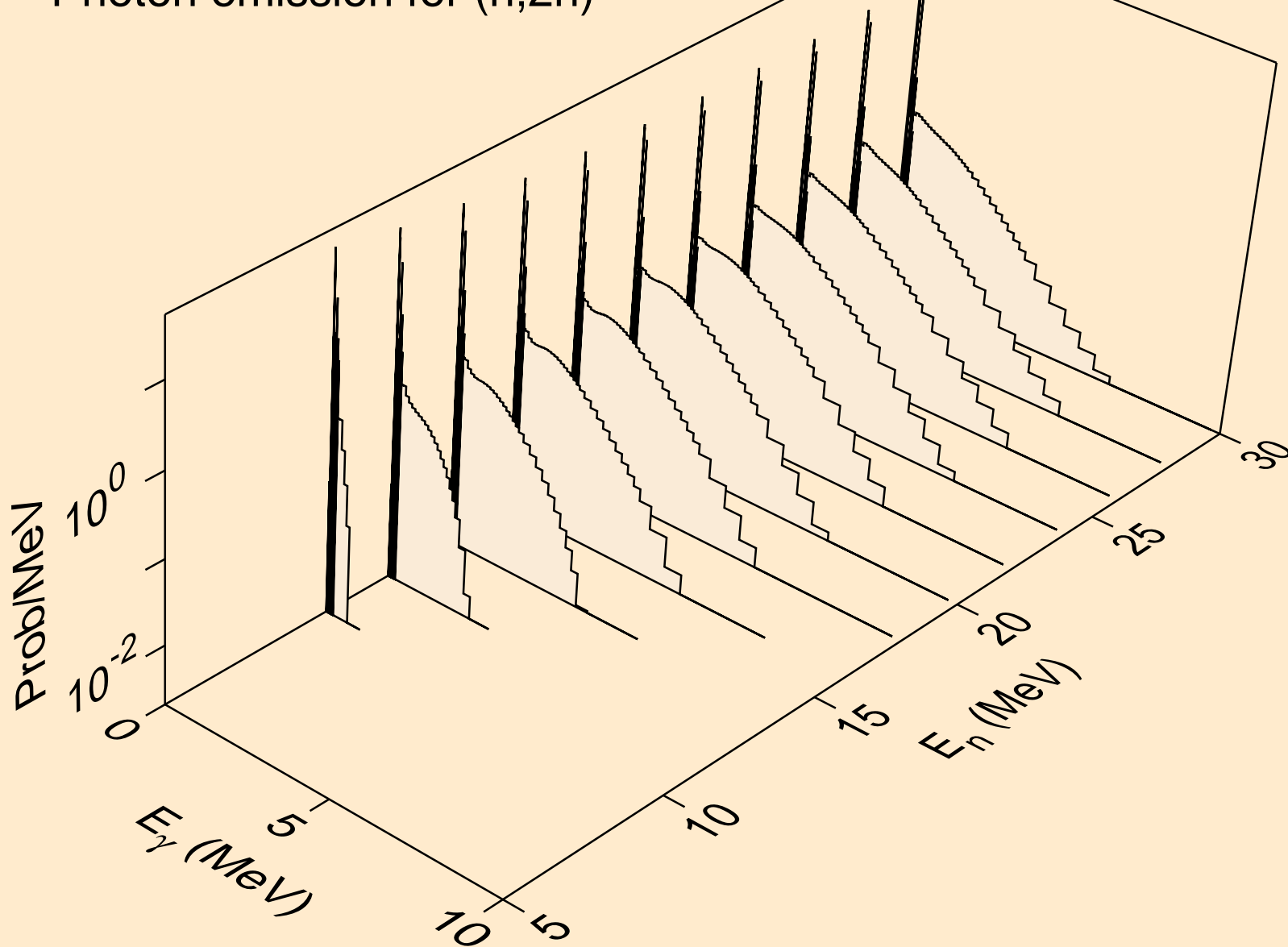

PT188 NEUTRON ACER TENDL-2019 LIBRARY; T=293.16K
Photon emission for (n,3n)

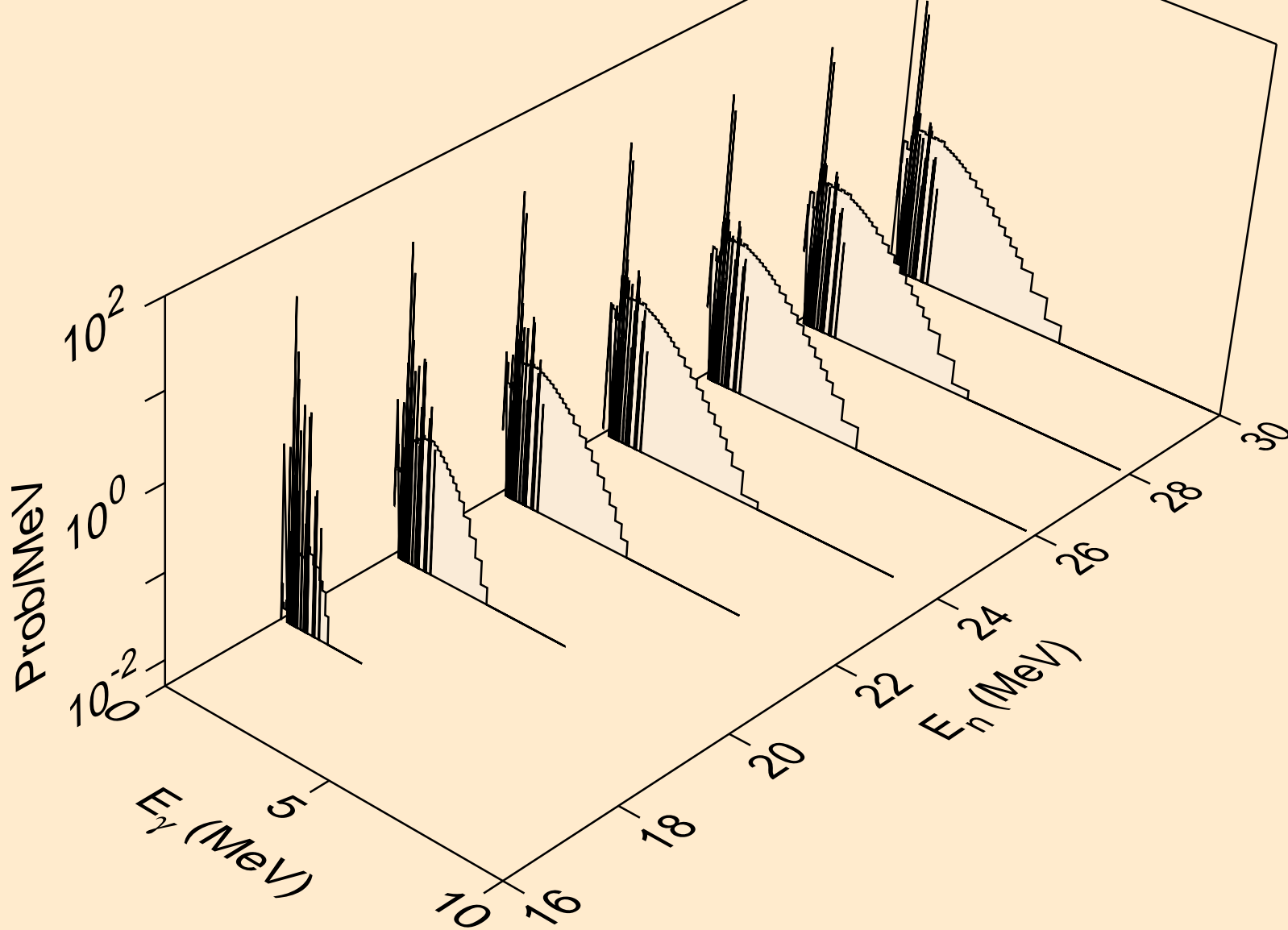

PT188 NEUTRON ACER TENDL-2019 LIBRARY; T=293.16K
Photon emission for (n,n*)a

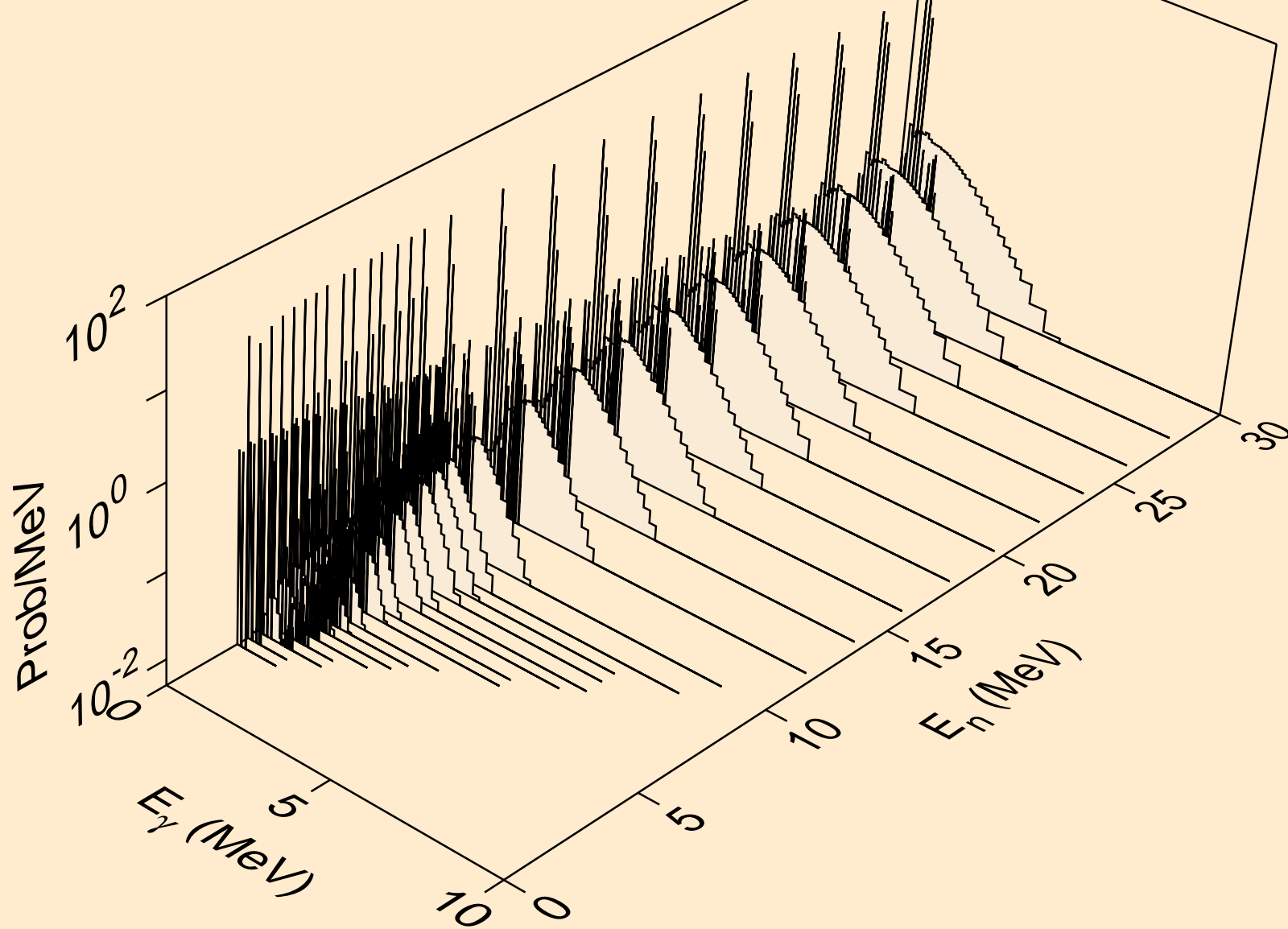

PT188 NEUTRON ACER TENDL-2019 LIBRARY; T=293.16K
Photon emission for (n,2n)a

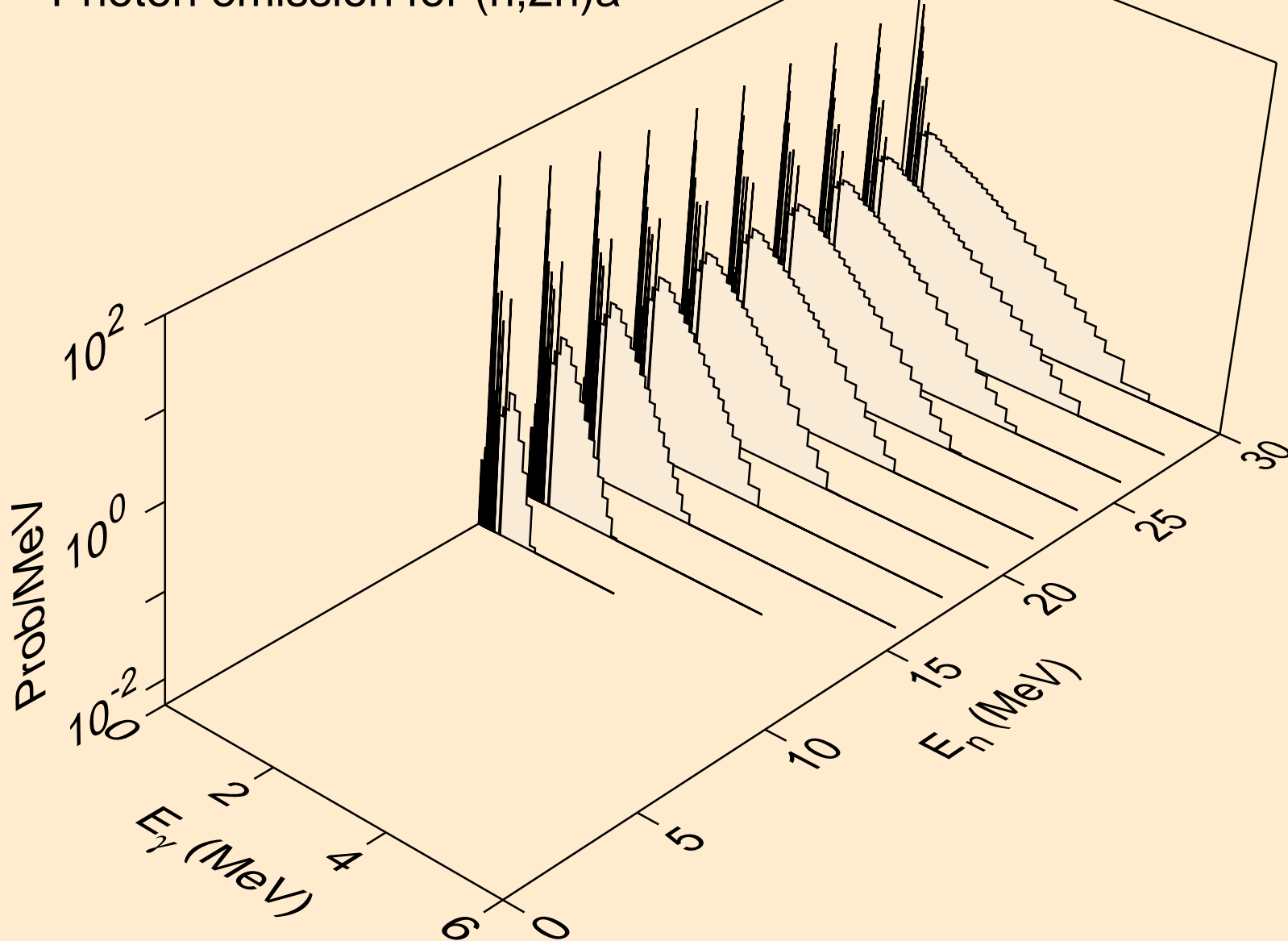

PT188 NEUTRON ACER TENDL-2019 LIBRARY; T=293.16K
Photon emission for (n,3n)a

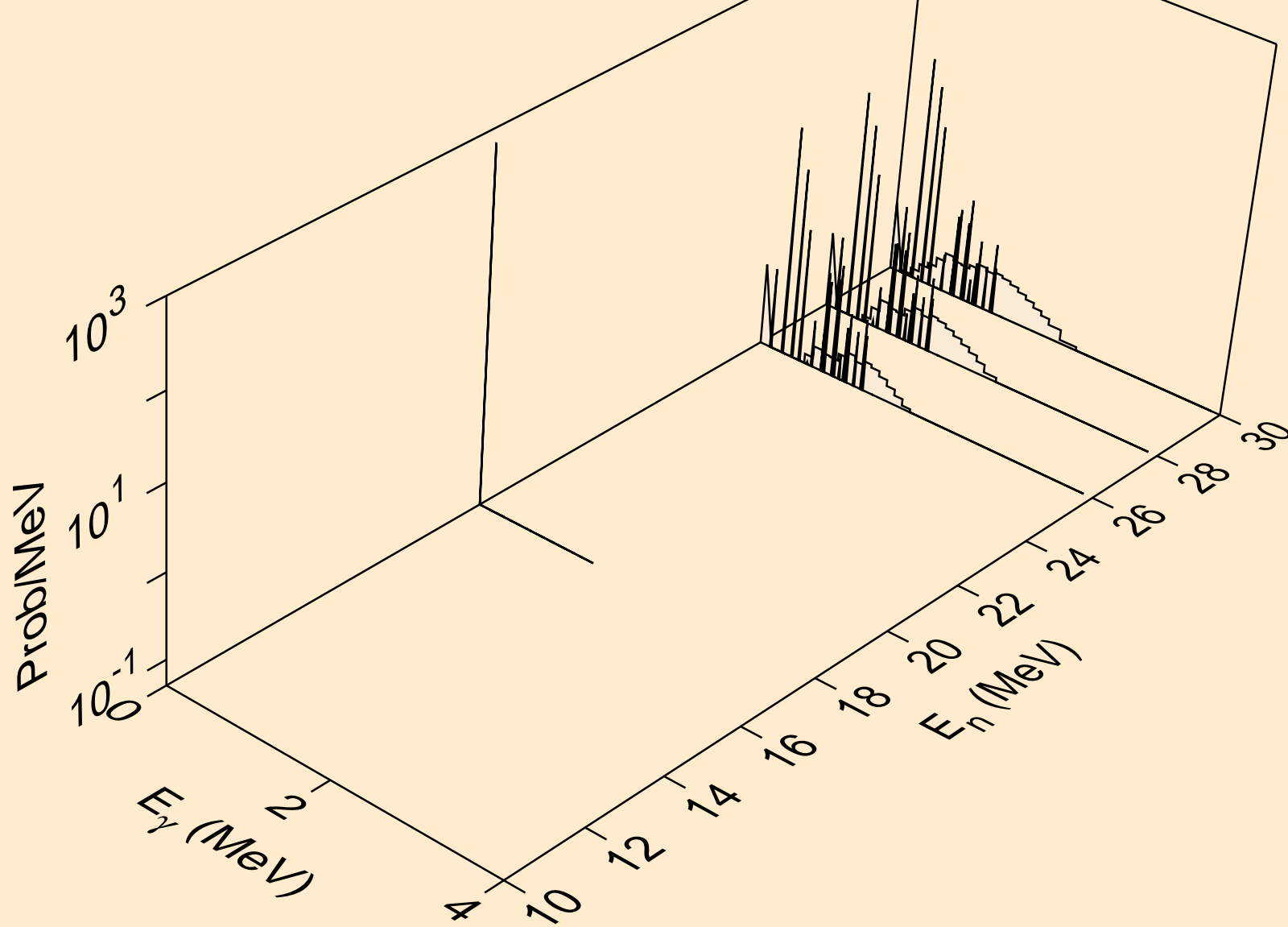

PT188 NEUTRON ACER TENDL-2019 LIBRARY; T=293.16K
Photon emission for (n,n*)p

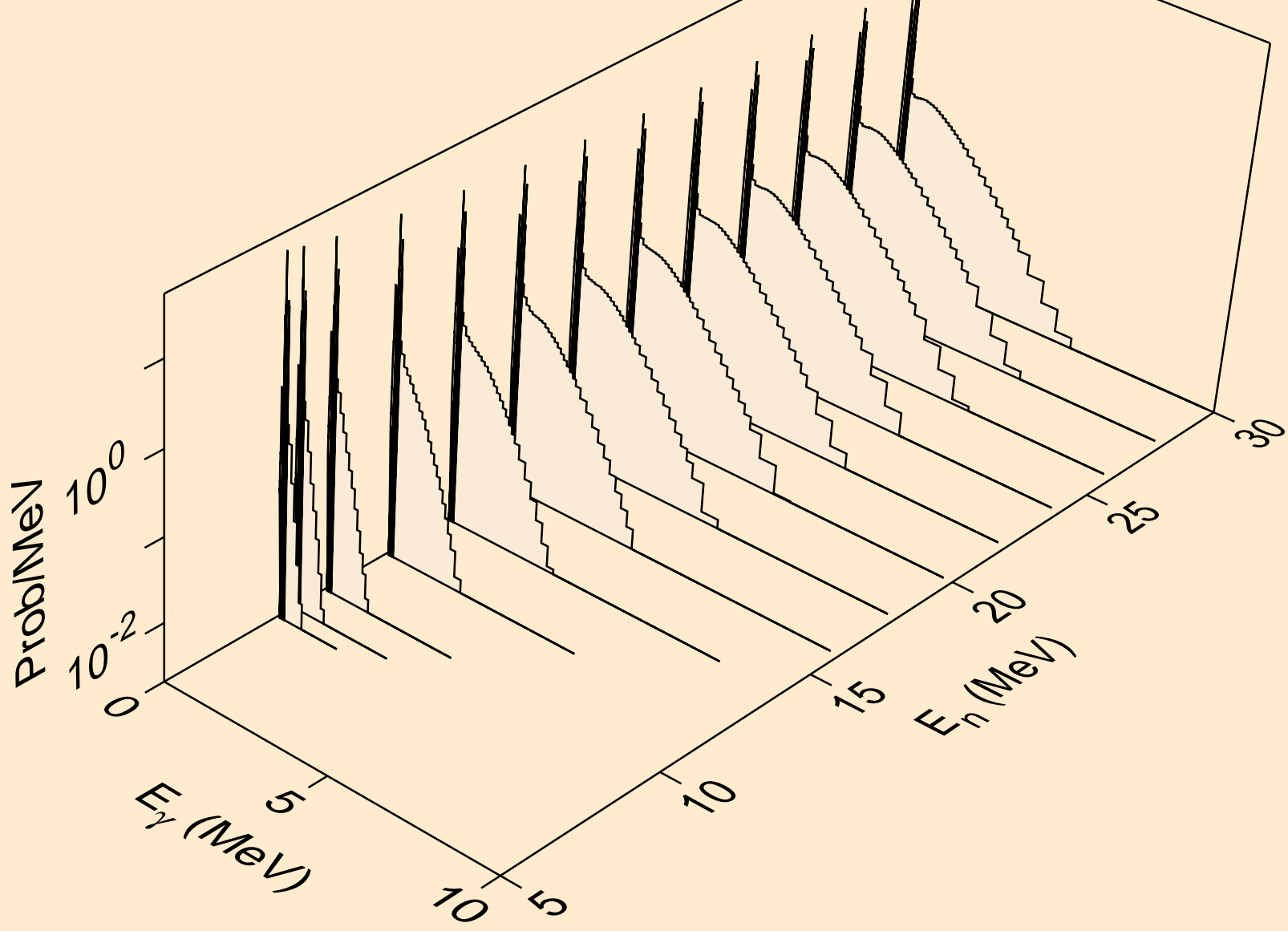

PT188 NEUTRON ACER TENDL-2019 LIBRARY; T=293.16K
Photon emission for (n,n*)2a

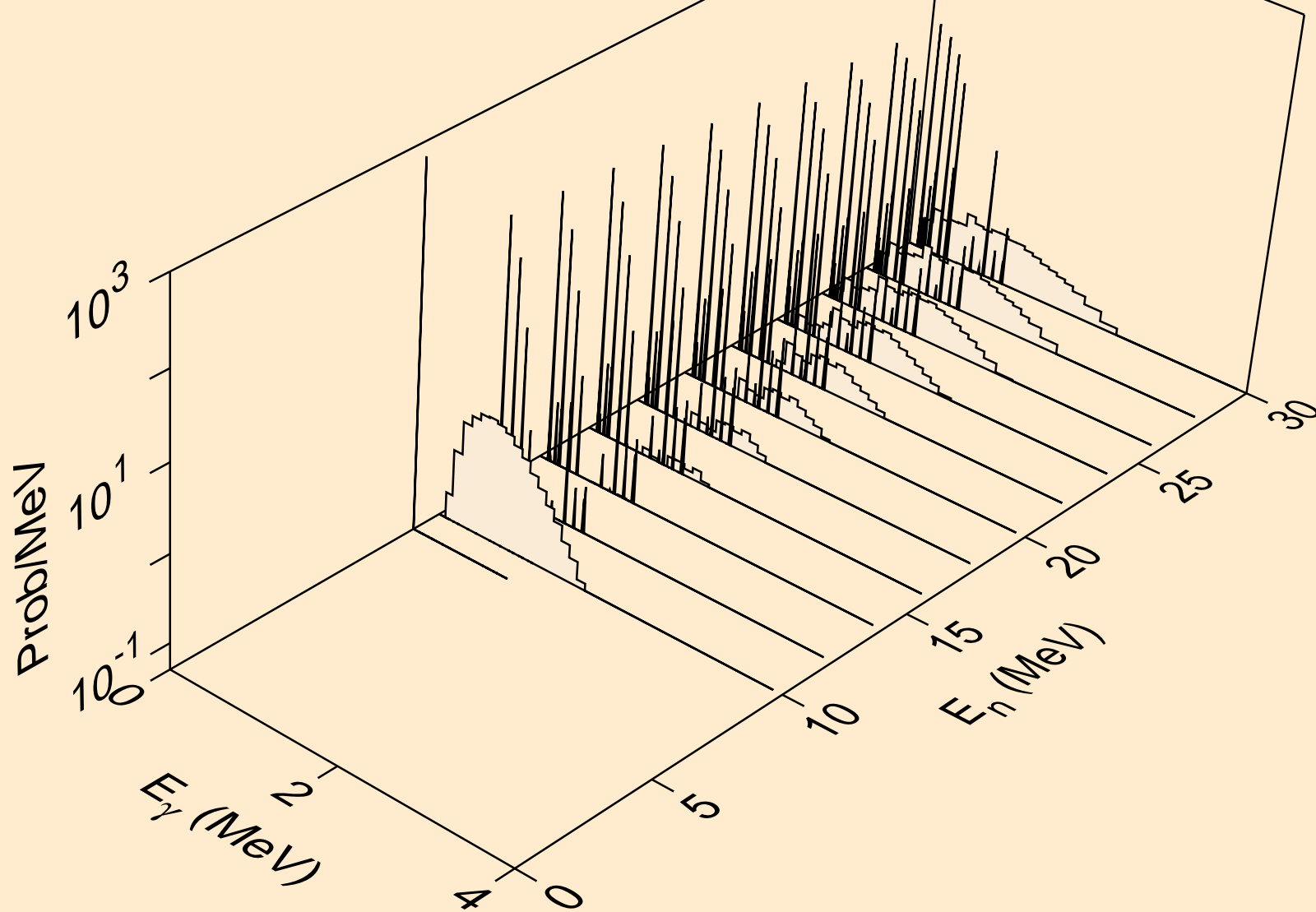

PT188 NEUTRON ACER TENDL-2019 LIBRARY; T=293.16K
Photon emission for (n,2n)2a

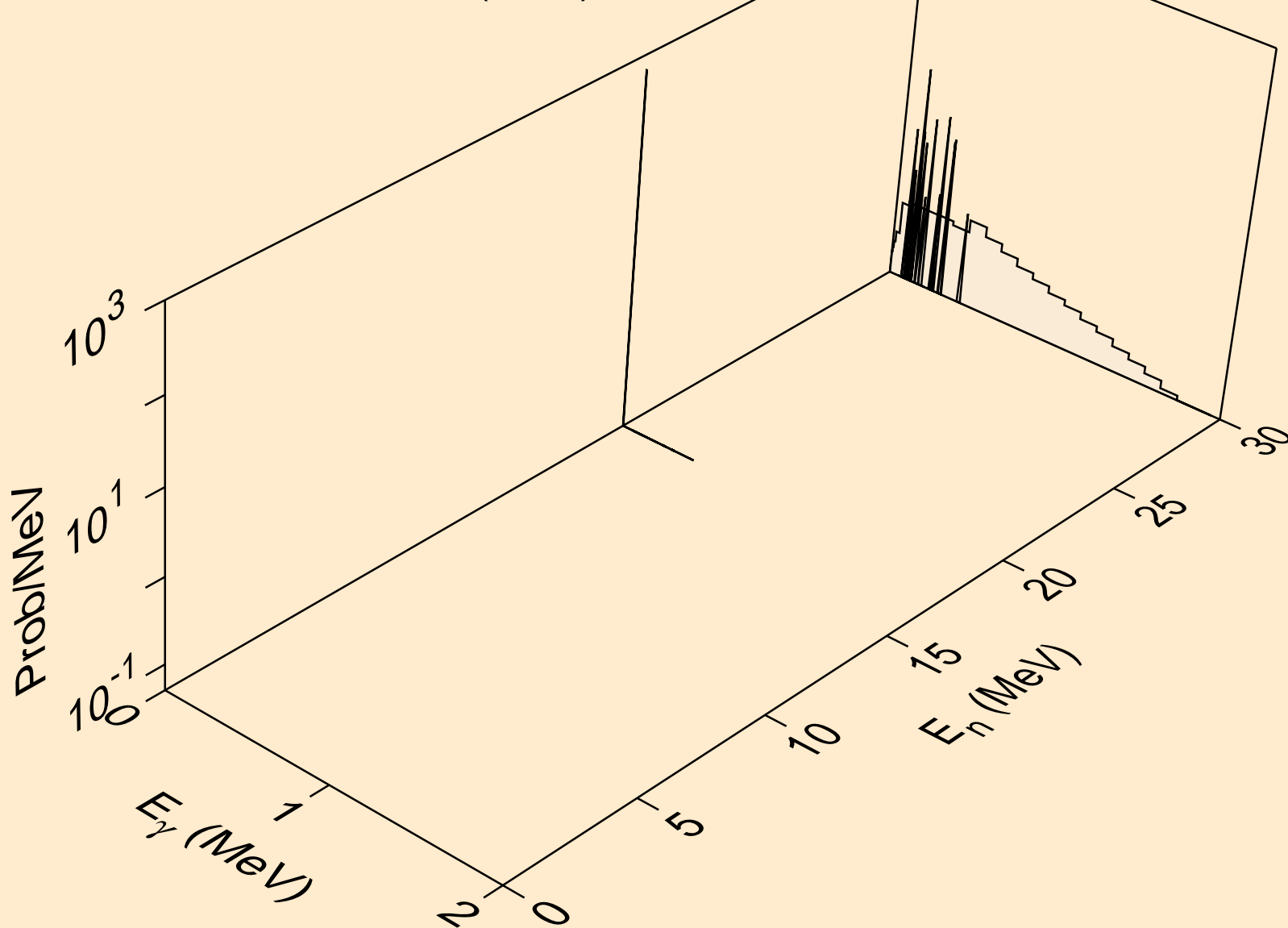

PT188 NEUTRON ACER TENDL-2019 LIBRARY; T=293.16K
Photon emission for (n,n*)d

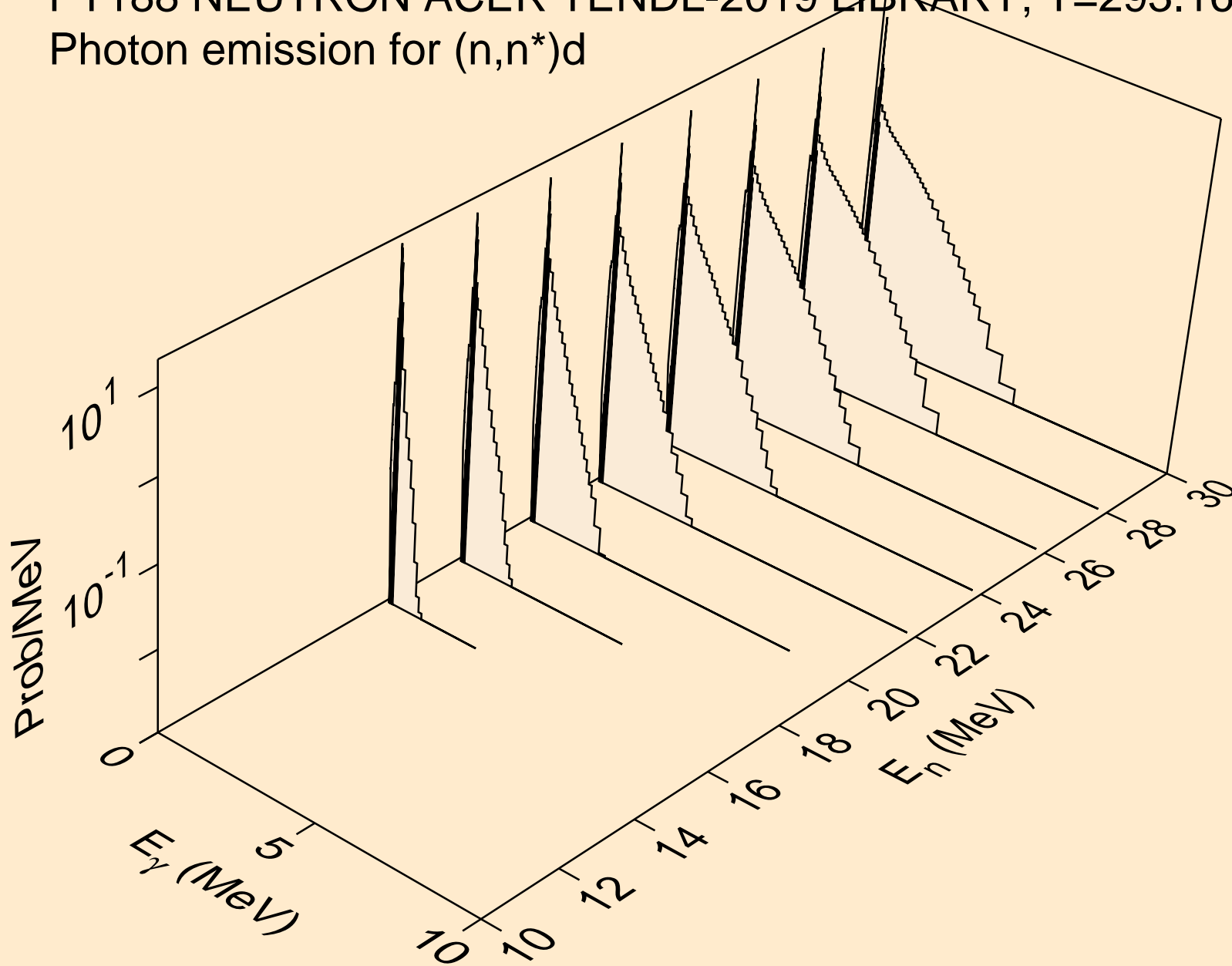

PT188 NEUTRON ACER TENDL-2019 LIBRARY; T=293.16K
Photon emission for (n,n*)t

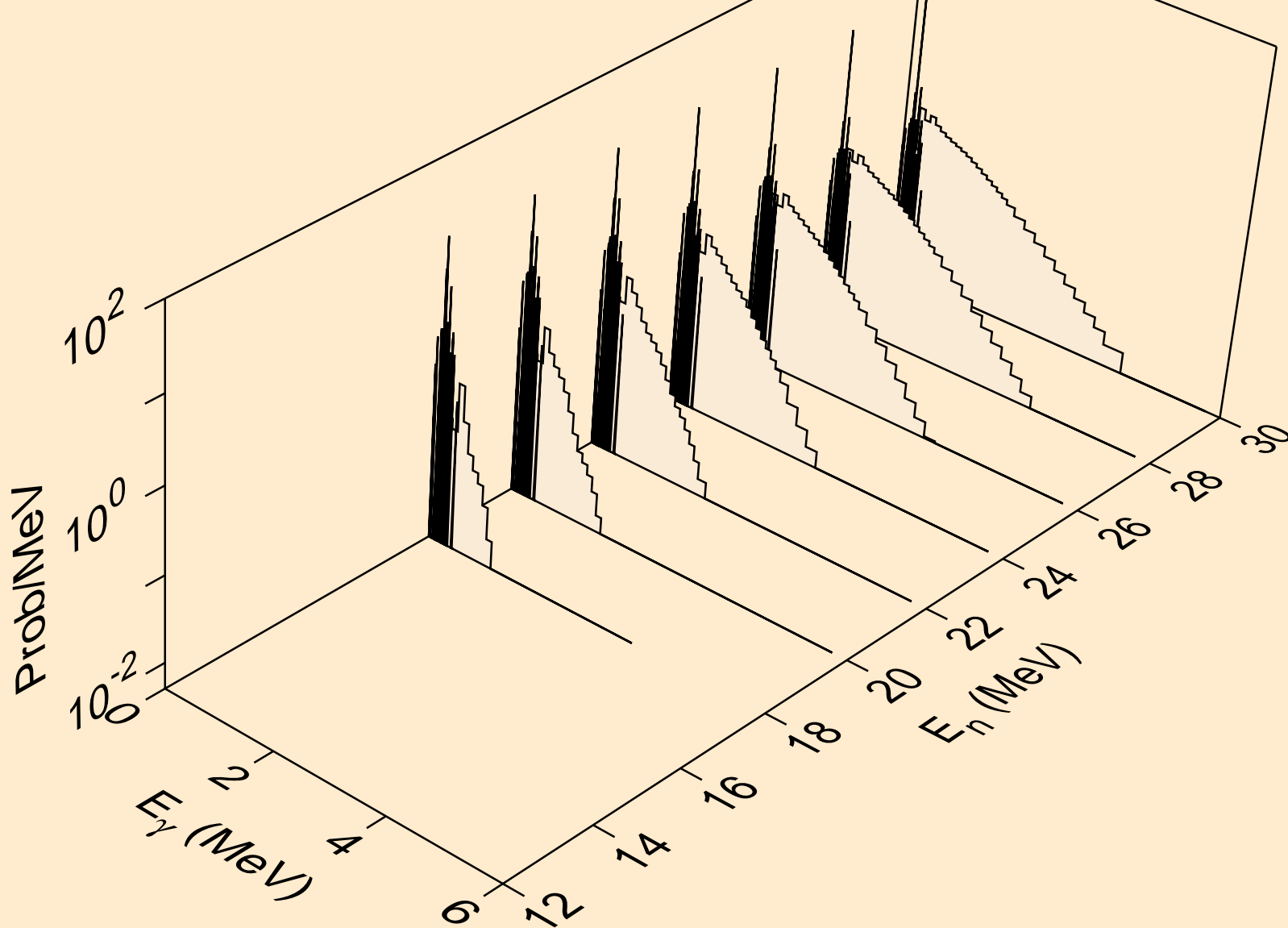

PT188 NEUTRON ACER TENDL-2019 LIBRARY; T=293.16K
Photon emission for (n,n*)he3

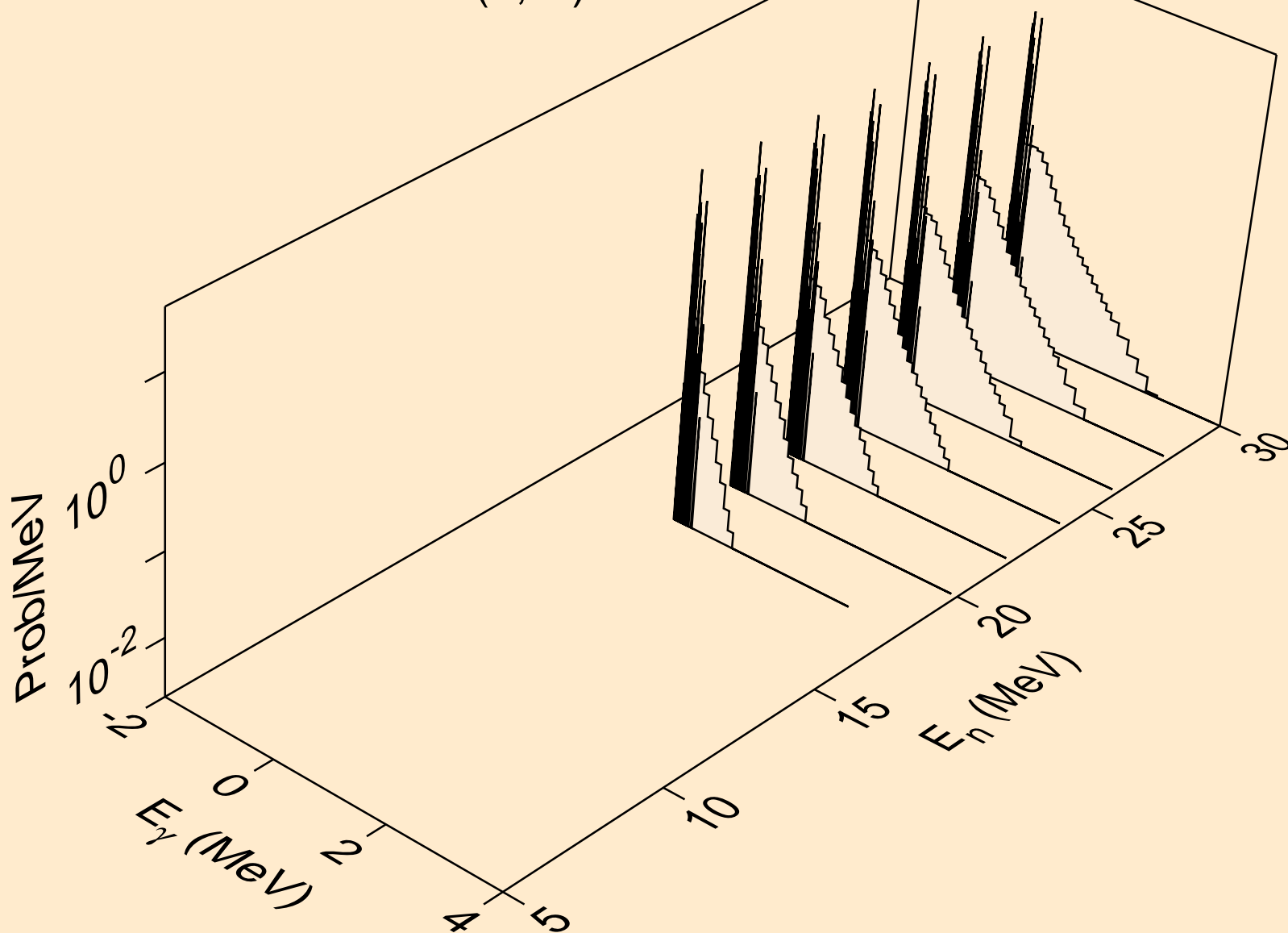

PT188 NEUTRON ACER TENDL-2019 LIBRARY; T=293.16K
Photon emission for (n,4n)

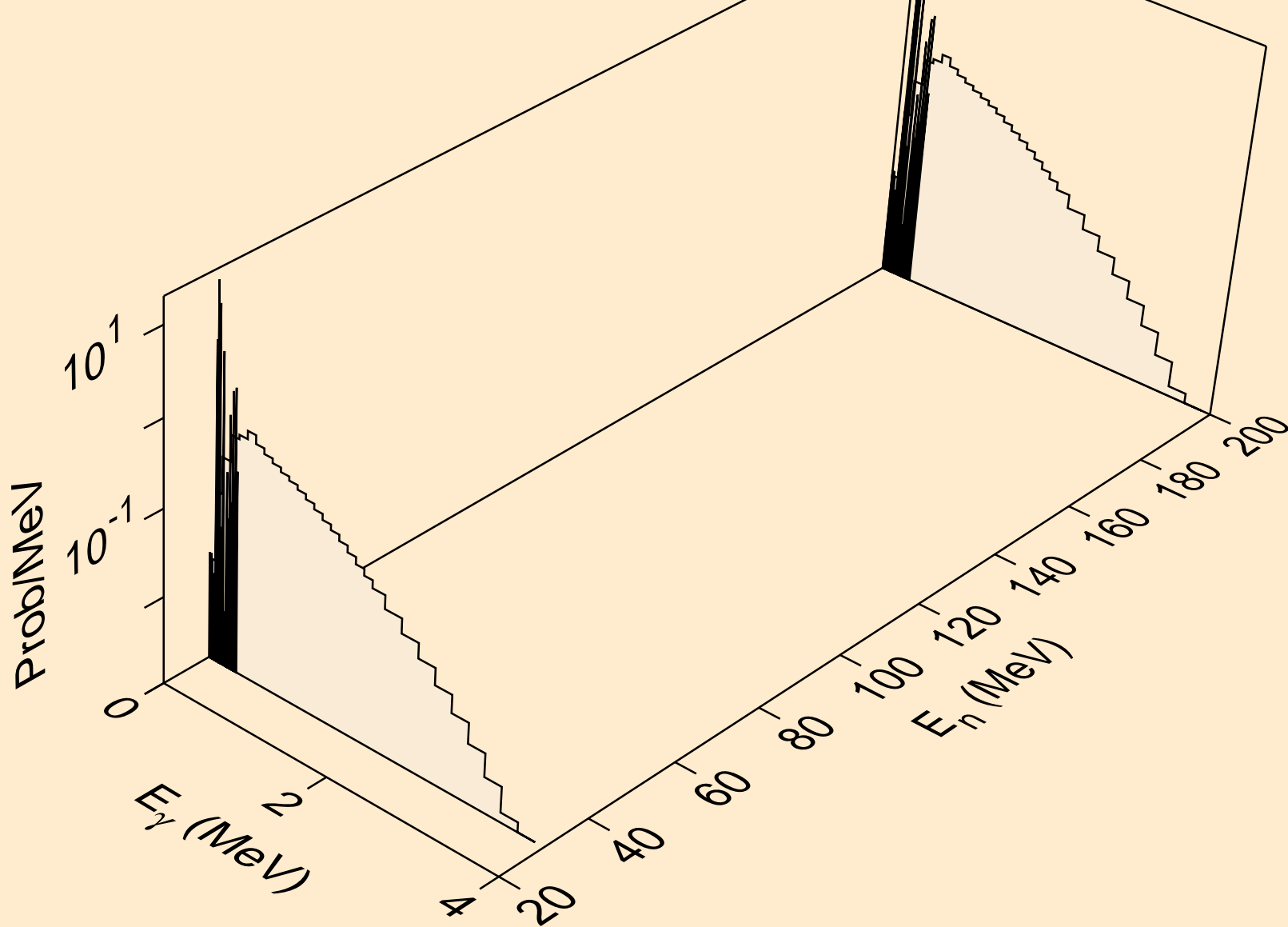

PT188 NEUTRON ACER TENDL-2019 LIBRARY; T=293.16K
Photon emission for (n,2np)

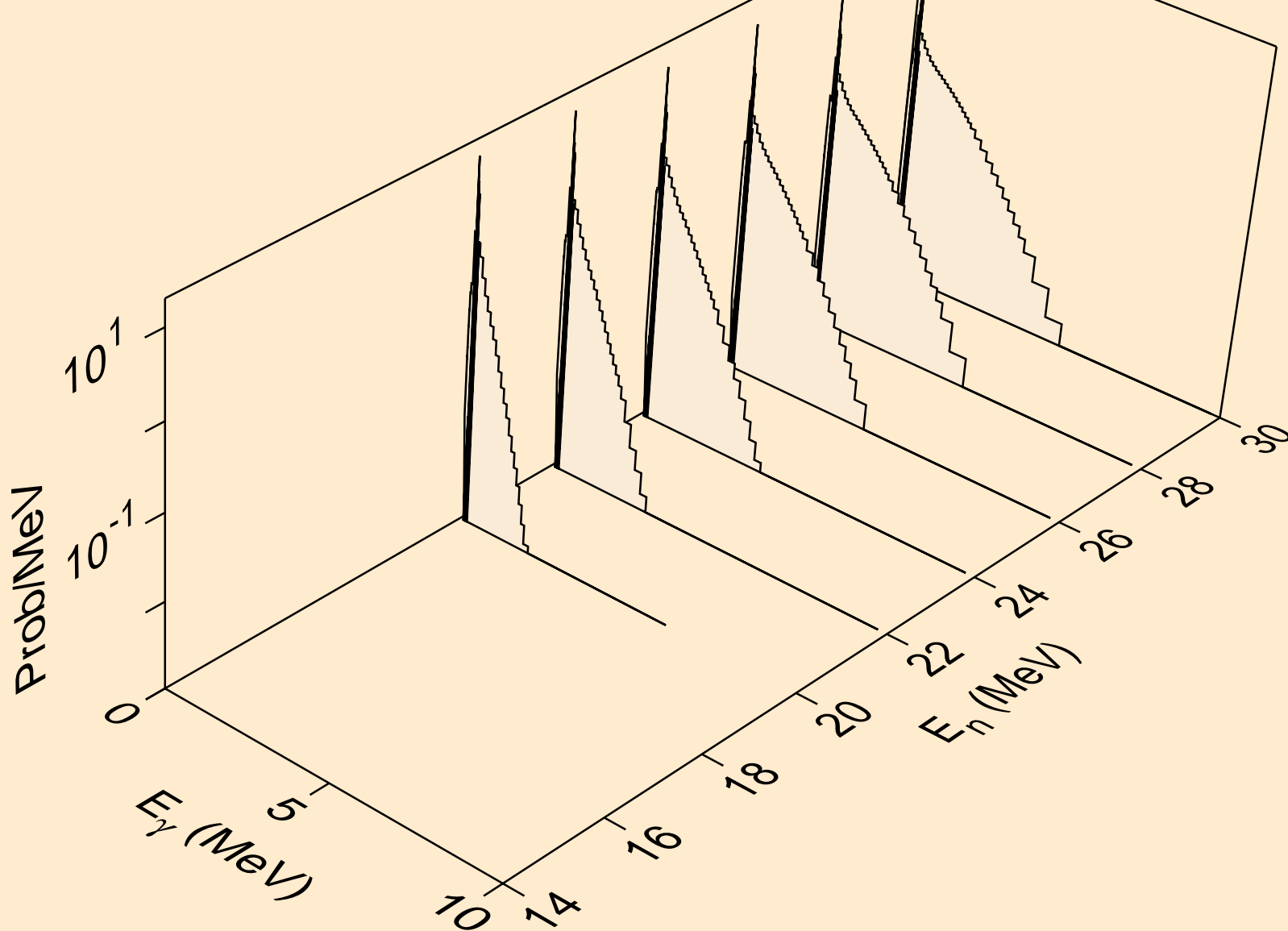

PT188 NEUTRON ACER TENDL-2019 LIBRARY; T=293.16K
Photon emission for (n,3np)

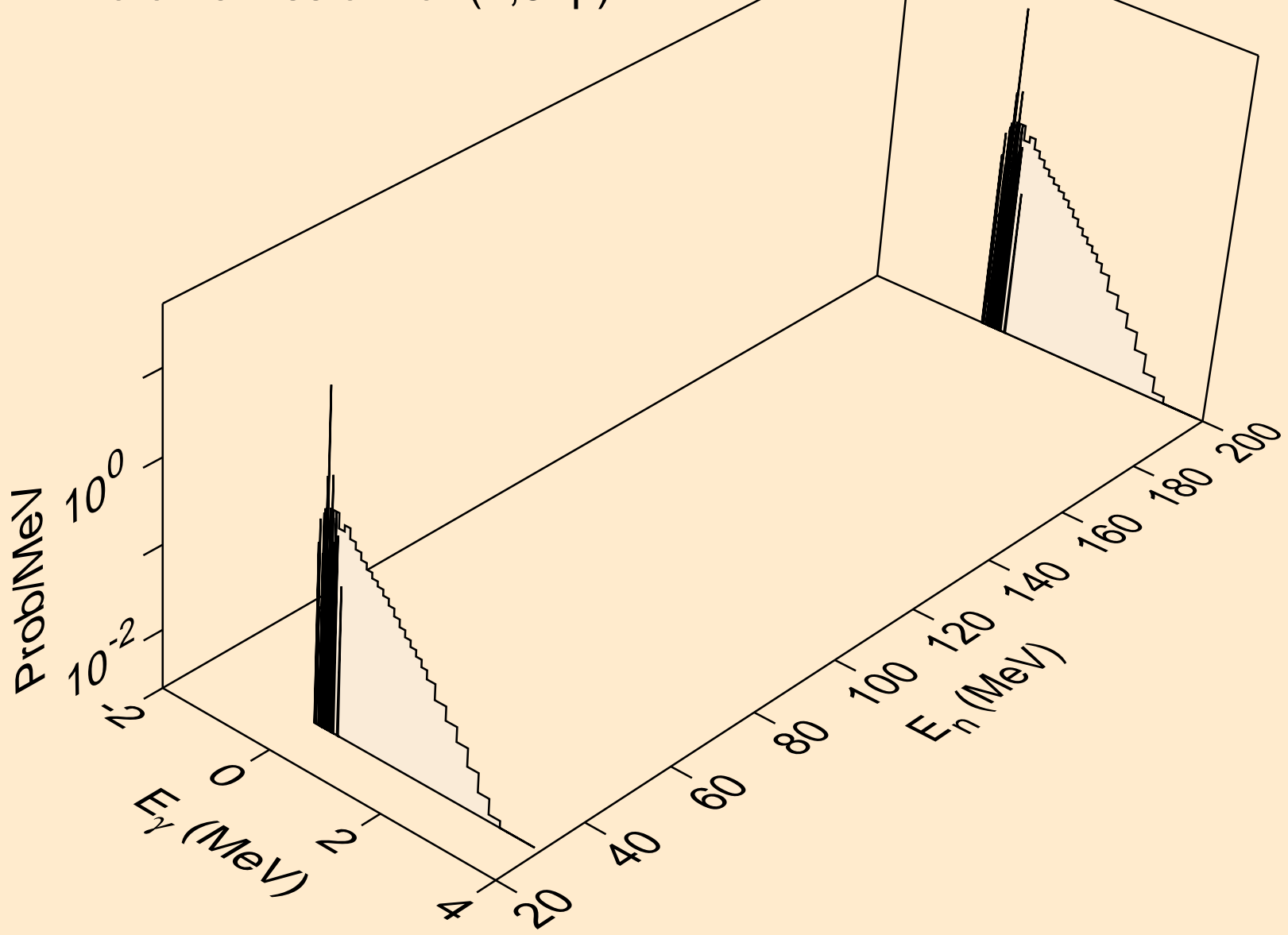

PT188 NEUTRON ACER TENDL-2019 LIBRARY; T=293.16K
Photon emission for (n,2np)

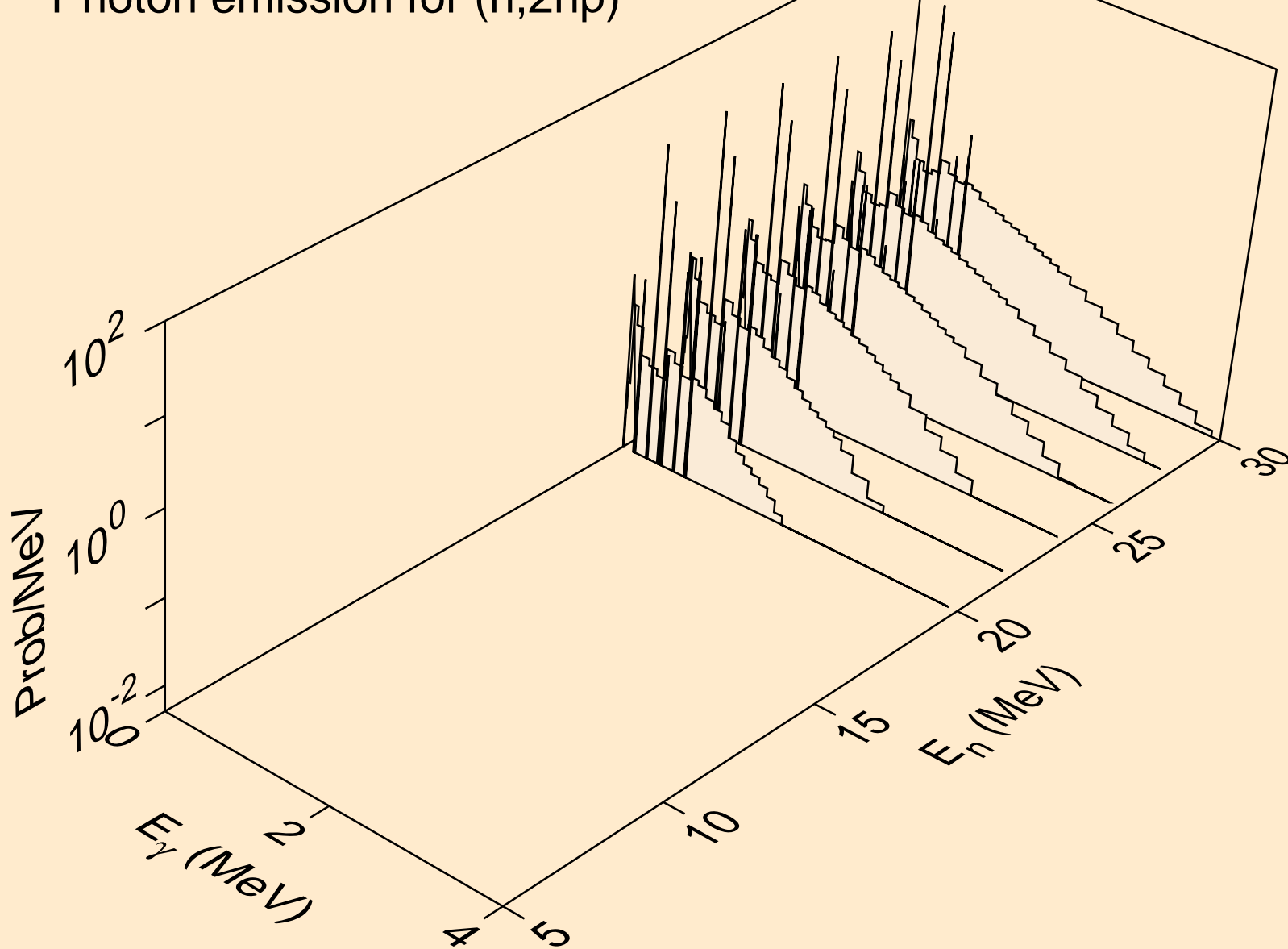

PT188 NEUTRON ACER TENDL-2019 LIBRARY; T=293.16K
Photon emission for (n,npa)

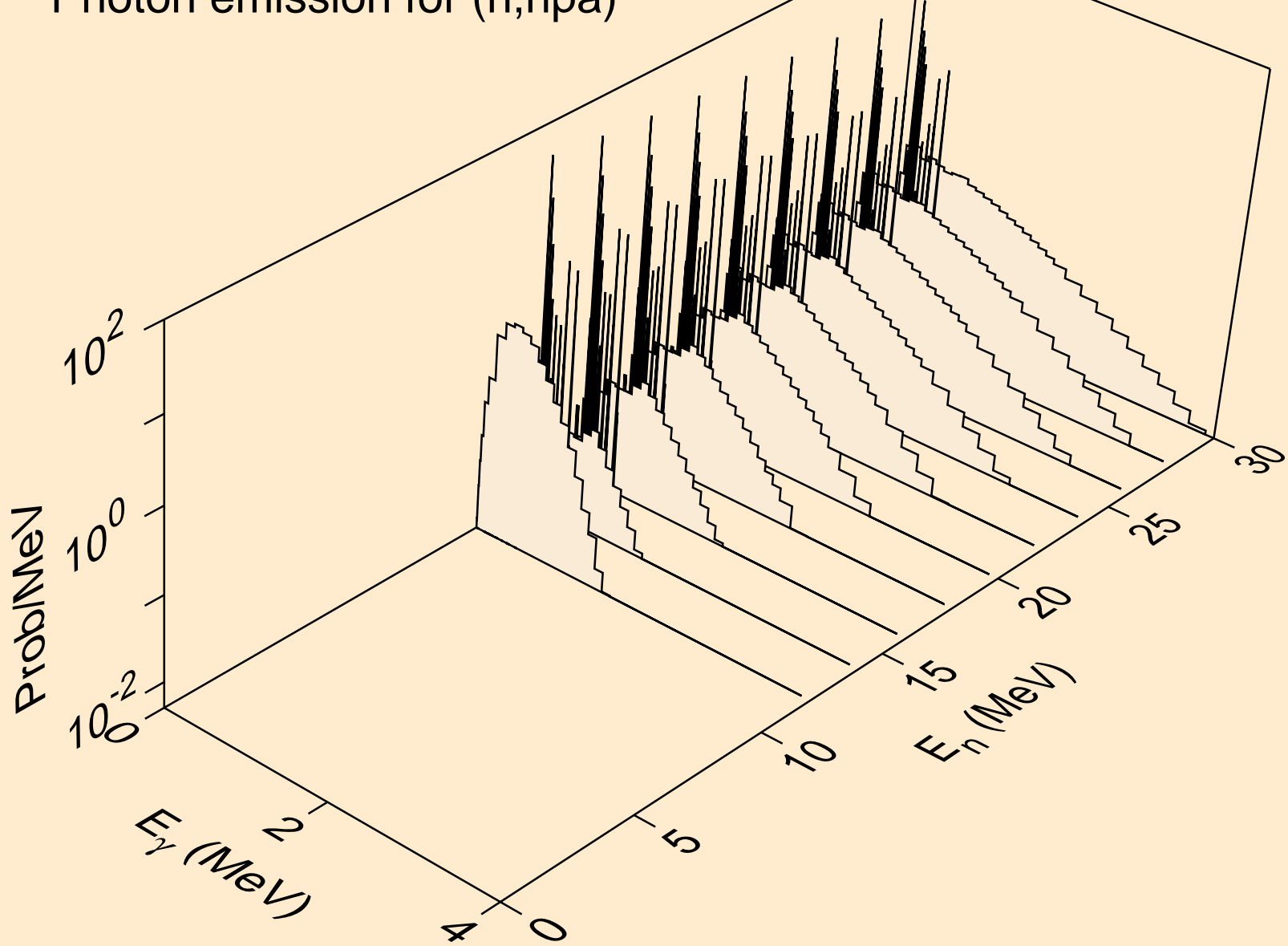

PT188 NEUTRON ACER TENDL-2019 LIBRARY; T=293.16K
Photon emission for (n,n*c)

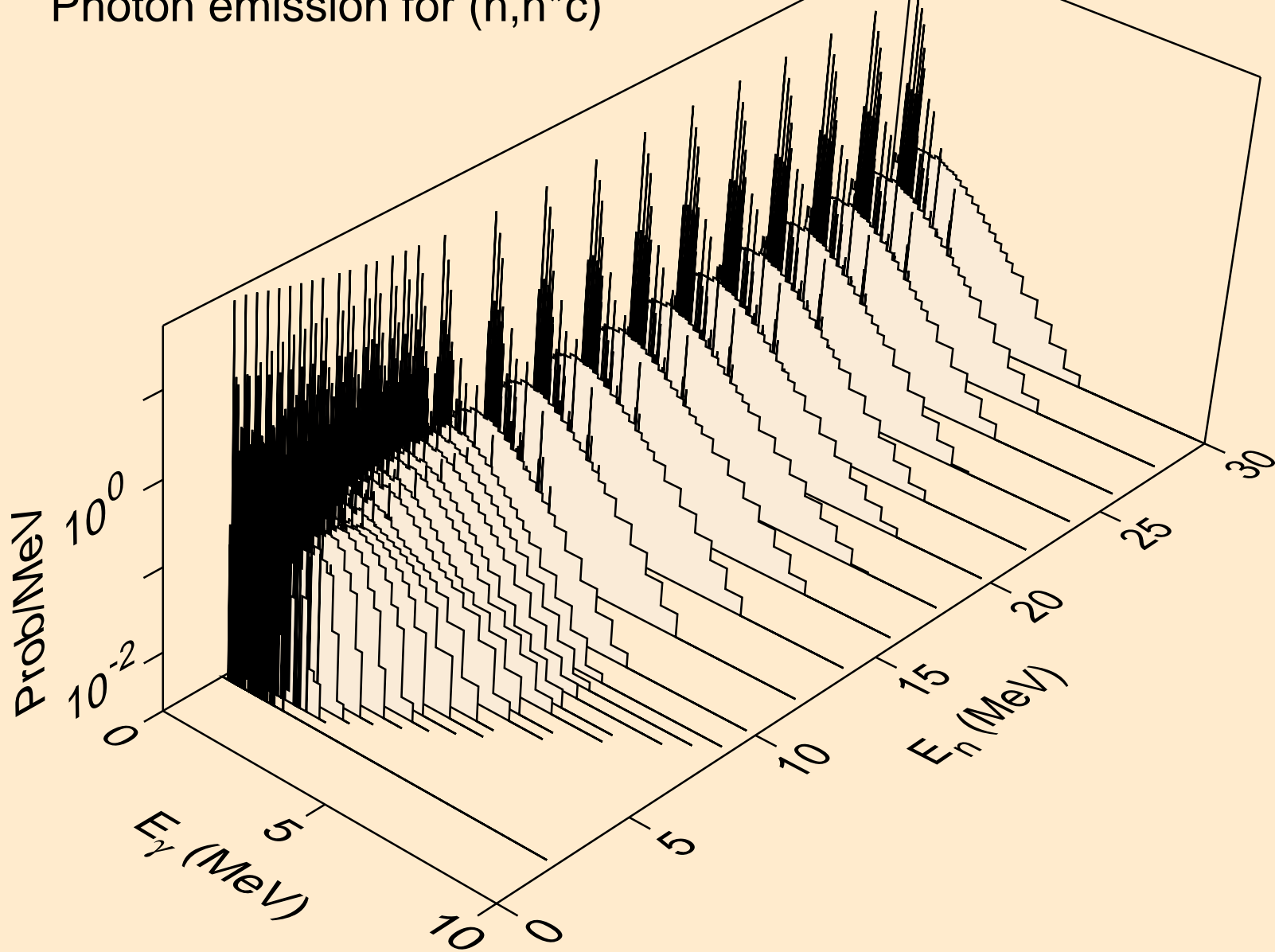

PT188 NEUTRON ACER TENDL-2019 LIBRARY; T=293.16K
Photon emission for (n,gma)

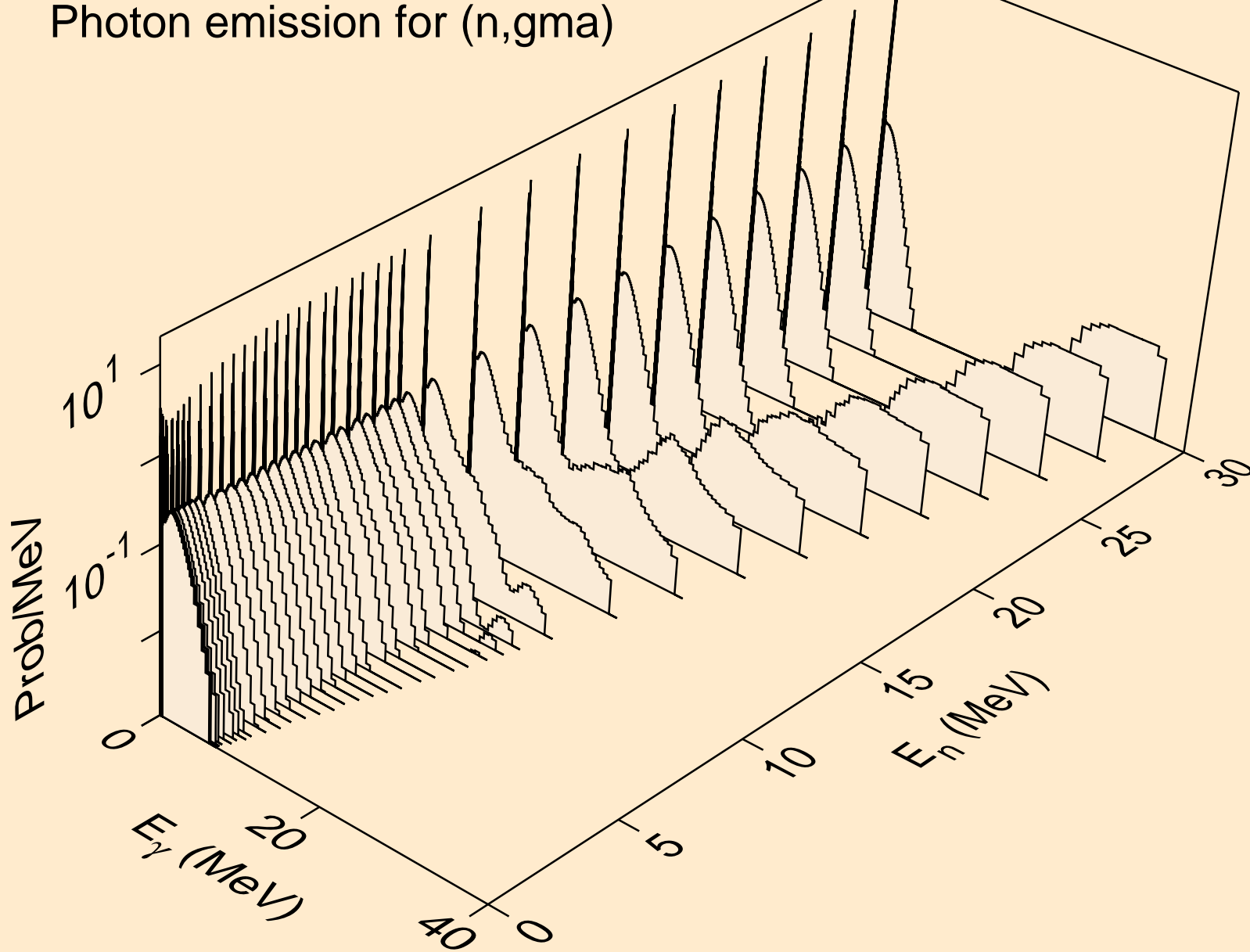

PT188 NEUTRON ACER TENDL-2019 LIBRARY; T=293.16K
Photon emission for (n,p)

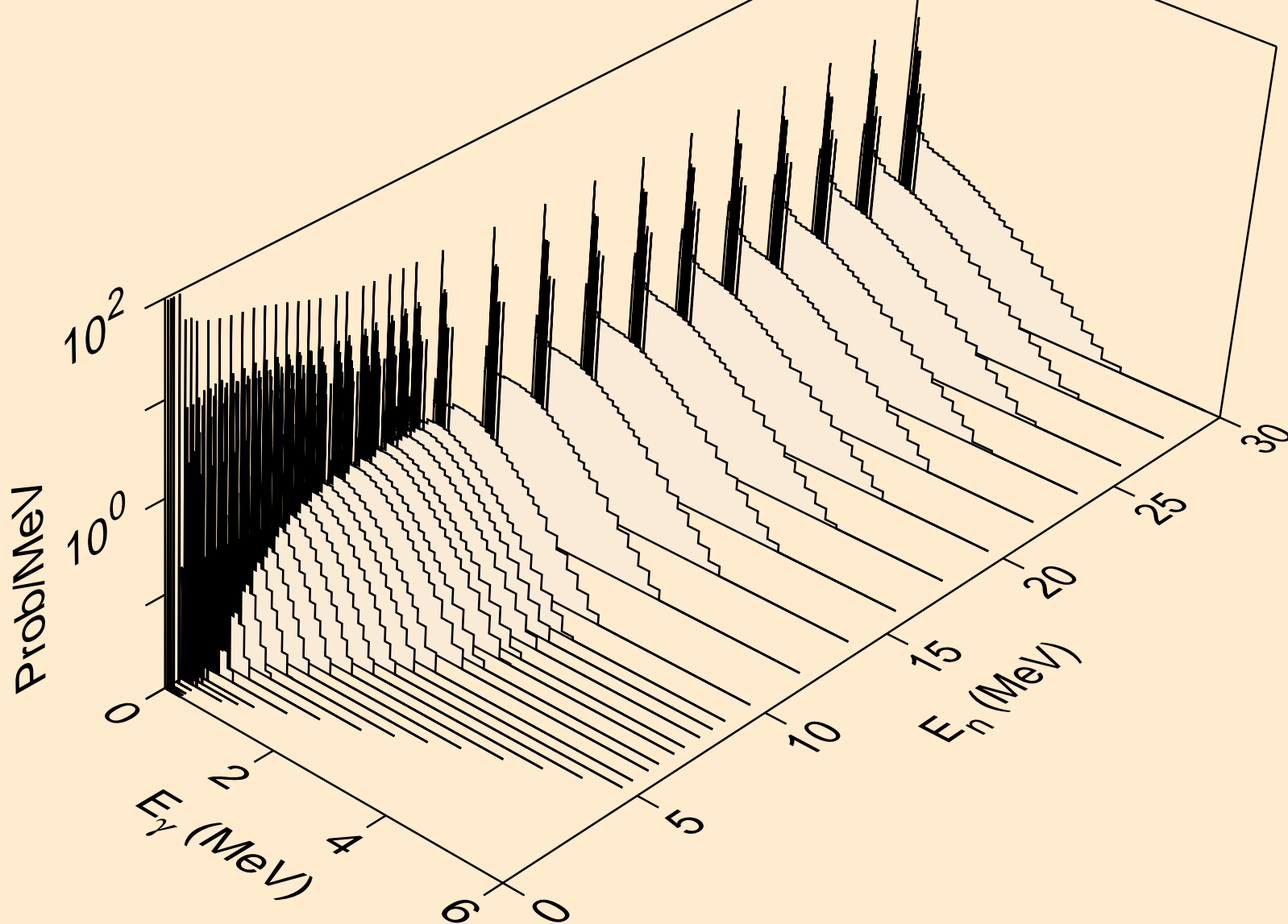

PT188 NEUTRON ACER TENDL-2019 LIBRARY; T=293.16K
Photon emission for (n,d)

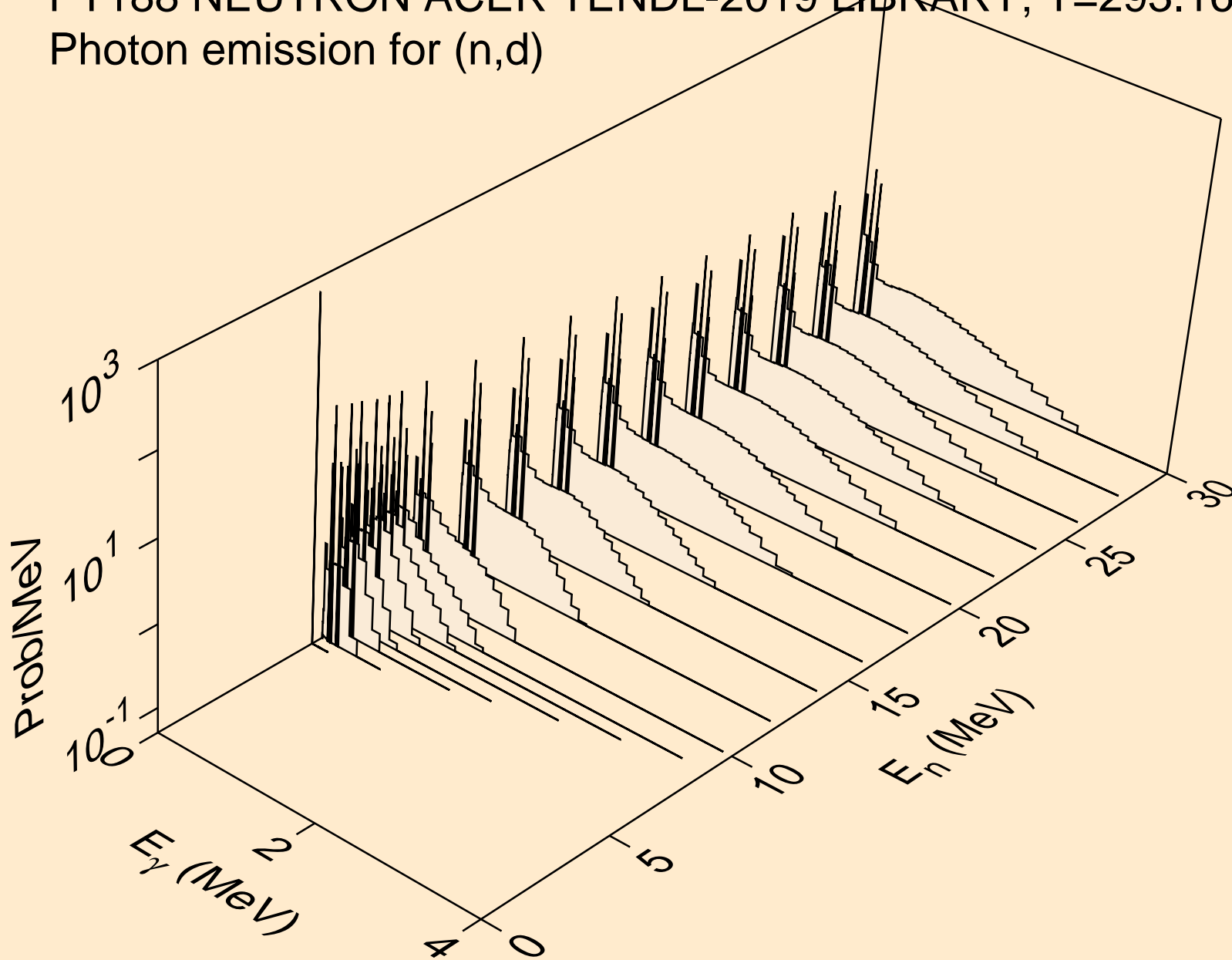

PT188 NEUTRON ACER TENDL-2019 LIBRARY; T=293.16K
Photon emission for (n,t)

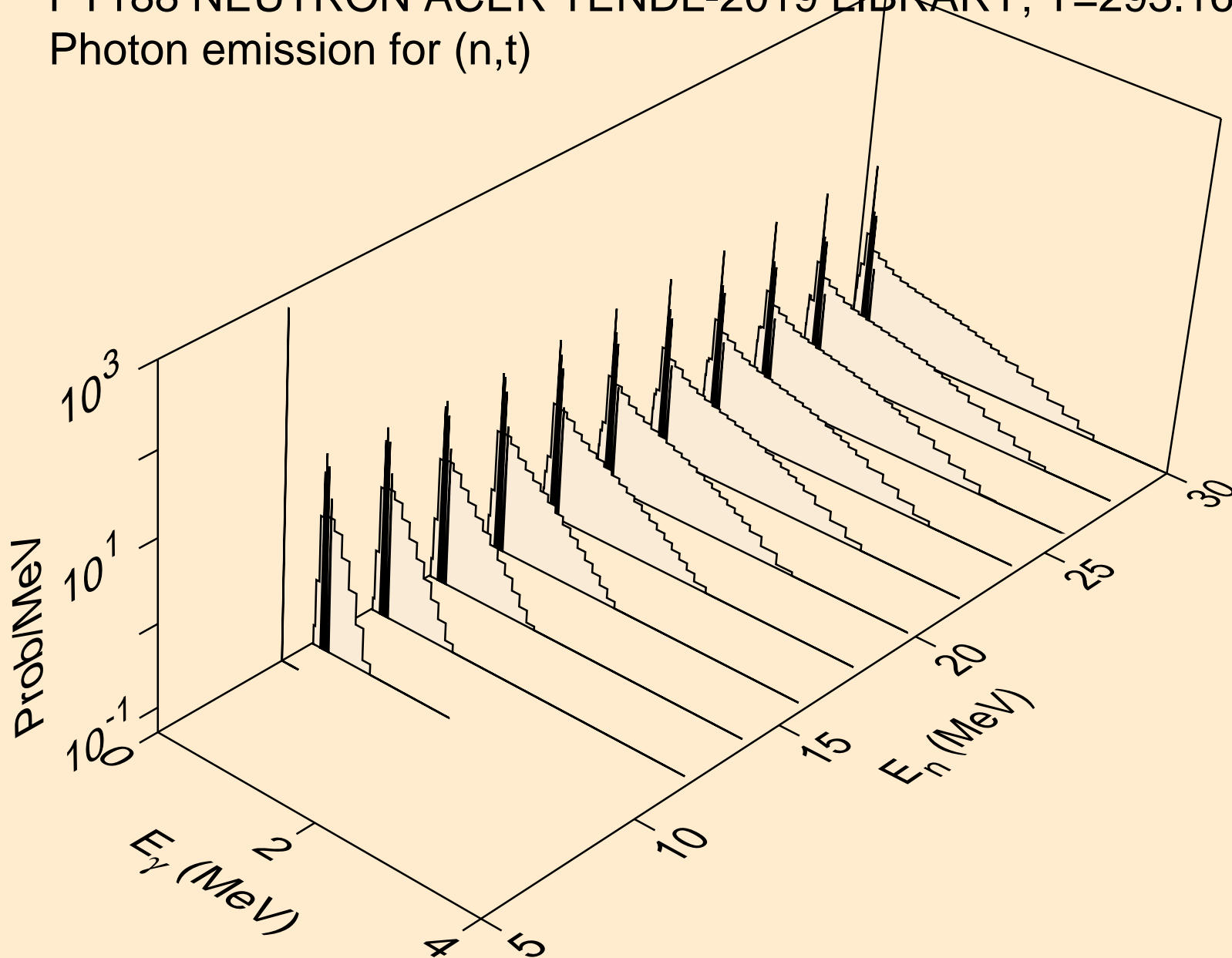

PT188 NEUTRON ACER TENDL-2019 LIBRARY; T=293.16K
Photon emission for (n,he3)

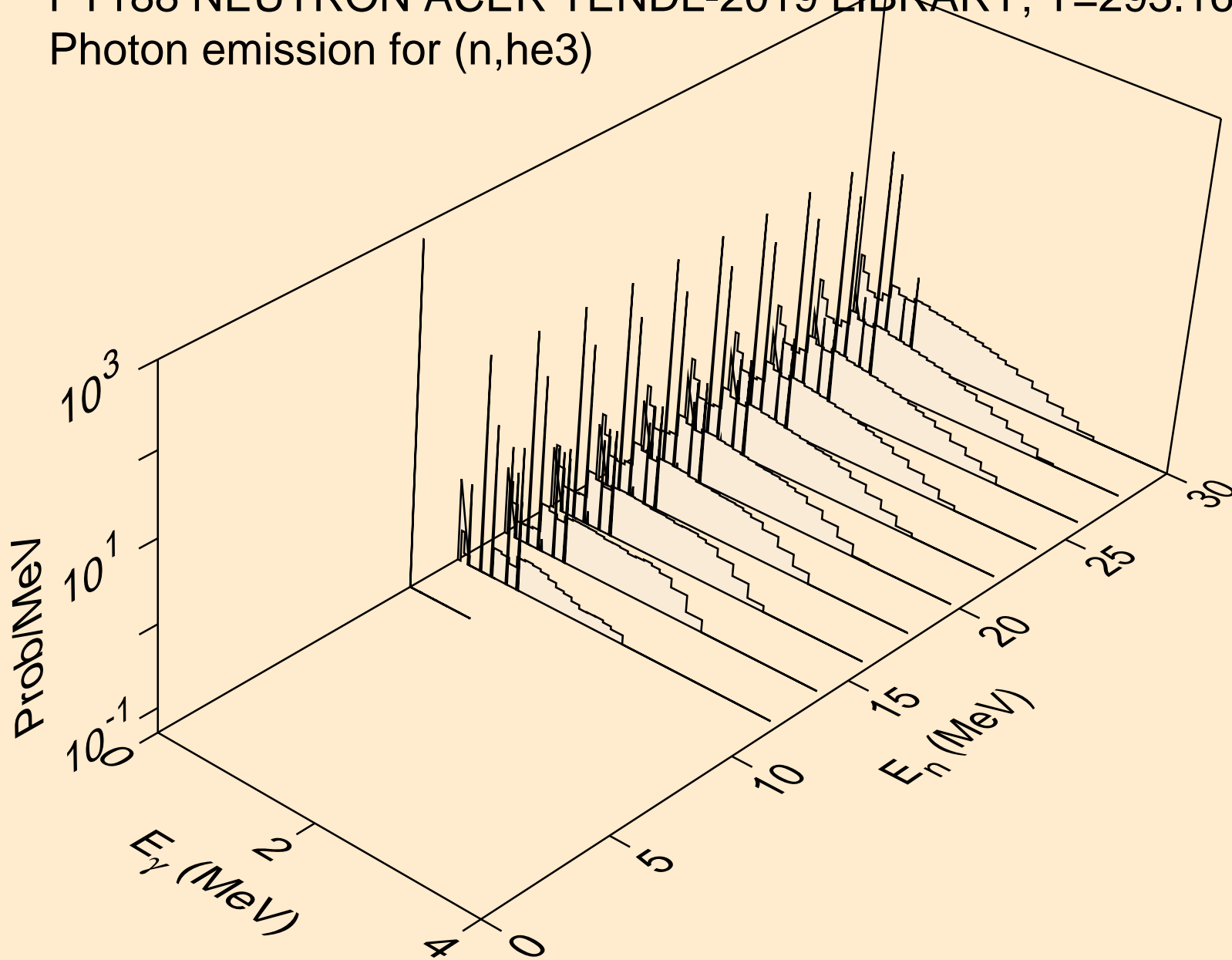

PT188 NEUTRON ACER TENDL-2019 LIBRARY; T=293.16K
Photon emission for (n,a)

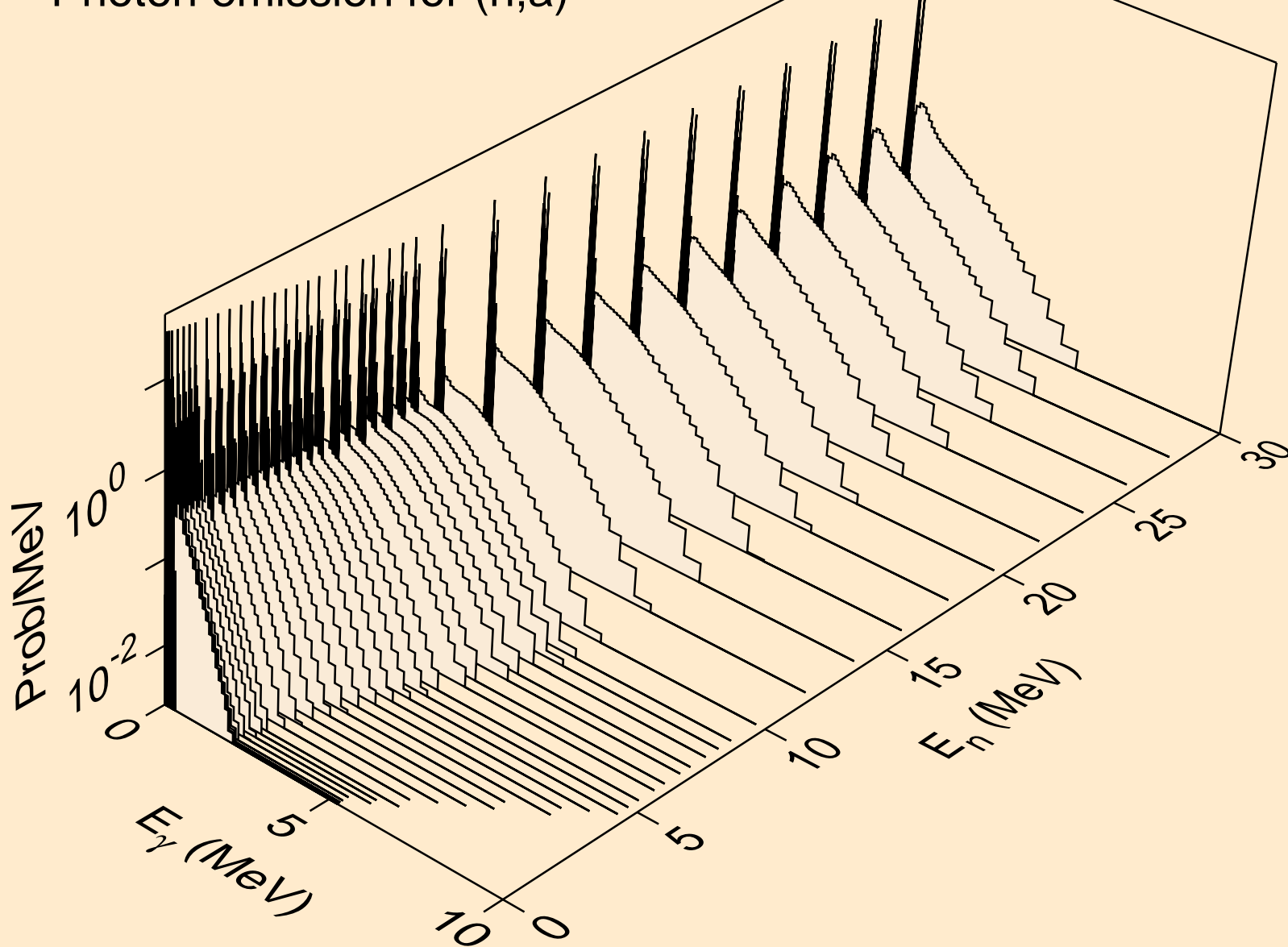

PT188 NEUTRON ACER TENDL-2019 LIBRARY; T=293.16K
Photon emission for (n,2a)

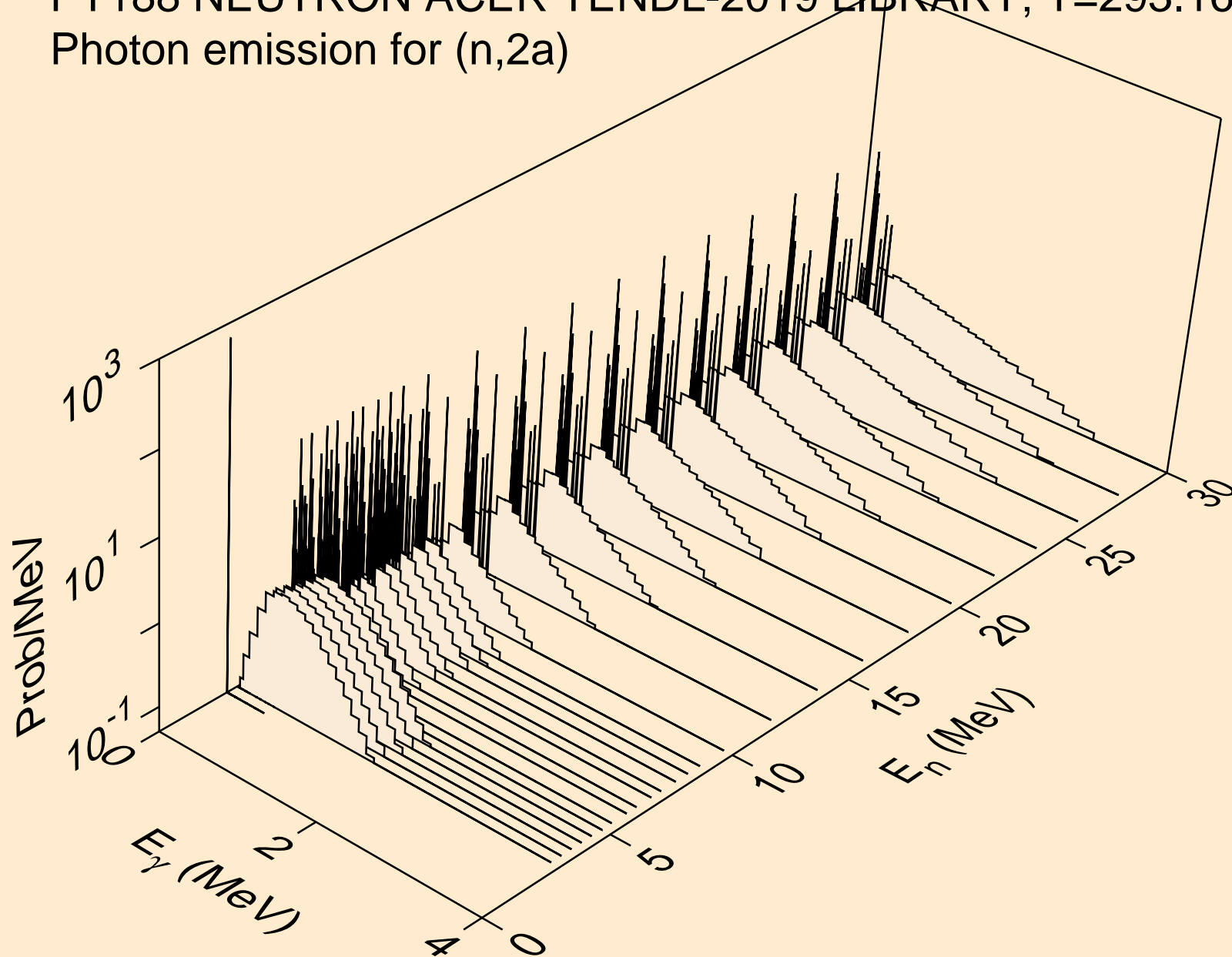

PT188 NEUTRON ACER TENDL-2019 LIBRARY; T=293.16K
Photon emission for (n,2p)

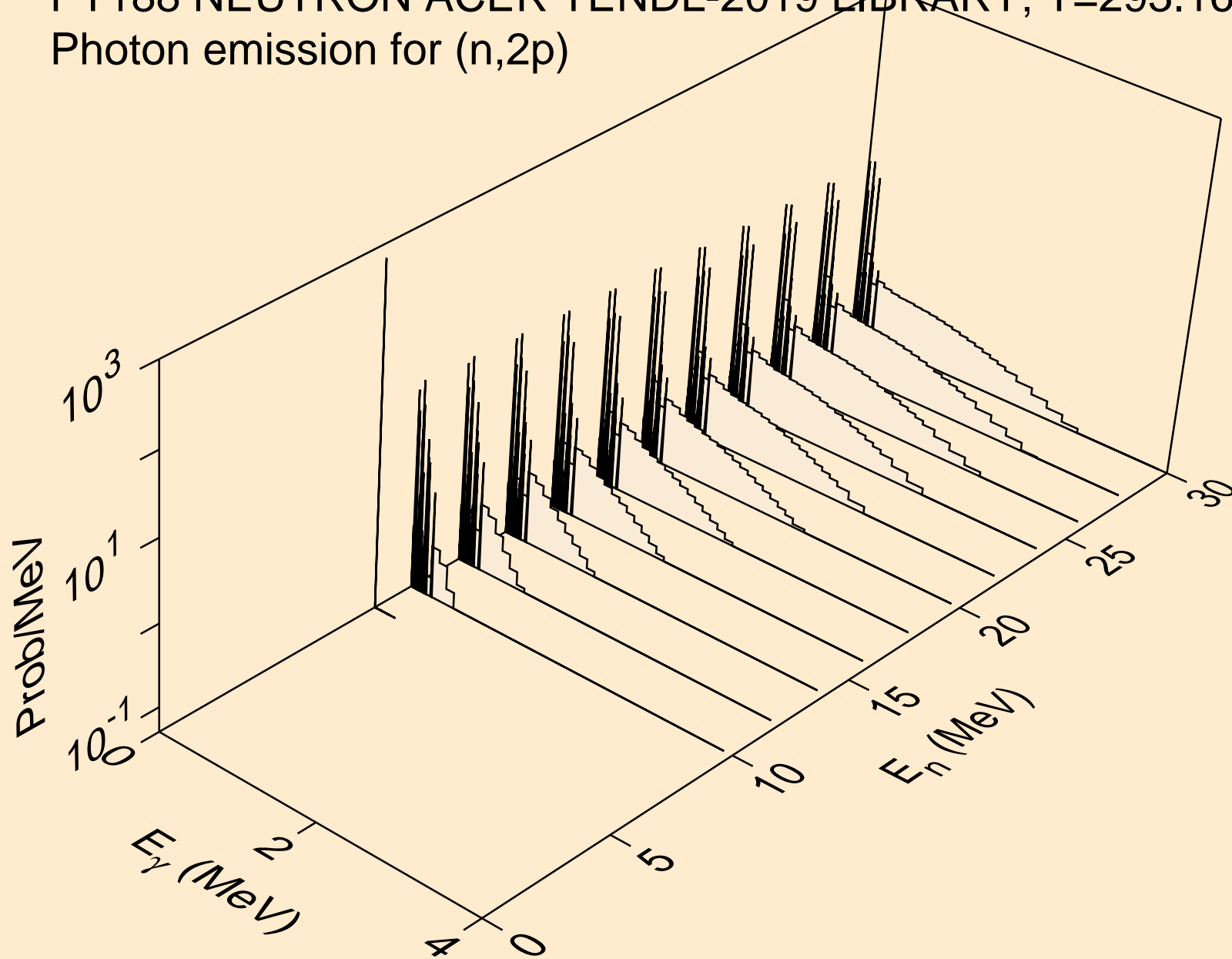

PT188 NEUTRON ACER TENDL-2019 LIBRARY; T=293.16K
Photon emission for (n,p α)

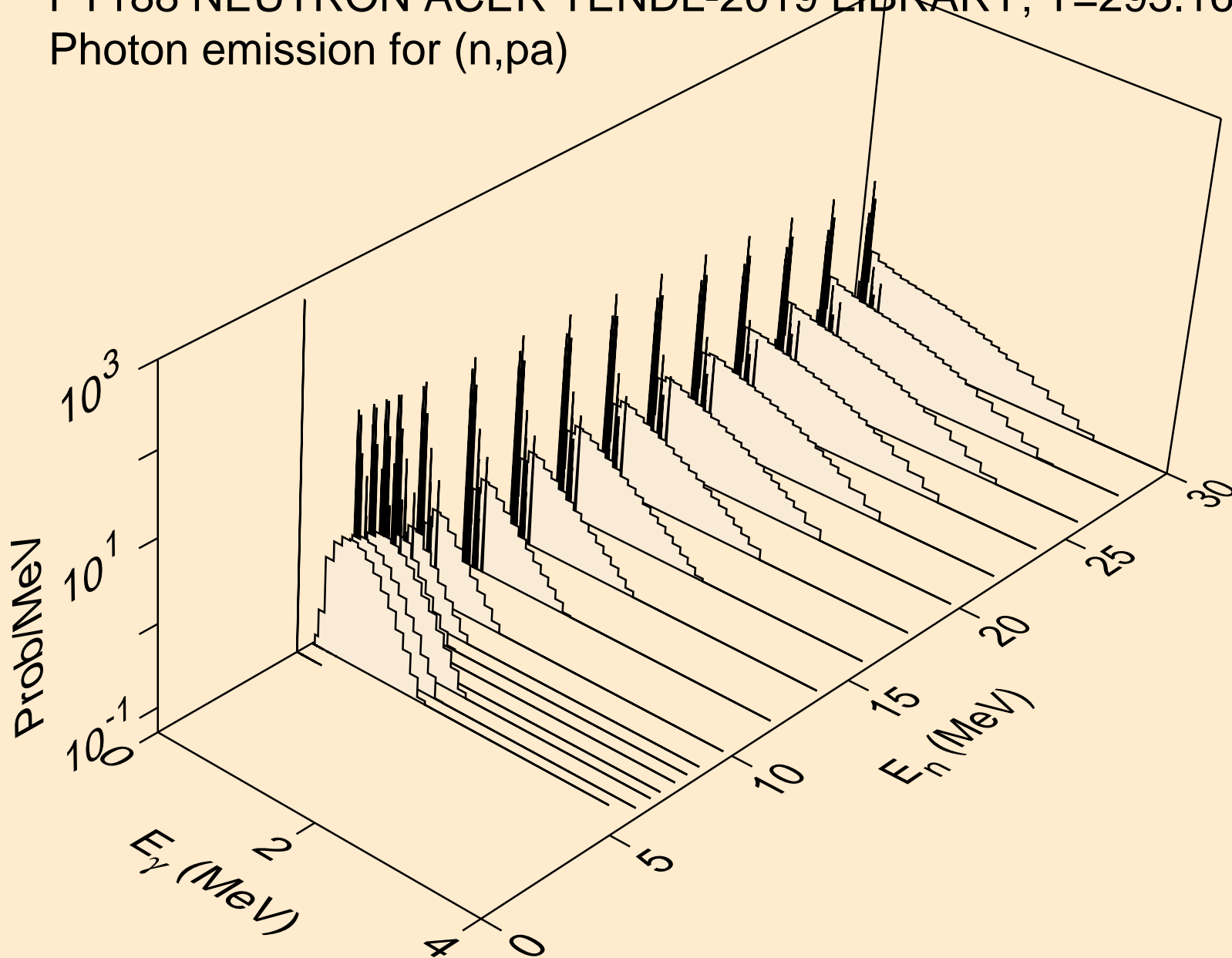

PT188 NEUTRON ACER TENDL-2019 LIBRARY; T=293.16K
Photon emission for (n,pd)

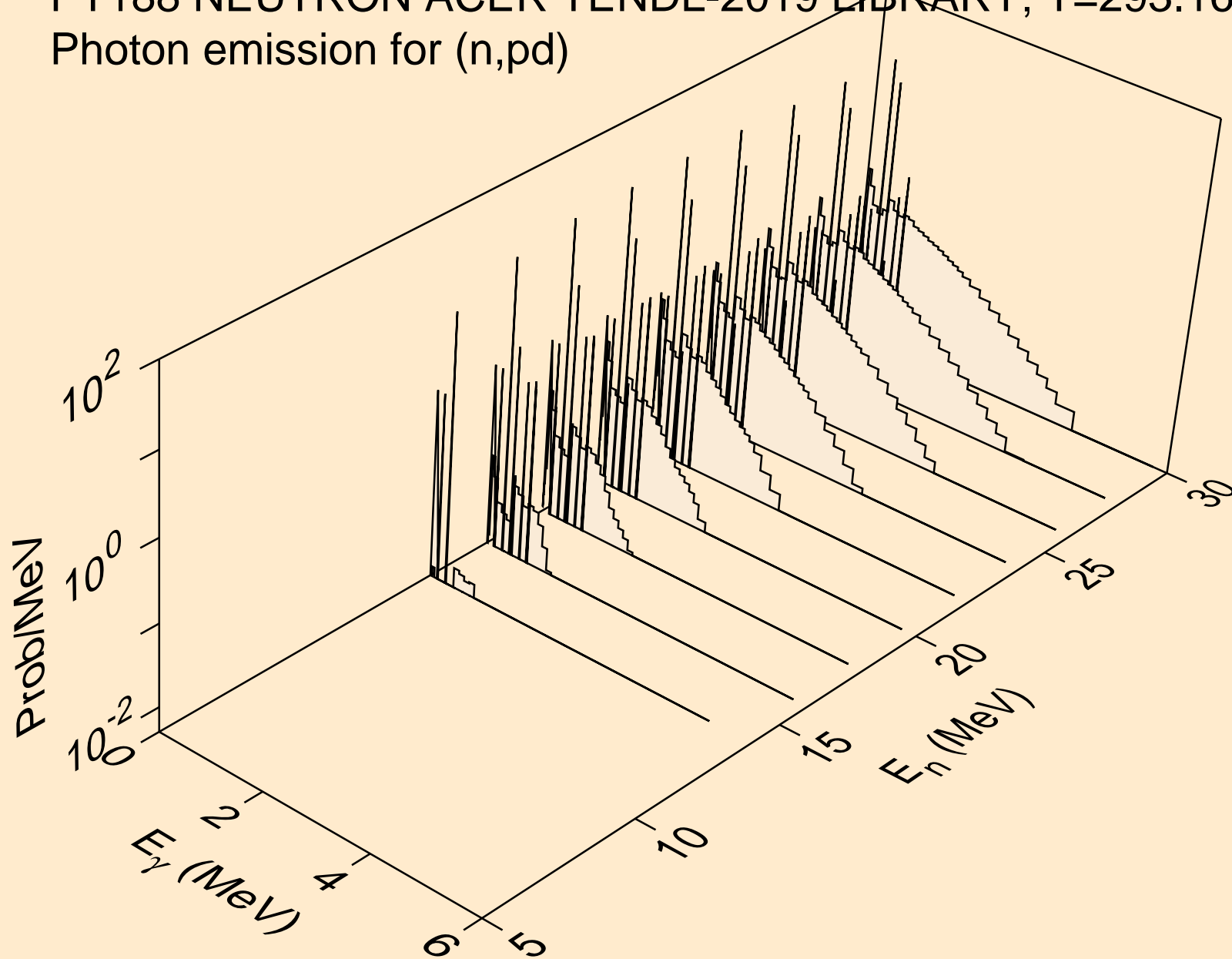

PT188 NEUTRON ACER TENDL-2019 LIBRARY; T=293.16K
Photon emission for (n,pt)

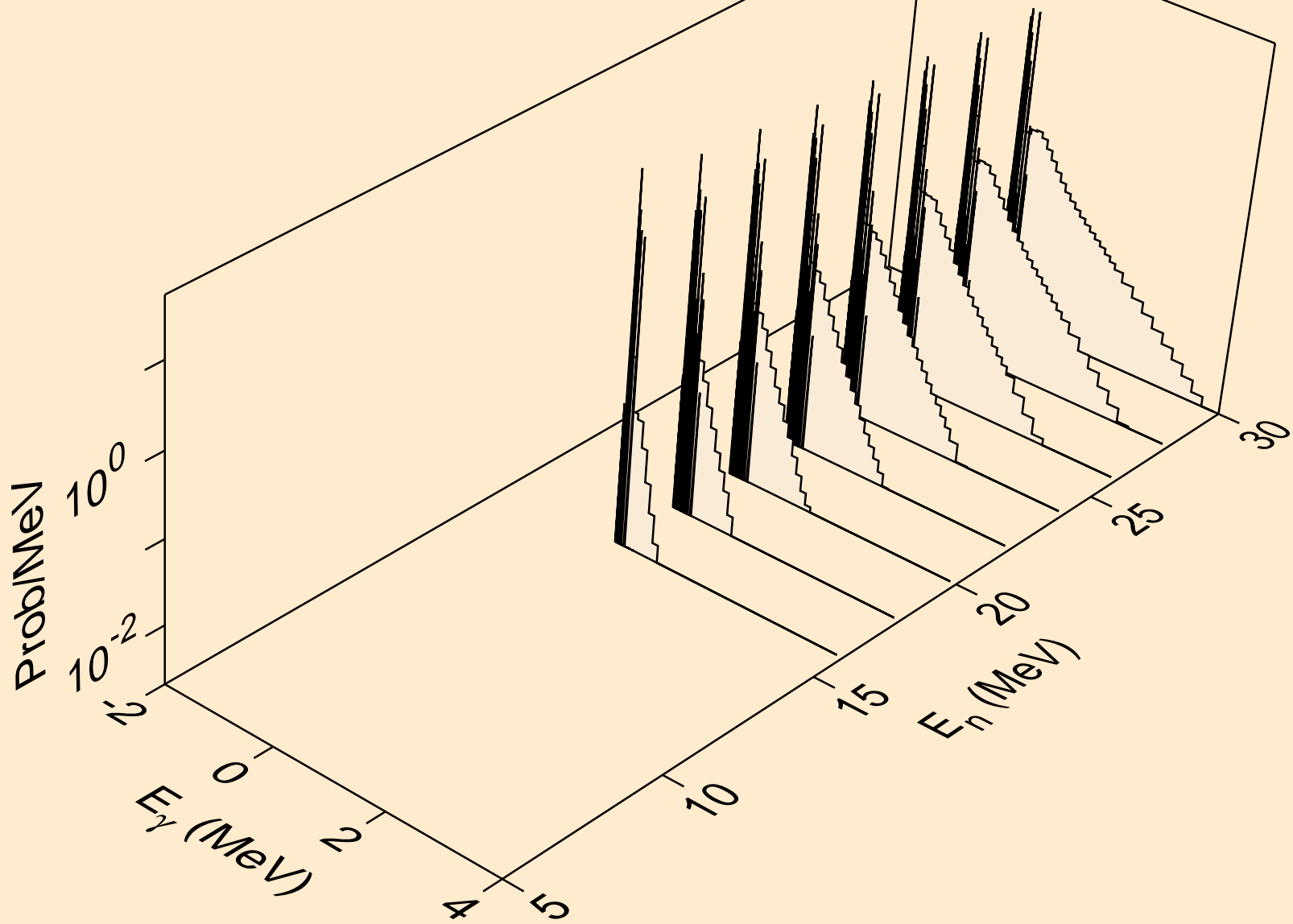

PT188 NEUTRON ACER TENDL-2019 LIBRARY; T=293.16K
Photon emission for (n,da)

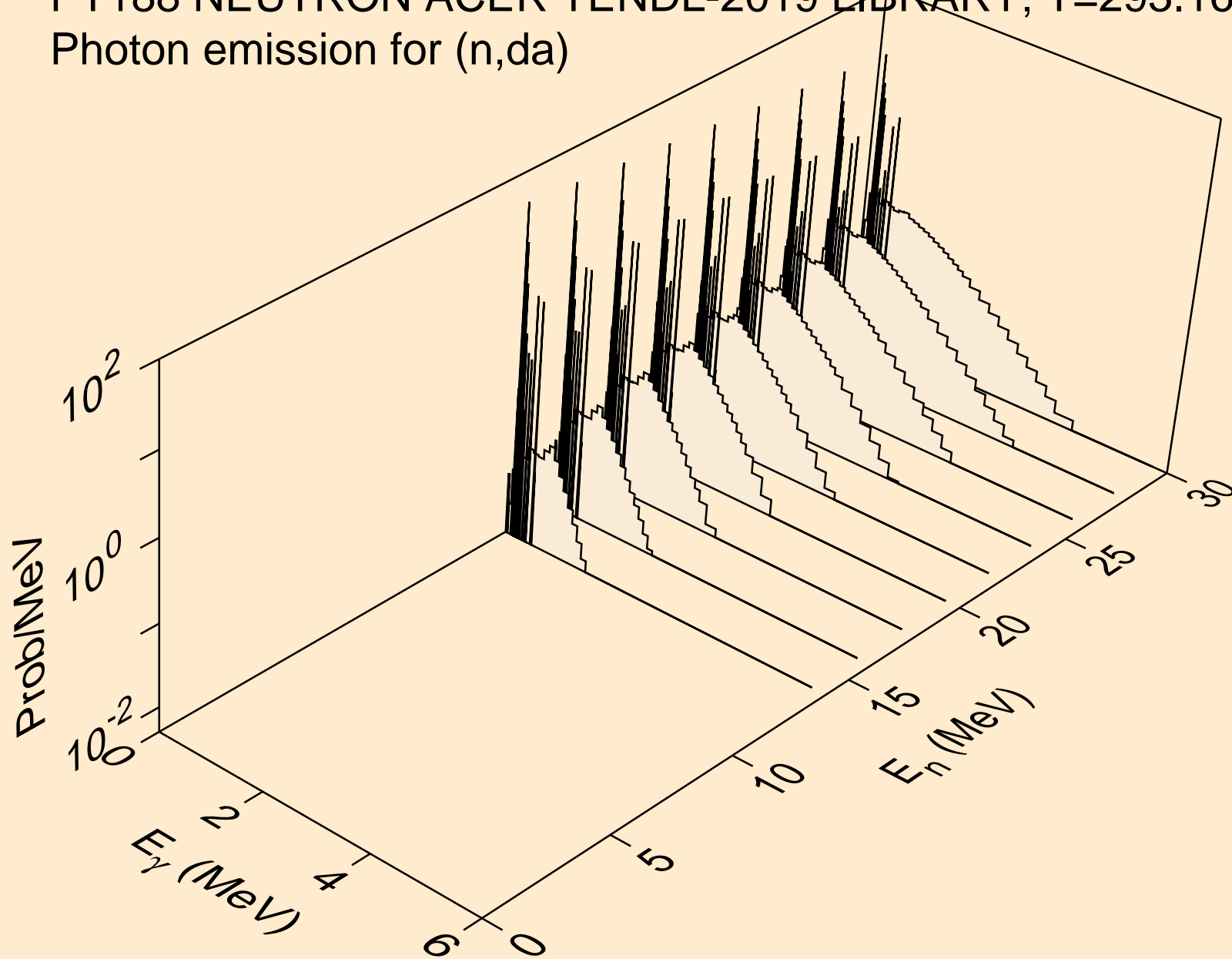

PT188 NEUTRON ACER TENDL-2019 LIBRARY; T=293.16K
thermal capture photon spectrum

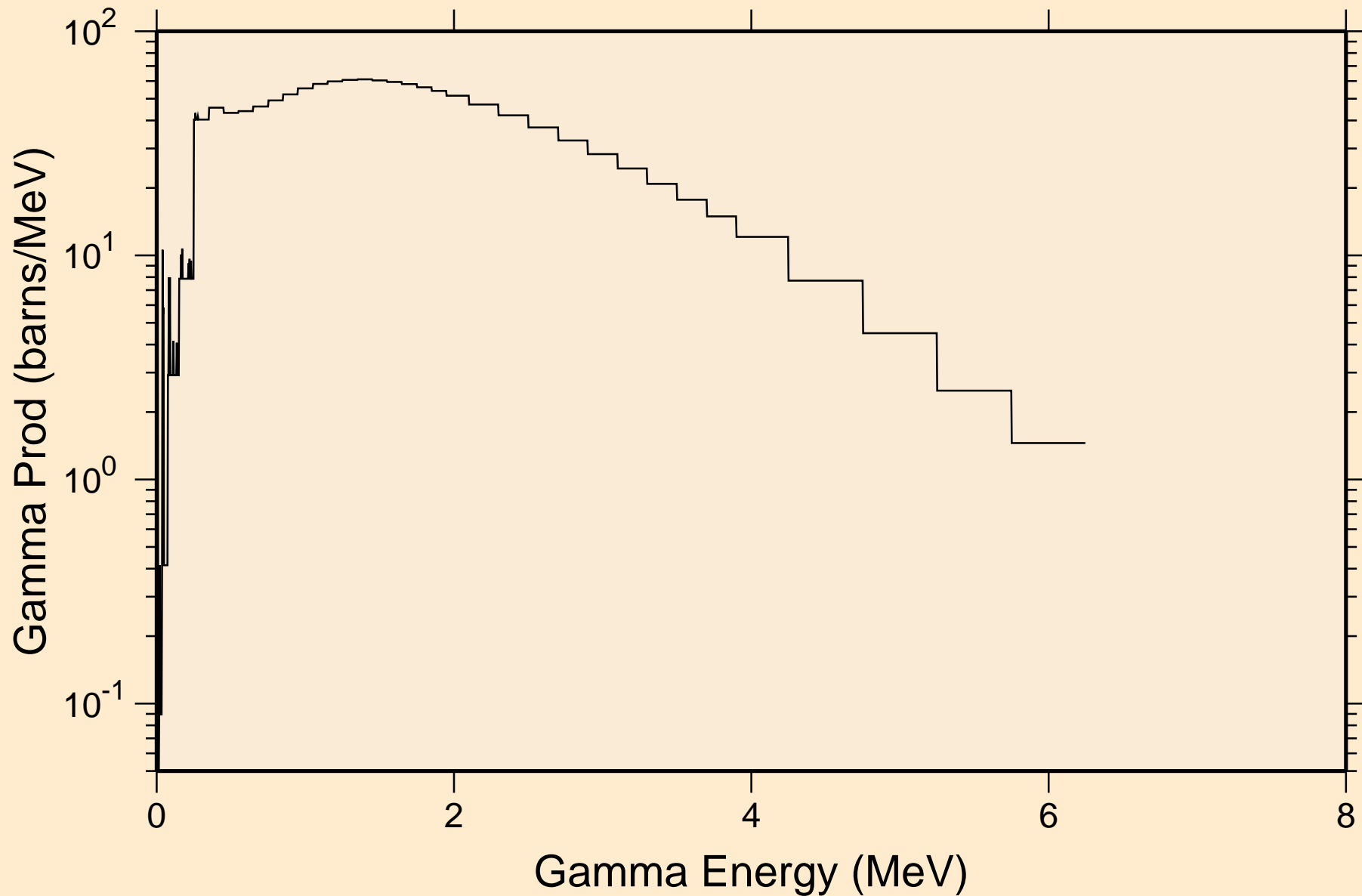

PT188 NEUTRON ACER TENDL-2019 LIBRARY; T=293.16K
14 MeV photon spectrum

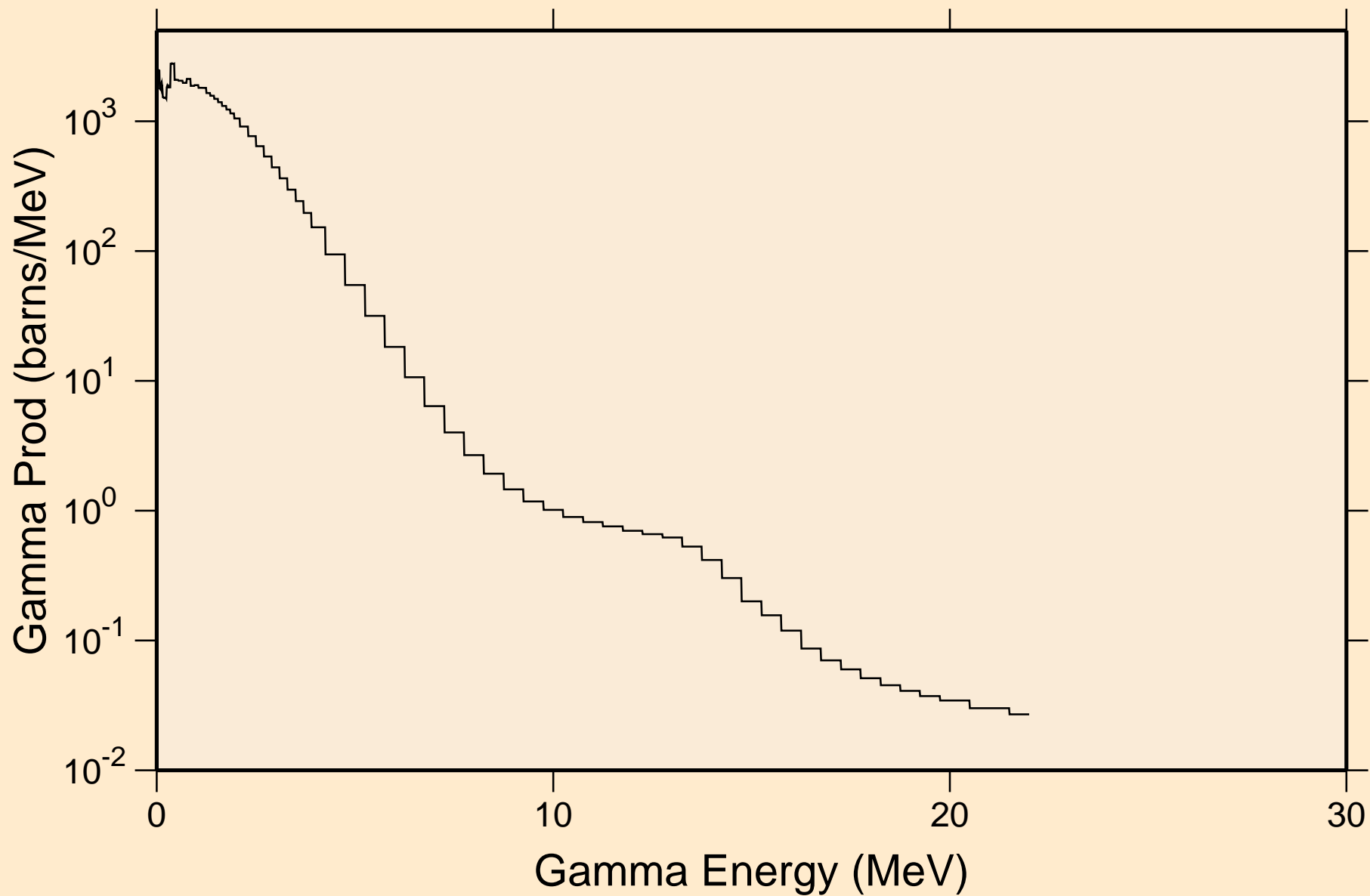

PT188 NEUTRON ACER TENDL-2019 LIBRARY; T=293.16K
Particle heating contributions

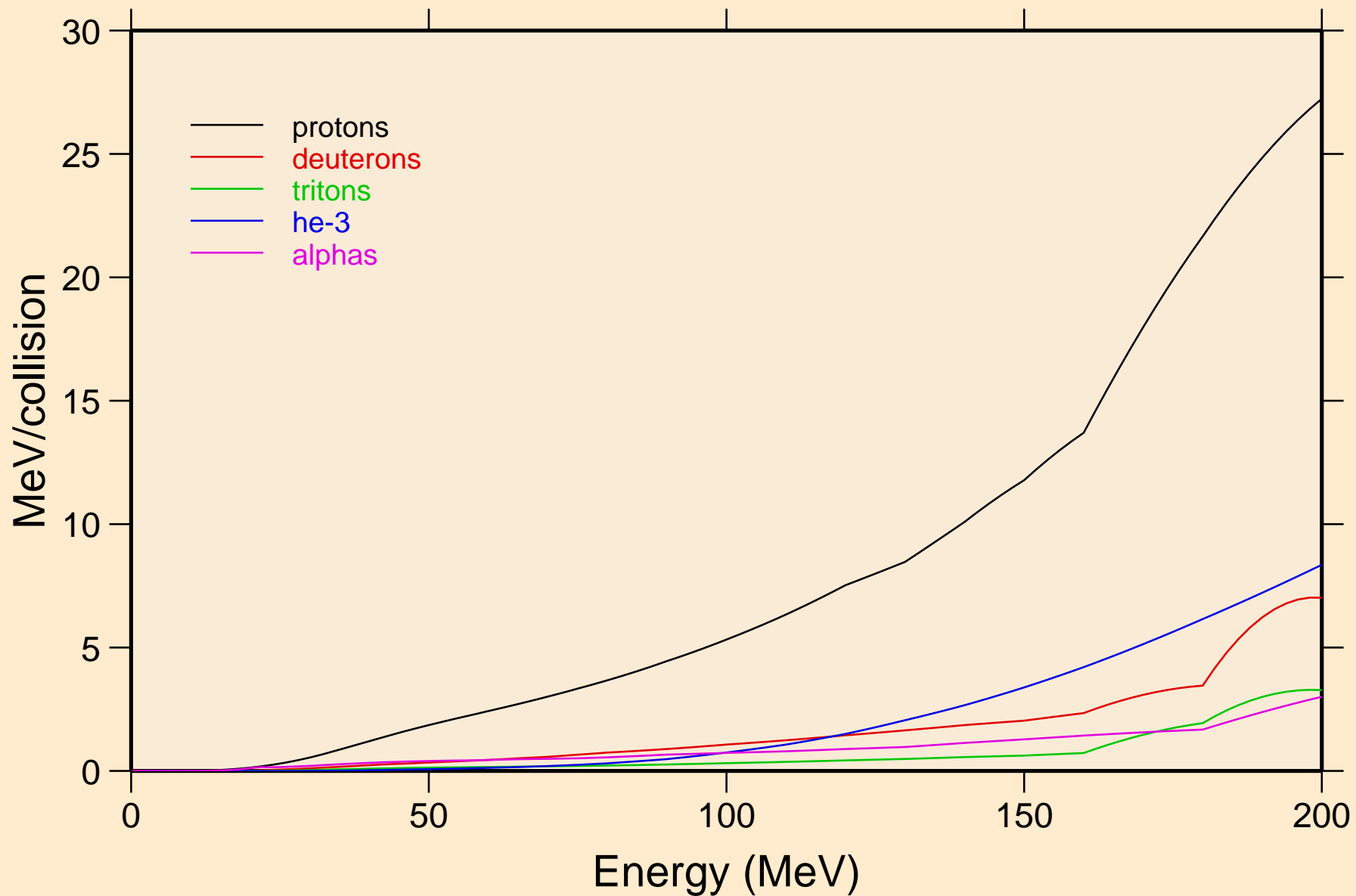

PT188 NEUTRON ACER TENDL-2019 LIBRARY; T=293.16K
Recoil Heating

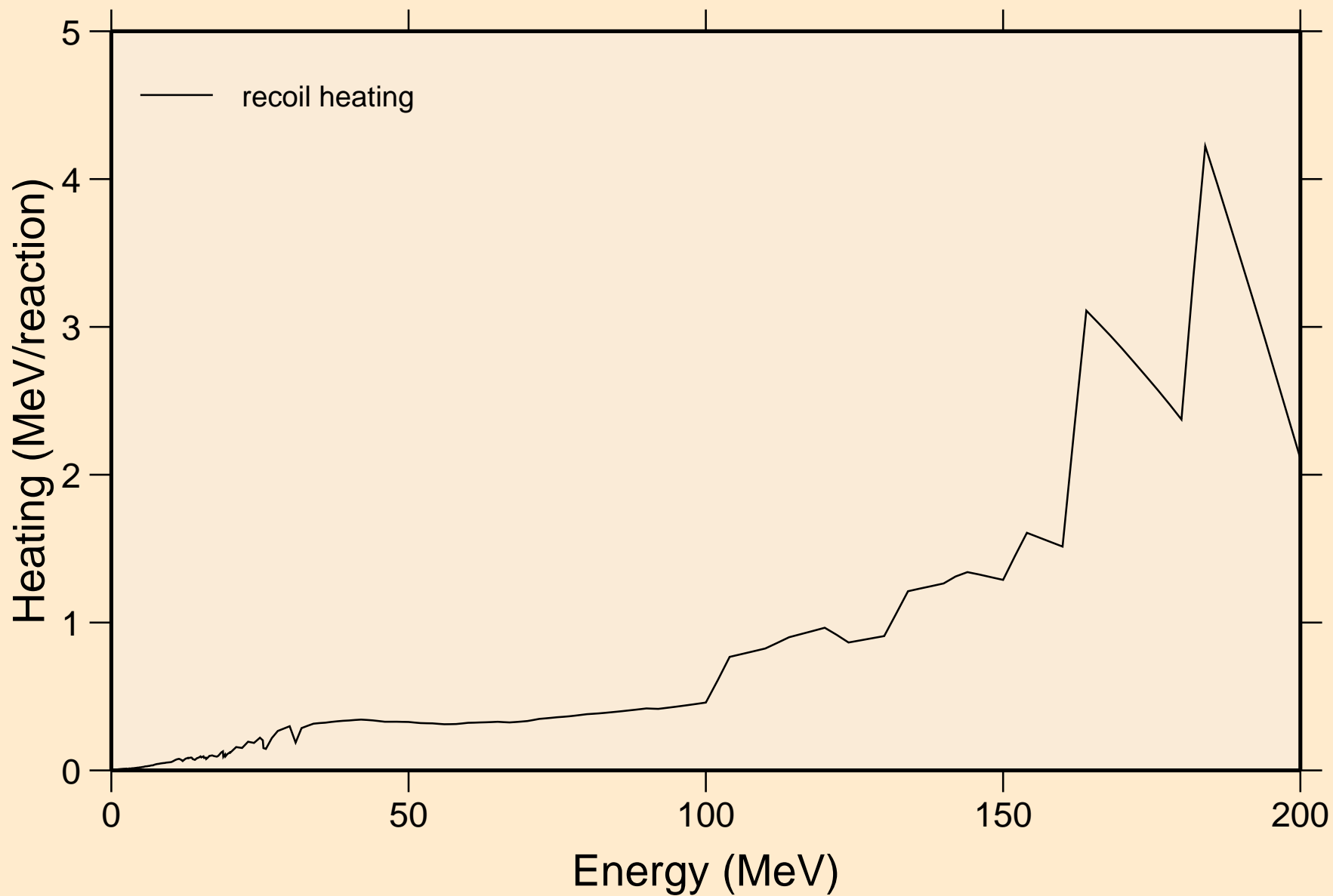

PT188 NEUTRON ACER TENDL-2019 LIBRARY; T=293.16K
Particle production cross sections

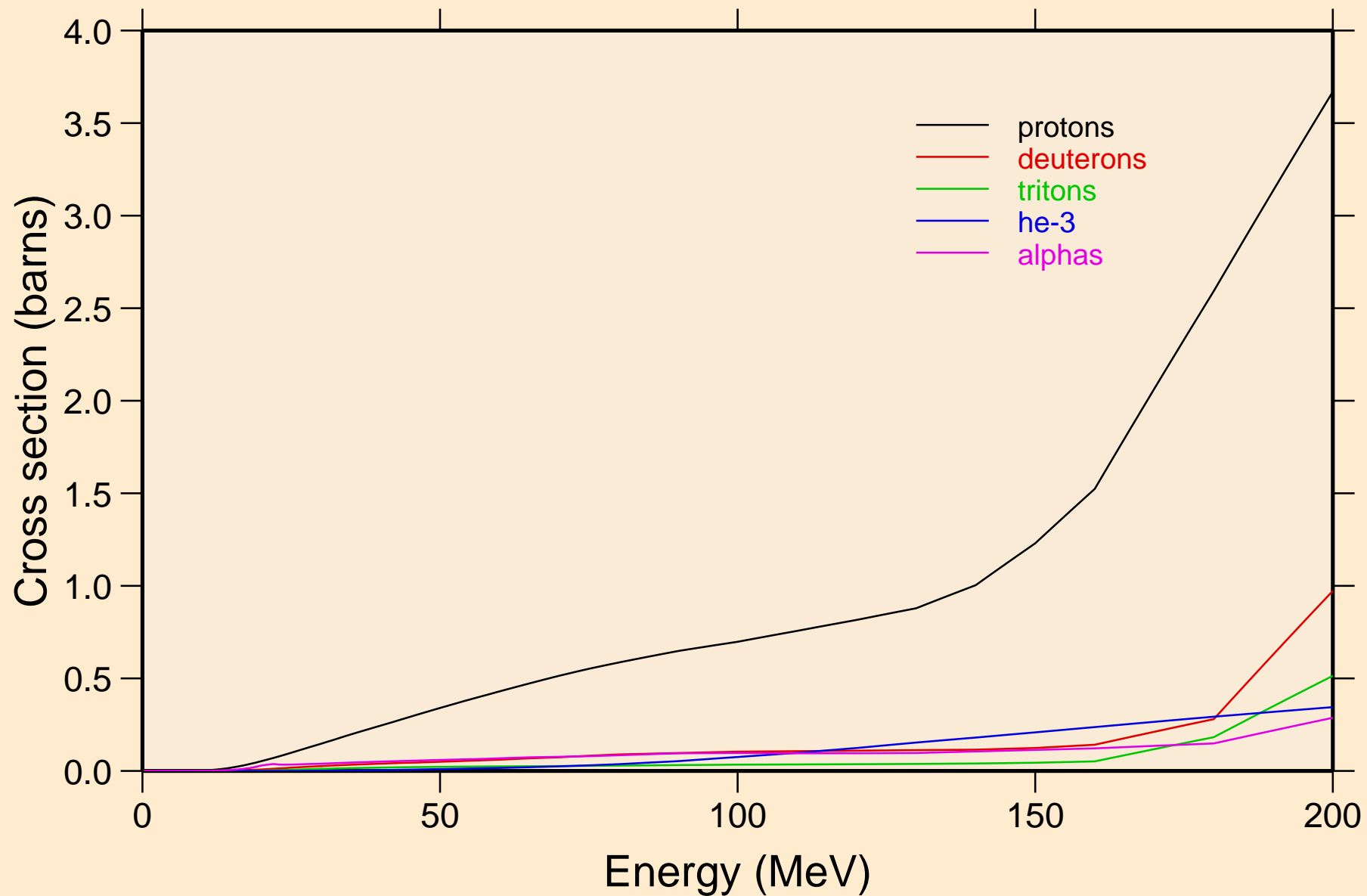

PT188 NEUTRON ACER TENDL-2019 LIBRARY; T=293.16K
protons from (n,x)

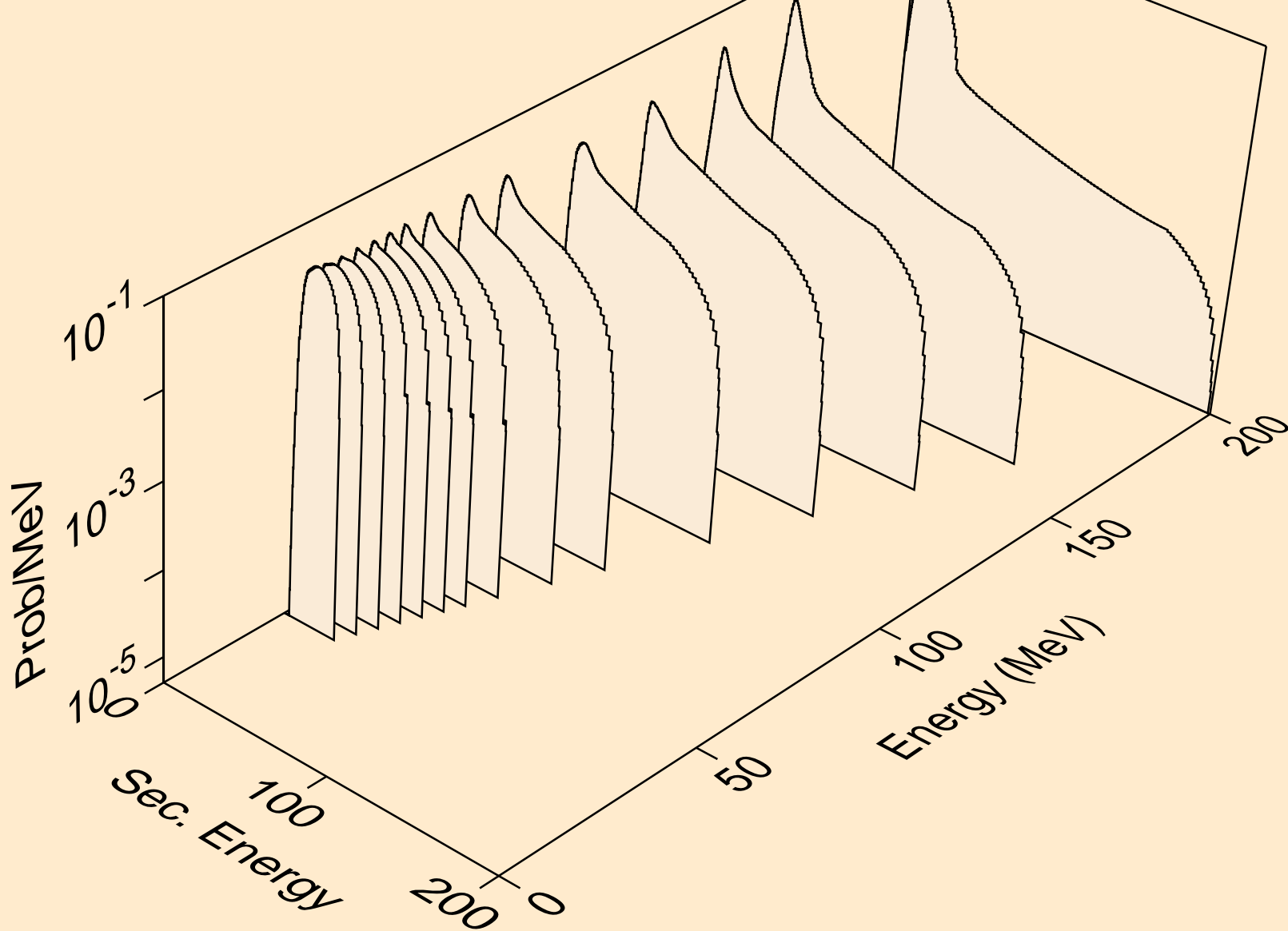

PT188 NEUTRON ACER TENDL-2019 LIBRARY; T=293.16K
protons from (n,n*)p

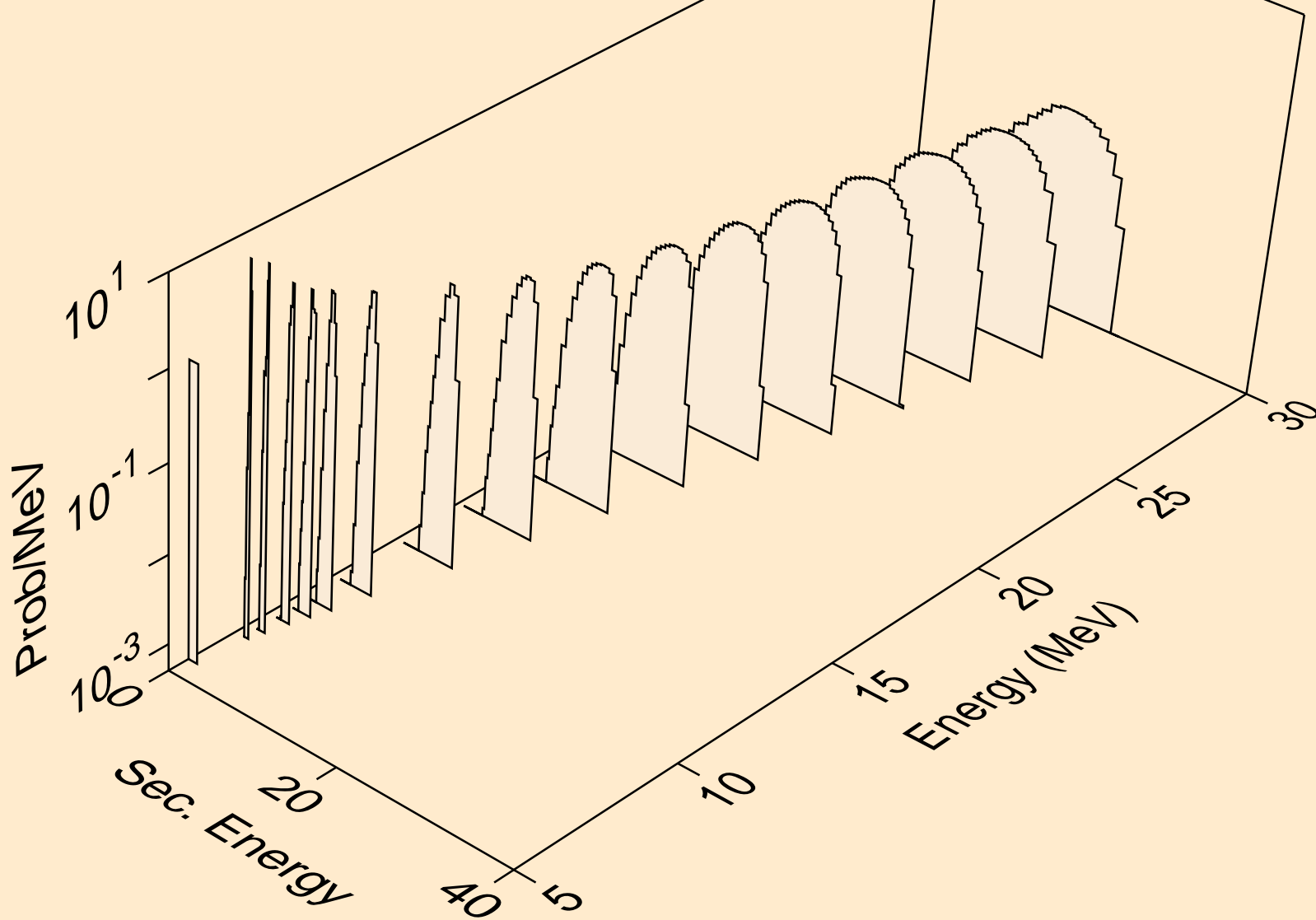

PT188 NEUTRON ACER TENDL-2019 LIBRARY; T=293.16K
protons from (n,2np)

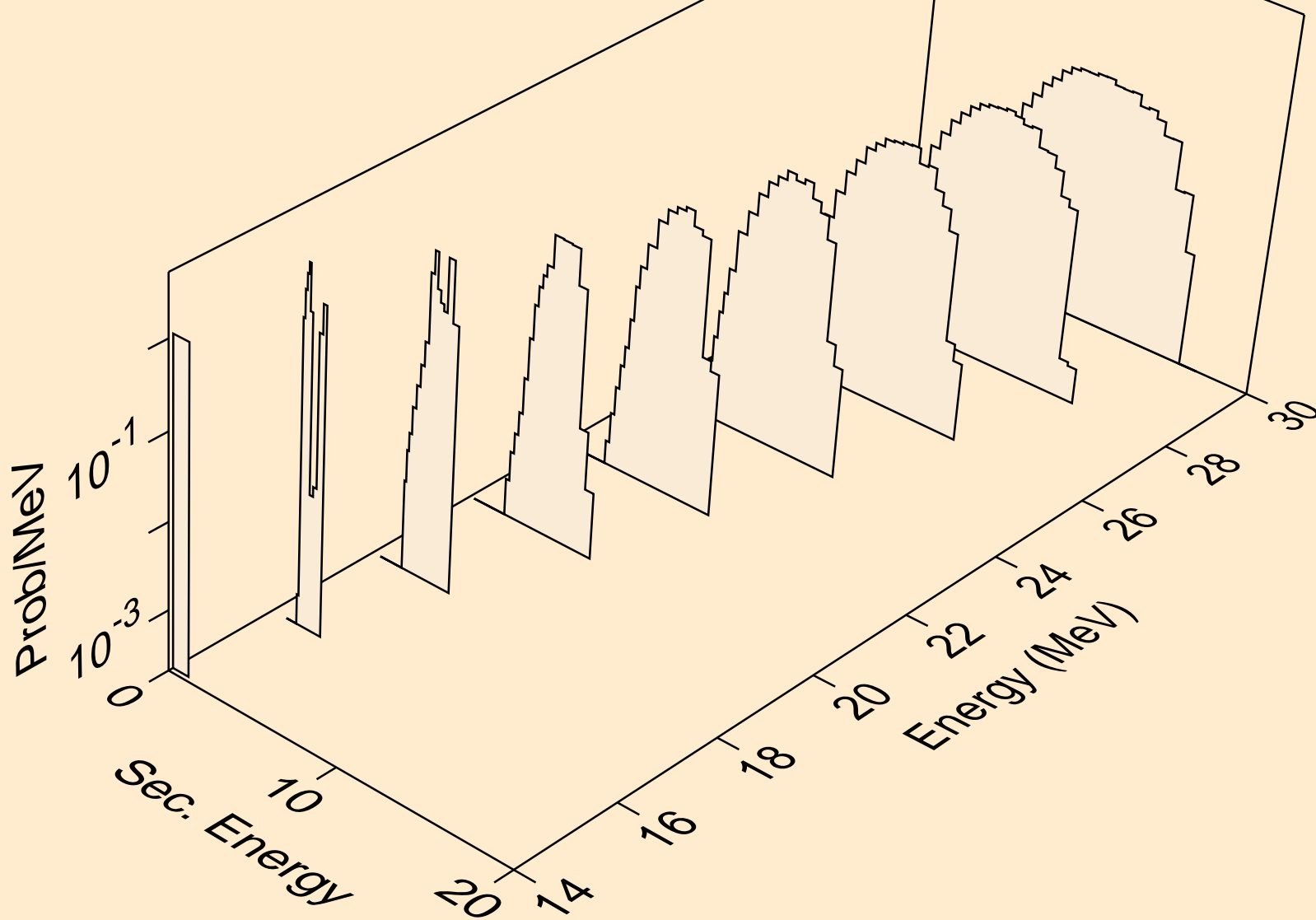

PT188 NEUTRON ACER TENDL-2019 LIBRARY; T=293.16K
protons from (n,3np)

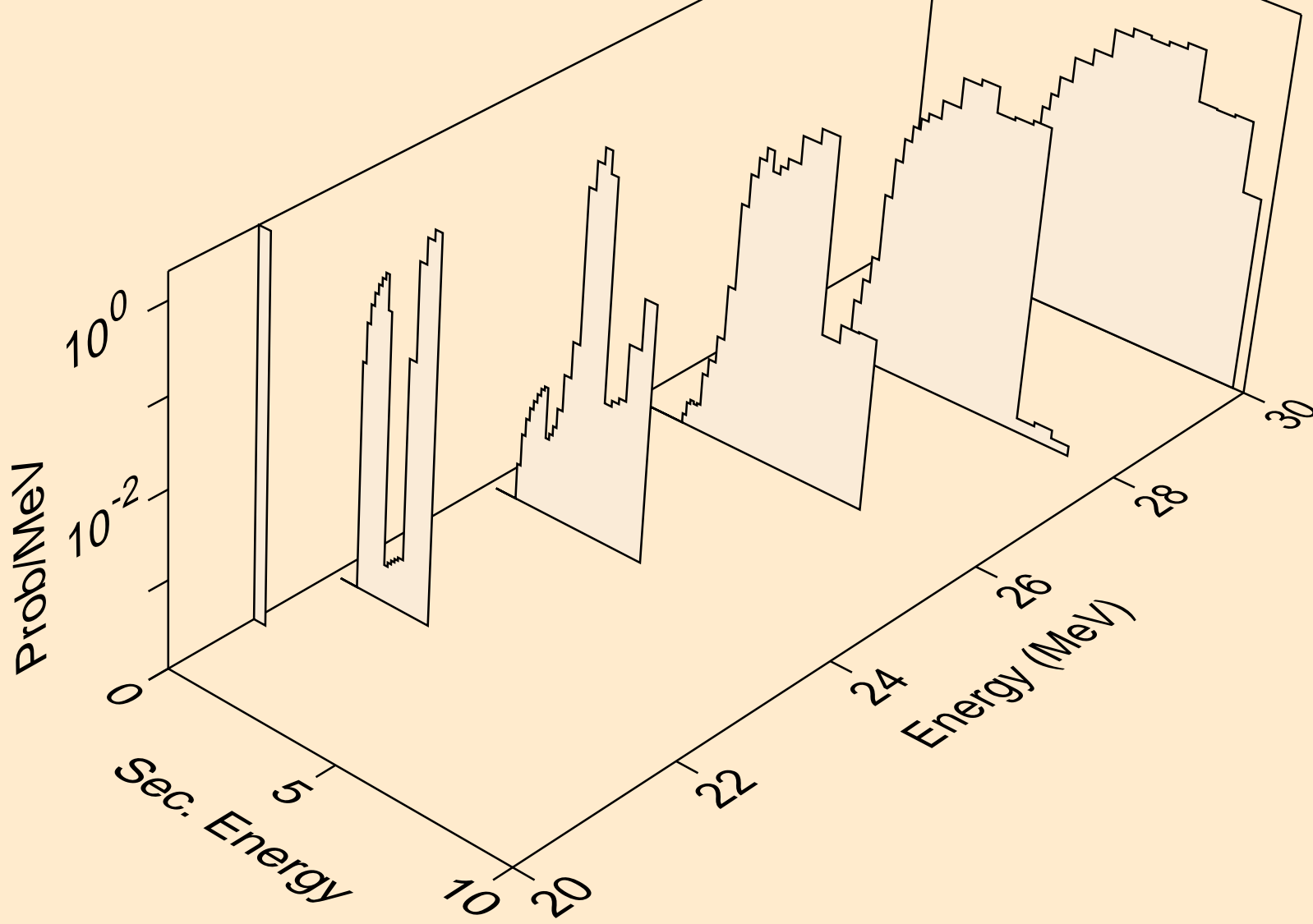

PT188 NEUTRON ACER TENDL-2019 LIBRARY; T=293.16K
protons from (n,2np)

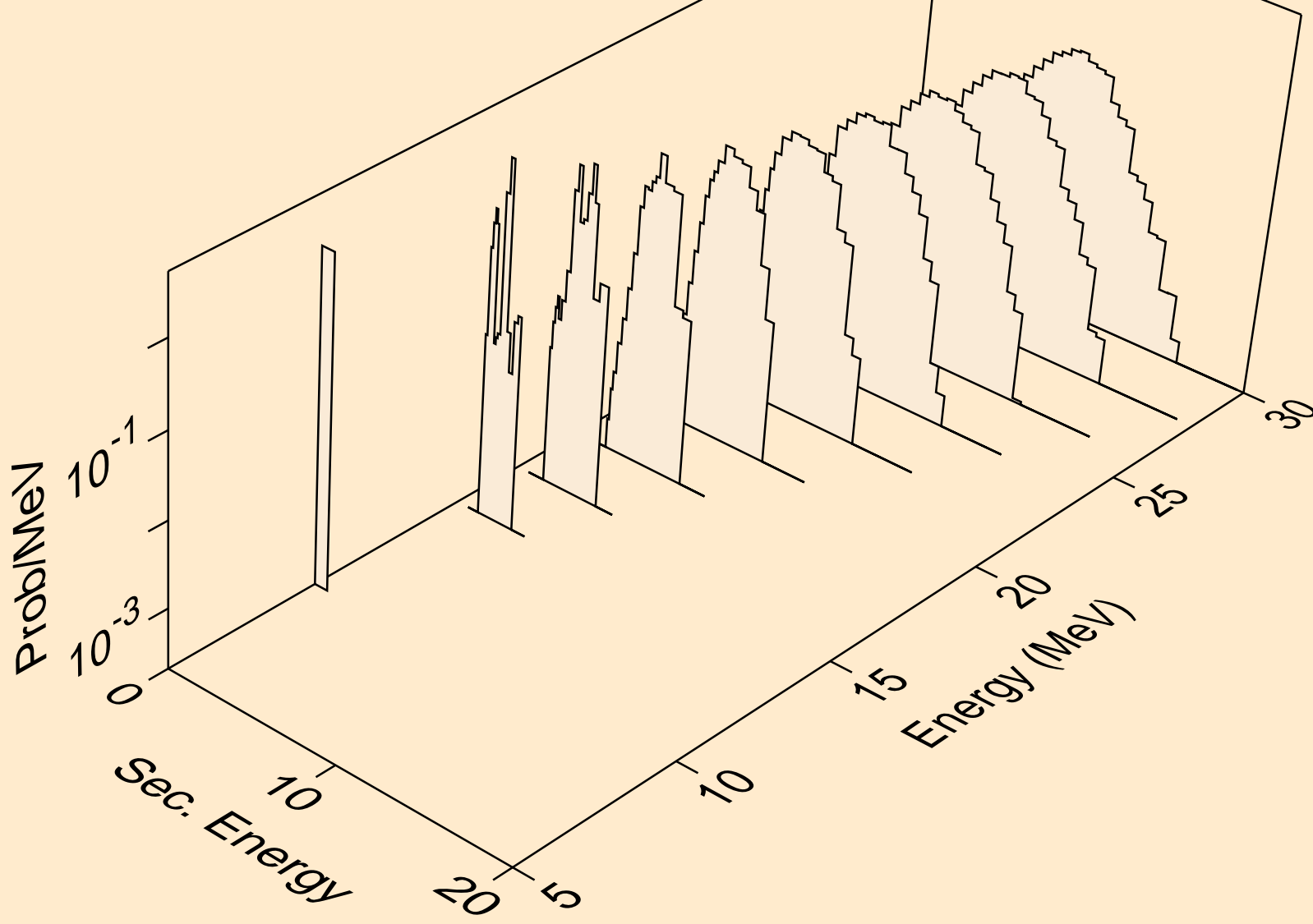

PT188 NEUTRON ACER TENDL-2019 LIBRARY; T=293.16K
protons from (n,npa)

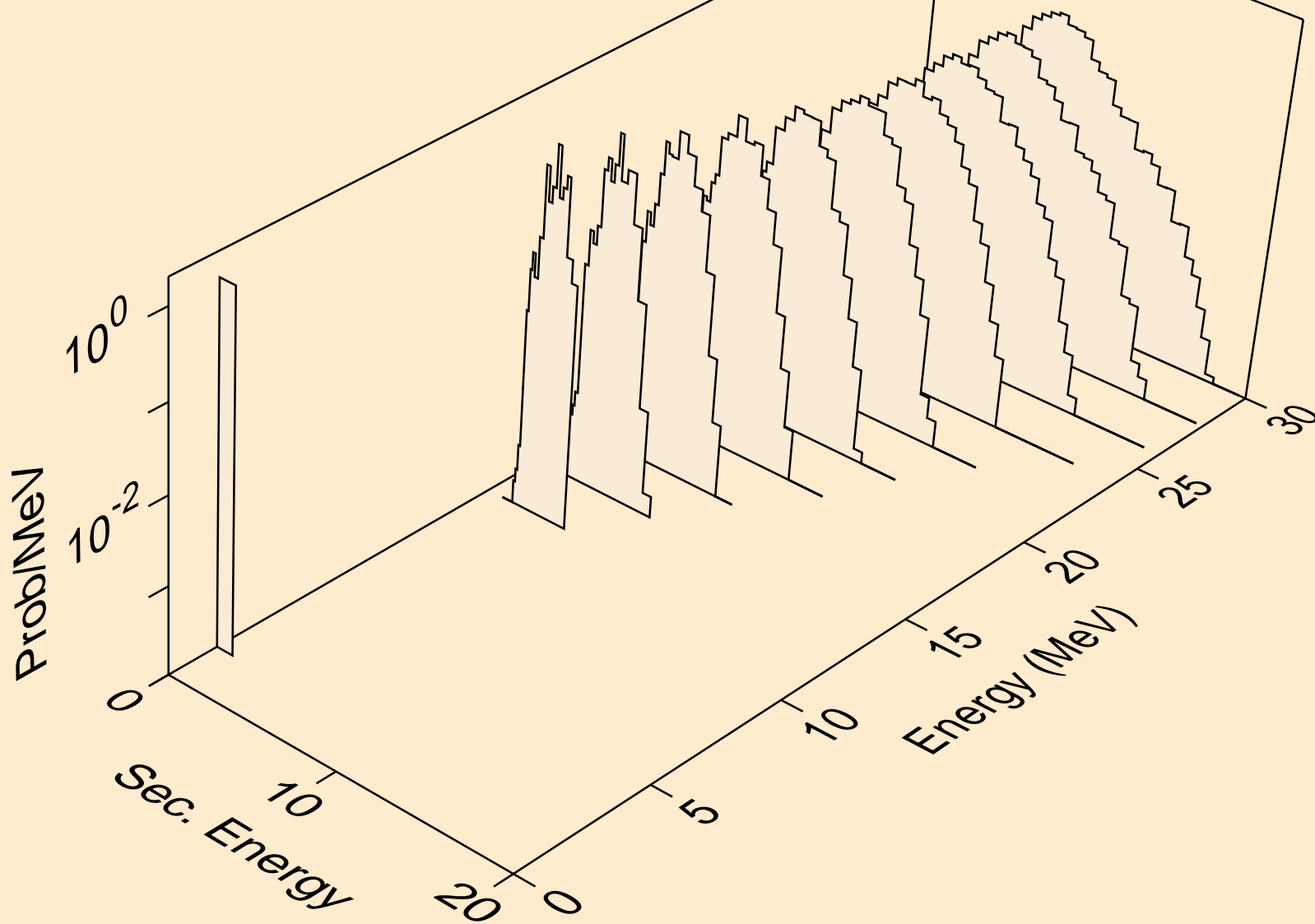

PT188 NEUTRON ACER TENDL-2019 LIBRARY; T=293.16K
protons from (n,p)

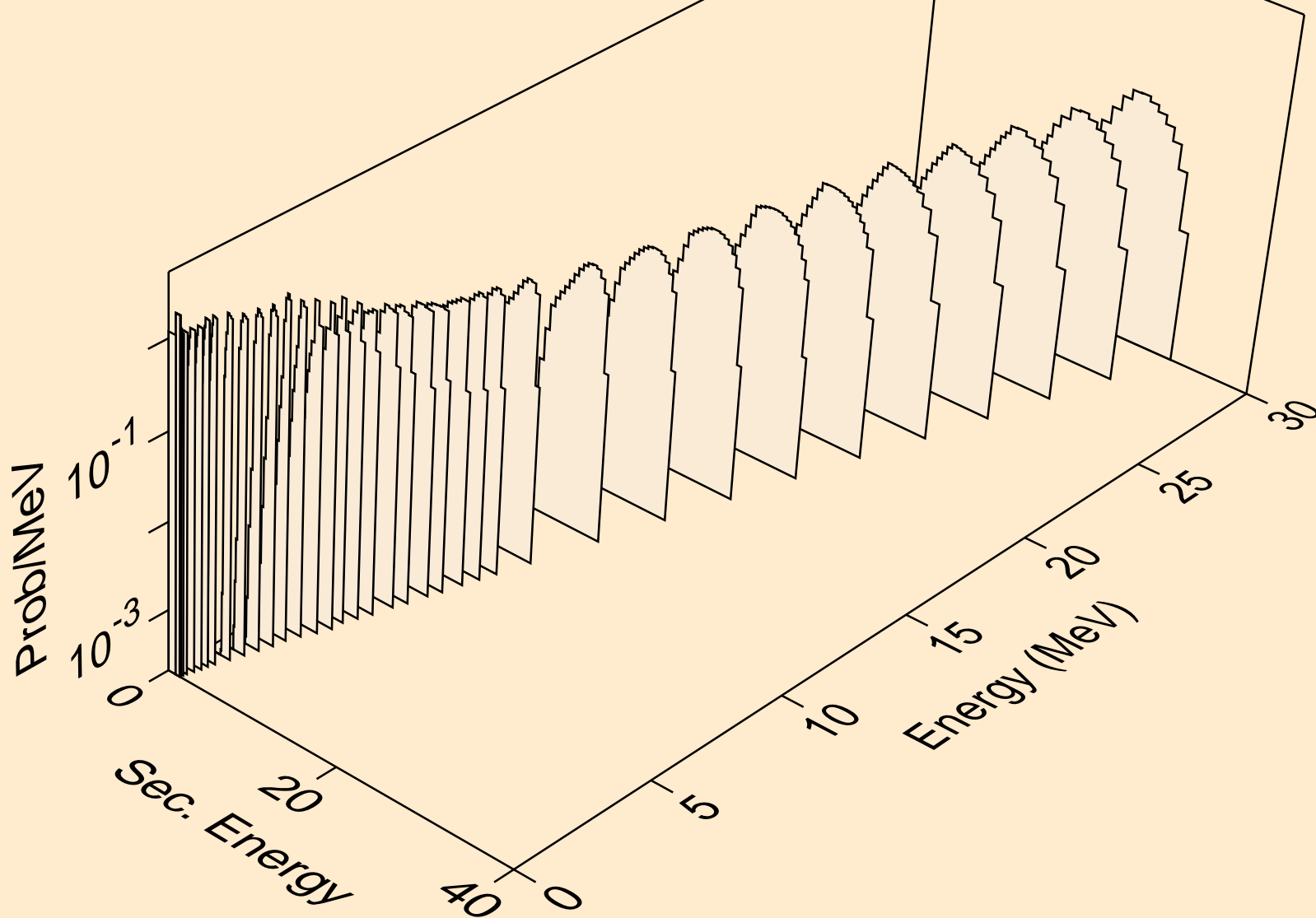

PT188 NEUTRON ACER TENDL-2019 LIBRARY; T=293.16K
protons from (n,2p)

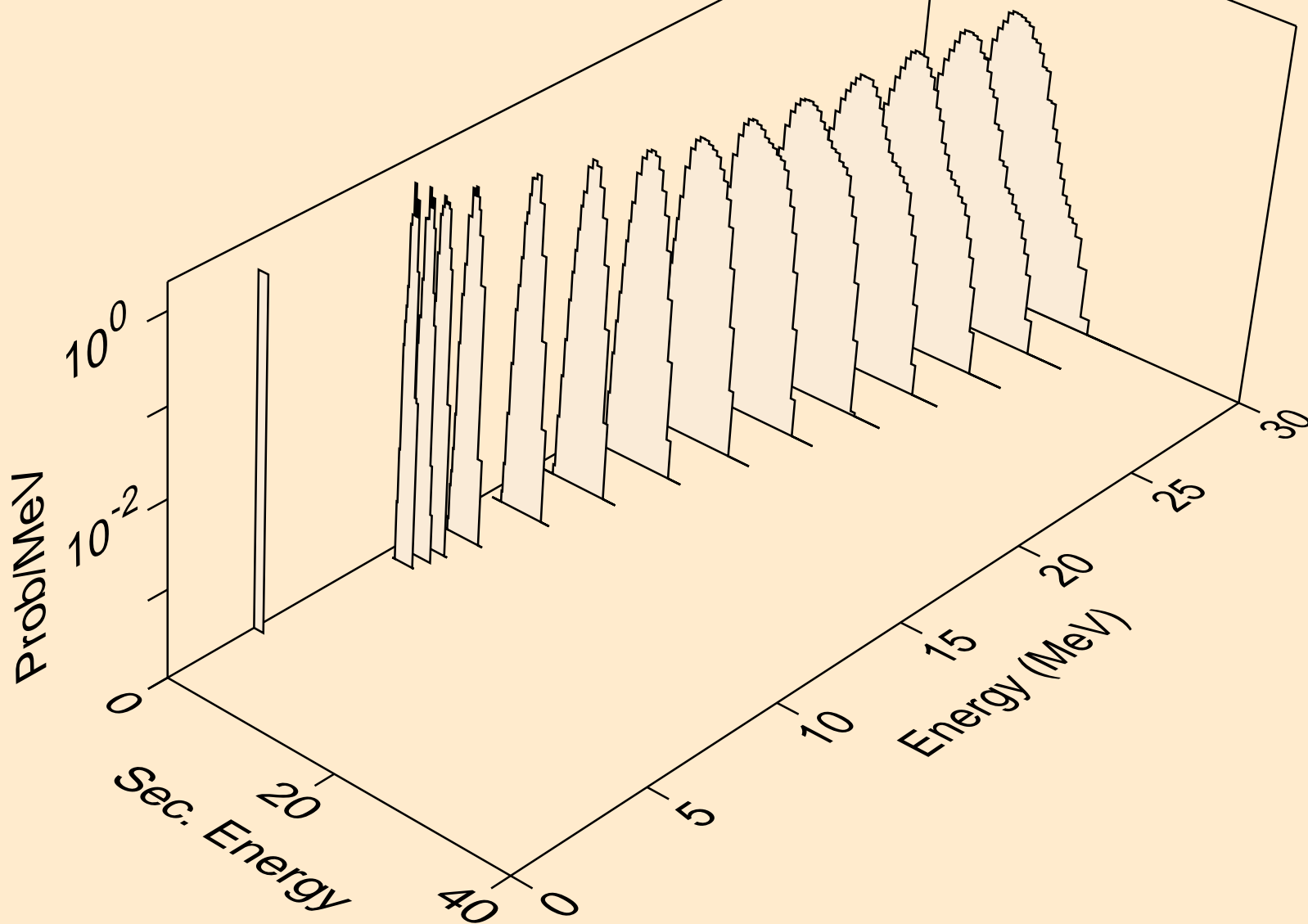

PT188 NEUTRON ACER TENDL-2019 LIBRARY; T=293.16K
protons from (n,p)

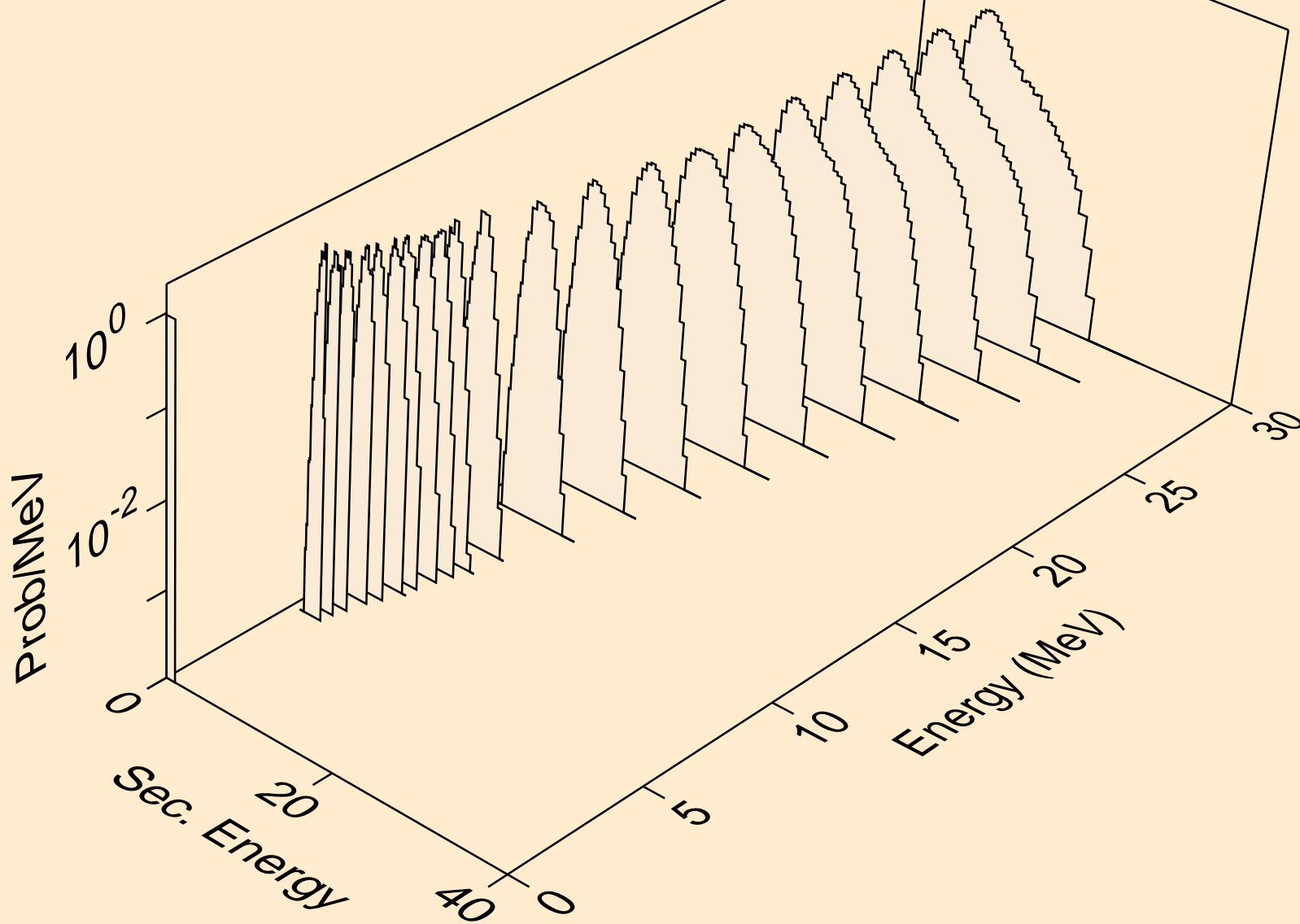

PT188 NEUTRON ACER TENDL-2019 LIBRARY; T=293.16K
protons from (n,pd)

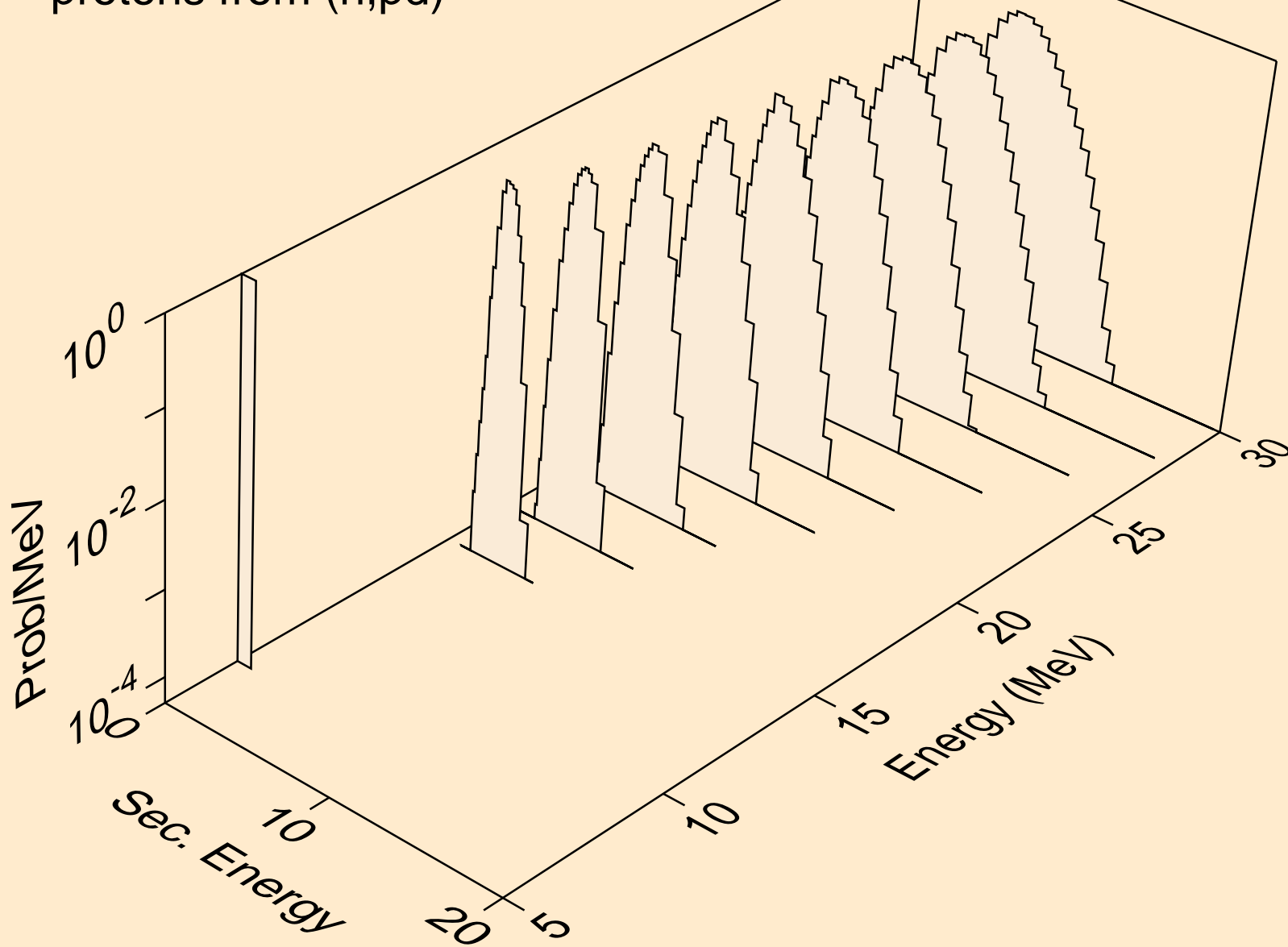

PT188 NEUTRON ACER TENDL-2019 LIBRARY; T=293.16K
protons from (n,pt)

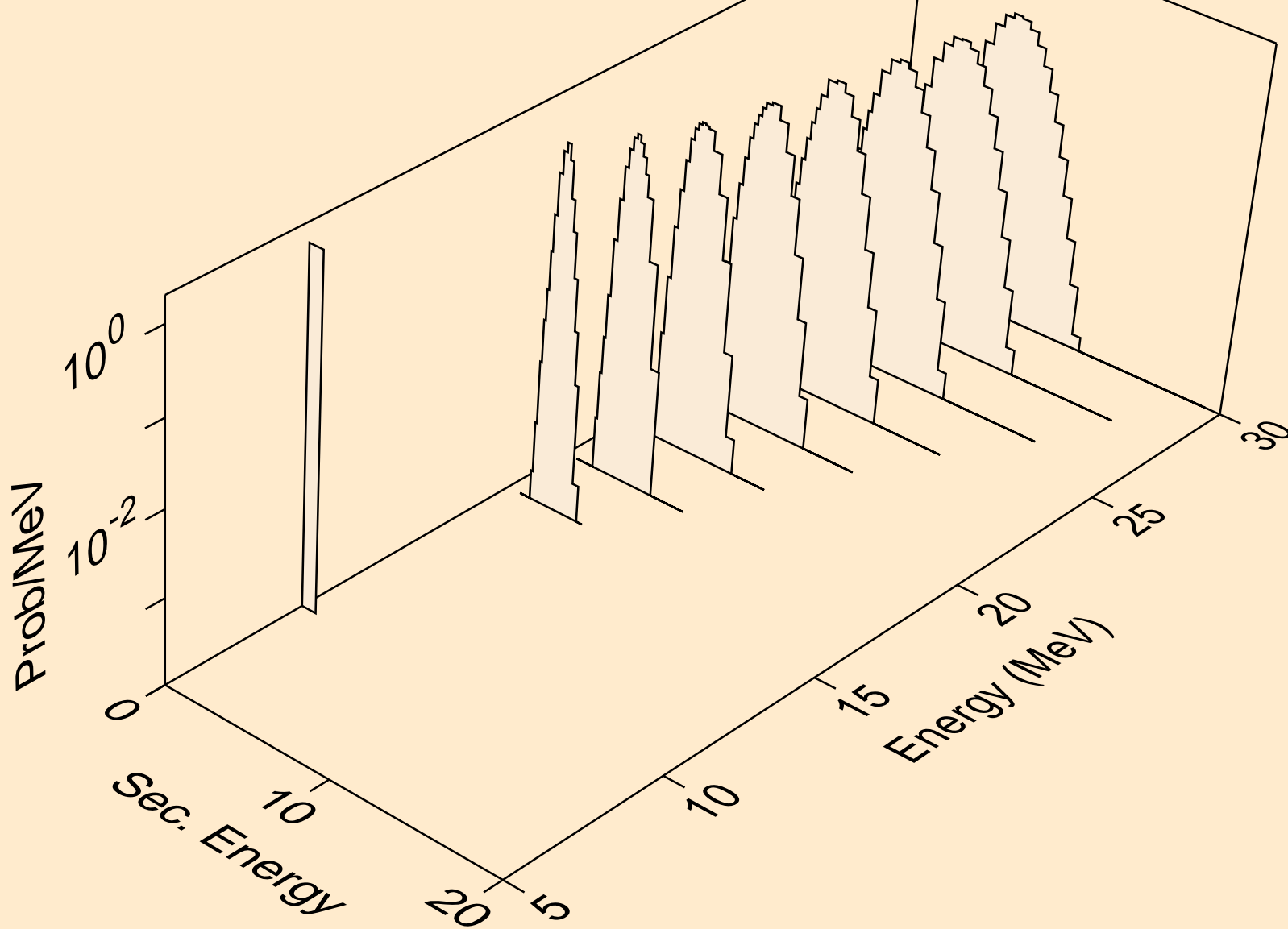

PT188 NEUTRON ACER TENDL-2019 LIBRARY; T=293.16K
deuterons from (n,x)

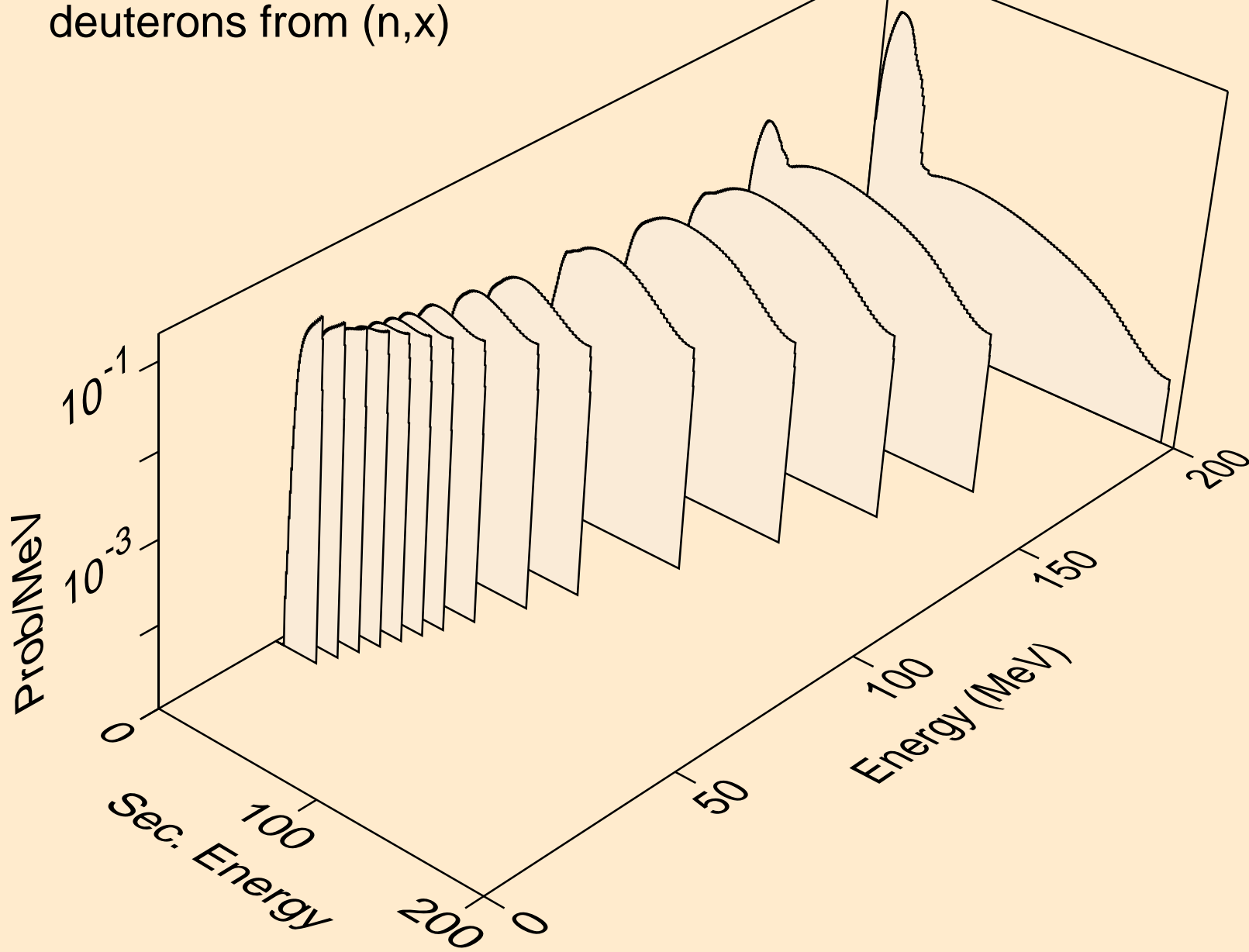

PT188 NEUTRON ACER TENDL-2019 LIBRARY; T=293.16K
deuterons from (n,2nd)

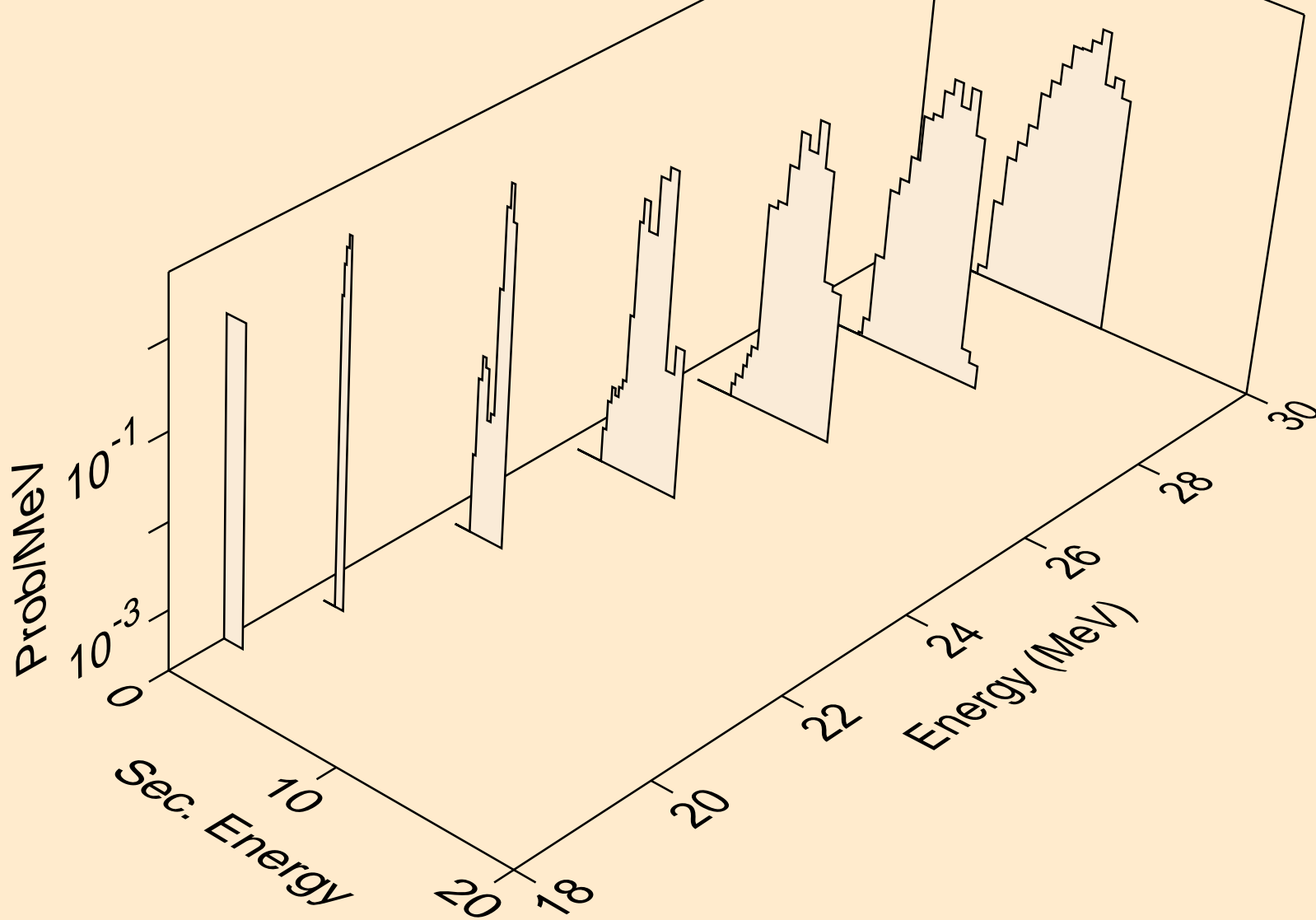

PT188 NEUTRON ACER TENDL-2019 LIBRARY; T=293.16K
deuterons from (n,n*)d

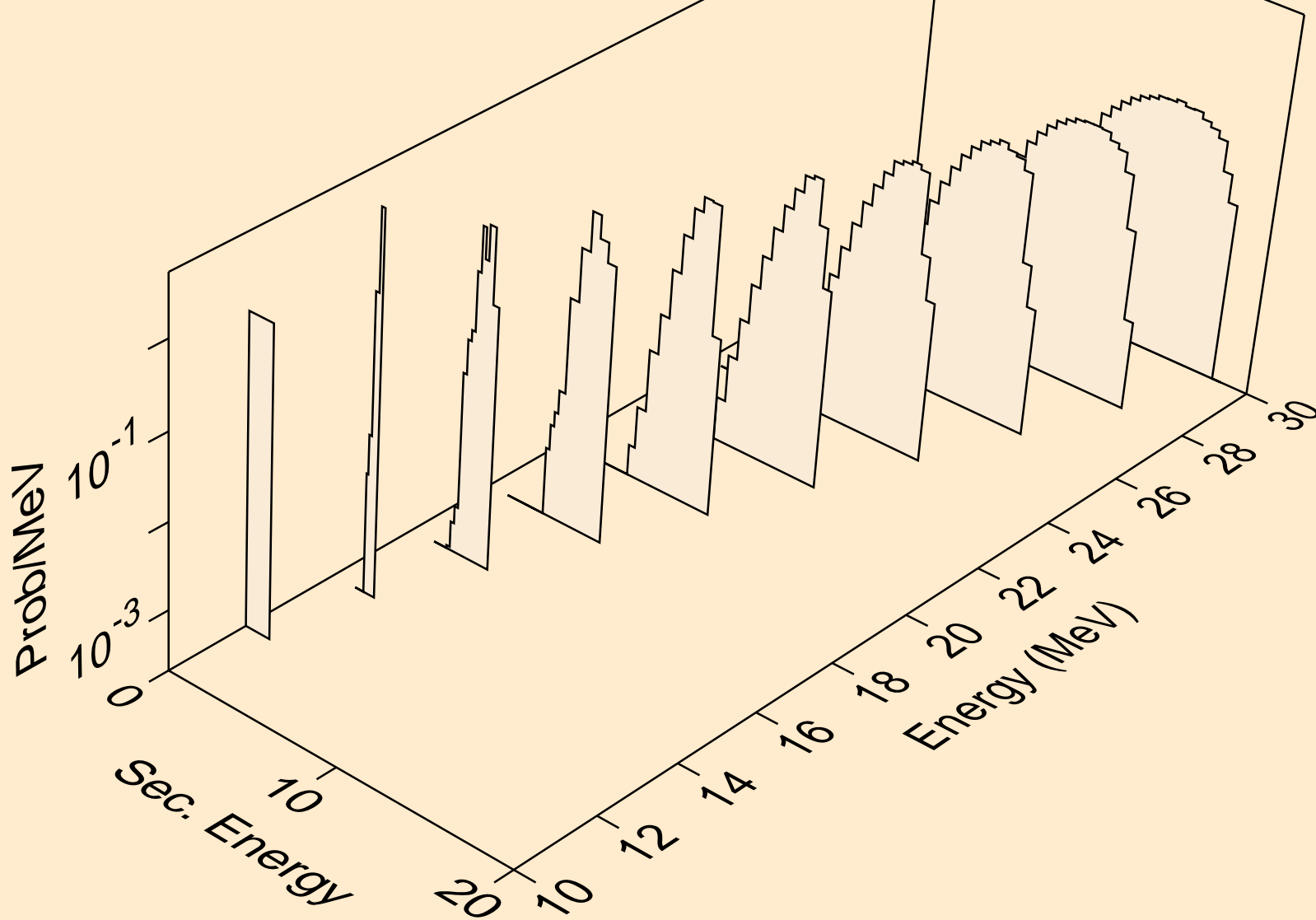

PT188 NEUTRON ACER TENDL-2019 LIBRARY; T=293.16K
deuterons from (n,d)

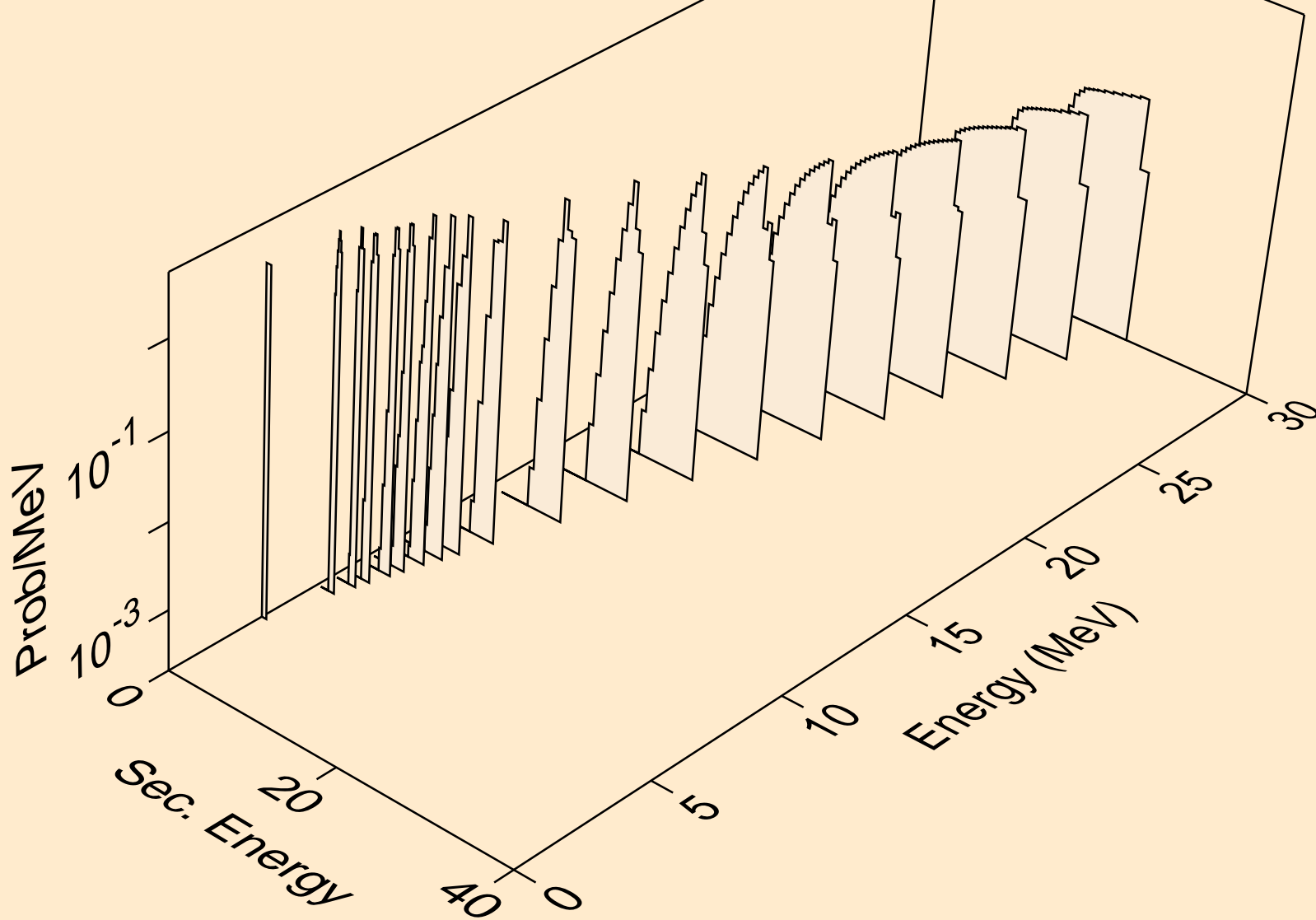

PT188 NEUTRON ACER TENDL-2019 LIBRARY; T=293.16K
deuterons from (n,pd)

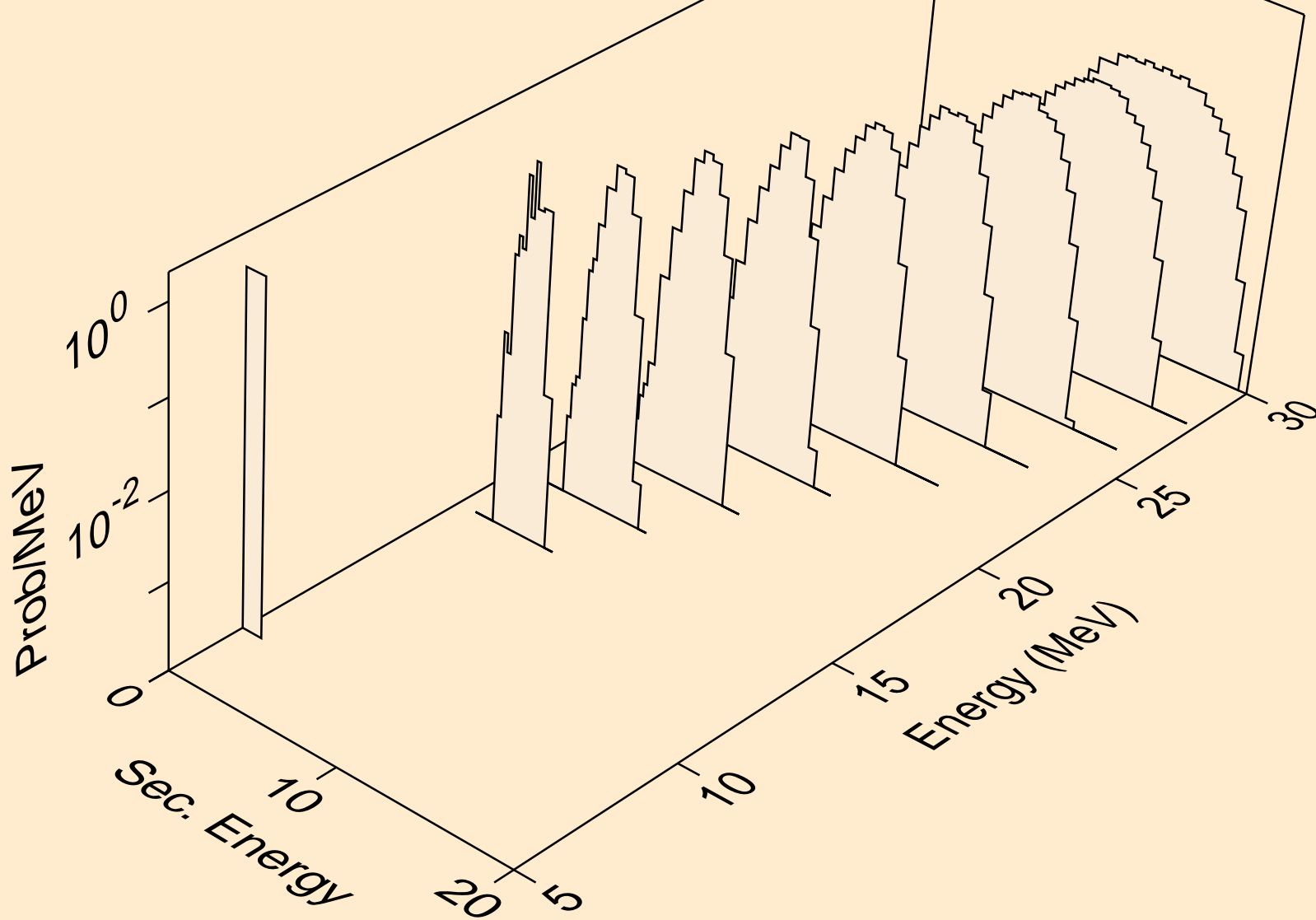

PT188 NEUTRON ACER TENDL-2019 LIBRARY; T=293.16K
deuterons from (n,da)

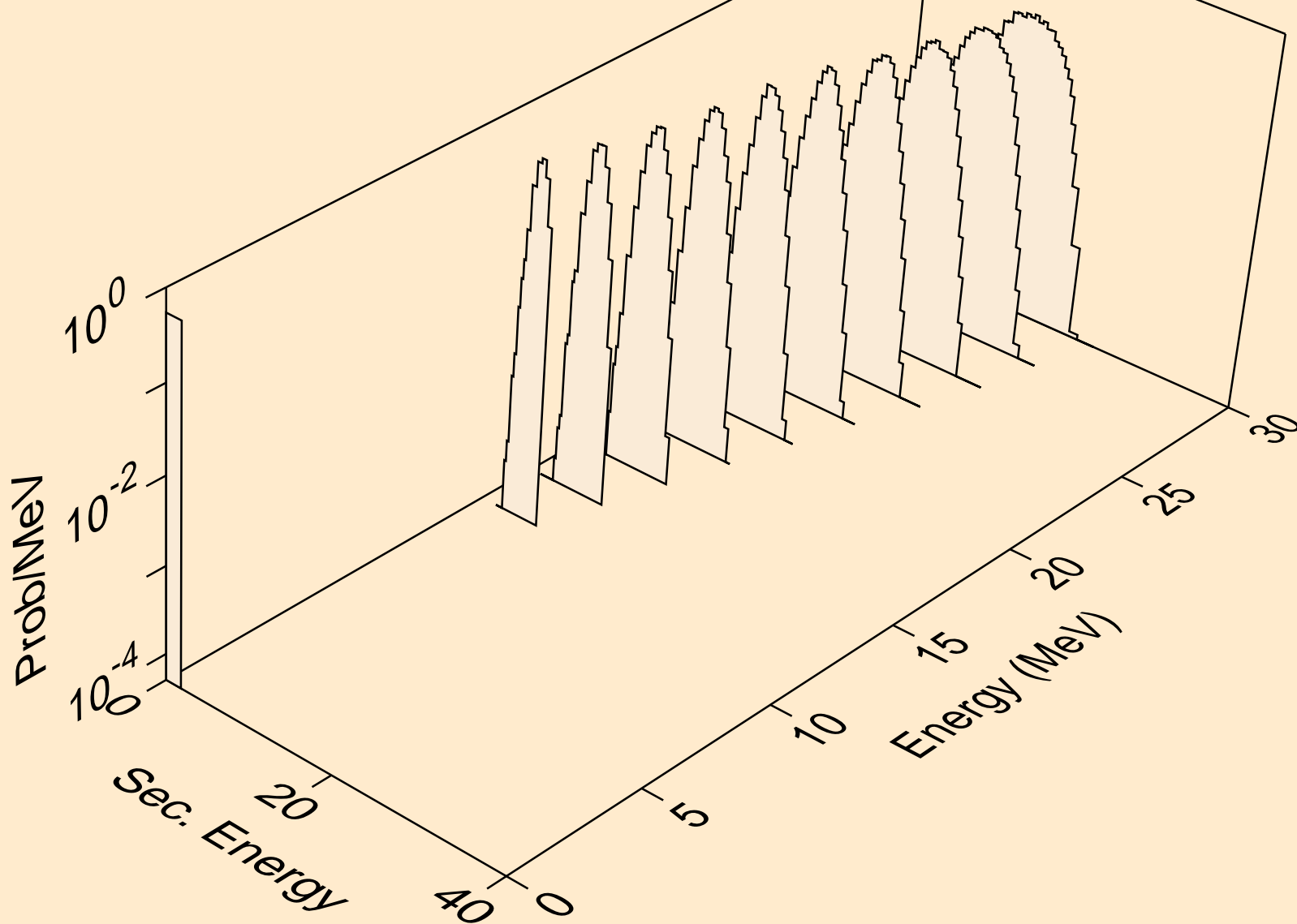

PT188 NEUTRON ACER TENDL-2019 LIBRARY; T=293.16K
tritons from (n,x)

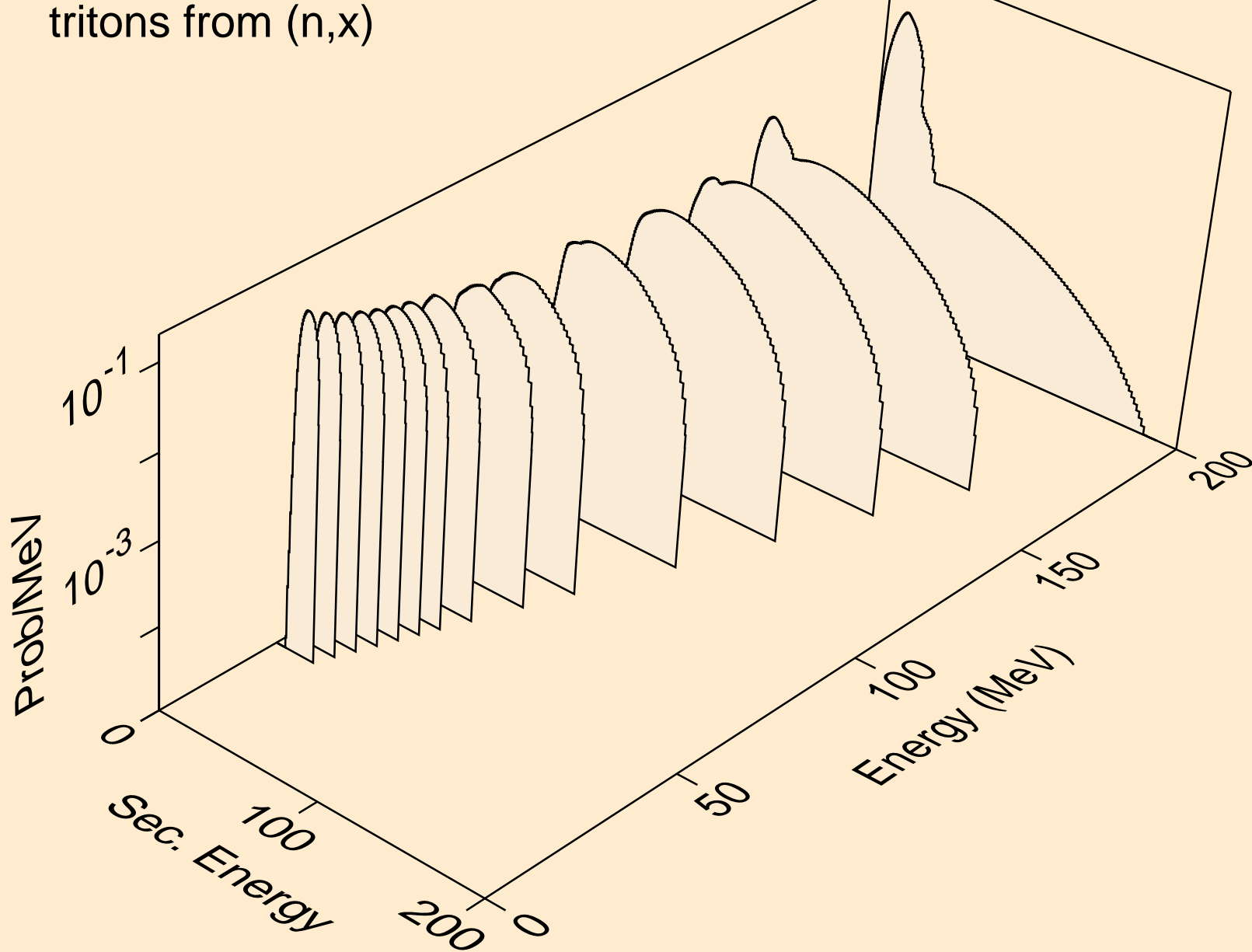

PT188 NEUTRON ACER TENDL-2019 LIBRARY; T=293.16K
tritons from (n,n*)t

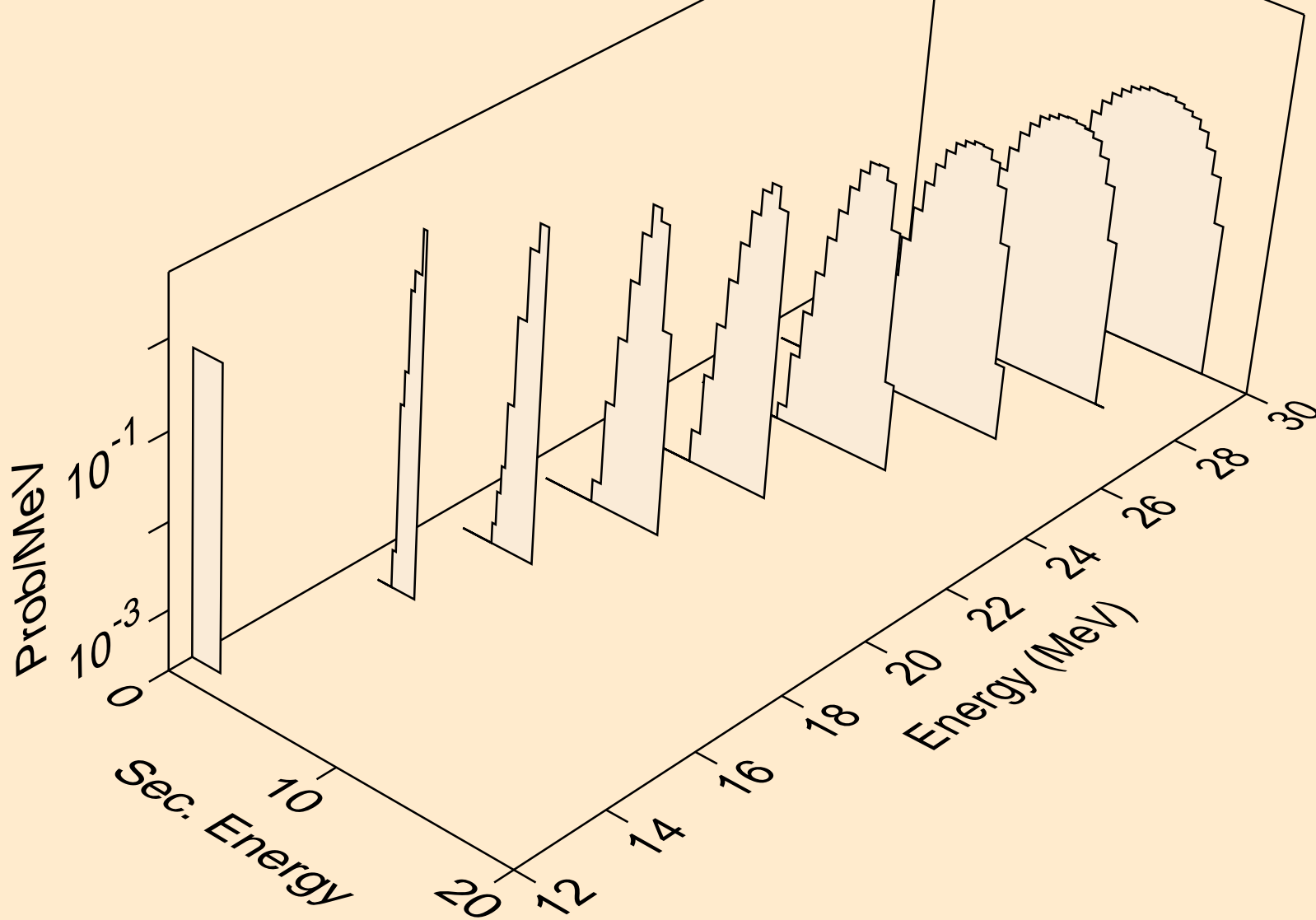

PT188 NEUTRON ACER TENDL-2019 LIBRARY; T=293.16K
tritons from (n,t)

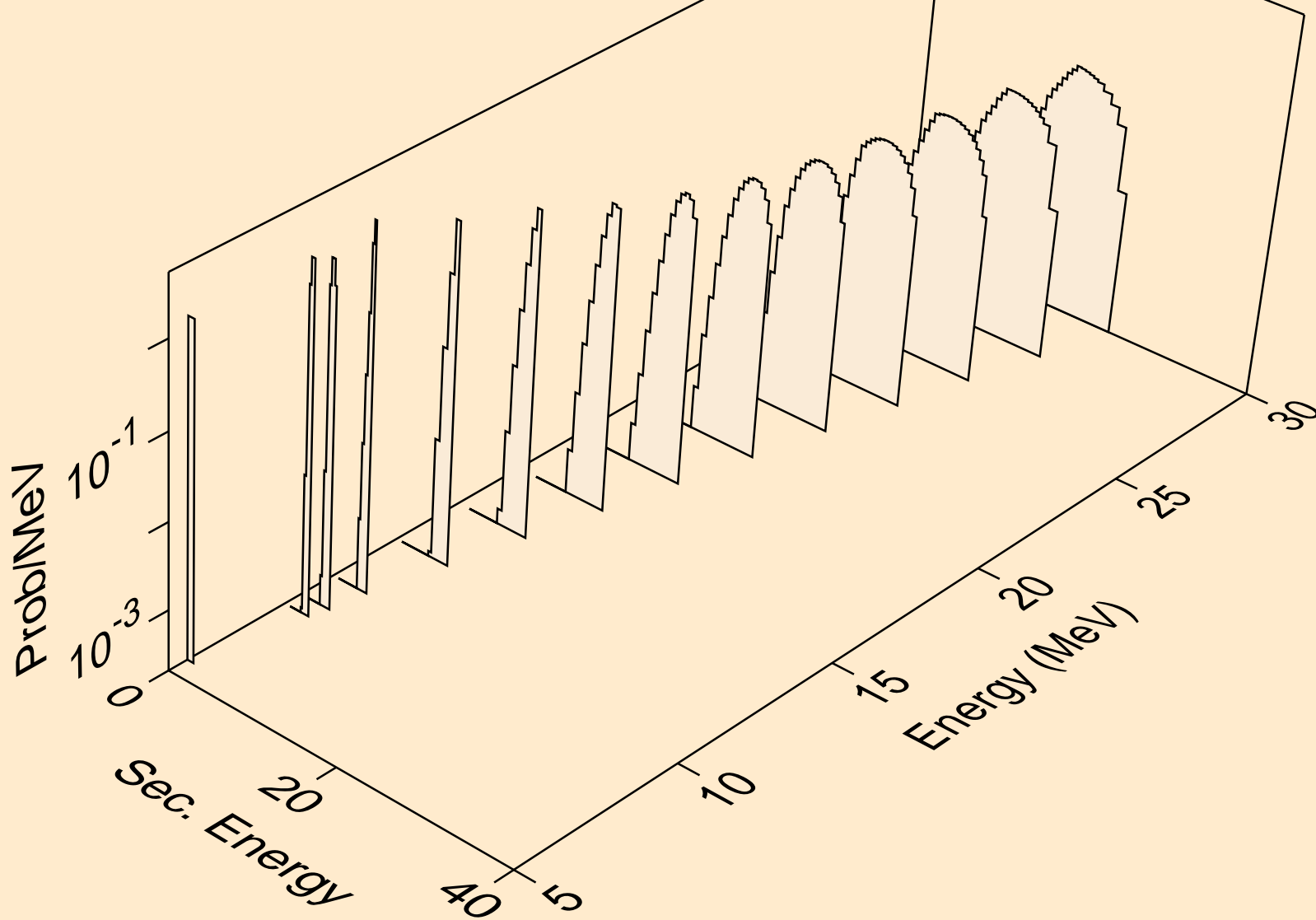

PT188 NEUTRON ACER TENDL-2019 LIBRARY; T=293.16K
tritons from (n,pt)

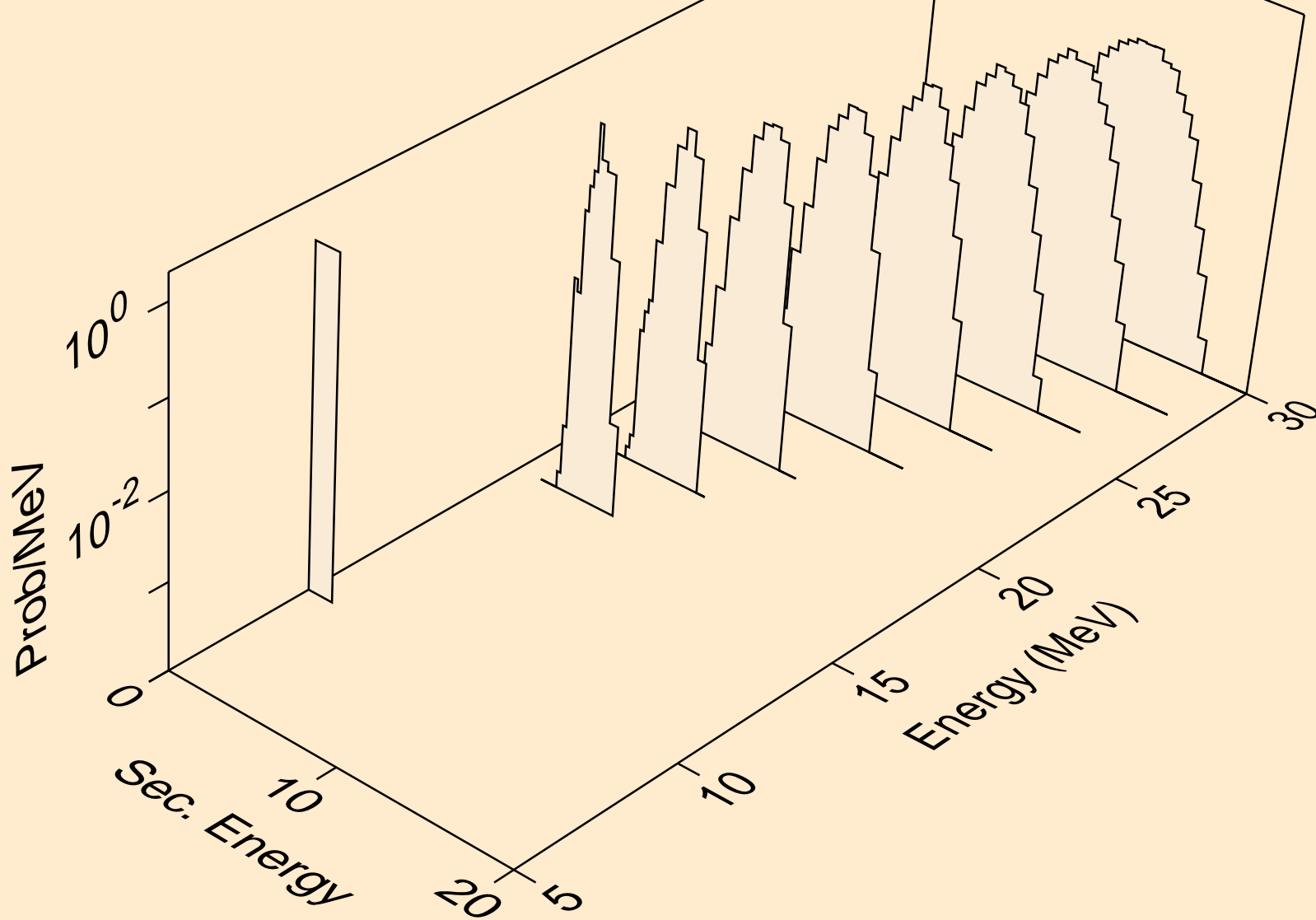

PT188 NEUTRON ACER TENDL-2019 LIBRARY; T=293.16K
he3s from (n,x)

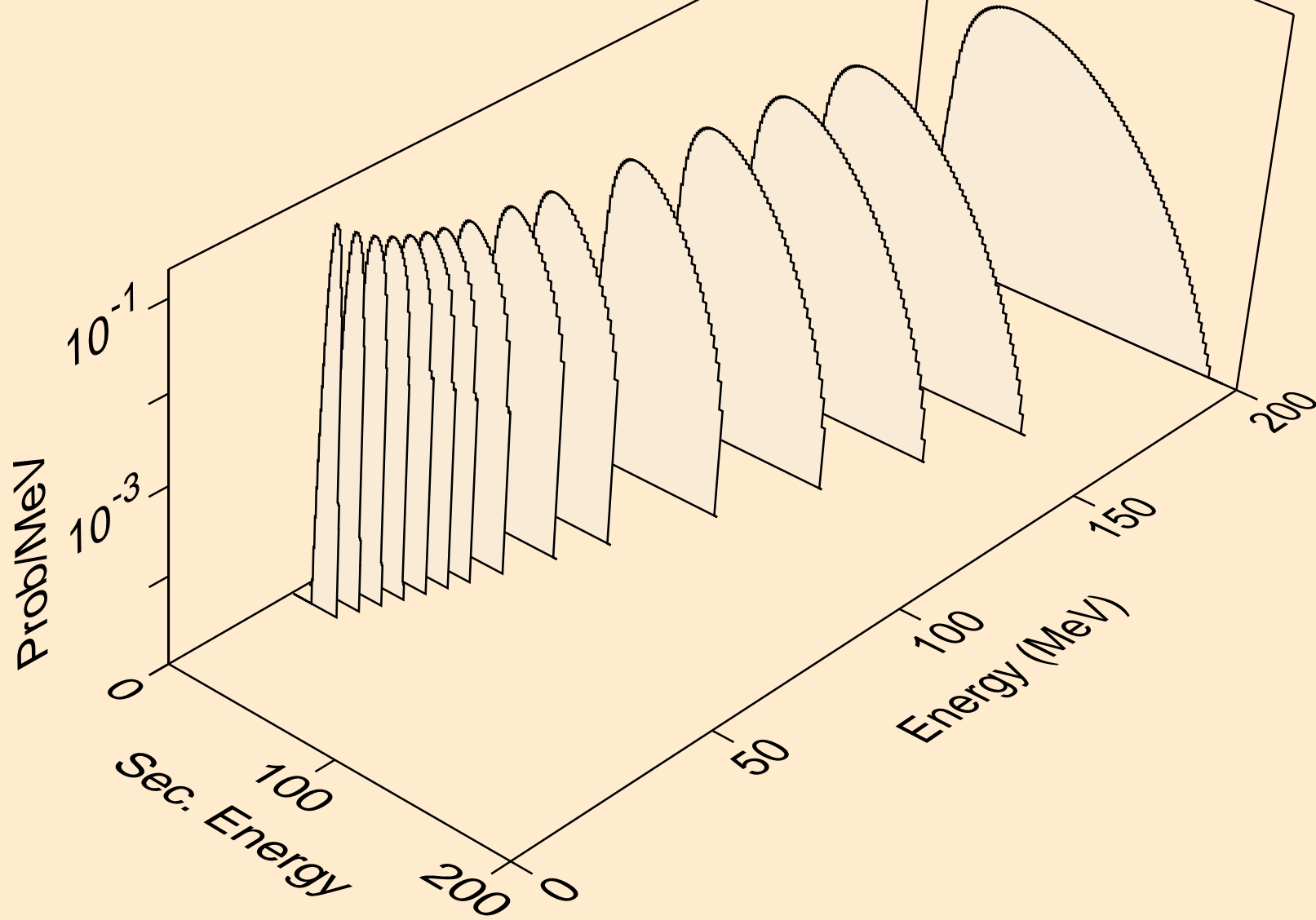

PT188 NEUTRON ACER TENDL-2019 LIBRARY; T=293.16K
he3s from (n,n*)he3

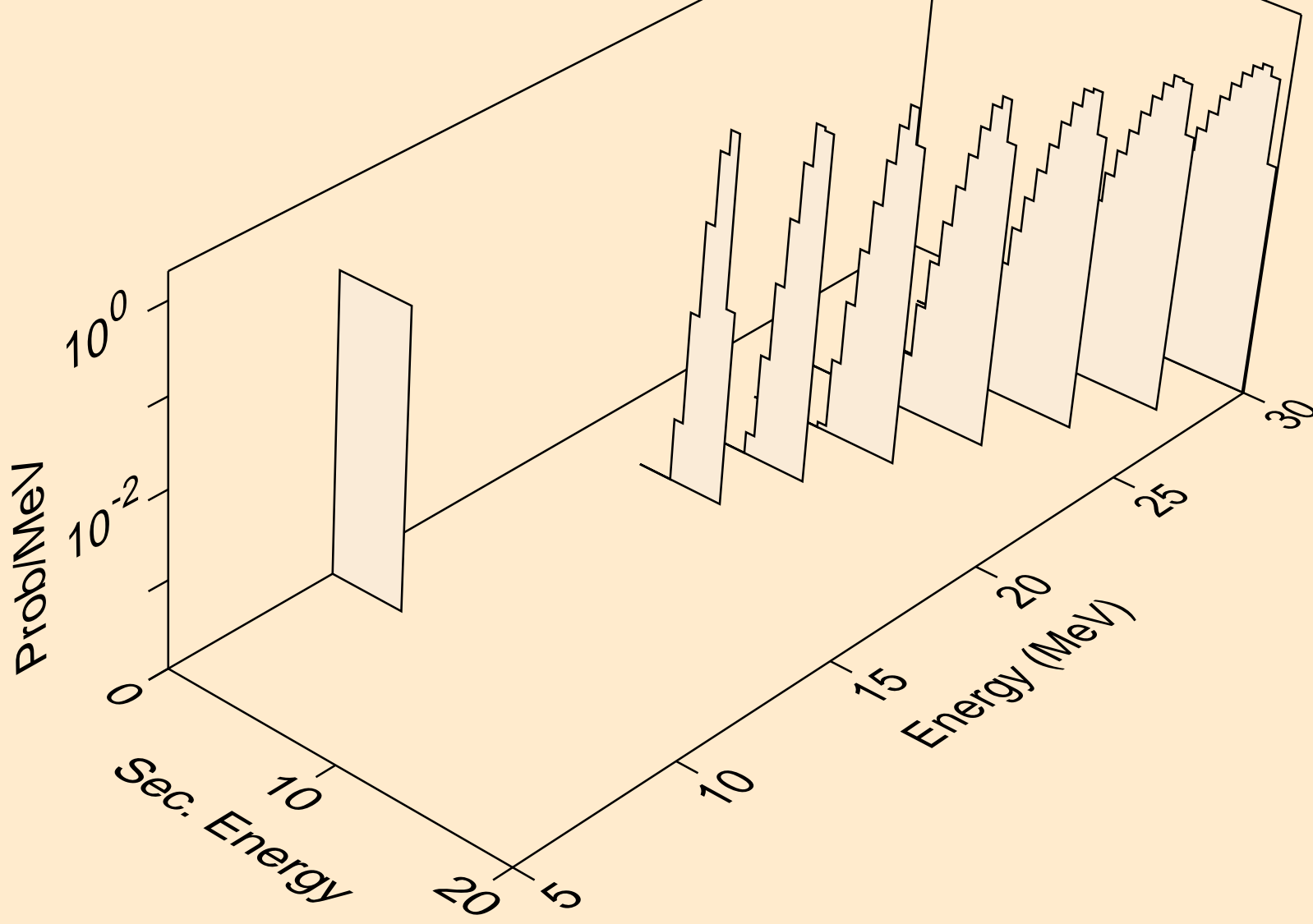

PT188 NEUTRON ACER TENDL-2019 LIBRARY; T=293.16K
he3s from (n,he3)

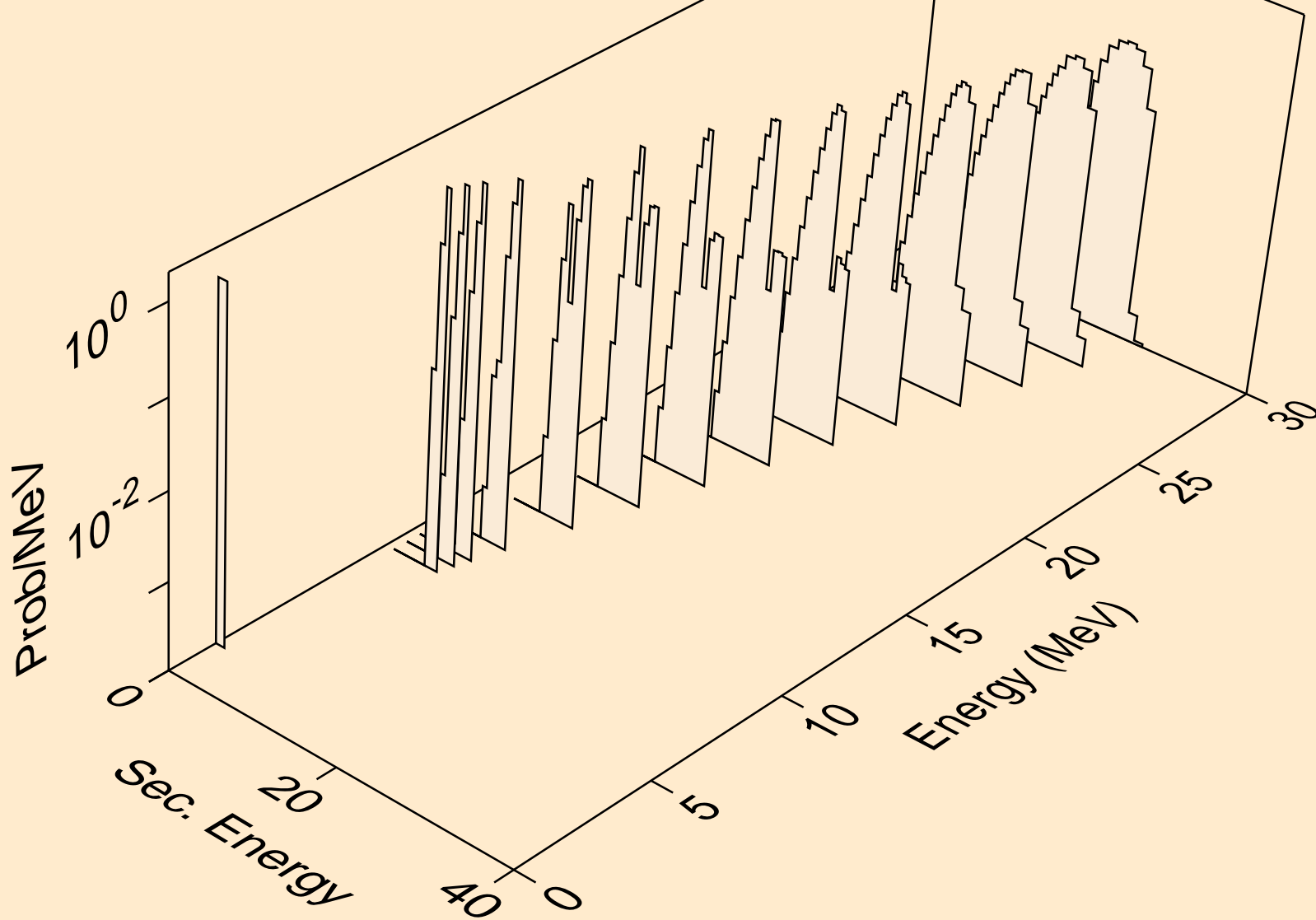

PT188 NEUTRON ACER TENDL-2019 LIBRARY; T=293.16K
alphas from (n,x)

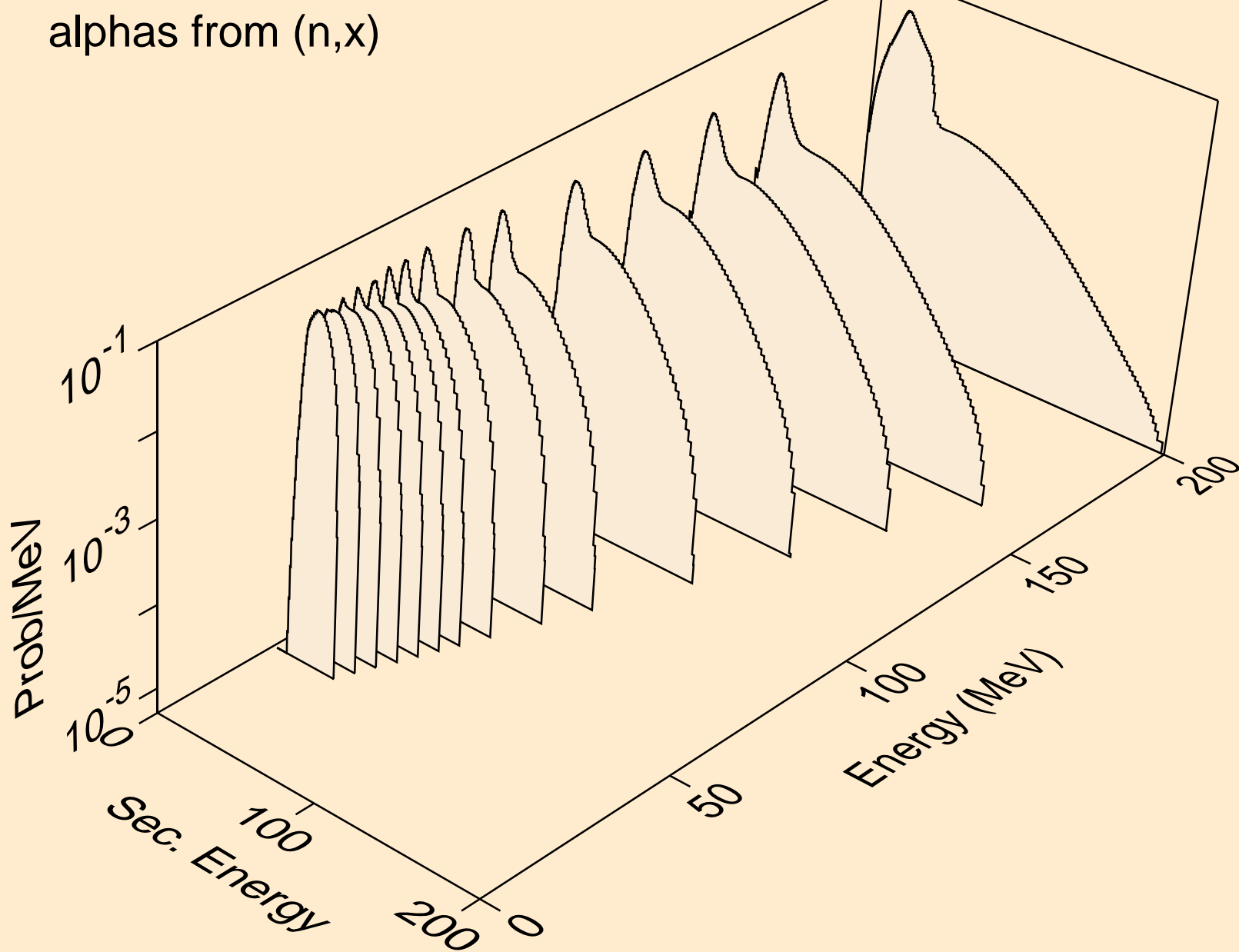

PT188 NEUTRON ACER TENDL-2019 LIBRARY; T=293.16K
alphas from (n,n*)a

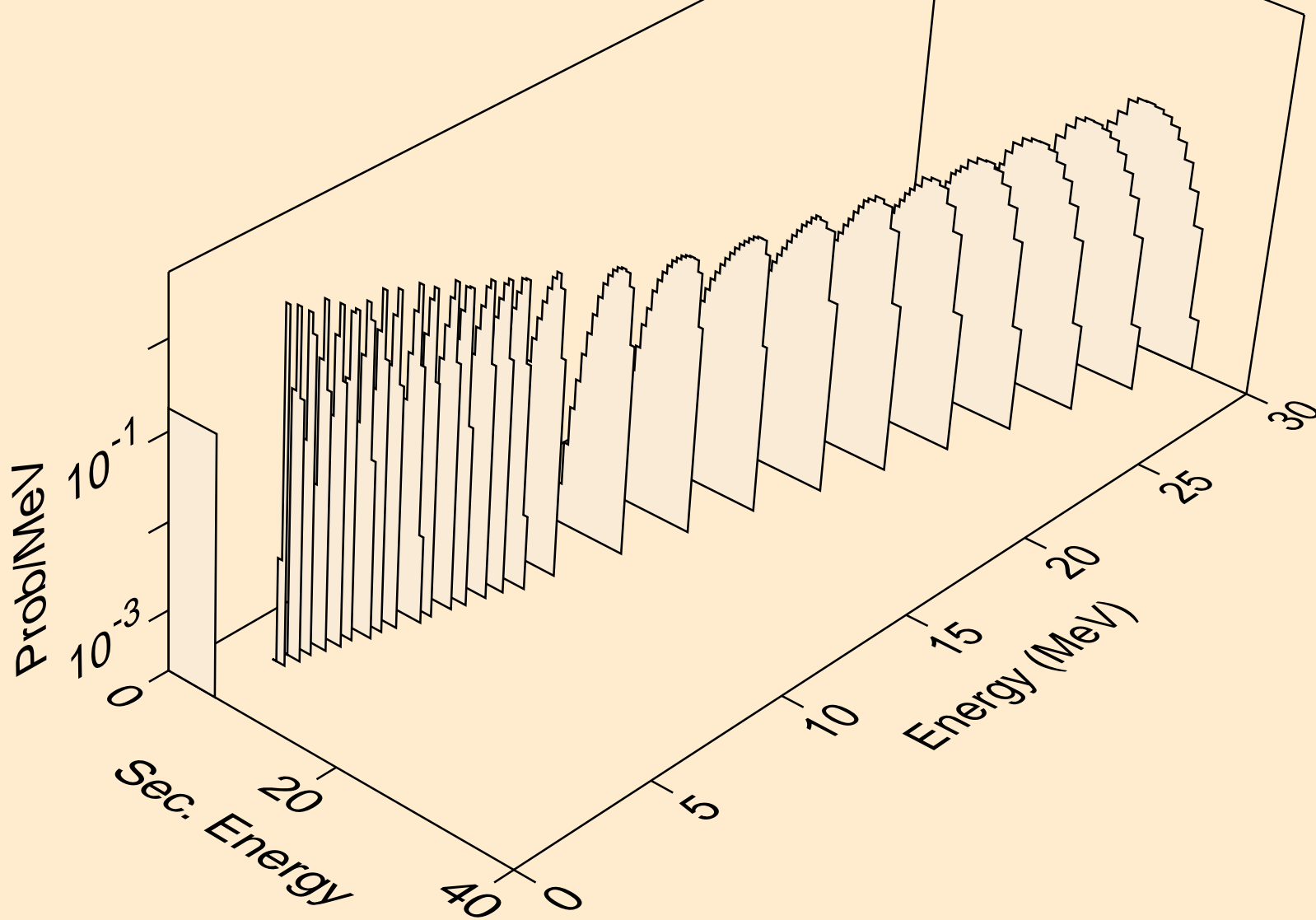

PT188 NEUTRON ACER TENDL-2019 LIBRARY; T=293.16K
alphas from (n,2n)a

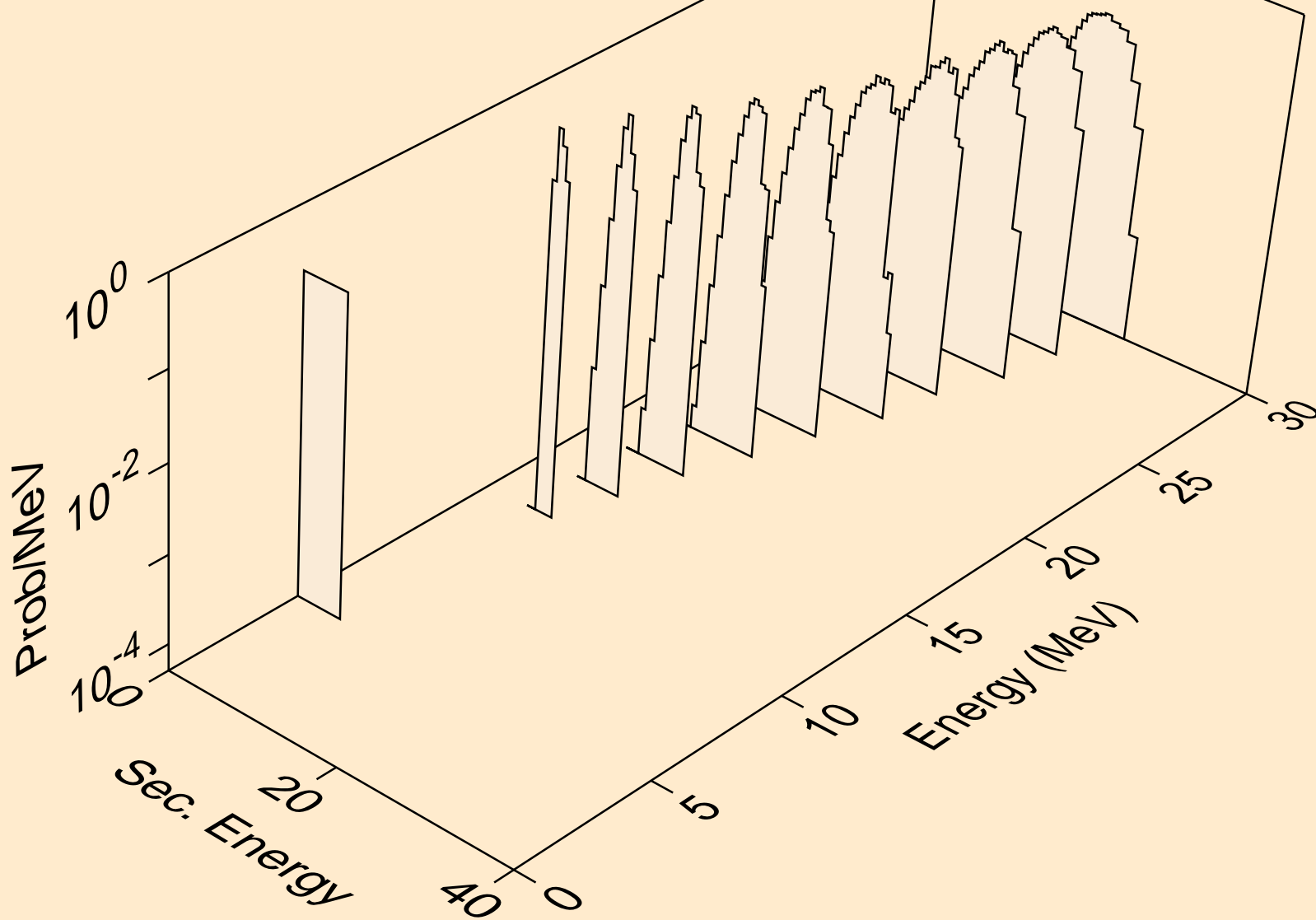

PT188 NEUTRON ACER TENDL-2019 LIBRARY; T=293.16K
alphas from (n,3n)a

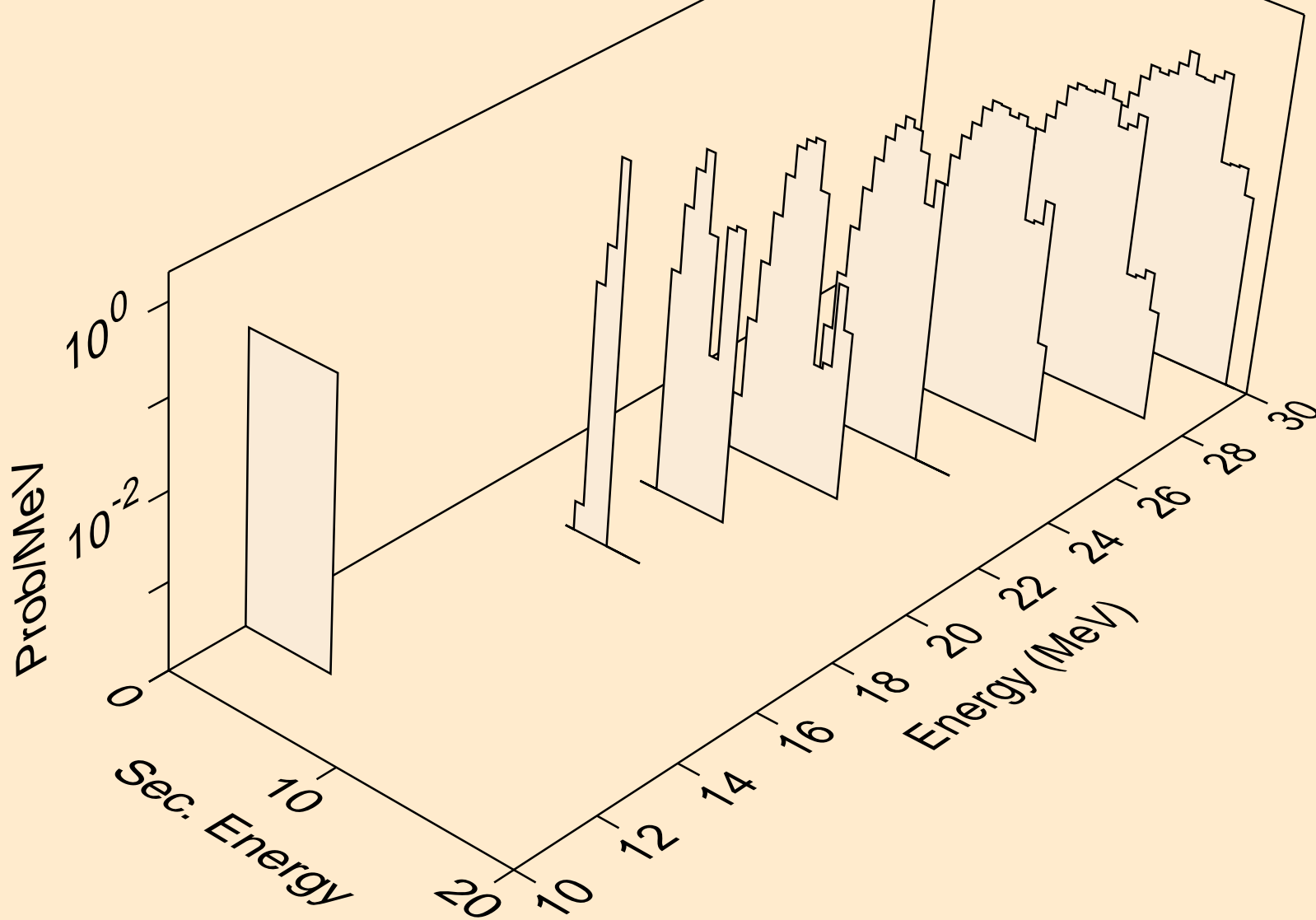

PT188 NEUTRON ACER TENDL-2019 LIBRARY; T=293.16K
alphas from (n,n*)2a

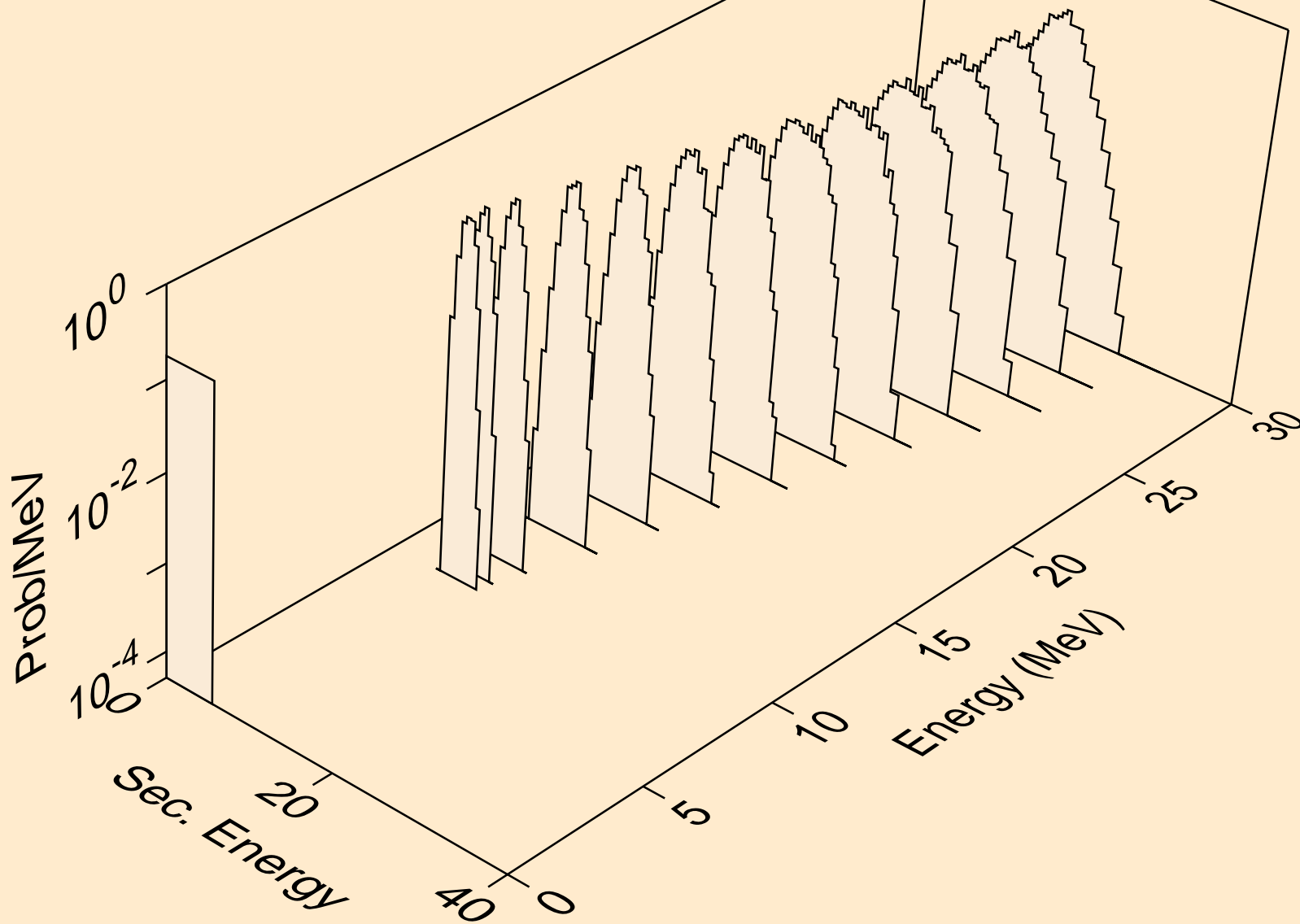

PT188 NEUTRON ACER TENDL-2019 LIBRARY; T=293.16K
alphas from (n,2n)2a

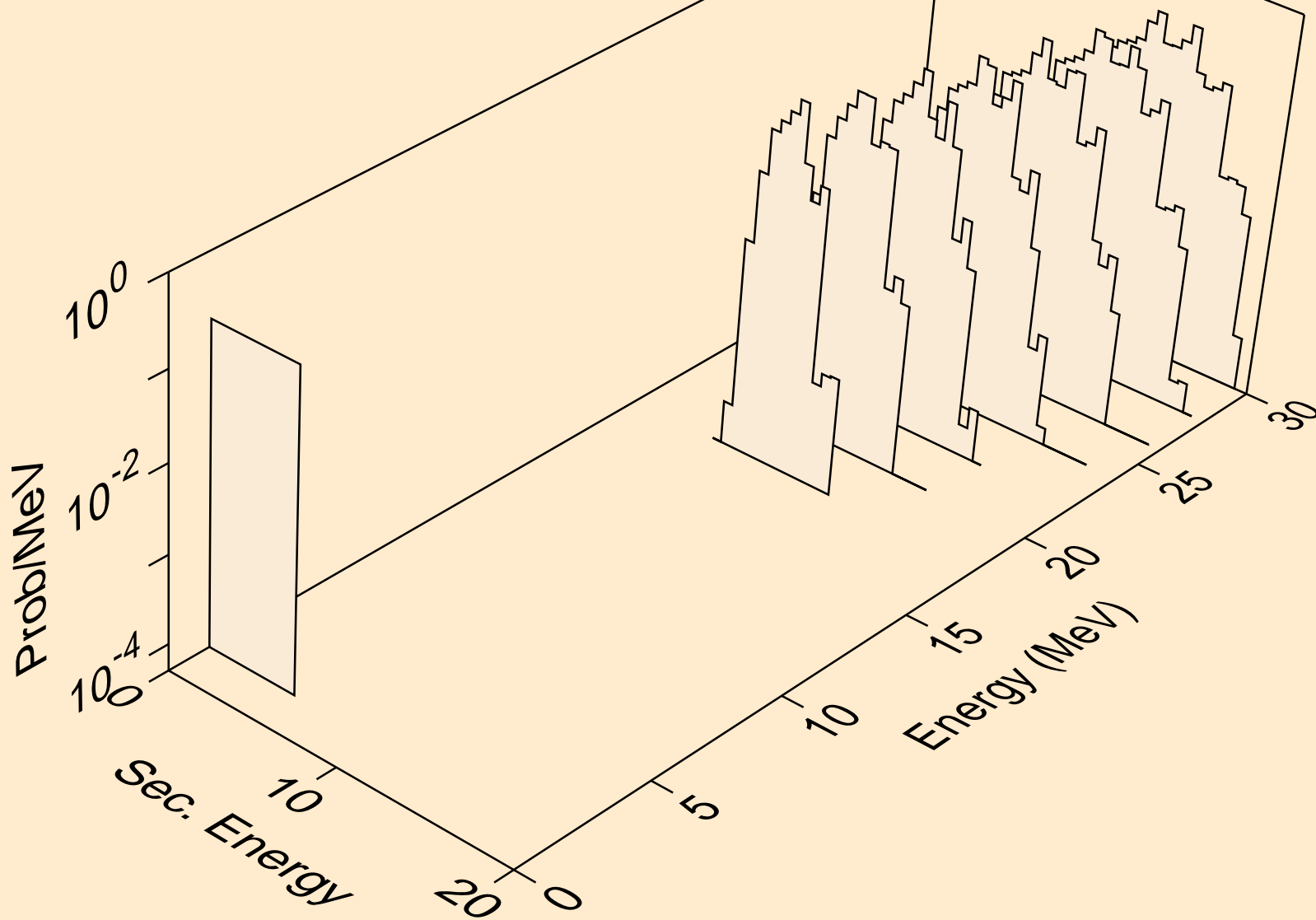

PT188 NEUTRON ACER TENDL-2019 LIBRARY; T=293.16K
alphas from (n,npa)

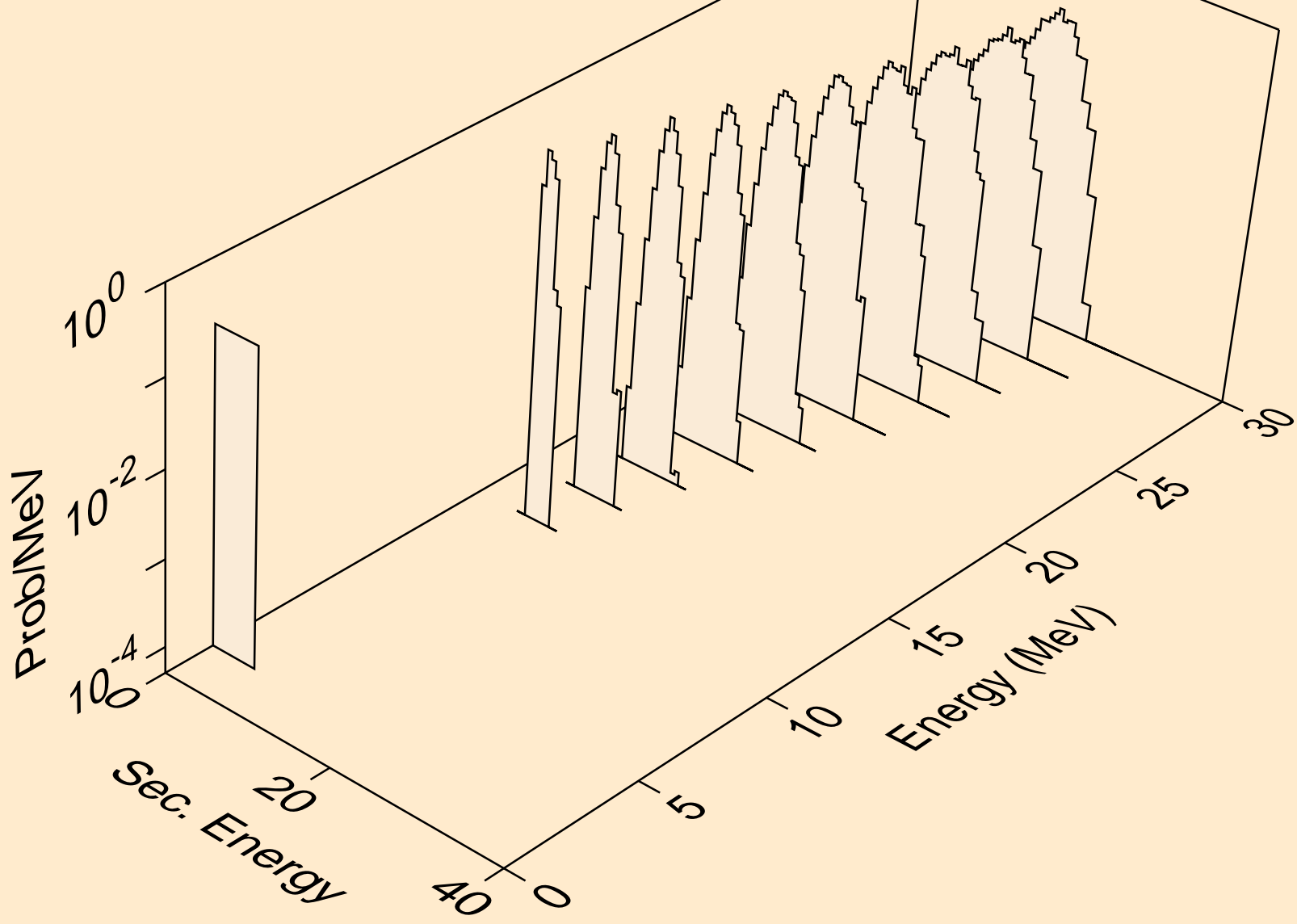

PT188 NEUTRON ACER TENDL-2019 LIBRARY; T=293.16K
alphas from (n,a)

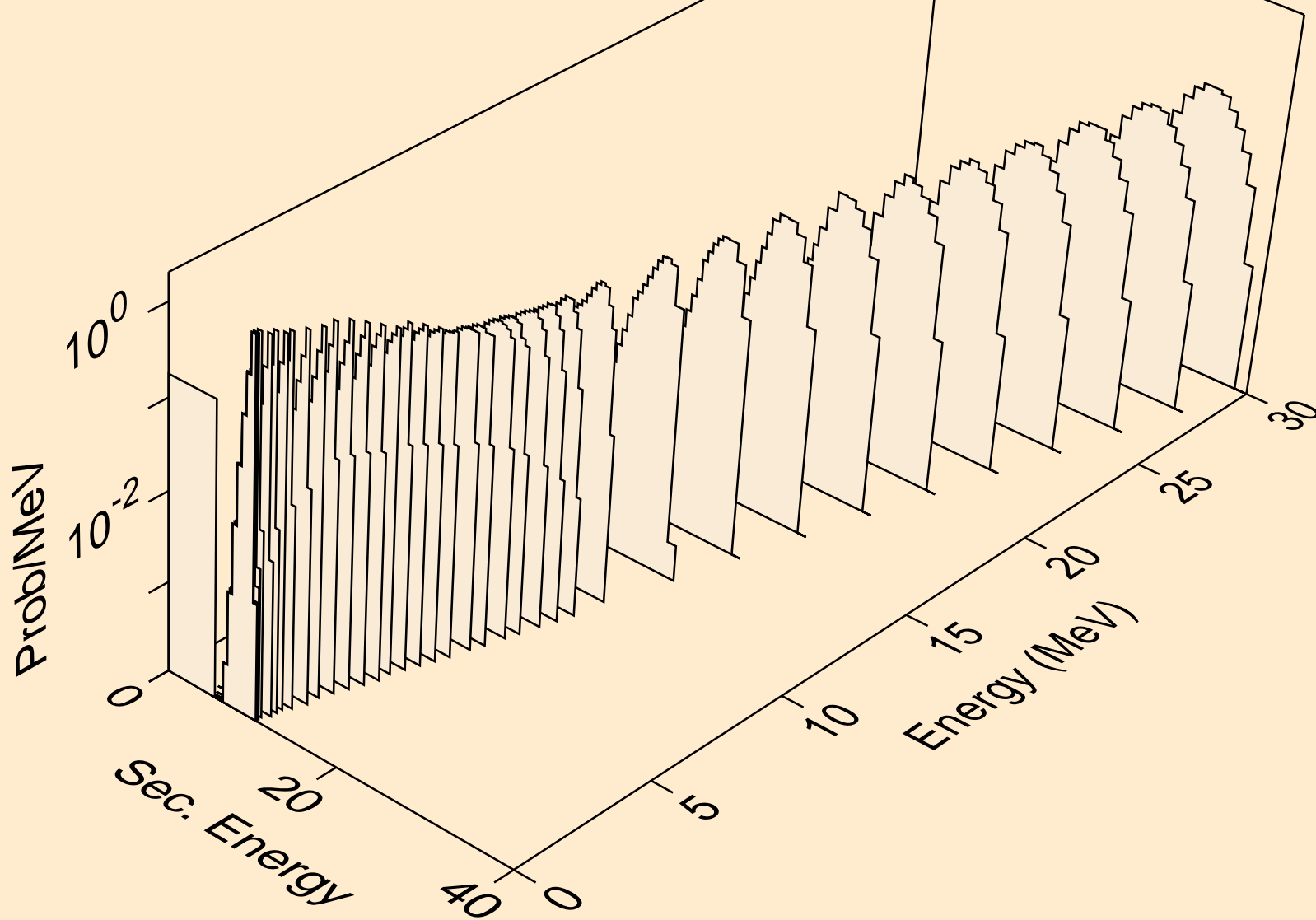

PT188 NEUTRON ACER TENDL-2019 LIBRARY; T=293.16K
alphas from (n,2a)

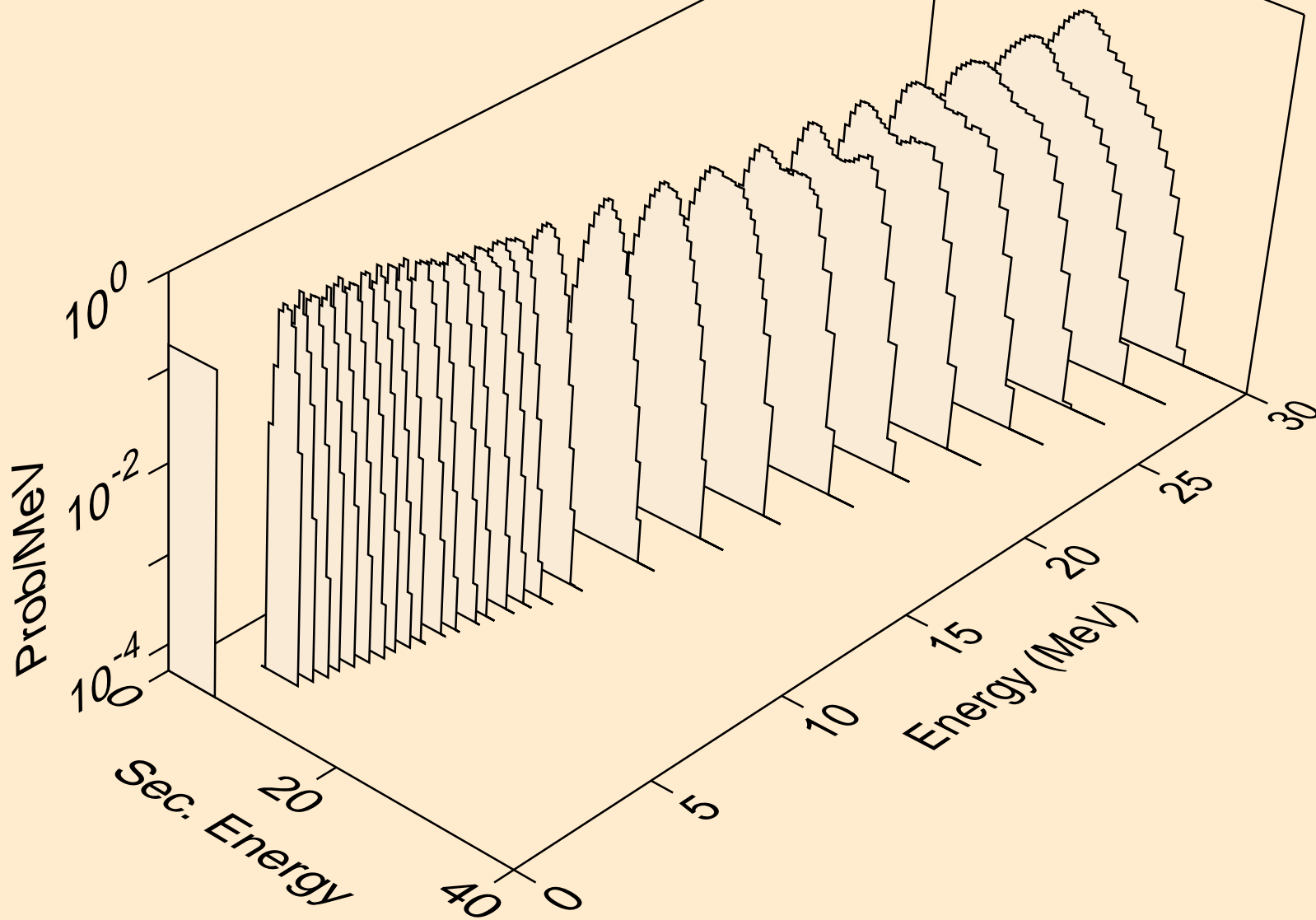

PT188 NEUTRON ACER TENDL-2019 LIBRARY; T=293.16K
alphas from (n,pa)

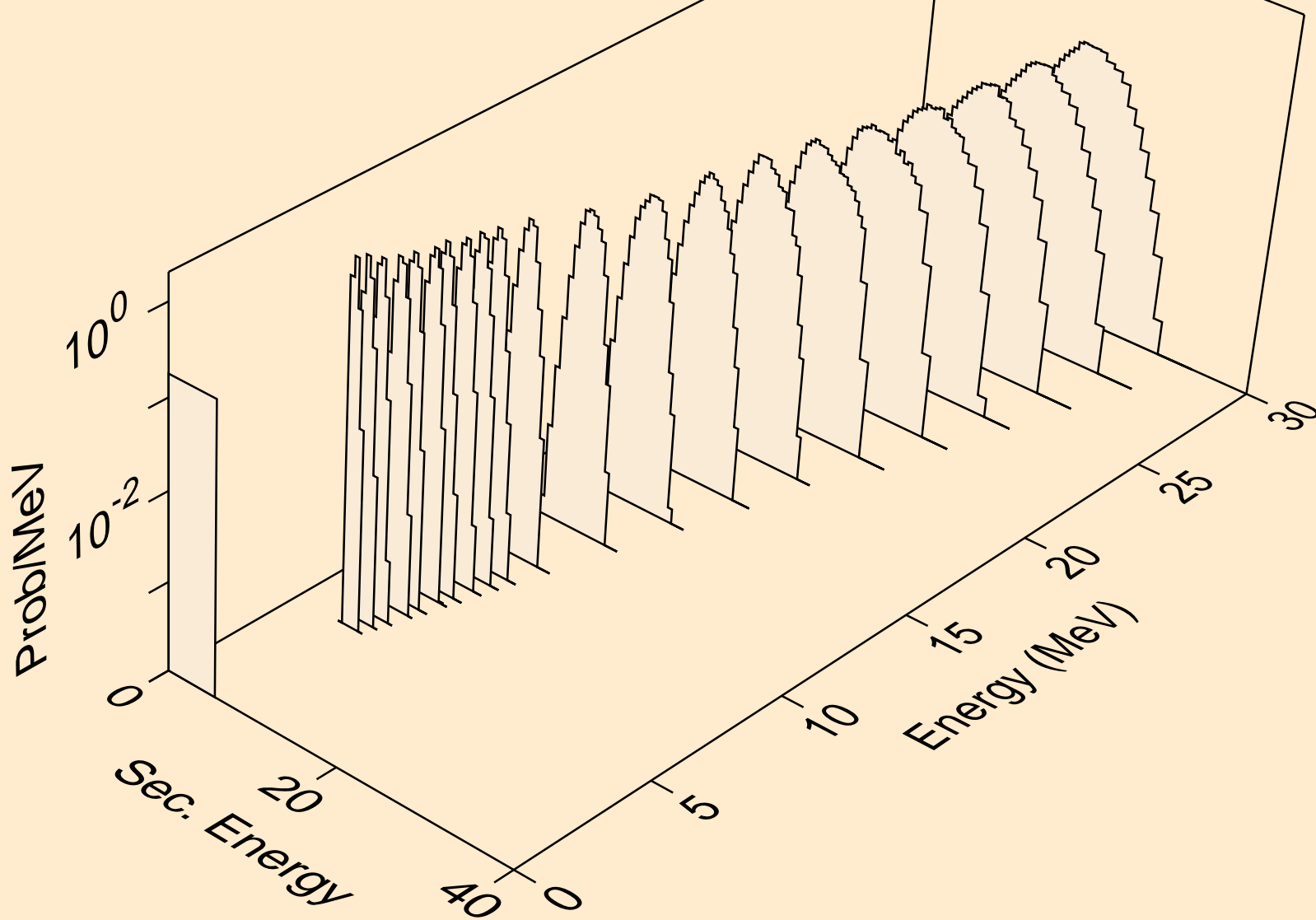

PT188 NEUTRON ACER TENDL-2019 LIBRARY; T=293.16K
alphas from (n,da)

