

PT193 NEUTRON ACER TENDL-2019 LIBRARY; T=293.16K
Principal cross sections

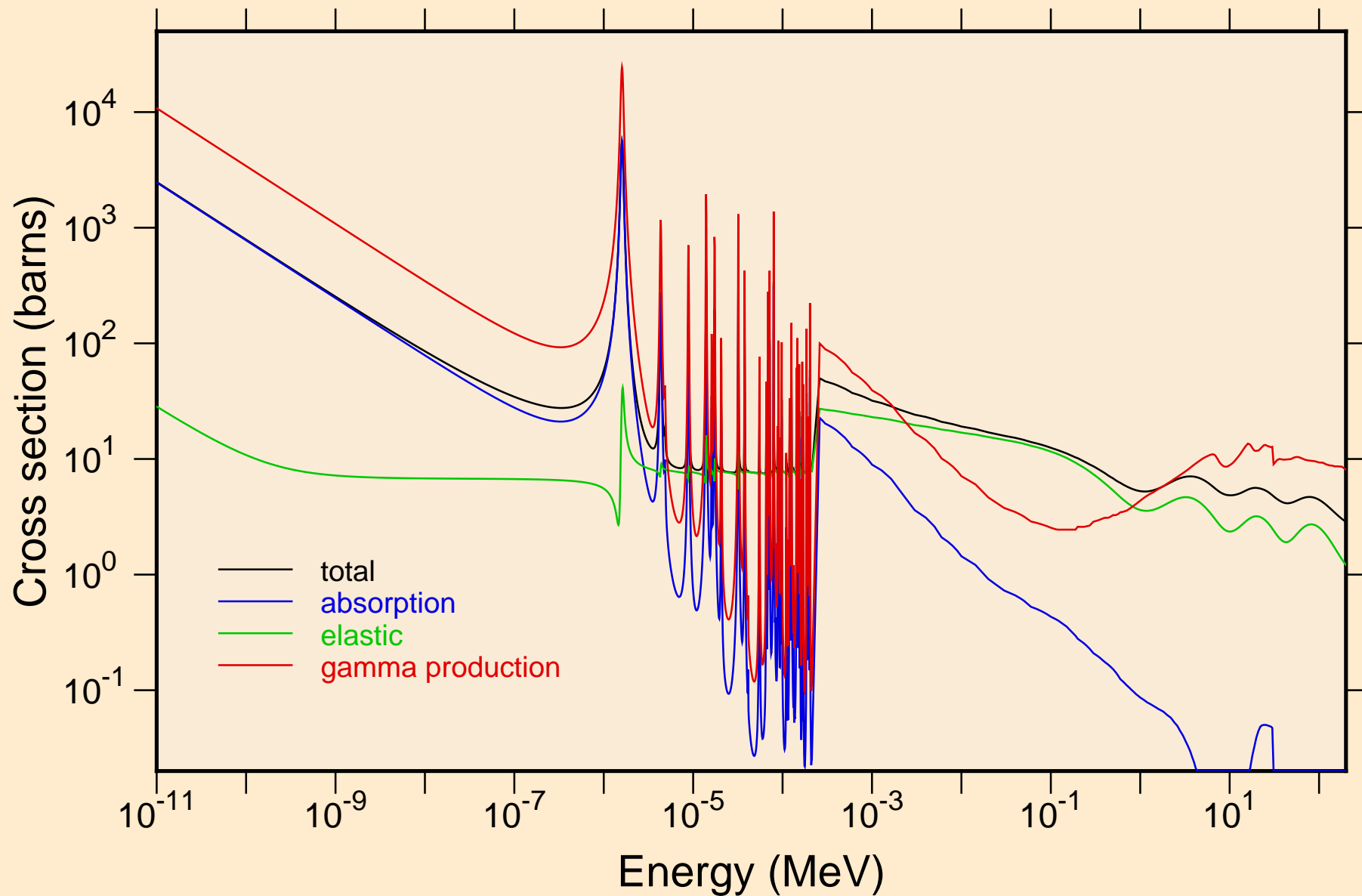

PT193 NEUTRON ACER TENDL-2019 LIBRARY; T=293.16K
resonance total cross section

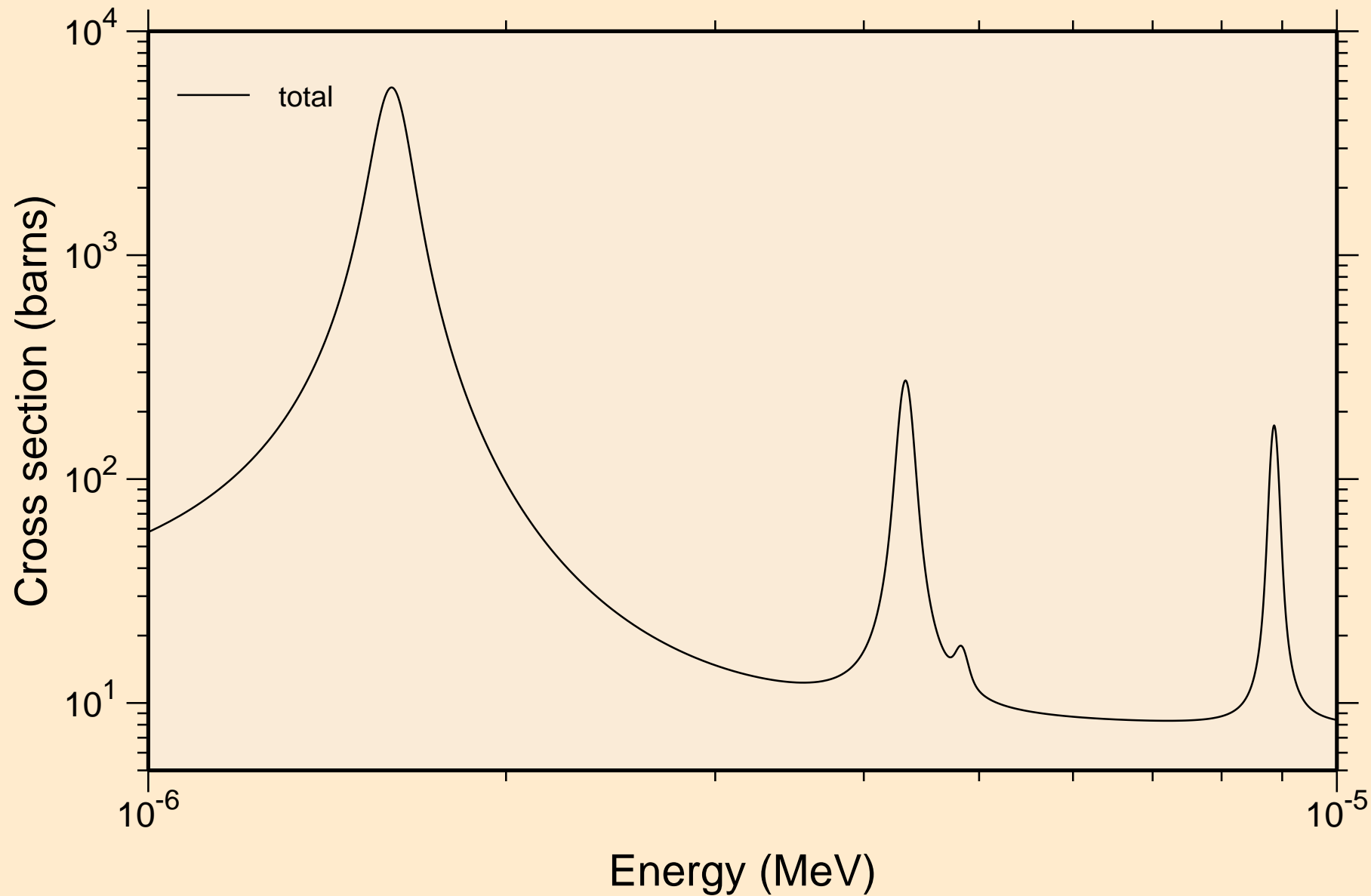

PT193 NEUTRON ACER TENDL-2019 LIBRARY; T=293.16K
resonance total cross section

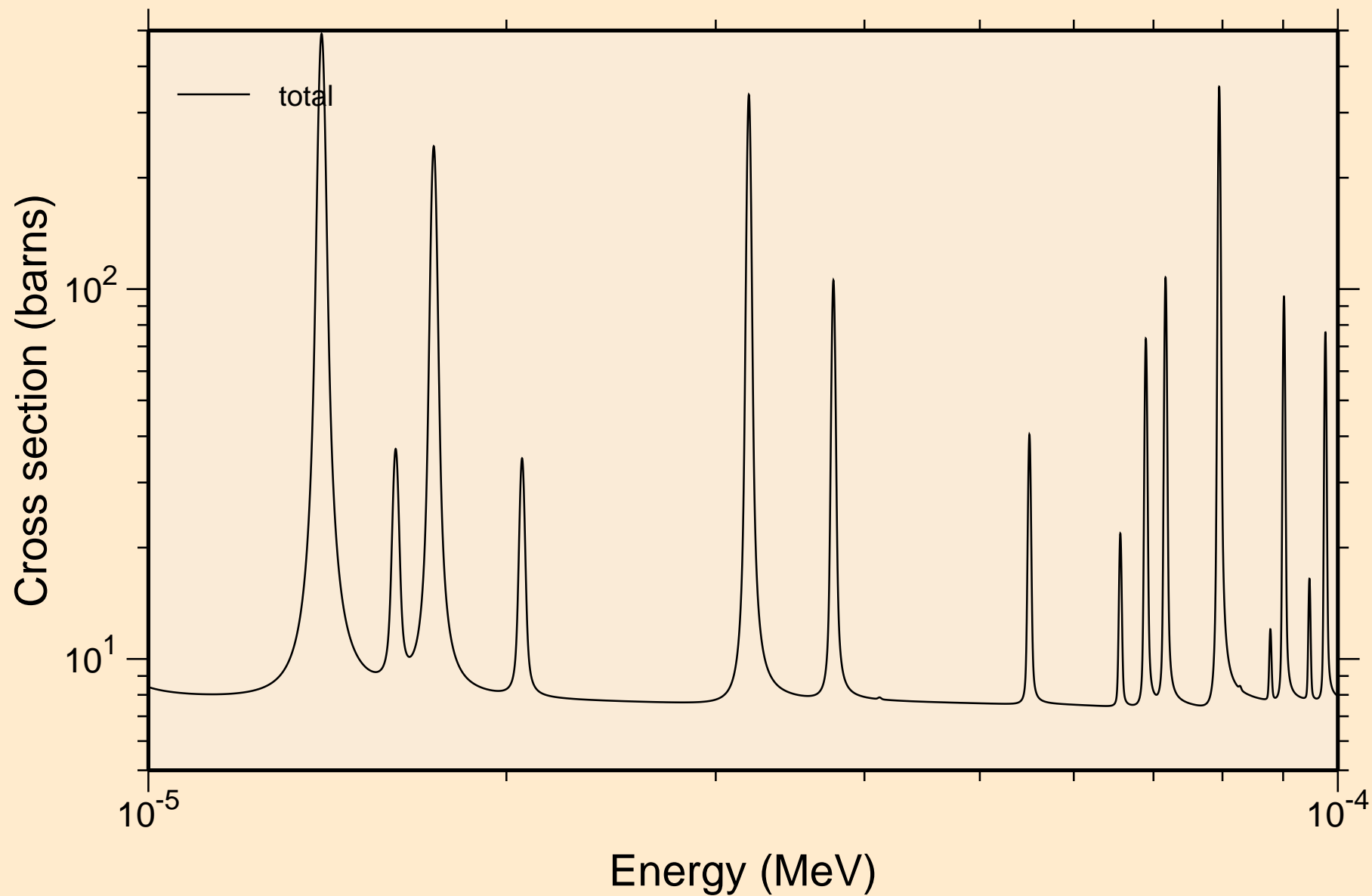

PT193 NEUTRON ACER TENDL-2019 LIBRARY; T=293.16K
resonance total cross section

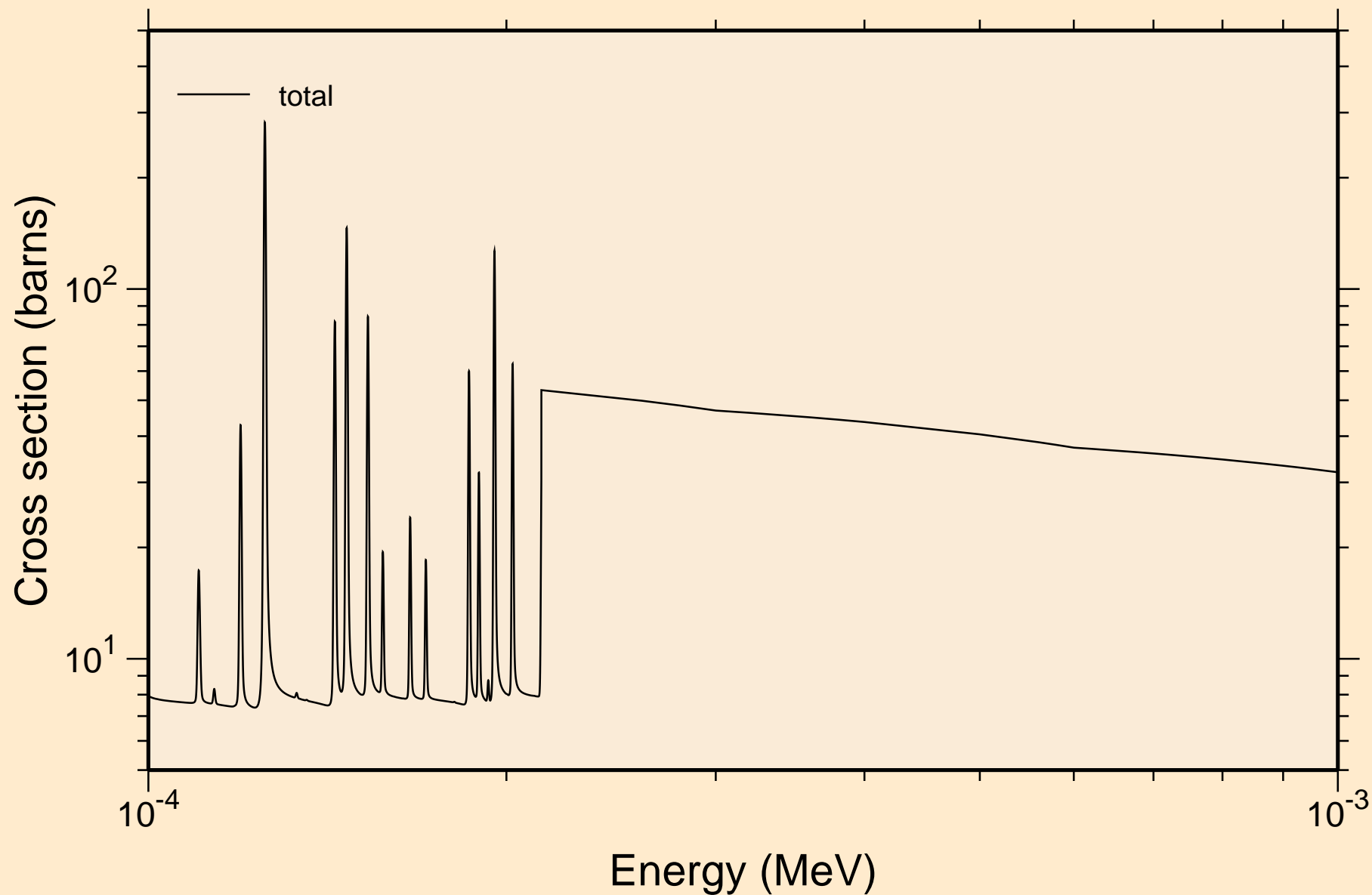

PT193 NEUTRON ACER TENDL-2019 LIBRARY; T=293.16K
resonance total cross section

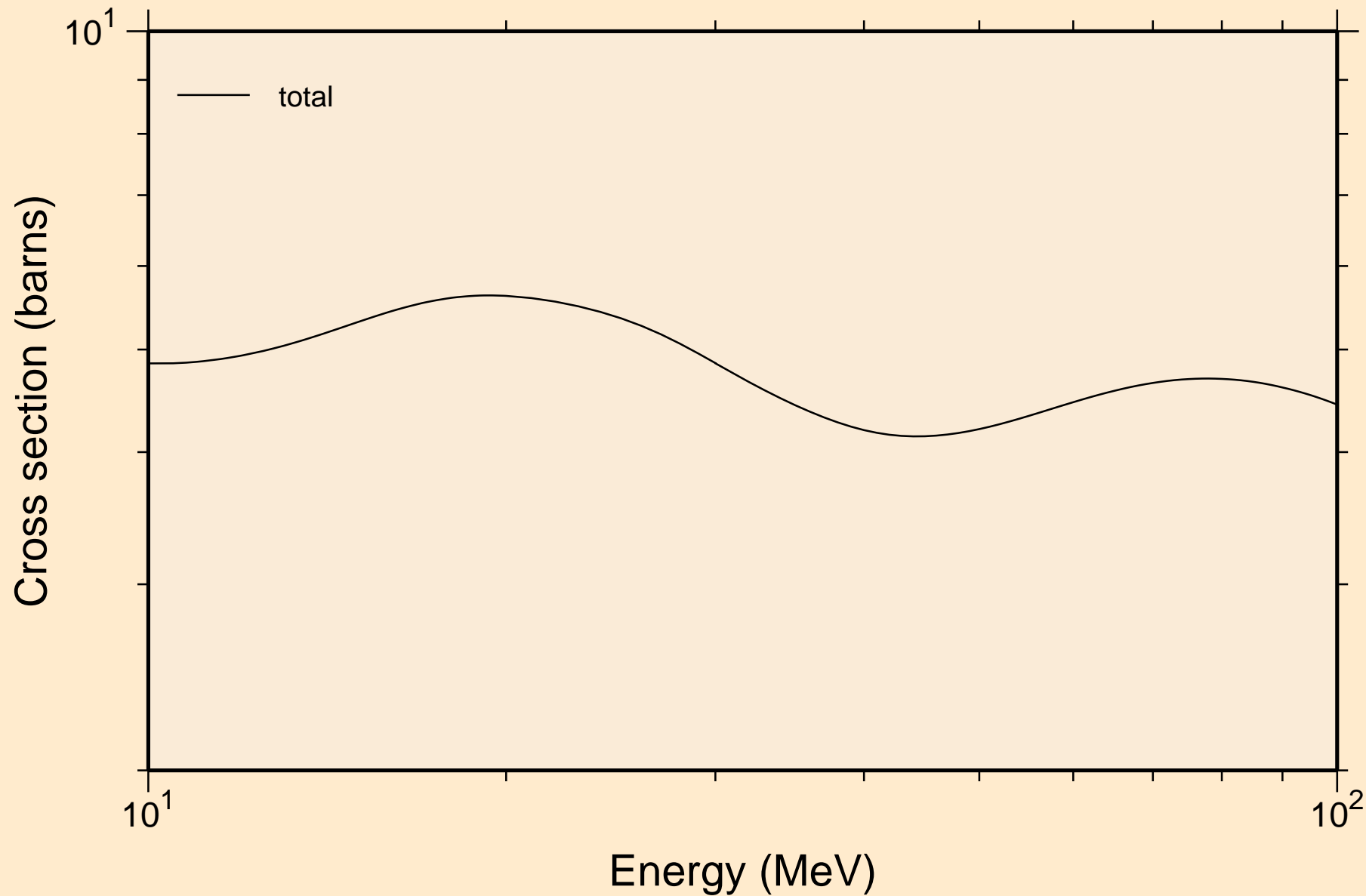

PT193 NEUTRON ACER TENDL-2019 LIBRARY; T=293.16K
resonance absorption cross sections

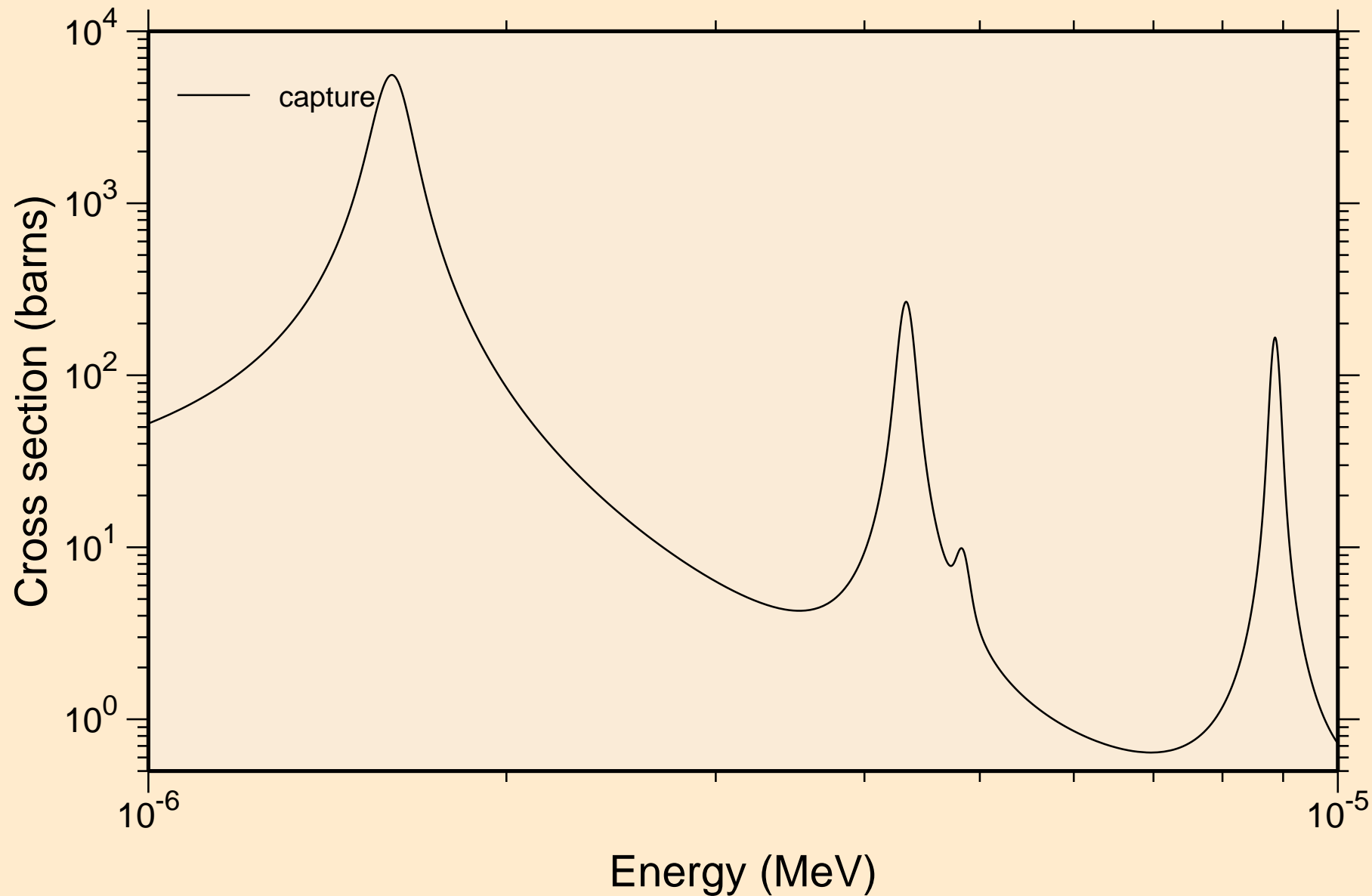

PT193 NEUTRON ACER TENDL-2019 LIBRARY; T=293.16K
resonance absorption cross sections

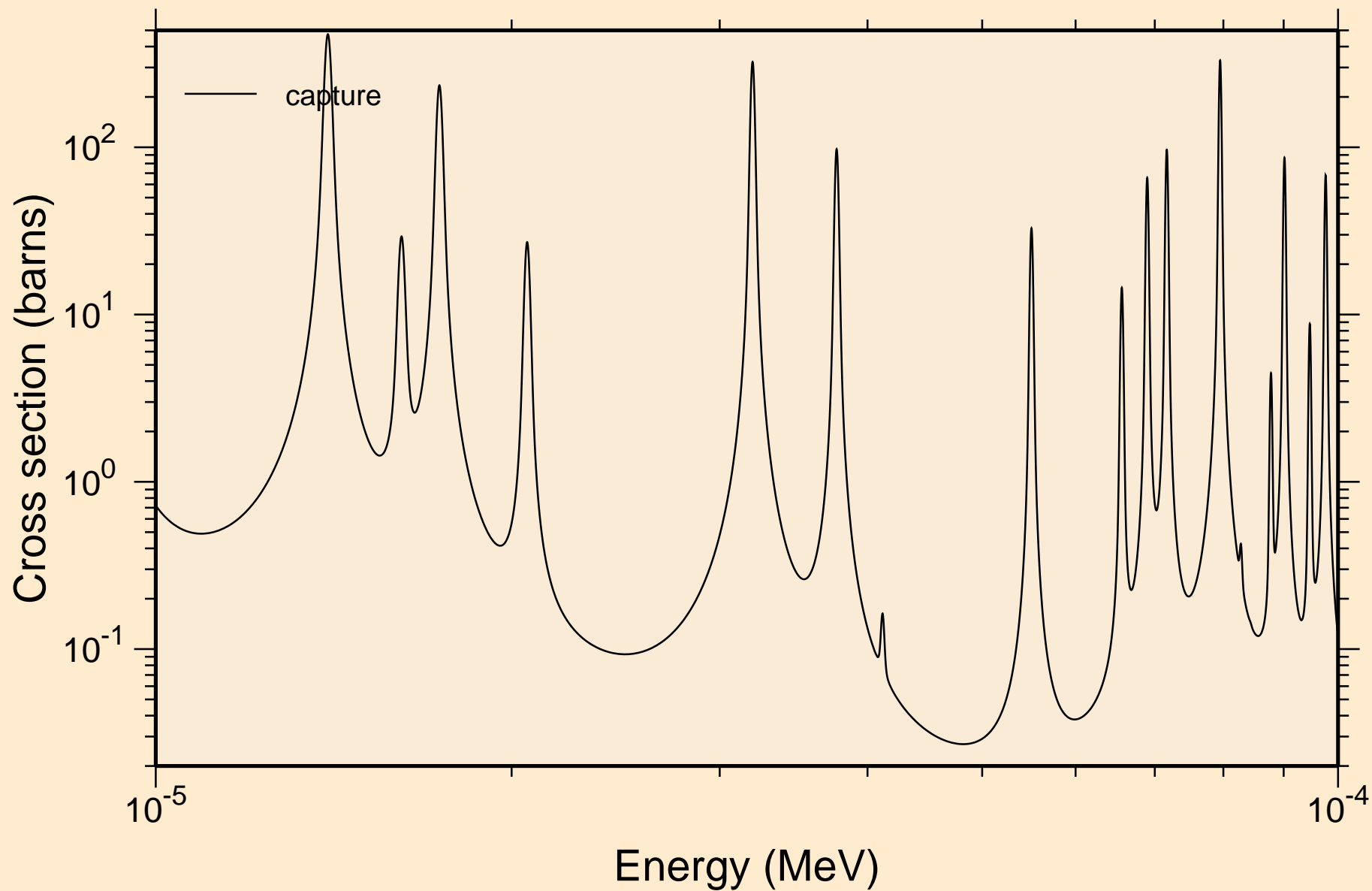

PT193 NEUTRON ACER TENDL-2019 LIBRARY; T=293.16K
resonance absorption cross sections

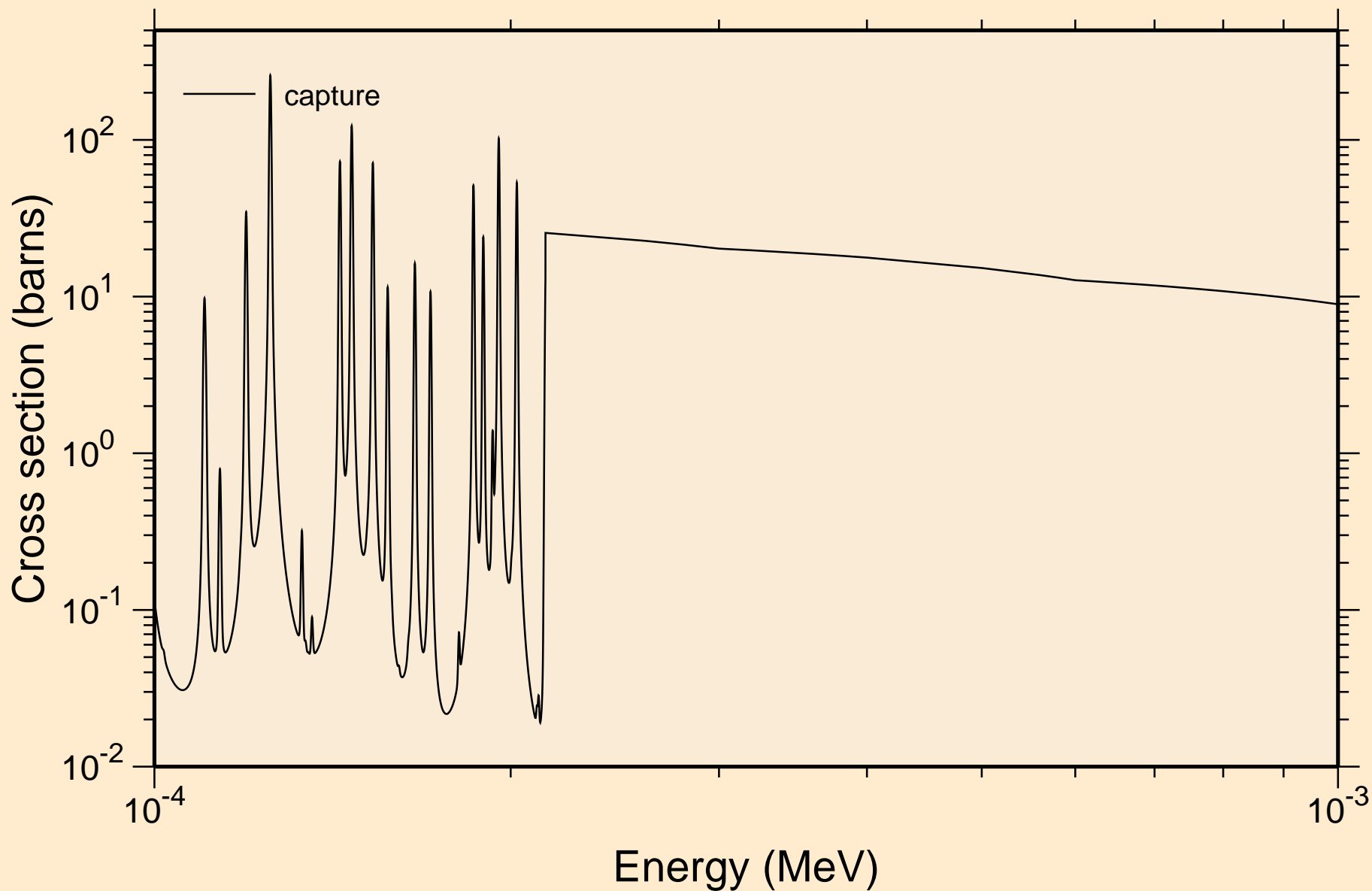

PT193 NEUTRON ACER TENDL-2019 LIBRARY; T=293.16K
resonance absorption cross sections

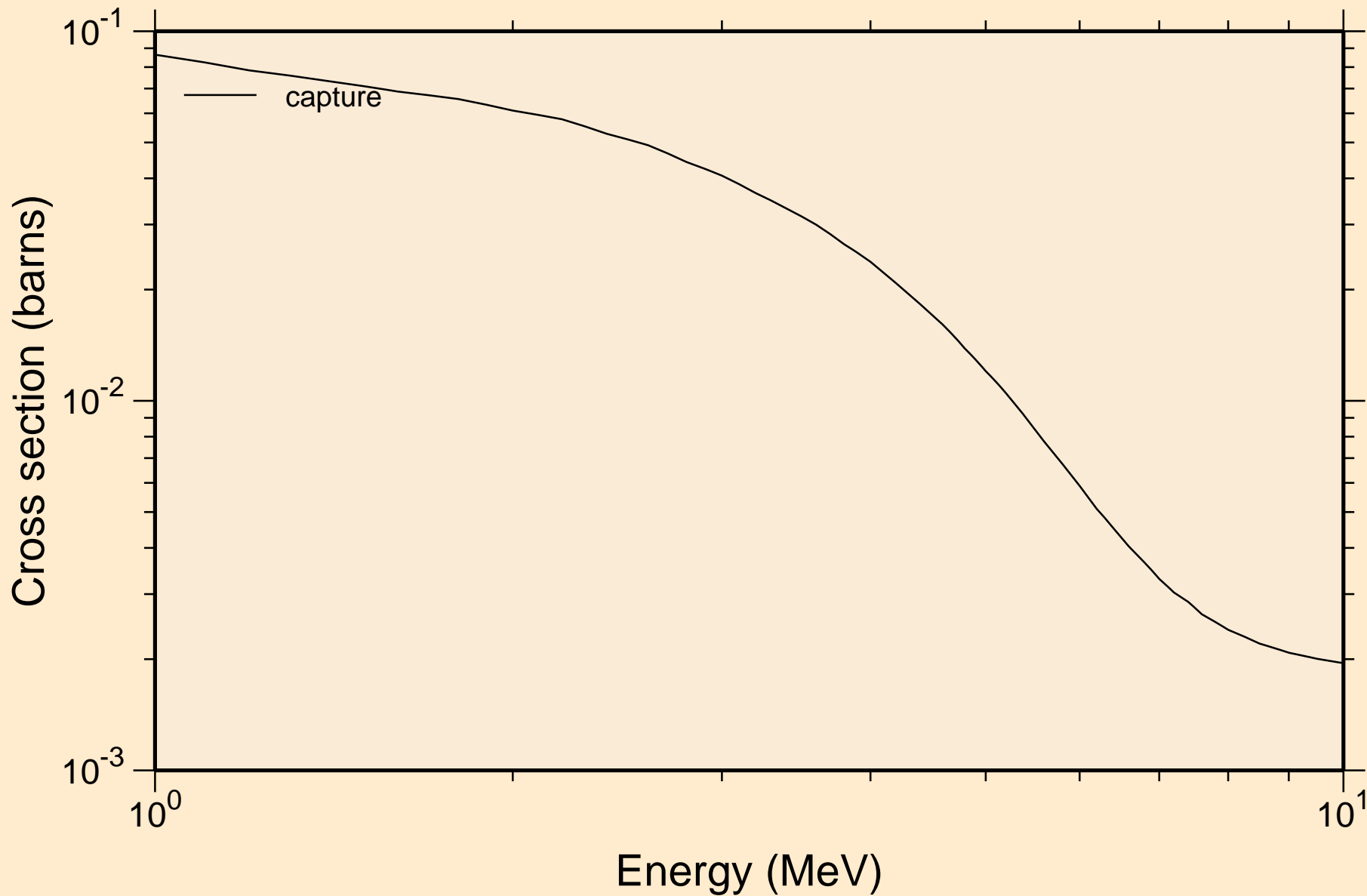

PT193 NEUTRON ACER TENDL-2019 LIBRARY; T=293.16K
Heating

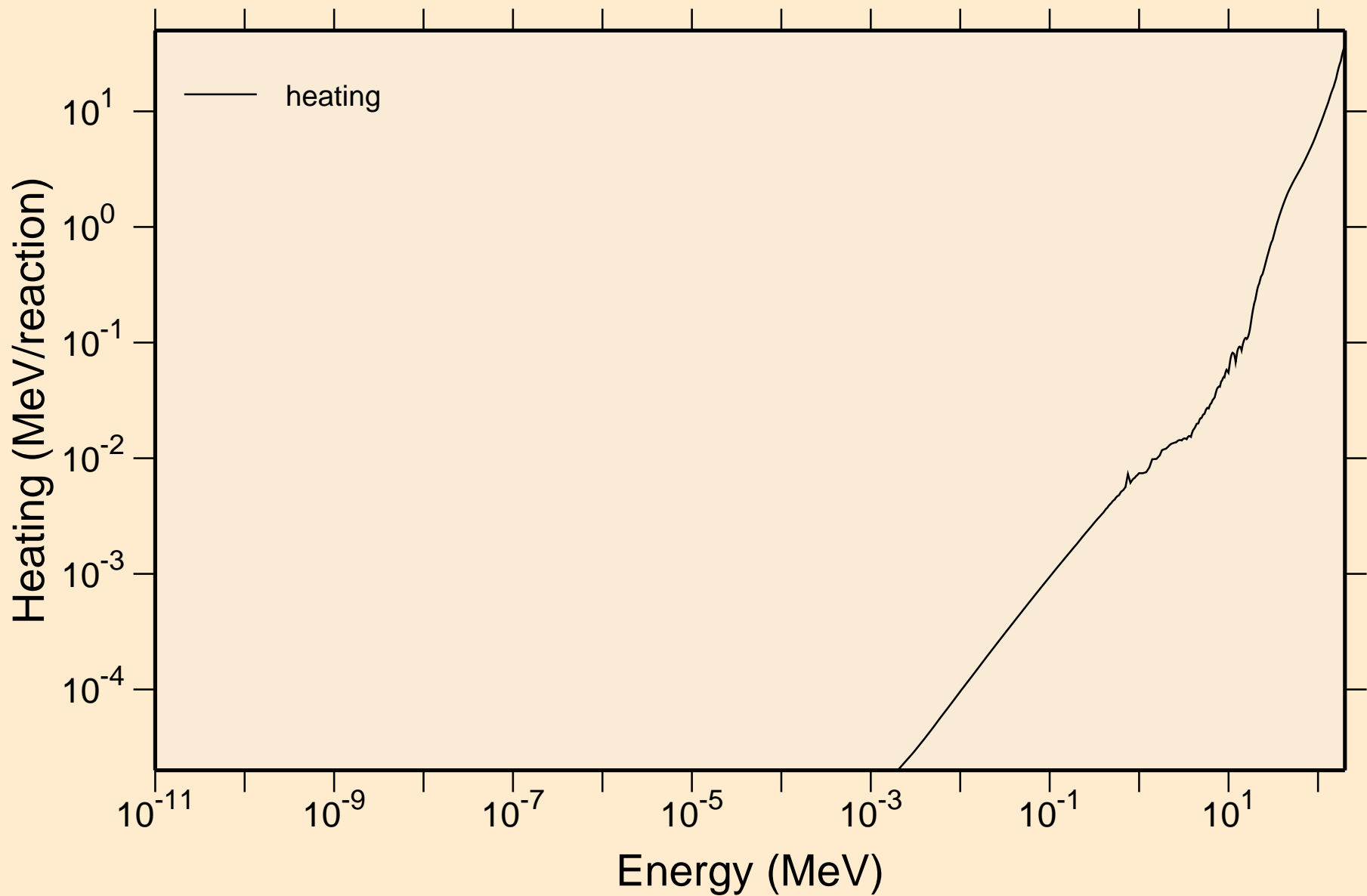

PT193 NEUTRON ACER TENDL-2019 LIBRARY; T=293.16K
Damage

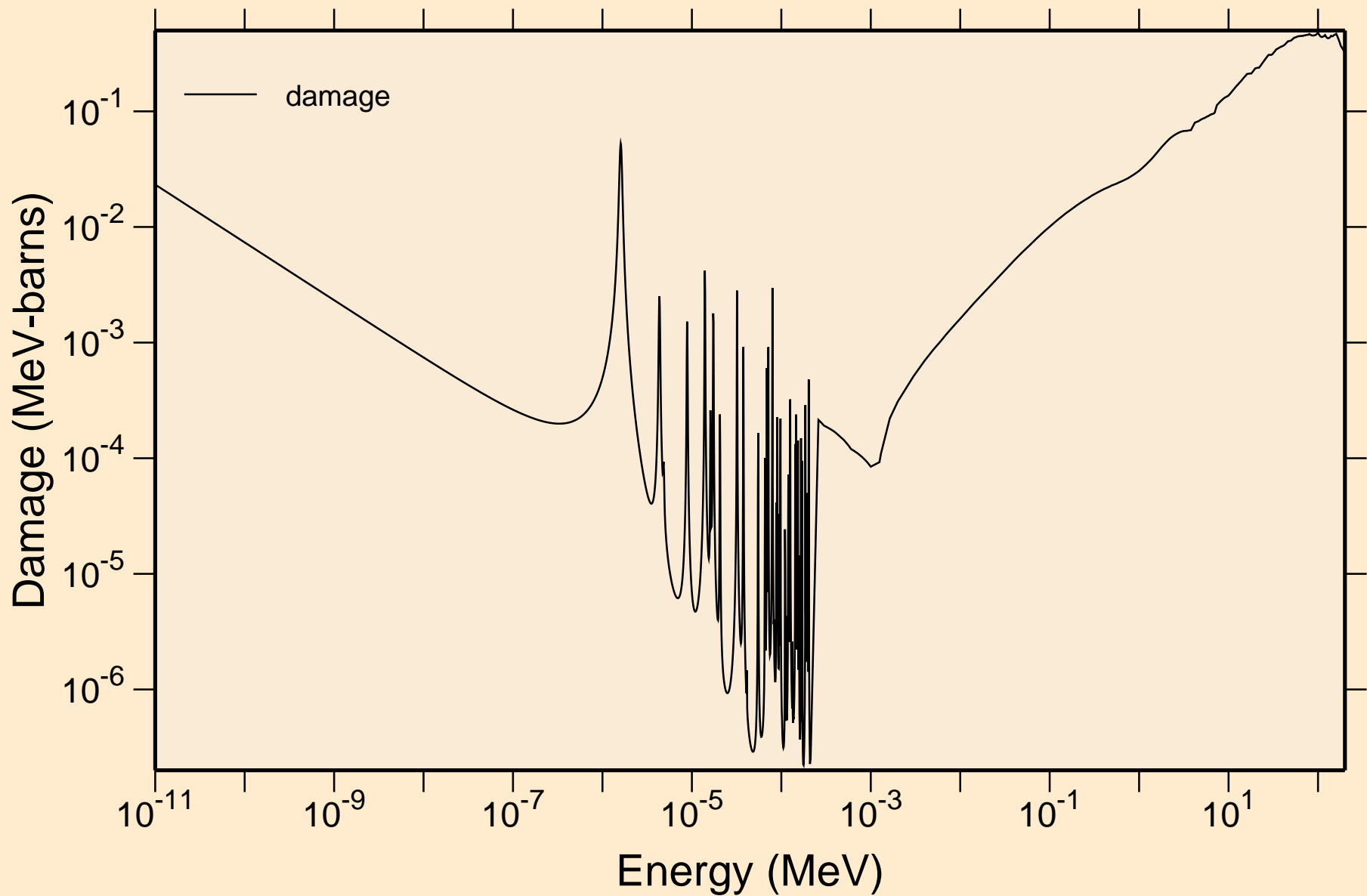

PT193 NEUTRON ACER TENDL-2019 LIBRARY; T=293.16K
Non-threshold reactions

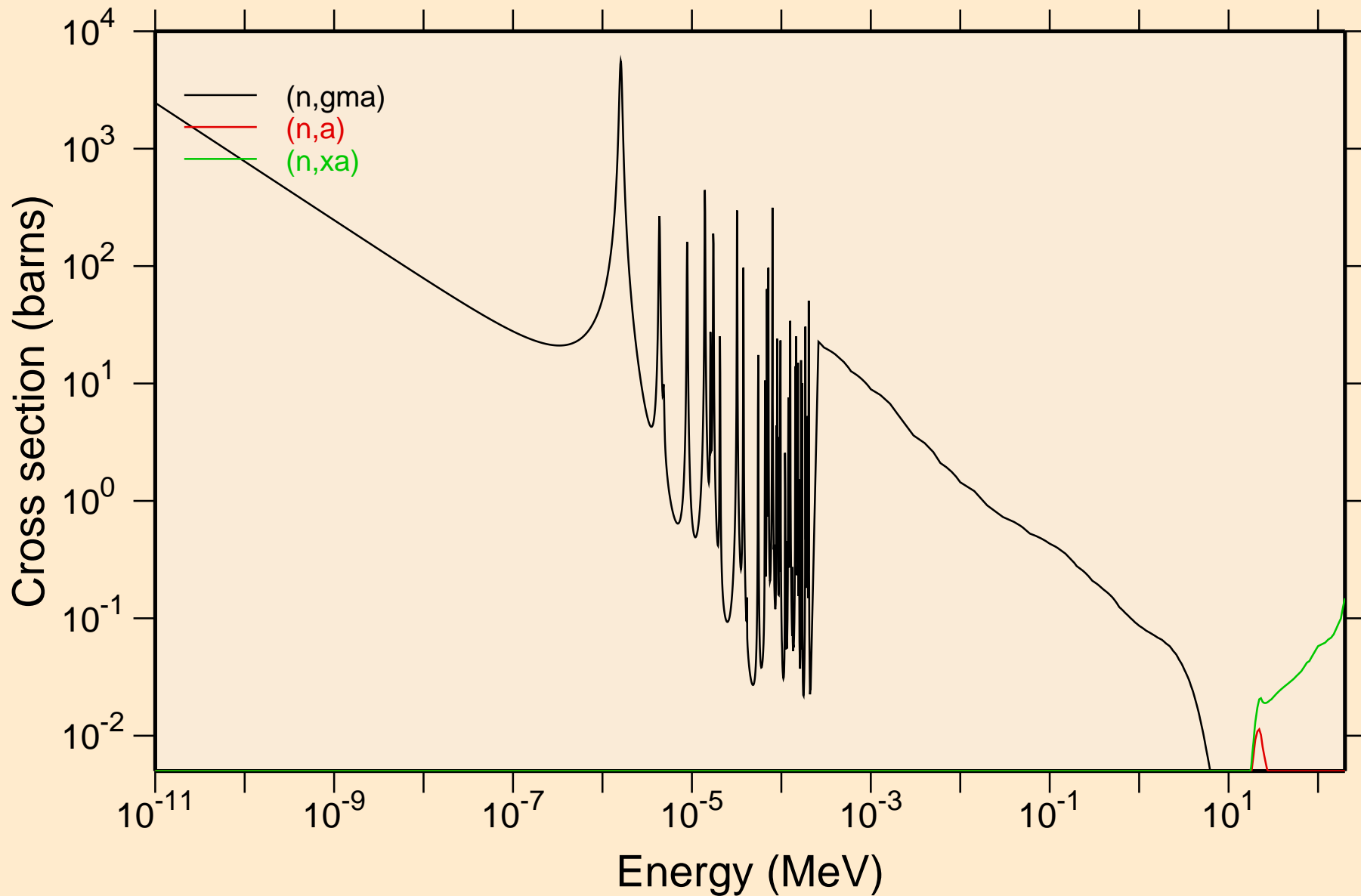

PT193 NEUTRON ACER TENDL-2019 LIBRARY; T=293.16K
Principal cross sections

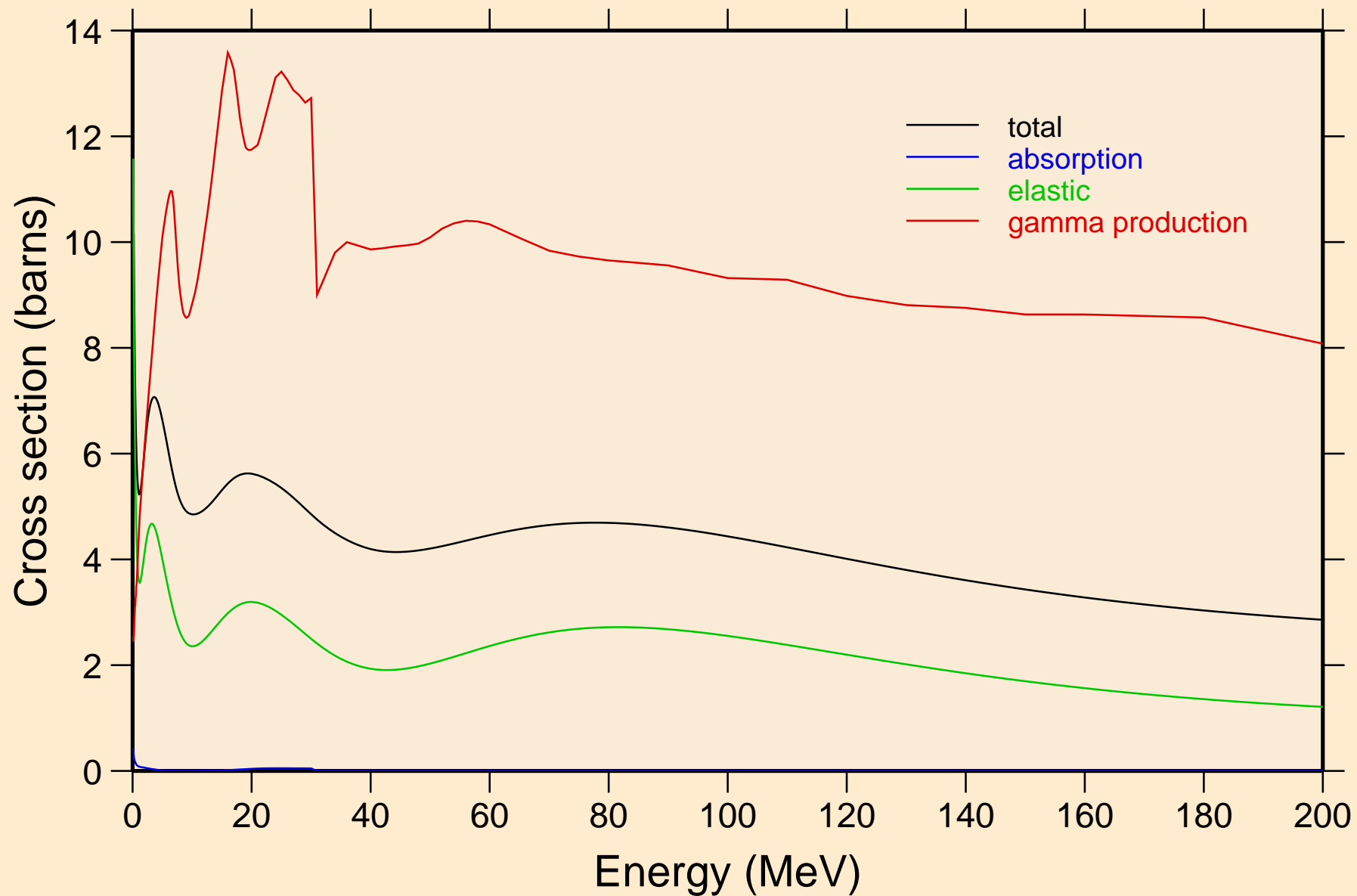

PT193 NEUTRON ACER TENDL-2019 LIBRARY; T=293.16K
Heating

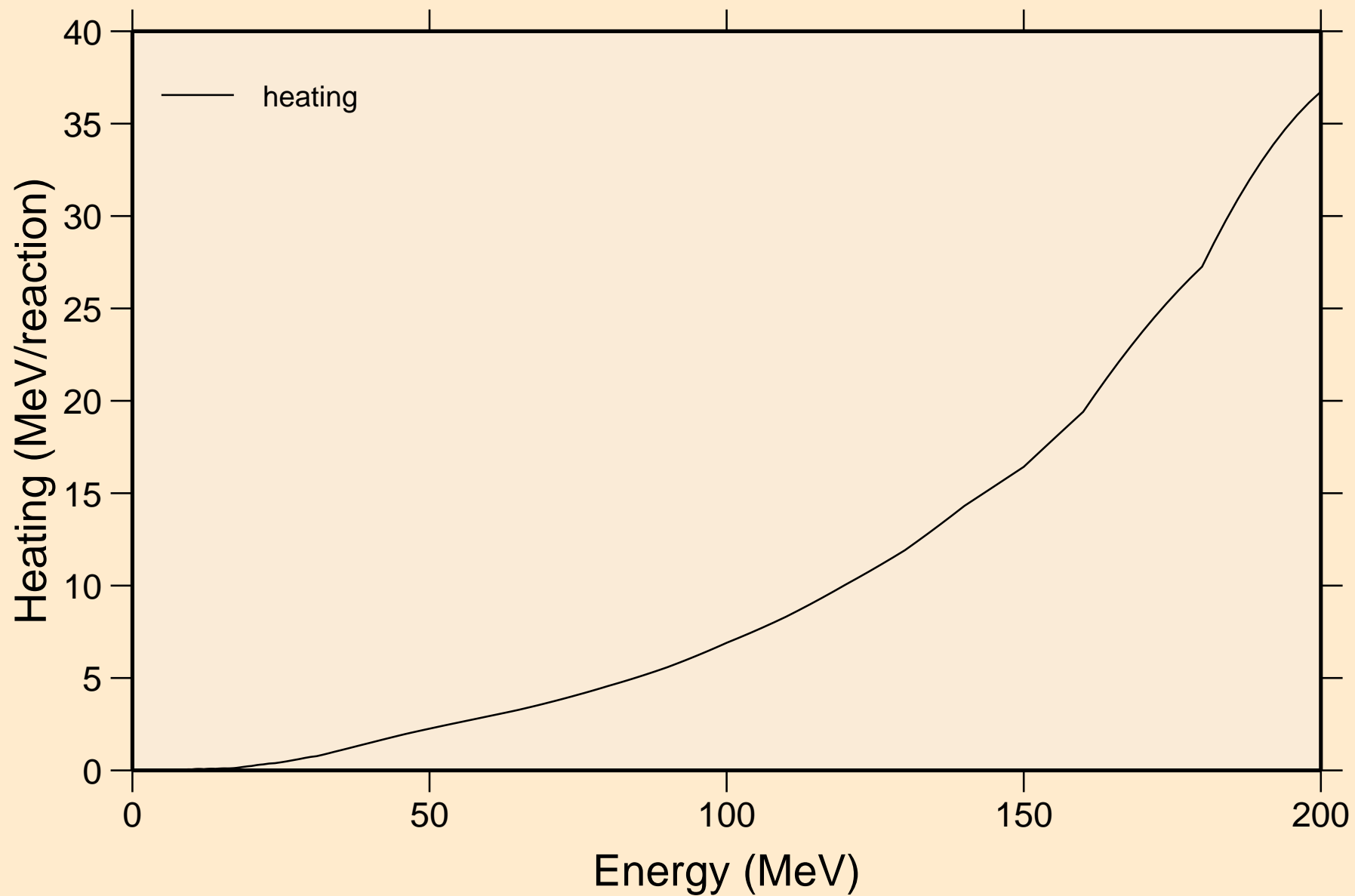

PT193 NEUTRON ACER TENDL-2019 LIBRARY; T=293.16K
Damage

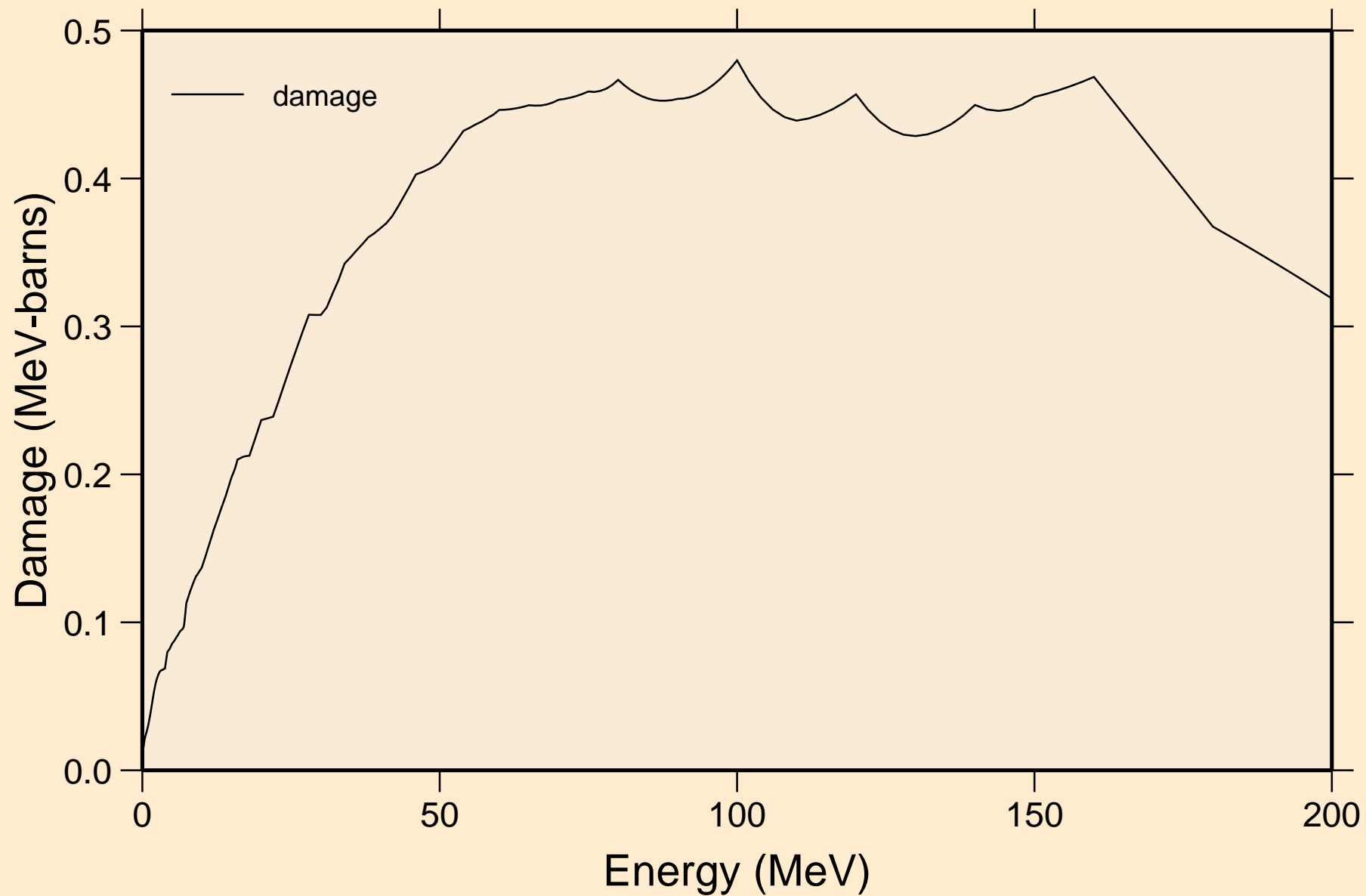

PT193 NEUTRON ACER TENDL-2019 LIBRARY; T=293.16K
Non-threshold reactions

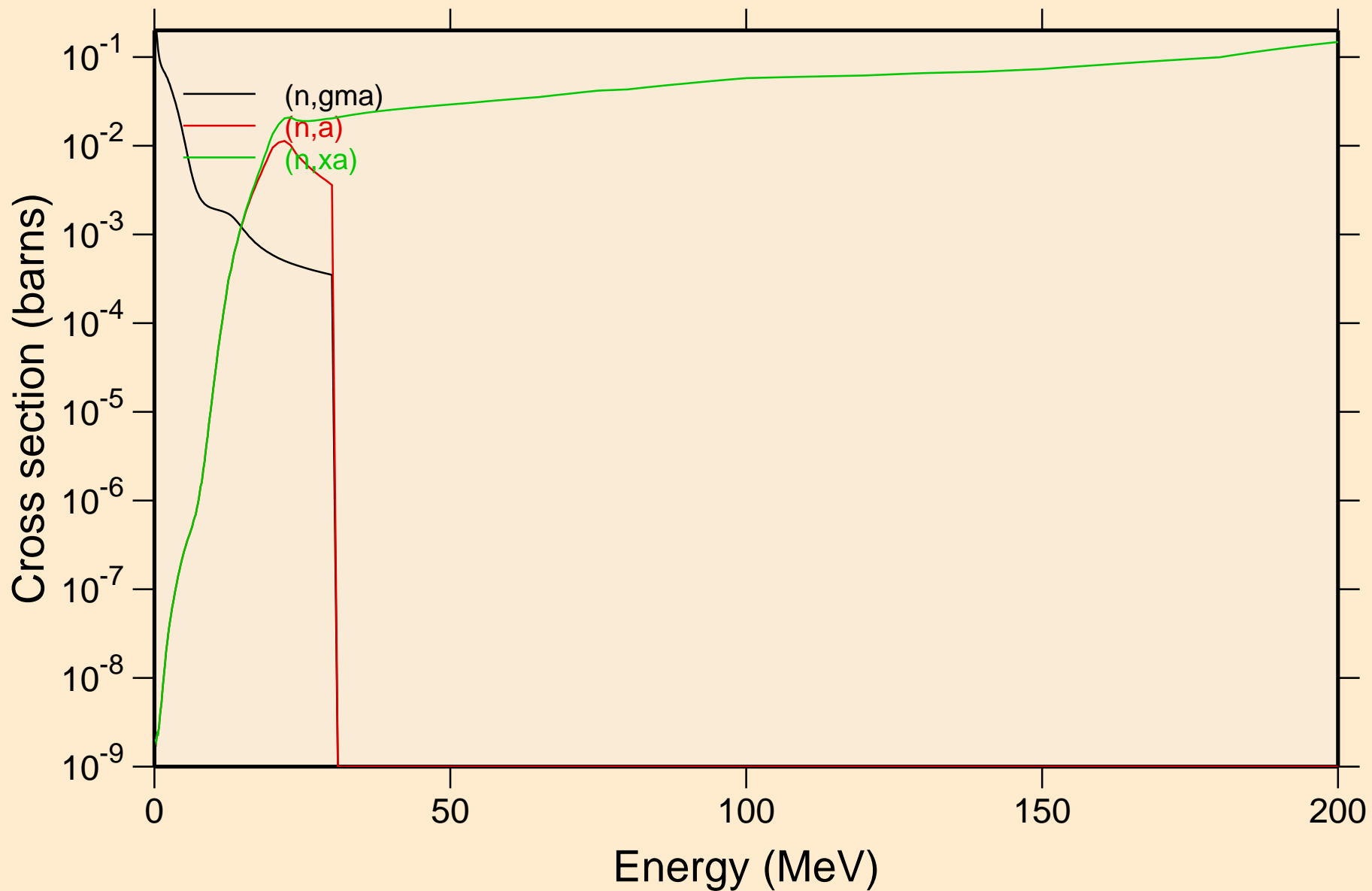

PT193 NEUTRON ACER TENDL-2019 LIBRARY; T=293.16K
Inelastic levels

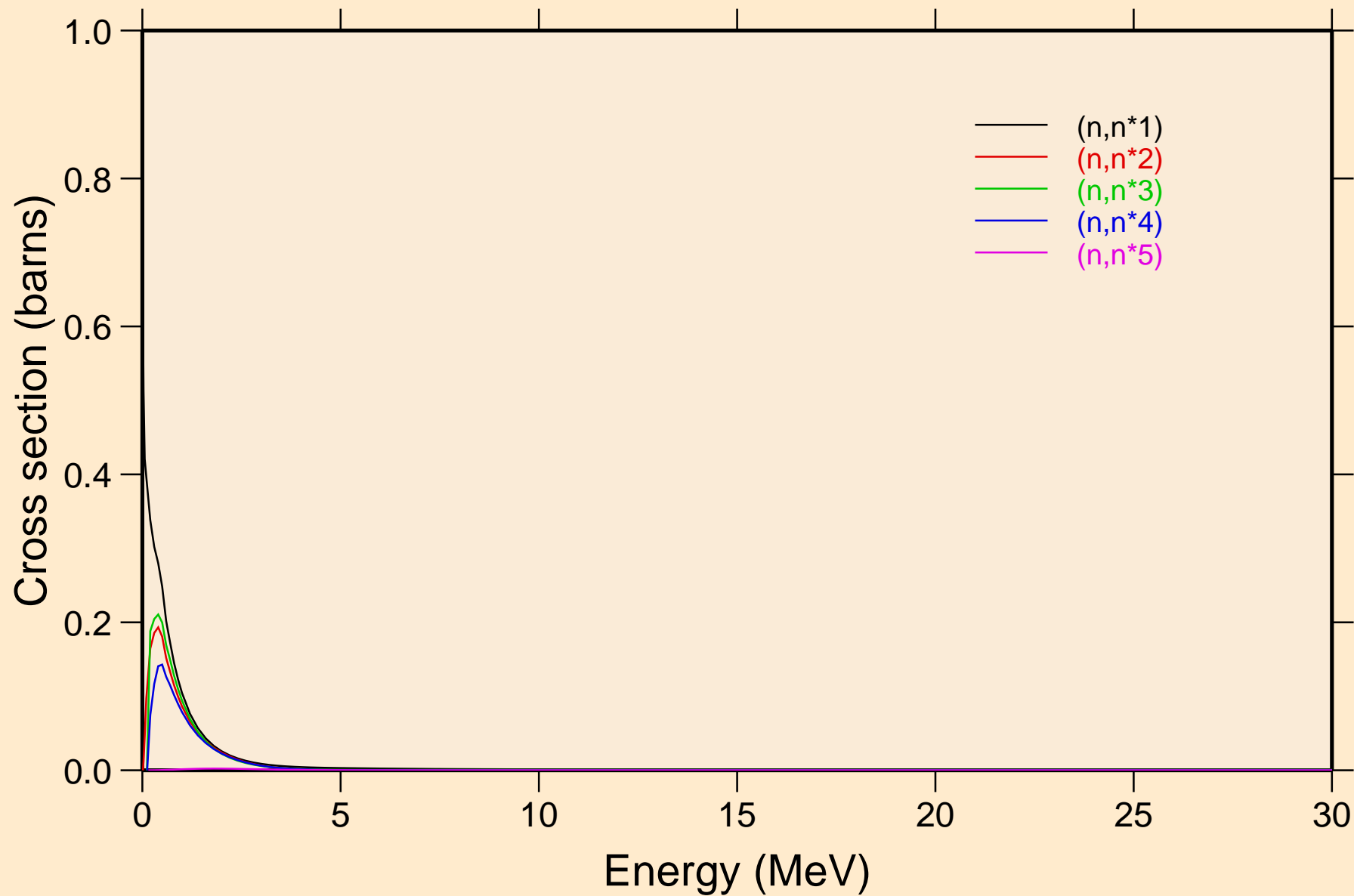

PT193 NEUTRON ACER TENDL-2019 LIBRARY; T=293.16K
Inelastic levels

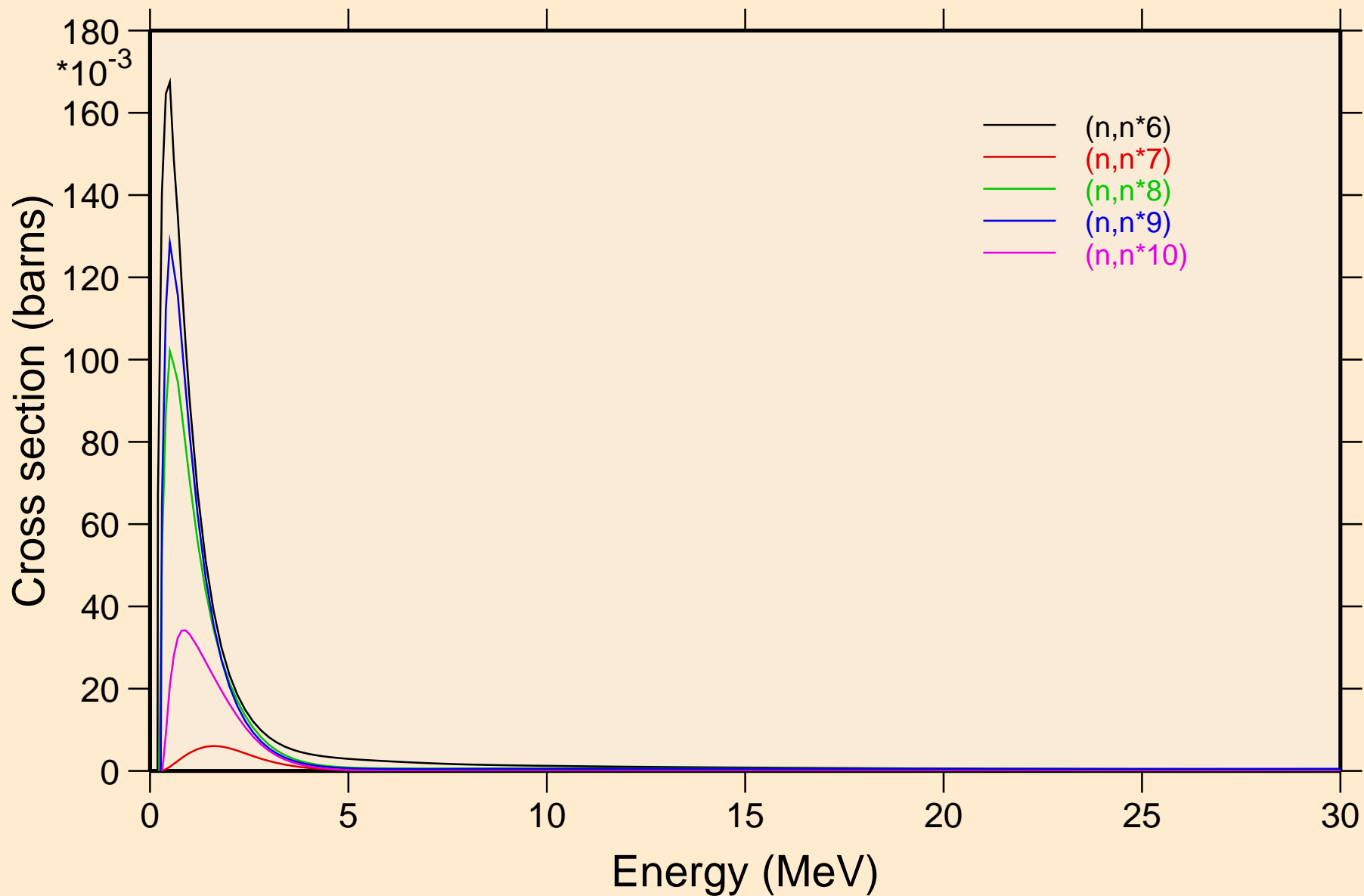

PT193 NEUTRON ACER TENDL-2019 LIBRARY; T=293.16K
Inelastic levels

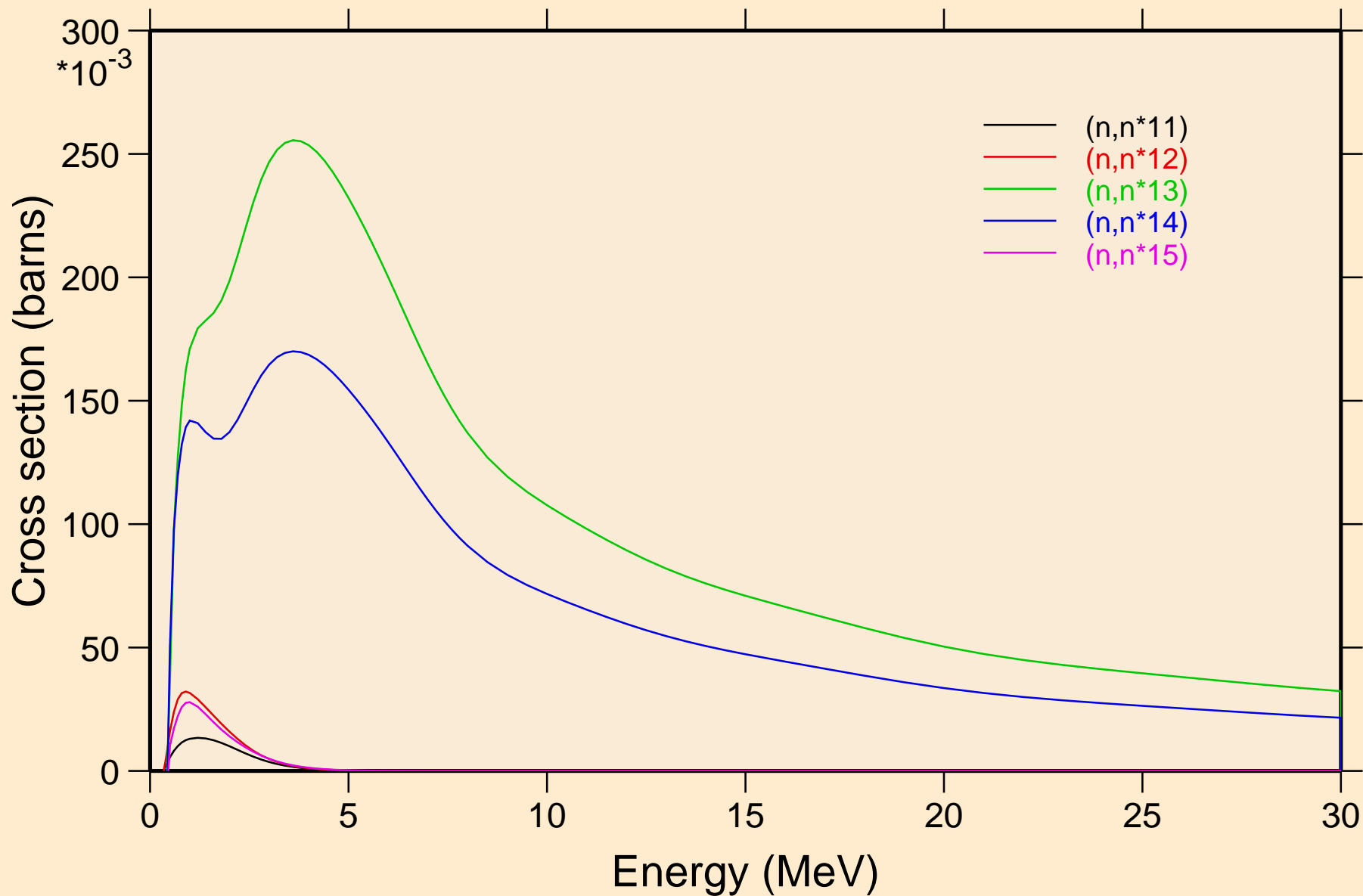

PT193 NEUTRON ACER TENDL-2019 LIBRARY; T=293.16K
Inelastic levels

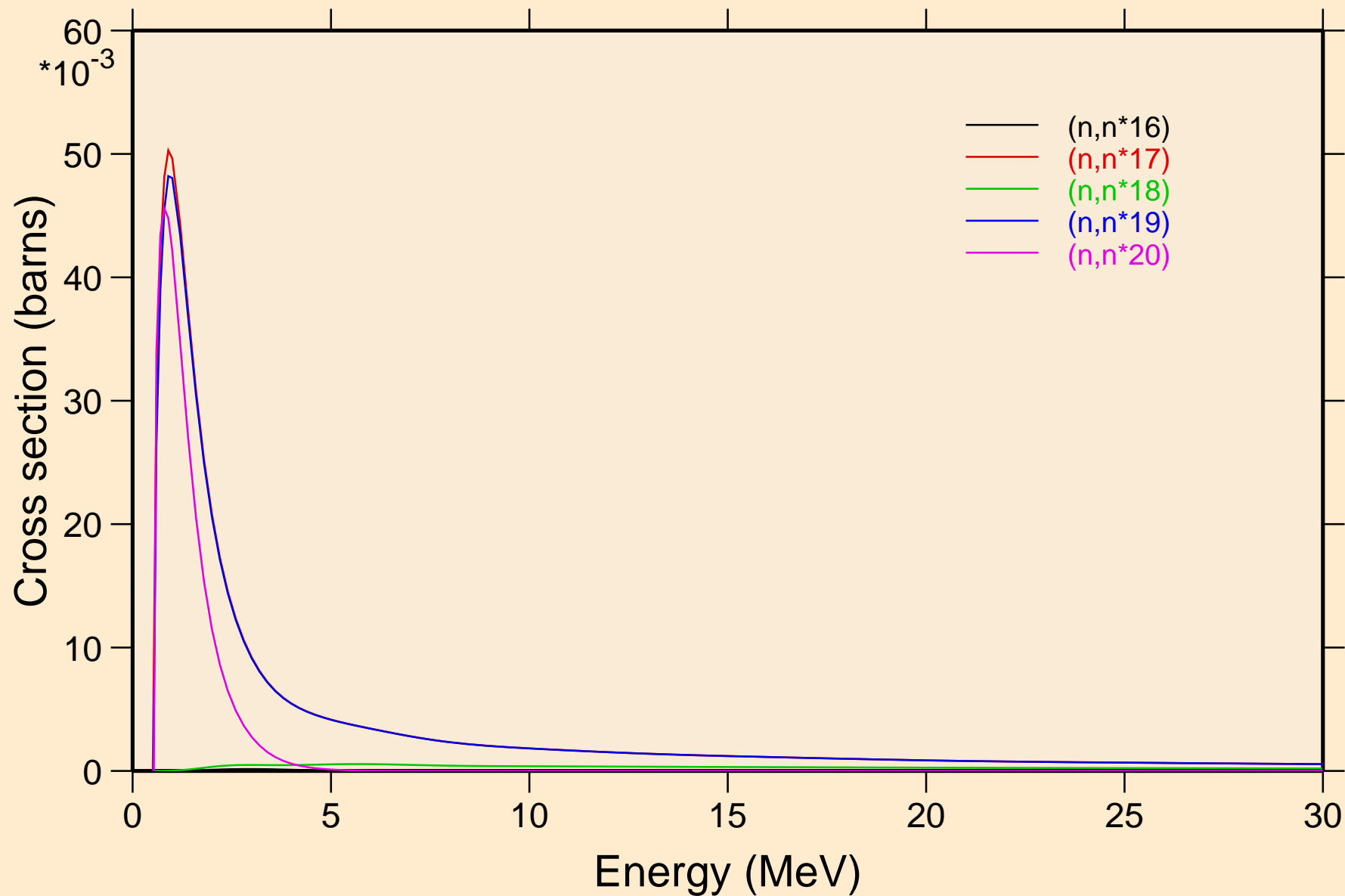

PT193 NEUTRON ACER TENDL-2019 LIBRARY; T=293.16K
Inelastic levels

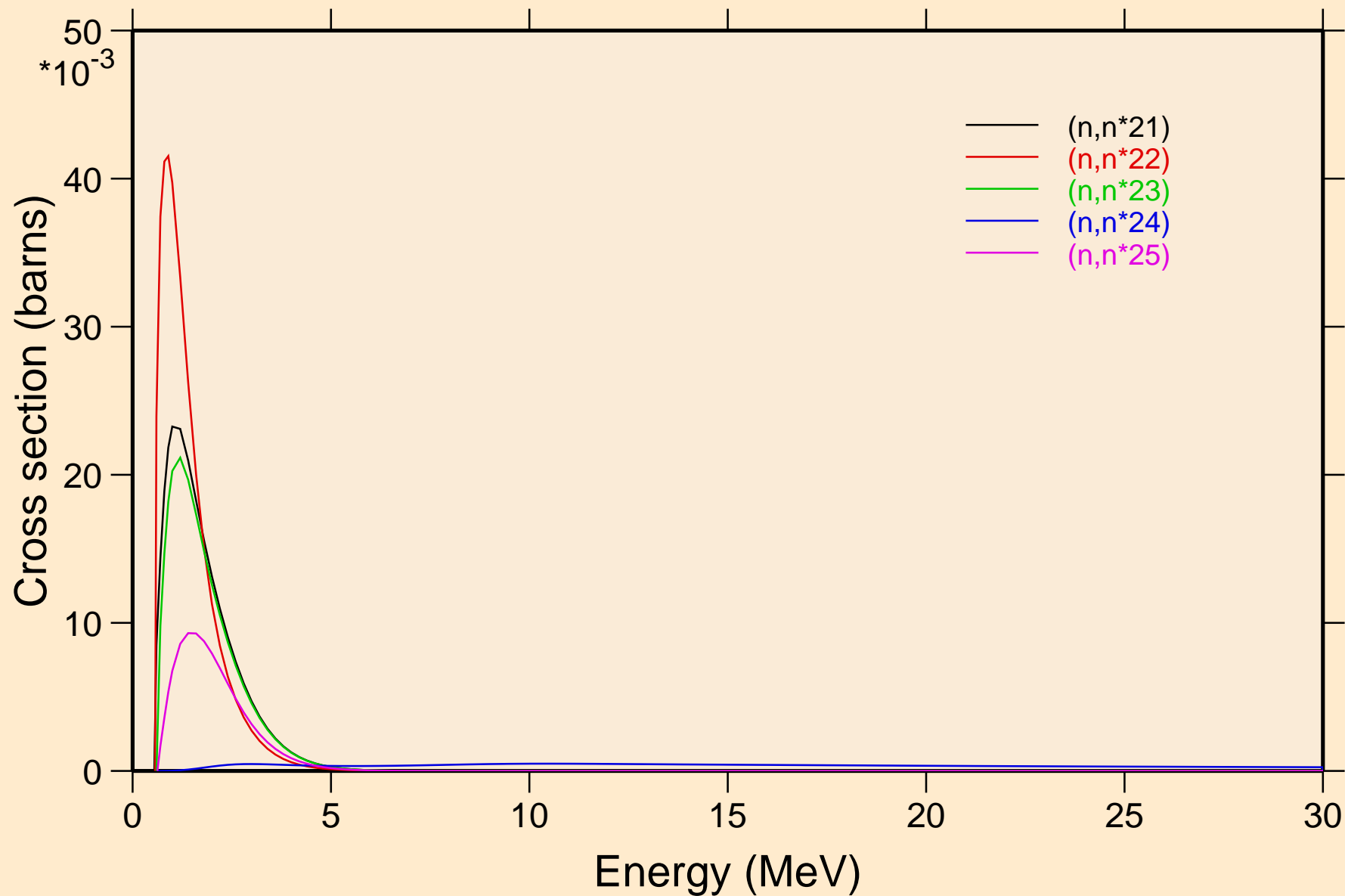

PT193 NEUTRON ACER TENDL-2019 LIBRARY; T=293.16K
Inelastic levels

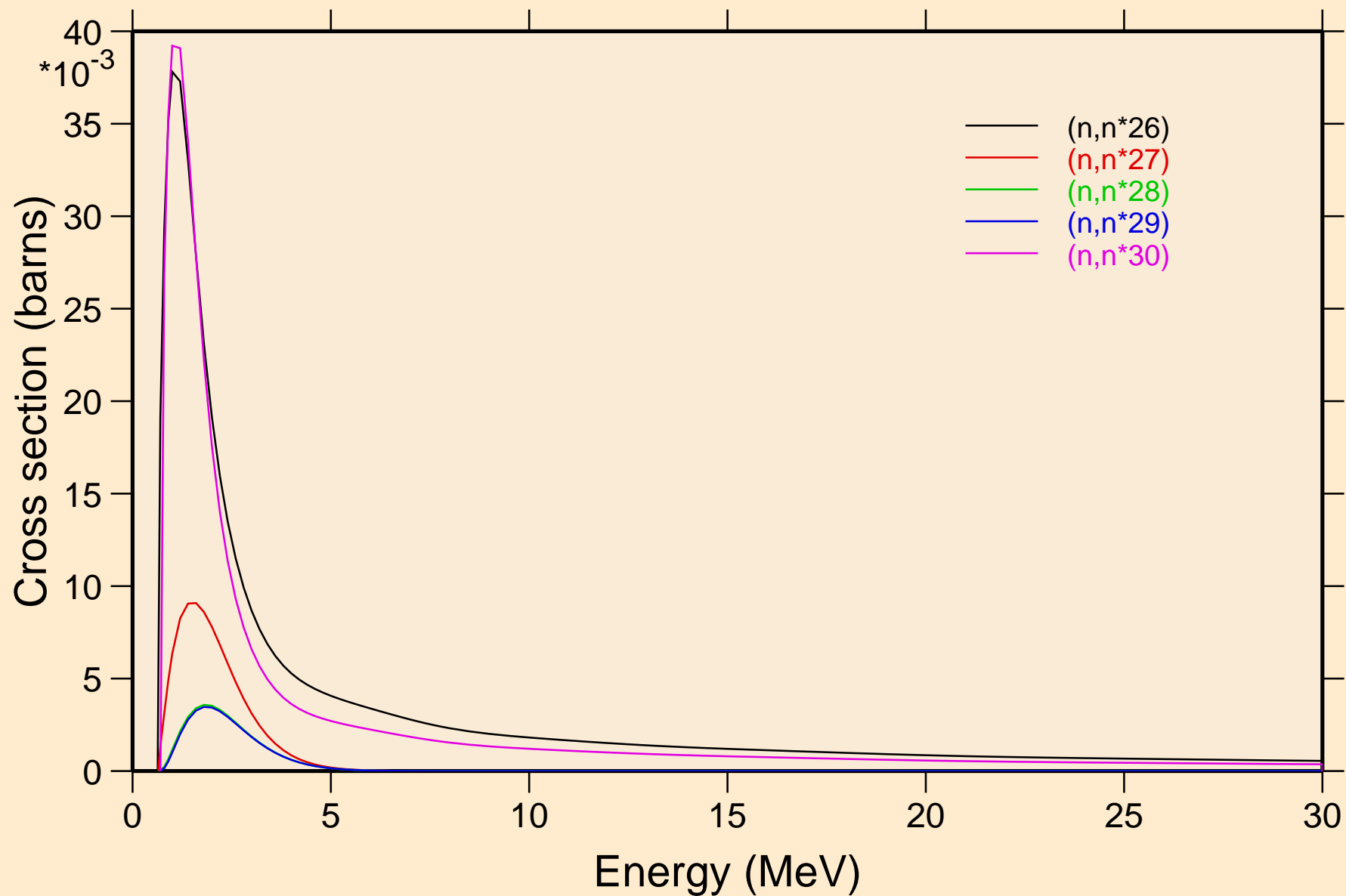

PT193 NEUTRON ACER TENDL-2019 LIBRARY; T=293.16K
Threshold reactions

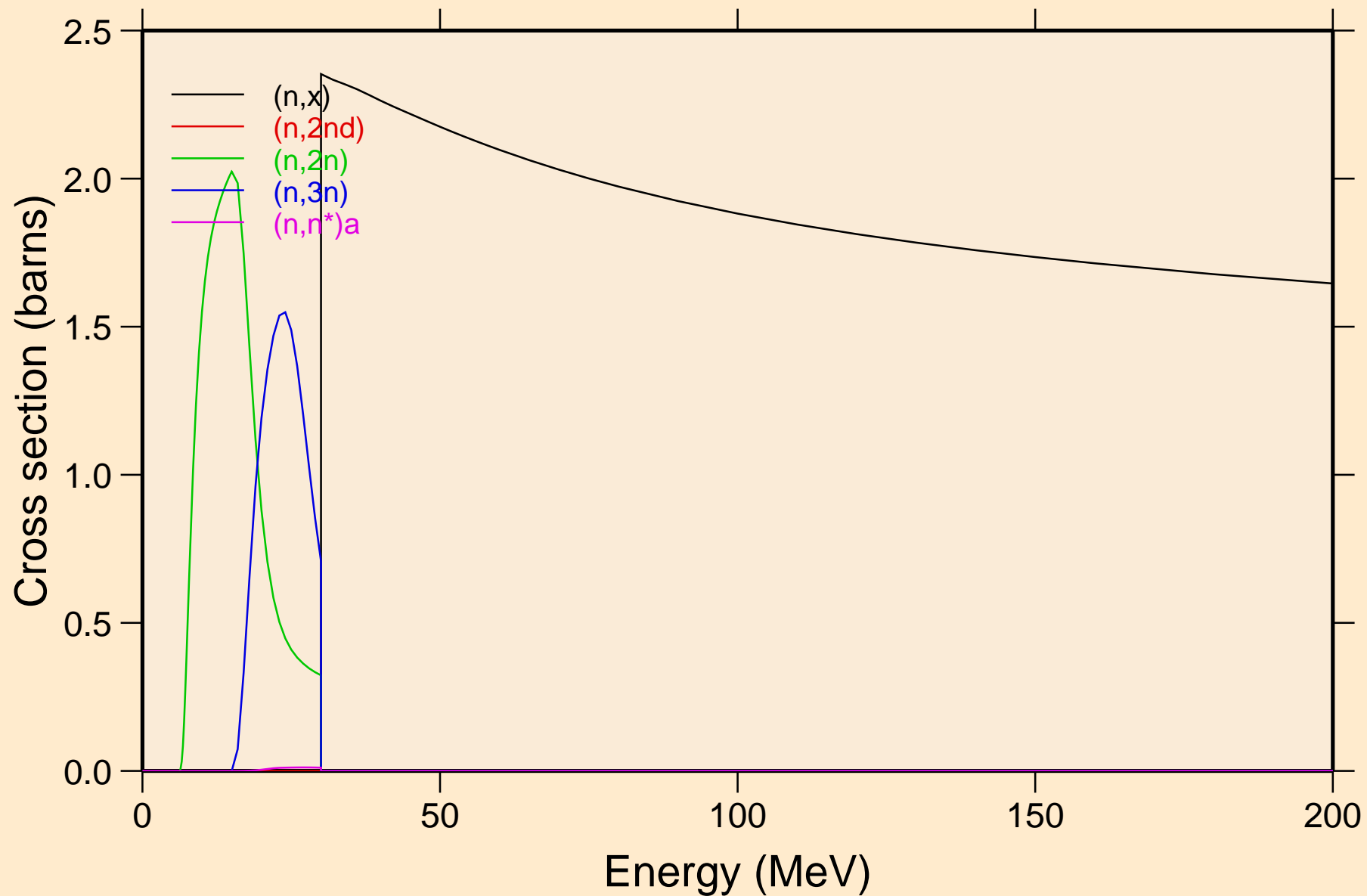

PT193 NEUTRON ACER TENDL-2019 LIBRARY; T=293.16K
Threshold reactions

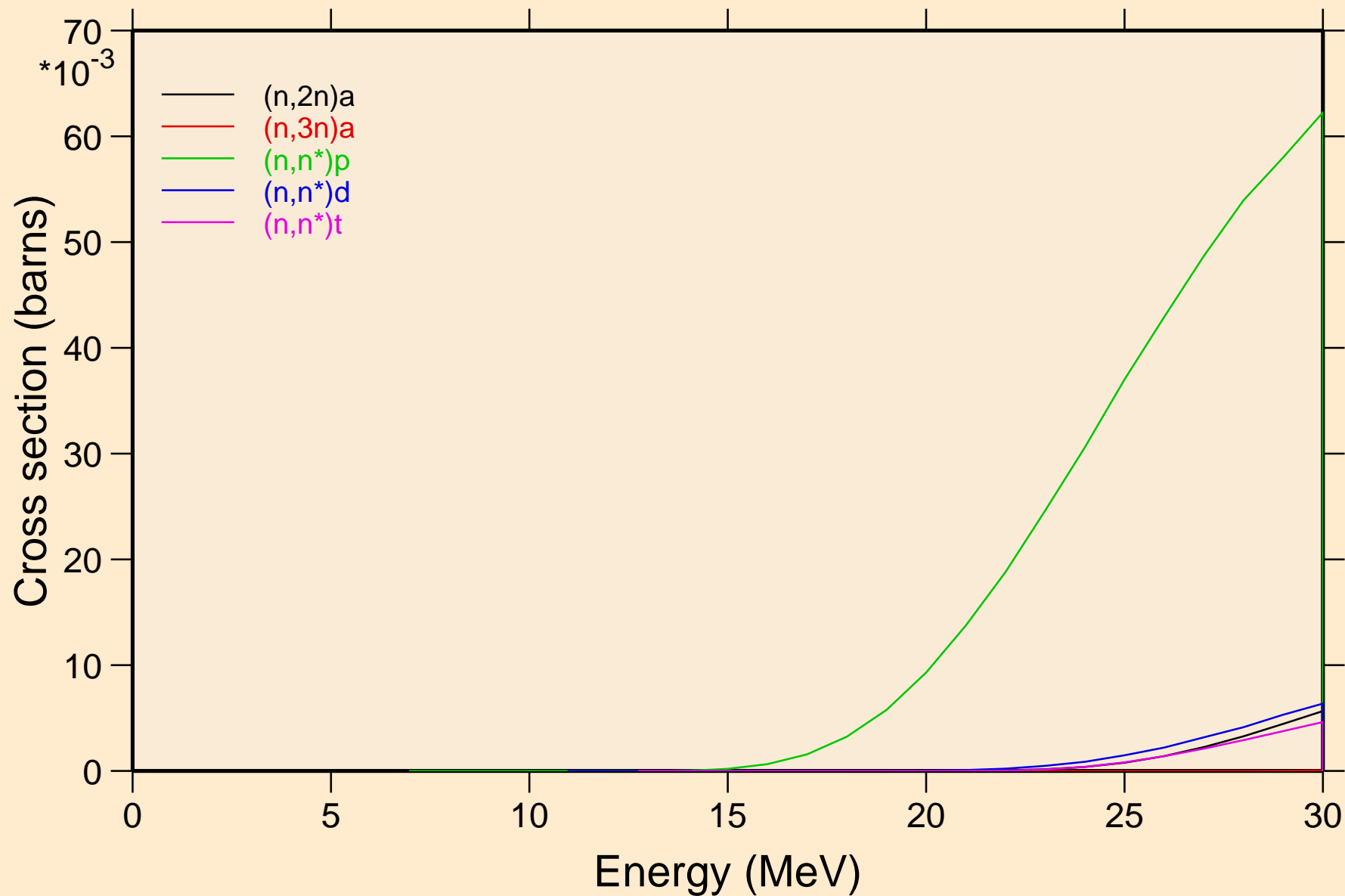

PT193 NEUTRON ACER TENDL-2019 LIBRARY; T=293.16K
Threshold reactions

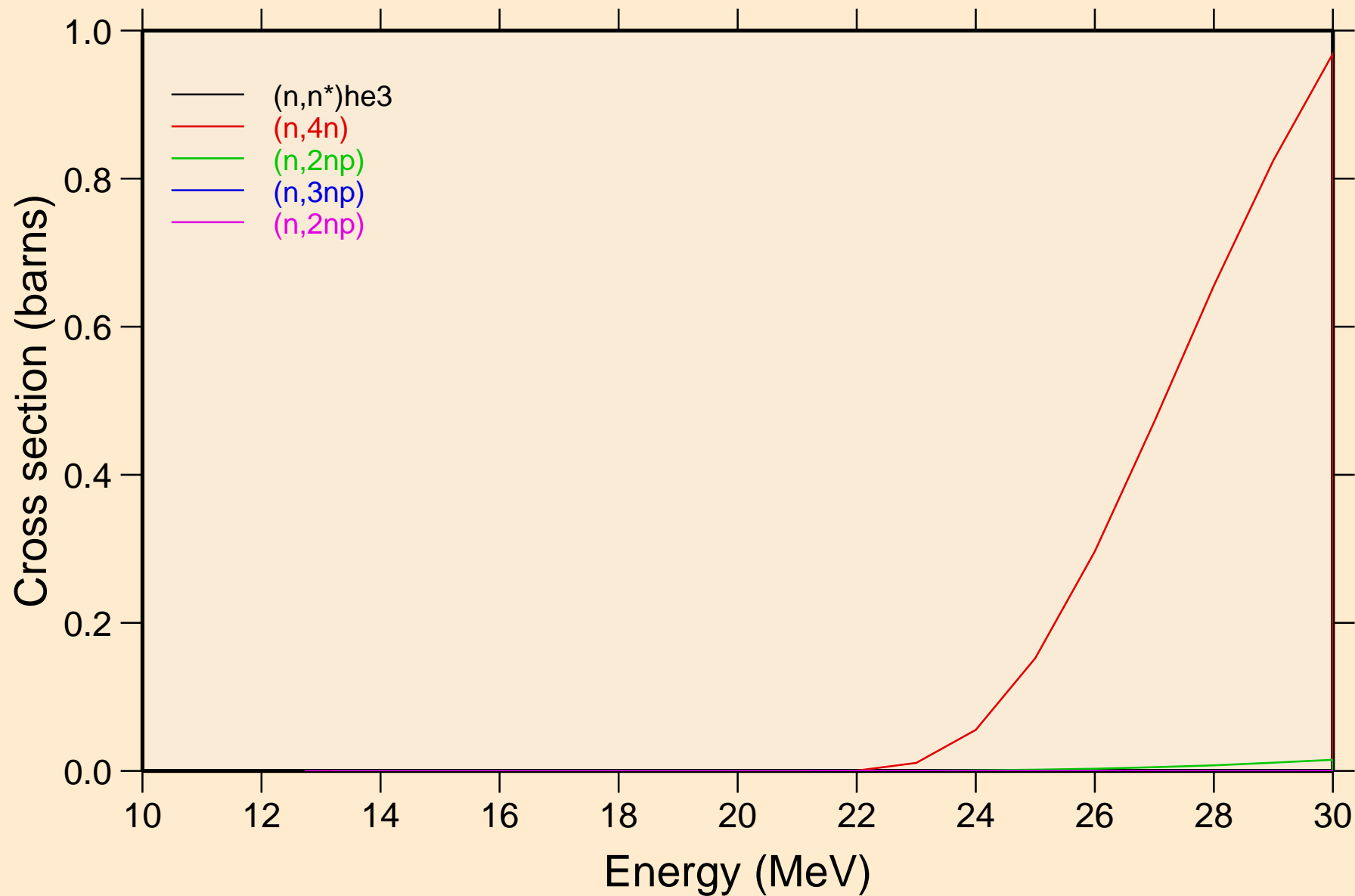

PT193 NEUTRON ACER TENDL-2019 LIBRARY; T=293.16K
Threshold reactions

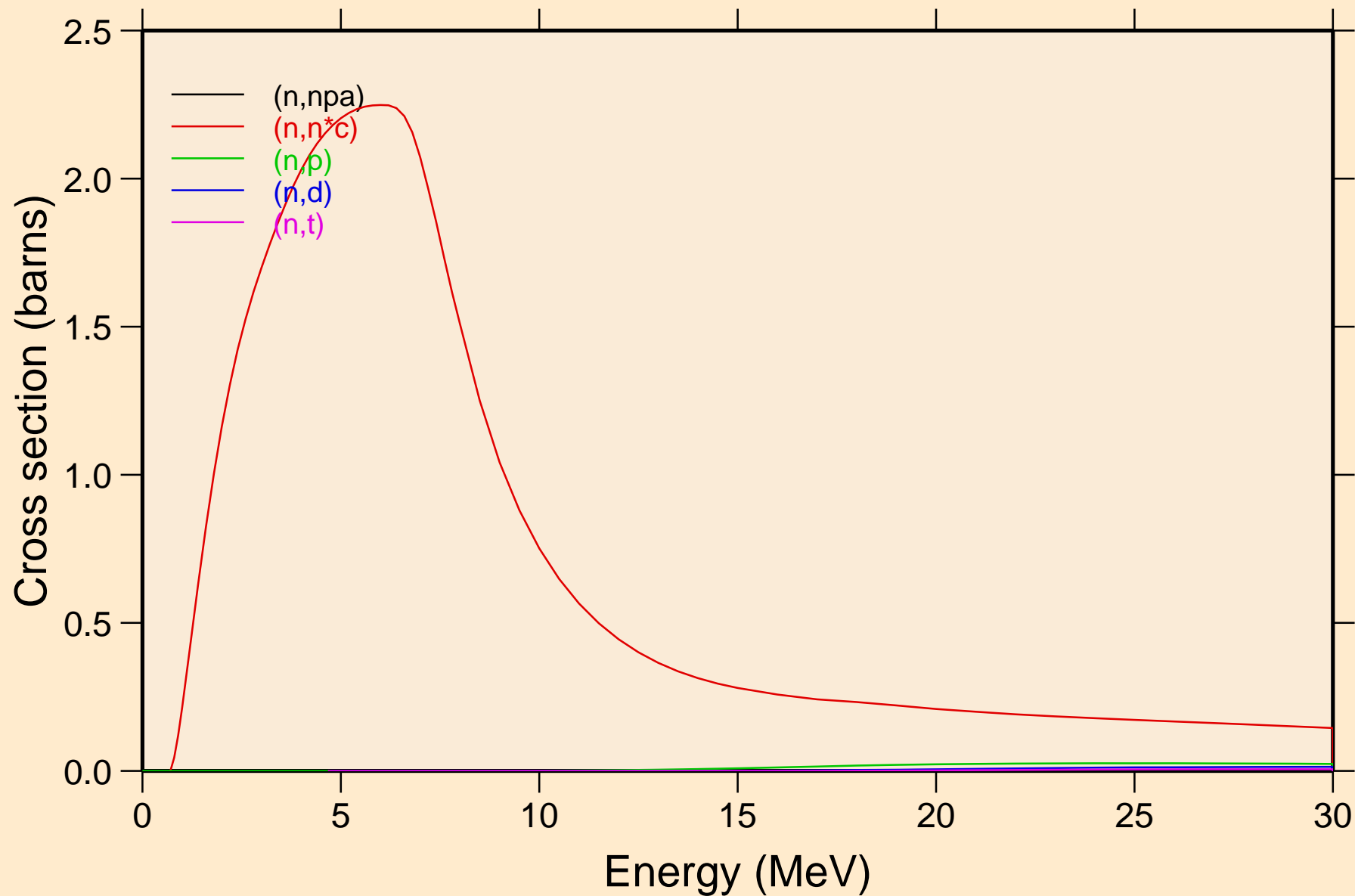

PT193 NEUTRON ACER TENDL-2019 LIBRARY; T=293.16K
Threshold reactions

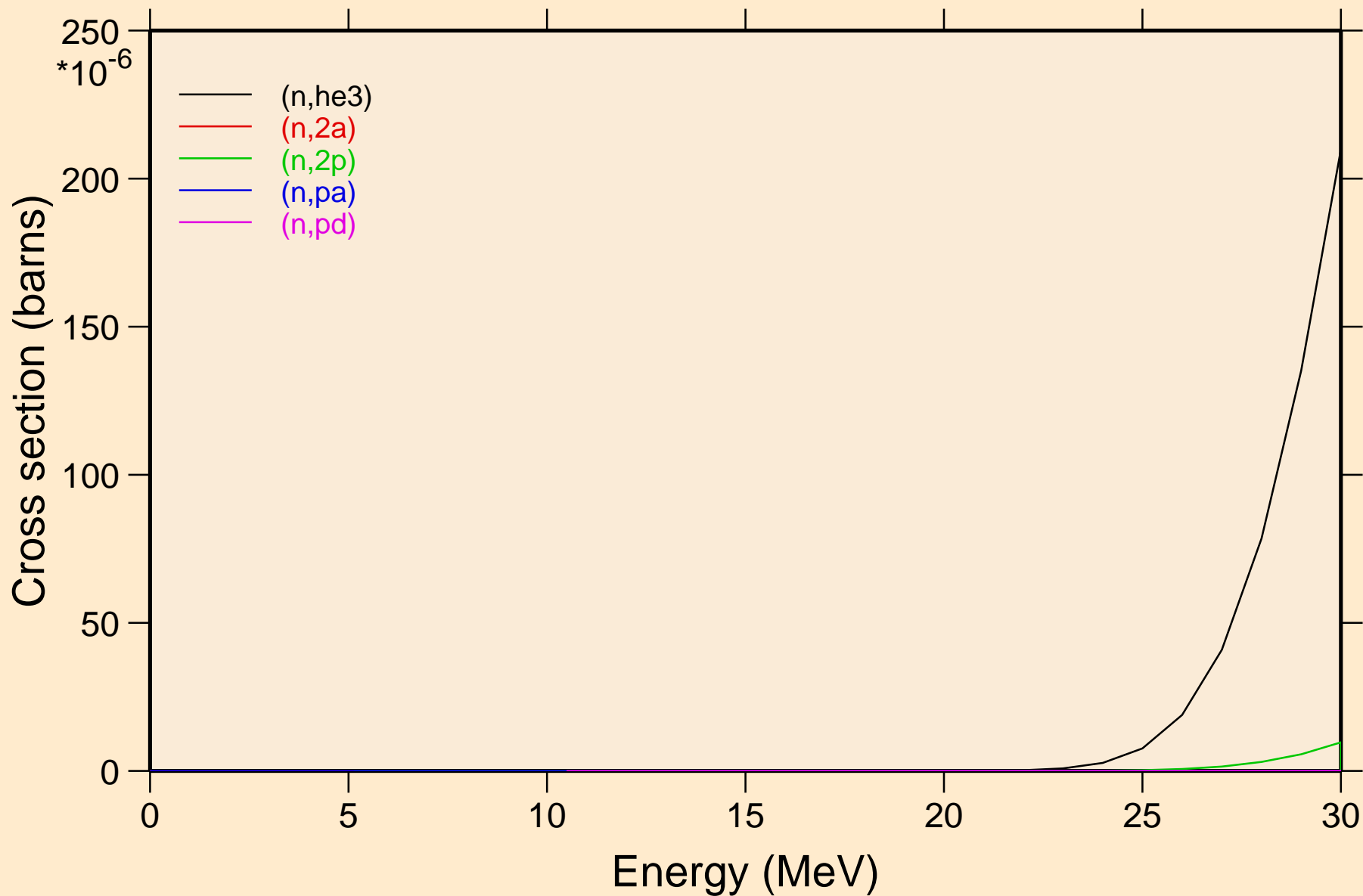

PT193 NEUTRON ACER TENDL-2019 LIBRARY; T=293.16K
Threshold reactions

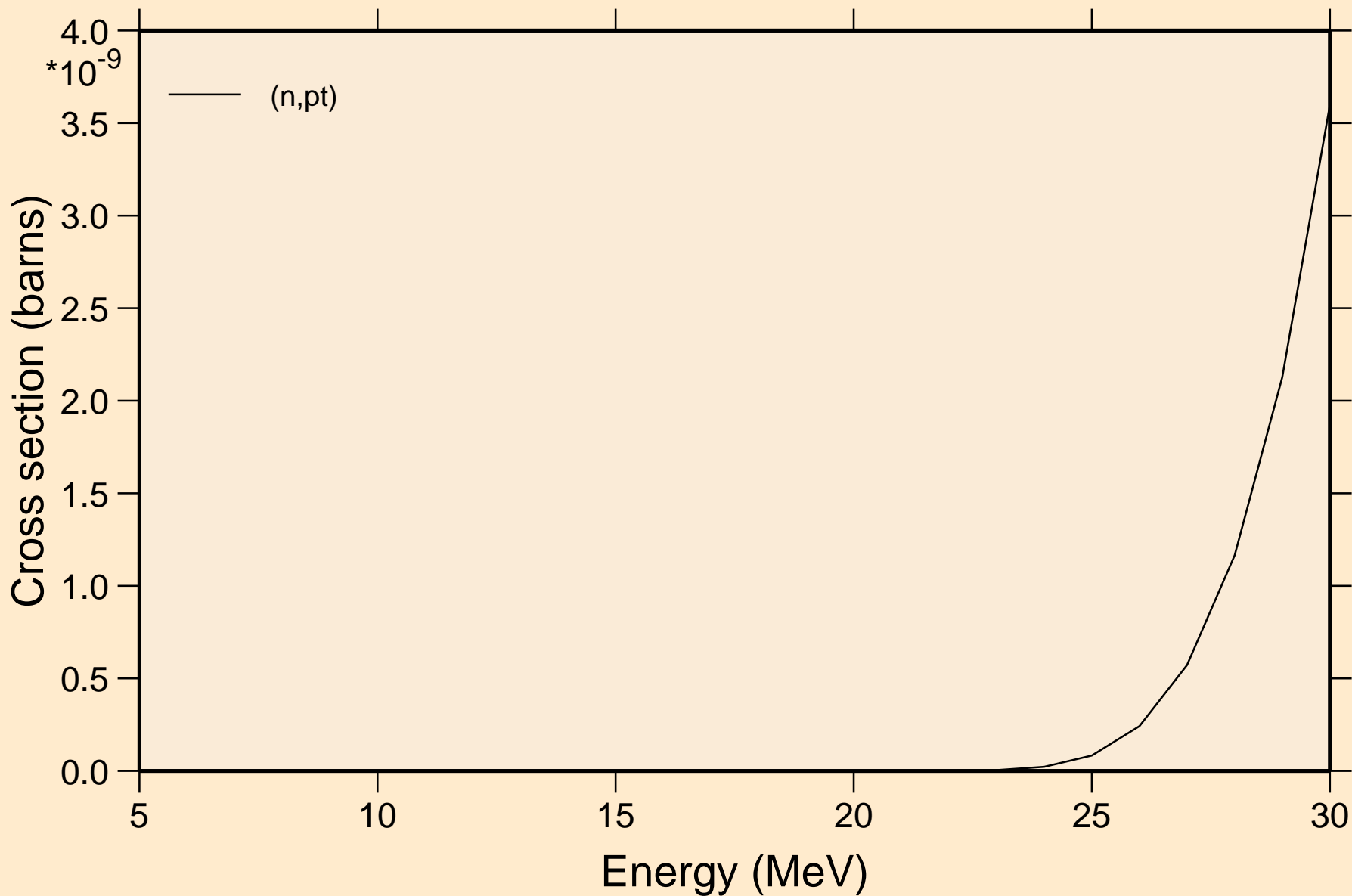

PT193 NEUTRON ACER TENDL-2019 LIBRARY; T=293.16K
Threshold reactions

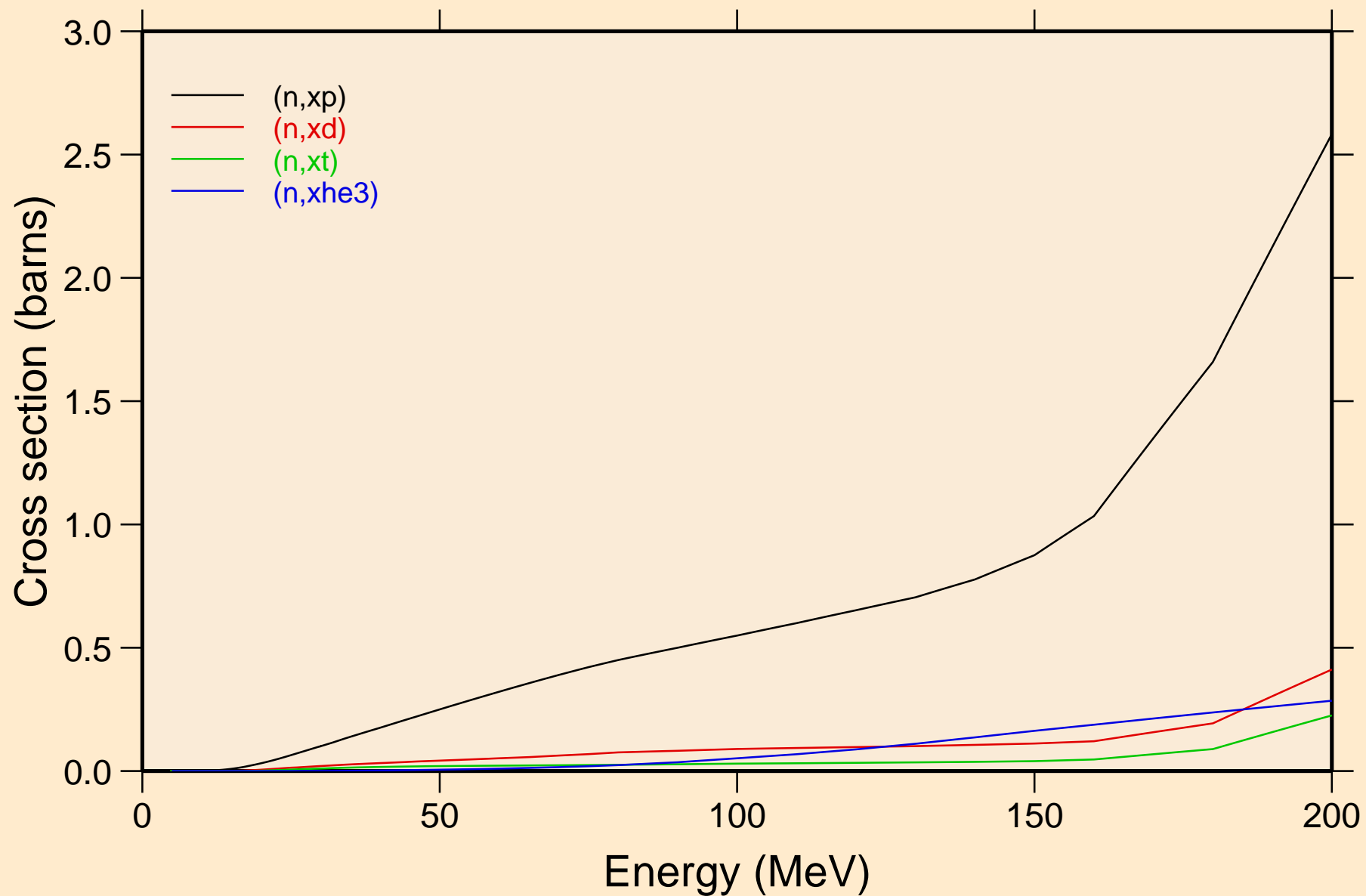

PT193 NEUTRON ACER TENDL-2019 LIBRARY; T=293.16K
angular distribution for elastic

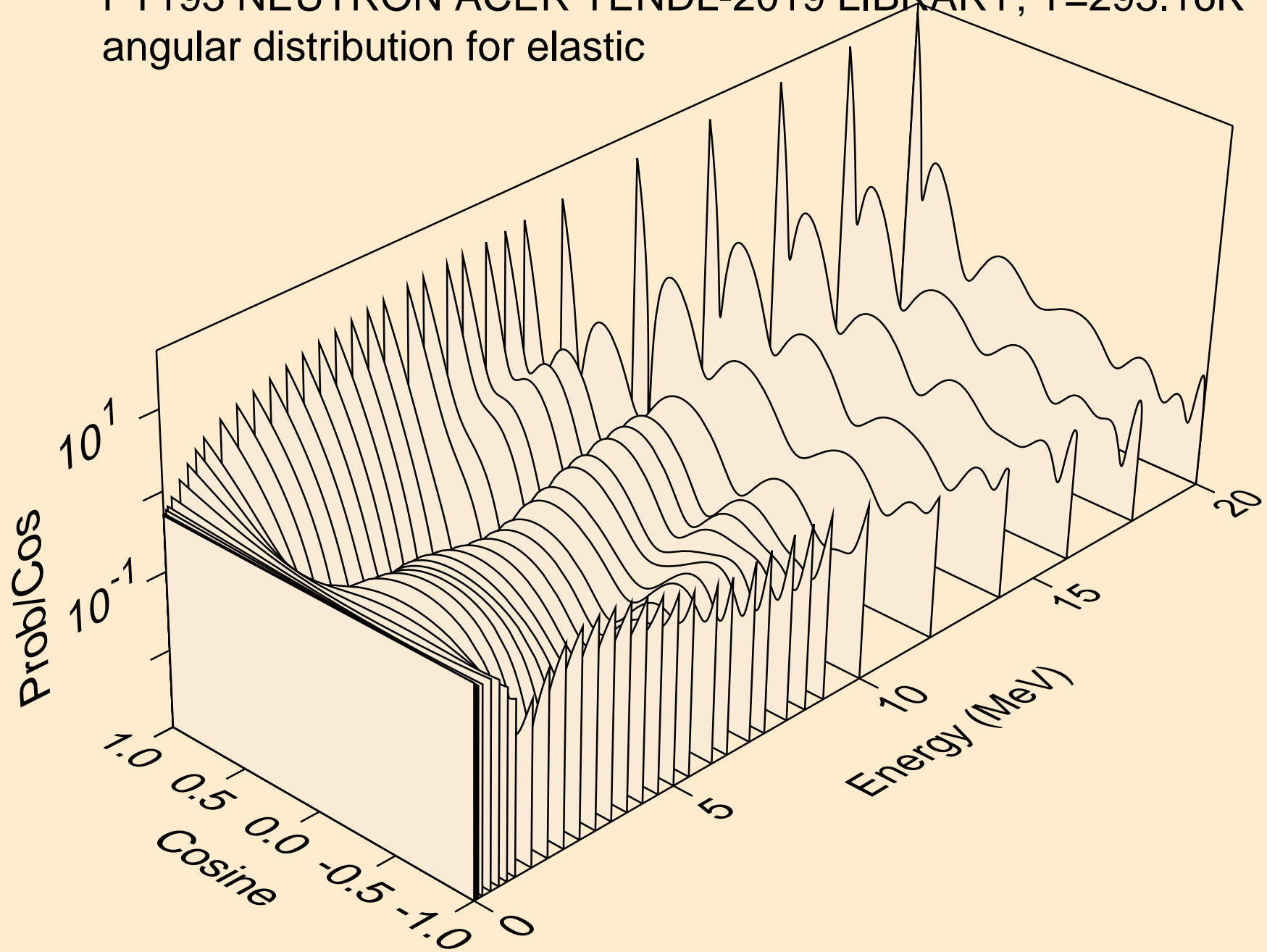

PT193 NEUTRON ACER TENDL-2019 LIBRARY; T=293.16K
angular distribution for elastic

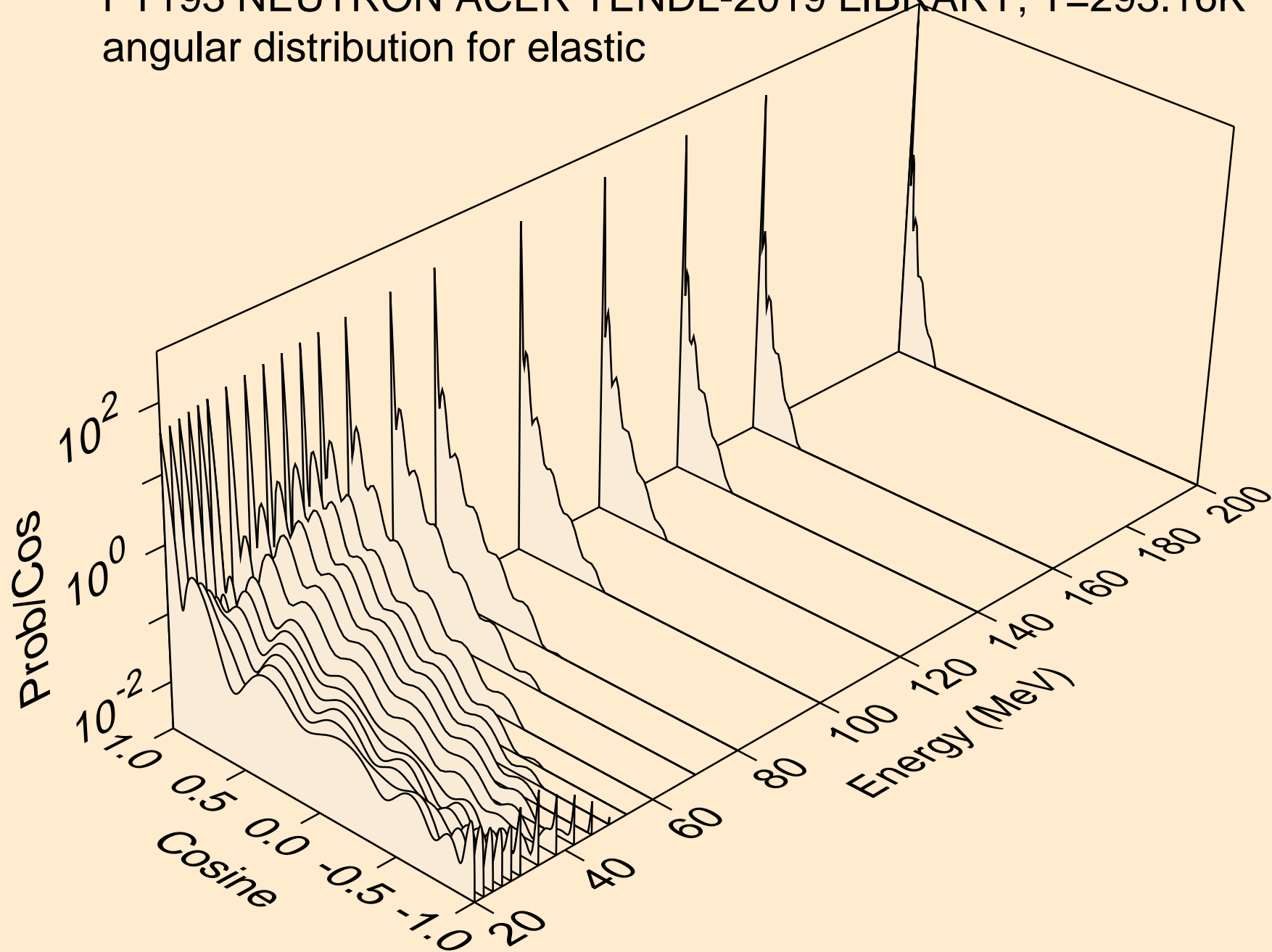

PT193 NEUTRON ACER TENDL-2019 LIBRARY; T=293.16K
angular distribution for (n,n*1)

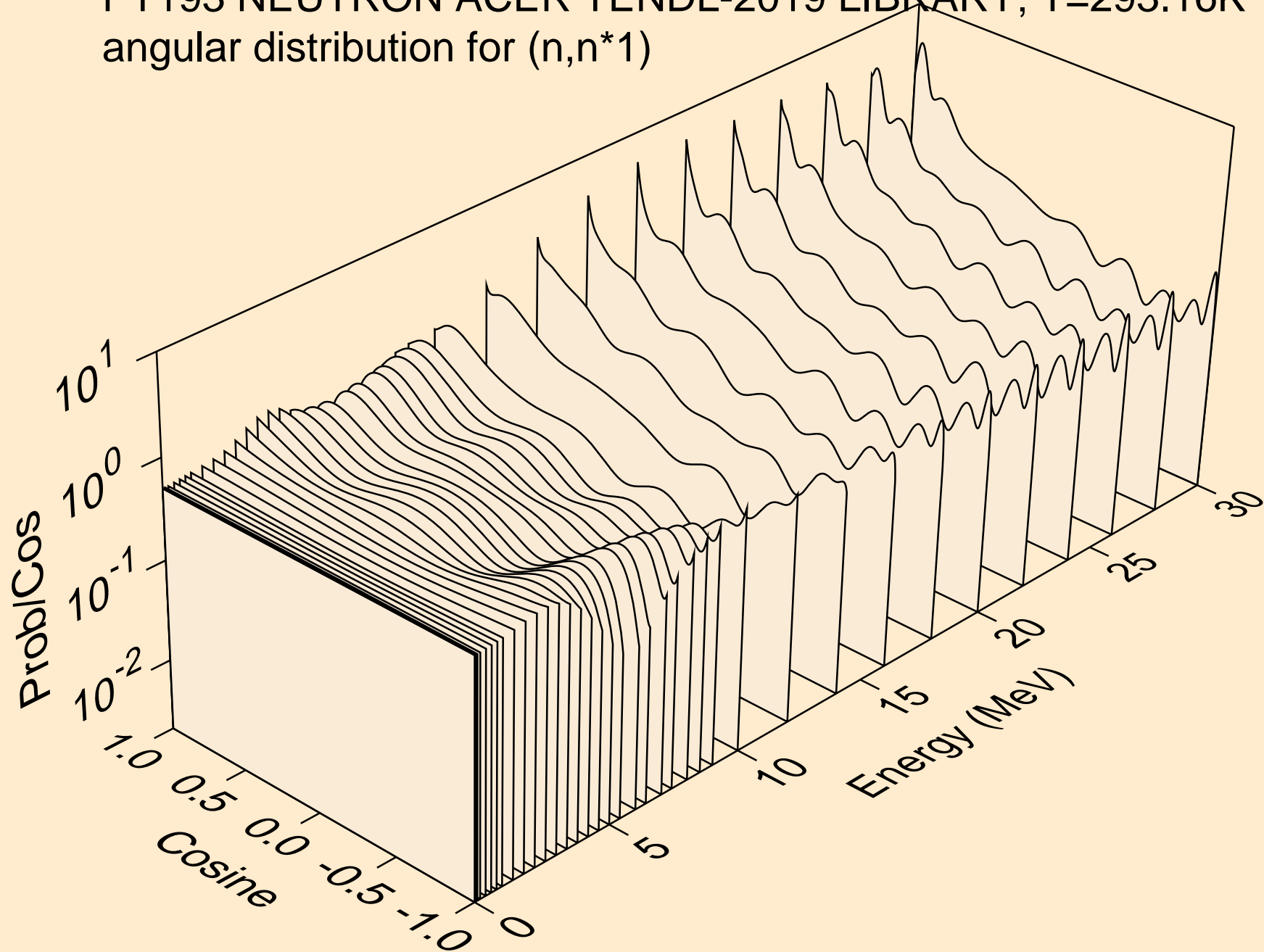

PT193 NEUTRON ACER TENDL-2019 LIBRARY; T=293.16K
angular distribution for (n,n*2)

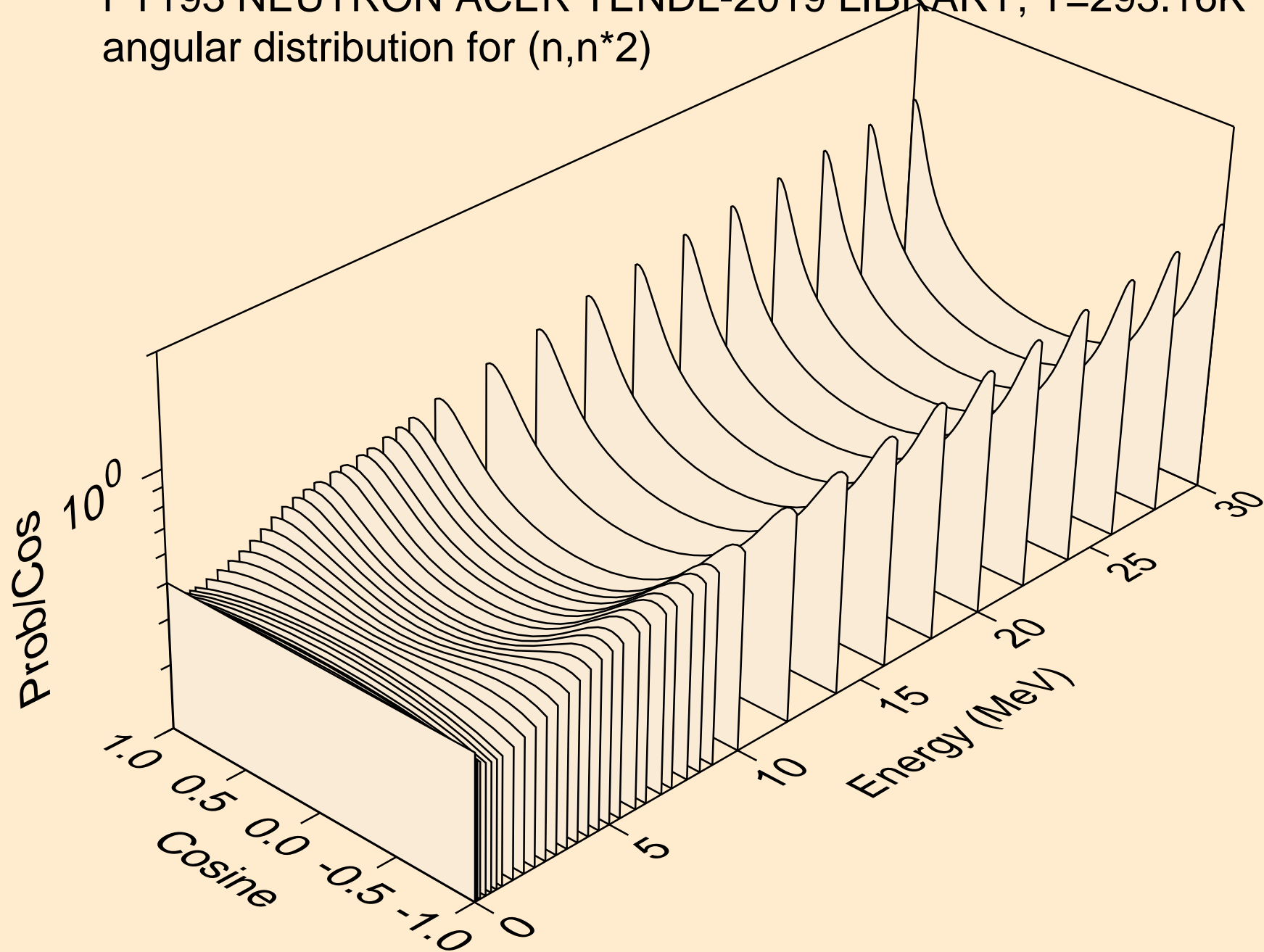

PT193 NEUTRON ACER TENDL-2019 LIBRARY; T=293.16K
angular distribution for (n,n*3)

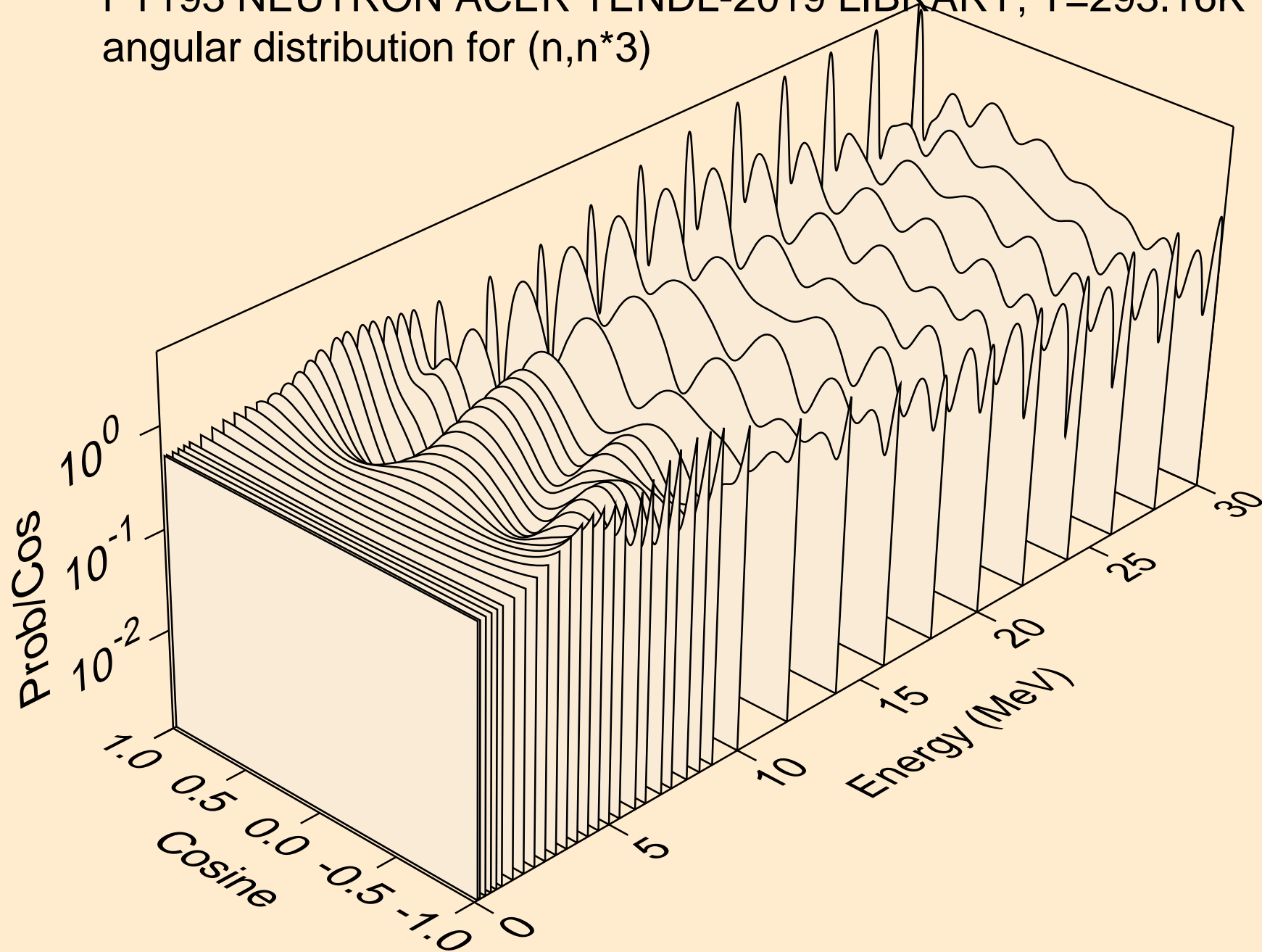

PT193 NEUTRON ACER TENDL-2019 LIBRARY; T=293.16K
angular distribution for (n,n*4)

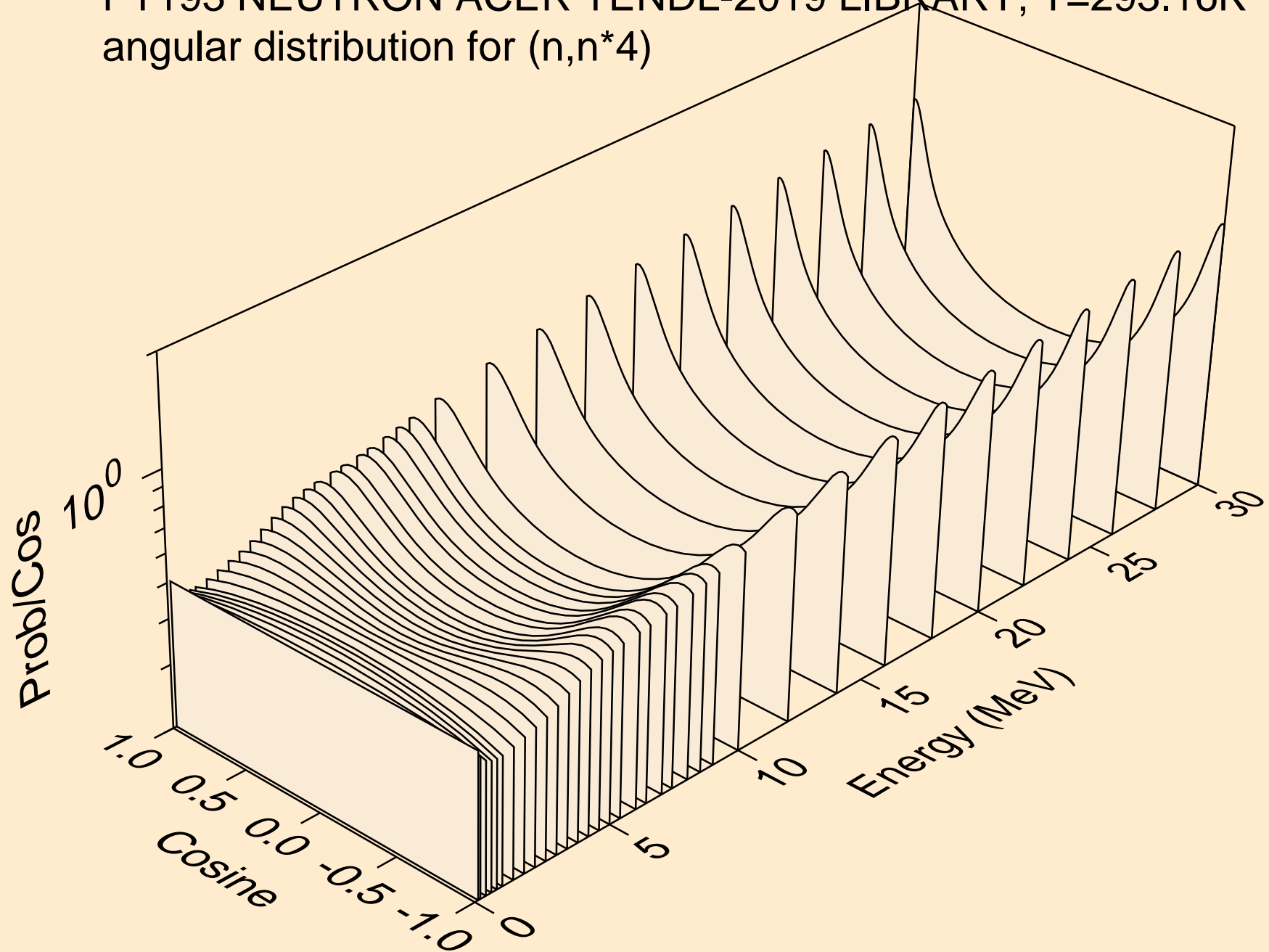

PT193 NEUTRON ACER TENDL-2019 LIBRARY; T=293.16K
angular distribution for (n,n*5)

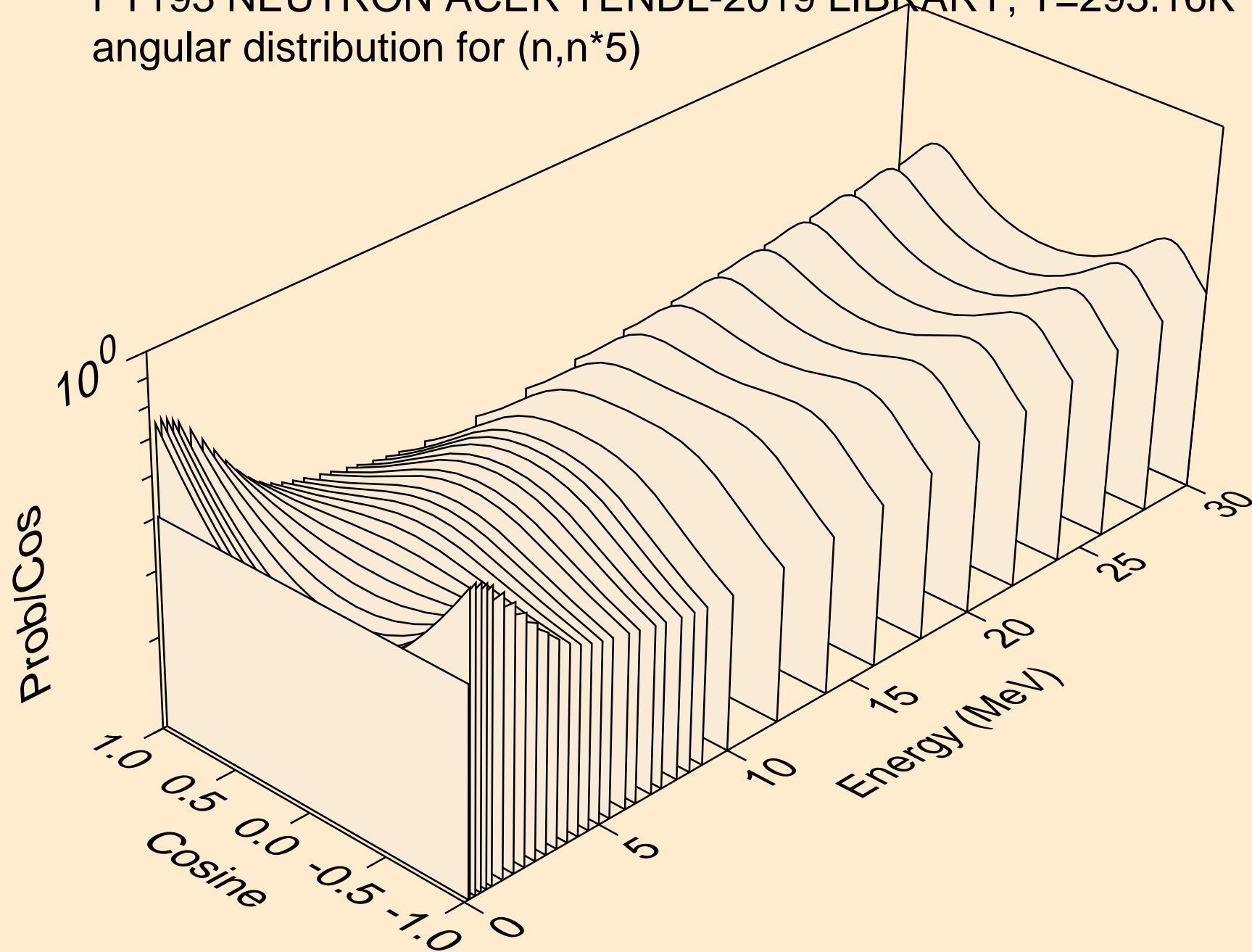

PT193 NEUTRON ACER TENDL-2019 LIBRARY; T=293.16K
angular distribution for (n,n*6)

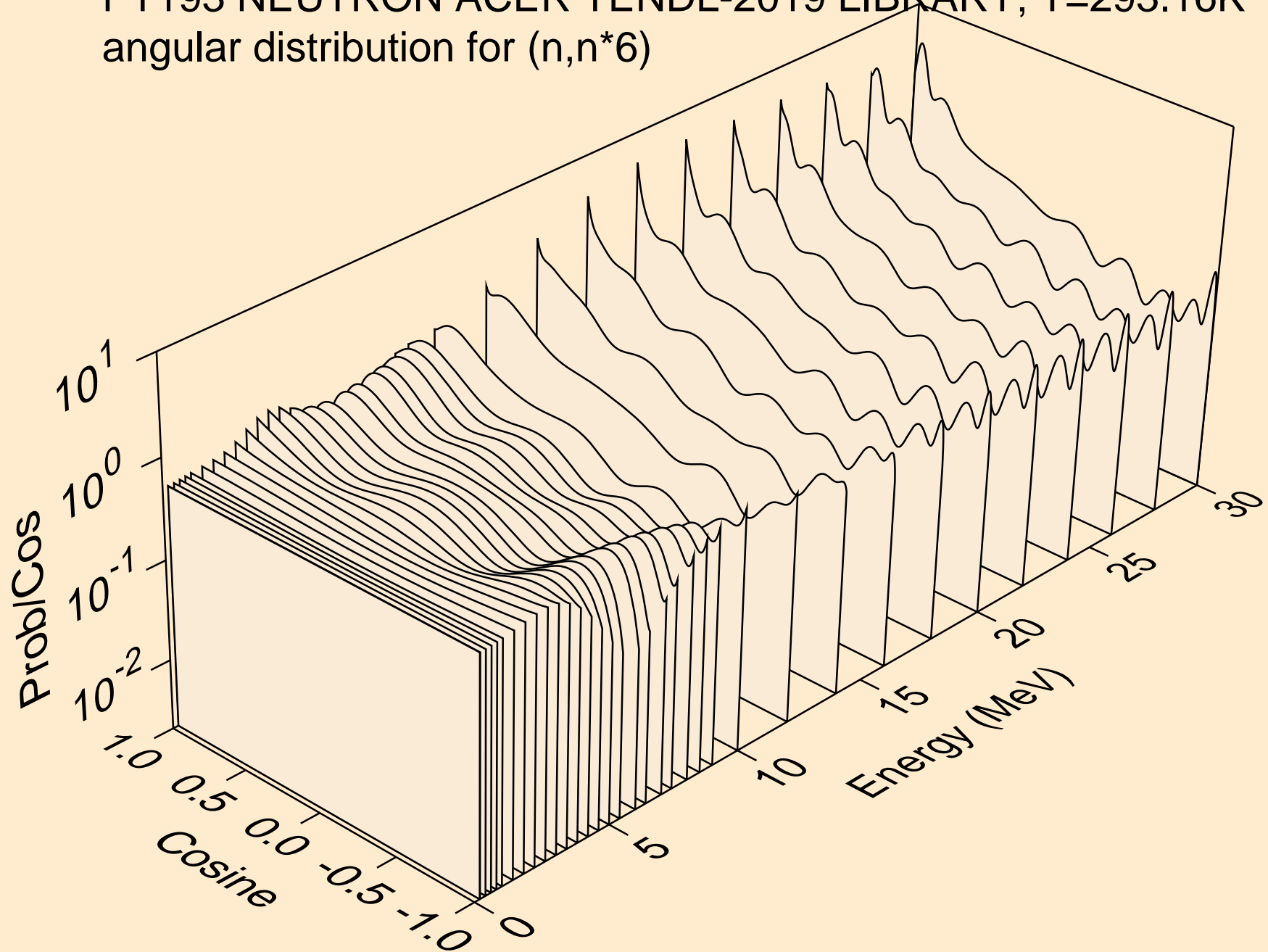

PT193 NEUTRON ACER TENDL-2019 LIBRARY; T=293.16K
angular distribution for (n,n*7)

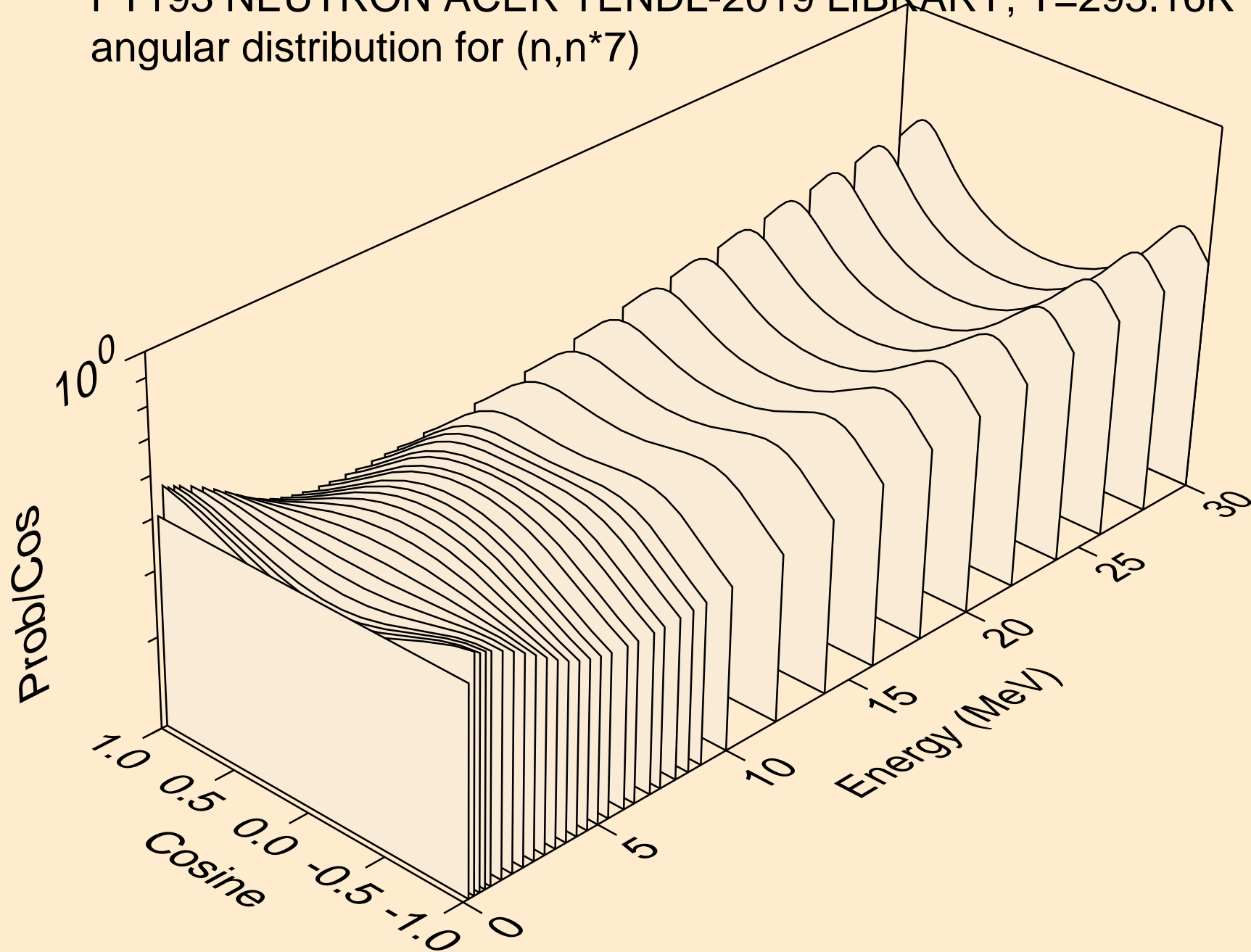

PT193 NEUTRON ACER TENDL-2019 LIBRARY; T=293.16K
angular distribution for (n,n*8)

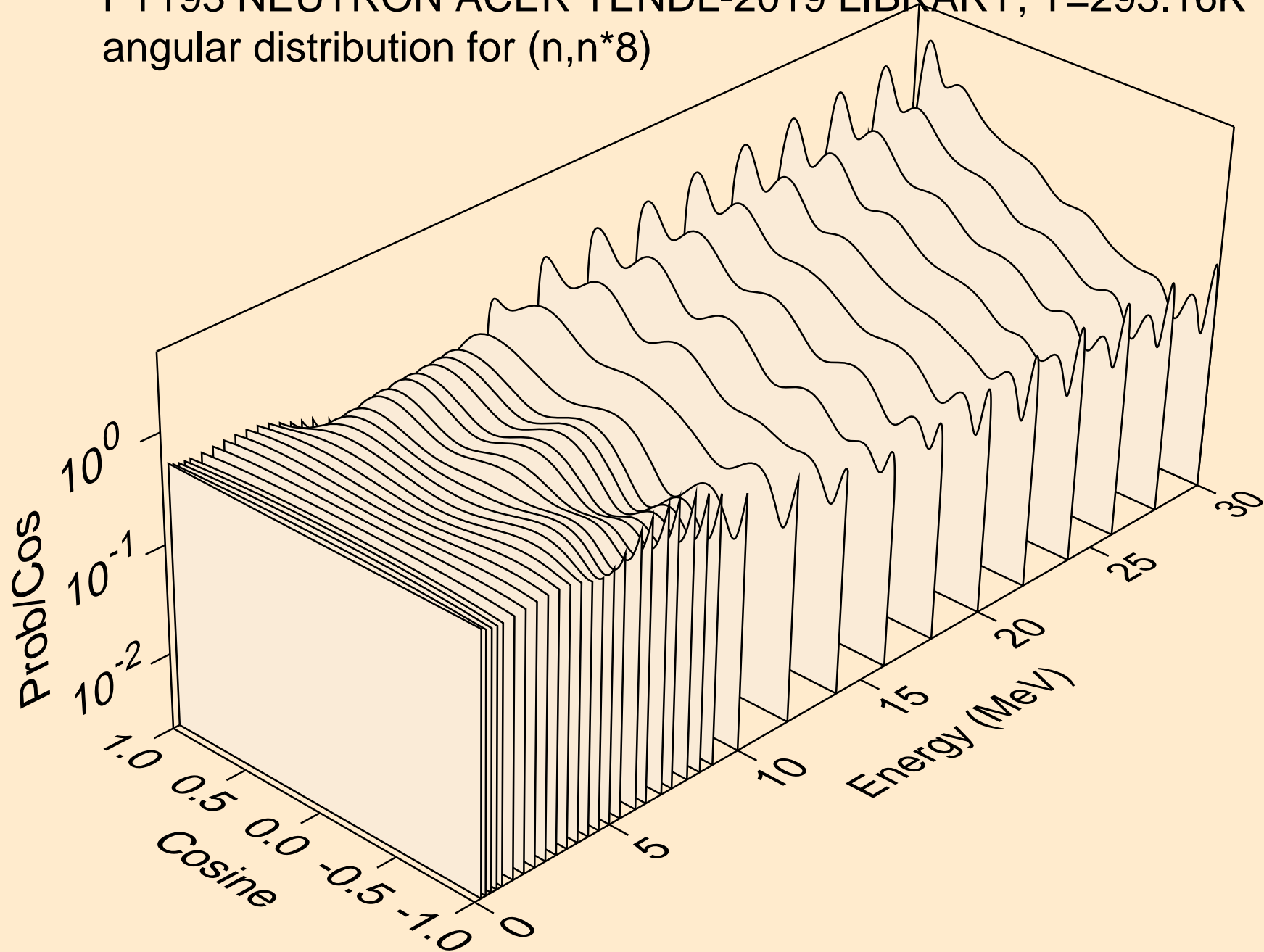

PT193 NEUTRON ACER TENDL-2019 LIBRARY; T=293.16K
angular distribution for (n,n*9)

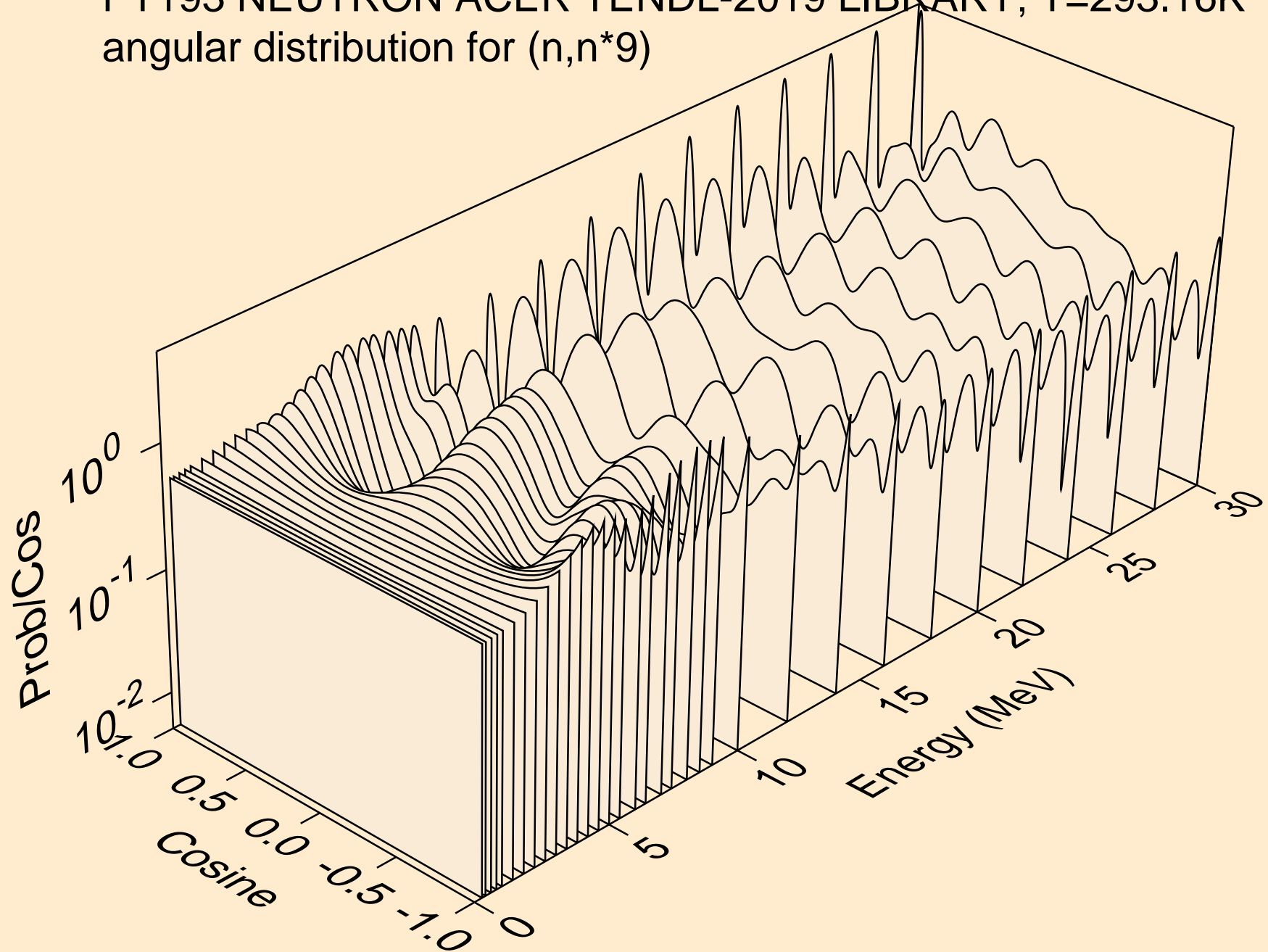

PT193 NEUTRON ACER TENDL-2019 LIBRARY; T=293.16K
angular distribution for (n,n*10)

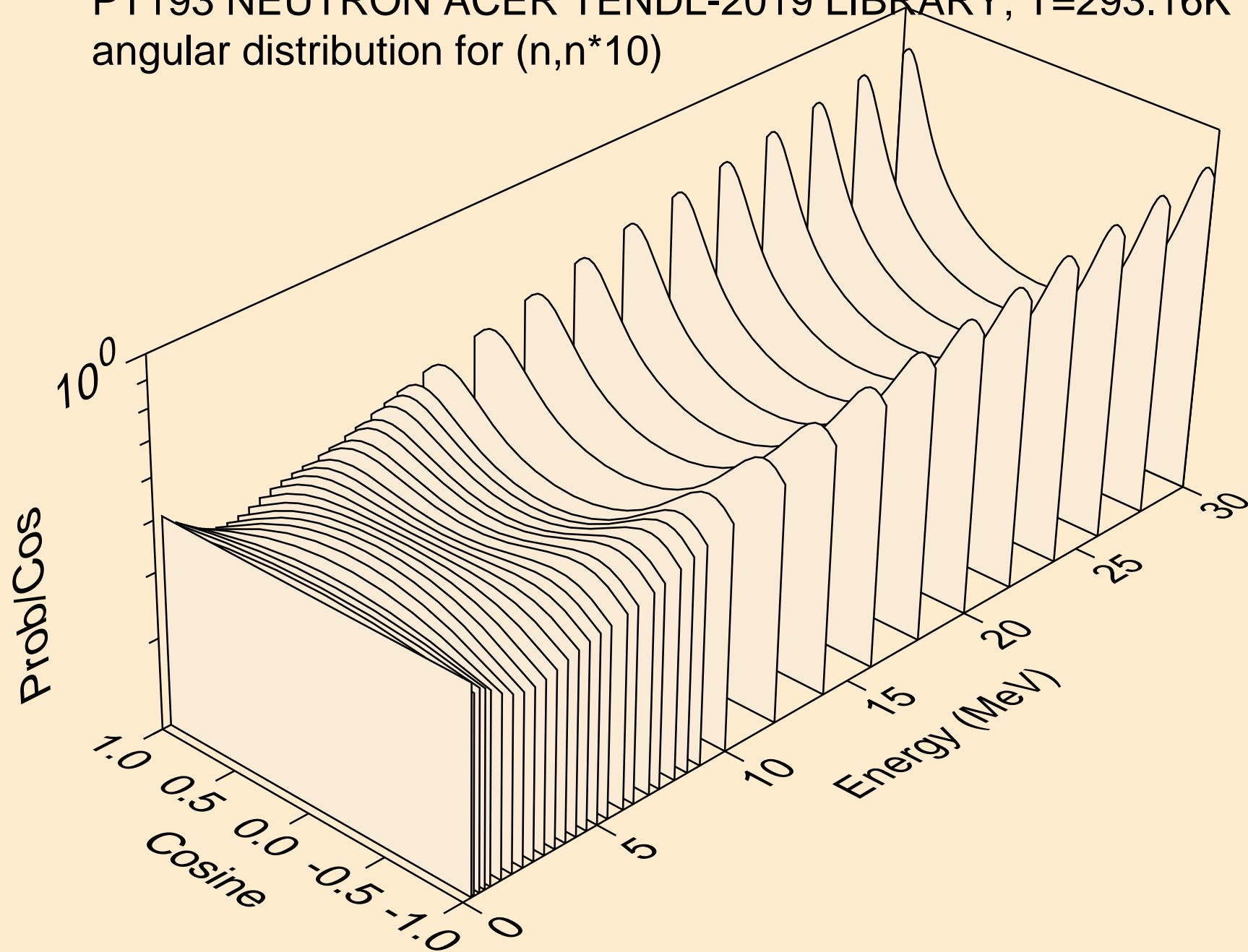

PT193 NEUTRON ACER TENDL-2019 LIBRARY; T=293.16K
angular distribution for (n,n*11)

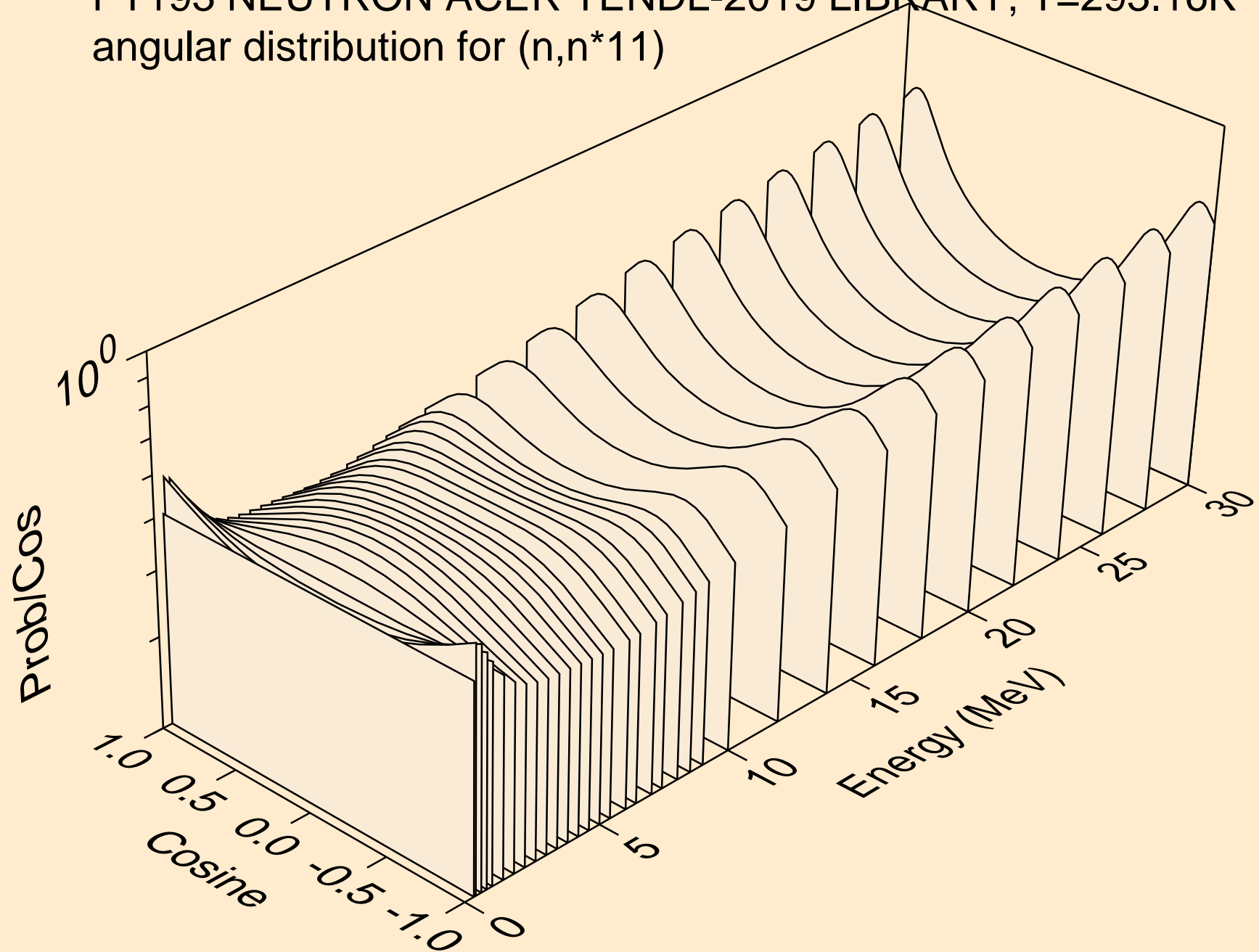

PT193 NEUTRON ACER TENDL-2019 LIBRARY; T=293.16K
angular distribution for (n,n*12)

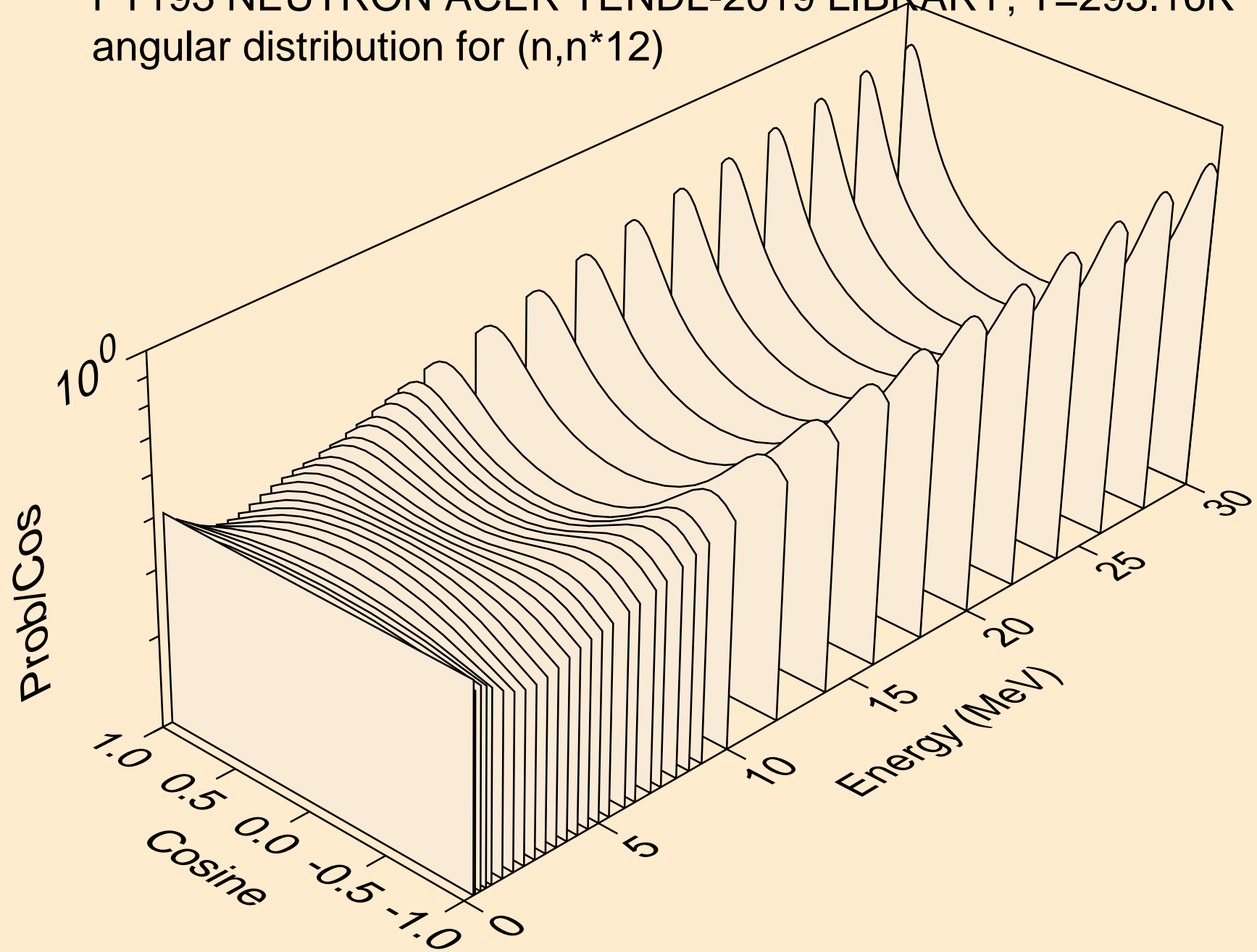

PT193 NEUTRON ACER TENDL-2019 LIBRARY; T=293.16K
angular distribution for (n,n*13)

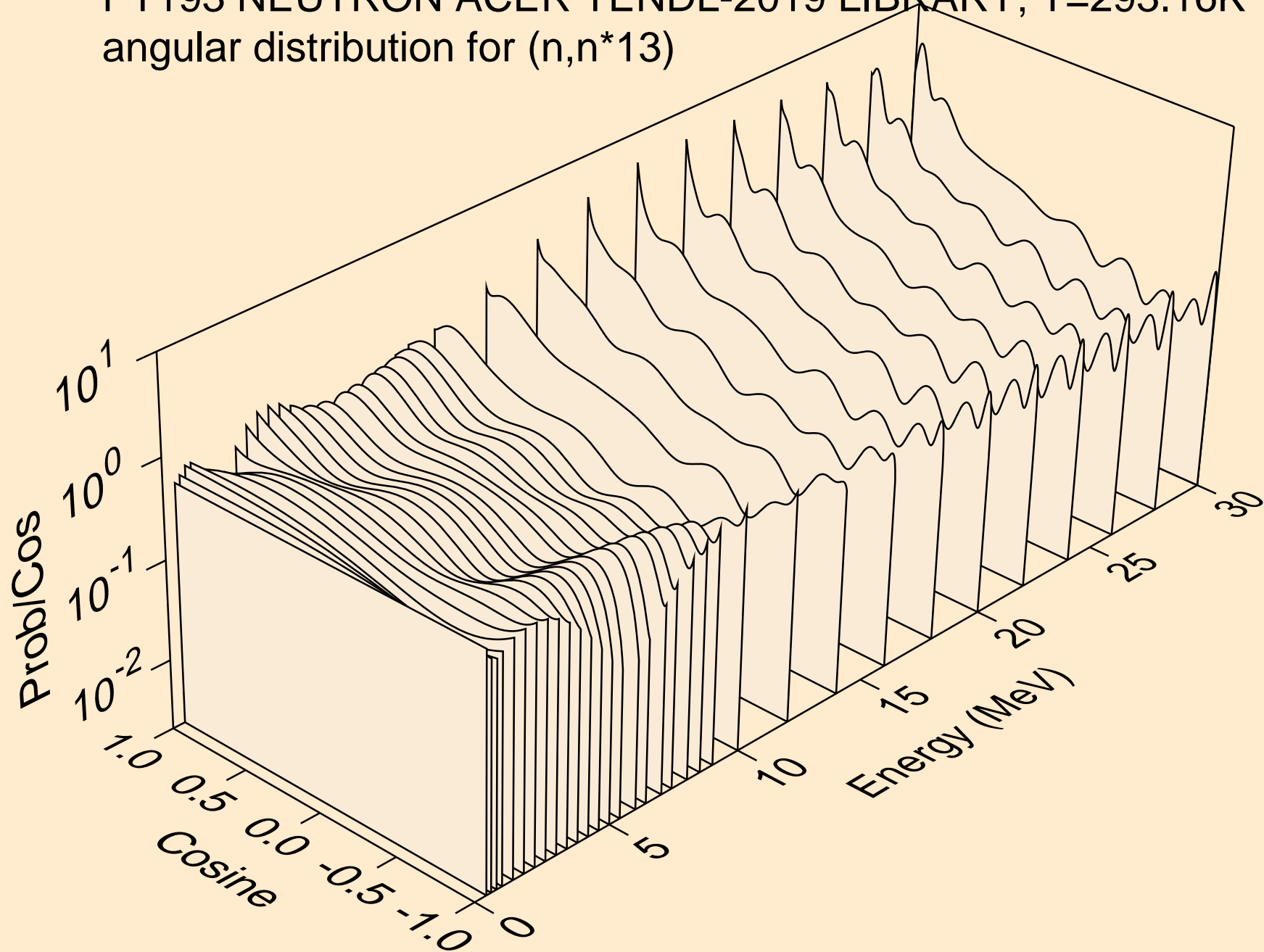

PT193 NEUTRON ACER TENDL-2019 LIBRARY; T=293.16K
angular distribution for (n,n*14)

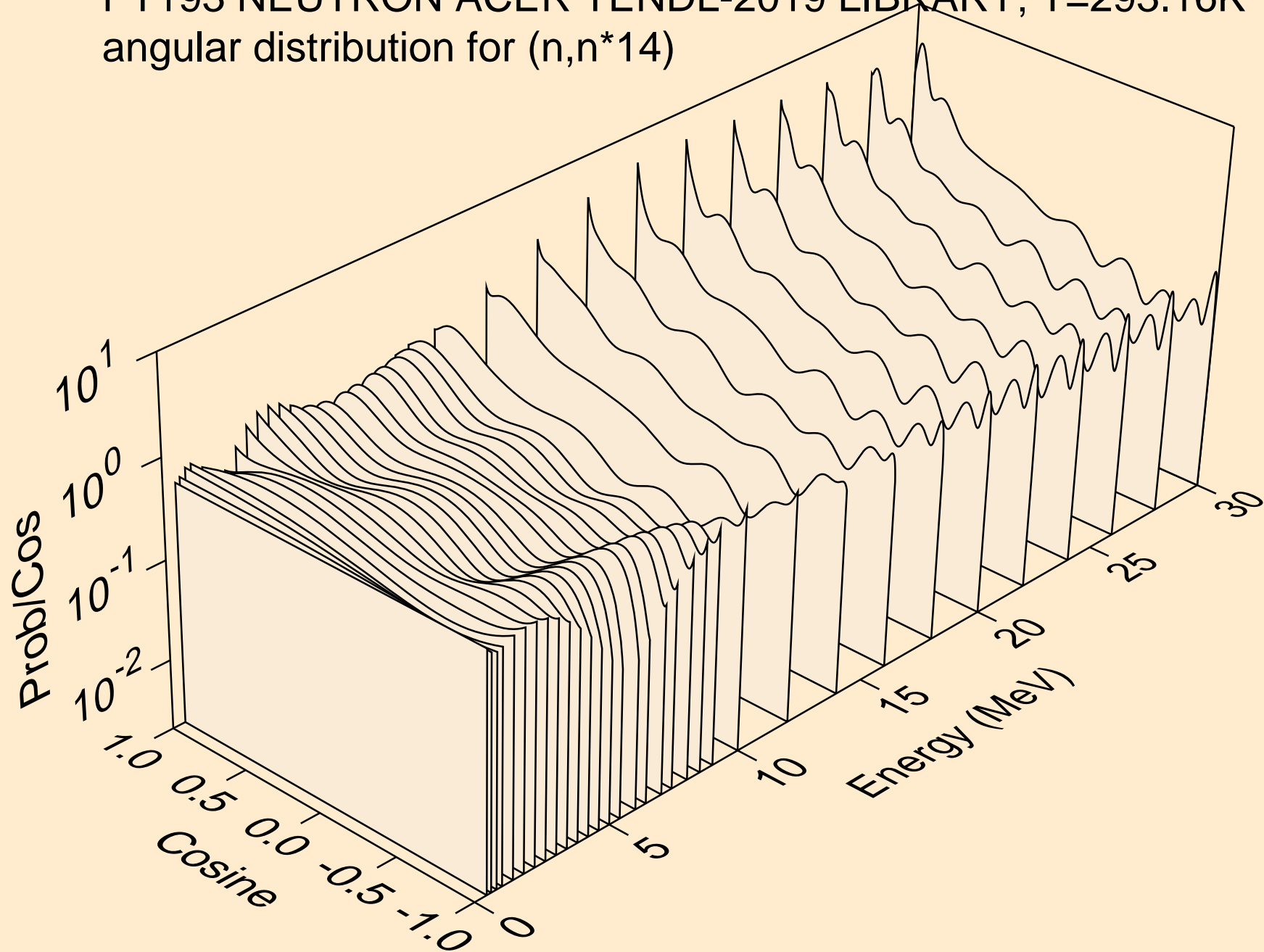

PT193 NEUTRON ACER TENDL-2019 LIBRARY; T=293.16K
angular distribution for (n,n*15)

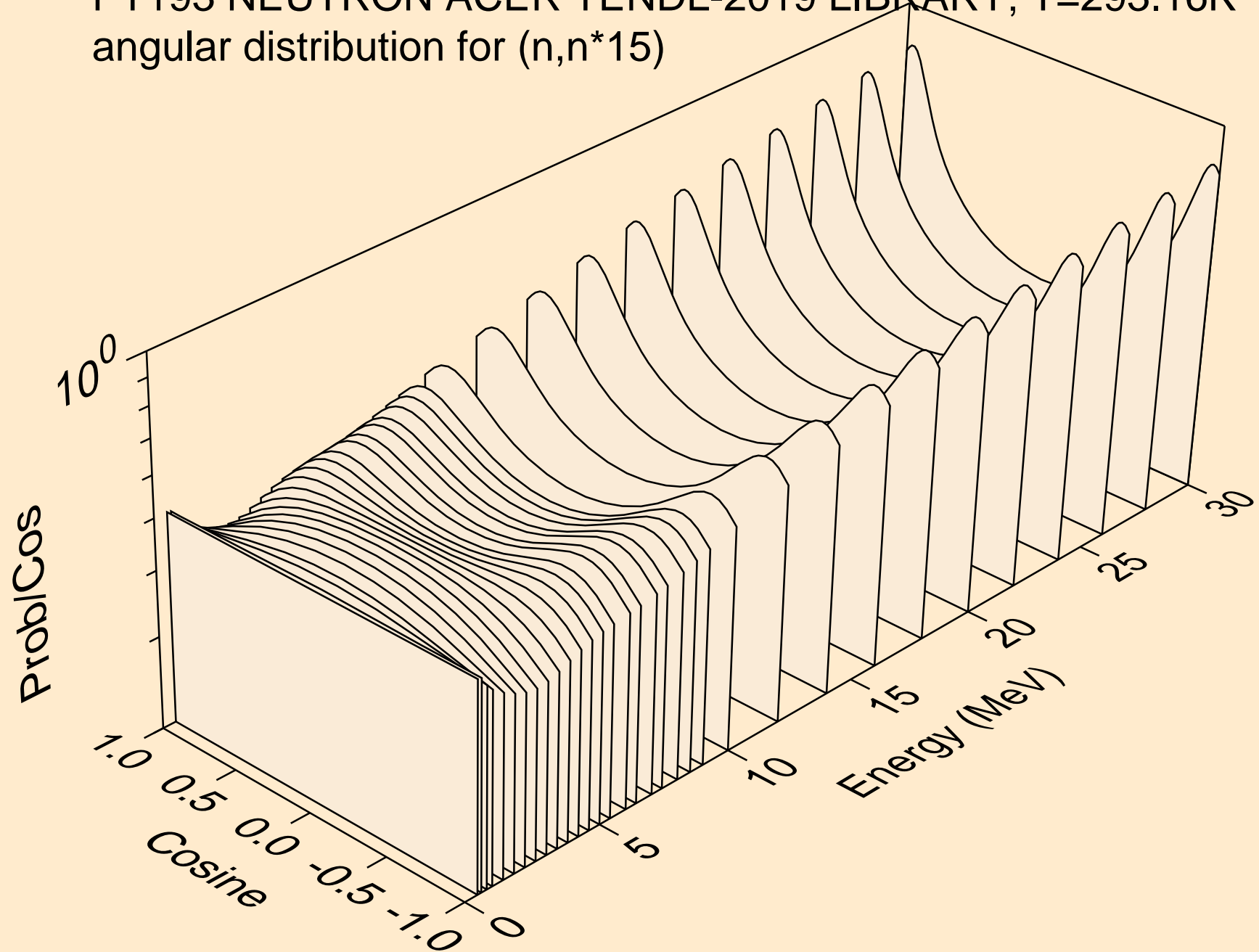

PT193 NEUTRON ACER TENDL-2019 LIBRARY; T=293.16K
angular distribution for (n,n*16)

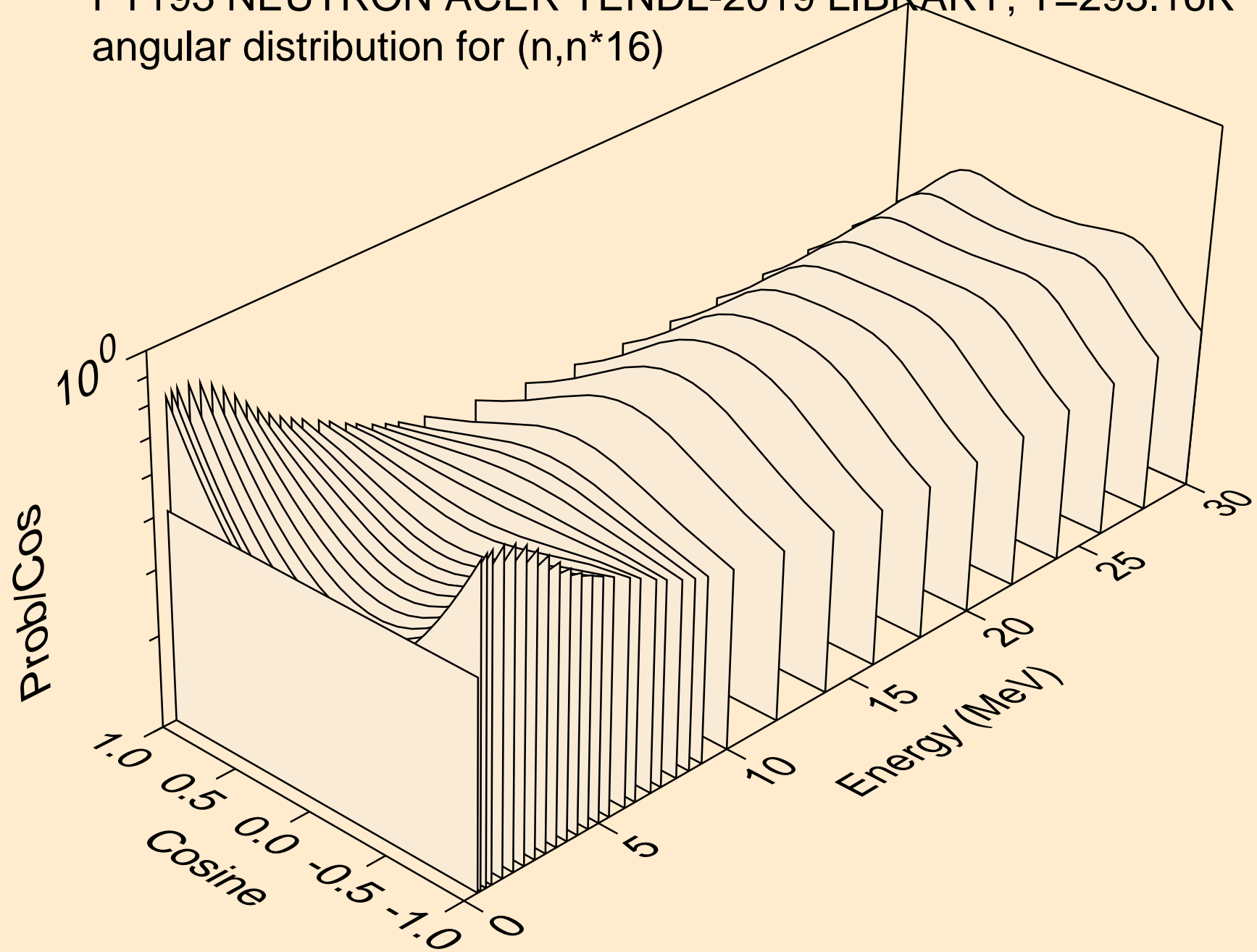

PT193 NEUTRON ACER TENDL-2019 LIBRARY; T=293.16K
angular distribution for (n,n*17)

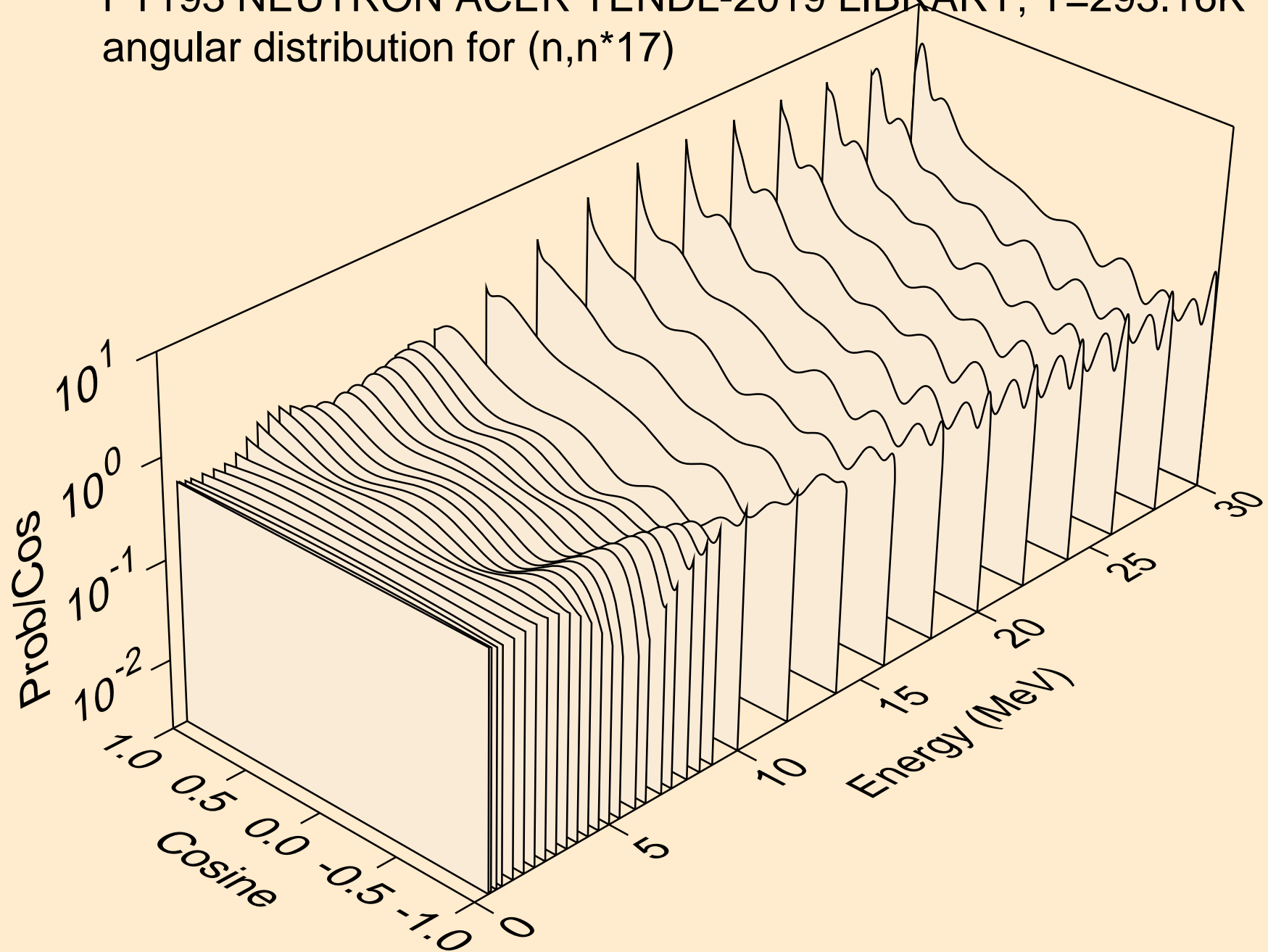

PT193 NEUTRON ACER TENDL-2019 LIBRARY; T=293.16K
angular distribution for (n,n*18)

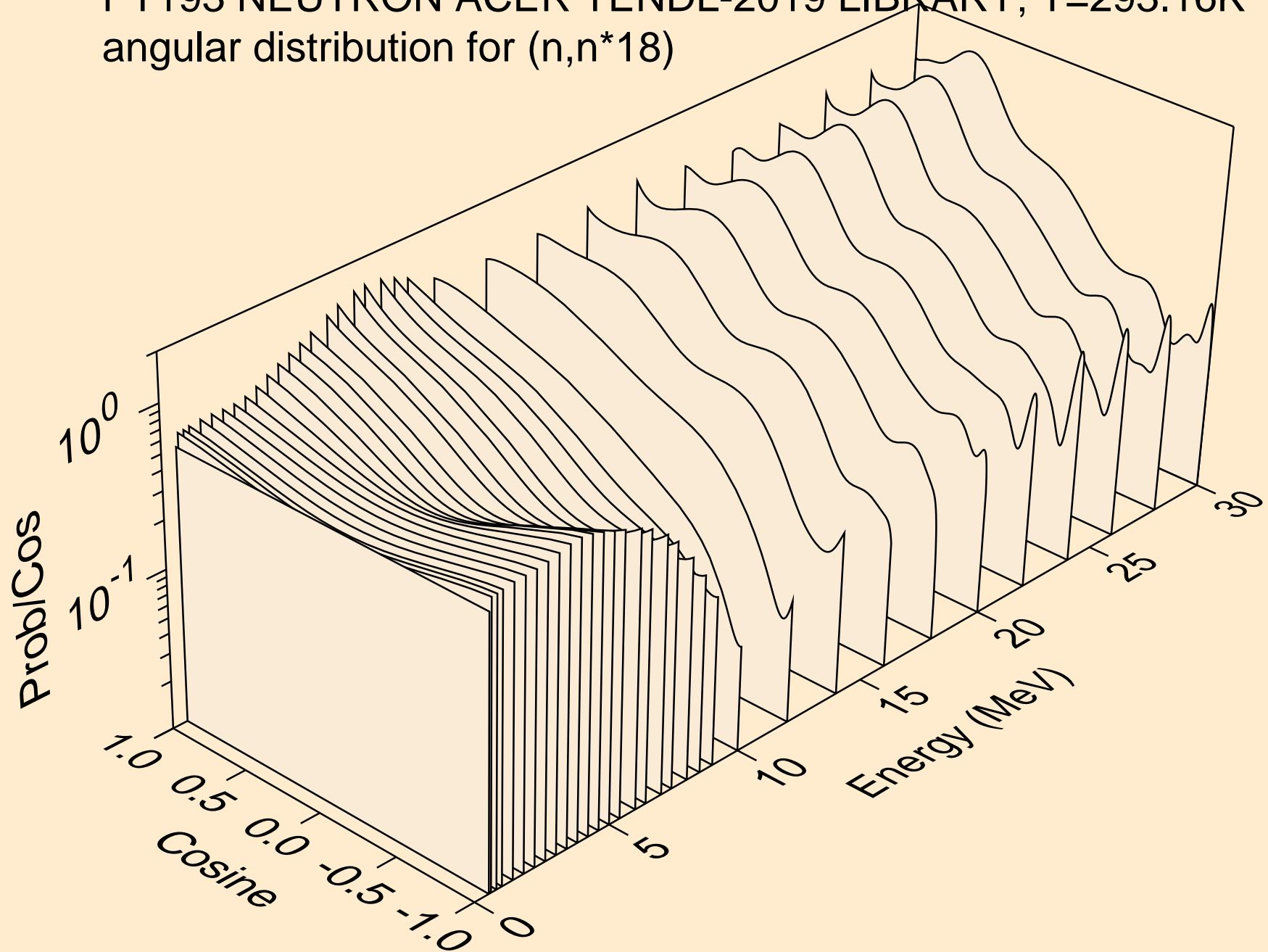

PT193 NEUTRON ACER TENDL-2019 LIBRARY; T=293.16K
angular distribution for (n,n*19)

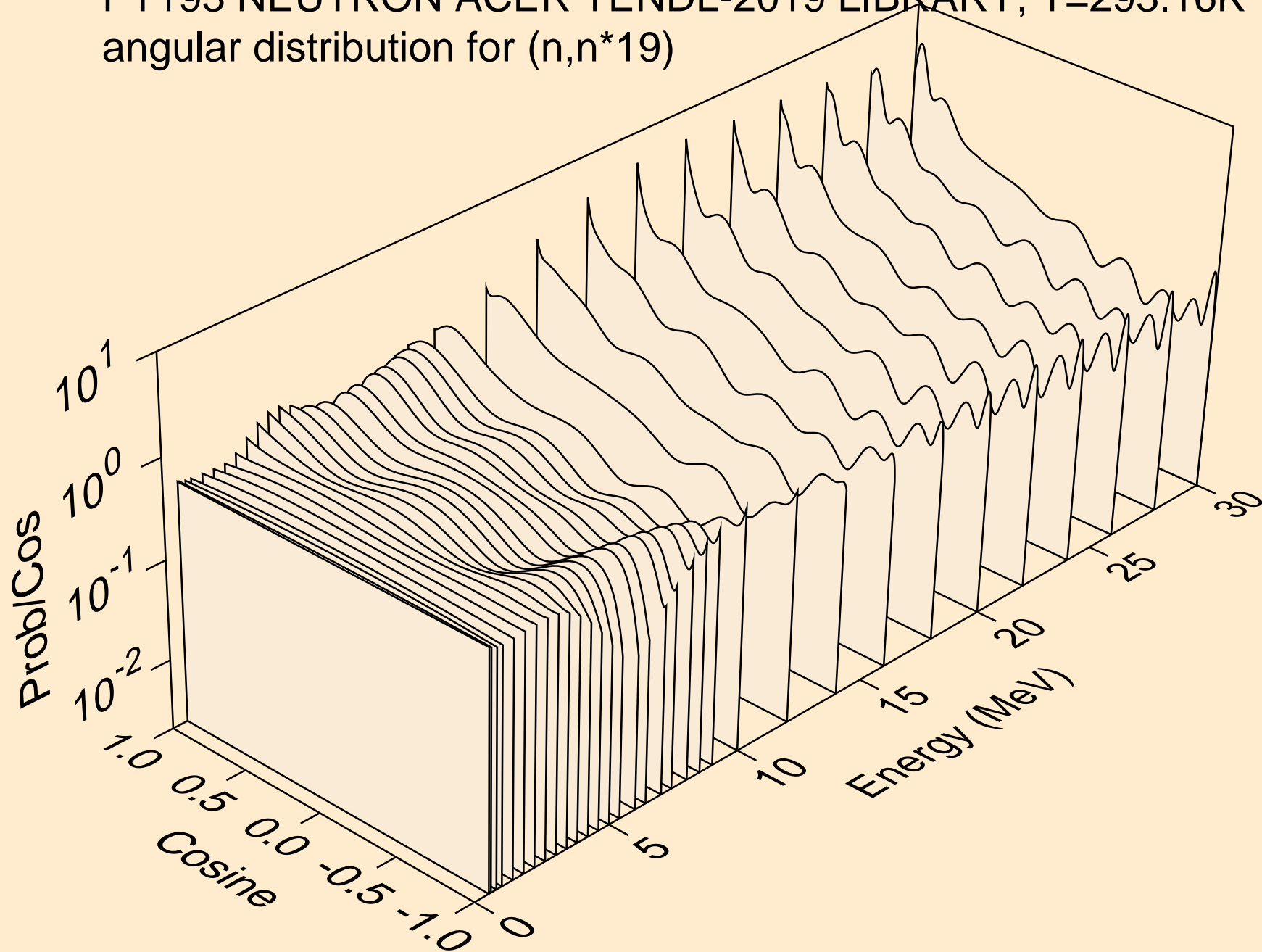

PT193 NEUTRON ACER TENDL-2019 LIBRARY; T=293.16K
angular distribution for (n,n*20)

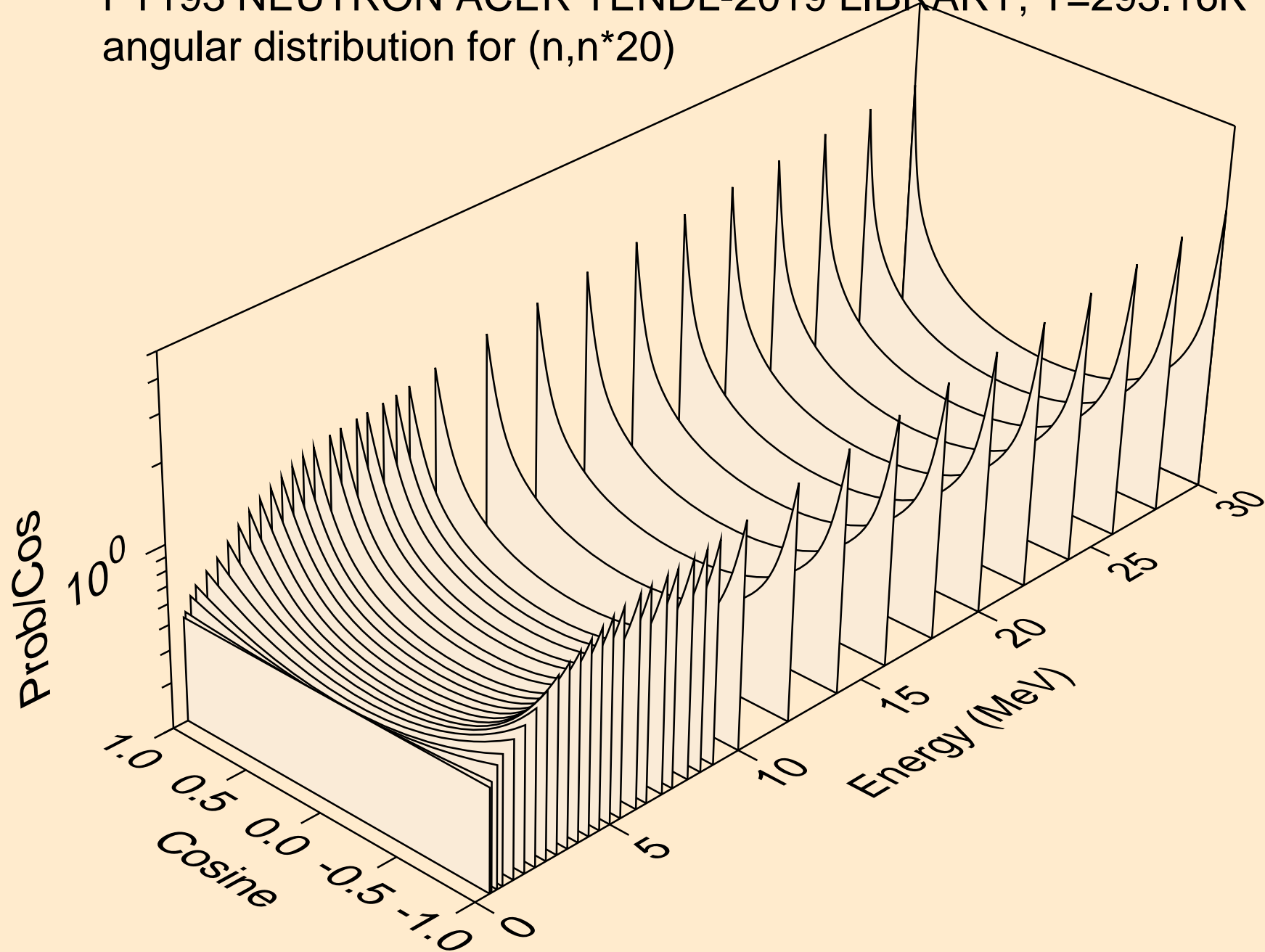

PT193 NEUTRON ACER TENDL-2019 LIBRARY; T=293.16K
angular distribution for (n,n*21)

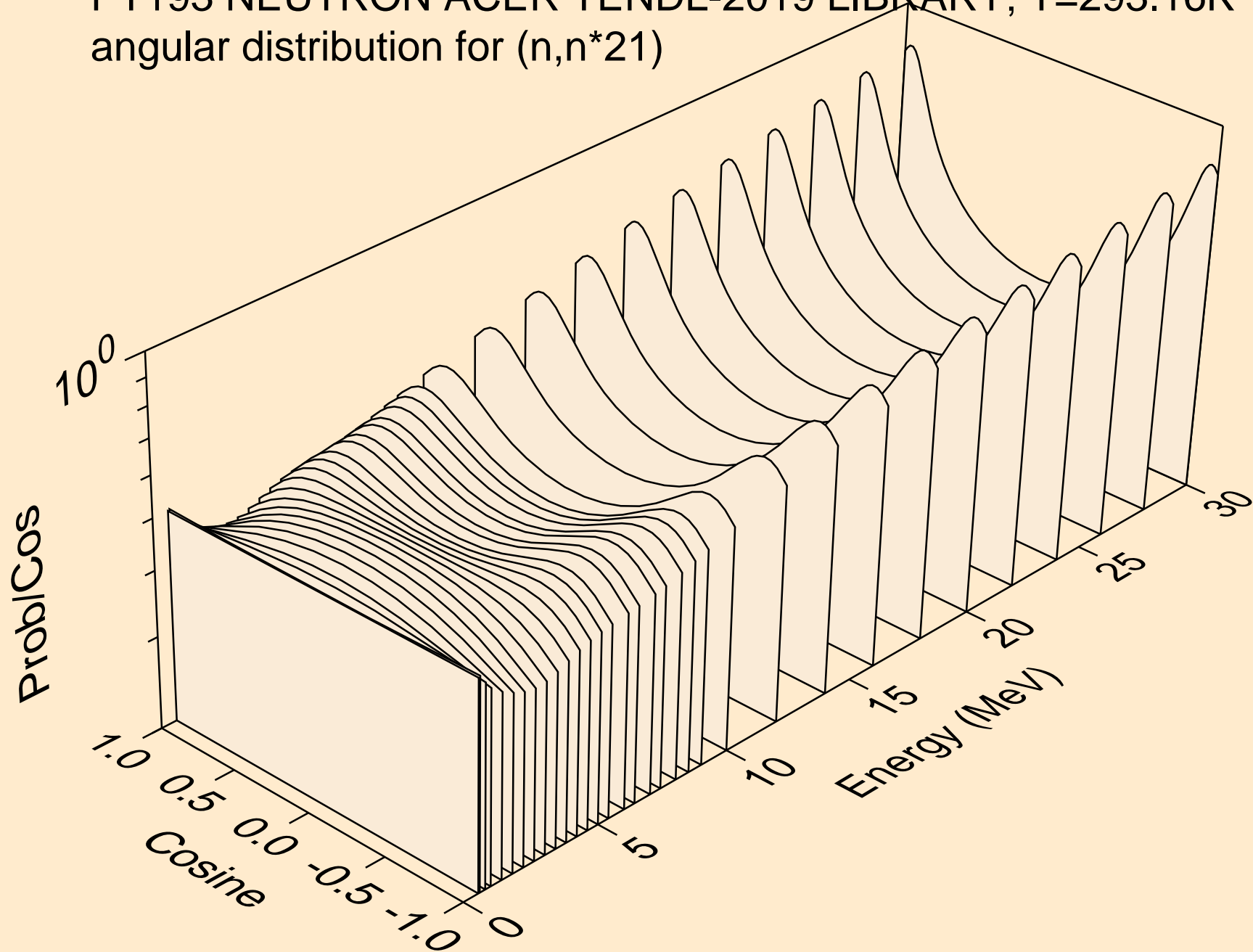

PT193 NEUTRON ACER TENDL-2019 LIBRARY; T=293.16K
angular distribution for (n,n*22)

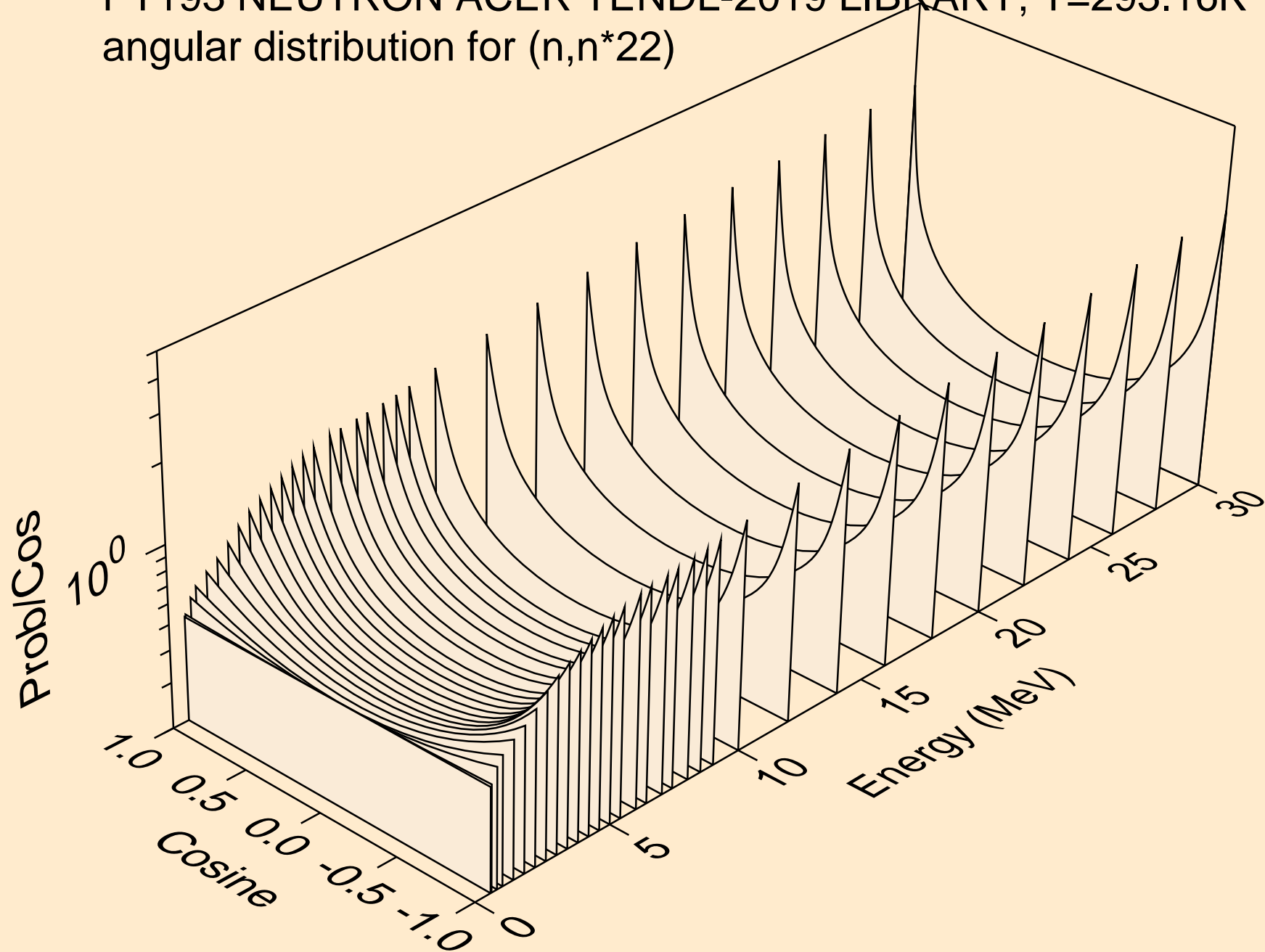

PT193 NEUTRON ACER TENDL-2019 LIBRARY; T=293.16K
angular distribution for (n,n*23)

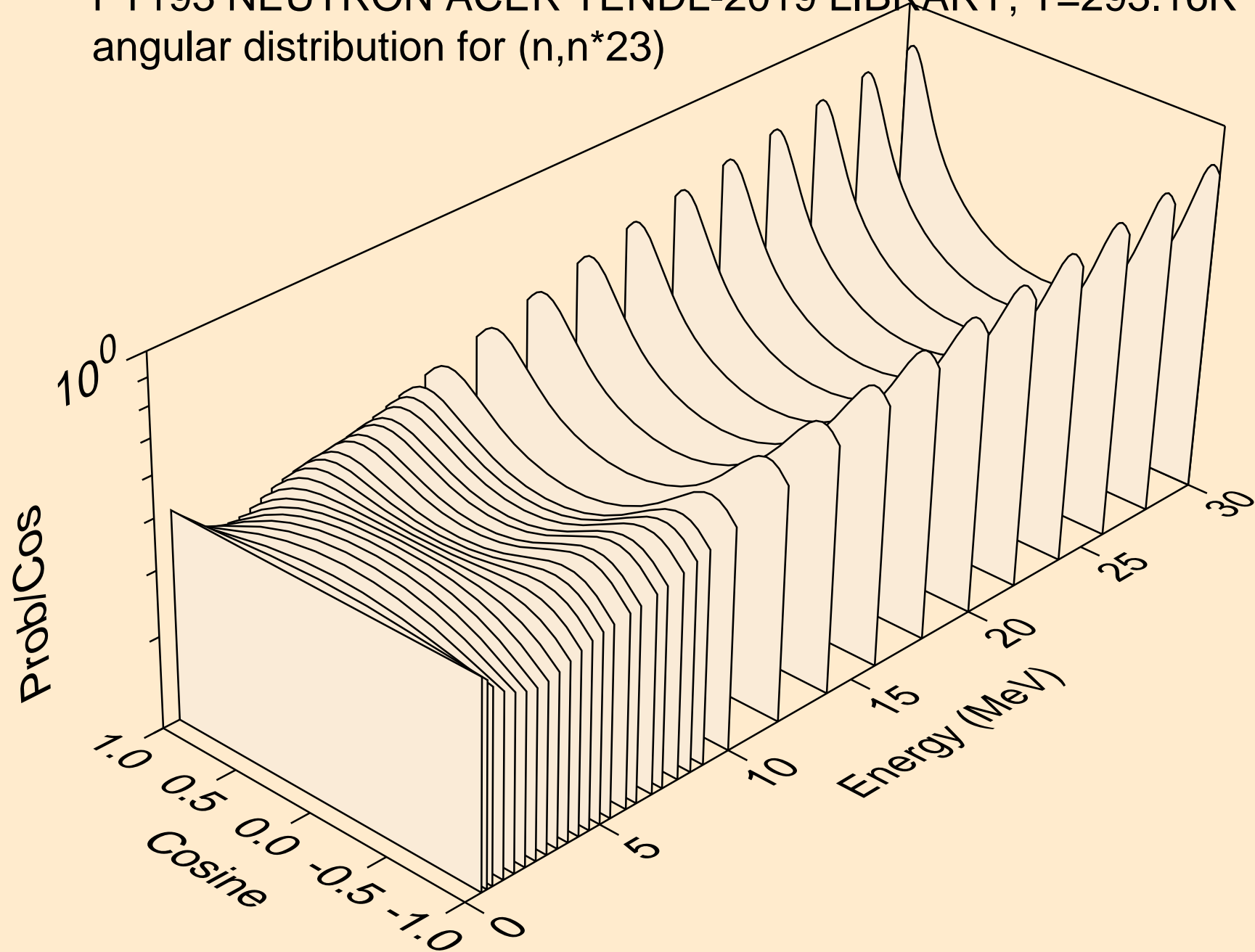

PT193 NEUTRON ACER TENDL-2019 LIBRARY; T=293.16K
angular distribution for (n,n*24)

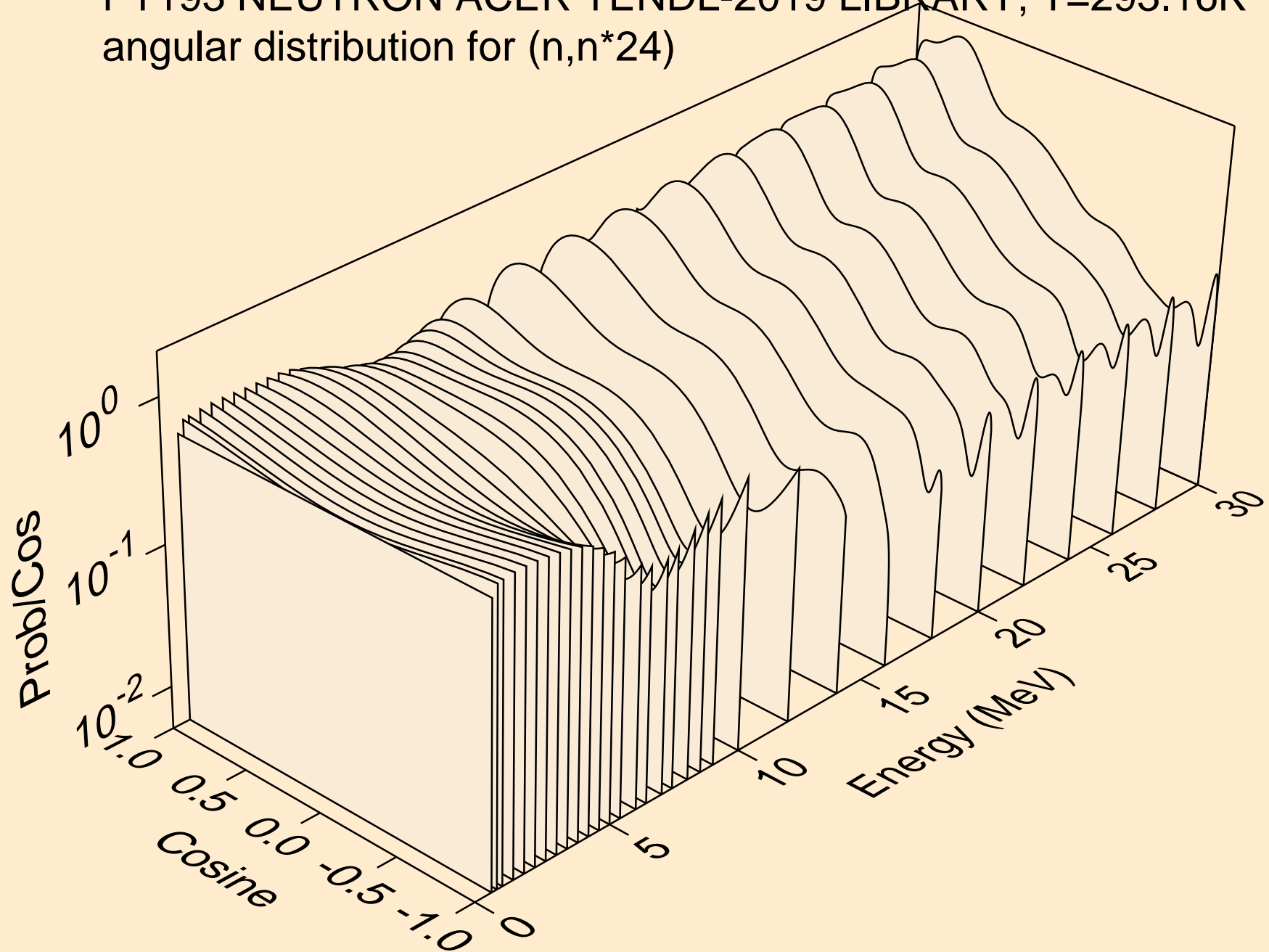

PT193 NEUTRON ACER TENDL-2019 LIBRARY; T=293.16K
angular distribution for (n,n*25)

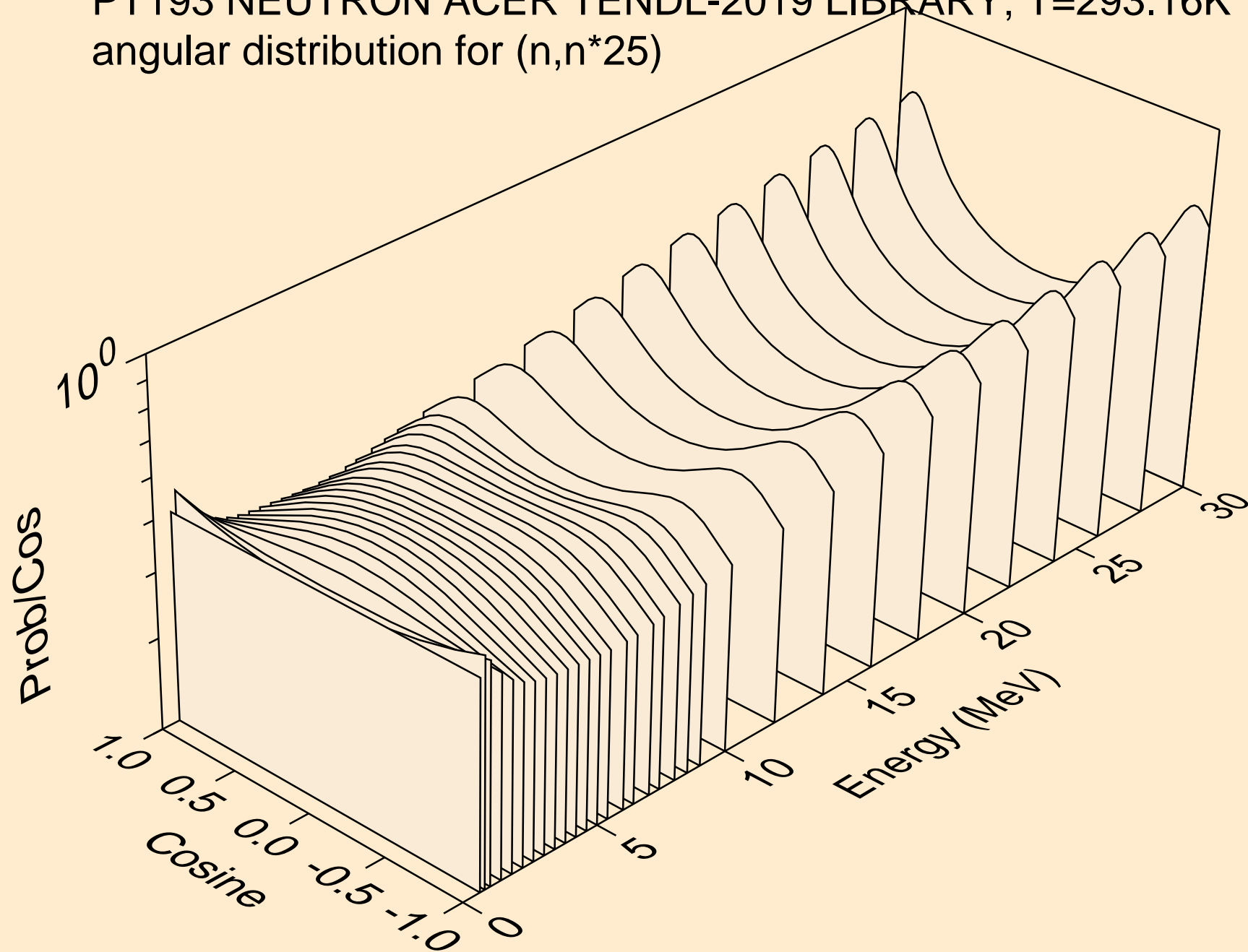

PT193 NEUTRON ACER TENDL-2019 LIBRARY; T=293.16K
angular distribution for (n,n*26)

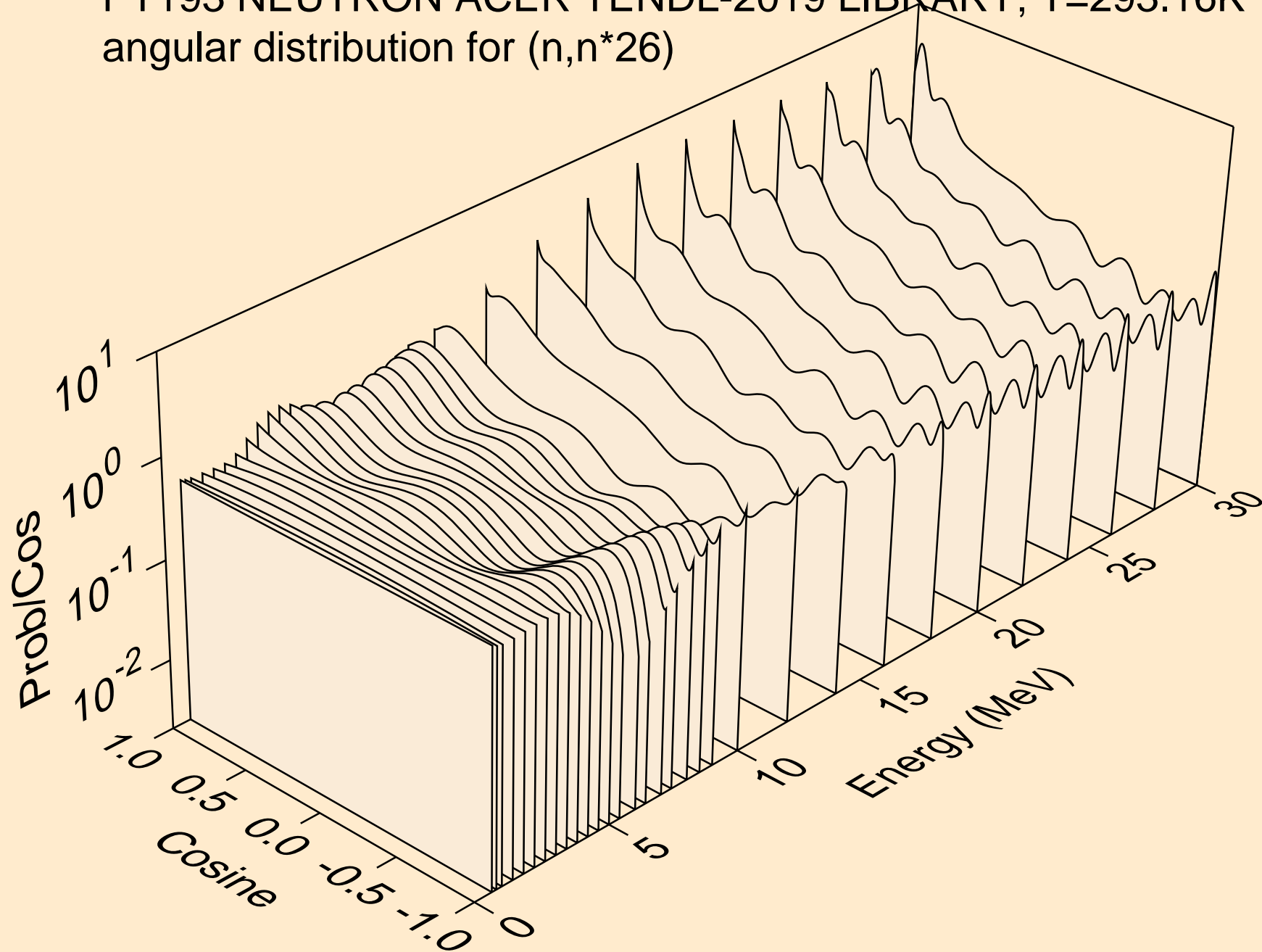

PT193 NEUTRON ACER TENDL-2019 LIBRARY; T=293.16K
angular distribution for (n,n*27)

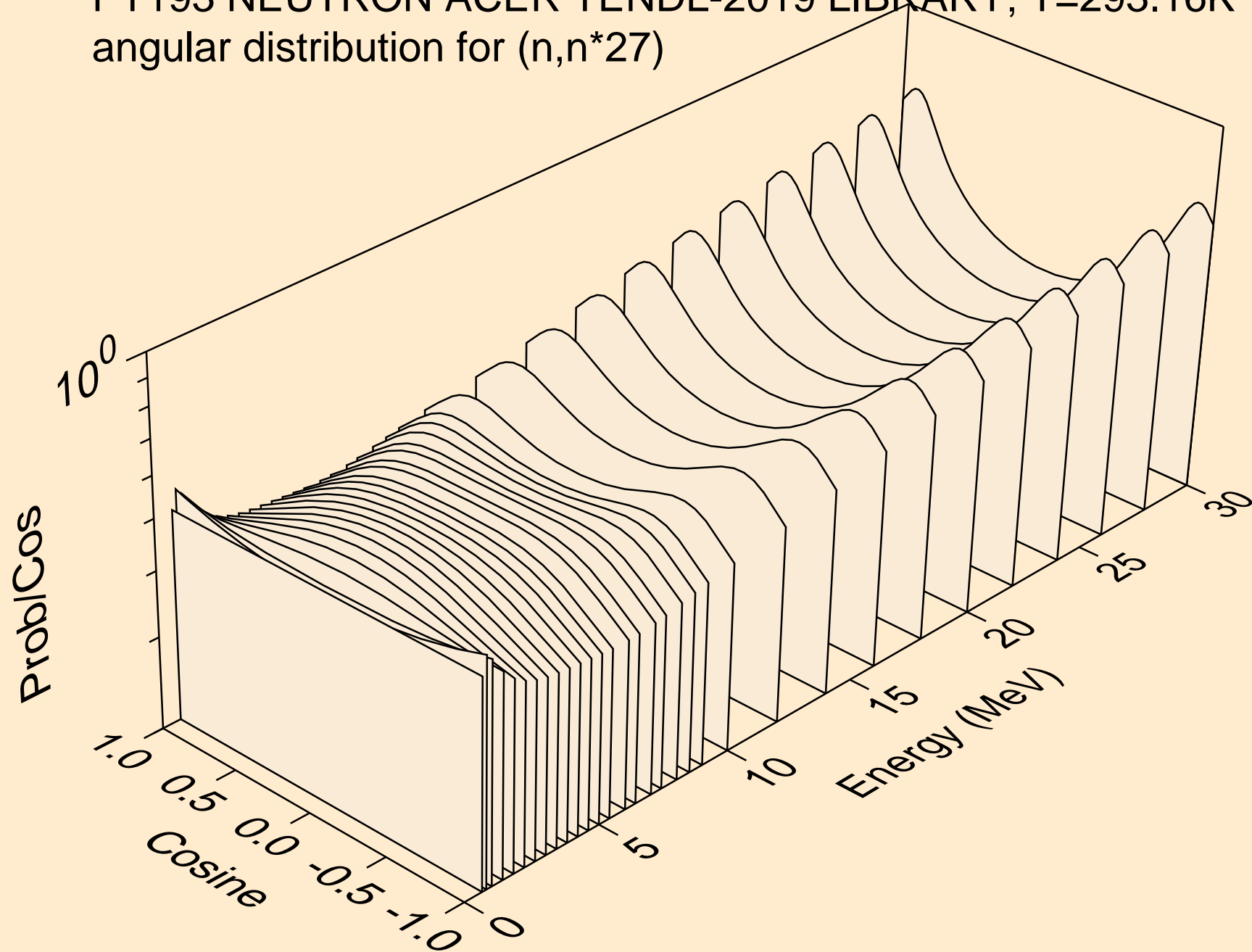

PT193 NEUTRON ACER TENDL-2019 LIBRARY; T=293.16K
angular distribution for (n,n*28)

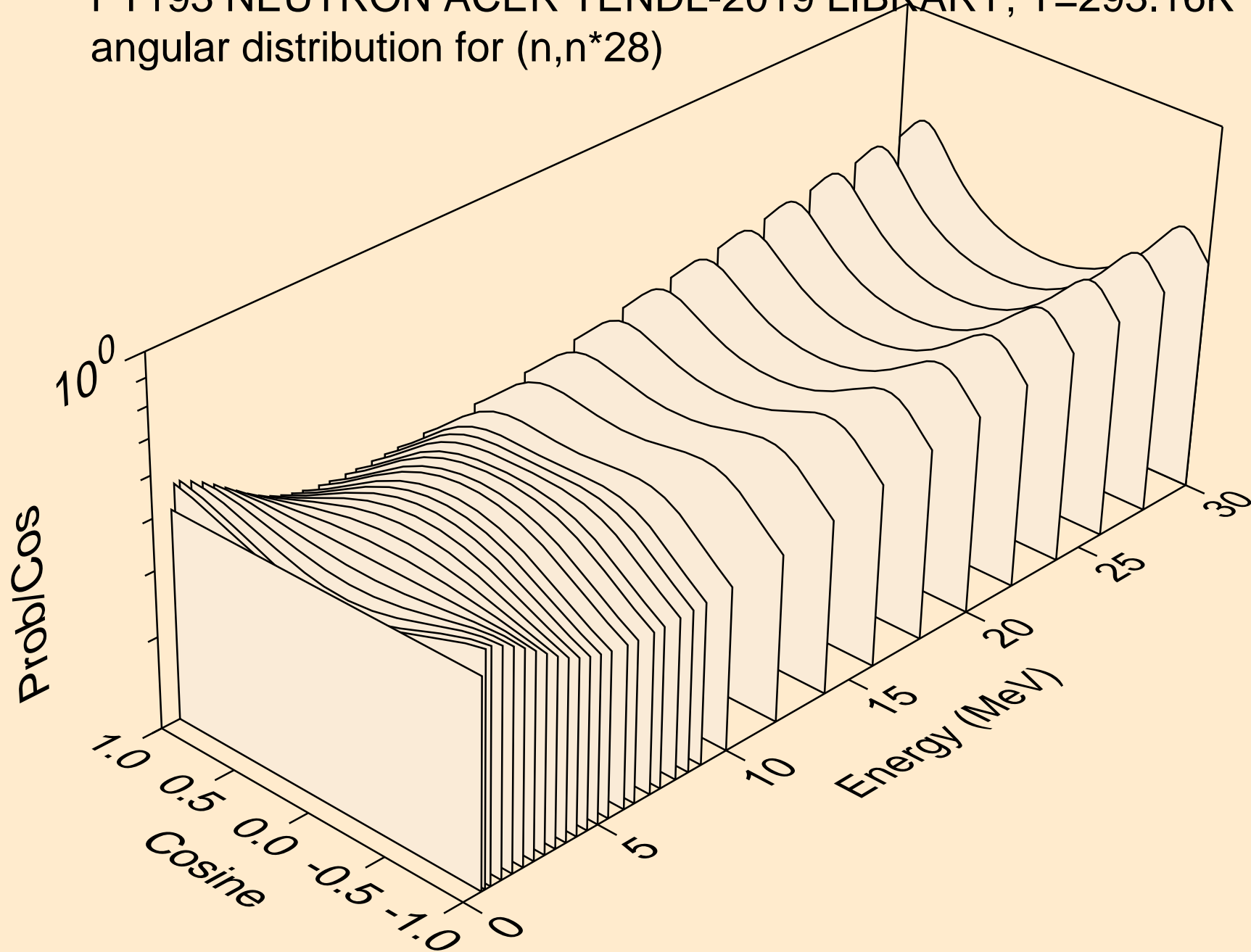

PT193 NEUTRON ACER TENDL-2019 LIBRARY; T=293.16K
angular distribution for (n,n*29)

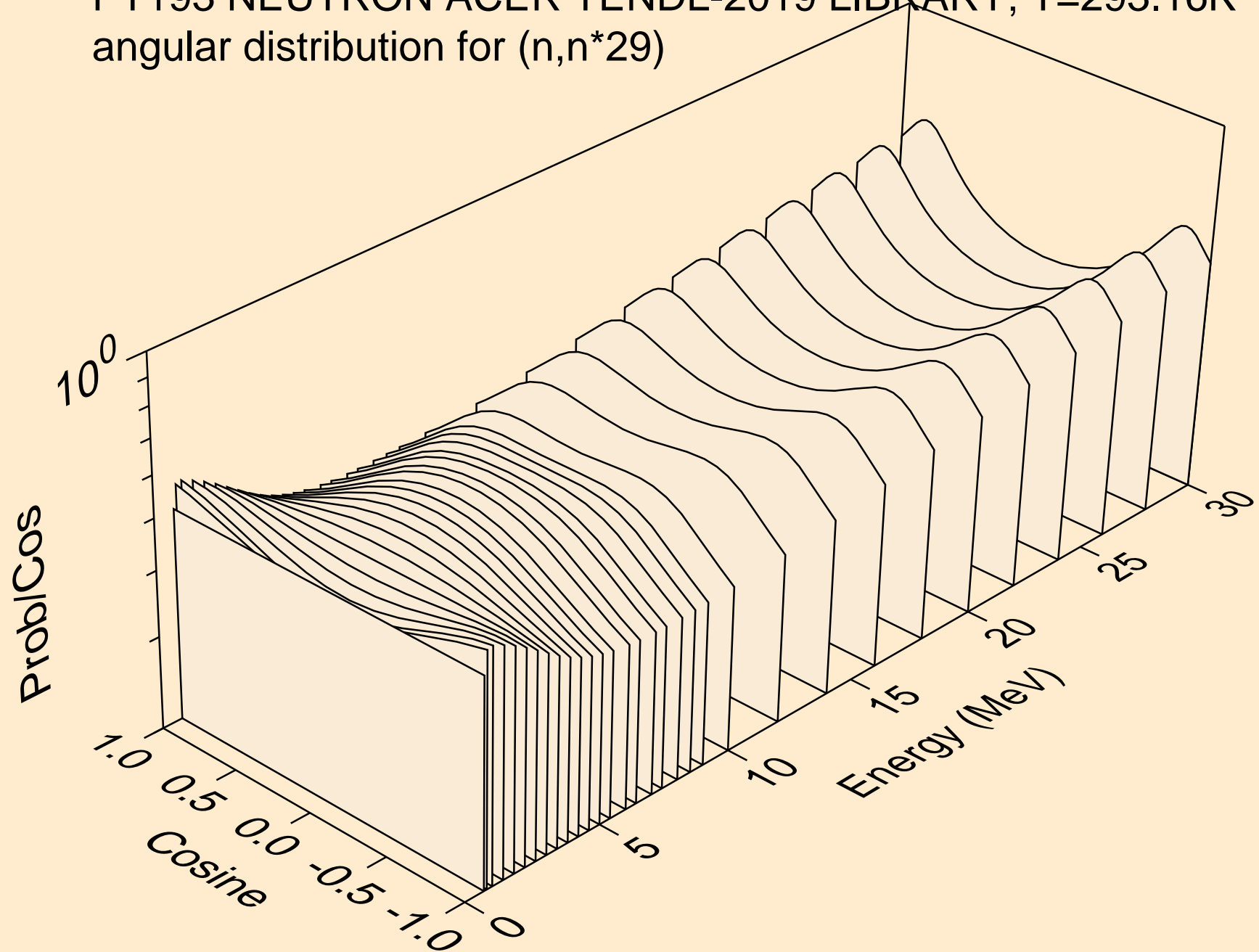

PT193 NEUTRON ACER TENDL-2019 LIBRARY; T=293.16K
angular distribution for (n,n*30)

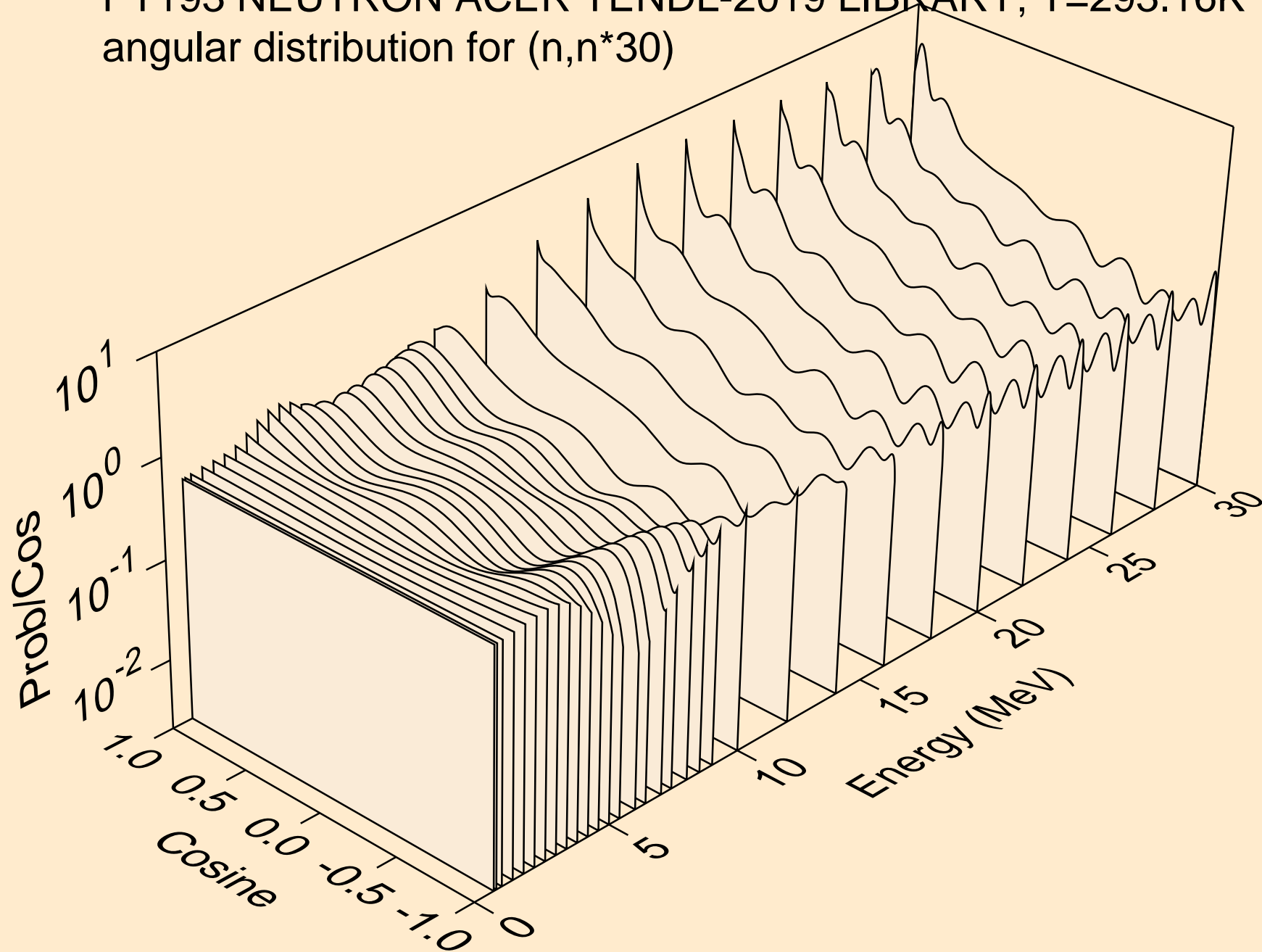

PT193 NEUTRON ACER TENDL-2019 LIBRARY; T=293.16K
Neutron emission for (n,x)

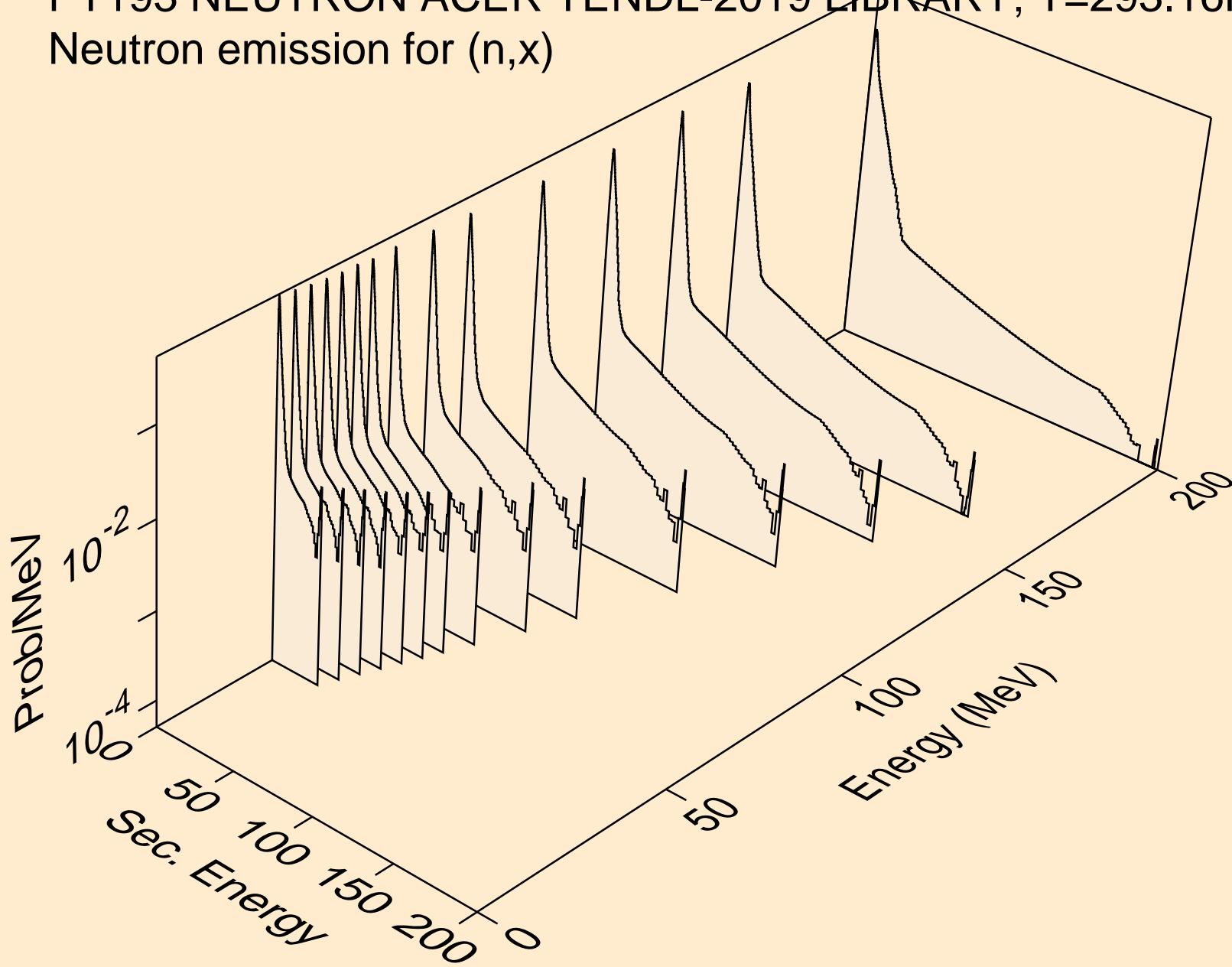

PT193 NEUTRON ACER TENDL-2019 LIBRARY; T=293.16K
Neutron emission for (n,2nd)

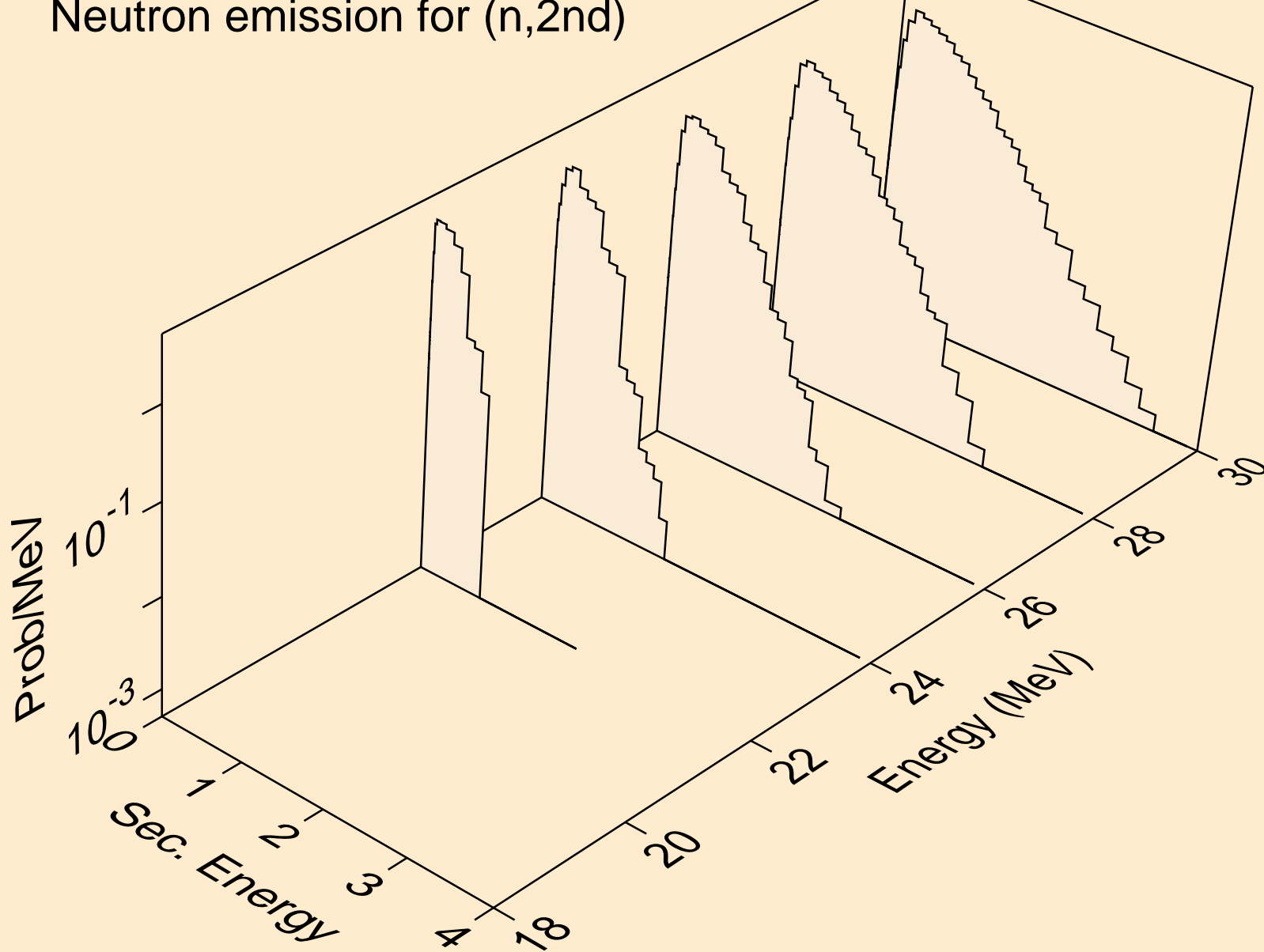

PT193 NEUTRON ACER TENDL-2019 LIBRARY; T=293.16K
Neutron emission for (n,2n)

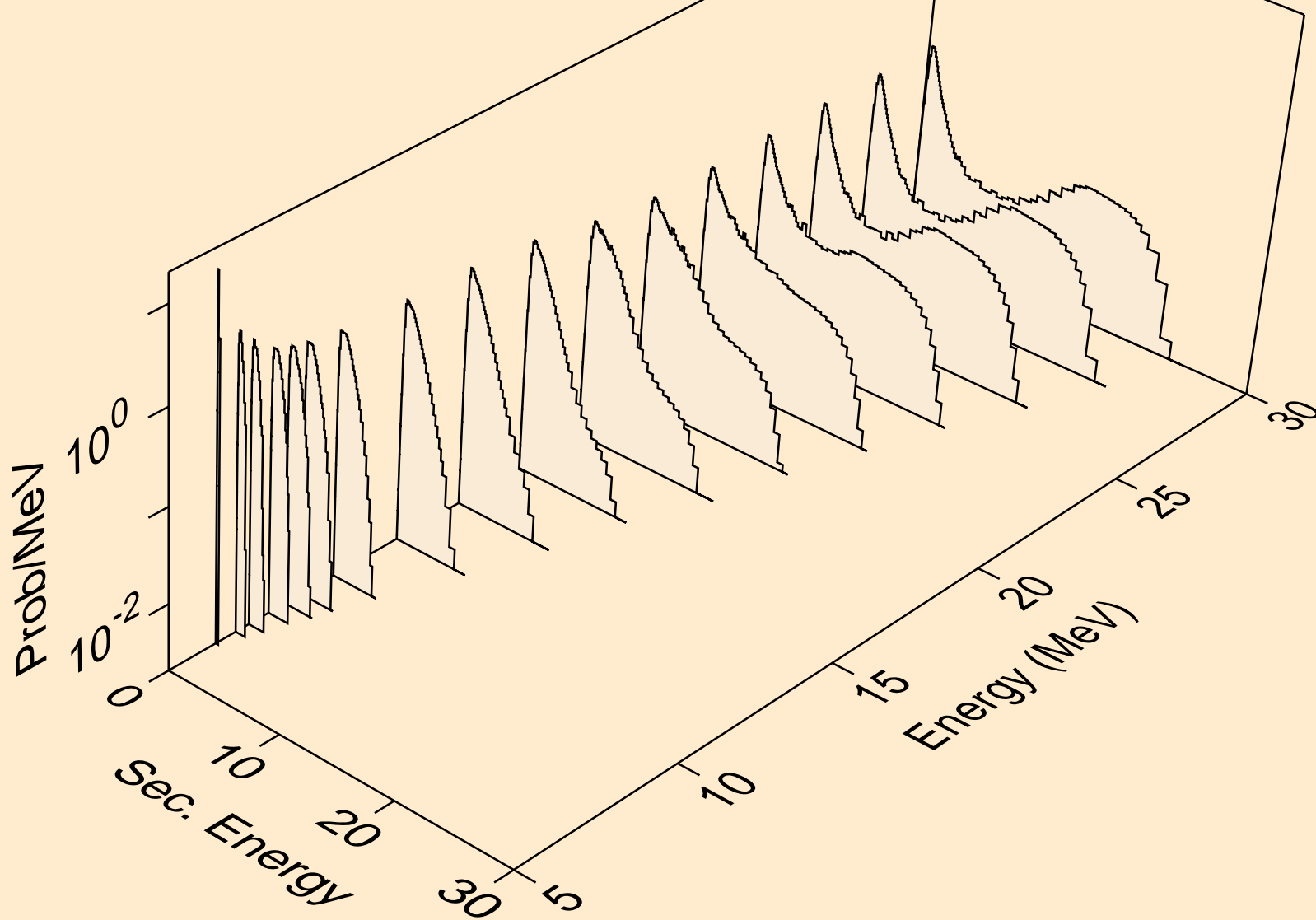

PT193 NEUTRON ACER TENDL-2019 LIBRARY; T=293.16K
Neutron emission for (n,3n)

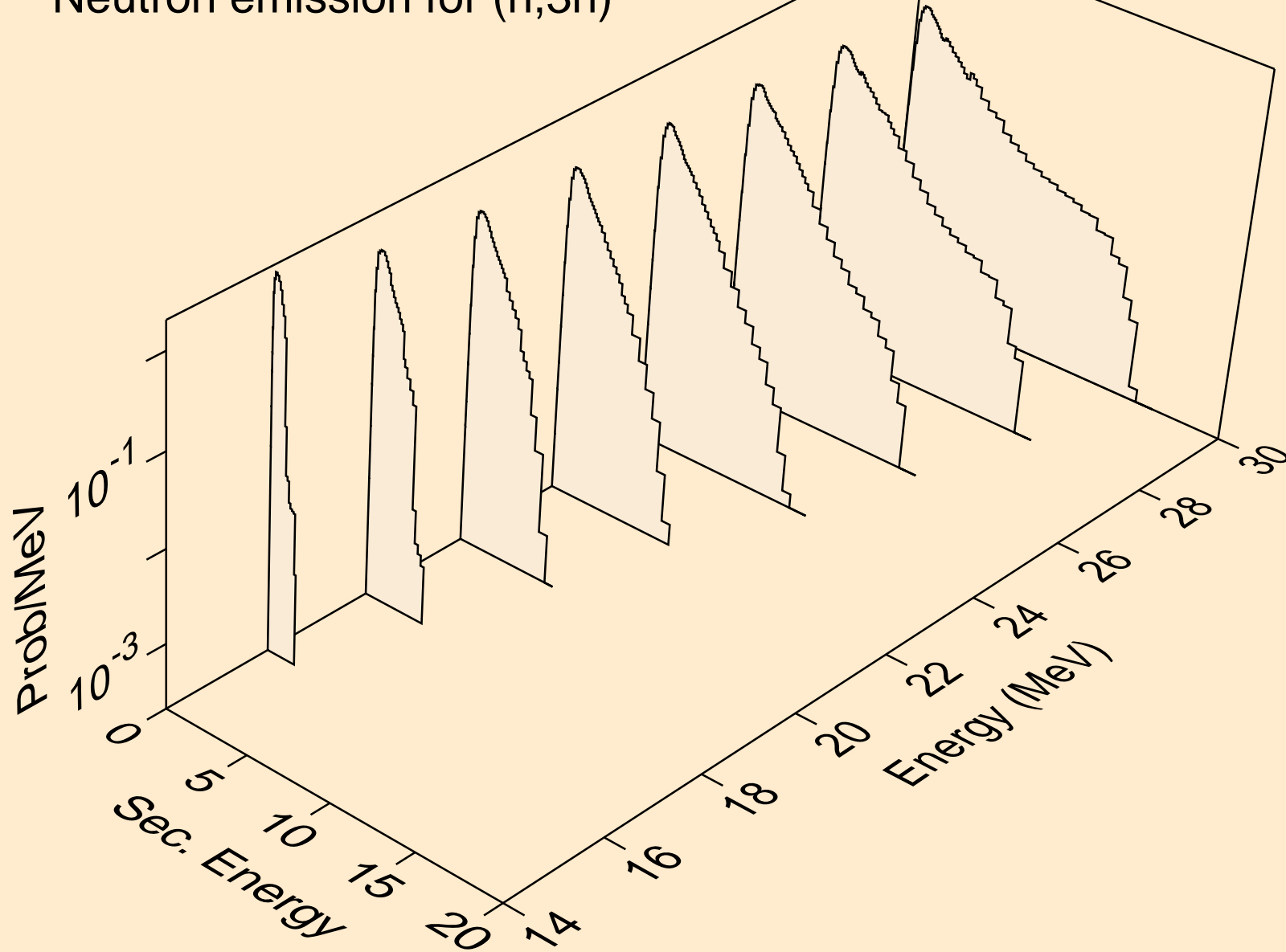

PT193 NEUTRON ACER TENDL-2019 LIBRARY; T=293.16K
Neutron emission for (n,n*)a

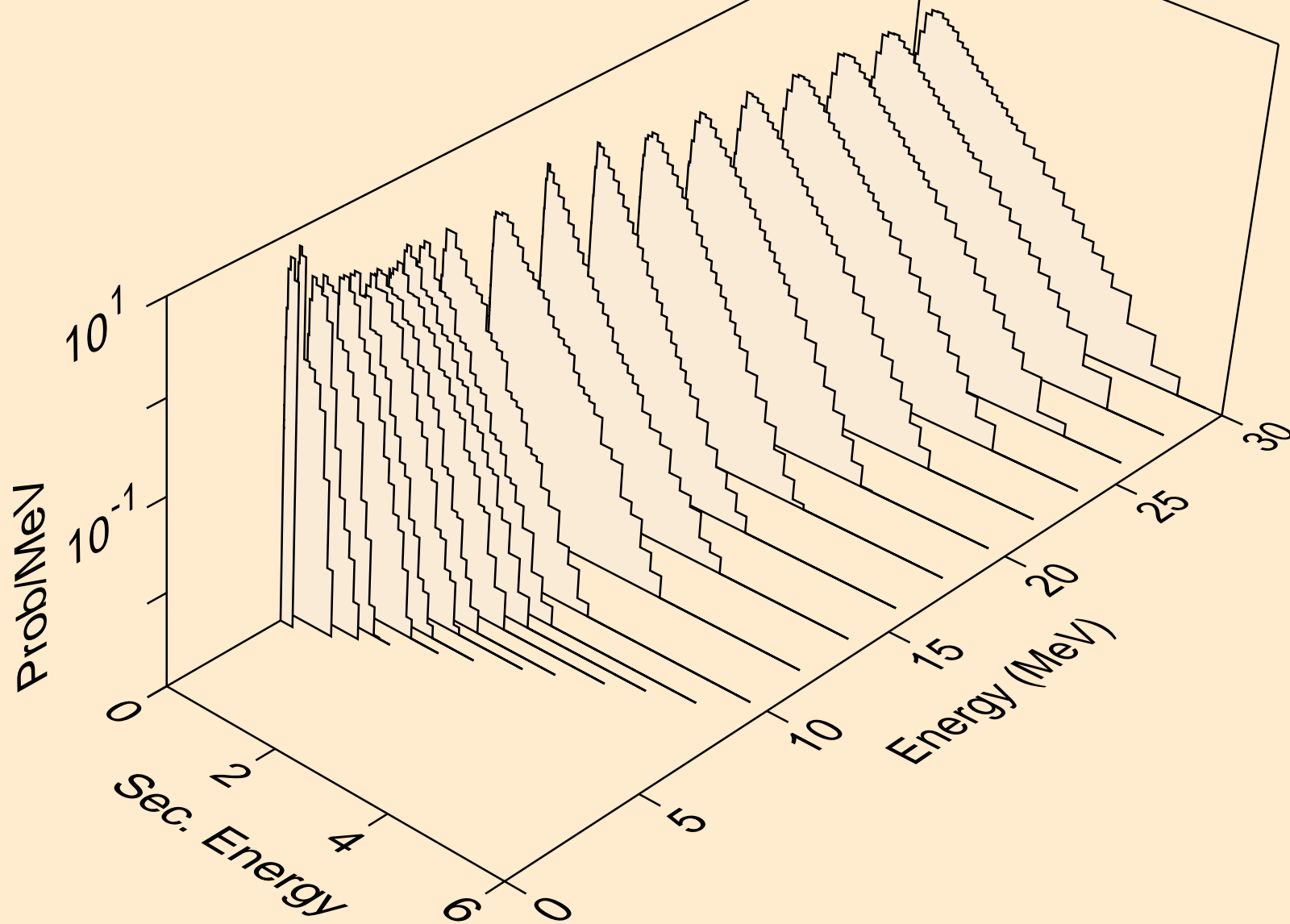

PT193 NEUTRON ACER TENDL-2019 LIBRARY; T=293.16K
Neutron emission for (n,2n)a

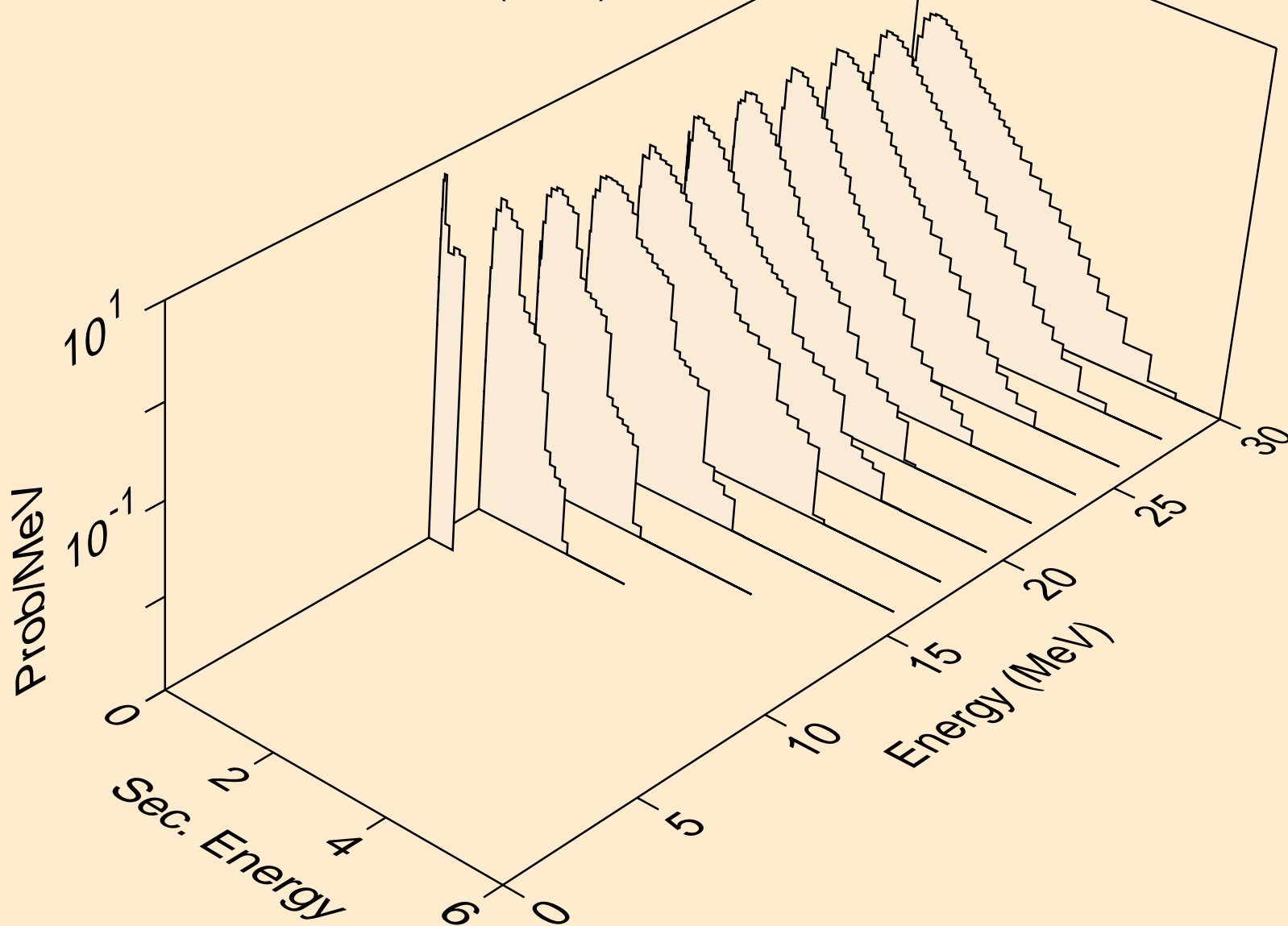

PT193 NEUTRON ACER TENDL-2019 LIBRARY; T=293.16K
Neutron emission for (n,3n)a

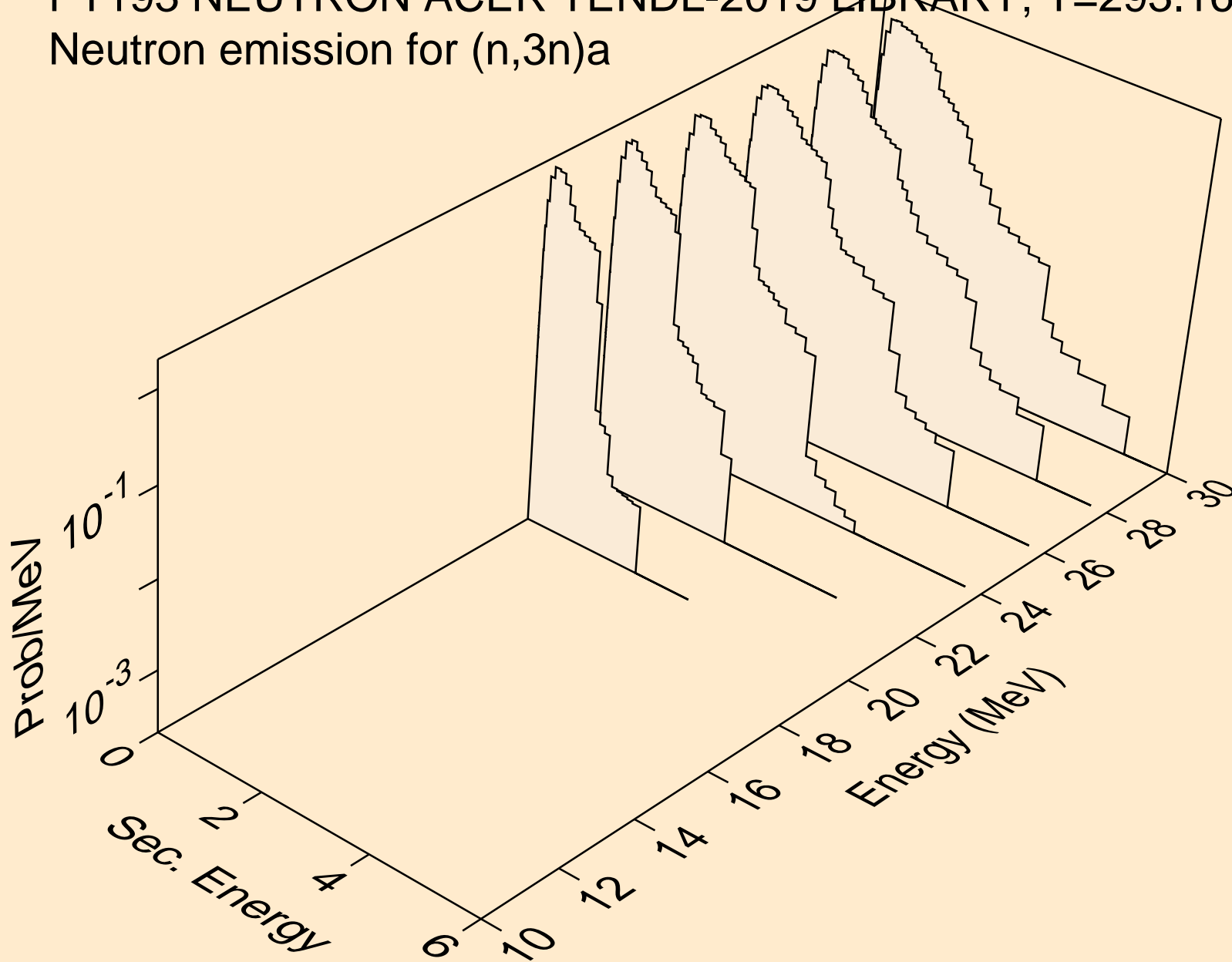

PT193 NEUTRON ACER TENDL-2019 LIBRARY; T=293.16K
Neutron emission for (n,n*)p

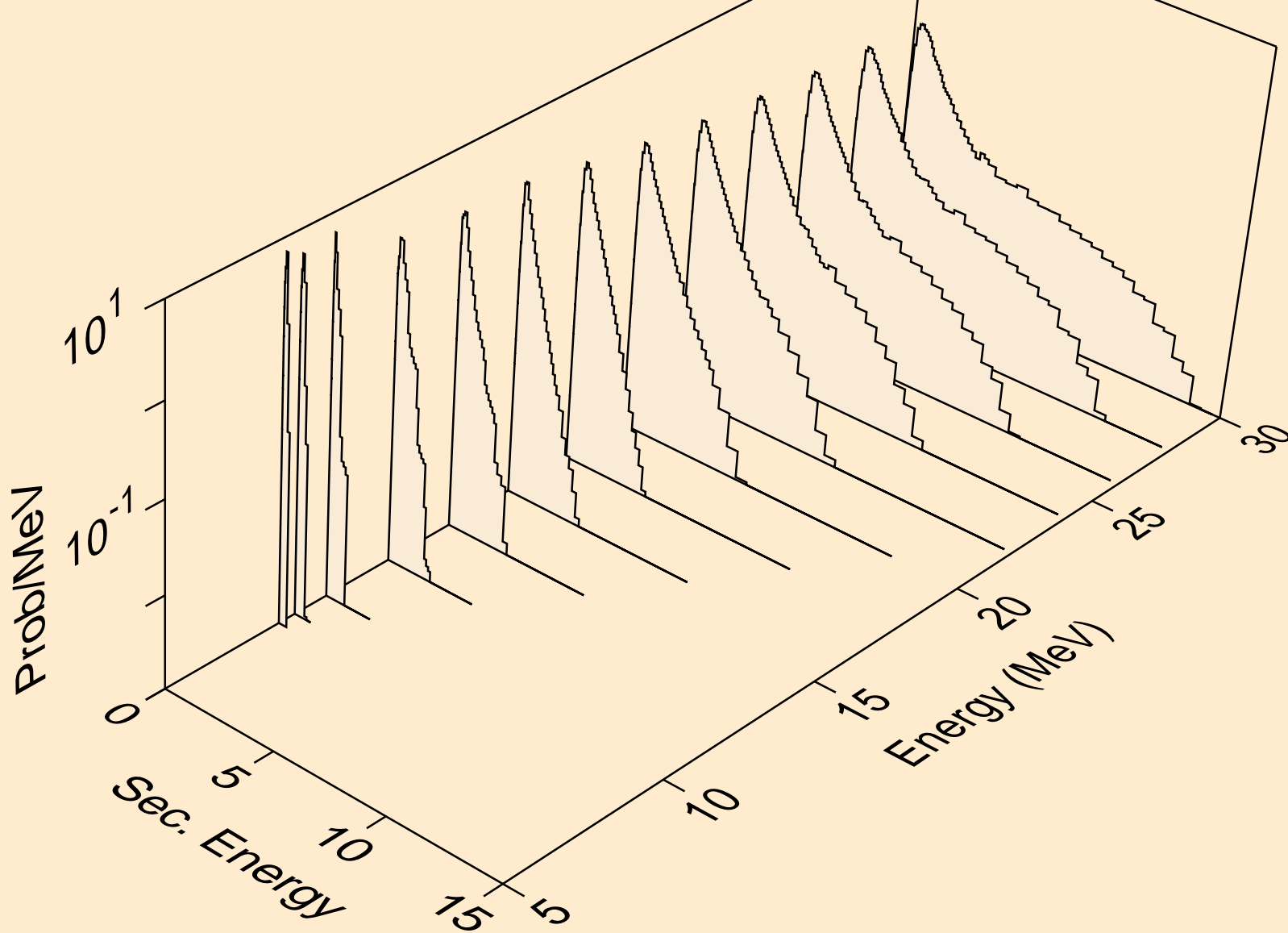

PT193 NEUTRON ACER TENDL-2019 LIBRARY; T=293.16K
Neutron emission for (n,n*)d

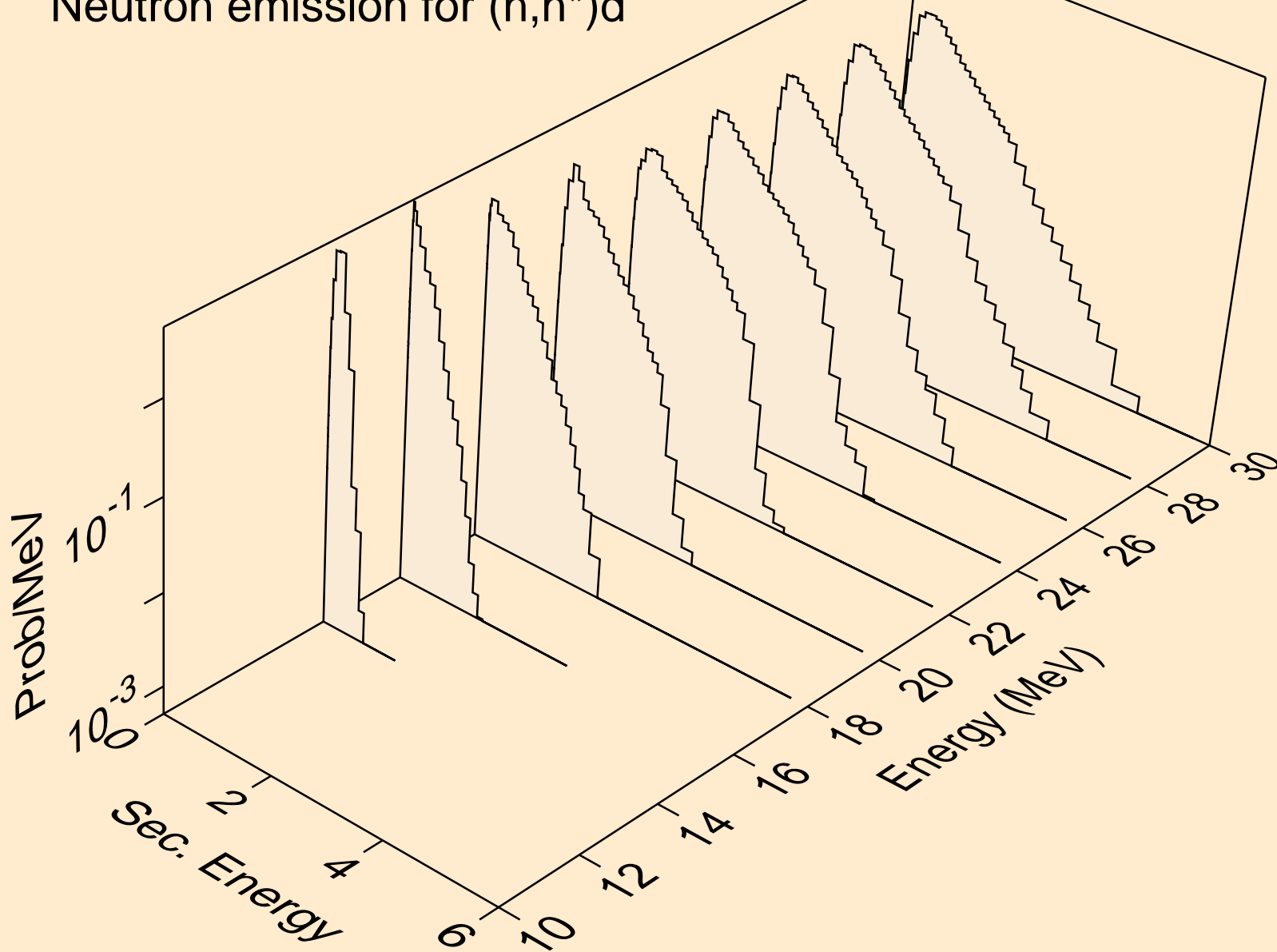

PT193 NEUTRON ACER TENDL-2019 LIBRARY; T=293.16K
Neutron emission for (n,n*)t

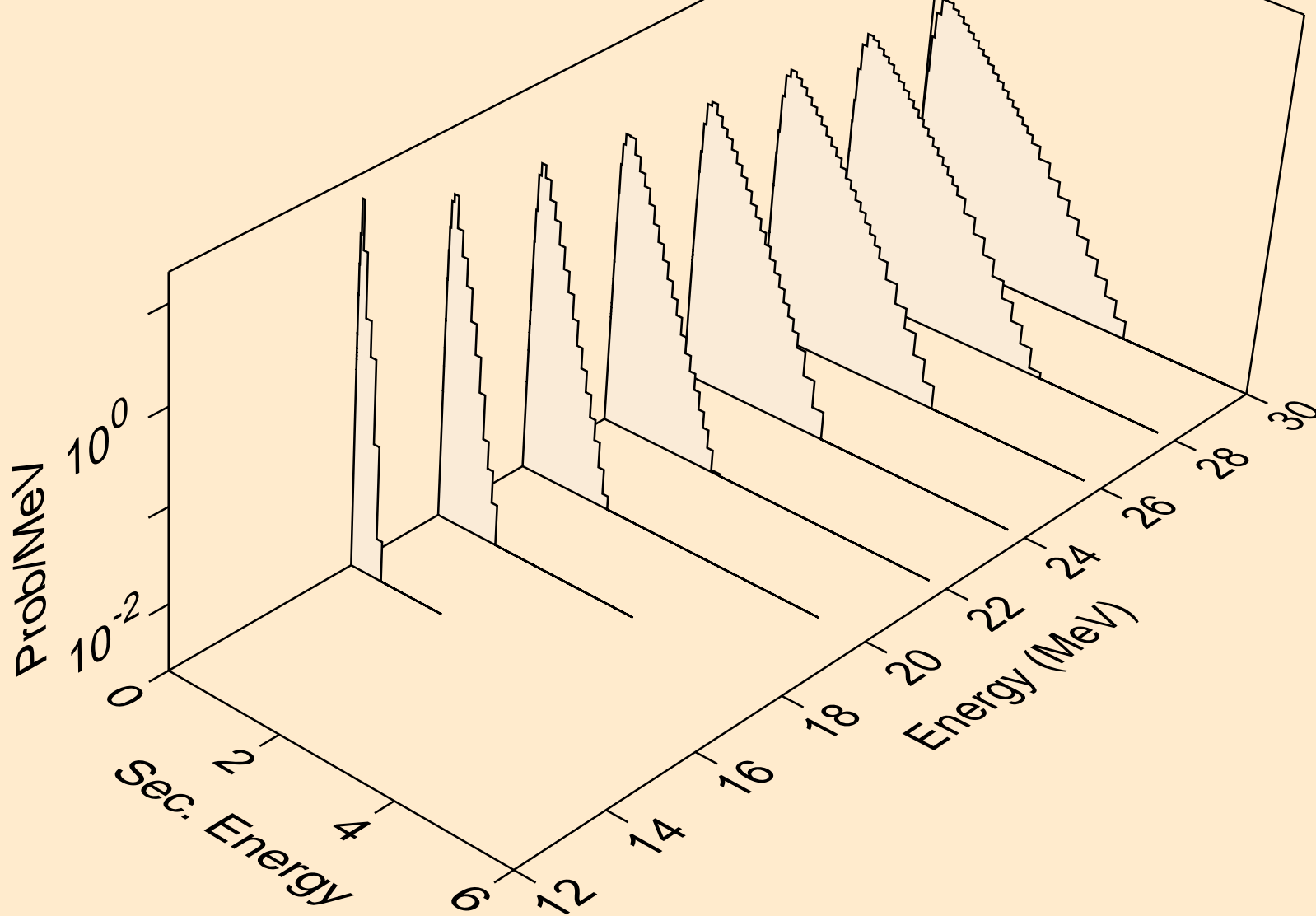

PT193 NEUTRON ACER TENDL-2019 LIBRARY; T=293.16K
Neutron emission for (n,n*)he3

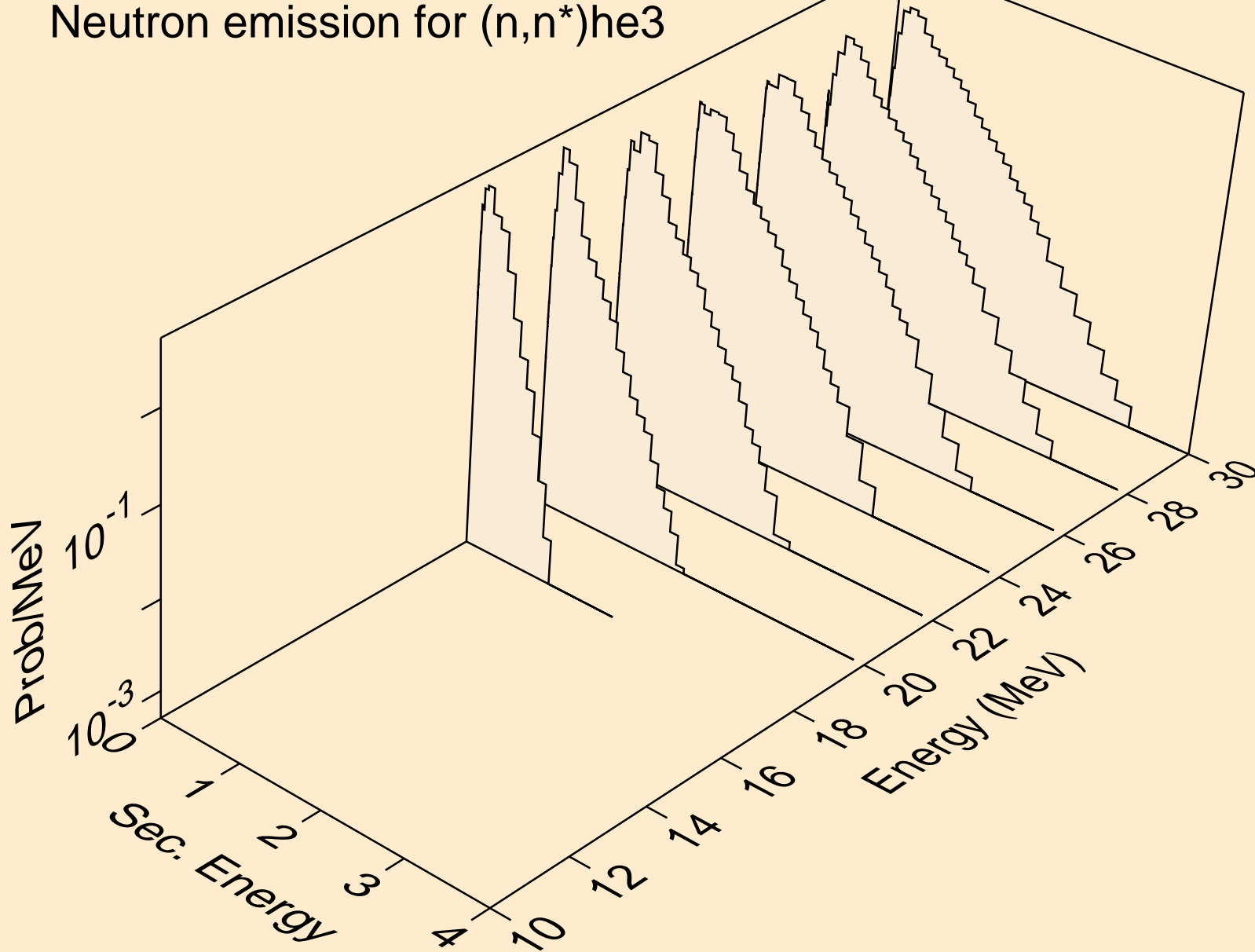

PT193 NEUTRON ACER TENDL-2019 LIBRARY; T=293.16K
Neutron emission for (n,4n)

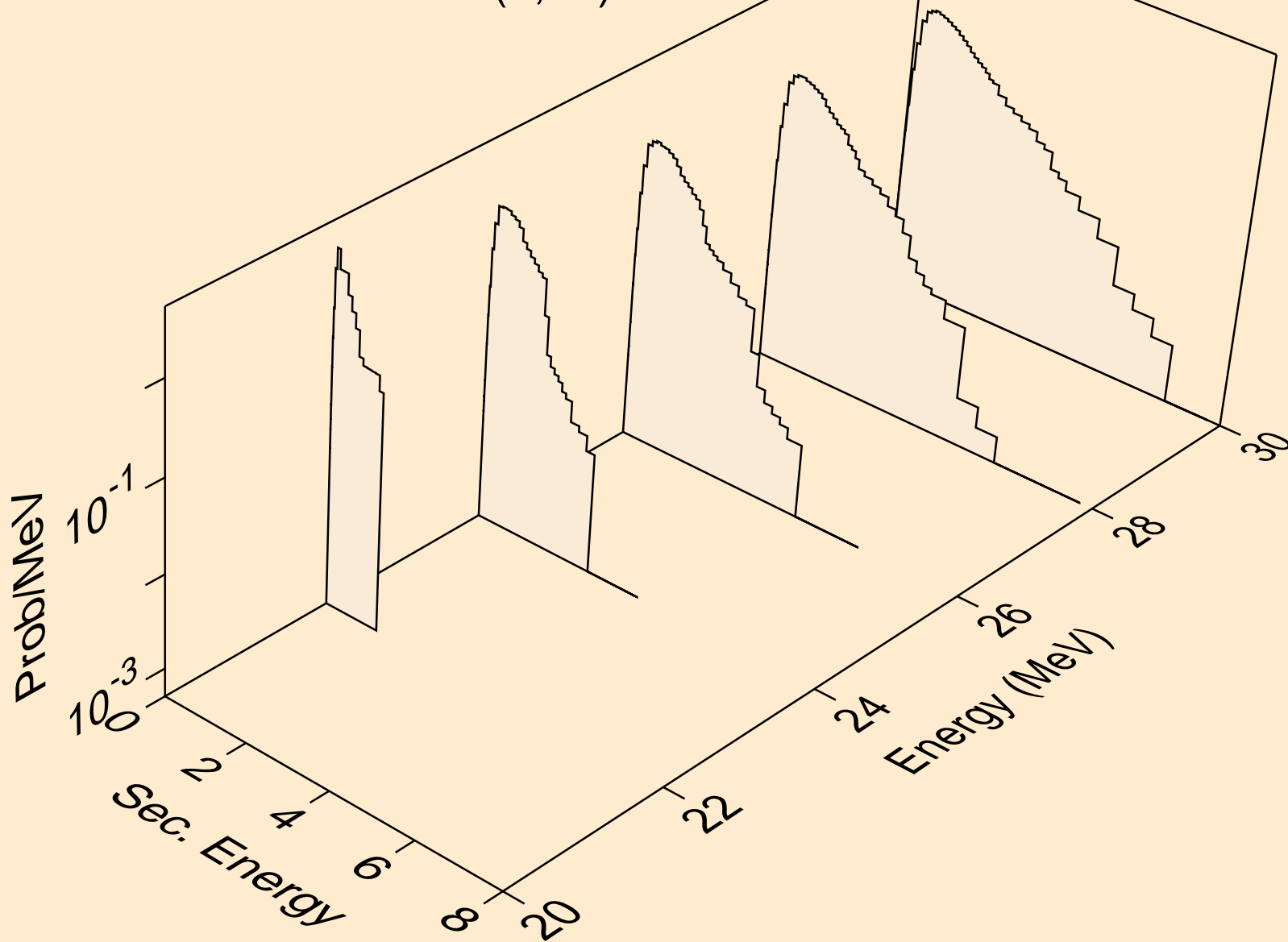

PT193 NEUTRON ACER TENDL-2019 LIBRARY; T=293.16K
Neutron emission for (n,2np)

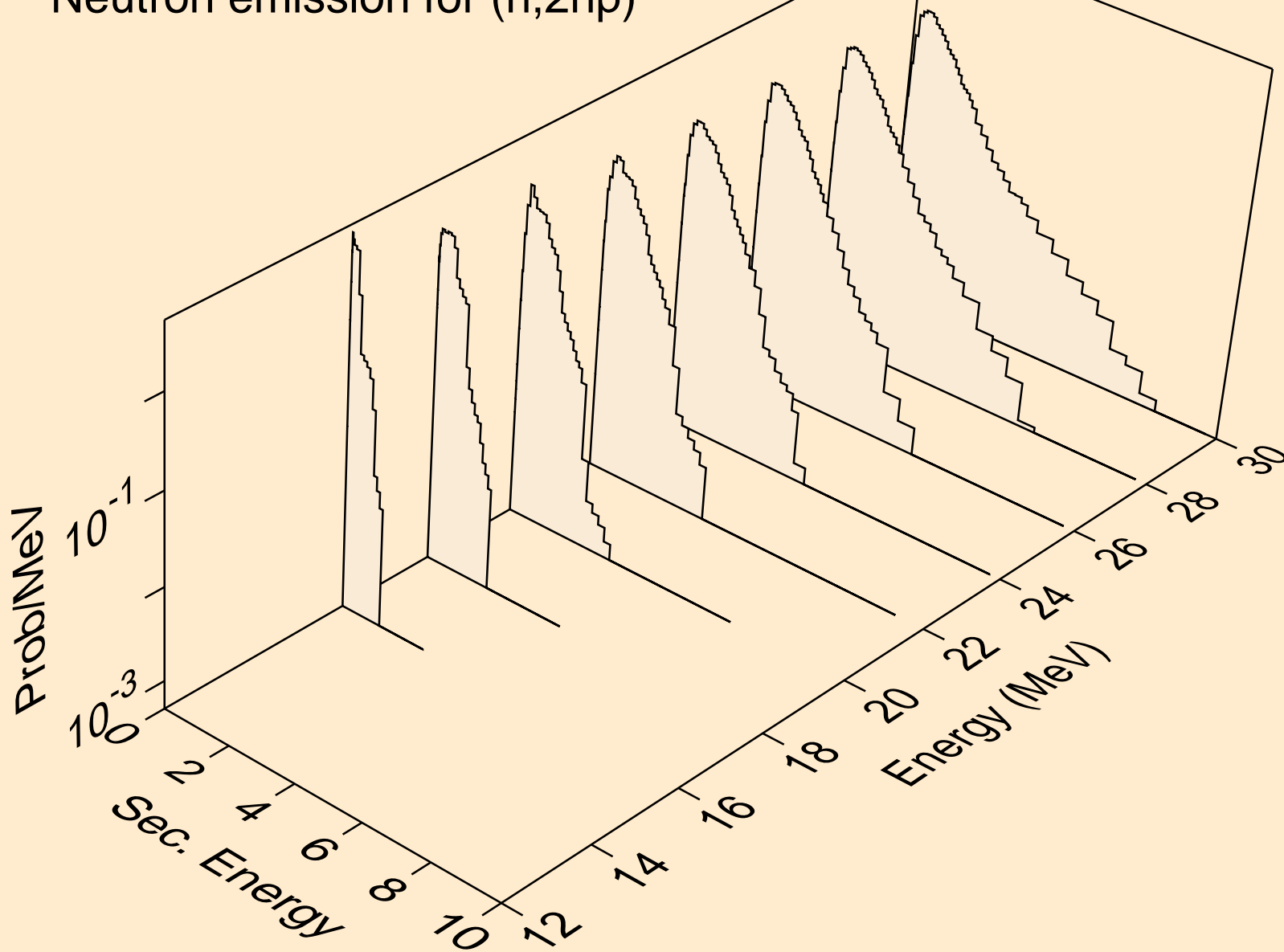

PT193 NEUTRON ACER TENDL-2019 LIBRARY; T=293.16K
Neutron emission for (n,3np)

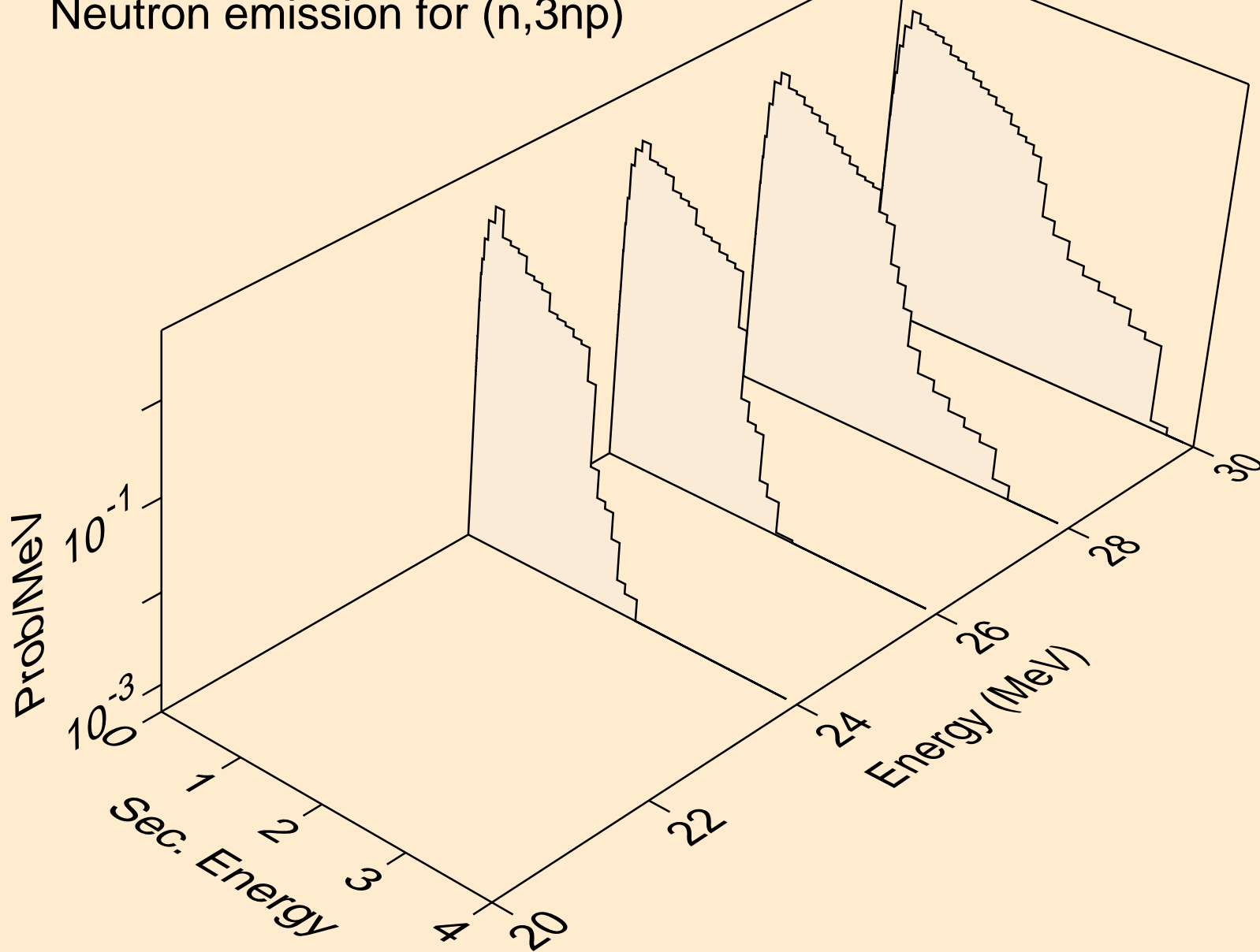

PT193 NEUTRON ACER TENDL-2019 LIBRARY; T=293.16K
Neutron emission for (n,2np)

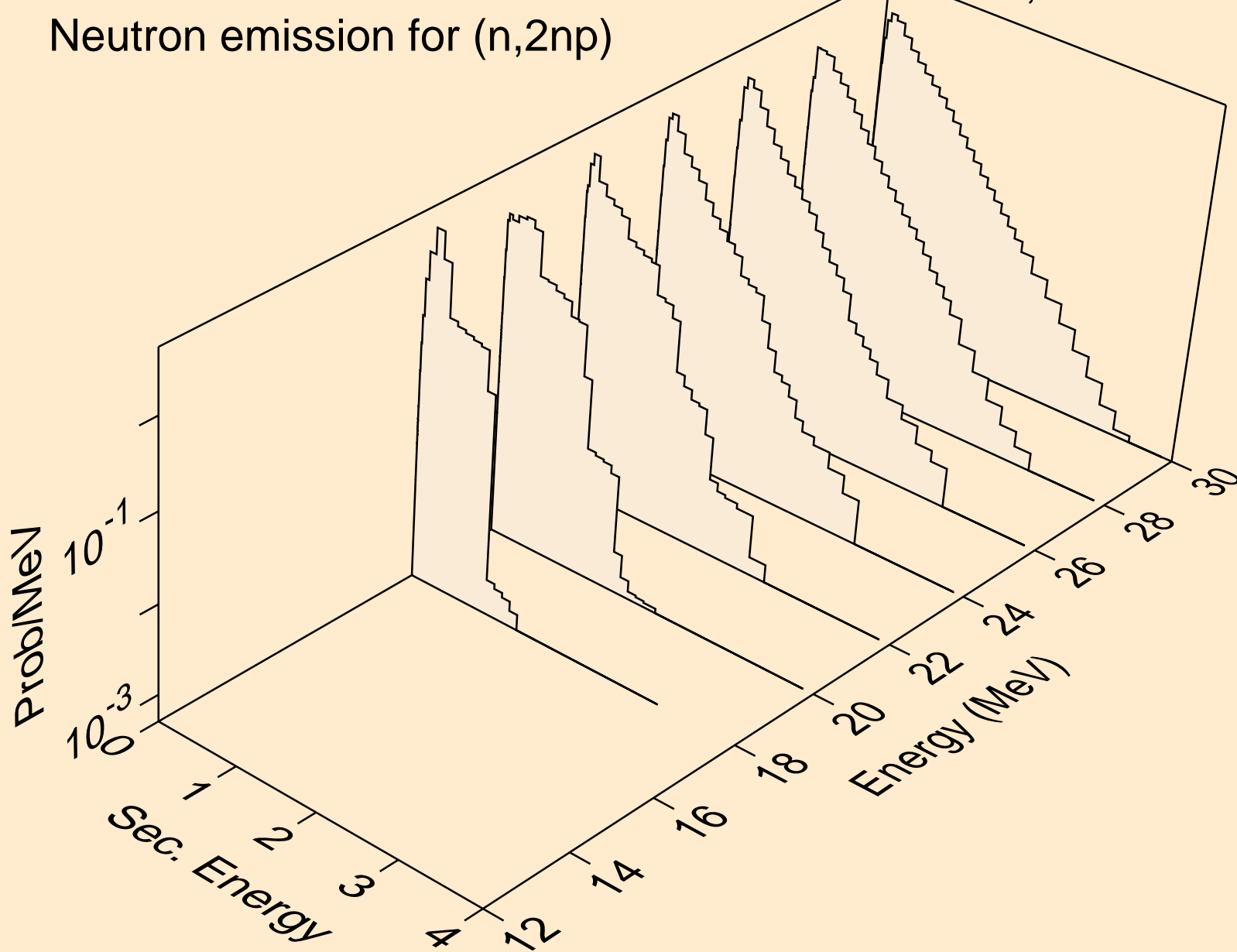

PT193 NEUTRON ACER TENDL-2019 LIBRARY; T=293.16K
Neutron emission for (n,npa)

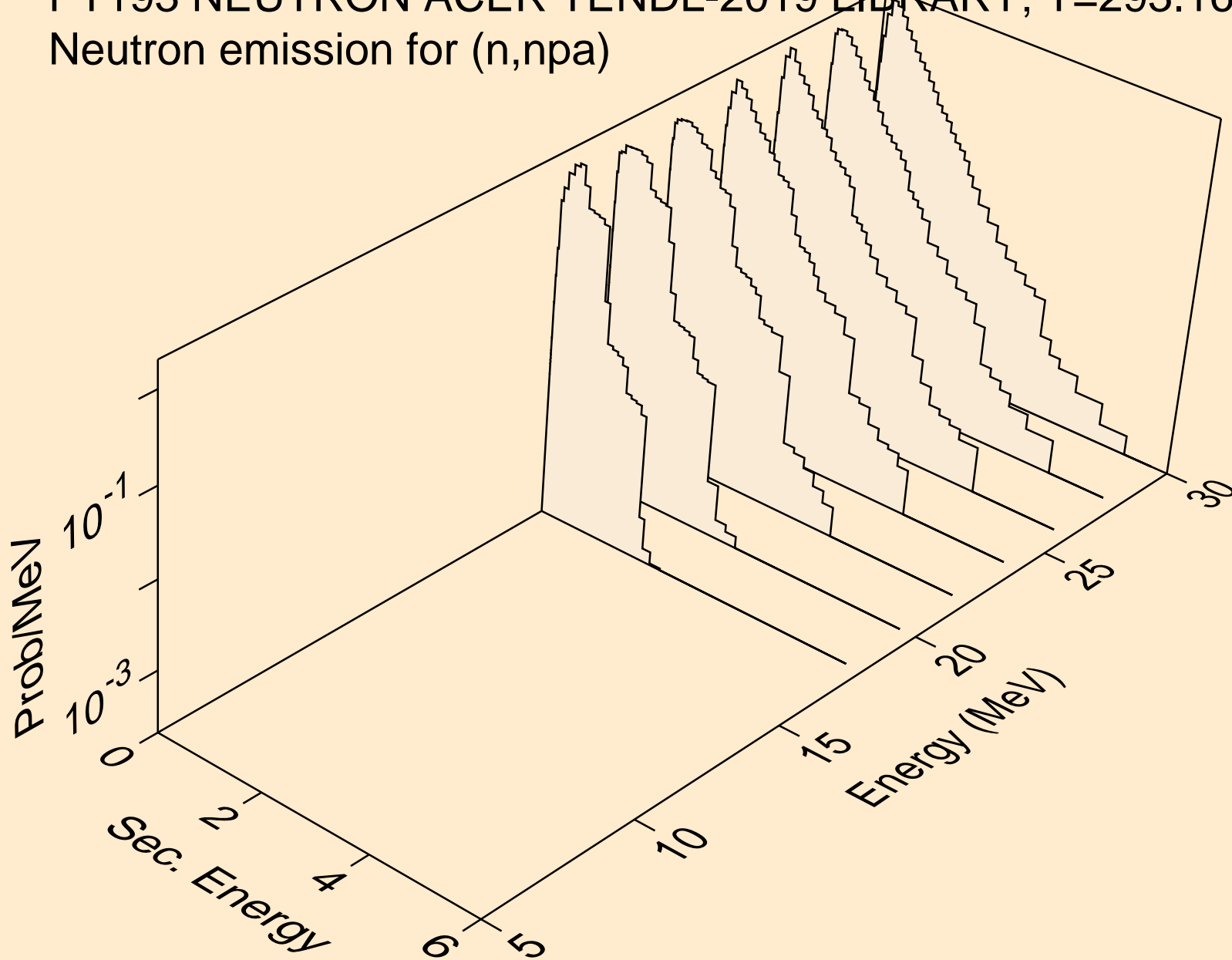

PT193 NEUTRON ACER TENDL-2019 LIBRARY; T=293.16K
Neutron emission for (n,n*c)

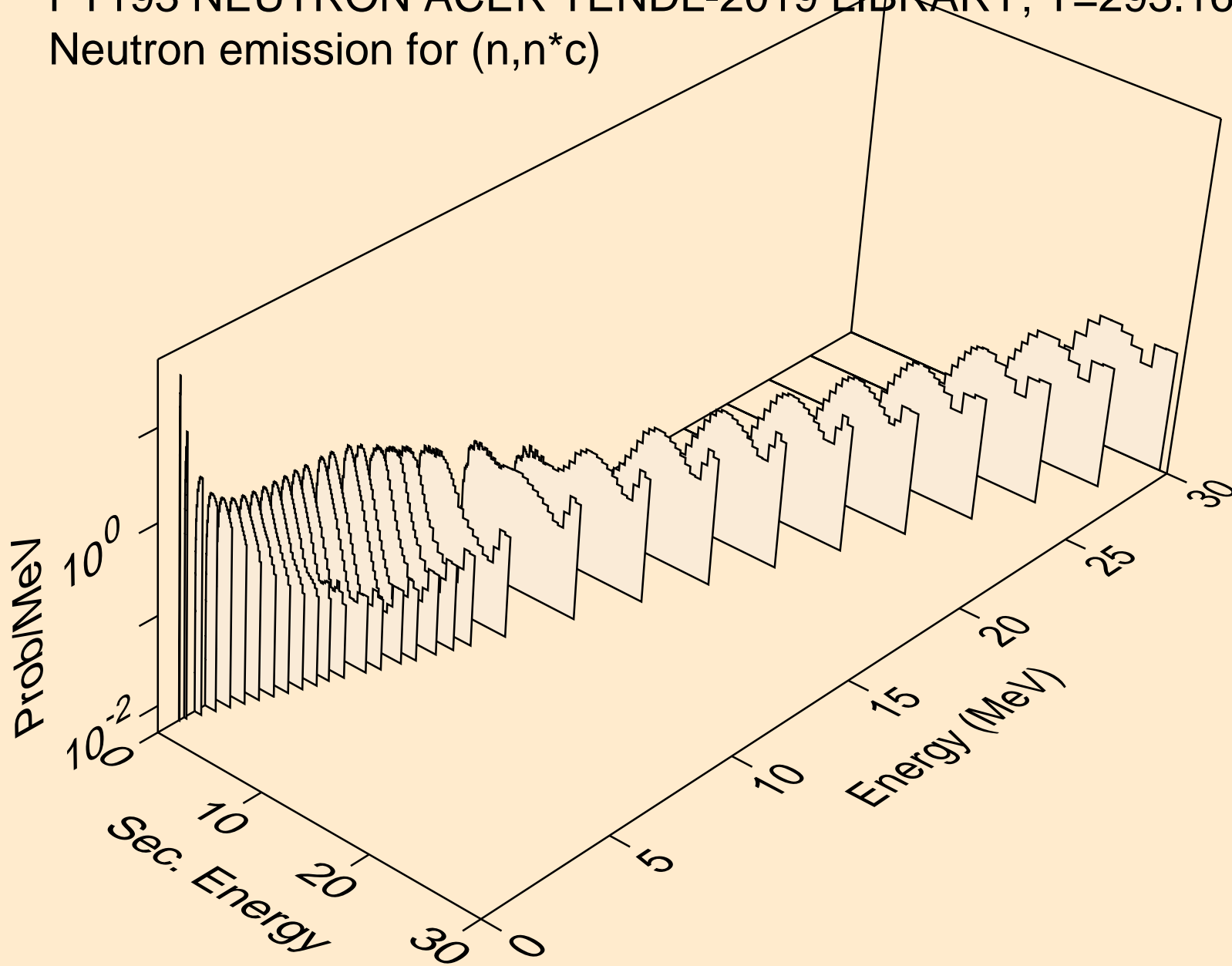

PT193 NEUTRON ACER TENDL-2019 LIBRARY; T=293.16K
Photon emission for (n,x)

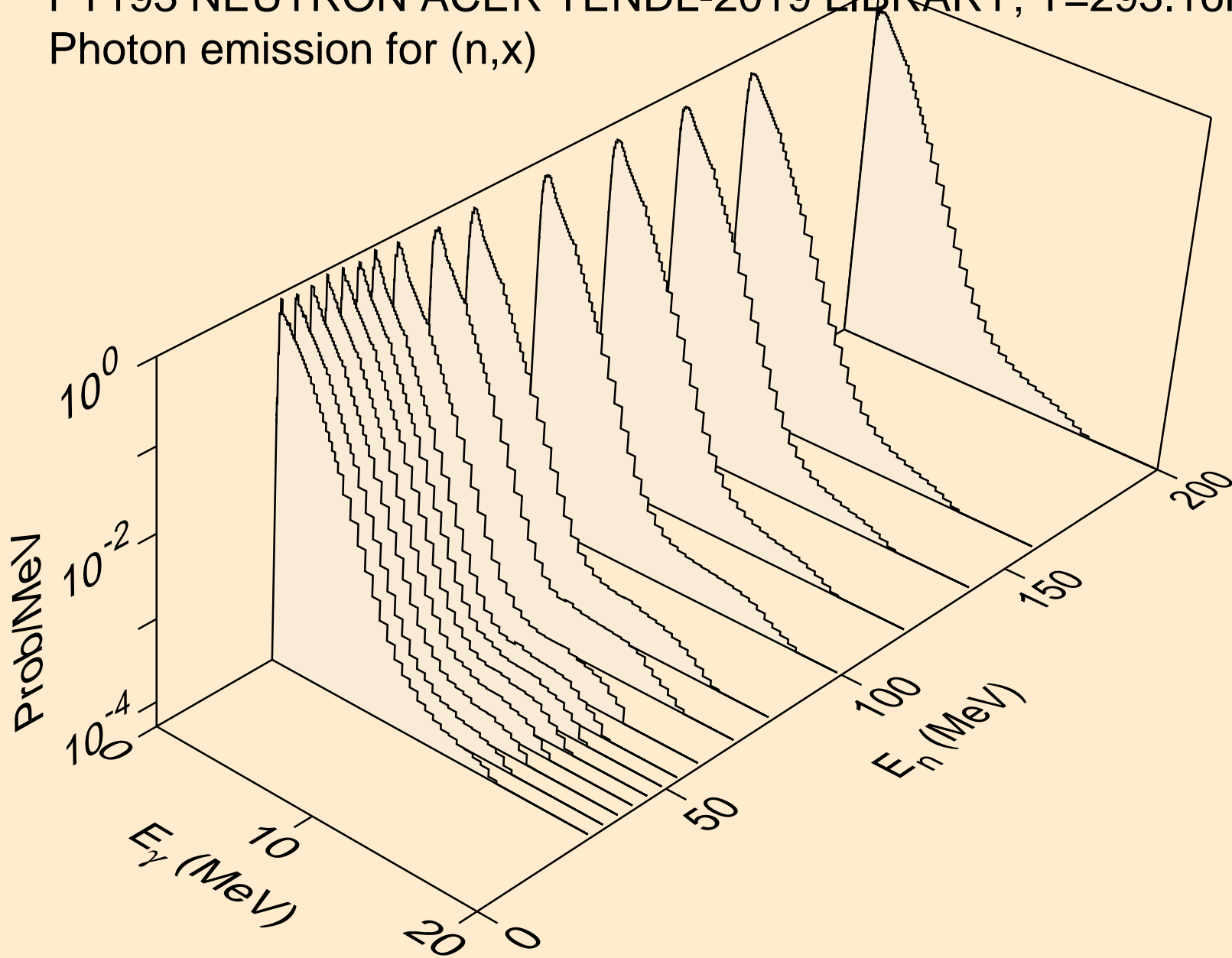

PT193 NEUTRON ACER TENDL-2019 LIBRARY; T=293.16K
Photon emission for (n,2nd)

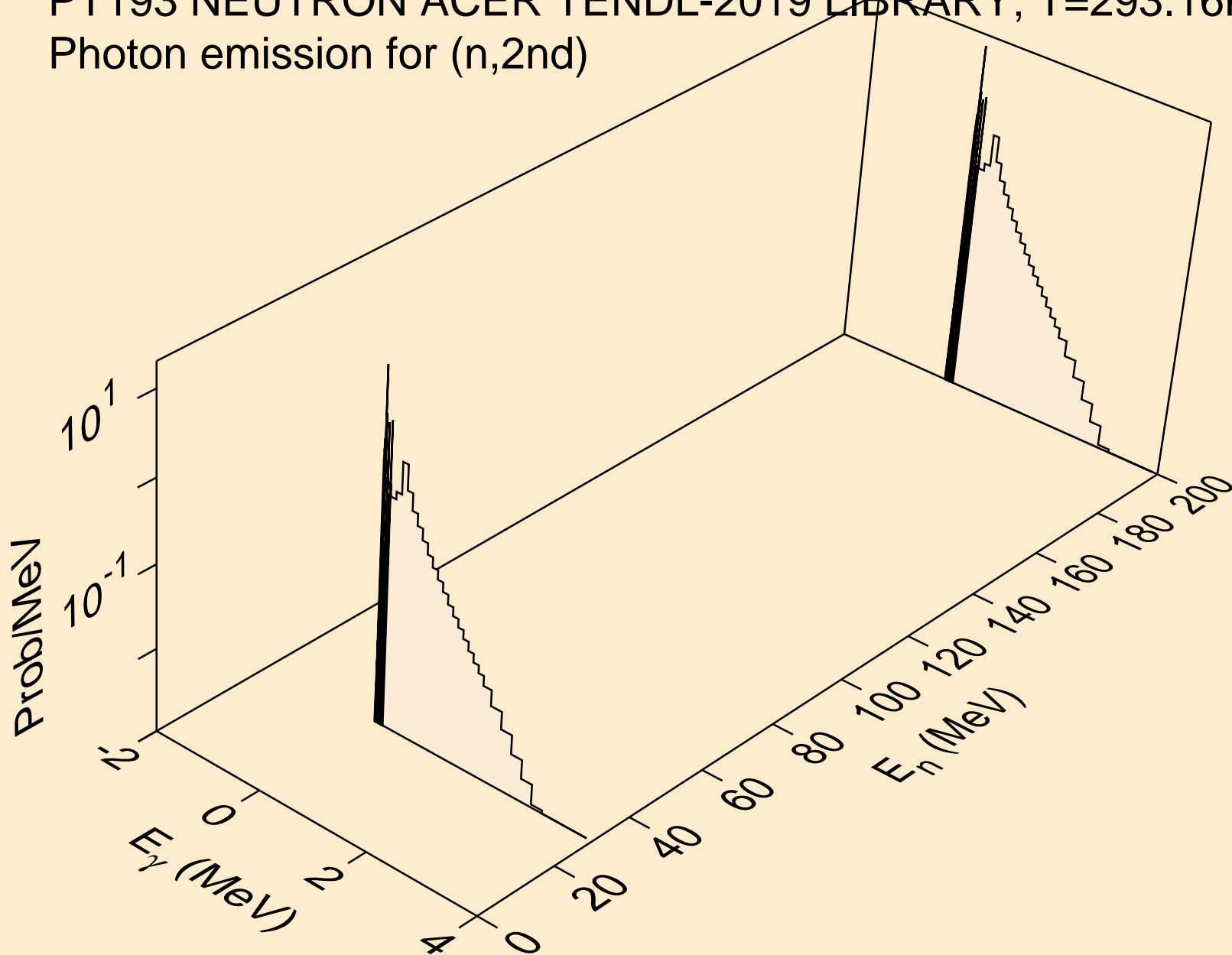

PT193 NEUTRON ACER TENDL-2019 LIBRARY; T=293.16K
Photon emission for (n,2n)

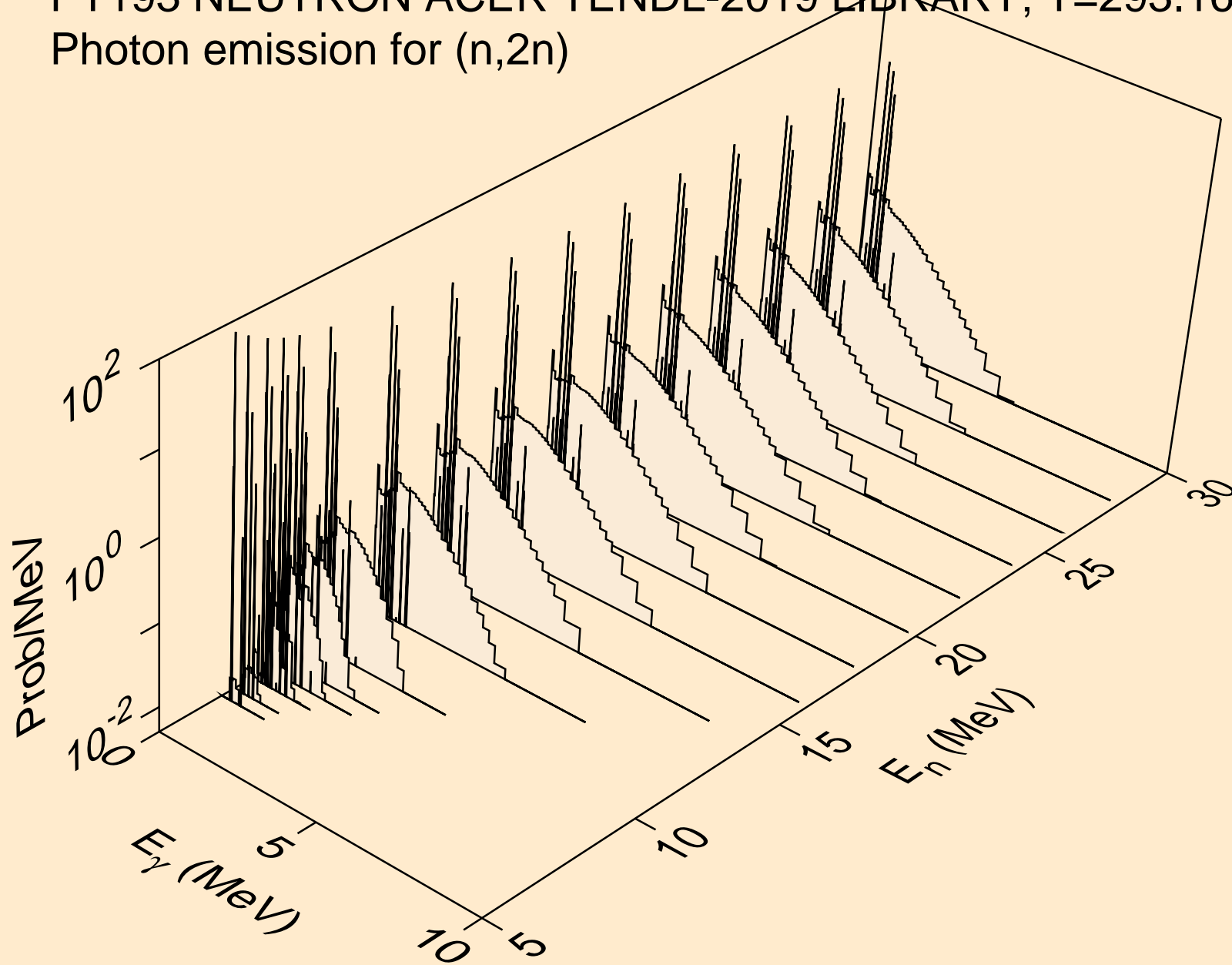

PT193 NEUTRON ACER TENDL-2019 LIBRARY; T=293.16K
Photon emission for (n,3n)

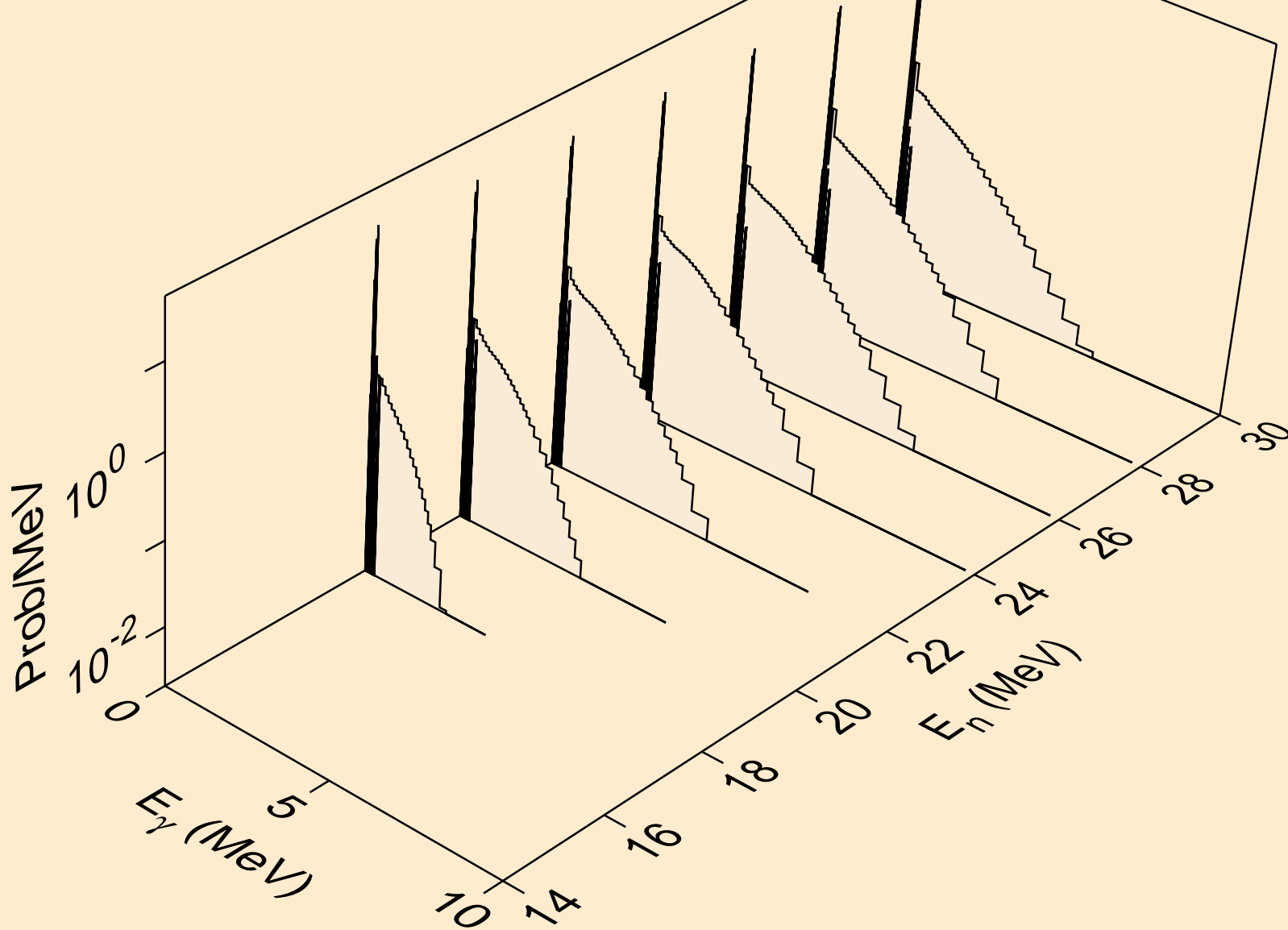

PT193 NEUTRON ACER TENDL-2019 LIBRARY; T=293.16K
Photon emission for (n,n*)a

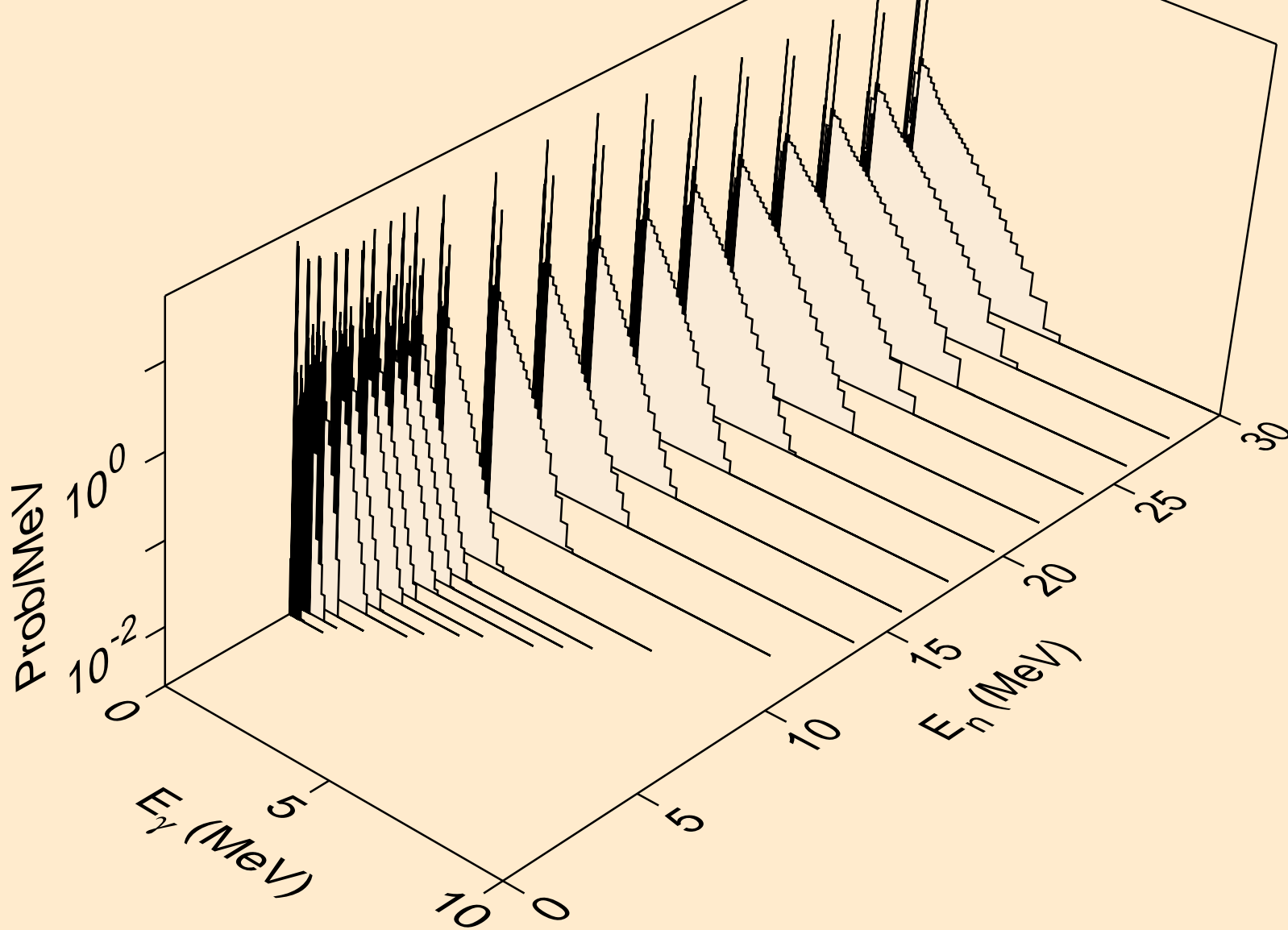

PT193 NEUTRON ACER TENDL-2019 LIBRARY; T=293.16K
Photon emission for (n,2n)a

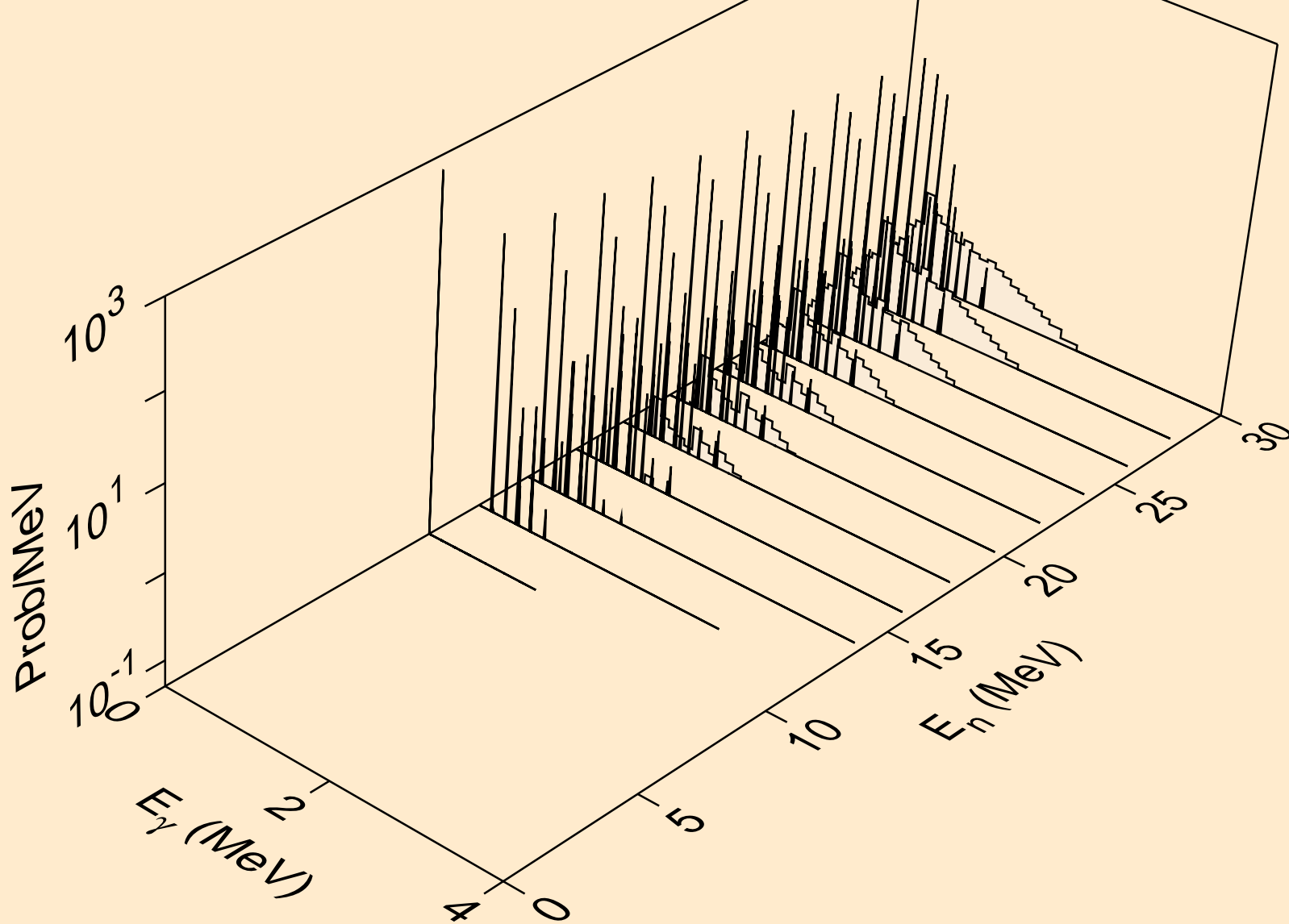

PT193 NEUTRON ACER TENDL-2019 LIBRARY; T=293.16K
Photon emission for (n,3n)a

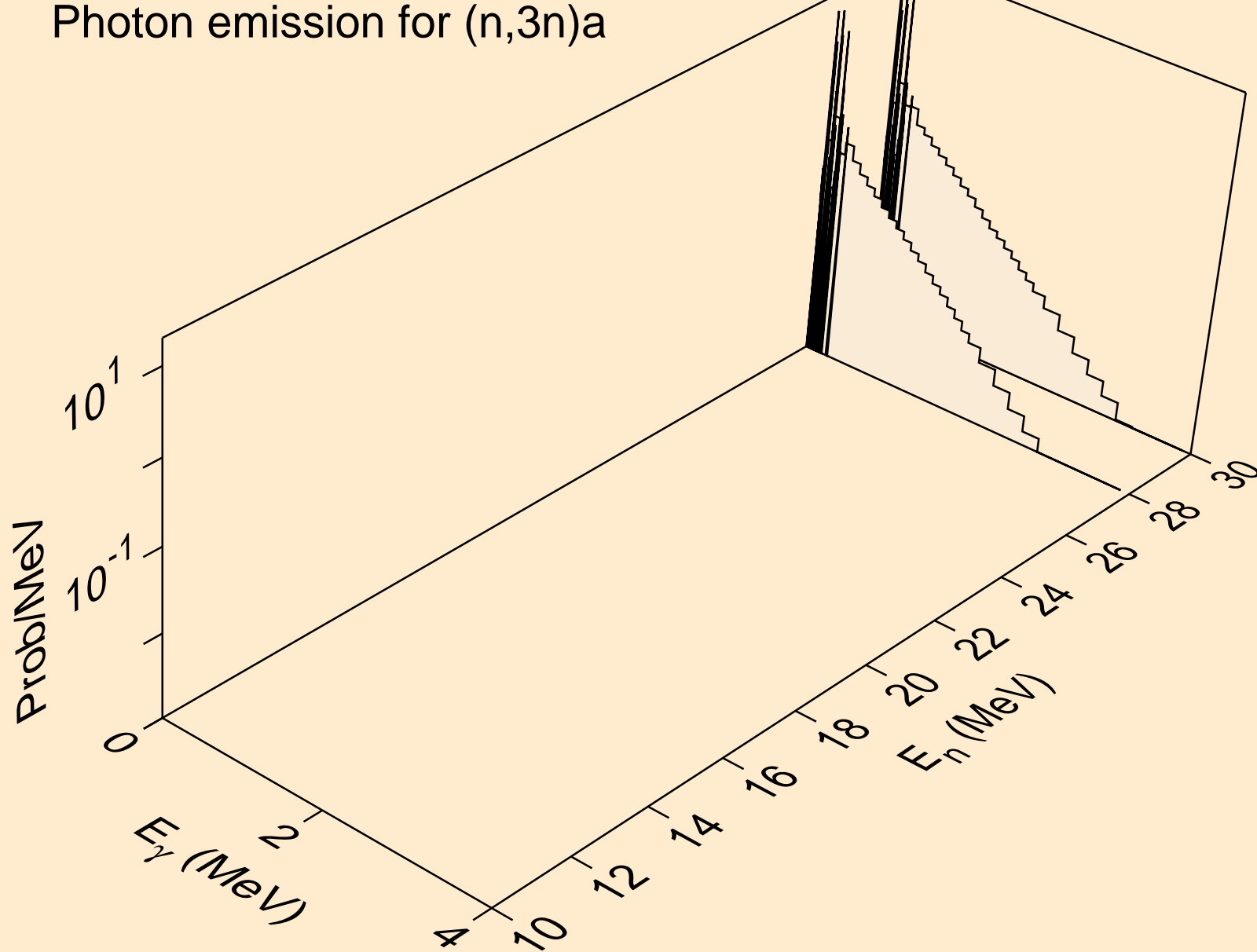

PT193 NEUTRON ACER TENDL-2019 LIBRARY; T=293.16K
Photon emission for (n,n*)p

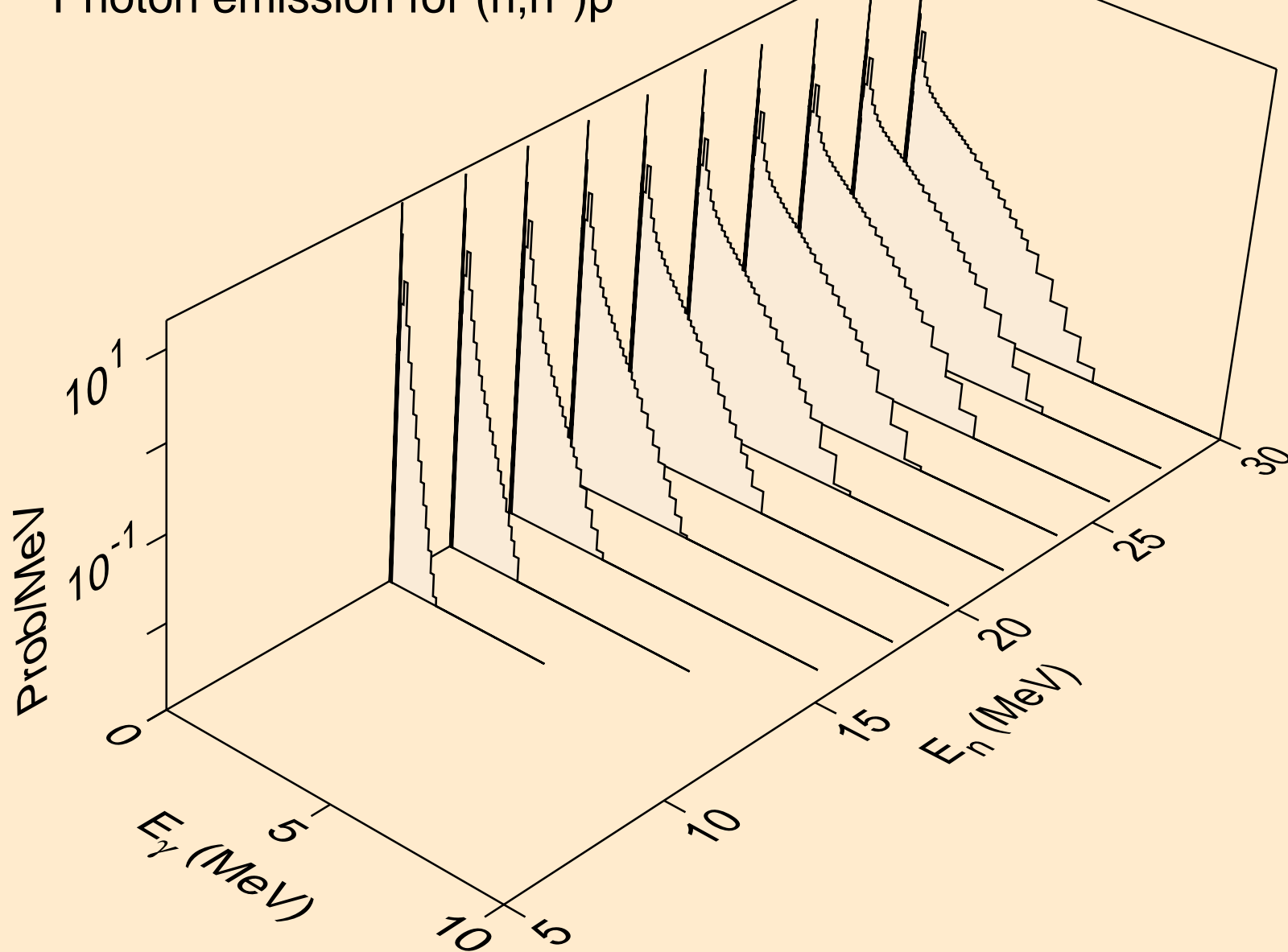

PT193 NEUTRON ACER TENDL-2019 LIBRARY; T=293.16K
Photon emission for (n,n*)d

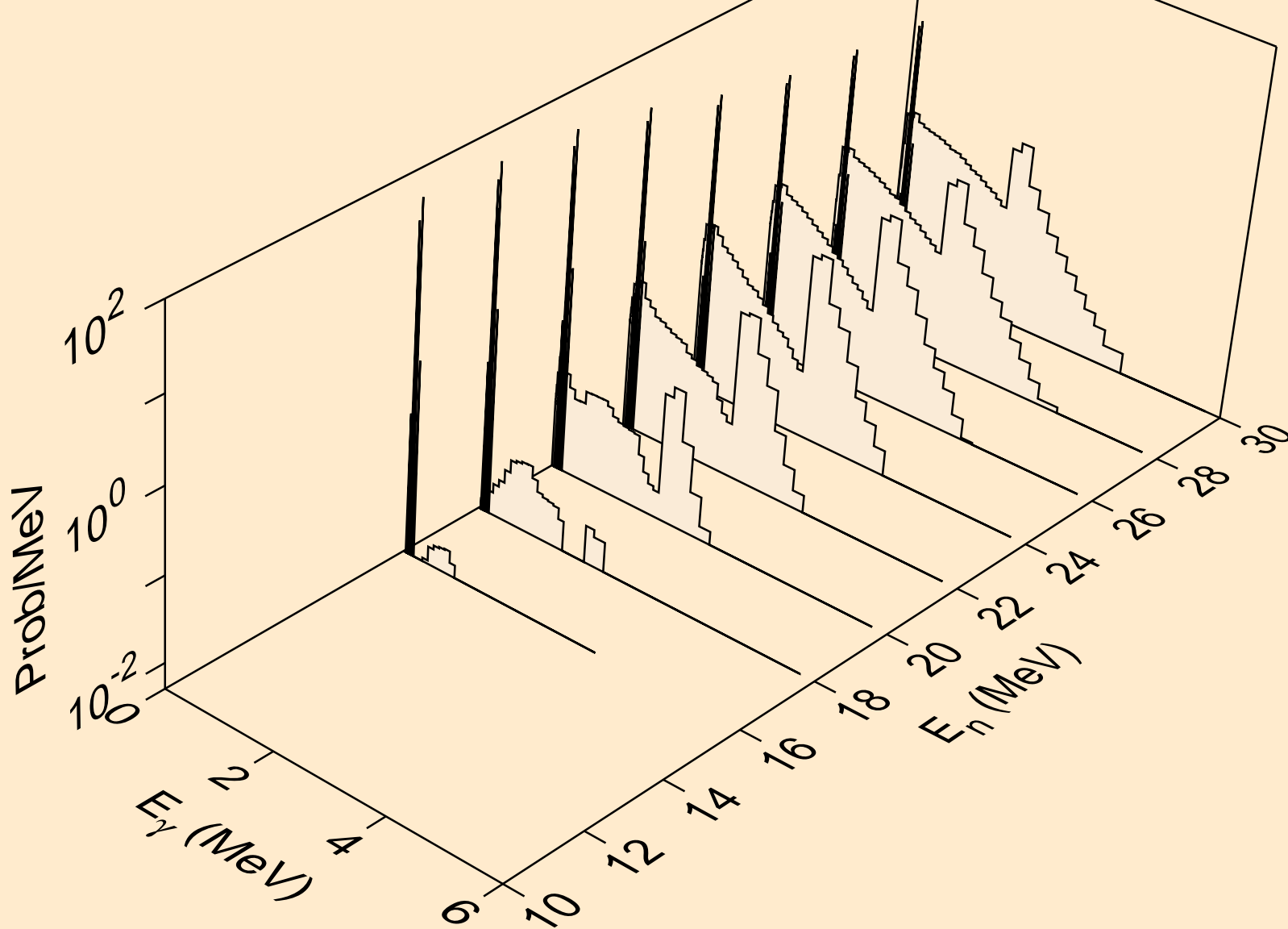

PT193 NEUTRON ACER TENDL-2019 LIBRARY; T=293.16K
Photon emission for (n,n*)t

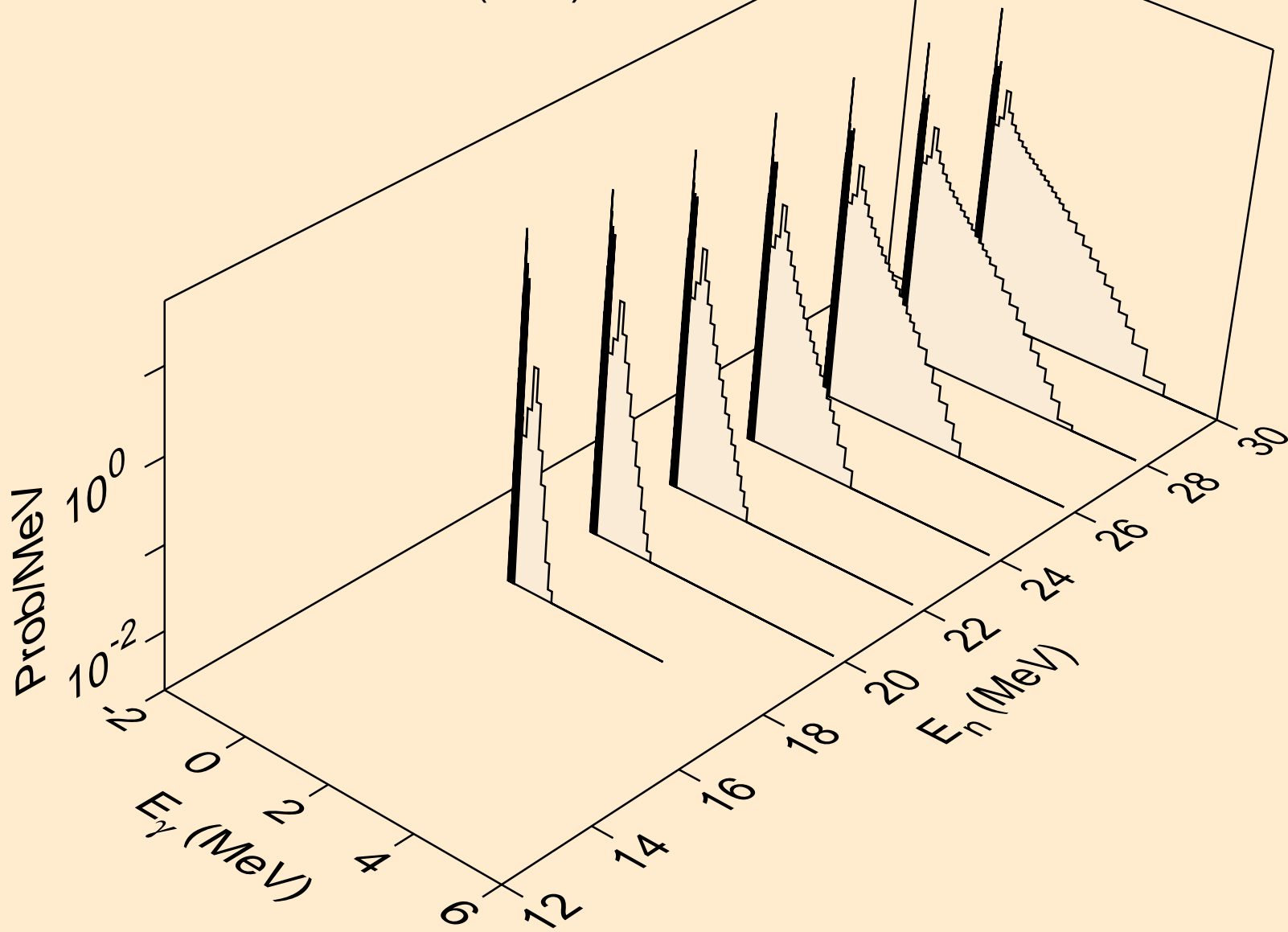

PT193 NEUTRON ACER TENDL-2019 LIBRARY; T=293.16K
Photon emission for (n,n*)he3

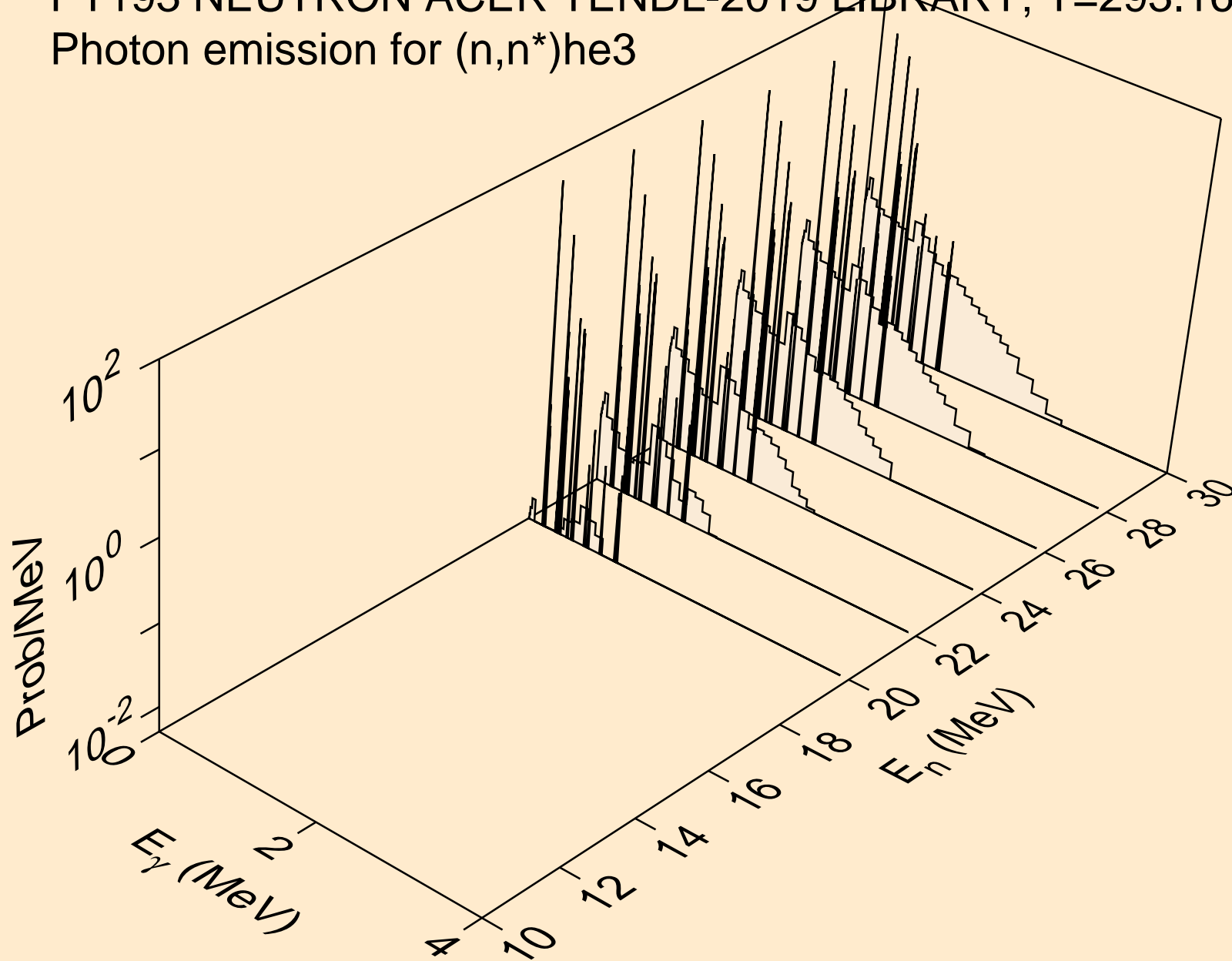

PT193 NEUTRON ACER TENDL-2019 LIBRARY; T=293.16K
Photon emission for (n,4n)

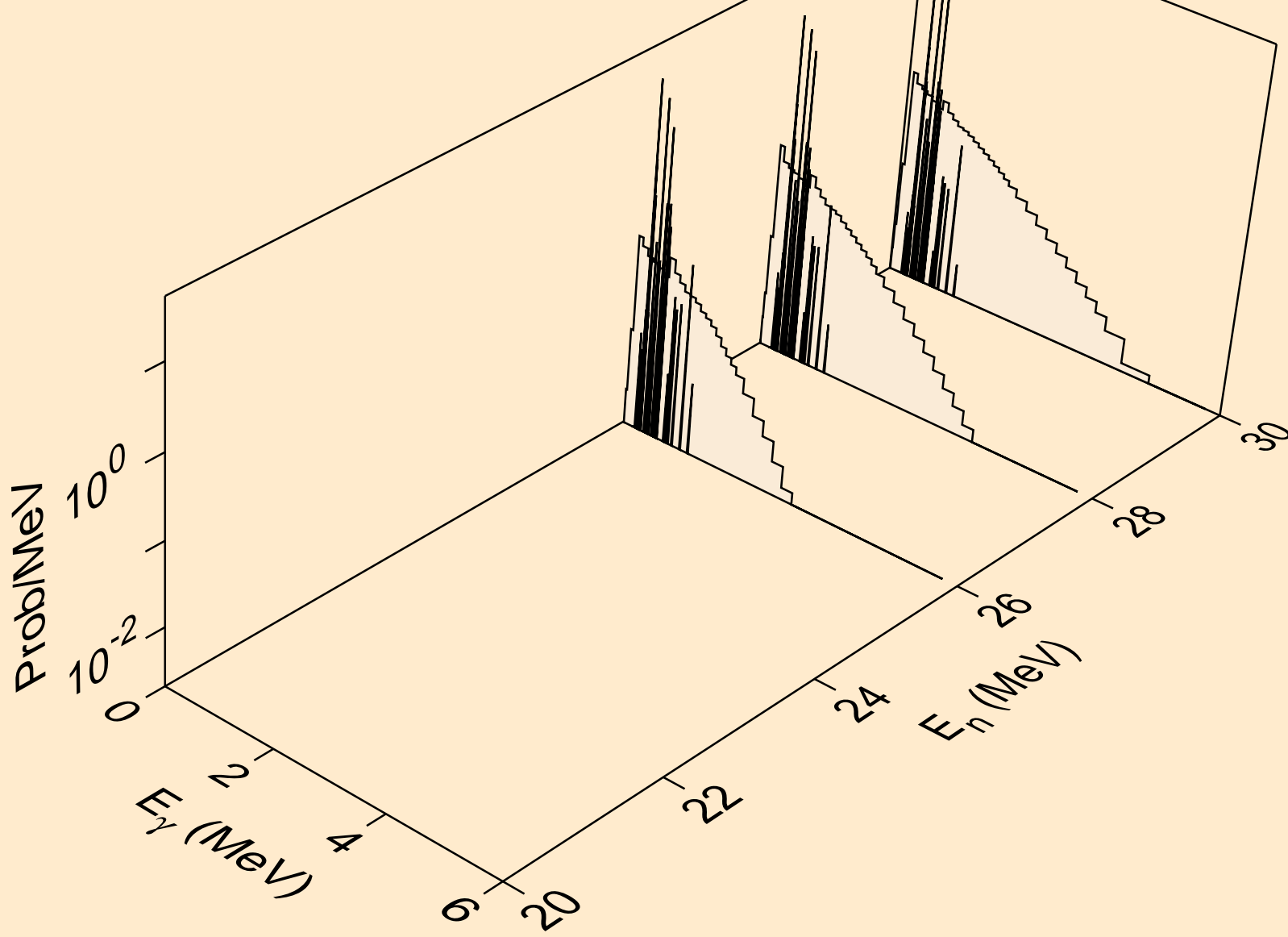

PT193 NEUTRON ACER TENDL-2019 LIBRARY; T=293.16K
Photon emission for (n,2np)

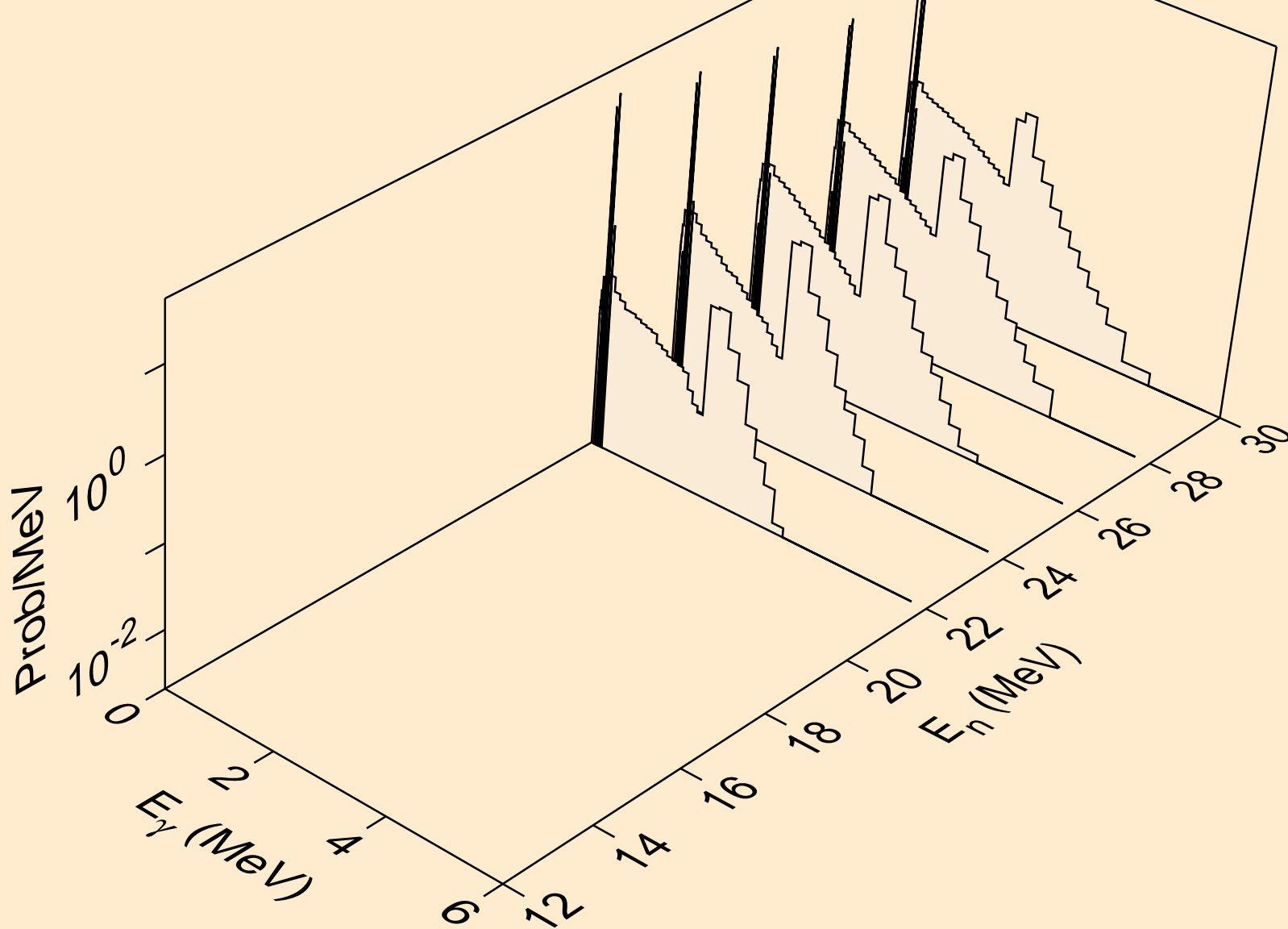

PT193 NEUTRON ACER TENDL-2019 LIBRARY; T=293.16K
Photon emission for (n,3np)

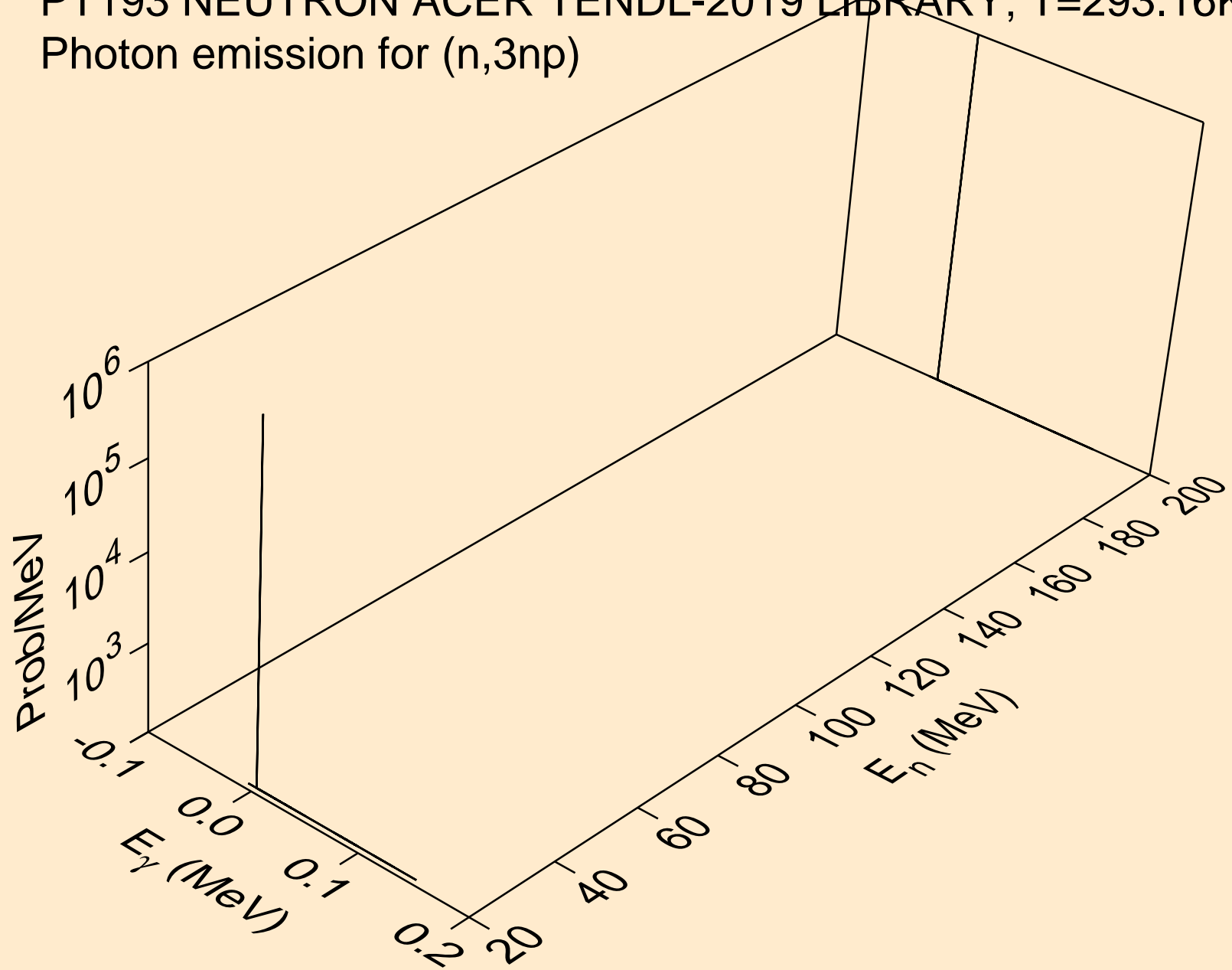

PT193 NEUTRON ACER TENDL-2019 LIBRARY; T=293.16K
Photon emission for (n,2np)

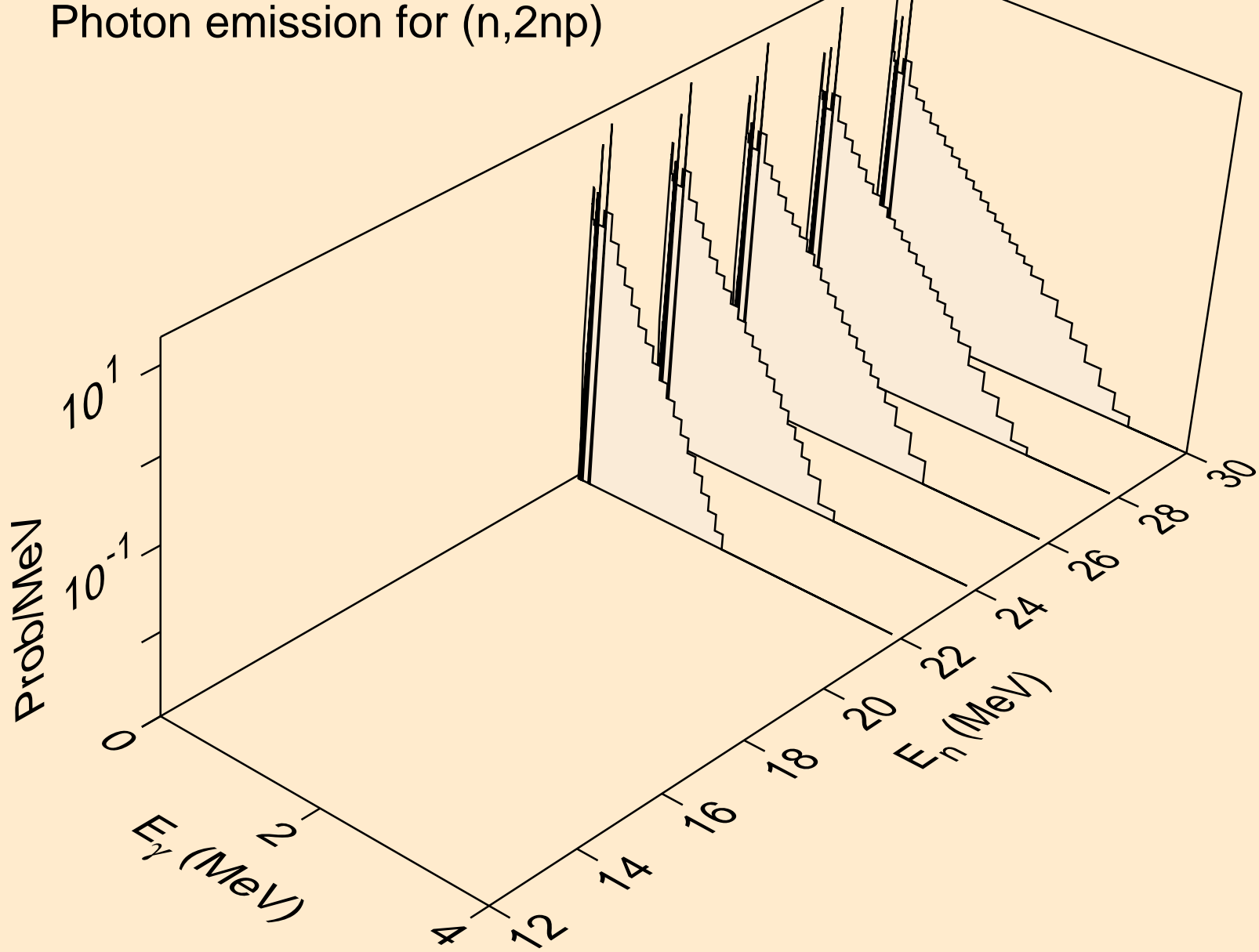

PT193 NEUTRON ACER TENDL-2019 LIBRARY; T=293.16K
Photon emission for (n,npa)

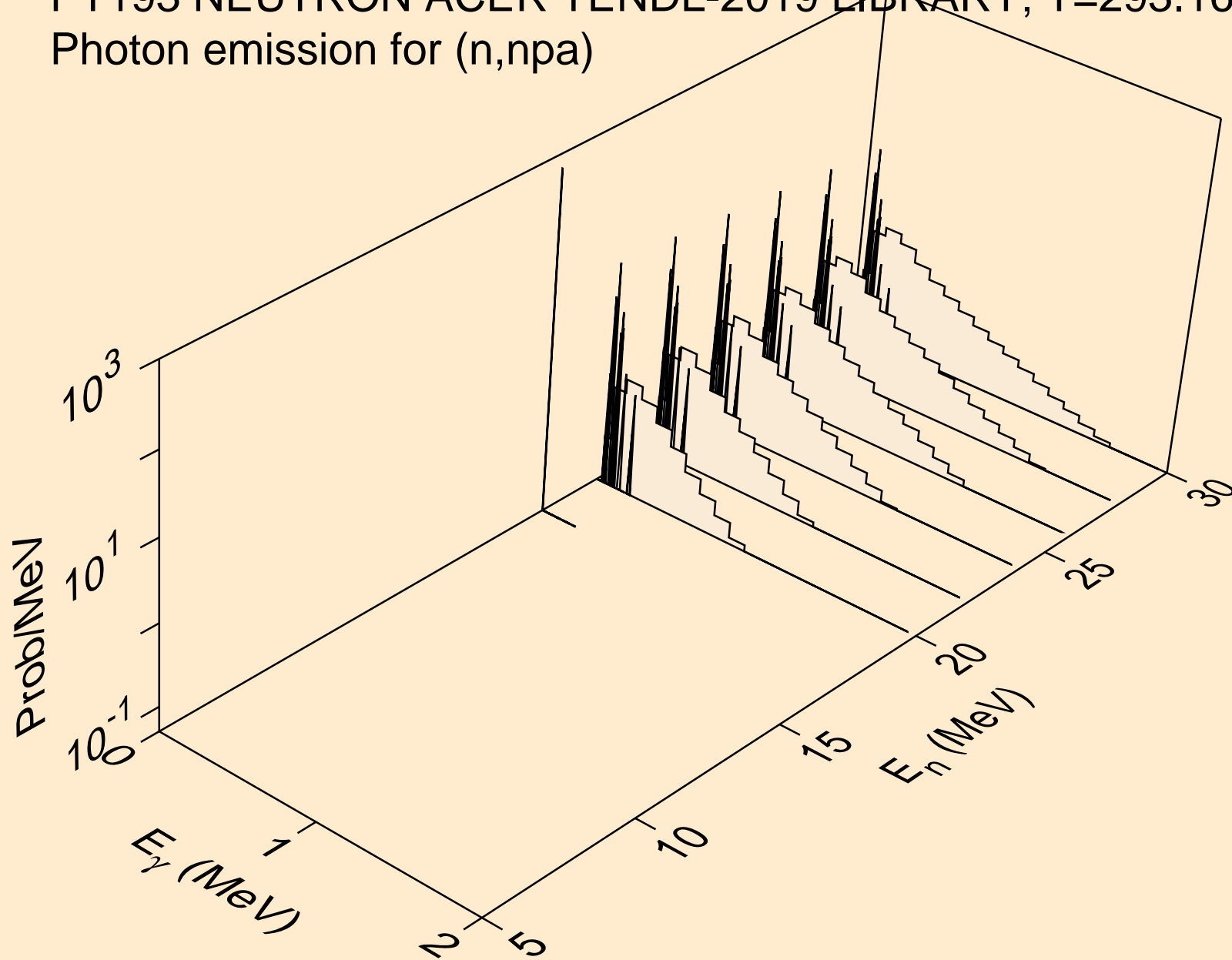

PT193 NEUTRON ACER TENDL-2019 LIBRARY; T=293.16K
Photon emission for (n,n*c)

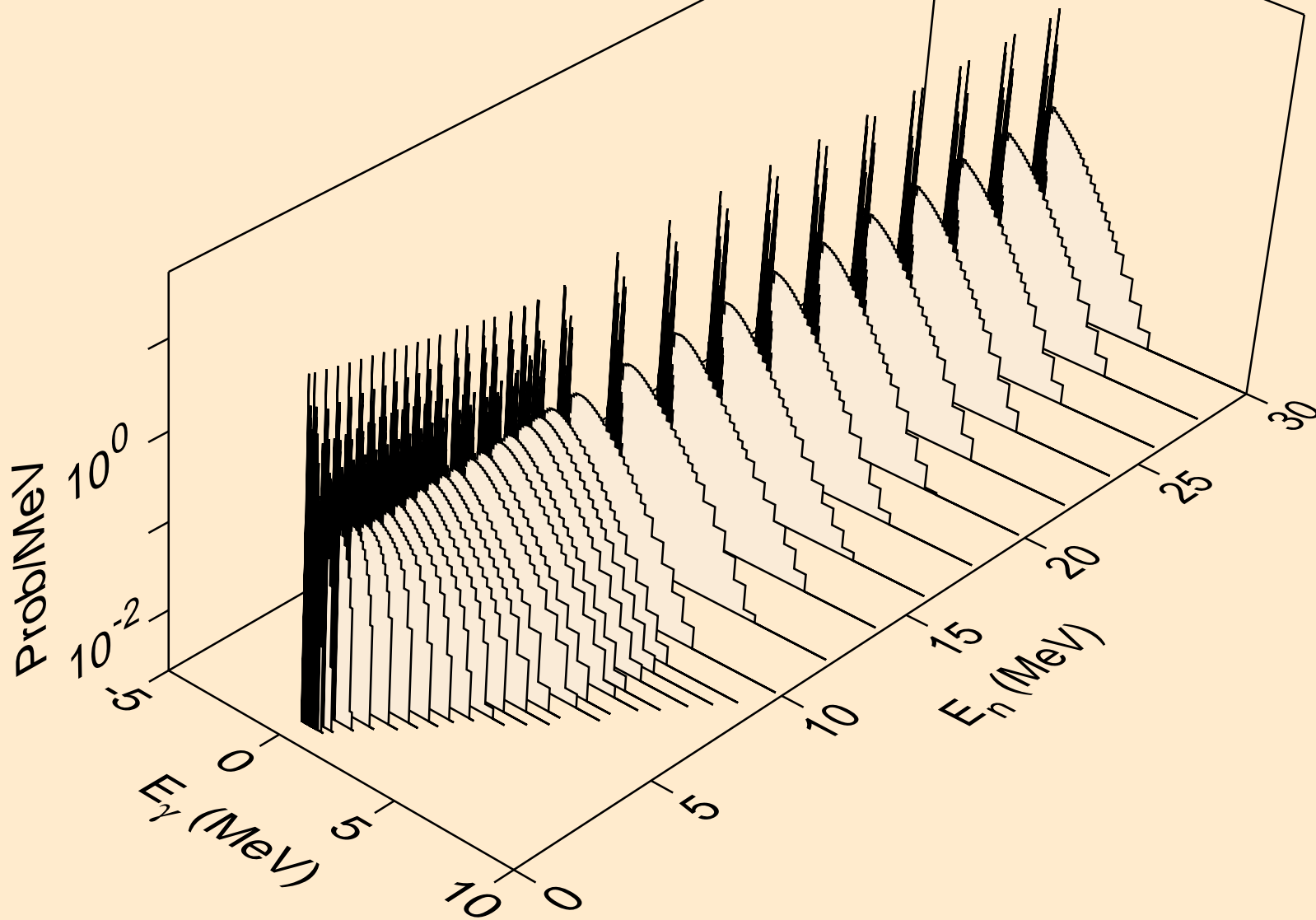

PT193 NEUTRON ACER TENDL-2019 LIBRARY; T=293.16K
Photon emission for (n,gma)

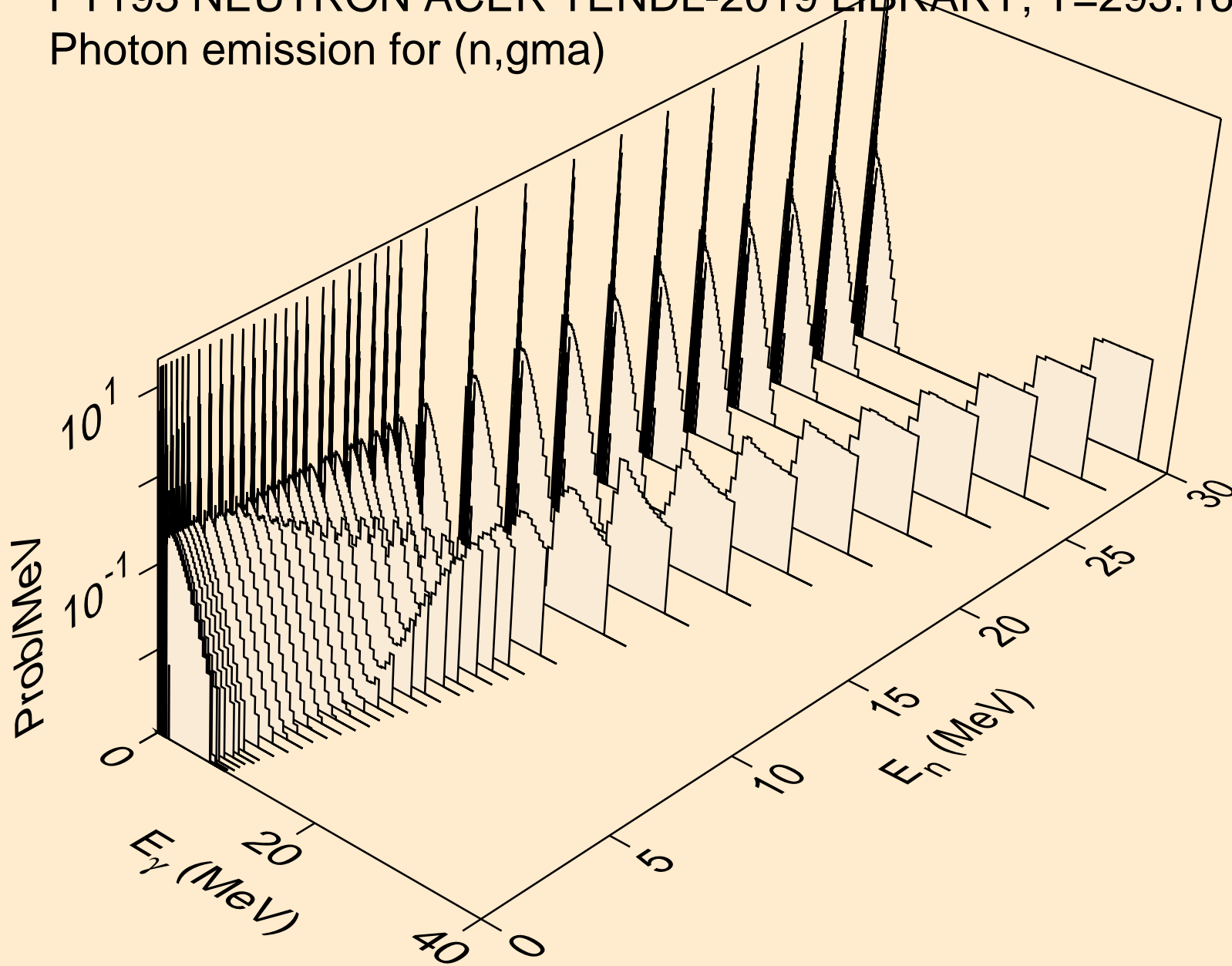

PT193 NEUTRON ACER TENDL-2019 LIBRARY; T=293.16K
Photon emission for (n,p)

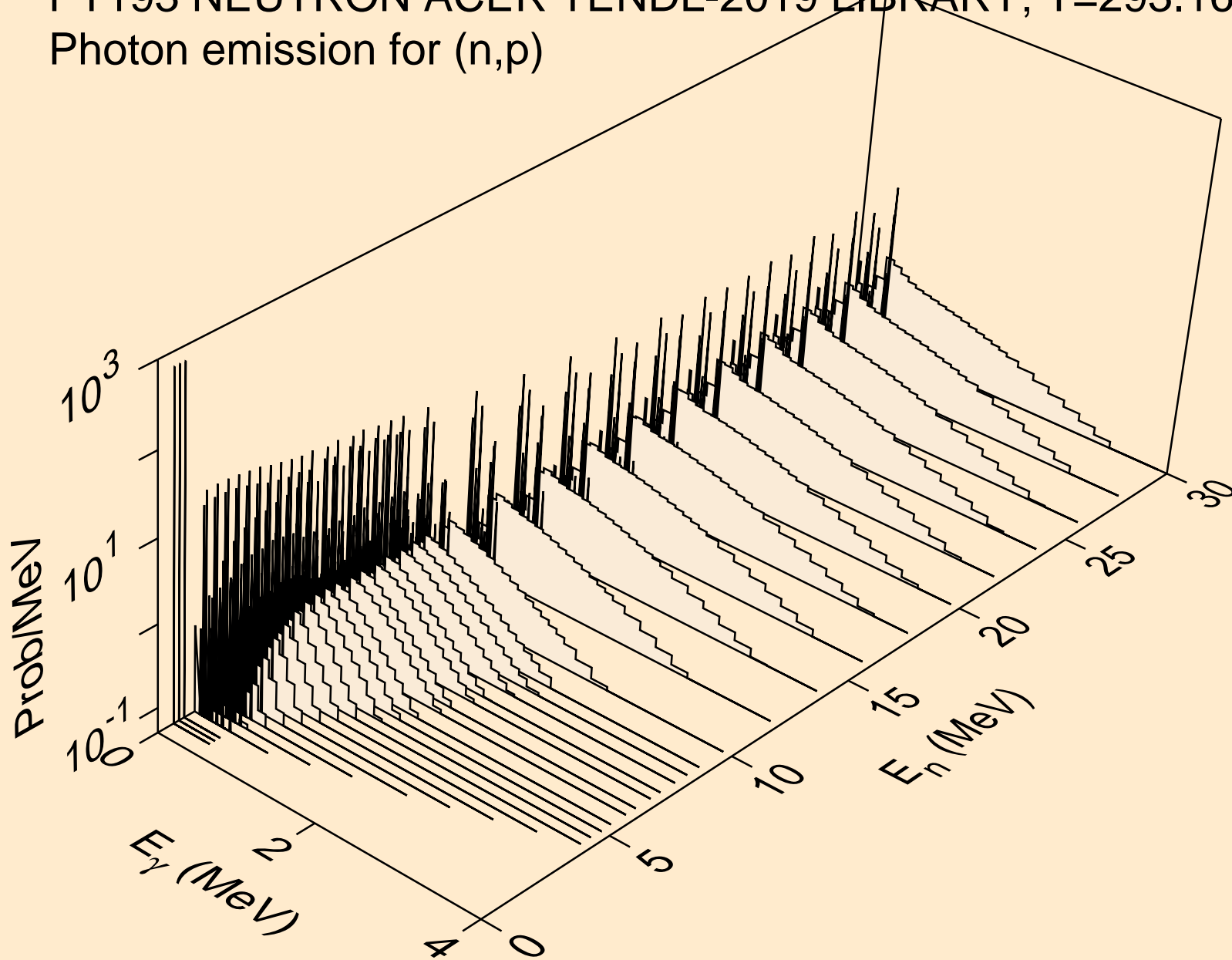

PT193 NEUTRON ACER TENDL-2019 LIBRARY; T=293.16K
Photon emission for (n,d)

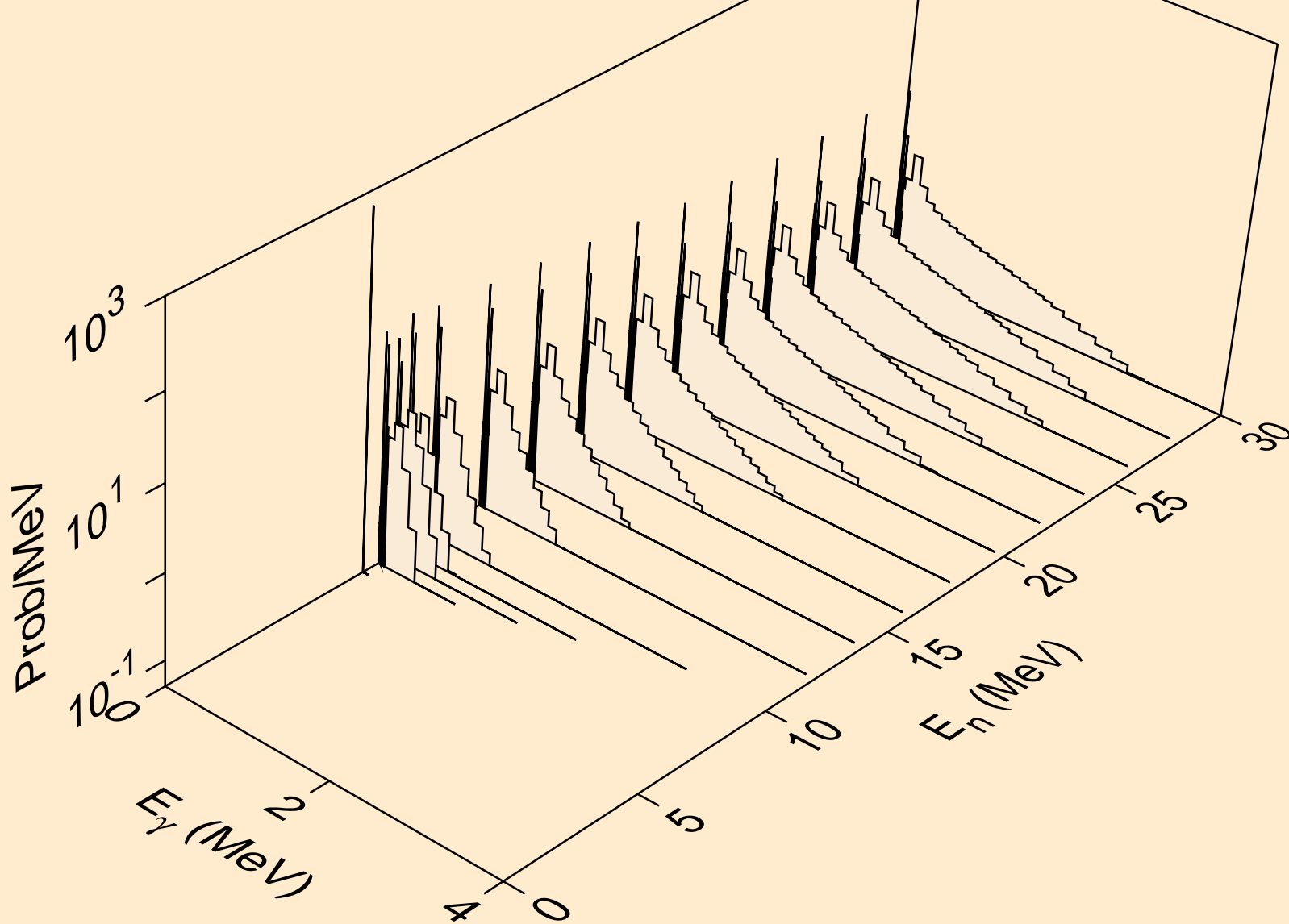

PT193 NEUTRON ACER TENDL-2019 LIBRARY; T=293.16K
Photon emission for (n,t)

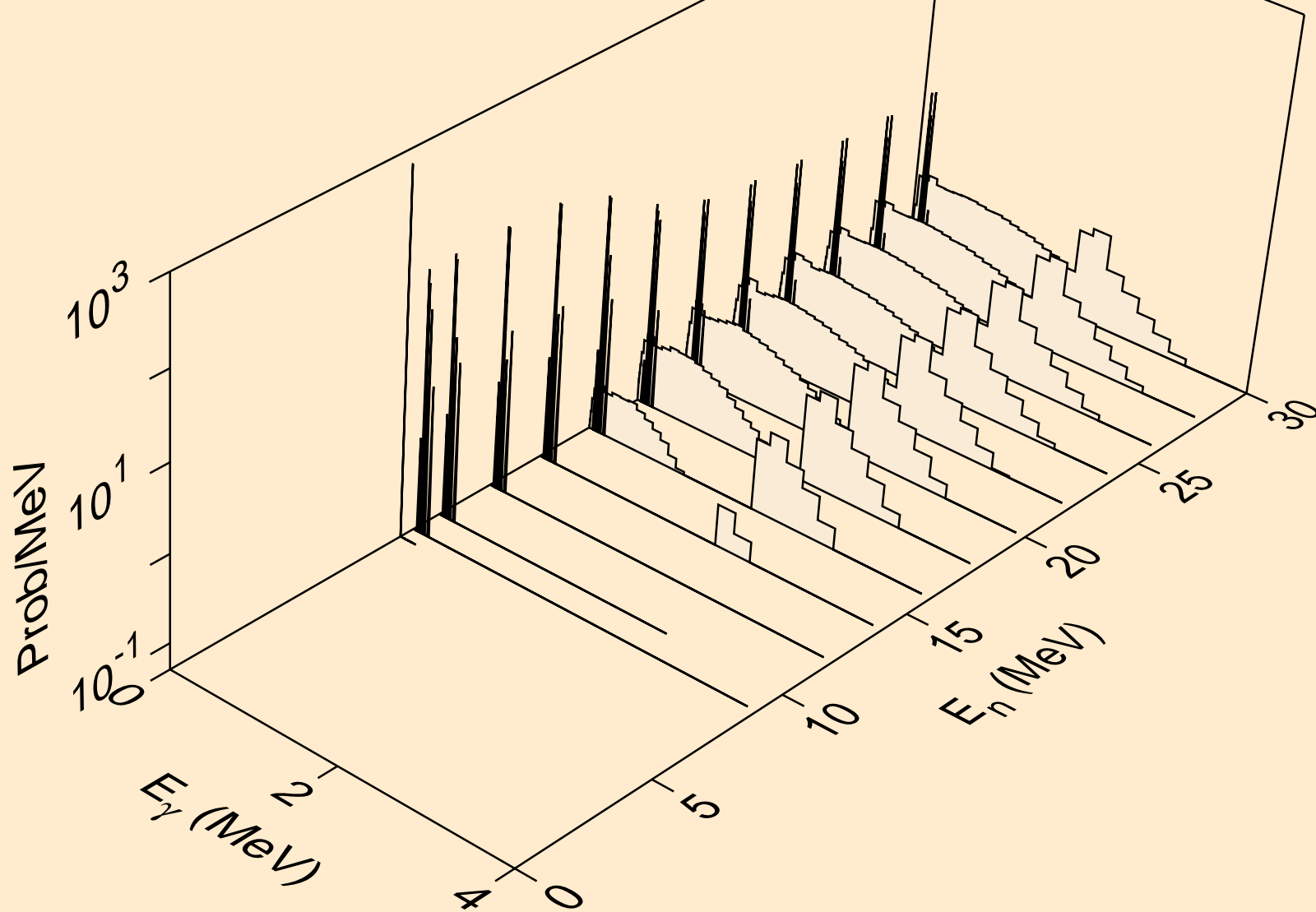

PT193 NEUTRON ACER TENDL-2019 LIBRARY; T=293.16K
Photon emission for (n,he3)

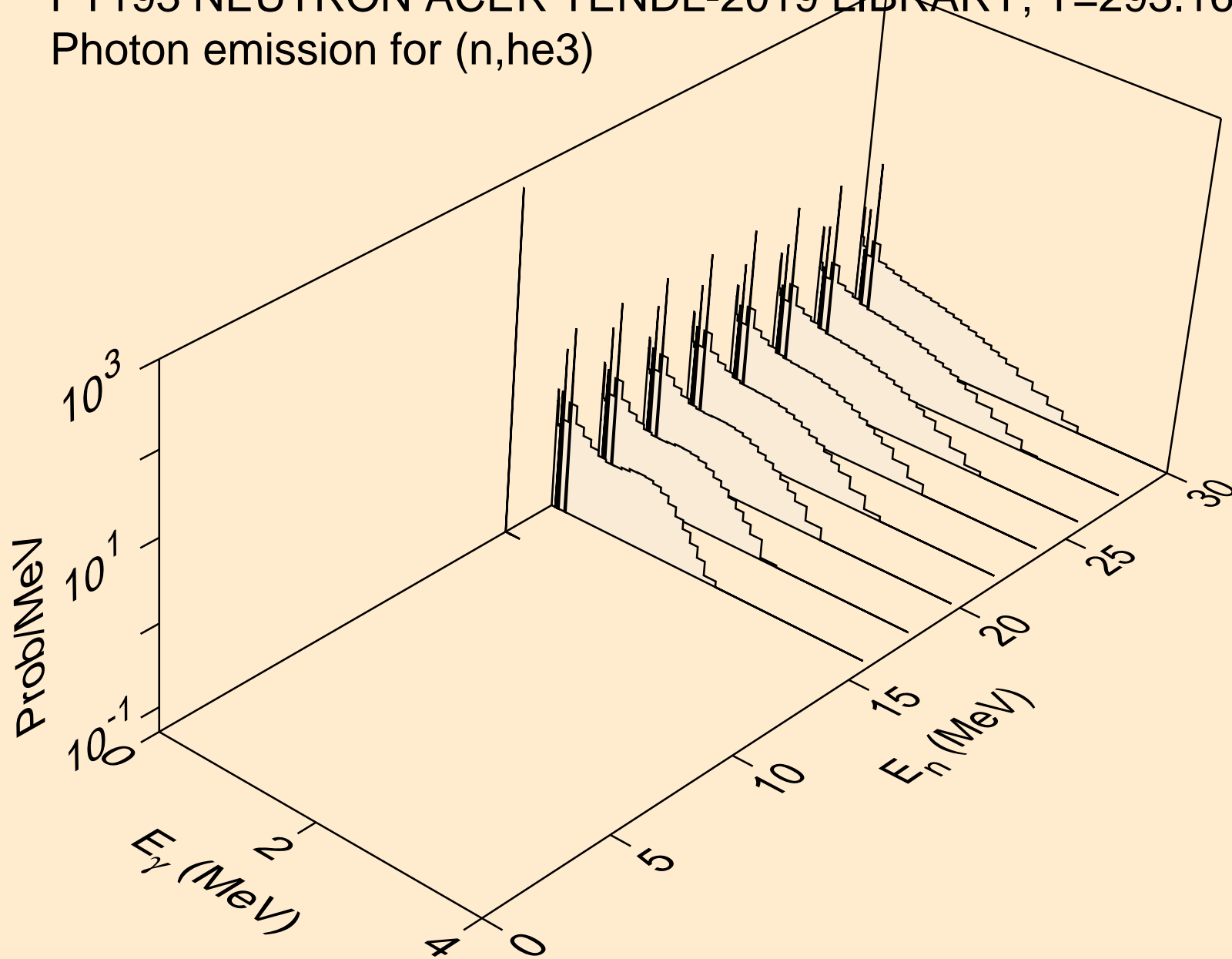

PT193 NEUTRON ACER TENDL-2019 LIBRARY; T=293.16K
Photon emission for (n,a)

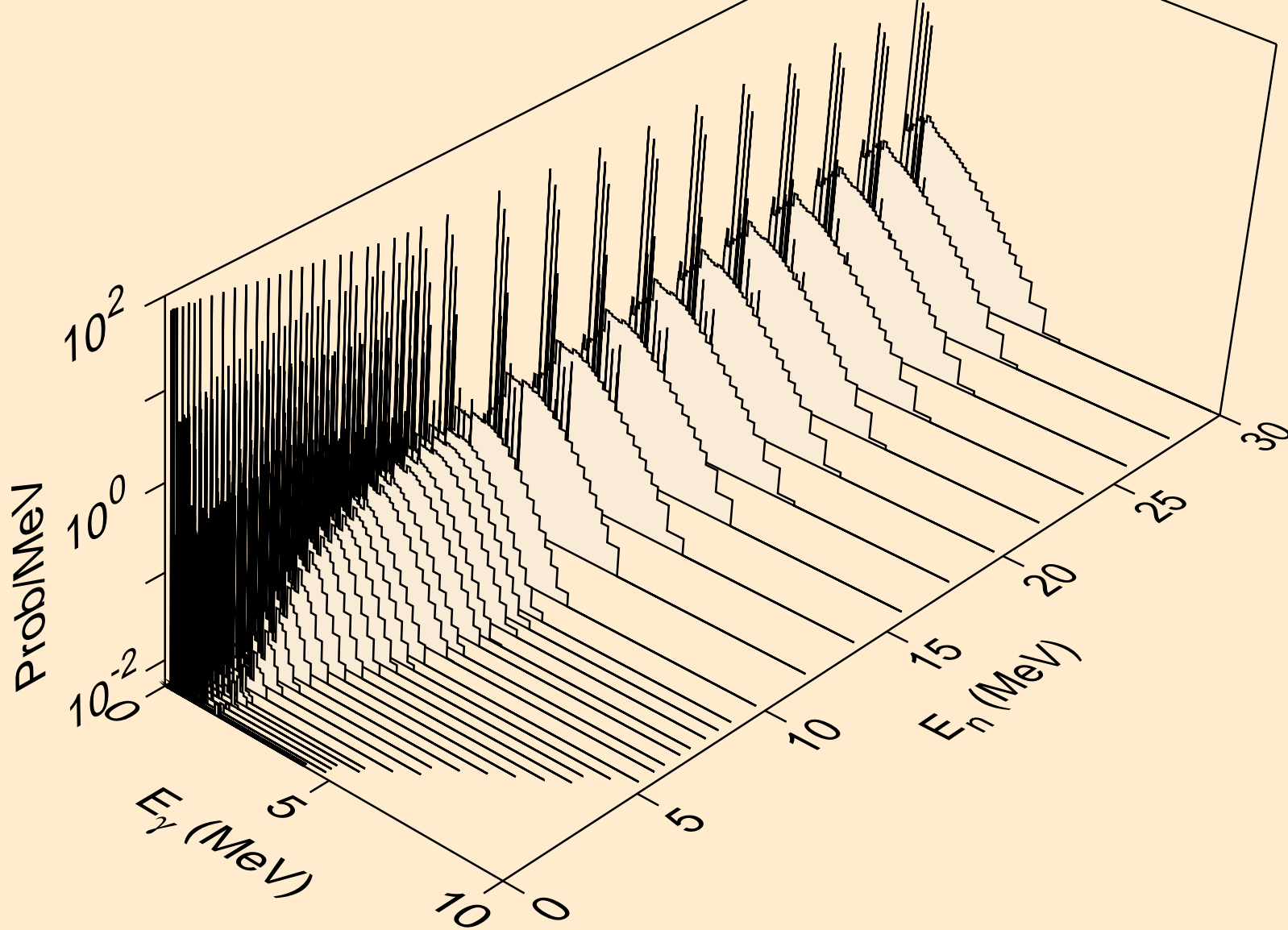

PT193 NEUTRON ACER TENDL-2019 LIBRARY; T=293.16K
Photon emission for (n,2a)

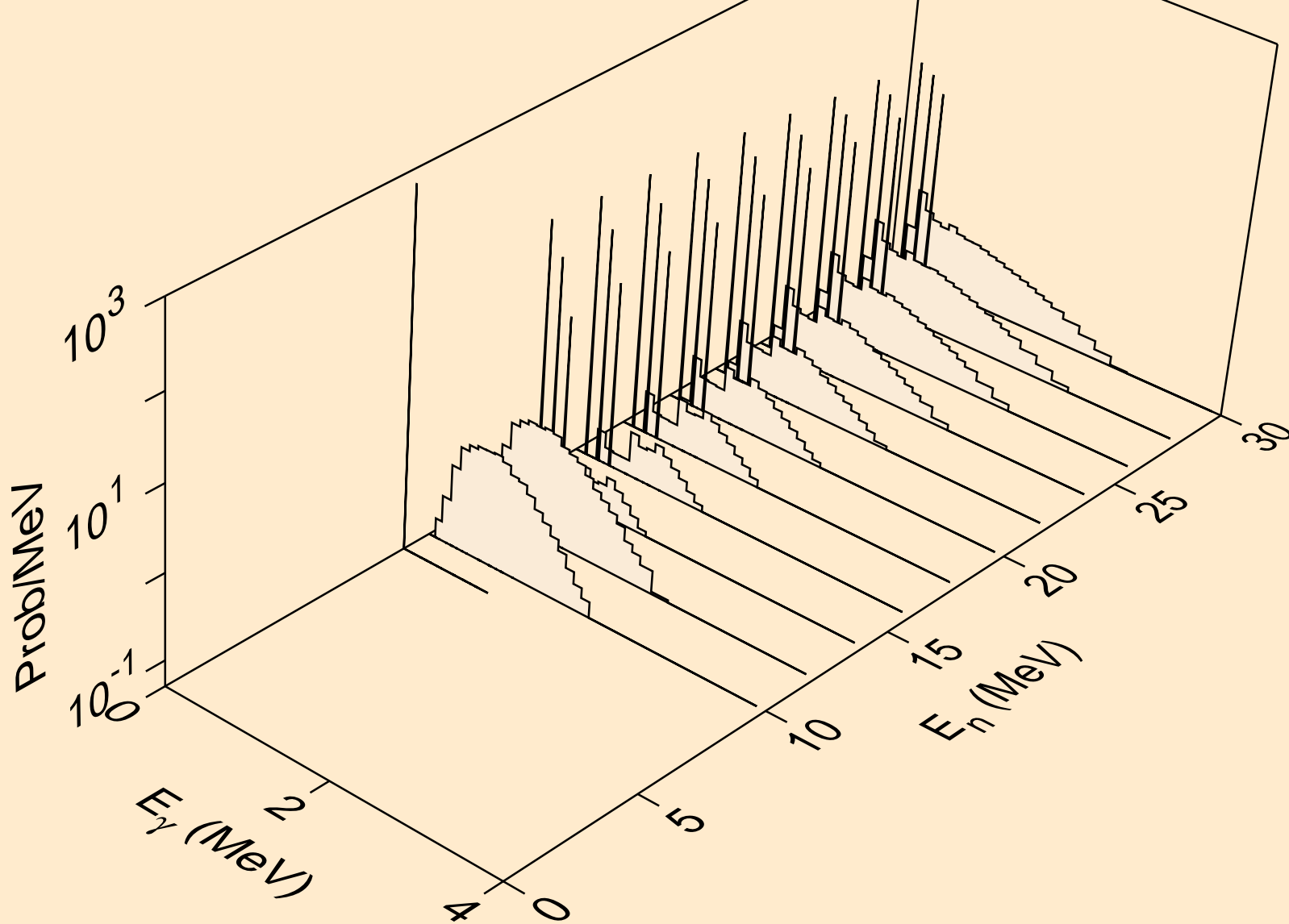

PT193 NEUTRON ACER TENDL-2019 LIBRARY; T=293.16K
Photon emission for (n,2p)

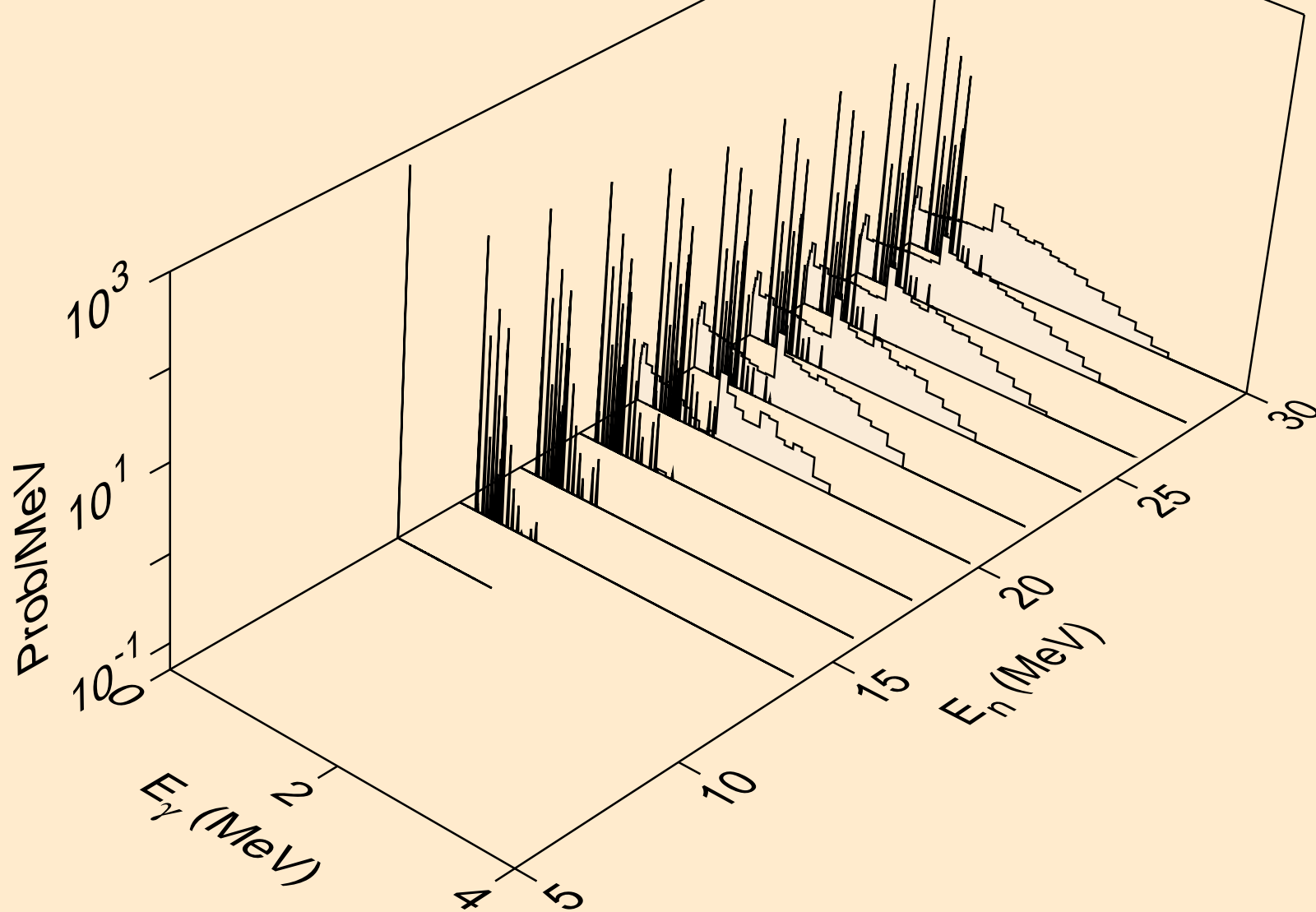

PT193 NEUTRON ACER TENDL-2019 LIBRARY; T=293.16K
Photon emission for (n,p)

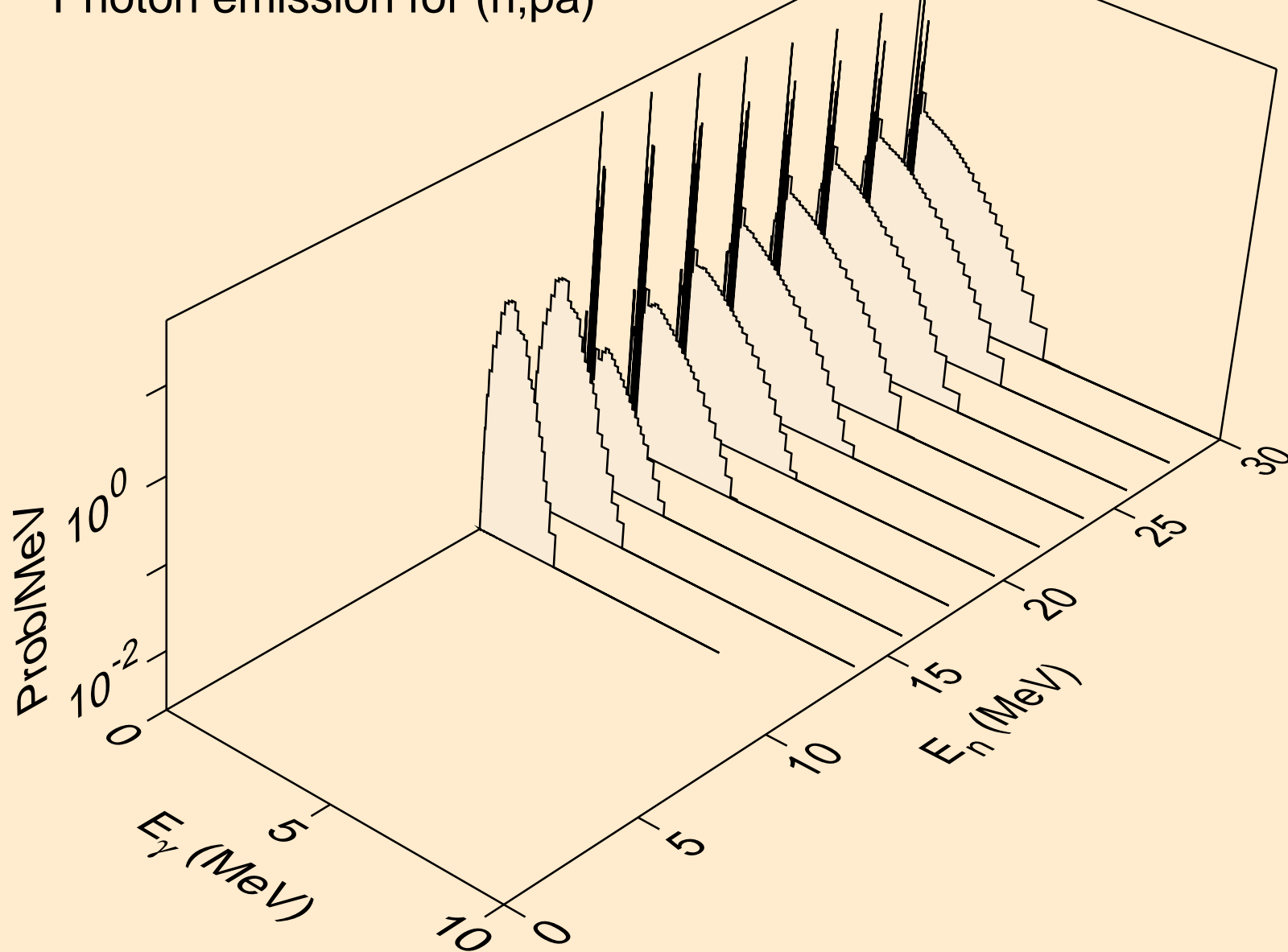

PT193 NEUTRON ACER TENDL-2019 LIBRARY; T=293.16K
Photon emission for (n,pd)

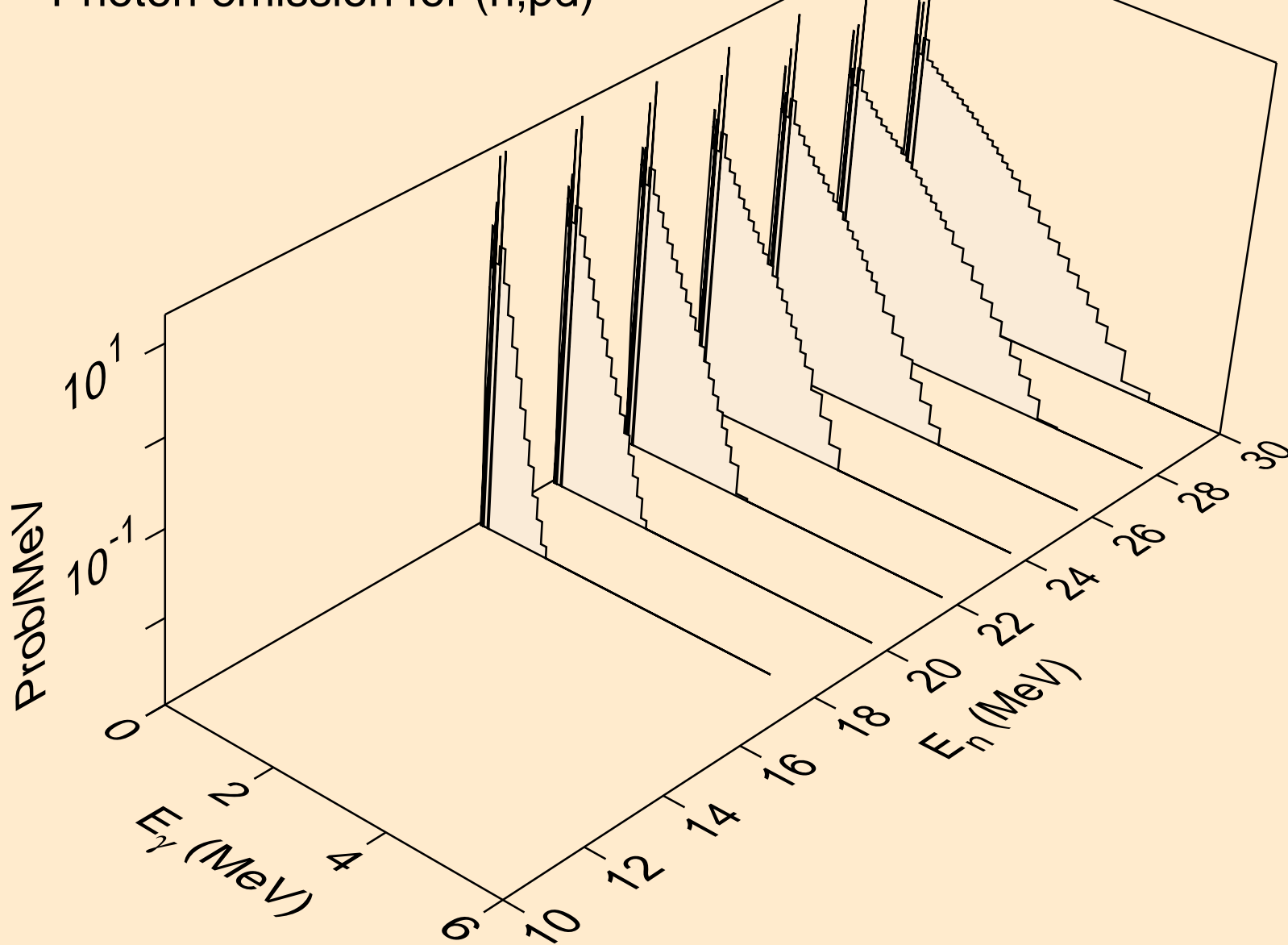

PT193 NEUTRON ACER TENDL-2019 LIBRARY; T=293.16K
Photon emission for (n,pt)

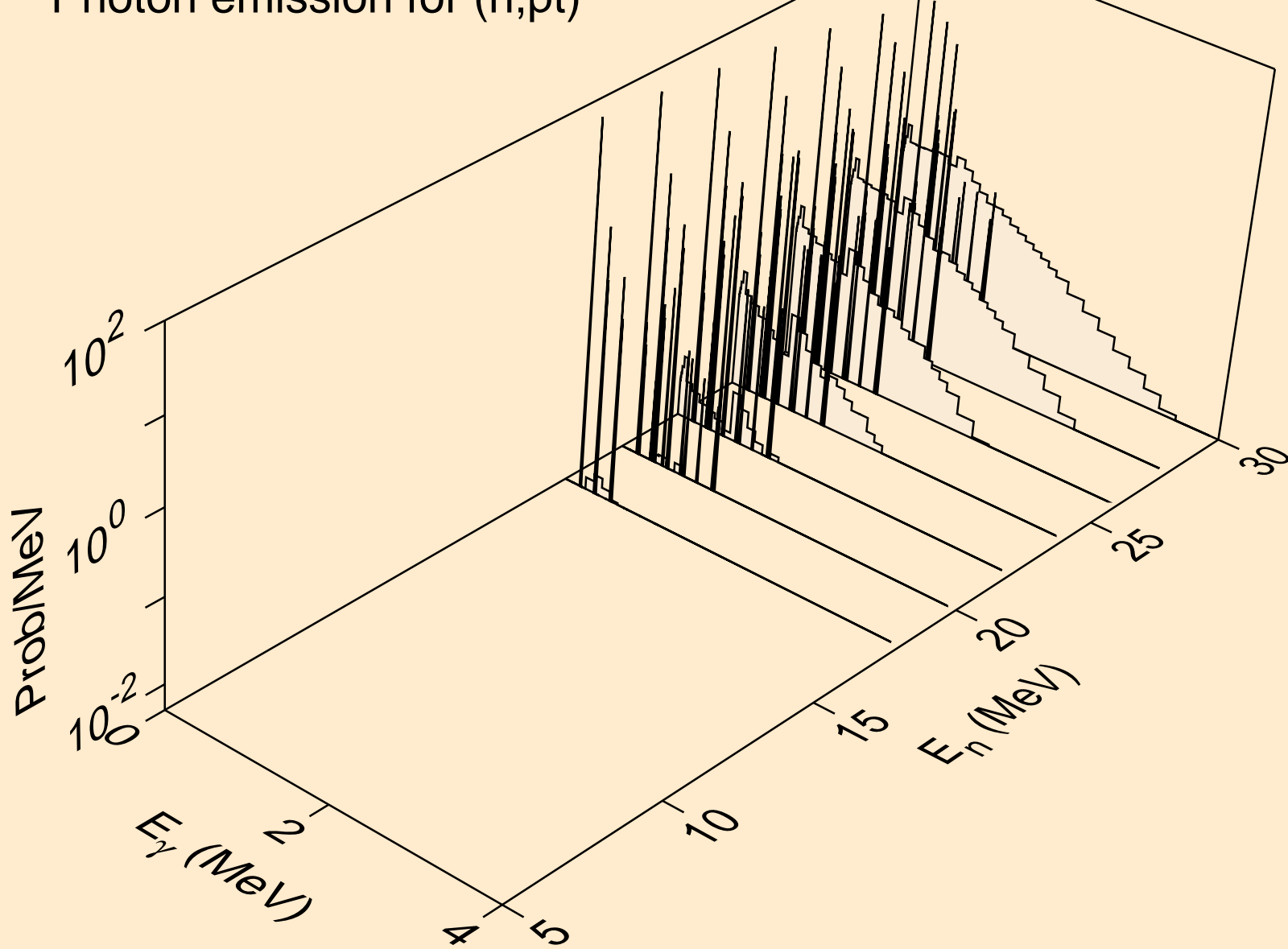

PT193 NEUTRON ACER TENDL-2019 LIBRARY; T=293.16K
thermal capture photon spectrum

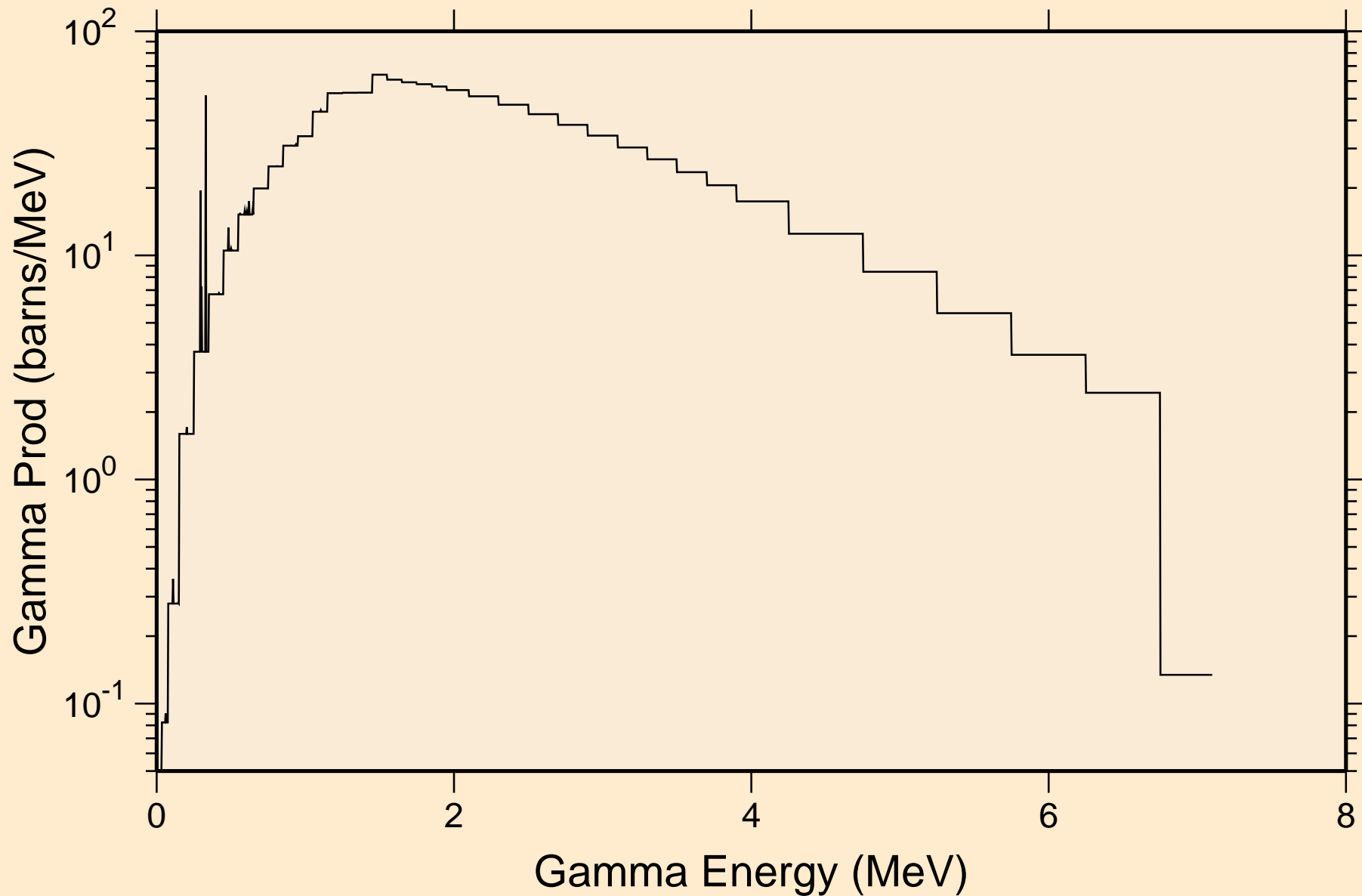

PT193 NEUTRON ACER TENDL-2019 LIBRARY; T=293.16K
14 MeV photon spectrum

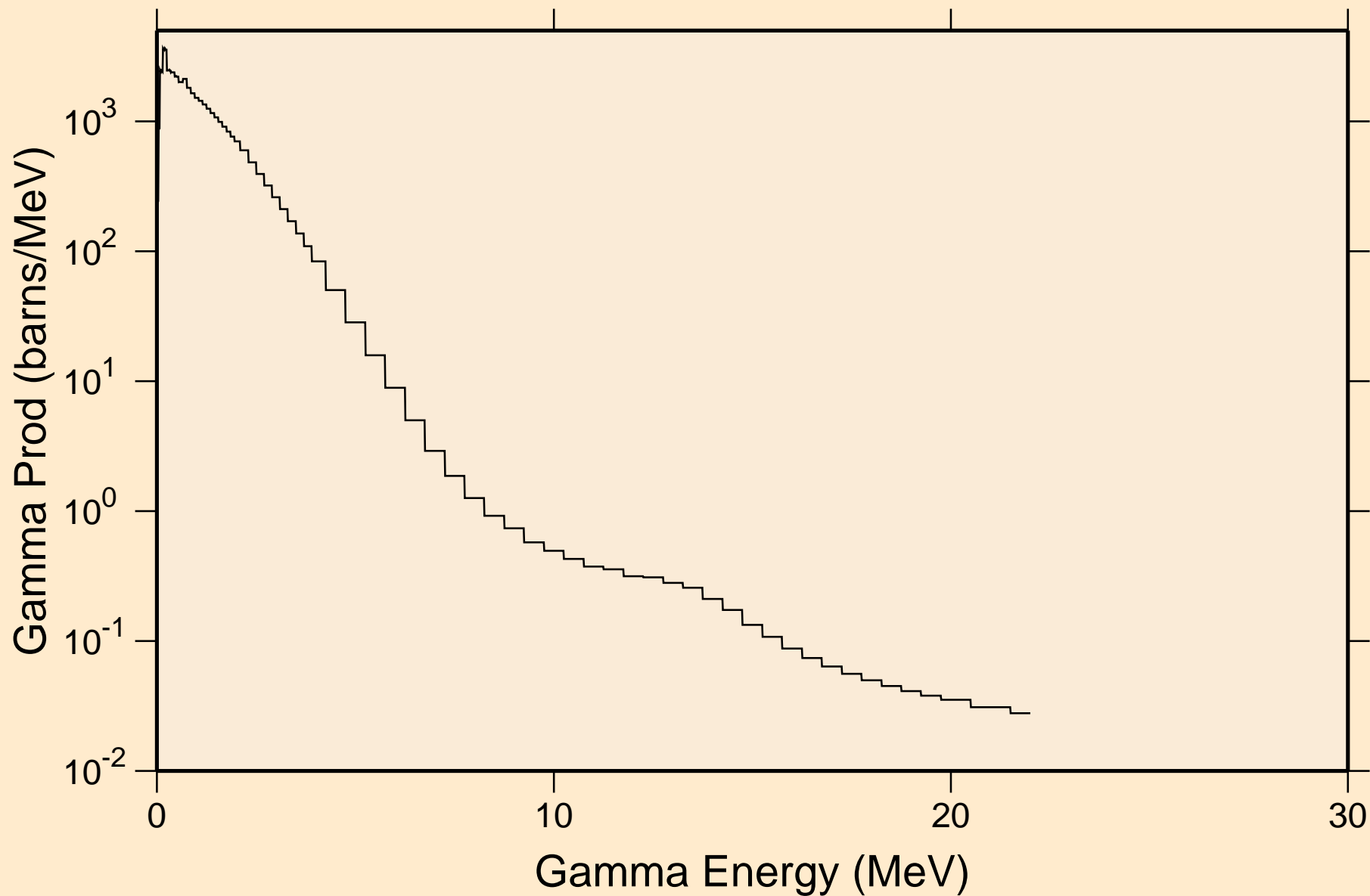

PT193 NEUTRON ACER TENDL-2019 LIBRARY; T=293.16K
Particle heating contributions

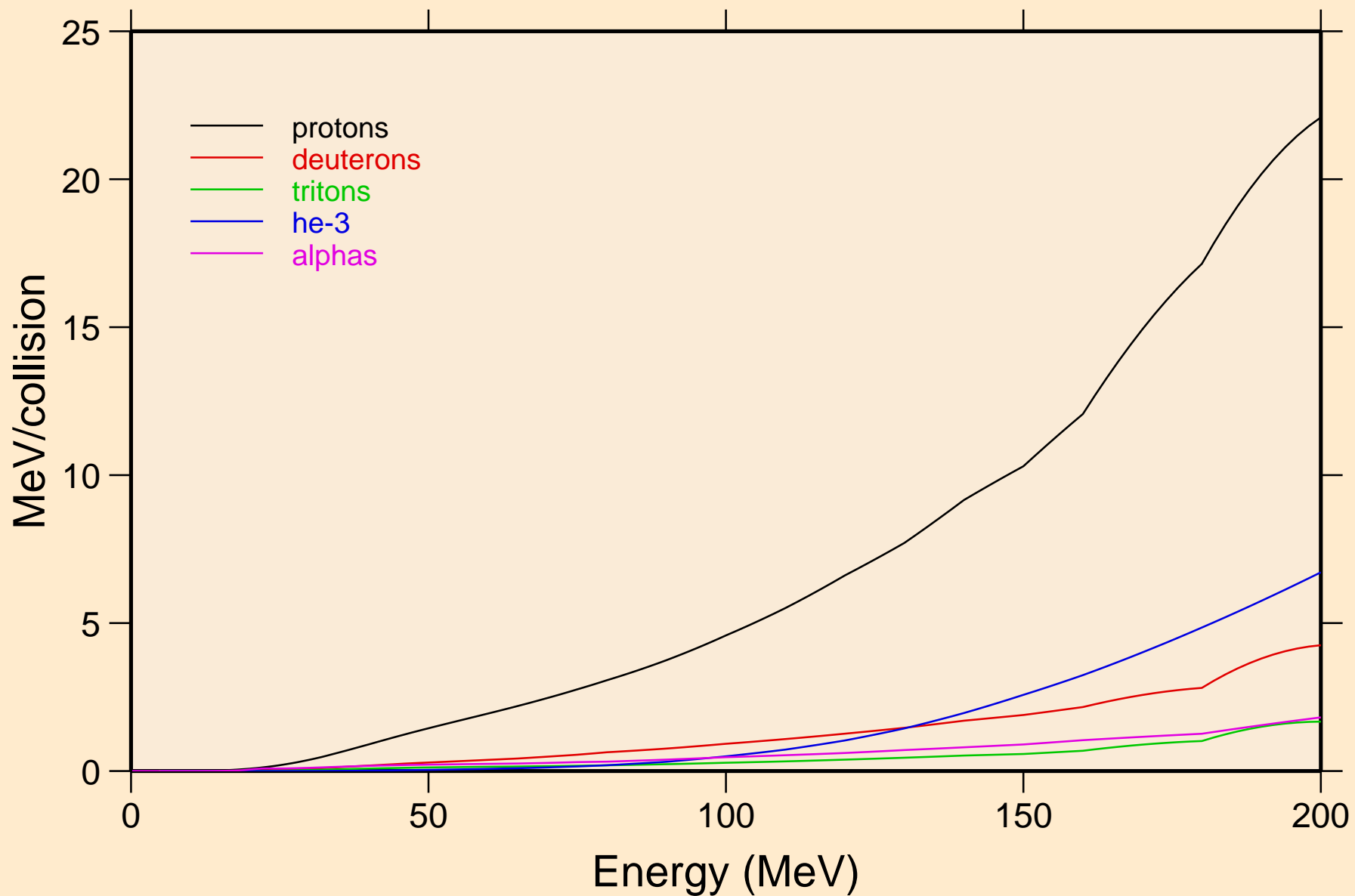

PT193 NEUTRON ACER TENDL-2019 LIBRARY; T=293.16K
Recoil Heating

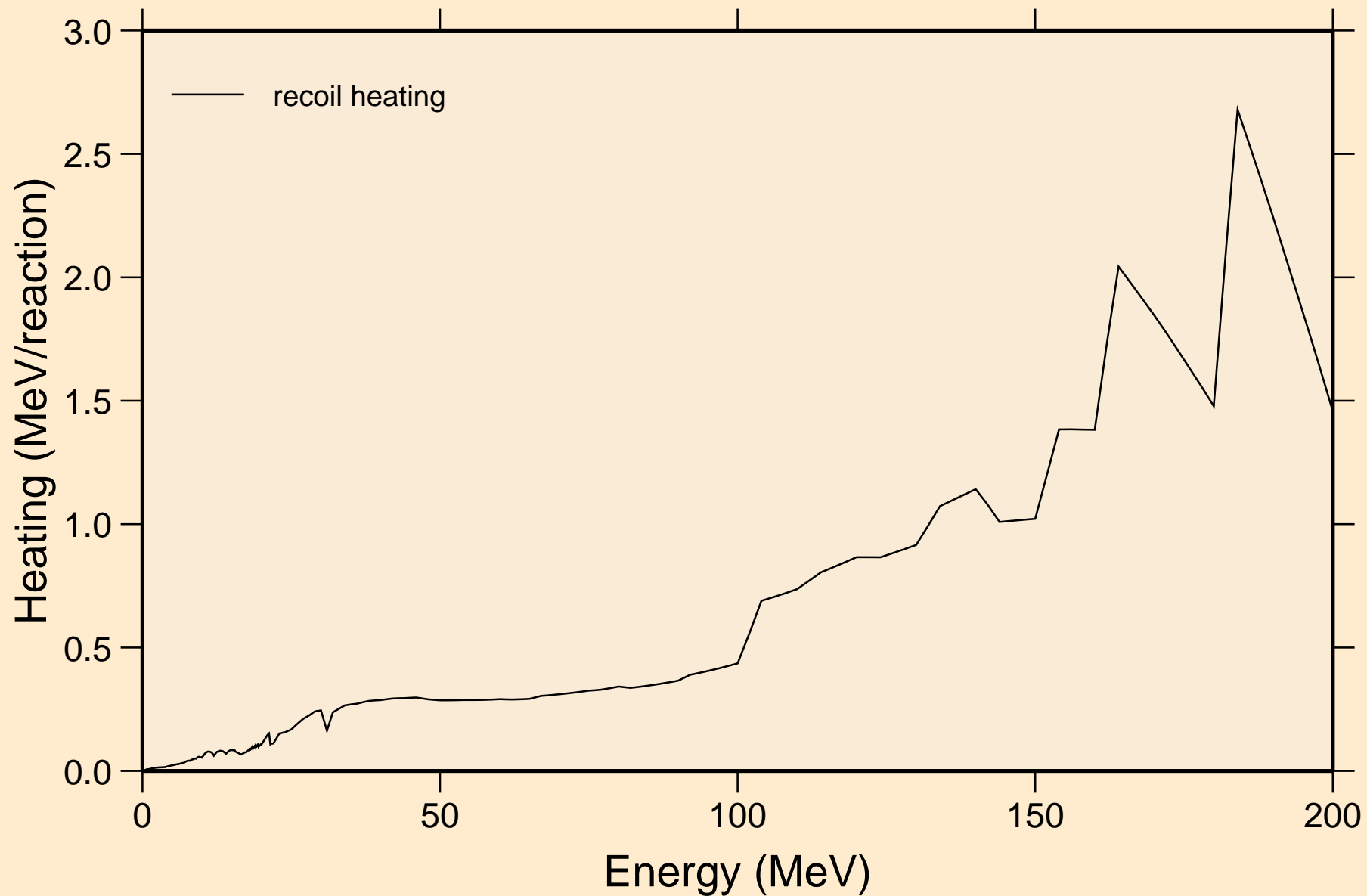

PT193 NEUTRON ACER TENDL-2019 LIBRARY; T=293.16K
Particle production cross sections

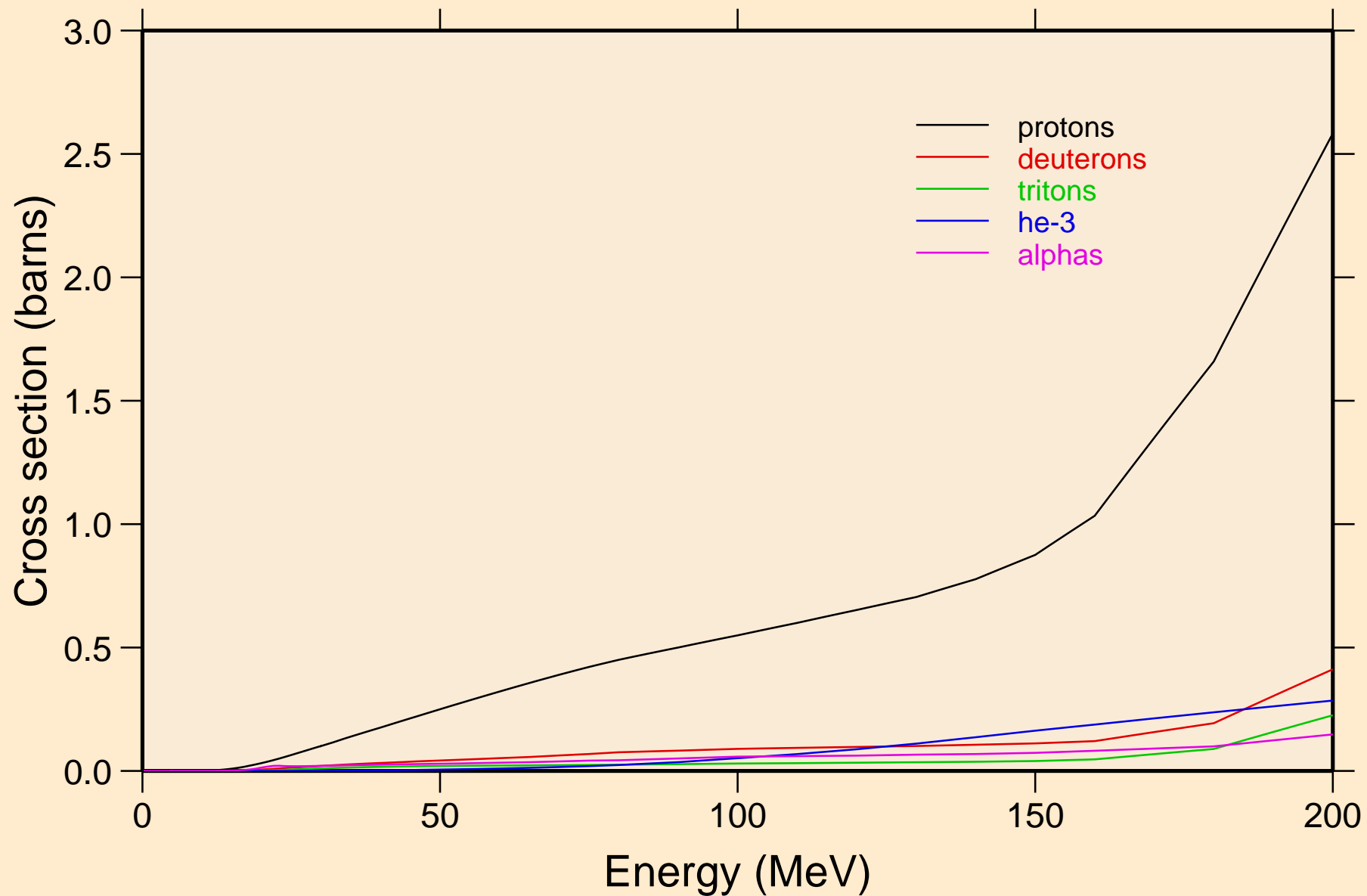

PT193 NEUTRON ACER TENDL-2019 LIBRARY; T=293.16K
protons from (n,x)

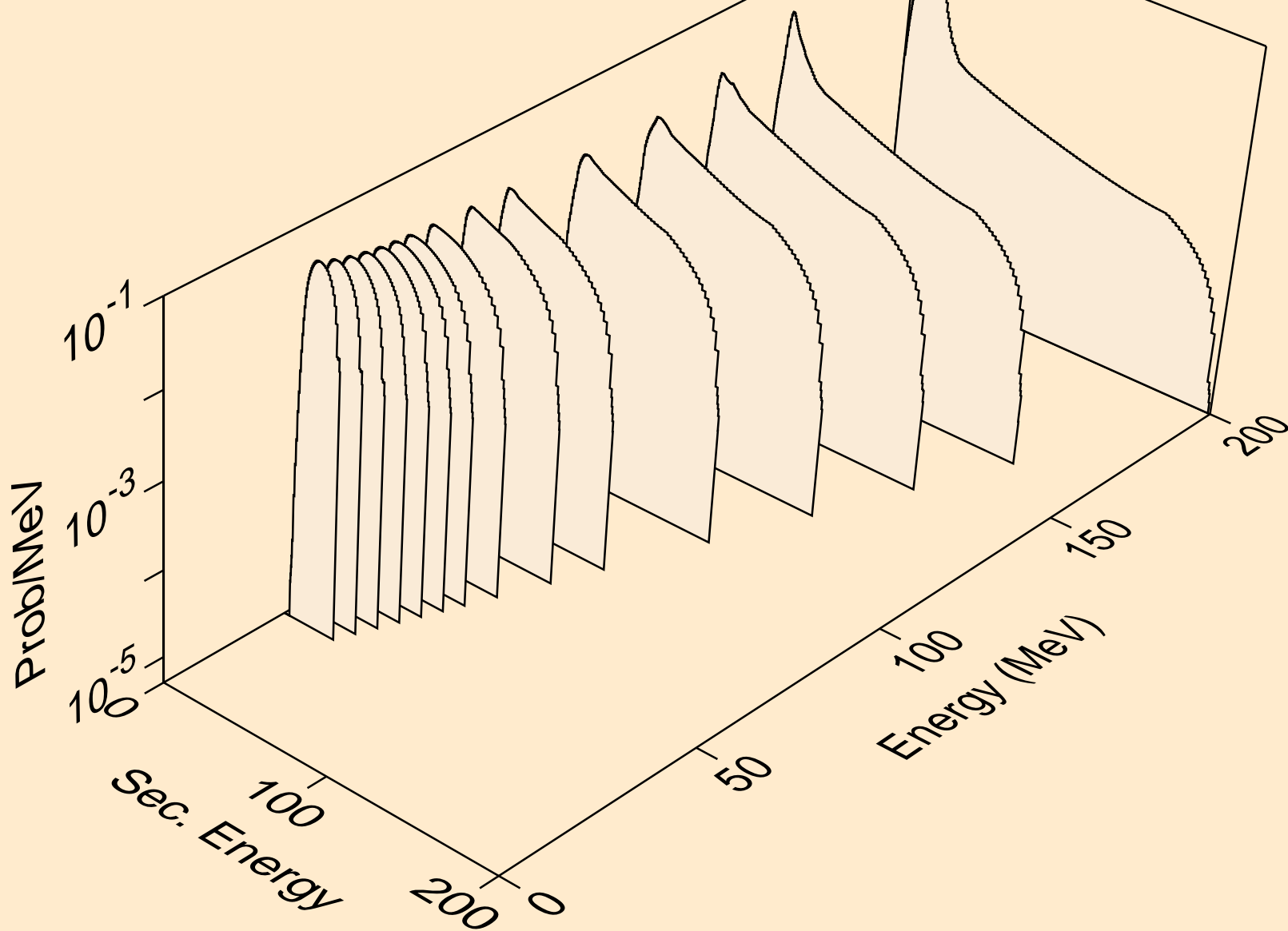

PT193 NEUTRON ACER TENDL-2019 LIBRARY; T=293.16K
protons from (n,n*)p

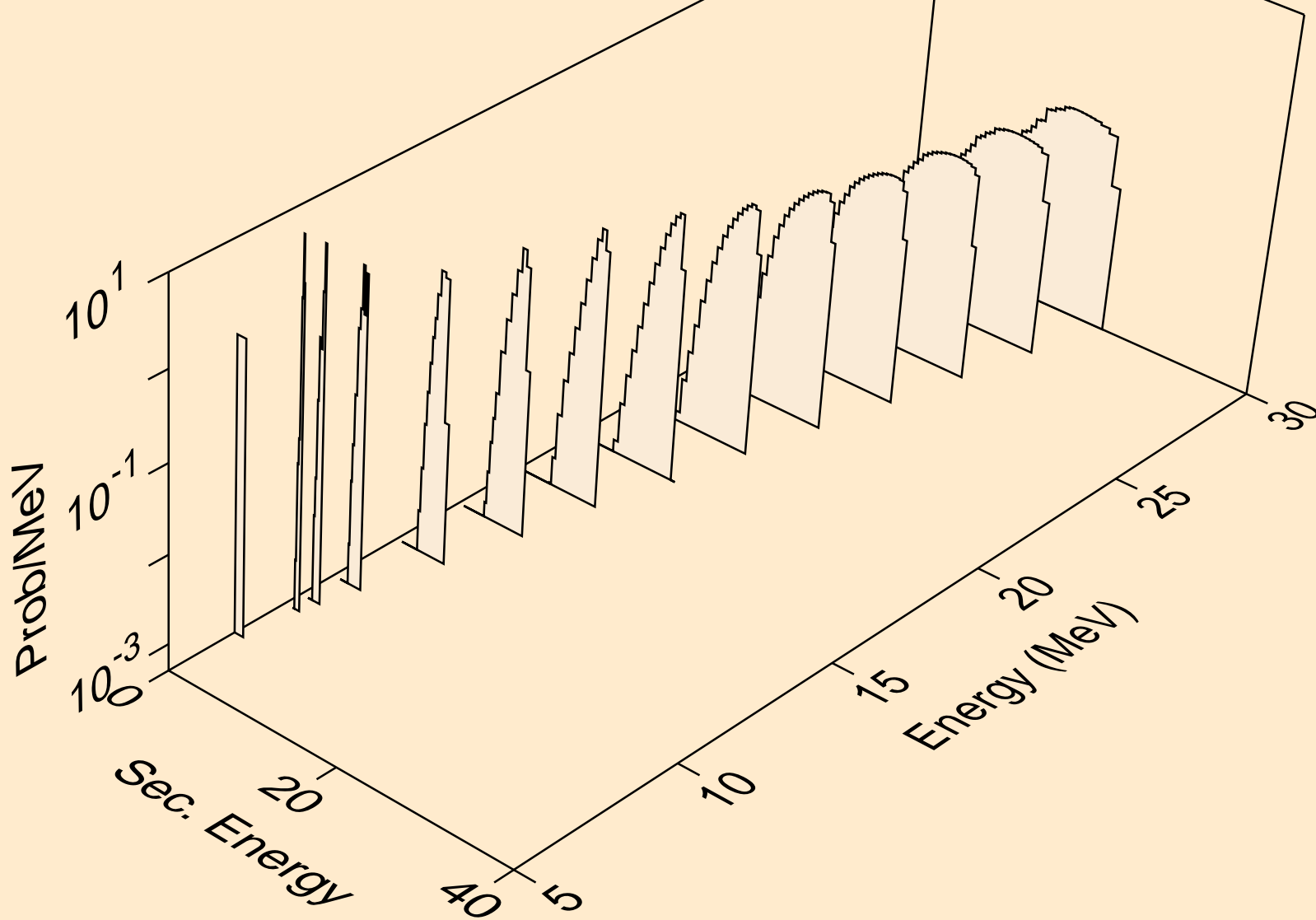

PT193 NEUTRON ACER TENDL-2019 LIBRARY; T=293.16K
protons from (n,2np)

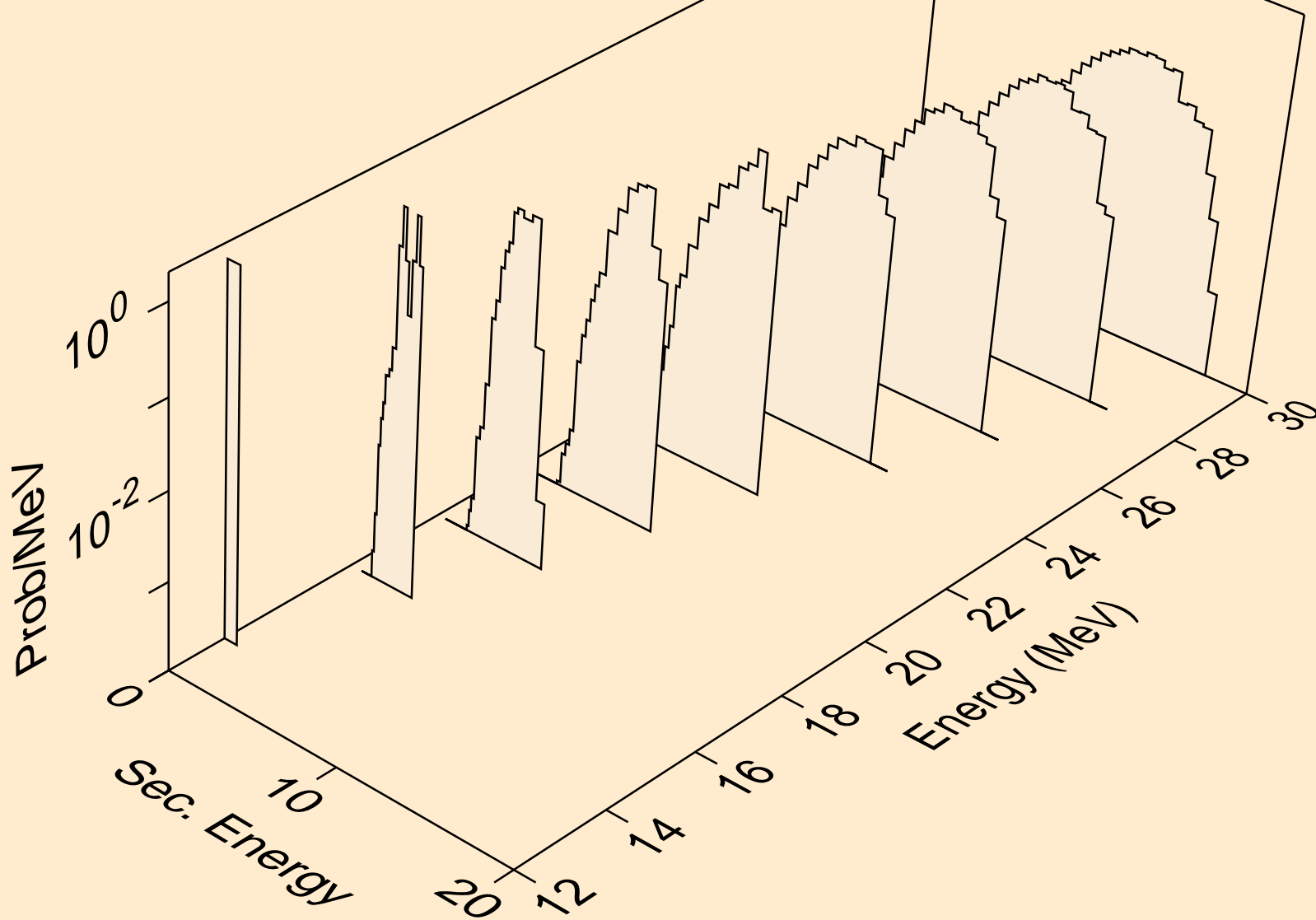

PT193 NEUTRON ACER TENDL-2019 LIBRARY; T=293.16K
protons from (n,3np)

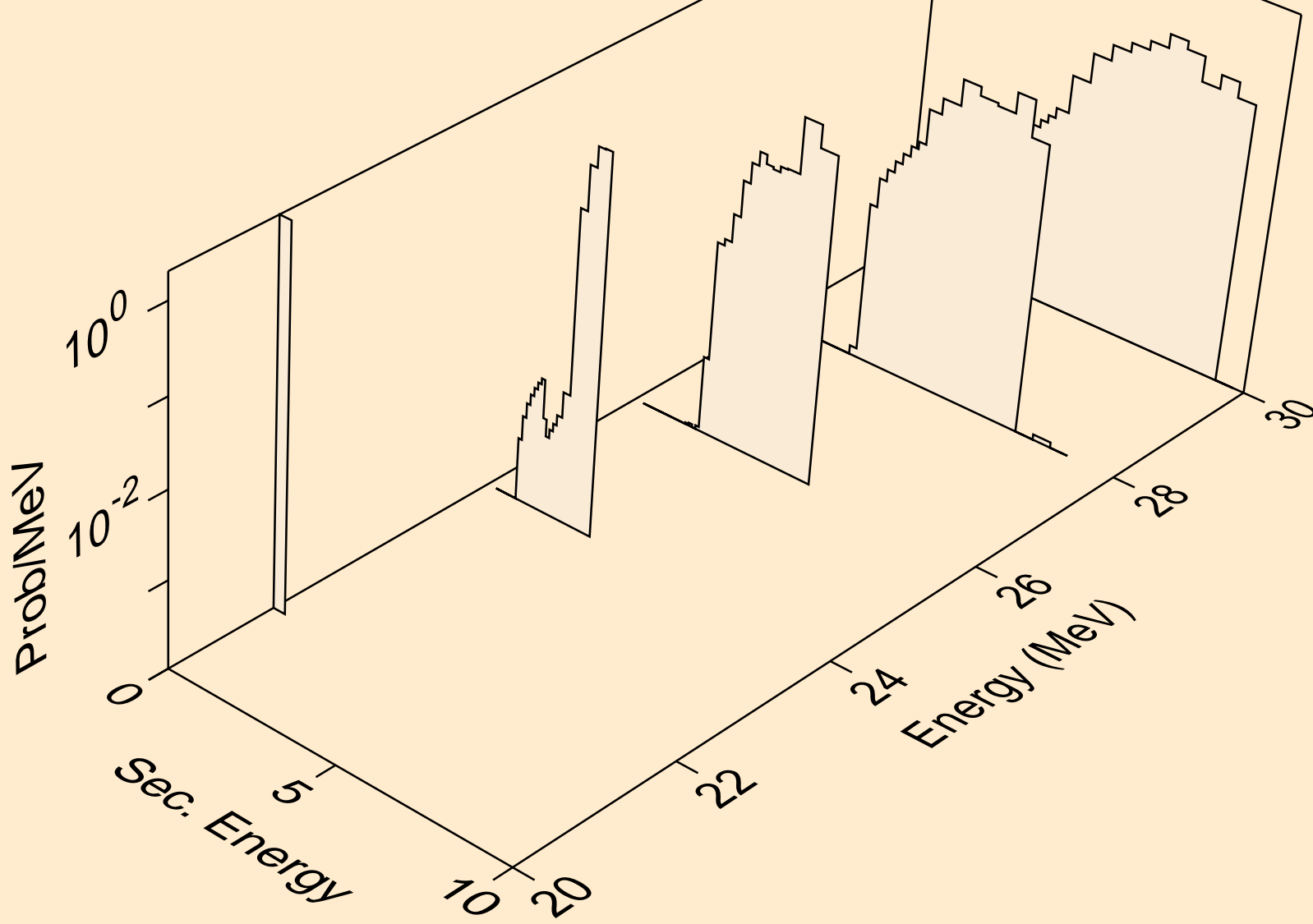

PT193 NEUTRON ACER TENDL-2019 LIBRARY; T=293.16K
protons from (n,2np)

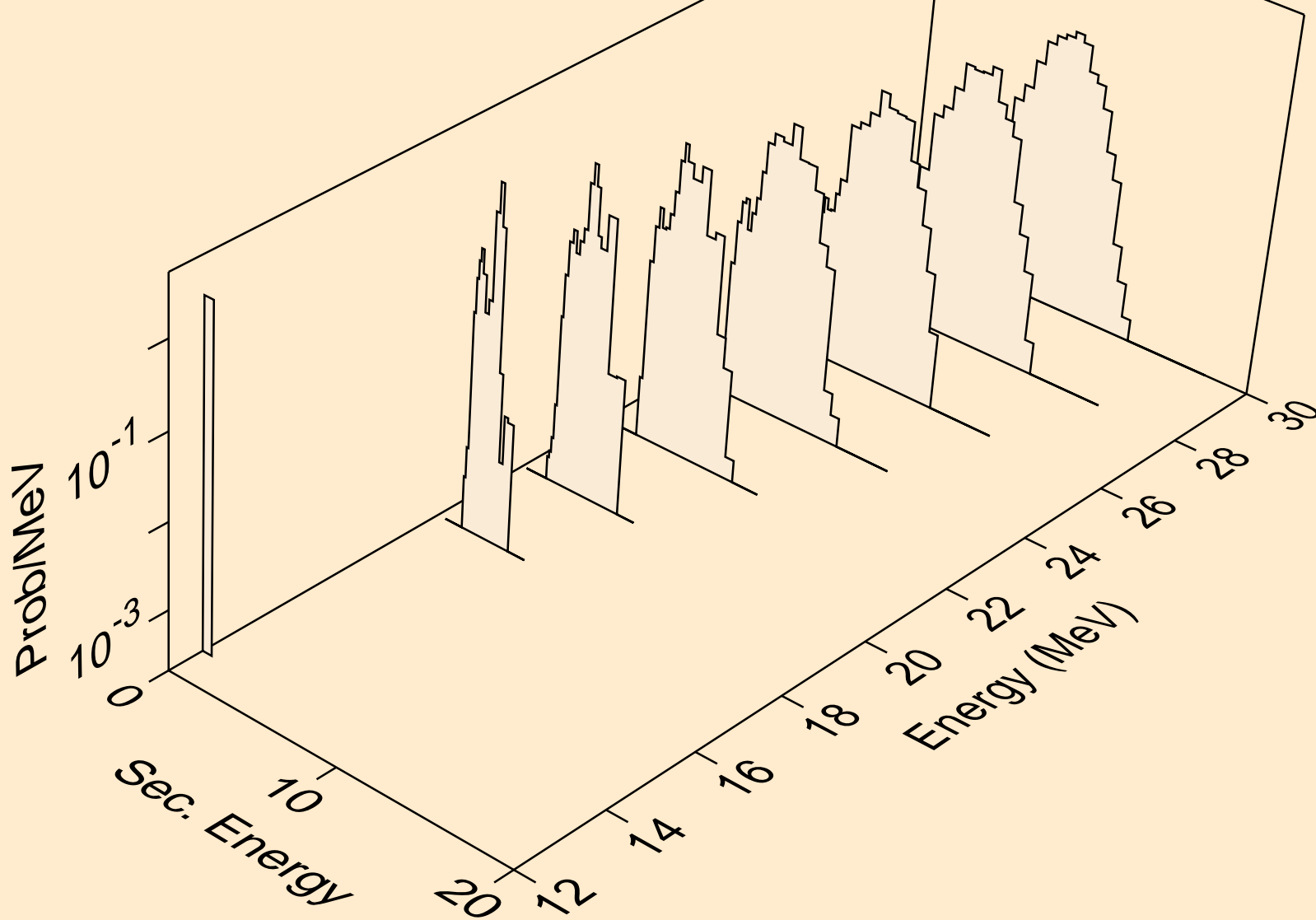

PT193 NEUTRON ACER TENDL-2019 LIBRARY; T=293.16K
protons from (n,npa)

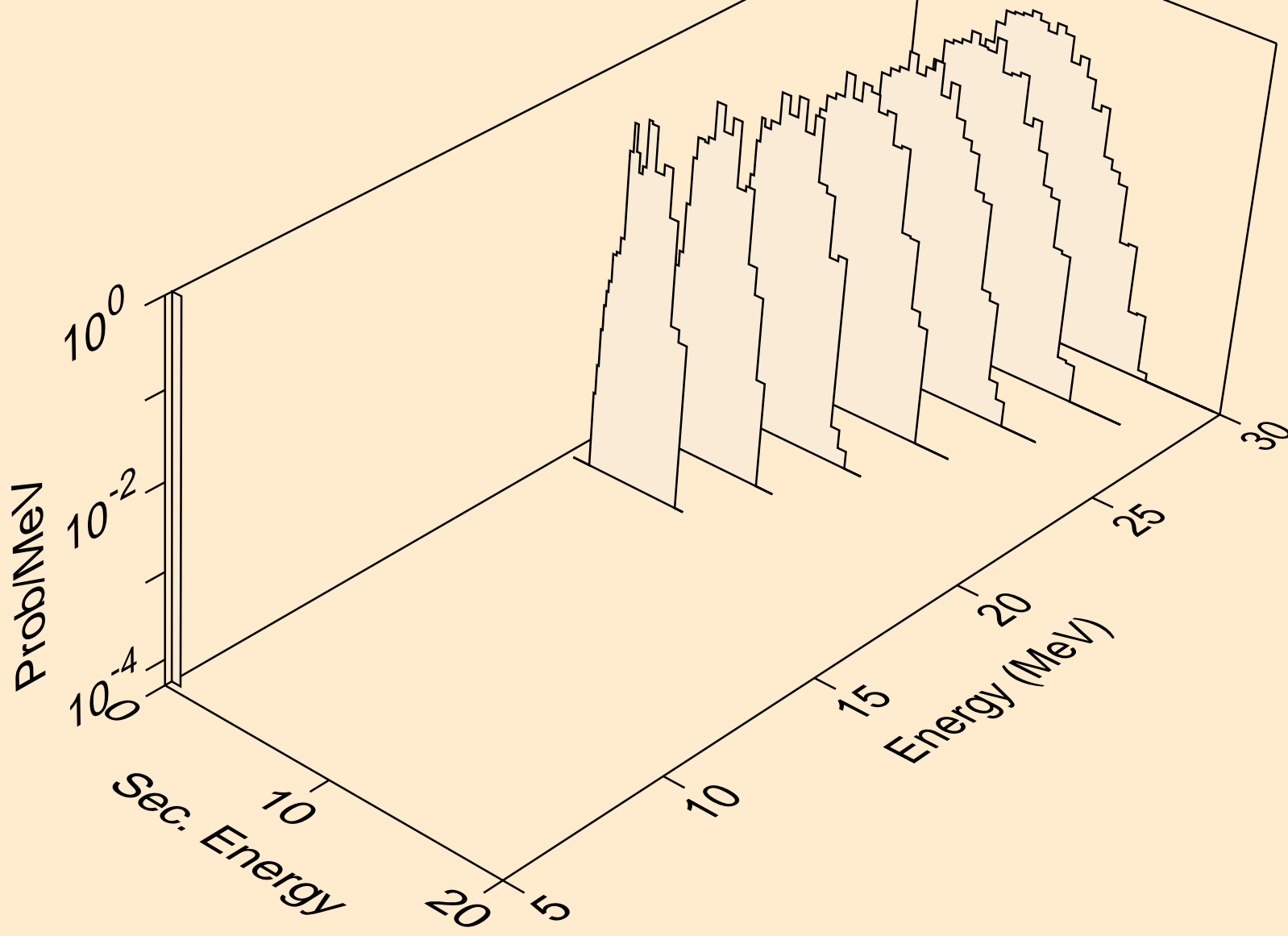

PT193 NEUTRON ACER TENDL-2019 LIBRARY; T=293.16K
protons from (n,p)

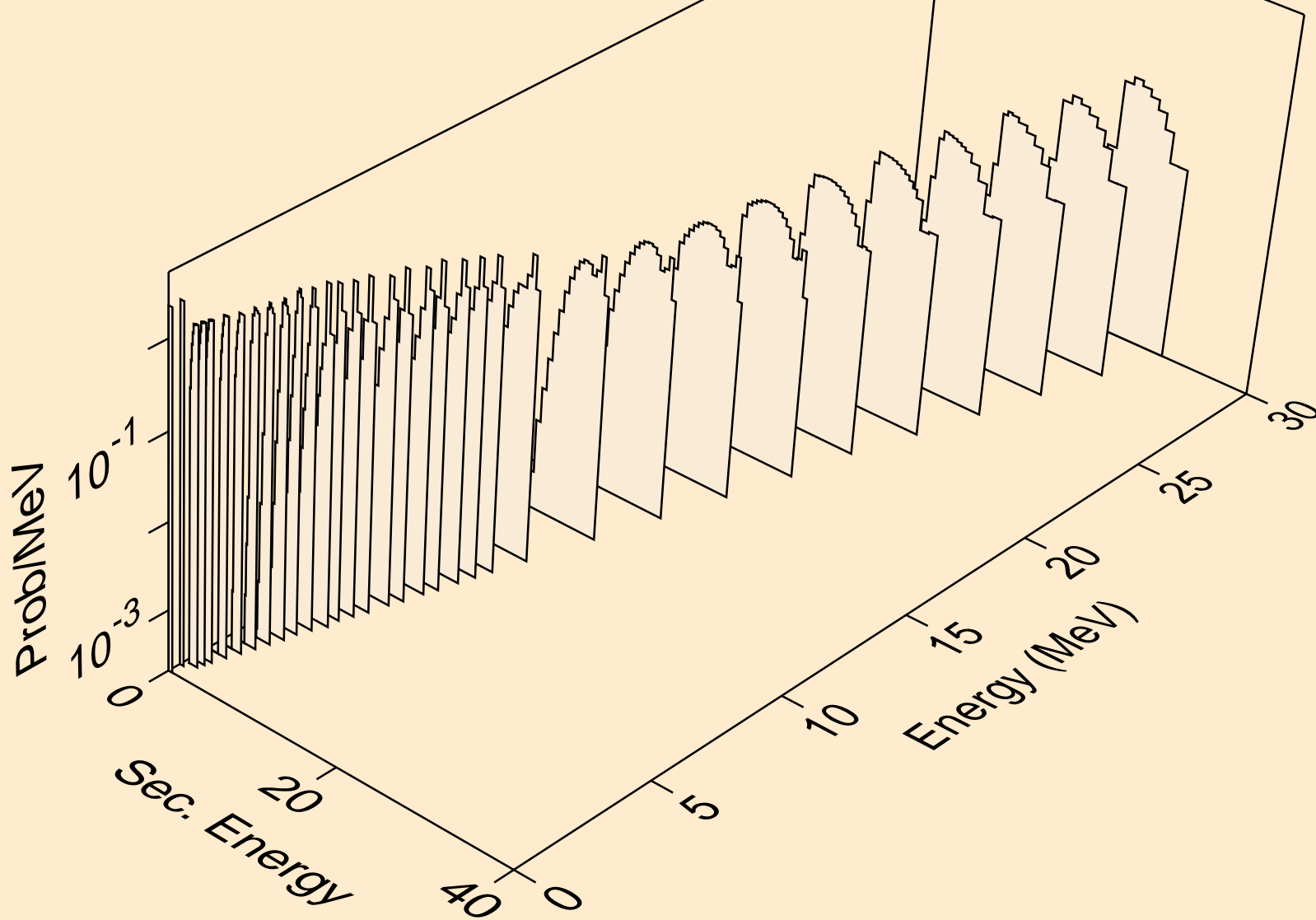

PT193 NEUTRON ACER TENDL-2019 LIBRARY; T=293.16K
protons from (n,2p)

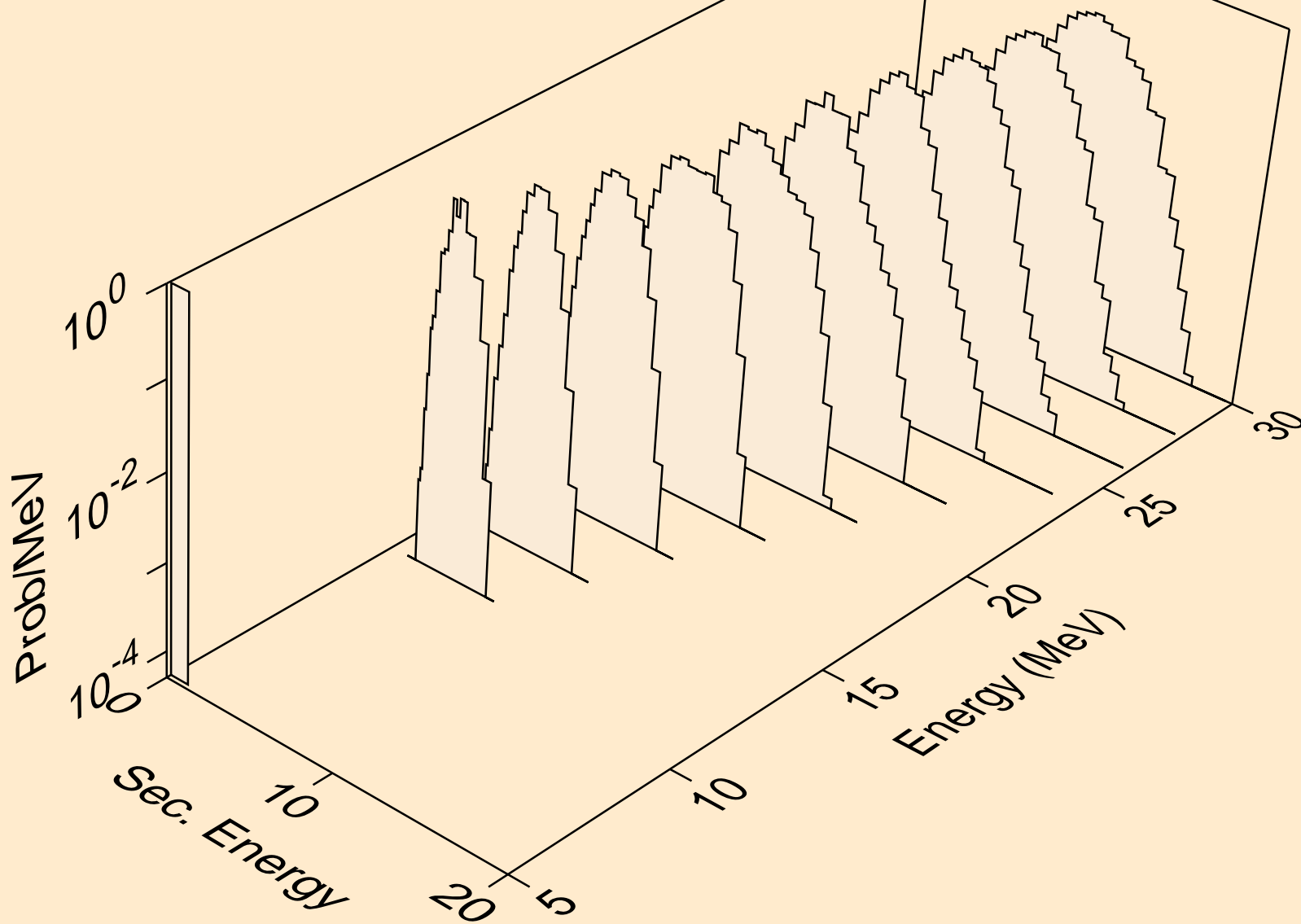

PT193 NEUTRON ACER TENDL-2019 LIBRARY; T=293.16K
protons from (n,p)

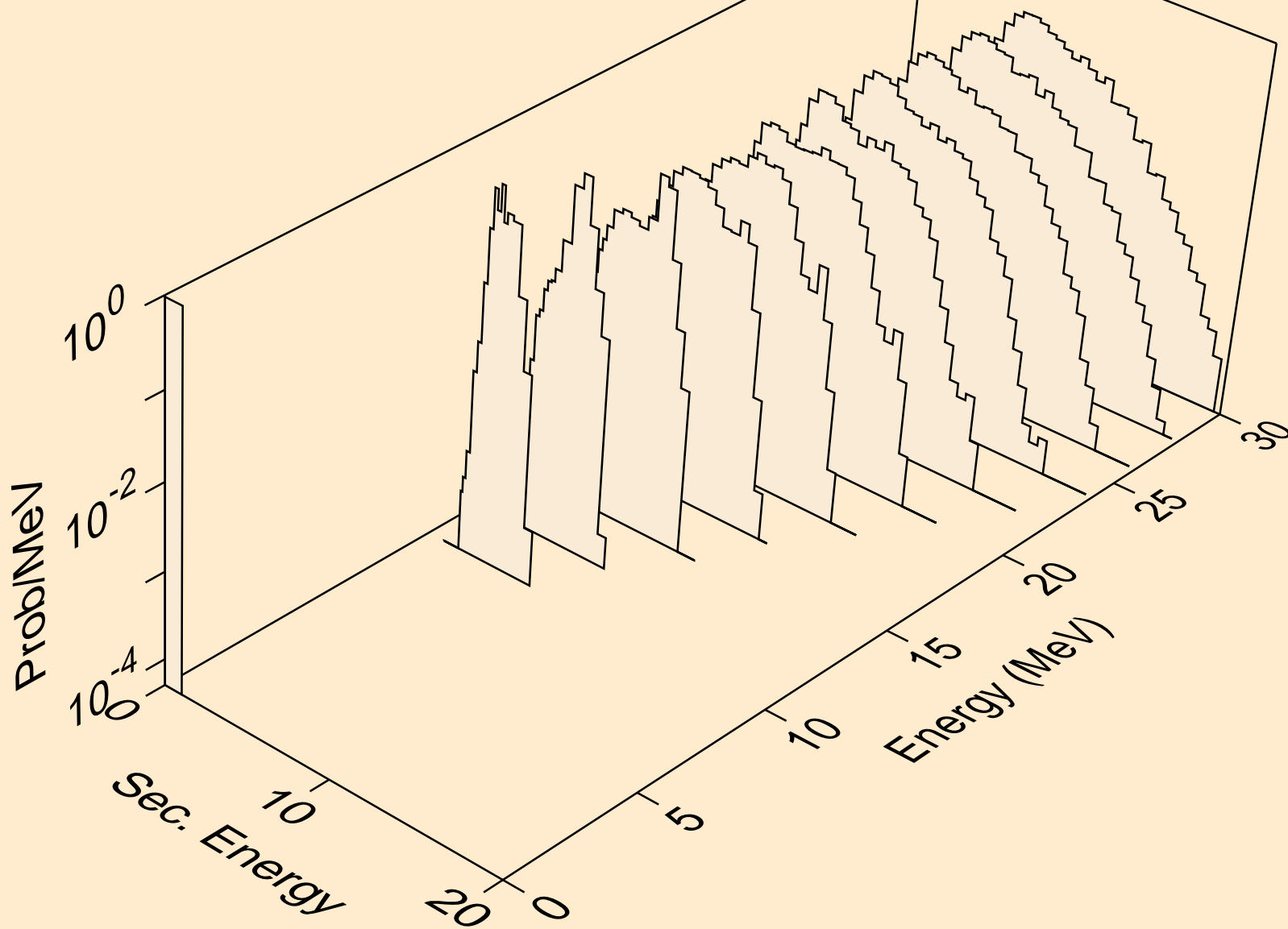

PT193 NEUTRON ACER TENDL-2019 LIBRARY; T=293.16K
protons from (n,pd)

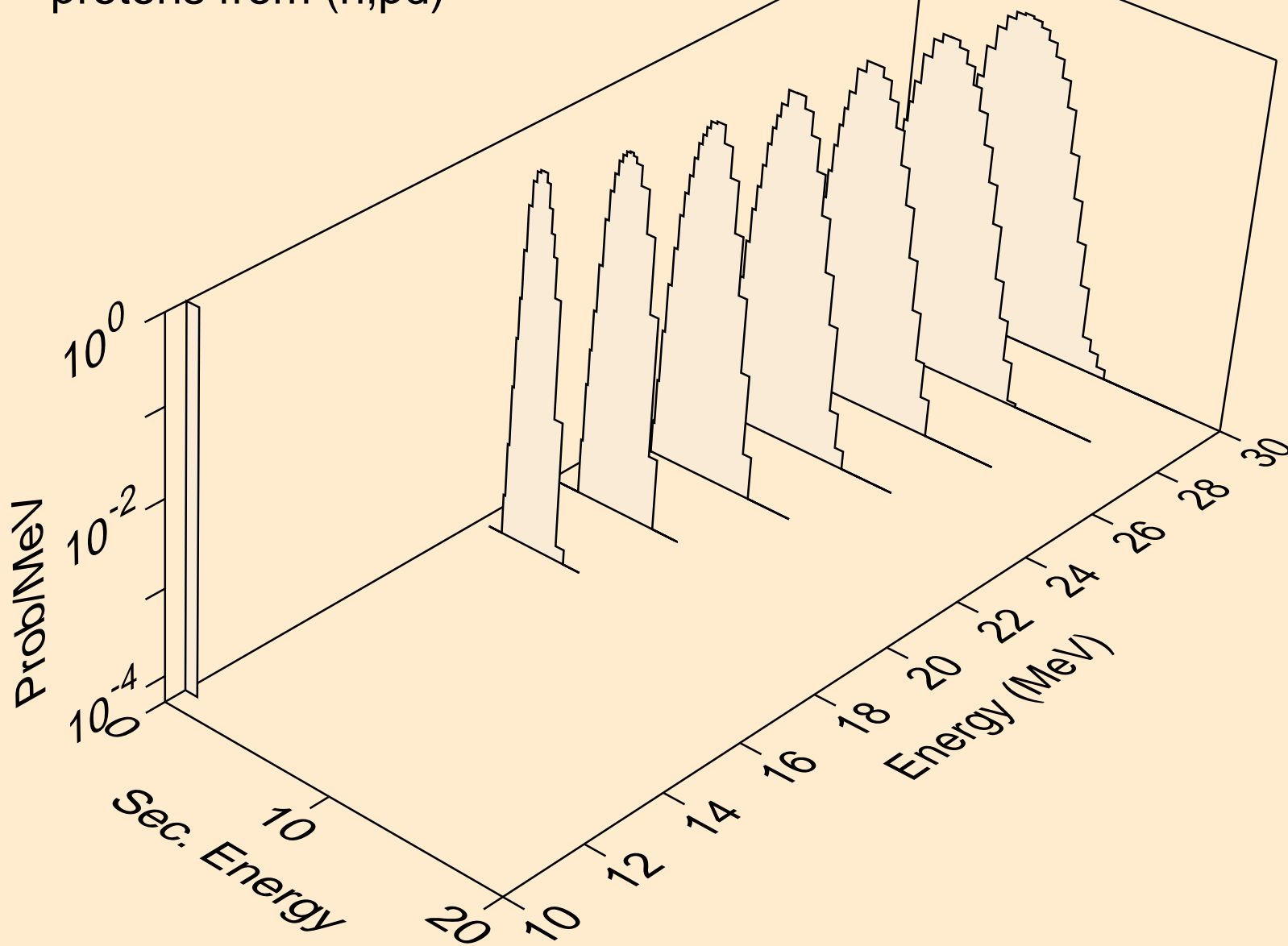

PT193 NEUTRON ACER TENDL-2019 LIBRARY; T=293.16K
protons from (n,pt)

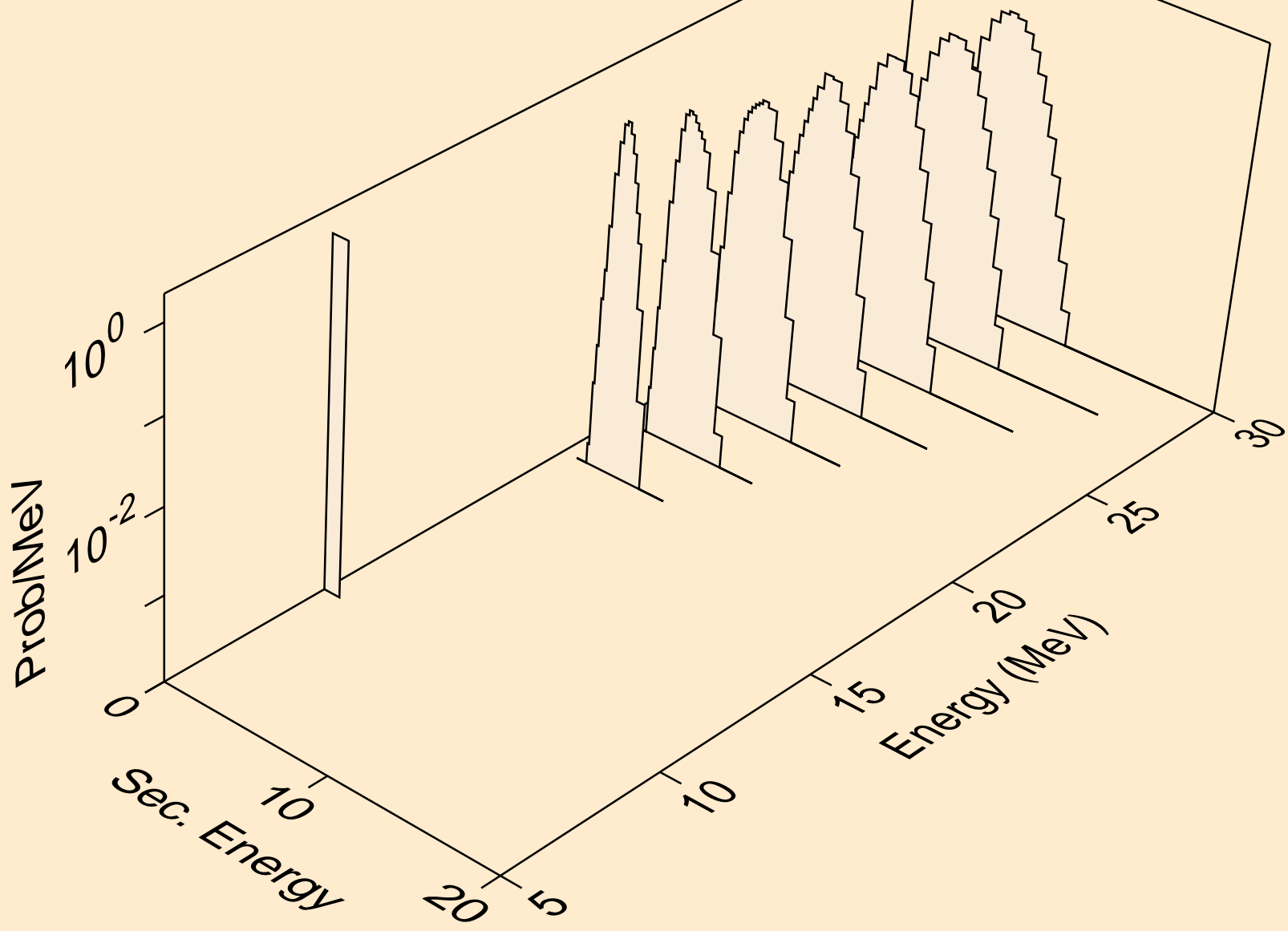

PT193 NEUTRON ACER TENDL-2019 LIBRARY; T=293.16K
deuterons from (n,x)

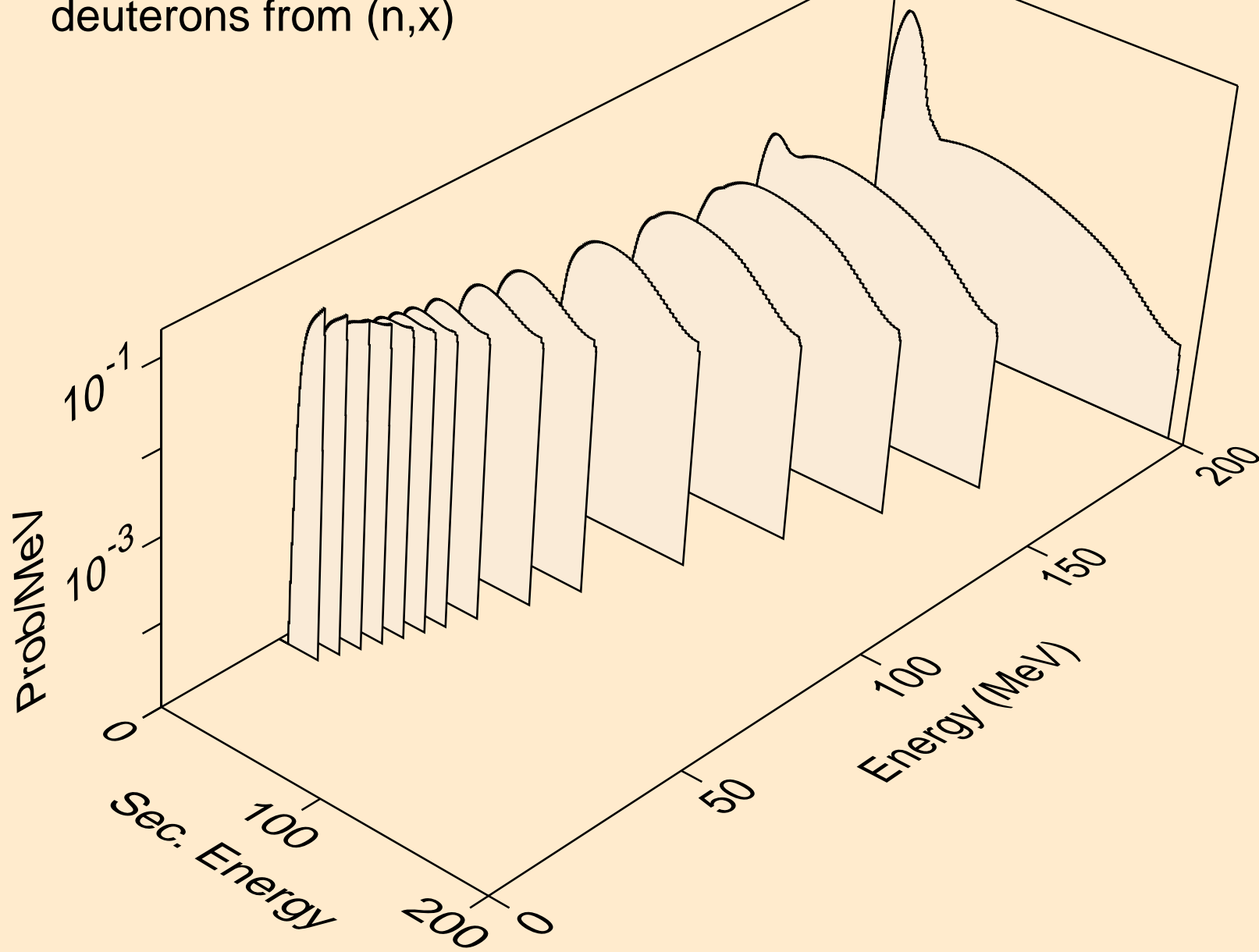

PT193 NEUTRON ACER TENDL-2019 LIBRARY; T=293.16K
deuterons from (n,2nd)

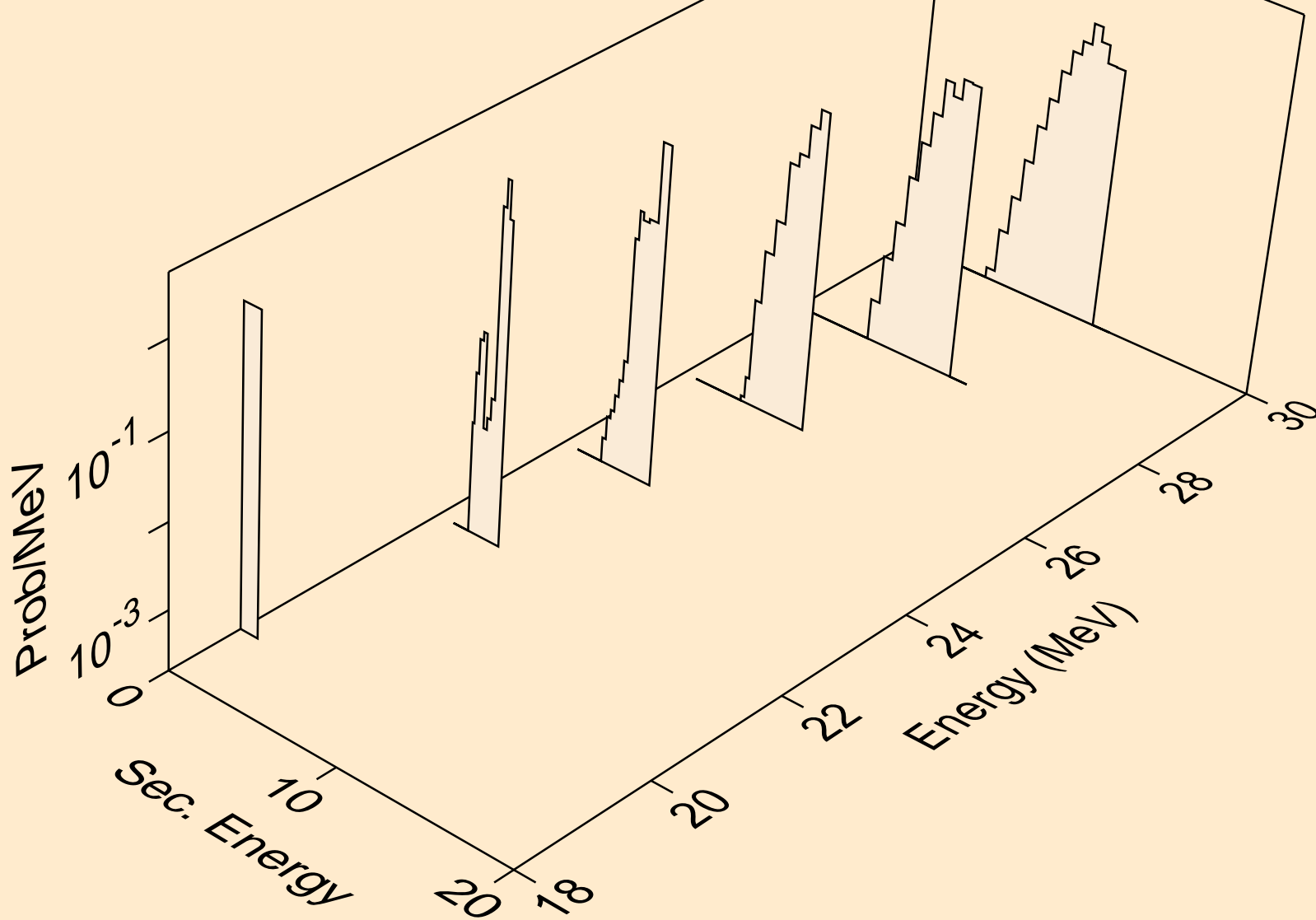

PT193 NEUTRON ACER TENDL-2019 LIBRARY; T=293.16K
deuterons from (n,n*)d

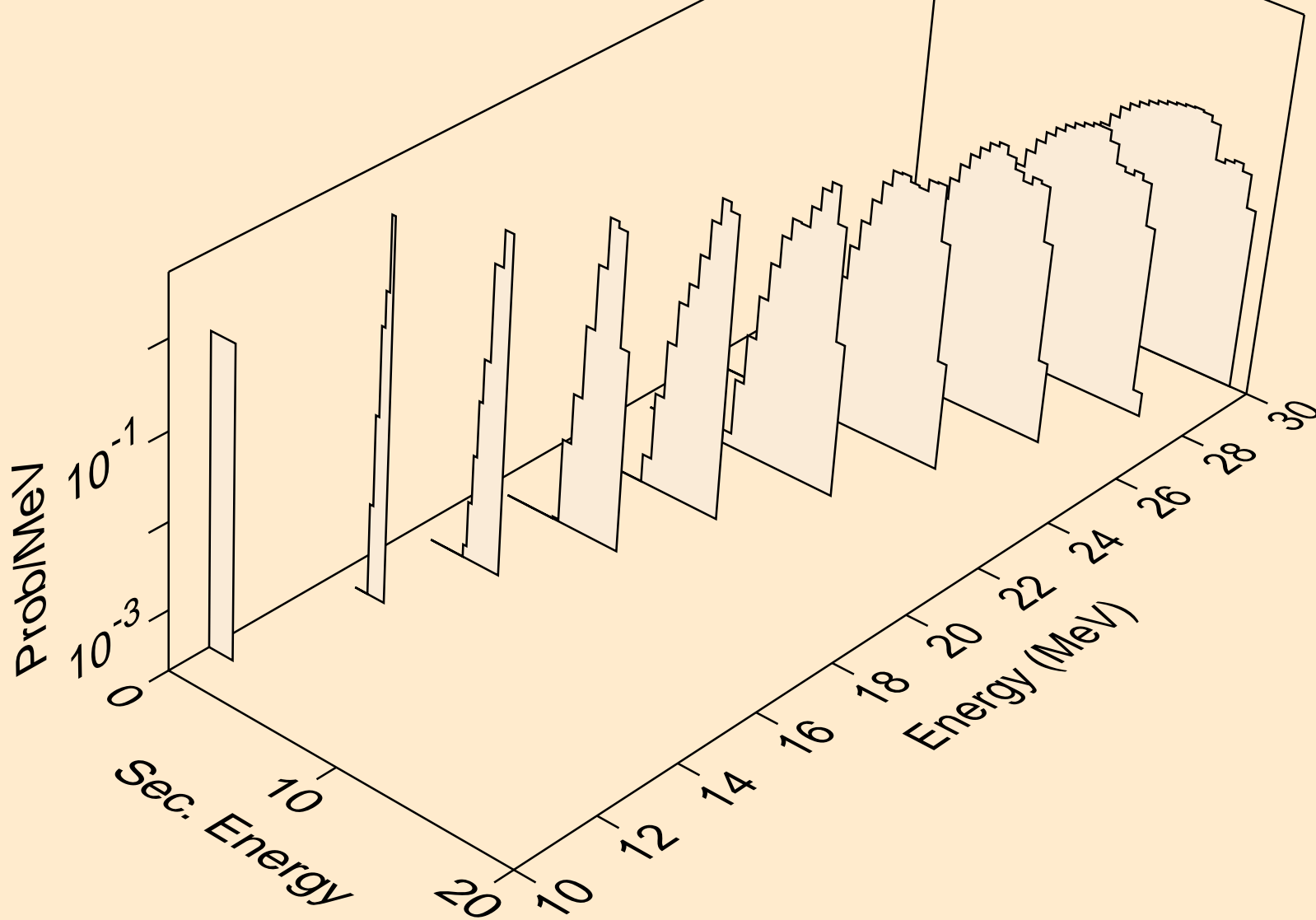

PT193 NEUTRON ACER TENDL-2019 LIBRARY; T=293.16K
deuterons from (n,d)

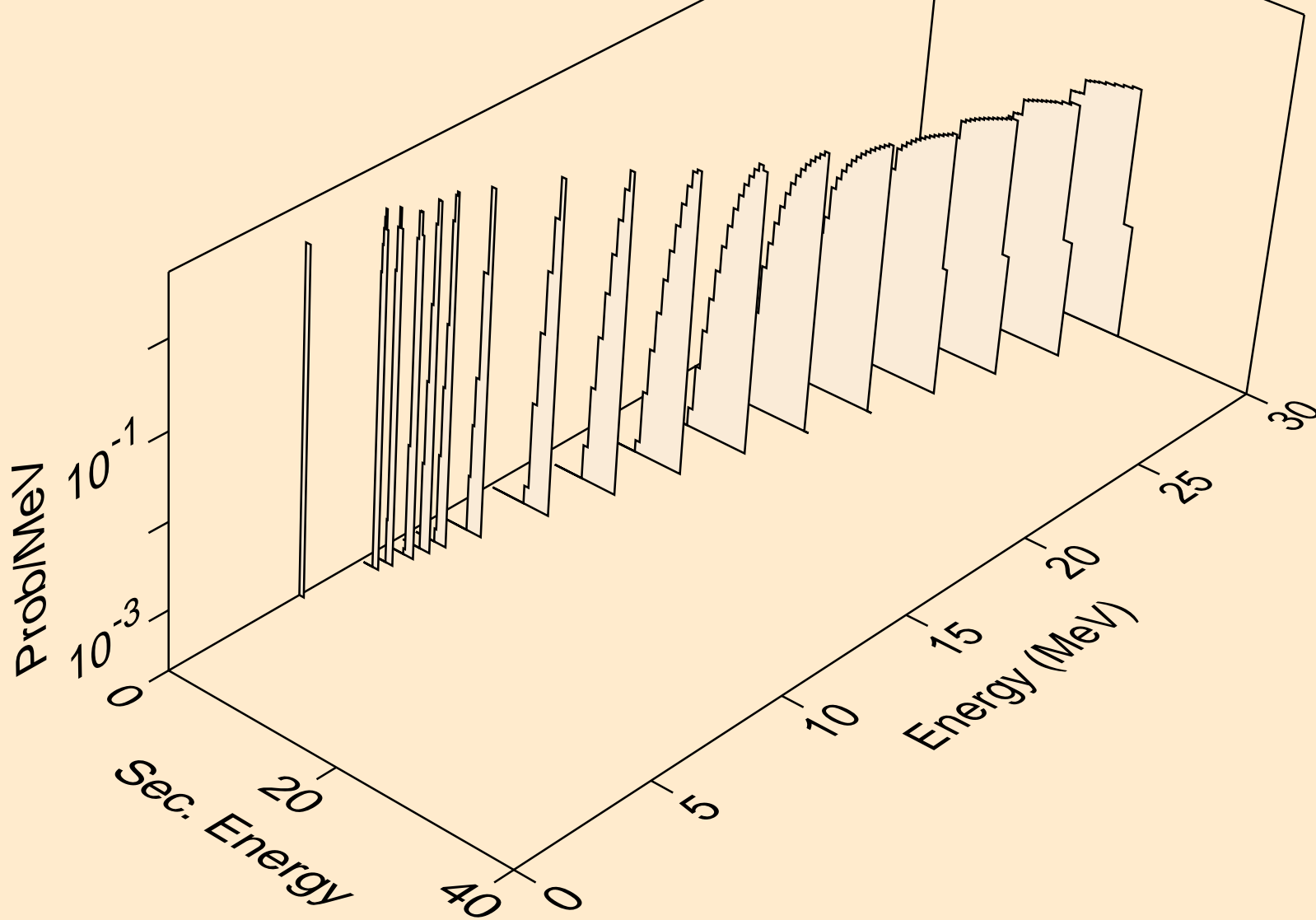

PT193 NEUTRON ACER TENDL-2019 LIBRARY; T=293.16K
deuterons from (n,pd)

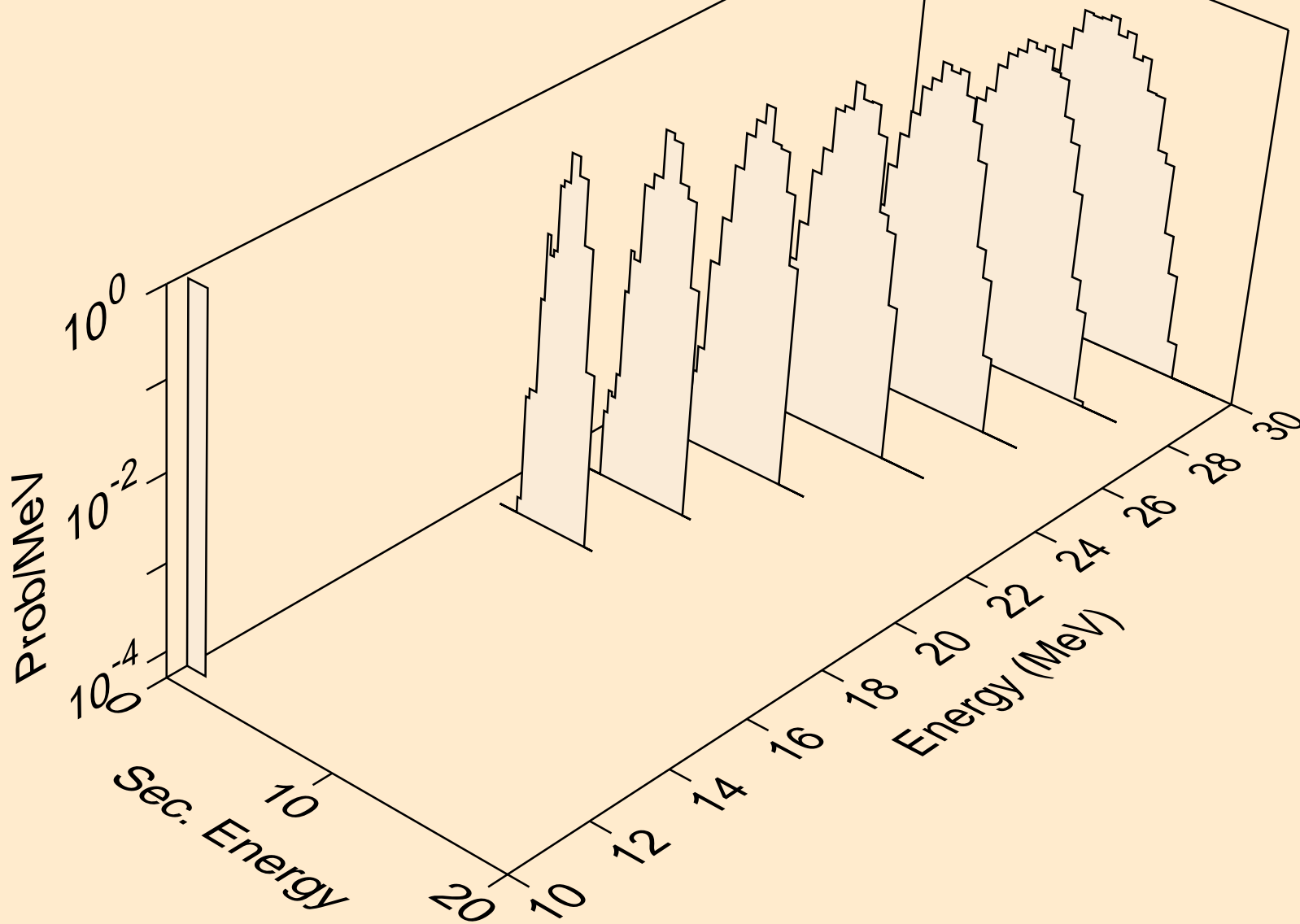

PT193 NEUTRON ACER TENDL-2019 LIBRARY; T=293.16K
tritons from (n,x)

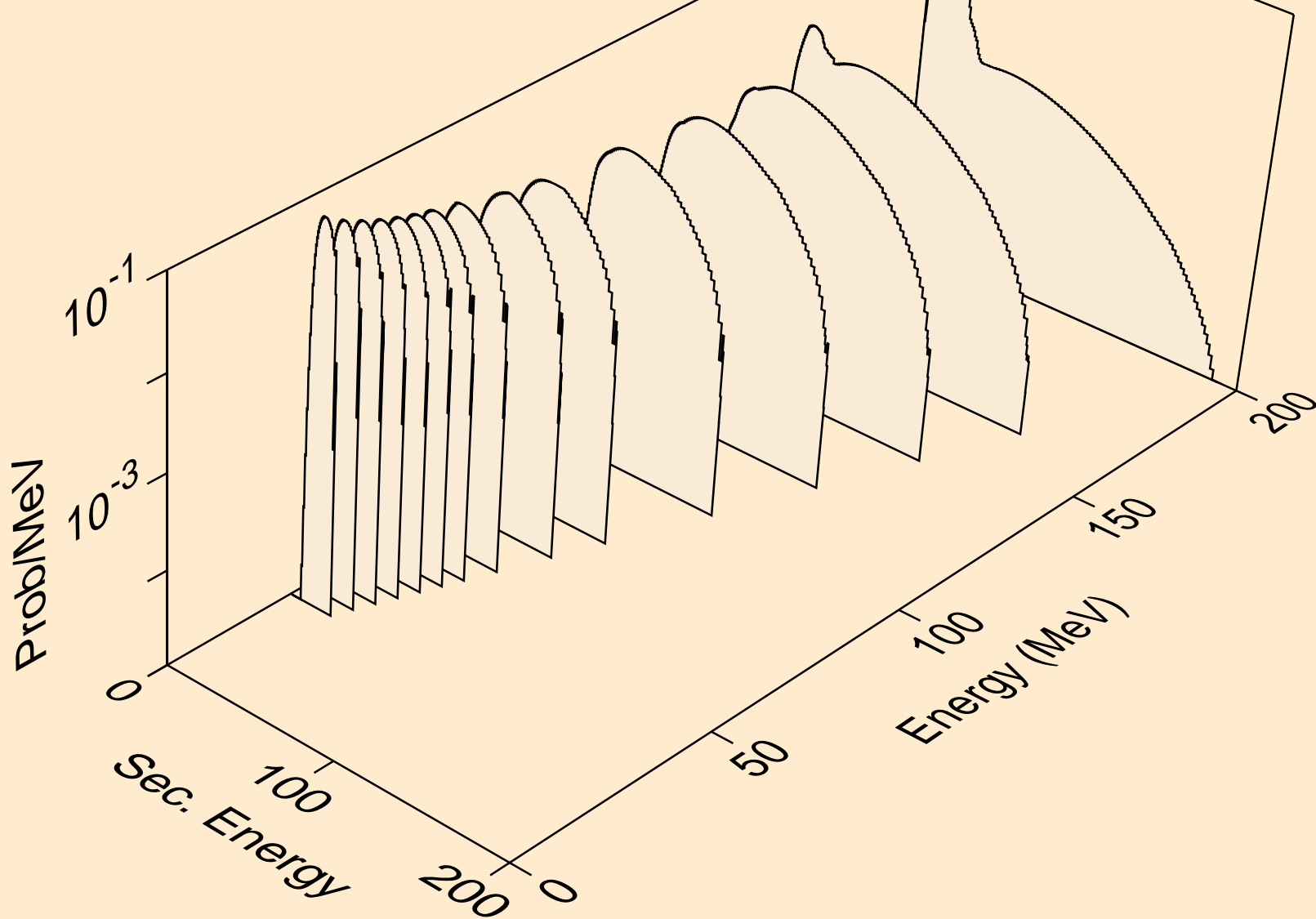

PT193 NEUTRON ACER TENDL-2019 LIBRARY; T=293.16K
tritons from (n,n*)t

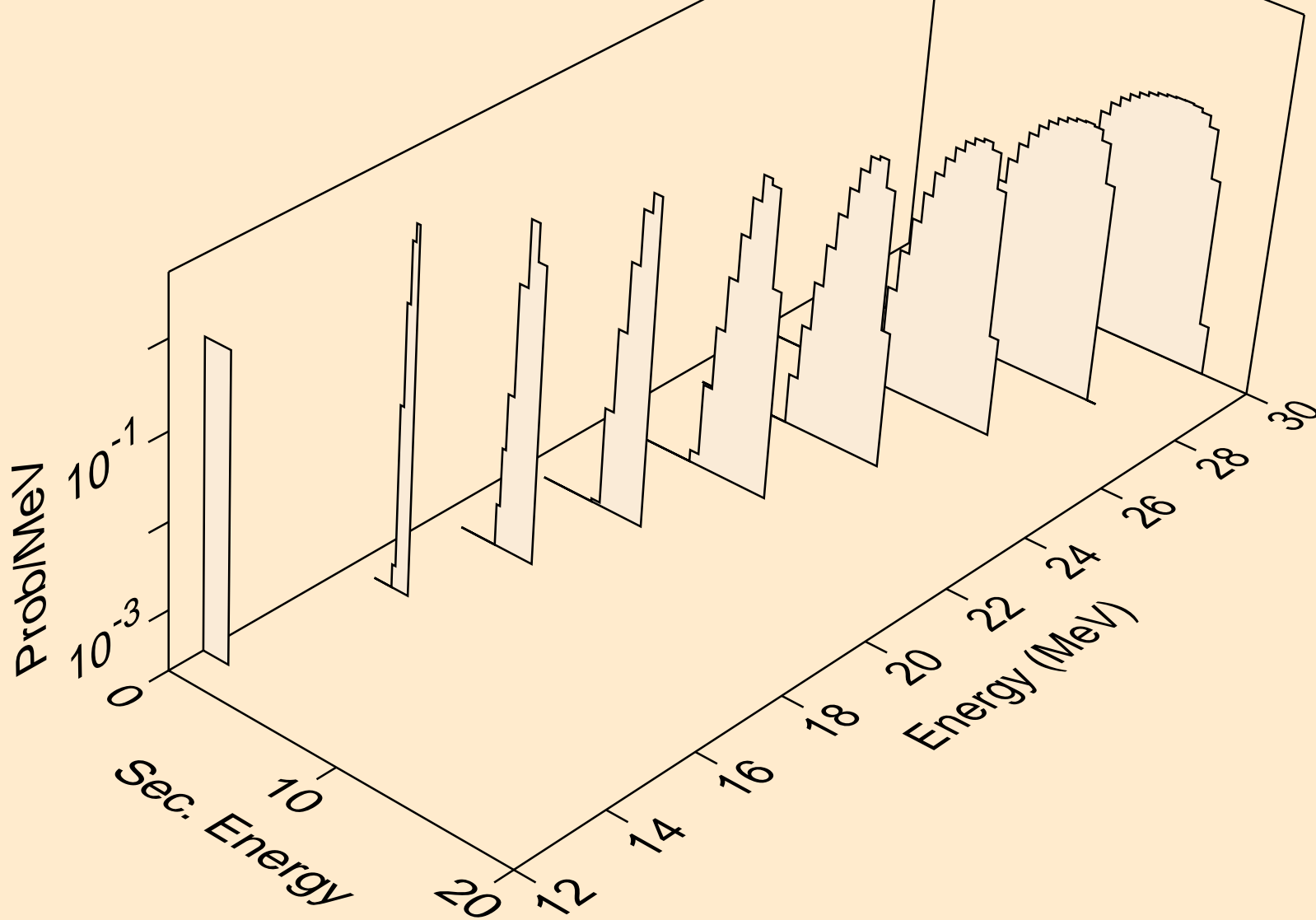

PT193 NEUTRON ACER TENDL-2019 LIBRARY; T=293.16K
tritons from (n,t)

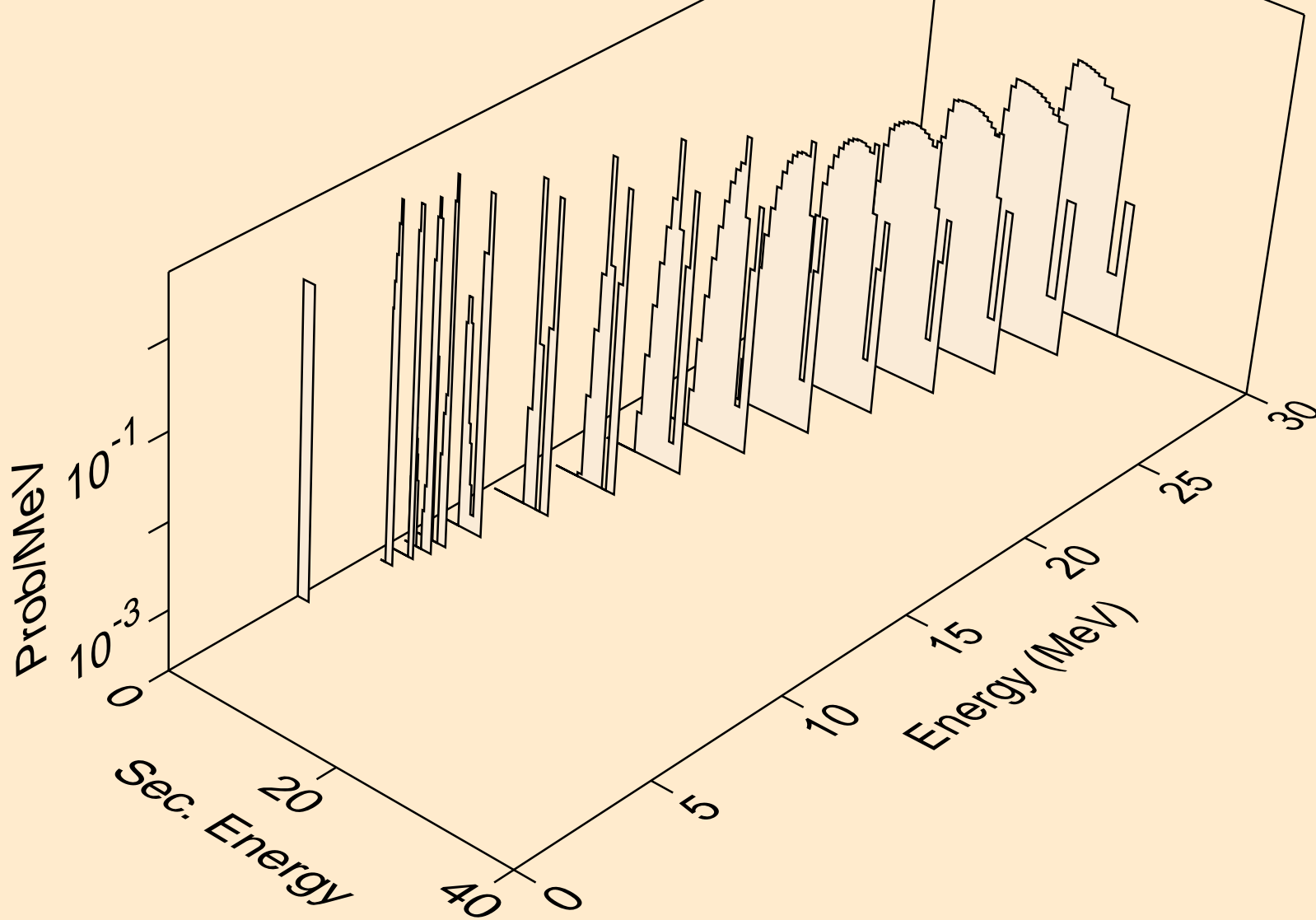

PT193 NEUTRON ACER TENDL-2019 LIBRARY; T=293.16K
tritons from (n,pt)

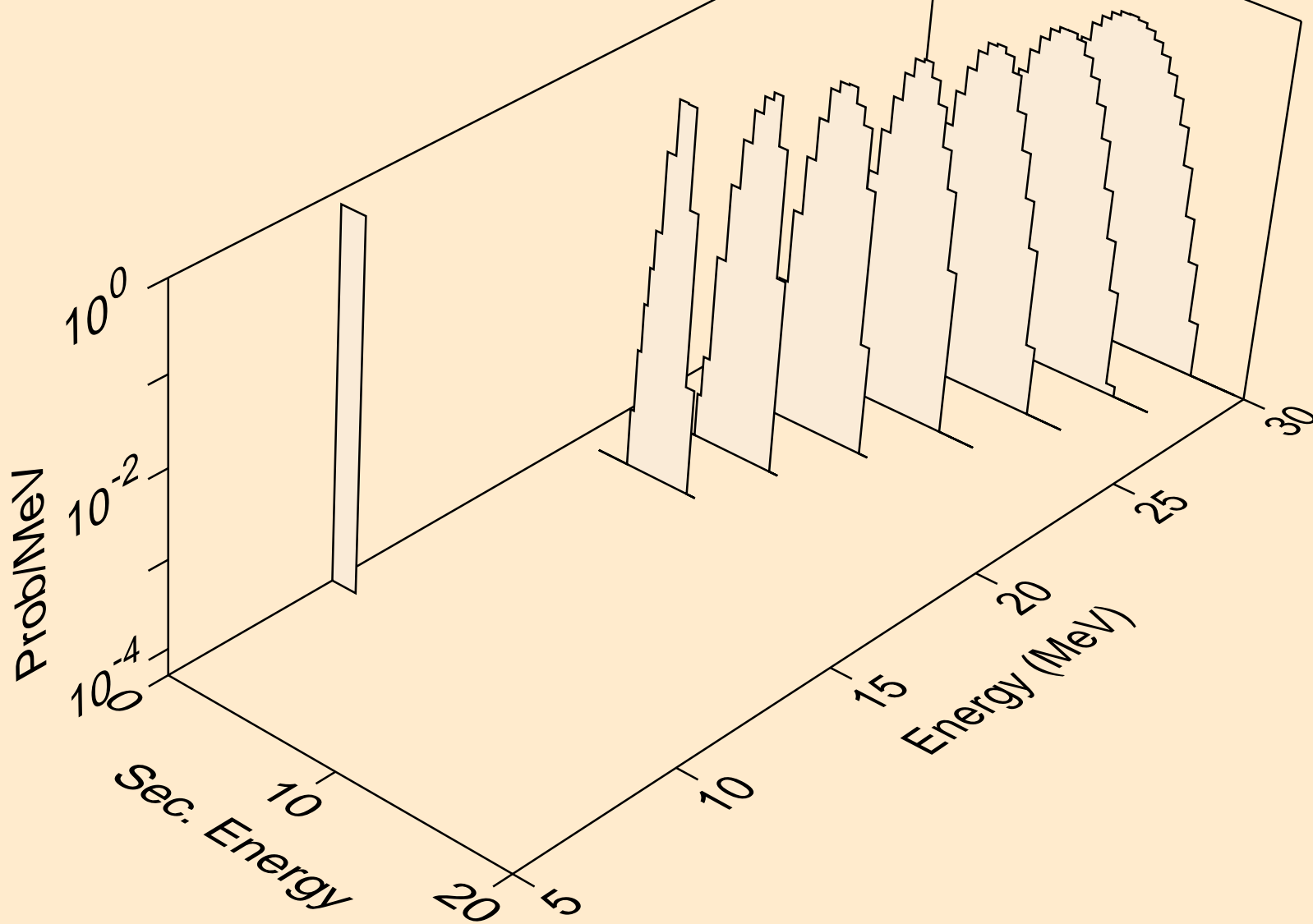

PT193 NEUTRON ACER TENDL-2019 LIBRARY; T=293.16K
he3s from (n,x)

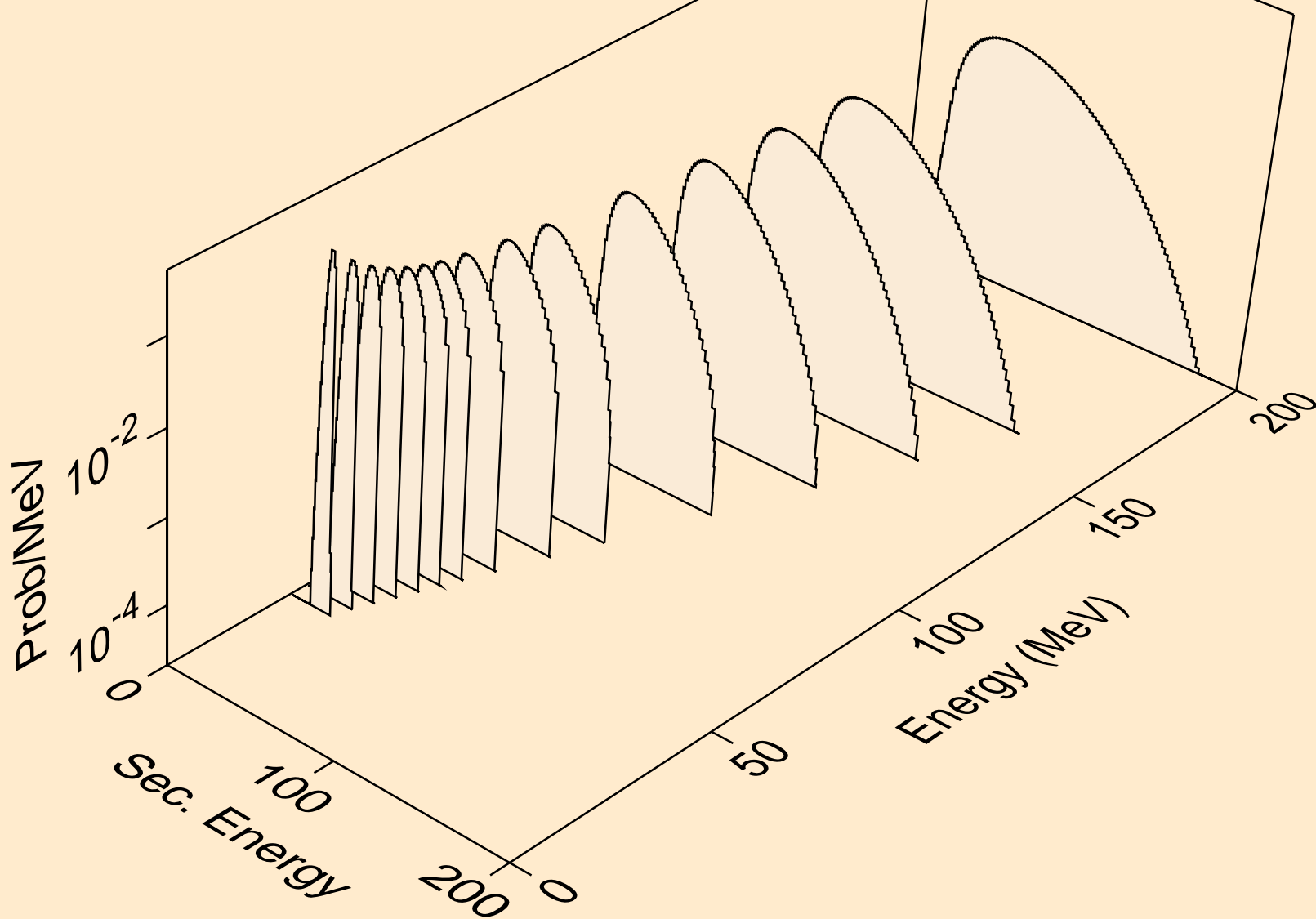

PT193 NEUTRON ACER TENDL-2019 LIBRARY; T=293.16K
he3s from (n,n*)he3

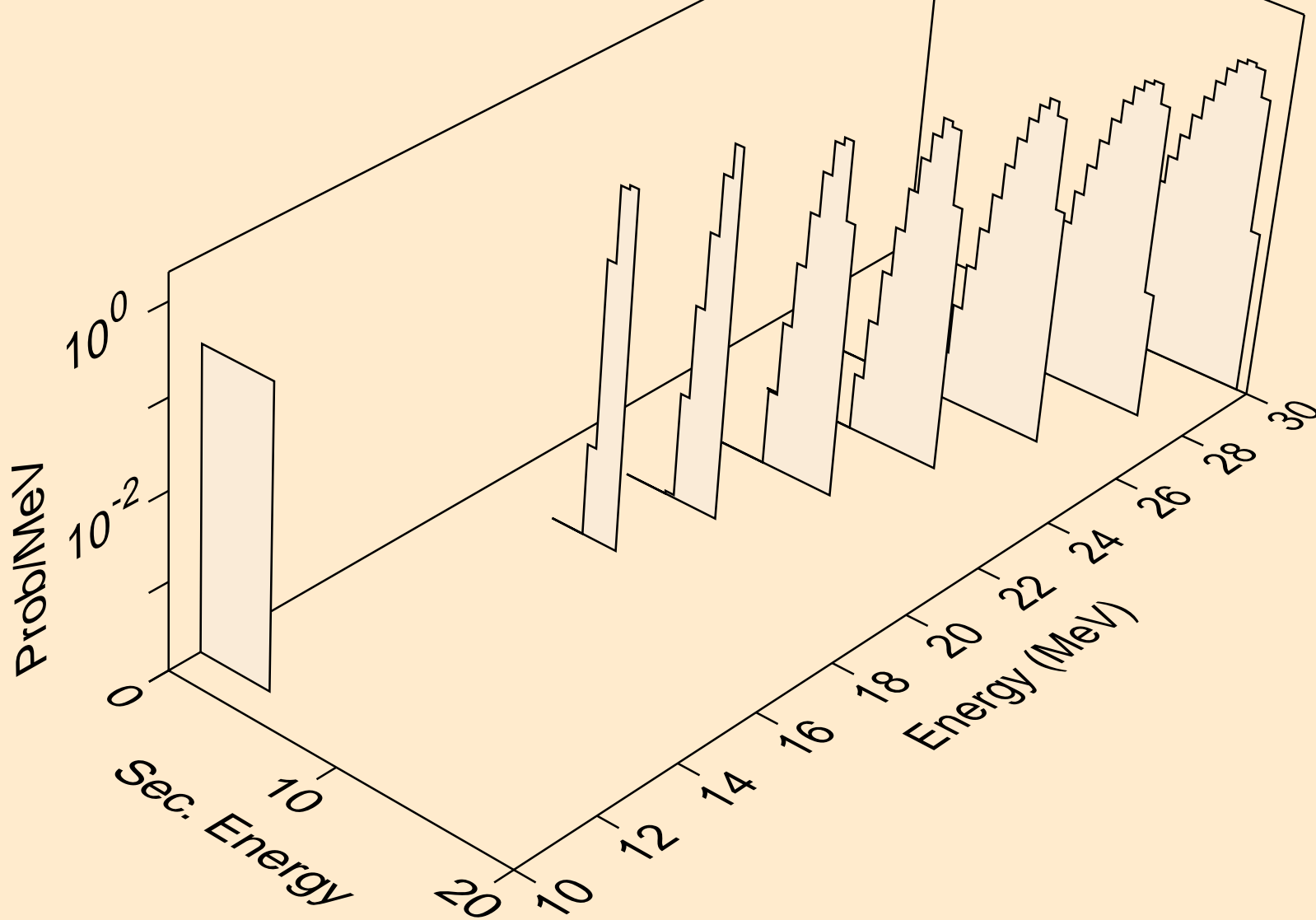

PT193 NEUTRON ACER TENDL-2019 LIBRARY; T=293.16K
he3s from (n,he3)

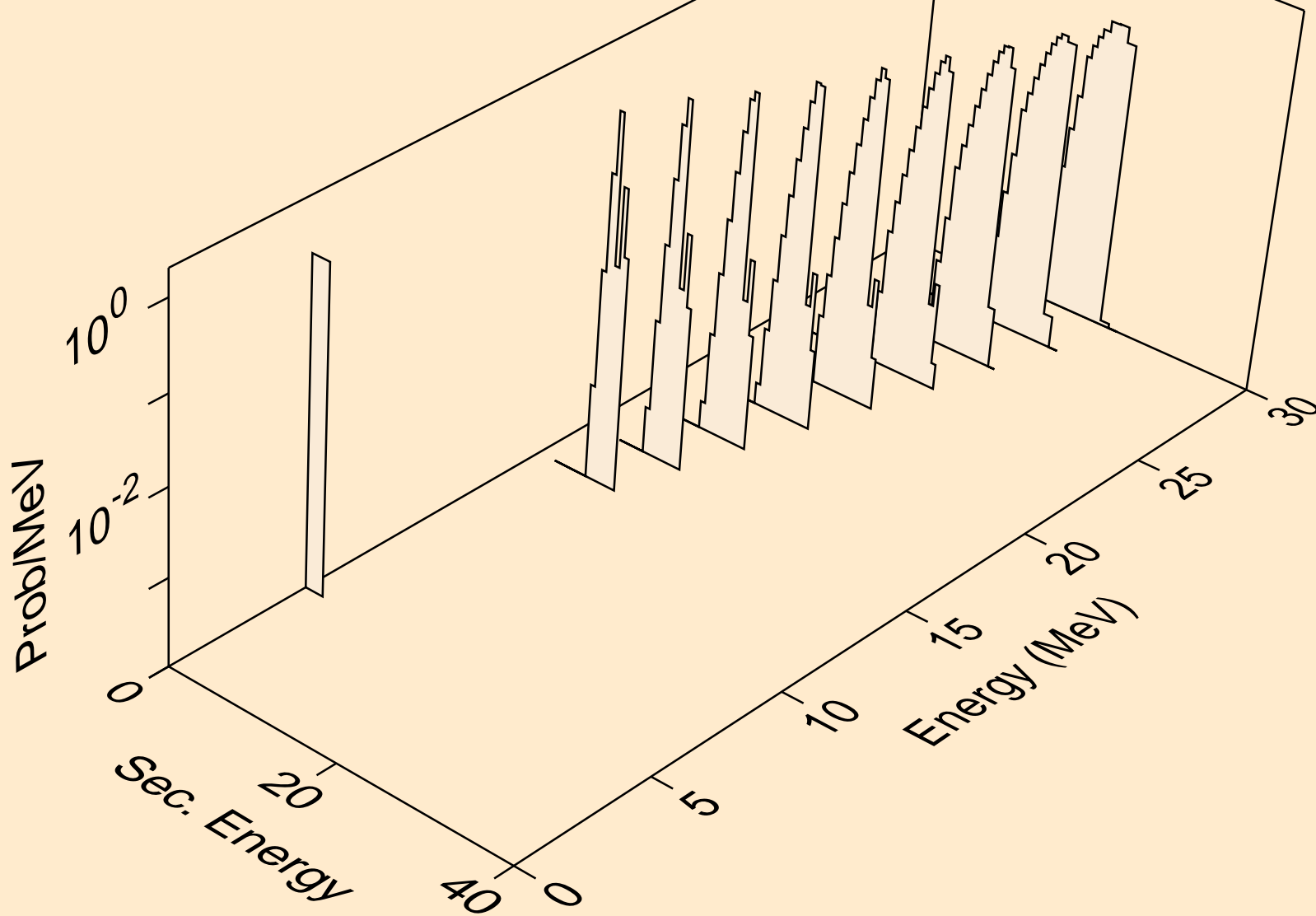

PT193 NEUTRON ACER TENDL-2019 LIBRARY; T=293.16K
alphas from (n,x)

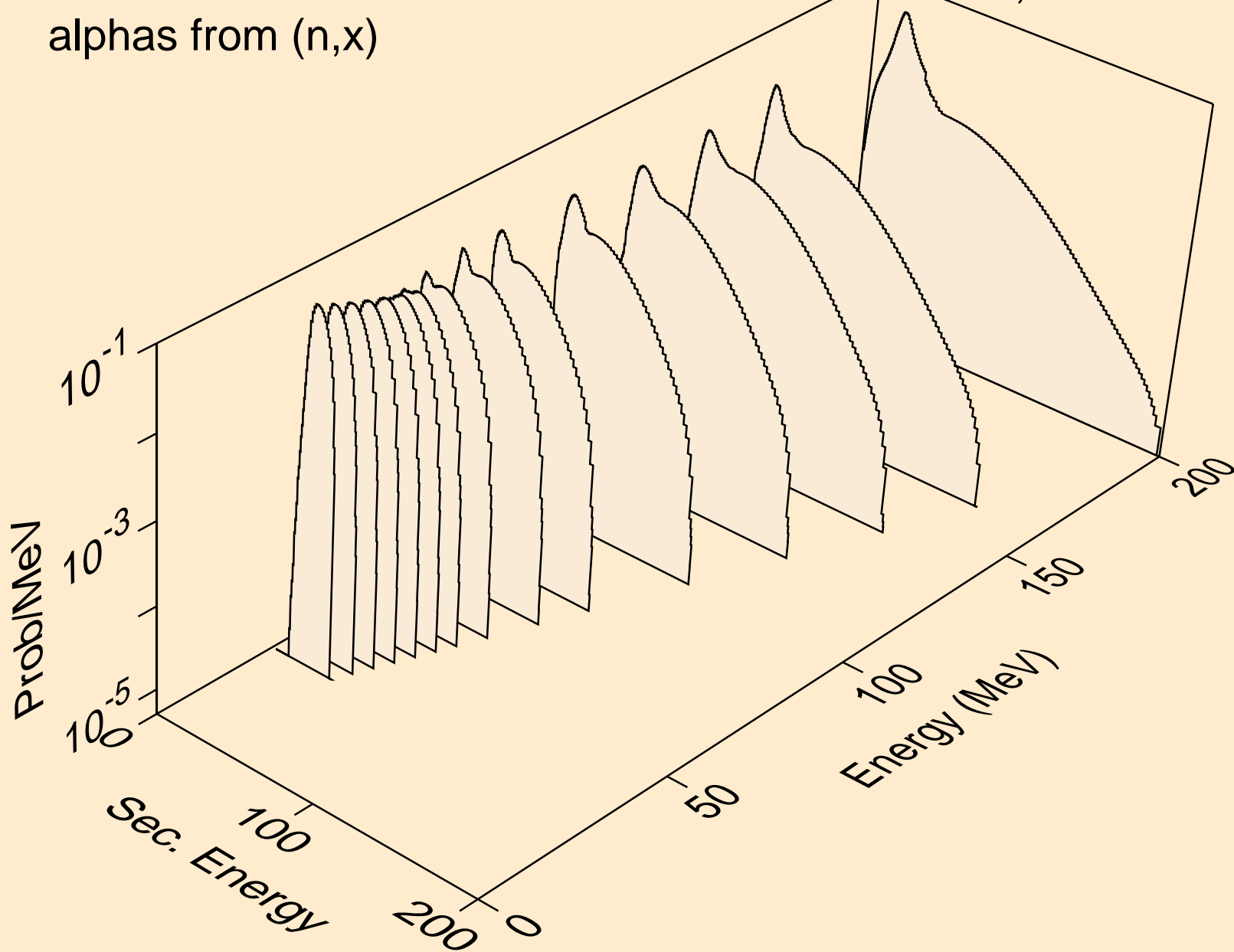

PT193 NEUTRON ACER TENDL-2019 LIBRARY; T=293.16K
alphas from (n,n*)a

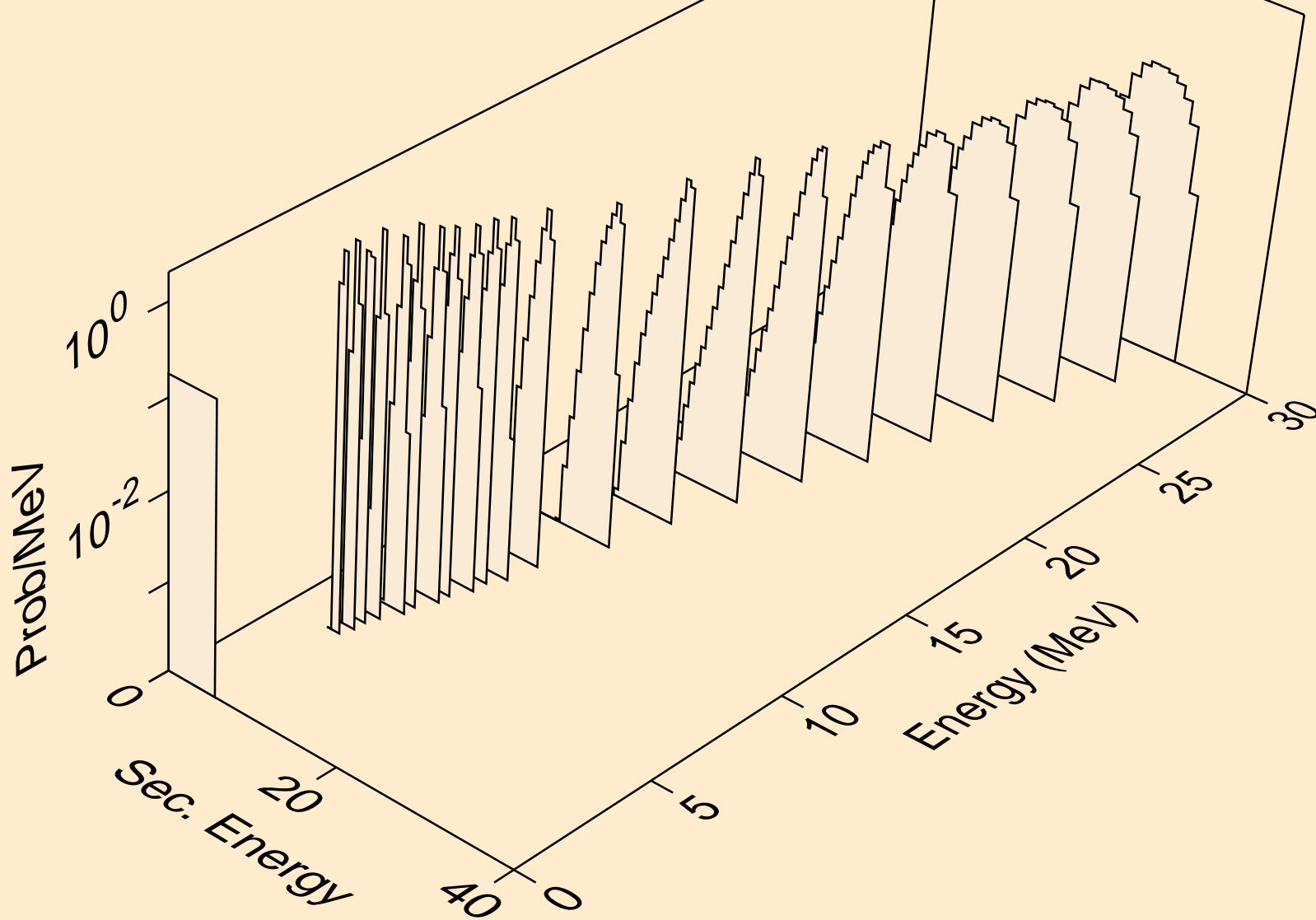

PT193 NEUTRON ACER TENDL-2019 LIBRARY; T=293.16K
alphas from (n,2n)a

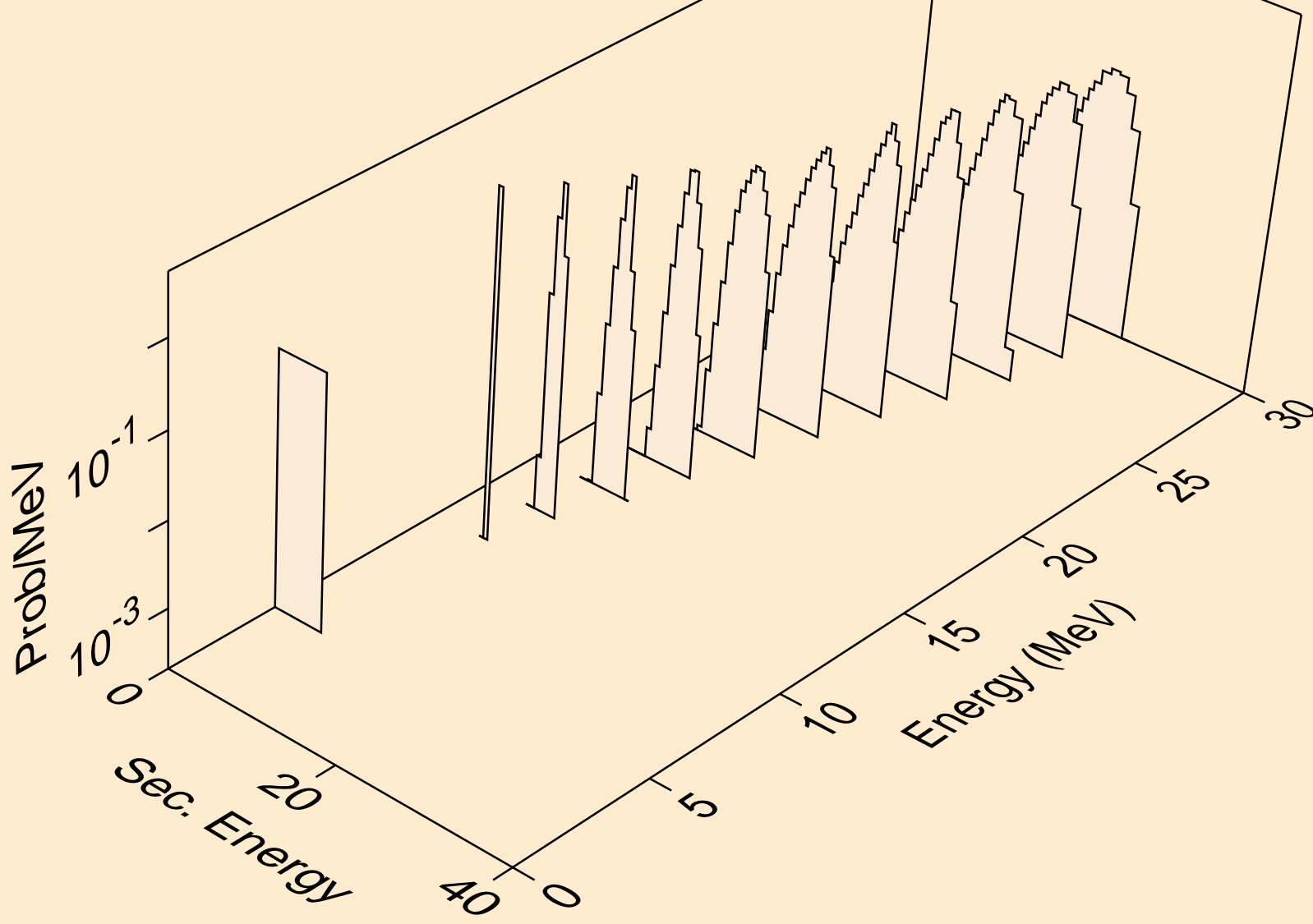

PT193 NEUTRON ACER TENDL-2019 LIBRARY; T=293.16K
alphas from (n,3n)a

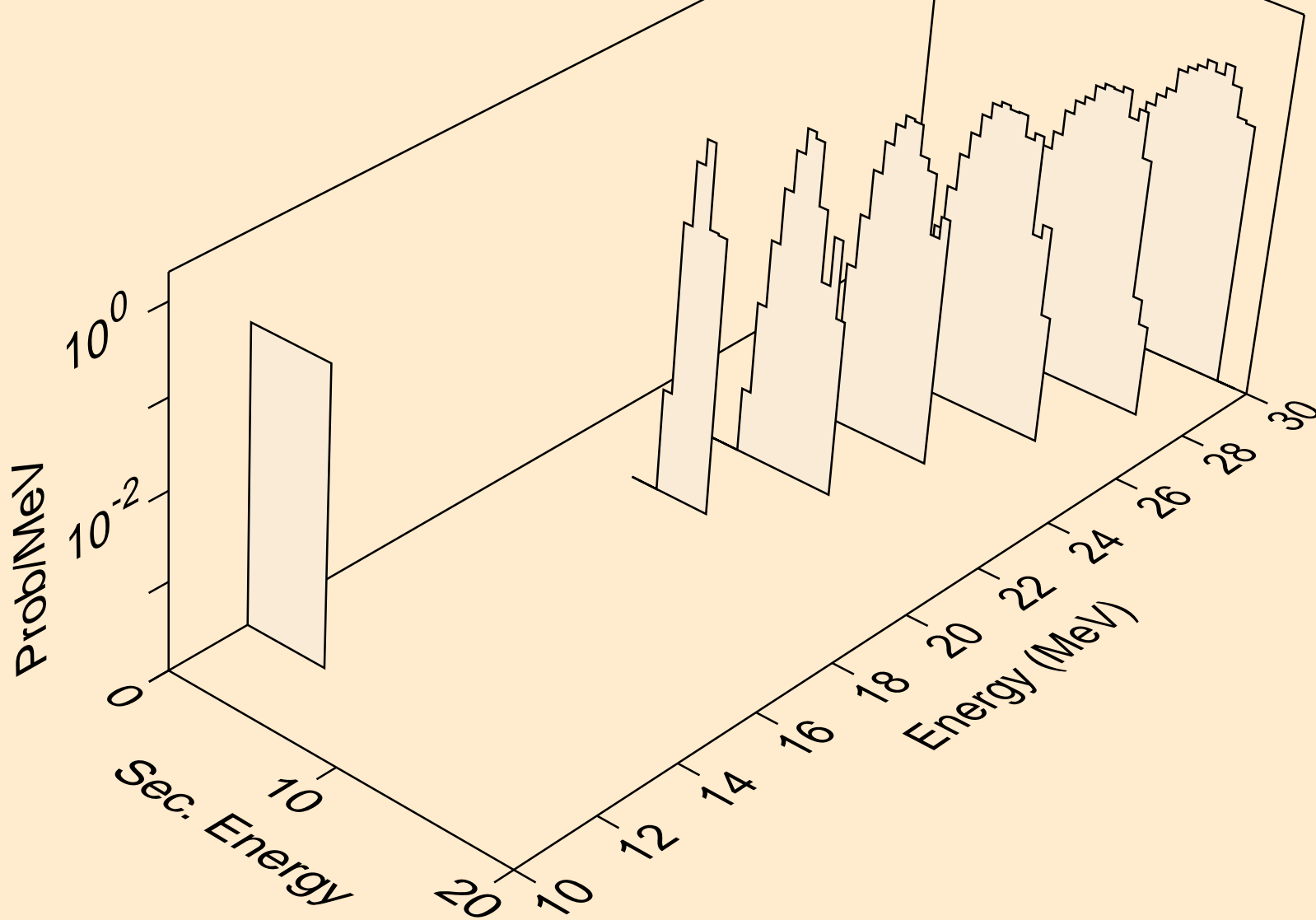

PT193 NEUTRON ACER TENDL-2019 LIBRARY; T=293.16K
alphas from (n,npa)

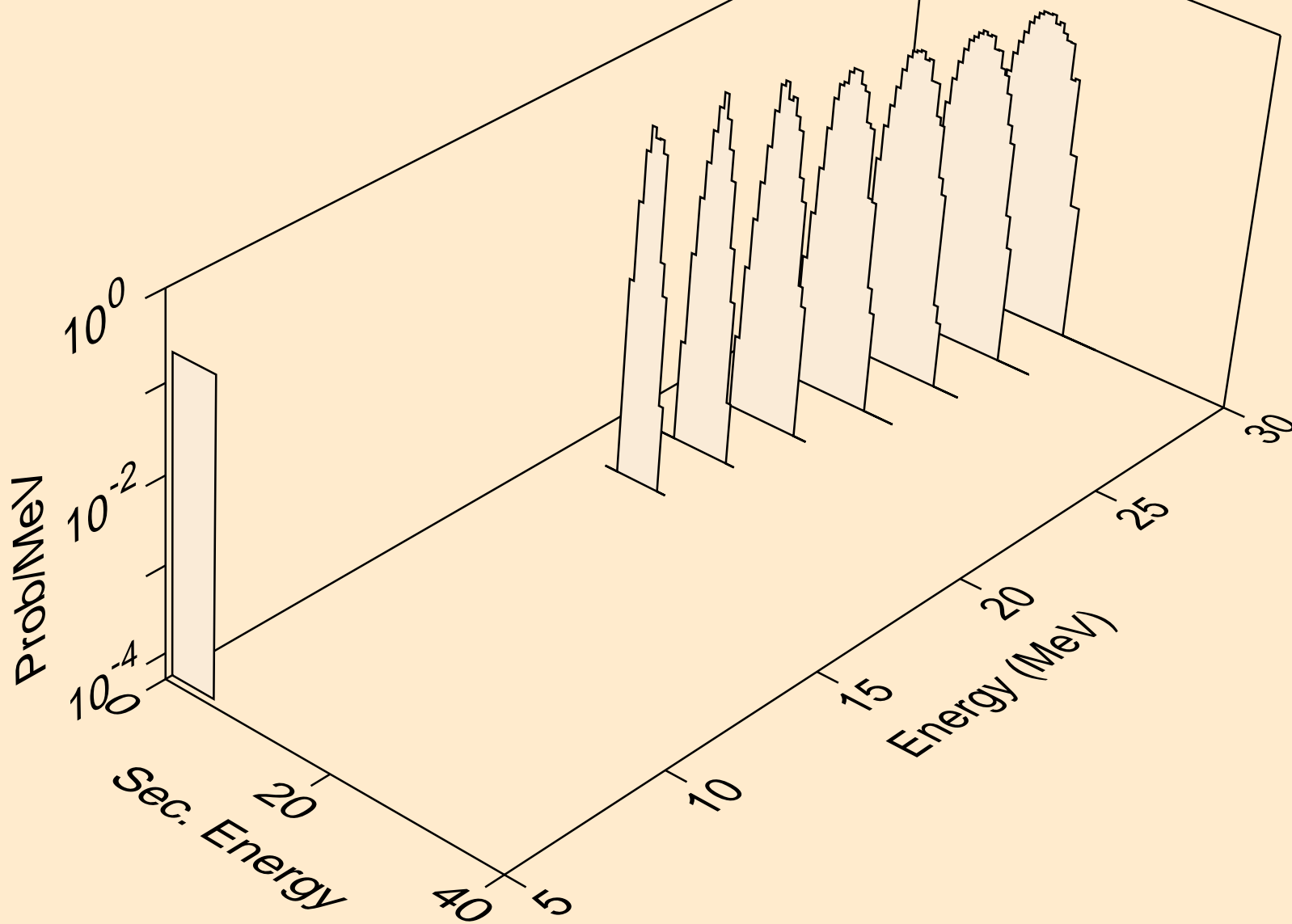

PT193 NEUTRON ACER TENDL-2019 LIBRARY; T=293.16K
alphas from (n,a)

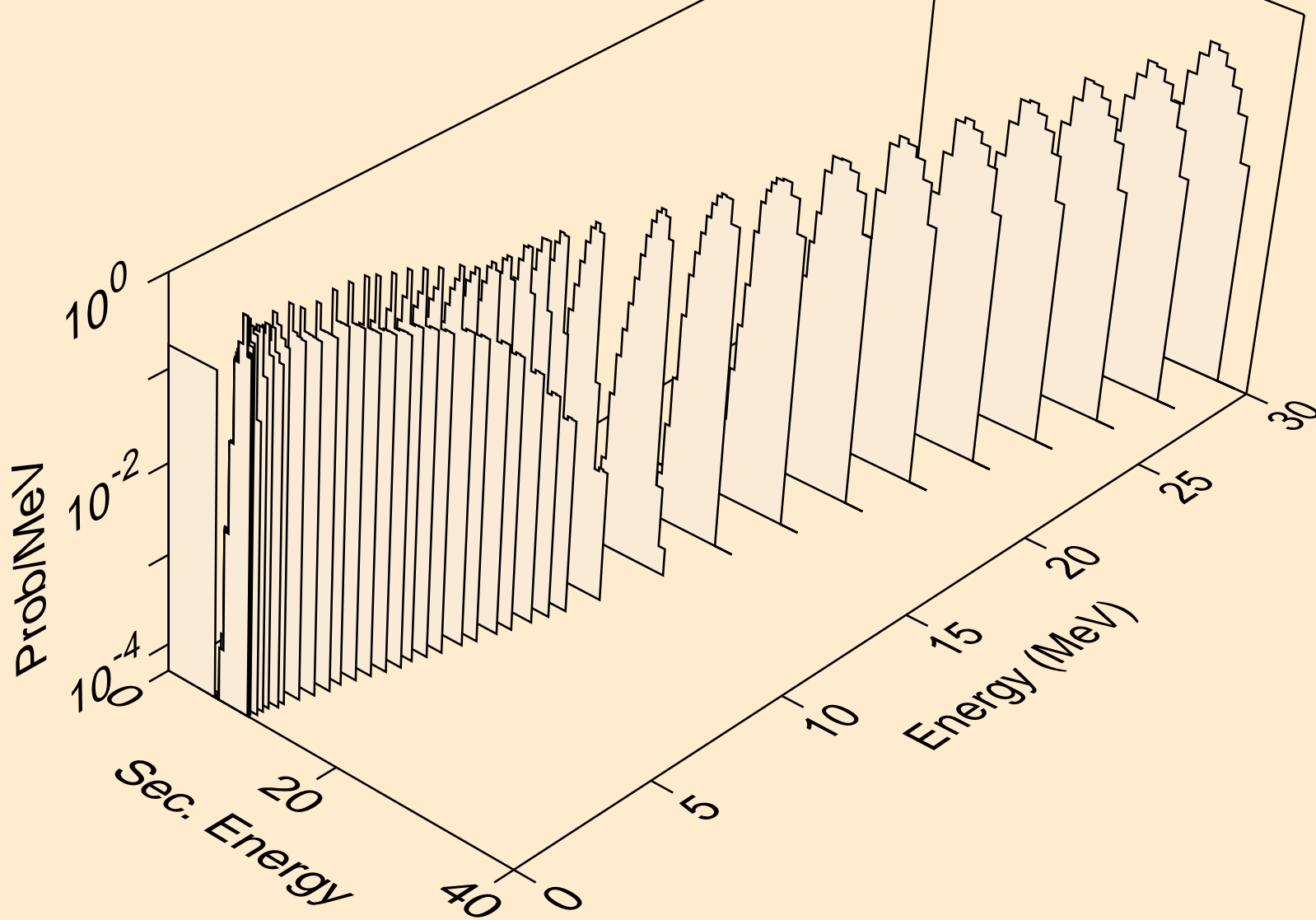

PT193 NEUTRON ACER TENDL-2019 LIBRARY; T=293.16K
alphas from (n,2a)

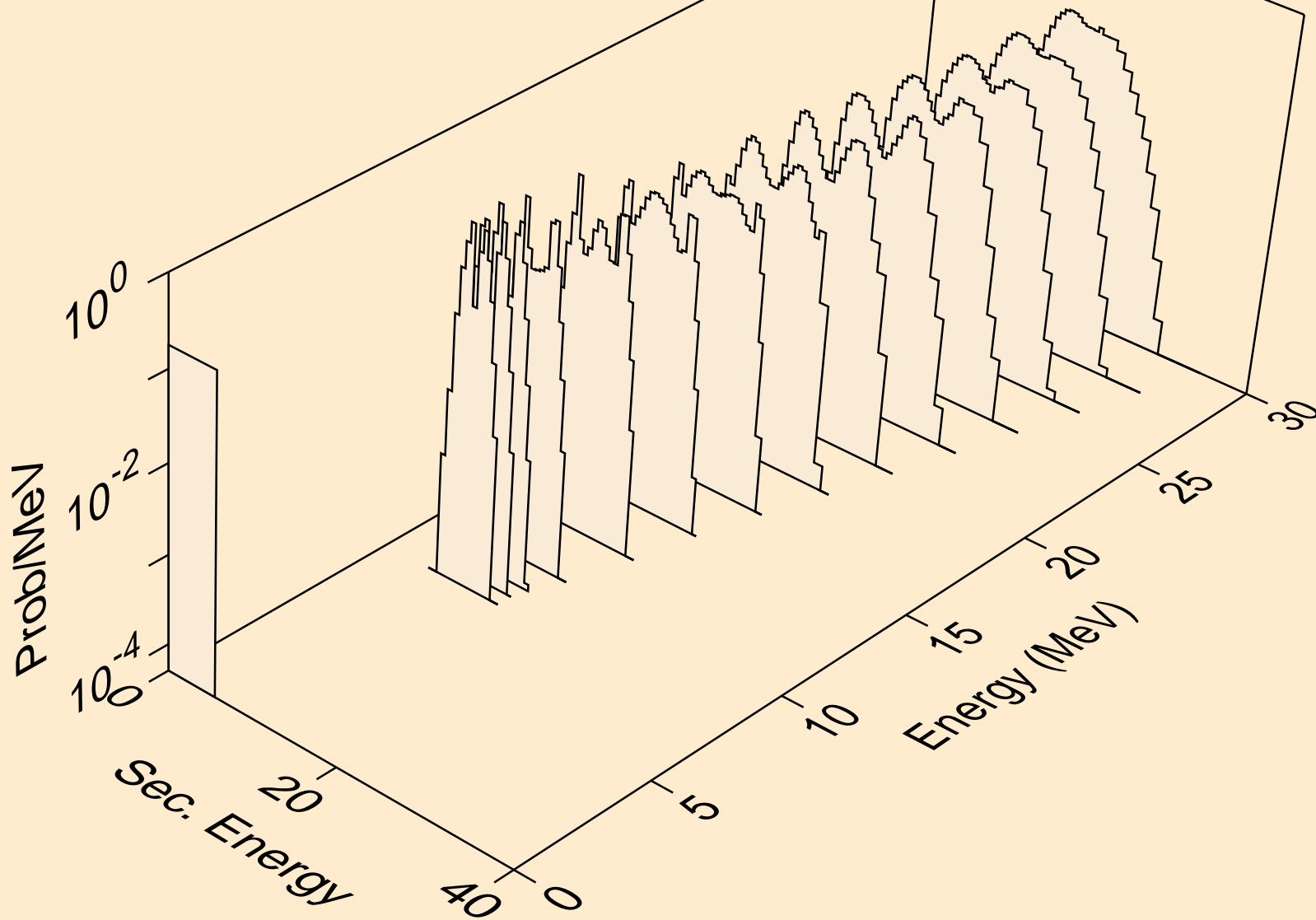

PT193 NEUTRON ACER TENDL-2019 LIBRARY; T=293.16K
alphas from (n,pa)

