

RA212 NEUTRON ACER TENDL-2019 LIBRARY; T=293.16K  
Principal cross sections

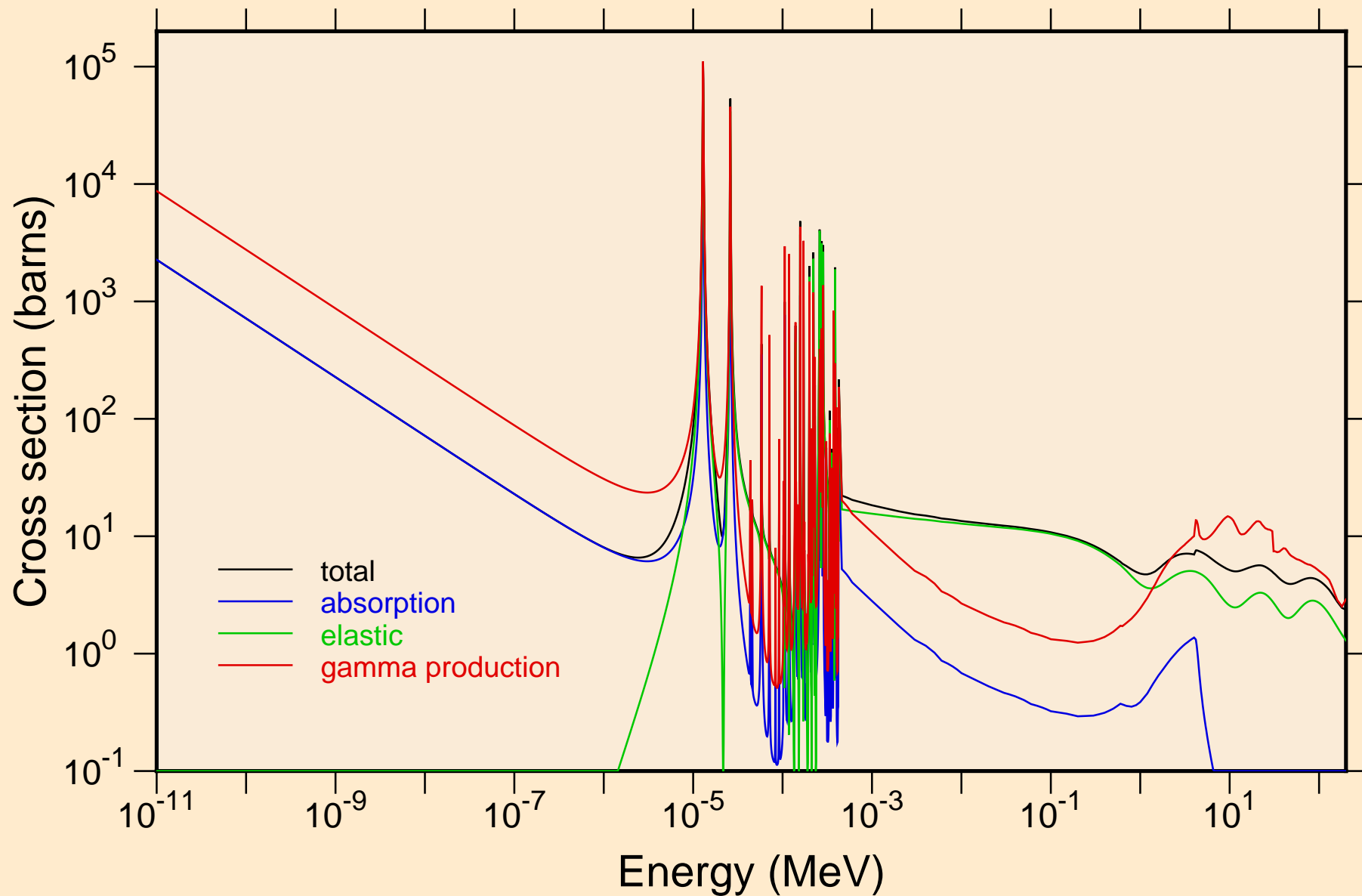

RA212 NEUTRON ACER TENDL-2019 LIBRARY; T=293.16K  
resonance total cross section

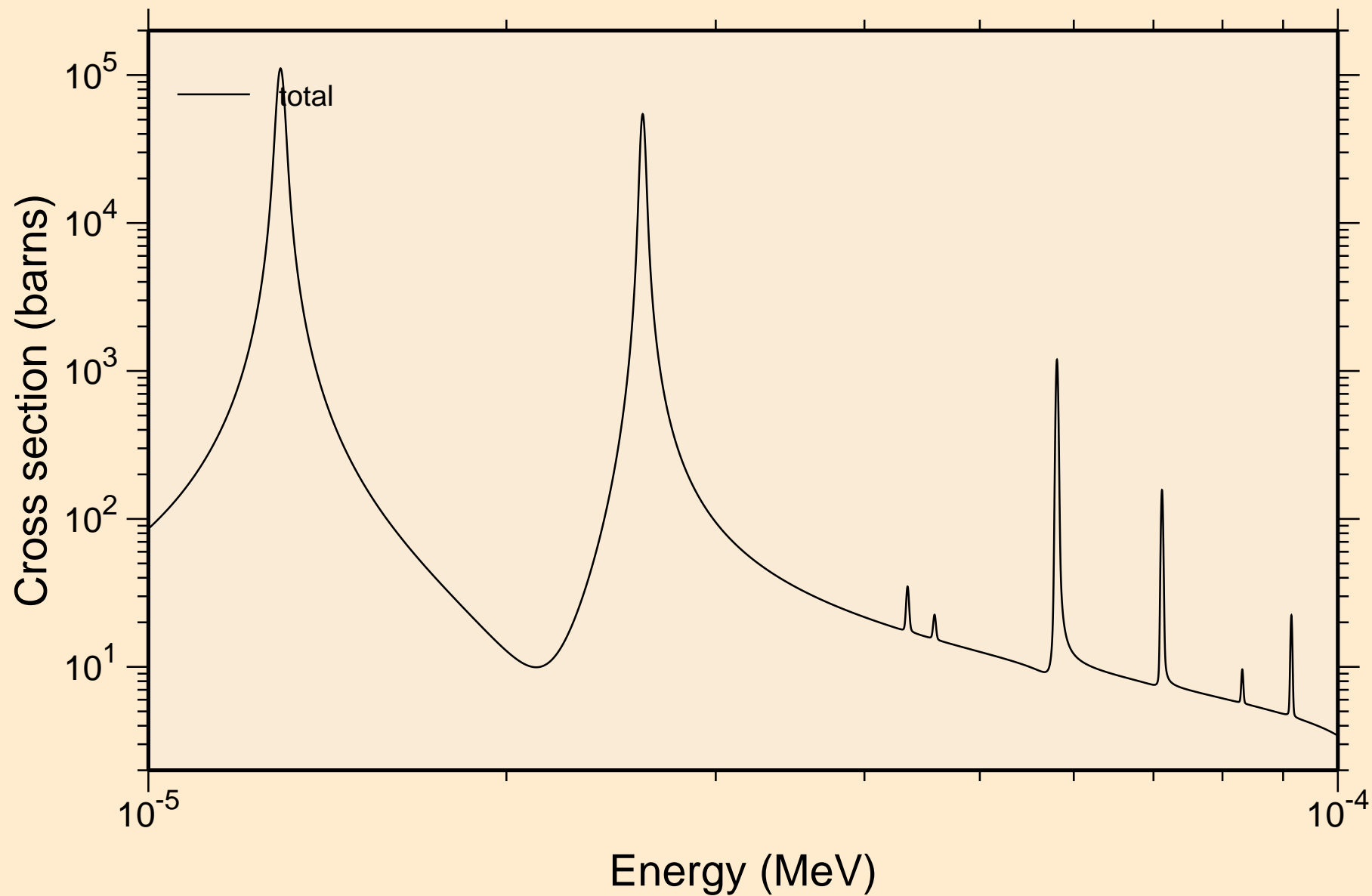

RA212 NEUTRON ACER TENDL-2019 LIBRARY; T=293.16K  
resonance total cross section

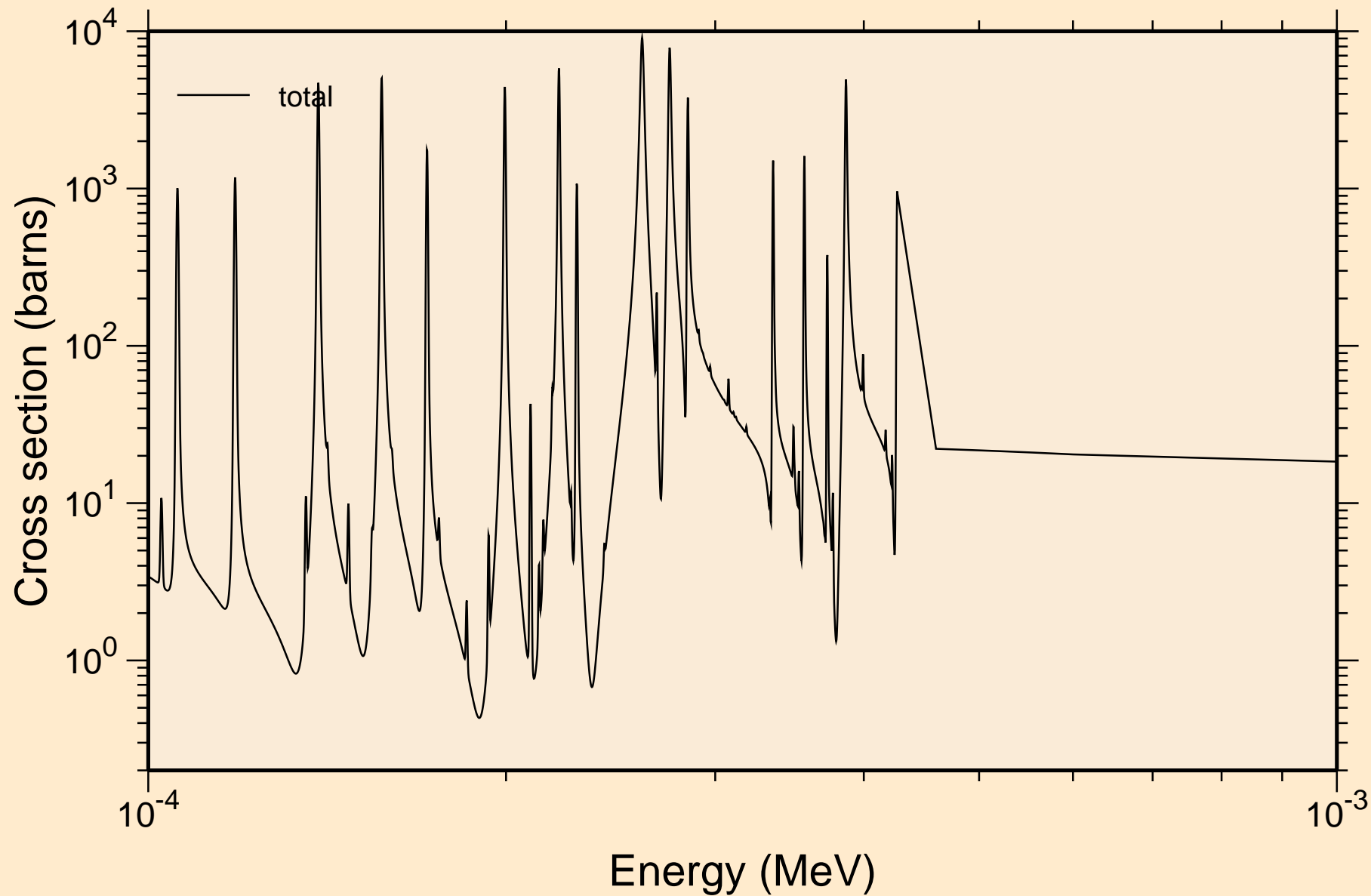

RA212 NEUTRON ACER TENDL-2019 LIBRARY; T=293.16K  
resonance total cross section

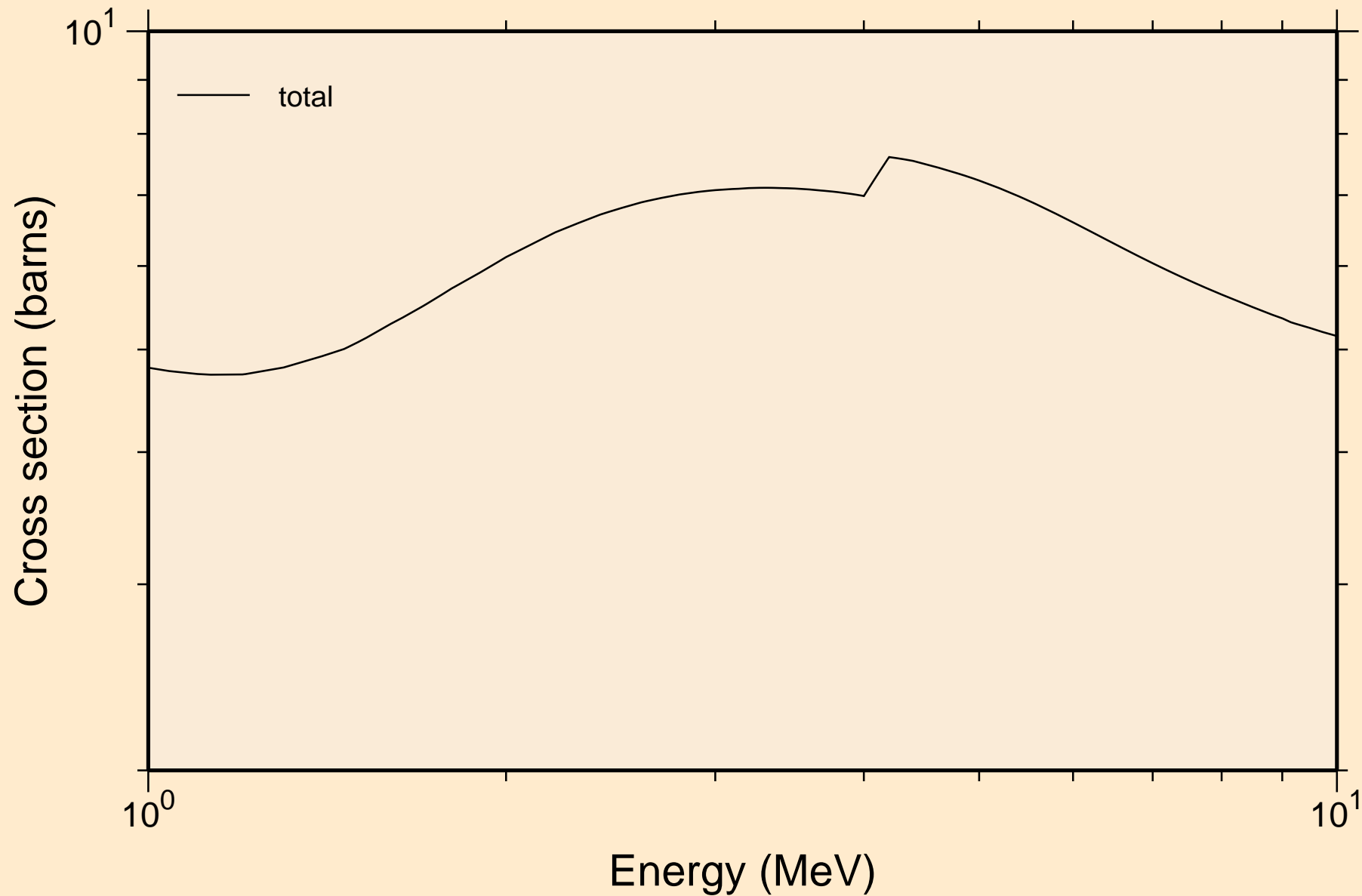

RA212 NEUTRON ACER TENDL-2019 LIBRARY; T=293.16K  
resonance absorption cross sections

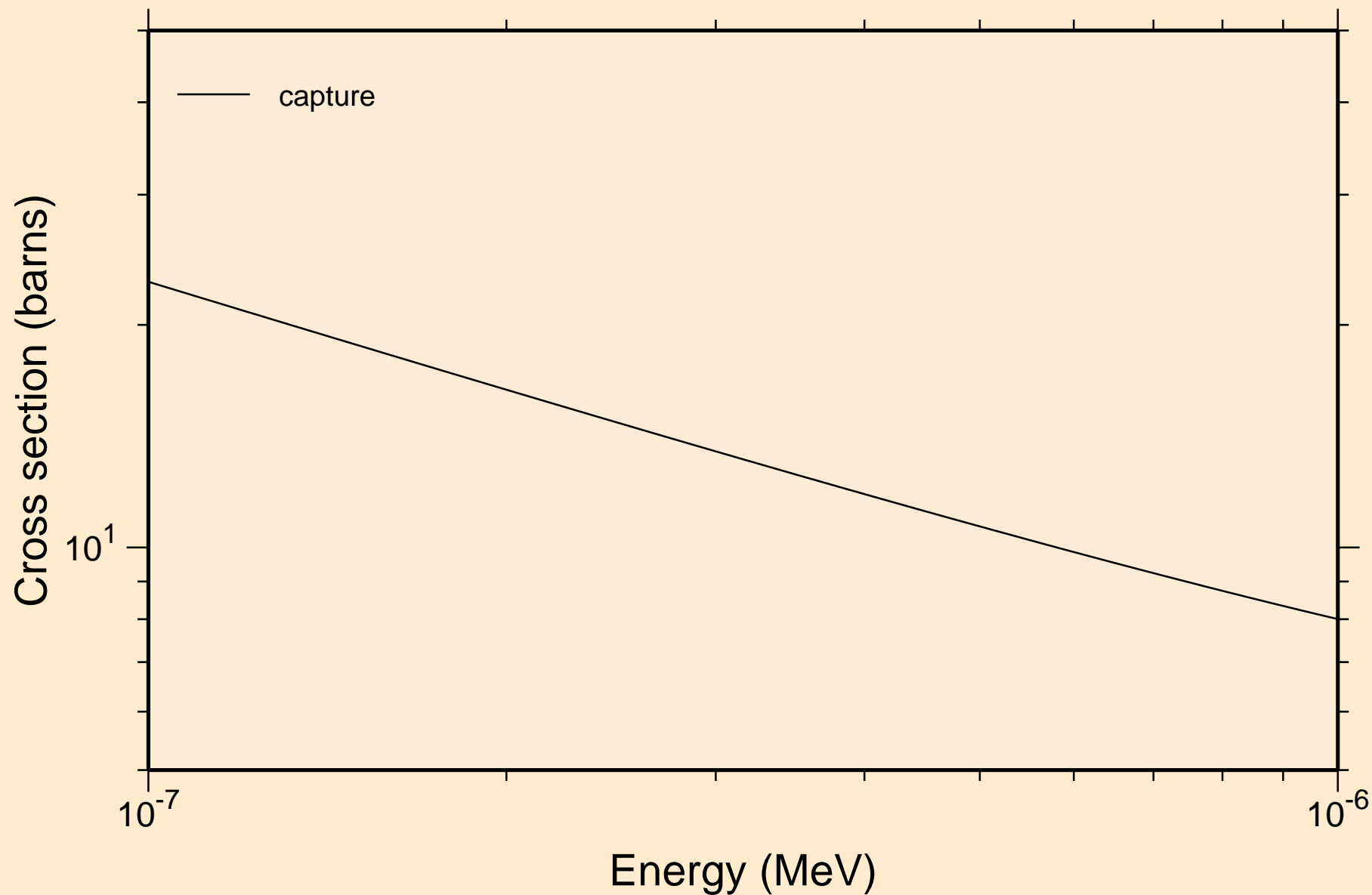

RA212 NEUTRON ACER TENDL-2019 LIBRARY; T=293.16K  
resonance absorption cross sections

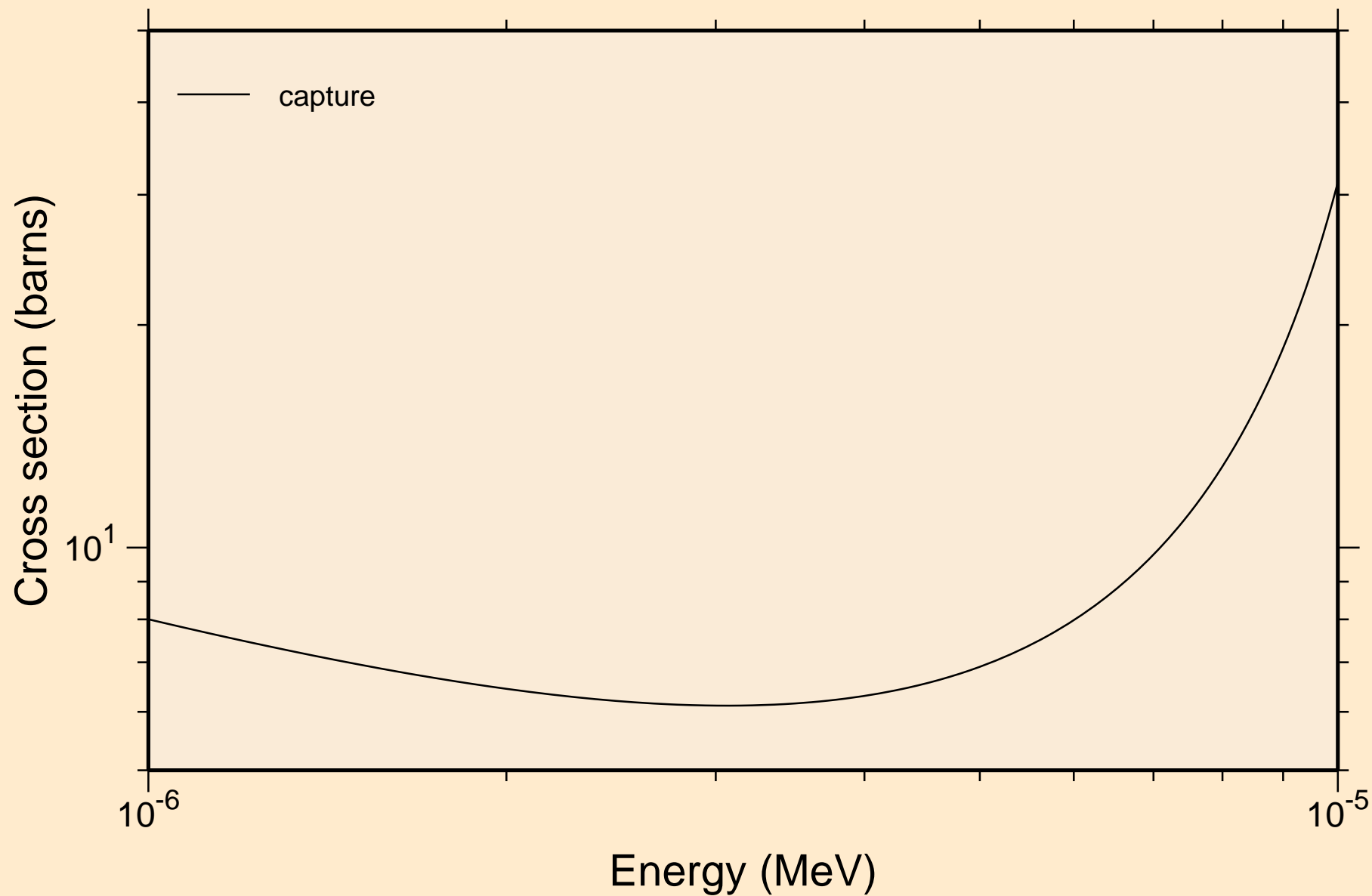

RA212 NEUTRON ACER TENDL-2019 LIBRARY; T=293.16K  
resonance absorption cross sections

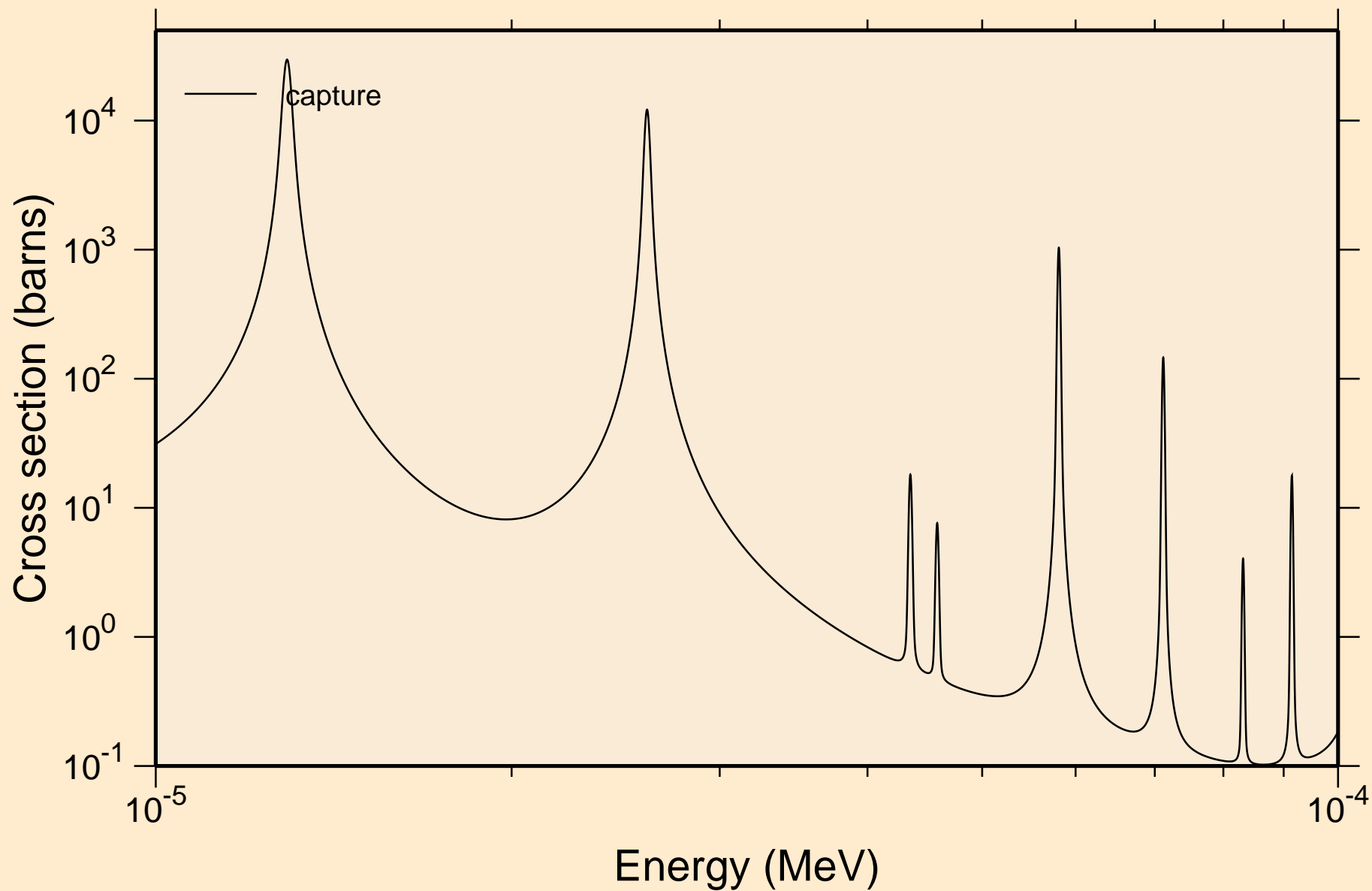

RA212 NEUTRON ACER TENDL-2019 LIBRARY; T=293.16K  
resonance absorption cross sections

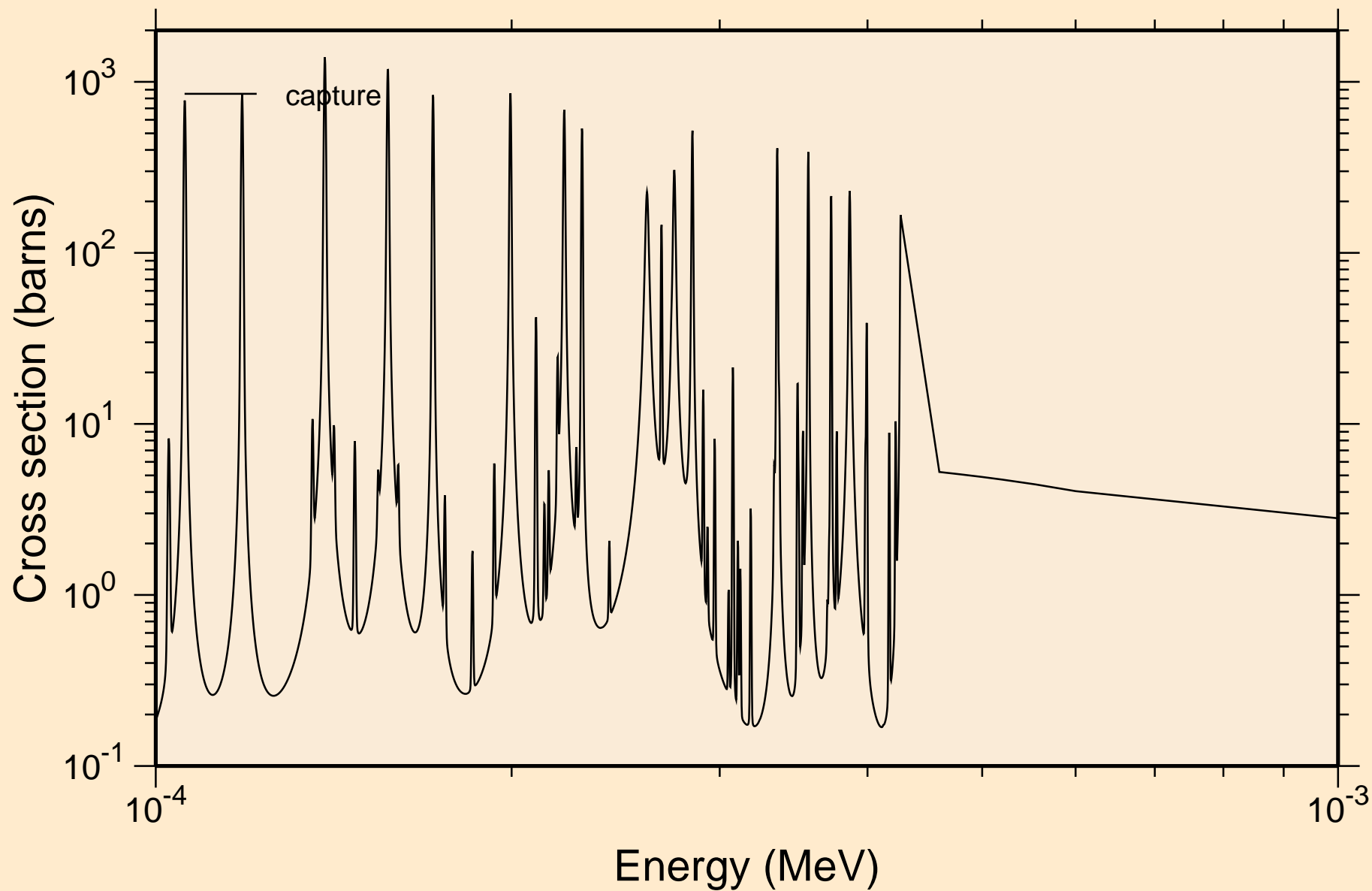



RA212 NEUTRON ACER TENDL-2019 LIBRARY; T=293.16K  
resonance absorption cross sections

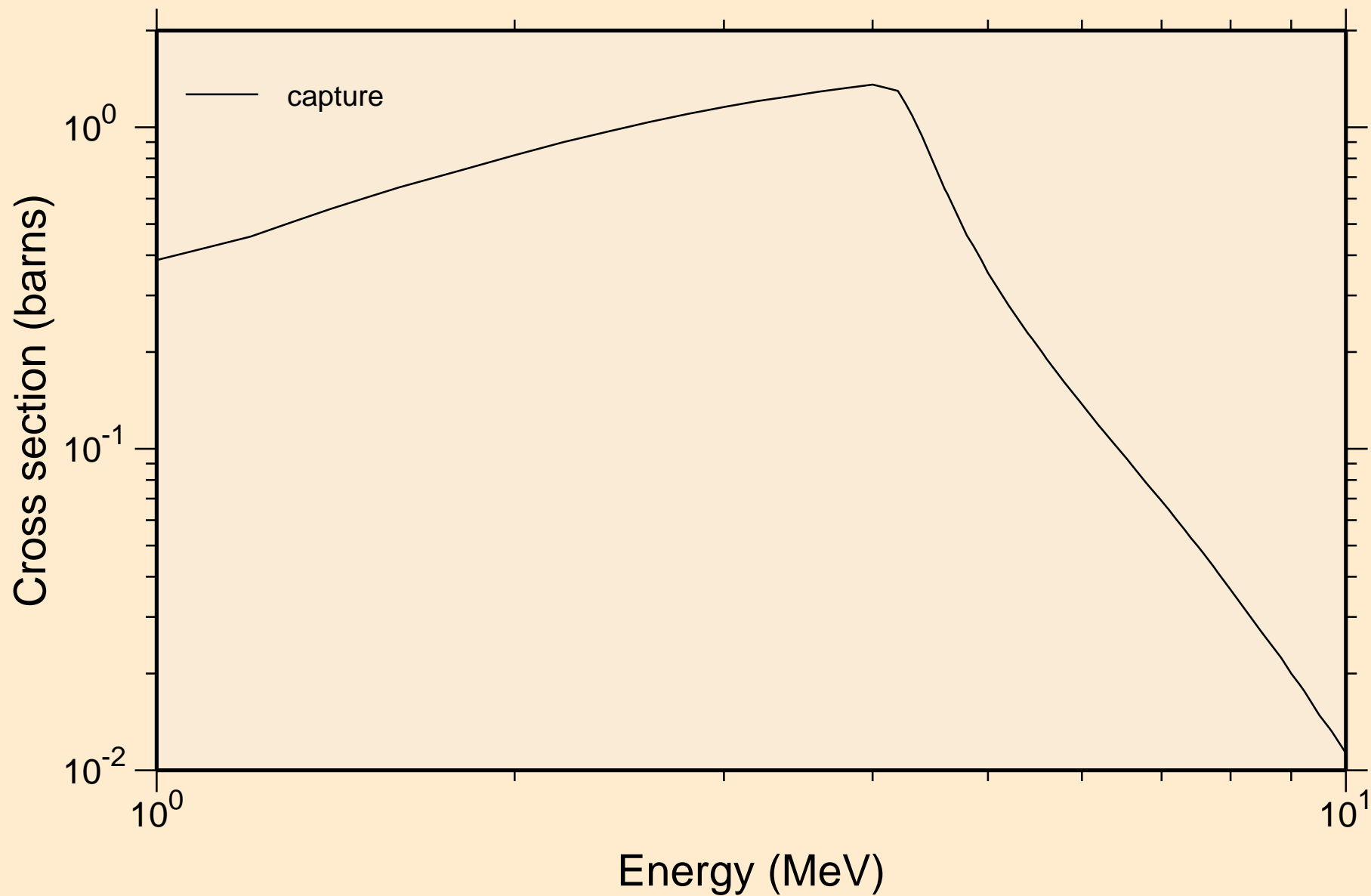

RA212 NEUTRON ACER TENDL-2019 LIBRARY; T=293.16K  
Heating

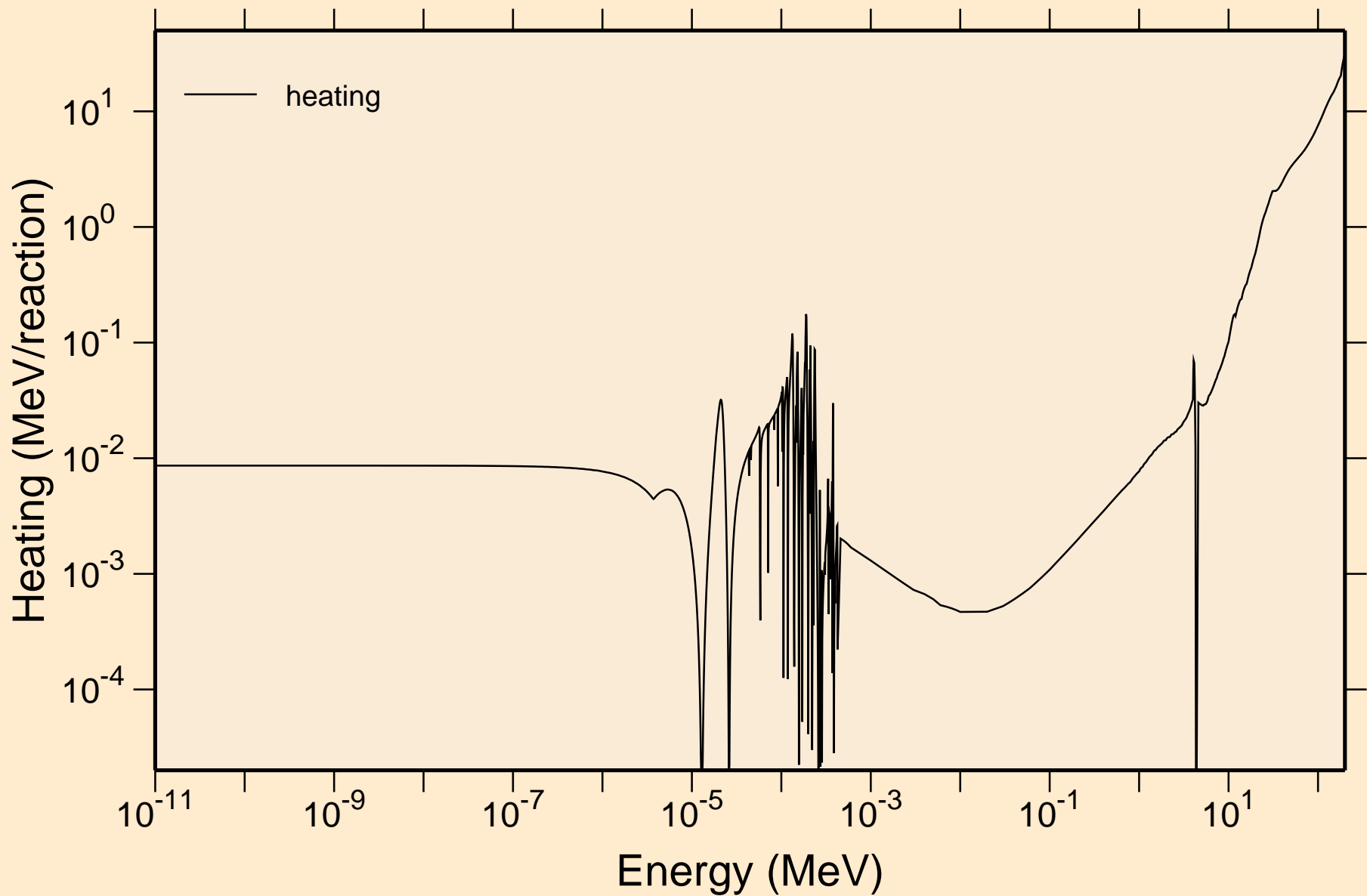

RA212 NEUTRON ACER TENDL-2019 LIBRARY; T=293.16K  
Damage

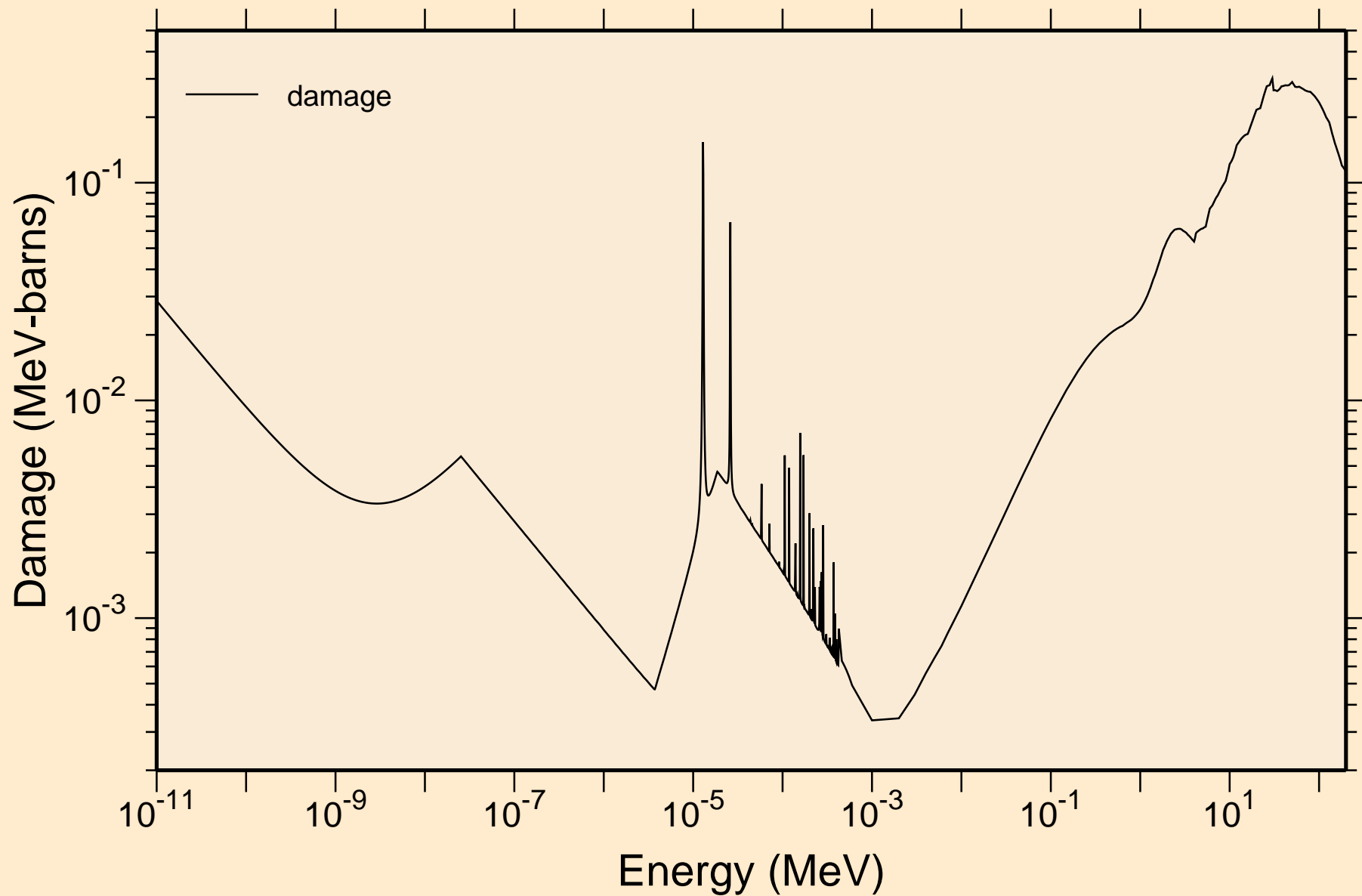

RA212 NEUTRON ACER TENDL-2019 LIBRARY; T=293.16K  
Non-threshold reactions

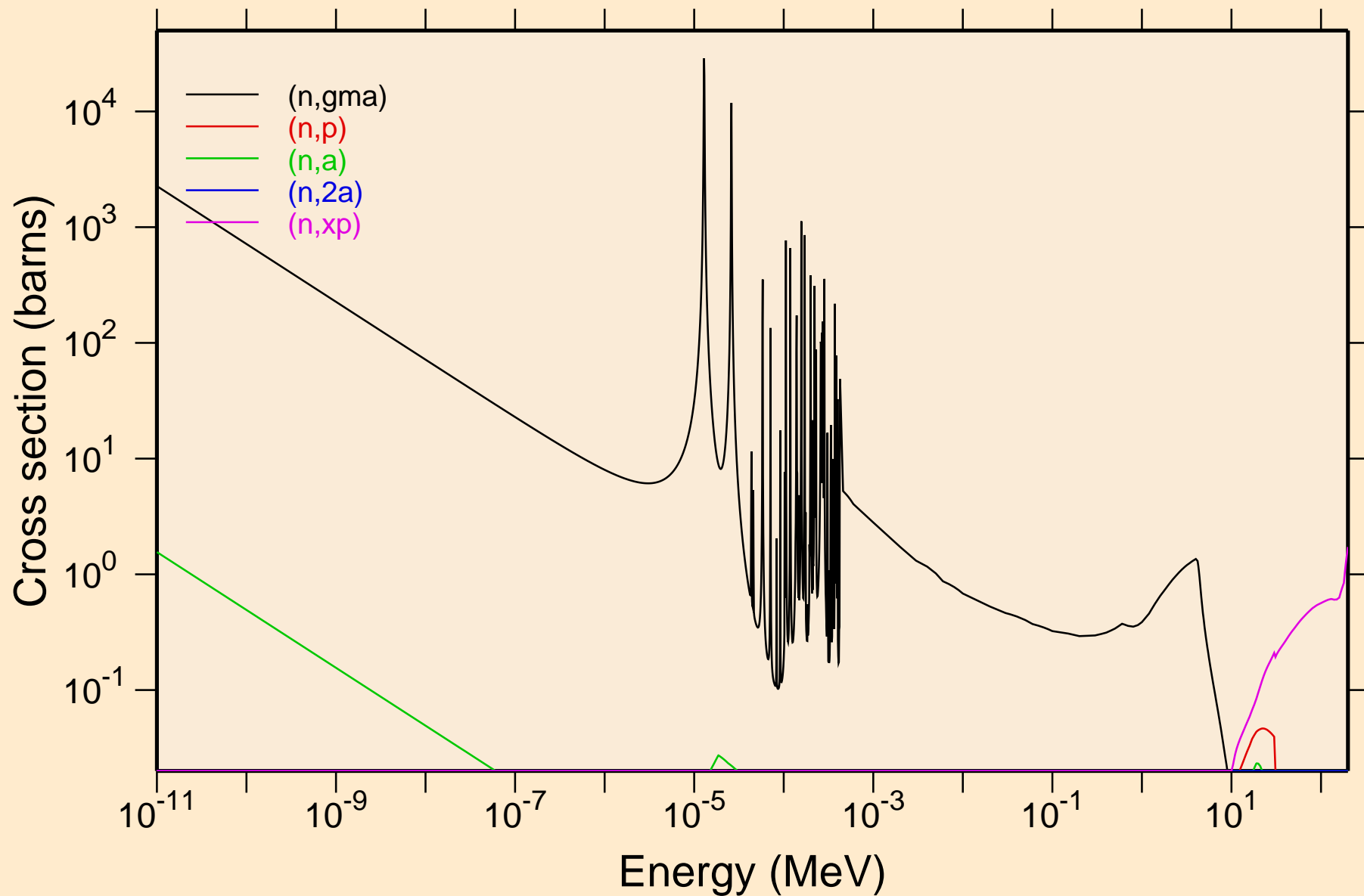

RA212 NEUTRON ACER TENDL-2019 LIBRARY; T=293.16K  
Non-threshold reactions

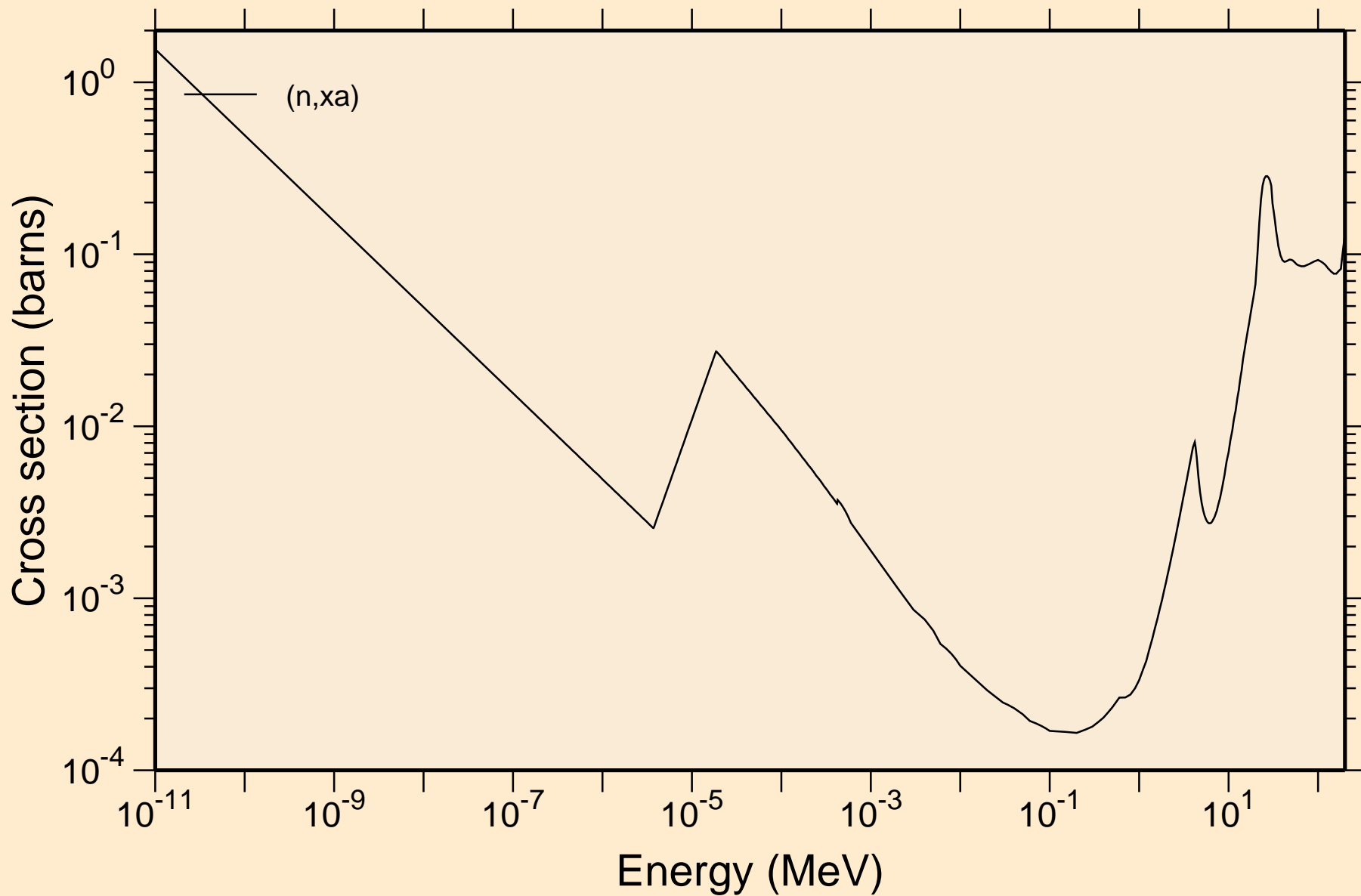

RA212 NEUTRON ACER TENDL-2019 LIBRARY; T=293.16K  
Principal cross sections

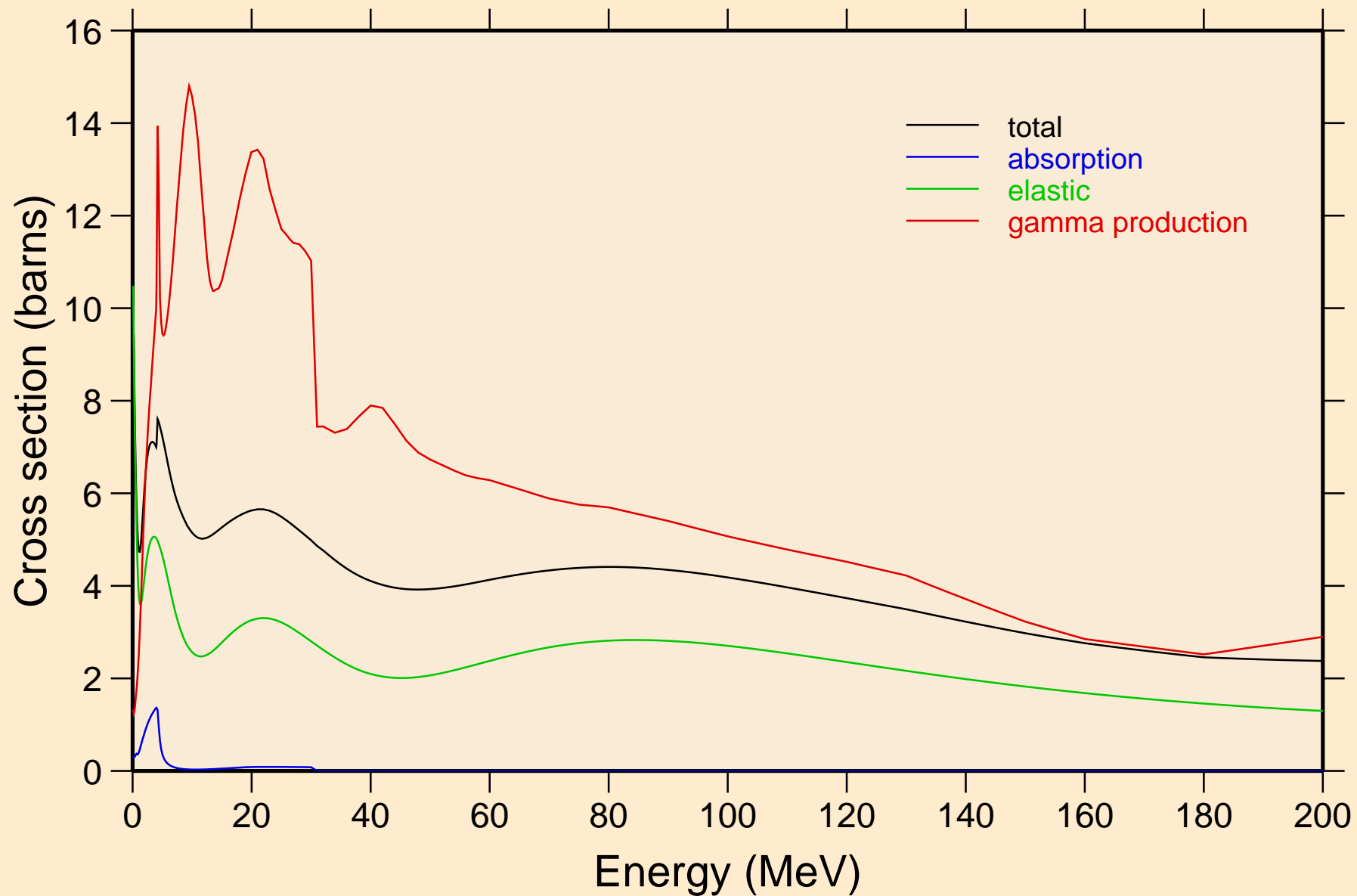

RA212 NEUTRON ACER TENDL-2019 LIBRARY; T=293.16K  
Heating

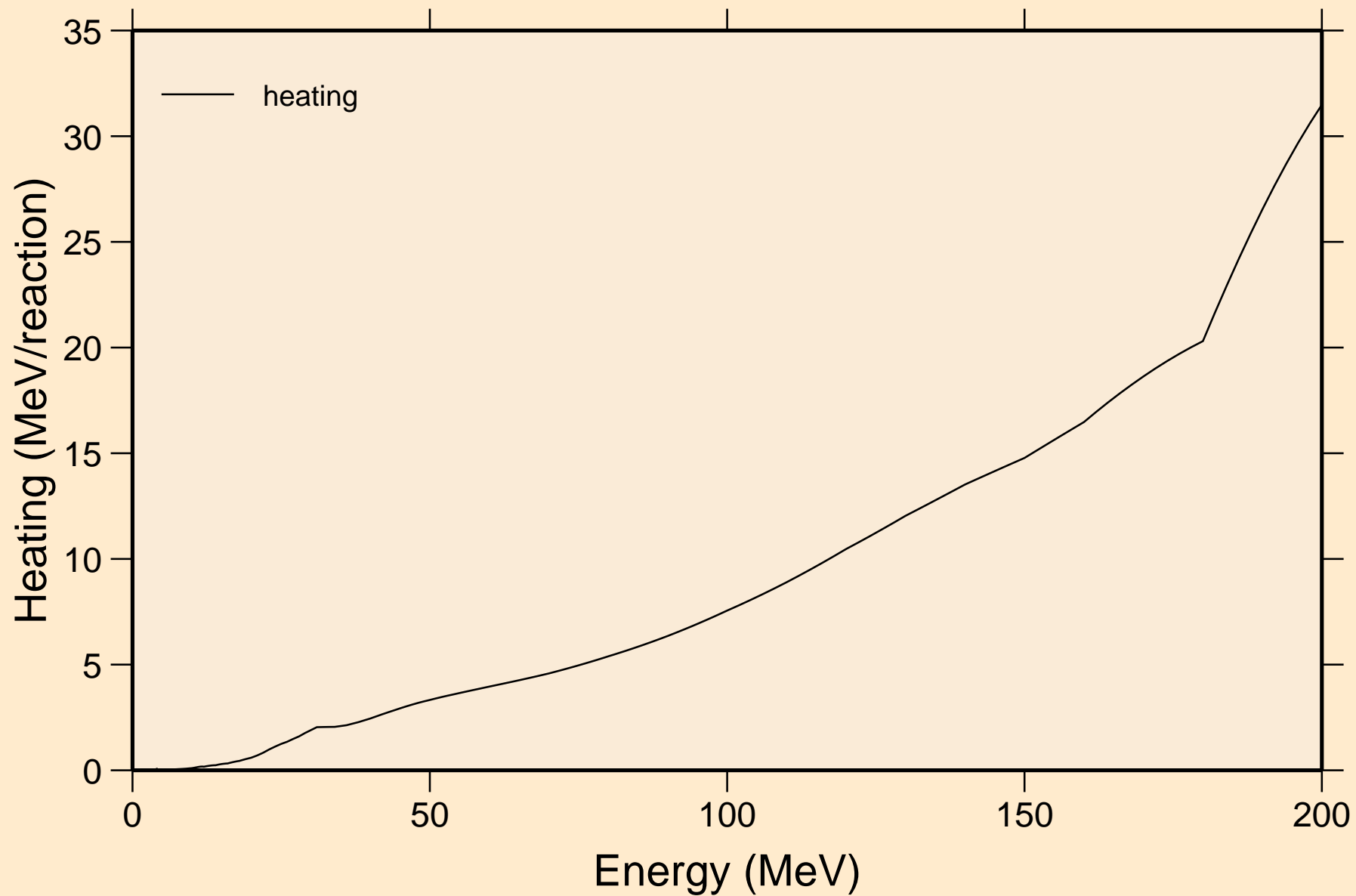

RA212 NEUTRON ACER TENDL-2019 LIBRARY; T=293.16K  
Damage

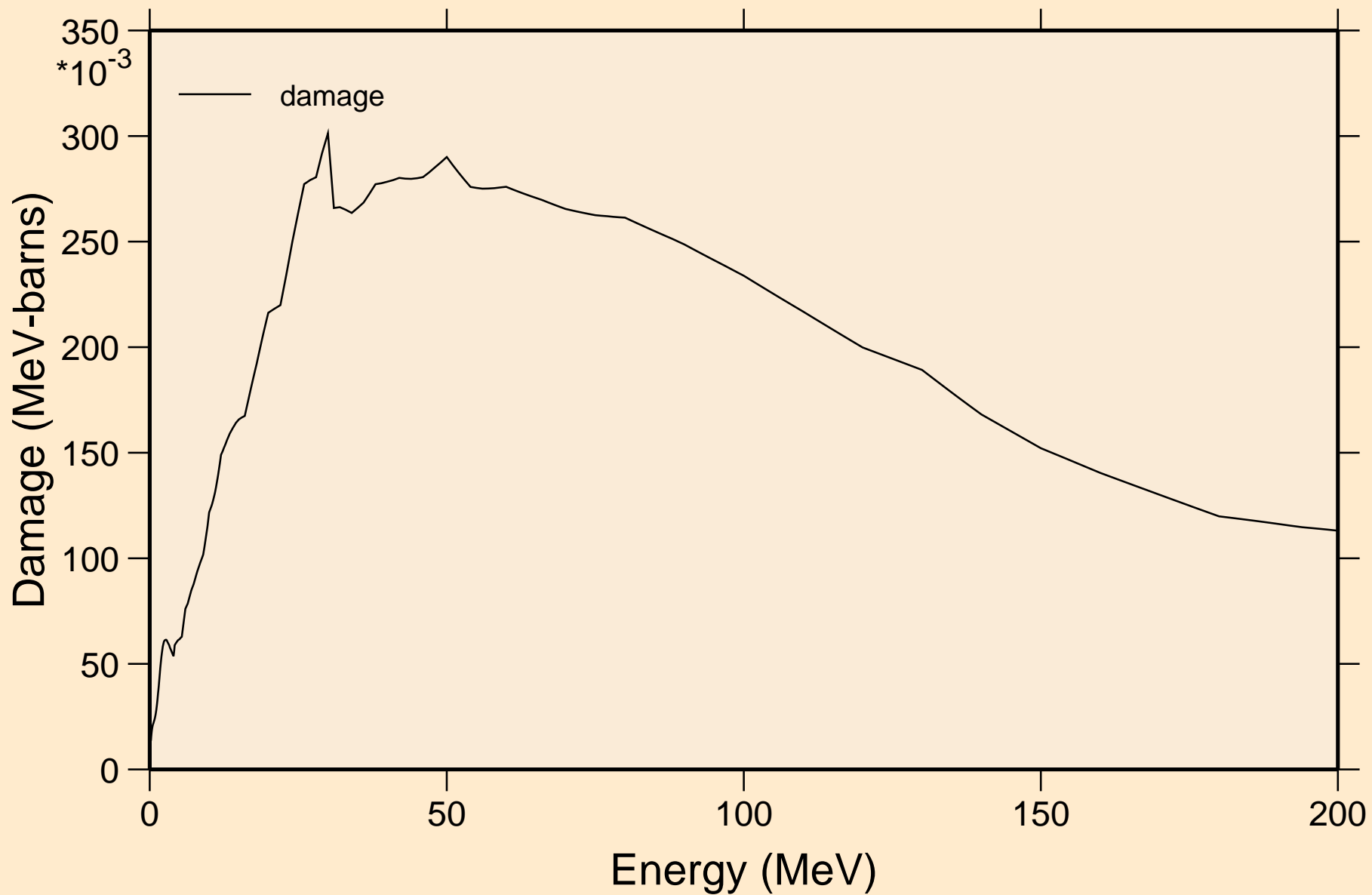



RA212 NEUTRON ACER TENDL-2019 LIBRARY; T=293.16K  
Non-threshold reactions

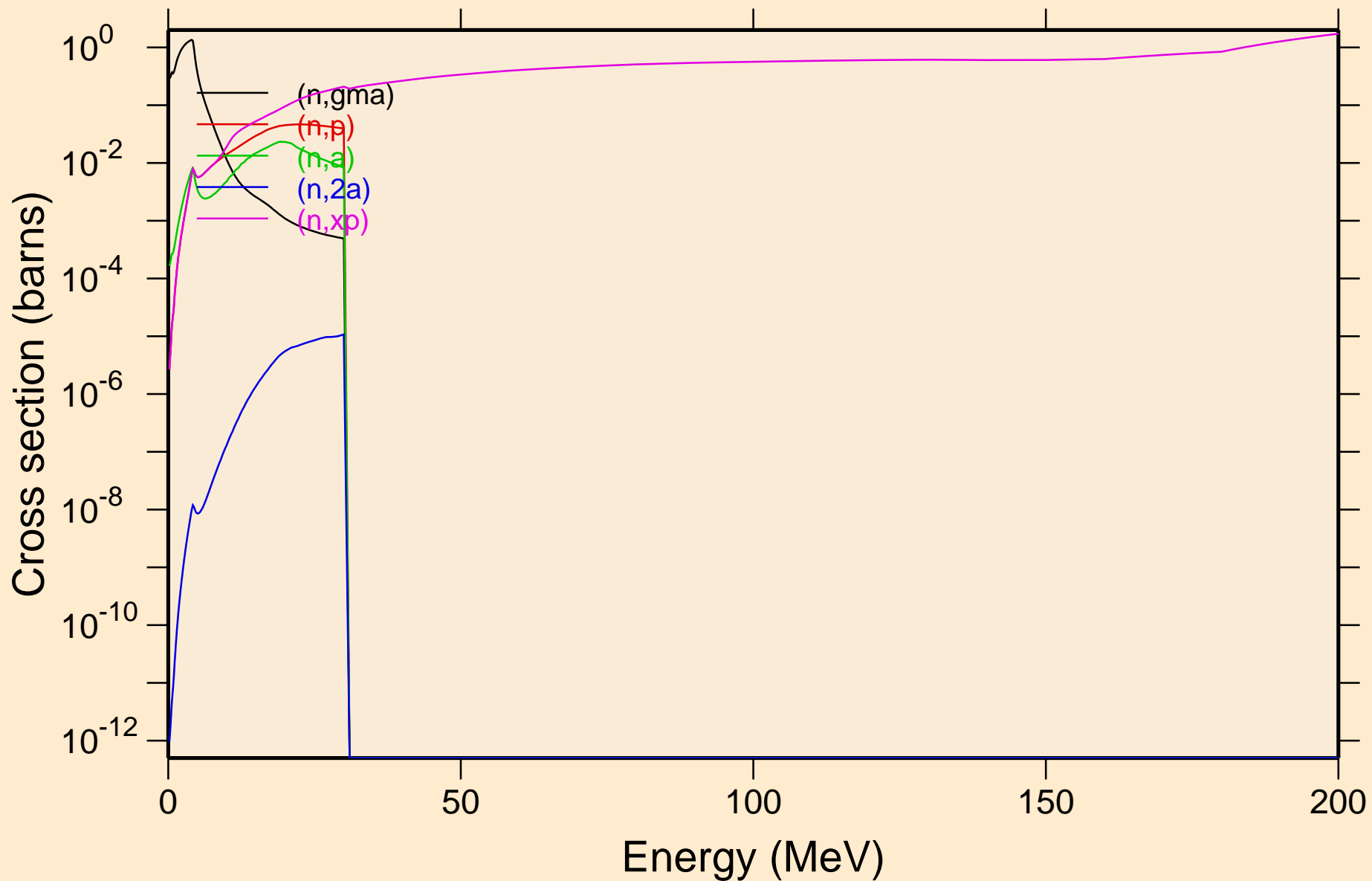

RA212 NEUTRON ACER TENDL-2019 LIBRARY; T=293.16K  
Non-threshold reactions

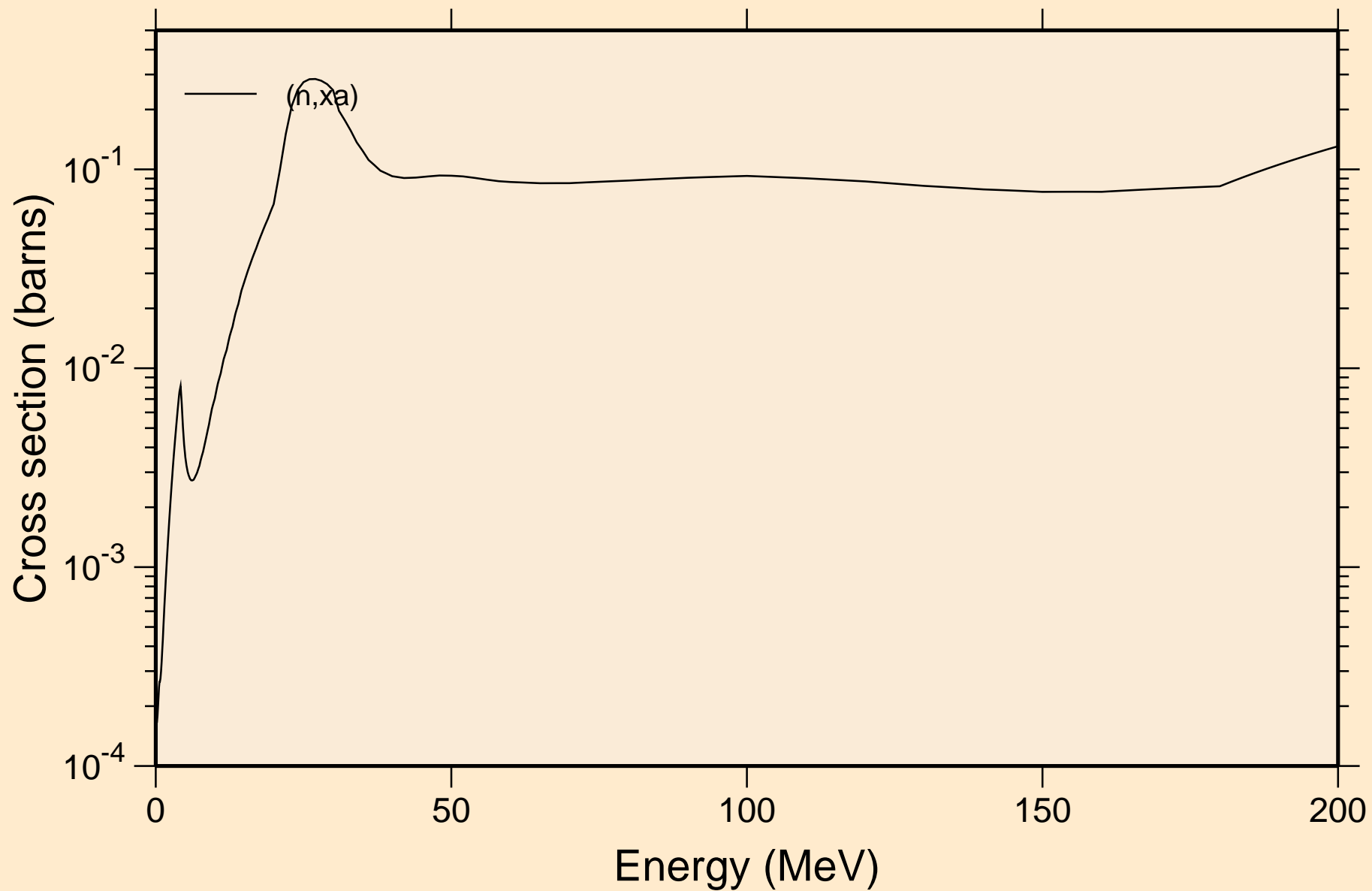

RA212 NEUTRON ACER TENDL-2019 LIBRARY; T=293.16K  
Inelastic levels

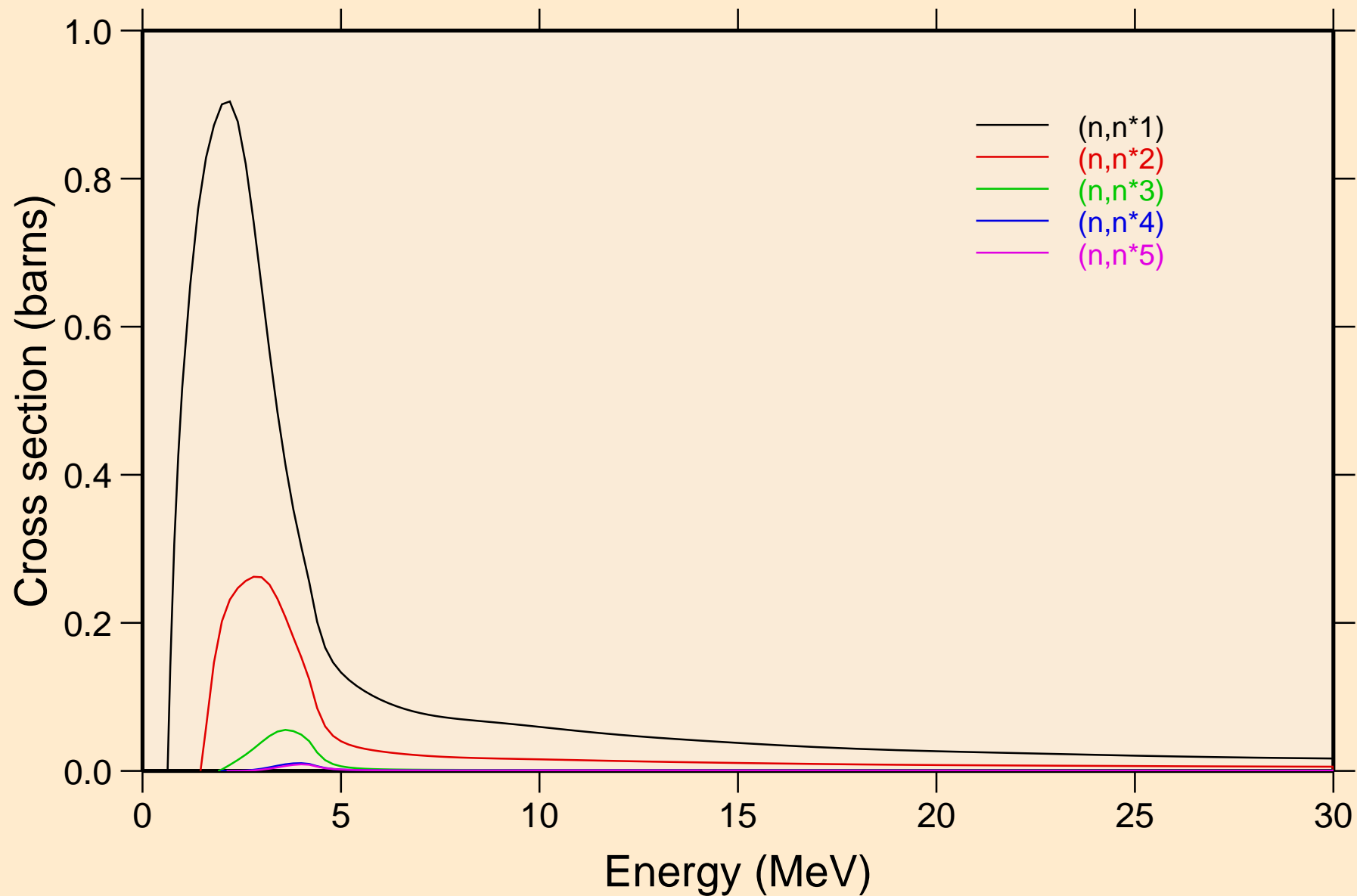

RA212 NEUTRON ACER TENDL-2019 LIBRARY; T=293.16K  
Inelastic levels

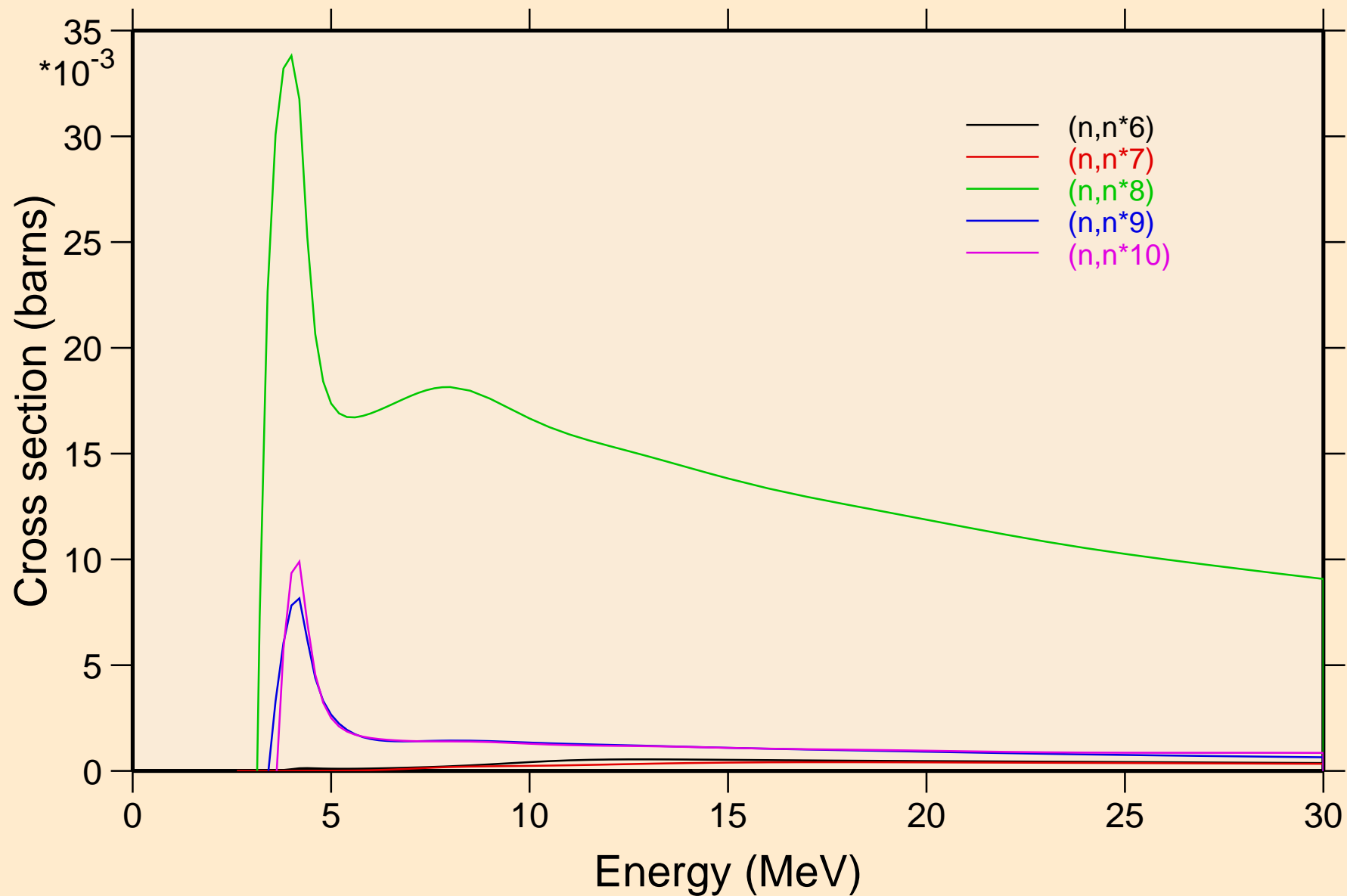

RA212 NEUTRON ACER TENDL-2019 LIBRARY; T=293.16K  
Inelastic levels

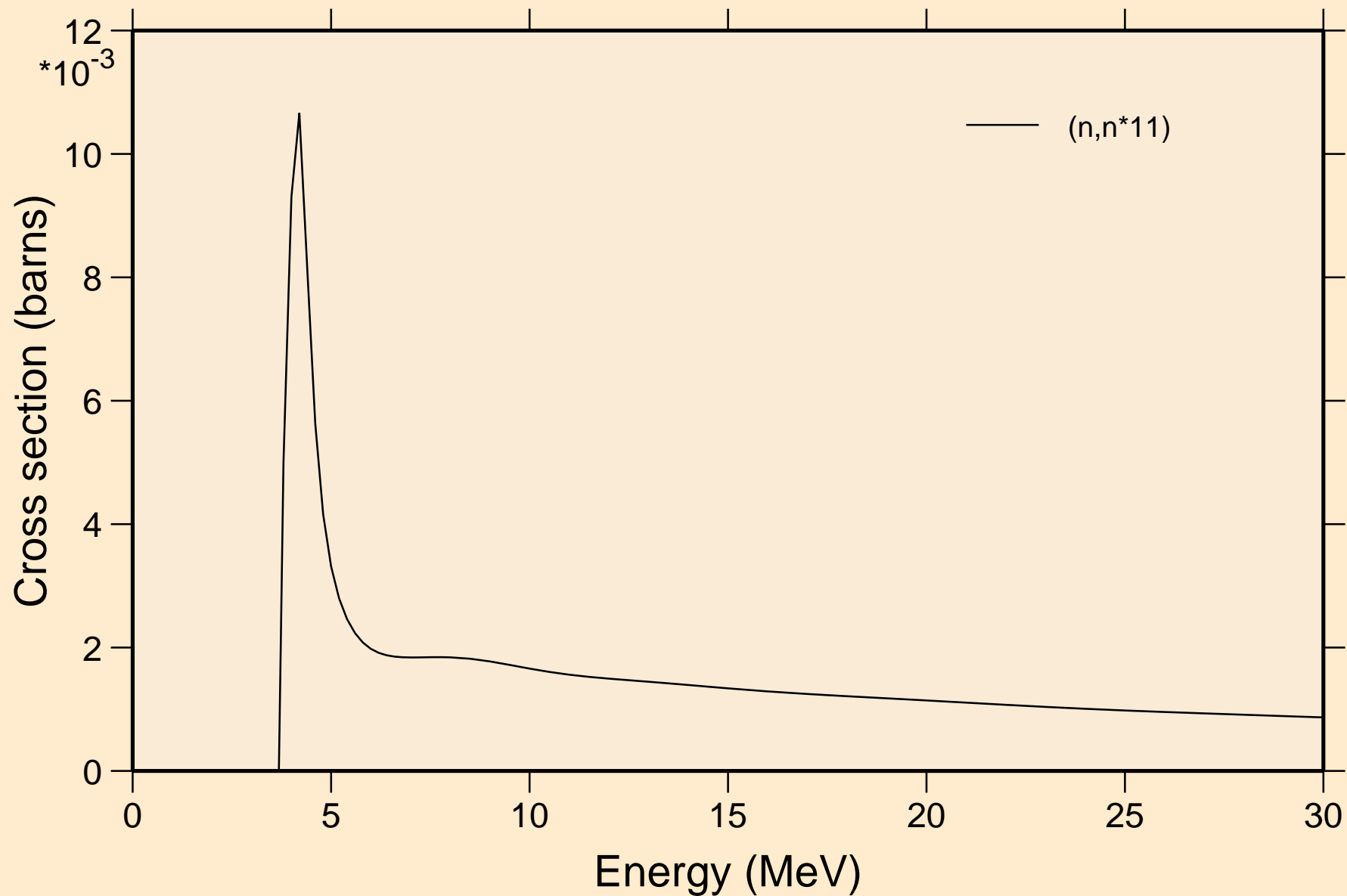

RA212 NEUTRON ACER TENDL-2019 LIBRARY; T=293.16K  
Threshold reactions

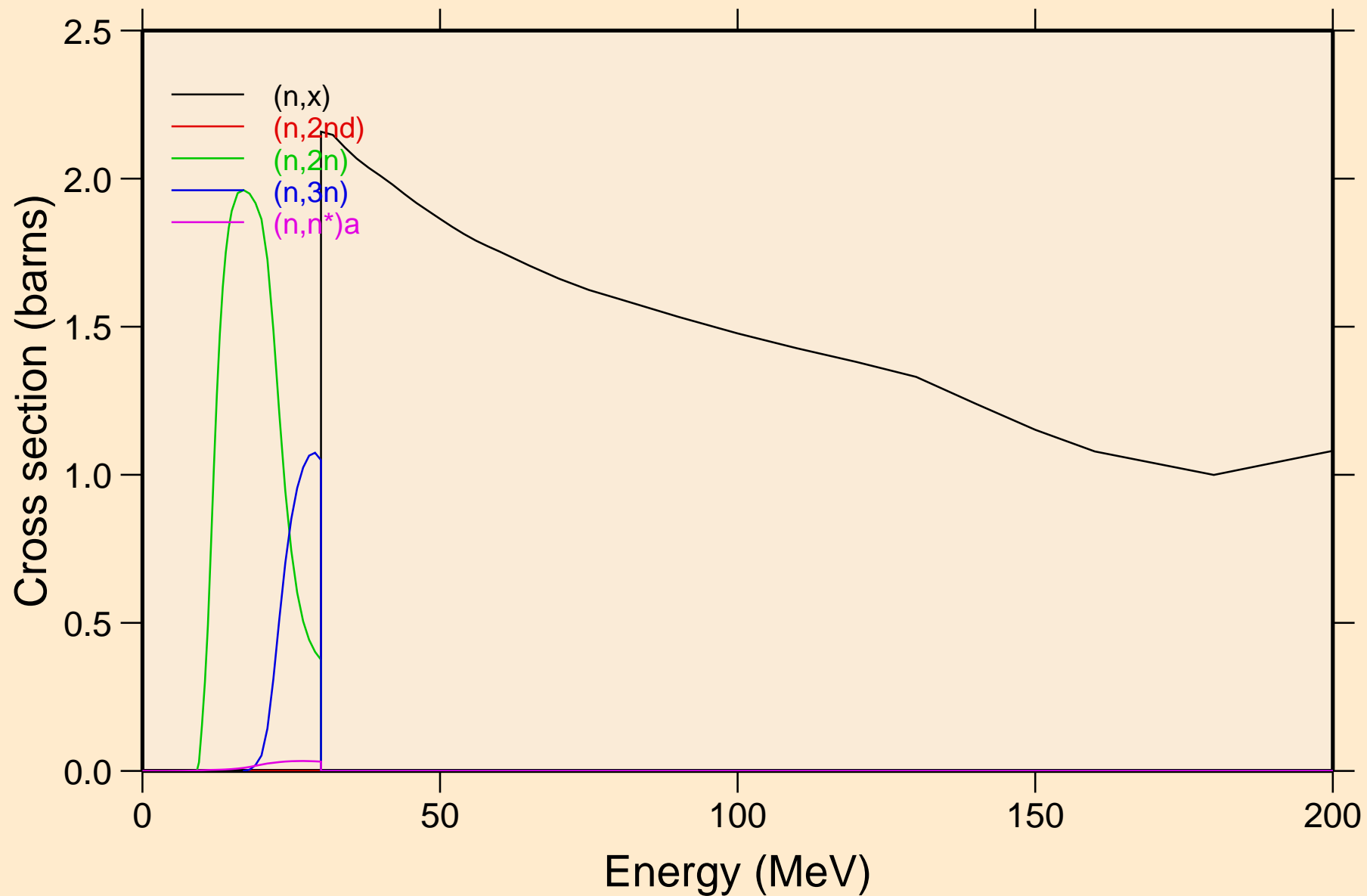

RA212 NEUTRON ACER TENDL-2019 LIBRARY; T=293.16K  
Threshold reactions

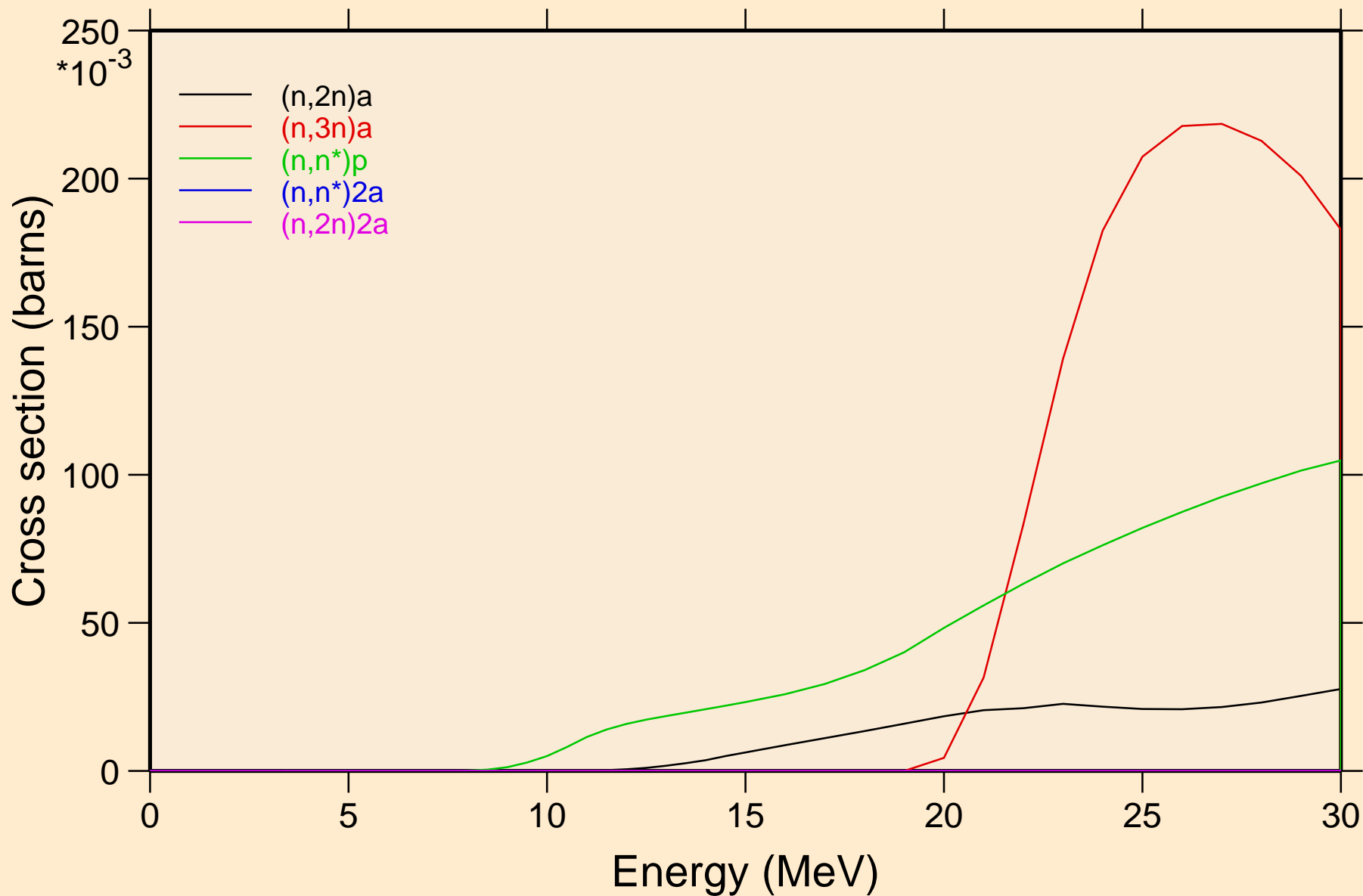

RA212 NEUTRON ACER TENDL-2019 LIBRARY; T=293.16K  
Threshold reactions

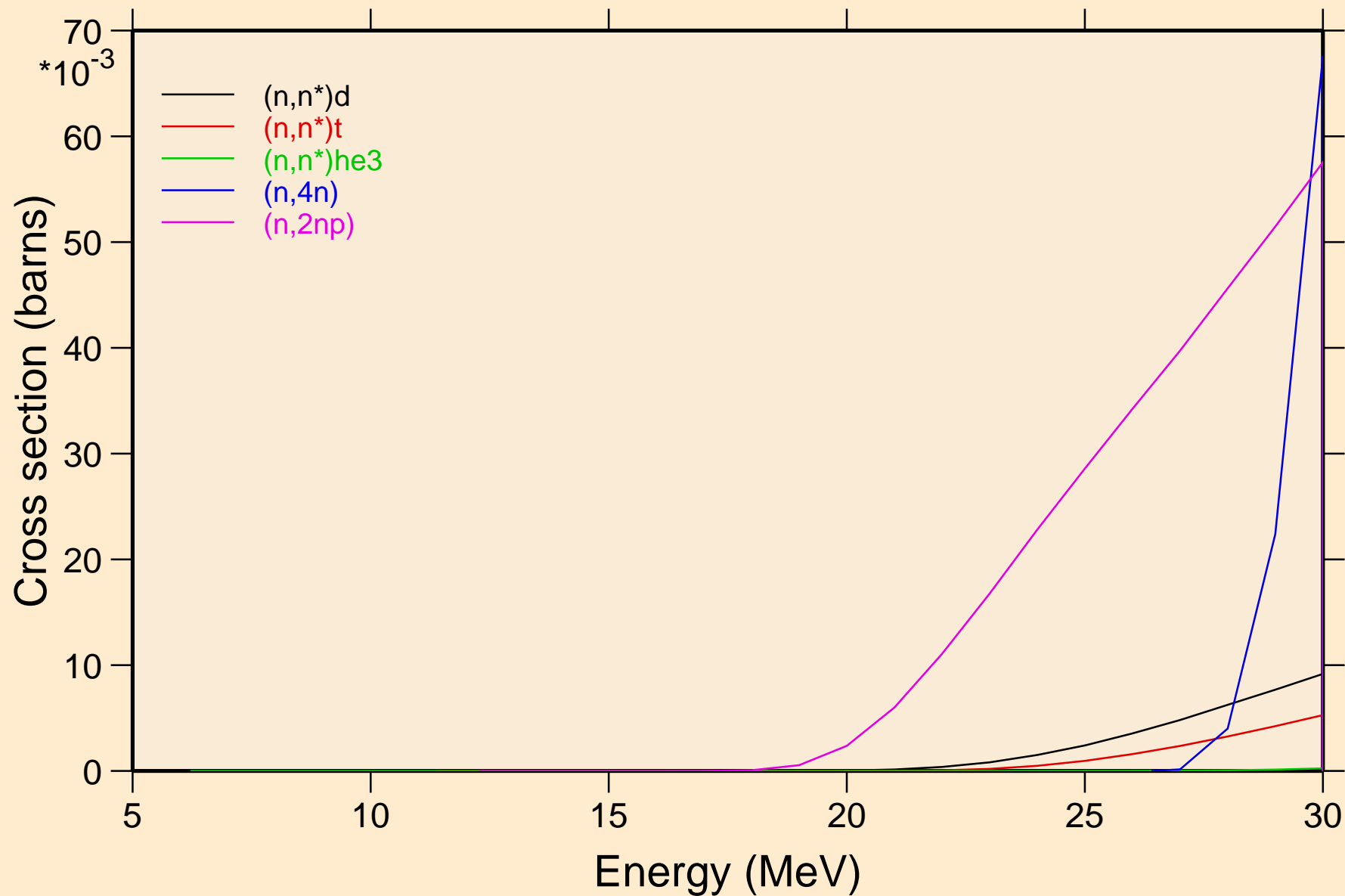



RA212 NEUTRON ACER TENDL-2019 LIBRARY; T=293.16K  
Threshold reactions

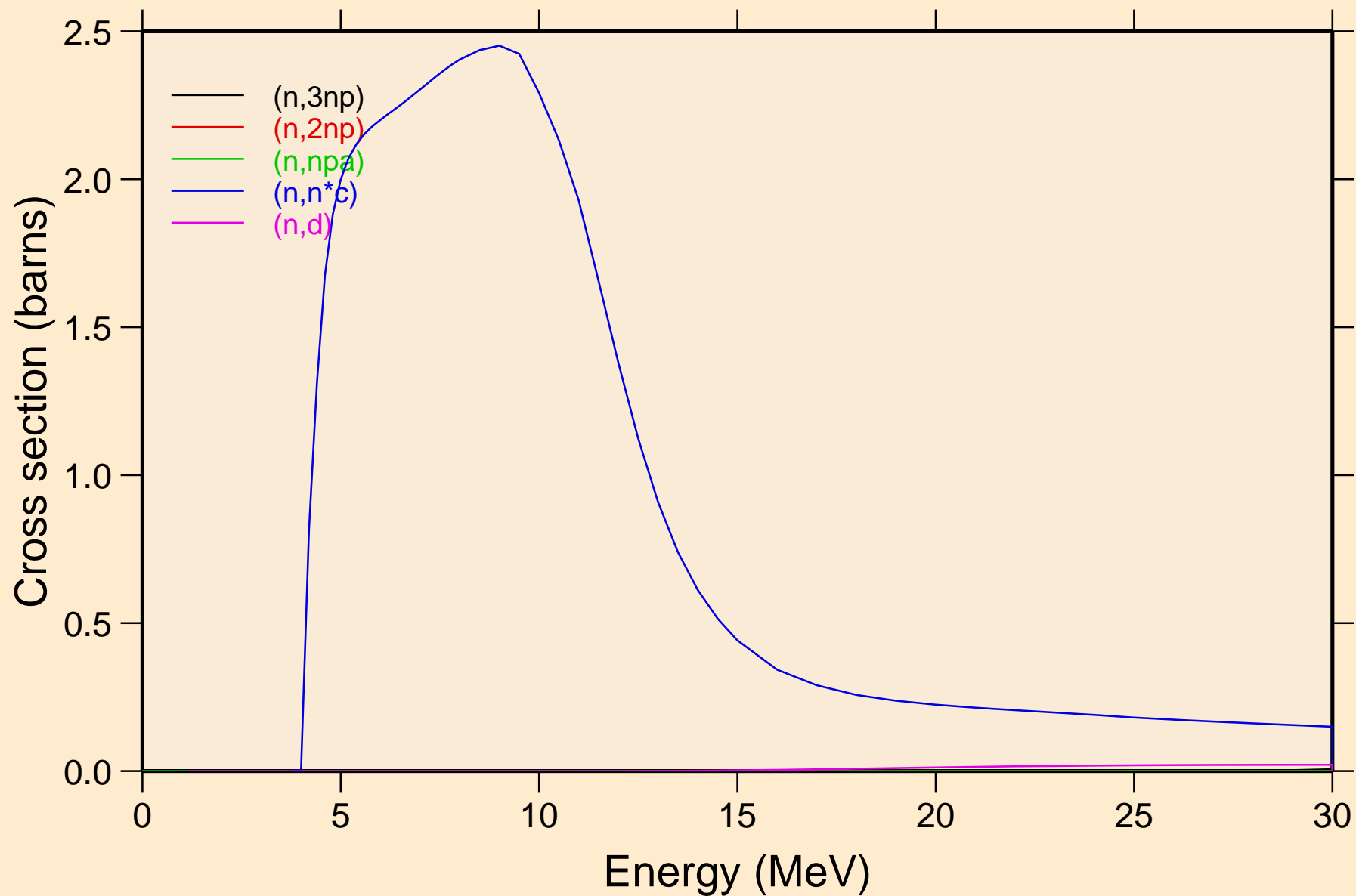

RA212 NEUTRON ACER TENDL-2019 LIBRARY; T=293.16K  
Threshold reactions

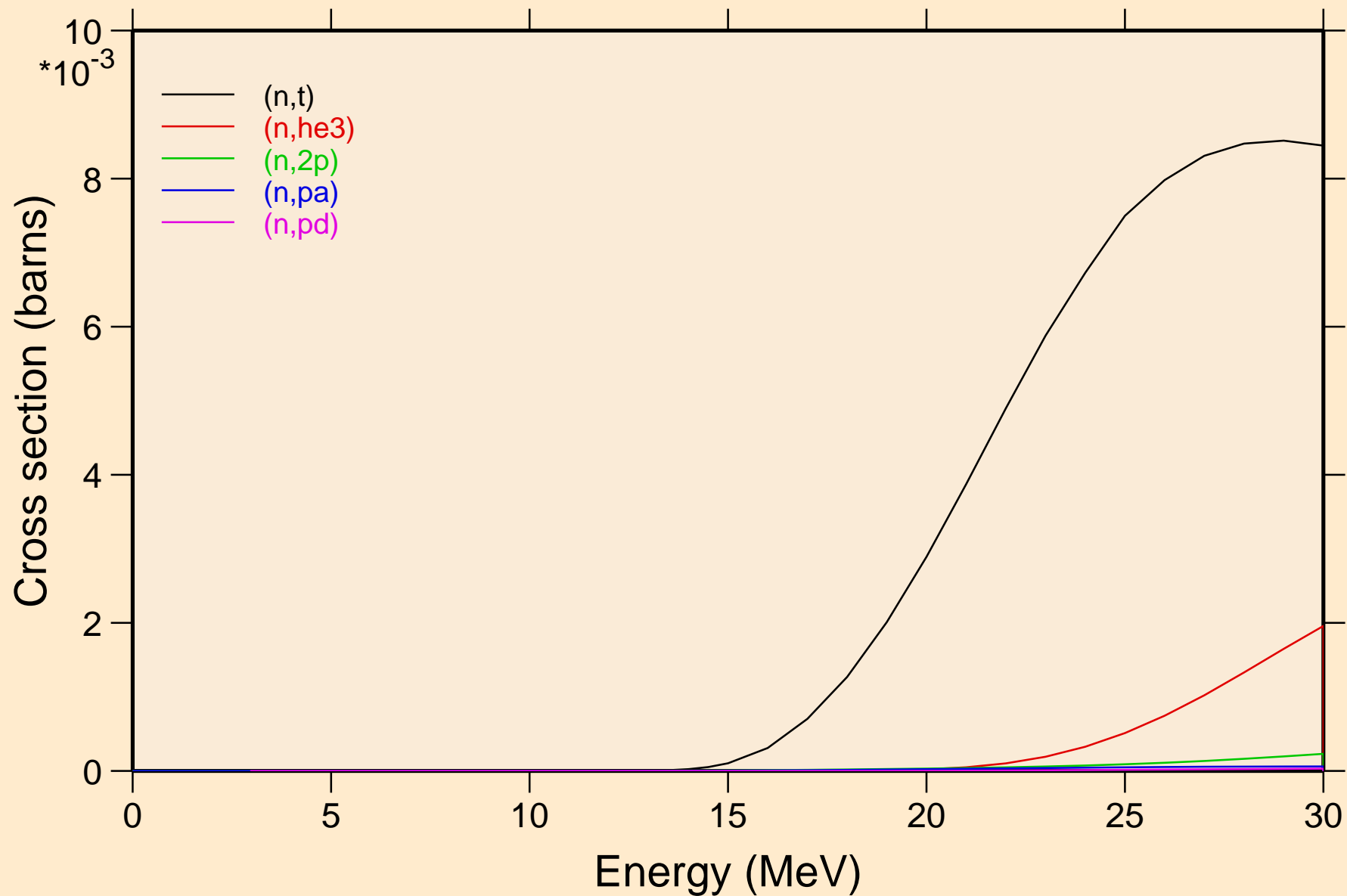

RA212 NEUTRON ACER TENDL-2019 LIBRARY; T=293.16K  
Threshold reactions

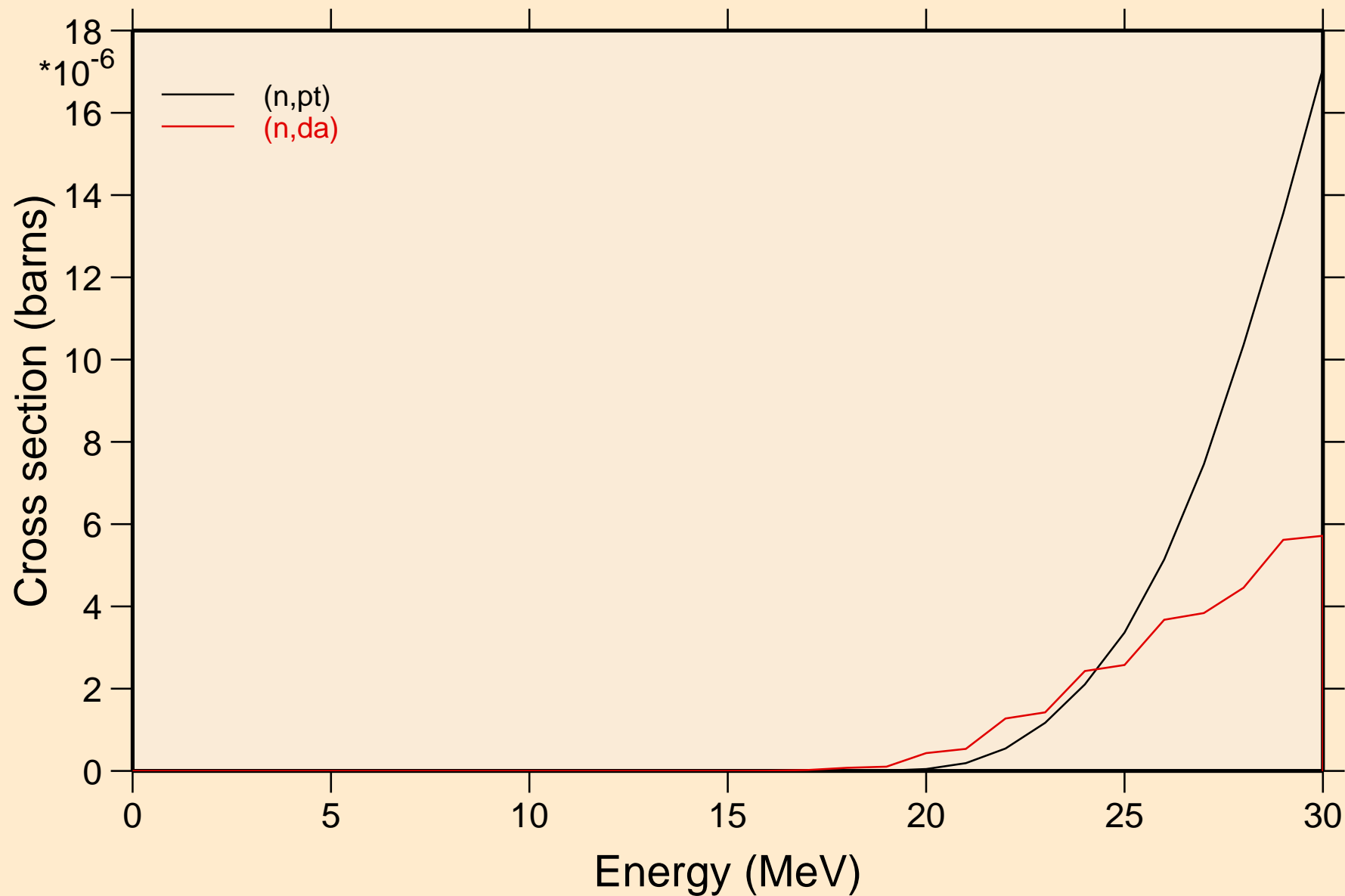

RA212 NEUTRON ACER TENDL-2019 LIBRARY; T=293.16K  
Threshold reactions

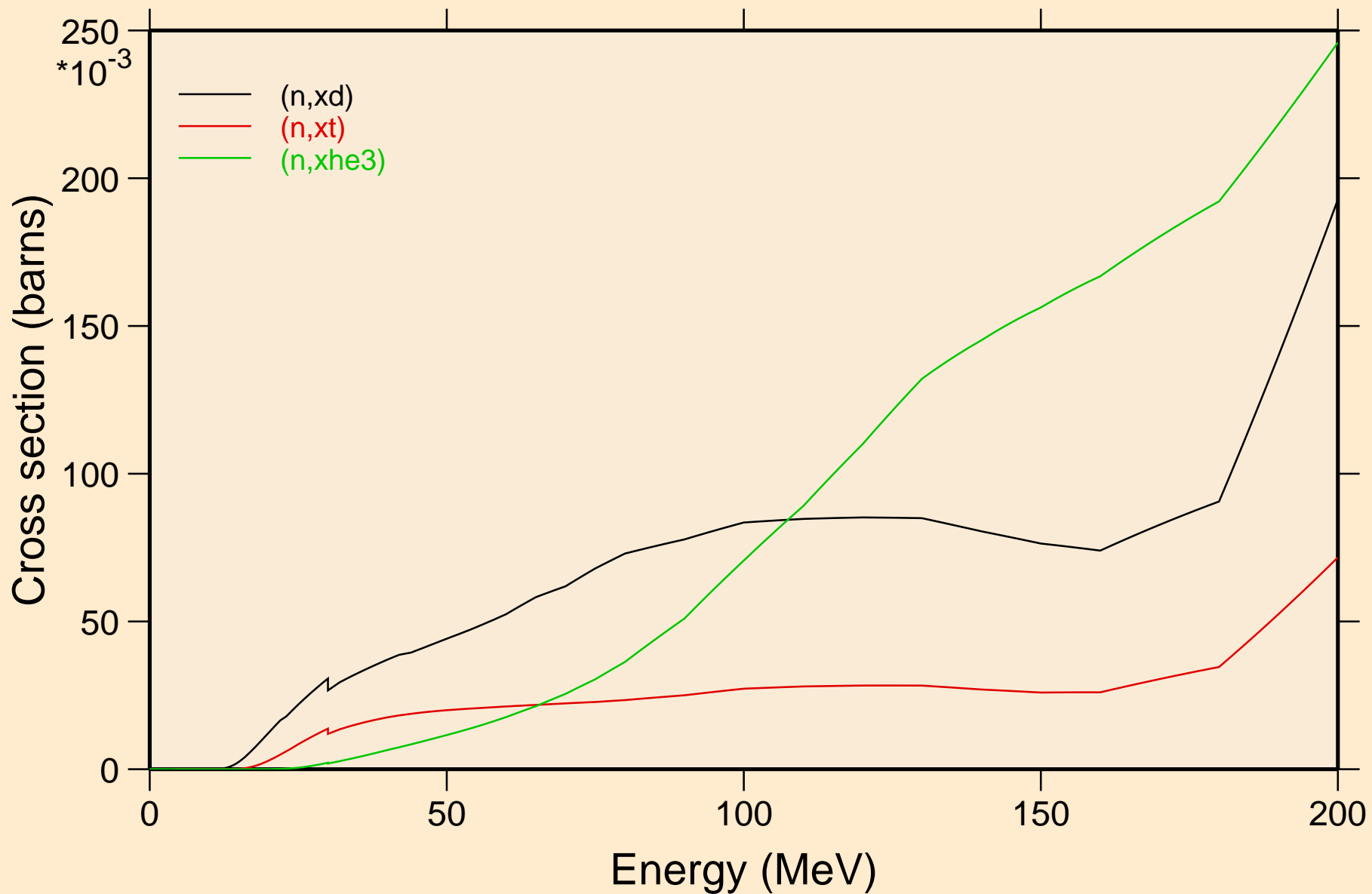

RA212 NEUTRON ACER TENDL-2019 LIBRARY; T=293.16K  
angular distribution for elastic

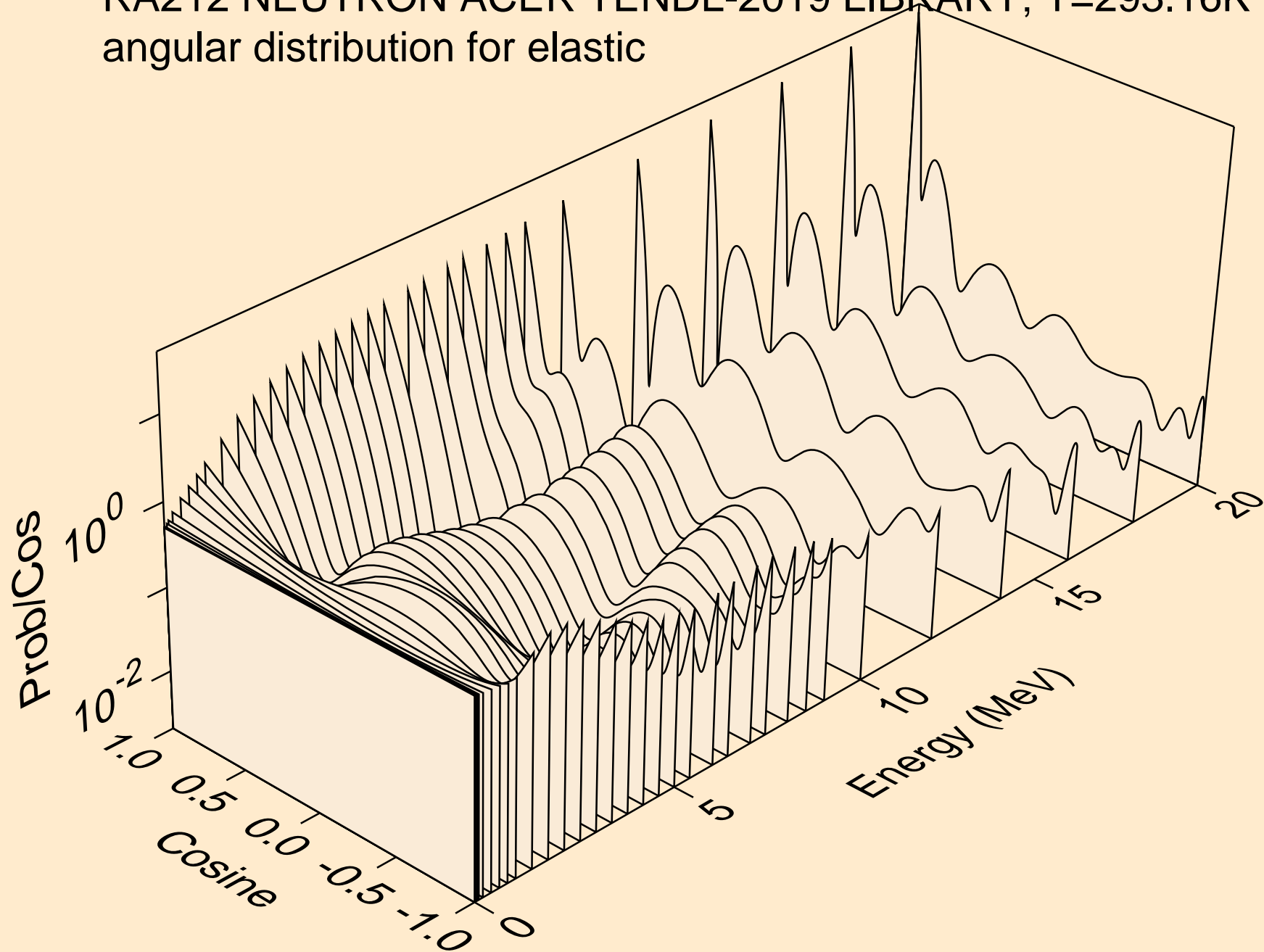

RA212 NEUTRON ACER TENDL-2019 LIBRARY; T=293.16K  
angular distribution for elastic

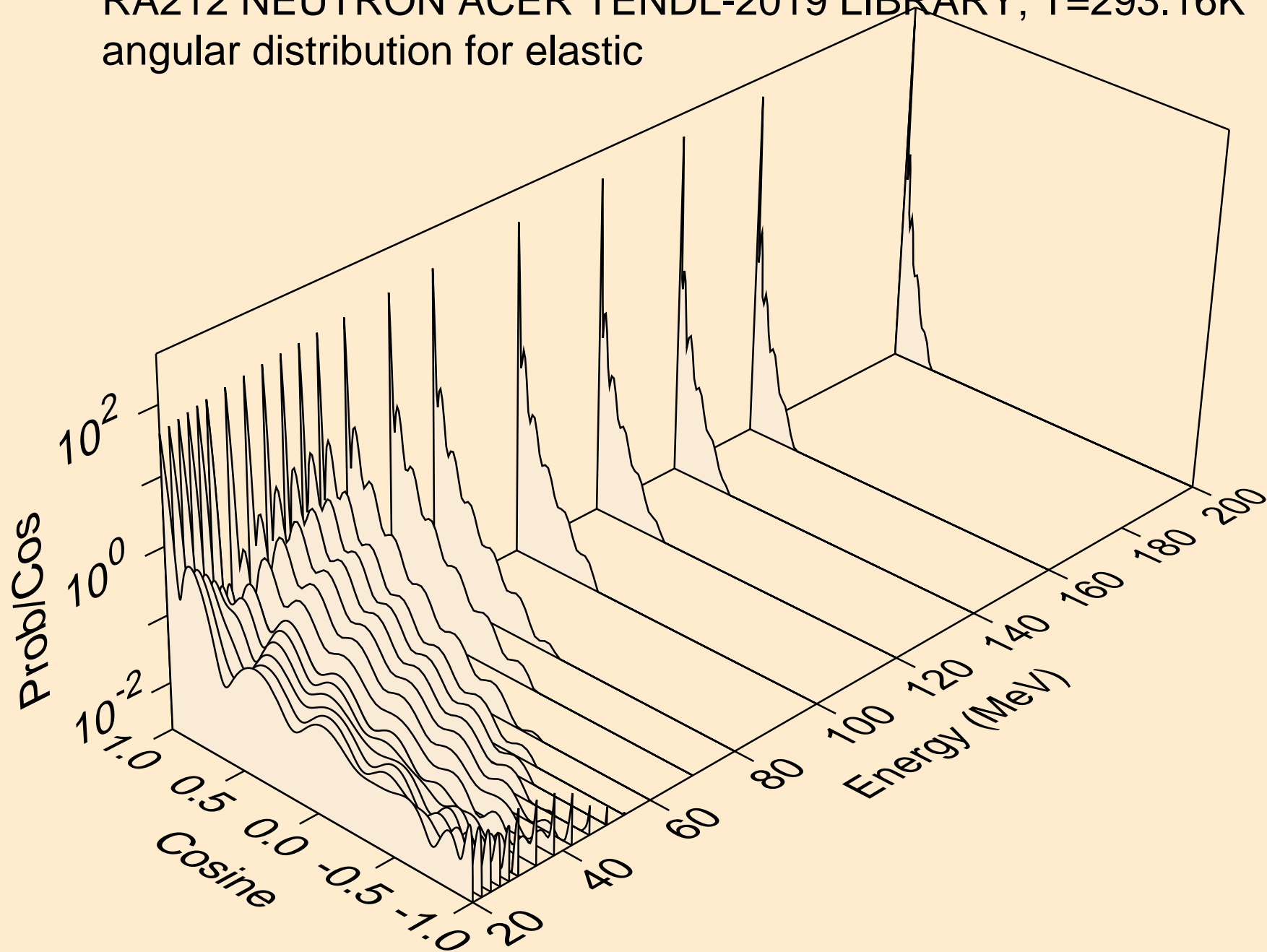

RA212 NEUTRON ACER TENDL-2019 LIBRARY; T=293.16K  
angular distribution for (n,n\*1)

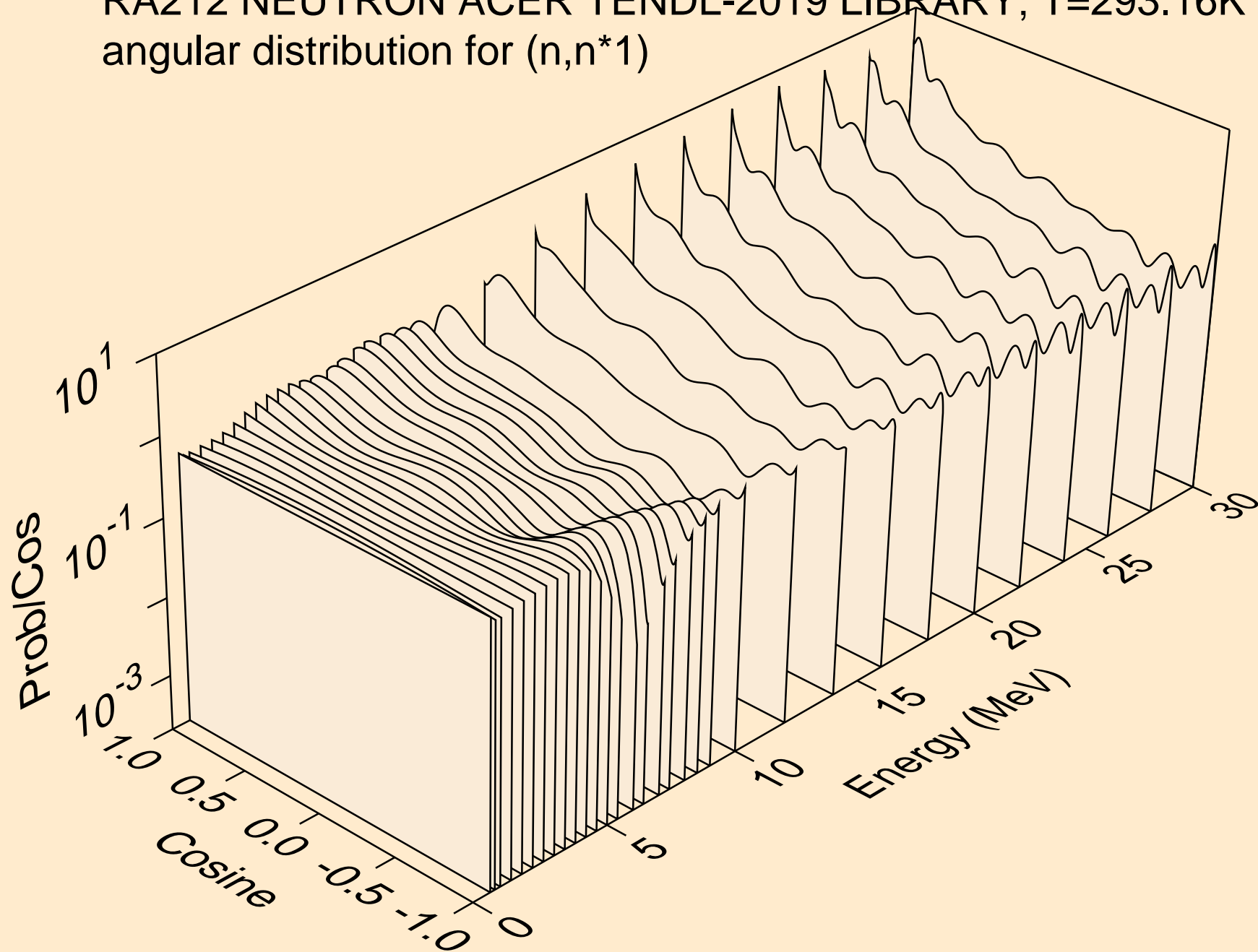

RA212 NEUTRON ACER TENDL-2019 LIBRARY; T=293.16K  
angular distribution for (n,n\*2)

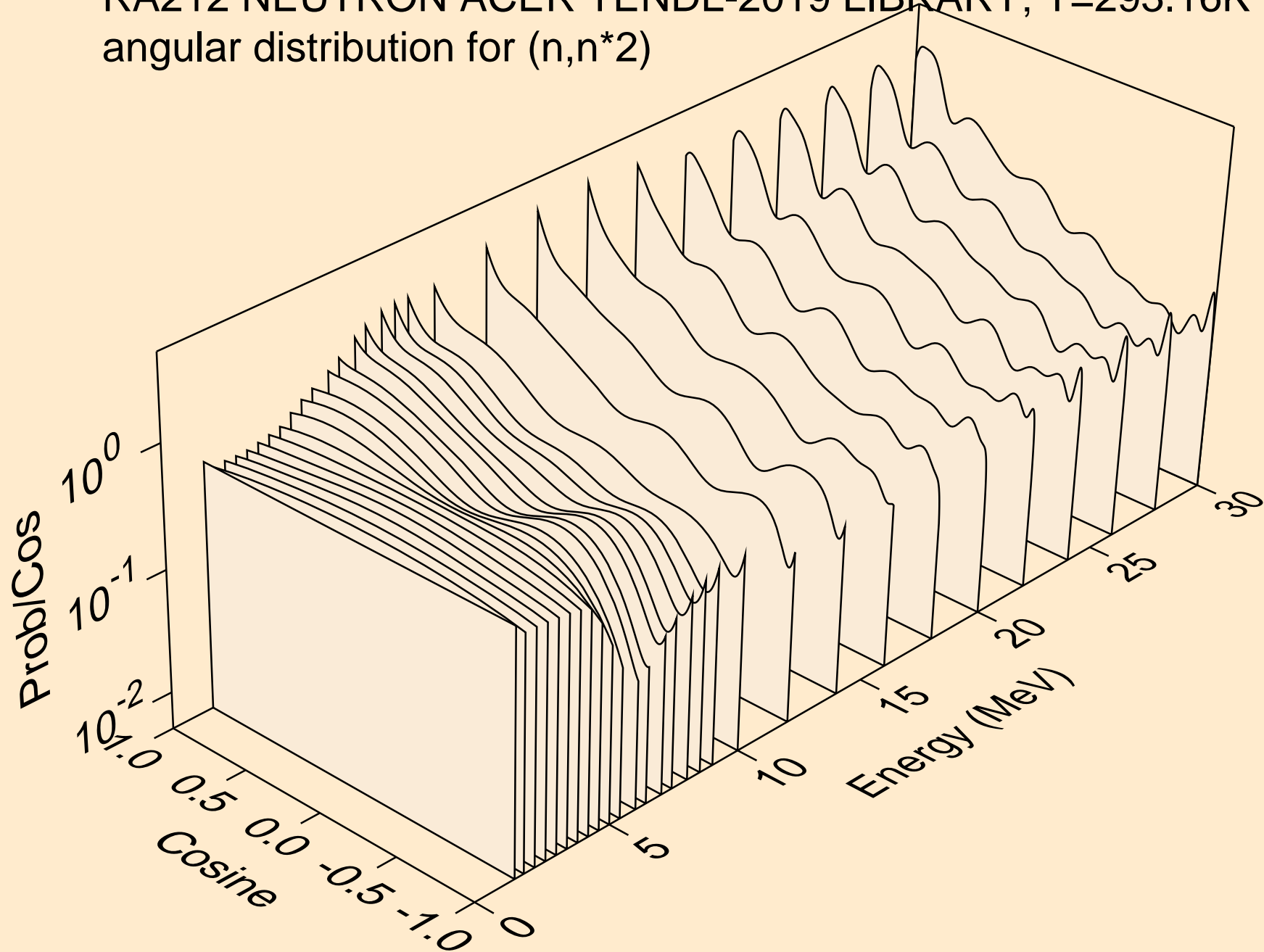



RA212 NEUTRON ACER TENDL-2019 LIBRARY; T=293.16K  
angular distribution for (n,n\*3)

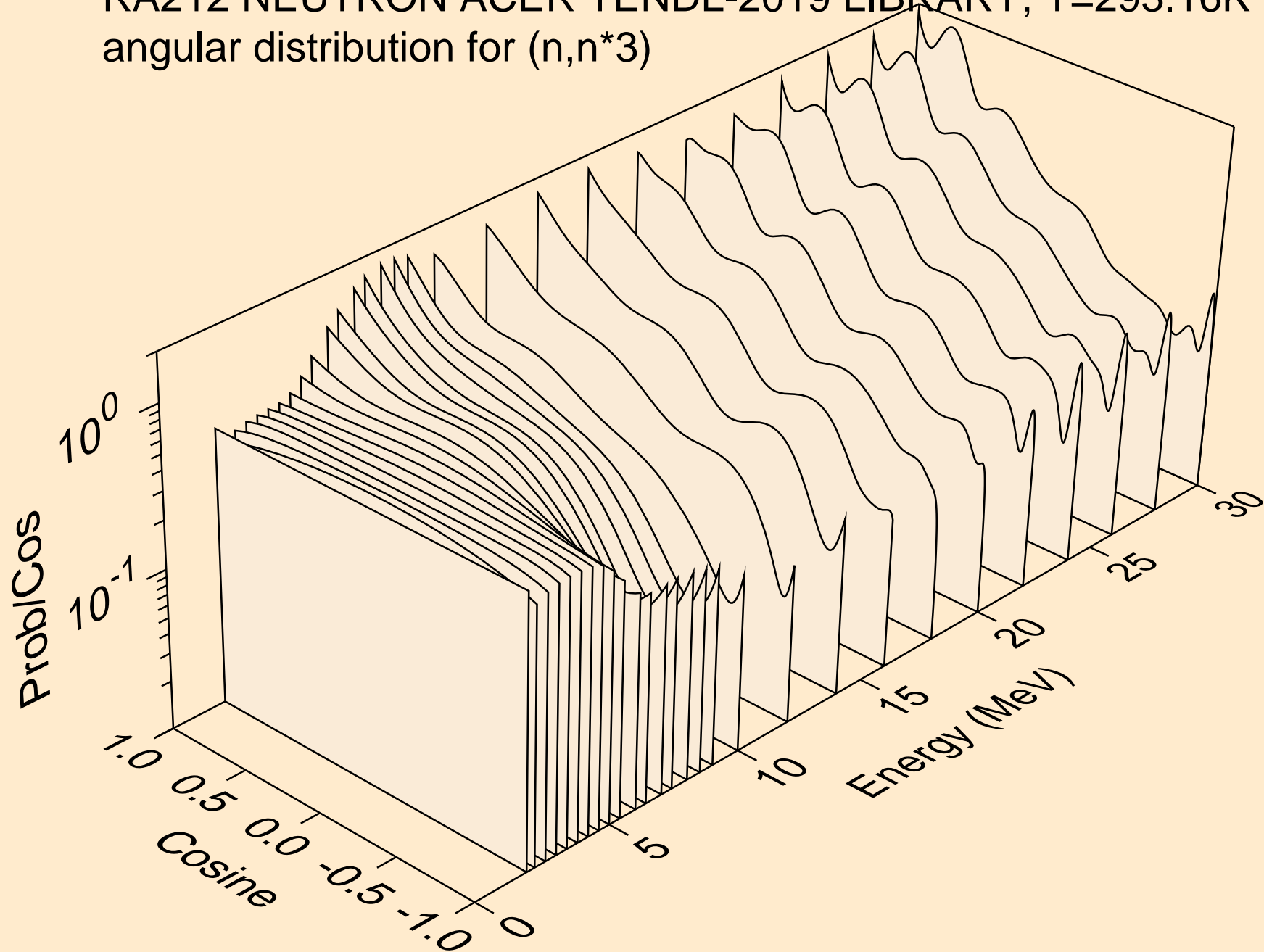

RA212 NEUTRON ACER TENDL-2019 LIBRARY; T=293.16K  
angular distribution for (n,n\*4)

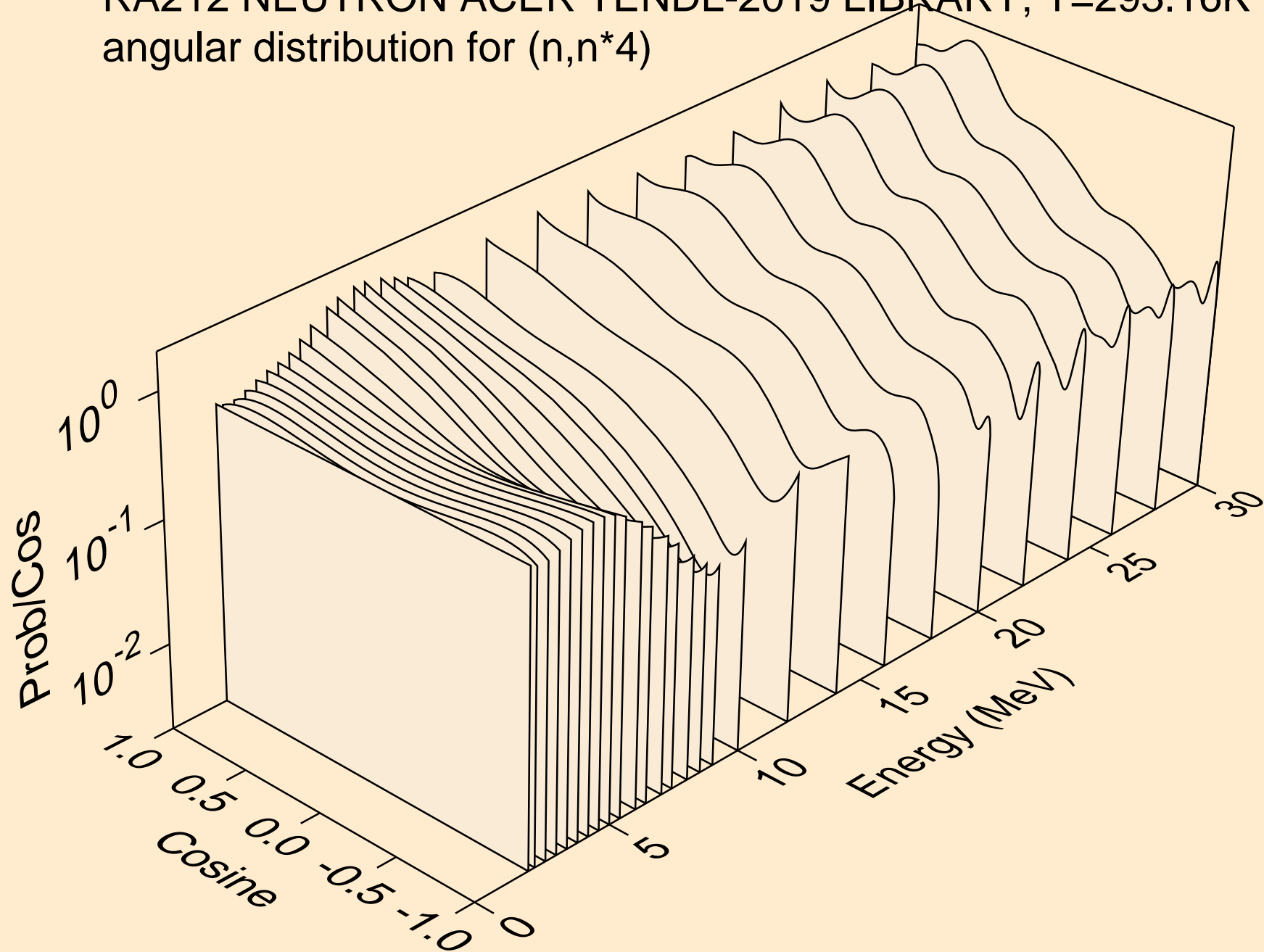

RA212 NEUTRON ACER TENDL-2019 LIBRARY; T=293.16K  
angular distribution for (n,n\*5)

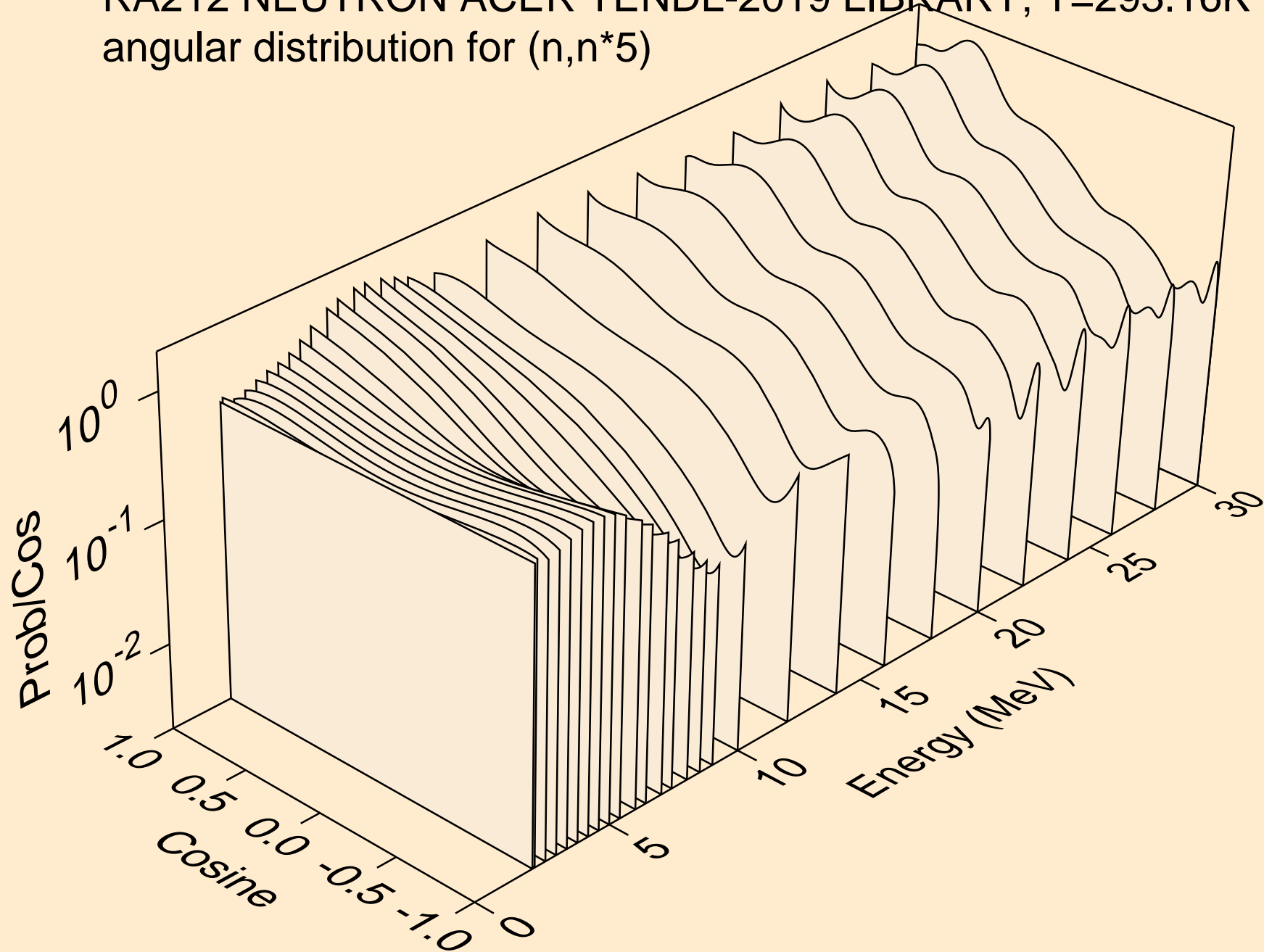

RA212 NEUTRON ACER TENDL-2019 LIBRARY; T=293.16K  
angular distribution for (n,n\*6)

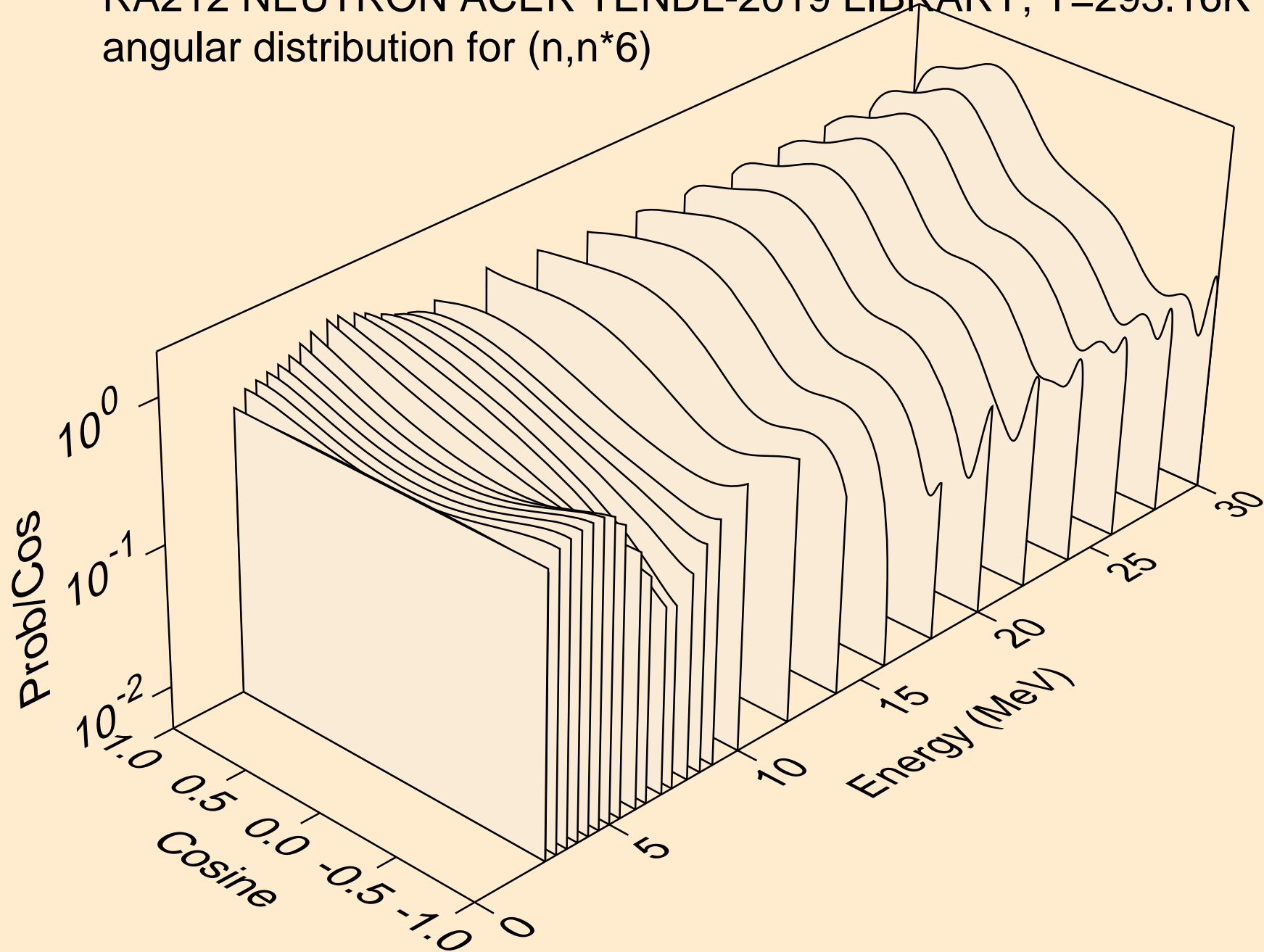

RA212 NEUTRON ACER TENDL-2019 LIBRARY; T=293.16K  
angular distribution for (n,n\*7)

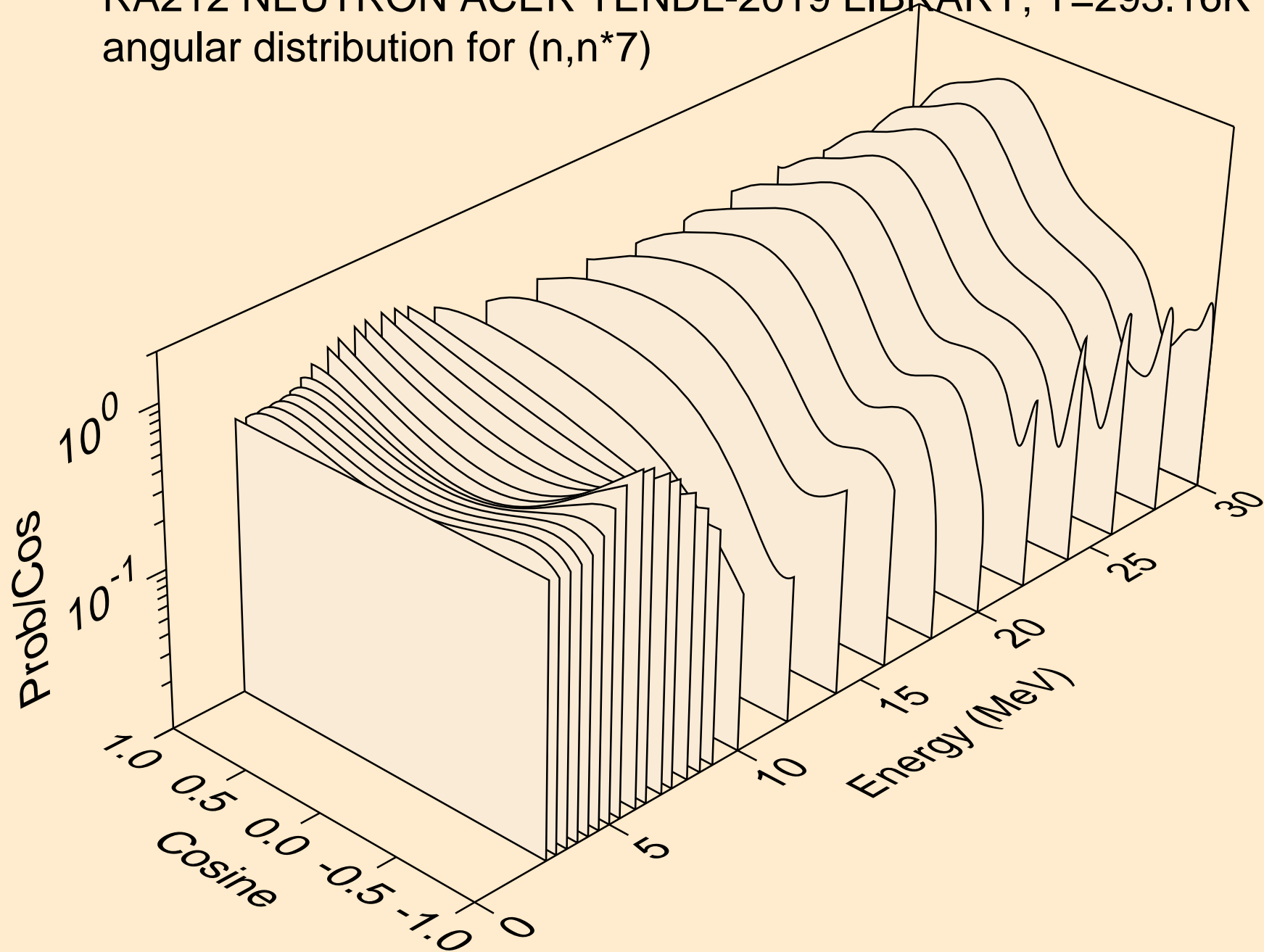

RA212 NEUTRON ACER TENDL-2019 LIBRARY; T=293.16K  
angular distribution for (n,n\*8)

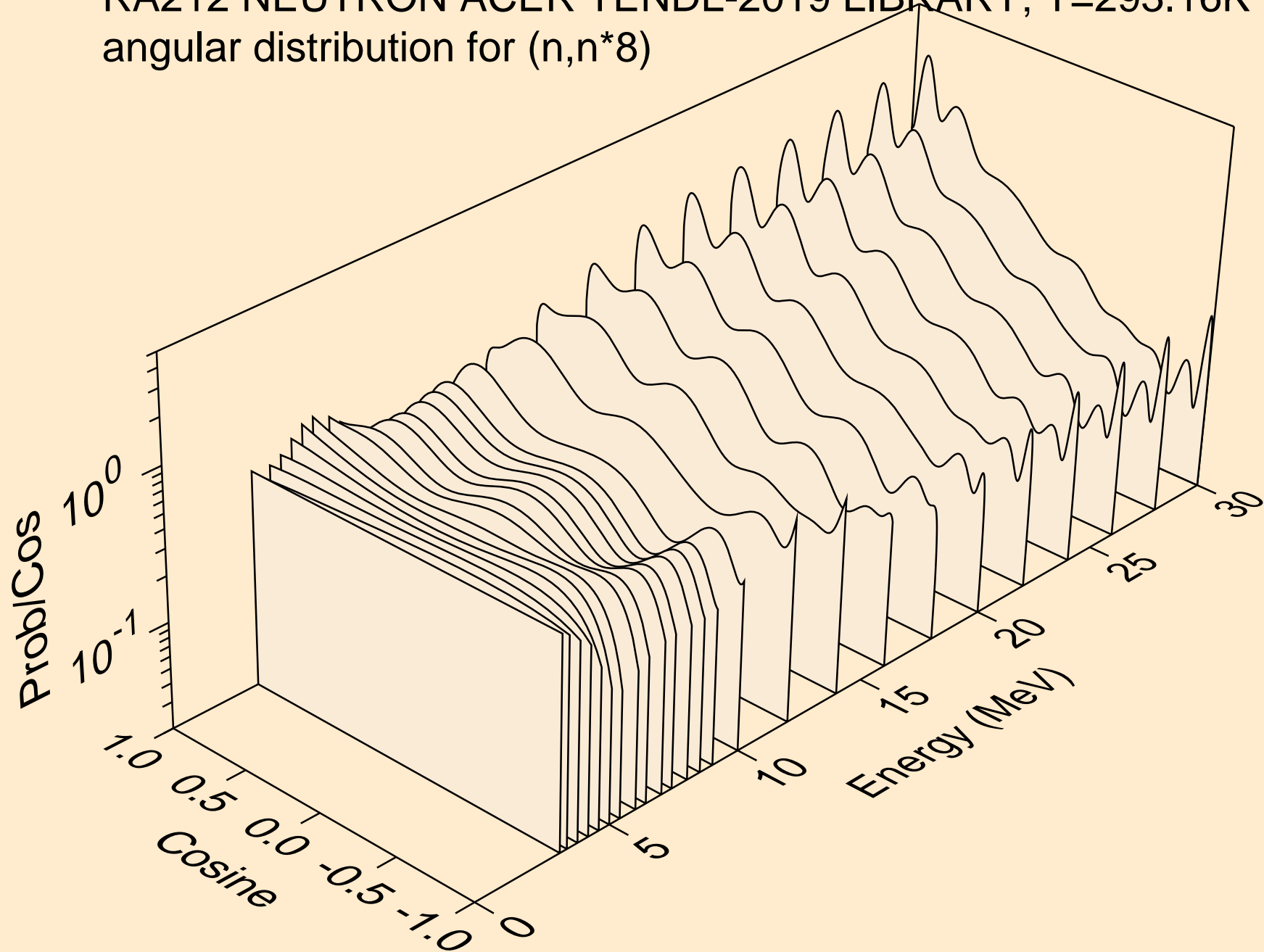

RA212 NEUTRON ACER TENDL-2019 LIBRARY; T=293.16K  
angular distribution for (n,n\*9)

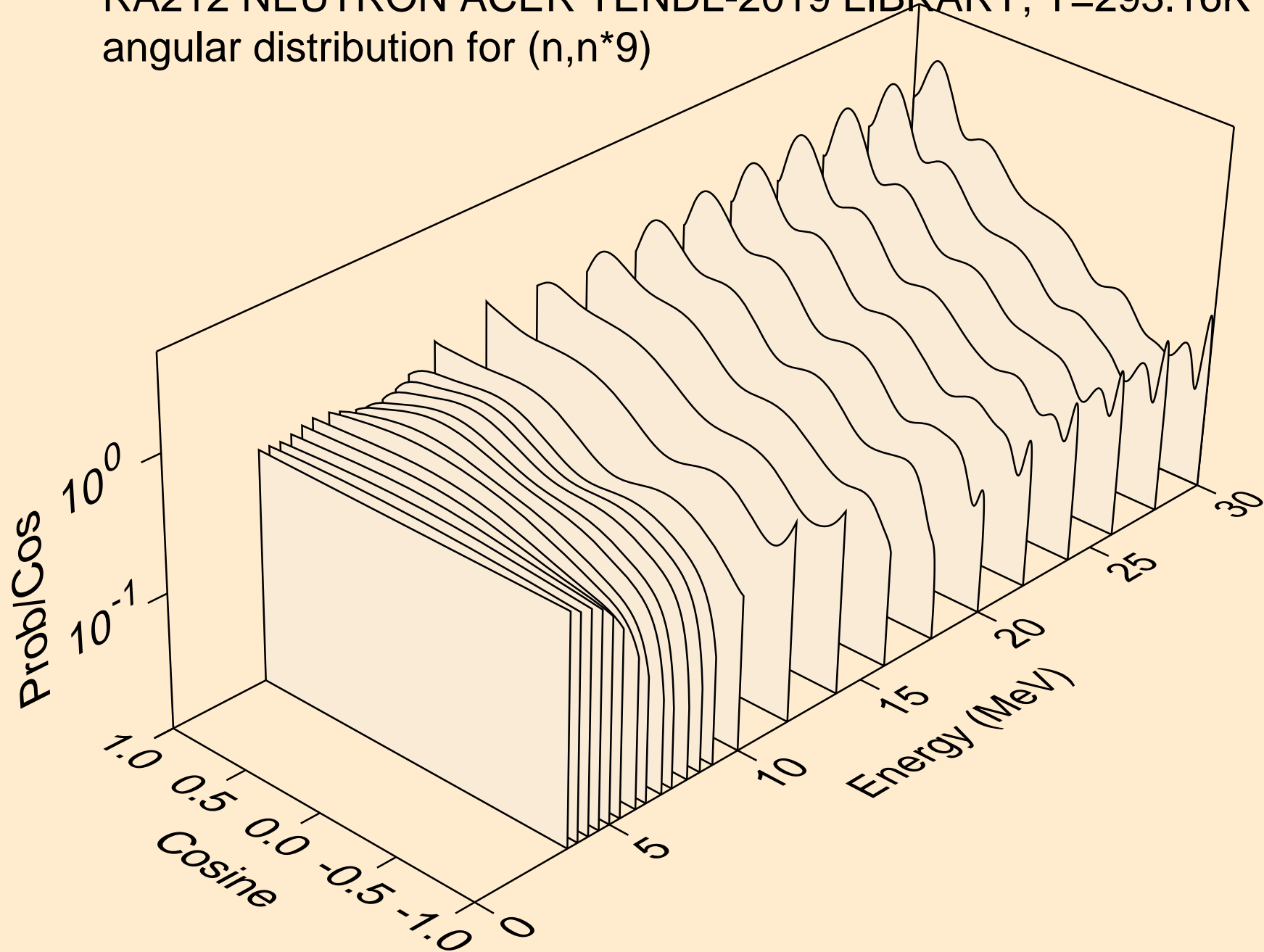

RA212 NEUTRON ACER TENDL-2019 LIBRARY; T=293.16K  
angular distribution for (n,n\*10)

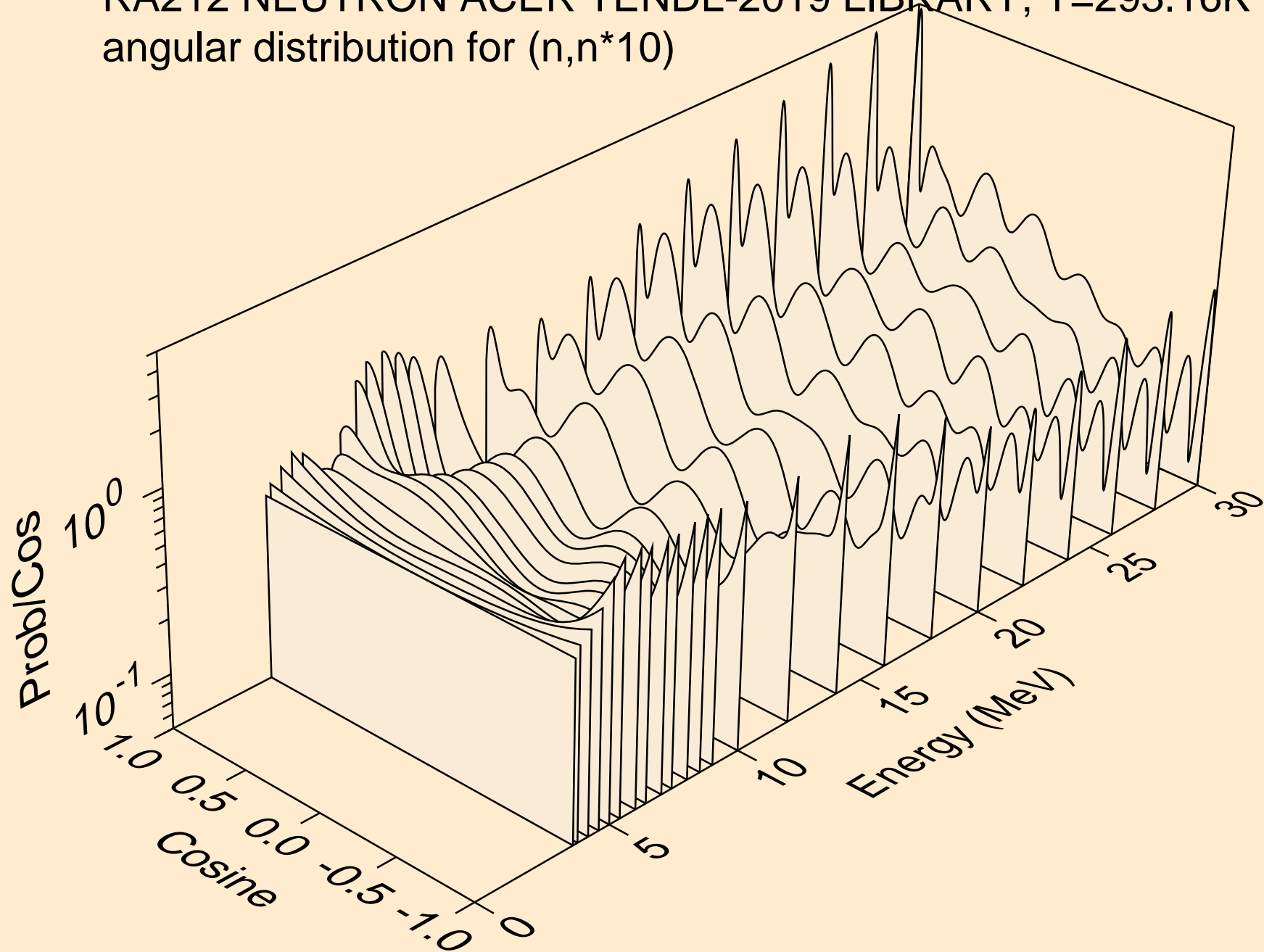



RA212 NEUTRON ACER TENDL-2019 LIBRARY; T=293.16K  
angular distribution for (n,n\*11)

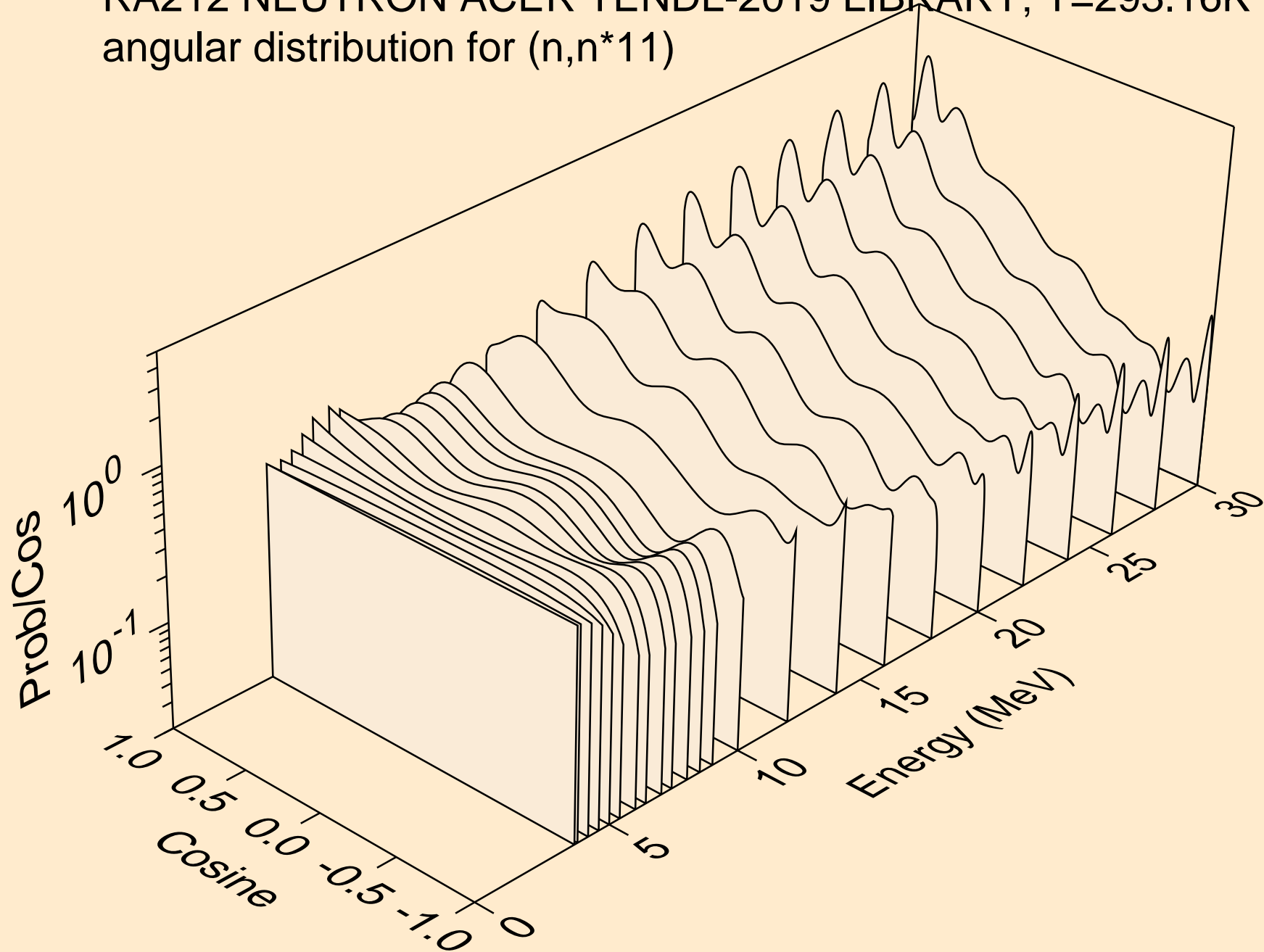

RA212 NEUTRON ACER TENDL-2019 LIBRARY; T=293.16K  
Neutron emission for (n,x)

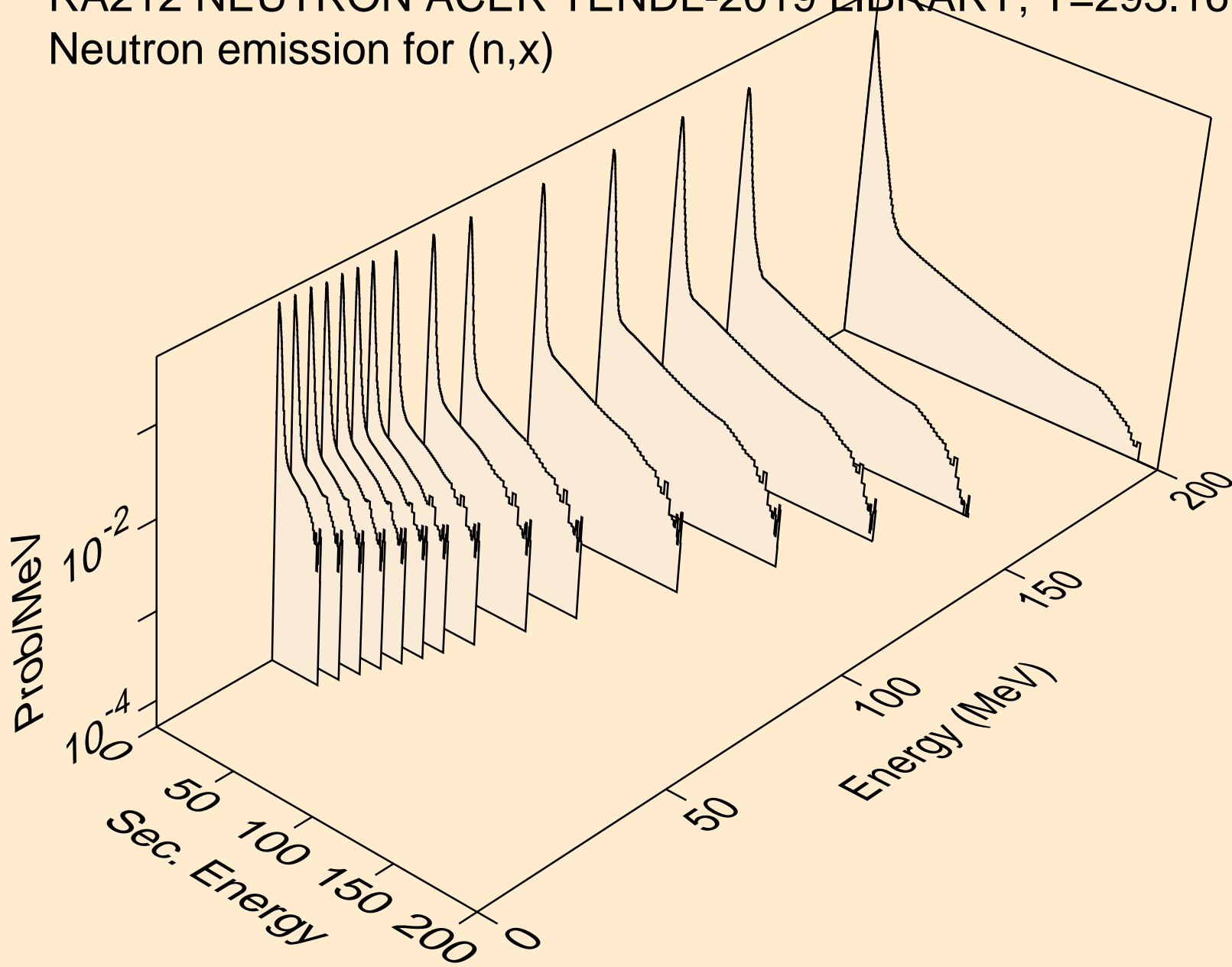

RA212 NEUTRON ACER TENDL-2019 LIBRARY; T=293.16K  
Neutron emission for (n,2nd)

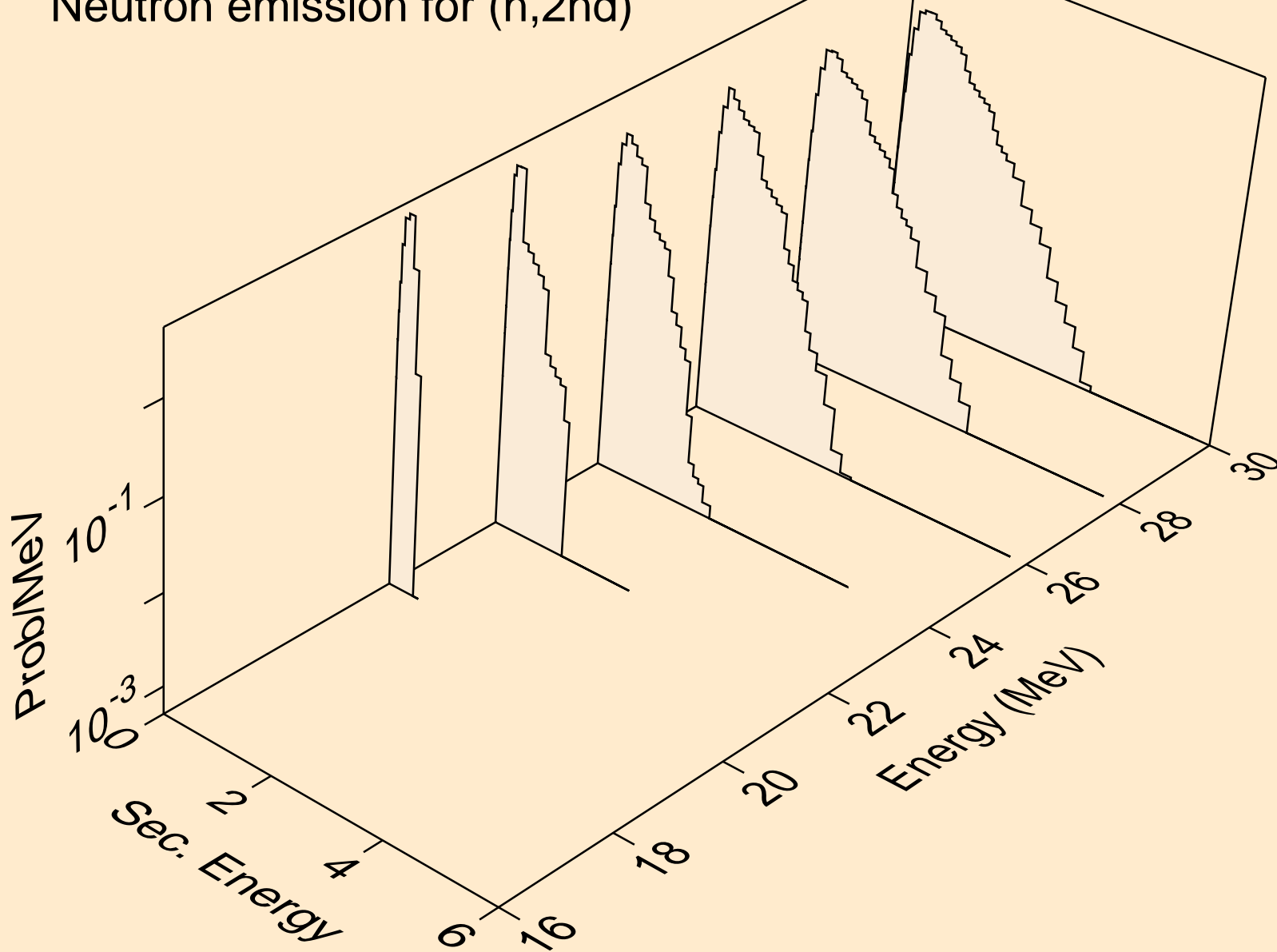

RA212 NEUTRON ACER TENDL-2019 LIBRARY; T=293.16K  
Neutron emission for (n,2n)

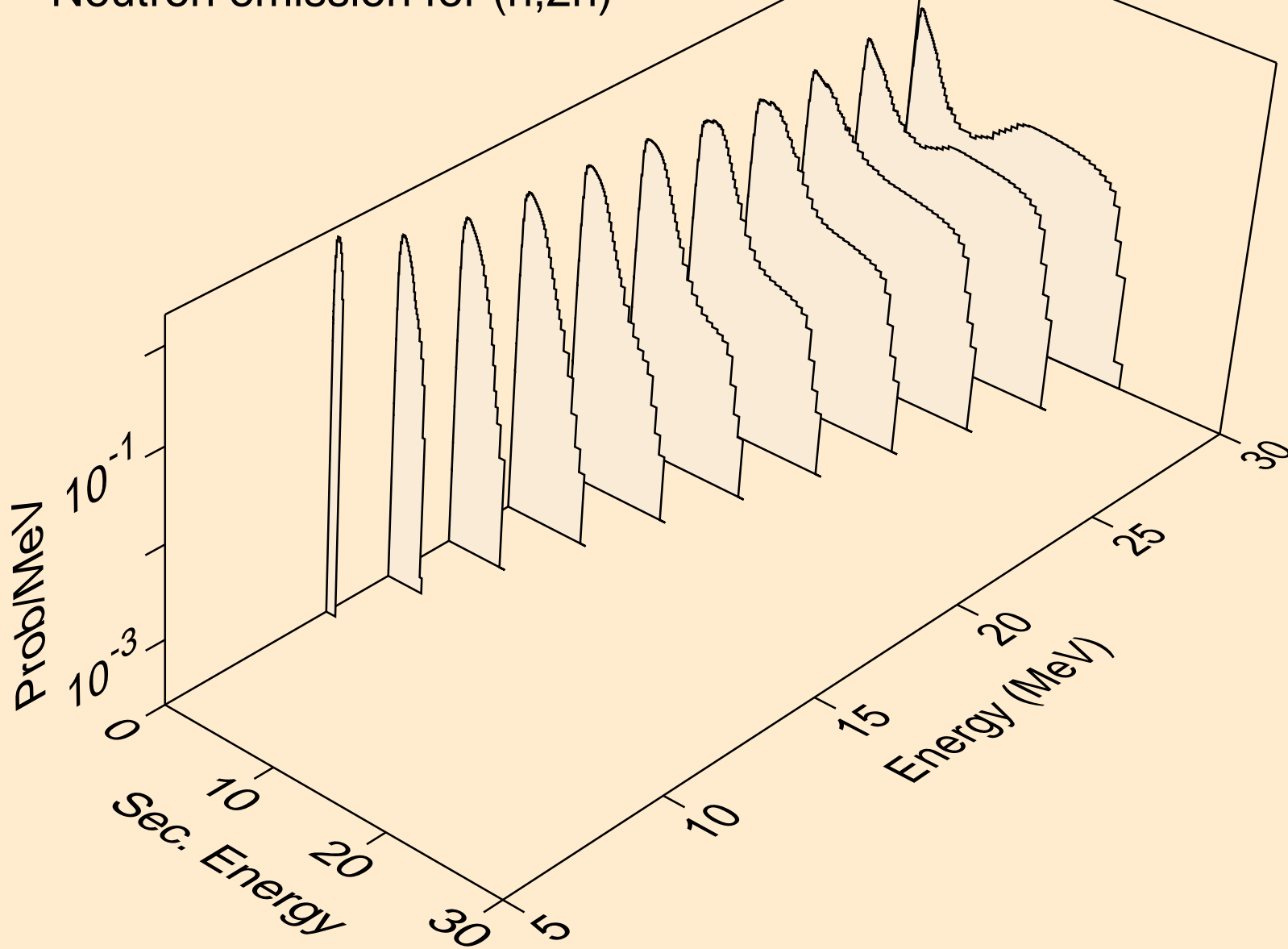

RA212 NEUTRON ACER TENDL-2019 LIBRARY; T=293.16K  
Neutron emission for (n,3n)

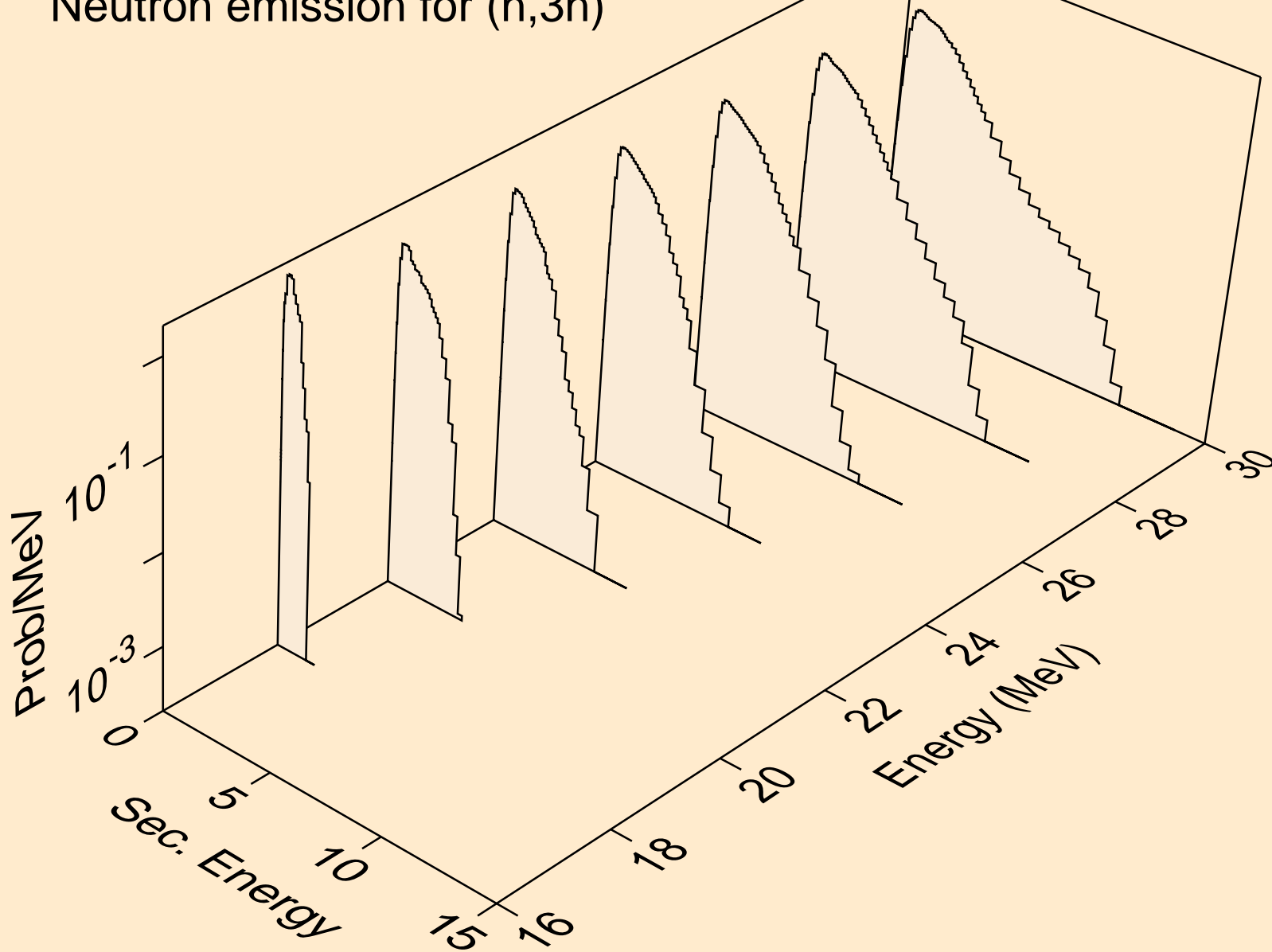

RA212 NEUTRON ACER TENDL-2019 LIBRARY; T=293.16K  
Neutron emission for (n,n\*)a

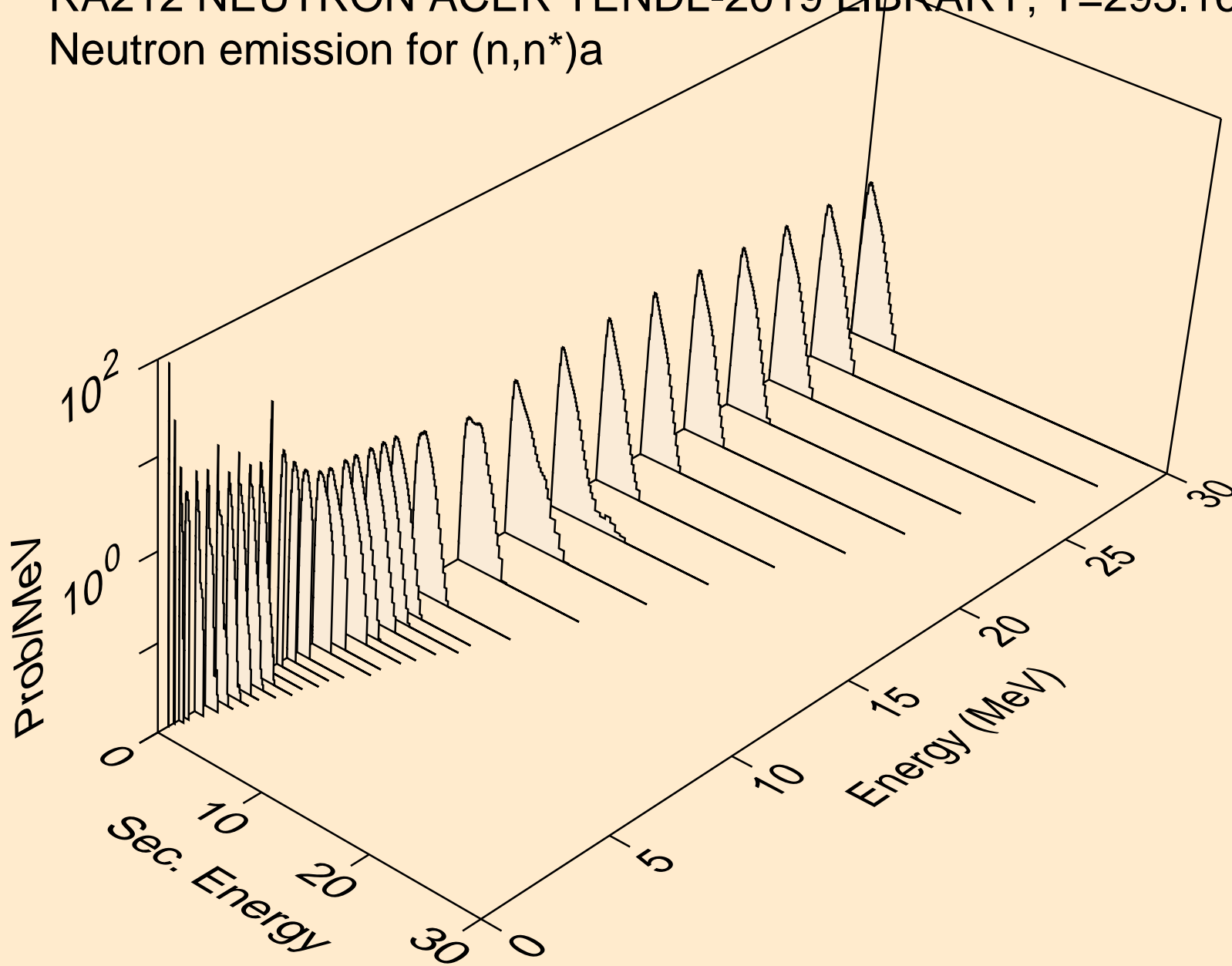

RA212 NEUTRON ACER TENDL-2019 LIBRARY; T=293.16K  
Neutron emission for (n,2n)a

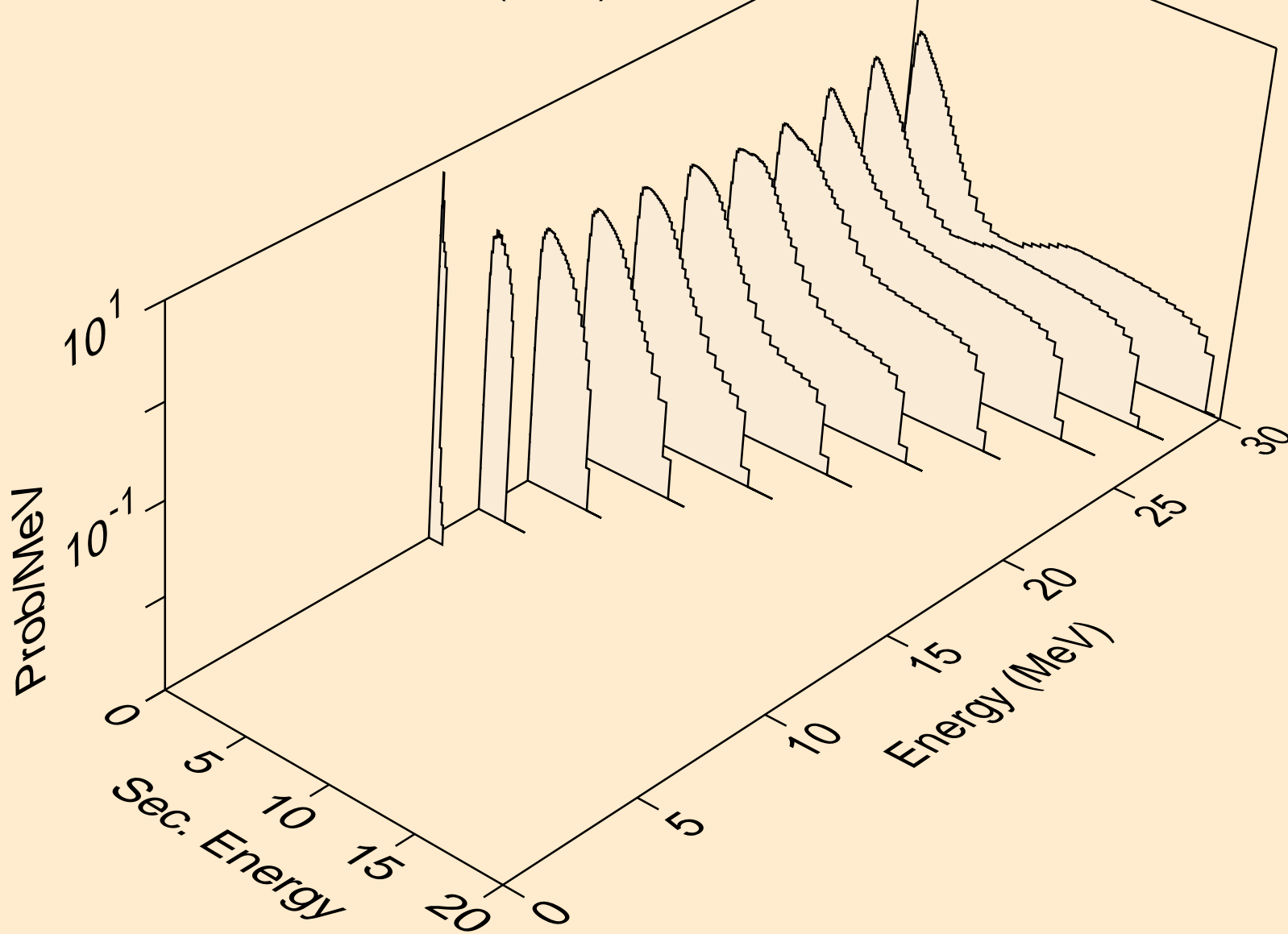

RA212 NEUTRON ACER TENDL-2019 LIBRARY; T=293.16K  
Neutron emission for (n,3n)a

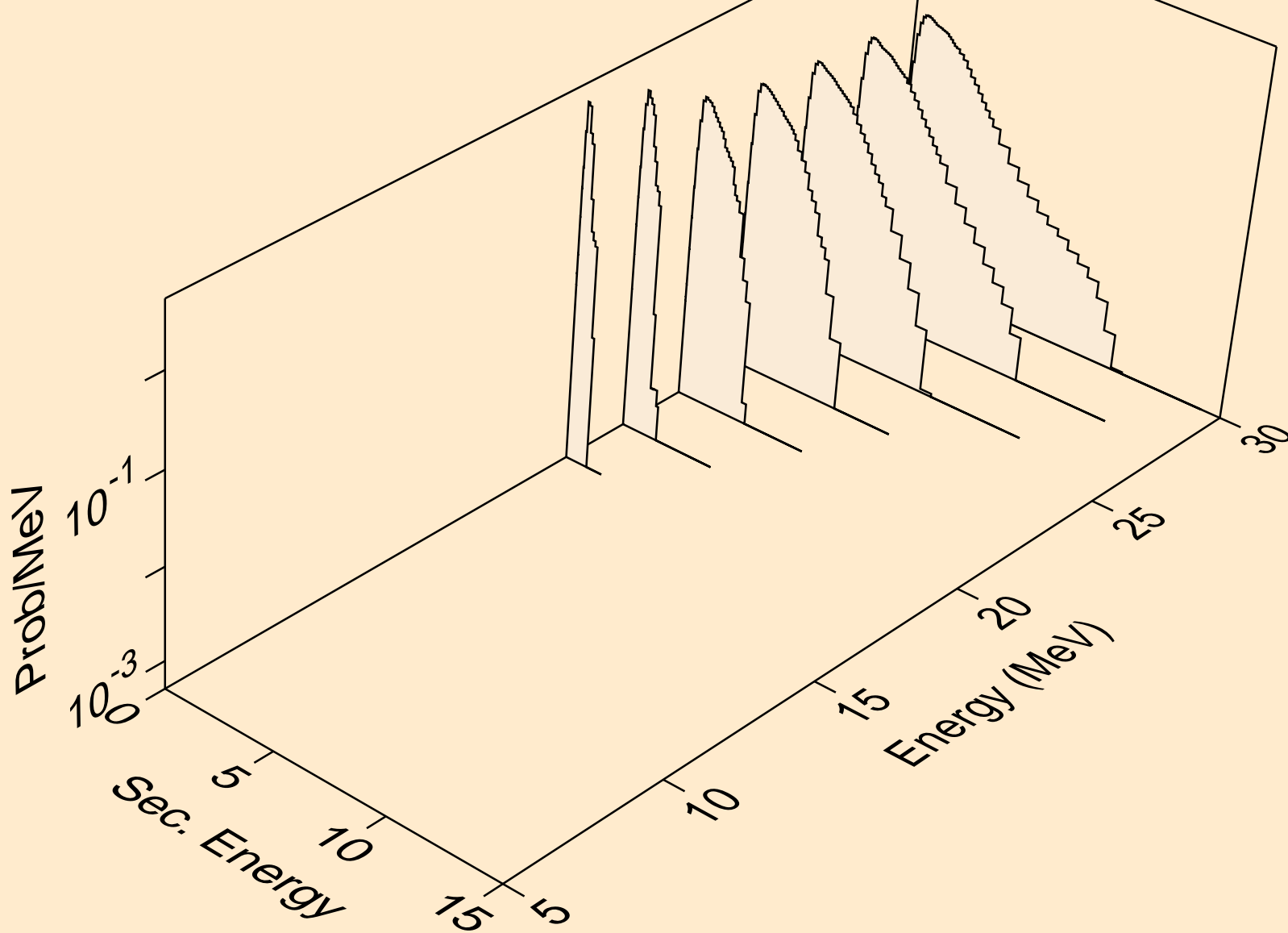



RA212 NEUTRON ACER TENDL-2019 LIBRARY; T=293.16K  
Neutron emission for (n,n\*)p

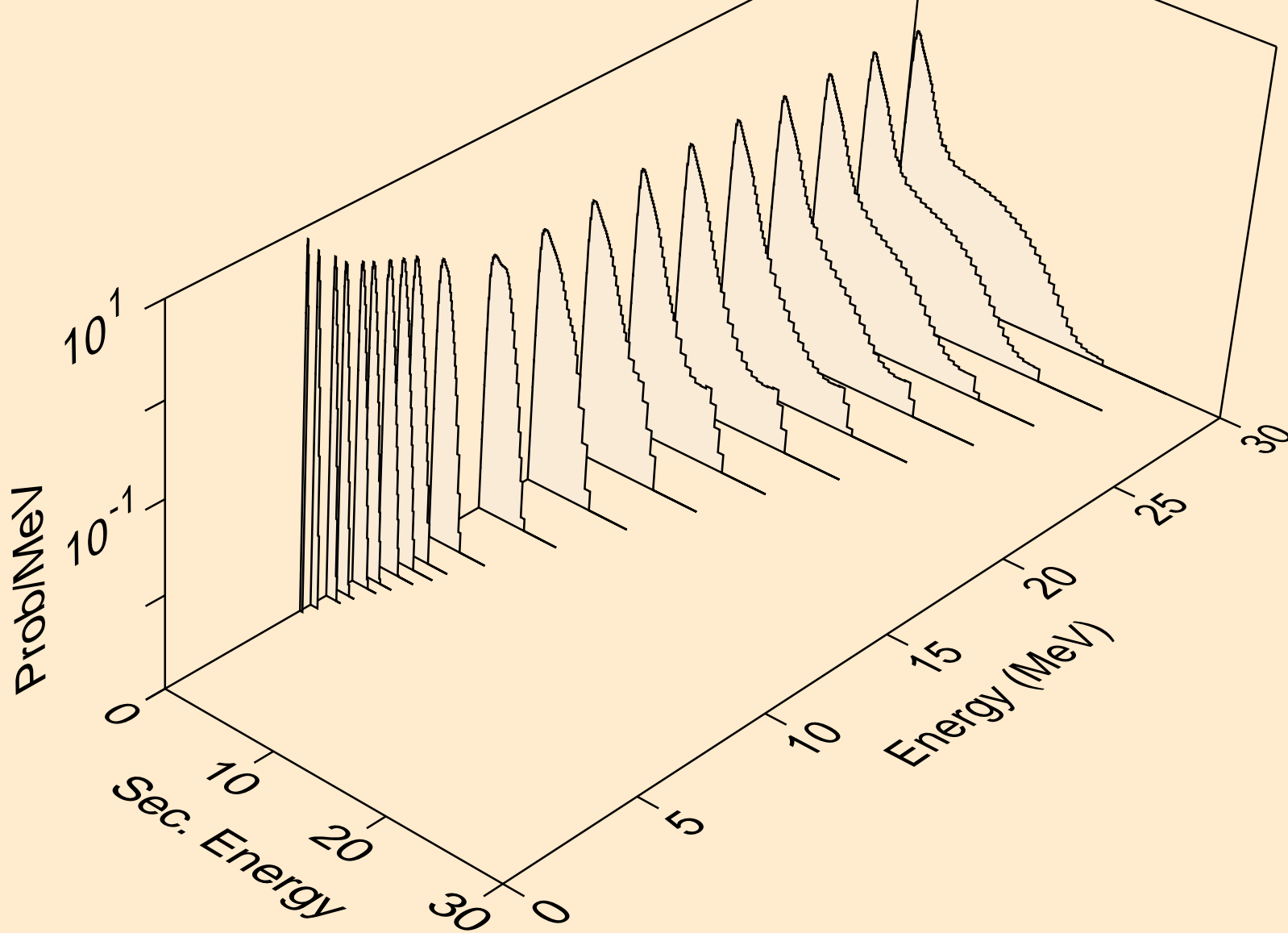

RA212 NEUTRON ACER TENDL-2019 LIBRARY; T=293.16K  
Neutron emission for (n,n\*)2a

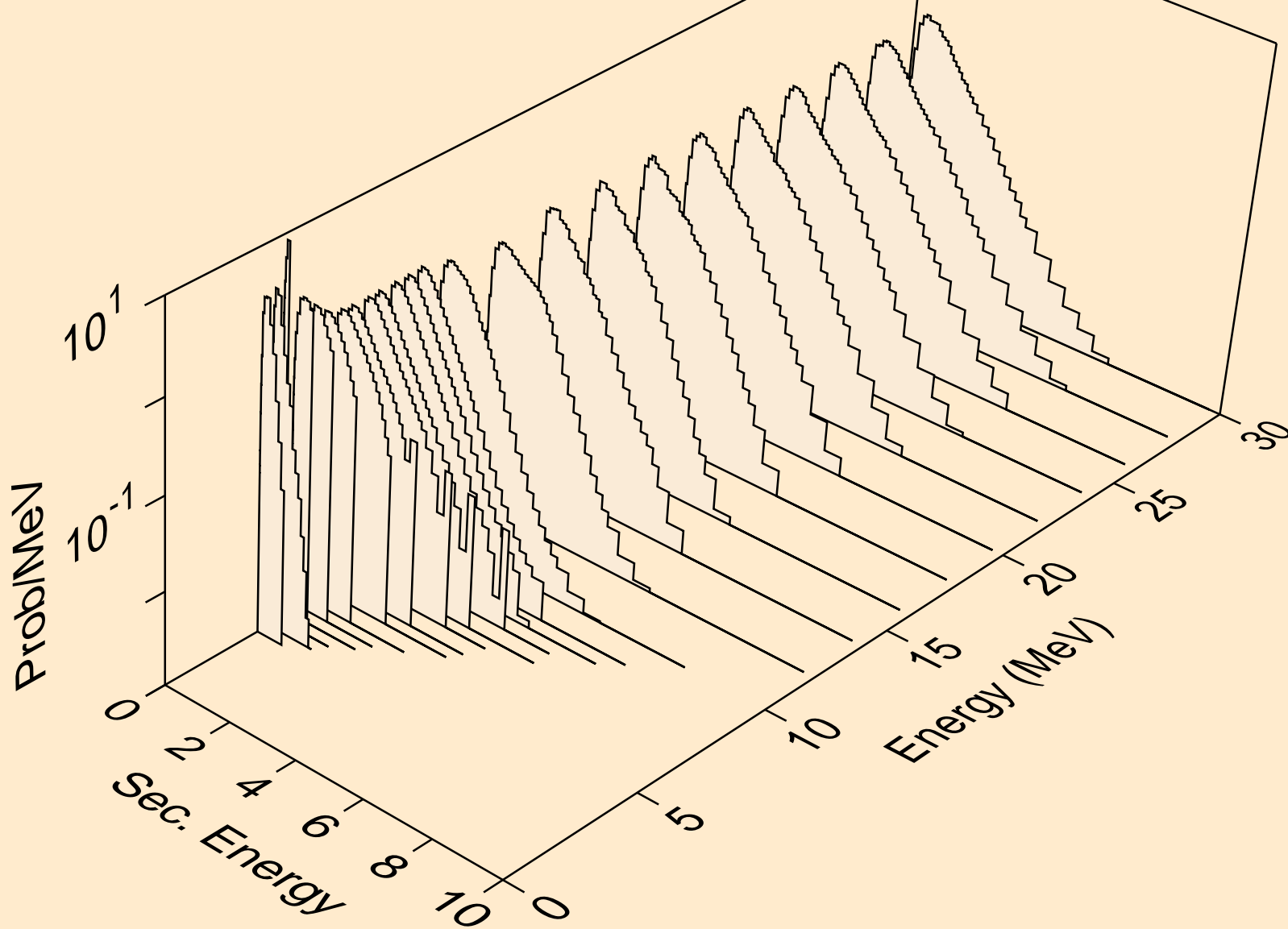

RA212 NEUTRON ACER TENDL-2019 LIBRARY; T=293.16K  
Neutron emission for (n,2n)2a

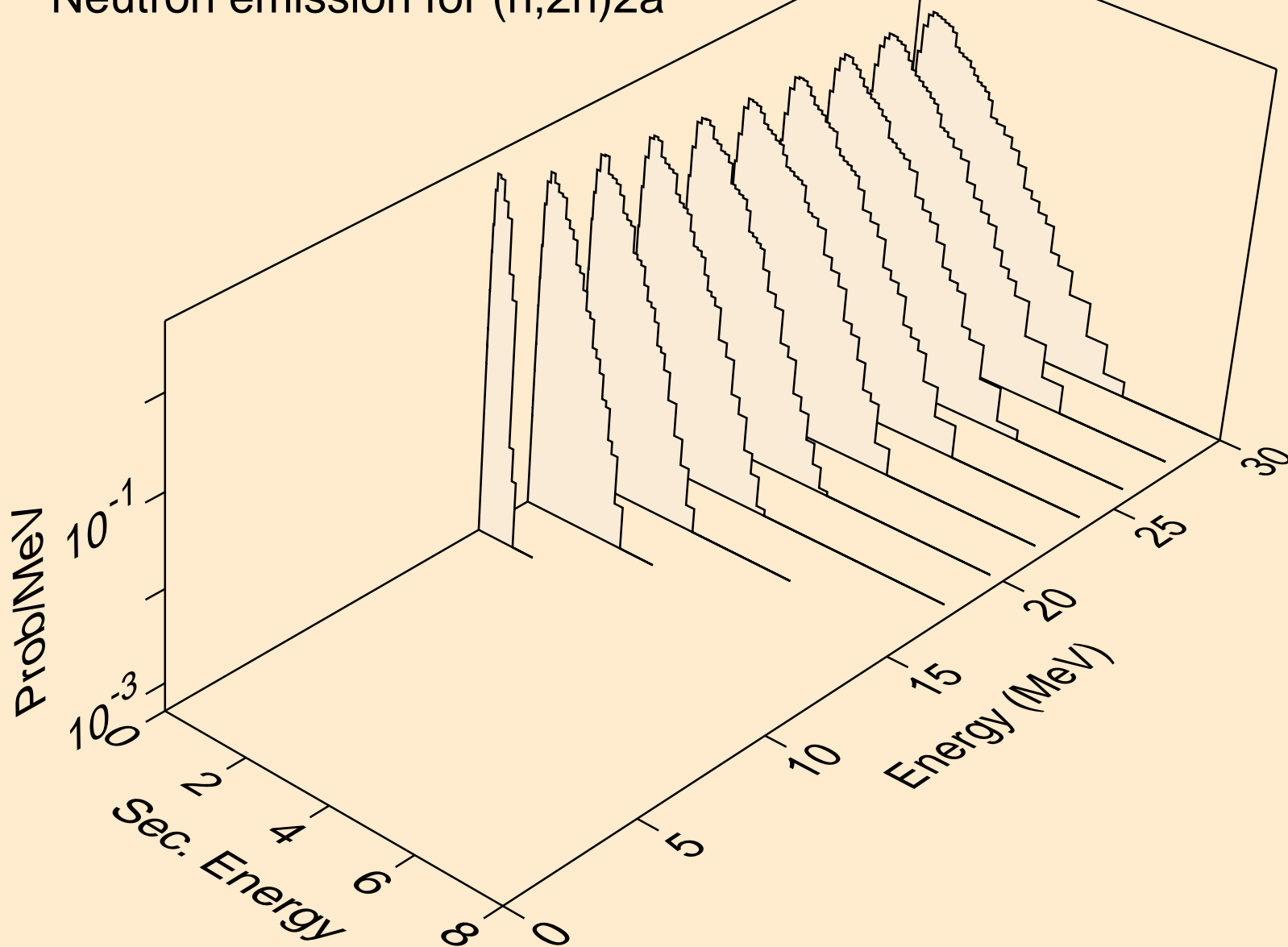

RA212 NEUTRON ACER TENDL-2019 LIBRARY; T=293.16K  
Neutron emission for (n,n\*)d

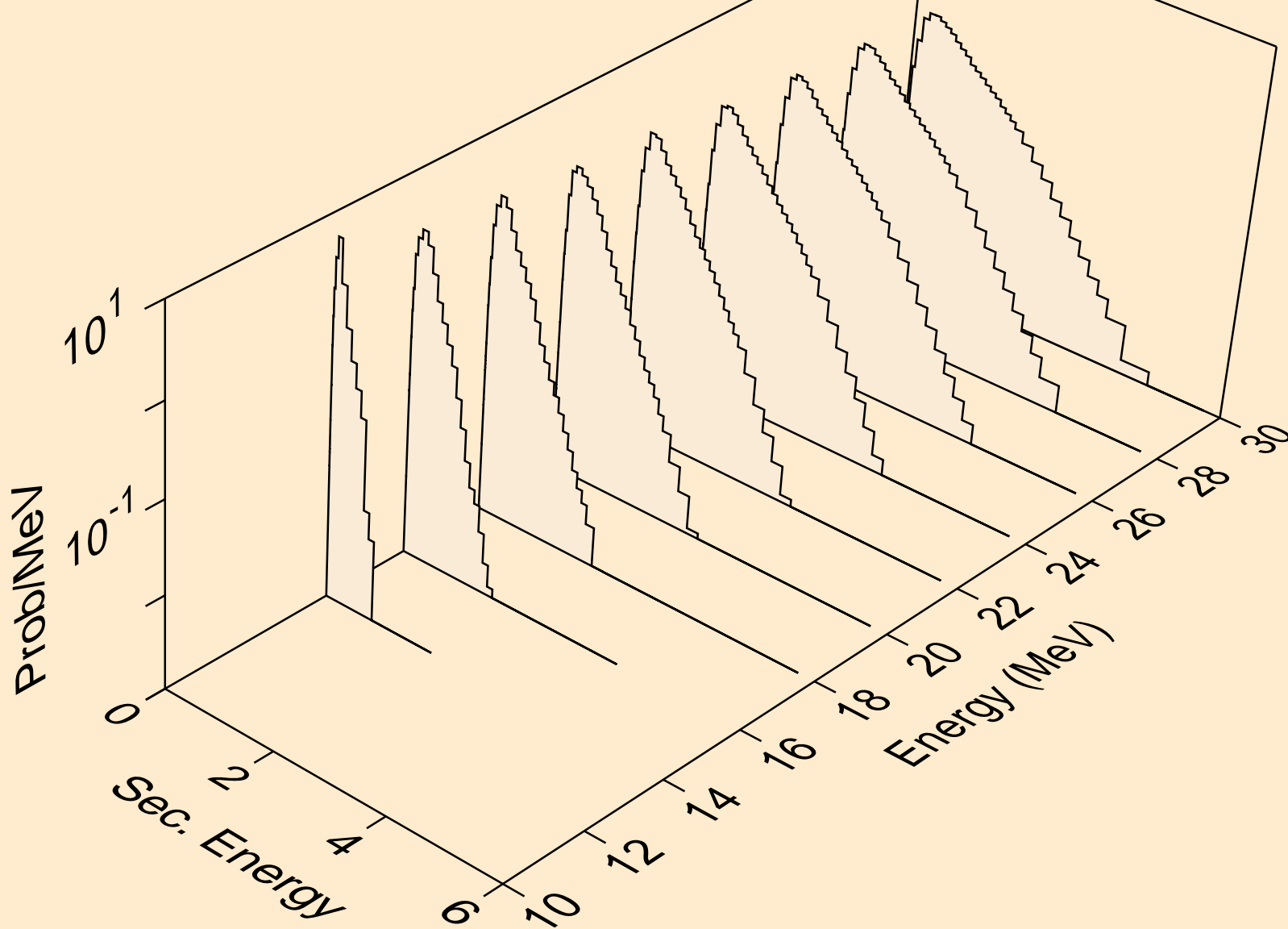

RA212 NEUTRON ACER TENDL-2019 LIBRARY; T=293.16K  
Neutron emission for (n,n\*)t

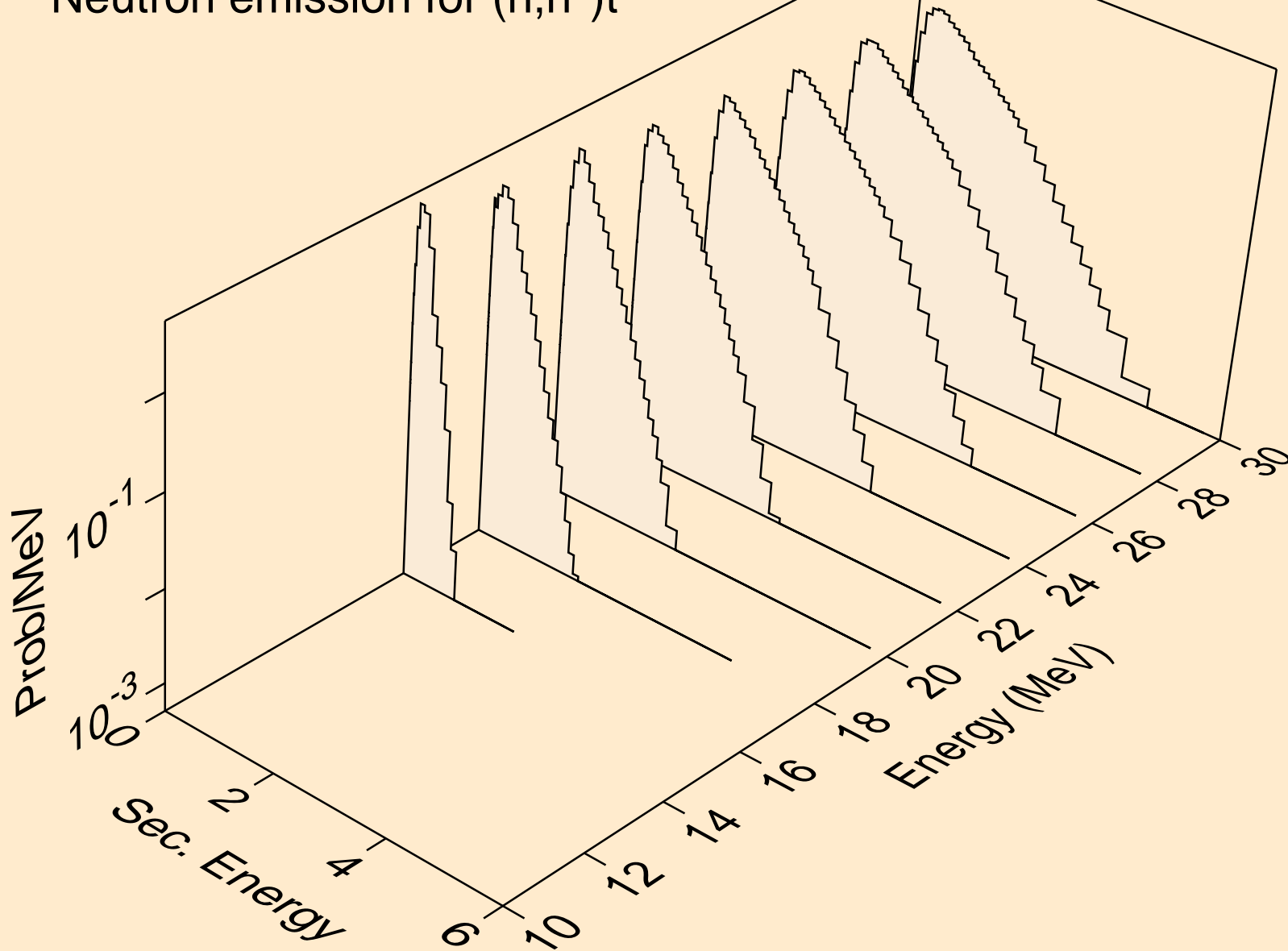

RA212 NEUTRON ACER TENDL-2019 LIBRARY; T=293.16K  
Neutron emission for (n,n\*)he3

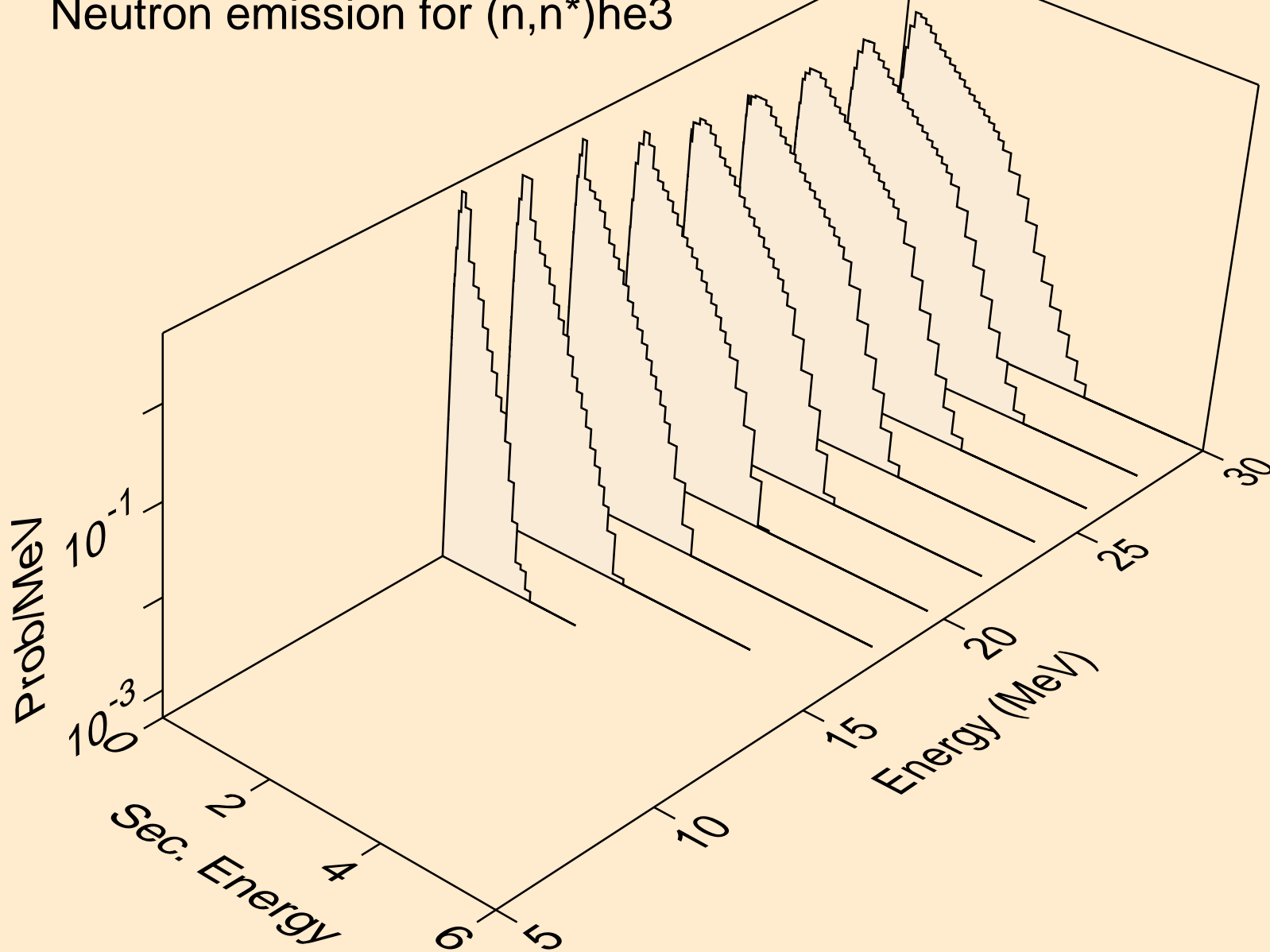

RA212 NEUTRON ACER TENDL-2019 LIBRARY; T=293.16K  
Neutron emission for (n,4n)

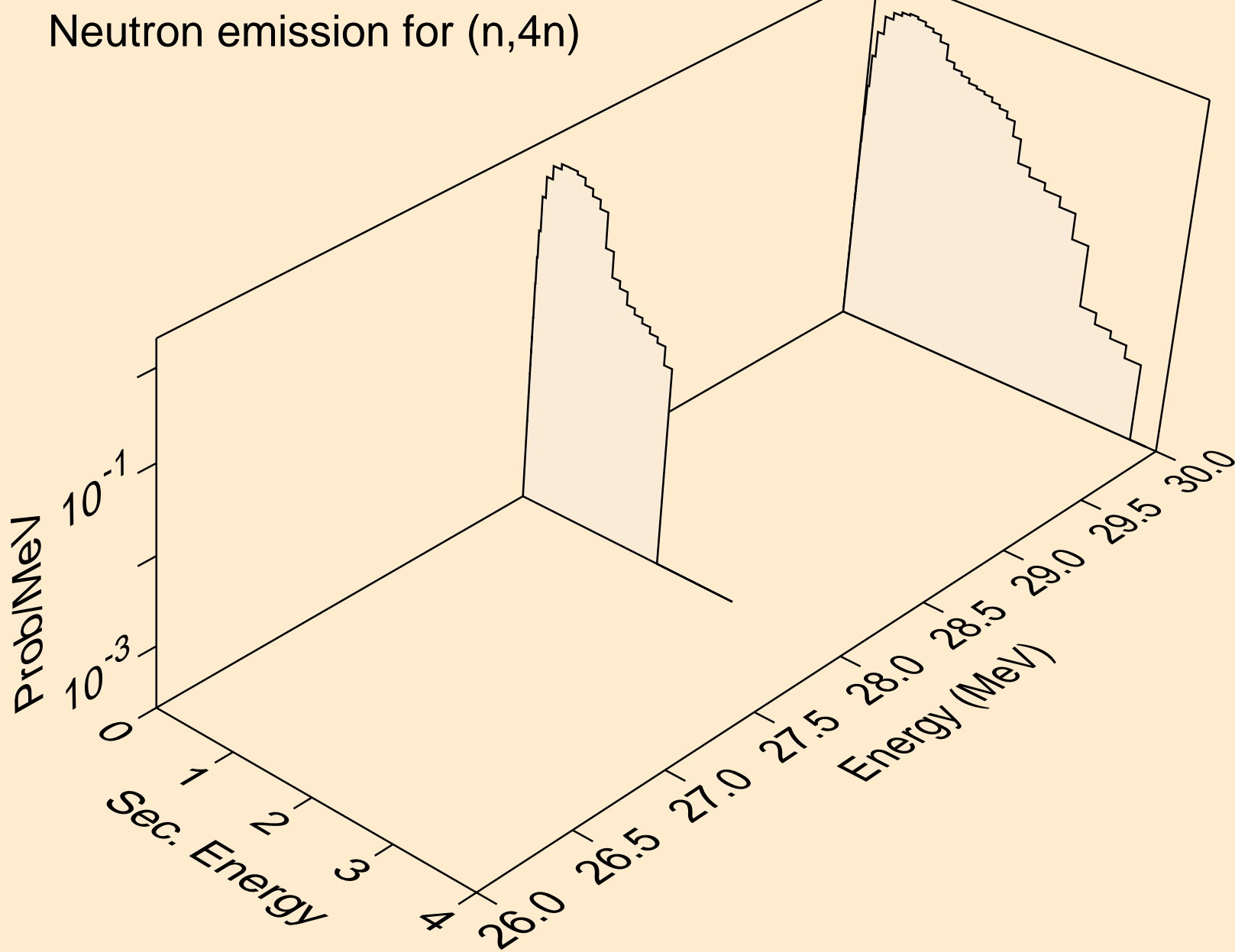

RA212 NEUTRON ACER TENDL-2019 LIBRARY; T=293.16K  
Neutron emission for (n,2np)

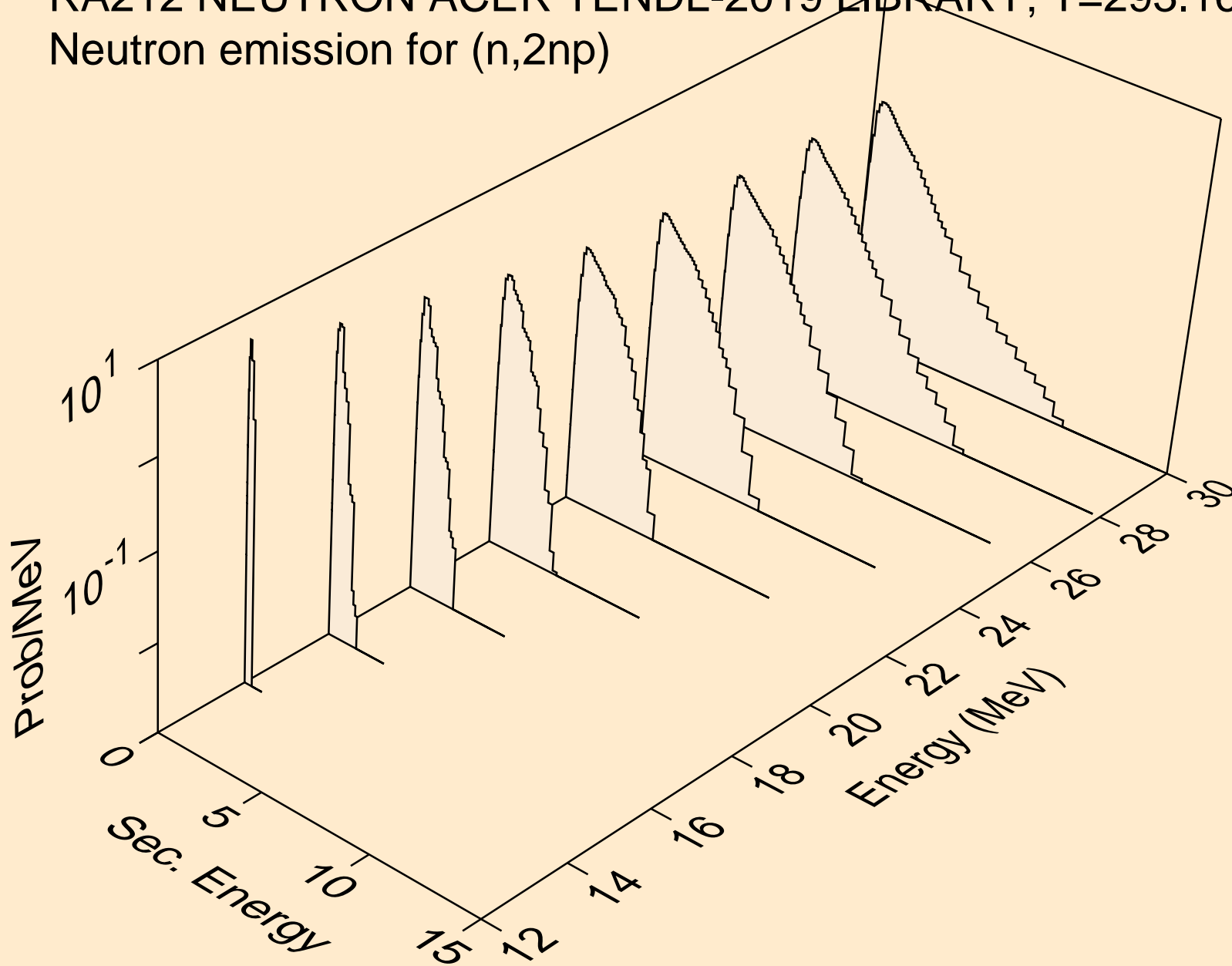



RA212 NEUTRON ACER TENDL-2019 LIBRARY; T=293.16K  
Neutron emission for (n,3np)

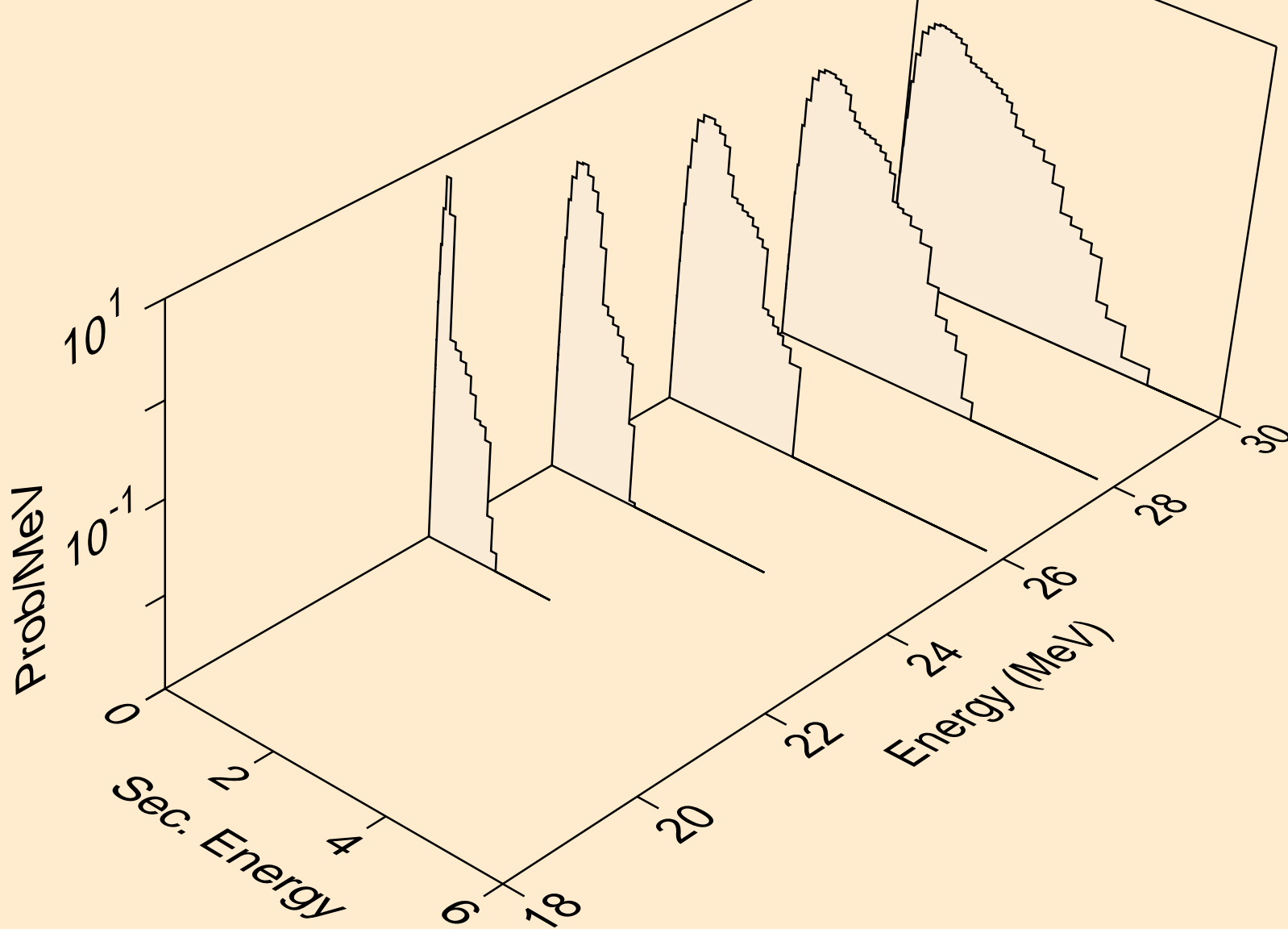

RA212 NEUTRON ACER TENDL-2019 LIBRARY; T=293.16K  
Neutron emission for (n,2np)

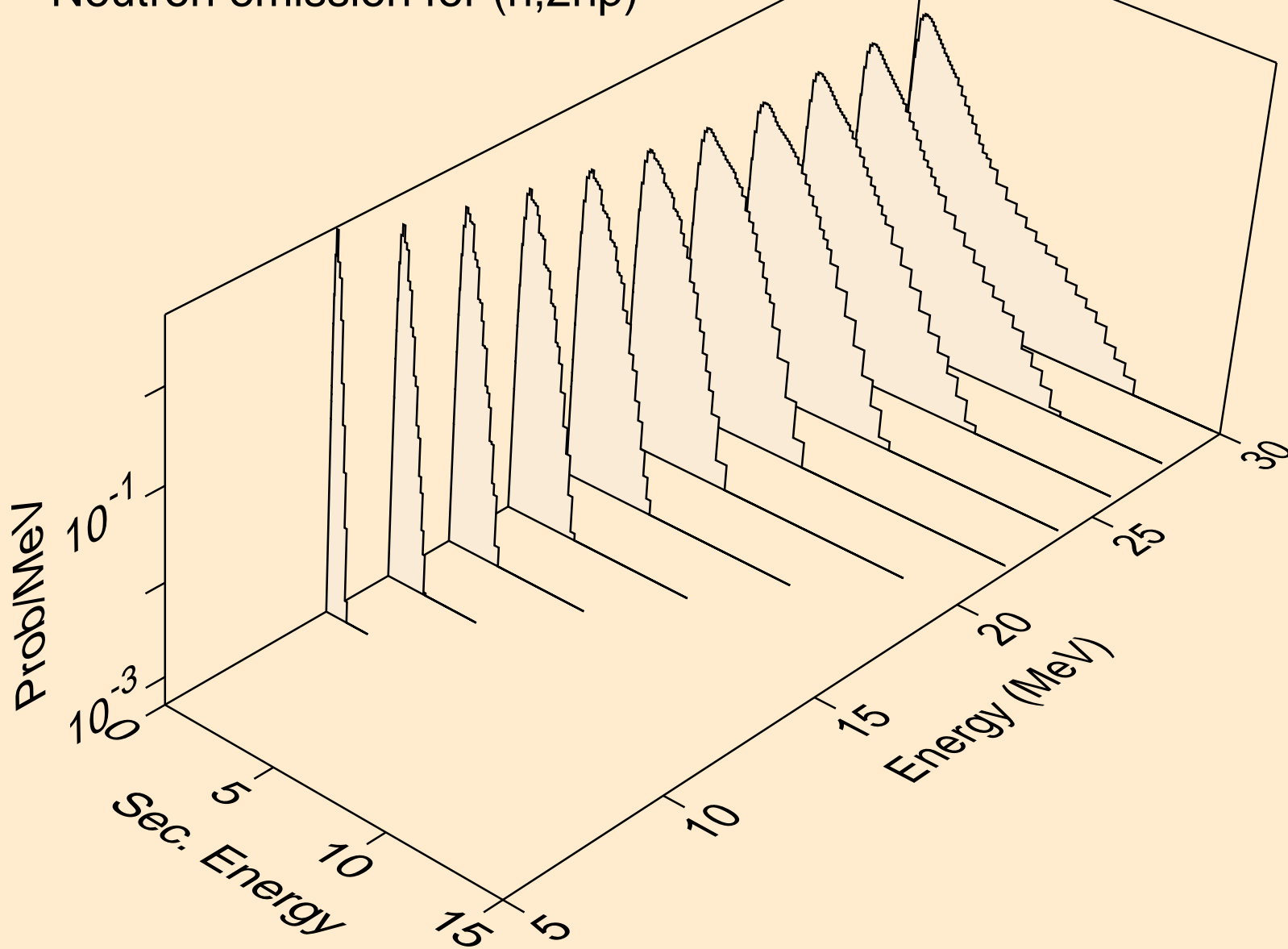

RA212 NEUTRON ACER TENDL-2019 LIBRARY; T=293.16K  
Neutron emission for (n,npa)

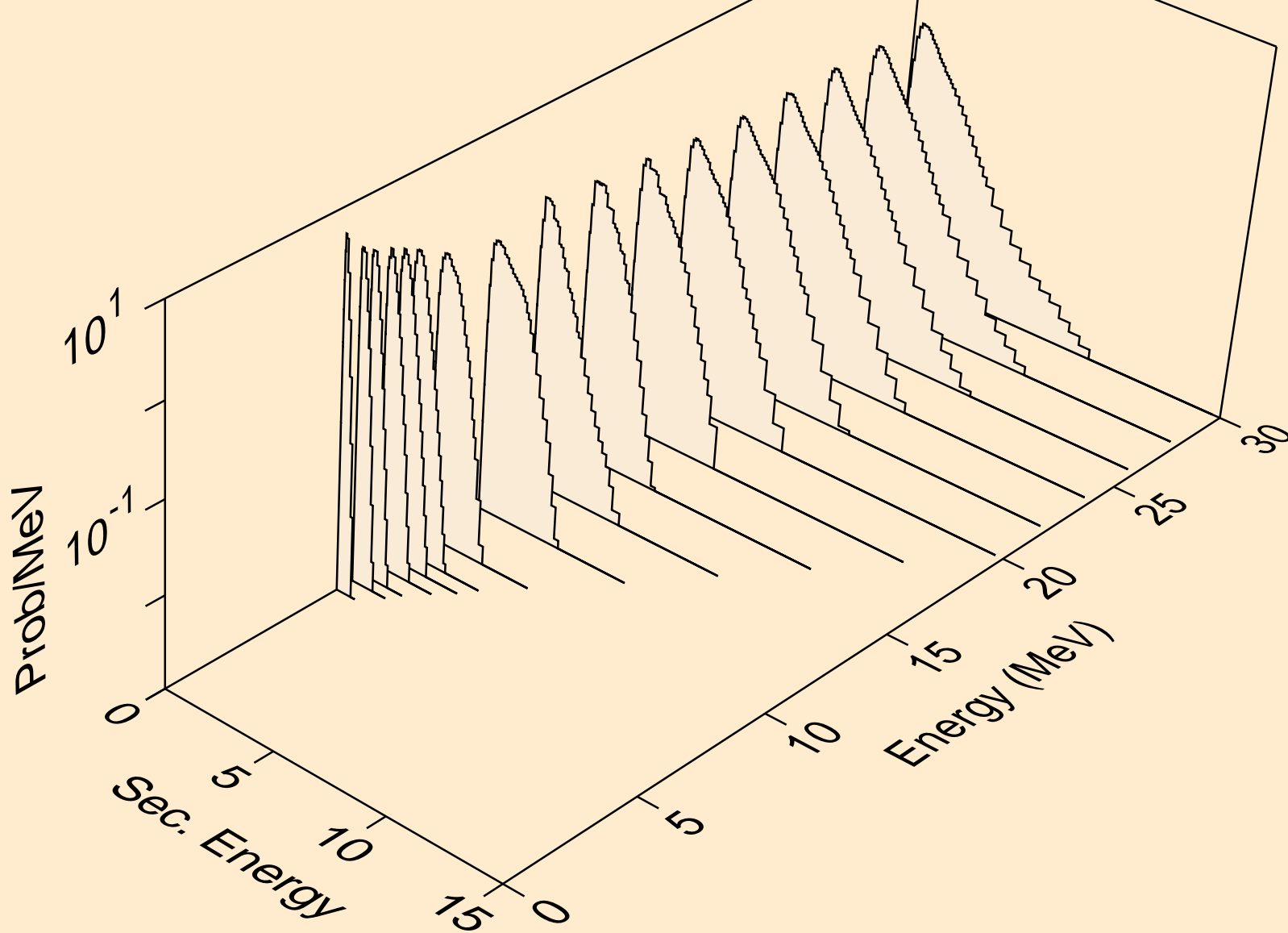

RA212 NEUTRON ACER TENDL-2019 LIBRARY; T=293.16K  
Neutron emission for (n,n\*c)

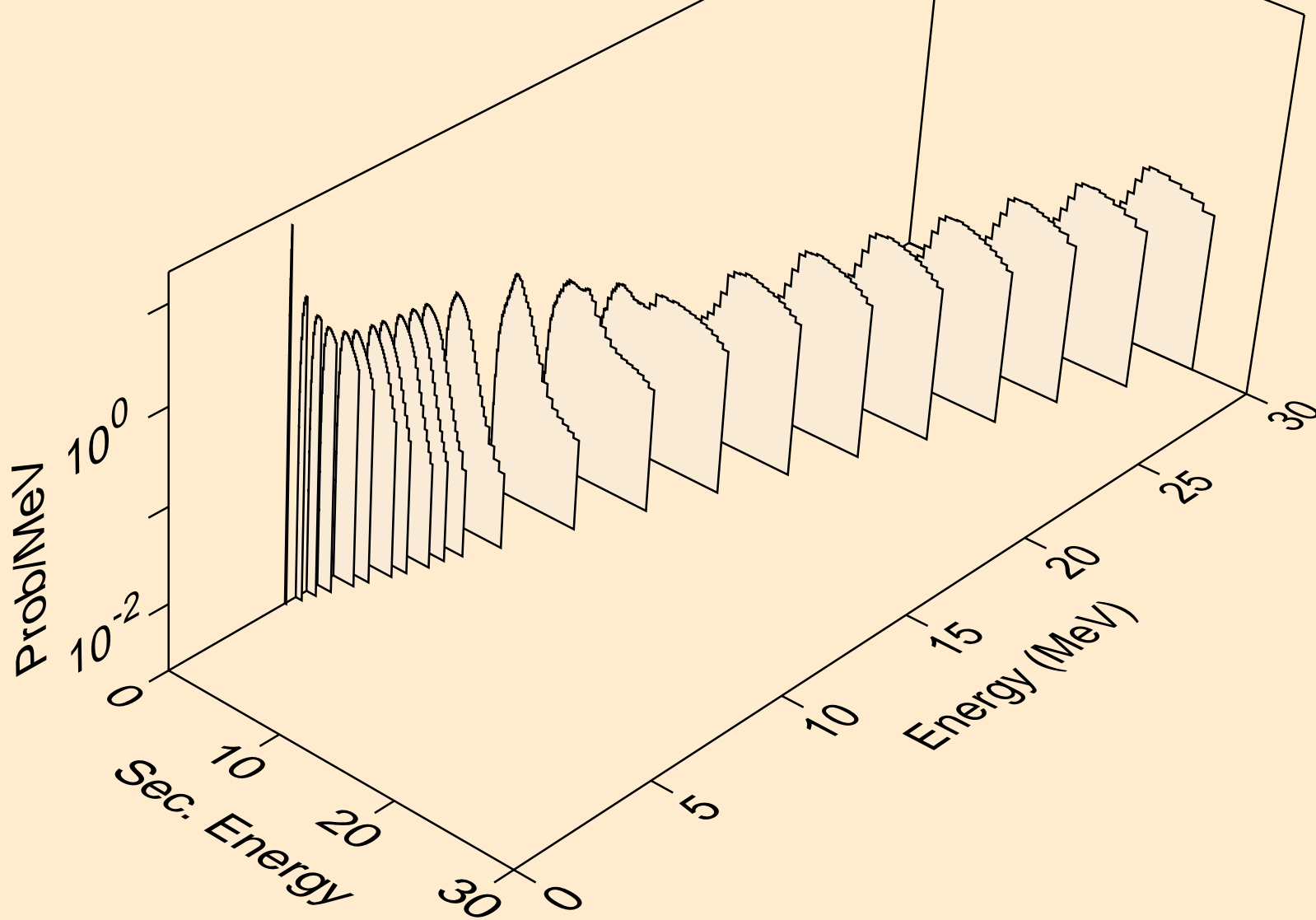

RA212 NEUTRON ACER TENDL-2019 LIBRARY; T=293.16K  
Photon emission for (n,x)

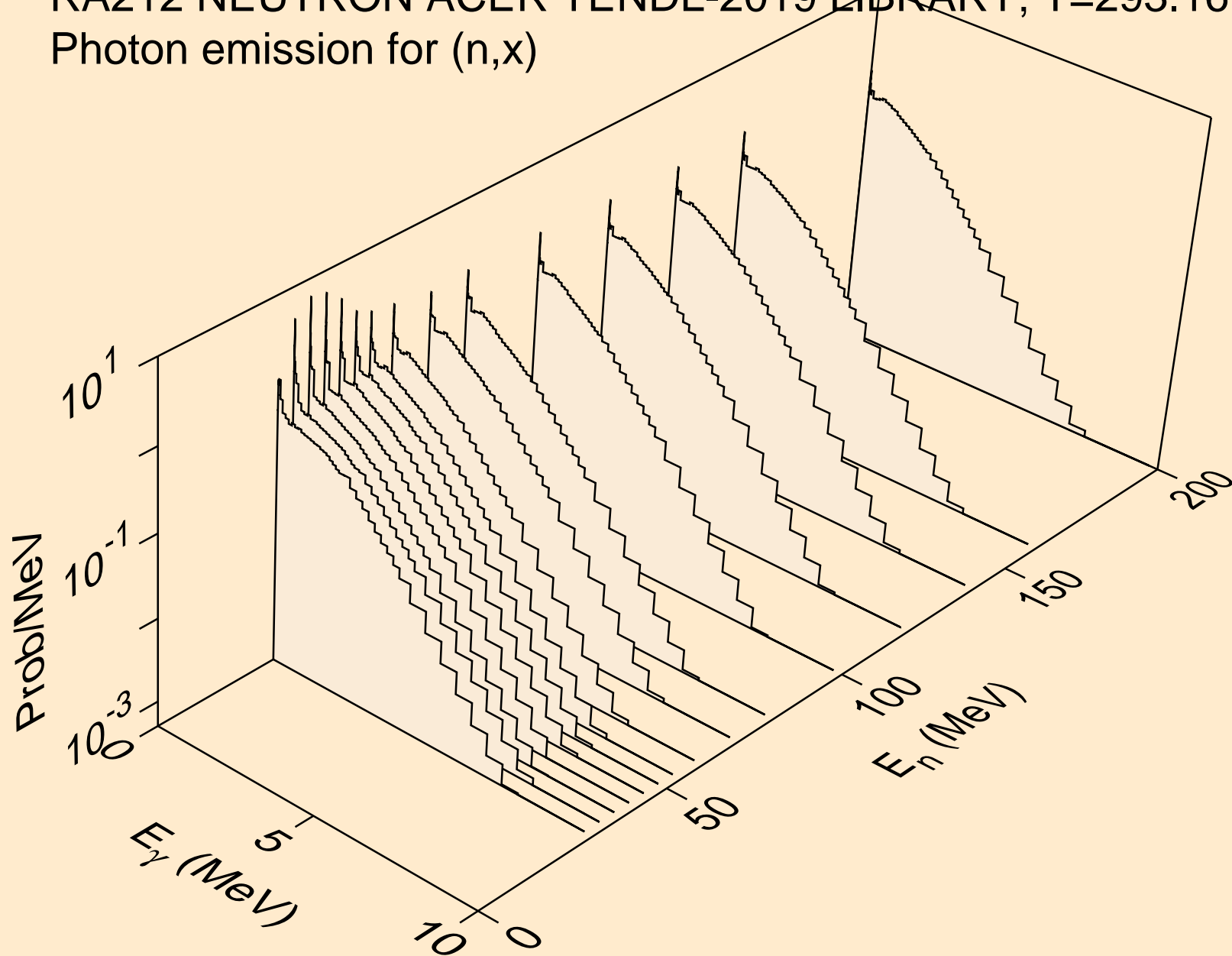

RA212 NEUTRON ACER TENDL-2019 LIBRARY; T=293.16K  
Photon emission for (n,2nd)

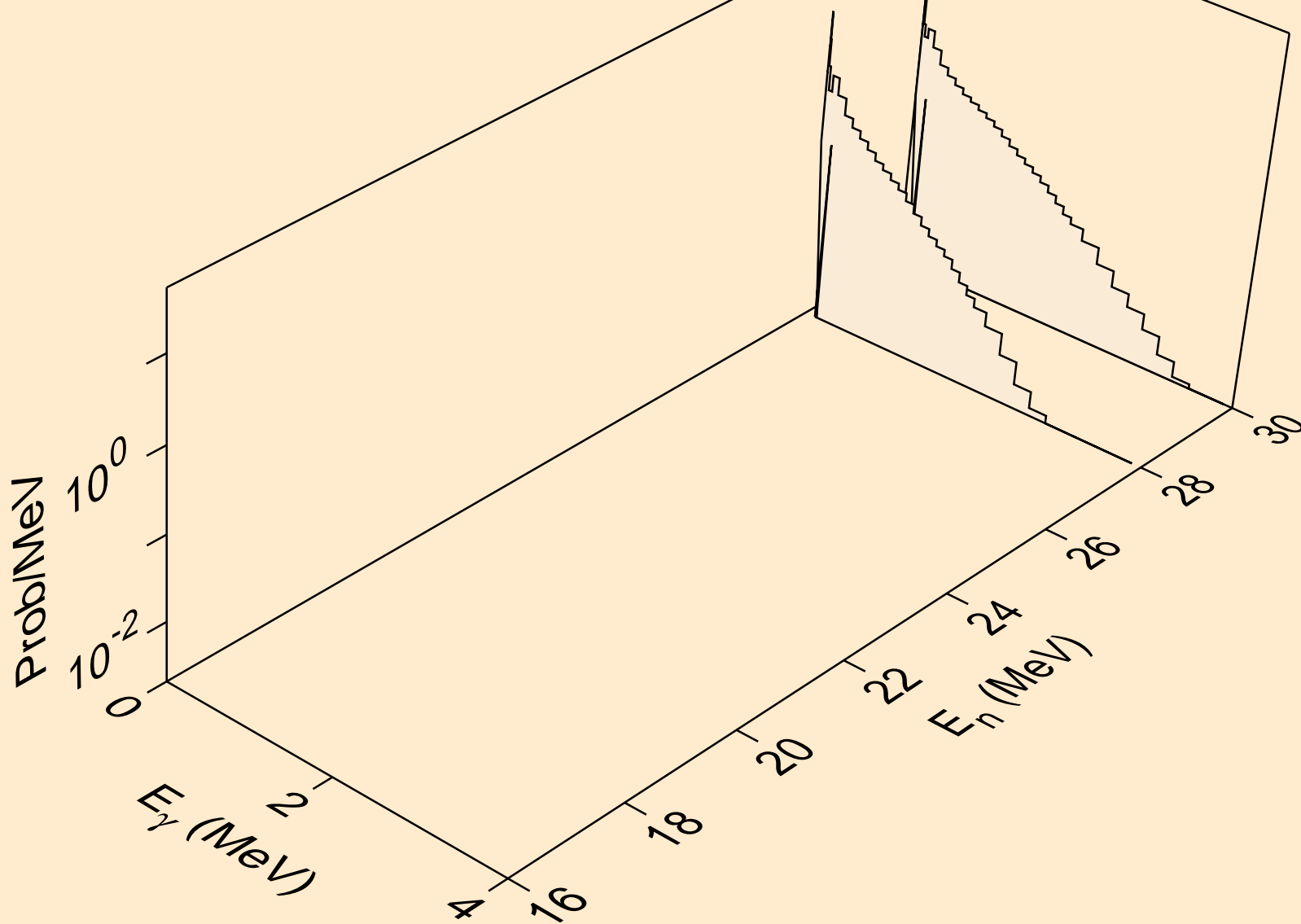

RA212 NEUTRON ACER TENDL-2019 LIBRARY; T=293.16K  
Photon emission for (n,2n)

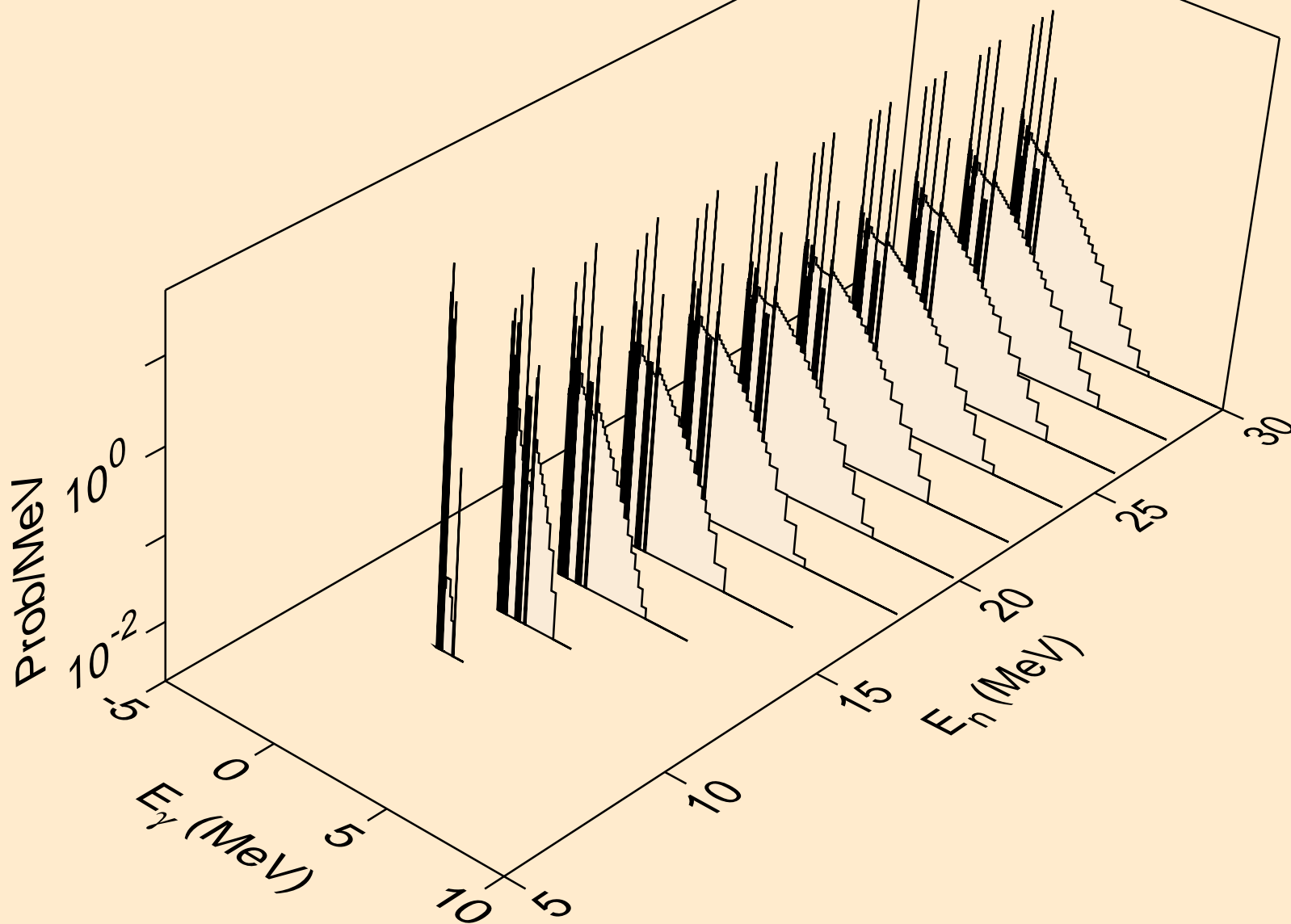

RA212 NEUTRON ACER TENDL-2019 LIBRARY; T=293.16K  
Photon emission for (n,3n)

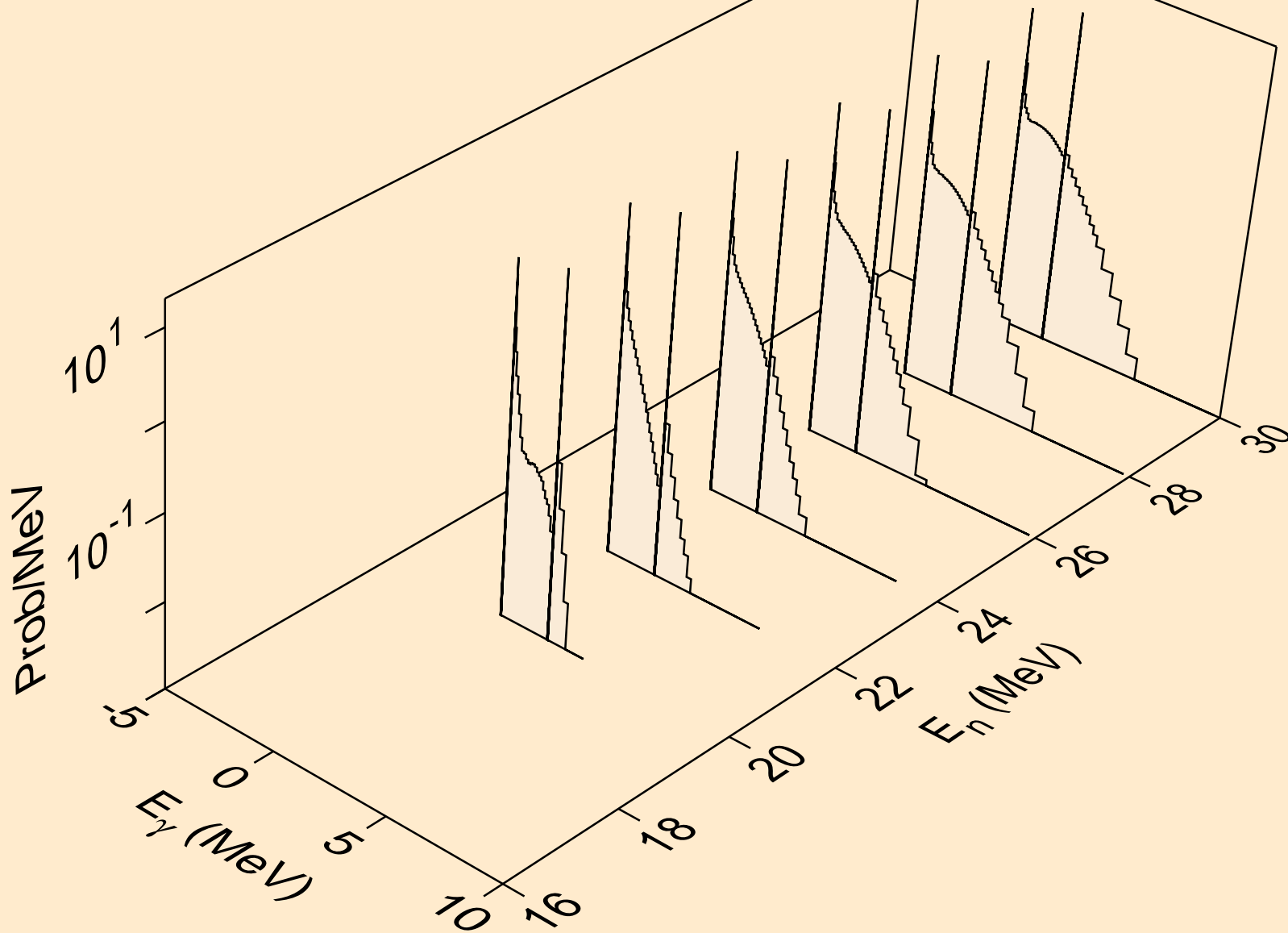



RA212 NEUTRON ACER TENDL-2019 LIBRARY; T=293.16K  
Photon emission for (n,n\*)a

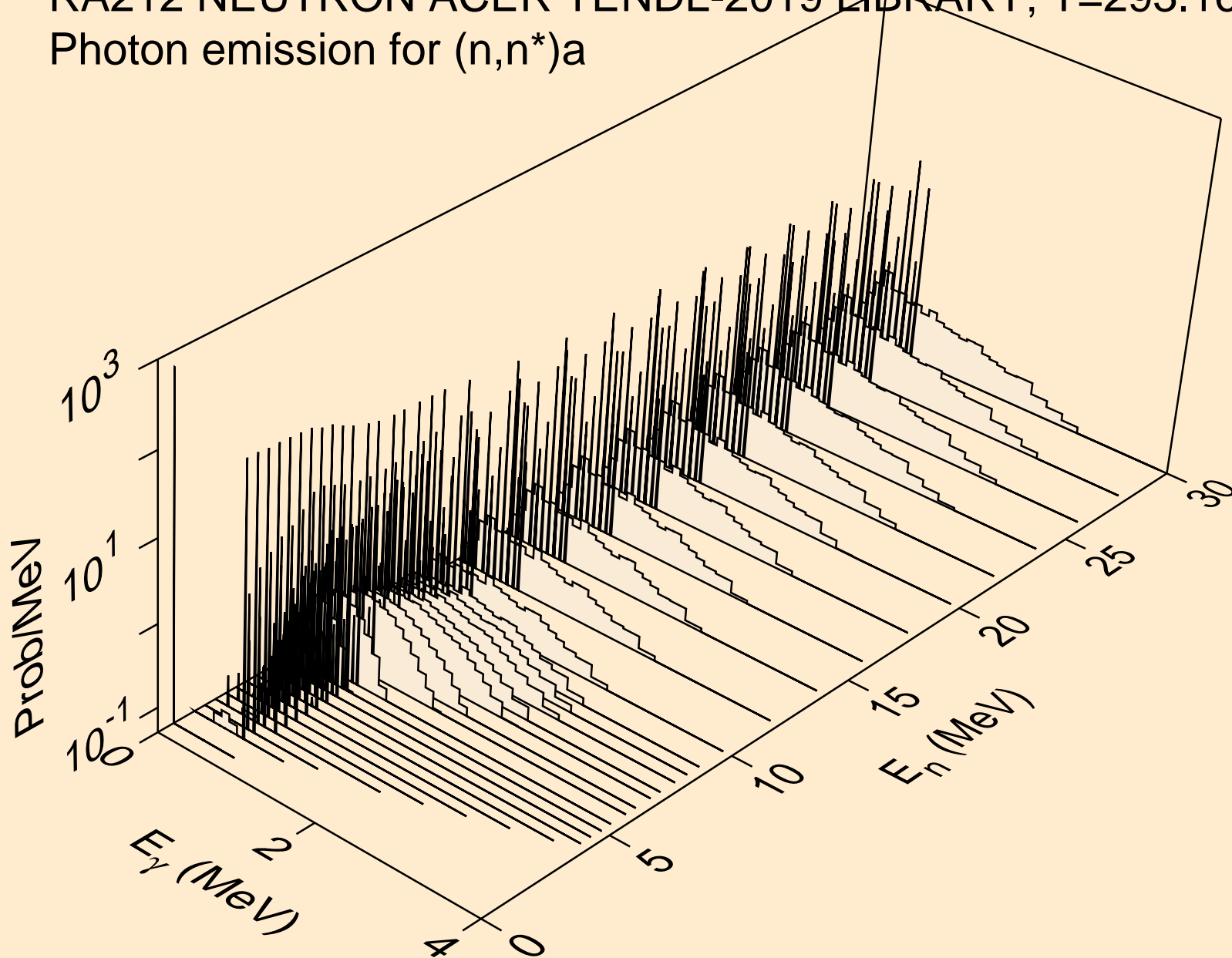

RA212 NEUTRON ACER TENDL-2019 LIBRARY; T=293.16K  
Photon emission for (n,2n)a

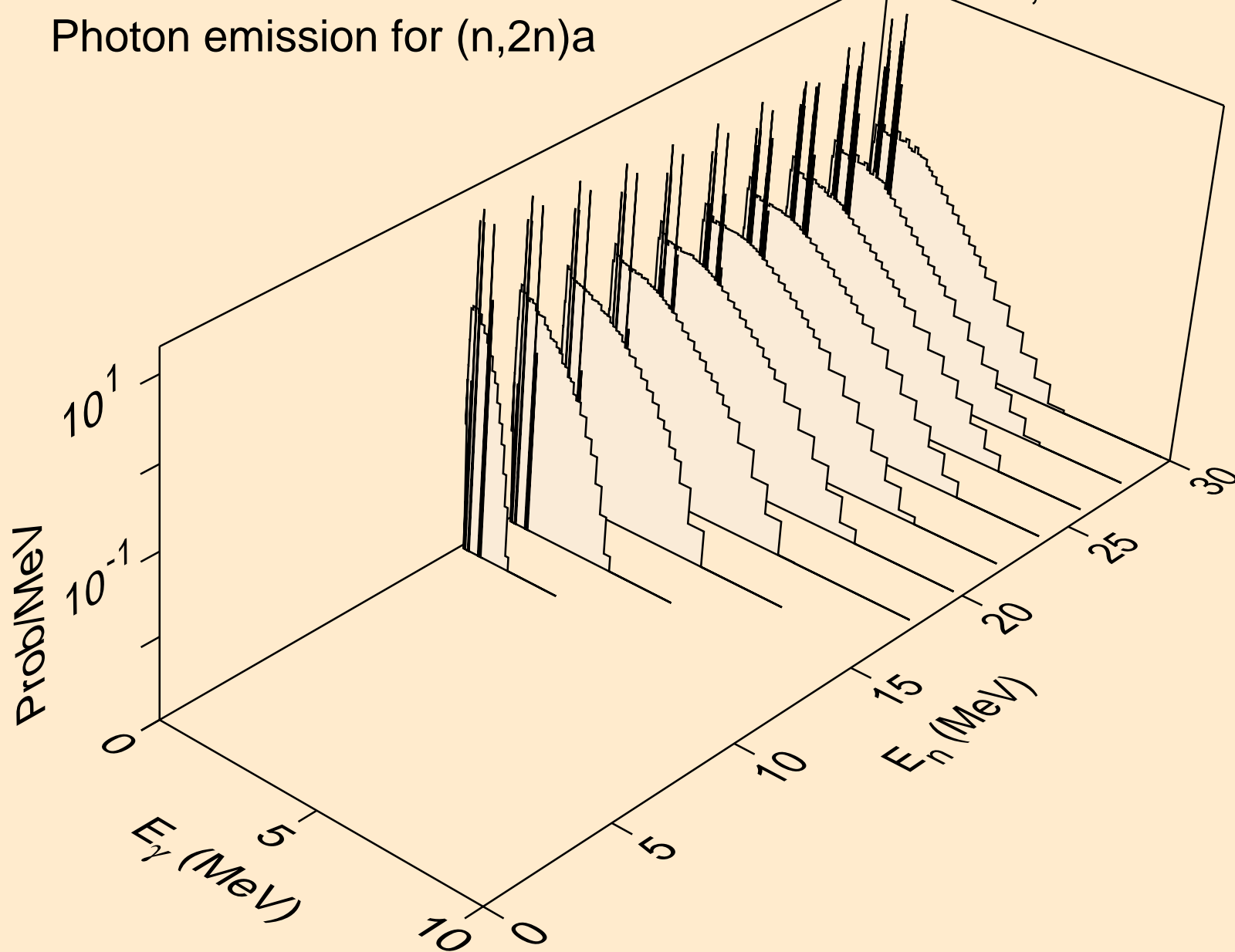

RA212 NEUTRON ACER TENDL-2019 LIBRARY; T=293.16K  
Photon emission for (n,3n)a

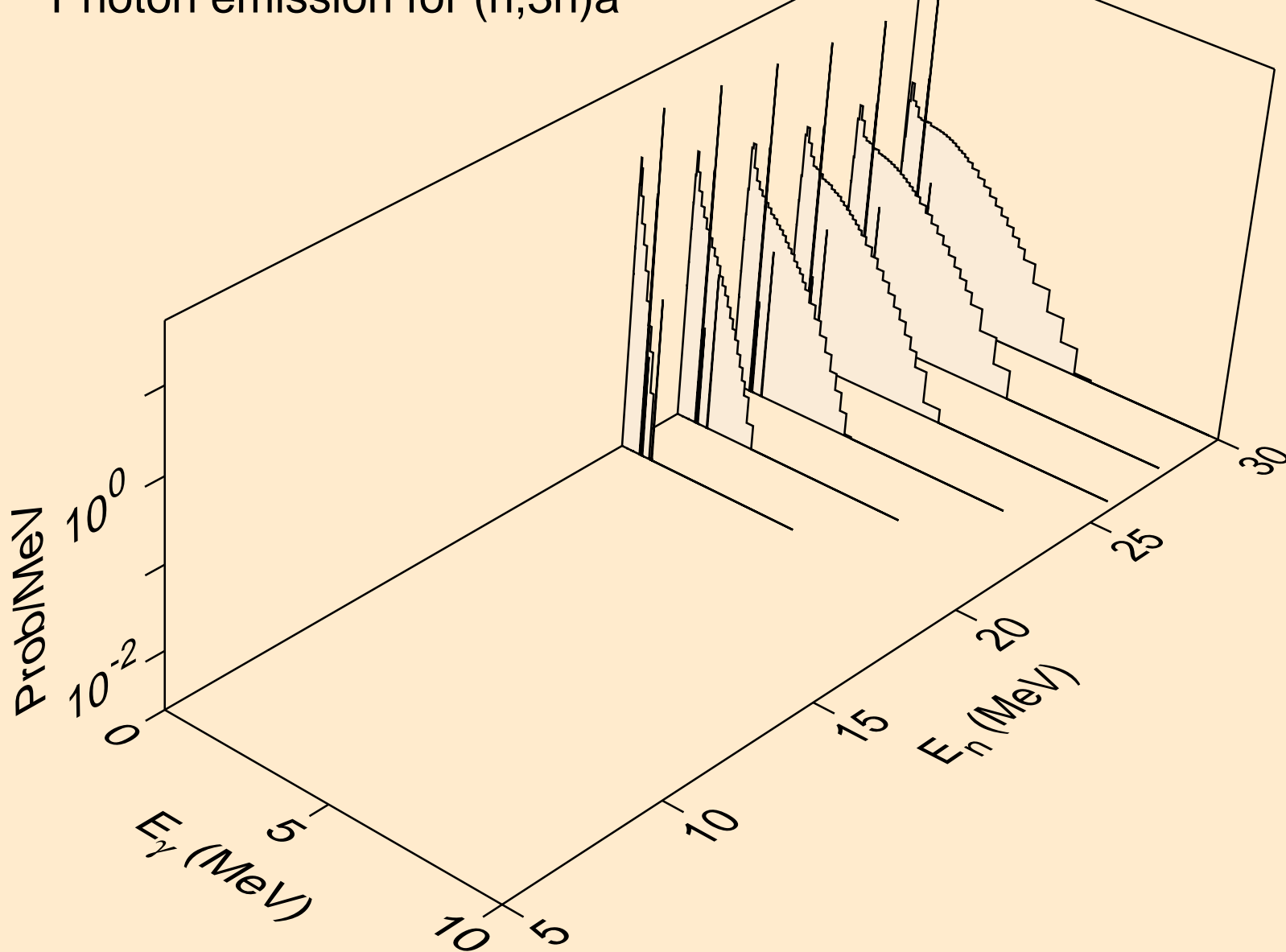

RA212 NEUTRON ACER TENDL-2019 LIBRARY; T=293.16K  
Photon emission for (n,n\*)p

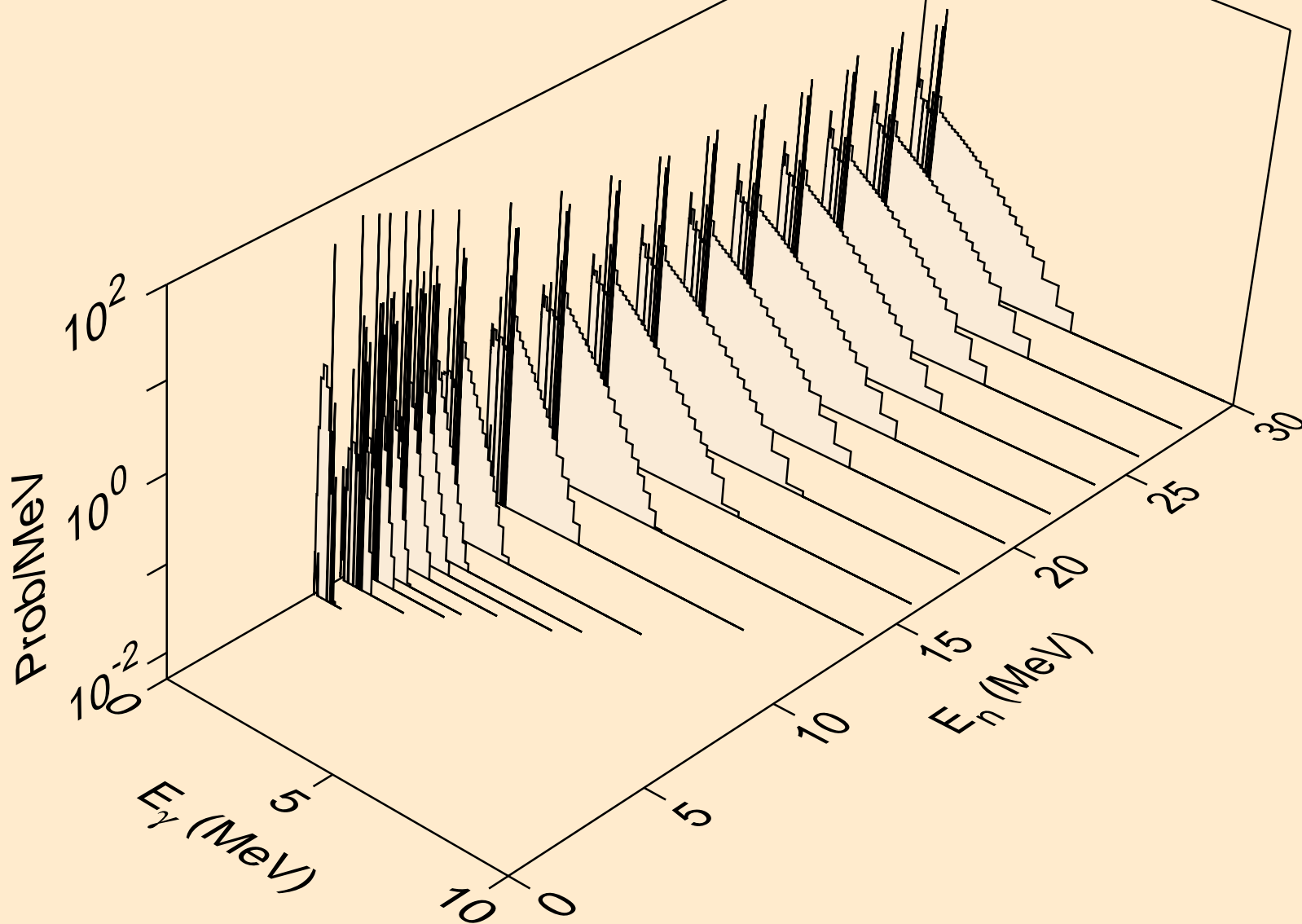

RA212 NEUTRON ACER TENDL-2019 LIBRARY; T=293.16K  
Photon emission for (n,n\*)2a

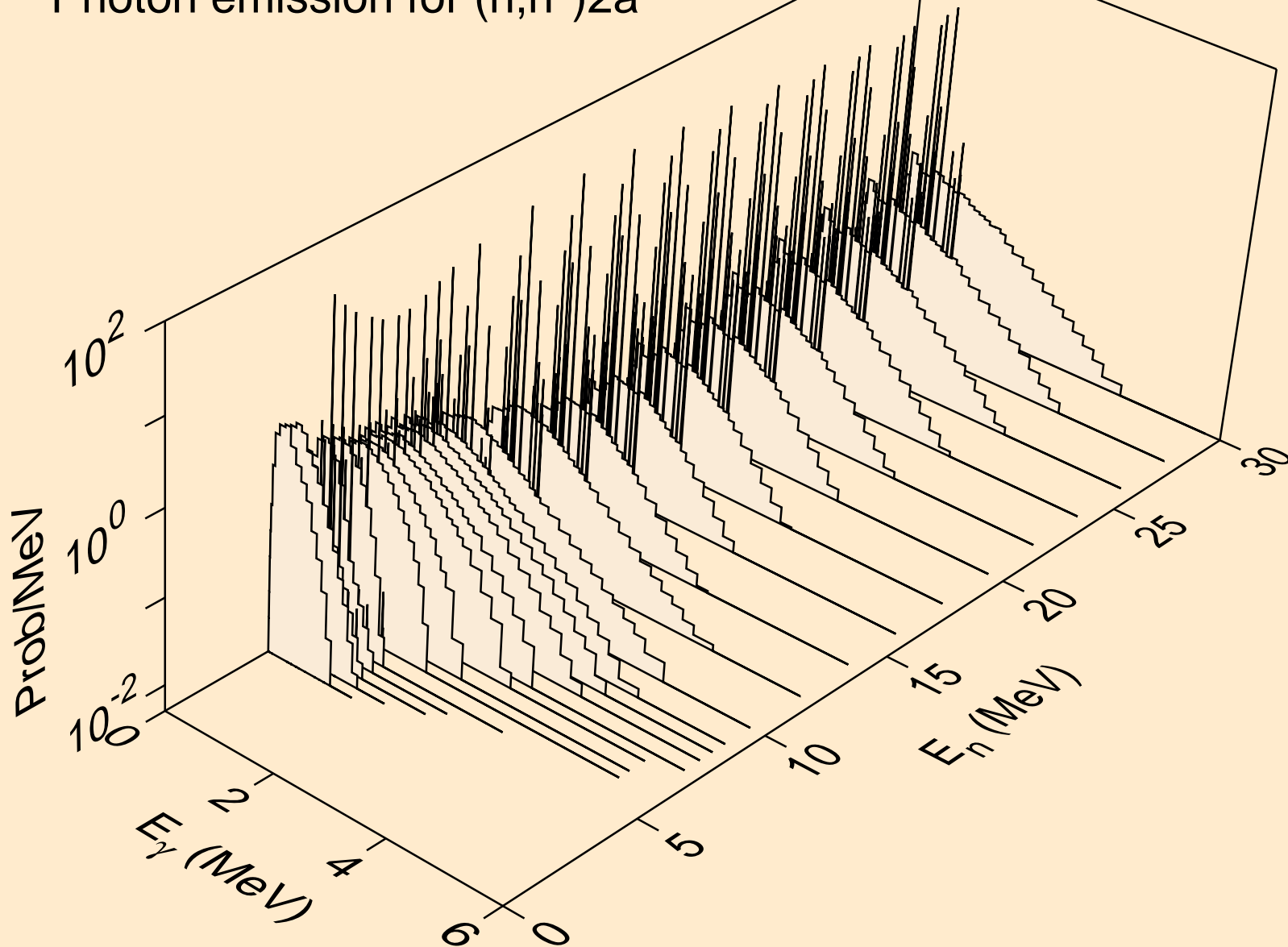

RA212 NEUTRON ACER TENDL-2019 LIBRARY; T=293.16K  
Photon emission for (n,2n)2a

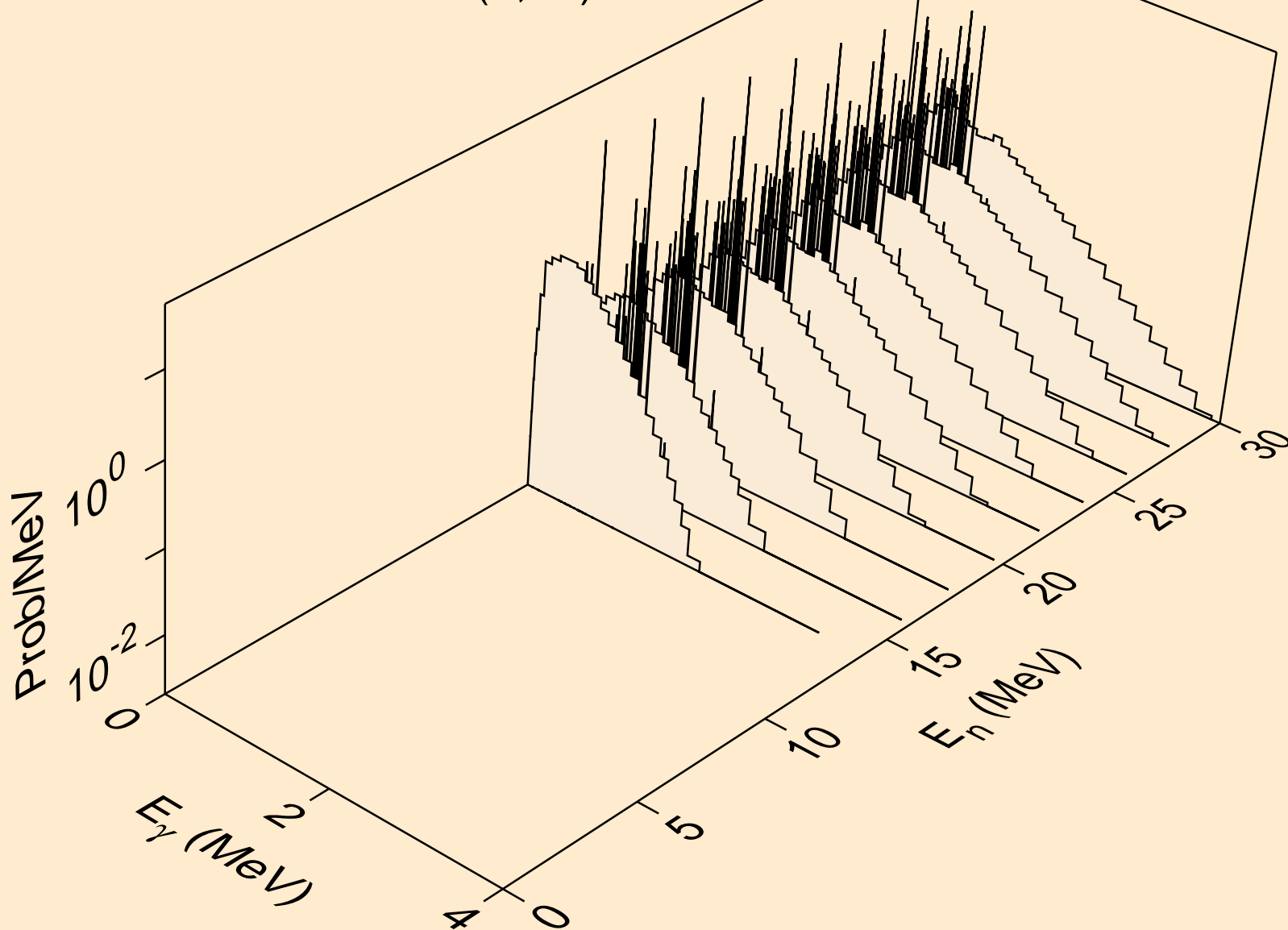

RA212 NEUTRON ACER TENDL-2019 LIBRARY; T=293.16K  
Photon emission for (n,n\*)d

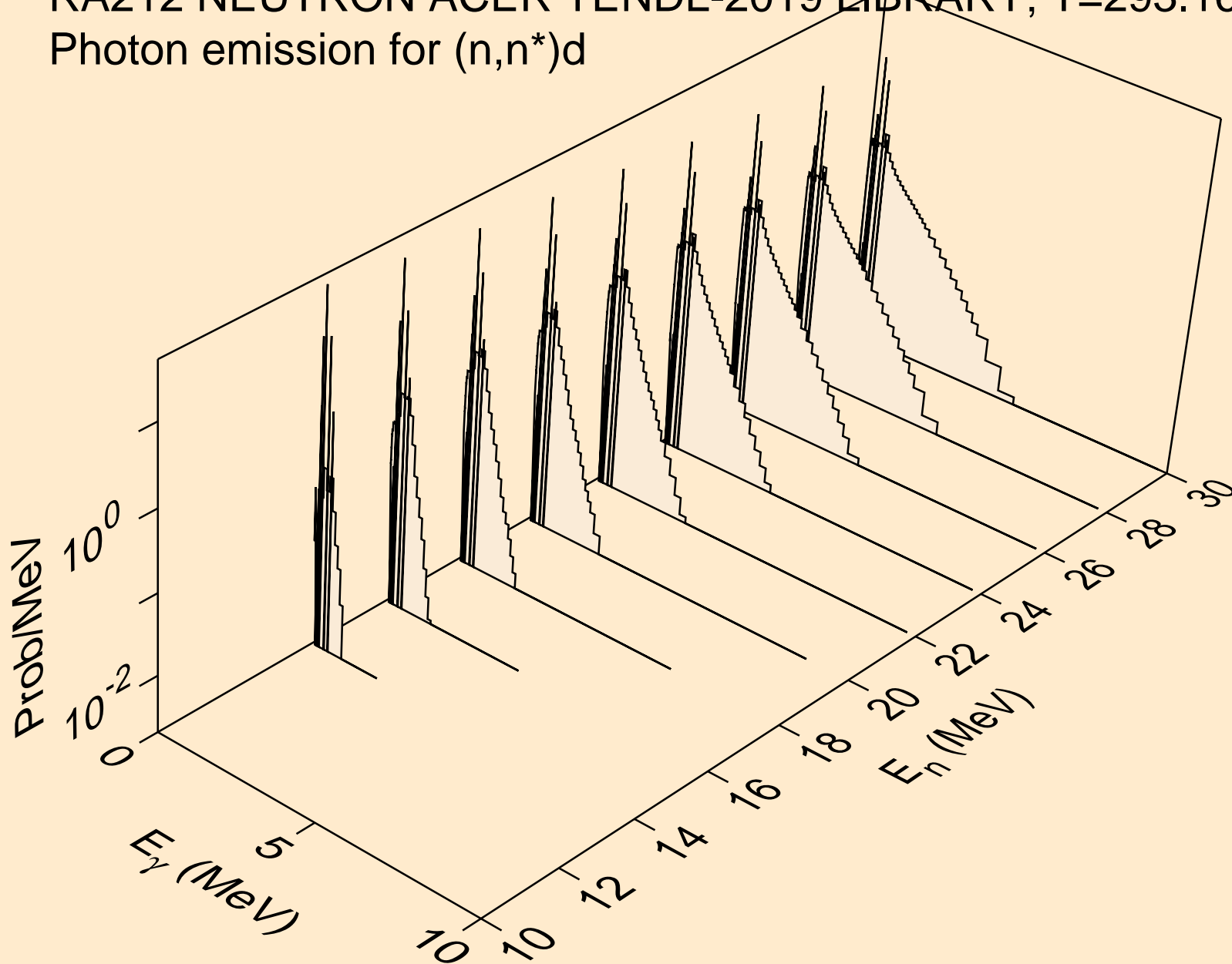

RA212 NEUTRON ACER TENDL-2019 LIBRARY; T=293.16K  
Photon emission for (n,n\*)t

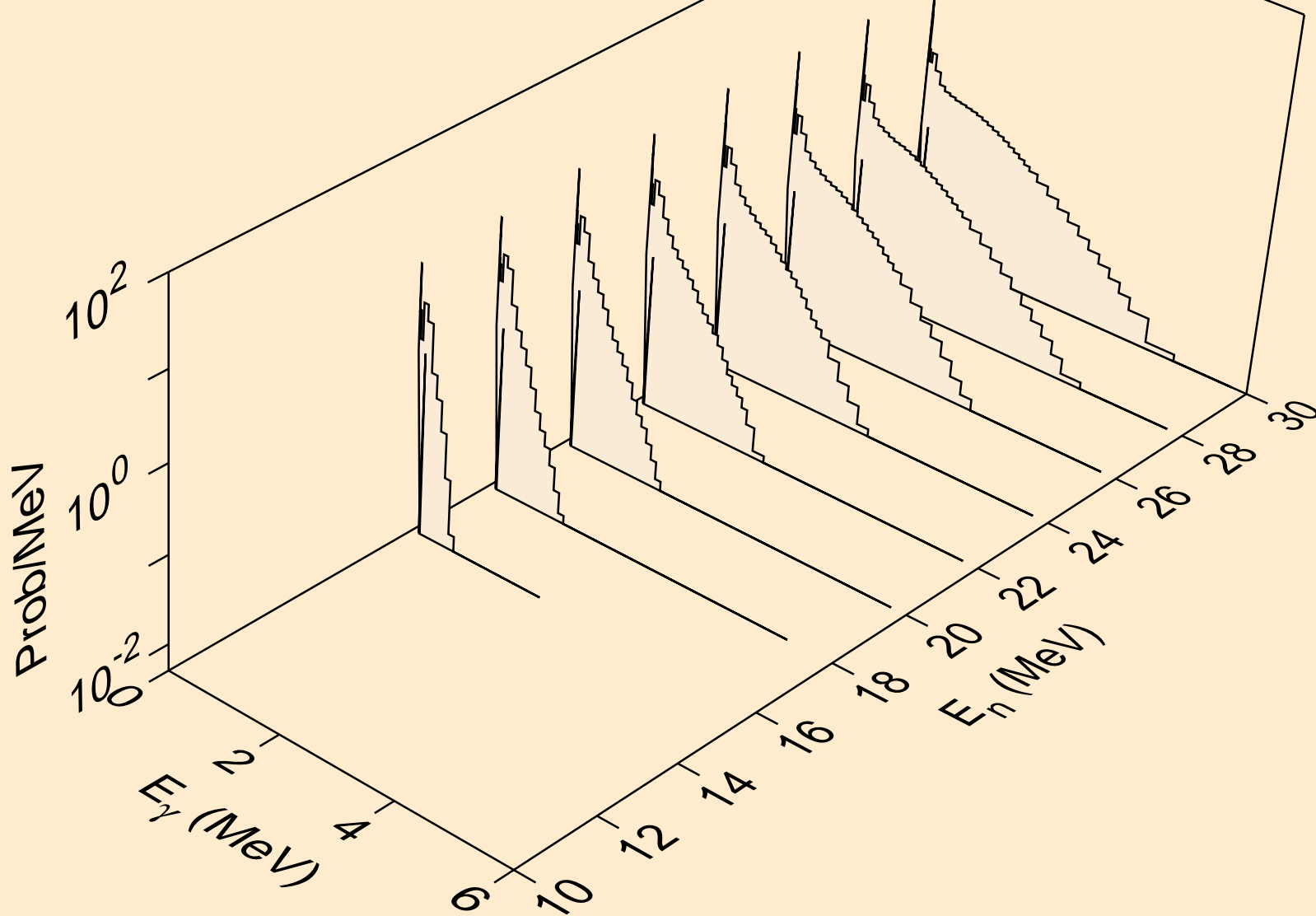



RA212 NEUTRON ACER TENDL-2019 LIBRARY; T=293.16K  
Photon emission for (n,n\*)he3

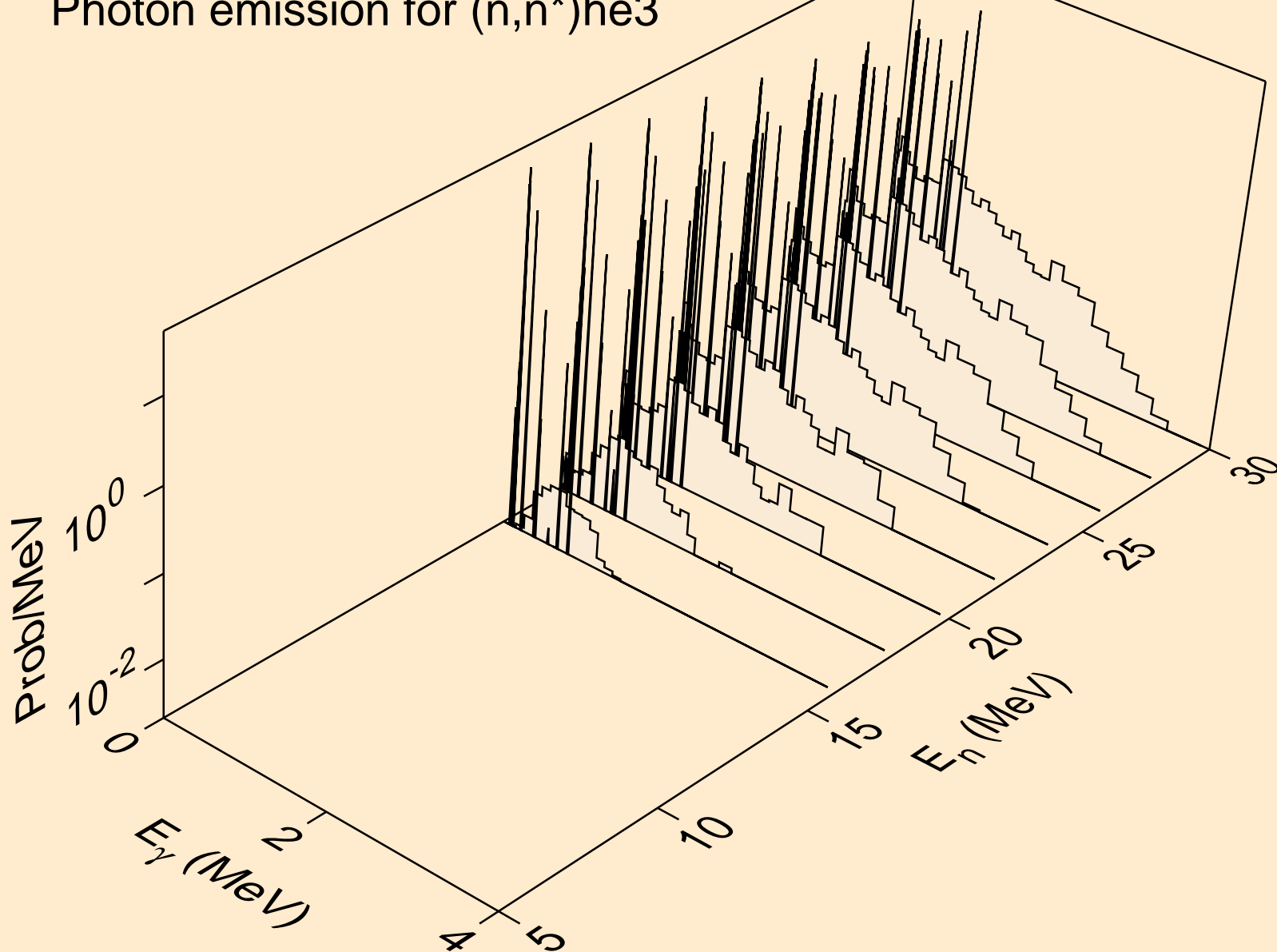

RA212 NEUTRON ACER TENDL-2019 LIBRARY; T=293.16K  
Photon emission for (n,4n)

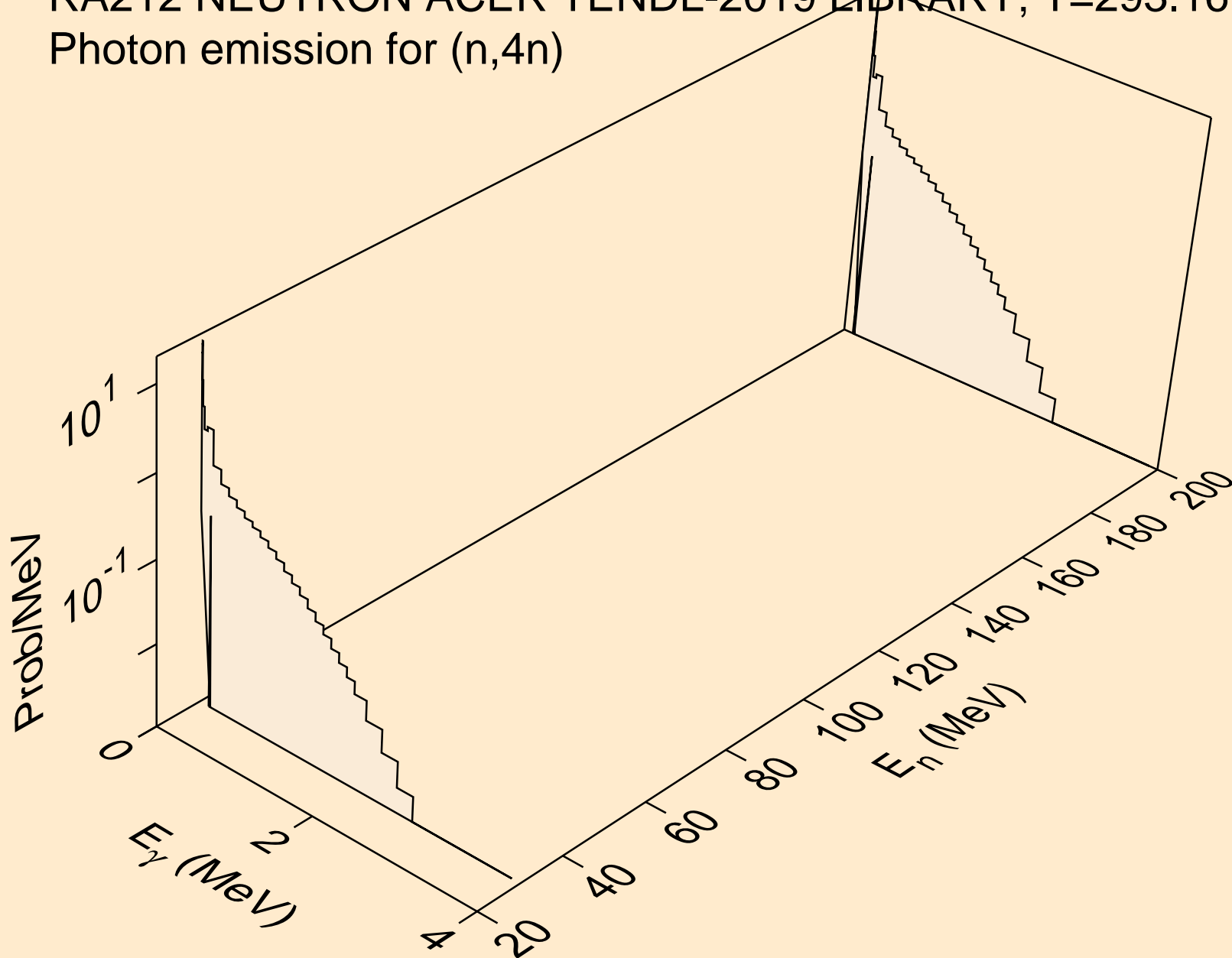

RA212 NEUTRON ACER TENDL-2019 LIBRARY; T=293.16K  
Photon emission for (n,2np)

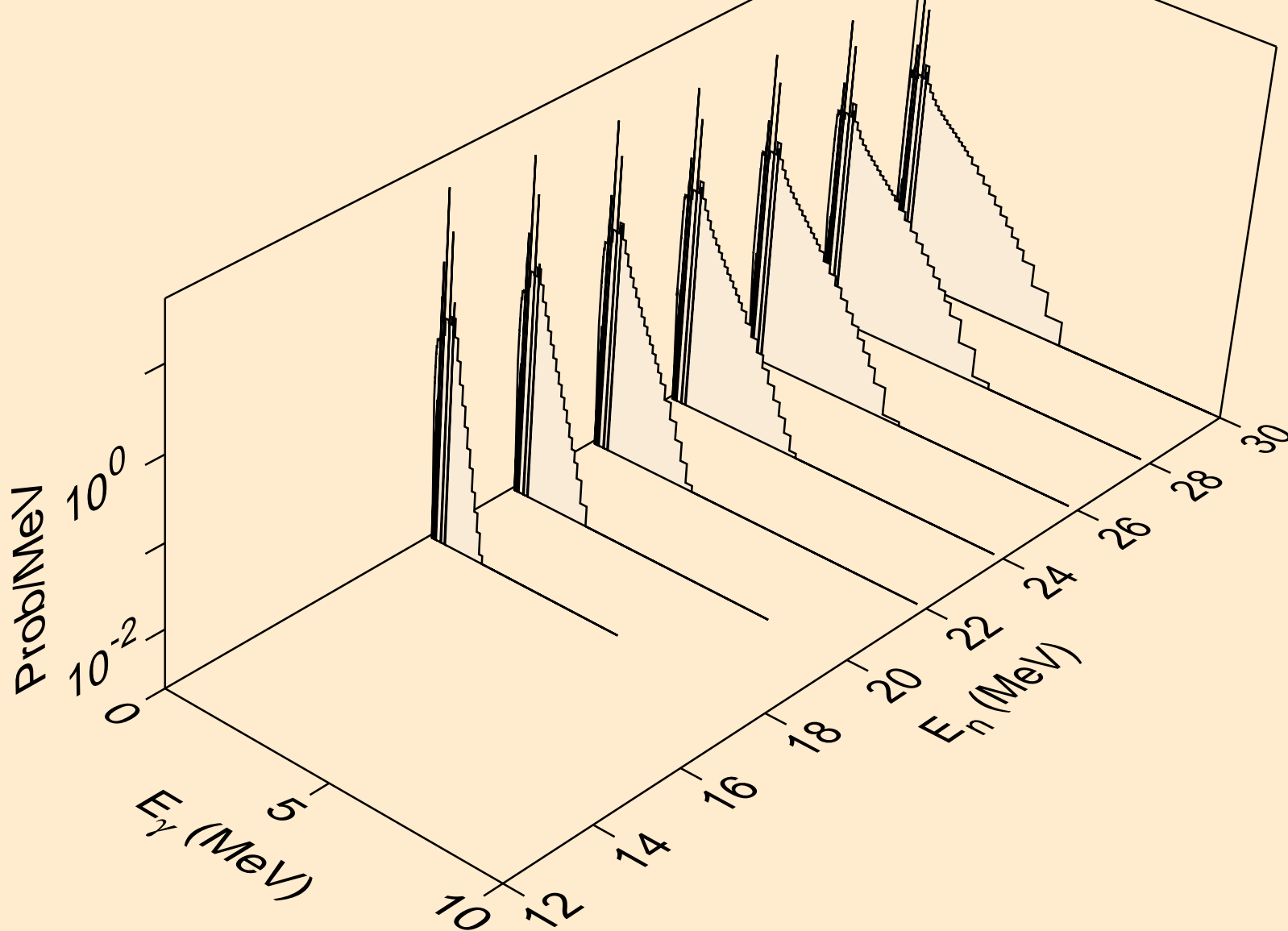

RA212 NEUTRON ACER TENDL-2019 LIBRARY; T=293.16K  
Photon emission for (n,3np)

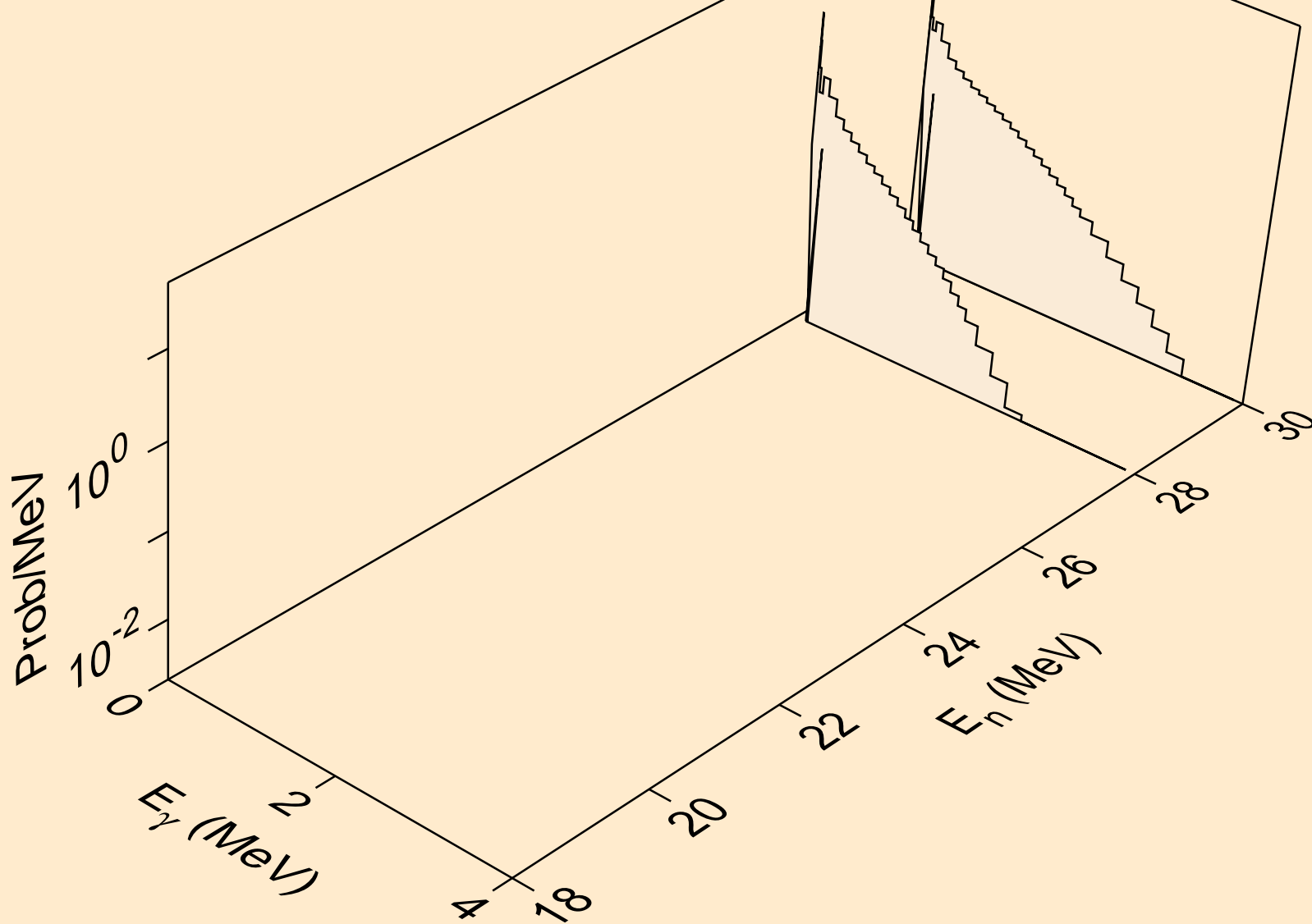

RA212 NEUTRON ACER TENDL-2019 LIBRARY; T=293.16K  
Photon emission for (n,2np)

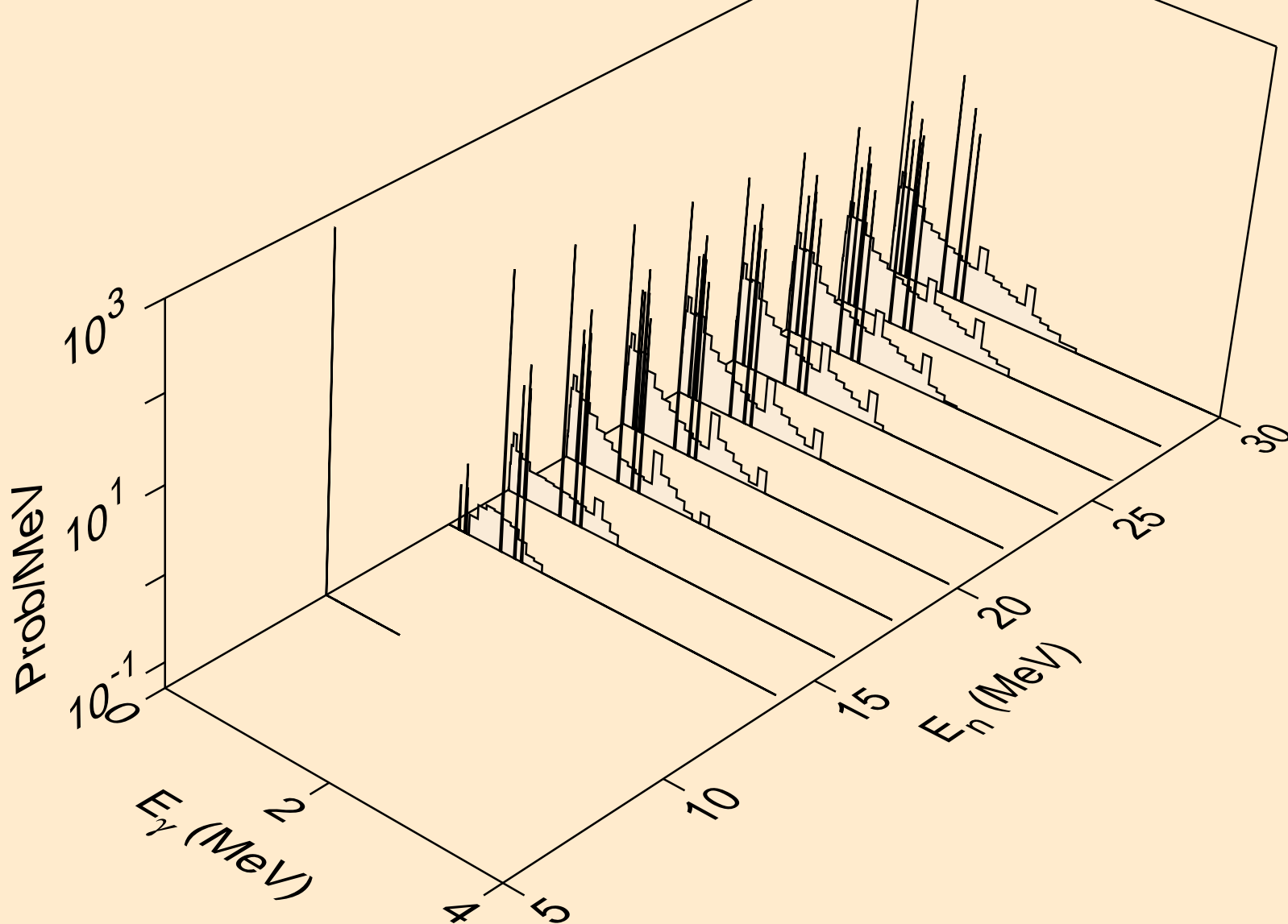

RA212 NEUTRON ACER TENDL-2019 LIBRARY; T=293.16K  
Photon emission for (n,npa)

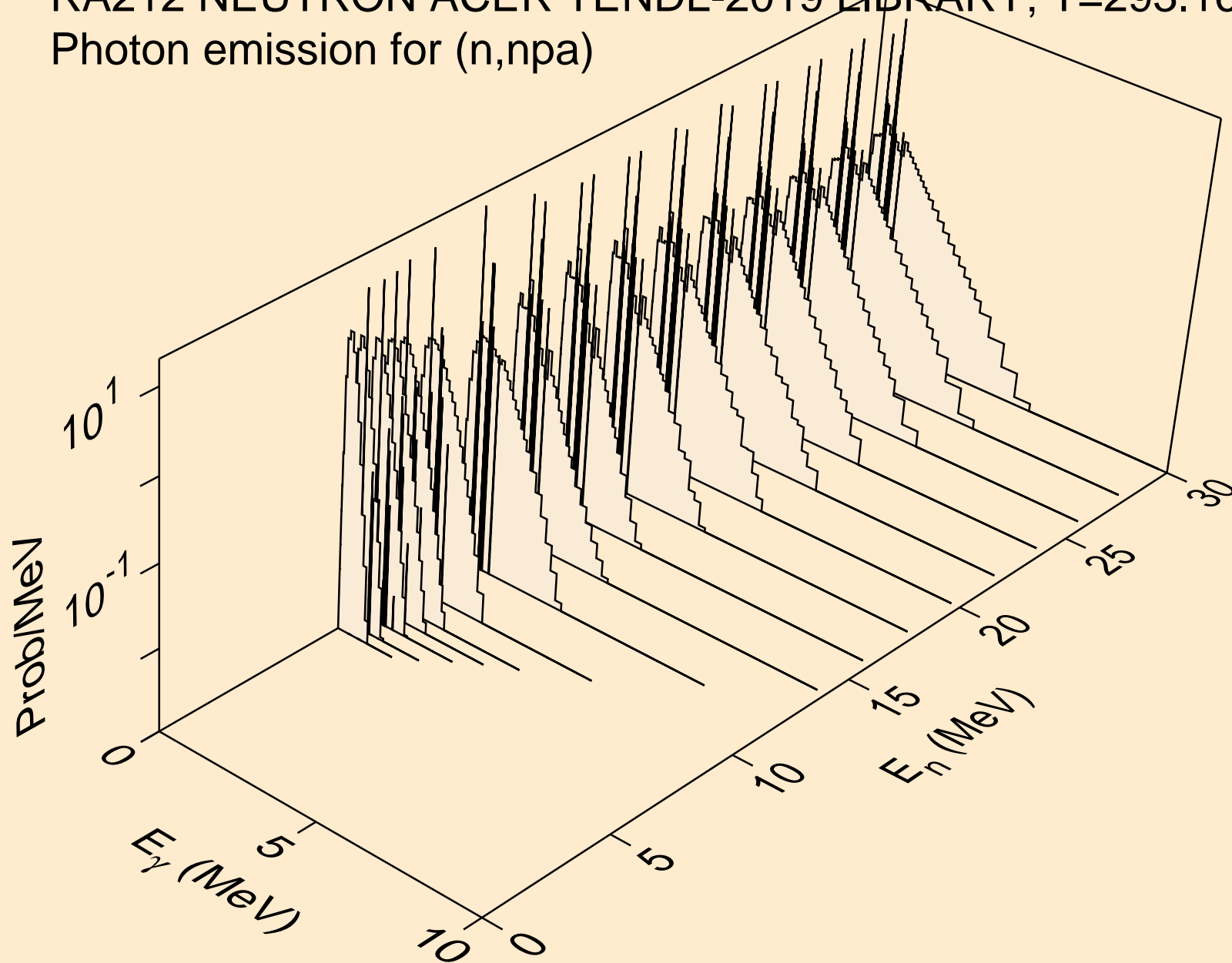

RA212 NEUTRON ACER TENDL-2019 LIBRARY; T=293.16K  
Photon emission for (n,n\*c)

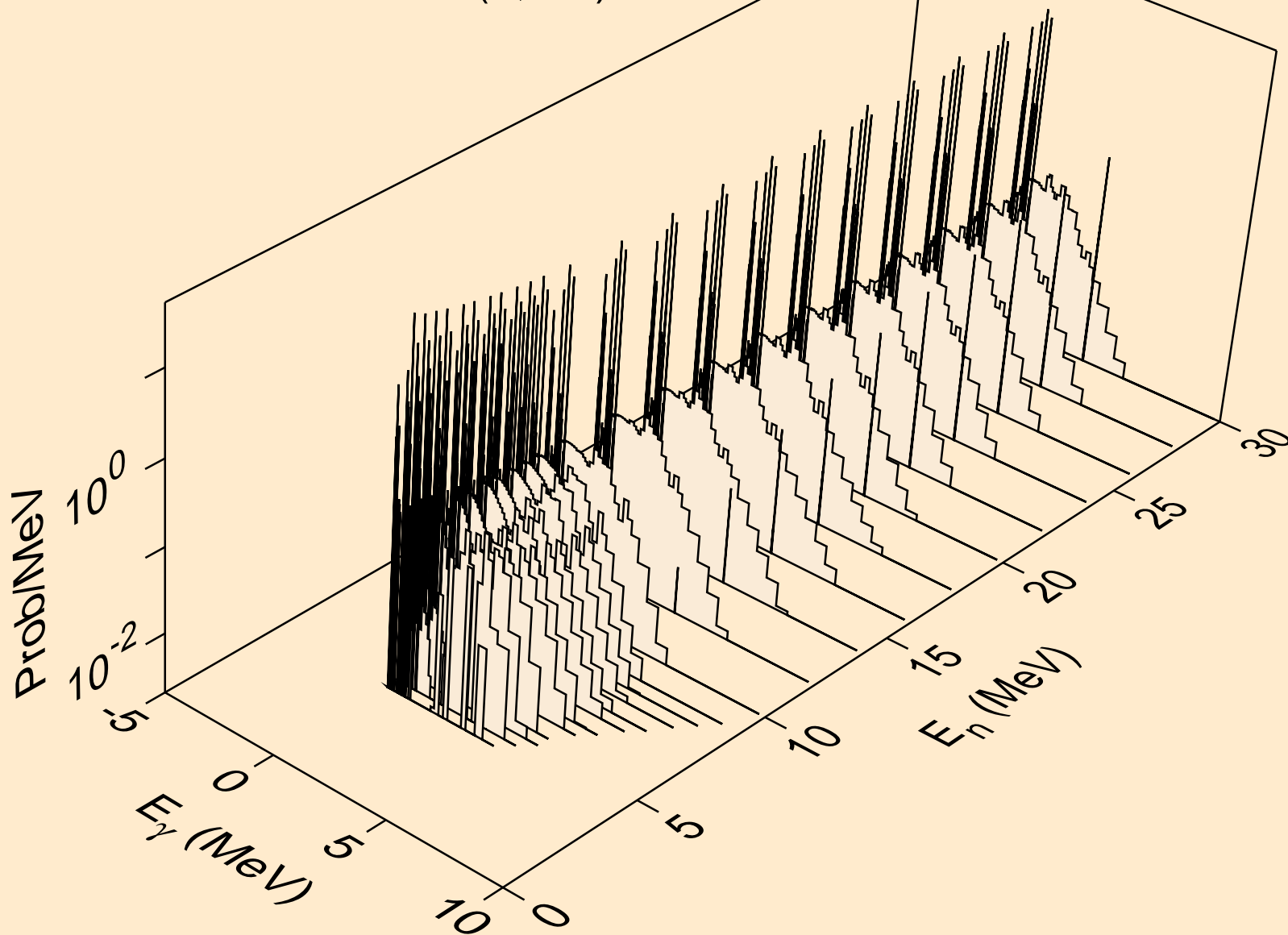

RA212 NEUTRON ACER TENDL-2019 LIBRARY; T=293.16K  
Photon emission for (n,gma)

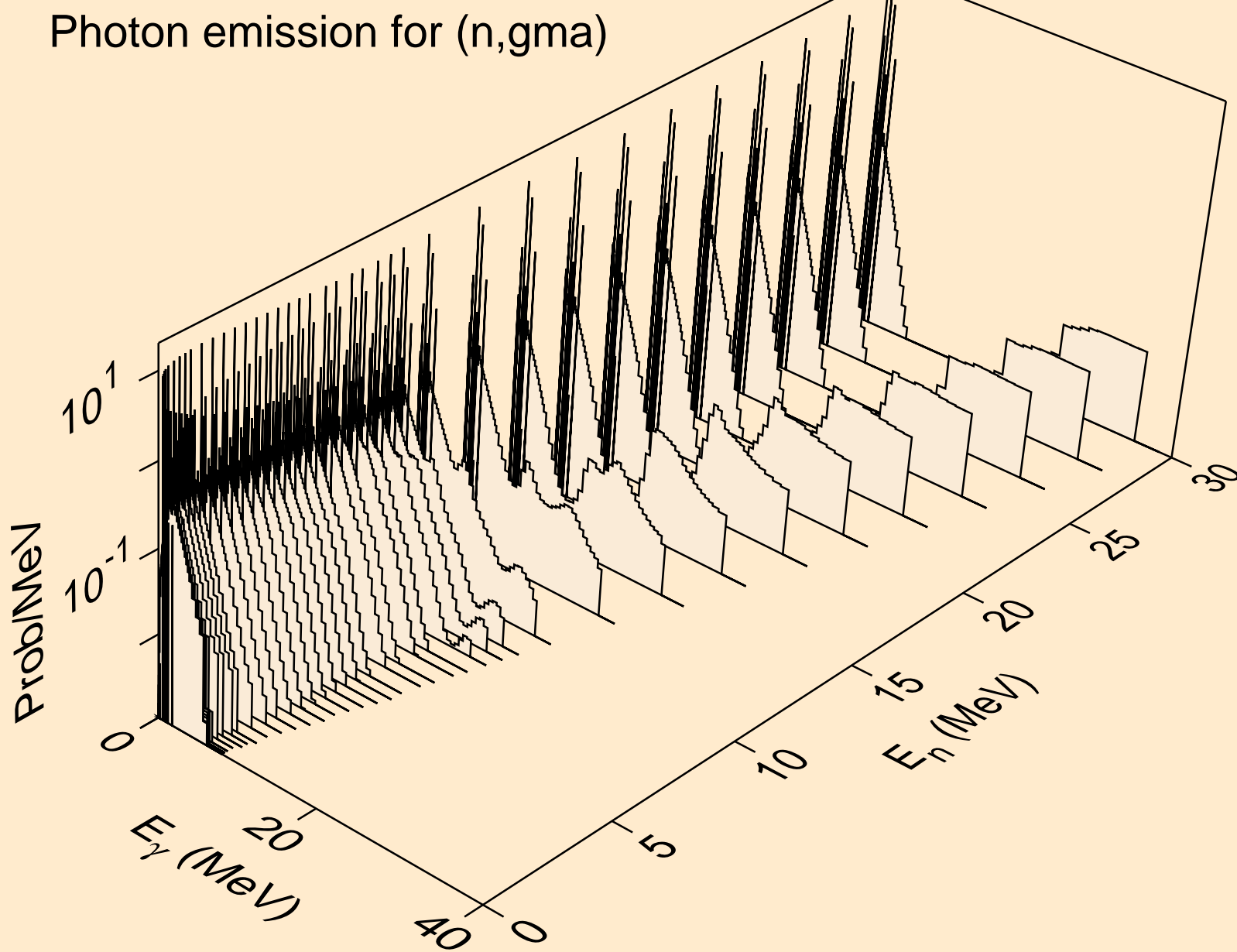



RA212 NEUTRON ACER TENDL-2019 LIBRARY; T=293.16K  
Photon emission for (n,p)

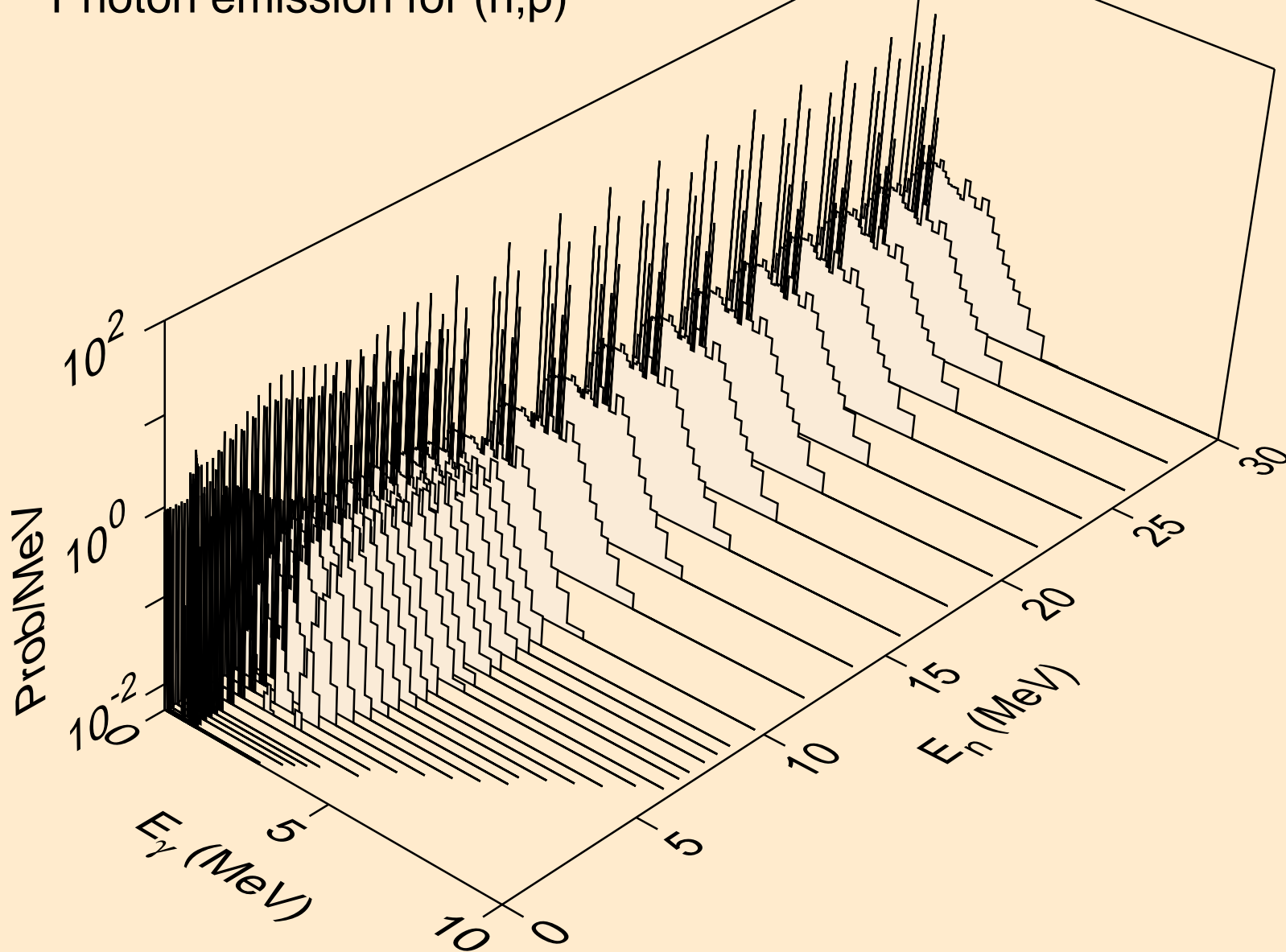

RA212 NEUTRON ACER TENDL-2019 LIBRARY; T=293.16K  
Photon emission for (n,d)

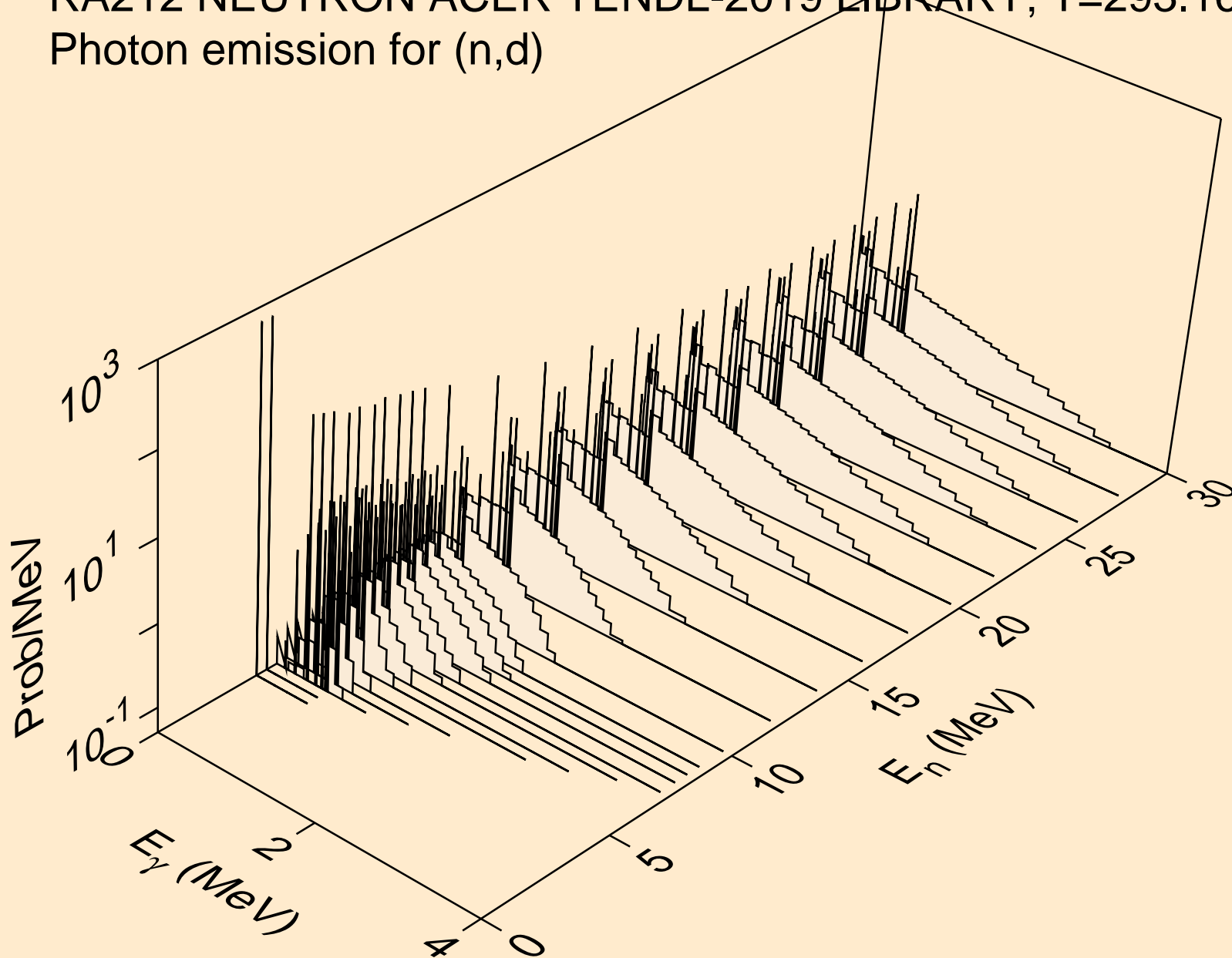

RA212 NEUTRON ACER TENDL-2019 LIBRARY; T=293.16K  
Photon emission for (n,t)

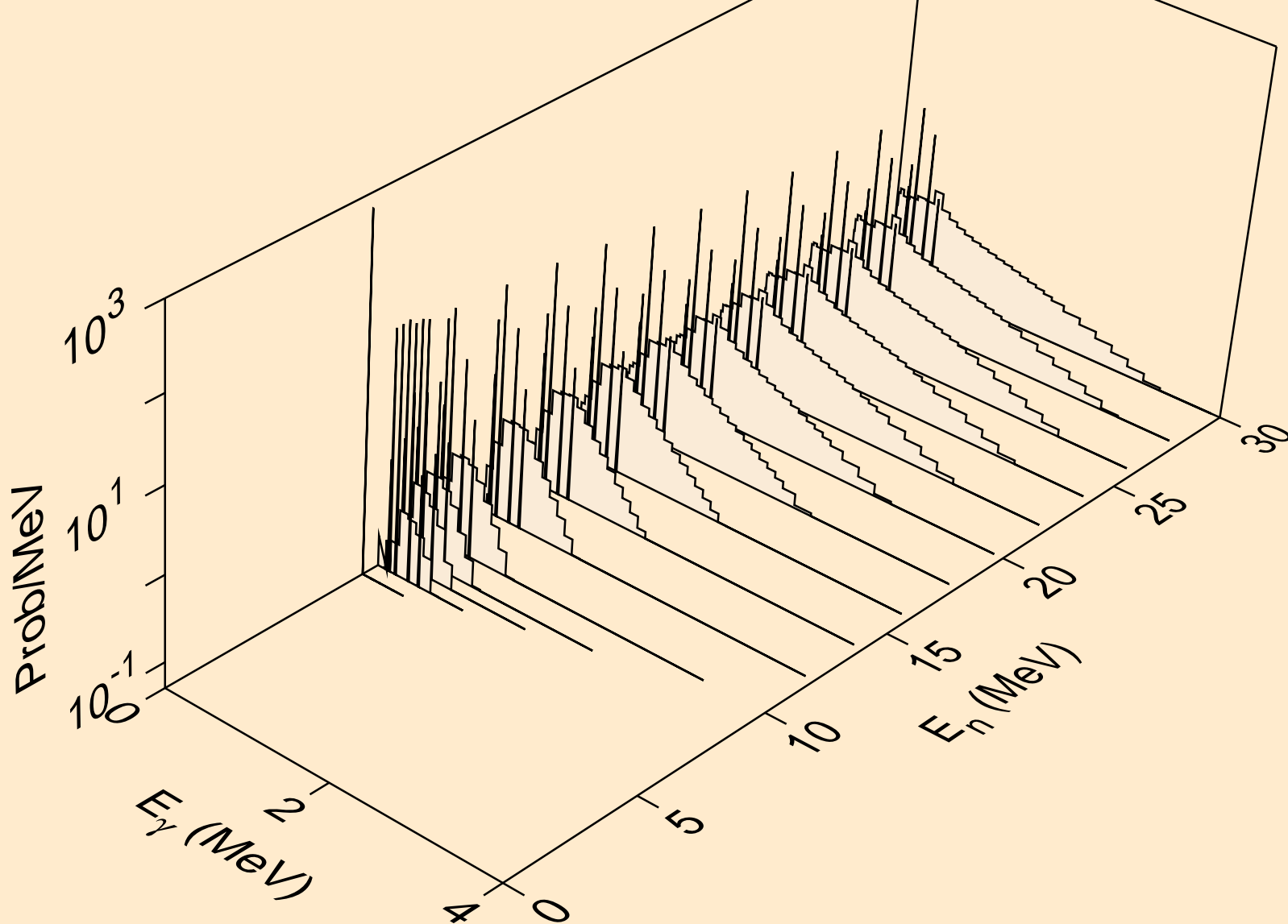

RA212 NEUTRON ACER TENDL-2019 LIBRARY; T=293.16K  
Photon emission for (n,he3)

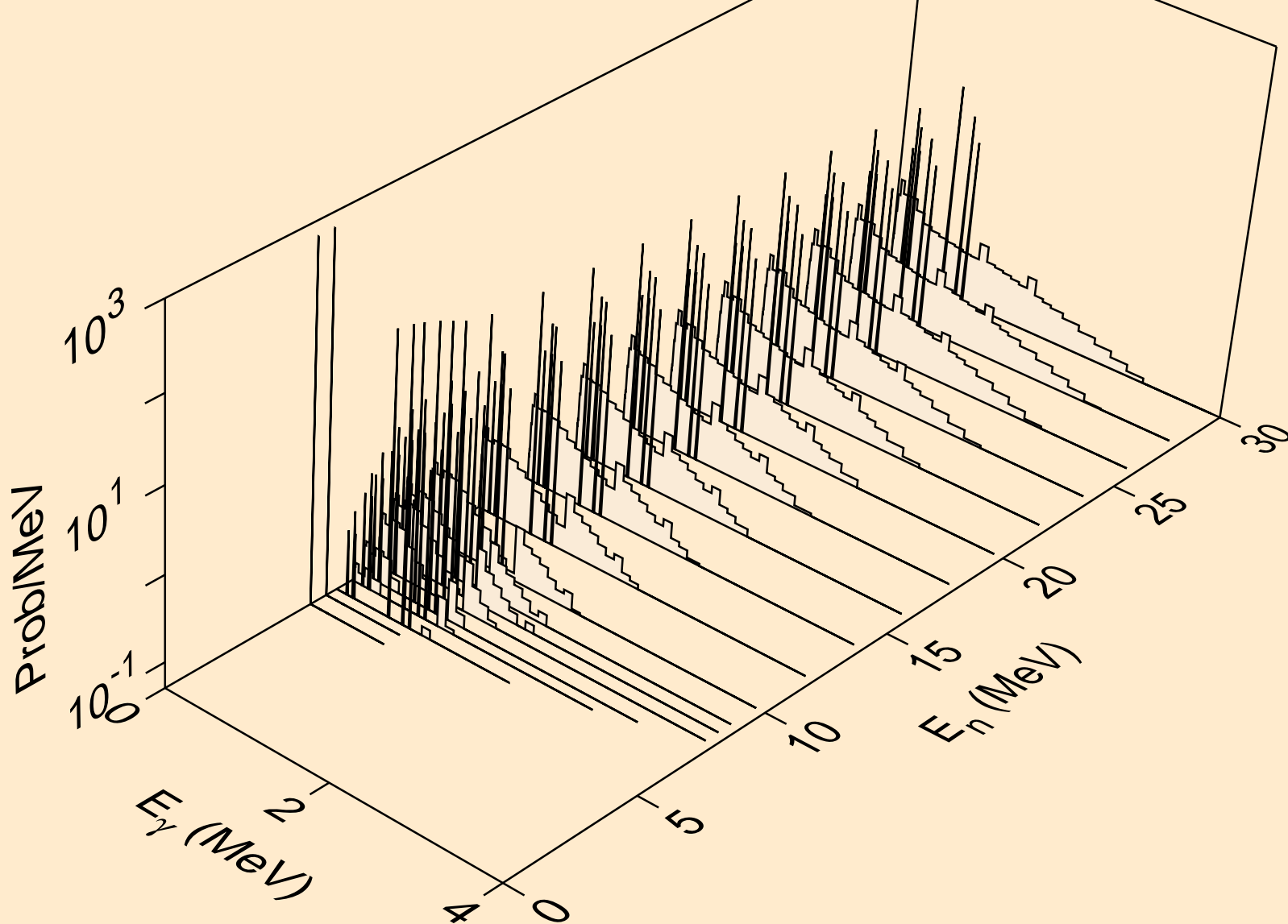

RA212 NEUTRON ACER TENDL-2019 LIBRARY; T=293.16K  
Photon emission for (n,a)

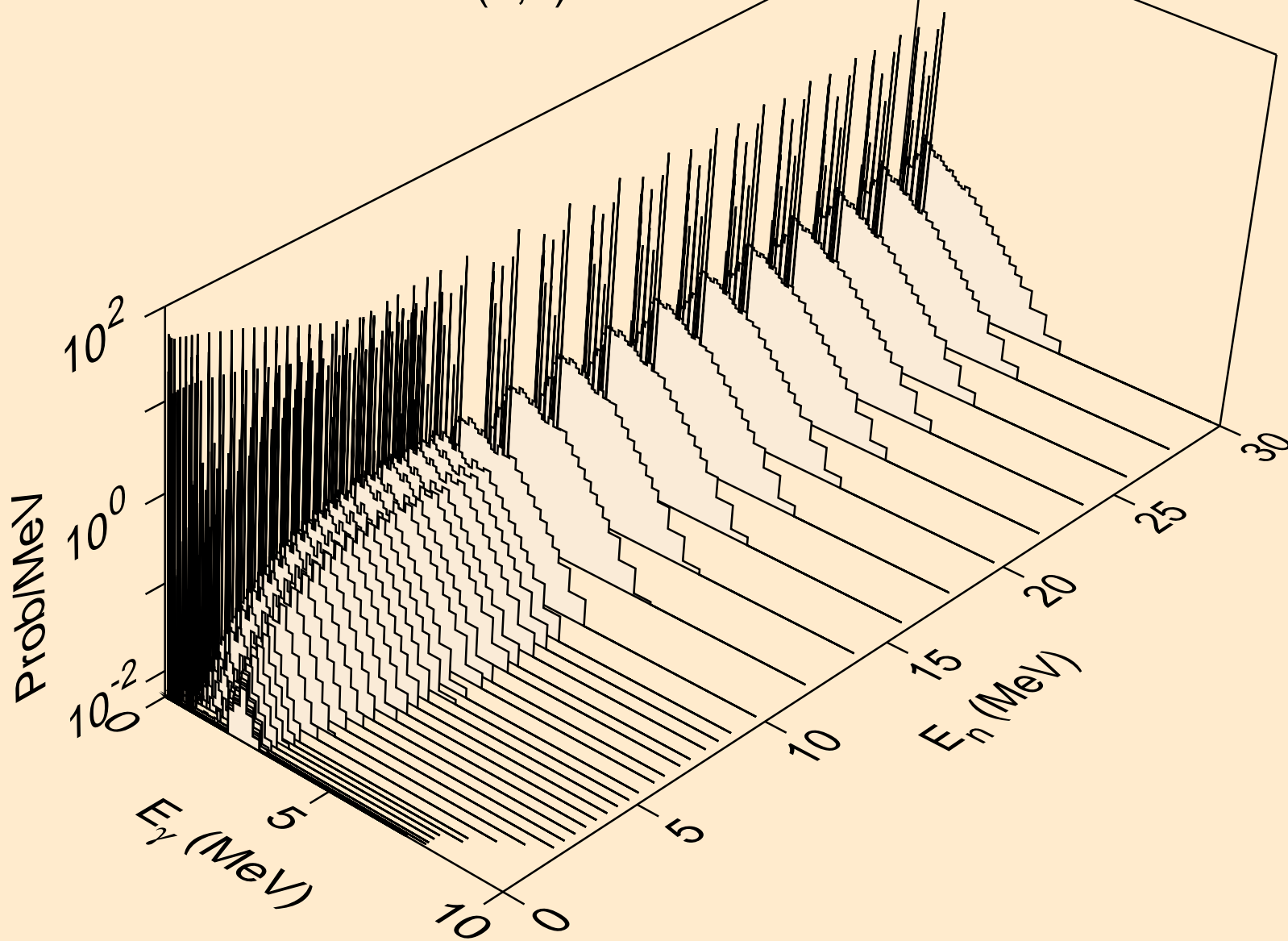

RA212 NEUTRON ACER TENDL-2019 LIBRARY; T=293.16K  
Photon emission for (n,2a)

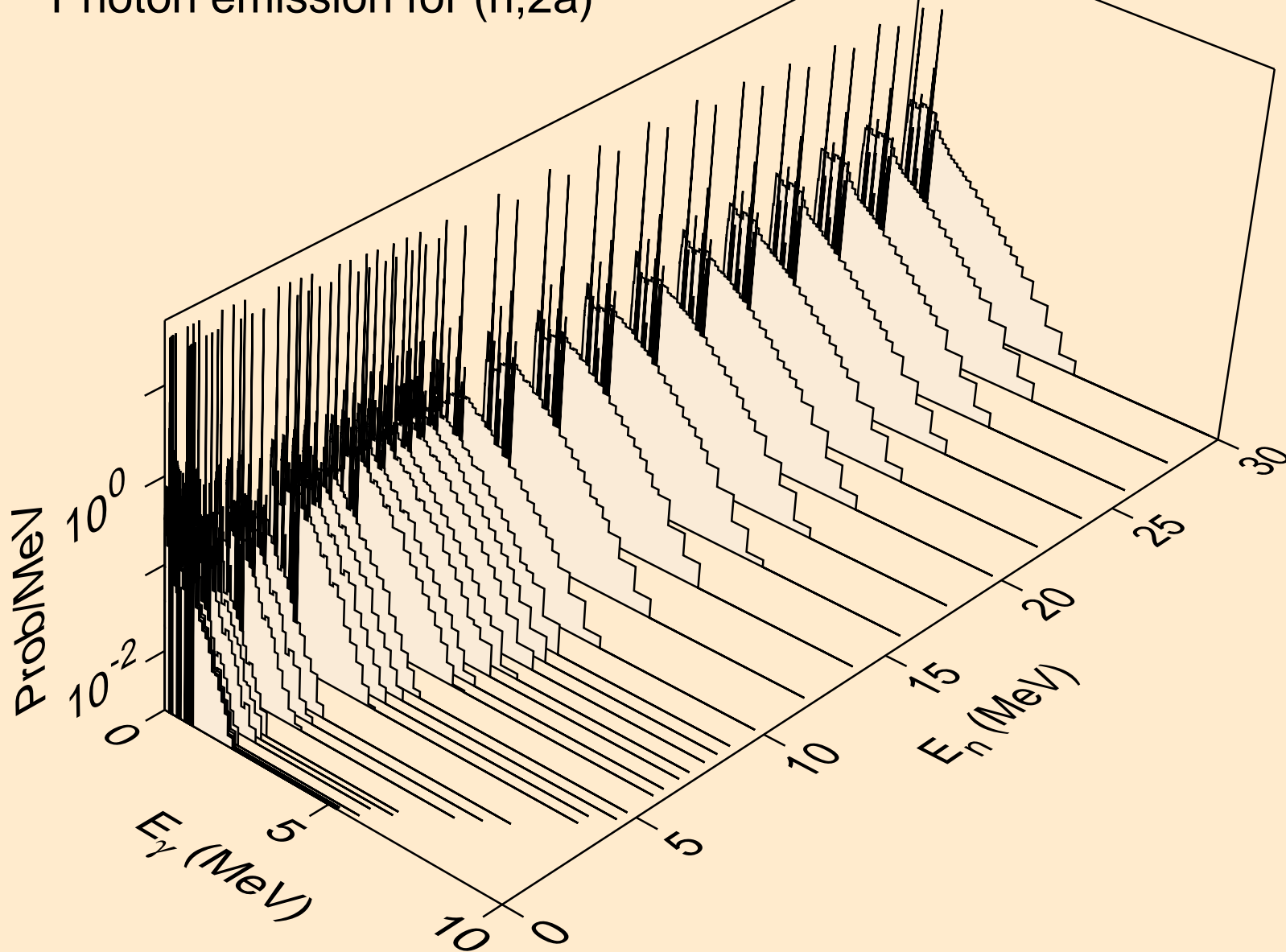

RA212 NEUTRON ACER TENDL-2019 LIBRARY; T=293.16K  
Photon emission for (n,2p)

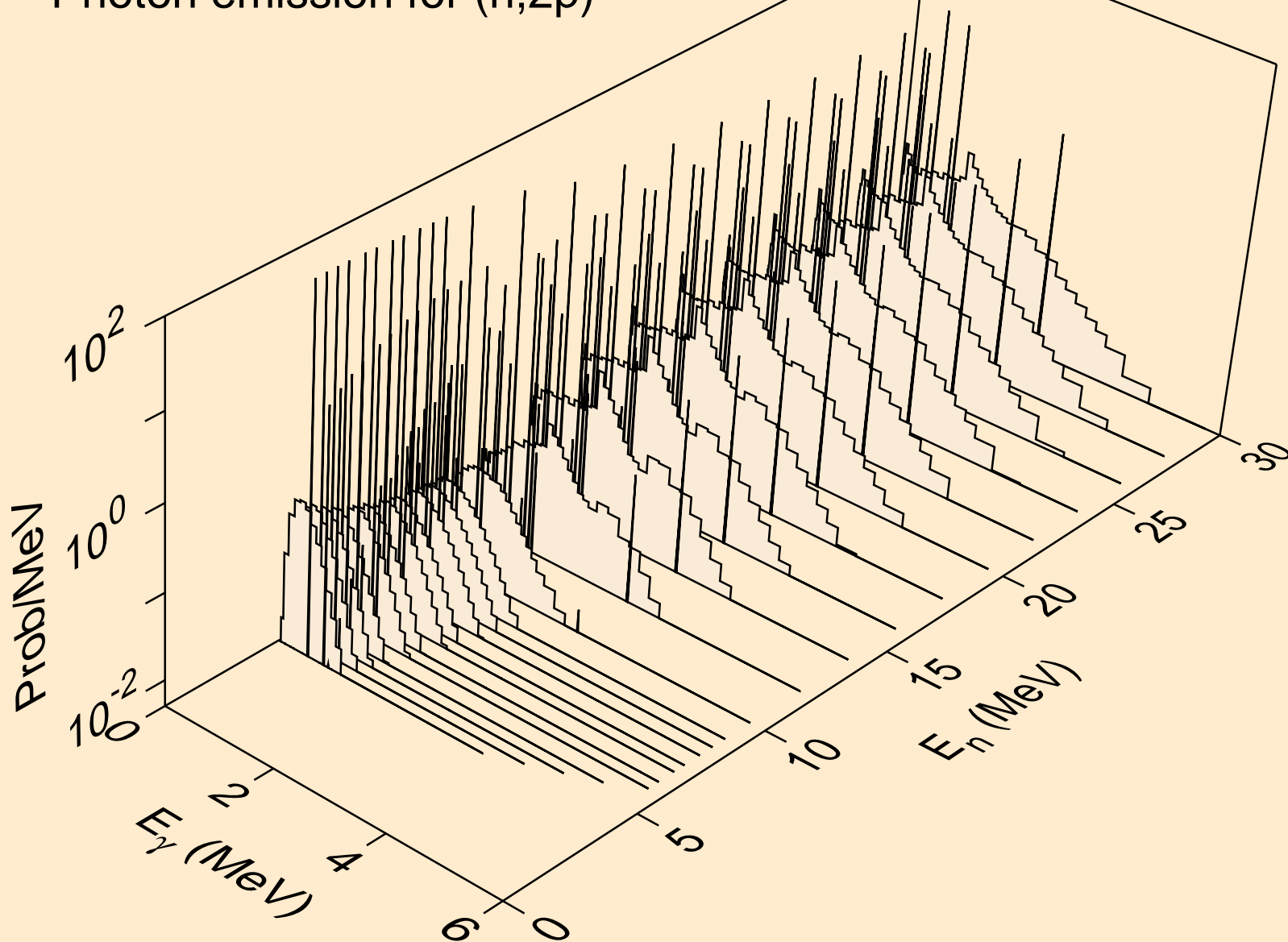

RA212 NEUTRON ACER TENDL-2019 LIBRARY; T=293.16K  
Photon emission for (n,p $\alpha$ )

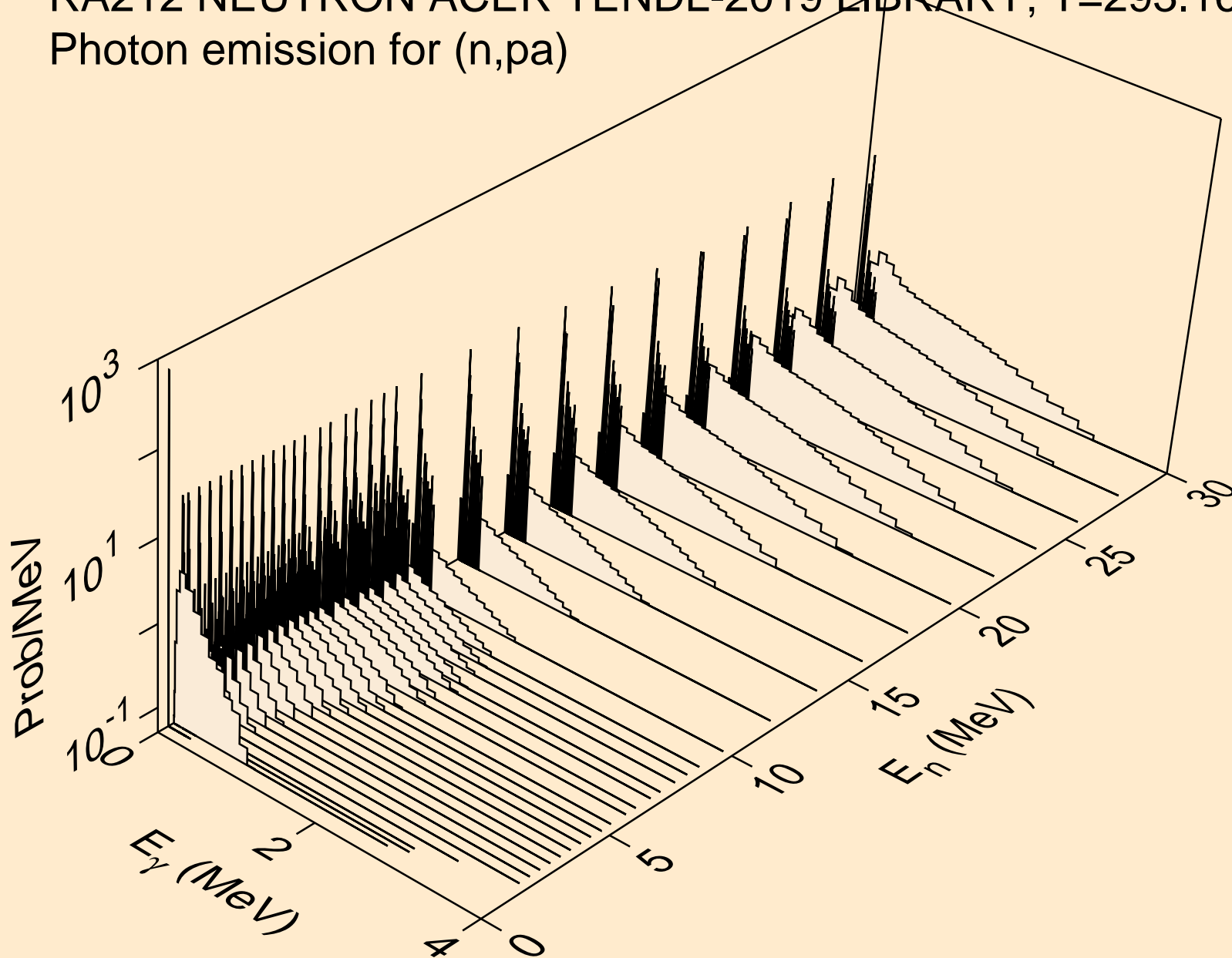



RA212 NEUTRON ACER TENDL-2019 LIBRARY; T=293.16K  
Photon emission for (n,pd)

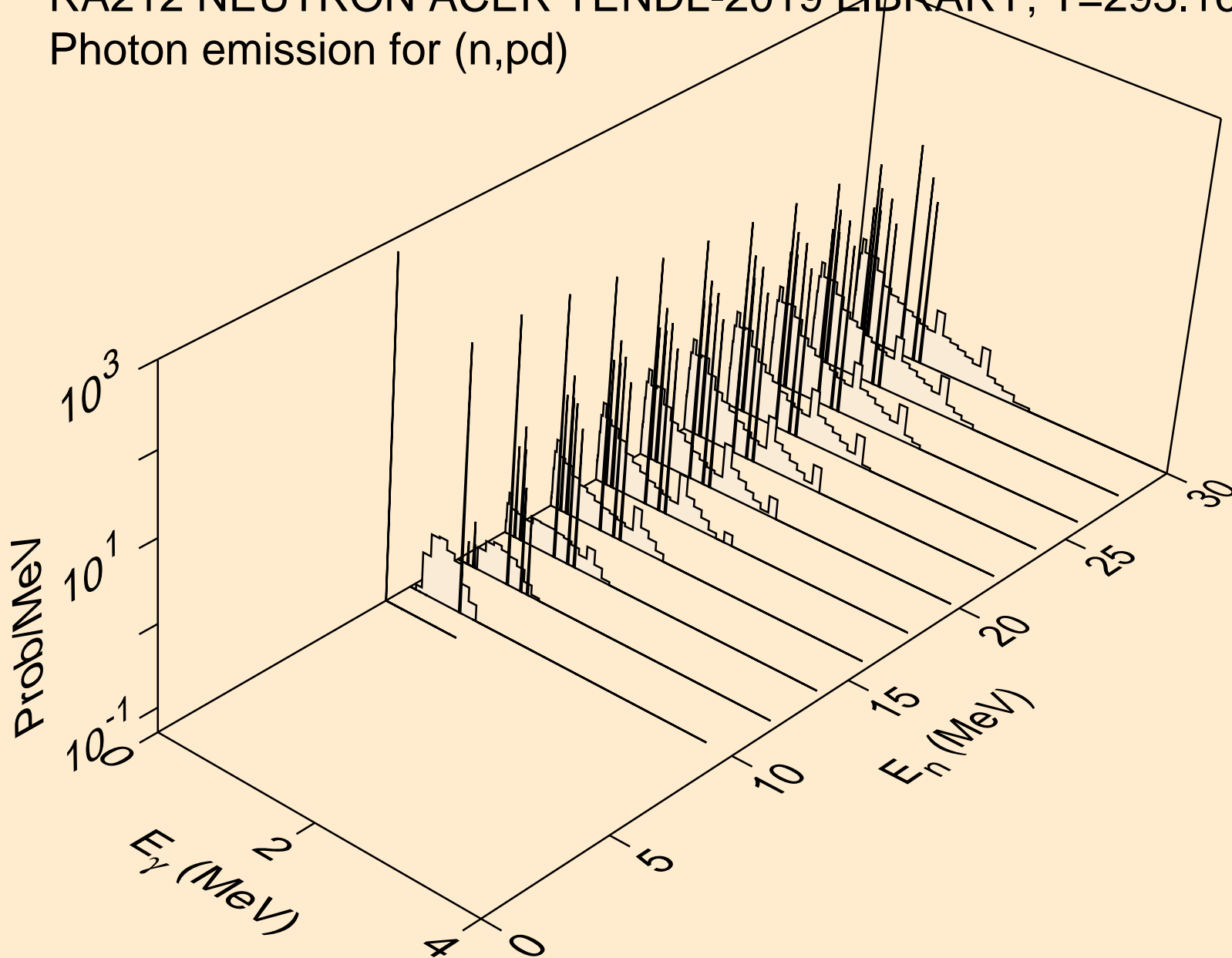

RA212 NEUTRON ACER TENDL-2019 LIBRARY; T=293.16K  
Photon emission for (n,pt)

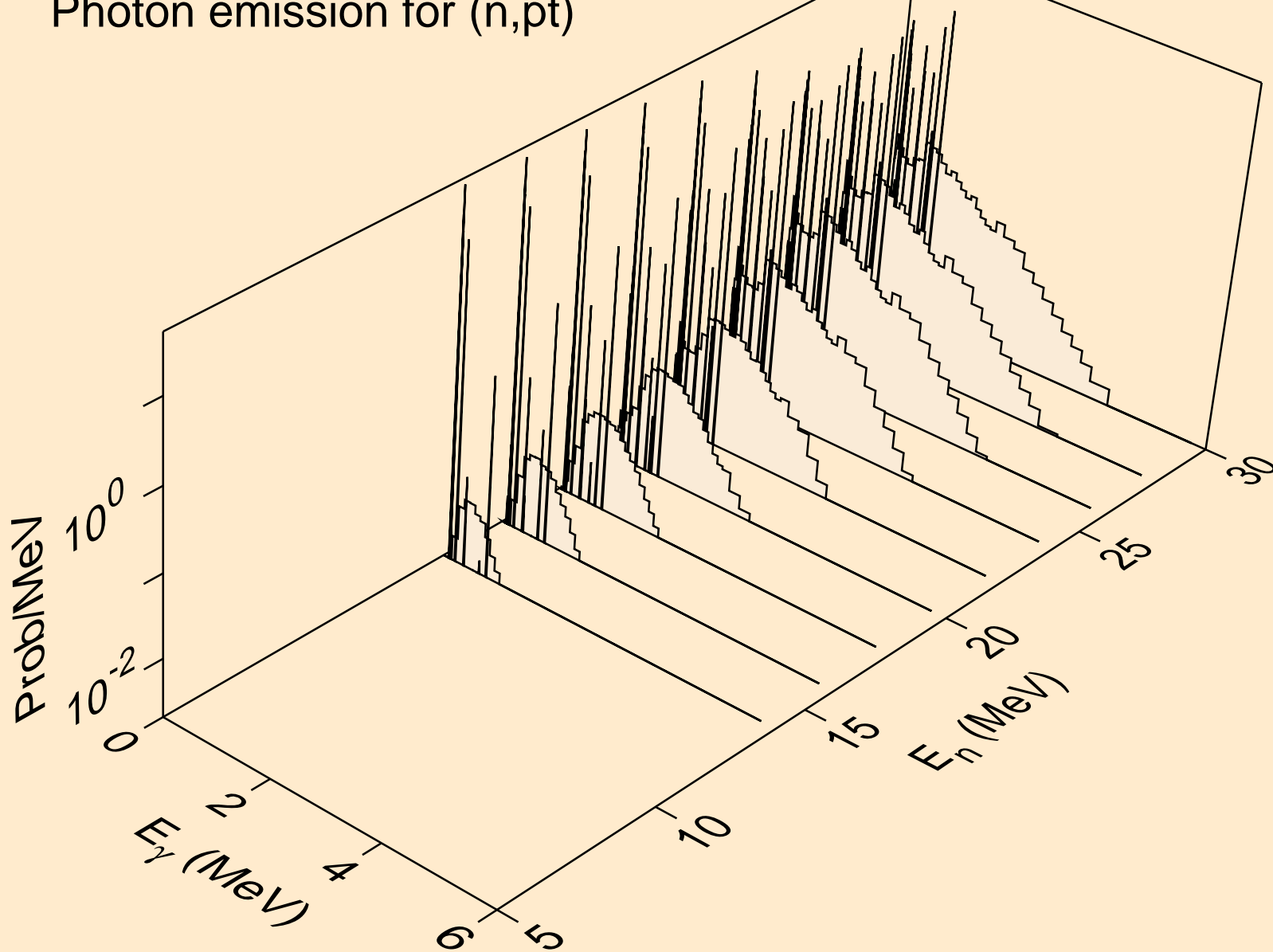

RA212 NEUTRON ACER TENDL-2019 LIBRARY; T=293.16K  
Photon emission for (n,da)

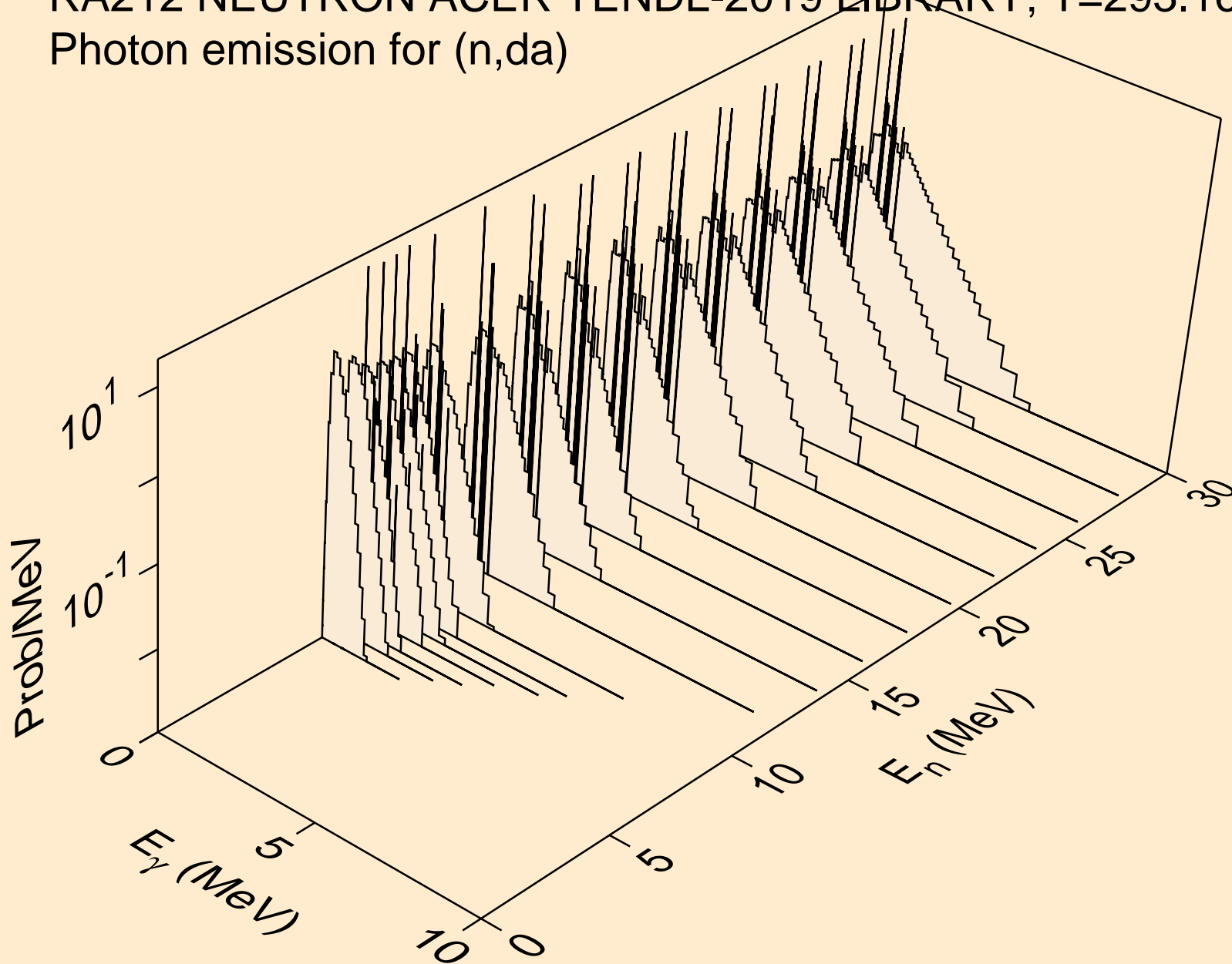

RA212 NEUTRON ACER TENDL-2019 LIBRARY; T=293.16K  
thermal capture photon spectrum

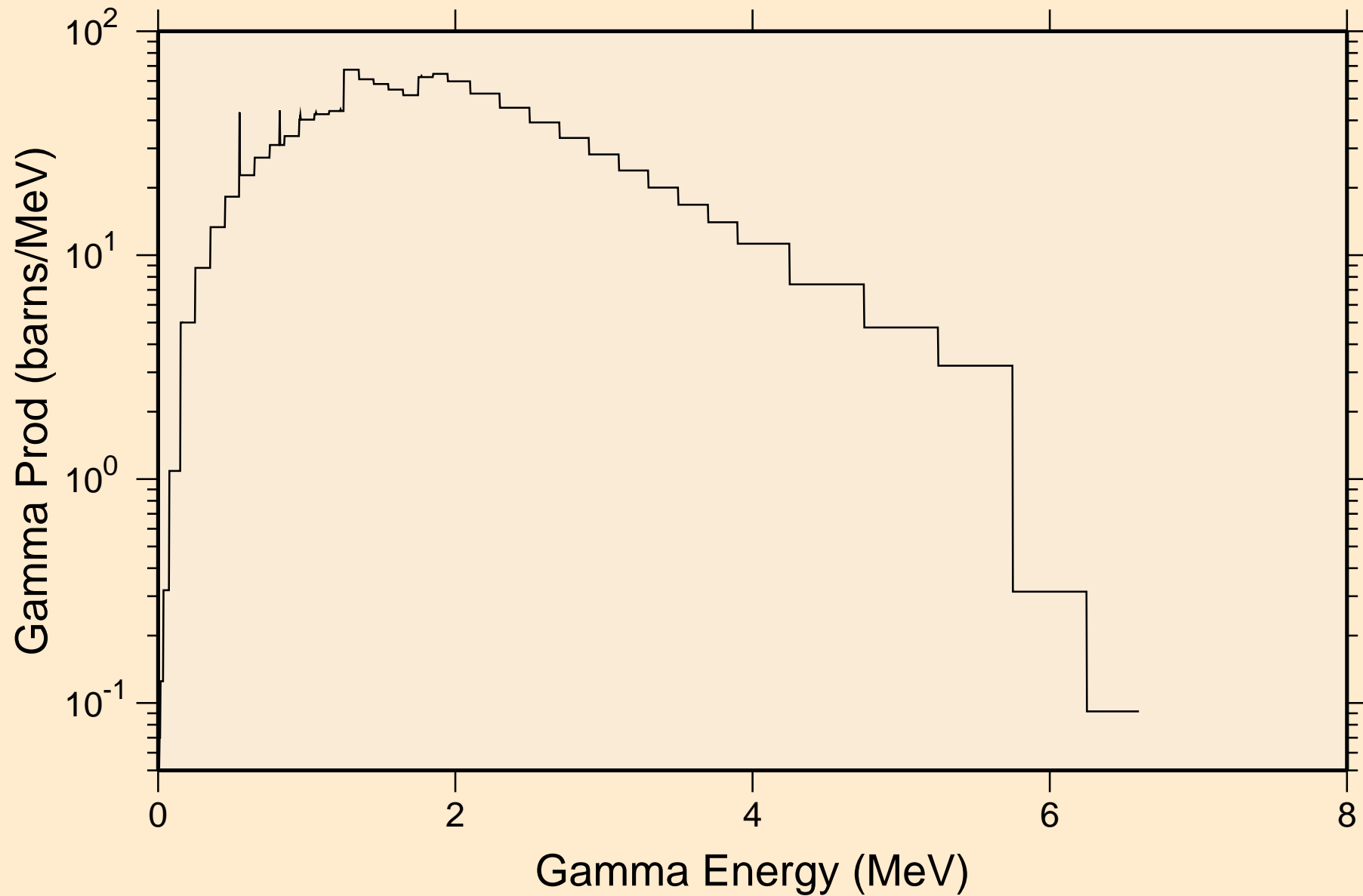

RA212 NEUTRON ACER TENDL-2019 LIBRARY; T=293.16K  
14 MeV photon spectrum

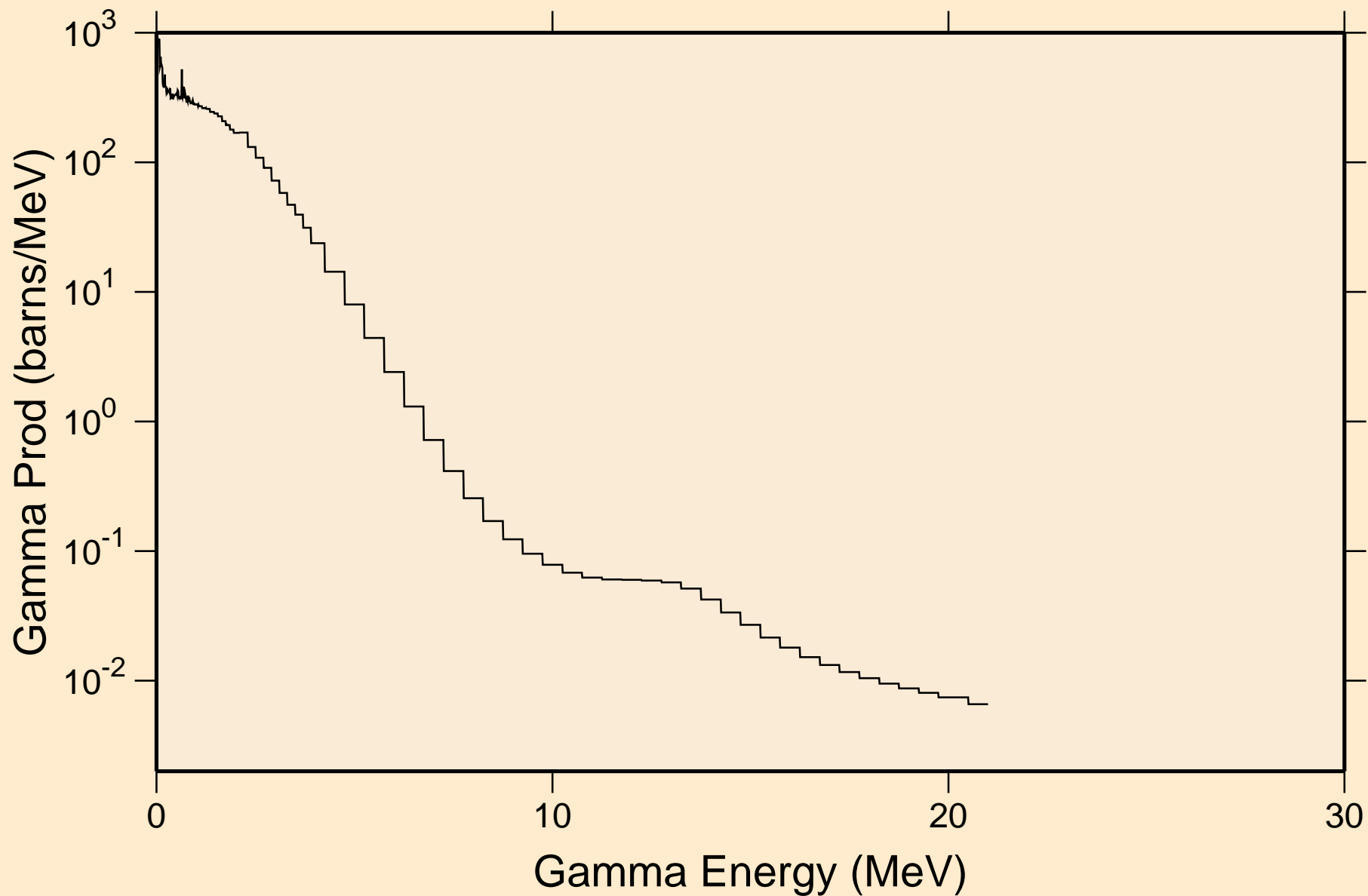

RA212 NEUTRON ACER TENDL-2019 LIBRARY; T=293.16K  
Particle heating contributions

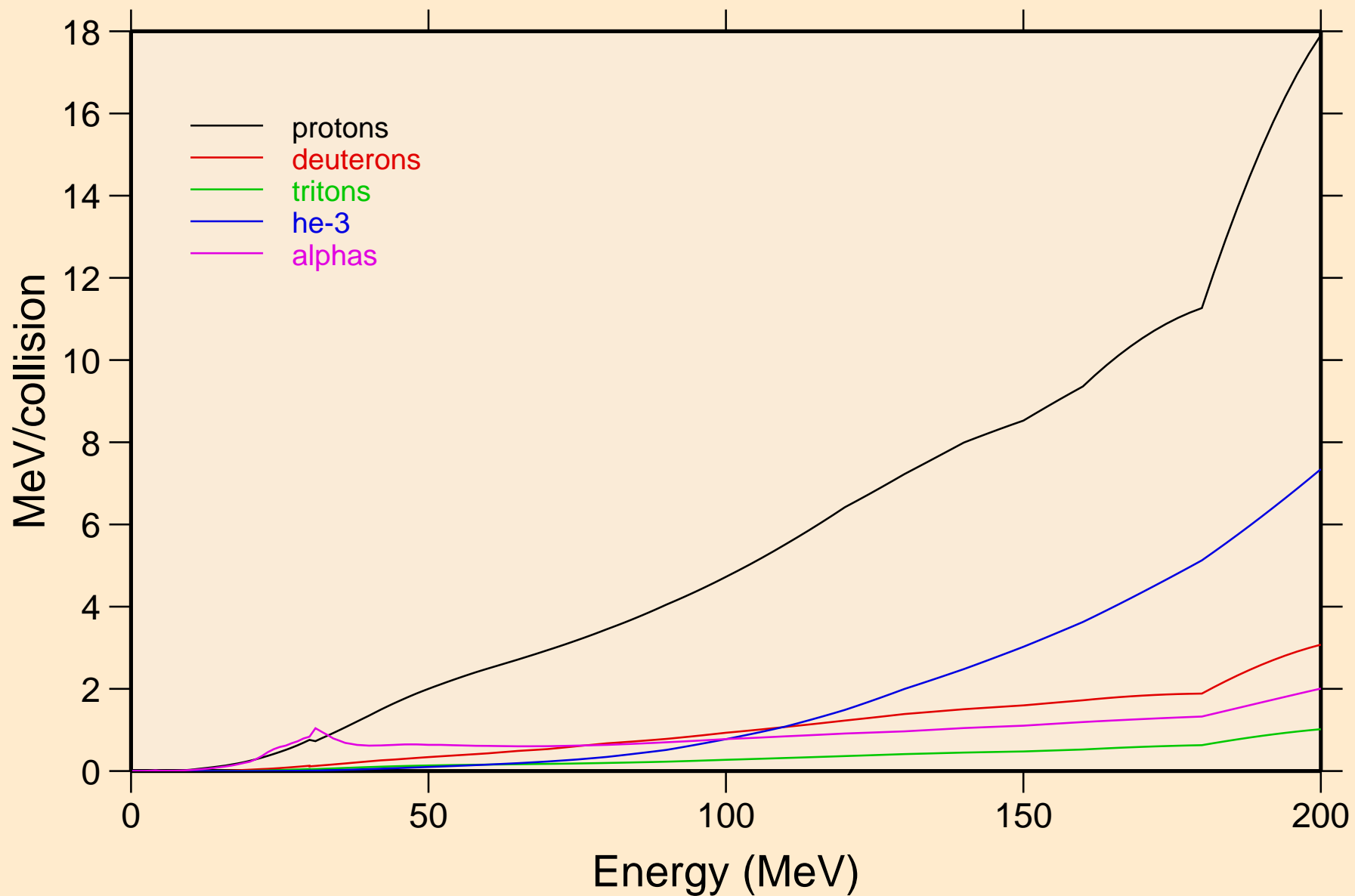

RA212 NEUTRON ACER TENDL-2019 LIBRARY; T=293.16K  
Recoil Heating

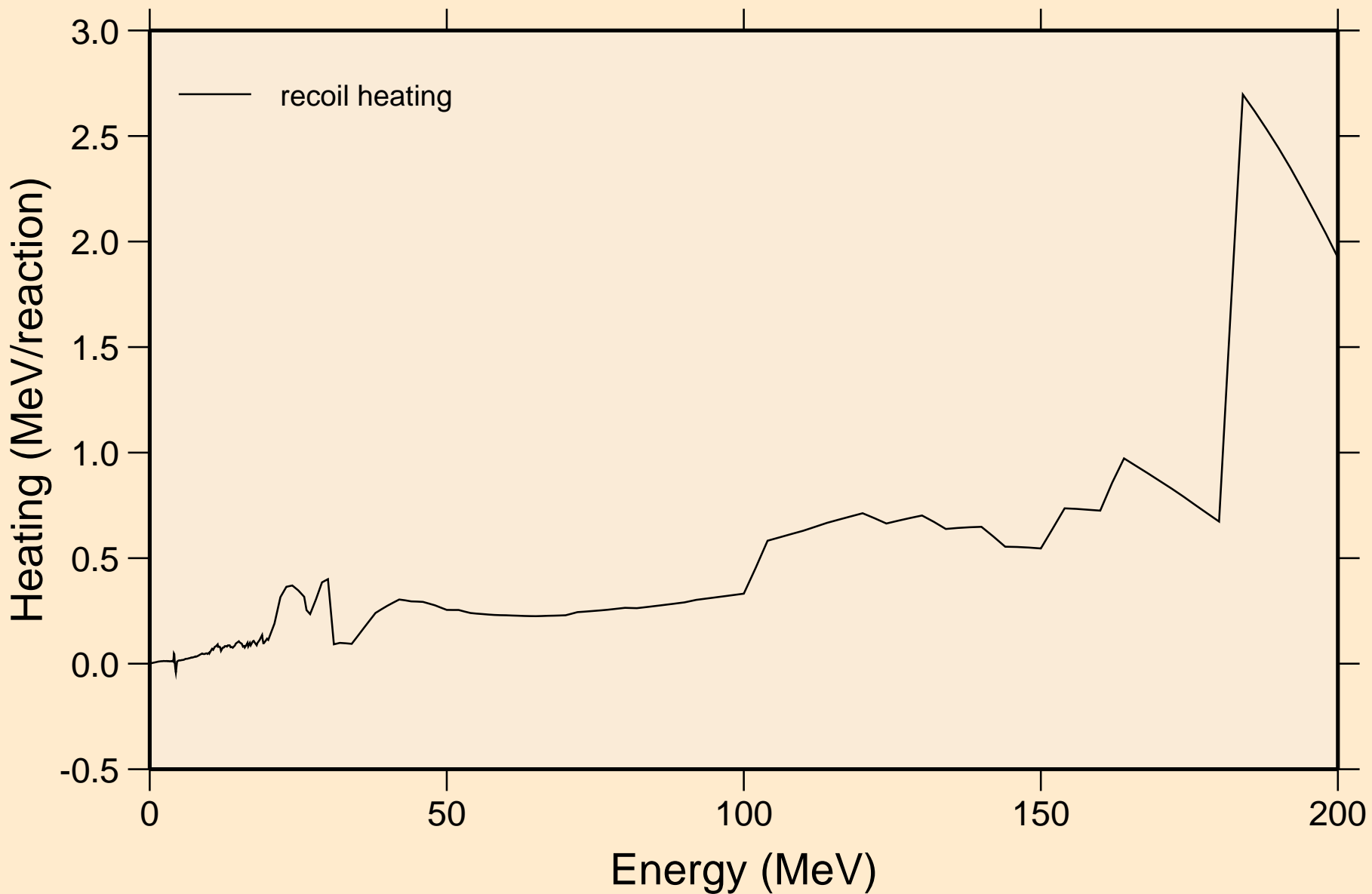

RA212 NEUTRON ACER TENDL-2019 LIBRARY; T=293.16K  
Particle production cross sections

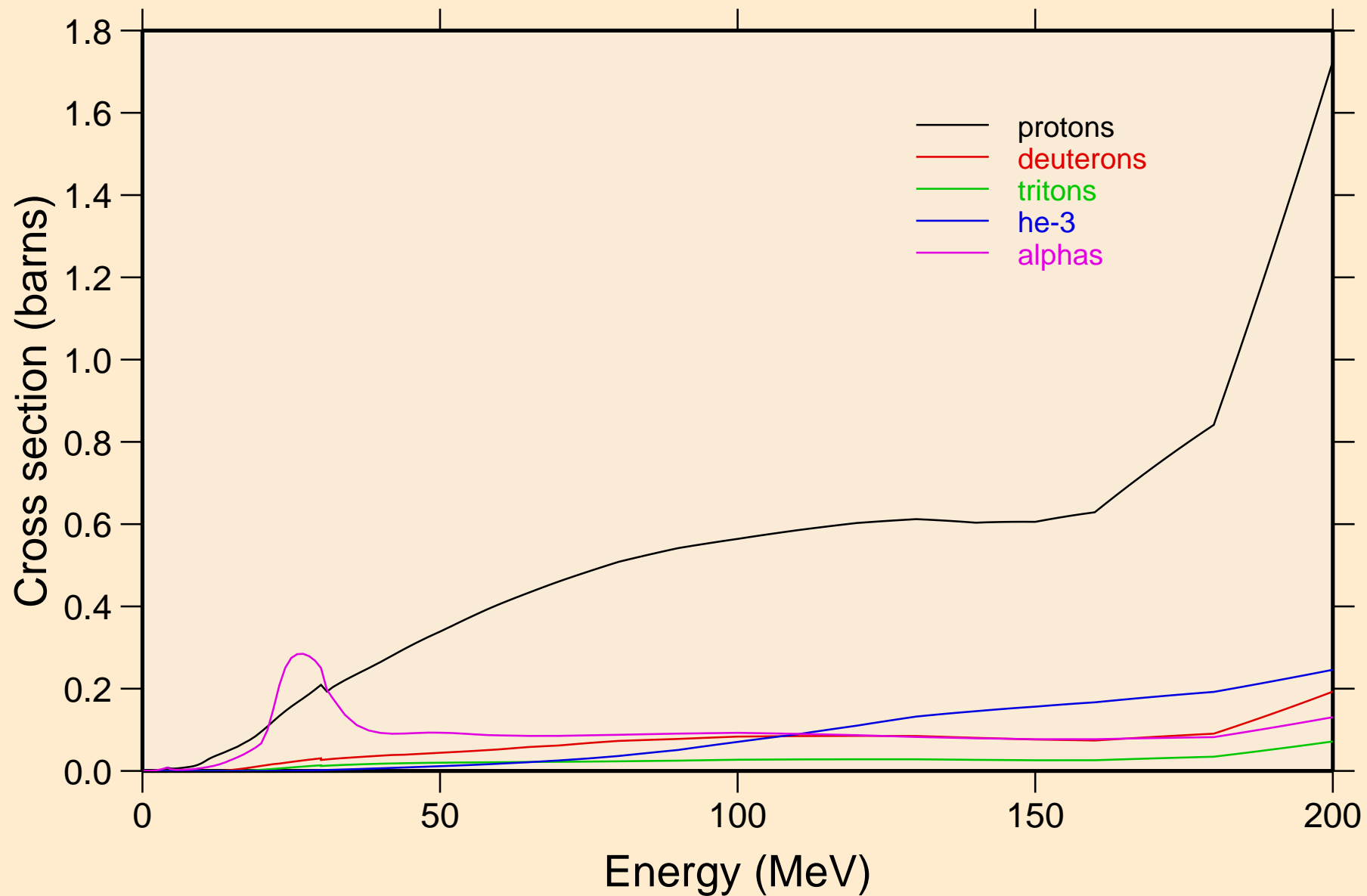



RA212 NEUTRON ACER TENDL-2019 LIBRARY; T=293.16K  
protons from (n,x)

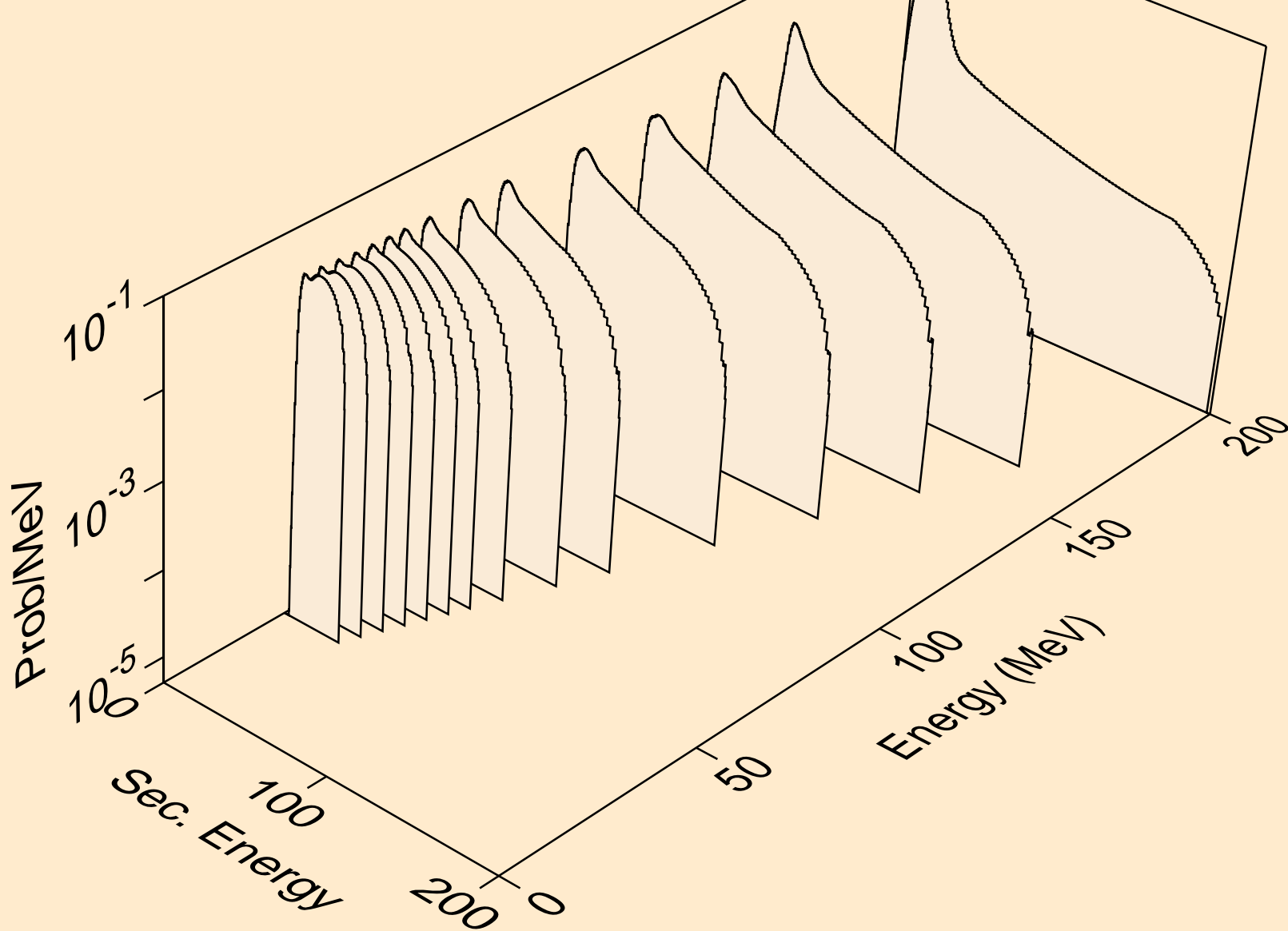

RA212 NEUTRON ACER TENDL-2019 LIBRARY; T=293.16K  
protons from (n,n\*)p

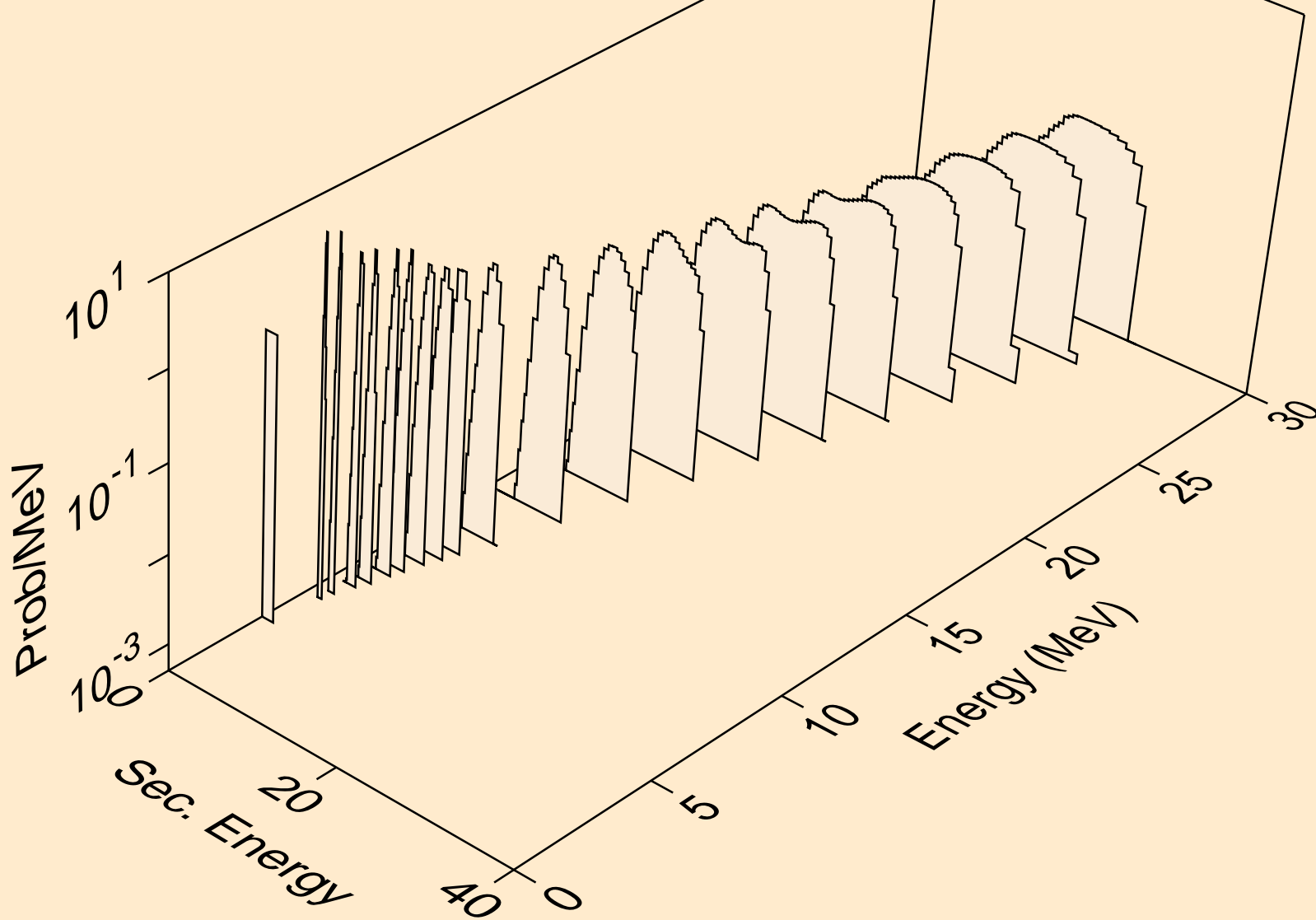

RA212 NEUTRON ACER TENDL-2019 LIBRARY; T=293.16K  
protons from (n,2np)

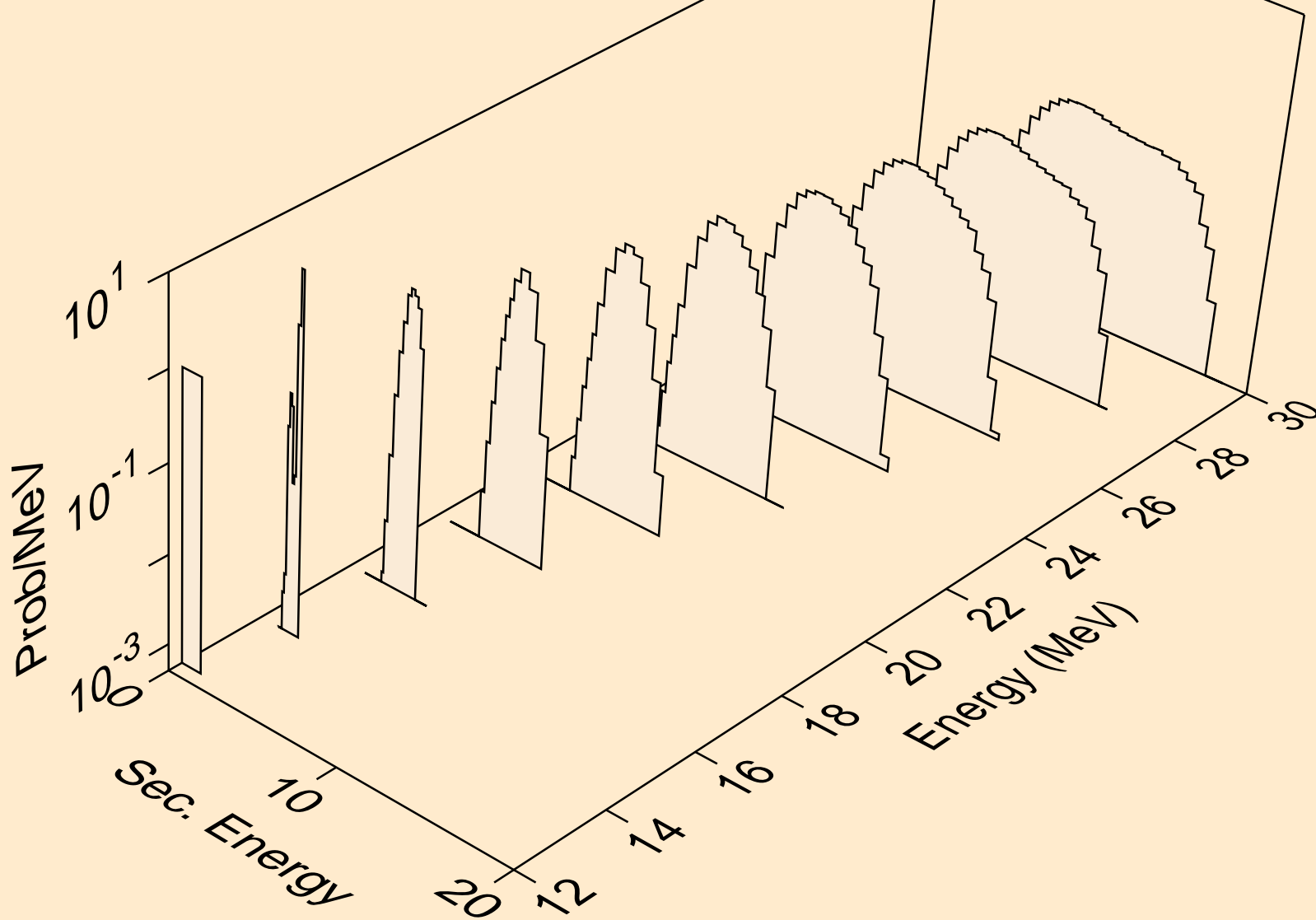

RA212 NEUTRON ACER TENDL-2019 LIBRARY; T=293.16K  
protons from (n,3np)

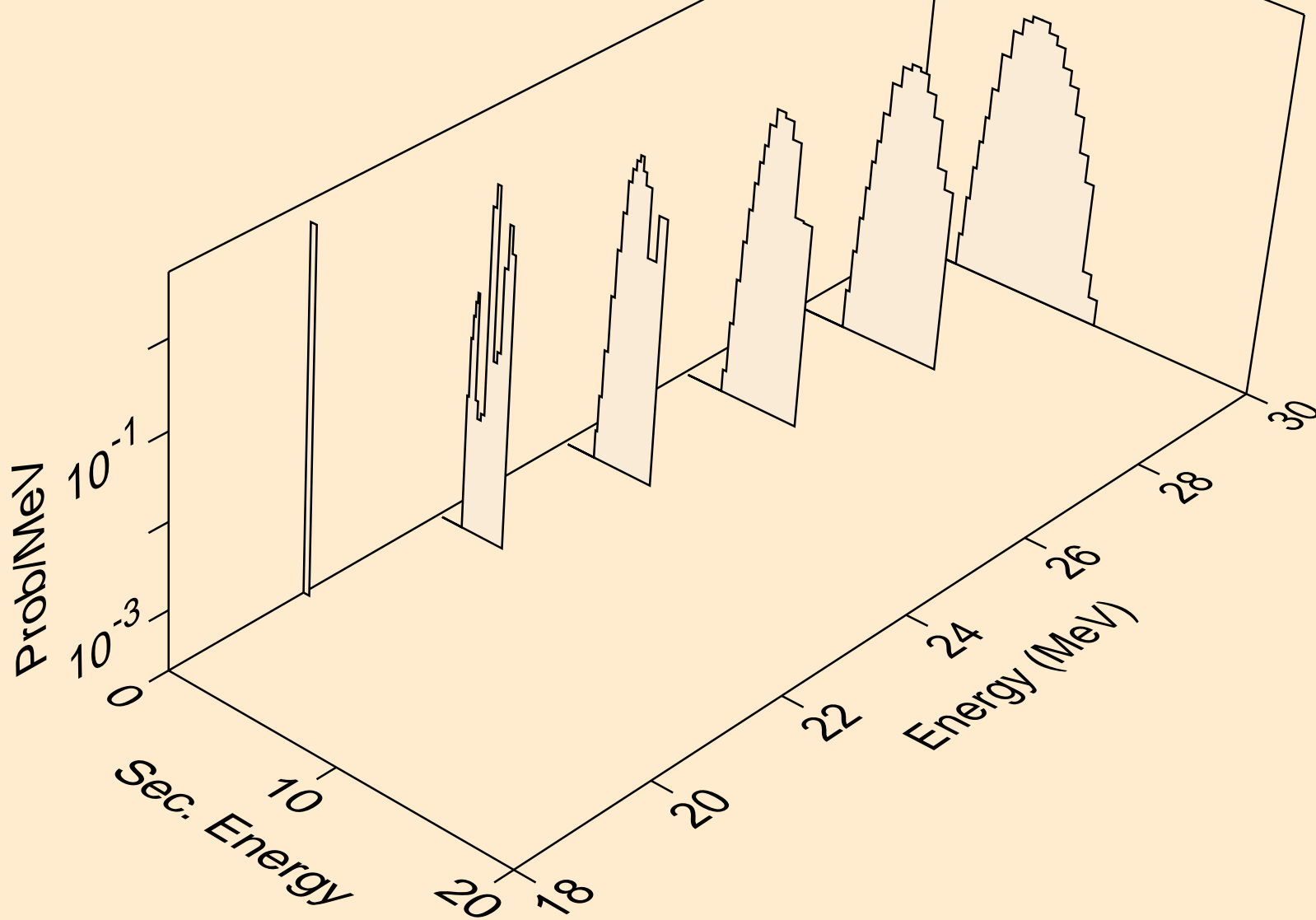

RA212 NEUTRON ACER TENDL-2019 LIBRARY; T=293.16K  
protons from (n,2np)

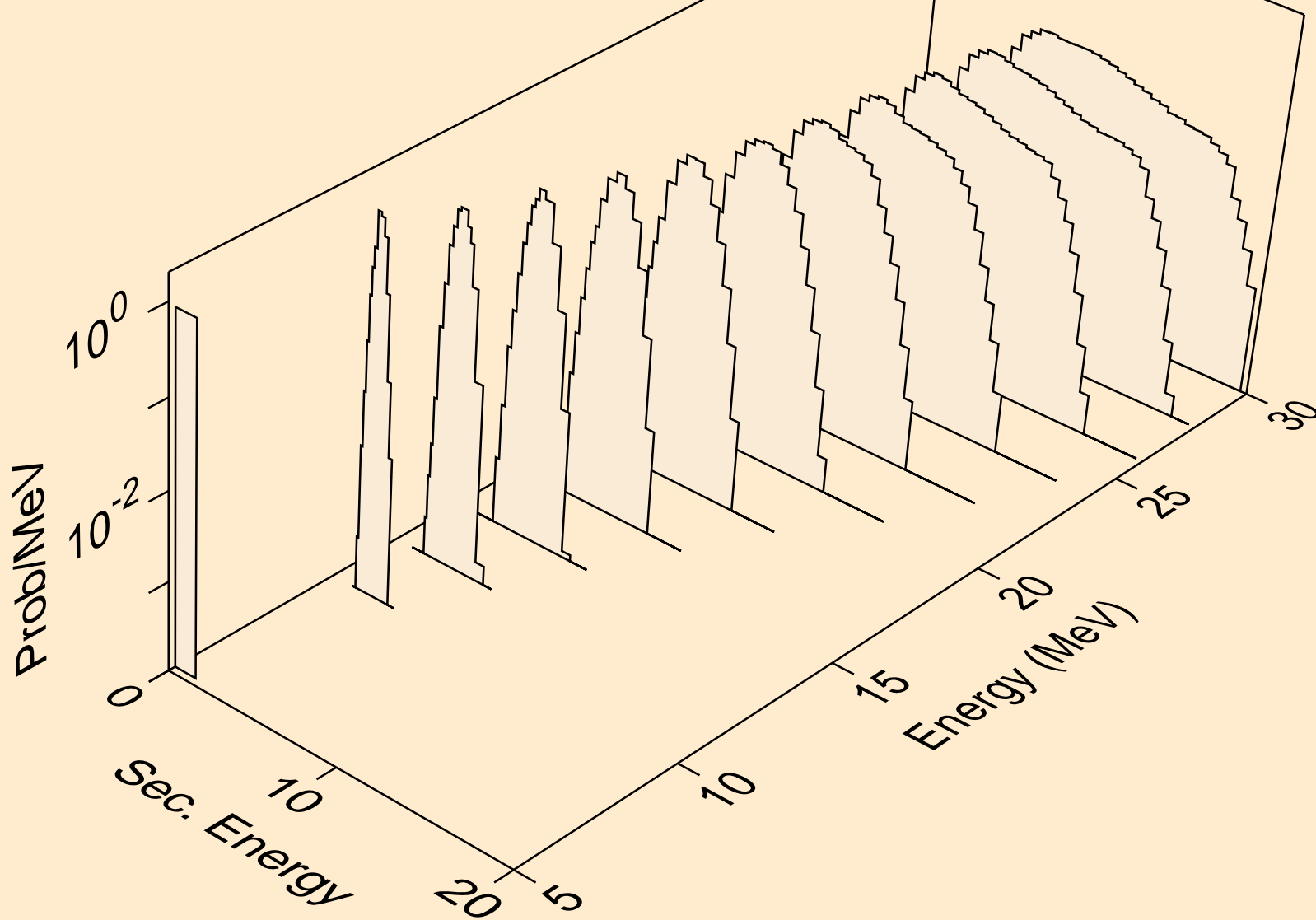

RA212 NEUTRON ACER TENDL-2019 LIBRARY; T=293.16K  
protons from (n,npa)

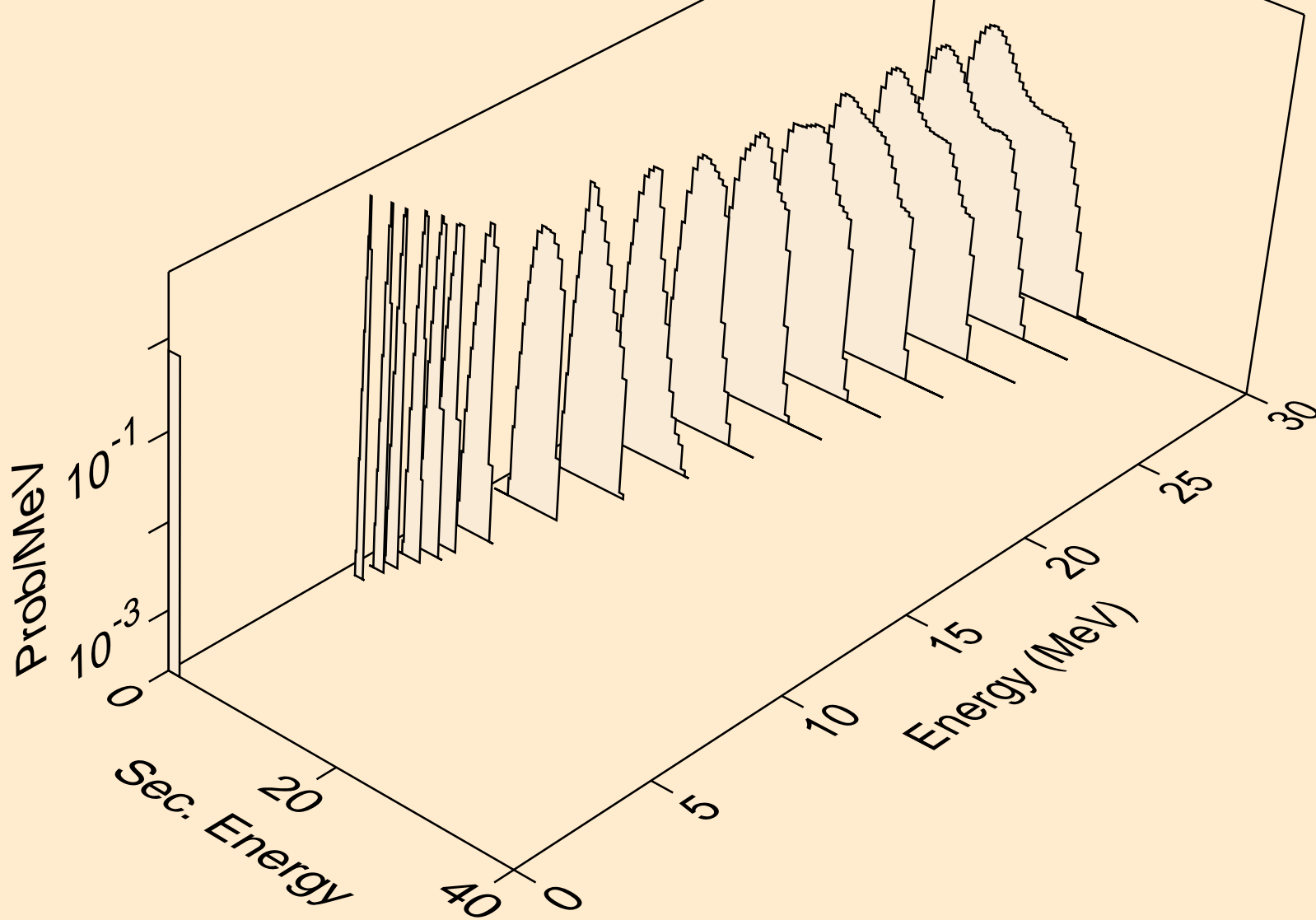

RA212 NEUTRON ACER TENDL-2019 LIBRARY; T=293.16K  
protons from (n,p)

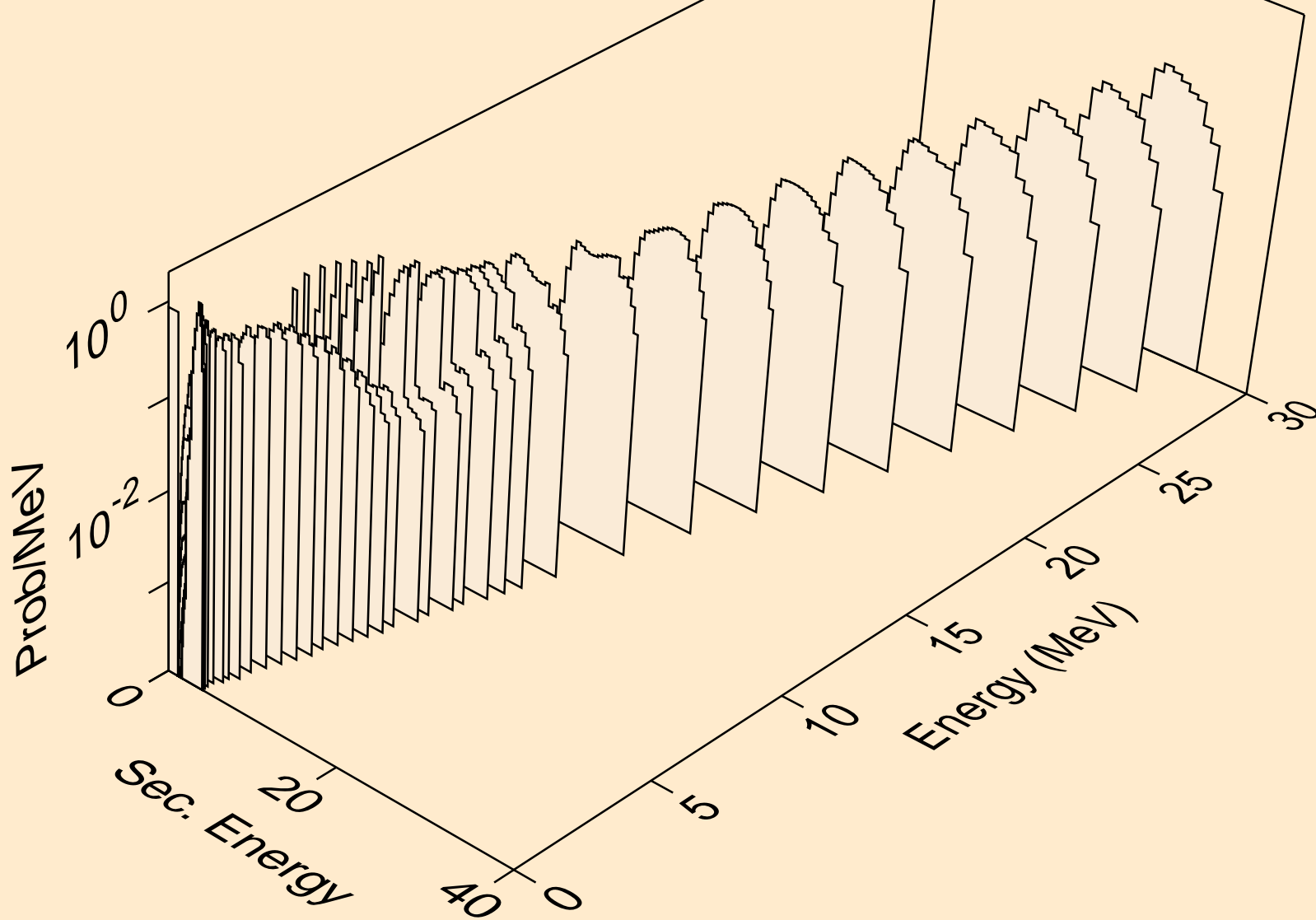

RA212 NEUTRON ACER TENDL-2019 LIBRARY; T=293.16K  
protons from (n,2p)

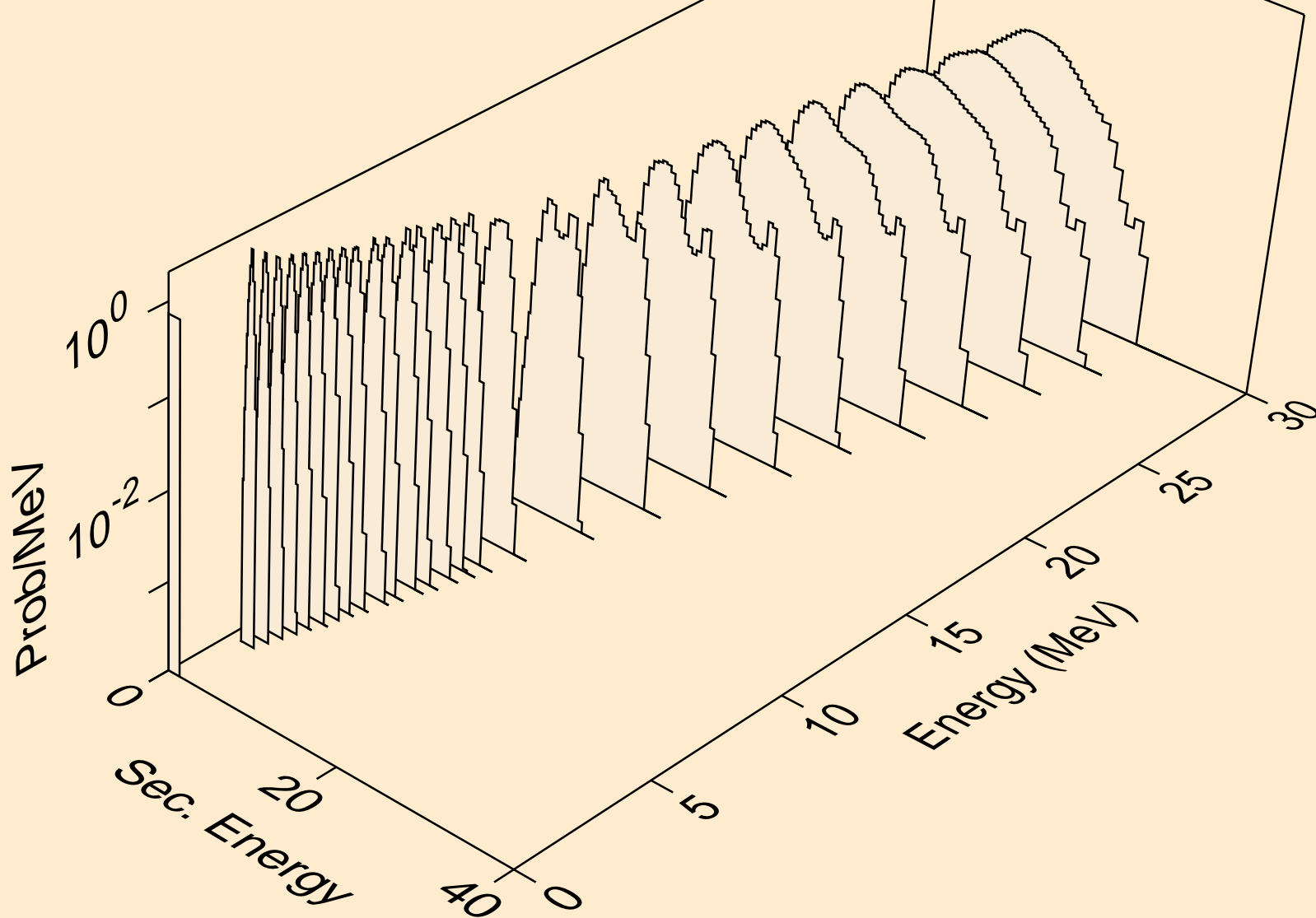



RA212 NEUTRON ACER TENDL-2019 LIBRARY; T=293.16K  
protons from (n,p)

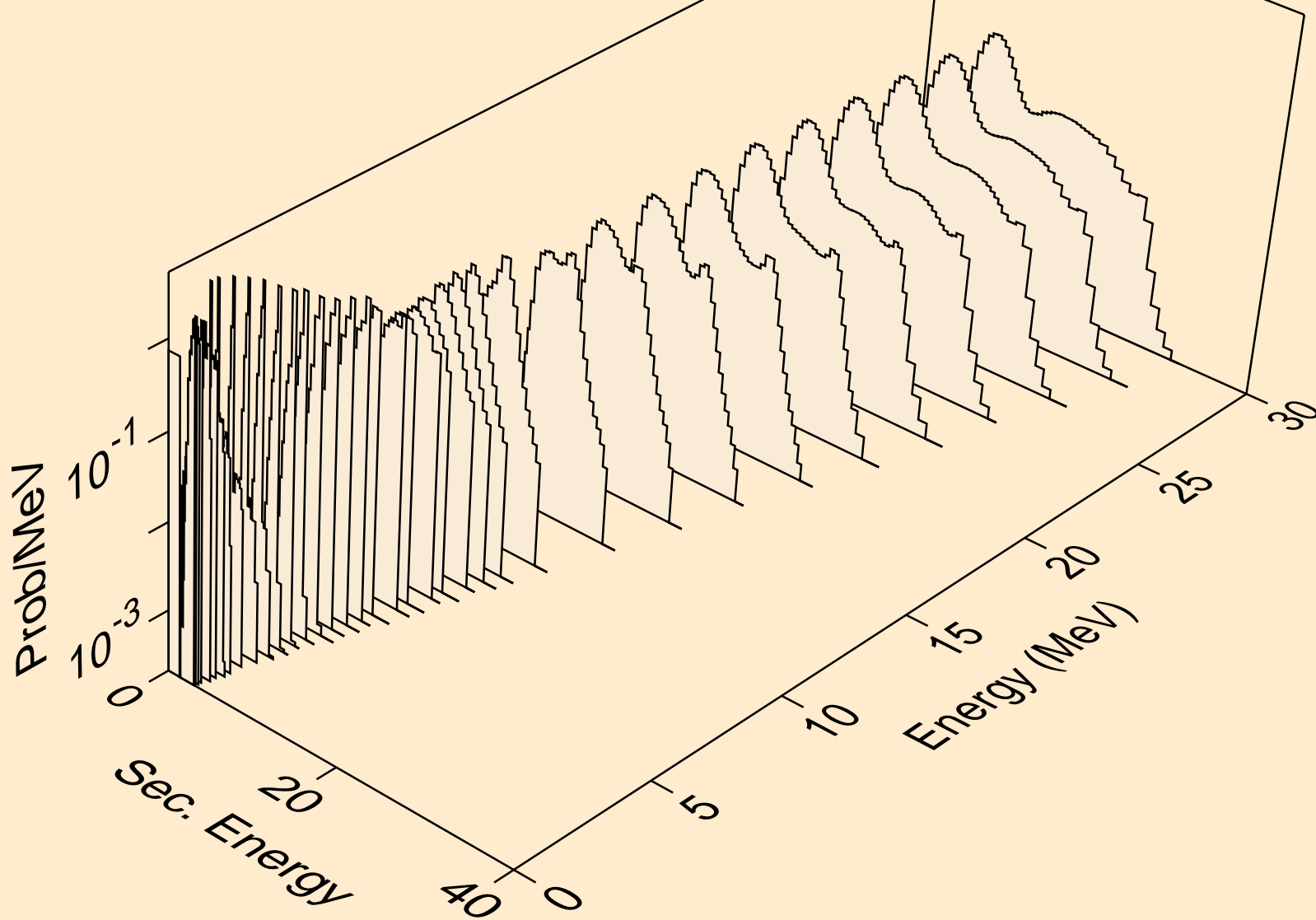

RA212 NEUTRON ACER TENDL-2019 LIBRARY; T=293.16K  
protons from (n,pd)

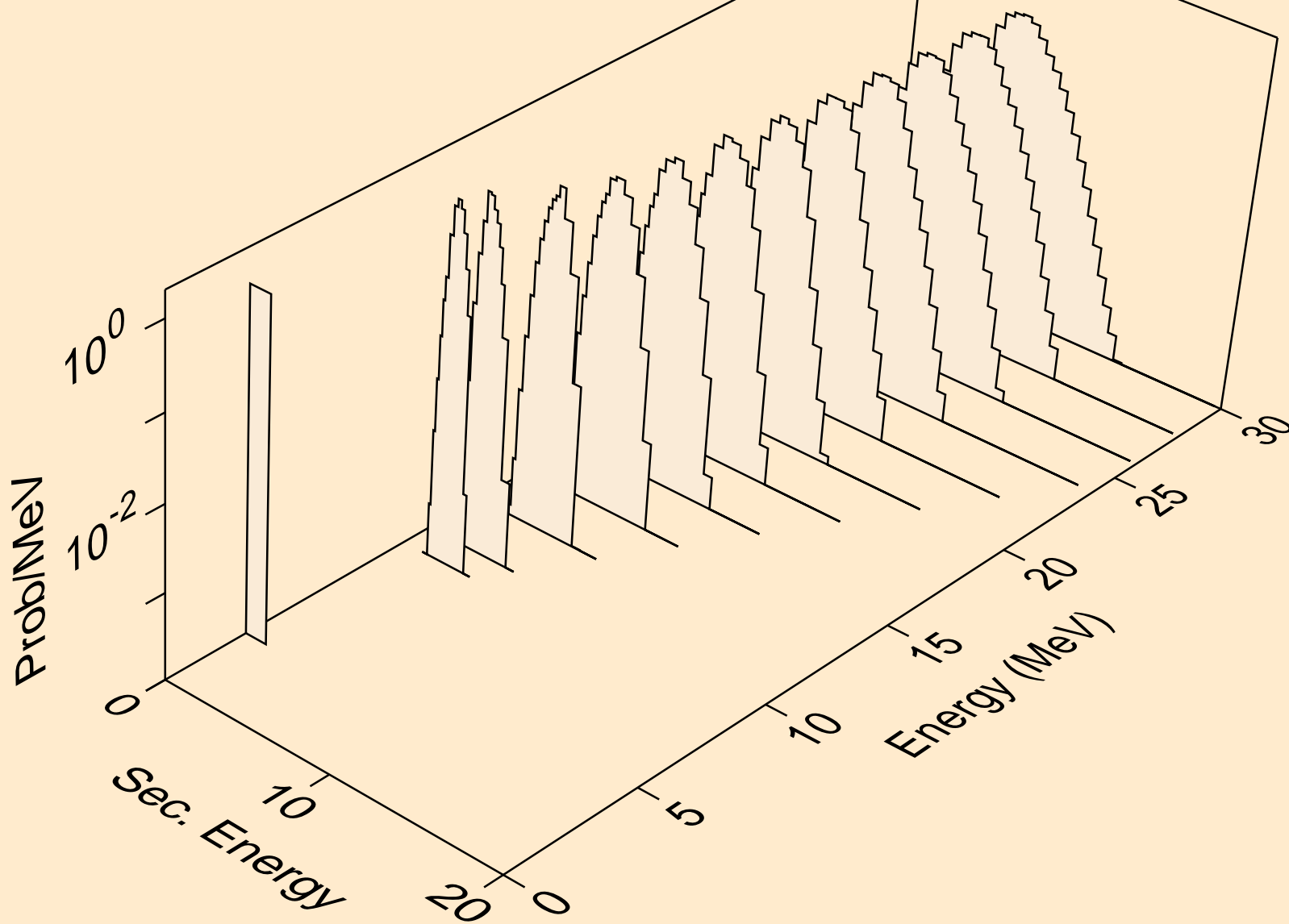

RA212 NEUTRON ACER TENDL-2019 LIBRARY; T=293.16K  
protons from (n,pt)

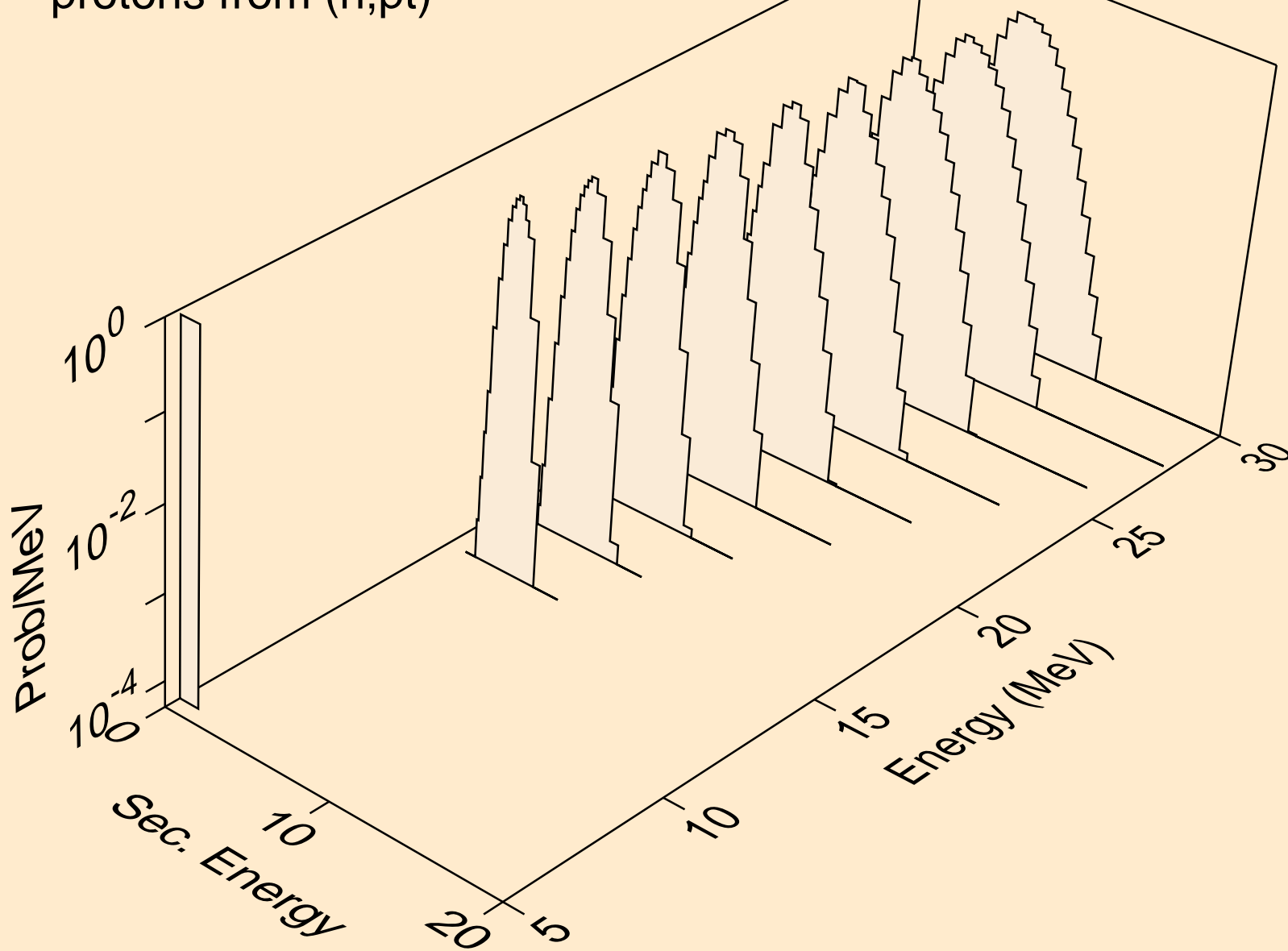

RA212 NEUTRON ACER TENDL-2019 LIBRARY; T=293.16K  
deuterons from (n,x)

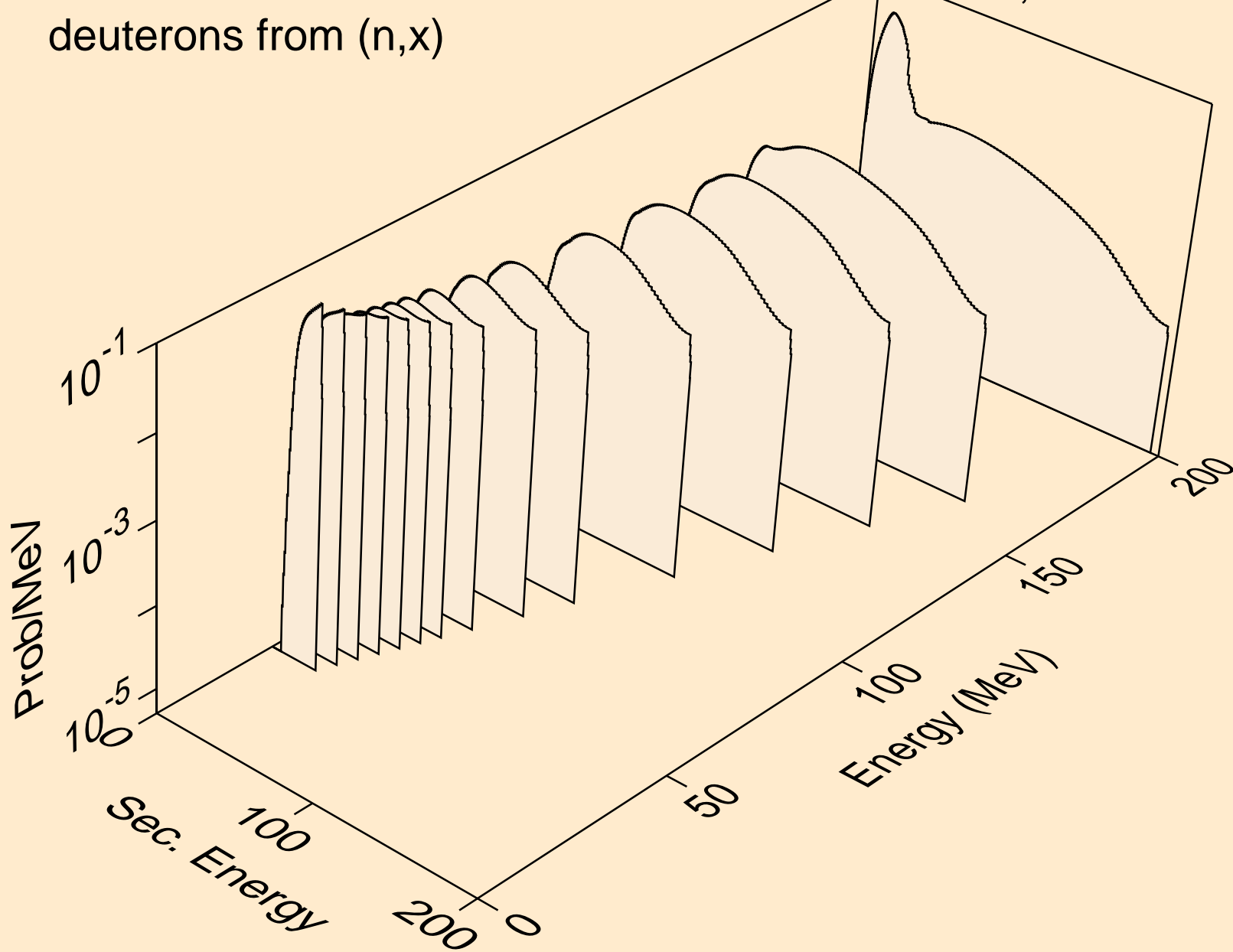

RA212 NEUTRON ACER TENDL-2019 LIBRARY; T=293.16K  
deuterons from (n,2nd)

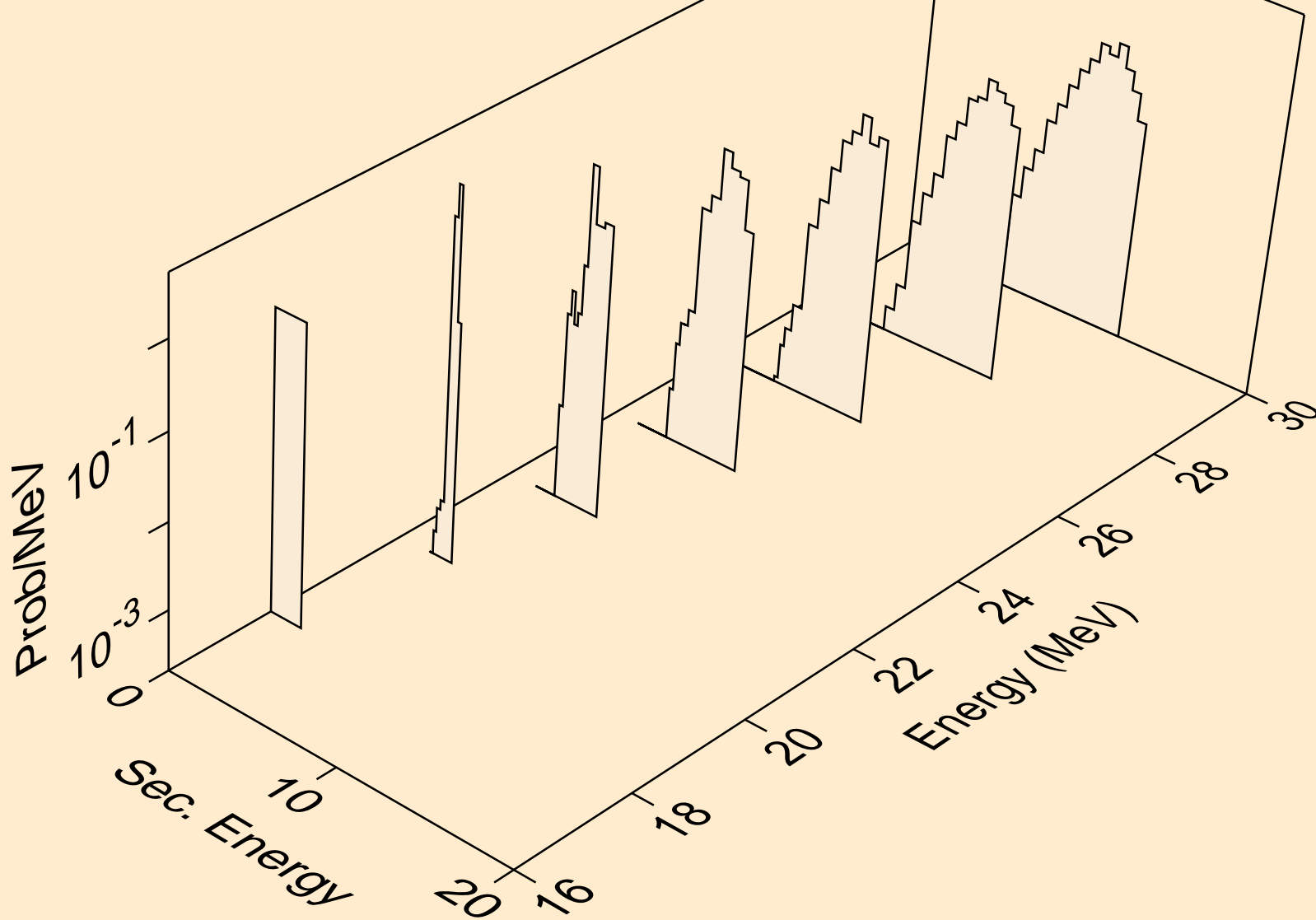

RA212 NEUTRON ACER TENDL-2019 LIBRARY; T=293.16K  
deuterons from (n,n\*)d

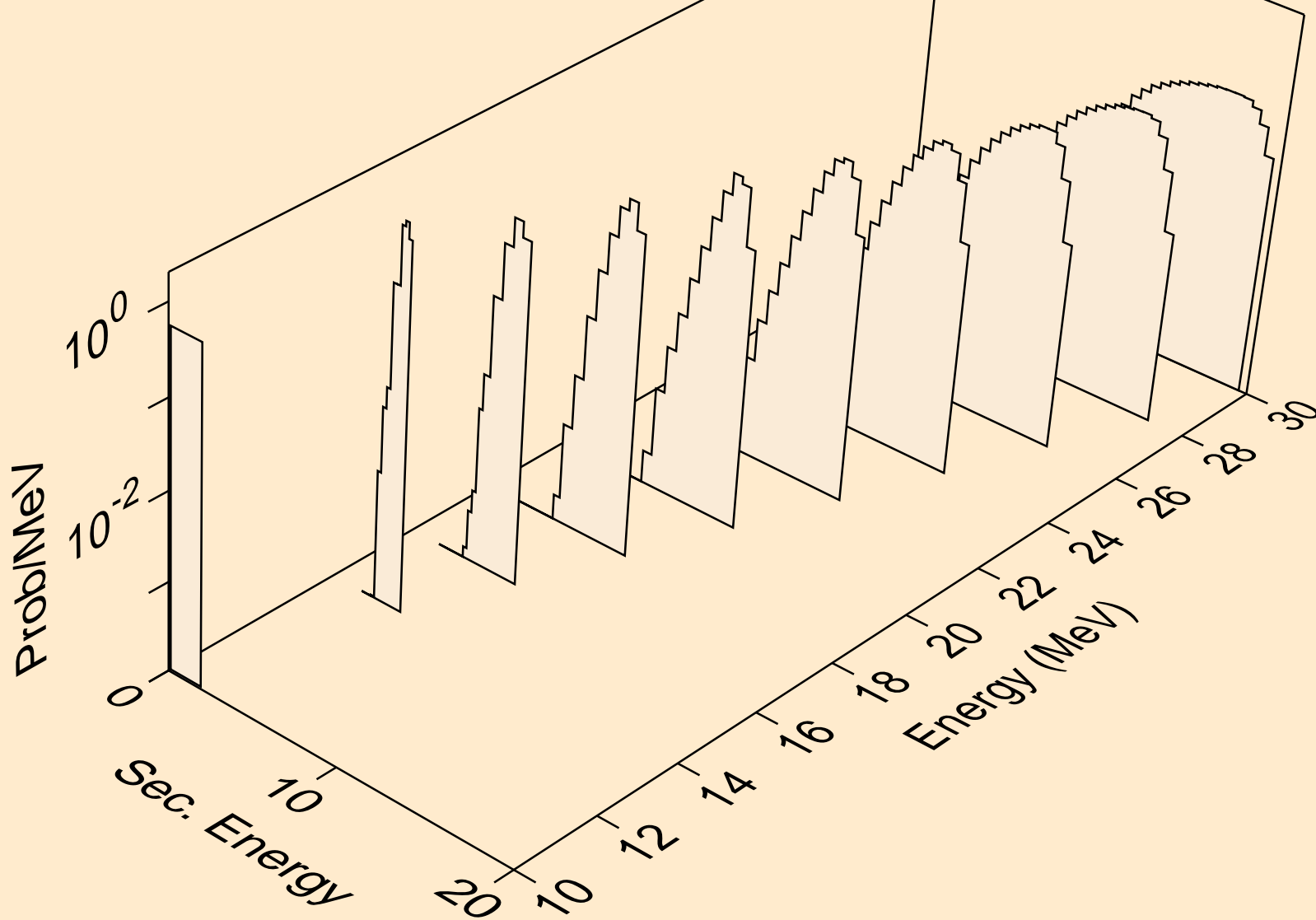

RA212 NEUTRON ACER TENDL-2019 LIBRARY; T=293.16K  
deuterons from (n,d)

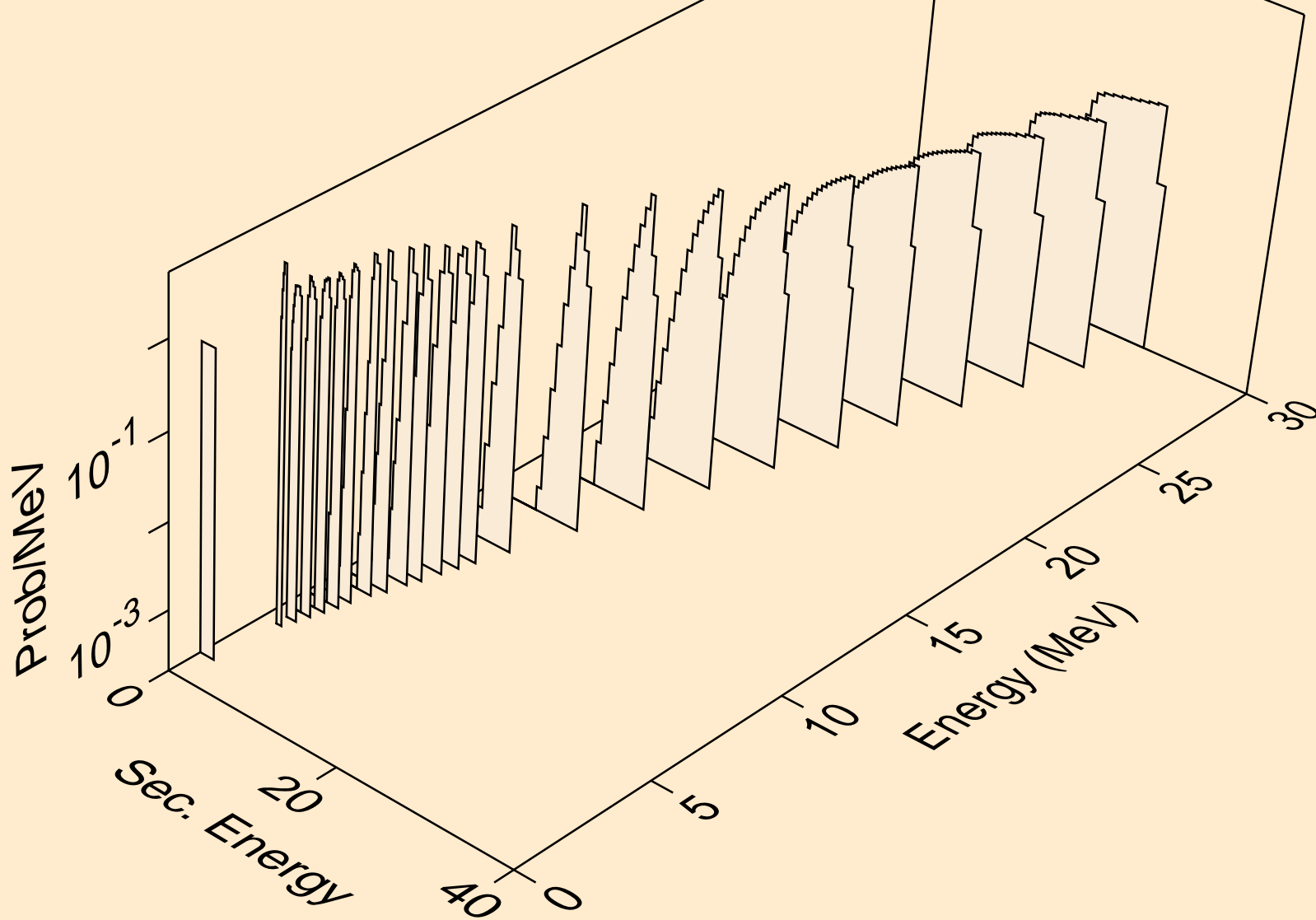

RA212 NEUTRON ACER TENDL-2019 LIBRARY; T=293.16K  
deuterons from (n,pd)

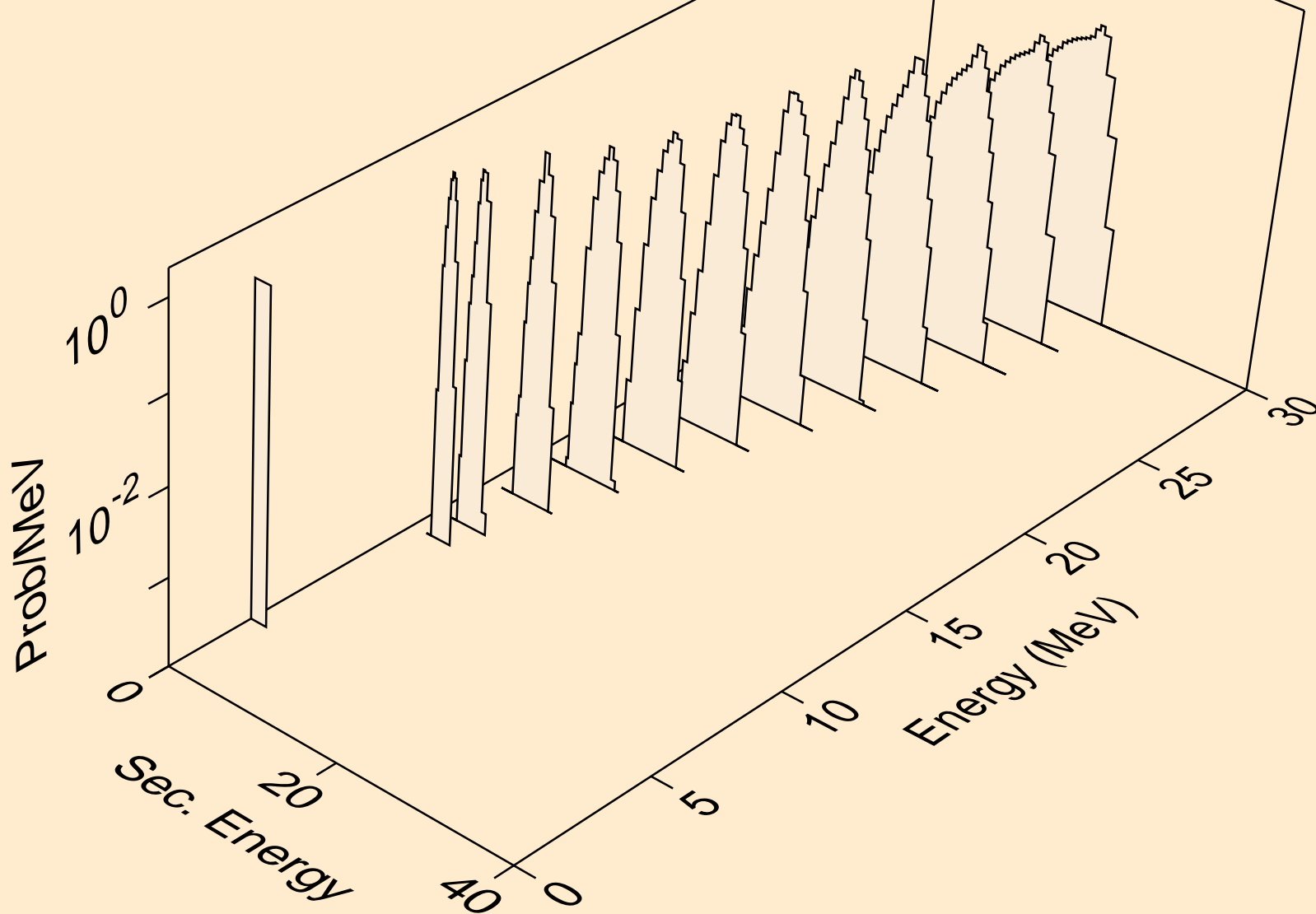



RA212 NEUTRON ACER TENDL-2019 LIBRARY; T=293.16K  
deuterons from (n,da)

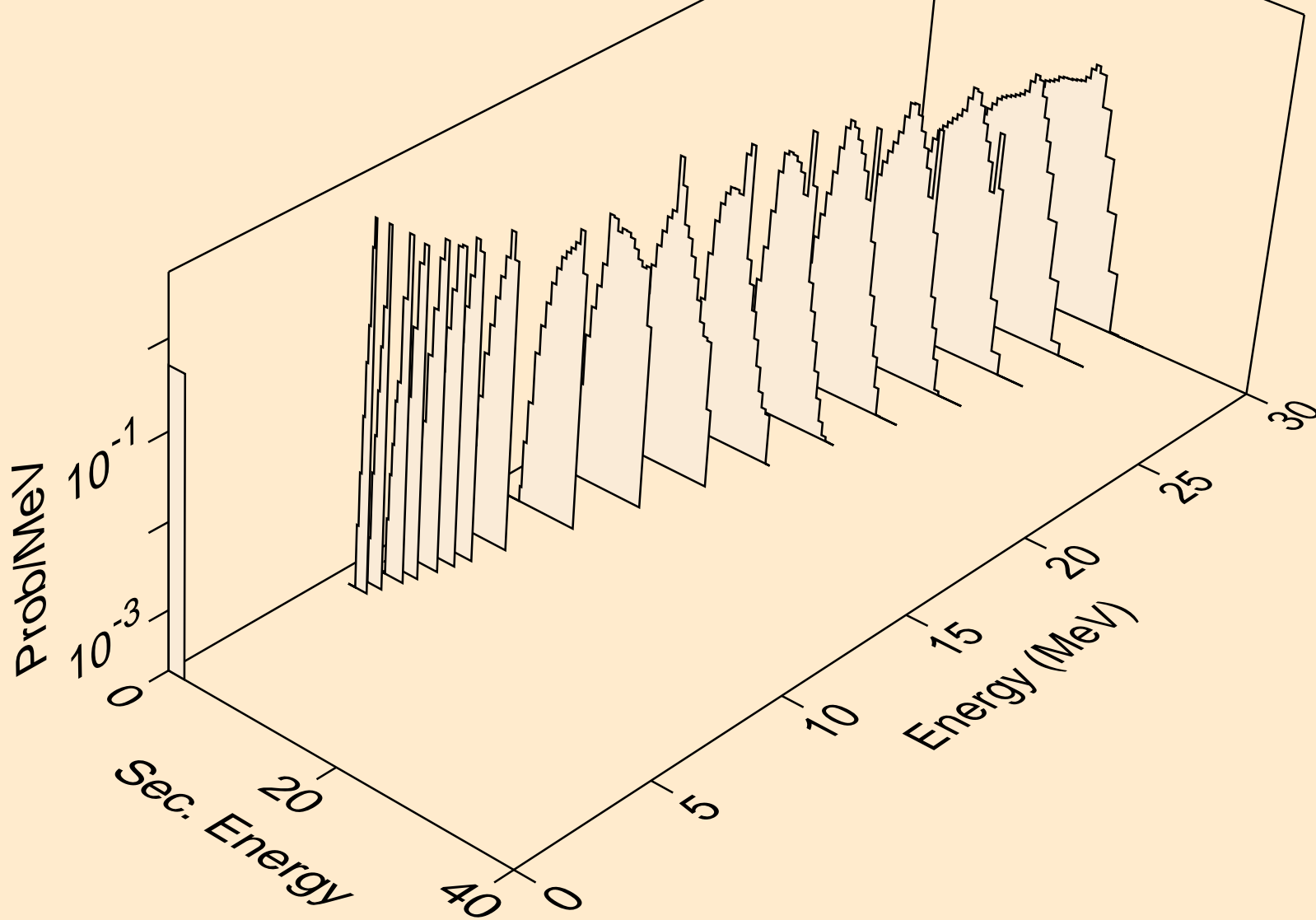

RA212 NEUTRON ACER TENDL-2019 LIBRARY; T=293.16K  
tritons from (n,x)

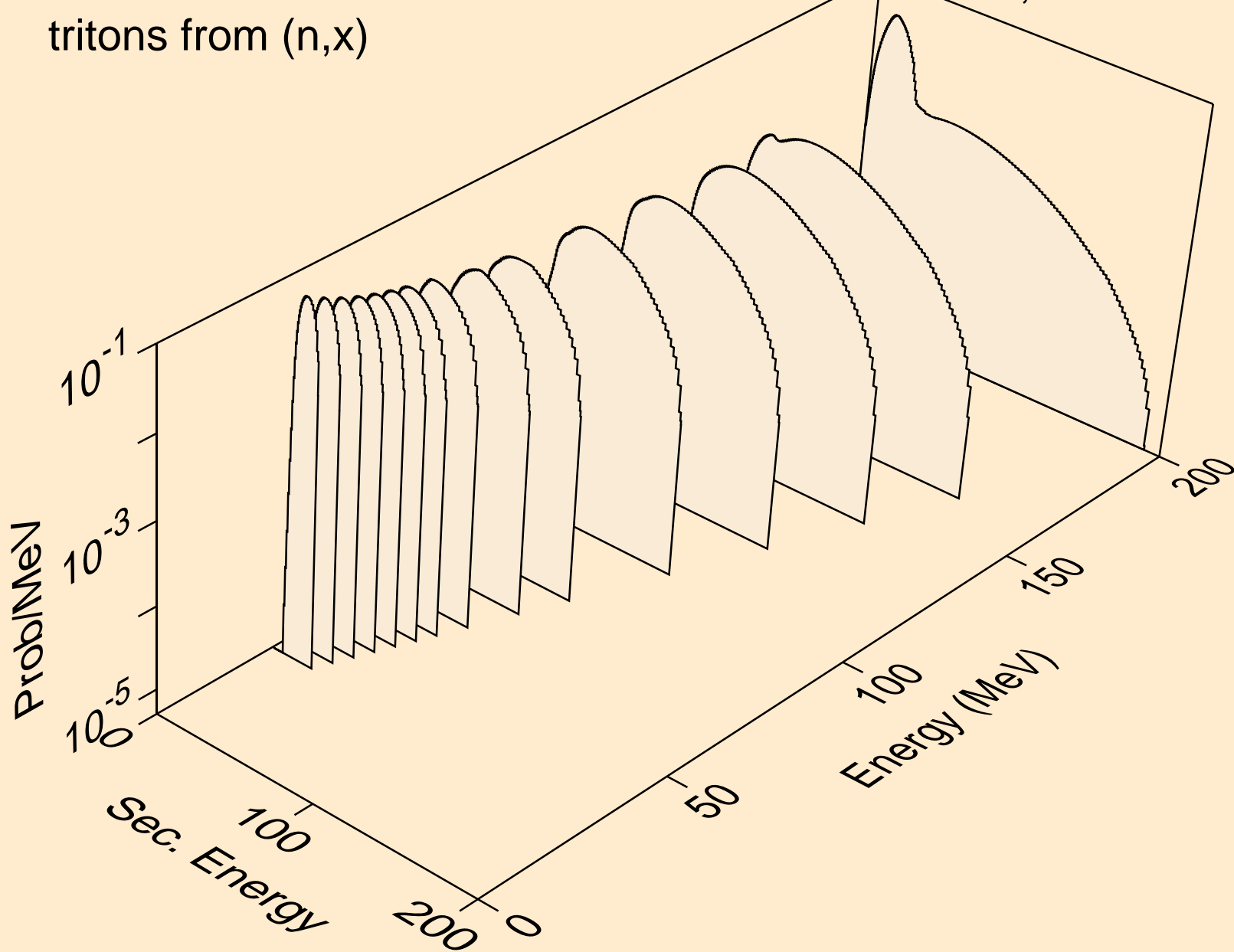

RA212 NEUTRON ACER TENDL-2019 LIBRARY; T=293.16K  
tritons from (n,n\*)t

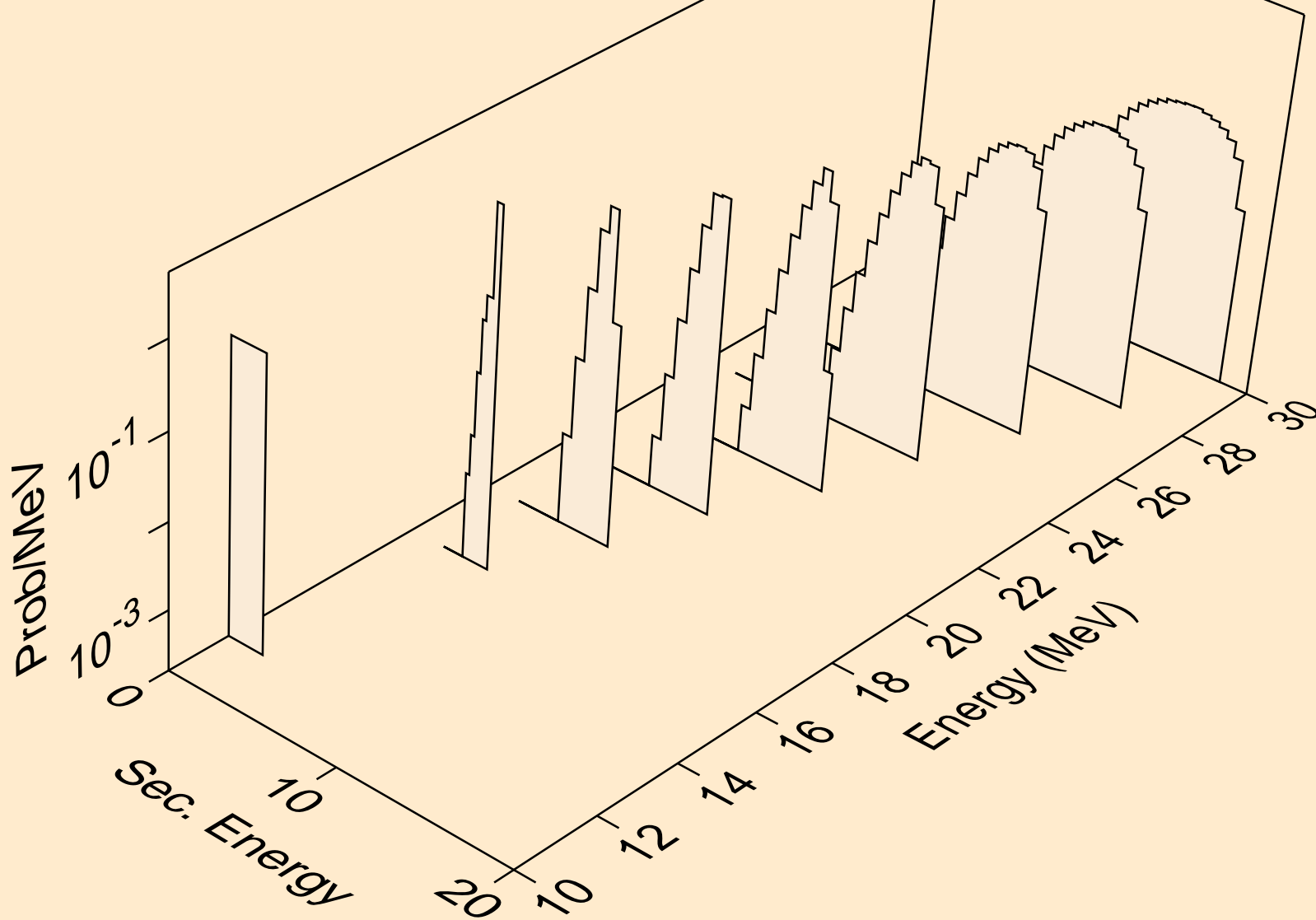

RA212 NEUTRON ACER TENDL-2019 LIBRARY; T=293.16K  
tritons from (n,t)

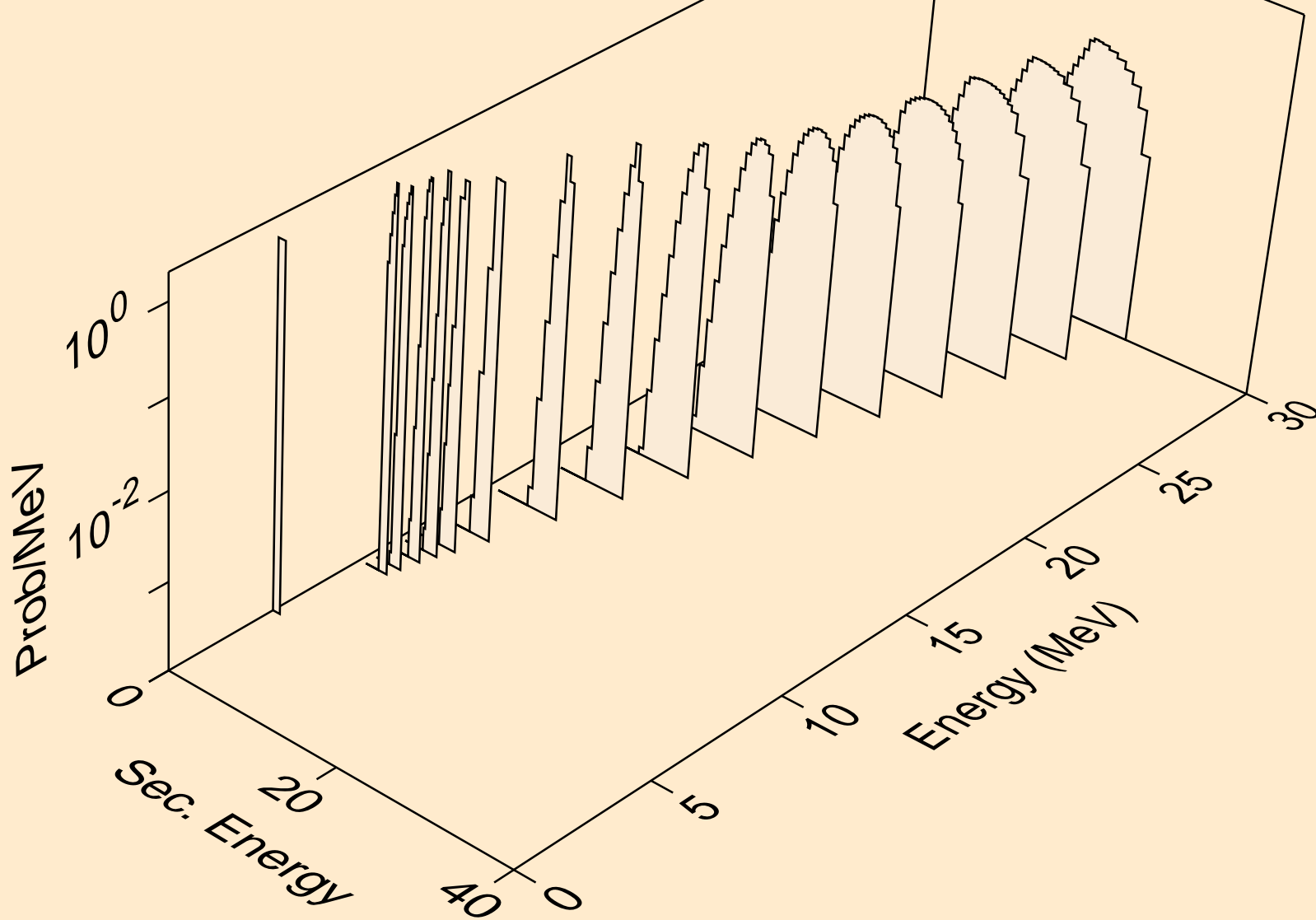

RA212 NEUTRON ACER TENDL-2019 LIBRARY; T=293.16K  
tritons from (n,pt)

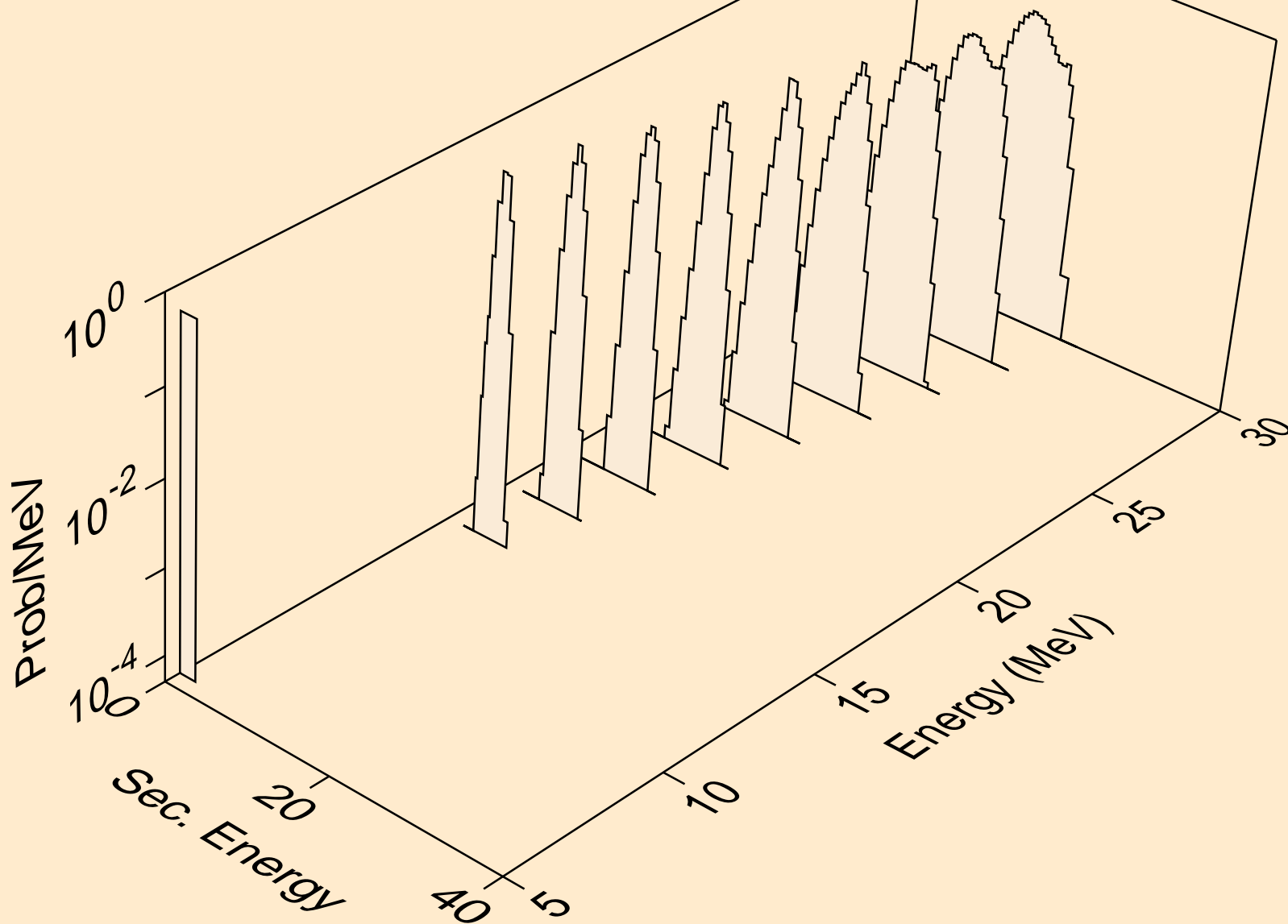

RA212 NEUTRON ACER TENDL-2019 LIBRARY; T=293.16K  
he3s from (n,x)

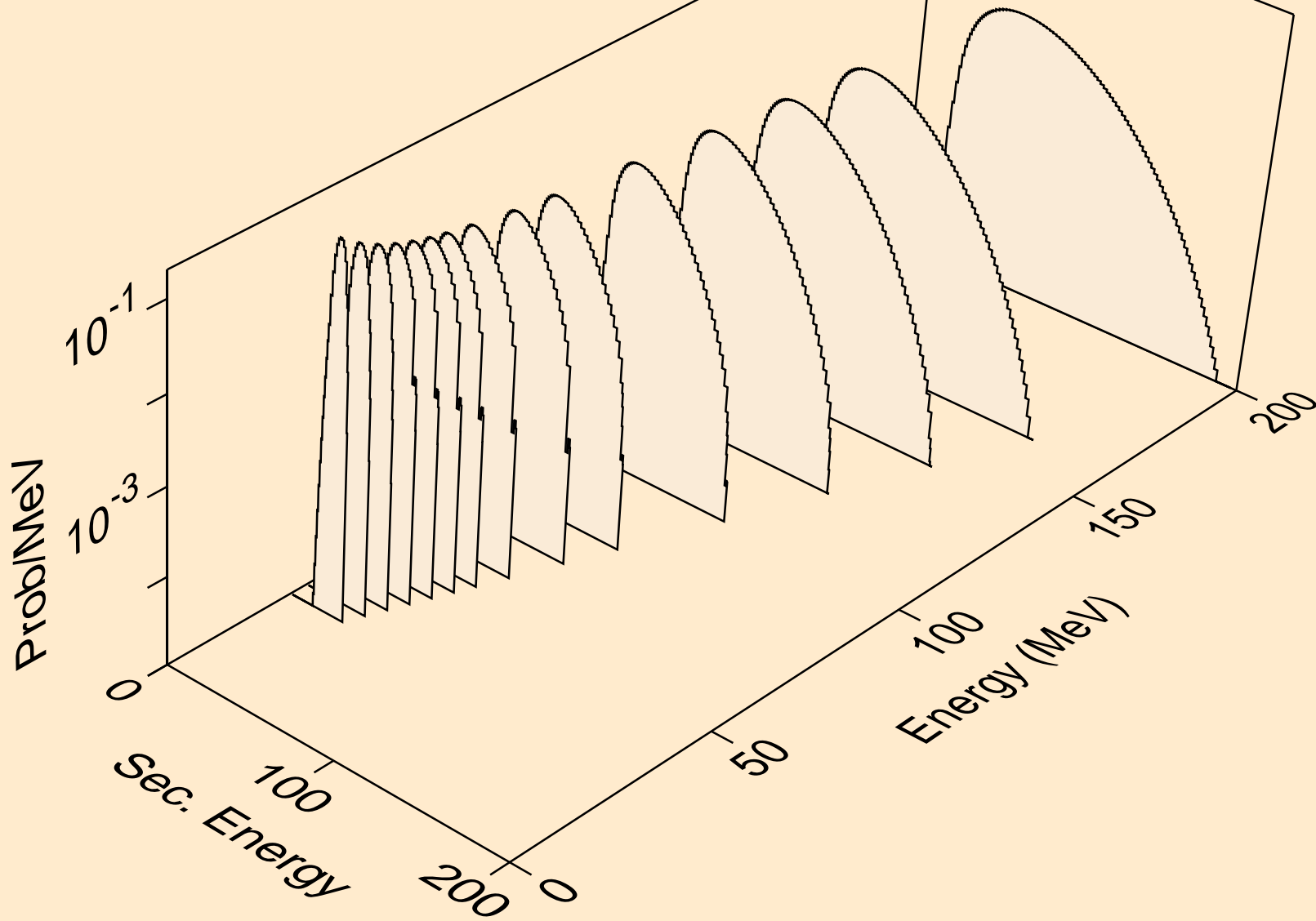

RA212 NEUTRON ACER TENDL-2019 LIBRARY; T=293.16K  
he3s from (n,n\*)he3

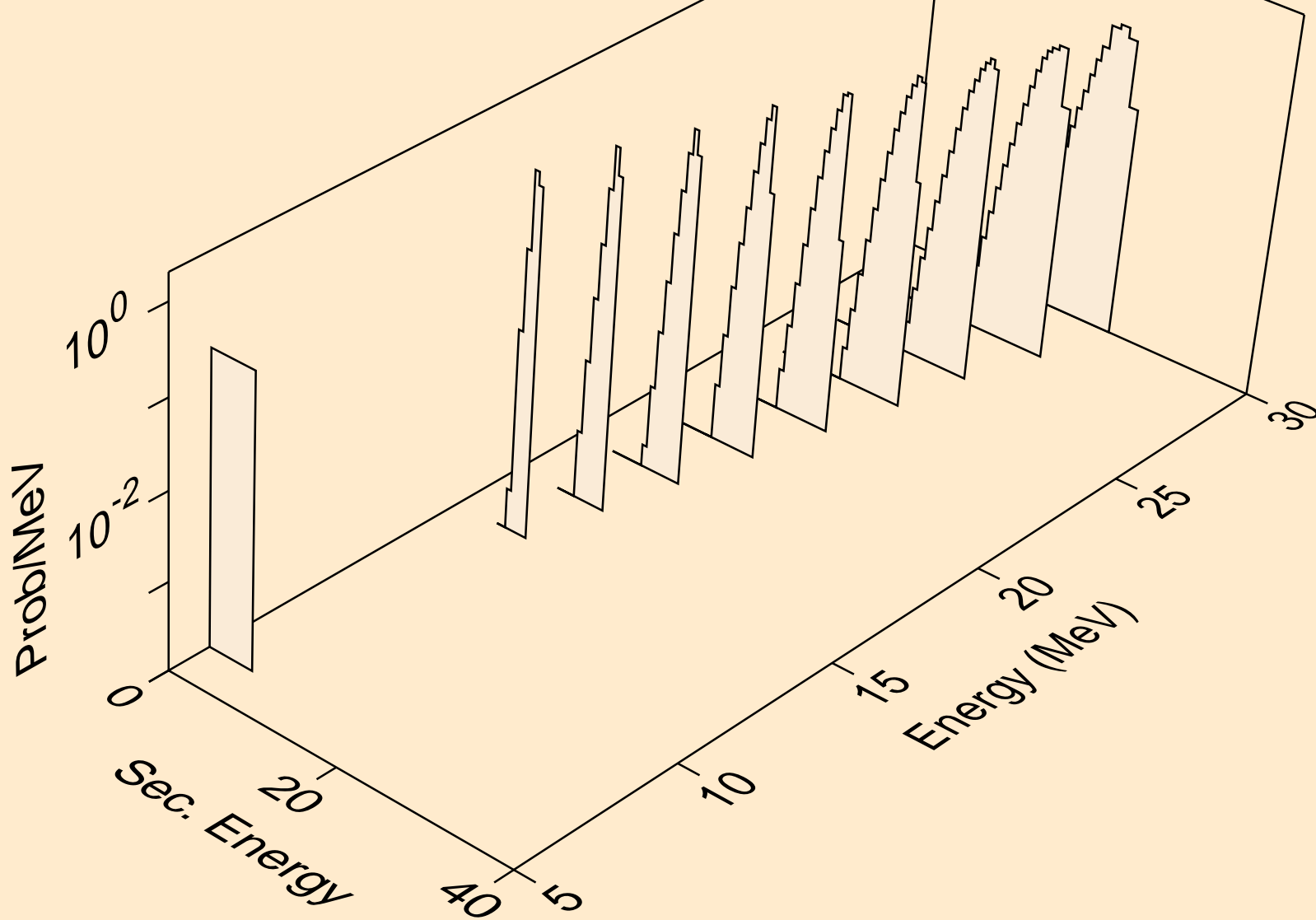

RA212 NEUTRON ACER TENDL-2019 LIBRARY; T=293.16K  
he3s from (n,he3)

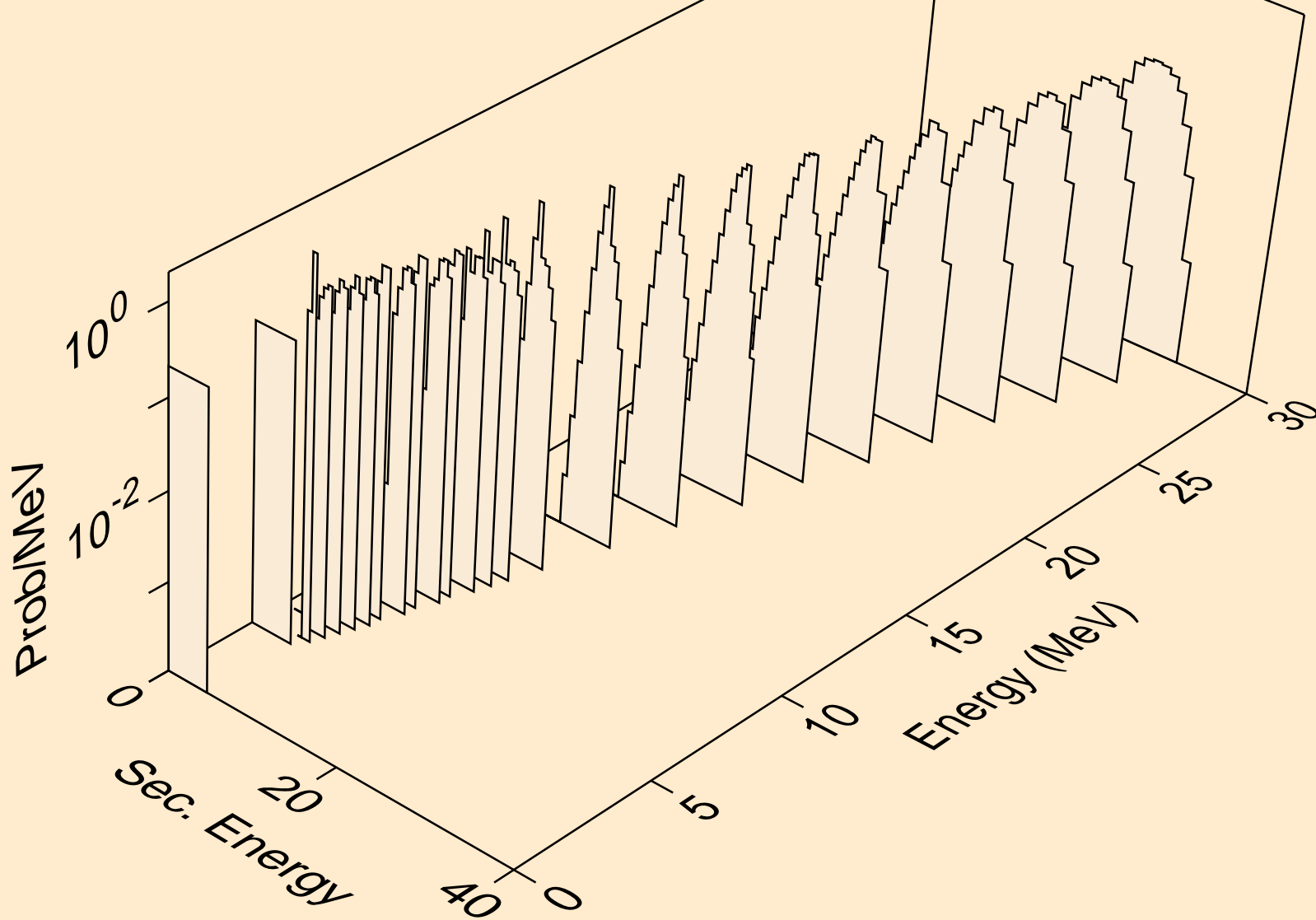



RA212 NEUTRON ACER TENDL-2019 LIBRARY; T=293.16K  
alphas from (n,x)

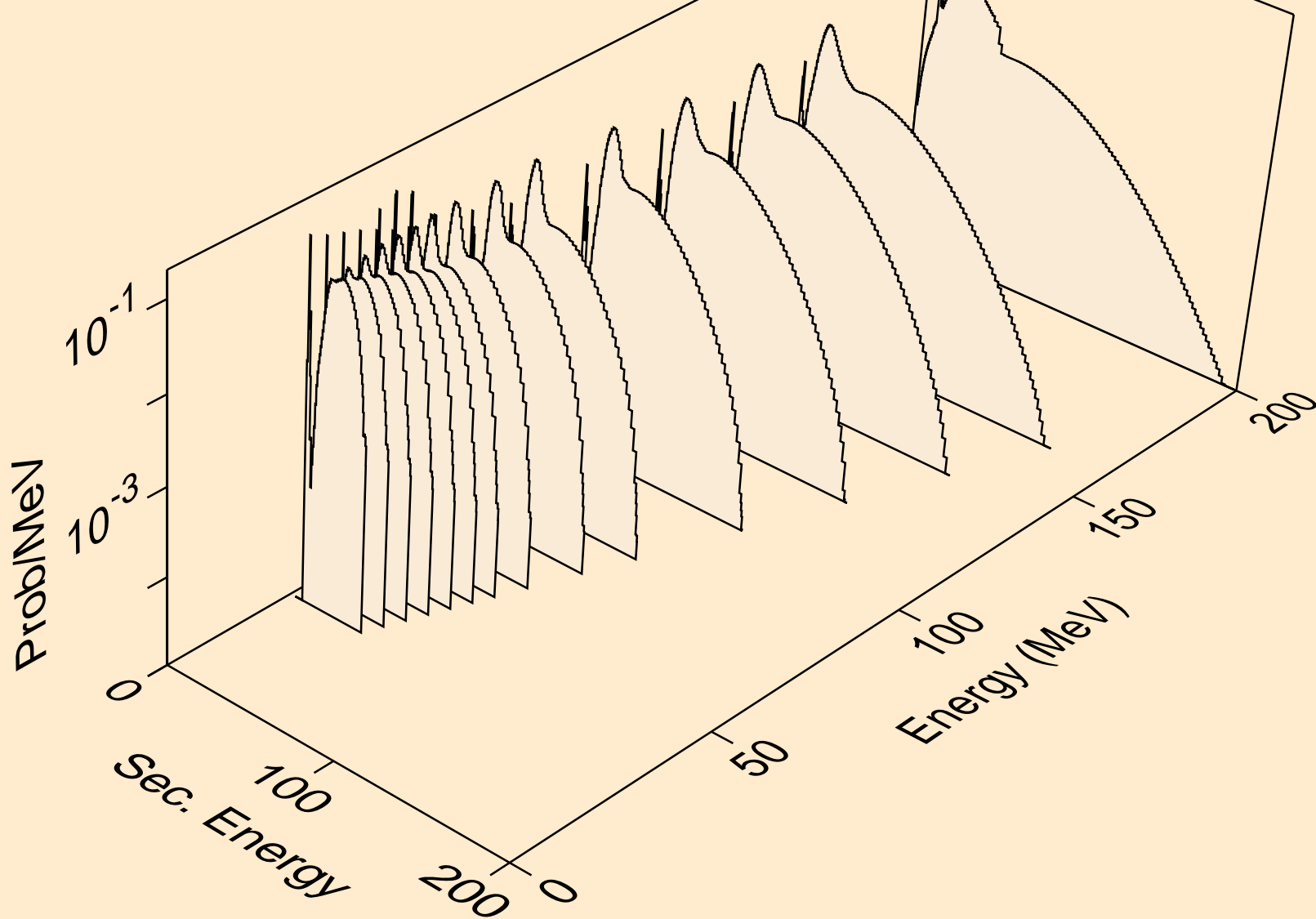

RA212 NEUTRON ACER TENDL-2019 LIBRARY; T=293.16K  
alphas from (n,n\*)a

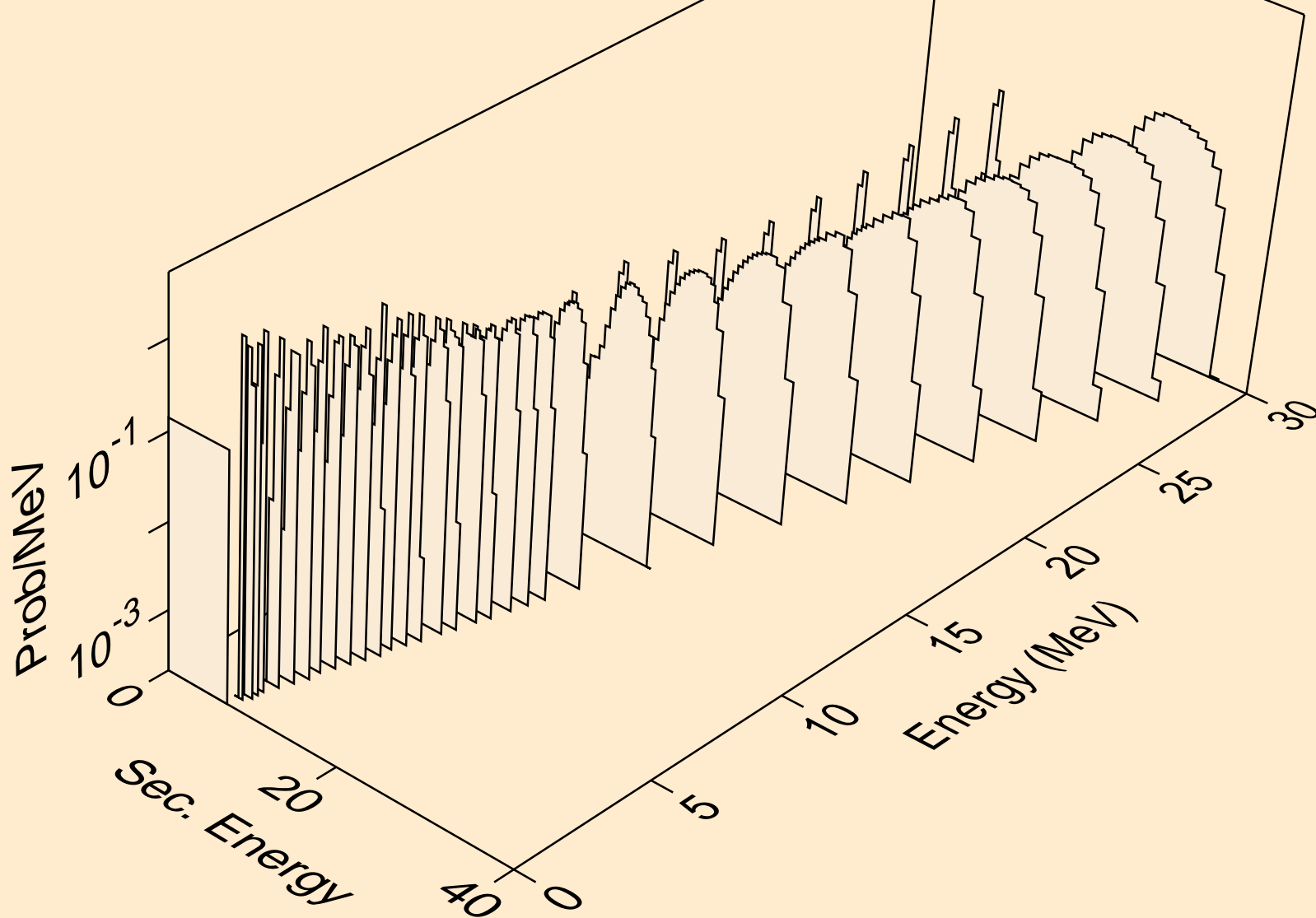

RA212 NEUTRON ACER TENDL-2019 LIBRARY; T=293.16K  
alphas from (n,2n)a

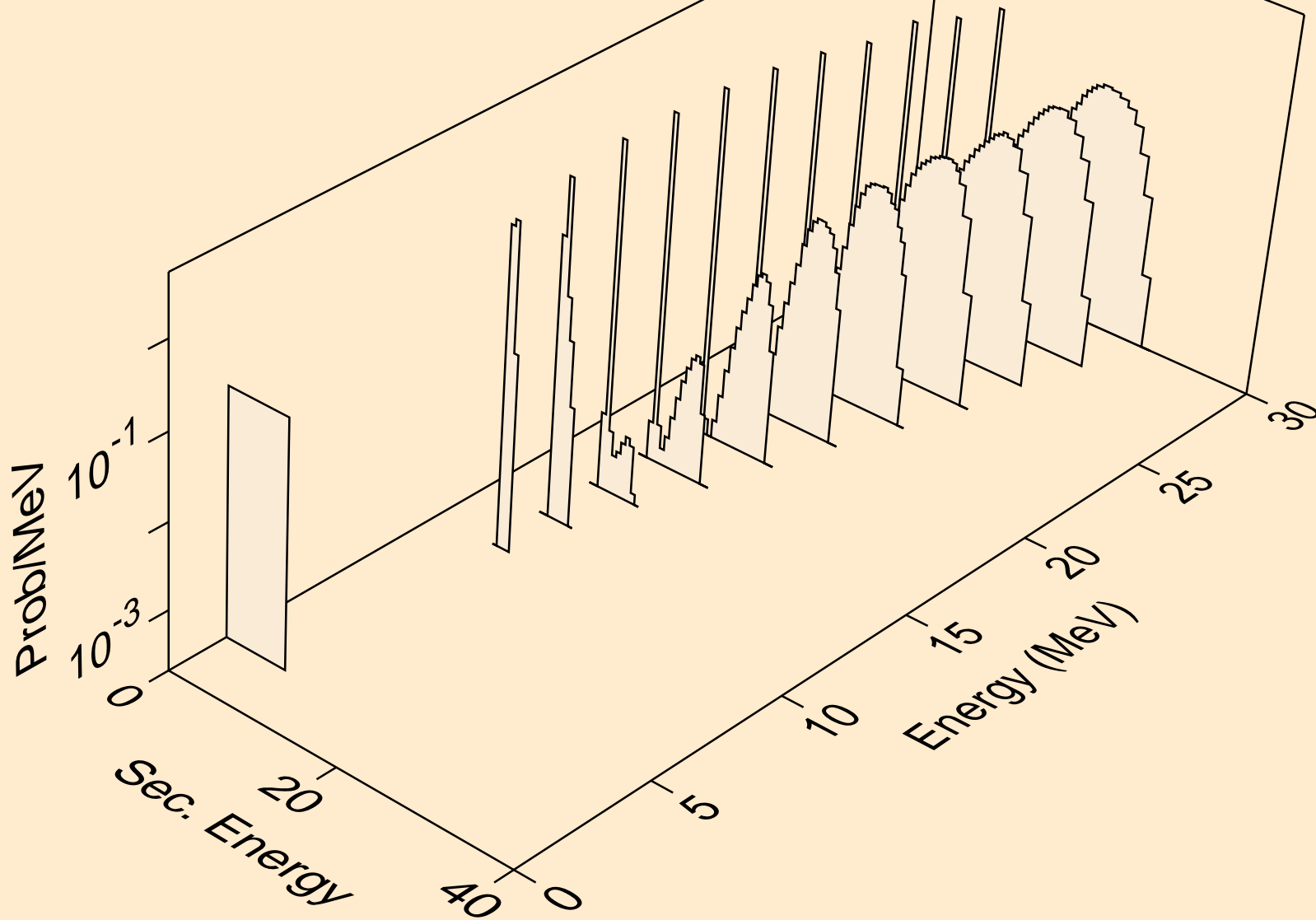

RA212 NEUTRON ACER TENDL-2019 LIBRARY; T=293.16K  
alphas from (n,3n)a

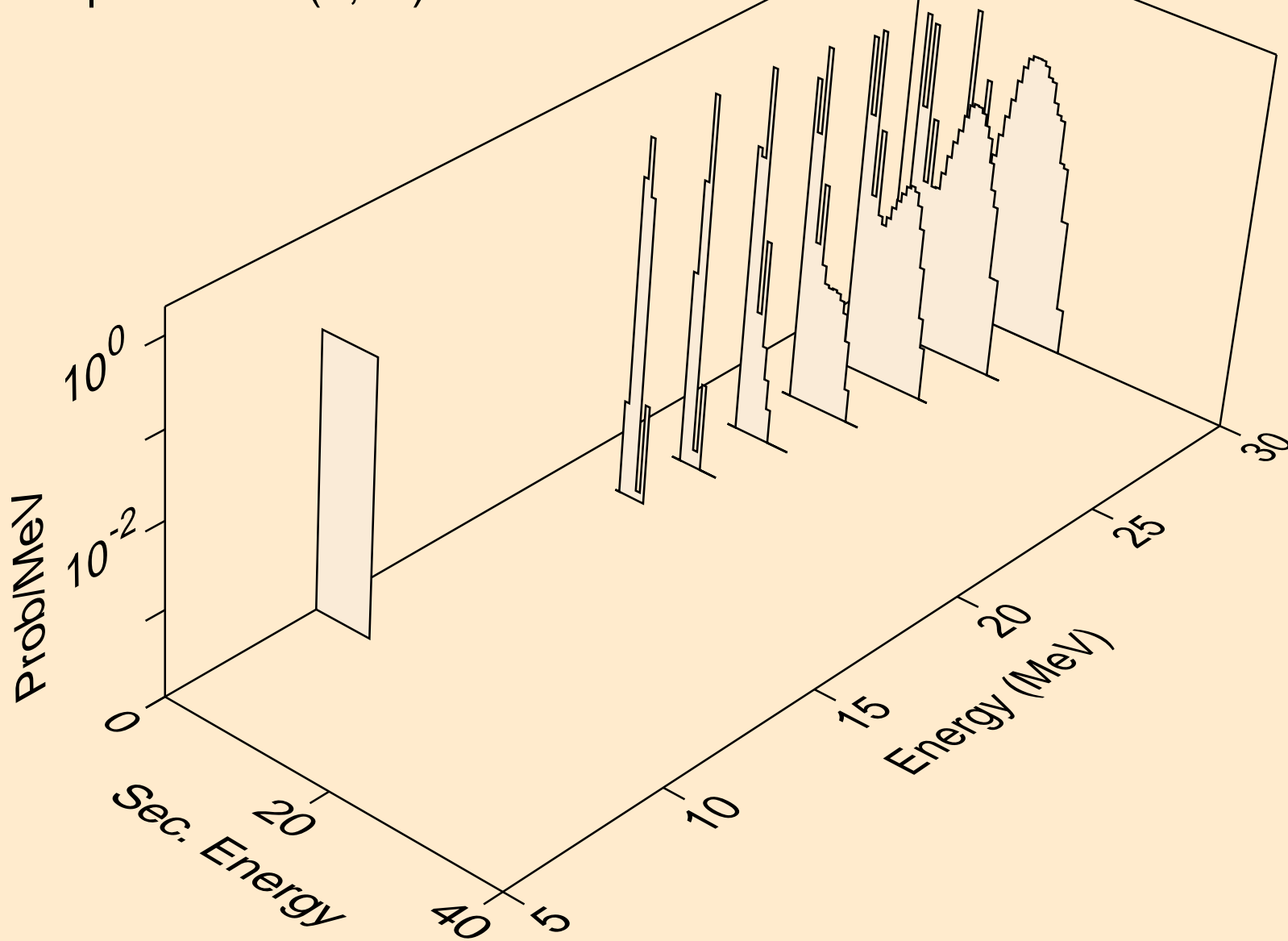

RA212 NEUTRON ACER TENDL-2019 LIBRARY; T=293.16K  
alphas from (n,n\*)2a

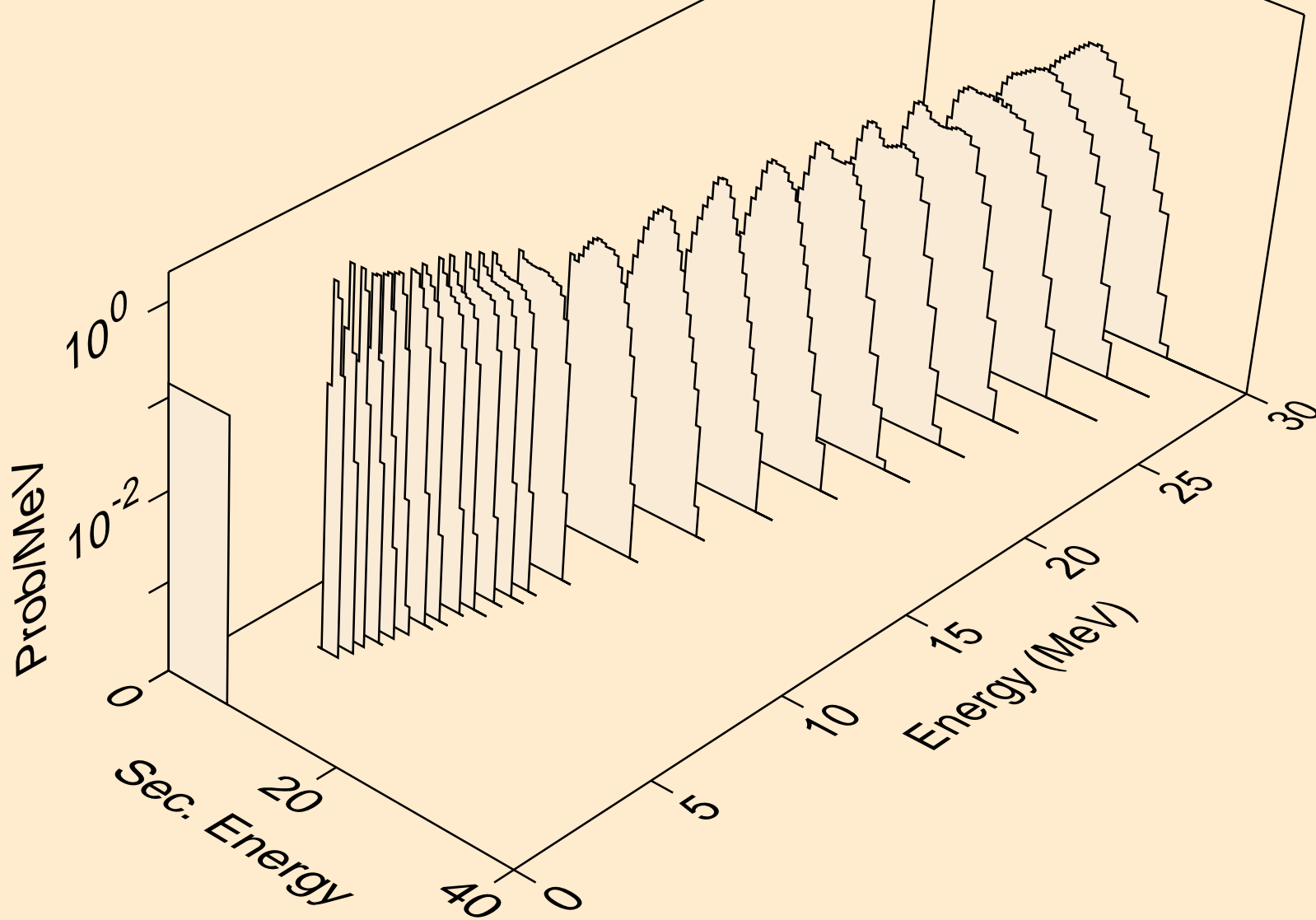

RA212 NEUTRON ACER TENDL-2019 LIBRARY; T=293.16K  
alphas from (n,2n)2a

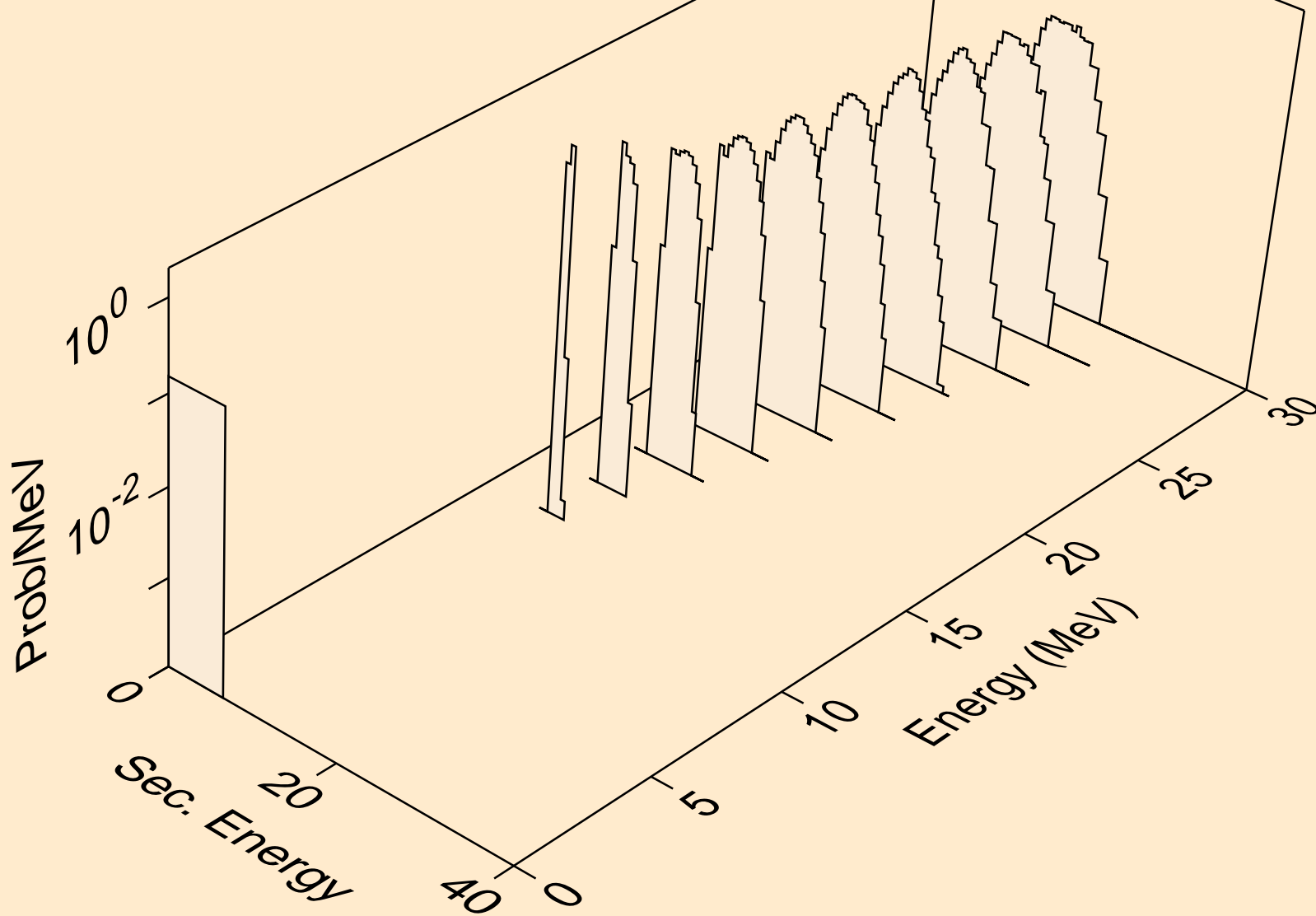

RA212 NEUTRON ACER TENDL-2019 LIBRARY; T=293.16K  
alphas from (n,npa)

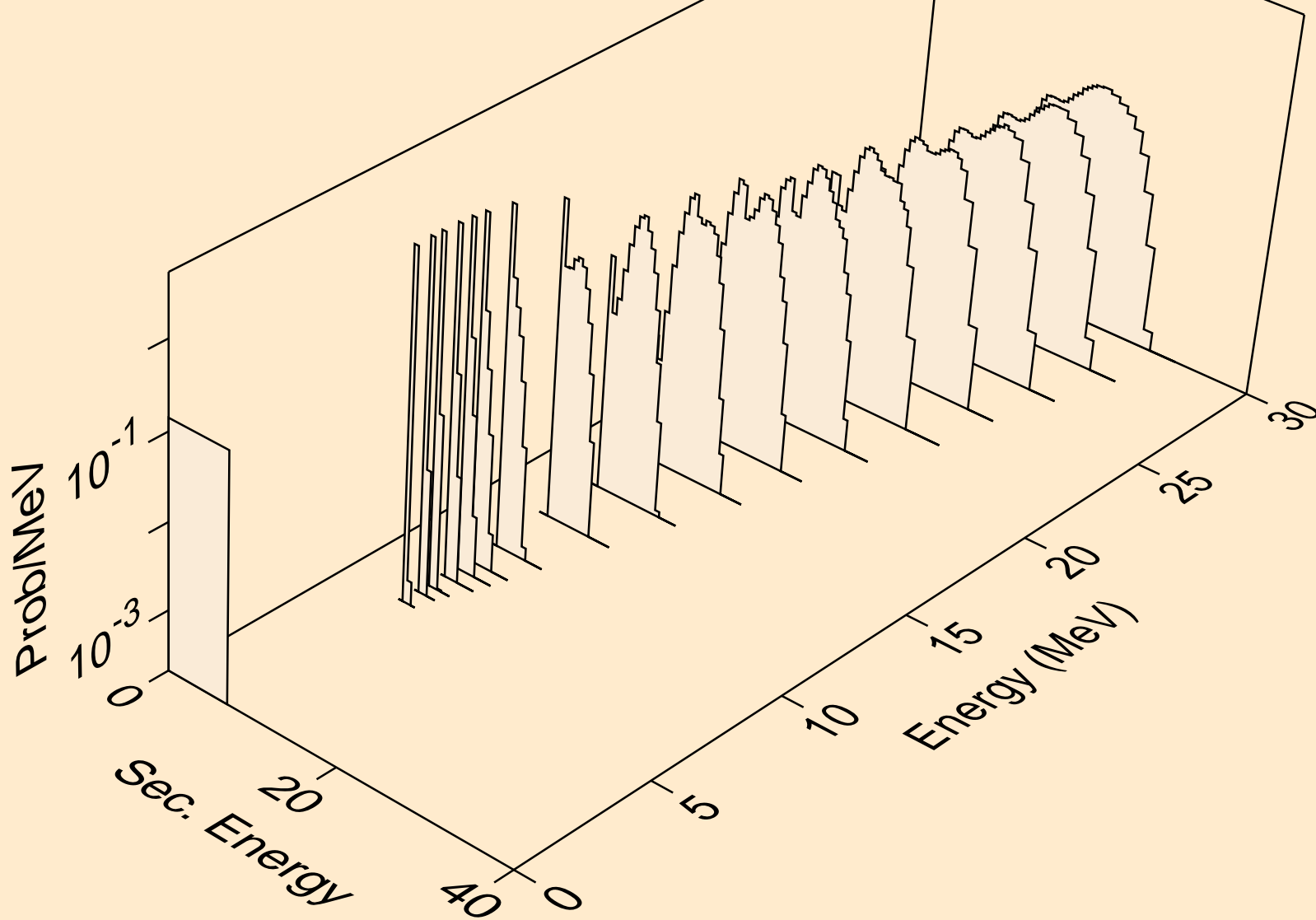

RA212 NEUTRON ACER TENDL-2019 LIBRARY; T=293.16K  
alphas from (n,a)

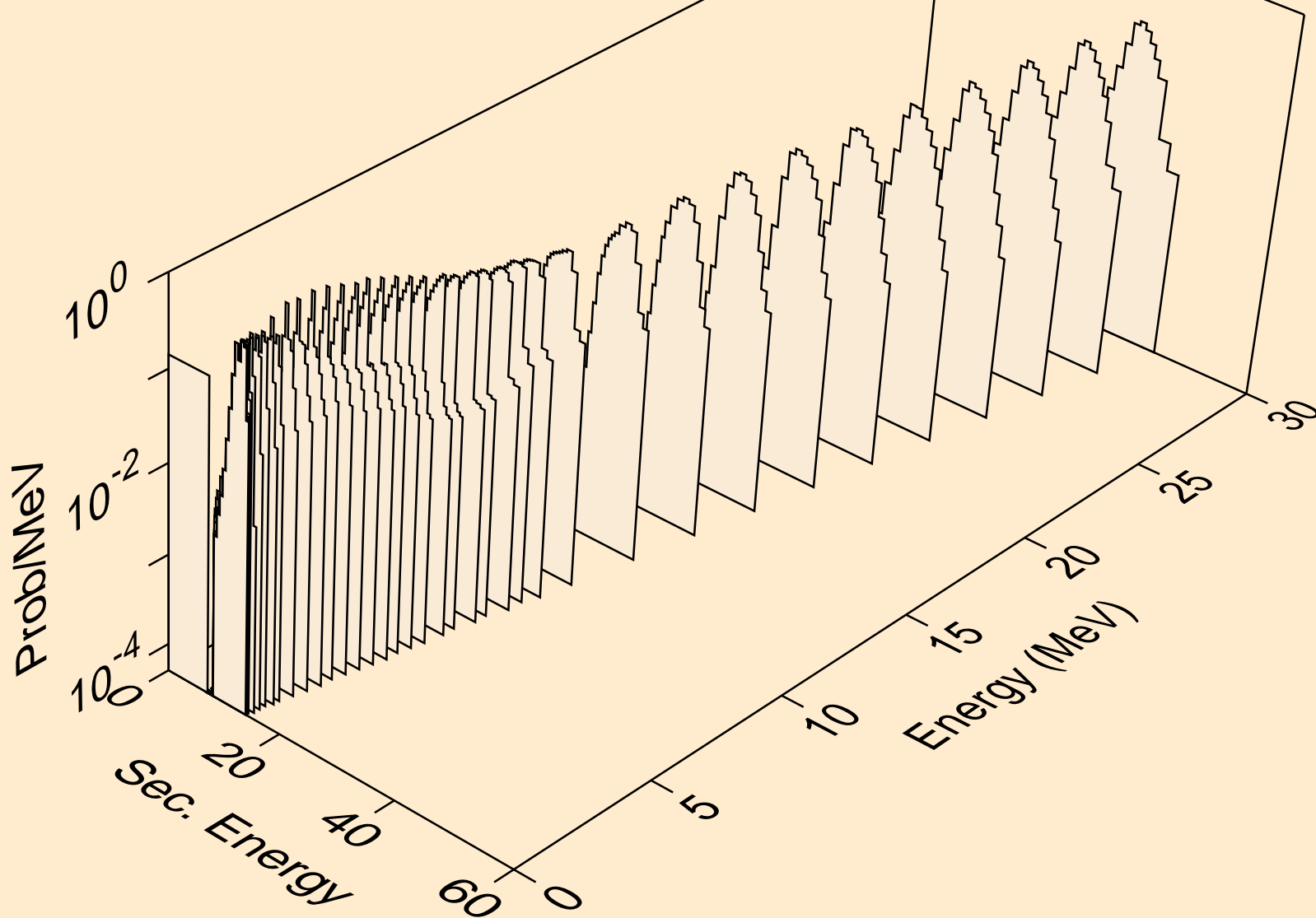



RA212 NEUTRON ACER TENDL-2019 LIBRARY; T=293.16K  
alphas from (n,2a)

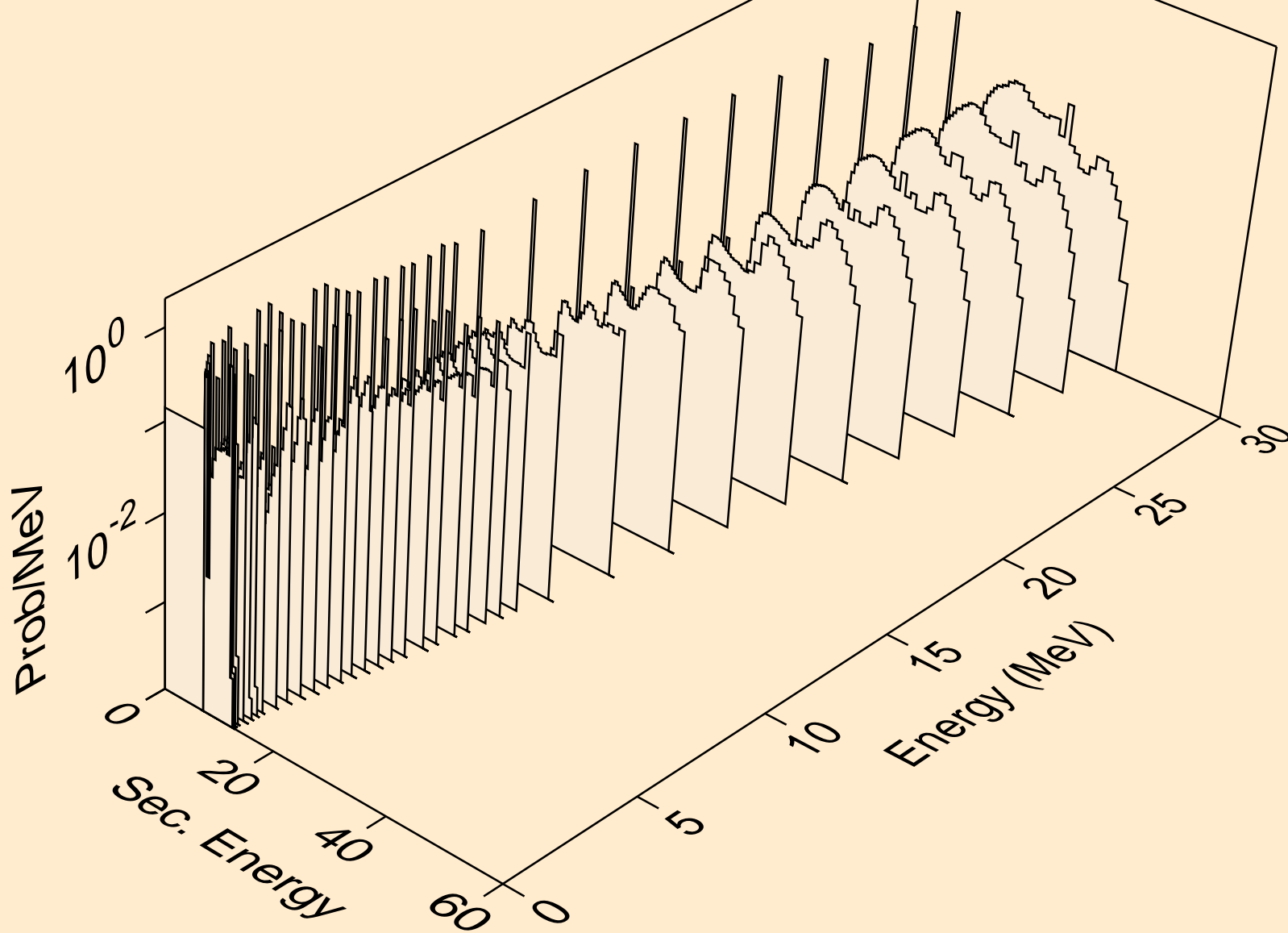

RA212 NEUTRON ACER TENDL-2019 LIBRARY; T=293.16K  
alphas from (n,pa)

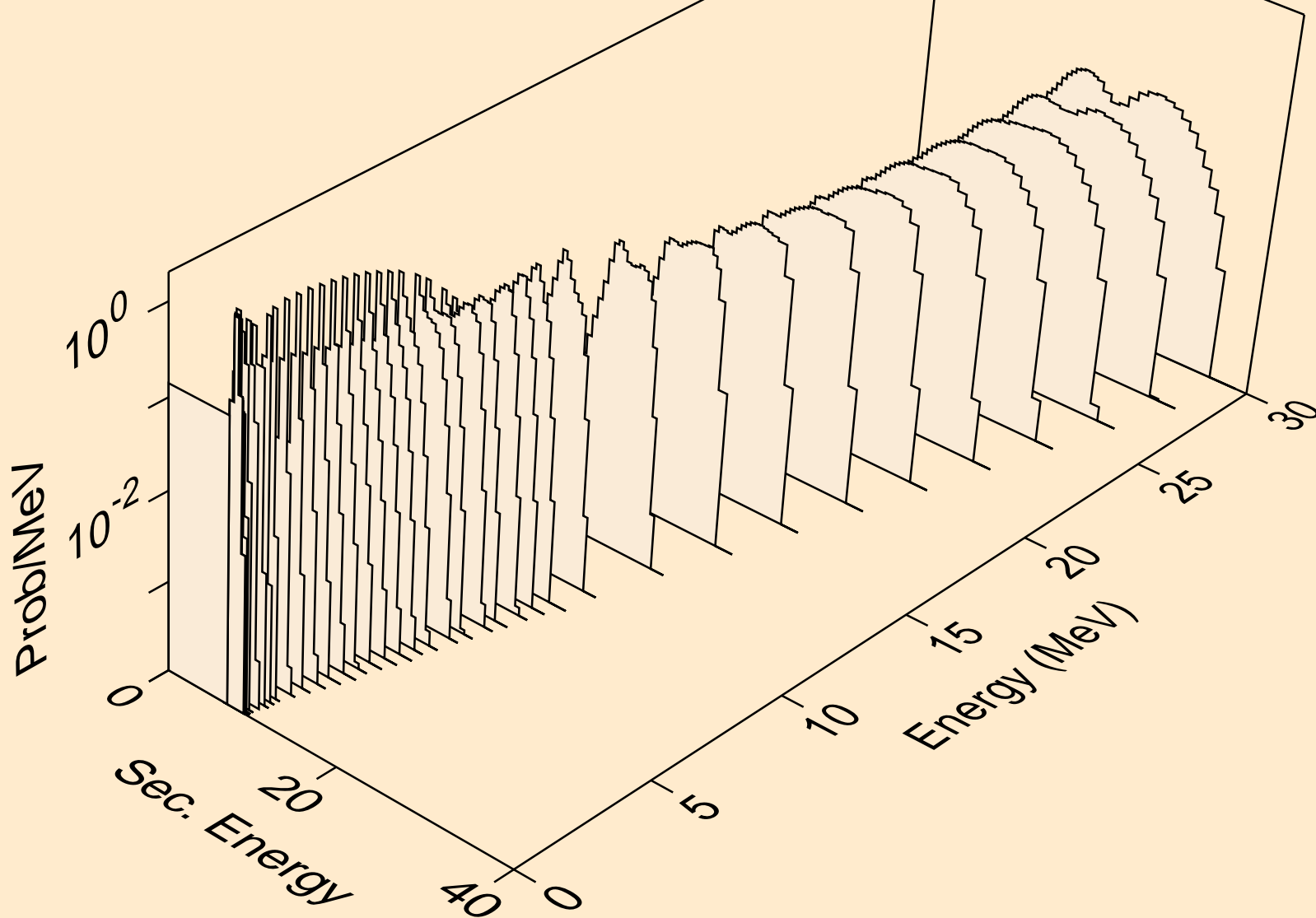

RA212 NEUTRON ACER TENDL-2019 LIBRARY; T=293.16K  
alphas from (n,da)

