

RA213 NEUTRON ACER TENDL-2019 LIBRARY; T=293.16K
Principal cross sections

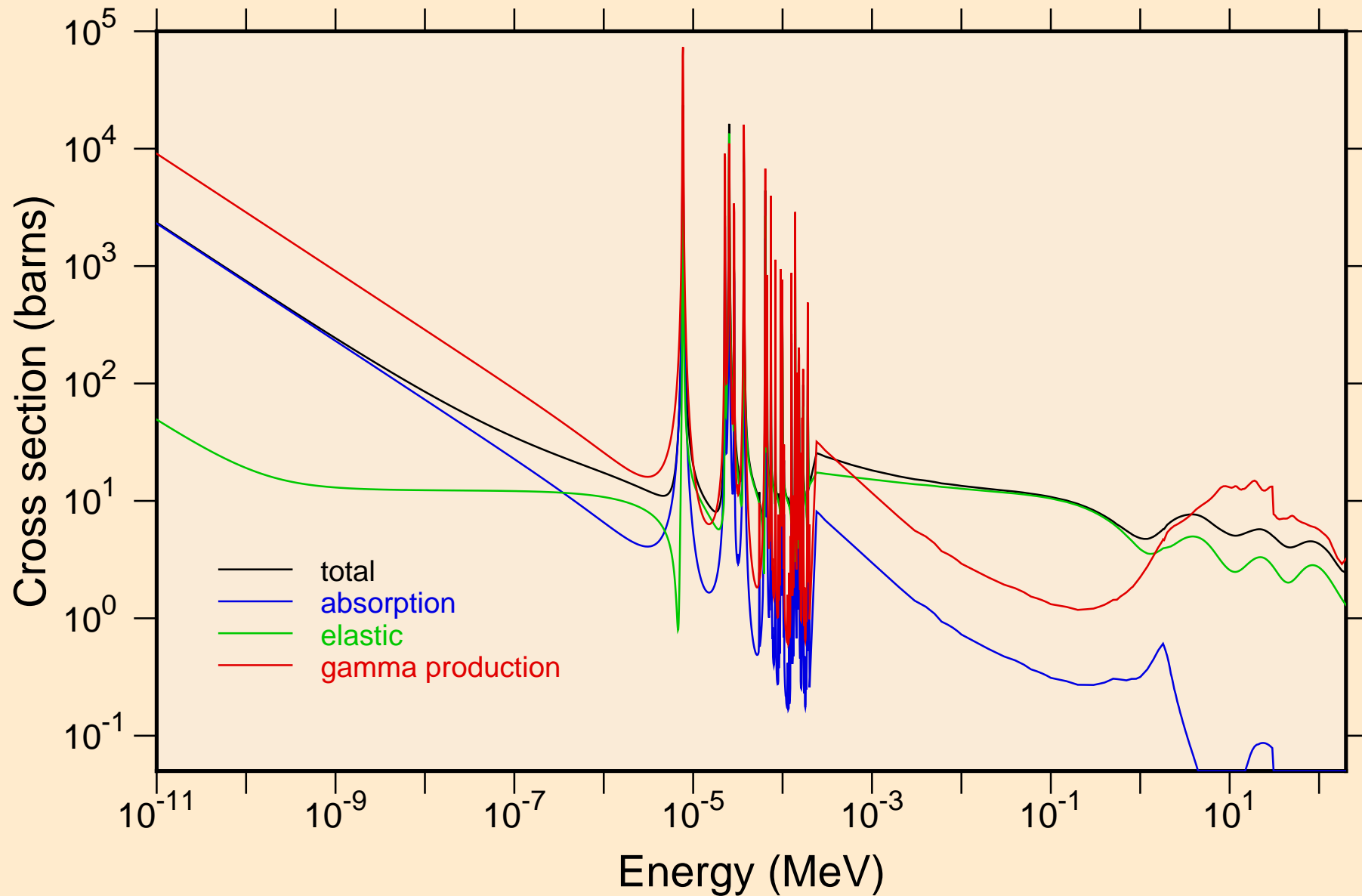

RA213 NEUTRON ACER TENDL-2019 LIBRARY; T=293.16K
resonance total cross section

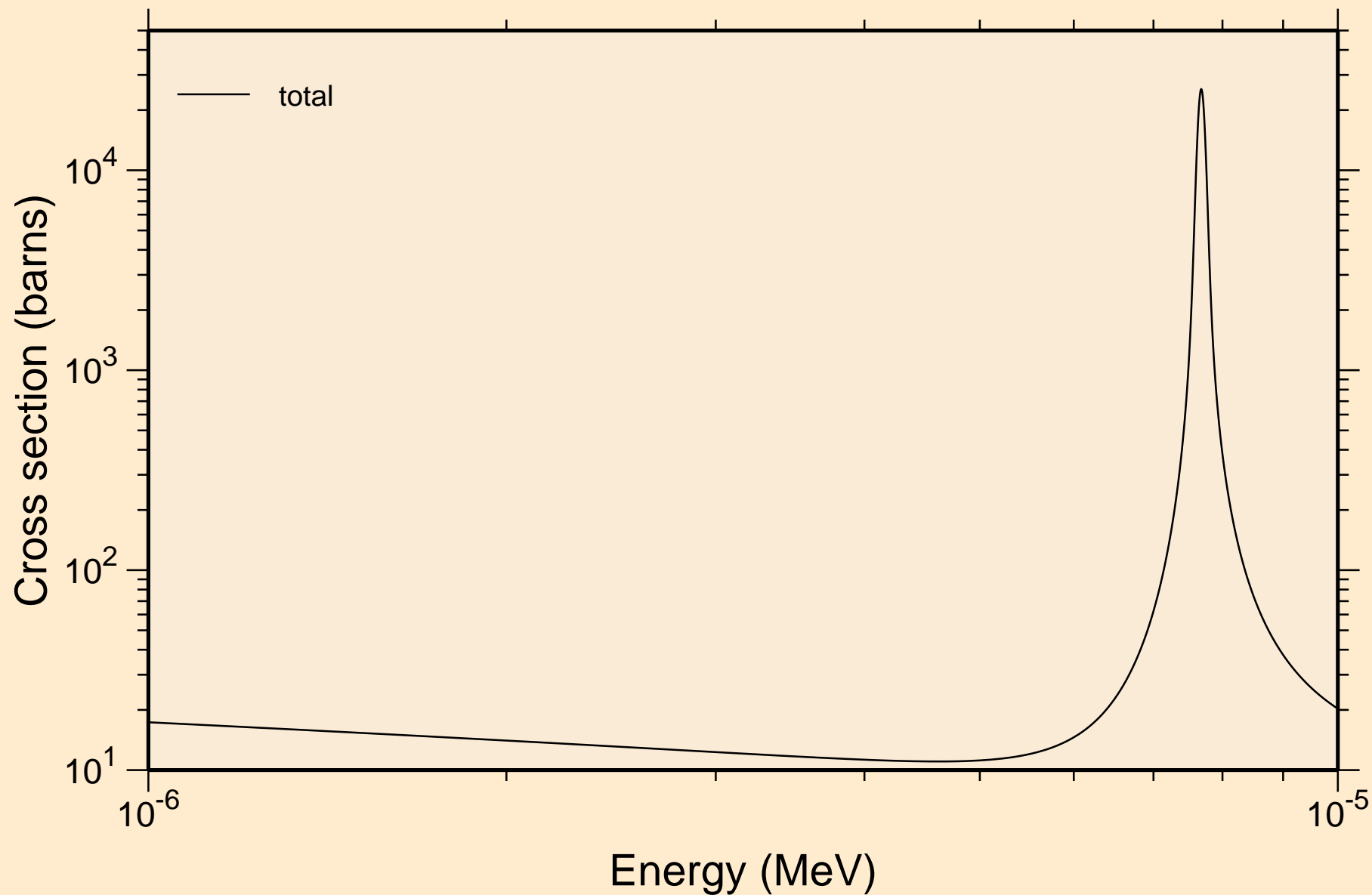

RA213 NEUTRON ACER TENDL-2019 LIBRARY; T=293.16K
resonance total cross section

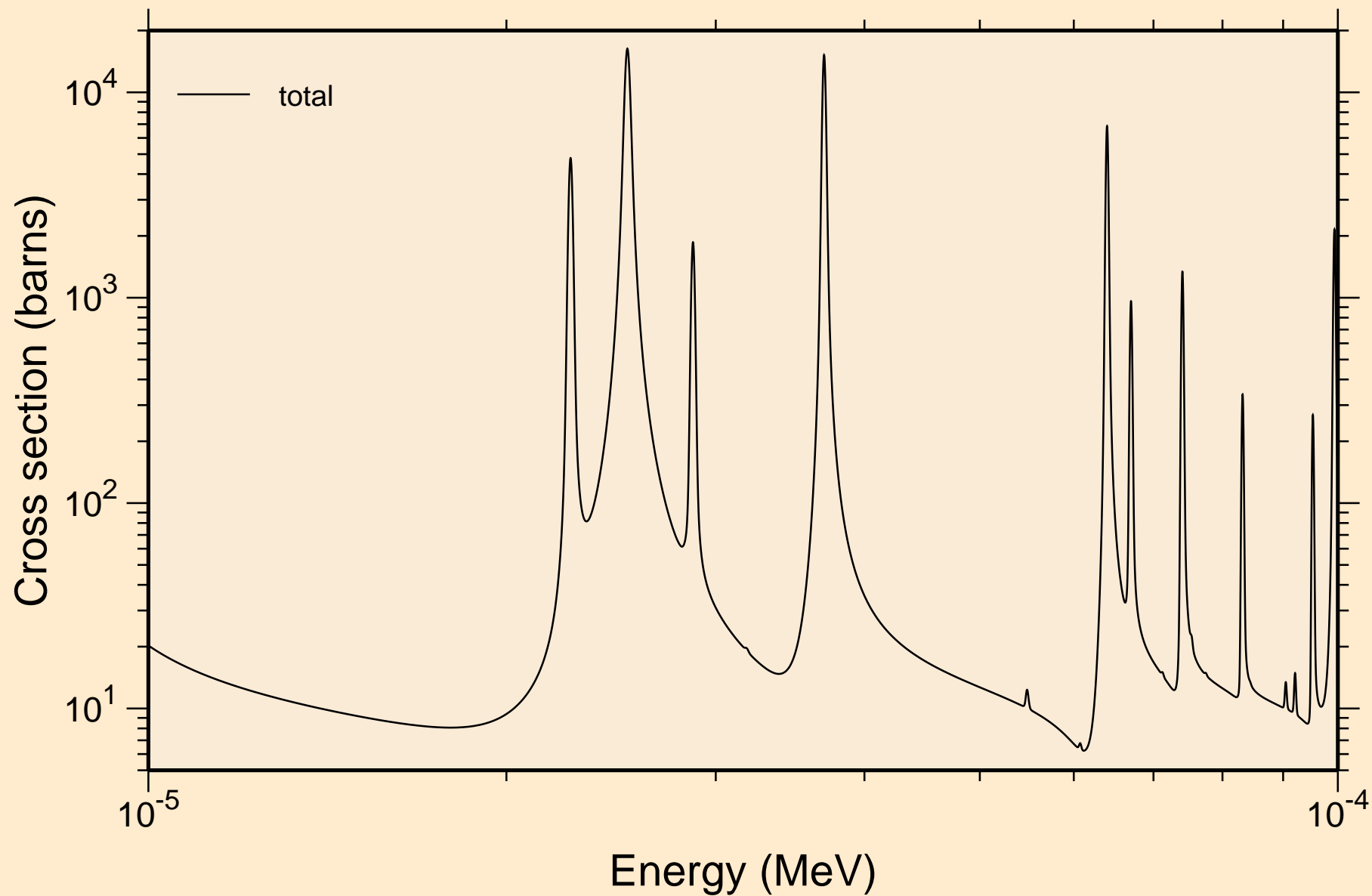

RA213 NEUTRON ACER TENDL-2019 LIBRARY; T=293.16K
resonance total cross section

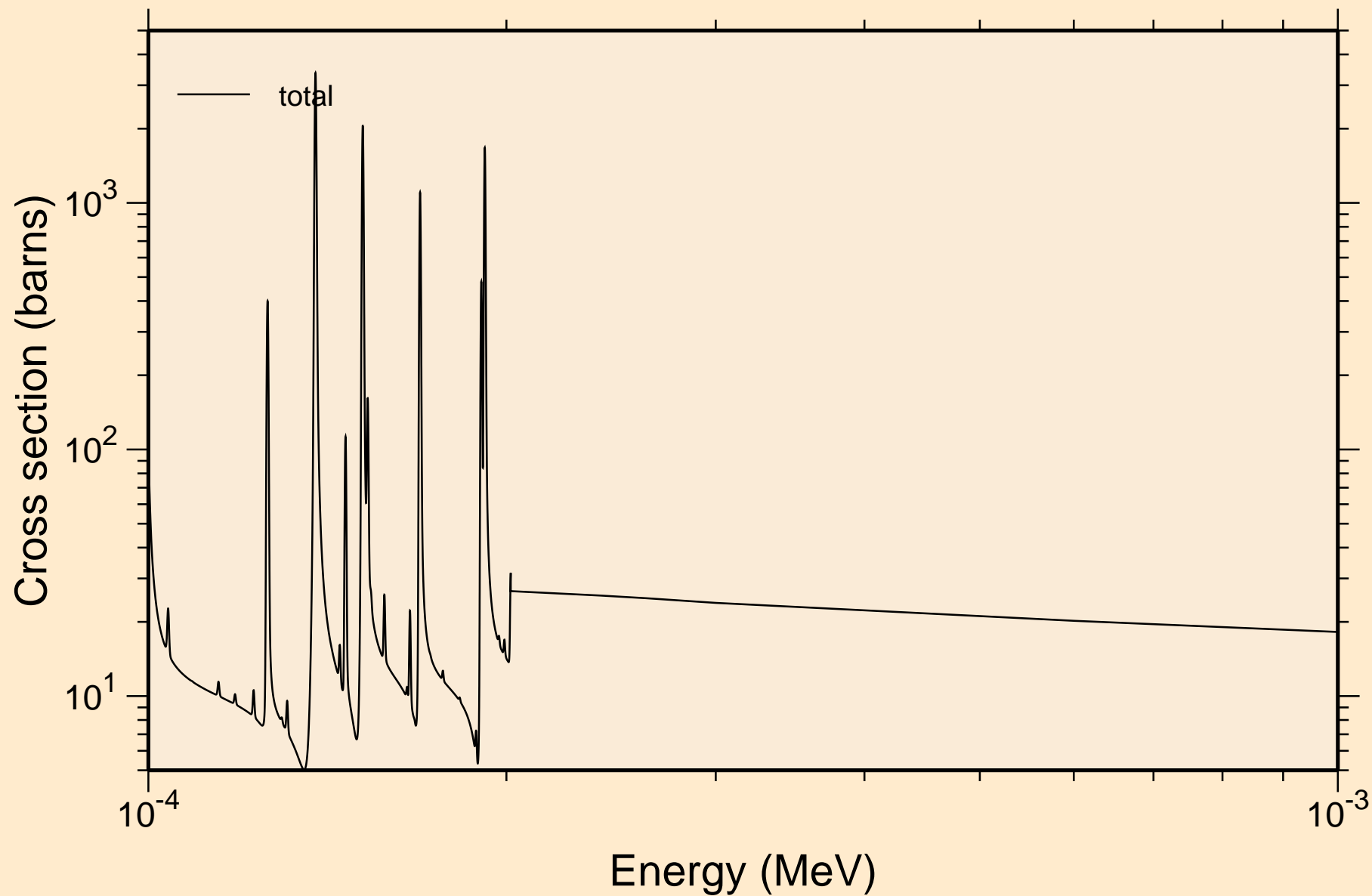

RA213 NEUTRON ACER TENDL-2019 LIBRARY; T=293.16K
resonance total cross section

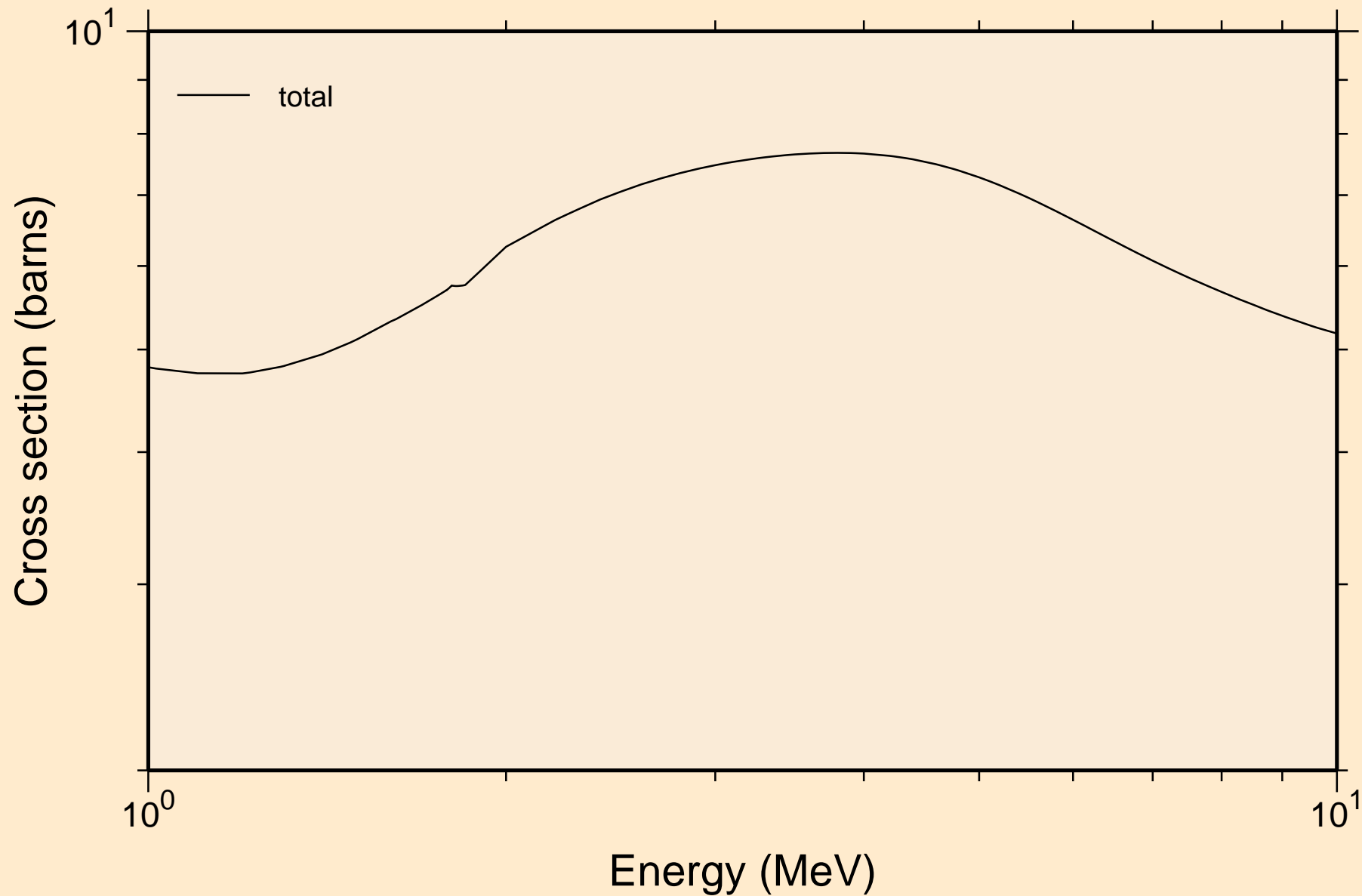

RA213 NEUTRON ACER TENDL-2019 LIBRARY; T=293.16K
resonance absorption cross sections

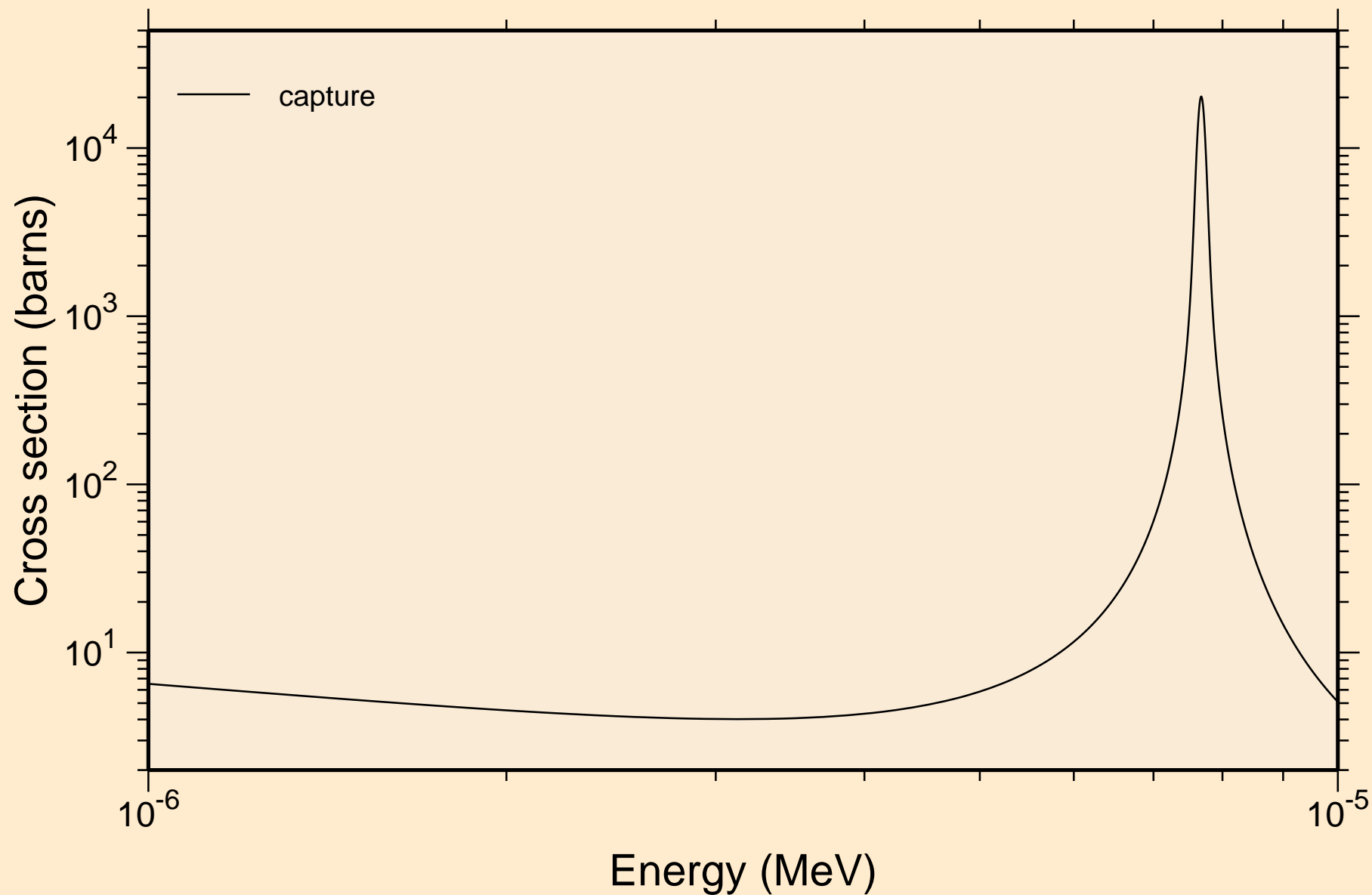

RA213 NEUTRON ACER TENDL-2019 LIBRARY; T=293.16K
resonance absorption cross sections

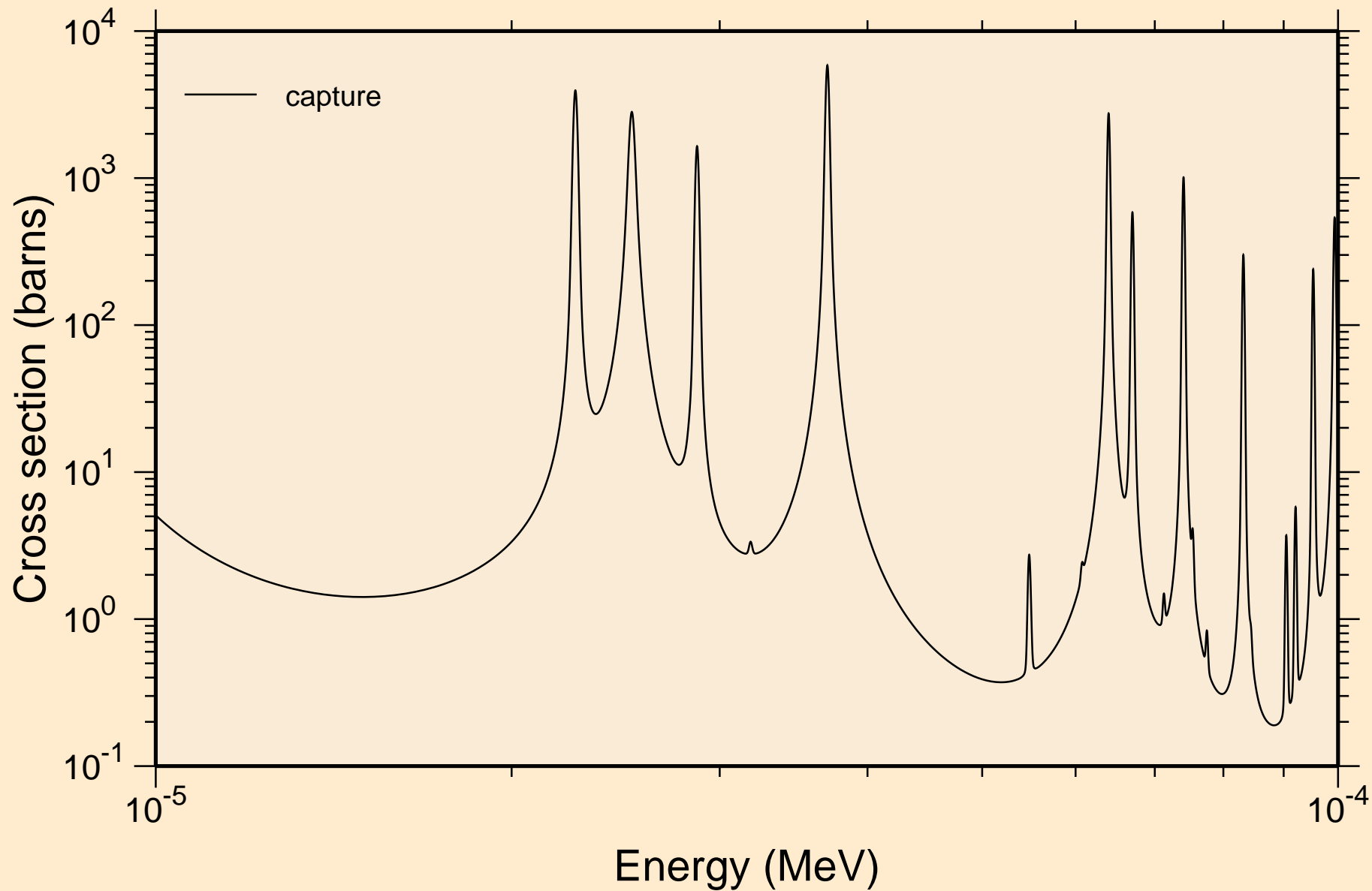

RA213 NEUTRON ACER TENDL-2019 LIBRARY; T=293.16K
resonance absorption cross sections

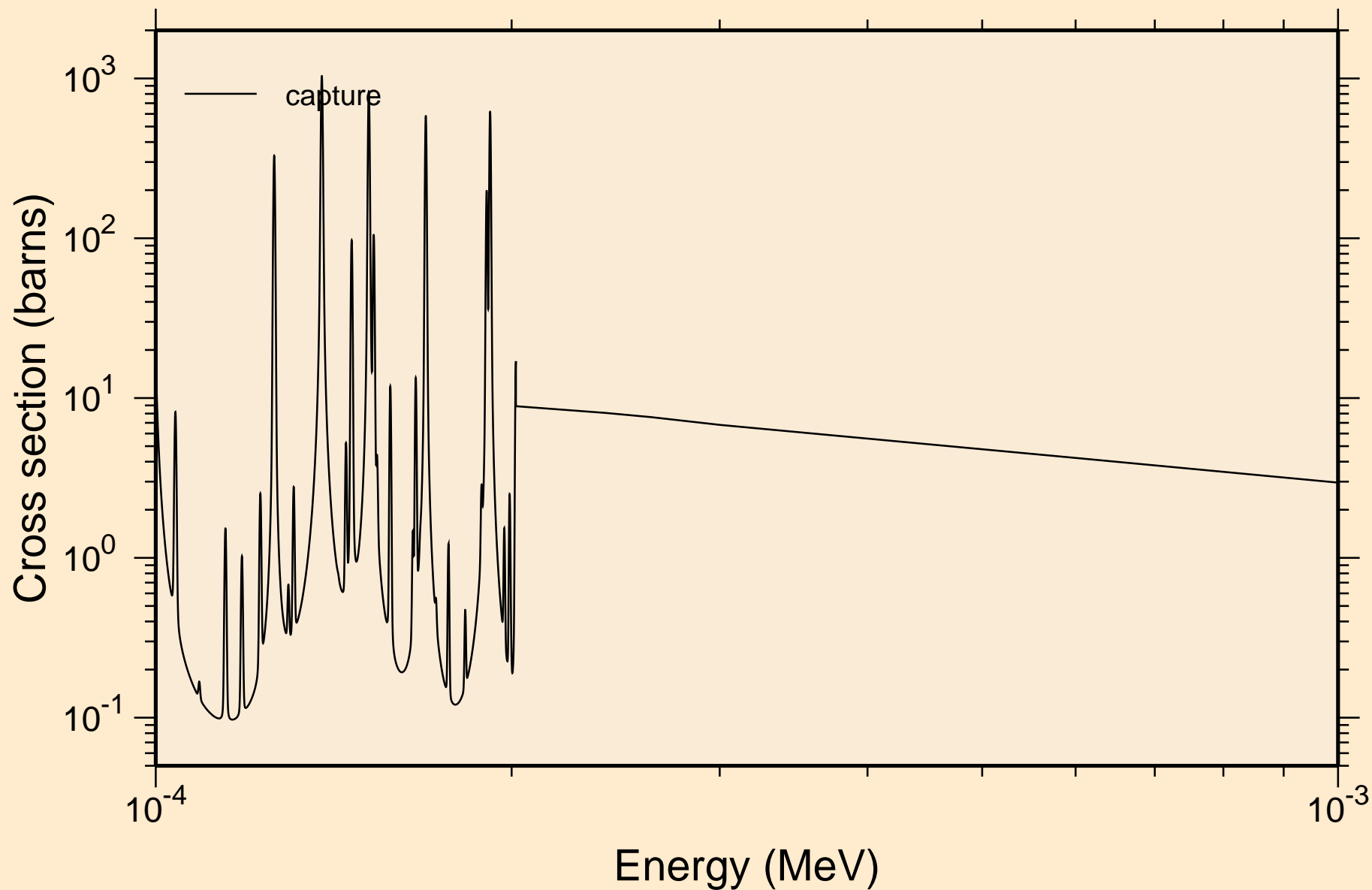

RA213 NEUTRON ACER TENDL-2019 LIBRARY; T=293.16K
resonance absorption cross sections

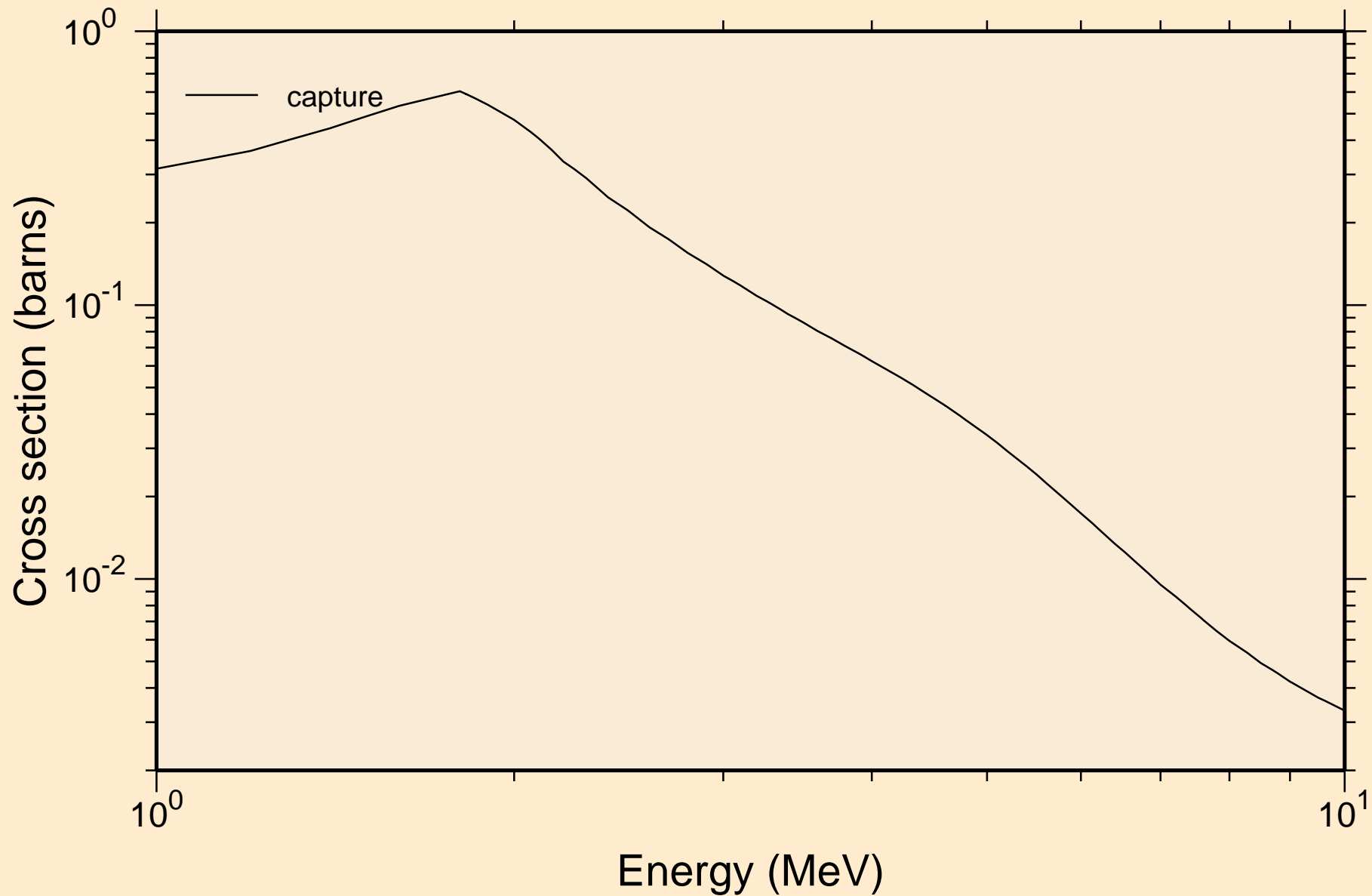

RA213 NEUTRON ACER TENDL-2019 LIBRARY; T=293.16K
Heating

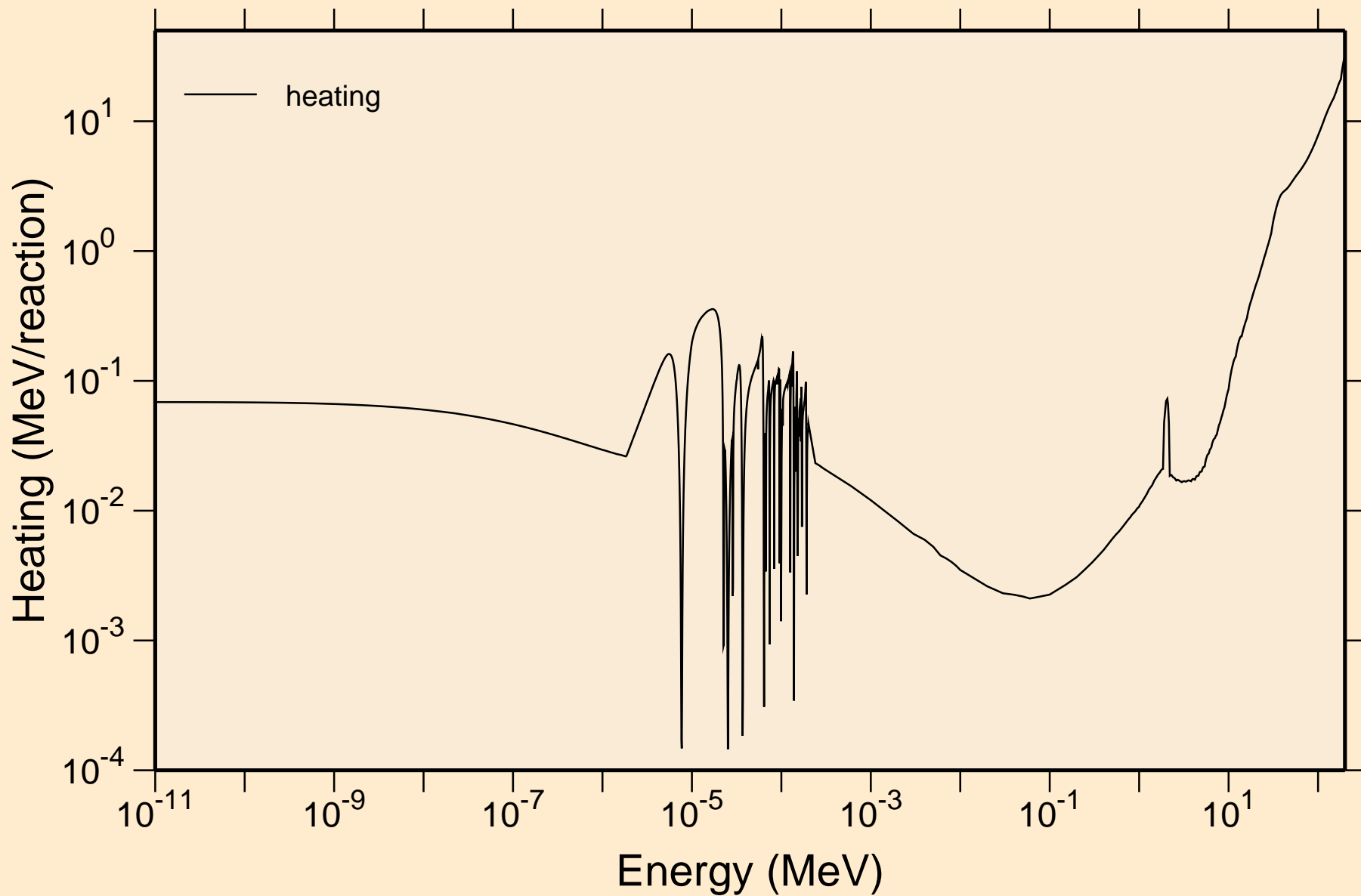

RA213 NEUTRON ACER TENDL-2019 LIBRARY; T=293.16K
Damage

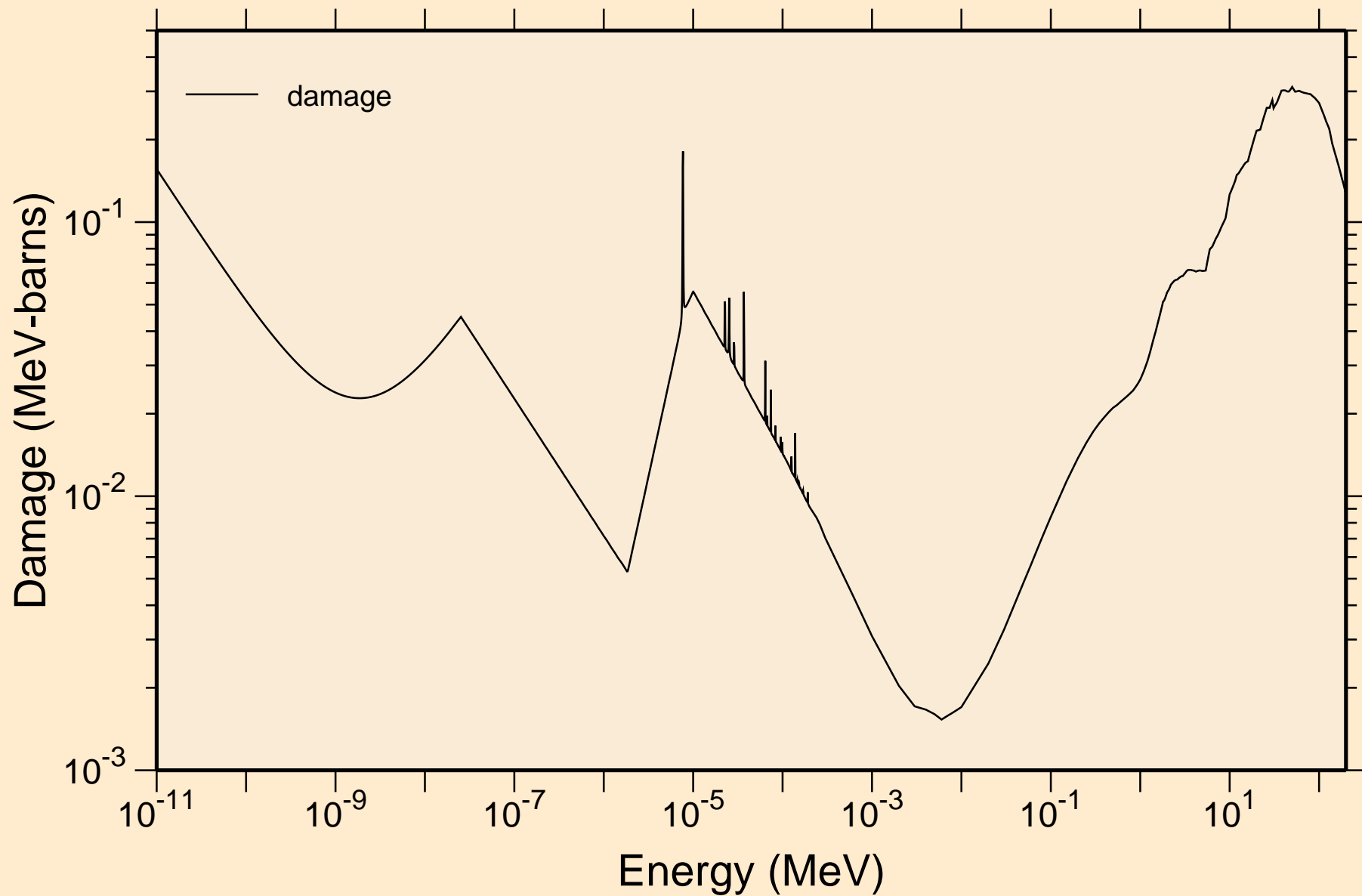

RA213 NEUTRON ACER TENDL-2019 LIBRARY; T=293.16K
Non-threshold reactions

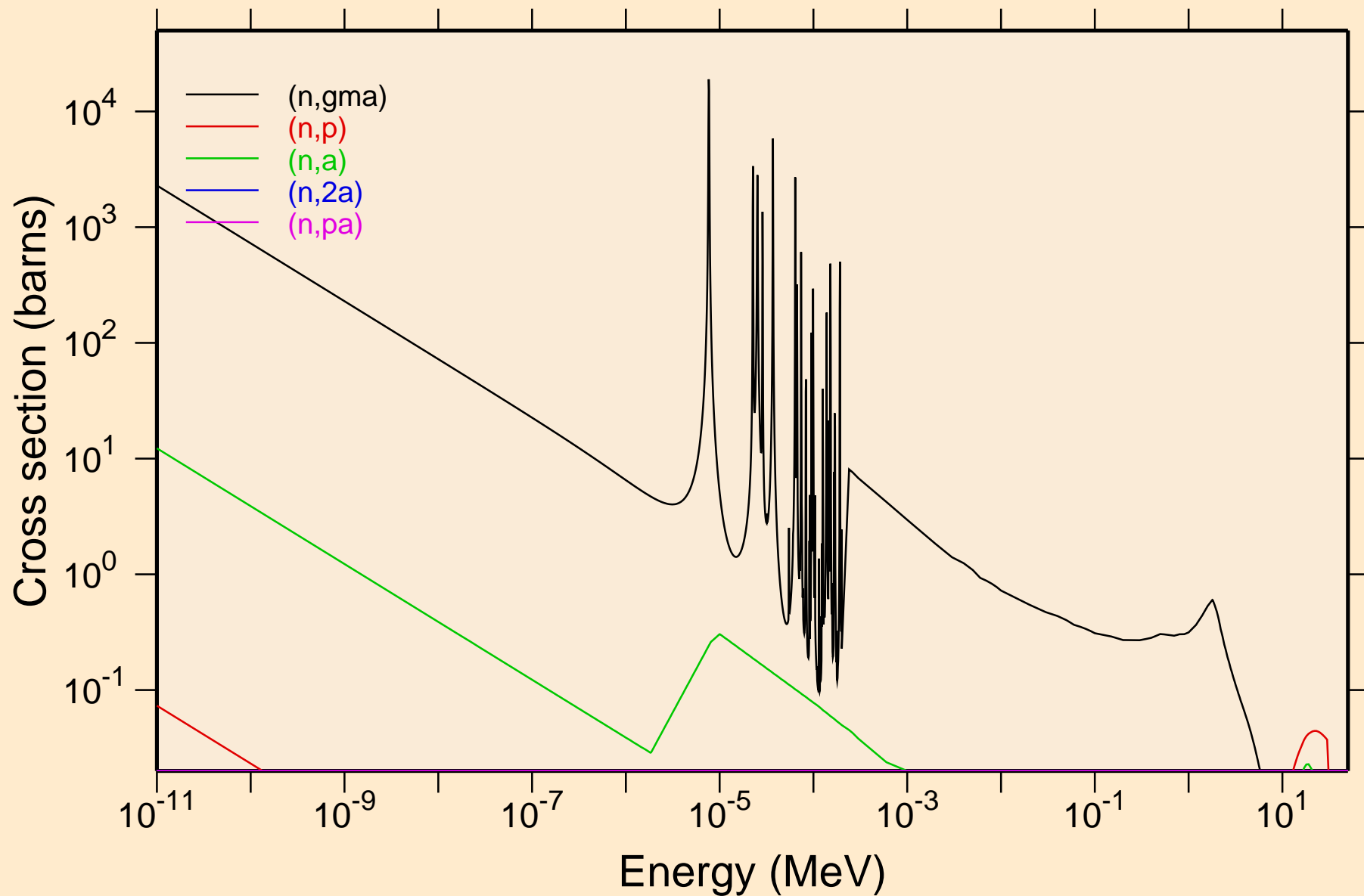

RA213 NEUTRON ACER TENDL-2019 LIBRARY; T=293.16K
Non-threshold reactions

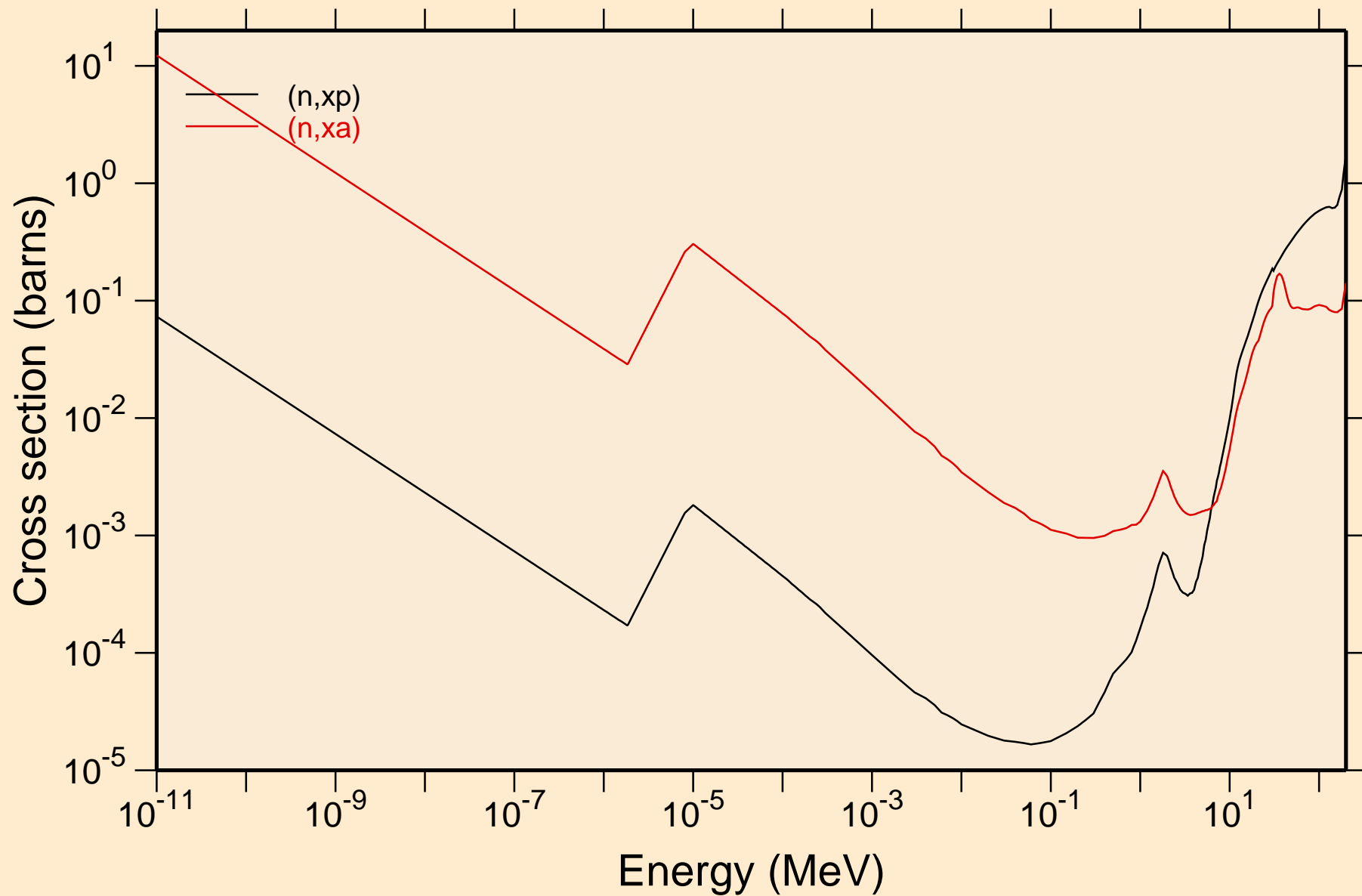

RA213 NEUTRON ACER TENDL-2019 LIBRARY; T=293.16K
Principal cross sections

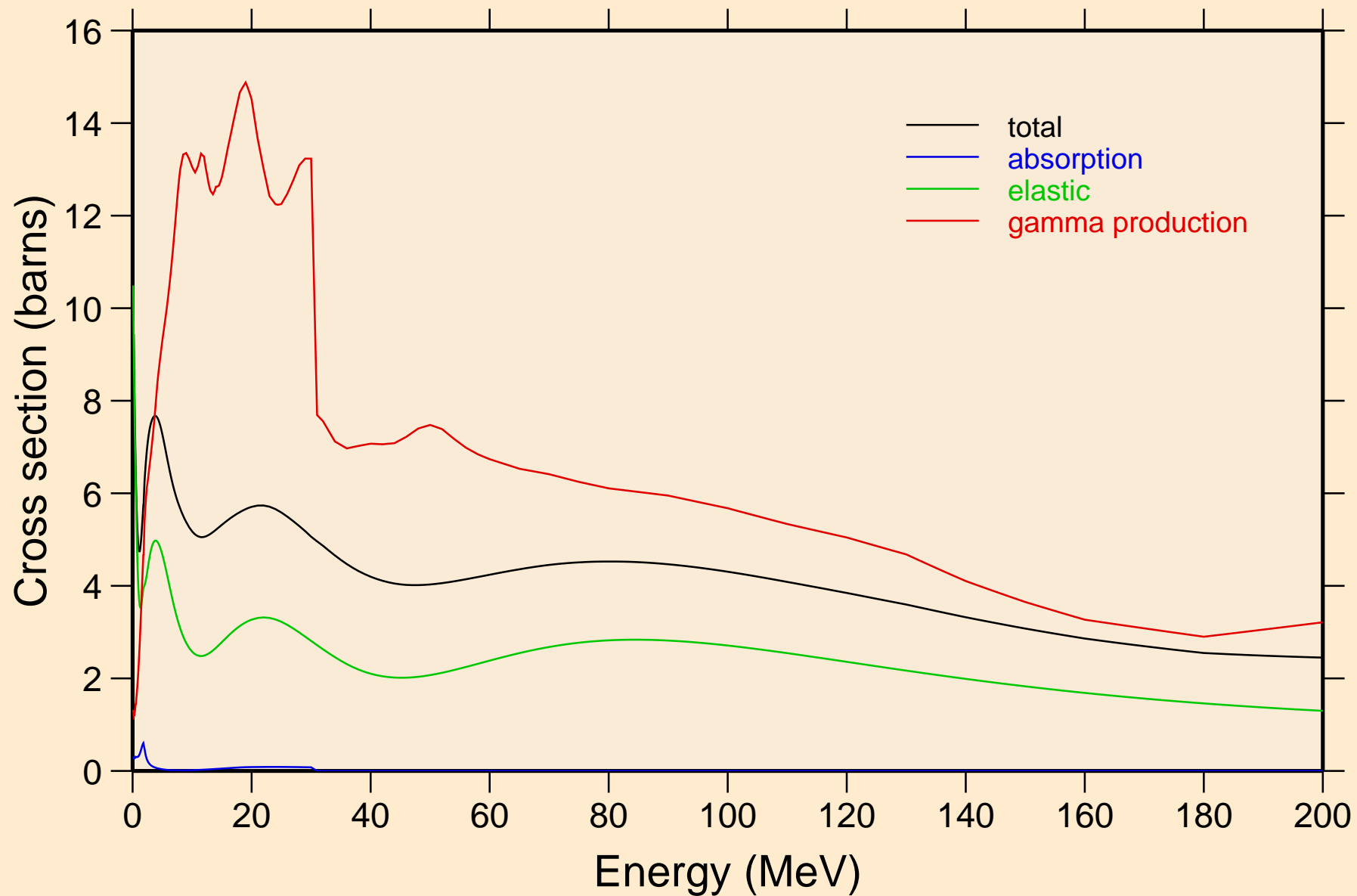

RA213 NEUTRON ACER TENDL-2019 LIBRARY; T=293.16K
Heating

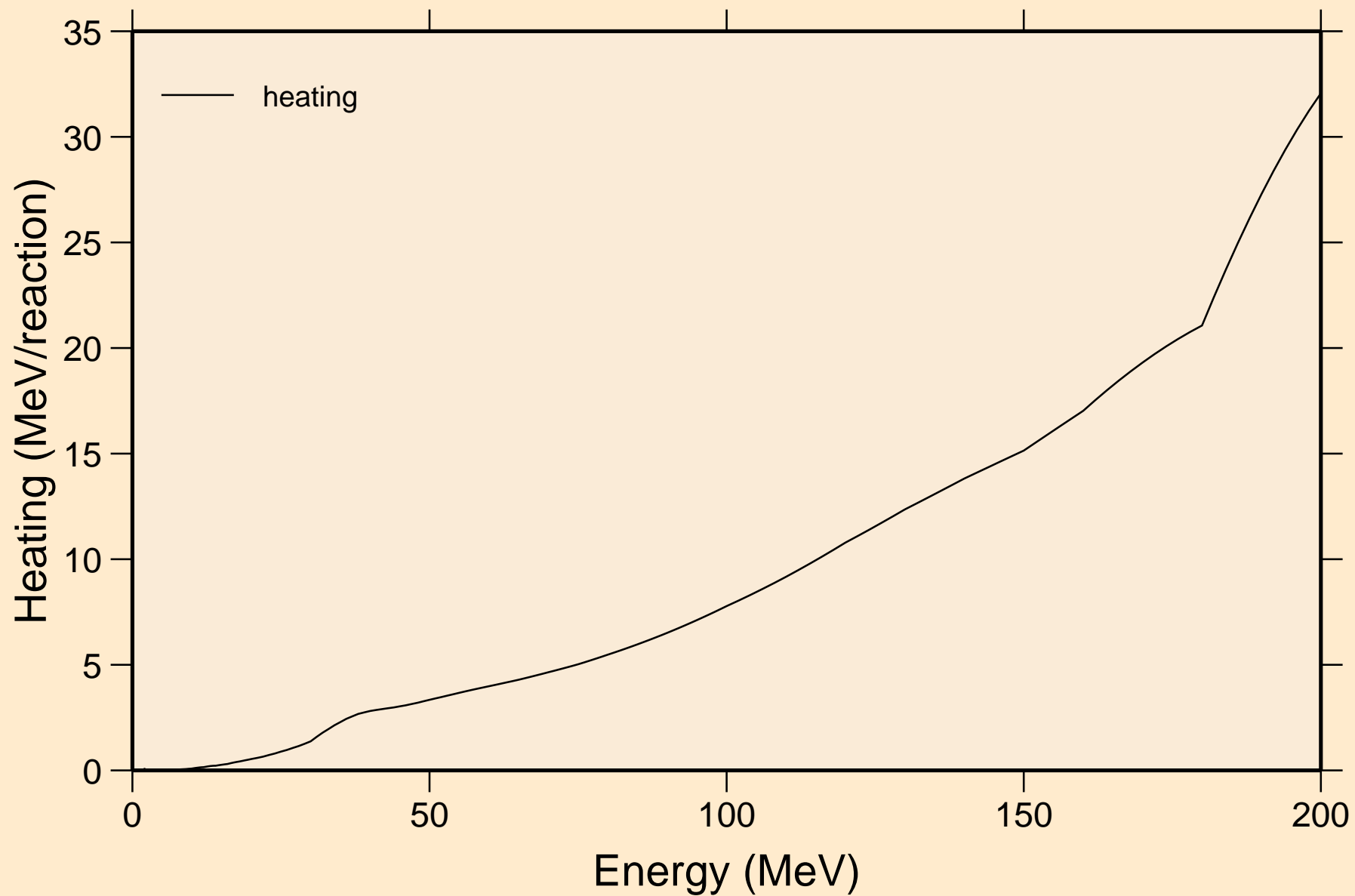

RA213 NEUTRON ACER TENDL-2019 LIBRARY; T=293.16K
Damage

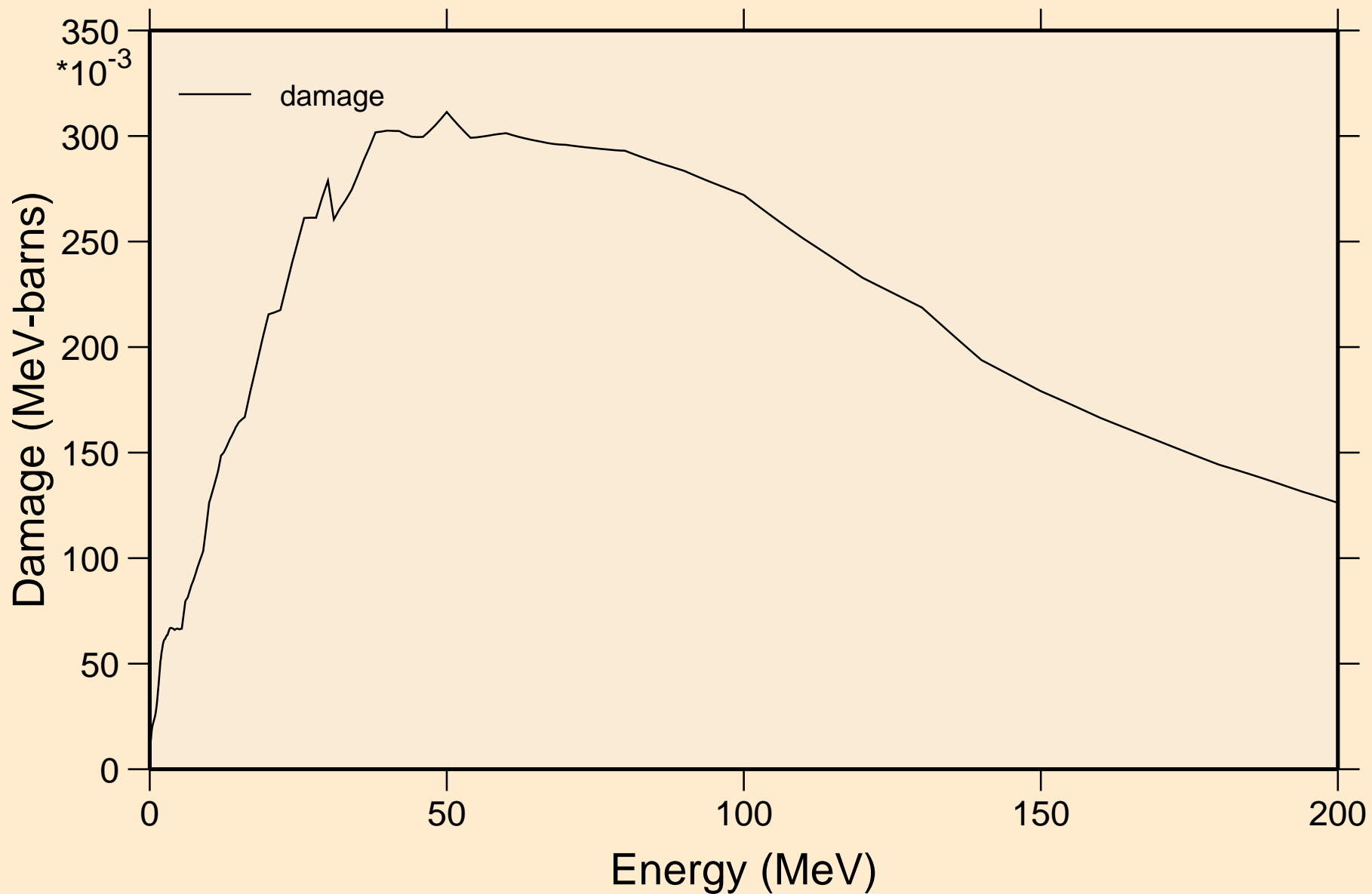

RA213 NEUTRON ACER TENDL-2019 LIBRARY; T=293.16K
Non-threshold reactions

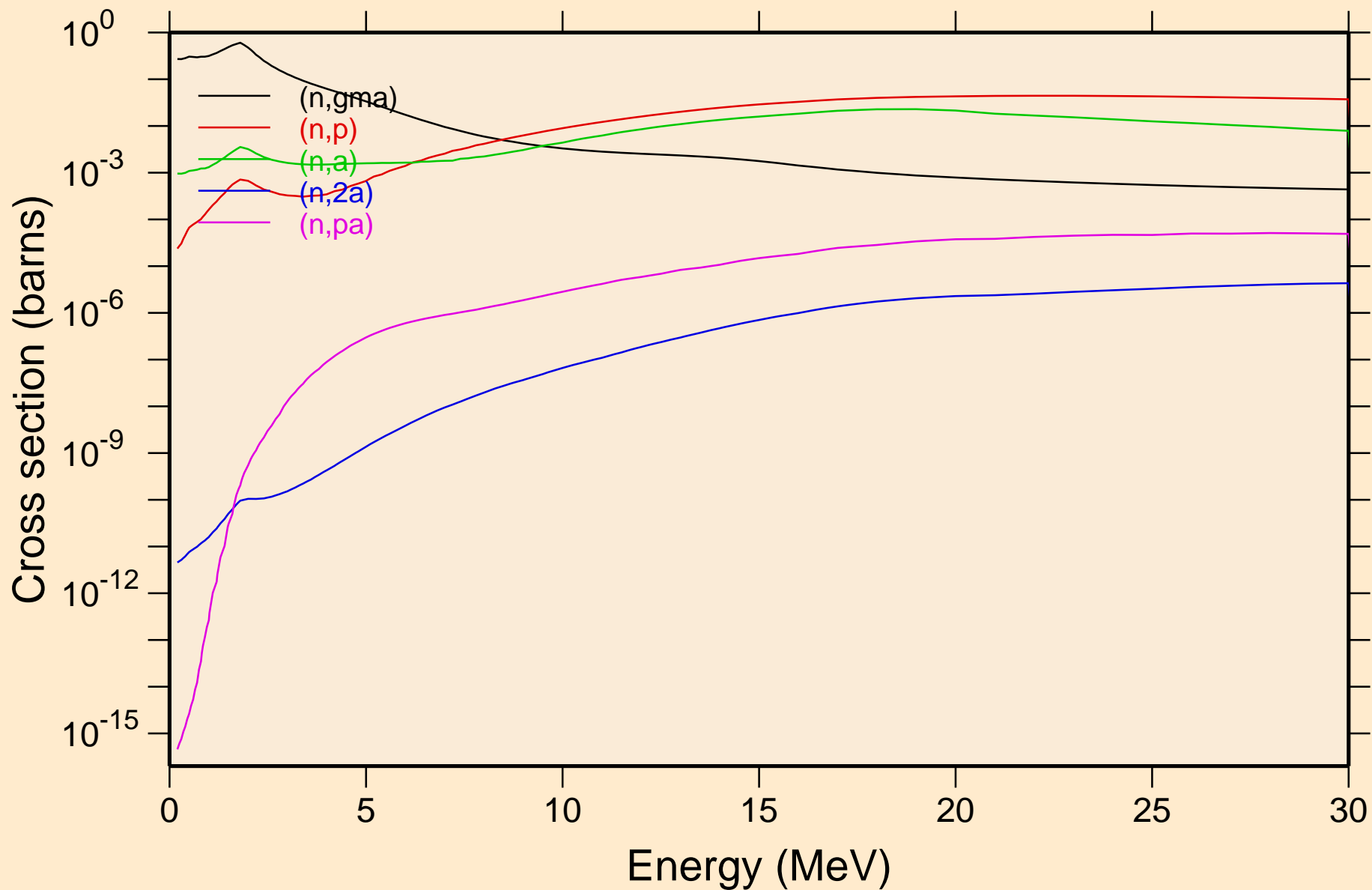

RA213 NEUTRON ACER TENDL-2019 LIBRARY; T=293.16K
Non-threshold reactions

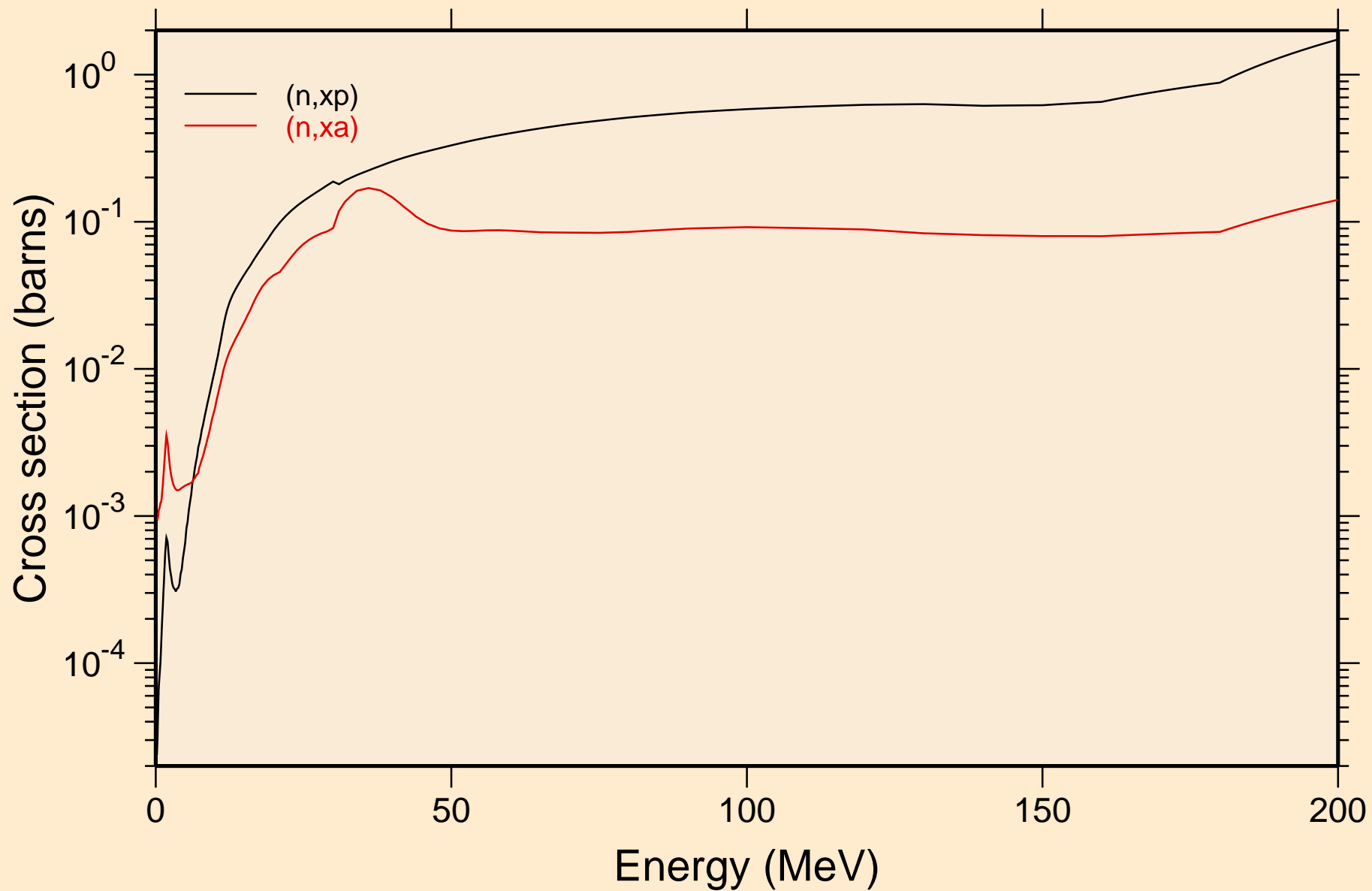

RA213 NEUTRON ACER TENDL-2019 LIBRARY; T=293.16K
Inelastic levels

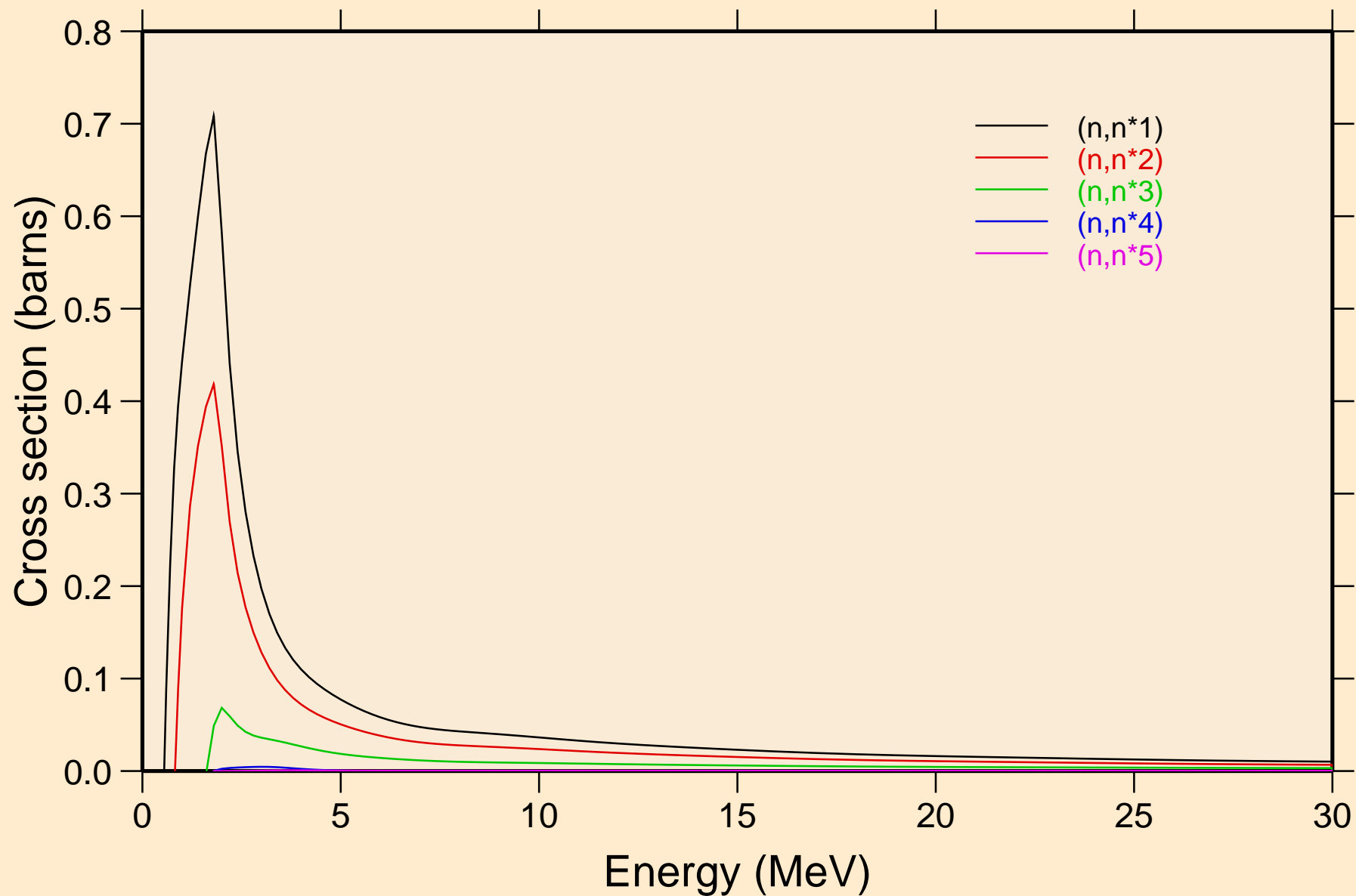

RA213 NEUTRON ACER TENDL-2019 LIBRARY; T=293.16K
Inelastic levels

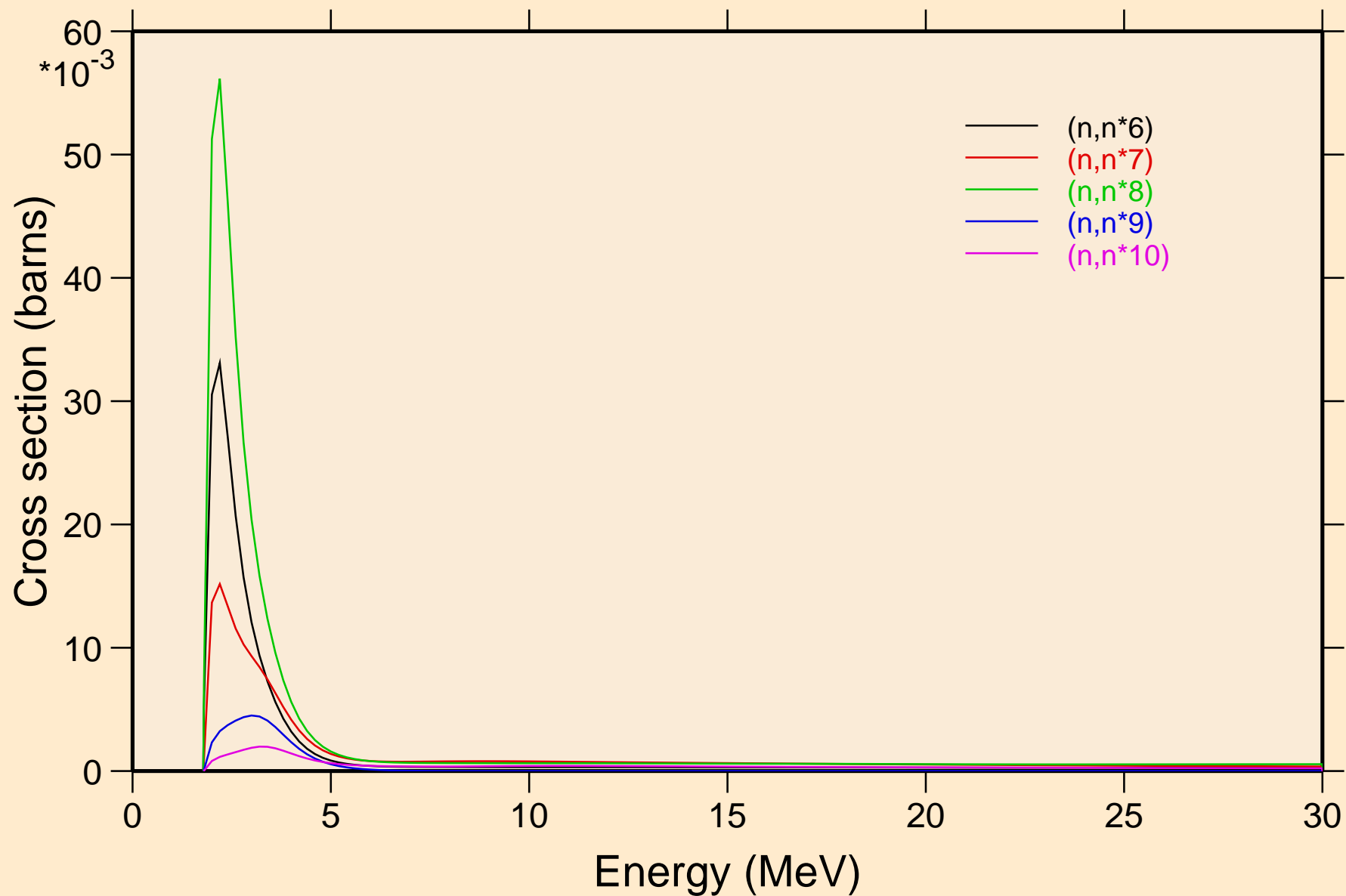

RA213 NEUTRON ACER TENDL-2019 LIBRARY; T=293.16K
Inelastic levels

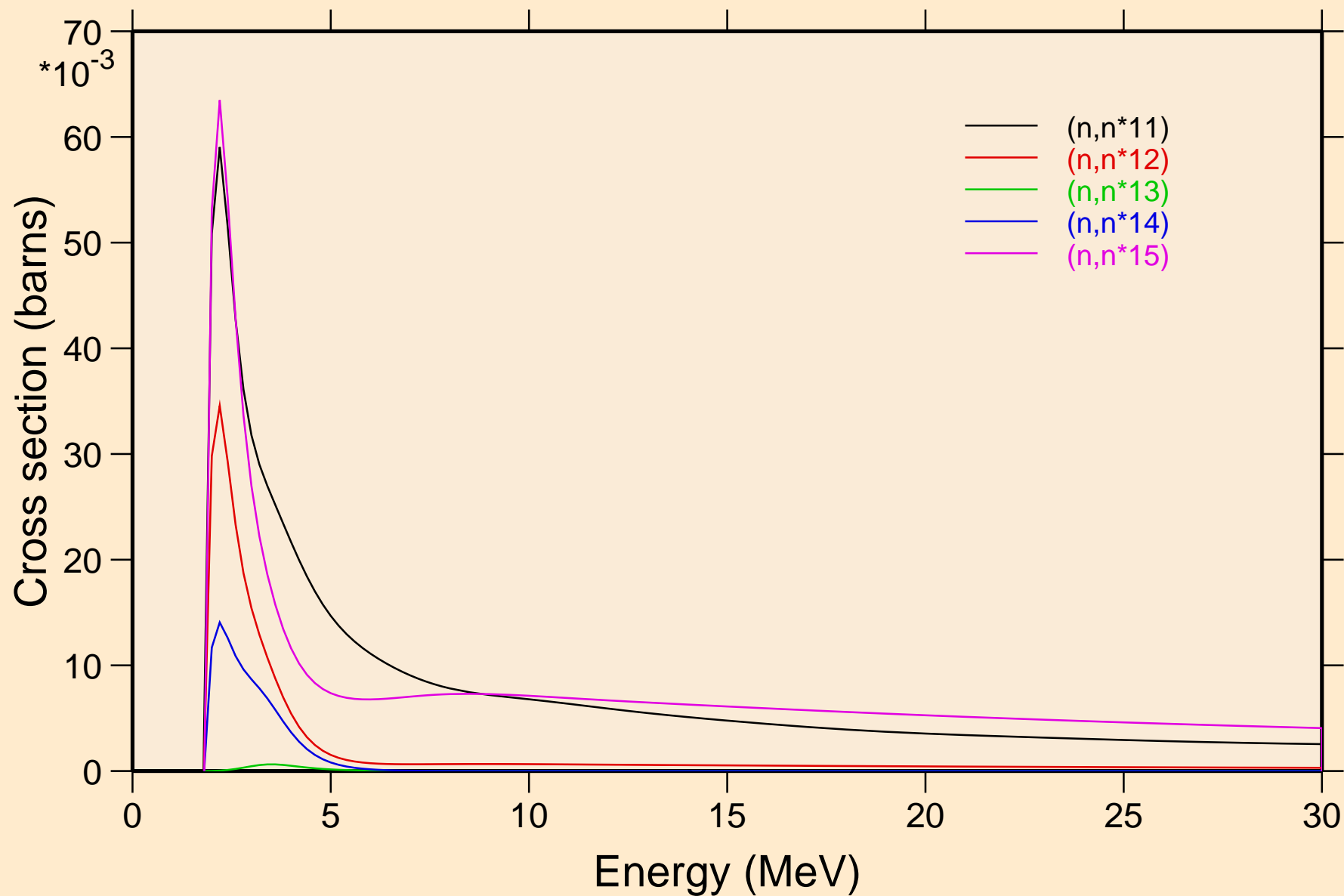

RA213 NEUTRON ACER TENDL-2019 LIBRARY; T=293.16K
Inelastic levels

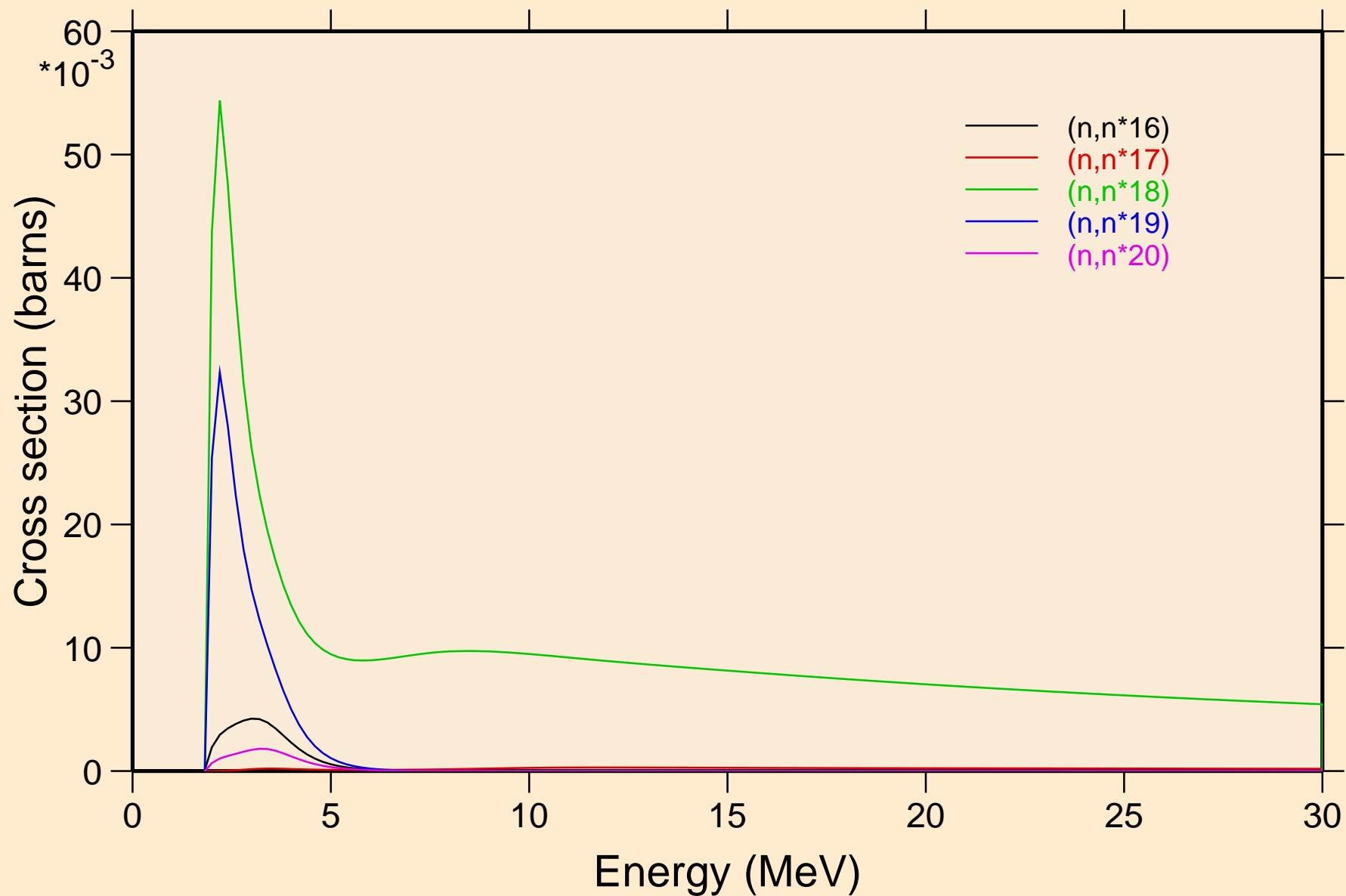

RA213 NEUTRON ACER TENDL-2019 LIBRARY; T=293.16K
Inelastic levels

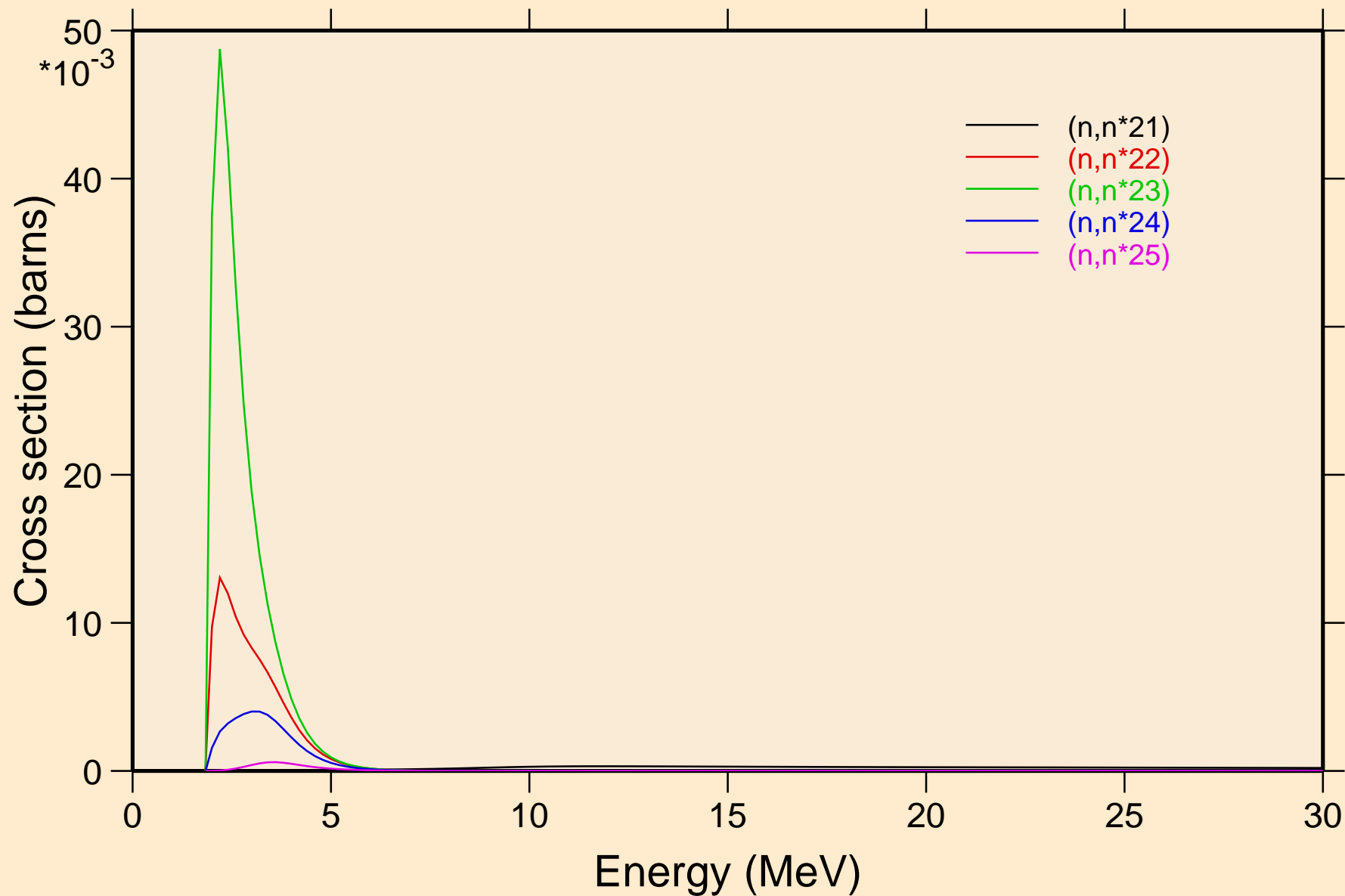

RA213 NEUTRON ACER TENDL-2019 LIBRARY; T=293.16K
Inelastic levels

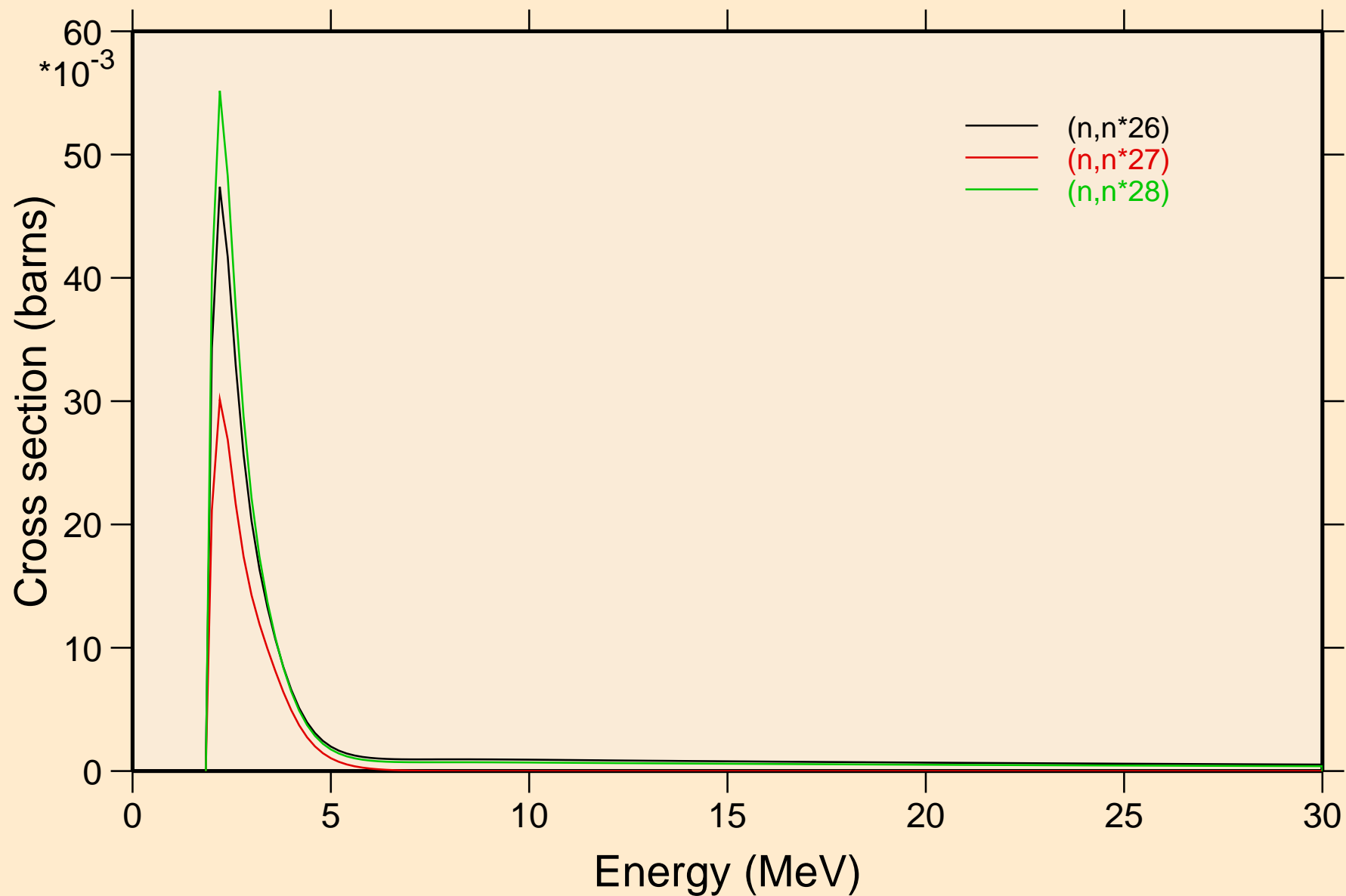

RA213 NEUTRON ACER TENDL-2019 LIBRARY; T=293.16K
Threshold reactions

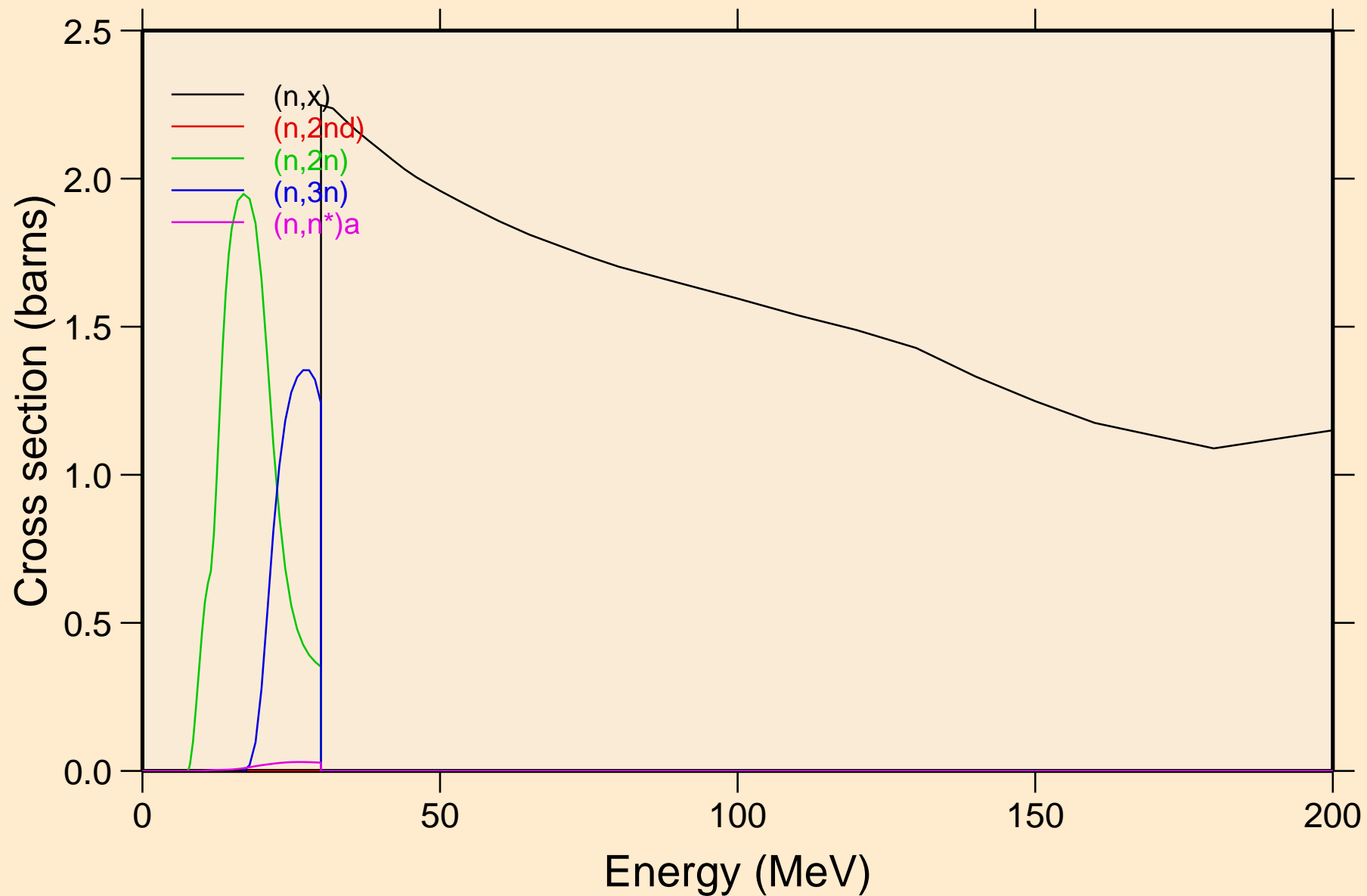

RA213 NEUTRON ACER TENDL-2019 LIBRARY; T=293.16K
Threshold reactions

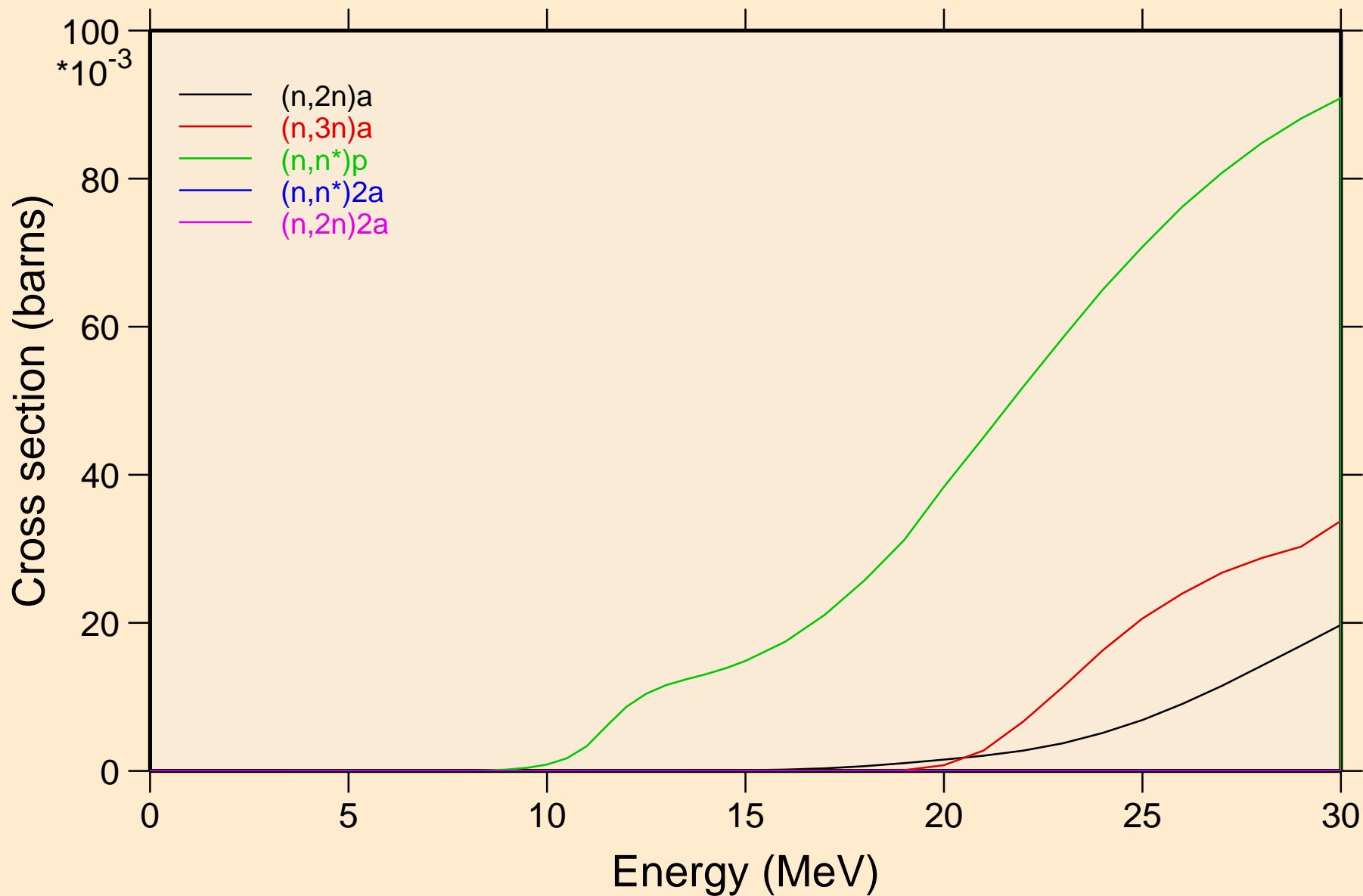

RA213 NEUTRON ACER TENDL-2019 LIBRARY; T=293.16K
Threshold reactions

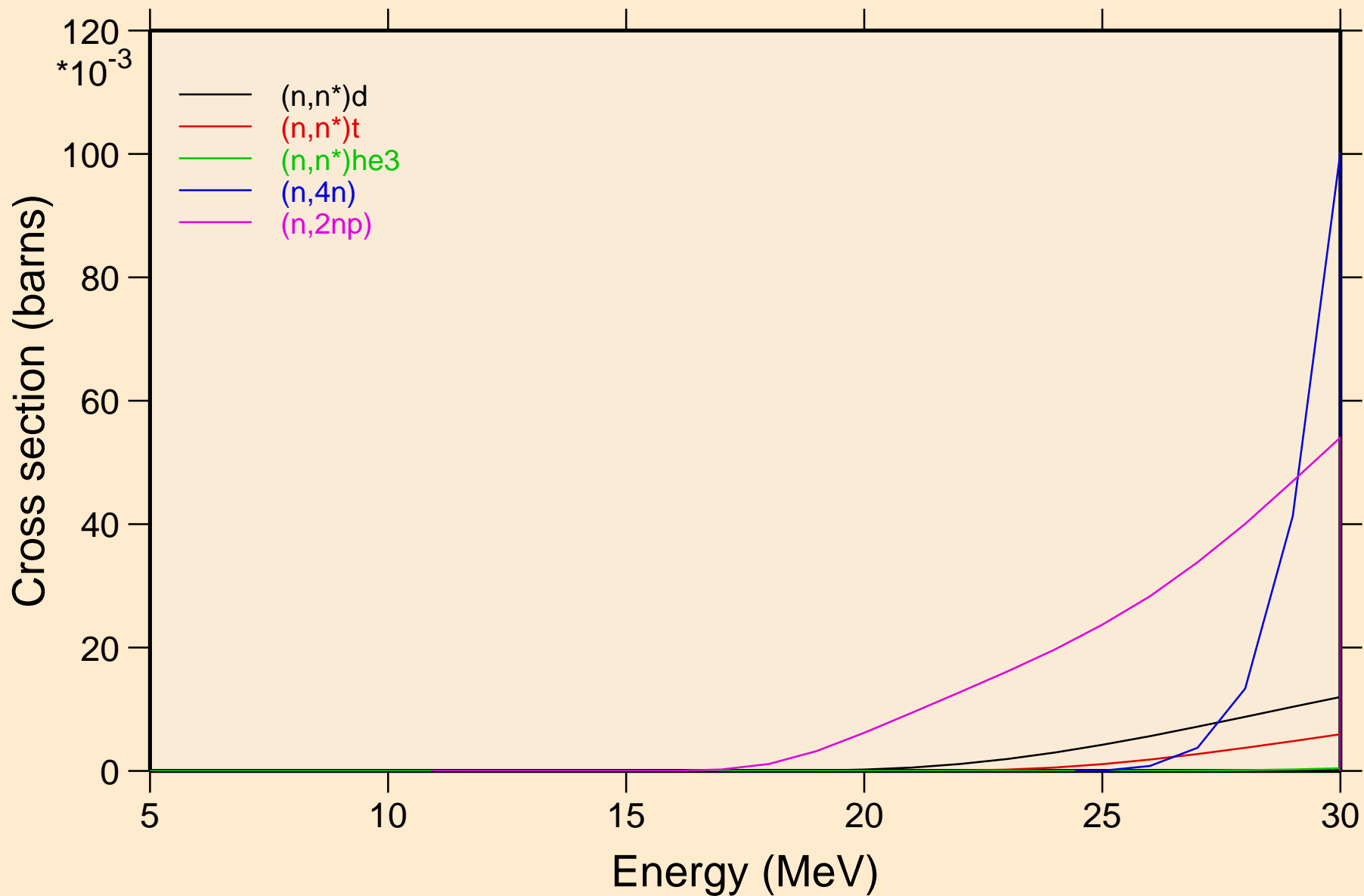

RA213 NEUTRON ACER TENDL-2019 LIBRARY; T=293.16K
Threshold reactions

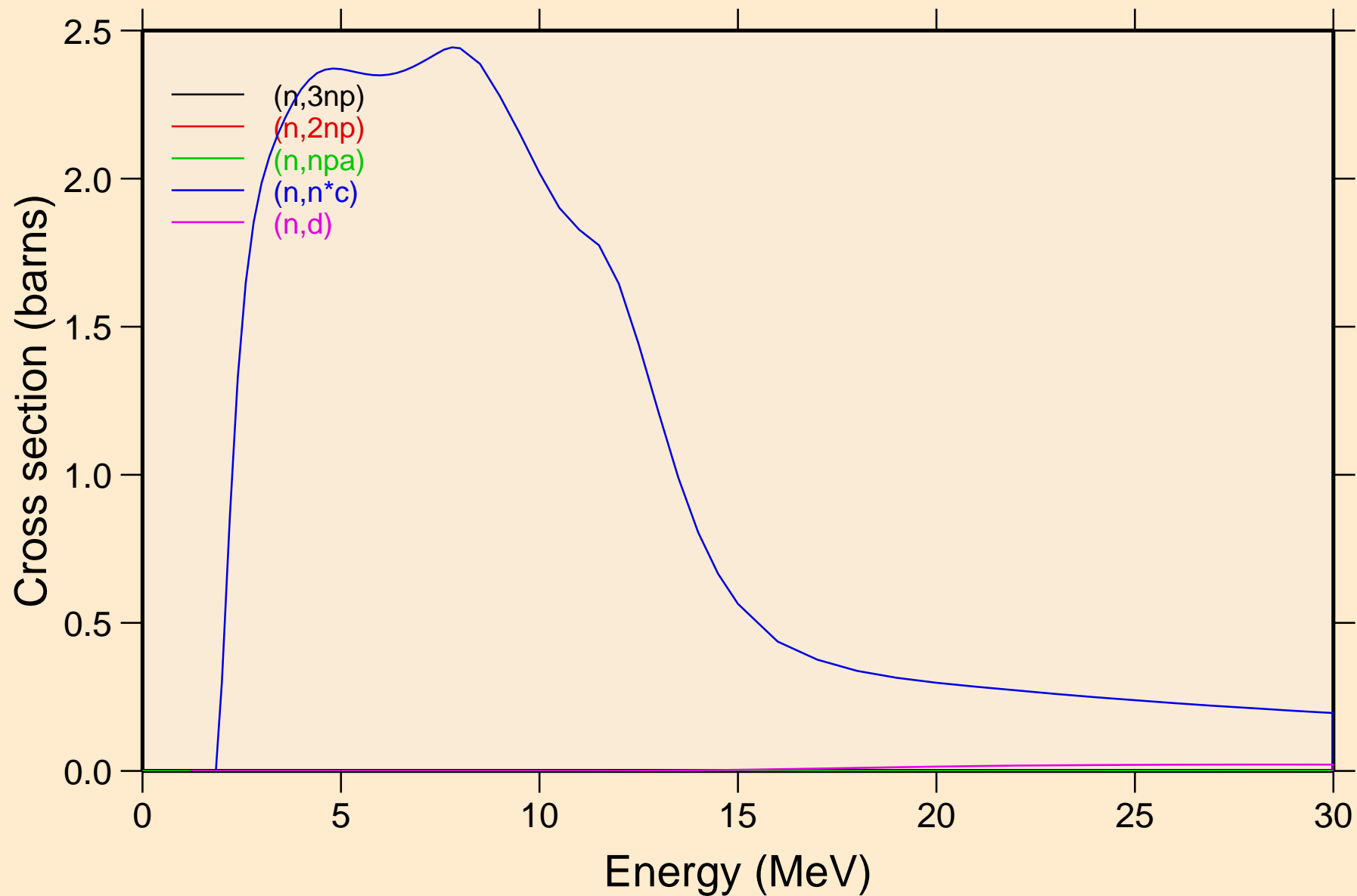

RA213 NEUTRON ACER TENDL-2019 LIBRARY; T=293.16K
Threshold reactions

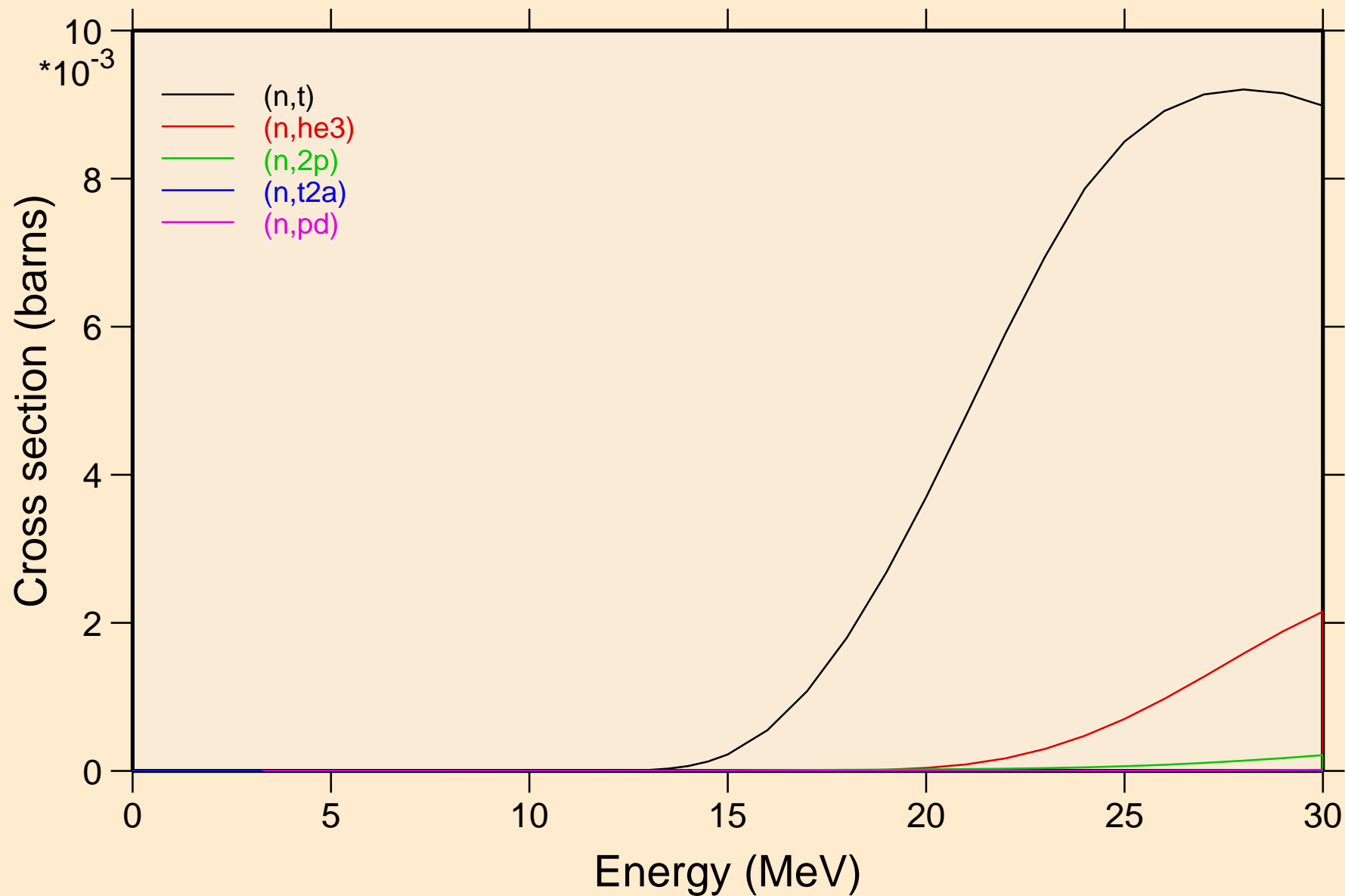

RA213 NEUTRON ACER TENDL-2019 LIBRARY; T=293.16K
Threshold reactions

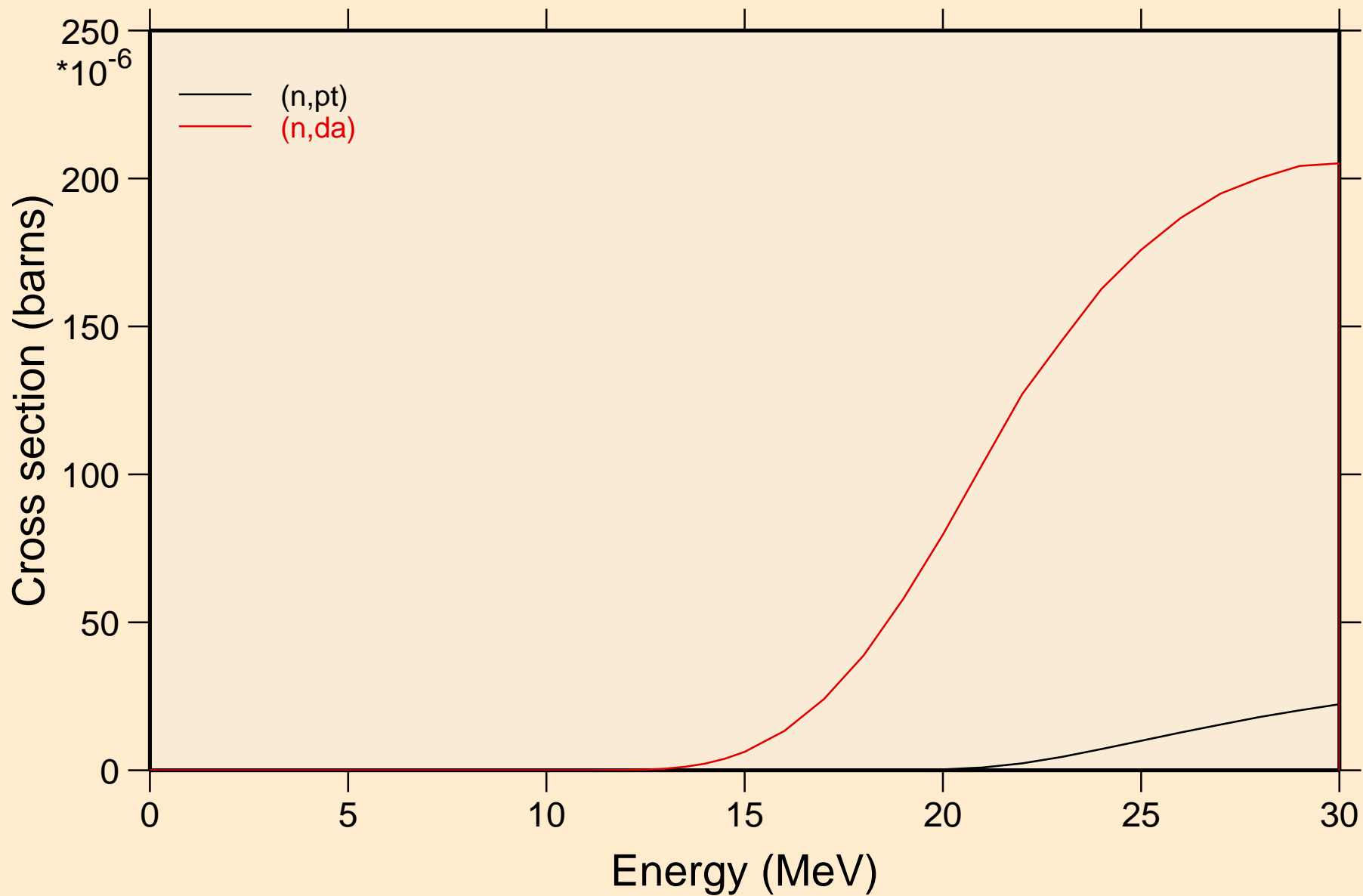

RA213 NEUTRON ACER TENDL-2019 LIBRARY; T=293.16K
Threshold reactions

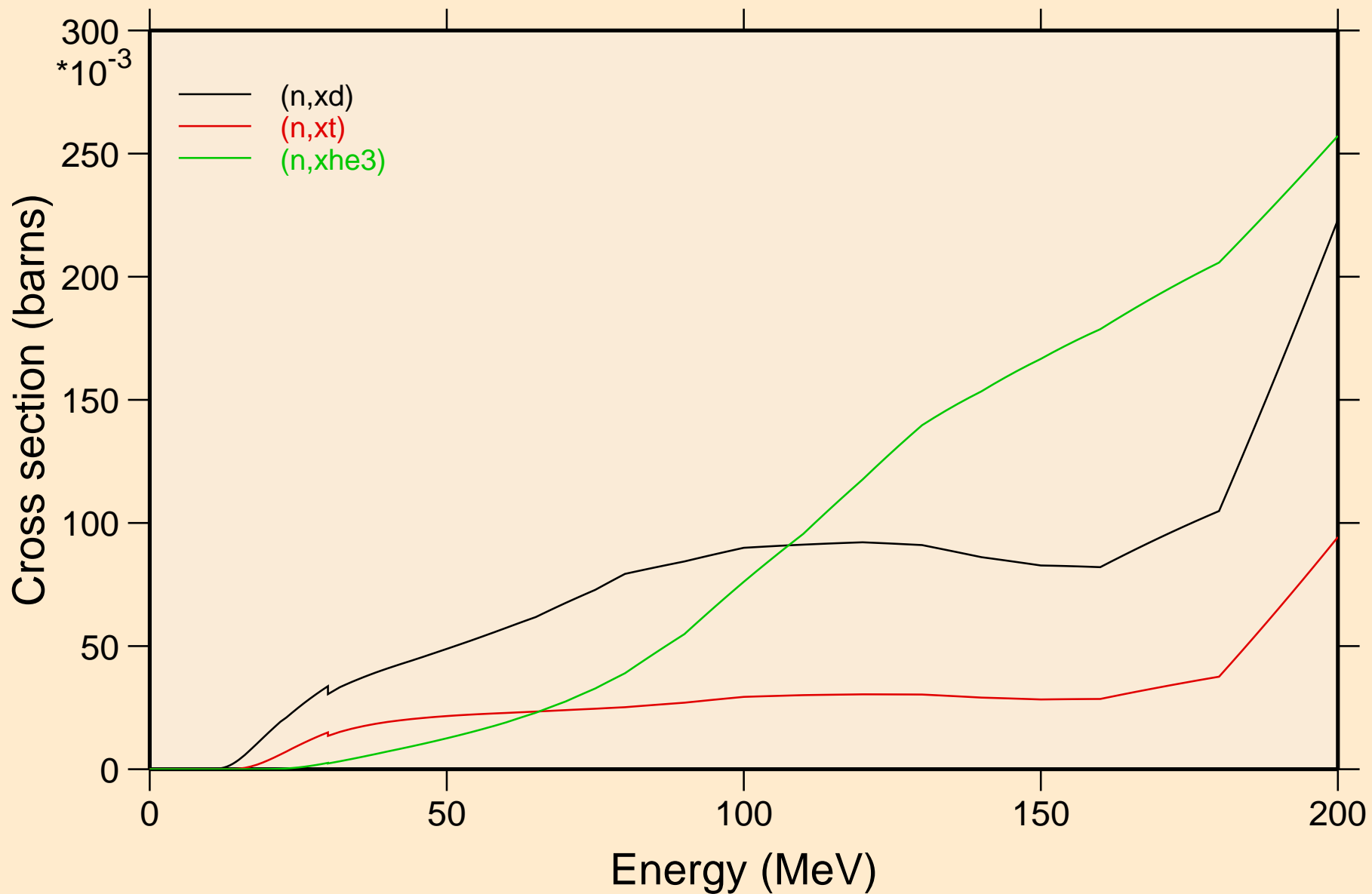

RA213 NEUTRON ACER TENDL-2019 LIBRARY; T=293.16K
angular distribution for elastic

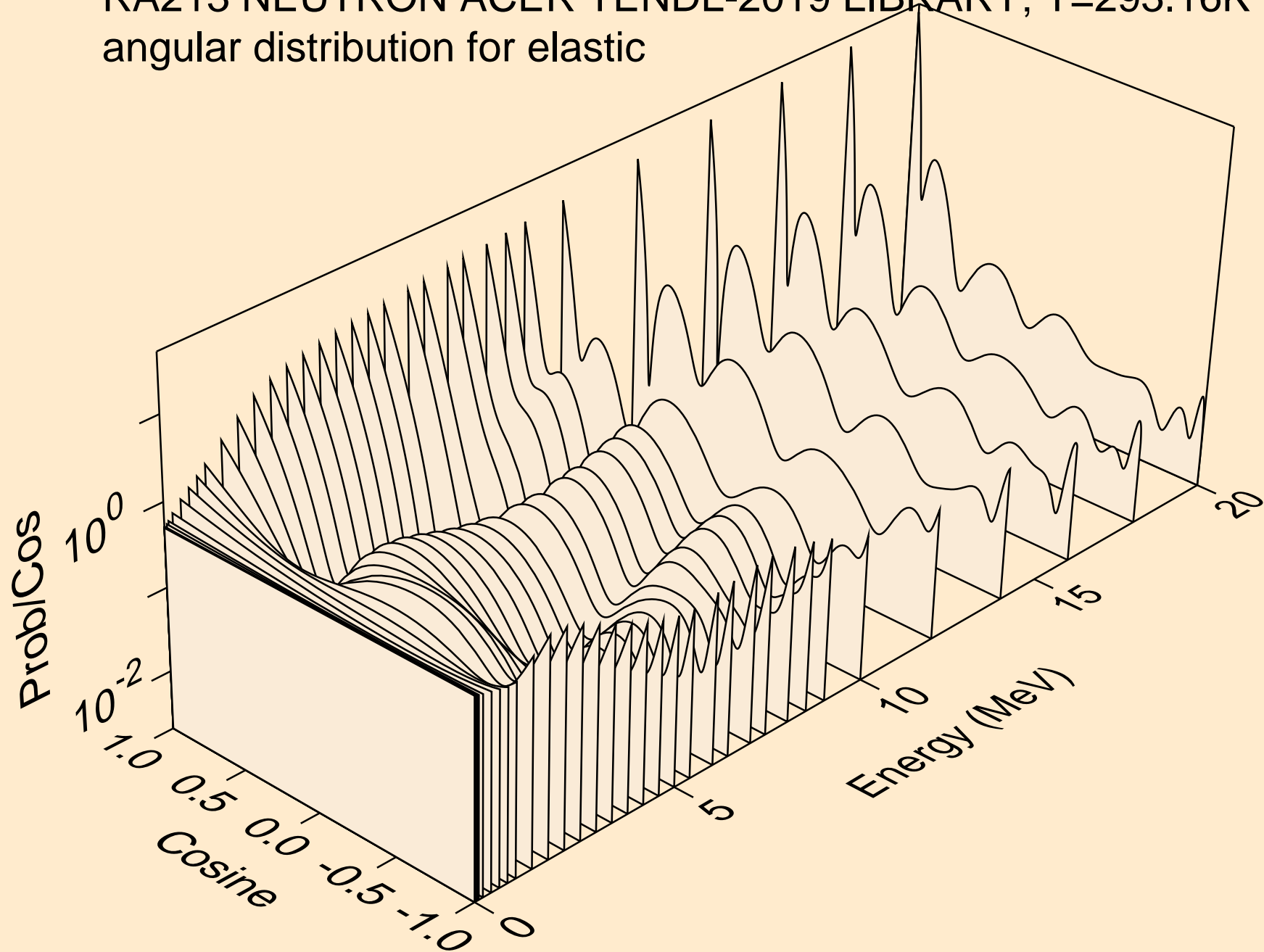

RA213 NEUTRON ACER TENDL-2019 LIBRARY; T=293.16K
angular distribution for elastic

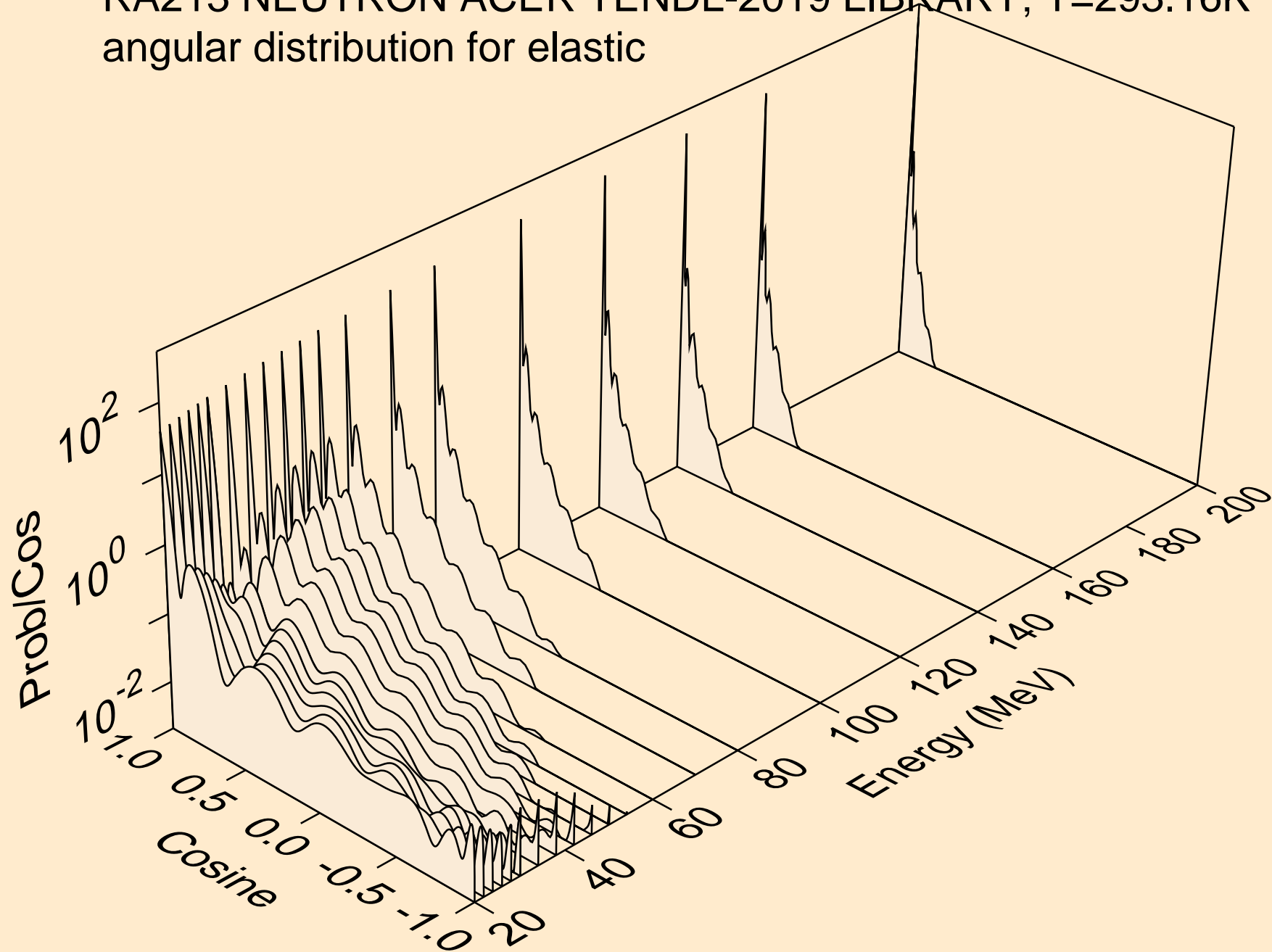

RA213 NEUTRON ACER TENDL-2019 LIBRARY; T=293.16K
angular distribution for (n,n*1)

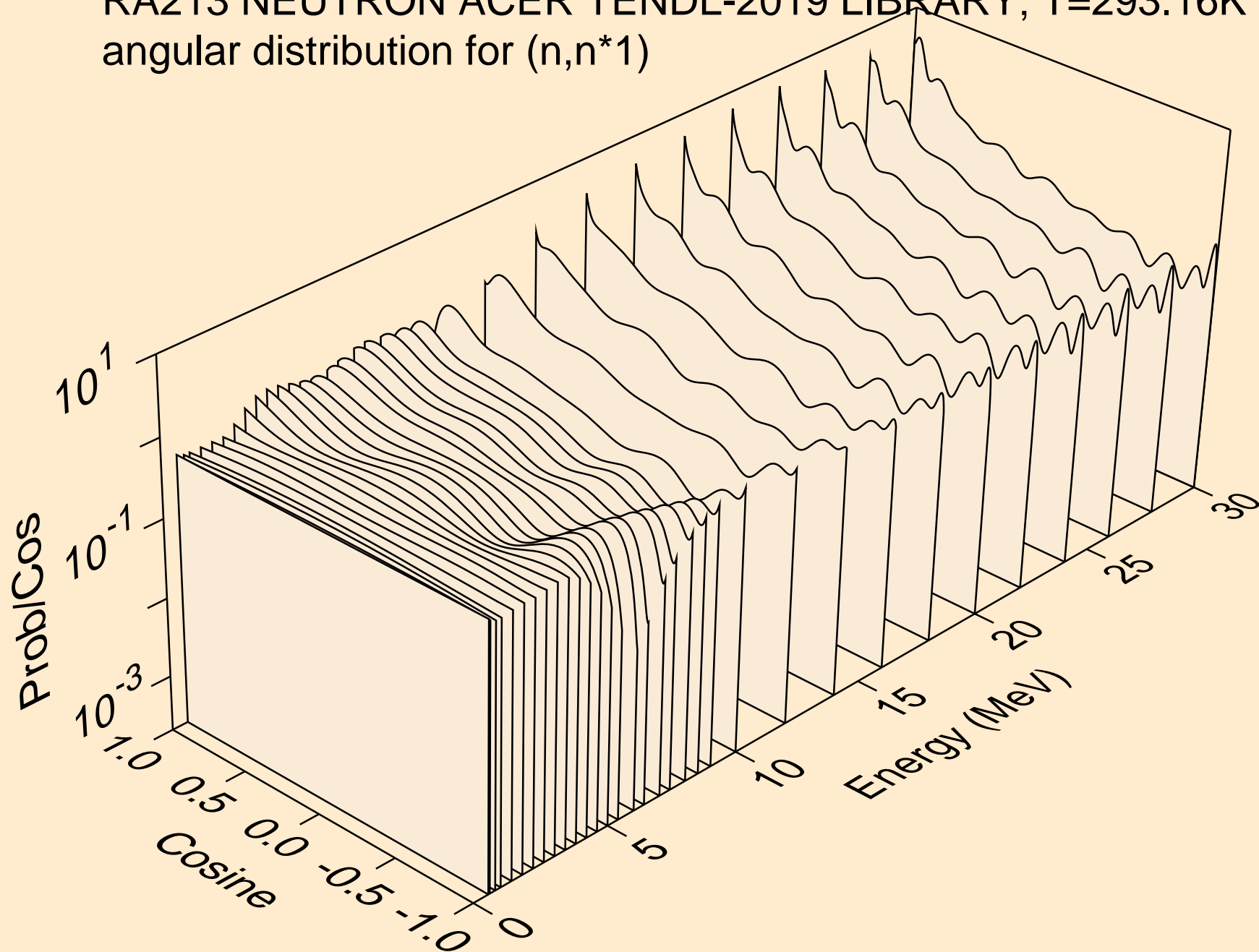

RA213 NEUTRON ACER TENDL-2019 LIBRARY; T=293.16K
angular distribution for (n,n*2)

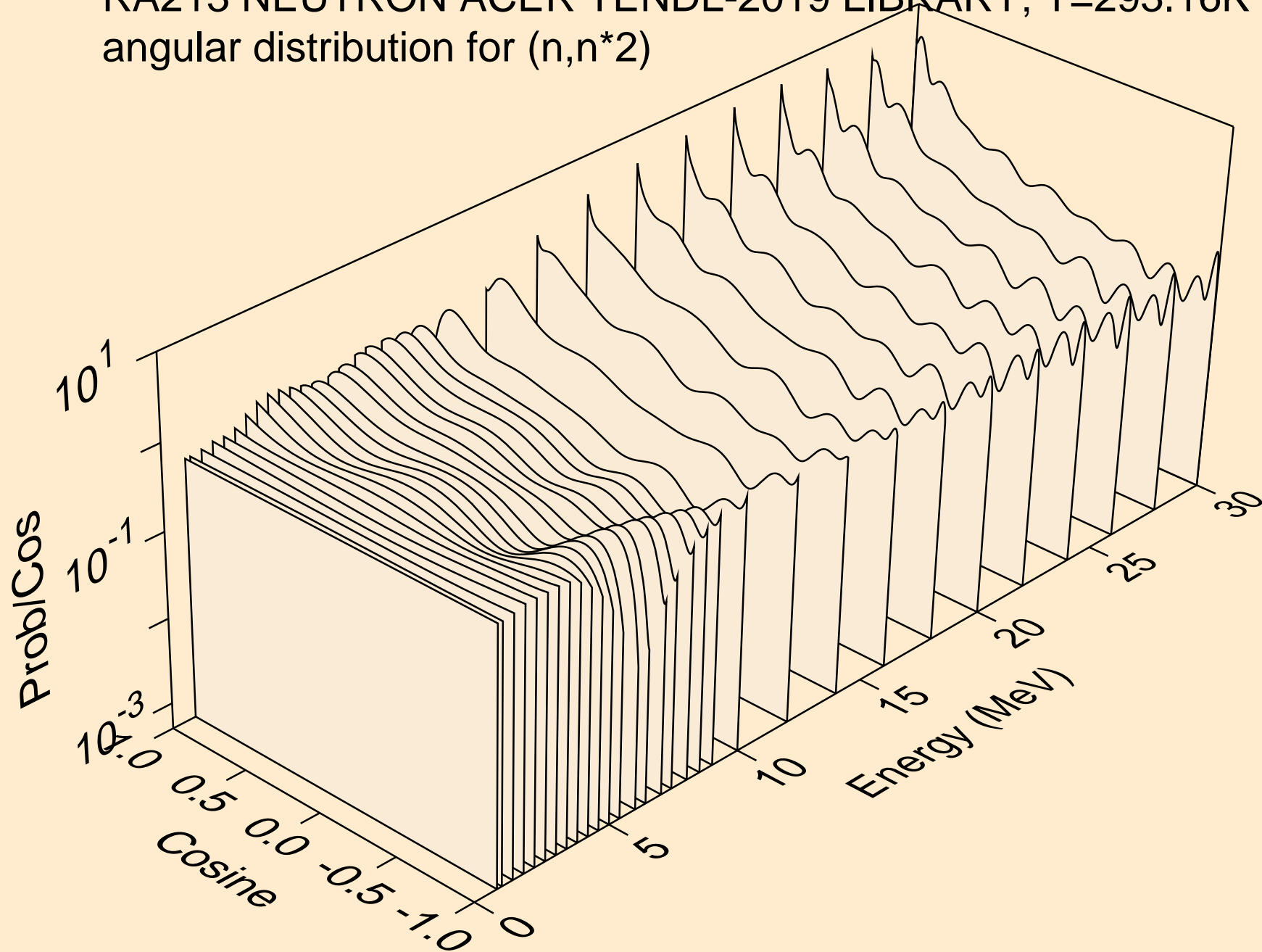

RA213 NEUTRON ACER TENDL-2019 LIBRARY; T=293.16K
angular distribution for (n,n*3)

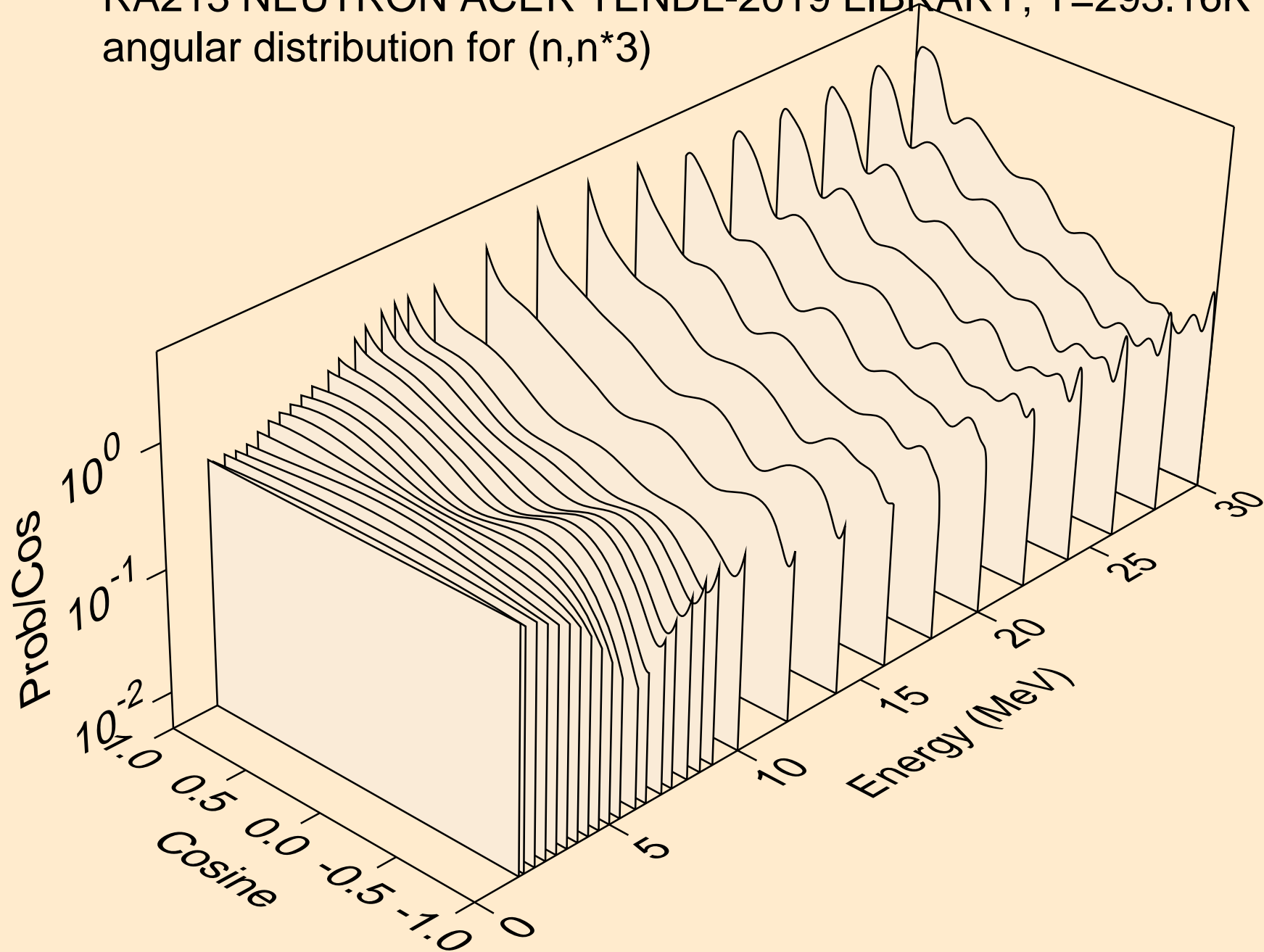

RA213 NEUTRON ACER TENDL-2019 LIBRARY; T=293.16K
angular distribution for (n,n*4)

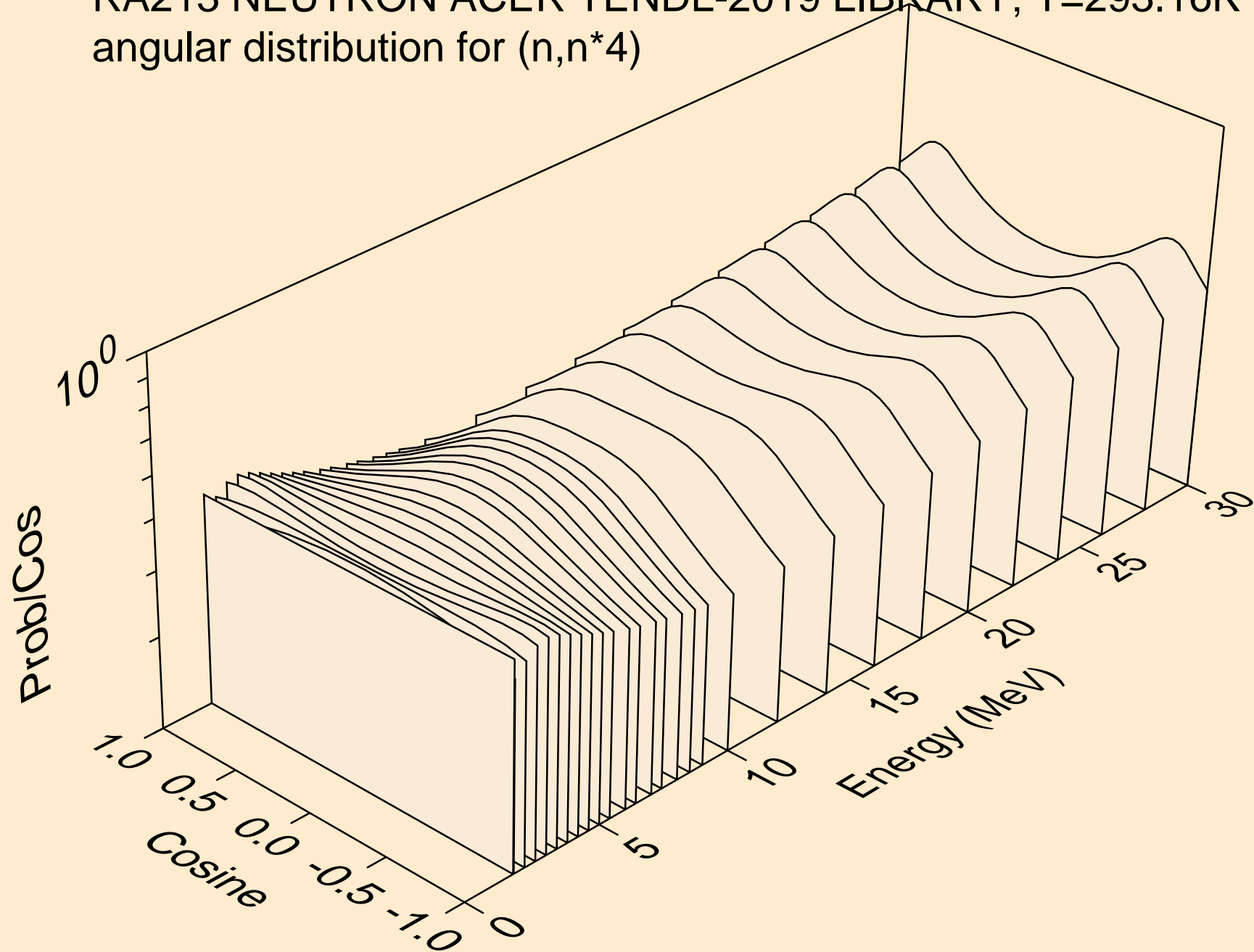

RA213 NEUTRON ACER TENDL-2019 LIBRARY; T=293.16K
angular distribution for (n,n*5)

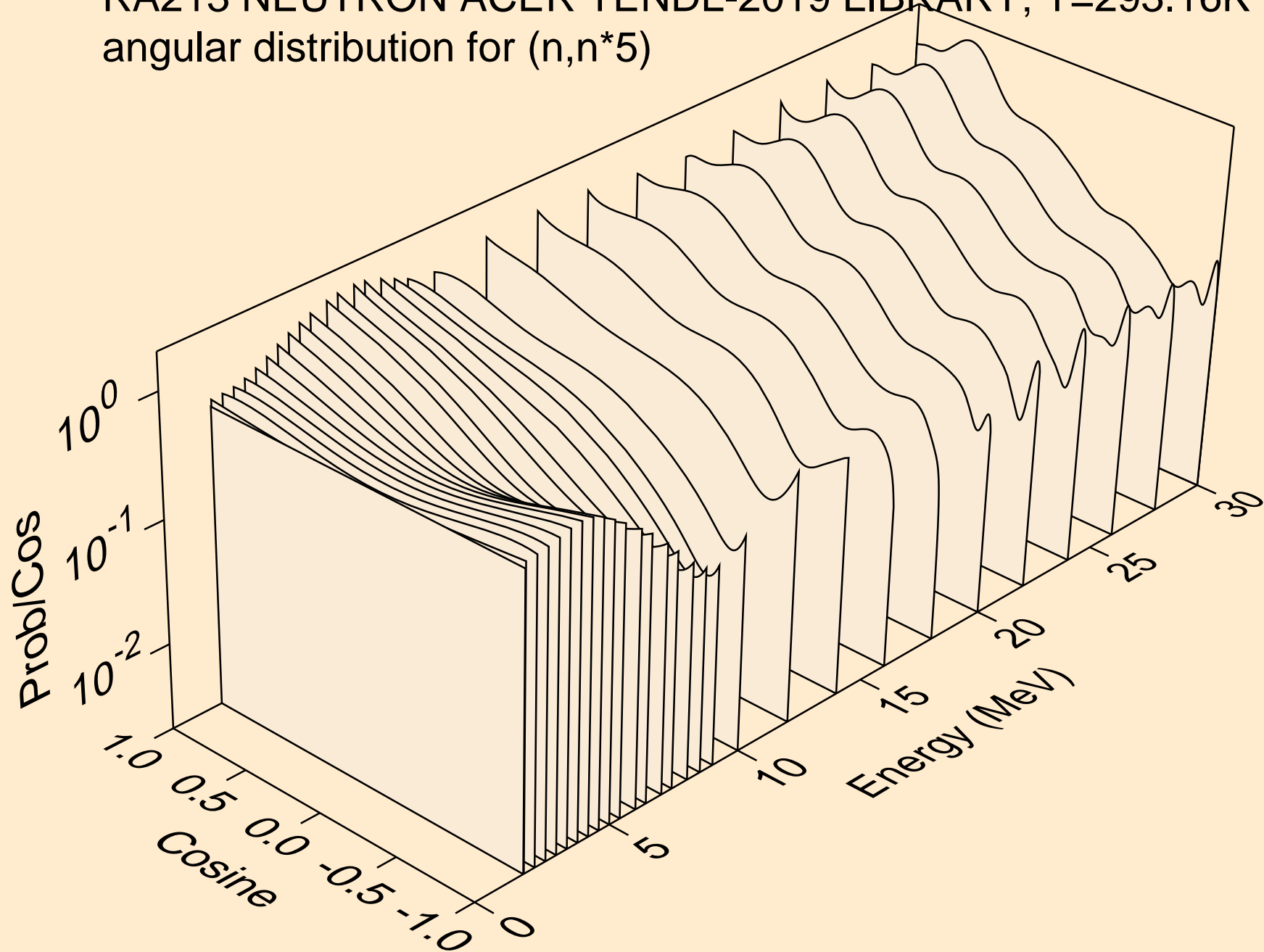

RA213 NEUTRON ACER TENDL-2019 LIBRARY; T=293.16K
angular distribution for (n,n*6)

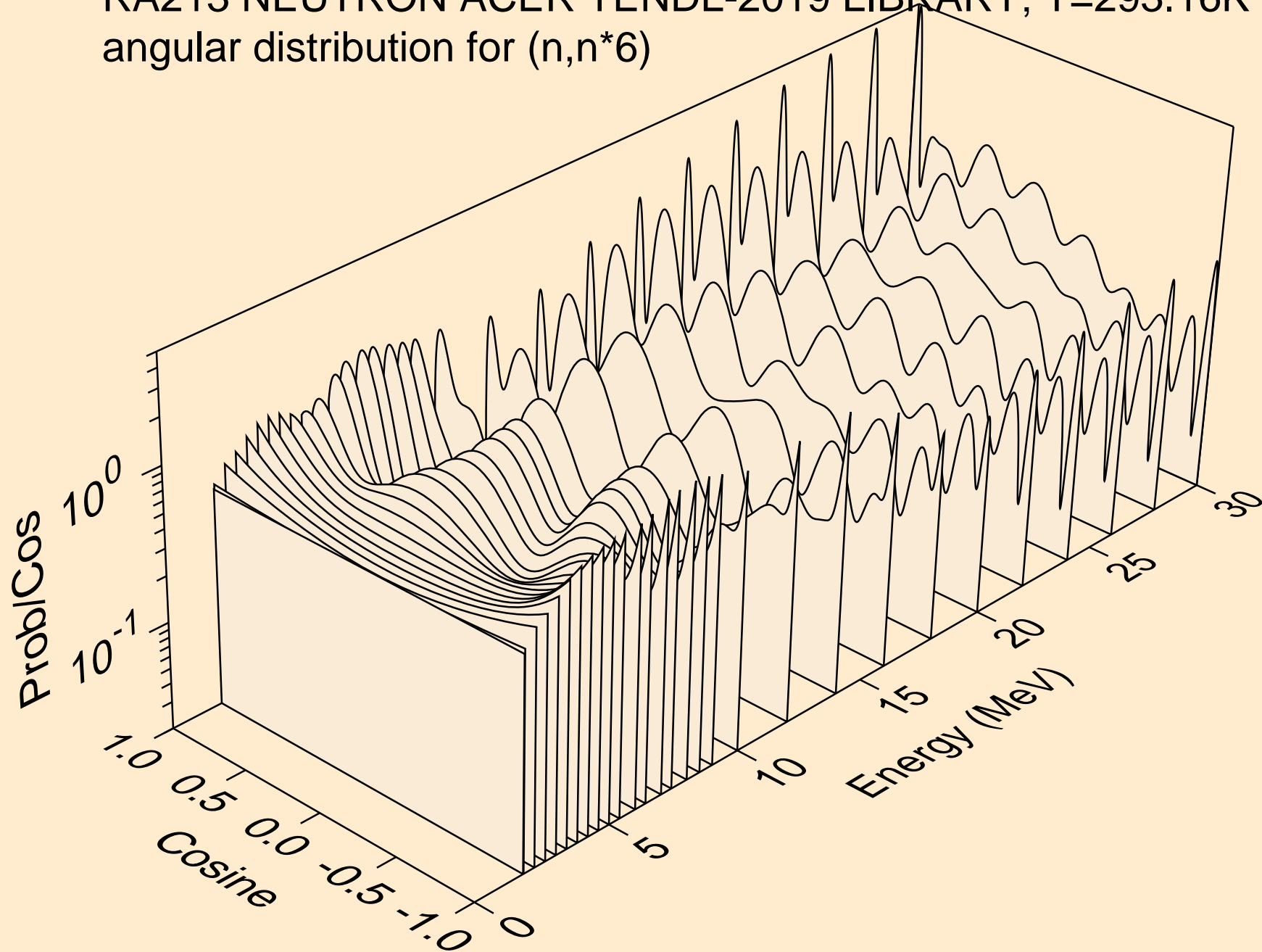

RA213 NEUTRON ACER TENDL-2019 LIBRARY; T=293.16K
angular distribution for (n,n*7)

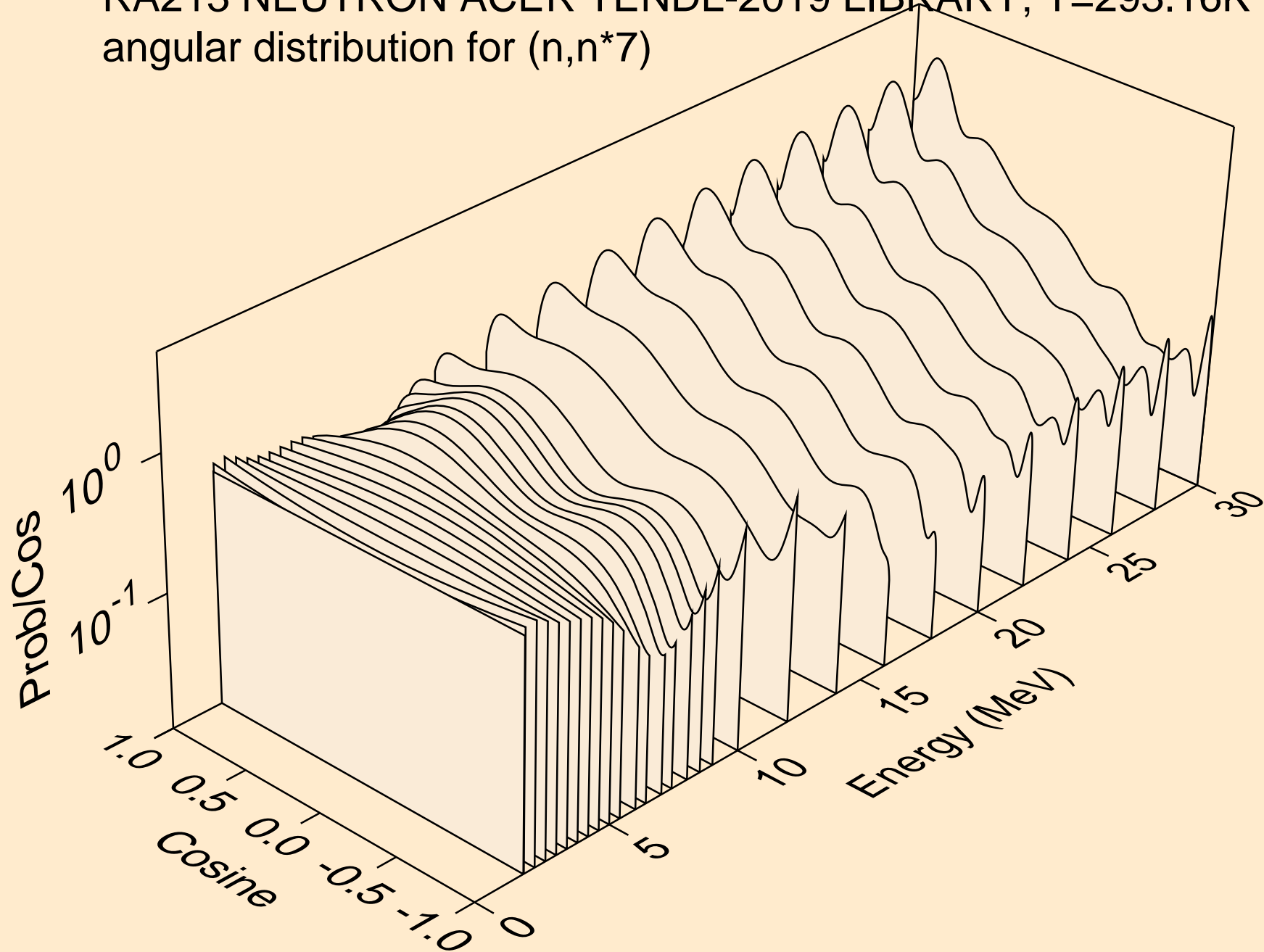

RA213 NEUTRON ACER TENDL-2019 LIBRARY; T=293.16K
angular distribution for (n,n*8)

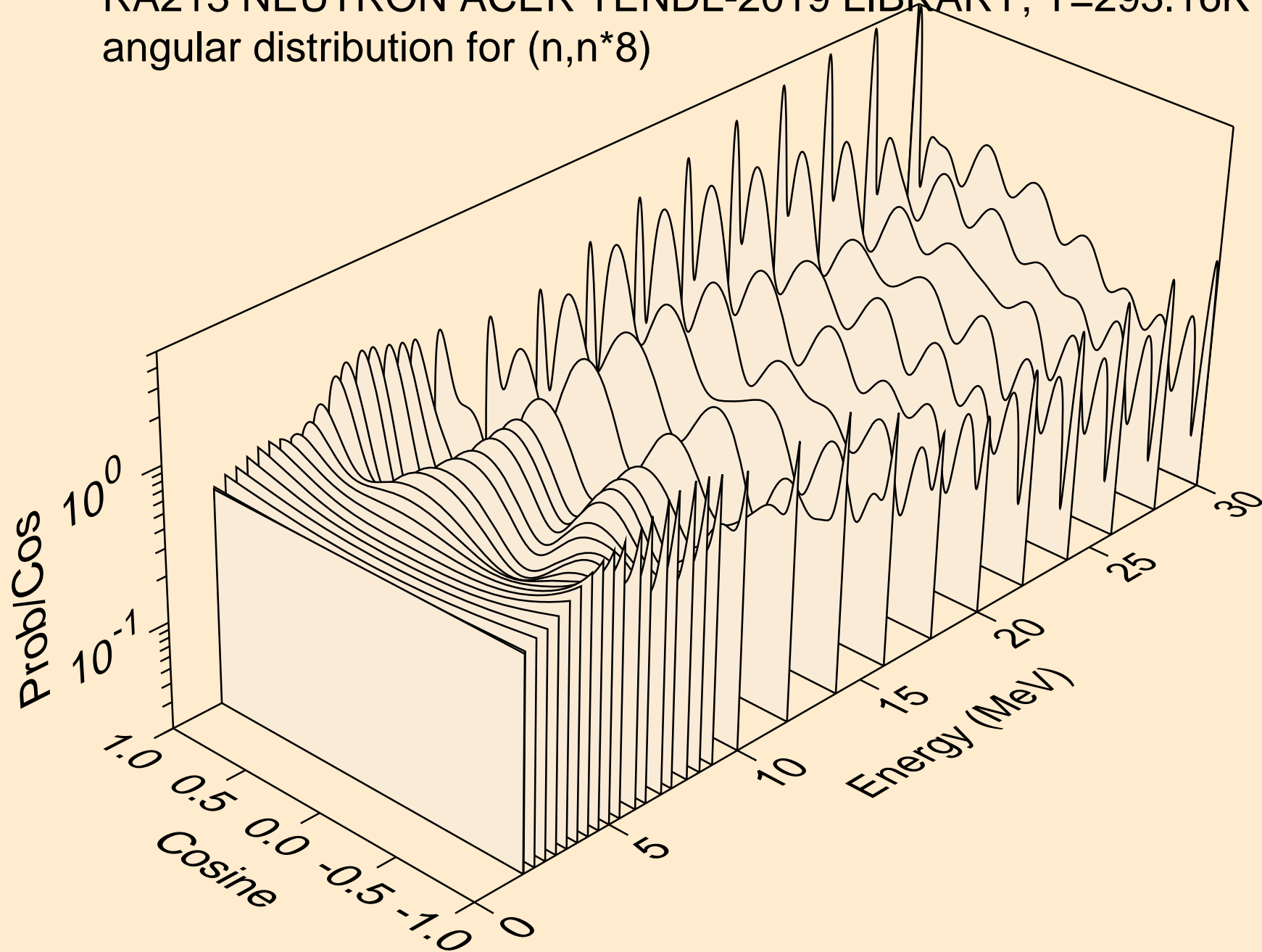

RA213 NEUTRON ACER TENDL-2019 LIBRARY; T=293.16K
angular distribution for (n,n*9)

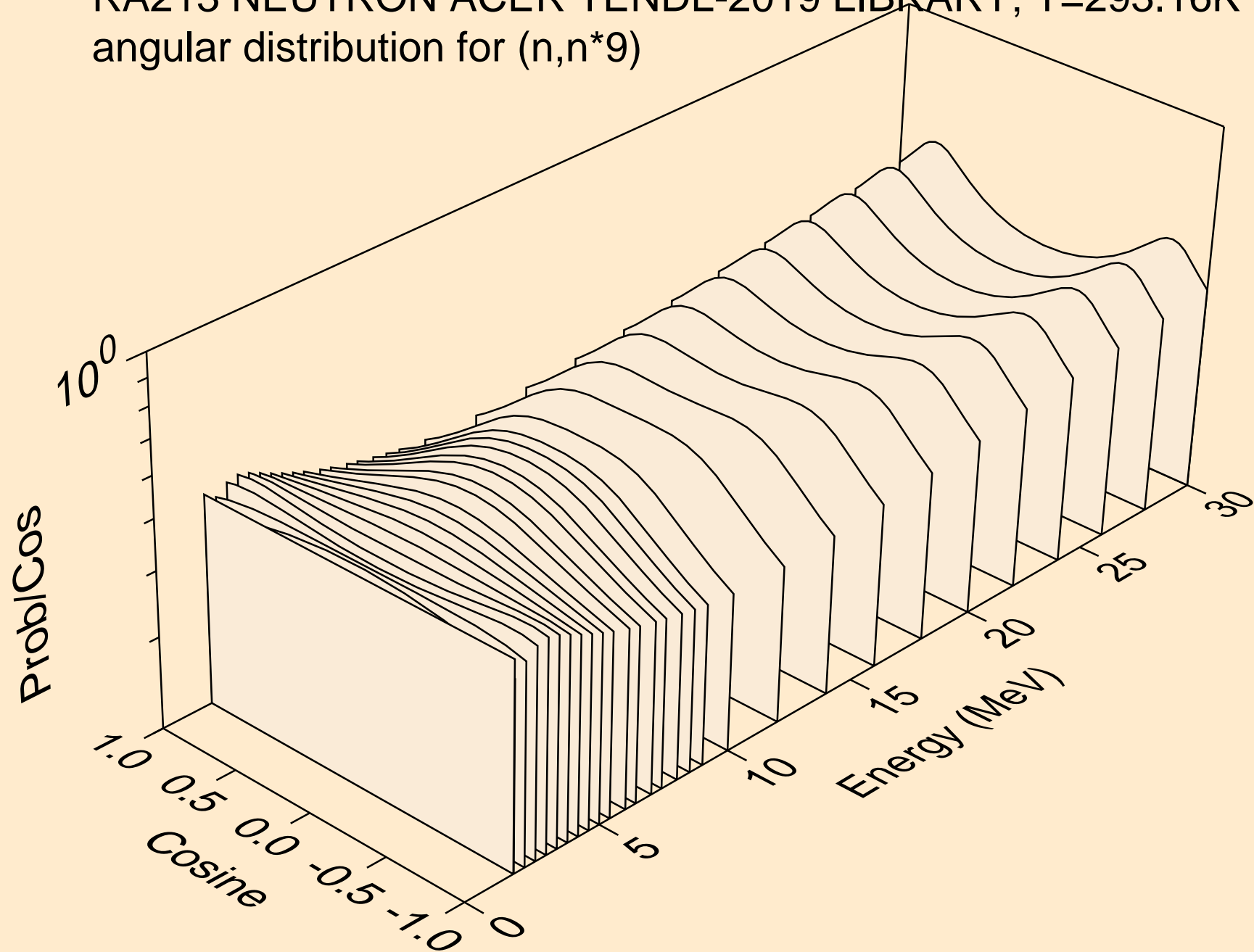

RA213 NEUTRON ACER TENDL-2019 LIBRARY; T=293.16K
angular distribution for (n,n*10)

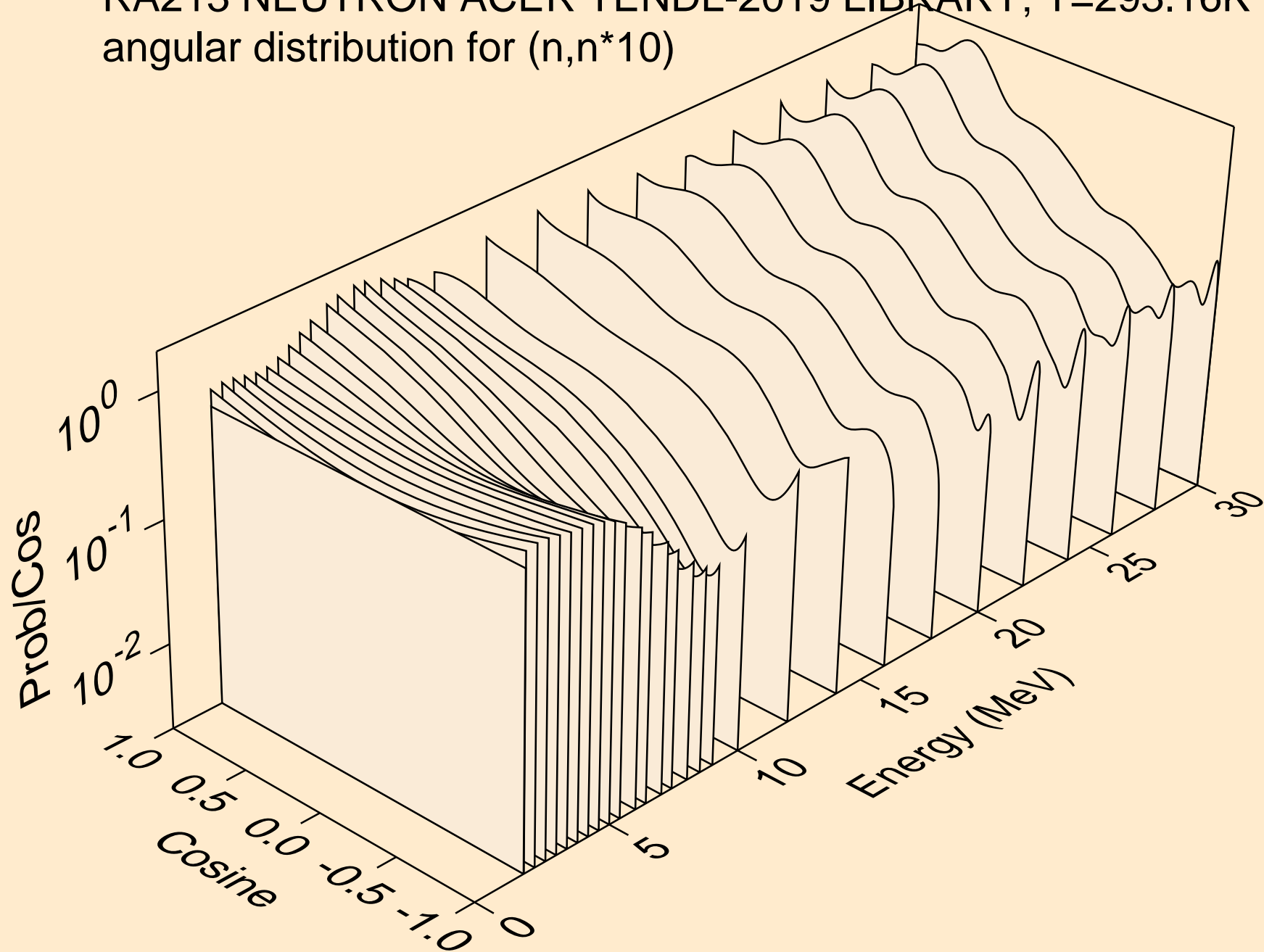

RA213 NEUTRON ACER TENDL-2019 LIBRARY; T=293.16K
angular distribution for (n,n*11)

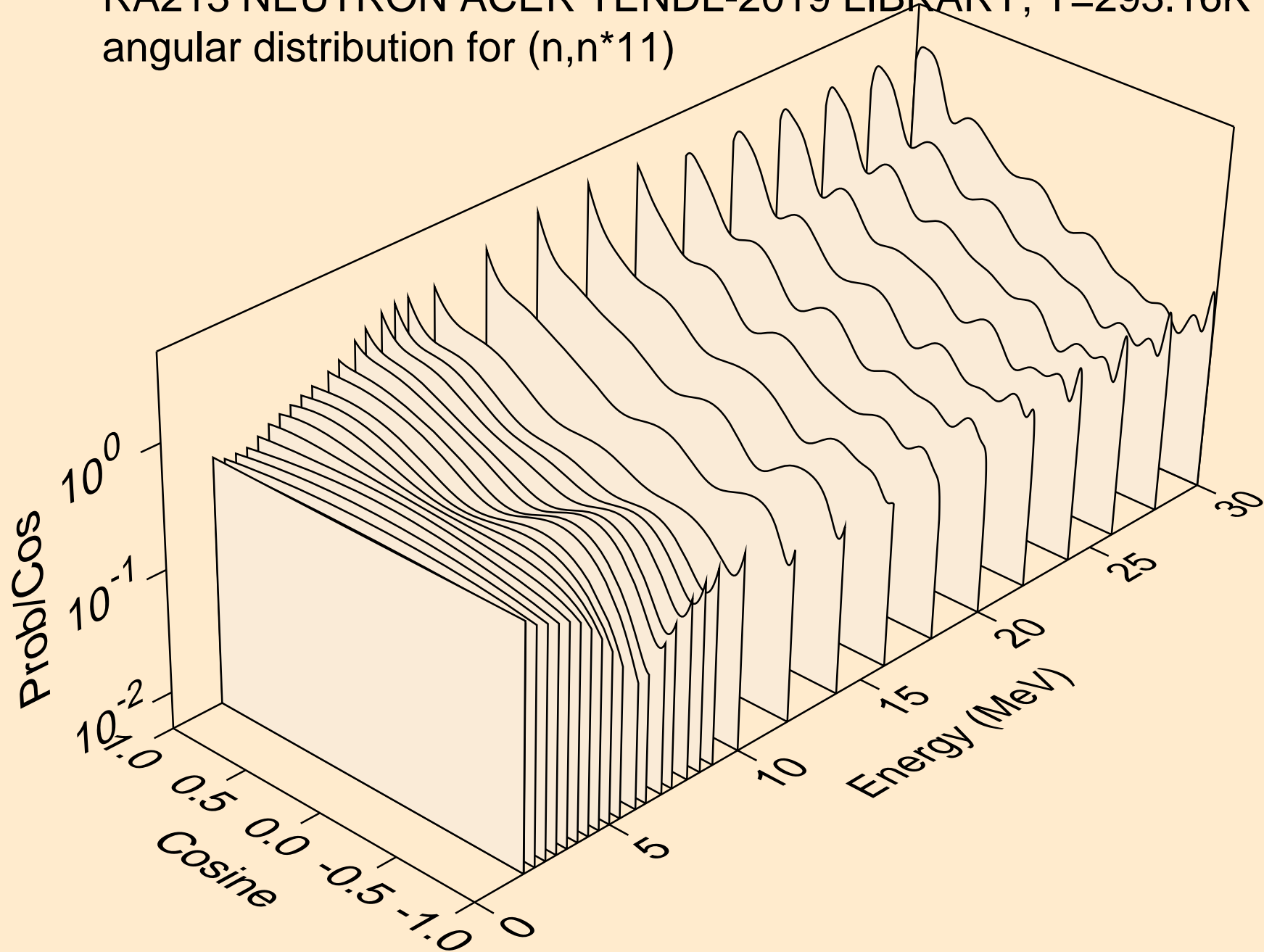

RA213 NEUTRON ACER TENDL-2019 LIBRARY; T=293.16K
angular distribution for (n,n*12)

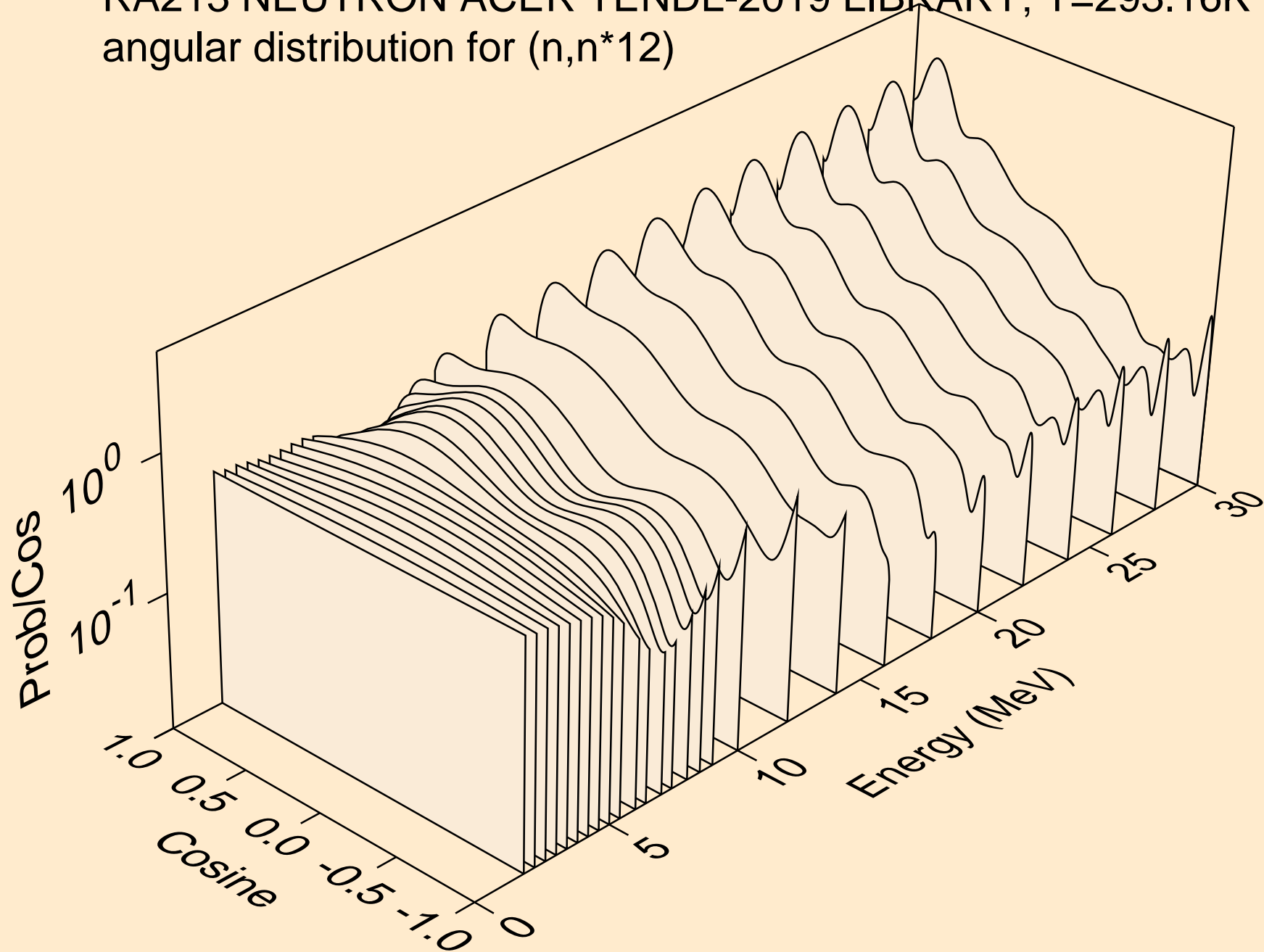

RA213 NEUTRON ACER TENDL-2019 LIBRARY; T=293.16K
angular distribution for (n,n*13)

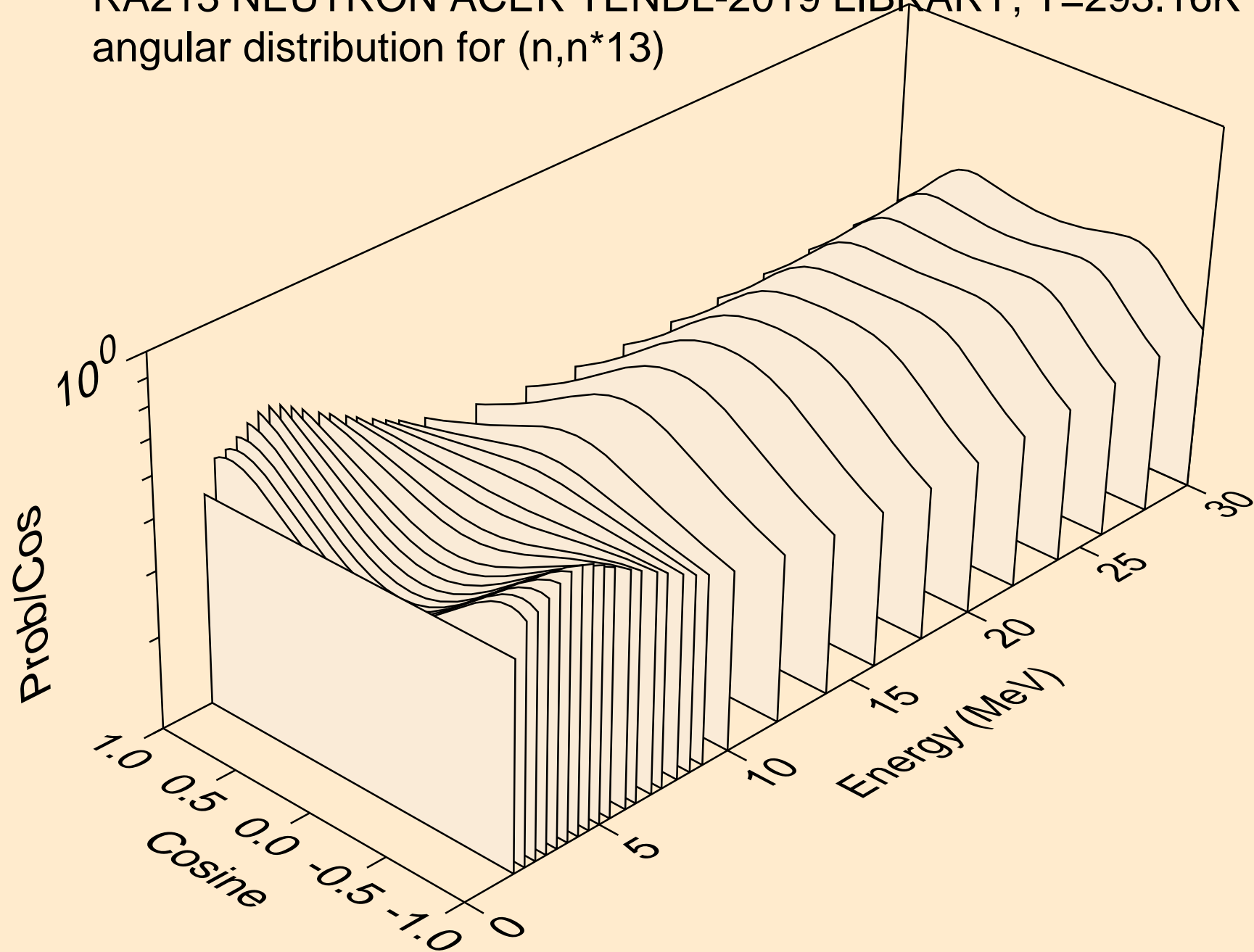

RA213 NEUTRON ACER TENDL-2019 LIBRARY; T=293.16K
angular distribution for (n,n*14)

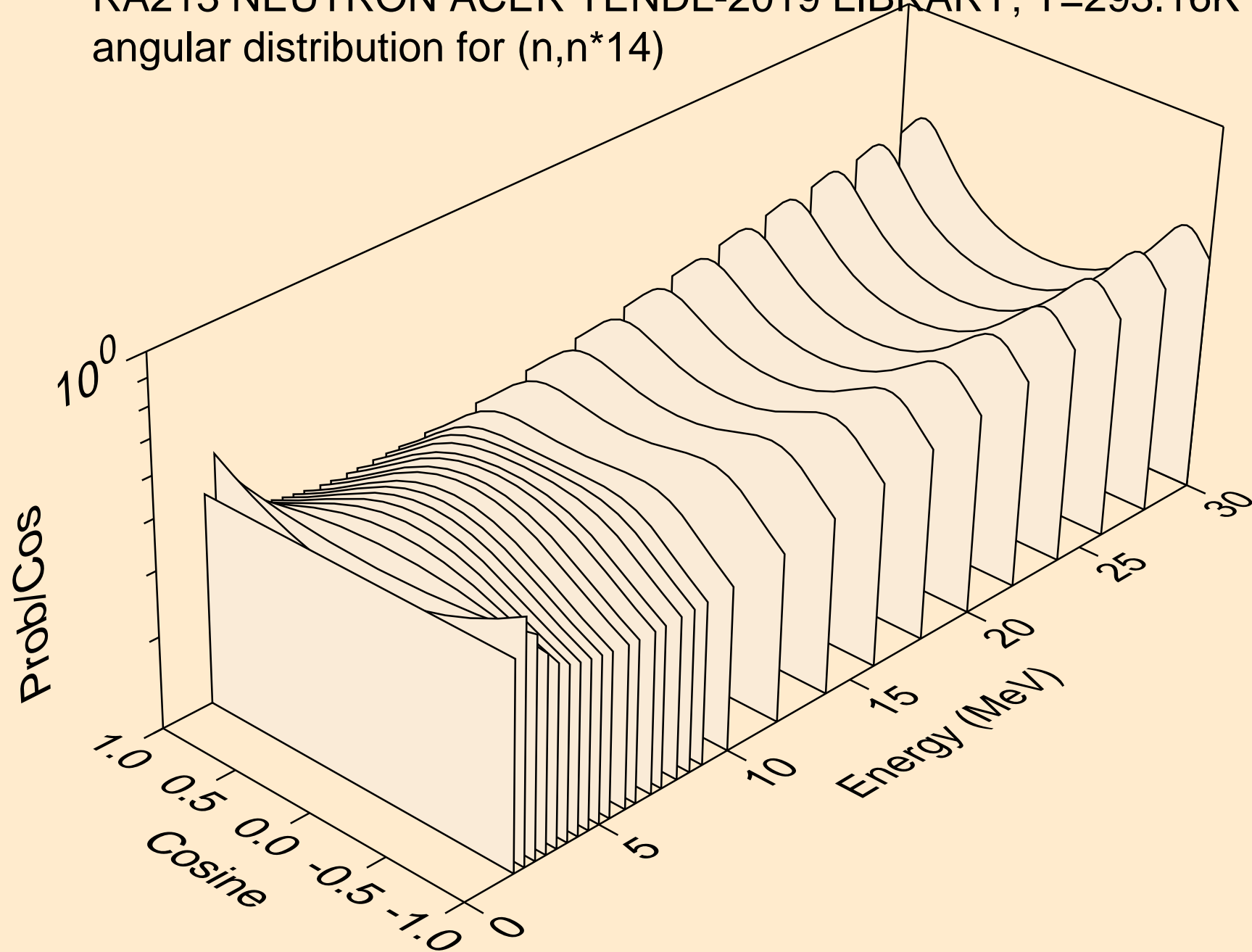

RA213 NEUTRON ACER TENDL-2019 LIBRARY; T=293.16K
angular distribution for (n,n*15)

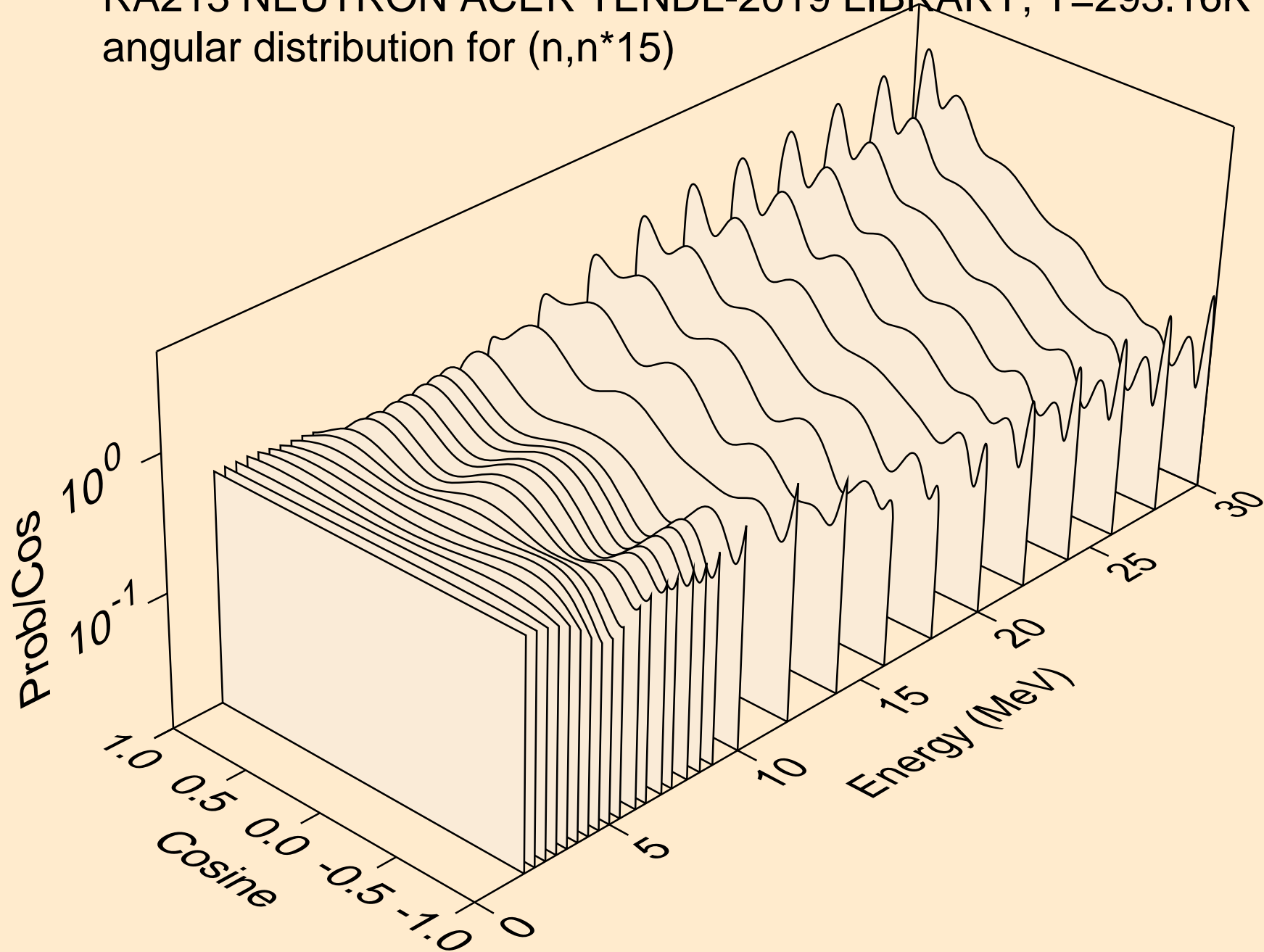

RA213 NEUTRON ACER TENDL-2019 LIBRARY; T=293.16K
angular distribution for (n,n*16)

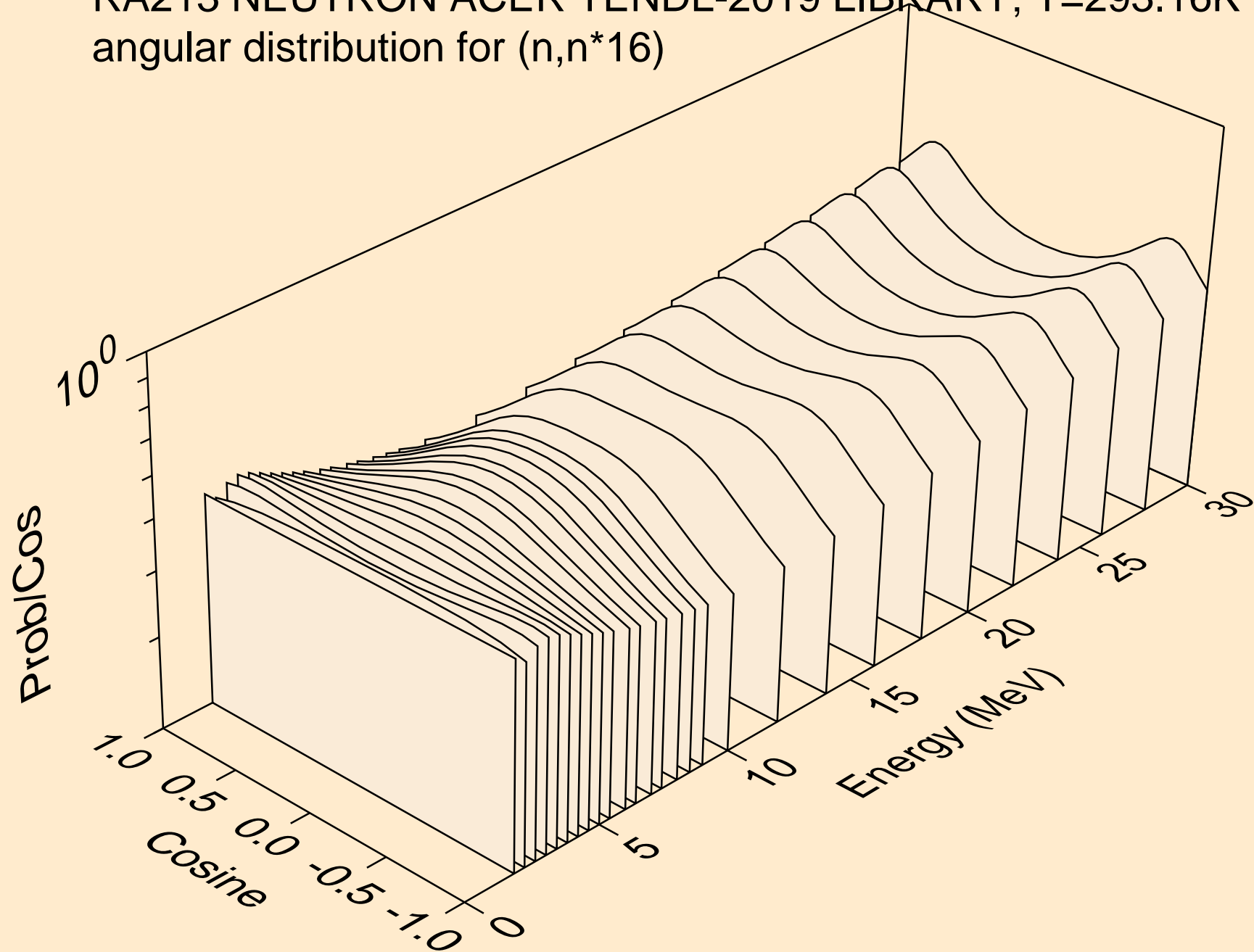

RA213 NEUTRON ACER TENDL-2019 LIBRARY; T=293.16K
angular distribution for (n,n*17)

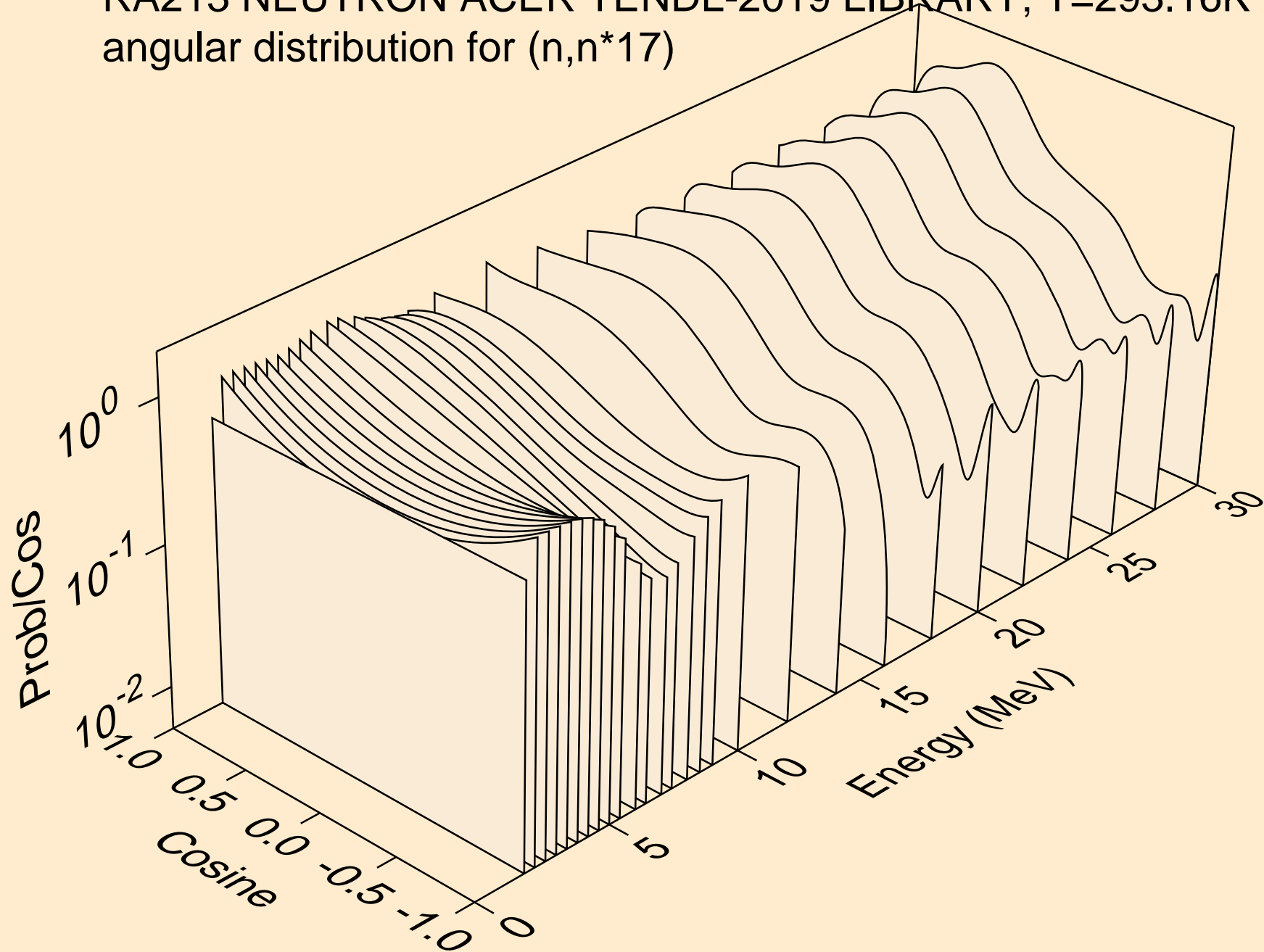

RA213 NEUTRON ACER TENDL-2019 LIBRARY; T=293.16K
angular distribution for (n,n*18)

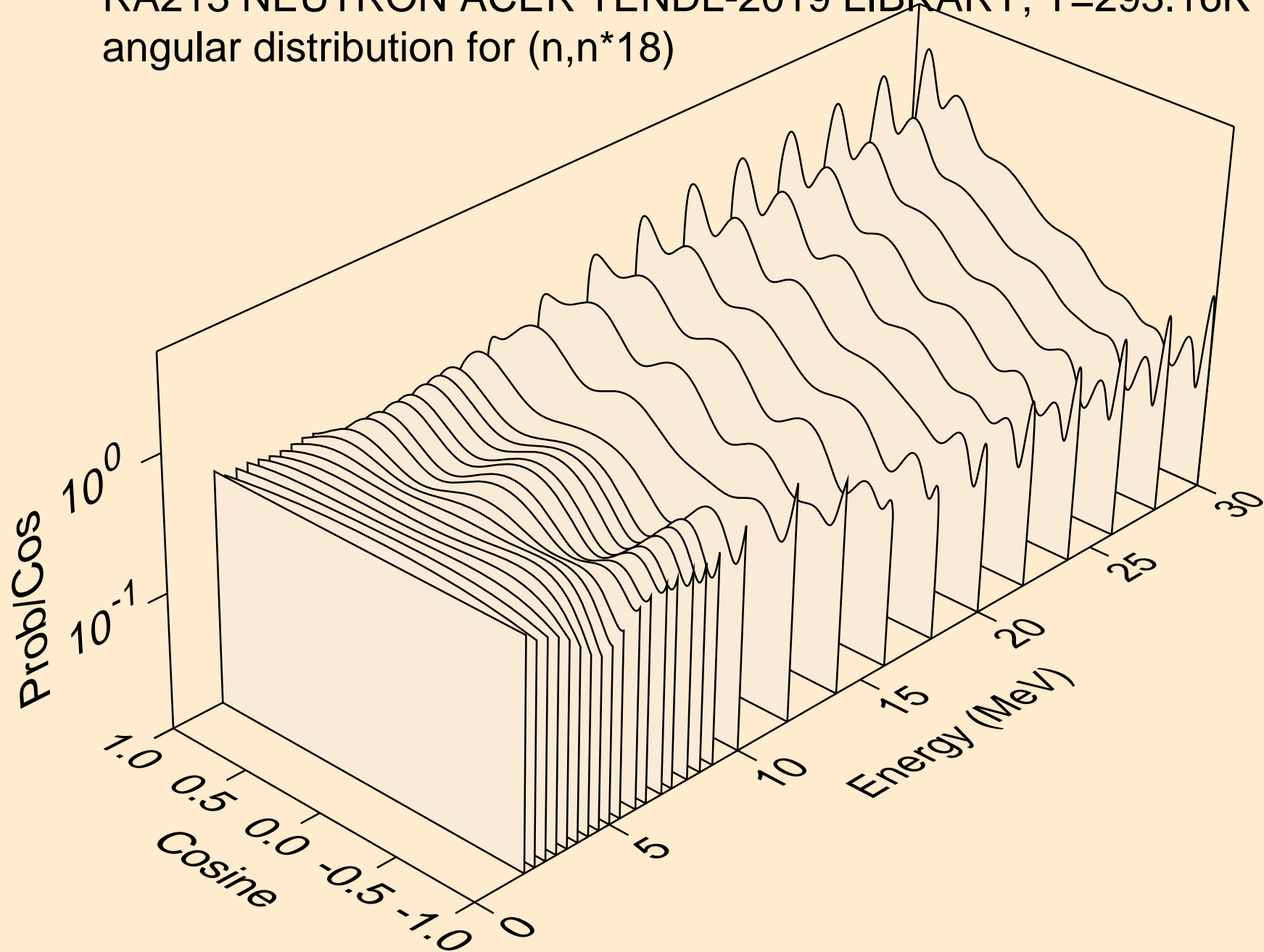

RA213 NEUTRON ACER TENDL-2019 LIBRARY; T=293.16K
angular distribution for (n,n*19)

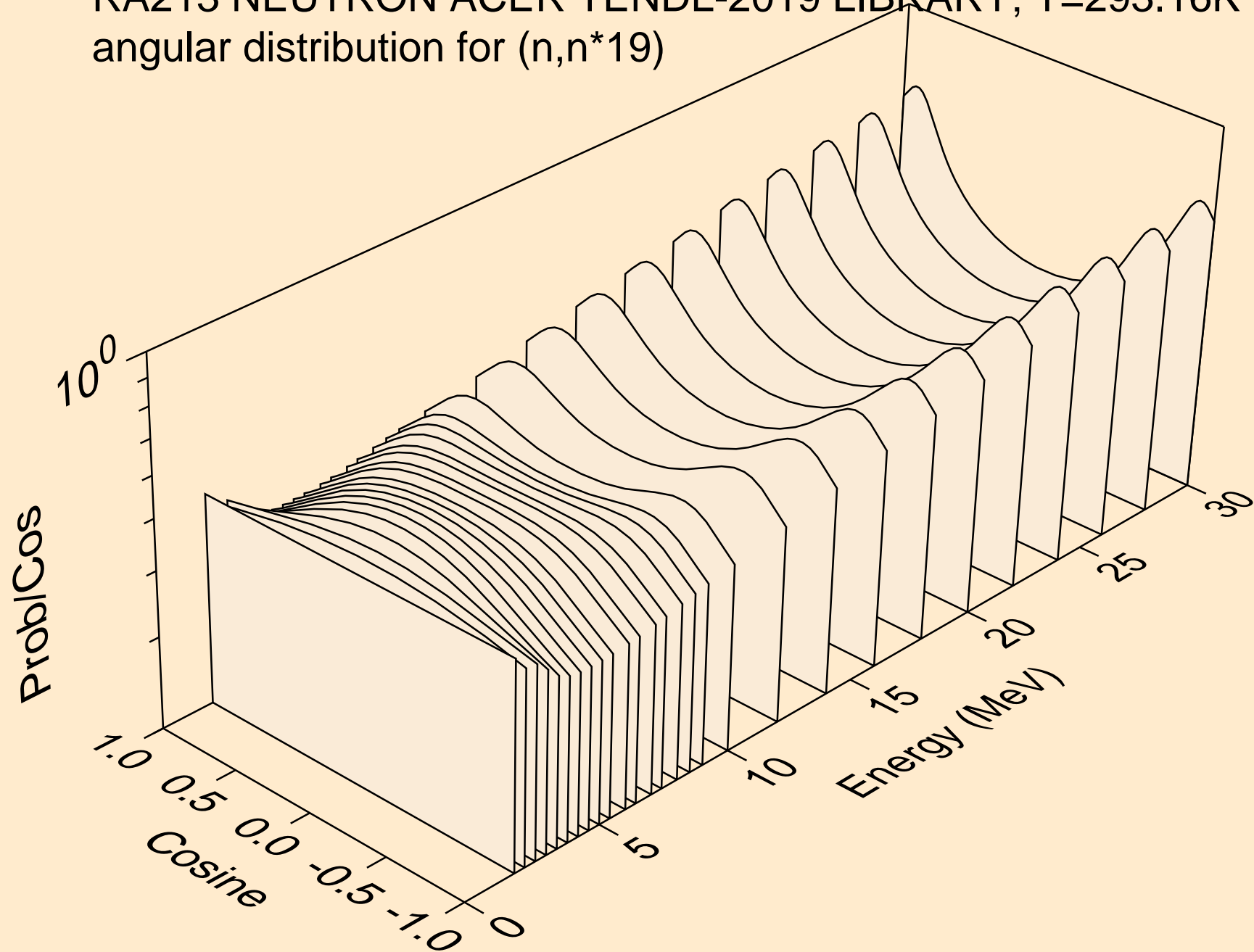

RA213 NEUTRON ACER TENDL-2019 LIBRARY; T=293.16K
angular distribution for (n,n*20)

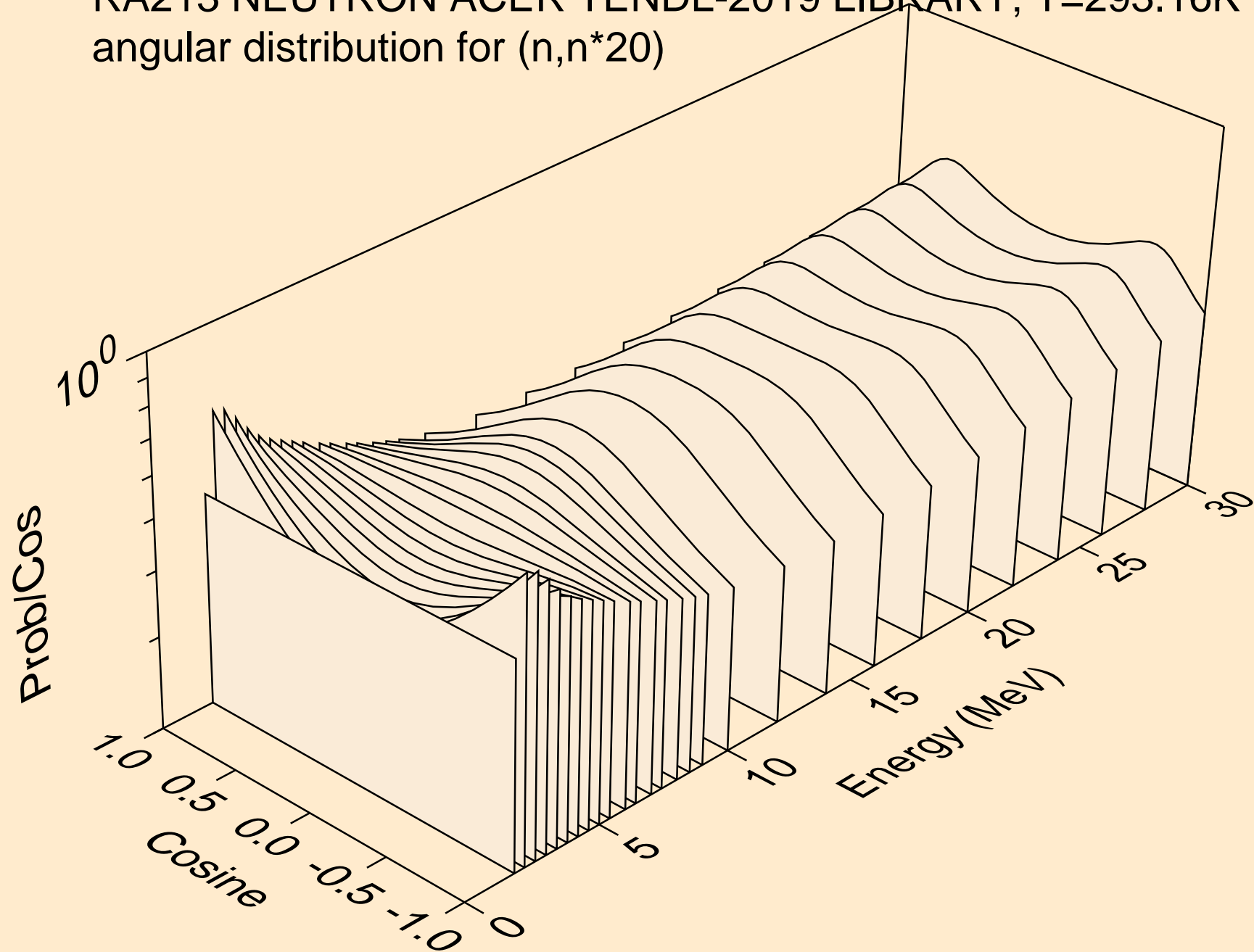

RA213 NEUTRON ACER TENDL-2019 LIBRARY; T=293.16K
angular distribution for (n,n*21)

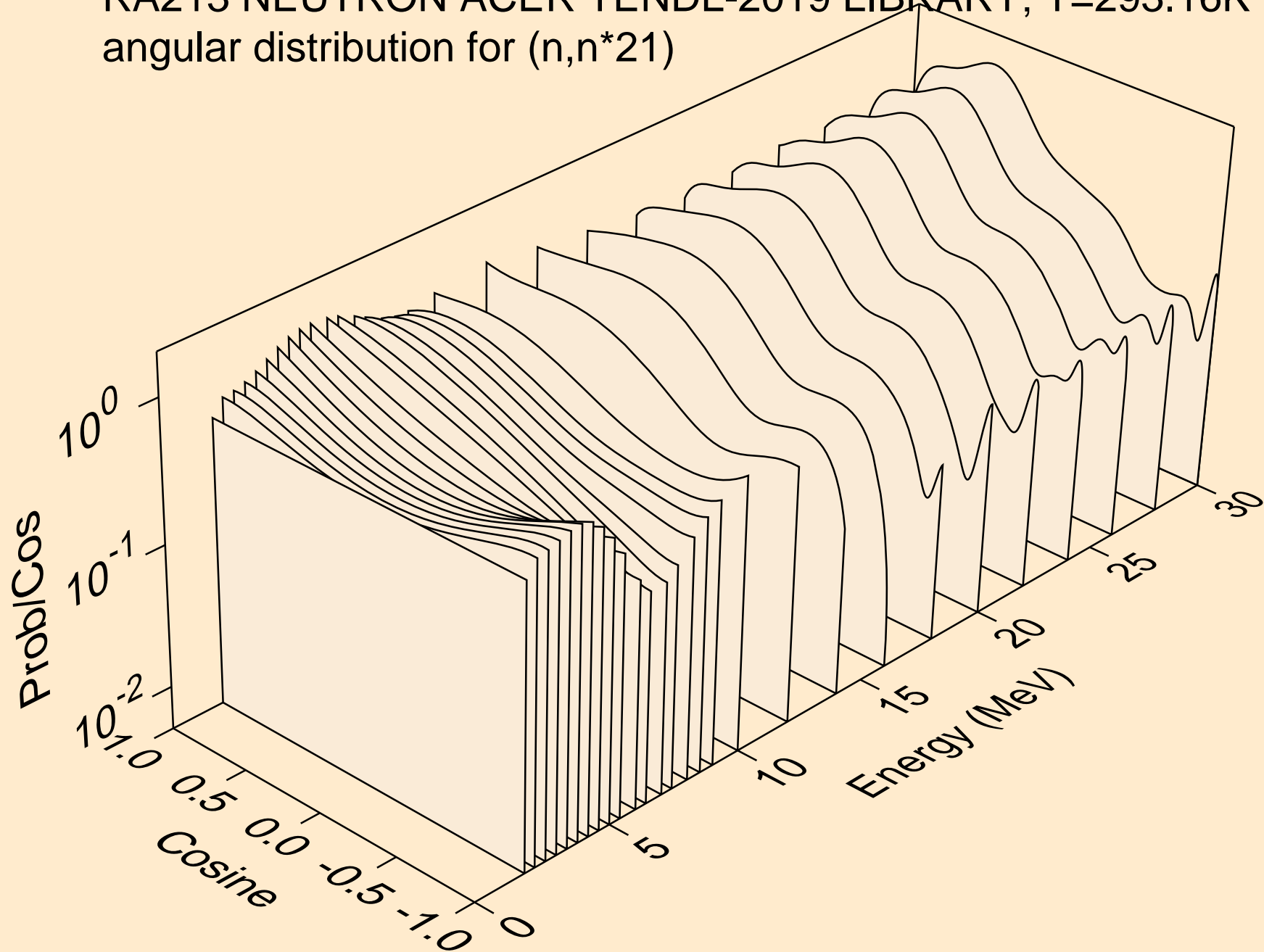

RA213 NEUTRON ACER TENDL-2019 LIBRARY; T=293.16K
angular distribution for (n,n*22)

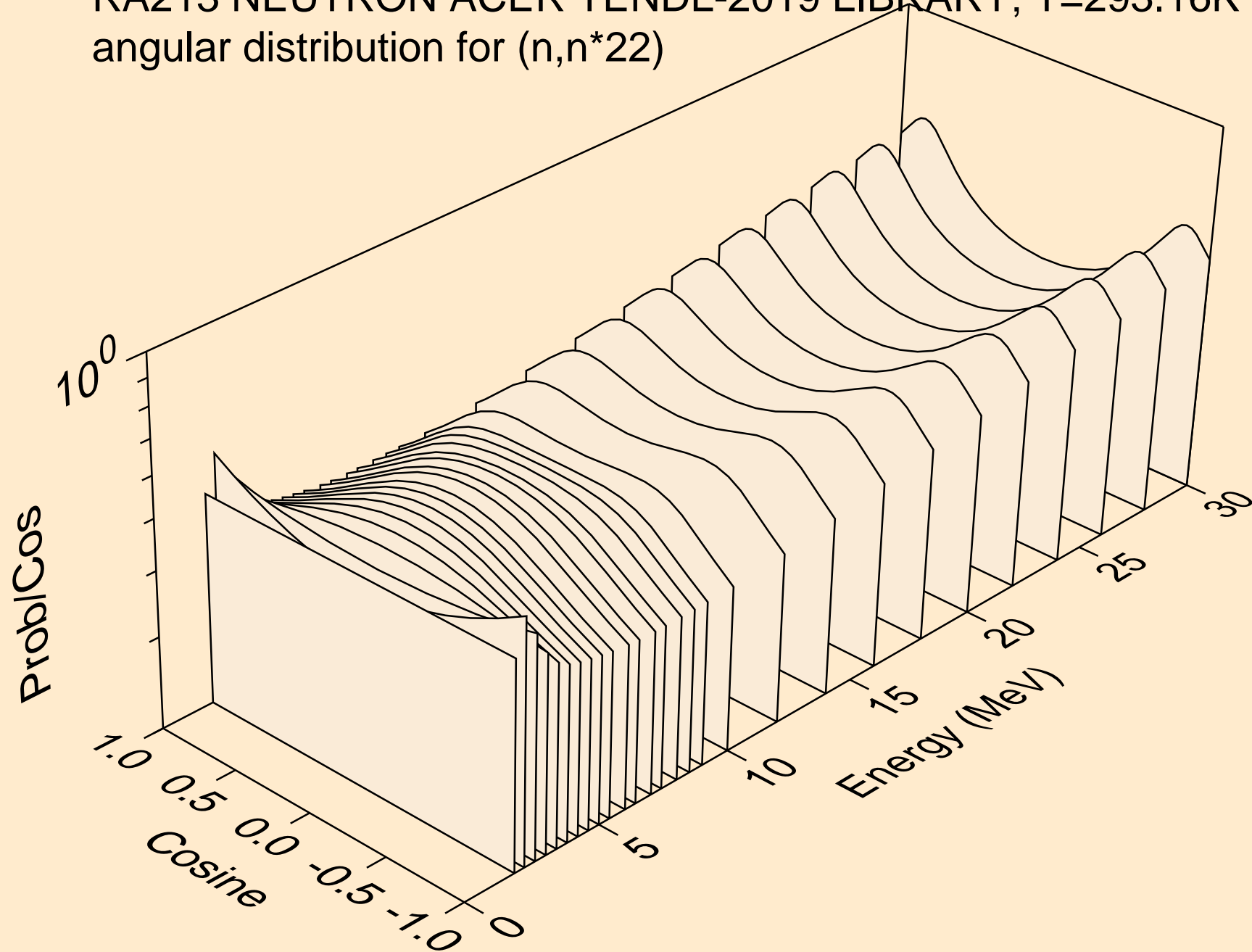

RA213 NEUTRON ACER TENDL-2019 LIBRARY; T=293.16K
angular distribution for (n,n*23)

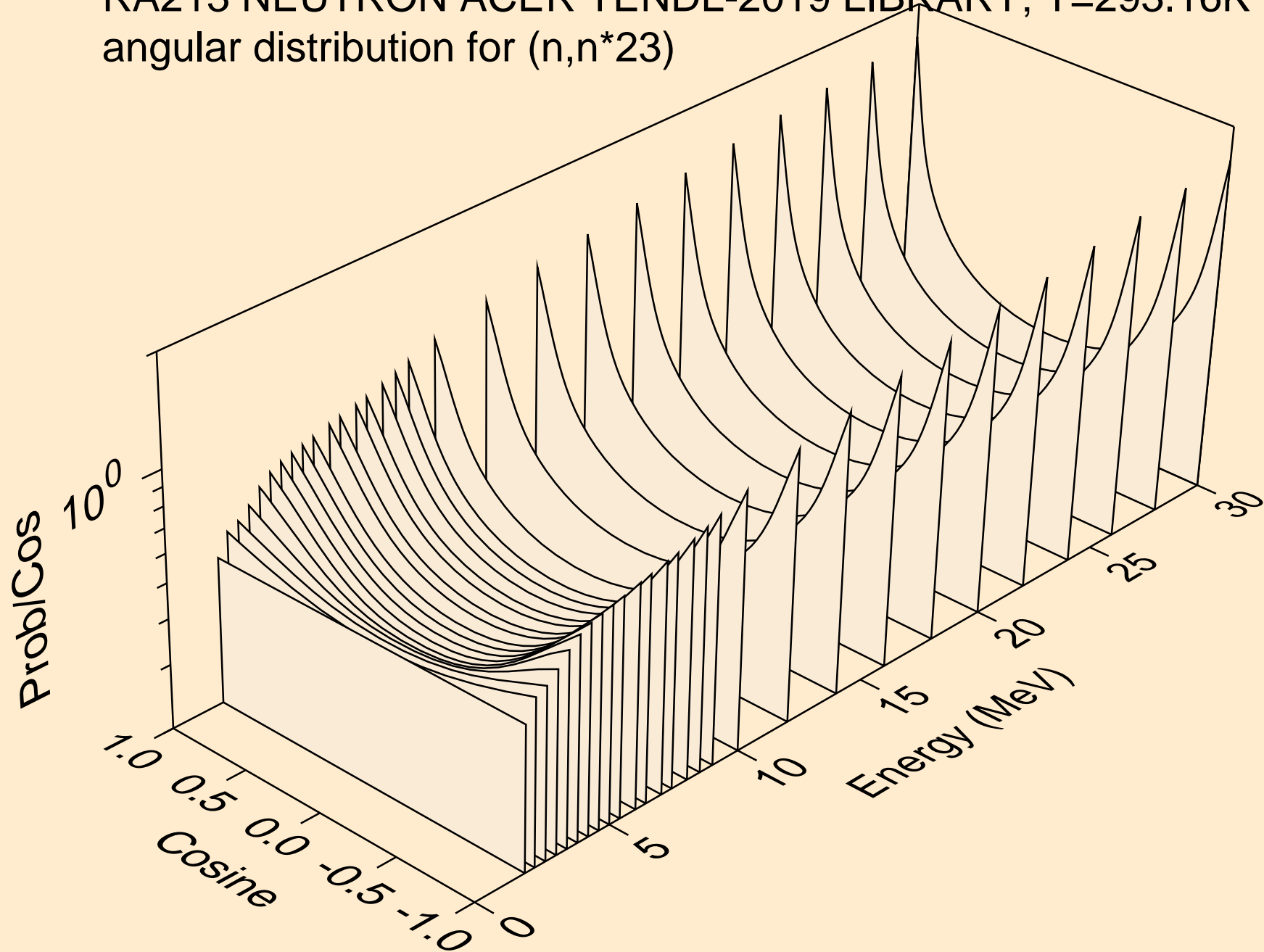

RA213 NEUTRON ACER TENDL-2019 LIBRARY; T=293.16K
angular distribution for (n,n*24)

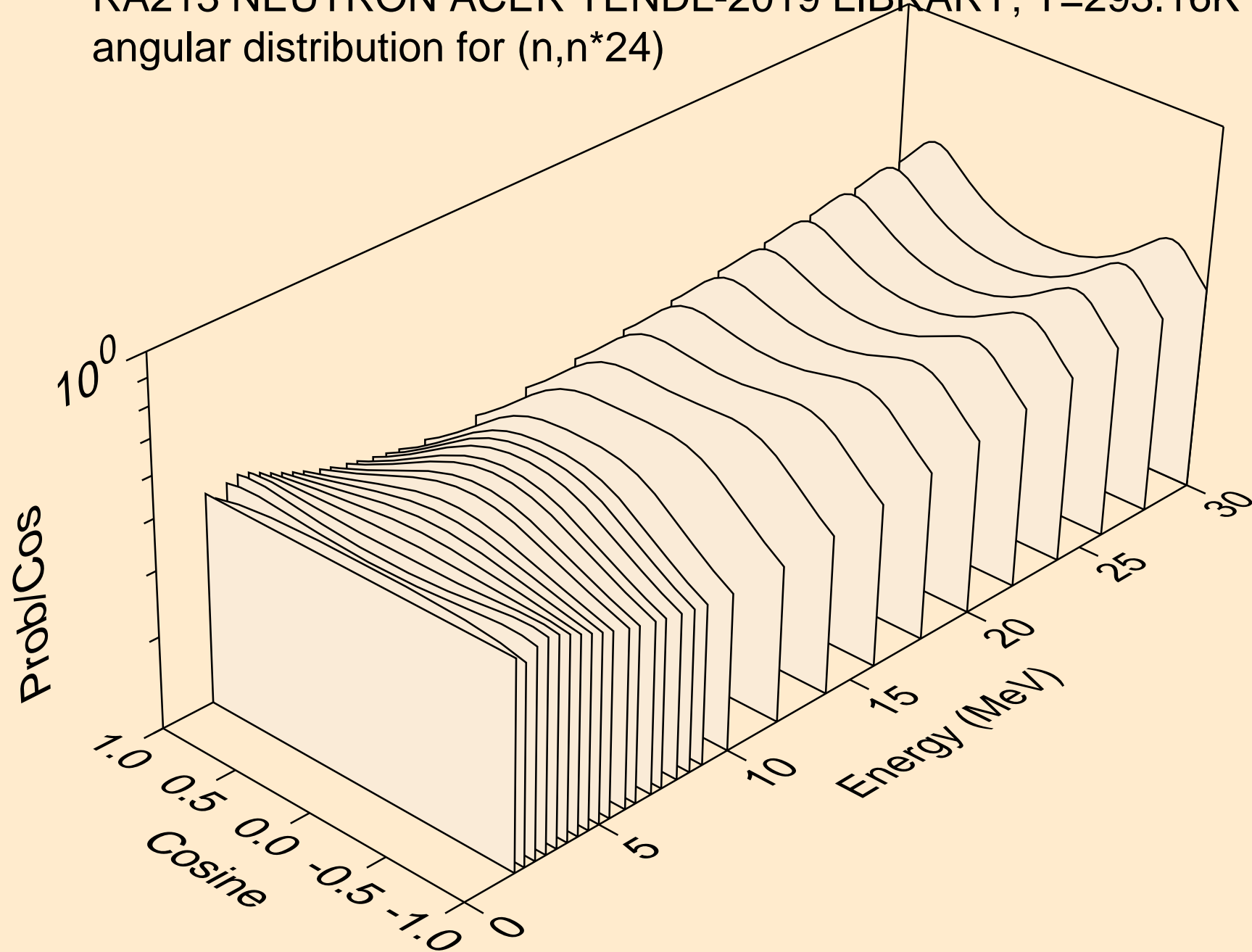

RA213 NEUTRON ACER TENDL-2019 LIBRARY; T=293.16K
angular distribution for (n,n*25)

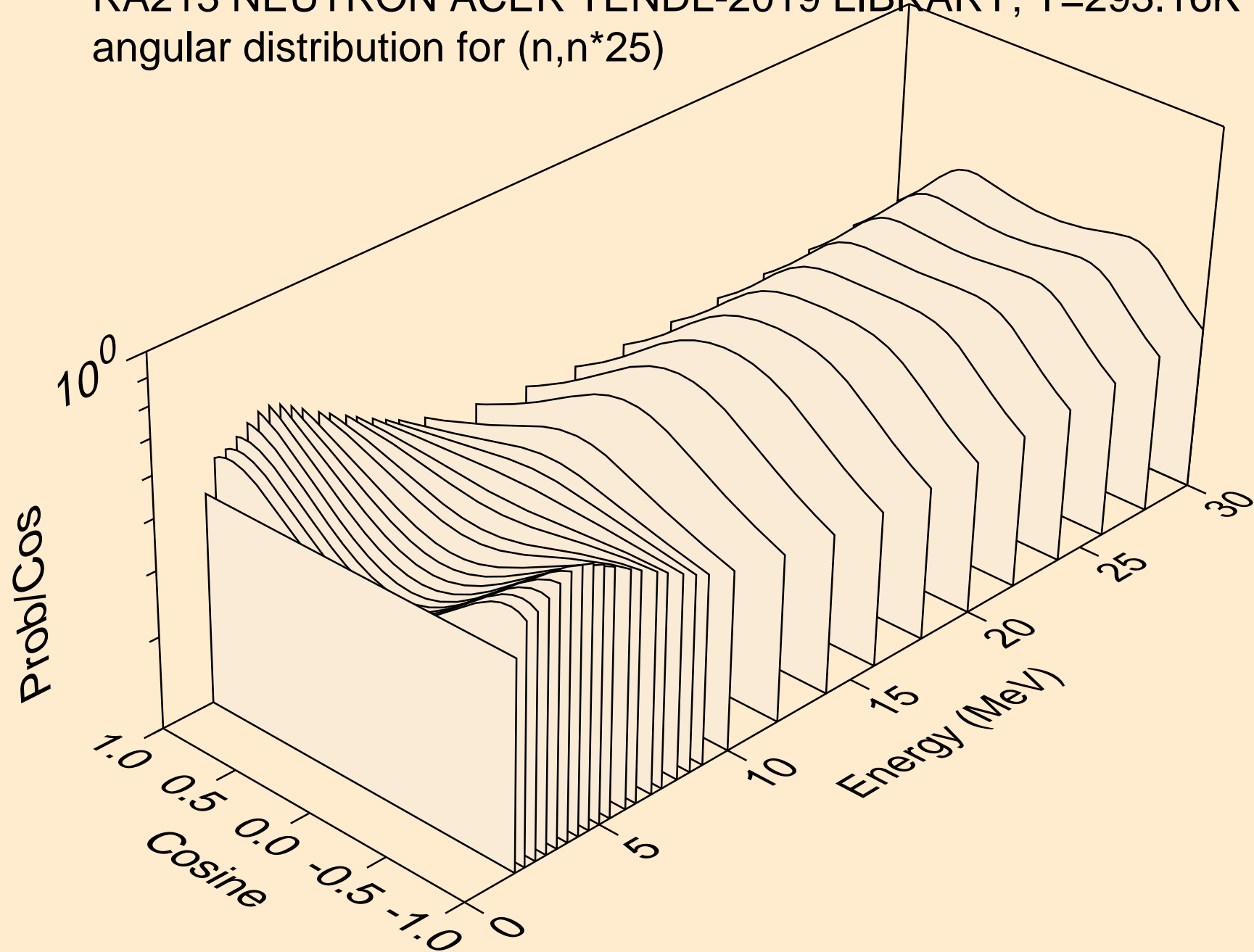

RA213 NEUTRON ACER TENDL-2019 LIBRARY; T=293.16K
angular distribution for (n,n*26)

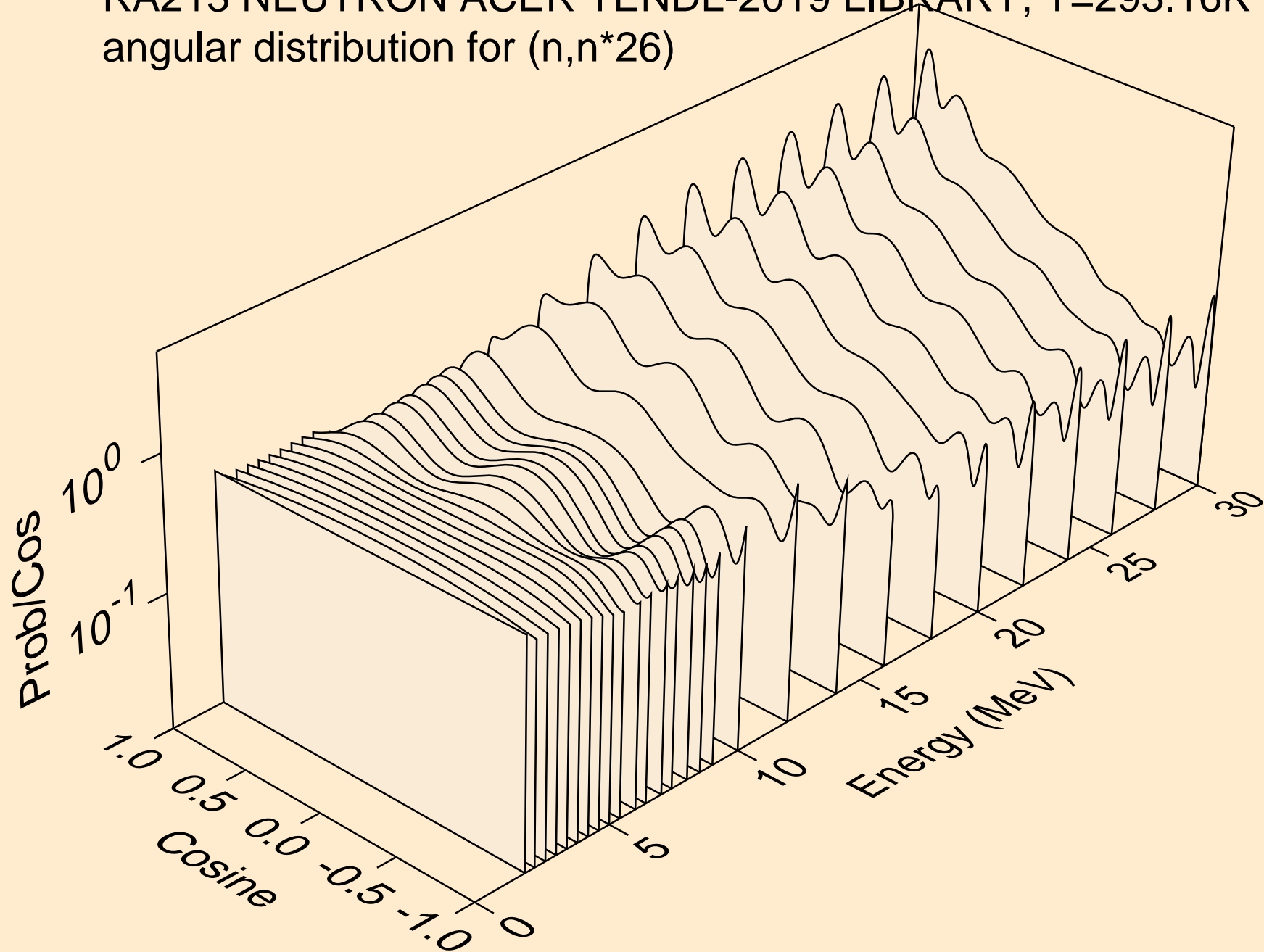

RA213 NEUTRON ACER TENDL-2019 LIBRARY; T=293.16K
angular distribution for (n,n*27)

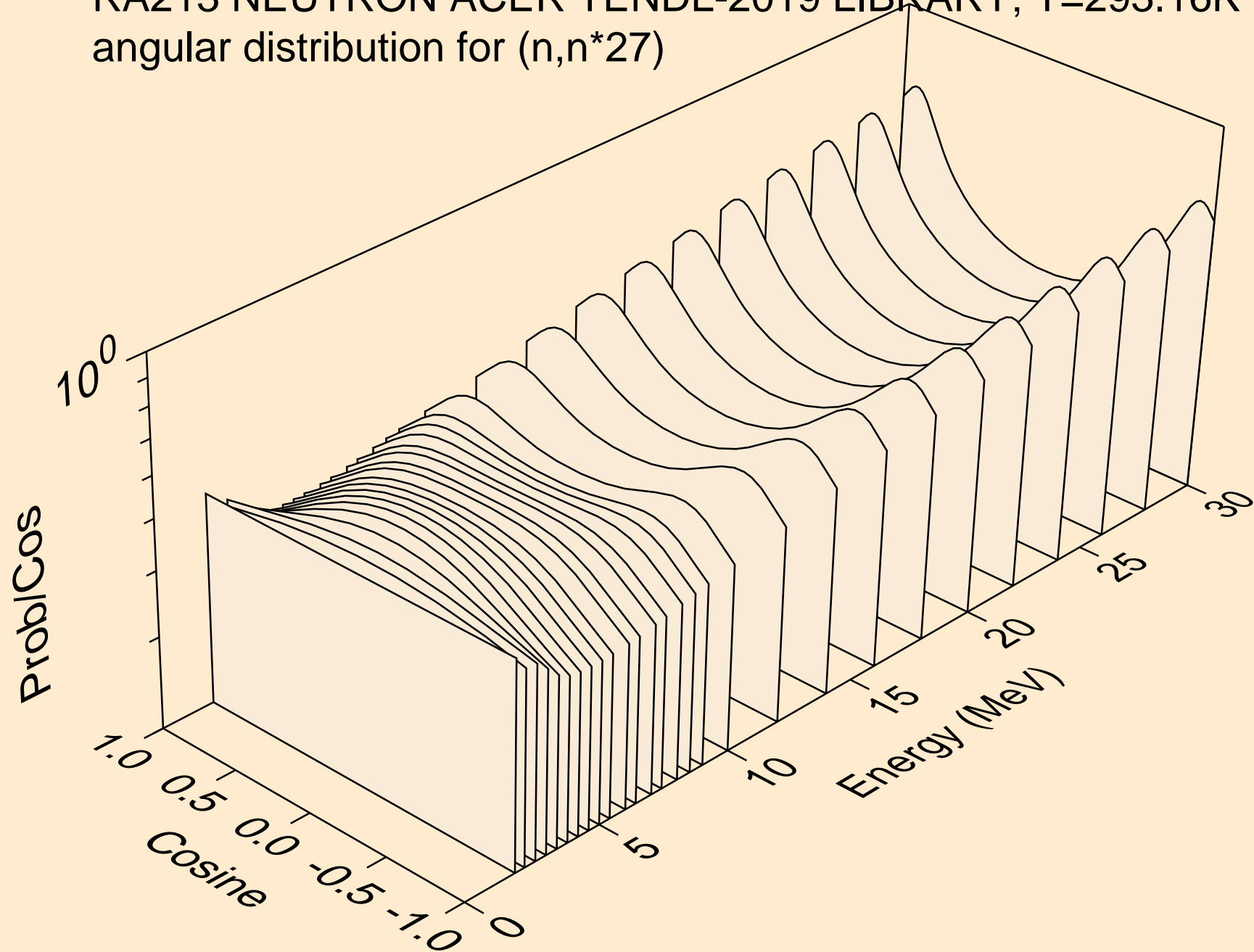

RA213 NEUTRON ACER TENDL-2019 LIBRARY; T=293.16K
angular distribution for (n,n*28)

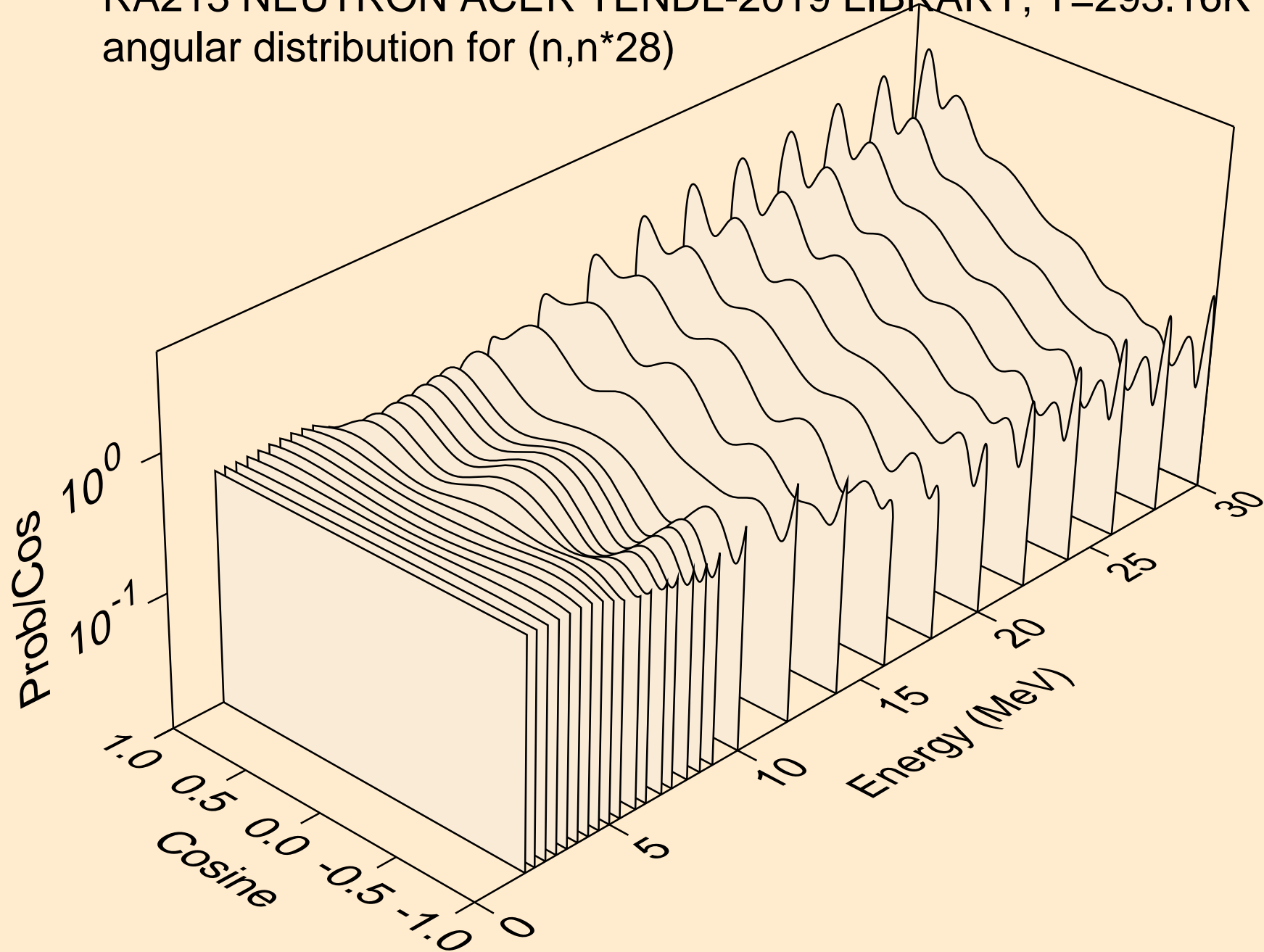

RA213 NEUTRON ACER TENDL-2019 LIBRARY; T=293.16K
Neutron emission for (n,x)

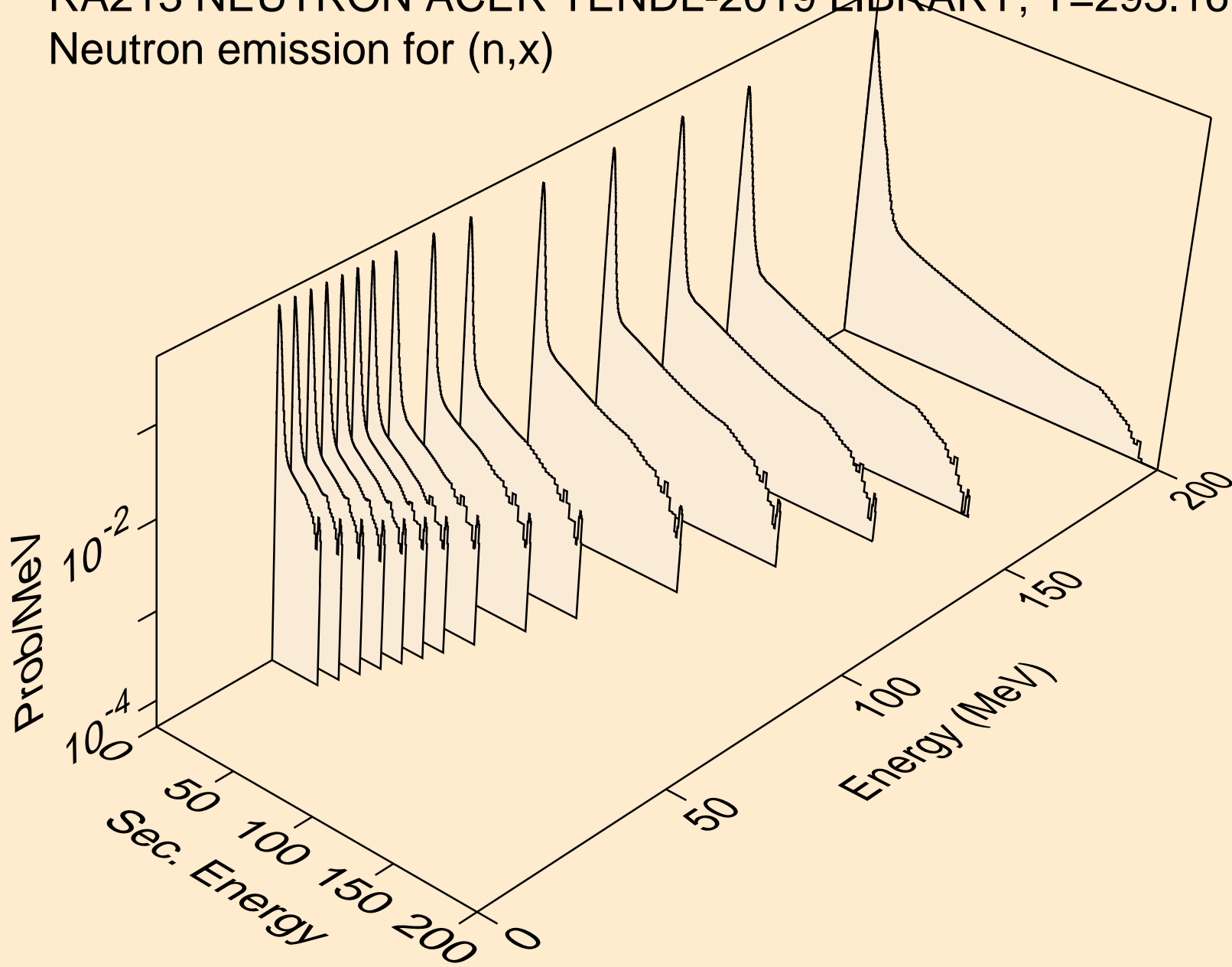

RA213 NEUTRON ACER TENDL-2019 LIBRARY; T=293.16K
Neutron emission for (n,2nd)

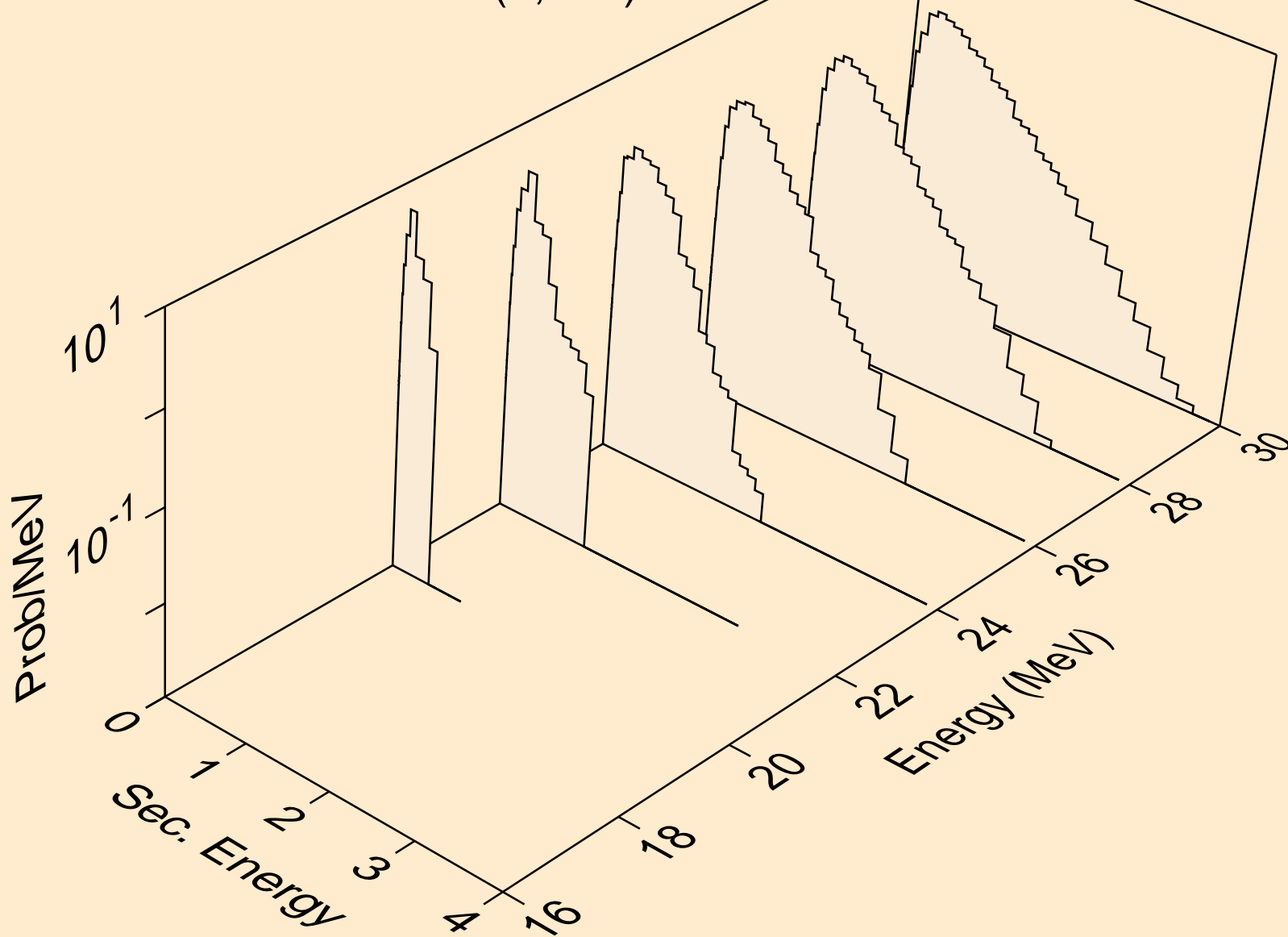

RA213 NEUTRON ACER TENDL-2019 LIBRARY; T=293.16K
Neutron emission for (n,2n)

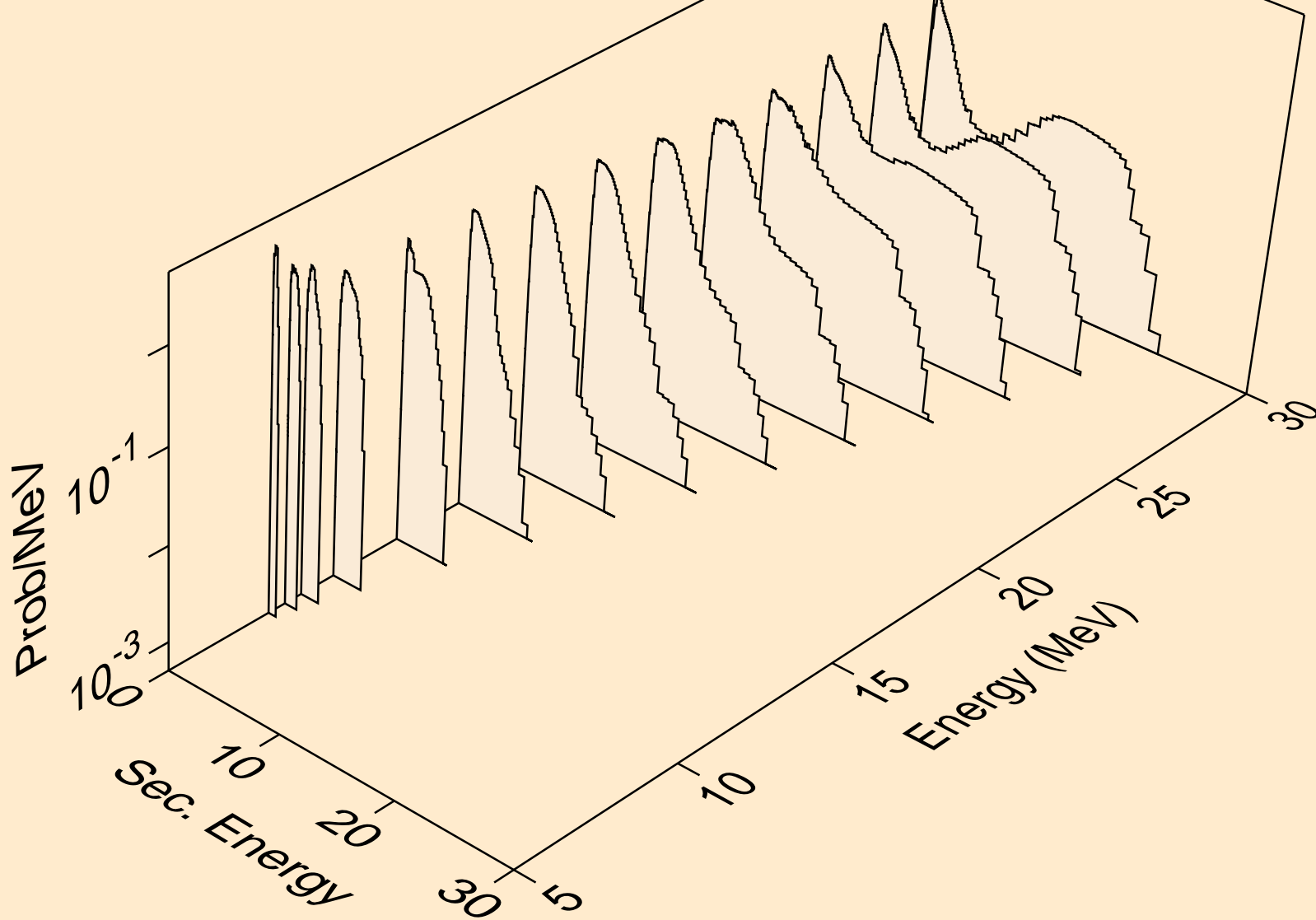

RA213 NEUTRON ACER TENDL-2019 LIBRARY; T=293.16K
Neutron emission for (n,3n)

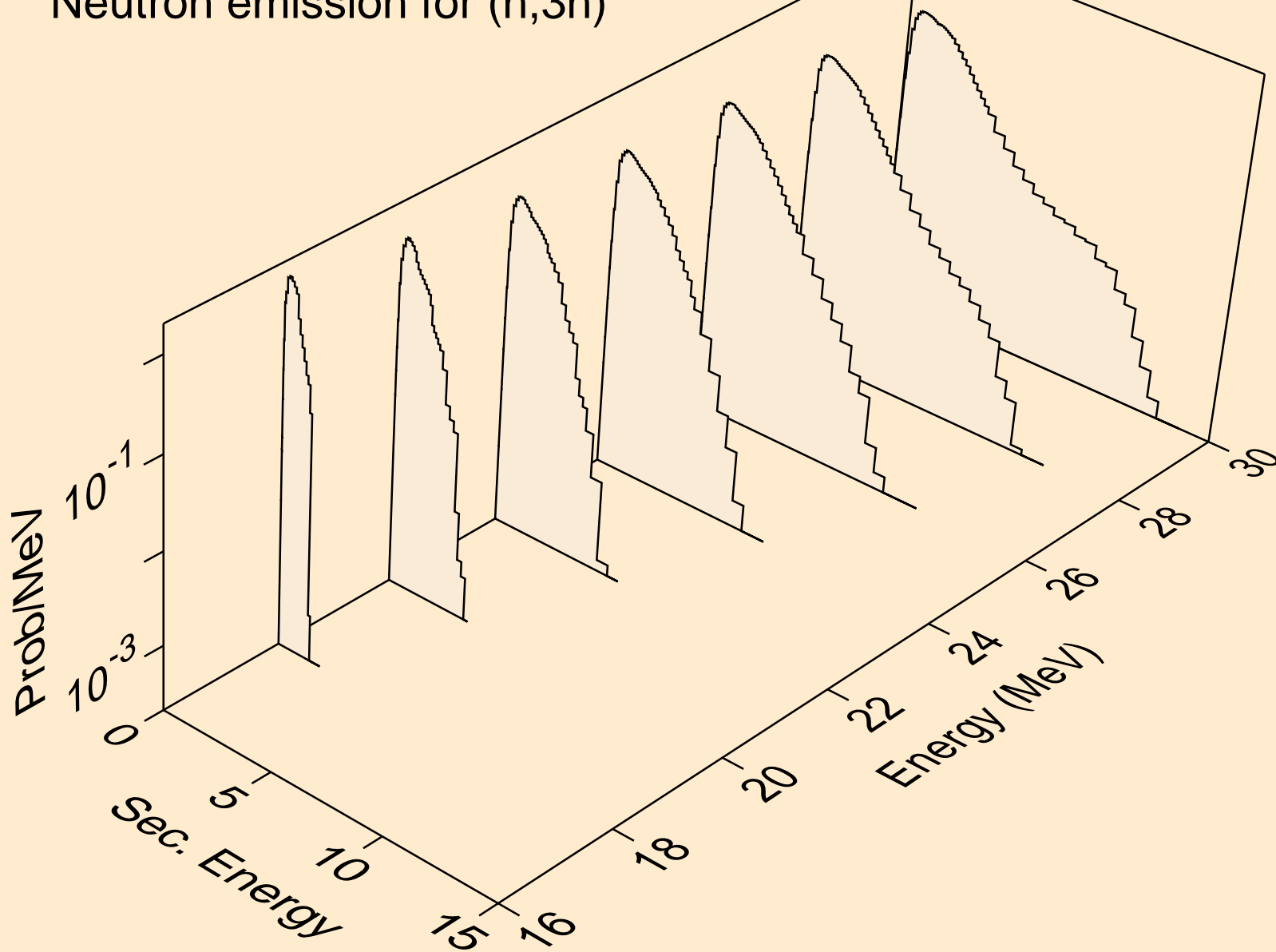

RA213 NEUTRON ACER TENDL-2019 LIBRARY; T=293.16K
Neutron emission for (n,n*)a

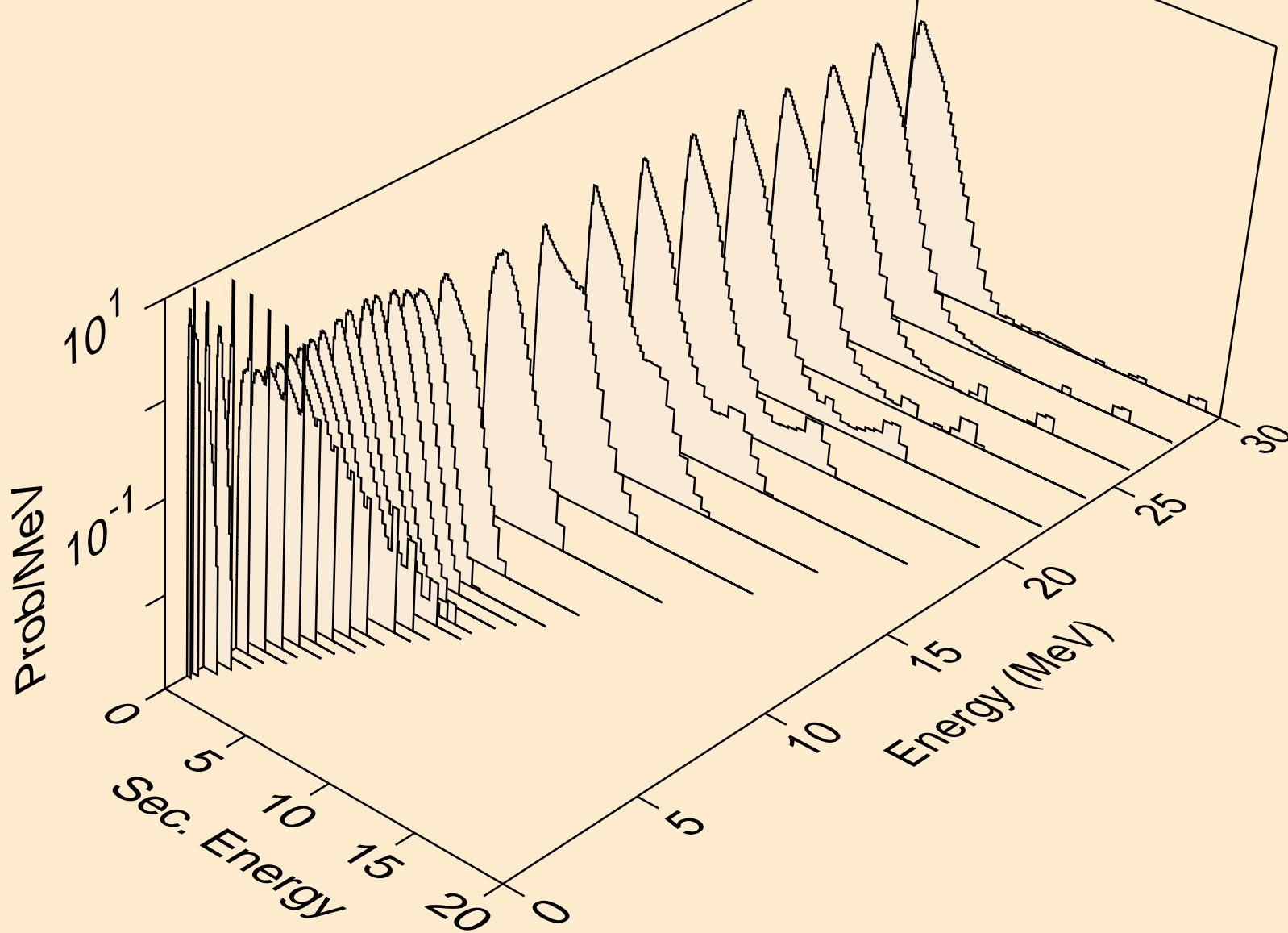

RA213 NEUTRON ACER TENDL-2019 LIBRARY; T=293.16K
Neutron emission for (n,2n)a

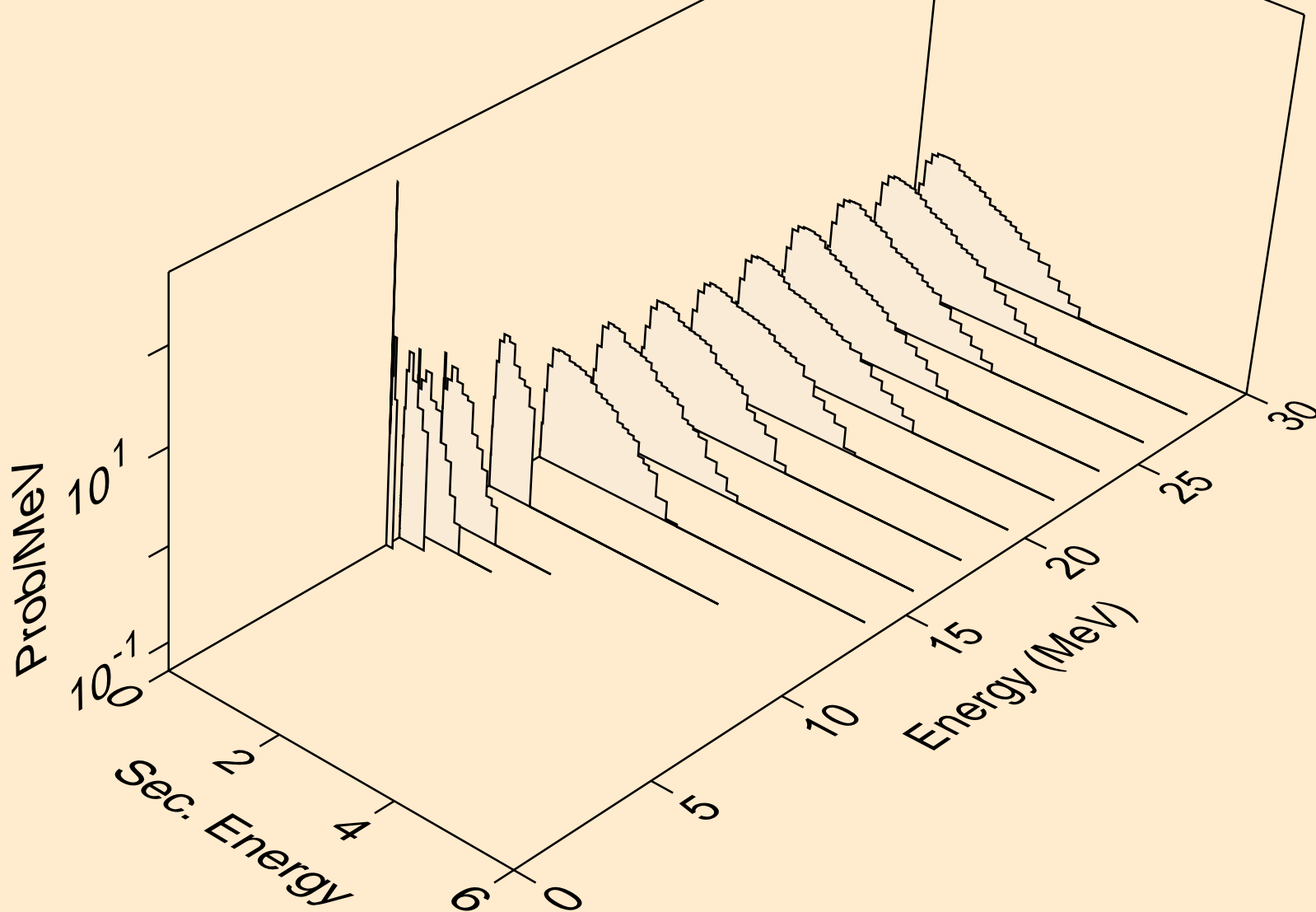

RA213 NEUTRON ACER TENDL-2019 LIBRARY; T=293.16K
Neutron emission for (n,3n)a

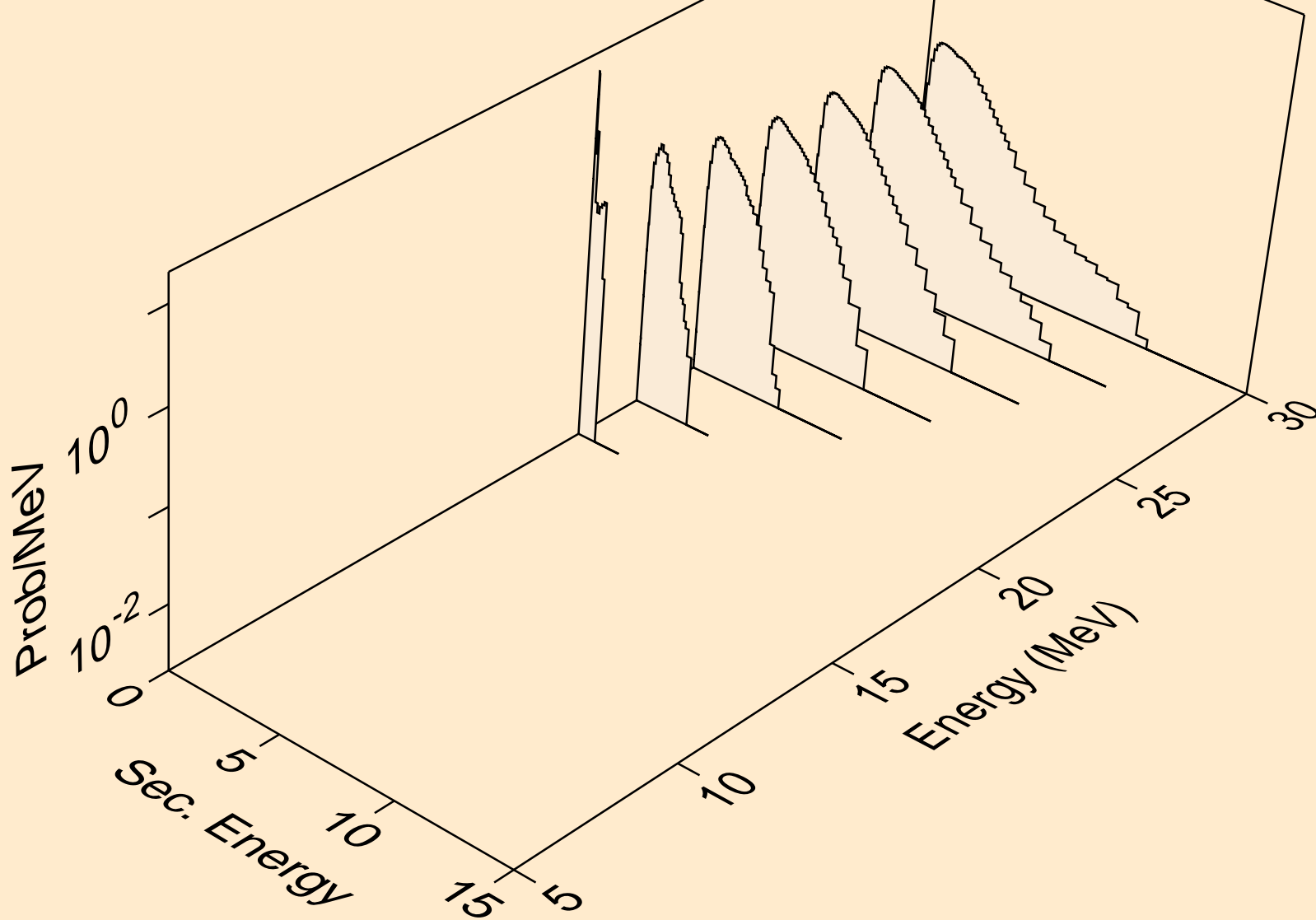

RA213 NEUTRON ACER TENDL-2019 LIBRARY; T=293.16K
Neutron emission for (n,n*)p

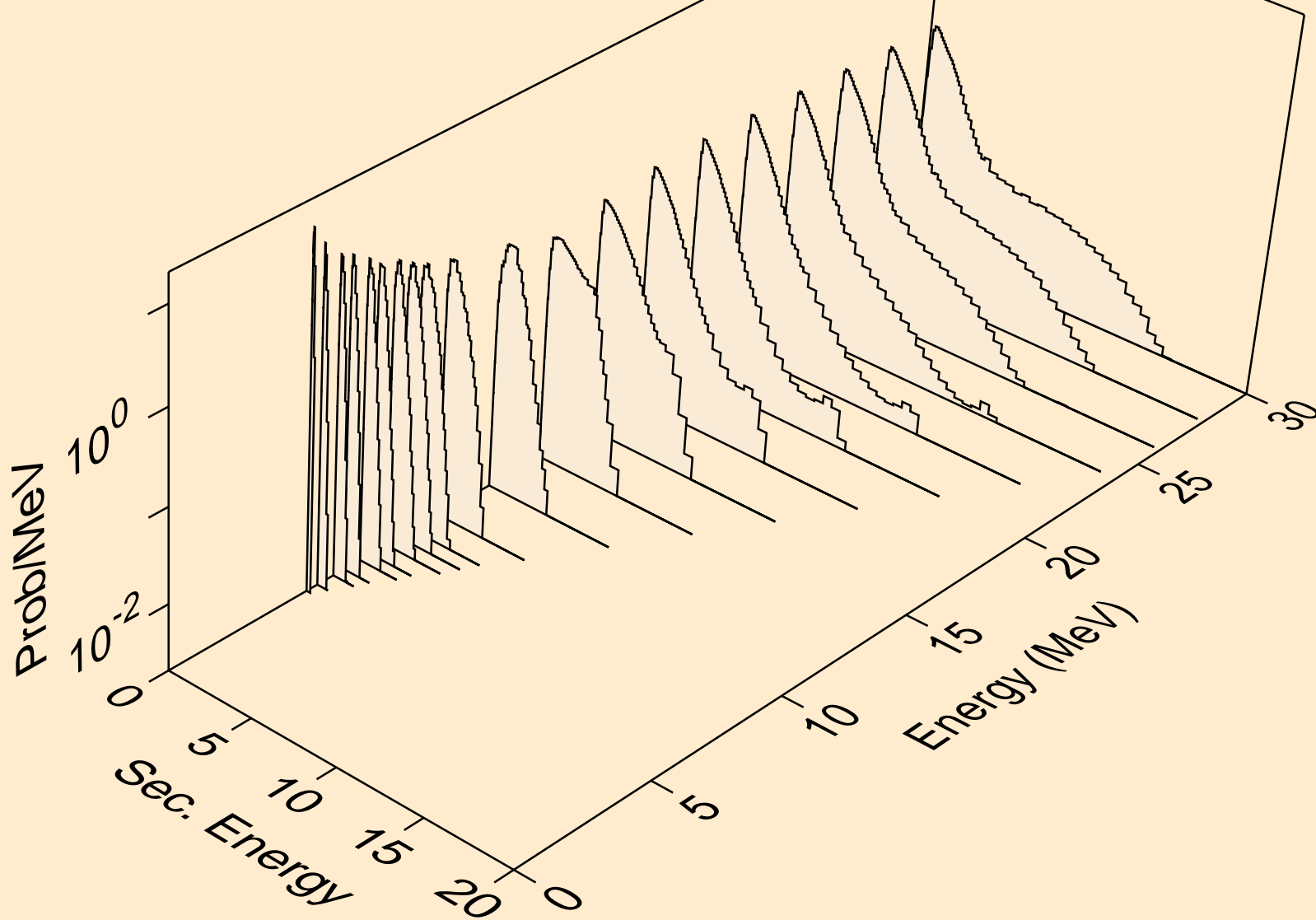

RA213 NEUTRON ACER TENDL-2019 LIBRARY; T=293.16K
Neutron emission for (n,n*)2a

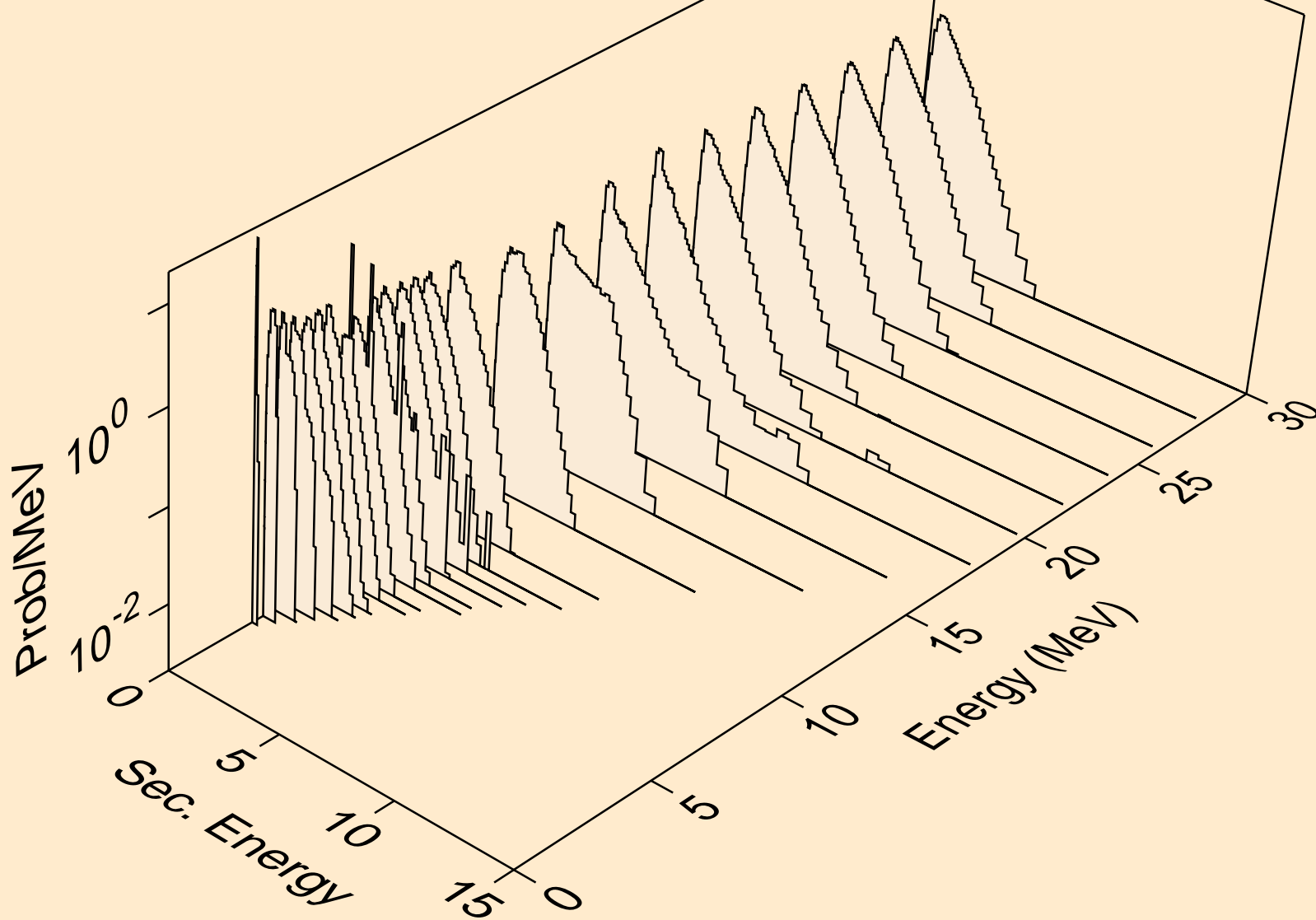

RA213 NEUTRON ACER TENDL-2019 LIBRARY; T=293.16K
Neutron emission for (n,2n)2a

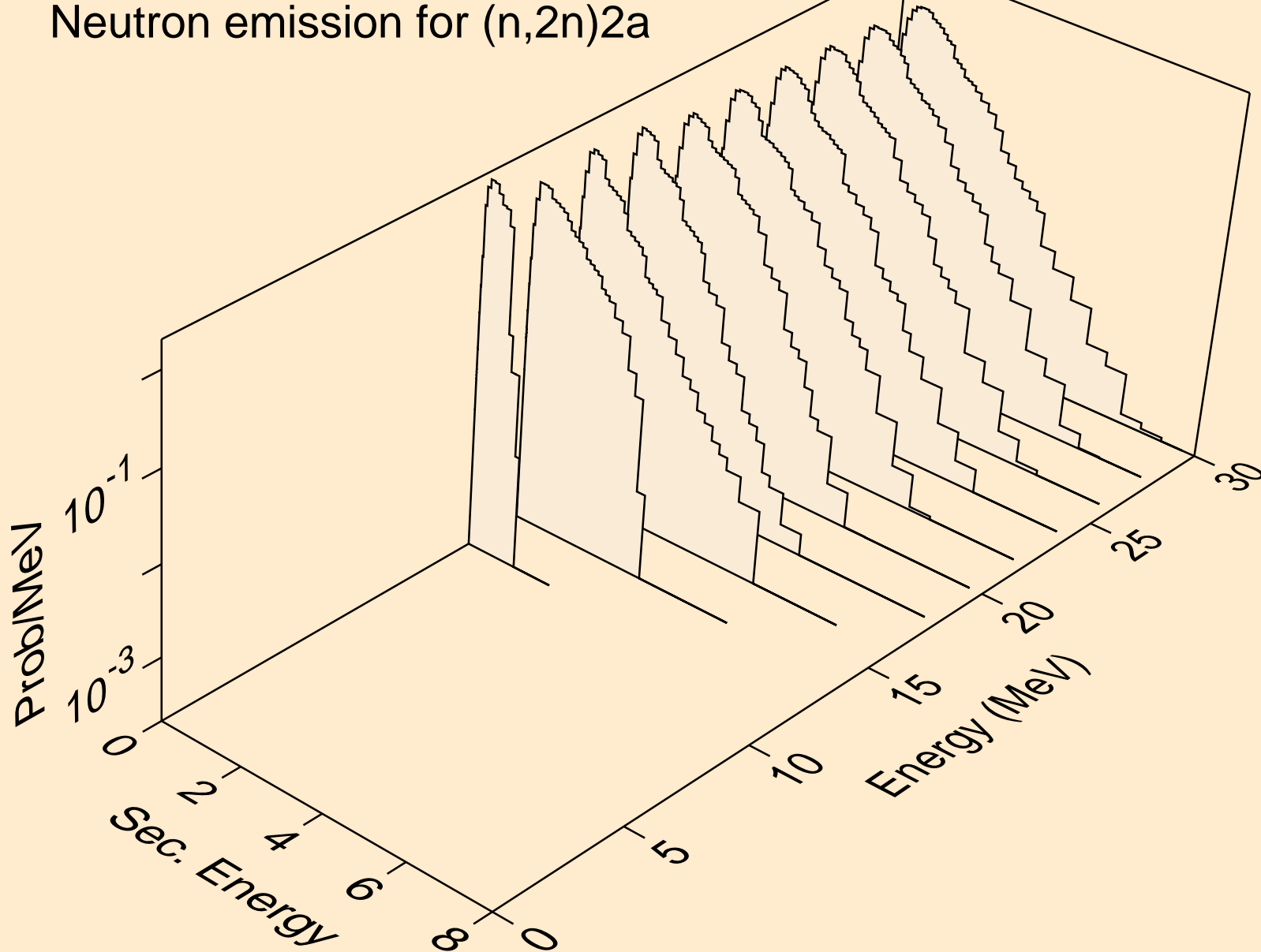

RA213 NEUTRON ACER TENDL-2019 LIBRARY; T=293.16K
Neutron emission for (n,n*)d

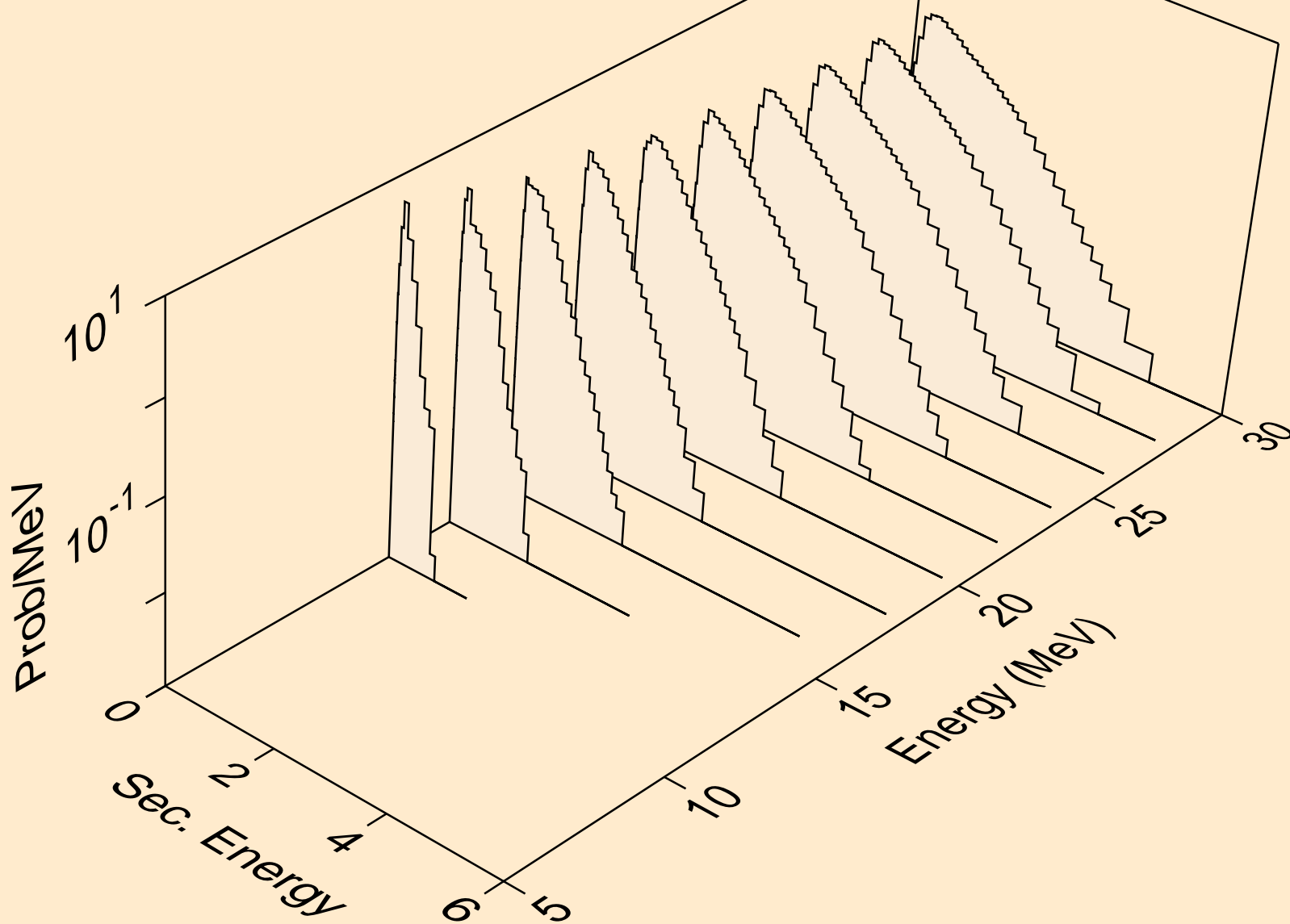

RA213 NEUTRON ACER TENDL-2019 LIBRARY; T=293.16K
Neutron emission for (n,n*)t

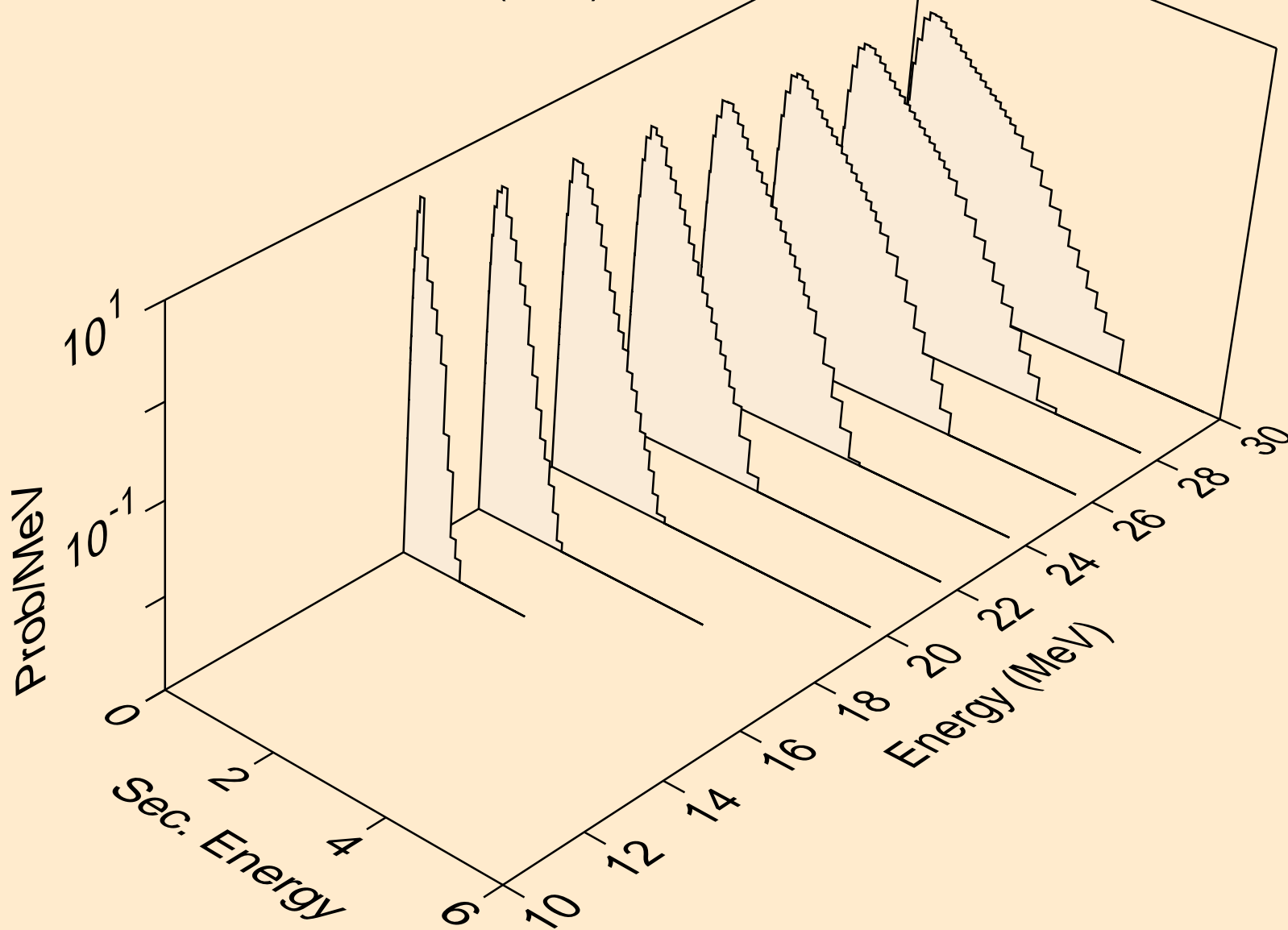

RA213 NEUTRON ACER TENDL-2019 LIBRARY; T=293.16K
Neutron emission for (n,n*)he3

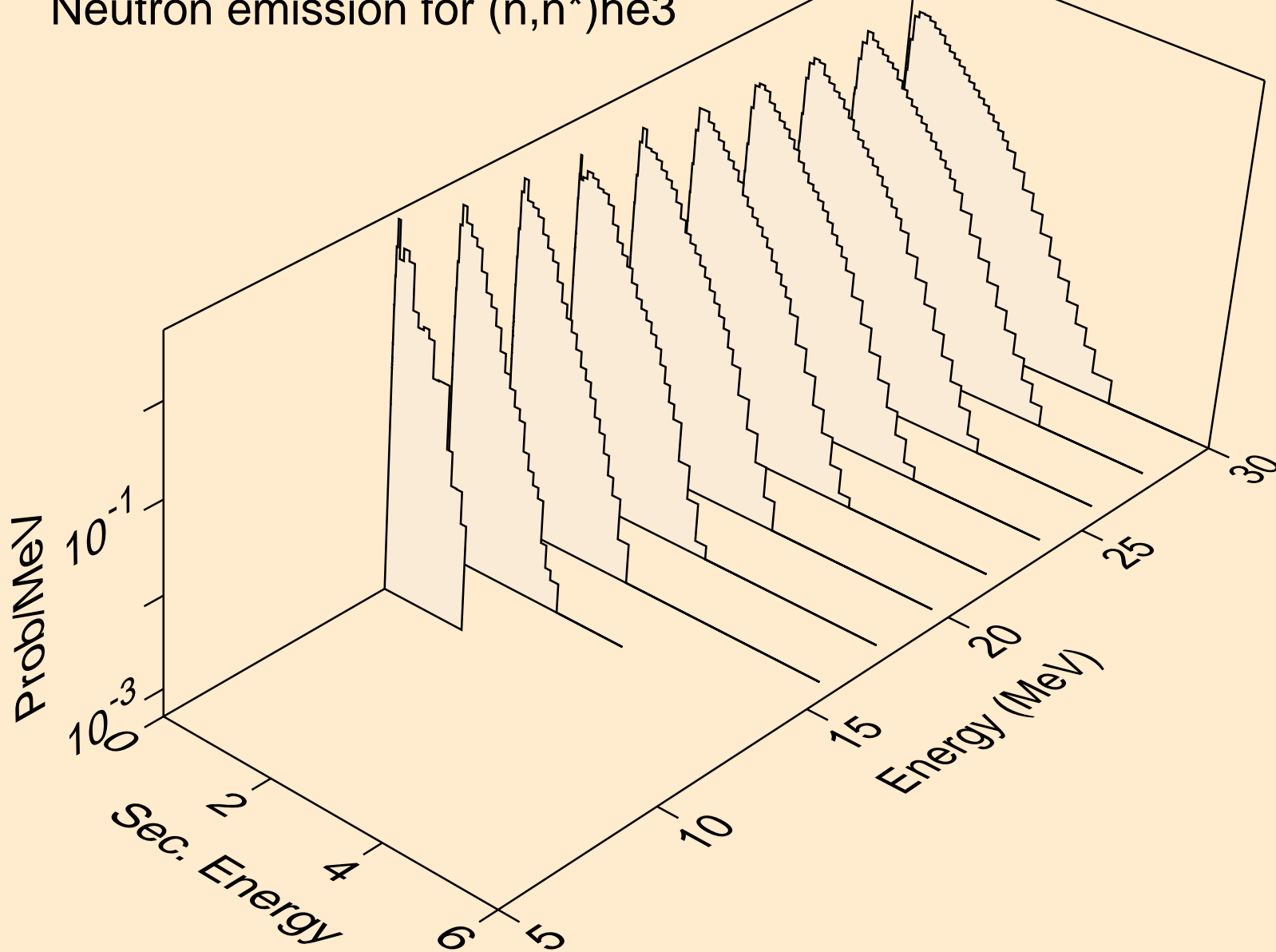

RA213 NEUTRON ACER TENDL-2019 LIBRARY; T=293.16K
Neutron emission for (n,4n)

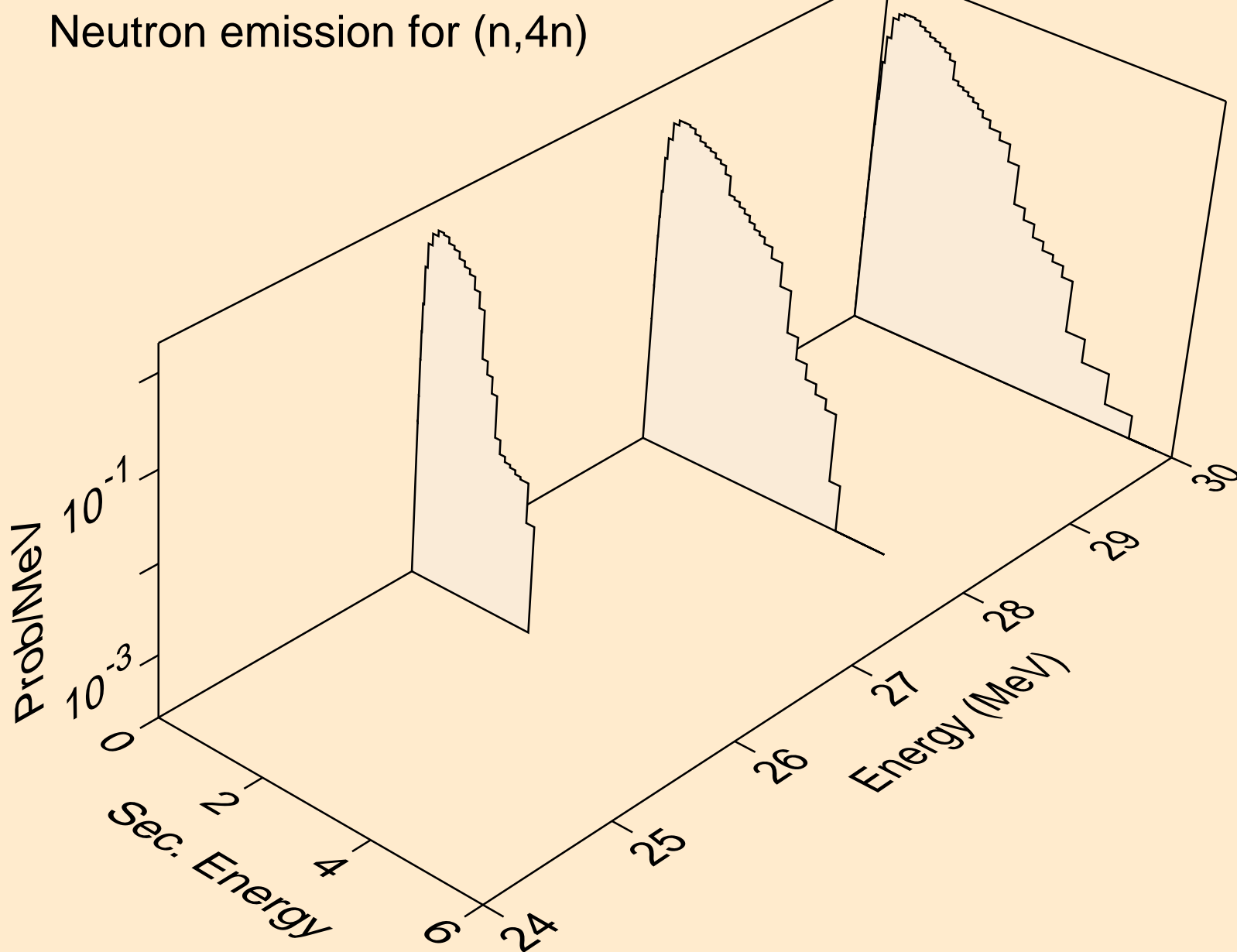

RA213 NEUTRON ACER TENDL-2019 LIBRARY; T=293.16K
Neutron emission for (n,2np)

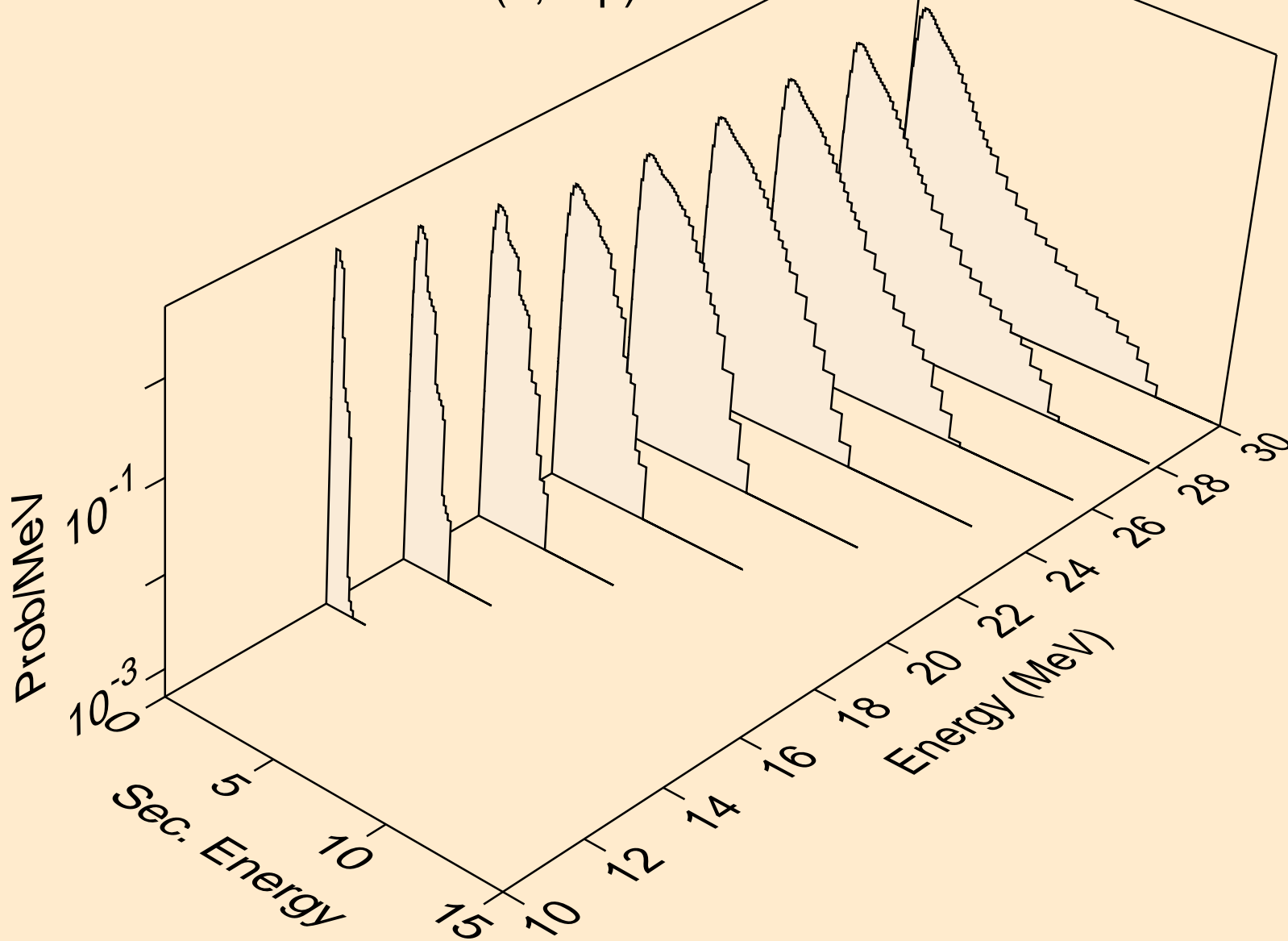

RA213 NEUTRON ACER TENDL-2019 LIBRARY; T=293.16K
Neutron emission for (n,3np)

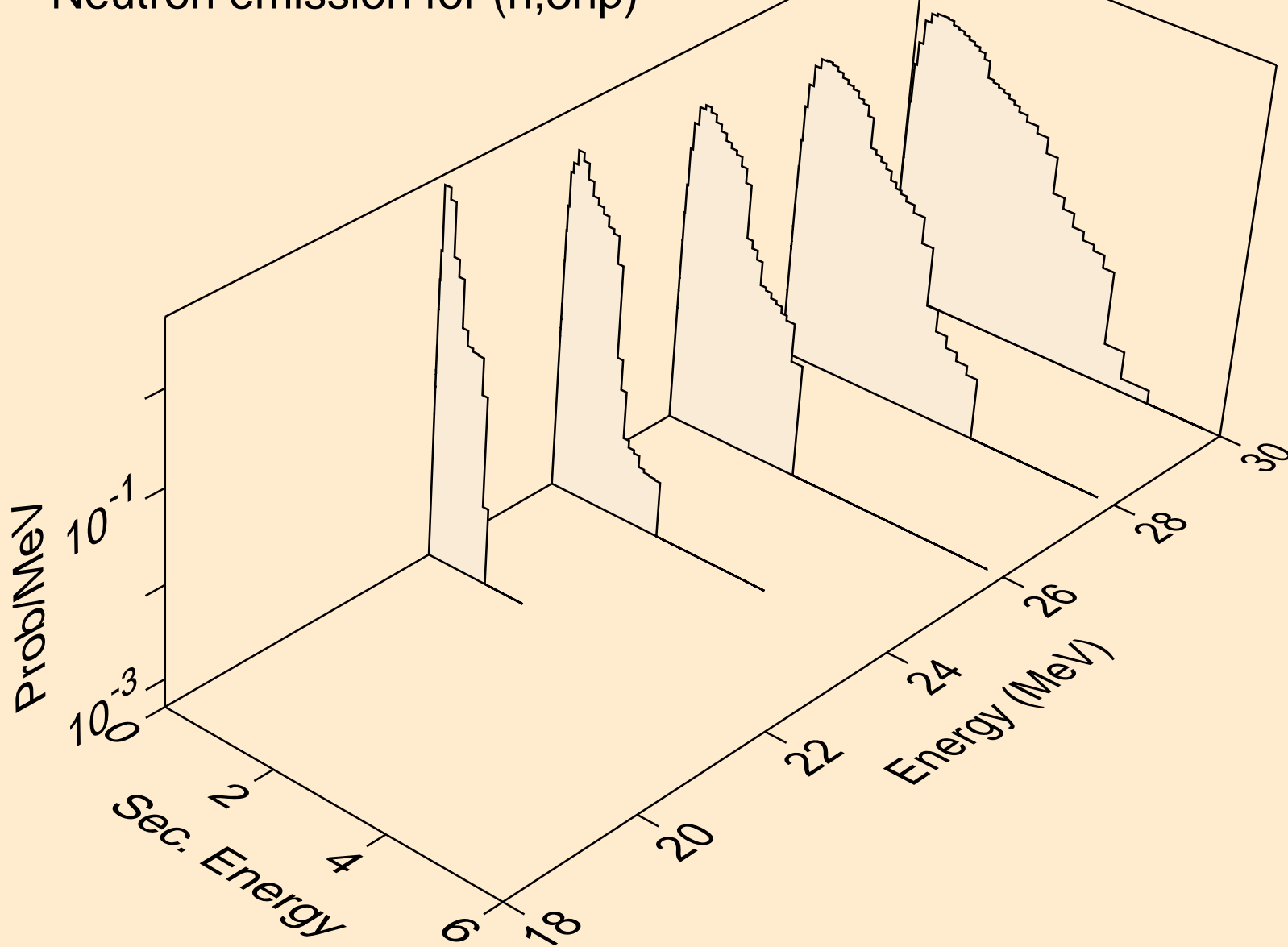

RA213 NEUTRON ACER TENDL-2019 LIBRARY; T=293.16K
Neutron emission for (n,2np)

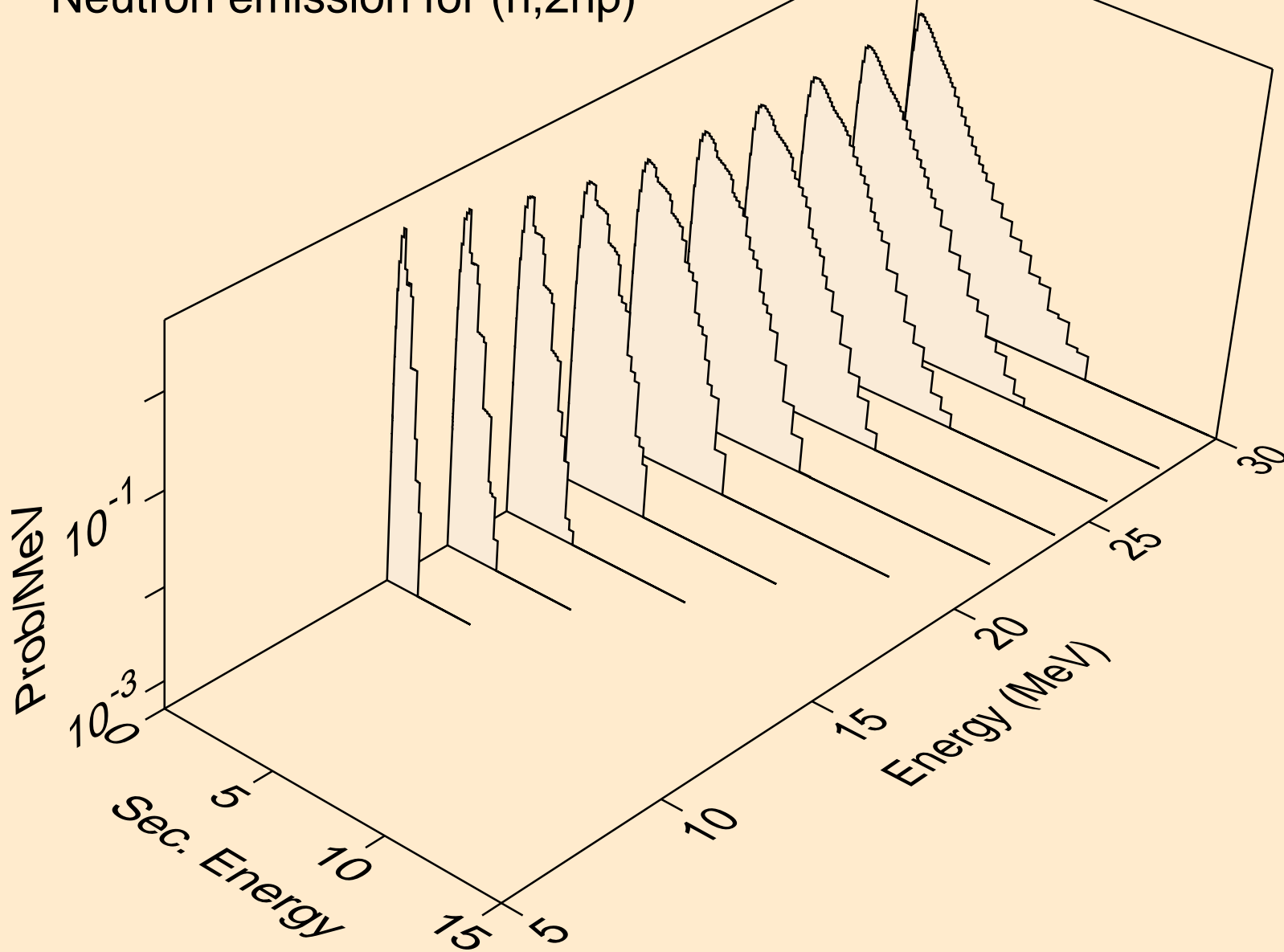

RA213 NEUTRON ACER TENDL-2019 LIBRARY; T=293.16K
Neutron emission for (n,npa)

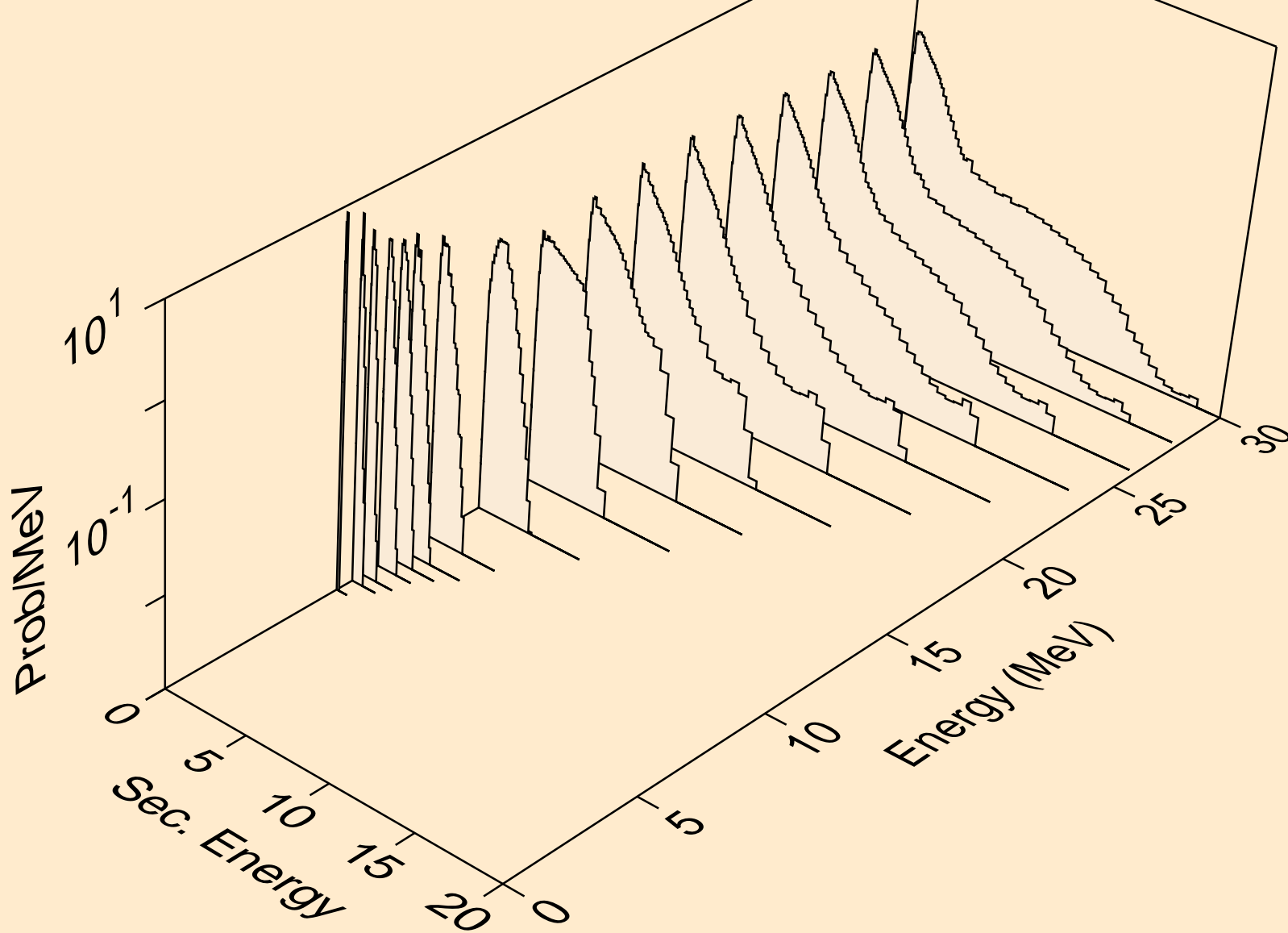

RA213 NEUTRON ACER TENDL-2019 LIBRARY; T=293.16K
Neutron emission for (n,n*c)

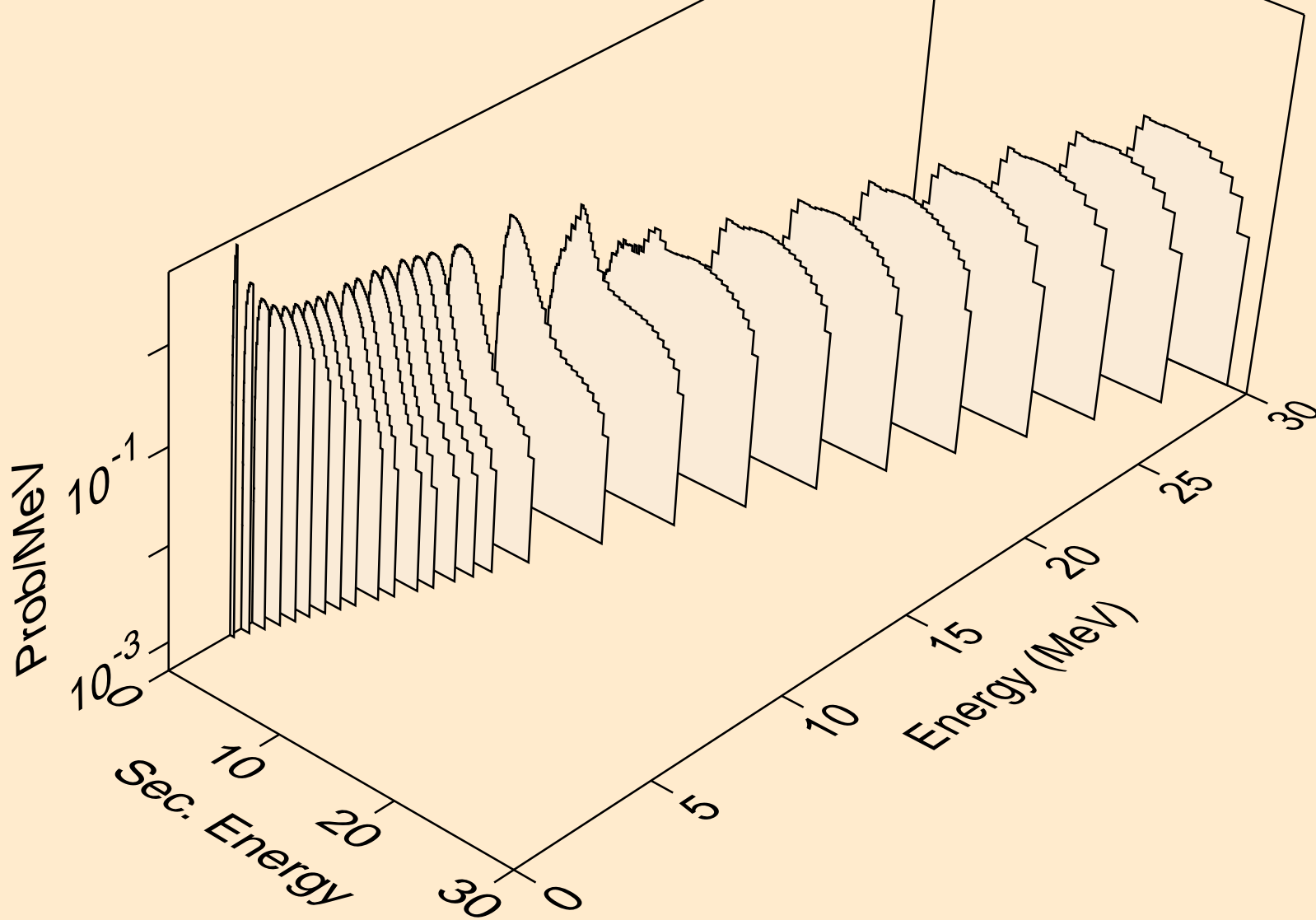

RA213 NEUTRON ACER TENDL-2019 LIBRARY; T=293.16K
Photon emission for (n,x)

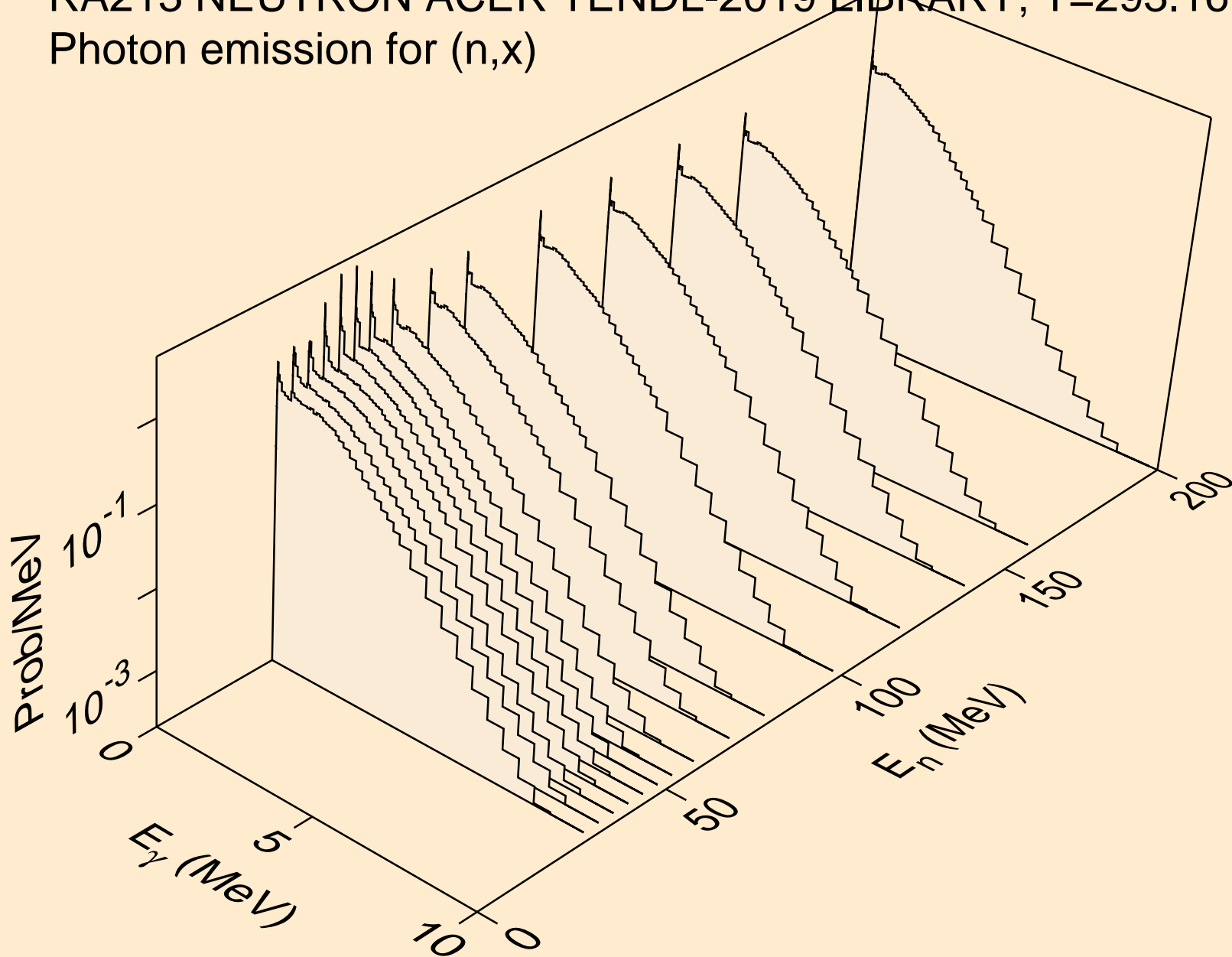

RA213 NEUTRON ACER TENDL-2019 LIBRARY; T=293.16K
Photon emission for (n,2nd)

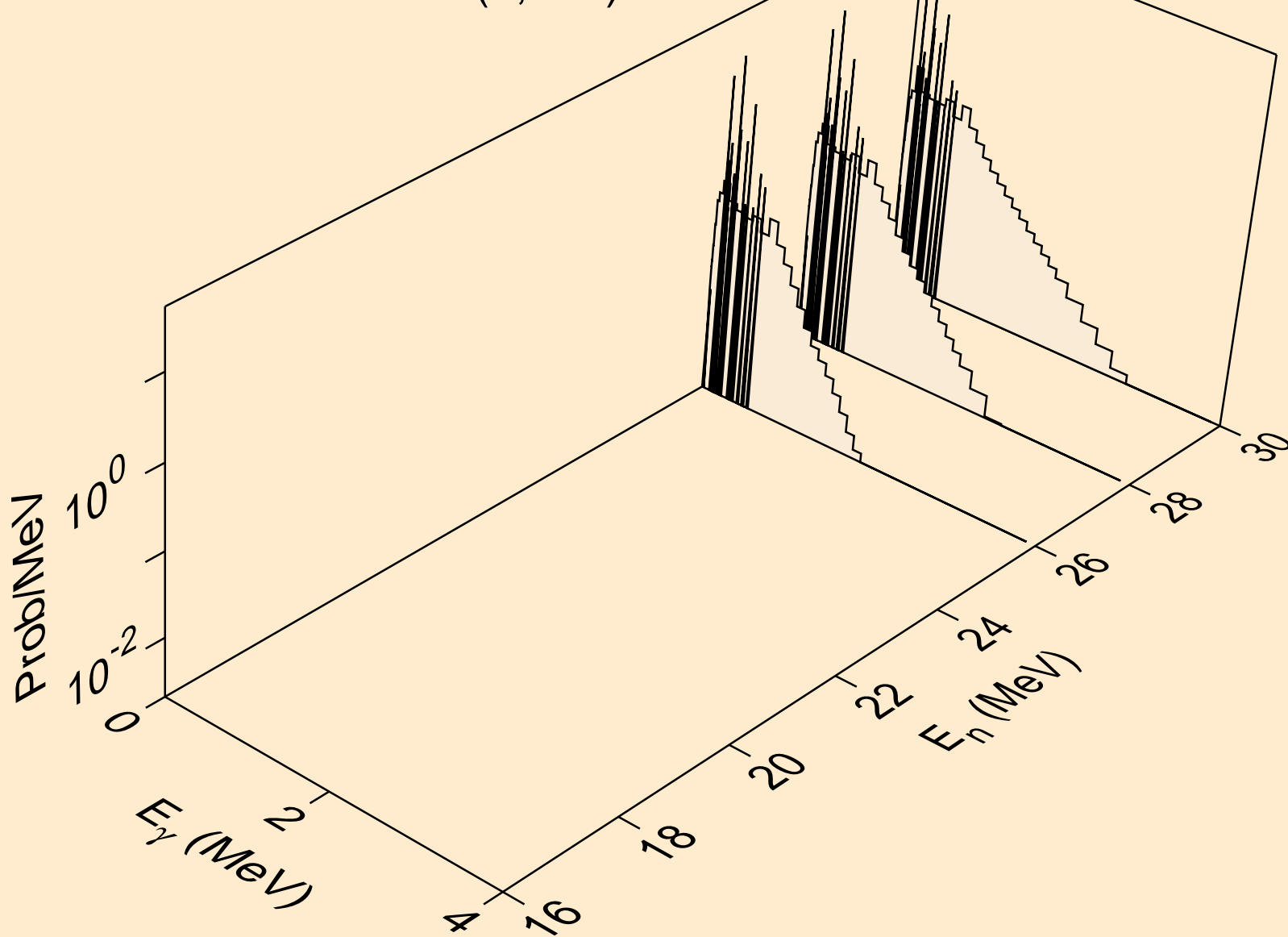

RA213 NEUTRON ACER TENDL-2019 LIBRARY; T=293.16K
Photon emission for (n,2n)

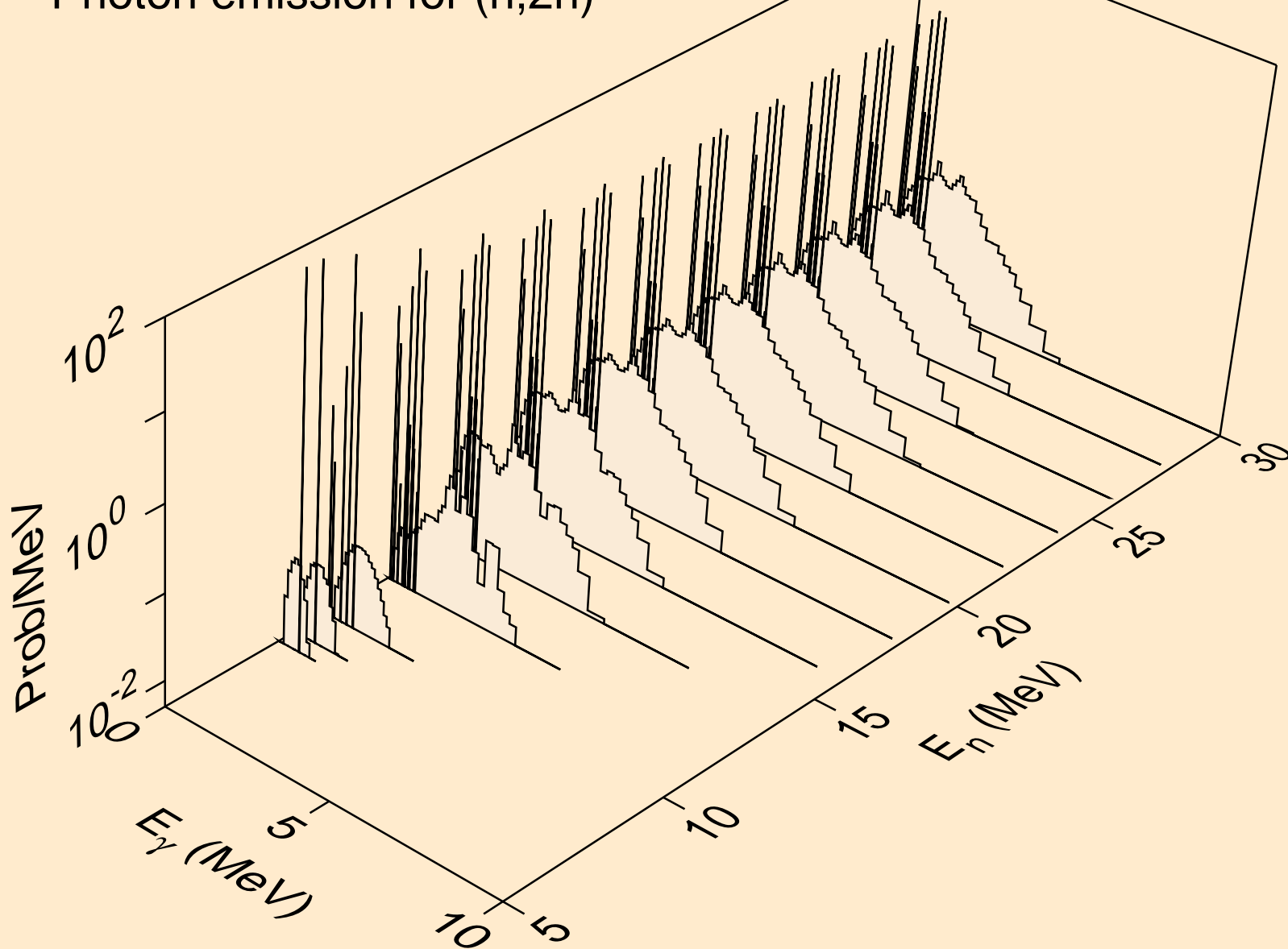

RA213 NEUTRON ACER TENDL-2019 LIBRARY; T=293.16K
Photon emission for (n,3n)

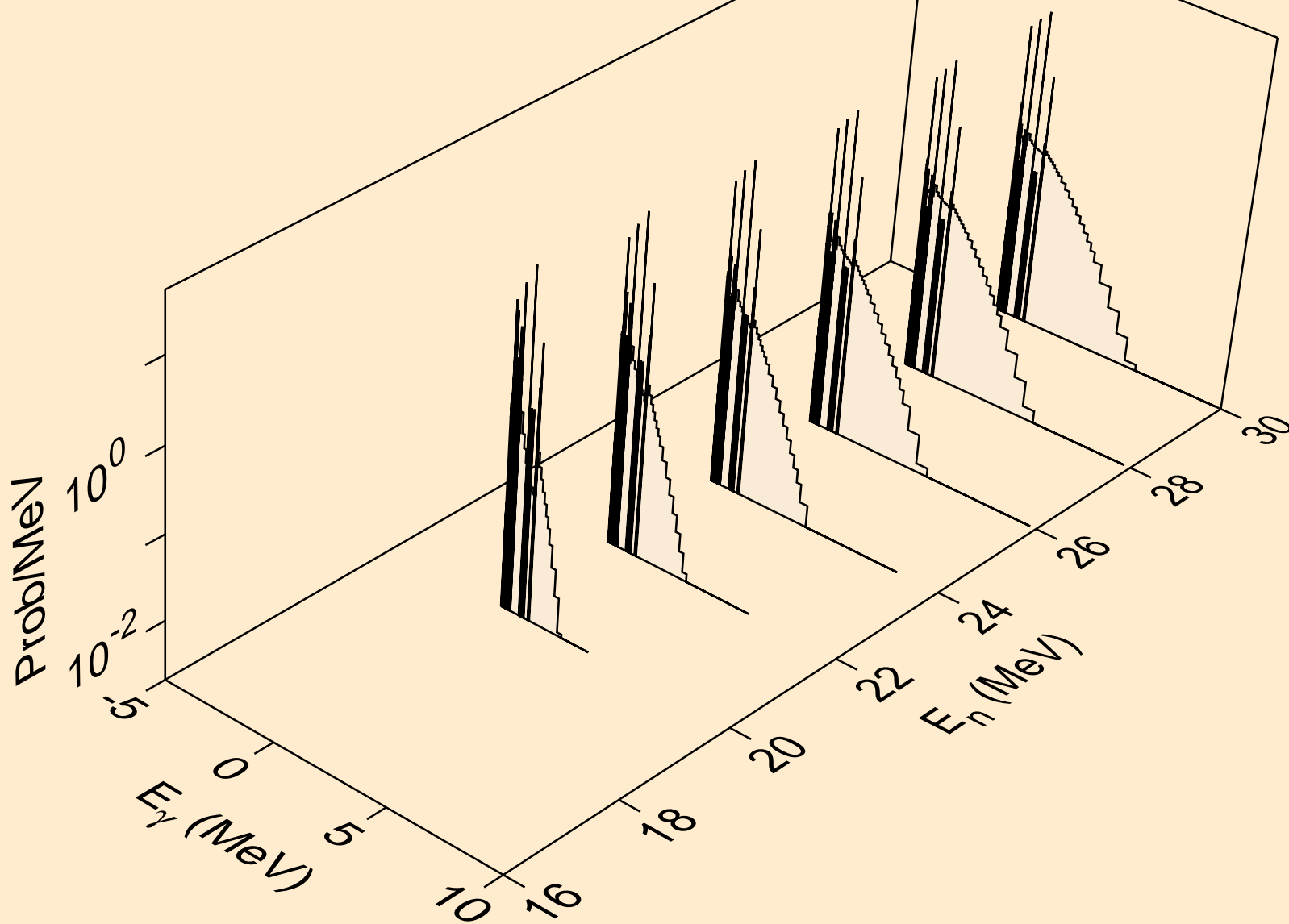

RA213 NEUTRON ACER TENDL-2019 LIBRARY; T=293.16K
Photon emission for (n,n*)a

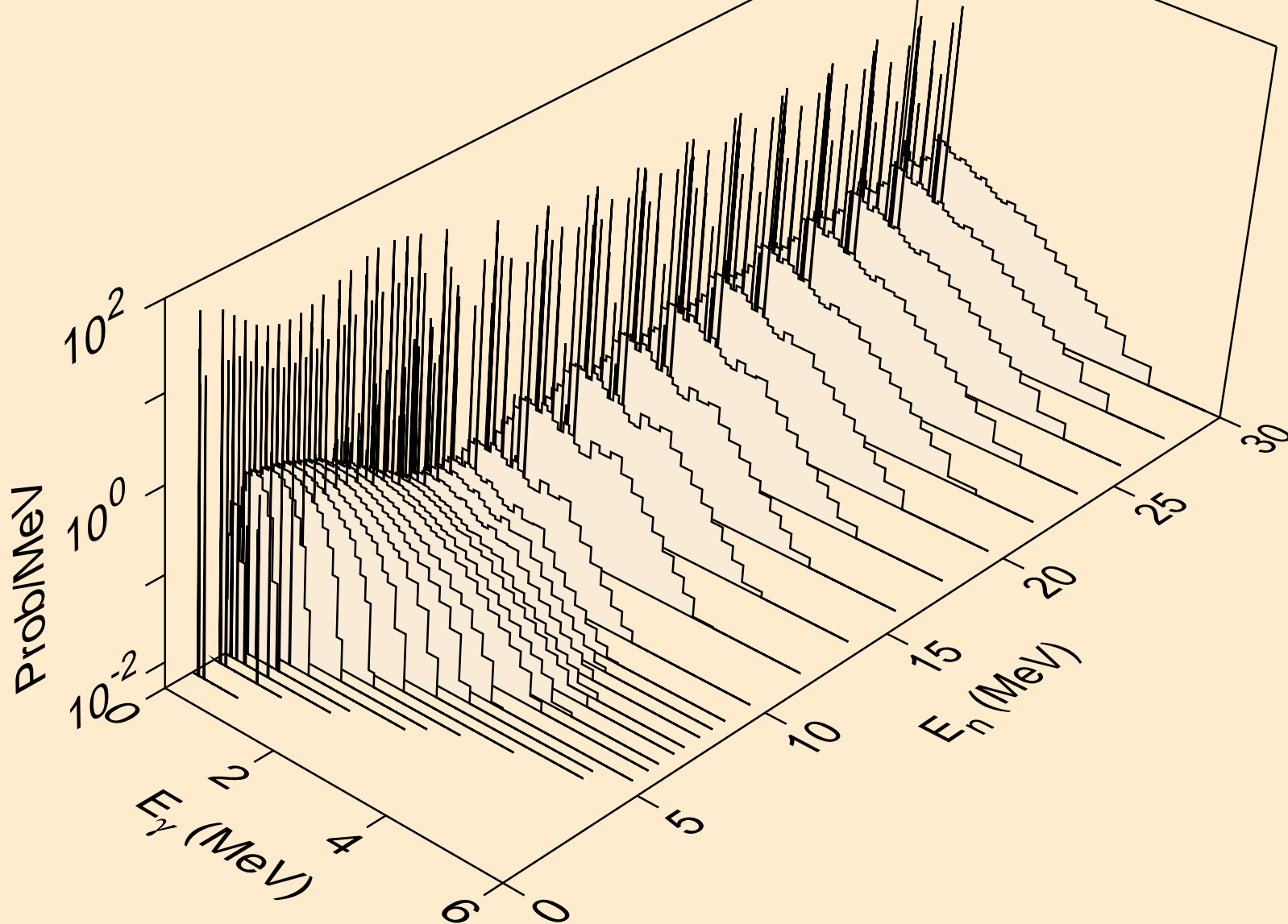

RA213 NEUTRON ACER TENDL-2019 LIBRARY; T=293.16K
Photon emission for (n,2n)a

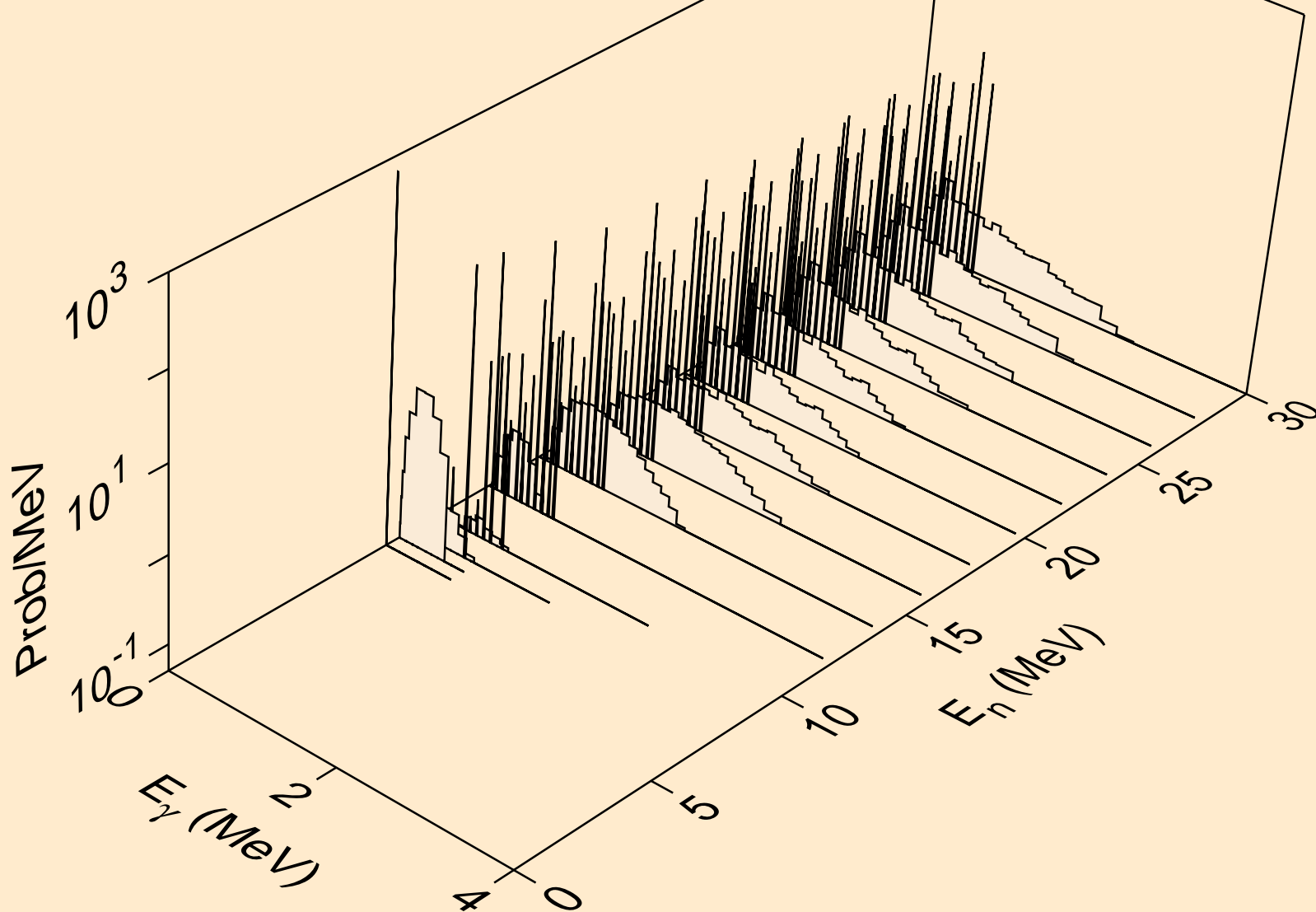

RA213 NEUTRON ACER TENDL-2019 LIBRARY; T=293.16K
Photon emission for (n,3n)a

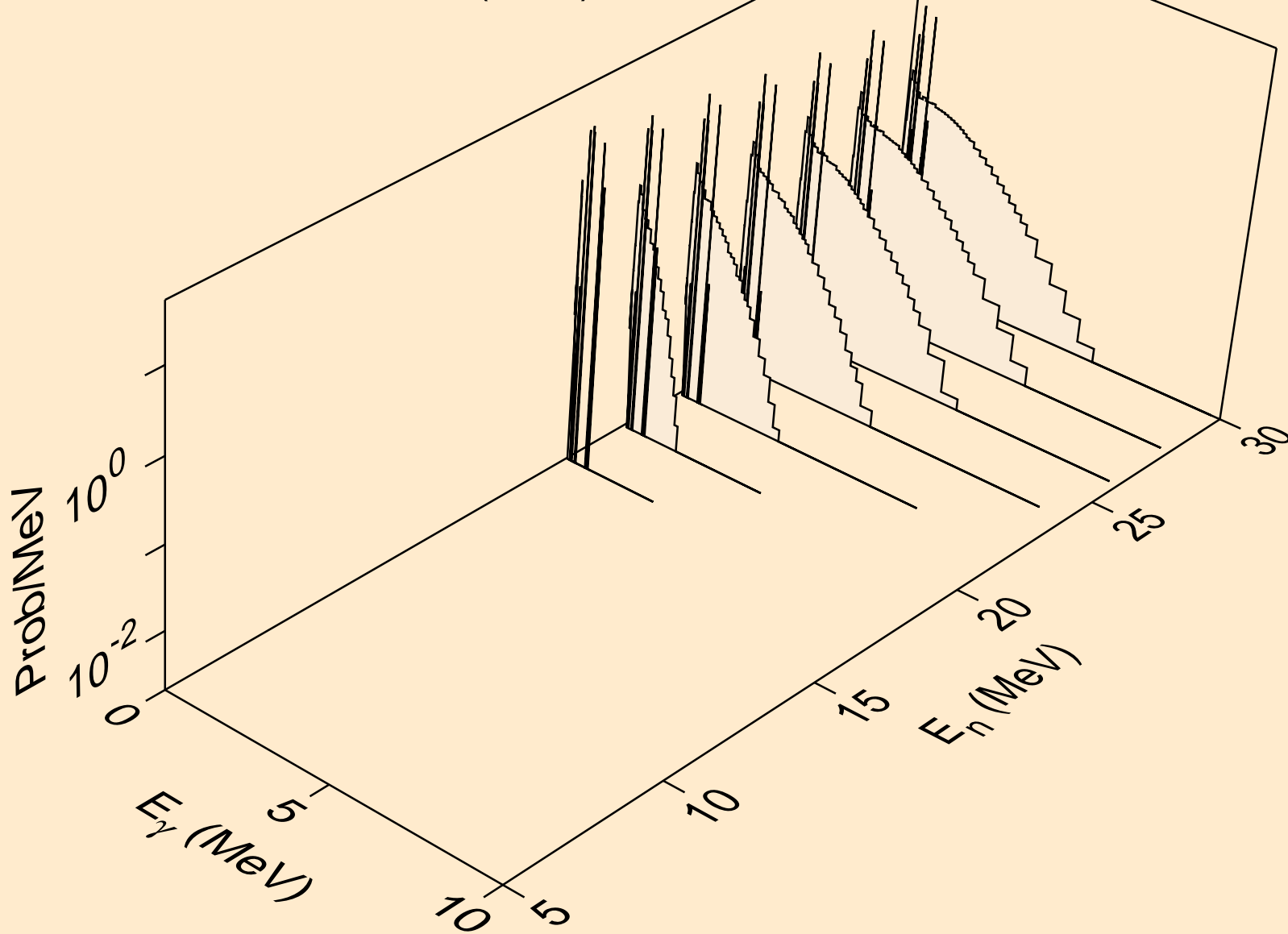

RA213 NEUTRON ACER TENDL-2019 LIBRARY; T=293.16K
Photon emission for (n,n*)p

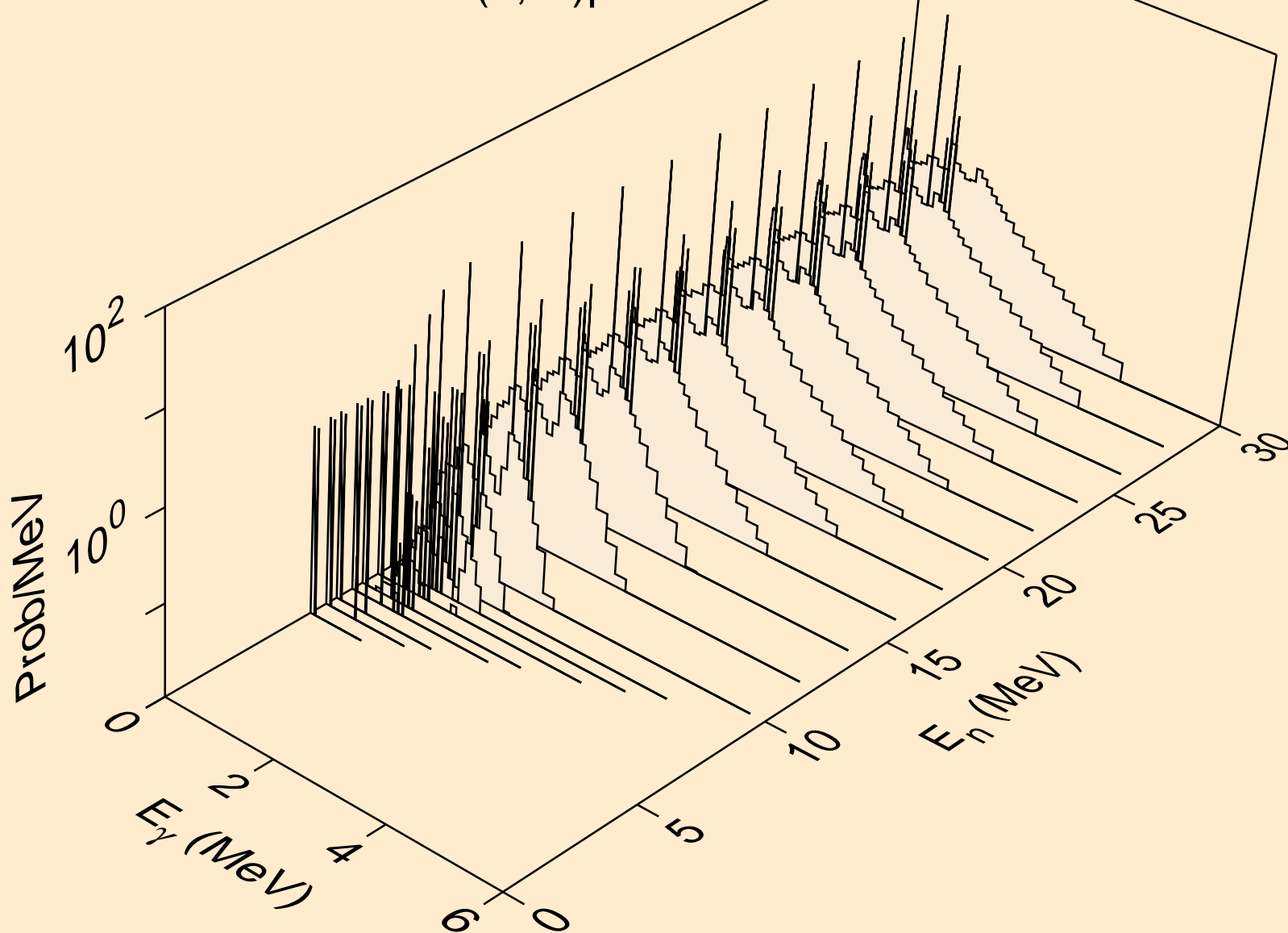

RA213 NEUTRON ACER TENDL-2019 LIBRARY; T=293.16K
Photon emission for (n,n*)2a

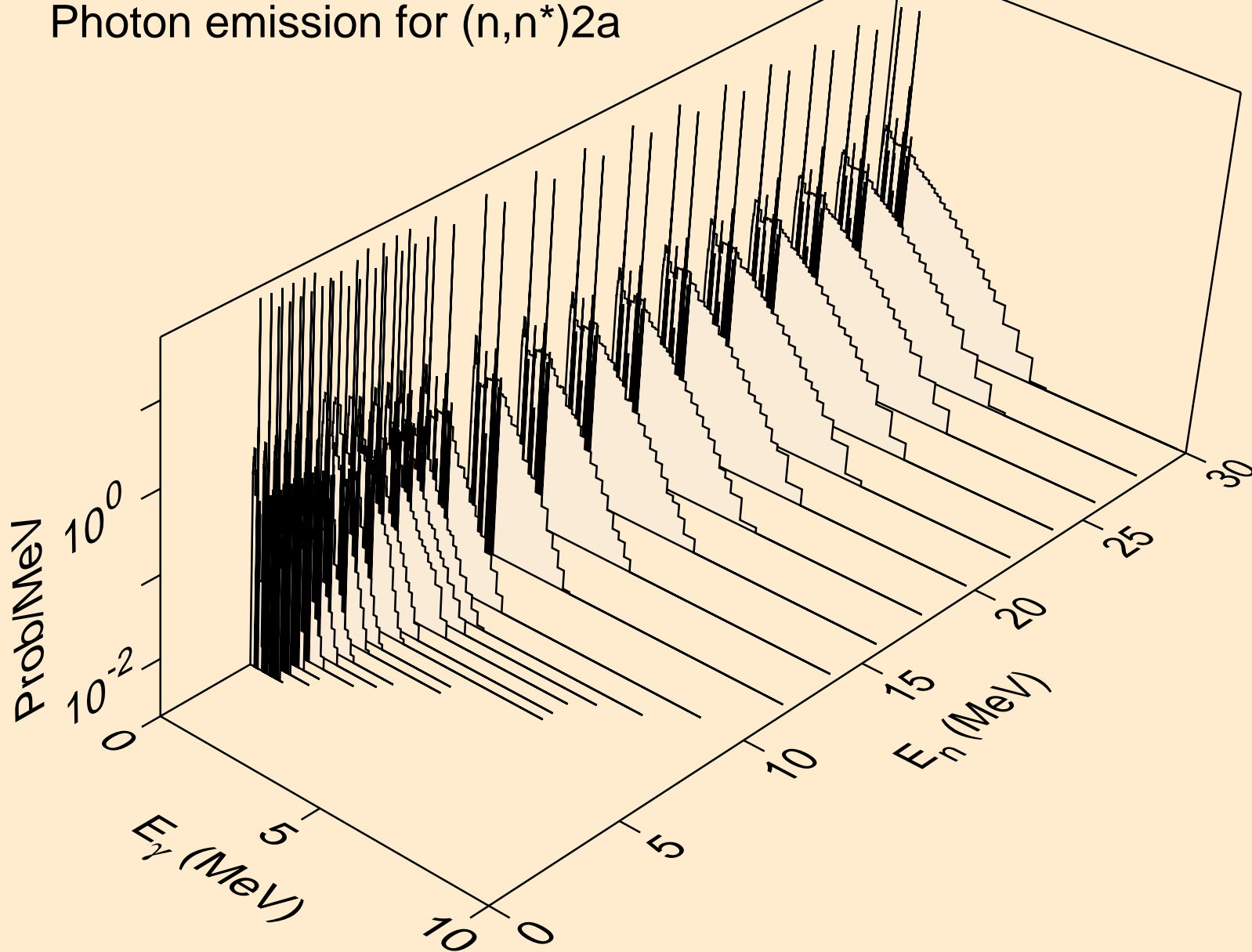

RA213 NEUTRON ACER TENDL-2019 LIBRARY; T=293.16K
Photon emission for (n,2n)2a

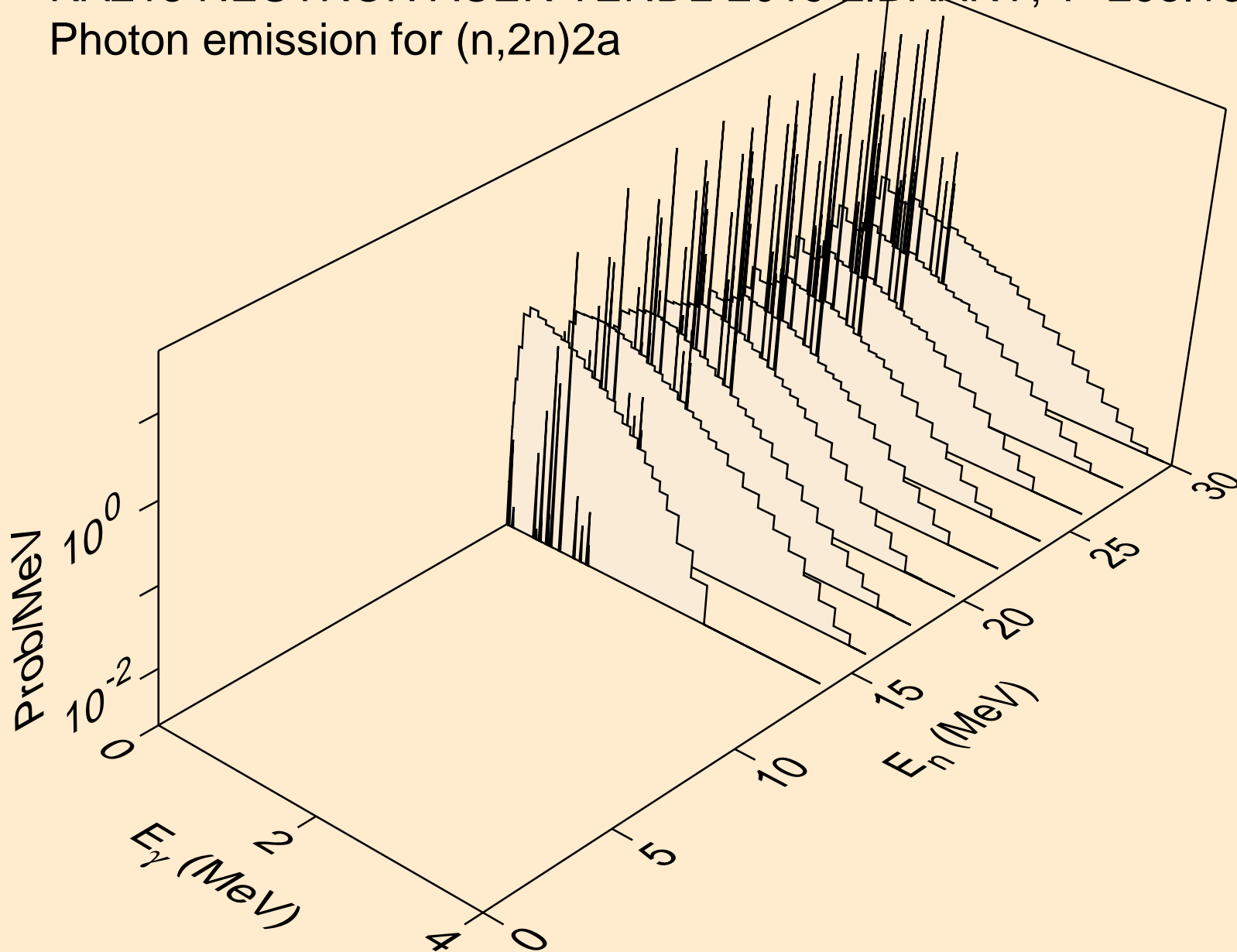

RA213 NEUTRON ACER TENDL-2019 LIBRARY; T=293.16K
Photon emission for (n,n*)d

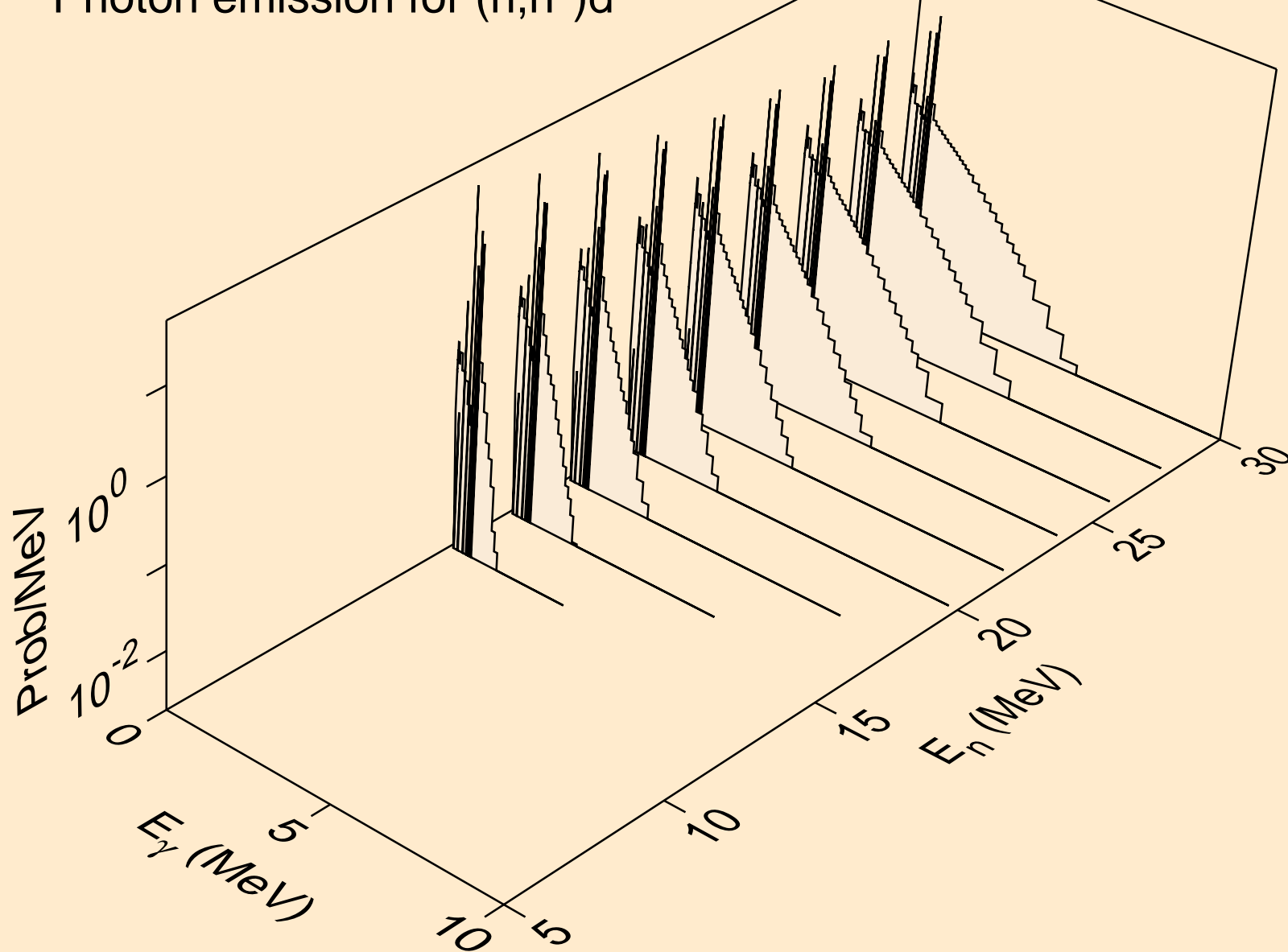

RA213 NEUTRON ACER TENDL-2019 LIBRARY; T=293.16K
Photon emission for (n,n*)t

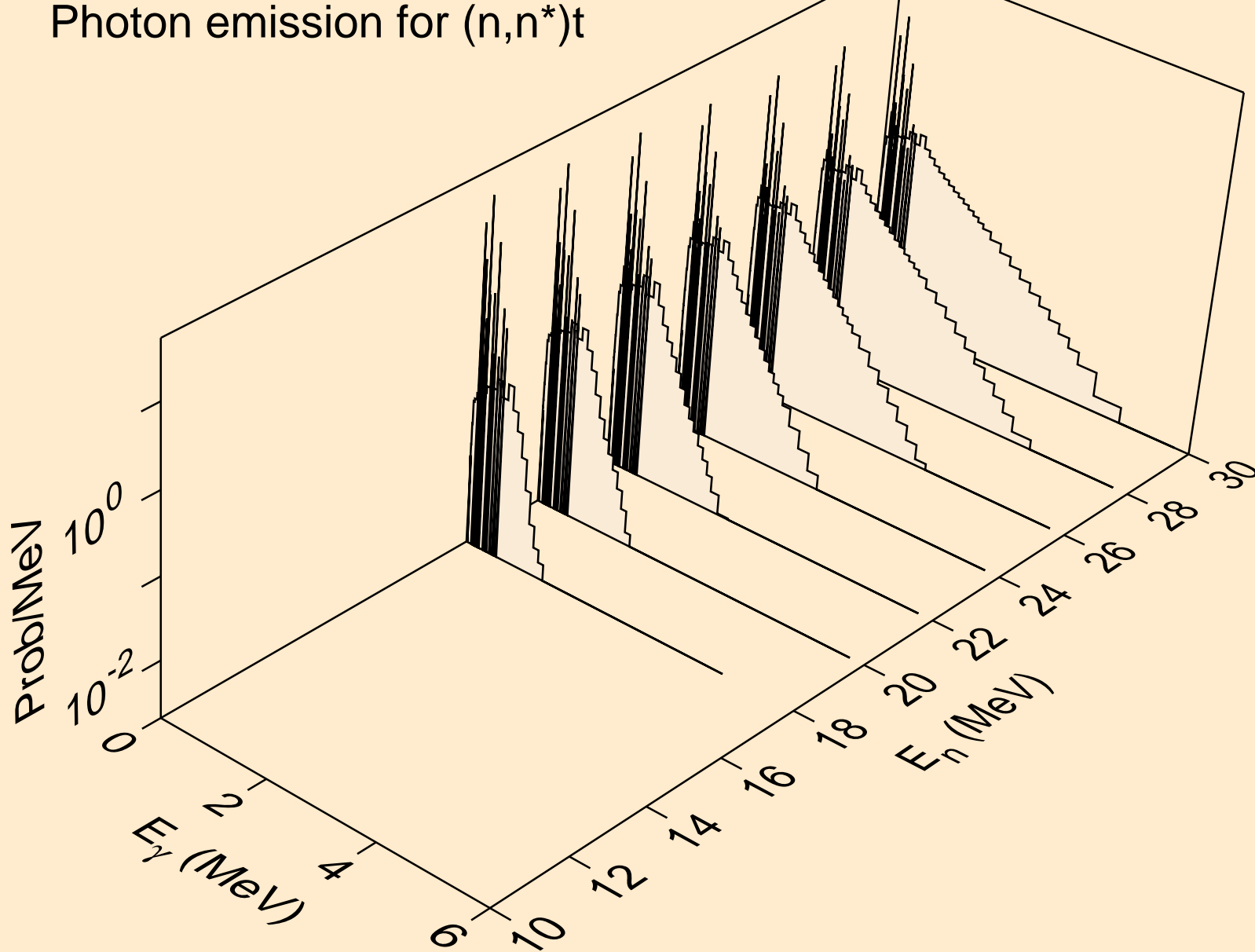

RA213 NEUTRON ACER TENDL-2019 LIBRARY; T=293.16K
Photon emission for (n,n*)he3

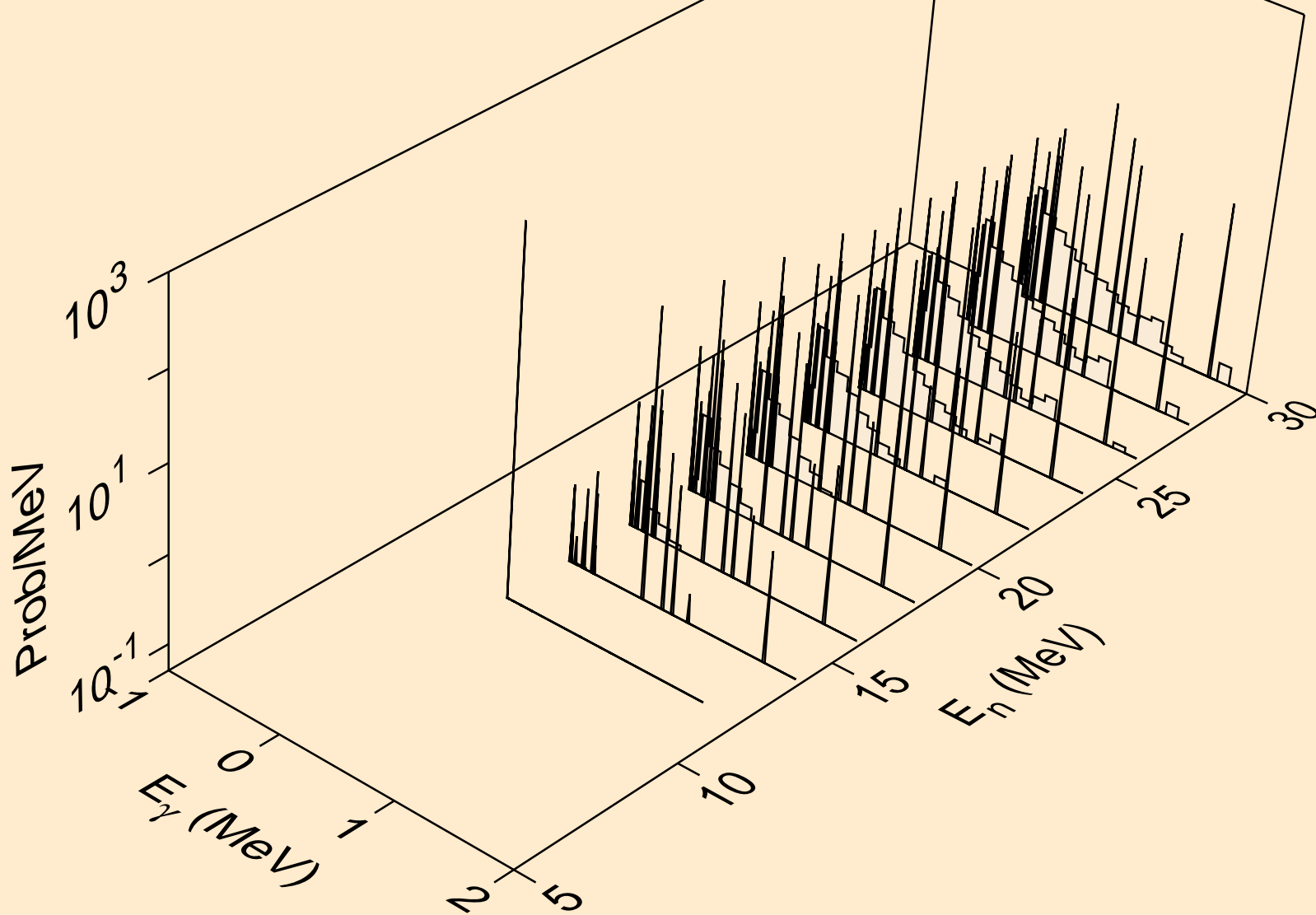

RA213 NEUTRON ACER TENDL-2019 LIBRARY; T=293.16K
Photon emission for (n,4n)

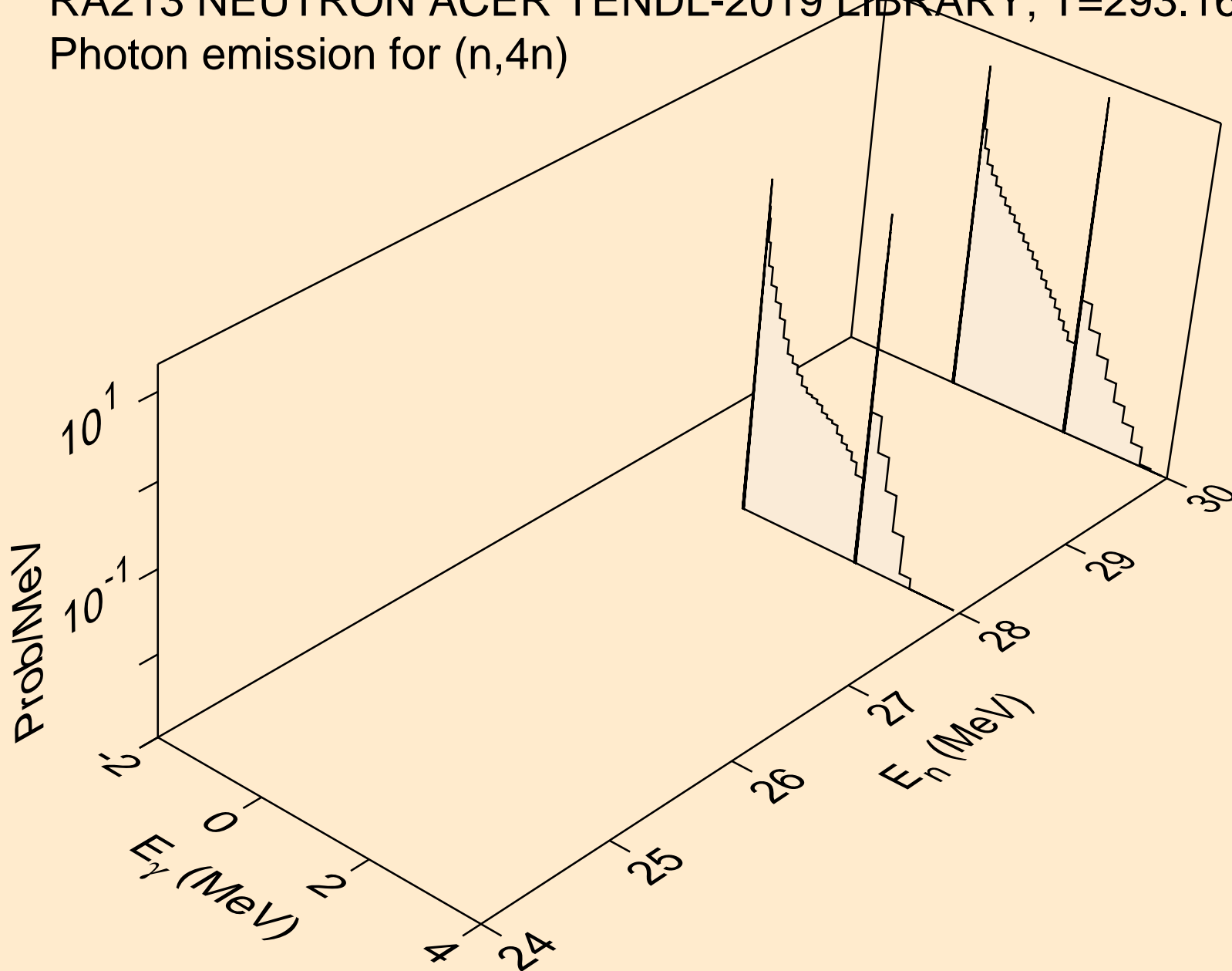

RA213 NEUTRON ACER TENDL-2019 LIBRARY; T=293.16K
Photon emission for (n,2np)

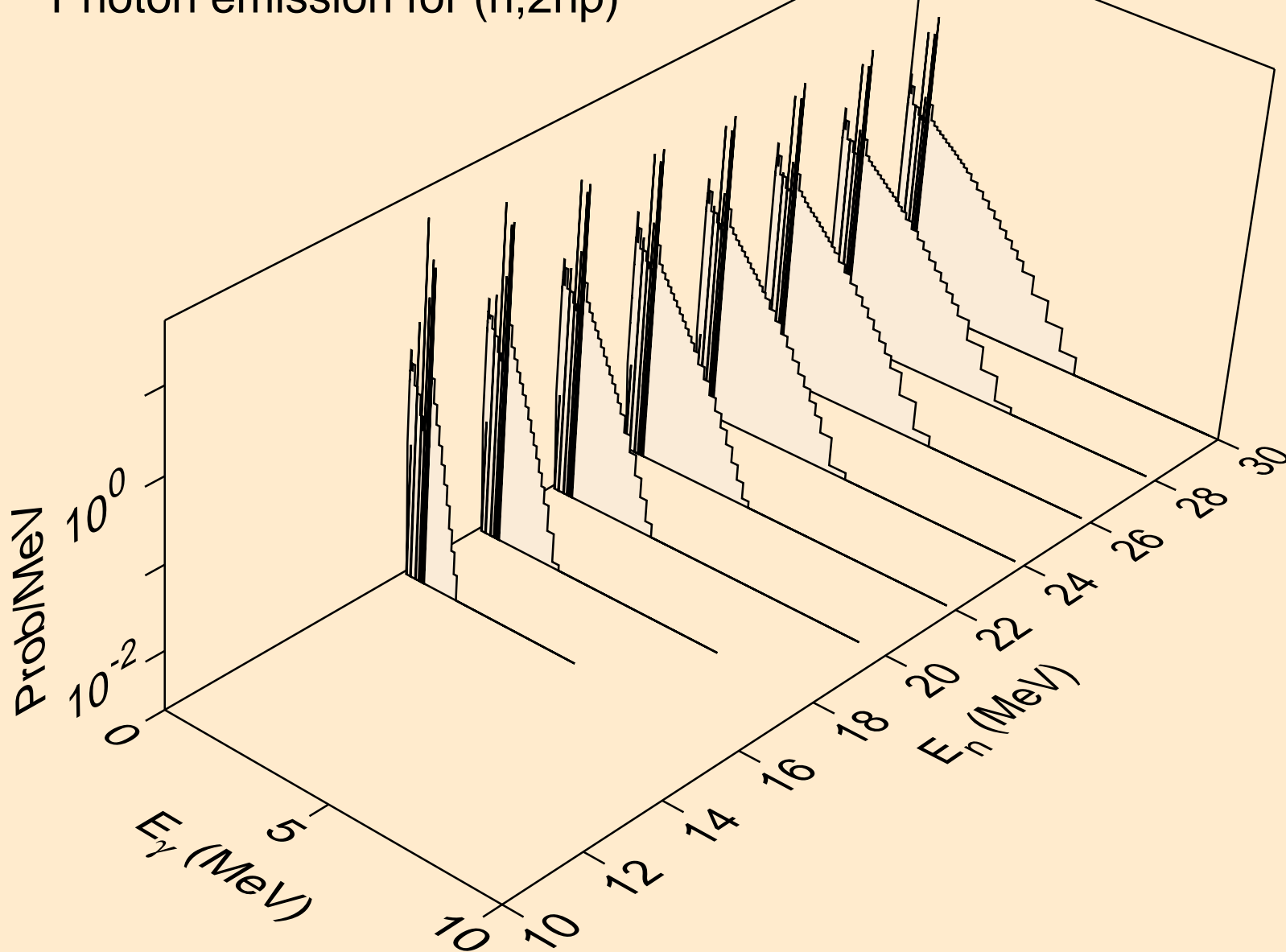

RA213 NEUTRON ACER TENDL-2019 LIBRARY; T=293.16K
Photon emission for (n,3np)

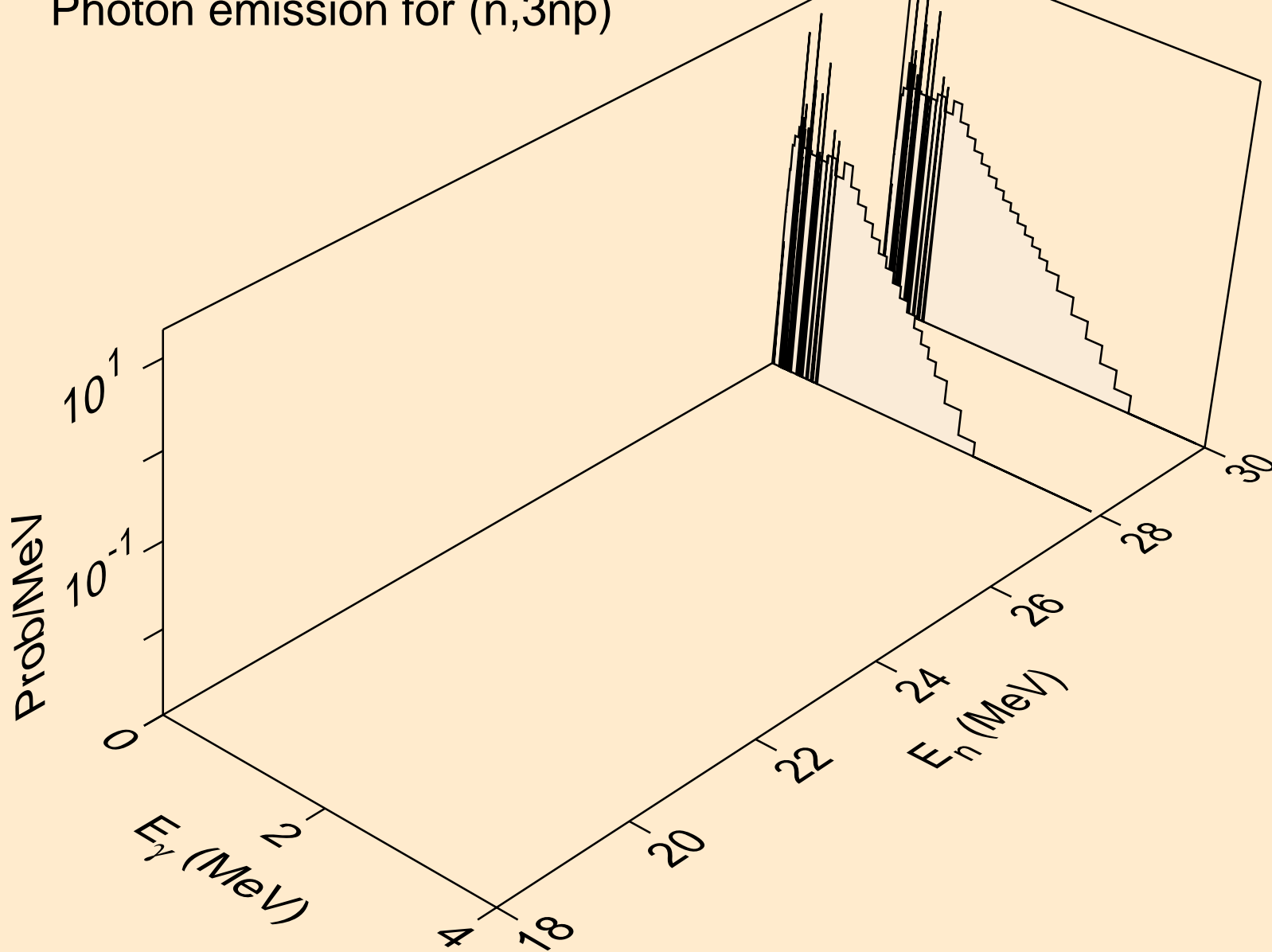

RA213 NEUTRON ACER TENDL-2019 LIBRARY; T=293.16K
Photon emission for (n,2np)

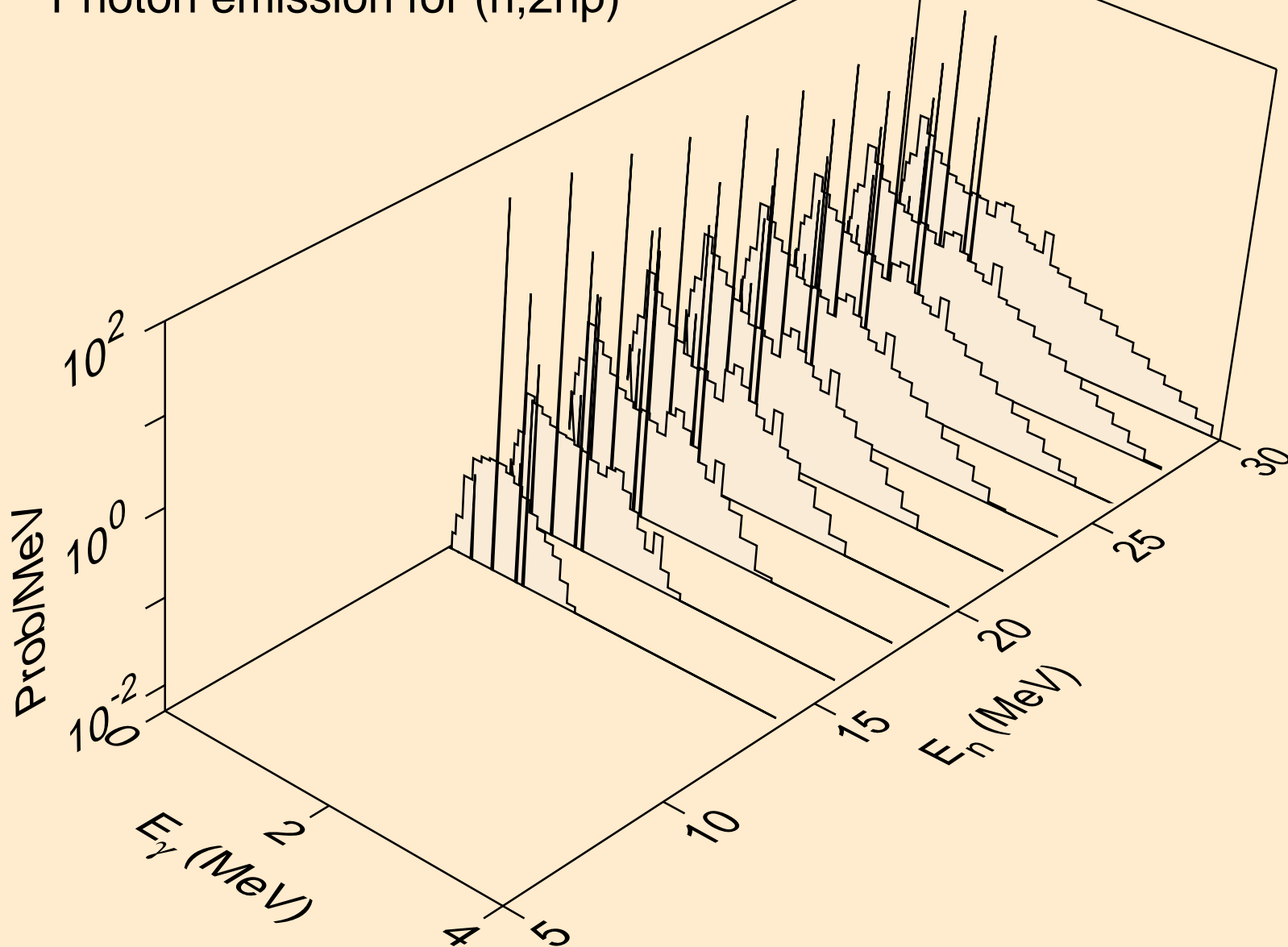

RA213 NEUTRON ACER TENDL-2019 LIBRARY; T=293.16K
Photon emission for (n,npa)

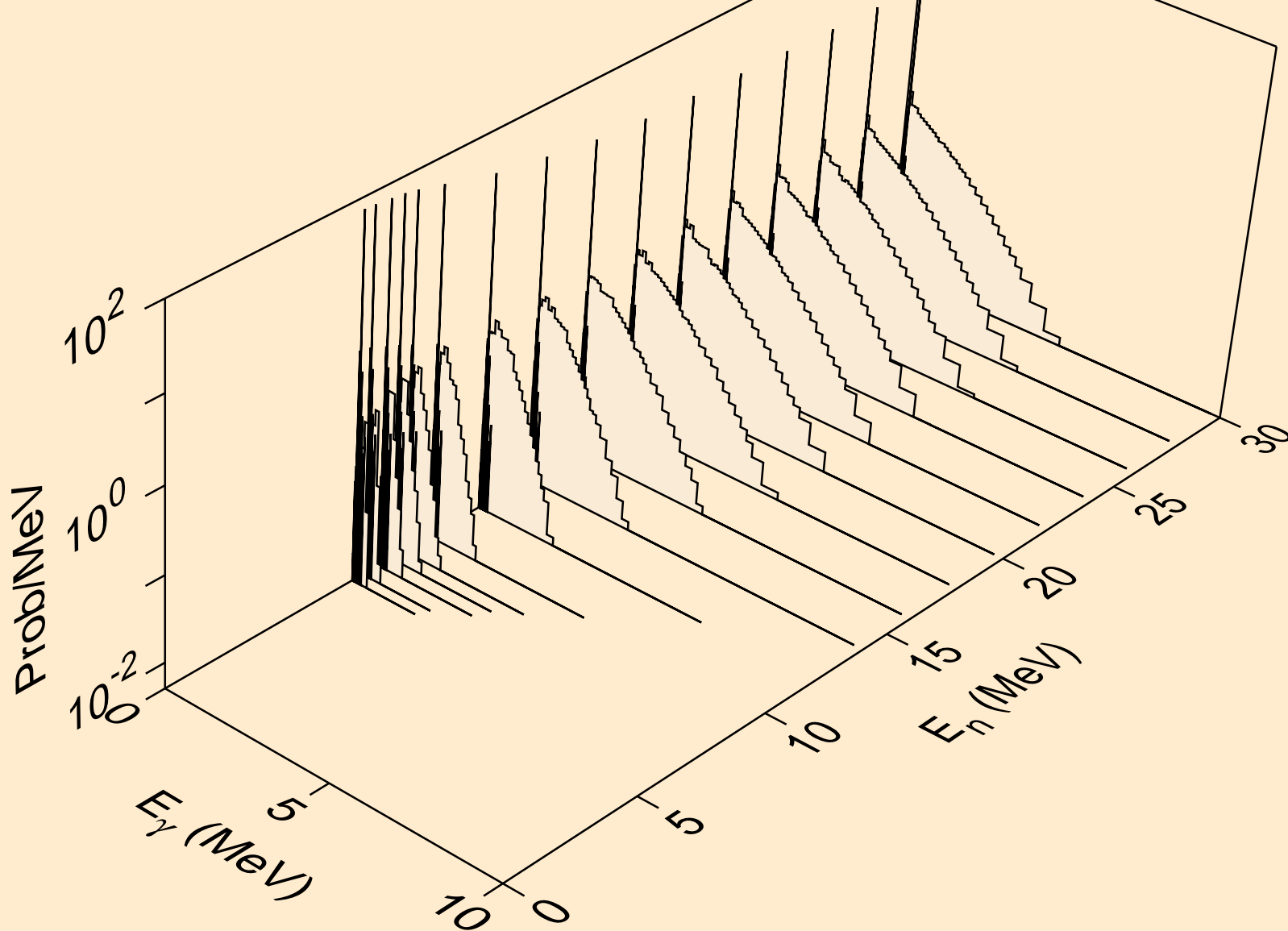

RA213 NEUTRON ACER TENDL-2019 LIBRARY; T=293.16K
Photon emission for (n,n*c)

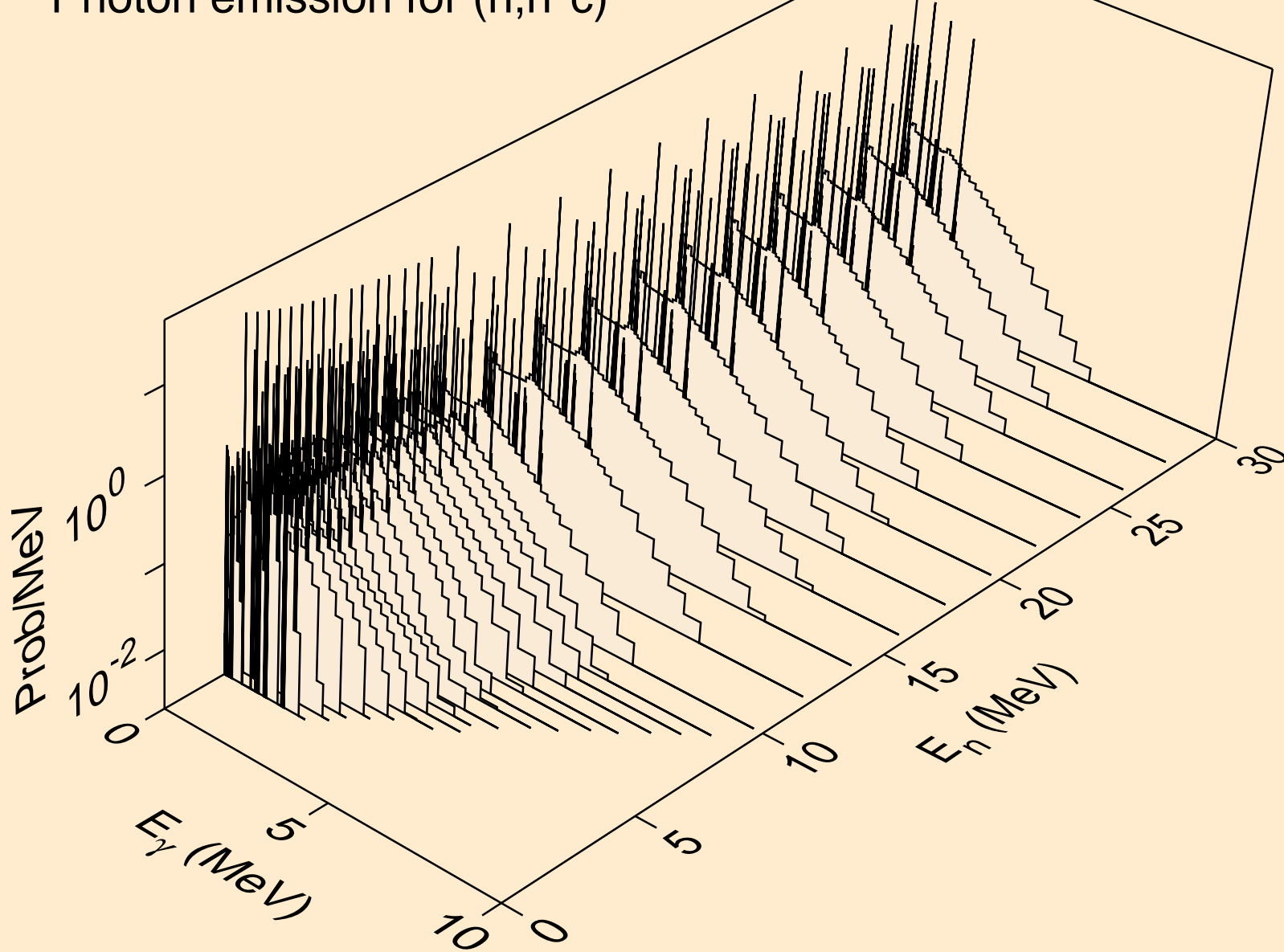

RA213 NEUTRON ACER TENDL-2019 LIBRARY; T=293.16K
Photon emission for (n,gma)

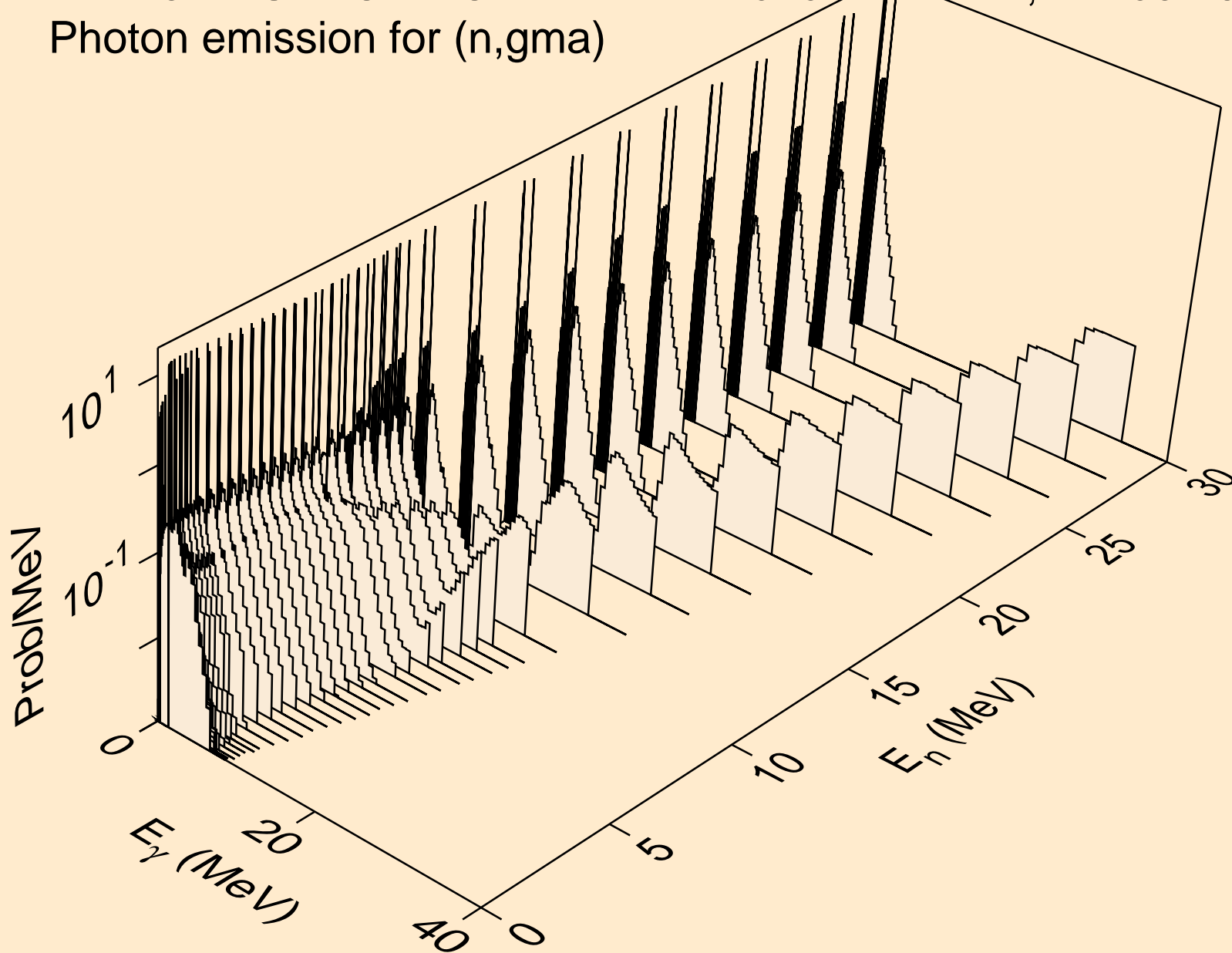

RA213 NEUTRON ACER TENDL-2019 LIBRARY; T=293.16K
Photon emission for (n,p)

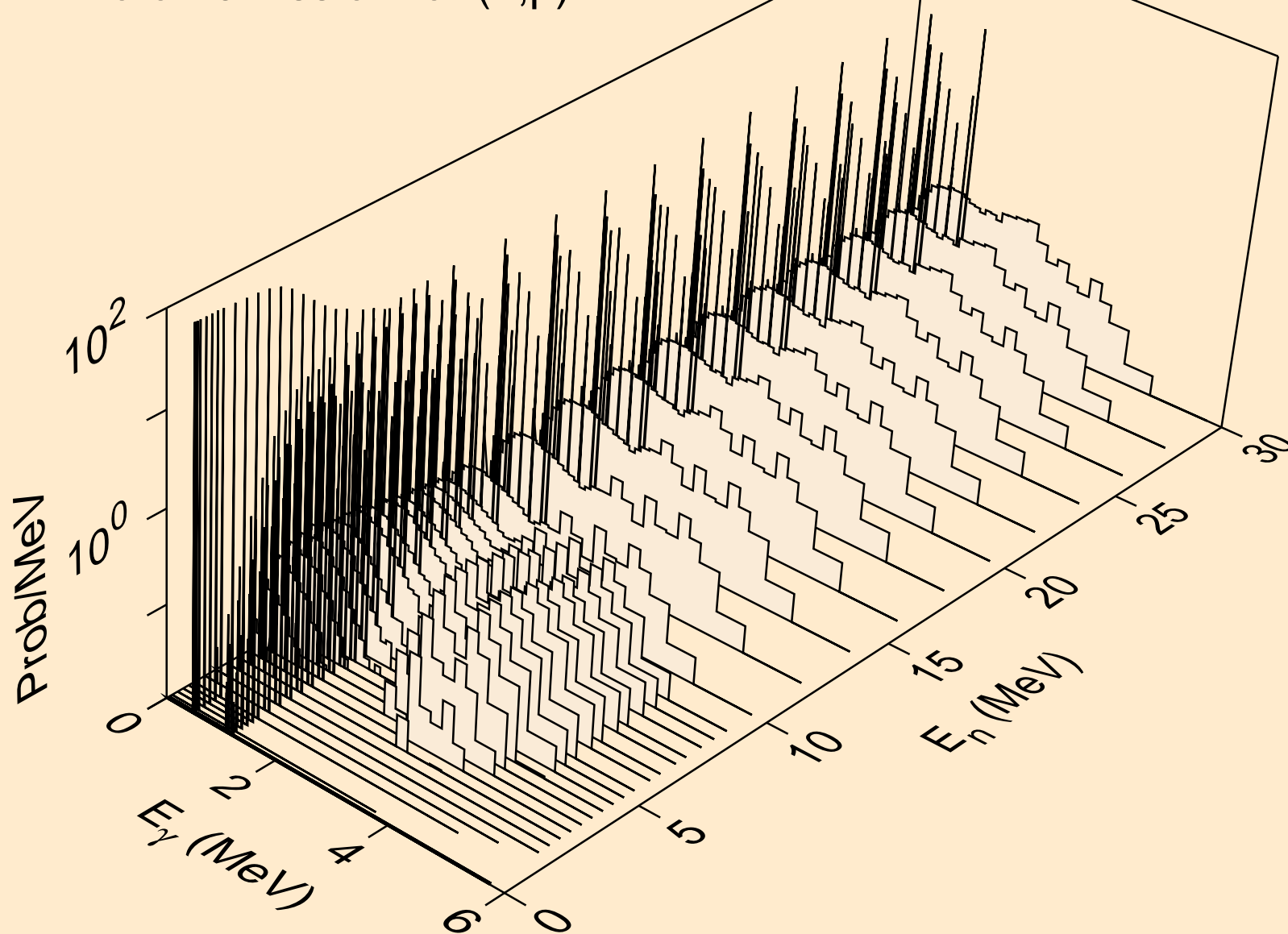

RA213 NEUTRON ACER TENDL-2019 LIBRARY; T=293.16K
Photon emission for (n,d)

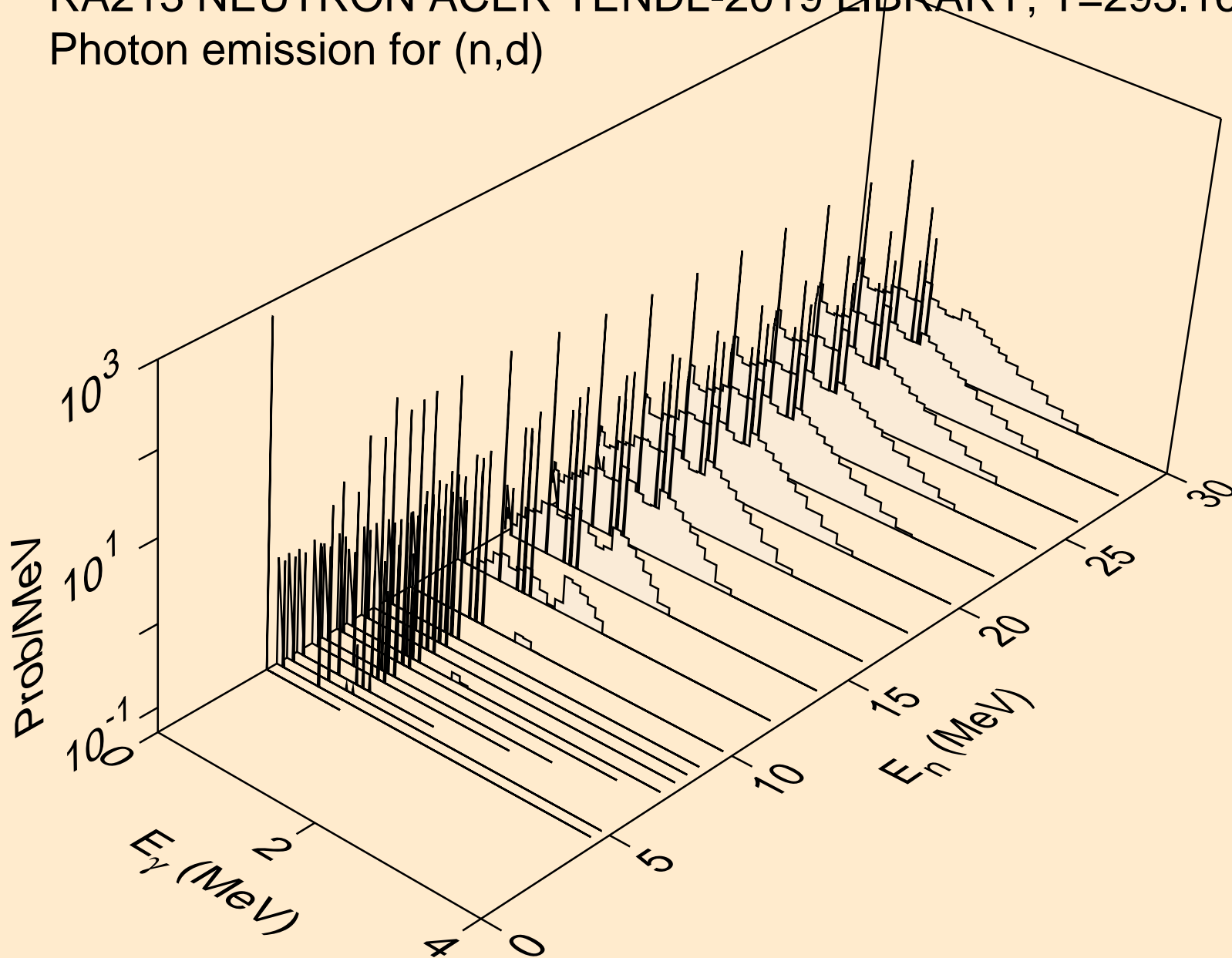

RA213 NEUTRON ACER TENDL-2019 LIBRARY; T=293.16K
Photon emission for (n,t)

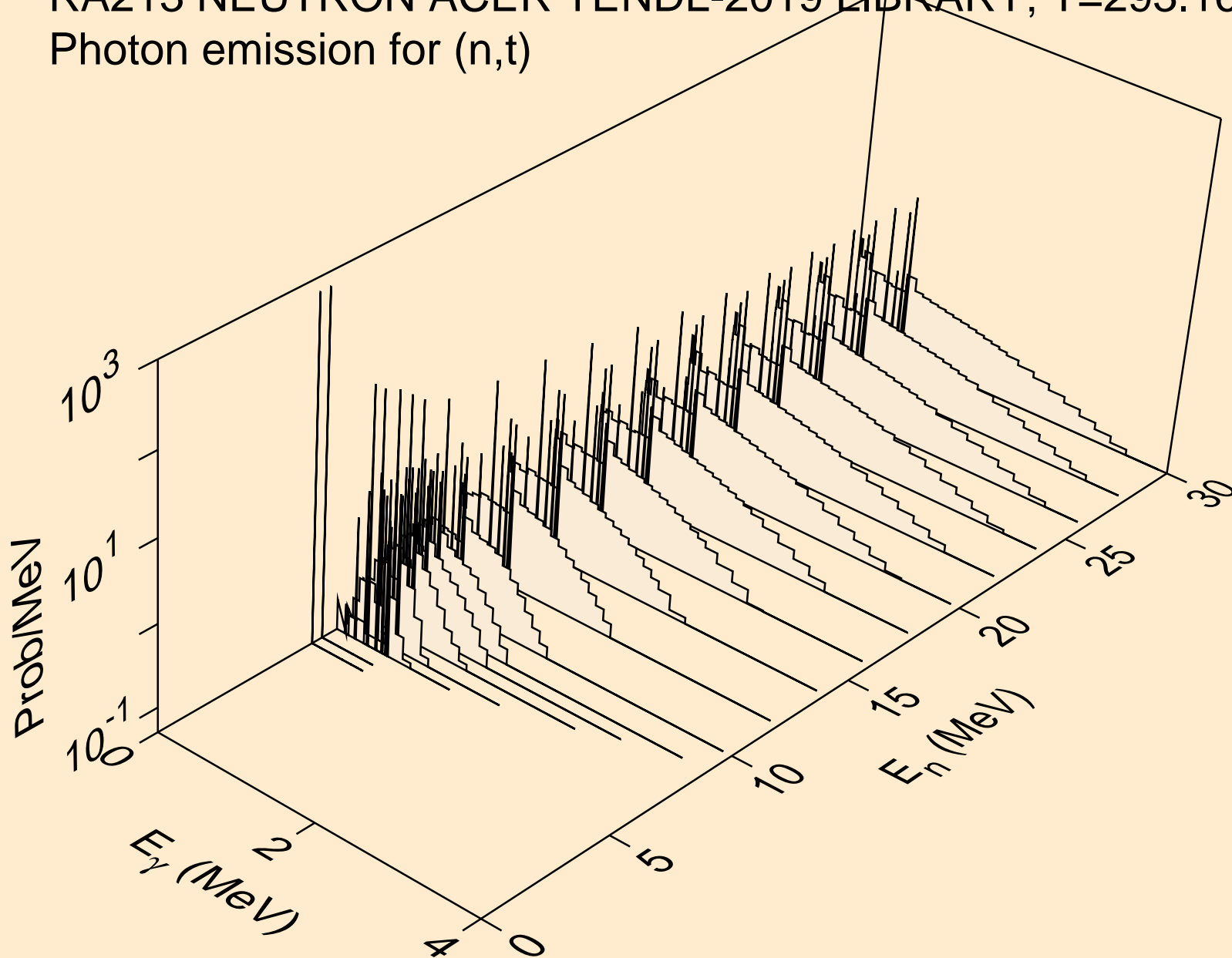

RA213 NEUTRON ACER TENDL-2019 LIBRARY; T=293.16K
Photon emission for (n,he3)

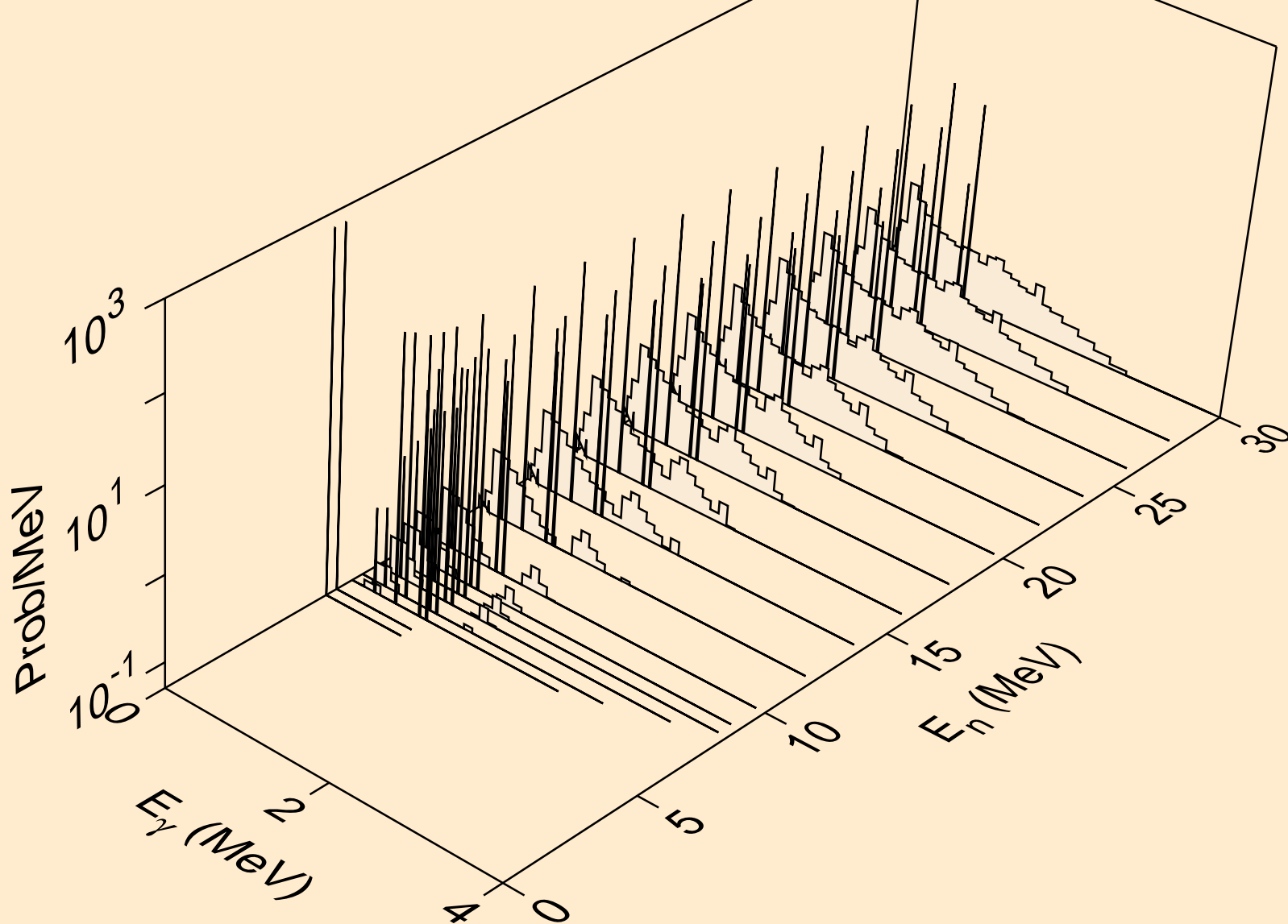

RA213 NEUTRON ACER TENDL-2019 LIBRARY; T=293.16K
Photon emission for (n,a)

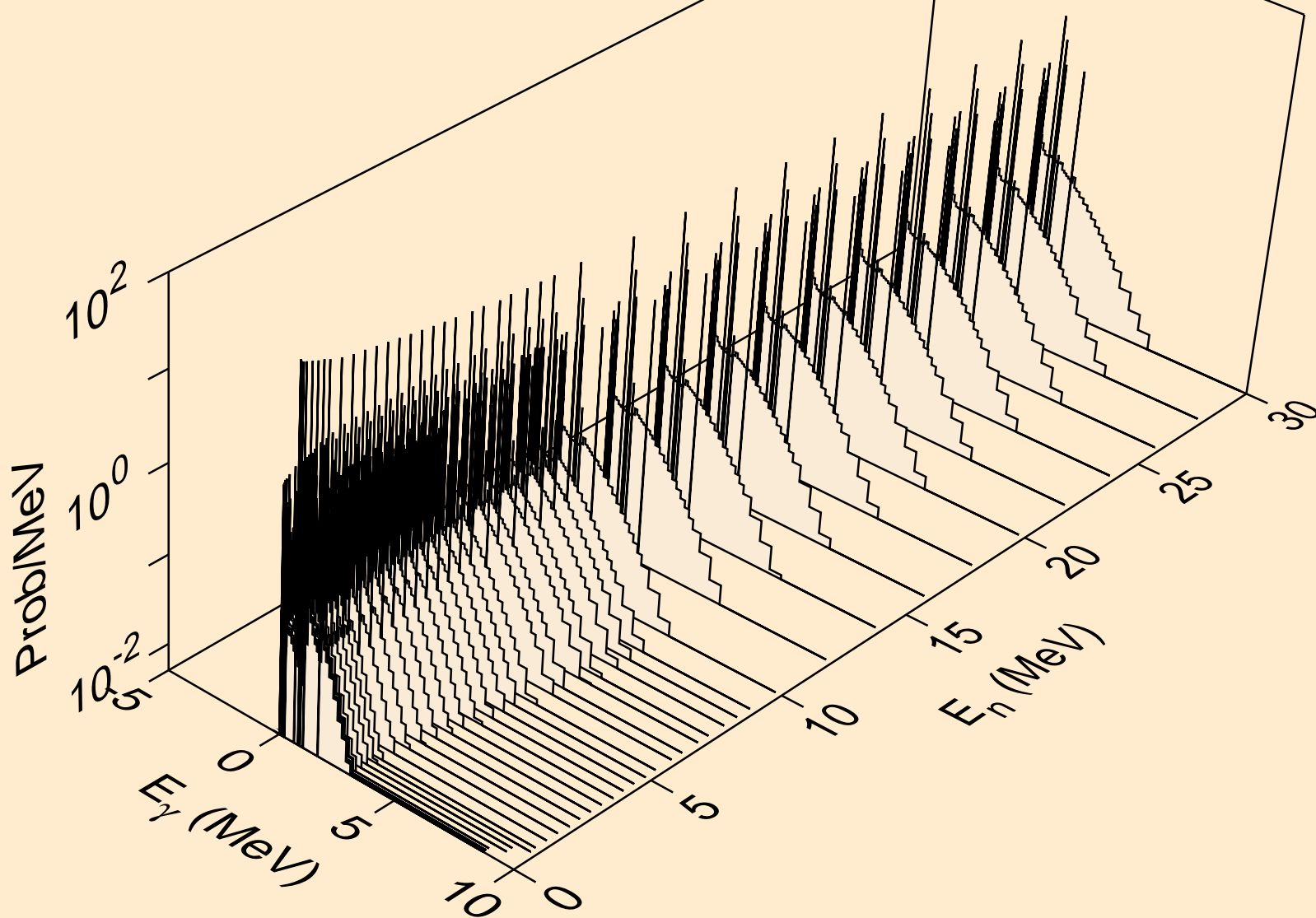

RA213 NEUTRON ACER TENDL-2019 LIBRARY; T=293.16K
Photon emission for (n,2a)

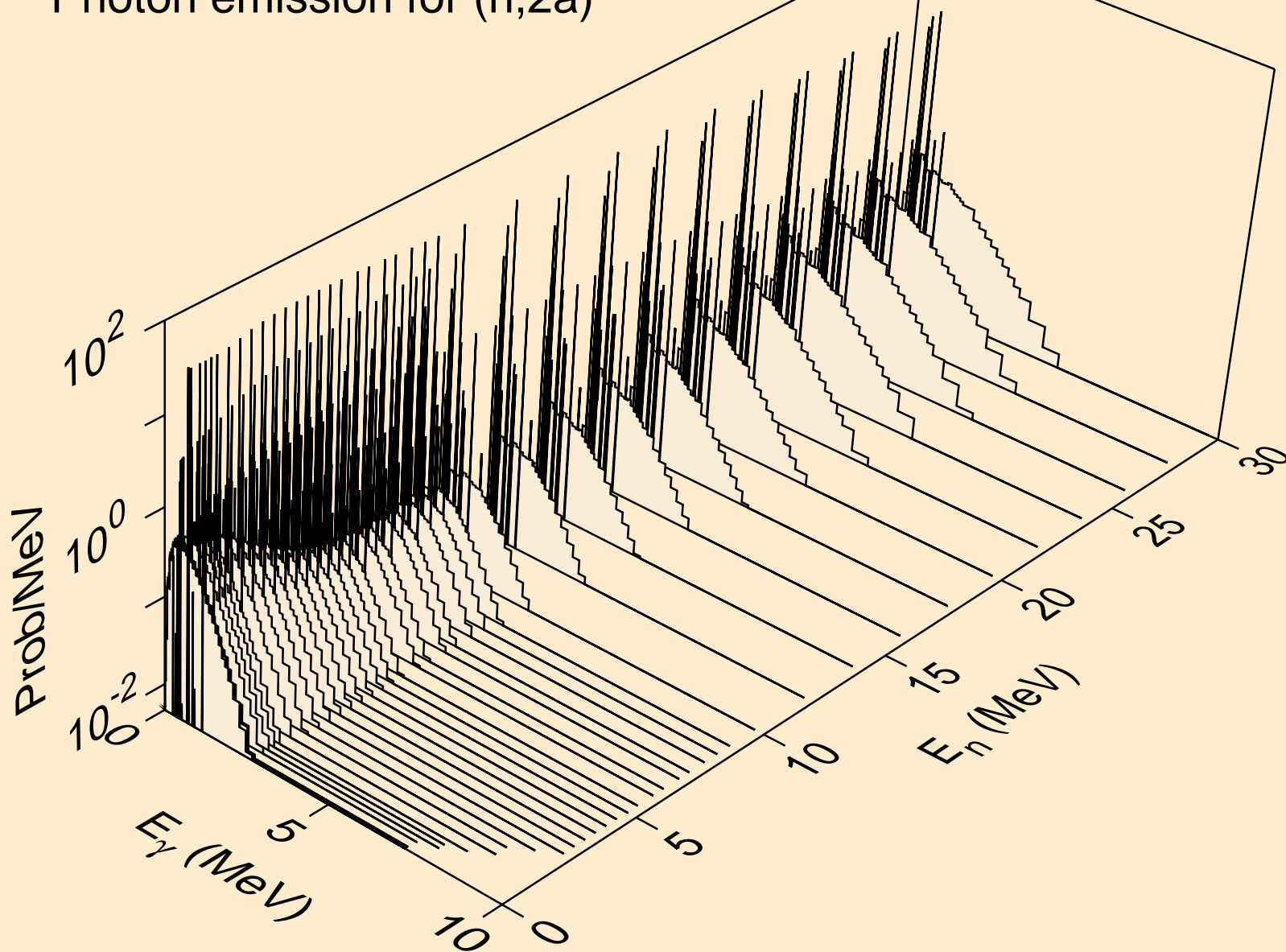

RA213 NEUTRON ACER TENDL-2019 LIBRARY; T=293.16K
Photon emission for (n,2p)

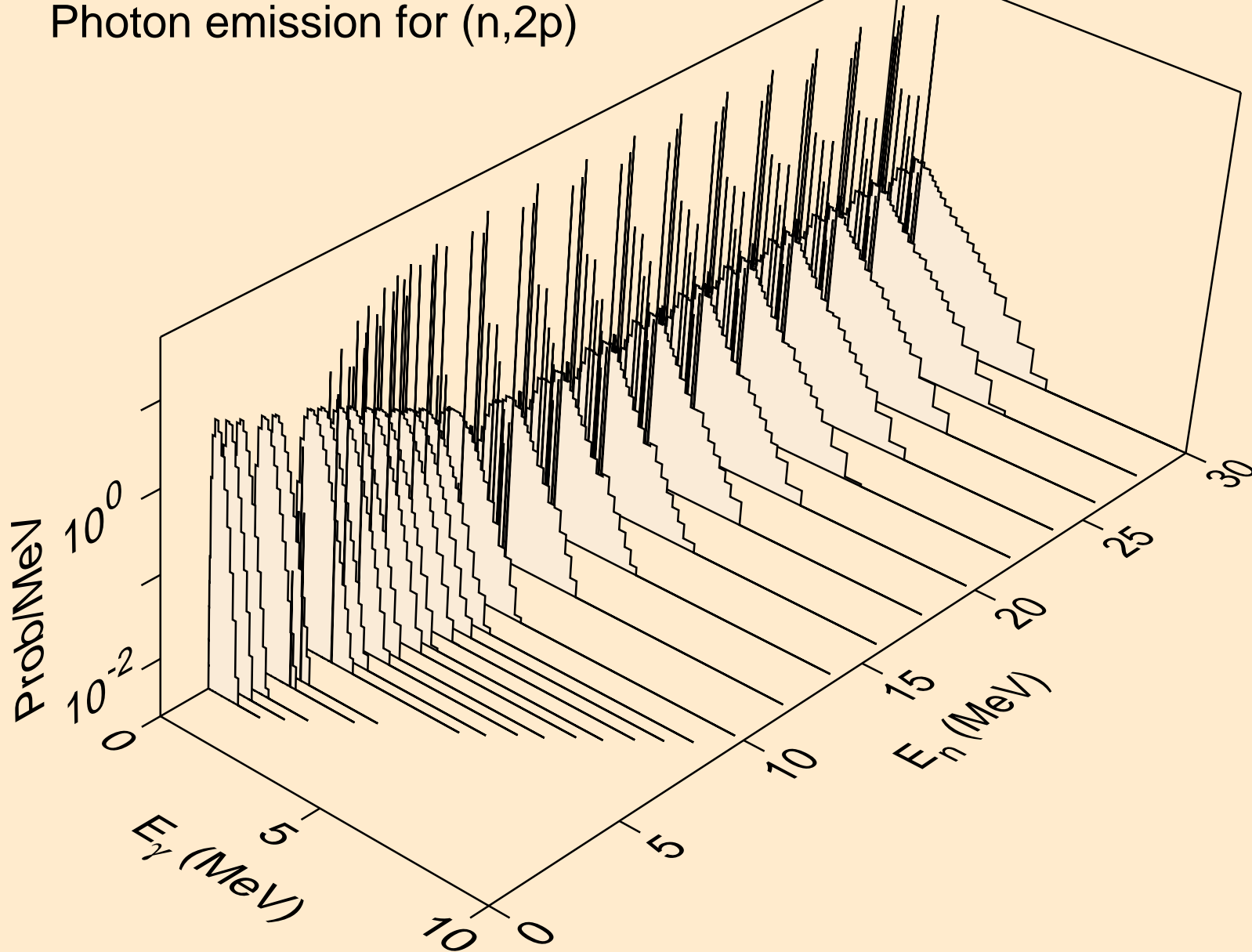

RA213 NEUTRON ACER TENDL-2019 LIBRARY; T=293.16K
Photon emission for (n,p α)

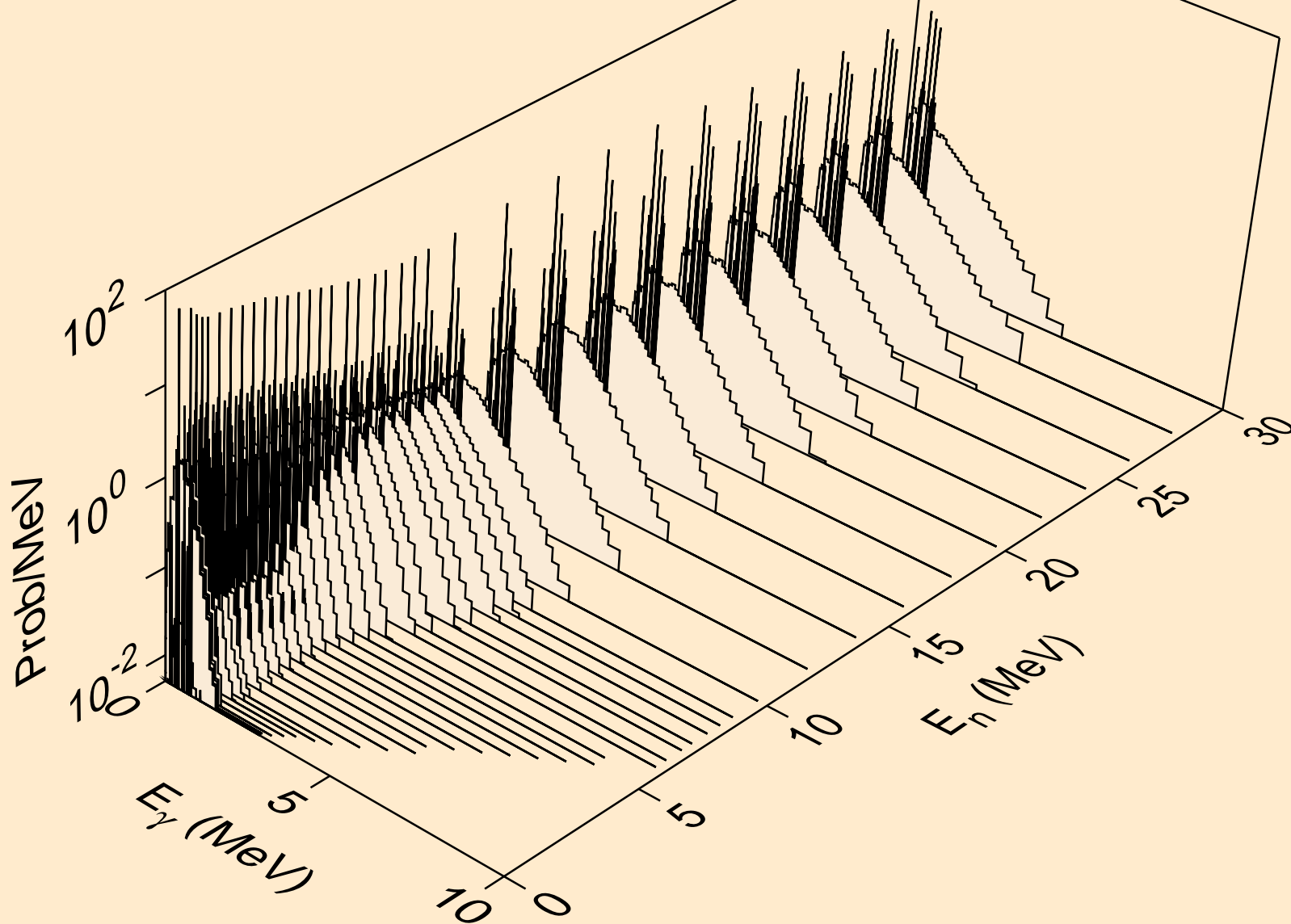

RA213 NEUTRON ACER TENDL-2019 LIBRARY; T=293.16K
Photon emission for (n,t2a)

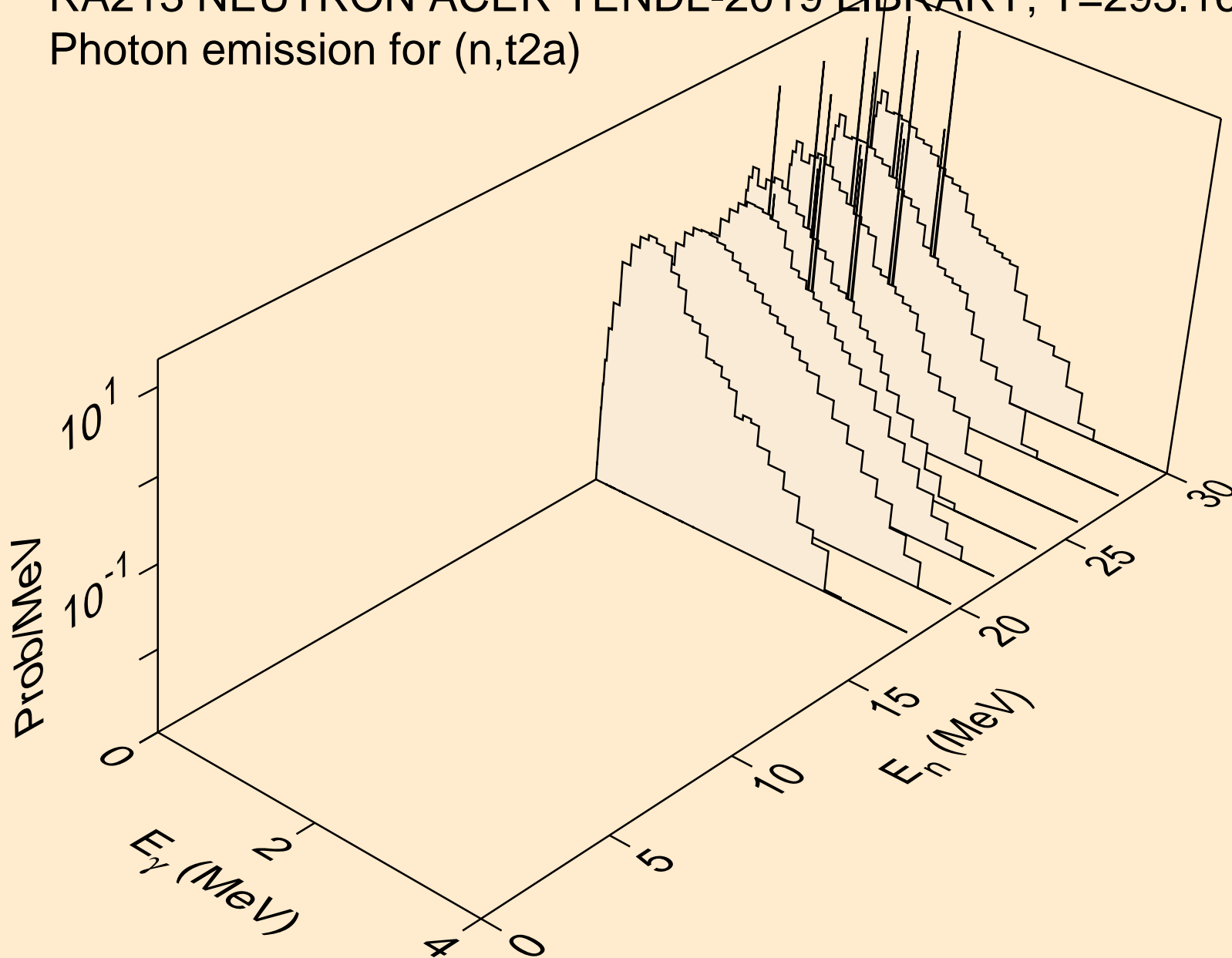

RA213 NEUTRON ACER TENDL-2019 LIBRARY; T=293.16K
Photon emission for (n,pd)

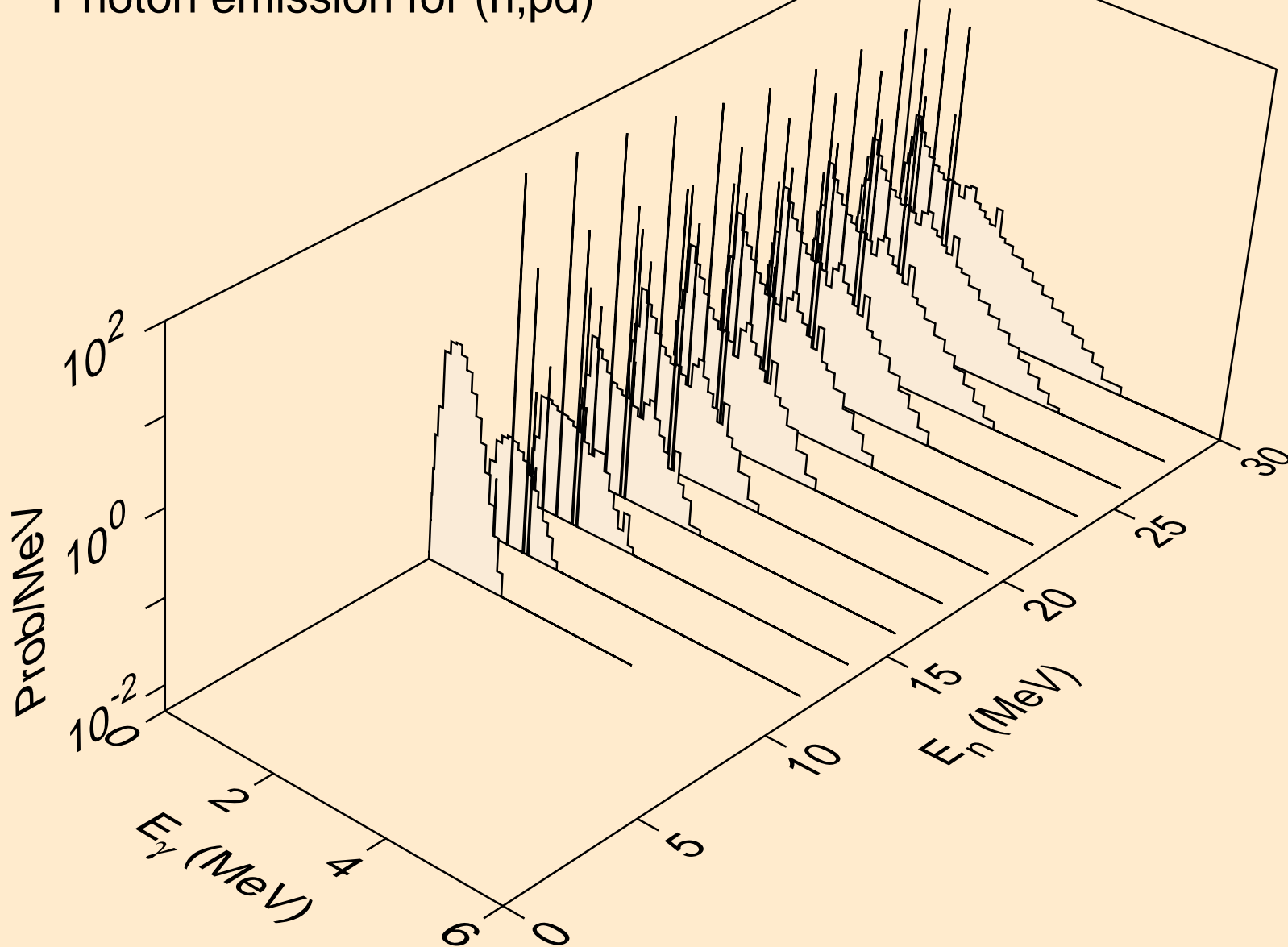

RA213 NEUTRON ACER TENDL-2019 LIBRARY; T=293.16K
Photon emission for (n,pt)

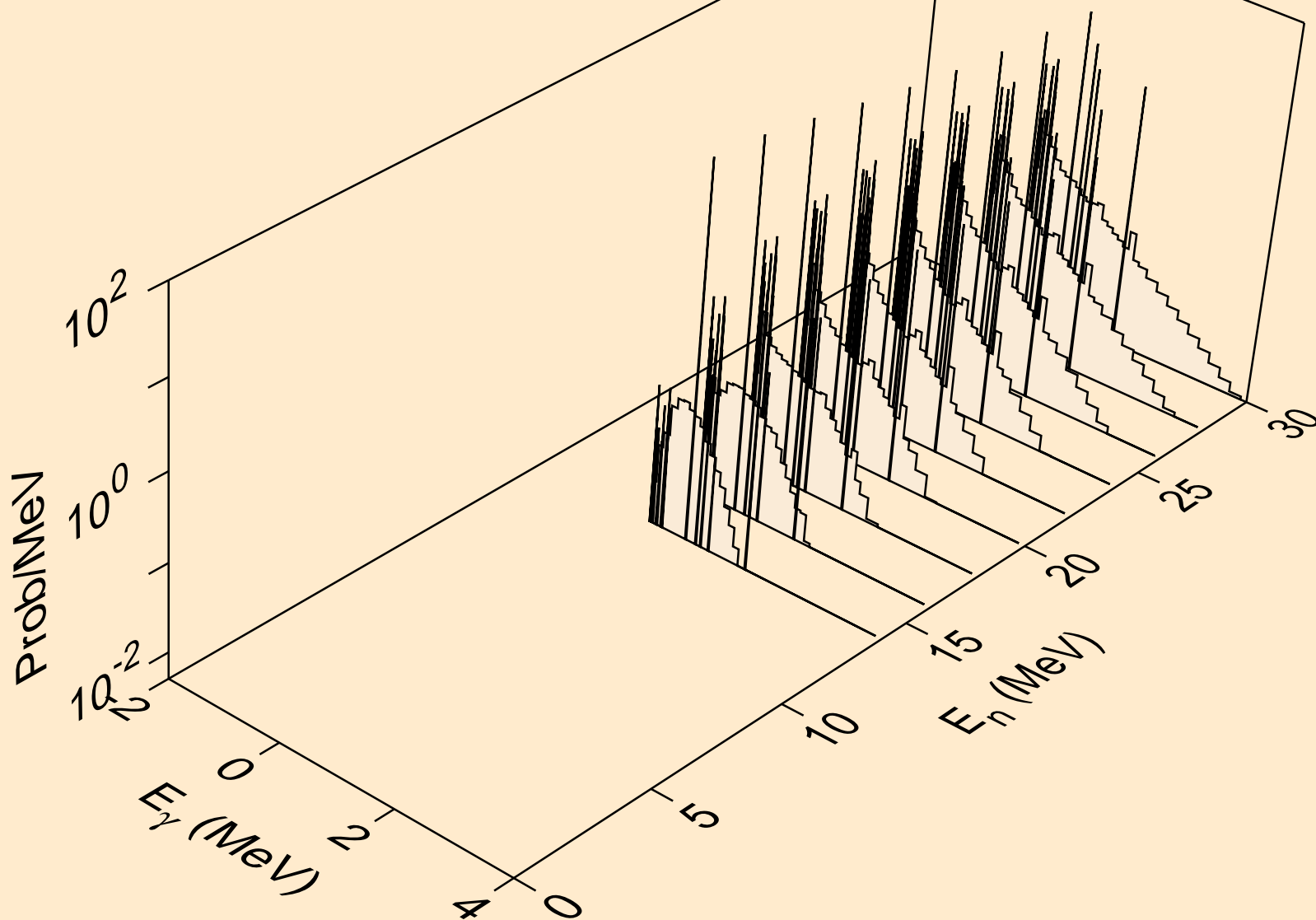

RA213 NEUTRON ACER TENDL-2019 LIBRARY; T=293.16K
Photon emission for (n,da)

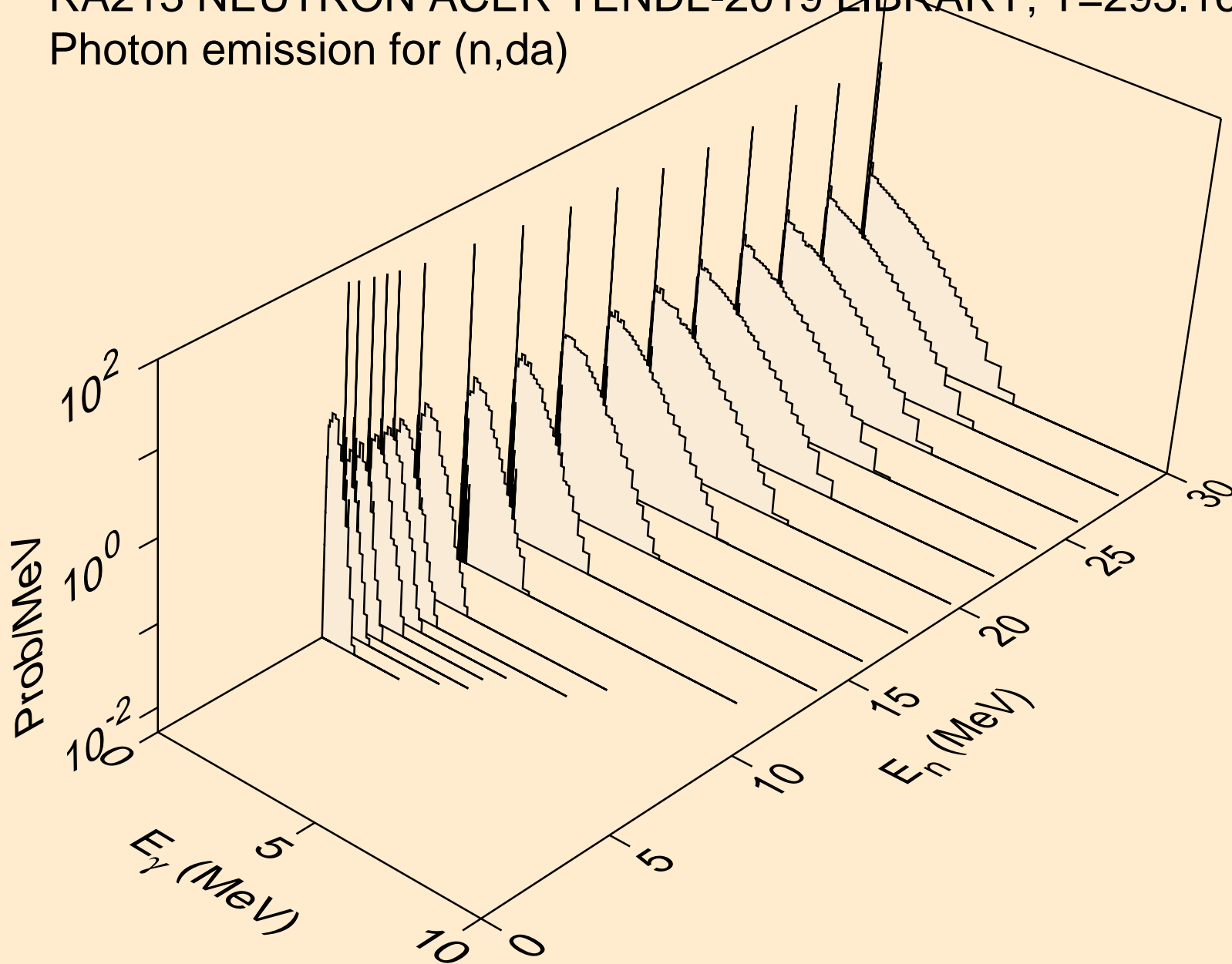

RA213 NEUTRON ACER TENDL-2019 LIBRARY; T=293.16K
thermal capture photon spectrum

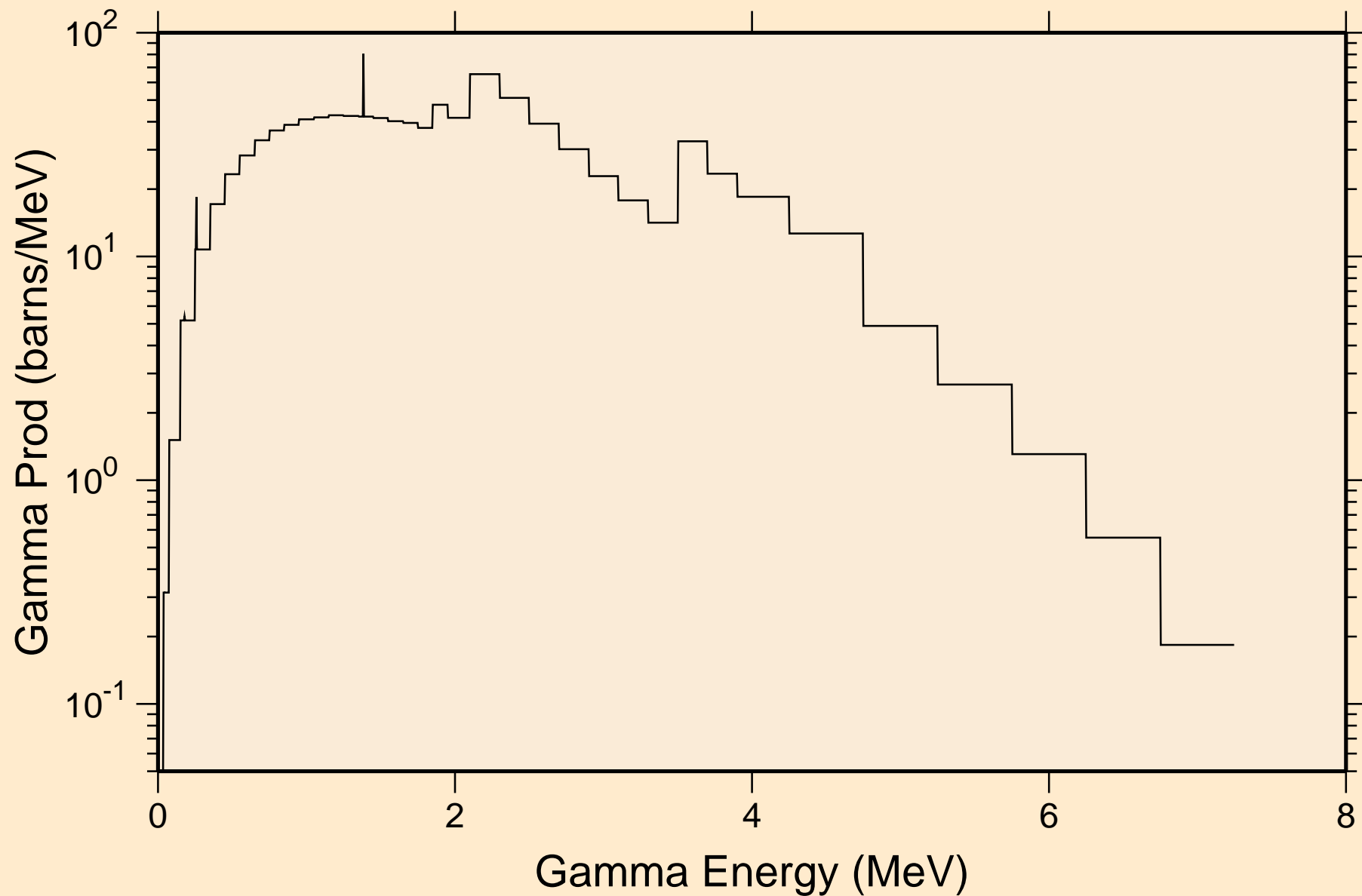

RA213 NEUTRON ACER TENDL-2019 LIBRARY; T=293.16K
14 MeV photon spectrum

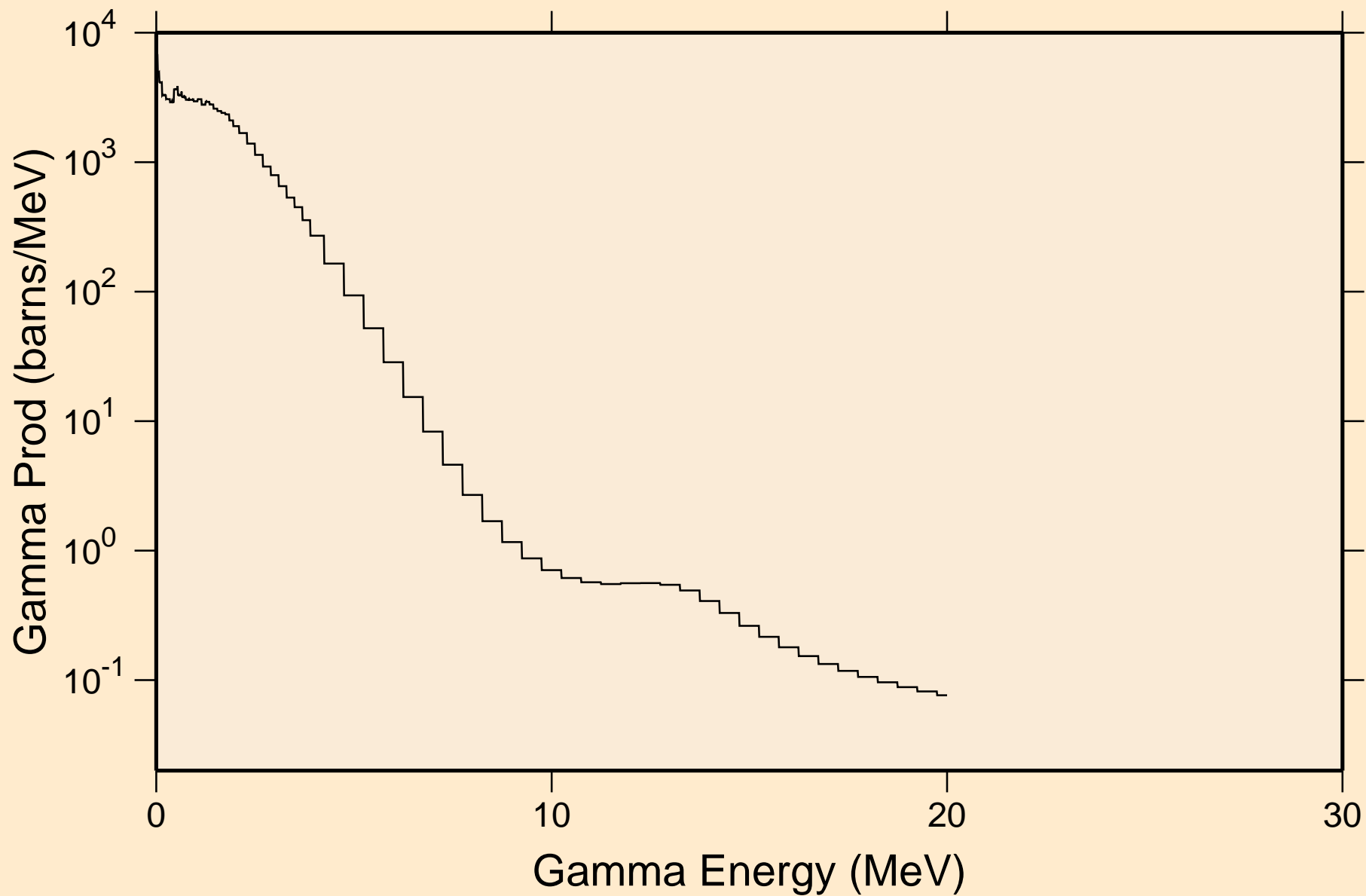

RA213 NEUTRON ACER TENDL-2019 LIBRARY; T=293.16K
Particle heating contributions

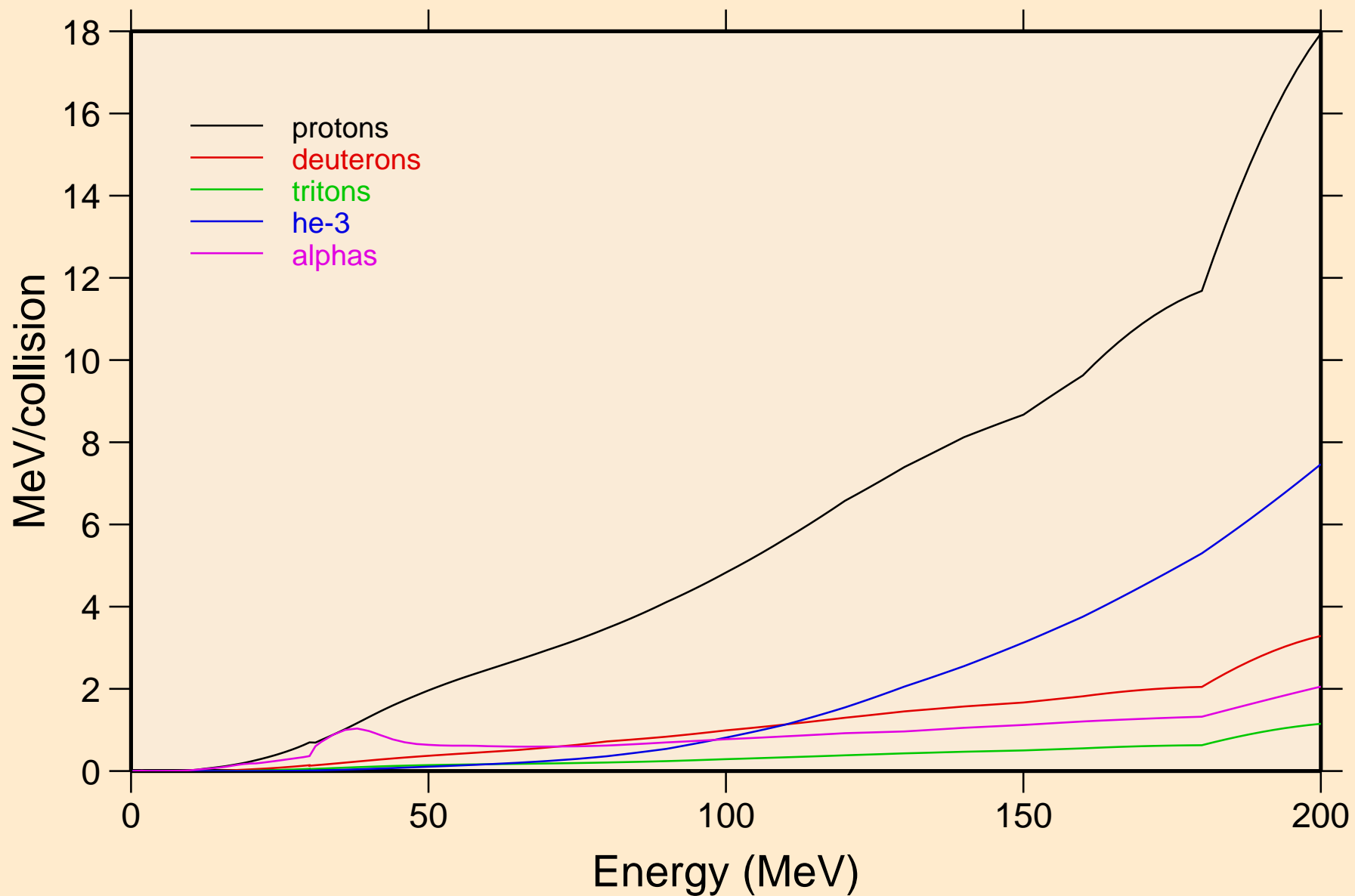

RA213 NEUTRON ACER TENDL-2019 LIBRARY; T=293.16K
Recoil Heating

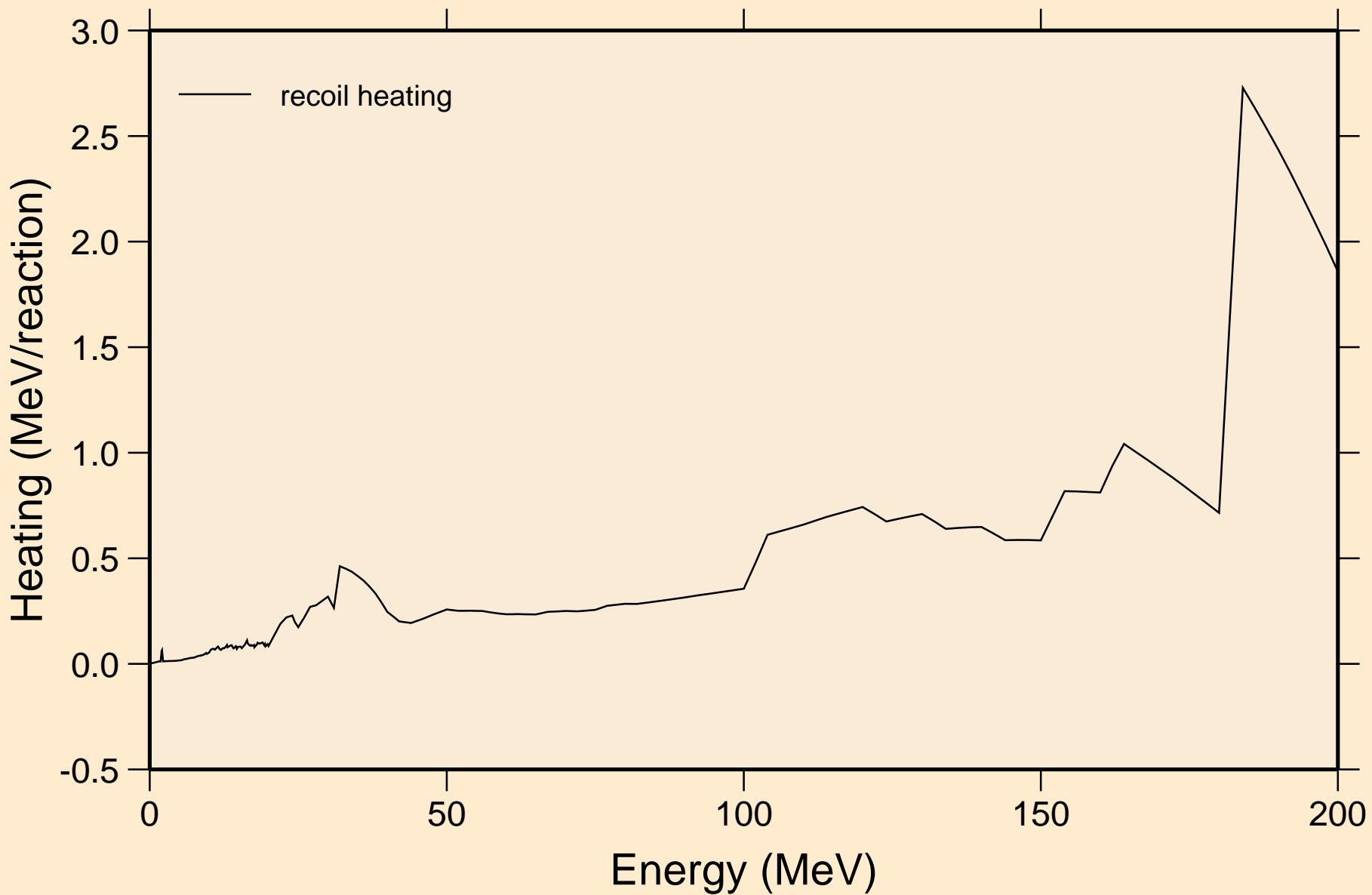

RA213 NEUTRON ACER TENDL-2019 LIBRARY; T=293.16K
Particle production cross sections

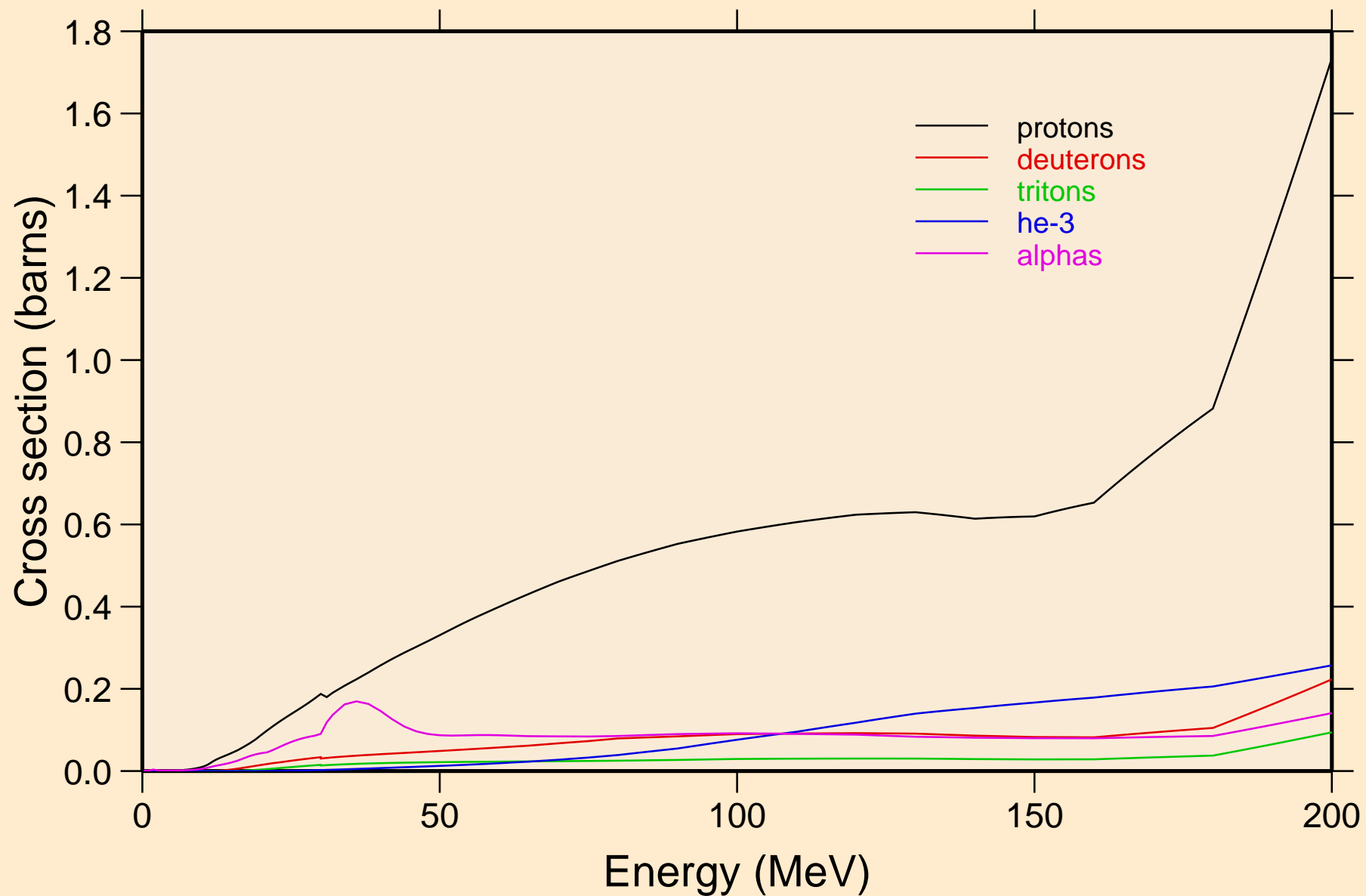

RA213 NEUTRON ACER TENDL-2019 LIBRARY; T=293.16K
protons from (n,x)

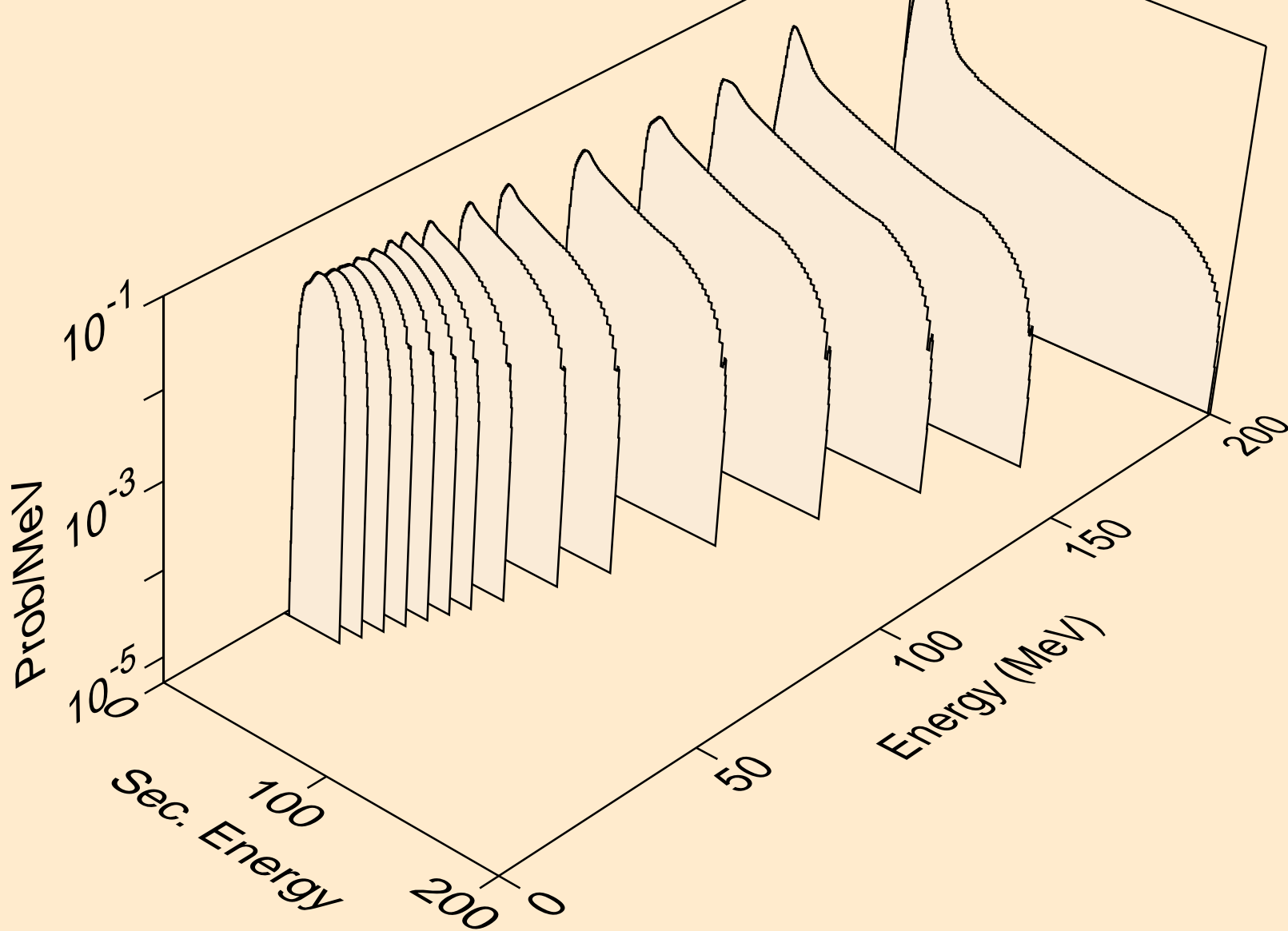

RA213 NEUTRON ACER TENDL-2019 LIBRARY; T=293.16K
protons from (n,n*)p

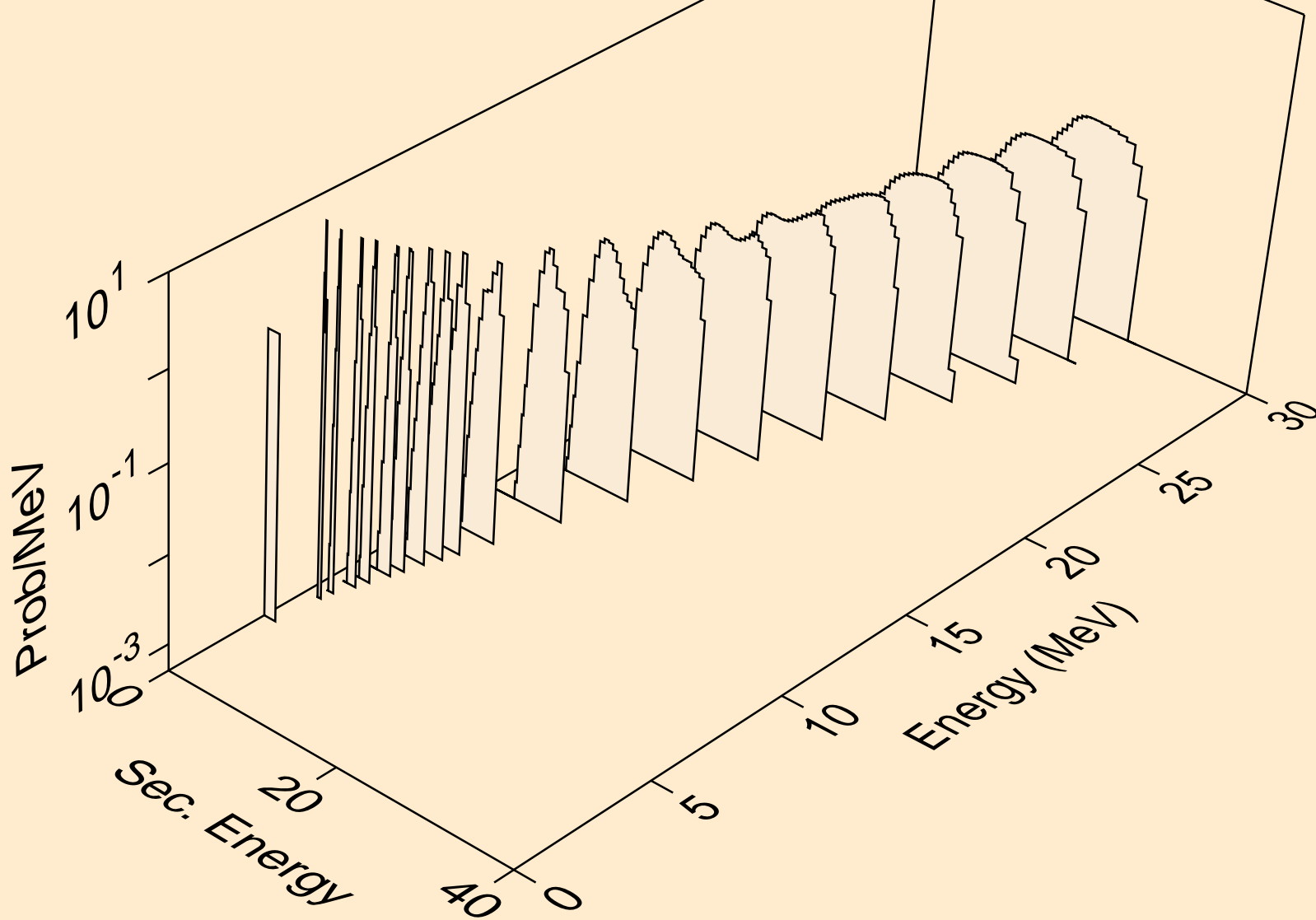

RA213 NEUTRON ACER TENDL-2019 LIBRARY; T=293.16K
protons from (n,2np)

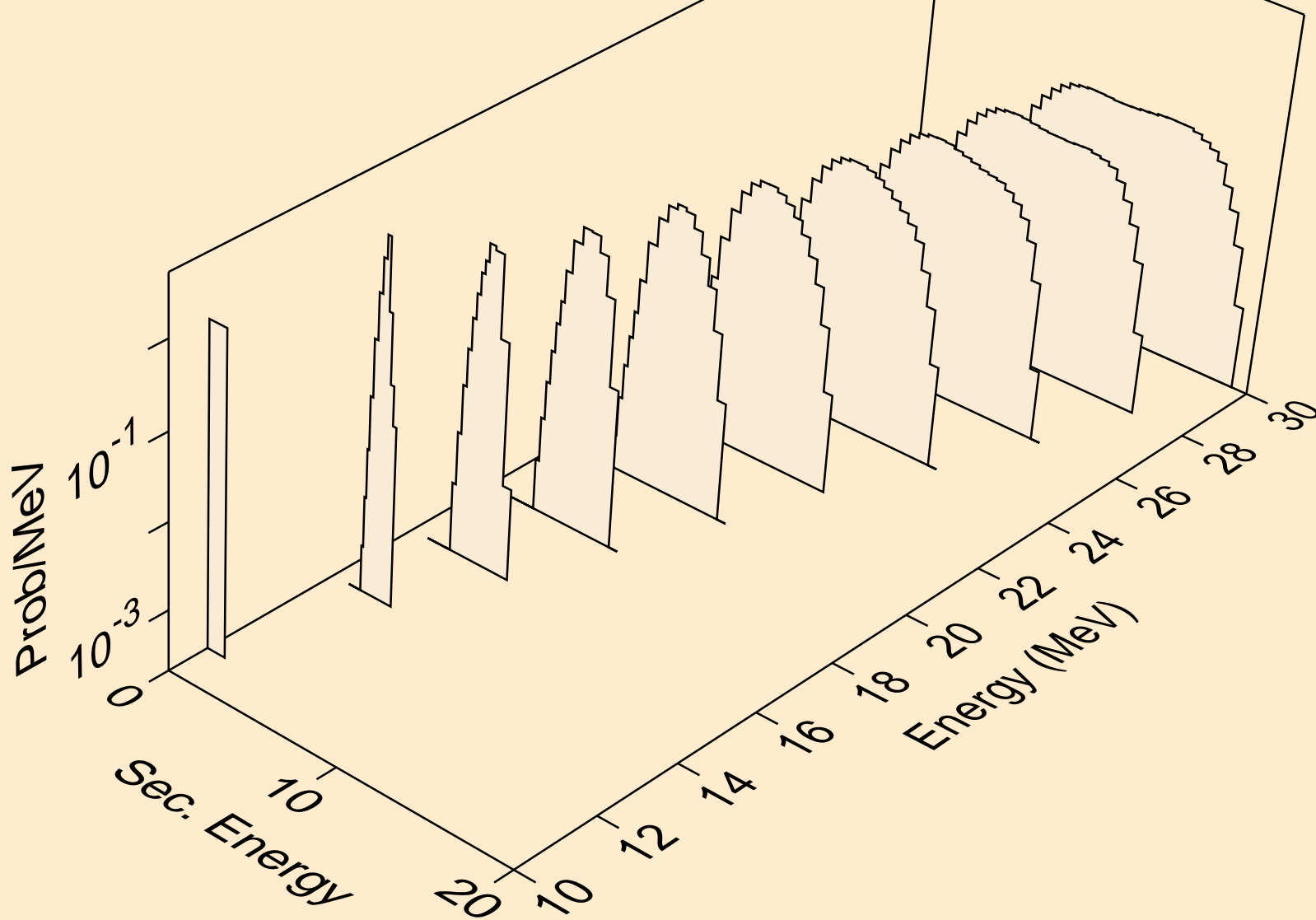

RA213 NEUTRON ACER TENDL-2019 LIBRARY; T=293.16K
protons from (n,3np)

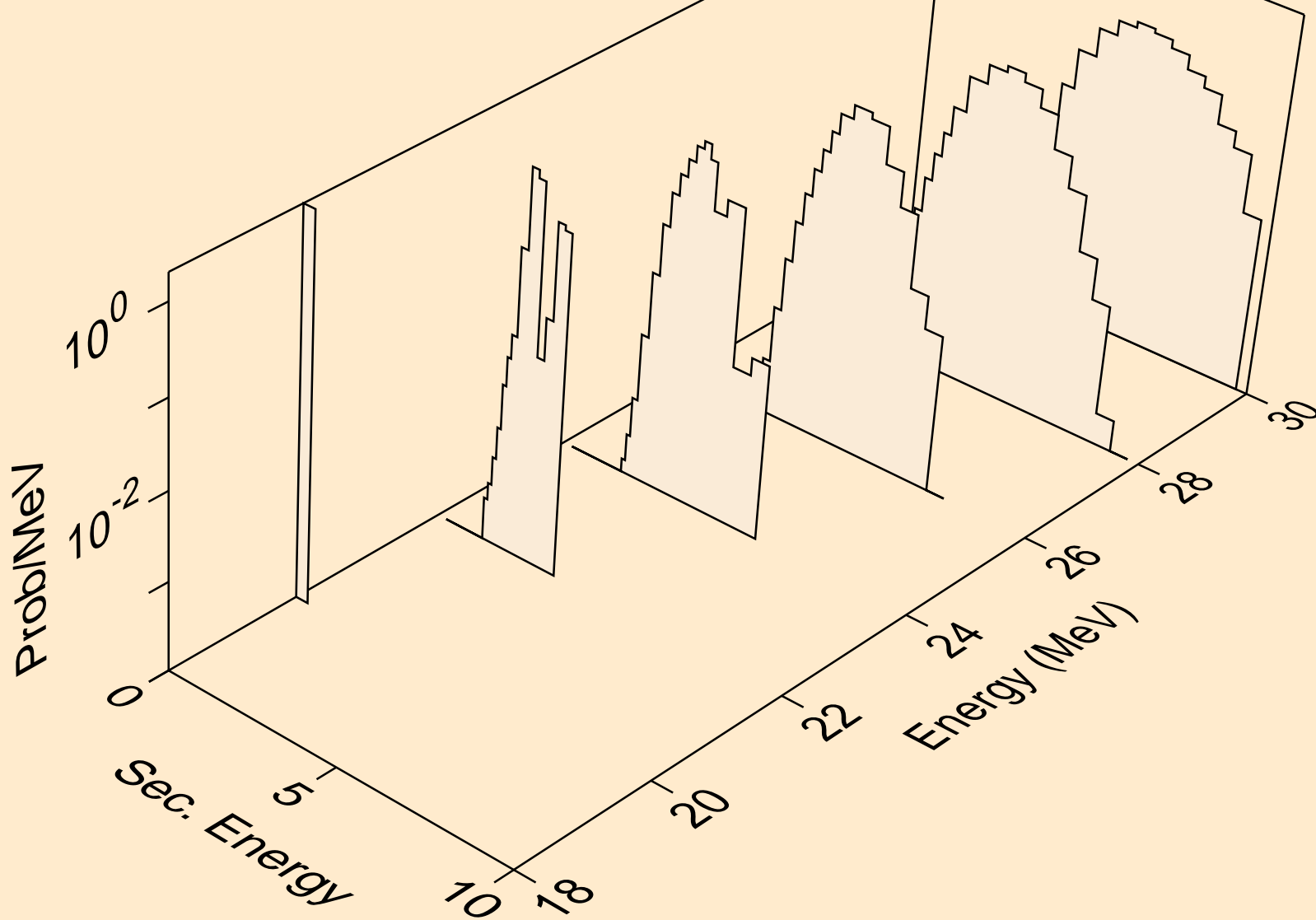

RA213 NEUTRON ACER TENDL-2019 LIBRARY; T=293.16K
protons from (n,2np)

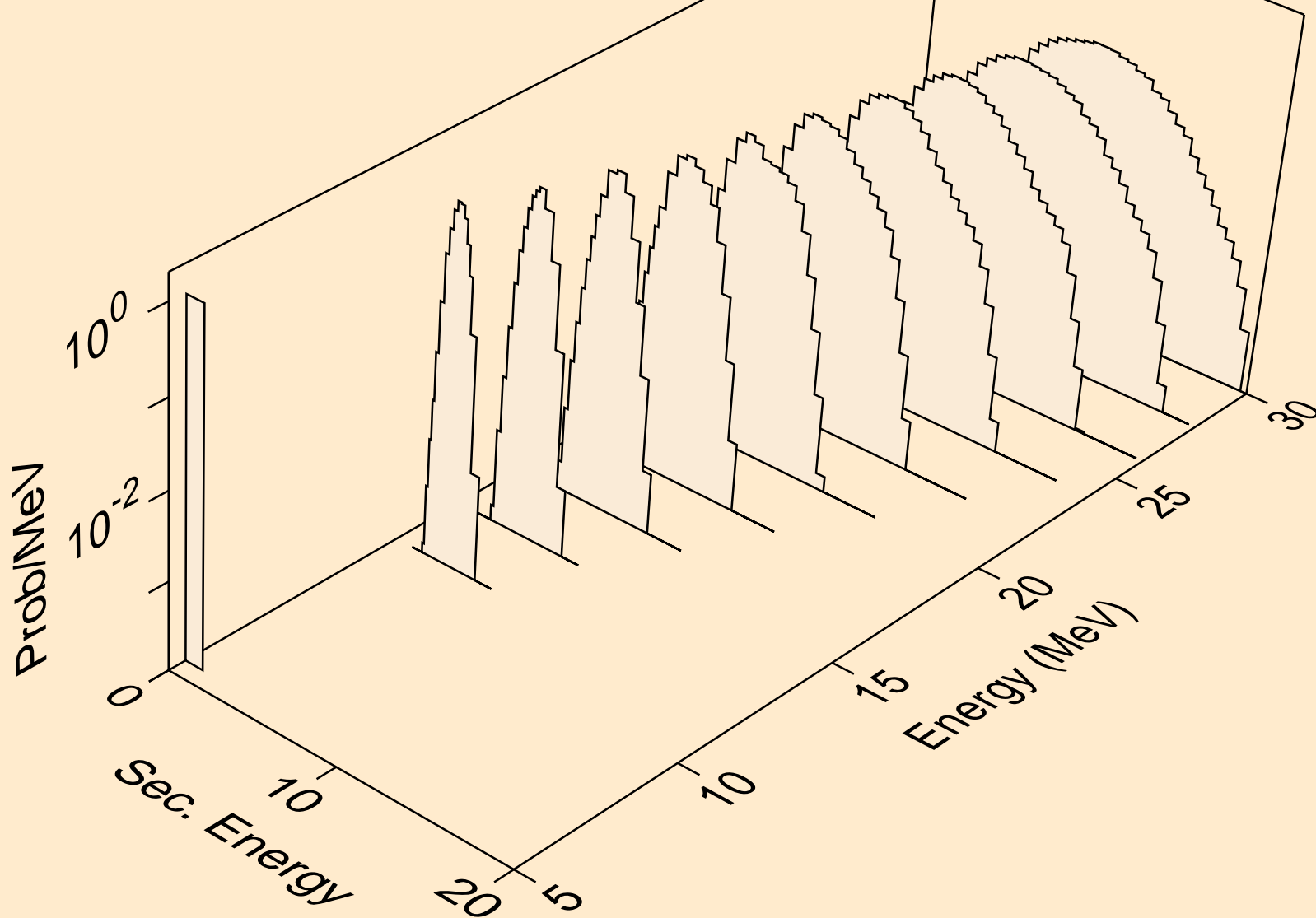

RA213 NEUTRON ACER TENDL-2019 LIBRARY; T=293.16K
protons from (n,npa)

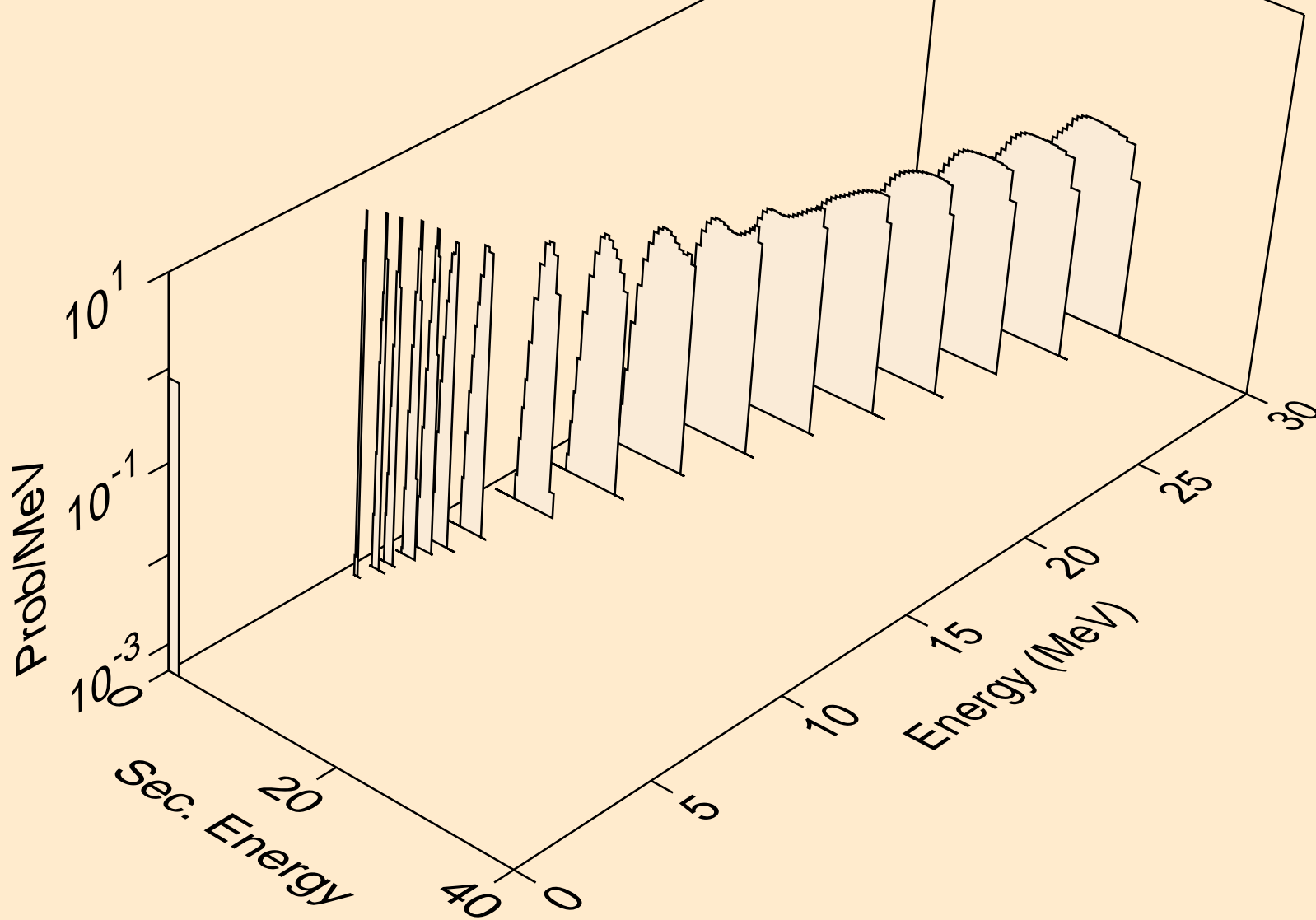

RA213 NEUTRON ACER TENDL-2019 LIBRARY; T=293.16K
protons from (n,p)

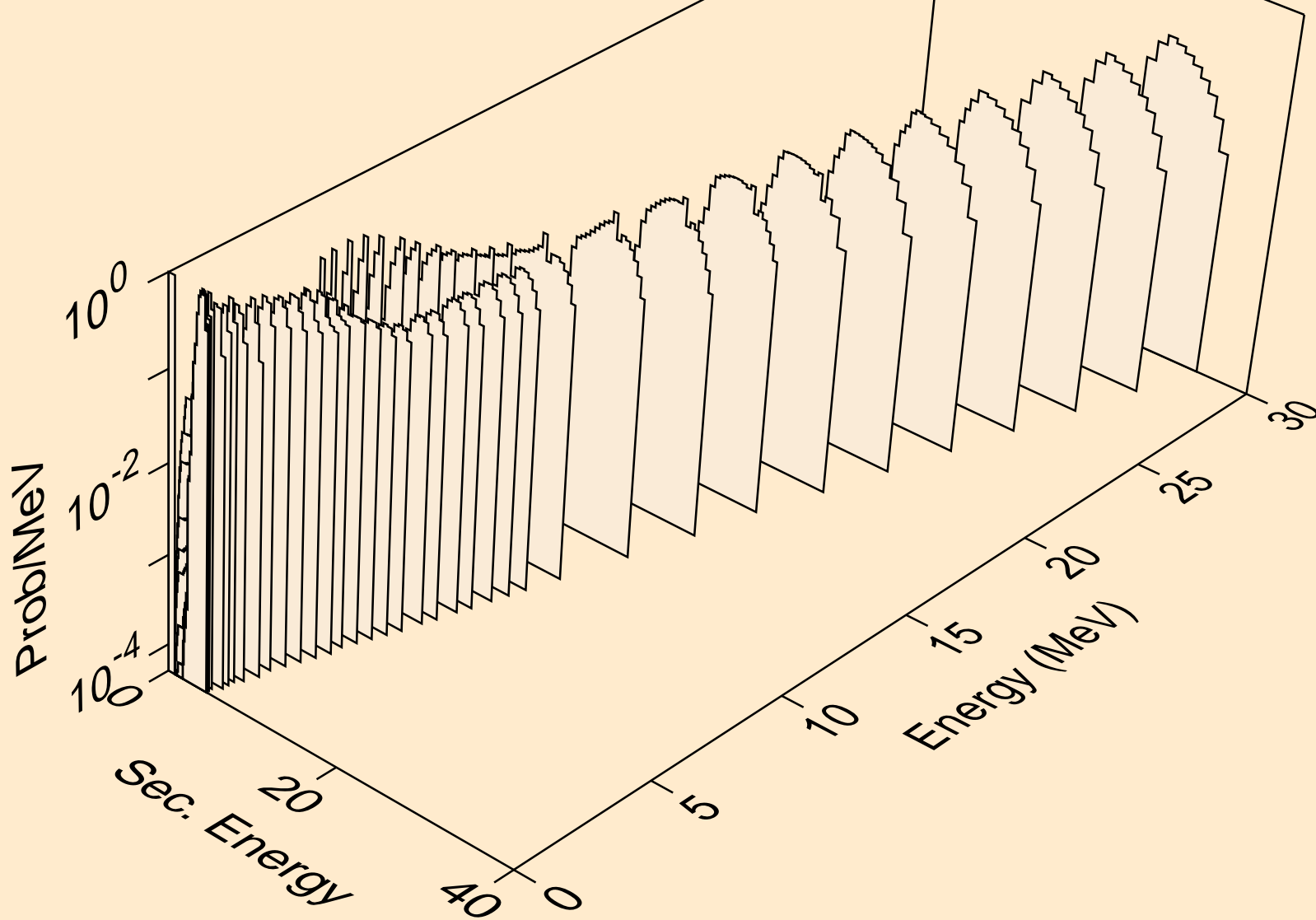

RA213 NEUTRON ACER TENDL-2019 LIBRARY; T=293.16K
protons from (n,2p)

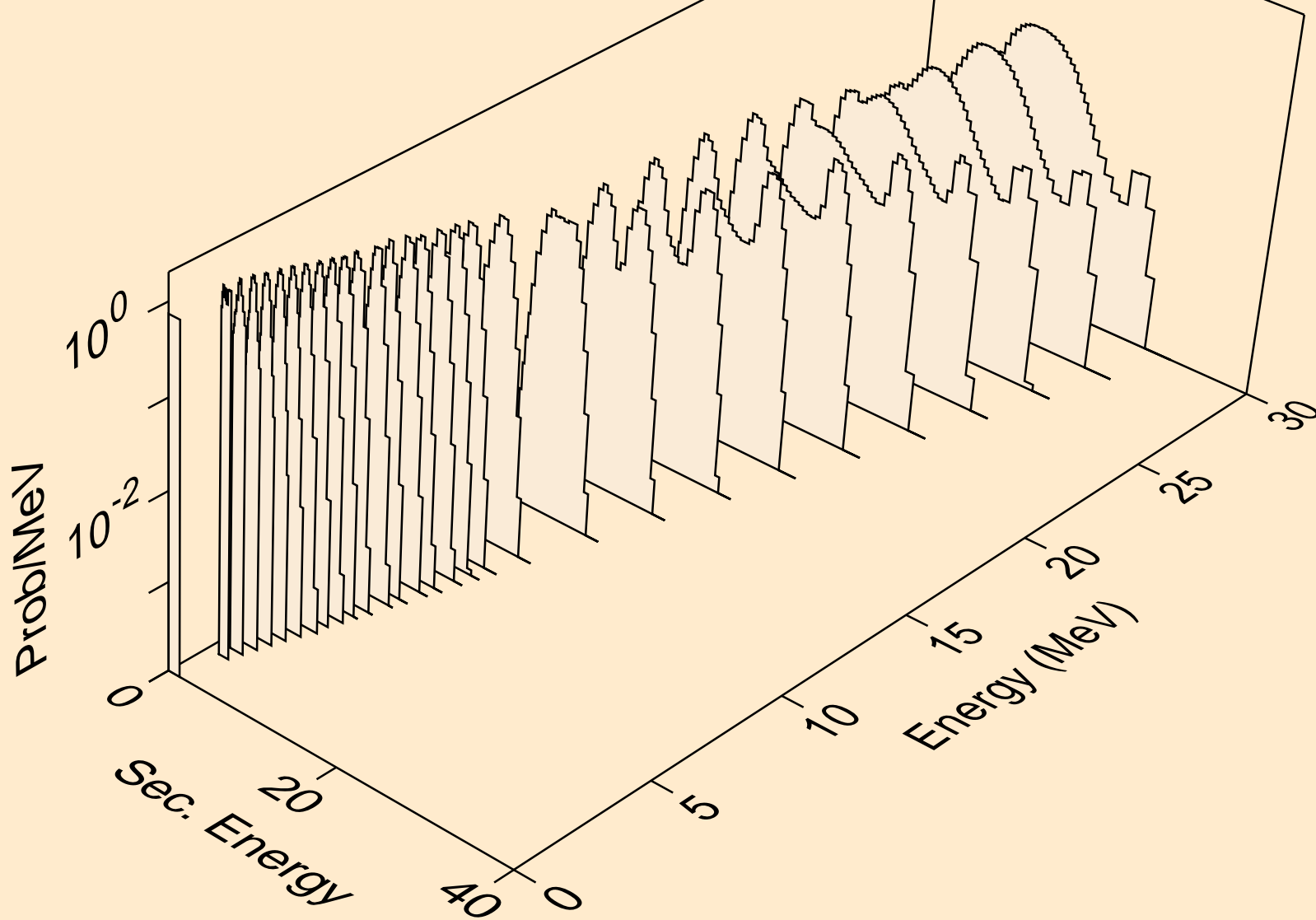

RA213 NEUTRON ACER TENDL-2019 LIBRARY; T=293.16K
protons from (n,p)

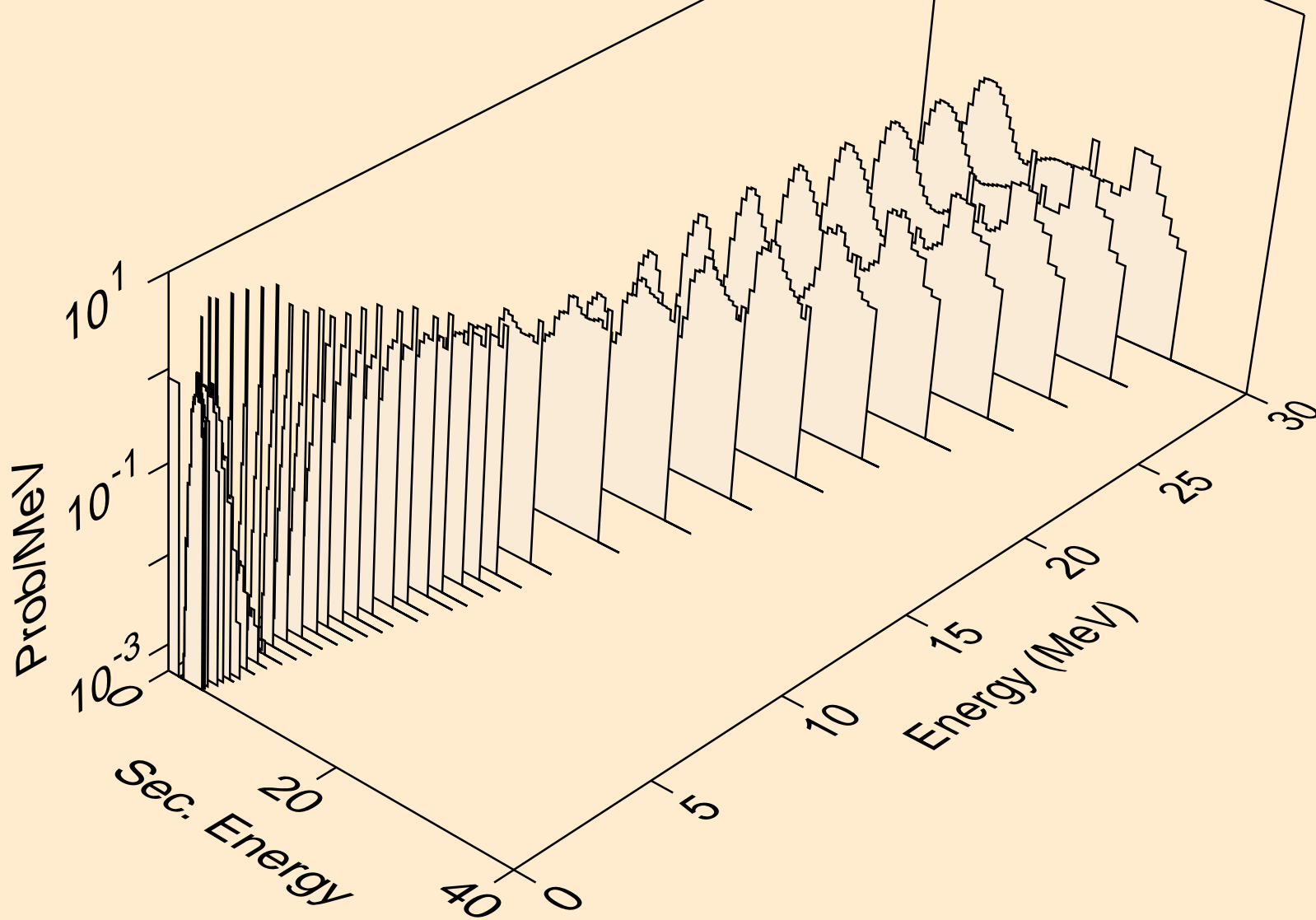

RA213 NEUTRON ACER TENDL-2019 LIBRARY; T=293.16K
protons from (n,pd)

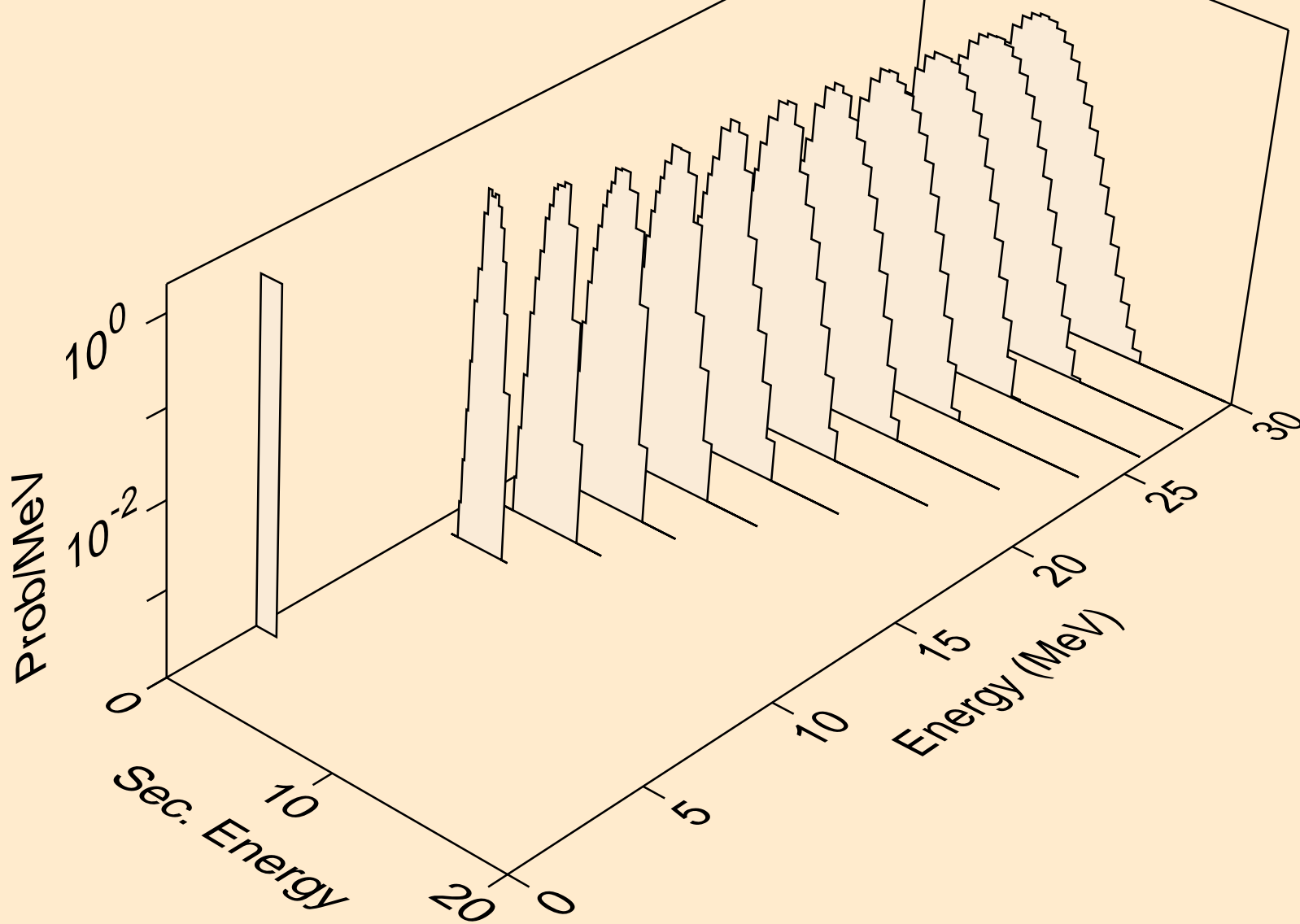

RA213 NEUTRON ACER TENDL-2019 LIBRARY; T=293.16K
protons from (n,pt)

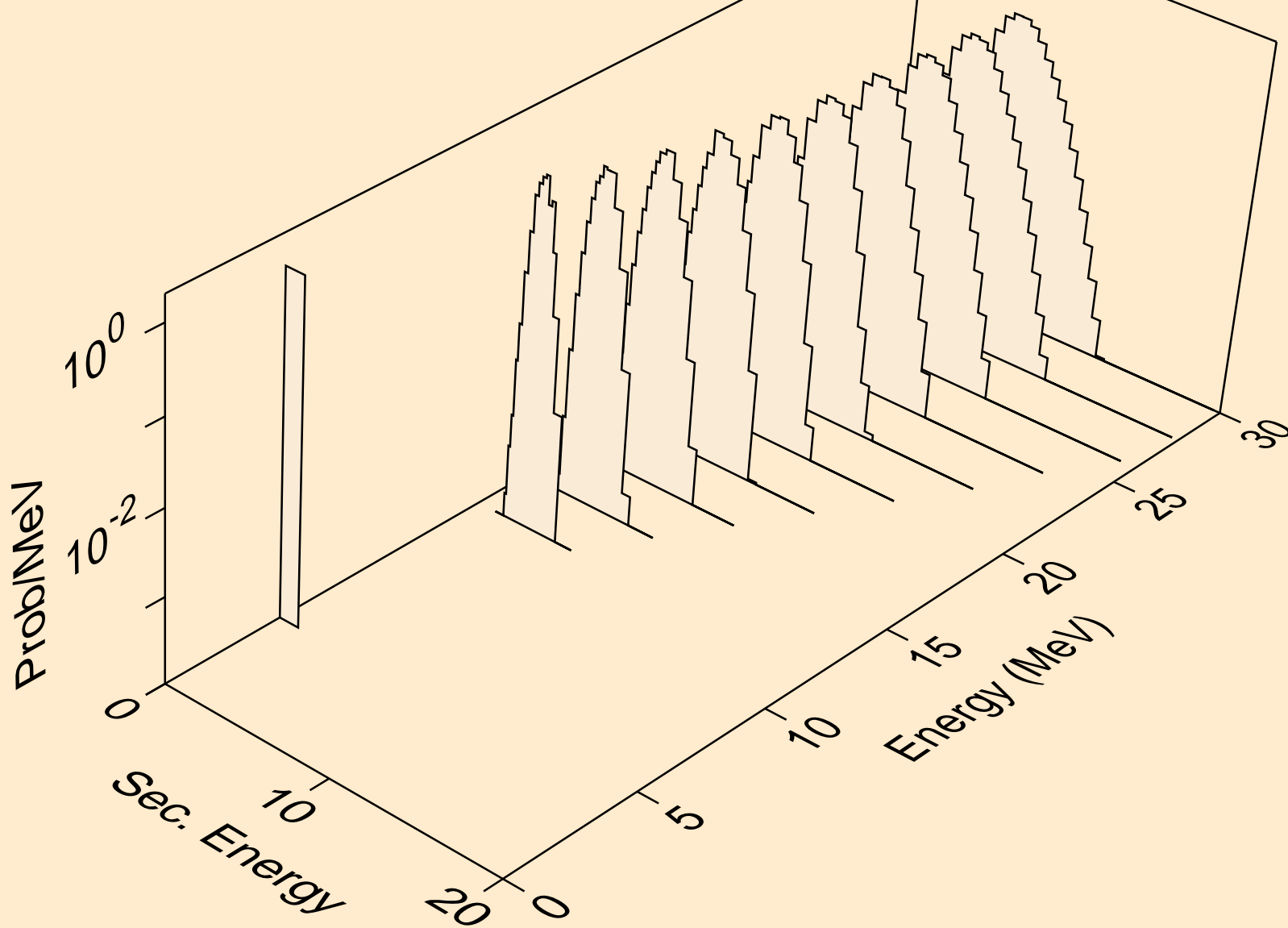

RA213 NEUTRON ACER TENDL-2019 LIBRARY; T=293.16K
deuterons from (n,x)

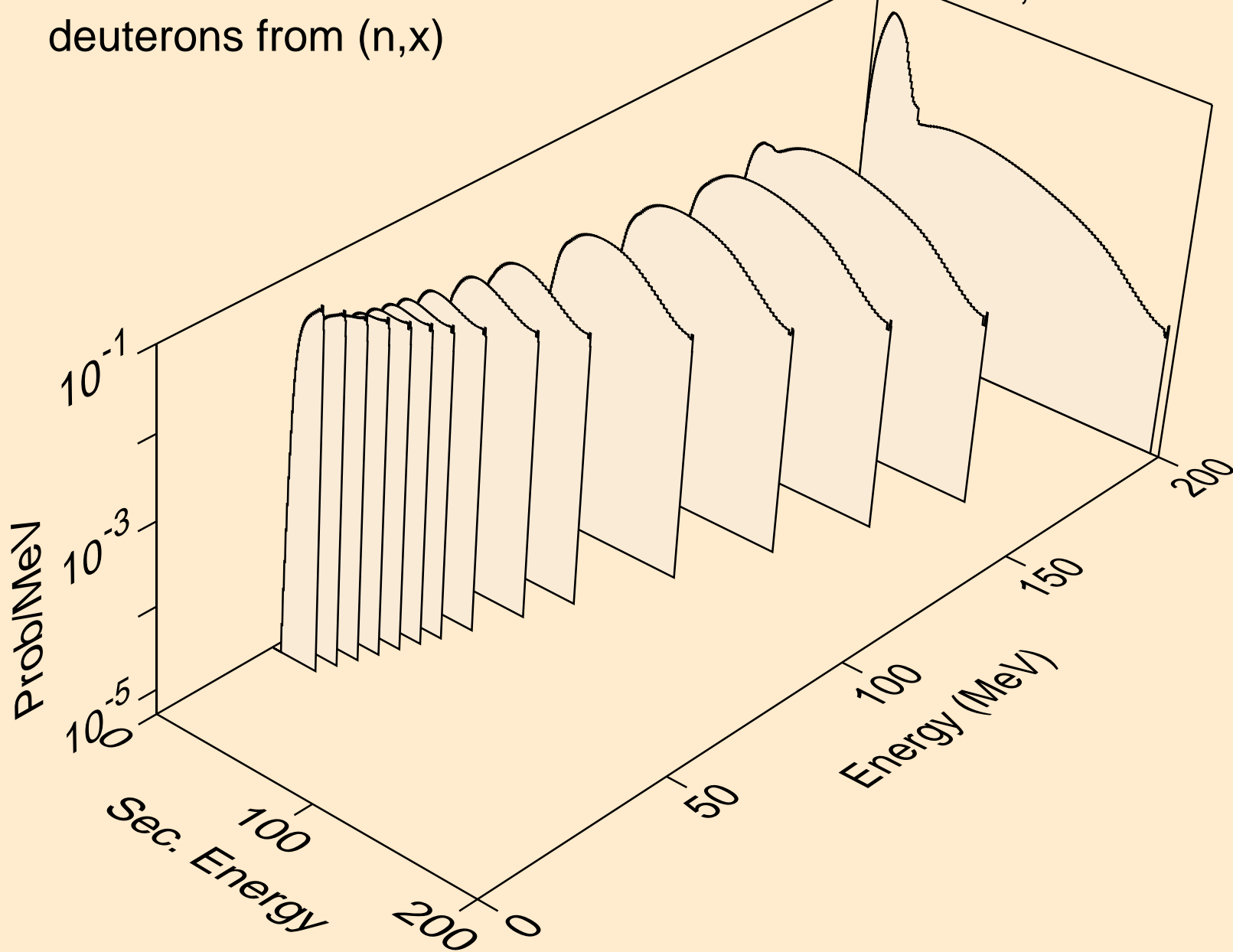

RA213 NEUTRON ACER TENDL-2019 LIBRARY; T=293.16K
deuterons from (n,2nd)

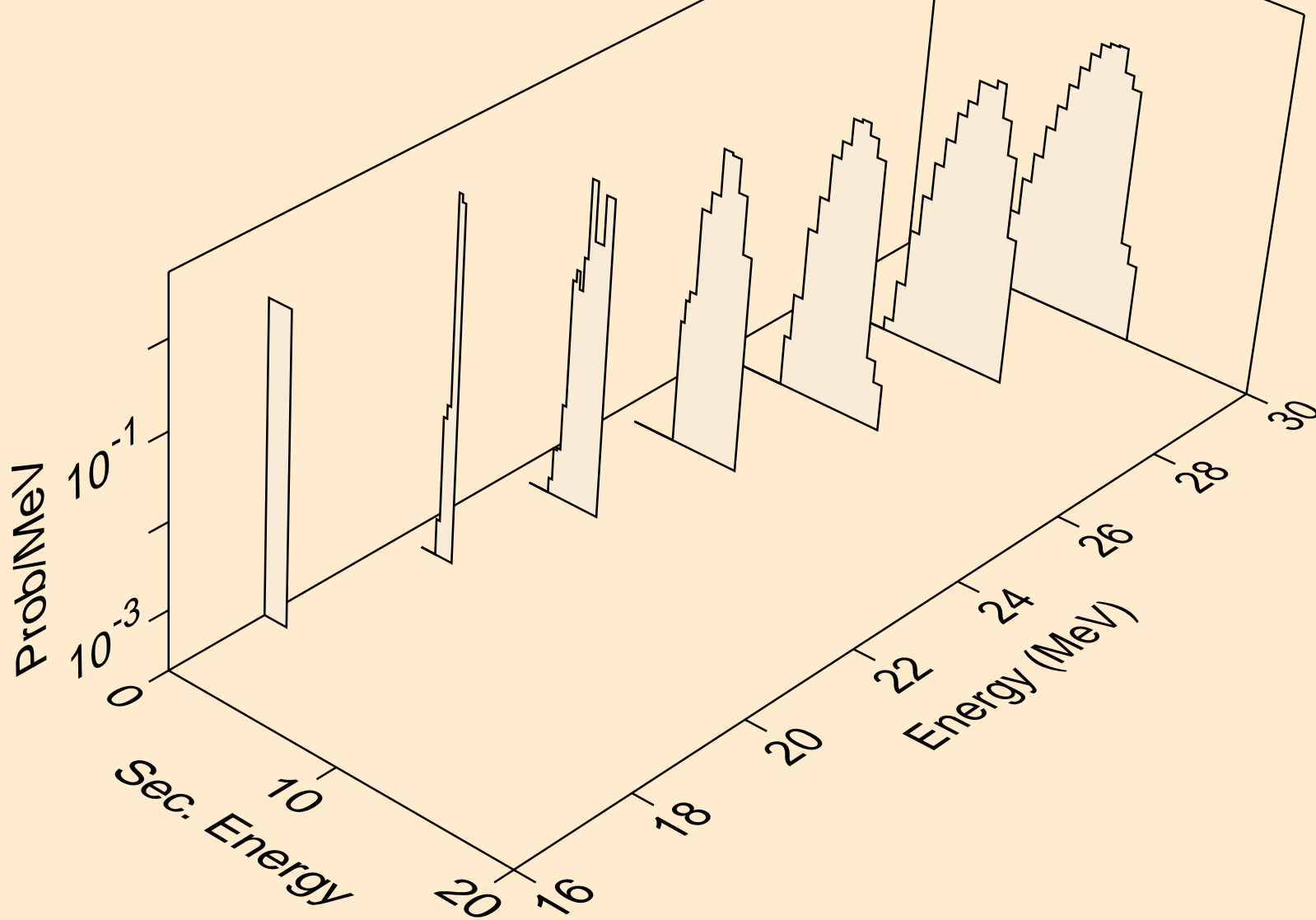

RA213 NEUTRON ACER TENDL-2019 LIBRARY; T=293.16K
deuterons from (n,n*)d

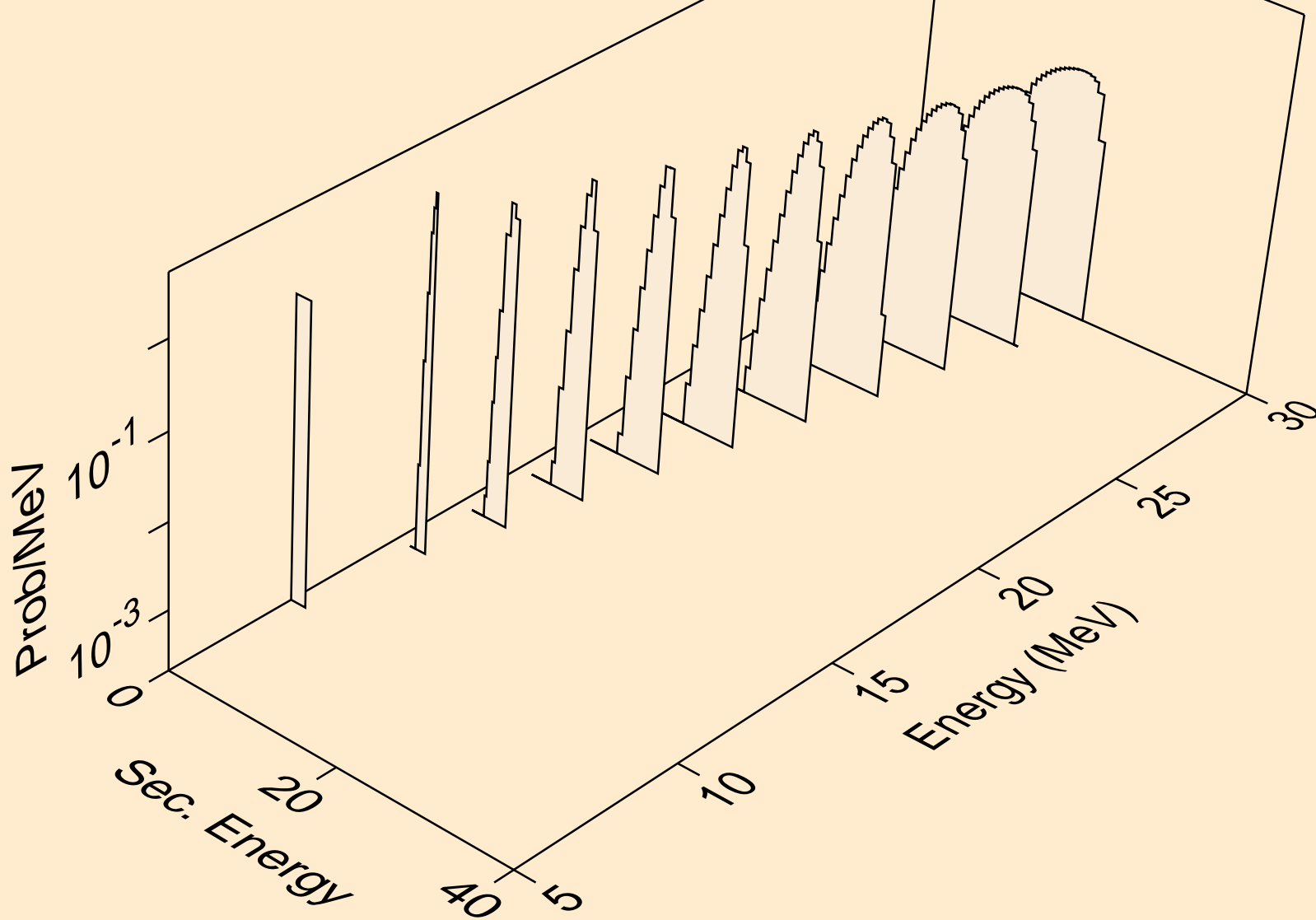

RA213 NEUTRON ACER TENDL-2019 LIBRARY; T=293.16K
deuterons from (n,d)

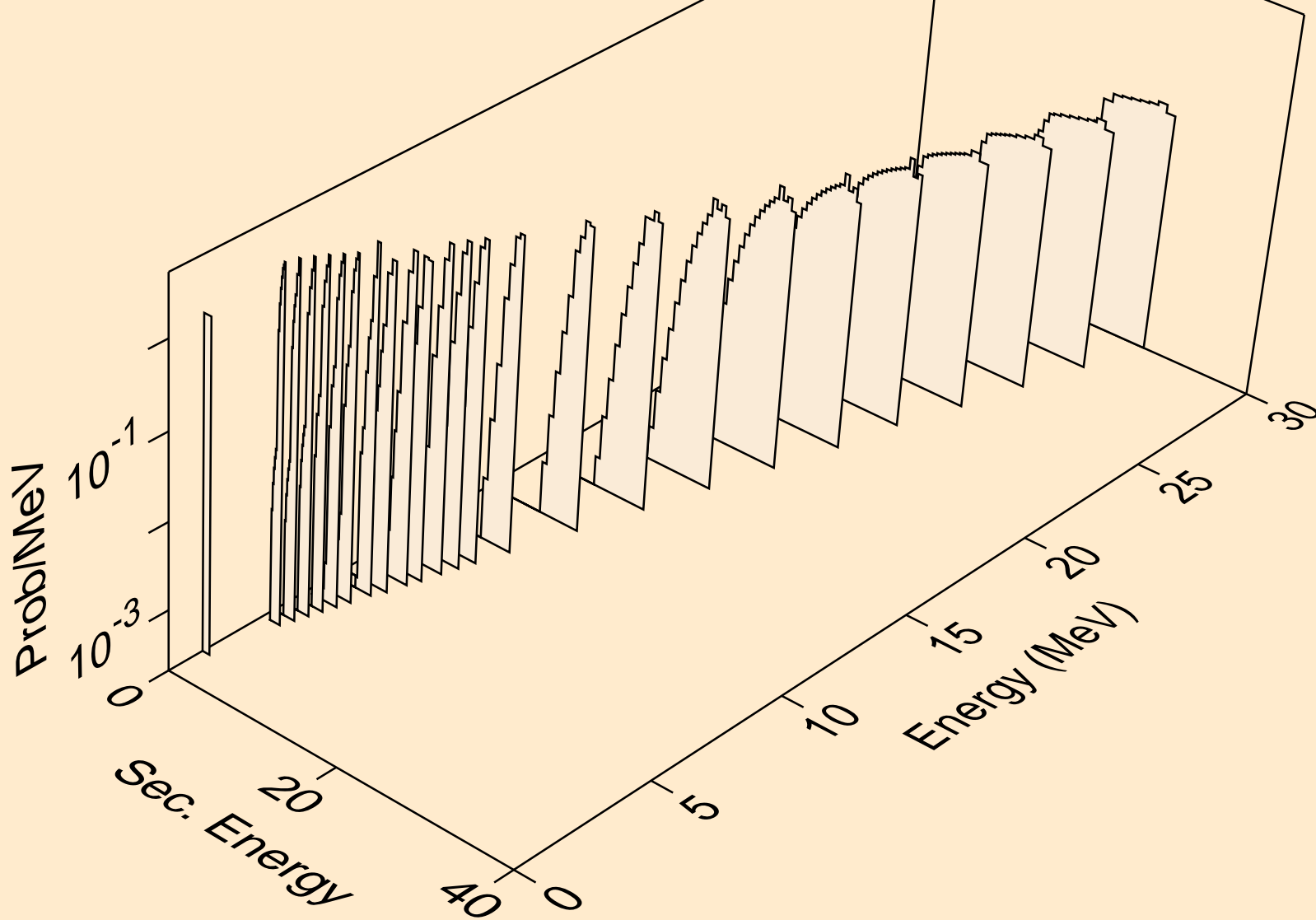

RA213 NEUTRON ACER TENDL-2019 LIBRARY; T=293.16K
deuterons from (n,pd)

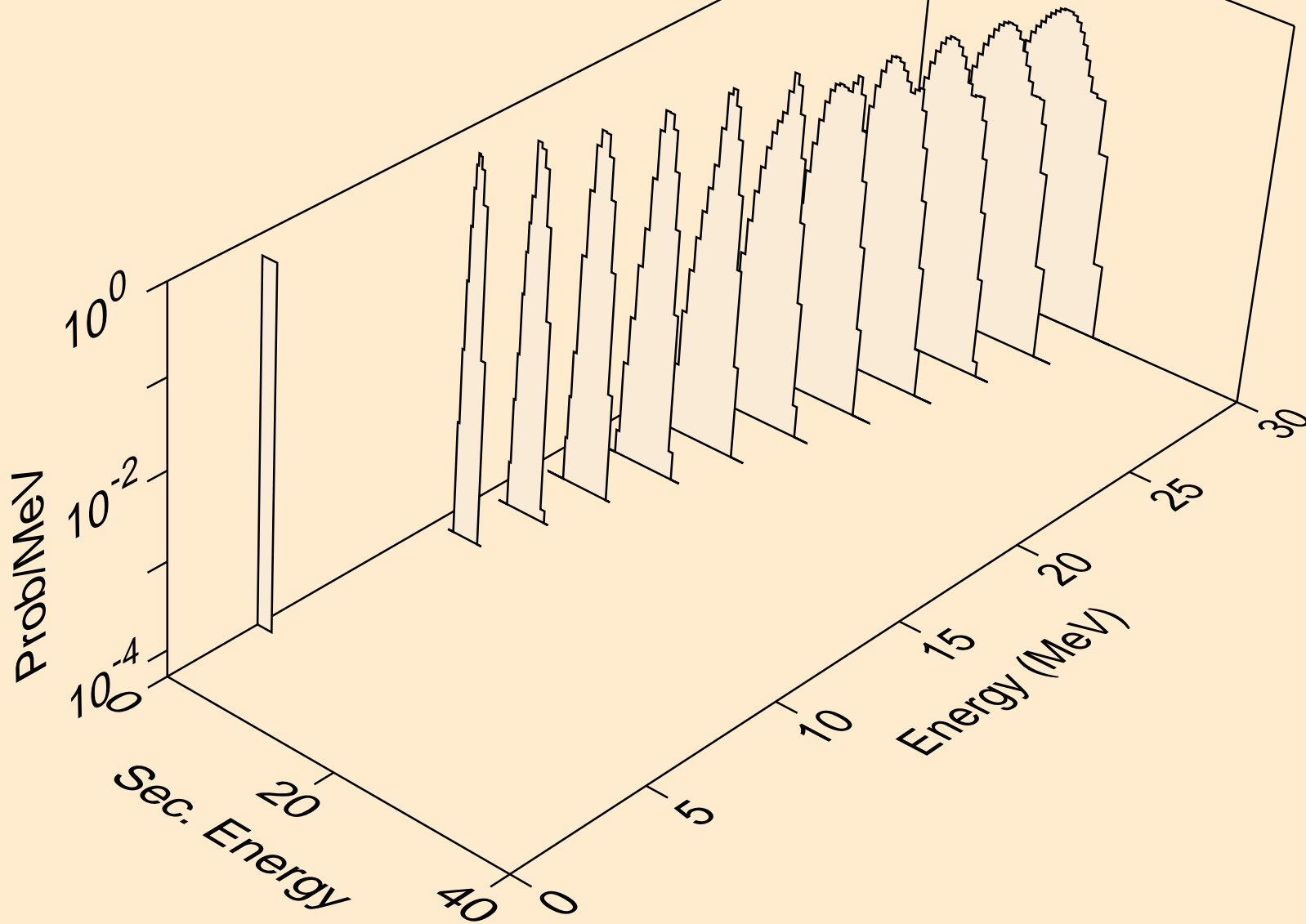

RA213 NEUTRON ACER TENDL-2019 LIBRARY; T=293.16K
deuterons from (n,da)

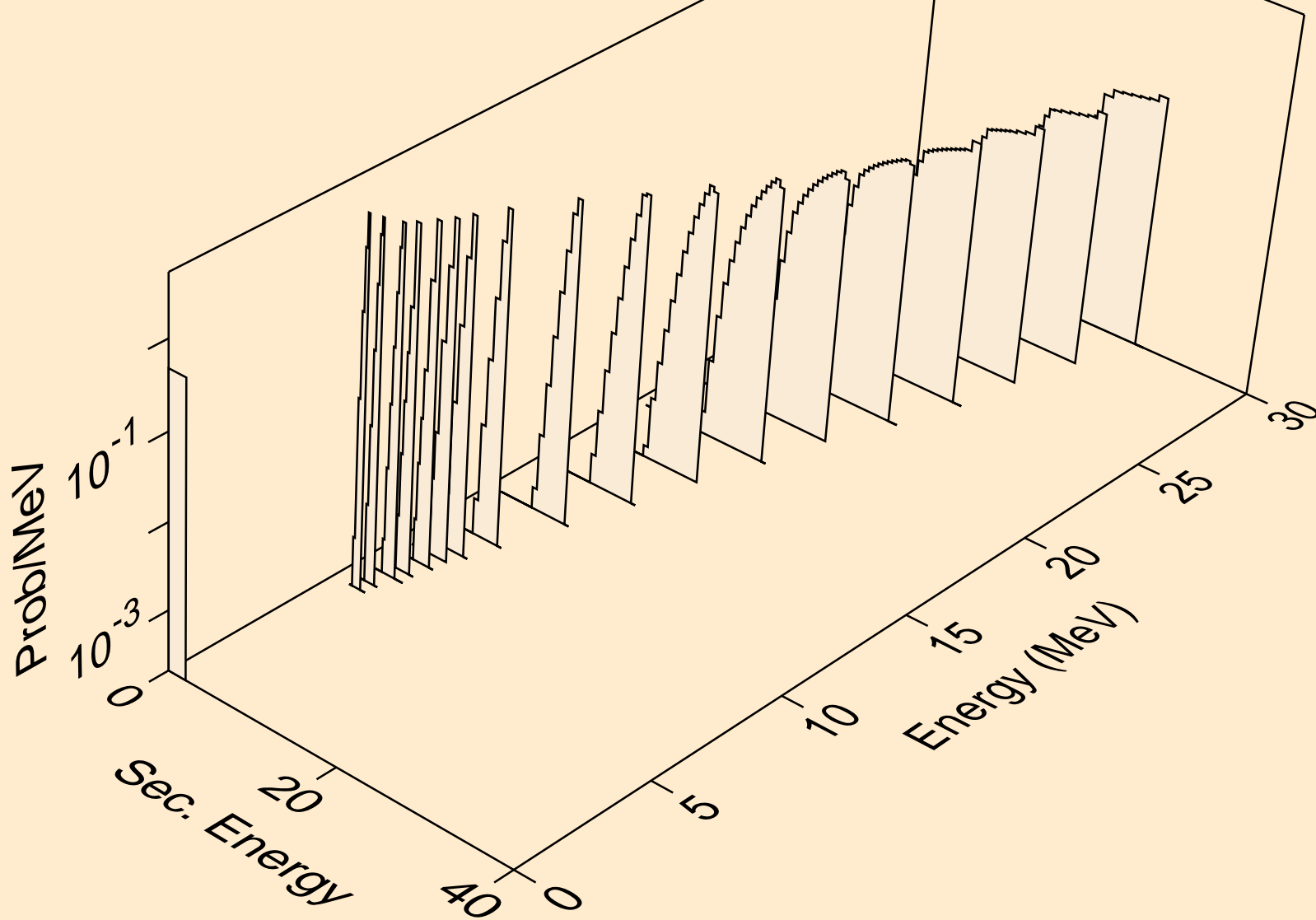

RA213 NEUTRON ACER TENDL-2019 LIBRARY; T=293.16K
tritons from (n,x)

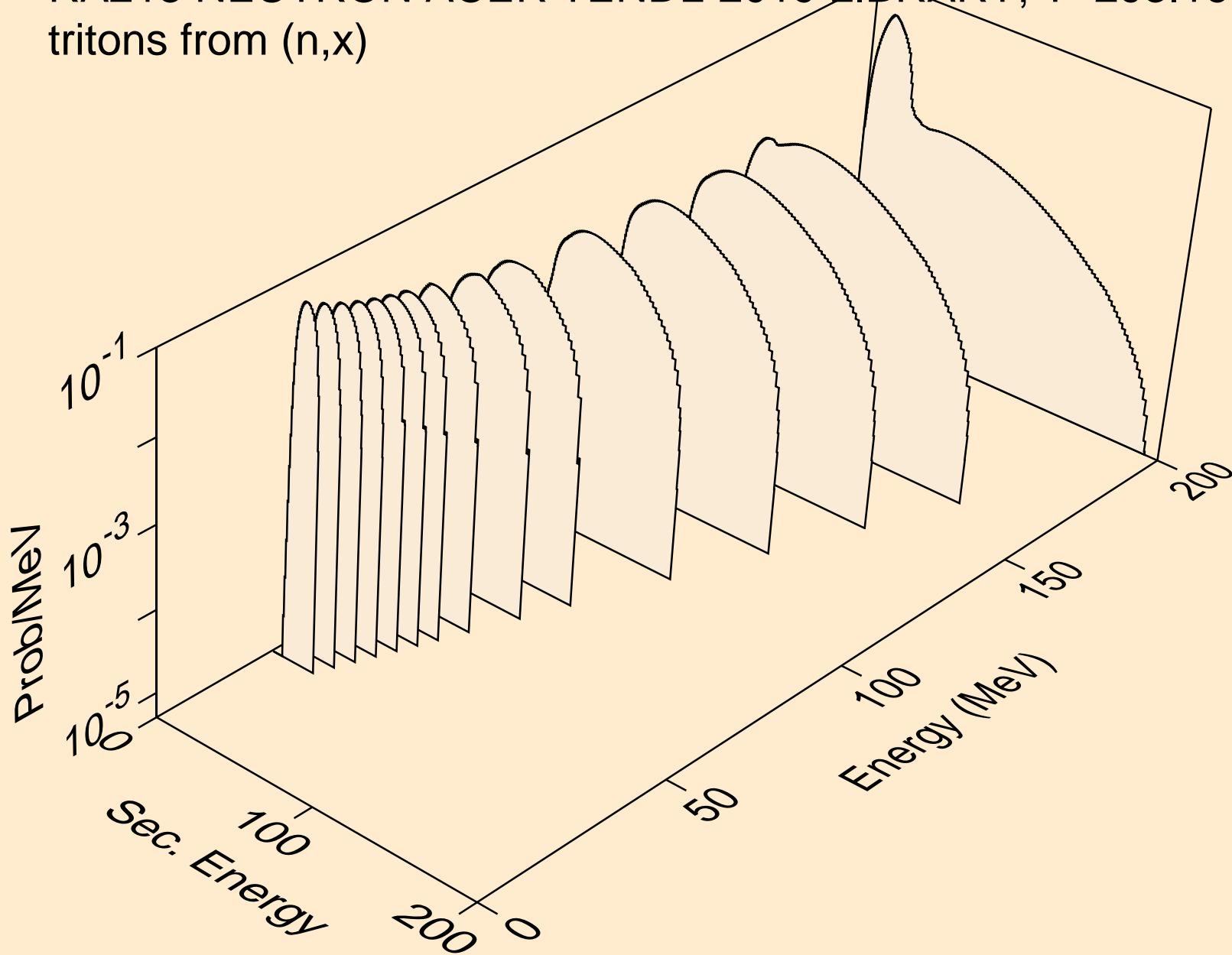

RA213 NEUTRON ACER TENDL-2019 LIBRARY; T=293.16K
tritons from (n,n*)t

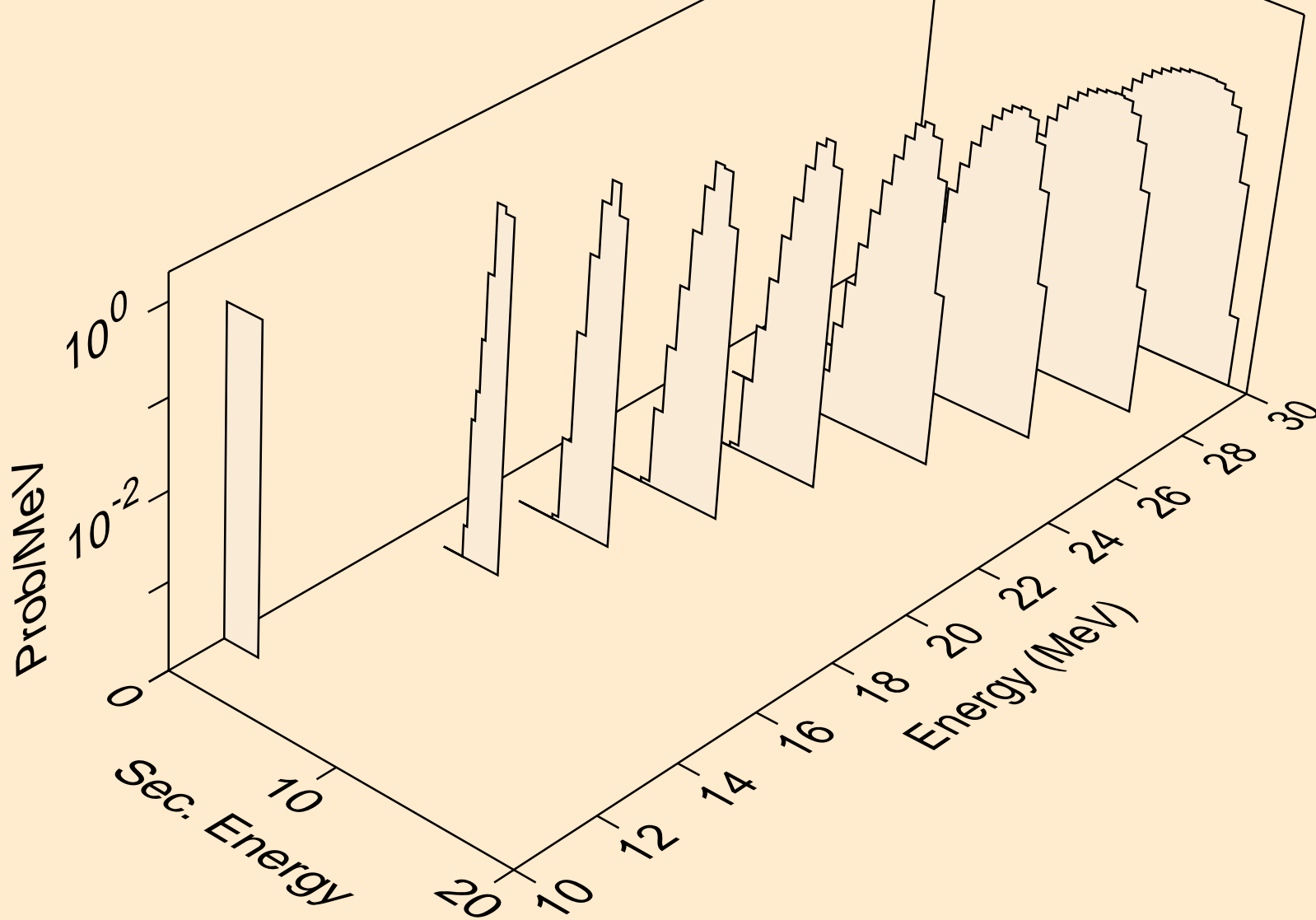

RA213 NEUTRON ACER TENDL-2019 LIBRARY; T=293.16K
tritons from (n,t)

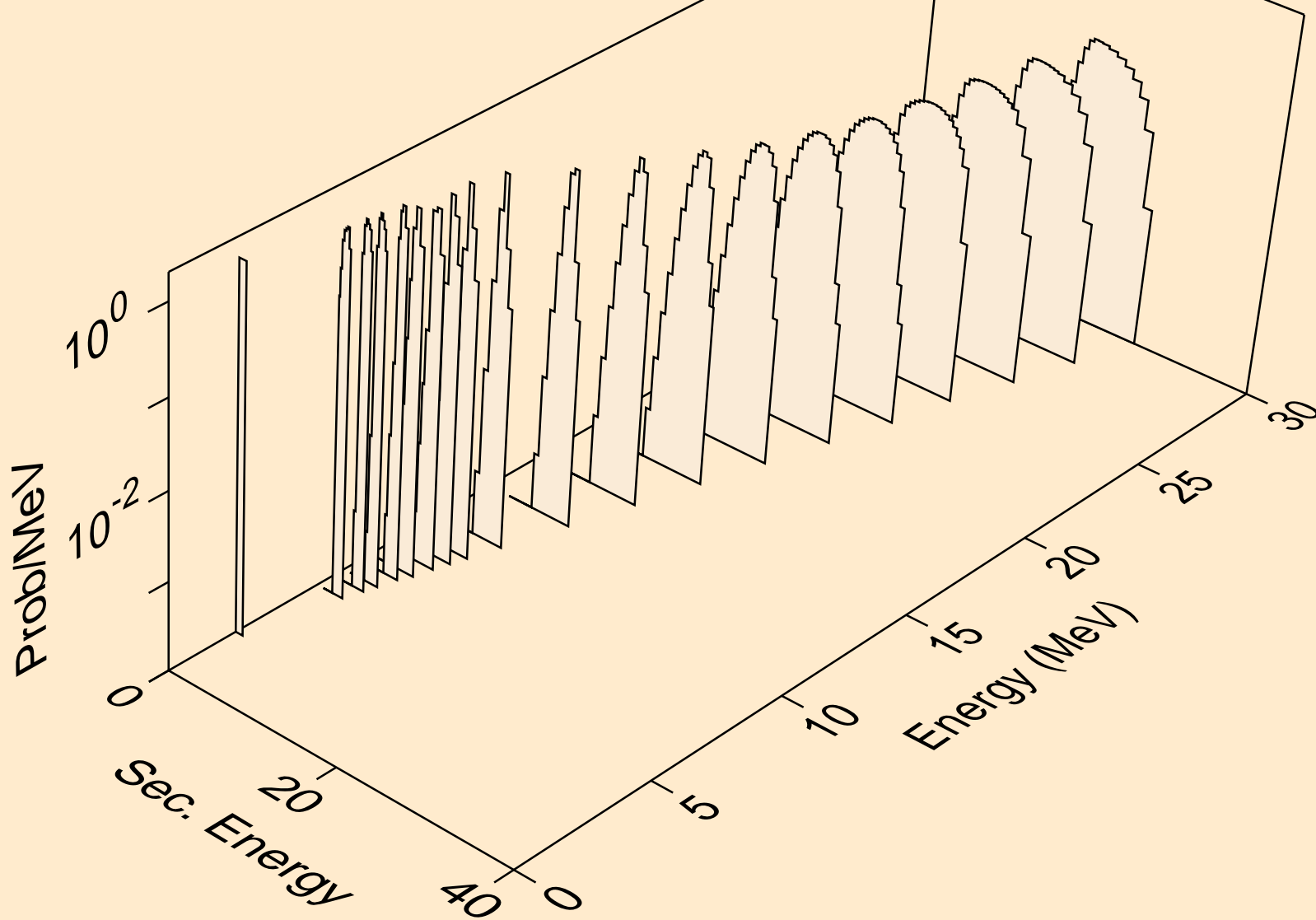

RA213 NEUTRON ACER TENDL-2019 LIBRARY; T=293.16K
tritons from (n,t2a)

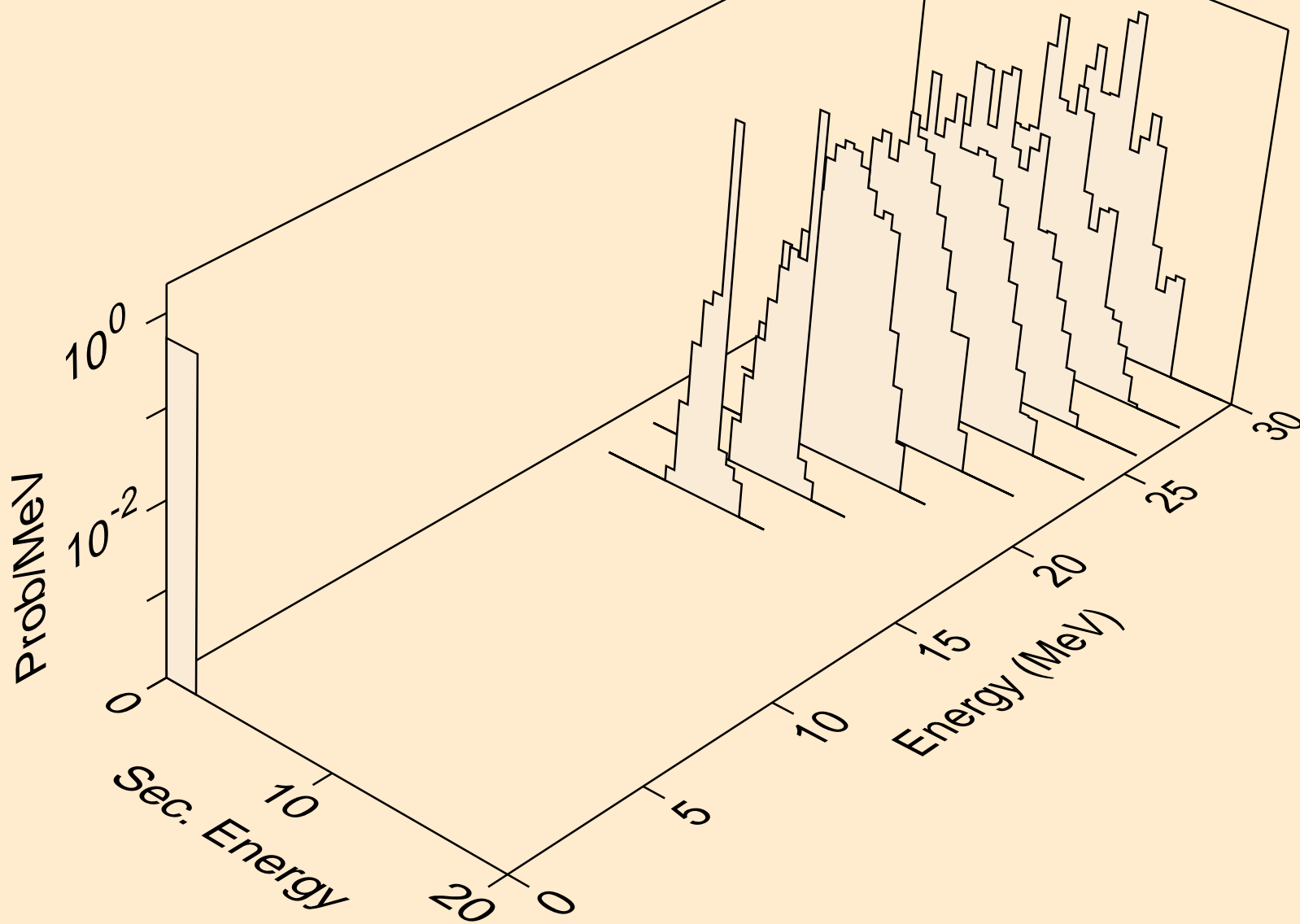

RA213 NEUTRON ACER TENDL-2019 LIBRARY; T=293.16K
tritons from (n,pt)

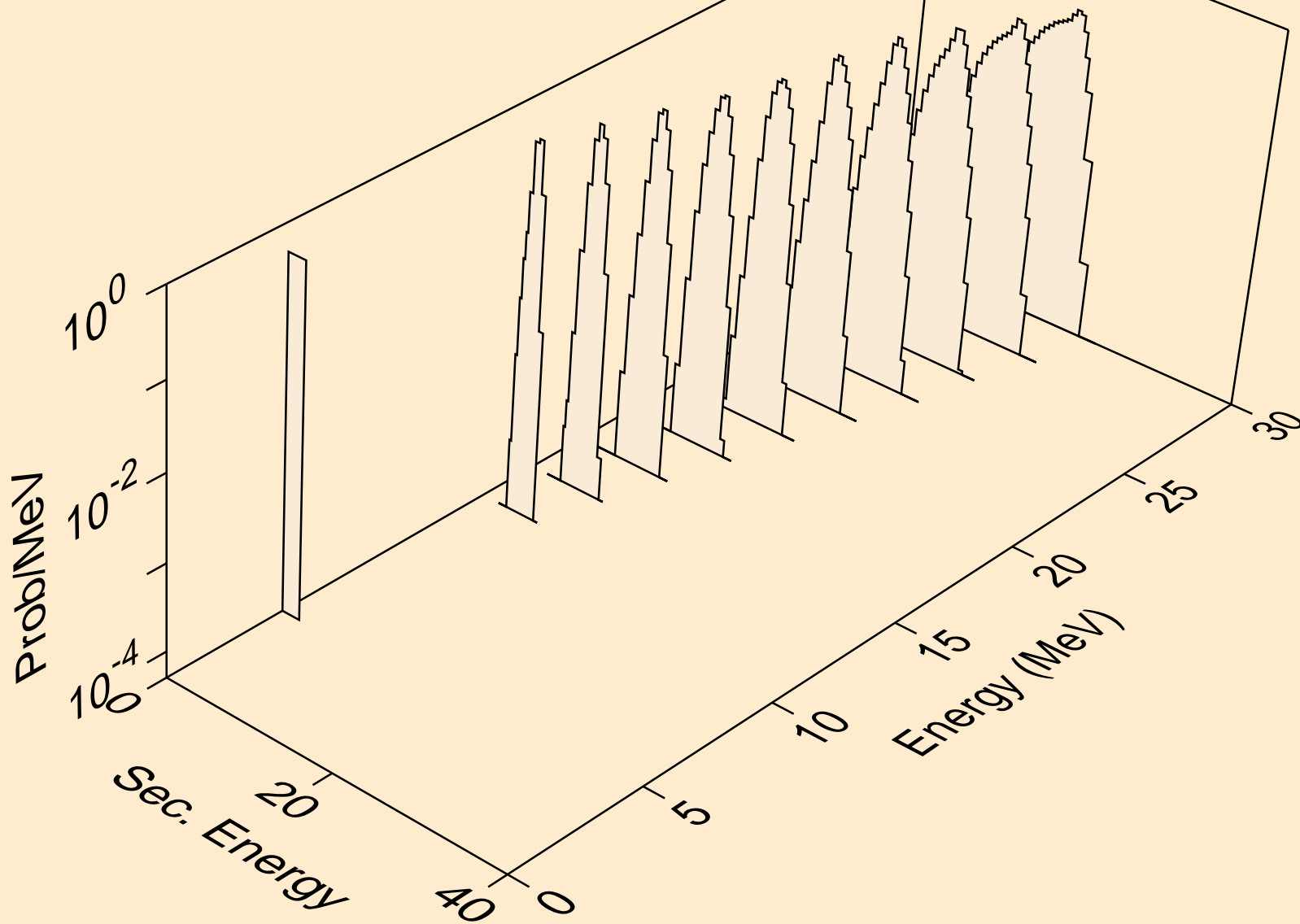

RA213 NEUTRON ACER TENDL-2019 LIBRARY; T=293.16K
he3s from (n,x)

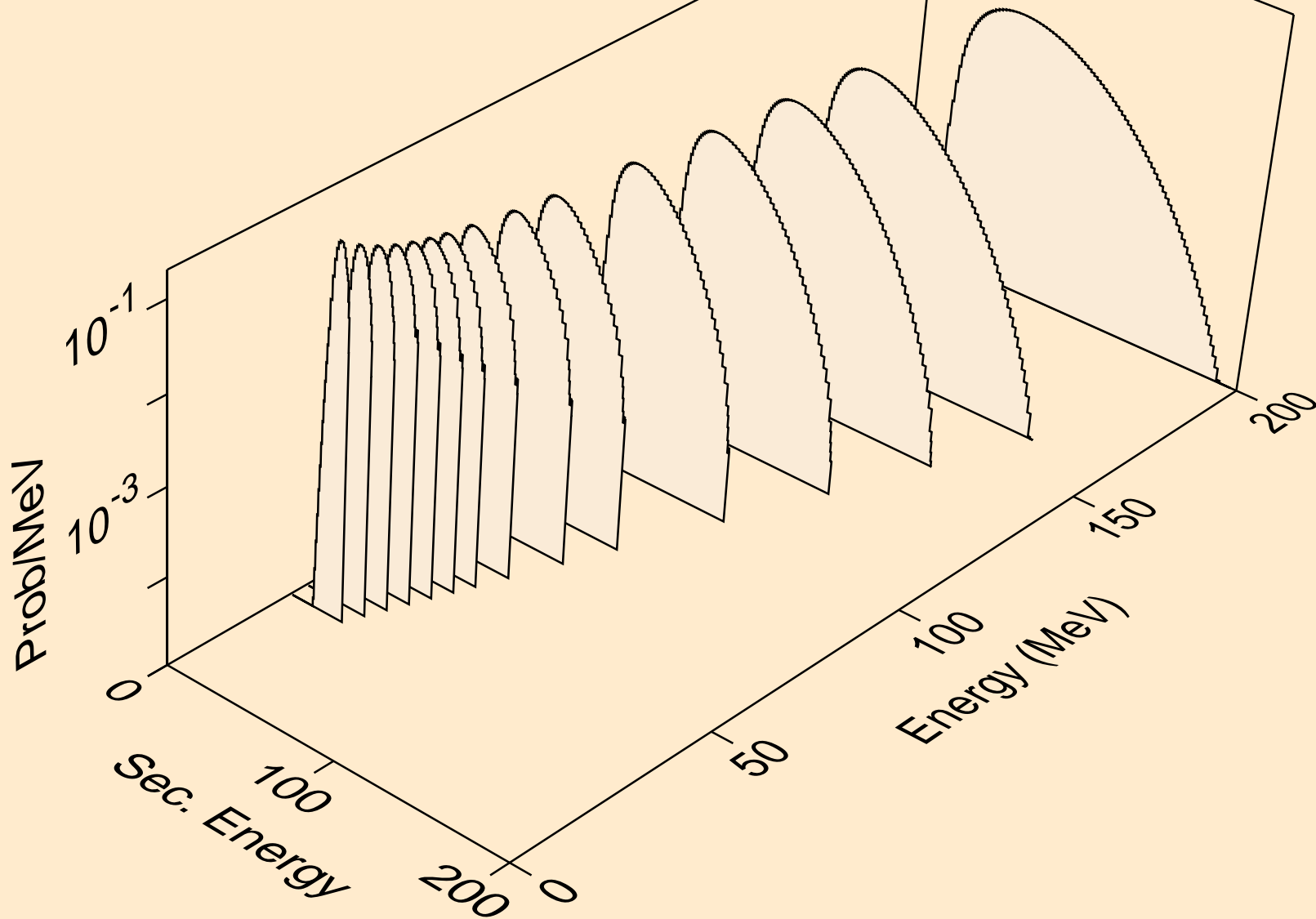

RA213 NEUTRON ACER TENDL-2019 LIBRARY; T=293.16K
he3s from (n,n*)he3

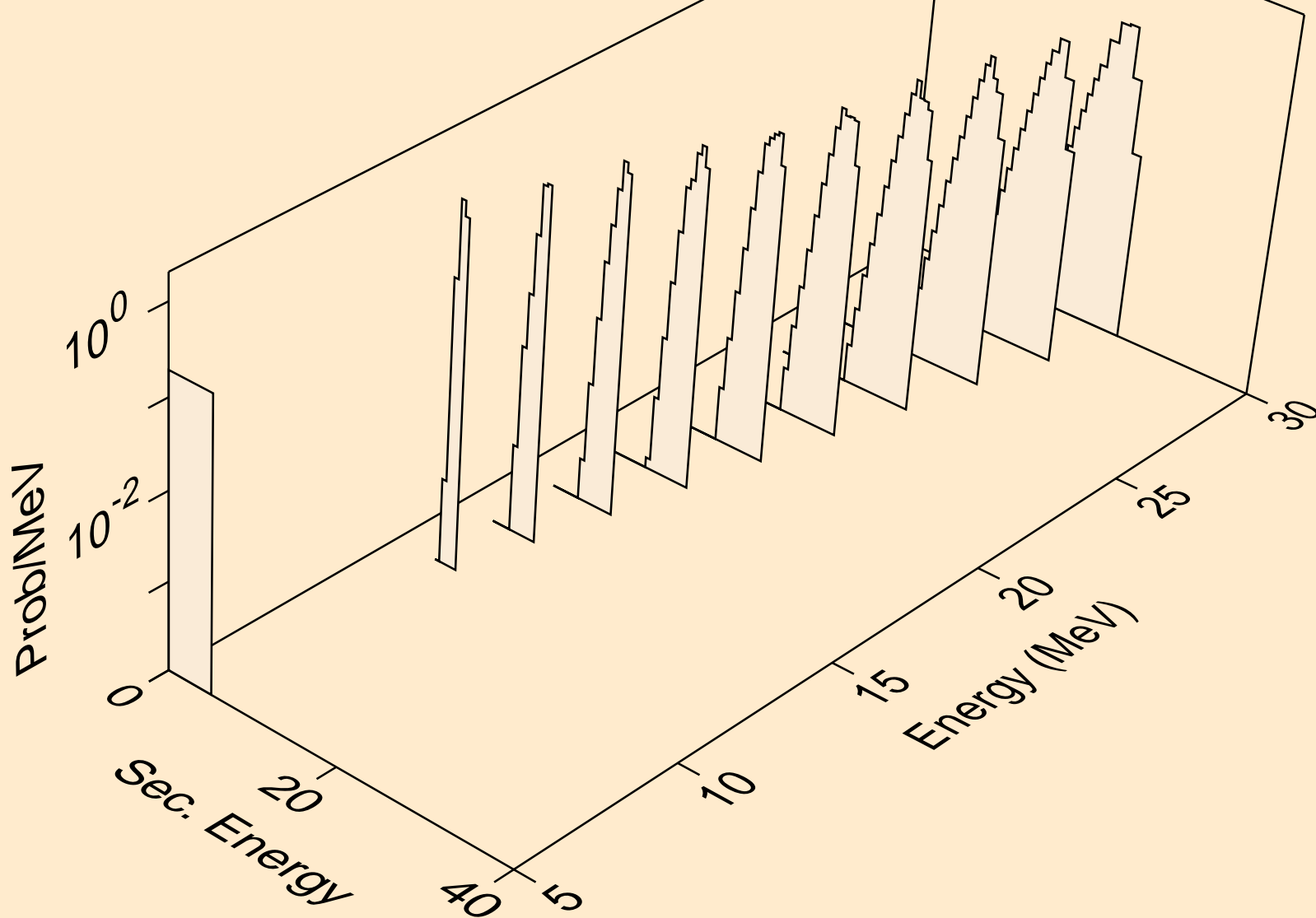

RA213 NEUTRON ACER TENDL-2019 LIBRARY; T=293.16K
he3s from (n,he3)

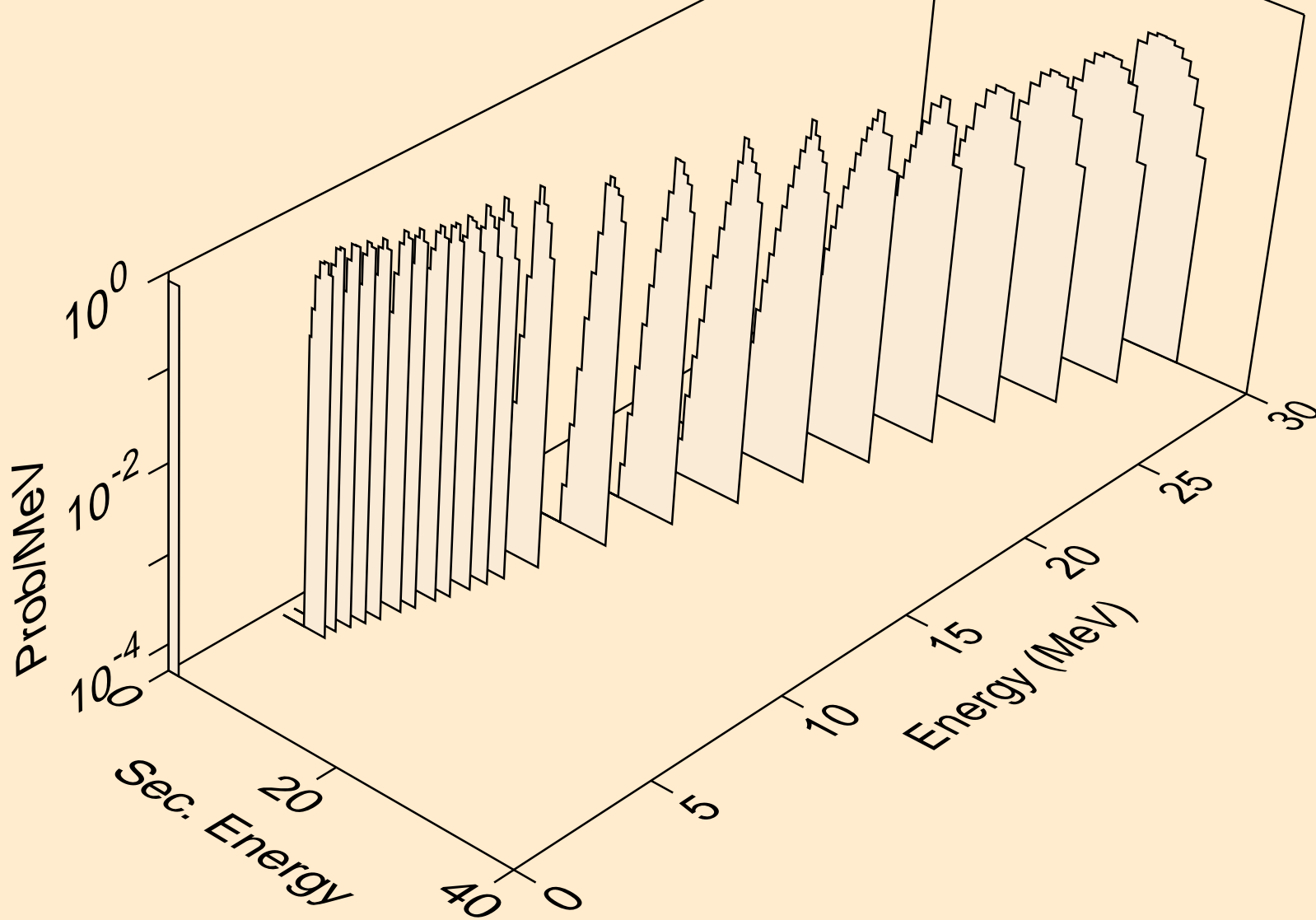

RA213 NEUTRON ACER TENDL-2019 LIBRARY; T=293.16K
alphas from (n,x)

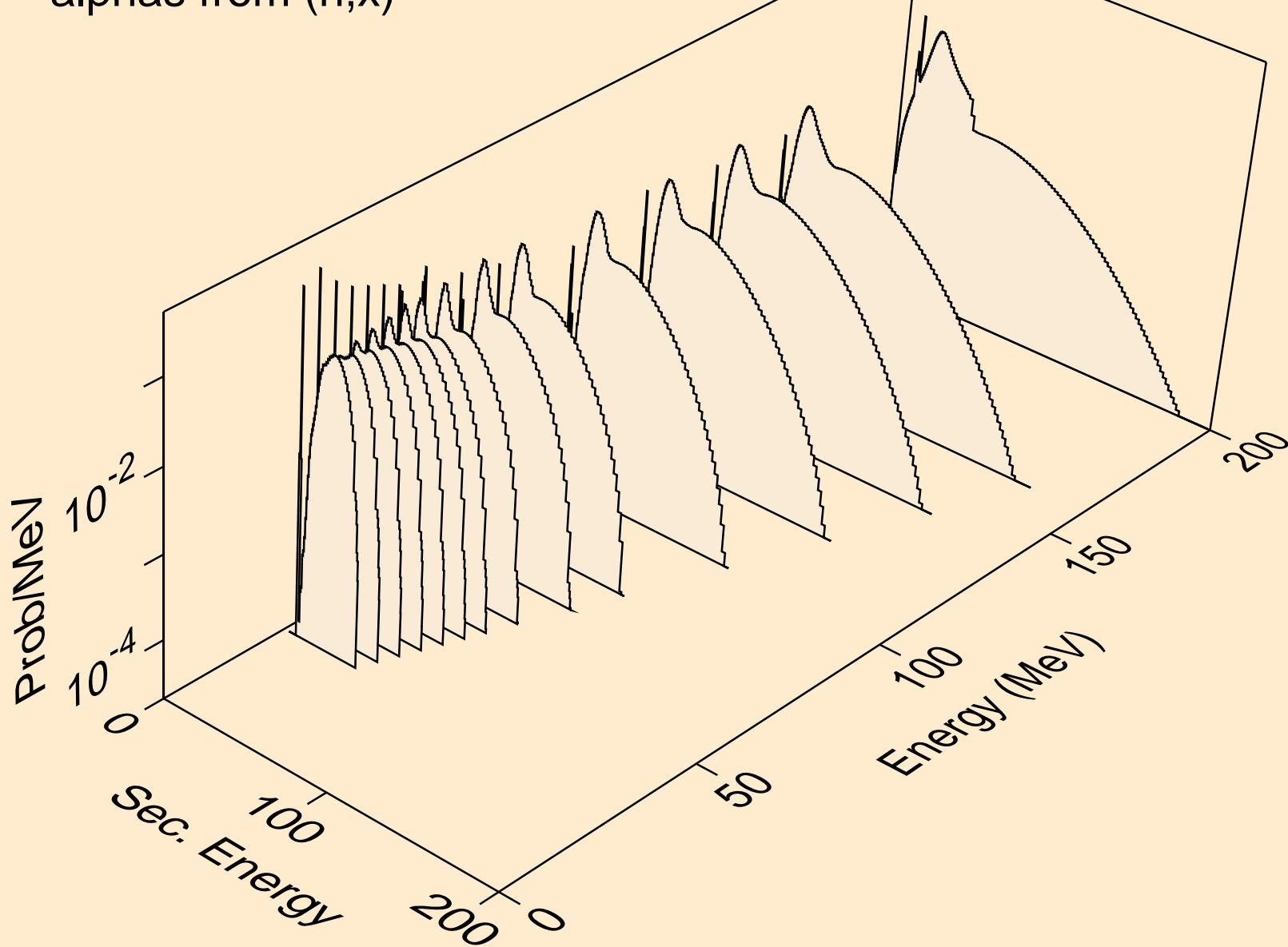

RA213 NEUTRON ACER TENDL-2019 LIBRARY; T=293.16K
alphas from (n,n*)a

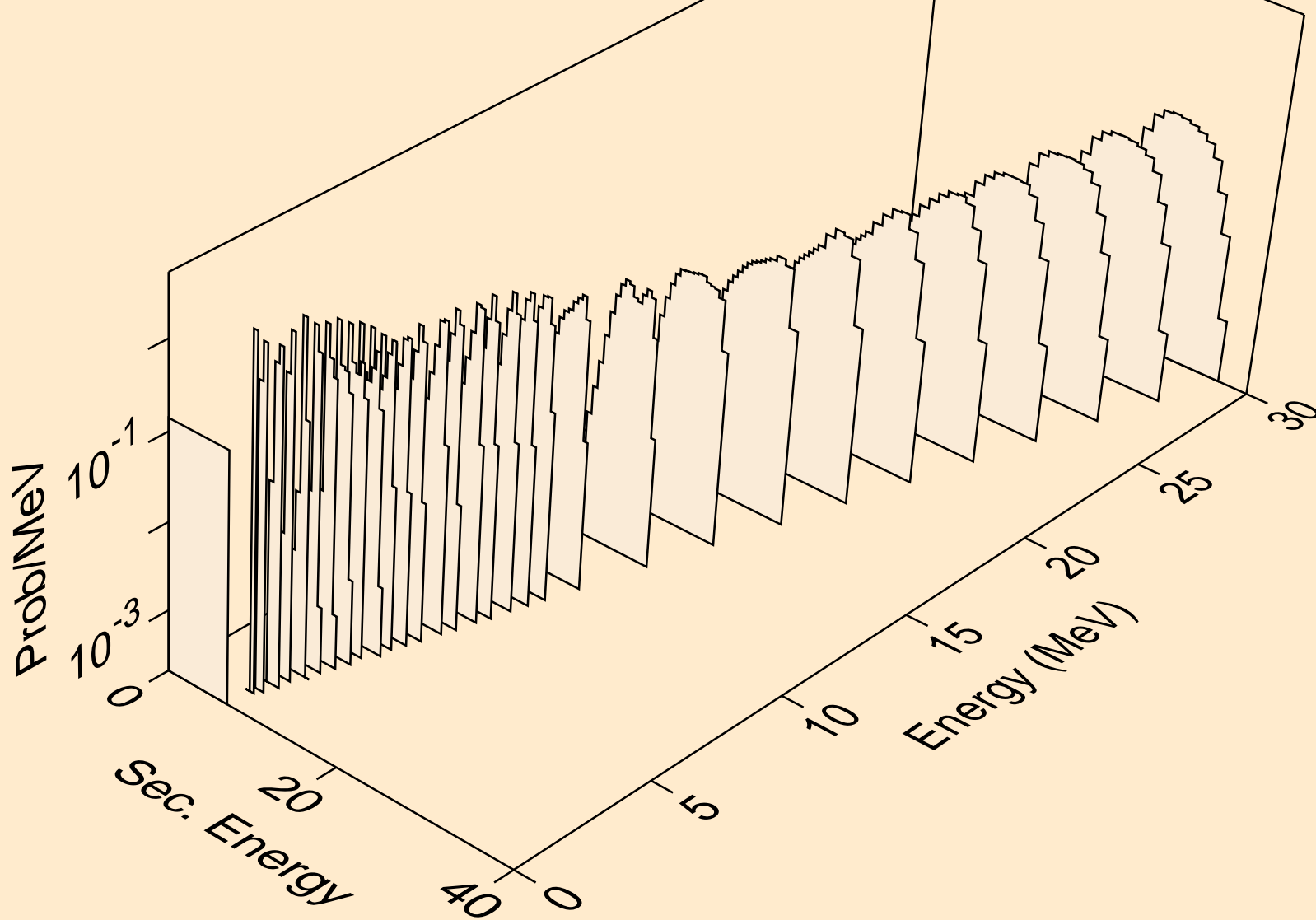

RA213 NEUTRON ACER TENDL-2019 LIBRARY; T=293.16K
alphas from (n,2n)a

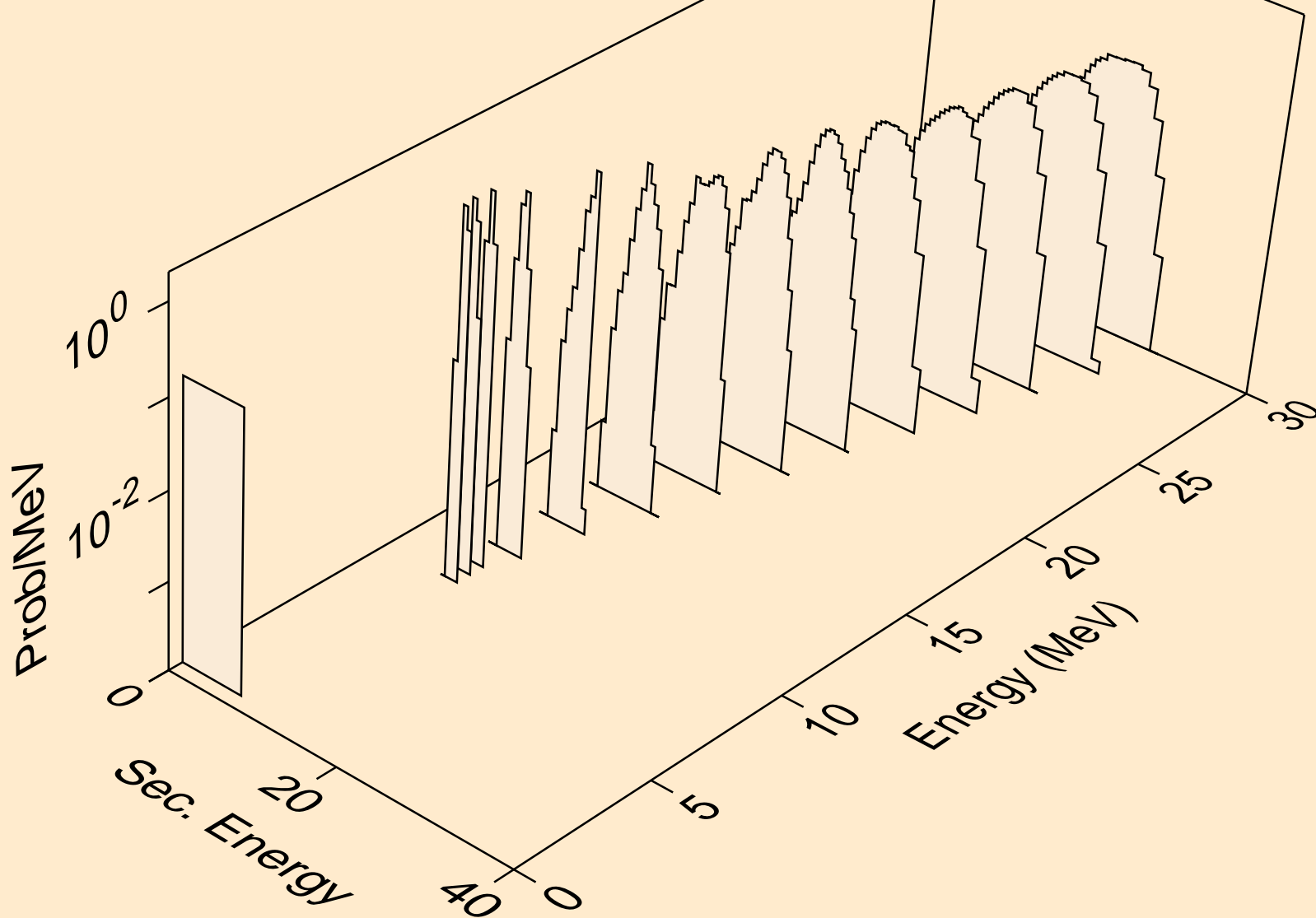

RA213 NEUTRON ACER TENDL-2019 LIBRARY; T=293.16K
alphas from (n,3n)a

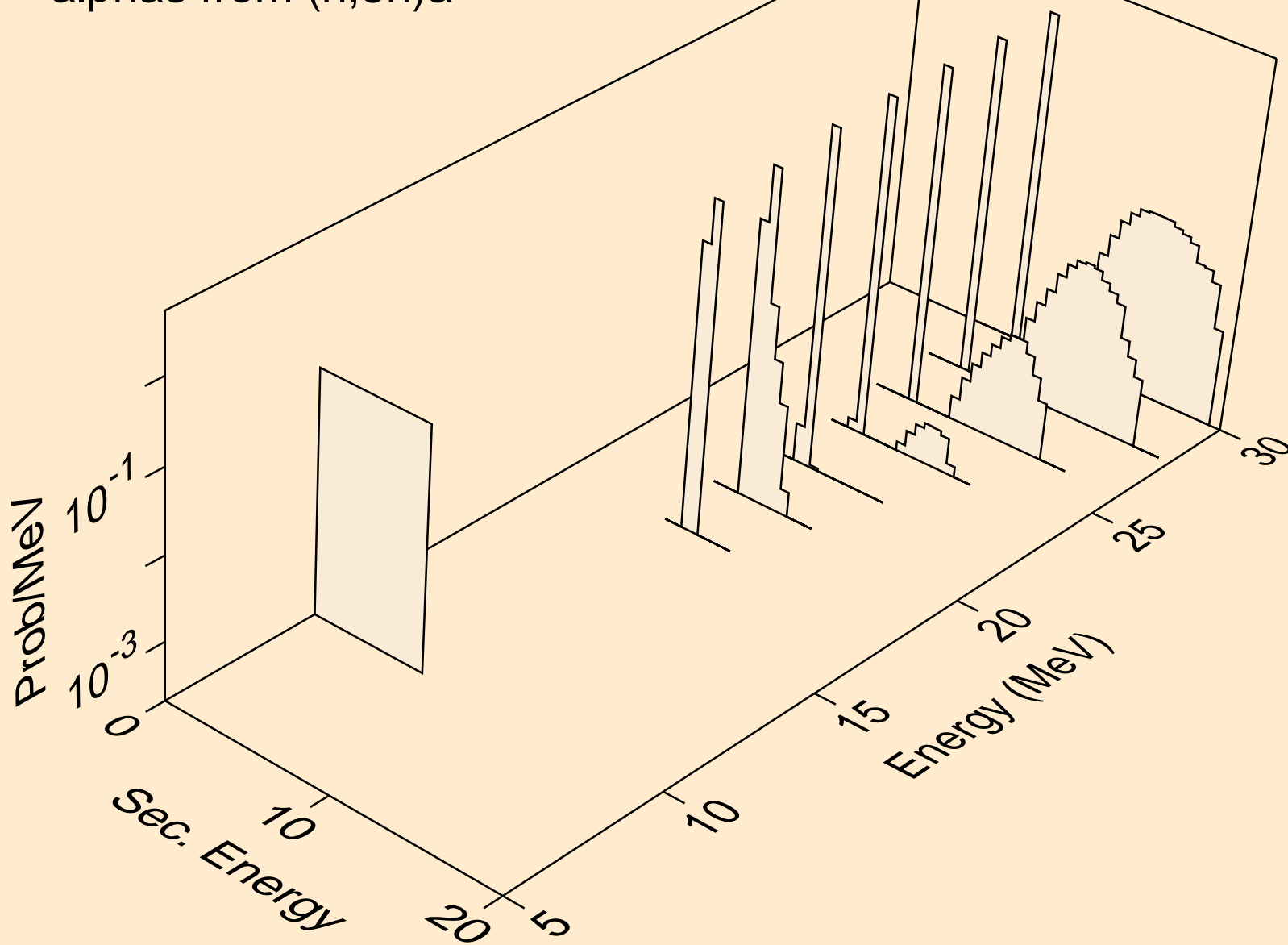

RA213 NEUTRON ACER TENDL-2019 LIBRARY; T=293.16K
alphas from (n,n*)2a

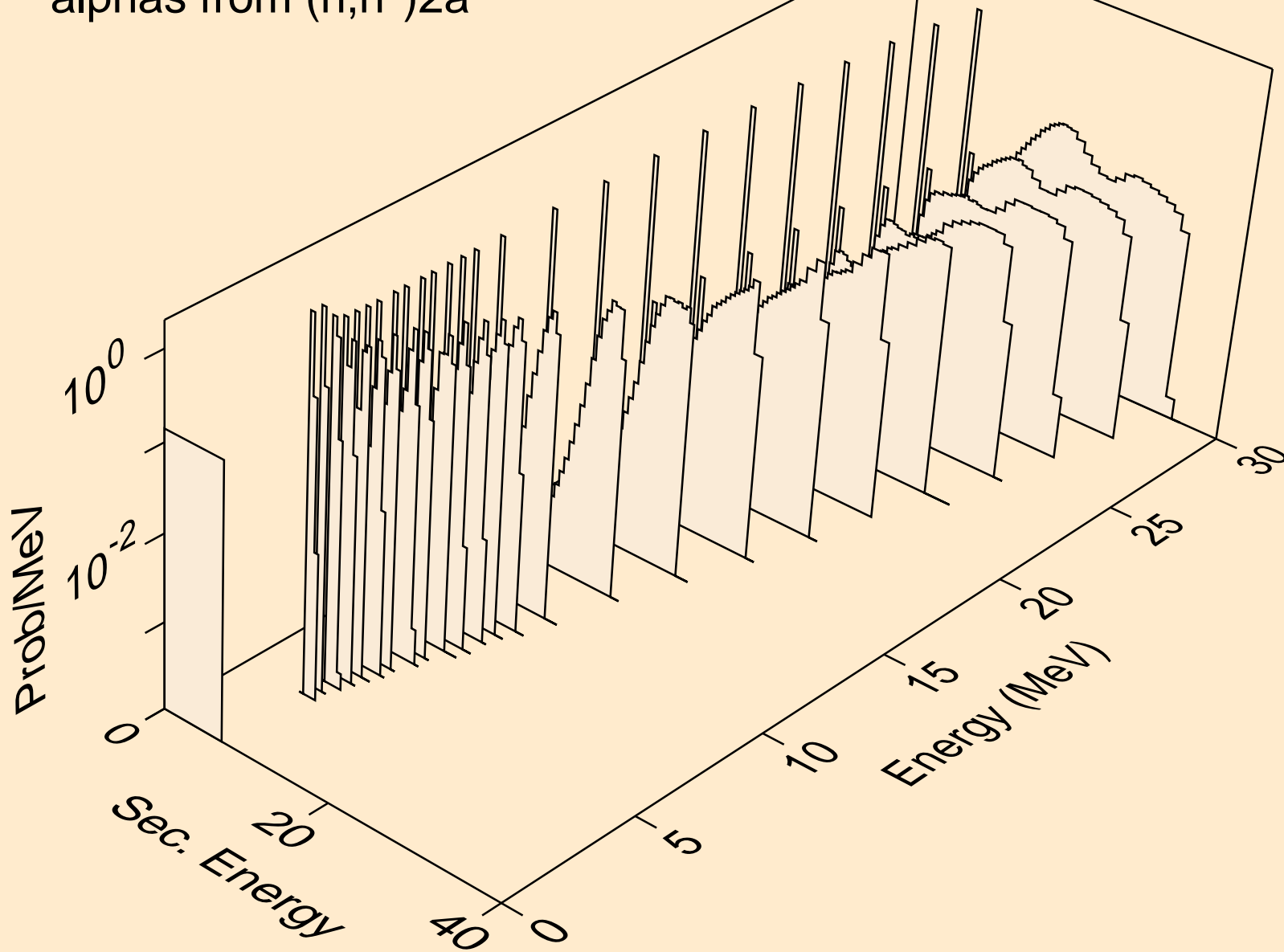

RA213 NEUTRON ACER TENDL-2019 LIBRARY; T=293.16K
alphas from (n,2n)2a

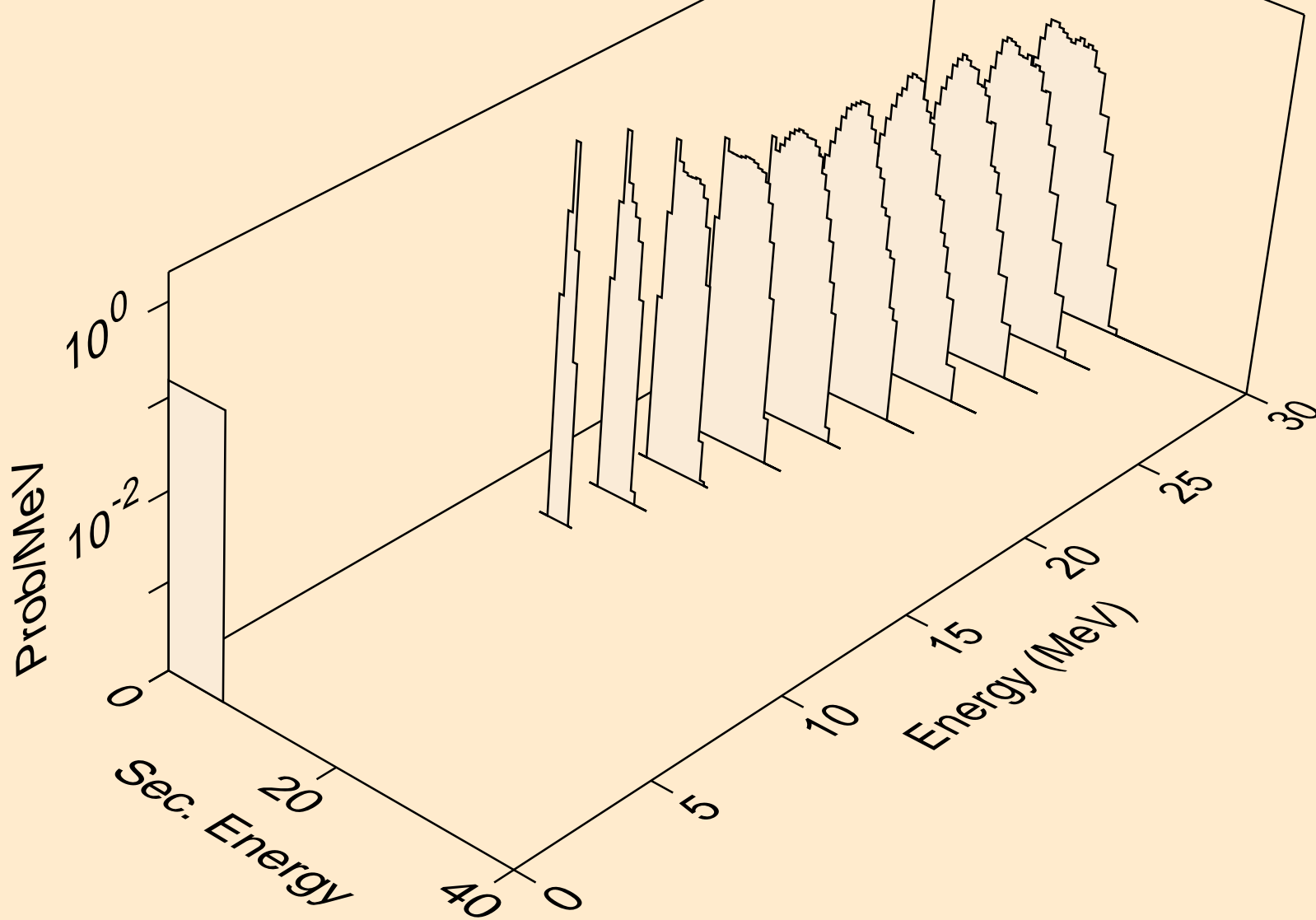

RA213 NEUTRON ACER TENDL-2019 LIBRARY; T=293.16K
alphas from (n,npa)

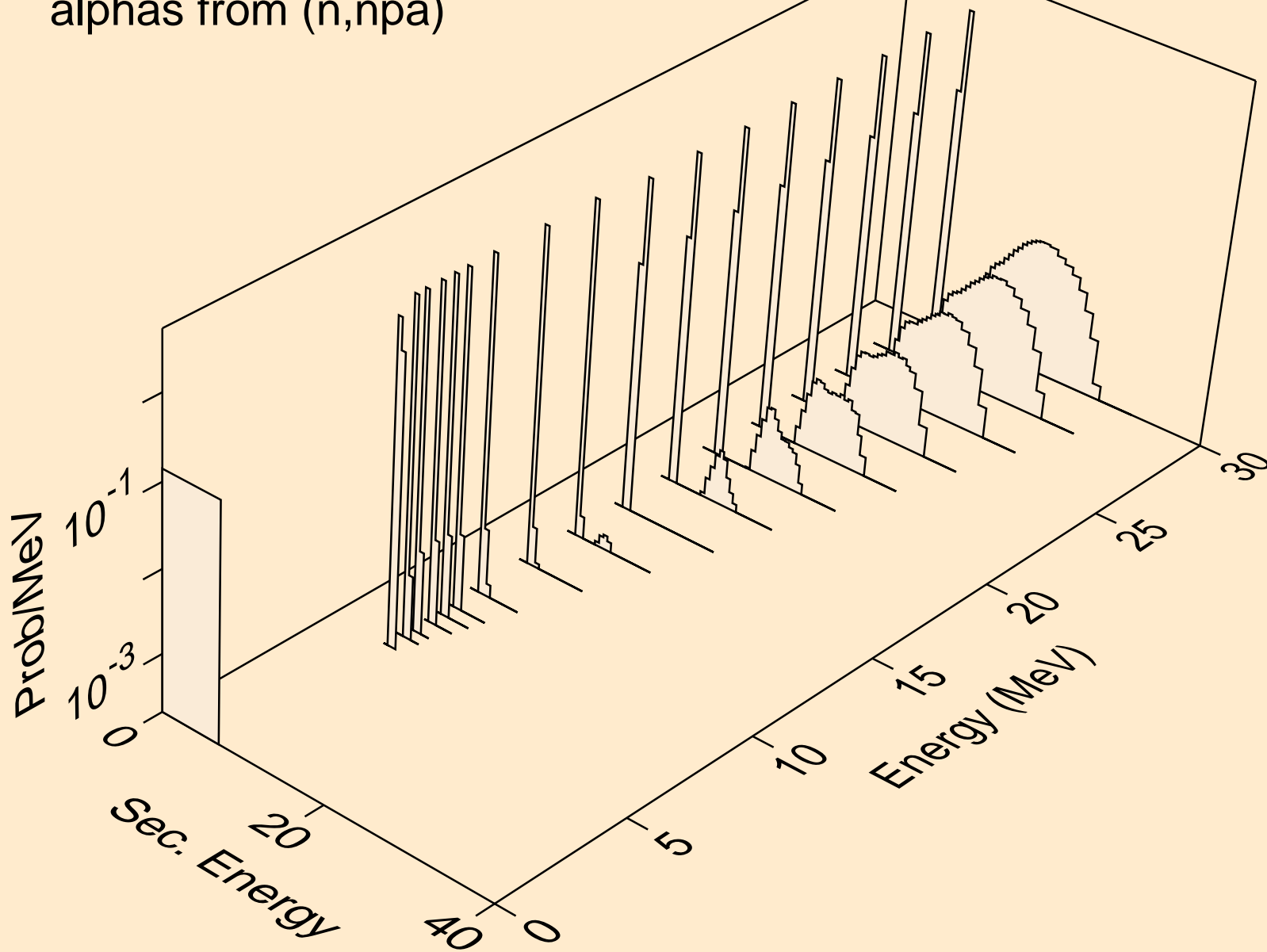

RA213 NEUTRON ACER TENDL-2019 LIBRARY; T=293.16K
alphas from (n,a)

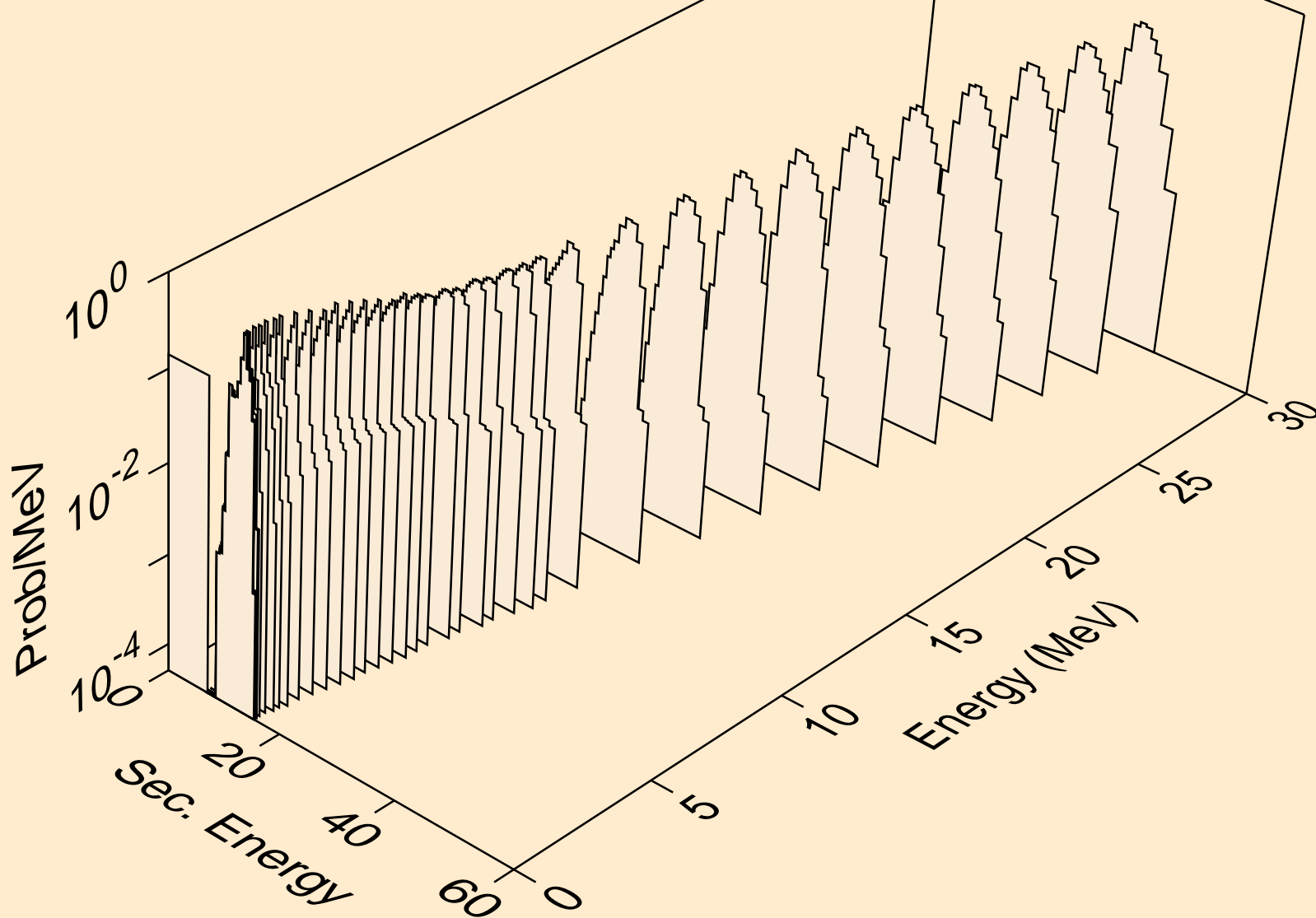

RA213 NEUTRON ACER TENDL-2019 LIBRARY; T=293.16K
alphas from (n,2a)

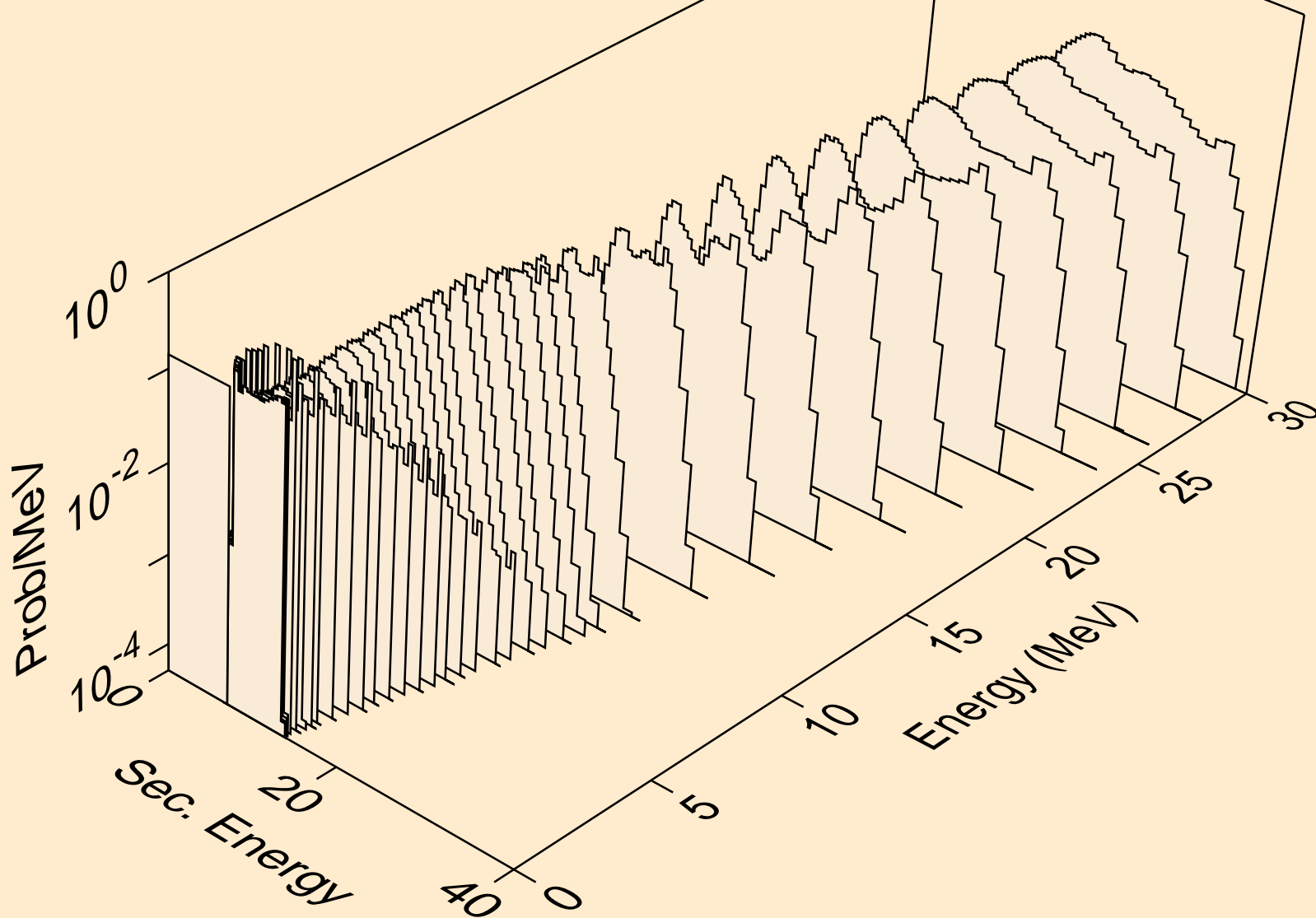

RA213 NEUTRON ACER TENDL-2019 LIBRARY; T=293.16K
alphas from (n,pa)

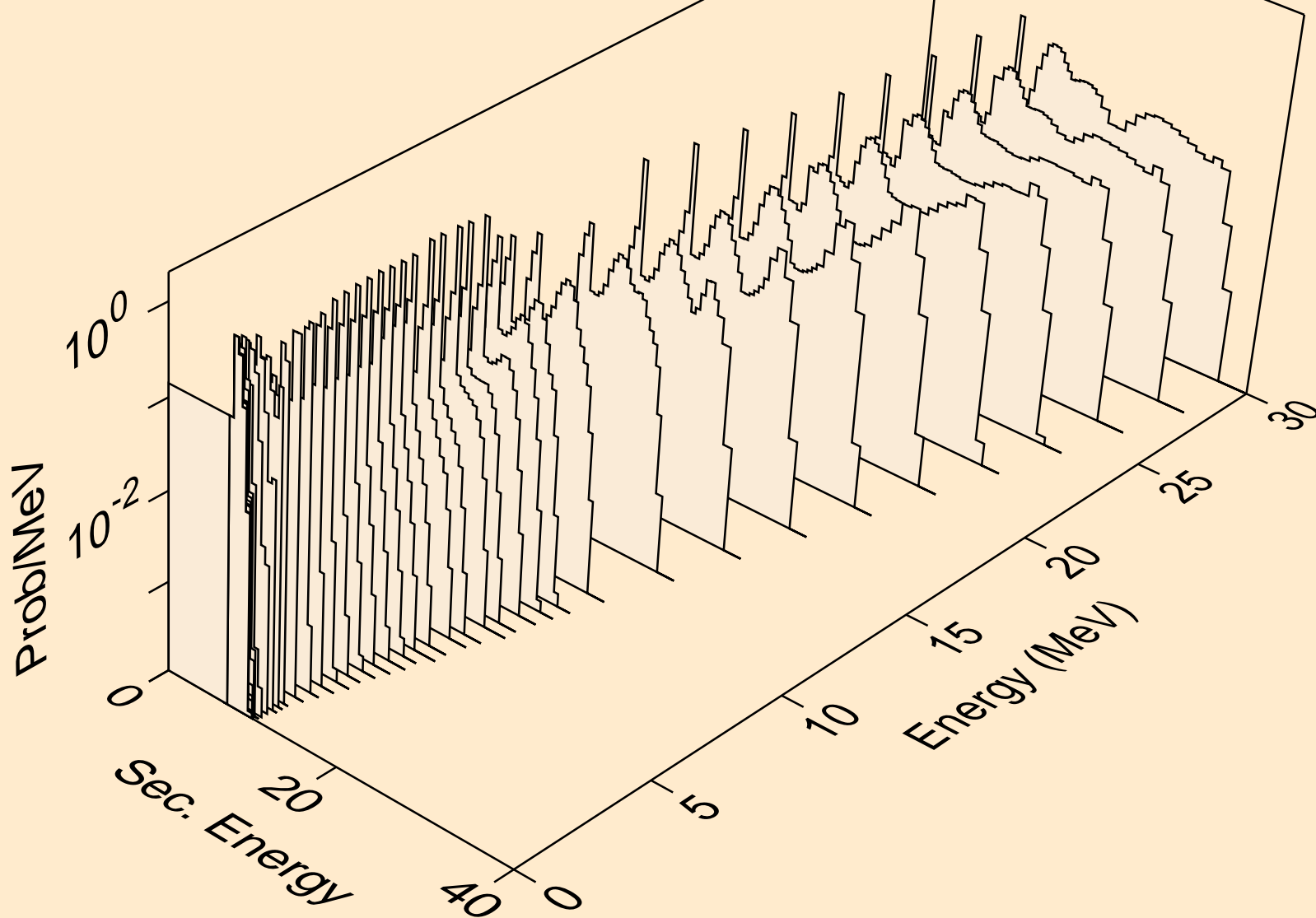

RA213 NEUTRON ACER TENDL-2019 LIBRARY; T=293.16K
alphas from (n,t2a)

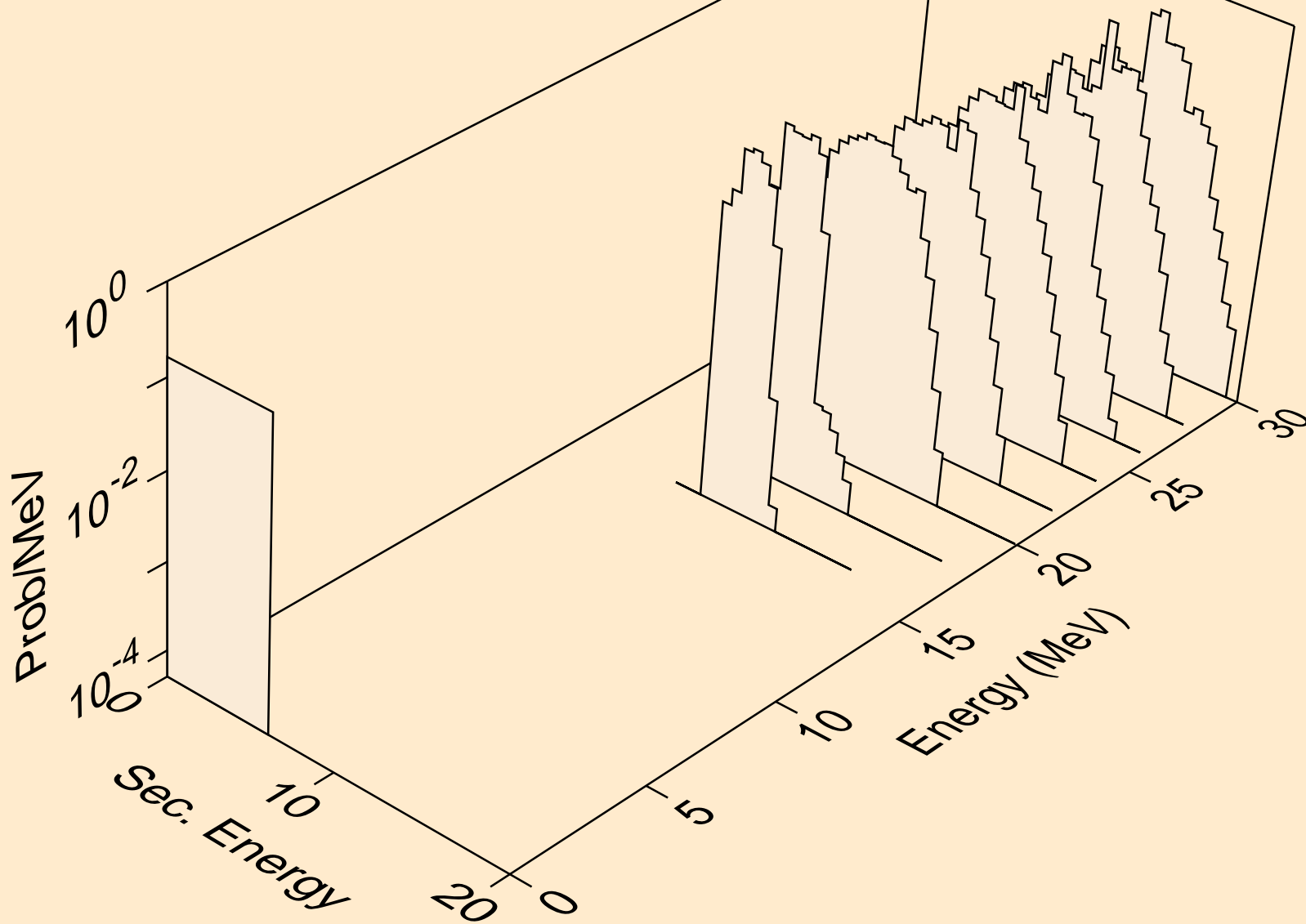

RA213 NEUTRON ACER TENDL-2019 LIBRARY; T=293.16K
alphas from (n,da)

