

RA225 NEUTRON ACER TENDL-2019 LIBRARY; T=293.16K
Principal cross sections

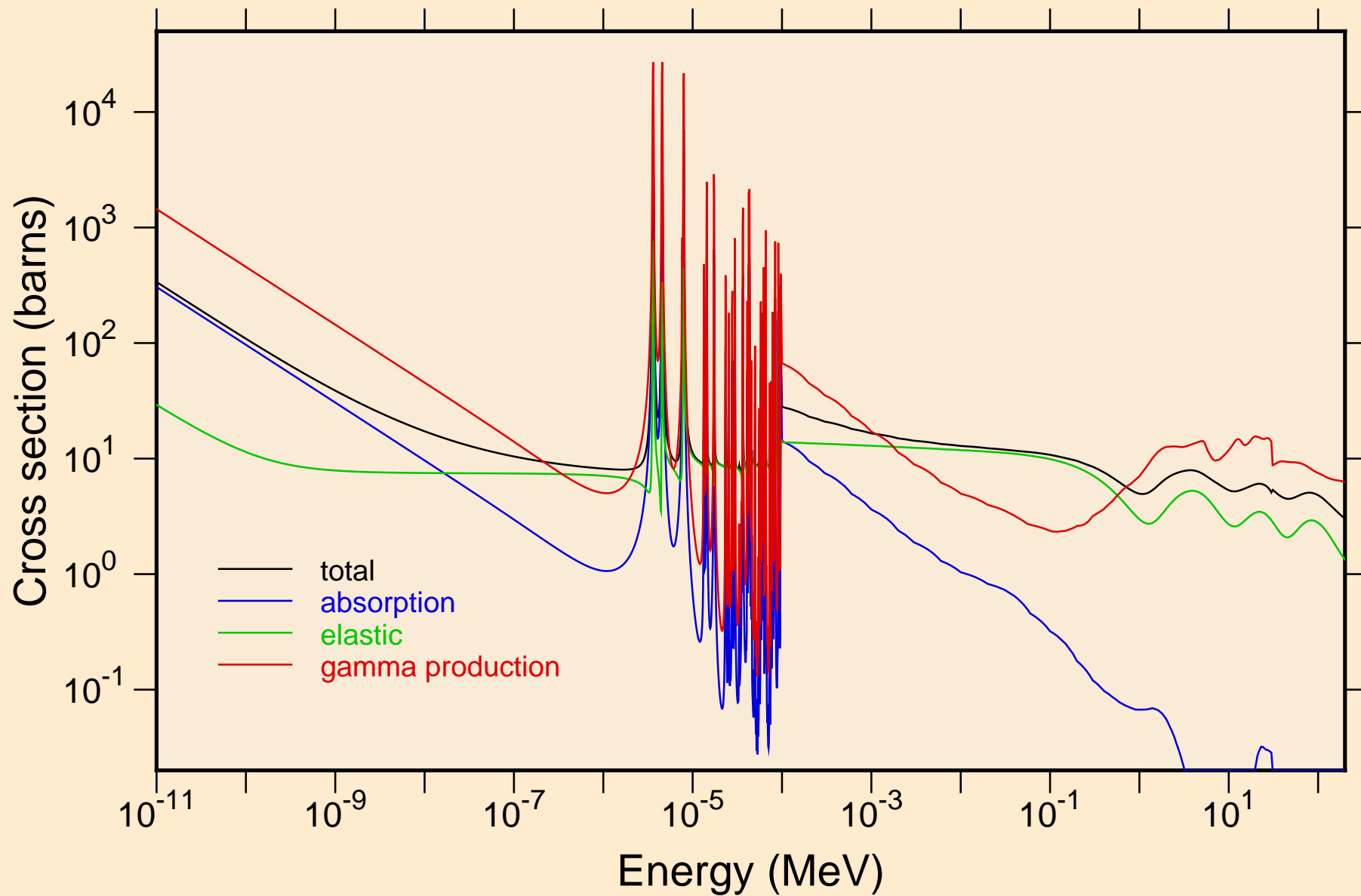

RA225 NEUTRON ACER TENDL-2019 LIBRARY; T=293.16K
resonance total cross section

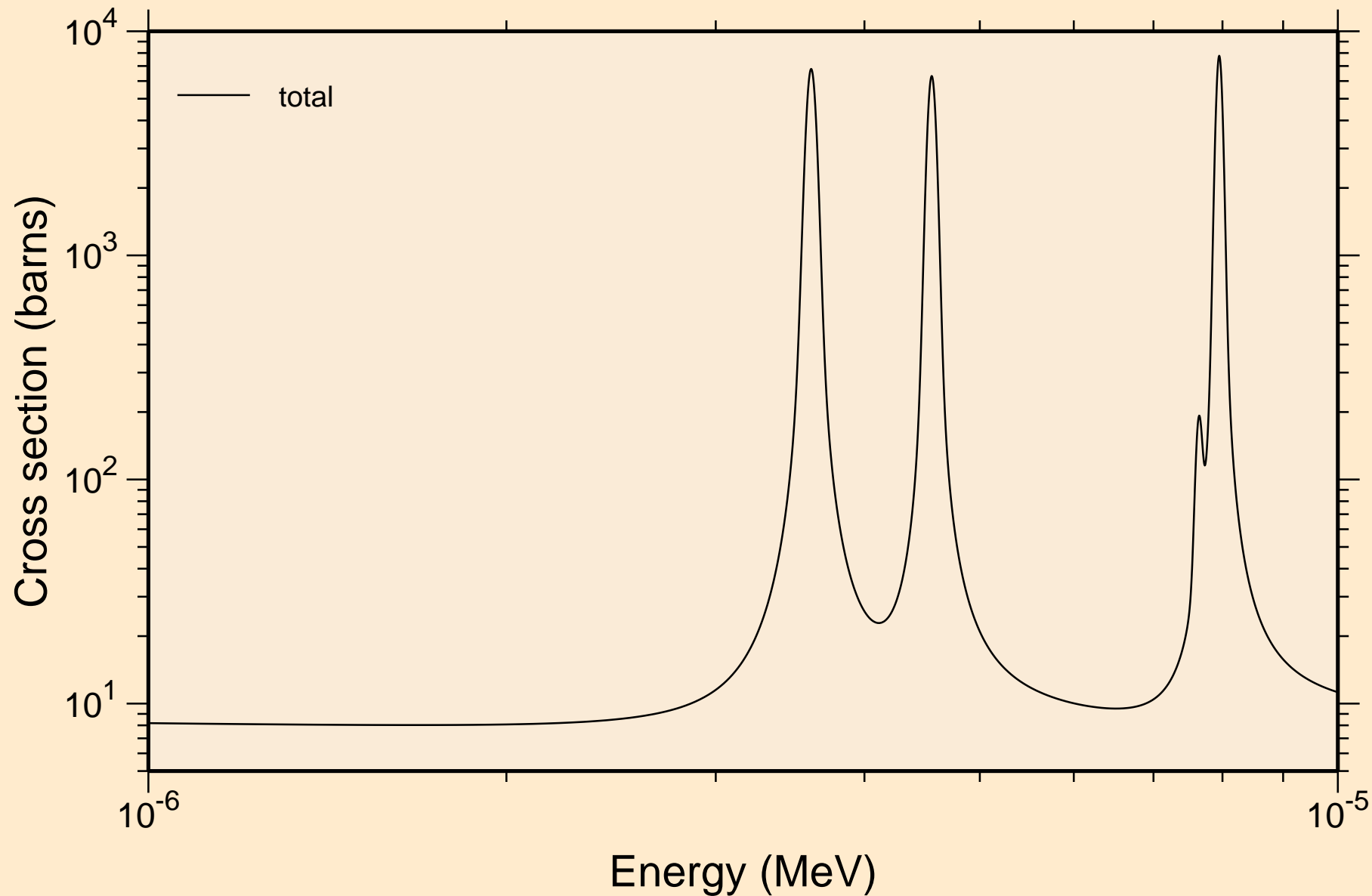

RA225 NEUTRON ACER TENDL-2019 LIBRARY; T=293.16K
resonance total cross section

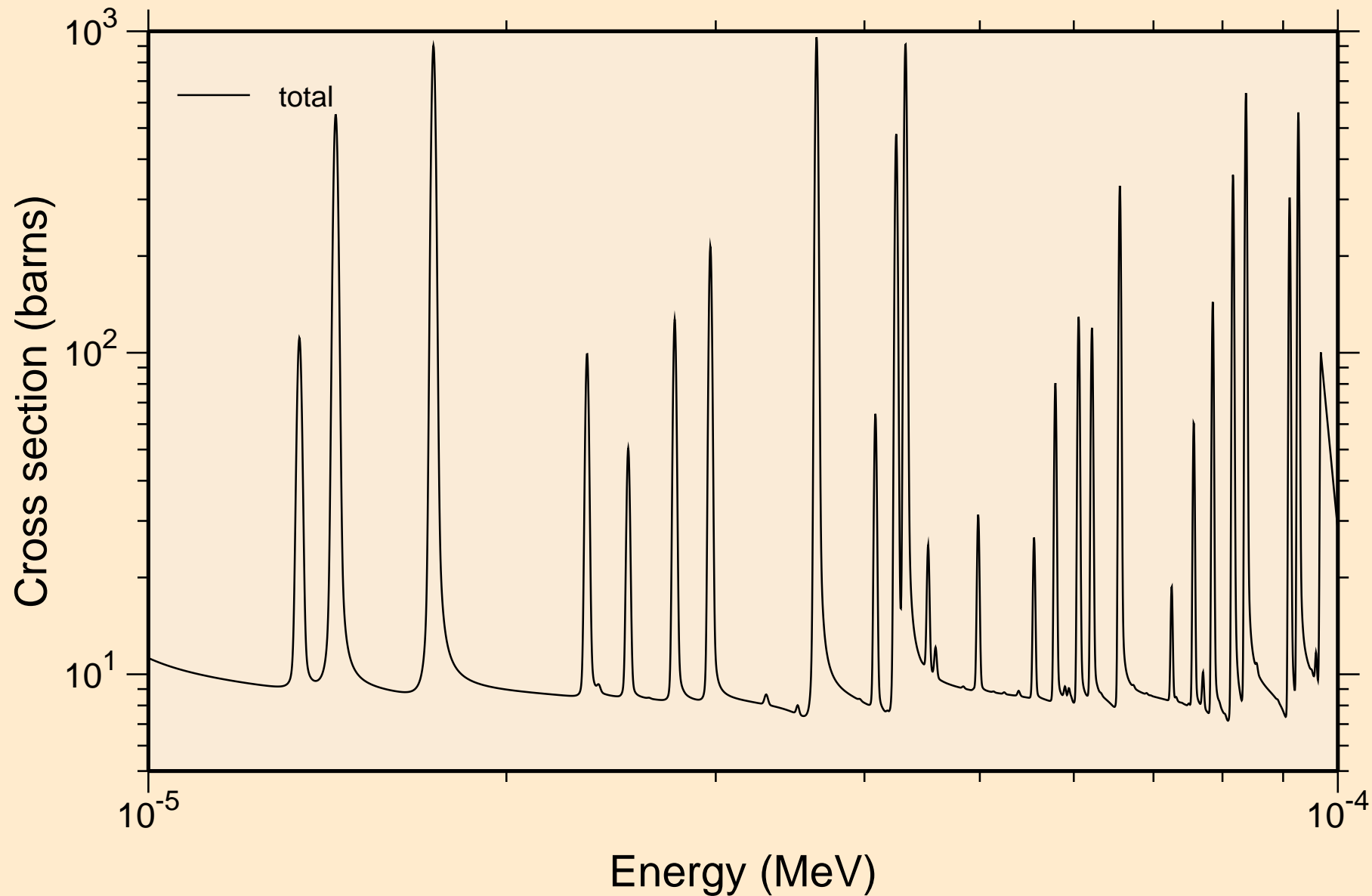

RA225 NEUTRON ACER TENDL-2019 LIBRARY; T=293.16K
resonance total cross section

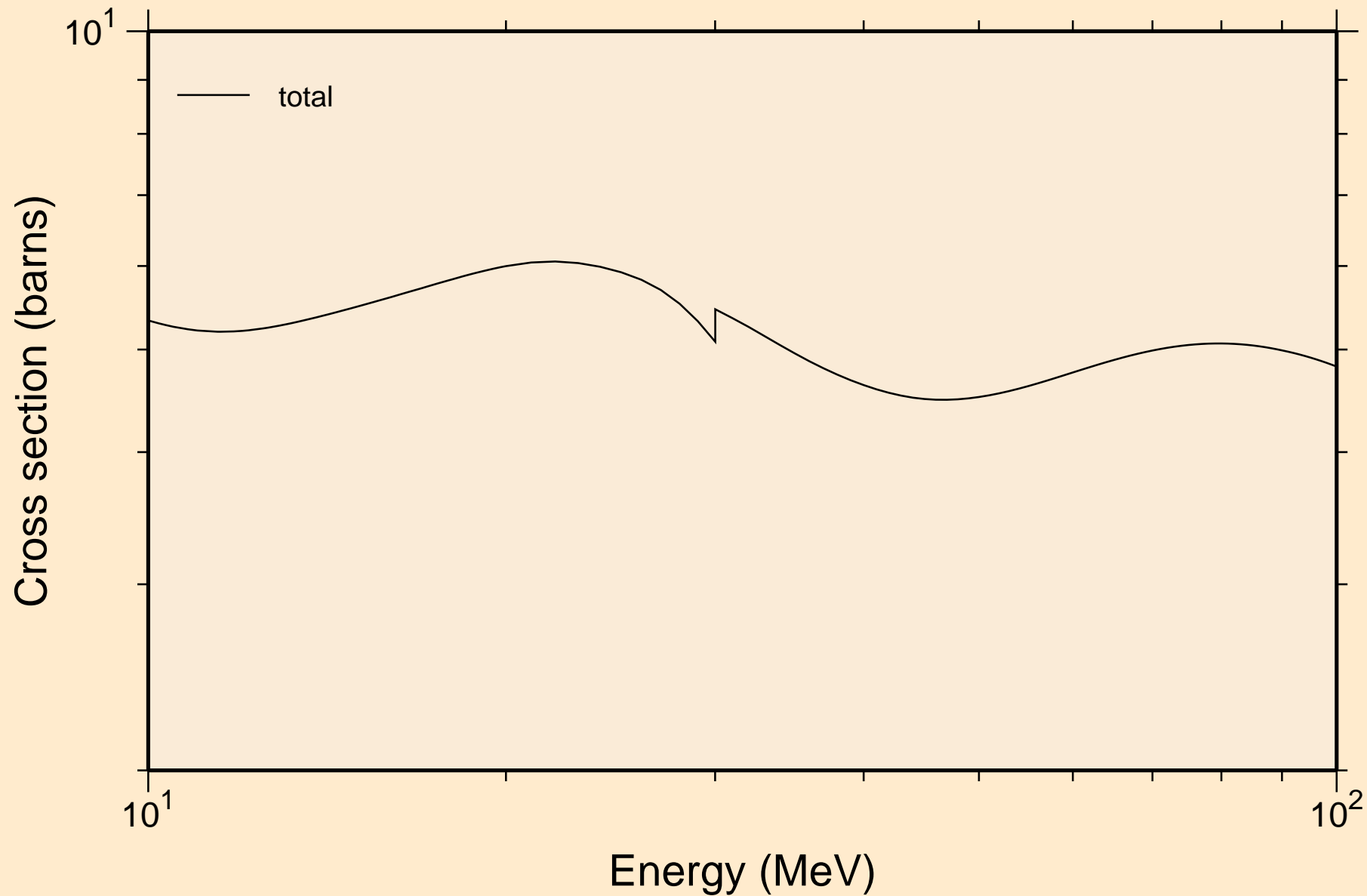

RA225 NEUTRON ACER TENDL-2019 LIBRARY; T=293.16K
resonance absorption cross sections

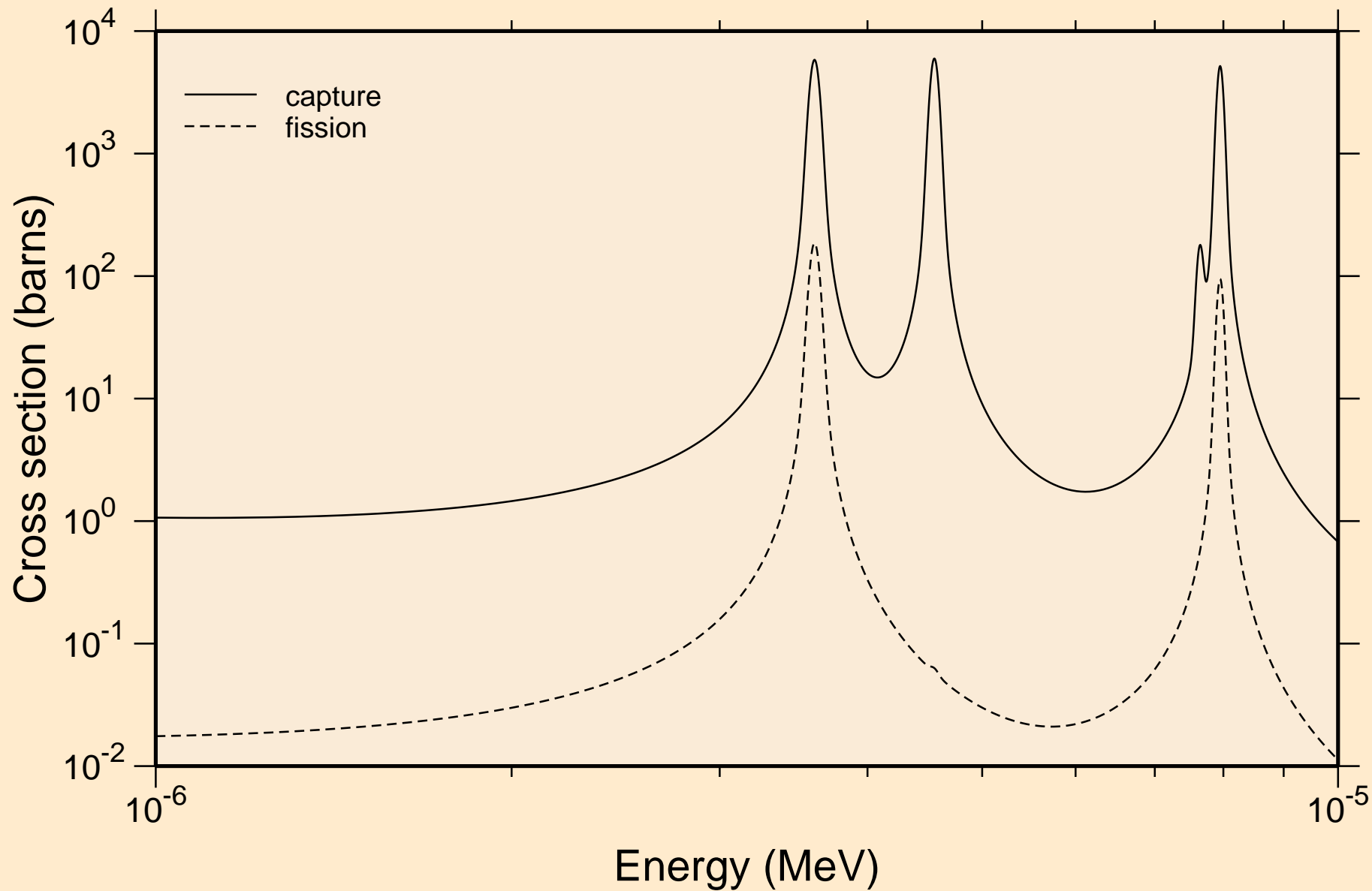

RA225 NEUTRON ACER TENDL-2019 LIBRARY; T=293.16K
resonance absorption cross sections

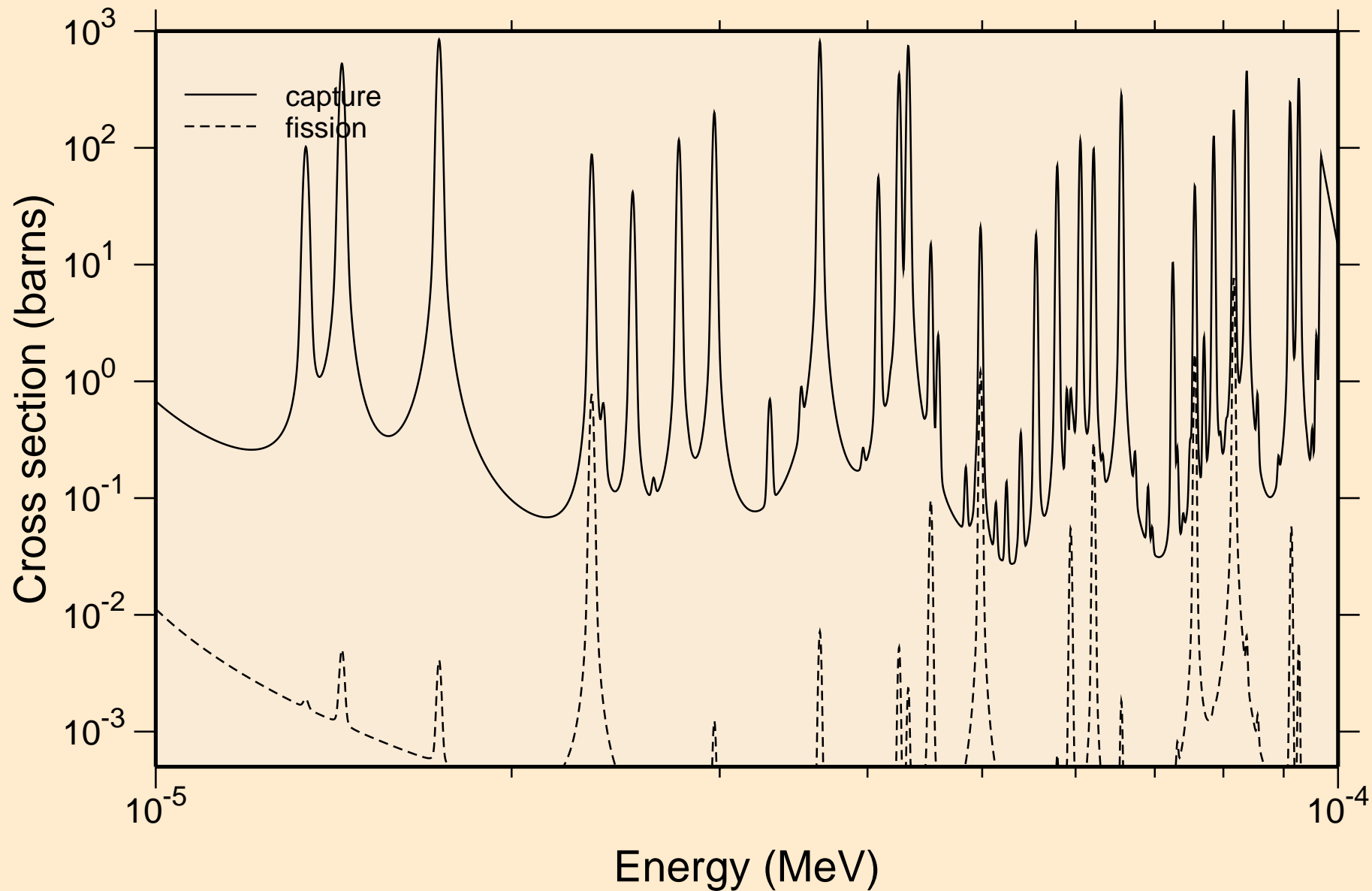

RA225 NEUTRON ACER TENDL-2019 LIBRARY; T=293.16K
resonance absorption cross sections

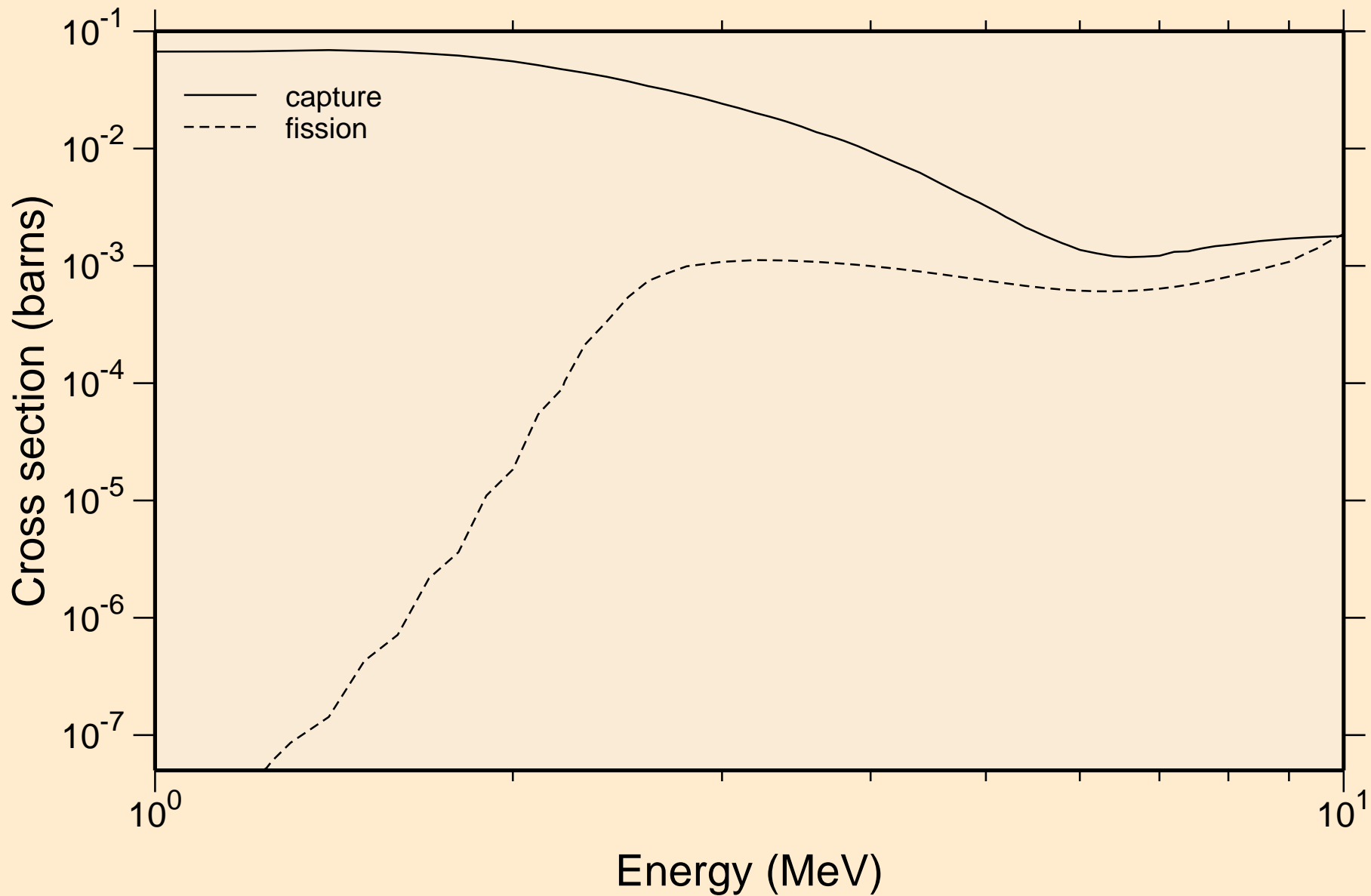

RA225 NEUTRON ACER TENDL-2019 LIBRARY; T=293.16K
Heating

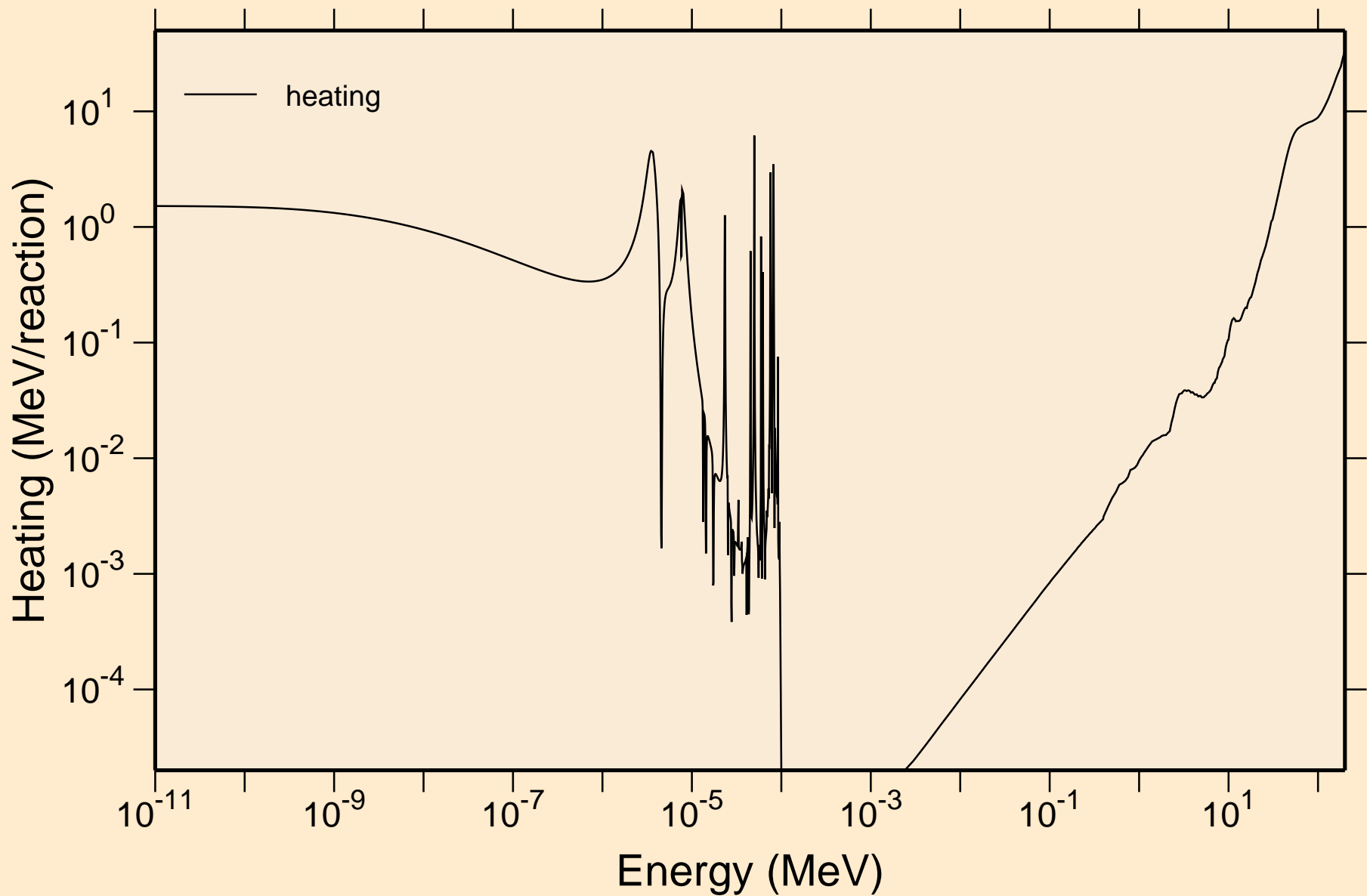

RA225 NEUTRON ACER TENDL-2019 LIBRARY; T=293.16K
Damage

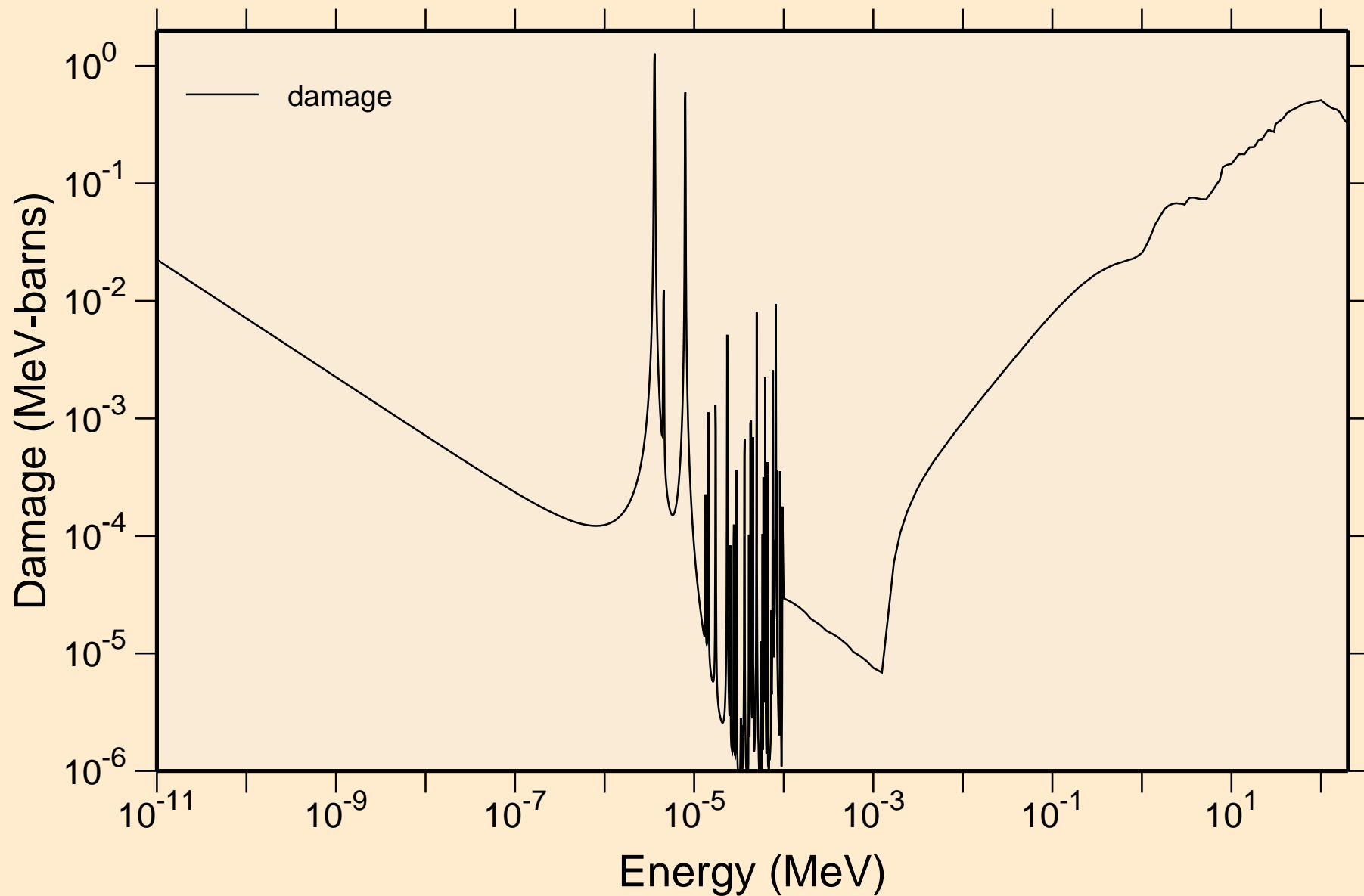

RA225 NEUTRON ACER TENDL-2019 LIBRARY; T=293.16K

Non-threshold reactions

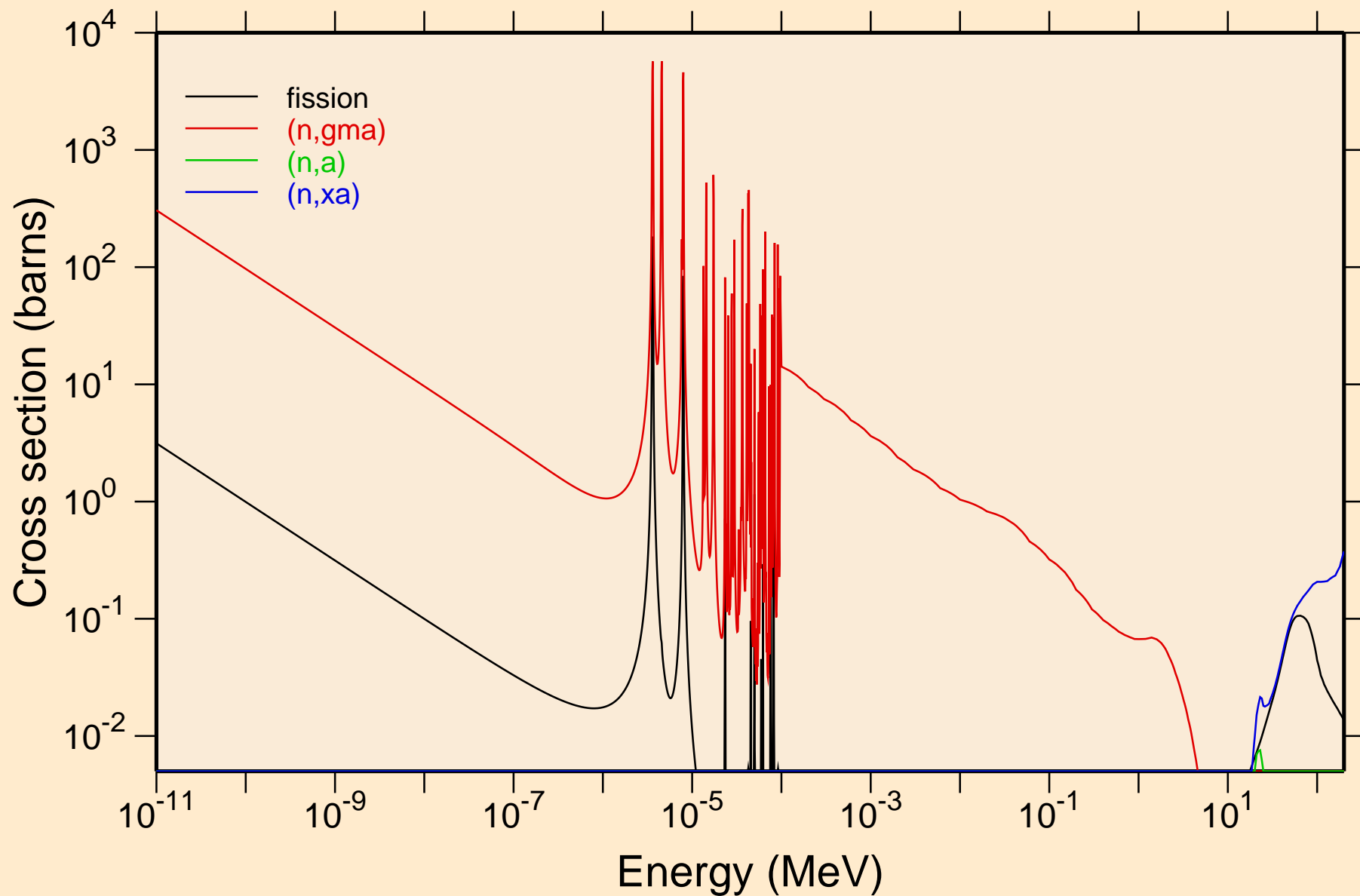

RA225 NEUTRON ACER TENDL-2019 LIBRARY; T=293.16K
Principal cross sections

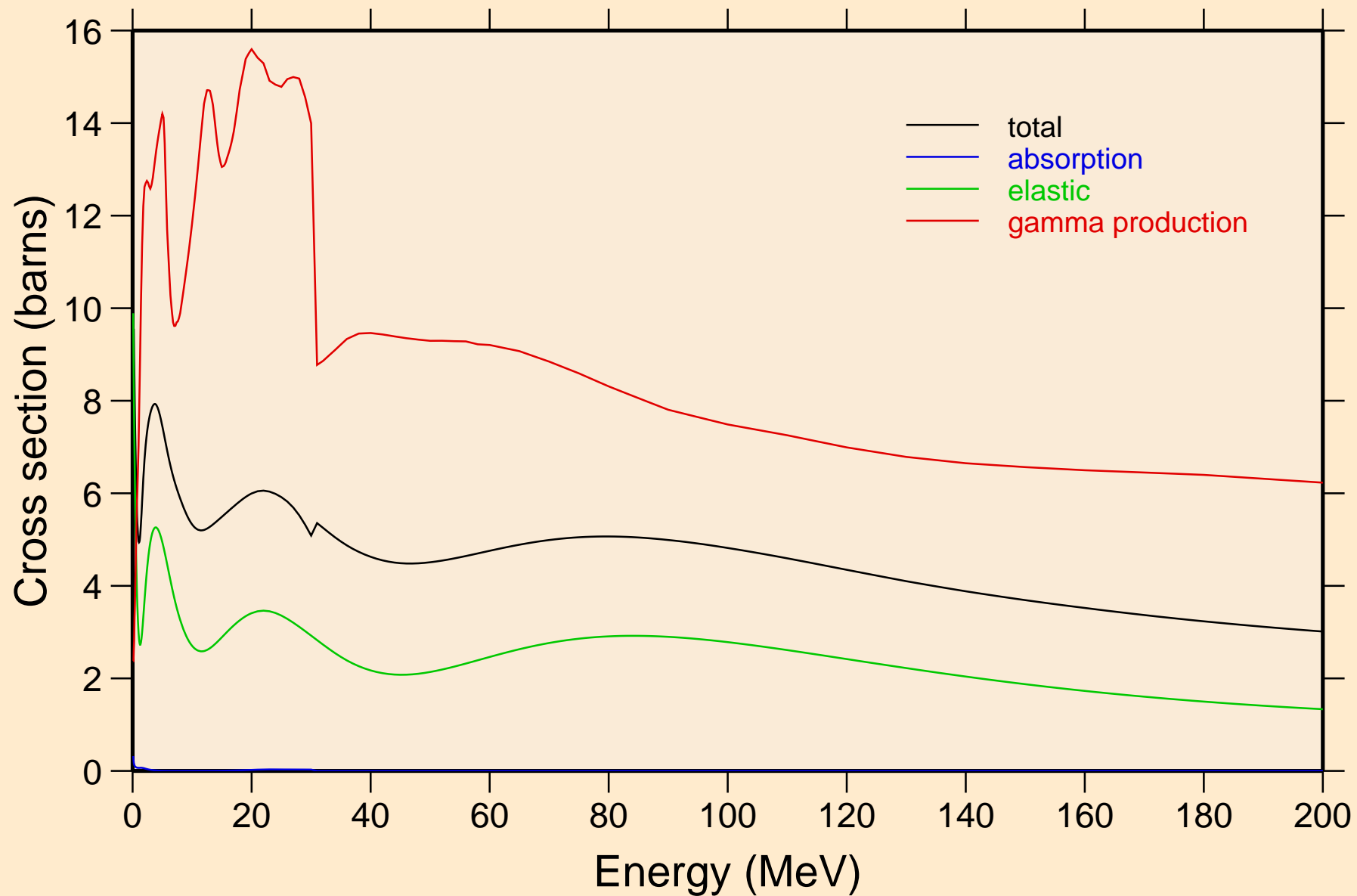

RA225 NEUTRON ACER TENDL-2019 LIBRARY; T=293.16K
Heating

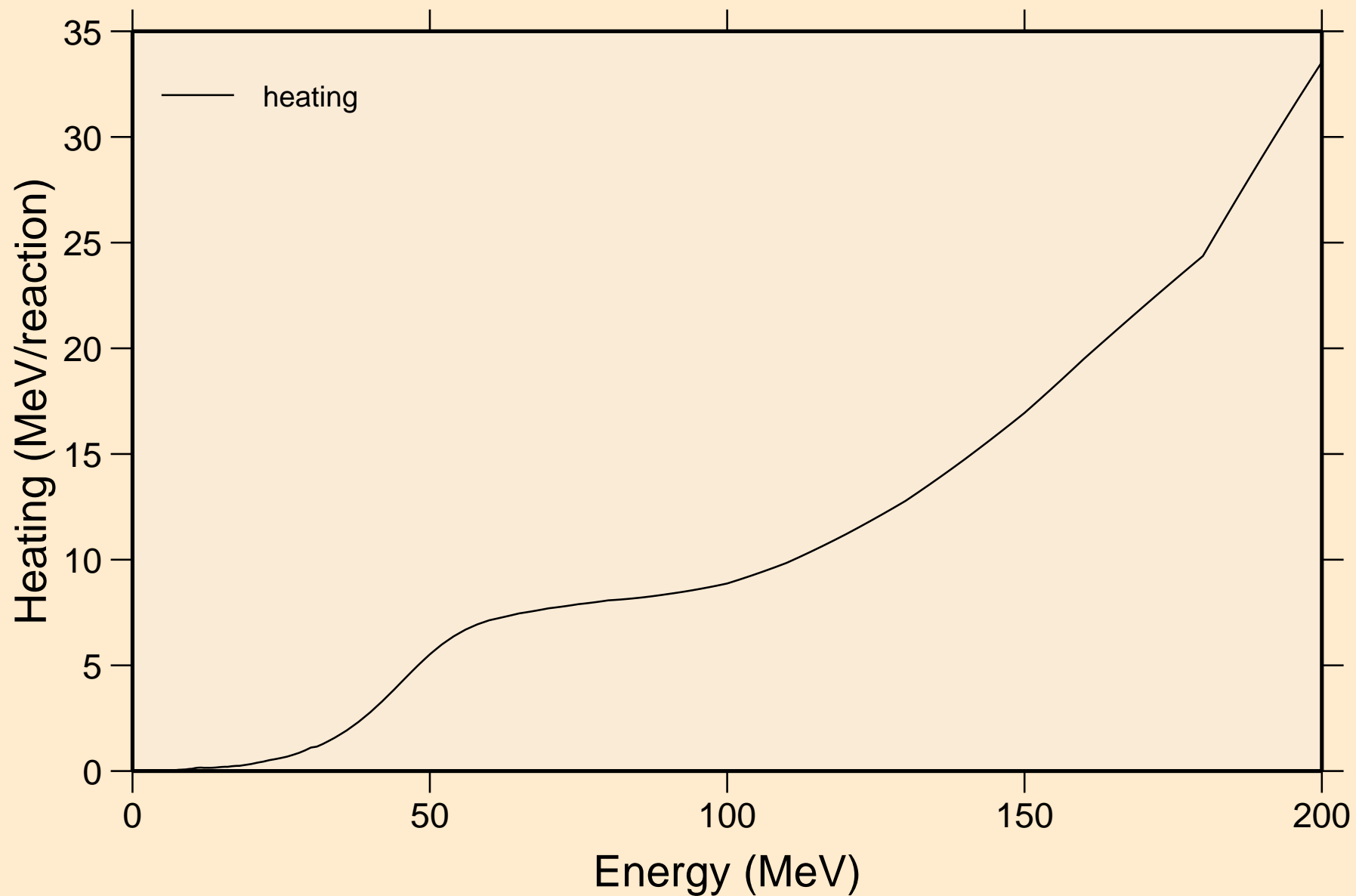

RA225 NEUTRON ACER TENDL-2019 LIBRARY; T=293.16K
Damage

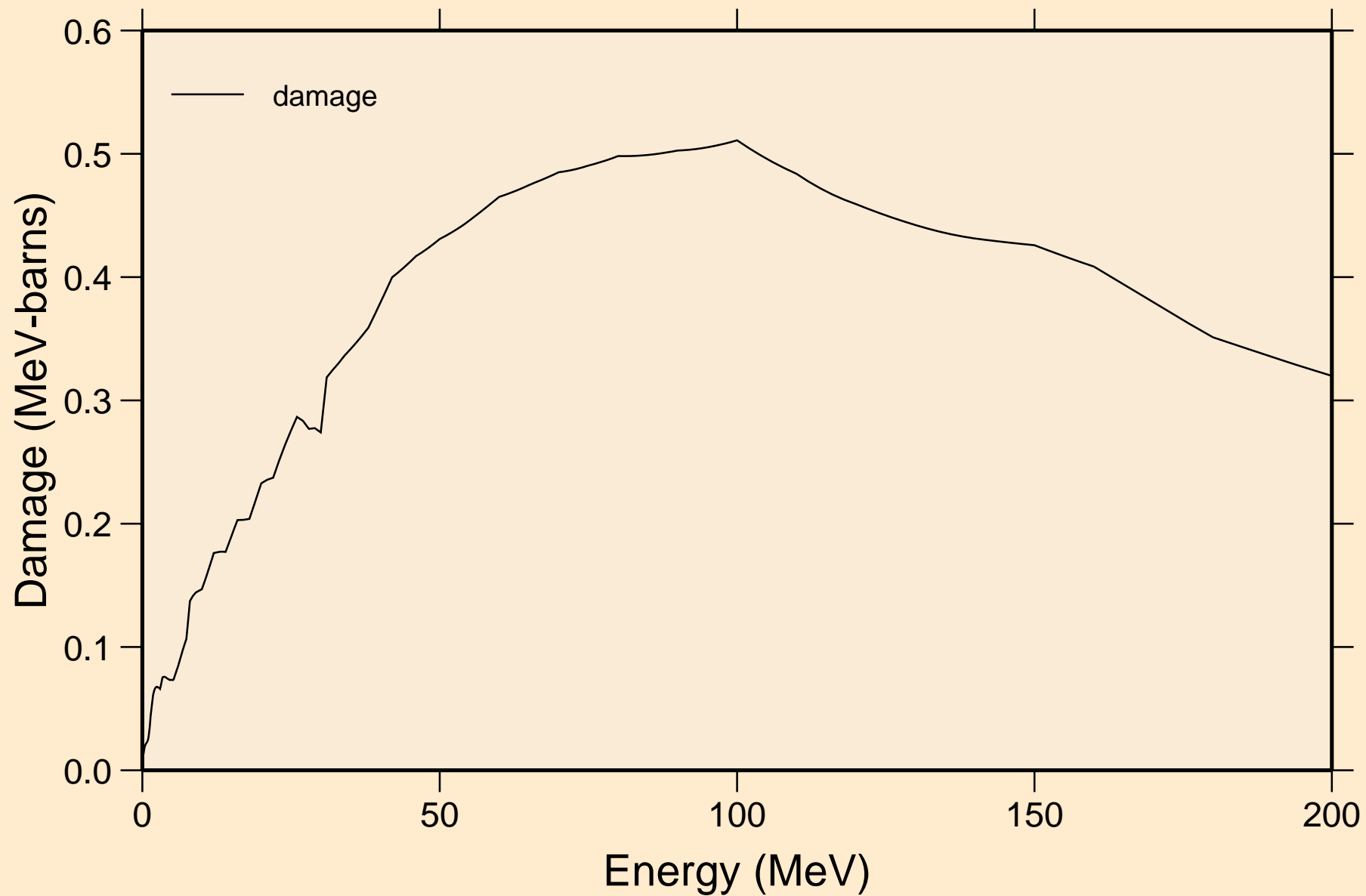

RA225 NEUTRON ACER TENDL-2019 LIBRARY; T=293.16K
Non-threshold reactions

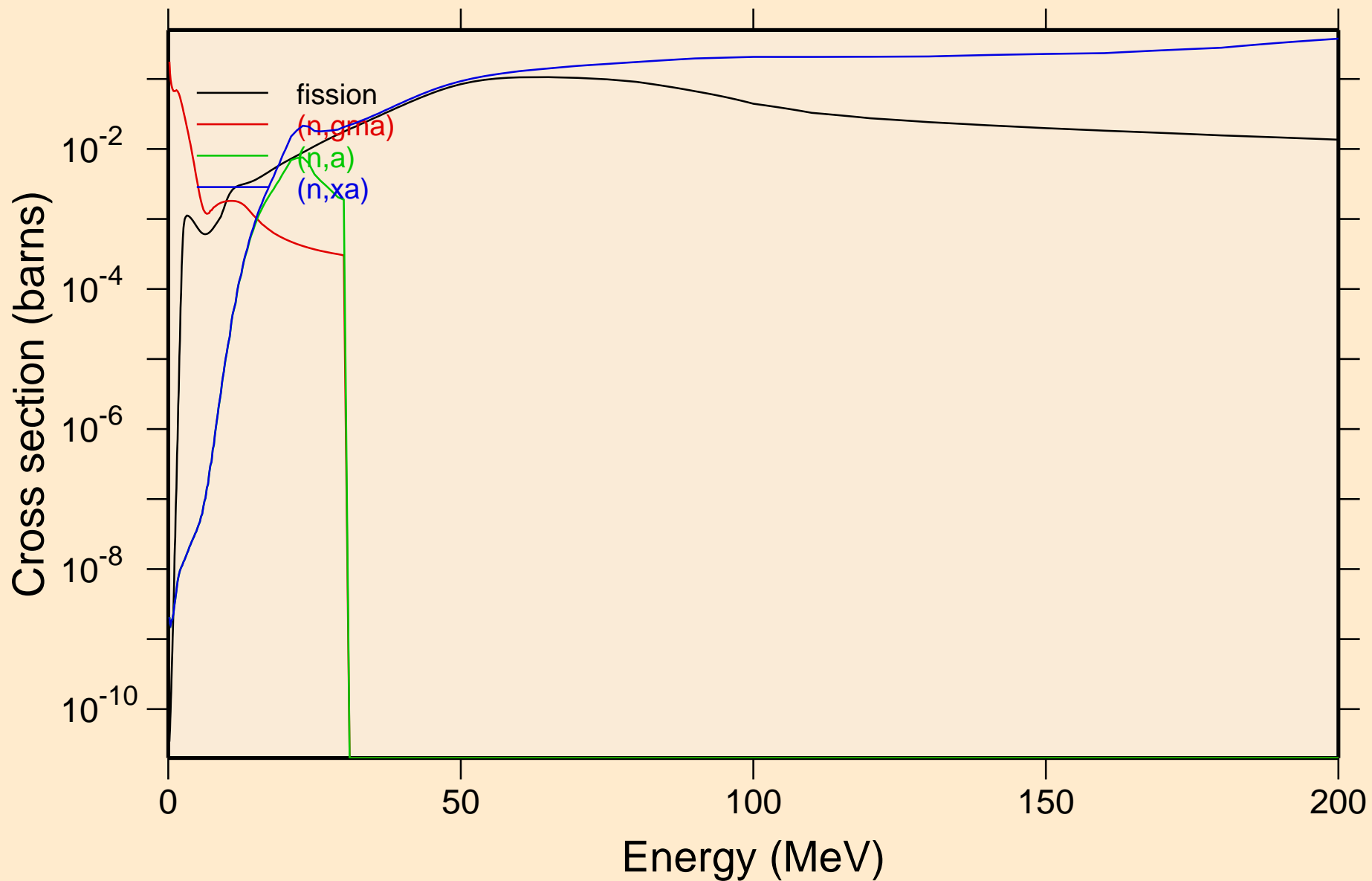

RA225 NEUTRON ACER TENDL-2019 LIBRARY; T=293.16K
Inelastic levels

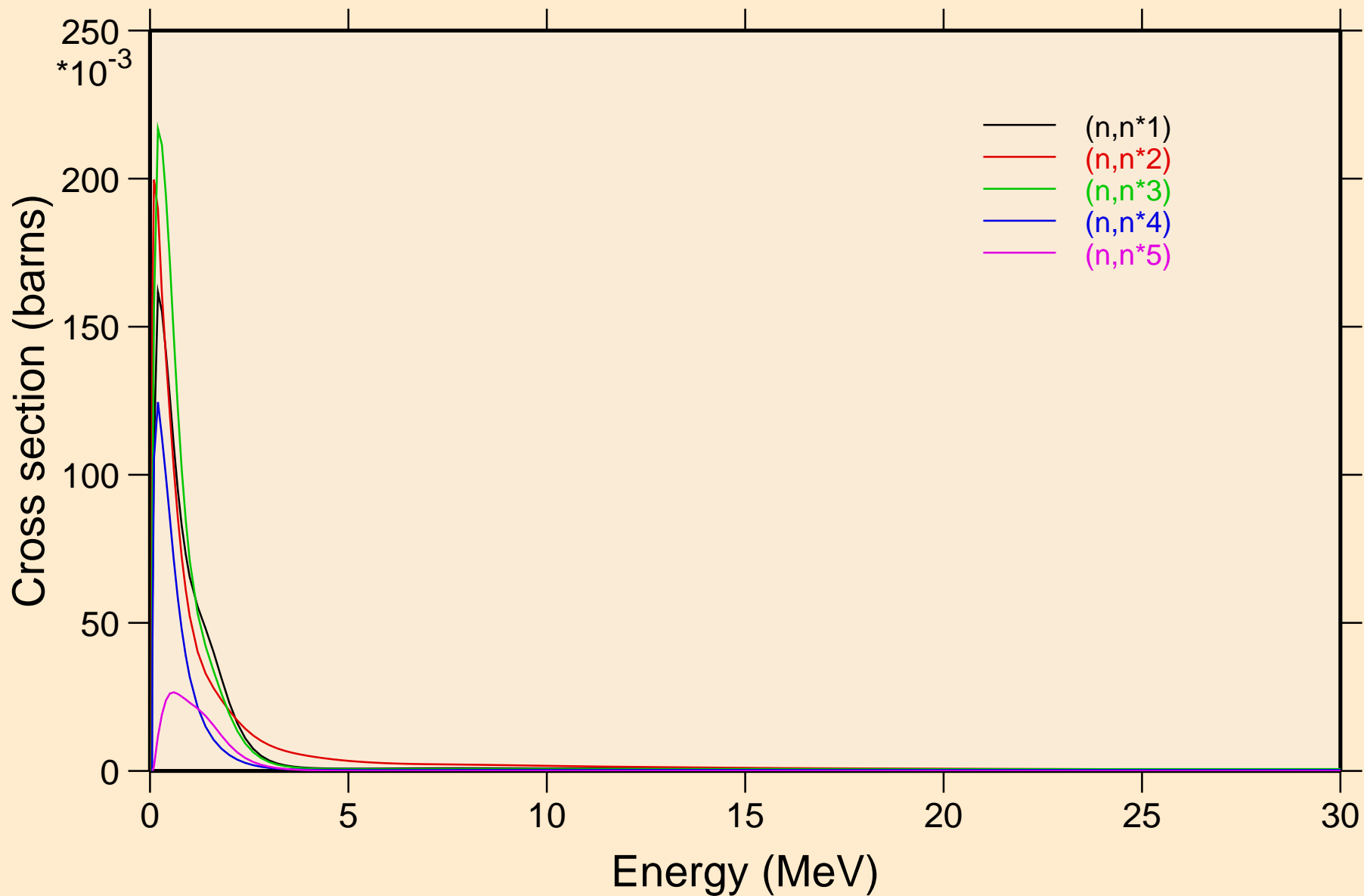

RA225 NEUTRON ACER TENDL-2019 LIBRARY; T=293.16K
Inelastic levels

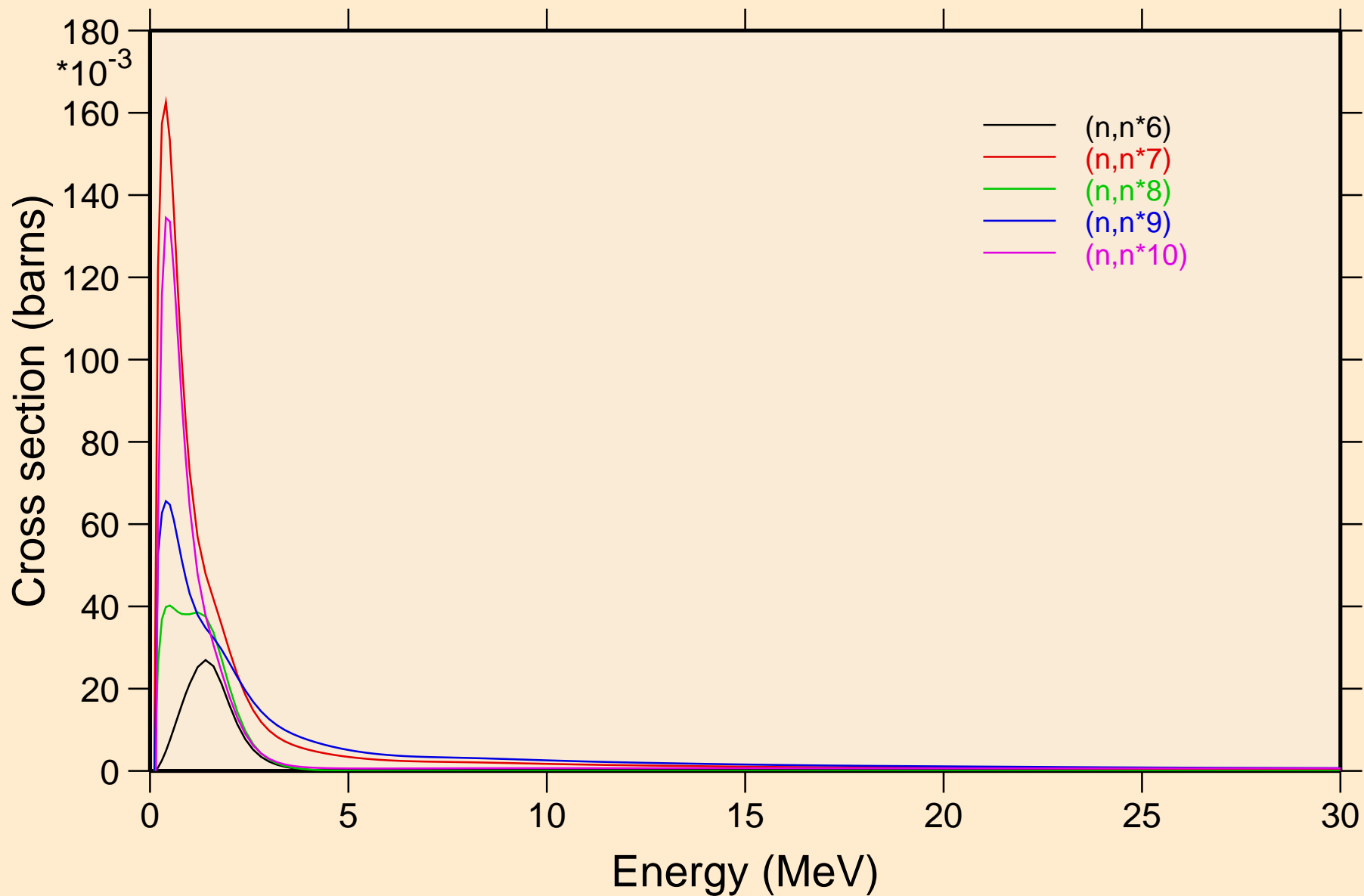

RA225 NEUTRON ACER TENDL-2019 LIBRARY; T=293.16K
Inelastic levels

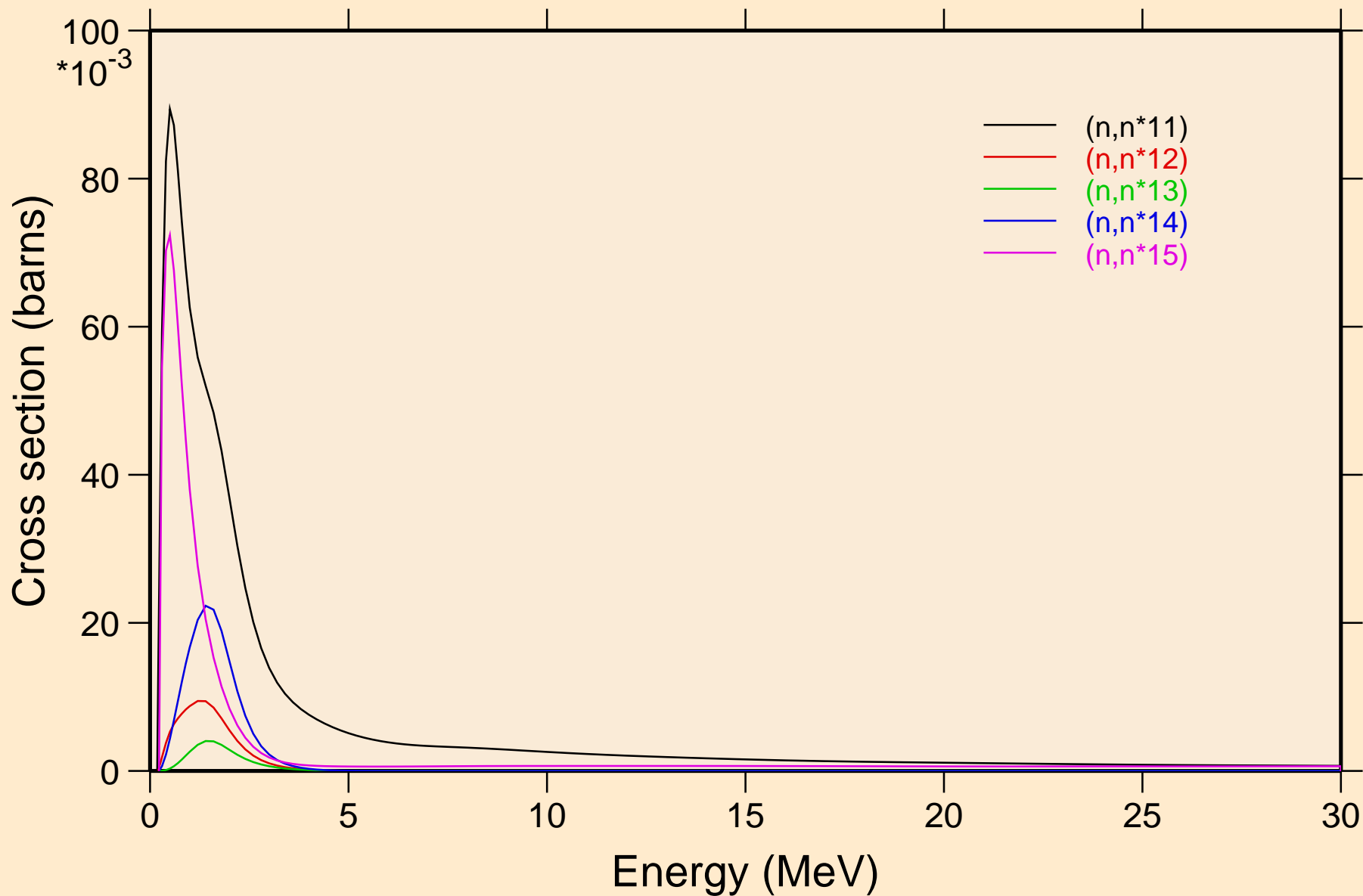

RA225 NEUTRON ACER TENDL-2019 LIBRARY; T=293.16K
Inelastic levels

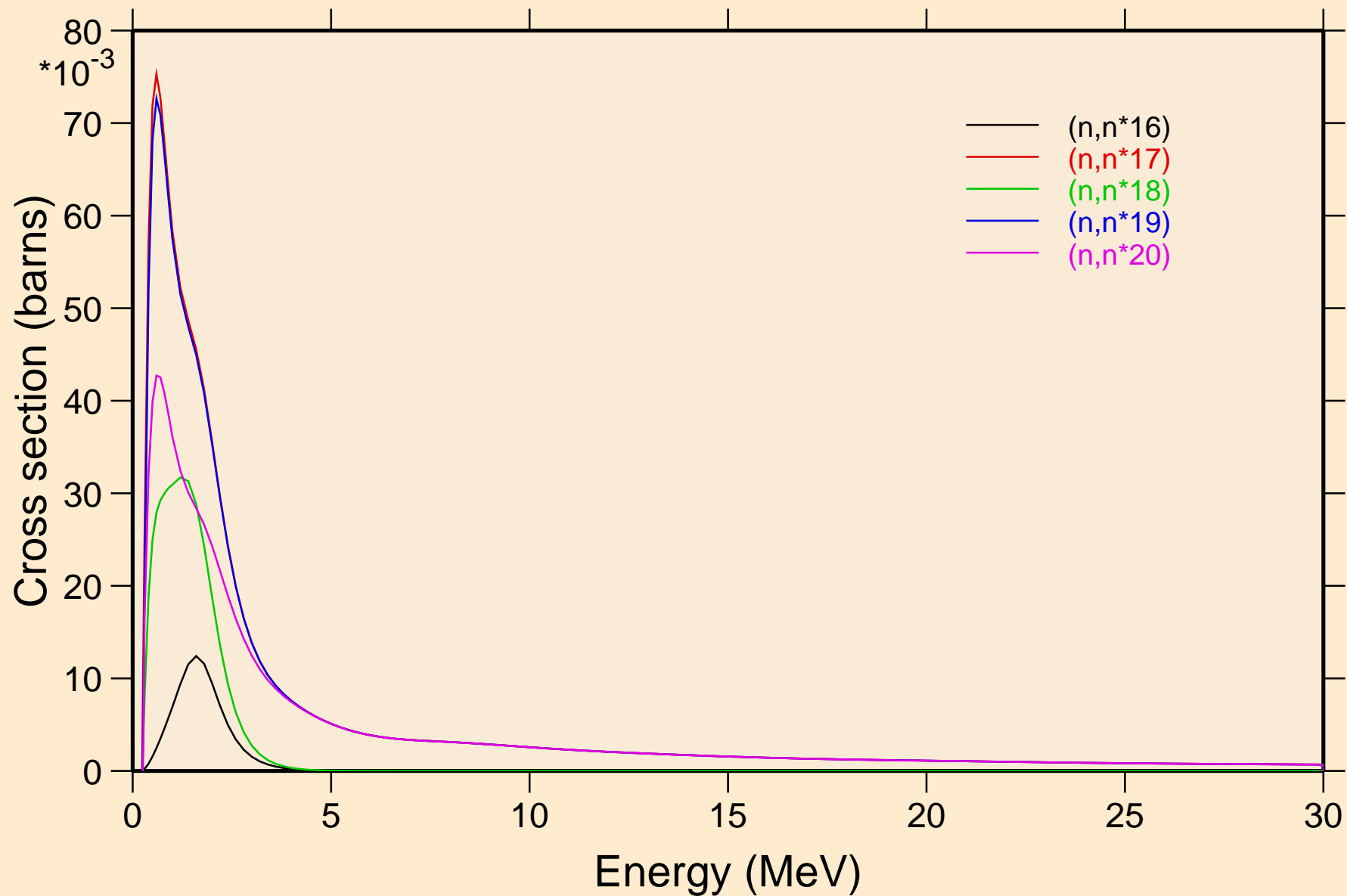

RA225 NEUTRON ACER TENDL-2019 LIBRARY; T=293.16K
Inelastic levels

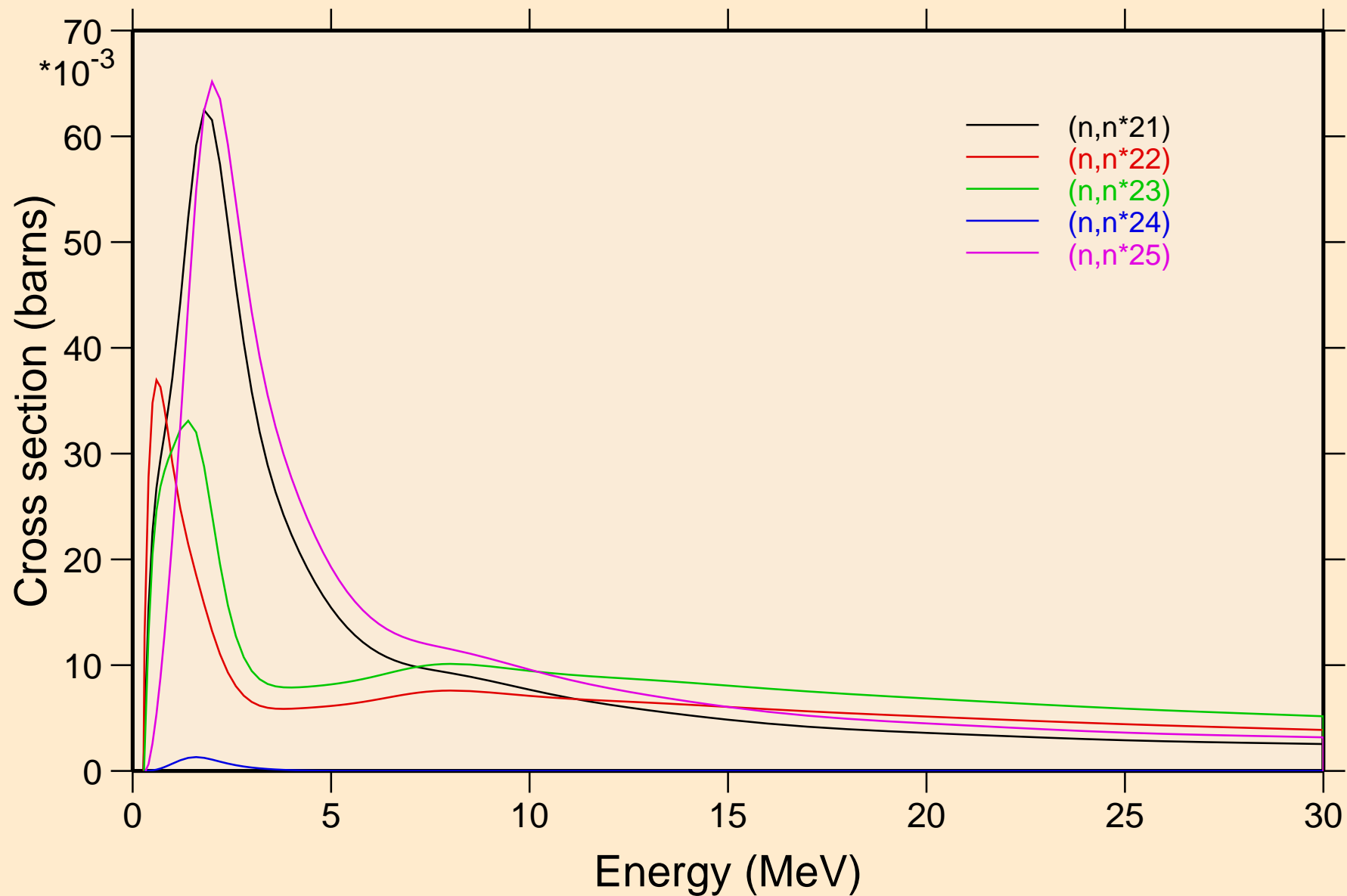

RA225 NEUTRON ACER TENDL-2019 LIBRARY; T=293.16K
Inelastic levels

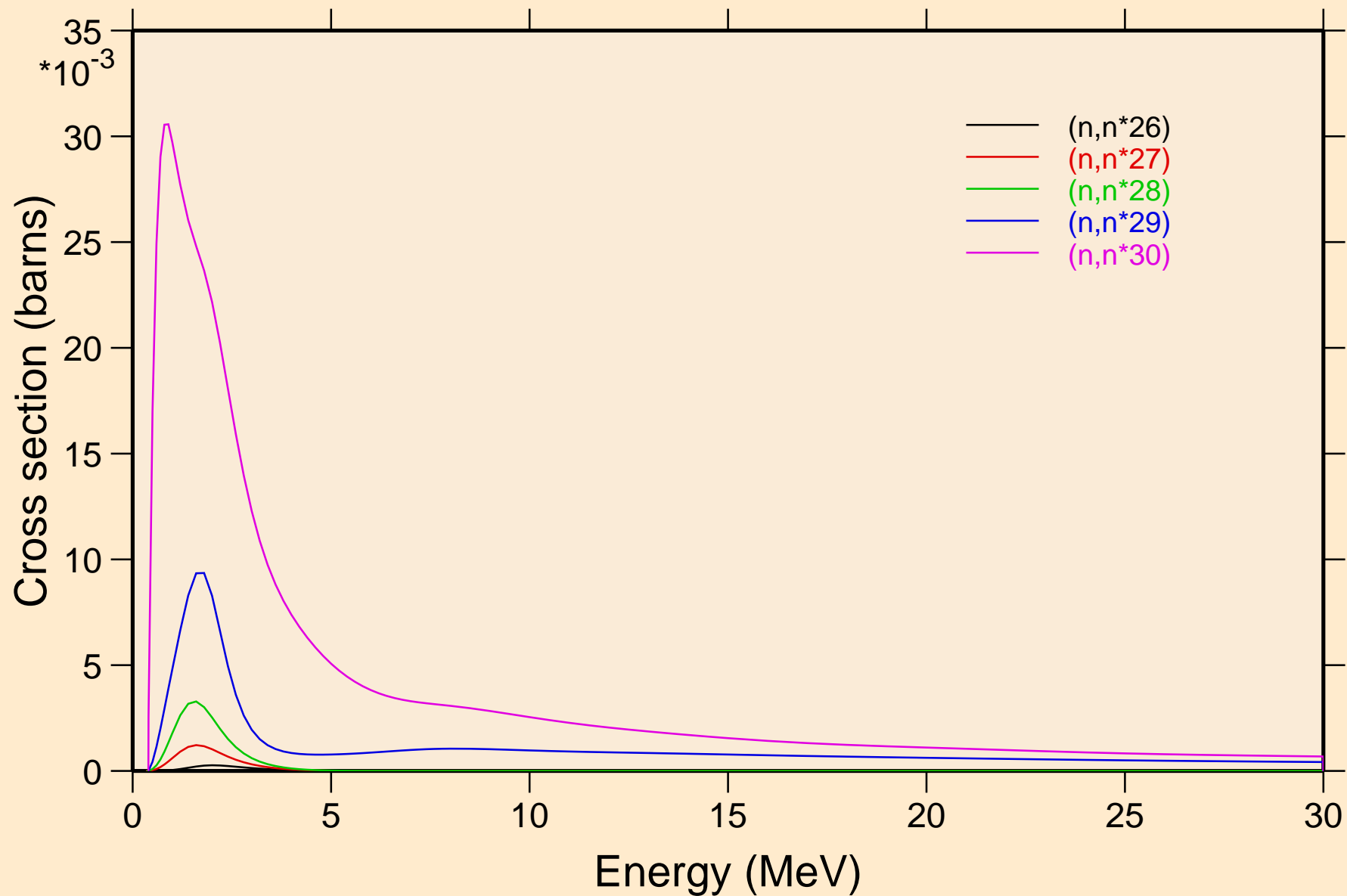

RA225 NEUTRON ACER TENDL-2019 LIBRARY; T=293.16K
Threshold reactions

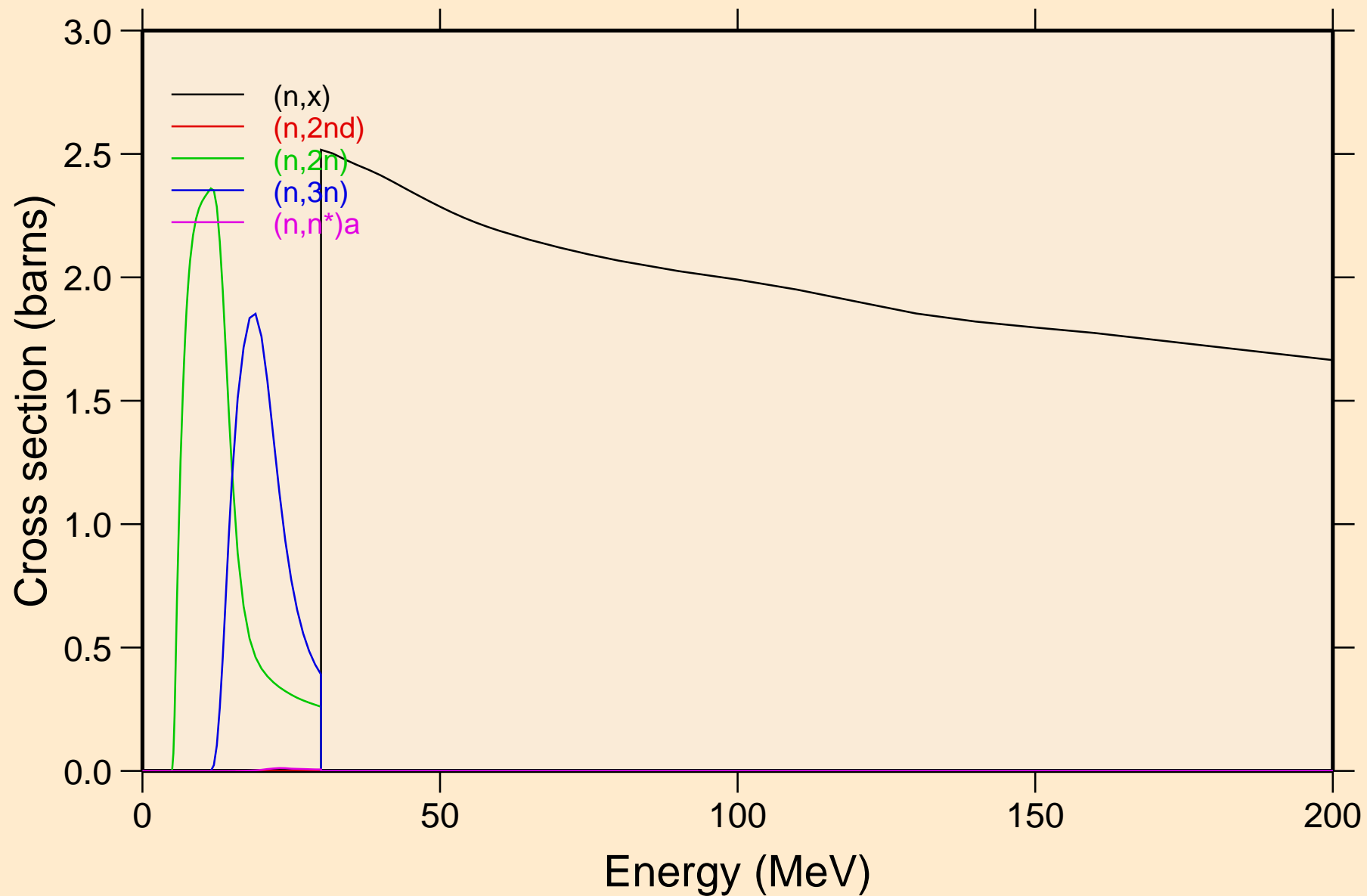

RA225 NEUTRON ACER TENDL-2019 LIBRARY; T=293.16K
Threshold reactions

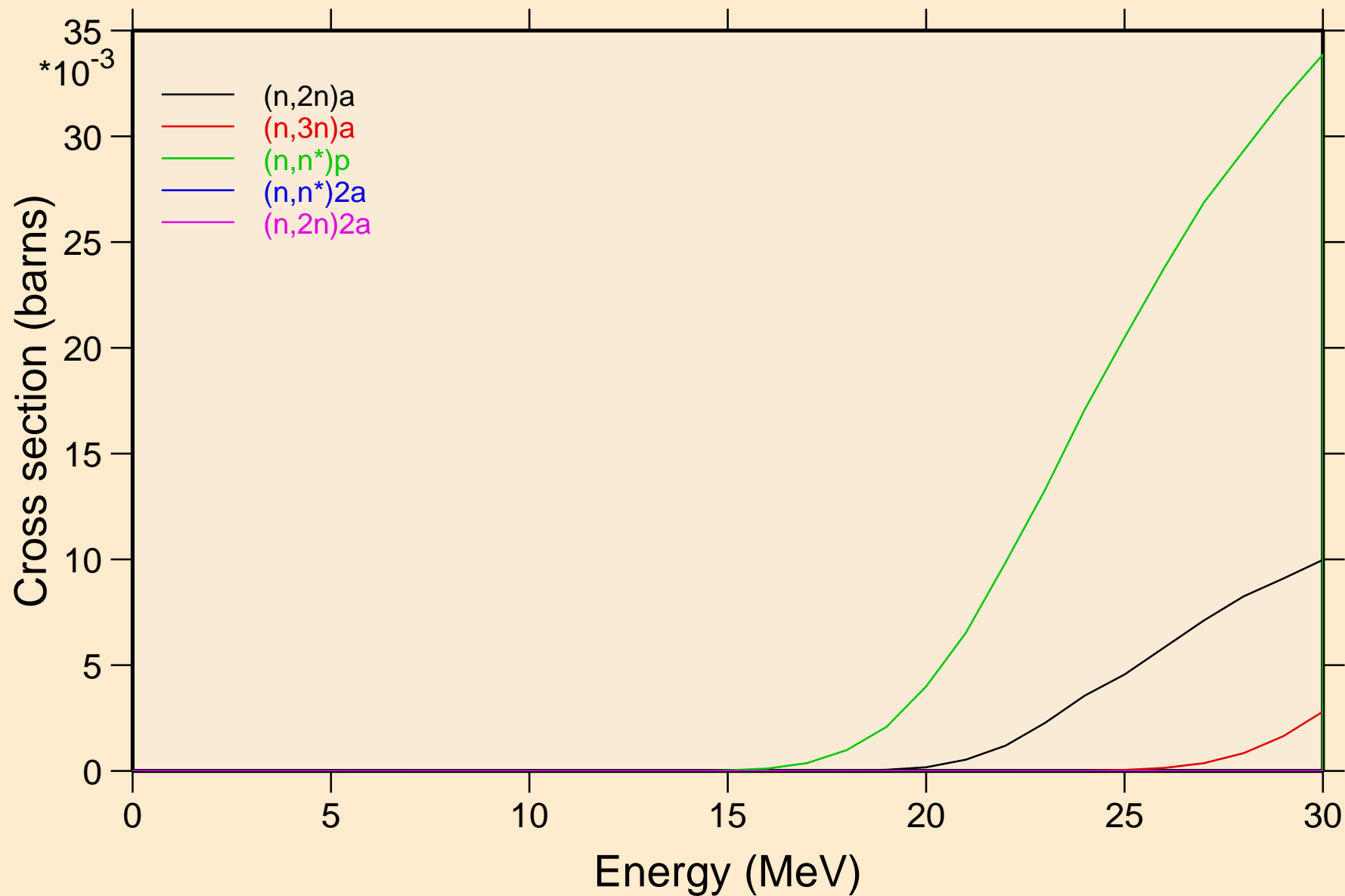

RA225 NEUTRON ACER TENDL-2019 LIBRARY; T=293.16K
Threshold reactions

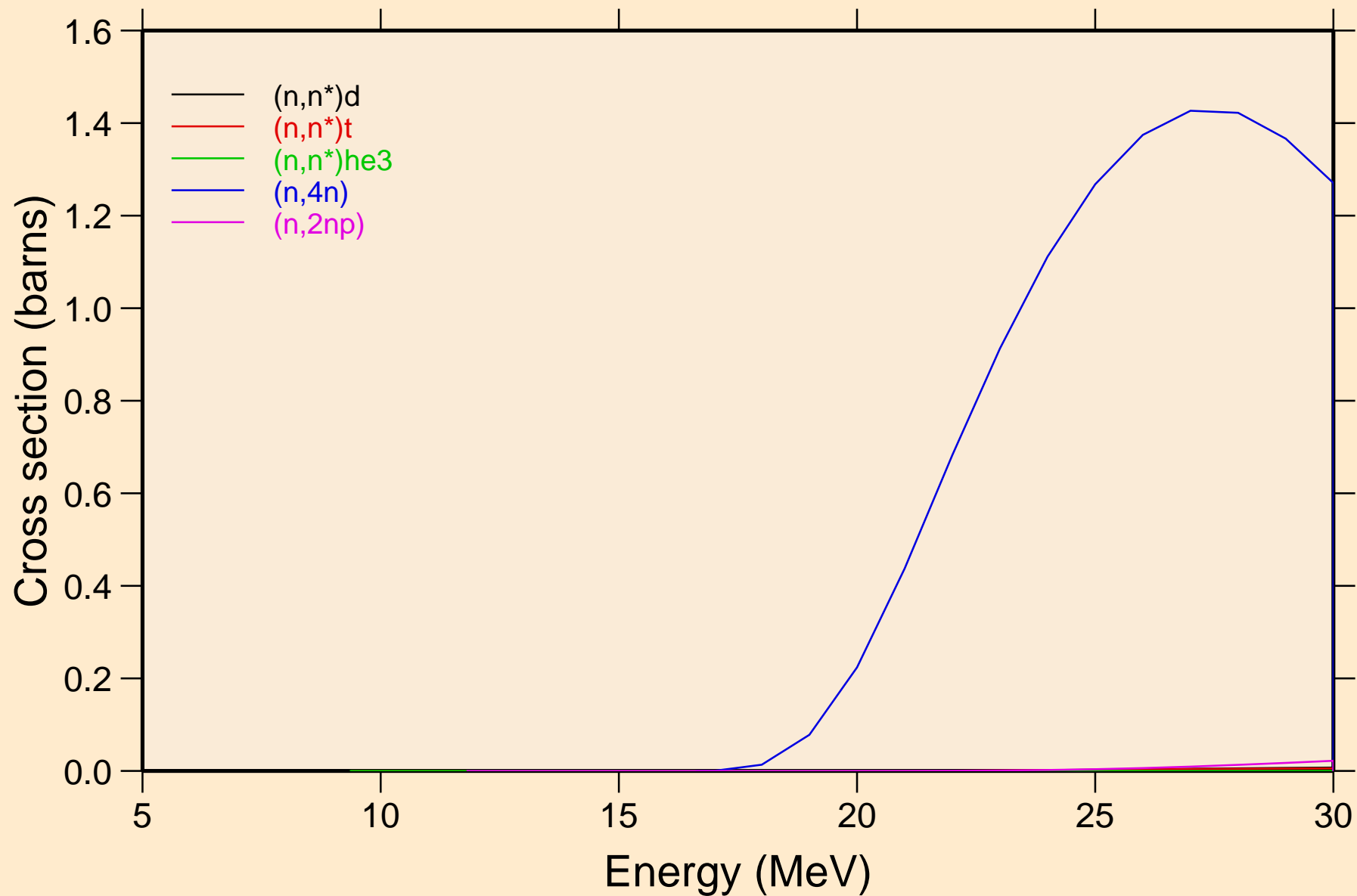

RA225 NEUTRON ACER TENDL-2019 LIBRARY; T=293.16K
Threshold reactions

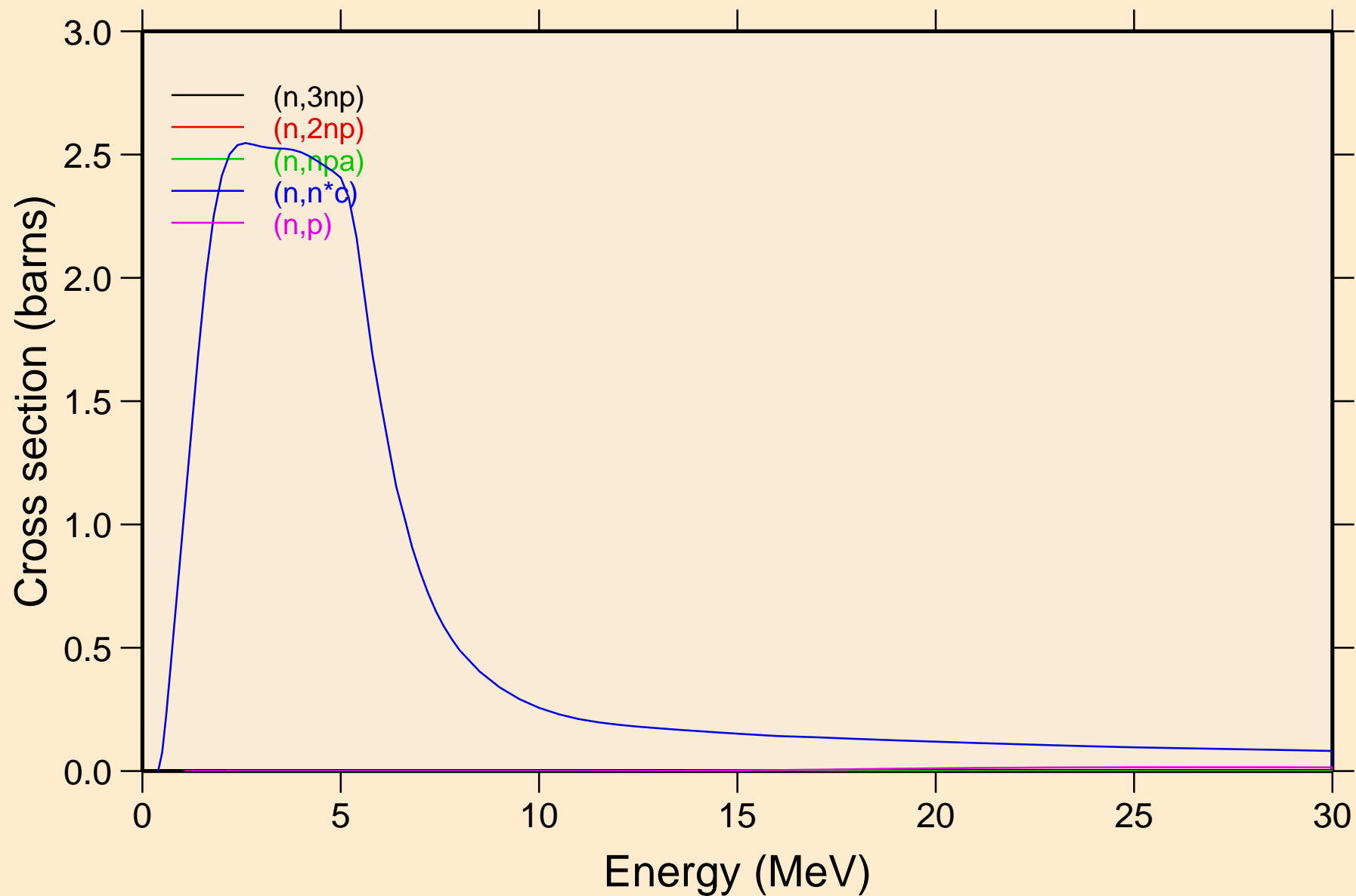

RA225 NEUTRON ACER TENDL-2019 LIBRARY; T=293.16K
Threshold reactions

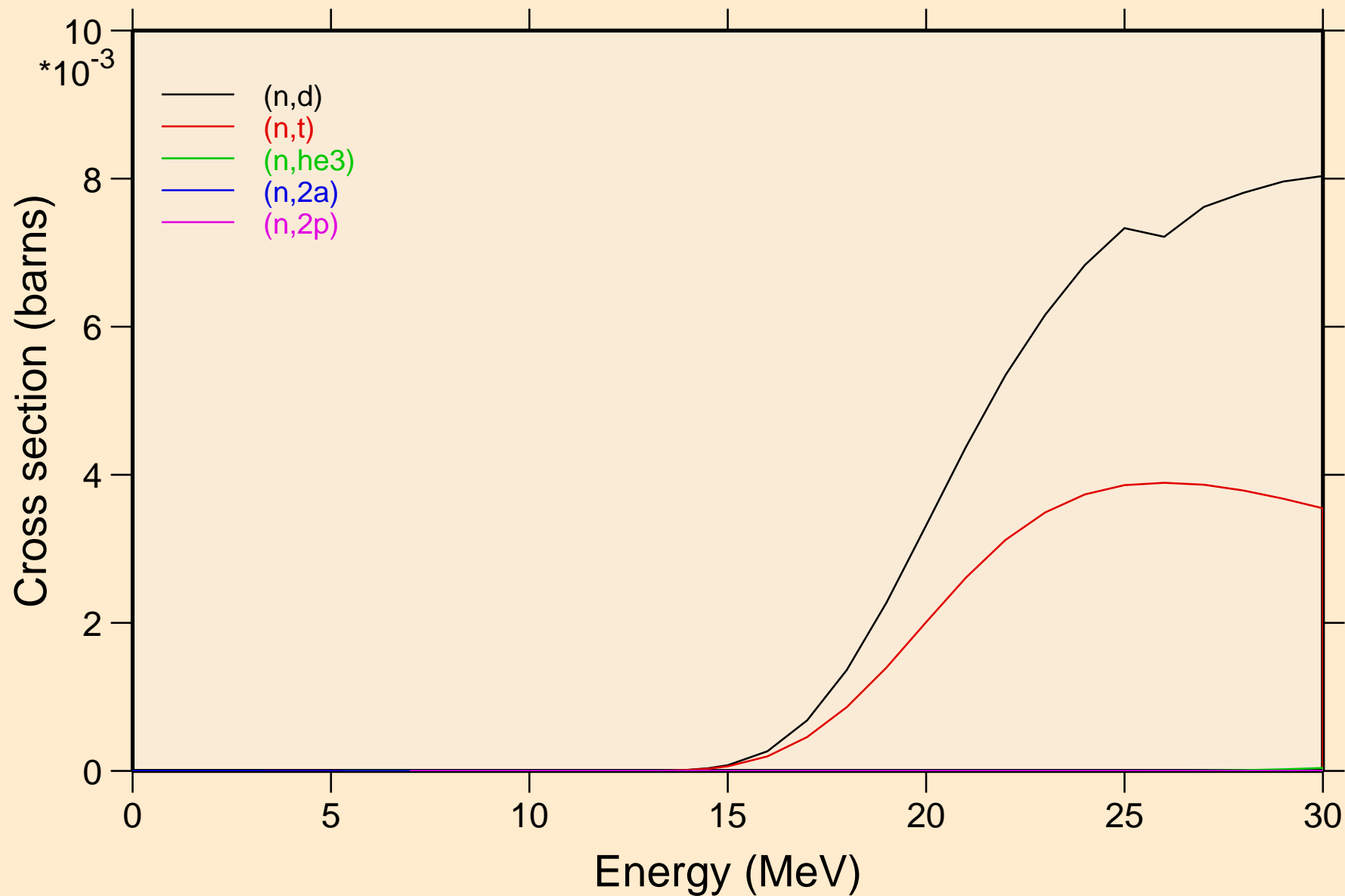

RA225 NEUTRON ACER TENDL-2019 LIBRARY; T=293.16K
Threshold reactions

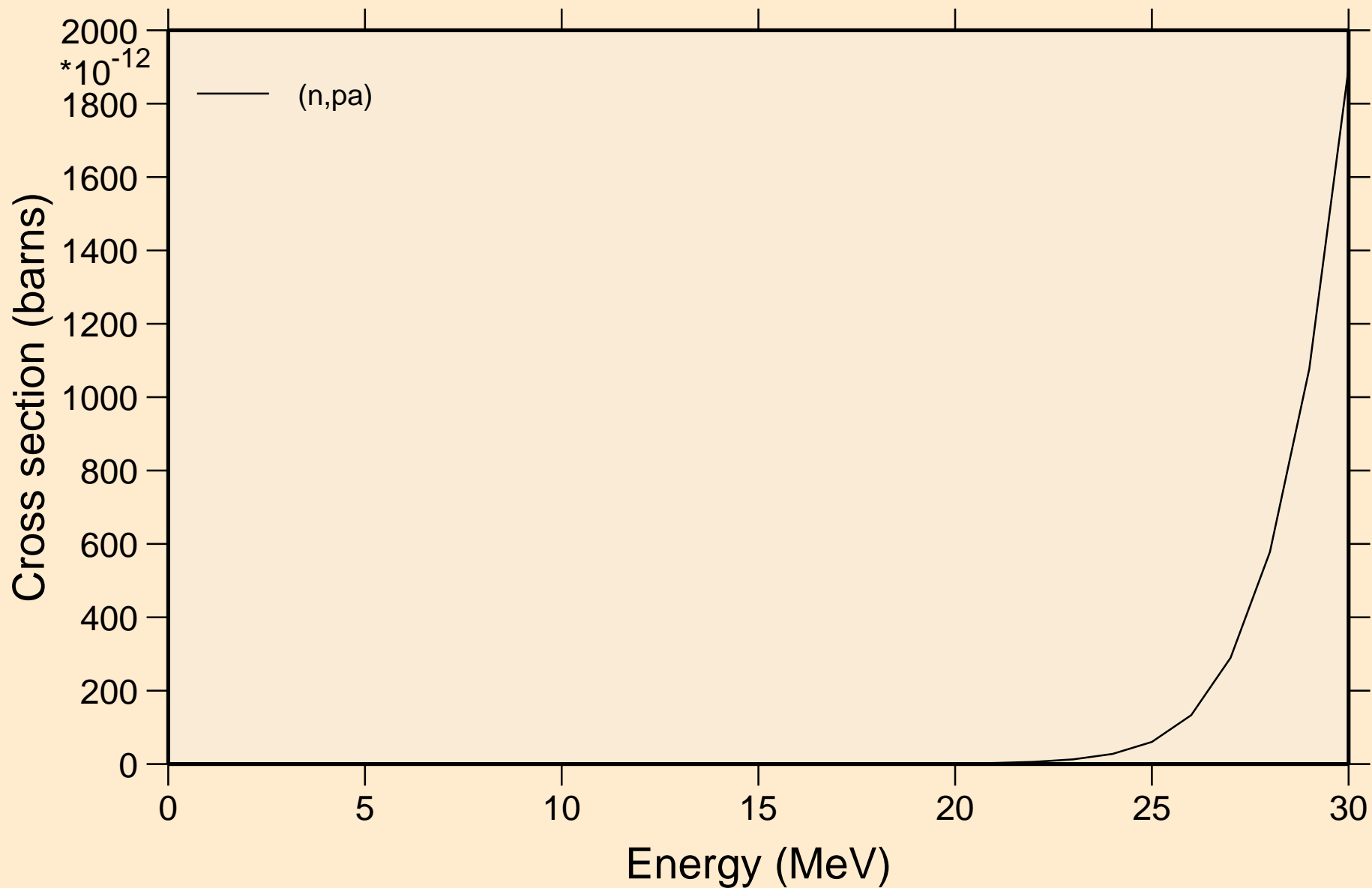

RA225 NEUTRON ACER TENDL-2019 LIBRARY; T=293.16K
Threshold reactions

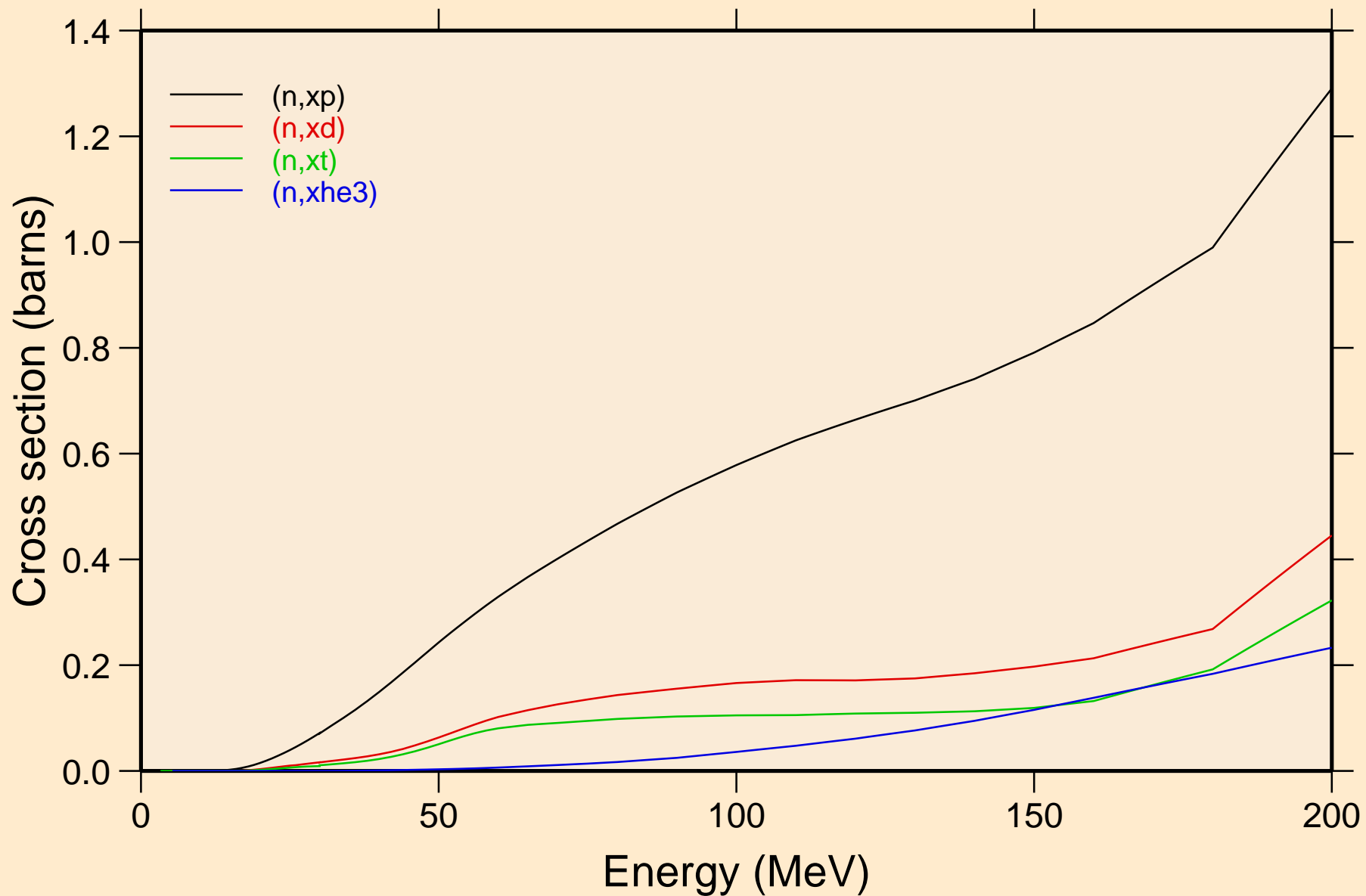

RA225 NEUTRON ACER TENDL-2019 LIBRARY; T=293.16K
angular distribution for elastic

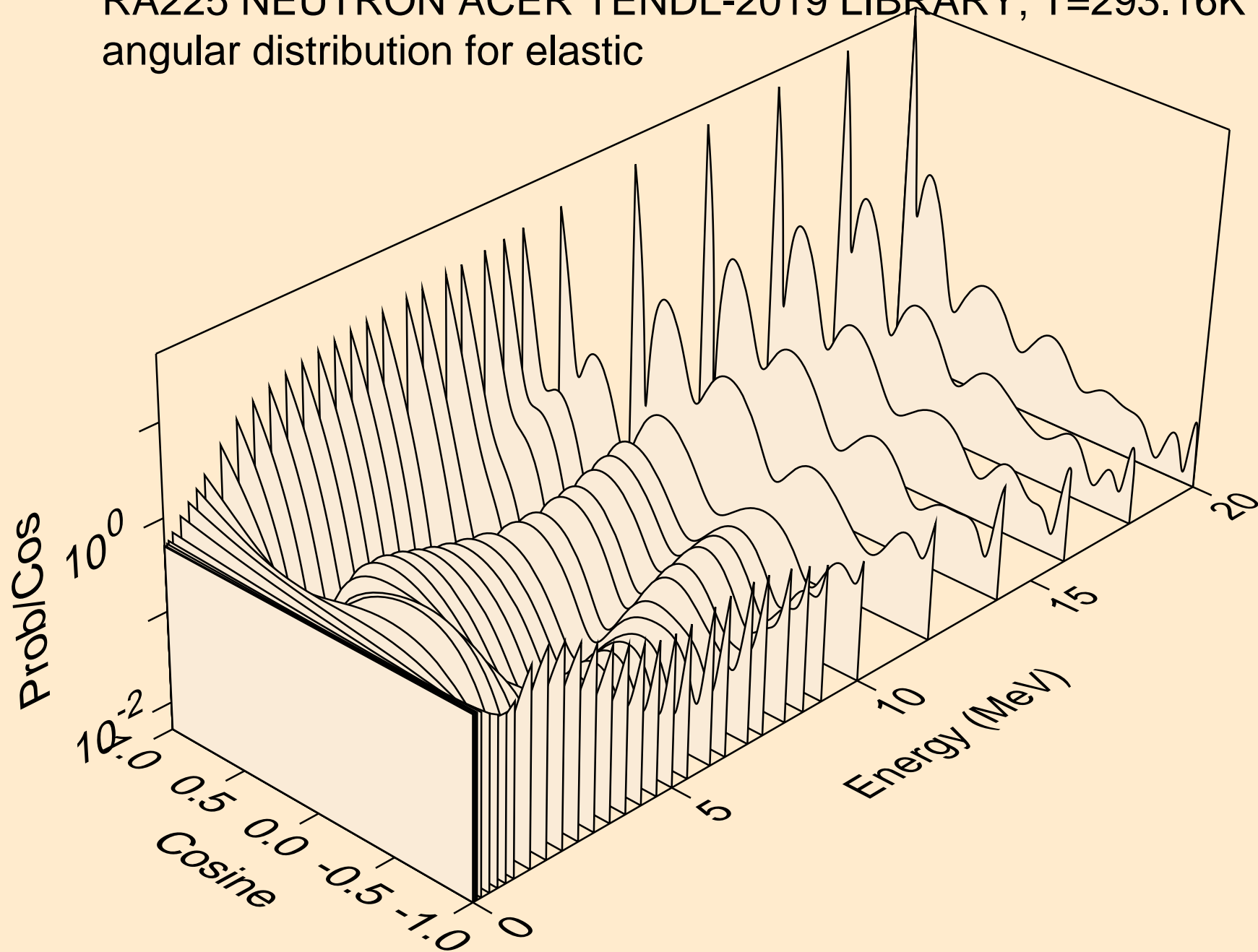

RA225 NEUTRON ACER TENDL-2019 LIBRARY; T=293.16K
angular distribution for elastic

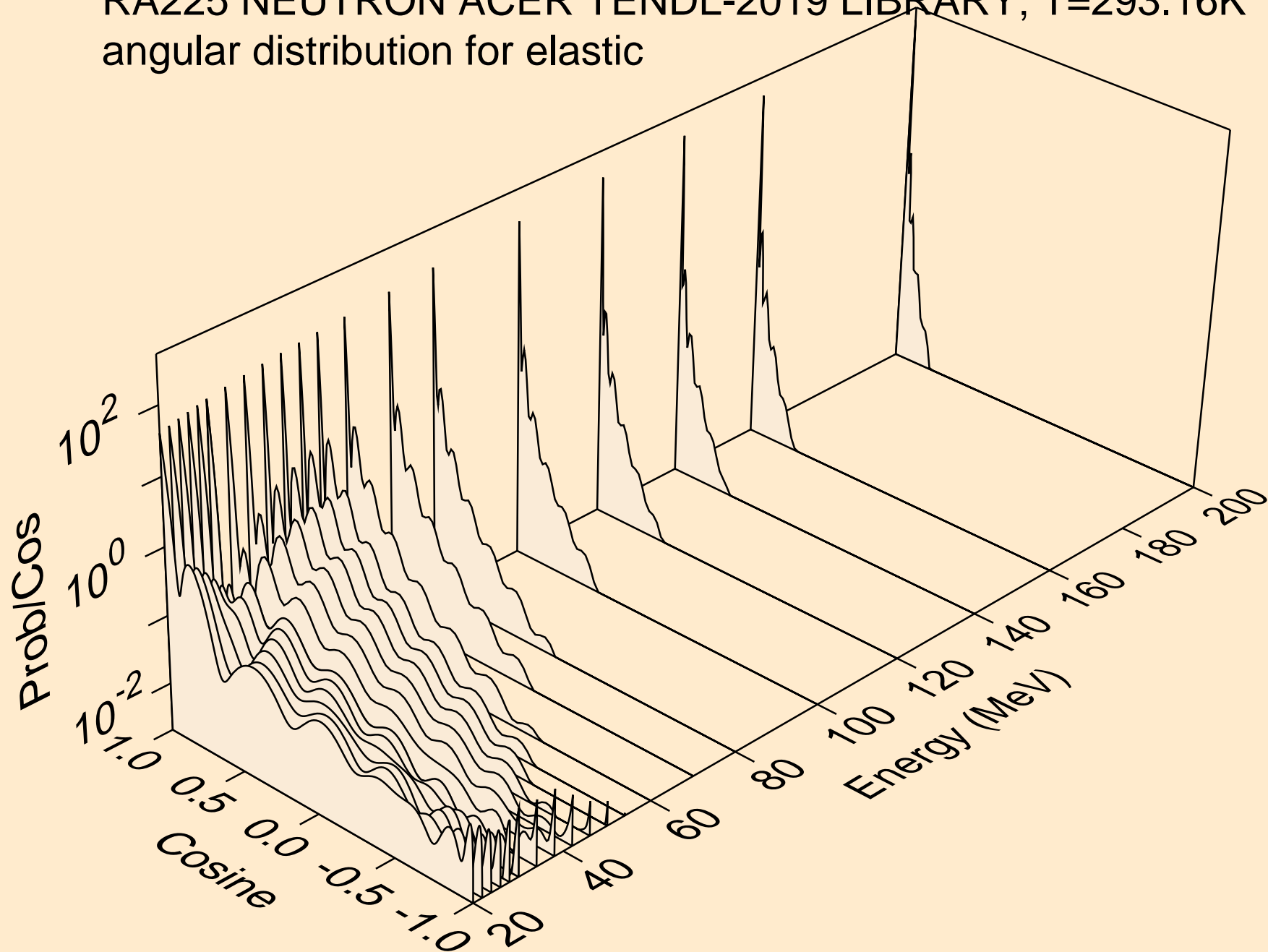

RA225 NEUTRON ACER TENDL-2019 LIBRARY; T=293.16K
angular distribution for (n,n*1)

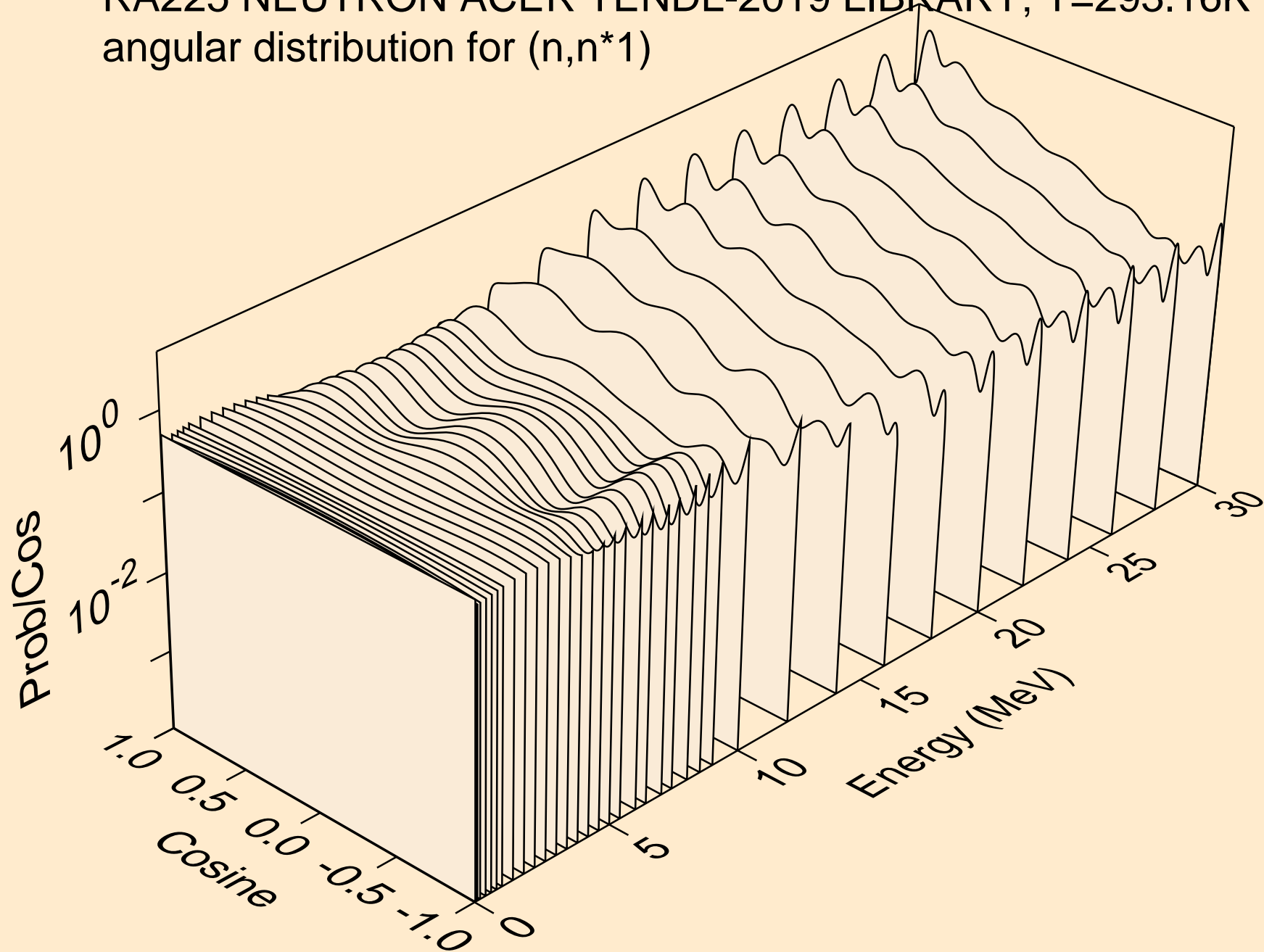

RA225 NEUTRON ACER TENDL-2019 LIBRARY; T=293.16K
angular distribution for (n,n*2)

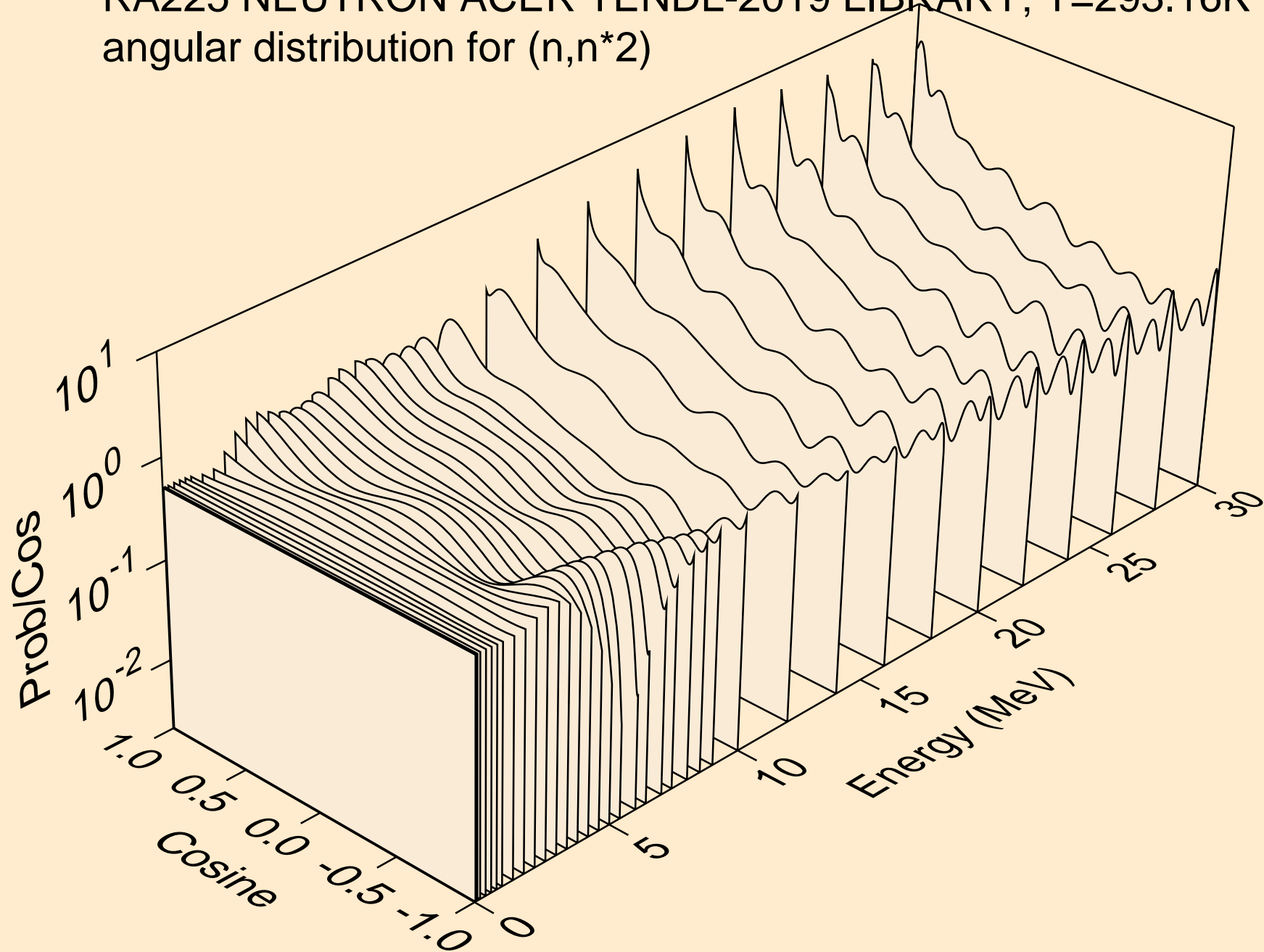

RA225 NEUTRON ACER TENDL-2019 LIBRARY; T=293.16K
angular distribution for (n,n*3)

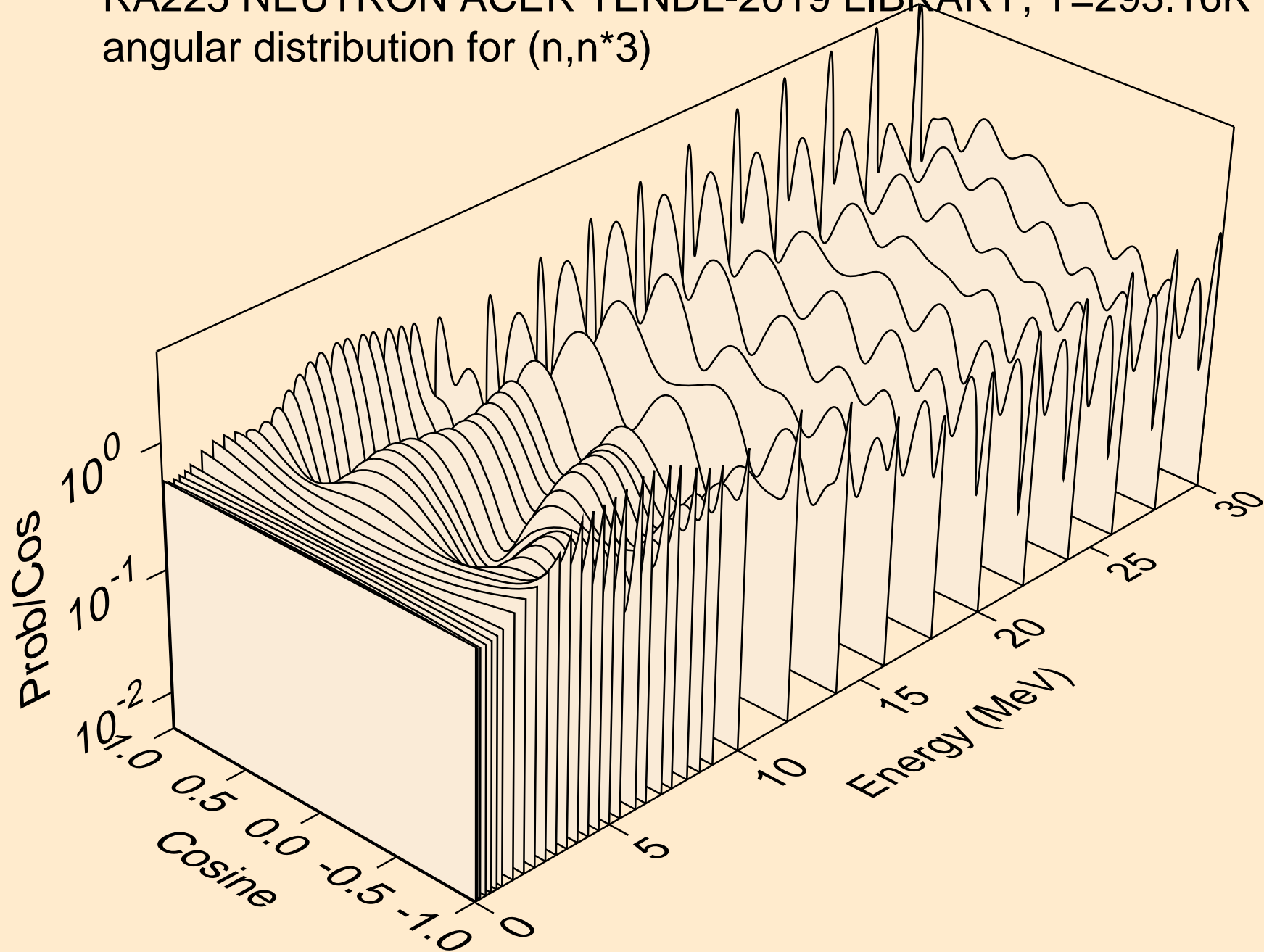

RA225 NEUTRON ACER TENDL-2019 LIBRARY; T=293.16K
angular distribution for (n,n*4)

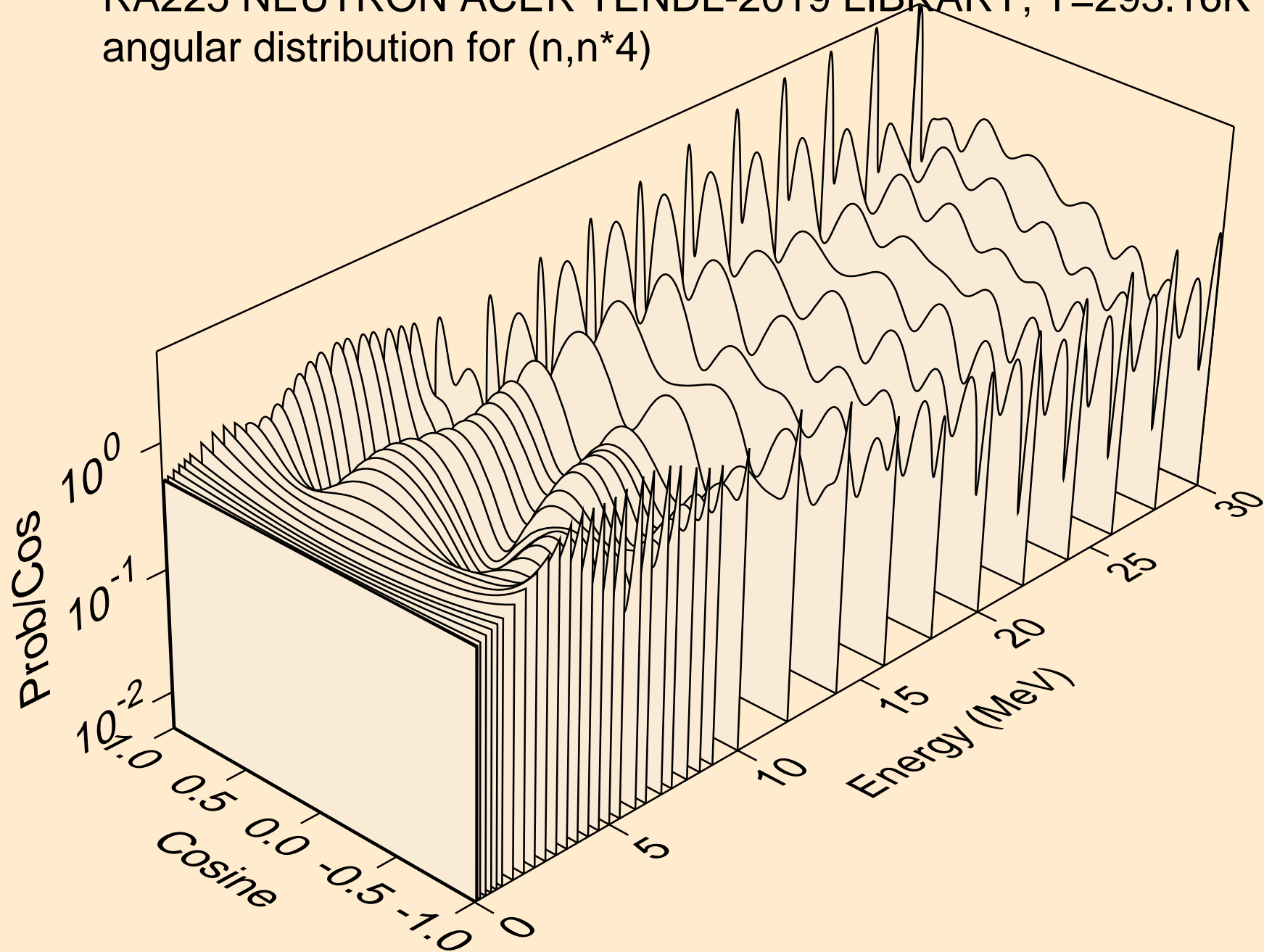

RA225 NEUTRON ACER TENDL-2019 LIBRARY; T=293.16K
angular distribution for (n,n*5)

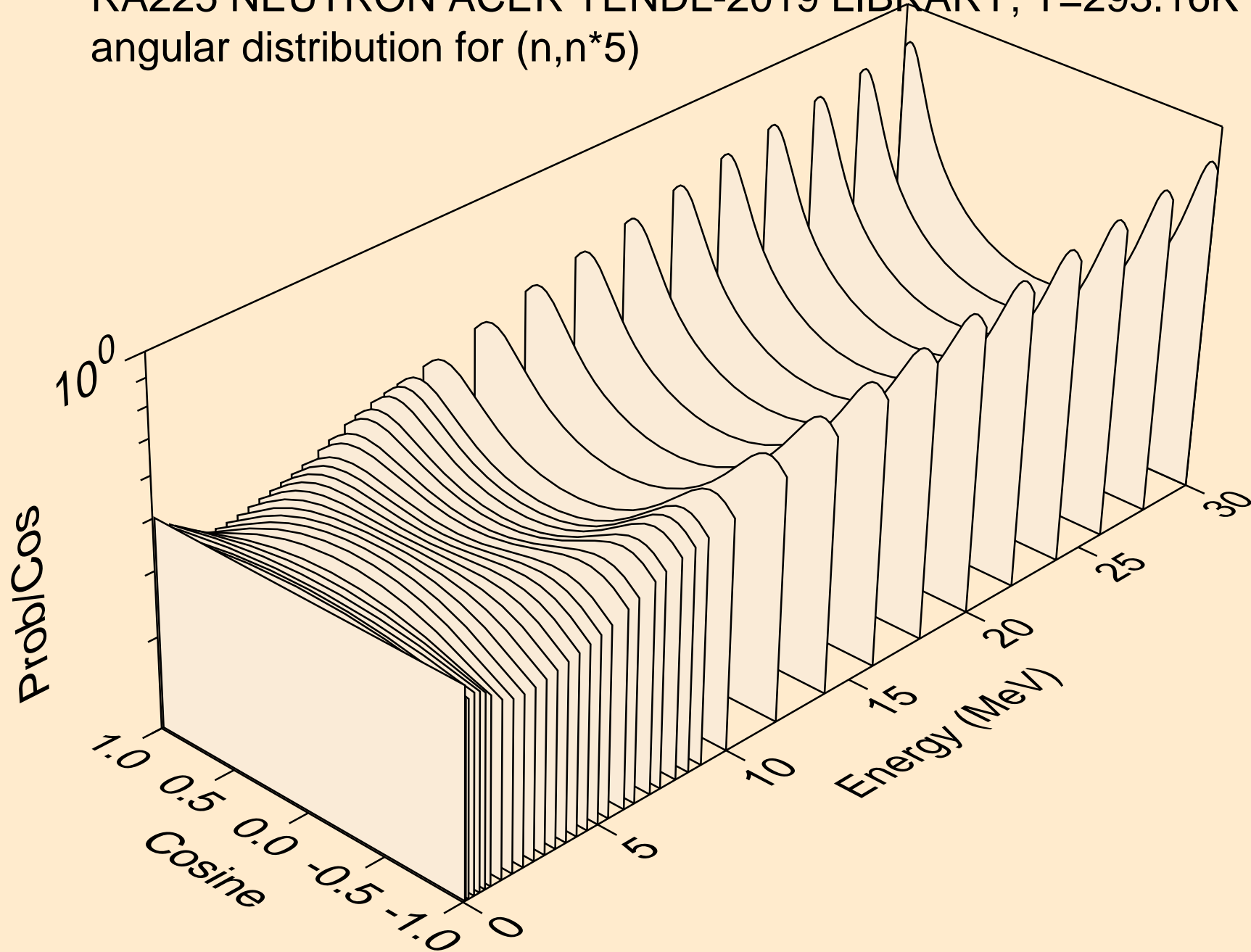

RA225 NEUTRON ACER TENDL-2019 LIBRARY; T=293.16K
angular distribution for (n,n*6)

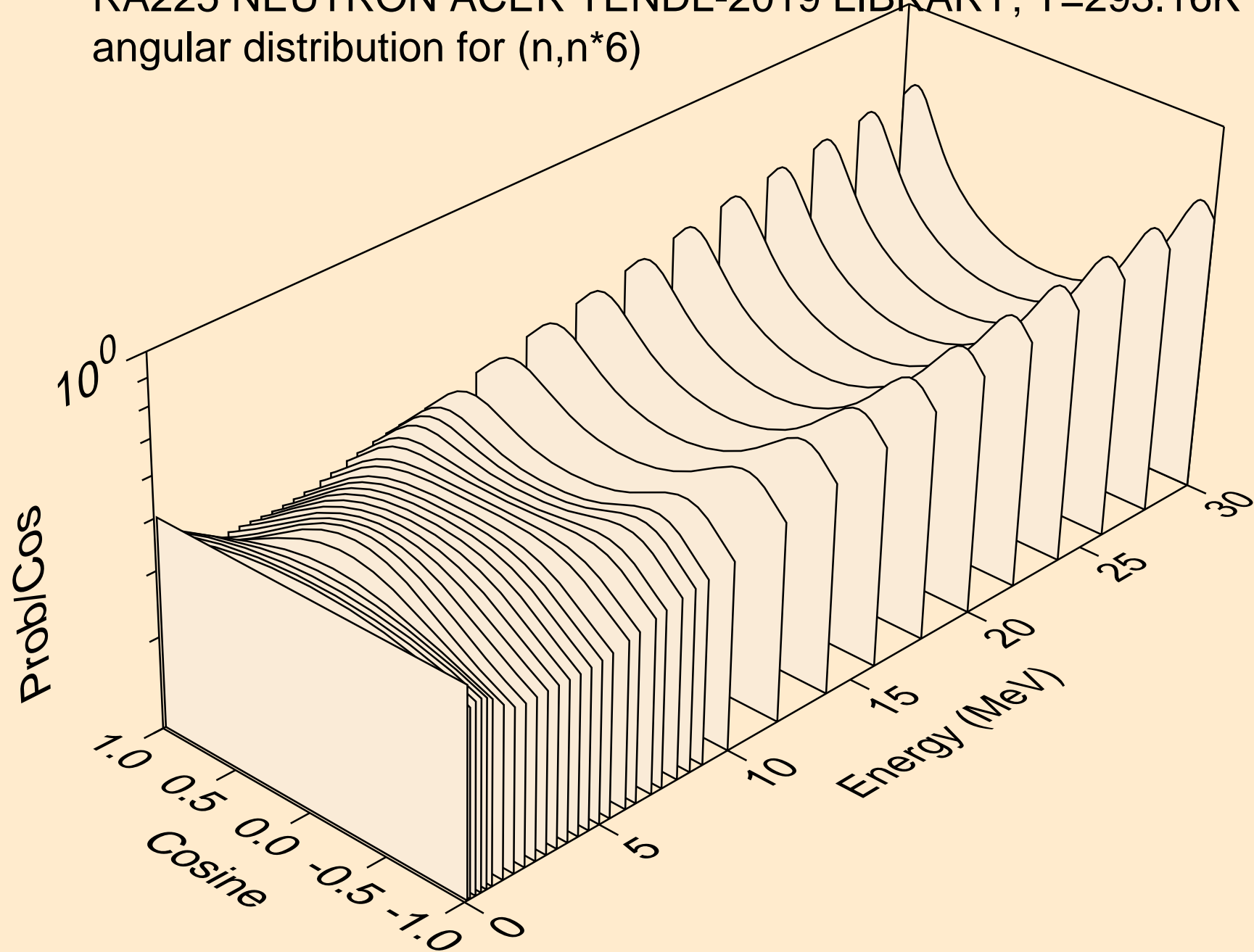

RA225 NEUTRON ACER TENDL-2019 LIBRARY; T=293.16K
angular distribution for (n,n*7)

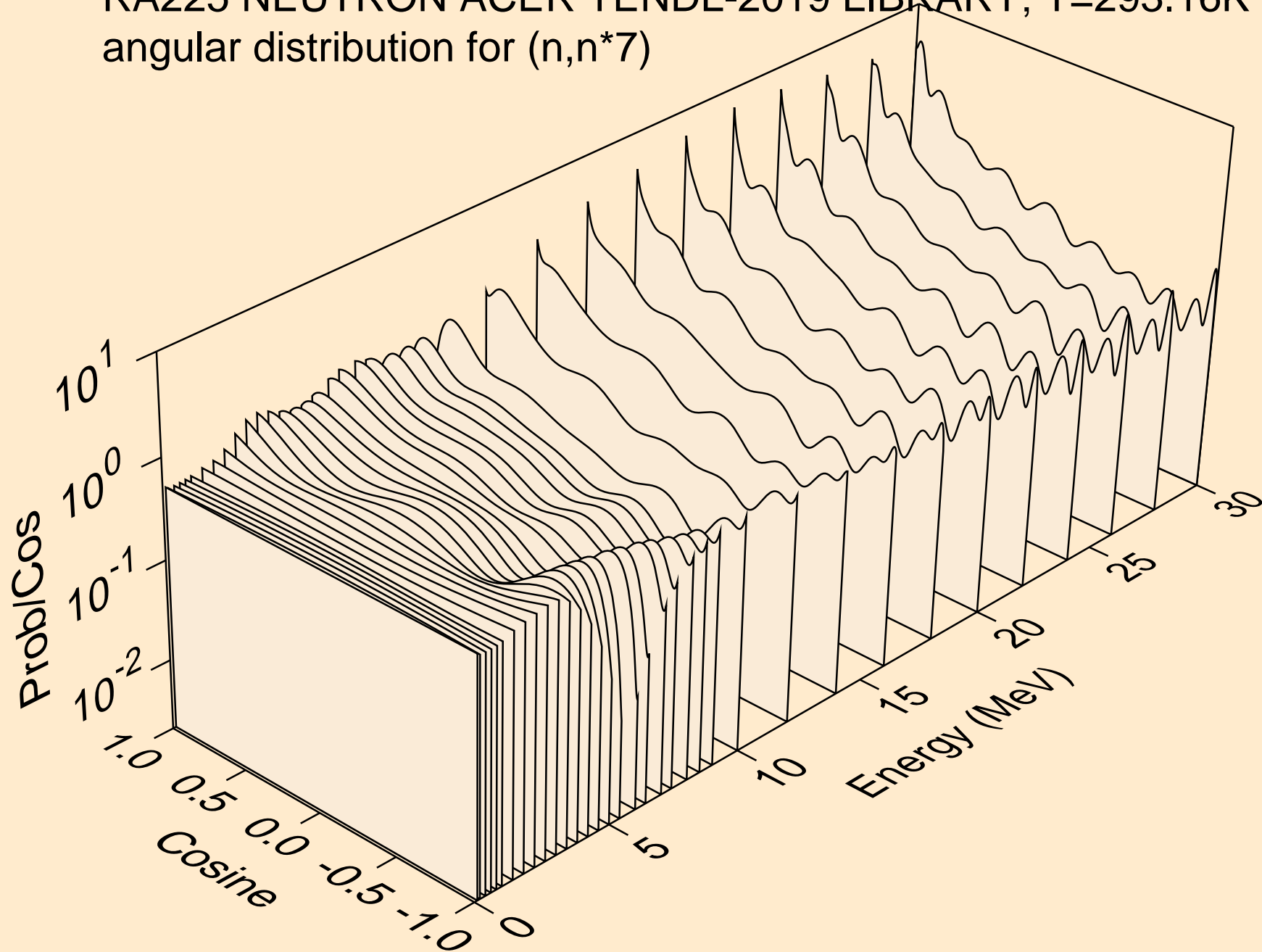

RA225 NEUTRON ACER TENDL-2019 LIBRARY; T=293.16K
angular distribution for (n,n*8)

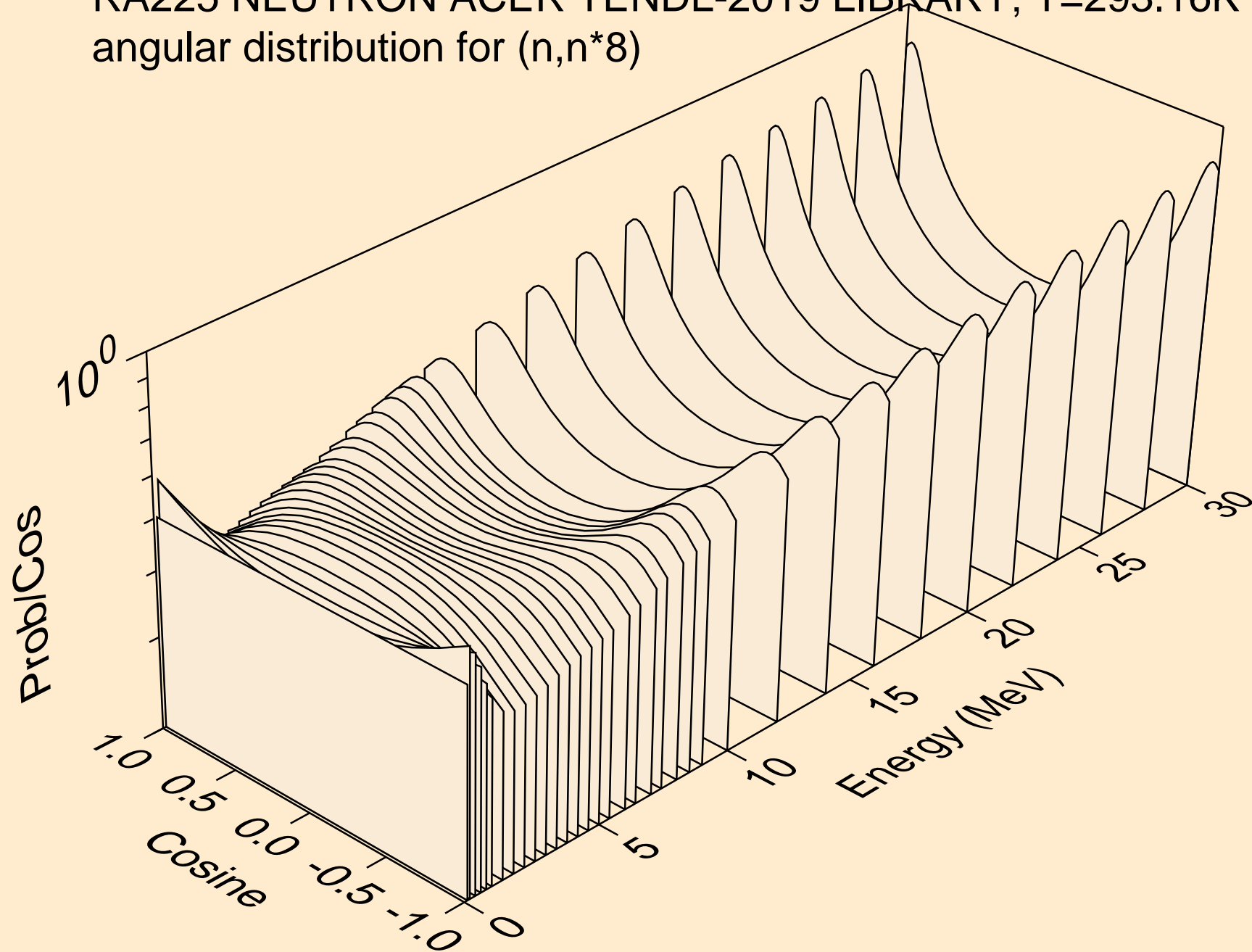

RA225 NEUTRON ACER TENDL-2019 LIBRARY; T=293.16K
angular distribution for (n,n*9)

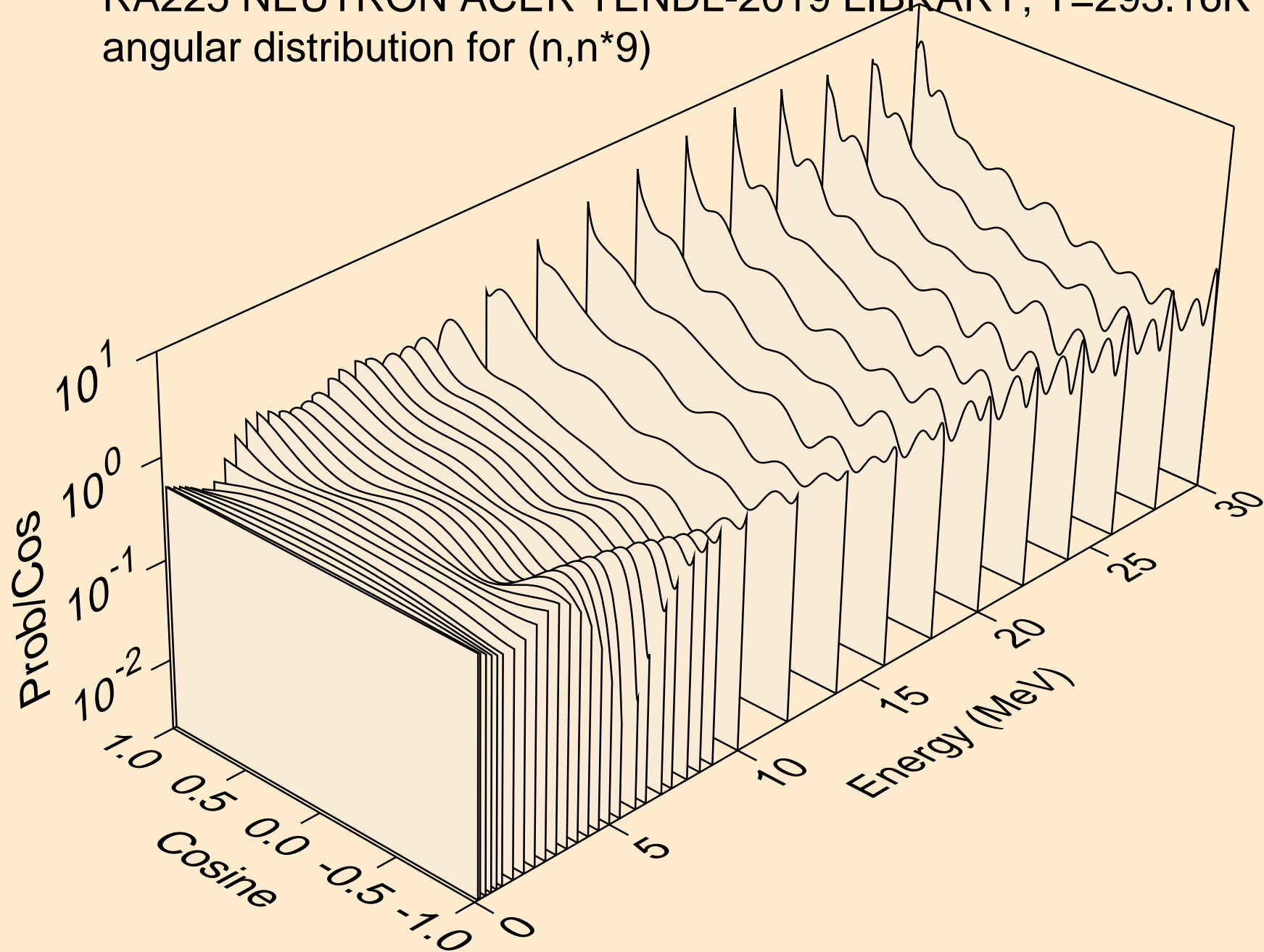

RA225 NEUTRON ACER TENDL-2019 LIBRARY; T=293.16K
angular distribution for (n,n*10)

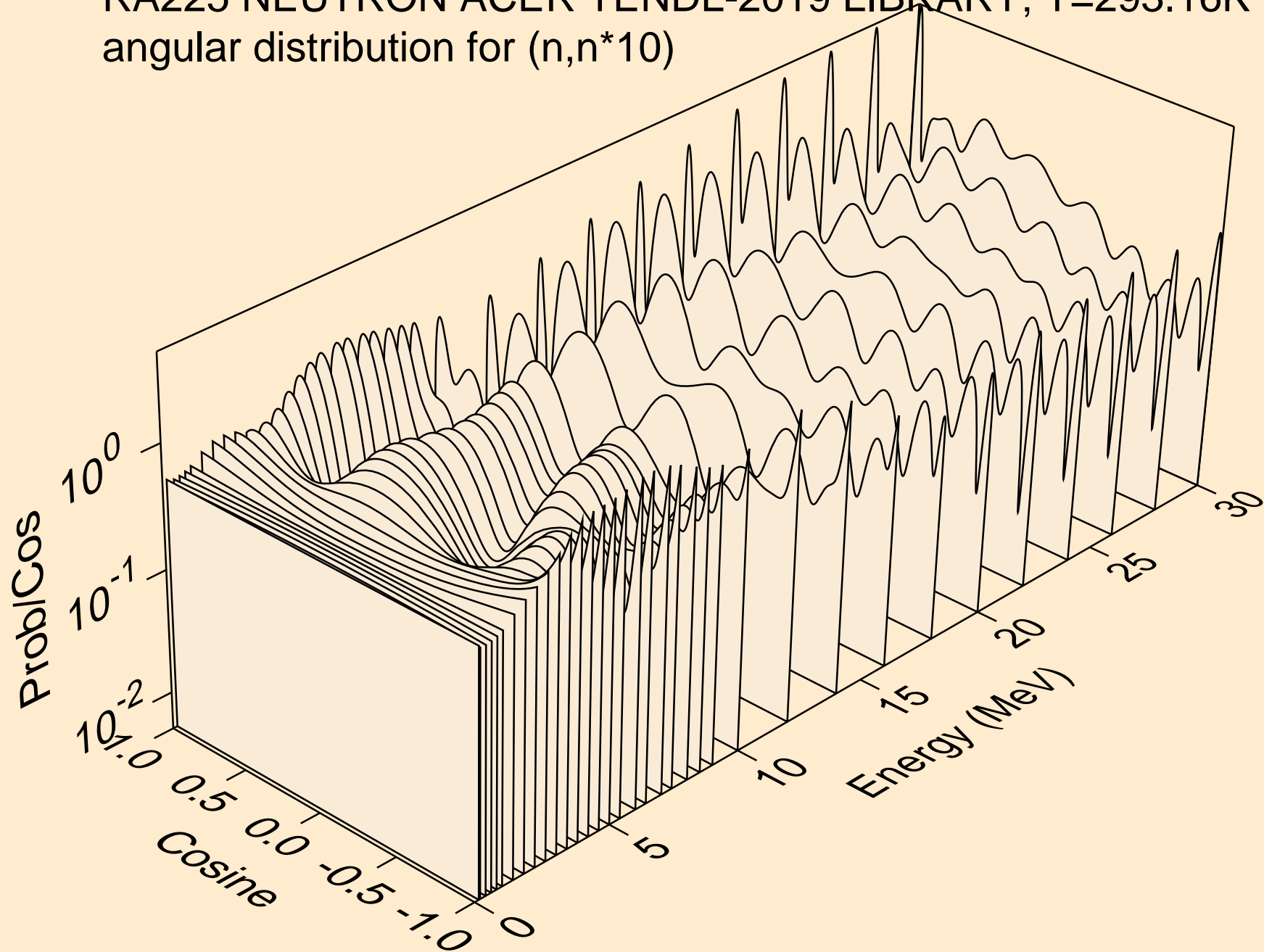

RA225 NEUTRON ACER TENDL-2019 LIBRARY; T=293.16K
angular distribution for (n,n*11)

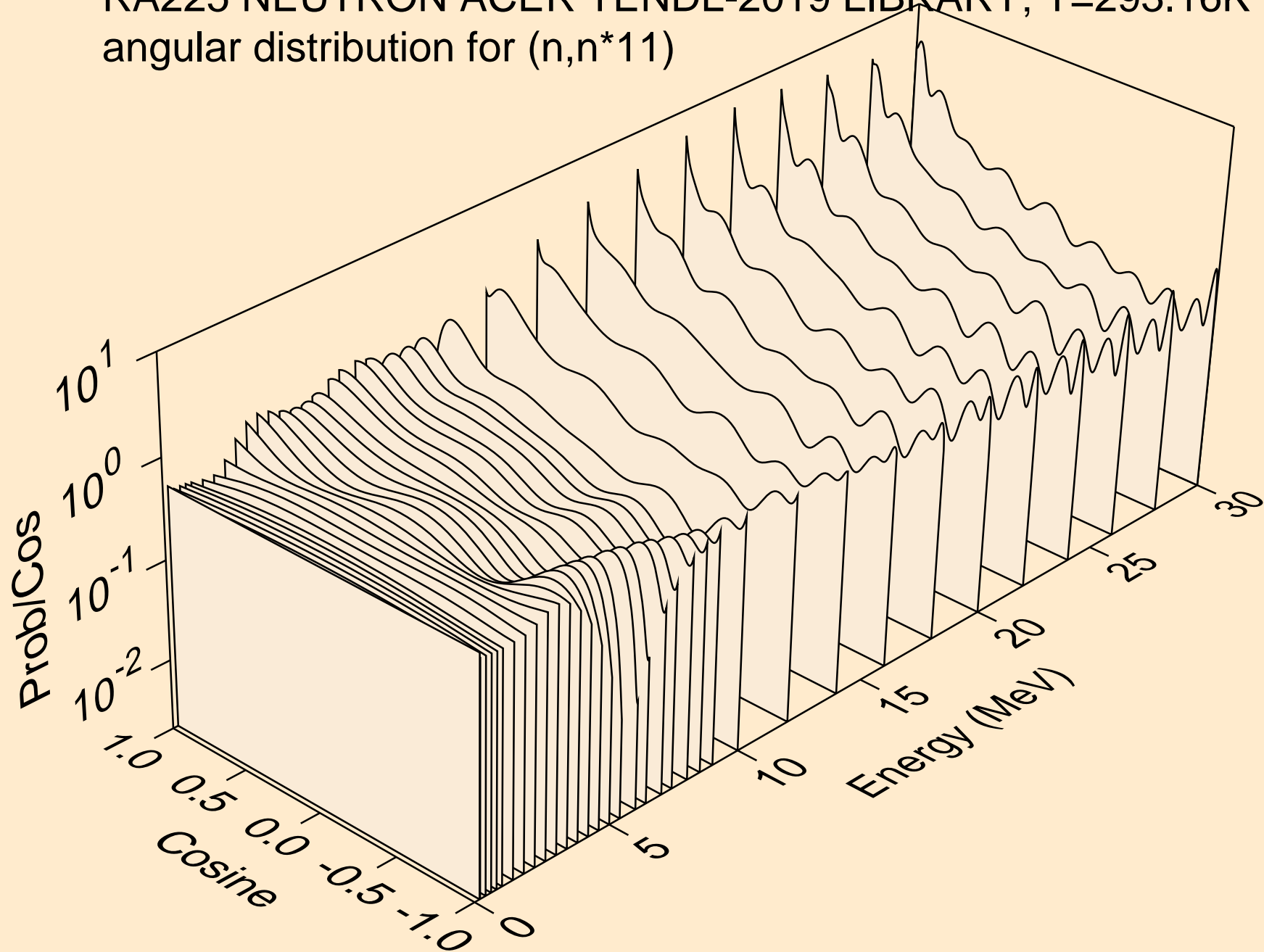

RA225 NEUTRON ACER TENDL-2019 LIBRARY; T=293.16K
angular distribution for (n,n*12)

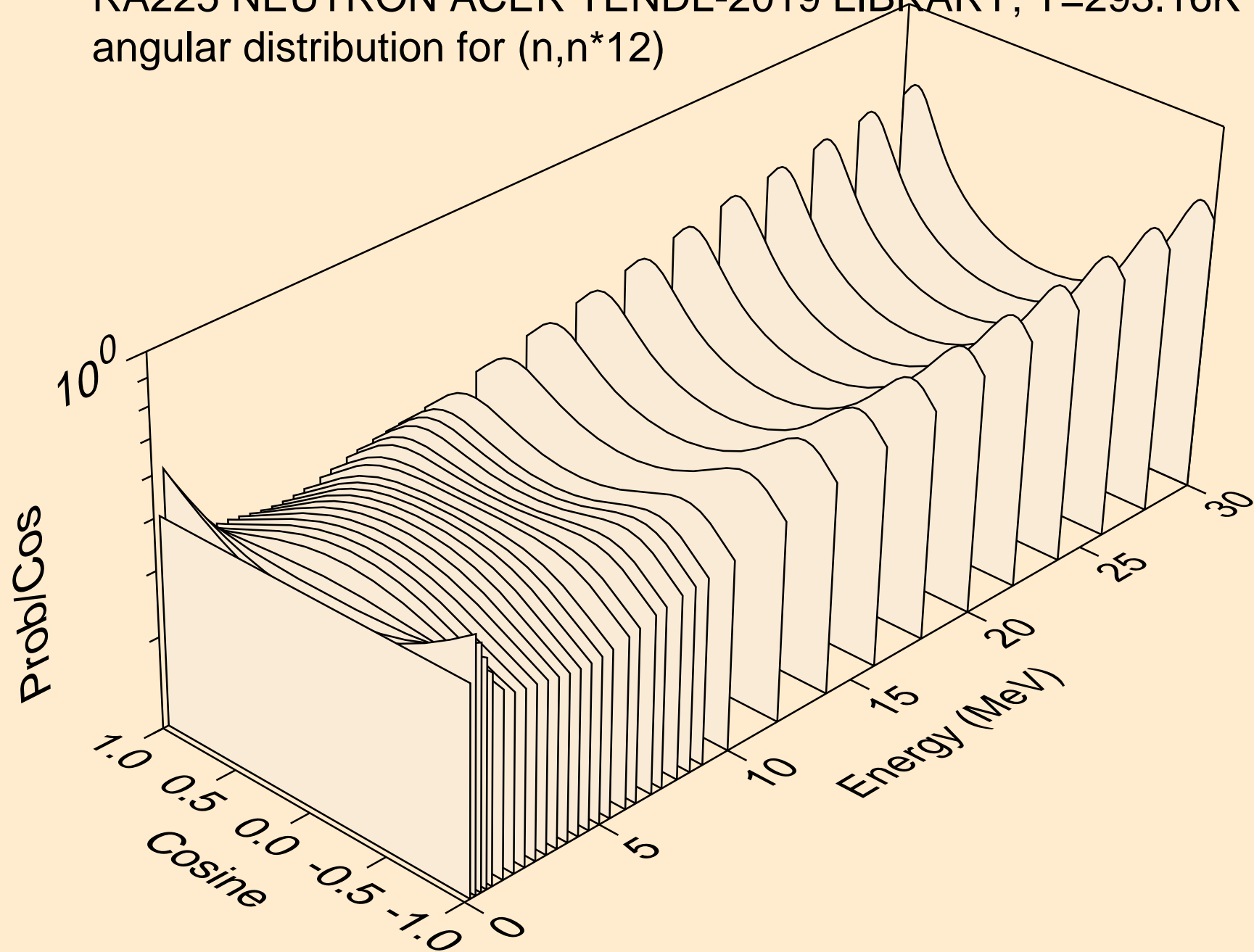

RA225 NEUTRON ACER TENDL-2019 LIBRARY; T=293.16K
angular distribution for (n,n*13)

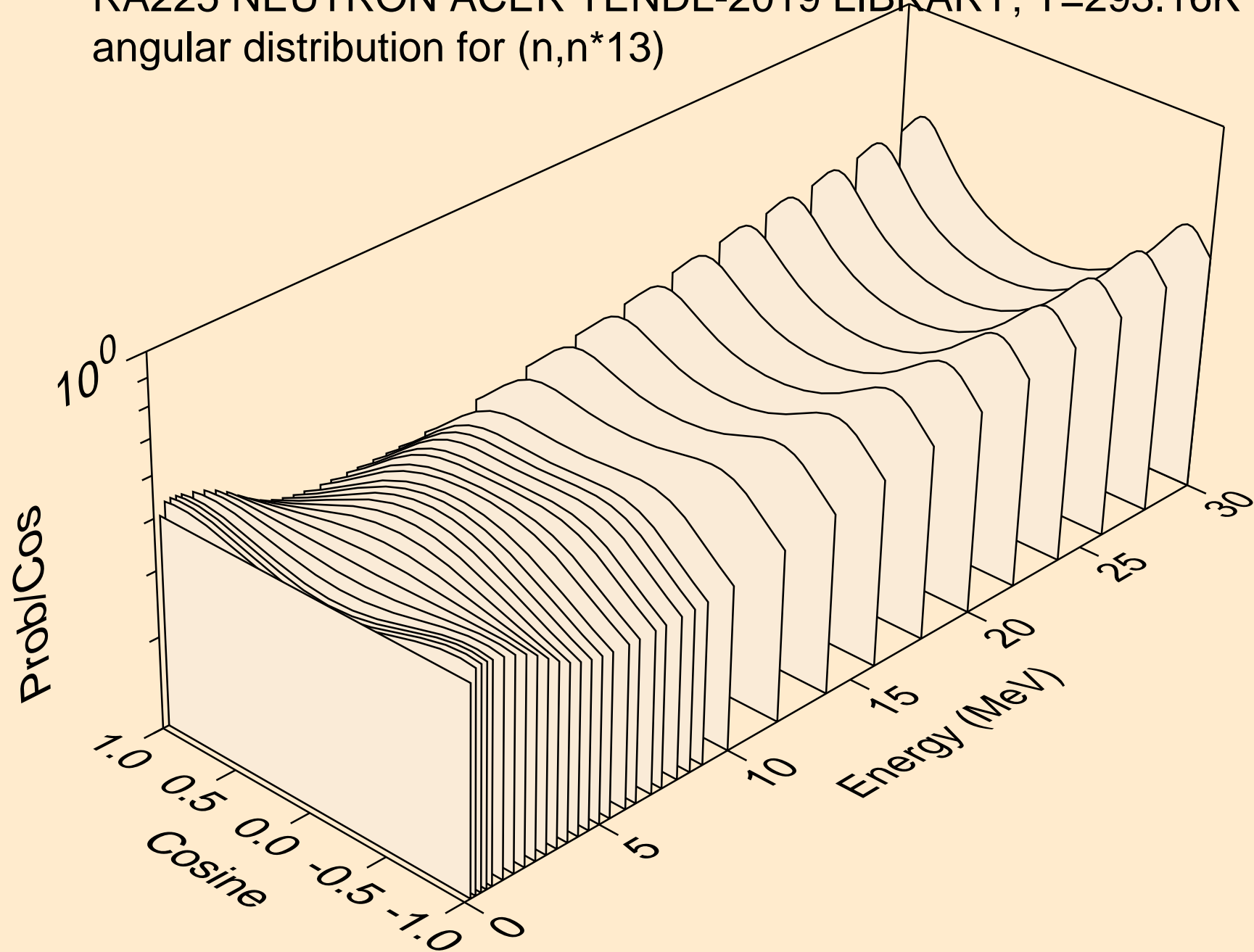

RA225 NEUTRON ACER TENDL-2019 LIBRARY; T=293.16K
angular distribution for (n,n*14)

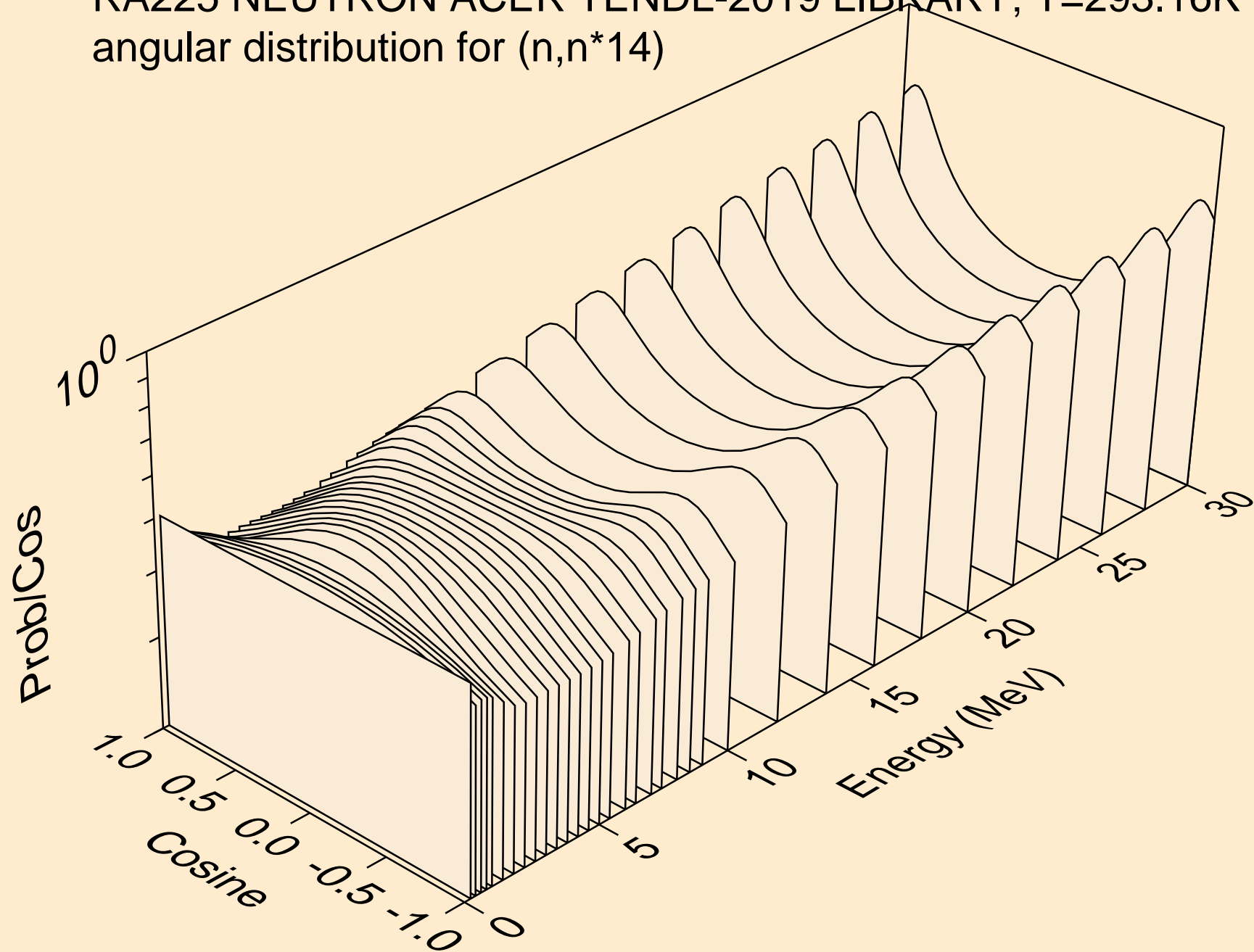

RA225 NEUTRON ACER TENDL-2019 LIBRARY; T=293.16K
angular distribution for (n,n*15)

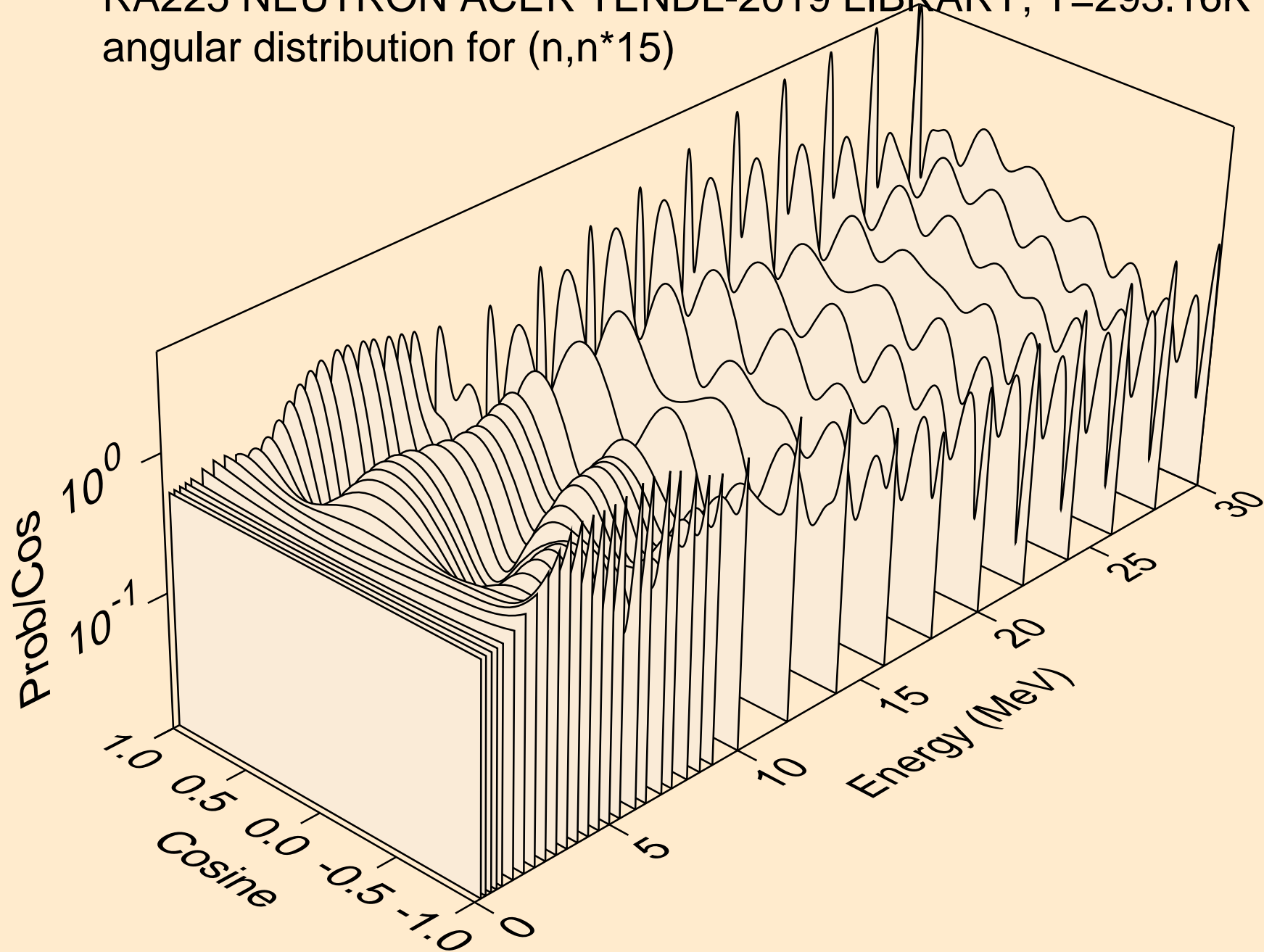

RA225 NEUTRON ACER TENDL-2019 LIBRARY; T=293.16K
angular distribution for (n,n*16)

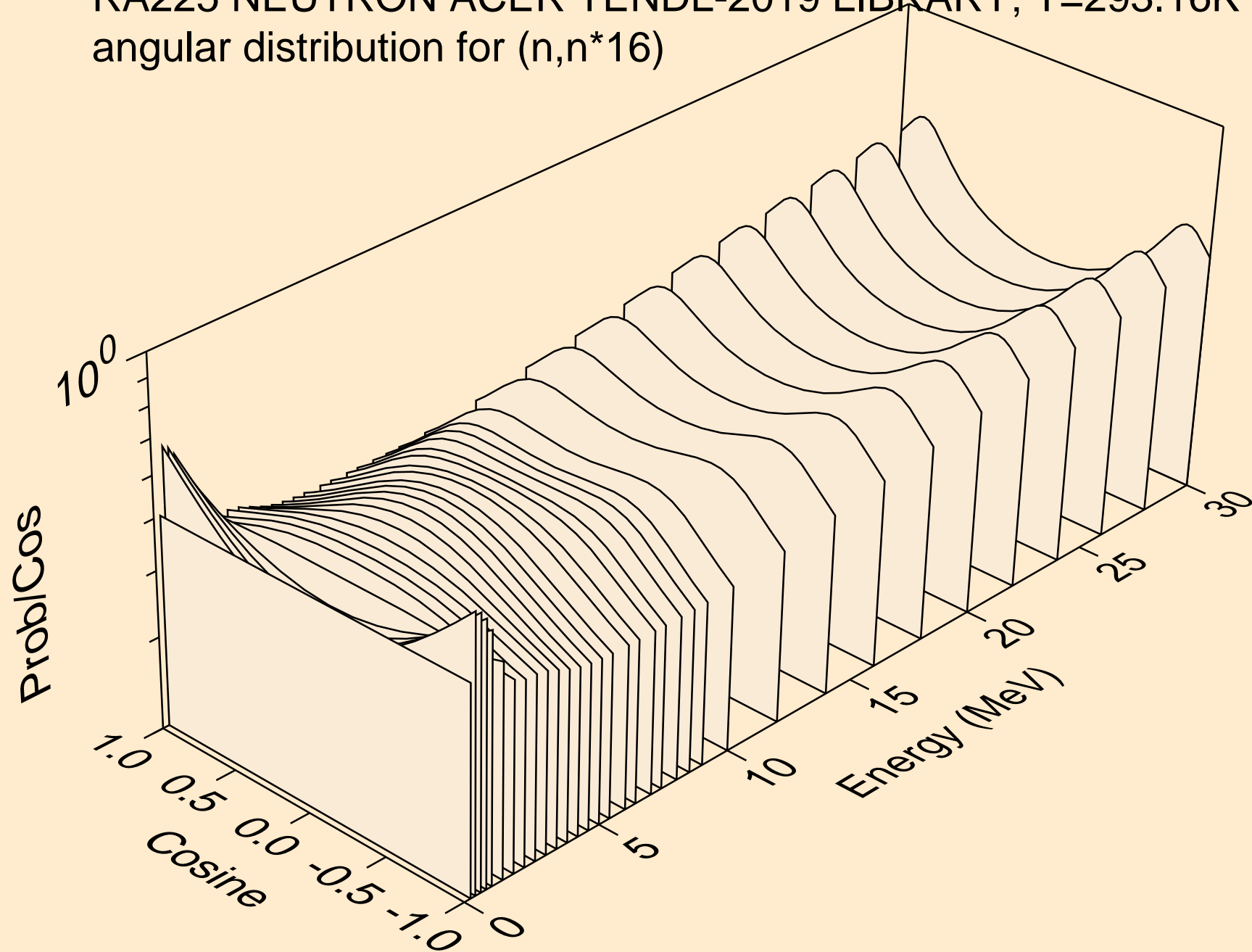

RA225 NEUTRON ACER TENDL-2019 LIBRARY; T=293.16K
angular distribution for (n,n*17)

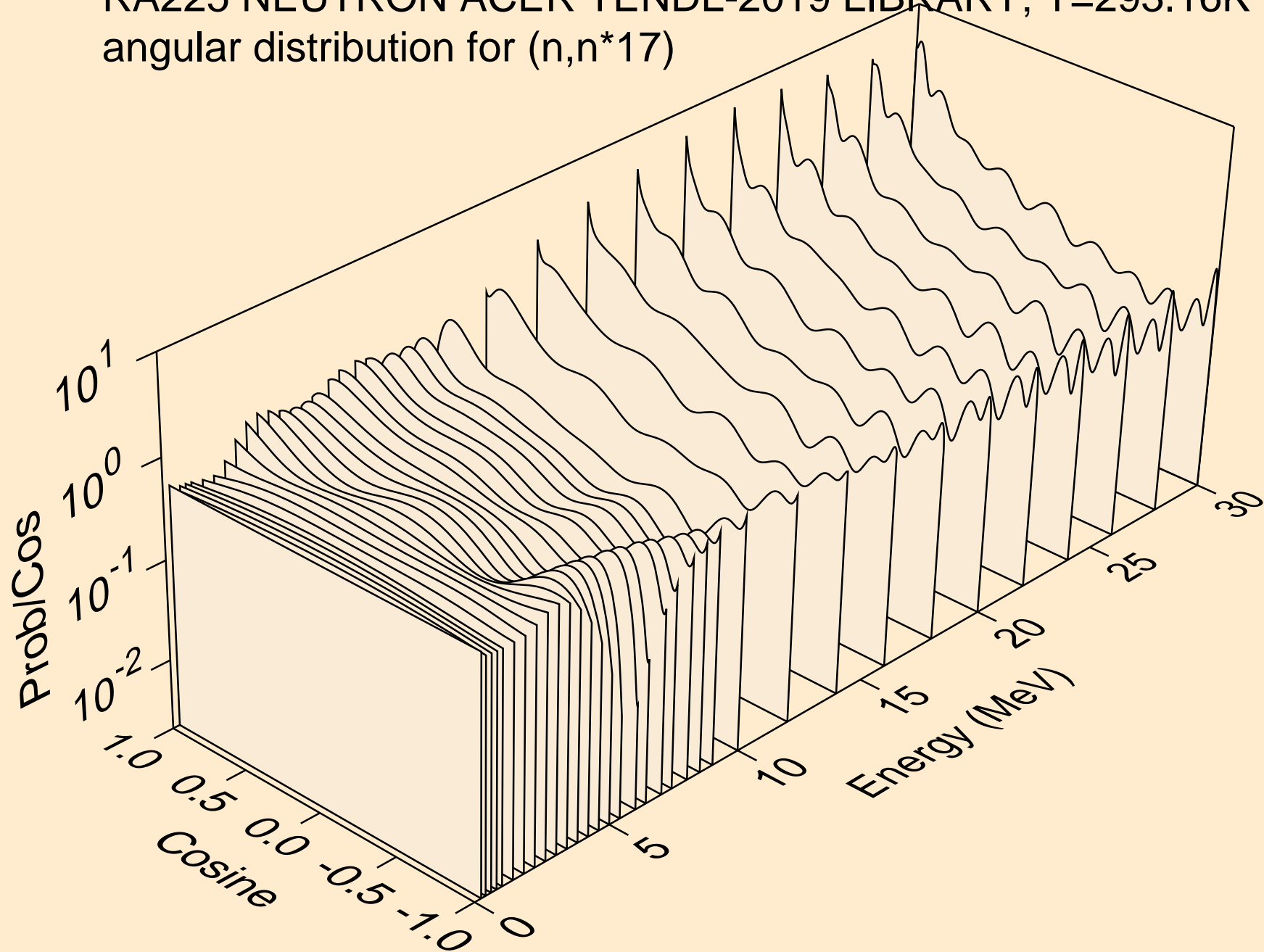

RA225 NEUTRON ACER TENDL-2019 LIBRARY; T=293.16K
angular distribution for (n,n*18)

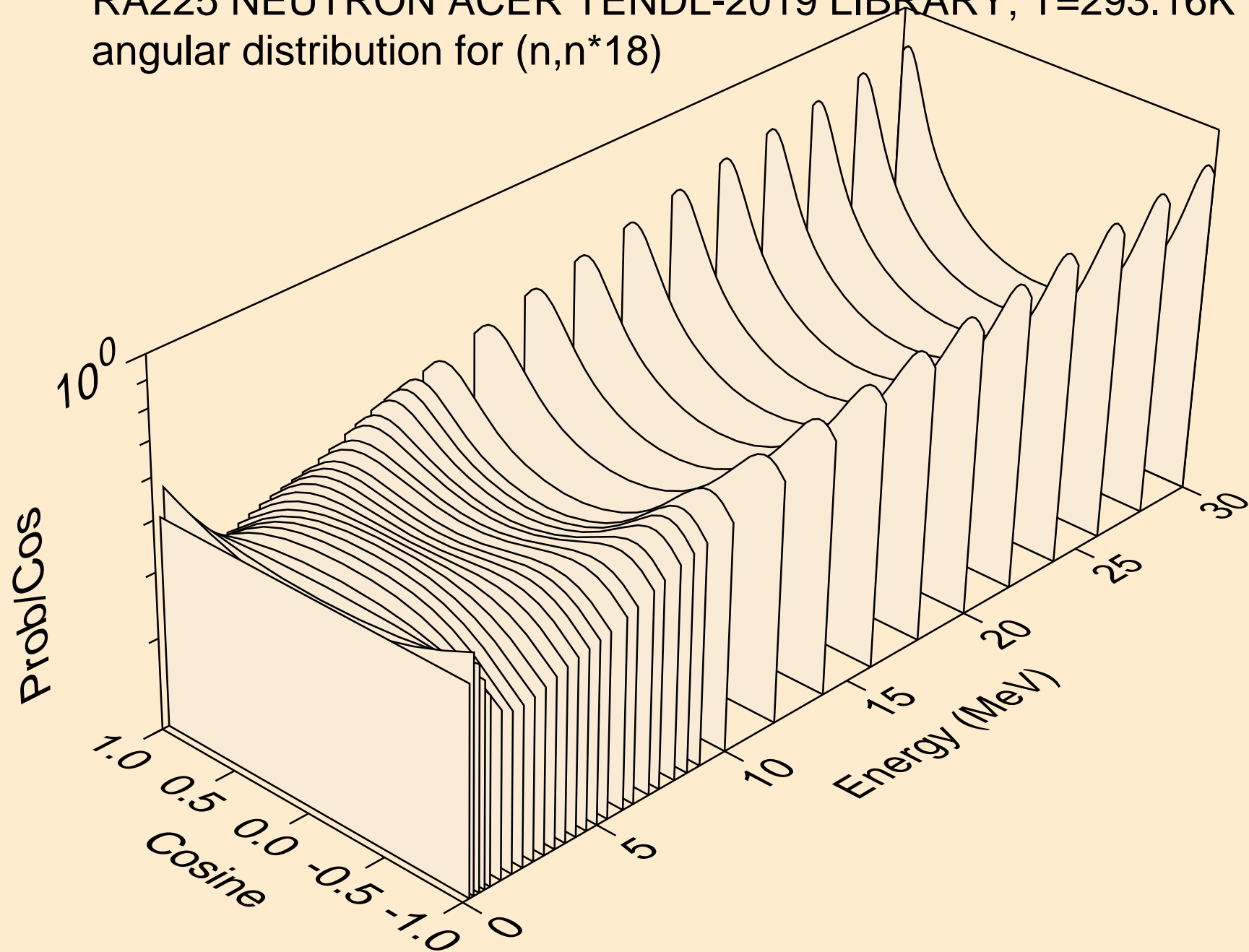

RA225 NEUTRON ACER TENDL-2019 LIBRARY; T=293.16K
angular distribution for (n,n*19)

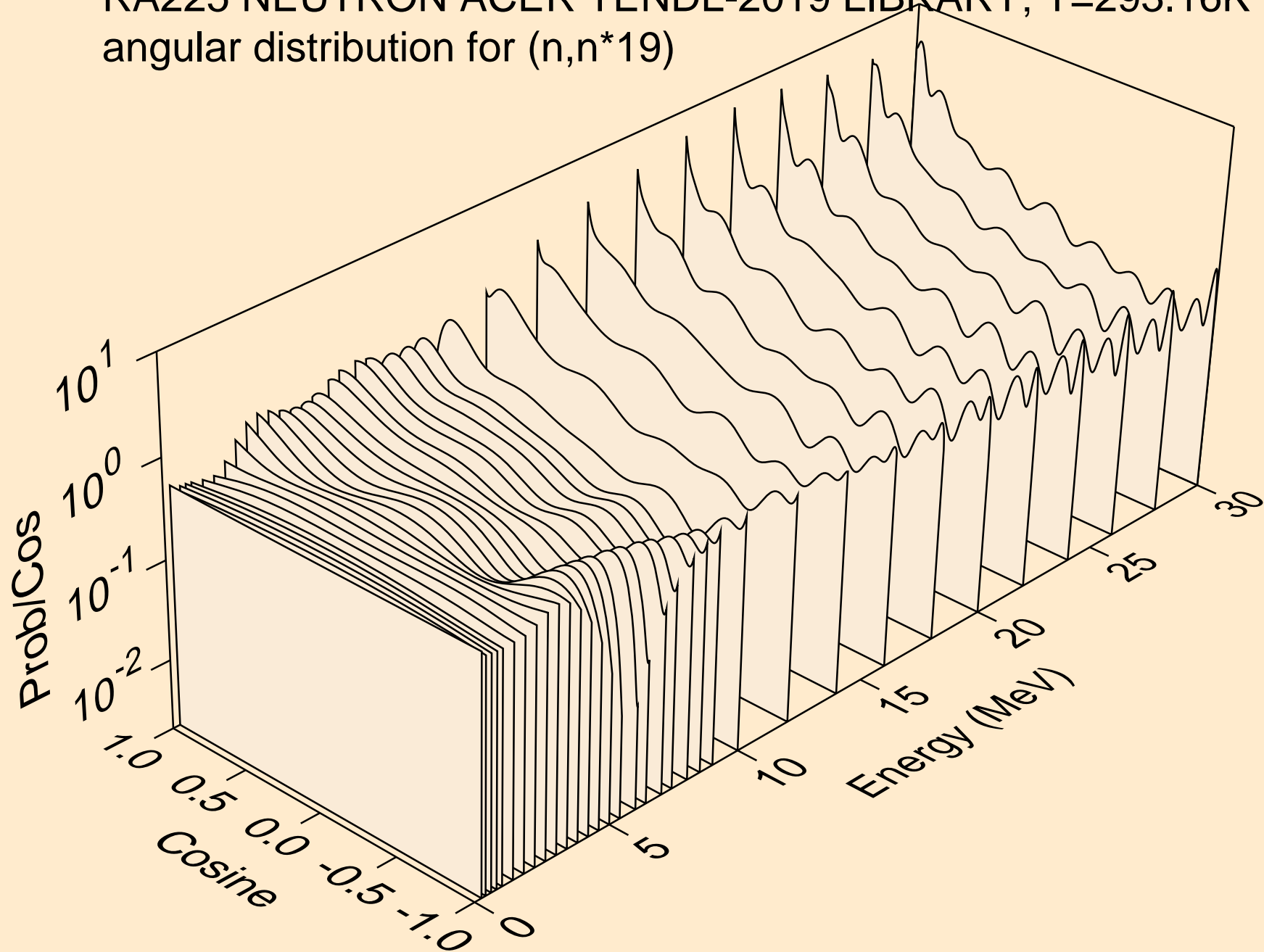

RA225 NEUTRON ACER TENDL-2019 LIBRARY; T=293.16K
angular distribution for (n,n*20)

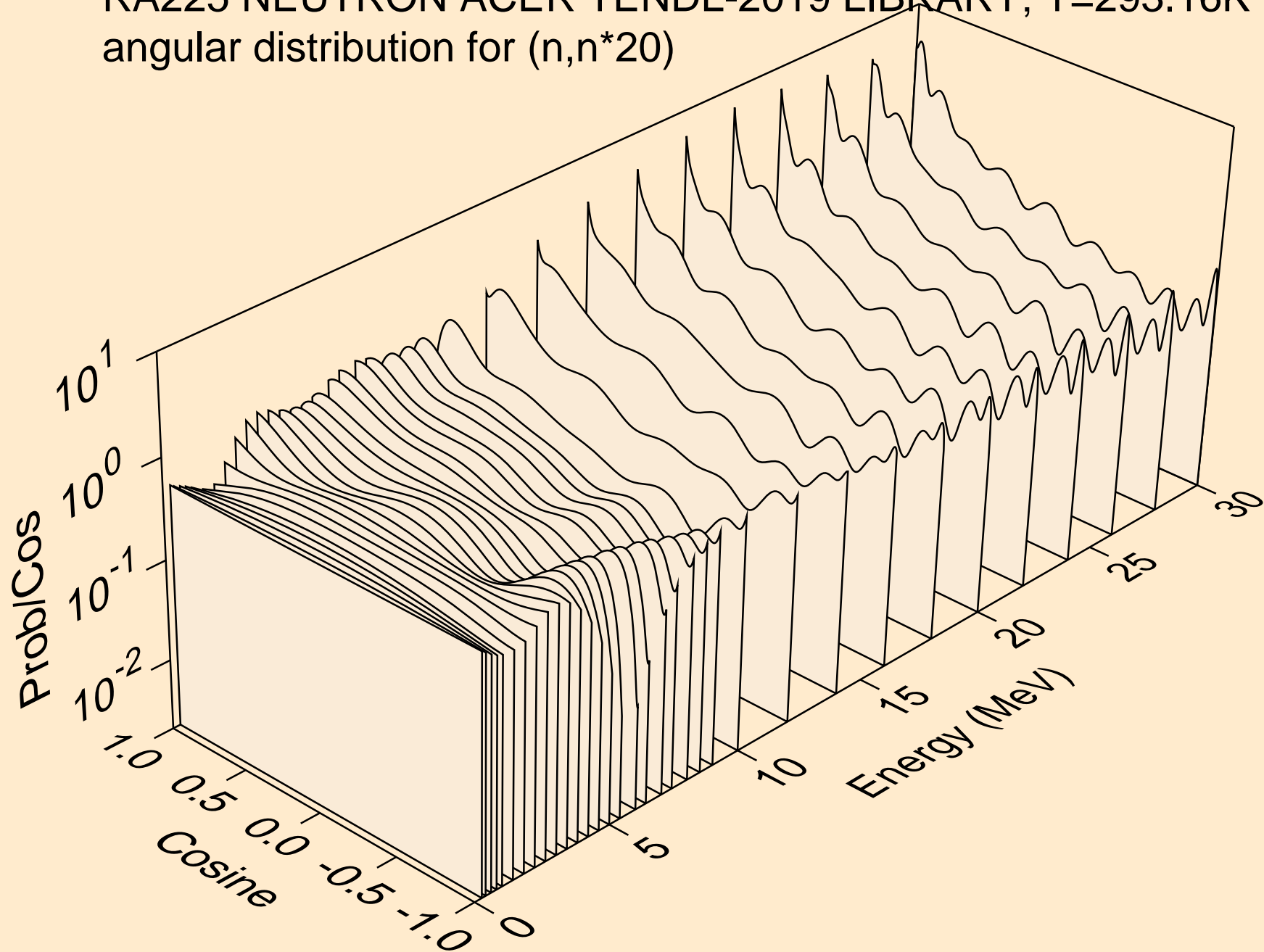

RA225 NEUTRON ACER TENDL-2019 LIBRARY; T=293.16K
angular distribution for (n,n*21)

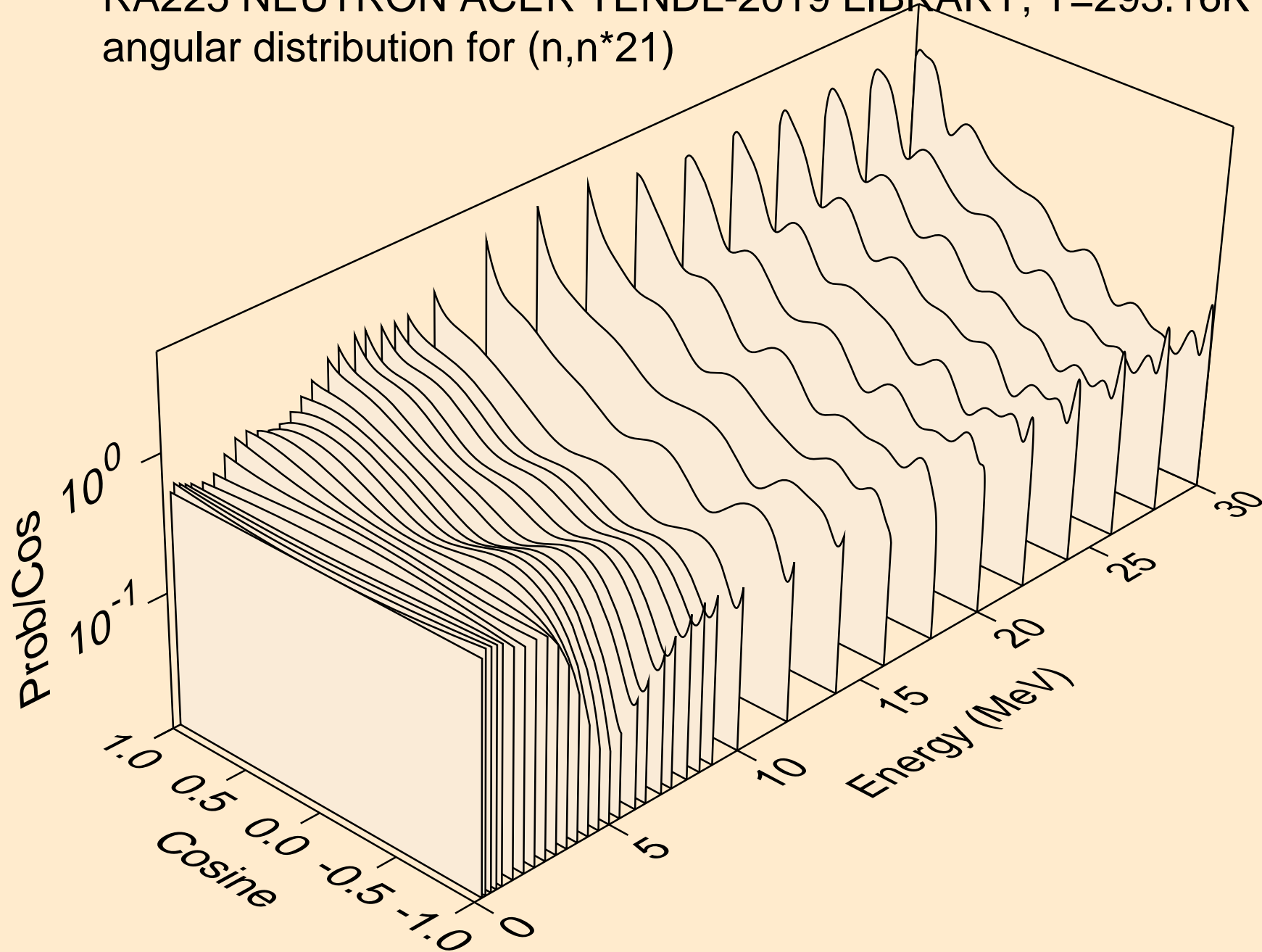

RA225 NEUTRON ACER TENDL-2019 LIBRARY; T=293.16K
angular distribution for (n,n*22)

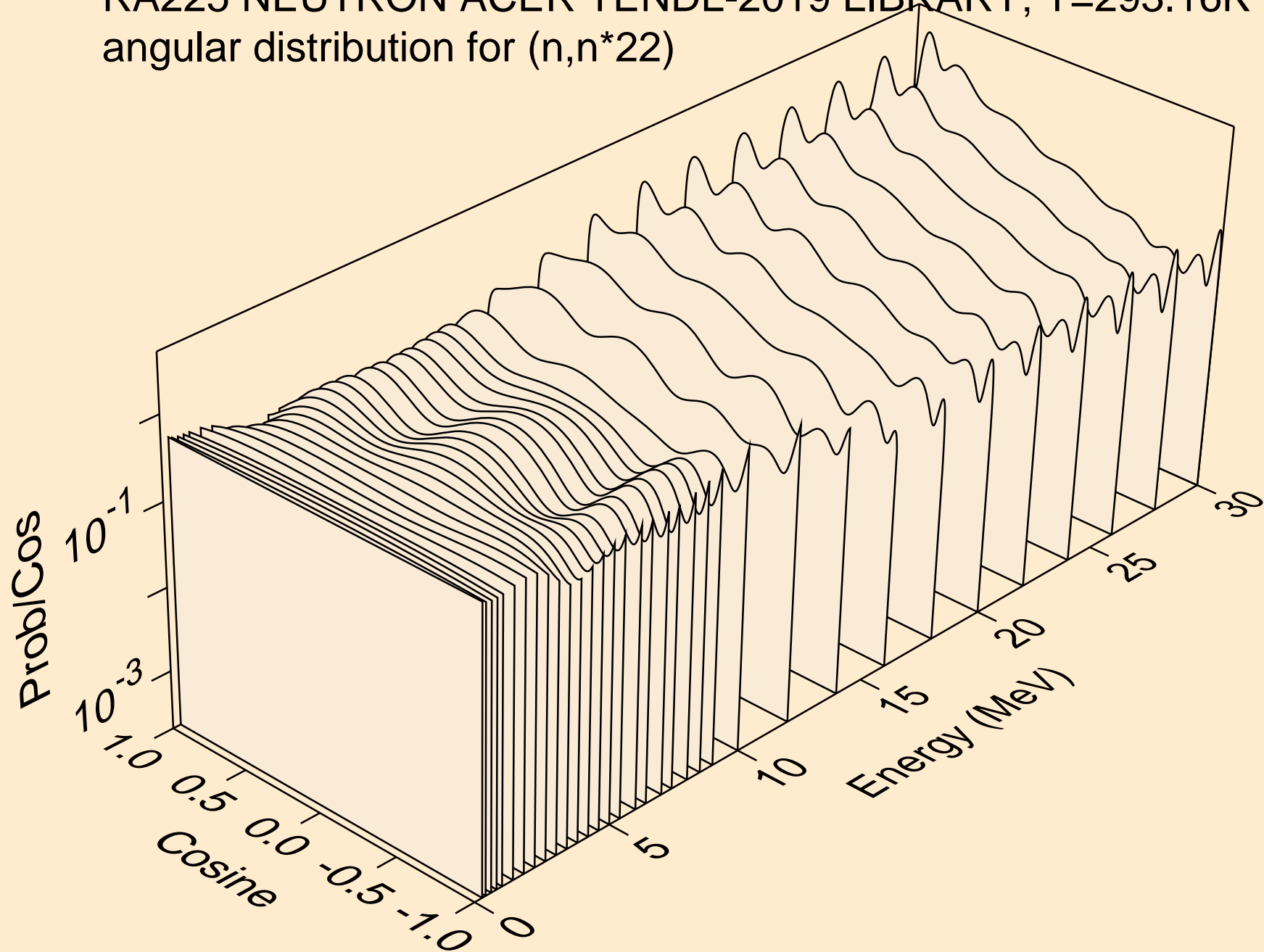

RA225 NEUTRON ACER TENDL-2019 LIBRARY; T=293.16K
angular distribution for (n,n*23)

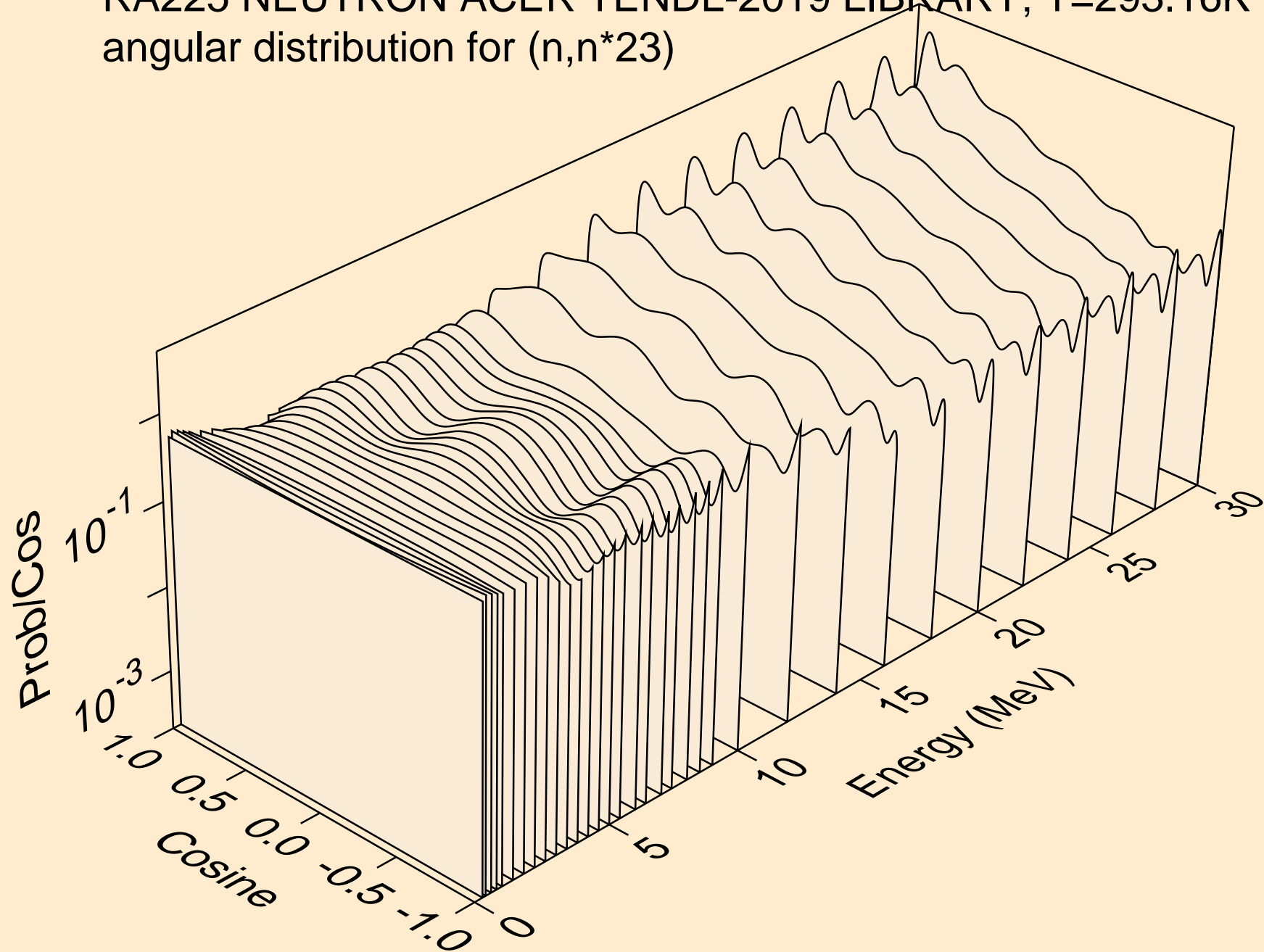

RA225 NEUTRON ACER TENDL-2019 LIBRARY; T=293.16K
angular distribution for (n,n*24)

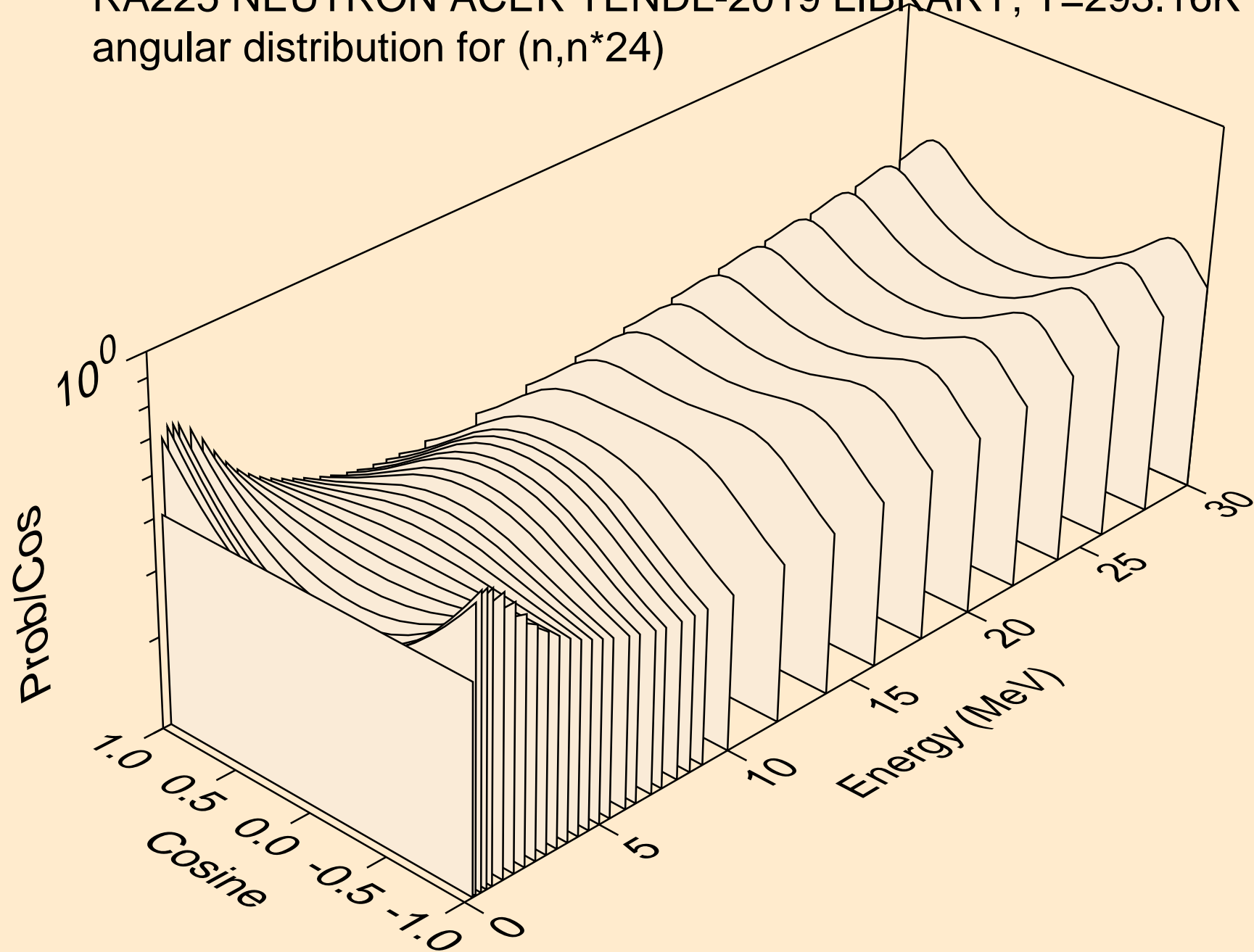

RA225 NEUTRON ACER TENDL-2019 LIBRARY; T=293.16K
angular distribution for (n,n*25)

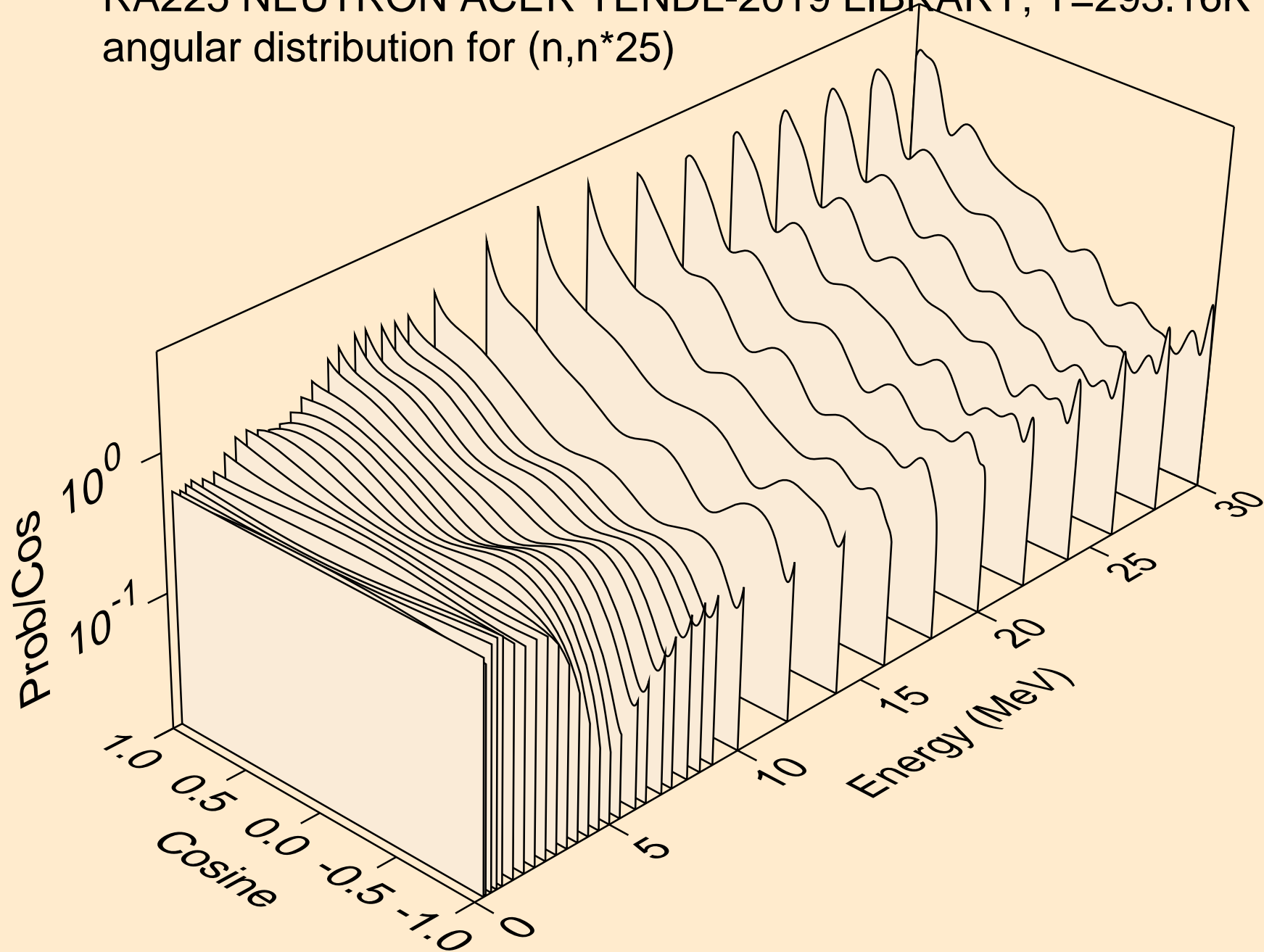

RA225 NEUTRON ACER TENDL-2019 LIBRARY; T=293.16K
angular distribution for (n,n*26)

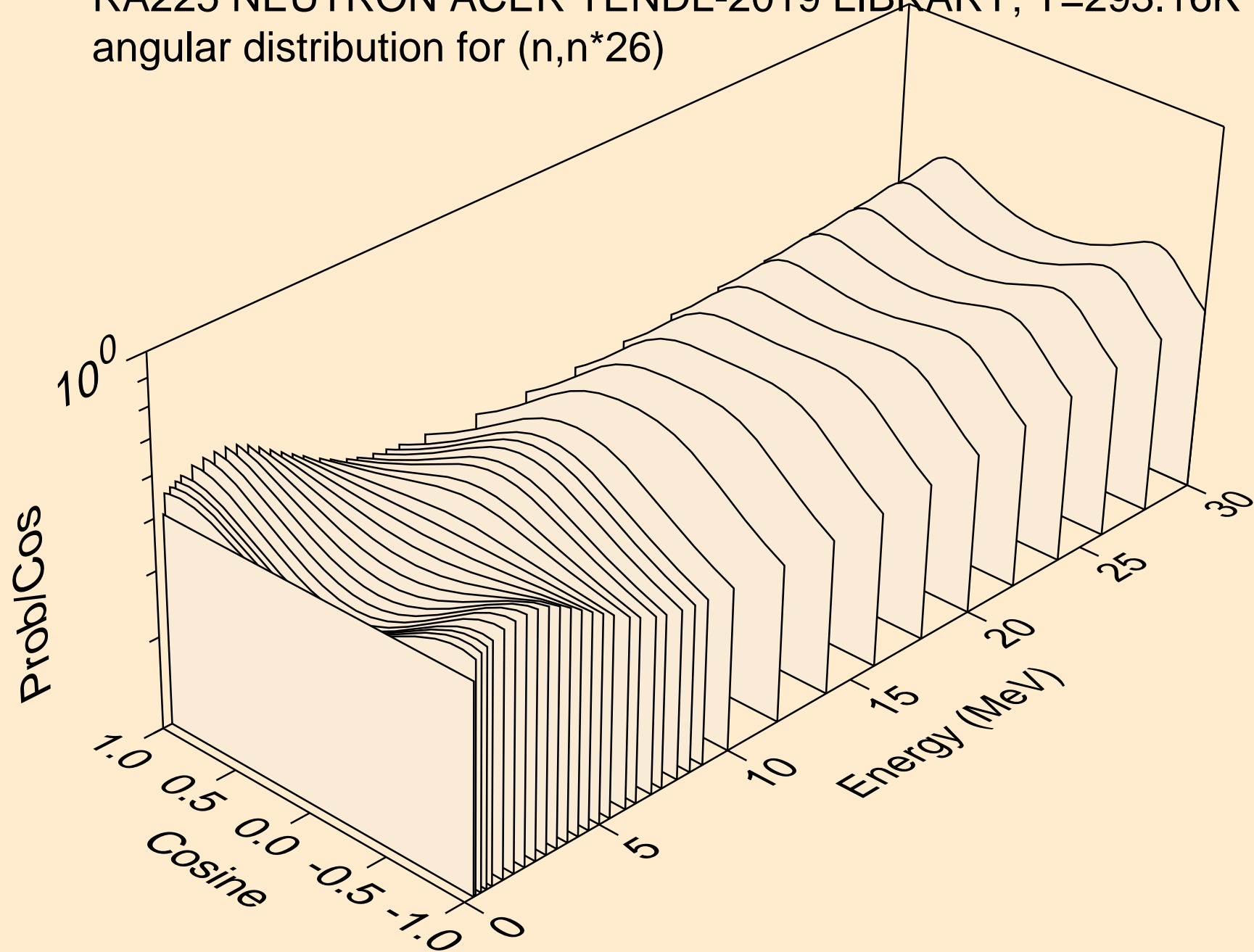

RA225 NEUTRON ACER TENDL-2019 LIBRARY; T=293.16K
angular distribution for (n,n*27)

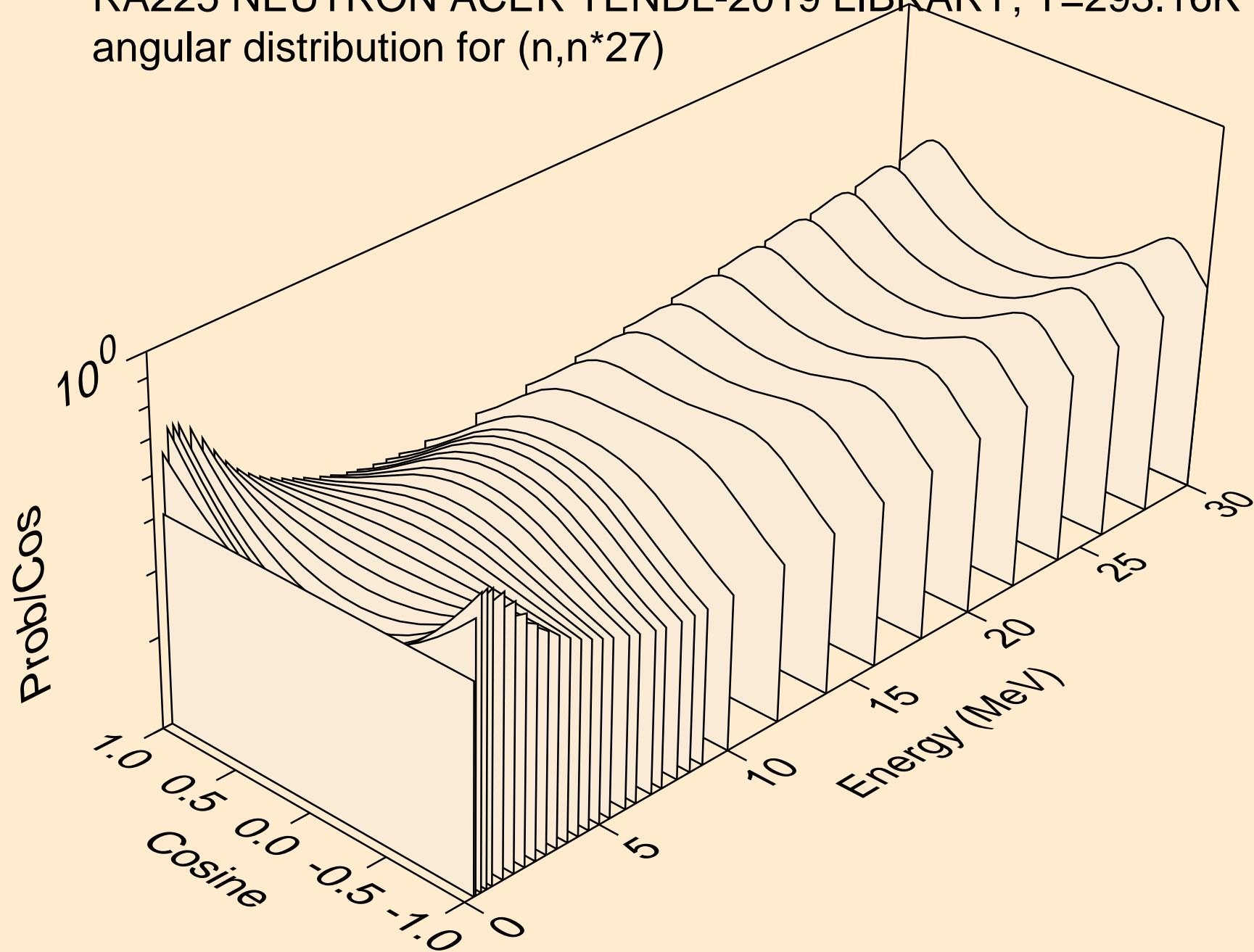

RA225 NEUTRON ACER TENDL-2019 LIBRARY; T=293.16K
angular distribution for (n,n*28)

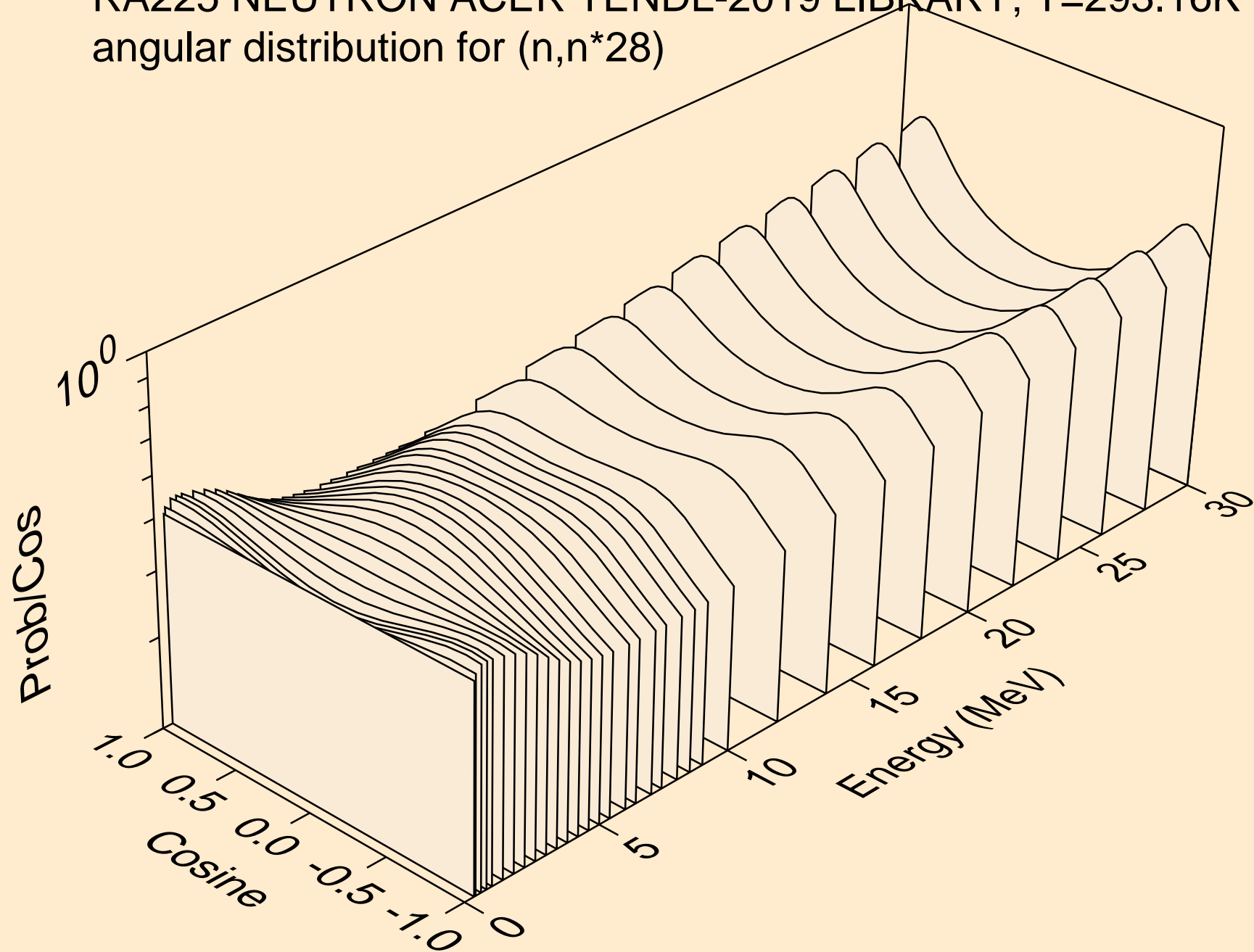

RA225 NEUTRON ACER TENDL-2019 LIBRARY; T=293.16K
angular distribution for (n,n*29)

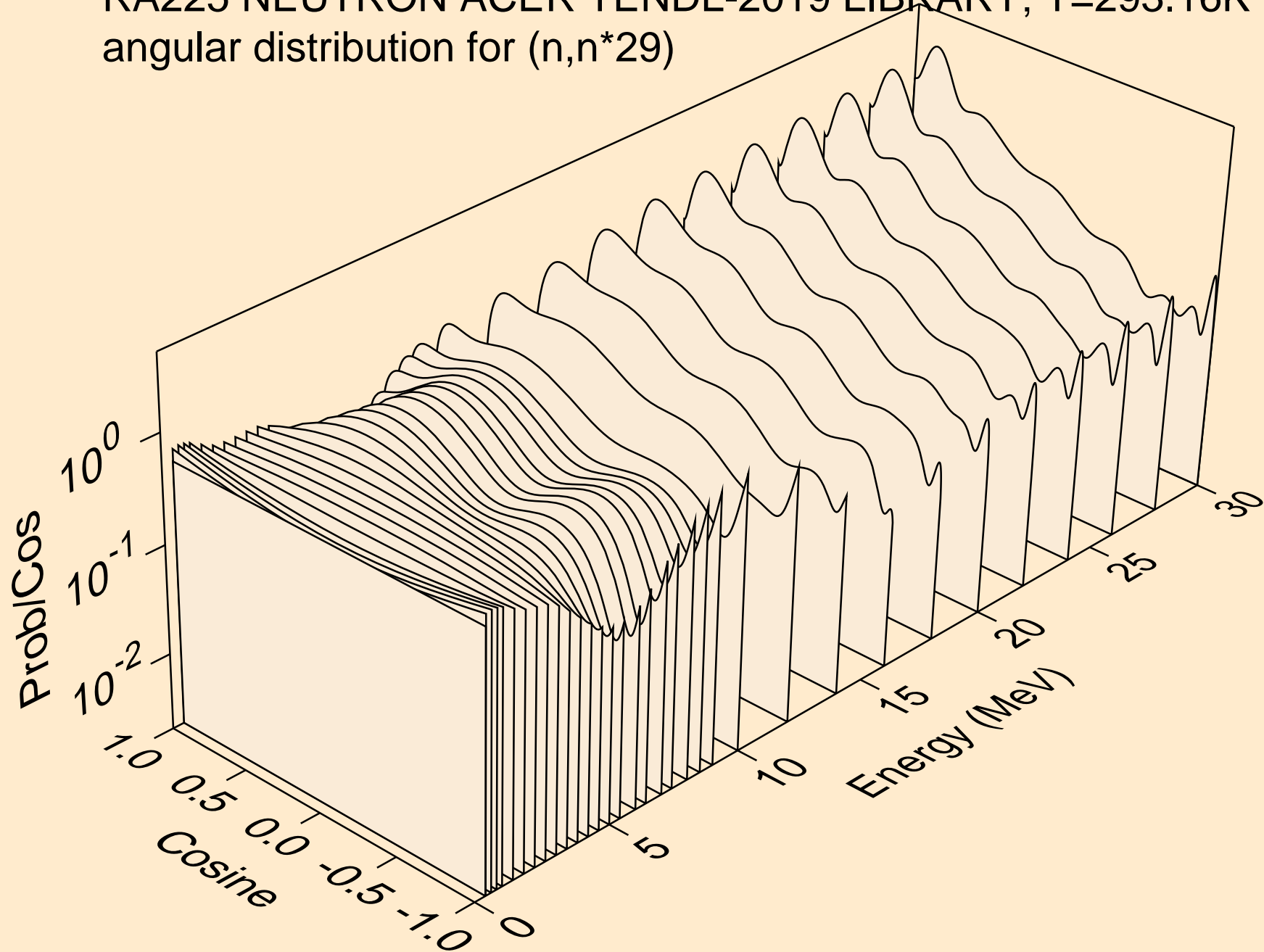

RA225 NEUTRON ACER TENDL-2019 LIBRARY; T=293.16K
angular distribution for (n,n*30)

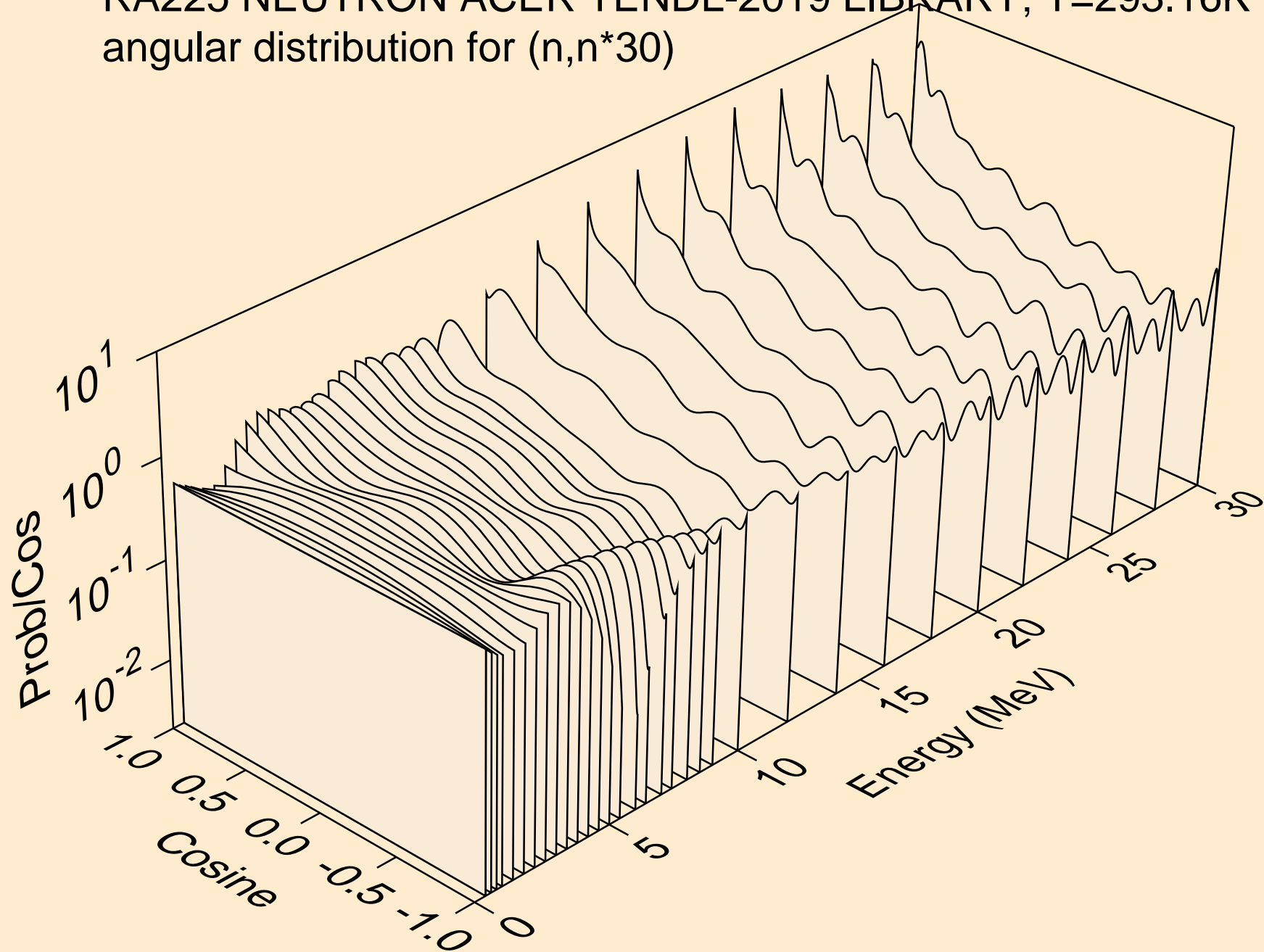

RA225 NEUTRON ACER TENDL-2019 LIBRARY; T=293.16K
Total fission nubar

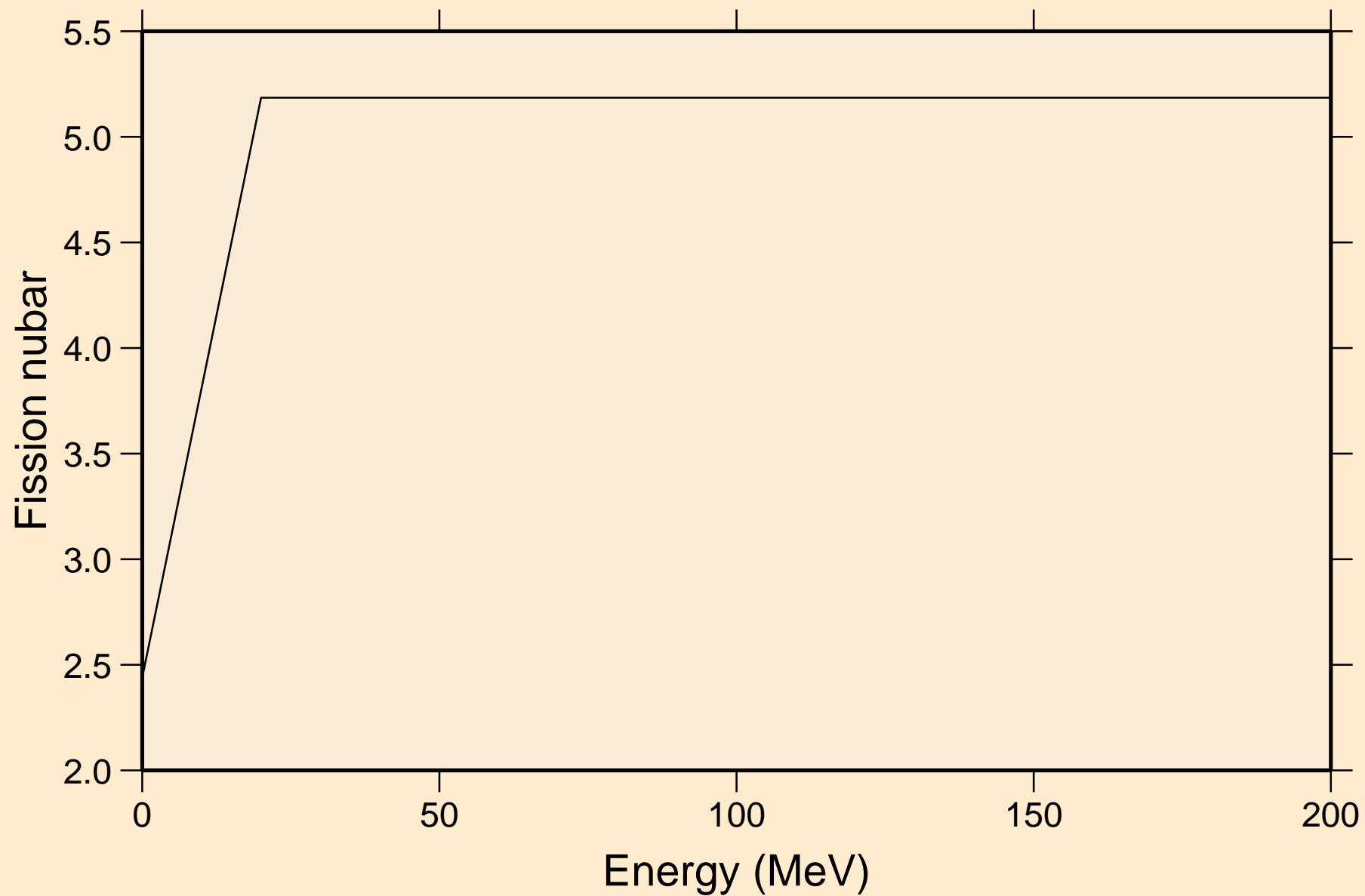

RA225 NEUTRON ACER TENDL-2019 LIBRARY; T=293.16K
Neutron emission for (n,x)

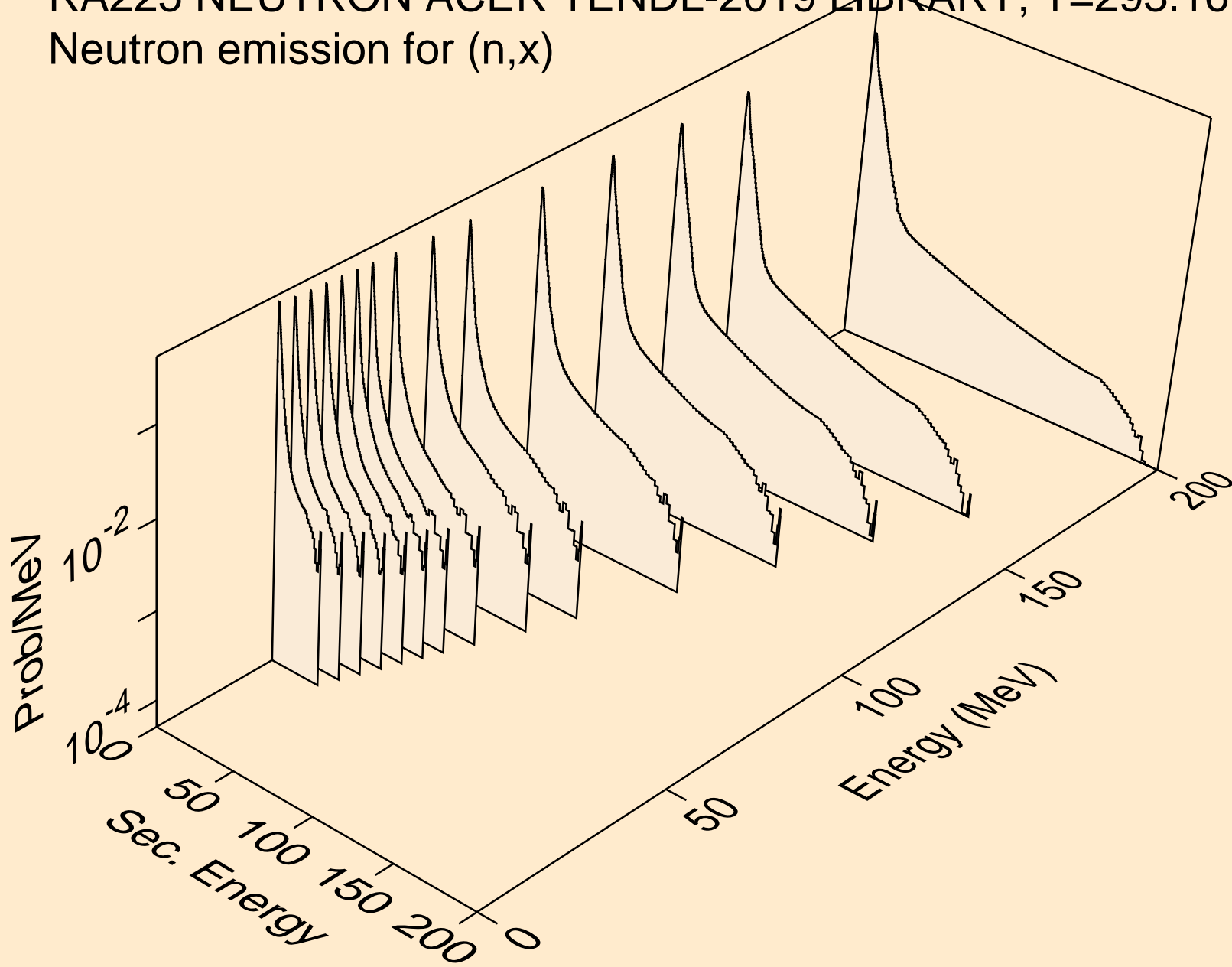

RA225 NEUTRON ACER TENDL-2019 LIBRARY; T=293.16K
Neutron emission for (n,2nd)

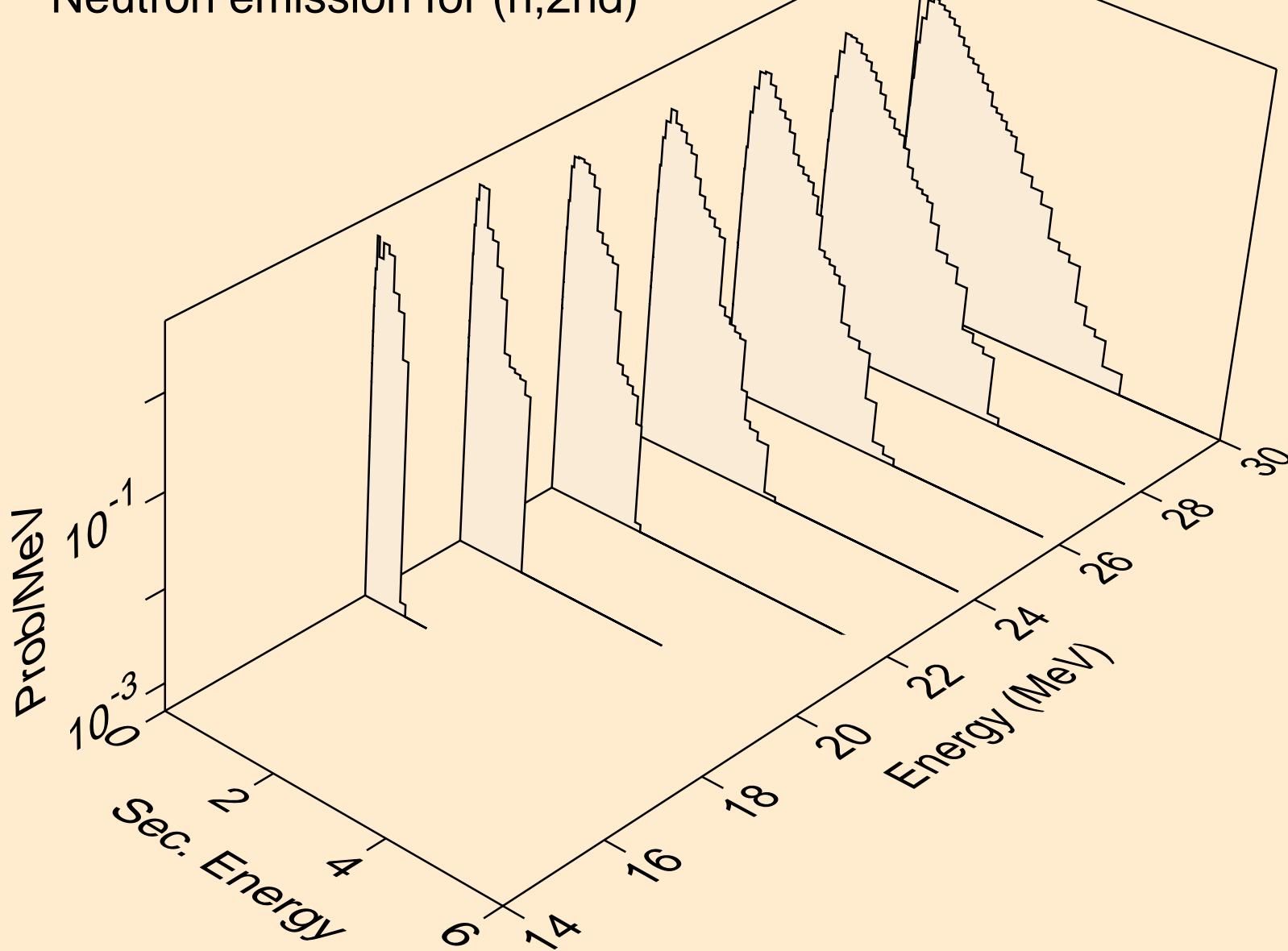

RA225 NEUTRON ACER TENDL-2019 LIBRARY; T=293.16K
Neutron emission for (n,2n)

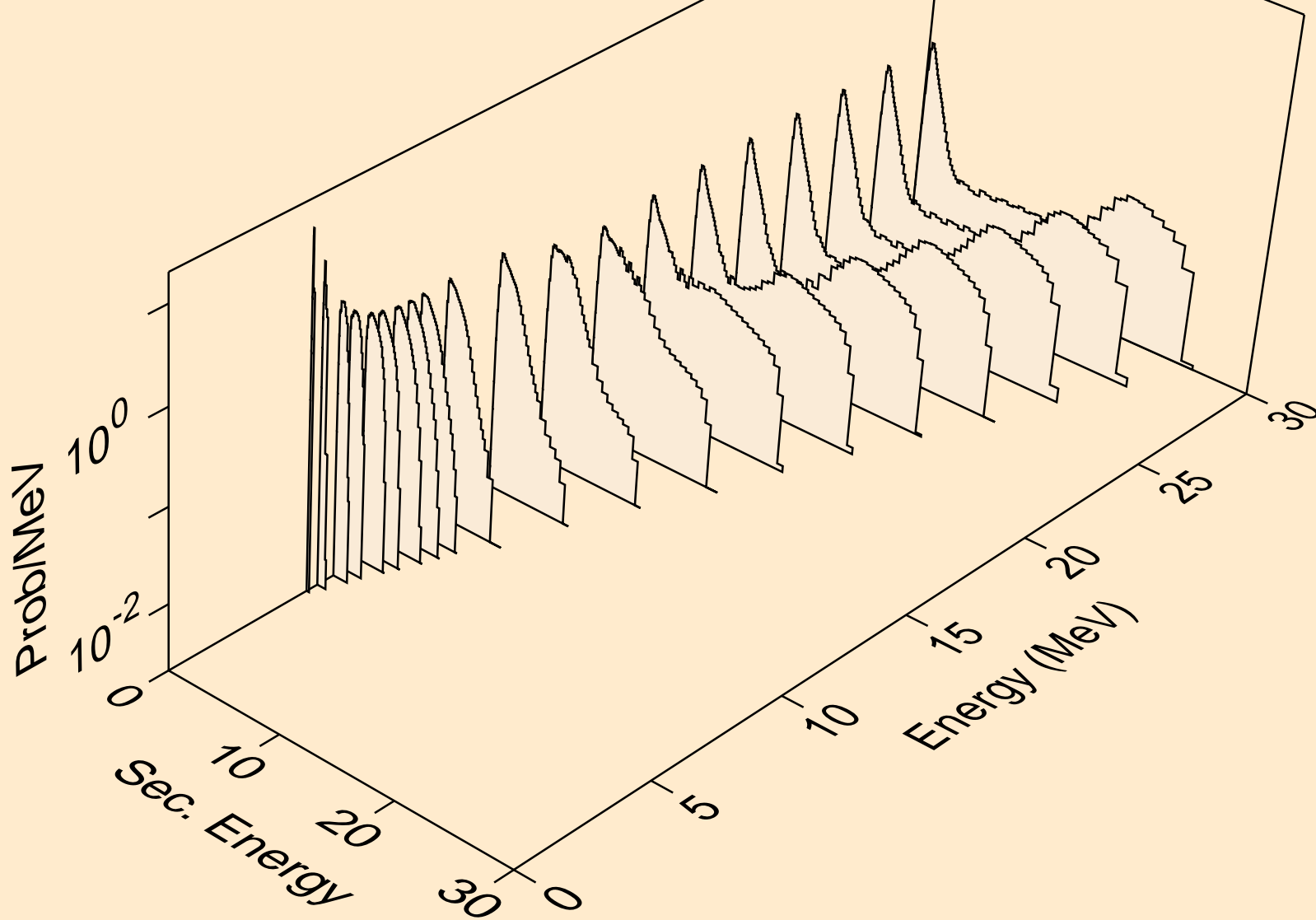

RA225 NEUTRON ACER TENDL-2019 LIBRARY; T=293.16K
Neutron emission for (n,3n)

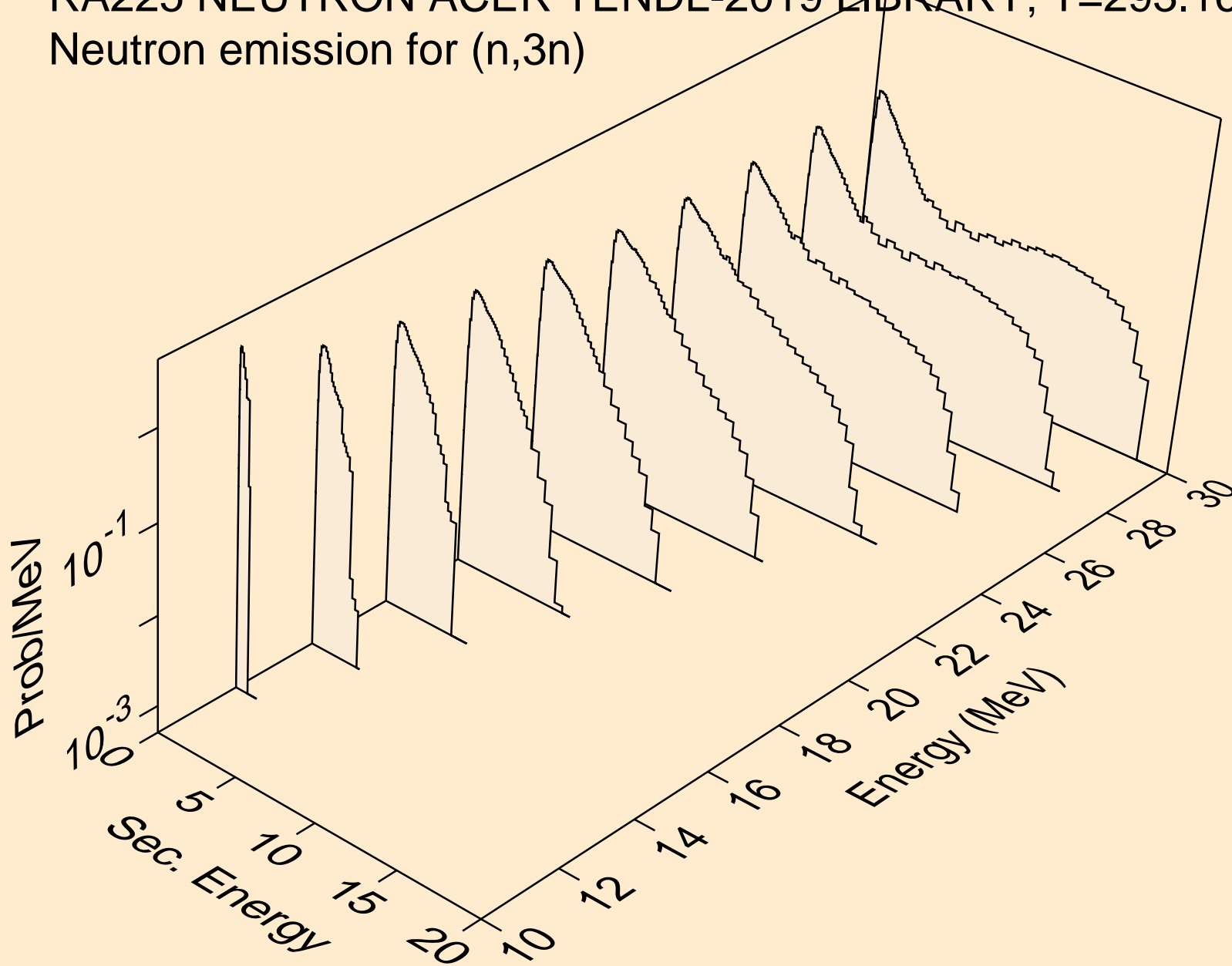

RA225 NEUTRON ACER TENDL-2019 LIBRARY; T=293.16K
Neutron emission for fission

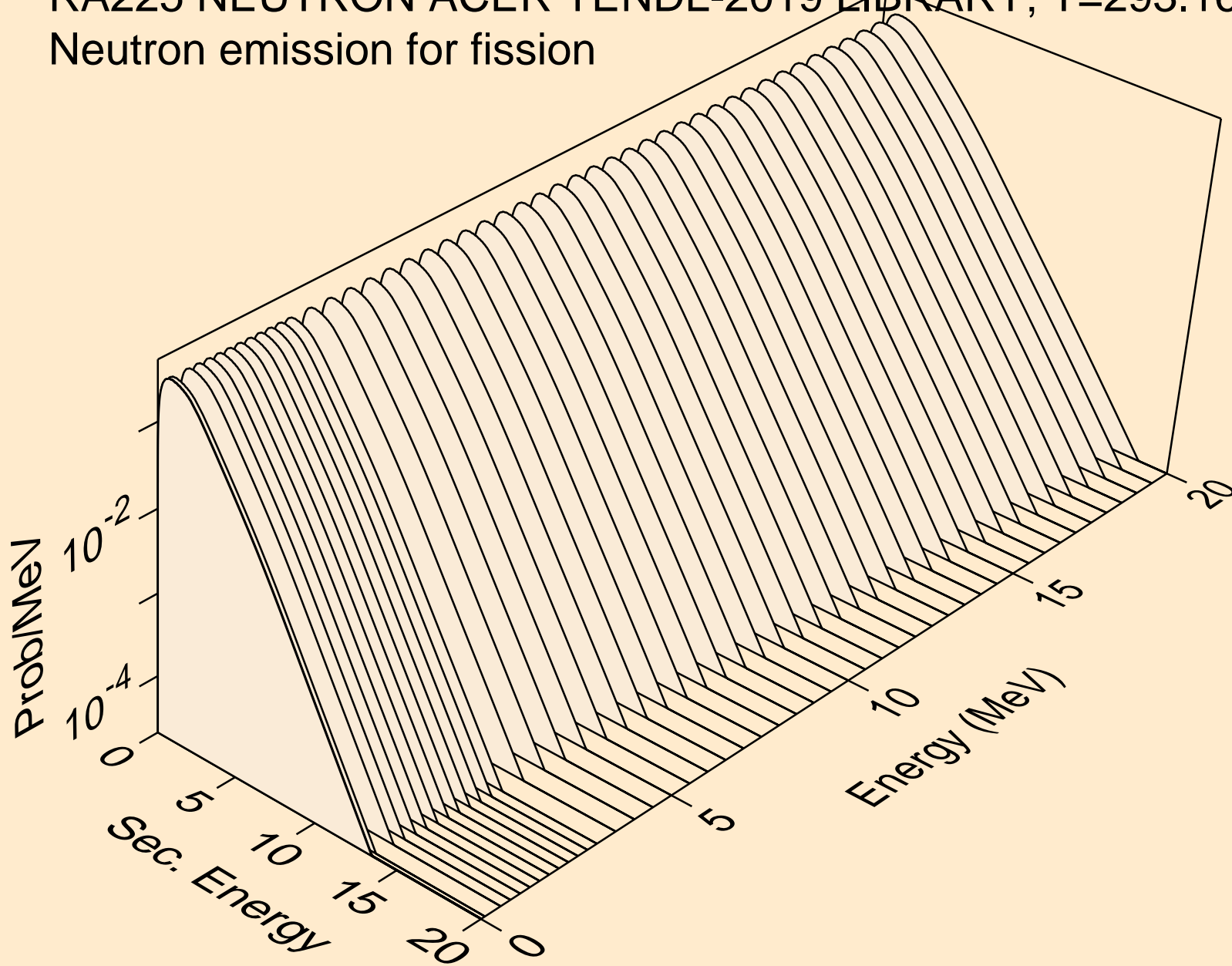

RA225 NEUTRON ACER TENDL-2019 LIBRARY; T=293.16K
Neutron emission for (n,n*)a

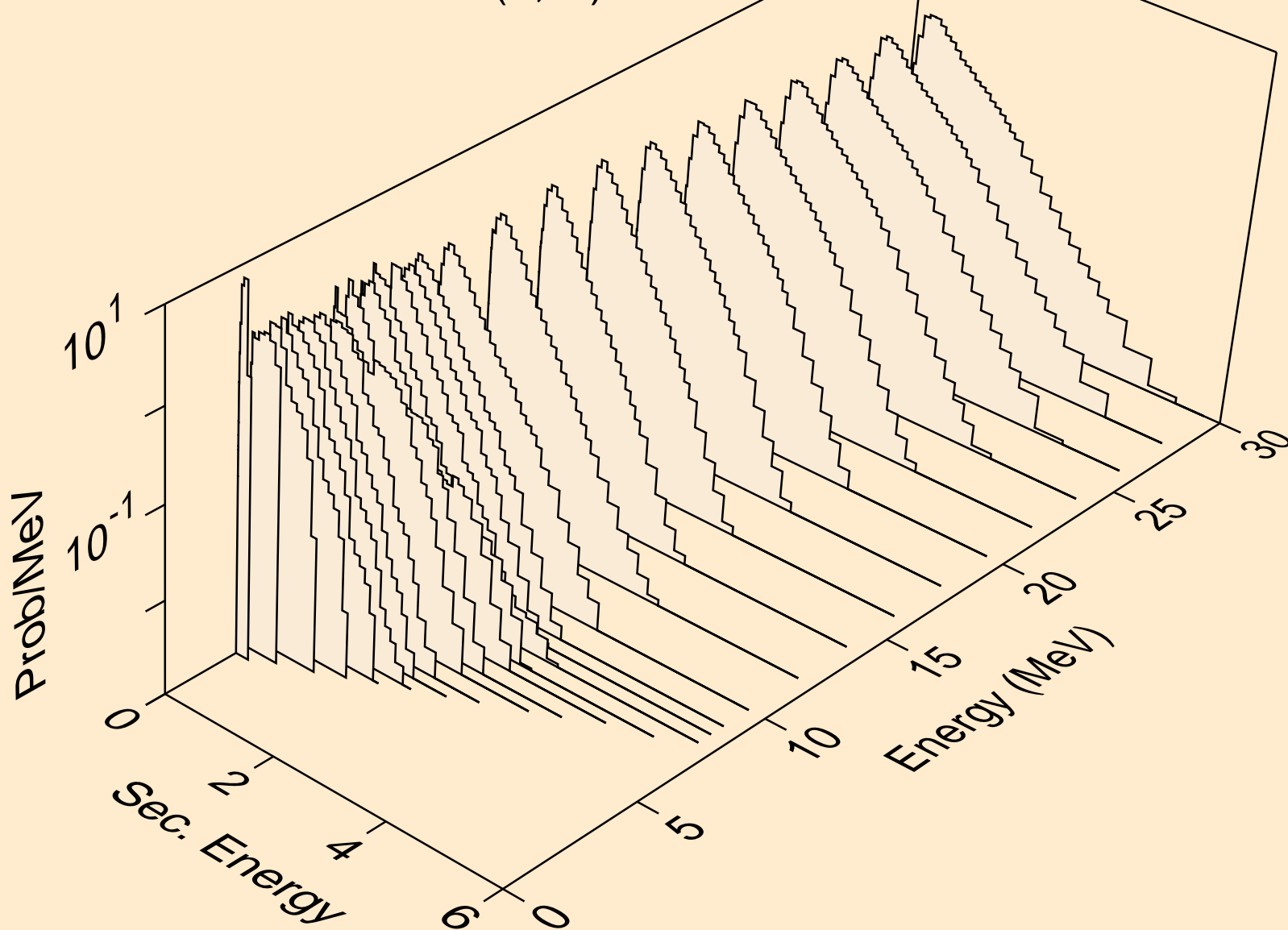

RA225 NEUTRON ACER TENDL-2019 LIBRARY; T=293.16K
Neutron emission for (n,2n)a

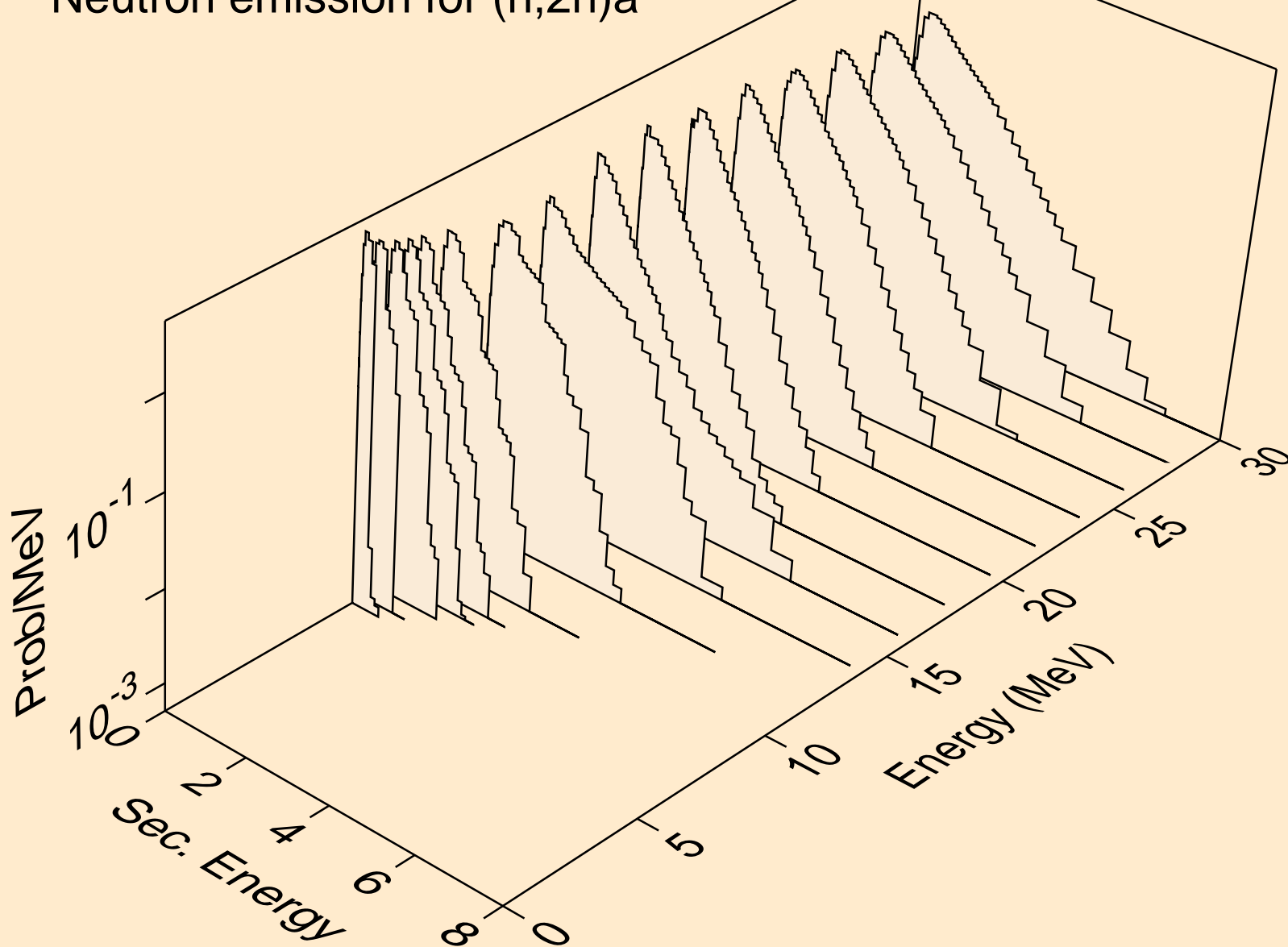

RA225 NEUTRON ACER TENDL-2019 LIBRARY; T=293.16K
Neutron emission for (n,3n)a

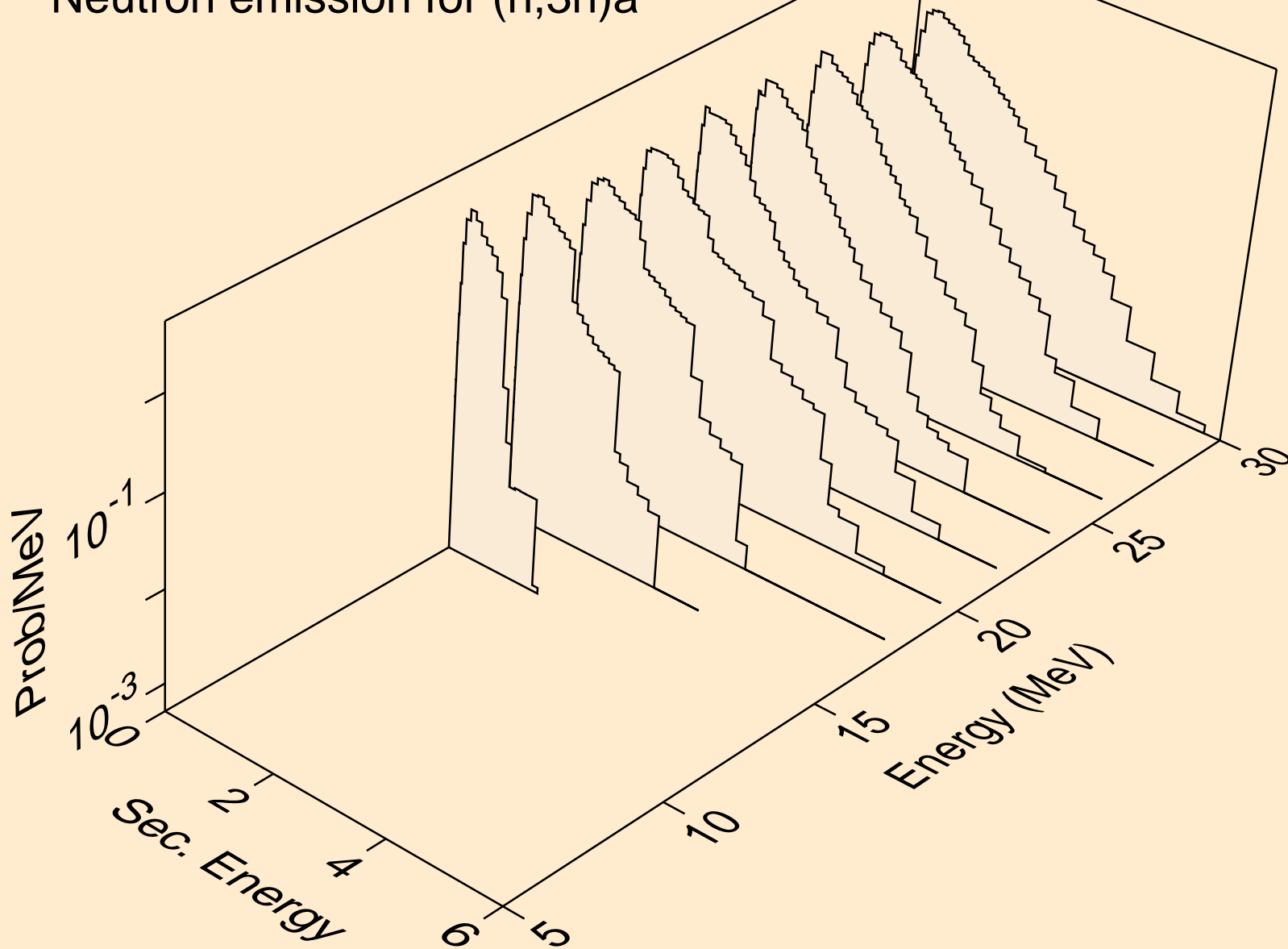

RA225 NEUTRON ACER TENDL-2019 LIBRARY; T=293.16K
Neutron emission for (n,n*)p

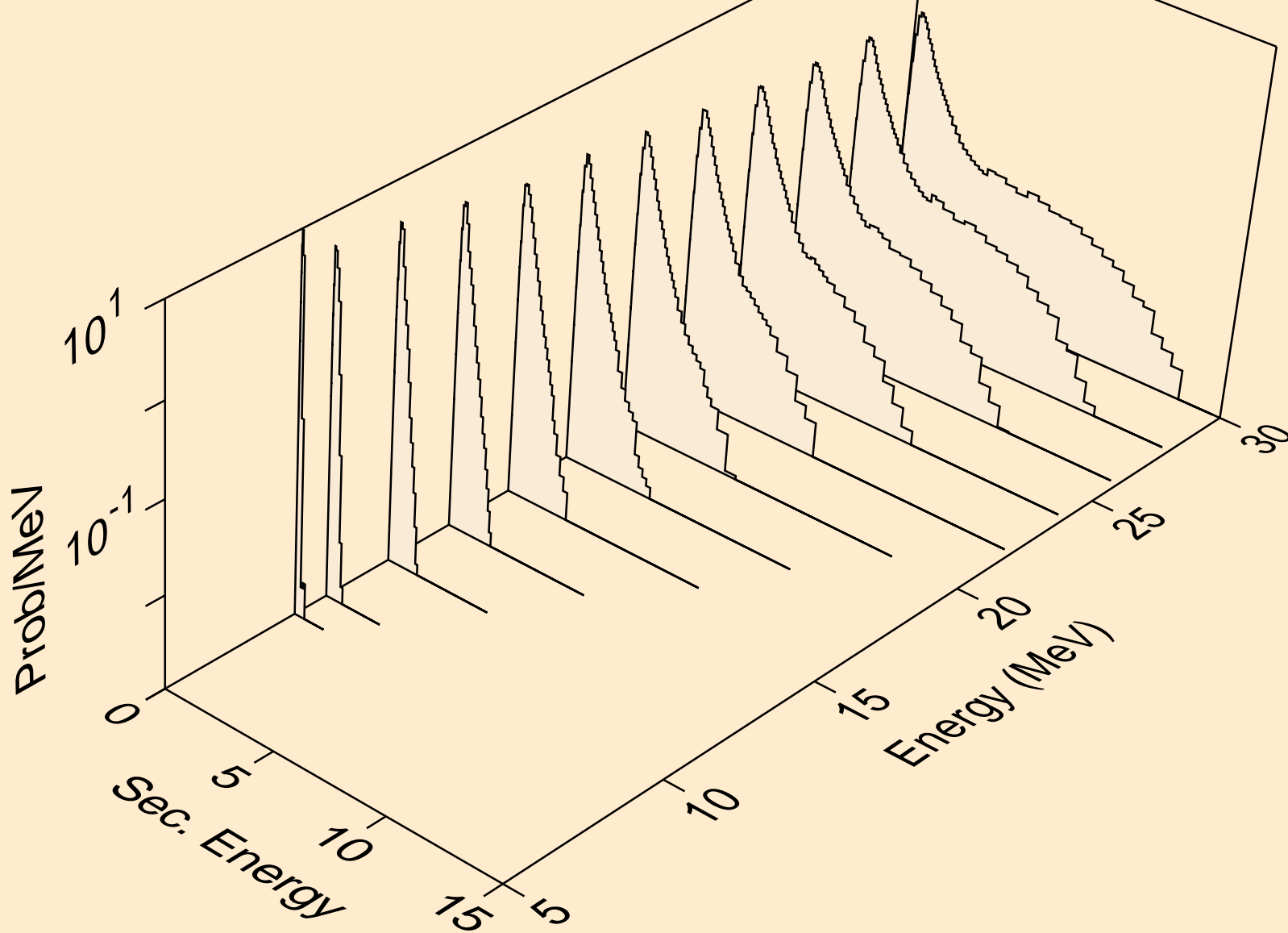

RA225 NEUTRON ACER TENDL-2019 LIBRARY; T=293.16K
Neutron emission for (n,n*)2a

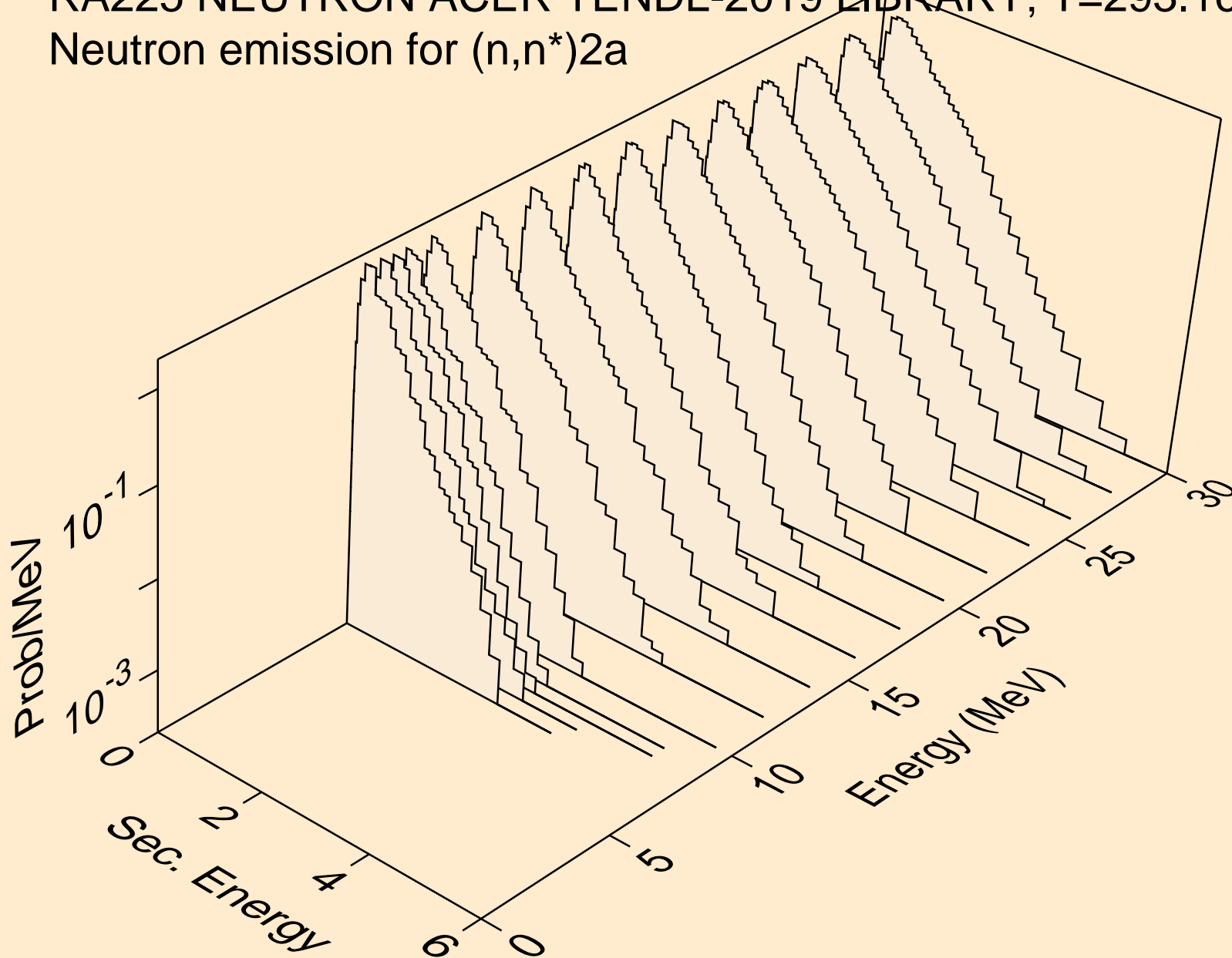

RA225 NEUTRON ACER TENDL-2019 LIBRARY; T=293.16K
Neutron emission for (n,2n)2a

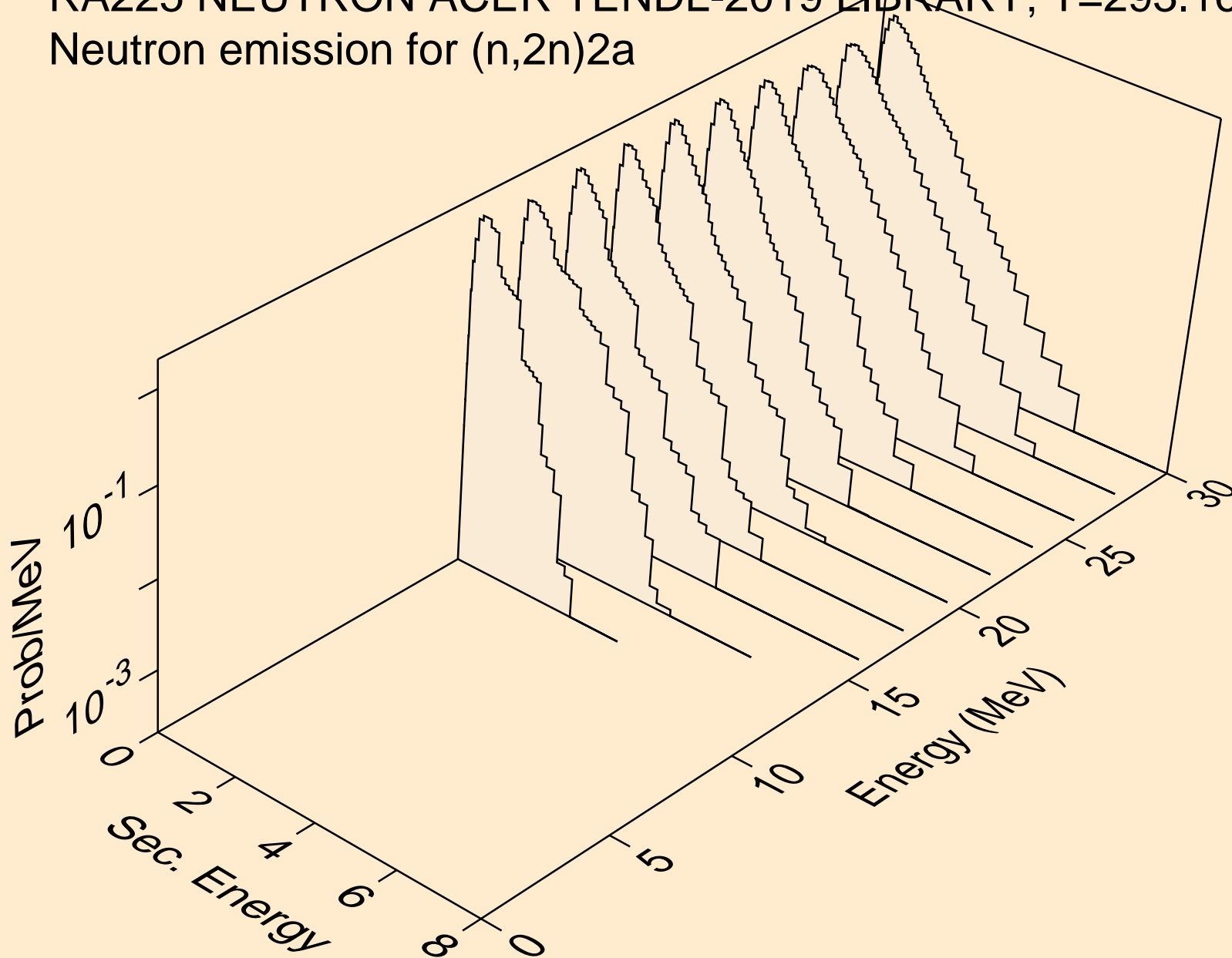

RA225 NEUTRON ACER TENDL-2019 LIBRARY; T=293.16K
Neutron emission for (n,n*)d

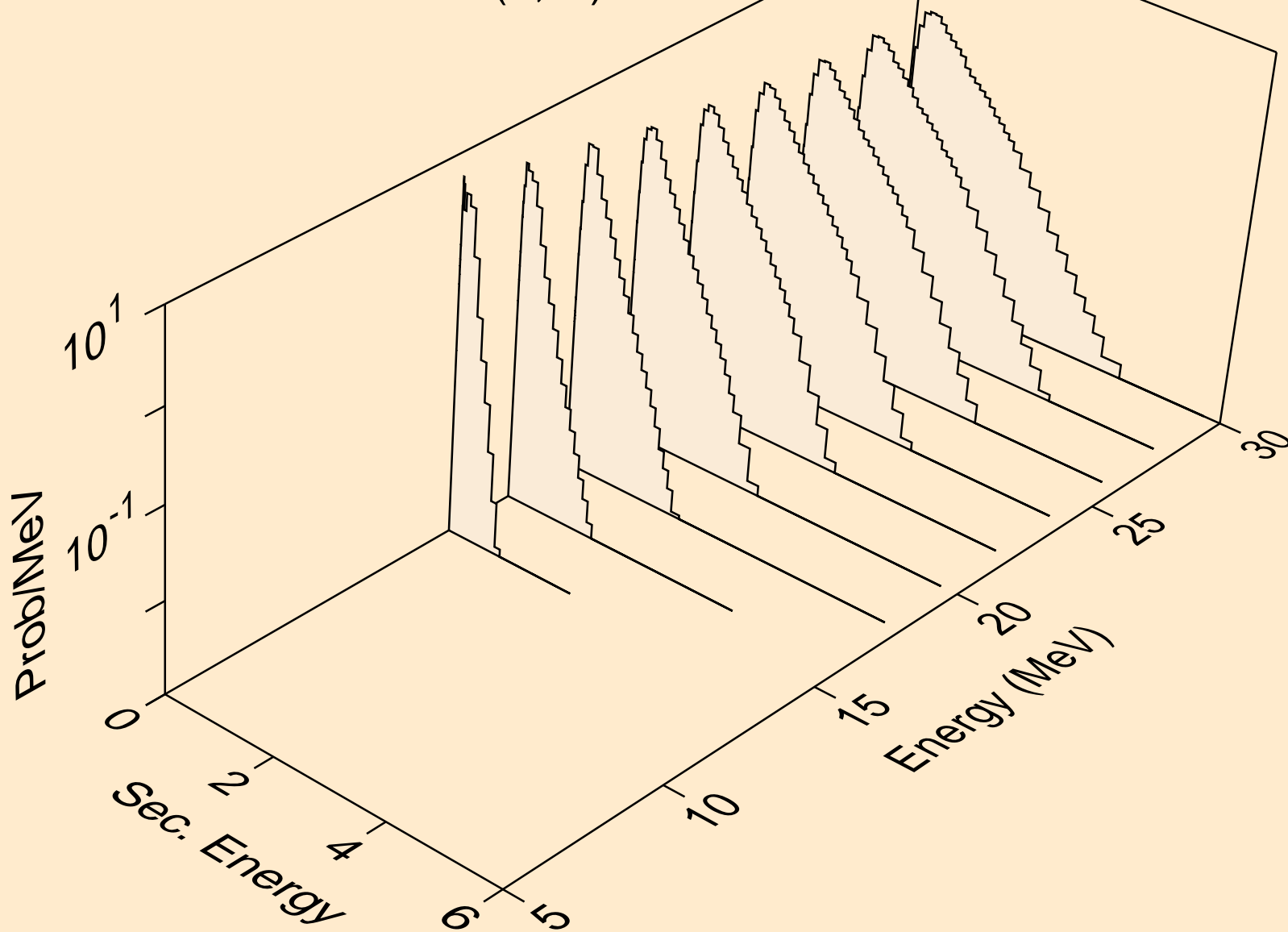

RA225 NEUTRON ACER TENDL-2019 LIBRARY; T=293.16K
Neutron emission for (n,n*)t

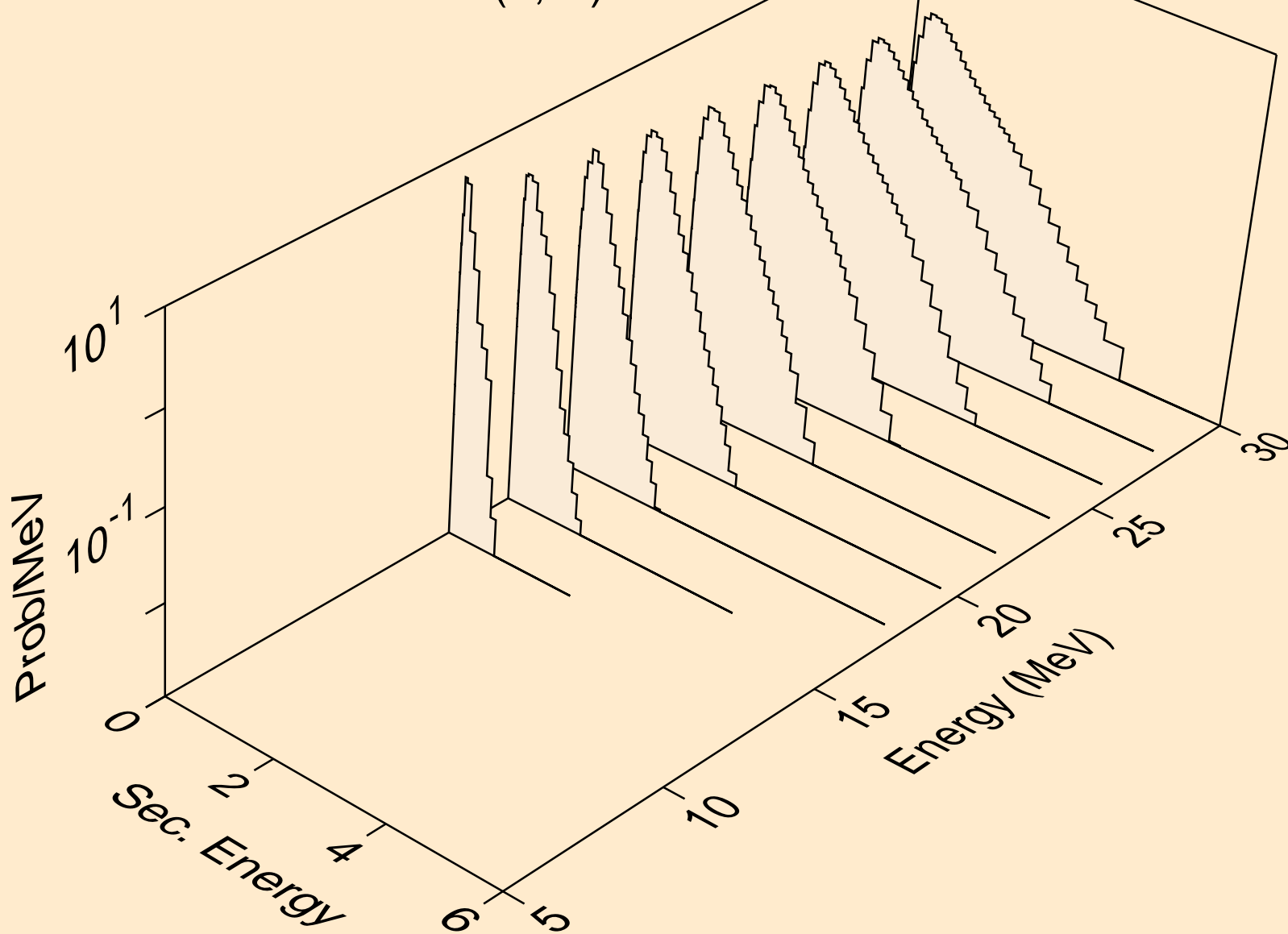

RA225 NEUTRON ACER TENDL-2019 LIBRARY; T=293.16K
Neutron emission for (n,n*)he3

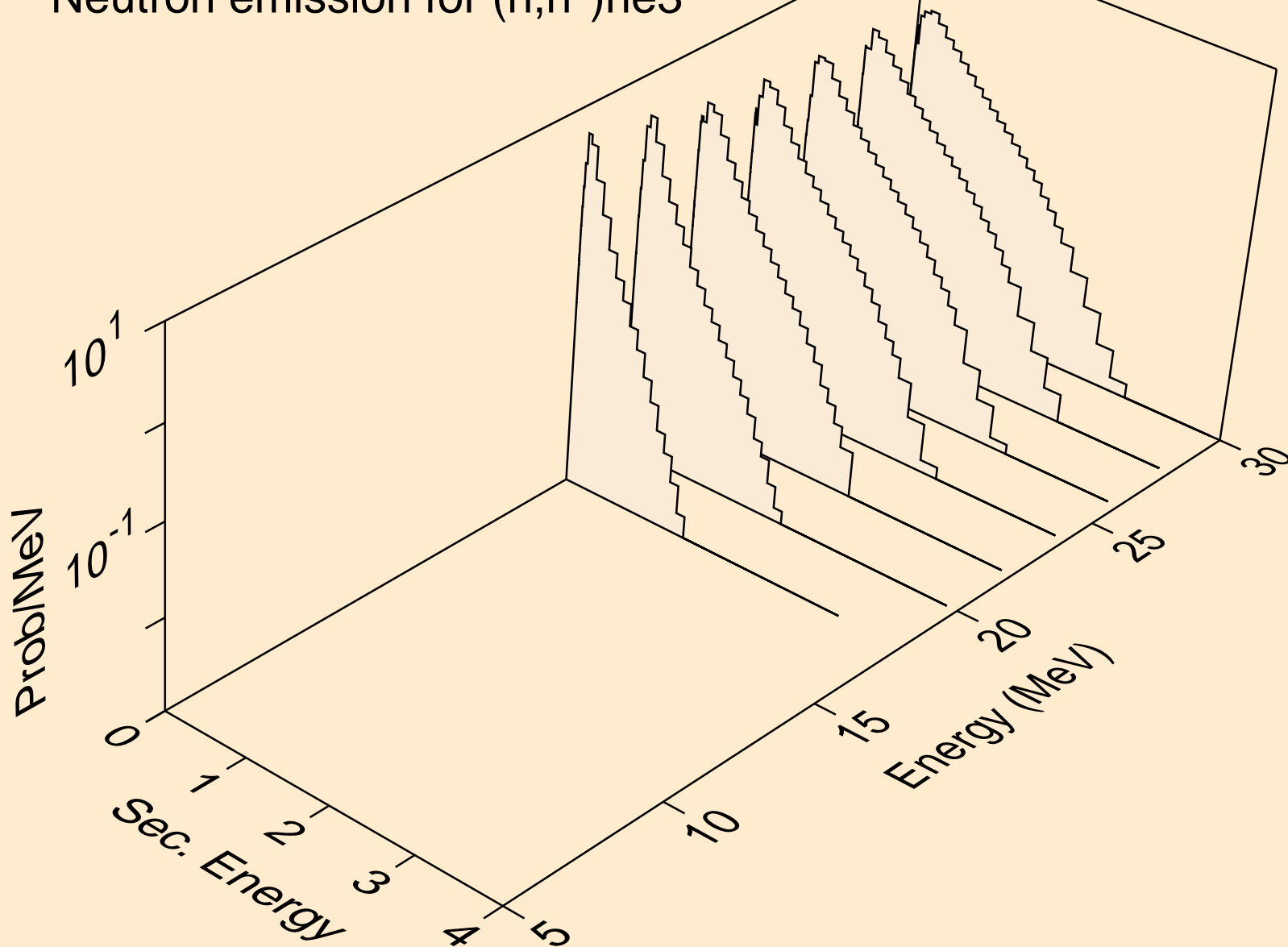

RA225 NEUTRON ACER TENDL-2019 LIBRARY; T=293.16K
Neutron emission for (n,4n)

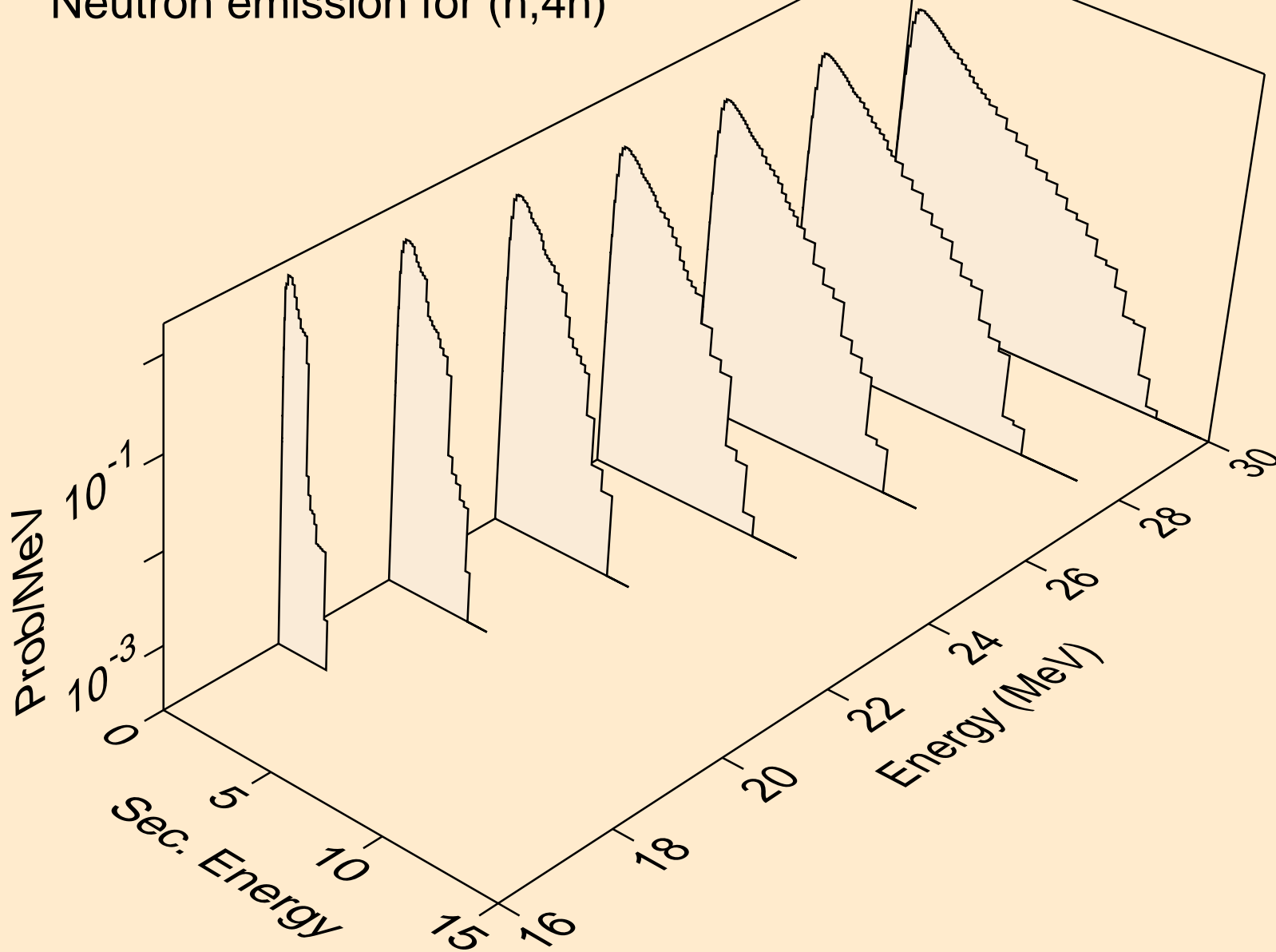

RA225 NEUTRON ACER TENDL-2019 LIBRARY; T=293.16K
Neutron emission for (n,2np)

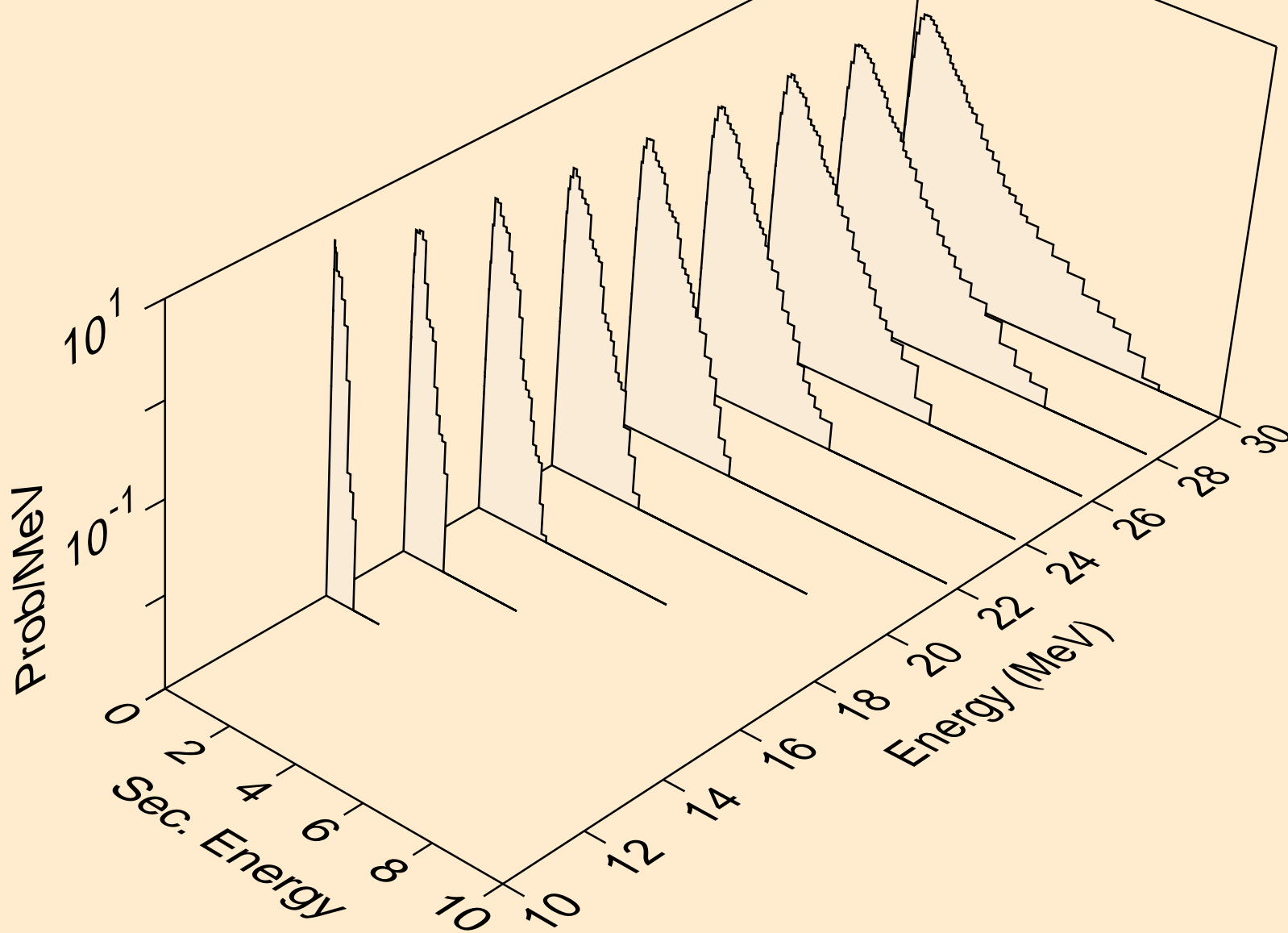

RA225 NEUTRON ACER TENDL-2019 LIBRARY; T=293.16K
Neutron emission for (n,3np)

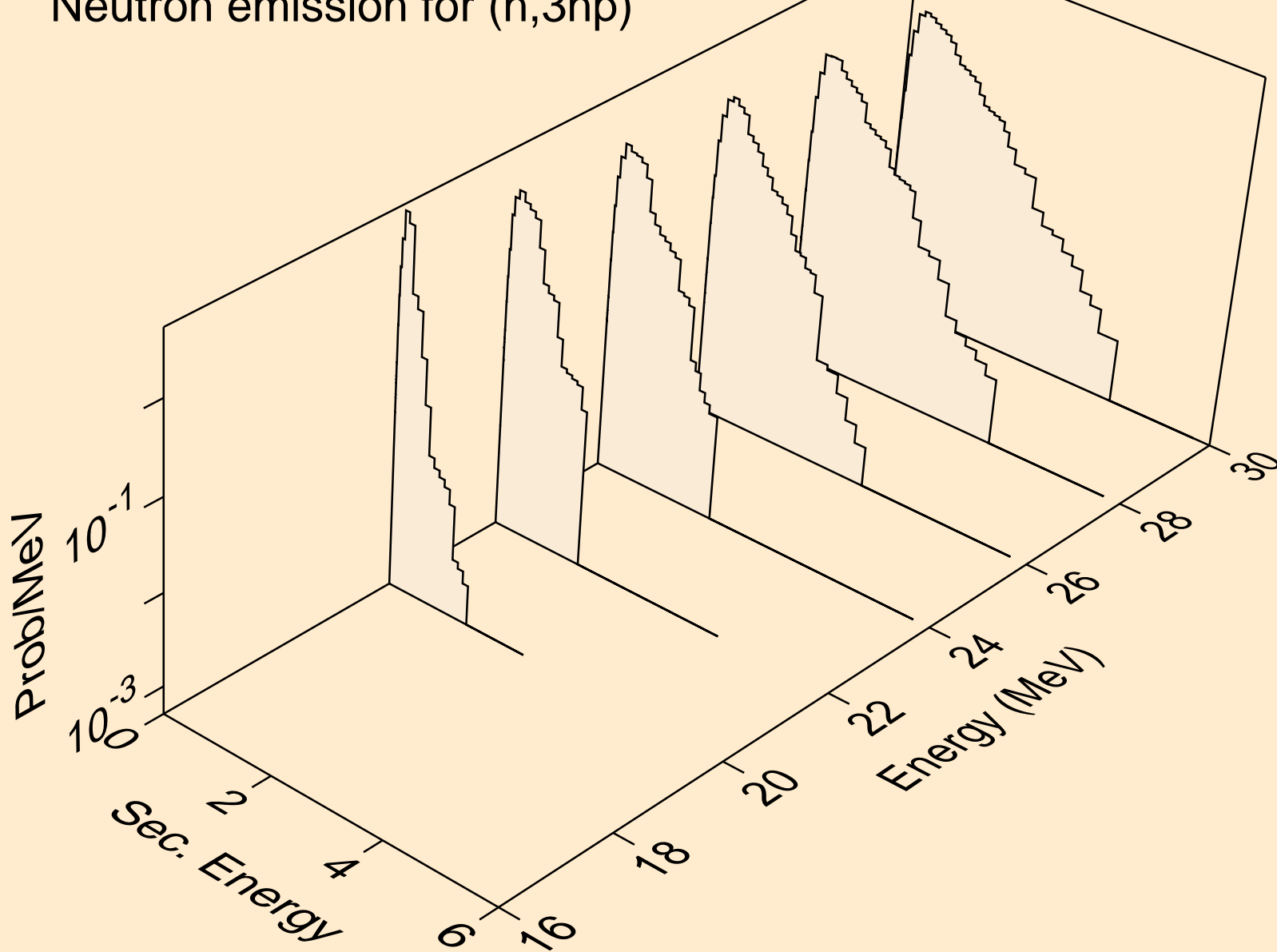

RA225 NEUTRON ACER TENDL-2019 LIBRARY; T=293.16K
Neutron emission for (n,2np)

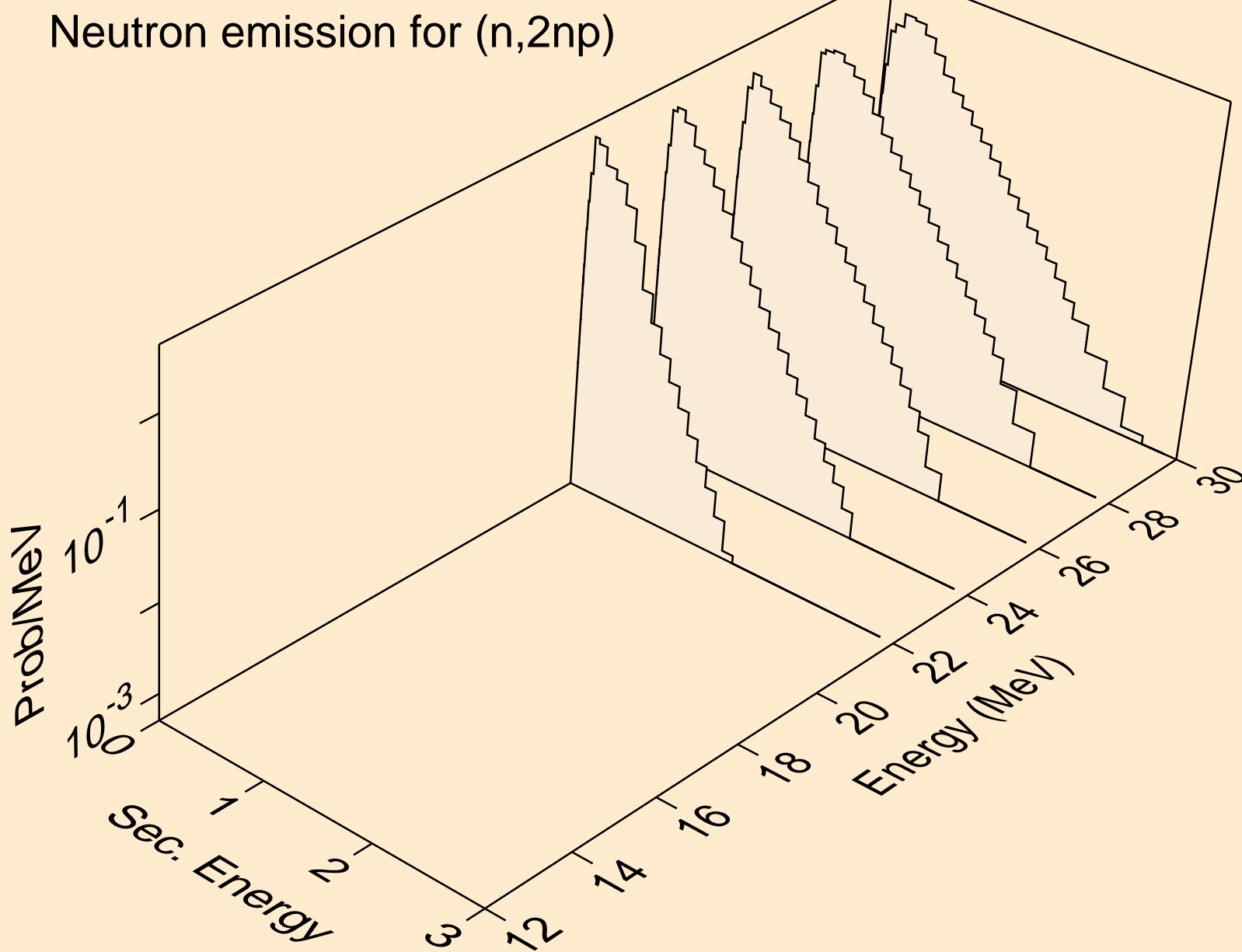

RA225 NEUTRON ACER TENDL-2019 LIBRARY; T=293.16K
Neutron emission for (n,npa)

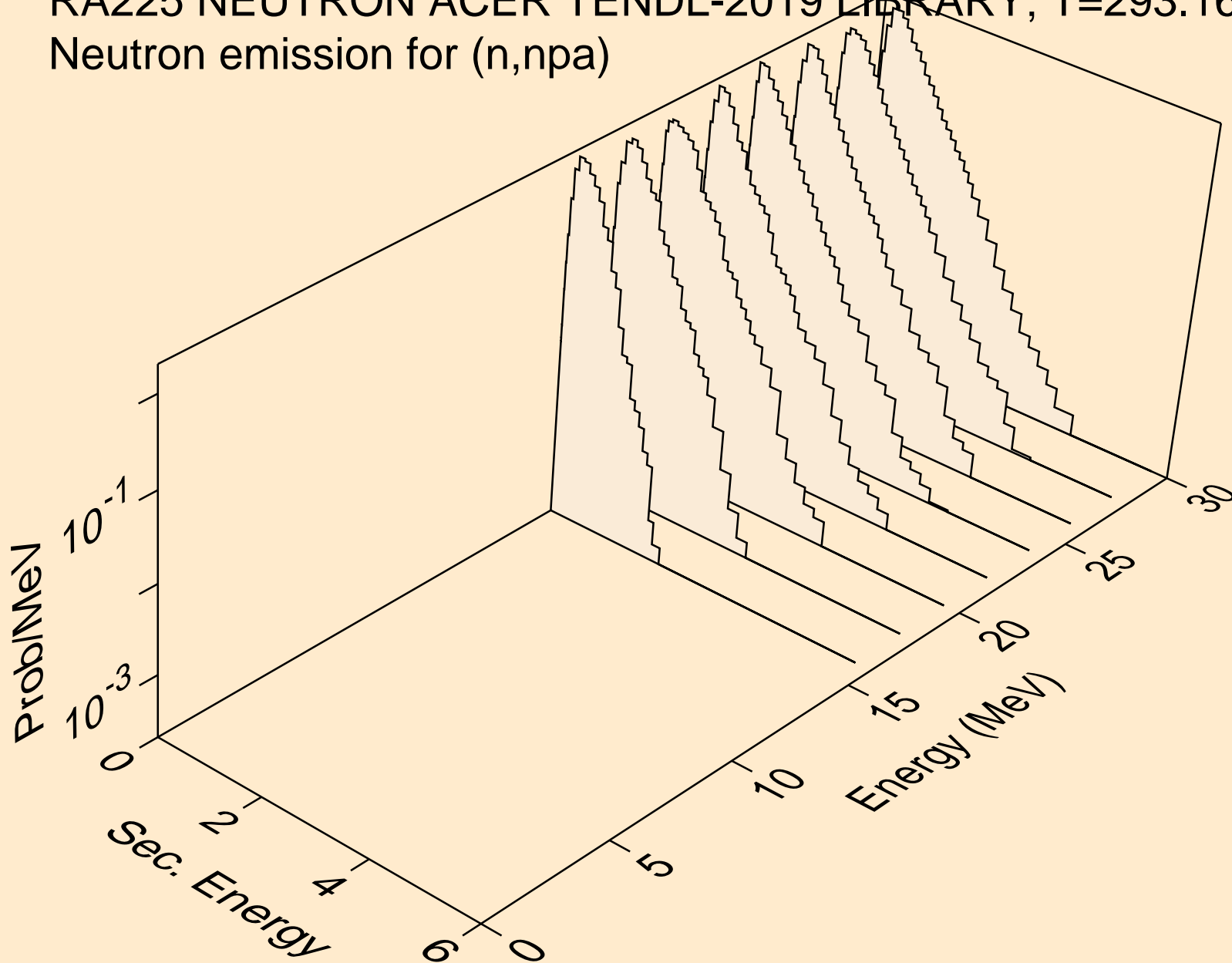

RA225 NEUTRON ACER TENDL-2019 LIBRARY; T=293.16K
Neutron emission for (n,n*c)

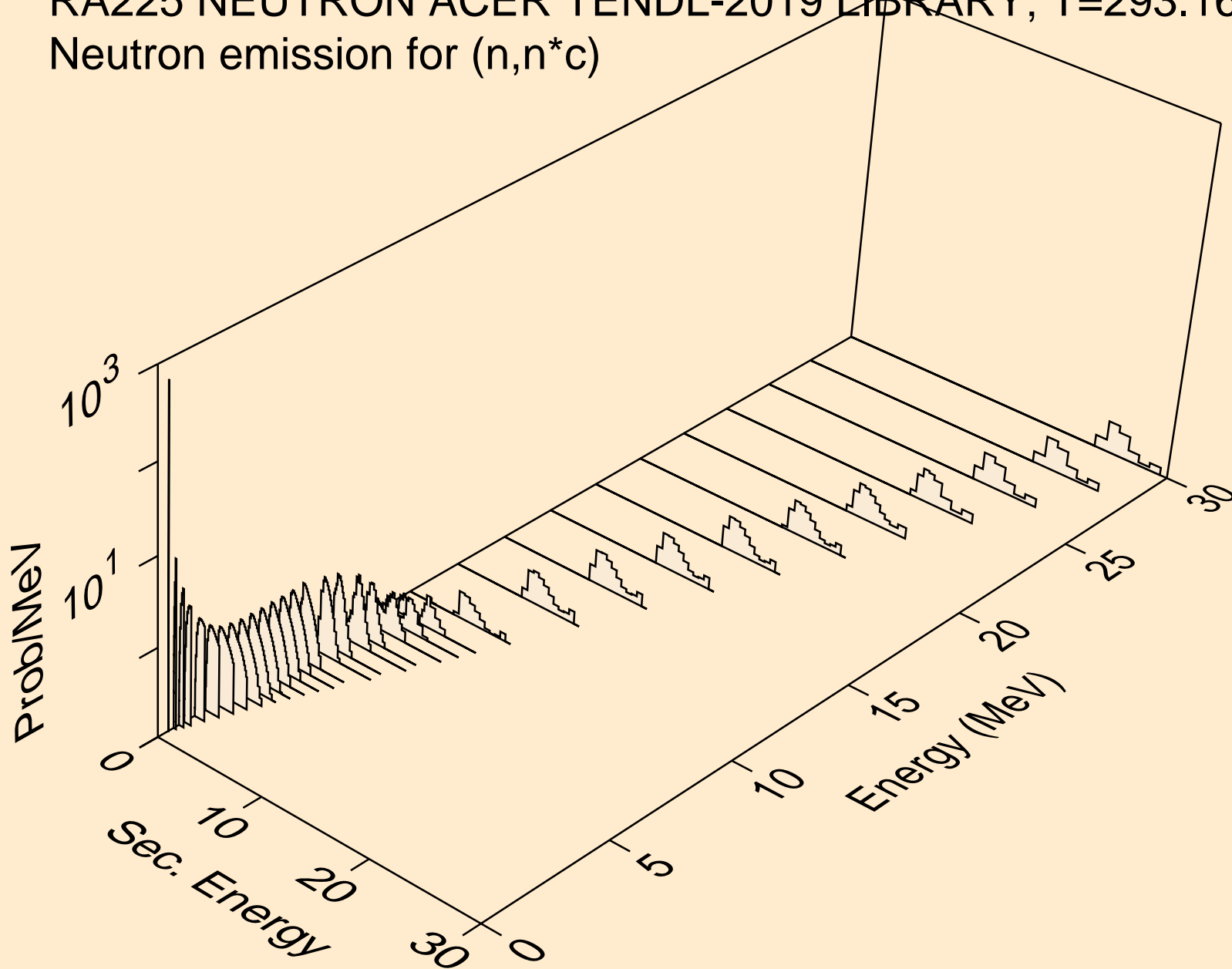

RA225 NEUTRON ACER TENDL-2019 LIBRARY; T=293.16K

Delayed nubar

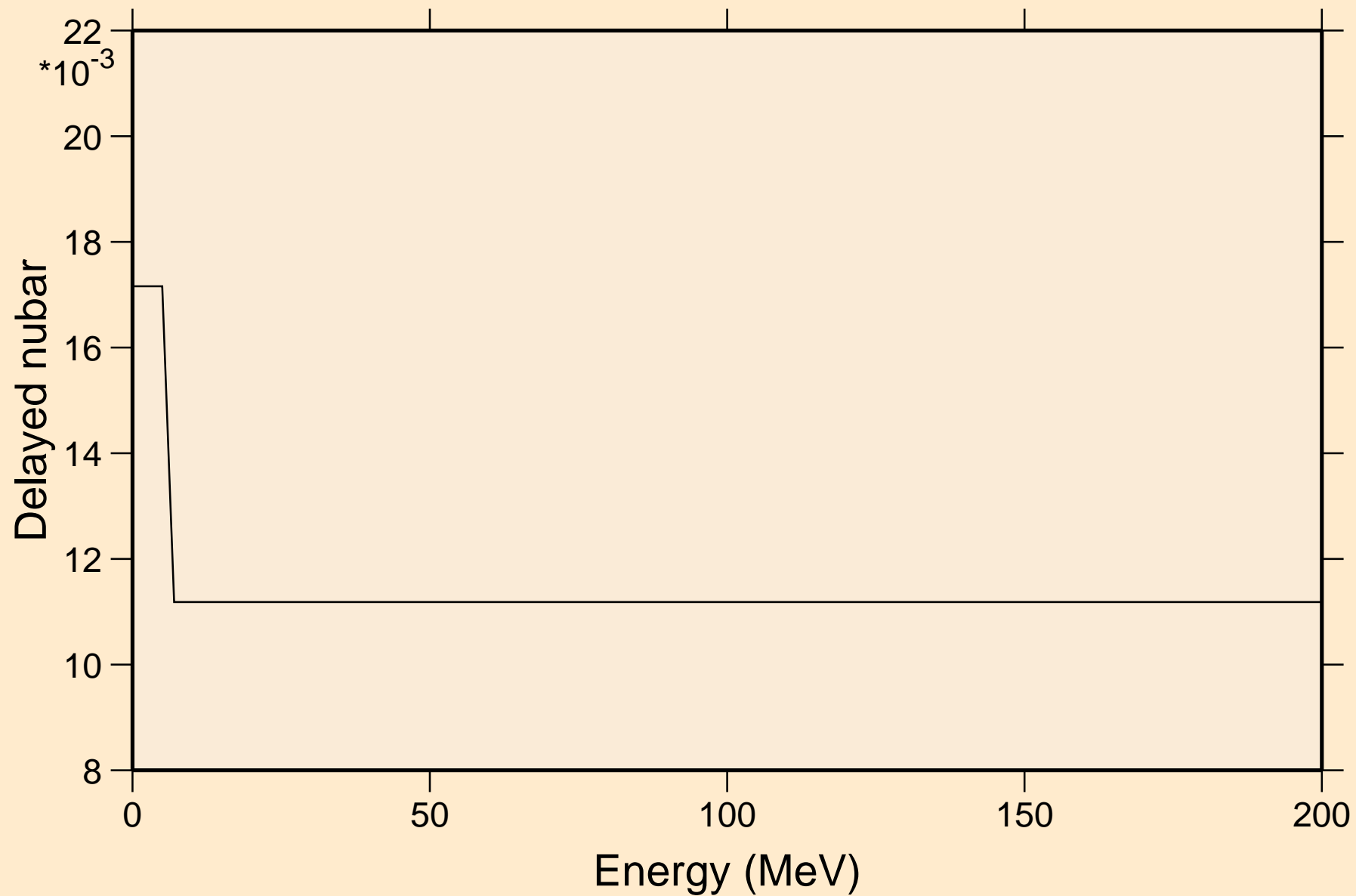

RA225 NEUTRON ACER TENDL-2019 LIBRARY; T=293.16K

Delayed neutron spectra

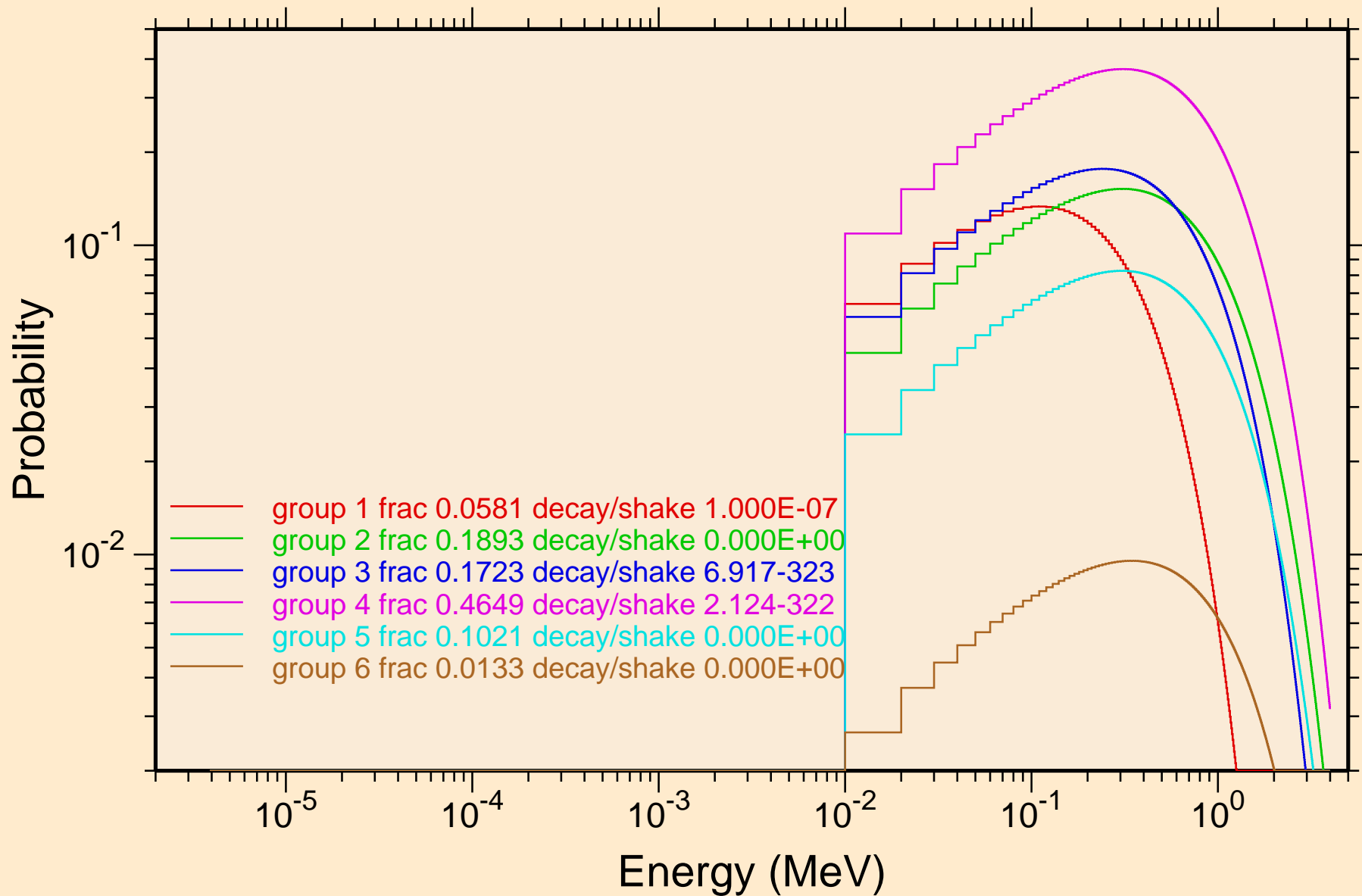

RA225 NEUTRON ACER TENDL-2019 LIBRARY; T=293.16K
Photon emission for (n,x)

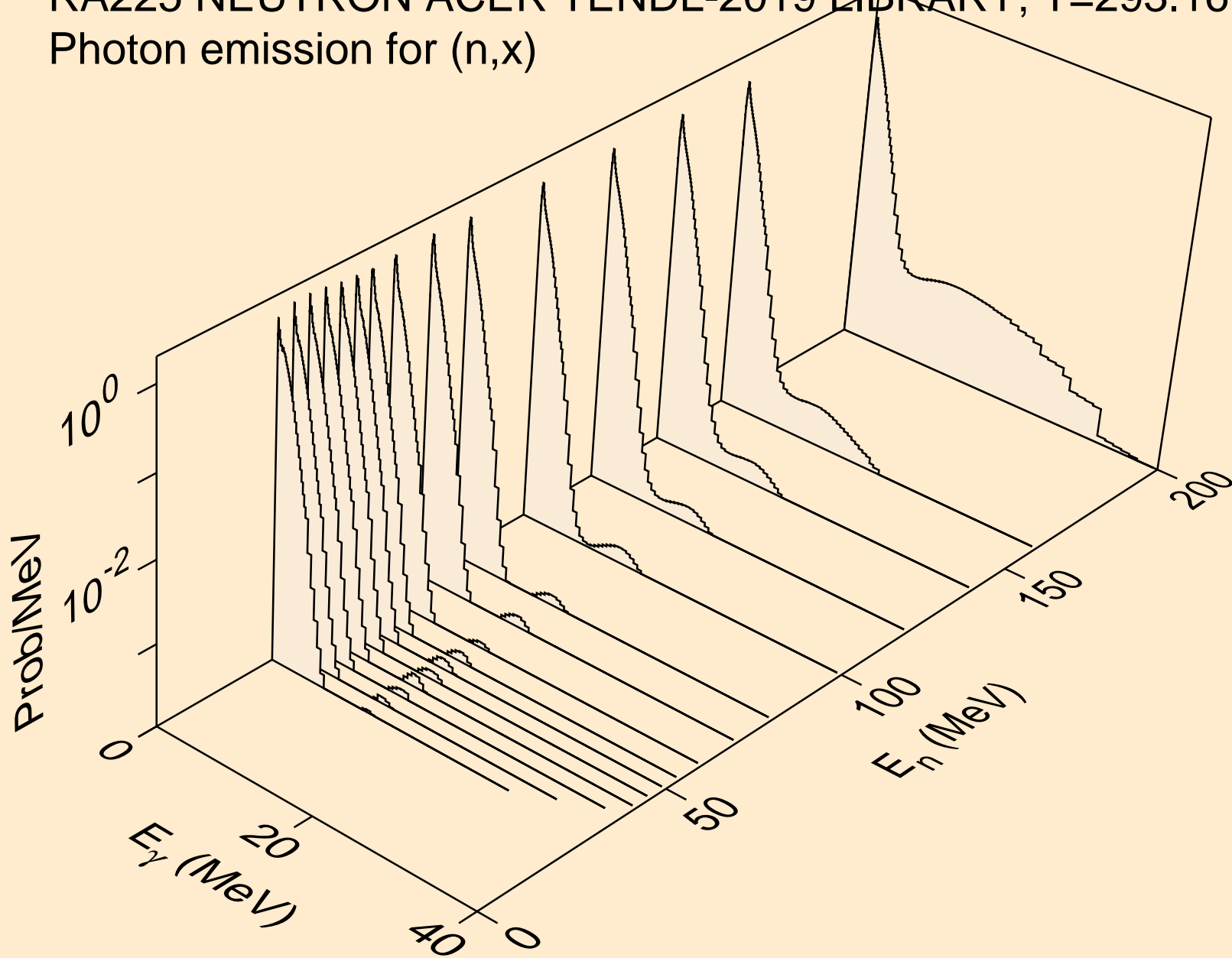

RA225 NEUTRON ACER TENDL-2019 LIBRARY; T=293.16K
Photon emission for (n,2nd)

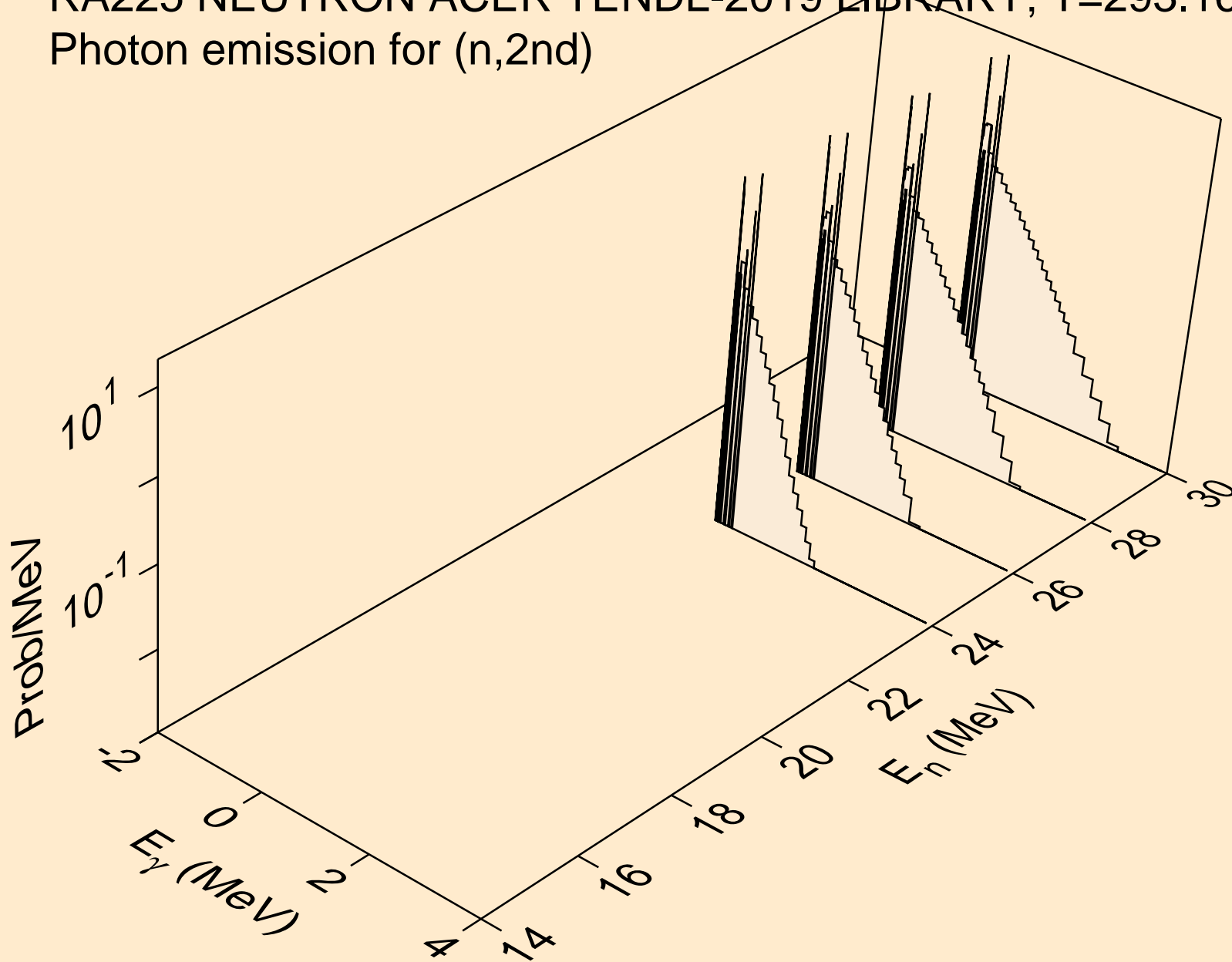

RA225 NEUTRON ACER TENDL-2019 LIBRARY; T=293.16K
Photon emission for (n,2n)

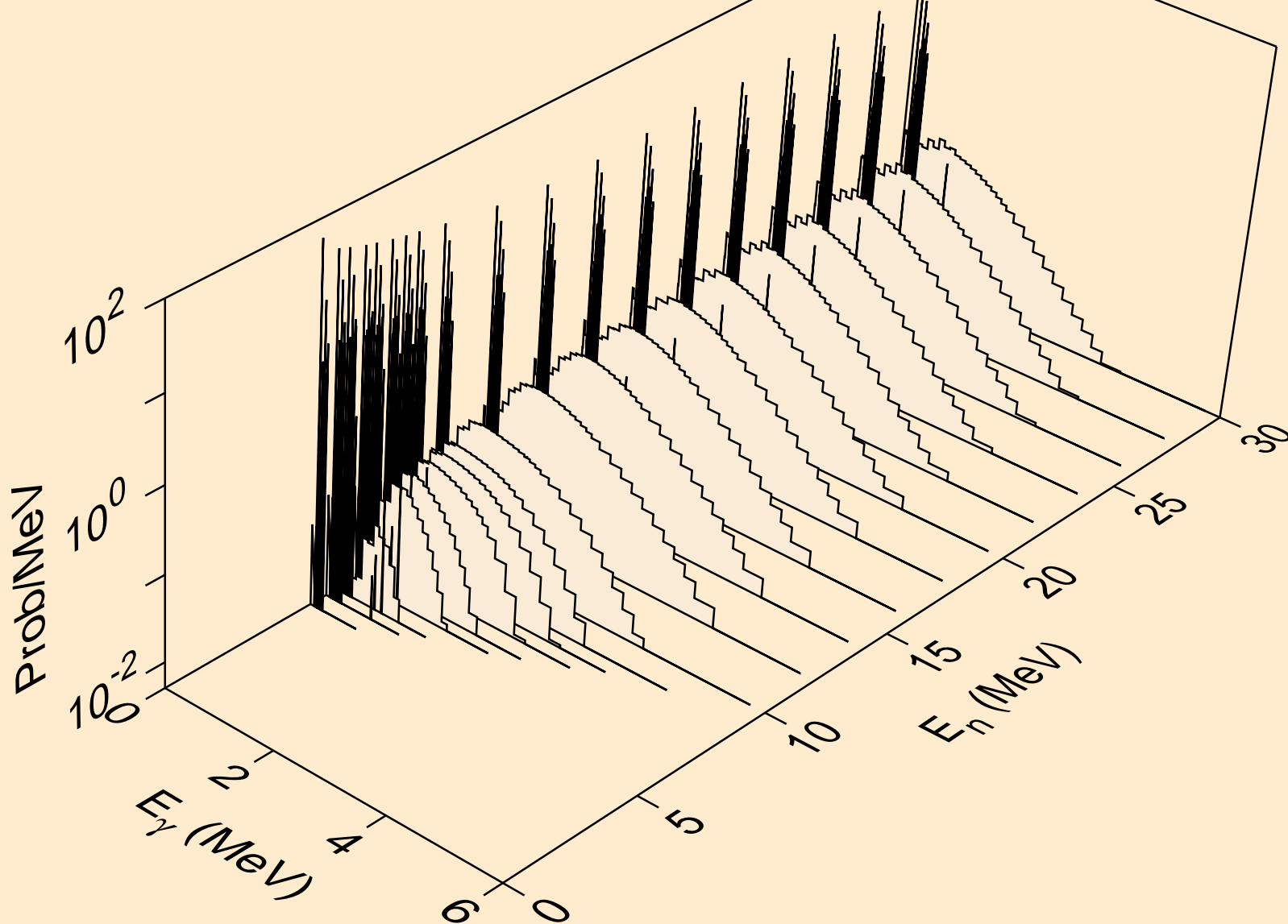

RA225 NEUTRON ACER TENDL-2019 LIBRARY; T=293.16K
Photon emission for (n,3n)

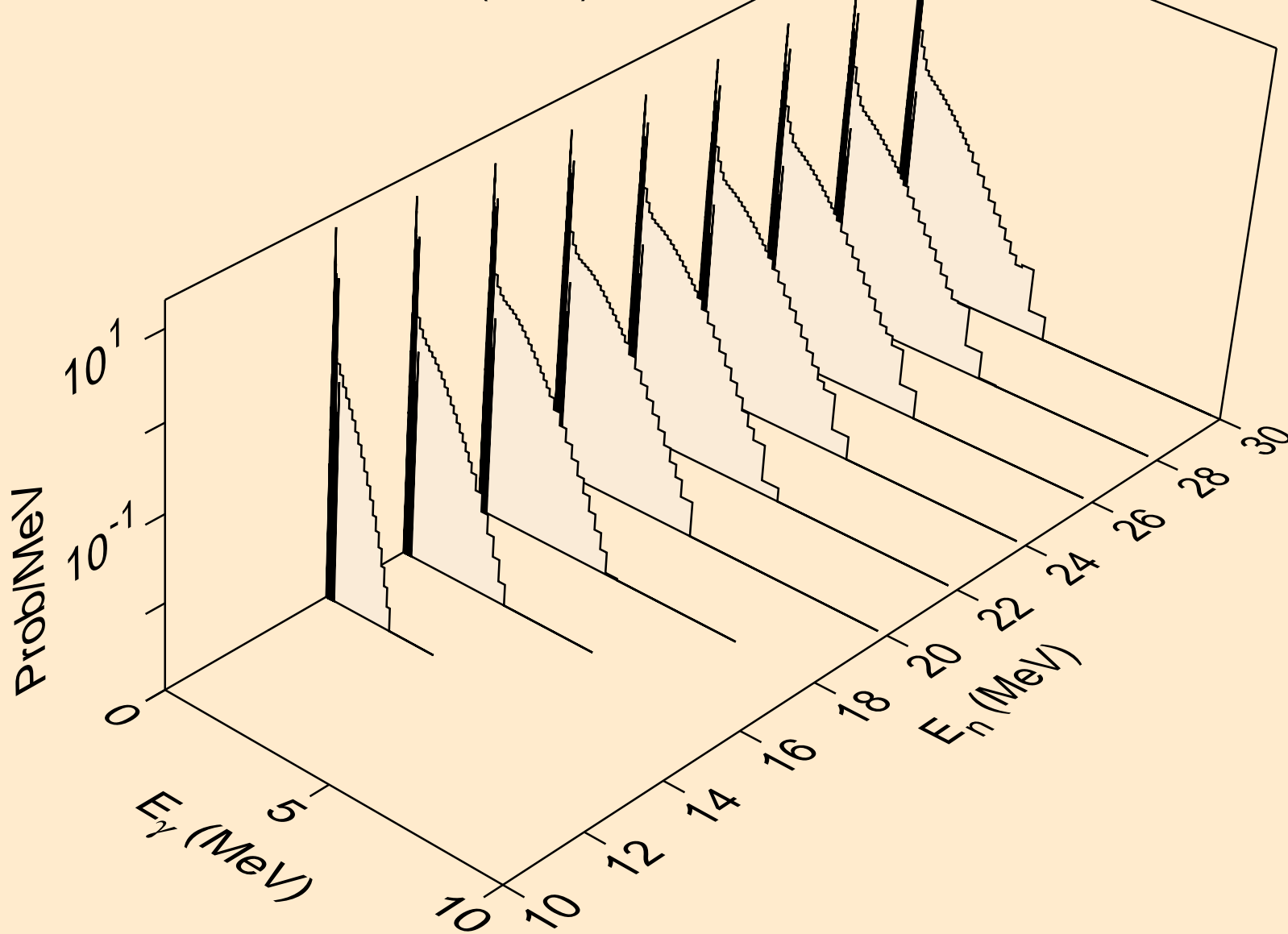

RA225 NEUTRON ACER TENDL-2019 LIBRARY; T=293.16K
Photon emission for (n,n*)a

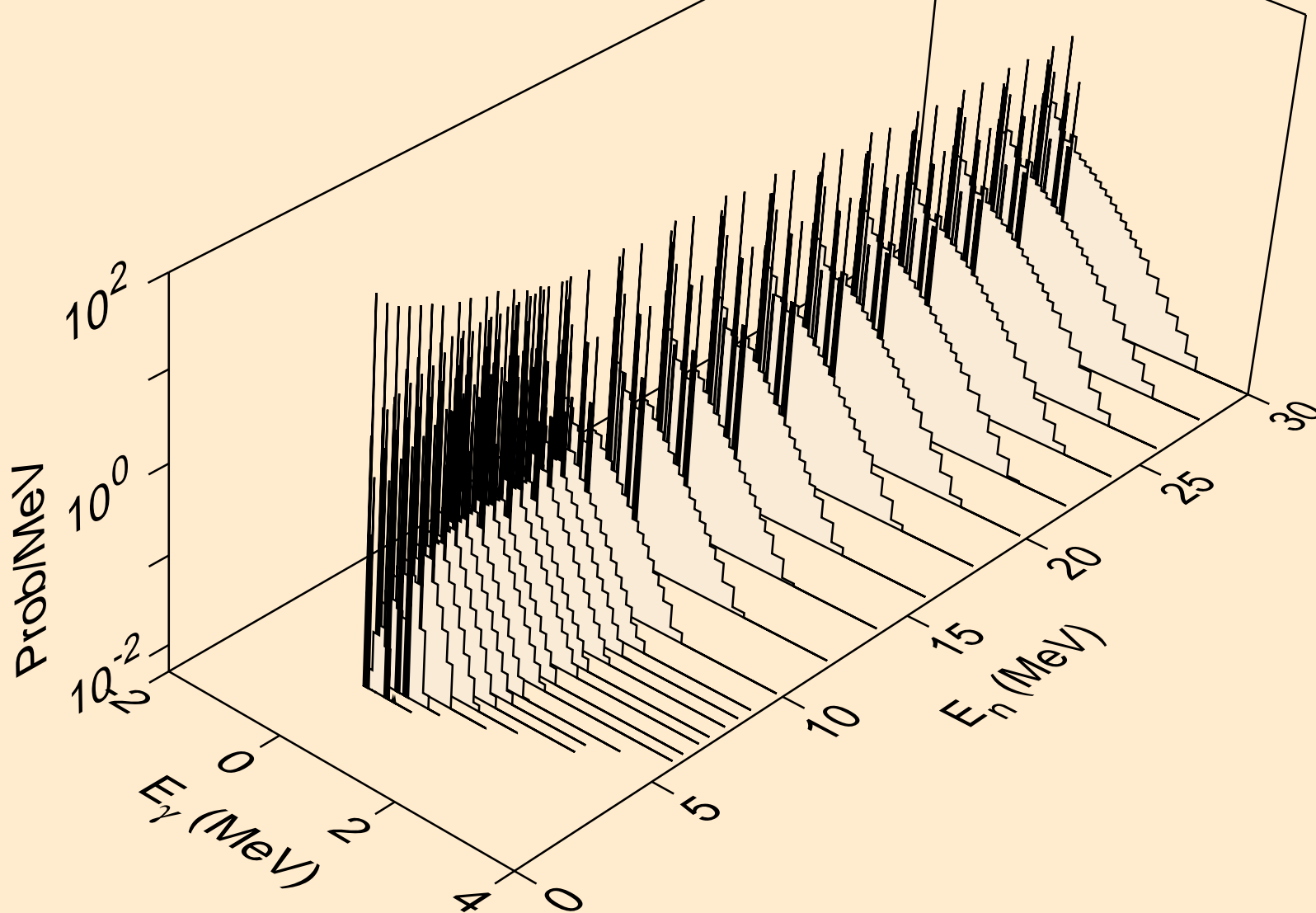

RA225 NEUTRON ACER TENDL-2019 LIBRARY; T=293.16K
Photon emission for (n,2n)a

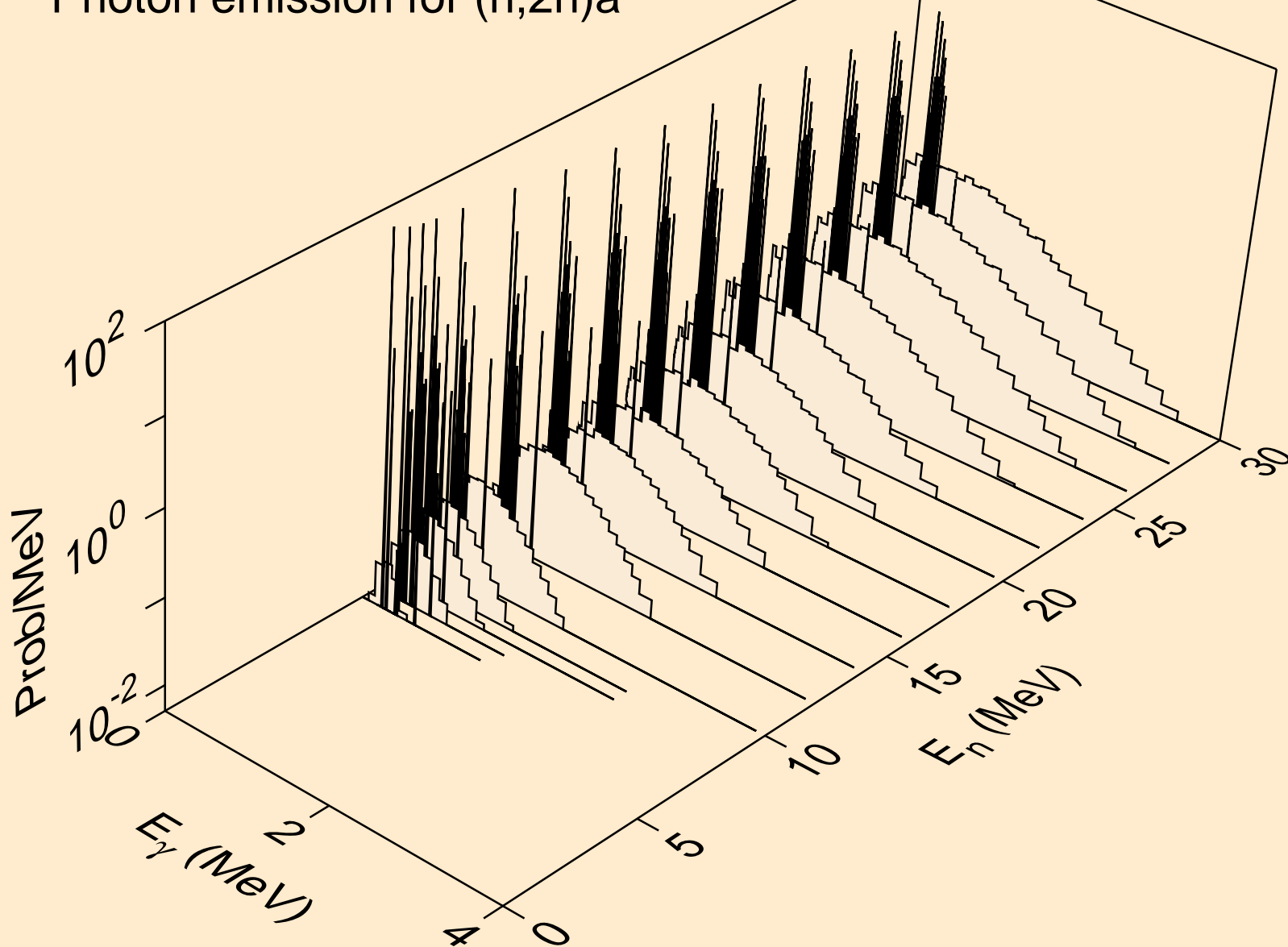

RA225 NEUTRON ACER TENDL-2019 LIBRARY; T=293.16K
Photon emission for (n,3n)a

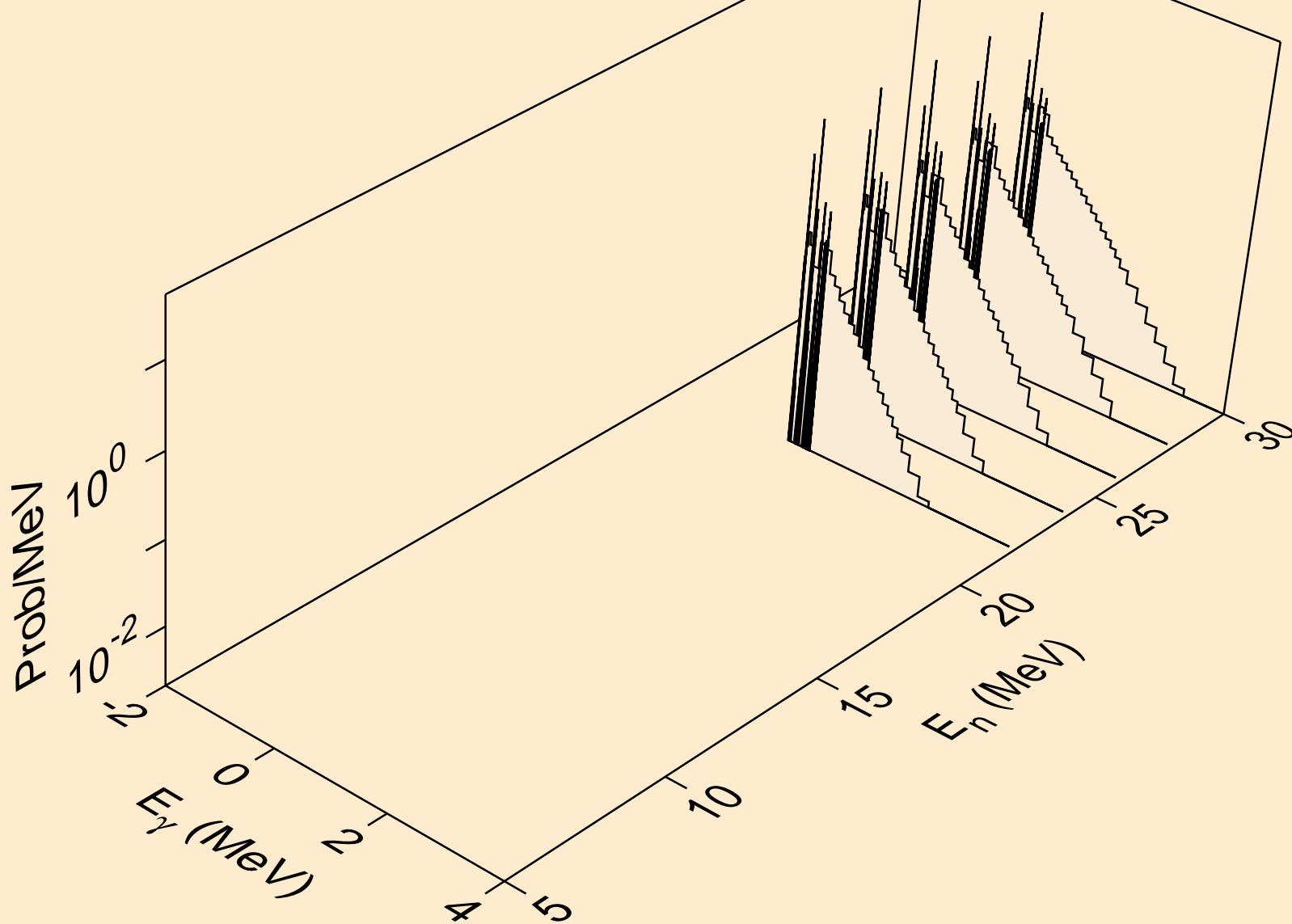

RA225 NEUTRON ACER TENDL-2019 LIBRARY; T=293.16K
Photon emission for (n,n*)p

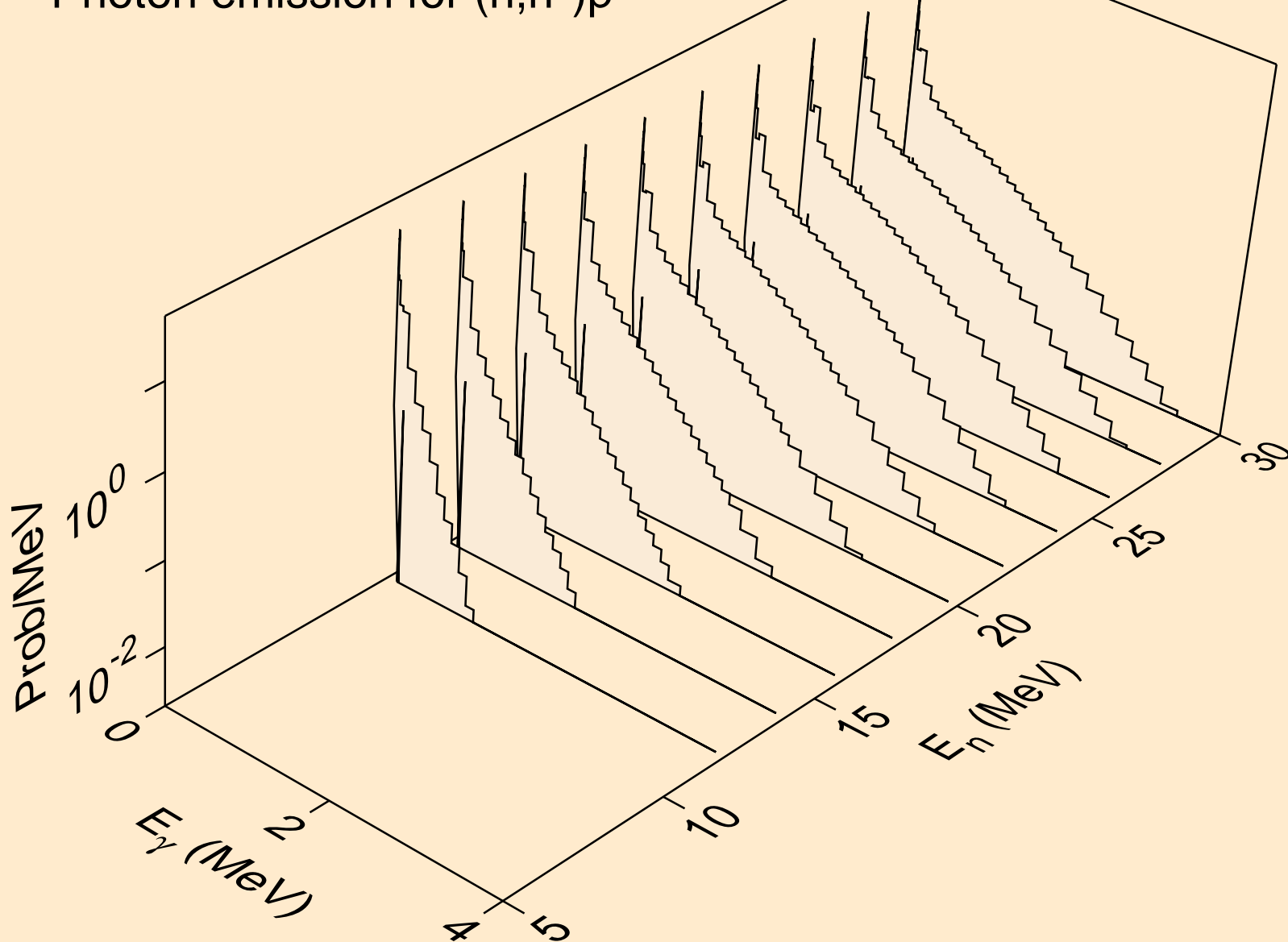

RA225 NEUTRON ACER TENDL-2019 LIBRARY; T=293.16K
Photon emission for (n,n*)2a

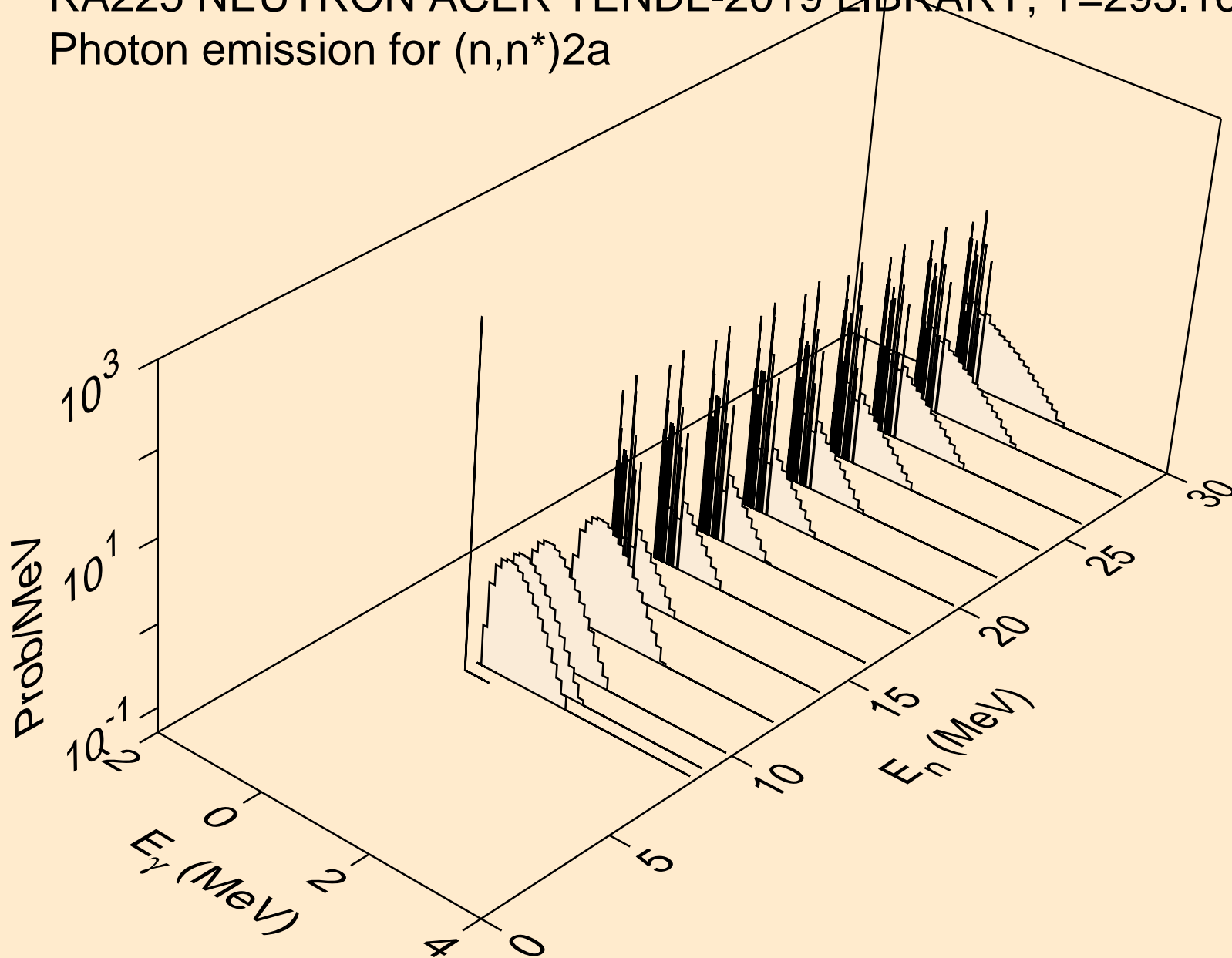

RA225 NEUTRON ACER TENDL-2019 LIBRARY; T=293.16K
Photon emission for (n,2n)2a

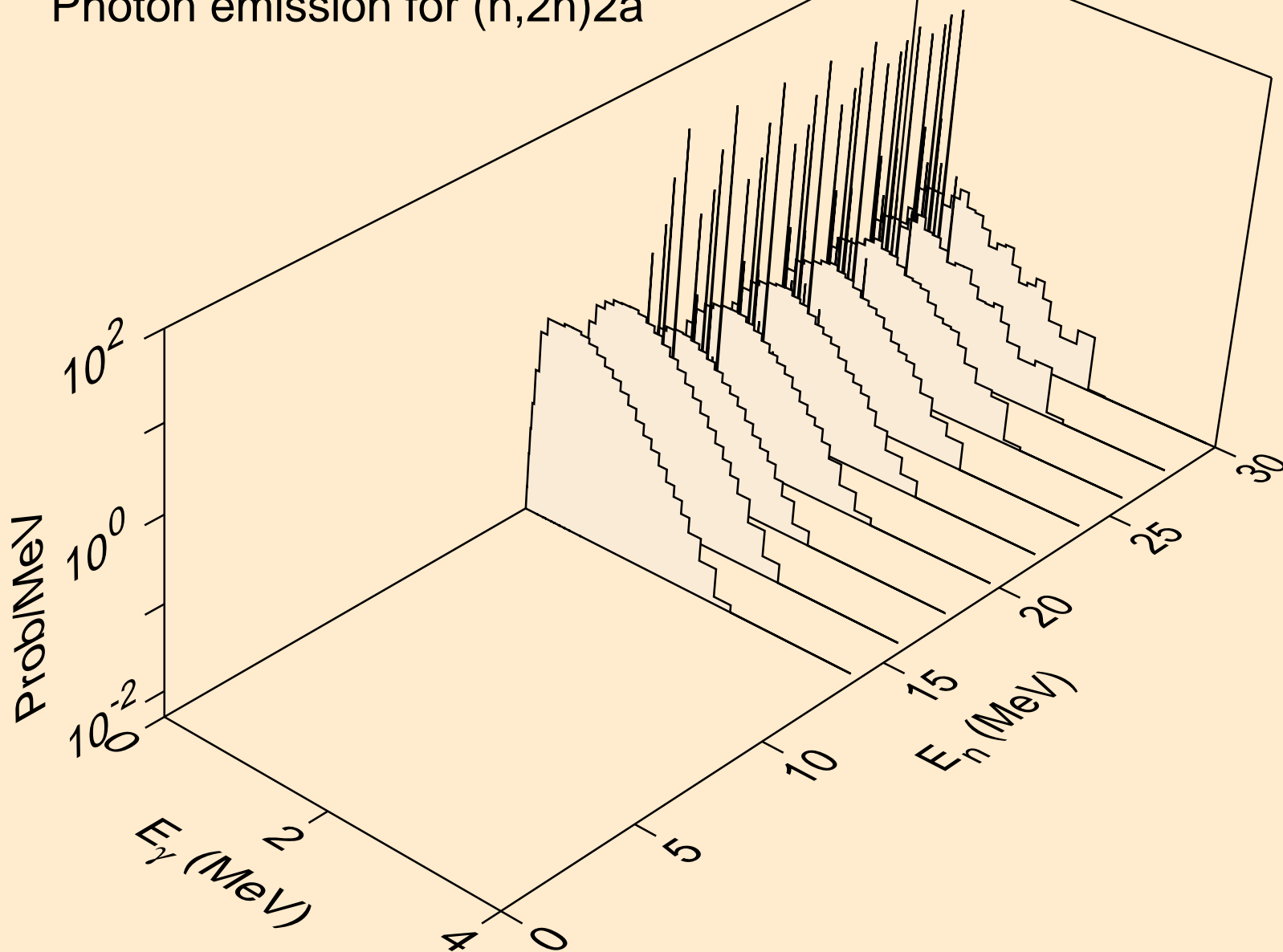

RA225 NEUTRON ACER TENDL-2019 LIBRARY; T=293.16K
Photon emission for (n,n*)d

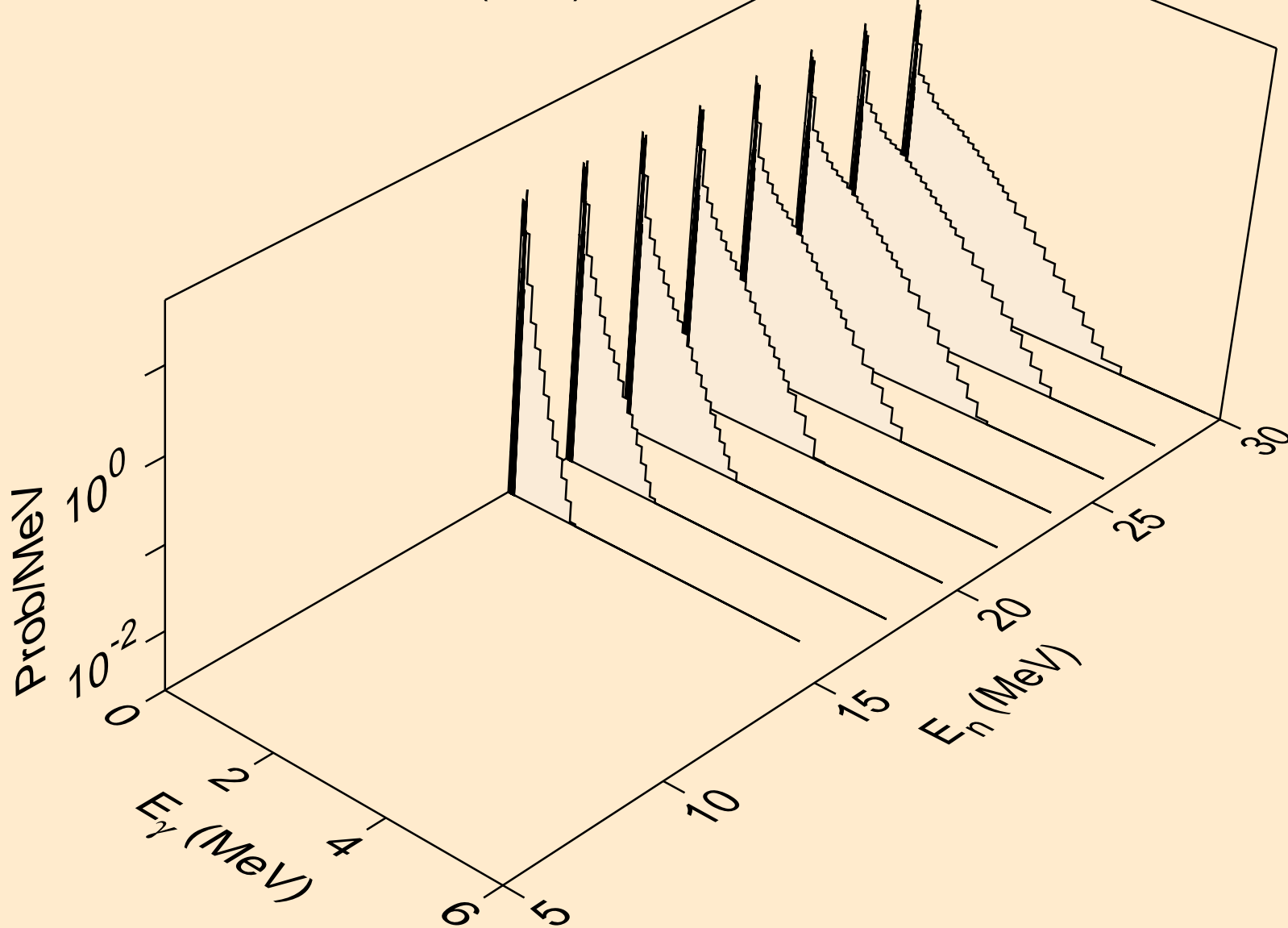

RA225 NEUTRON ACER TENDL-2019 LIBRARY; T=293.16K
Photon emission for (n,n*)t

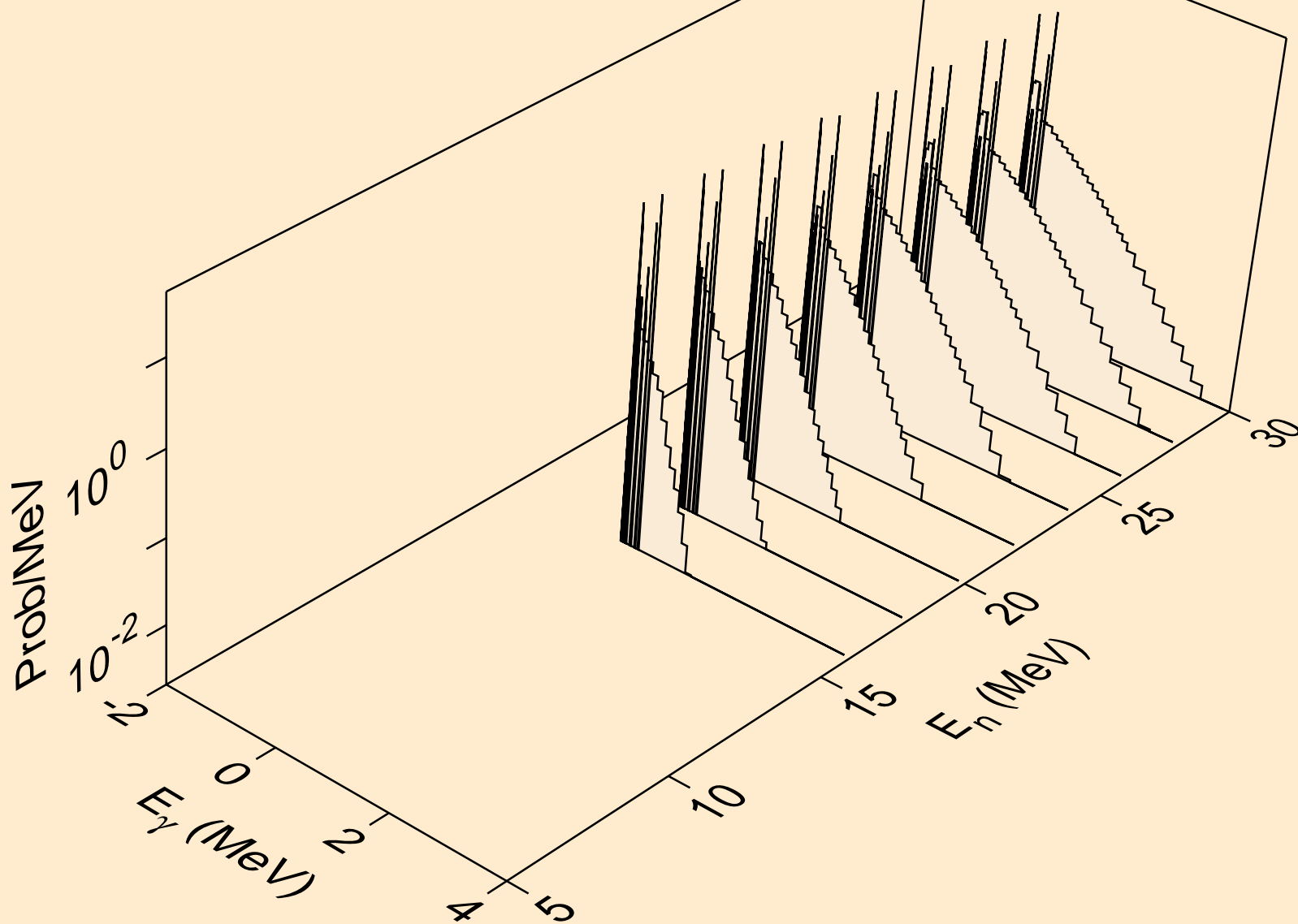

RA225 NEUTRON ACER TENDL-2019 LIBRARY; T=293.16K
Photon emission for (n,n*)he3

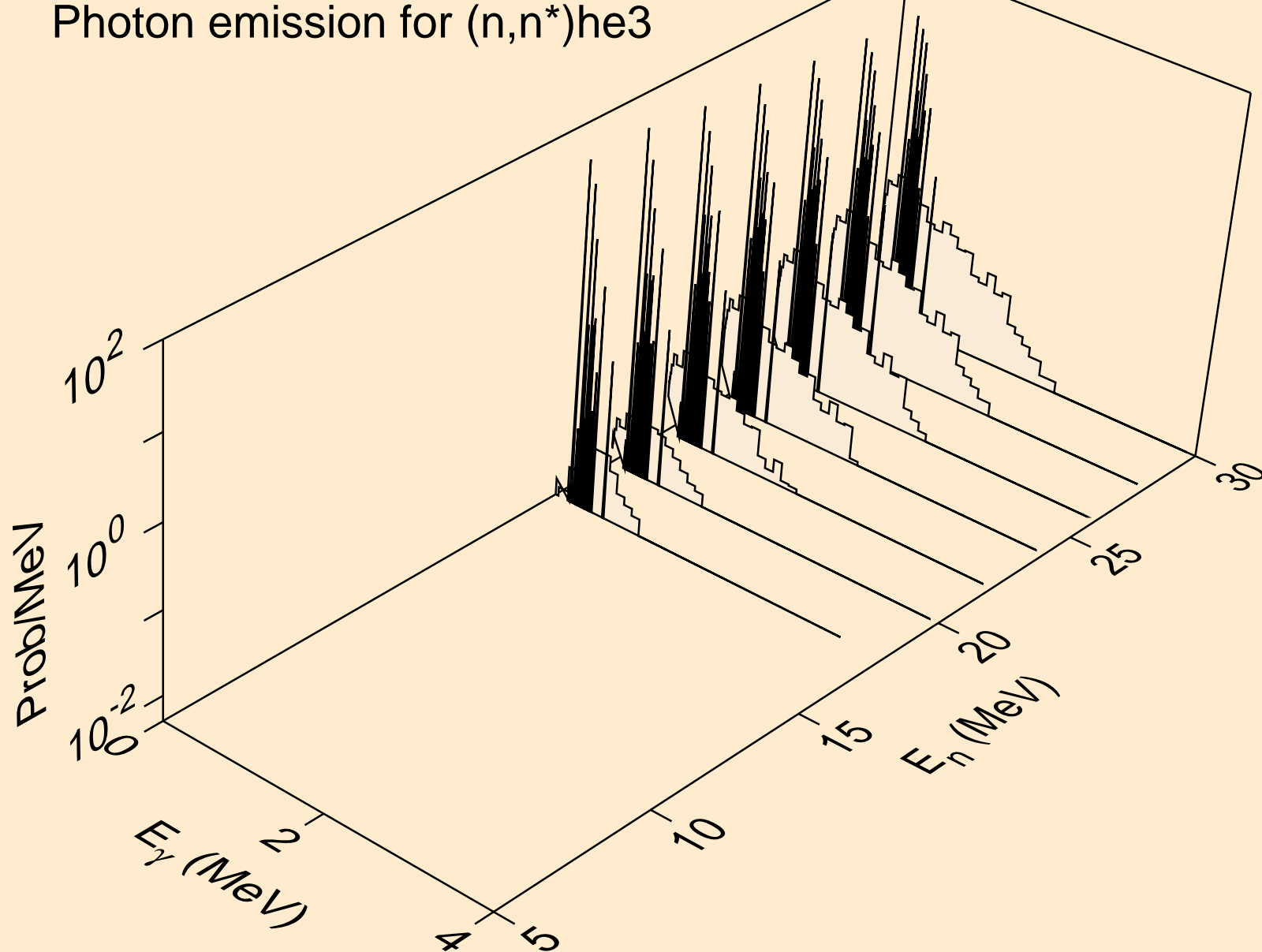

RA225 NEUTRON ACER TENDL-2019 LIBRARY; T=293.16K
Photon emission for (n,4n)

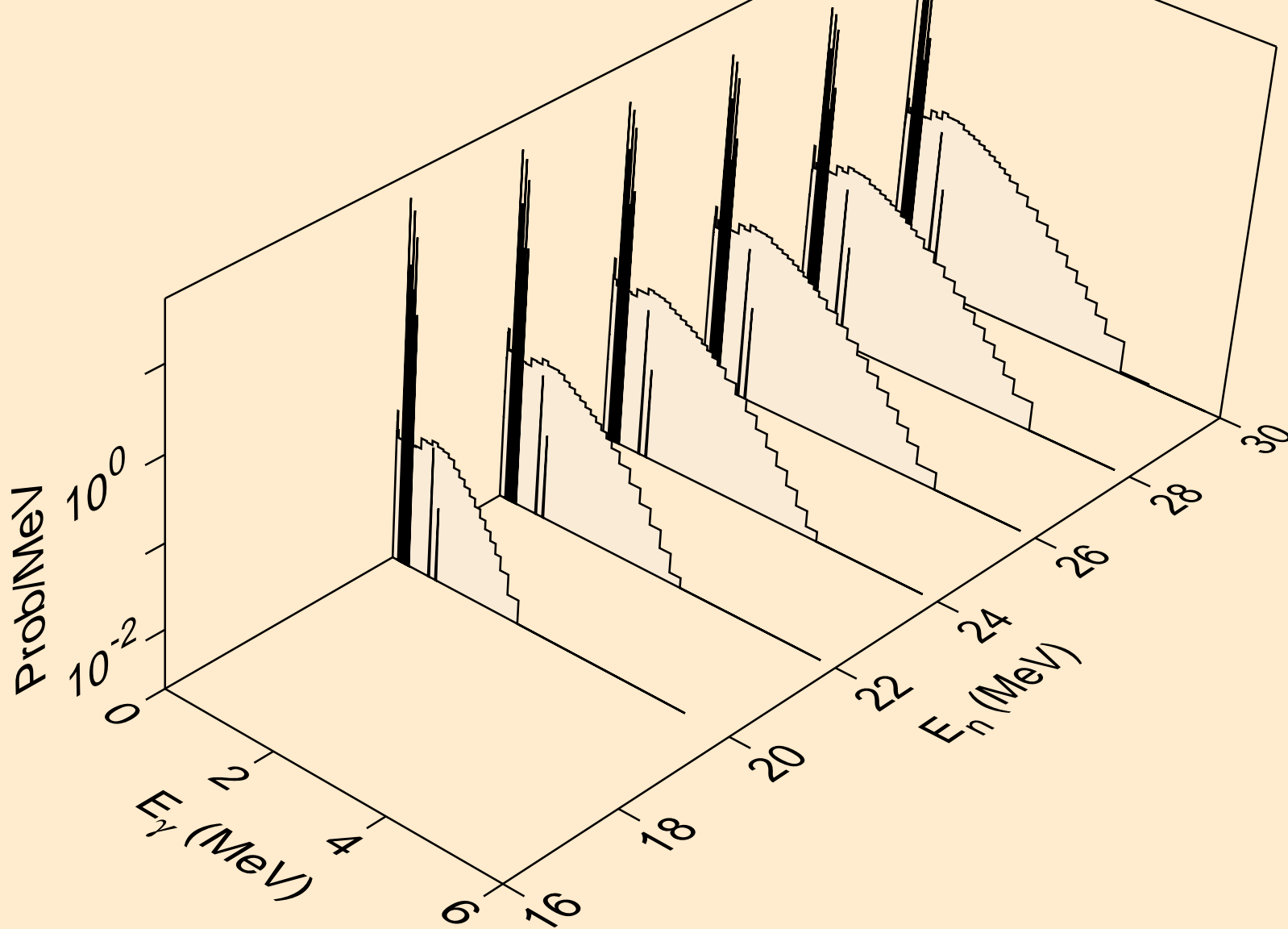

RA225 NEUTRON ACER TENDL-2019 LIBRARY; T=293.16K
Photon emission for (n,2np)

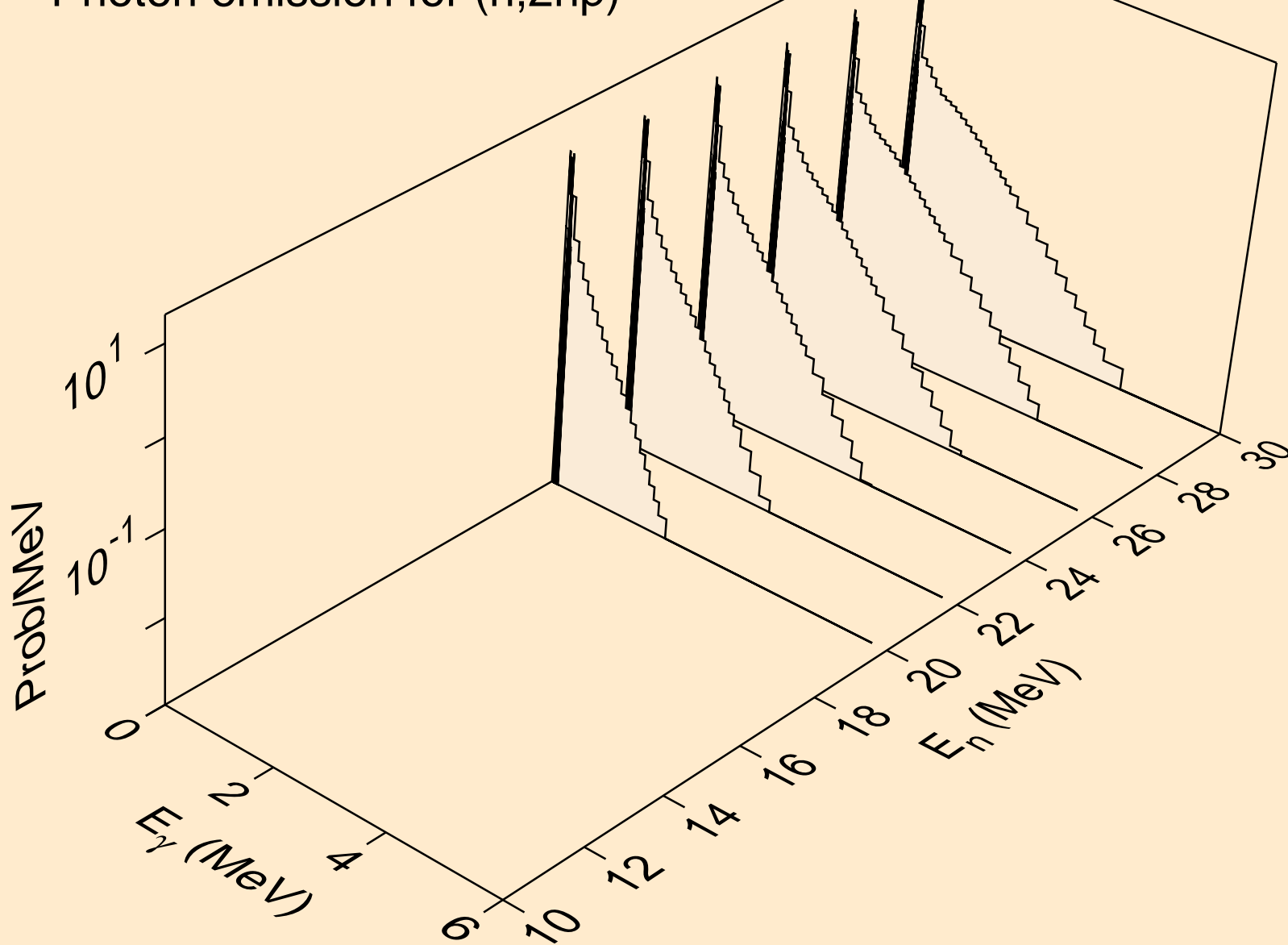

RA225 NEUTRON ACER TENDL-2019 LIBRARY; T=293.16K
Photon emission for (n,3np)

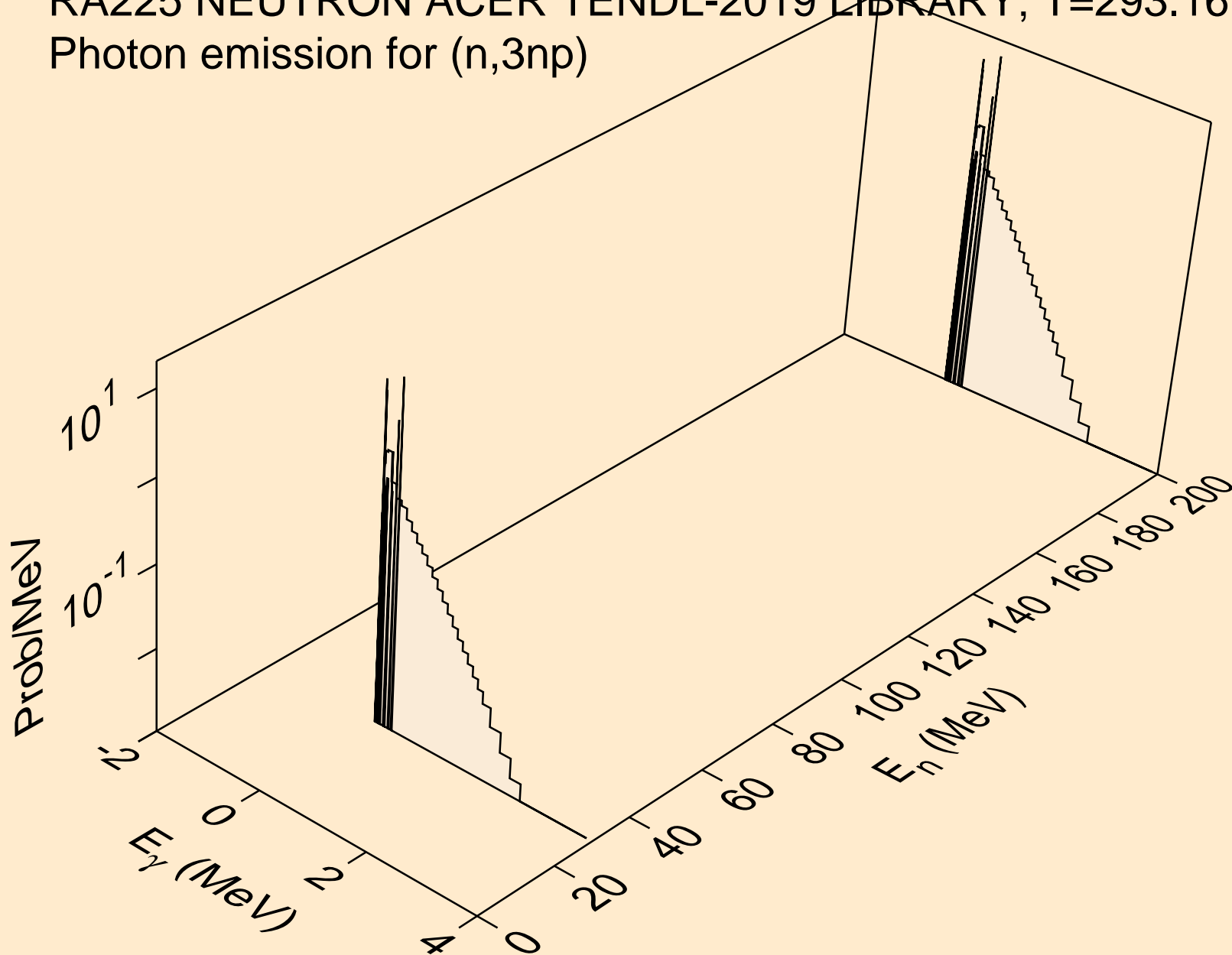

RA225 NEUTRON ACER TENDL-2019 LIBRARY; T=293.16K
Photon emission for (n,2np)

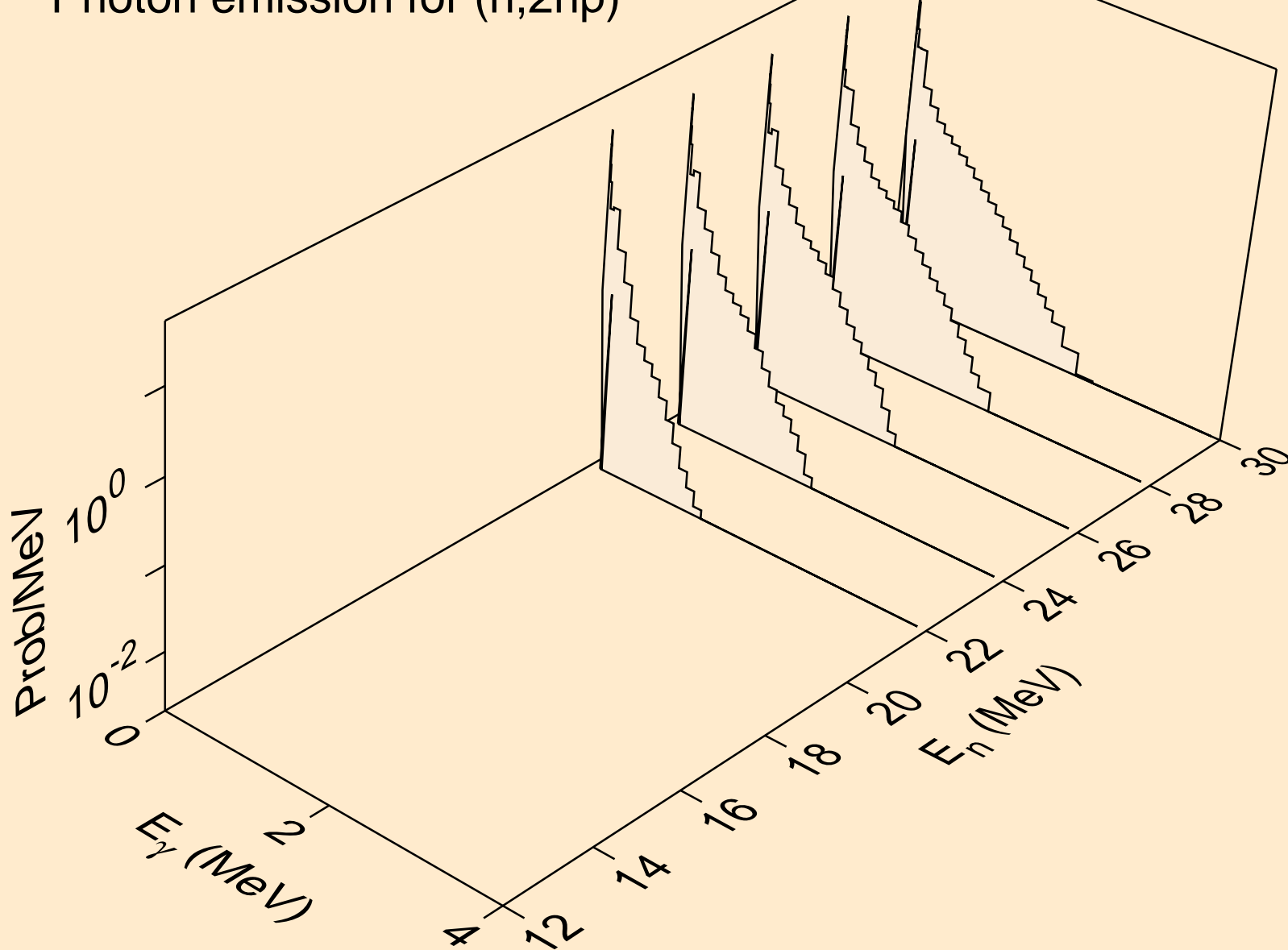

RA225 NEUTRON ACER TENDL-2019 LIBRARY; T=293.16K
Photon emission for (n,npa)

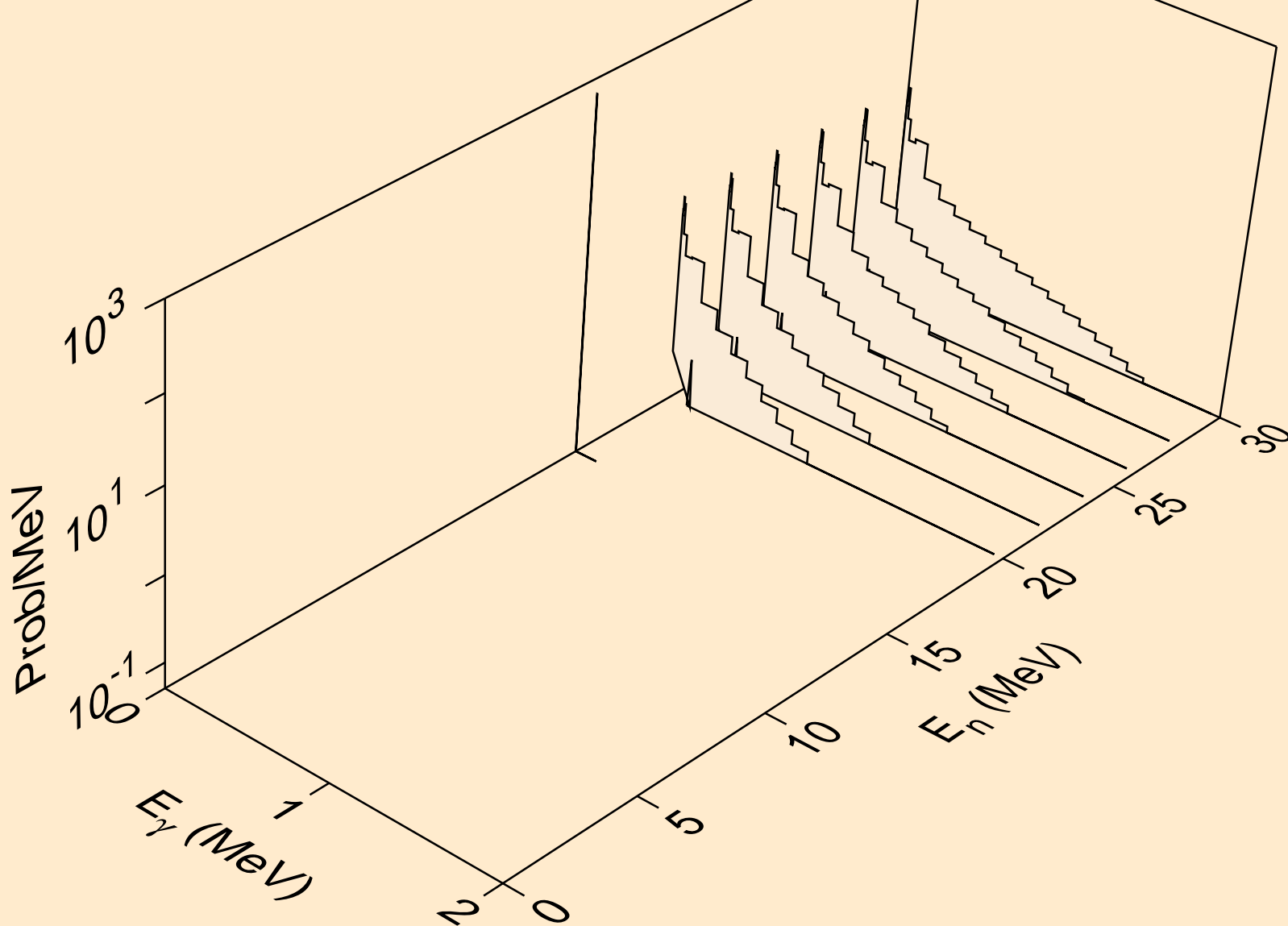

RA225 NEUTRON ACER TENDL-2019 LIBRARY; T=293.16K
Photon emission for (n,n*c)

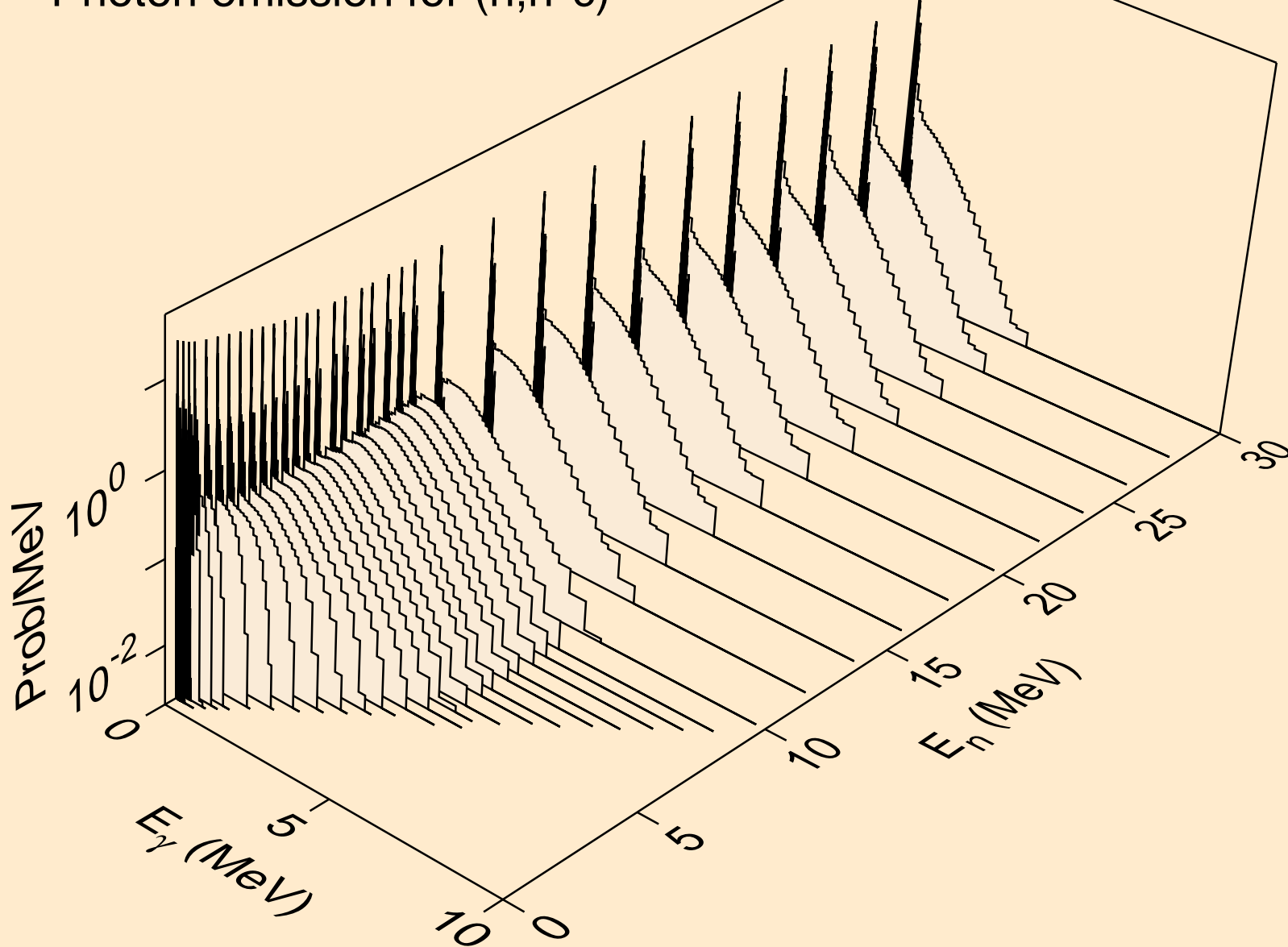

RA225 NEUTRON ACER TENDL-2019 LIBRARY; T=293.16K
Photon emission for (n,gma)

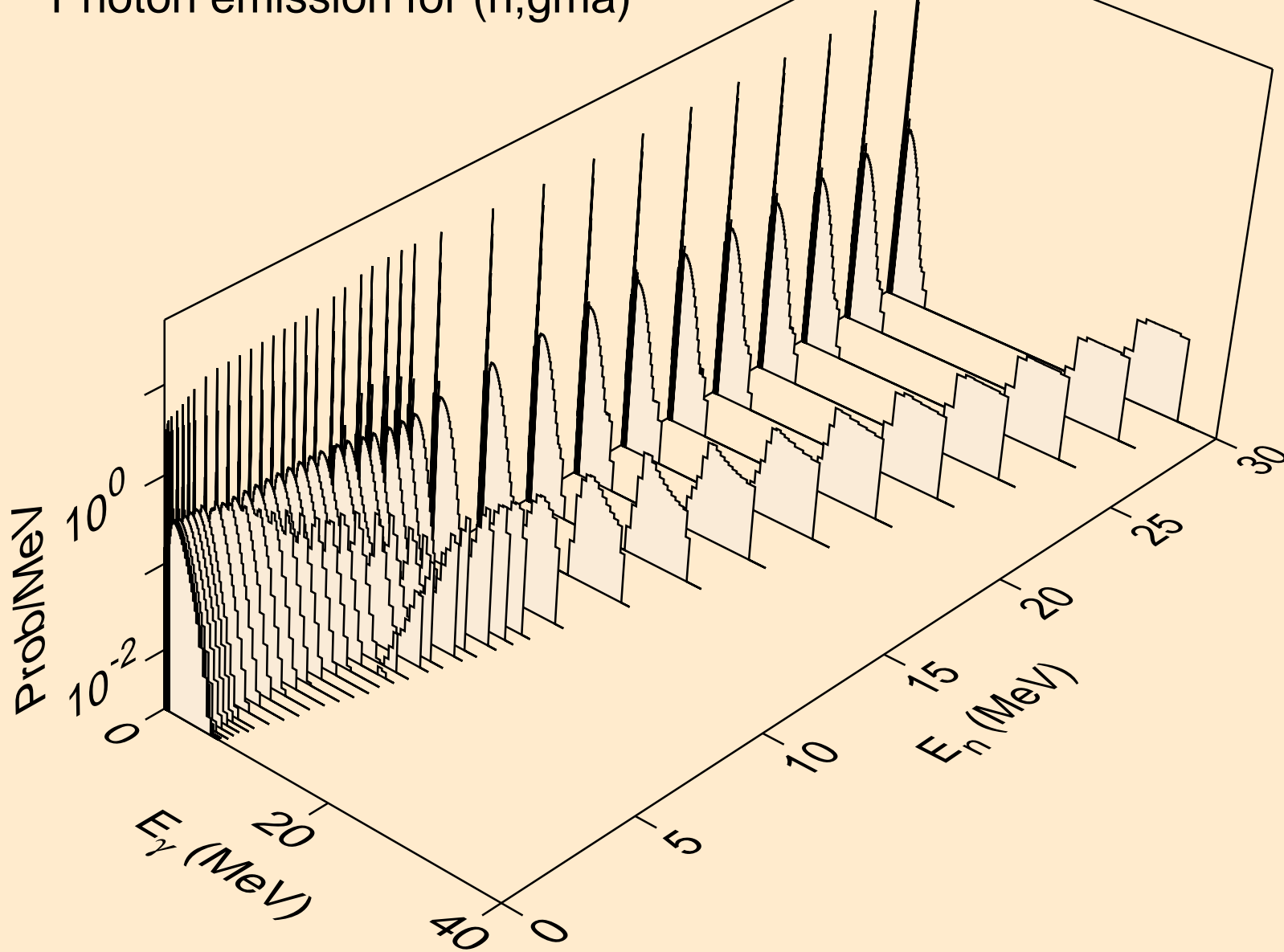

RA225 NEUTRON ACER TENDL-2019 LIBRARY; T=293.16K
Photon emission for (n,p)

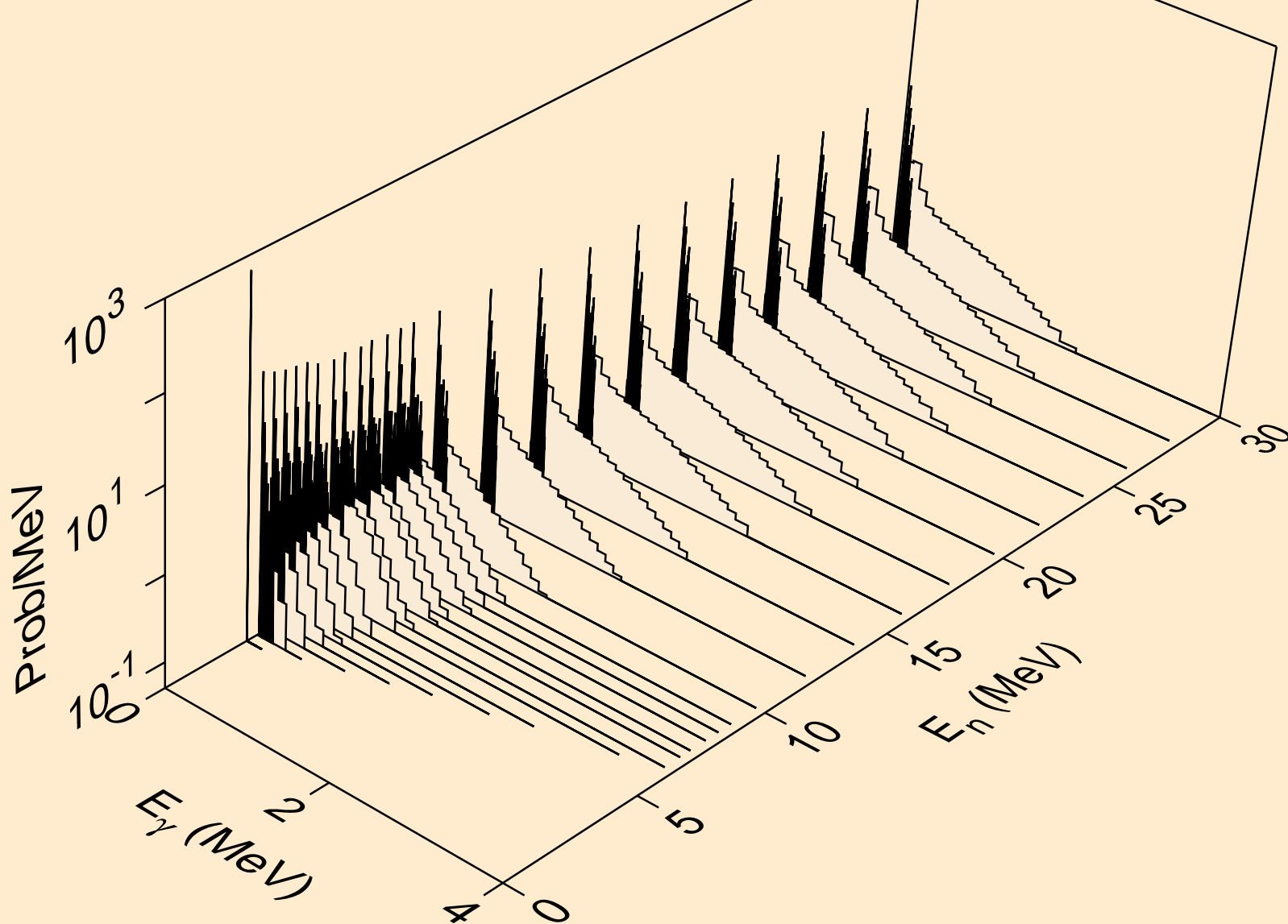

RA225 NEUTRON ACER TENDL-2019 LIBRARY; T=293.16K
Photon emission for (n,d)

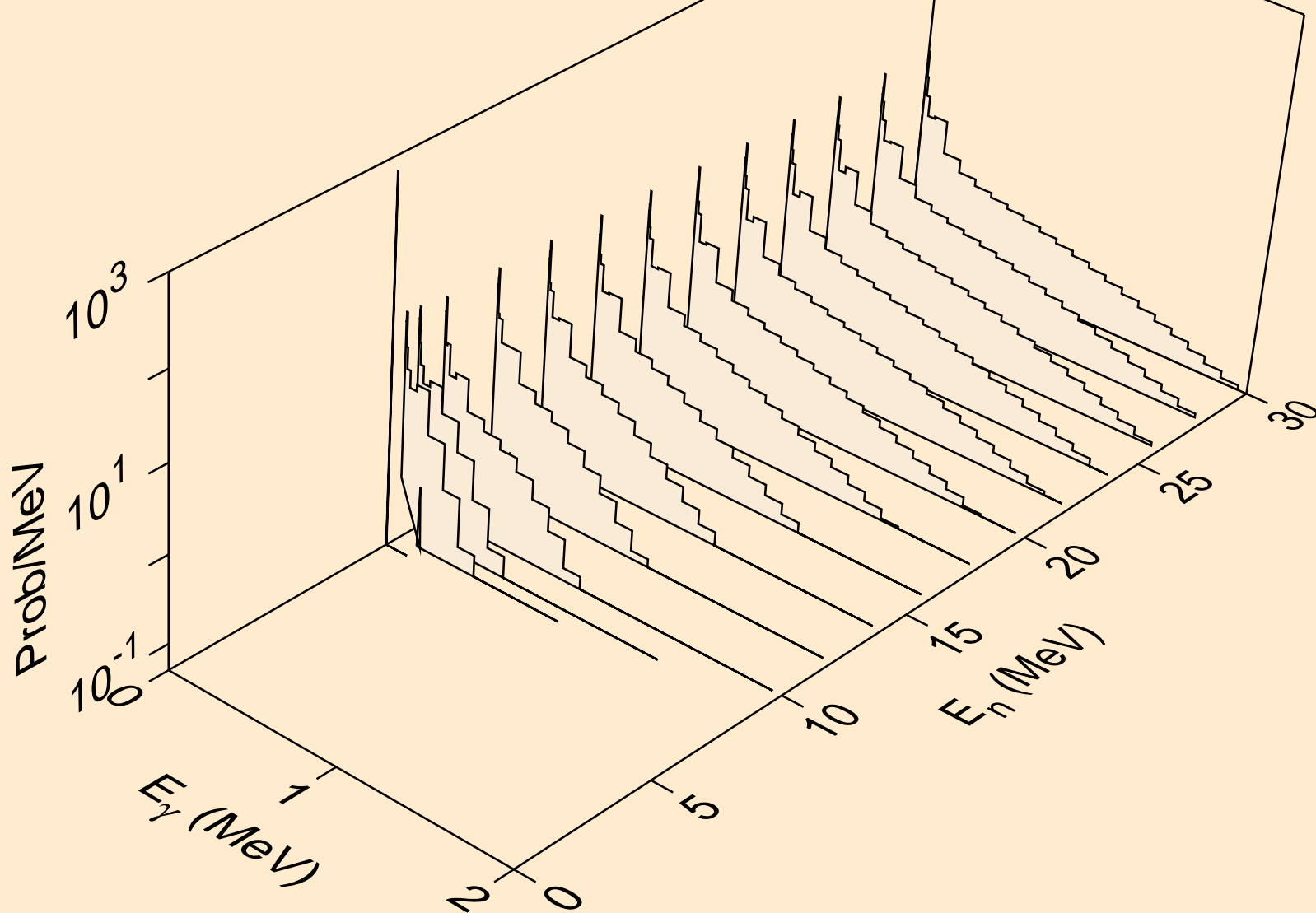

RA225 NEUTRON ACER TENDL-2019 LIBRARY; T=293.16K
Photon emission for (n,t)

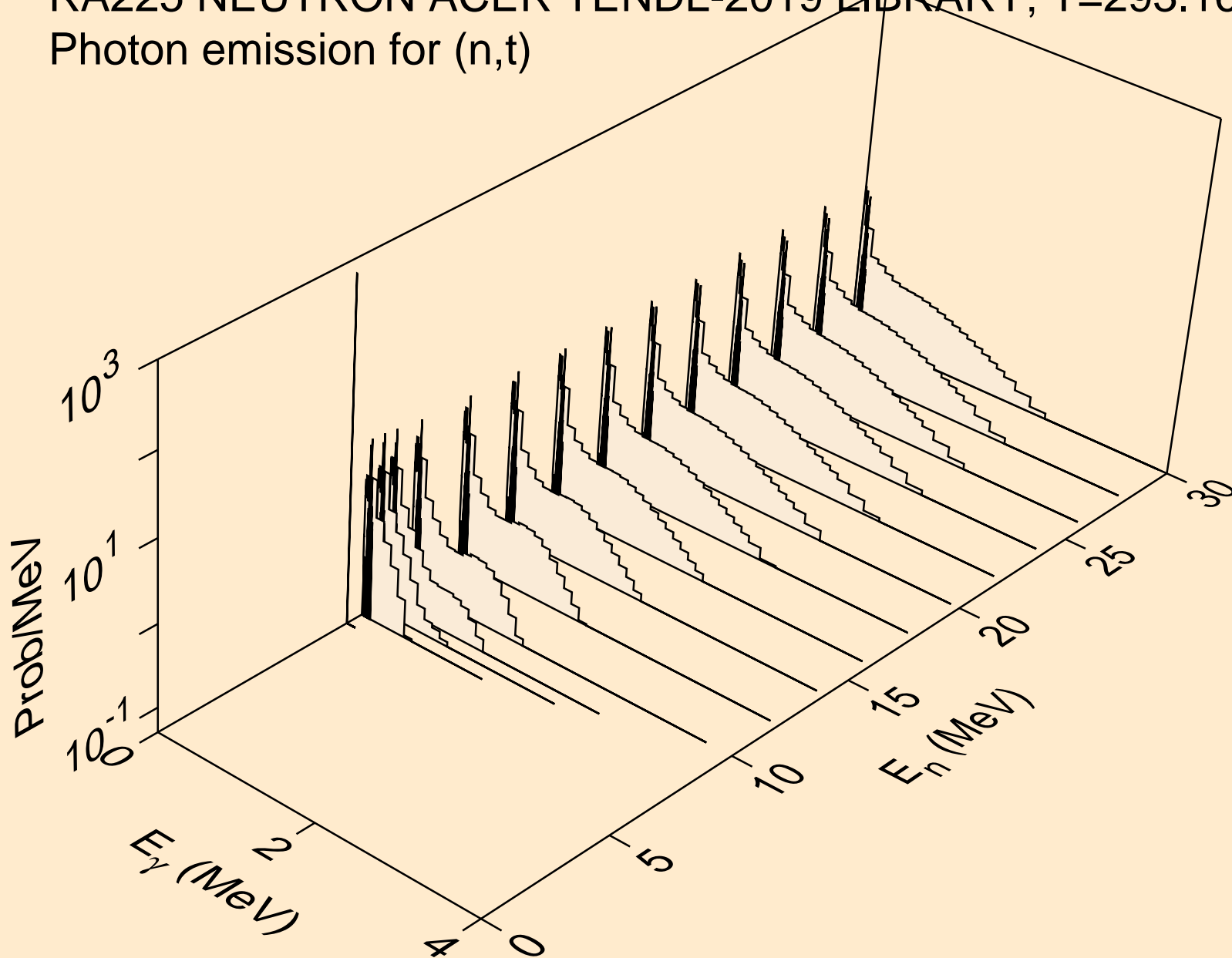

RA225 NEUTRON ACER TENDL-2019 LIBRARY; T=293.16K
Photon emission for (n,he3)

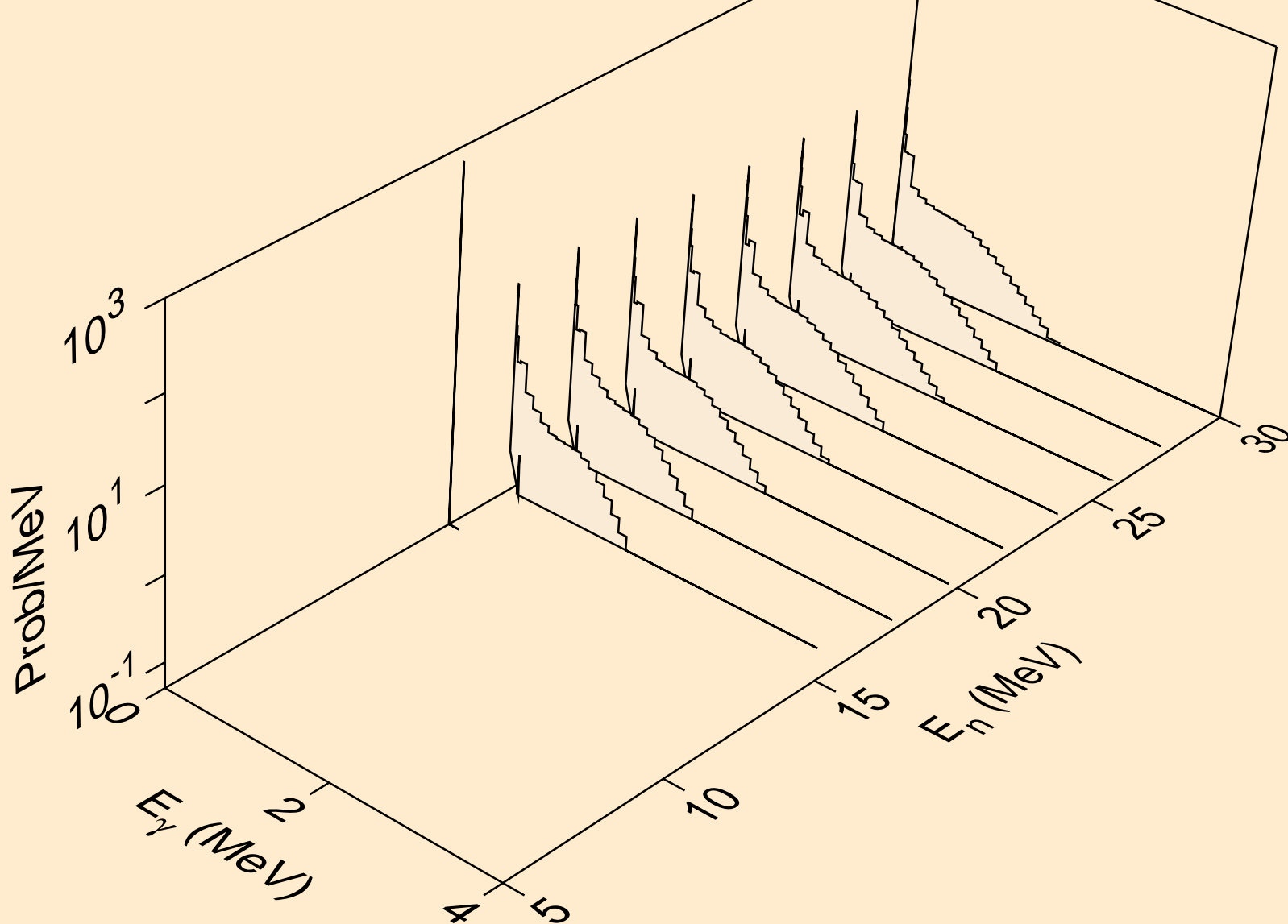

RA225 NEUTRON ACER TENDL-2019 LIBRARY; T=293.16K
Photon emission for (n,a)

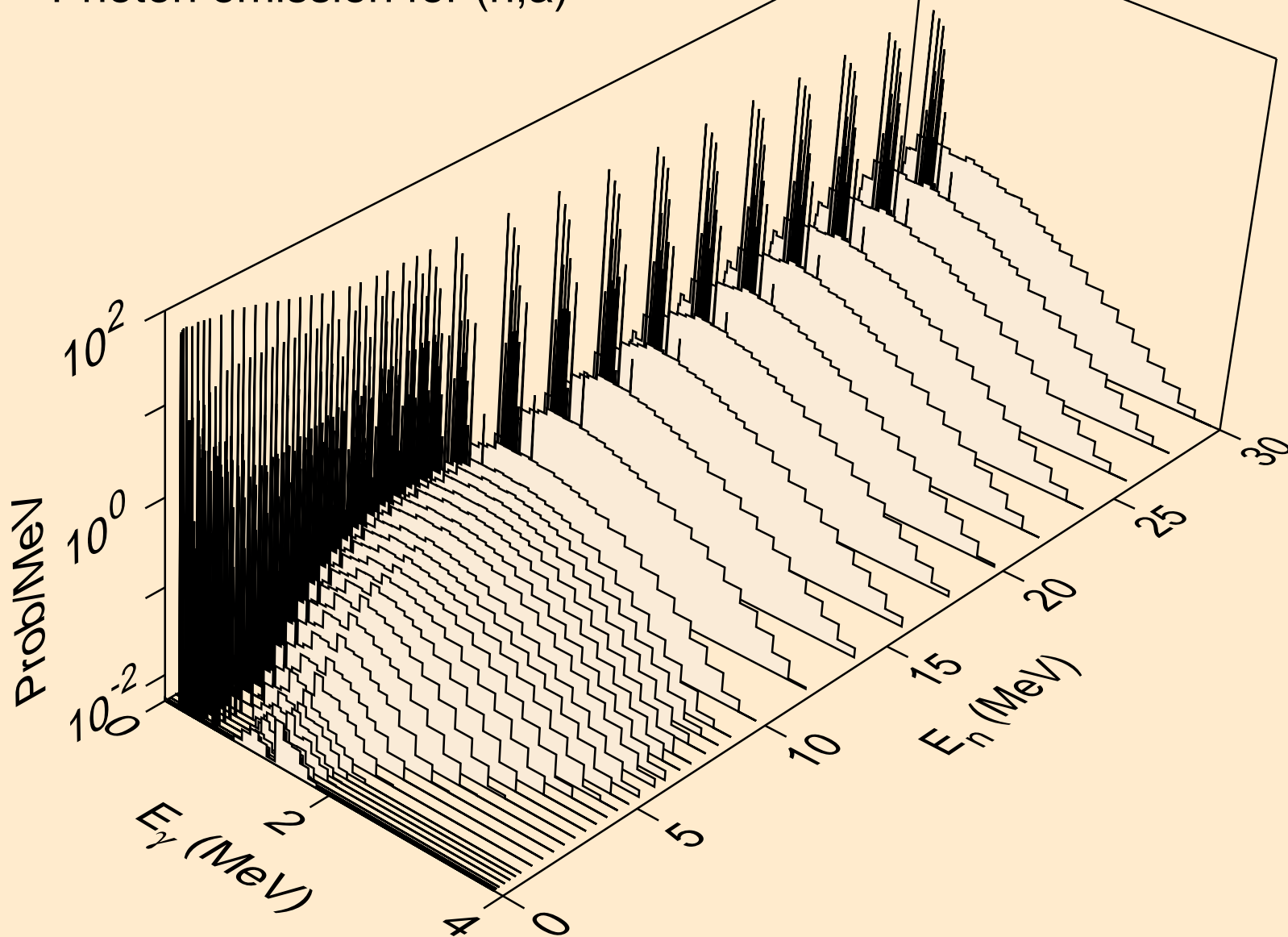

RA225 NEUTRON ACER TENDL-2019 LIBRARY; T=293.16K
Photon emission for (n,2a)

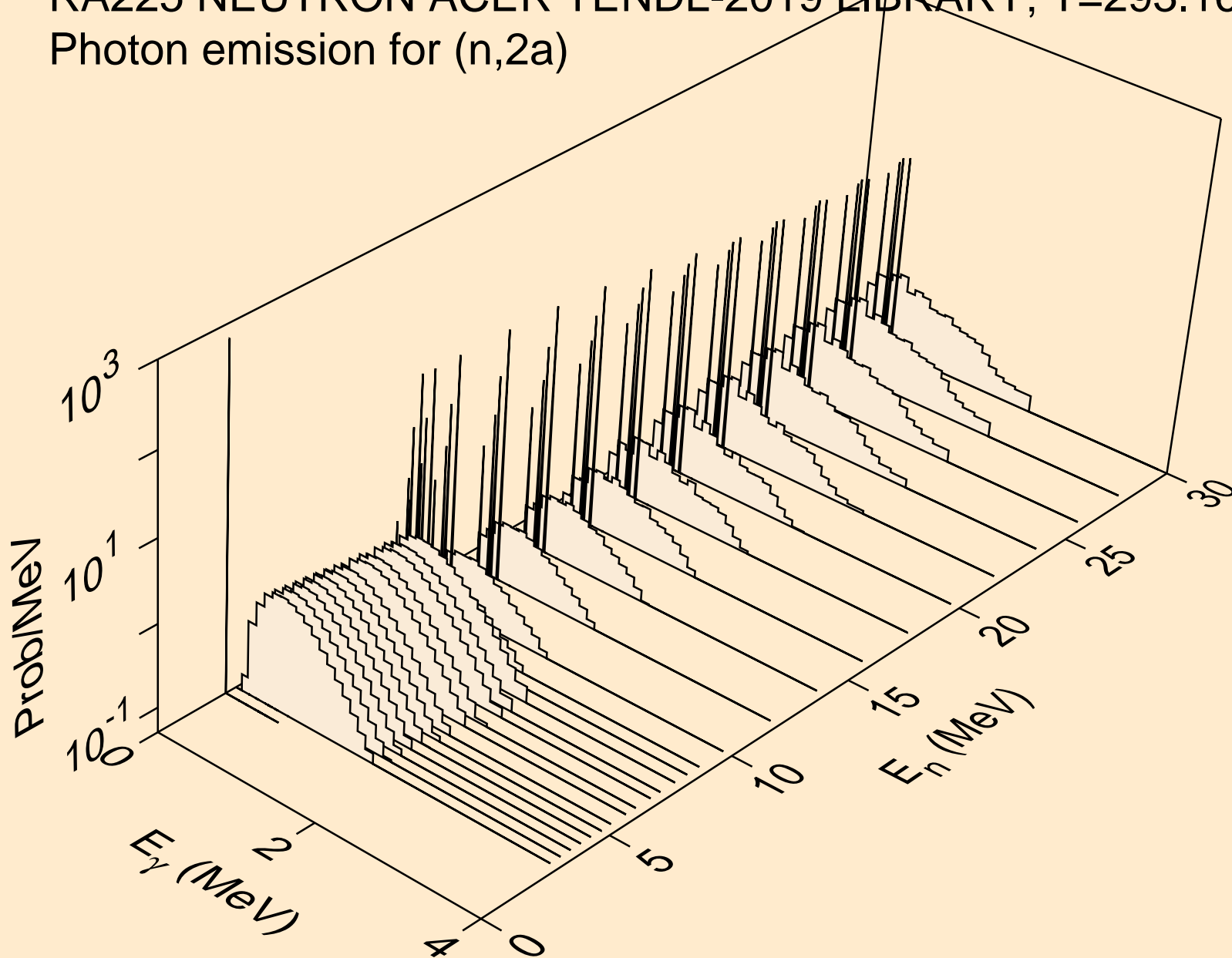

RA225 NEUTRON ACER TENDL-2019 LIBRARY; T=293.16K
Photon emission for (n,2p)

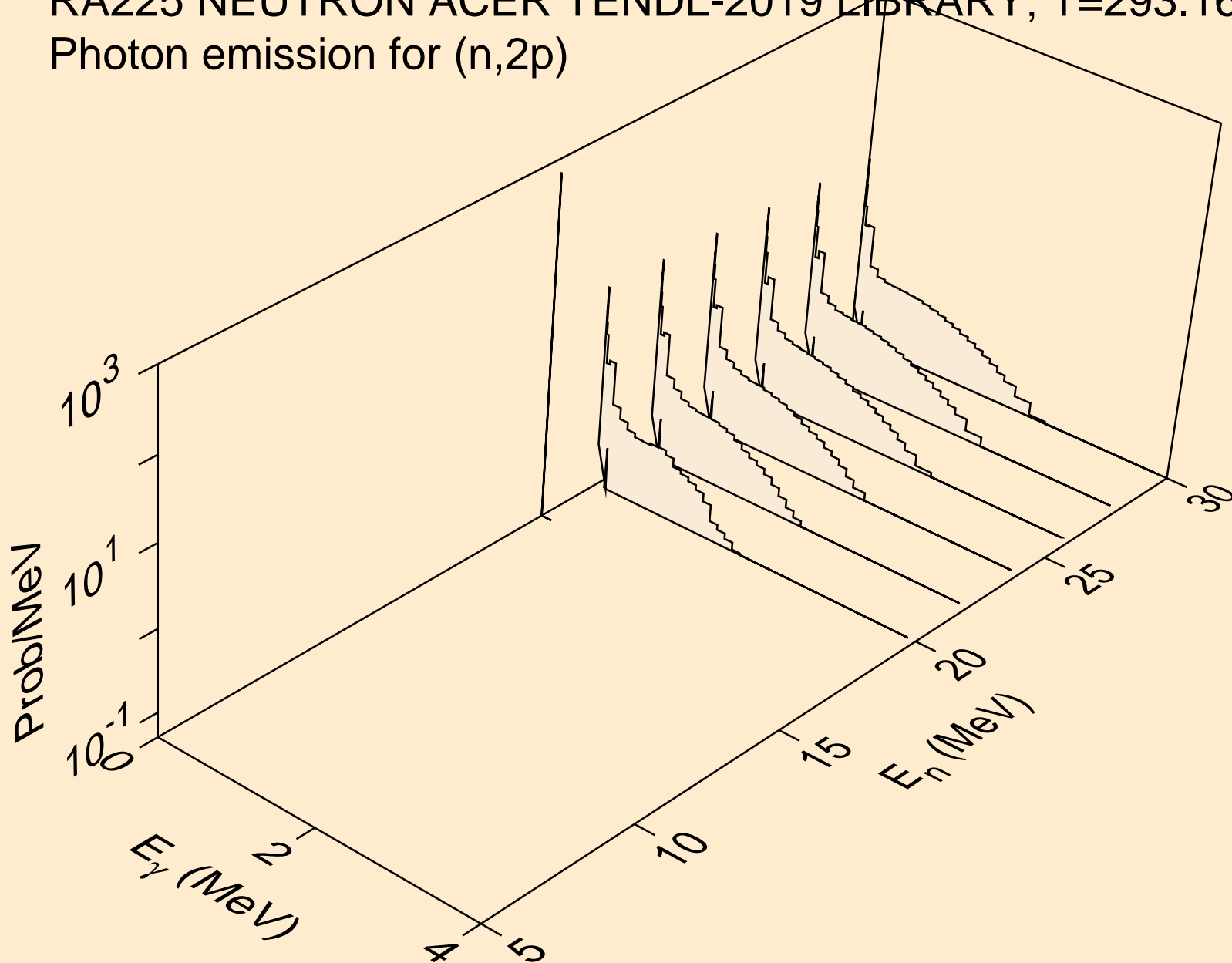

RA225 NEUTRON ACER TENDL-2019 LIBRARY; T=293.16K
Photon emission for (n,p α)

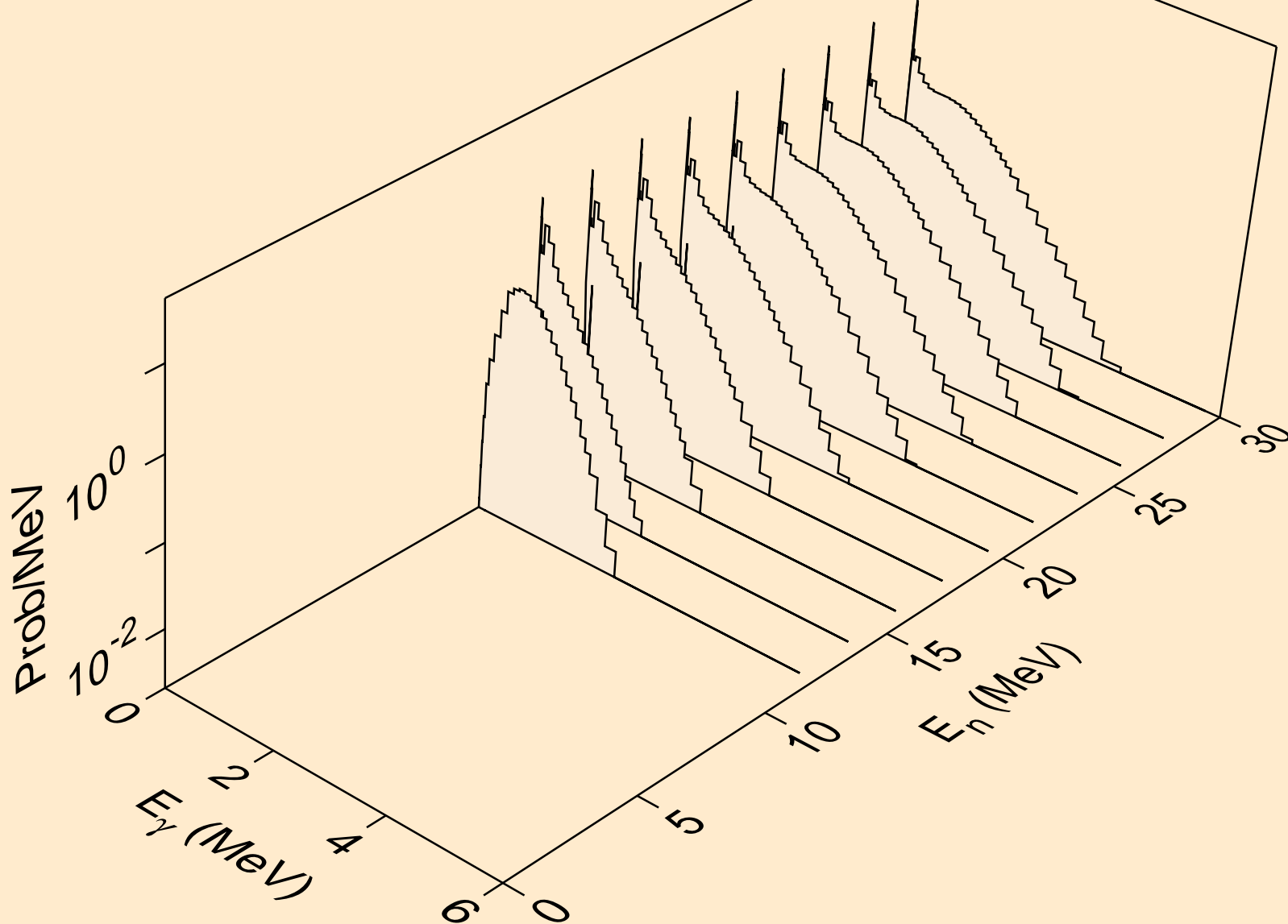

RA225 NEUTRON ACER TENDL-2019 LIBRARY; T=293.16K
thermal capture photon spectrum

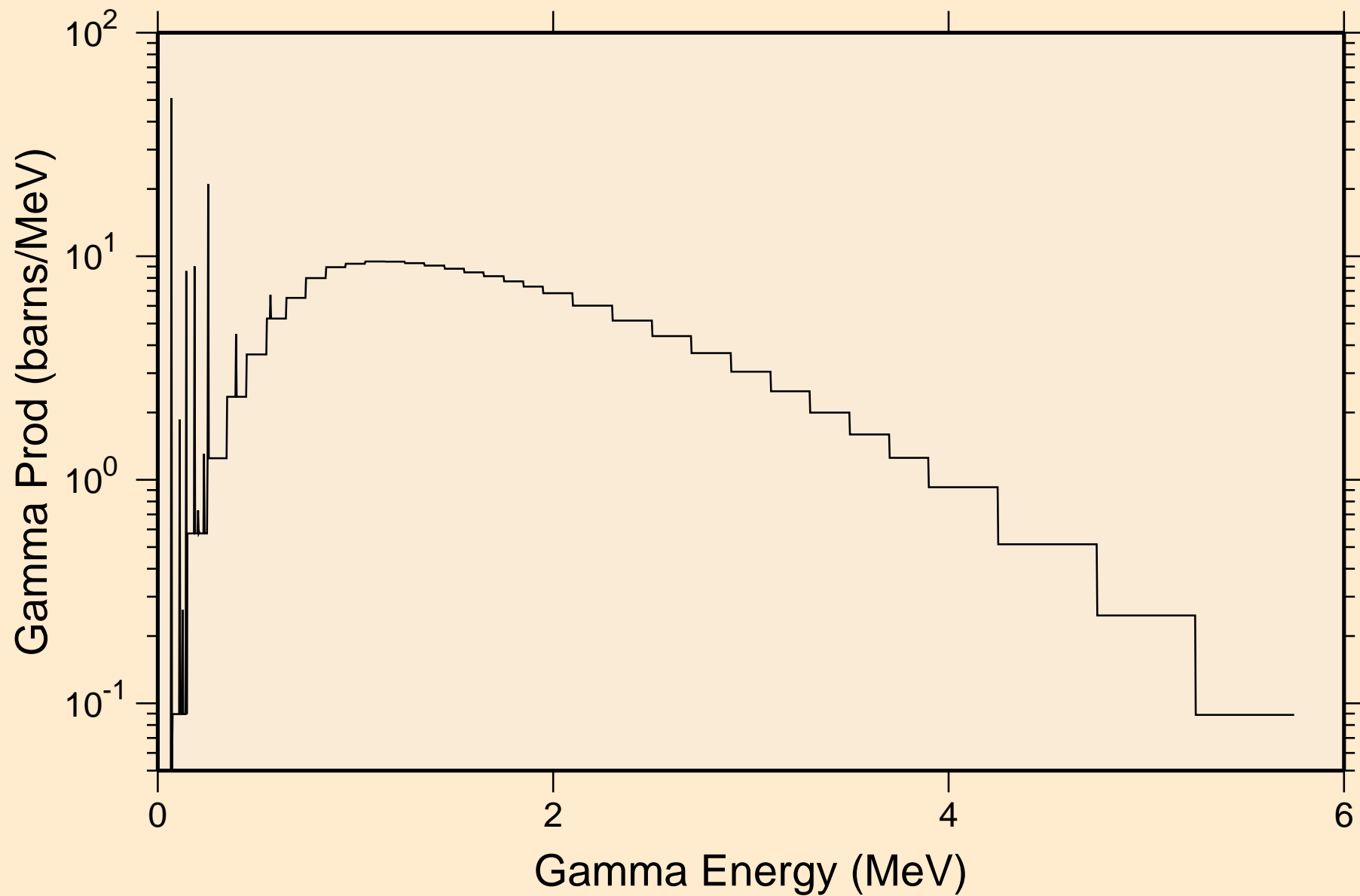

RA225 NEUTRON ACER TENDL-2019 LIBRARY; T=293.16K
14 MeV photon spectrum

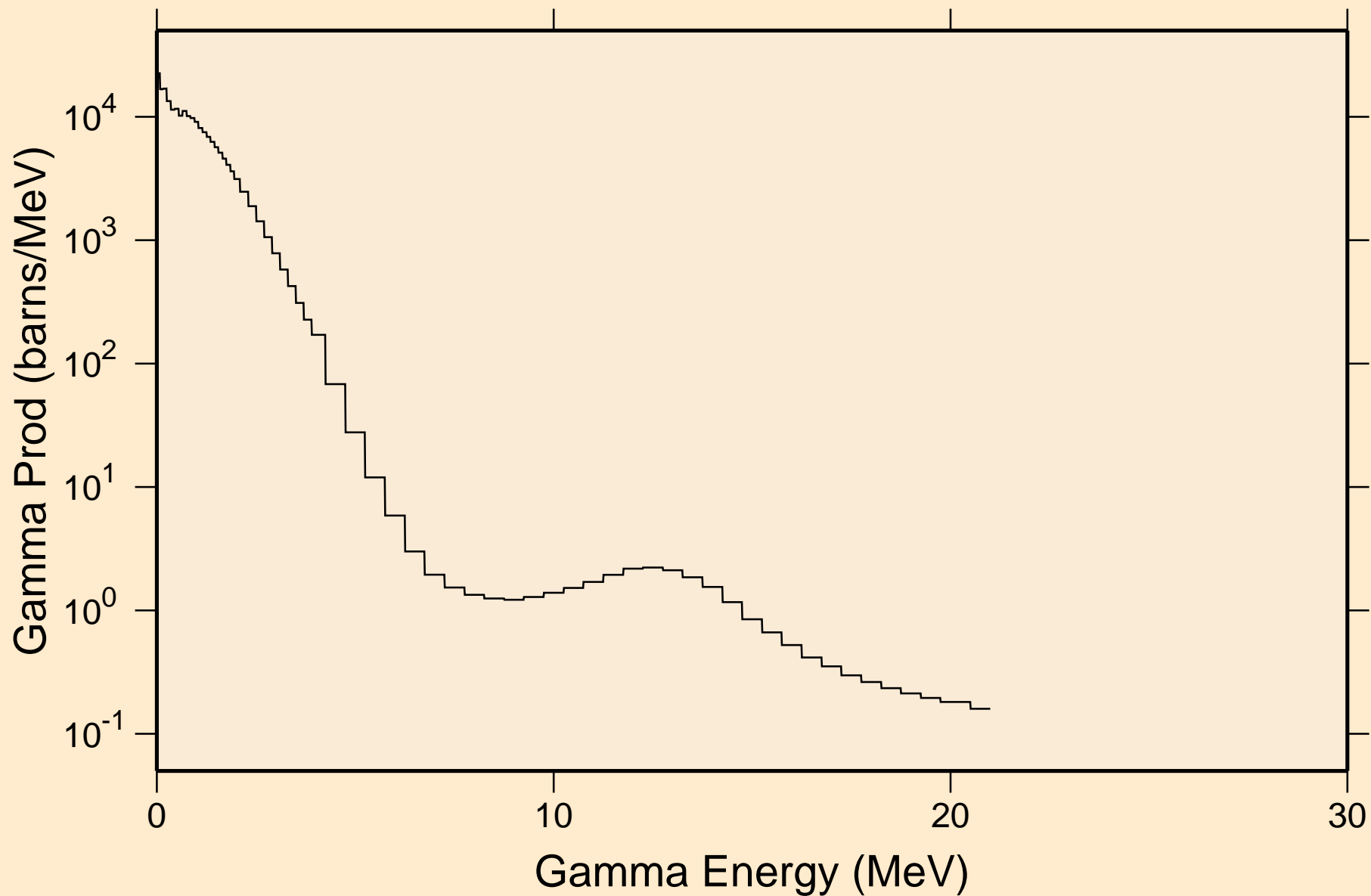

RA225 NEUTRON ACER TENDL-2019 LIBRARY; T=293.16K

Particle heating contributions

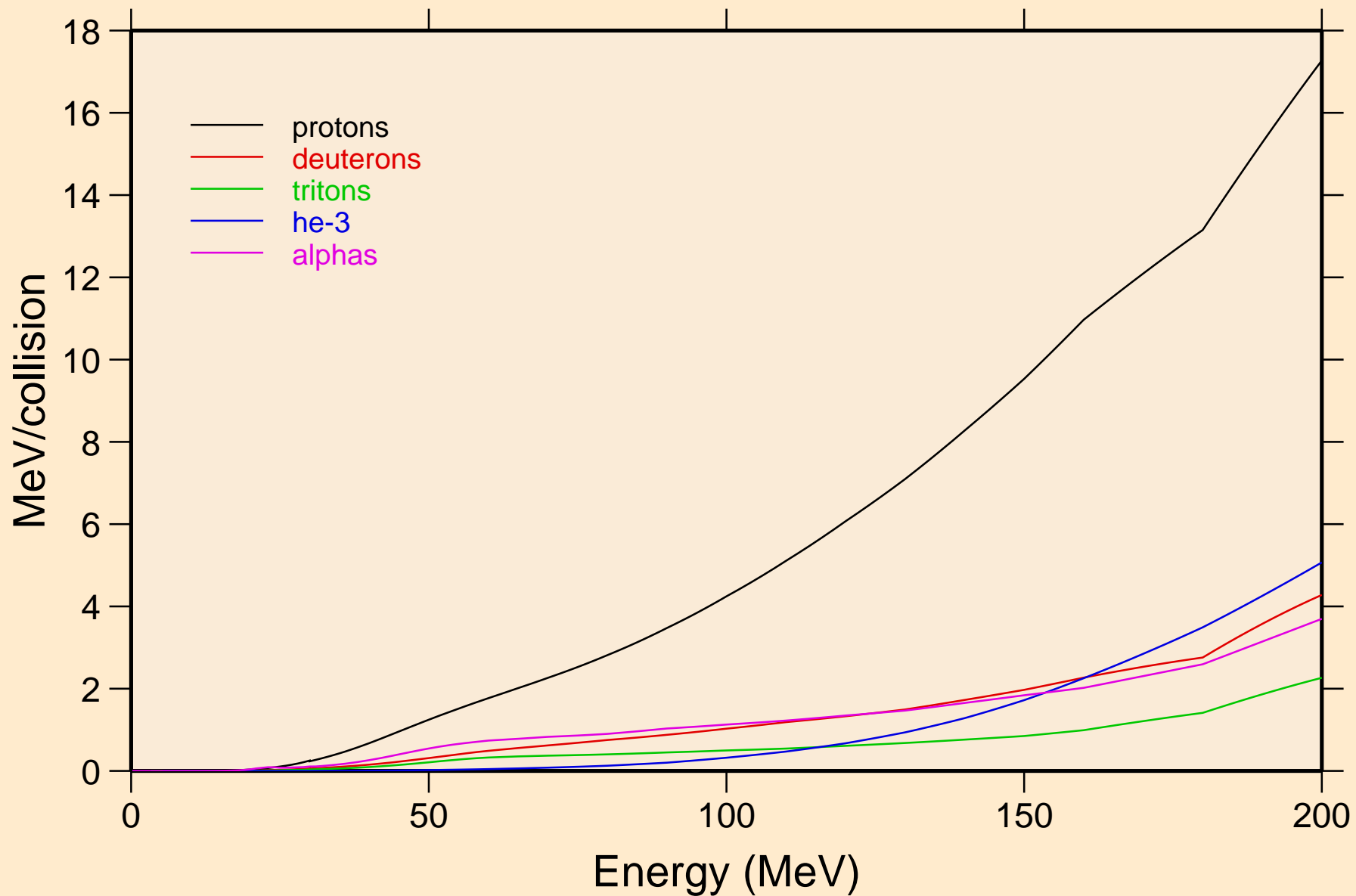

RA225 NEUTRON ACER TENDL-2019 LIBRARY; T=293.16K
Recoil Heating

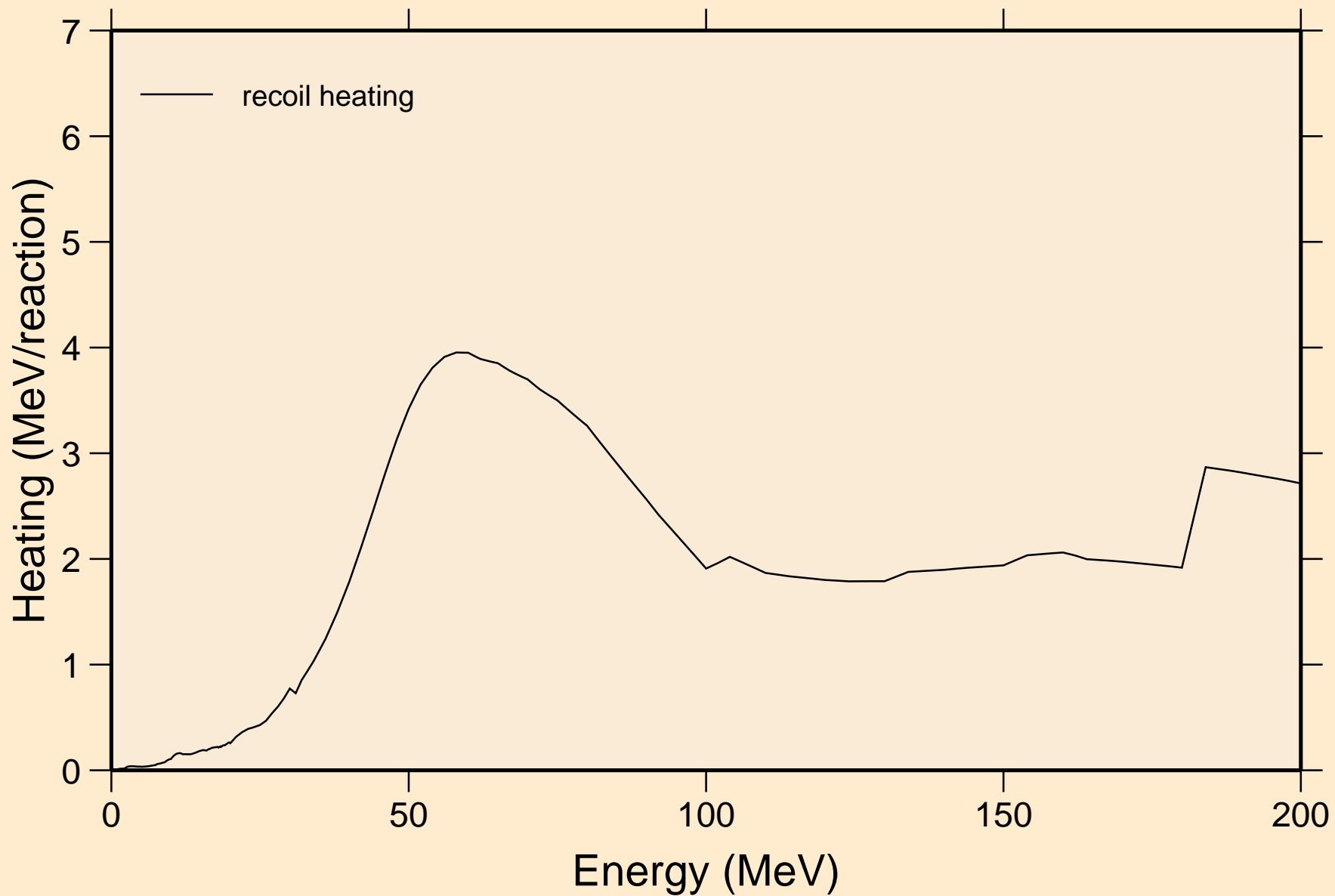

RA225 NEUTRON ACER TENDL-2019 LIBRARY; T=293.16K
Particle production cross sections

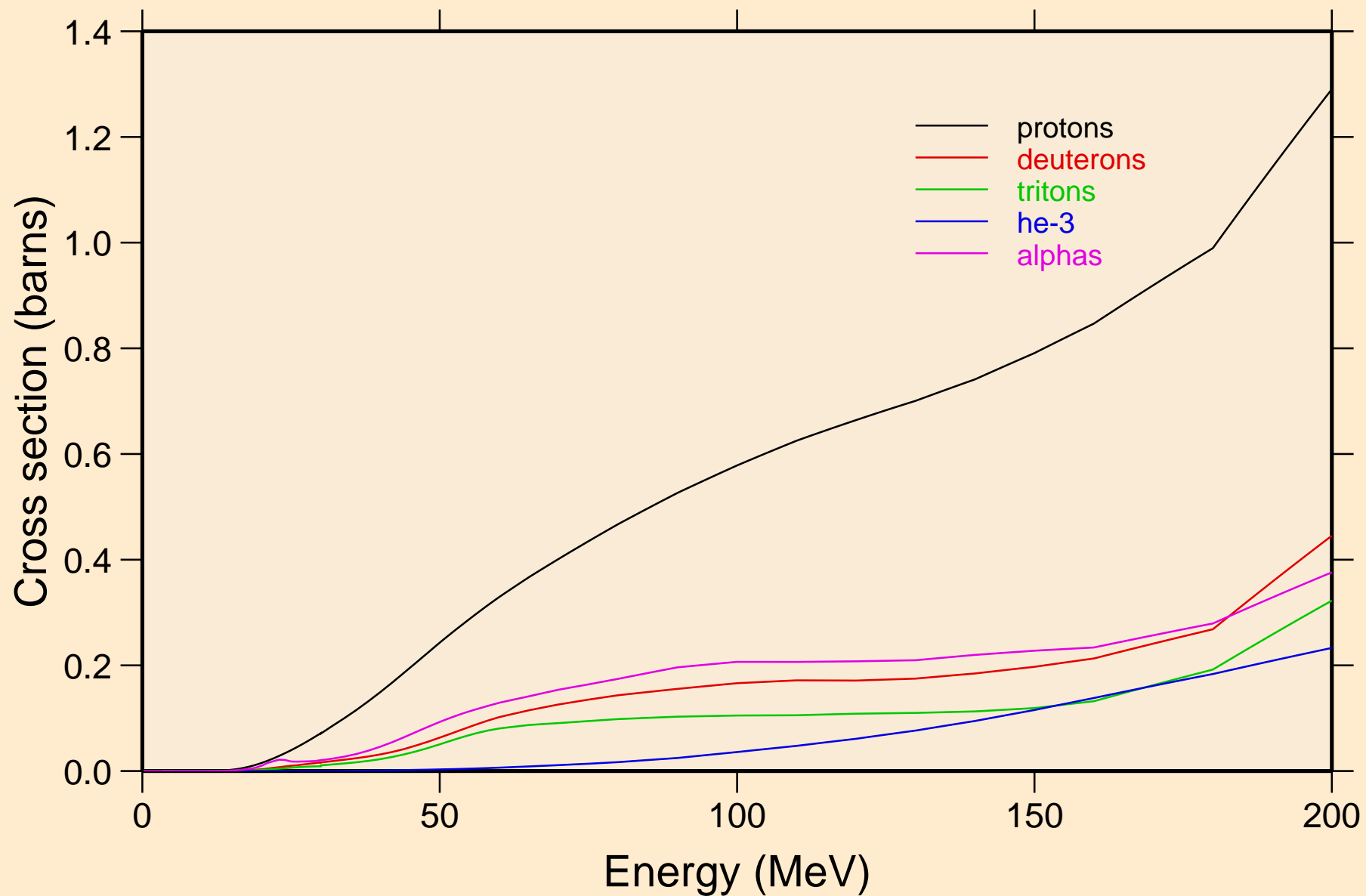

RA225 NEUTRON ACER TENDL-2019 LIBRARY; T=293.16K
protons from (n,x)

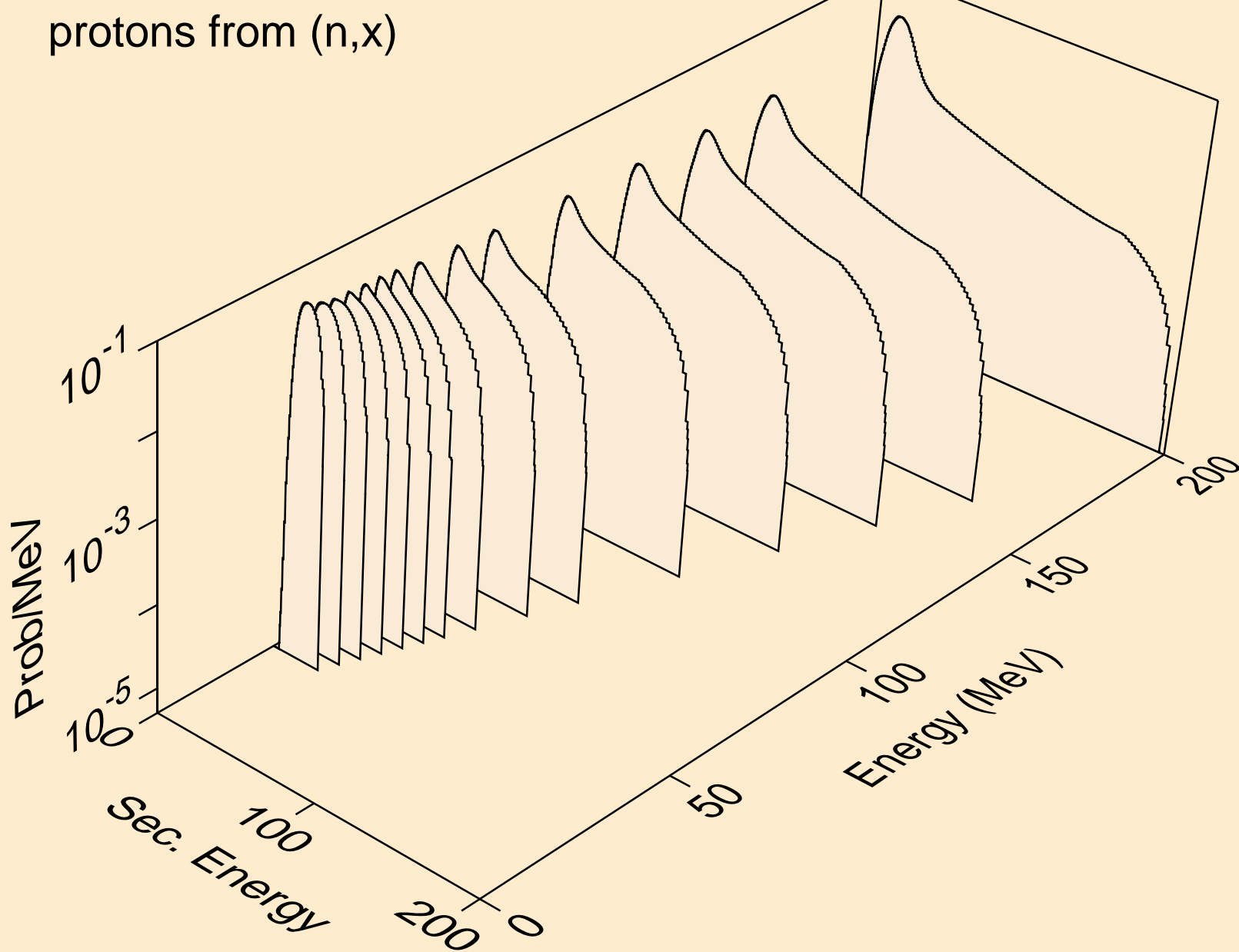

RA225 NEUTRON ACER TENDL-2019 LIBRARY; T=293.16K
protons from (n,n*)p

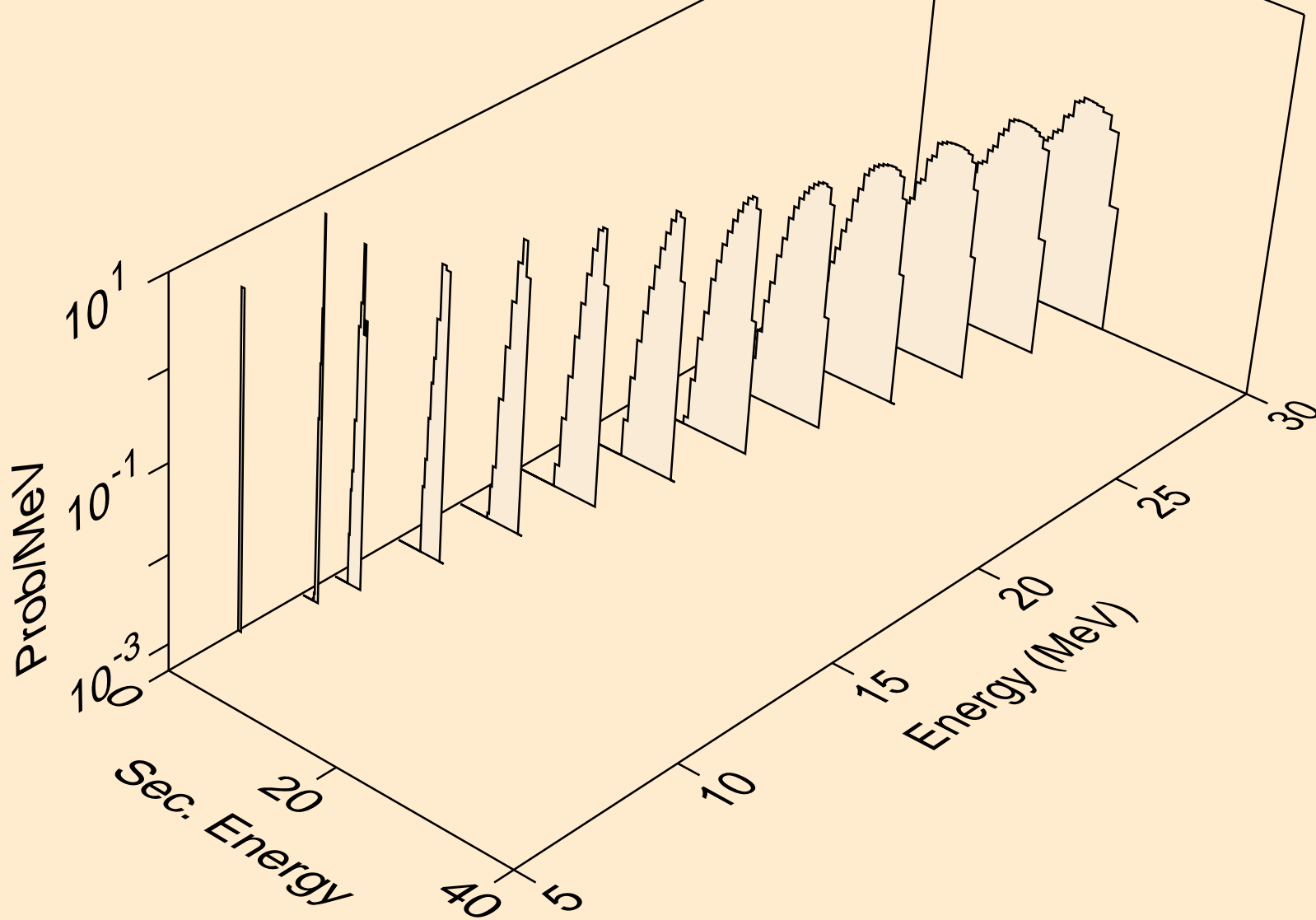

RA225 NEUTRON ACER TENDL-2019 LIBRARY; T=293.16K
protons from (n,2np)

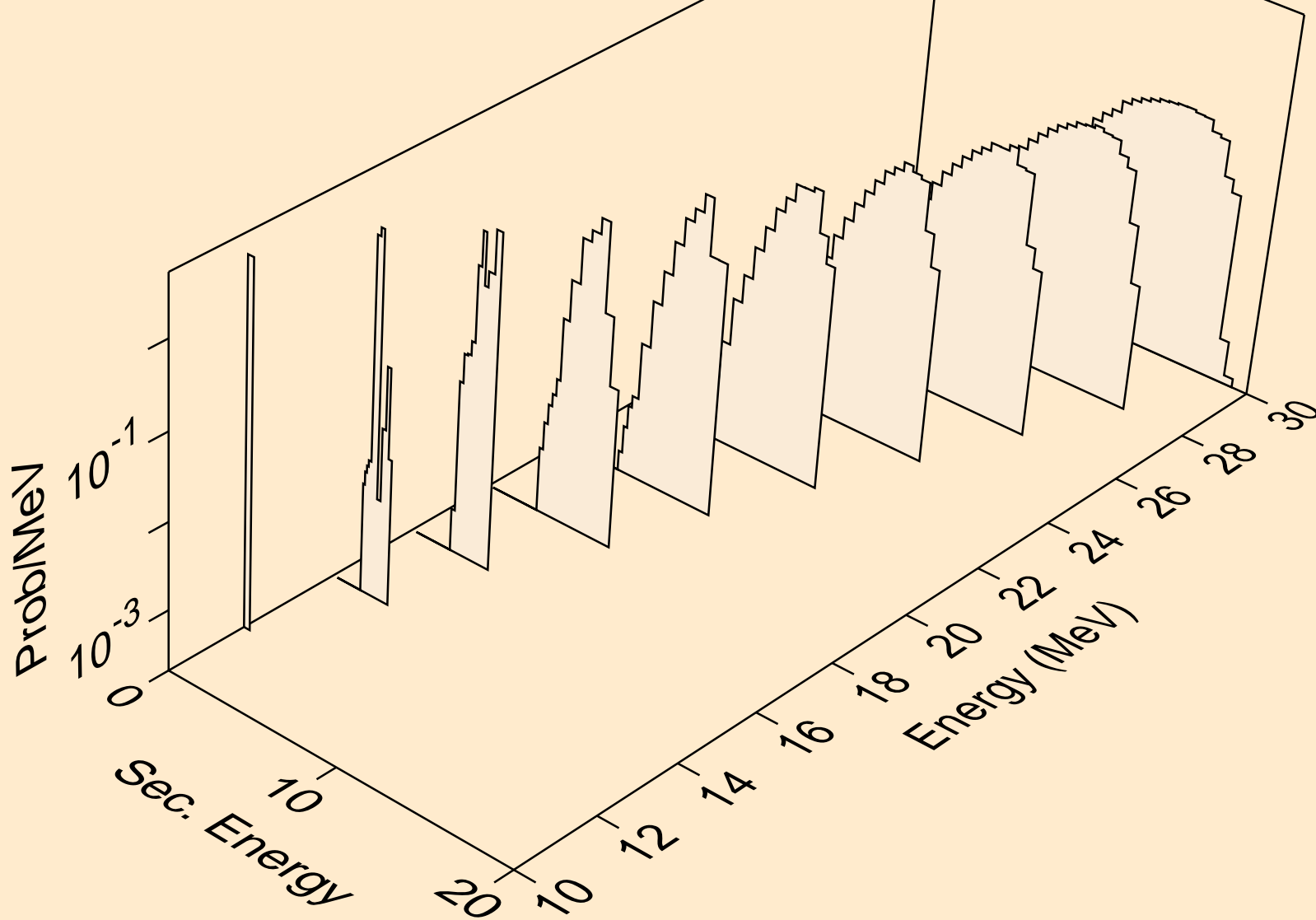

RA225 NEUTRON ACER TENDL-2019 LIBRARY; T=293.16K
protons from (n,3np)

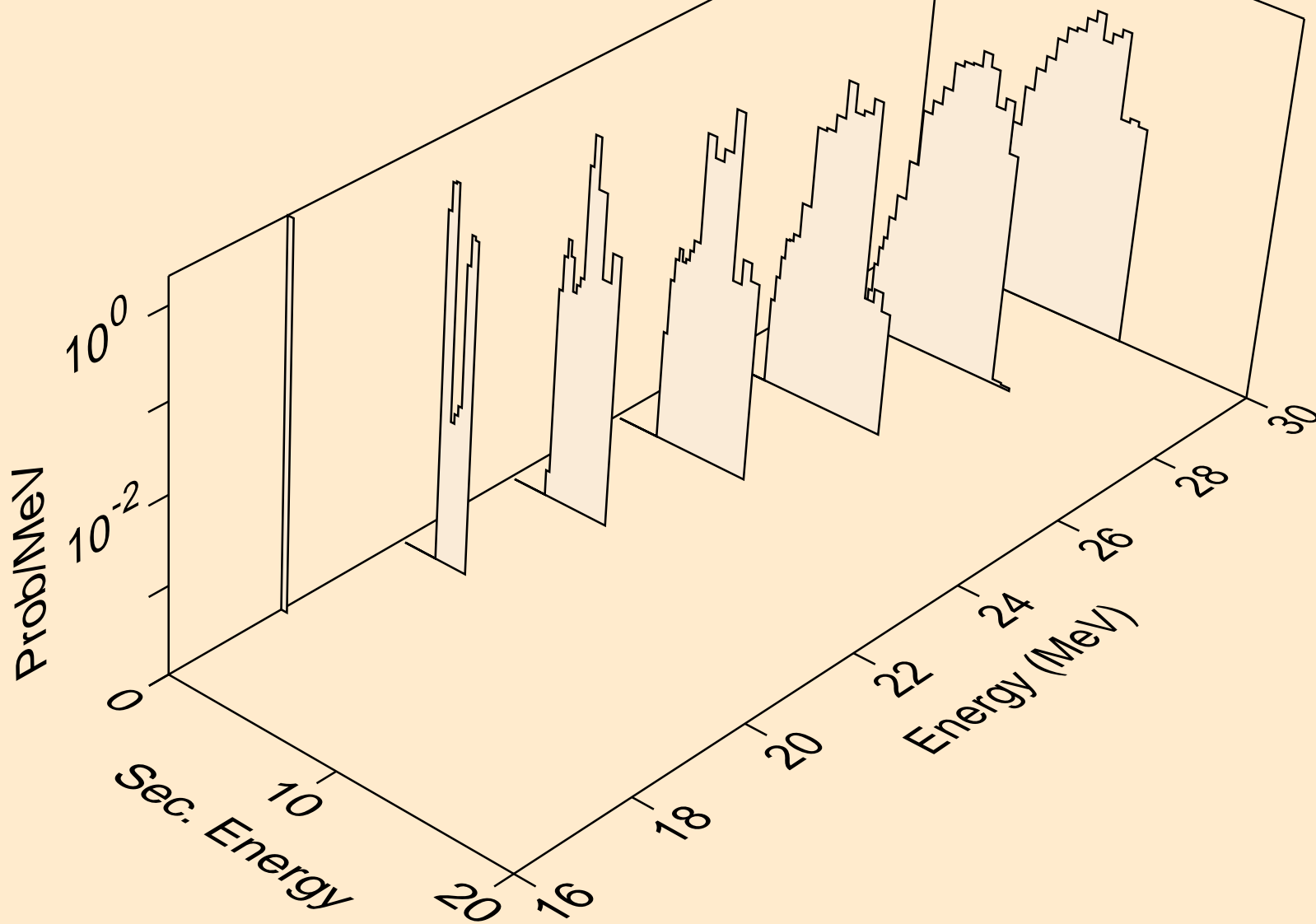

RA225 NEUTRON ACER TENDL-2019 LIBRARY; T=293.16K
protons from (n,2np)

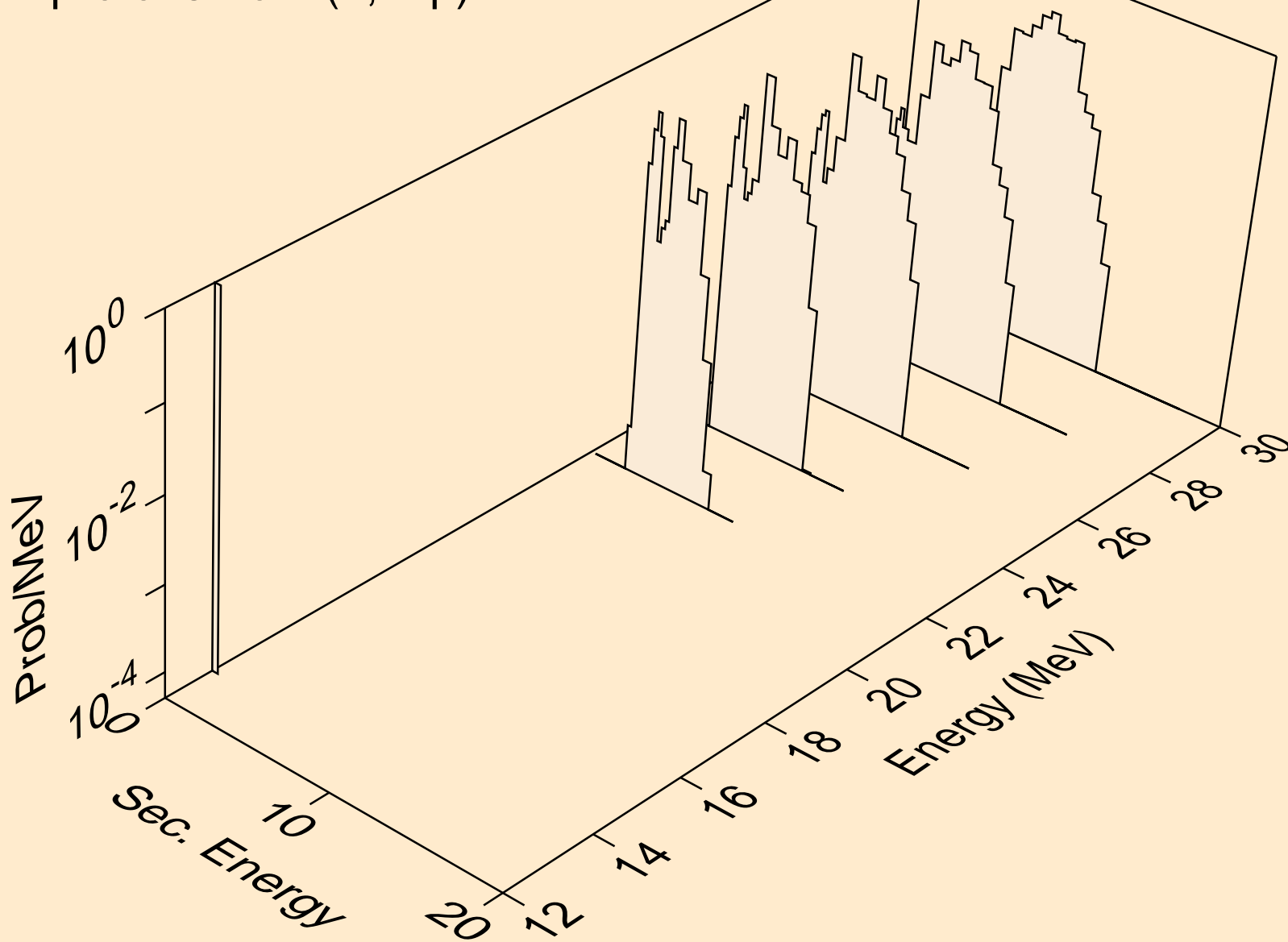

RA225 NEUTRON ACER TENDL-2019 LIBRARY; T=293.16K
protons from (n,npa)

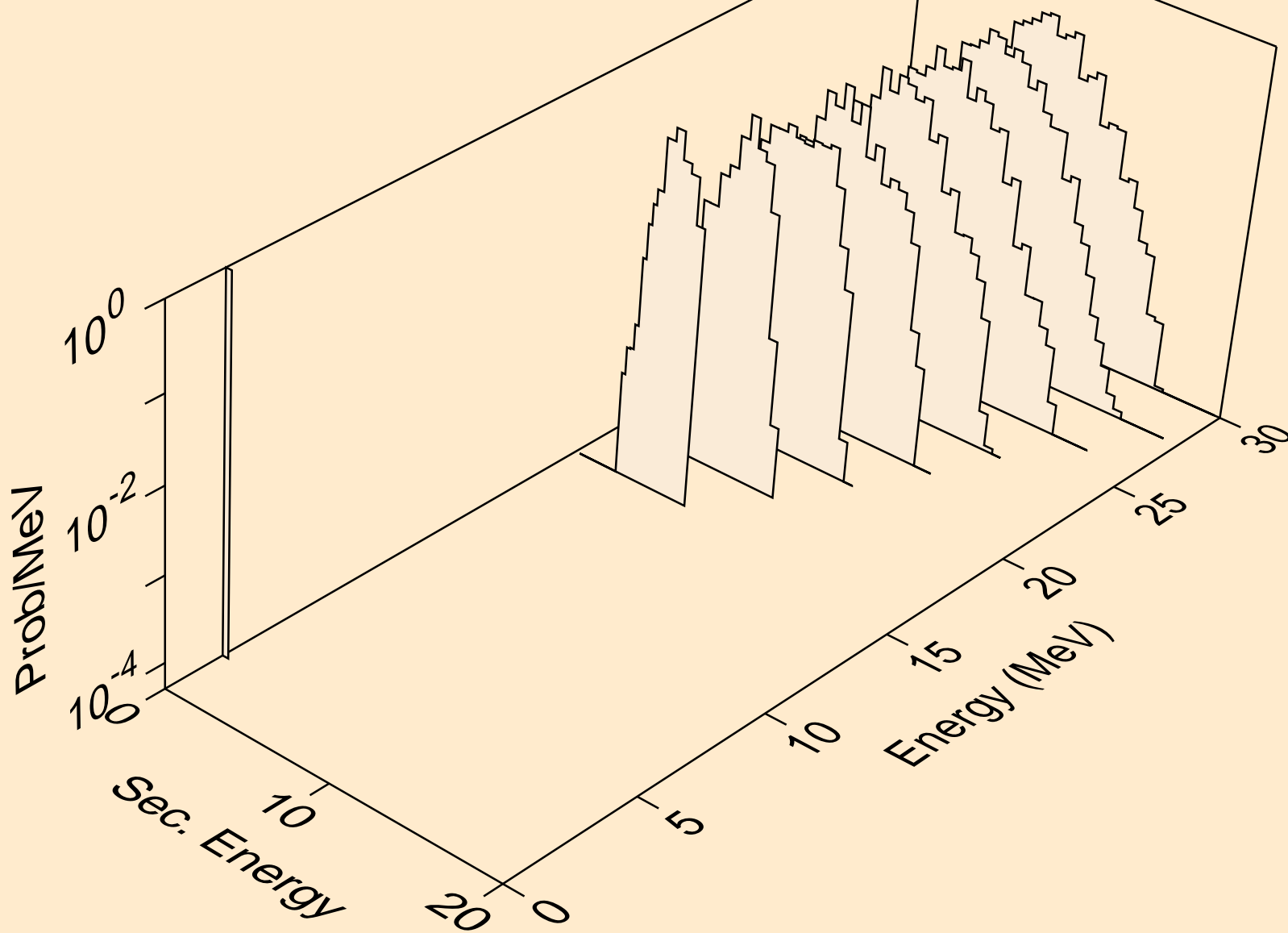

RA225 NEUTRON ACER TENDL-2019 LIBRARY; T=293.16K
protons from (n,p)

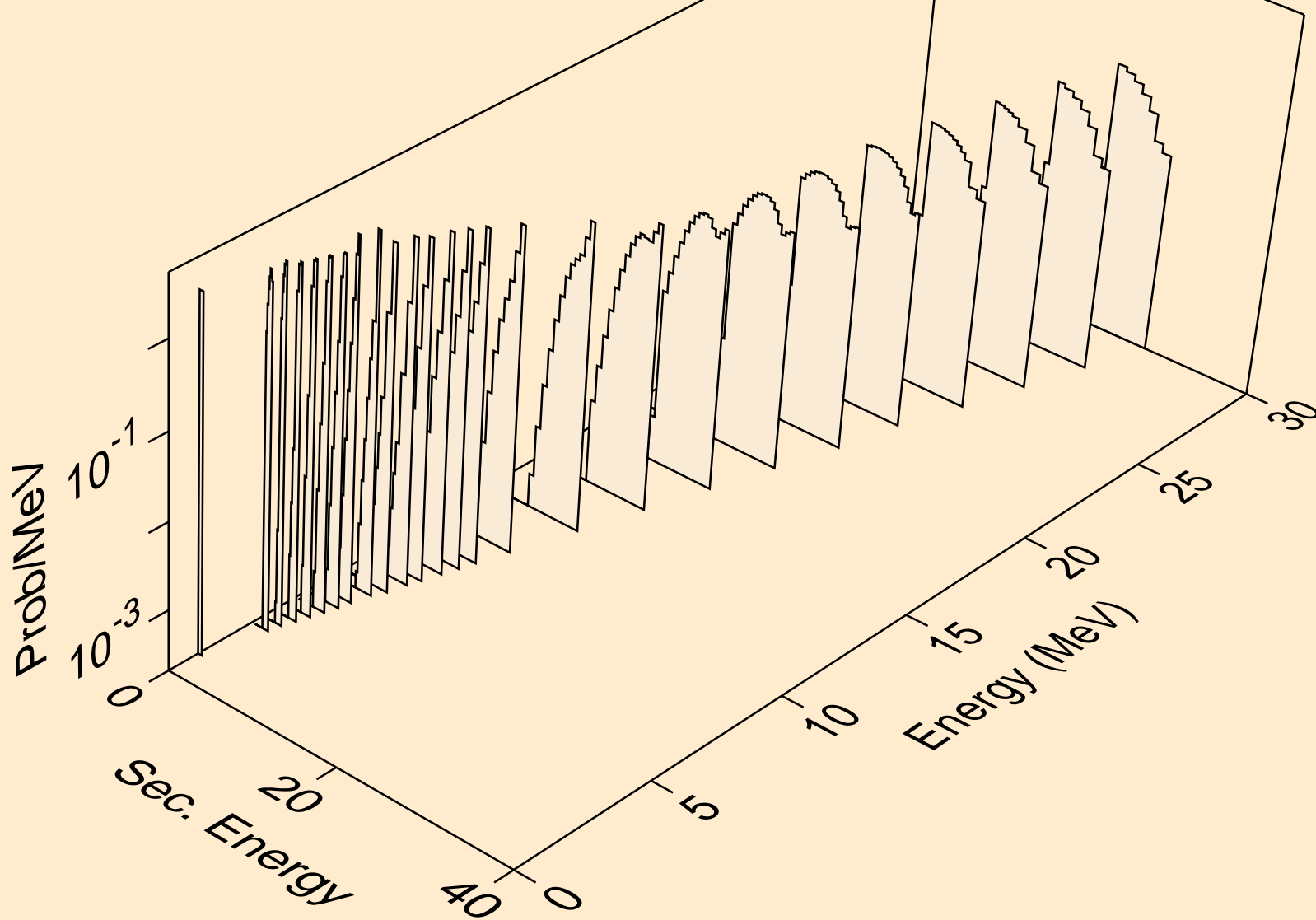

RA225 NEUTRON ACER TENDL-2019 LIBRARY; T=293.16K
protons from (n,2p)

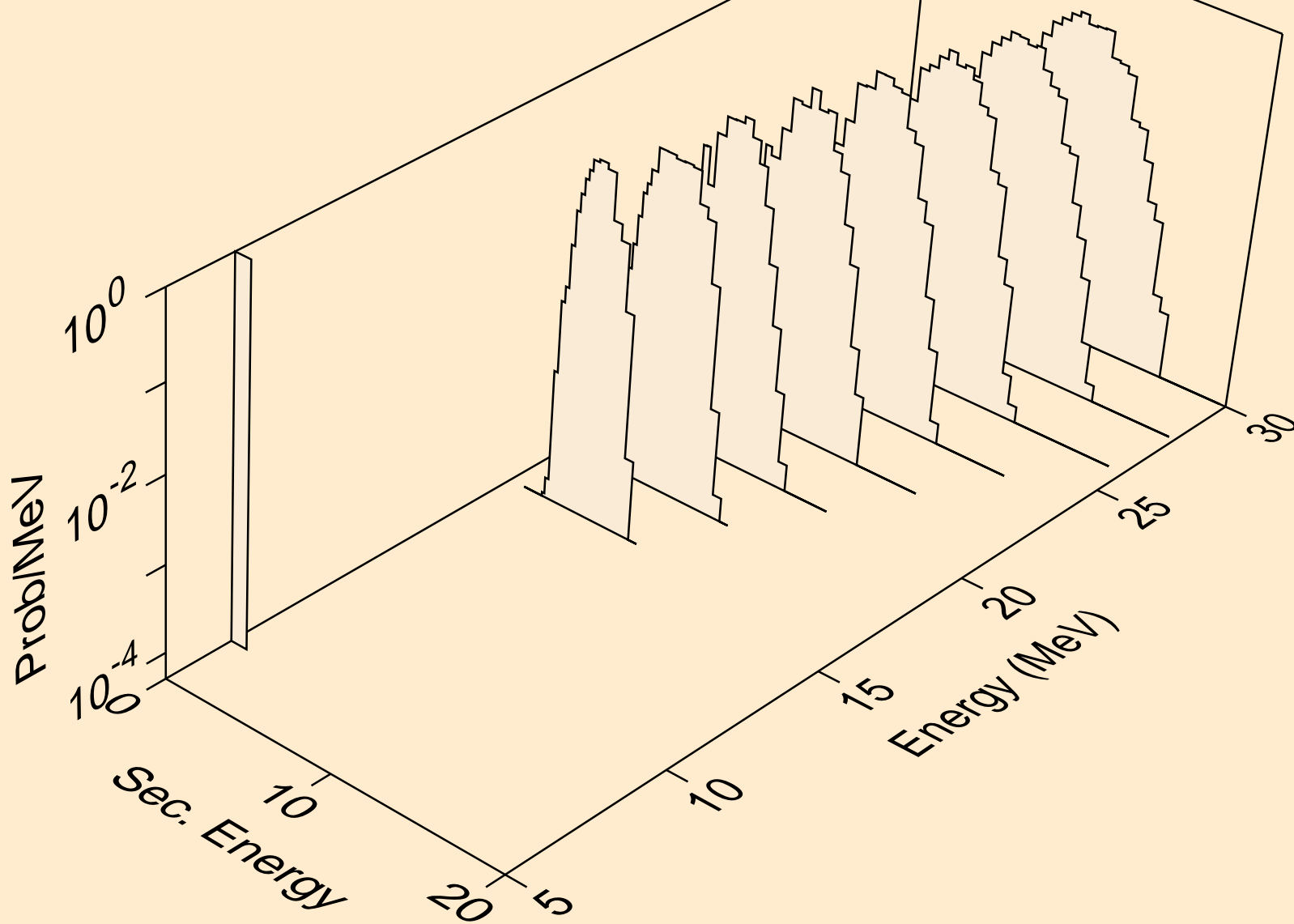

RA225 NEUTRON ACER TENDL-2019 LIBRARY; T=293.16K
protons from (n,p)

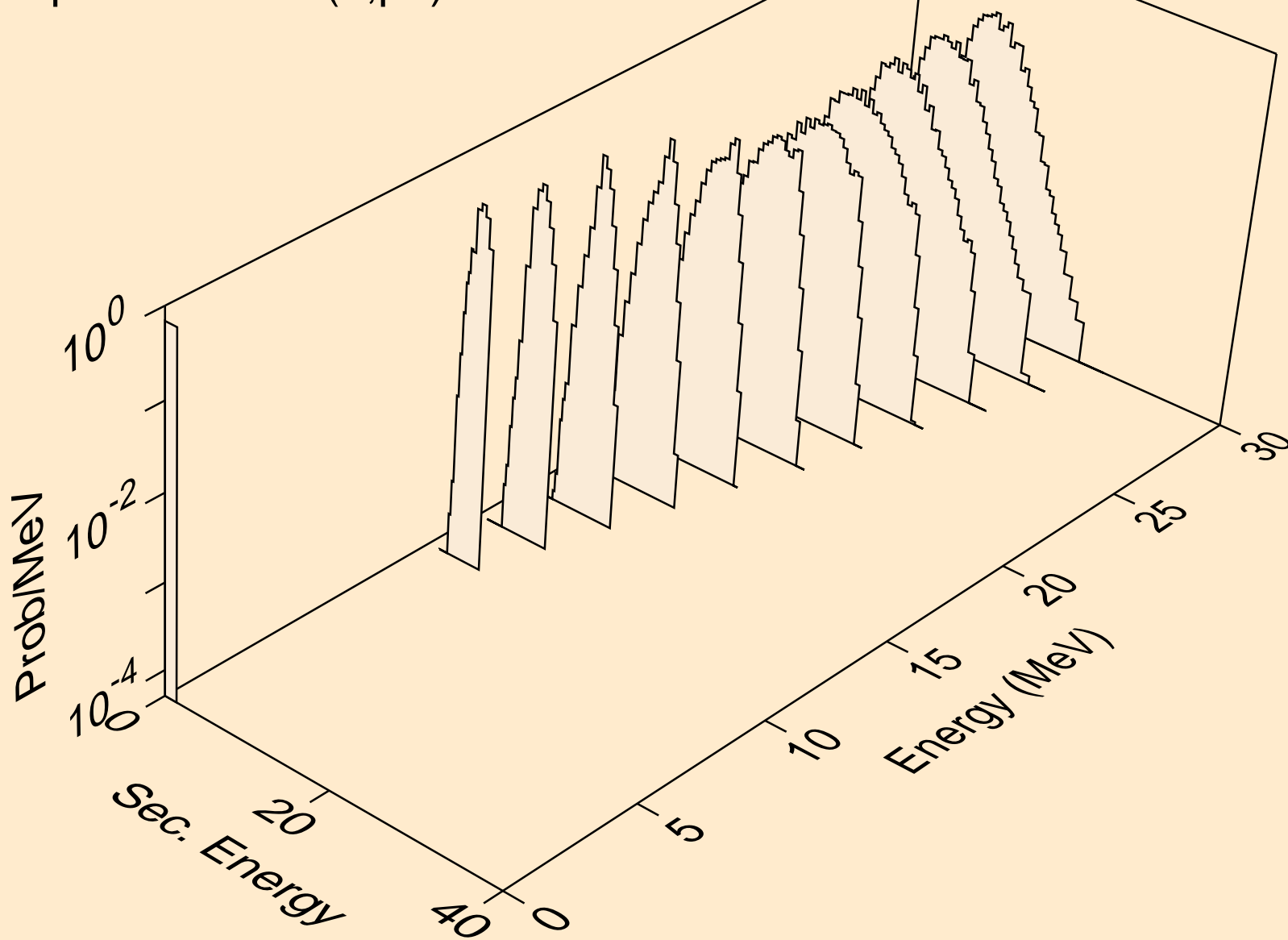

RA225 NEUTRON ACER TENDL-2019 LIBRARY; T=293.16K
deuterons from (n,x)

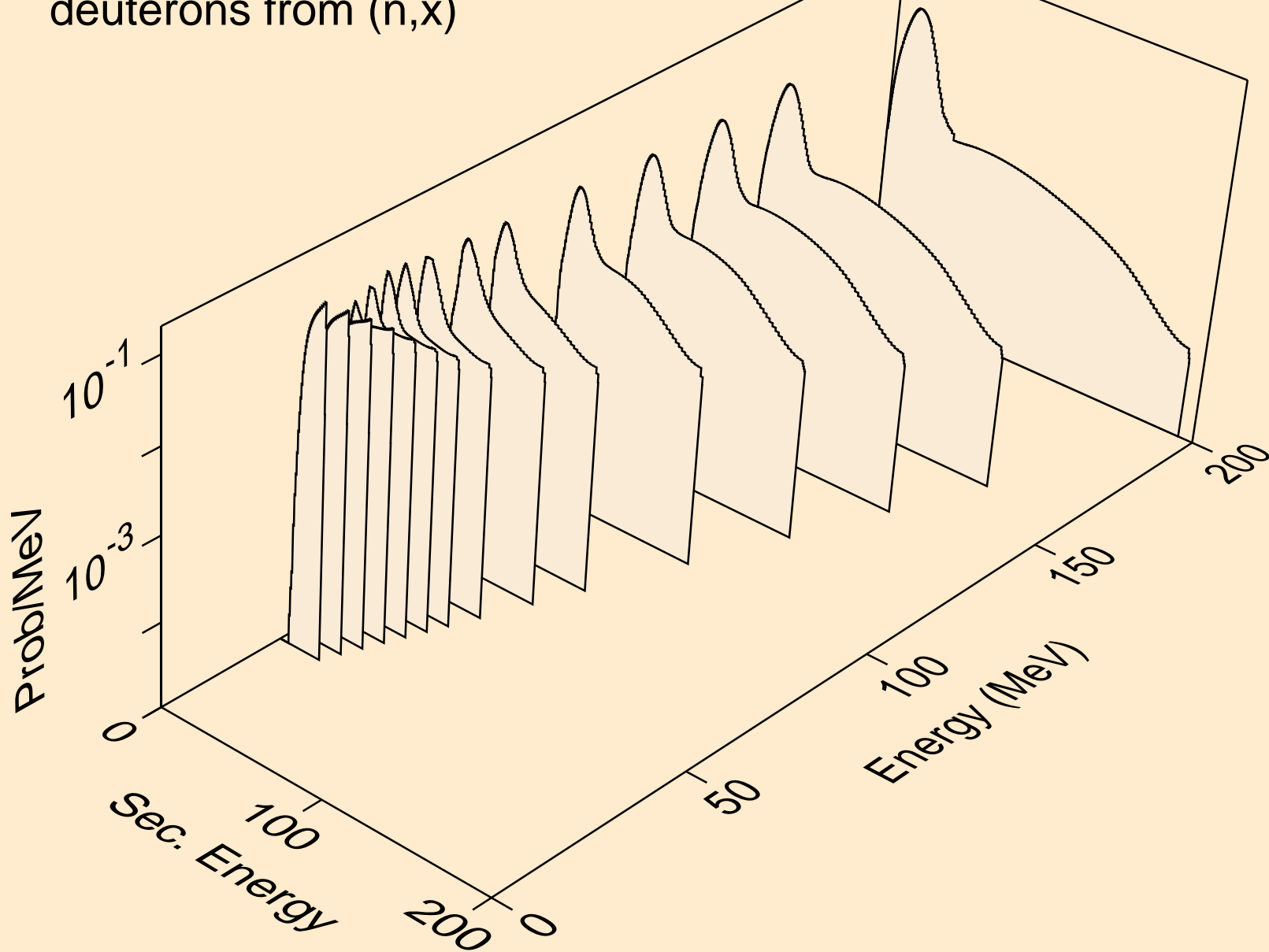

RA225 NEUTRON ACER TENDL-2019 LIBRARY; T=293.16K
deuterons from (n,2nd)

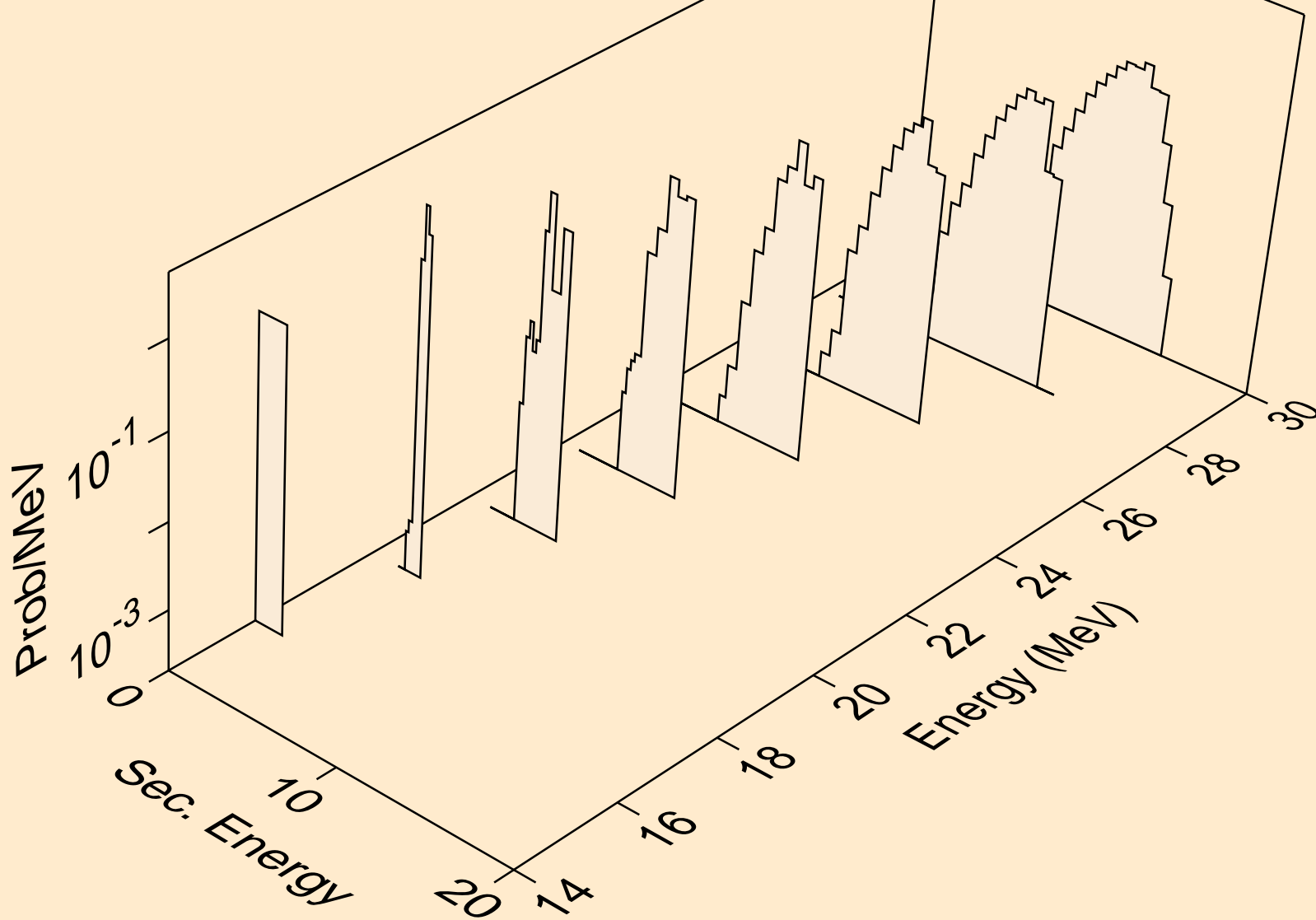

RA225 NEUTRON ACER TENDL-2019 LIBRARY; T=293.16K
deuterons from (n,n*)d

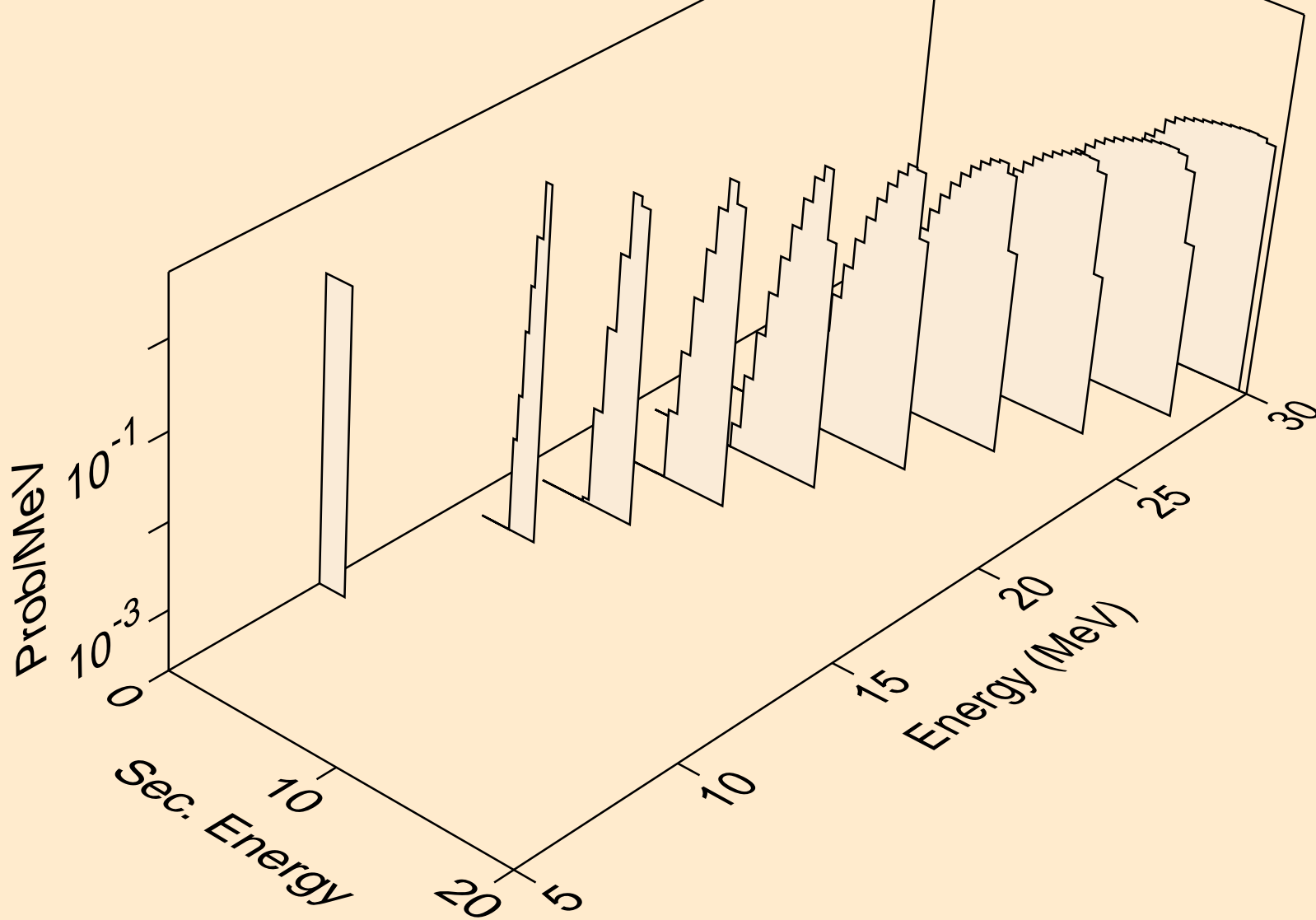

RA225 NEUTRON ACER TENDL-2019 LIBRARY; T=293.16K
deuterons from (n,d)

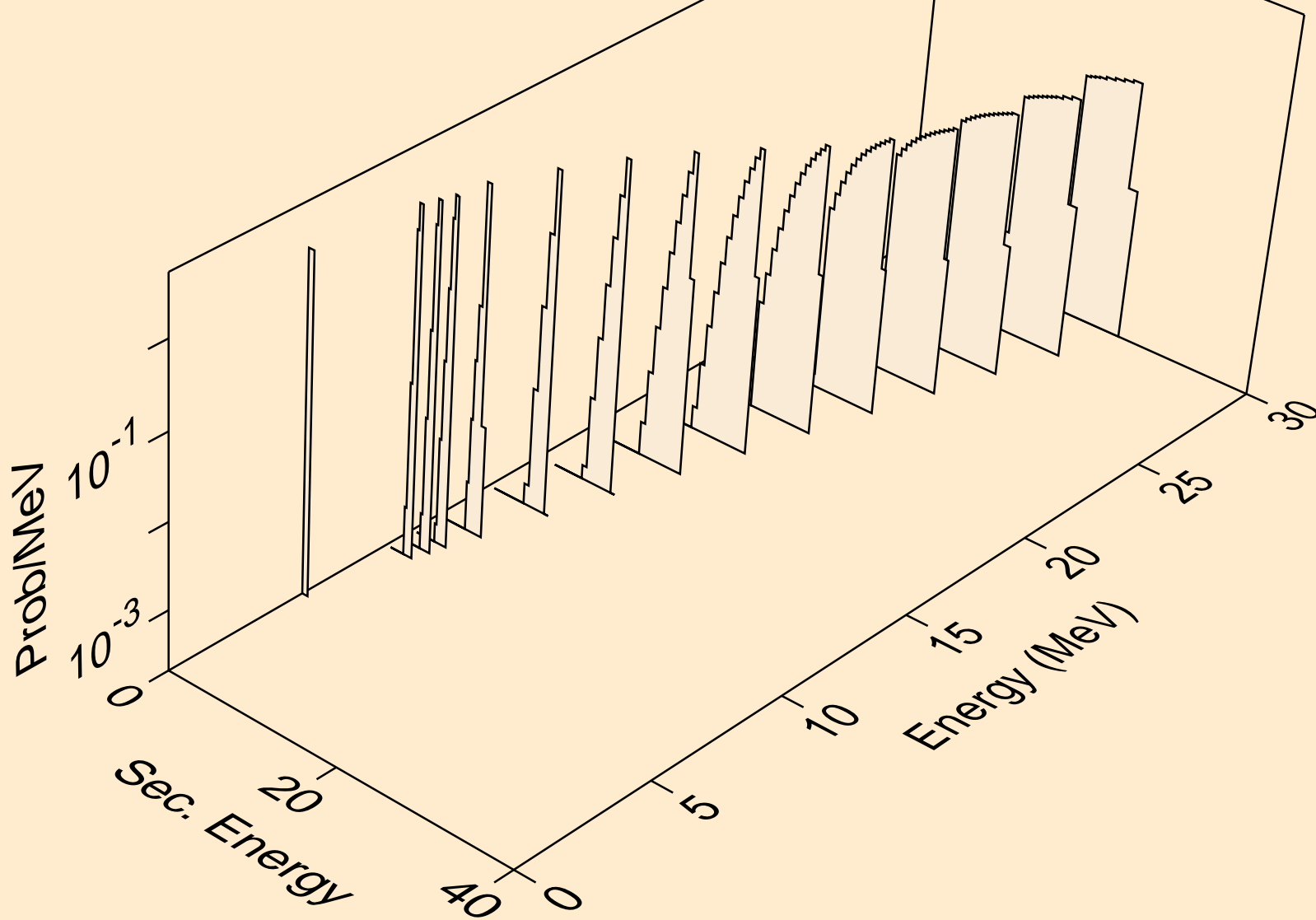

RA225 NEUTRON ACER TENDL-2019 LIBRARY; T=293.16K
tritons from (n,x)

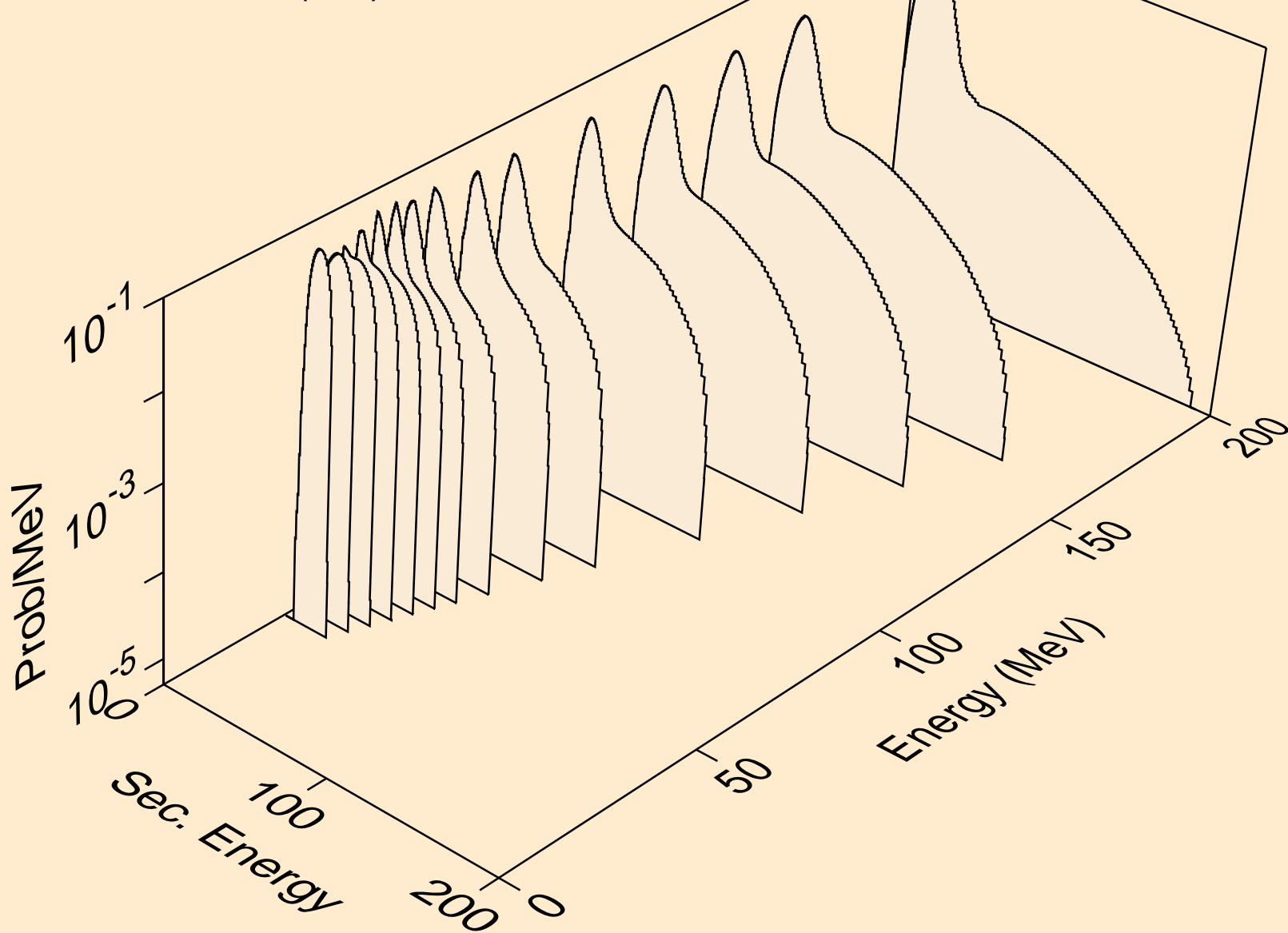

RA225 NEUTRON ACER TENDL-2019 LIBRARY; T=293.16K
tritons from (n,n*)t

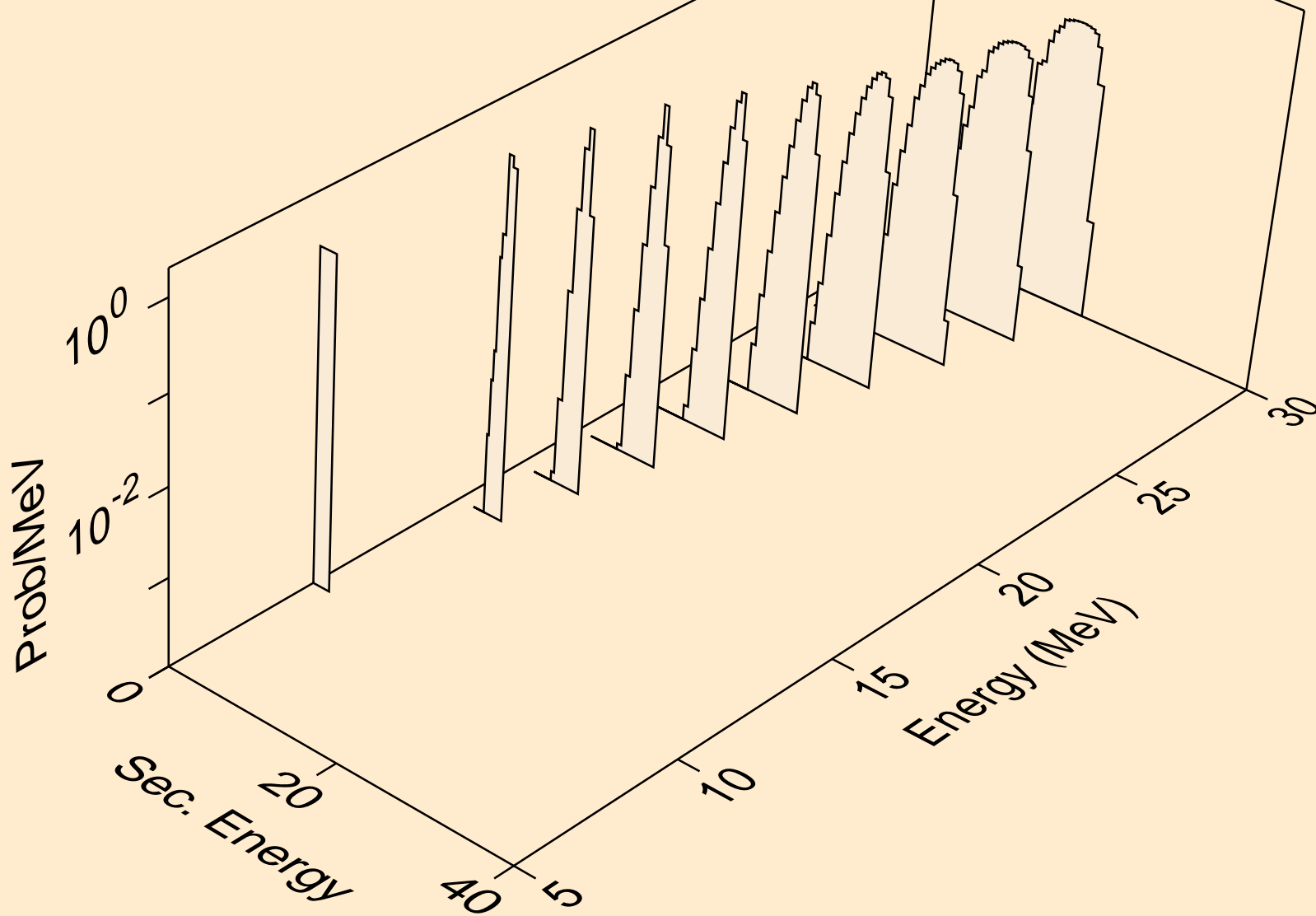

RA225 NEUTRON ACER TENDL-2019 LIBRARY; T=293.16K
tritons from (n,t)

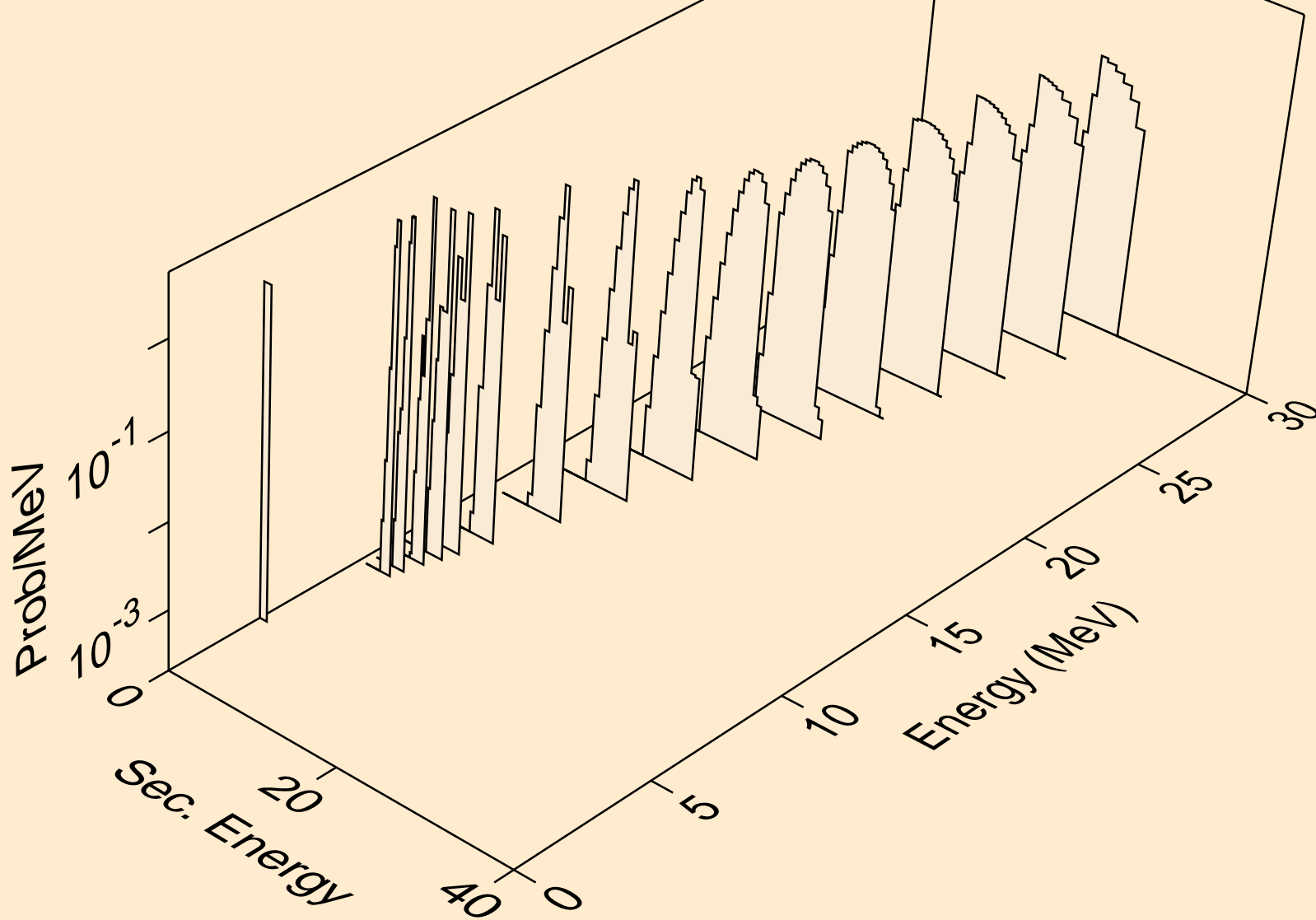

RA225 NEUTRON ACER TENDL-2019 LIBRARY; T=293.16K
he3s from (n,x)

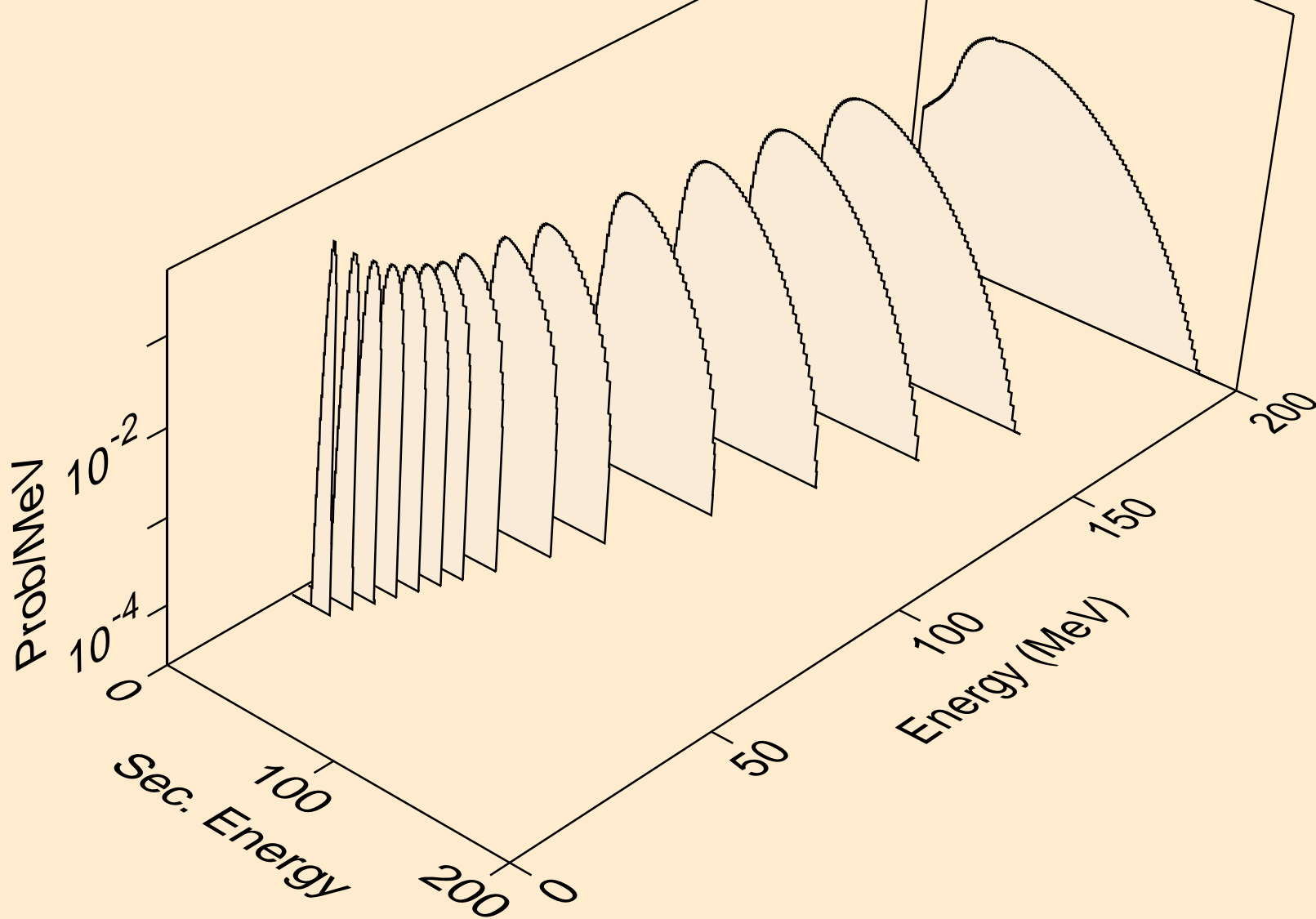

RA225 NEUTRON ACER TENDL-2019 LIBRARY; T=293.16K
he3s from (n,n*)he3

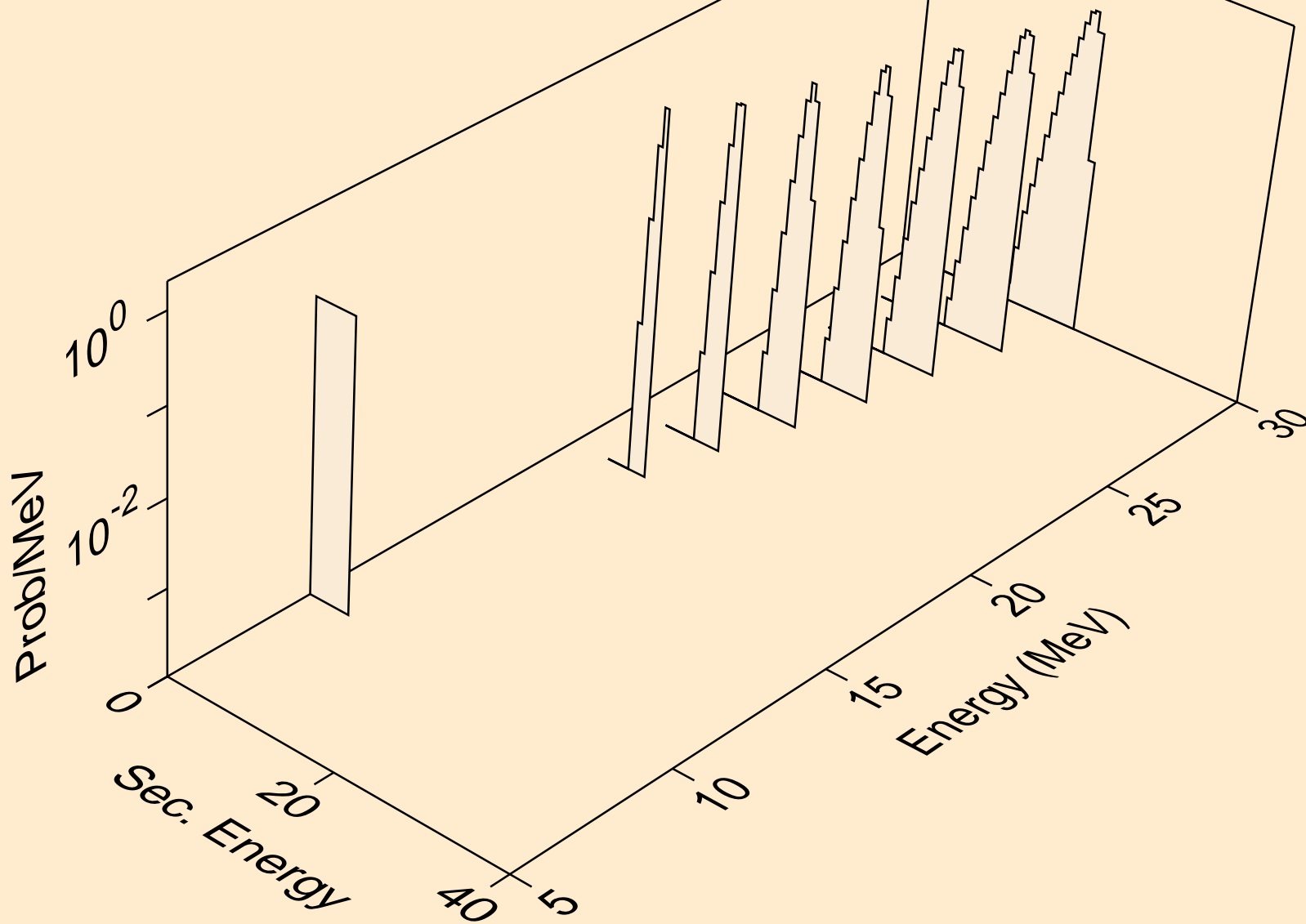

RA225 NEUTRON ACER TENDL-2019 LIBRARY; T=293.16K
he3s from (n,he3)

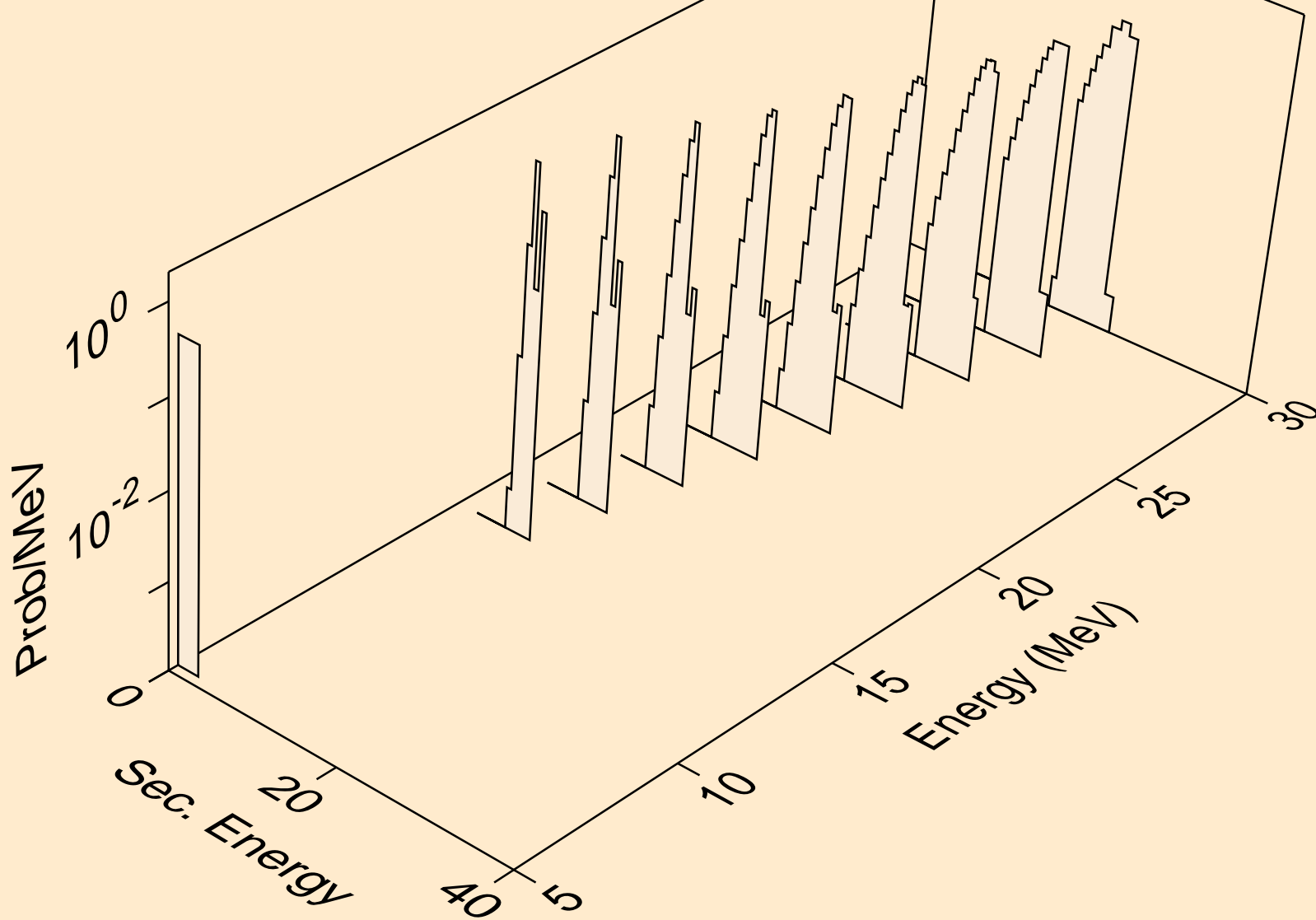

RA225 NEUTRON ACER TENDL-2019 LIBRARY; T=293.16K
alphas from (n,x)

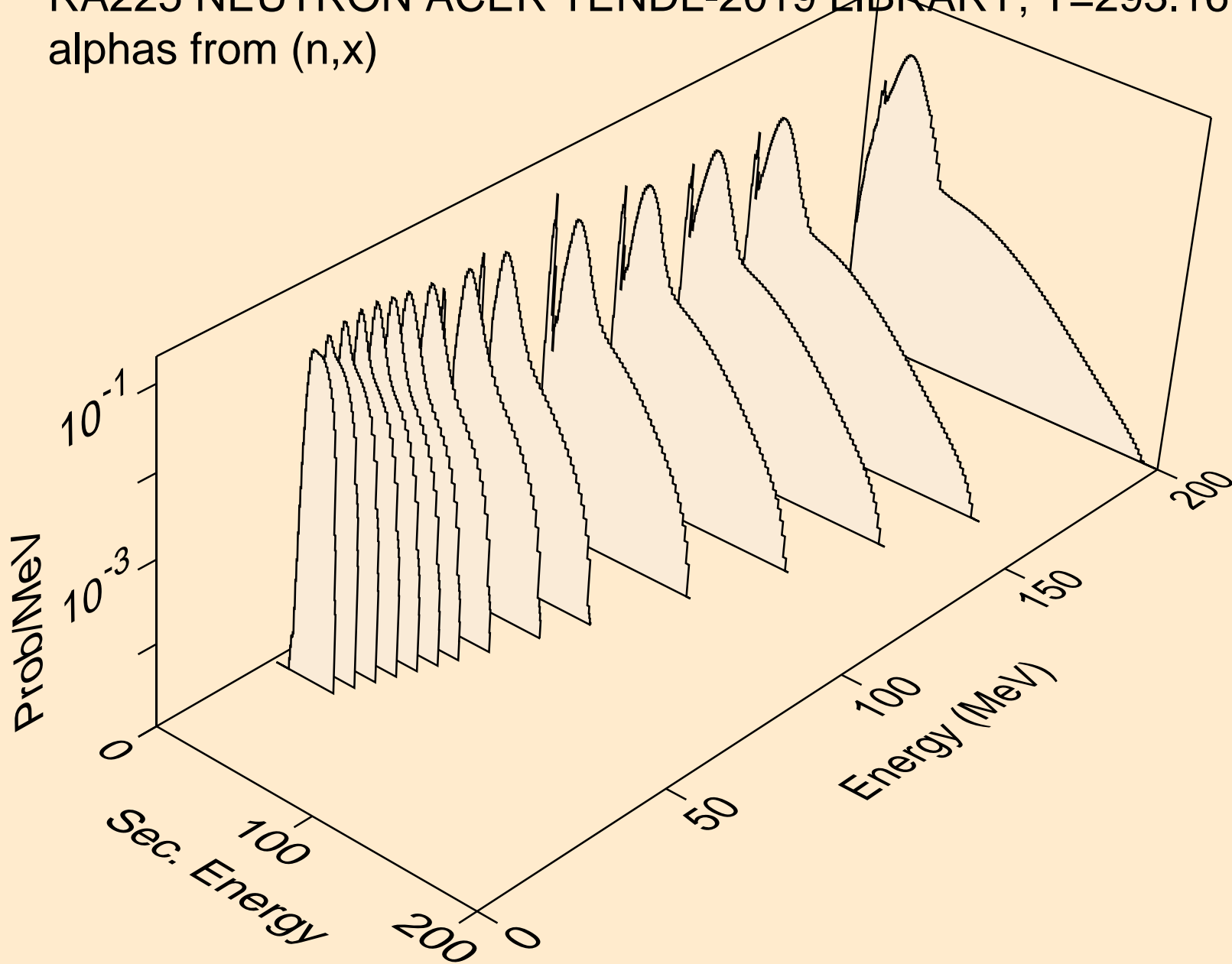

RA225 NEUTRON ACER TENDL-2019 LIBRARY; T=293.16K
alphas from (n,n*)a

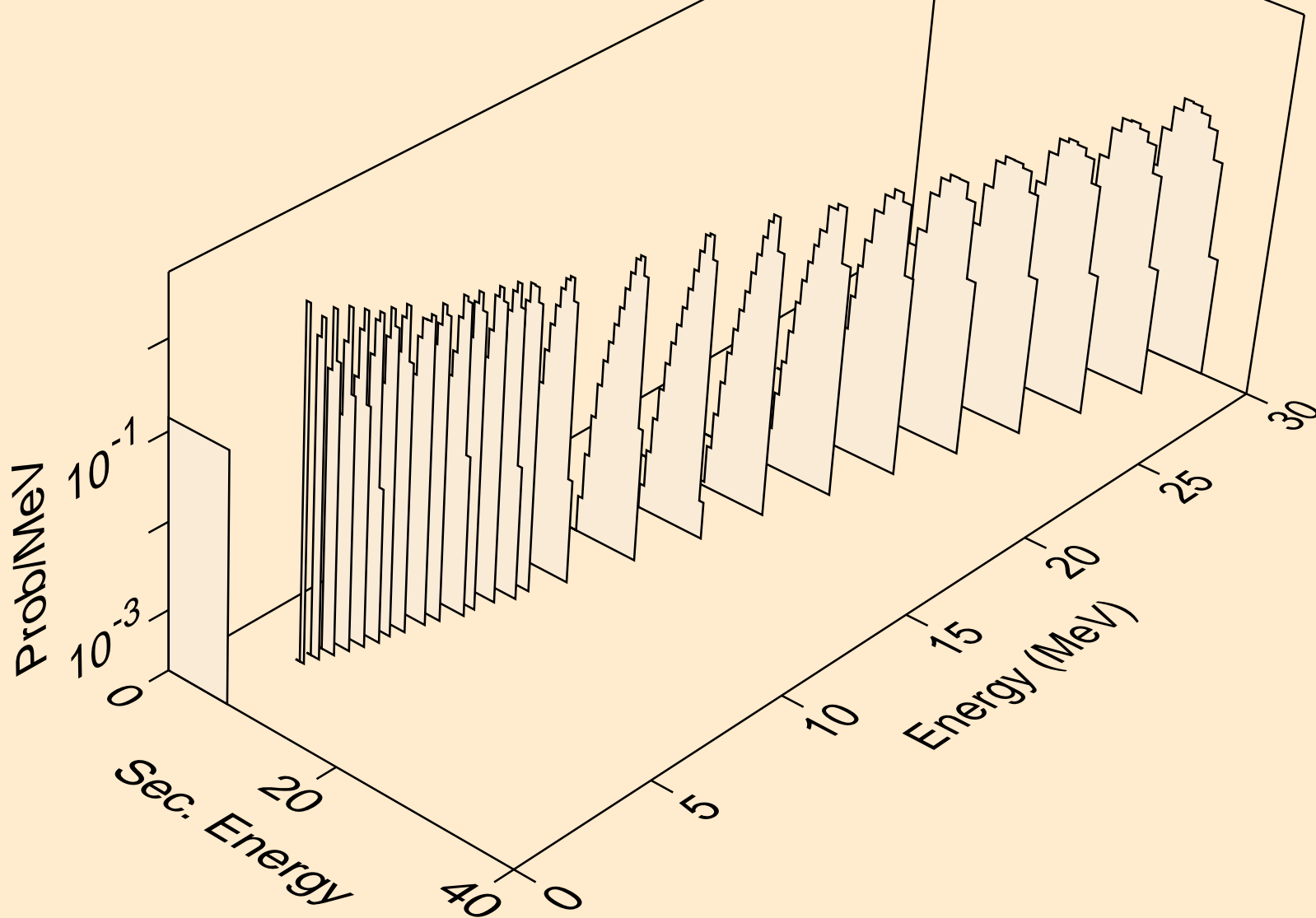

RA225 NEUTRON ACER TENDL-2019 LIBRARY; T=293.16K
alphas from (n,2n)a

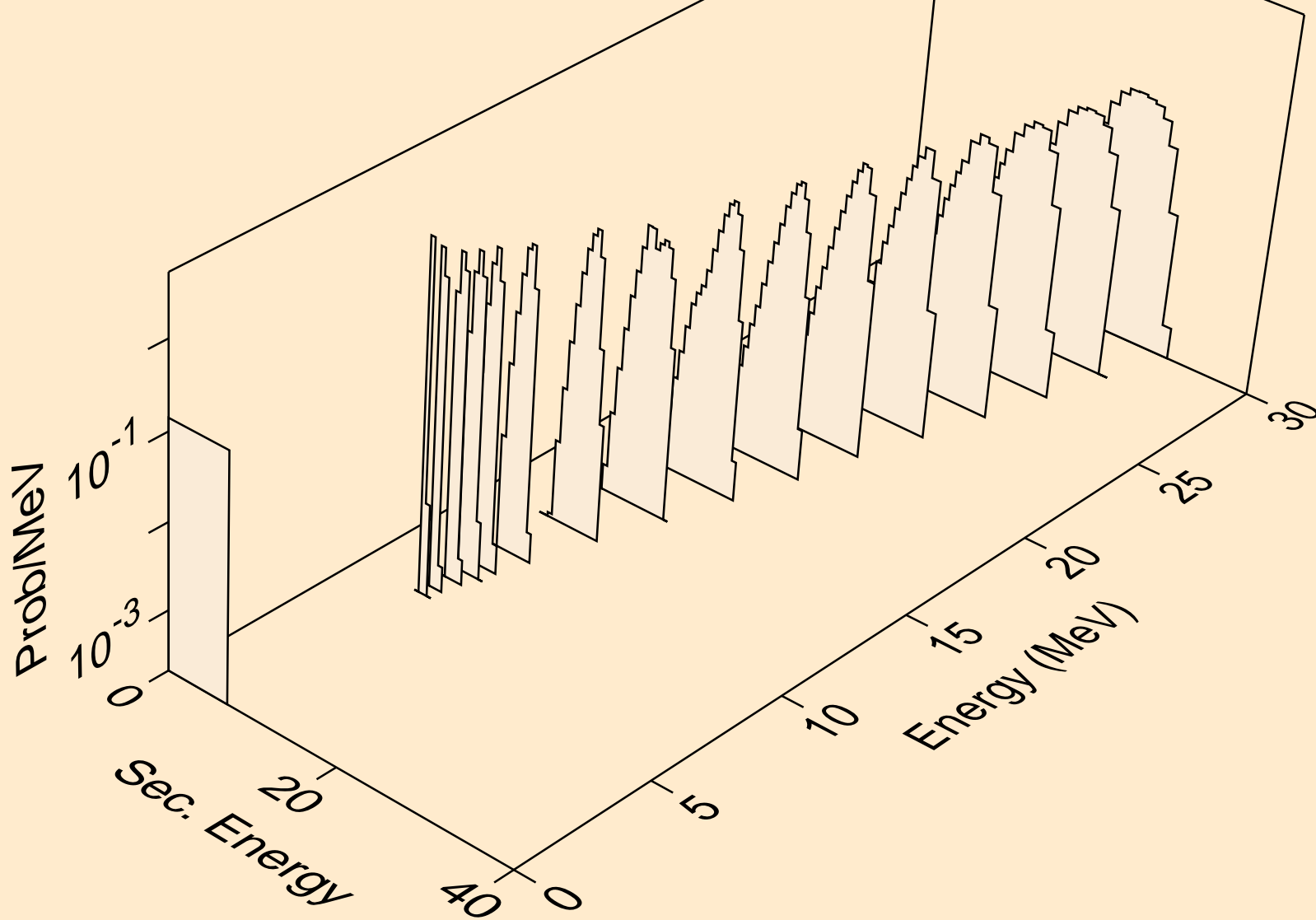

RA225 NEUTRON ACER TENDL-2019 LIBRARY; T=293.16K
alphas from (n,3n)a

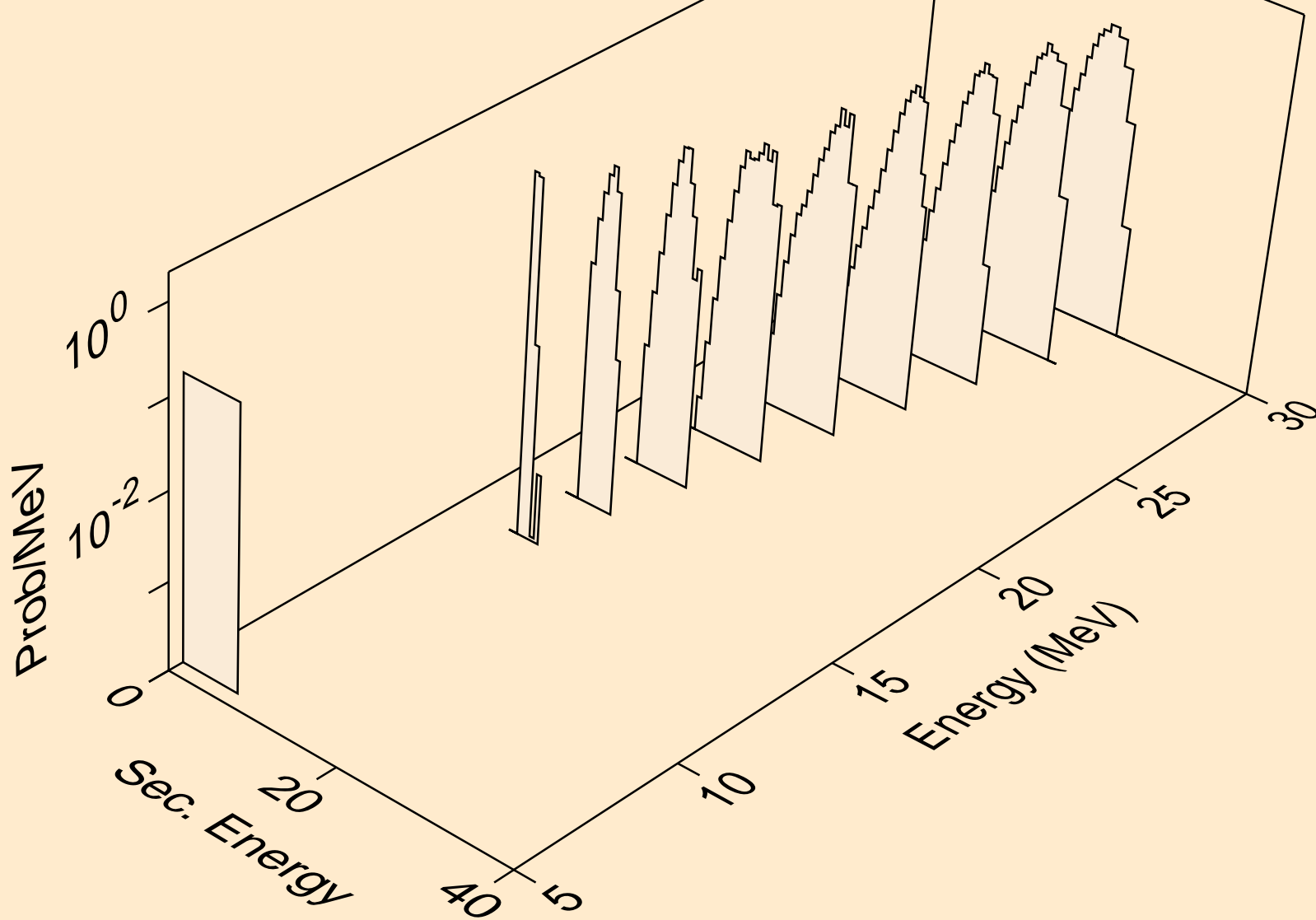

RA225 NEUTRON ACER TENDL-2019 LIBRARY; T=293.16K
alphas from (n,n*)2a

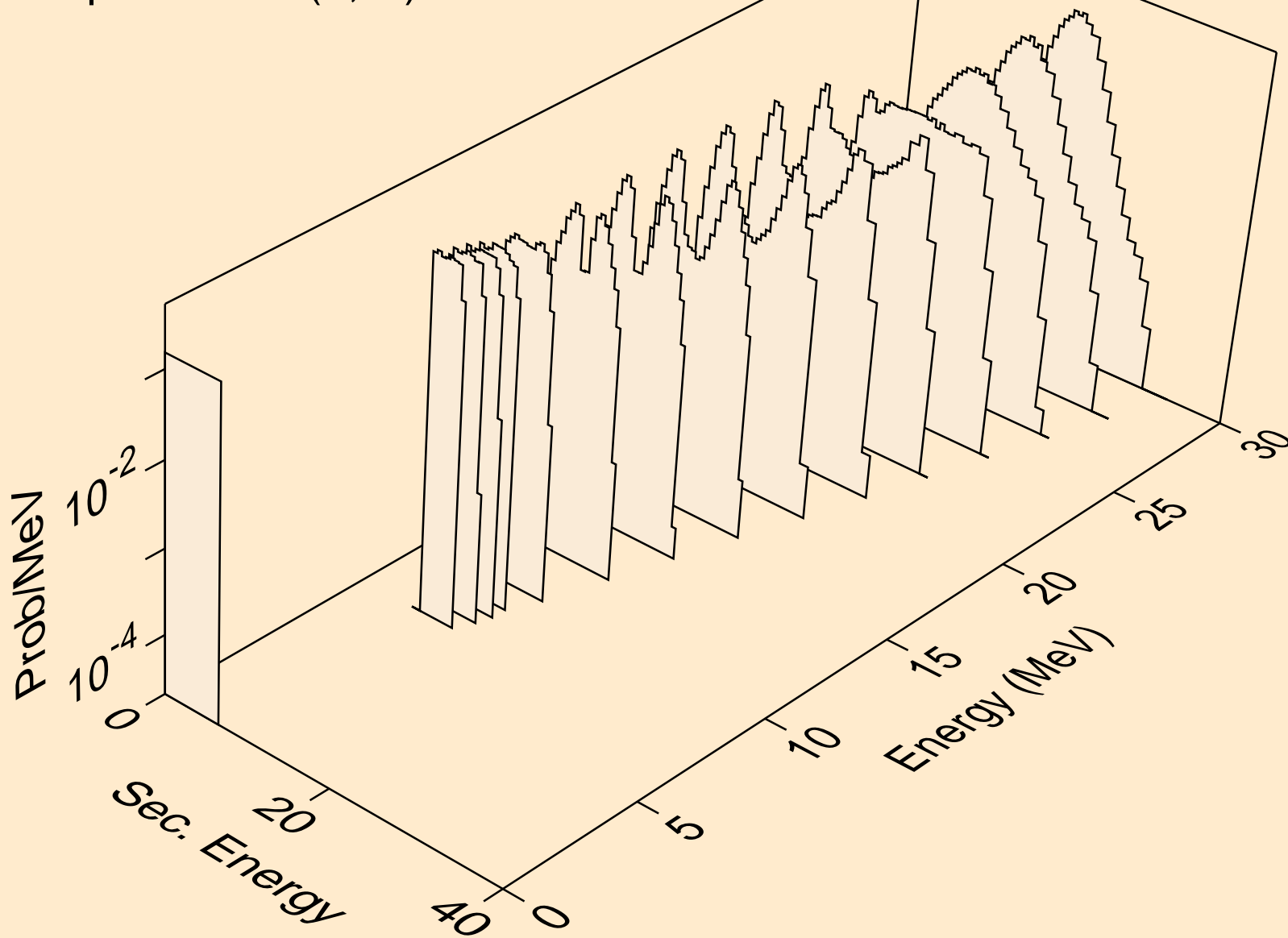

RA225 NEUTRON ACER TENDL-2019 LIBRARY; T=293.16K
alphas from (n,2n)2a

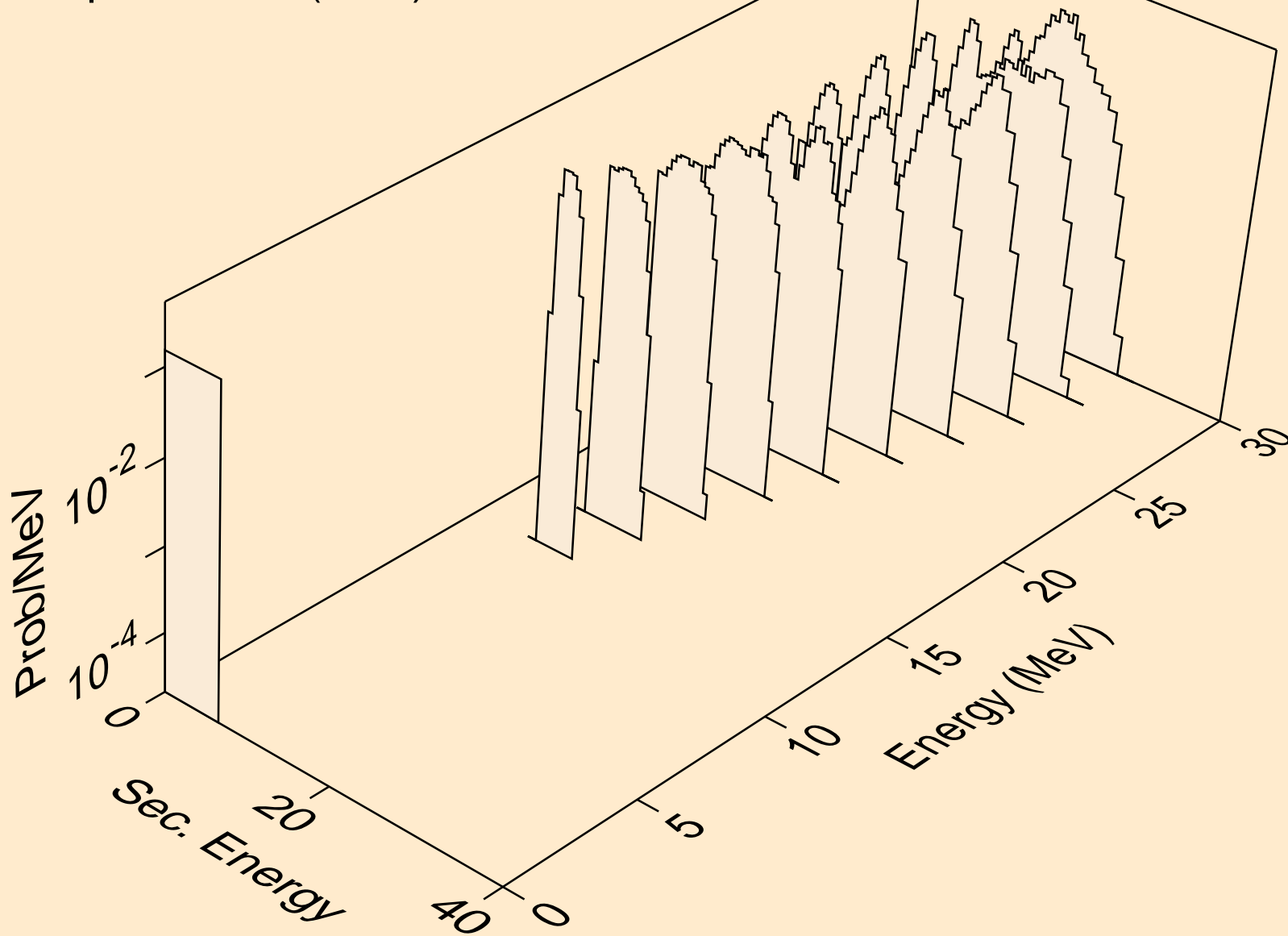

RA225 NEUTRON ACER TENDL-2019 LIBRARY; T=293.16K
alphas from (n,npa)

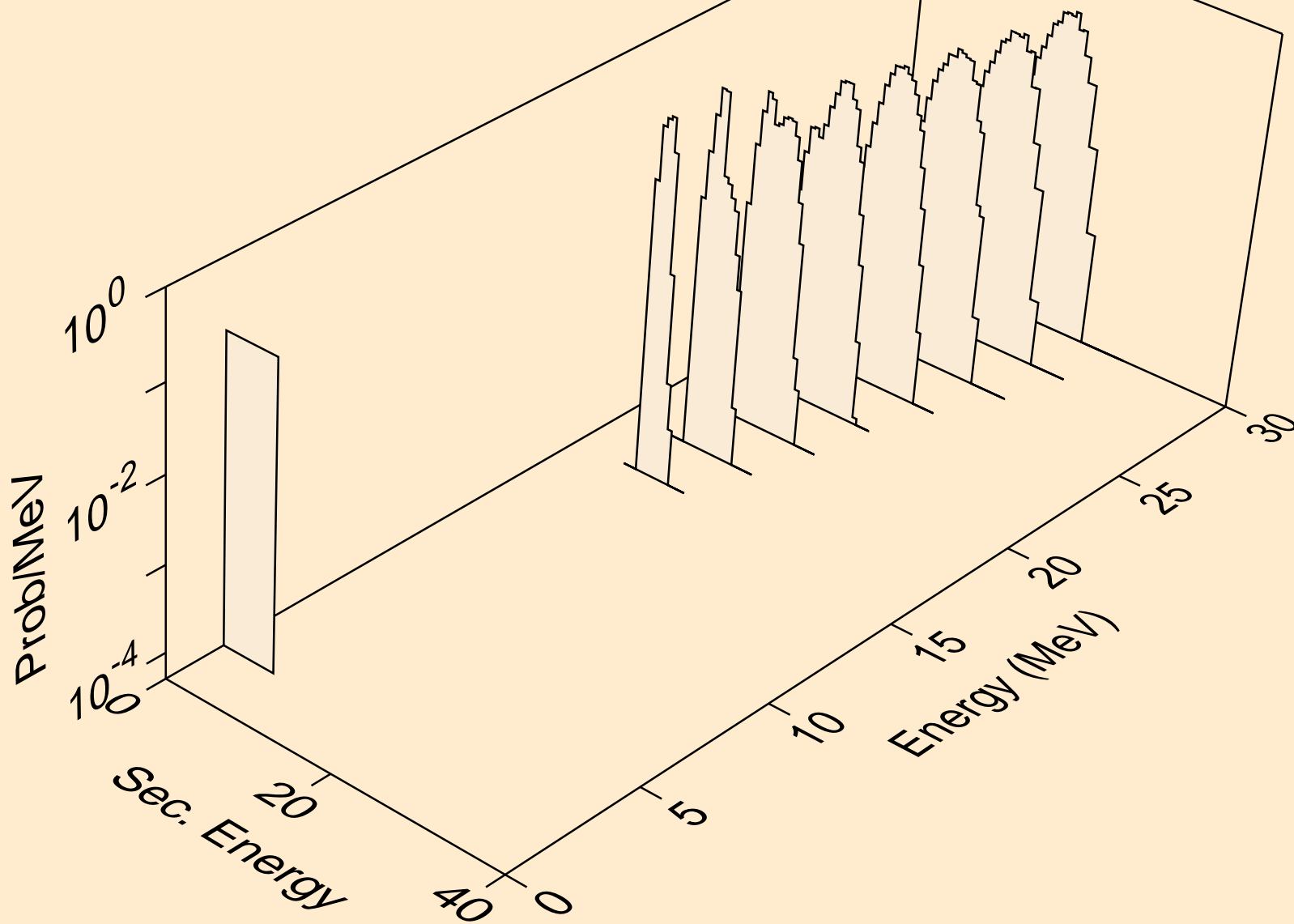

RA225 NEUTRON ACER TENDL-2019 LIBRARY; T=293.16K
alphas from (n,a)

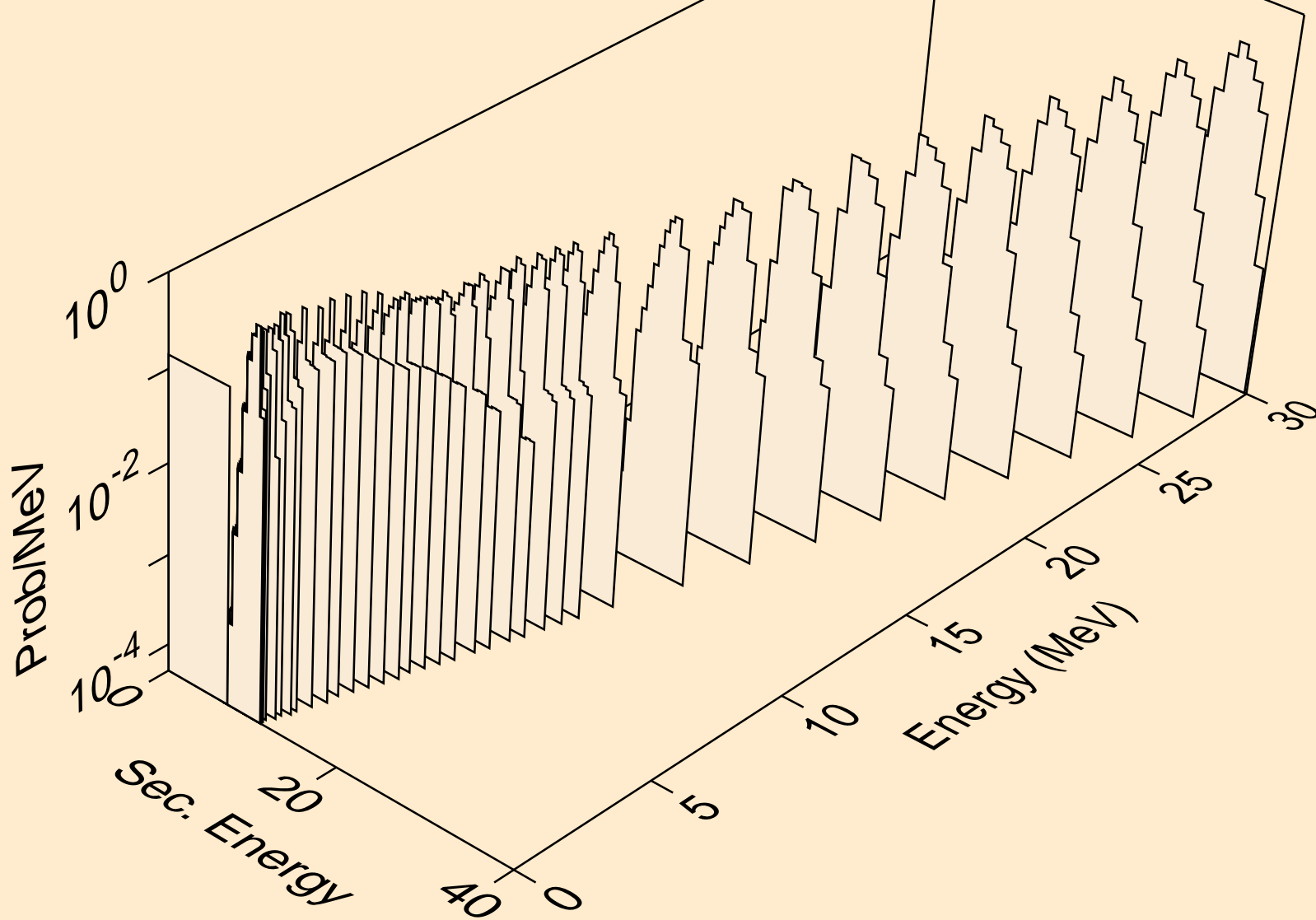

RA225 NEUTRON ACER TENDL-2019 LIBRARY; T=293.16K
alphas from (n,2a)

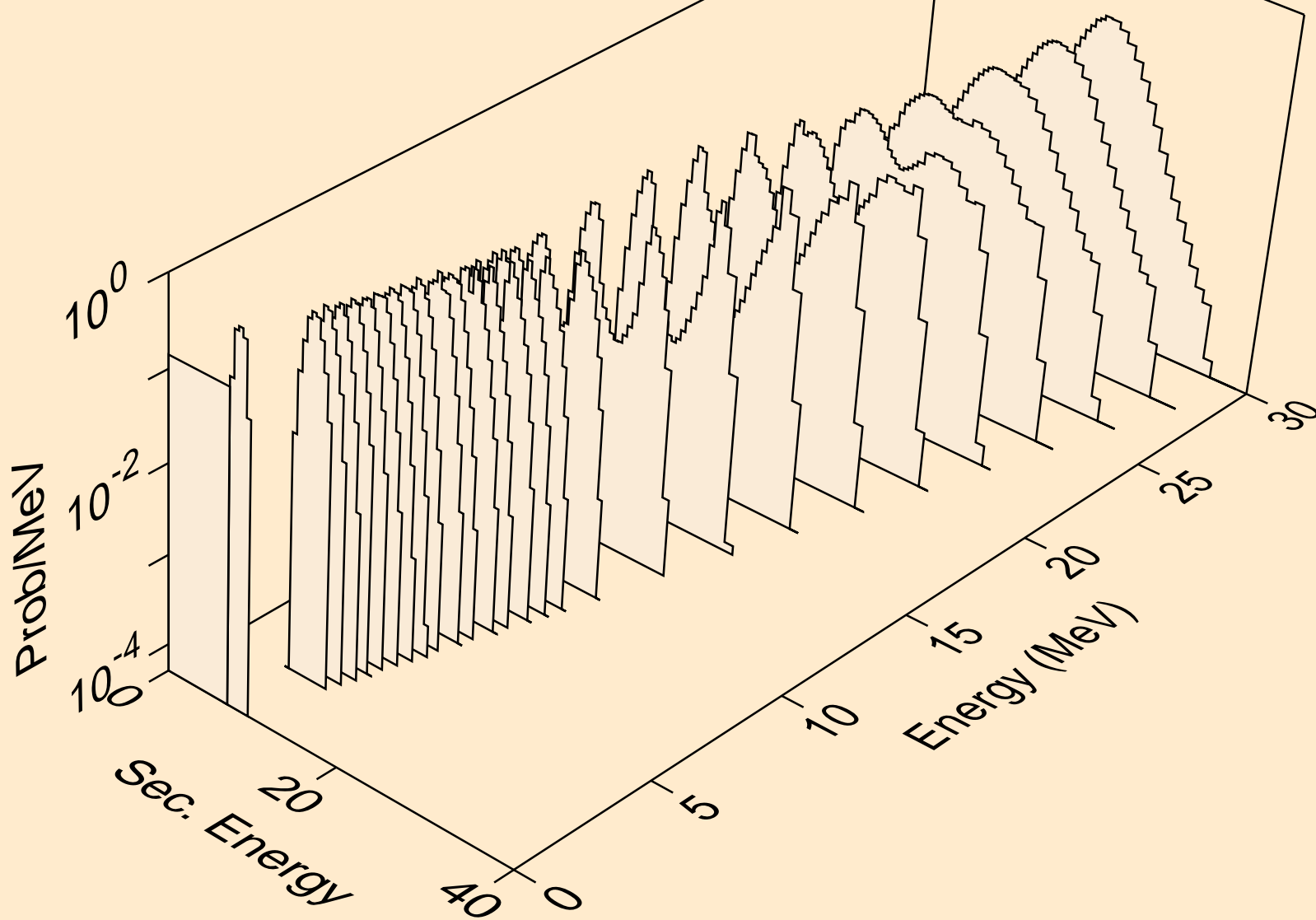

RA225 NEUTRON ACER TENDL-2019 LIBRARY; T=293.16K
alphas from (n,pa)

