

RA230 NEUTRON ACER TENDL-2019 LIBRARY; T=293.16K
Principal cross sections

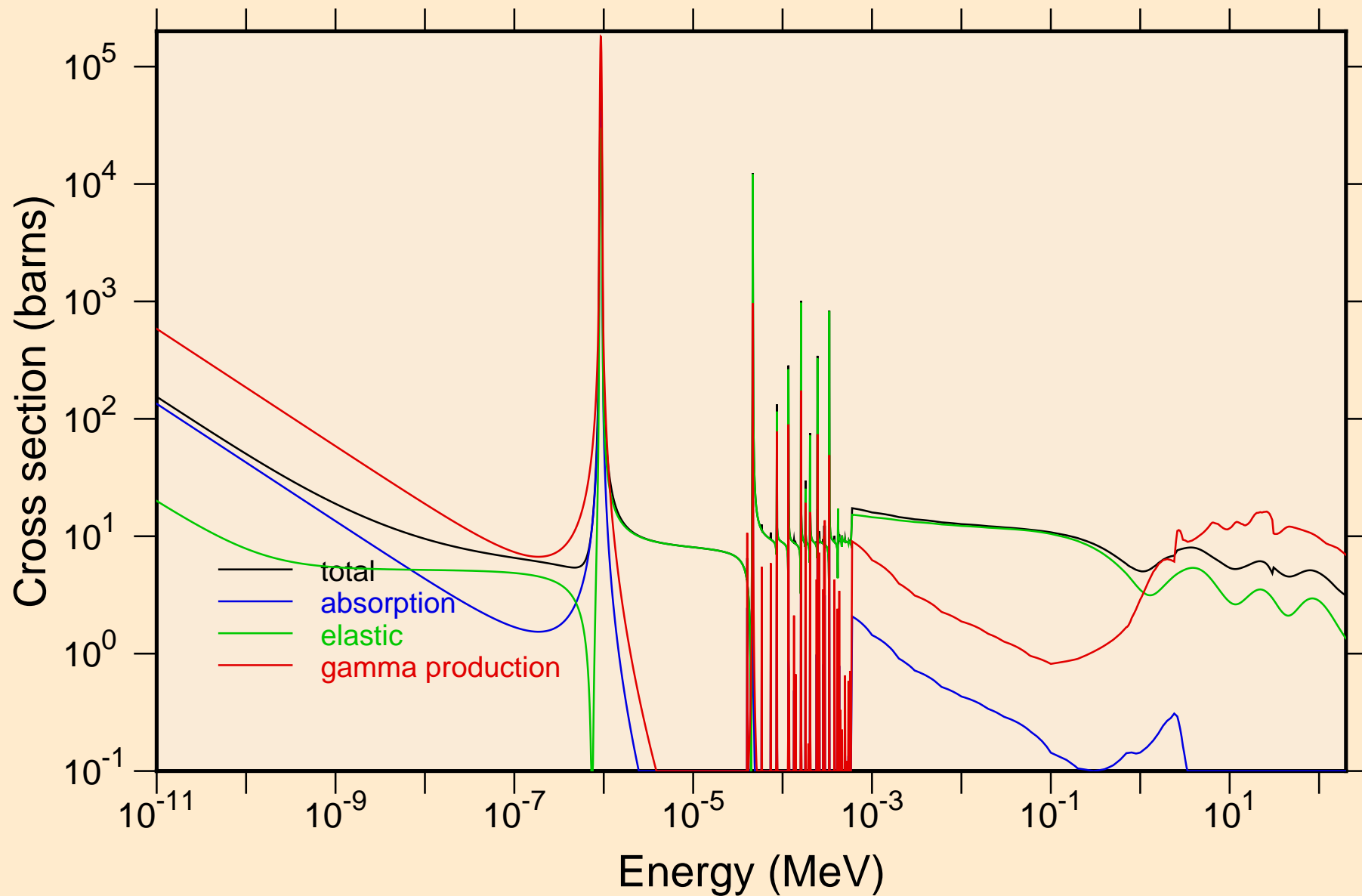

RA230 NEUTRON ACER TENDL-2019 LIBRARY; T=293.16K
resonance total cross section

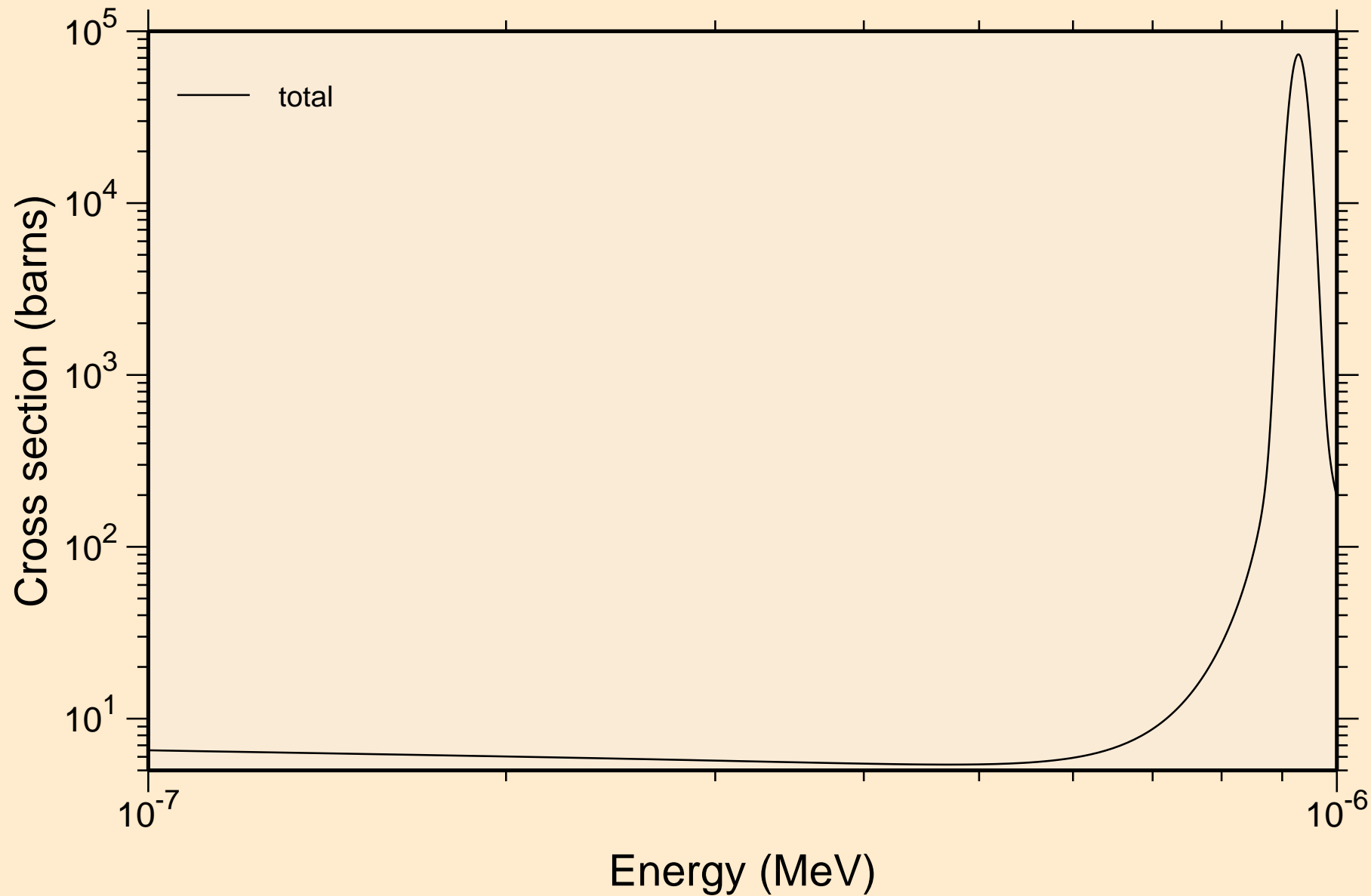

RA230 NEUTRON ACER TENDL-2019 LIBRARY; T=293.16K
resonance total cross section

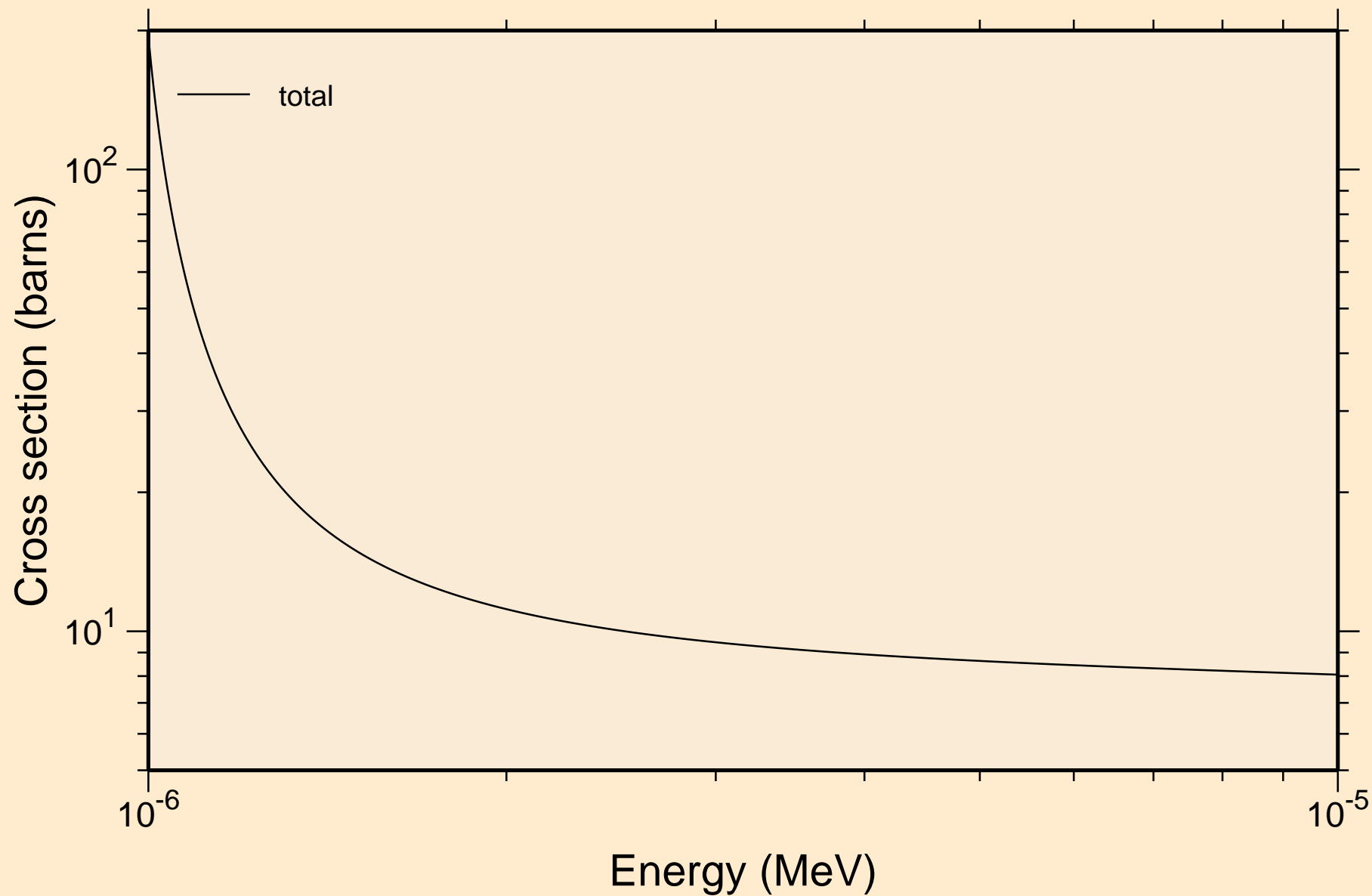

RA230 NEUTRON ACER TENDL-2019 LIBRARY; T=293.16K
resonance total cross section

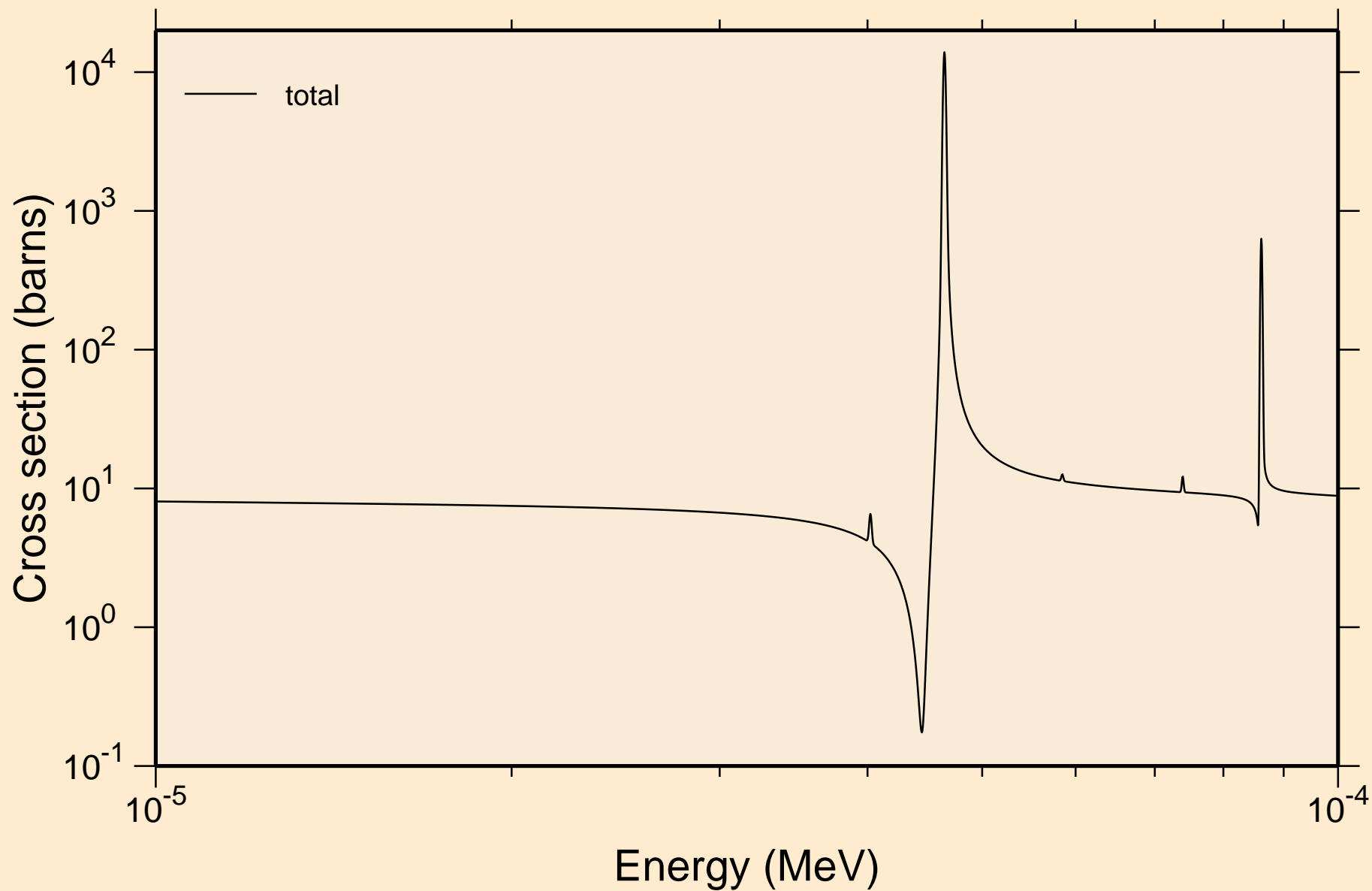

RA230 NEUTRON ACER TENDL-2019 LIBRARY; T=293.16K
resonance total cross section

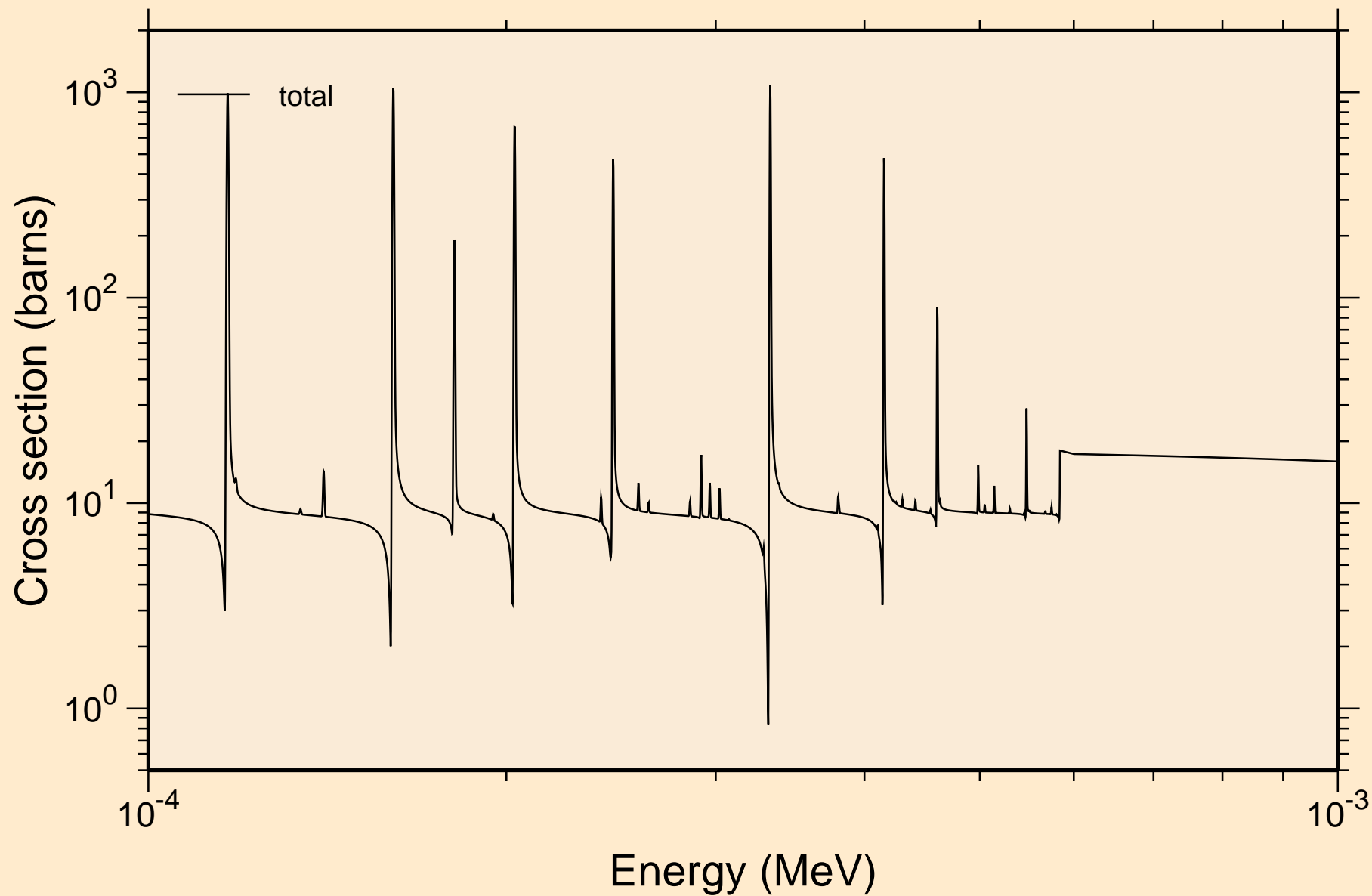

RA230 NEUTRON ACER TENDL-2019 LIBRARY; T=293.16K
resonance total cross section

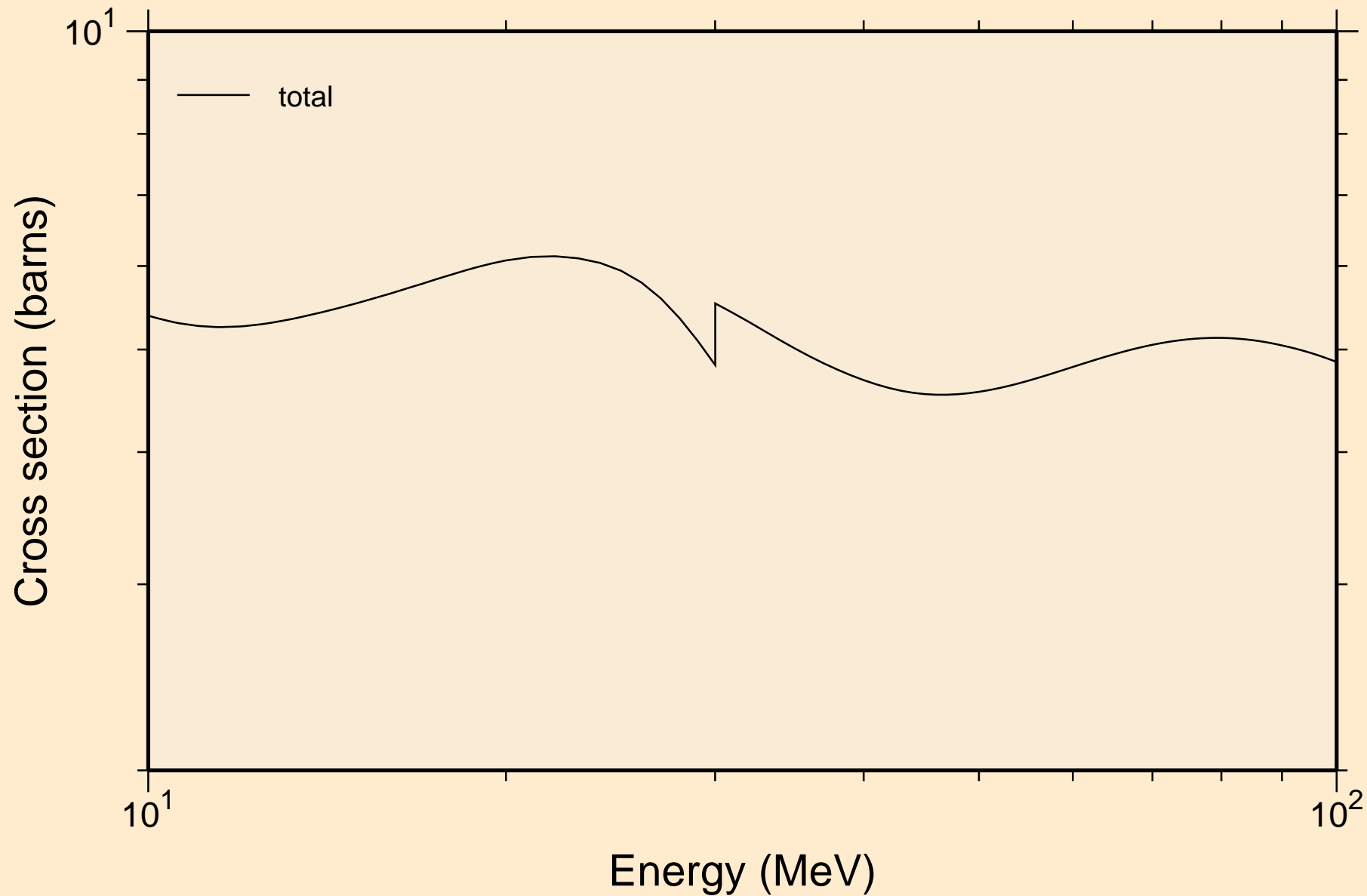

RA230 NEUTRON ACER TENDL-2019 LIBRARY; T=293.16K
resonance absorption cross sections

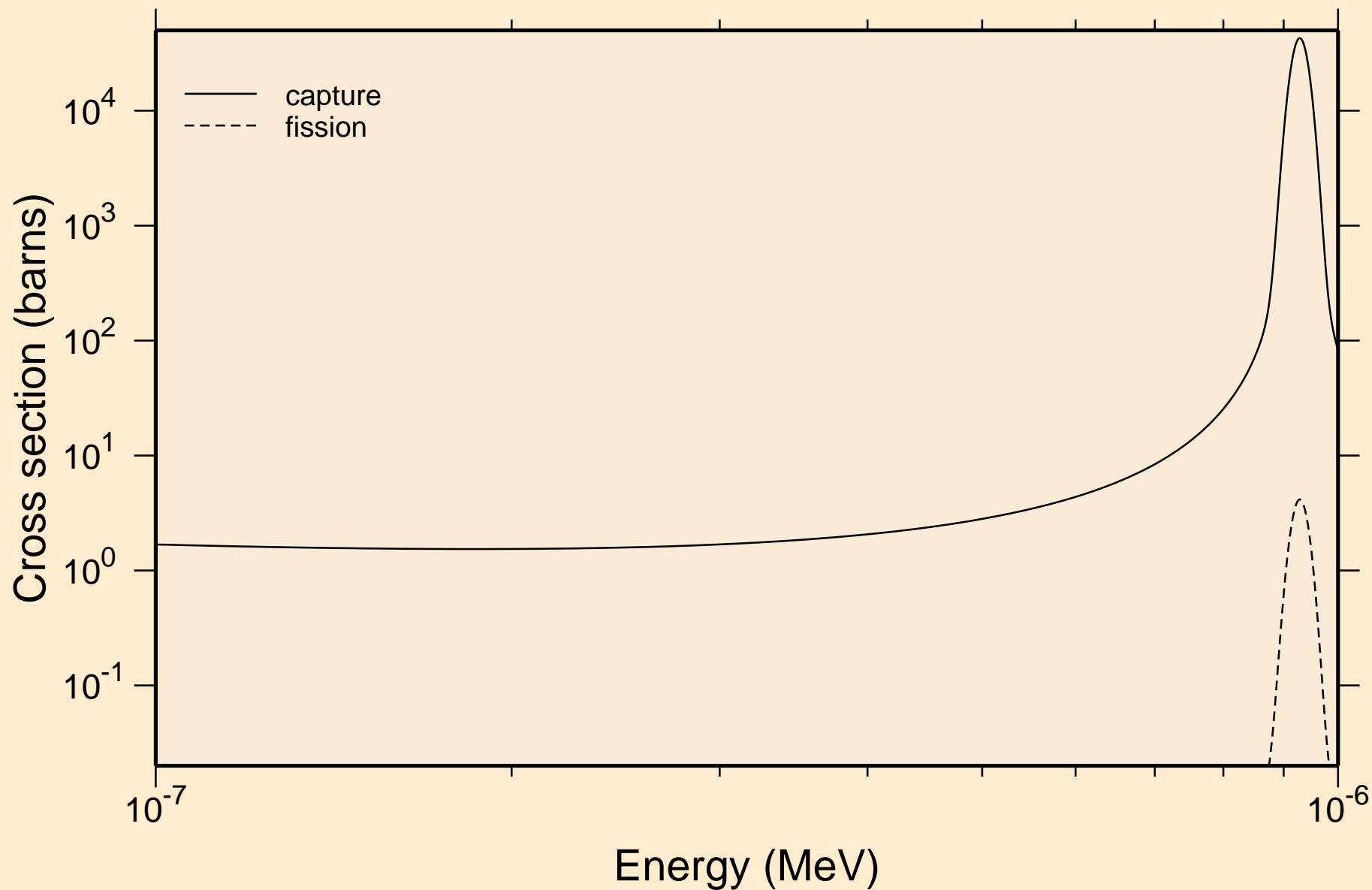

RA230 NEUTRON ACER TENDL-2019 LIBRARY; T=293.16K
resonance absorption cross sections

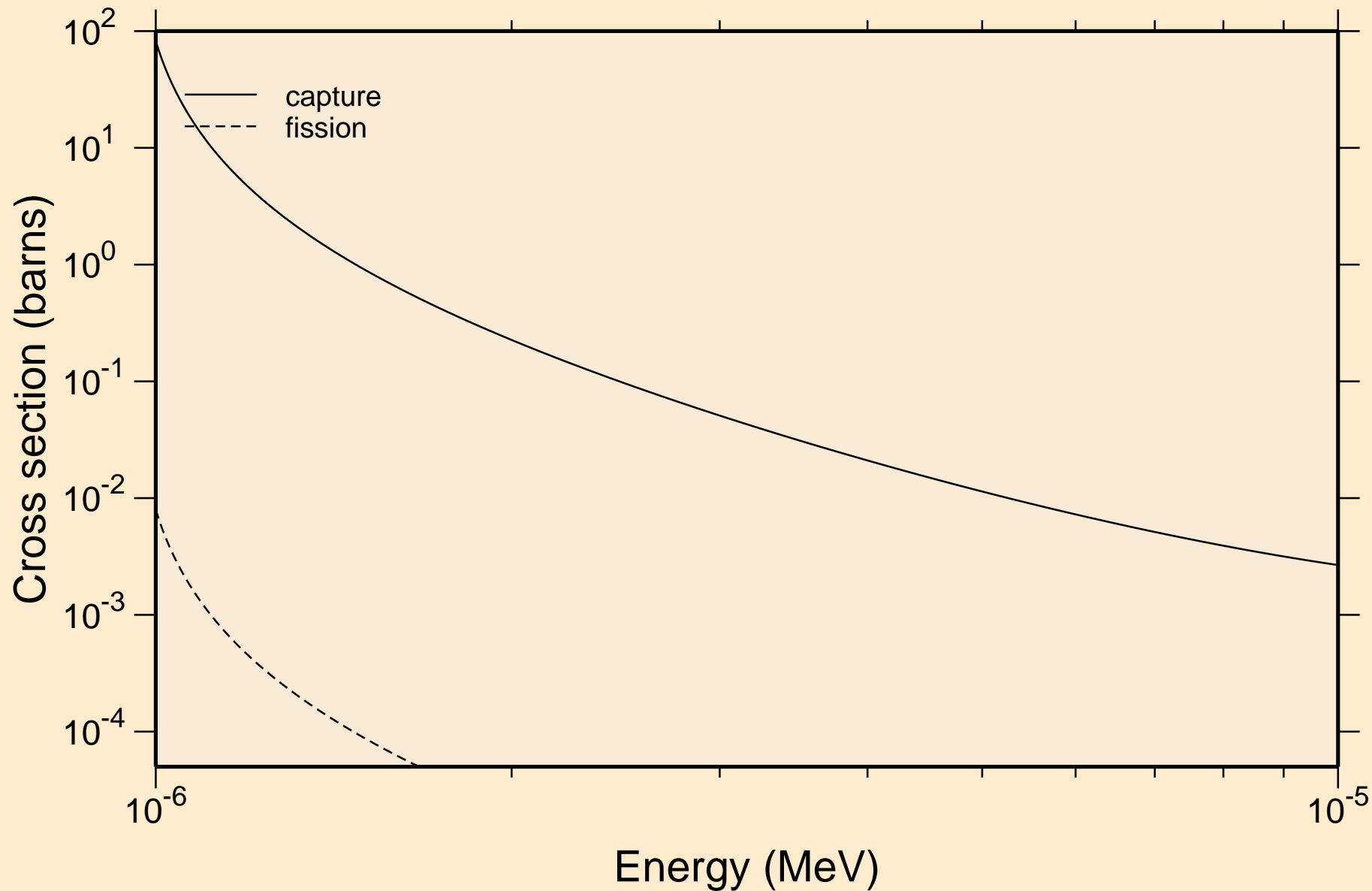

RA230 NEUTRON ACER TENDL-2019 LIBRARY; T=293.16K
resonance absorption cross sections

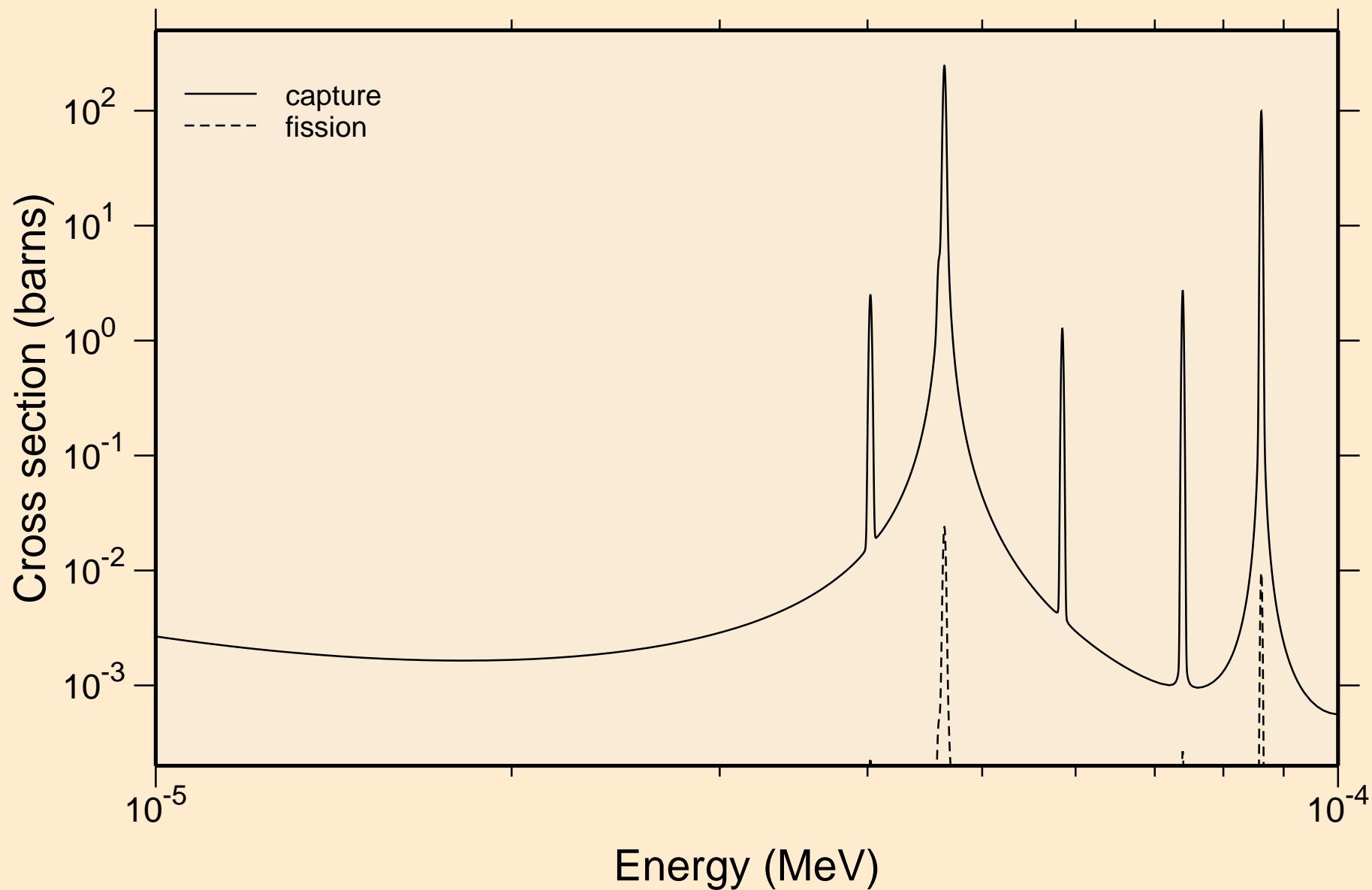

RA230 NEUTRON ACER TENDL-2019 LIBRARY; T=293.16K
resonance absorption cross sections

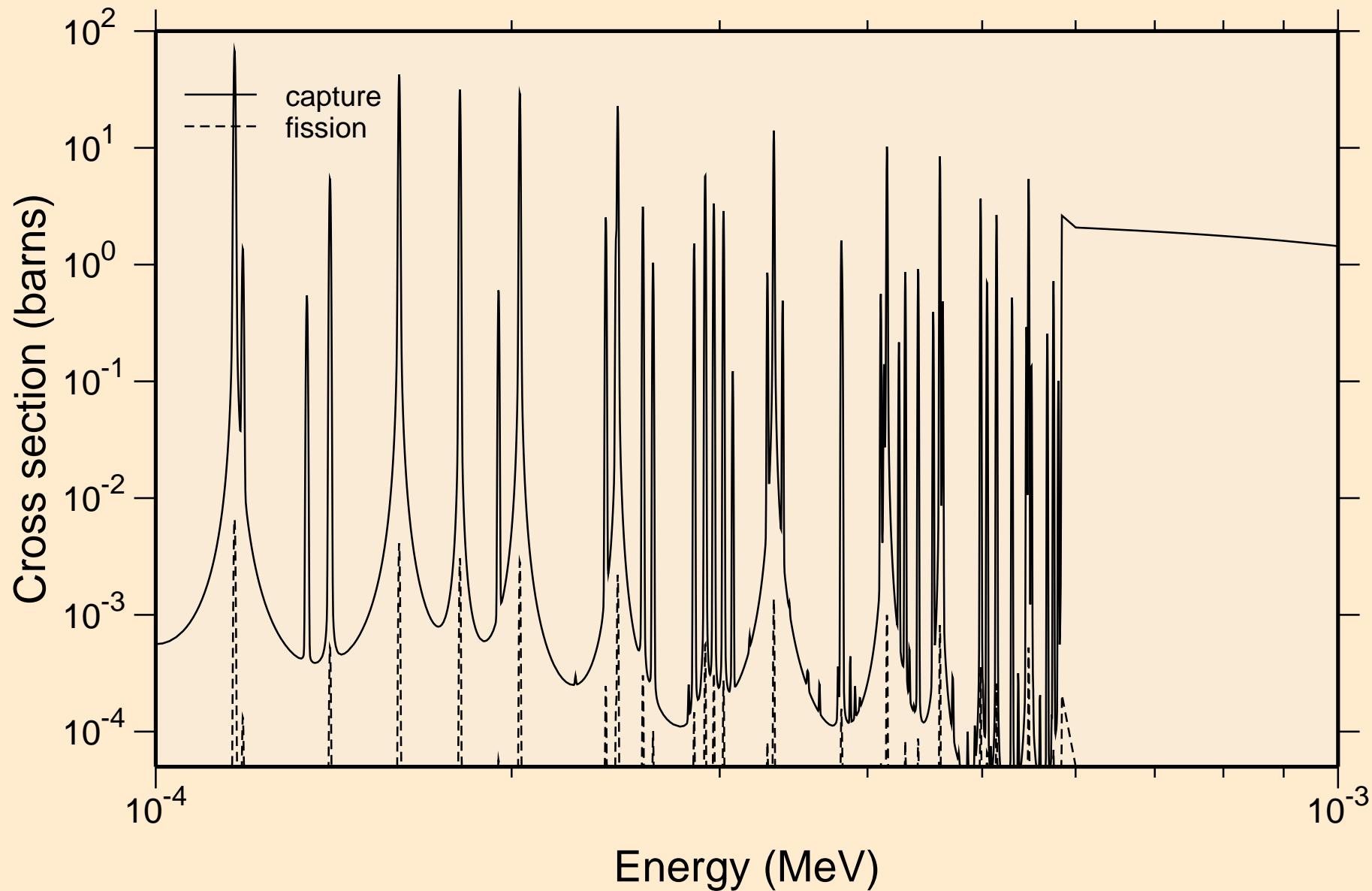

RA230 NEUTRON ACER TENDL-2019 LIBRARY; T=293.16K
resonance absorption cross sections

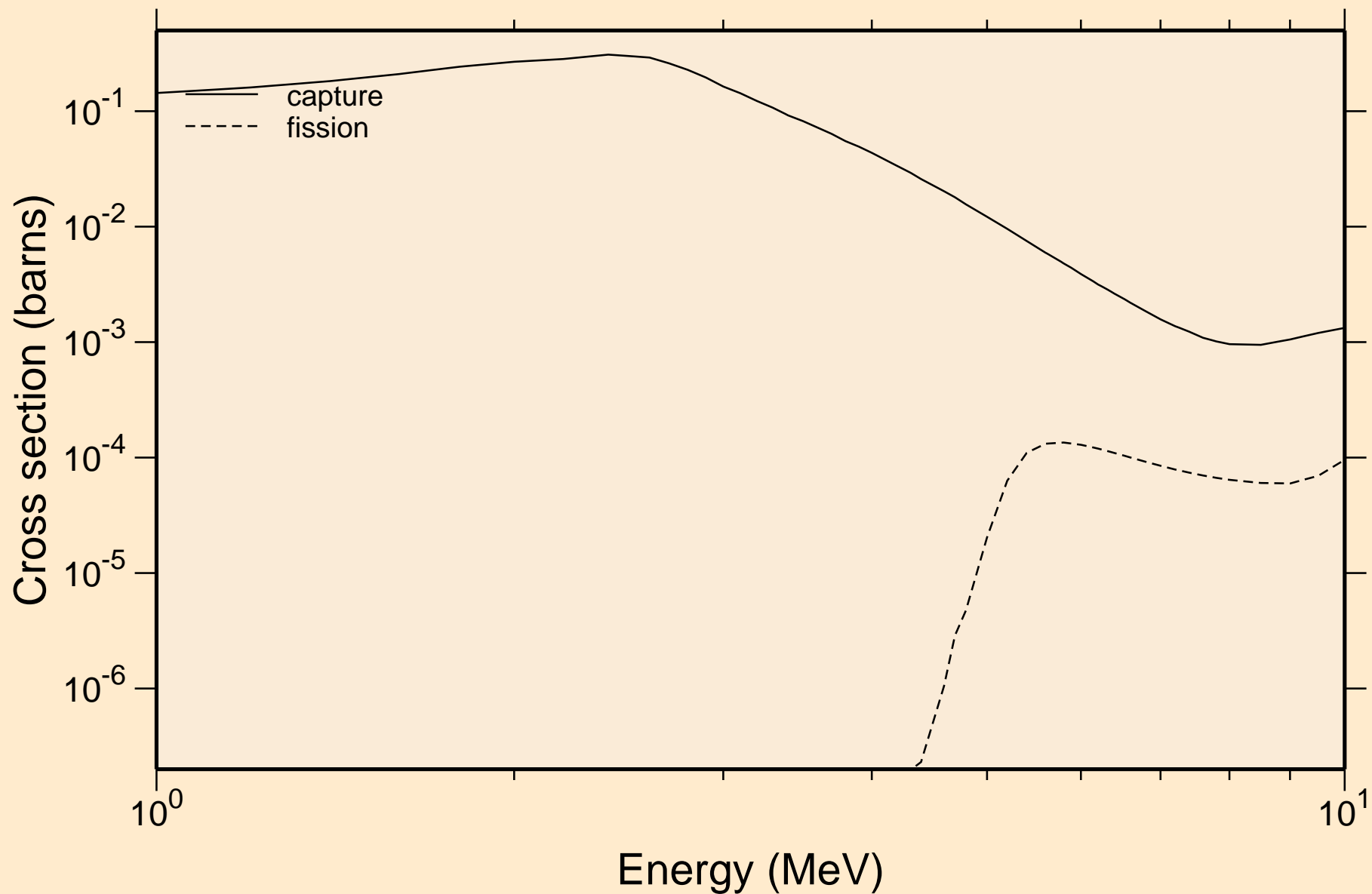

RA230 NEUTRON ACER TENDL-2019 LIBRARY; T=293.16K
Heating

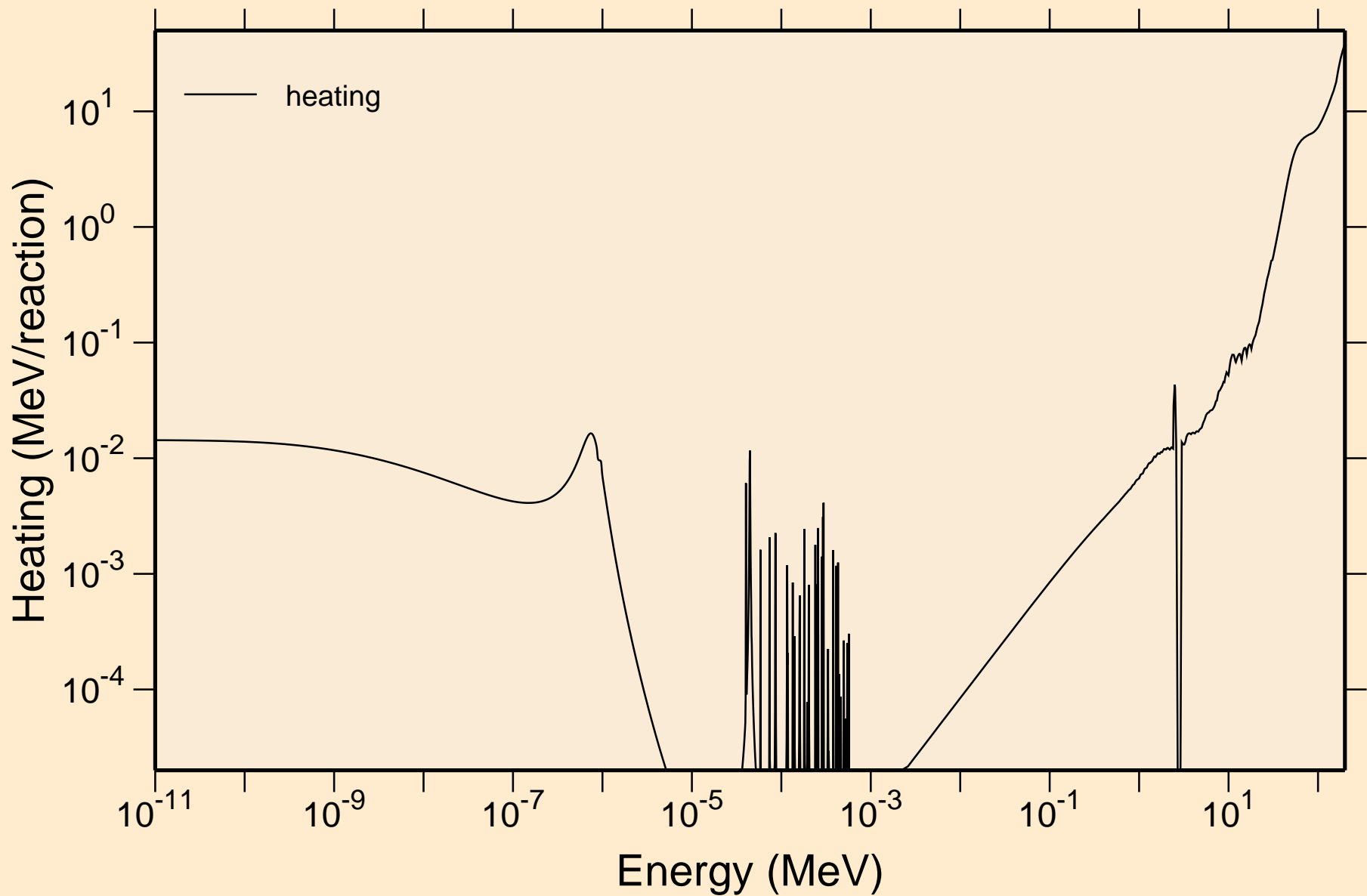

RA230 NEUTRON ACER TENDL-2019 LIBRARY; T=293.16K
Damage

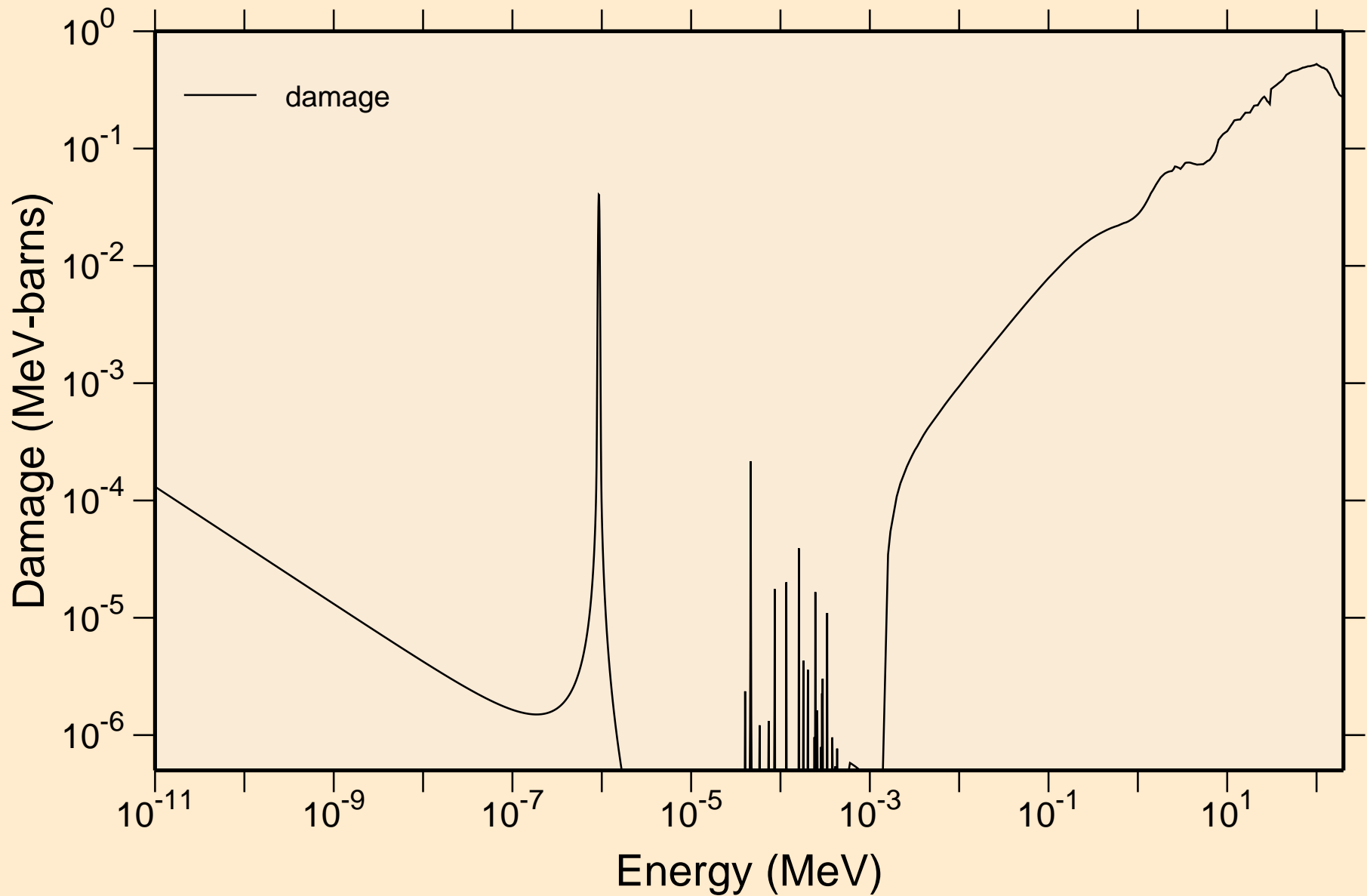

RA230 NEUTRON ACER TENDL-2019 LIBRARY; T=293.16K

Non-threshold reactions

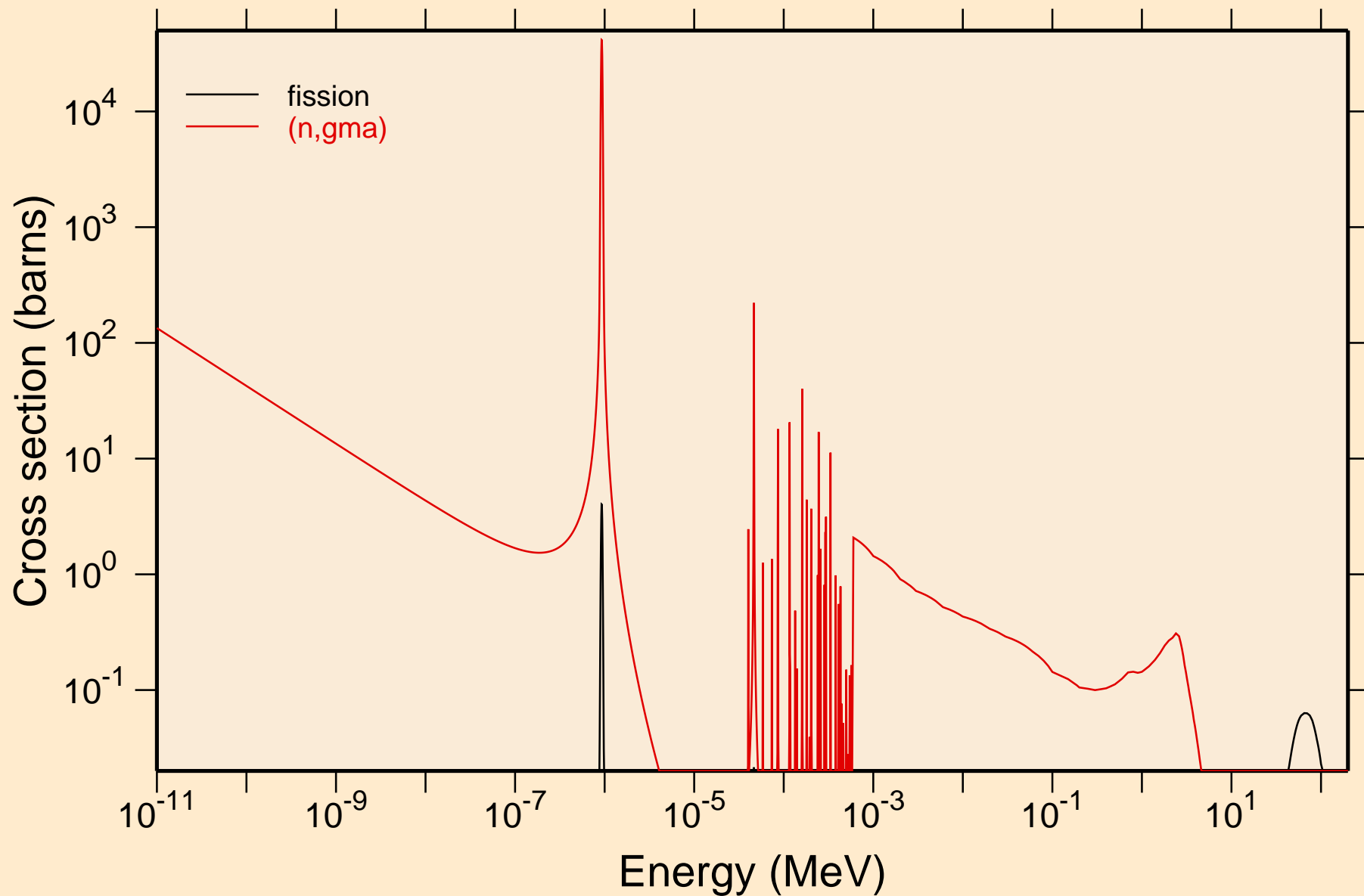

RA230 NEUTRON ACER TENDL-2019 LIBRARY; T=293.16K
Principal cross sections

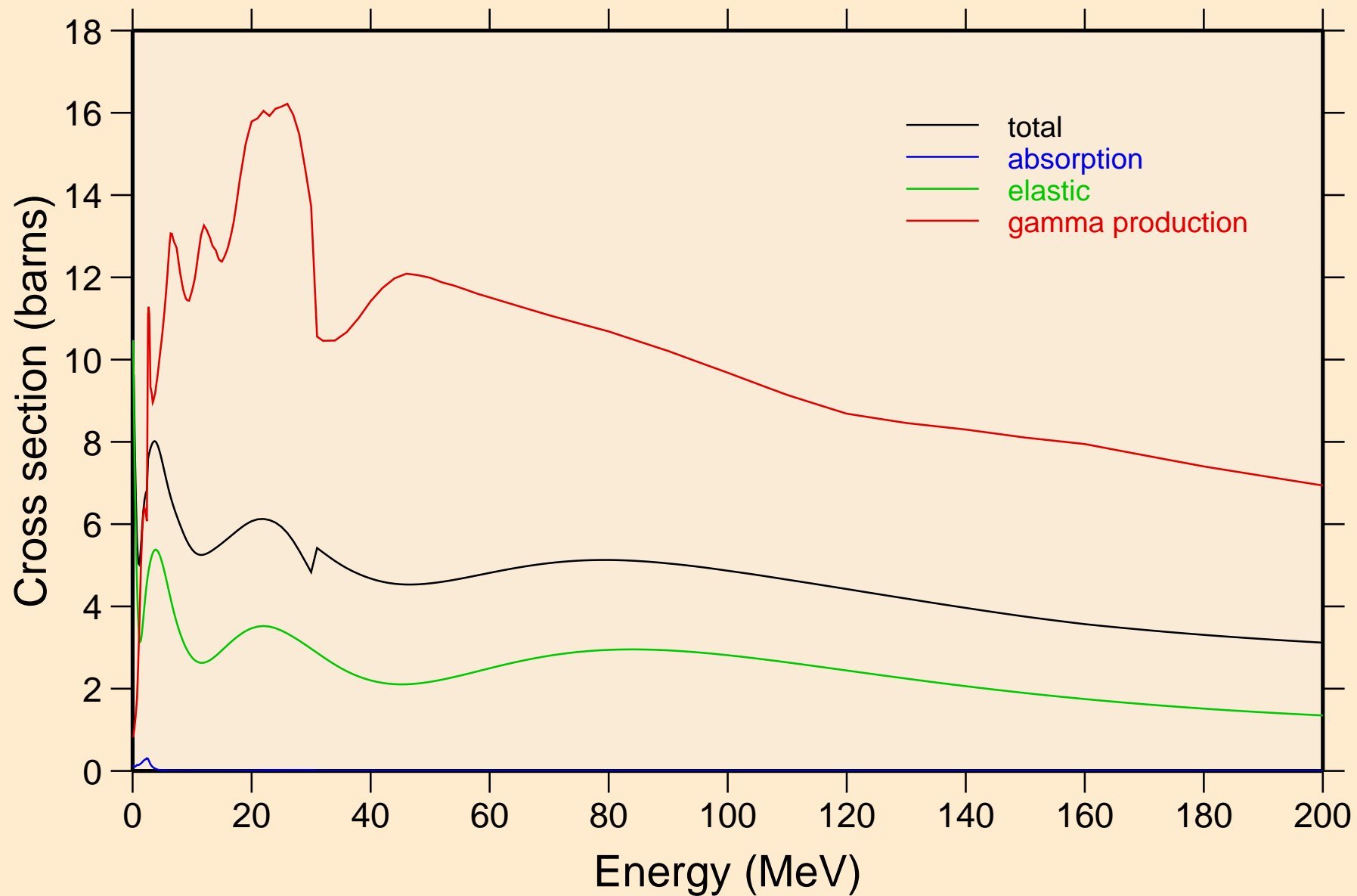

RA230 NEUTRON ACER TENDL-2019 LIBRARY; T=293.16K
Heating

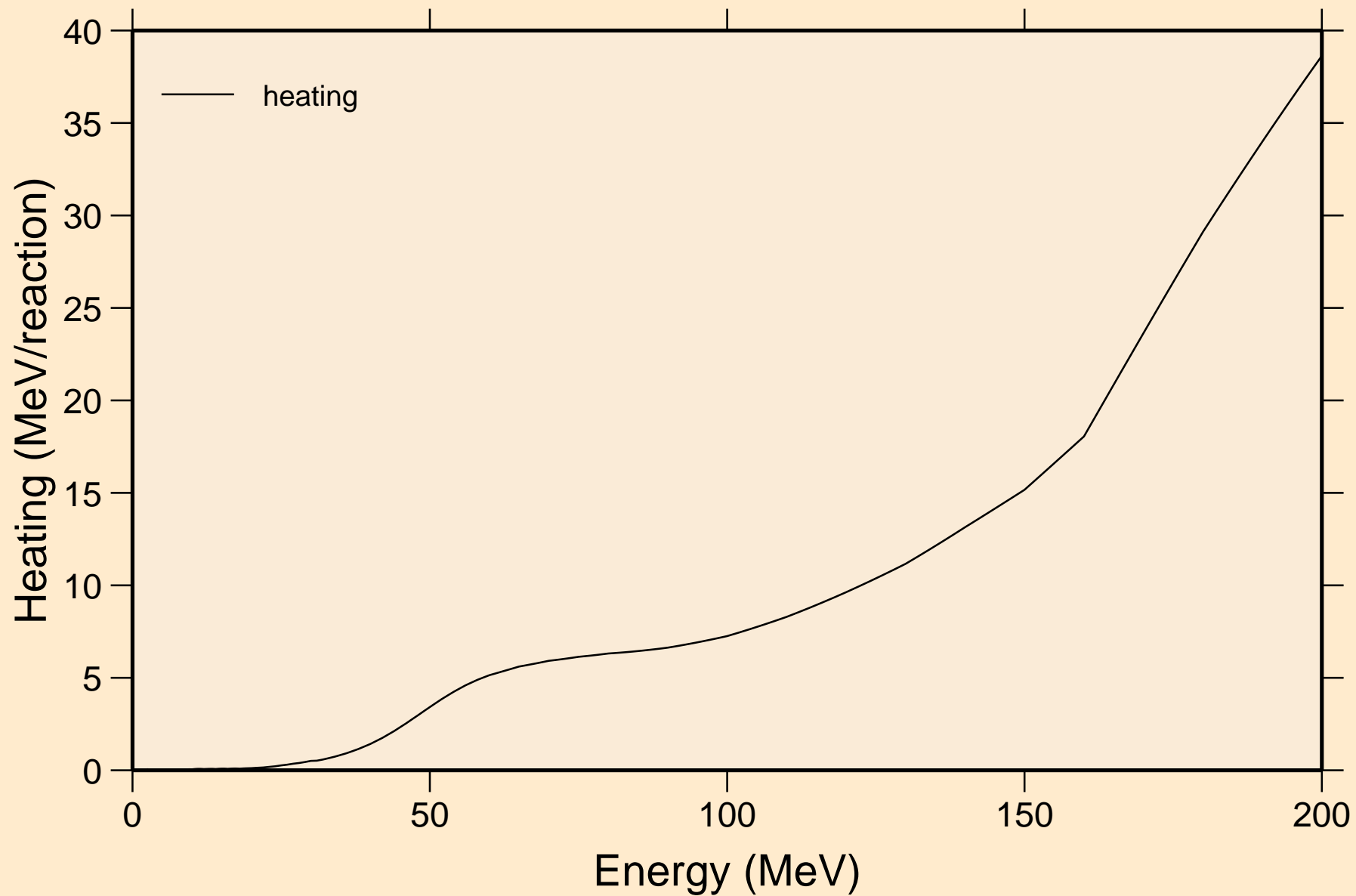

RA230 NEUTRON ACER TENDL-2019 LIBRARY; T=293.16K
Damage

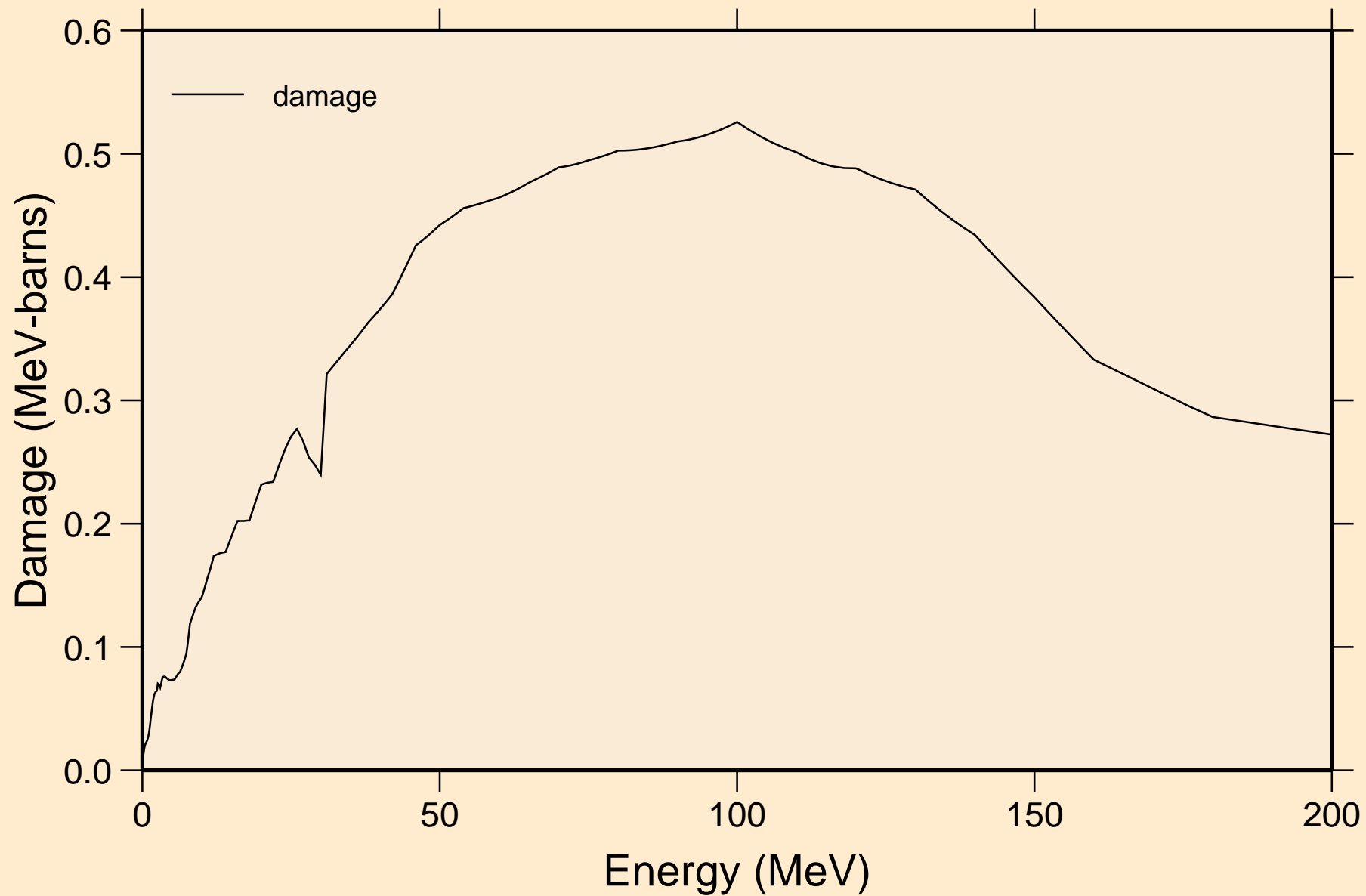

RA230 NEUTRON ACER TENDL-2019 LIBRARY; T=293.16K
Non-threshold reactions

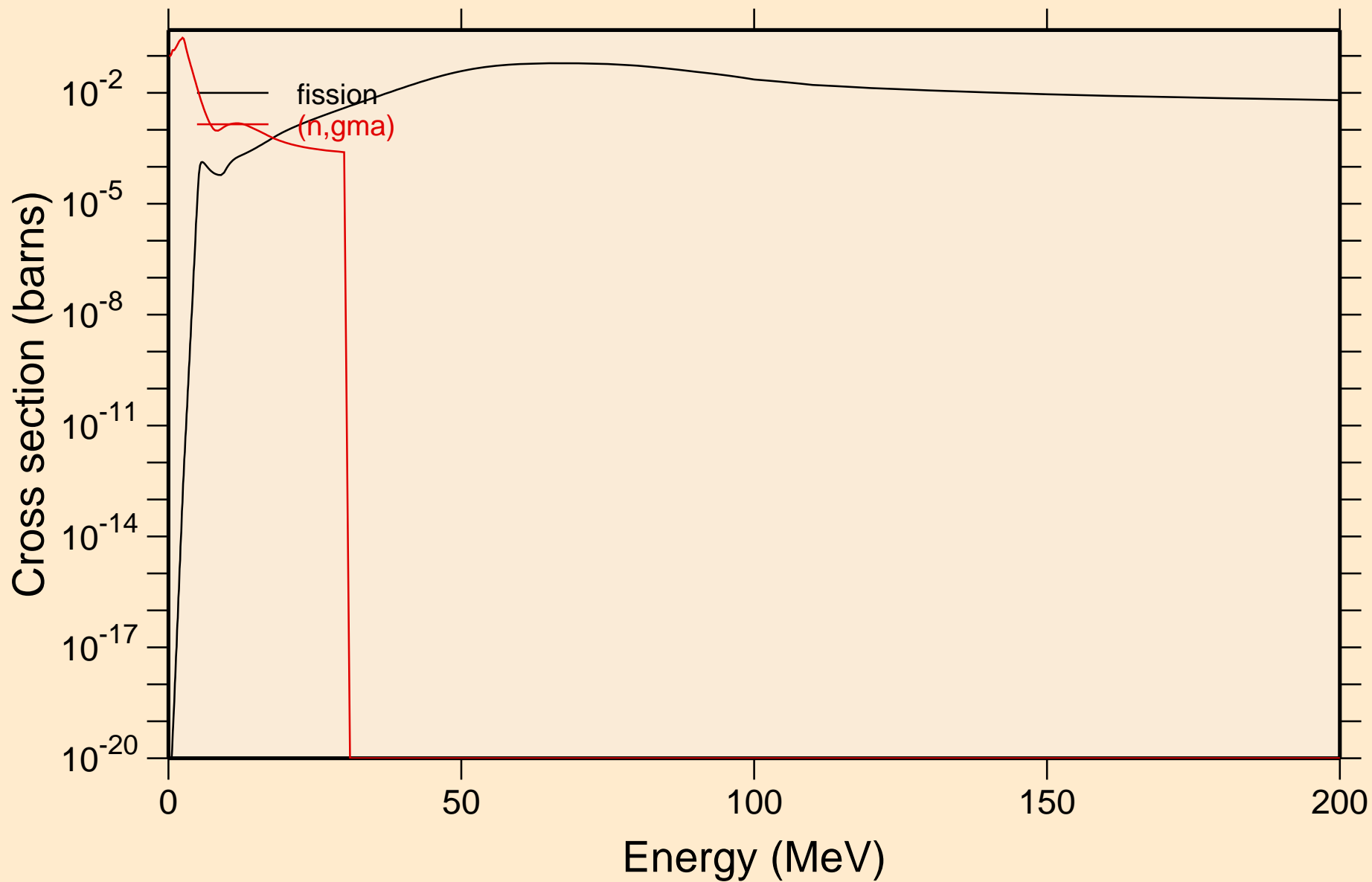

RA230 NEUTRON ACER TENDL-2019 LIBRARY; T=293.16K
Inelastic levels

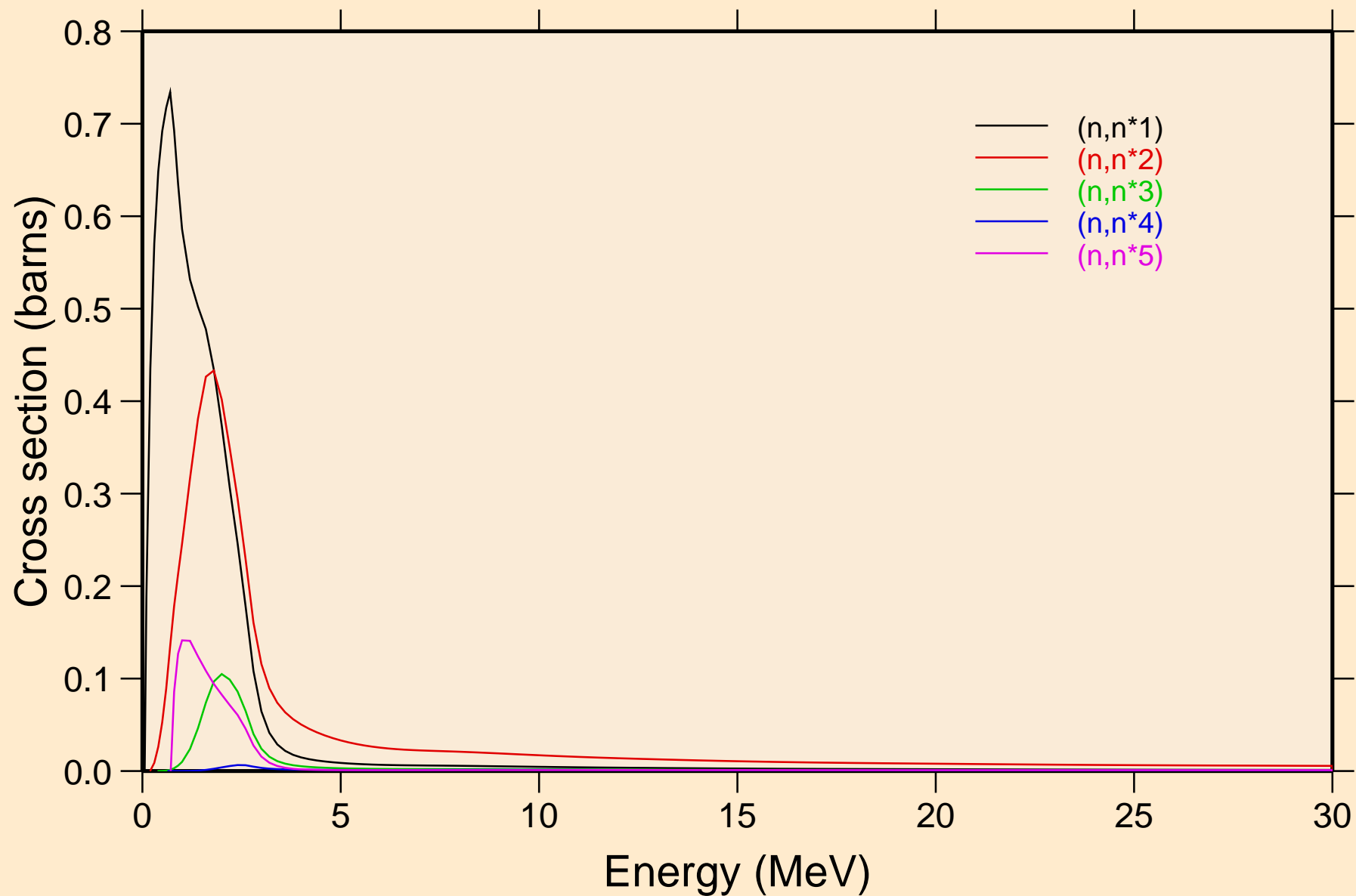

RA230 NEUTRON ACER TENDL-2019 LIBRARY; T=293.16K
Inelastic levels

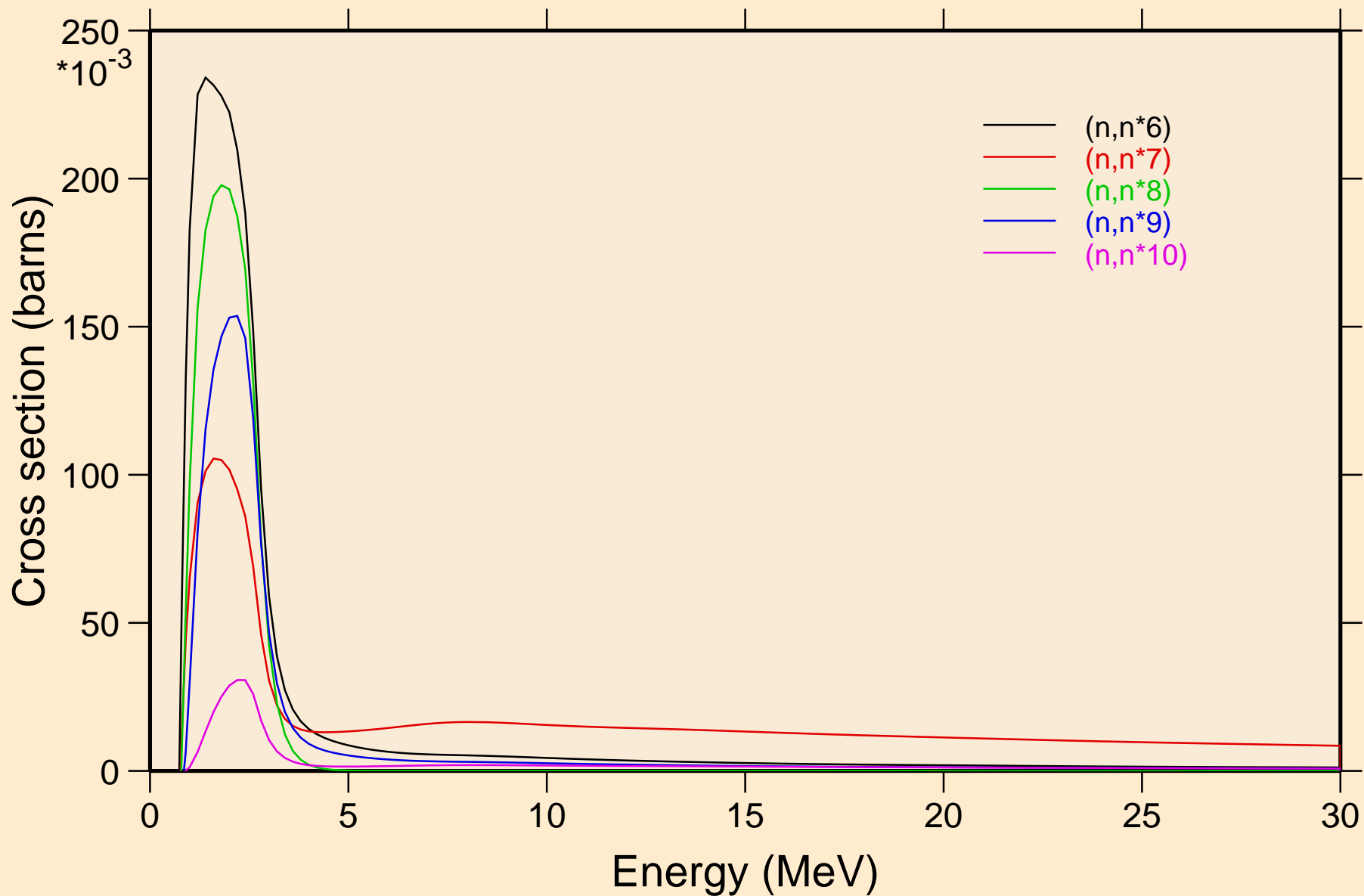

RA230 NEUTRON ACER TENDL-2019 LIBRARY; T=293.16K
Inelastic levels

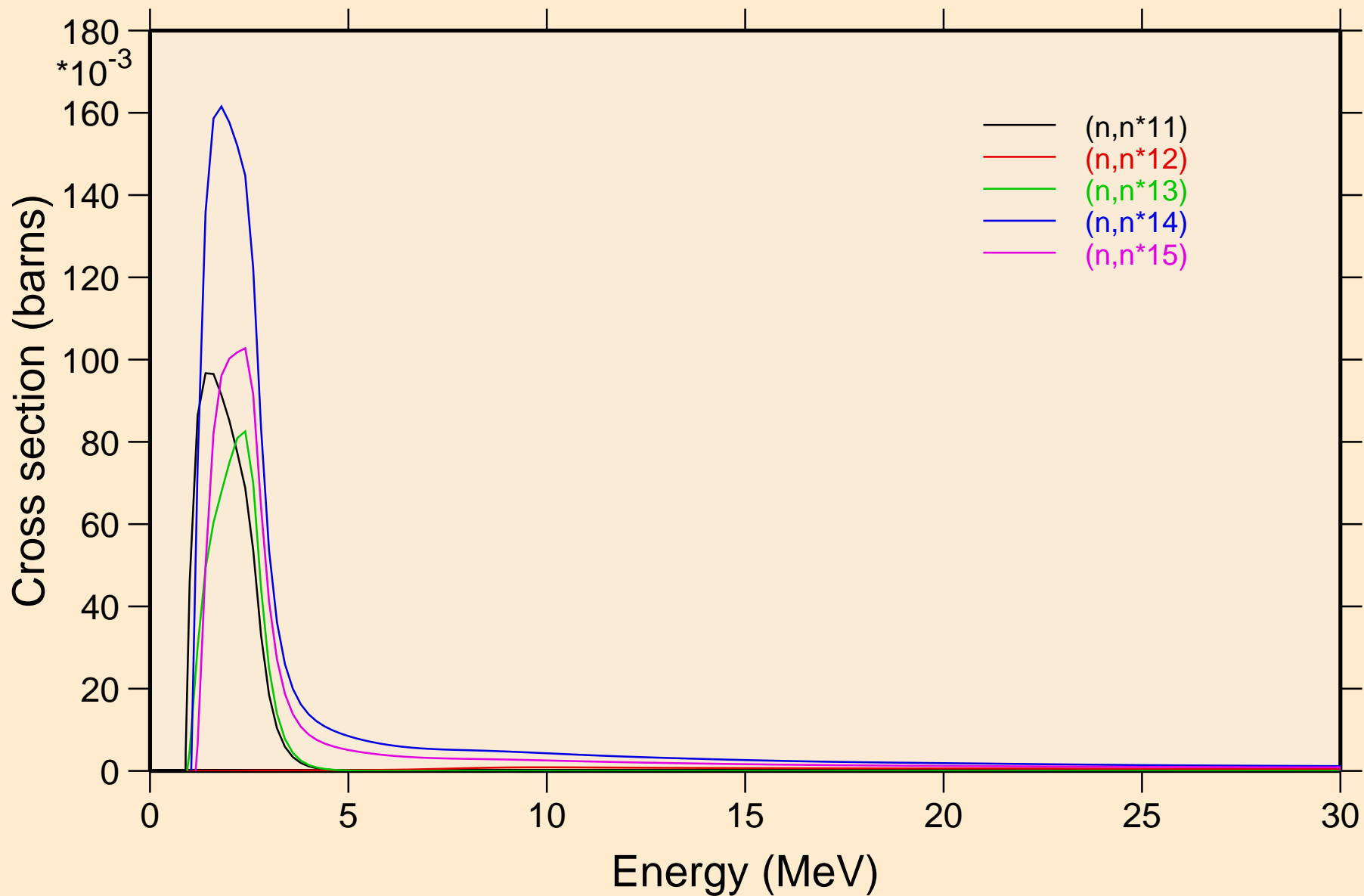

RA230 NEUTRON ACER TENDL-2019 LIBRARY; T=293.16K
Inelastic levels

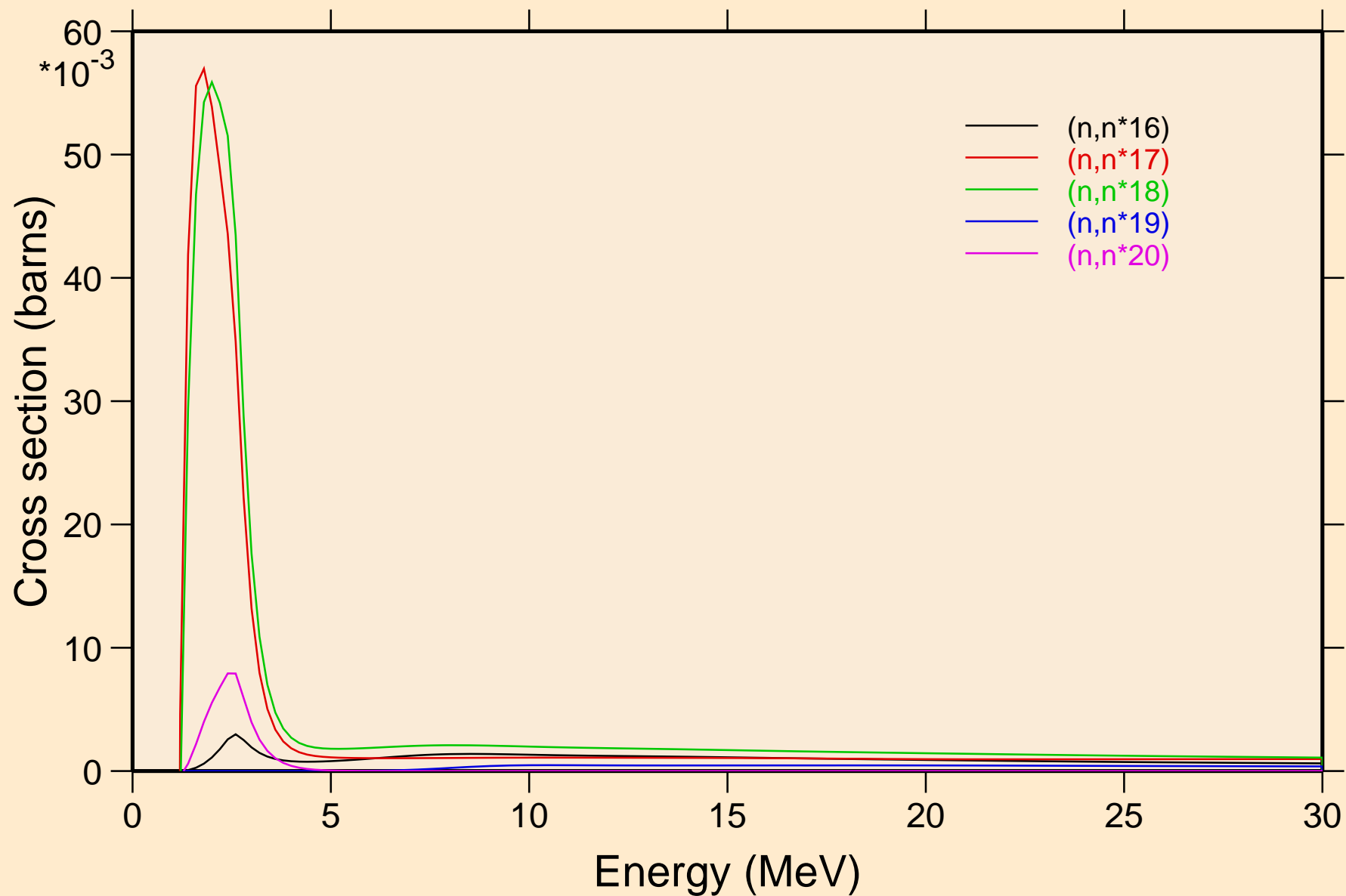

RA230 NEUTRON ACER TENDL-2019 LIBRARY; T=293.16K
Inelastic levels

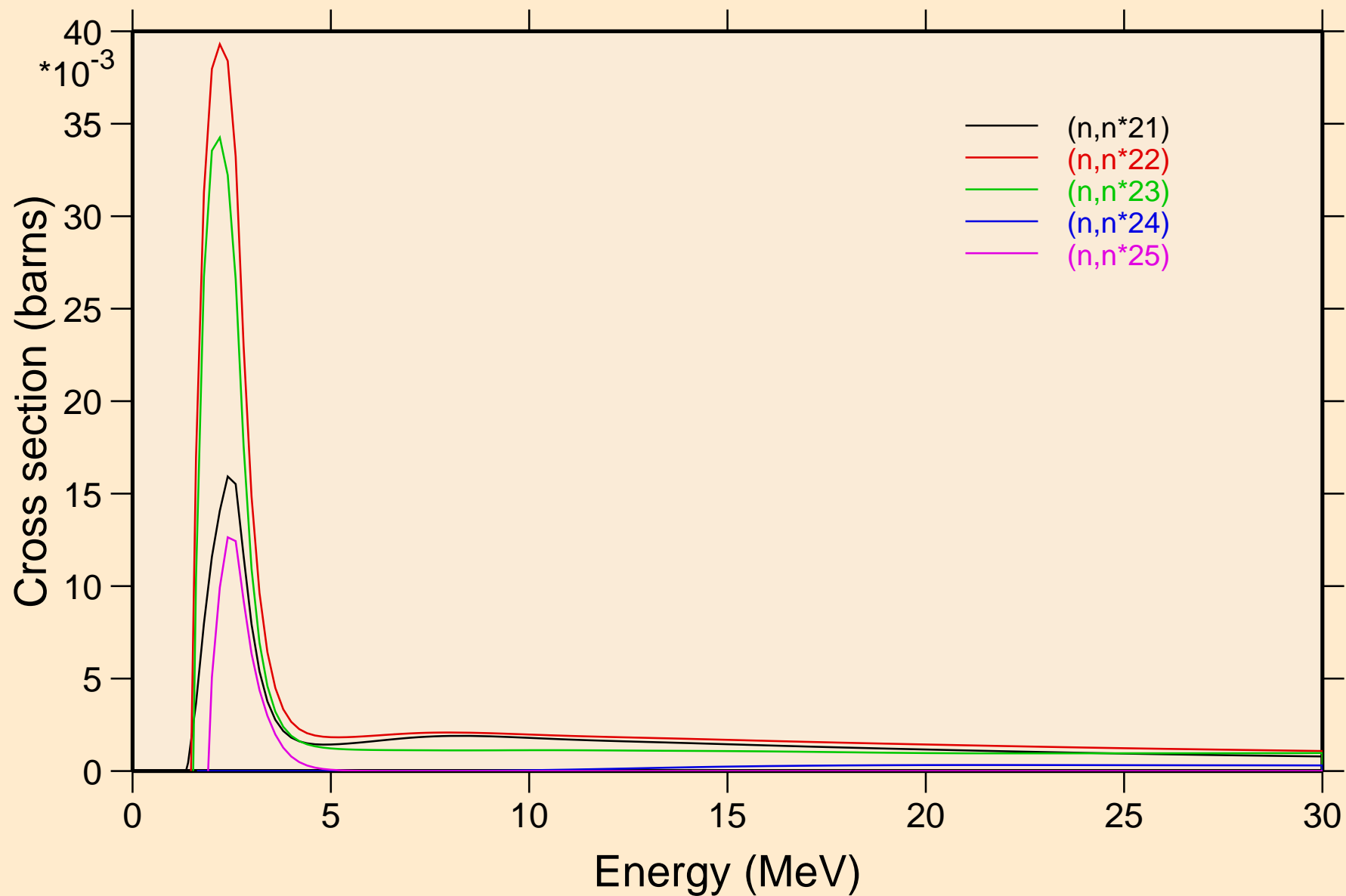

RA230 NEUTRON ACER TENDL-2019 LIBRARY; T=293.16K
Inelastic levels

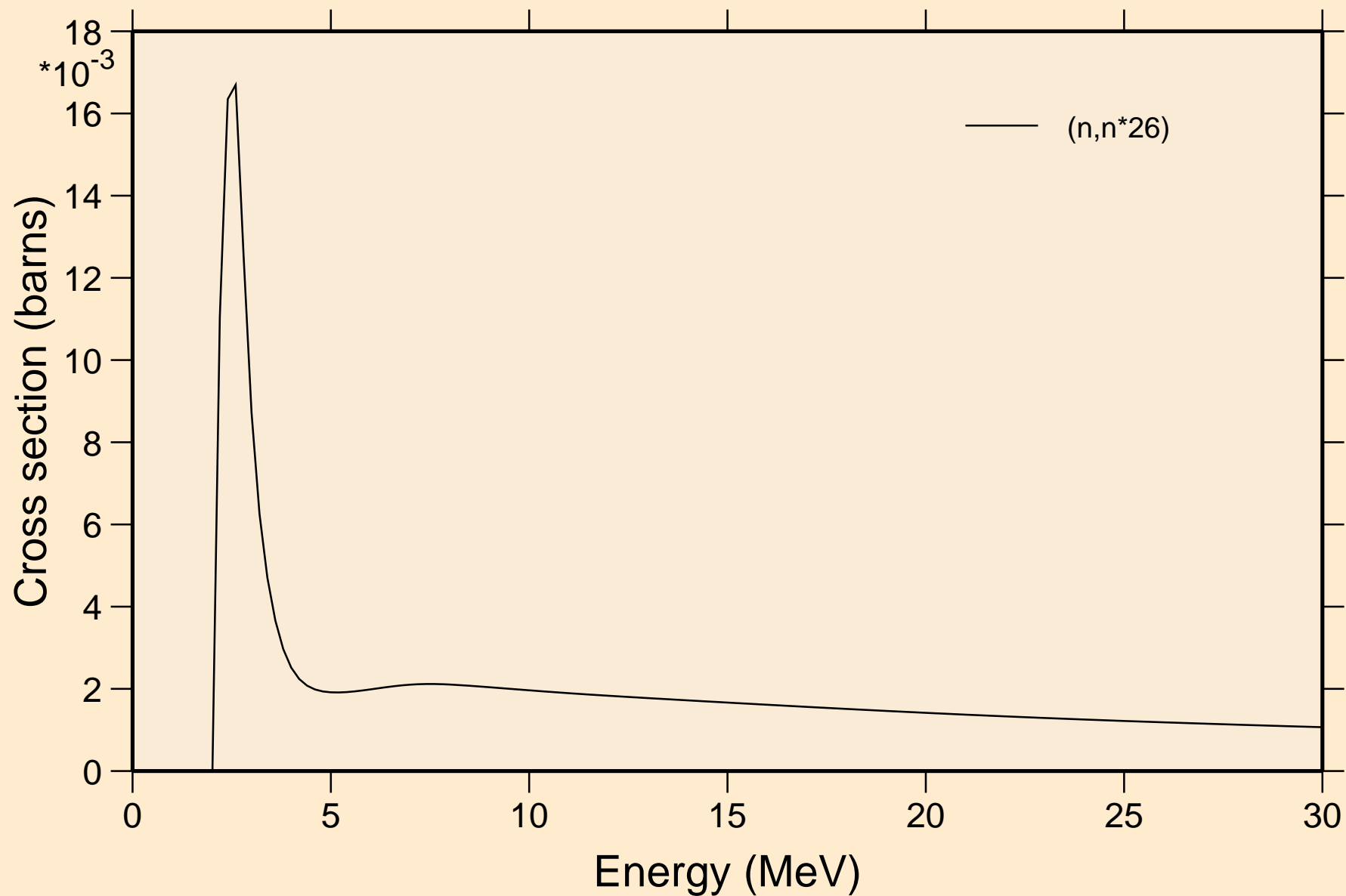

RA230 NEUTRON ACER TENDL-2019 LIBRARY; T=293.16K
Threshold reactions

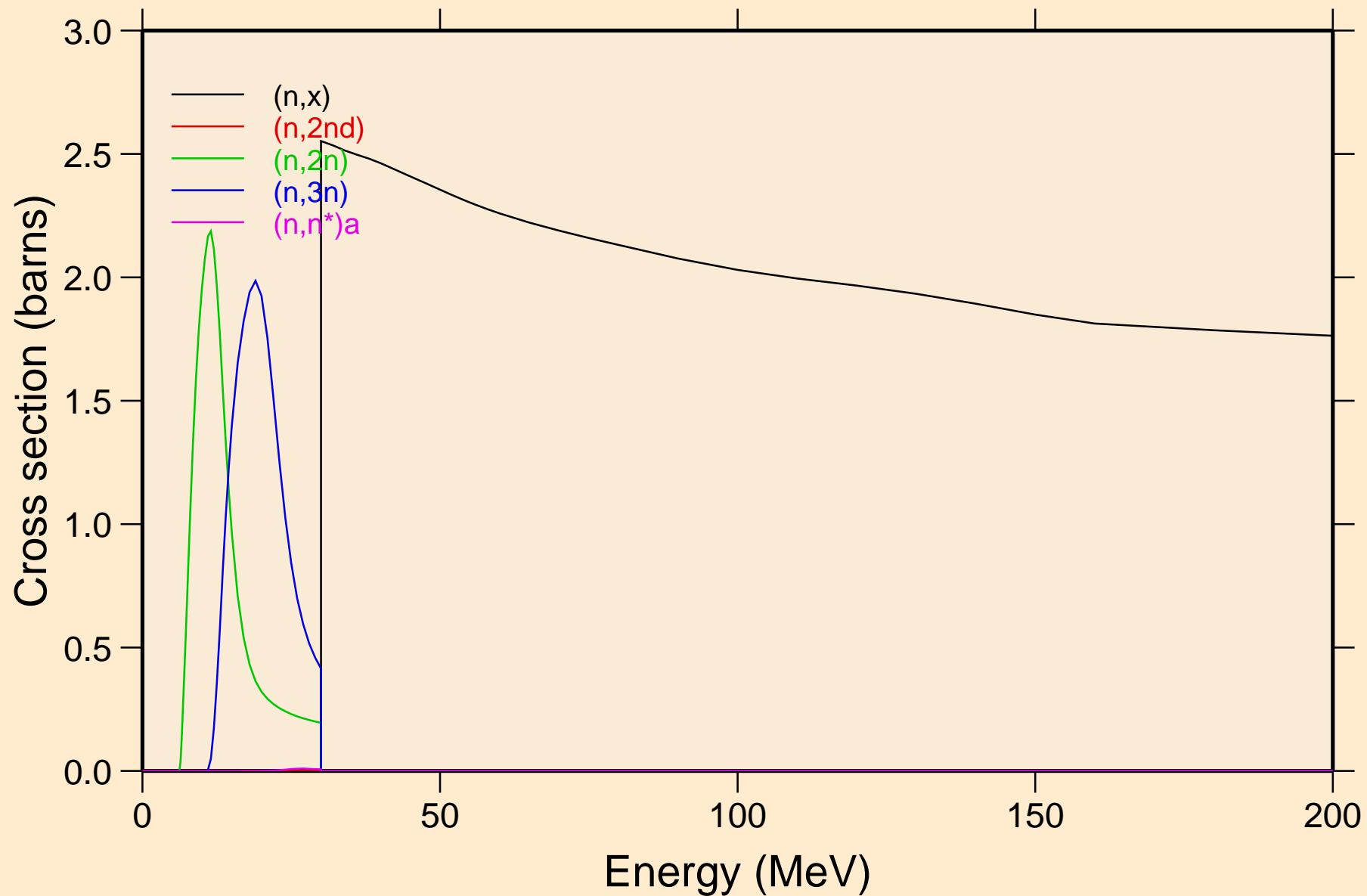

RA230 NEUTRON ACER TENDL-2019 LIBRARY; T=293.16K
Threshold reactions

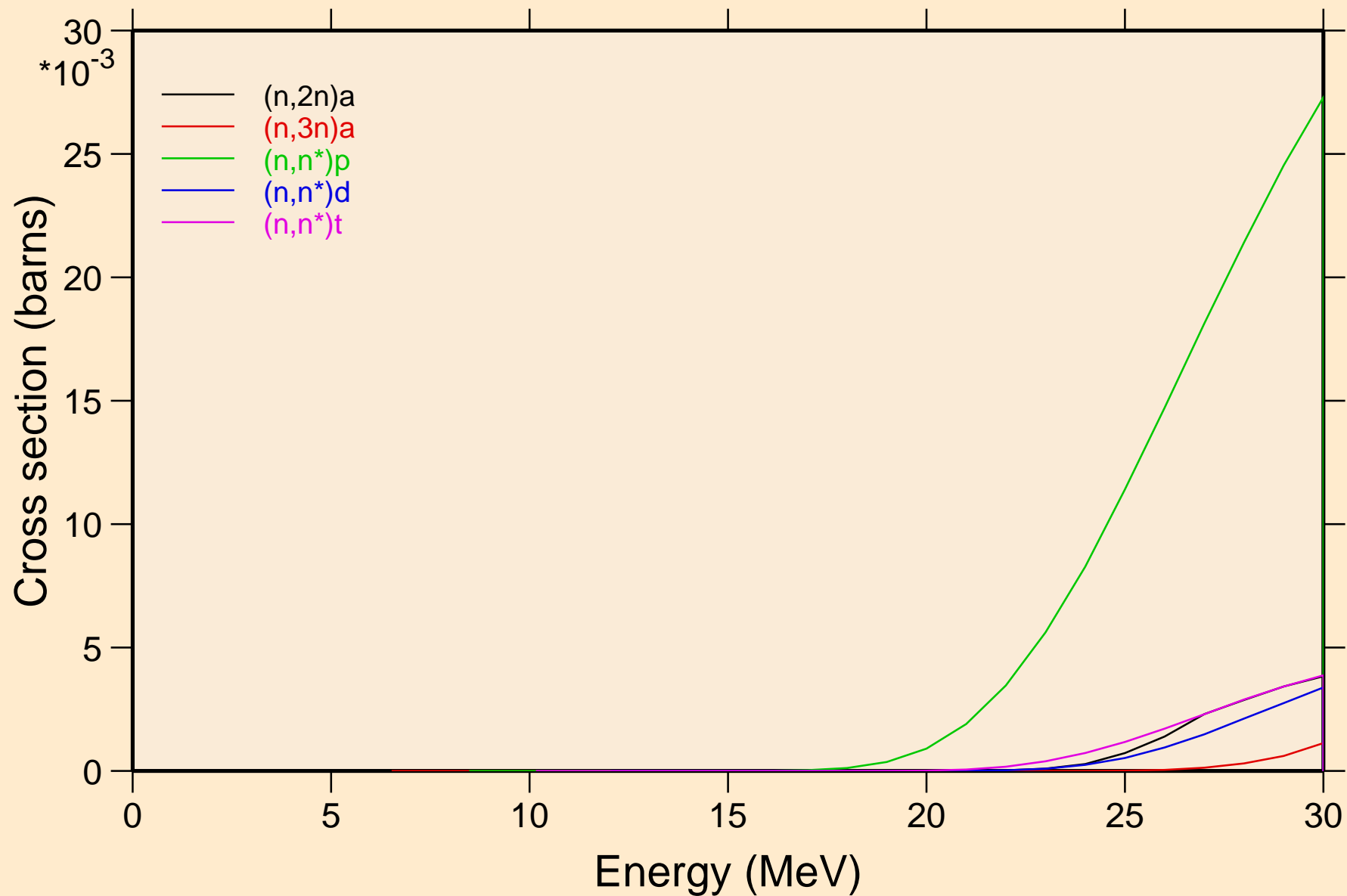

RA230 NEUTRON ACER TENDL-2019 LIBRARY; T=293.16K
Threshold reactions

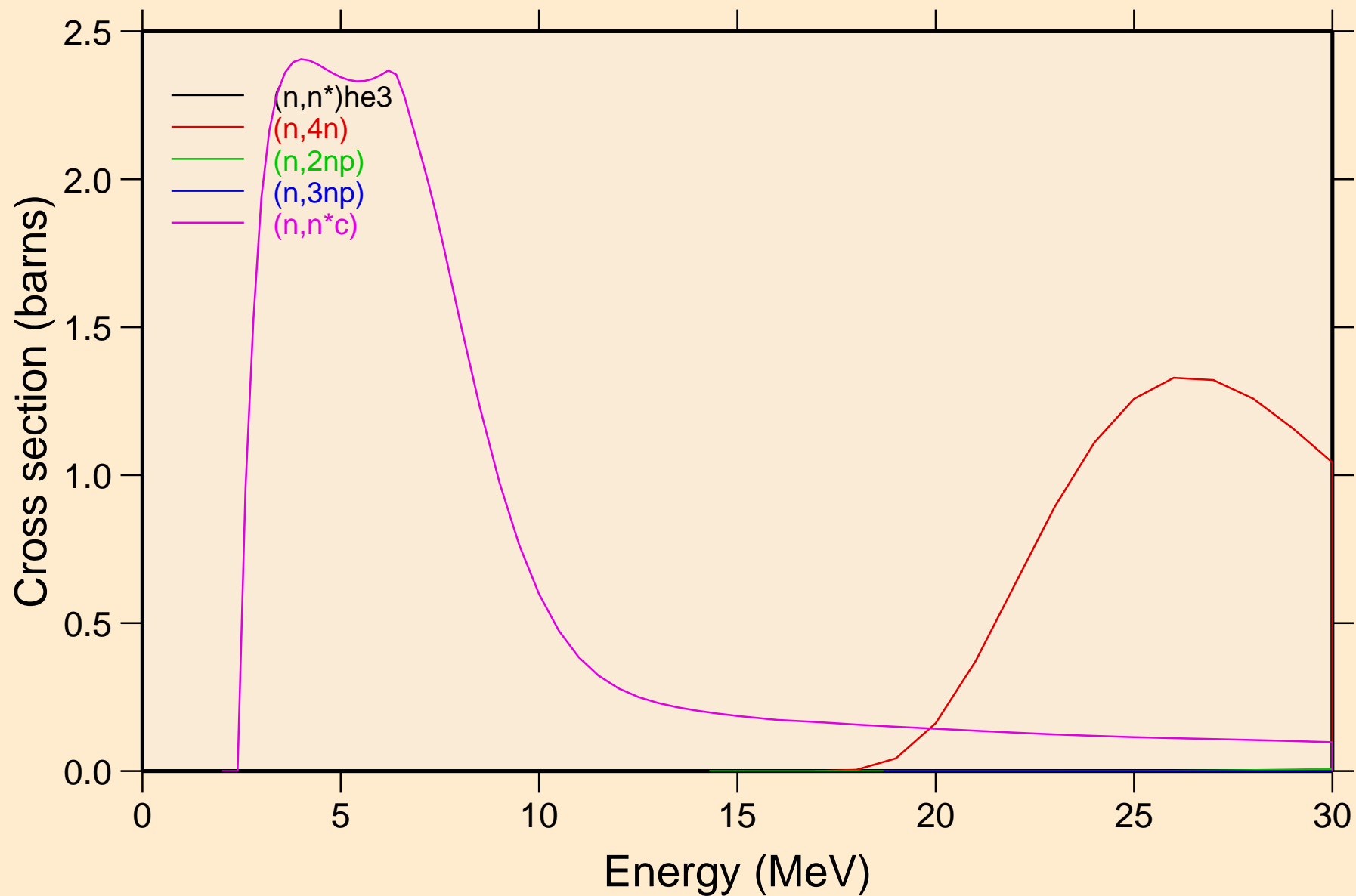

RA230 NEUTRON ACER TENDL-2019 LIBRARY; T=293.16K
Threshold reactions

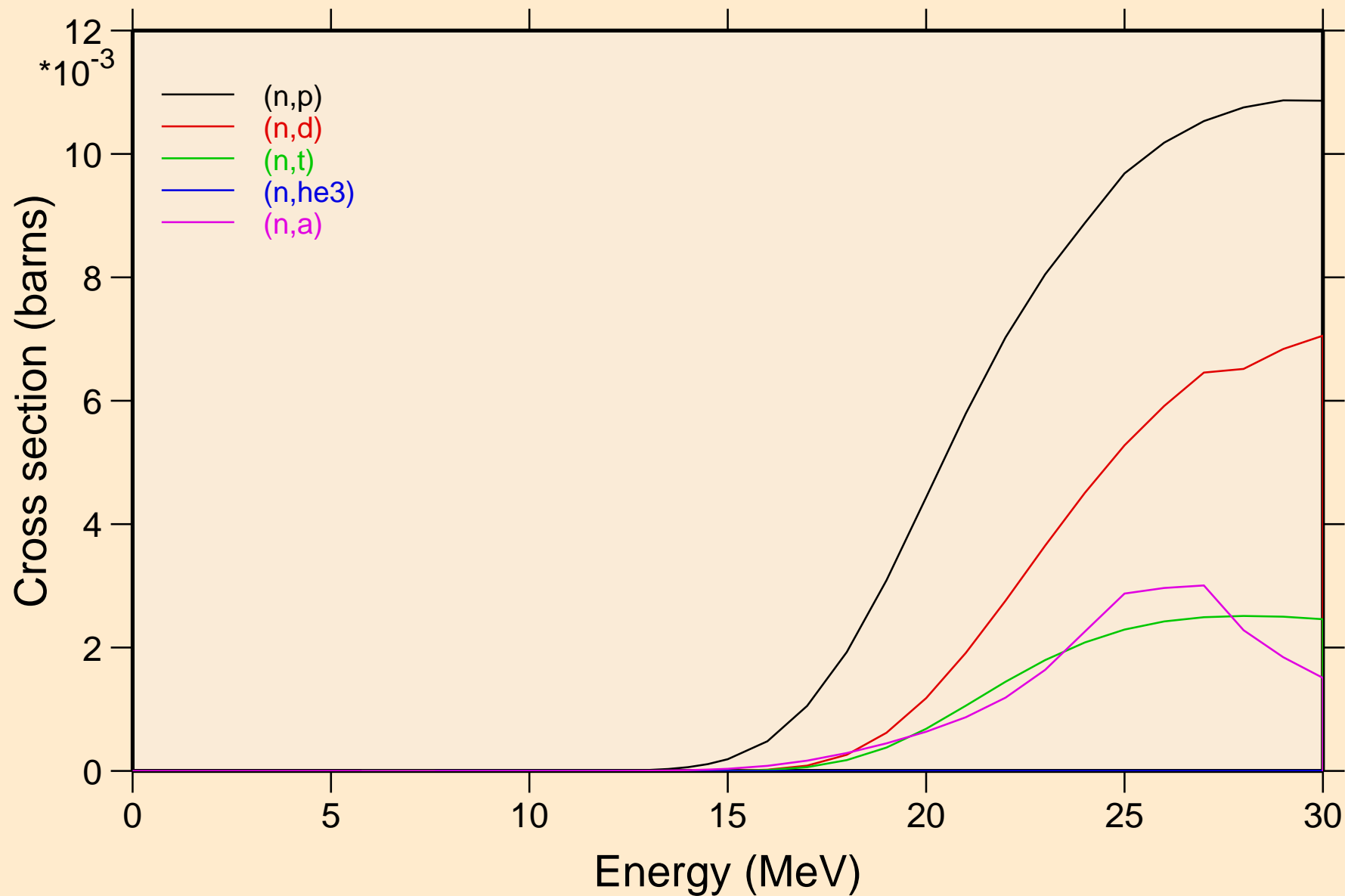

RA230 NEUTRON ACER TENDL-2019 LIBRARY; T=293.16K
Threshold reactions

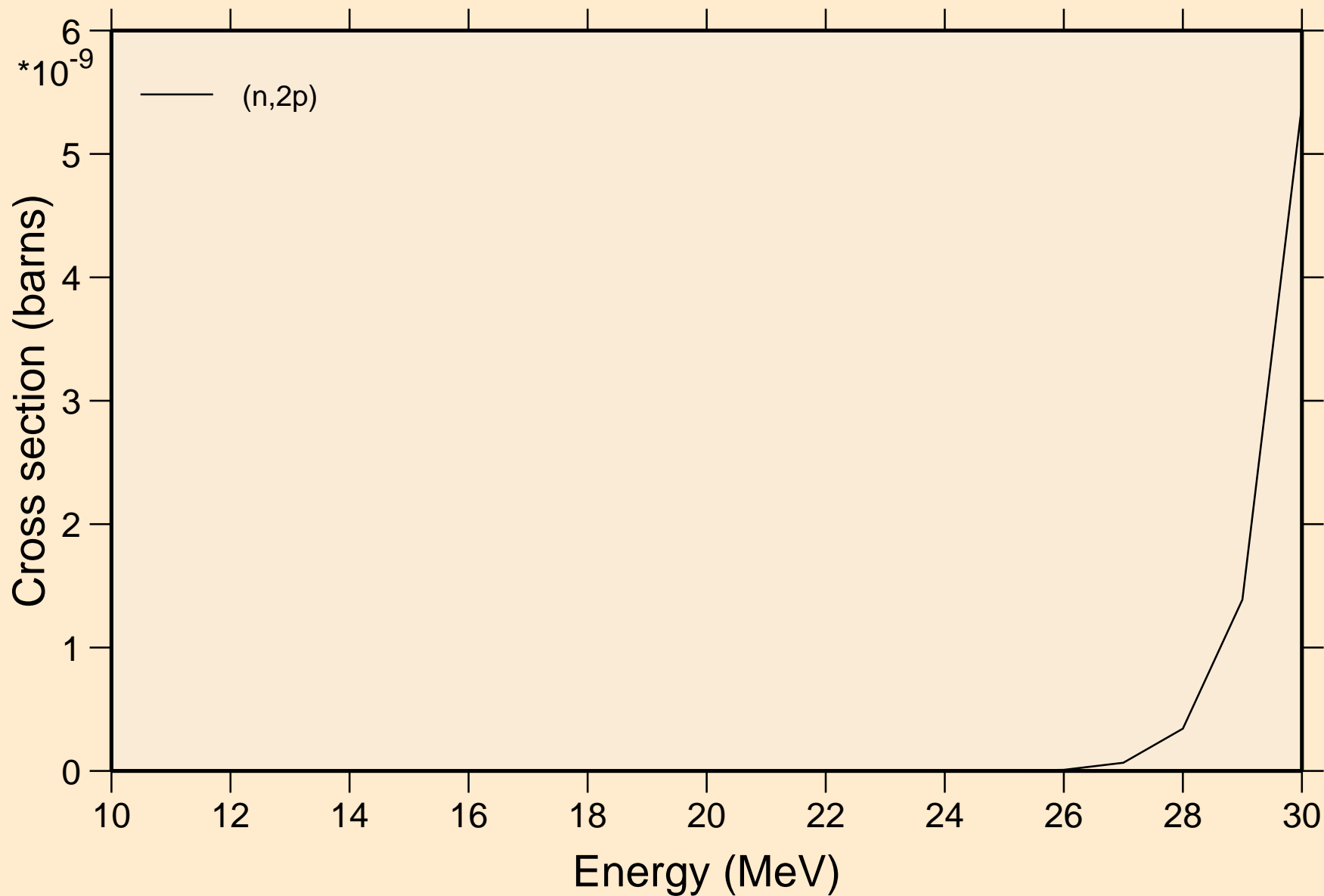

RA230 NEUTRON ACER TENDL-2019 LIBRARY; T=293.16K
Threshold reactions

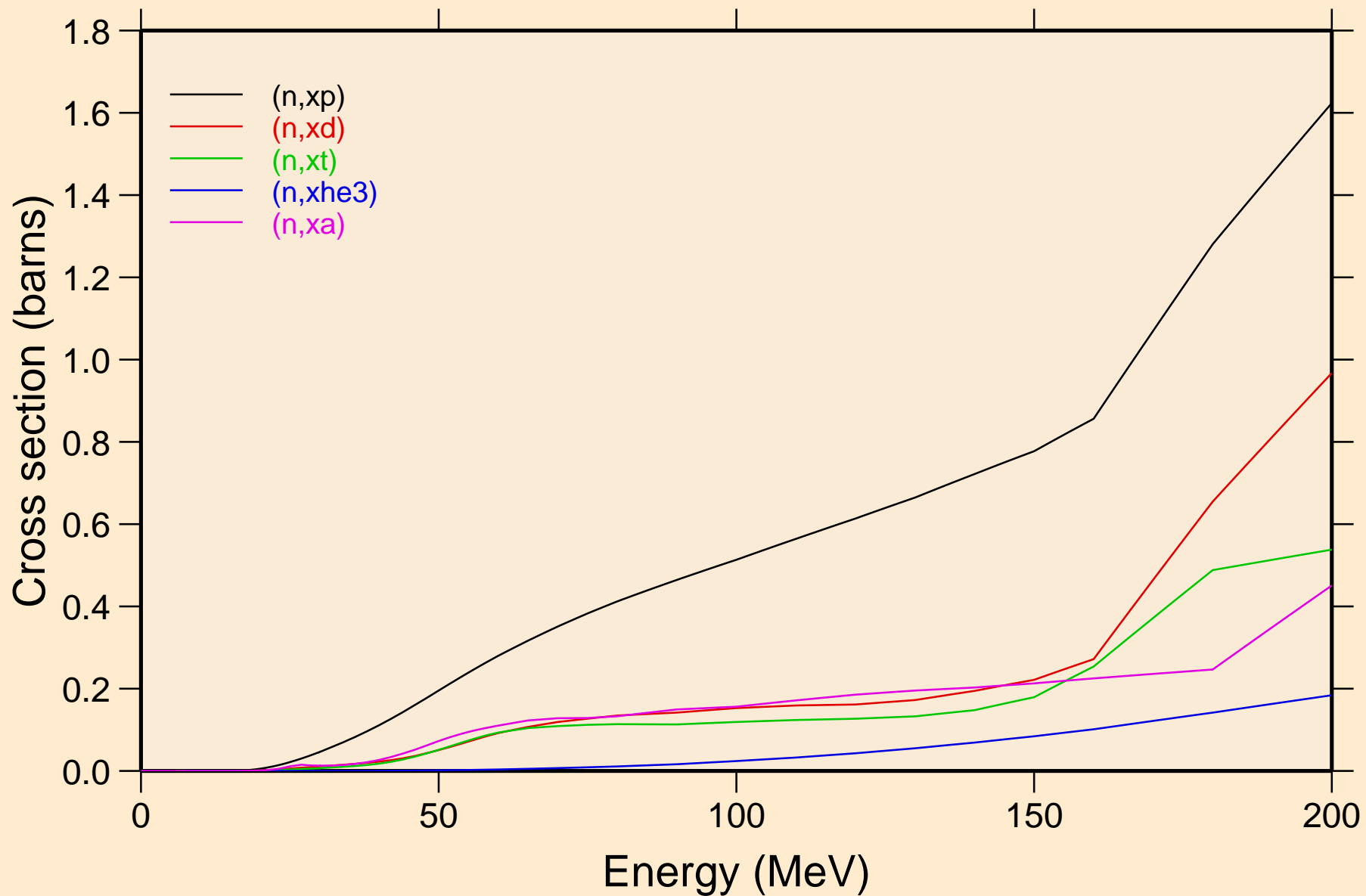

RA230 NEUTRON ACER TENDL-2019 LIBRARY; T=293.16K
angular distribution for elastic

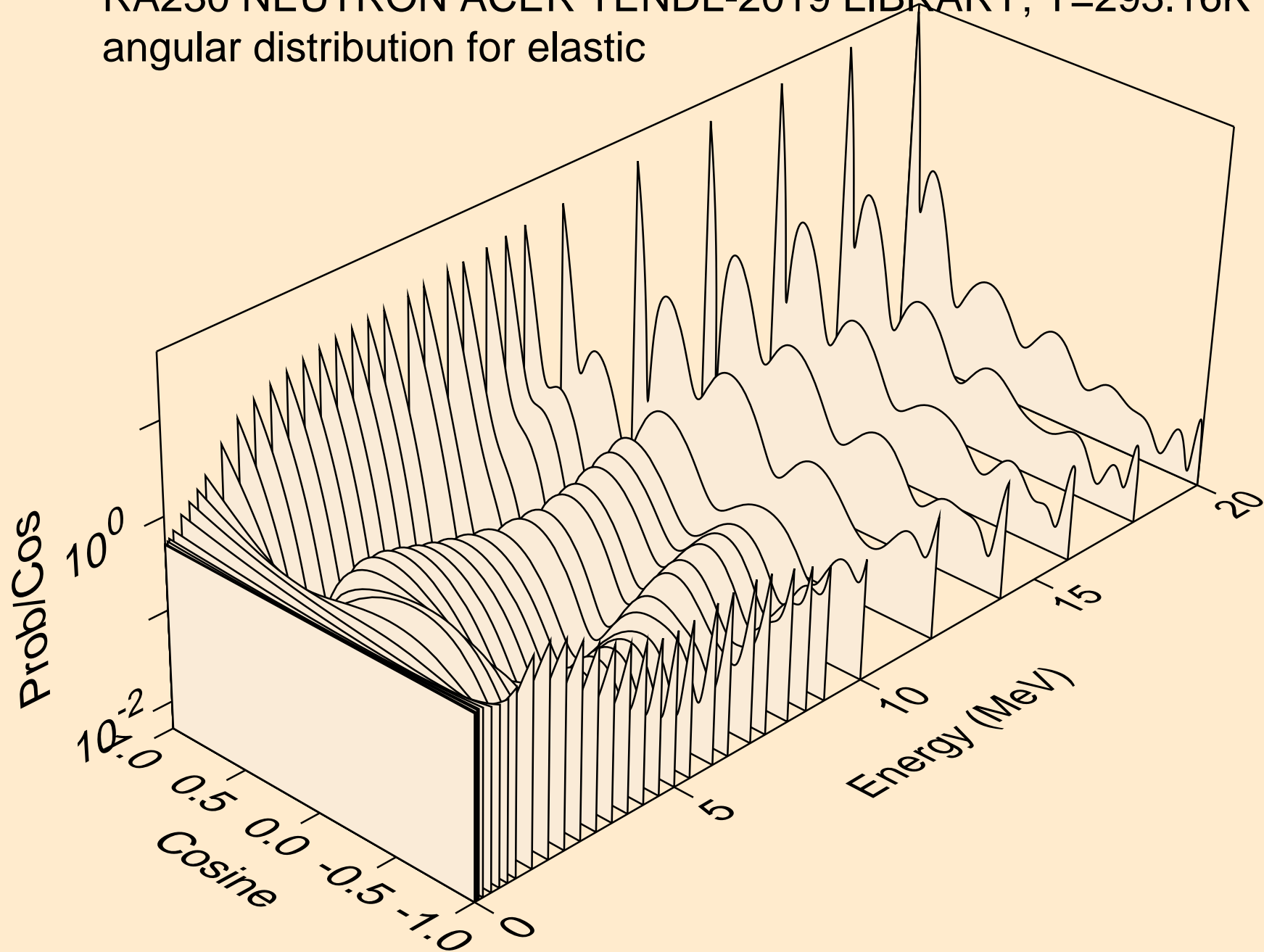

RA230 NEUTRON ACER TENDL-2019 LIBRARY; T=293.16K
angular distribution for elastic

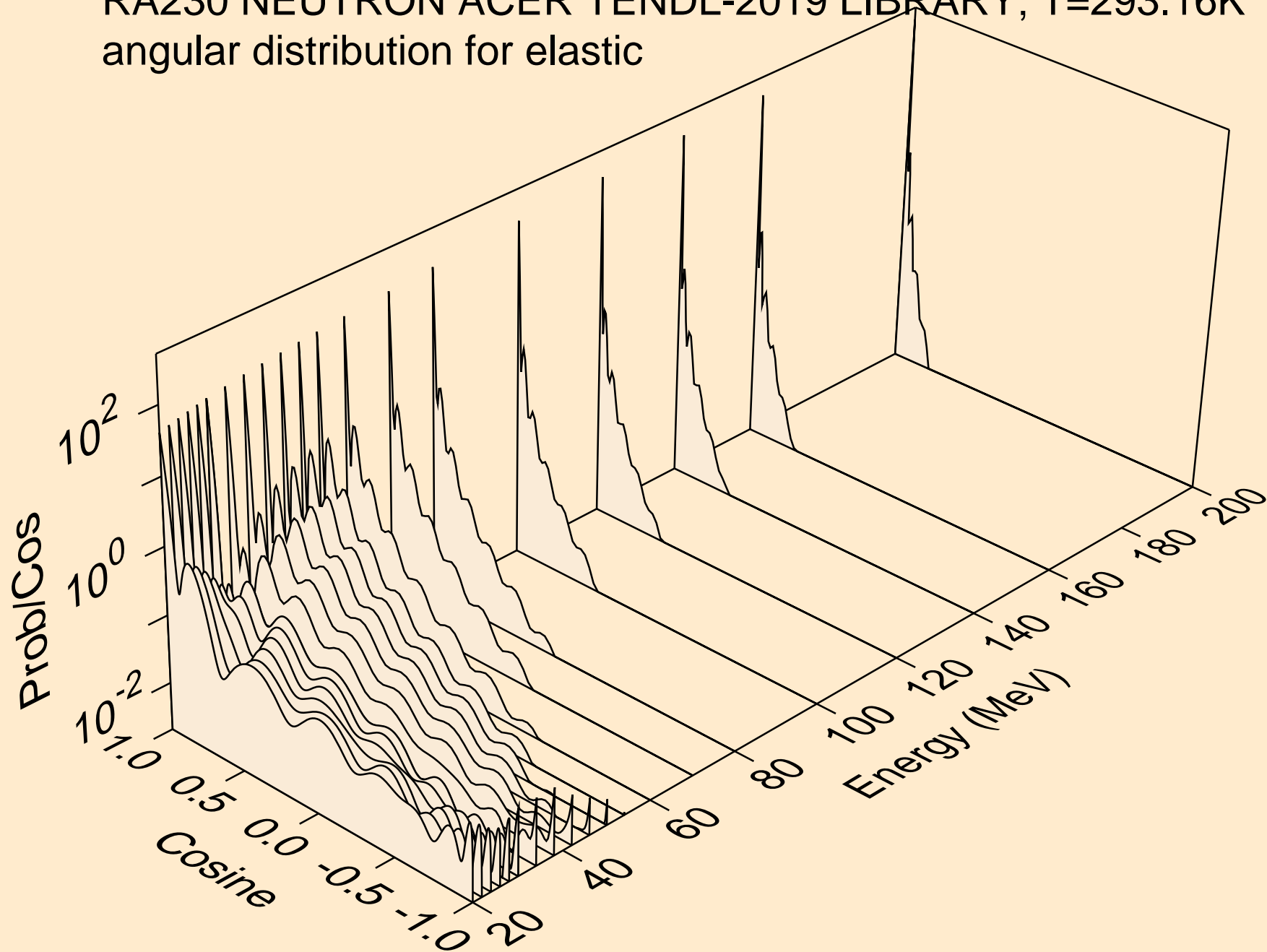

RA230 NEUTRON ACER TENDL-2019 LIBRARY; T=293.16K
angular distribution for (n,n*1)

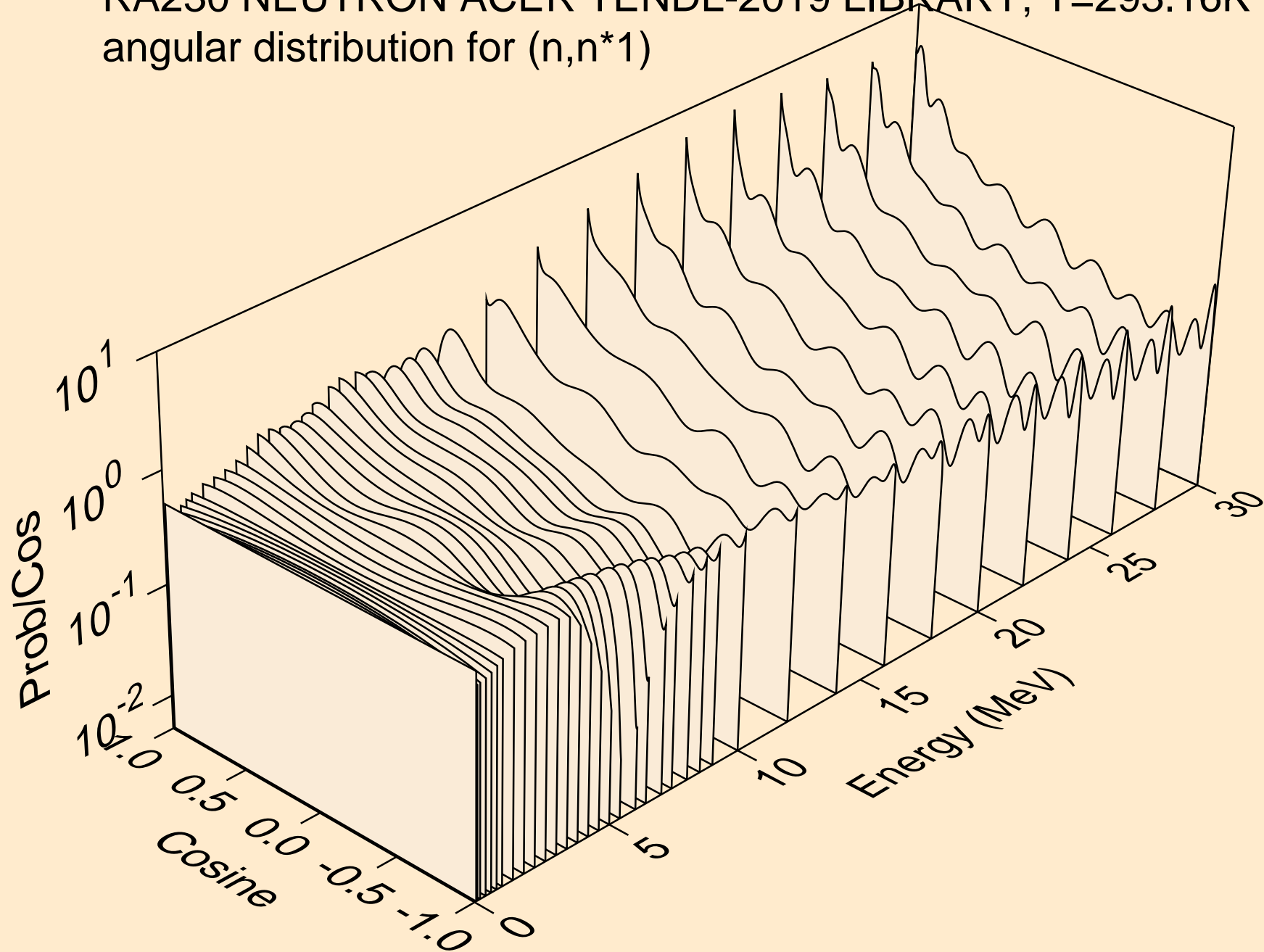

RA230 NEUTRON ACER TENDL-2019 LIBRARY; T=293.16K
angular distribution for (n,n*2)

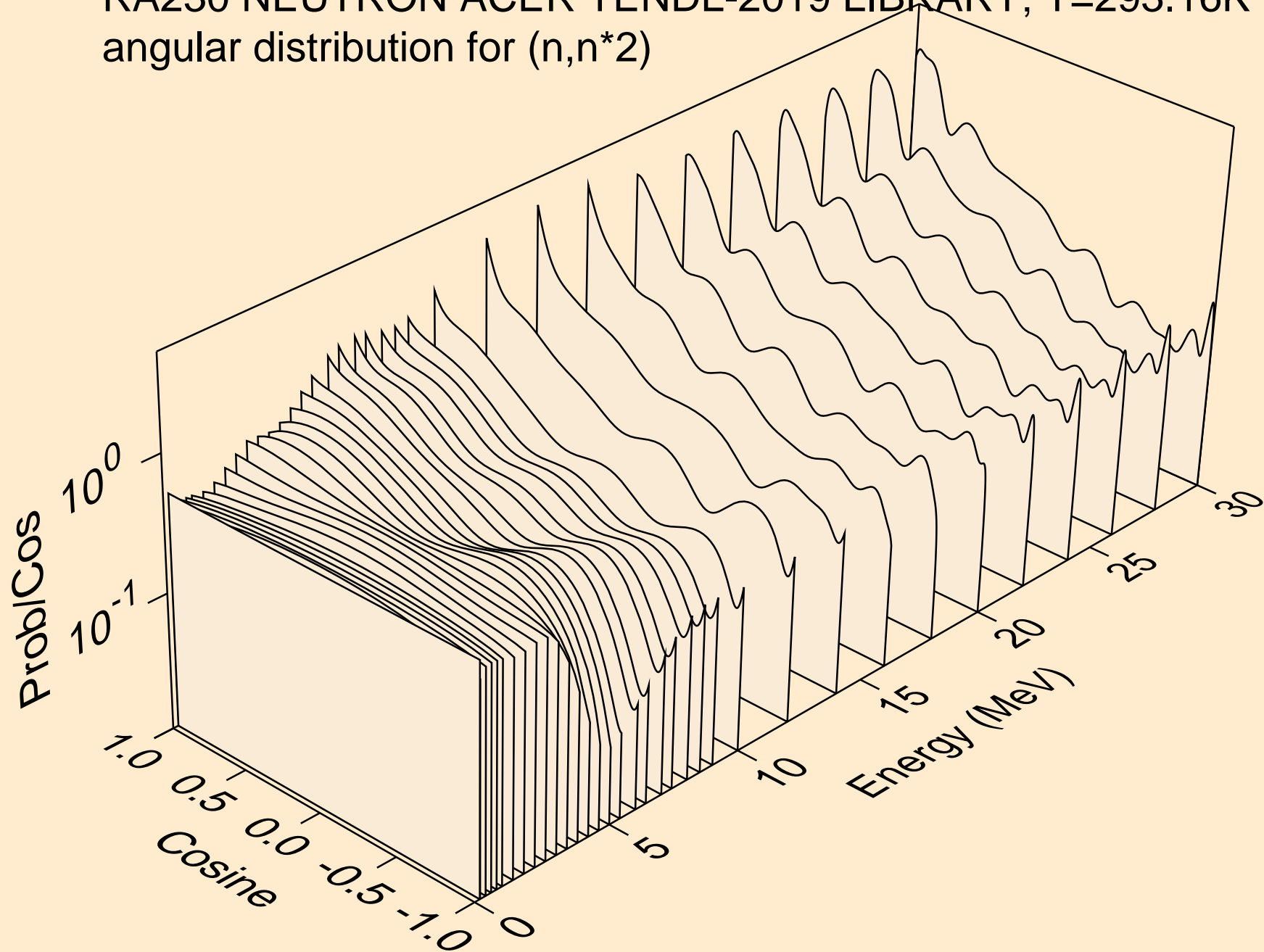

RA230 NEUTRON ACER TENDL-2019 LIBRARY; T=293.16K
angular distribution for (n,n*3)

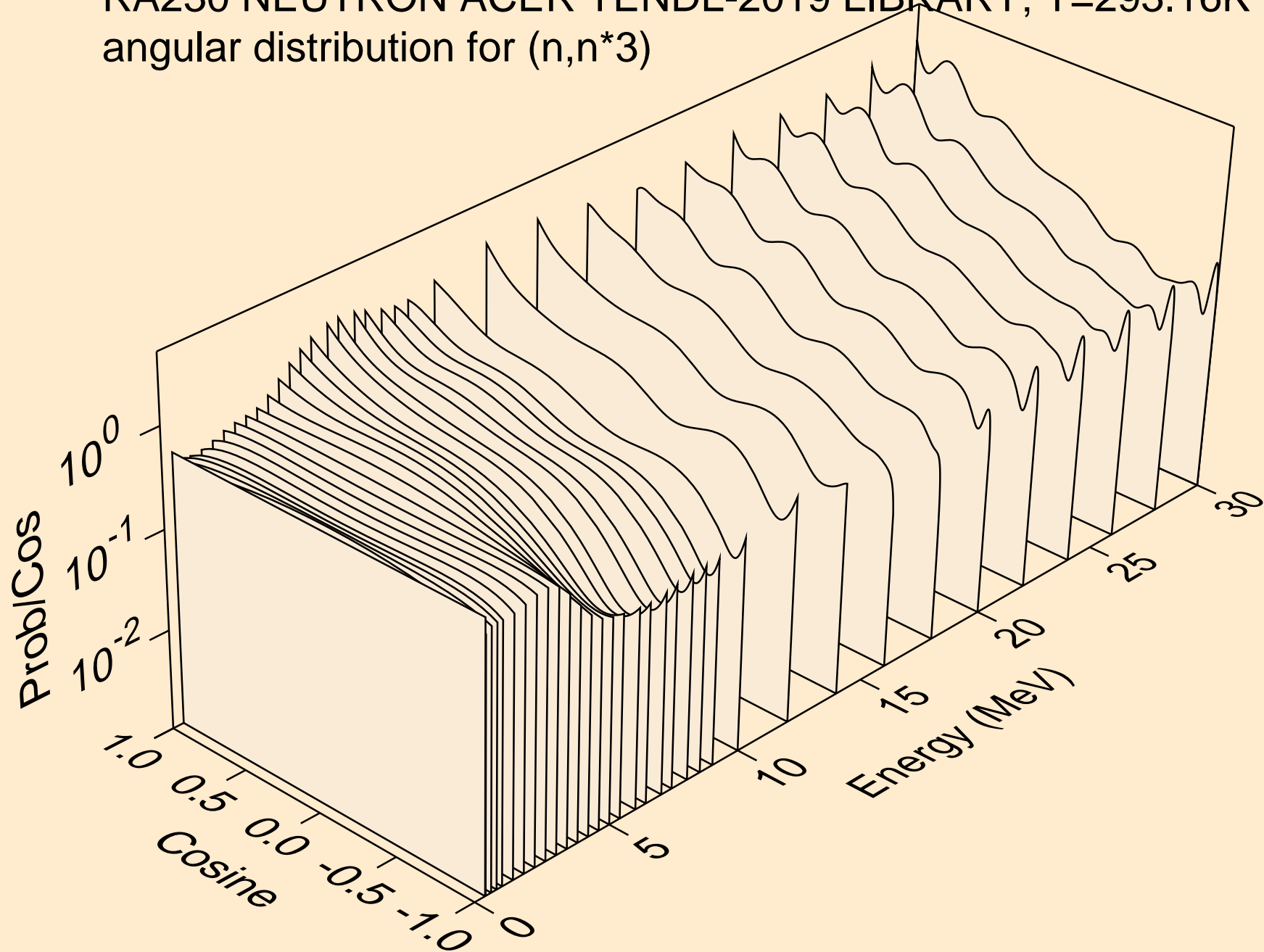

RA230 NEUTRON ACER TENDL-2019 LIBRARY; T=293.16K
angular distribution for (n,n*4)

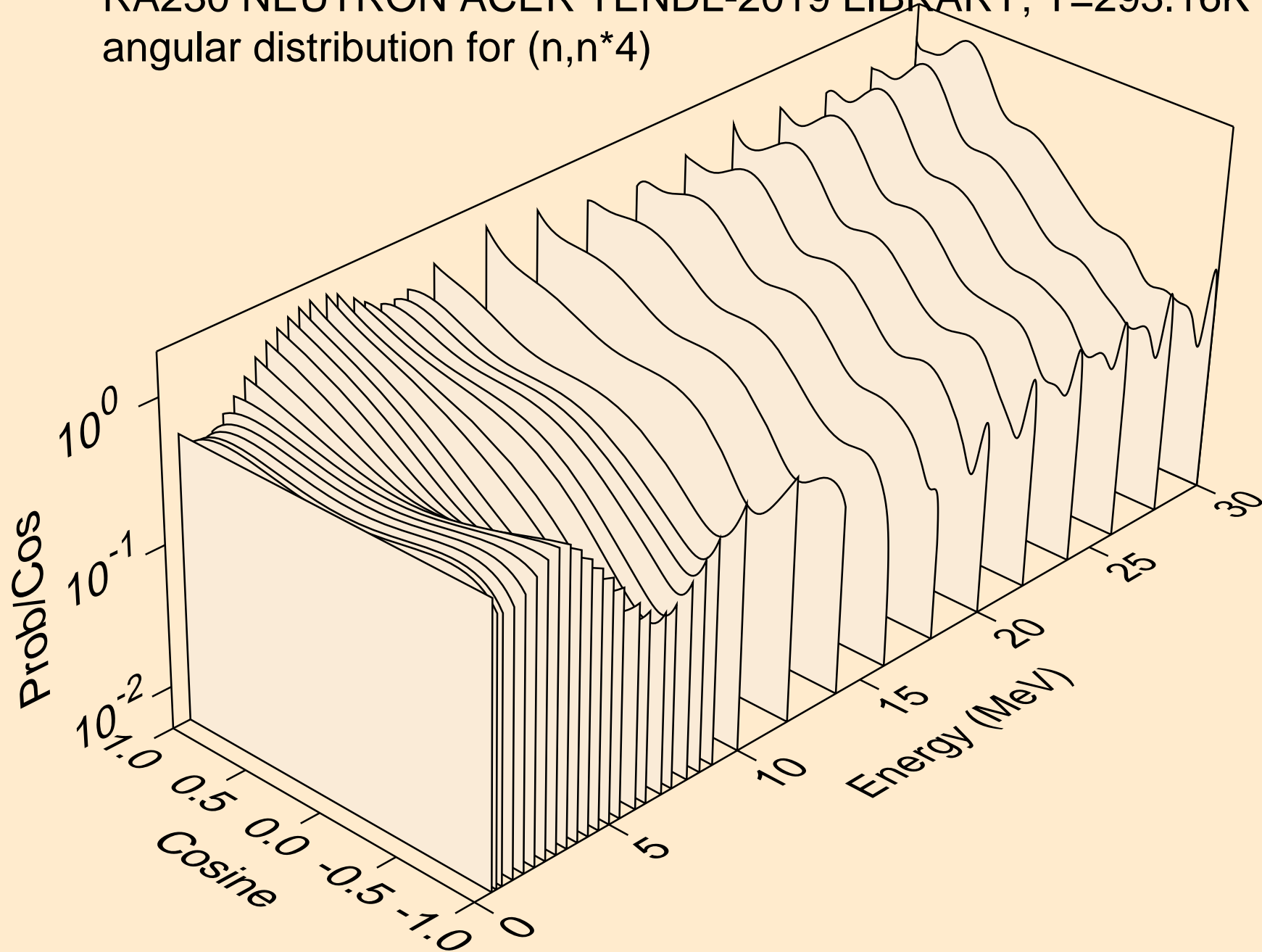

RA230 NEUTRON ACER TENDL-2019 LIBRARY; T=293.16K
angular distribution for (n,n*5)

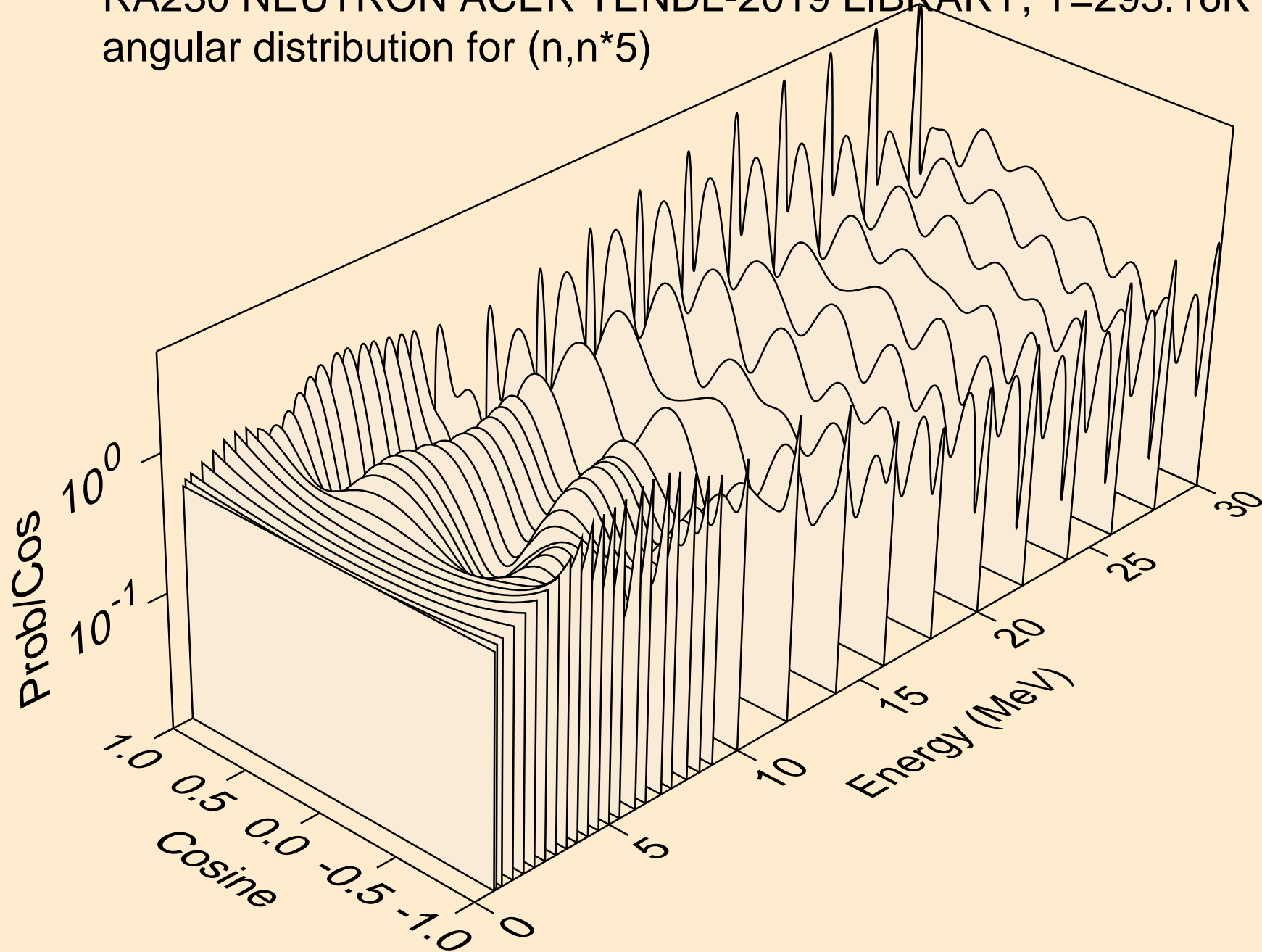

RA230 NEUTRON ACER TENDL-2019 LIBRARY; T=293.16K
angular distribution for (n,n*6)

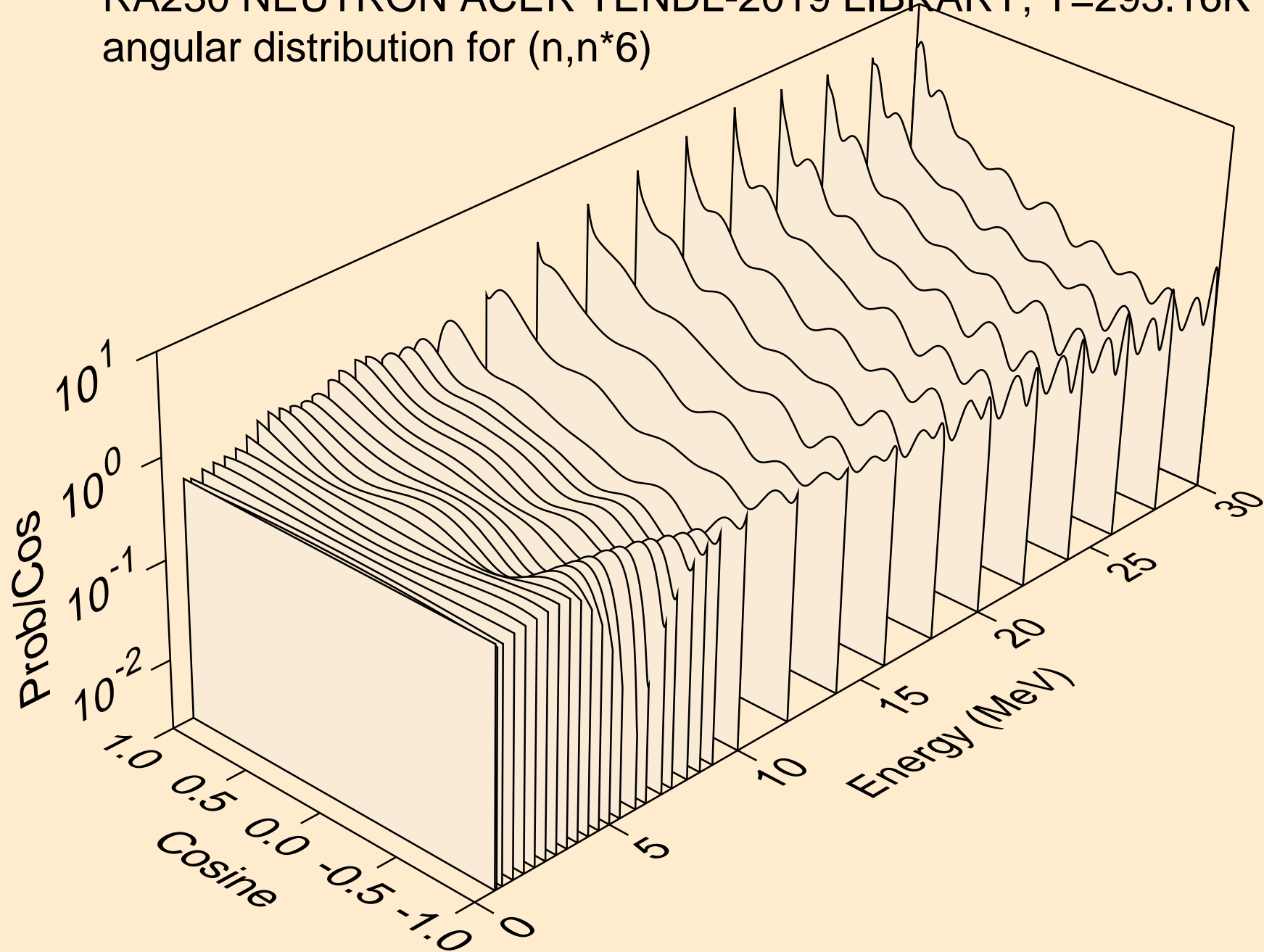

RA230 NEUTRON ACER TENDL-2019 LIBRARY; T=293.16K
angular distribution for (n,n*7)

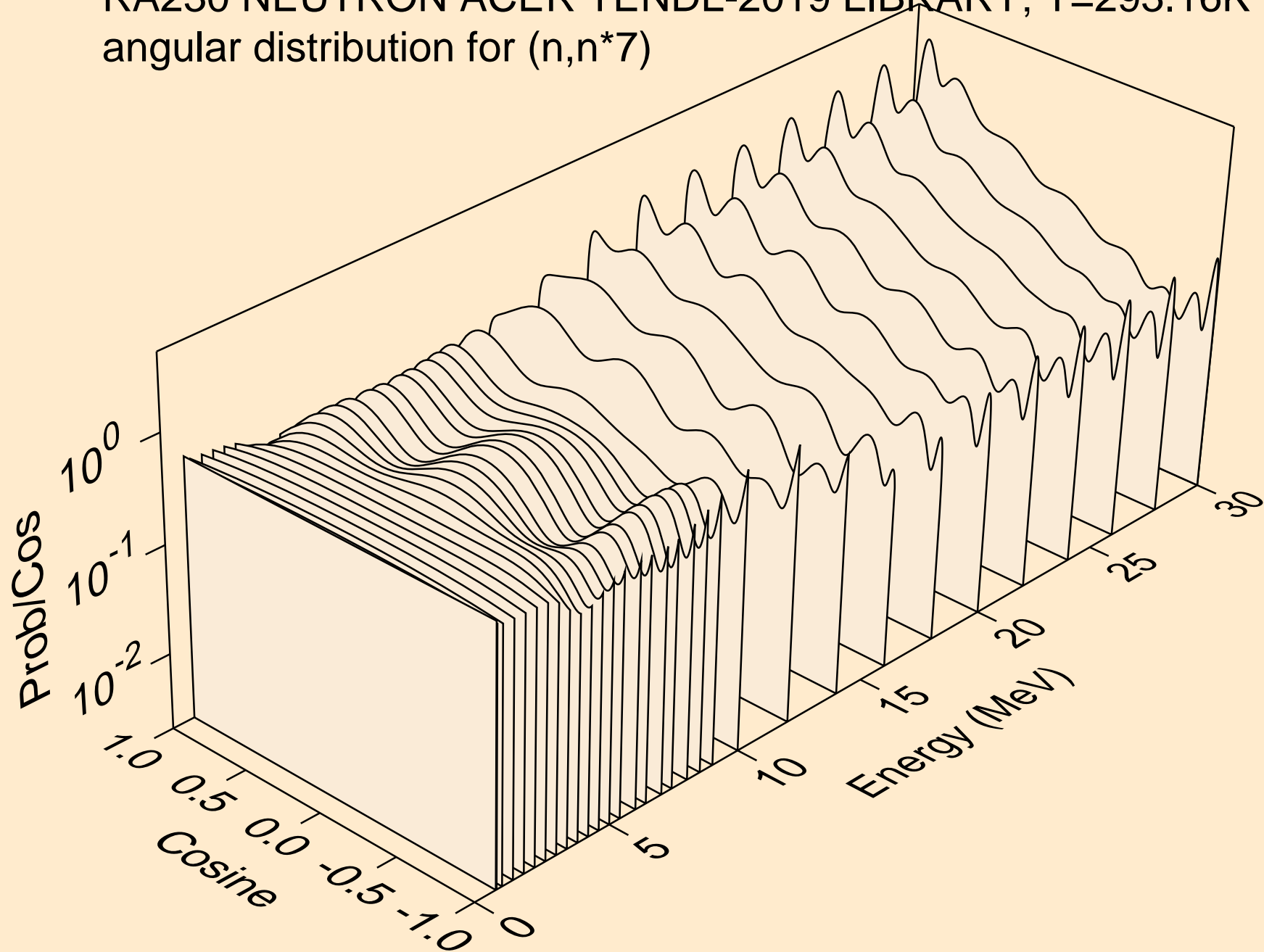

RA230 NEUTRON ACER TENDL-2019 LIBRARY; T=293.16K
angular distribution for (n,n*8)

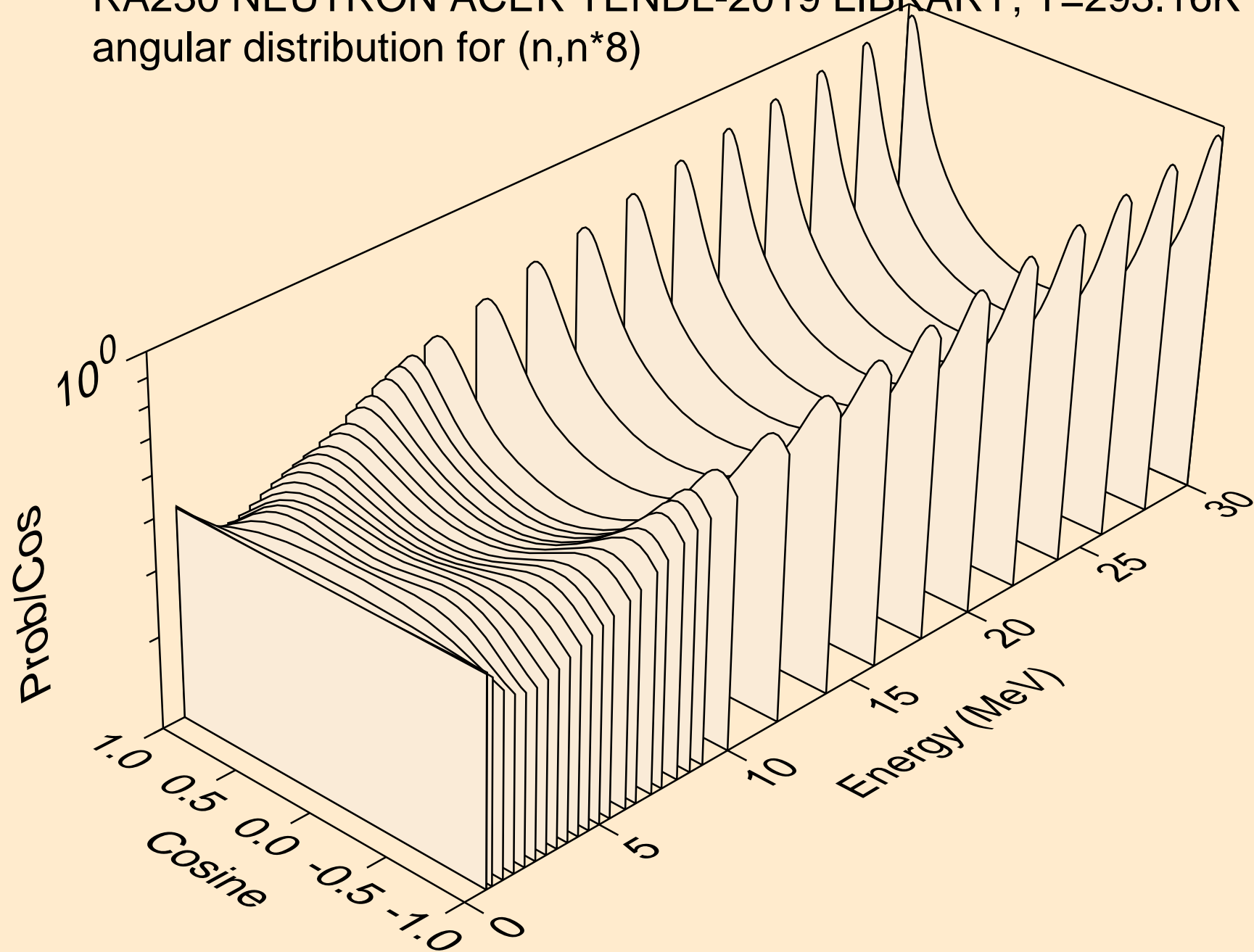

RA230 NEUTRON ACER TENDL-2019 LIBRARY; T=293.16K
angular distribution for (n,n*9)

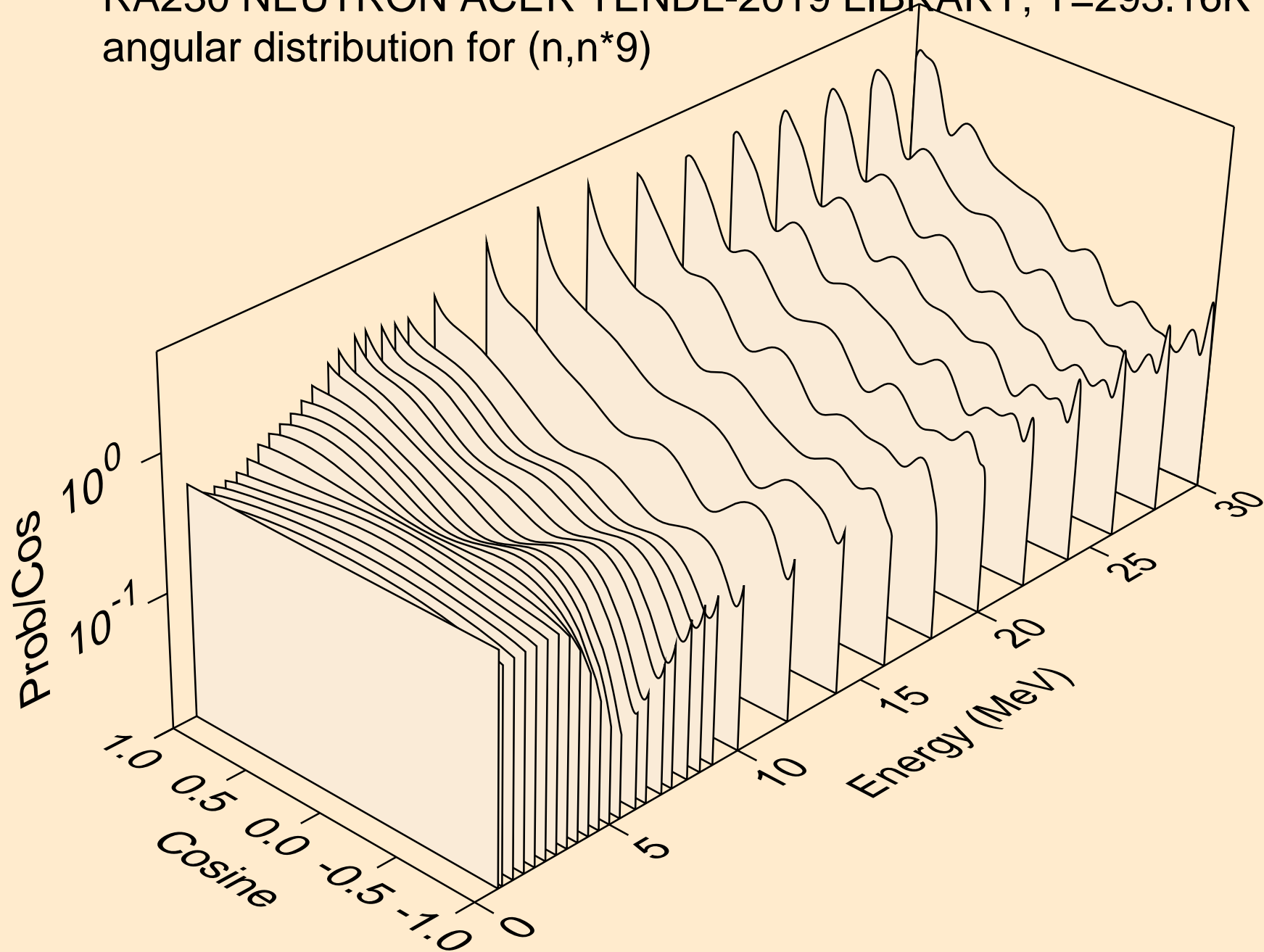

RA230 NEUTRON ACER TENDL-2019 LIBRARY; T=293.16K
angular distribution for (n,n*10)

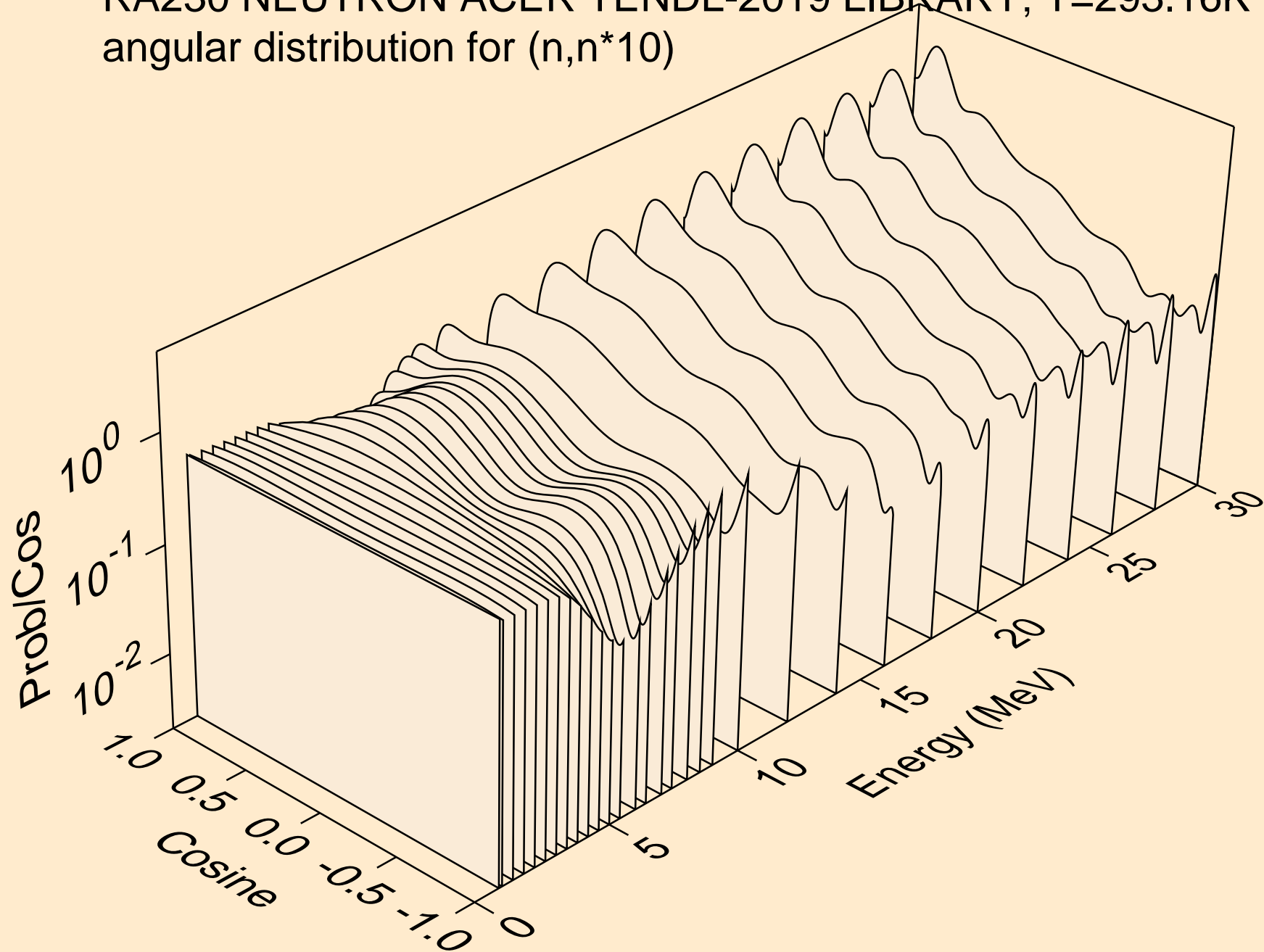

RA230 NEUTRON ACER TENDL-2019 LIBRARY; T=293.16K
angular distribution for (n,n*11)

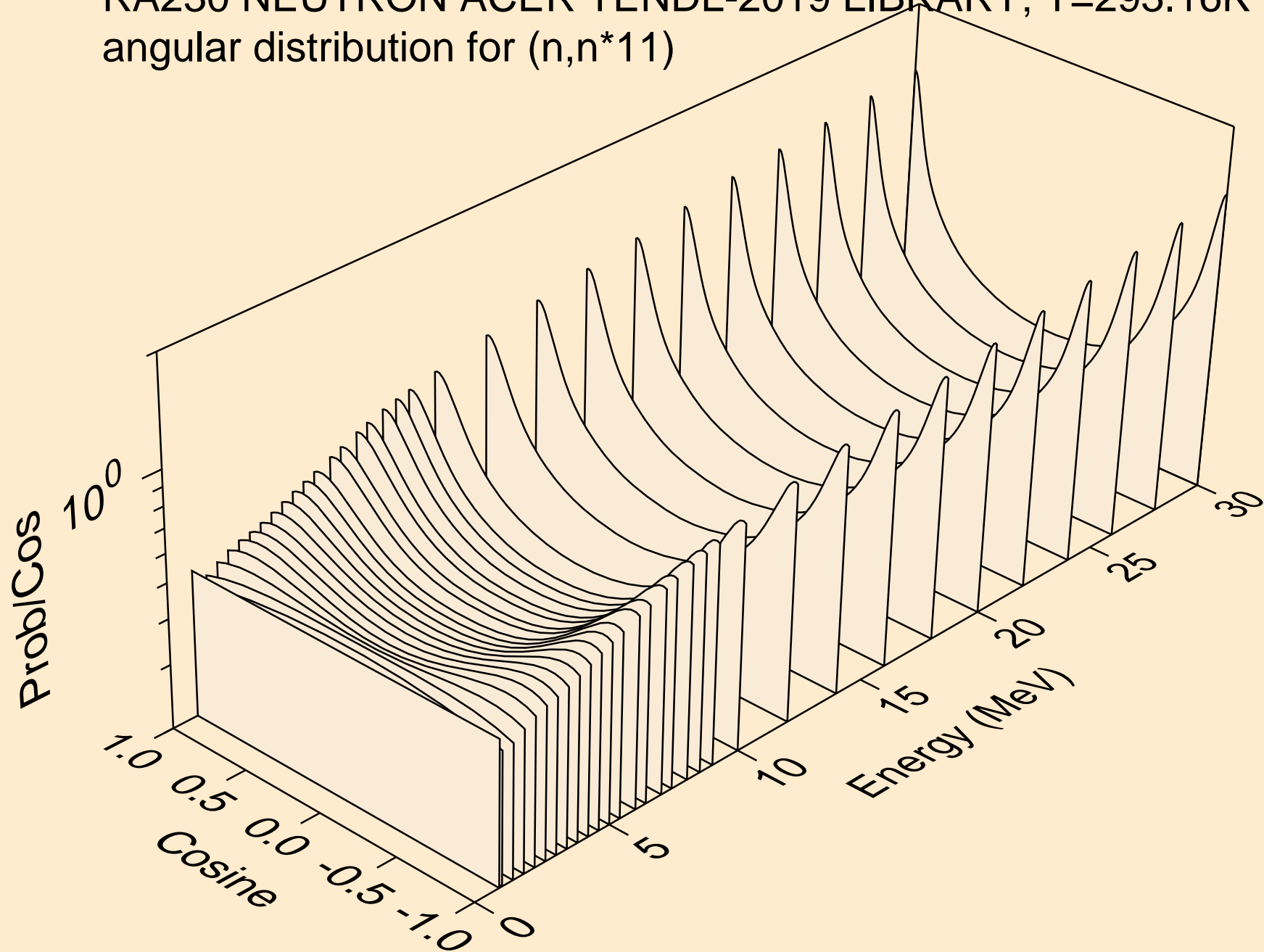

RA230 NEUTRON ACER TENDL-2019 LIBRARY; T=293.16K
angular distribution for (n,n*12)

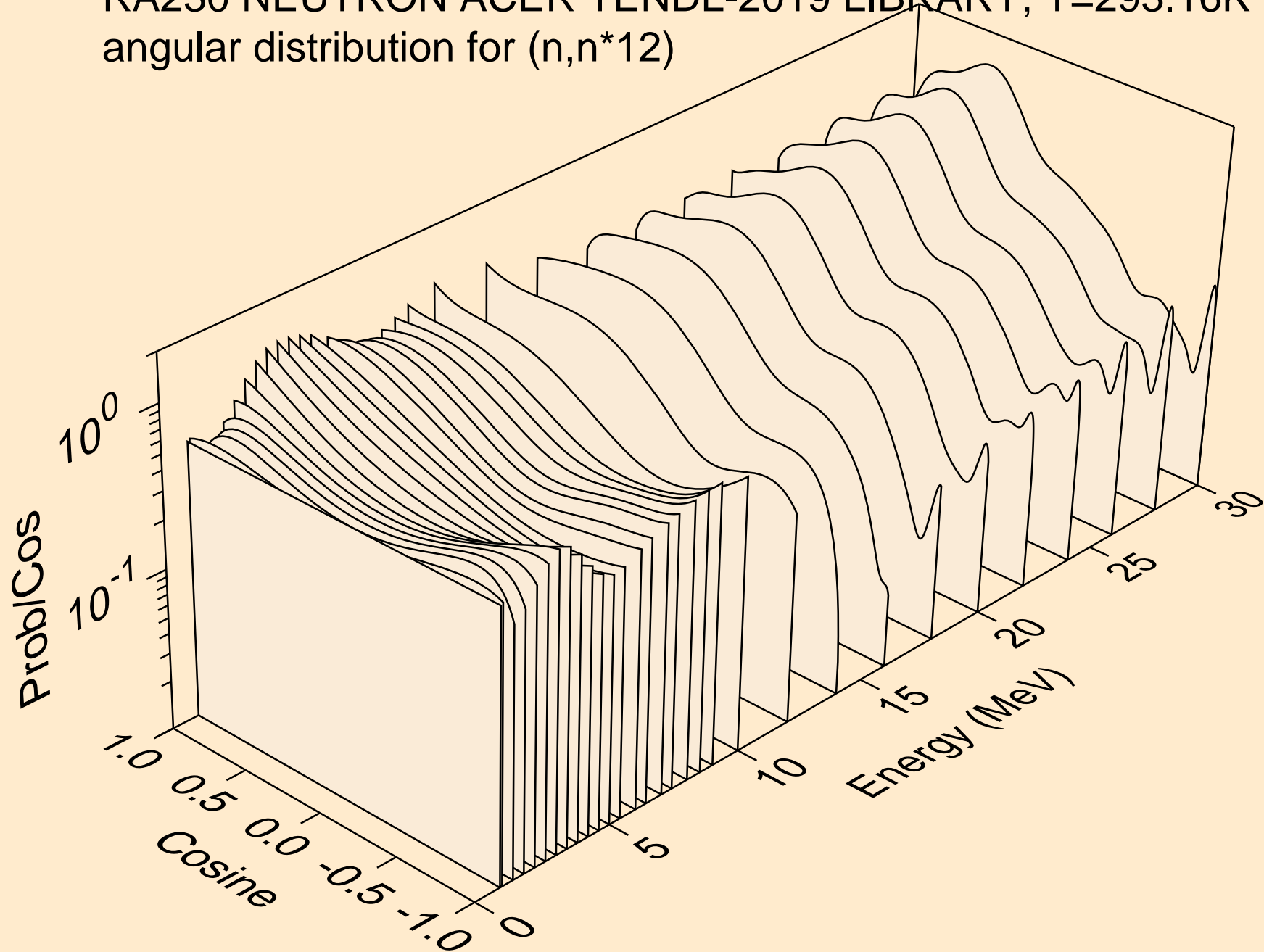

RA230 NEUTRON ACER TENDL-2019 LIBRARY; T=293.16K
angular distribution for (n,n*13)

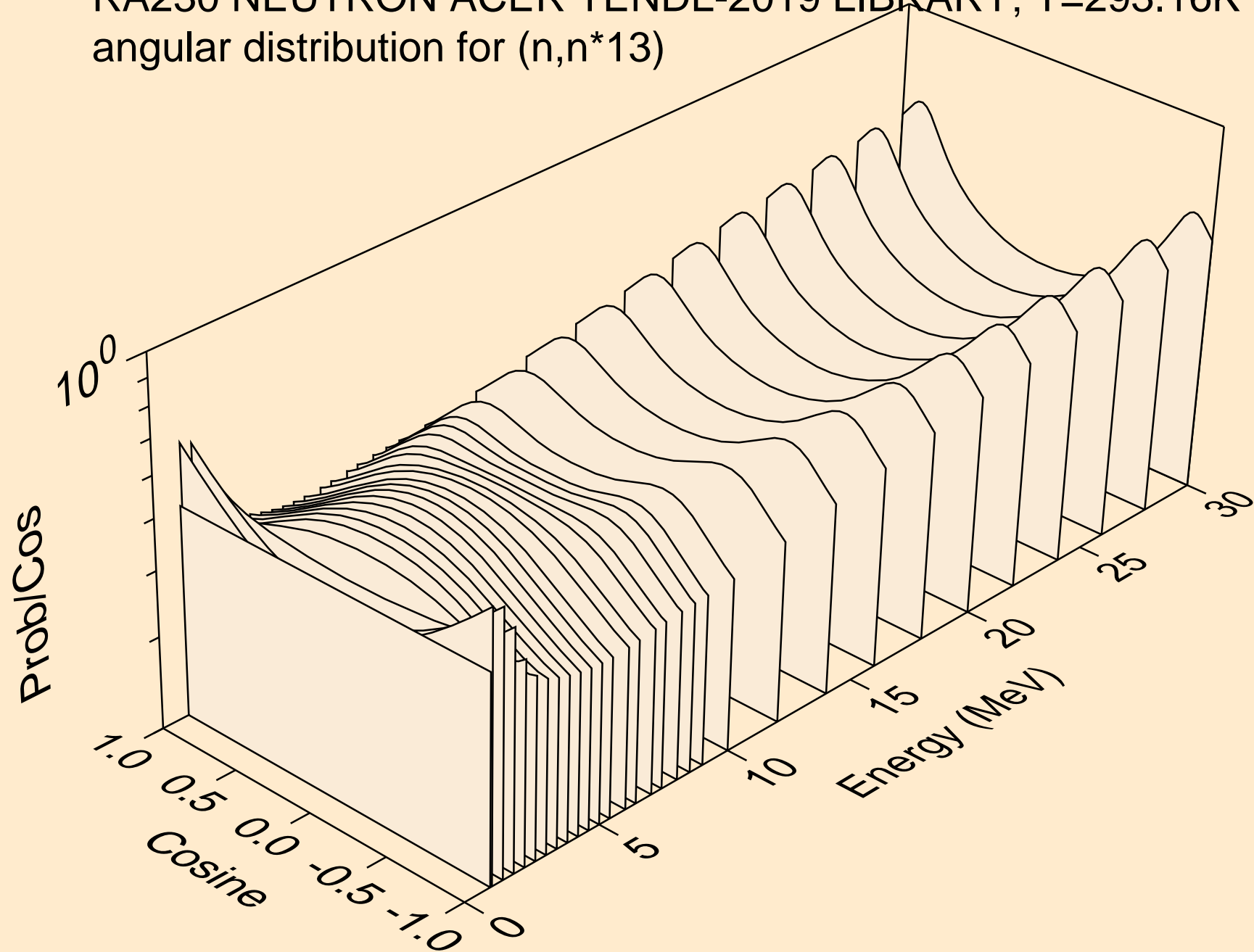

RA230 NEUTRON ACER TENDL-2019 LIBRARY; T=293.16K
angular distribution for (n,n*14)

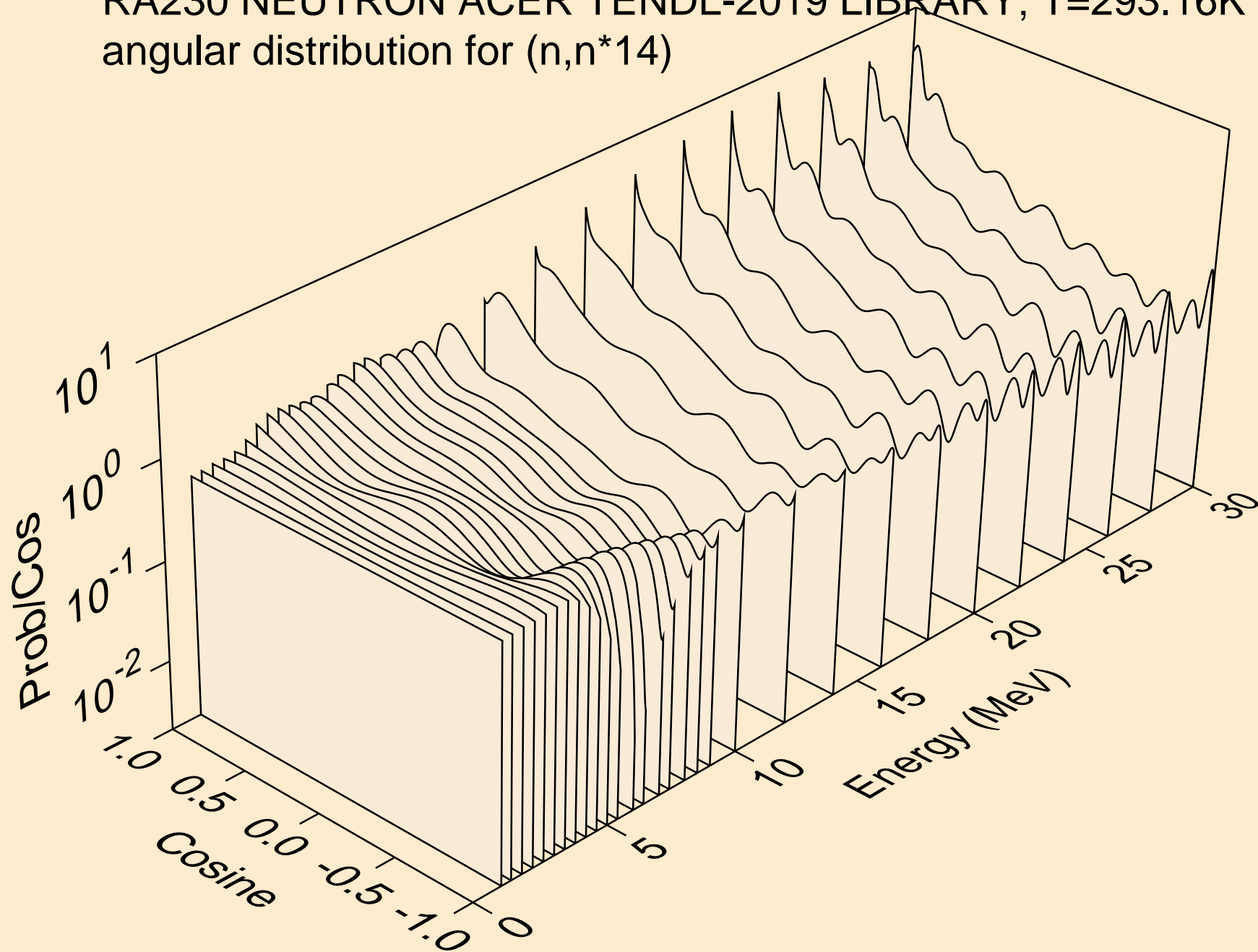

RA230 NEUTRON ACER TENDL-2019 LIBRARY; T=293.16K
angular distribution for (n,n*15)

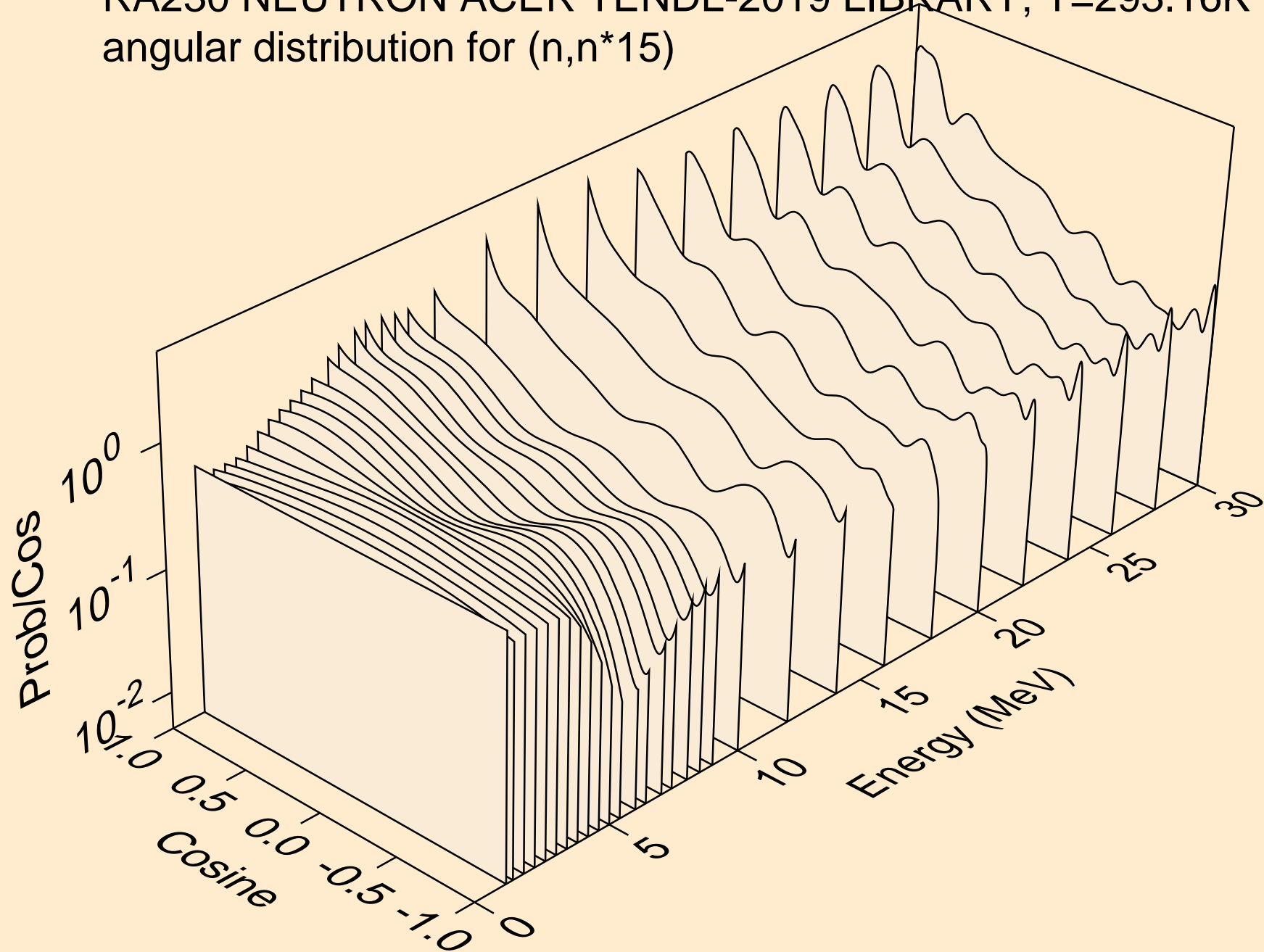

RA230 NEUTRON ACER TENDL-2019 LIBRARY; T=293.16K
angular distribution for (n,n*16)

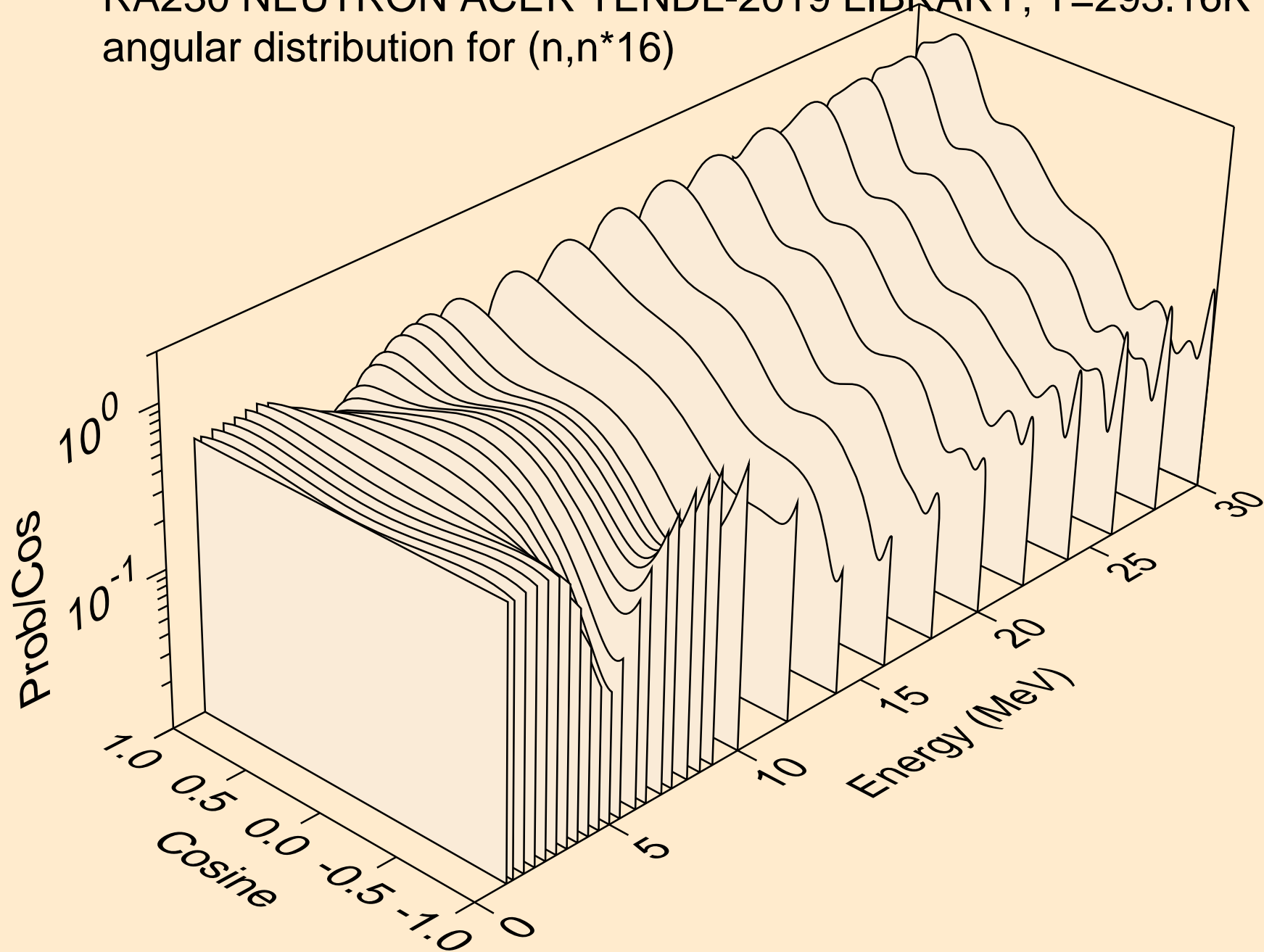

RA230 NEUTRON ACER TENDL-2019 LIBRARY; T=293.16K
angular distribution for (n,n*17)

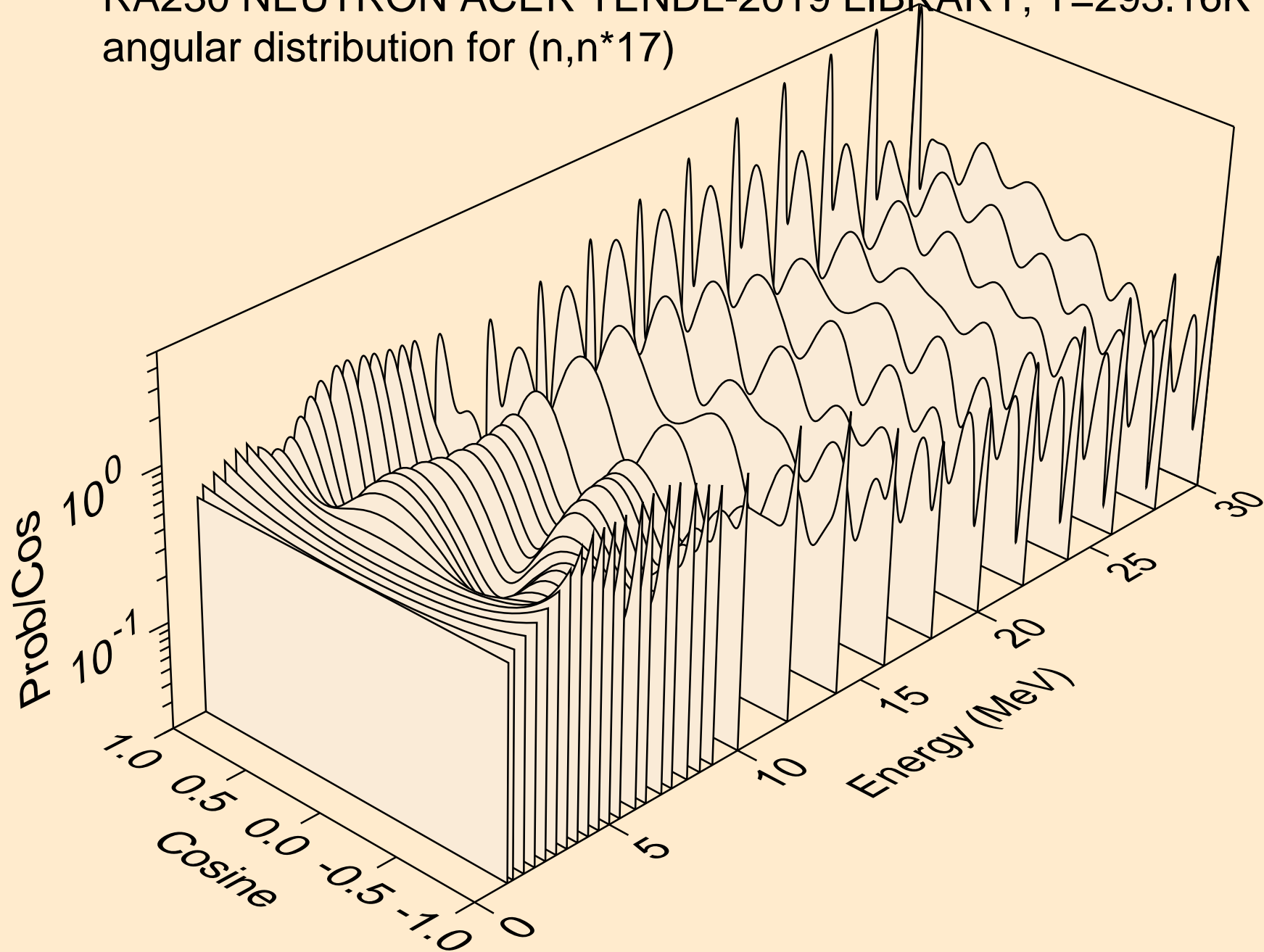

RA230 NEUTRON ACER TENDL-2019 LIBRARY; T=293.16K
angular distribution for (n,n*18)

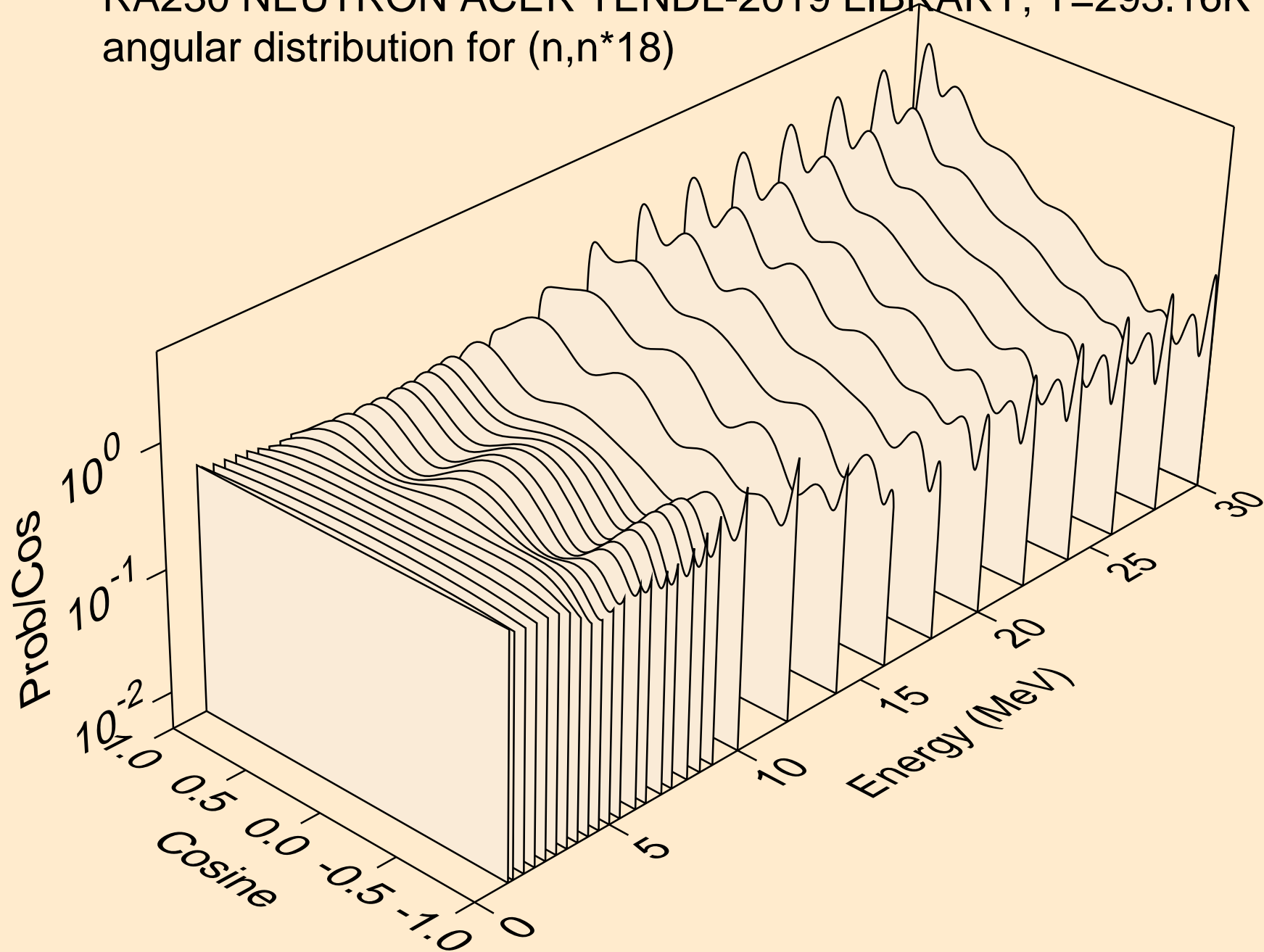

RA230 NEUTRON ACER TENDL-2019 LIBRARY; T=293.16K
angular distribution for (n,n*19)

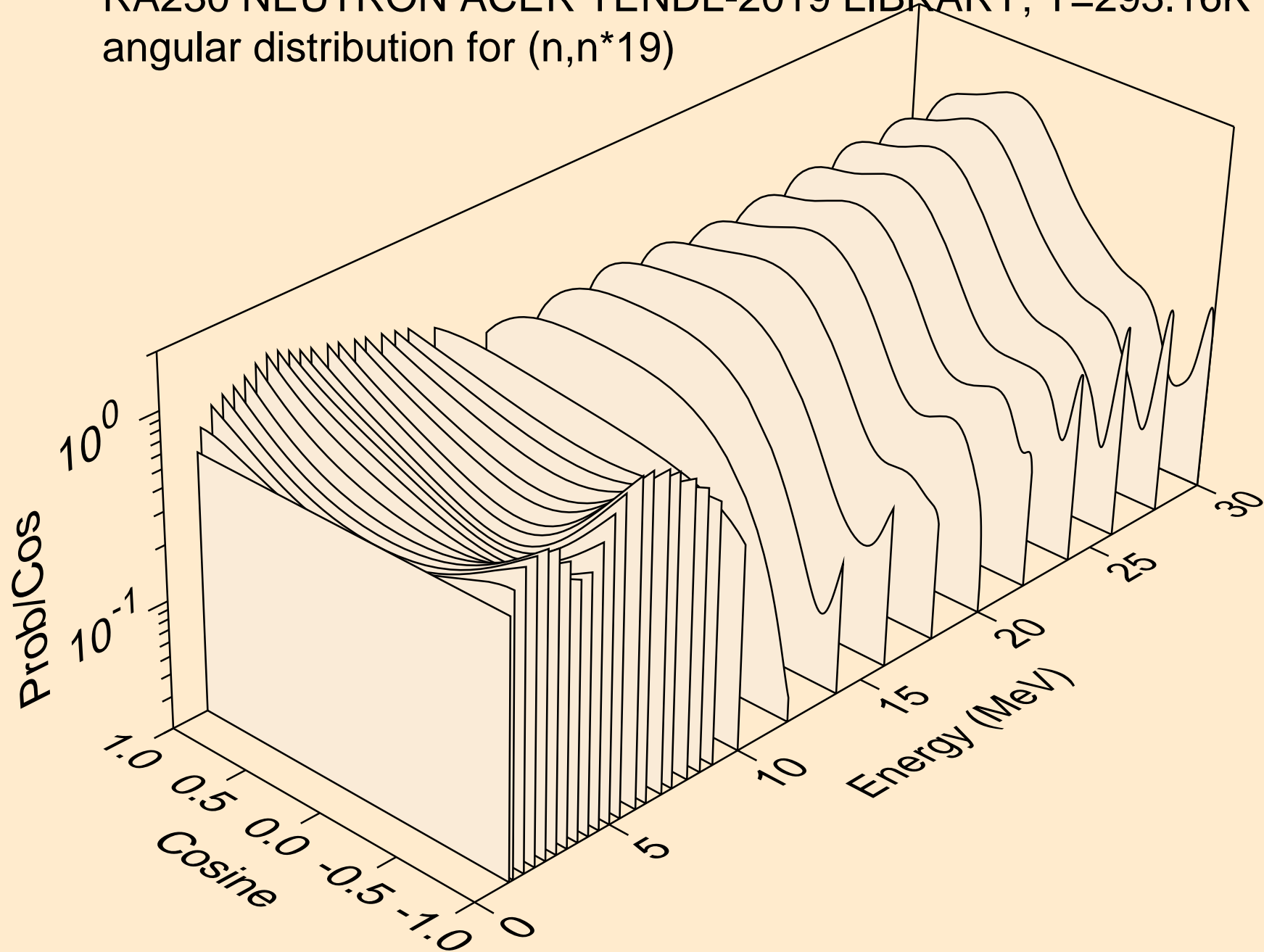

RA230 NEUTRON ACER TENDL-2019 LIBRARY; T=293.16K
angular distribution for (n,n*20)

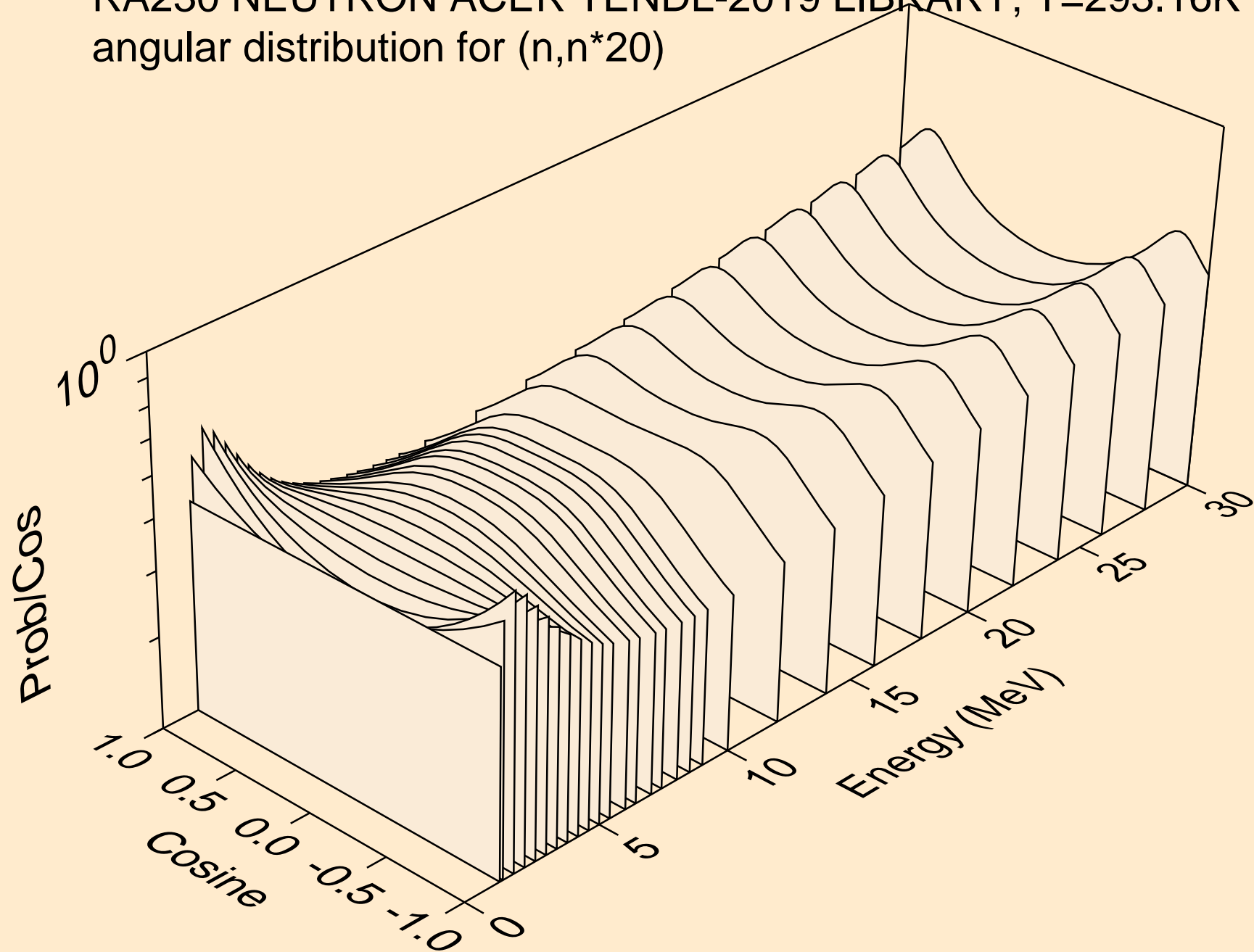

RA230 NEUTRON ACER TENDL-2019 LIBRARY; T=293.16K
angular distribution for (n,n*21)

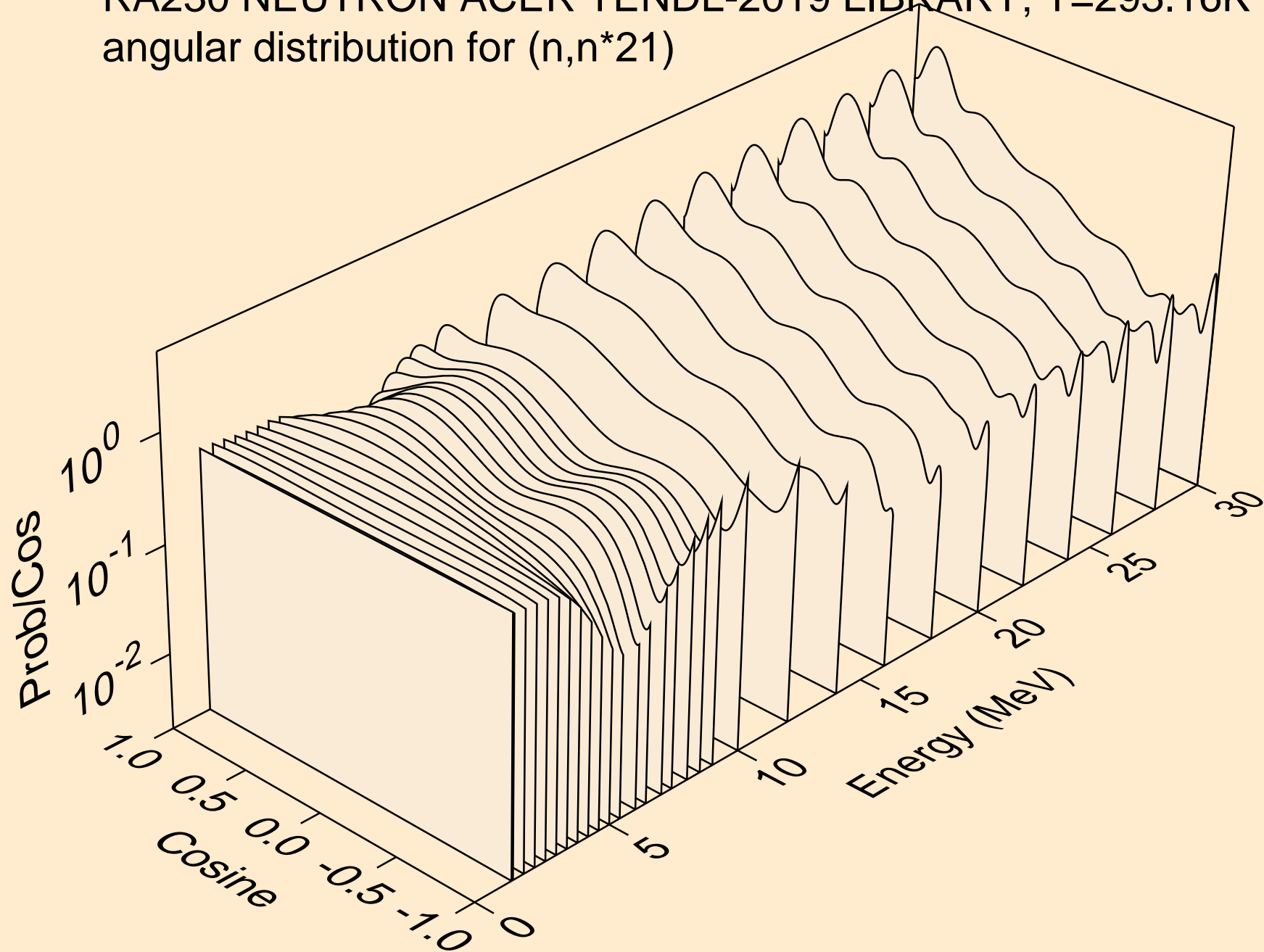

RA230 NEUTRON ACER TENDL-2019 LIBRARY; T=293.16K
angular distribution for (n,n*22)

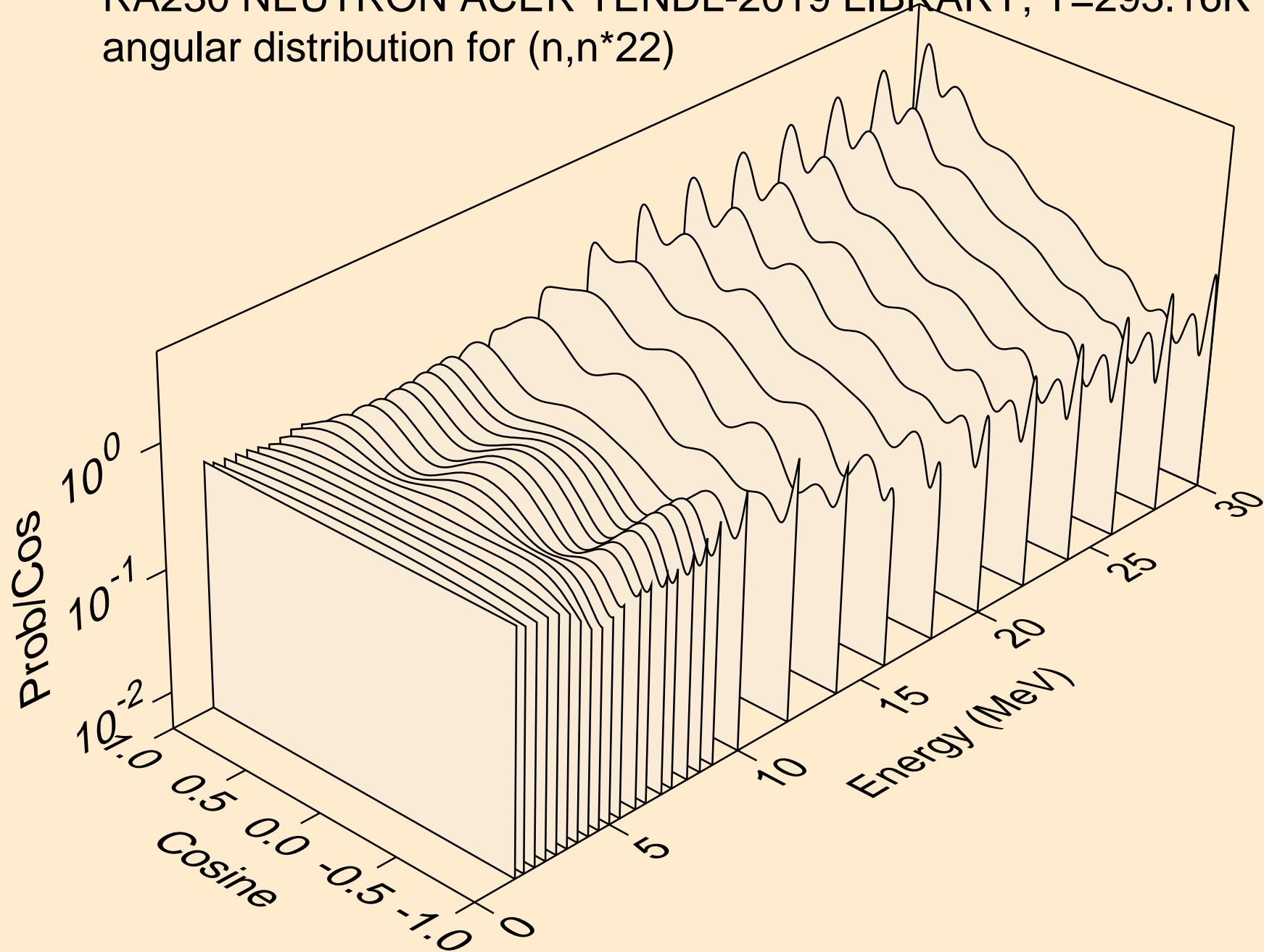

RA230 NEUTRON ACER TENDL-2019 LIBRARY; T=293.16K
angular distribution for (n,n*23)

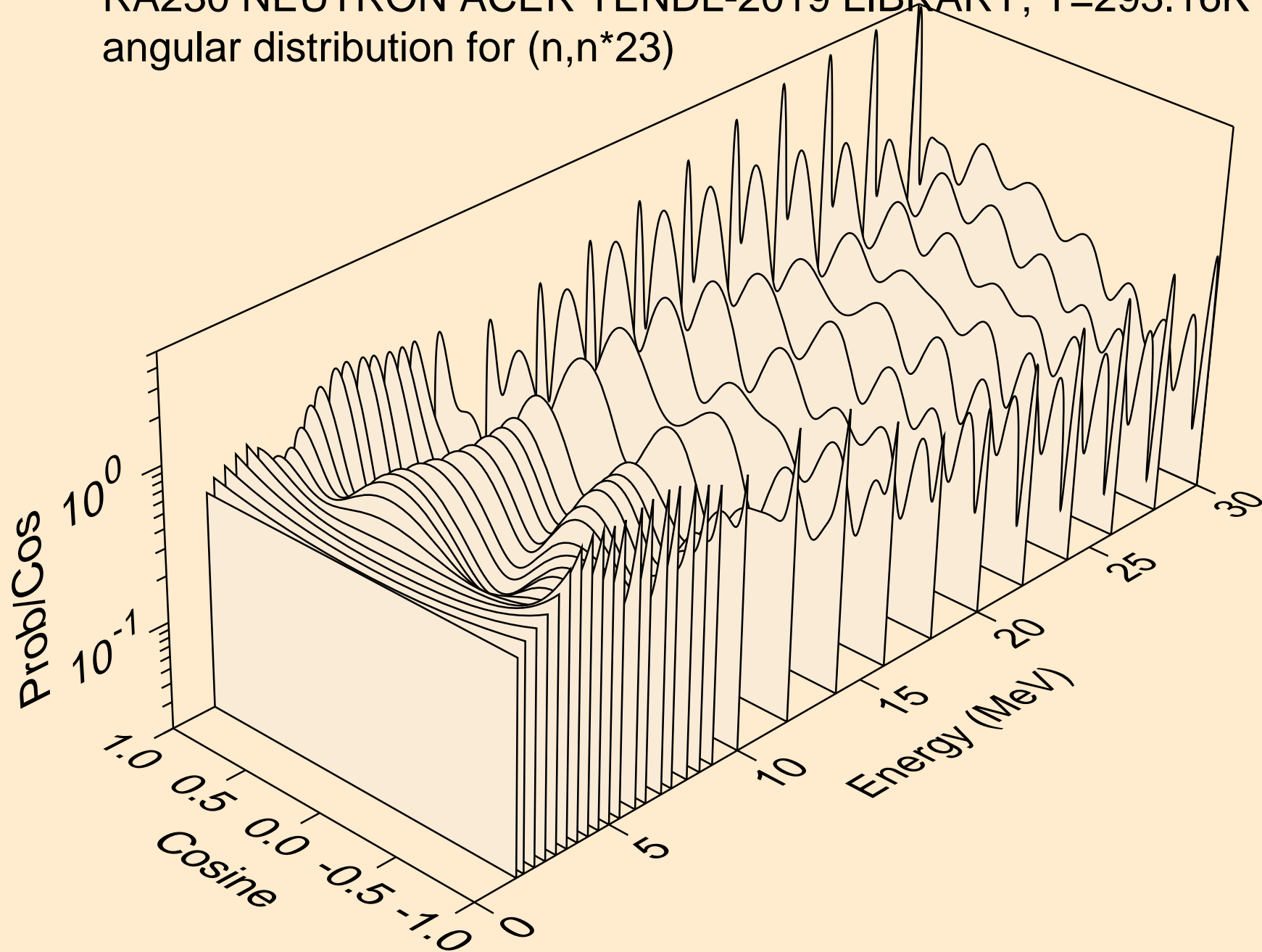

RA230 NEUTRON ACER TENDL-2019 LIBRARY; T=293.16K
angular distribution for (n,n*24)

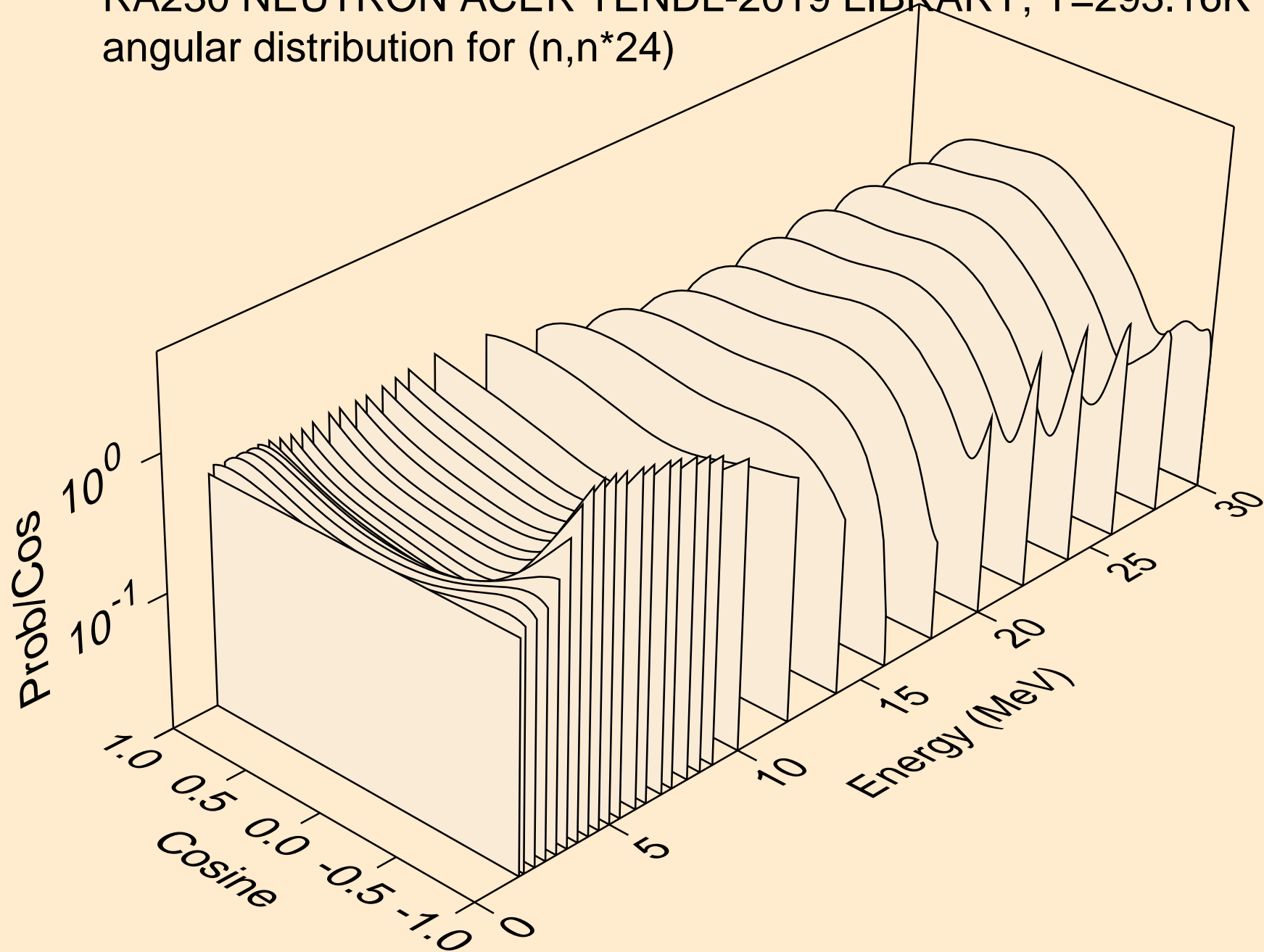

RA230 NEUTRON ACER TENDL-2019 LIBRARY; T=293.16K
angular distribution for (n,n*25)

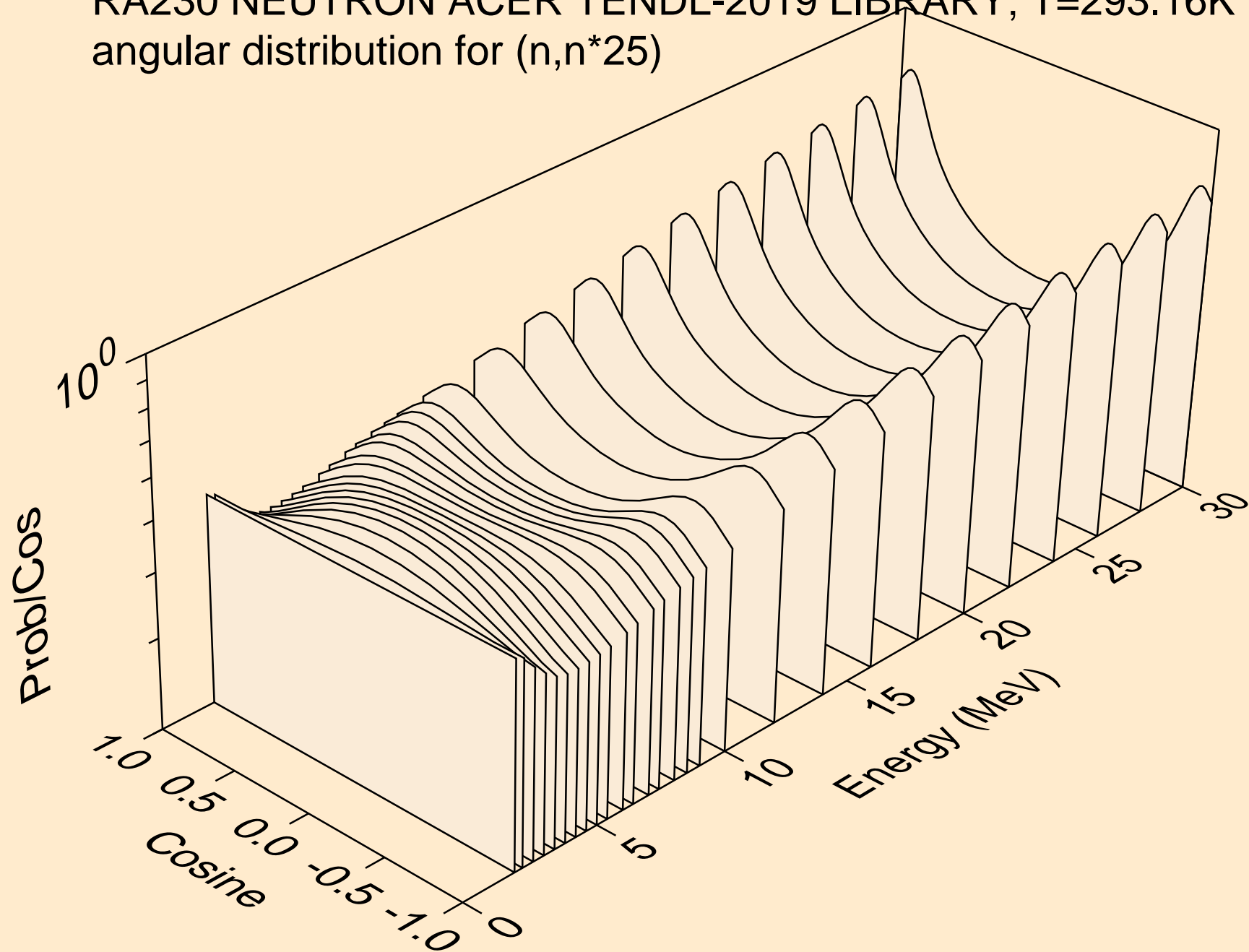

RA230 NEUTRON ACER TENDL-2019 LIBRARY; T=293.16K
angular distribution for (n,n*26)

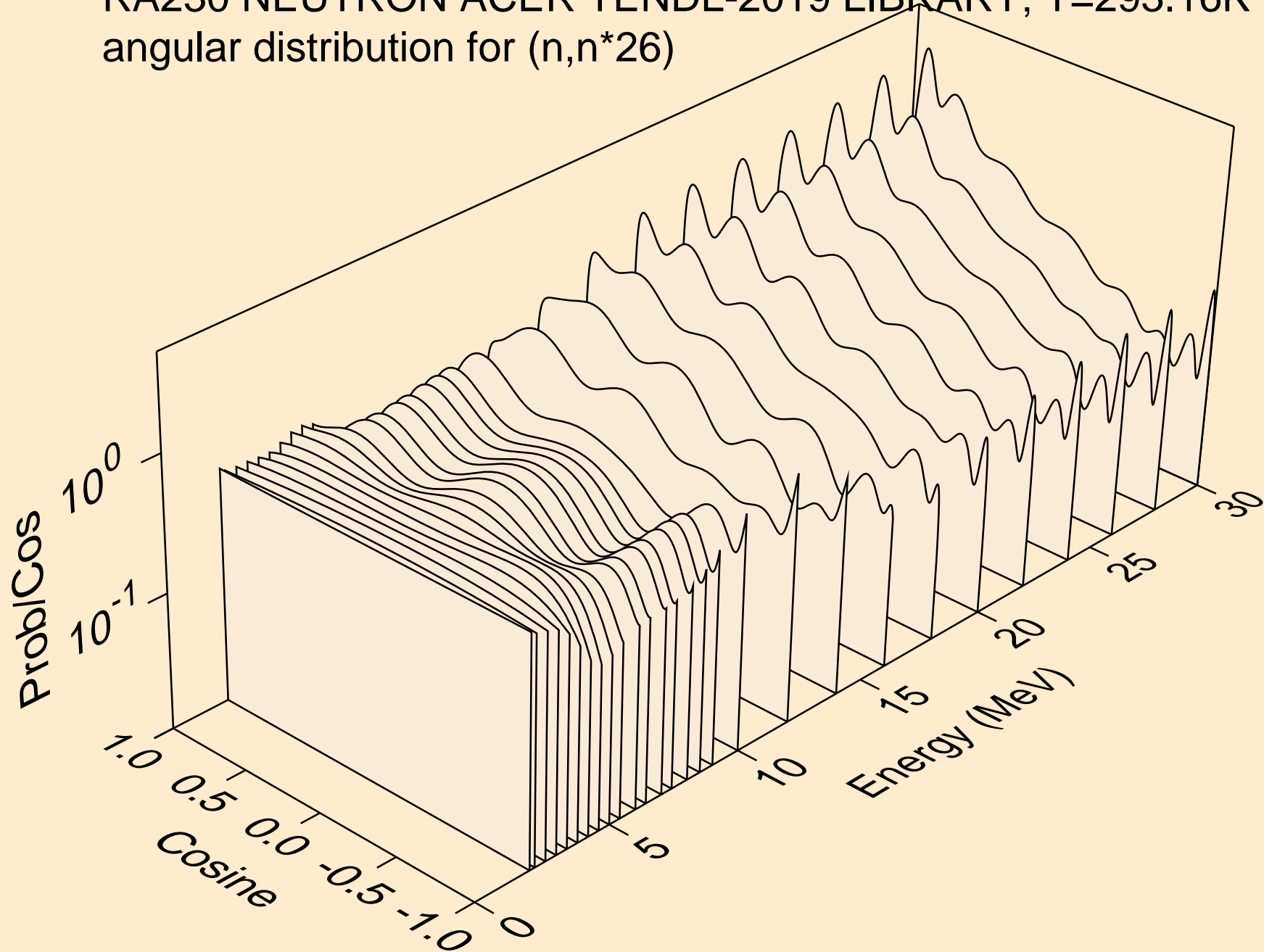

RA230 NEUTRON ACER TENDL-2019 LIBRARY; T=293.16K
Total fission nubar

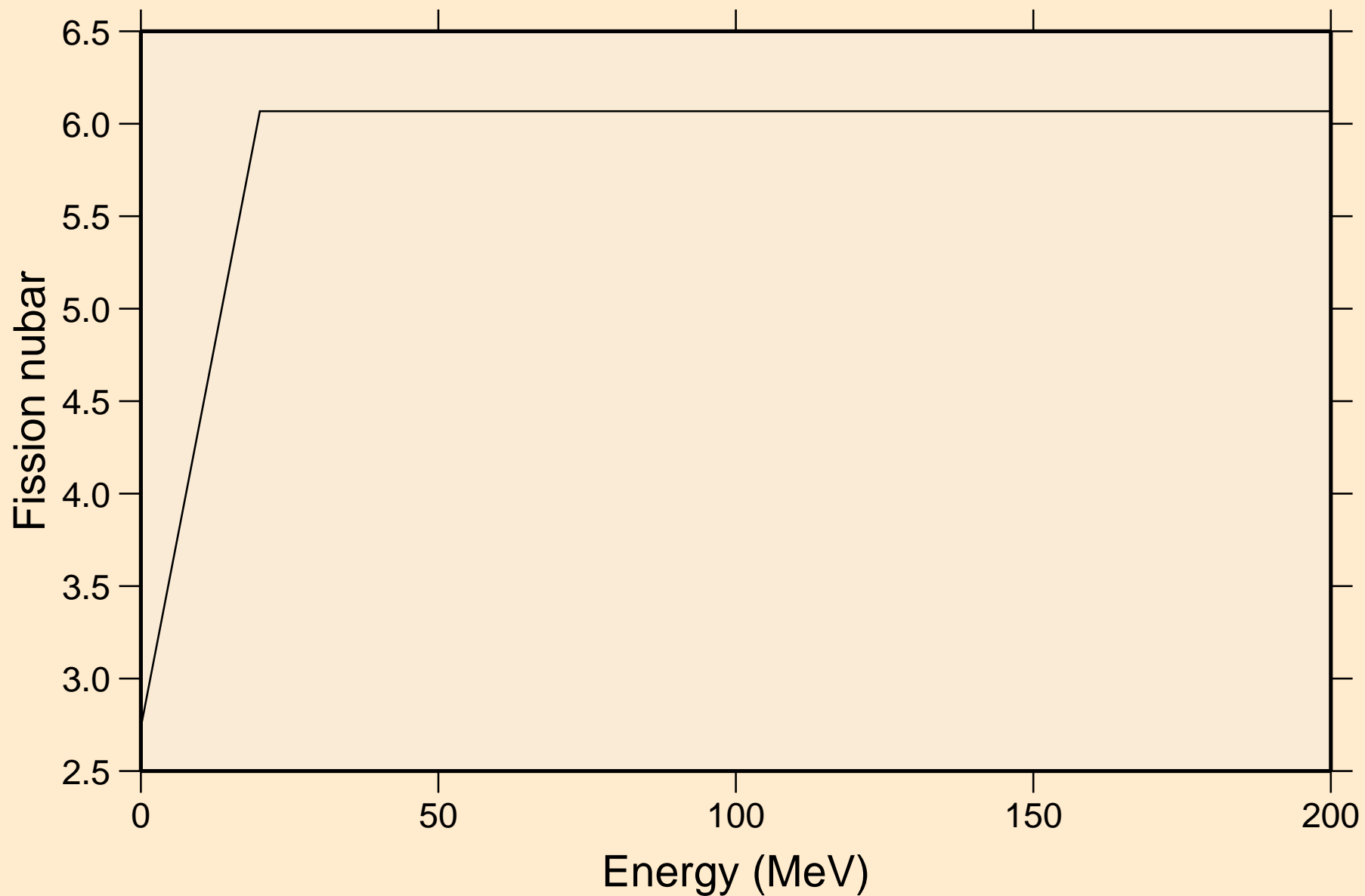

RA230 NEUTRON ACER TENDL-2019 LIBRARY; T=293.16K
Neutron emission for (n,x)

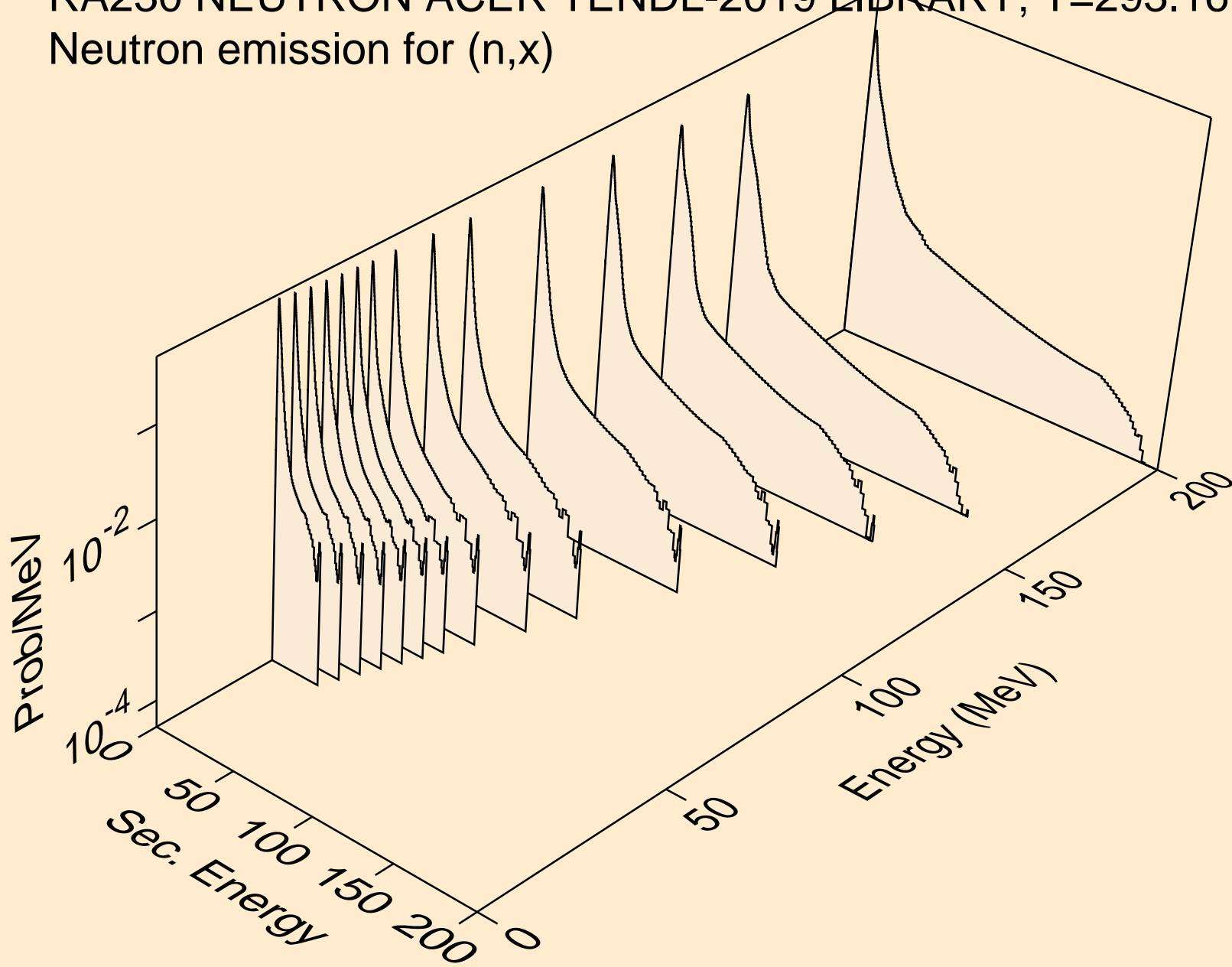

RA230 NEUTRON ACER TENDL-2019 LIBRARY; T=293.16K
Neutron emission for (n,2nd)

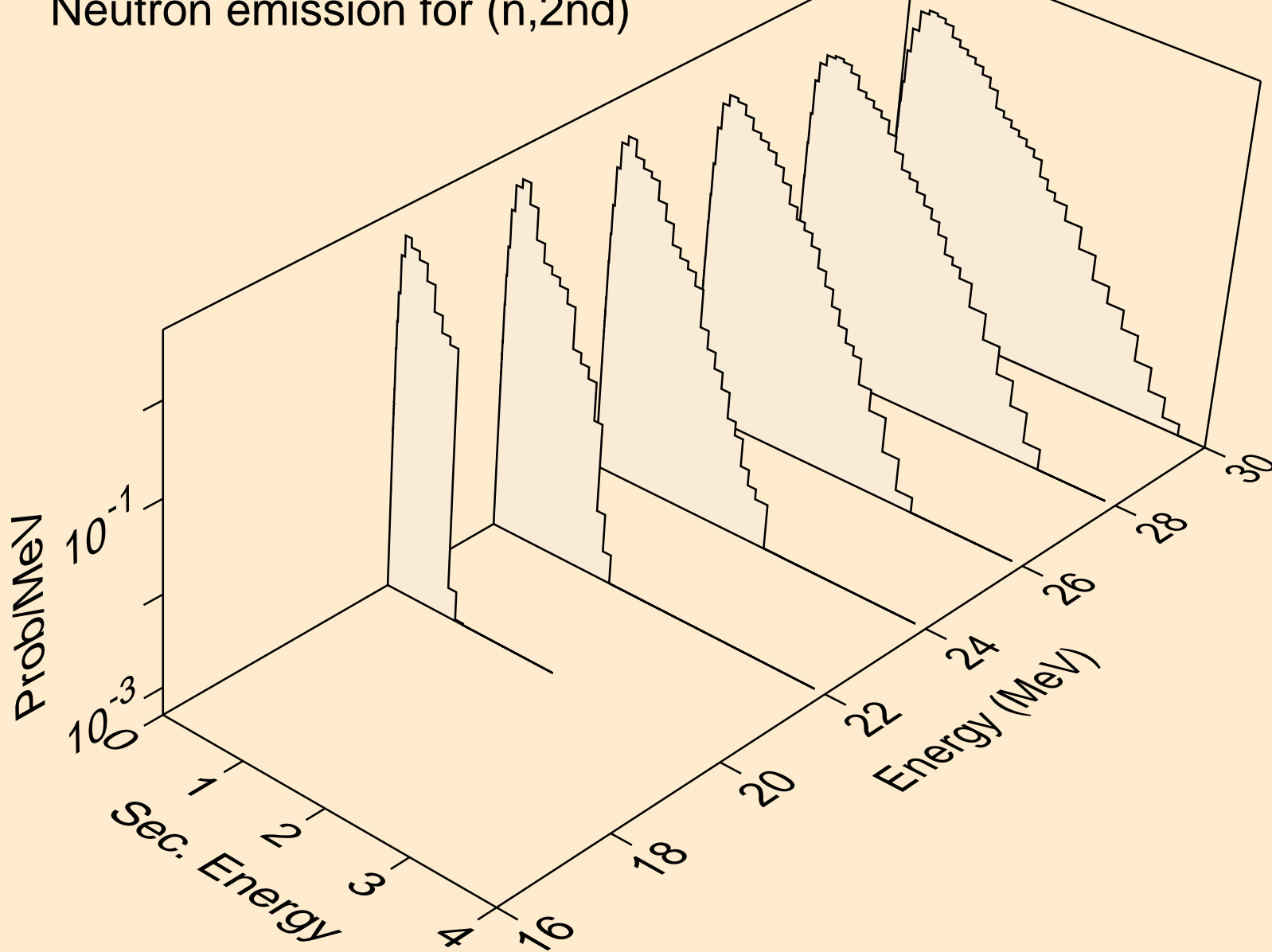

RA230 NEUTRON ACER TENDL-2019 LIBRARY; T=293.16K
Neutron emission for (n,2n)

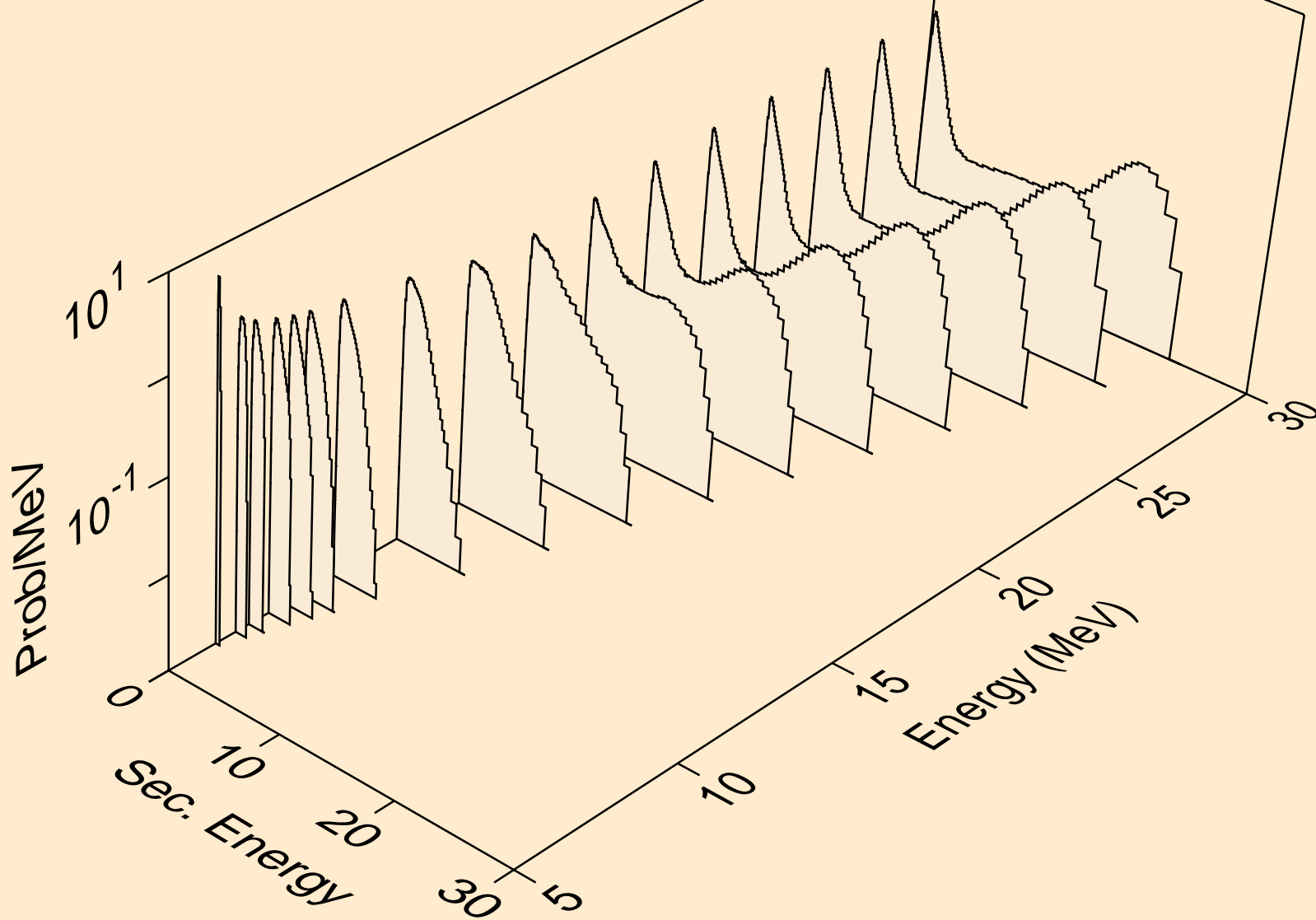

RA230 NEUTRON ACER TENDL-2019 LIBRARY; T=293.16K
Neutron emission for (n,3n)

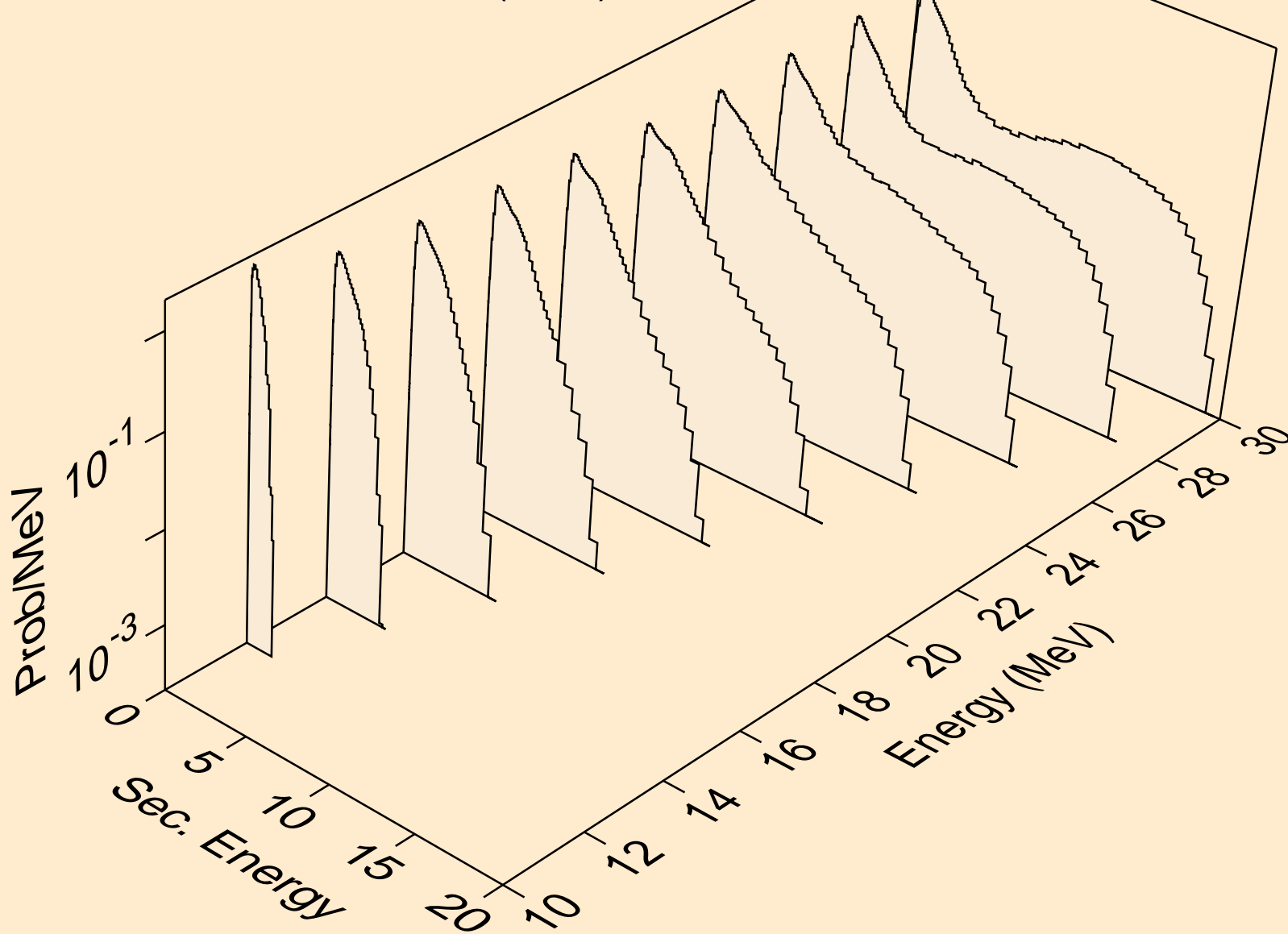

RA230 NEUTRON ACER TENDL-2019 LIBRARY; T=293.16K
Neutron emission for fission

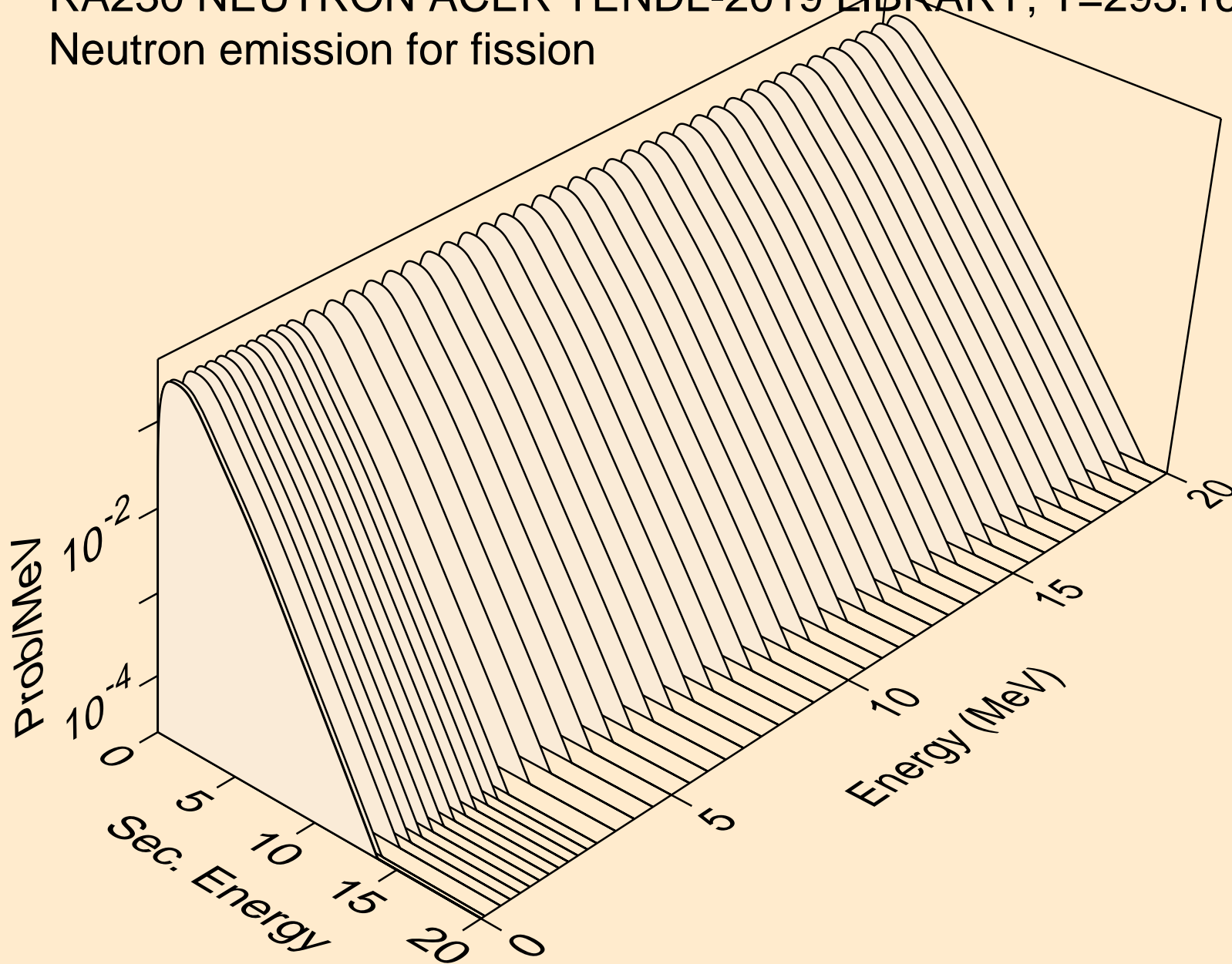

RA230 NEUTRON ACER TENDL-2019 LIBRARY; T=293.16K
Neutron emission for (n,n*)a

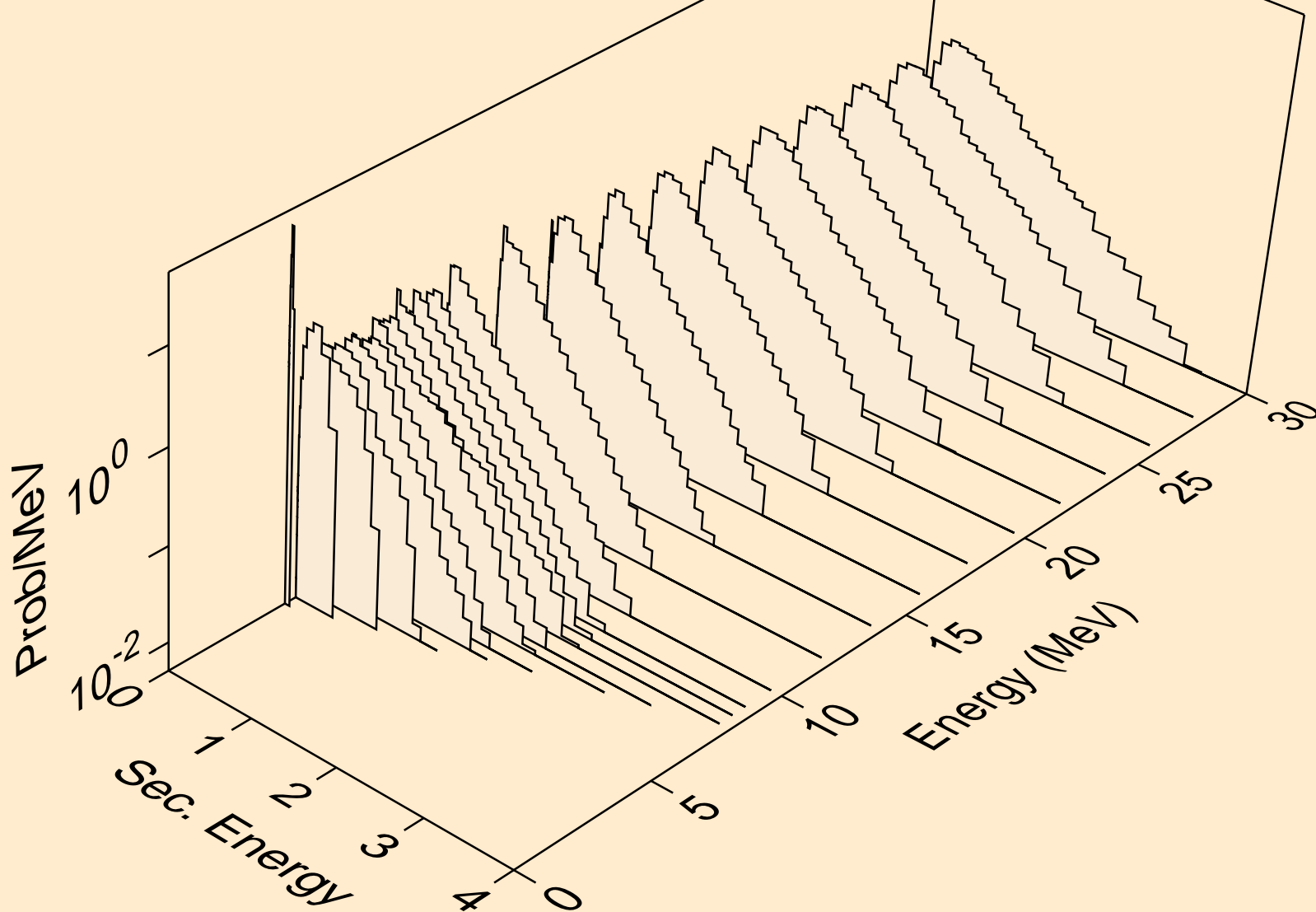

RA230 NEUTRON ACER TENDL-2019 LIBRARY; T=293.16K
Neutron emission for (n,2n)a

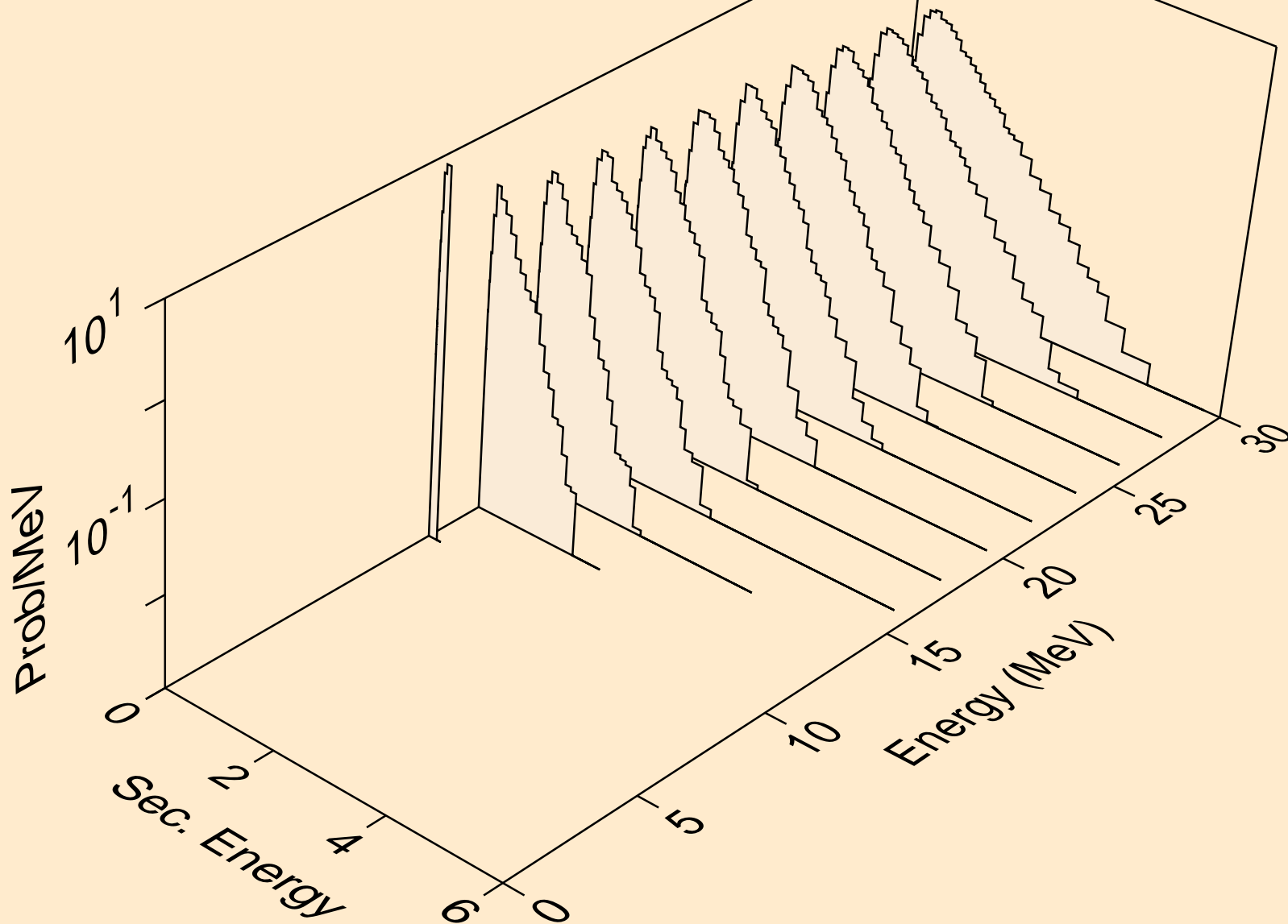

RA230 NEUTRON ACER TENDL-2019 LIBRARY; T=293.16K
Neutron emission for (n,3n)a

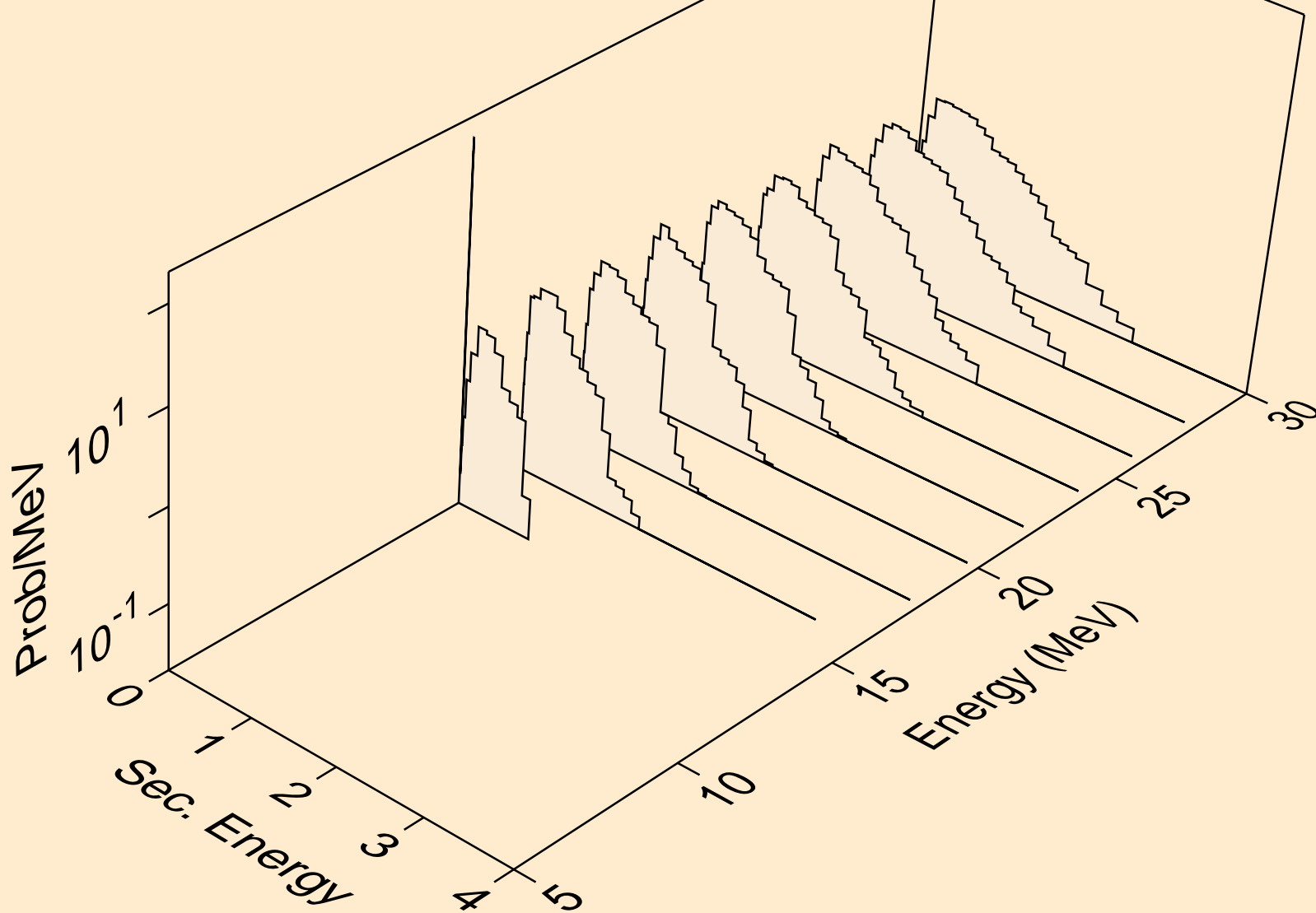

RA230 NEUTRON ACER TENDL-2019 LIBRARY; T=293.16K
Neutron emission for (n,n*)p

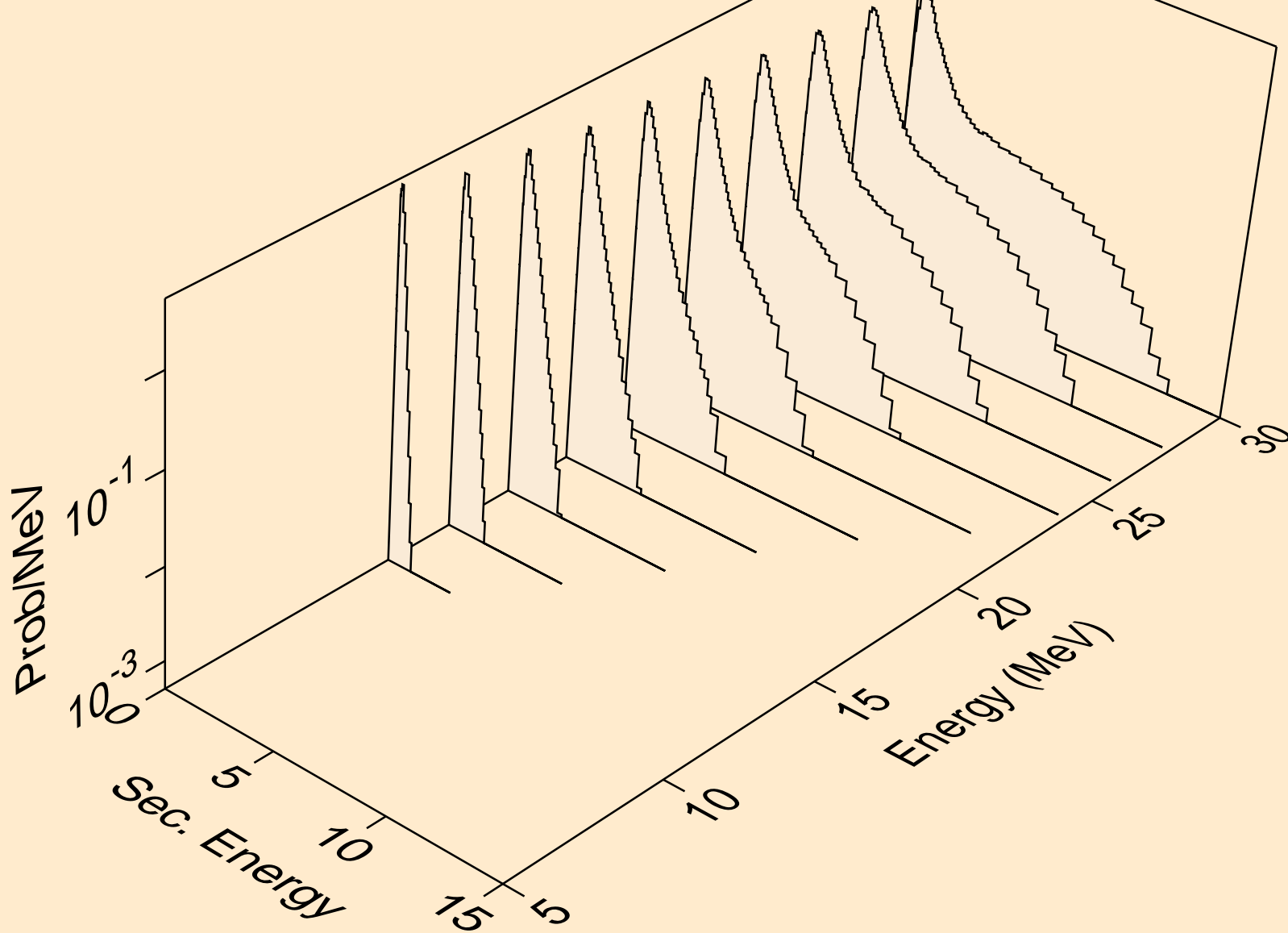

RA230 NEUTRON ACER TENDL-2019 LIBRARY; T=293.16K
Neutron emission for (n,n*)d

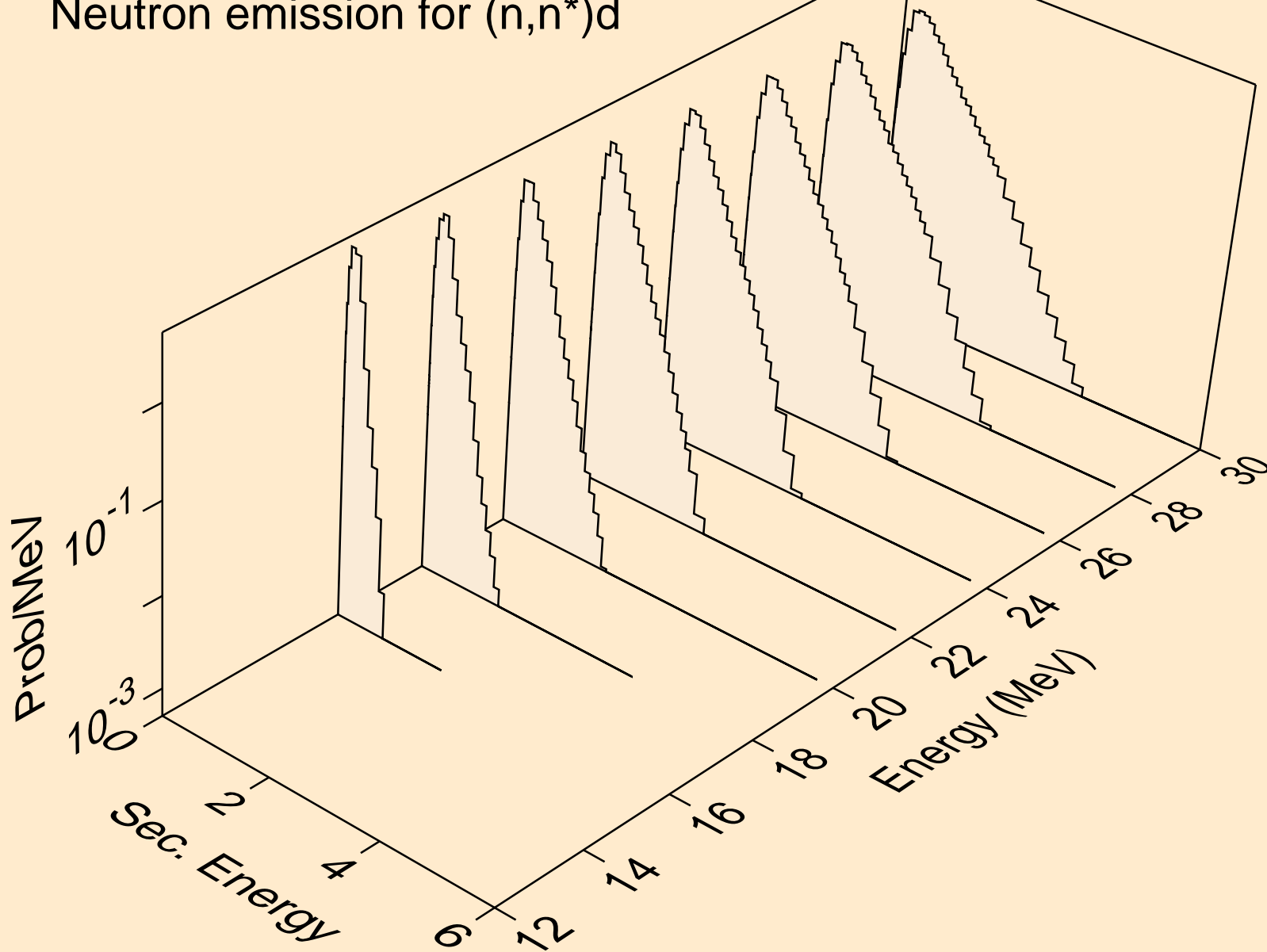

RA230 NEUTRON ACER TENDL-2019 LIBRARY; T=293.16K
Neutron emission for (n,n*)t

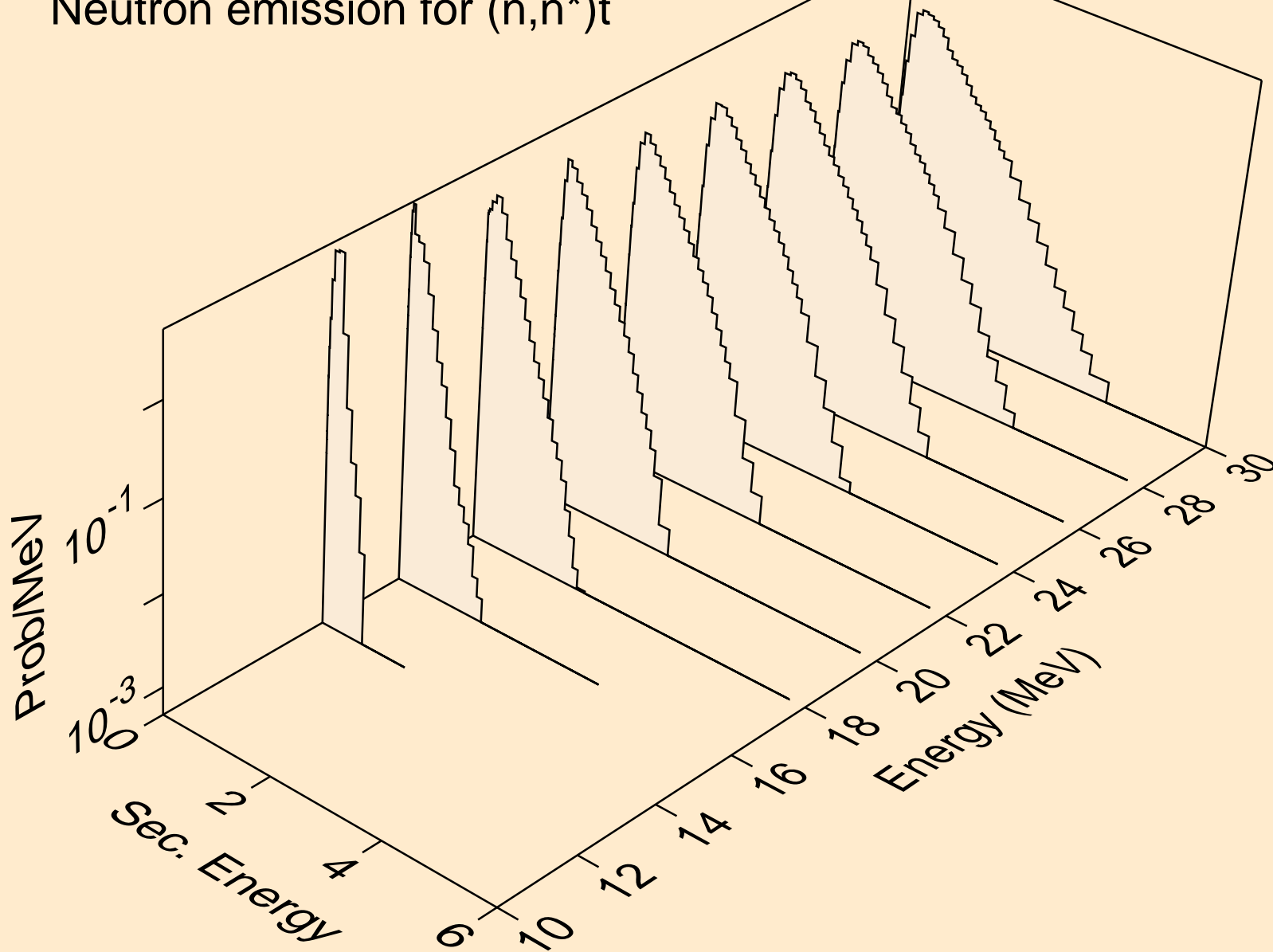

RA230 NEUTRON ACER TENDL-2019 LIBRARY; T=293.16K
Neutron emission for (n,n*)he3

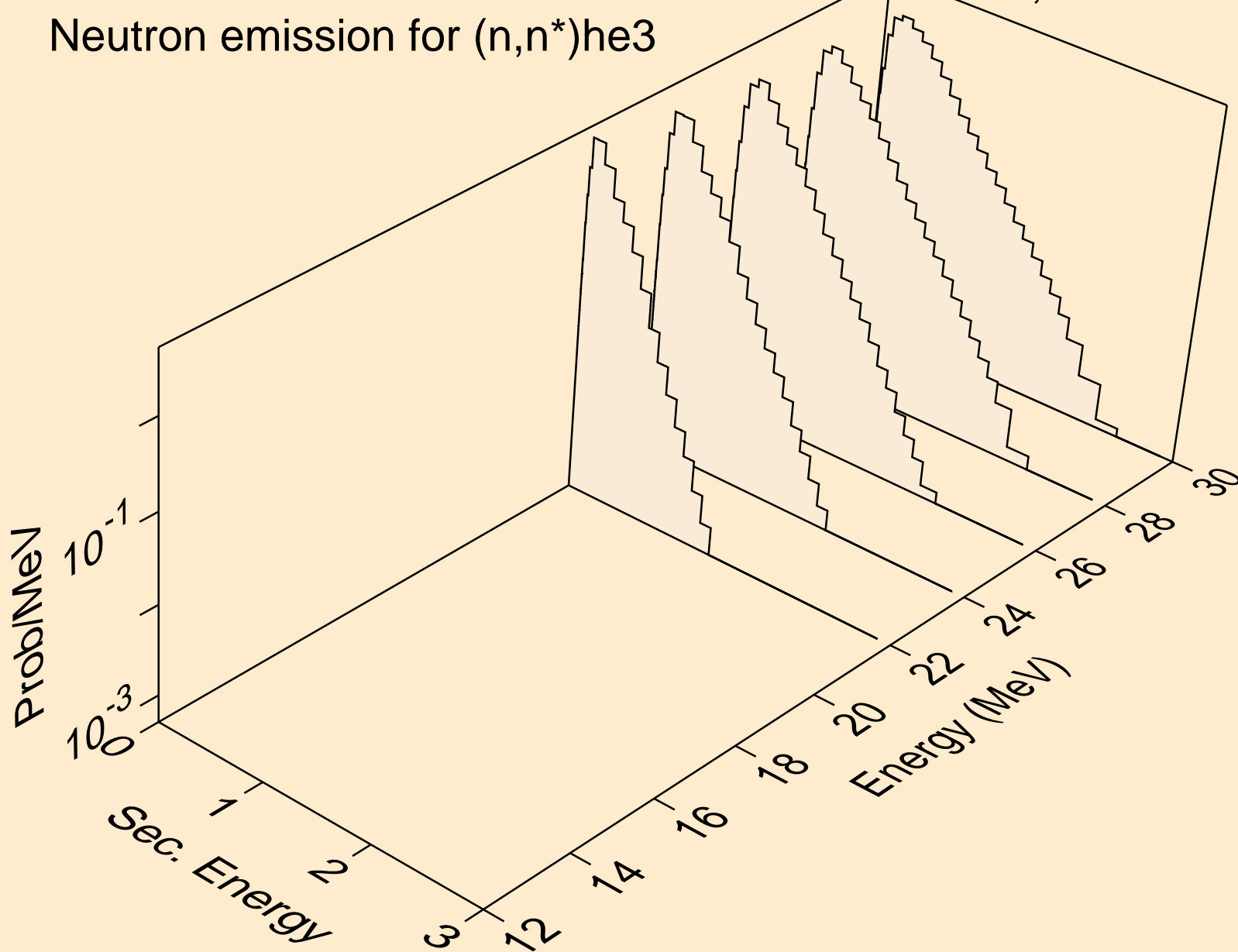

RA230 NEUTRON ACER TENDL-2019 LIBRARY; T=293.16K
Neutron emission for (n,4n)

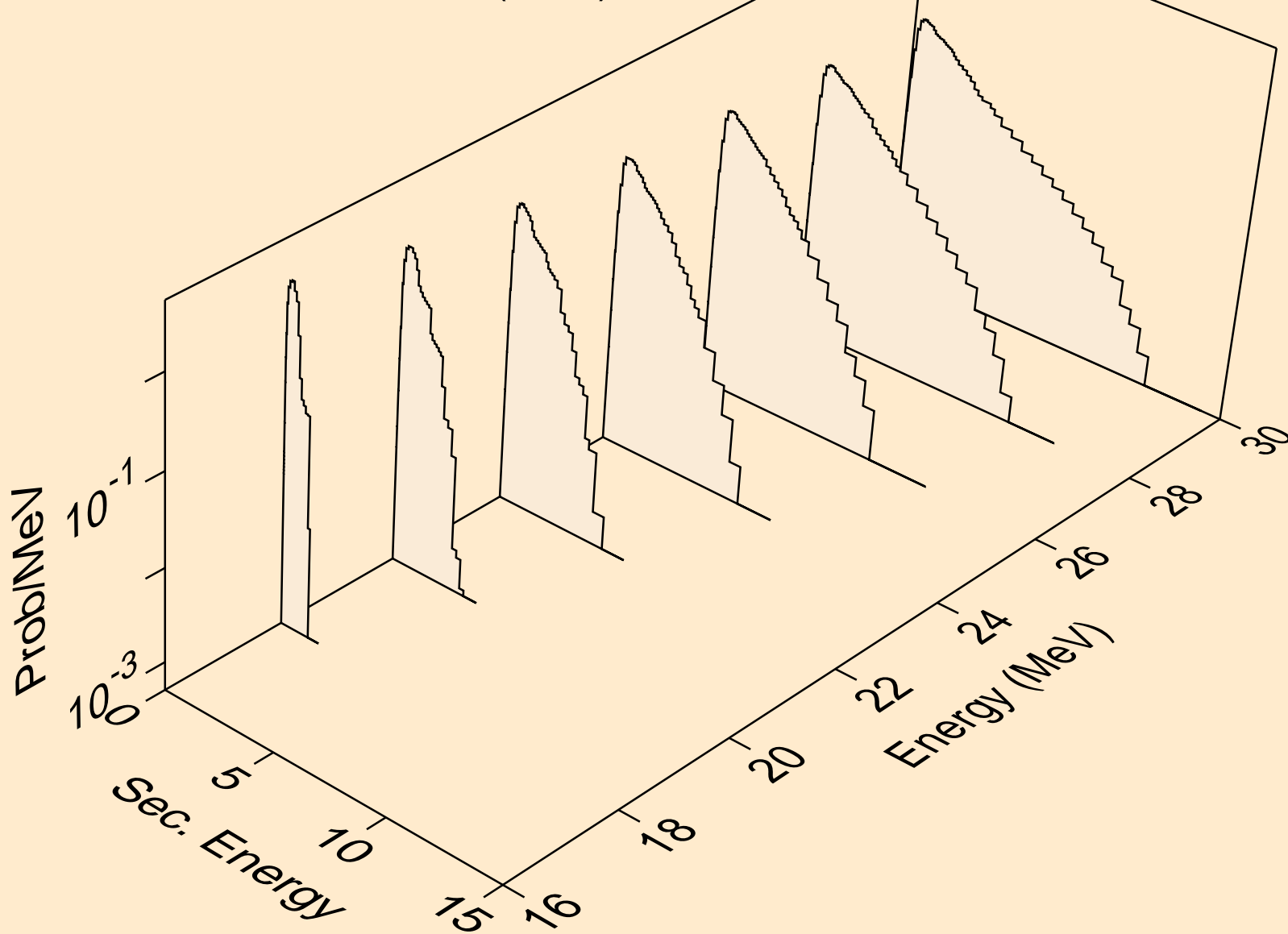

RA230 NEUTRON ACER TENDL-2019 LIBRARY; T=293.16K
Neutron emission for (n,2np)

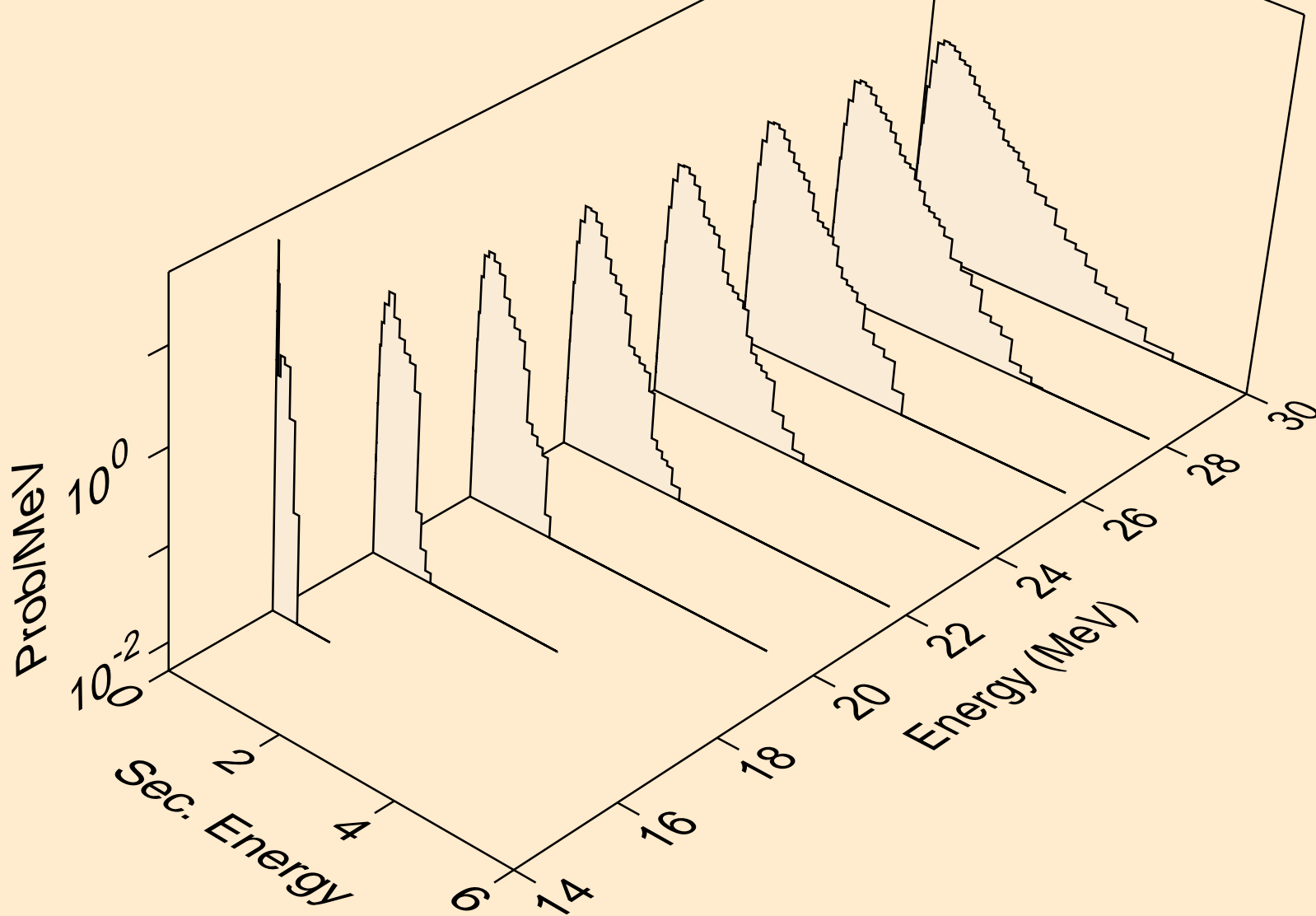

RA230 NEUTRON ACER TENDL-2019 LIBRARY; T=293.16K
Neutron emission for (n,3np)

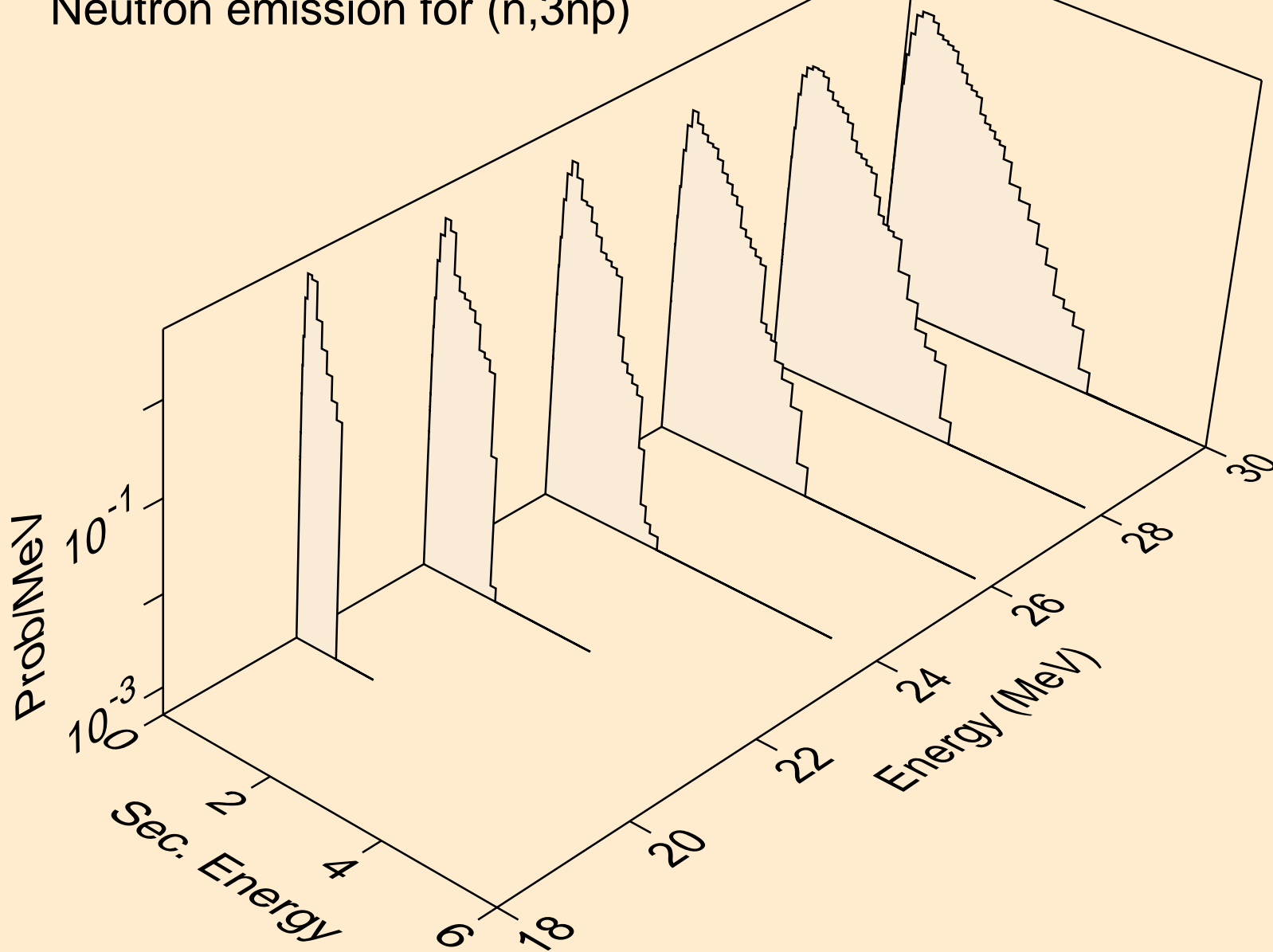

RA230 NEUTRON ACER TENDL-2019 LIBRARY; T=293.16K
Neutron emission for (n,n*c)

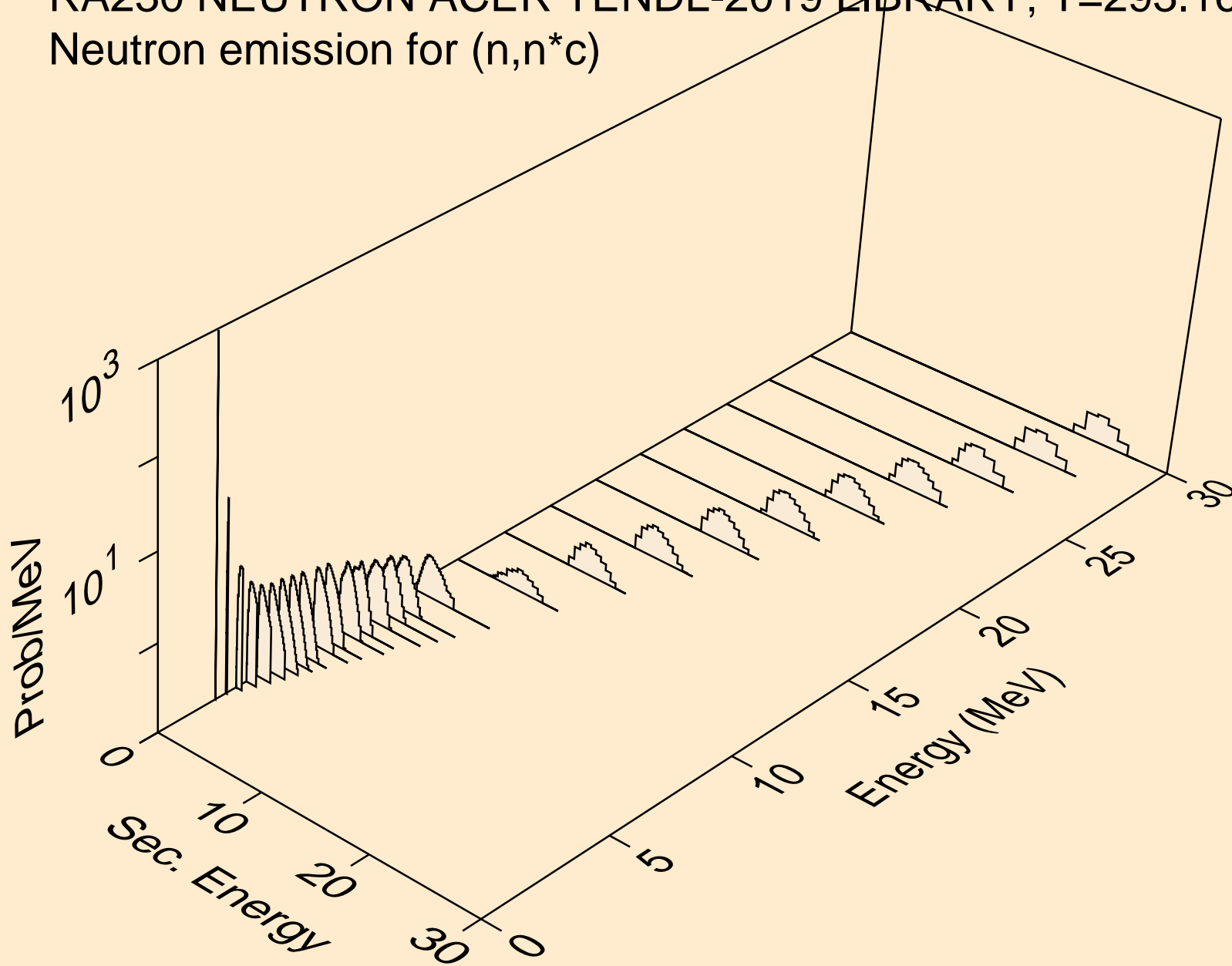

RA230 NEUTRON ACER TENDL-2019 LIBRARY; T=293.16K

Delayed nubar

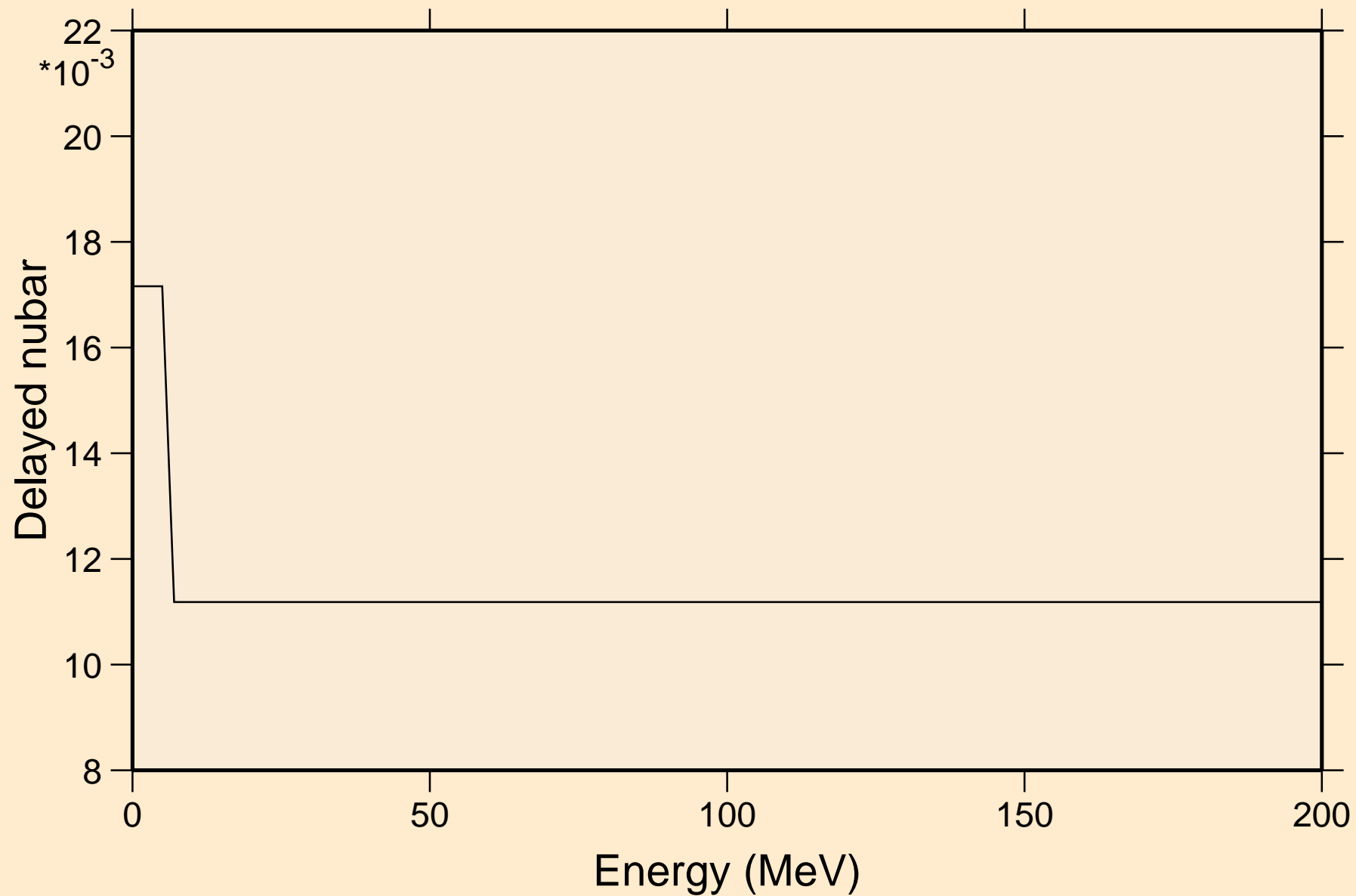

RA230 NEUTRON ACER TENDL-2019 LIBRARY; T=293.16K
Delayed neutron spectra

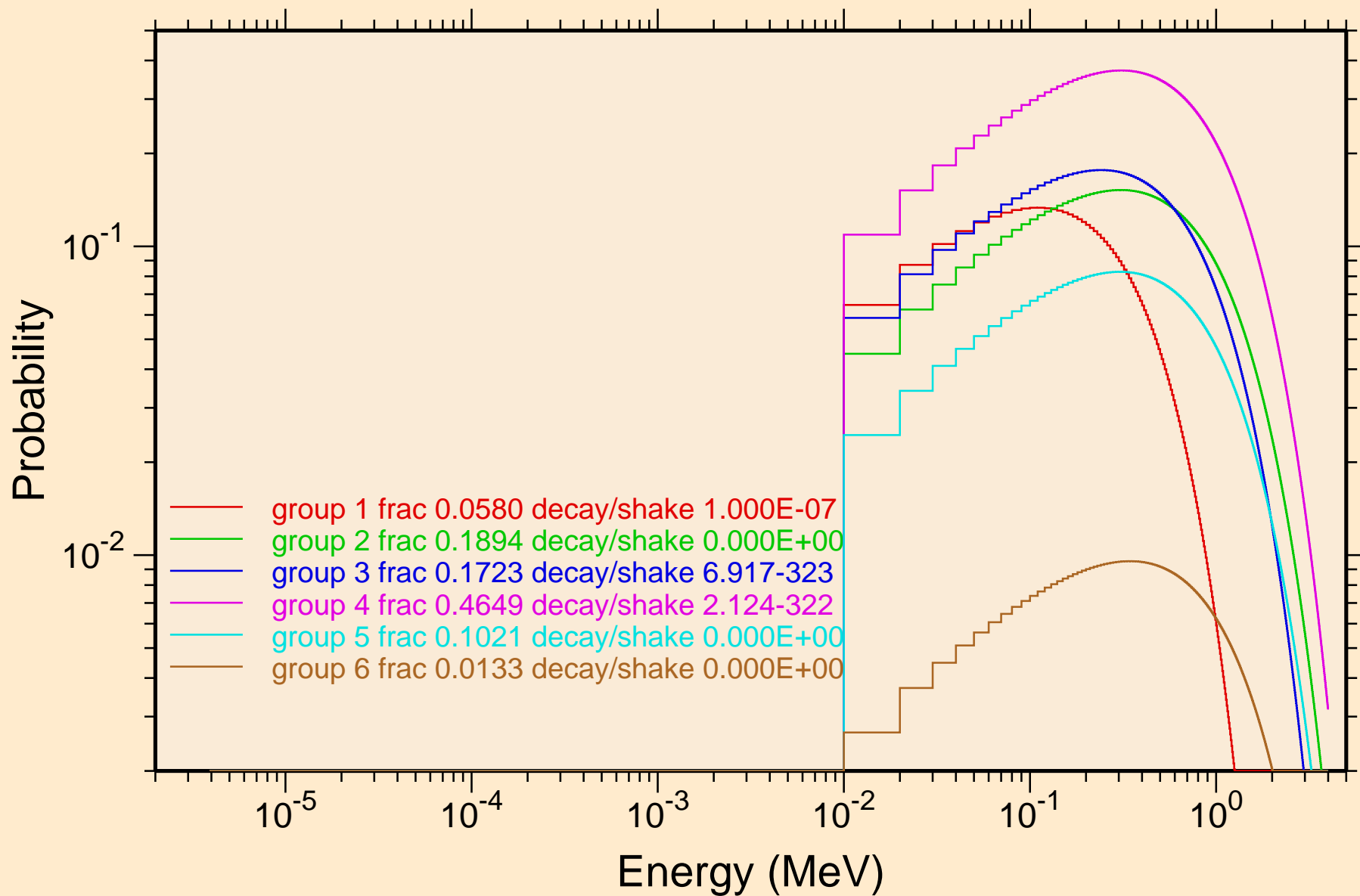

RA230 NEUTRON ACER TENDL-2019 LIBRARY; T=293.16K
Photon emission for (n,x)

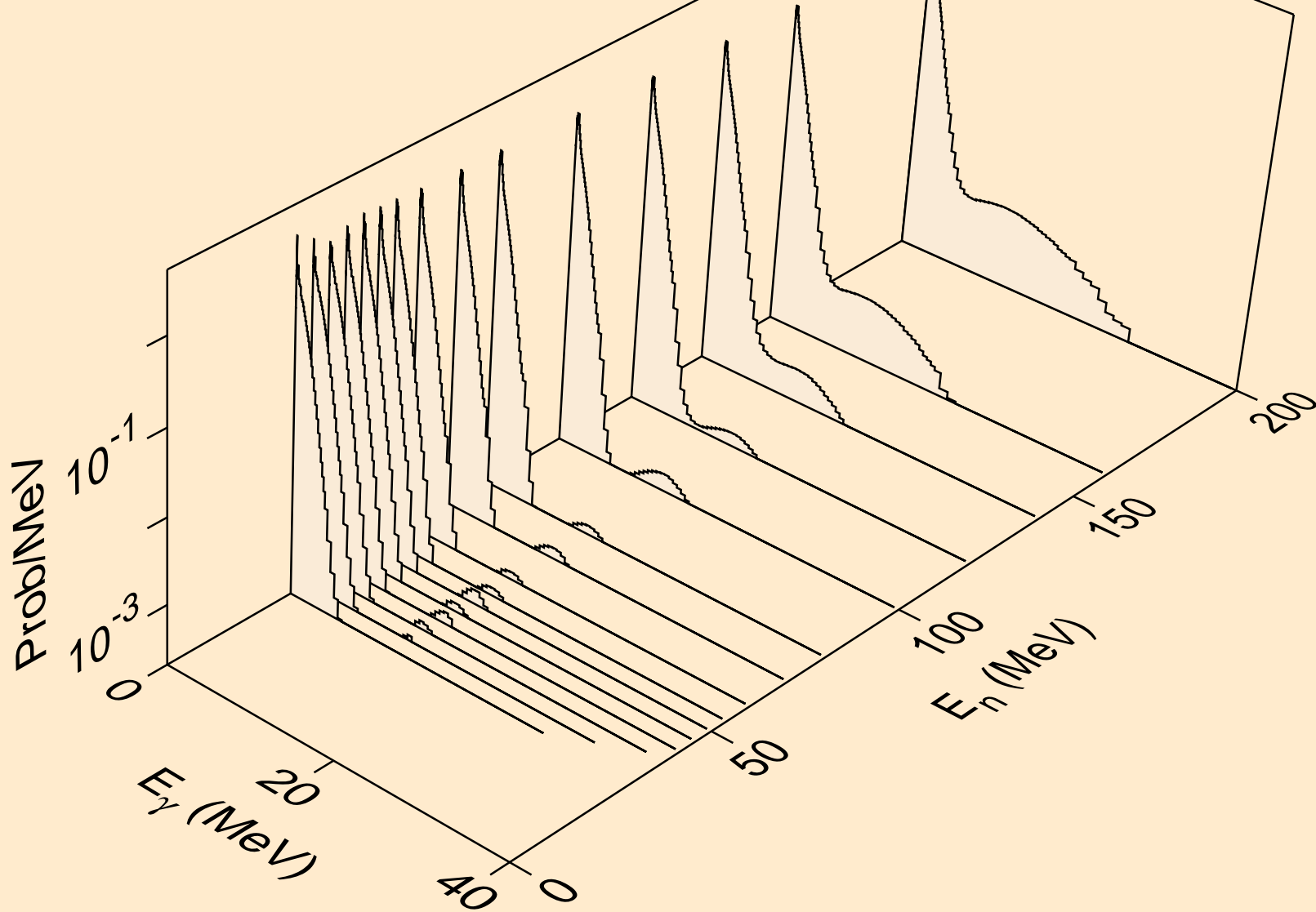

RA230 NEUTRON ACER TENDL-2019 LIBRARY; T=293.16K
Photon emission for (n,2nd)

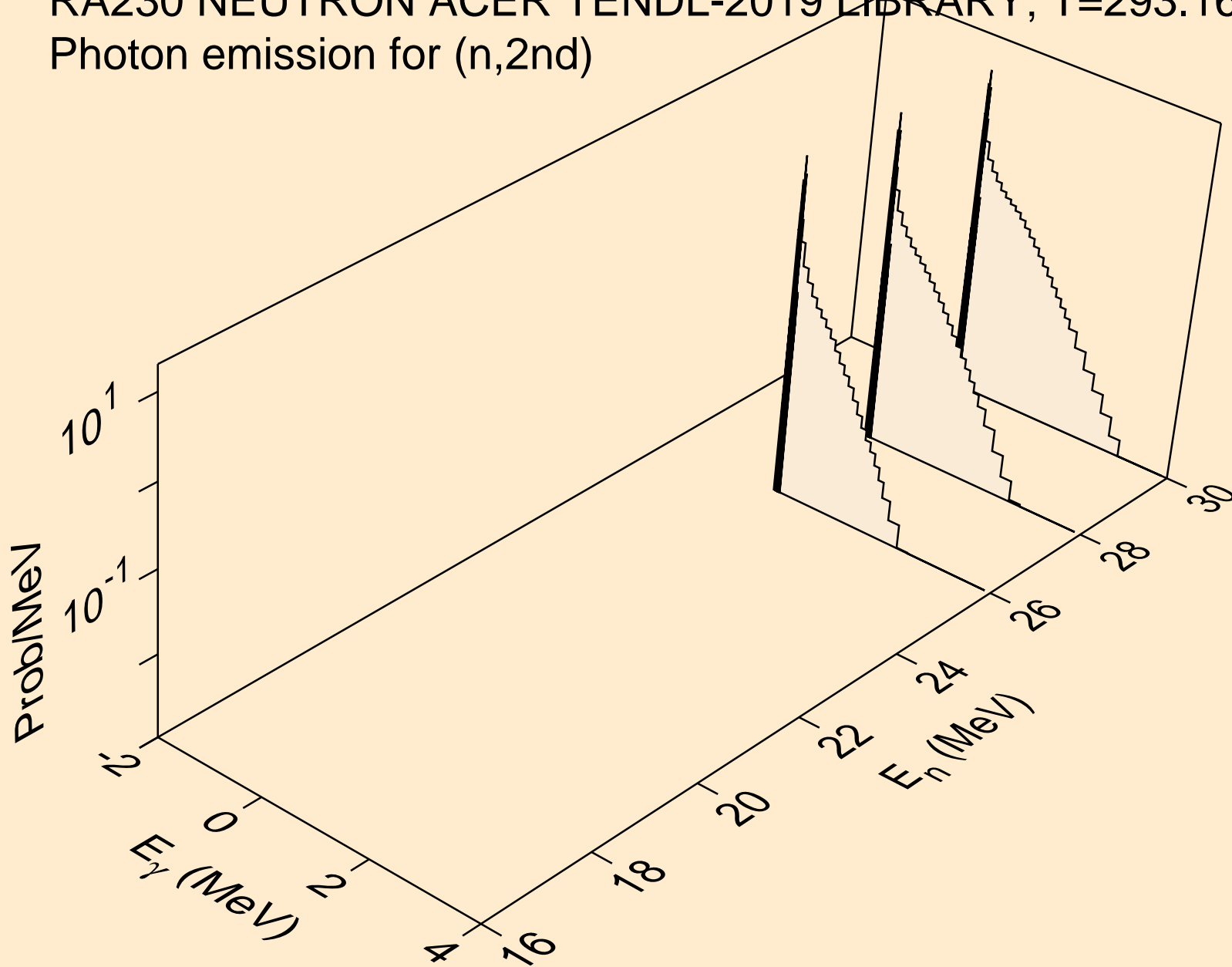

RA230 NEUTRON ACER TENDL-2019 LIBRARY; T=293.16K
Photon emission for (n,2n)

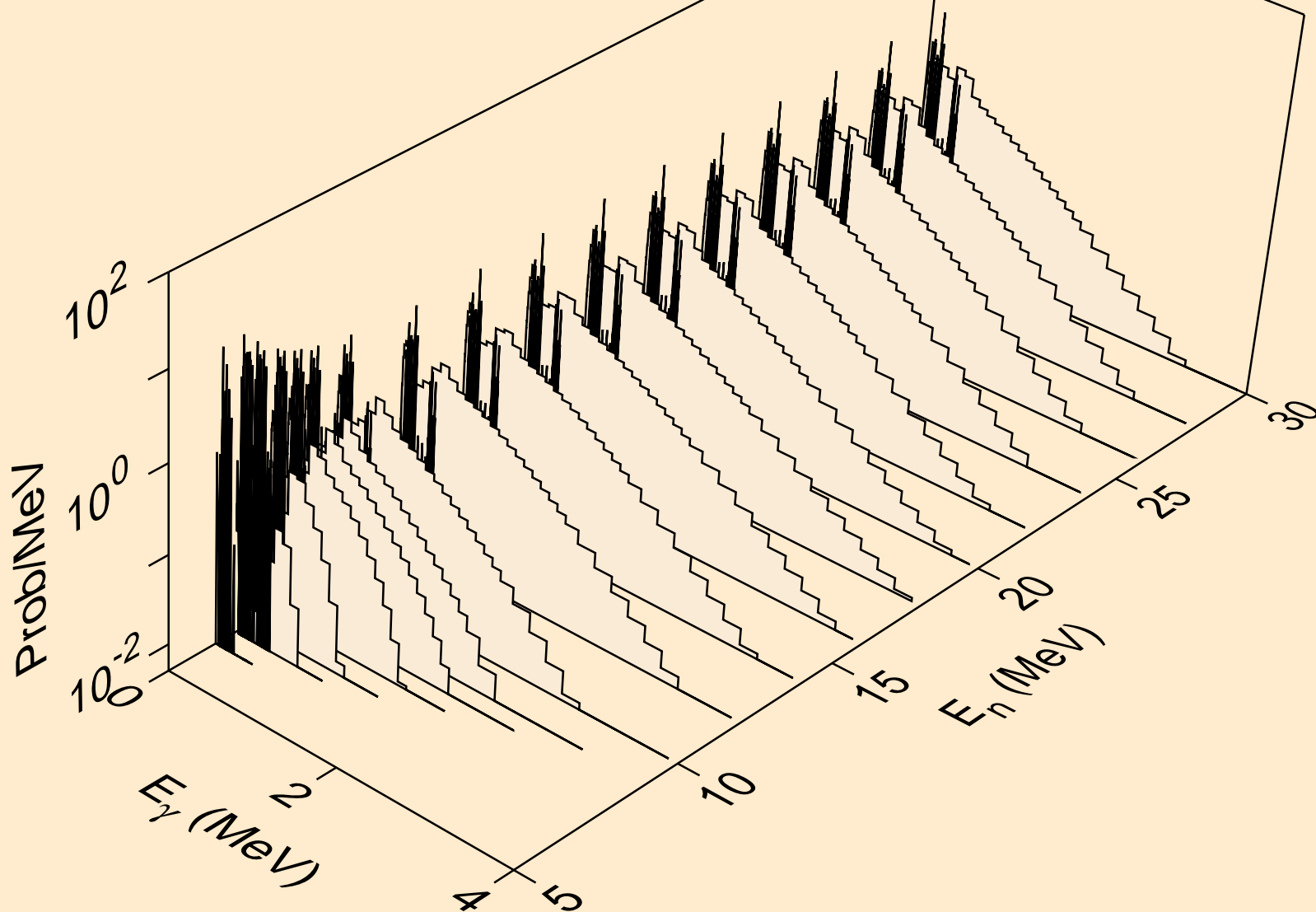

RA230 NEUTRON ACER TENDL-2019 LIBRARY; T=293.16K
Photon emission for (n,3n)

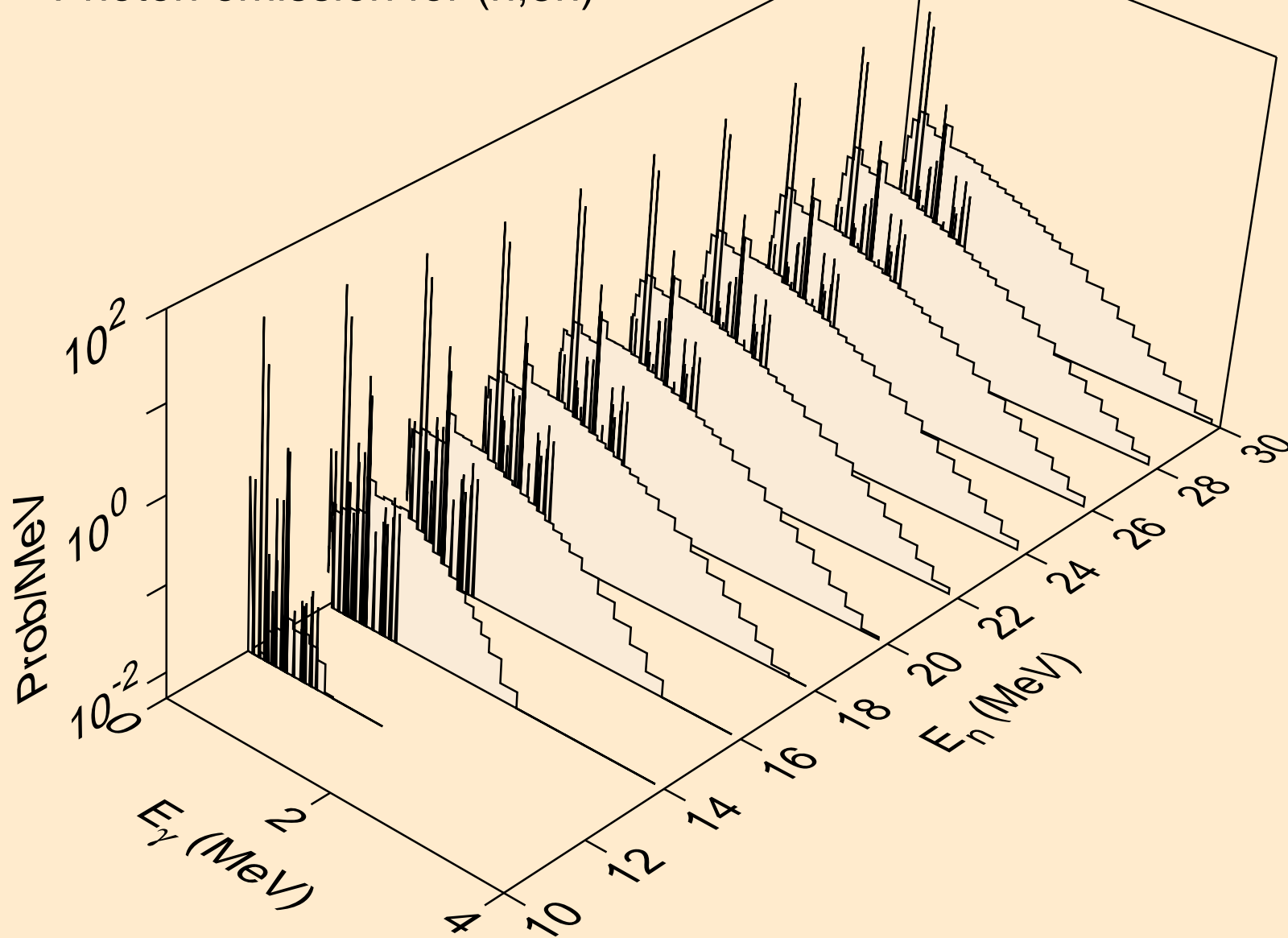

RA230 NEUTRON ACER TENDL-2019 LIBRARY; T=293.16K
Photon emission for (n,n*)a

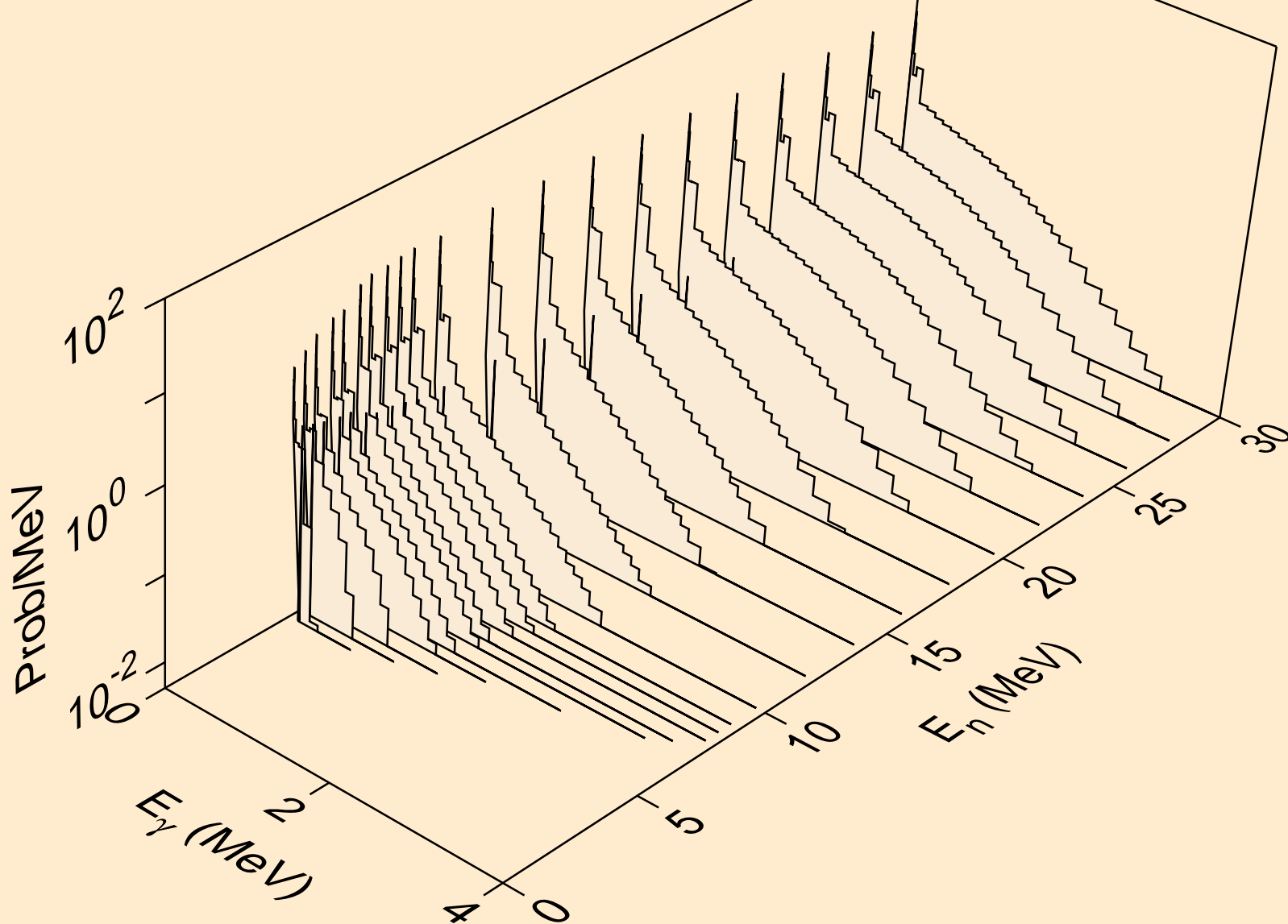

RA230 NEUTRON ACER TENDL-2019 LIBRARY; T=293.16K
Photon emission for (n,2n) α

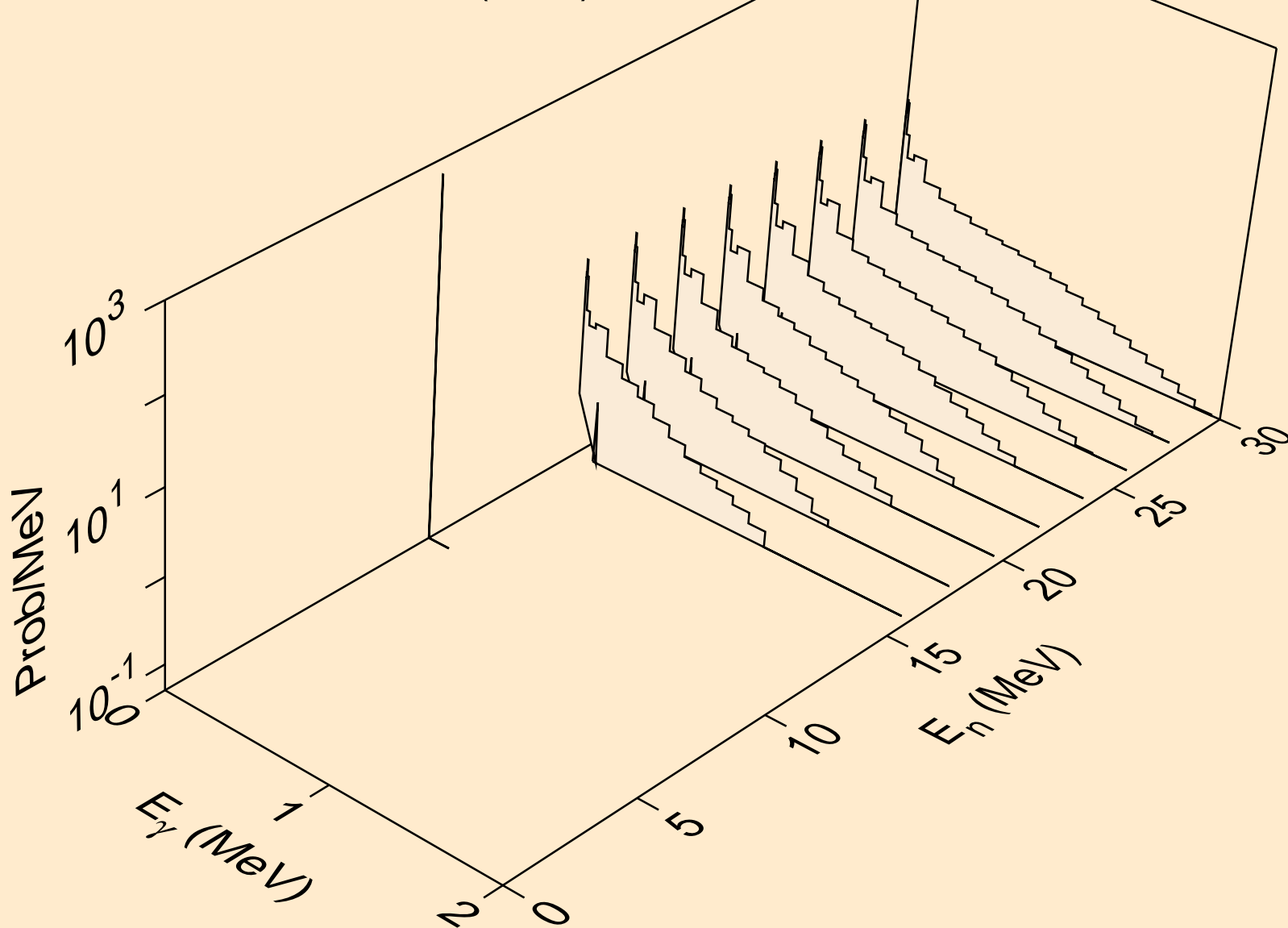

RA230 NEUTRON ACER TENDL-2019 LIBRARY; T=293.16K
Photon emission for (n,3n)a

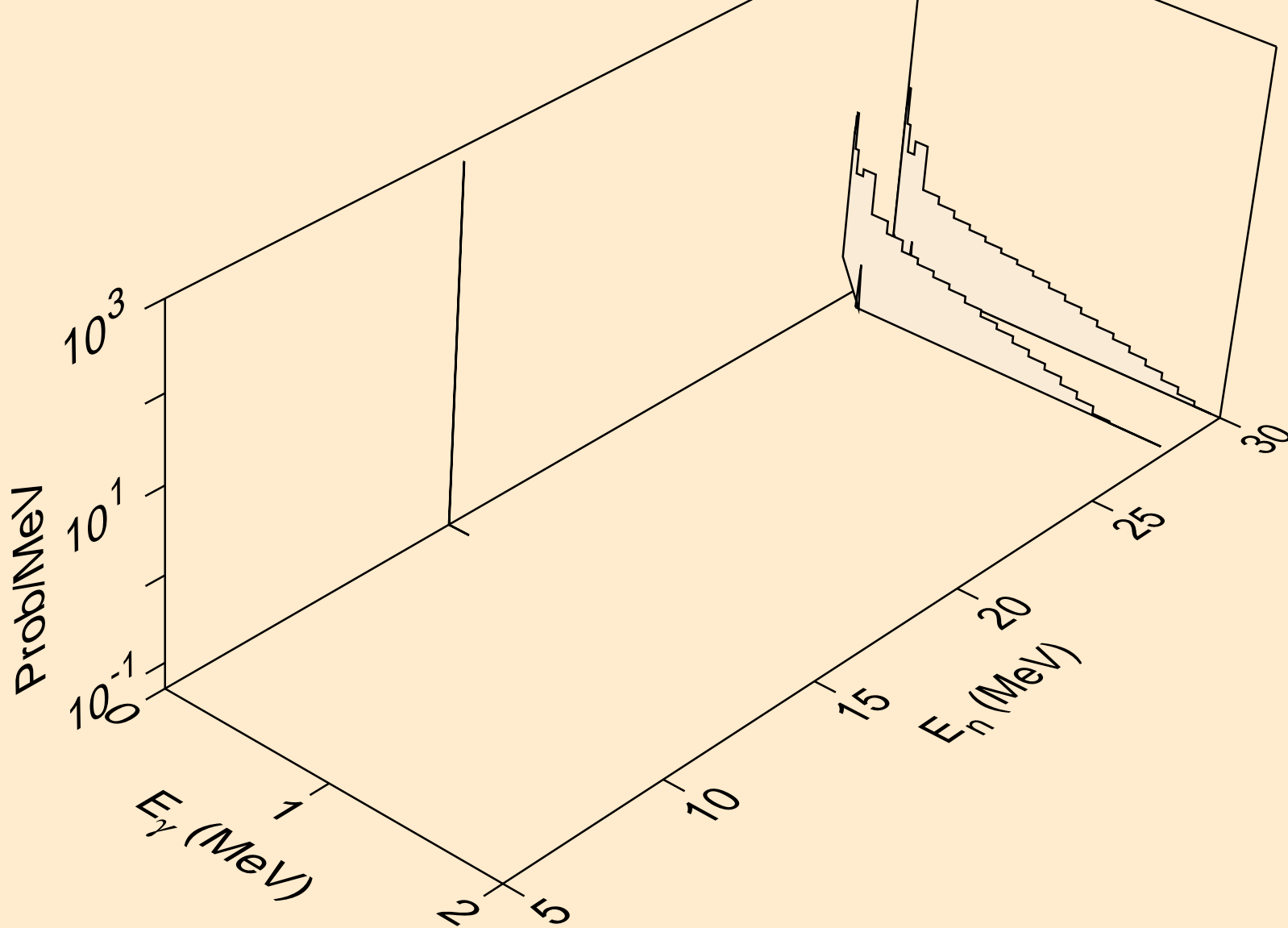

RA230 NEUTRON ACER TENDL-2019 LIBRARY; T=293.16K
Photon emission for (n,n*)p

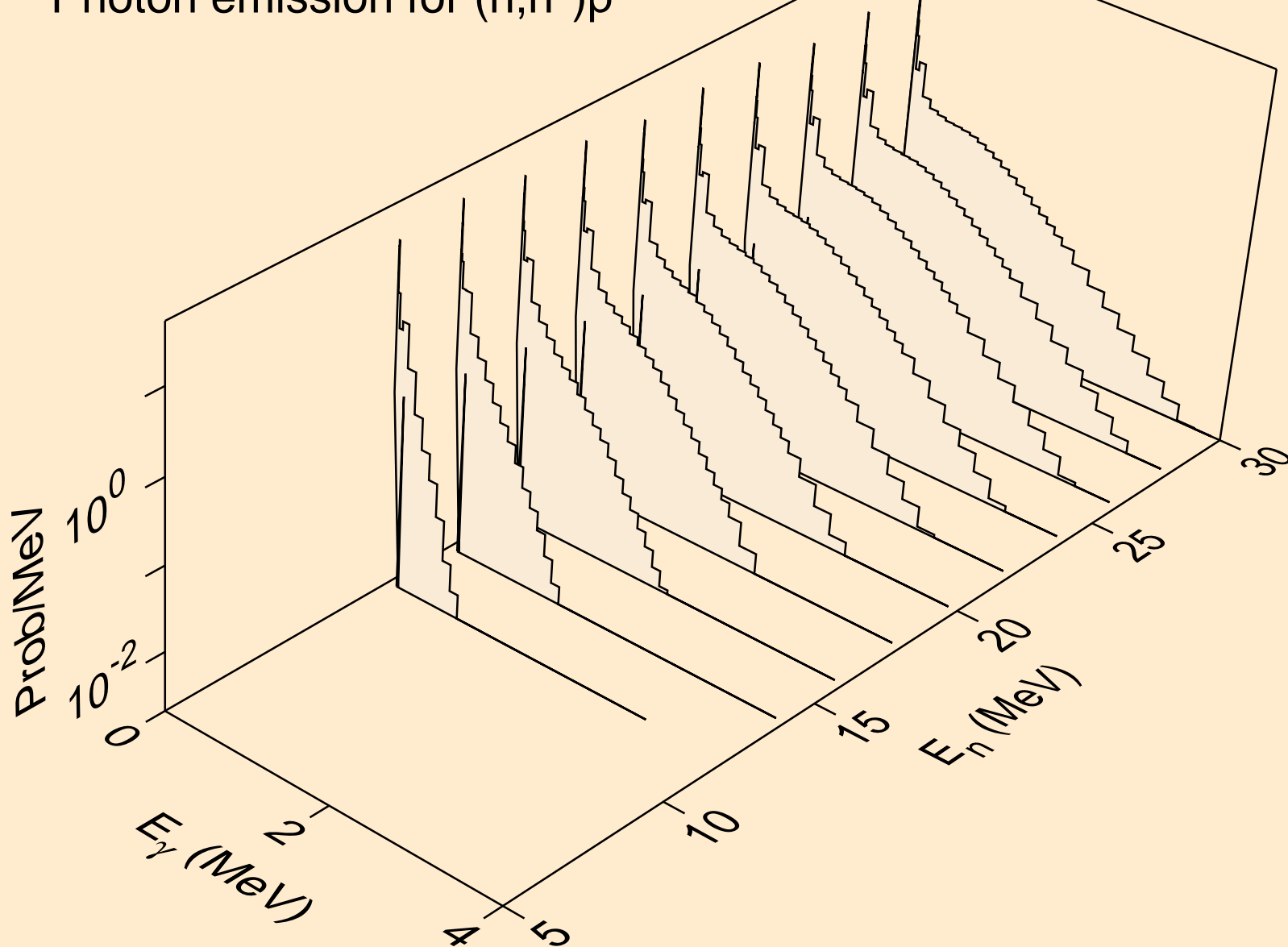

RA230 NEUTRON ACER TENDL-2019 LIBRARY; T=293.16K
Photon emission for (n,n*)d

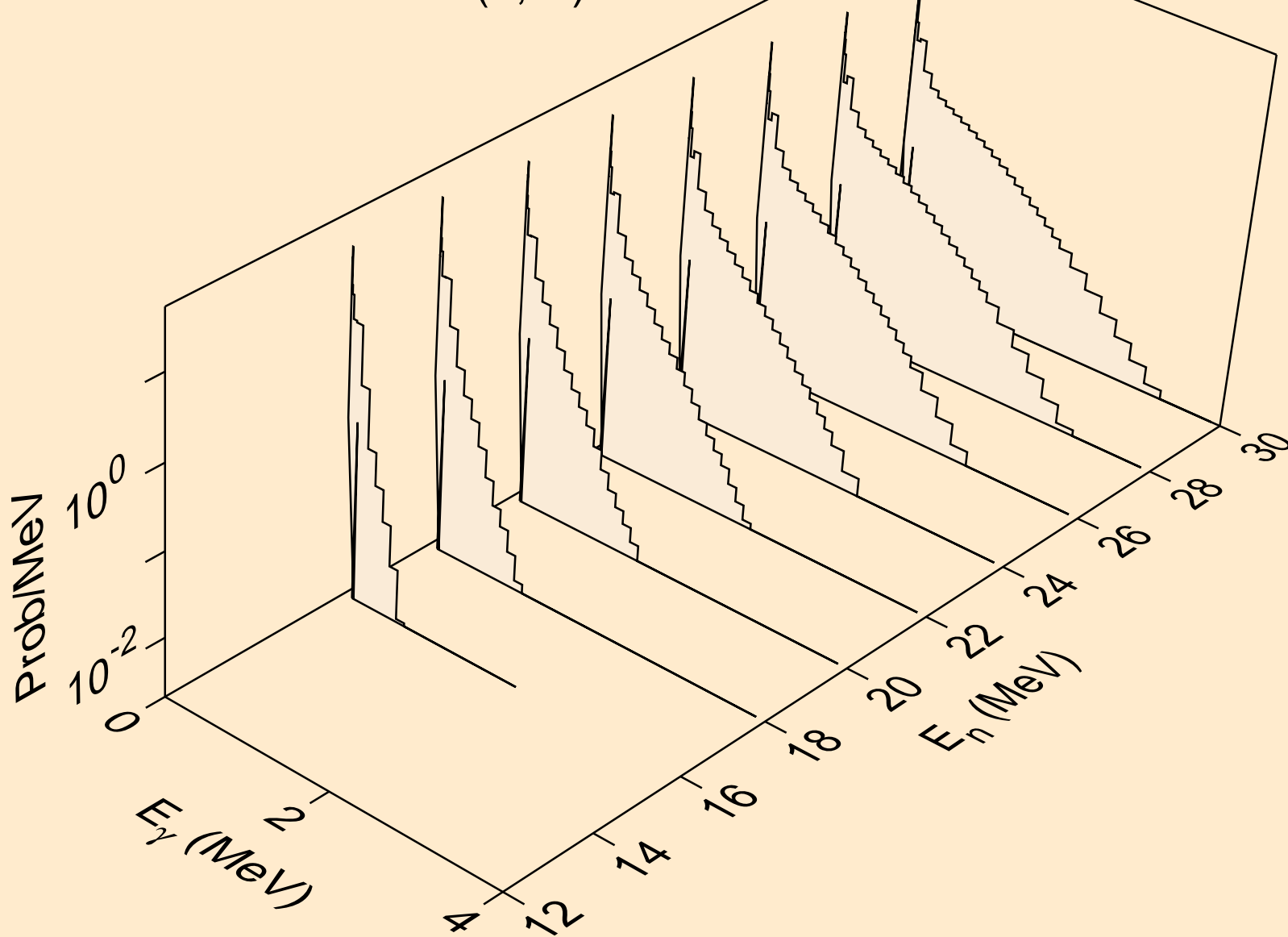

RA230 NEUTRON ACER TENDL-2019 LIBRARY; T=293.16K
Photon emission for (n,n*)t

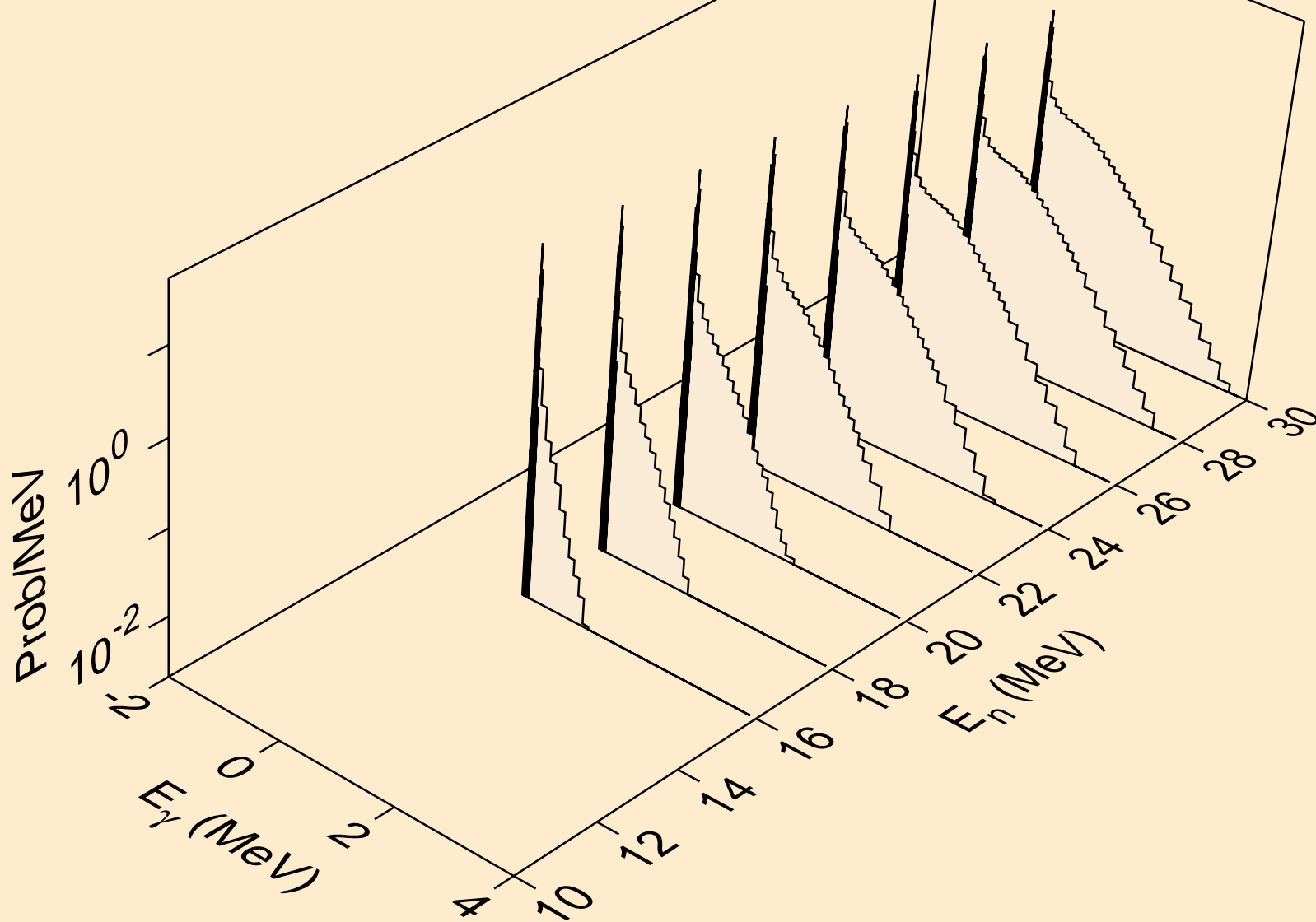

RA230 NEUTRON ACER TENDL-2019 LIBRARY; T=293.16K
Photon emission for (n,n*)he3

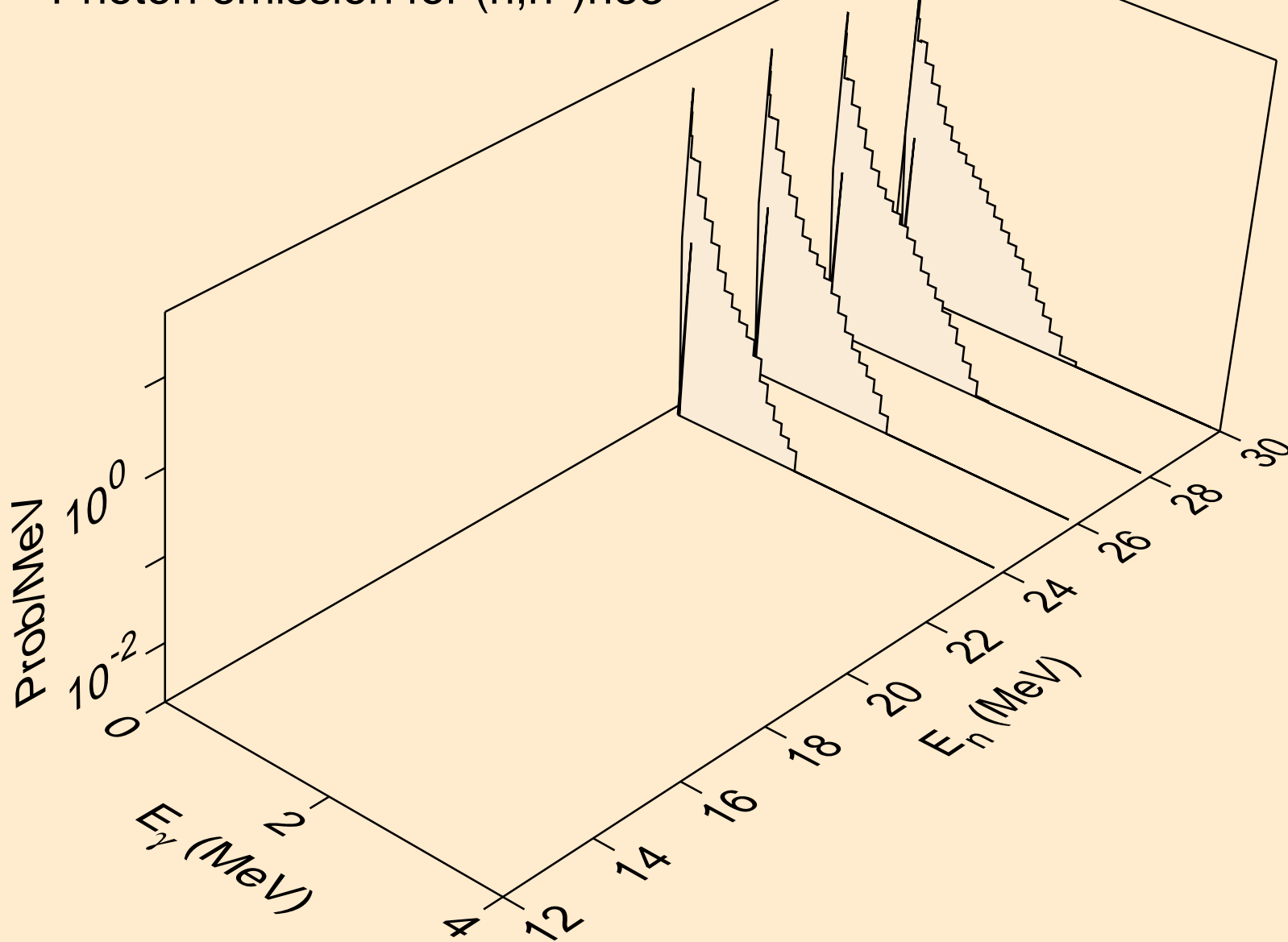

RA230 NEUTRON ACER TENDL-2019 LIBRARY; T=293.16K
Photon emission for (n,4n)

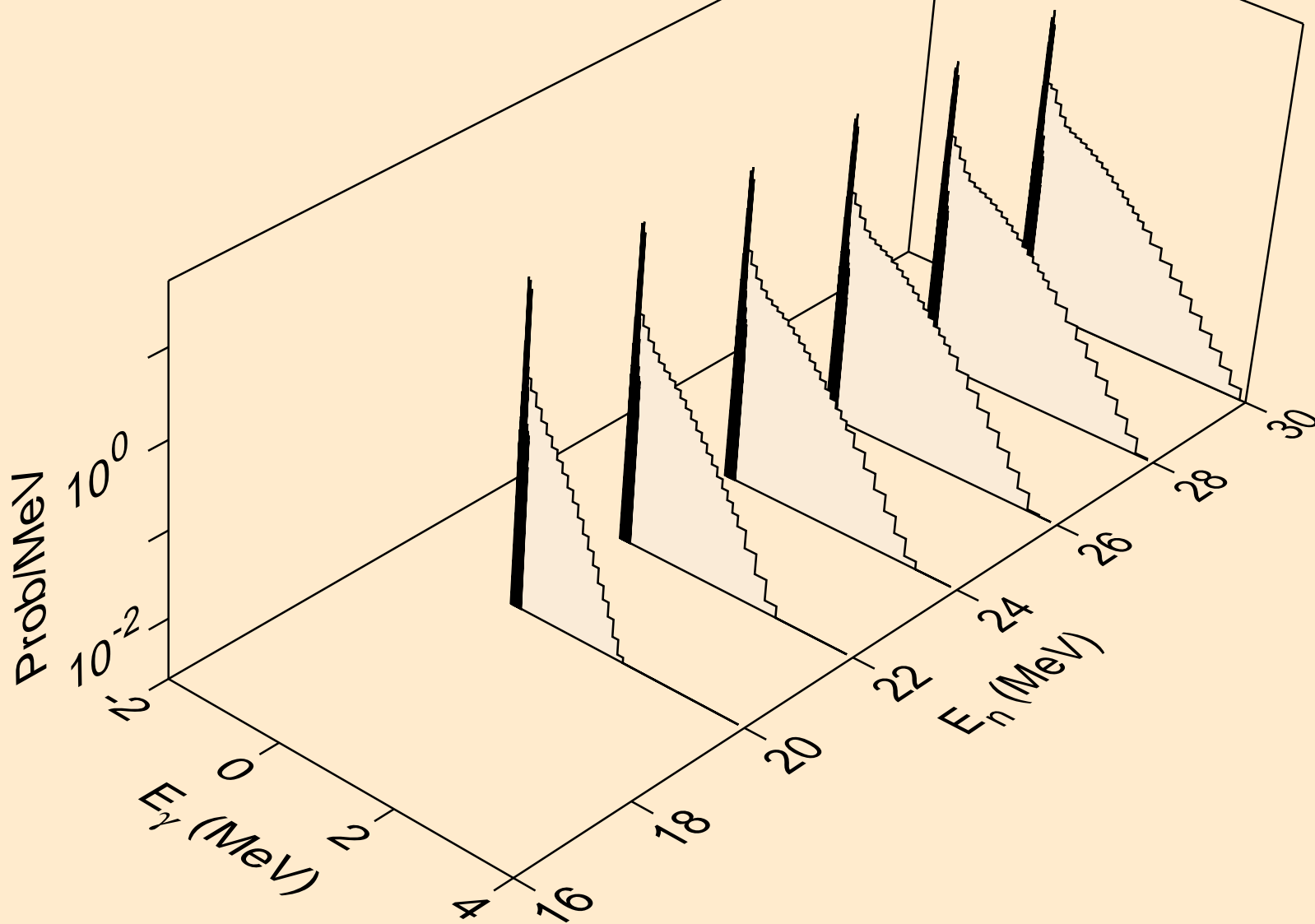

RA230 NEUTRON ACER TENDL-2019 LIBRARY; T=293.16K
Photon emission for (n,2np)

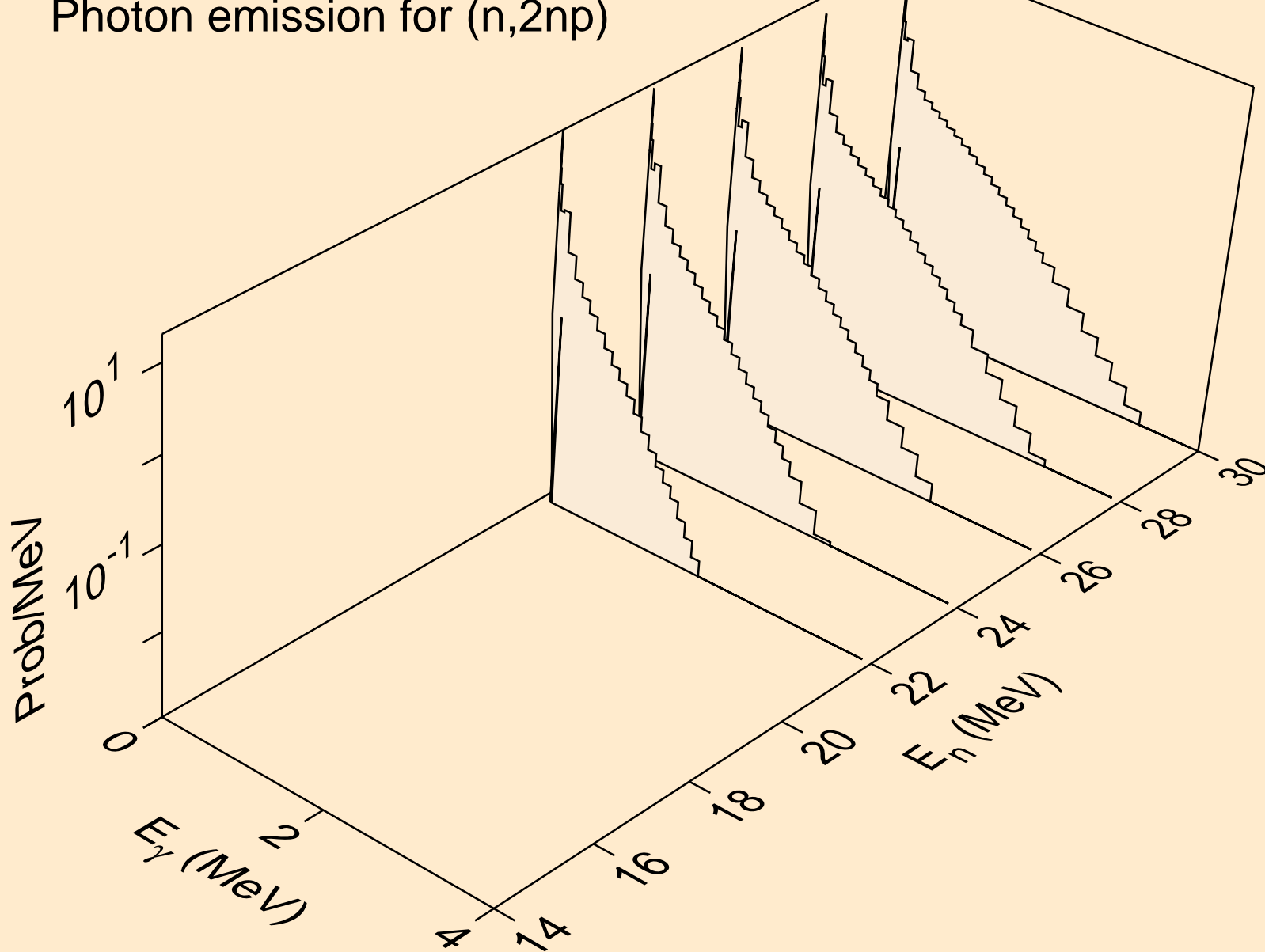

RA230 NEUTRON ACER TENDL-2019 LIBRARY; T=293.16K
Photon emission for (n,3np)

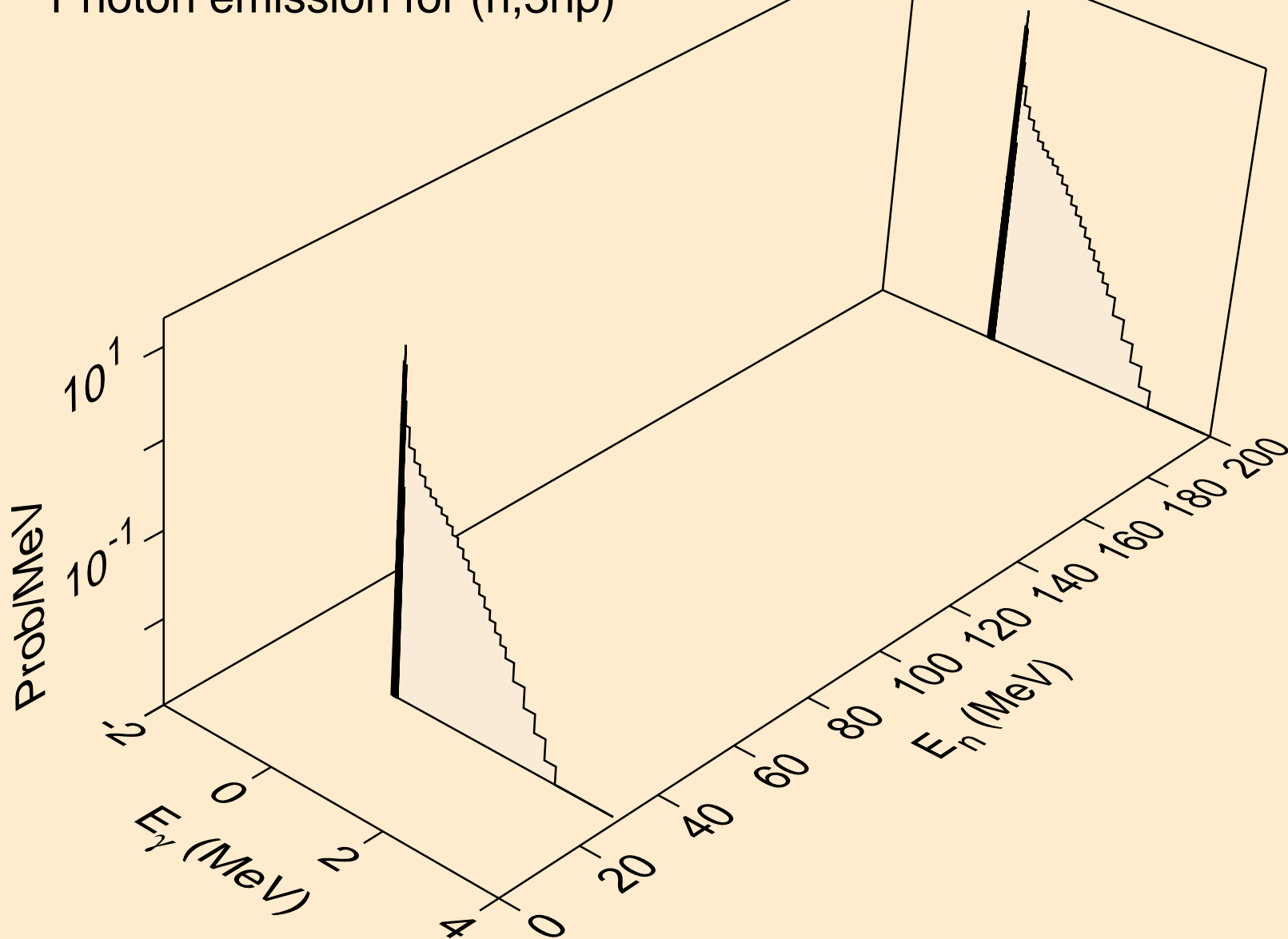

RA230 NEUTRON ACER TENDL-2019 LIBRARY; T=293.16K
Photon emission for (n,n*c)

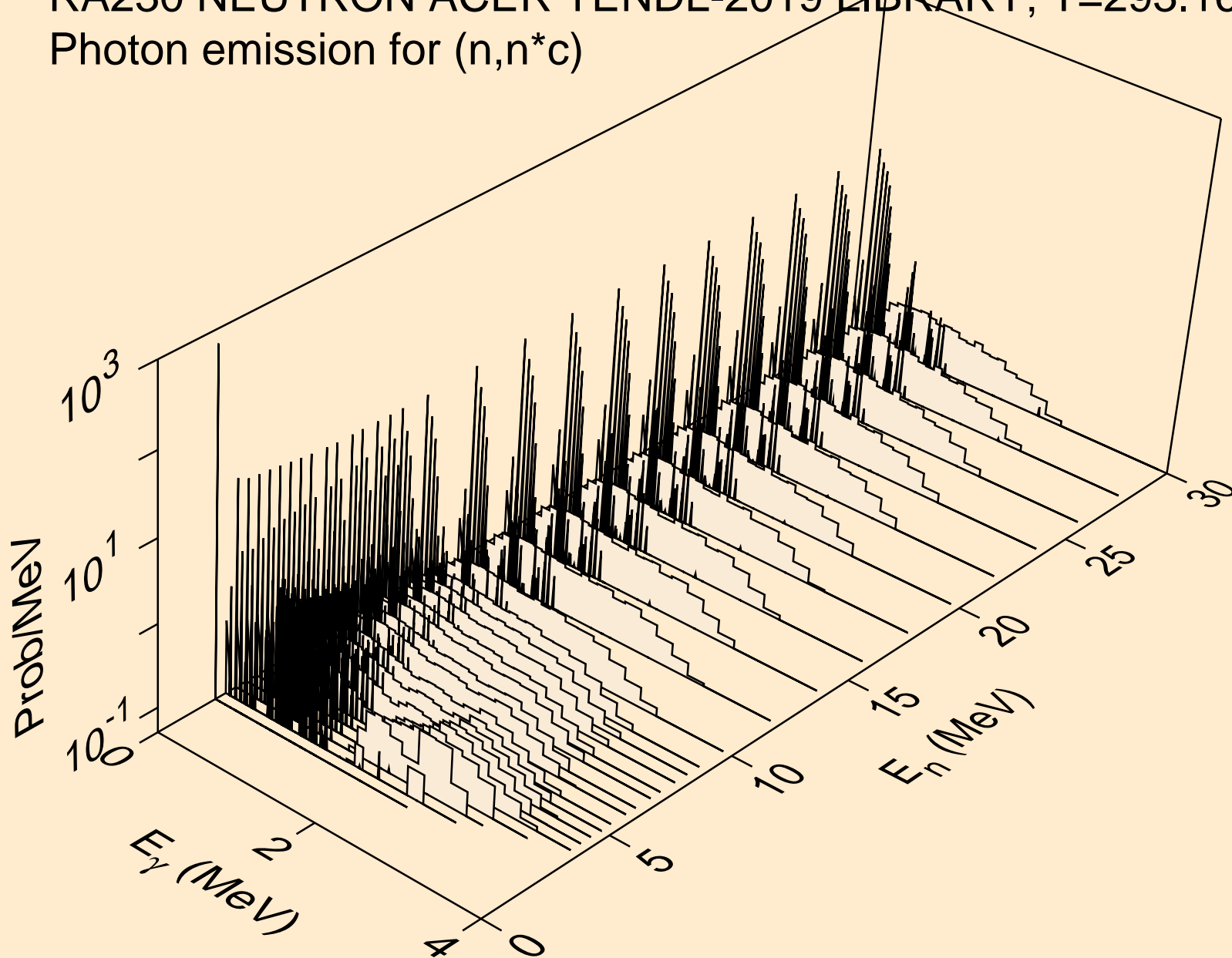

RA230 NEUTRON ACER TENDL-2019 LIBRARY; T=293.16K
Photon emission for (n,gma)

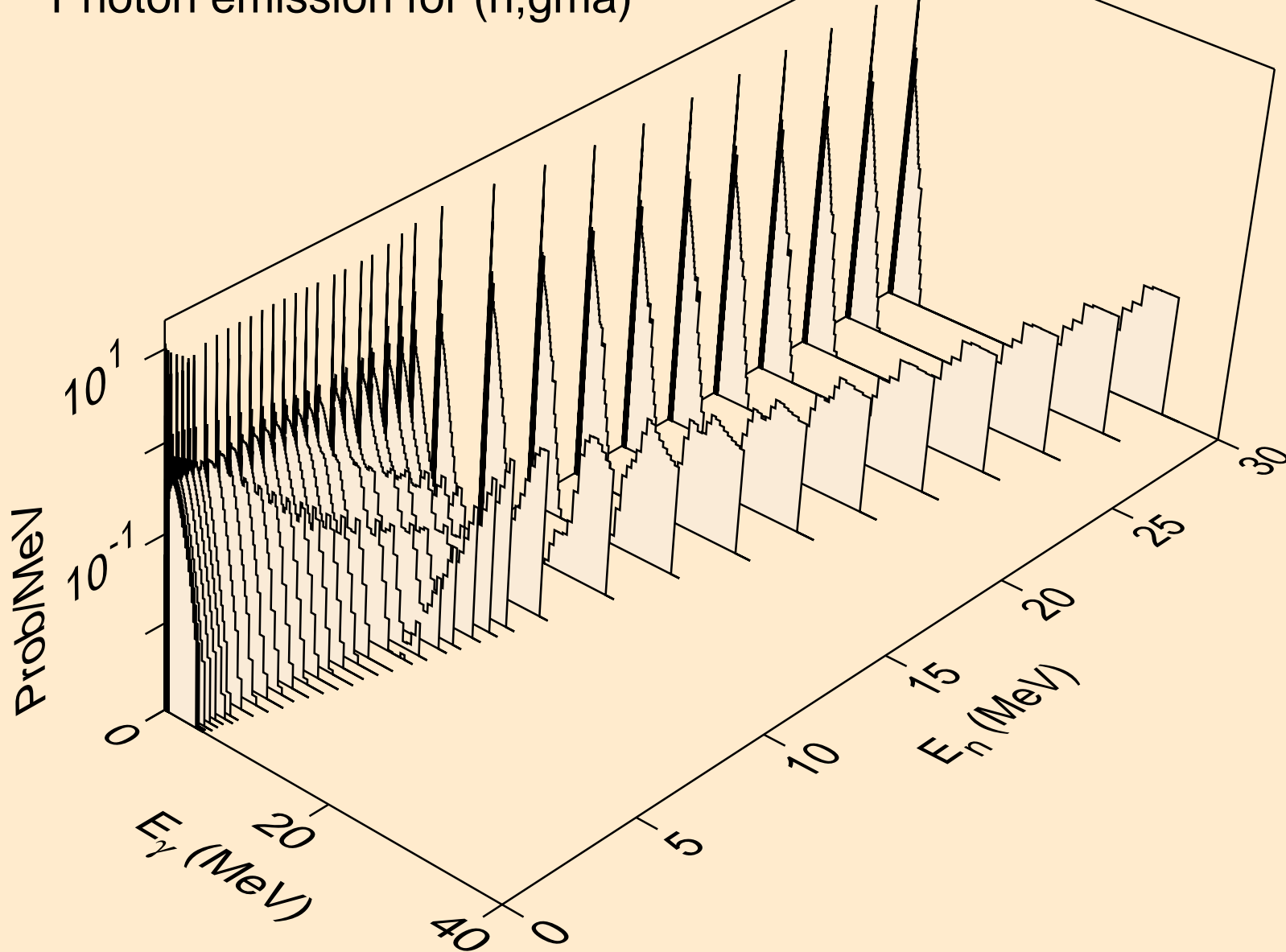

RA230 NEUTRON ACER TENDL-2019 LIBRARY; T=293.16K
Photon emission for (n,p)

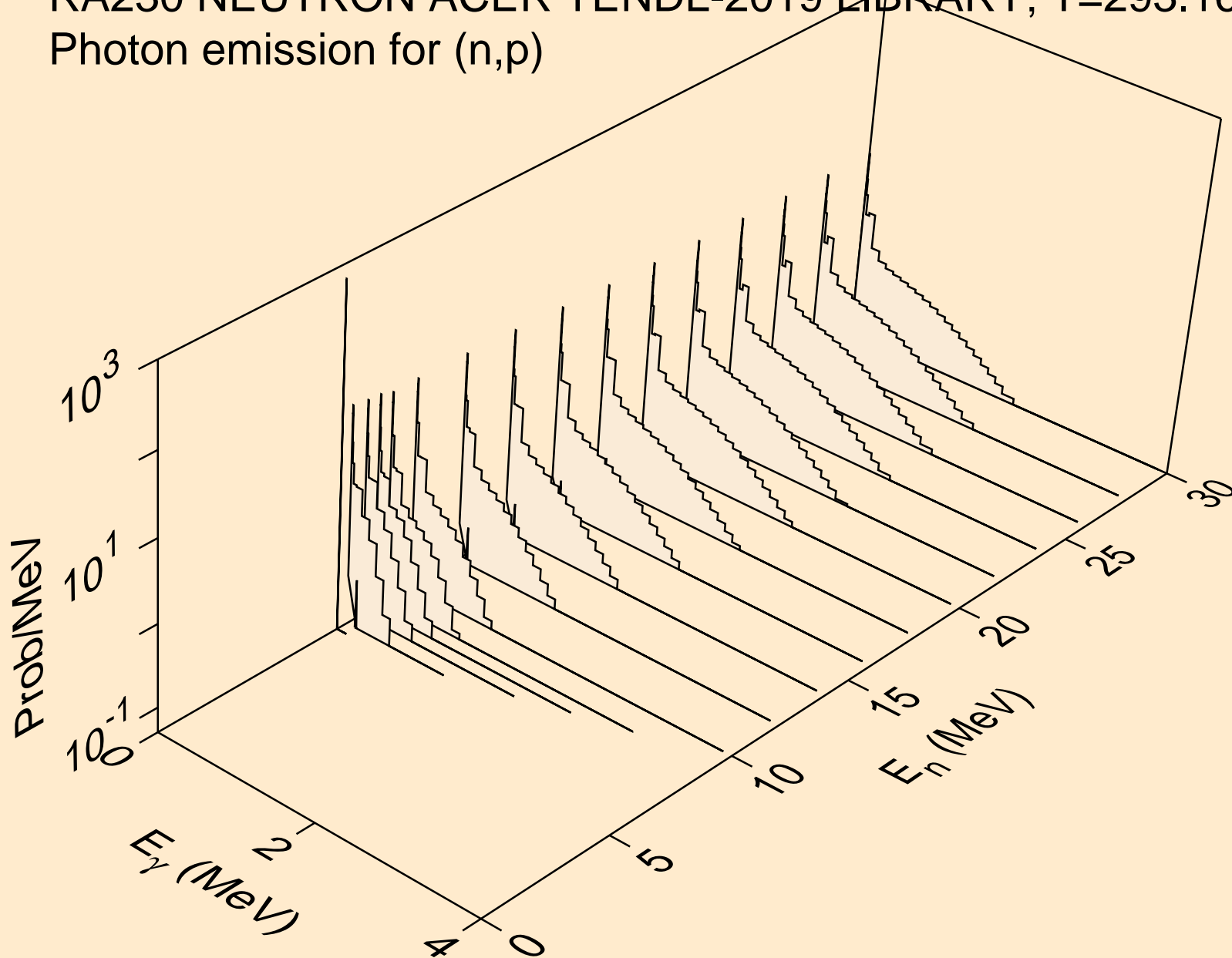

RA230 NEUTRON ACER TENDL-2019 LIBRARY; T=293.16K
Photon emission for (n,d)

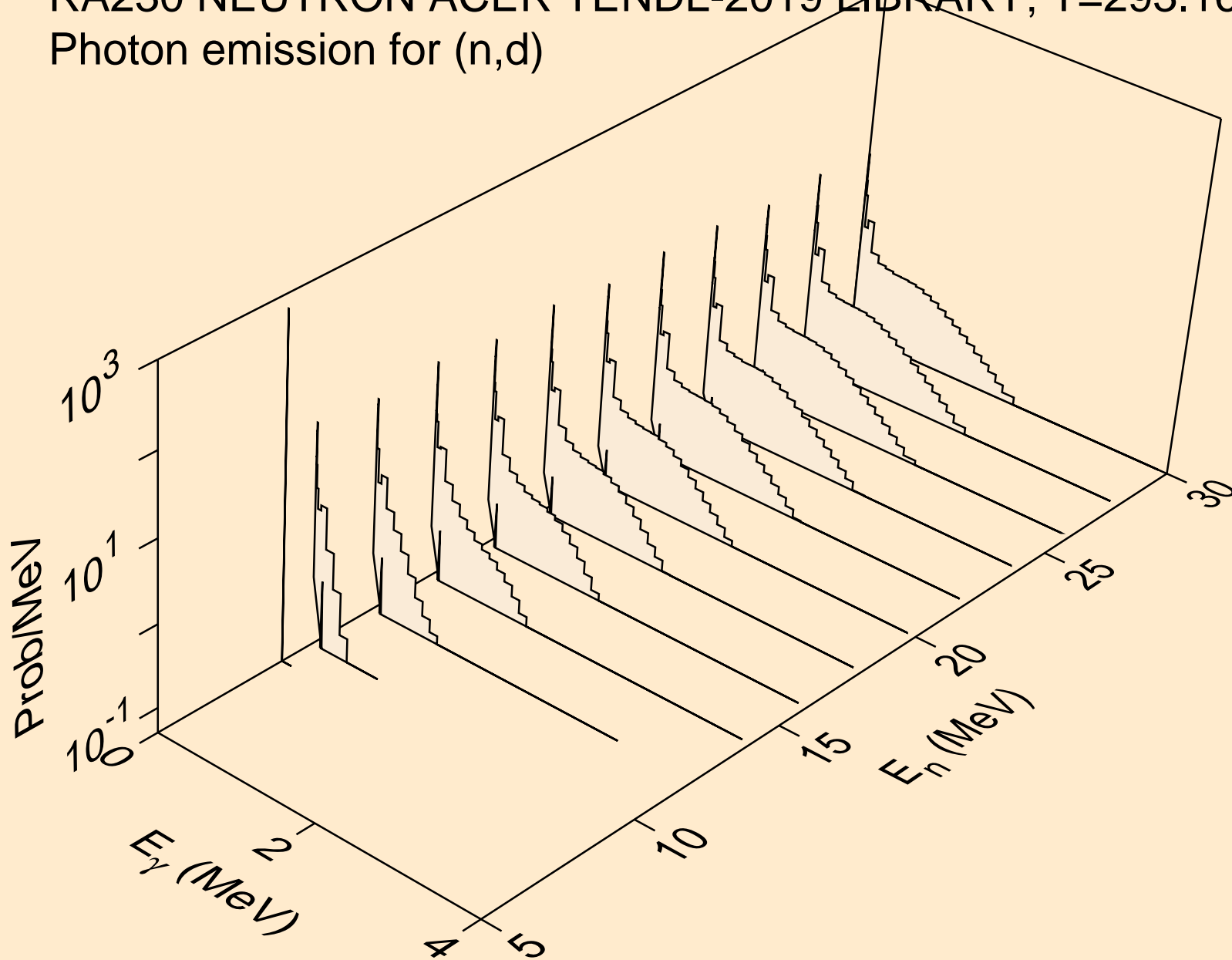

RA230 NEUTRON ACER TENDL-2019 LIBRARY; T=293.16K
Photon emission for (n,t)

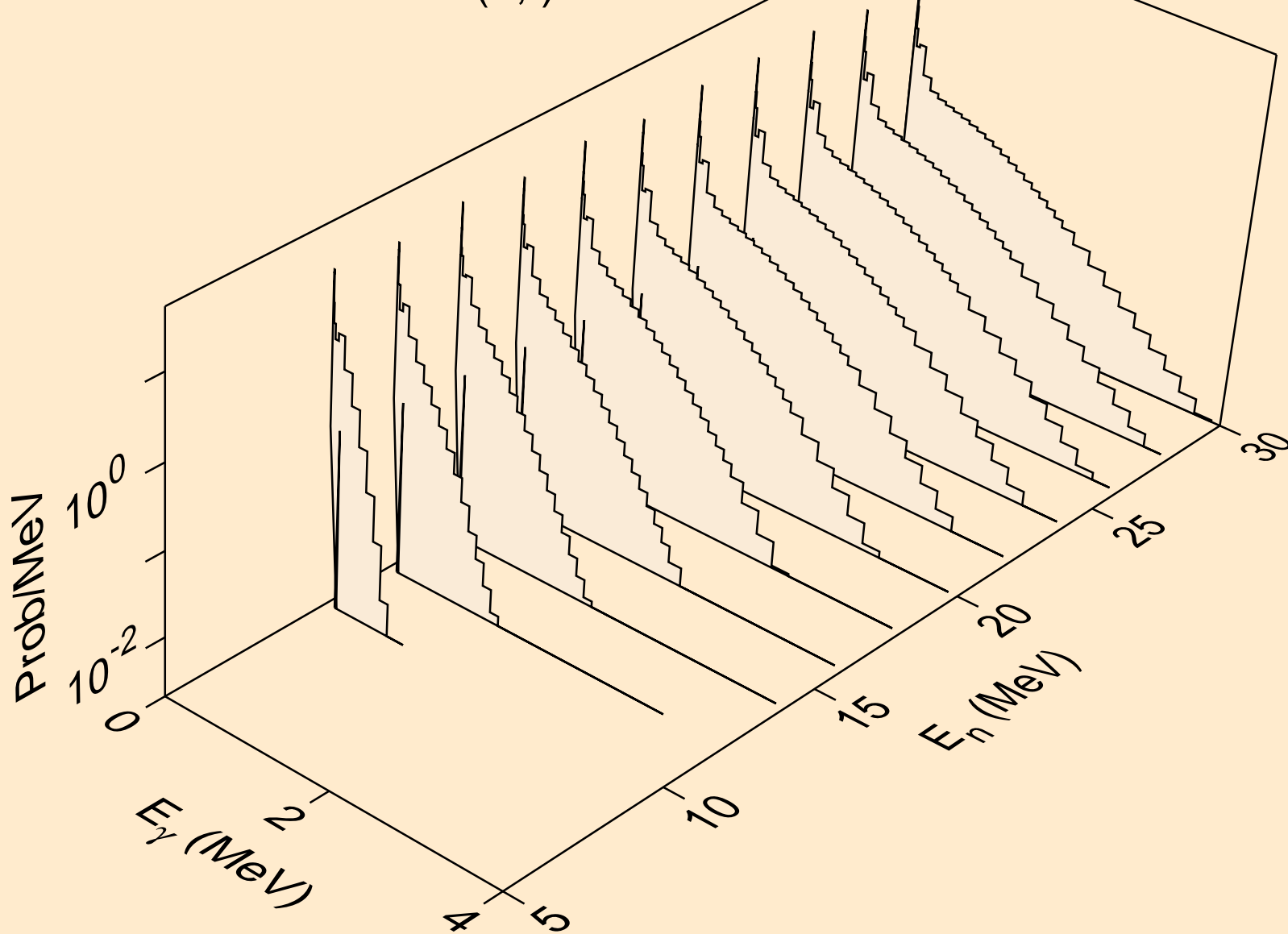

RA230 NEUTRON ACER TENDL-2019 LIBRARY; T=293.16K
Photon emission for (n,he3)

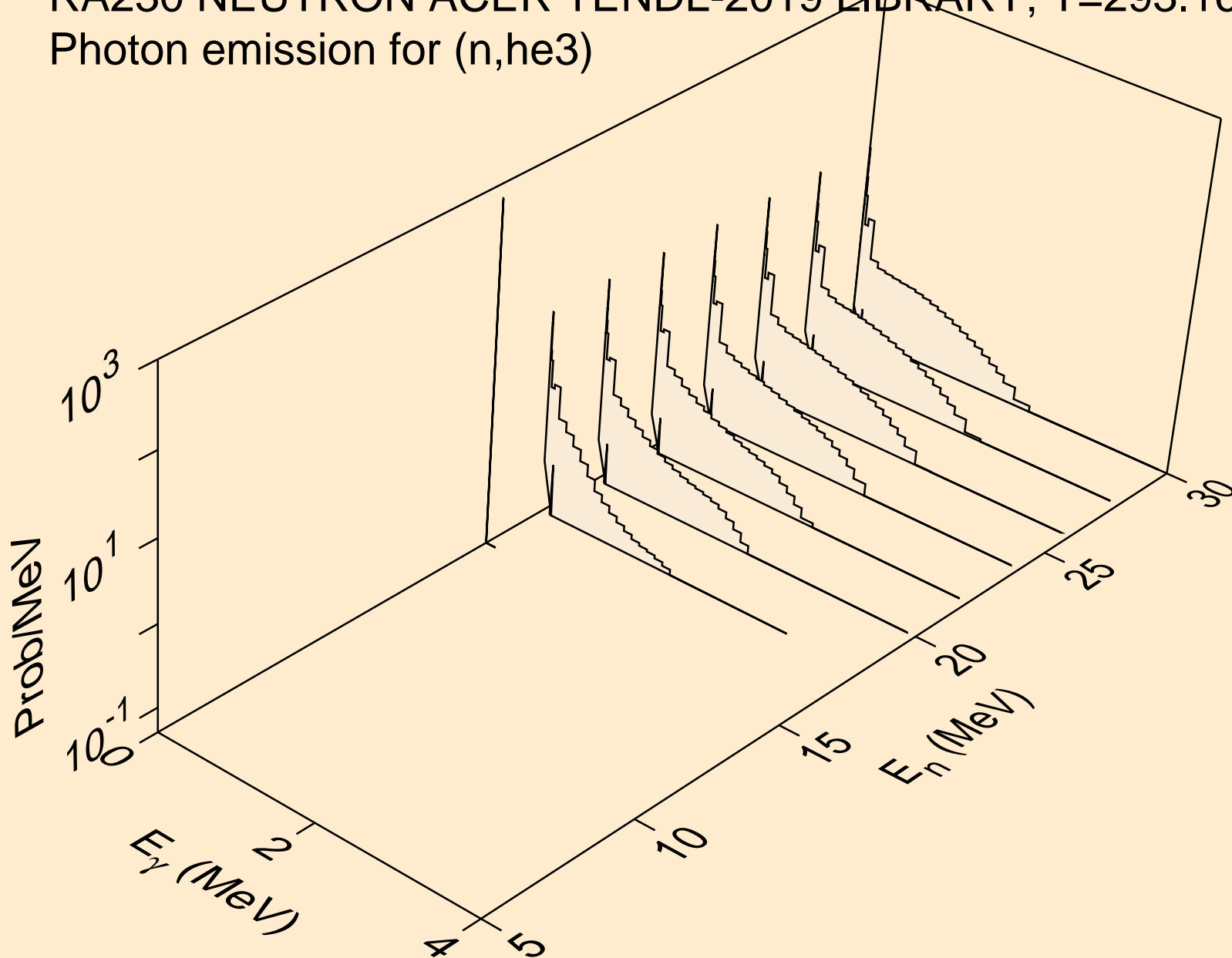

RA230 NEUTRON ACER TENDL-2019 LIBRARY; T=293.16K
Photon emission for (n,a)

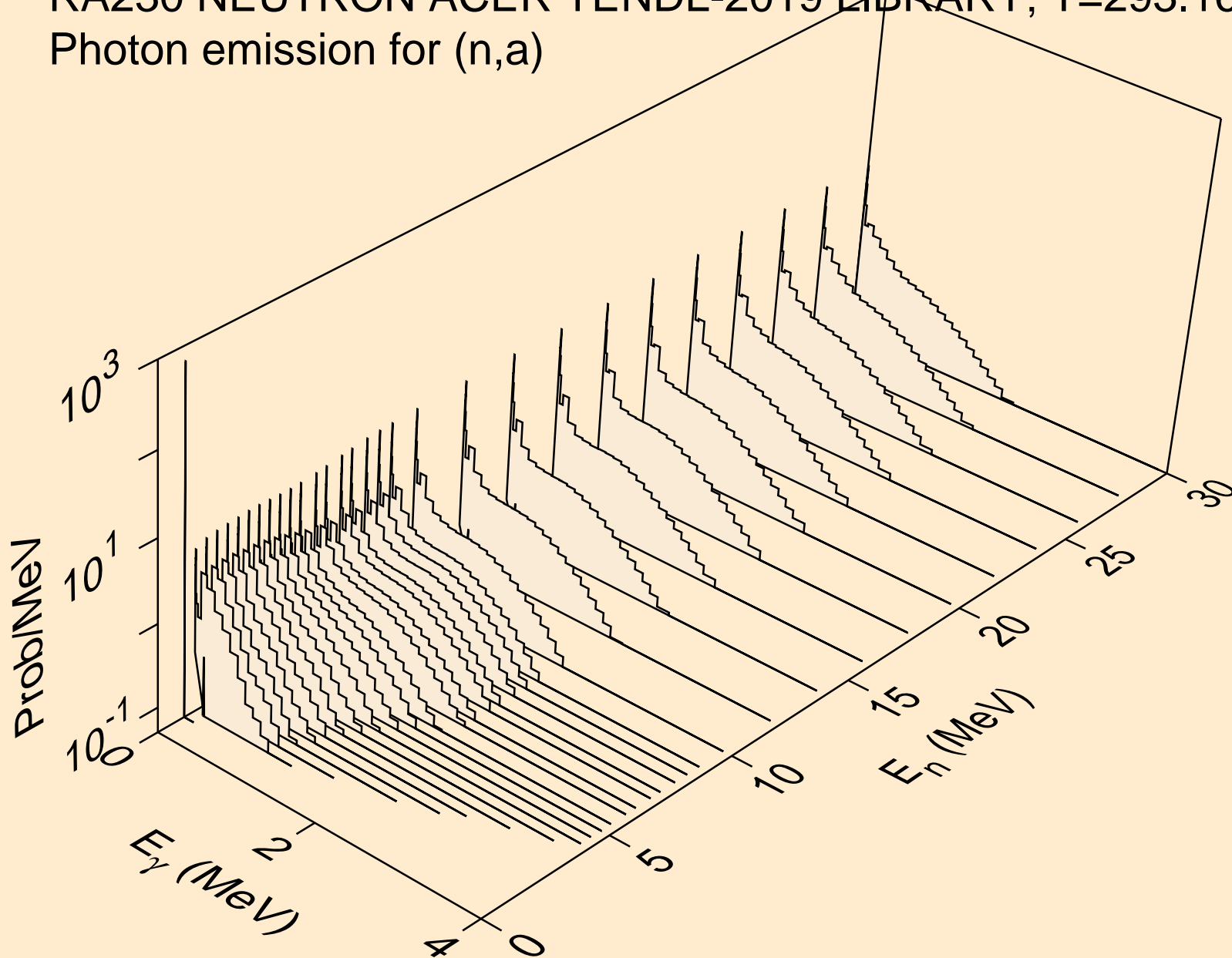

RA230 NEUTRON ACER TENDL-2019 LIBRARY; T=293.16K
Photon emission for (n,2p)

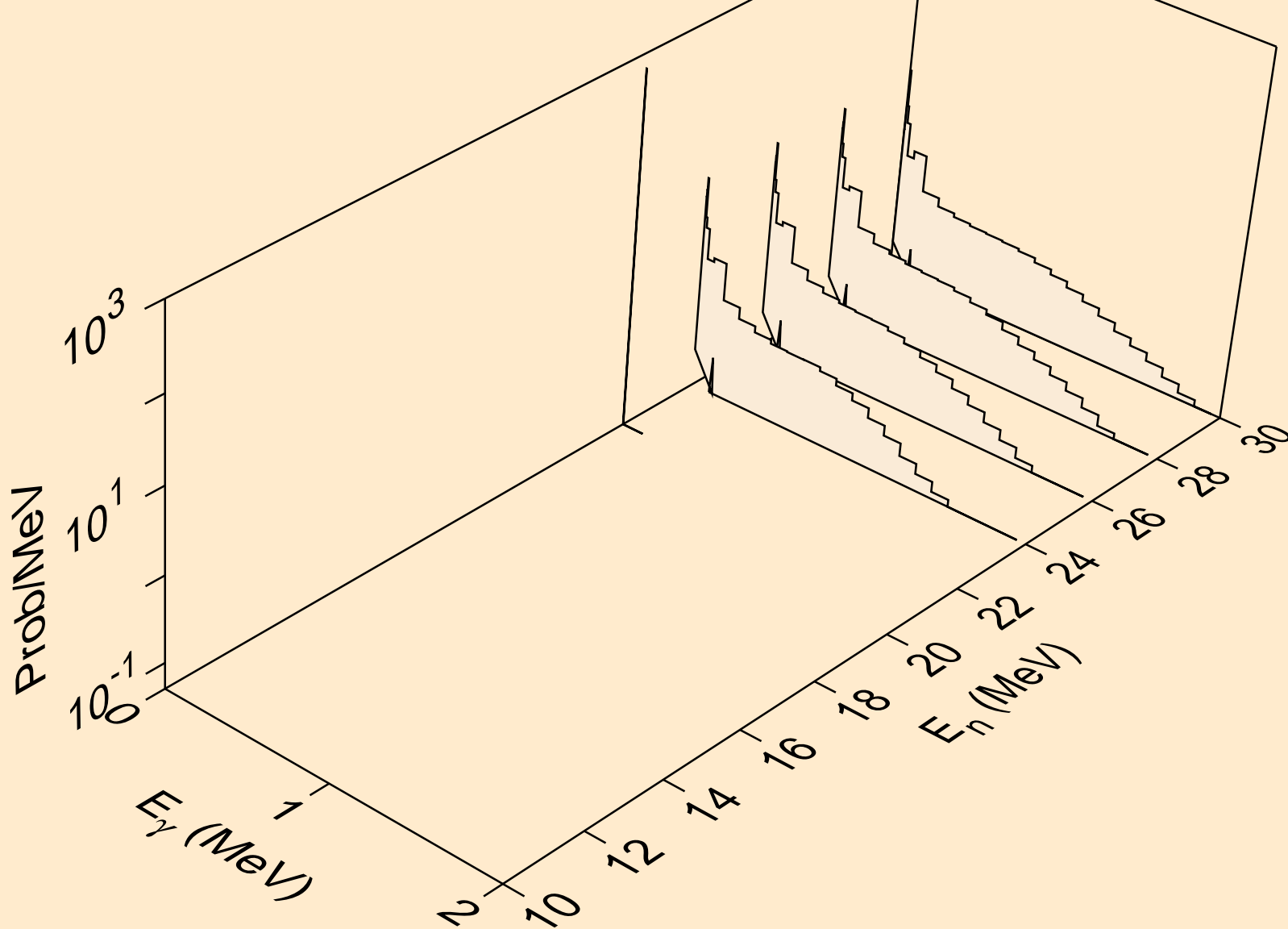

RA230 NEUTRON ACER TENDL-2019 LIBRARY; T=293.16K
thermal capture photon spectrum

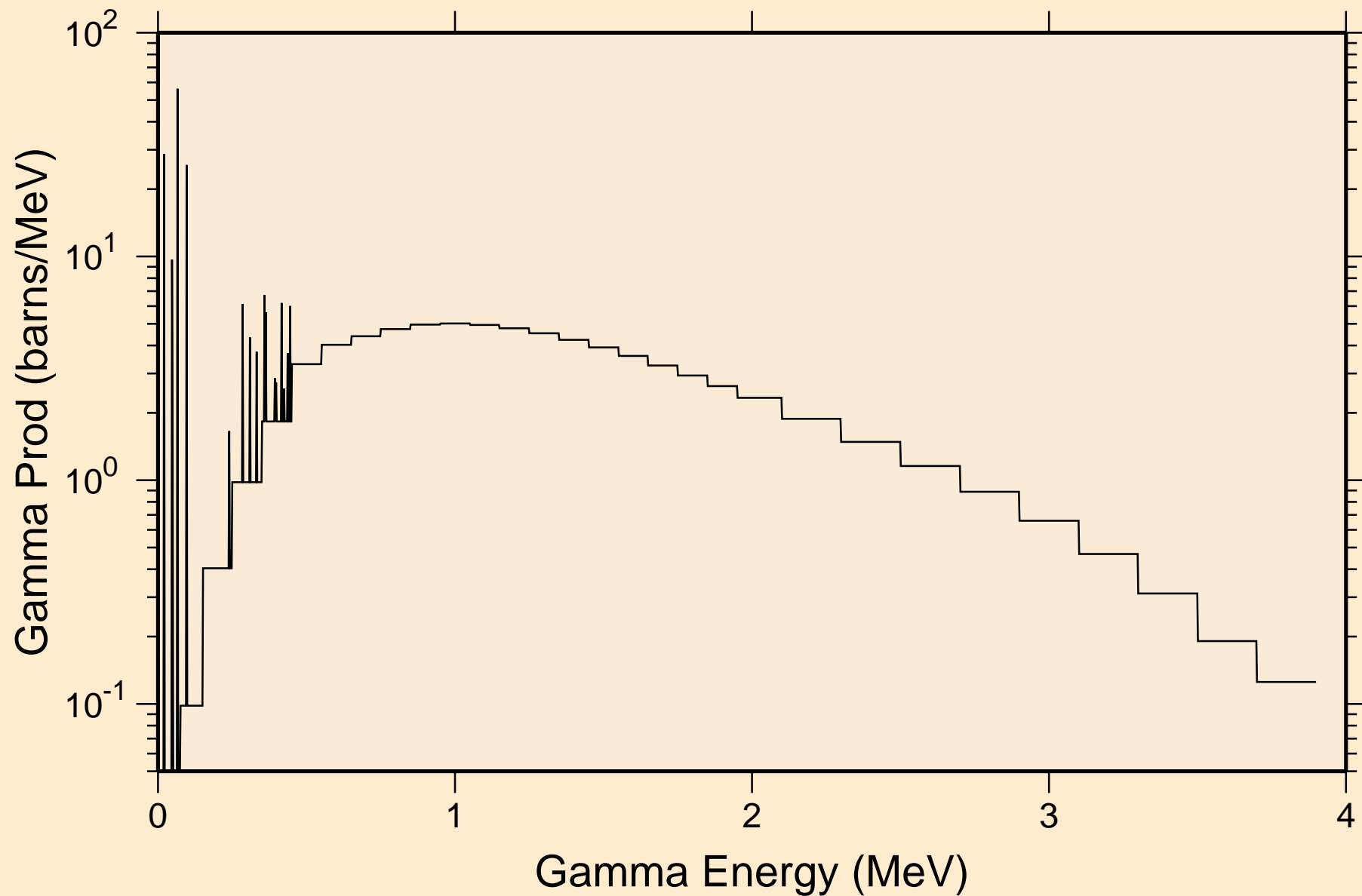

RA230 NEUTRON ACER TENDL-2019 LIBRARY; T=293.16K
14 MeV photon spectrum

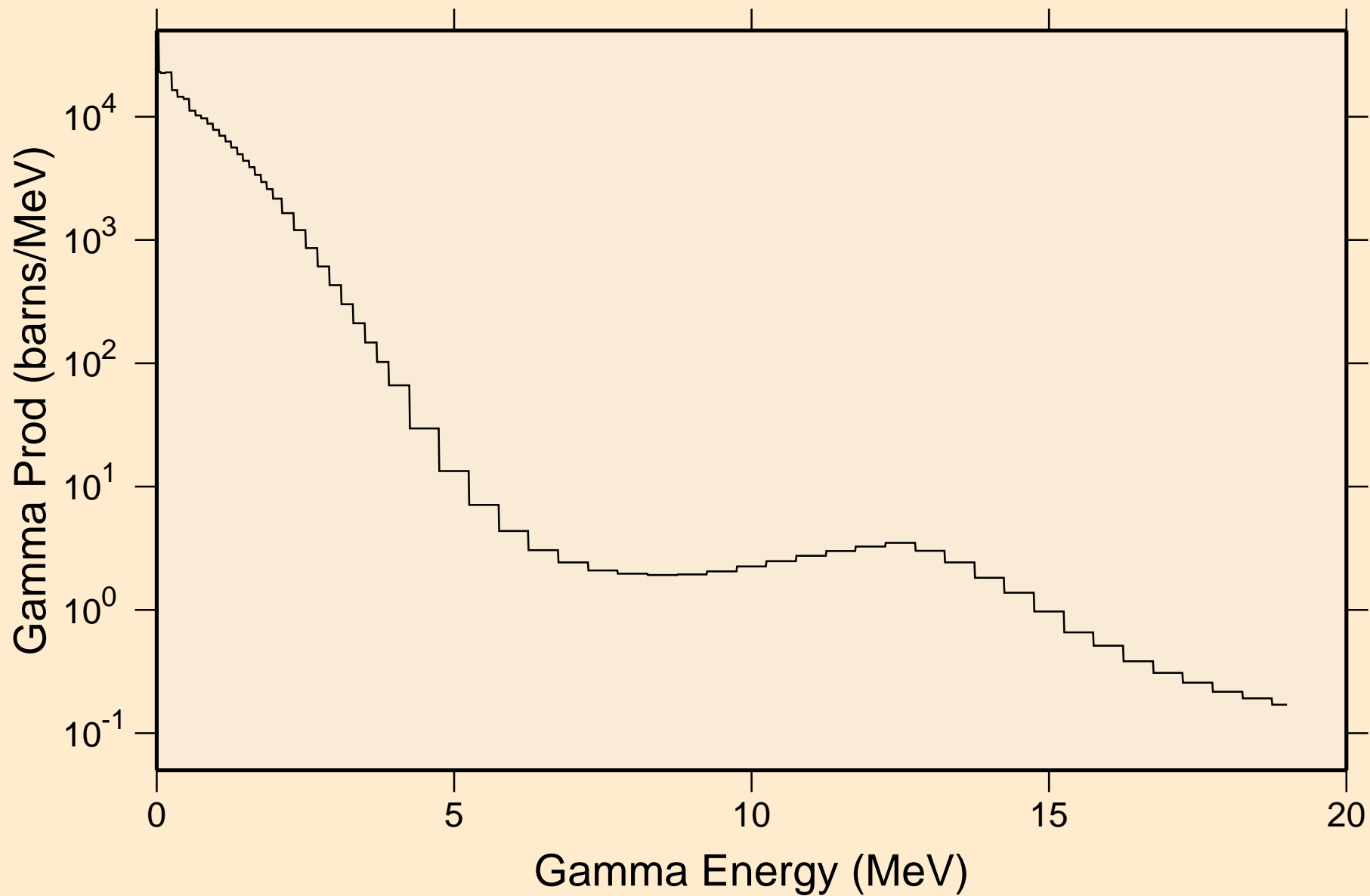

RA230 NEUTRON ACER TENDL-2019 LIBRARY; T=293.16K
Particle heating contributions

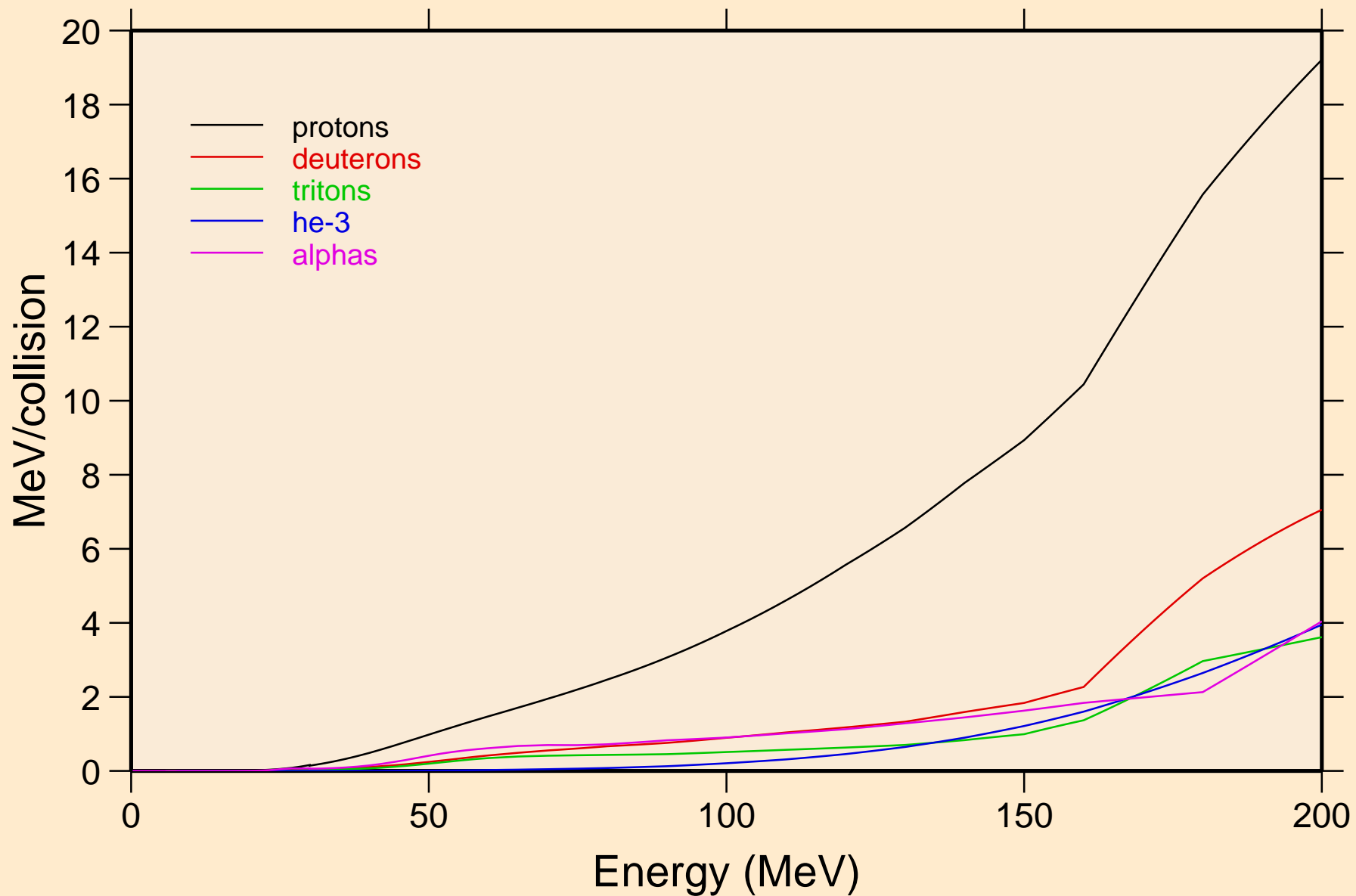

RA230 NEUTRON ACER TENDL-2019 LIBRARY; T=293.16K
Recoil Heating

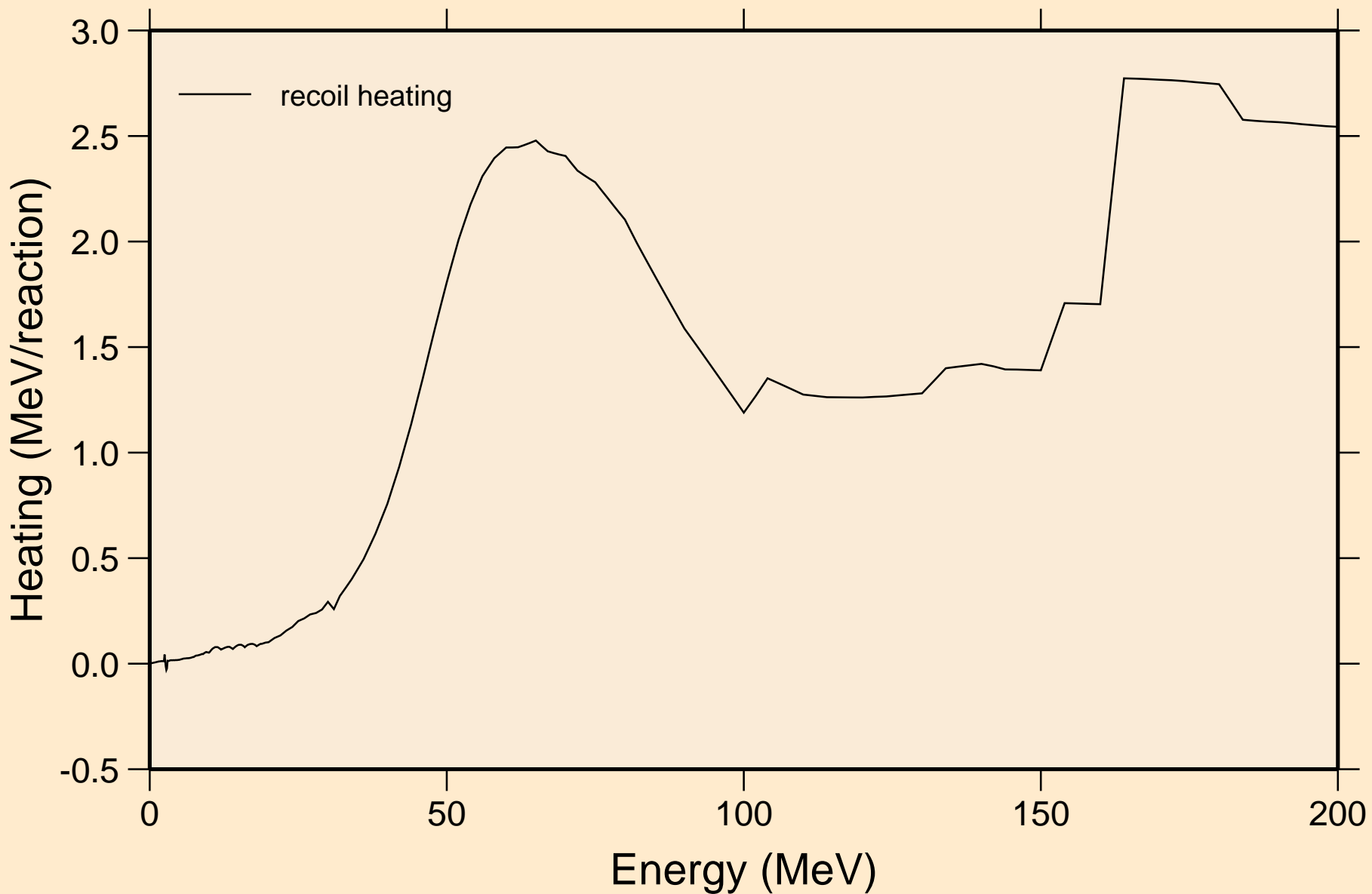

RA230 NEUTRON ACER TENDL-2019 LIBRARY; T=293.16K
Particle production cross sections

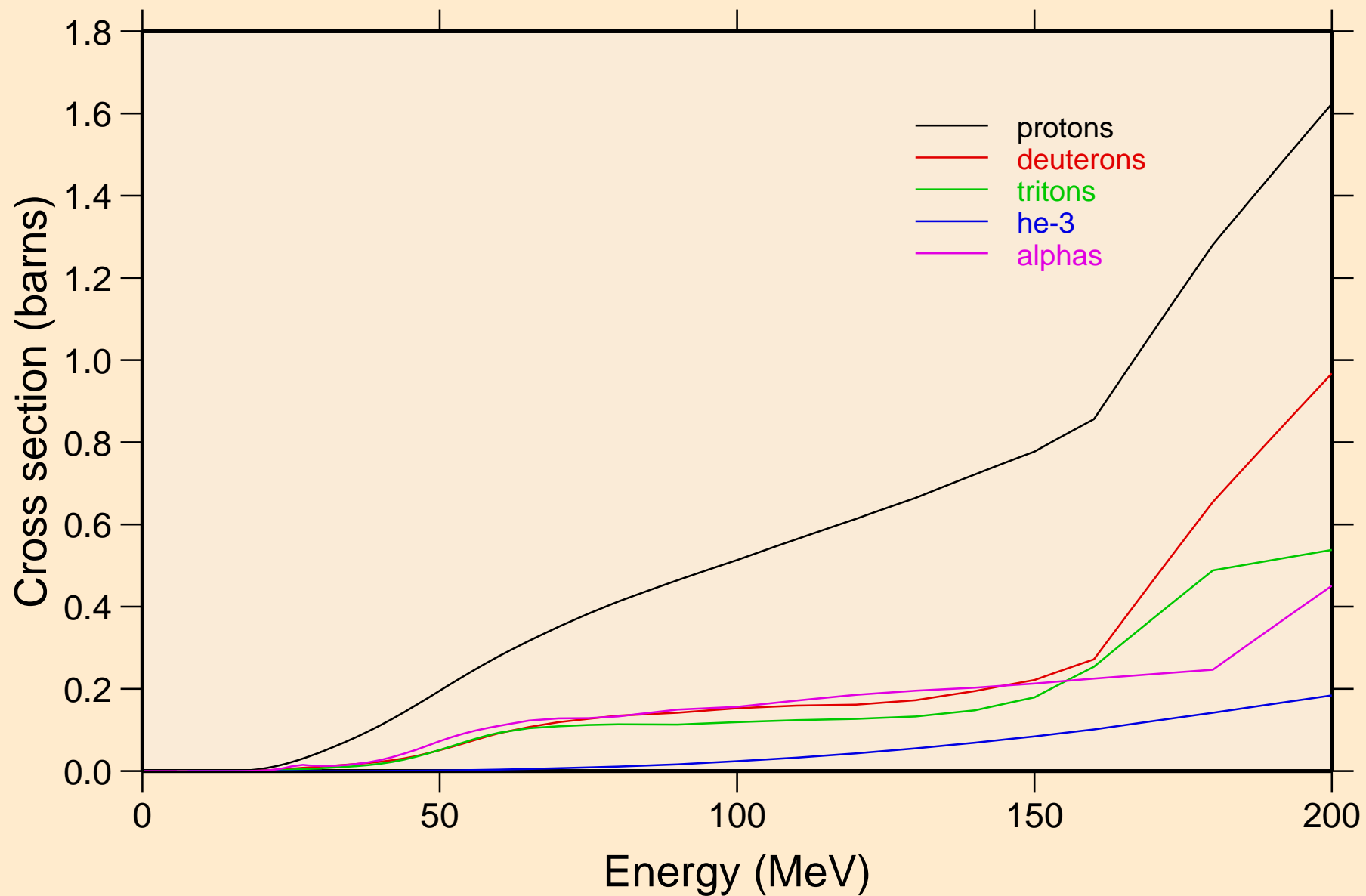

RA230 NEUTRON ACER TENDL-2019 LIBRARY; T=293.16K
protons from (n,x)

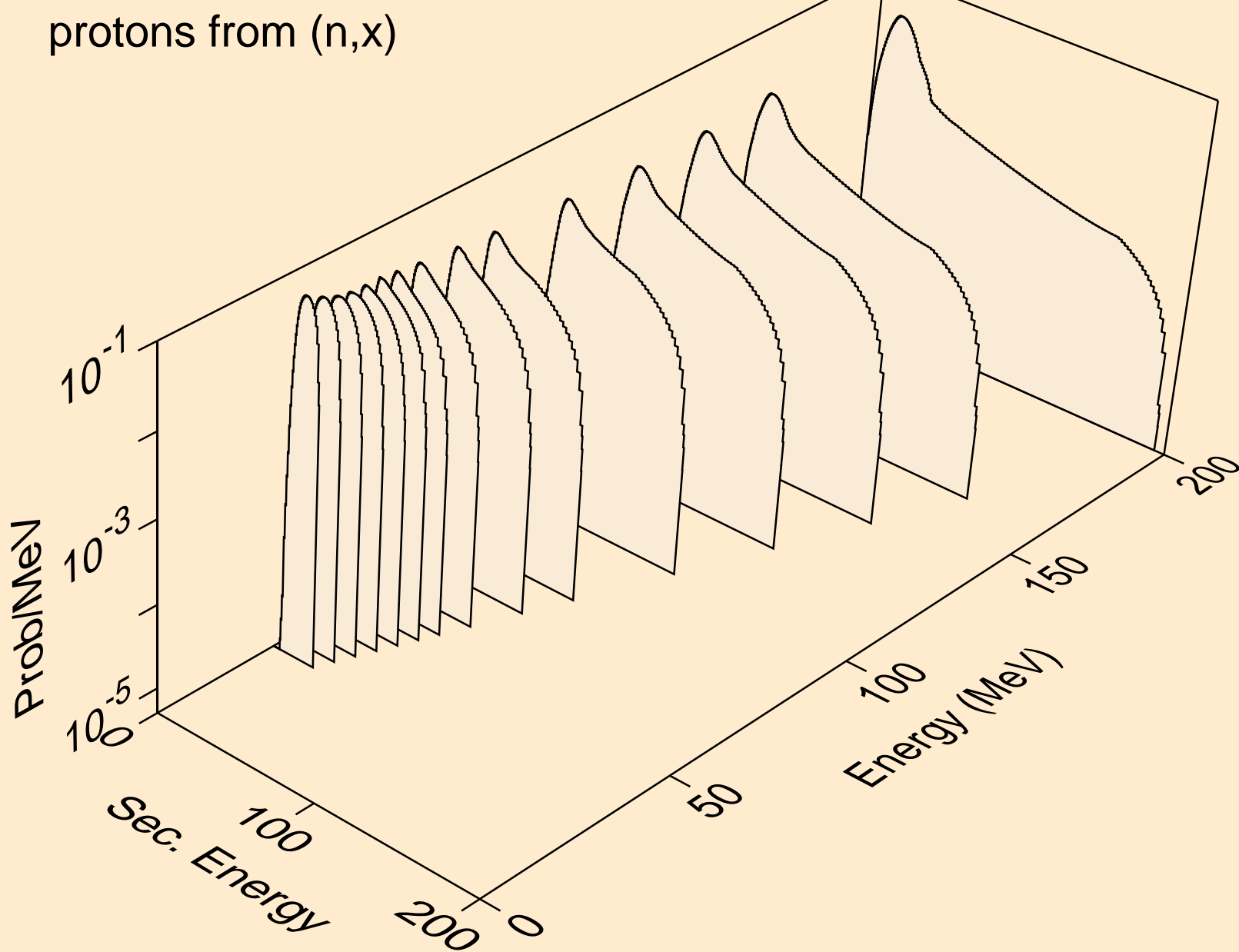

RA230 NEUTRON ACER TENDL-2019 LIBRARY; T=293.16K
protons from (n,n*)p

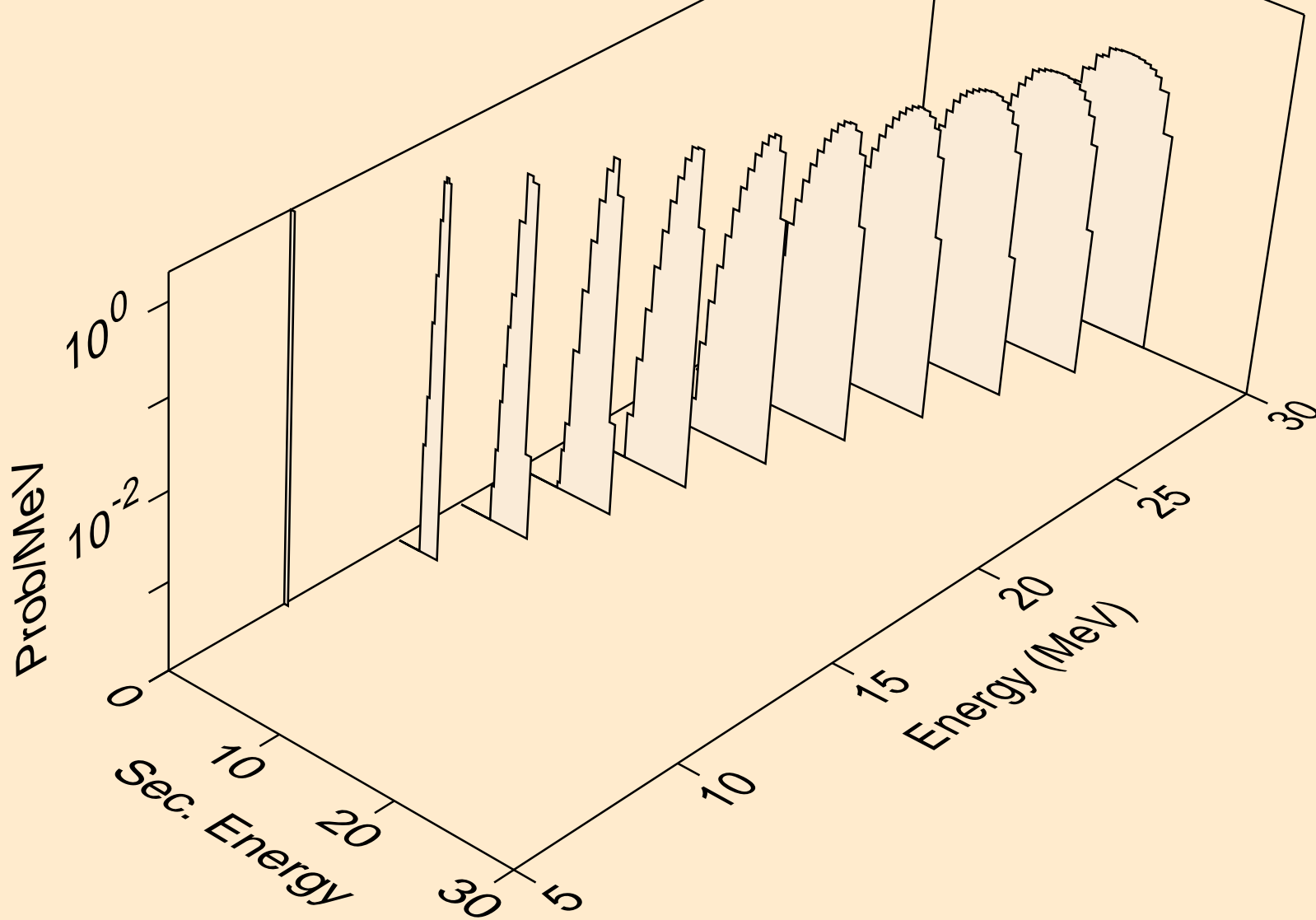

RA230 NEUTRON ACER TENDL-2019 LIBRARY; T=293.16K
protons from (n,2np)

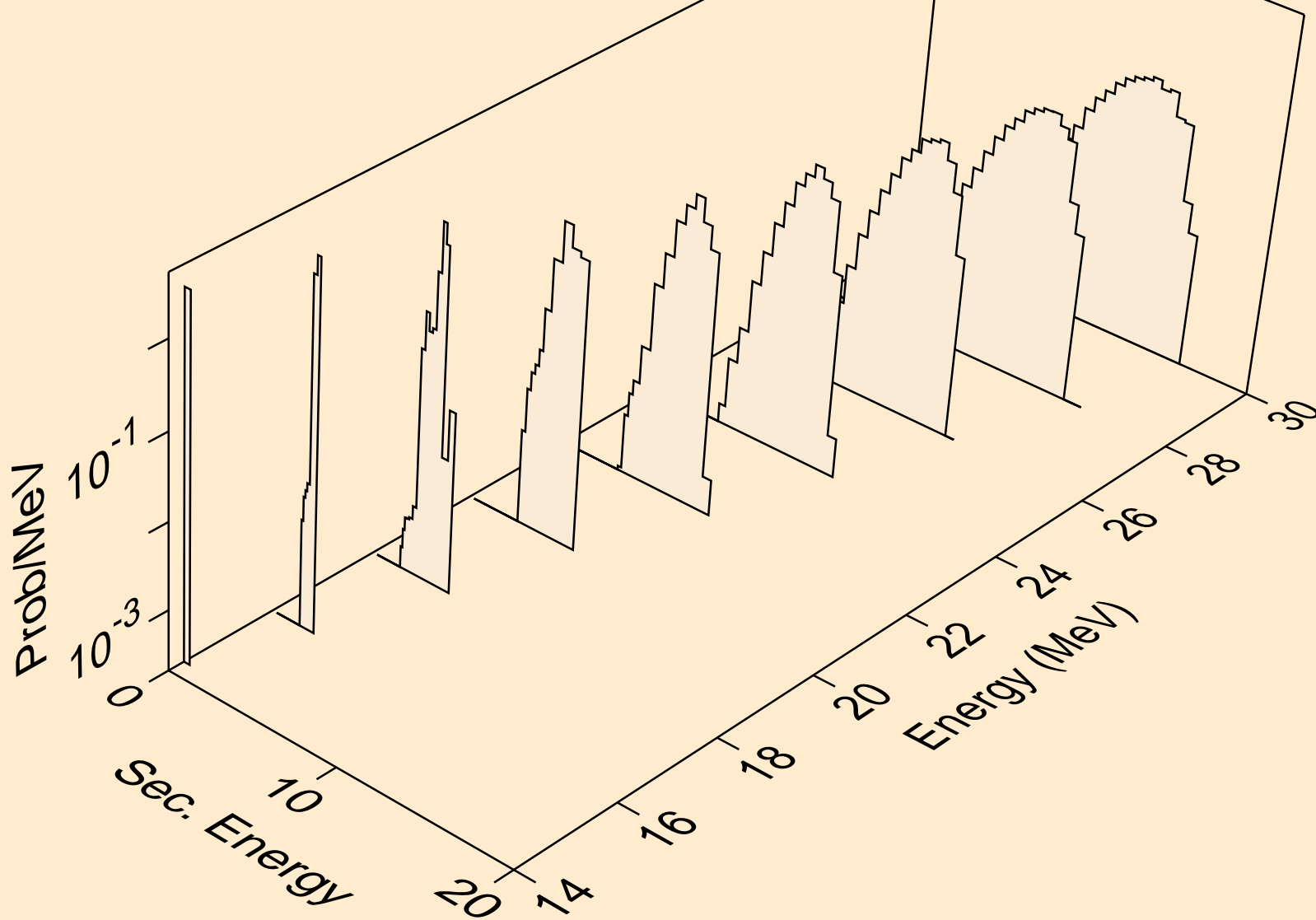

RA230 NEUTRON ACER TENDL-2019 LIBRARY; T=293.16K
protons from (n,3np)

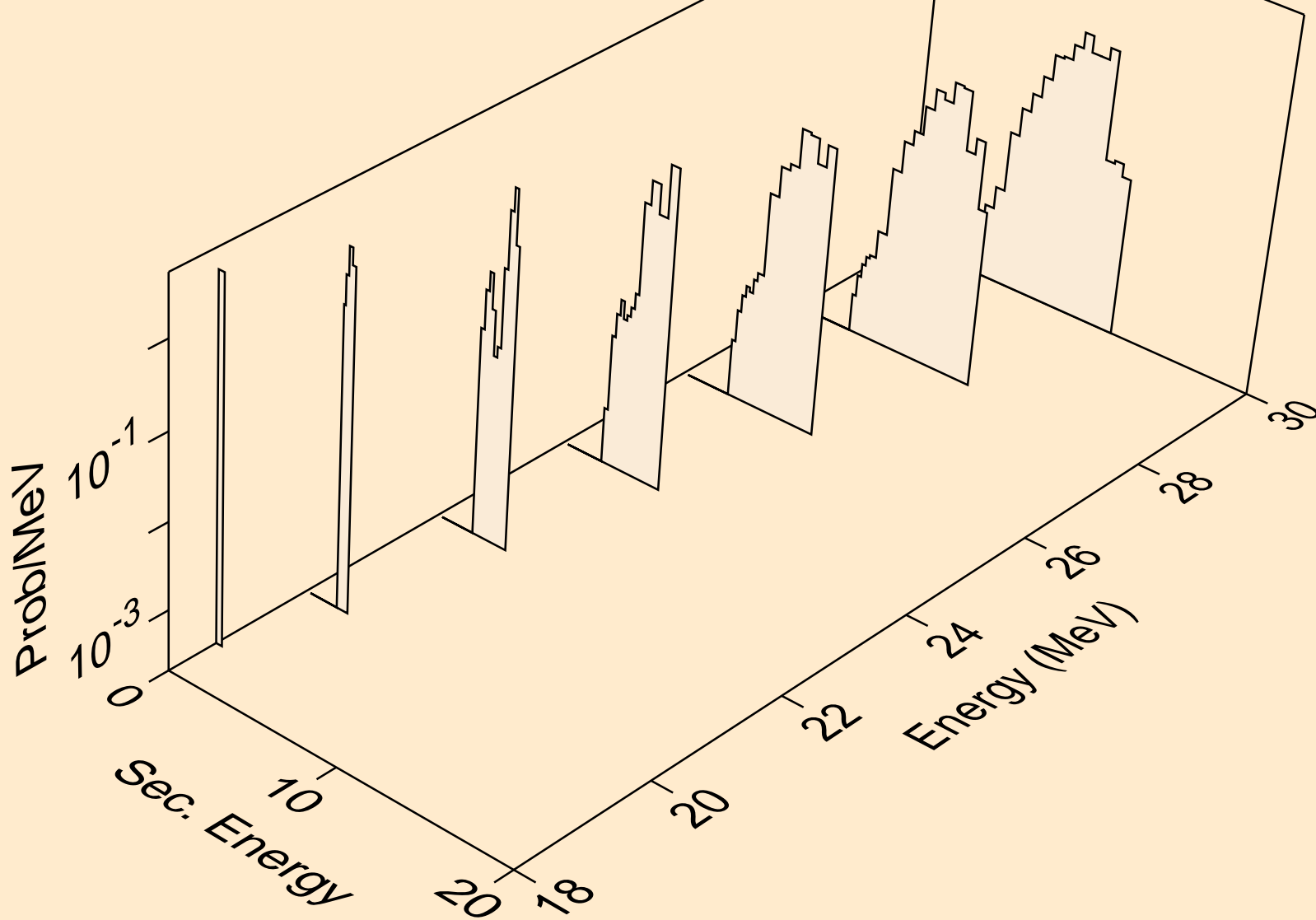

RA230 NEUTRON ACER TENDL-2019 LIBRARY; T=293.16K
protons from (n,p)

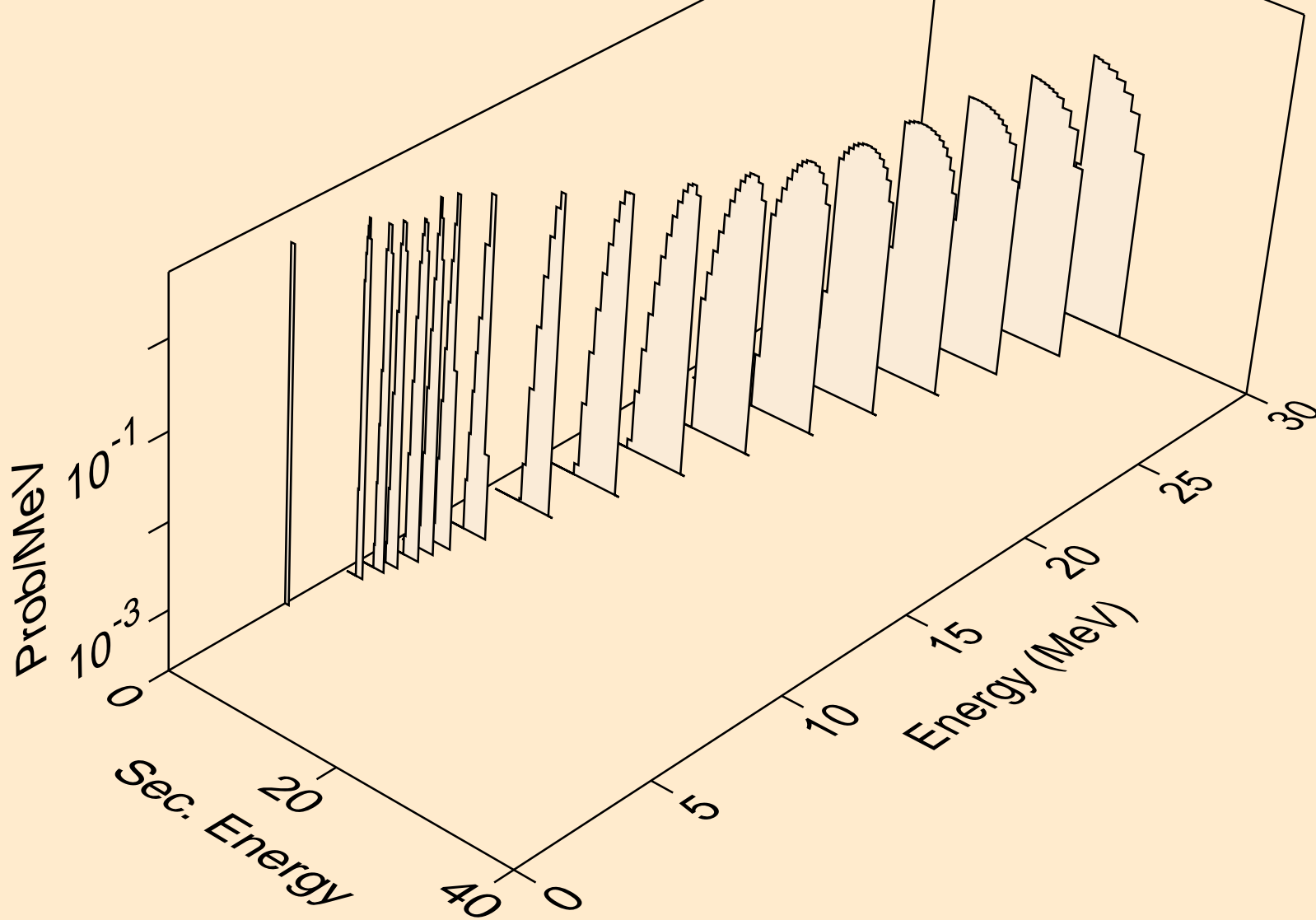

RA230 NEUTRON ACER TENDL-2019 LIBRARY; T=293.16K
protons from (n,2p)

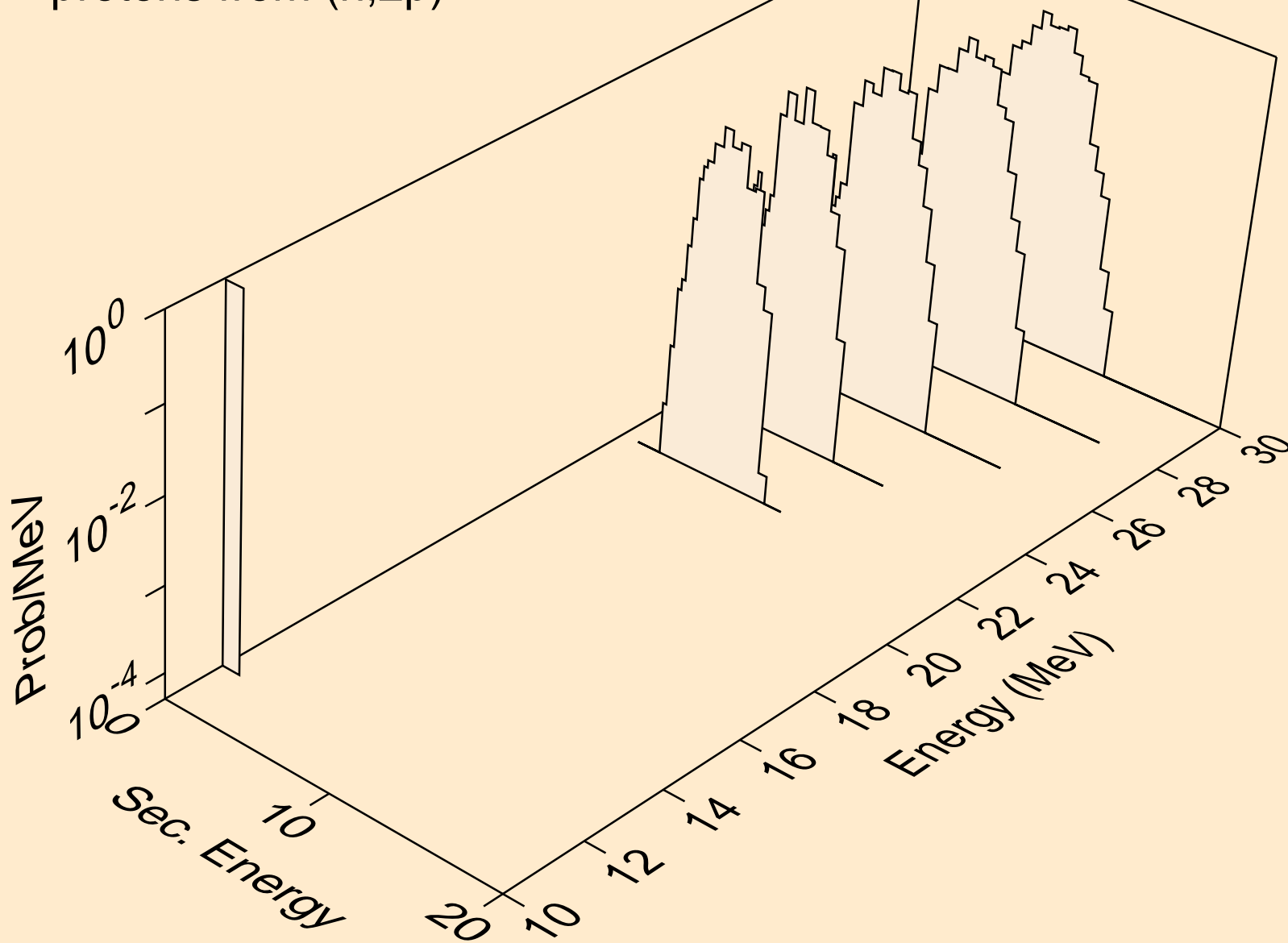

RA230 NEUTRON ACER TENDL-2019 LIBRARY; T=293.16K
deuterons from (n,x)

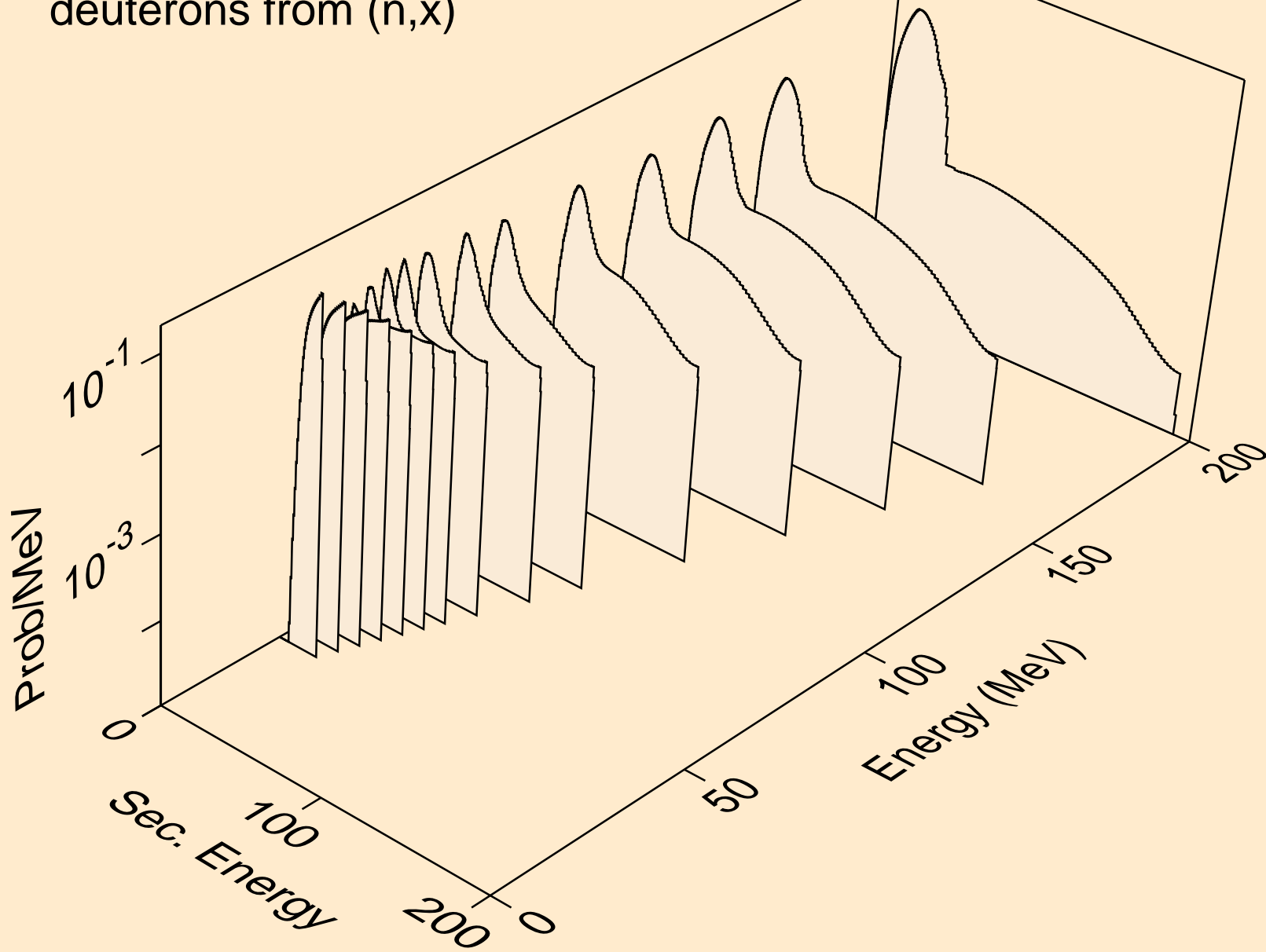

RA230 NEUTRON ACER TENDL-2019 LIBRARY; T=293.16K
deuterons from (n,2nd)

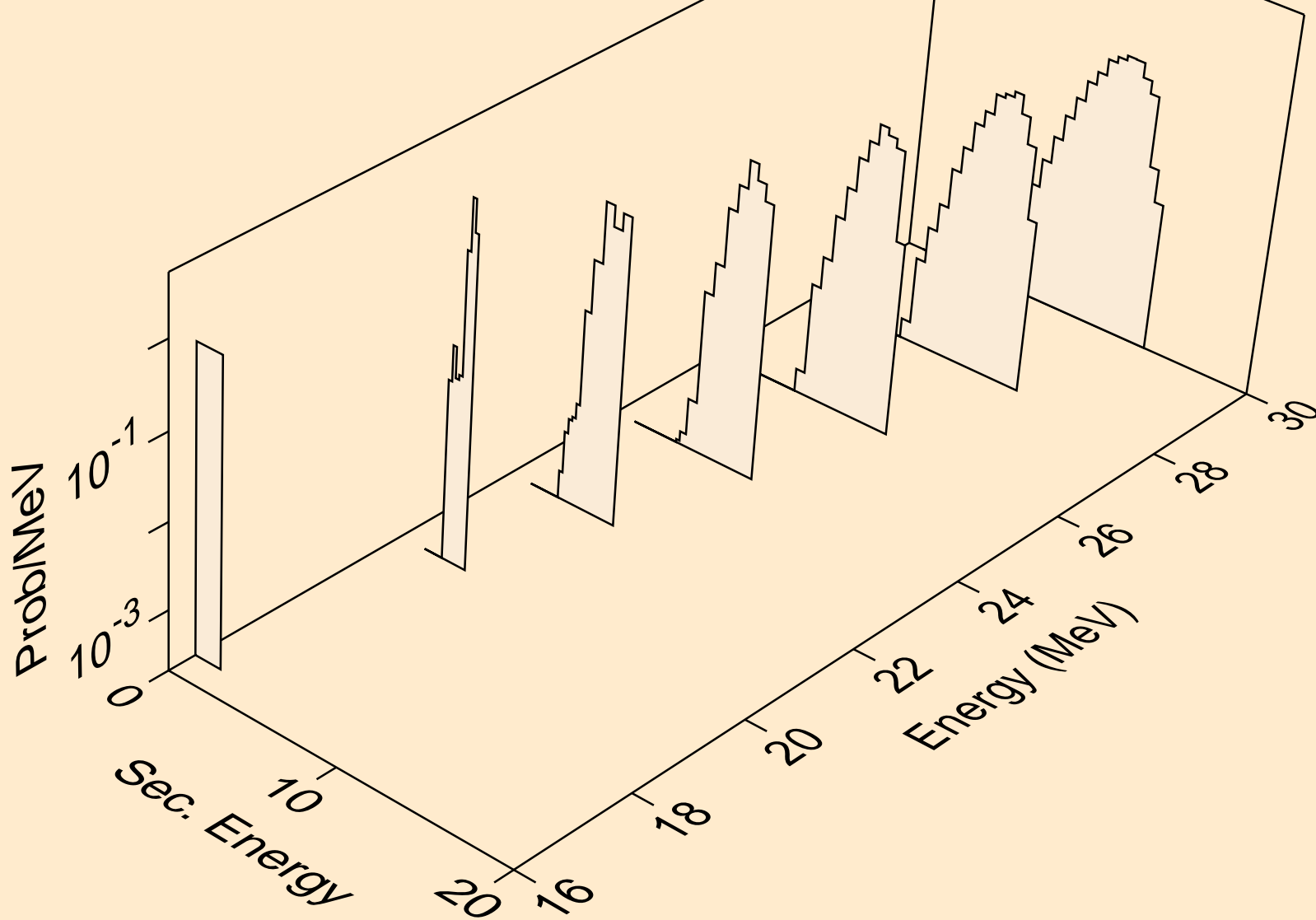

RA230 NEUTRON ACER TENDL-2019 LIBRARY; T=293.16K
deuterons from (n,n*)d

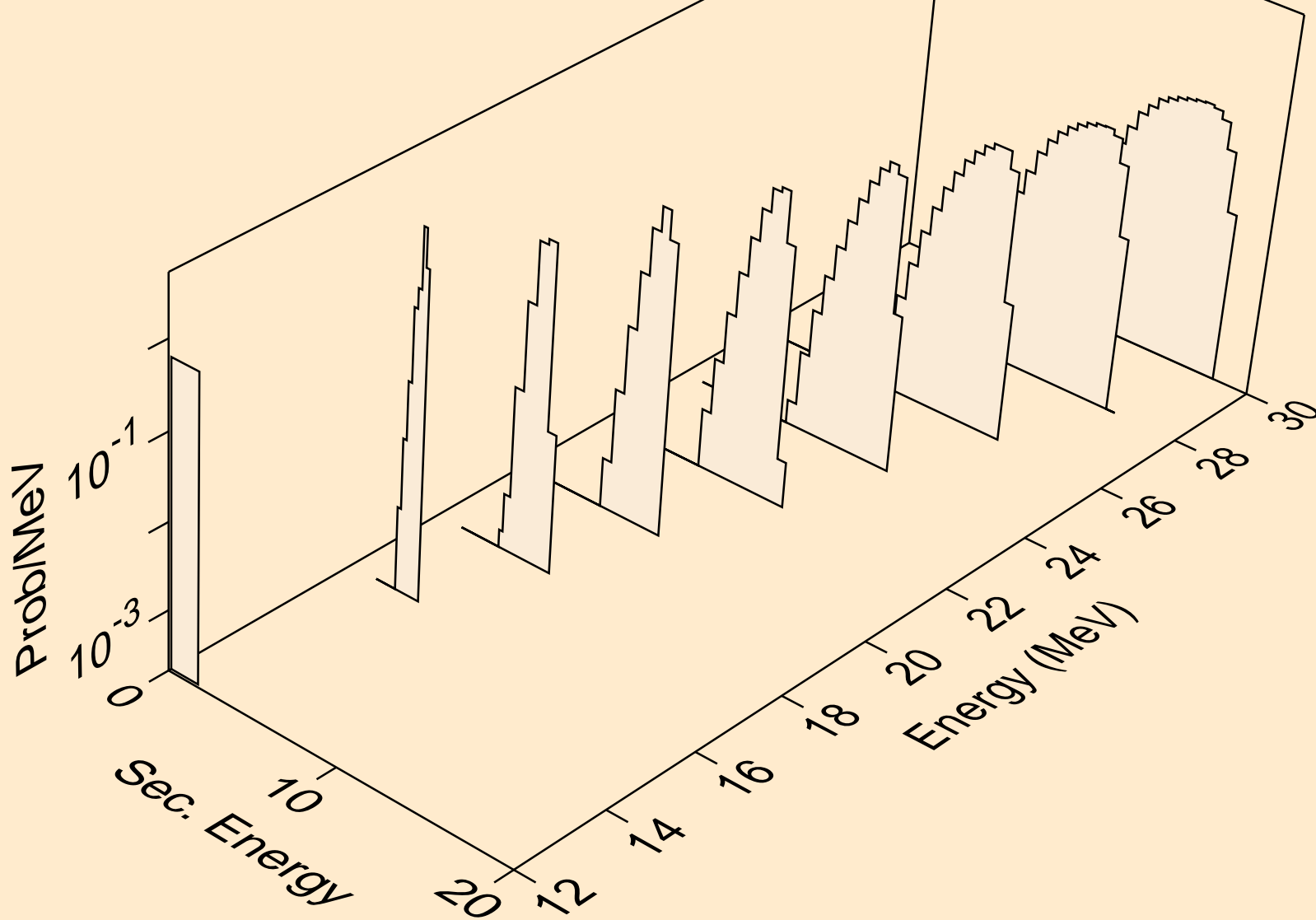

RA230 NEUTRON ACER TENDL-2019 LIBRARY; T=293.16K
deuterons from (n,d)

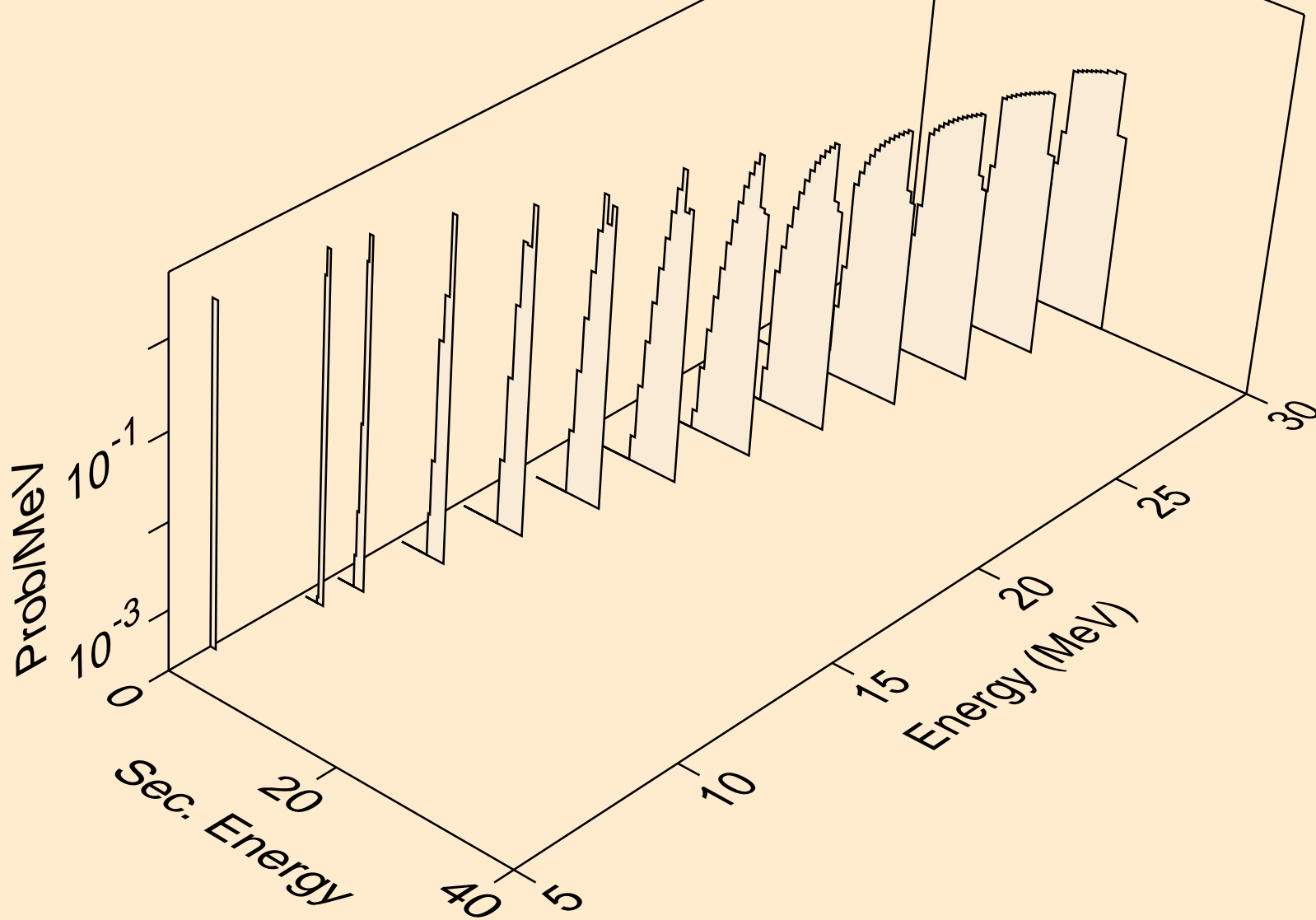

RA230 NEUTRON ACER TENDL-2019 LIBRARY; T=293.16K
tritons from (n,x)

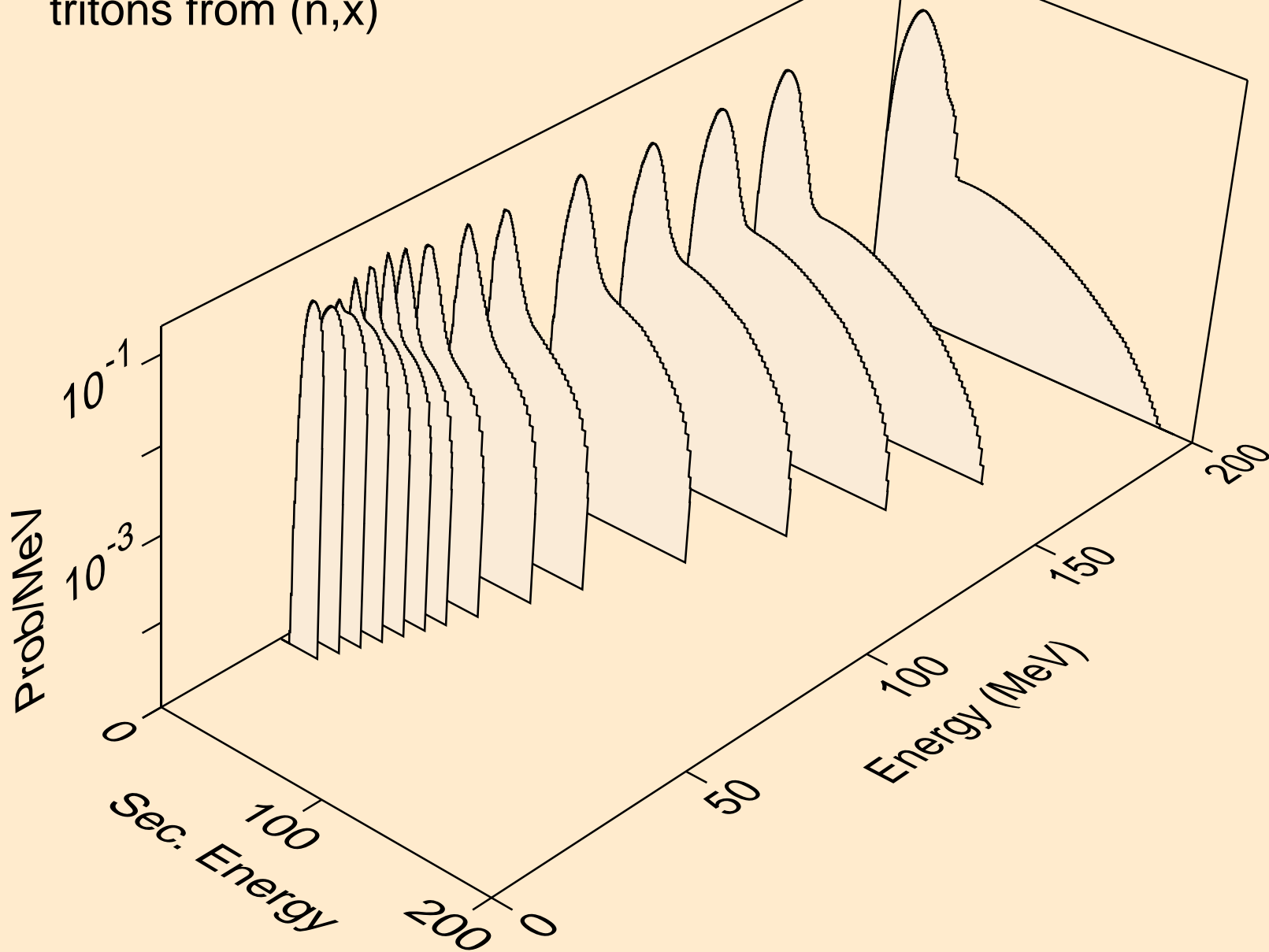

RA230 NEUTRON ACER TENDL-2019 LIBRARY; T=293.16K
tritons from (n,n*)t

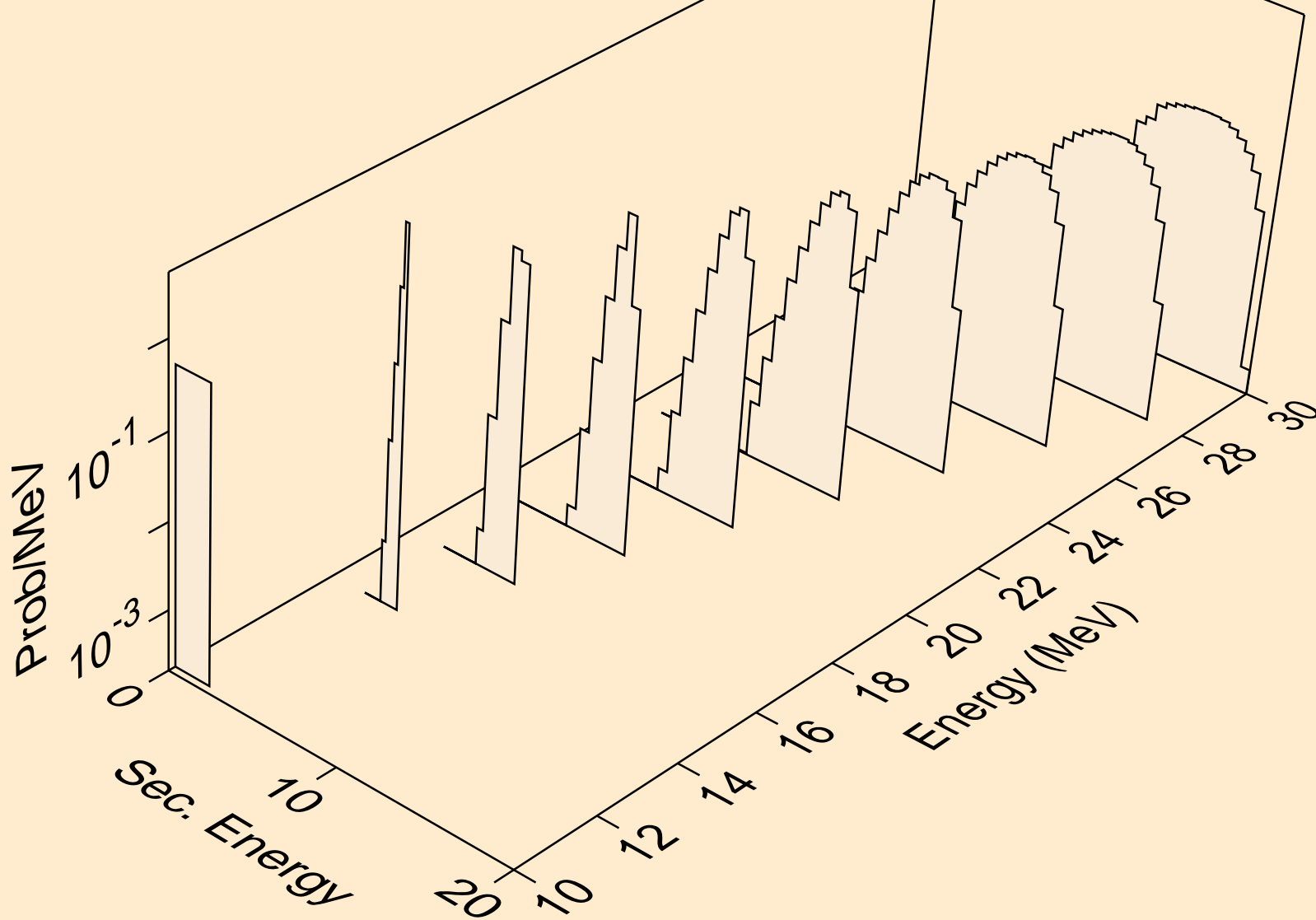

RA230 NEUTRON ACER TENDL-2019 LIBRARY; T=293.16K
tritons from (n,t)

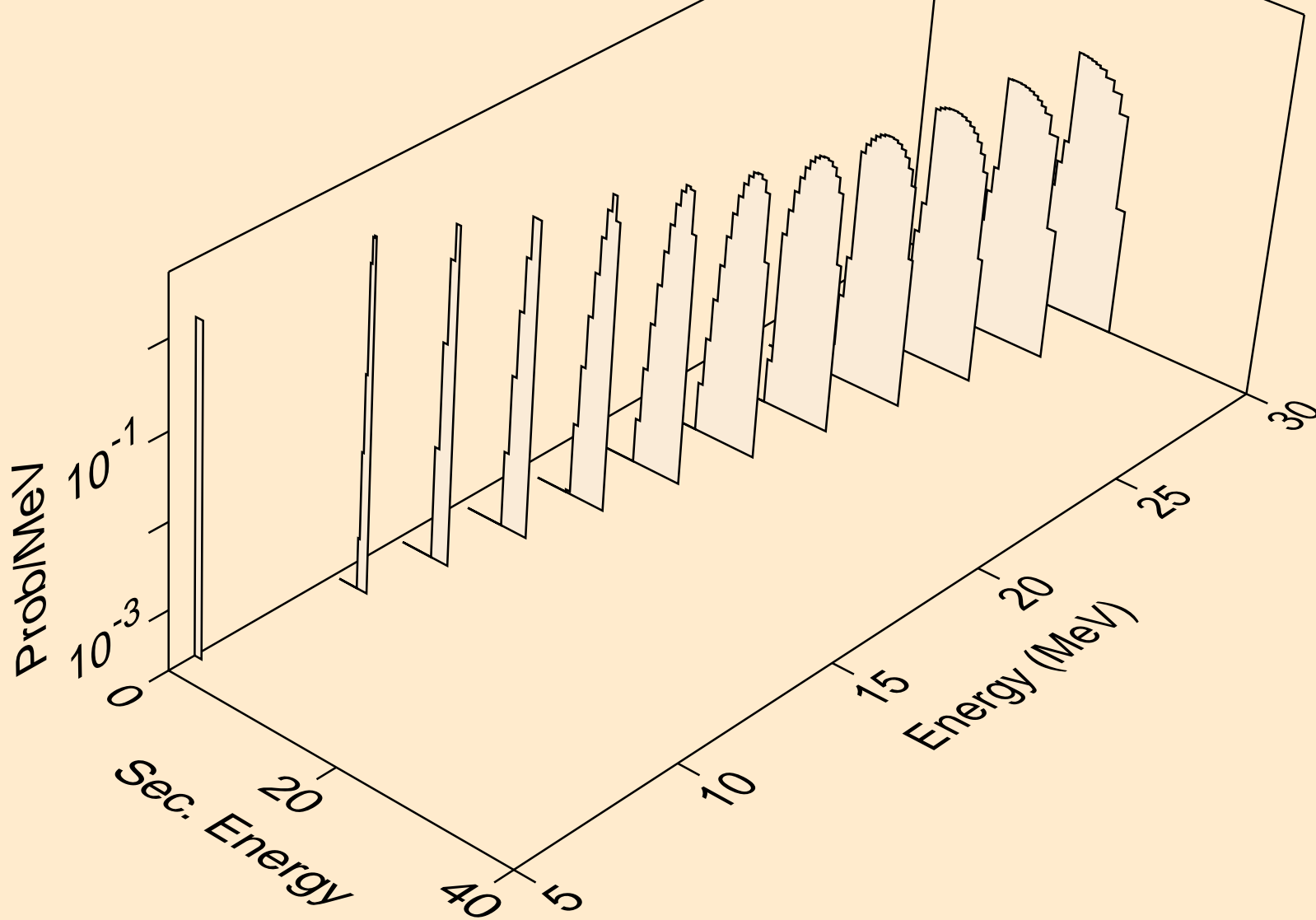

RA230 NEUTRON ACER TENDL-2019 LIBRARY; T=293.16K
he3s from (n,x)

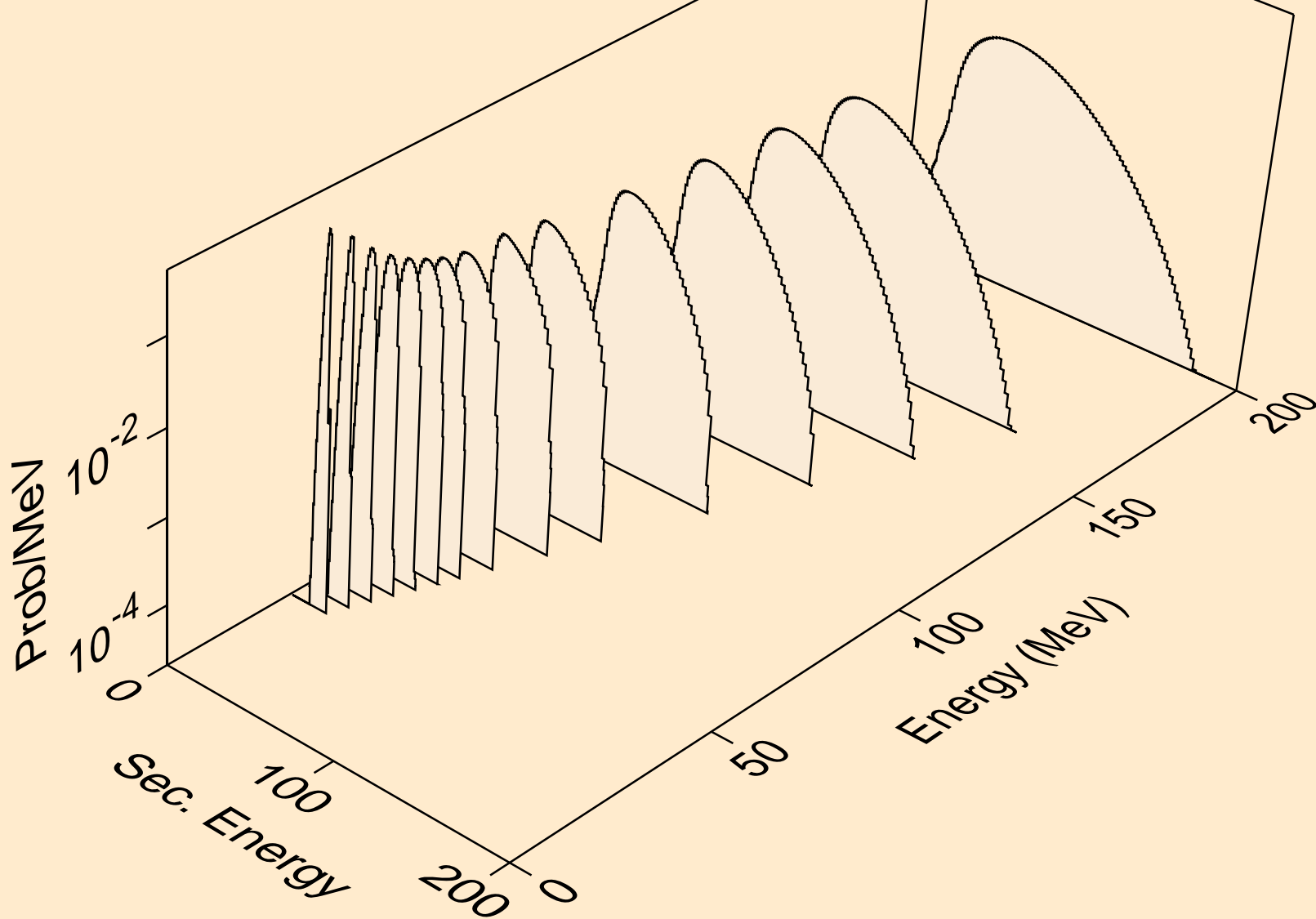

RA230 NEUTRON ACER TENDL-2019 LIBRARY; T=293.16K
he3s from (n,n*)he3

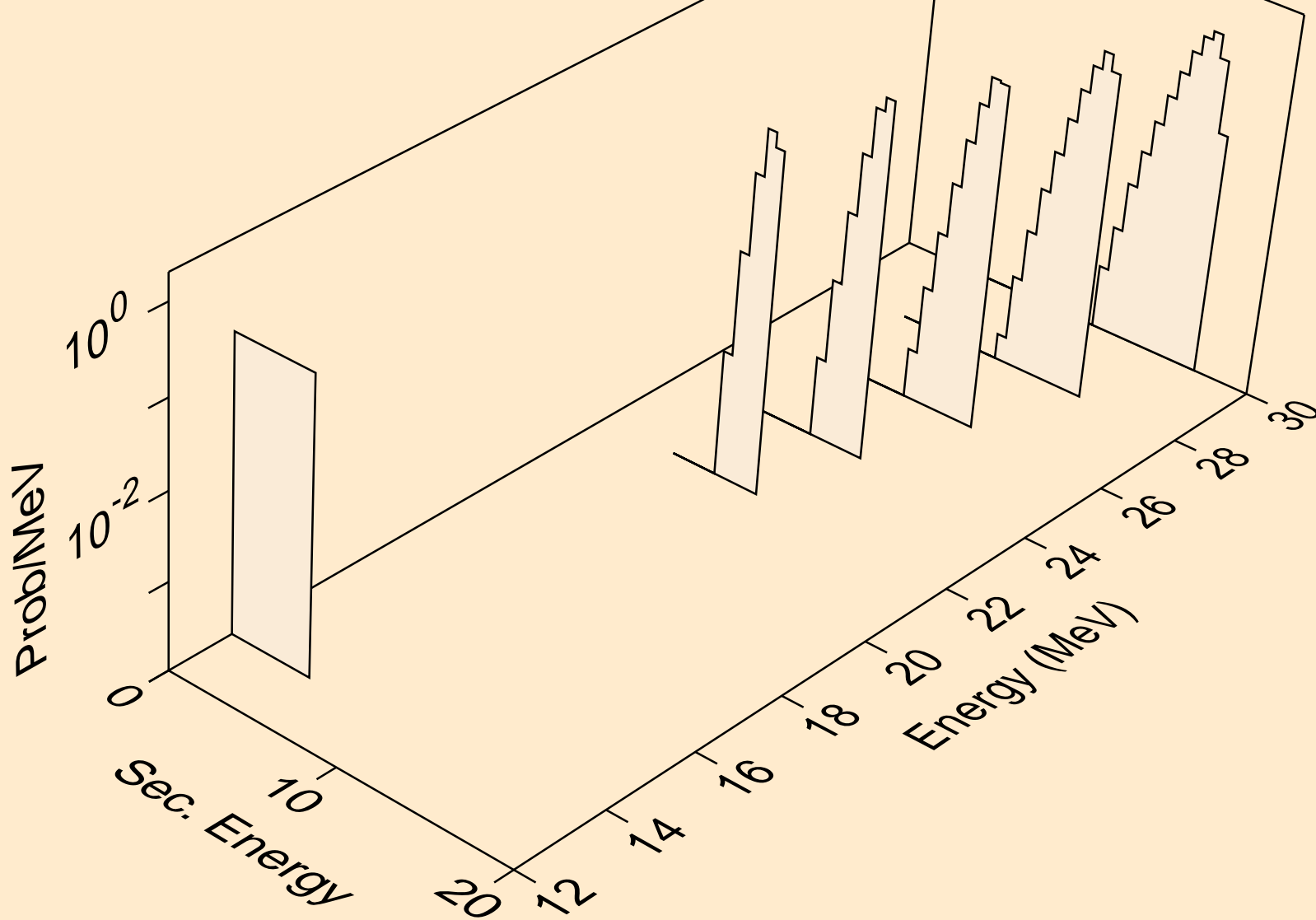

RA230 NEUTRON ACER TENDL-2019 LIBRARY; T=293.16K
he3s from (n,he3)

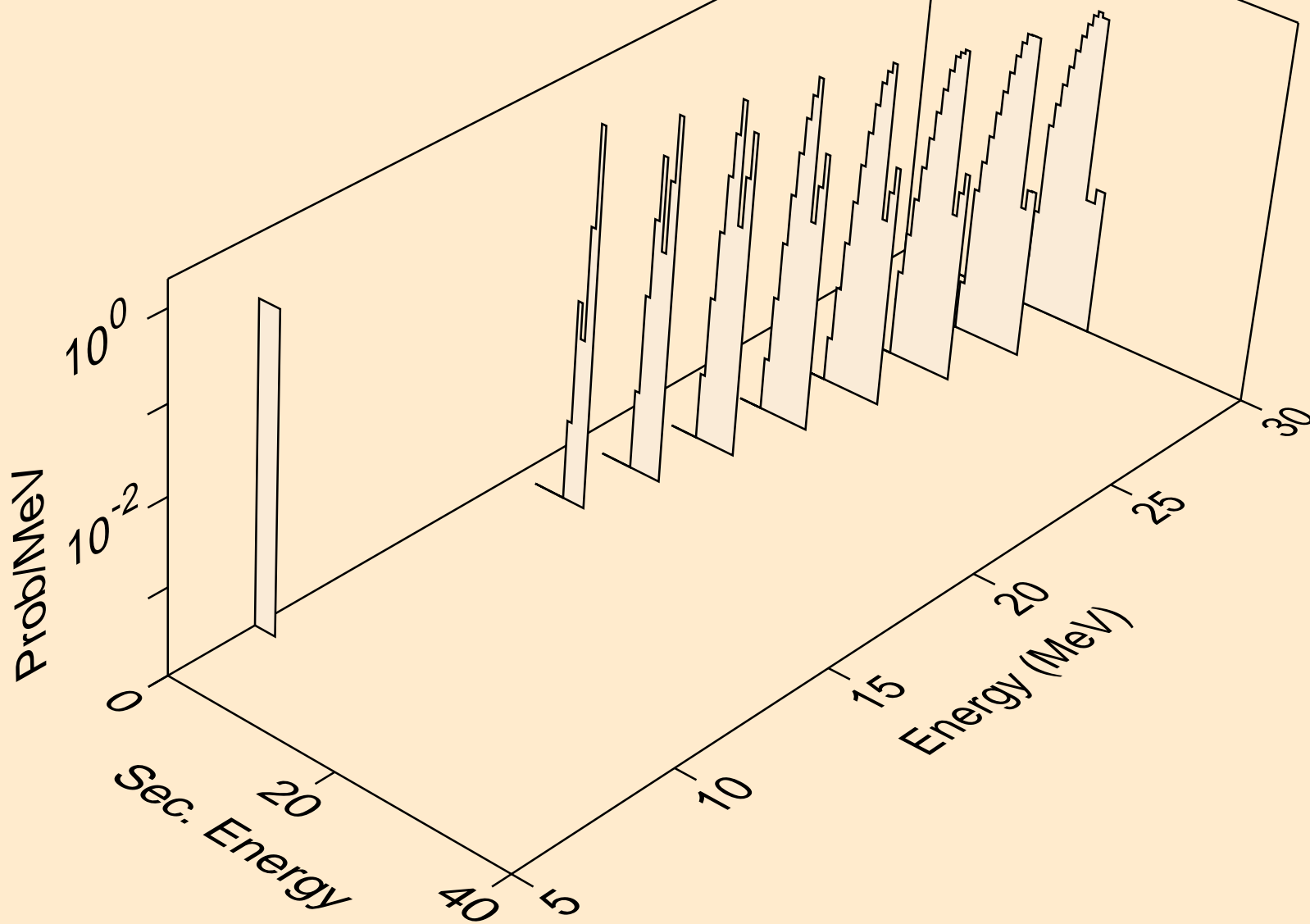

RA230 NEUTRON ACER TENDL-2019 LIBRARY; T=293.16K
alphas from (n,x)

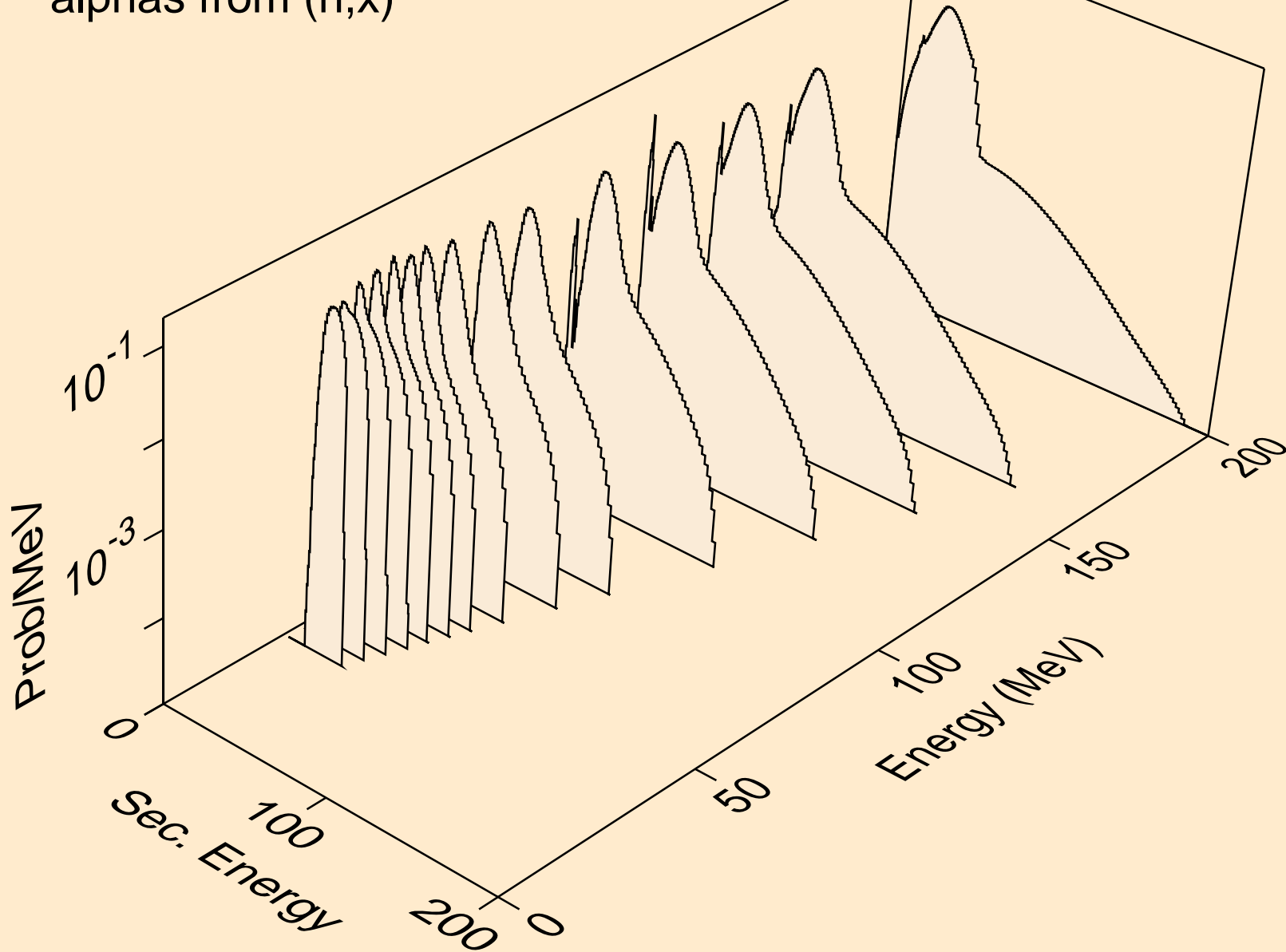

RA230 NEUTRON ACER TENDL-2019 LIBRARY; T=293.16K
alphas from (n,n*)a

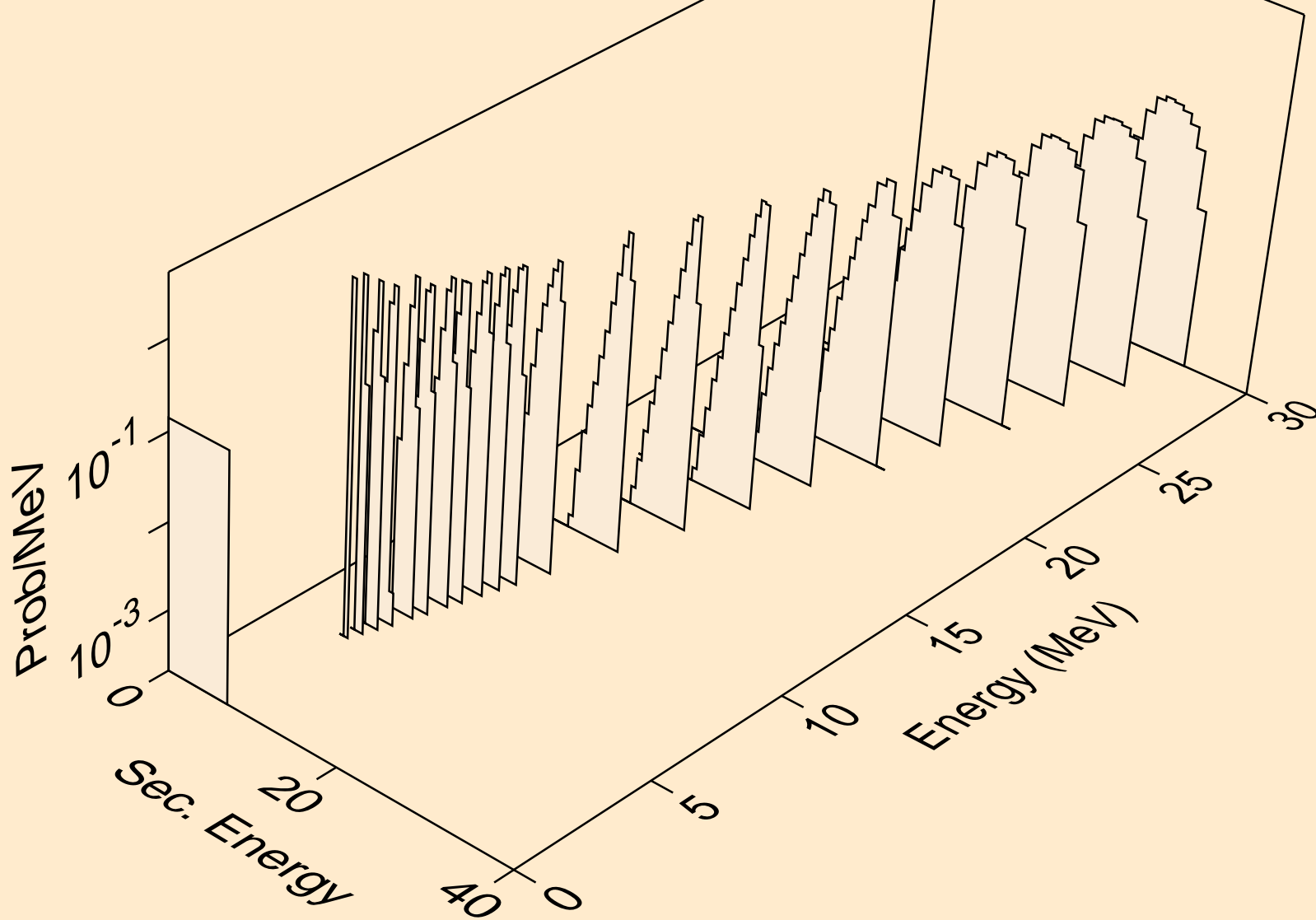

RA230 NEUTRON ACER TENDL-2019 LIBRARY; T=293.16K
alphas from (n,2n)a

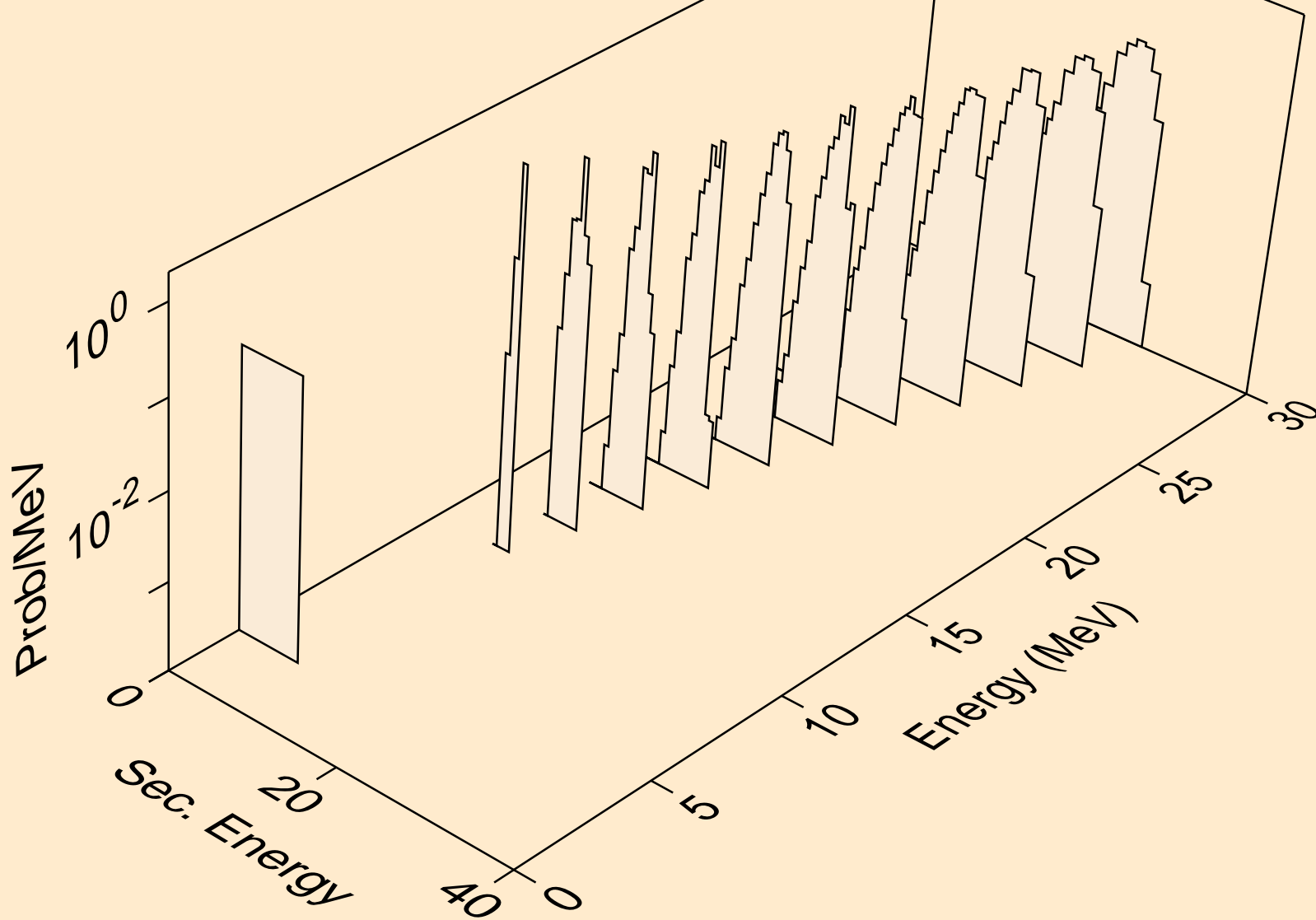

RA230 NEUTRON ACER TENDL-2019 LIBRARY; T=293.16K
alphas from (n,3n)a

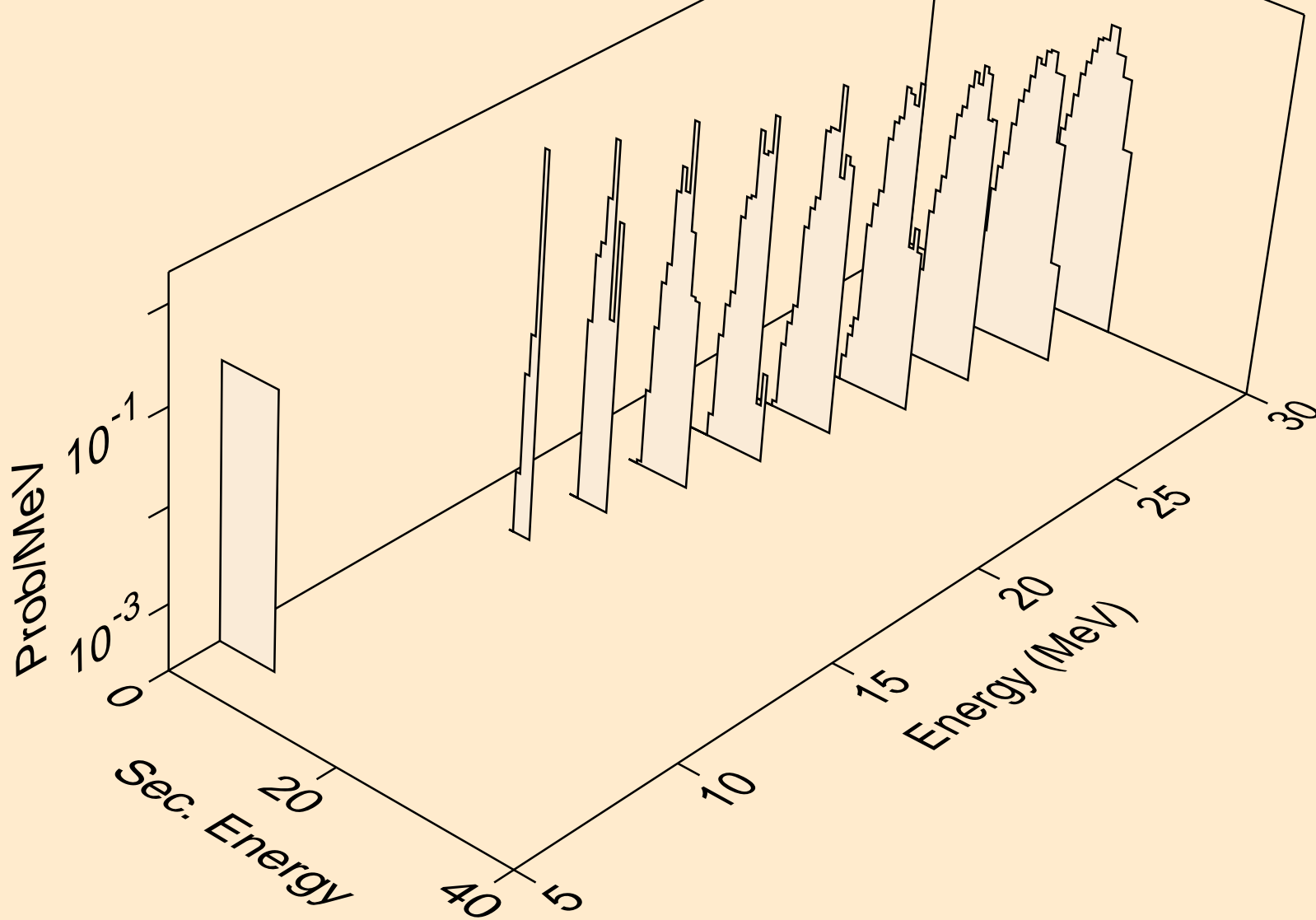

RA230 NEUTRON ACER TENDL-2019 LIBRARY; T=293.16K
alphas from (n,a)

