

RB082 NEUTRON ACER TENDL-2019 LIBRARY; T=293.16K  
Principal cross sections

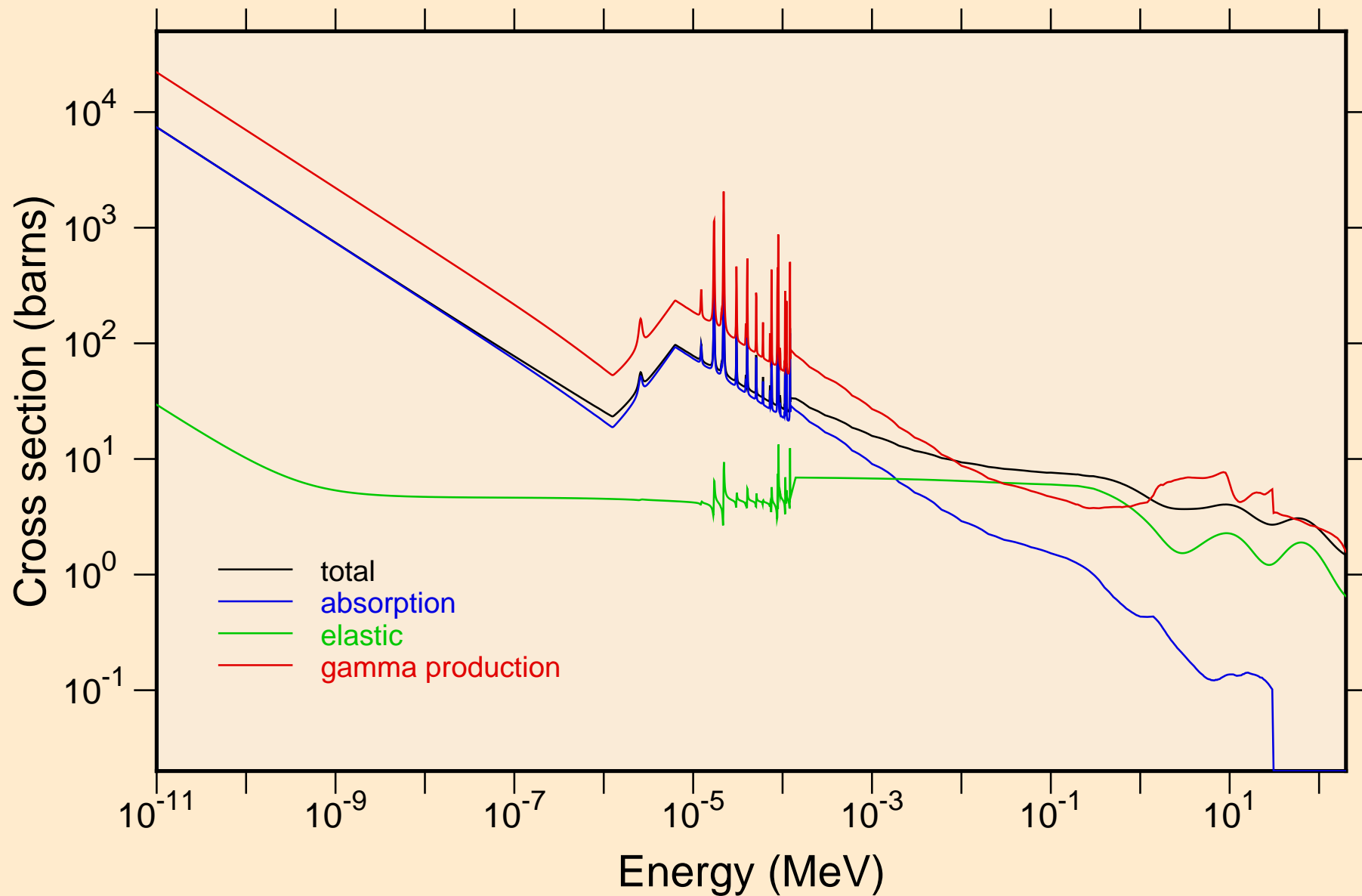

RB082 NEUTRON ACER TENDL-2019 LIBRARY; T=293.16K  
resonance total cross section

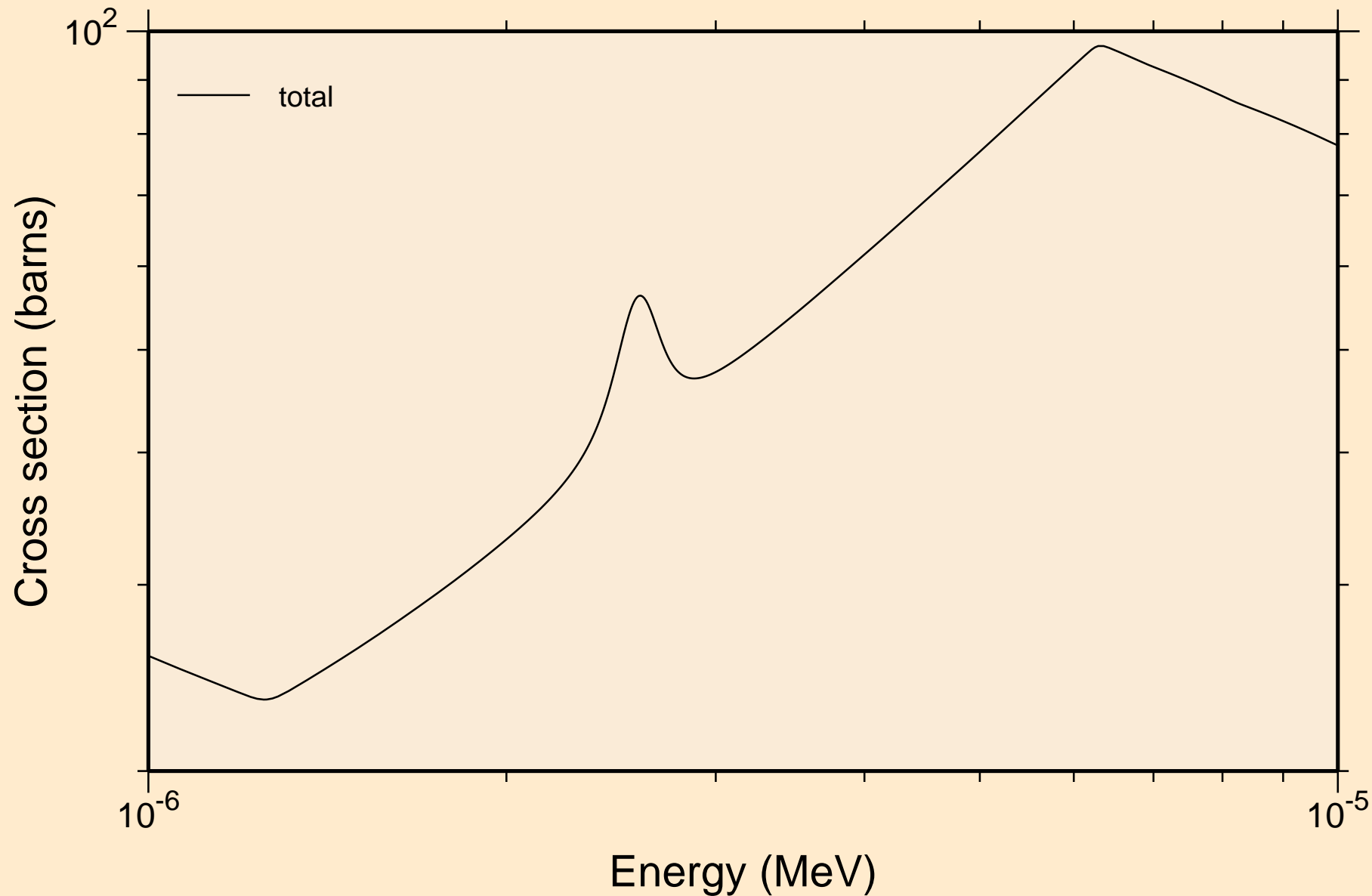

RB082 NEUTRON ACER TENDL-2019 LIBRARY; T=293.16K  
resonance total cross section

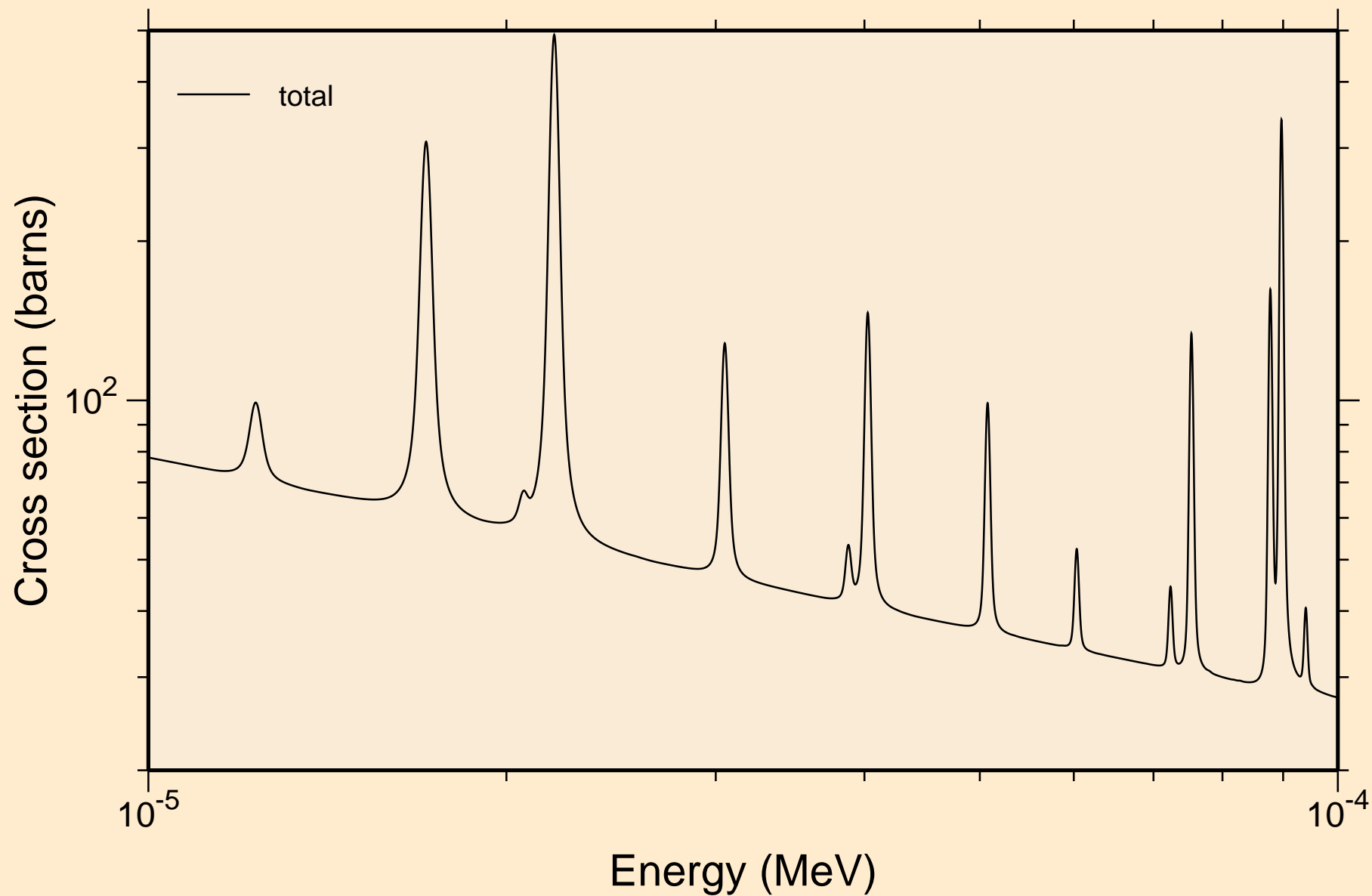

RB082 NEUTRON ACER TENDL-2019 LIBRARY; T=293.16K  
resonance total cross section

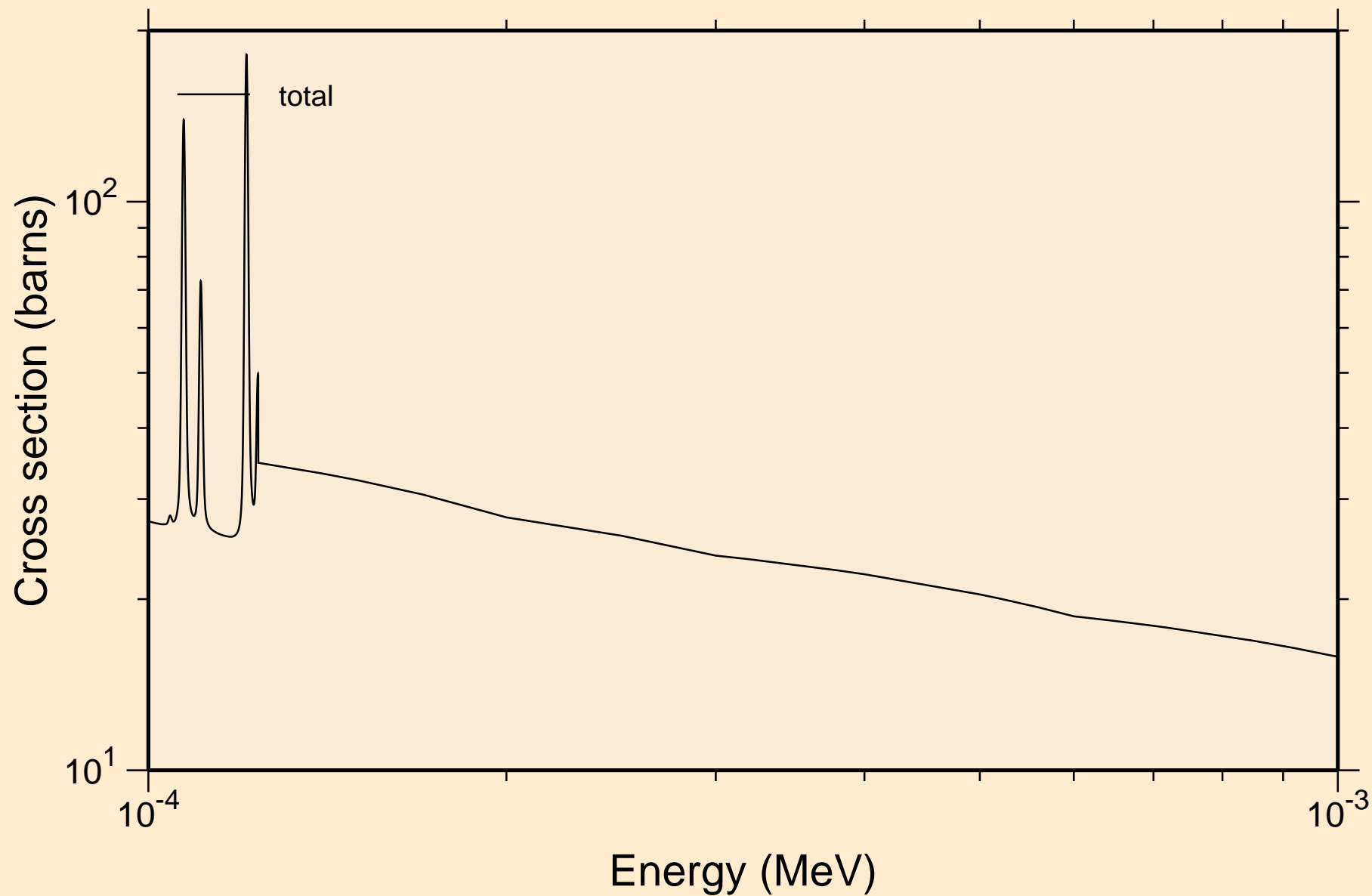

R̄082 NEUTRON ACER TENDL-2019 LIBRARY; T=293.16K  
resonance total cross section

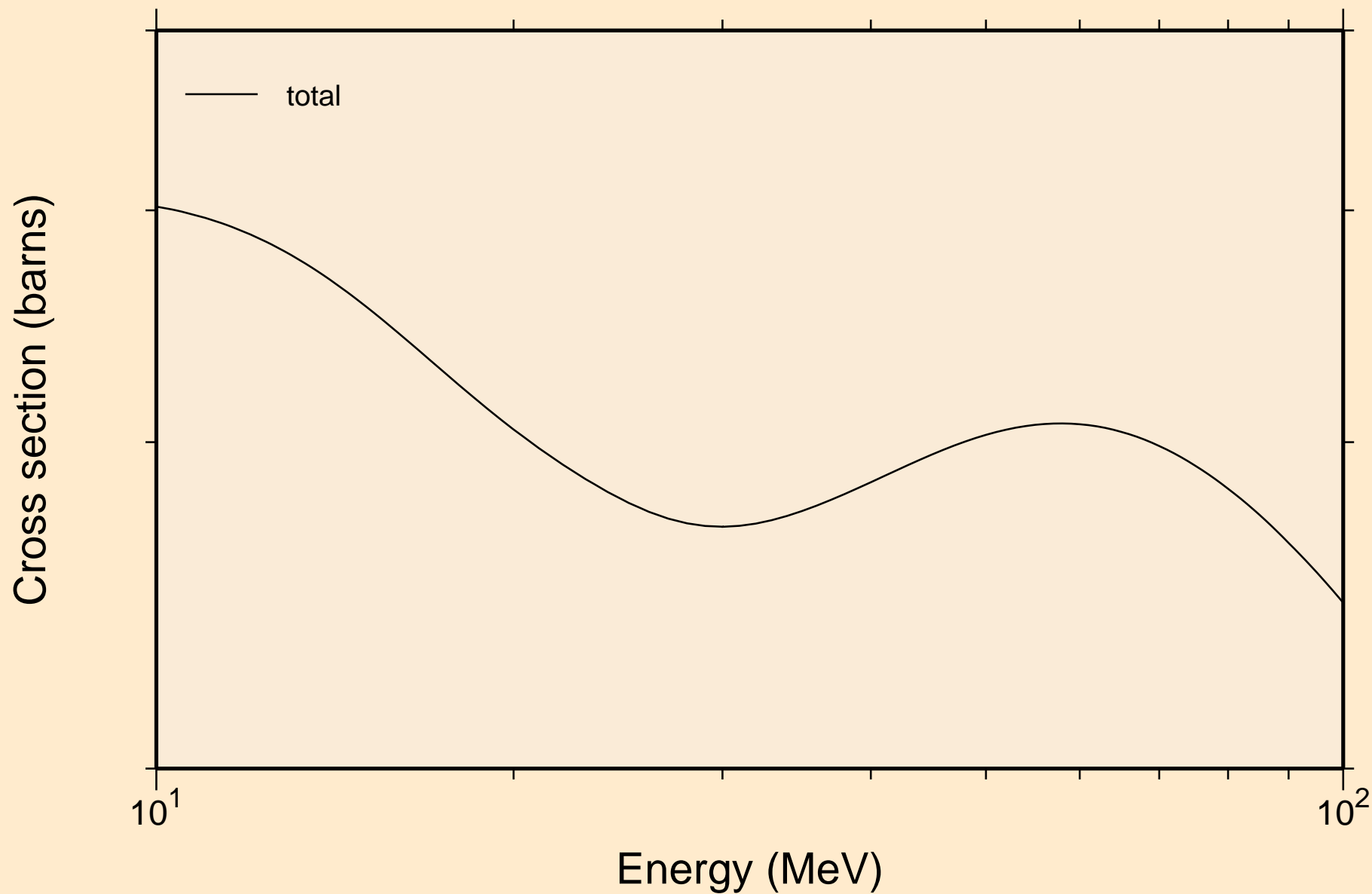

RB082 NEUTRON ACER TENDL-2019 LIBRARY; T=293.16K  
resonance absorption cross sections

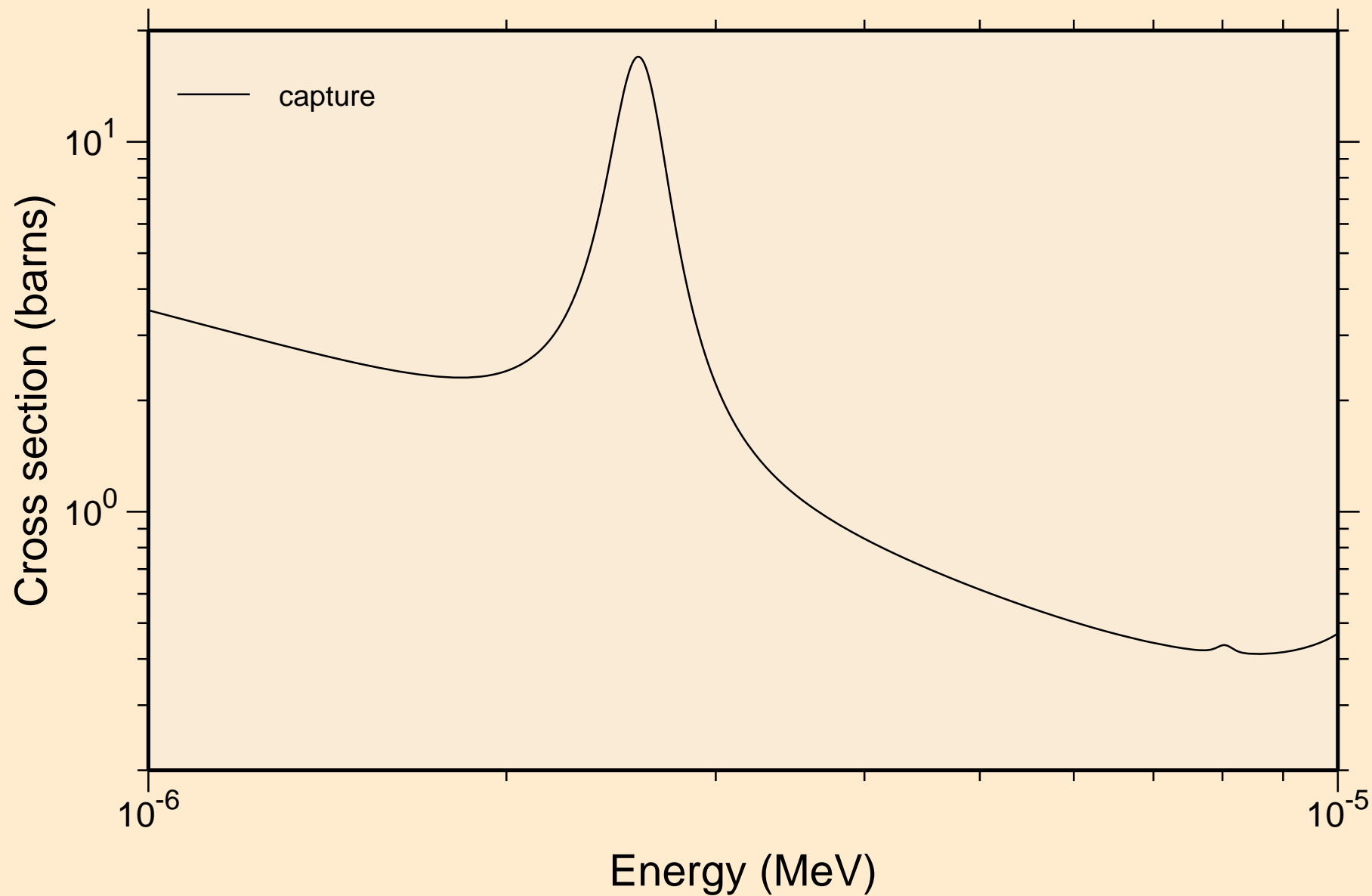

RB082 NEUTRON ACER TENDL-2019 LIBRARY; T=293.16K  
resonance absorption cross sections

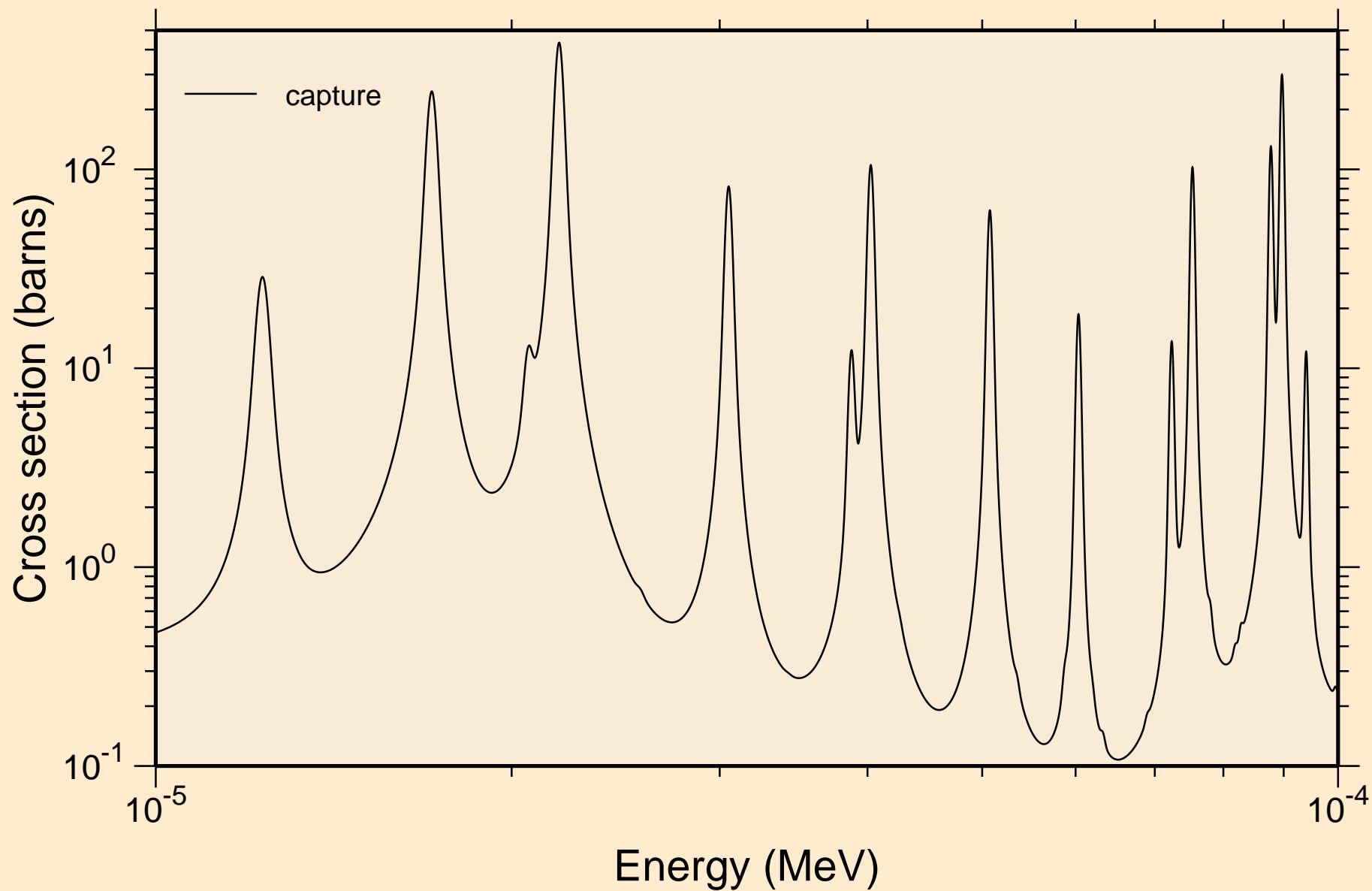

RB082 NEUTRON ACER TENDL-2019 LIBRARY; T=293.16K  
resonance absorption cross sections

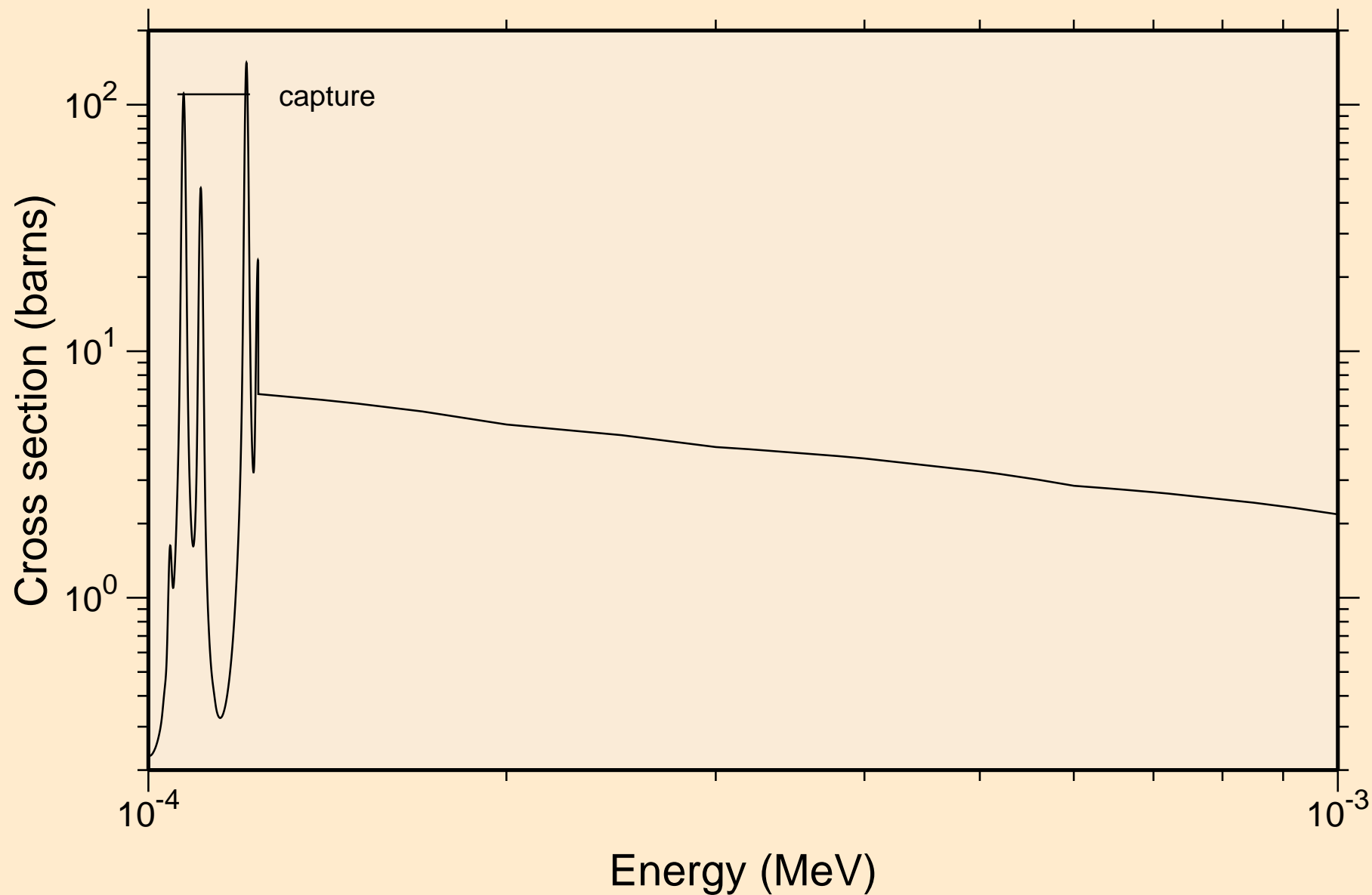



RB082 NEUTRON ACER TENDL-2019 LIBRARY; T=293.16K  
resonance absorption cross sections

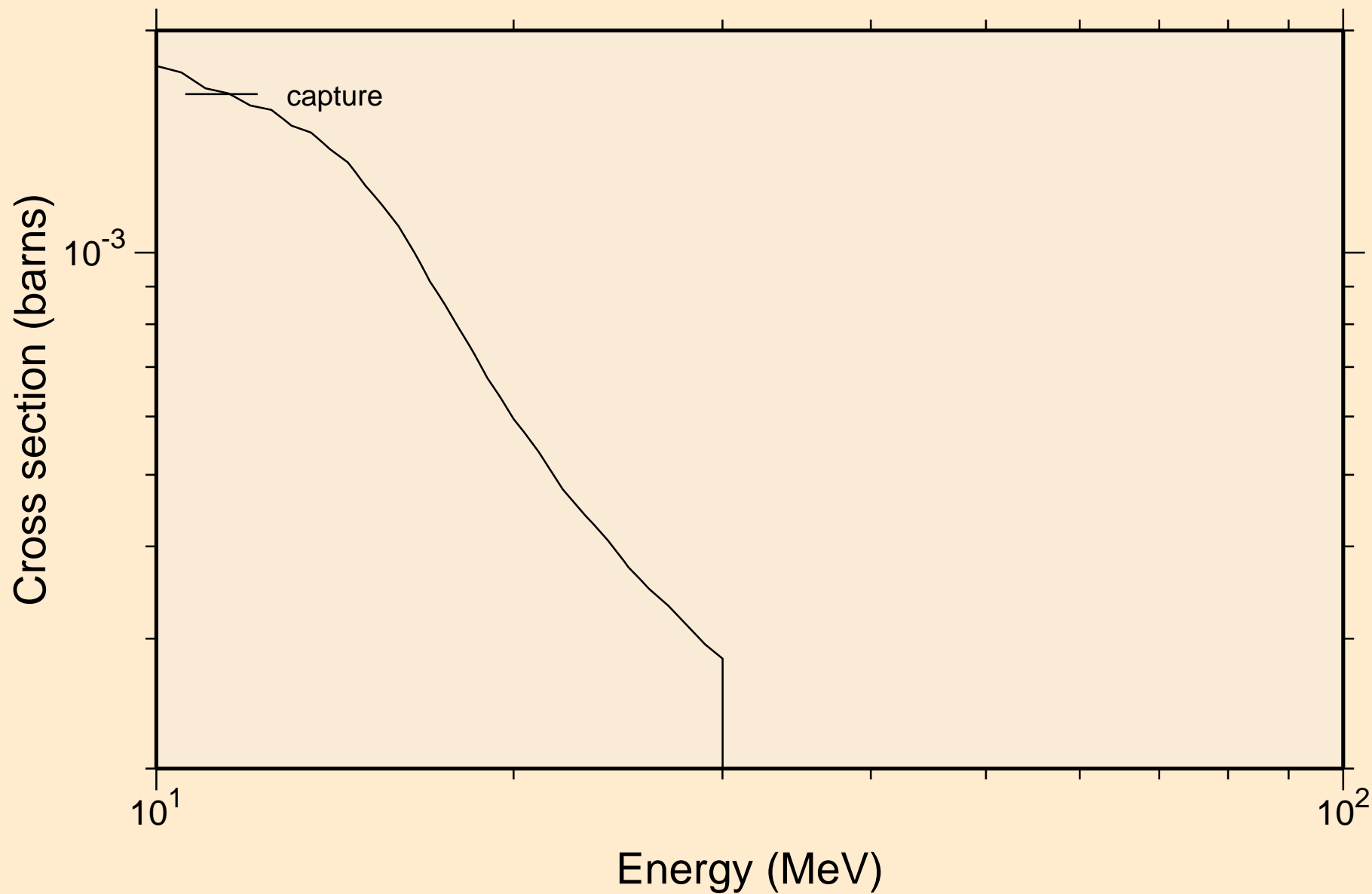

RB082 NEUTRON ACER TENDL-2019 LIBRARY; T=293.16K  
Heating

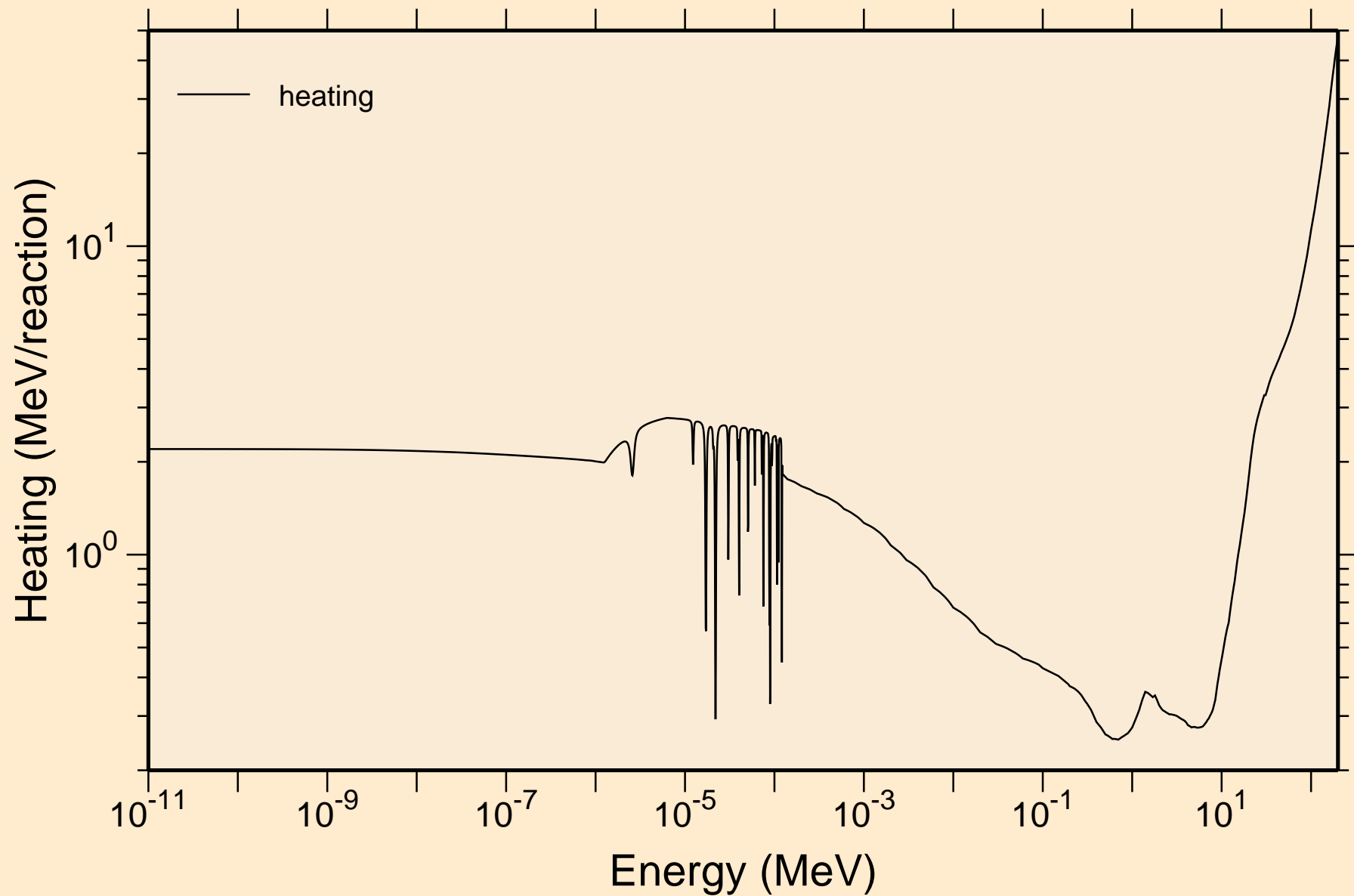

RB082 NEUTRON ACER TENDL-2019 LIBRARY; T=293.16K  
Damage

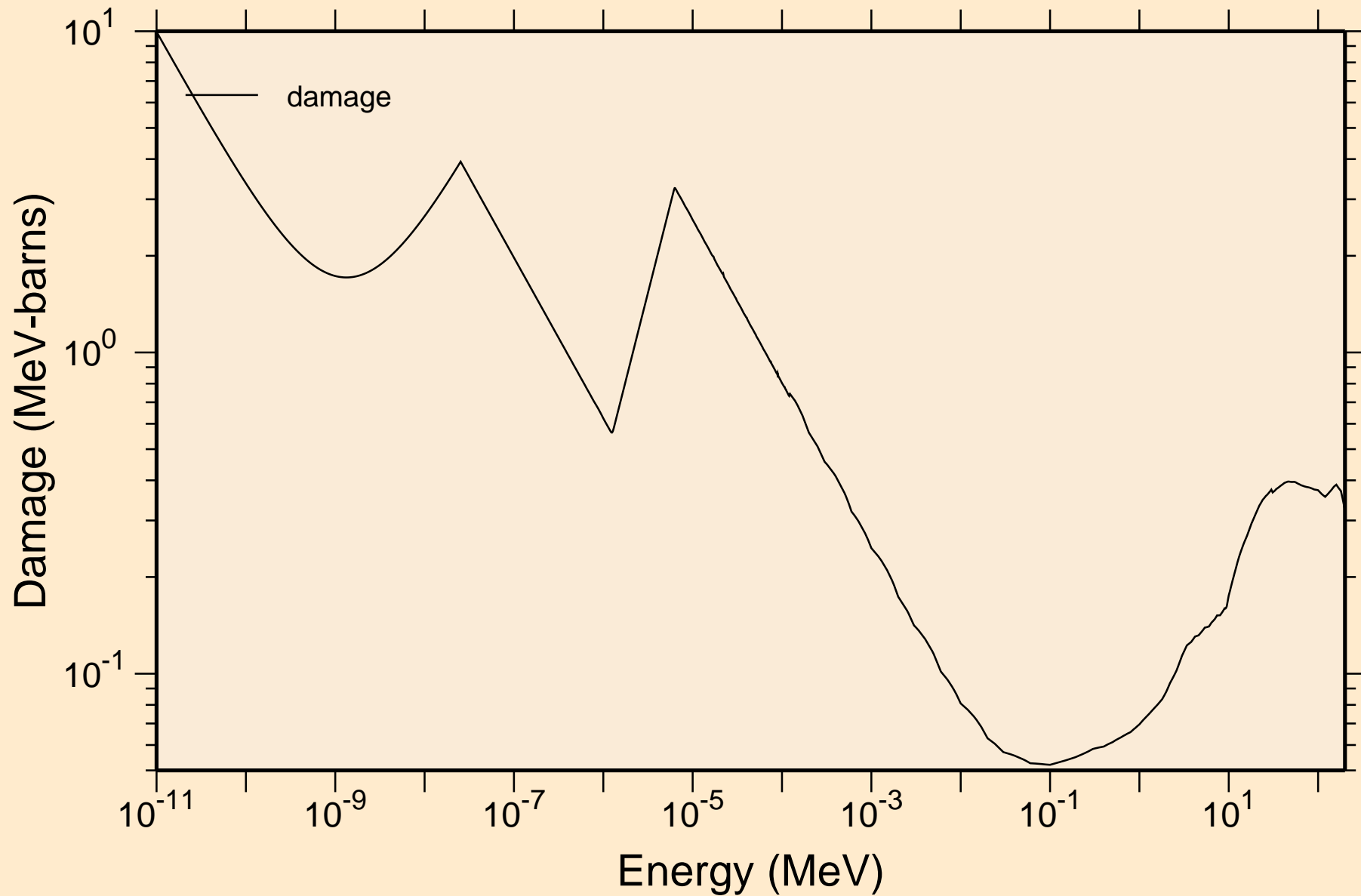

RB082 NEUTRON ACER TENDL-2019 LIBRARY; T=293.16K  
Non-threshold reactions

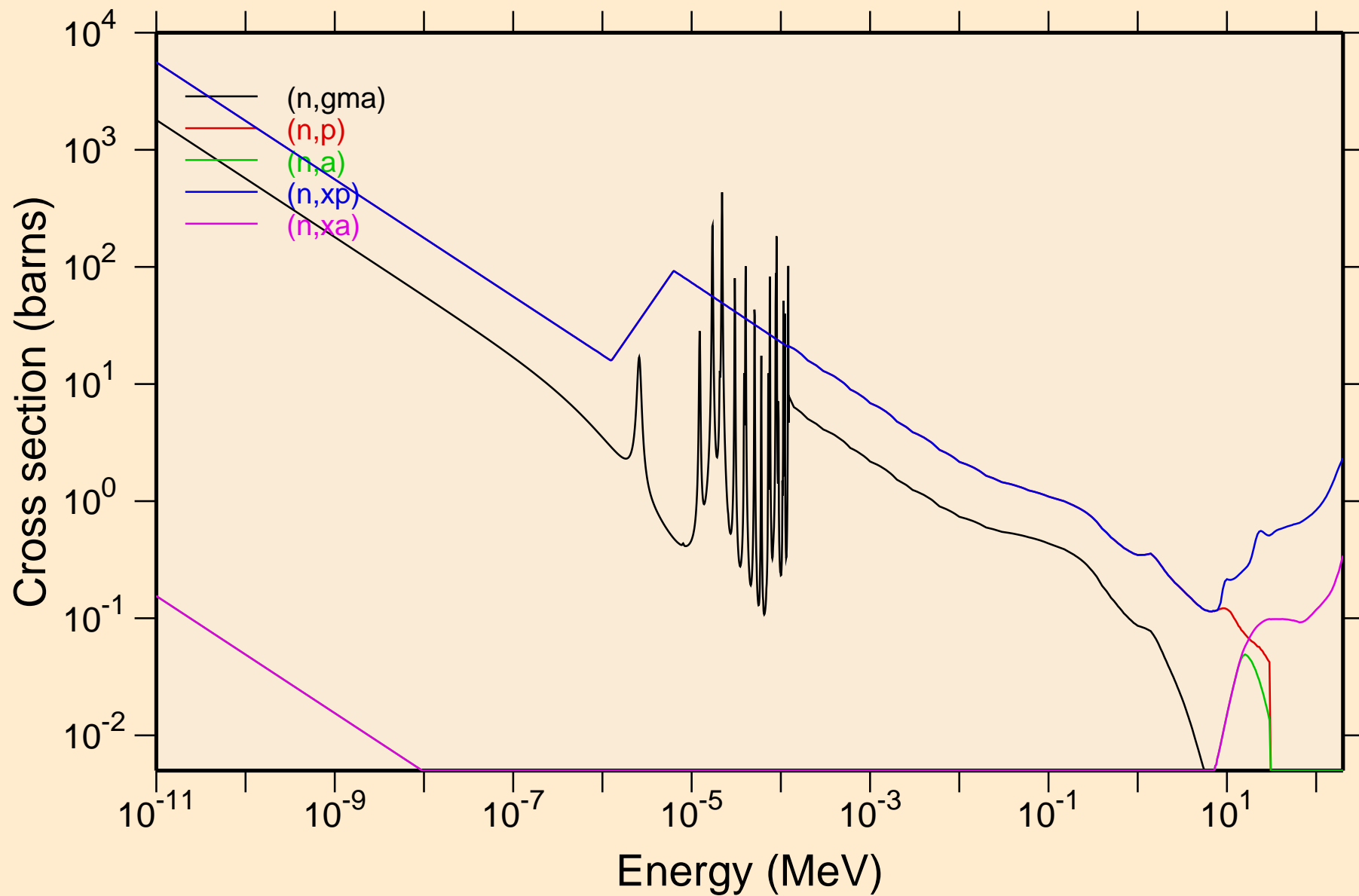

RB082 NEUTRON ACER TENDL-2019 LIBRARY; T=293.16K  
Principal cross sections

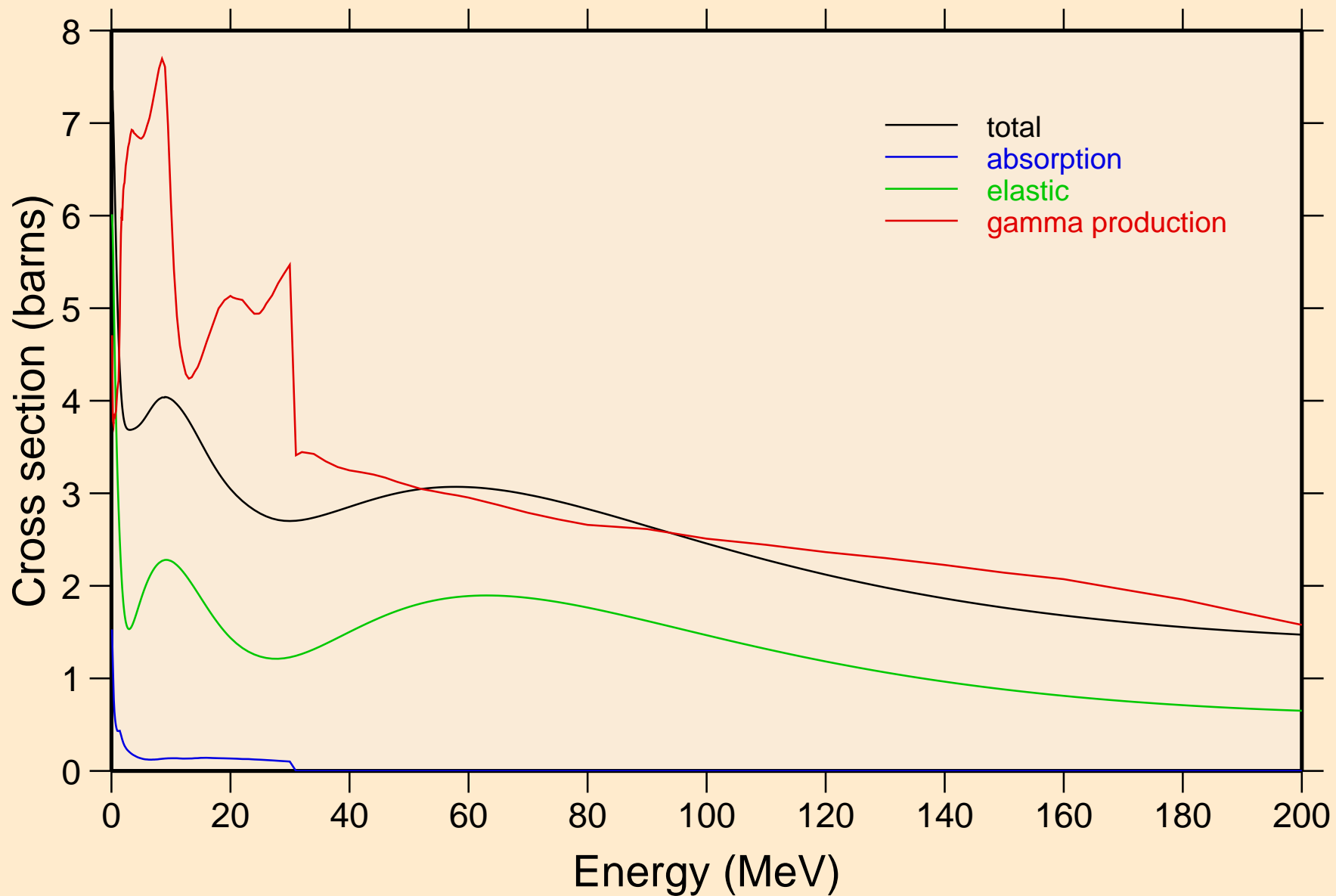

RB082 NEUTRON ACER TENDL-2019 LIBRARY; T=293.16K  
Heating

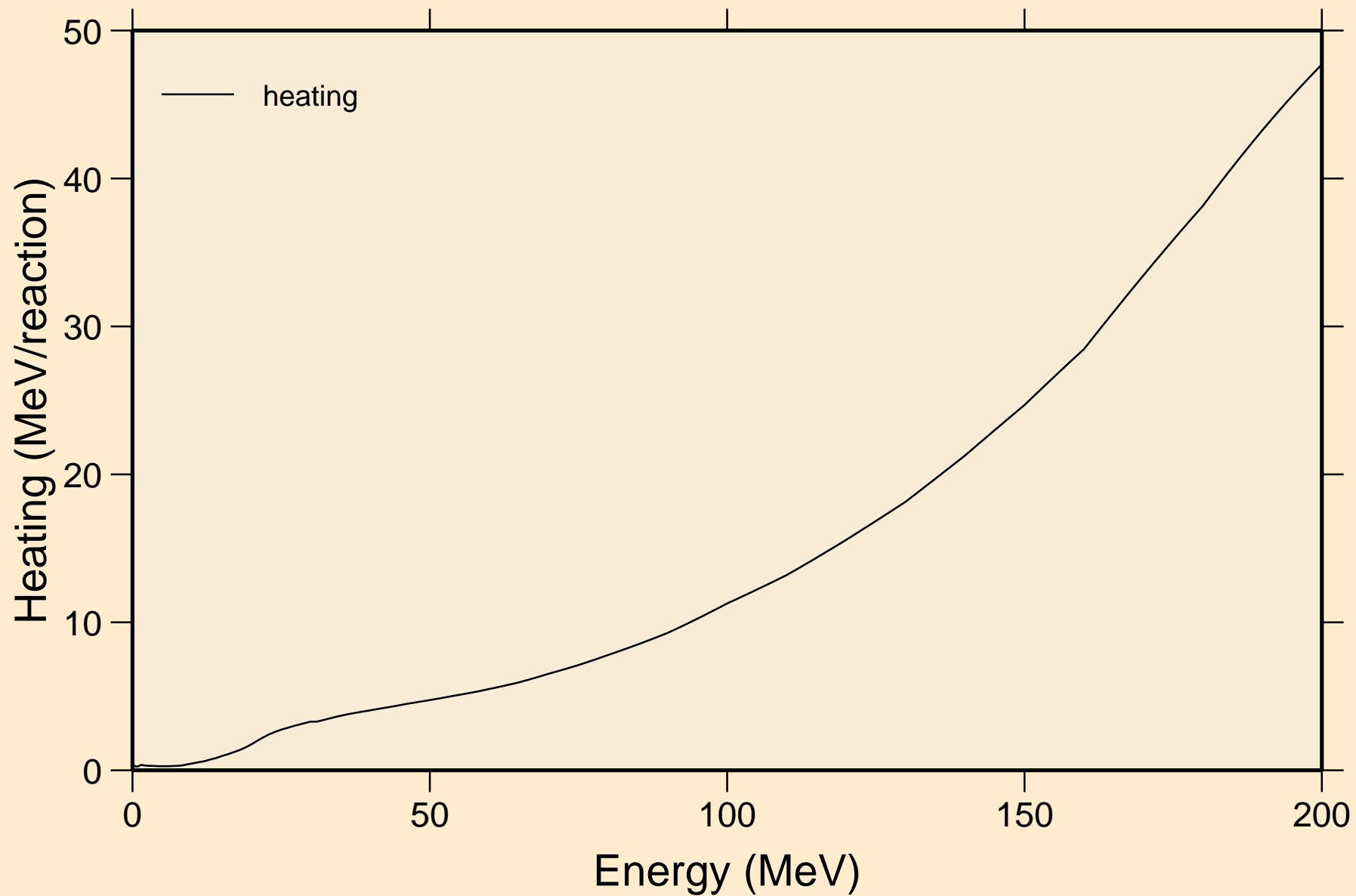

RB082 NEUTRON ACER TENDL-2019 LIBRARY; T=293.16K  
Damage

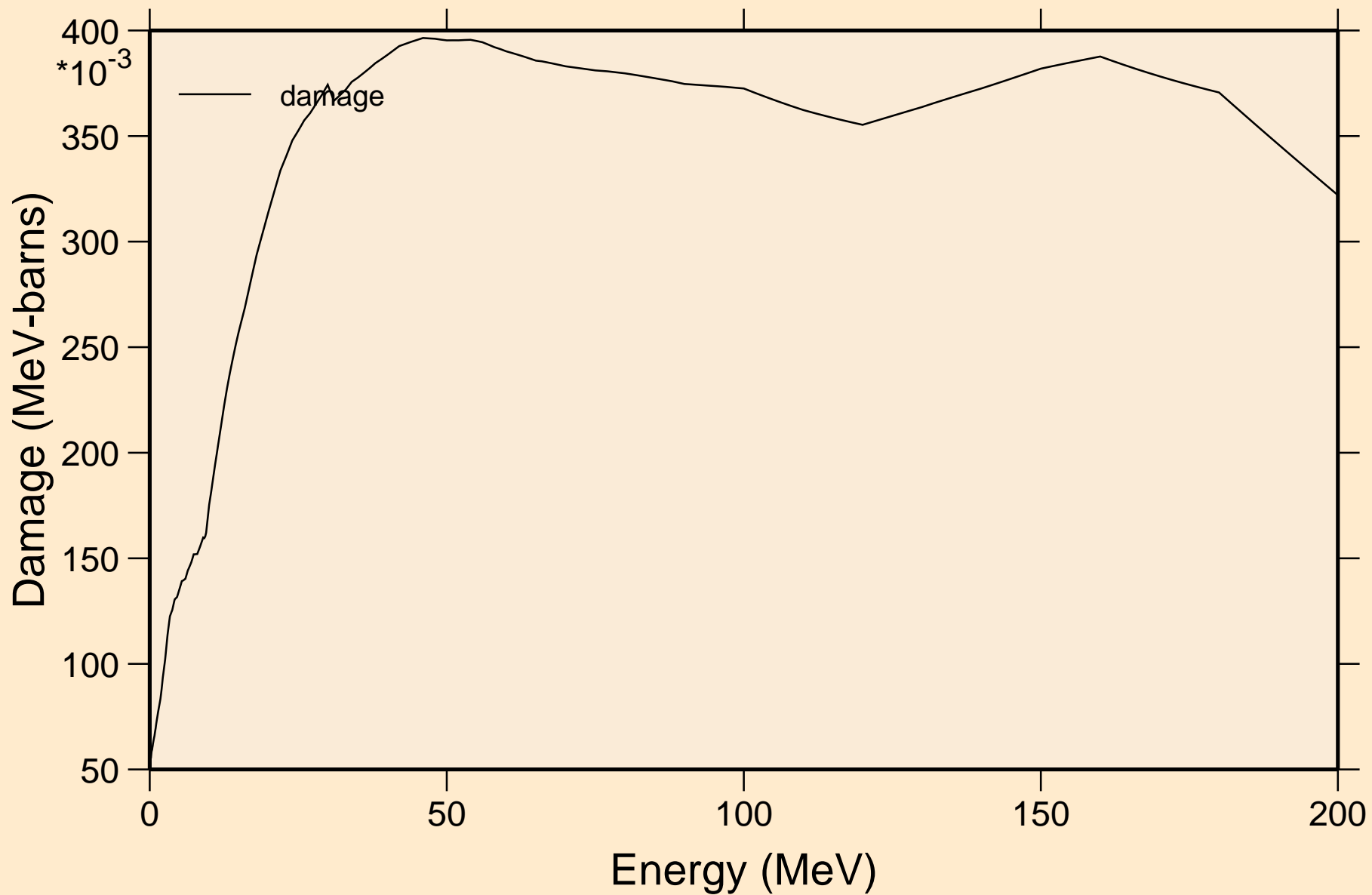

RB082 NEUTRON ACER TENDL-2019 LIBRARY; T=293.16K  
Non-threshold reactions

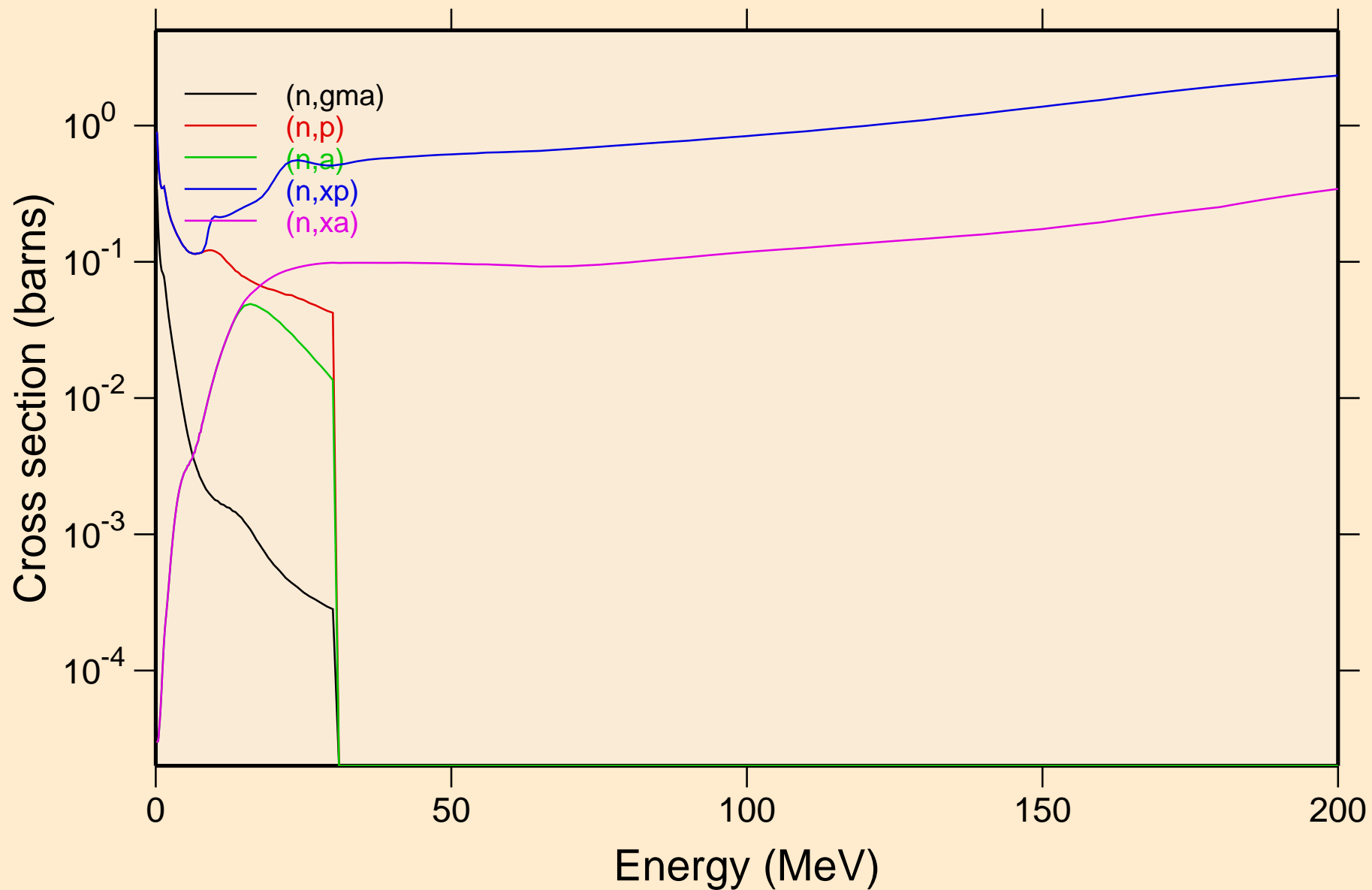



RB082 NEUTRON ACER TENDL-2019 LIBRARY; T=293.16K  
Inelastic levels

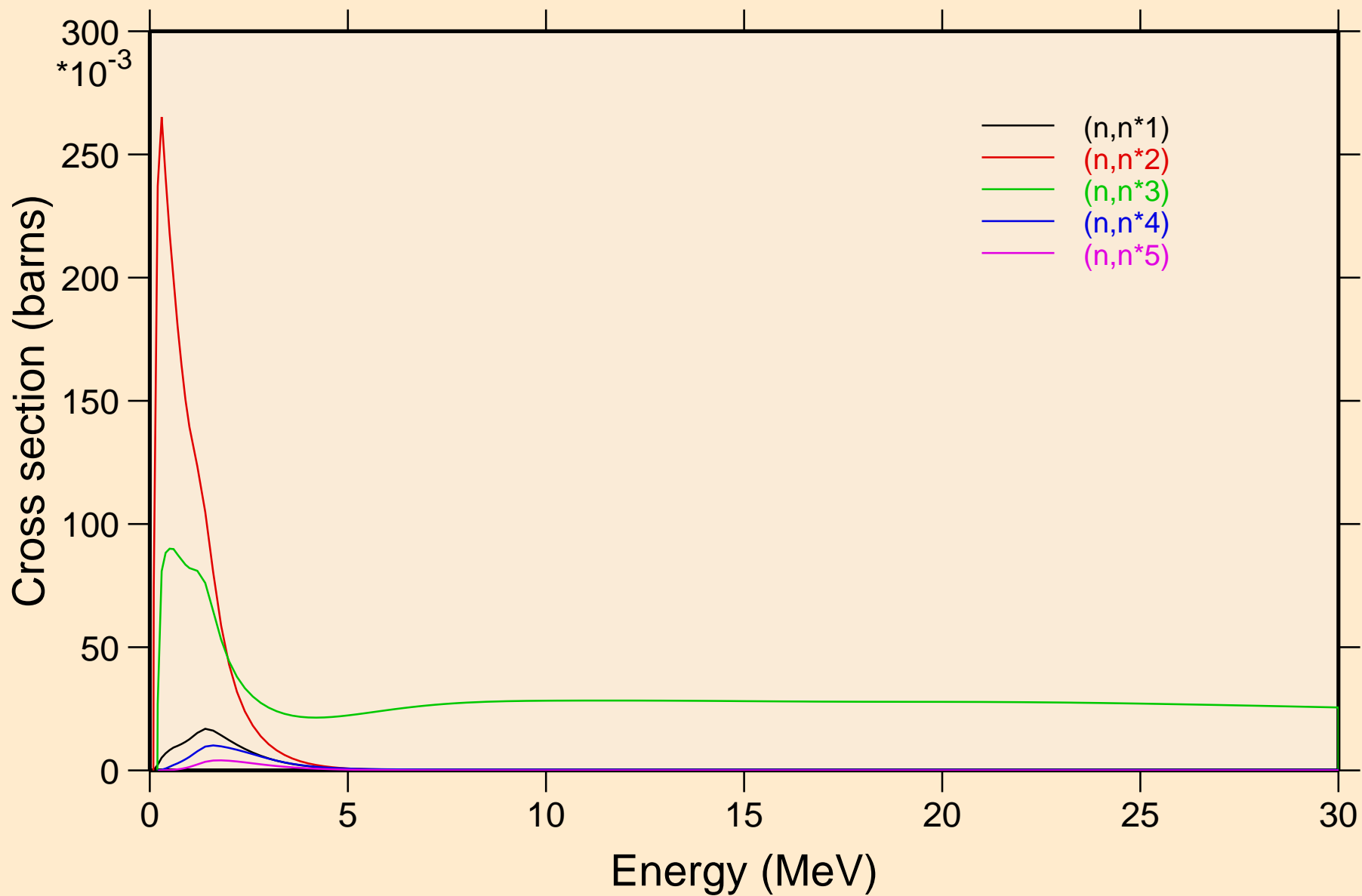

RB082 NEUTRON ACER TENDL-2019 LIBRARY; T=293.16K  
Inelastic levels

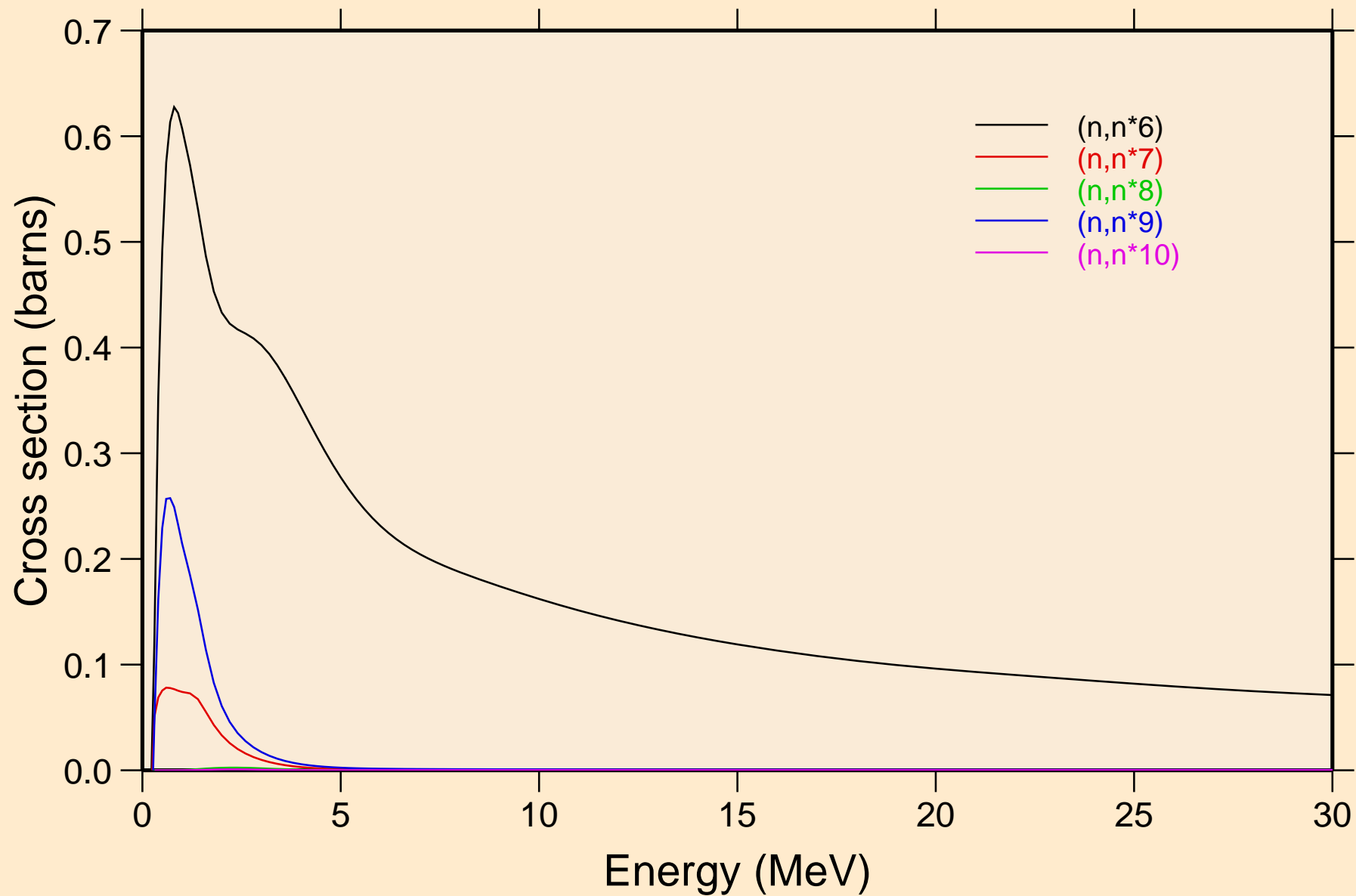

RB082 NEUTRON ACER TENDL-2019 LIBRARY; T=293.16K  
Inelastic levels

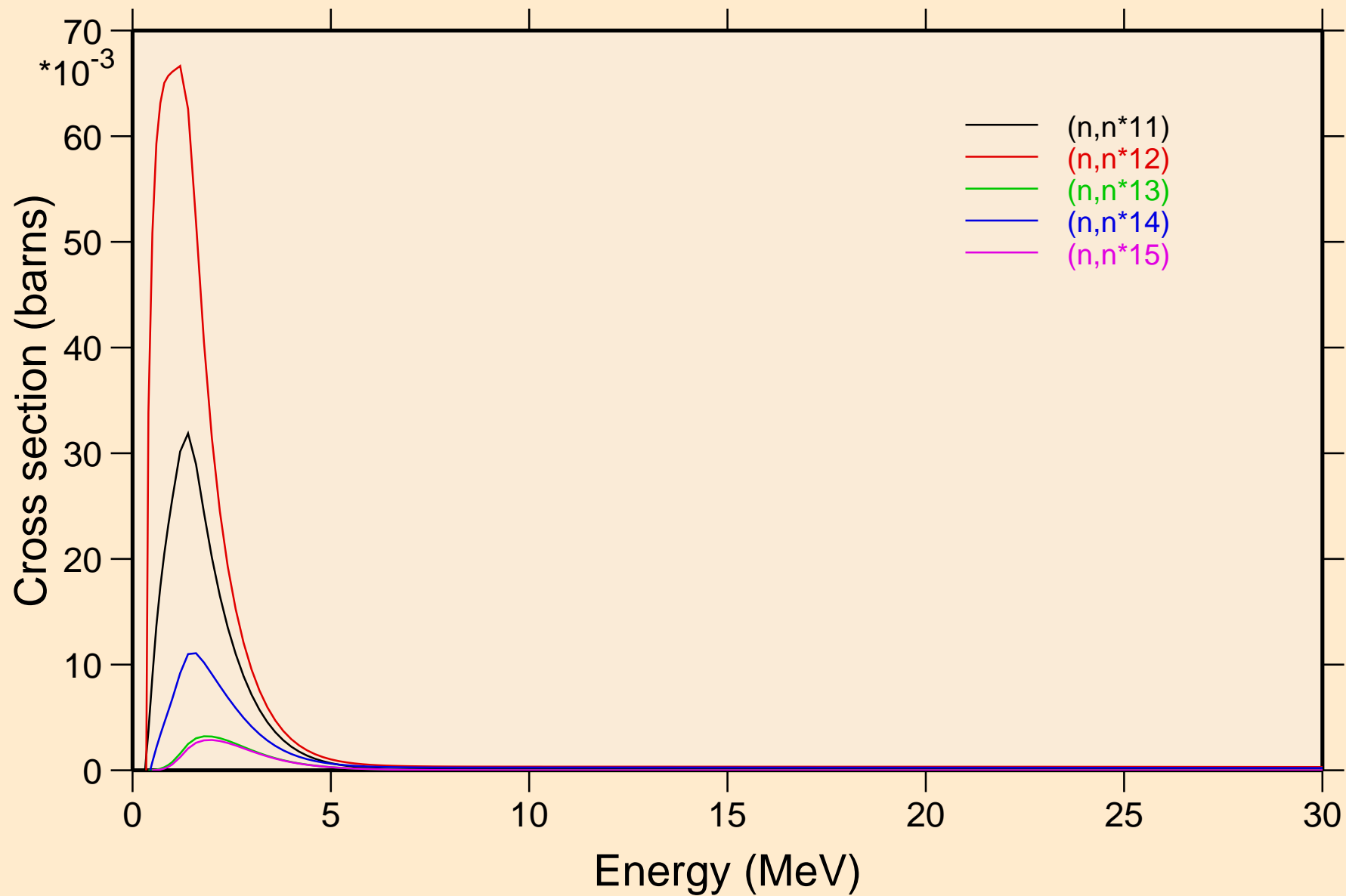

RB082 NEUTRON ACER TENDL-2019 LIBRARY; T=293.16K  
Inelastic levels

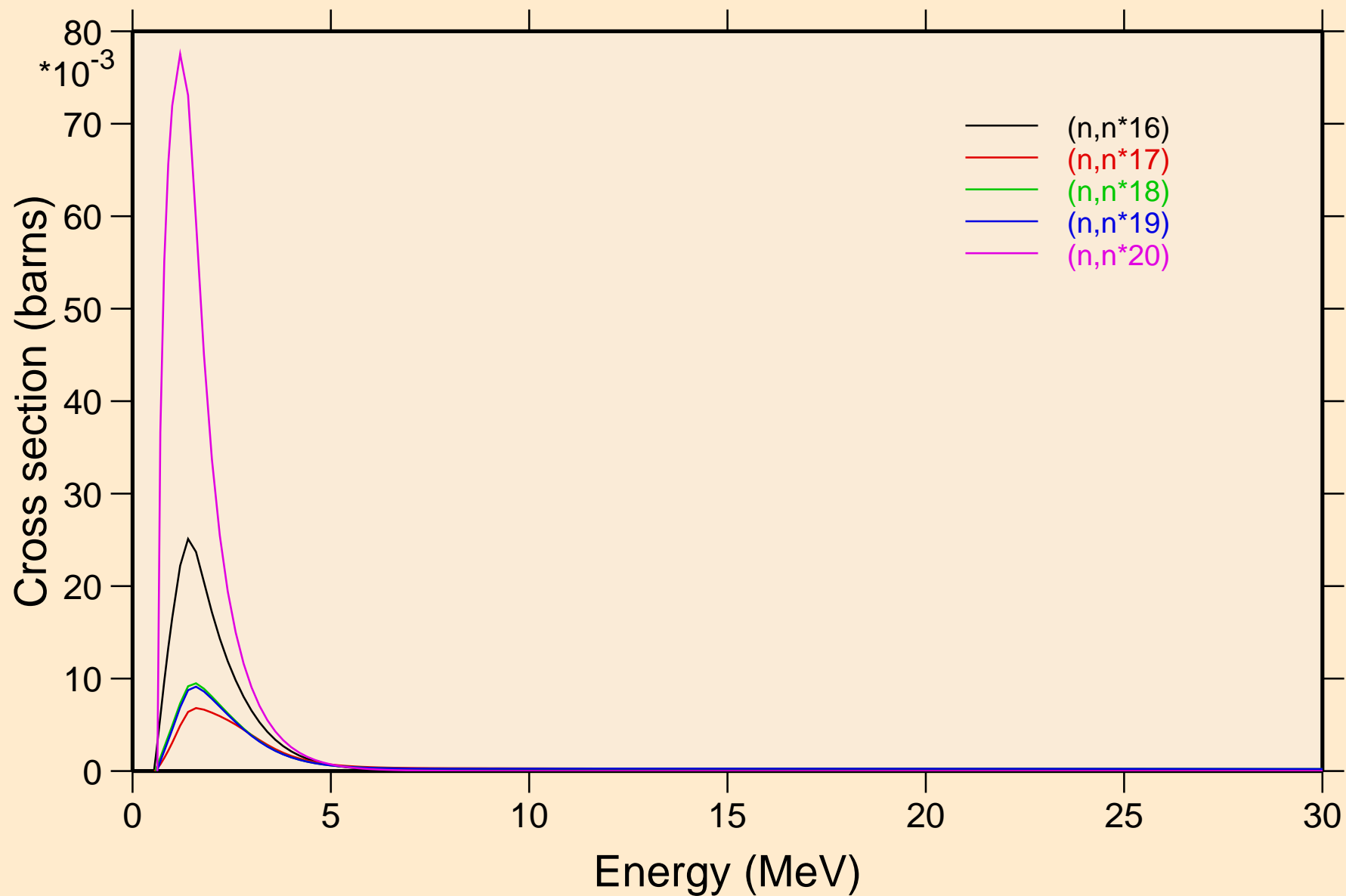

RB082 NEUTRON ACER TENDL-2019 LIBRARY; T=293.16K  
Inelastic levels

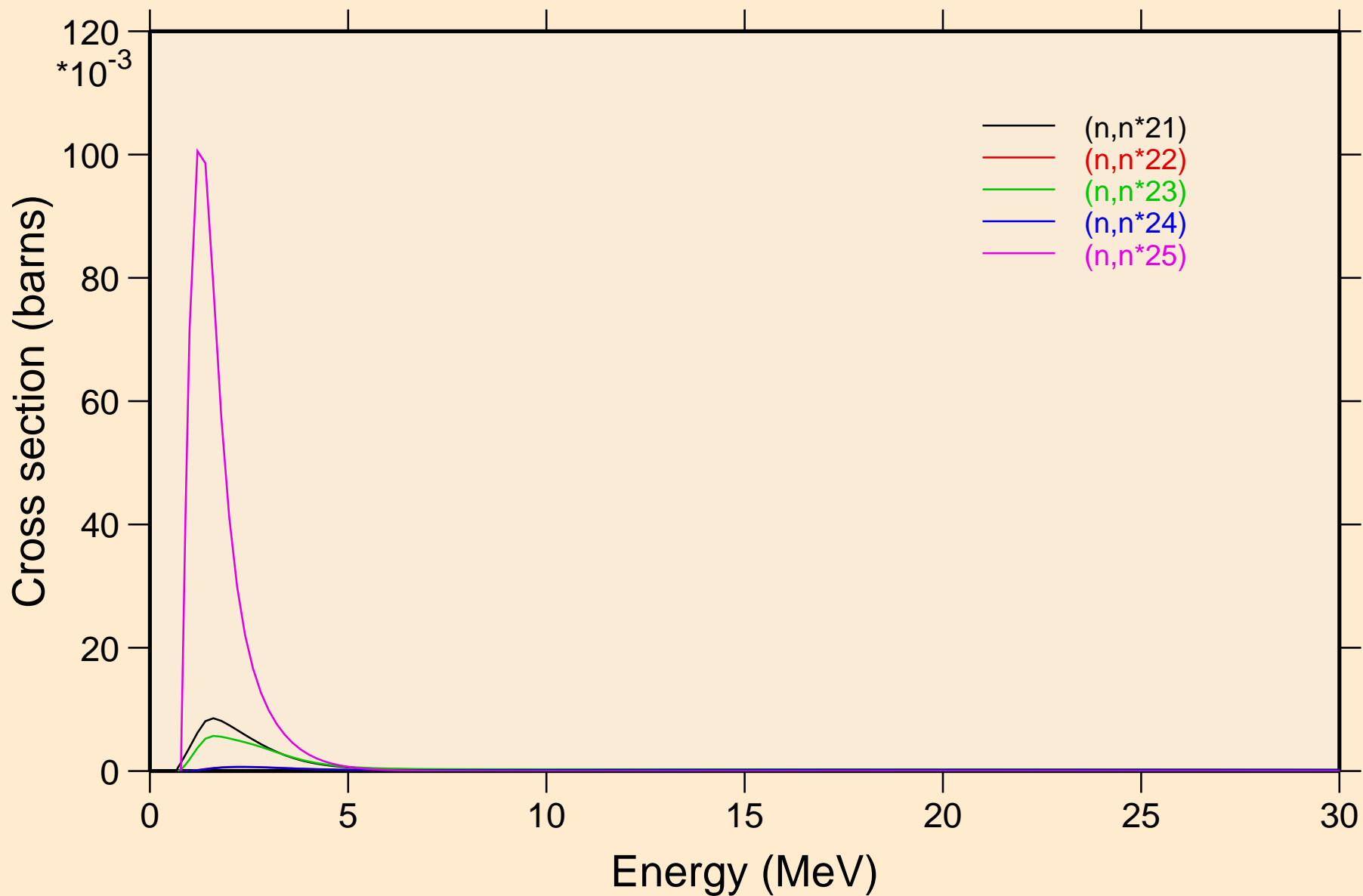

RB082 NEUTRON ACER TENDL-2019 LIBRARY; T=293.16K  
Threshold reactions

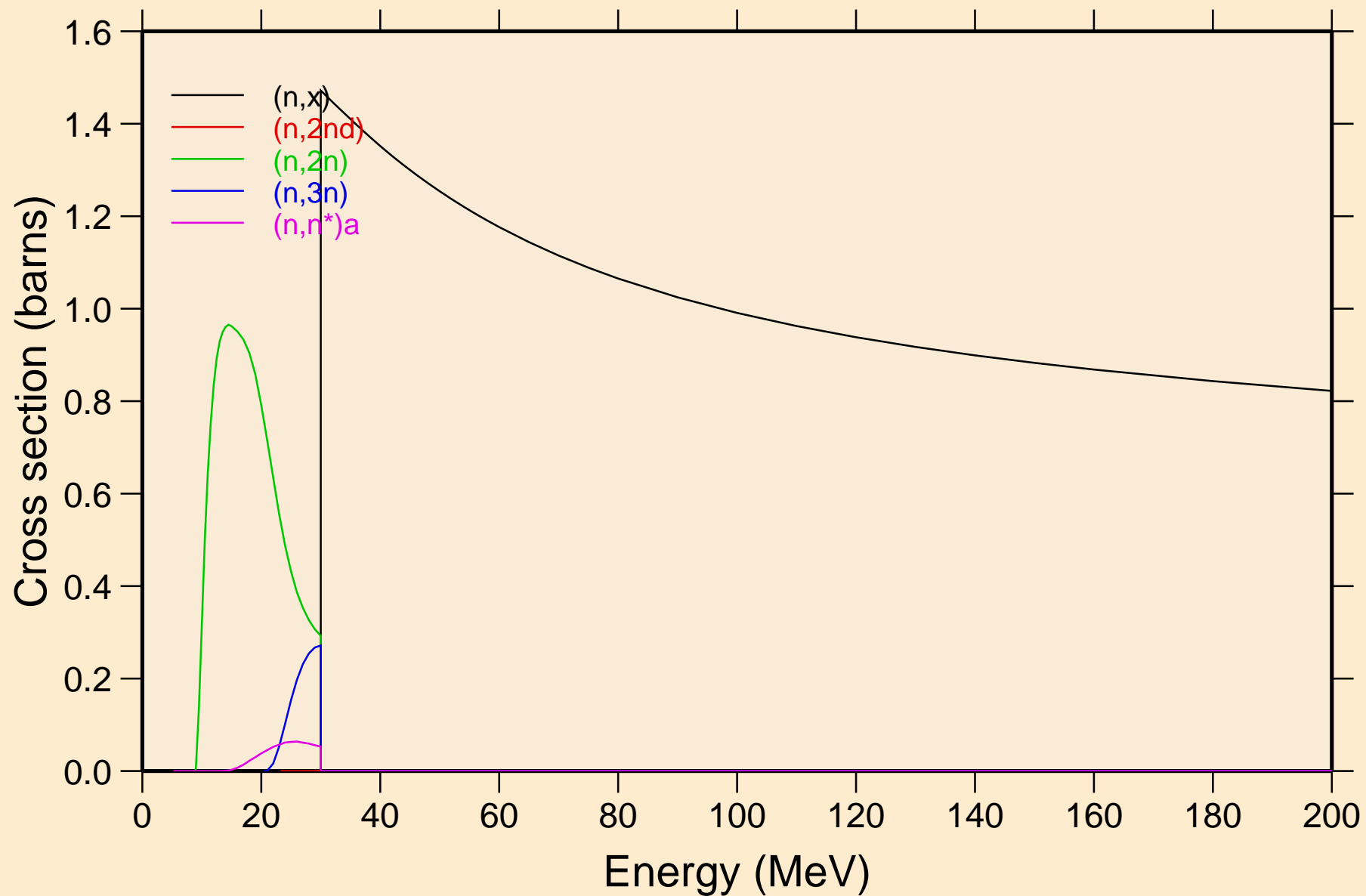

RB082 NEUTRON ACER TENDL-2019 LIBRARY; T=293.16K  
Threshold reactions

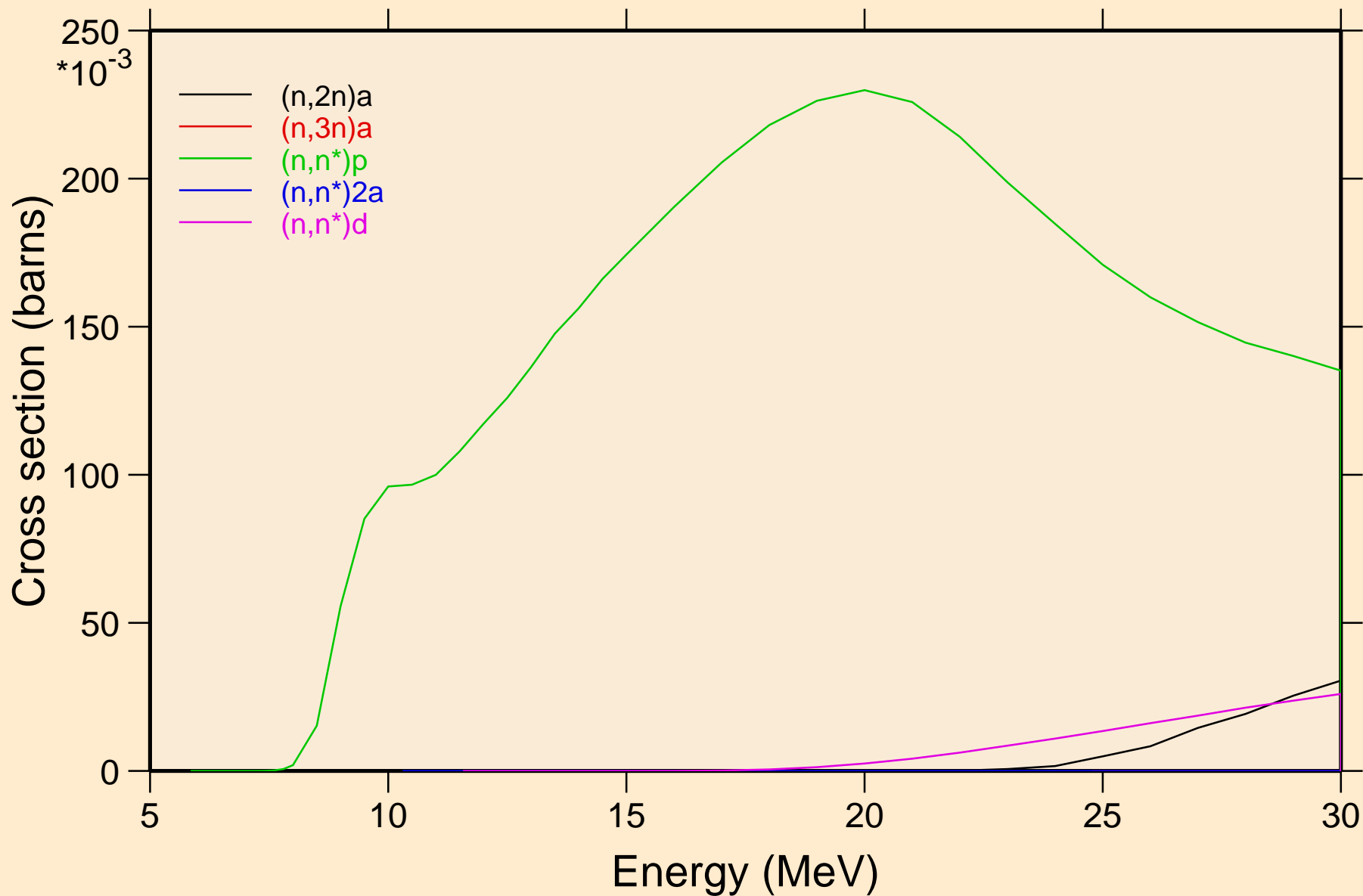

RB082 NEUTRON ACER TENDL-2019 LIBRARY; T=293.16K  
Threshold reactions

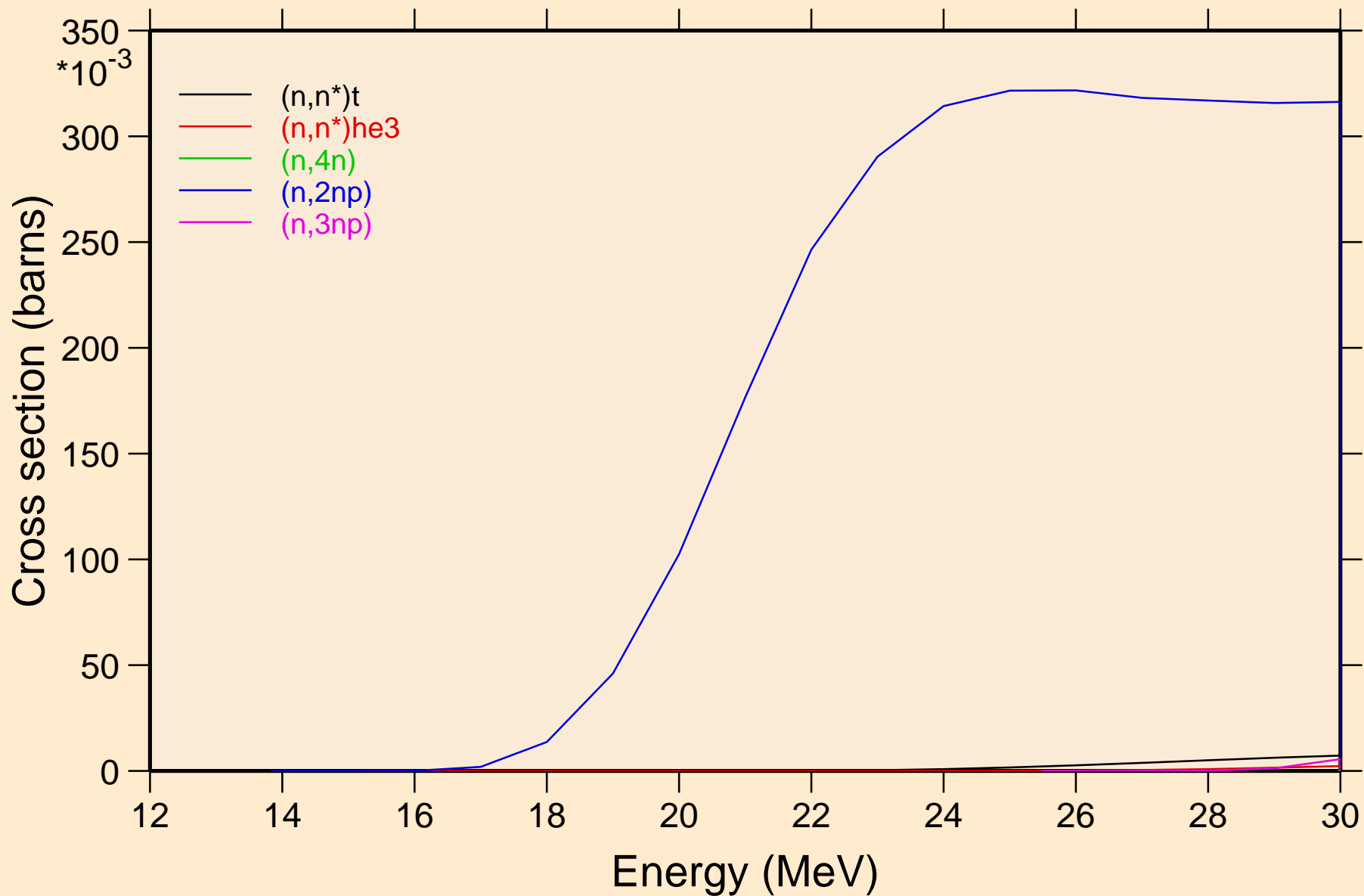



RB082 NEUTRON ACER TENDL-2019 LIBRARY; T=293.16K  
Threshold reactions

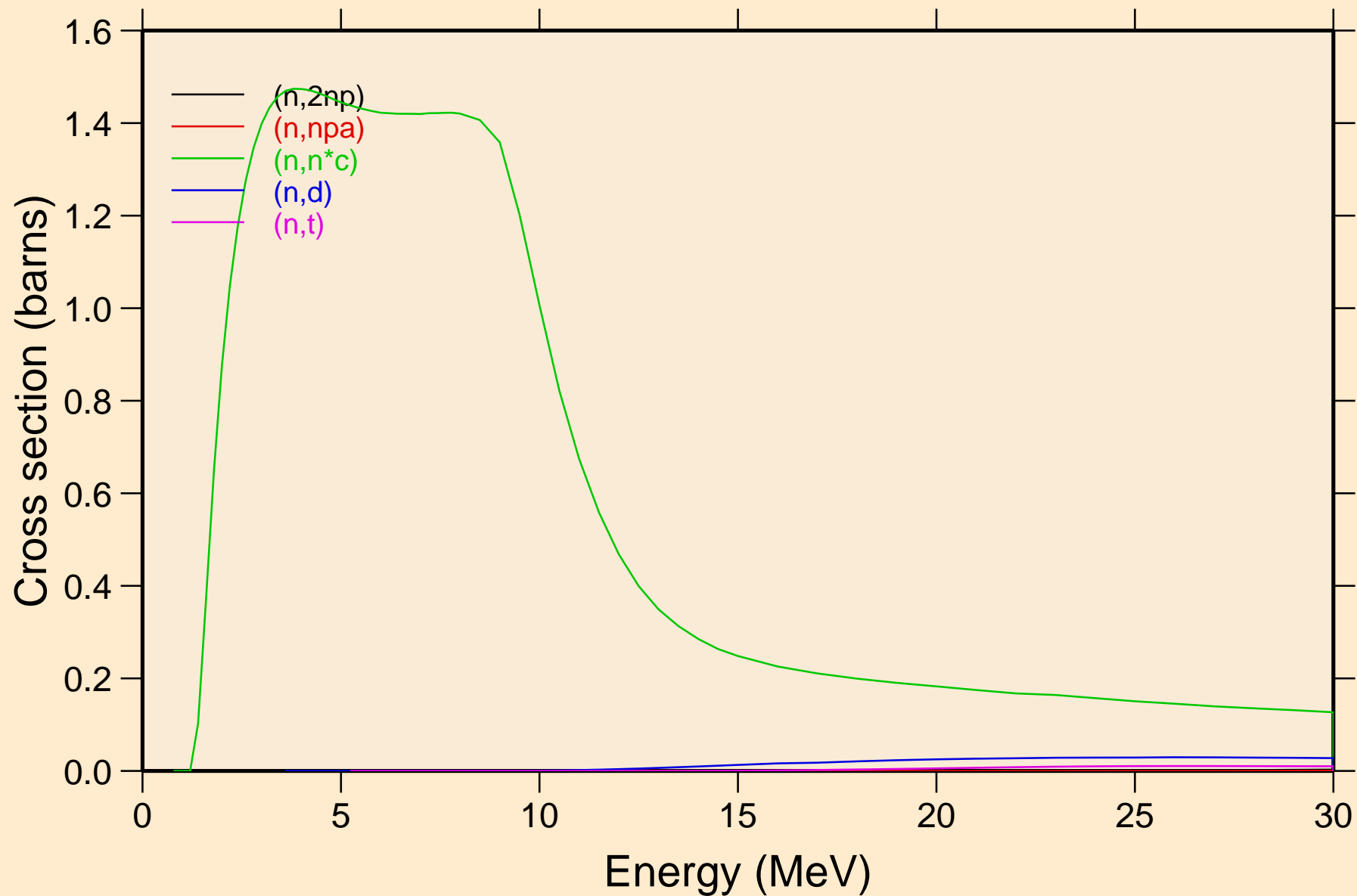

RB082 NEUTRON ACER TENDL-2019 LIBRARY; T=293.16K  
Threshold reactions

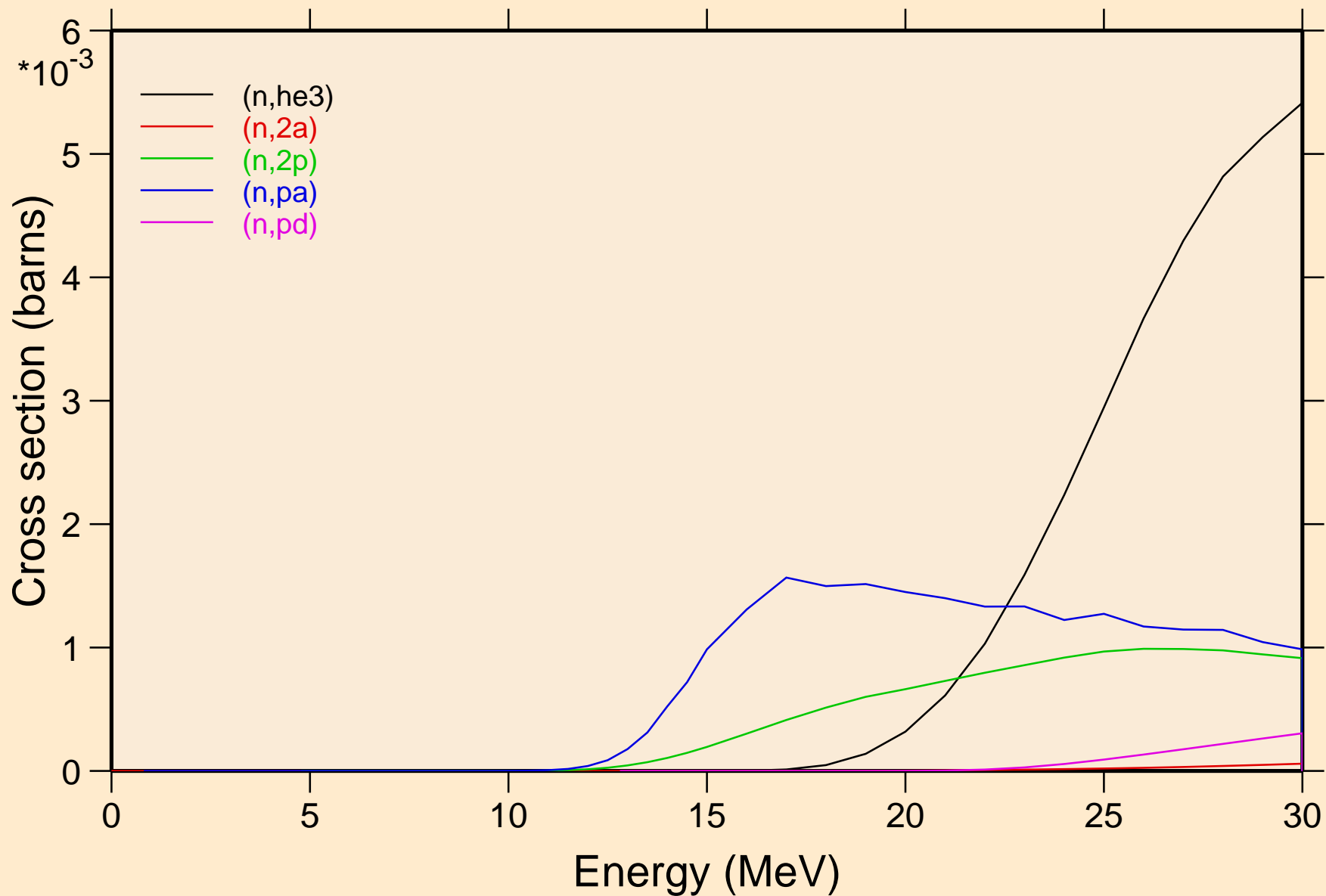

RB082 NEUTRON ACER TENDL-2019 LIBRARY; T=293.16K  
Threshold reactions

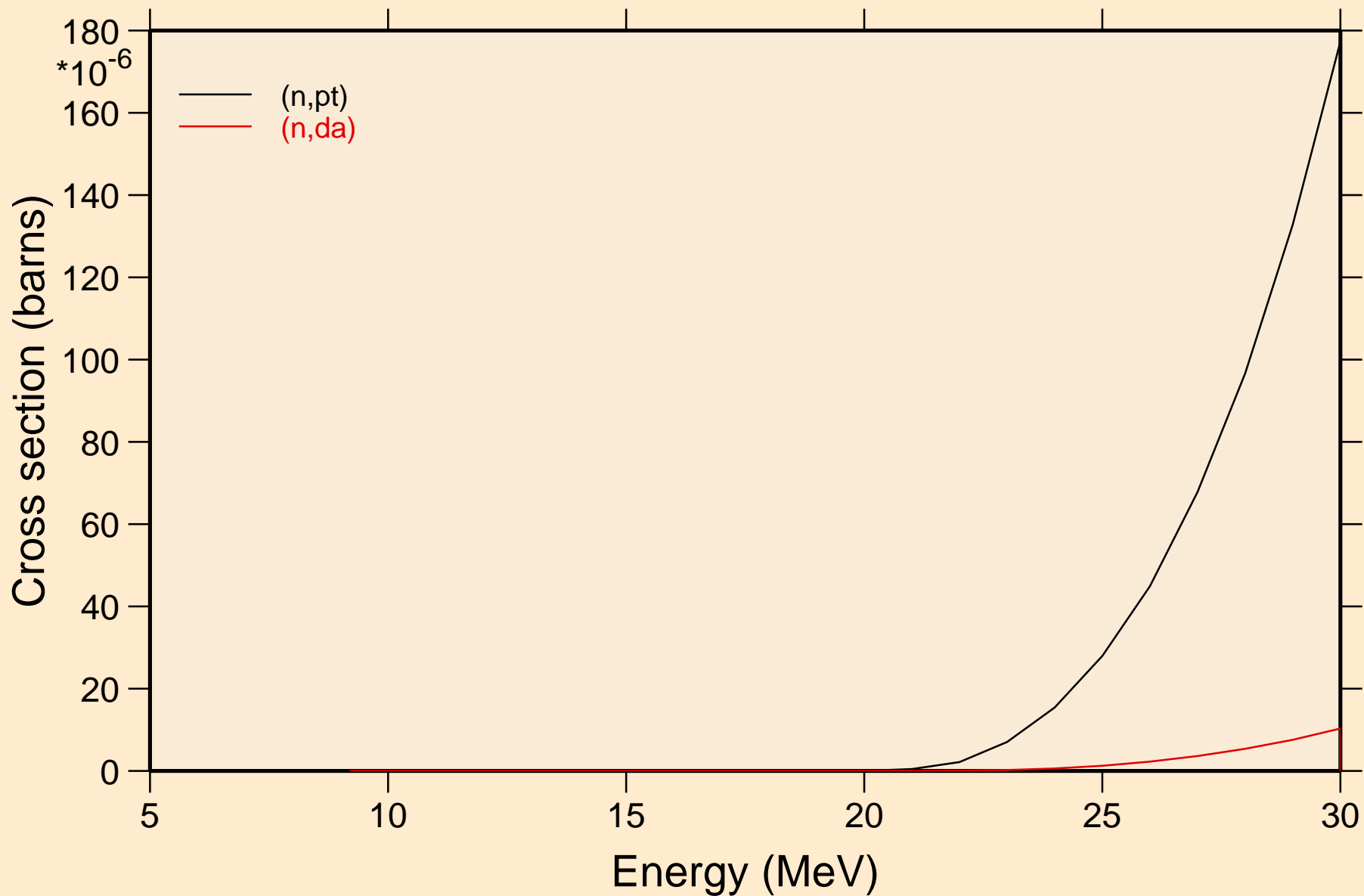

RB082 NEUTRON ACER TENDL-2019 LIBRARY; T=293.16K  
Threshold reactions

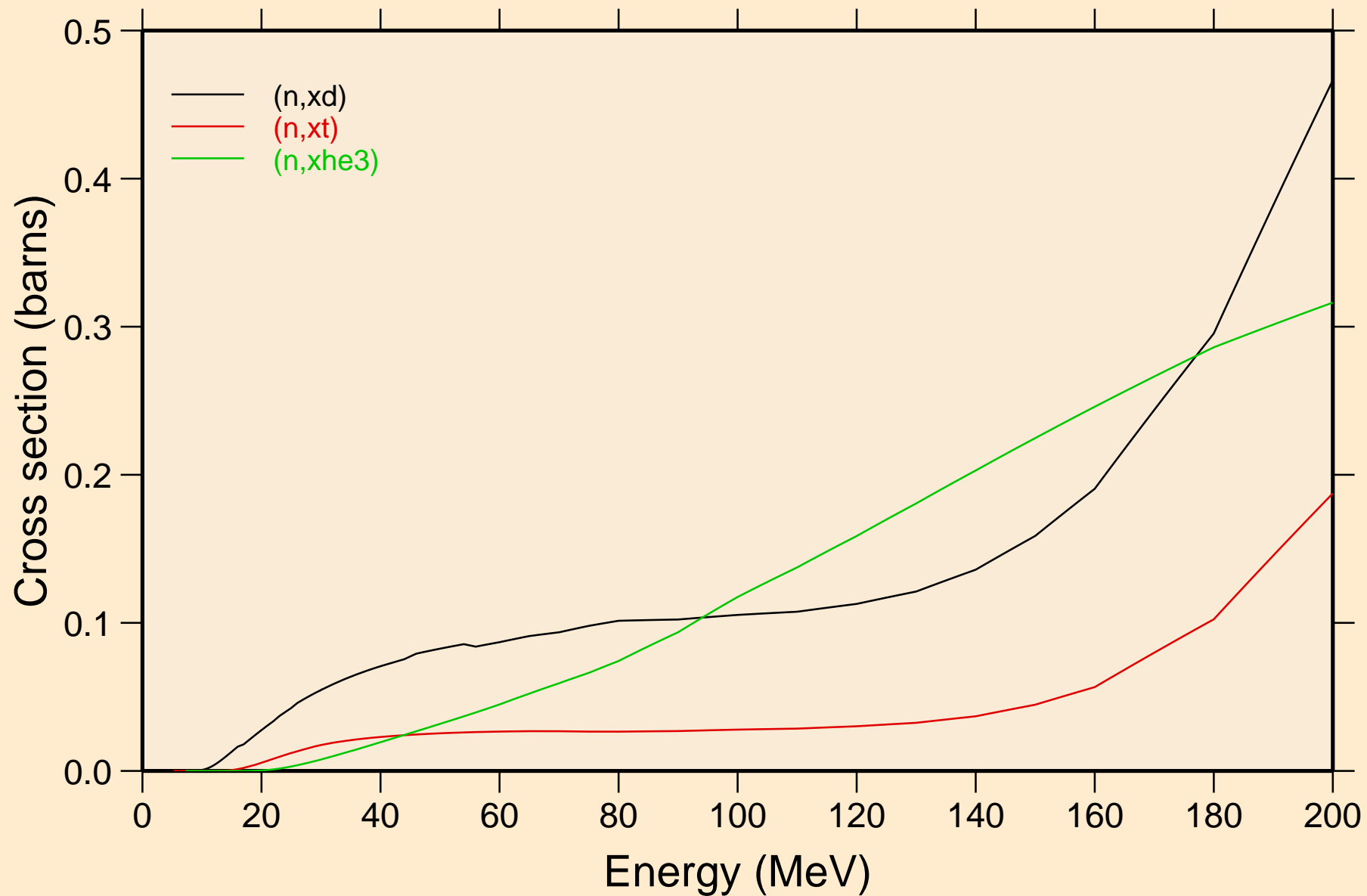

RB082 NEUTRON ACER TENDL-2019 LIBRARY; T=293.16K  
angular distribution for elastic

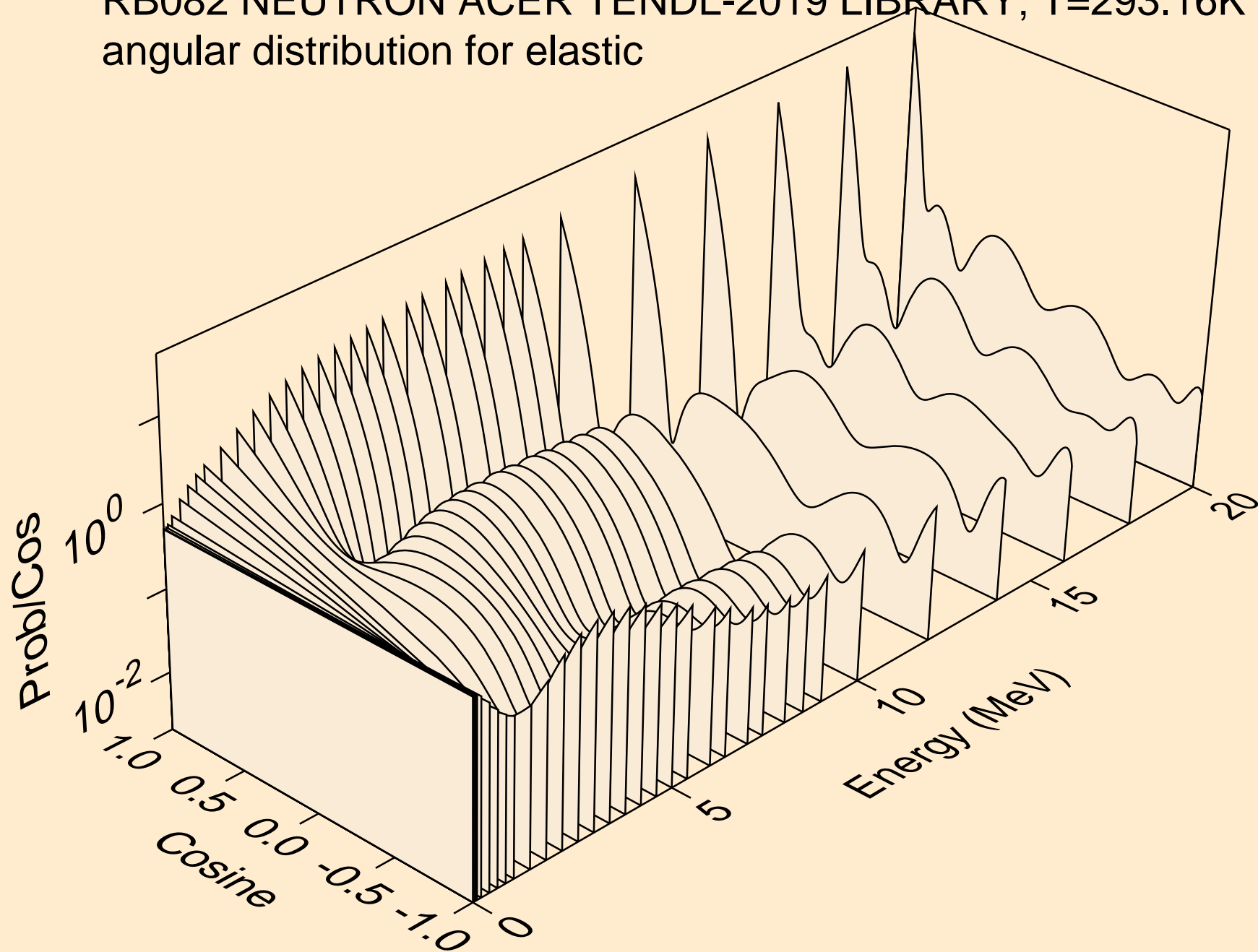

RB082 NEUTRON ACER TENDL-2019 LIBRARY; T=293.16K  
angular distribution for elastic

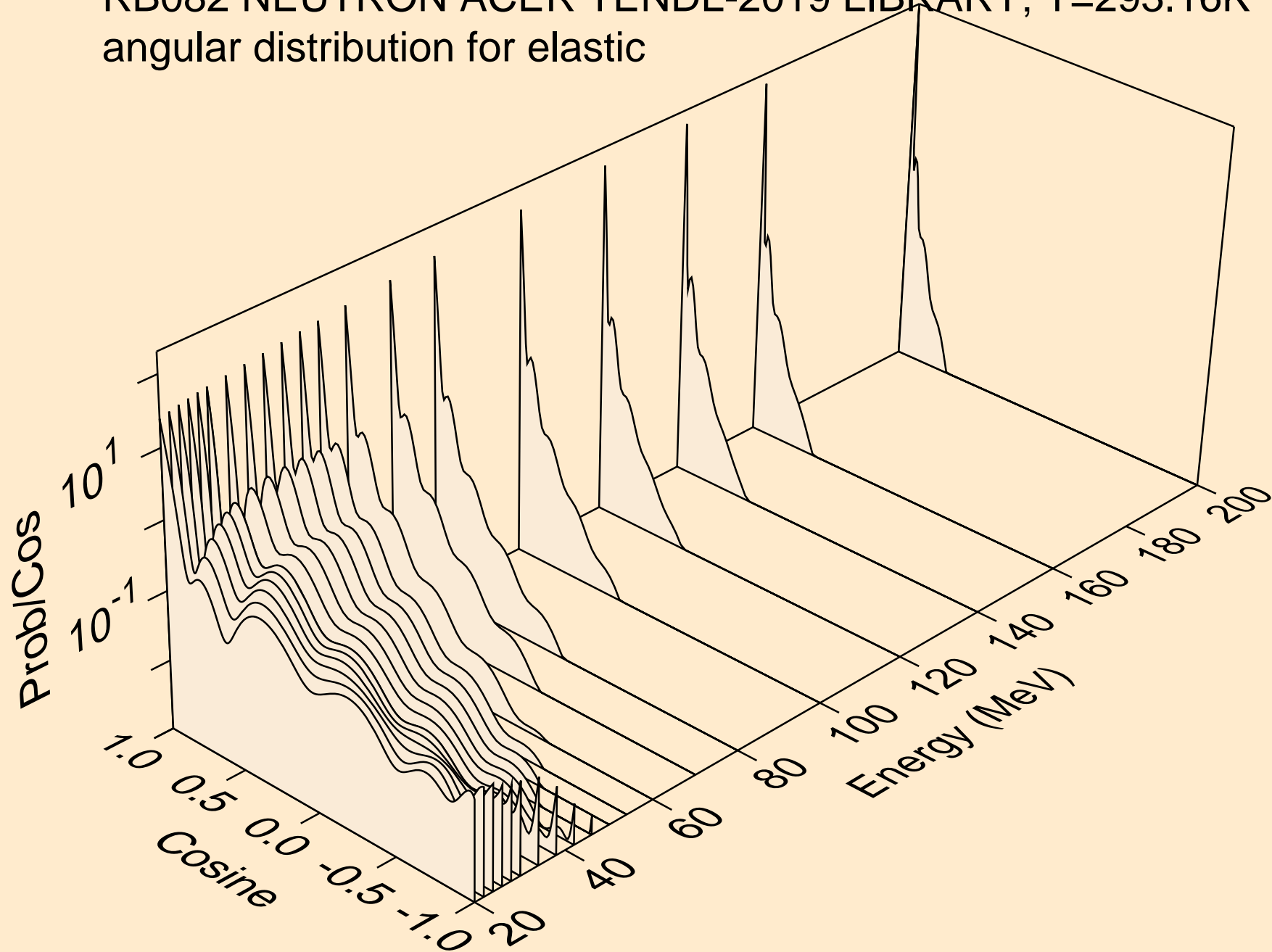

RB082 NEUTRON ACER TENDL-2019 LIBRARY; T=293.16K  
angular distribution for (n,n\*1)

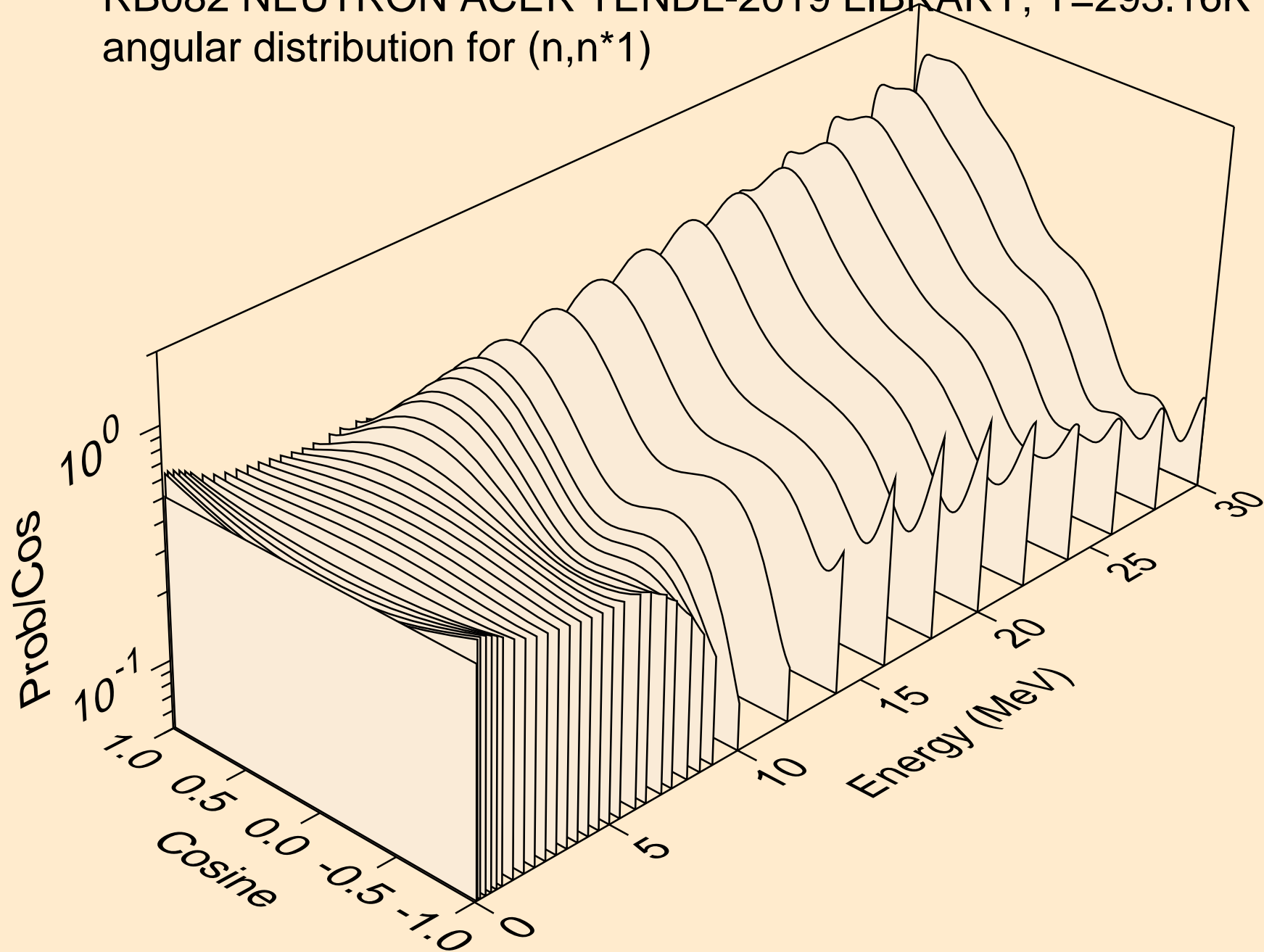

RB082 NEUTRON ACER TENDL-2019 LIBRARY; T=293.16K  
angular distribution for (n,n\*2)

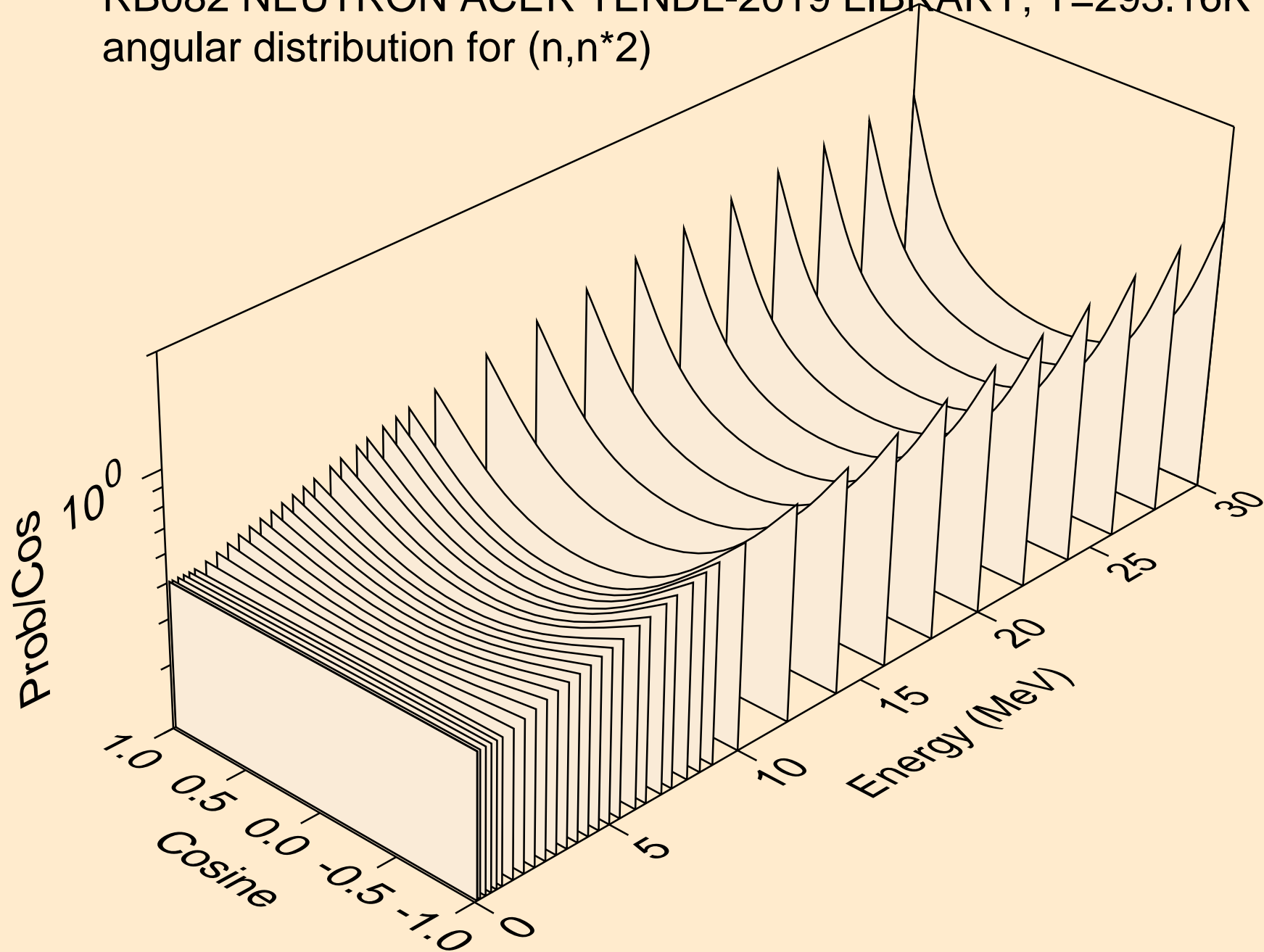



RB082 NEUTRON ACER TENDL-2019 LIBRARY; T=293.16K  
angular distribution for (n,n\*3)

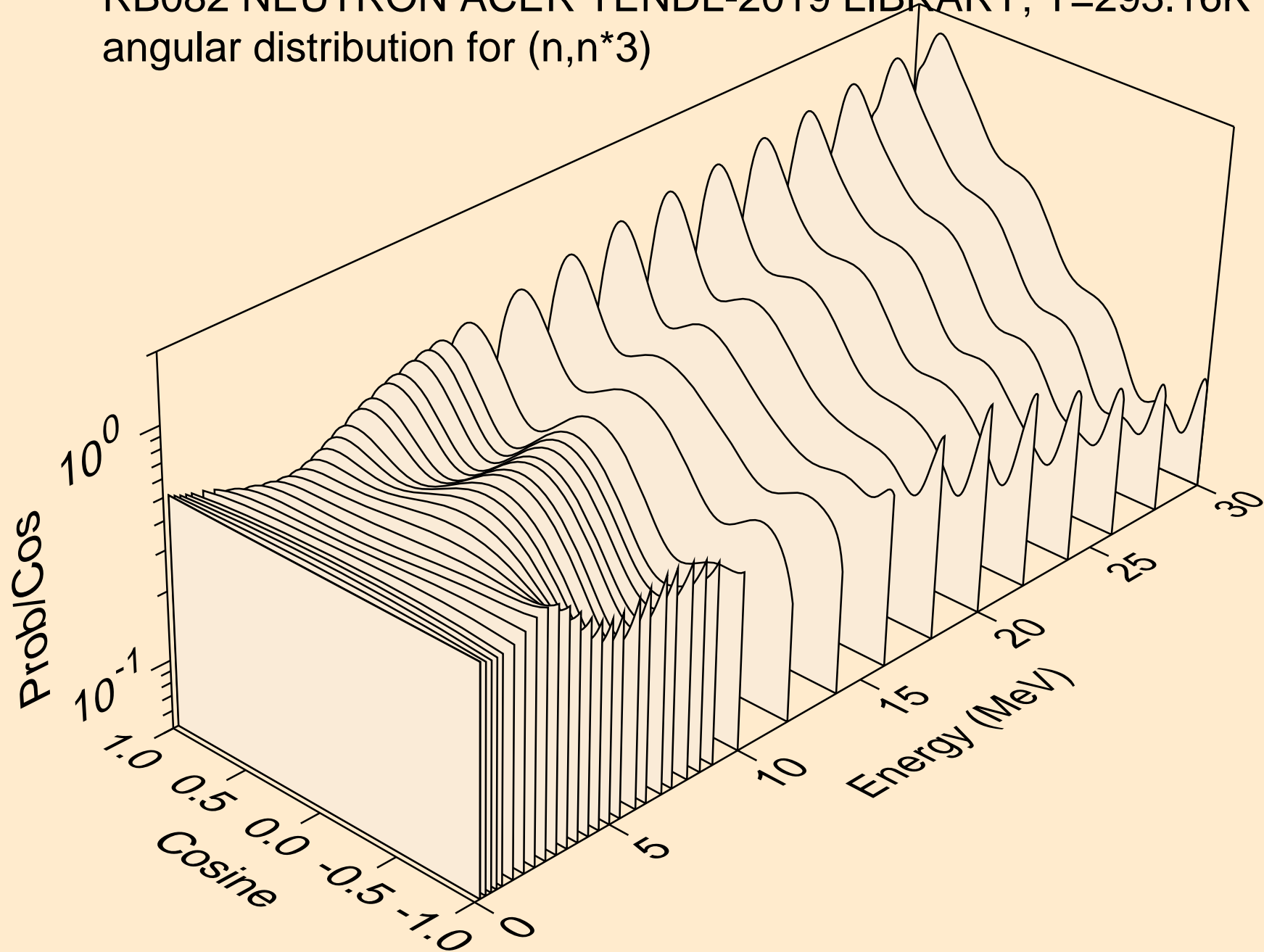

RB082 NEUTRON ACER TENDL-2019 LIBRARY; T=293.16K  
angular distribution for (n,n\*4)

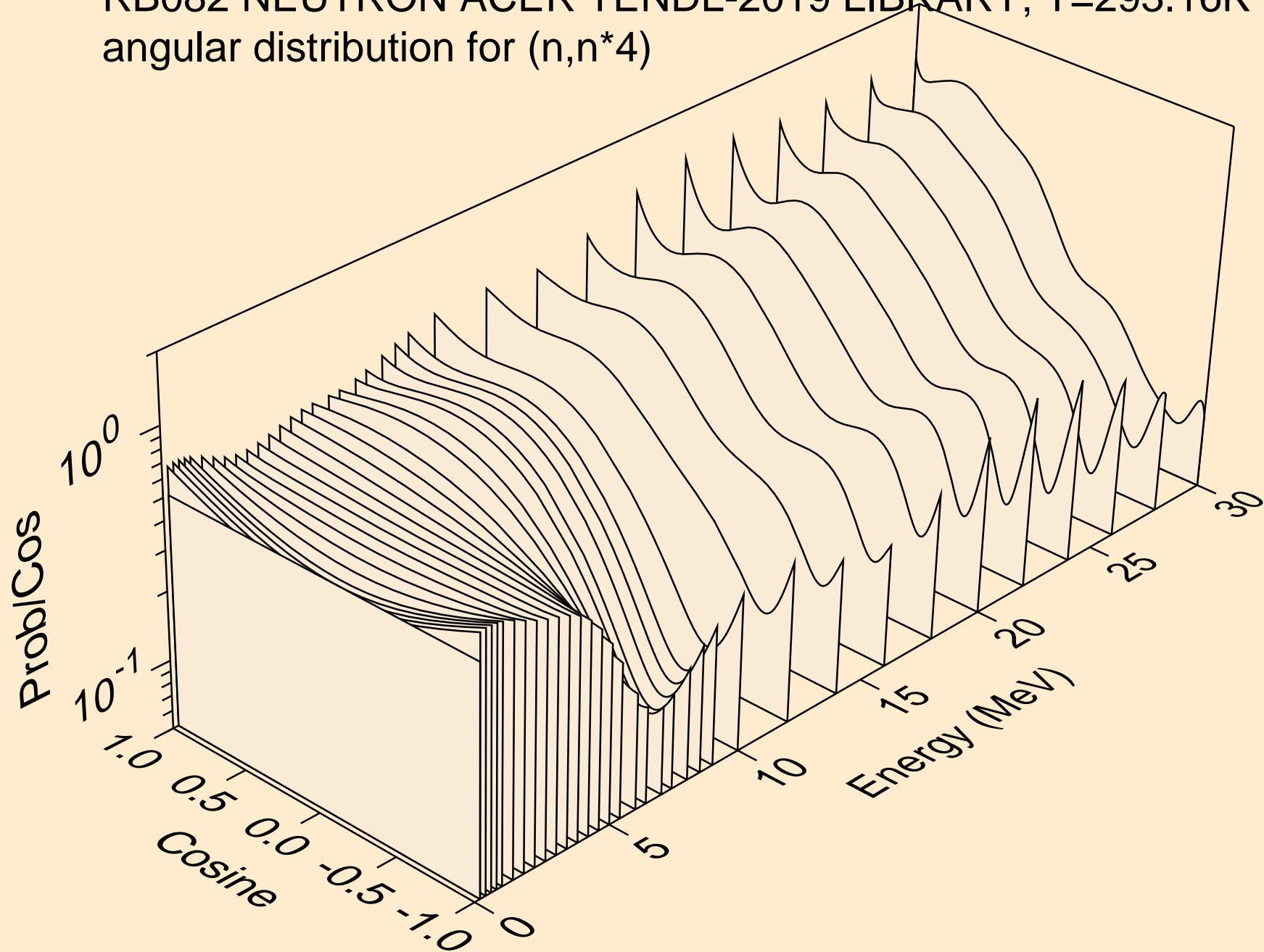

RB082 NEUTRON ACER TENDL-2019 LIBRARY; T=293.16K  
angular distribution for (n,n\*5)

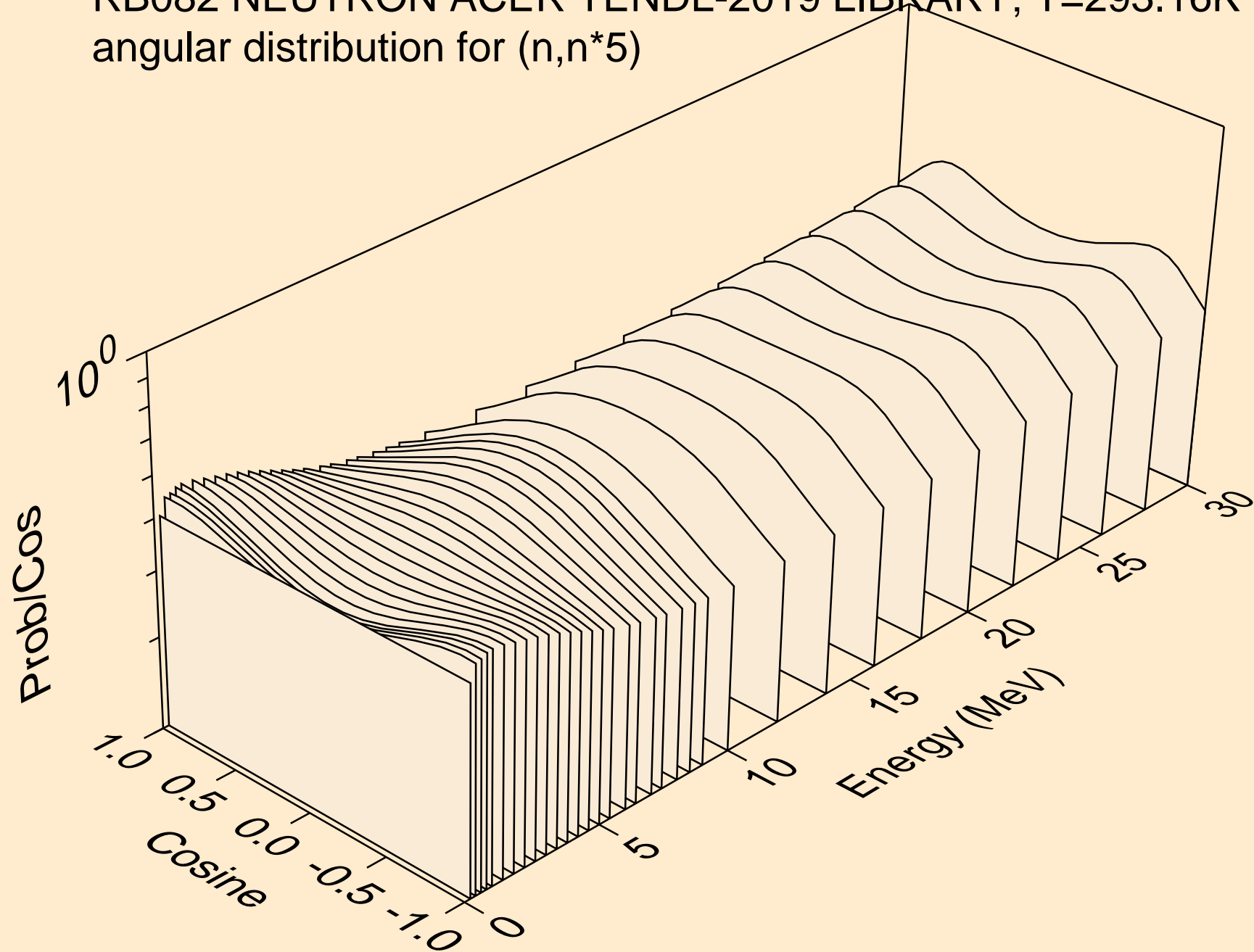

RB082 NEUTRON ACER TENDL-2019 LIBRARY; T=293.16K  
angular distribution for (n,n\*6)

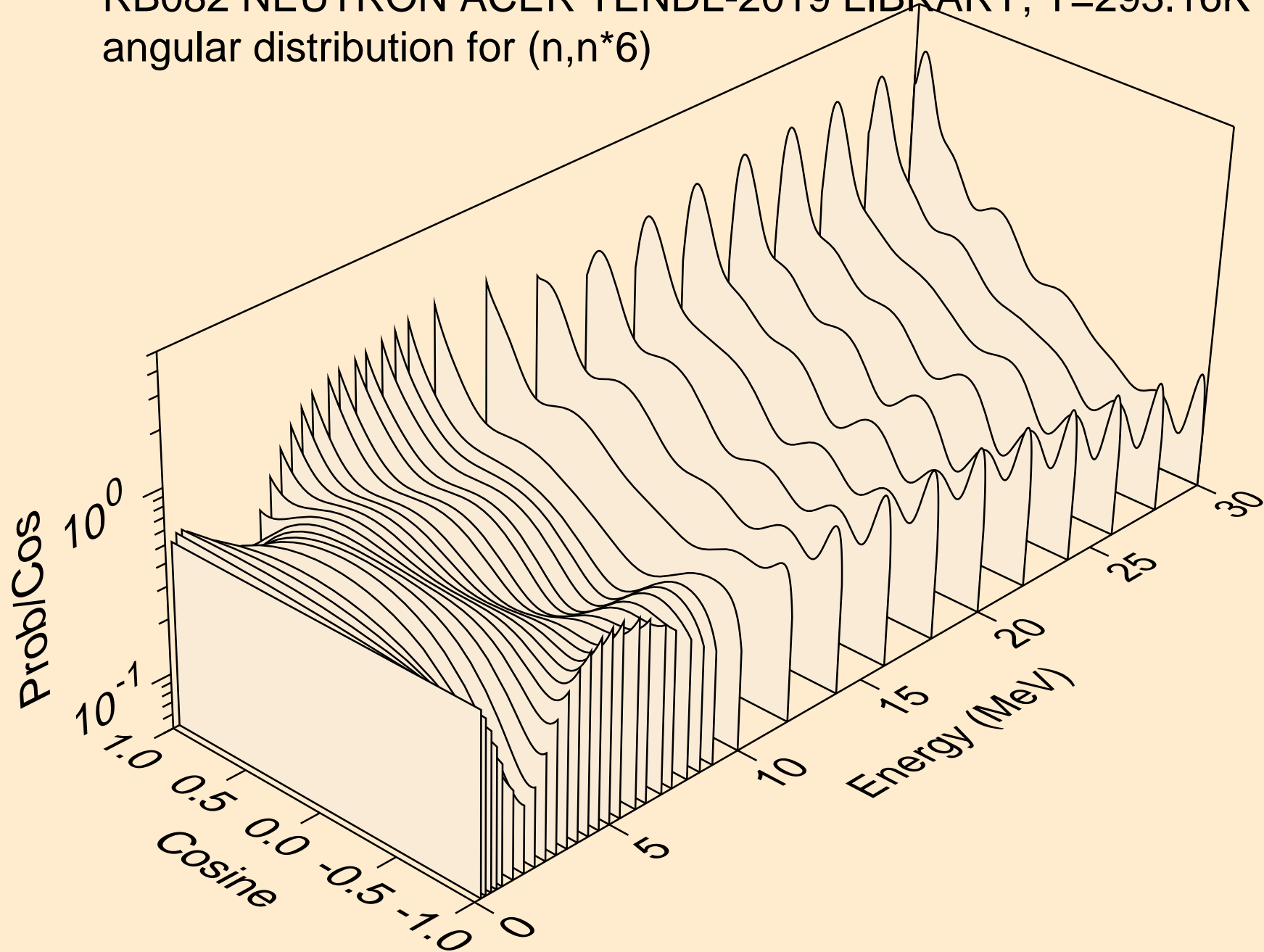

RB082 NEUTRON ACER TENDL-2019 LIBRARY; T=293.16K  
angular distribution for (n,n\*7)

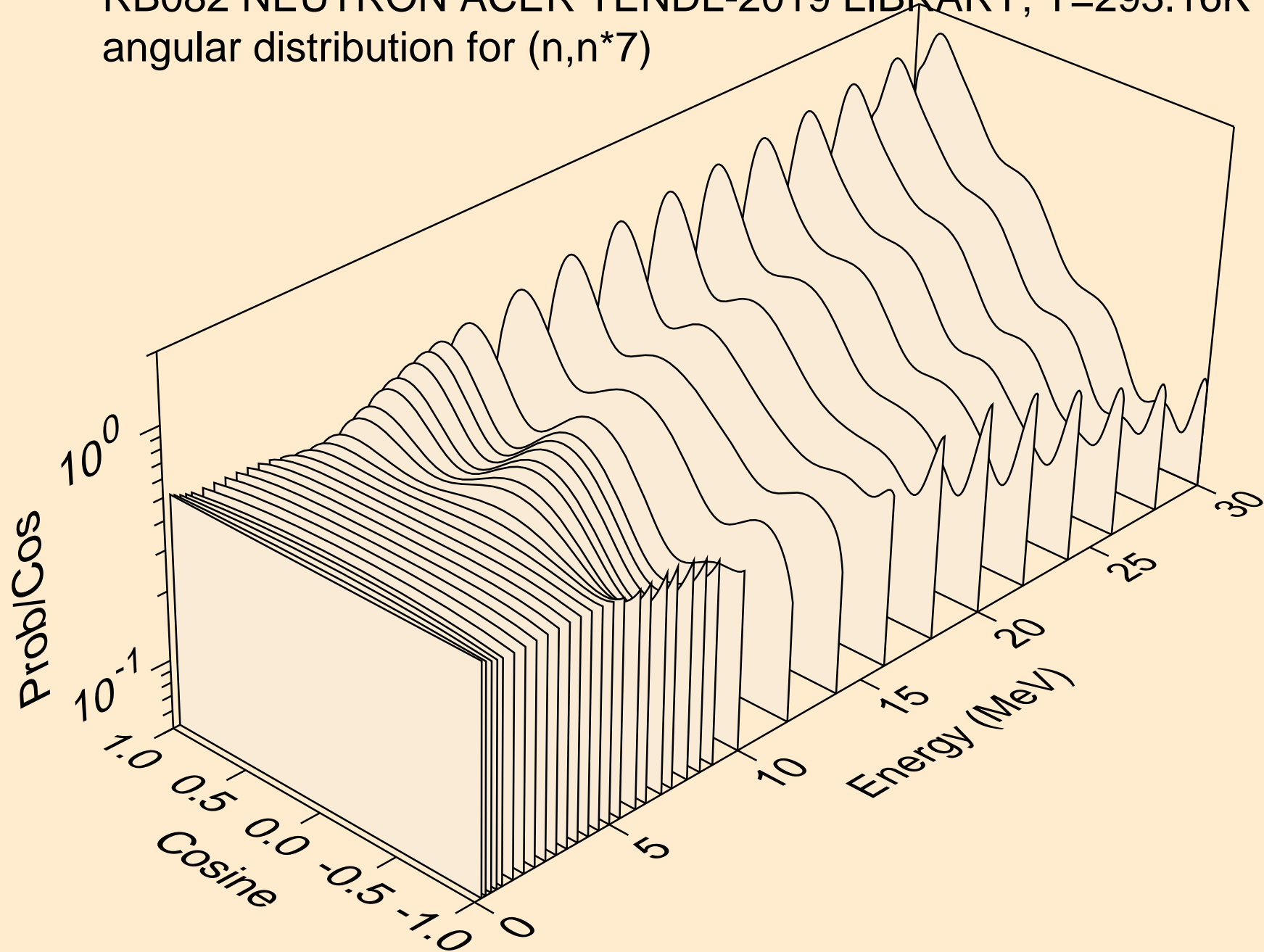

RB082 NEUTRON ACER TENDL-2019 LIBRARY; T=293.16K  
angular distribution for (n,n\*8)

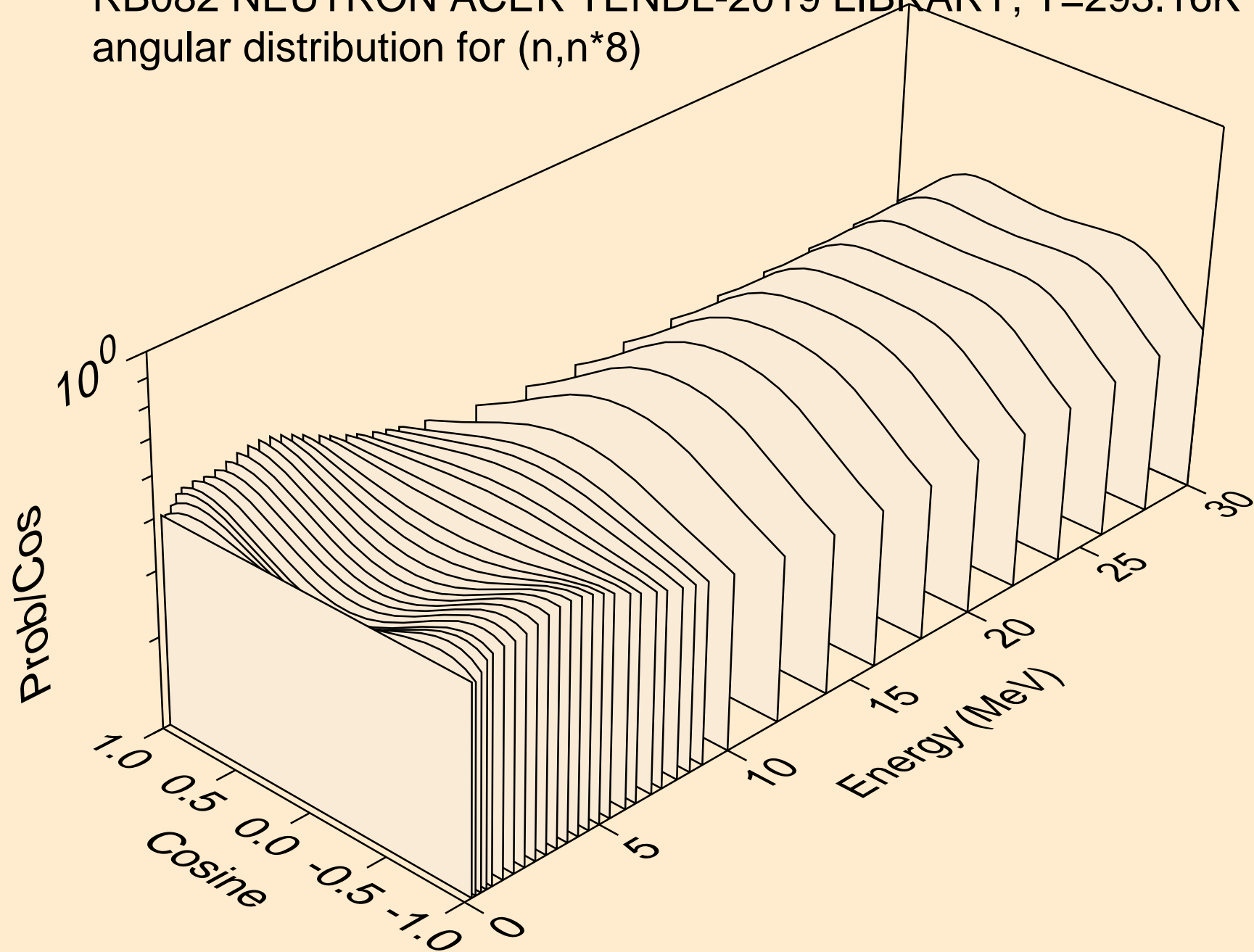

RB082 NEUTRON ACER TENDL-2019 LIBRARY; T=293.16K  
angular distribution for (n,n\*9)

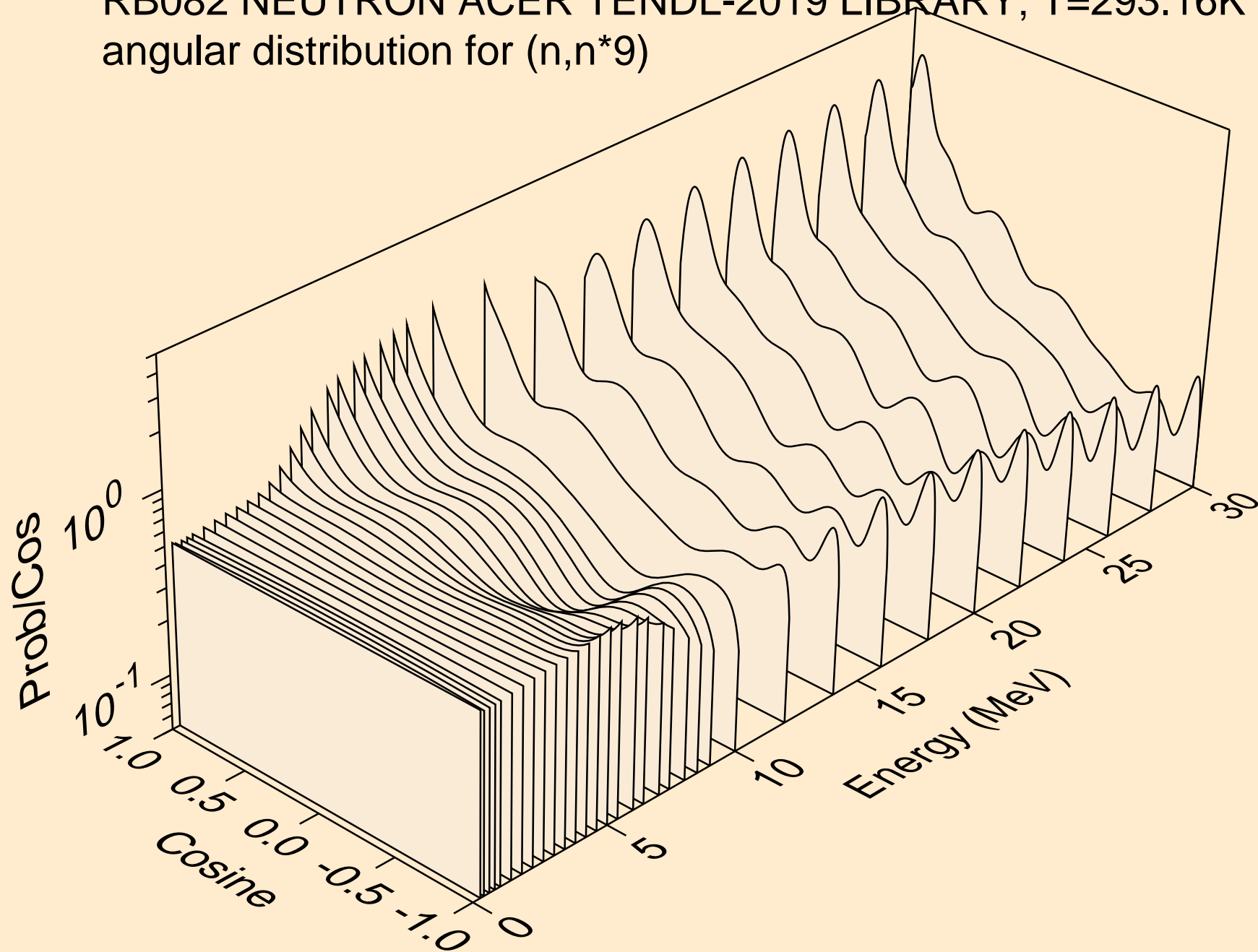

RB082 NEUTRON ACER TENDL-2019 LIBRARY; T=293.16K  
angular distribution for (n,n\*10)

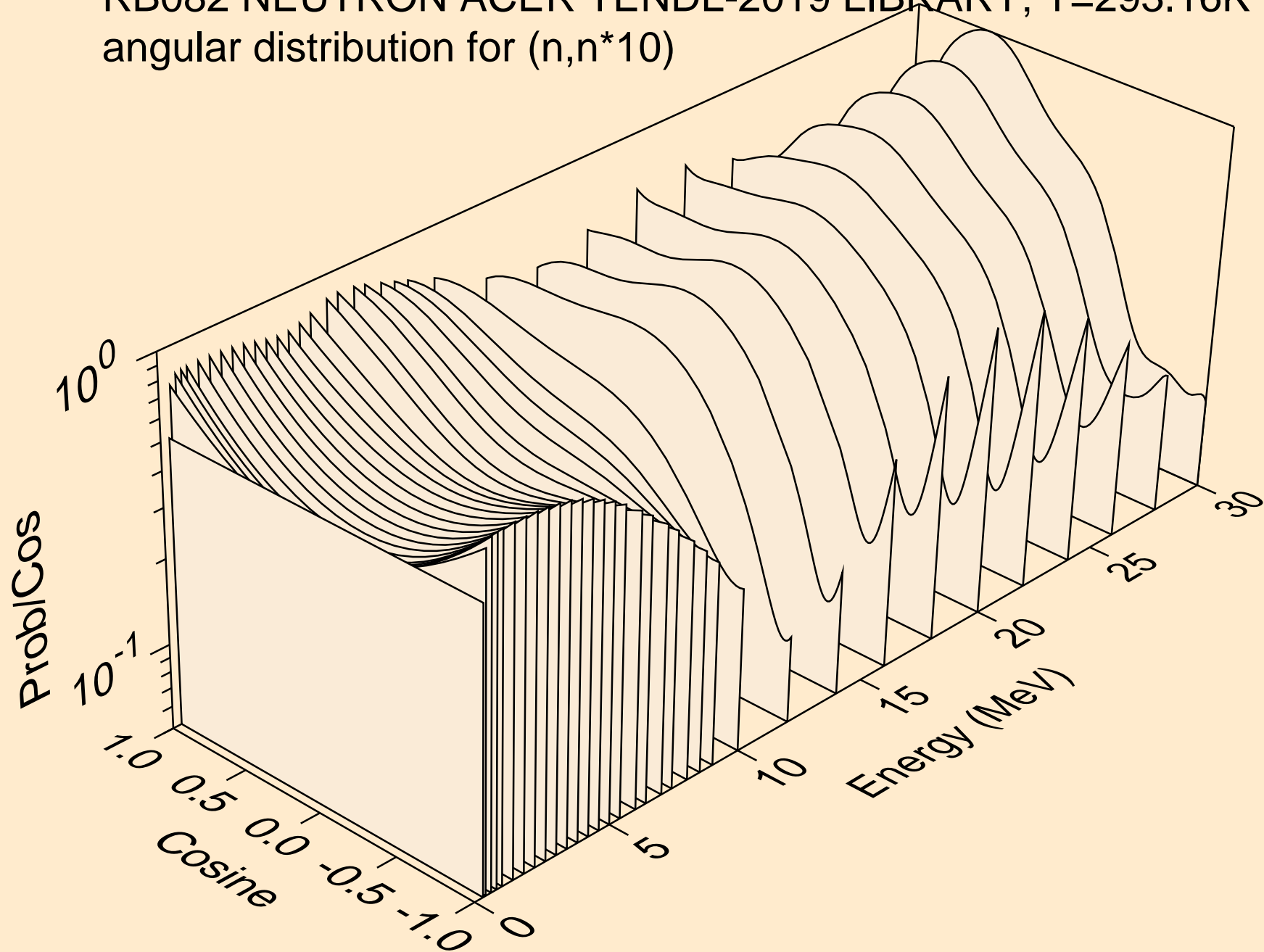



RB082 NEUTRON ACER TENDL-2019 LIBRARY; T=293.16K  
angular distribution for (n,n\*11)

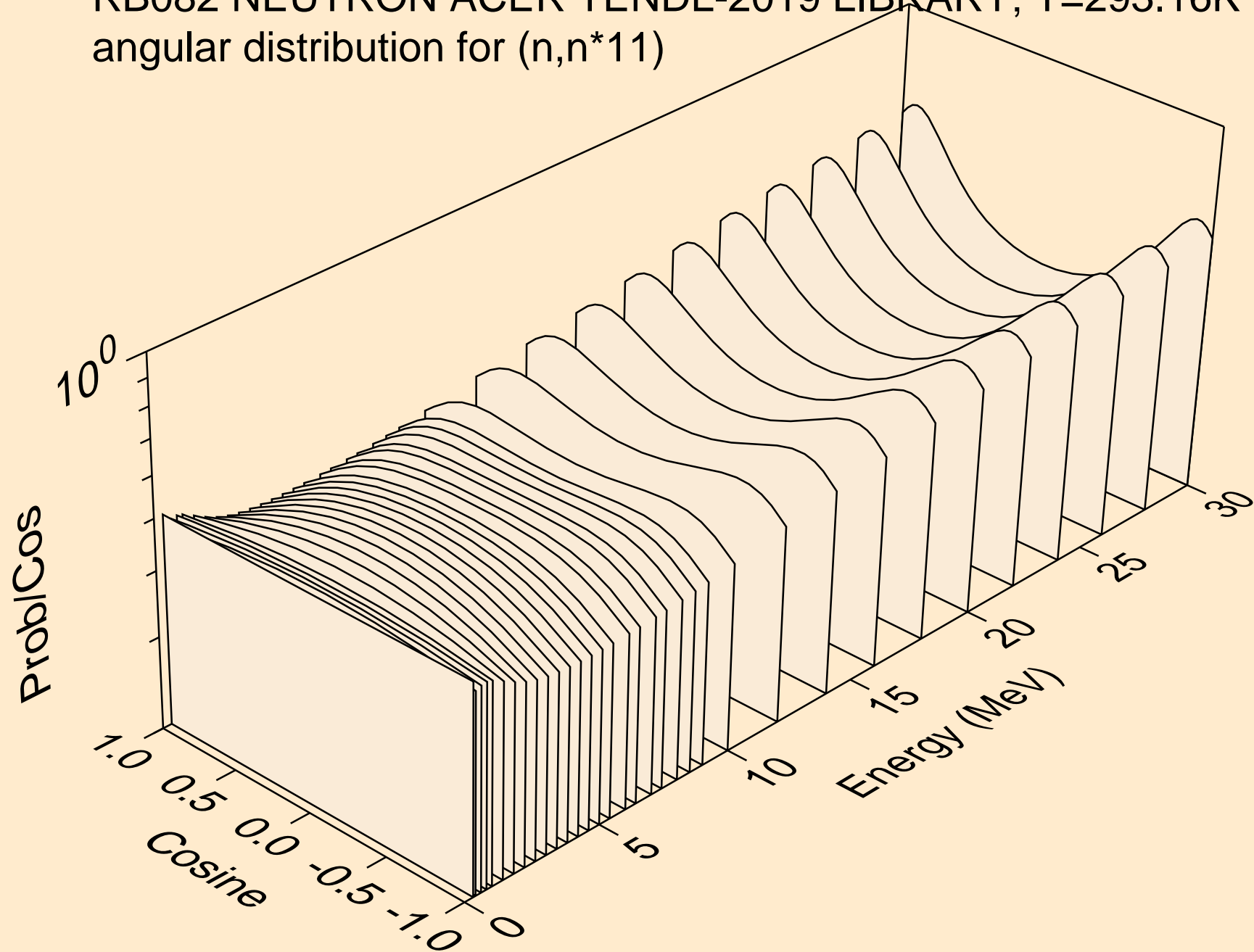

RB082 NEUTRON ACER TENDL-2019 LIBRARY; T=293.16K  
angular distribution for (n,n\*12)

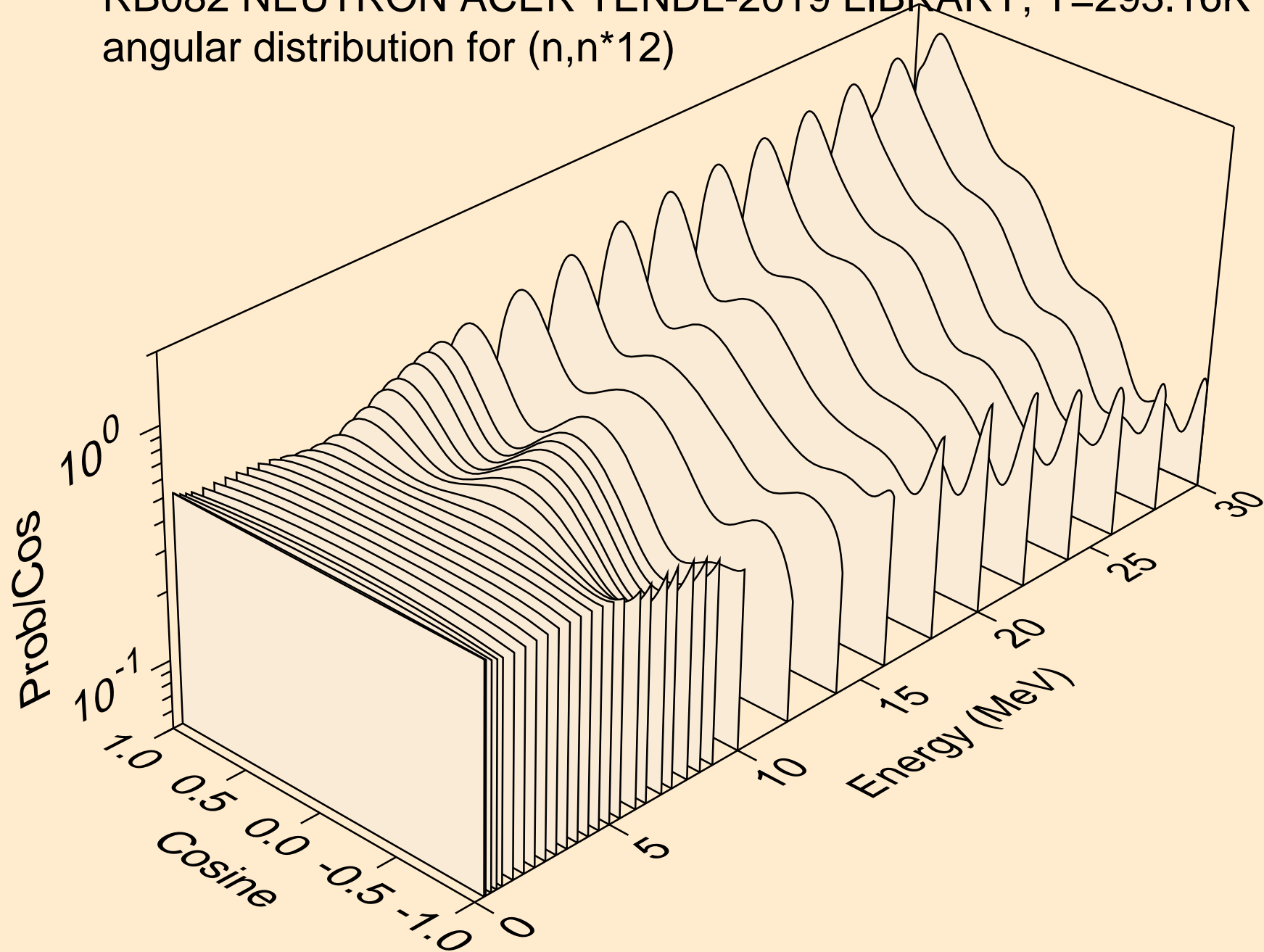

RB082 NEUTRON ACER TENDL-2019 LIBRARY; T=293.16K  
angular distribution for (n,n\*13)

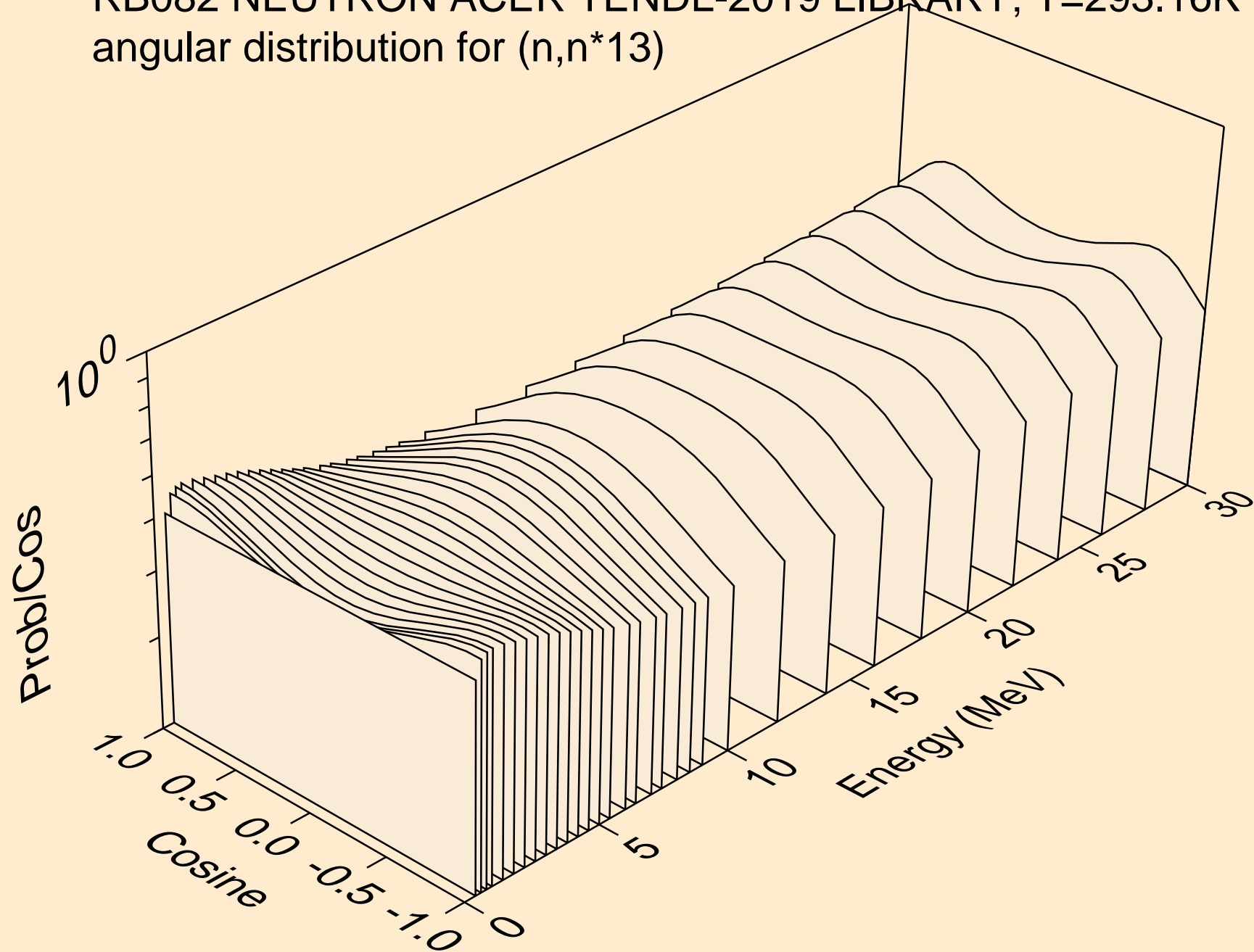

RB082 NEUTRON ACER TENDL-2019 LIBRARY; T=293.16K  
angular distribution for (n,n\*14)

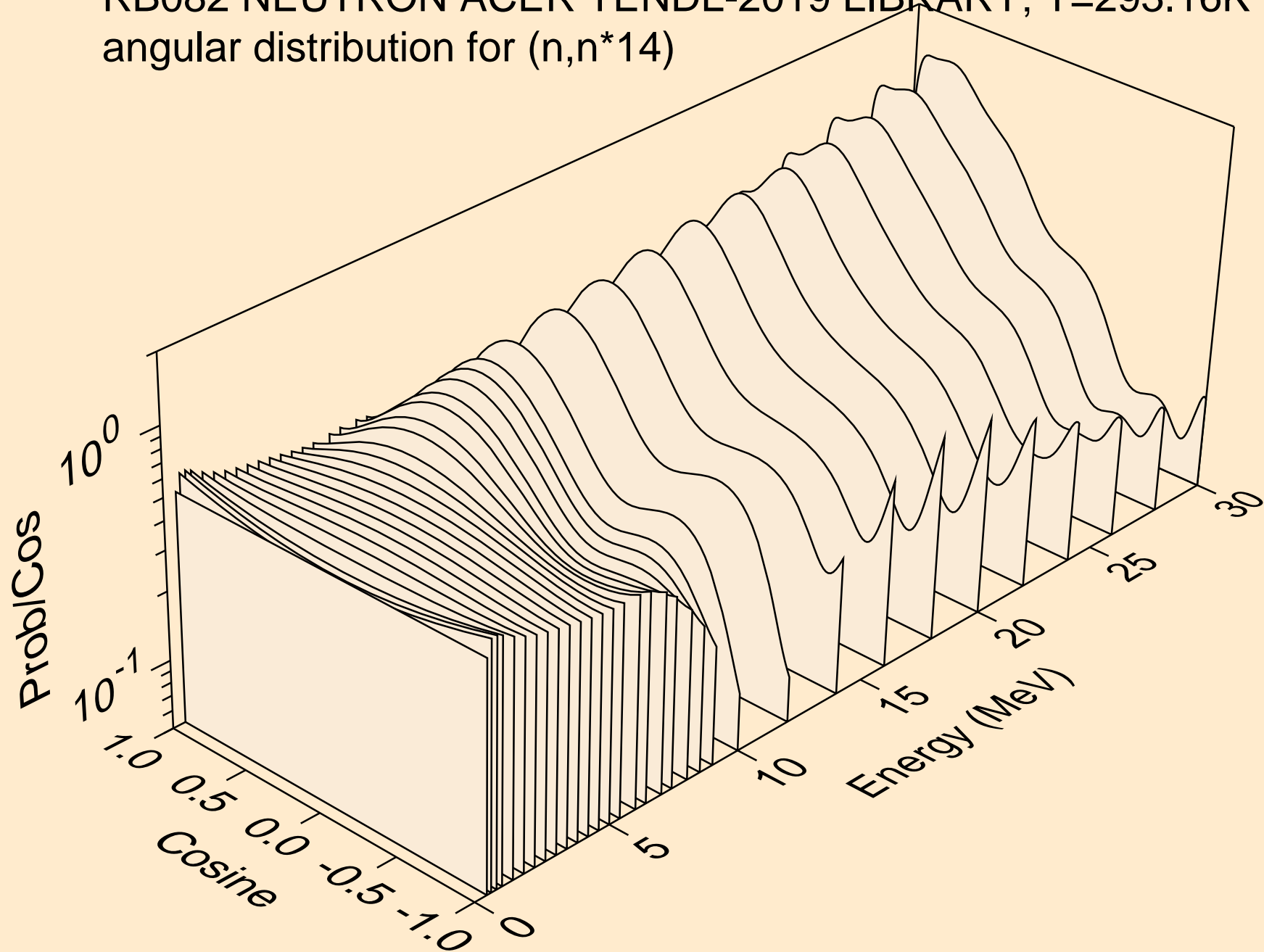

RB082 NEUTRON ACER TENDL-2019 LIBRARY; T=293.16K  
angular distribution for (n,n\*15)

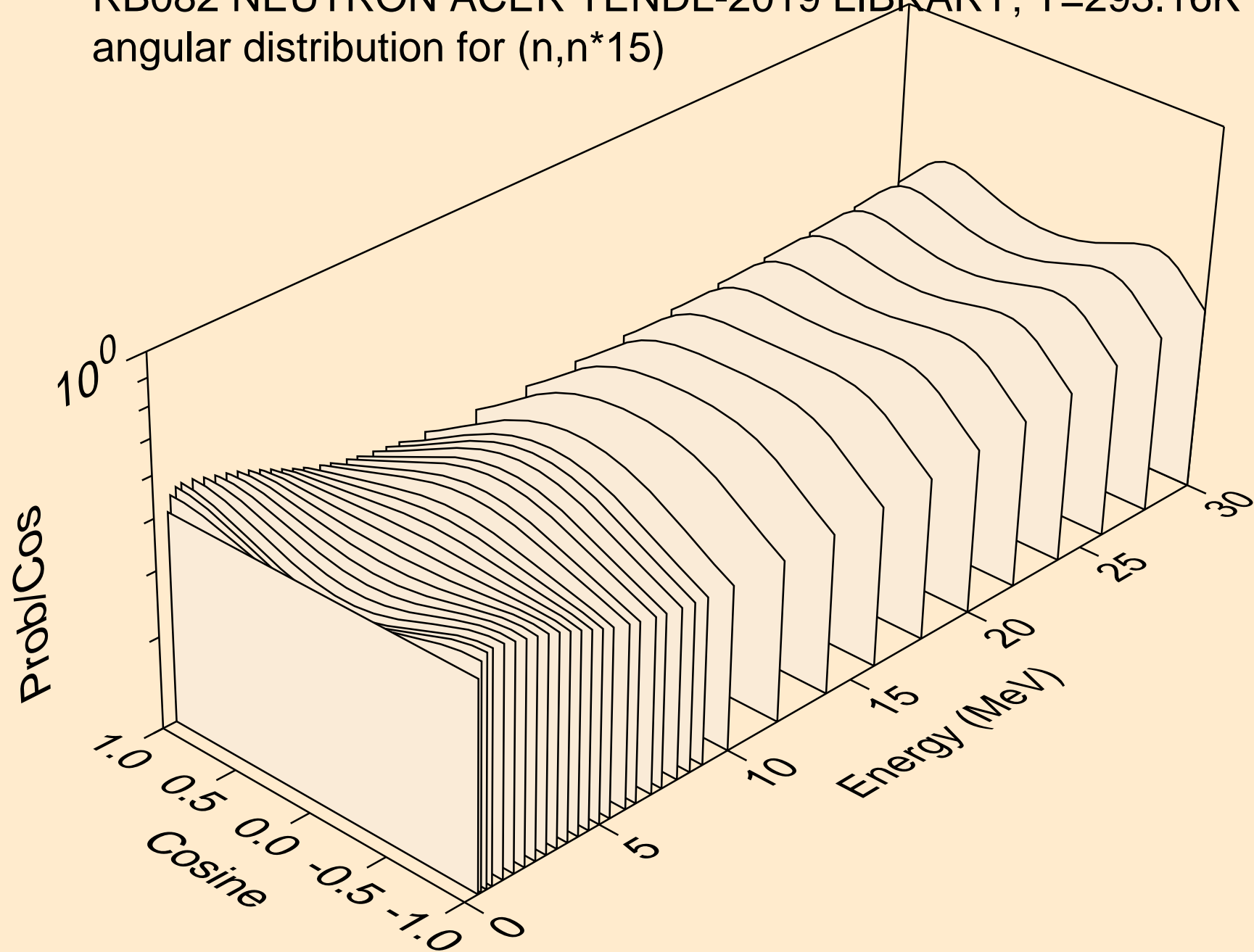

RB082 NEUTRON ACER TENDL-2019 LIBRARY; T=293.16K  
angular distribution for (n,n\*16)

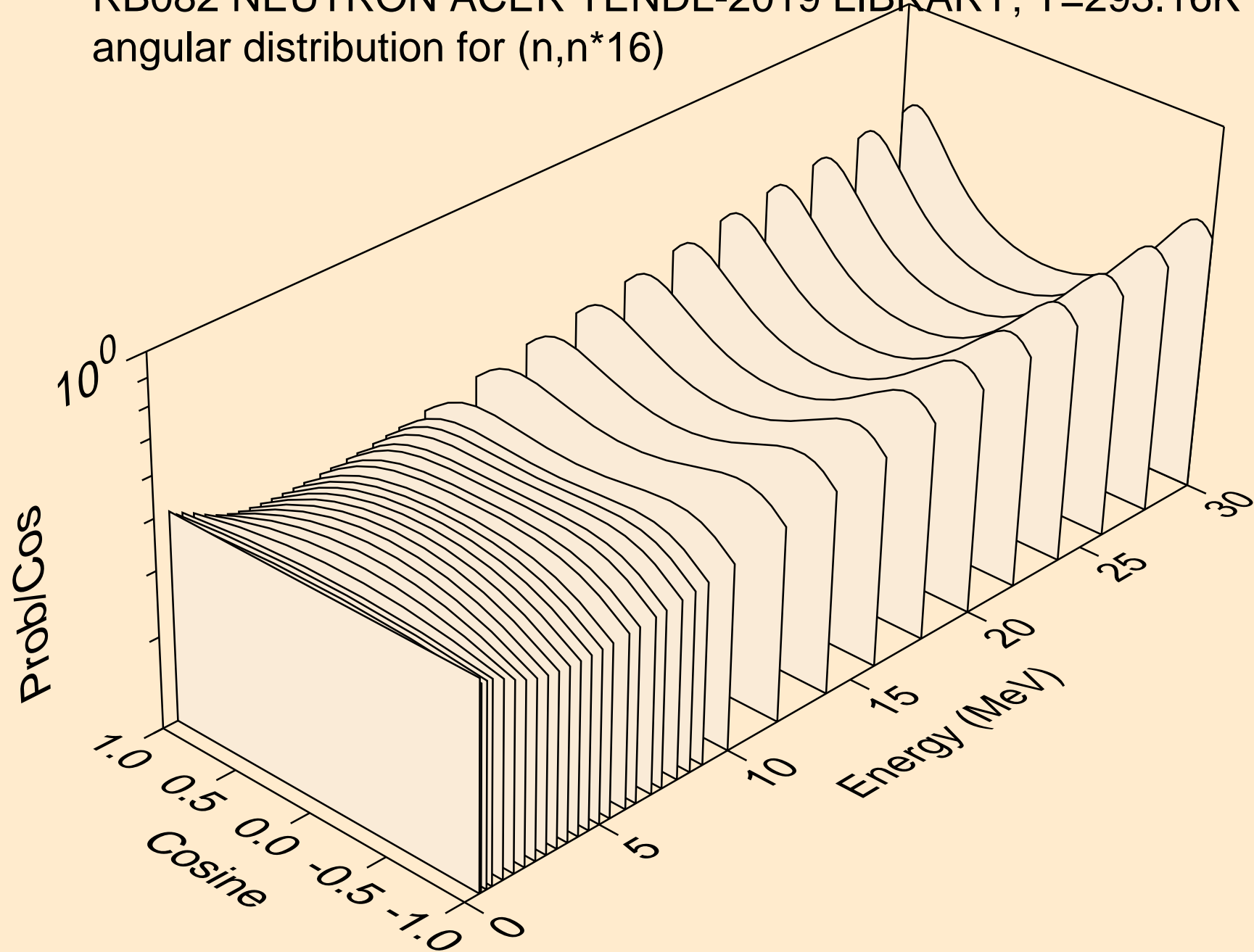

RB082 NEUTRON ACER TENDL-2019 LIBRARY; T=293.16K  
angular distribution for (n,n\*17)

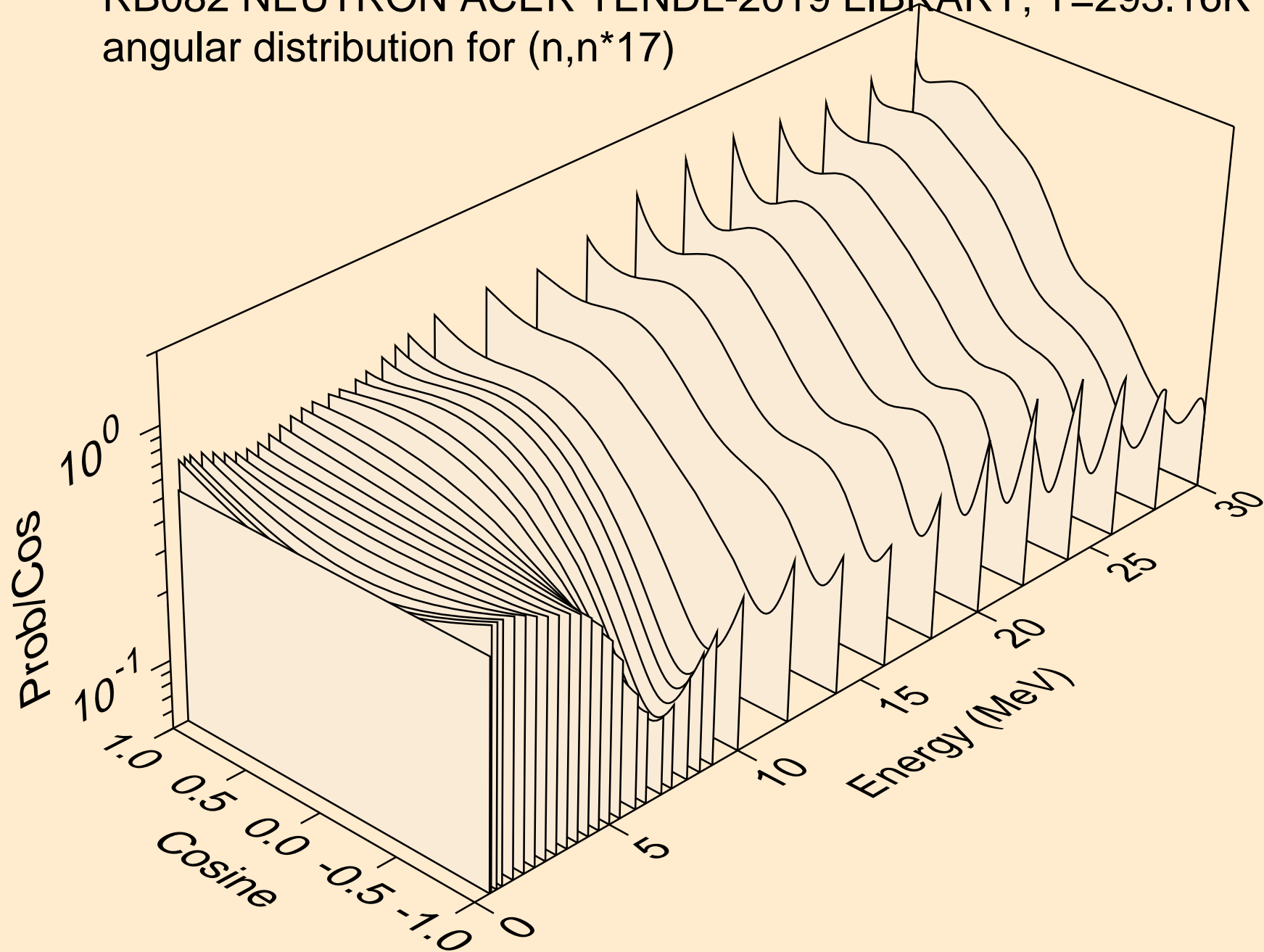

RB082 NEUTRON ACER TENDL-2019 LIBRARY; T=293.16K  
angular distribution for (n,n\*18)

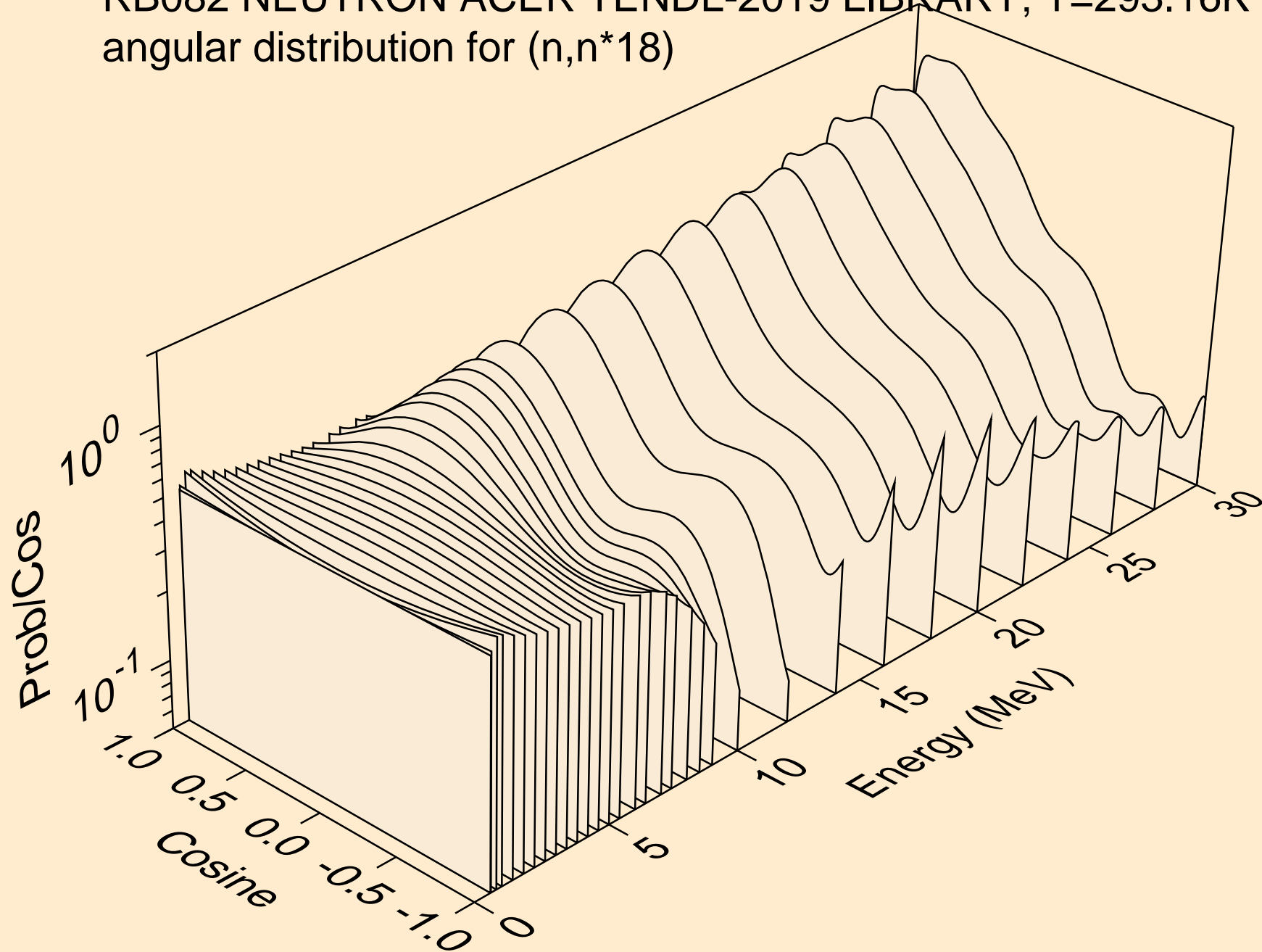



RB082 NEUTRON ACER TENDL-2019 LIBRARY; T=293.16K  
angular distribution for (n,n\*19)

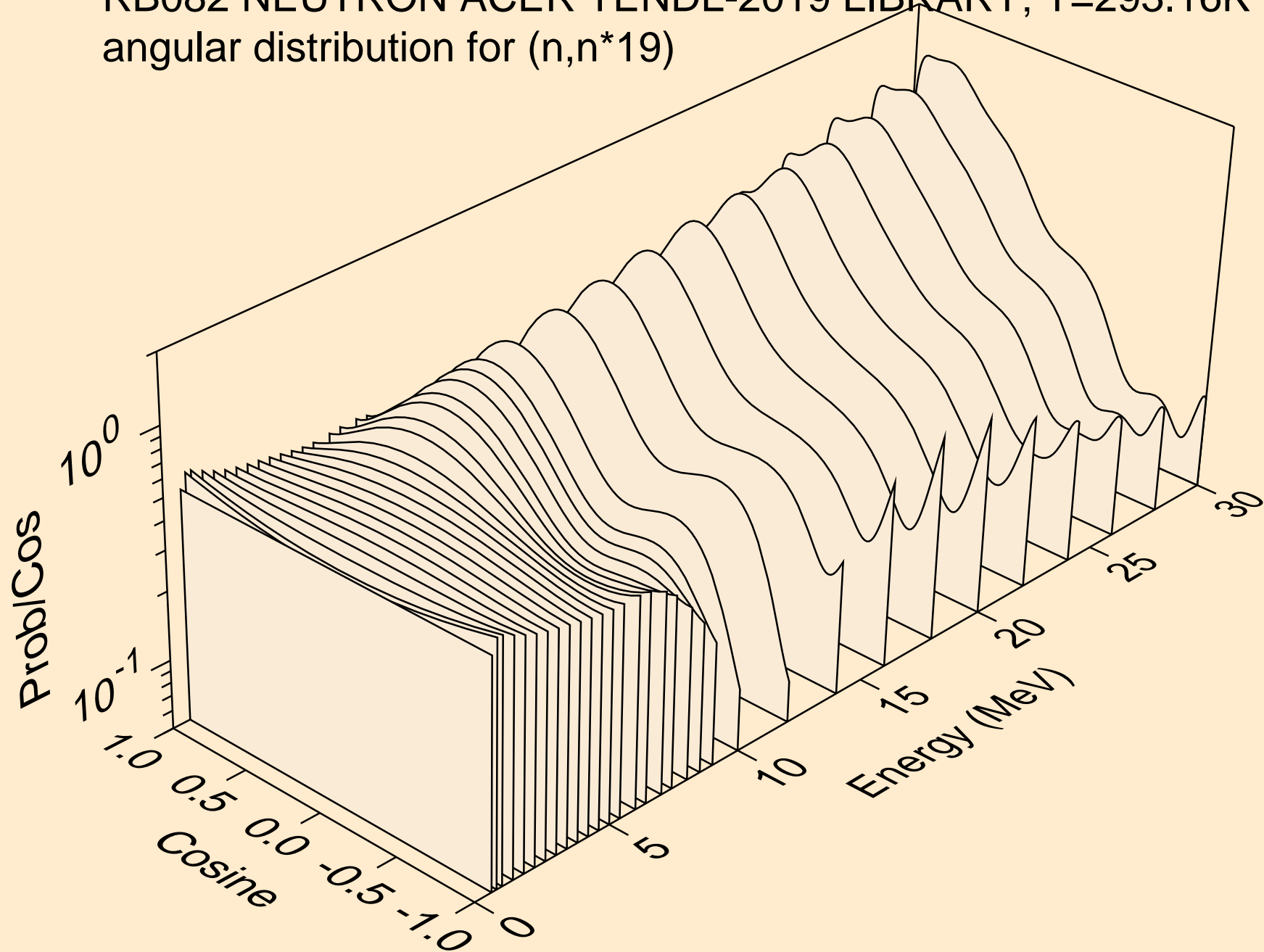

RB082 NEUTRON ACER TENDL-2019 LIBRARY; T=293.16K  
angular distribution for (n,n\*20)

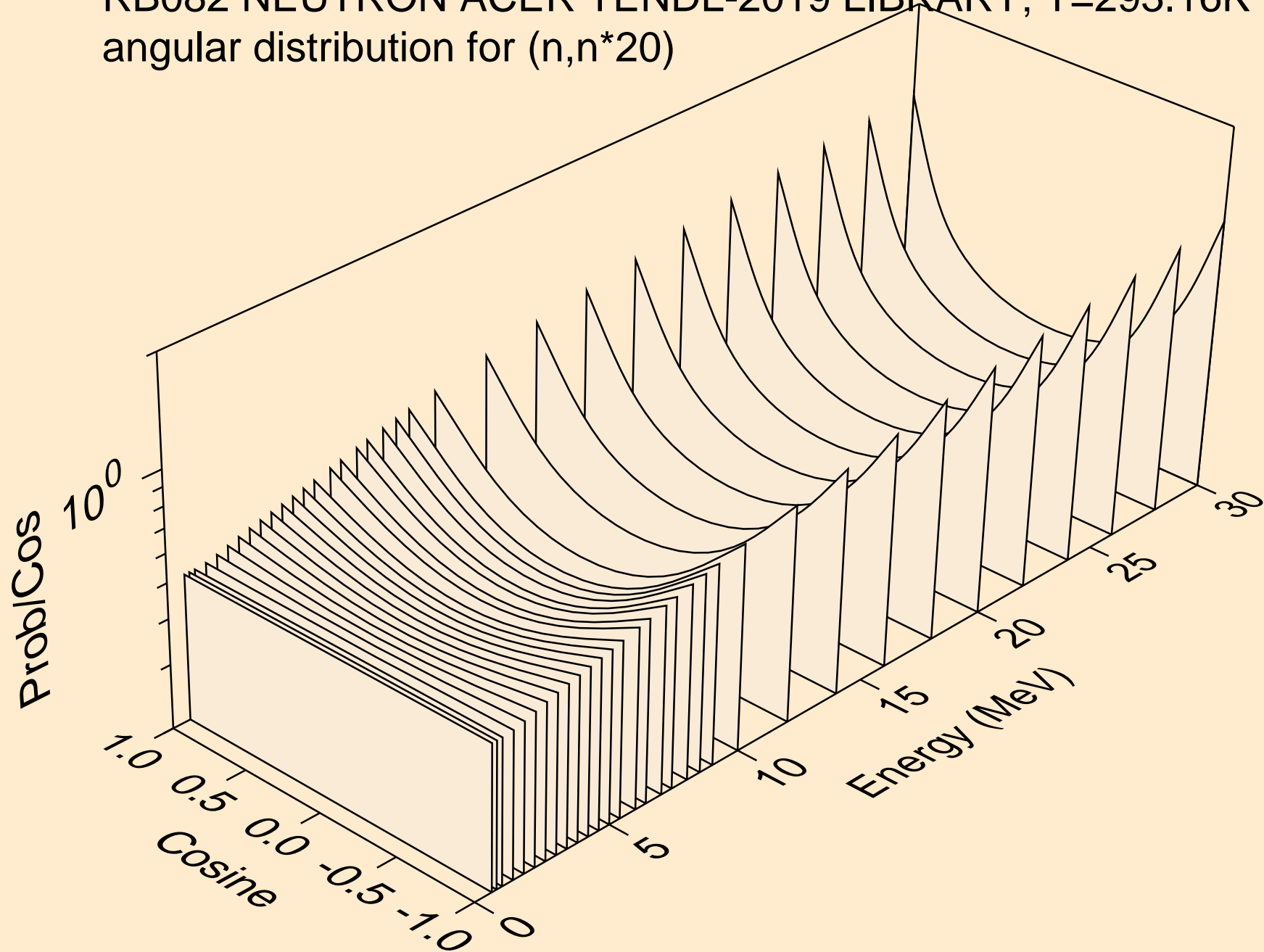

RB082 NEUTRON ACER TENDL-2019 LIBRARY; T=293.16K  
angular distribution for (n,n\*21)

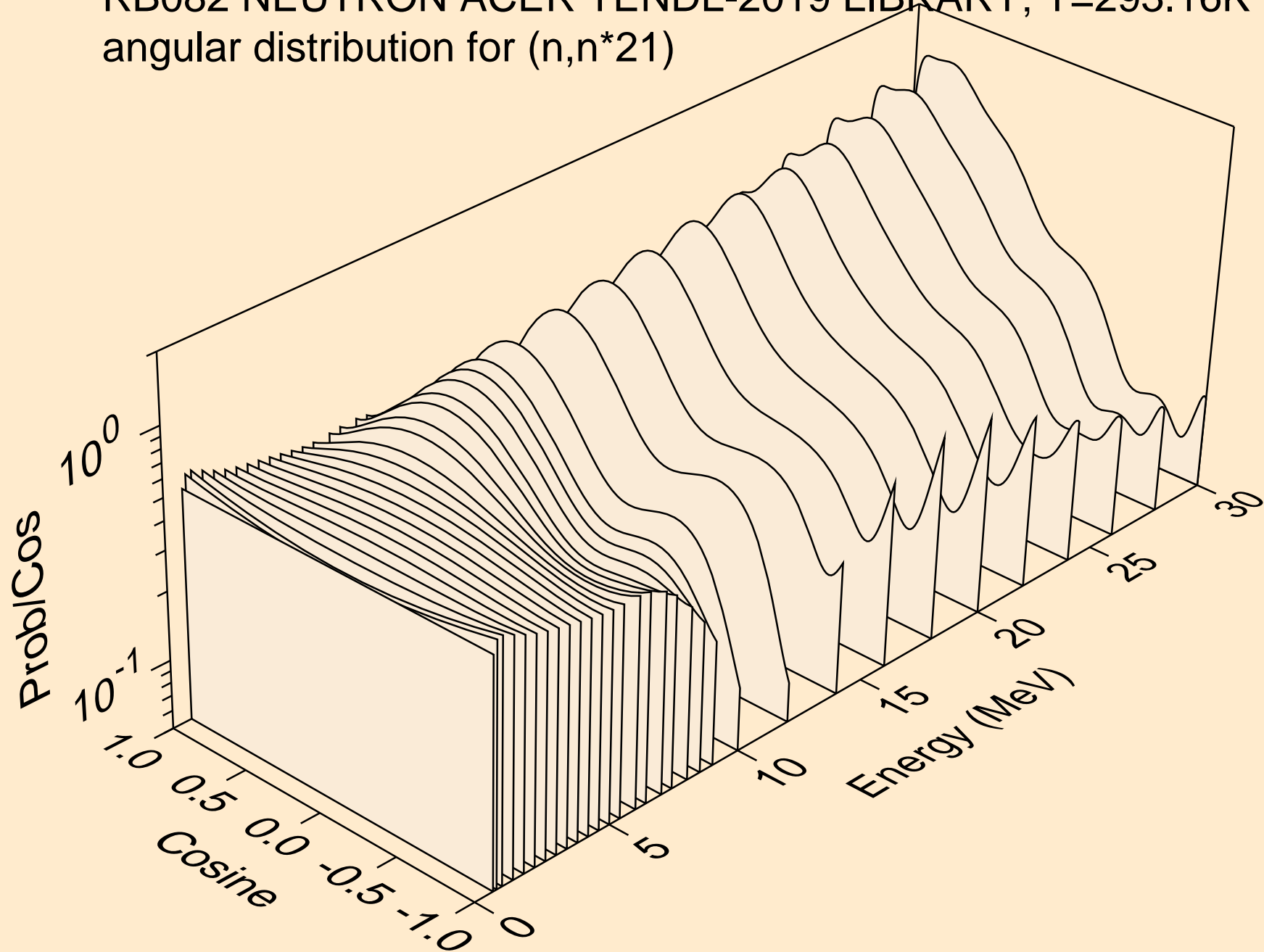

RB082 NEUTRON ACER TENDL-2019 LIBRARY; T=293.16K  
angular distribution for (n,n\*22)

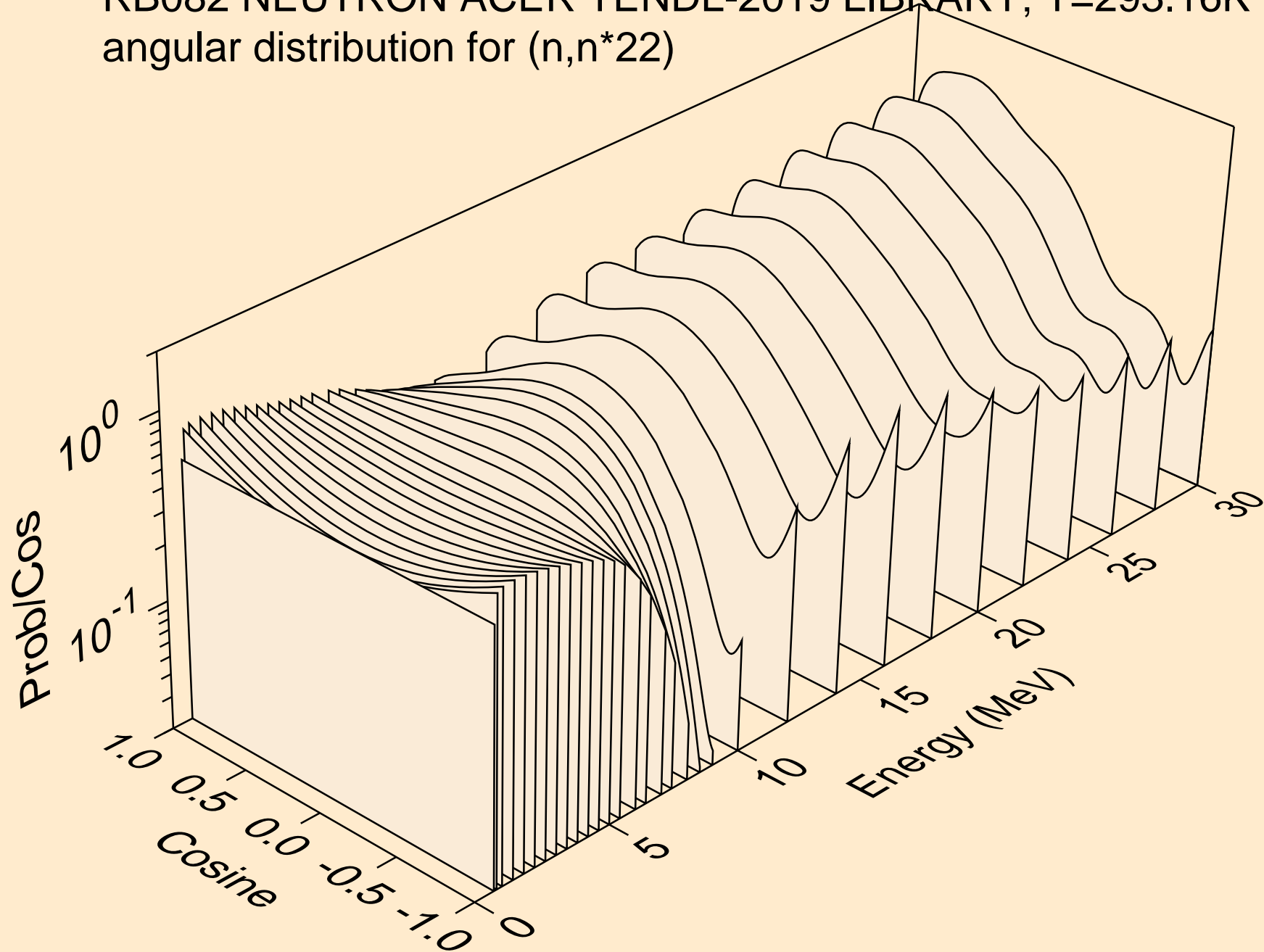

RB082 NEUTRON ACER TENDL-2019 LIBRARY; T=293.16K  
angular distribution for (n,n\*23)

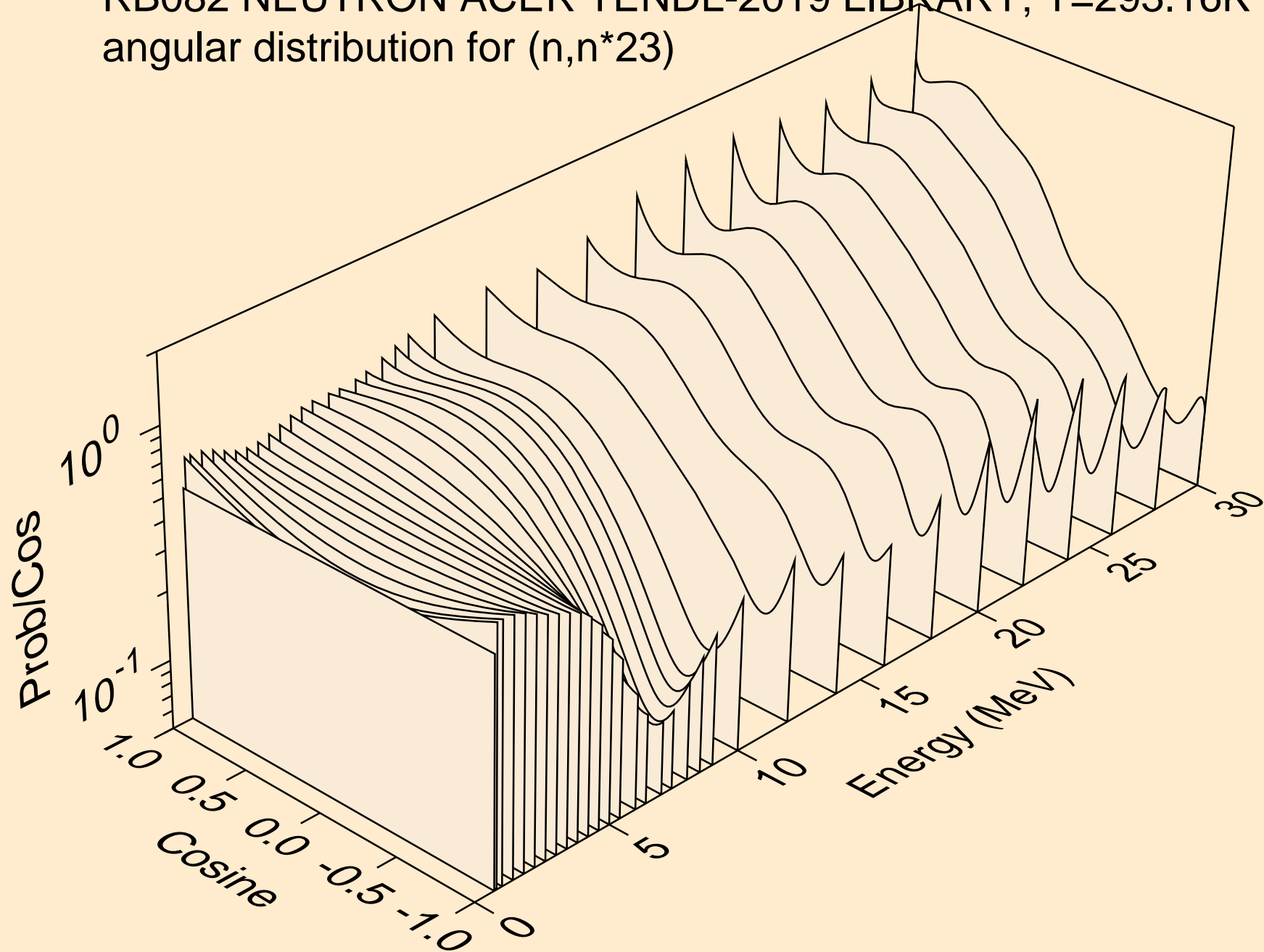

RB082 NEUTRON ACER TENDL-2019 LIBRARY; T=293.16K  
angular distribution for (n,n\*24)

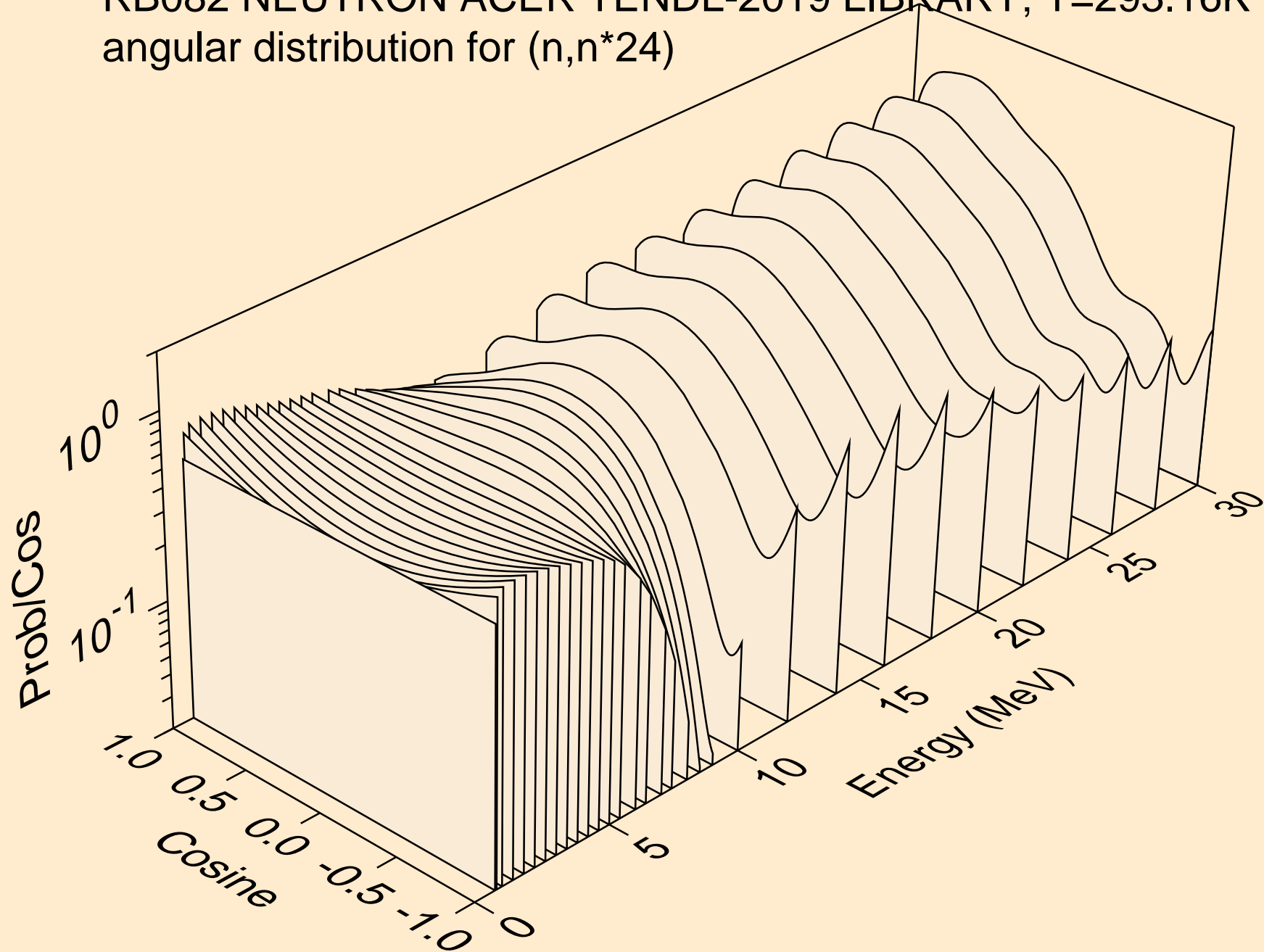

RB082 NEUTRON ACER TENDL-2019 LIBRARY; T=293.16K  
angular distribution for (n,n\*25)

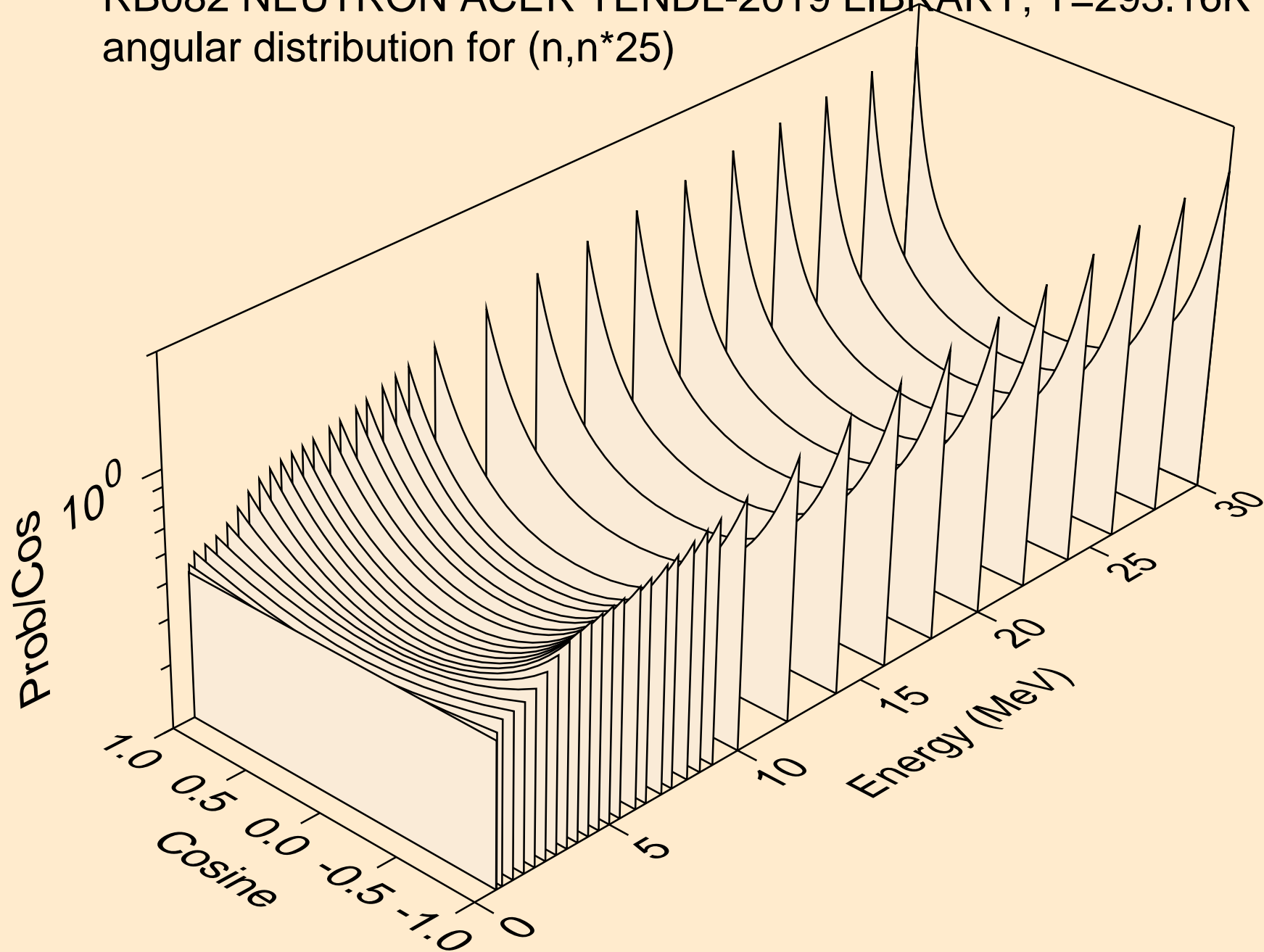

RB082 NEUTRON ACER TENDL-2019 LIBRARY; T=293.16K  
Neutron emission for (n,x)

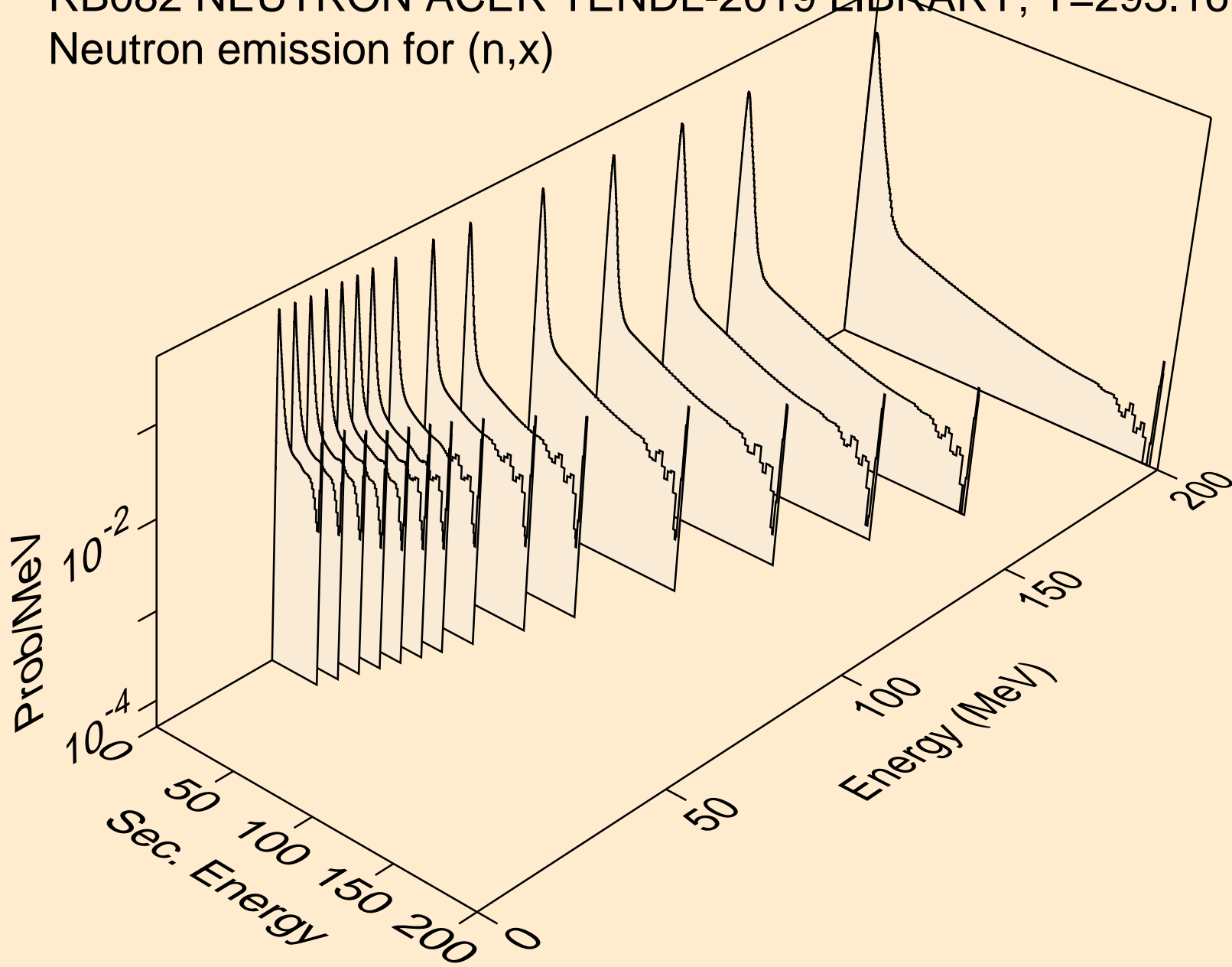



RB082 NEUTRON ACER TENDL-2019 LIBRARY; T=293.16K  
Neutron emission for (n,2nd)

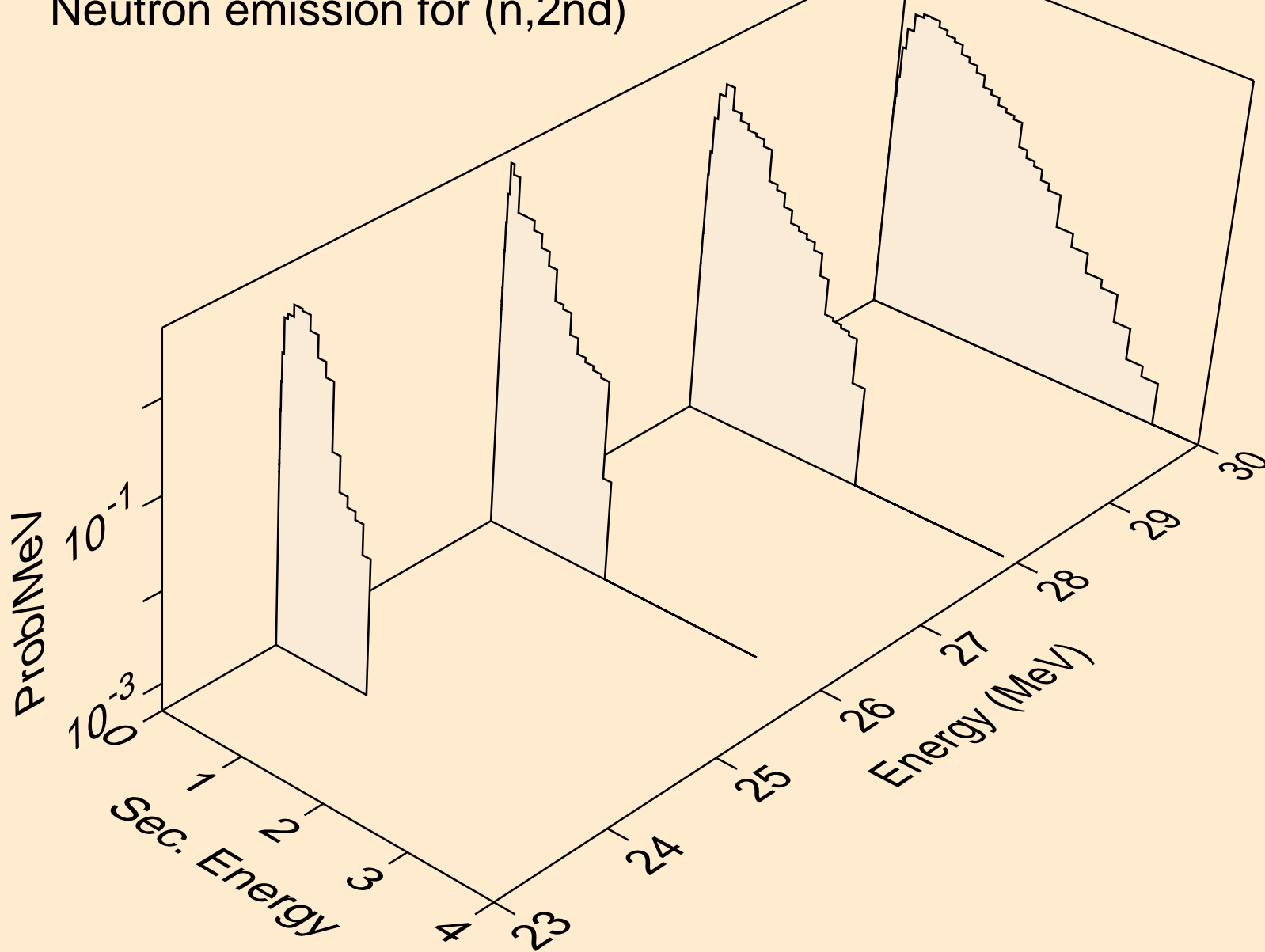

RB082 NEUTRON ACER TENDL-2019 LIBRARY; T=293.16K  
Neutron emission for (n,2n)

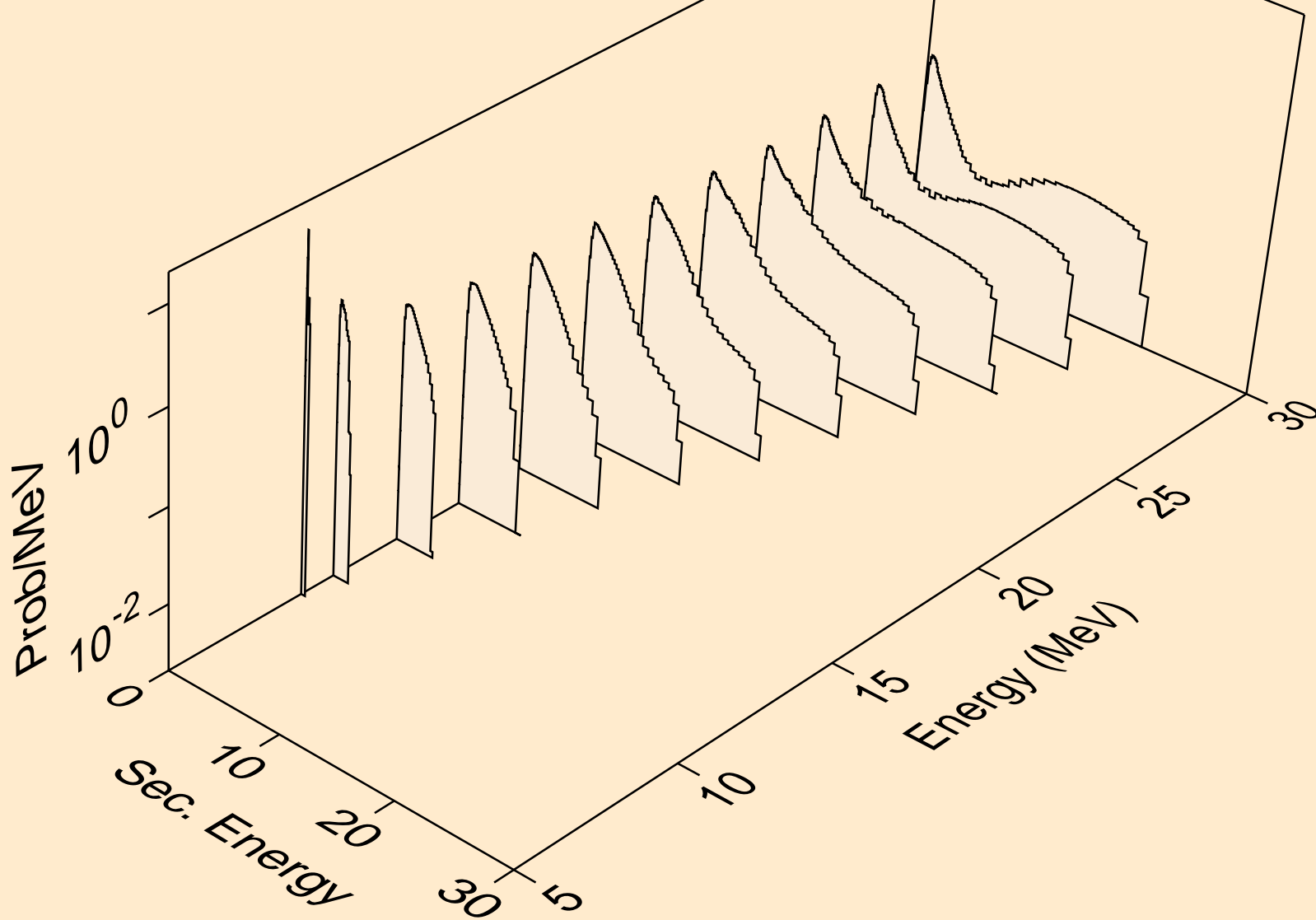

RB082 NEUTRON ACER TENDL-2019 LIBRARY; T=293.16K  
Neutron emission for (n,3n)

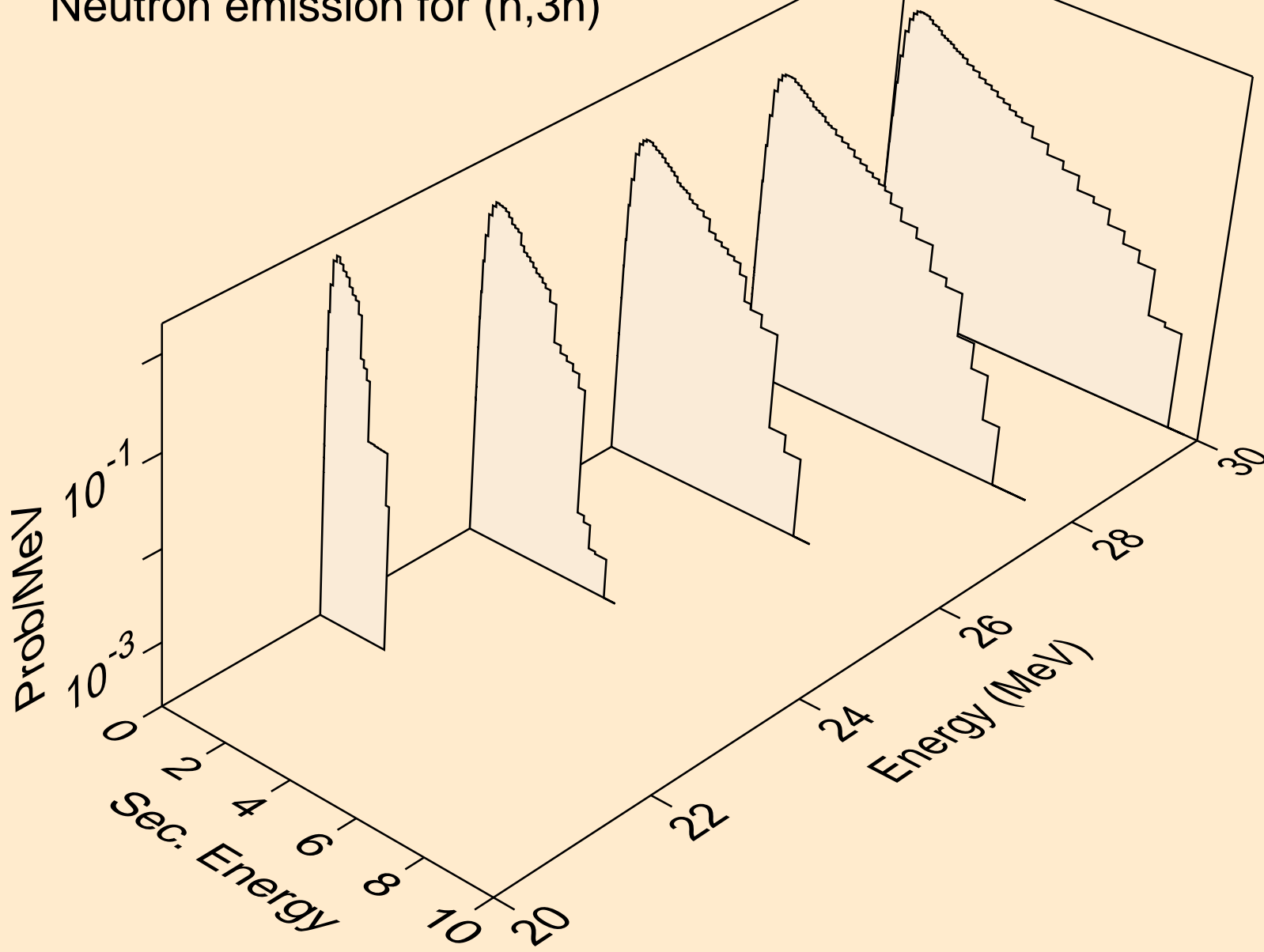

RB082 NEUTRON ACER TENDL-2019 LIBRARY; T=293.16K  
Neutron emission for (n,n\*)a

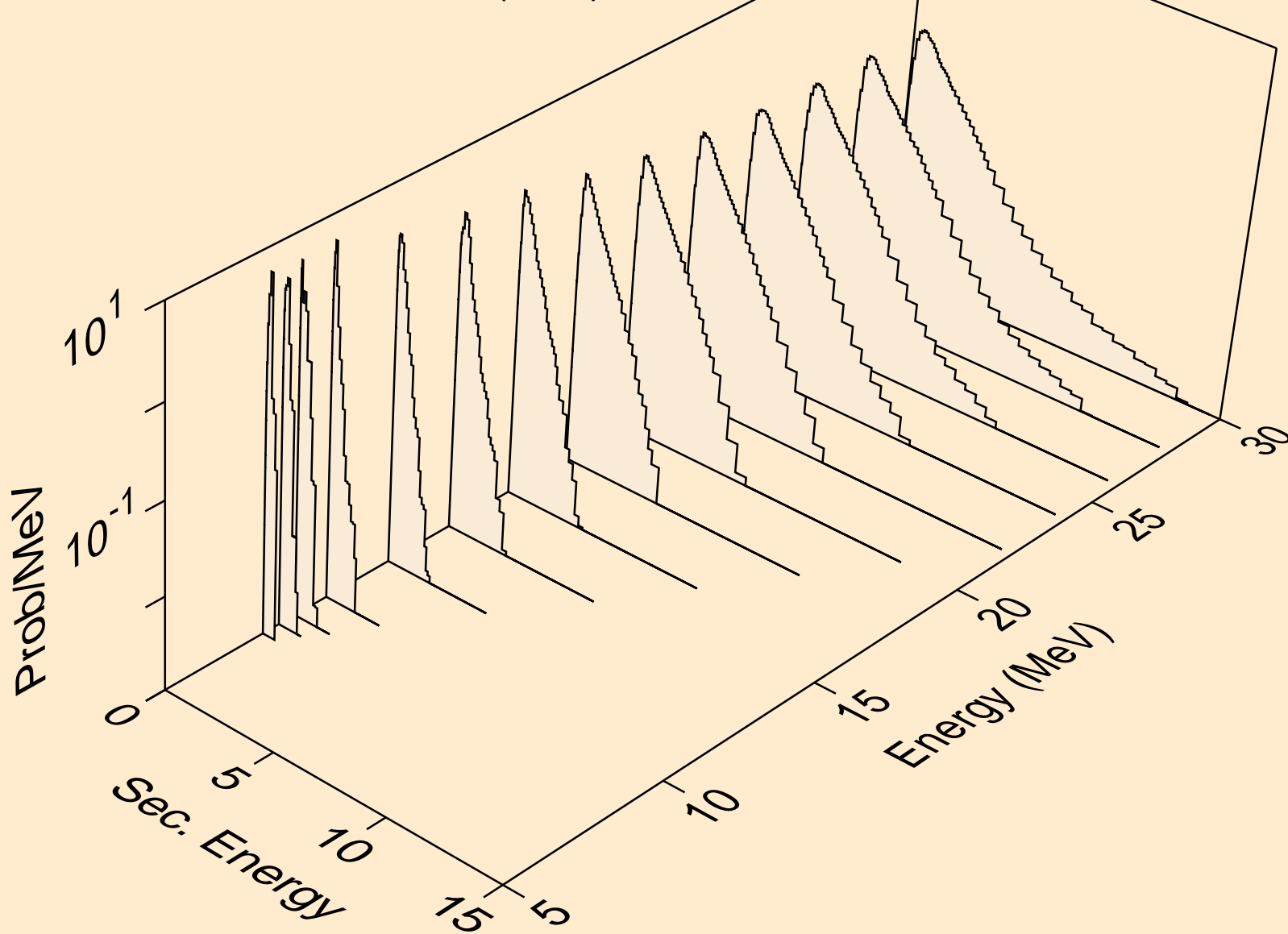

RB082 NEUTRON ACER TENDL-2019 LIBRARY; T=293.16K  
Neutron emission for (n,2n)<sub>a</sub>

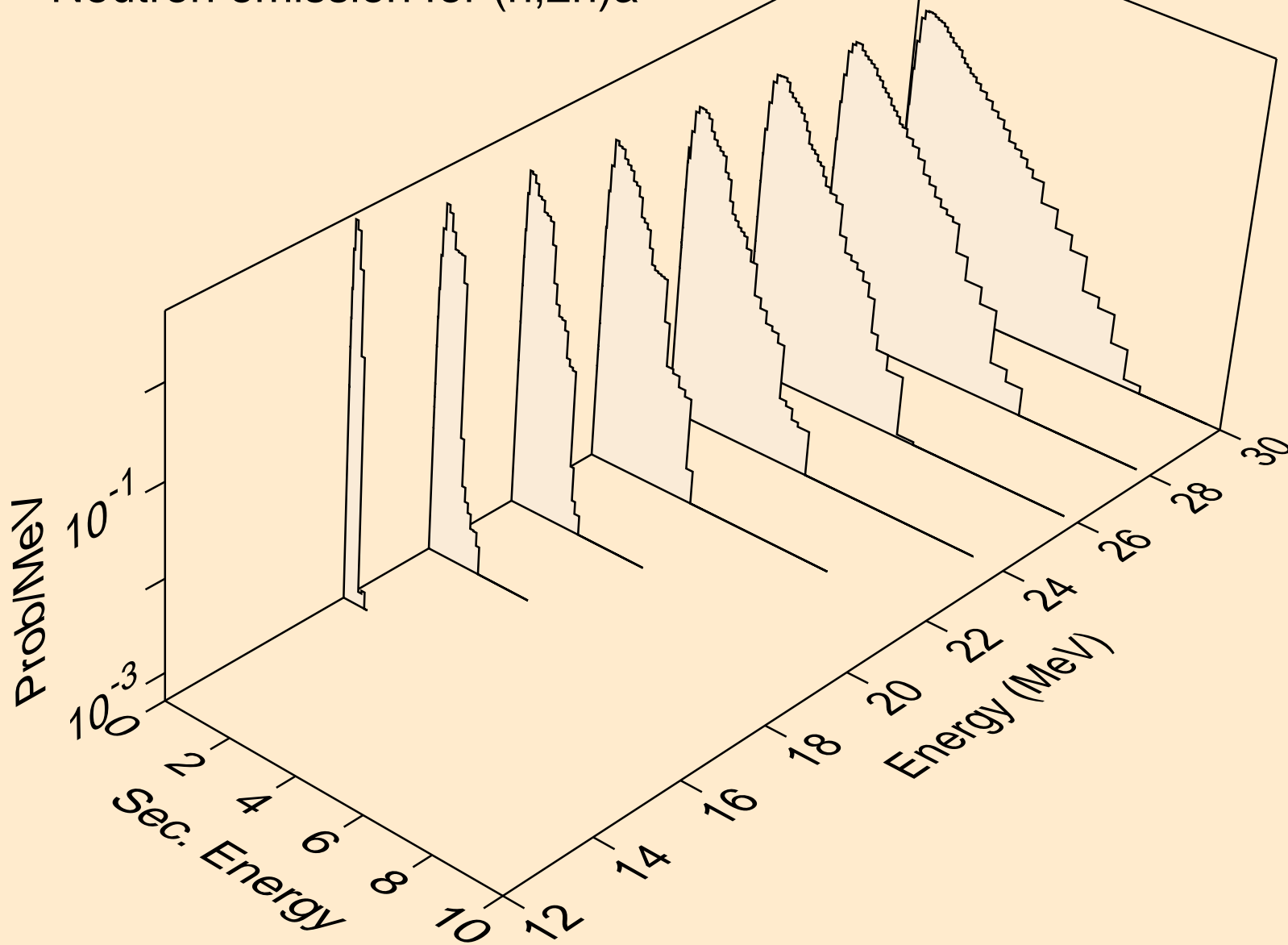

RB082 NEUTRON ACER TENDL-2019 LIBRARY; T=293.16K  
Neutron emission for (n,3n)a

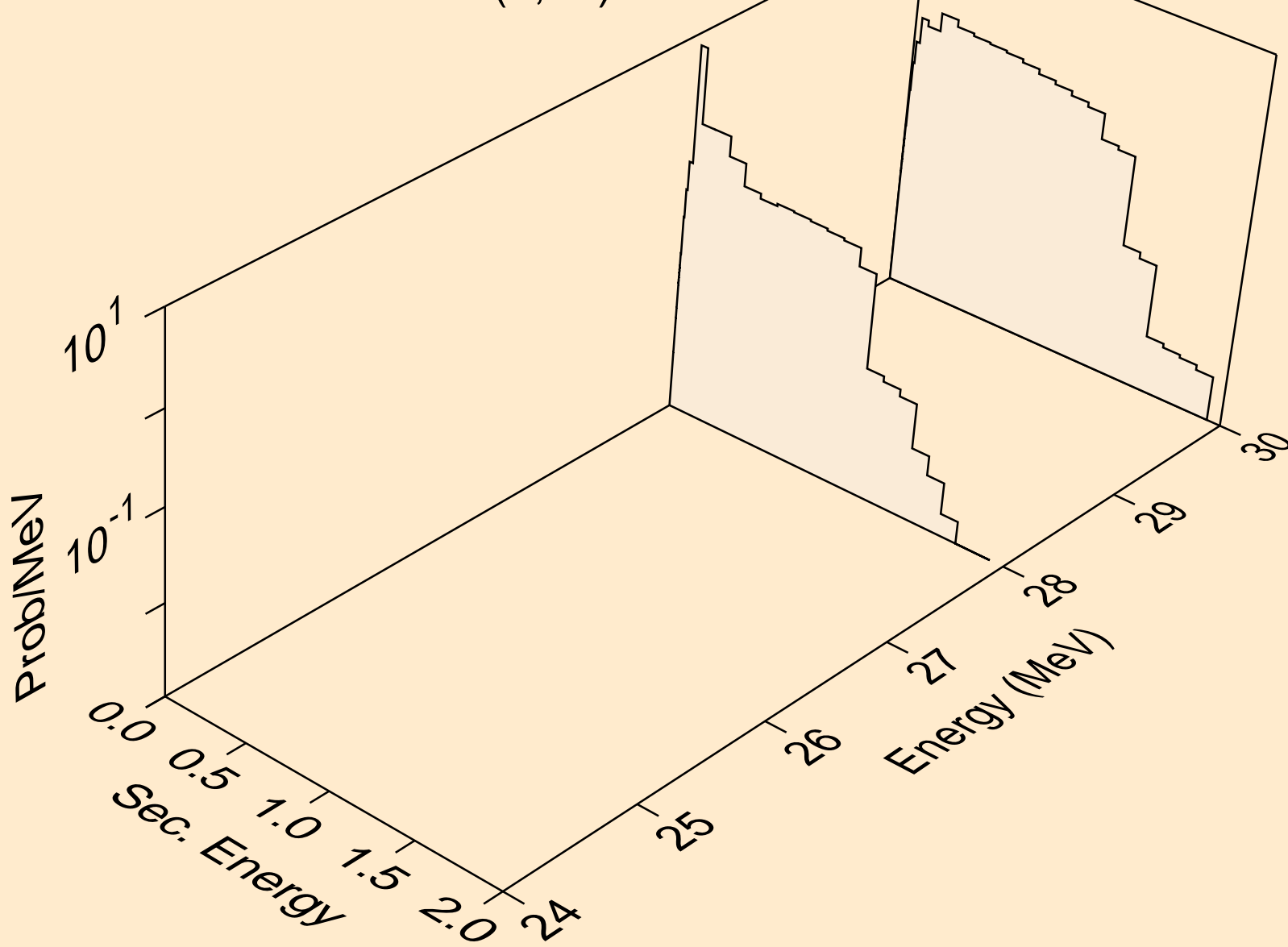

RB082 NEUTRON ACER TENDL-2019 LIBRARY; T=293.16K  
Neutron emission for (n,n\*)p

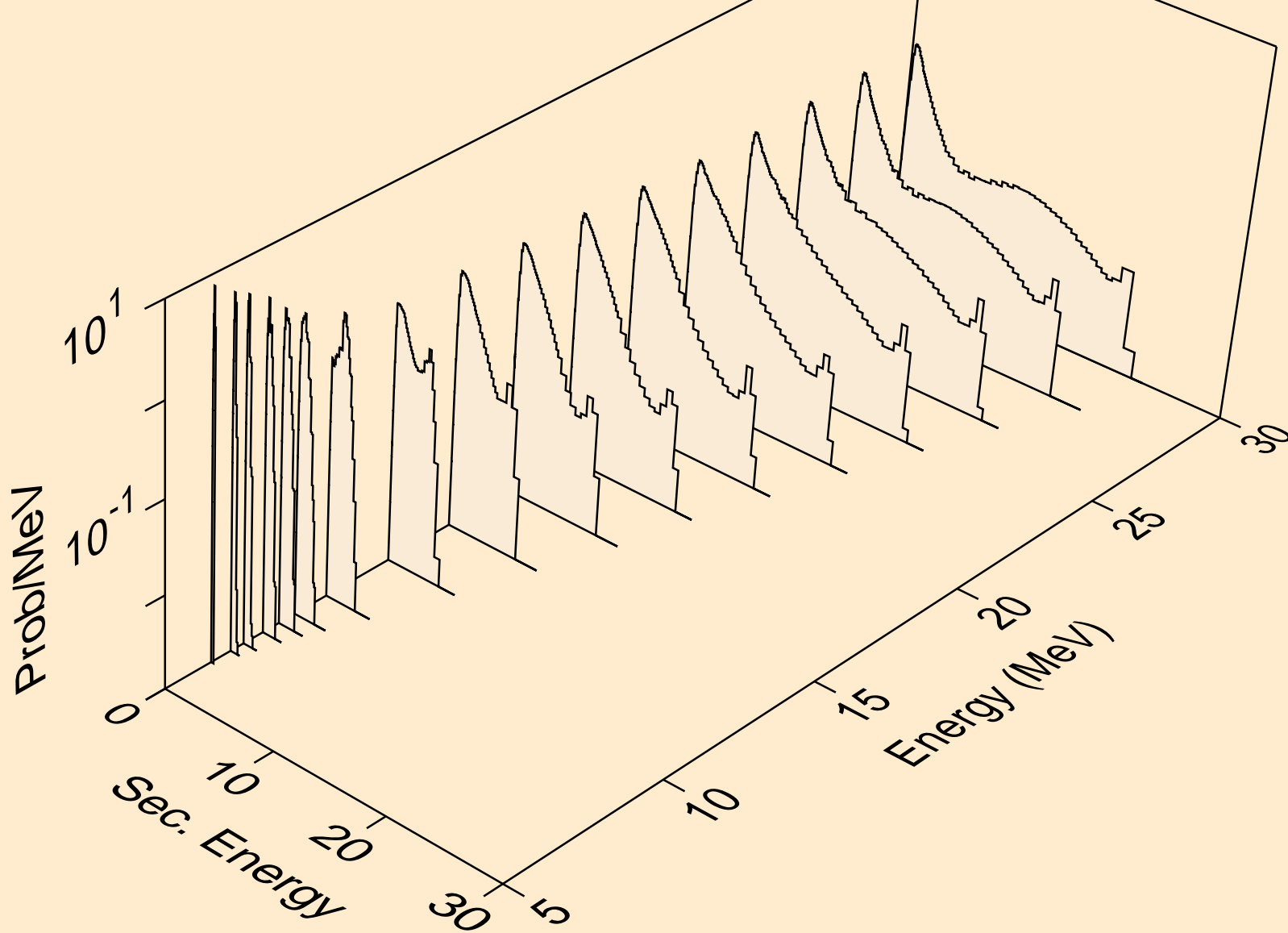

RB082 NEUTRON ACER TENDL-2019 LIBRARY; T=293.16K  
Neutron emission for (n,n\*)2a

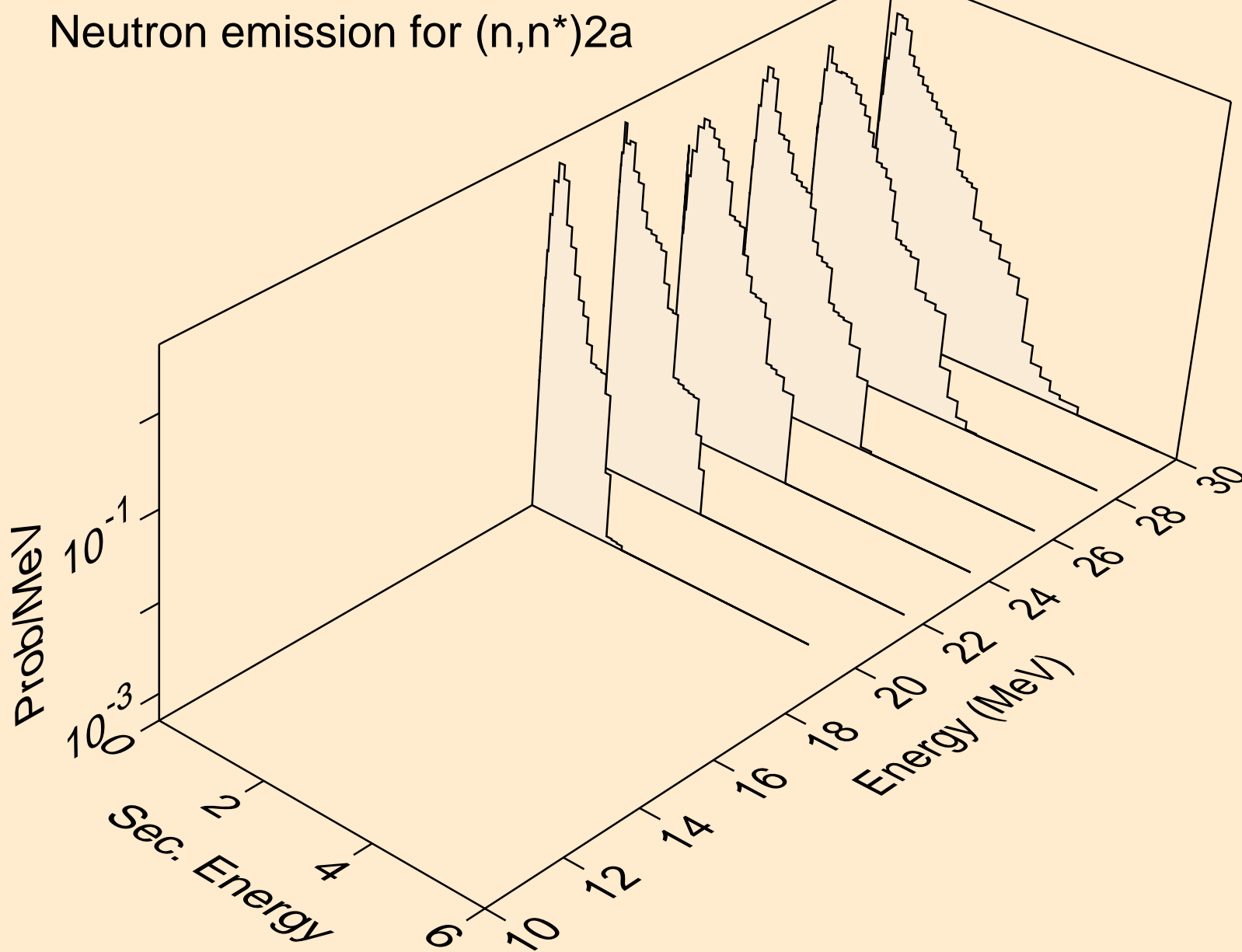



RB082 NEUTRON ACER TENDL-2019 LIBRARY; T=293.16K  
Neutron emission for (n,n\*)d

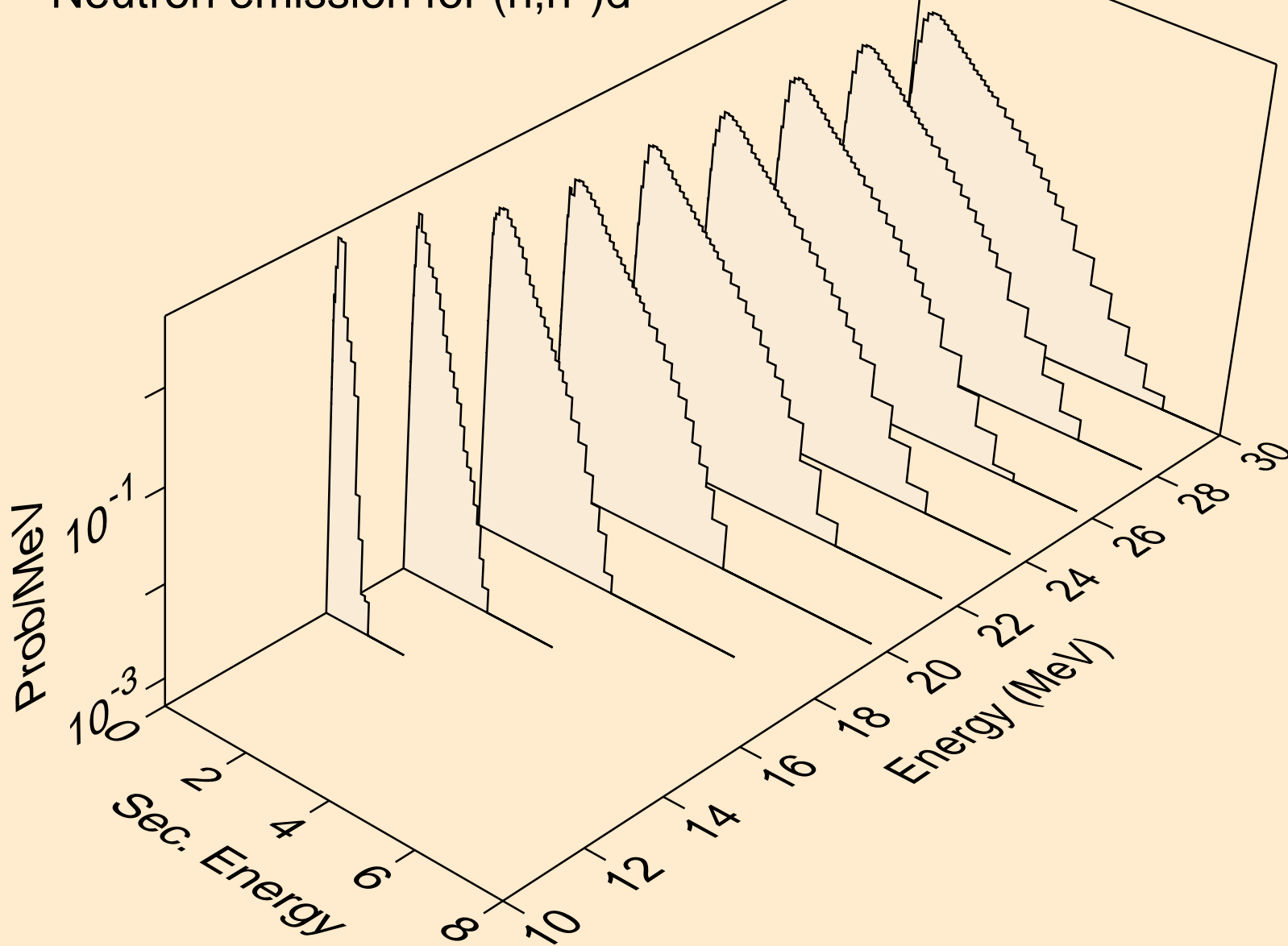

RB082 NEUTRON ACER TENDL-2019 LIBRARY; T=293.16K  
Neutron emission for (n,n\*)t

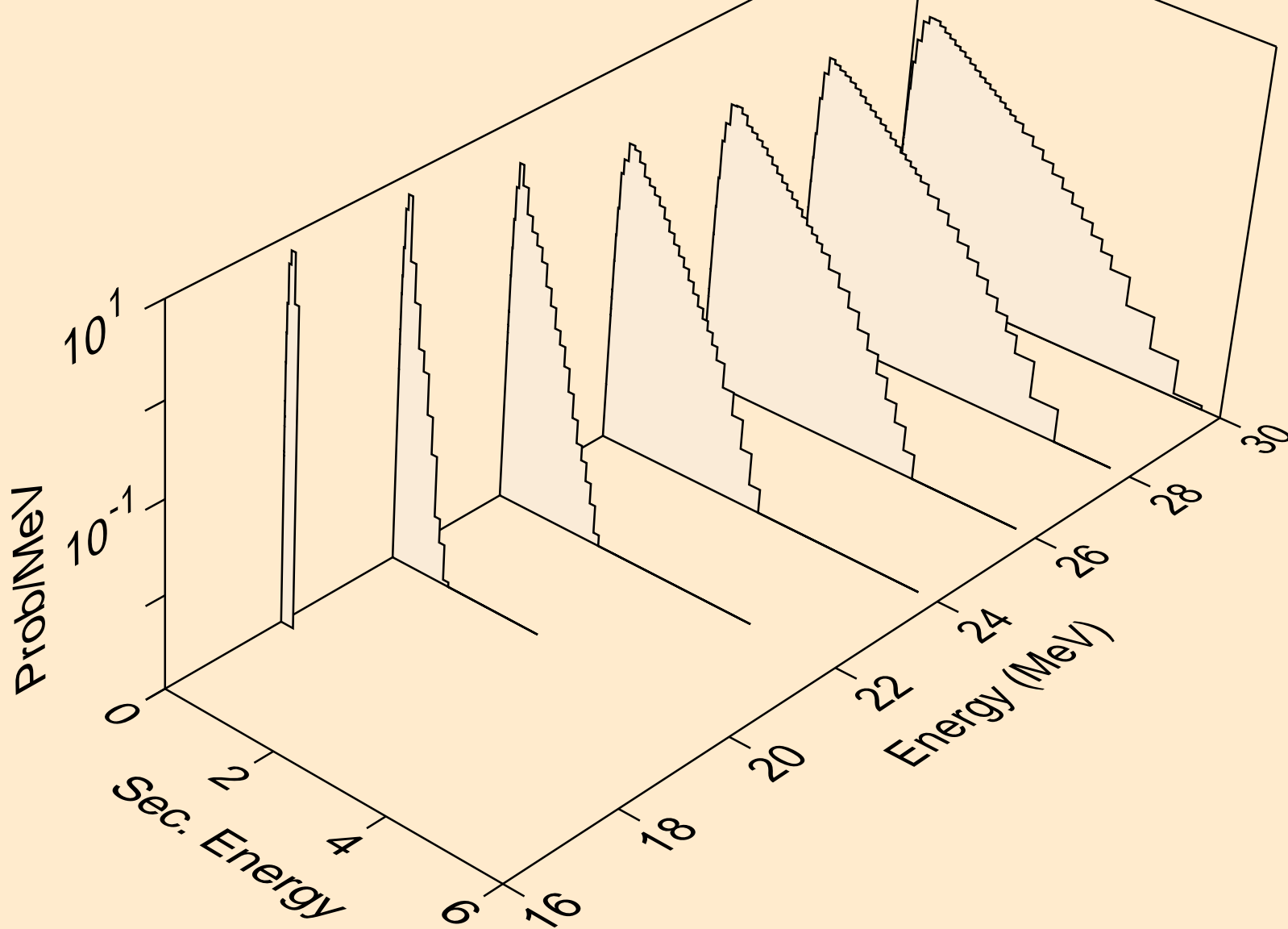

RB082 NEUTRON ACER TENDL-2019 LIBRARY; T=293.16K  
Neutron emission for (n,n\*)he3

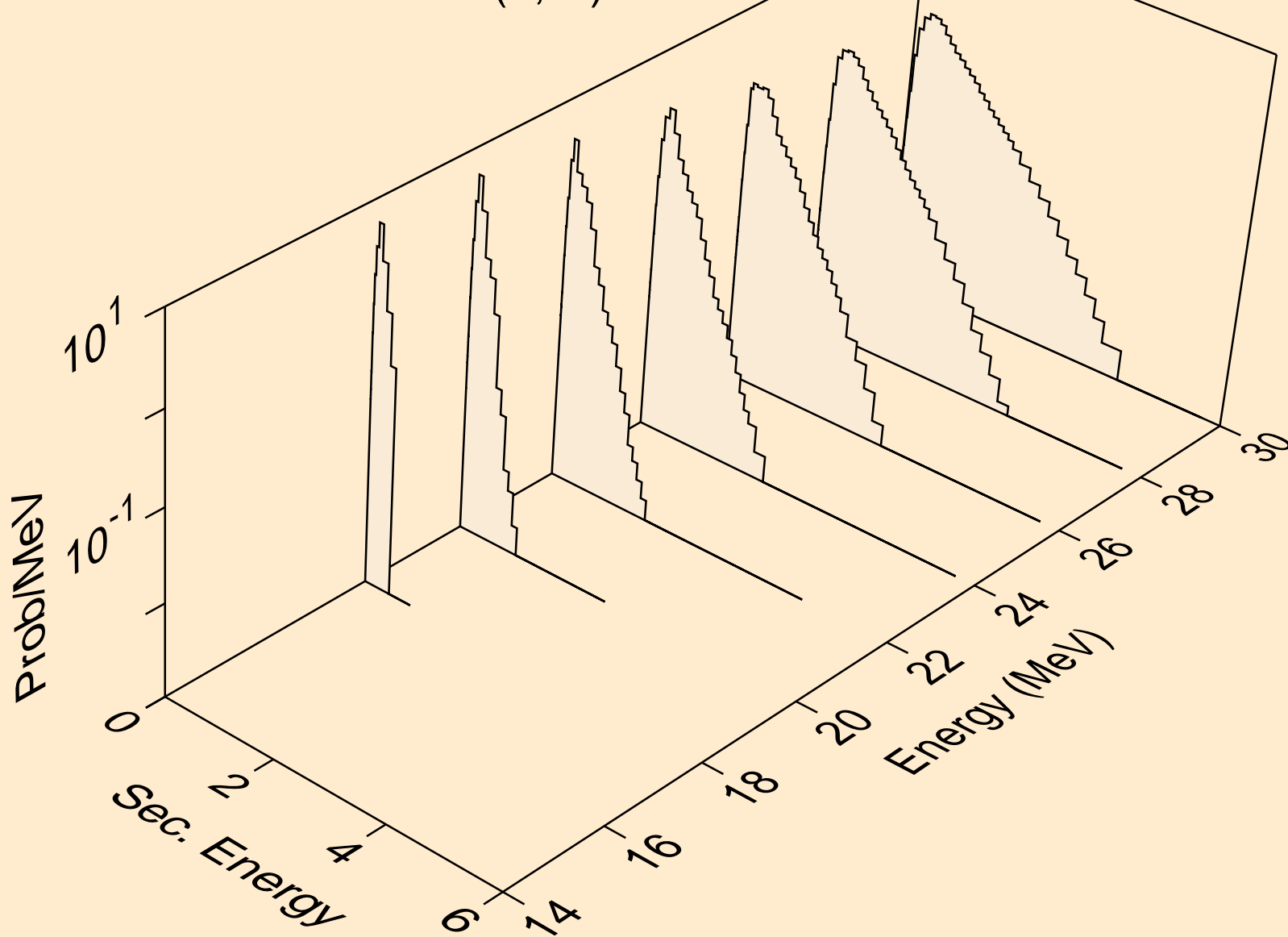

RB082 NEUTRON ACER TENDL-2019 LIBRARY; T=293.16K  
Neutron emission for (n,4n)

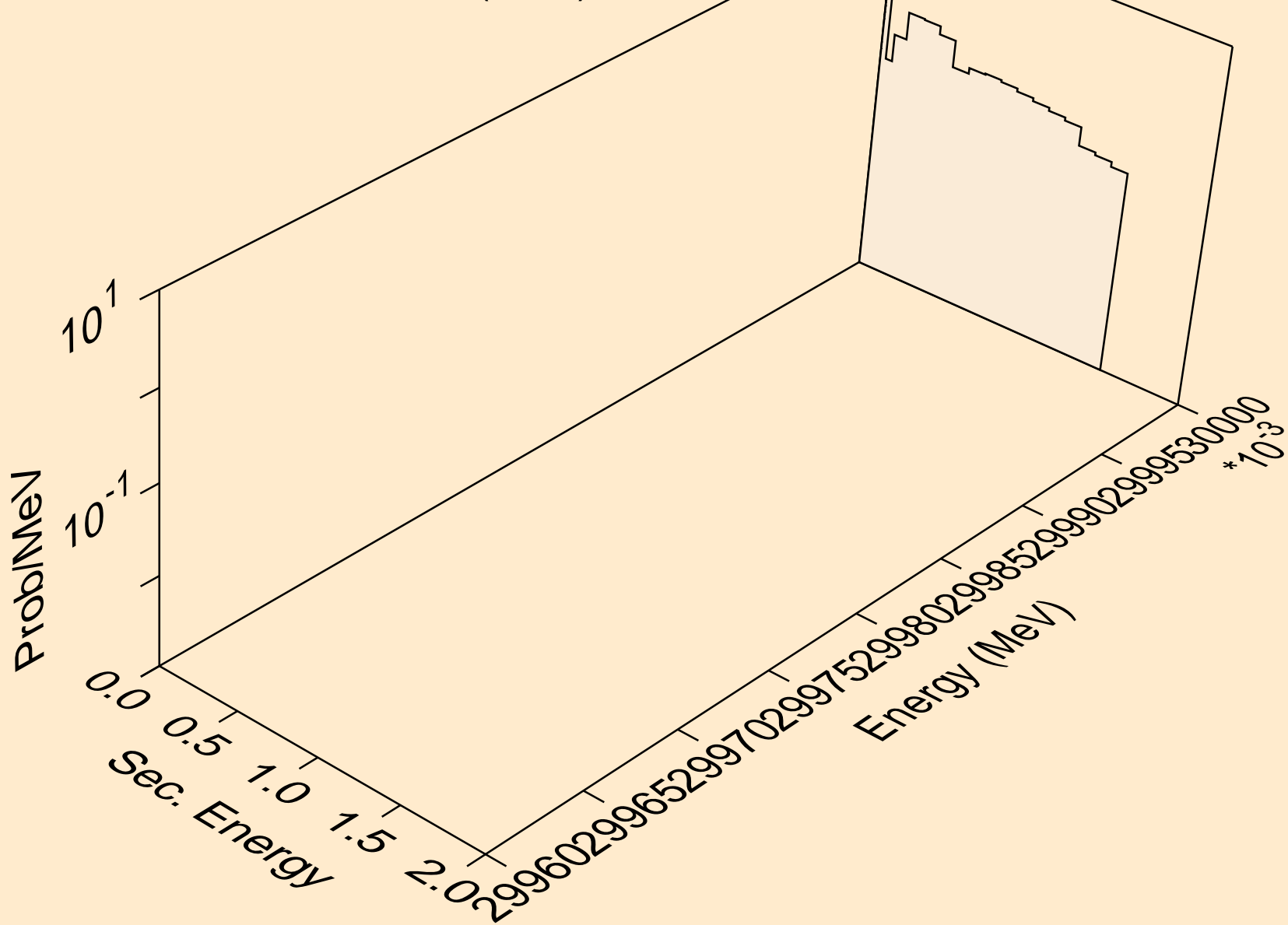

RB082 NEUTRON ACER TENDL-2019 LIBRARY; T=293.16K  
Neutron emission for (n,2np)

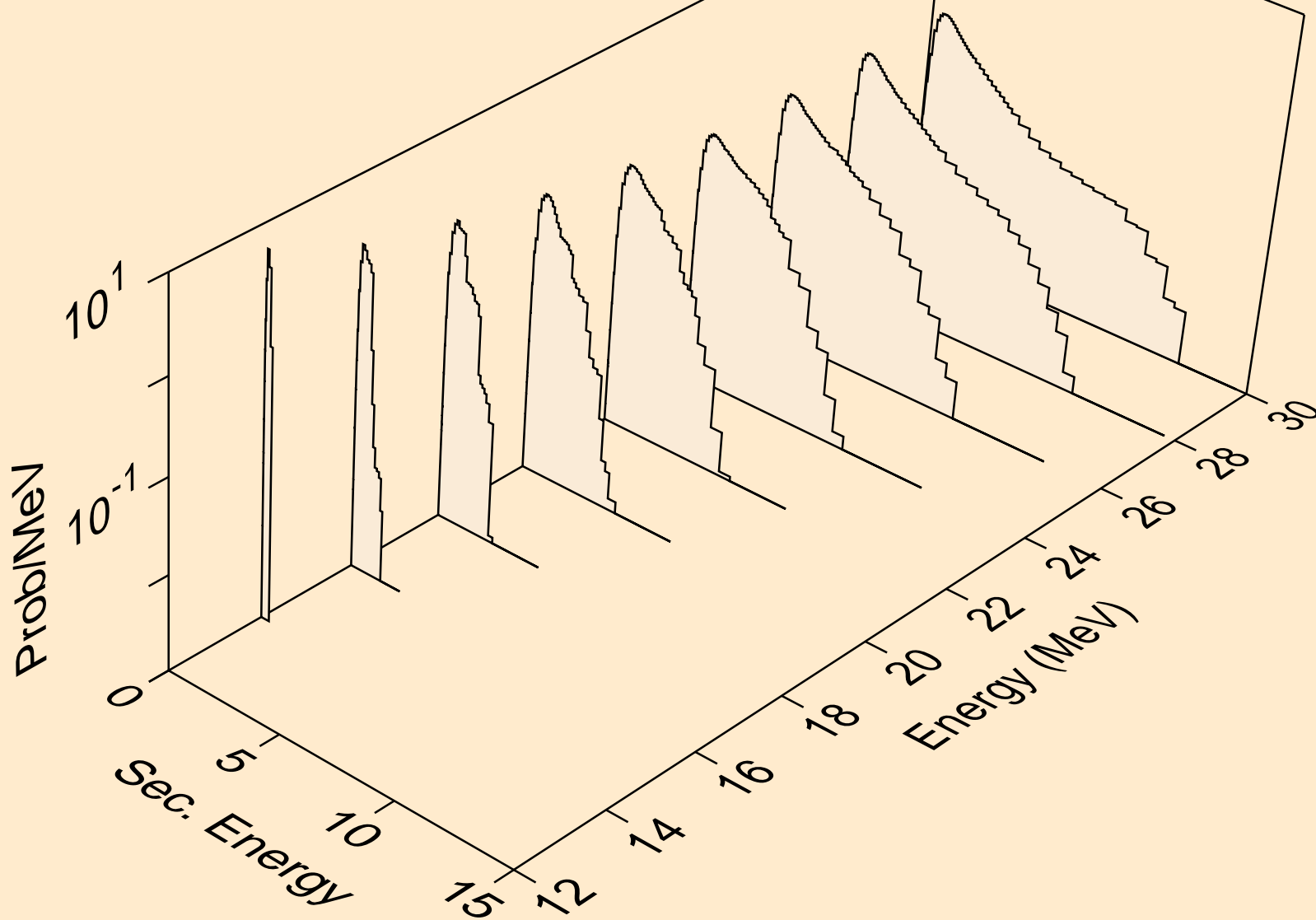

RB082 NEUTRON ACER TENDL-2019 LIBRARY; T=293.16K  
Neutron emission for (n,3np)

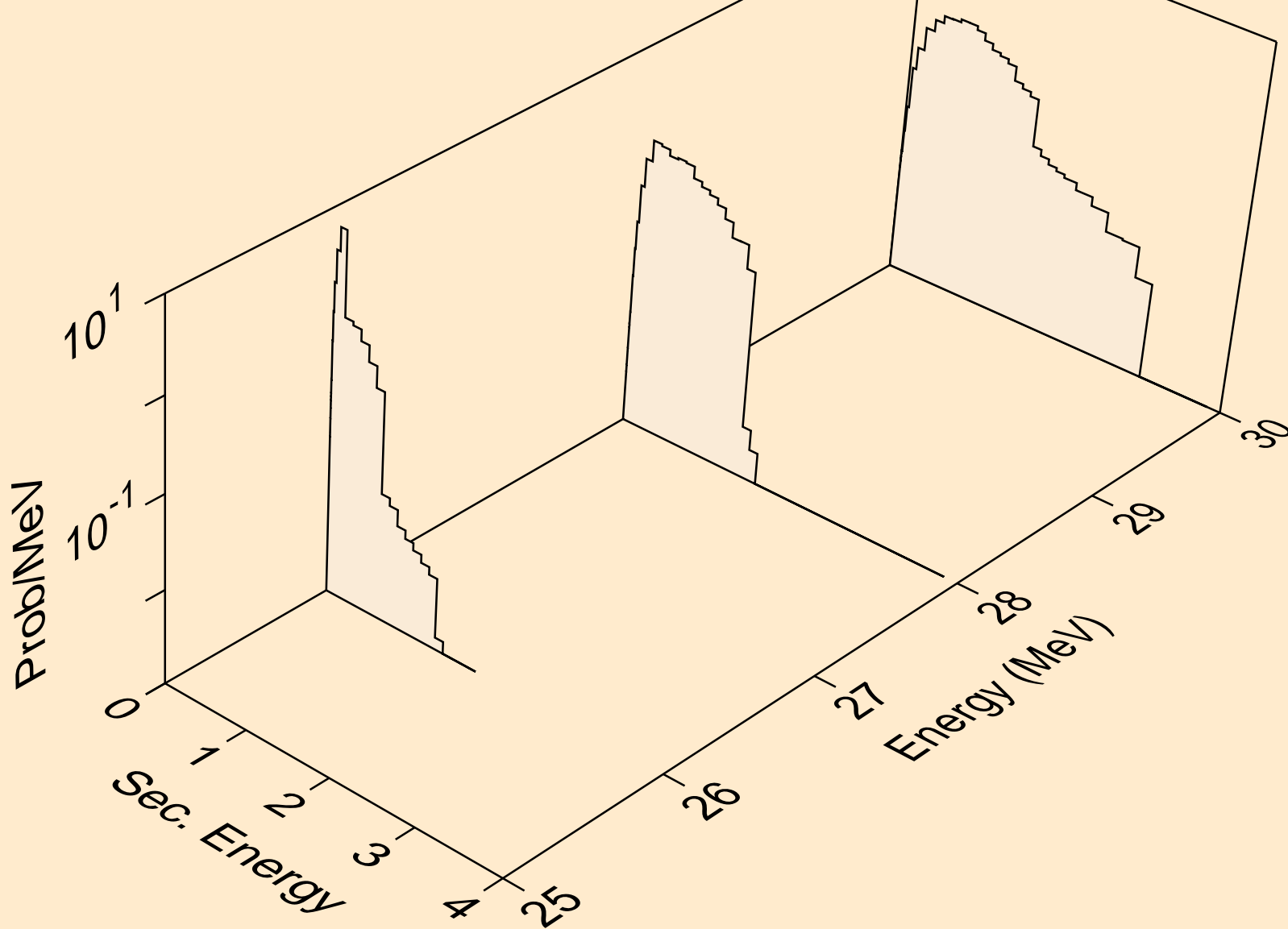

RB082 NEUTRON ACER TENDL-2019 LIBRARY; T=293.16K  
Neutron emission for (n,2np)

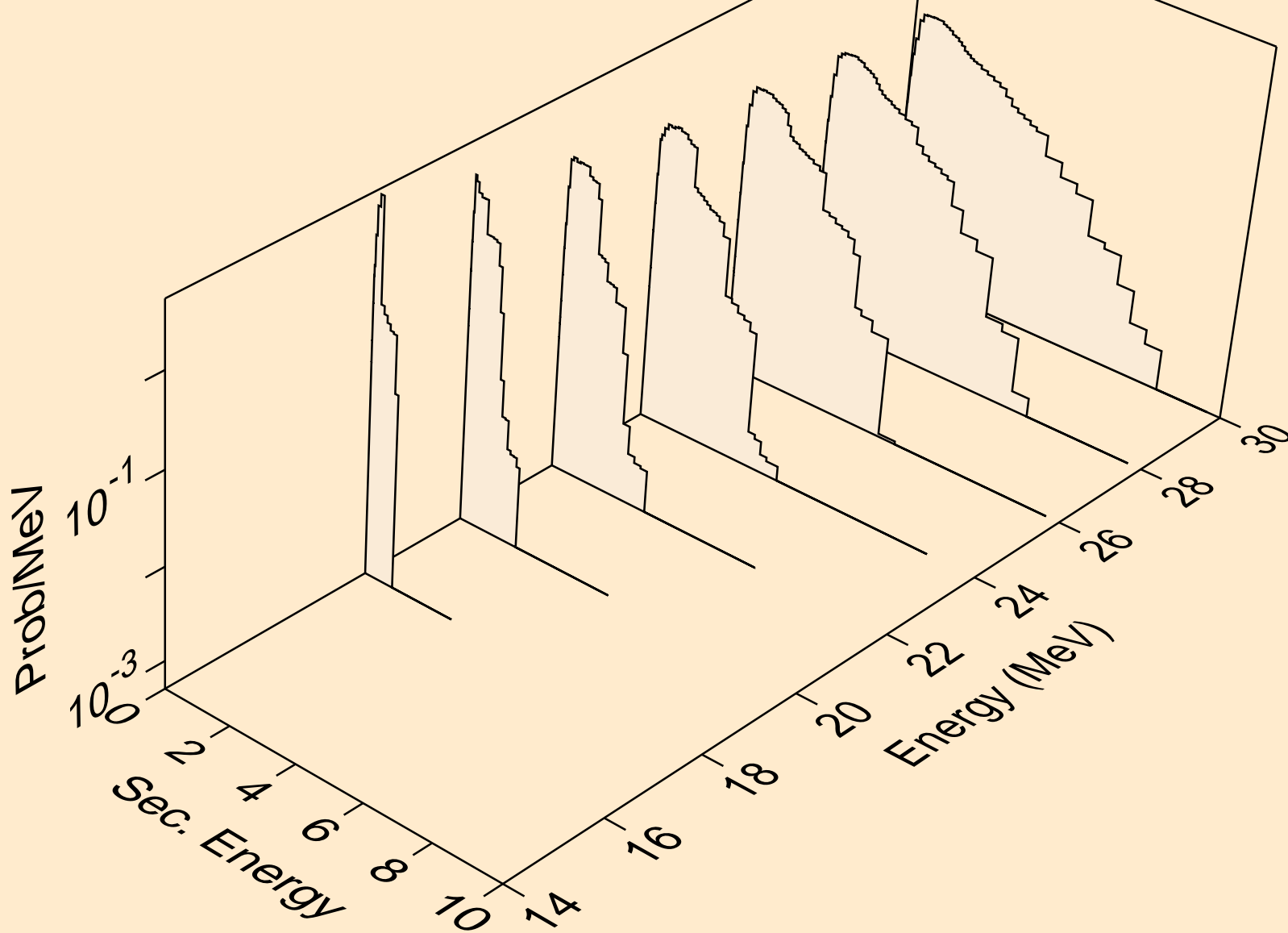

RB082 NEUTRON ACER TENDL-2019 LIBRARY; T=293.16K  
Neutron emission for (n,npa)

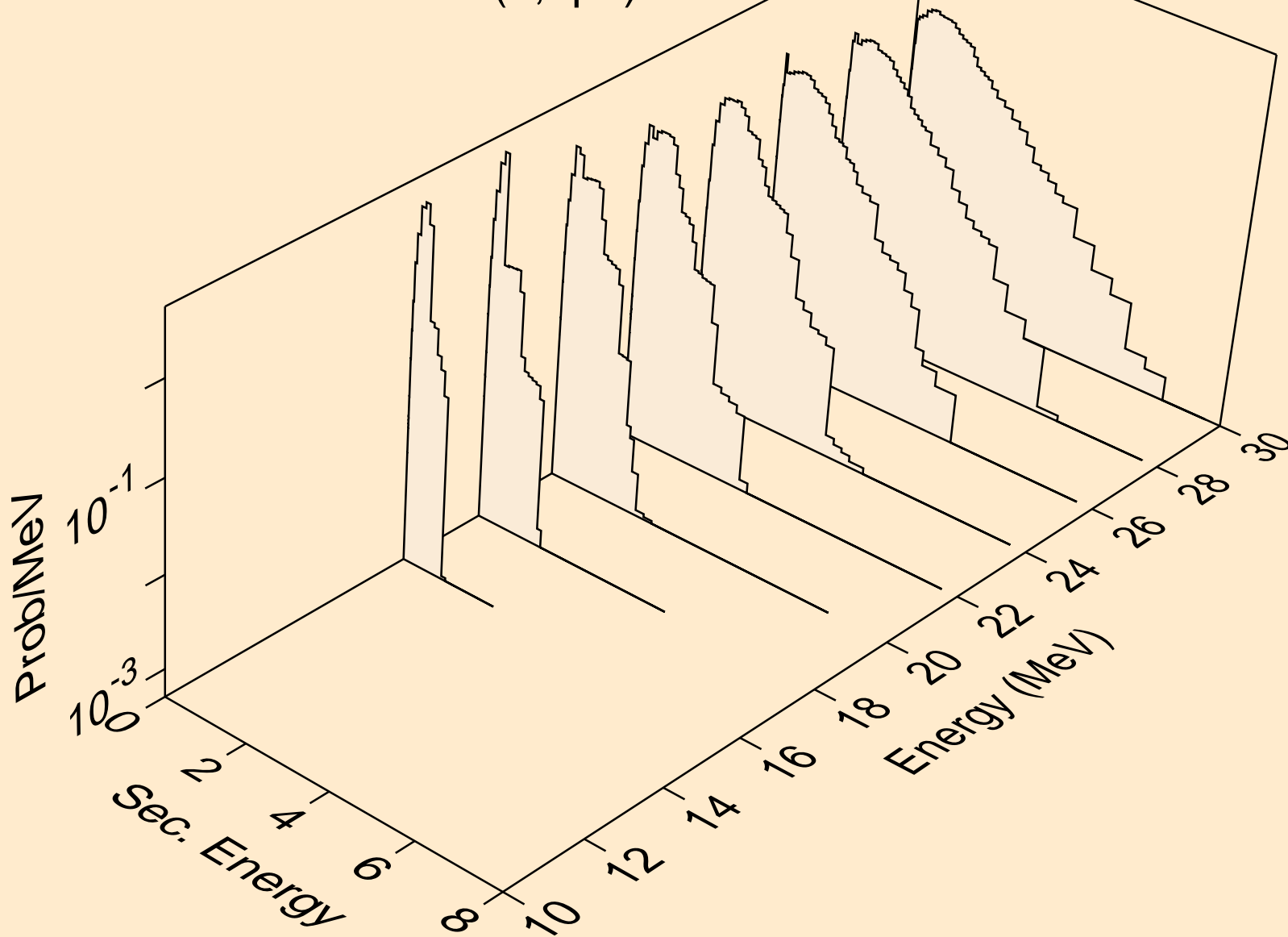



RB082 NEUTRON ACER TENDL-2019 LIBRARY; T=293.16K  
Neutron emission for (n,n\*c)

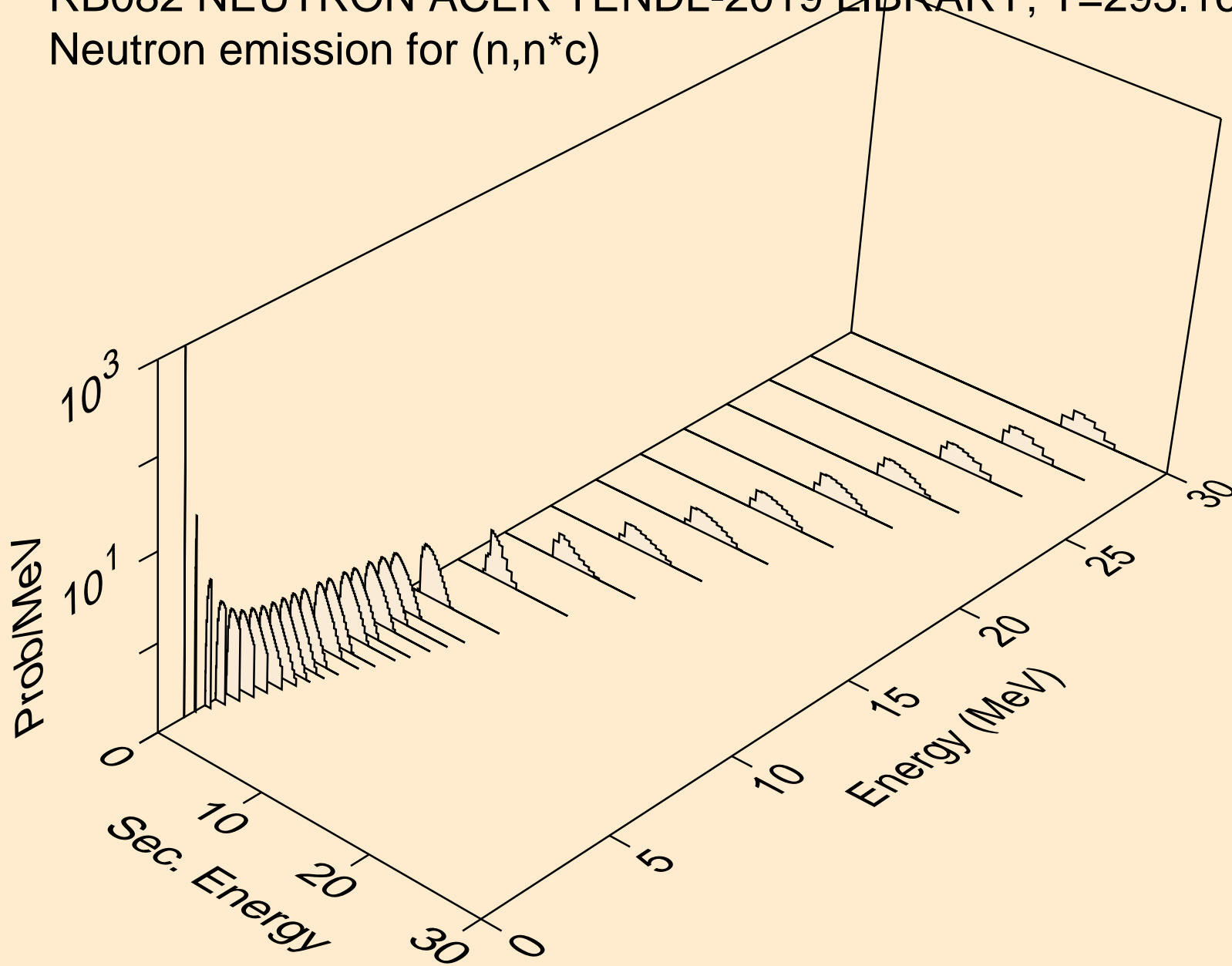

RB082 NEUTRON ACER TENDL-2019 LIBRARY; T=293.16K  
Photon emission for (n,x)

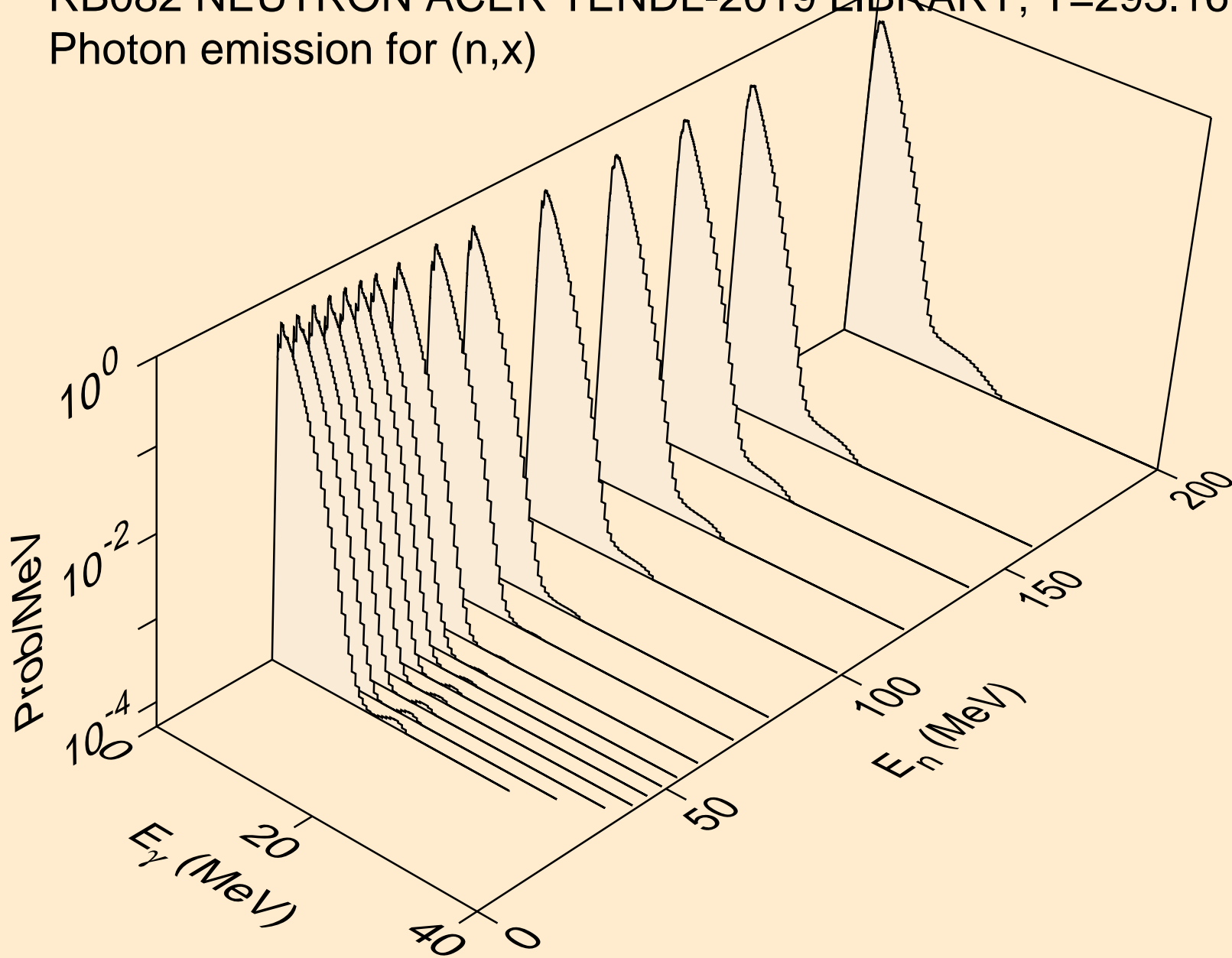

RB082 NEUTRON ACER TENDL-2019 LIBRARY; T=293.16K  
Photon emission for (n,2nd)

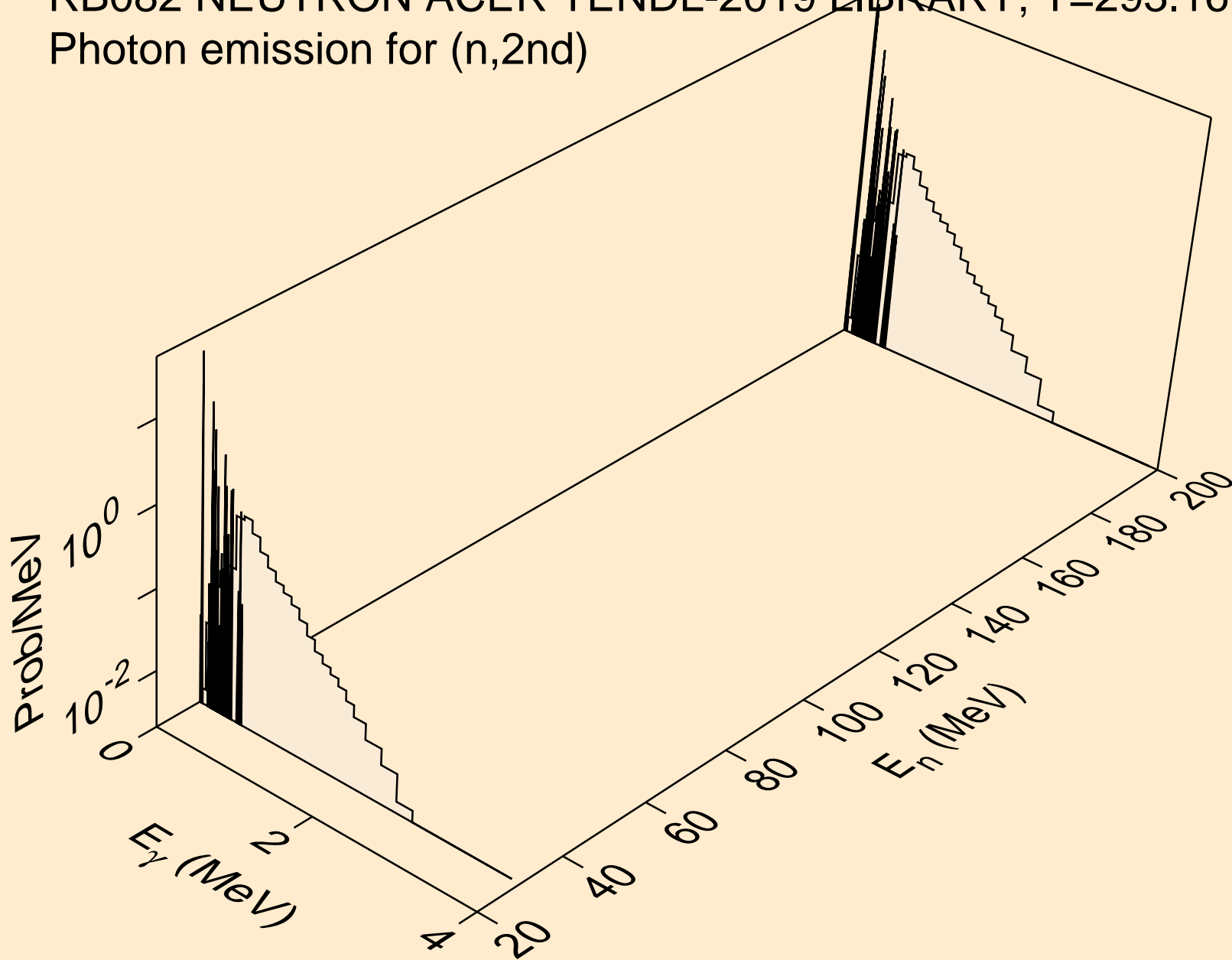

RB082 NEUTRON ACER TENDL-2019 LIBRARY; T=293.16K  
Photon emission for (n,2n)

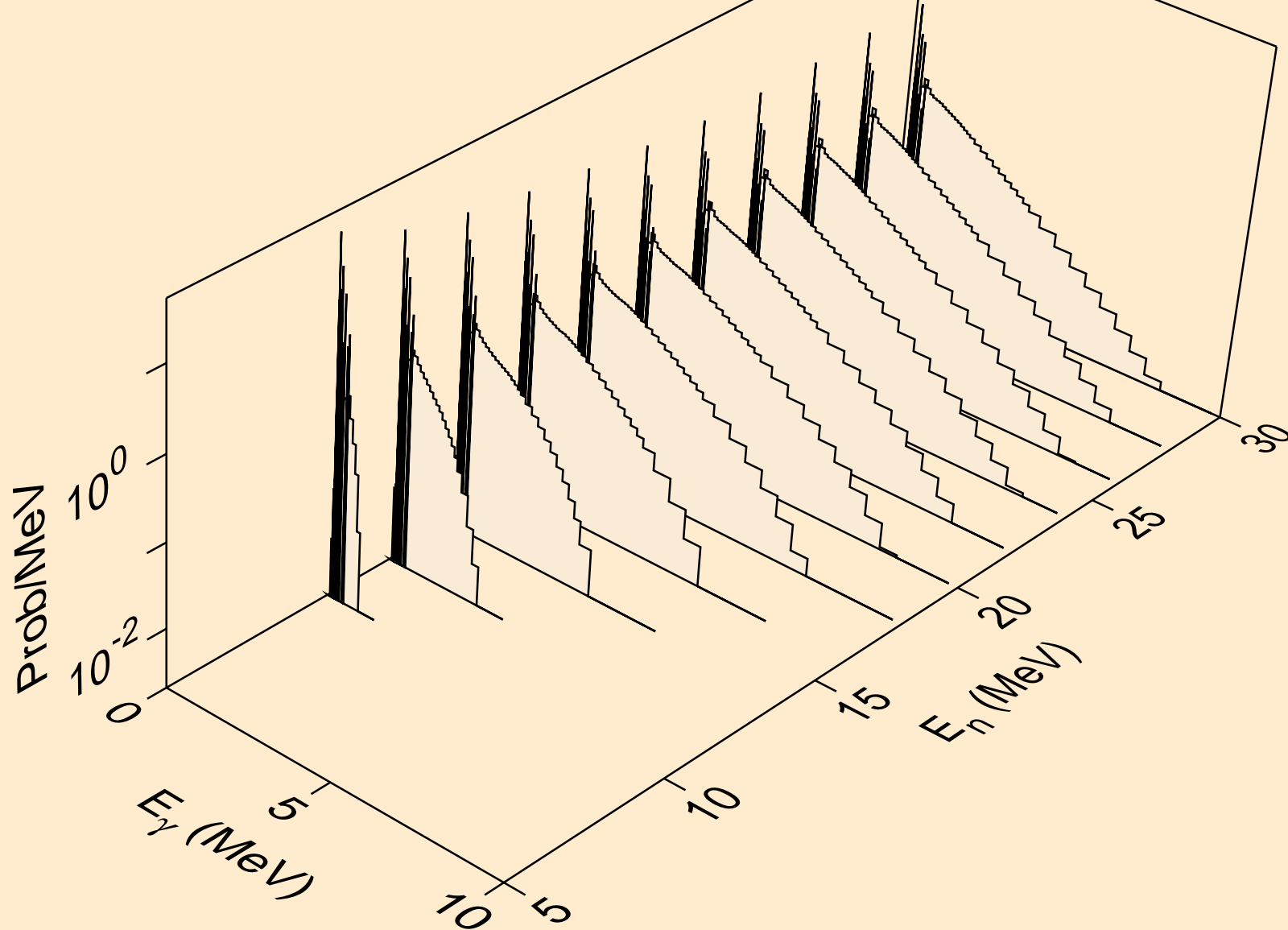

RB082 NEUTRON ACER TENDL-2019 LIBRARY; T=293.16K  
Photon emission for (n,3n)

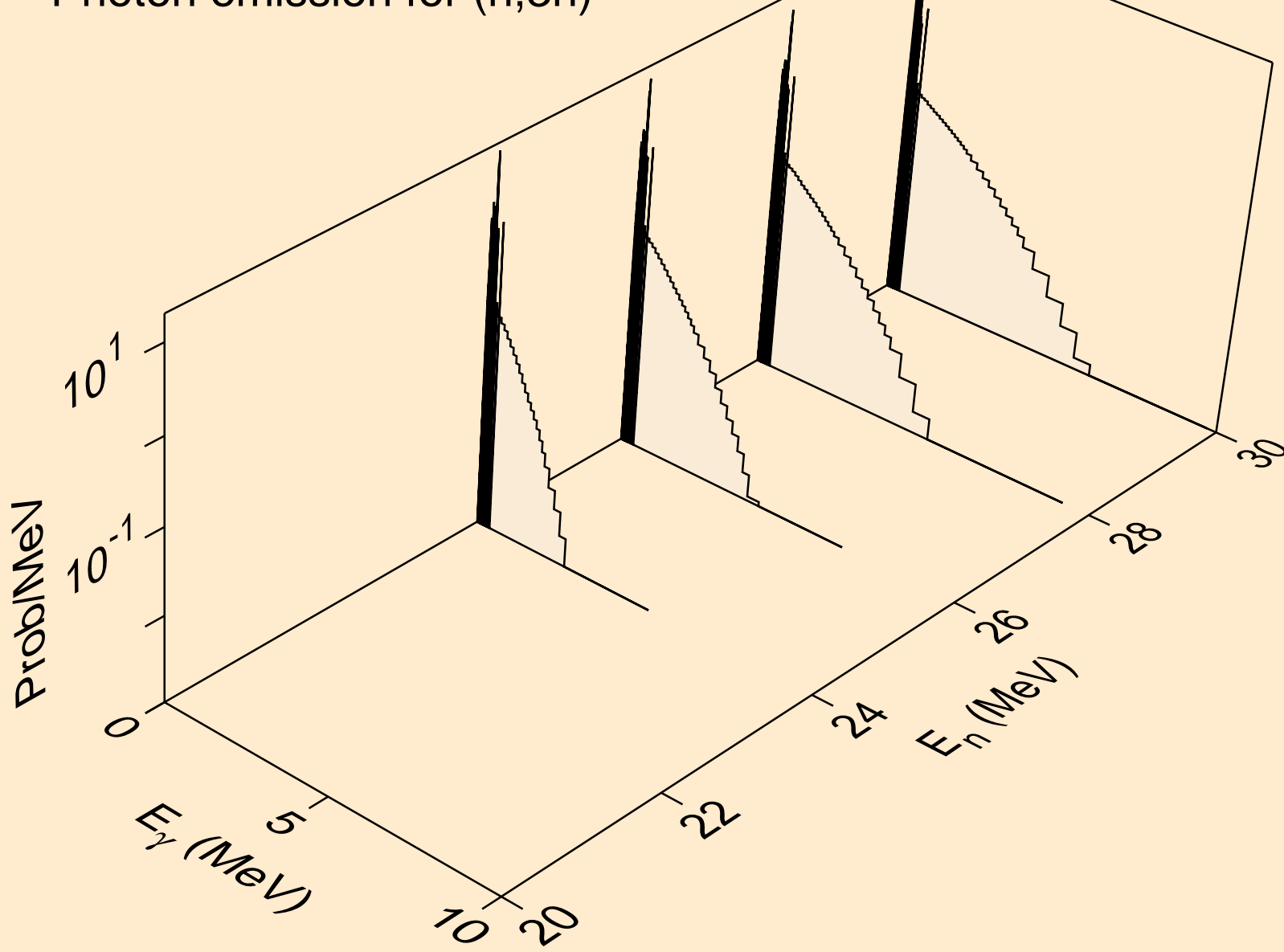

RB082 NEUTRON ACER TENDL-2019 LIBRARY; T=293.16K  
Photon emission for (n,n\*)a

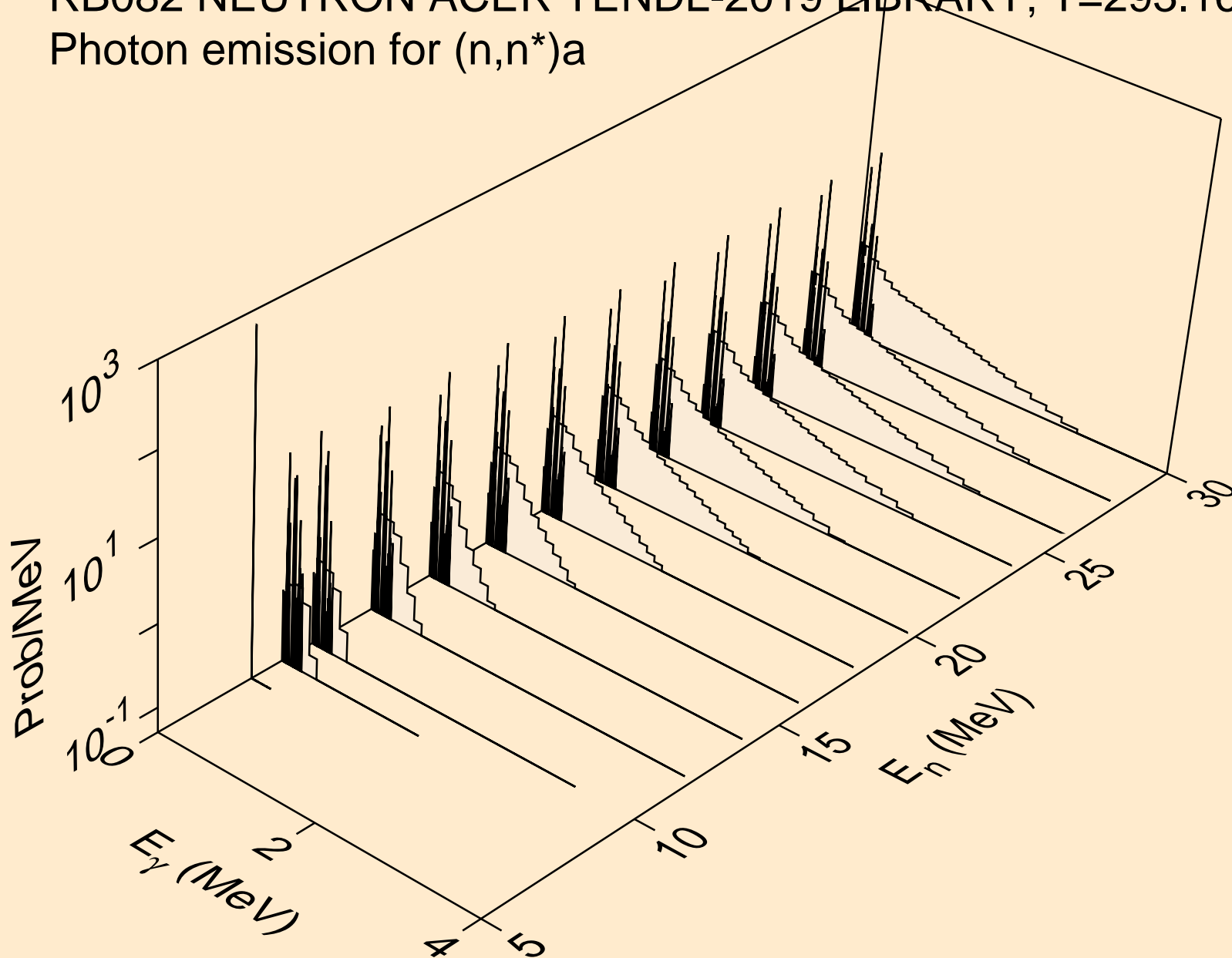

RB082 NEUTRON ACER TENDL-2019 LIBRARY; T=293.16K  
Photon emission for (n,2n)a

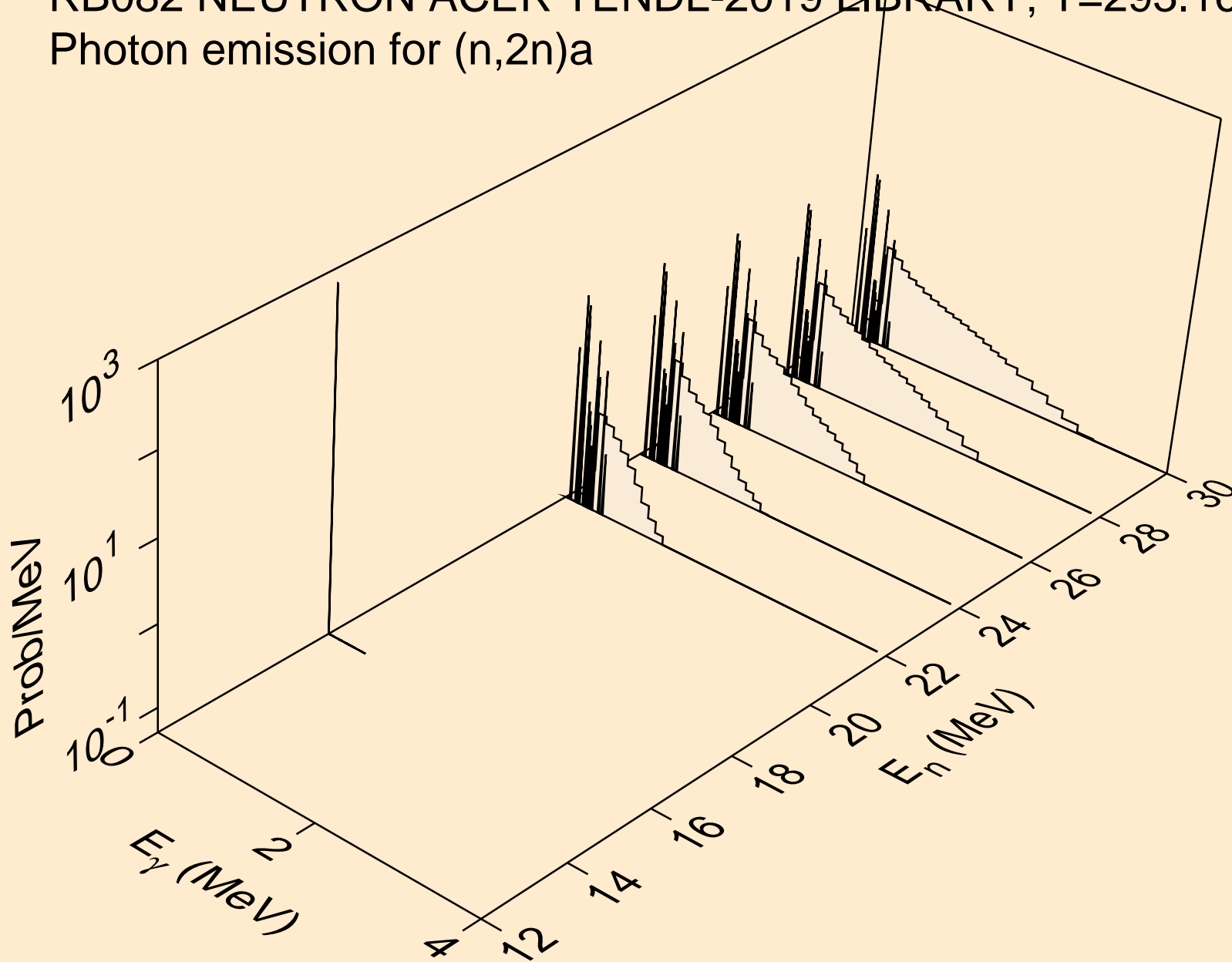

RB082 NEUTRON ACER TENDL-2019 LIBRARY; T=293.16K  
Photon emission for (n,3n)a

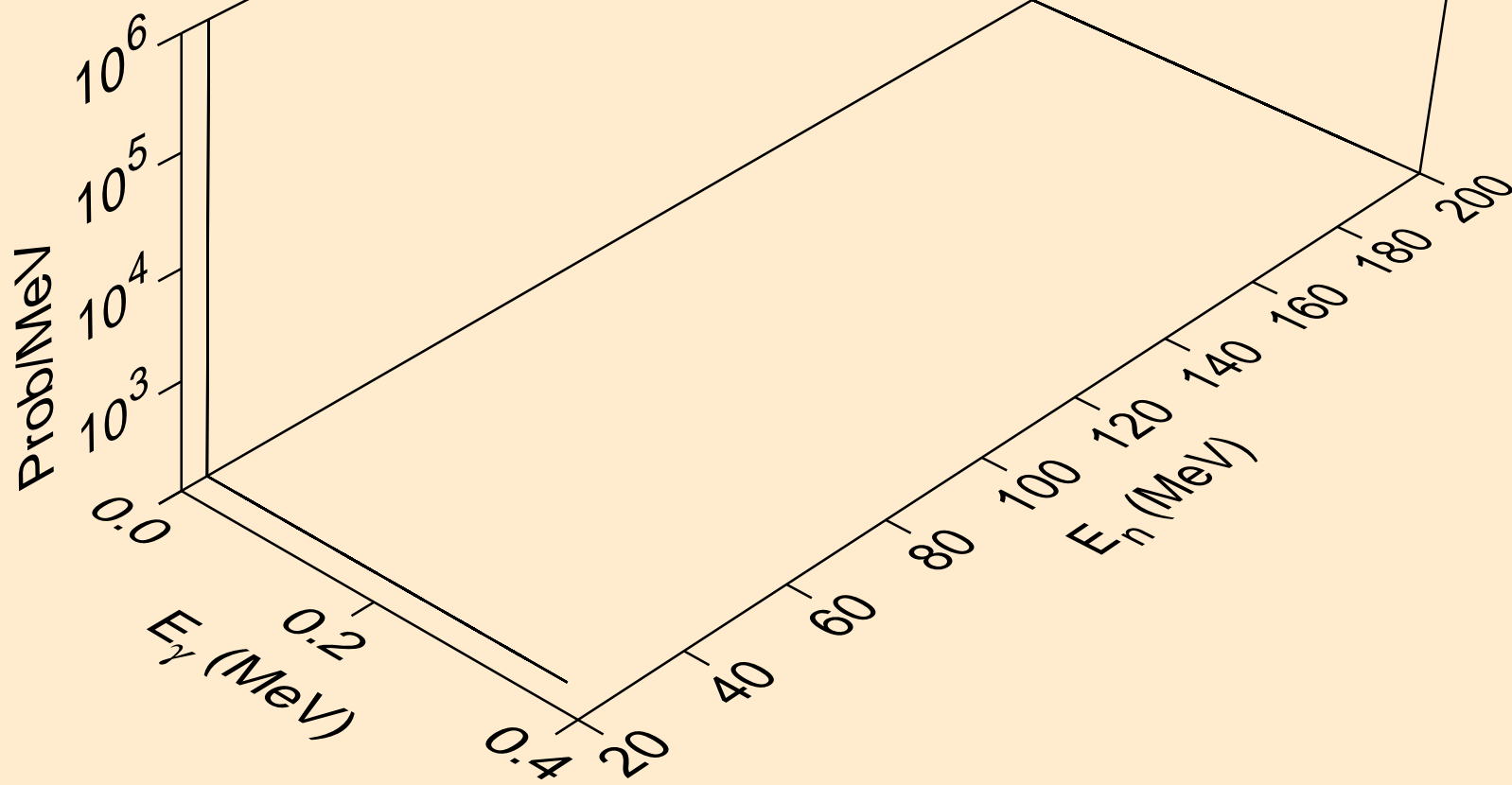



RB082 NEUTRON ACER TENDL-2019 LIBRARY; T=293.16K  
Photon emission for (n,n\*)p

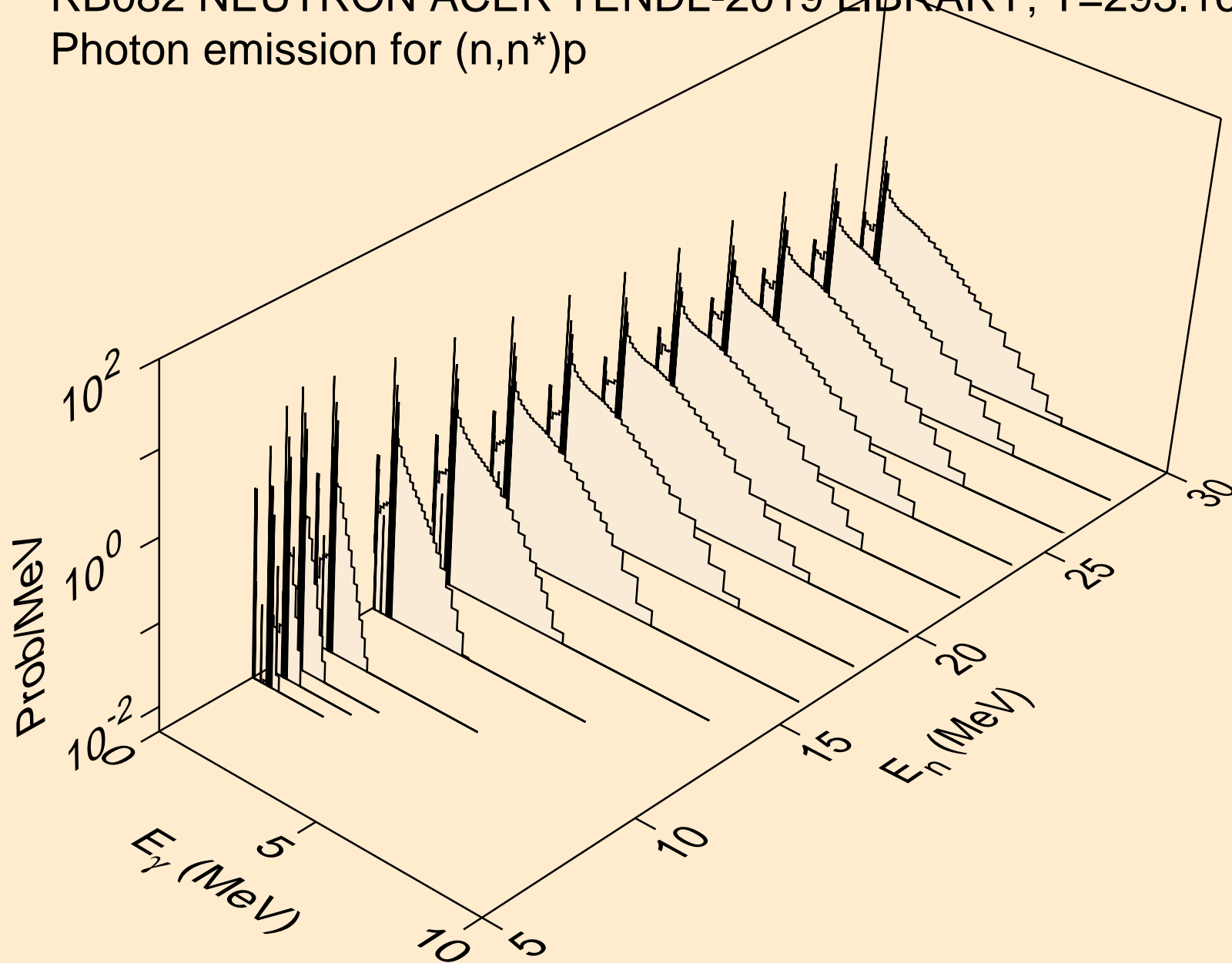

RB082 NEUTRON ACER TENDL-2019 LIBRARY; T=293.16K  
Photon emission for (n,n\*)2a

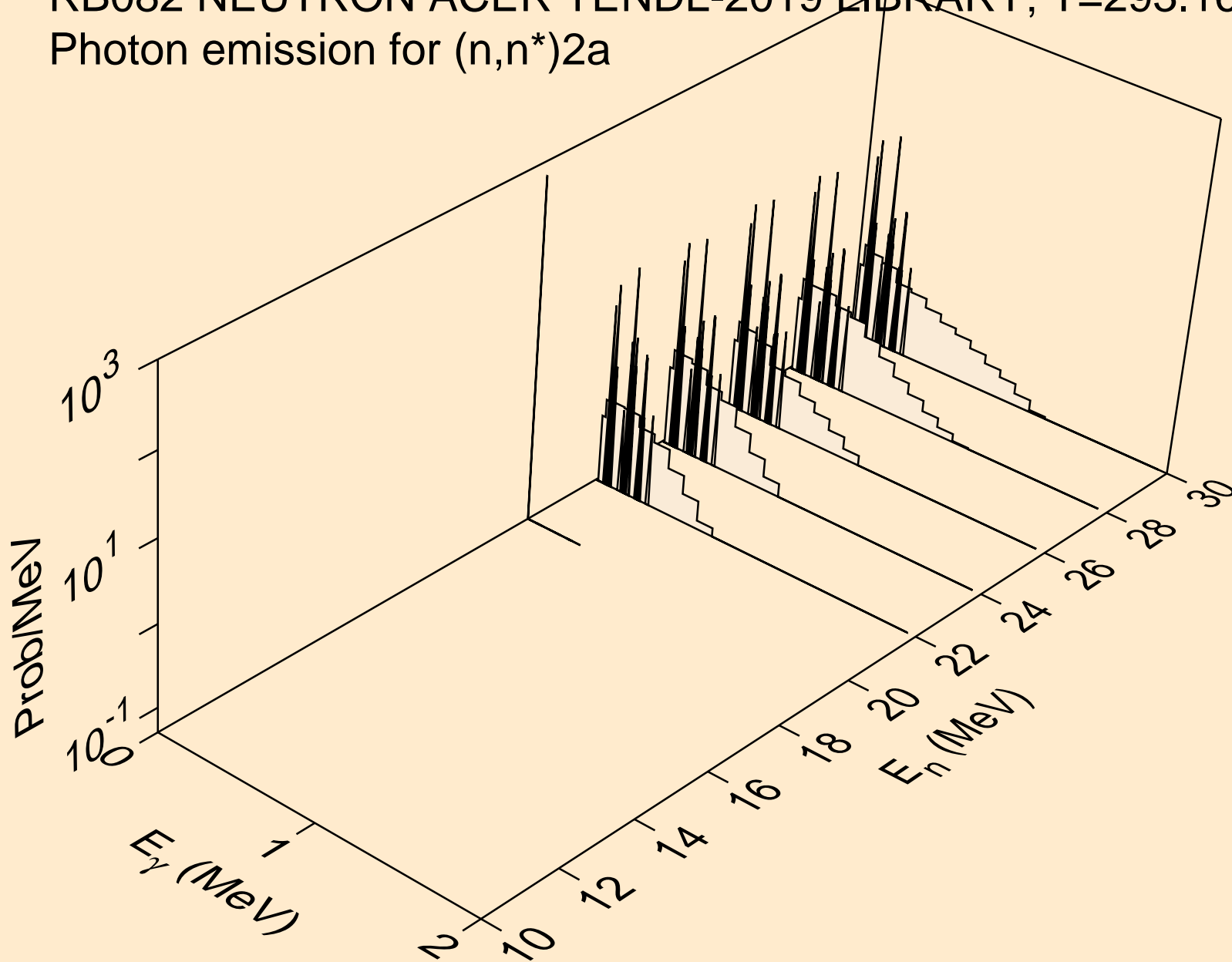

RB082 NEUTRON ACER TENDL-2019 LIBRARY; T=293.16K  
Photon emission for (n,n\*)d

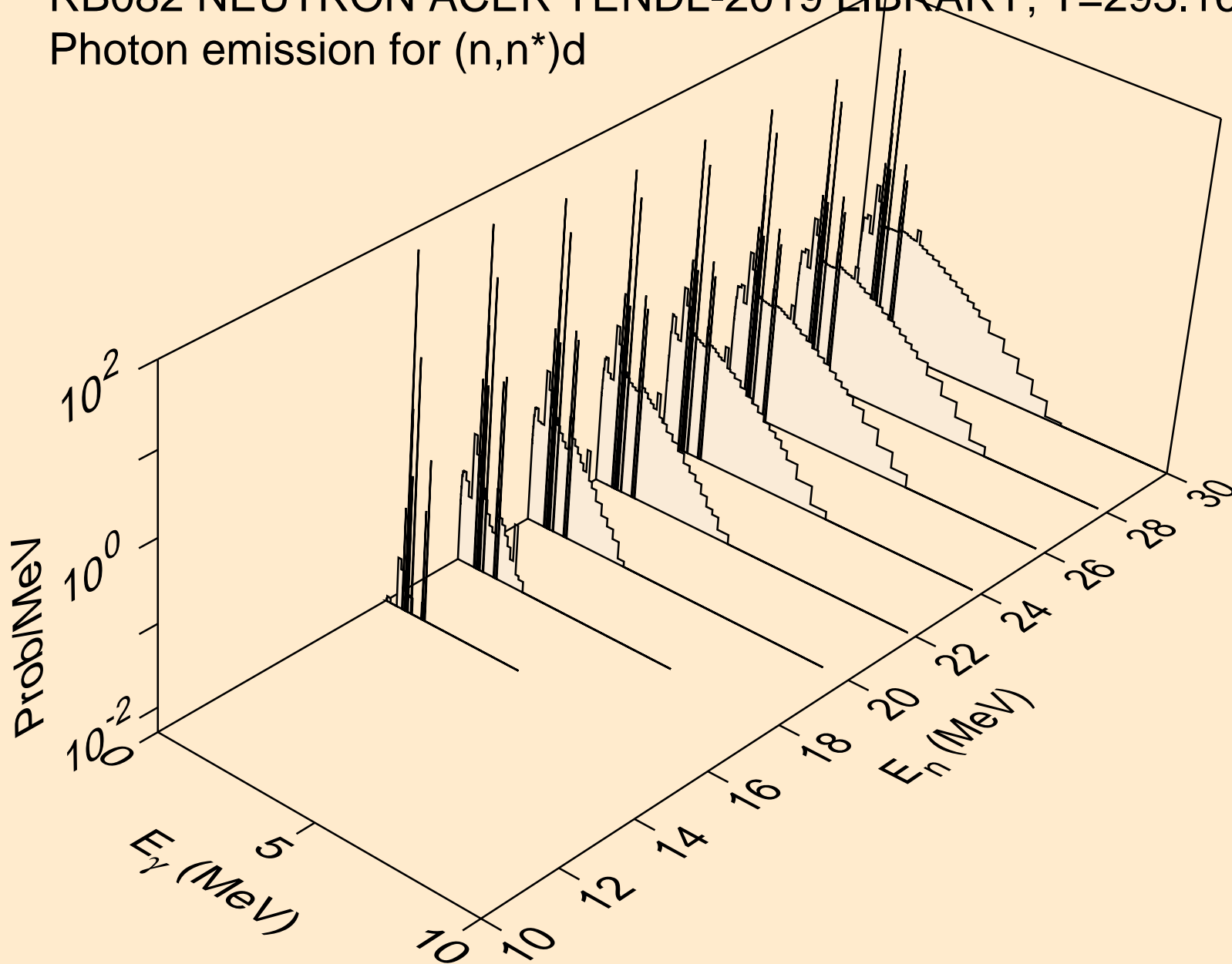

RB082 NEUTRON ACER TENDL-2019 LIBRARY; T=293.16K  
Photon emission for (n,n\*)t

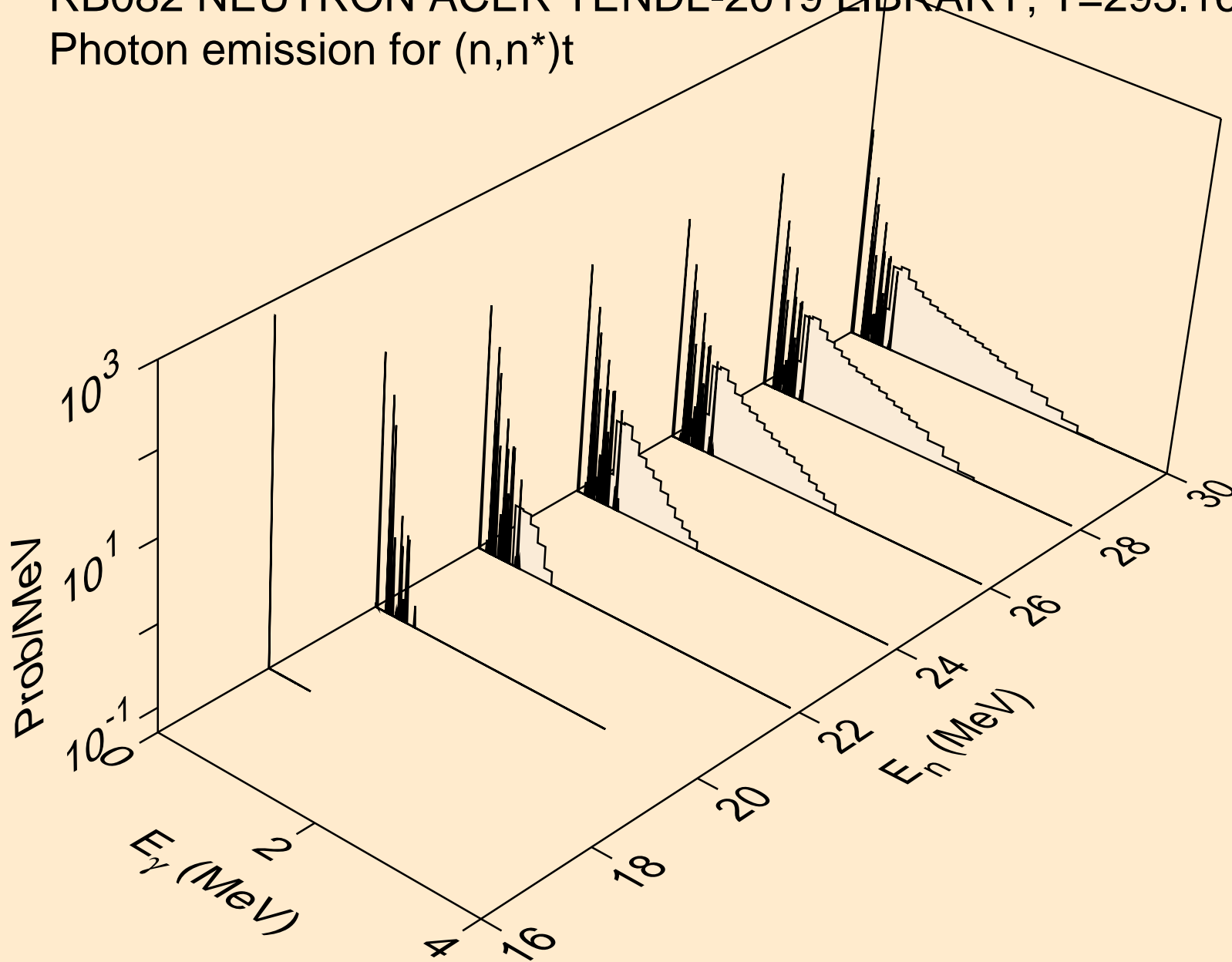

RB082 NEUTRON ACER TENDL-2019 LIBRARY; T=293.16K  
Photon emission for (n,n\*)he3

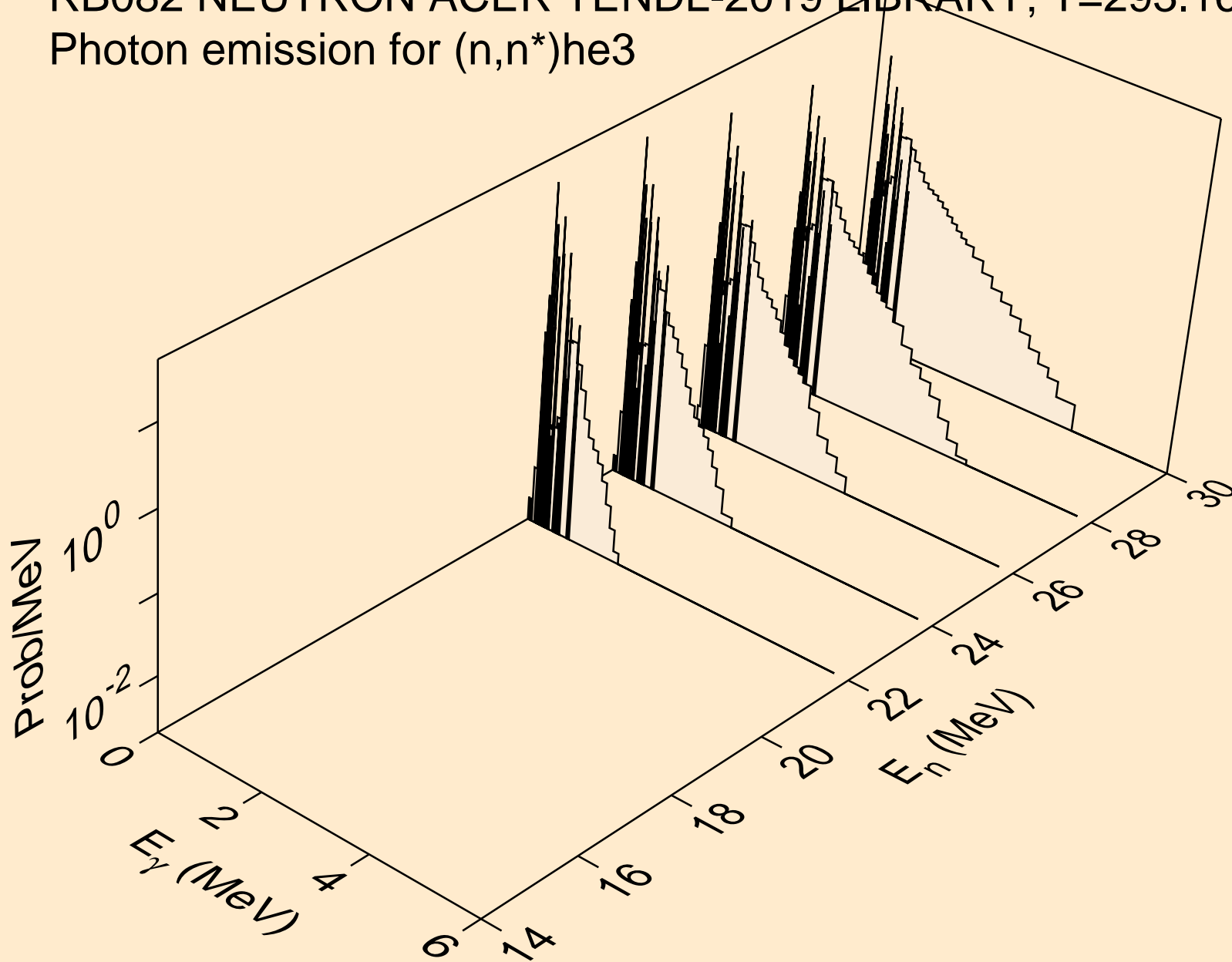

RB082 NEUTRON ACER TENDL-2019 LIBRARY; T=293.16K  
Photon emission for (n,4n)

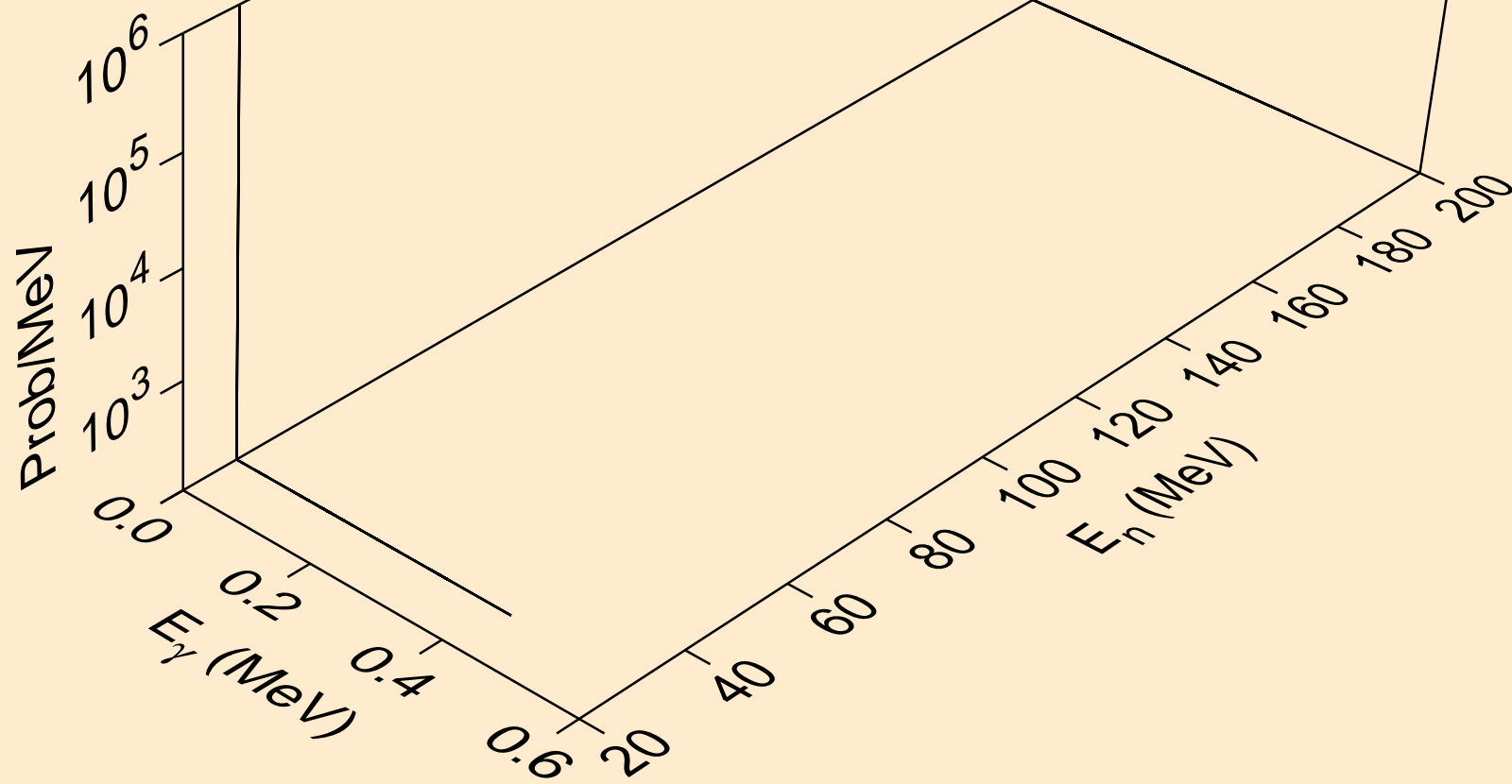

RB082 NEUTRON ACER TENDL-2019 LIBRARY; T=293.16K  
Photon emission for (n,2np)

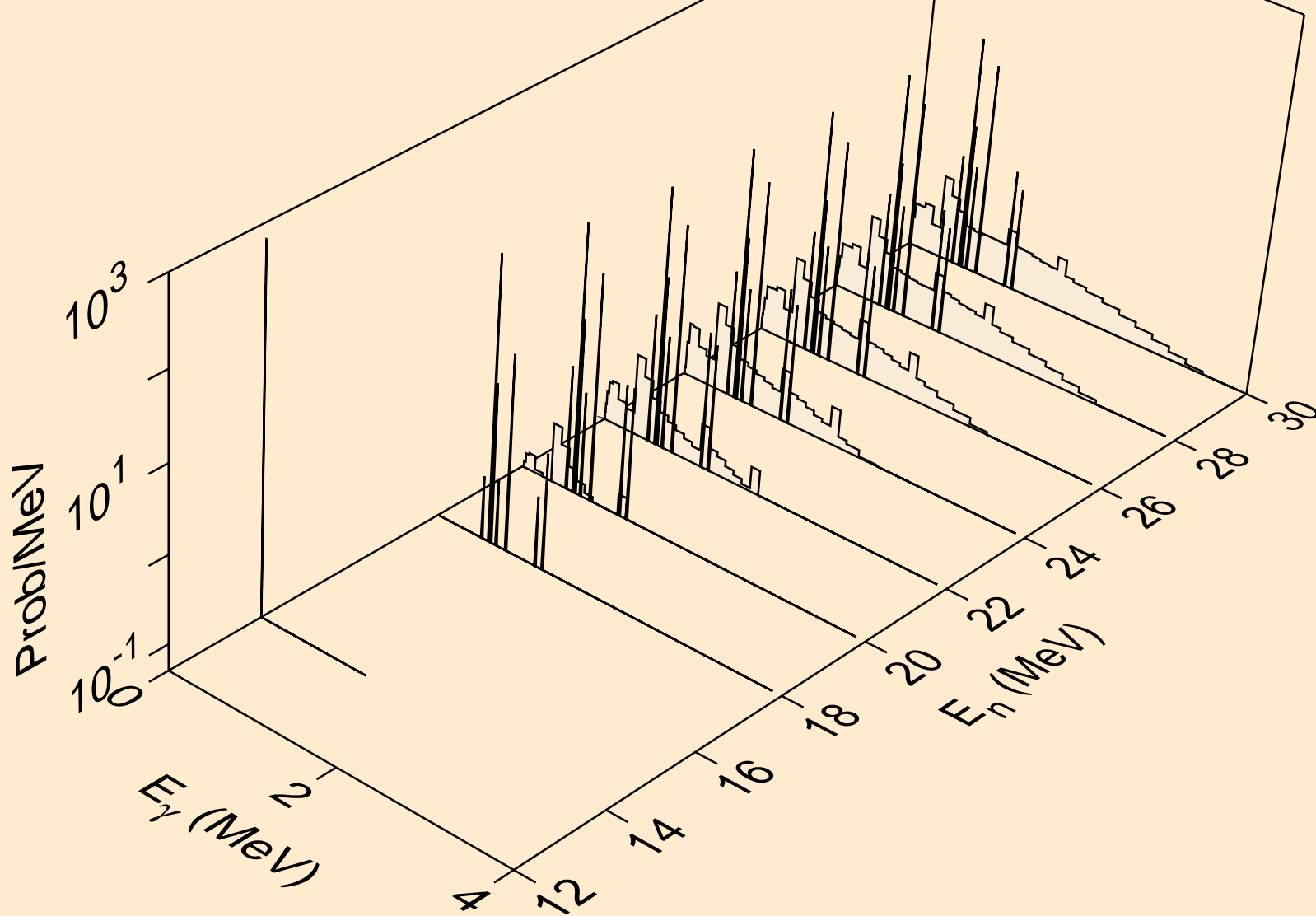

RB082 NEUTRON ACER TENDL-2019 LIBRARY; T=293.16K  
Photon emission for (n,3np)

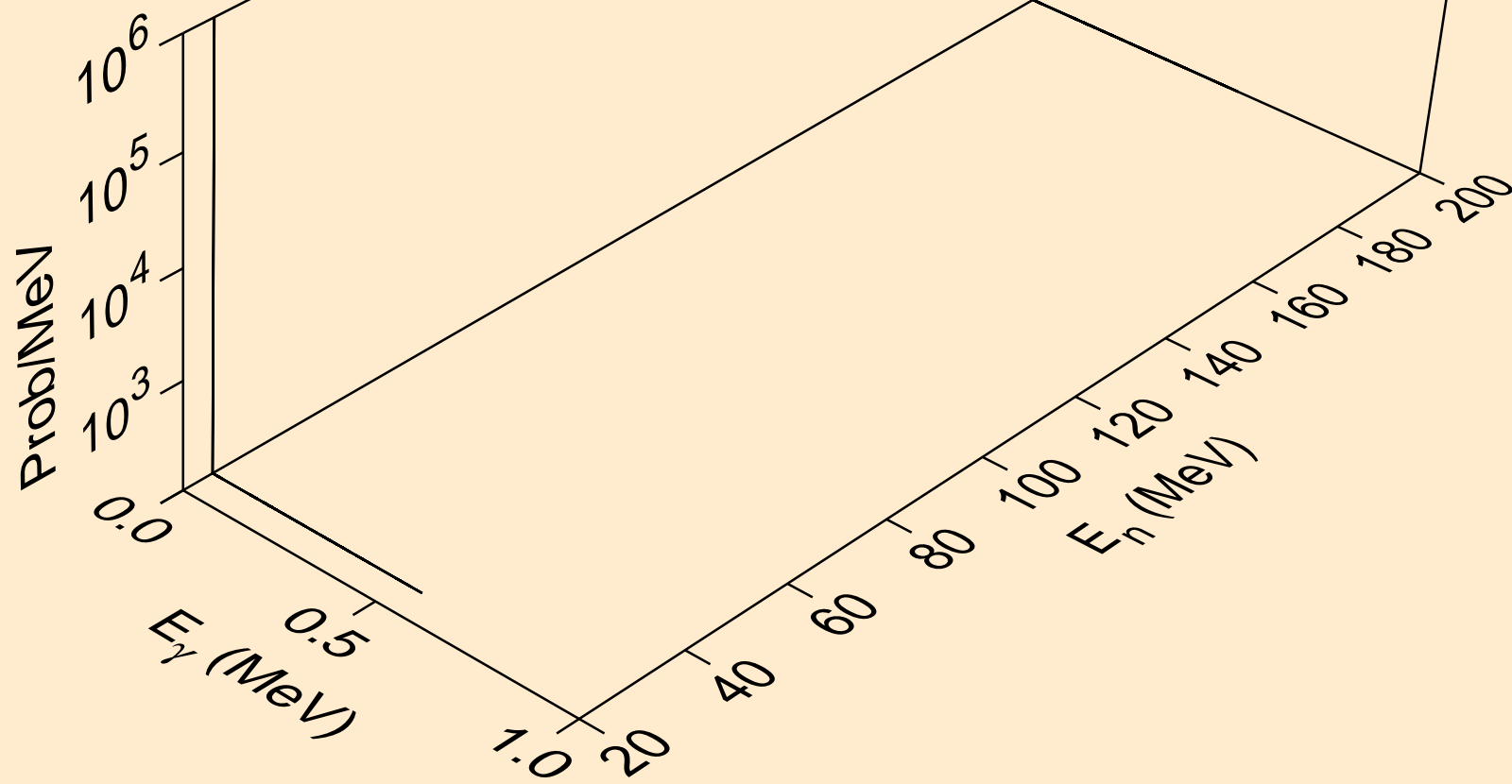



RB082 NEUTRON ACER TENDL-2019 LIBRARY; T=293.16K  
Photon emission for (n,2np)

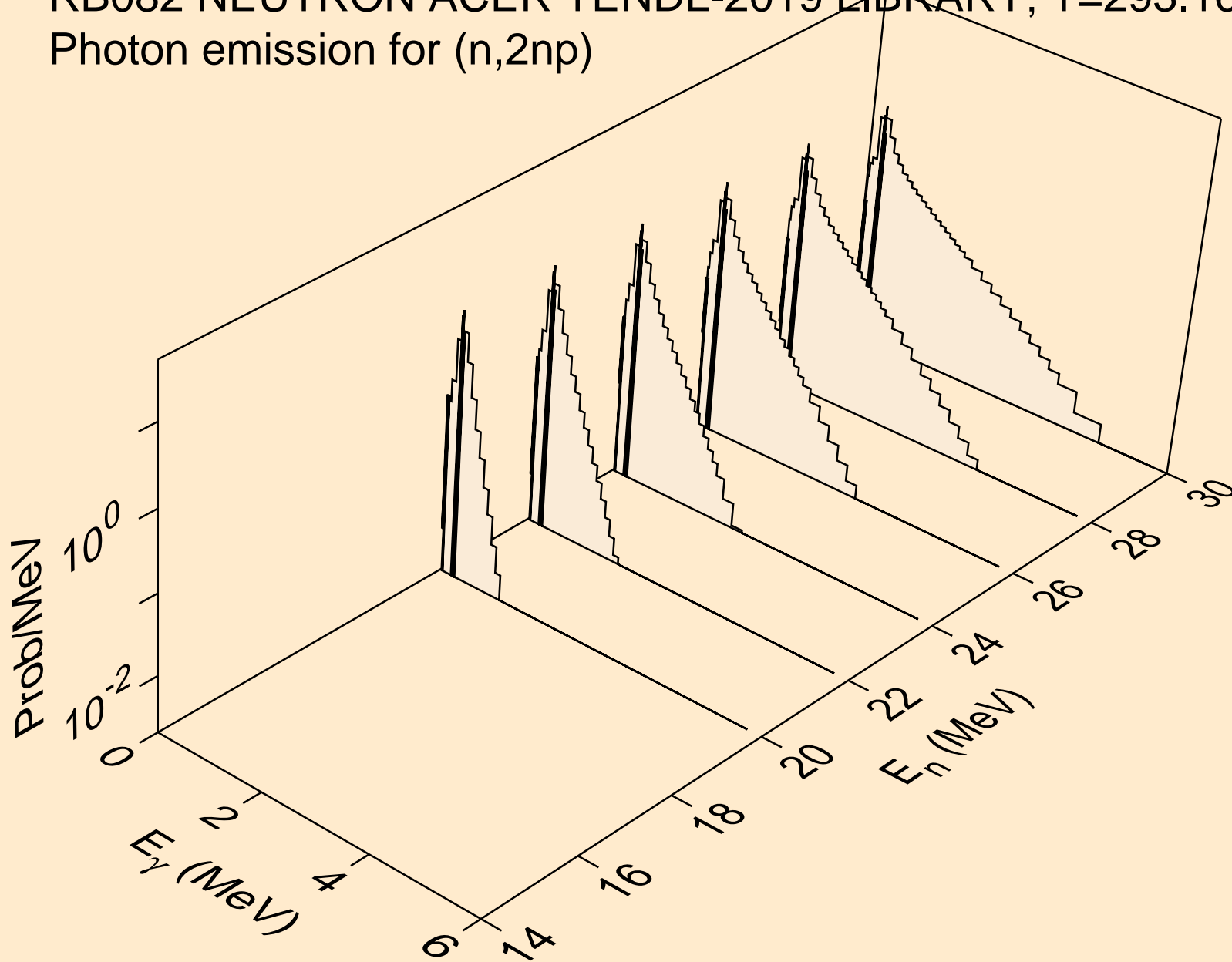

RB082 NEUTRON ACER TENDL-2019 LIBRARY; T=293.16K  
Photon emission for (n,npa)

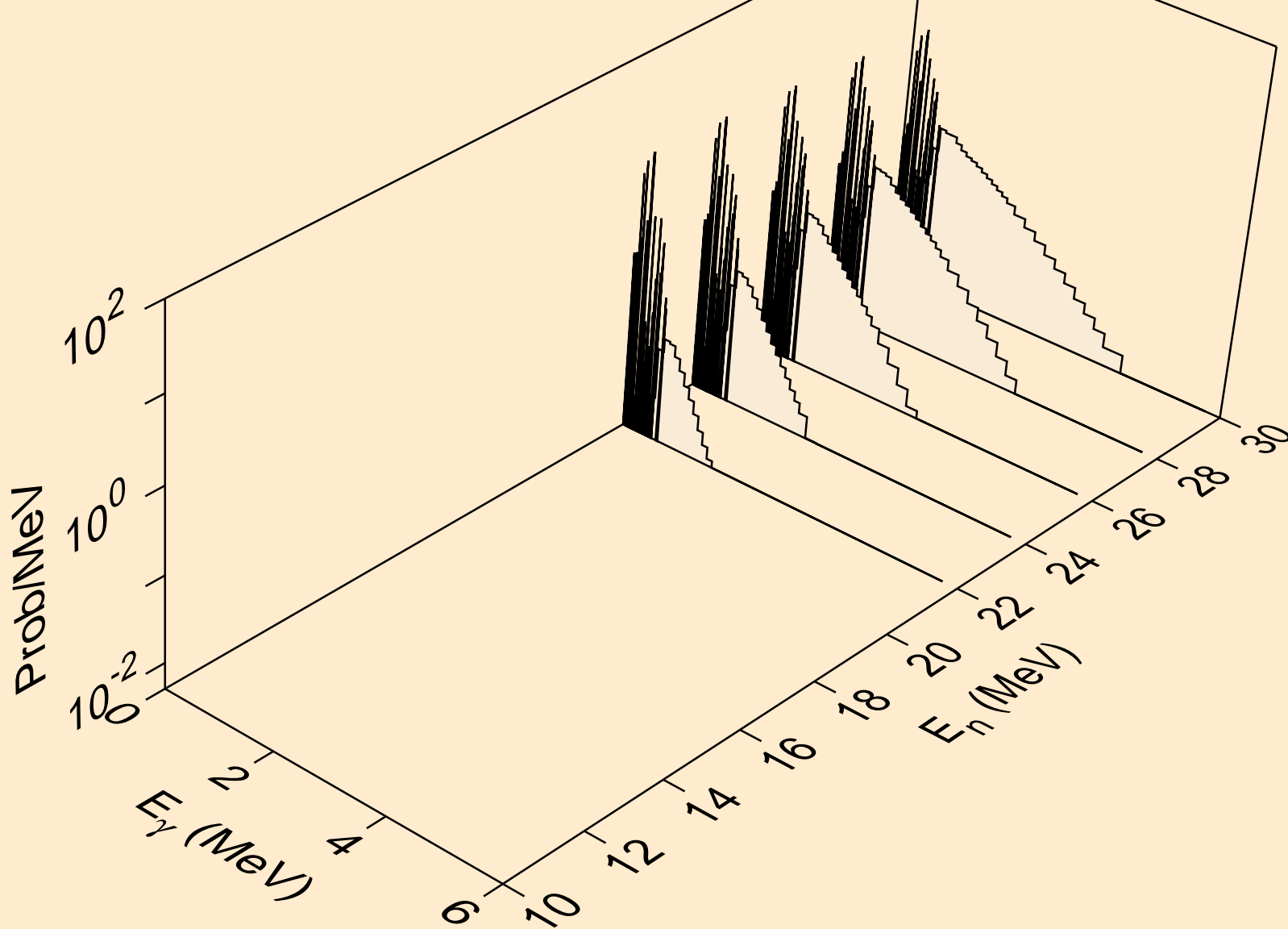

RB082 NEUTRON ACER TENDL-2019 LIBRARY; T=293.16K  
Photon emission for (n,n\*c)

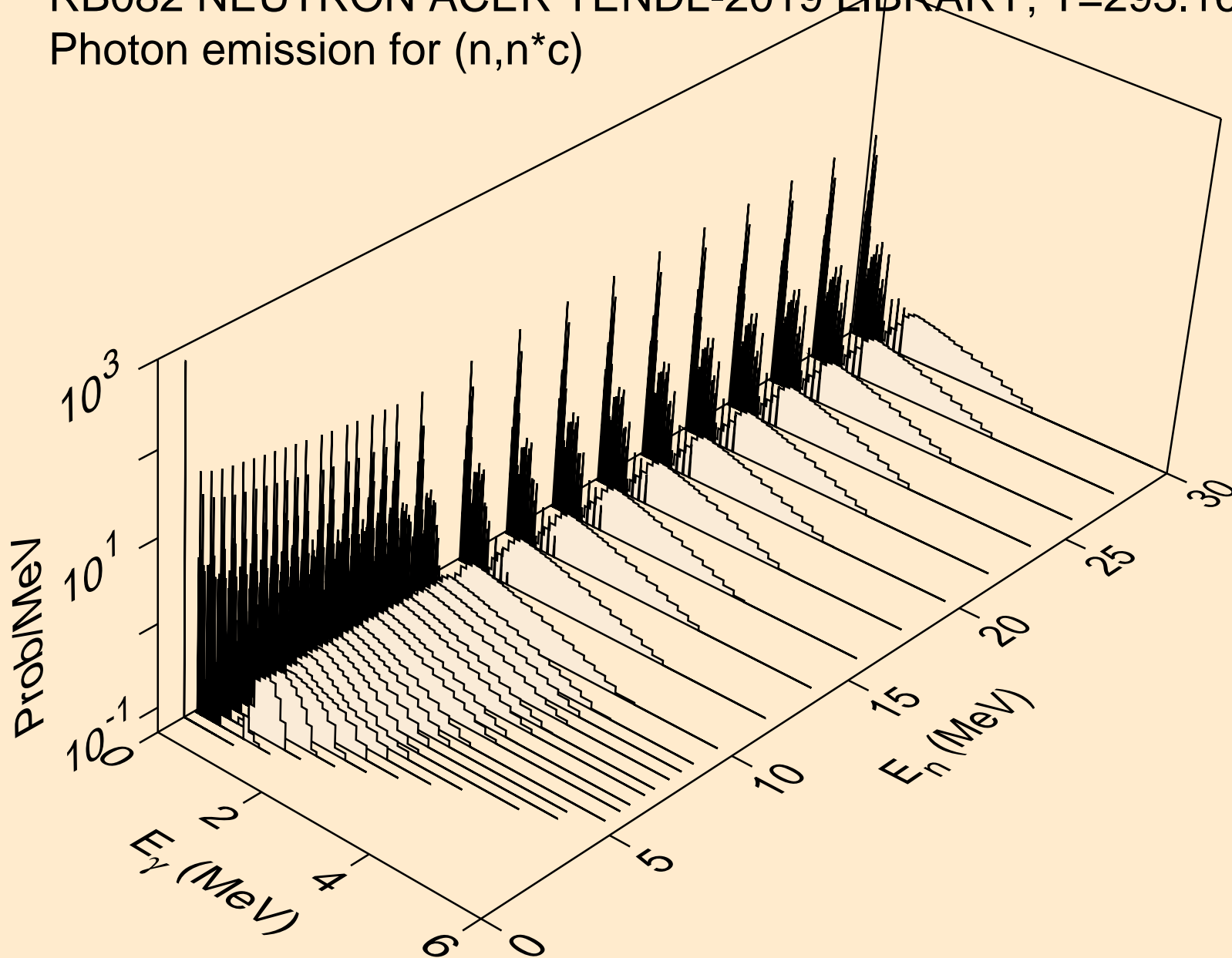

RB082 NEUTRON ACER TENDL-2019 LIBRARY; T=293.16K  
Photon emission for (n,gma)

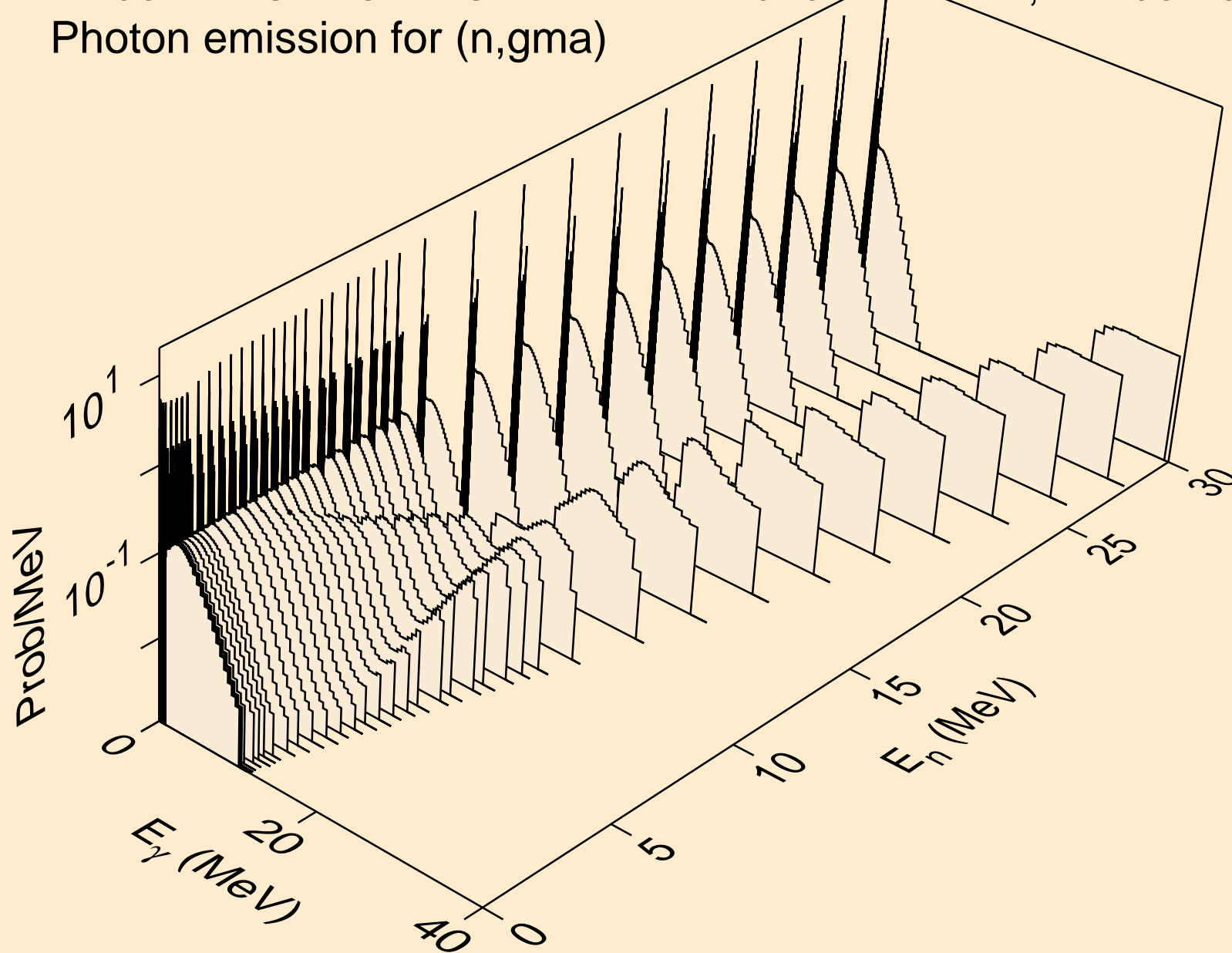

RB082 NEUTRON ACER TENDL-2019 LIBRARY; T=293.16K  
Photon emission for (n,p)

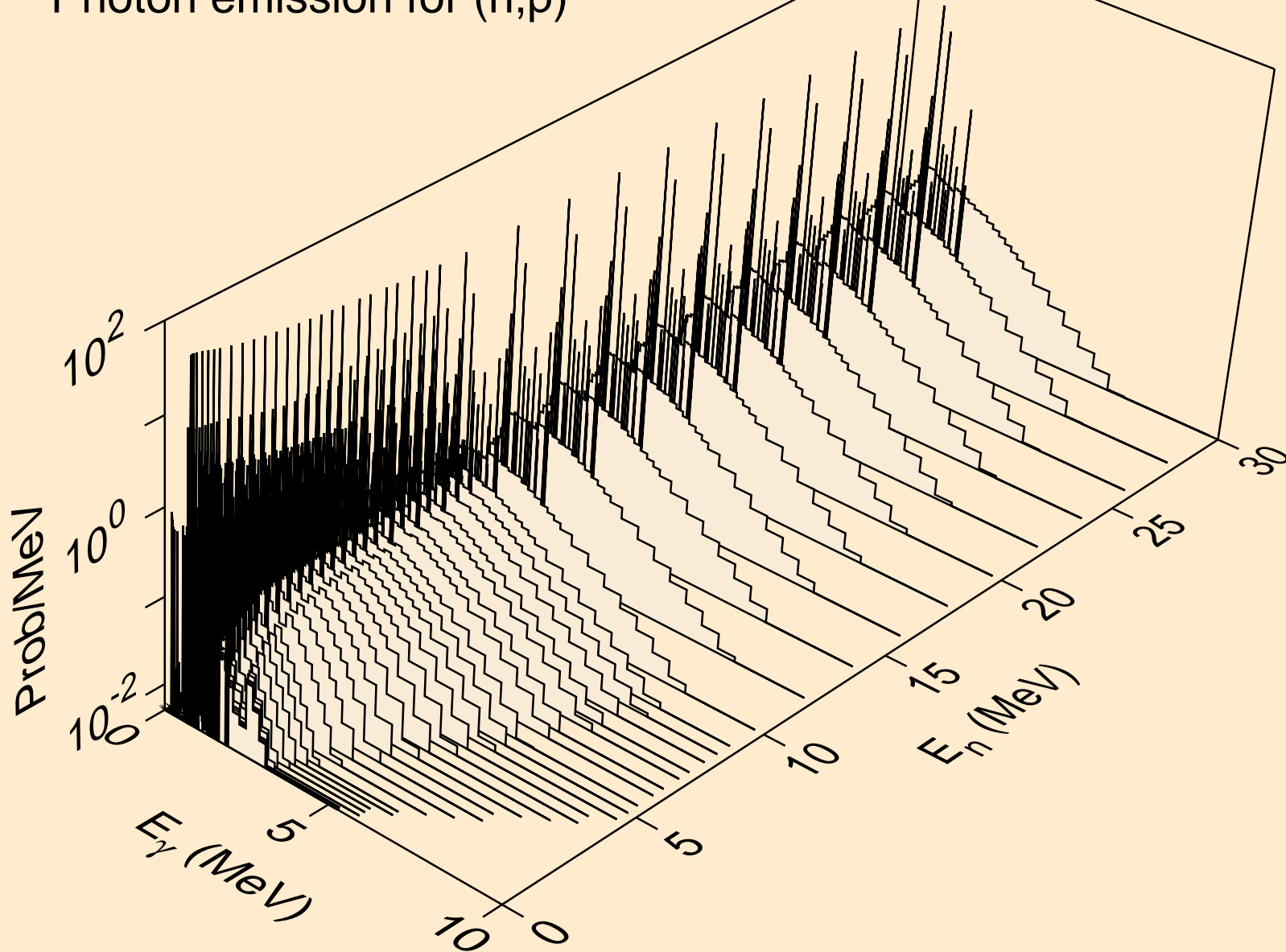

RB082 NEUTRON ACER TENDL-2019 LIBRARY; T=293.16K  
Photon emission for (n,d)

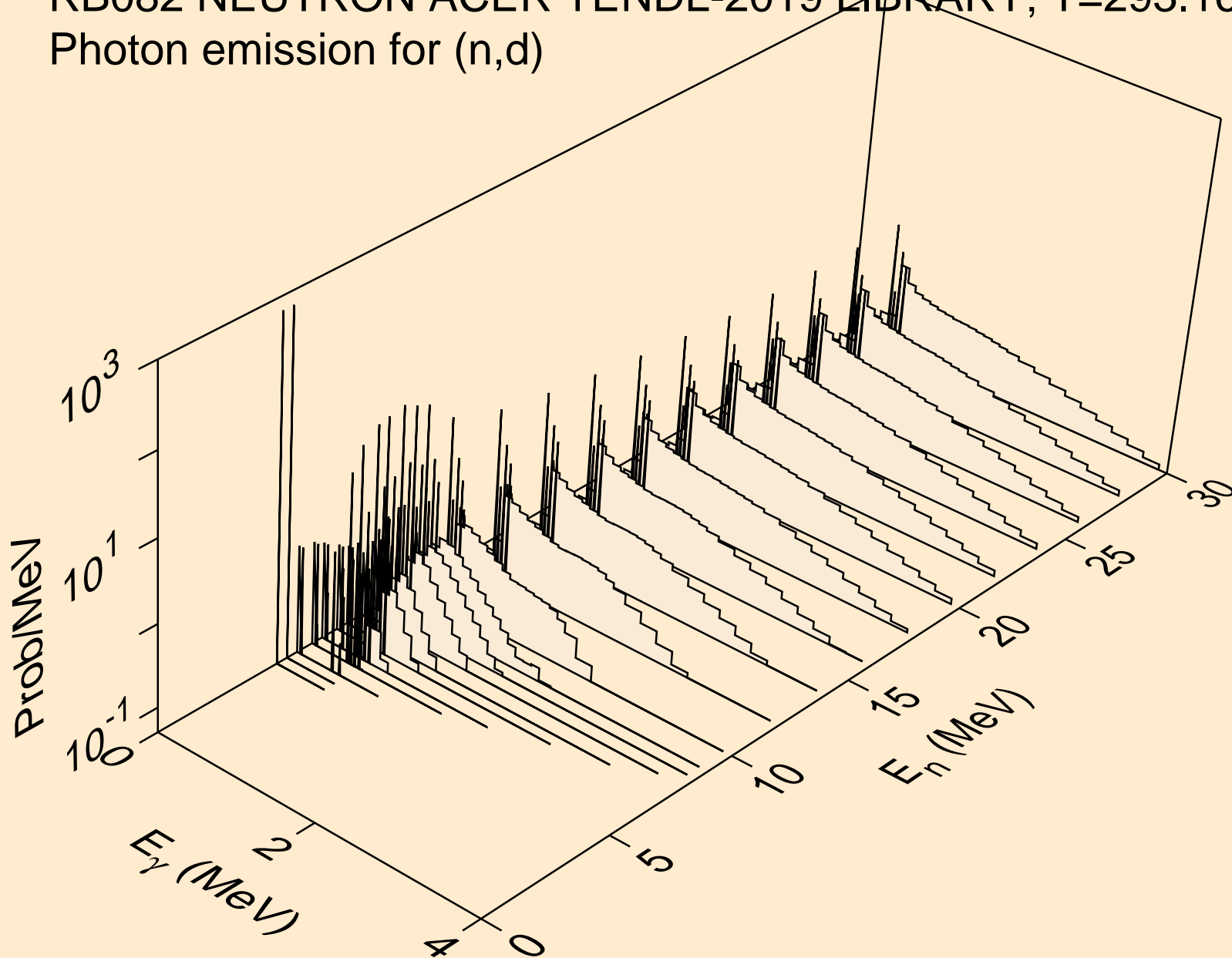

RB082 NEUTRON ACER TENDL-2019 LIBRARY; T=293.16K  
Photon emission for (n,t)

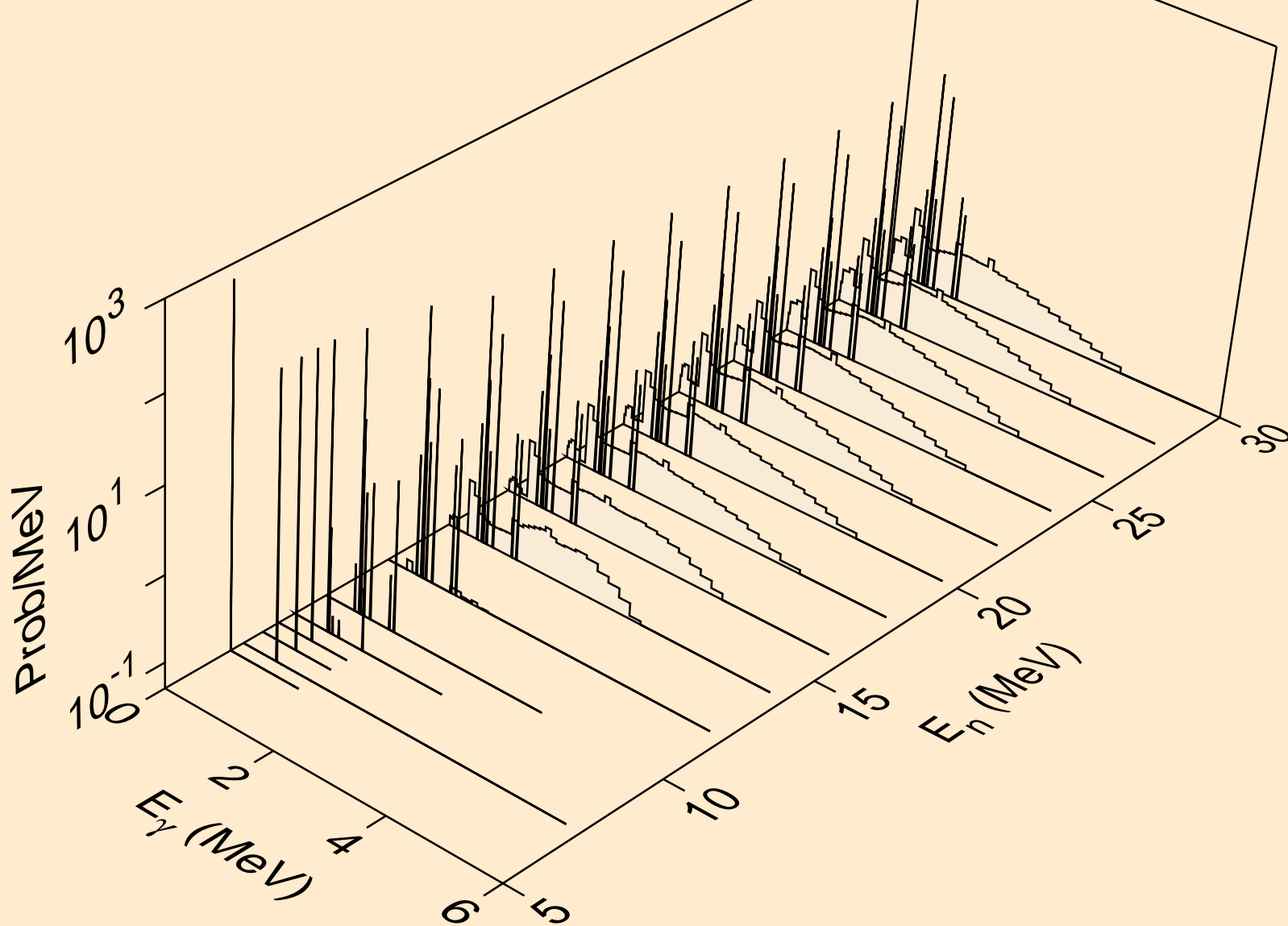

RB082 NEUTRON ACER TENDL-2019 LIBRARY; T=293.16K  
Photon emission for (n,he3)

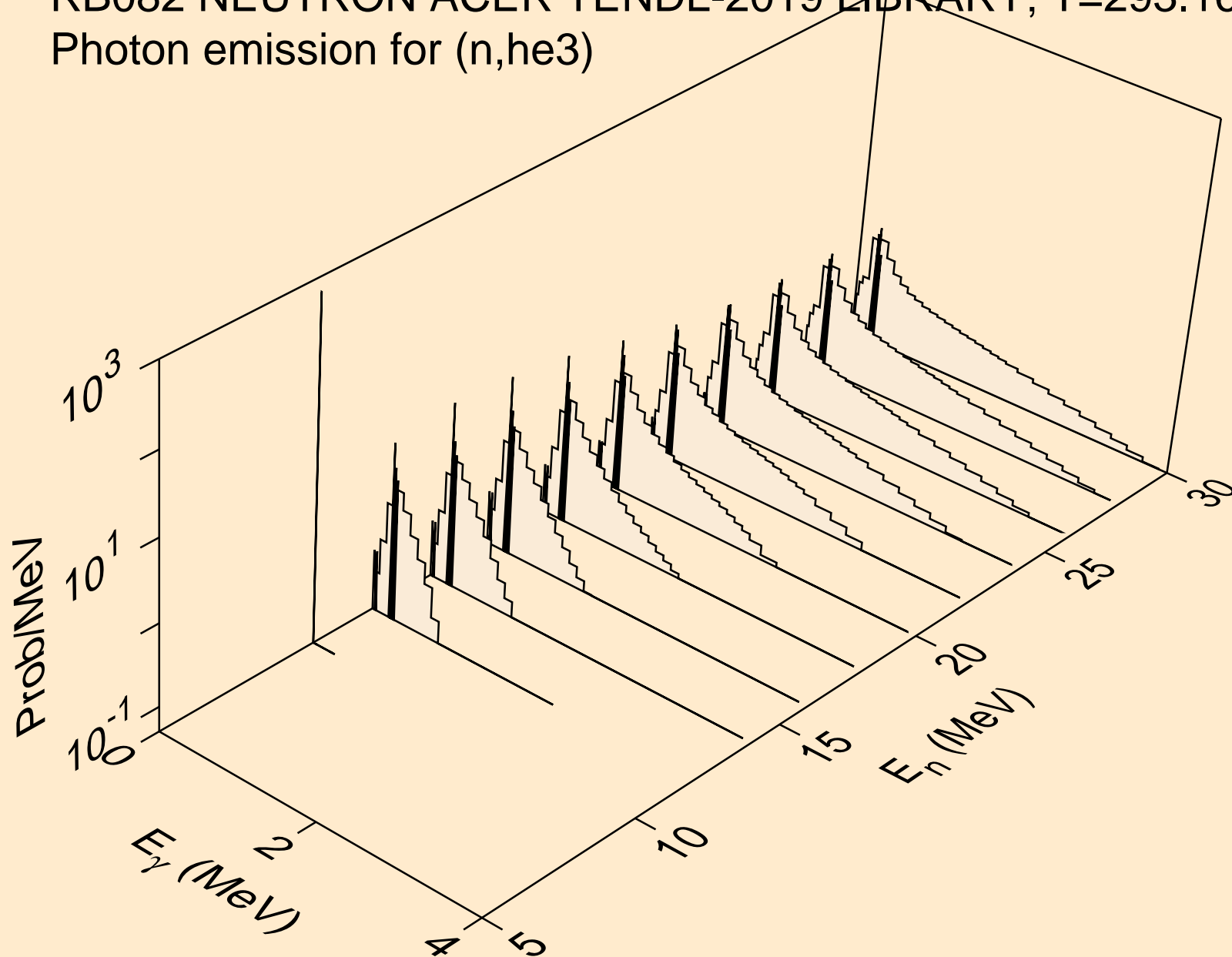



RB082 NEUTRON ACER TENDL-2019 LIBRARY; T=293.16K  
Photon emission for (n,a)

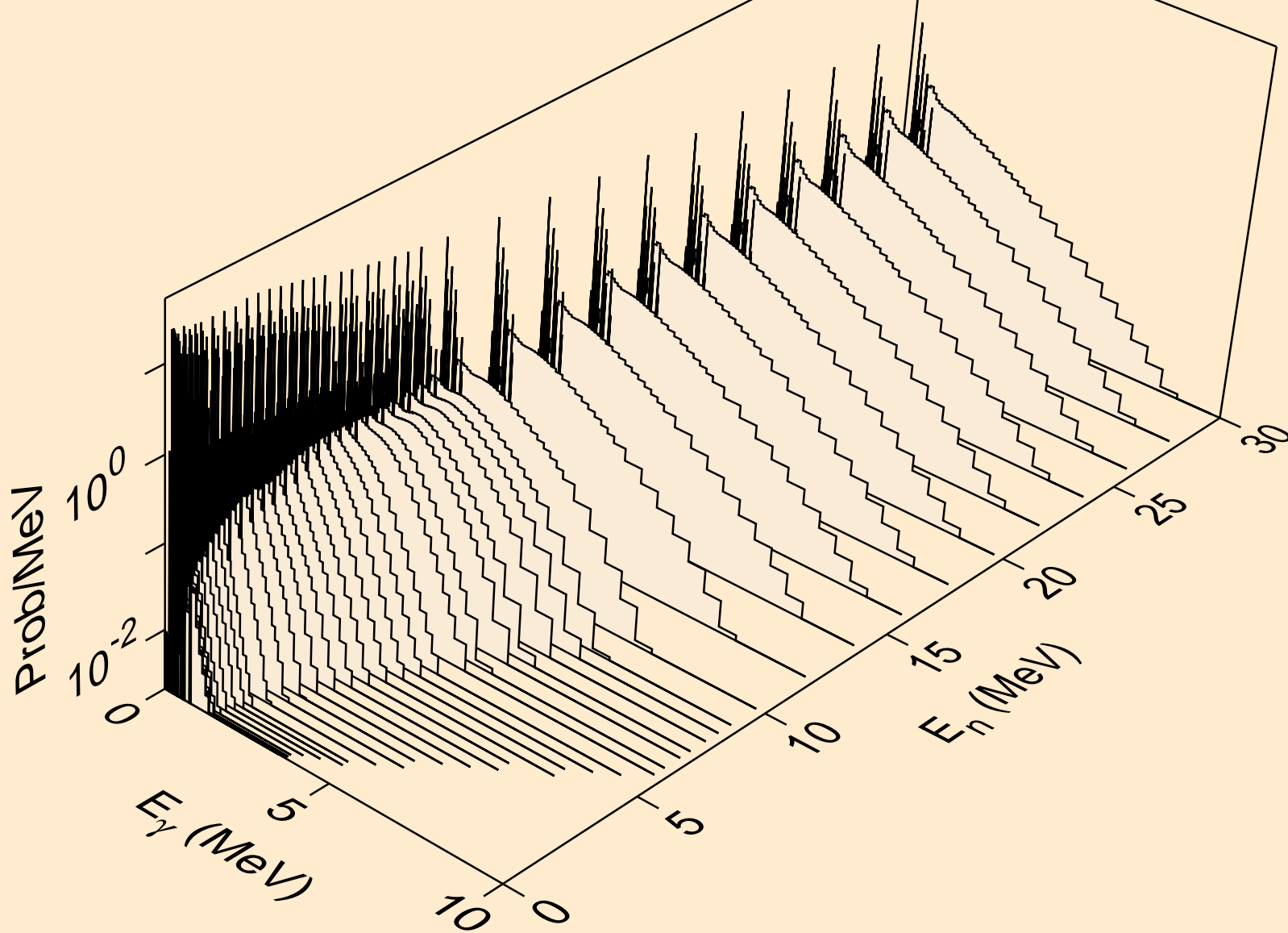

RB082 NEUTRON ACER TENDL-2019 LIBRARY; T=293.16K  
Photon emission for (n,2a)

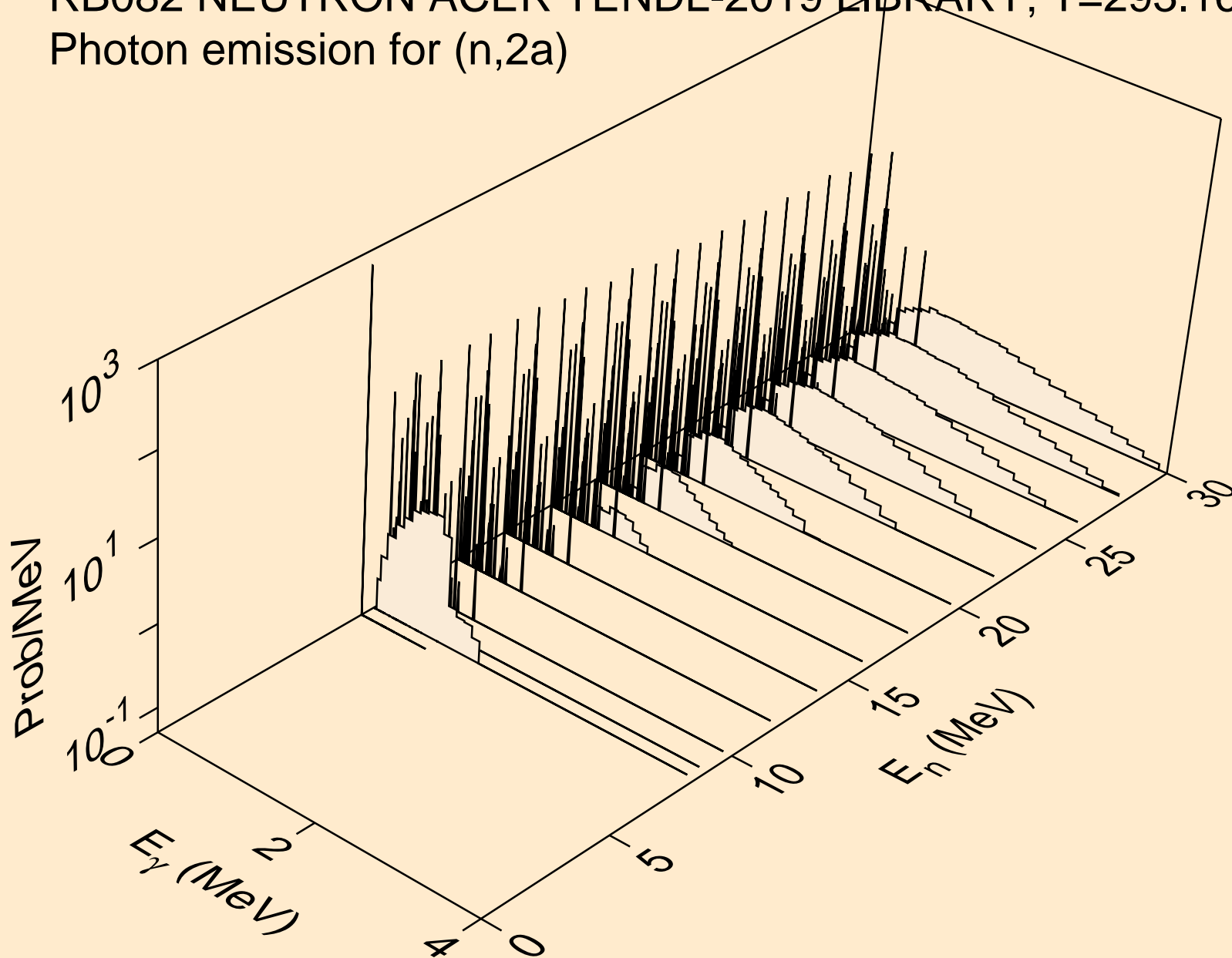

RB082 NEUTRON ACER TENDL-2019 LIBRARY; T=293.16K  
Photon emission for (n,2p)

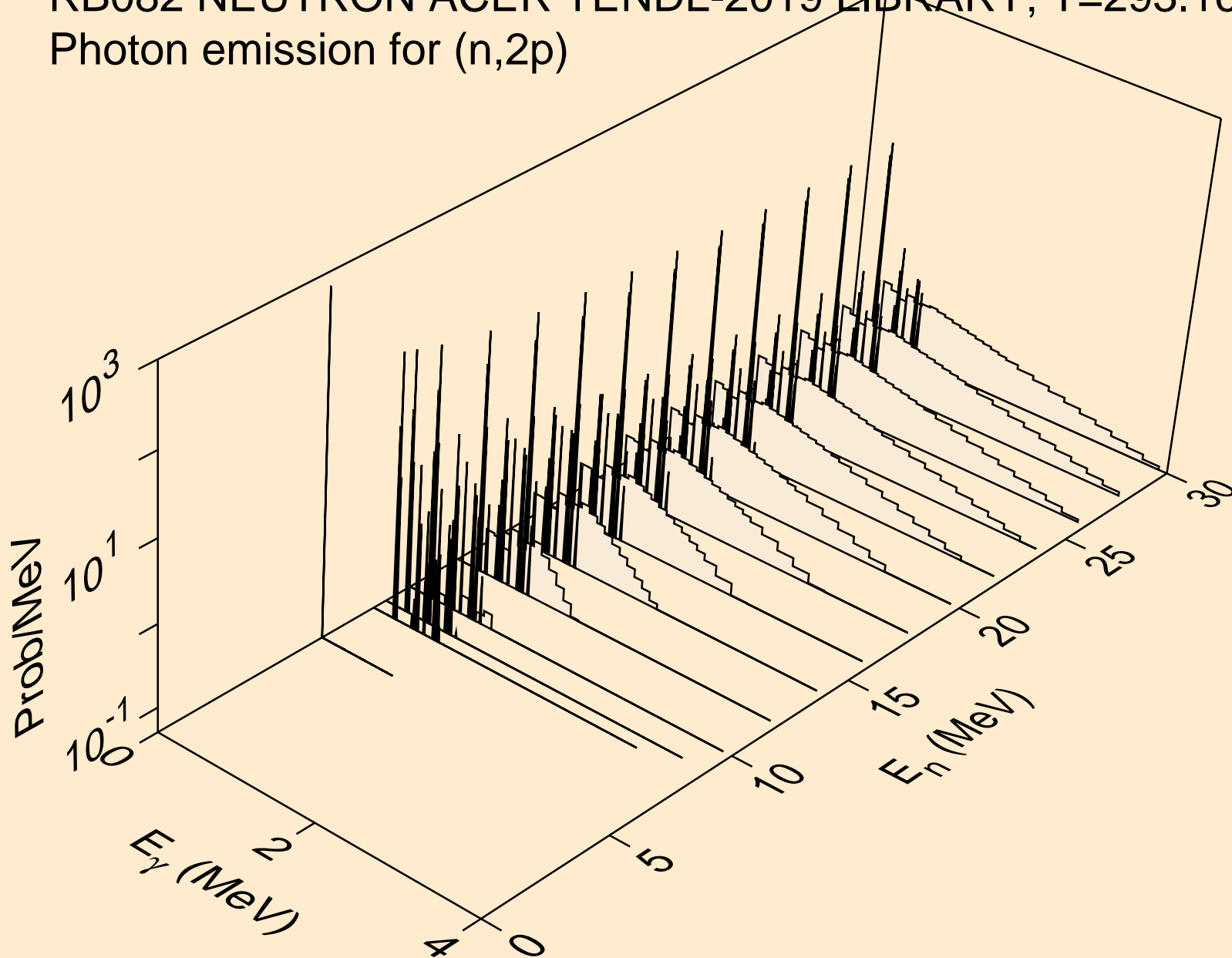

RB082 NEUTRON ACER TENDL-2019 LIBRARY; T=293.16K  
Photon emission for (n,p $\alpha$ )

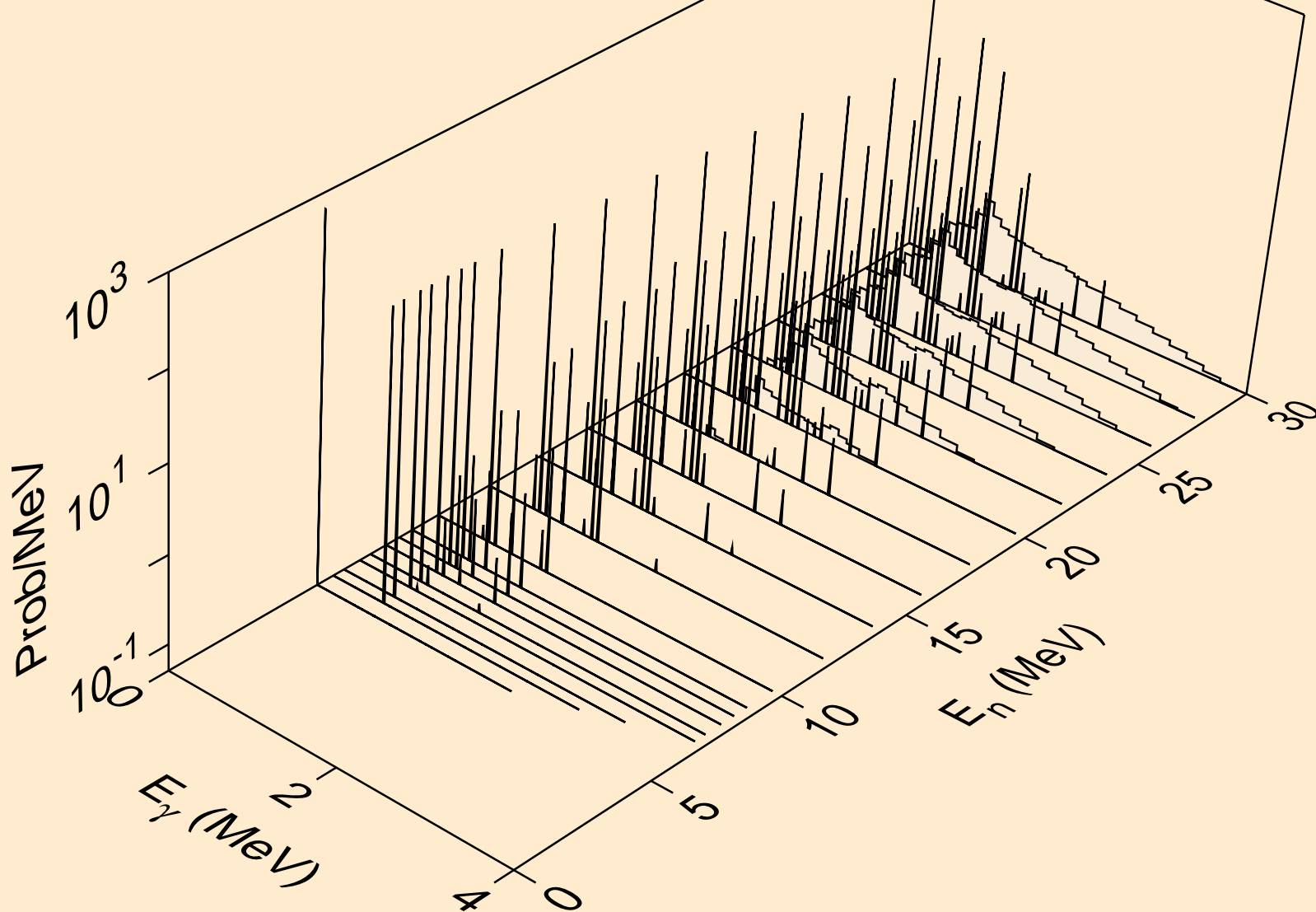

RB082 NEUTRON ACER TENDL-2019 LIBRARY; T=293.16K  
Photon emission for (n,pd)

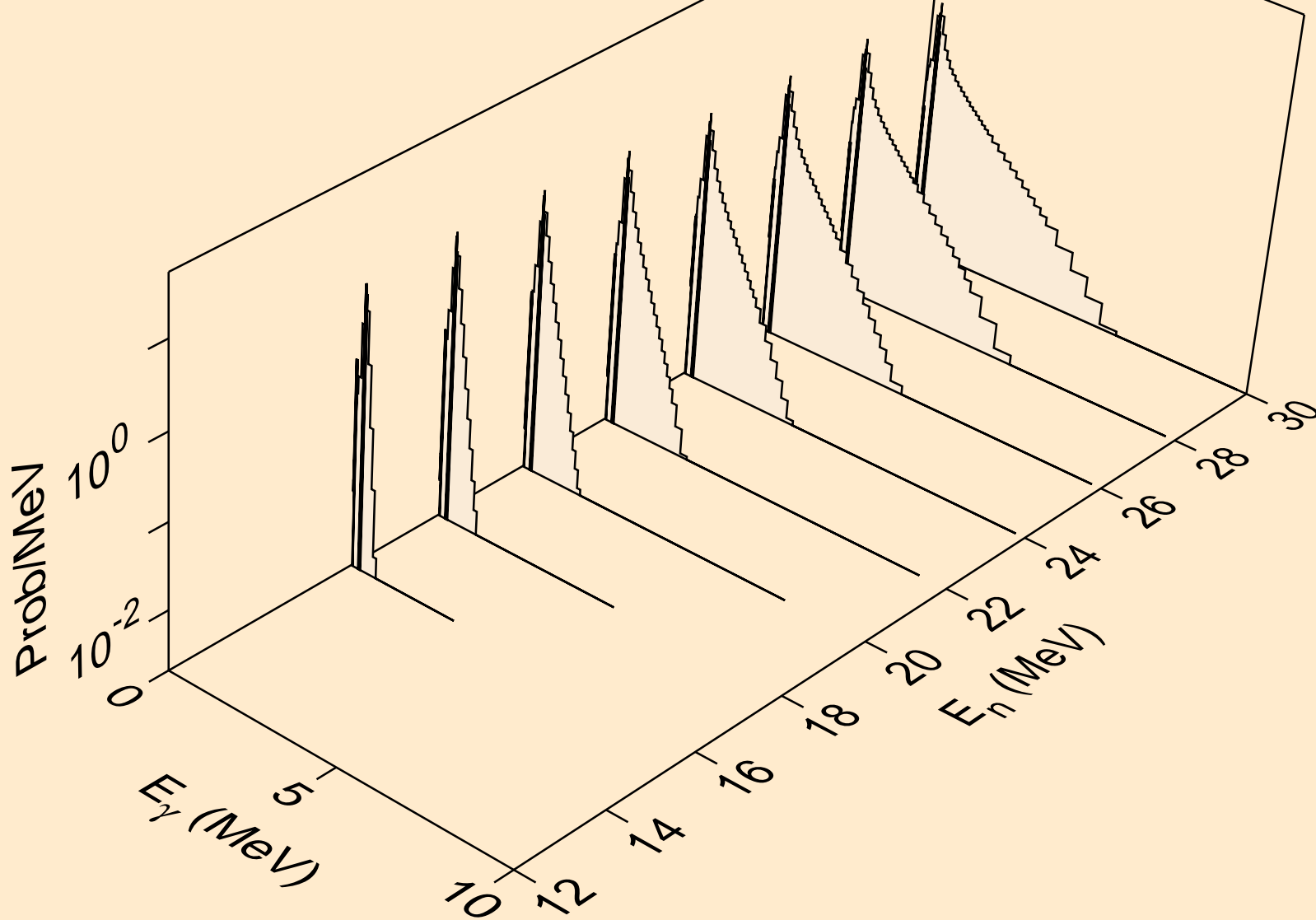

RB082 NEUTRON ACER TENDL-2019 LIBRARY; T=293.16K  
Photon emission for (n,pt)

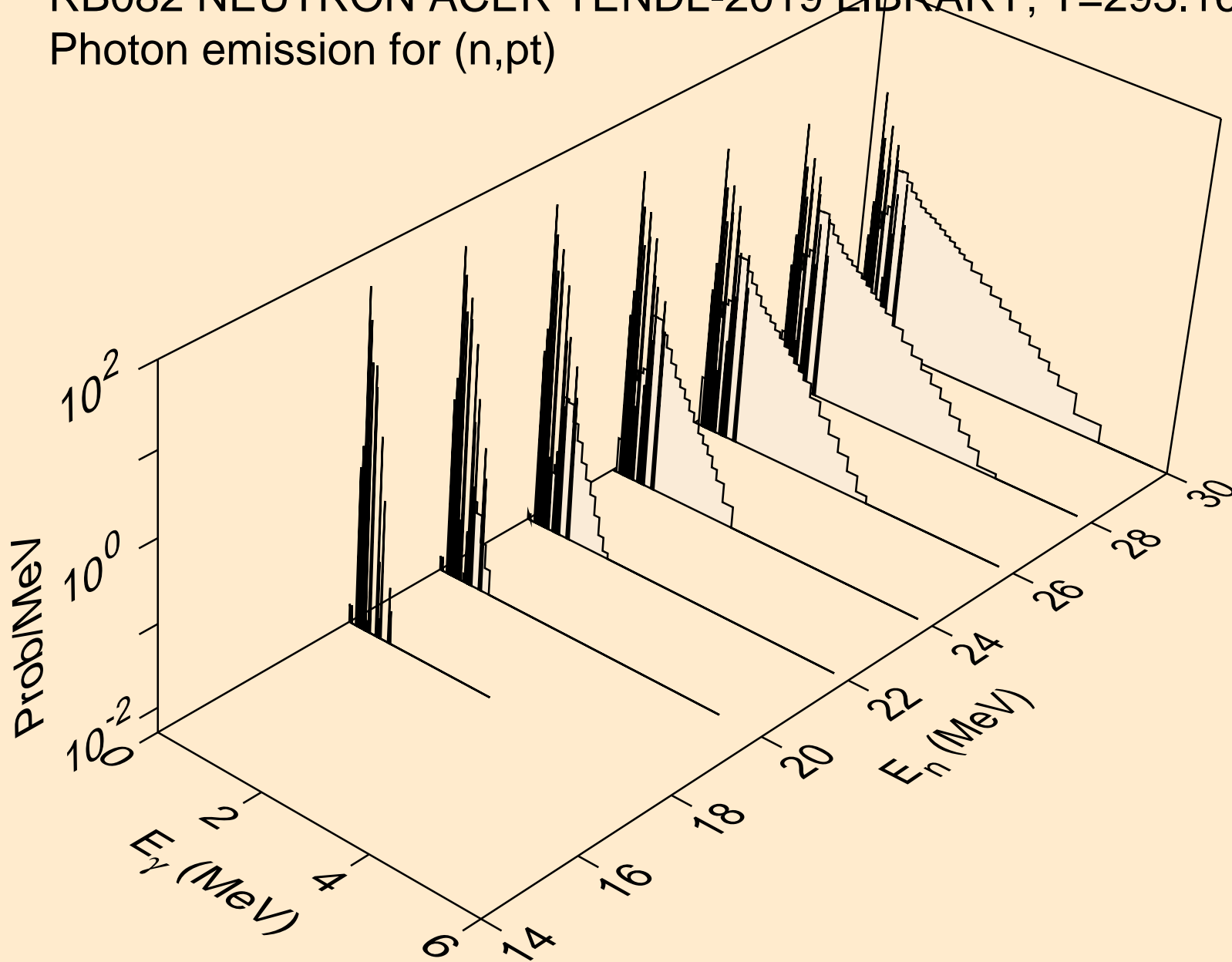

RB082 NEUTRON ACER TENDL-2019 LIBRARY; T=293.16K  
Photon emission for (n,da)

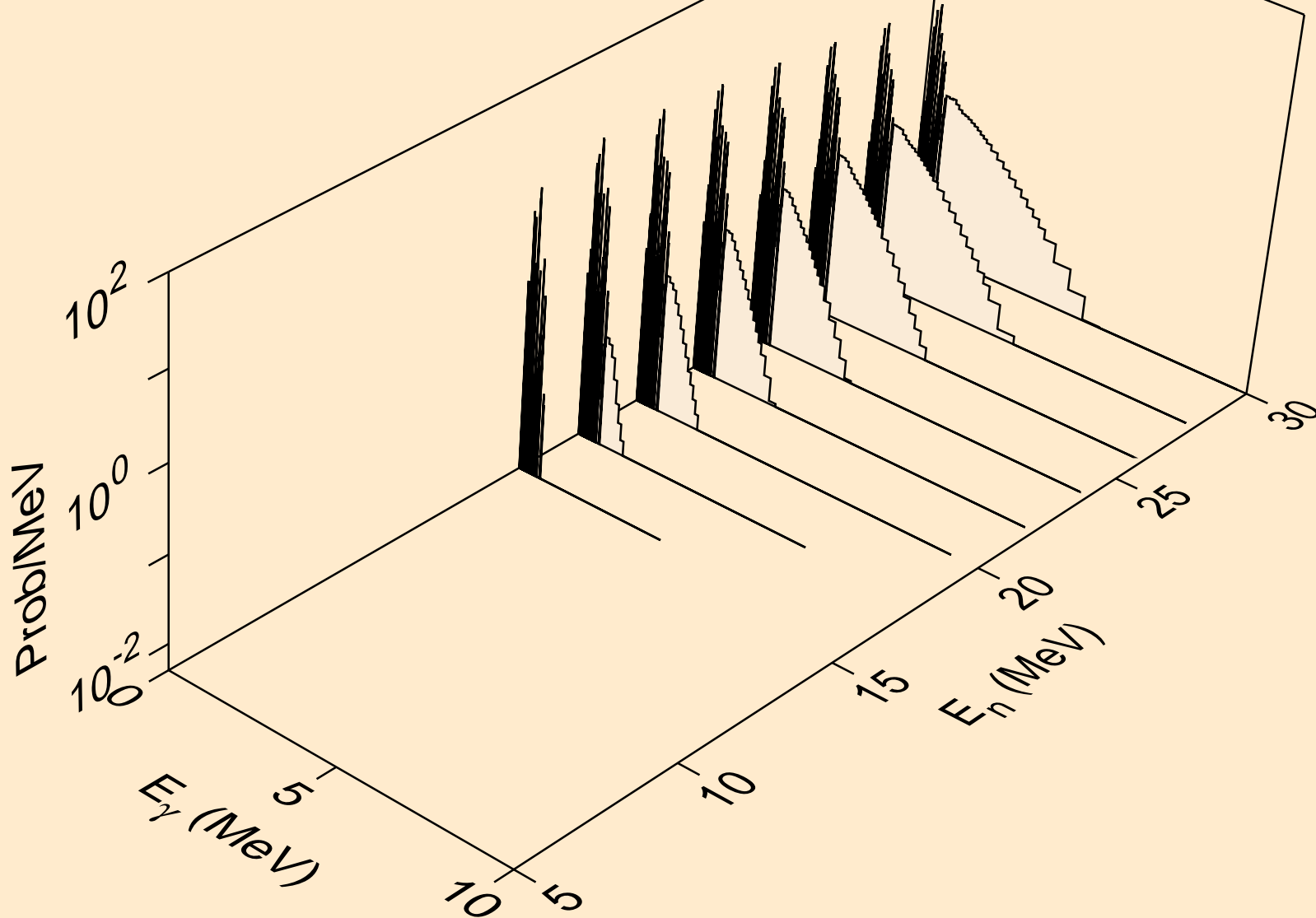

RB082 NEUTRON ACER TENDL-2019 LIBRARY; T=293.16K  
thermal capture photon spectrum

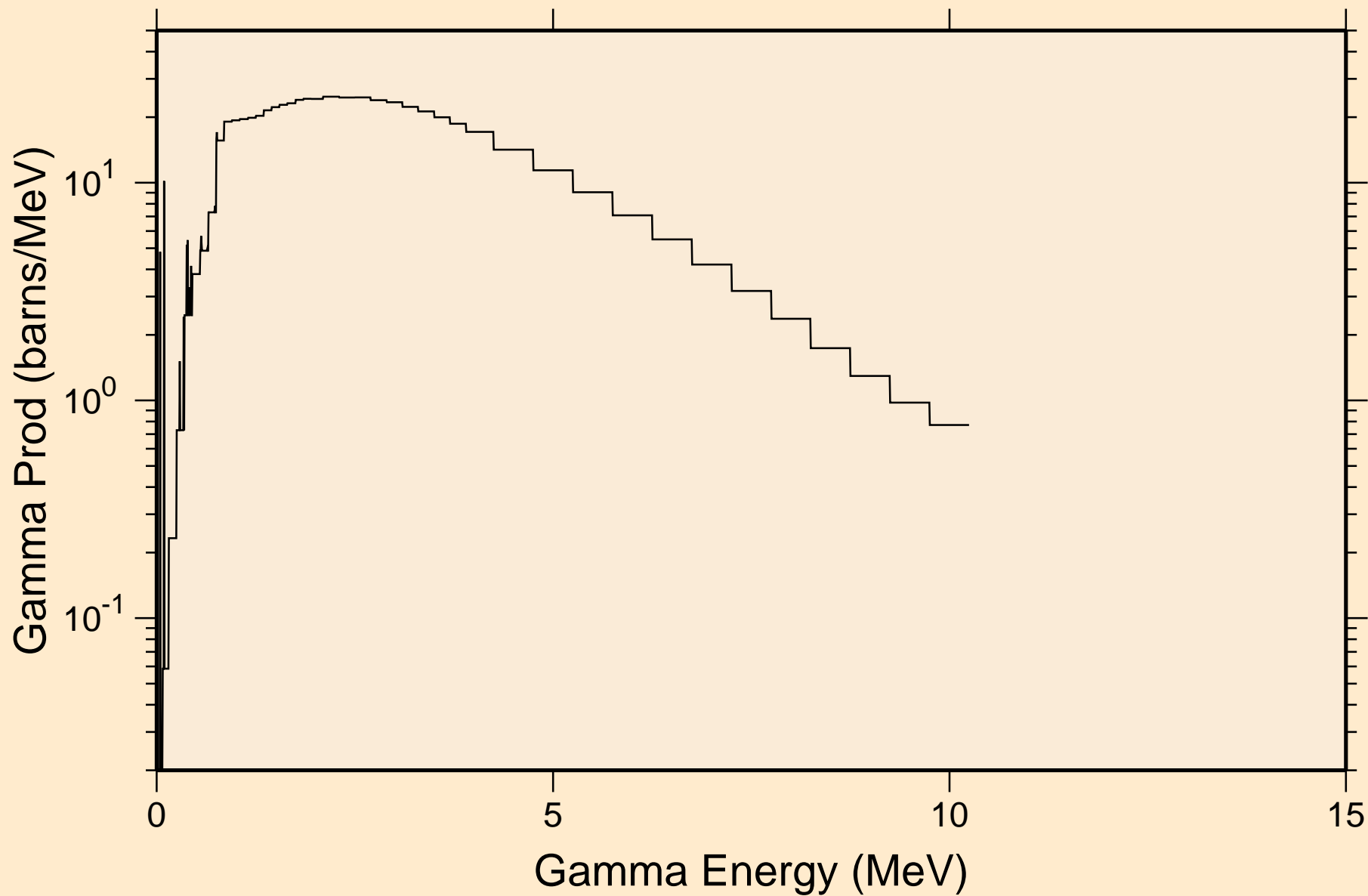



RB082 NEUTRON ACER TENDL-2019 LIBRARY; T=293.16K  
14 MeV photon spectrum

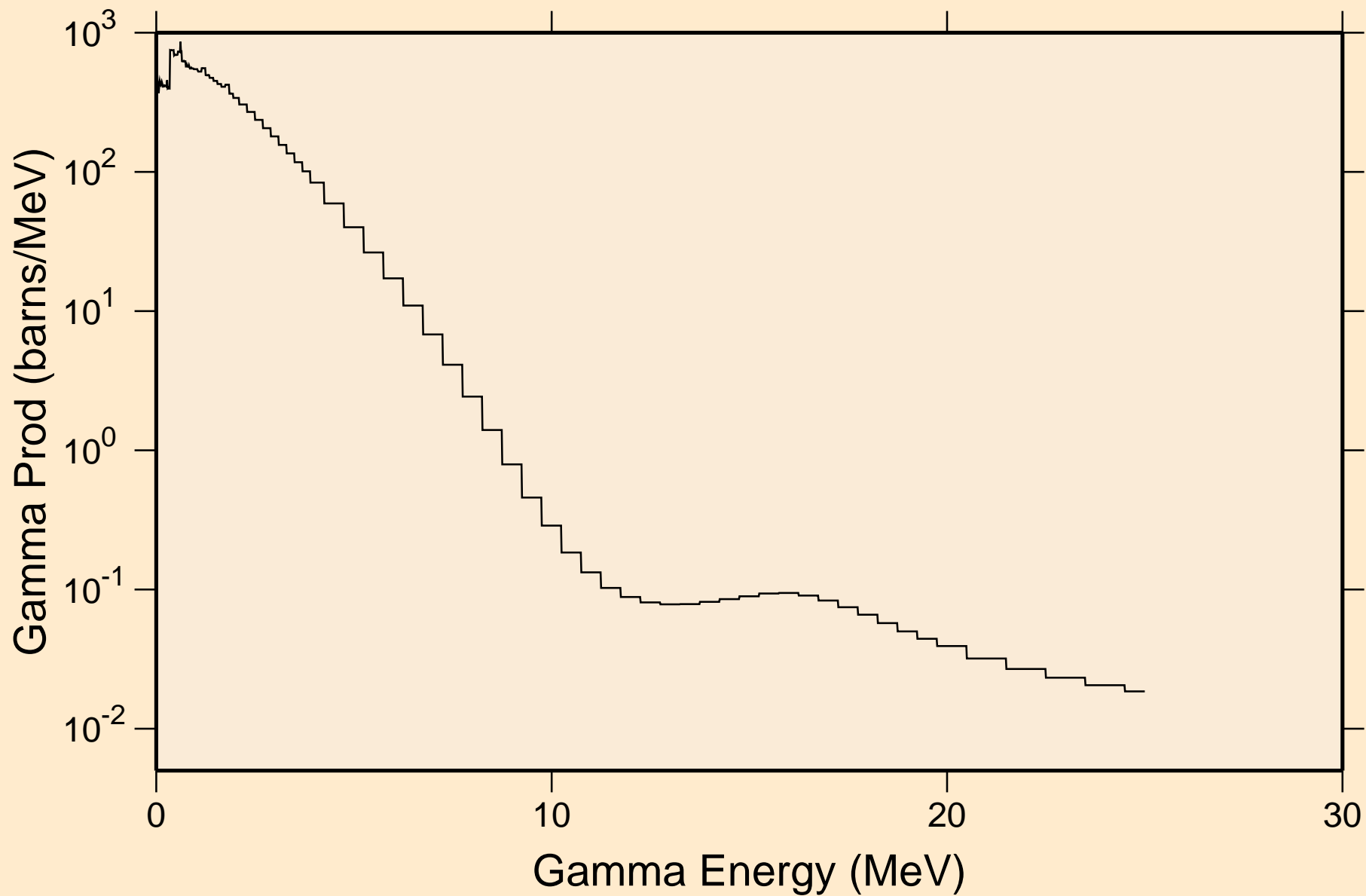

RB082 NEUTRON ACER TENDL-2019 LIBRARY; T=293.16K  
Particle heating contributions

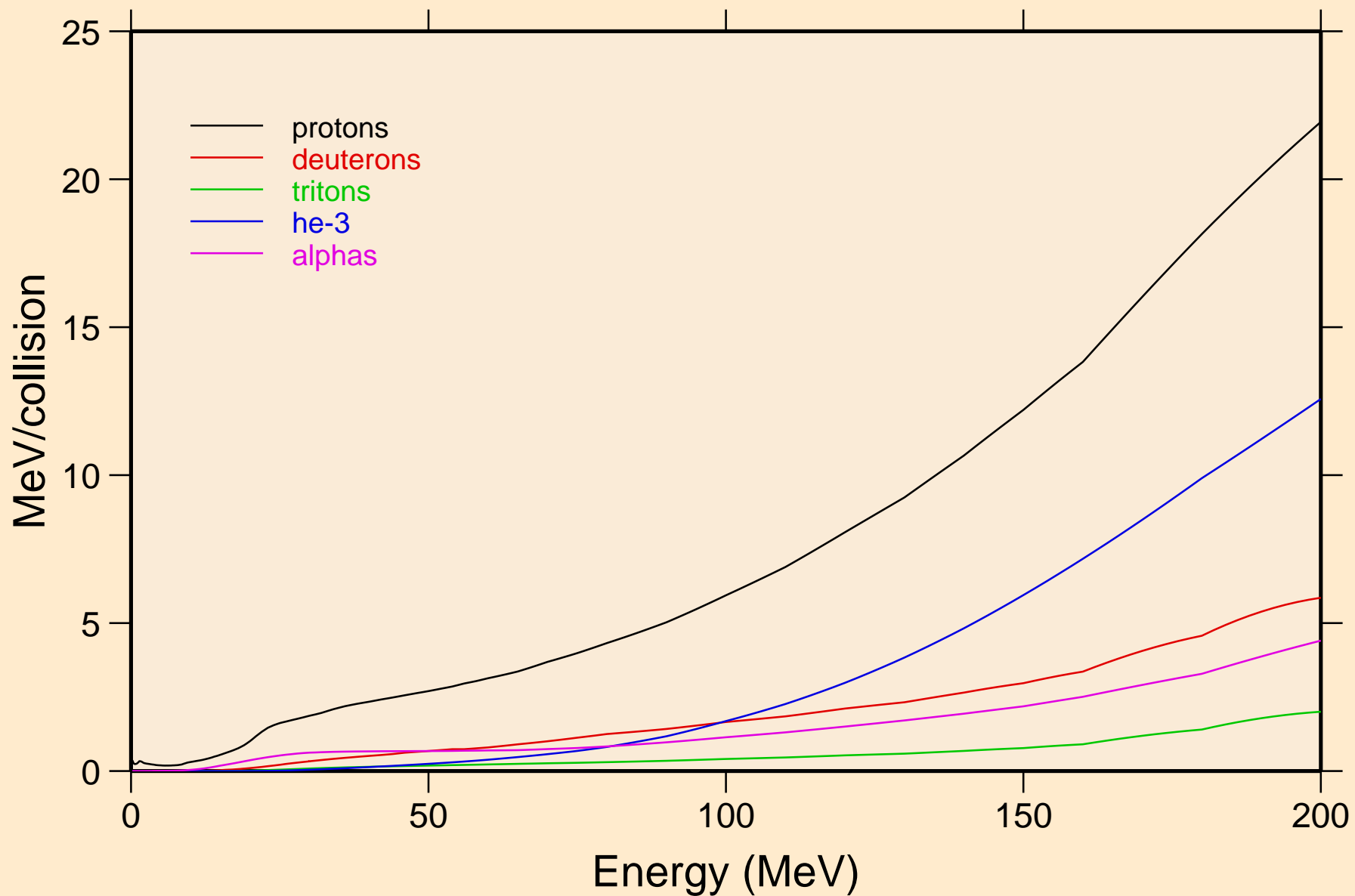

RB082 NEUTRON ACER TENDL-2019 LIBRARY; T=293.16K  
Recoil Heating

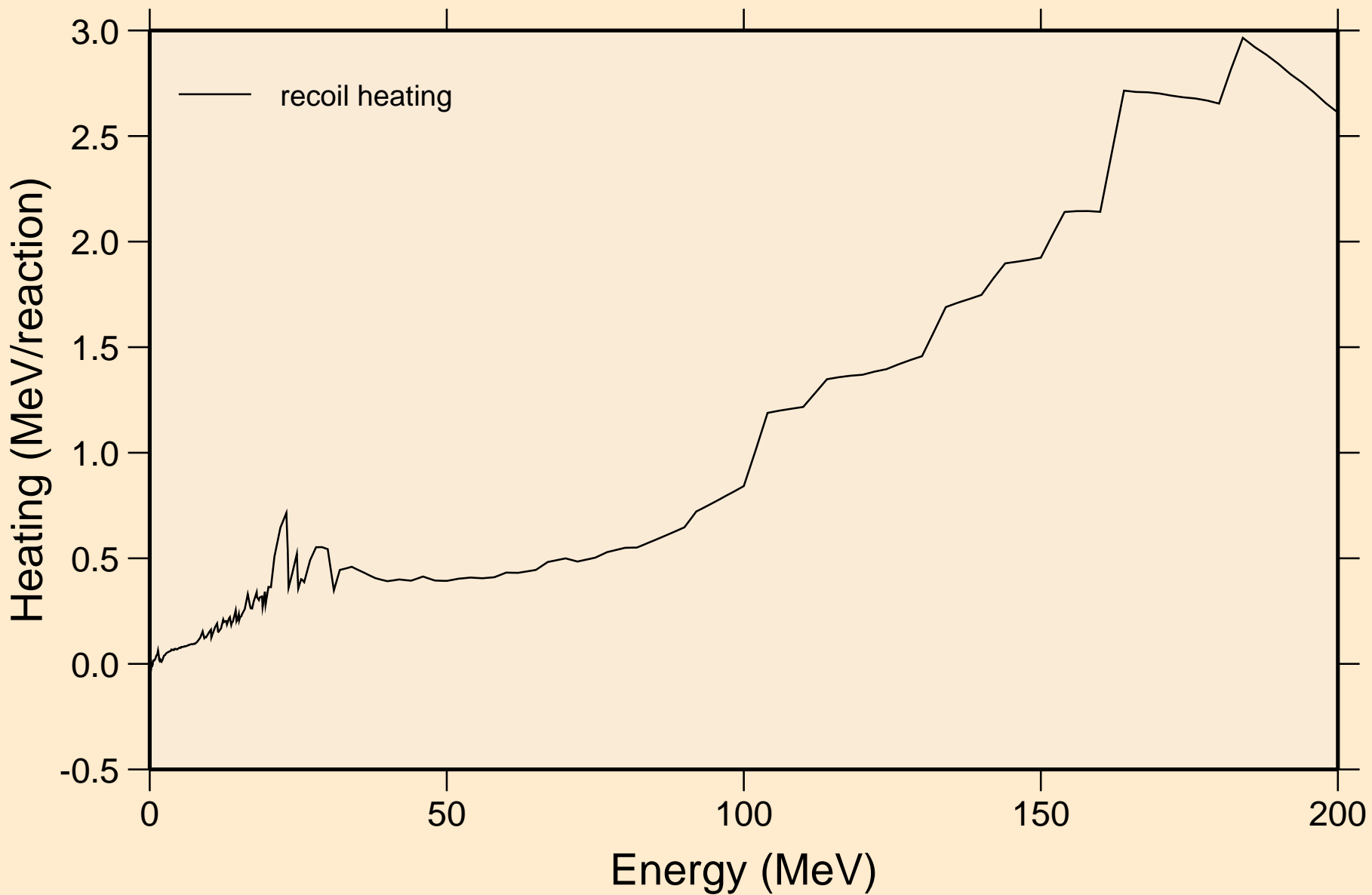

RB082 NEUTRON ACER TENDL-2019 LIBRARY; T=293.16K  
Particle production cross sections

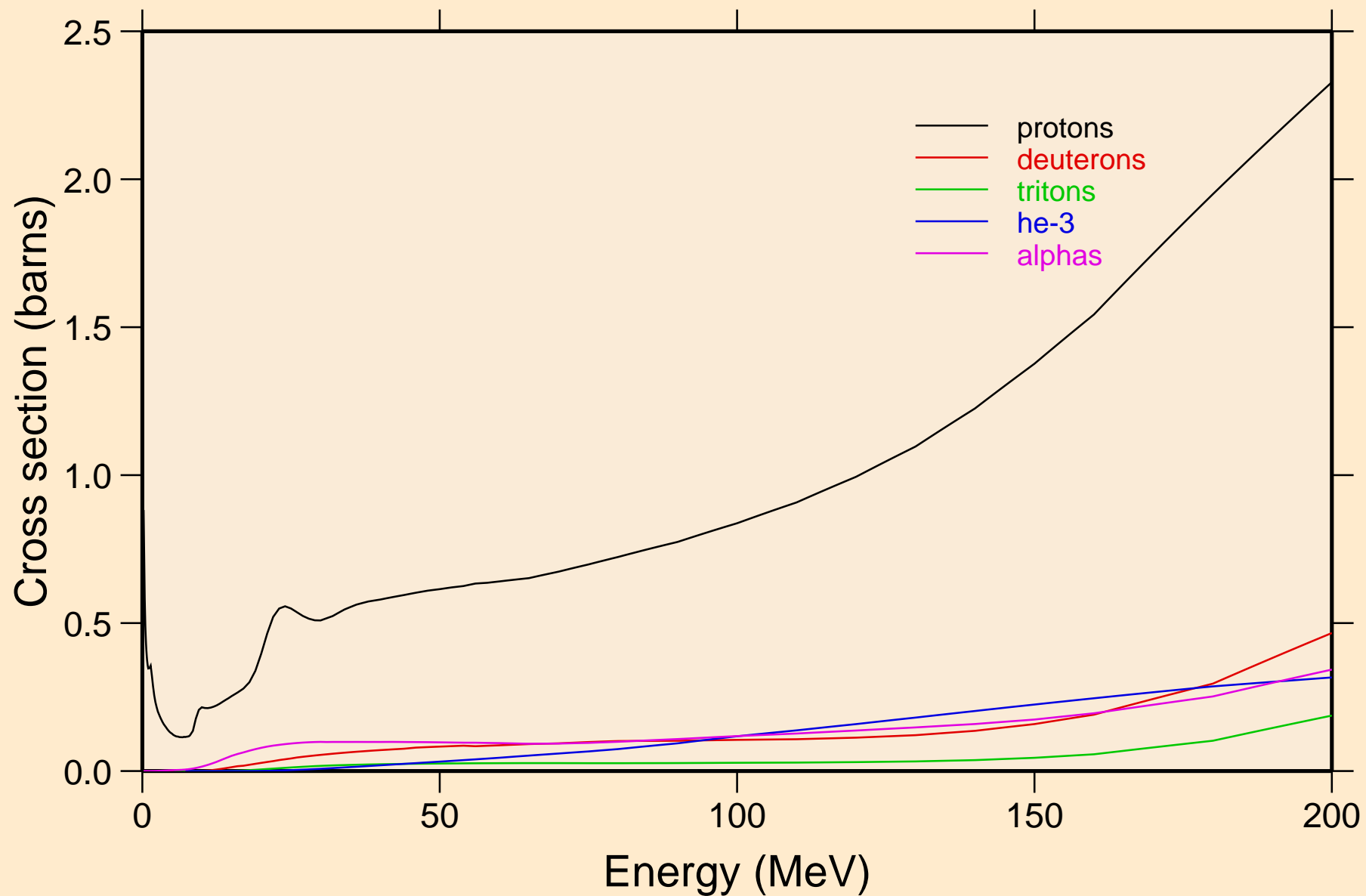

RB082 NEUTRON ACER TENDL-2019 LIBRARY; T=293.16K  
protons from (n,x)

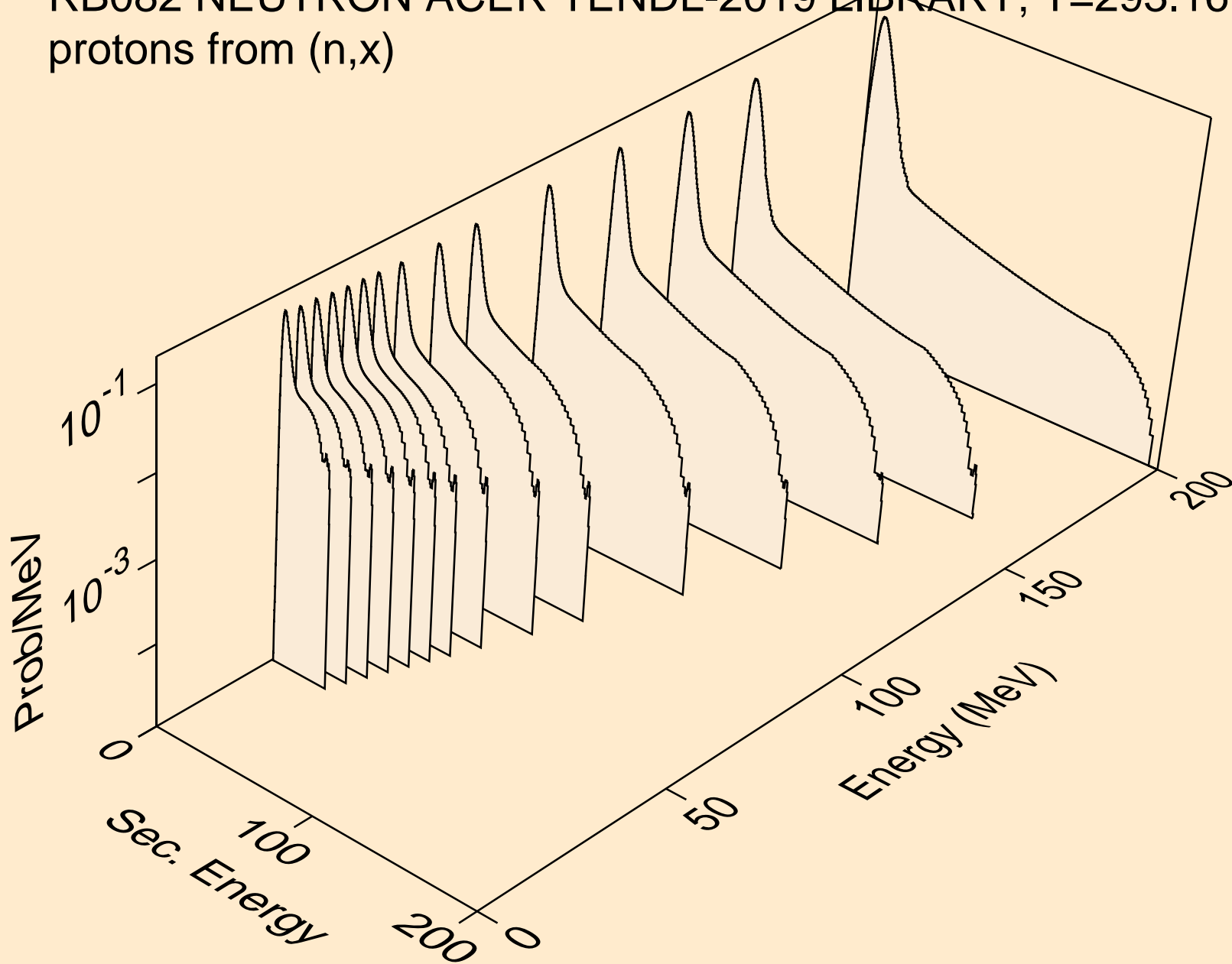

RB082 NEUTRON ACER TENDL-2019 LIBRARY; T=293.16K  
protons from (n,n\*)p

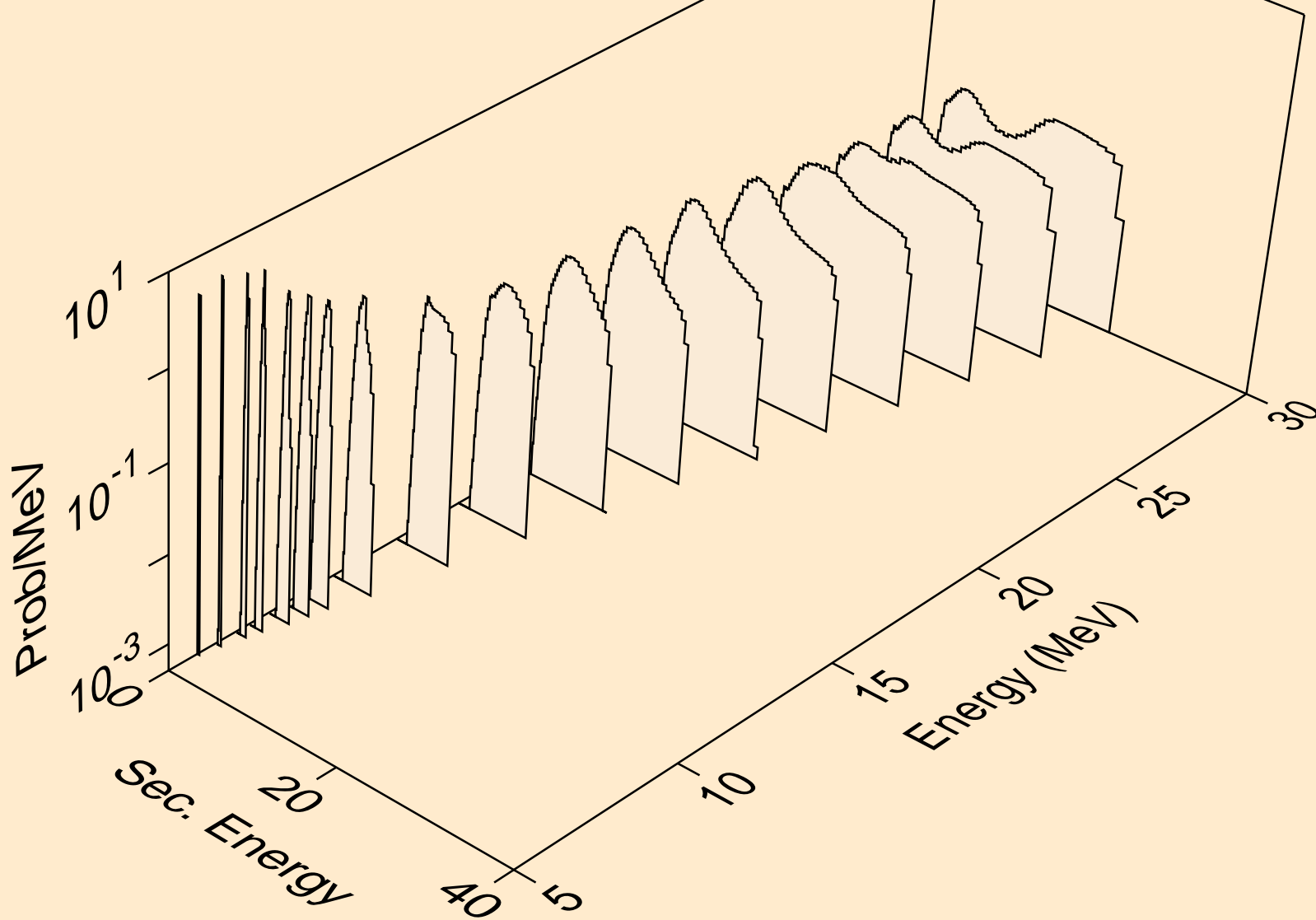

RB082 NEUTRON ACER TENDL-2019 LIBRARY; T=293.16K  
protons from (n,2np)

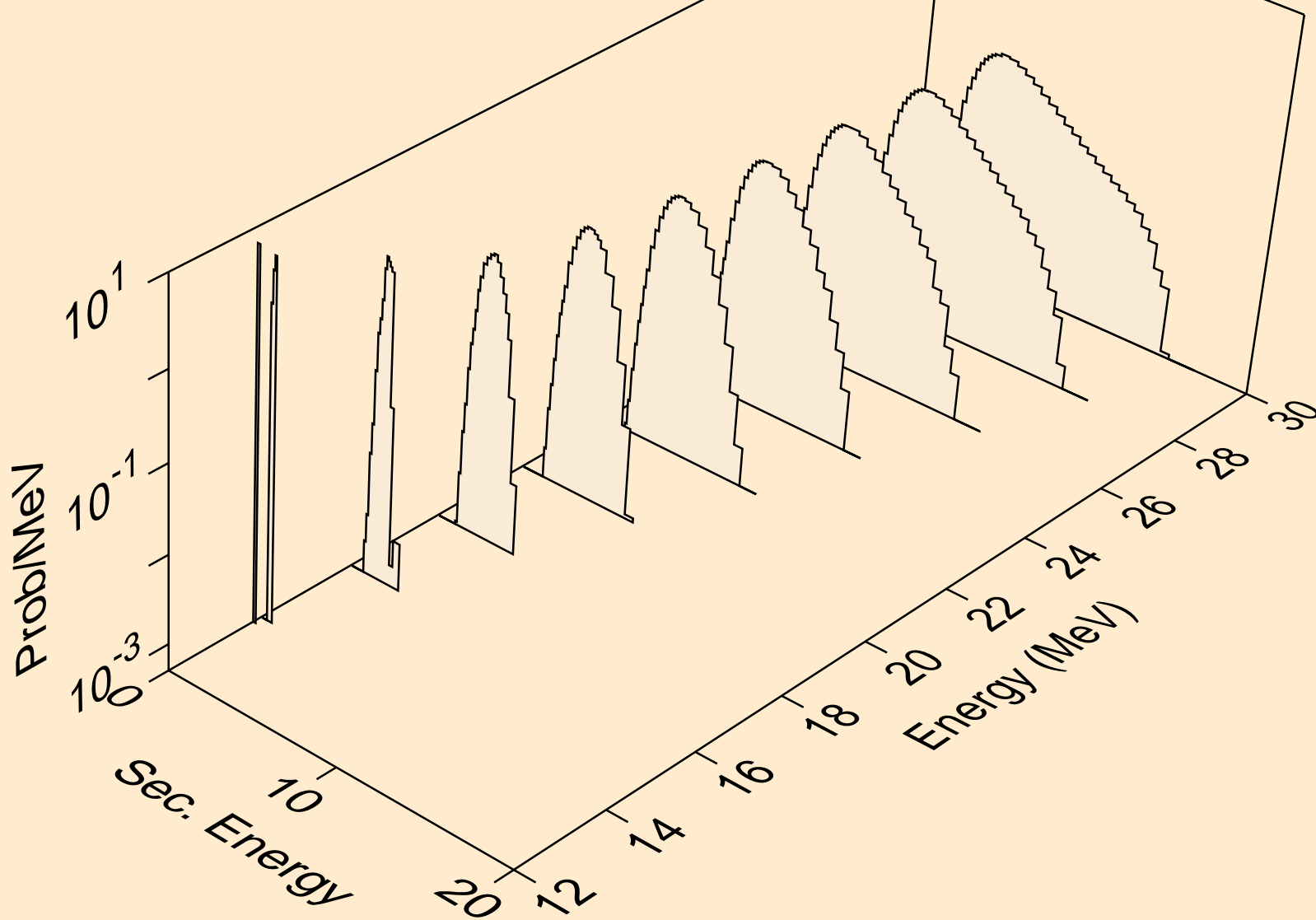

RB082 NEUTRON ACER TENDL-2019 LIBRARY; T=293.16K  
protons from (n,3np)

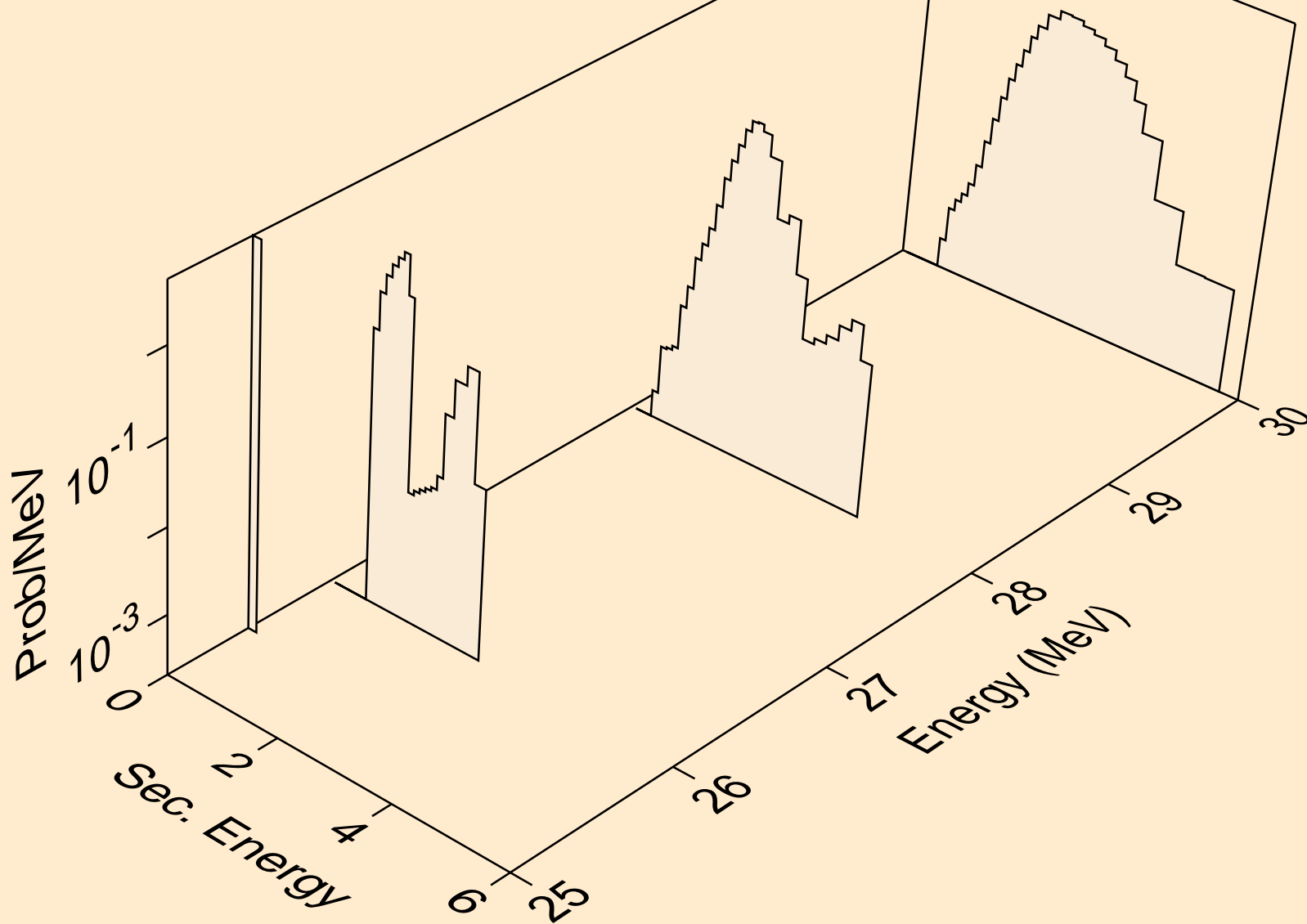



RB082 NEUTRON ACER TENDL-2019 LIBRARY; T=293.16K  
protons from (n,2np)

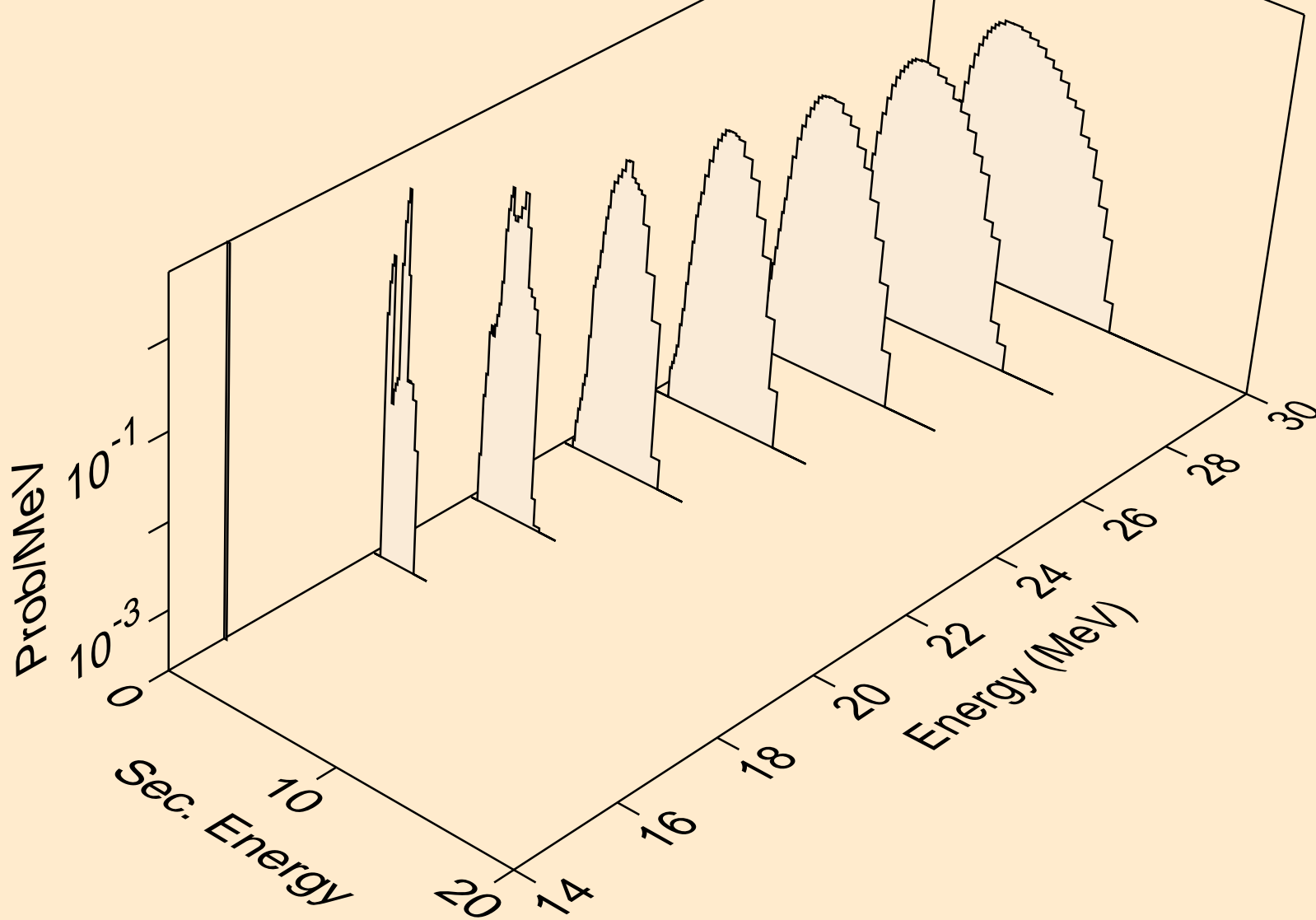

RB082 NEUTRON ACER TENDL-2019 LIBRARY; T=293.16K  
protons from (n,npa)

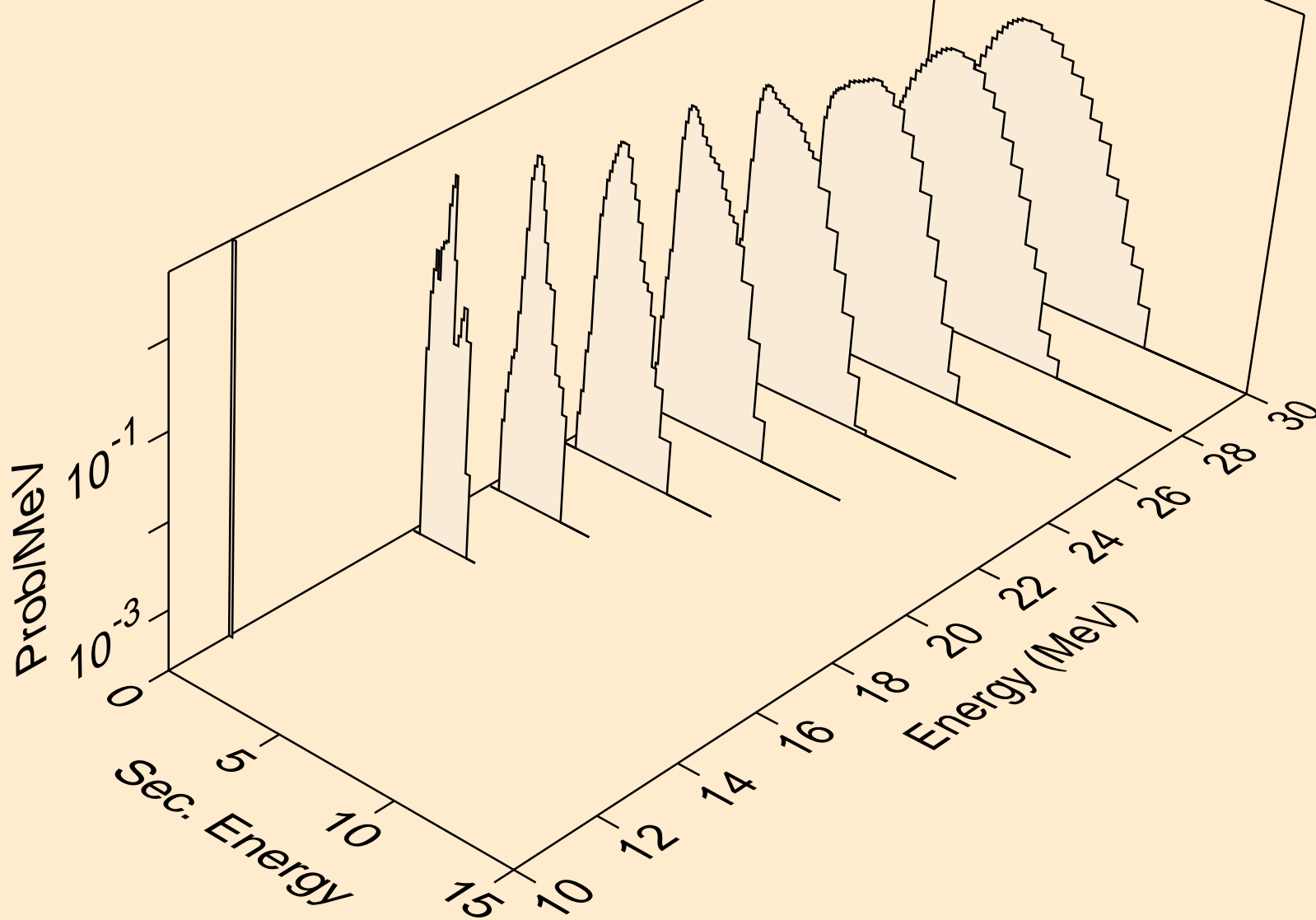

RB082 NEUTRON ACER TENDL-2019 LIBRARY; T=293.16K  
protons from (n,p)

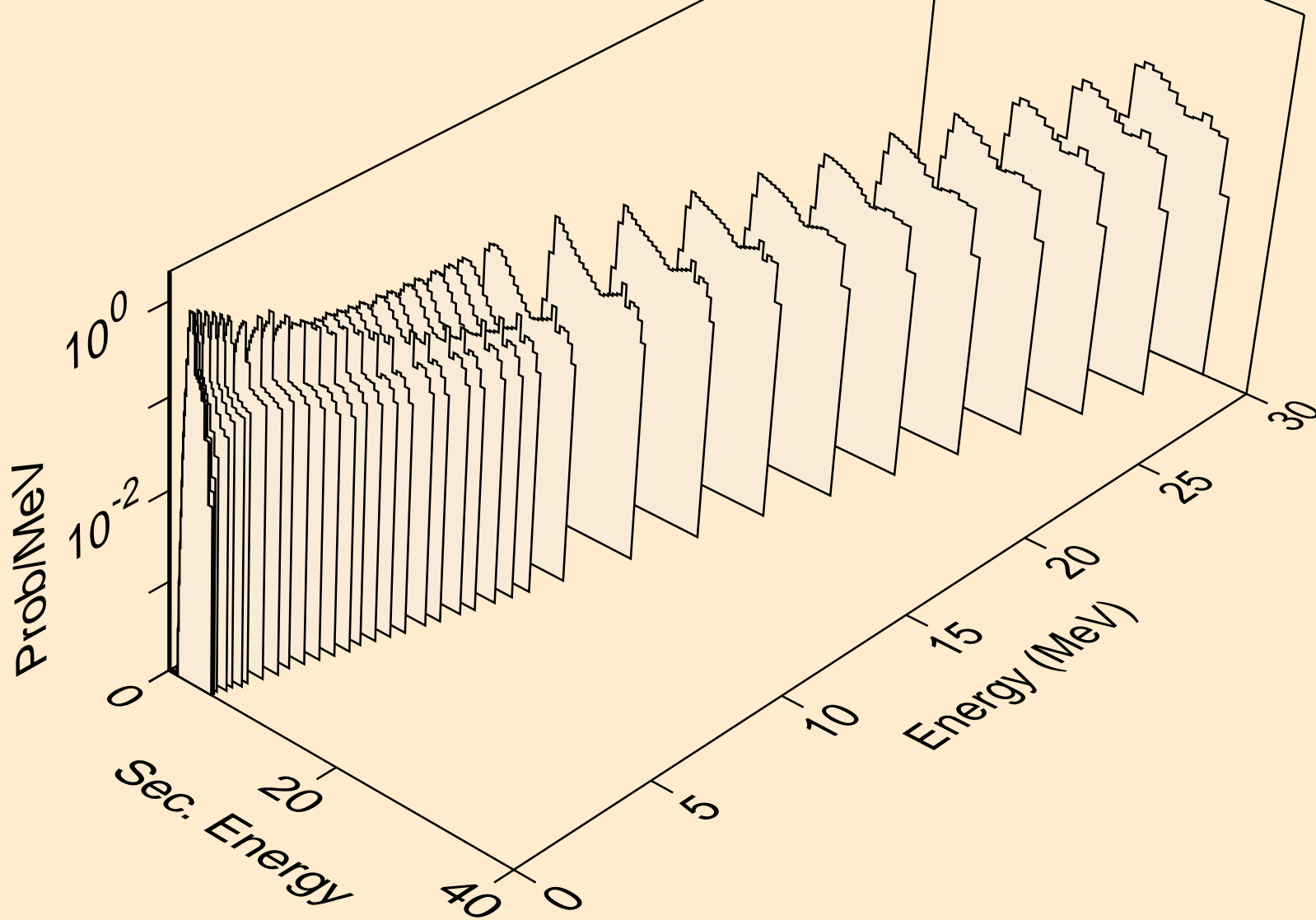

RB082 NEUTRON ACER TENDL-2019 LIBRARY; T=293.16K  
protons from (n,2p)

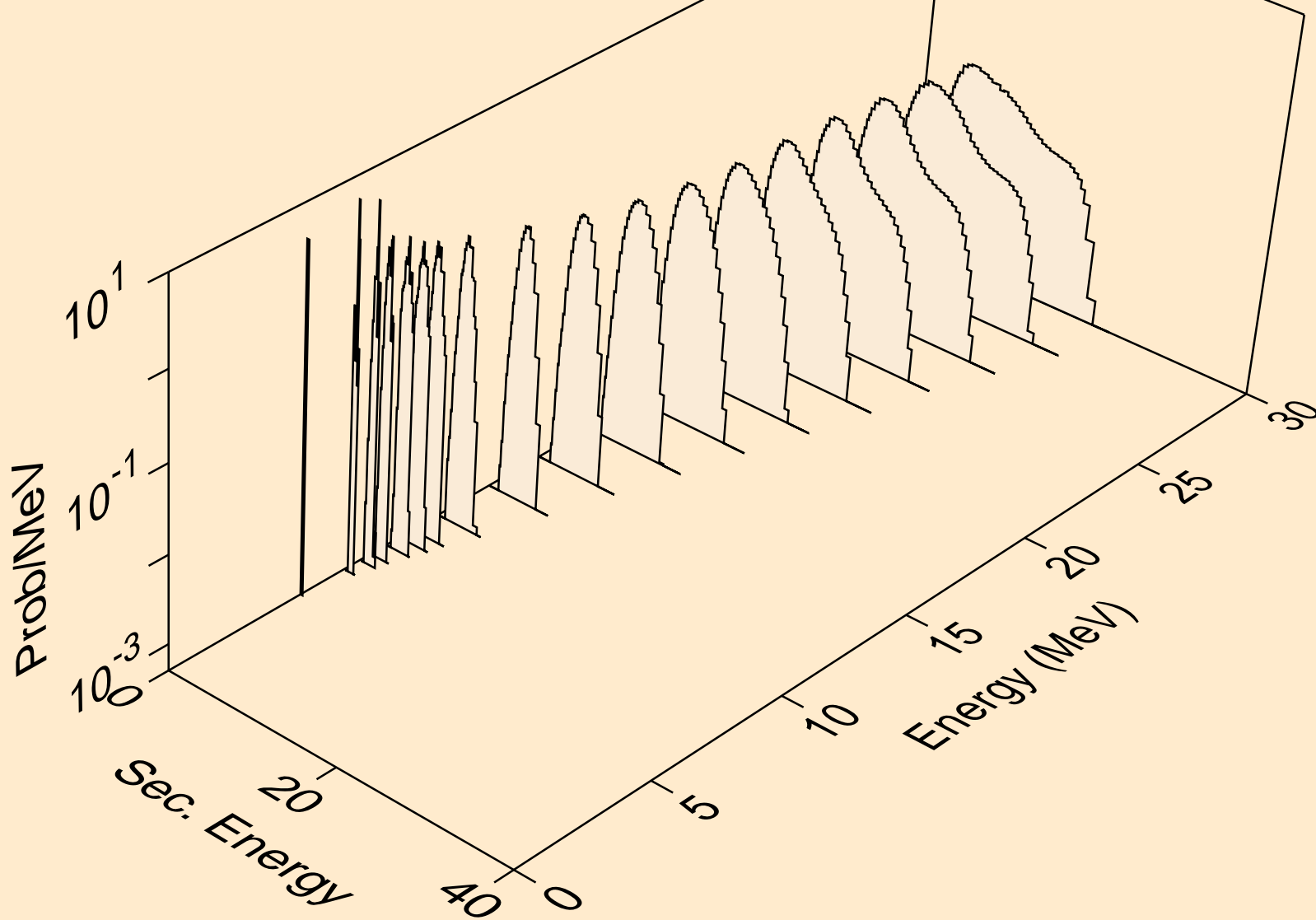

RB082 NEUTRON ACER TENDL-2019 LIBRARY; T=293.16K  
protons from (n,p)

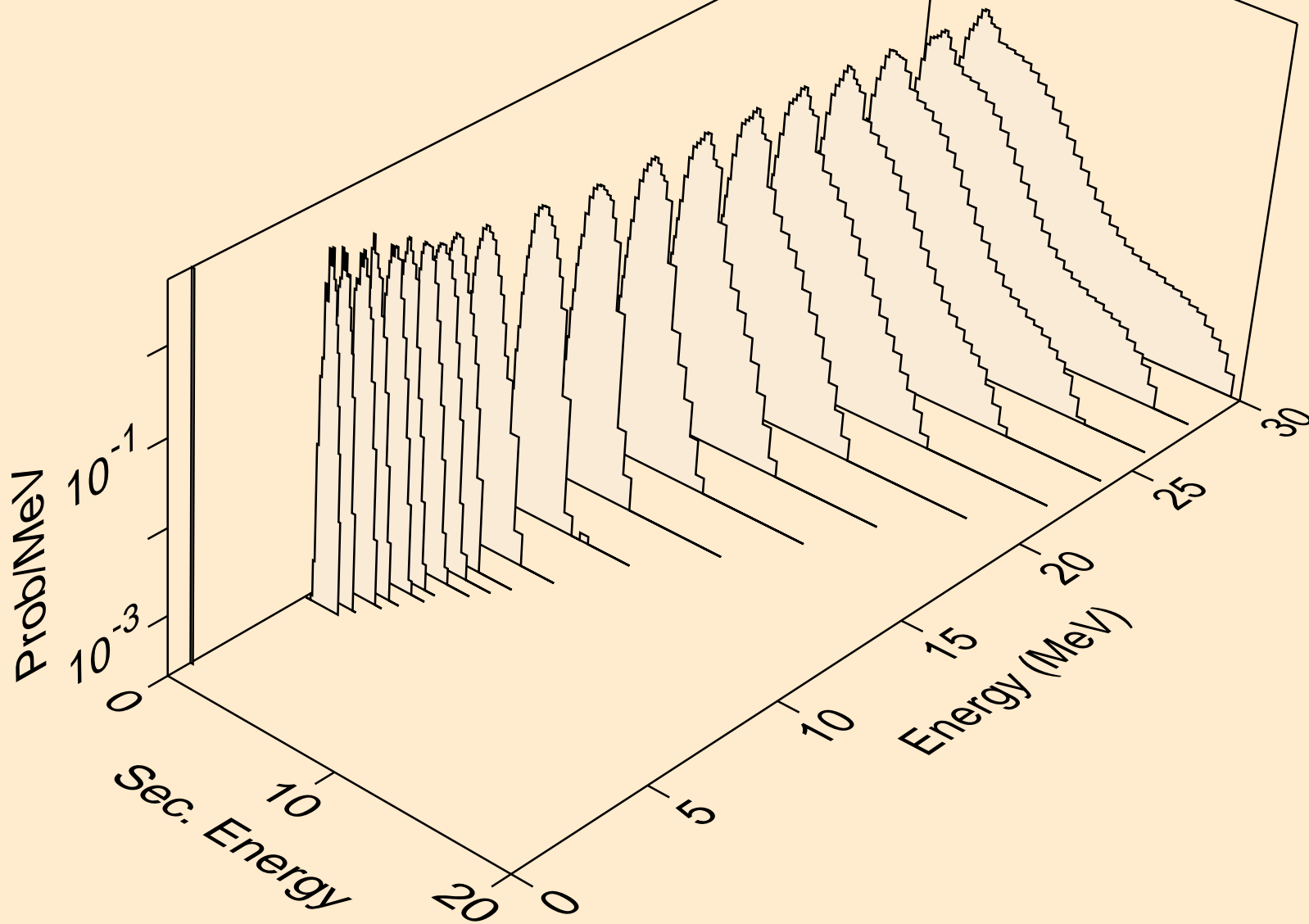

RB082 NEUTRON ACER TENDL-2019 LIBRARY; T=293.16K  
protons from (n,pd)

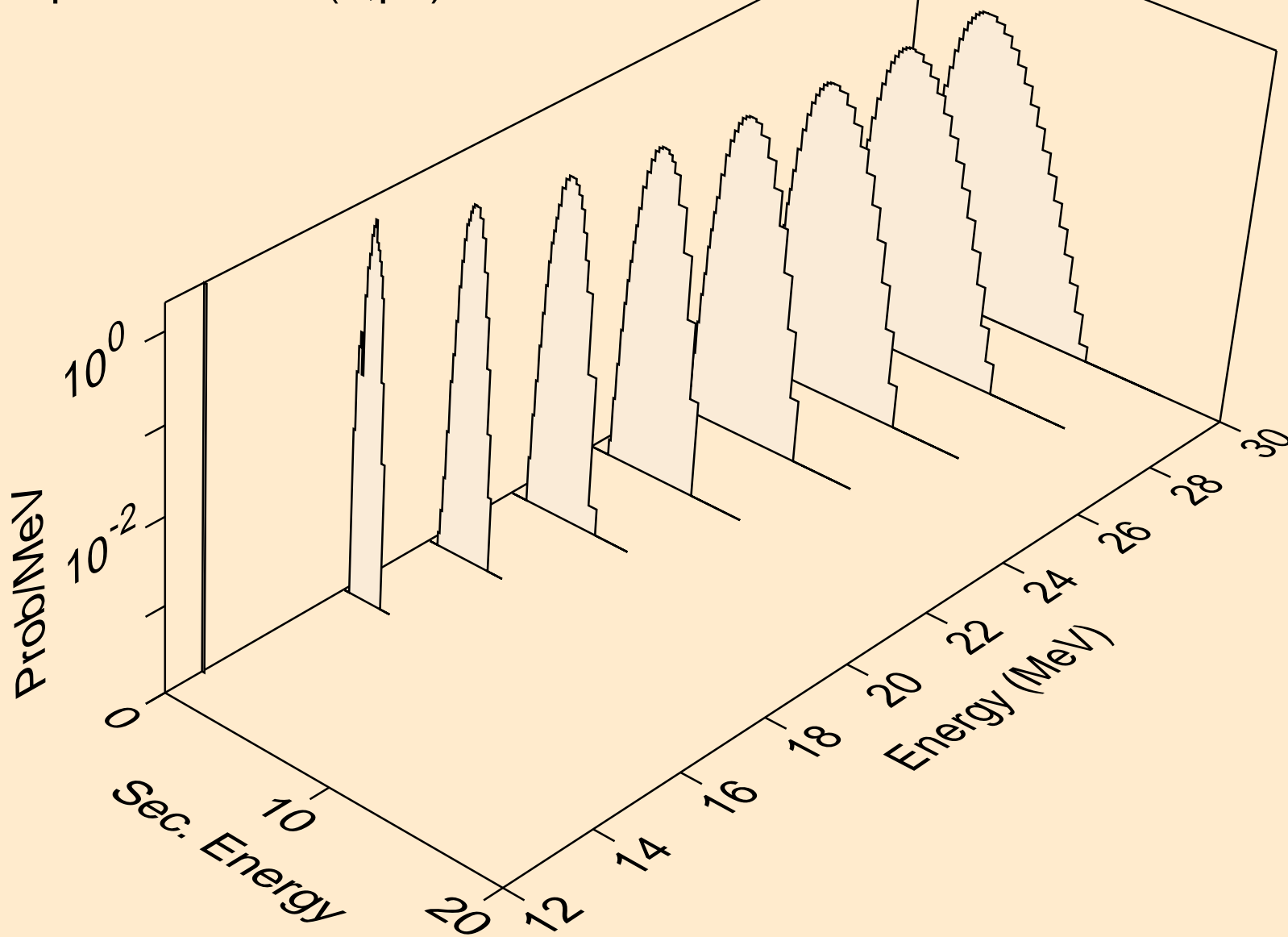

RB082 NEUTRON ACER TENDL-2019 LIBRARY; T=293.16K  
protons from (n,pt)

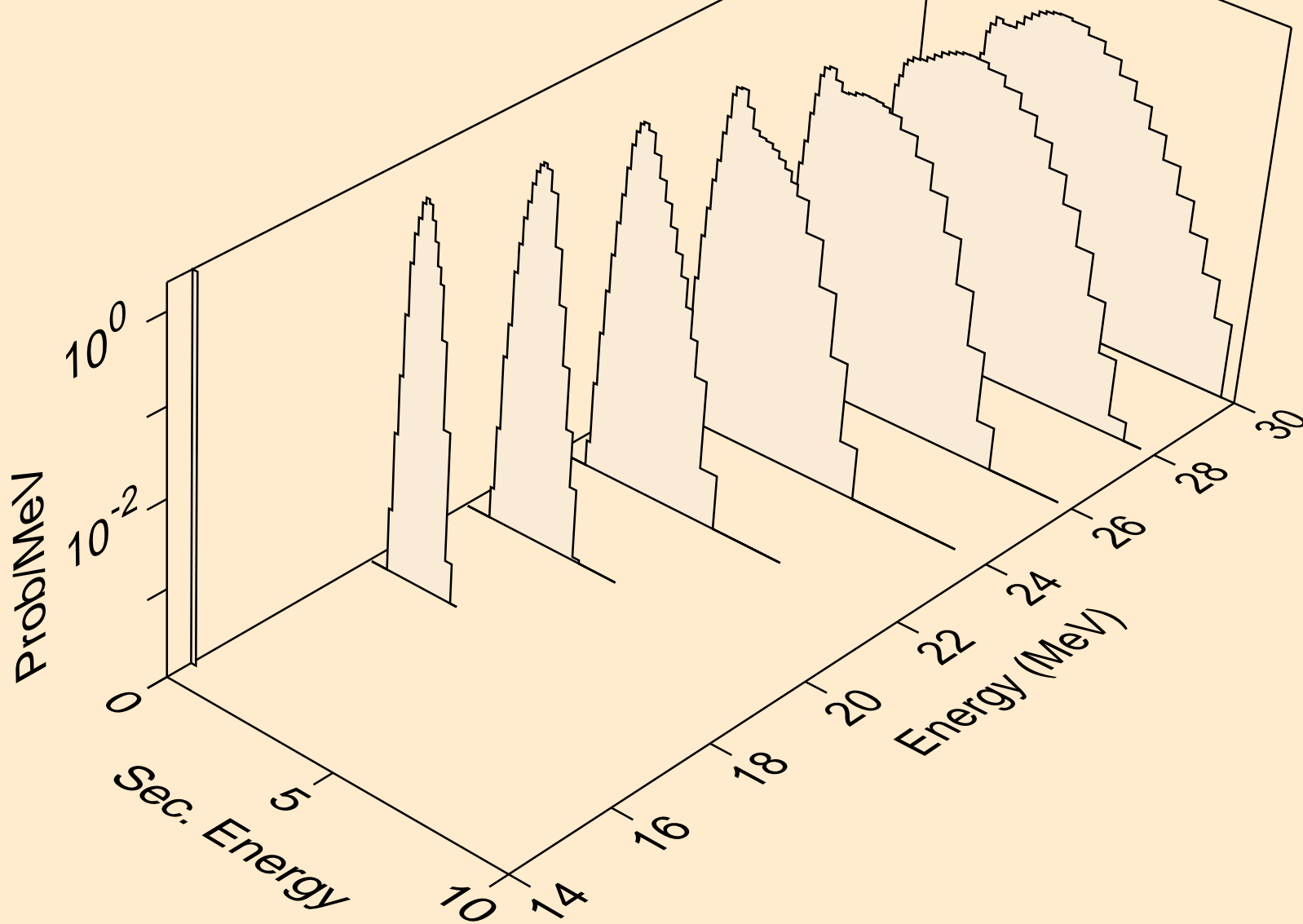

RB082 NEUTRON ACER TENDL-2019 LIBRARY; T=293.16K  
deuterons from (n,x)

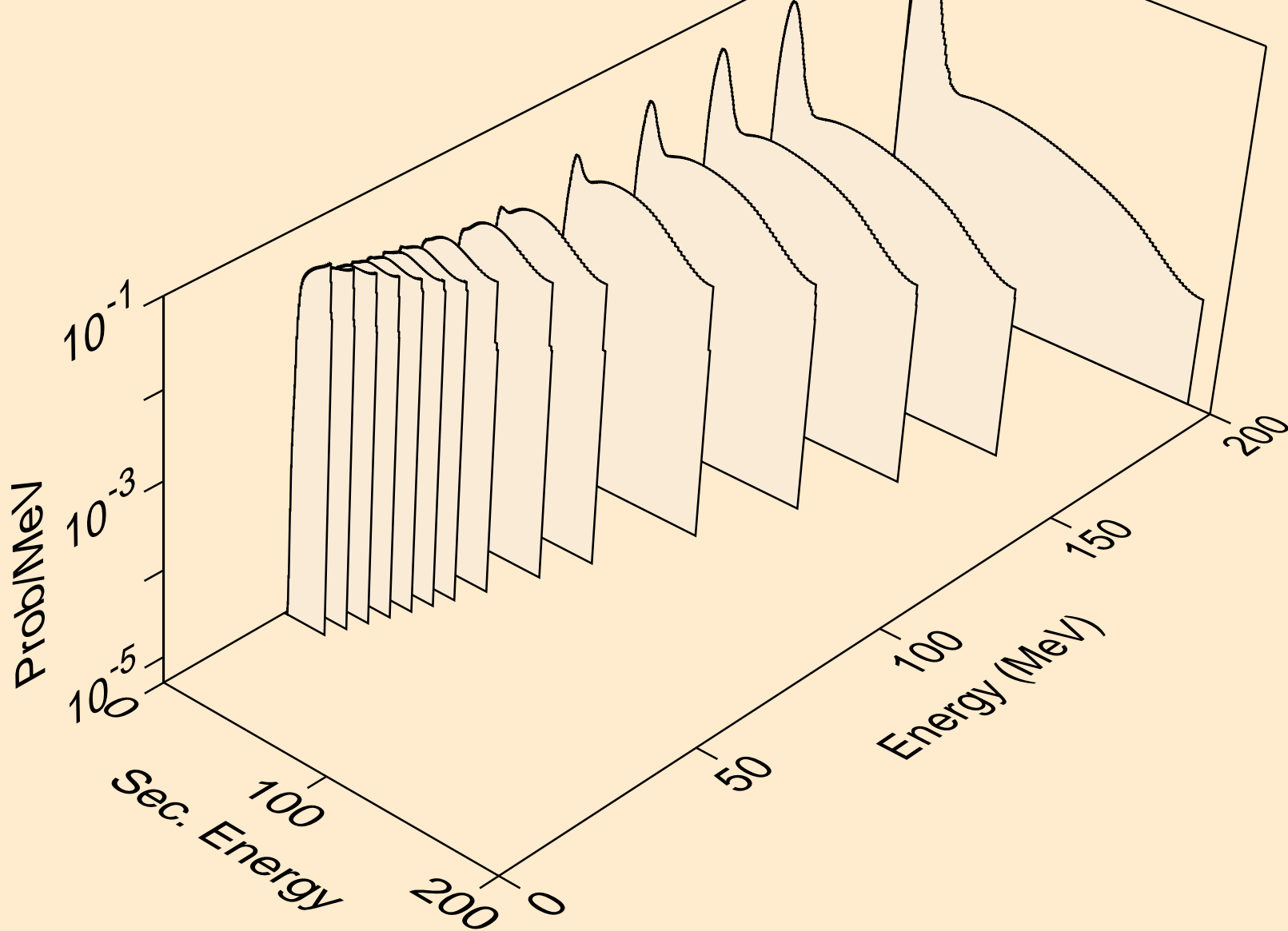



RB082 NEUTRON ACER TENDL-2019 LIBRARY; T=293.16K  
deuterons from (n,2nd)

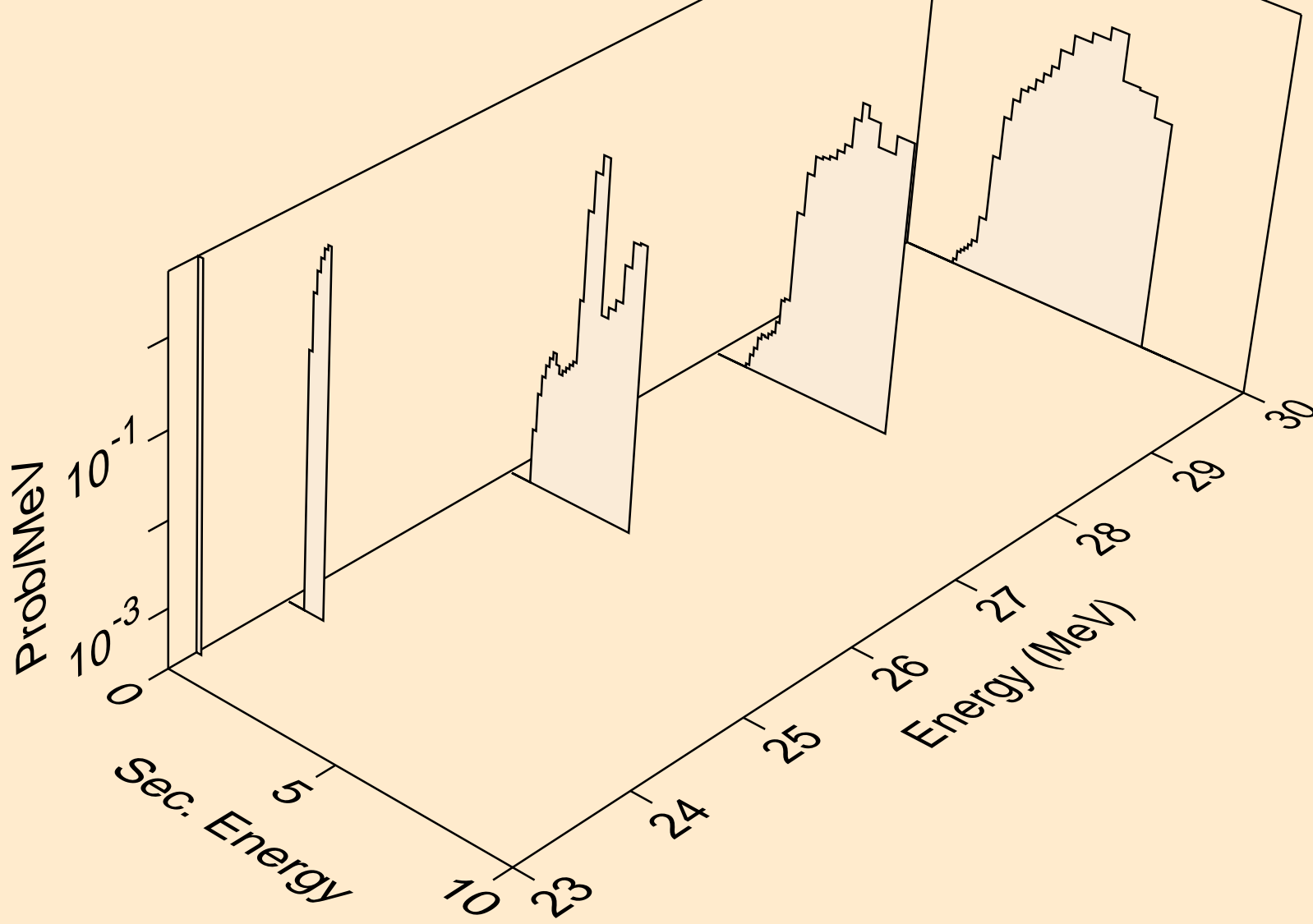

RB082 NEUTRON ACER TENDL-2019 LIBRARY; T=293.16K  
deuterons from (n,n\*)d

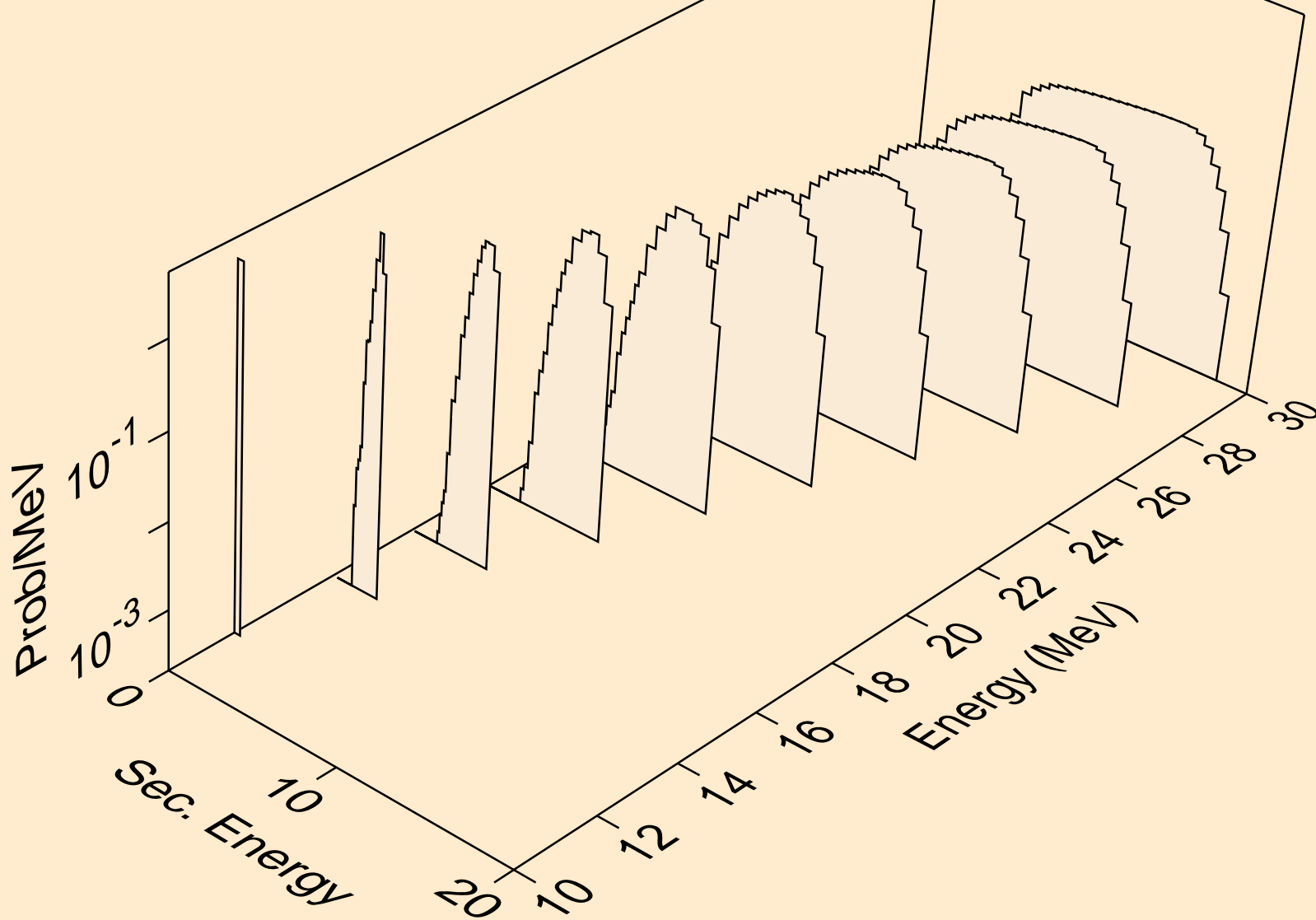

RB082 NEUTRON ACER TENDL-2019 LIBRARY; T=293.16K  
deuterons from (n,d)

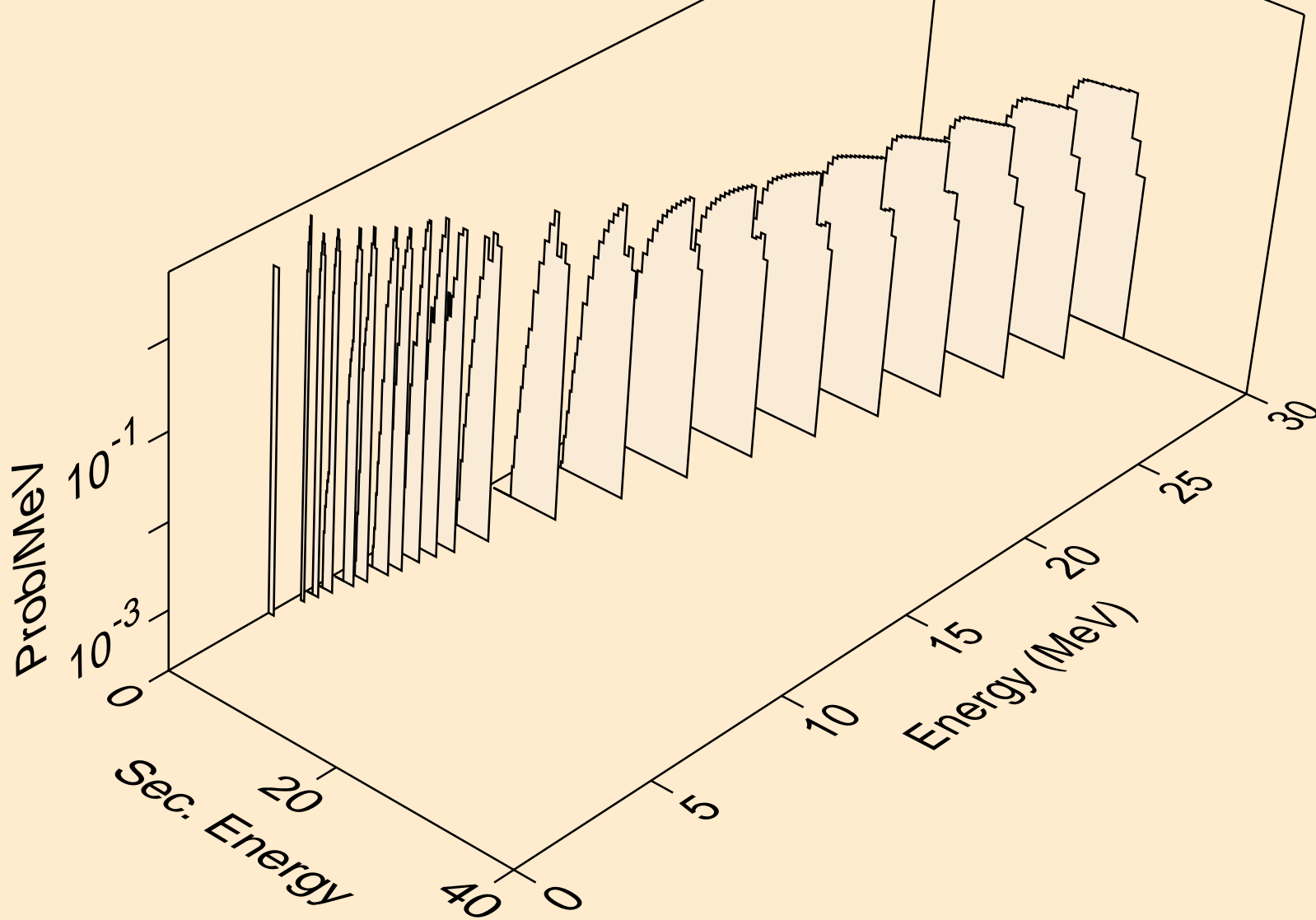

RB082 NEUTRON ACER TENDL-2019 LIBRARY; T=293.16K  
deuterons from (n,pd)

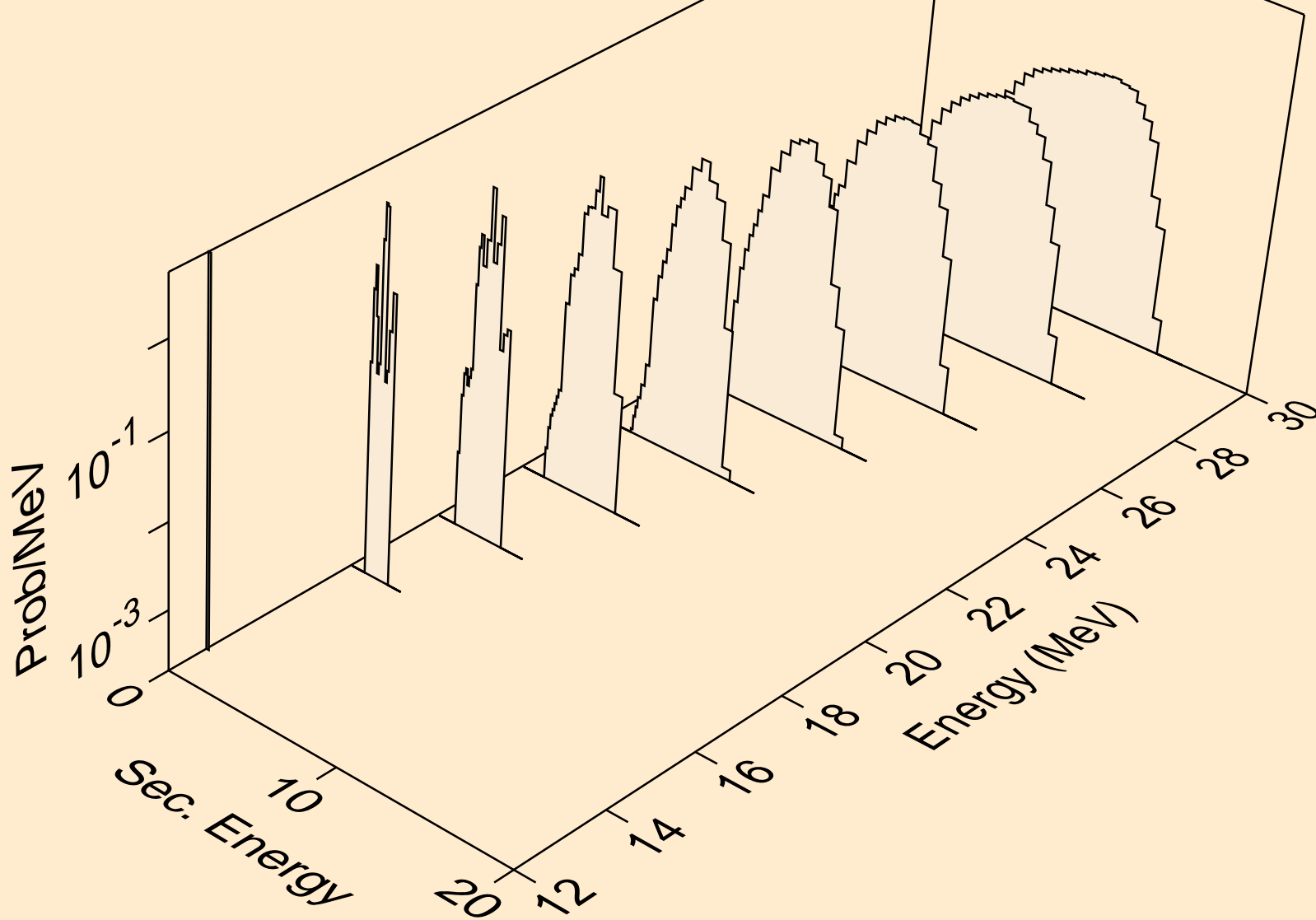

RB082 NEUTRON ACER TENDL-2019 LIBRARY; T=293.16K  
deuterons from (n,da)

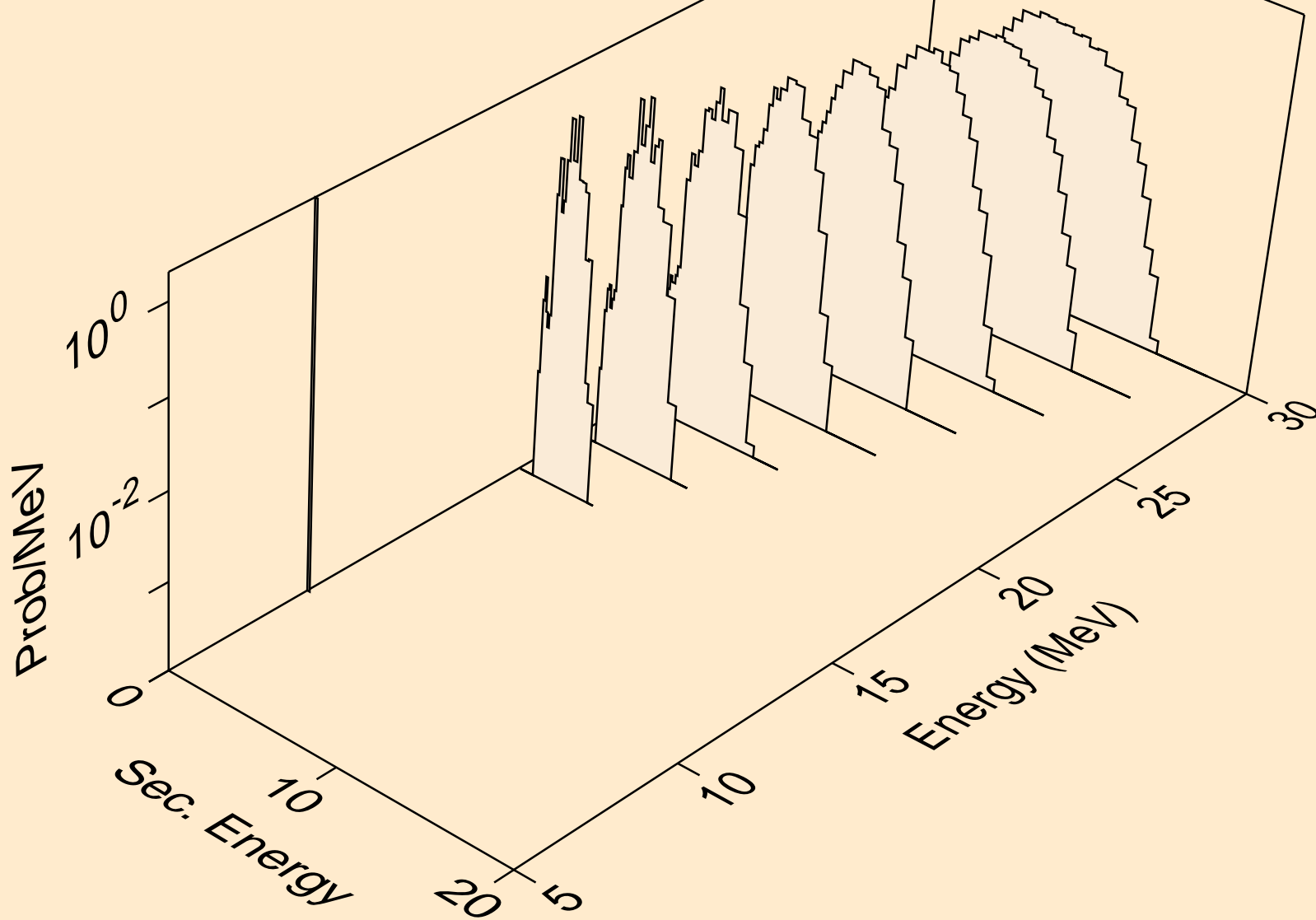

RB082 NEUTRON ACER TENDL-2019 LIBRARY; T=293.16K  
tritons from (n,x)

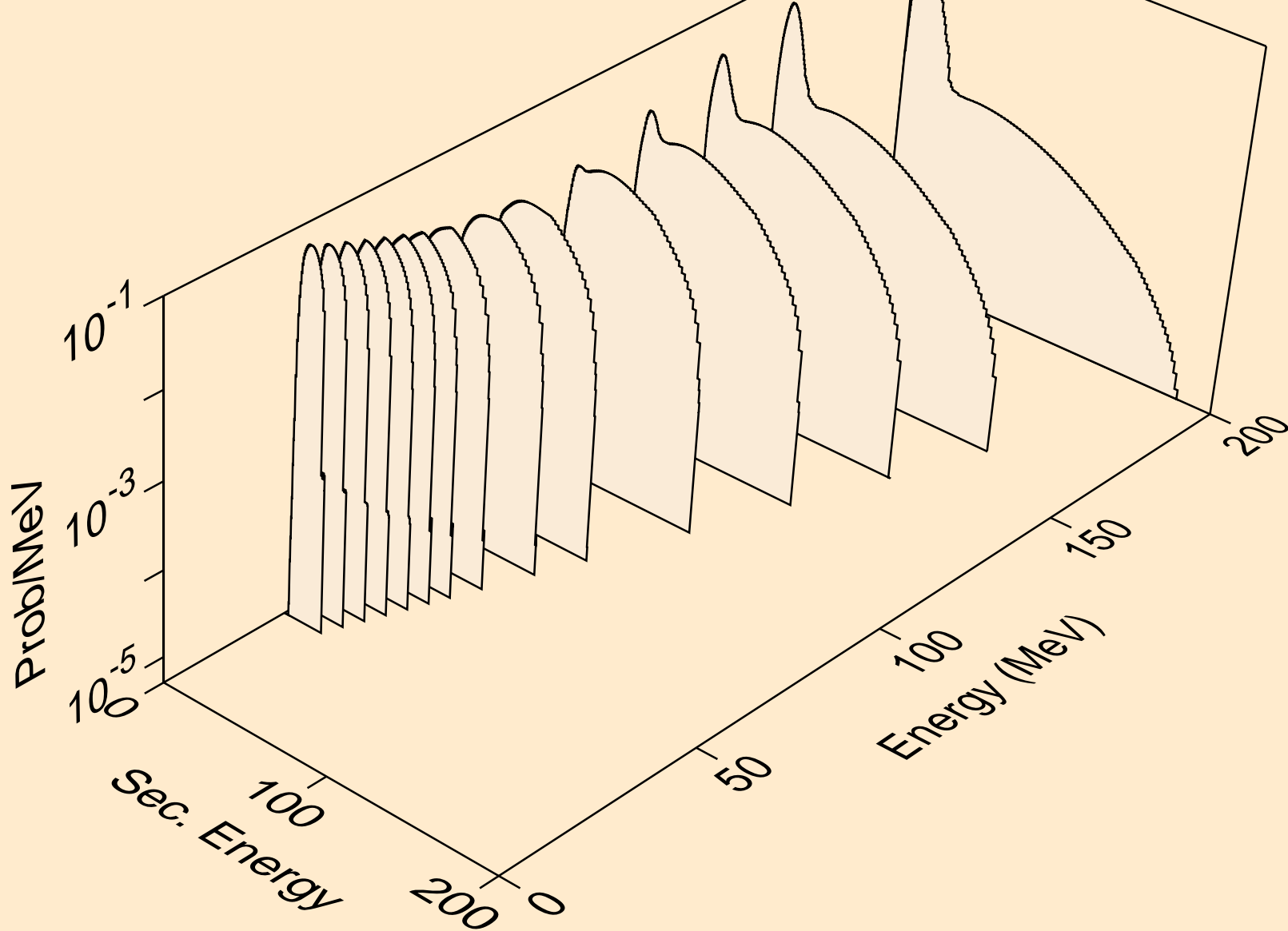

RB082 NEUTRON ACER TENDL-2019 LIBRARY; T=293.16K  
tritons from (n,n\*)t

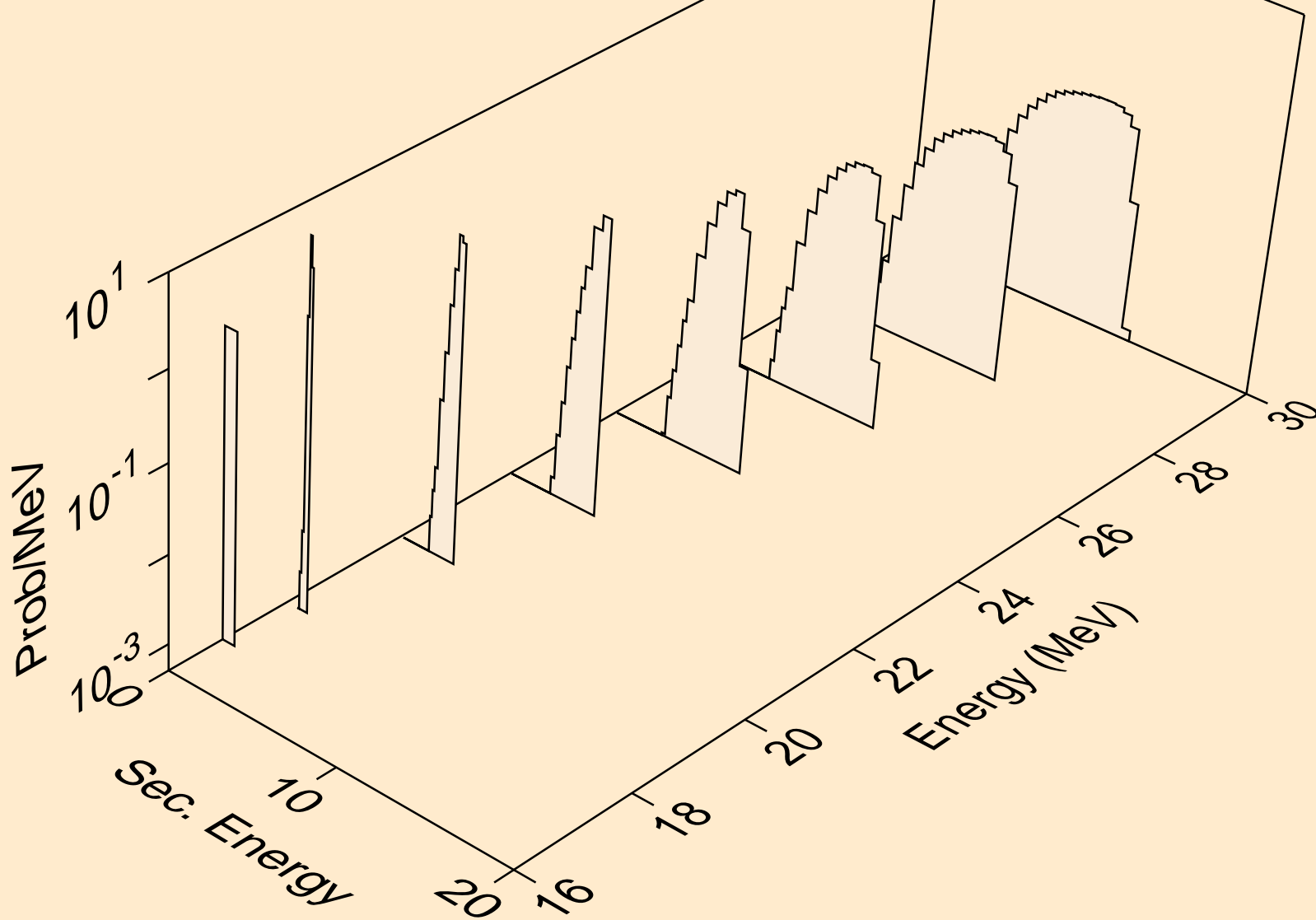

RB082 NEUTRON ACER TENDL-2019 LIBRARY; T=293.16K  
tritons from (n,t)

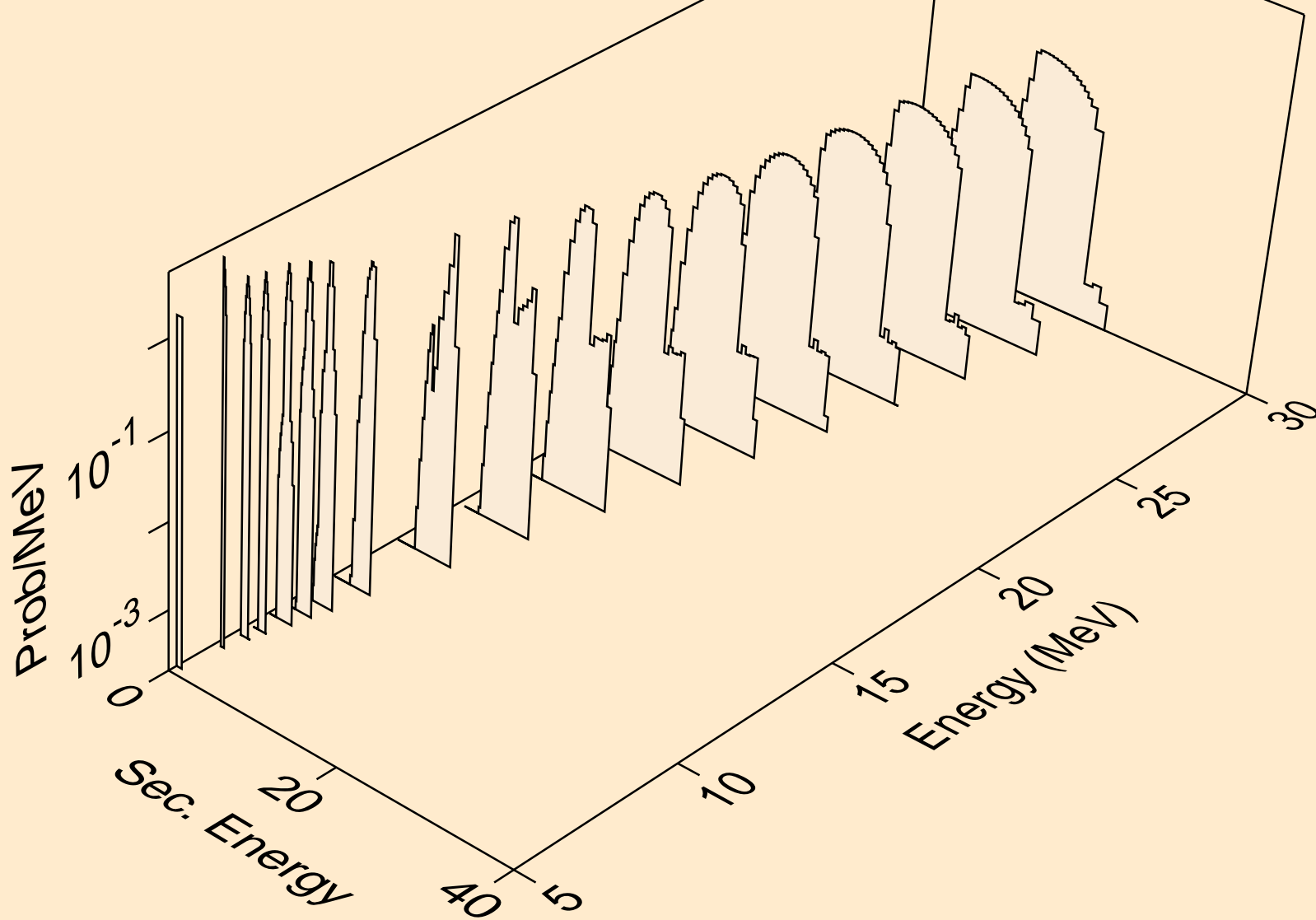



RB082 NEUTRON ACER TENDL-2019 LIBRARY; T=293.16K  
tritons from (n,pt)

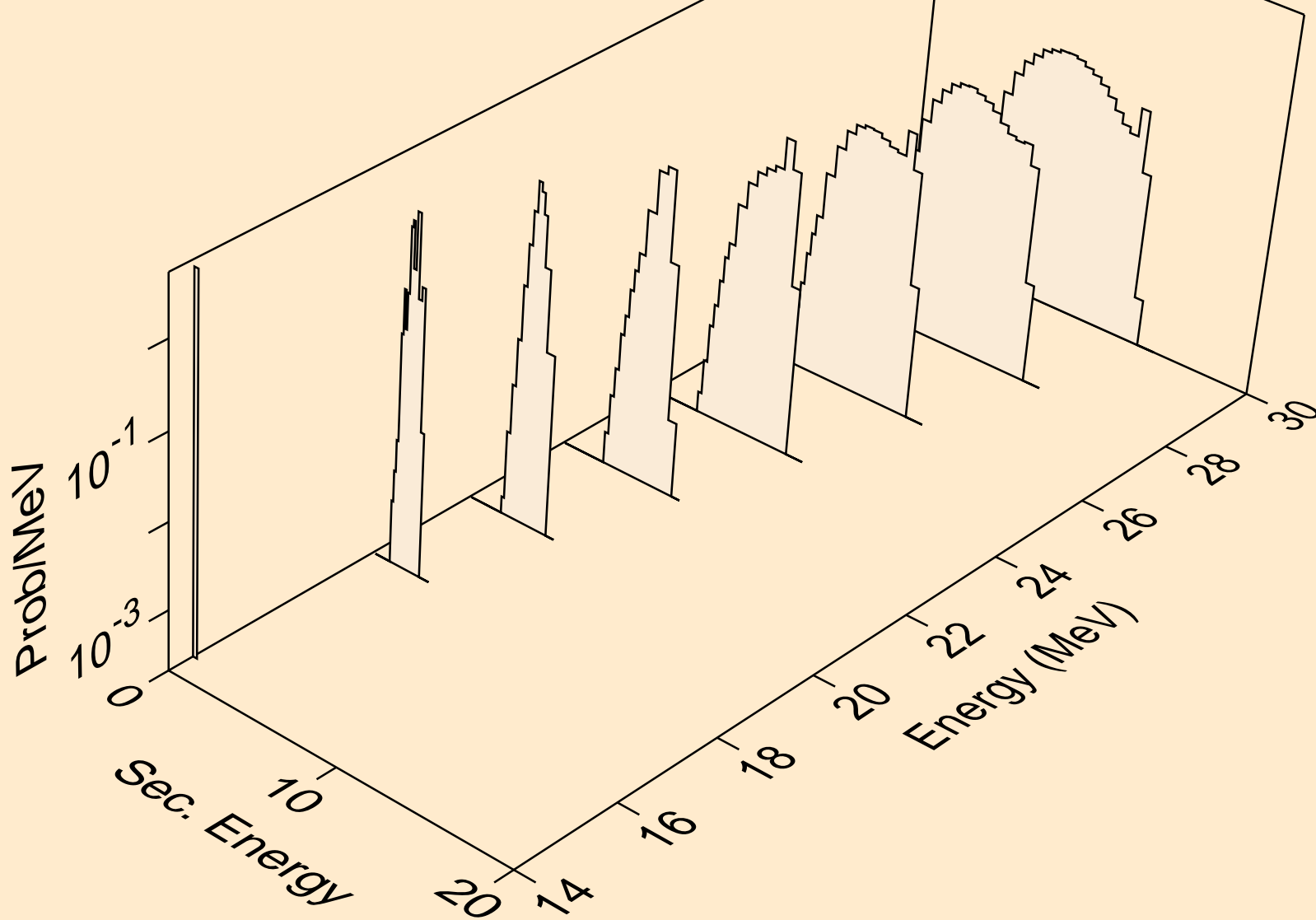

RB082 NEUTRON ACER TENDL-2019 LIBRARY; T=293.16K  
he3s from (n,x)

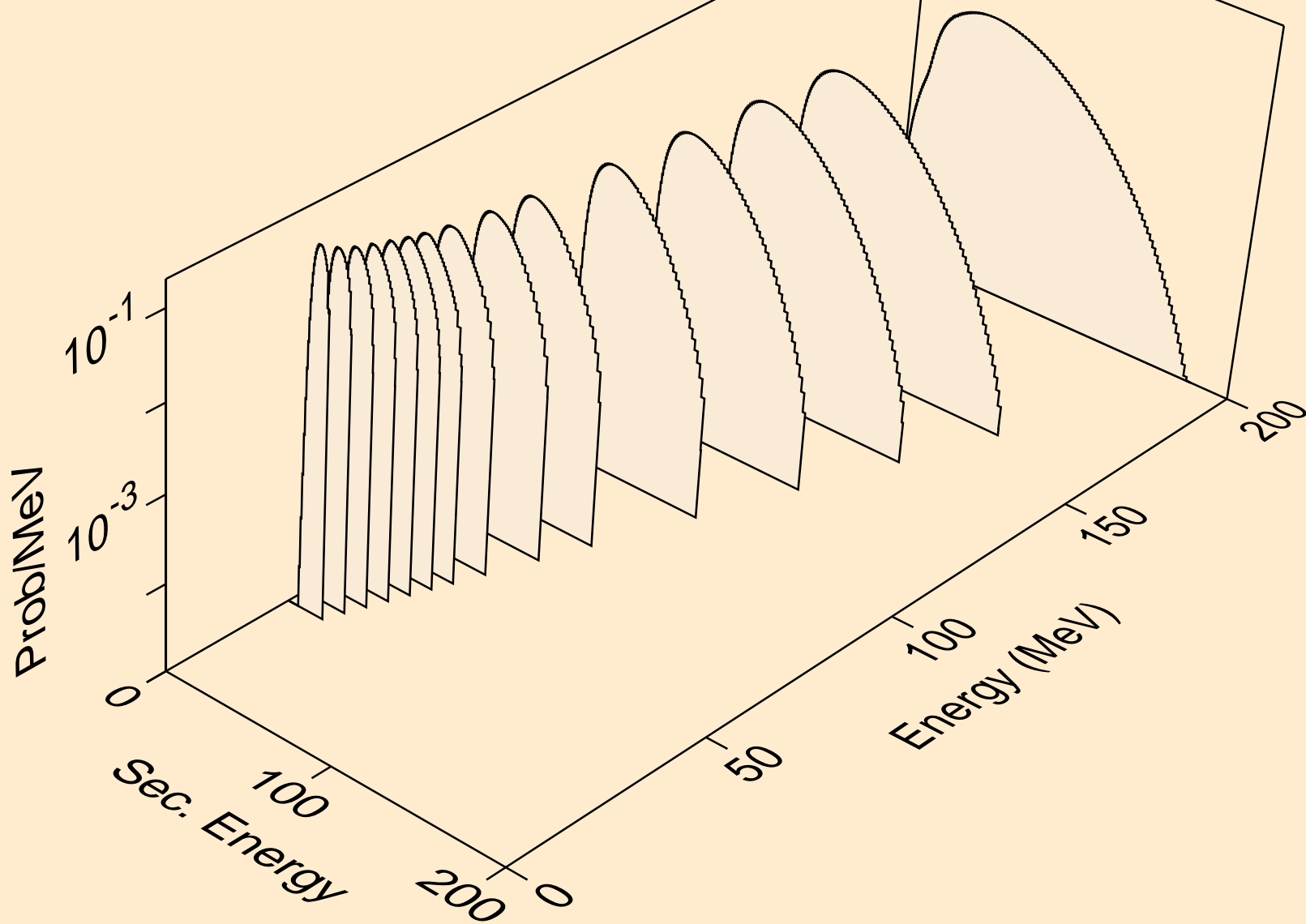

RB082 NEUTRON ACER TENDL-2019 LIBRARY; T=293.16K  
he3s from (n,n\*)he3

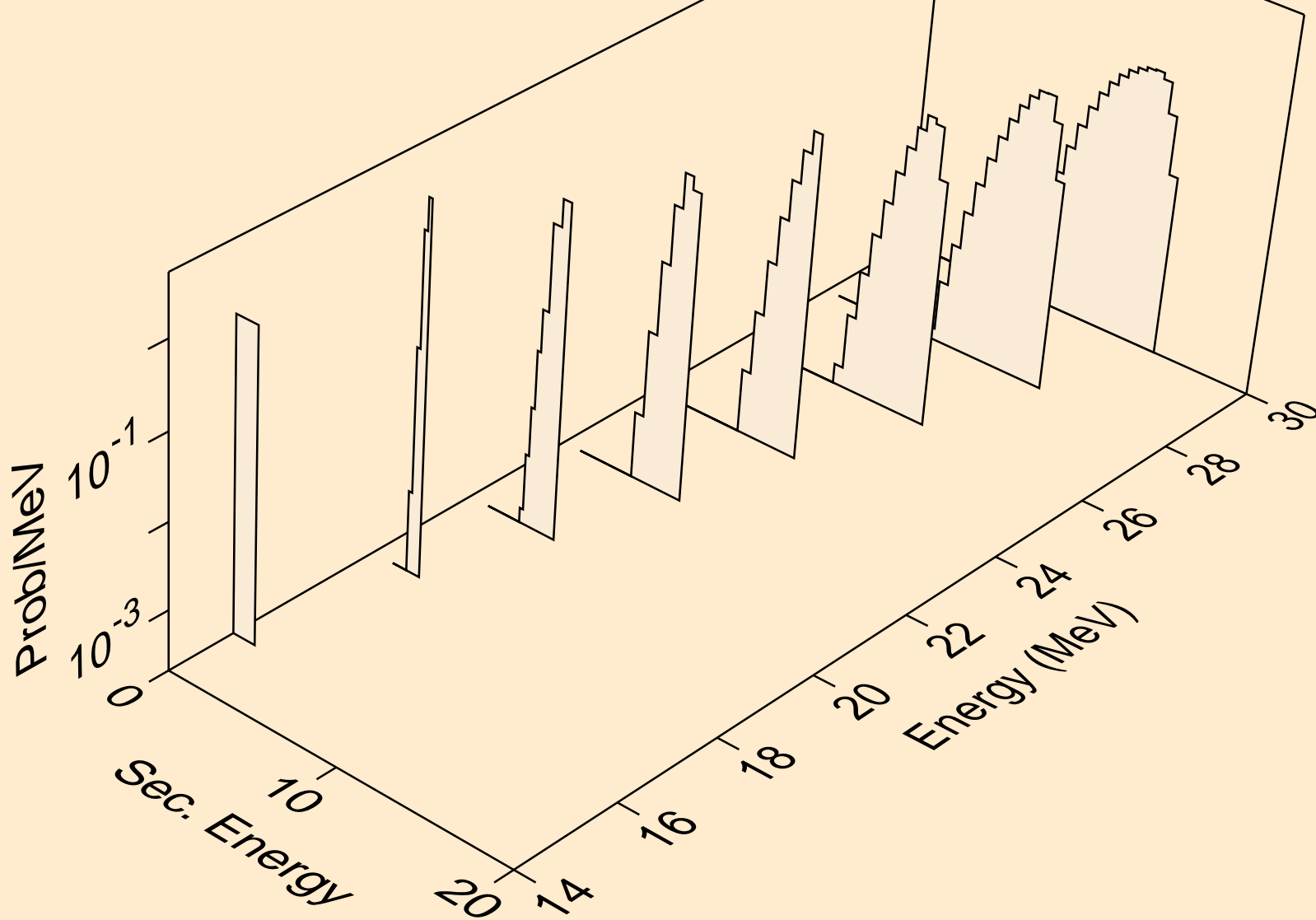

RB082 NEUTRON ACER TENDL-2019 LIBRARY; T=293.16K  
he3s from (n,he3)

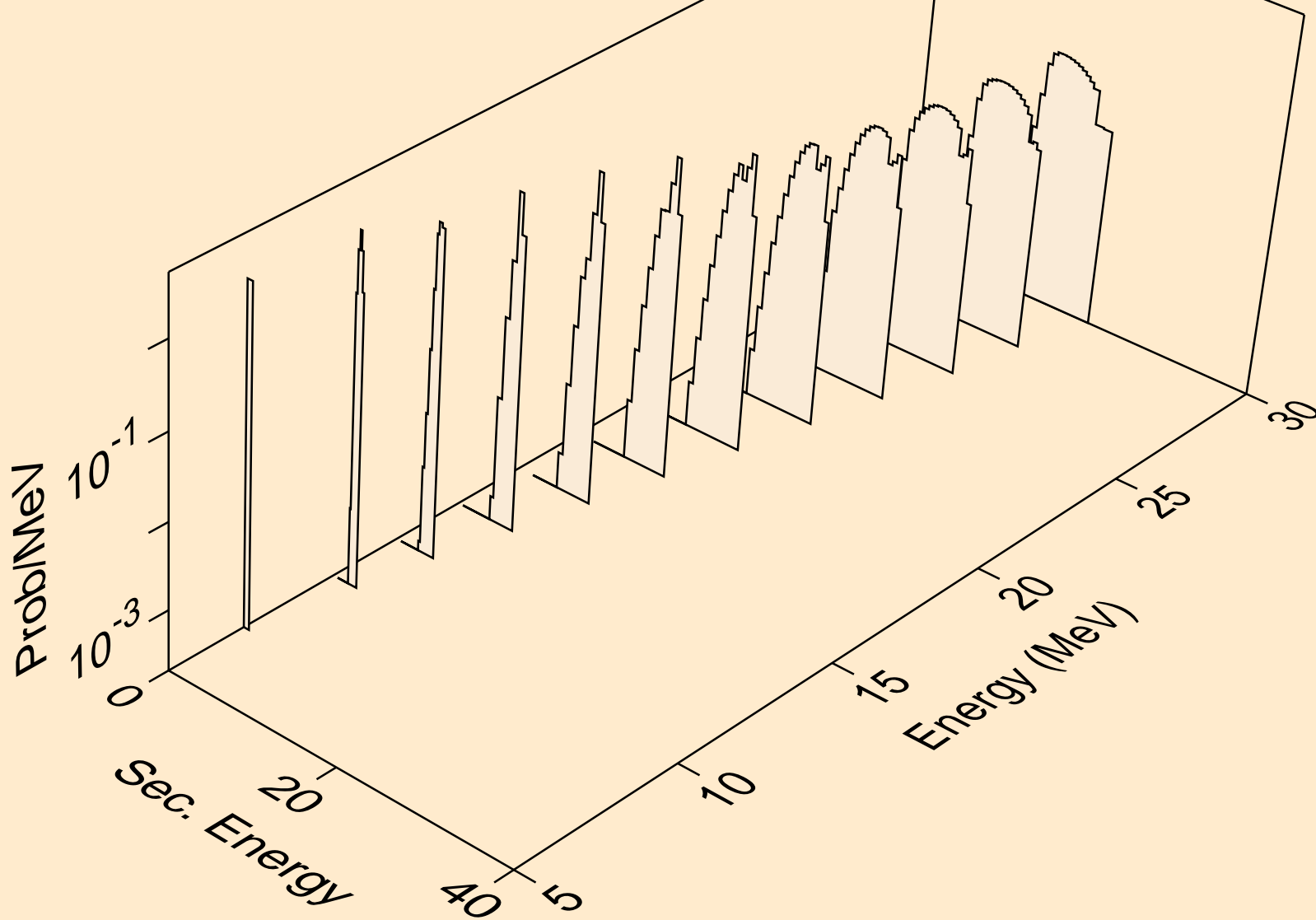

RB082 NEUTRON ACER TENDL-2019 LIBRARY; T=293.16K  
alphas from (n,x)

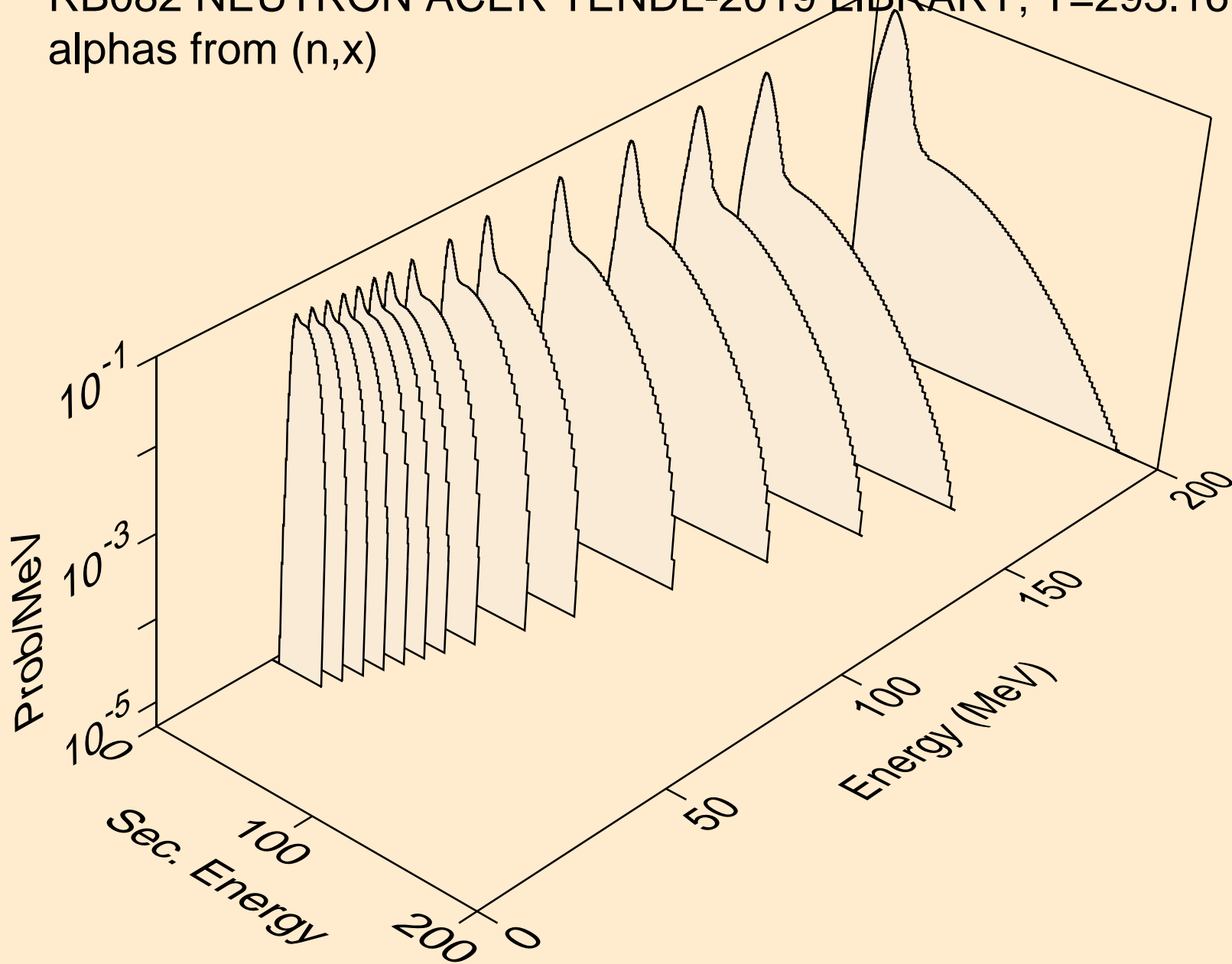

RB082 NEUTRON ACER TENDL-2019 LIBRARY; T=293.16K  
alphas from (n,n\*)a

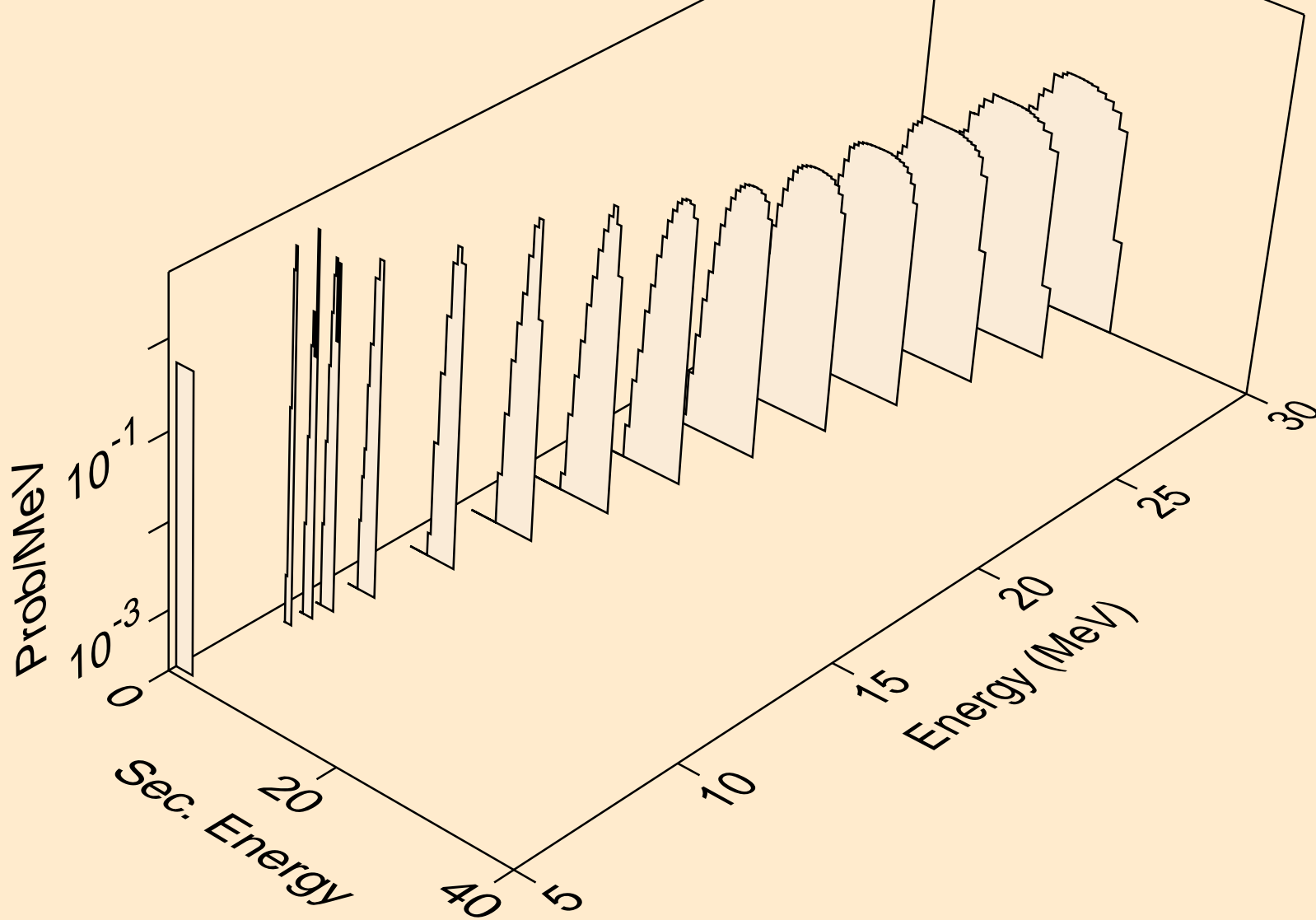

RB082 NEUTRON ACER TENDL-2019 LIBRARY; T=293.16K  
alphas from (n,2n)a

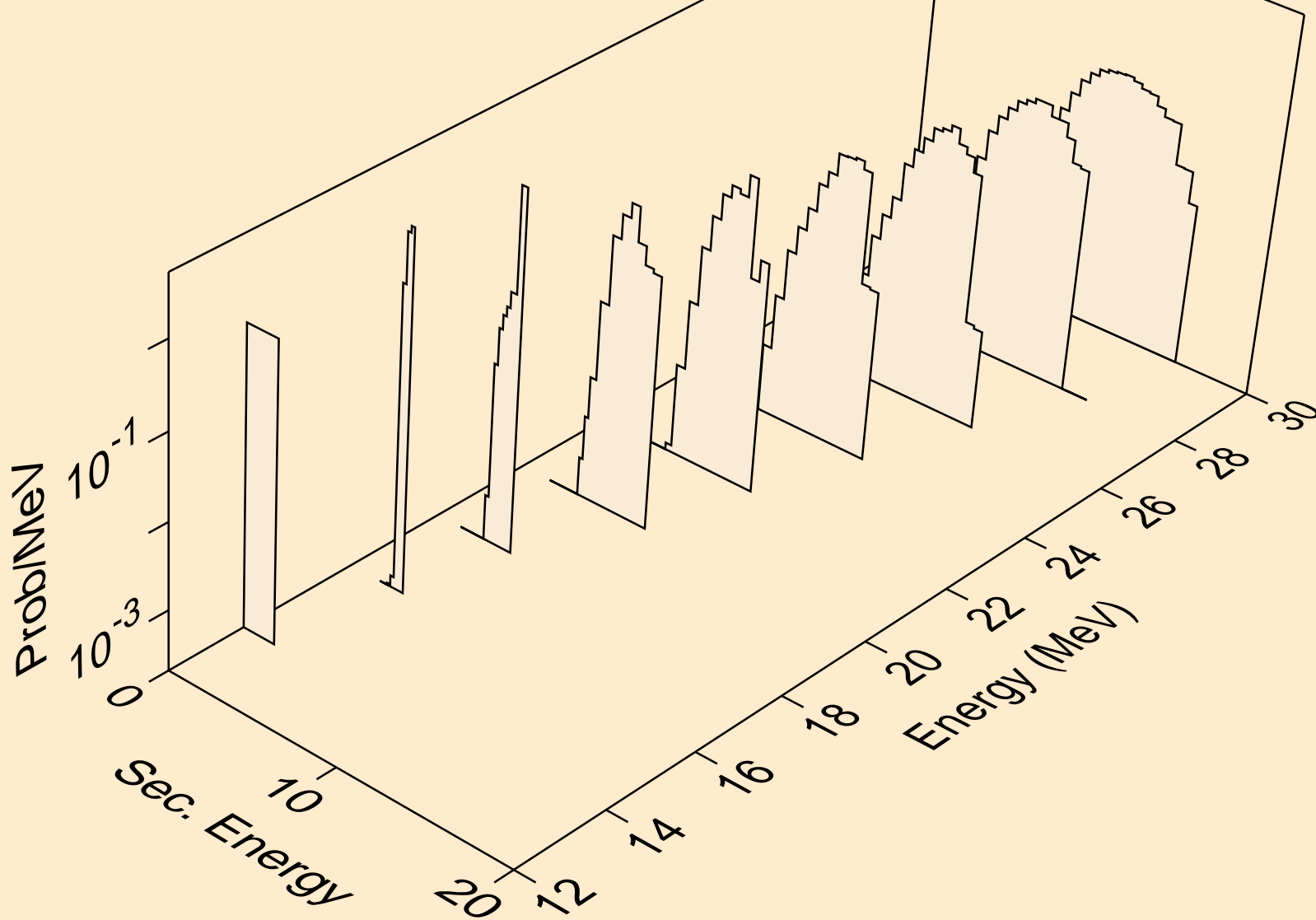

RB082 NEUTRON ACER TENDL-2019 LIBRARY; T=293.16K  
alphas from (n,3n)a

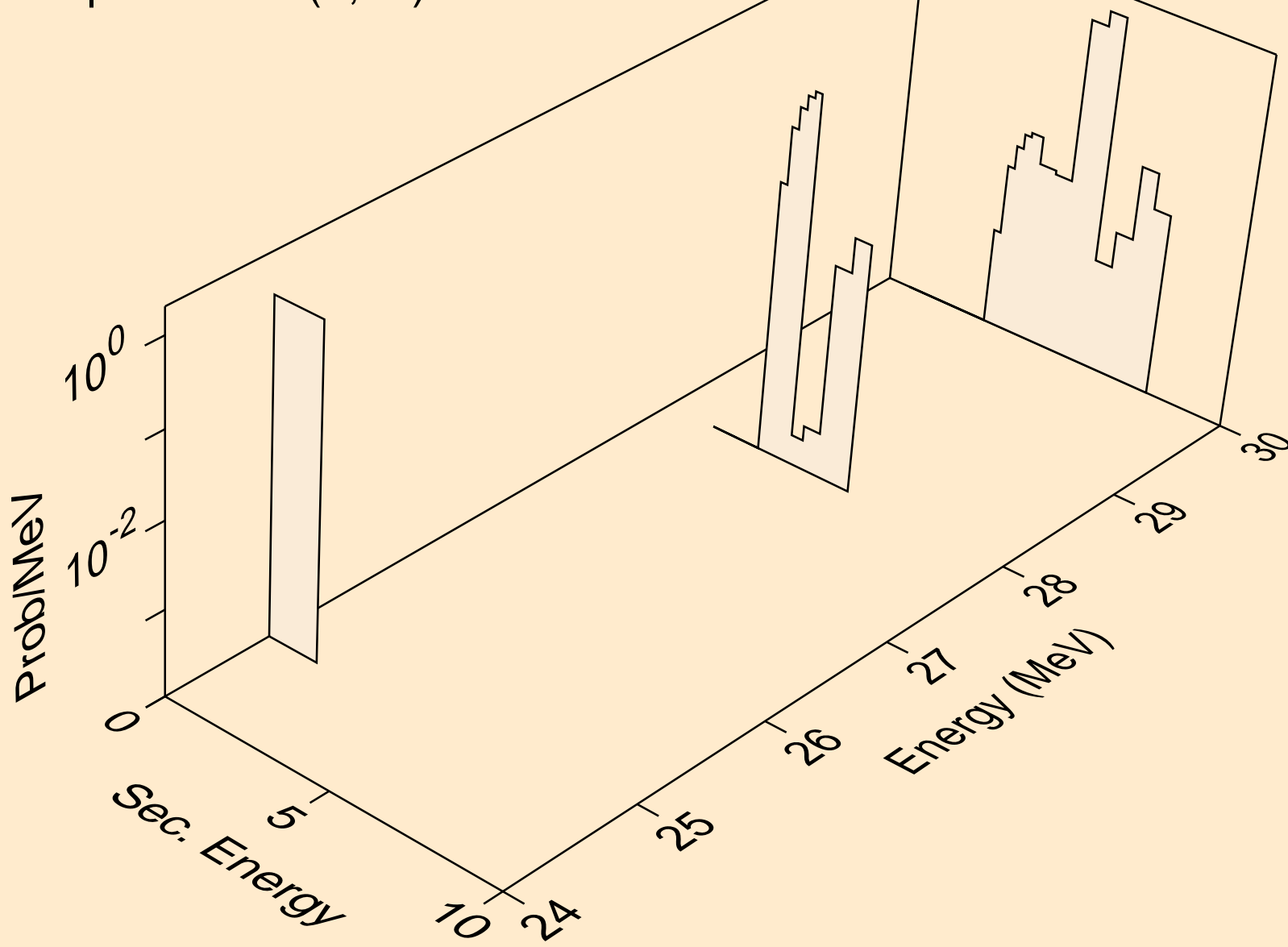



RB082 NEUTRON ACER TENDL-2019 LIBRARY; T=293.16K  
alphas from (n,n\*)2a

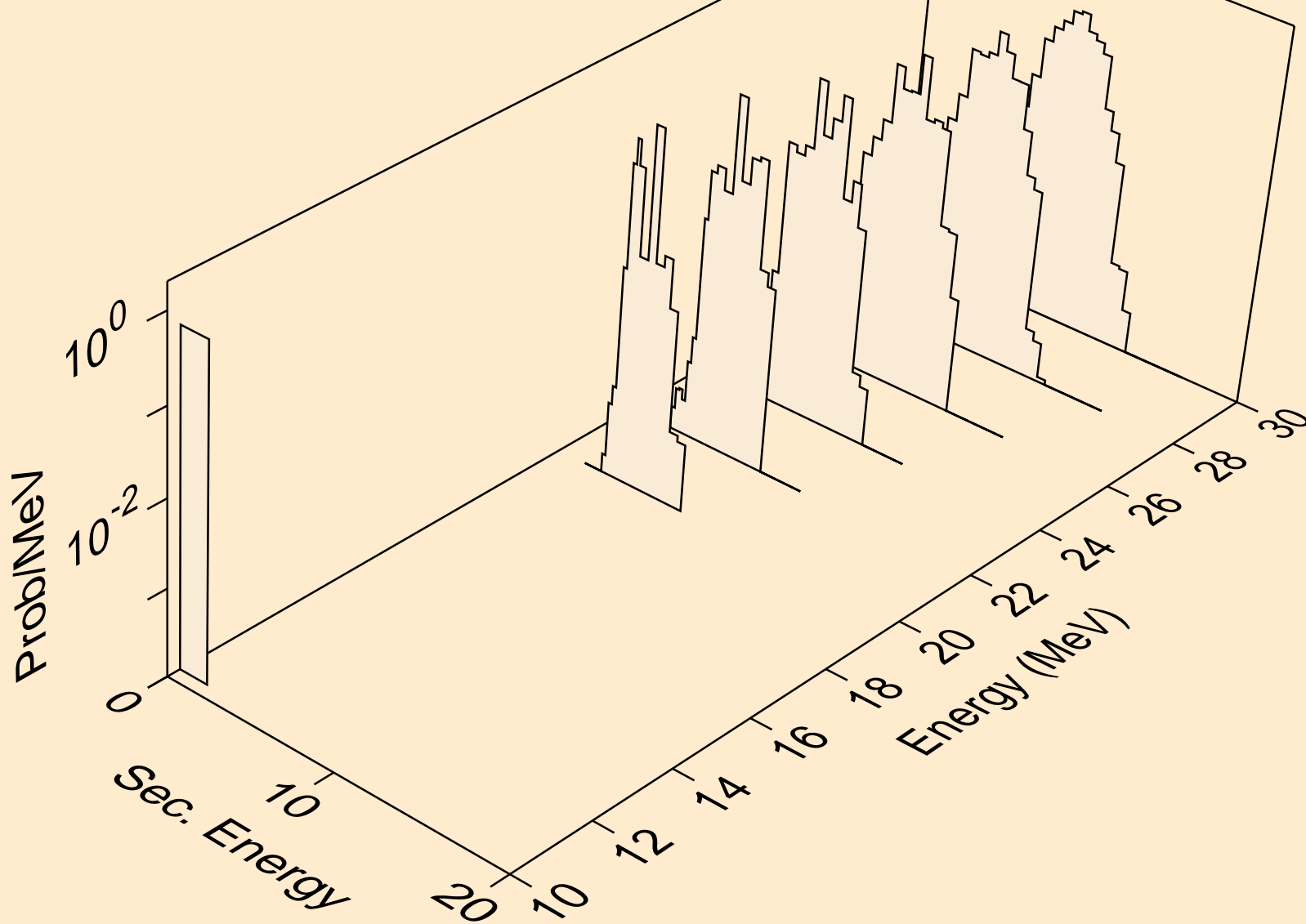

RB082 NEUTRON ACER TENDL-2019 LIBRARY; T=293.16K  
alphas from (n,npa)

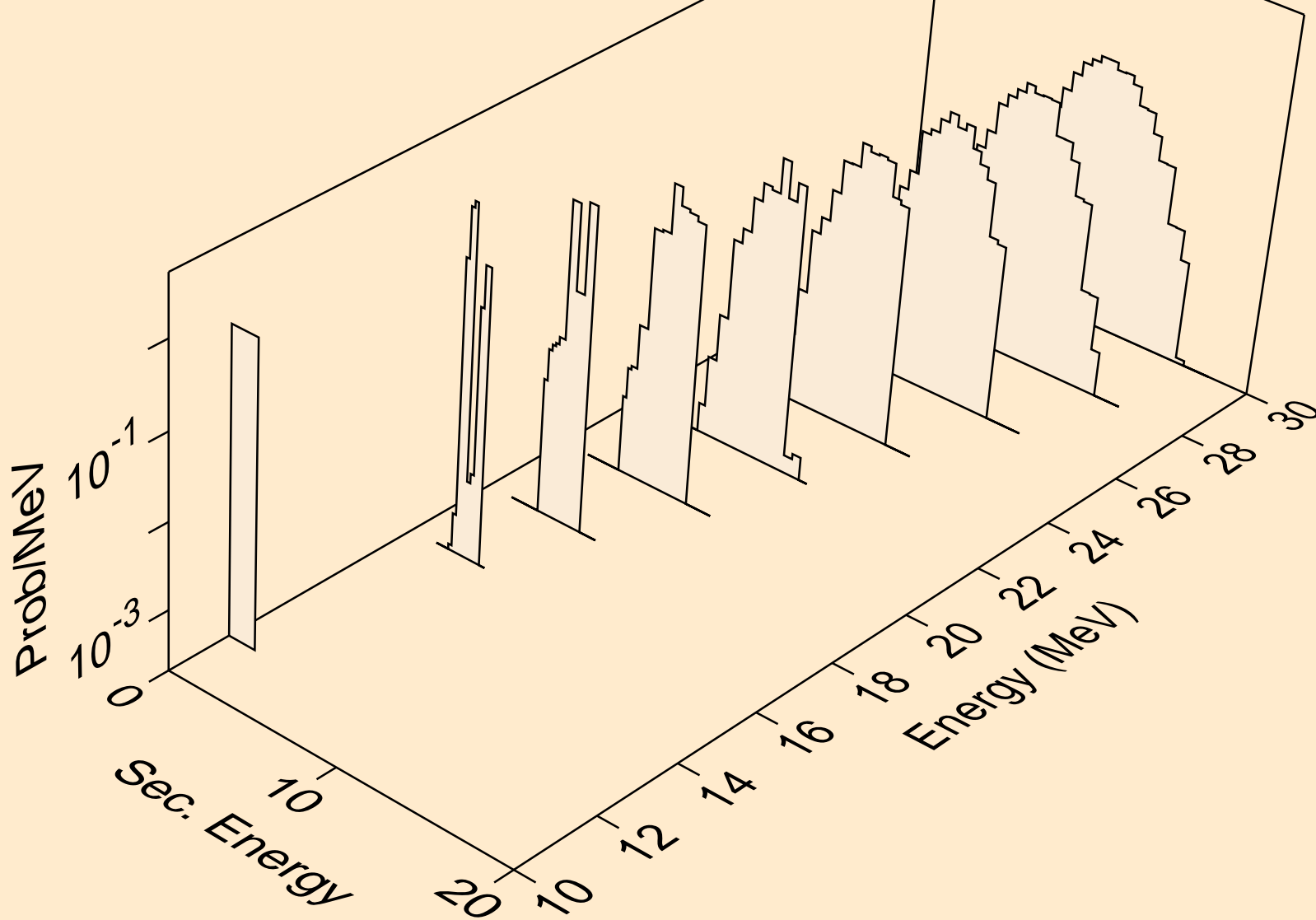

RB082 NEUTRON ACER TENDL-2019 LIBRARY; T=293.16K  
alphas from (n,a)

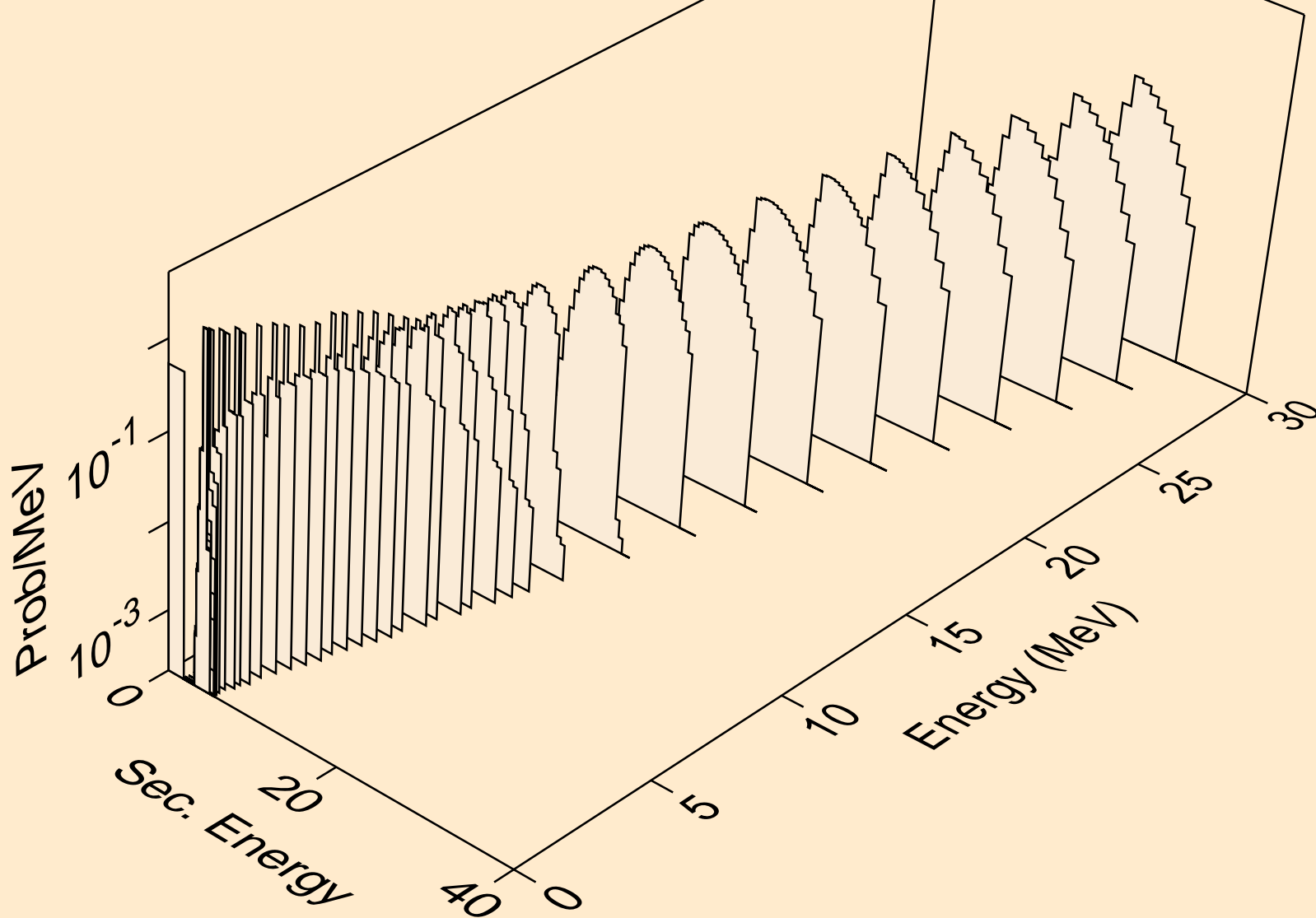

RB082 NEUTRON ACER TENDL-2019 LIBRARY; T=293.16K  
alphas from (n,2a)

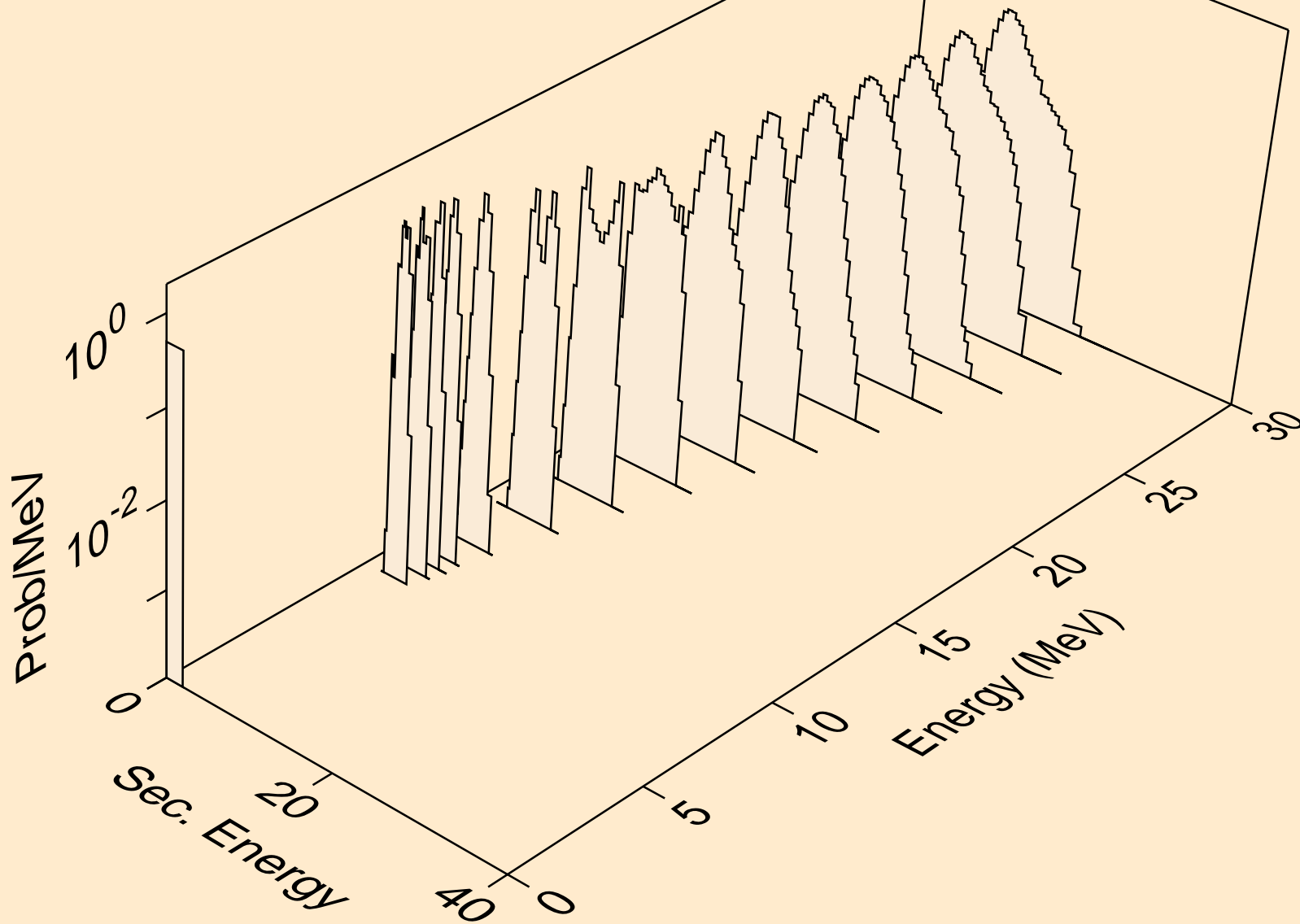

RB082 NEUTRON ACER TENDL-2019 LIBRARY; T=293.16K  
alphas from (n,pa)

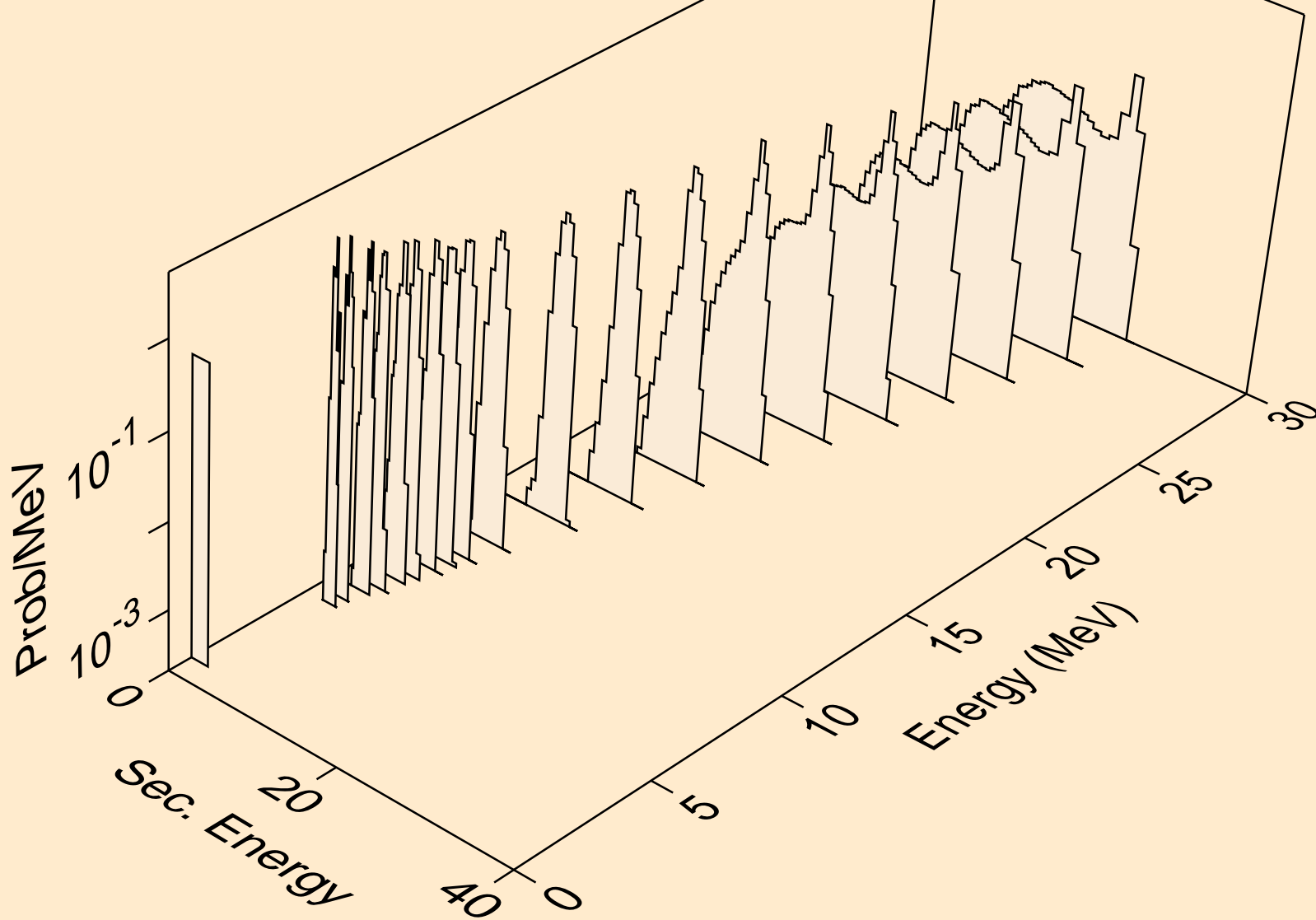

RB082 NEUTRON ACER TENDL-2019 LIBRARY; T=293.16K  
alphas from (n,da)

