

RB089 NEUTRON ACER TENDL-2019 LIBRARY; T=293.16K
Principal cross sections

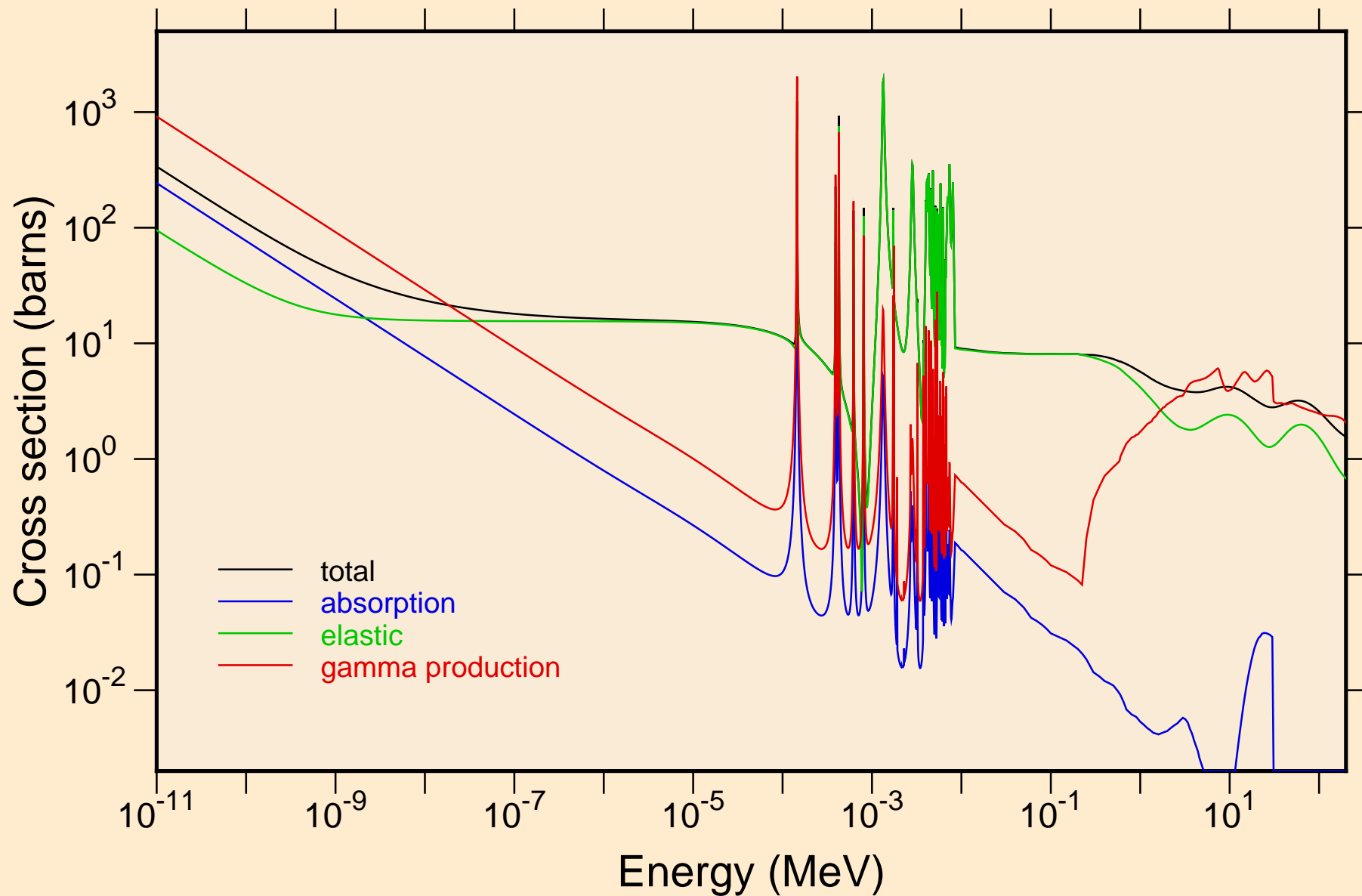

RB089 NEUTRON ACER TENDL-2019 LIBRARY; T=293.16K
resonance total cross section

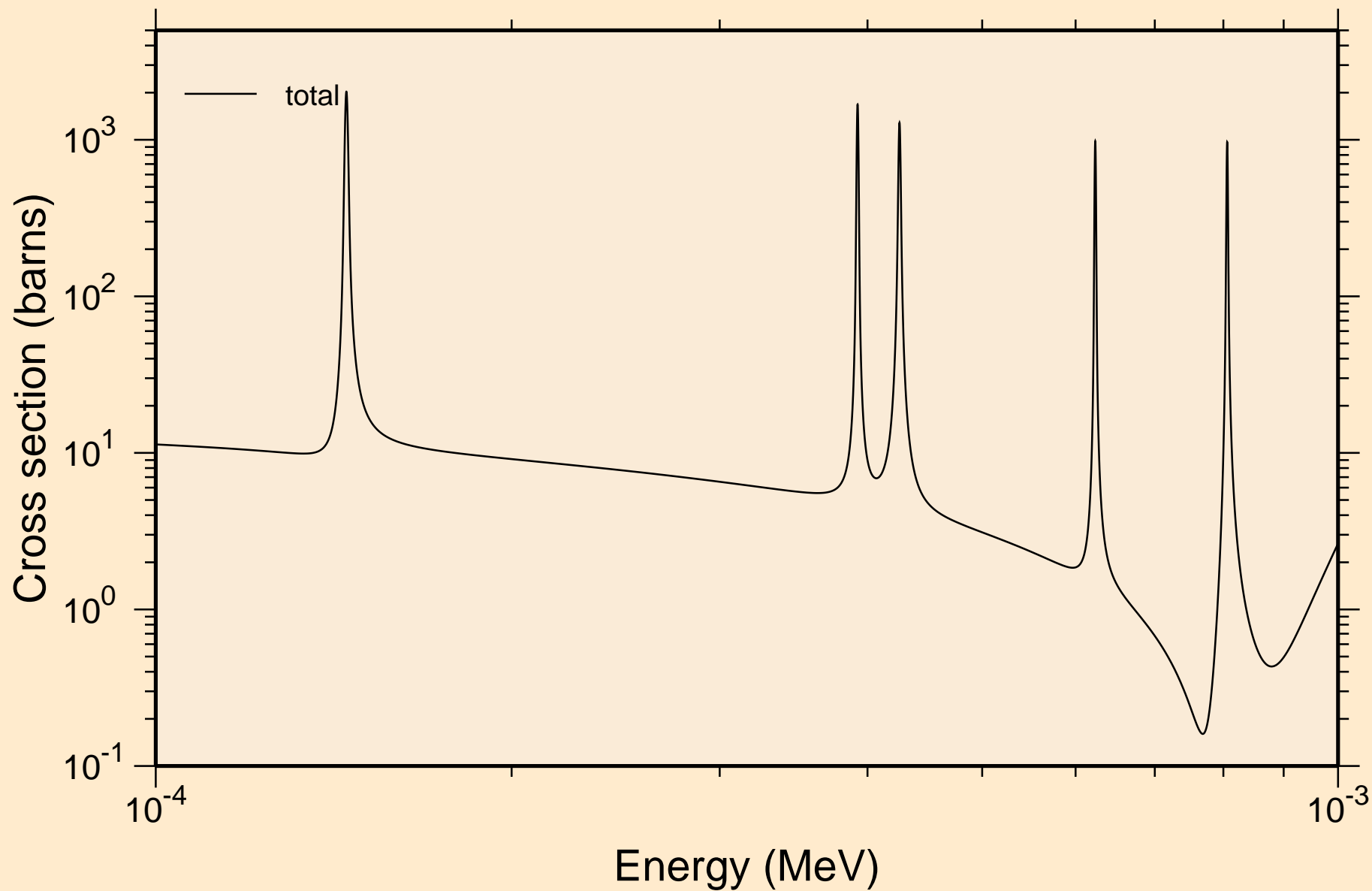

RB089 NEUTRON ACER TENDL-2019 LIBRARY; T=293.16K
resonance total cross section

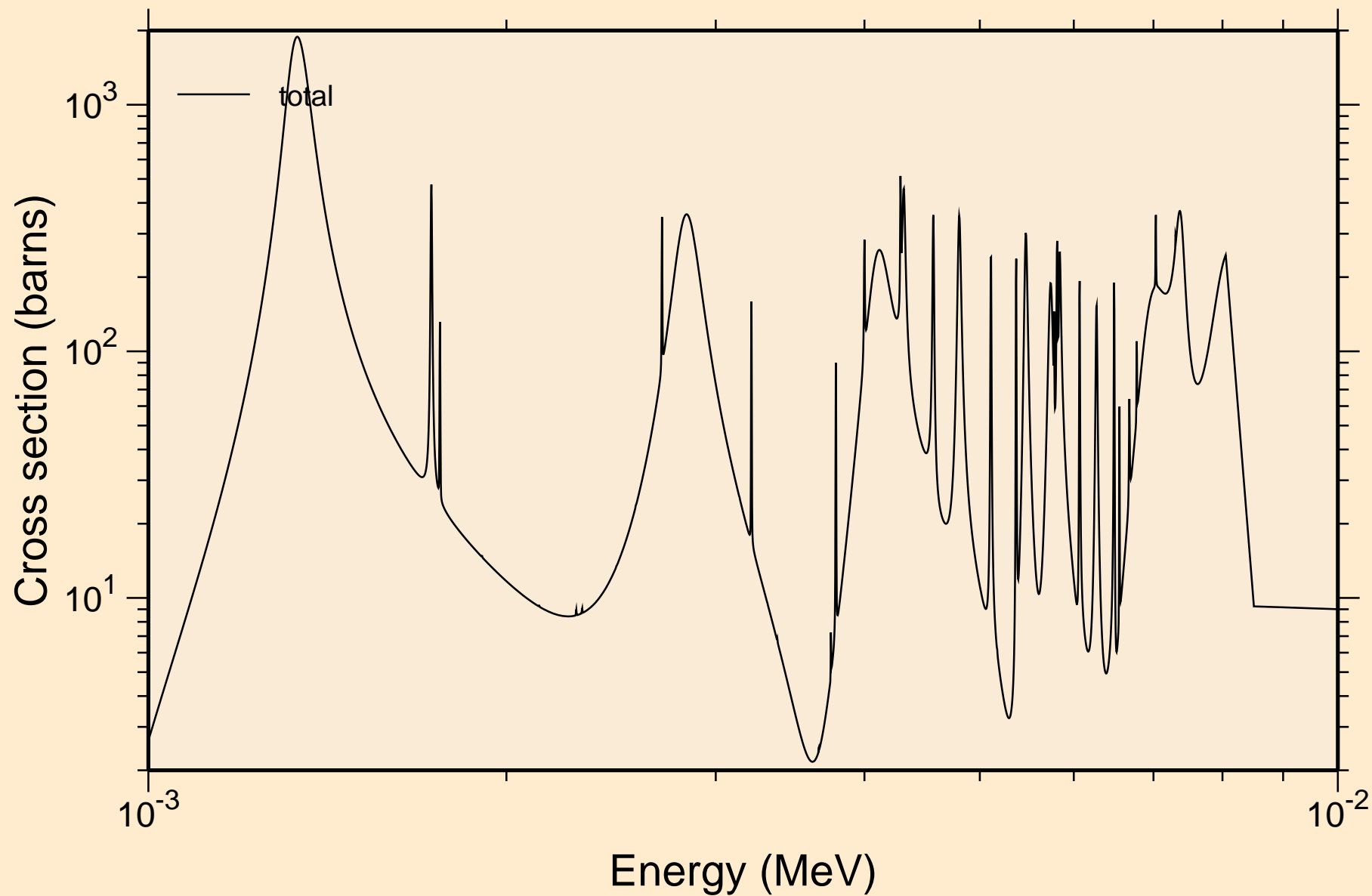

RB089 NEUTRON ACER TENDL-2019 LIBRARY; T=293.16K
resonance total cross section

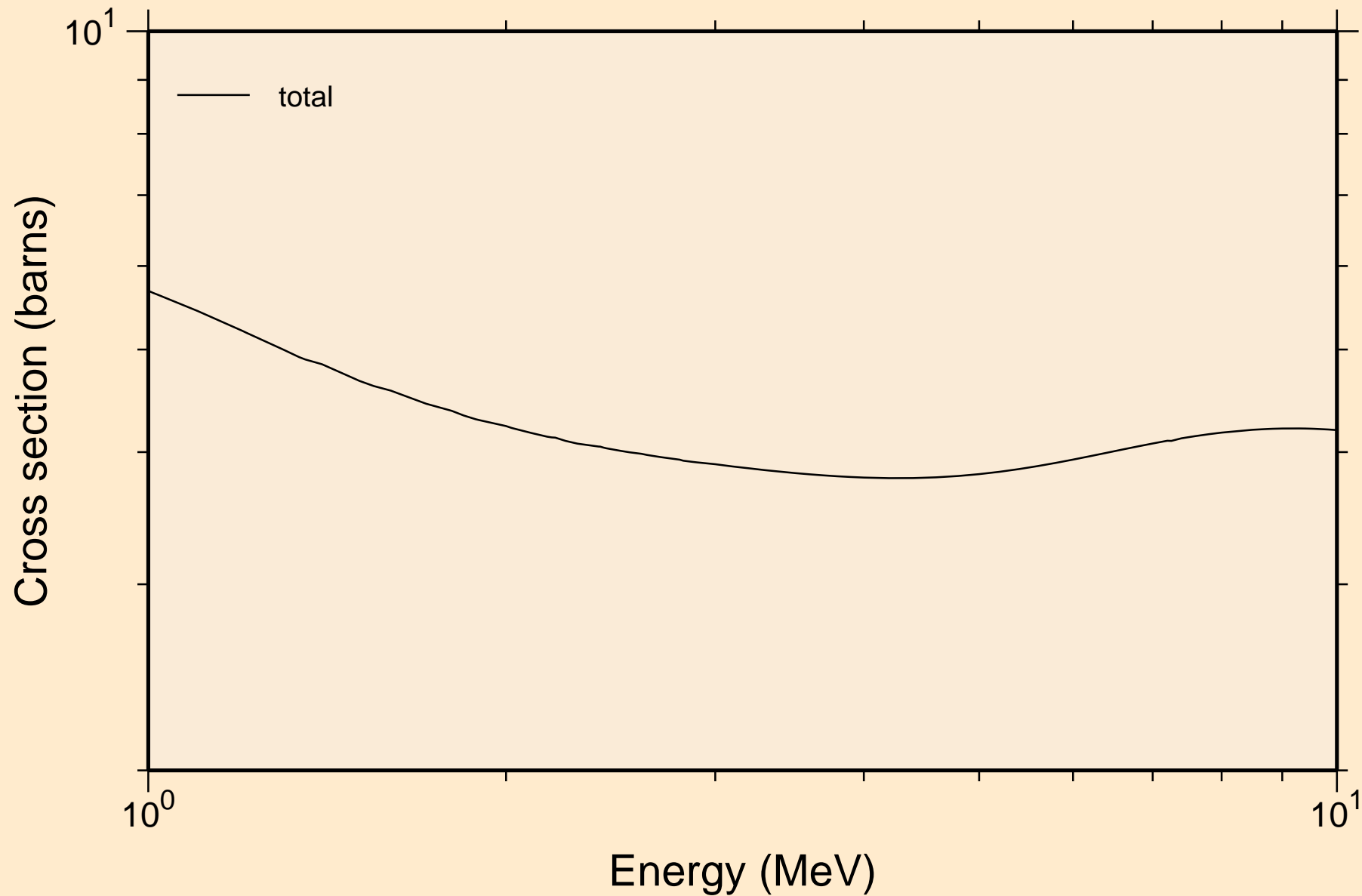

RB089 NEUTRON ACER TENDL-2019 LIBRARY; T=293.16K
resonance absorption cross sections

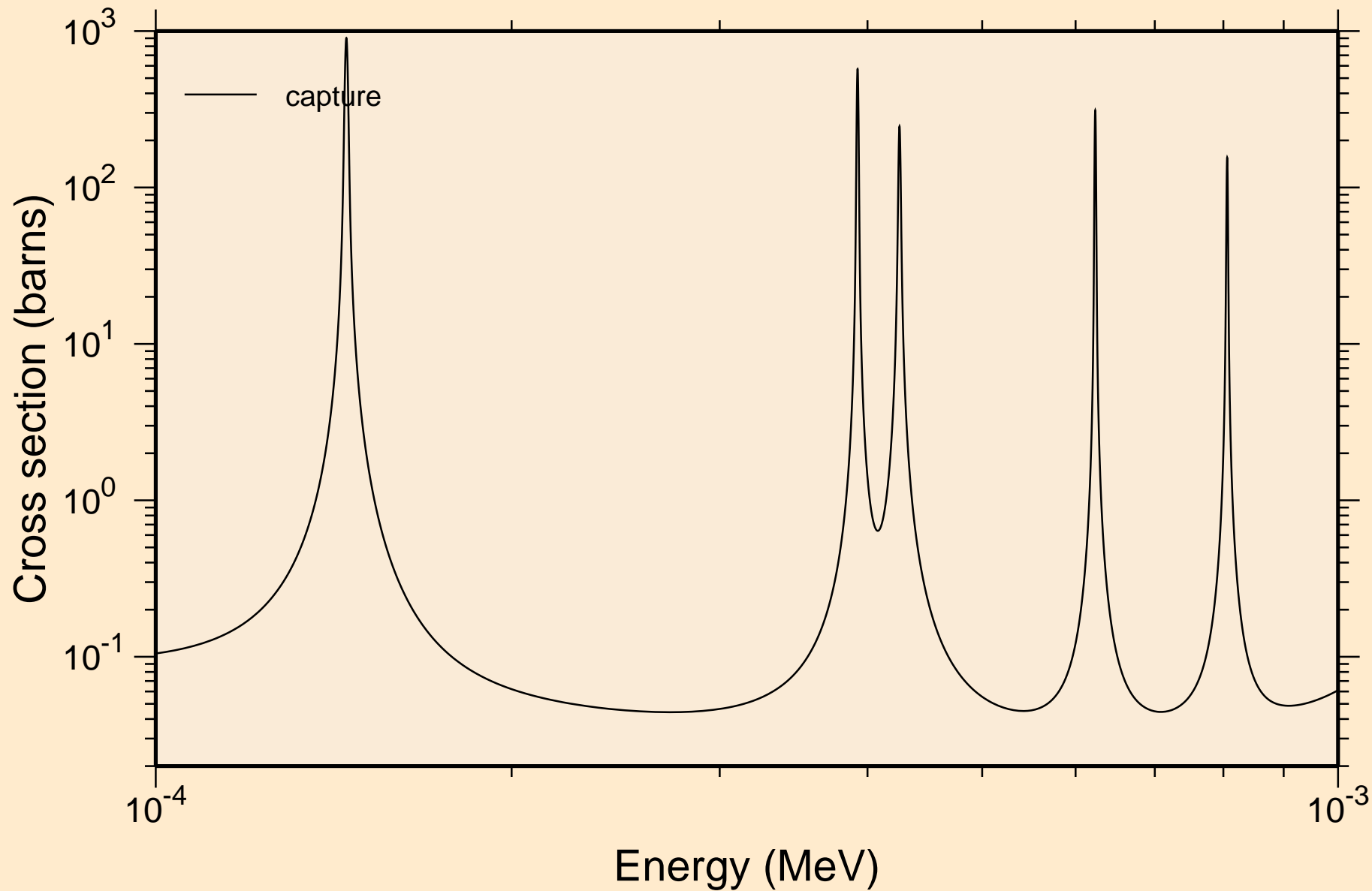

RB089 NEUTRON ACER TENDL-2019 LIBRARY; T=293.16K
resonance absorption cross sections

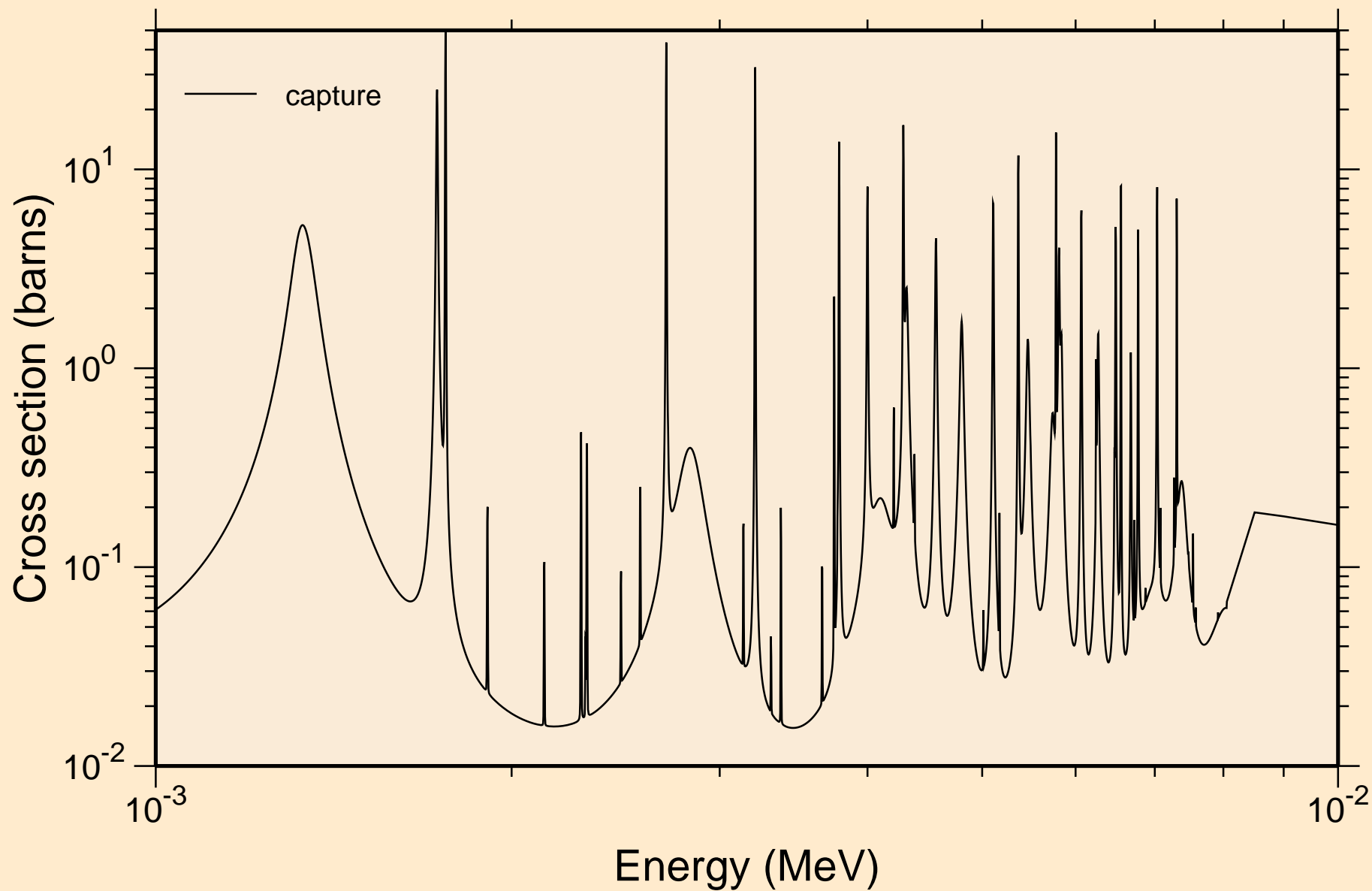

RB089 NEUTRON ACER TENDL-2019 LIBRARY; T=293.16K
resonance absorption cross sections

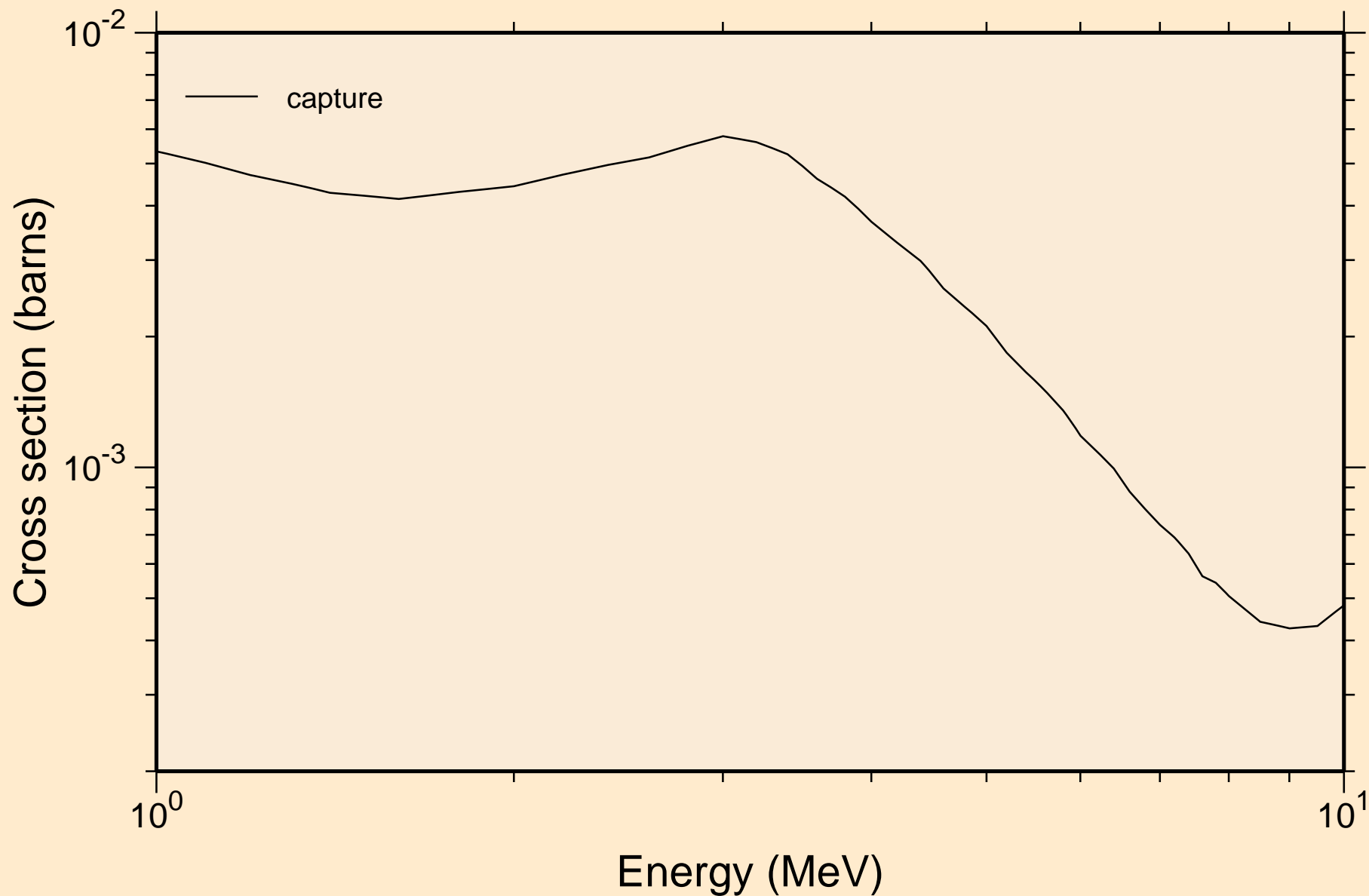

RB089 NEUTRON ACER TENDL-2019 LIBRARY; T=293.16K
Heating

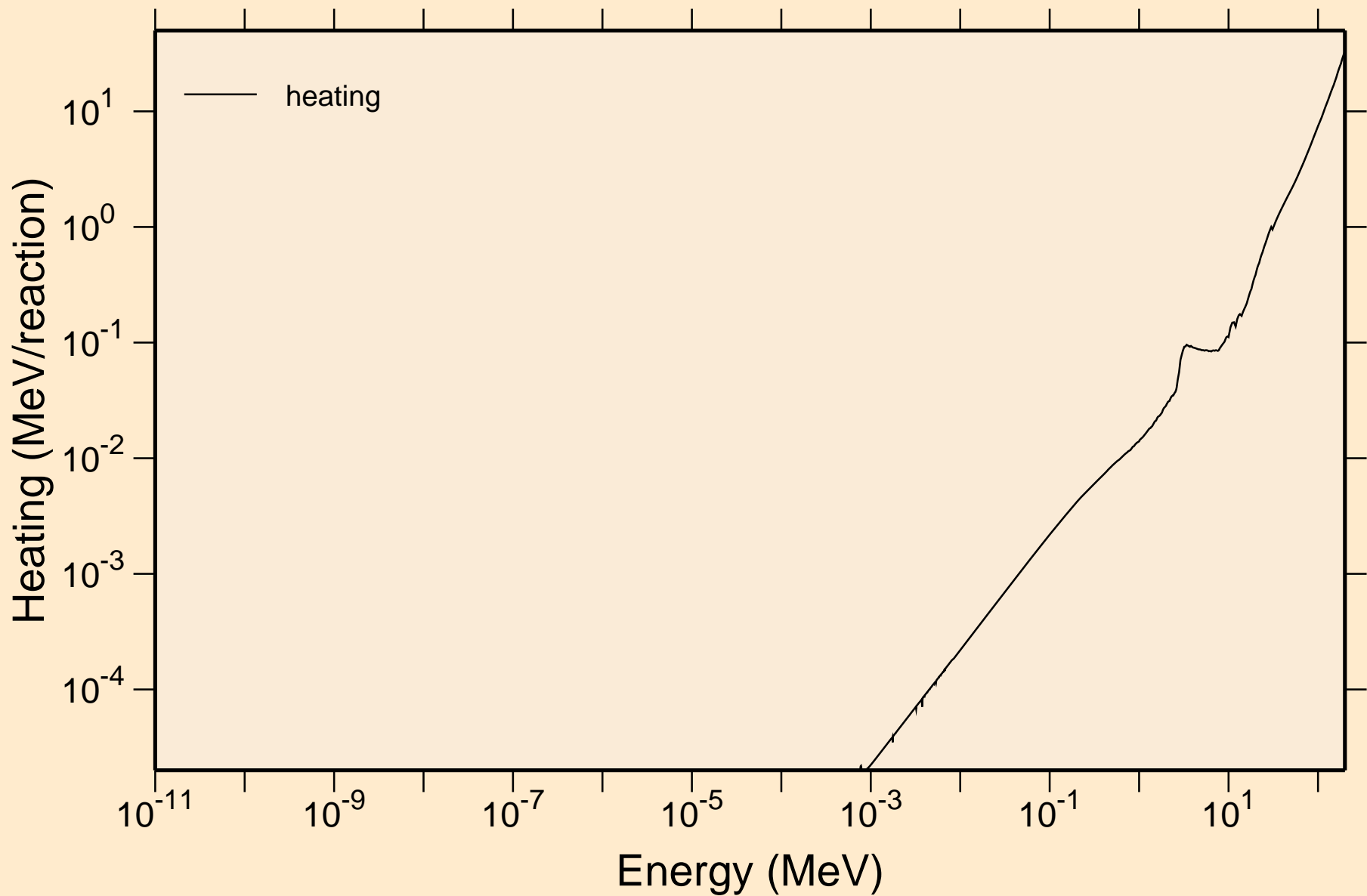

RB089 NEUTRON ACER TENDL-2019 LIBRARY; T=293.16K
Damage

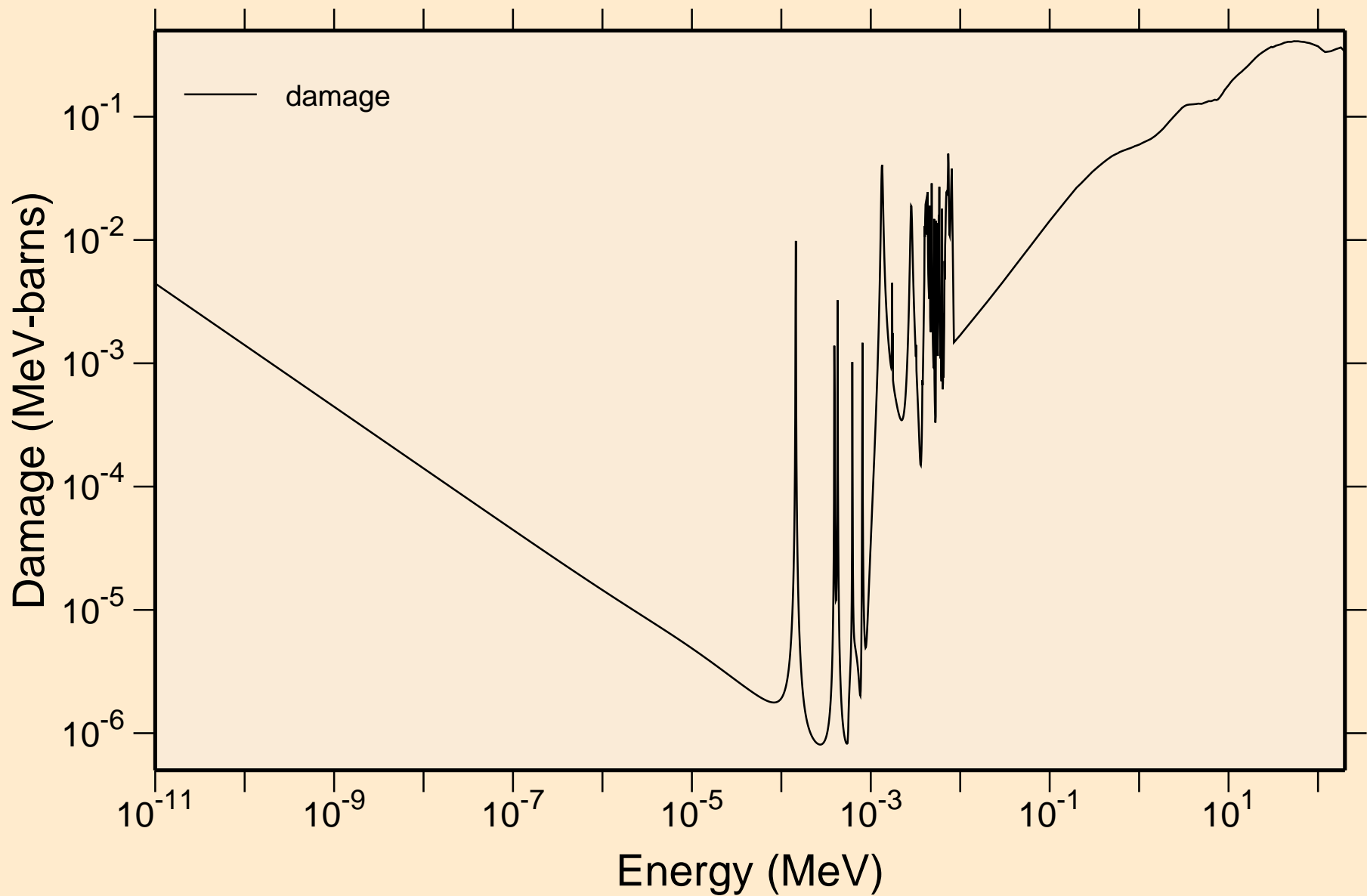

RB089 NEUTRON ACER TENDL-2019 LIBRARY; T=293.16K
Non-threshold reactions

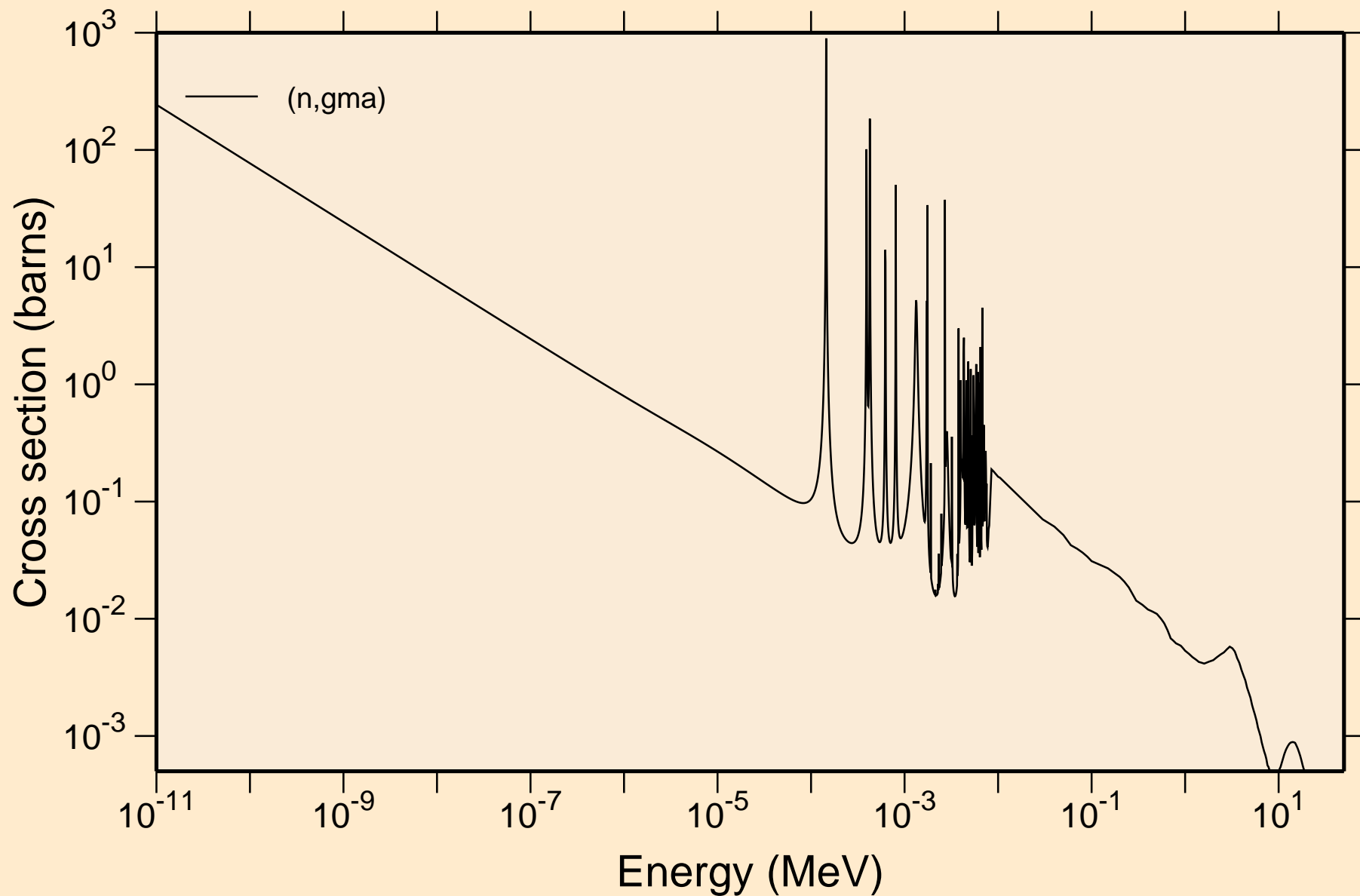

RB089 NEUTRON ACER TENDL-2019 LIBRARY; T=293.16K
Principal cross sections

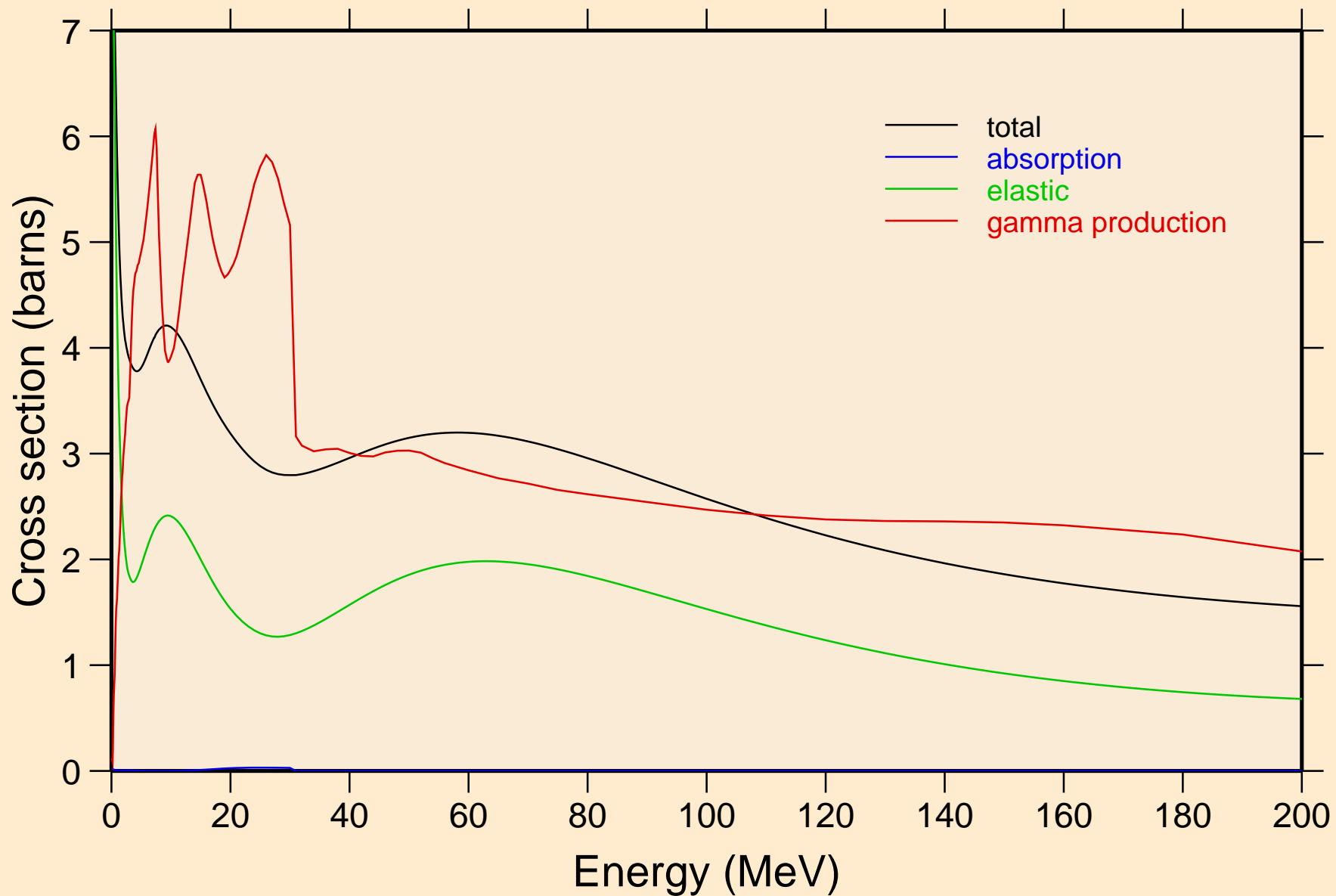

RB089 NEUTRON ACER TENDL-2019 LIBRARY; T=293.16K
Heating

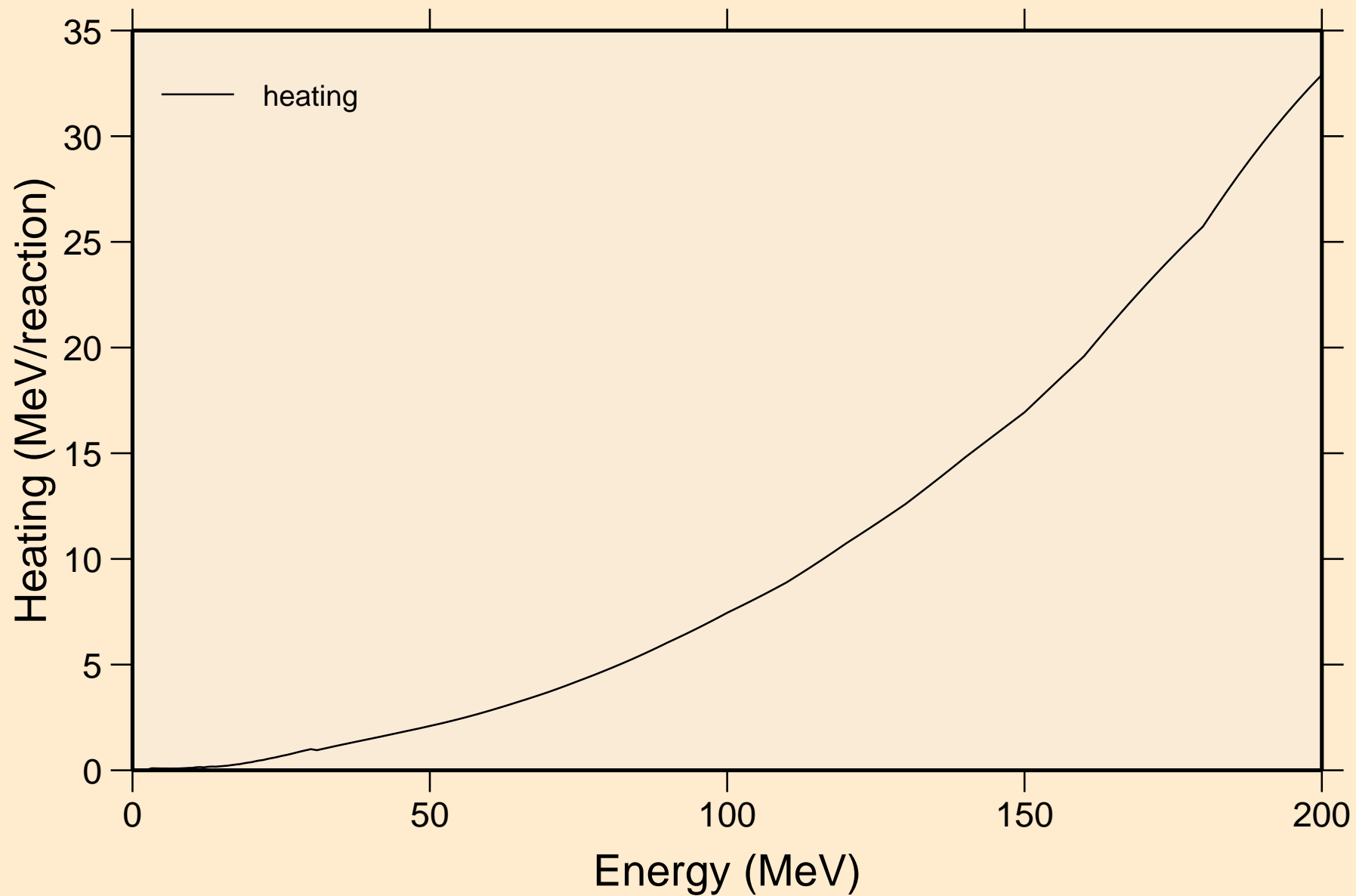

RB089 NEUTRON ACER TENDL-2019 LIBRARY; T=293.16K
Damage

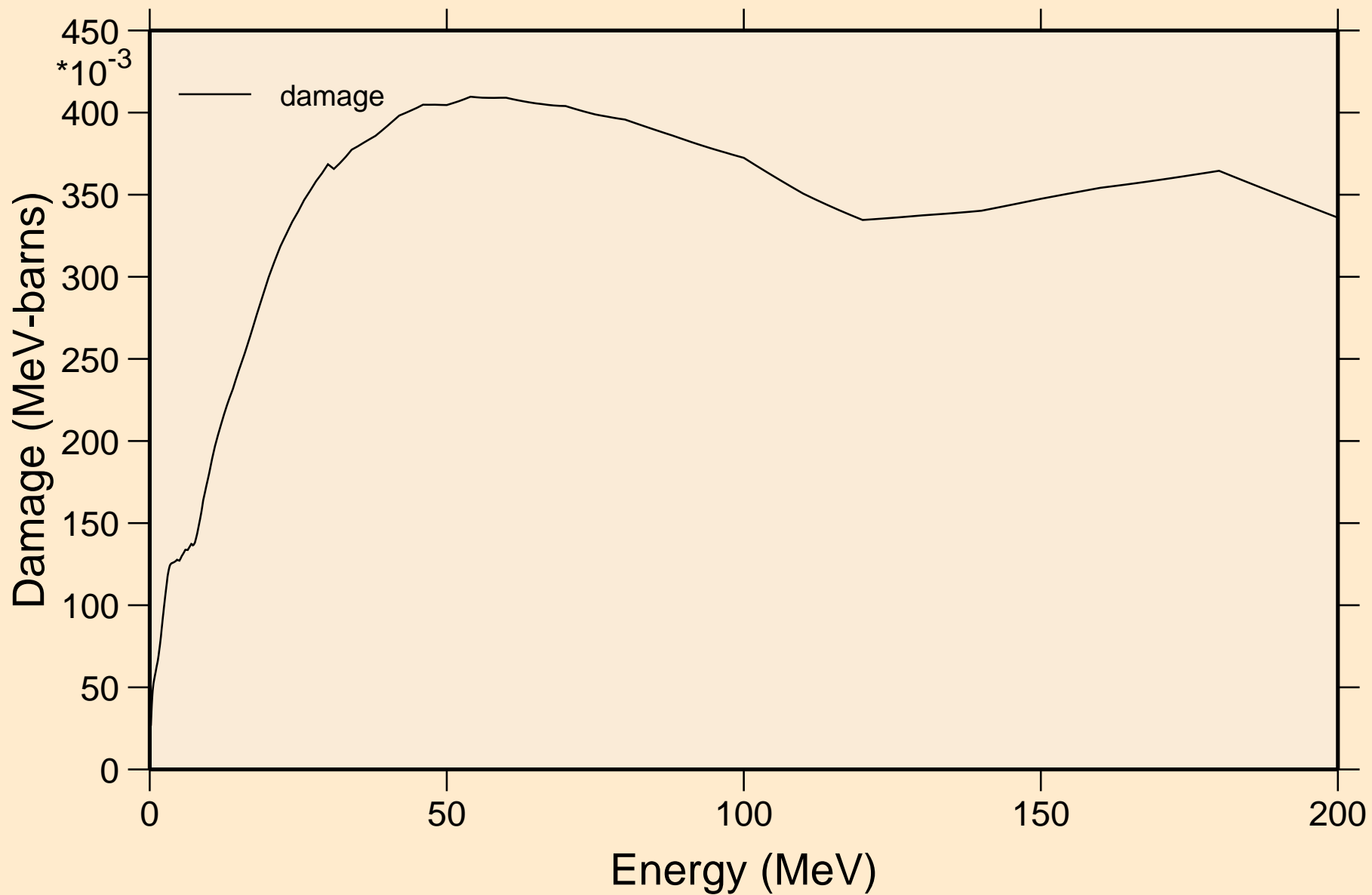

RB089 NEUTRON ACER TENDL-2019 LIBRARY; T=293.16K
Non-threshold reactions

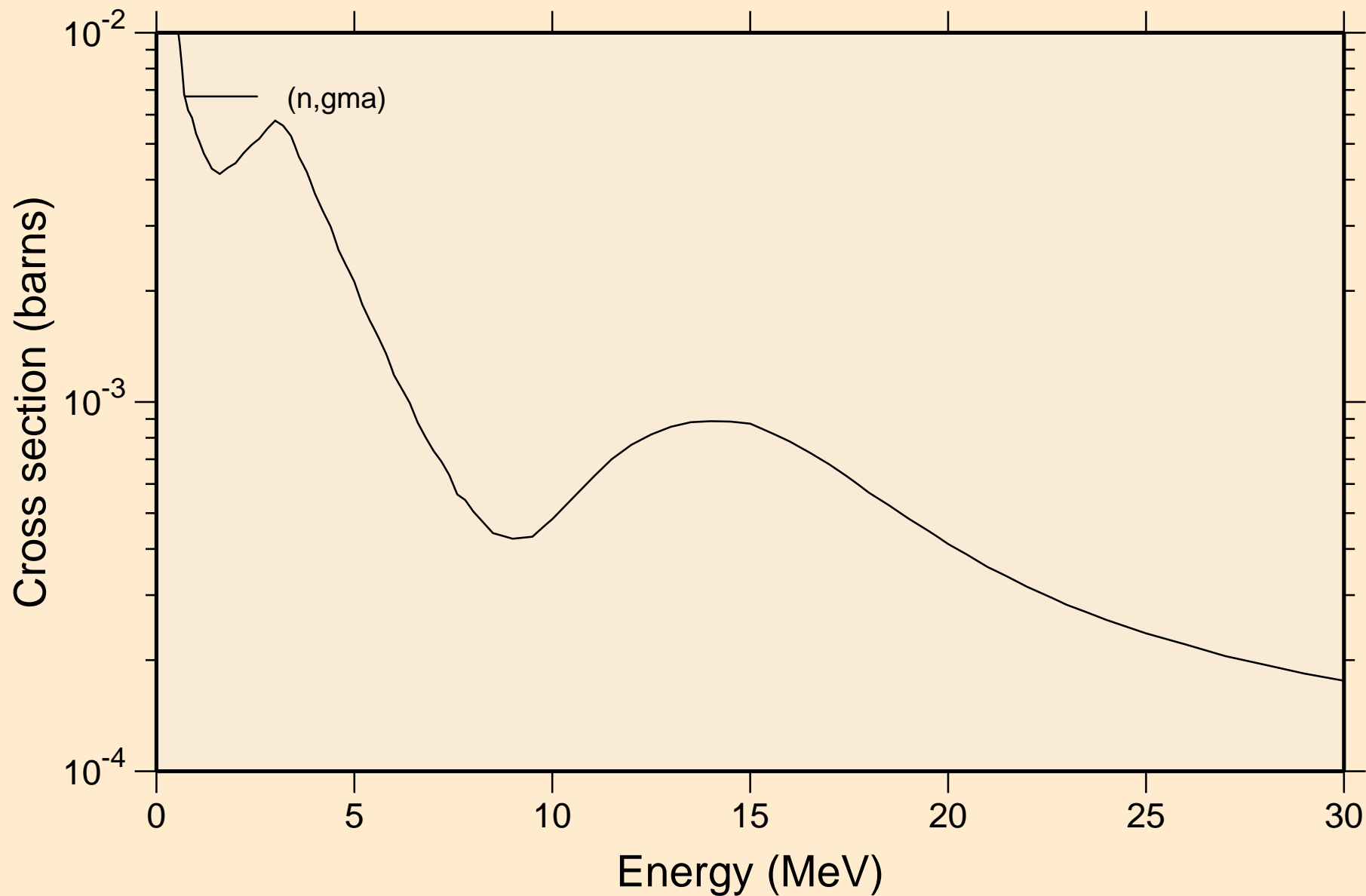

RB089 NEUTRON ACER TENDL-2019 LIBRARY; T=293.16K
Inelastic levels

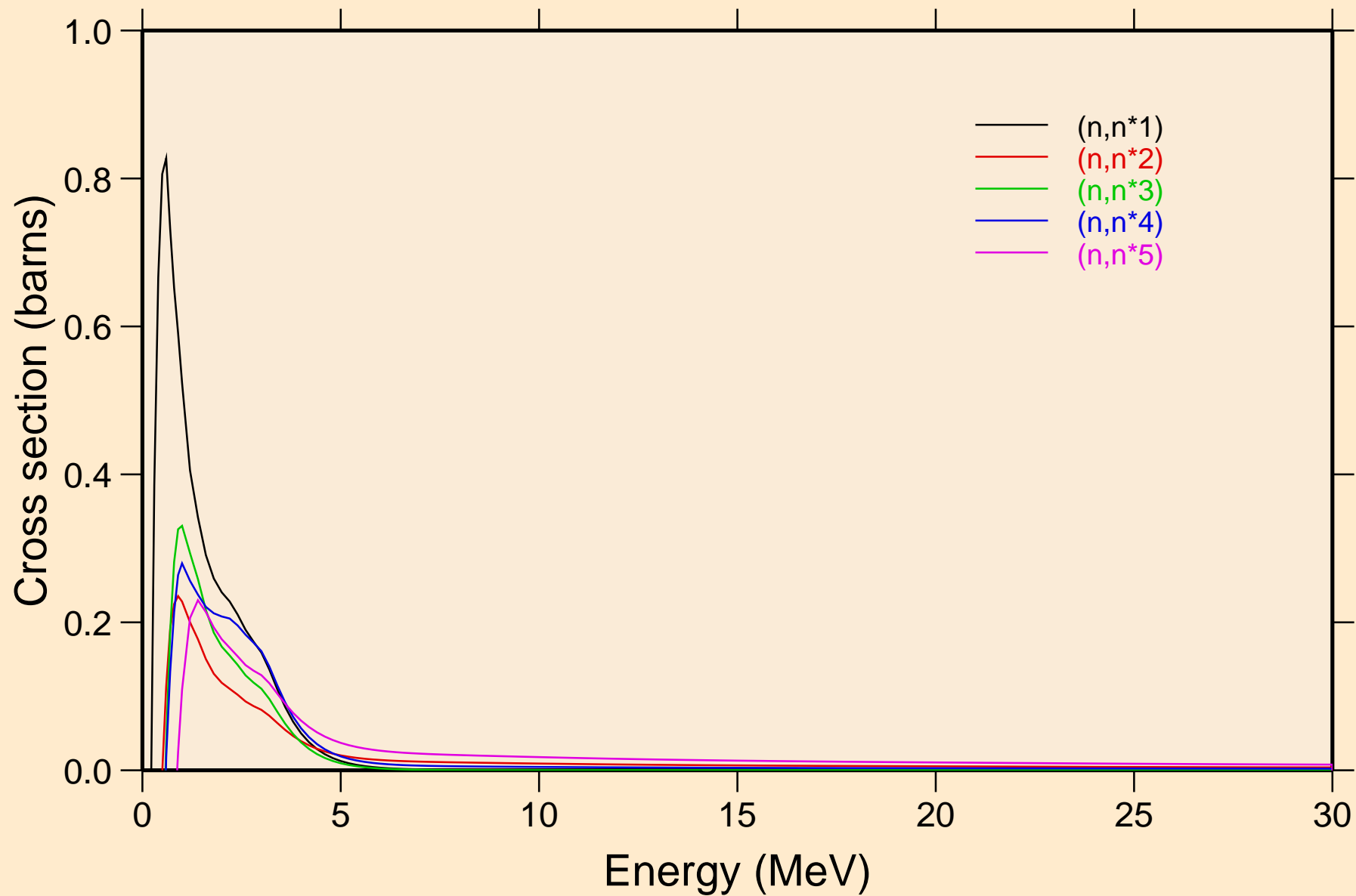

RB089 NEUTRON ACER TENDL-2019 LIBRARY; T=293.16K
Inelastic levels

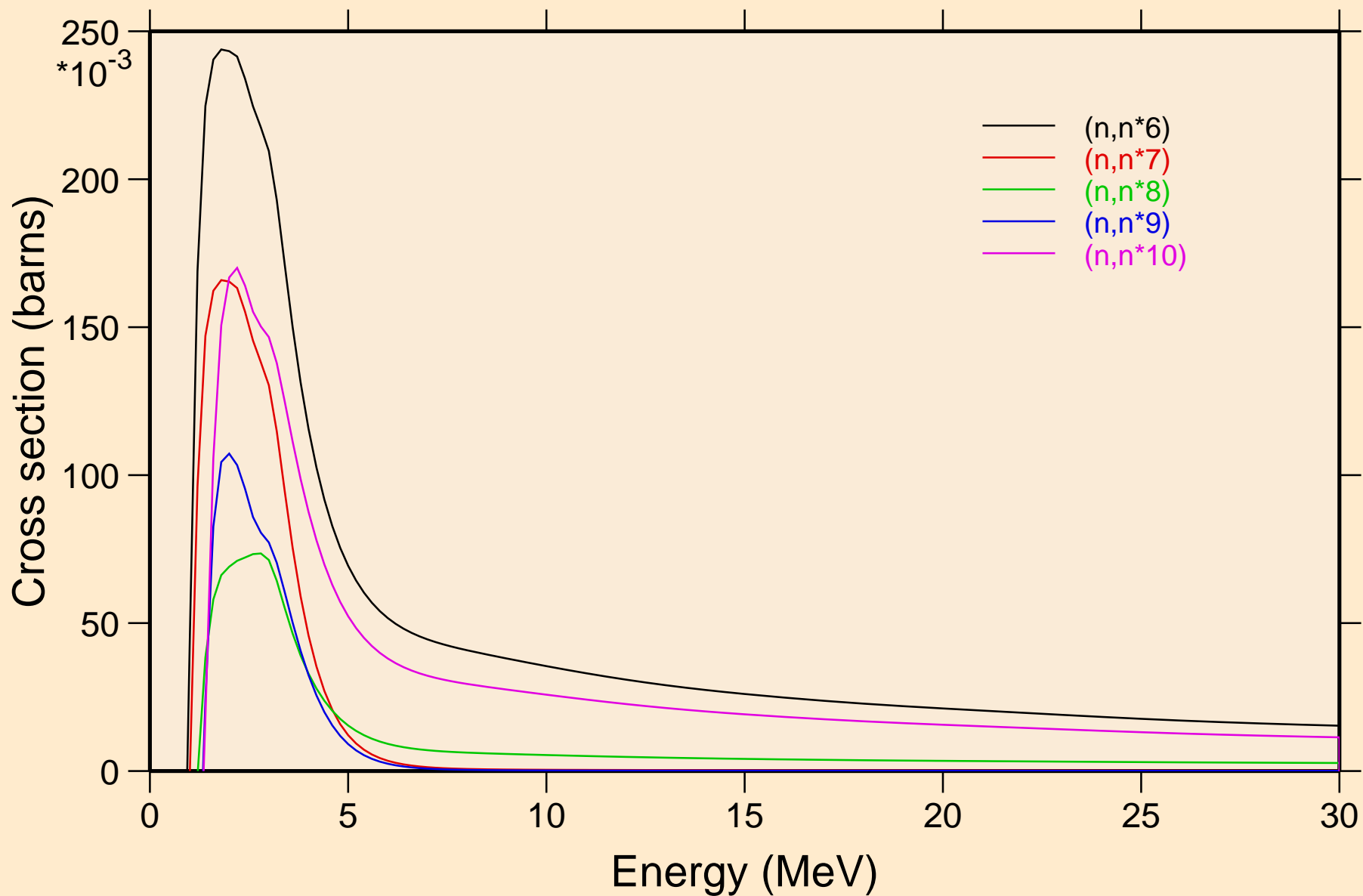

RB089 NEUTRON ACER TENDL-2019 LIBRARY; T=293.16K
Inelastic levels

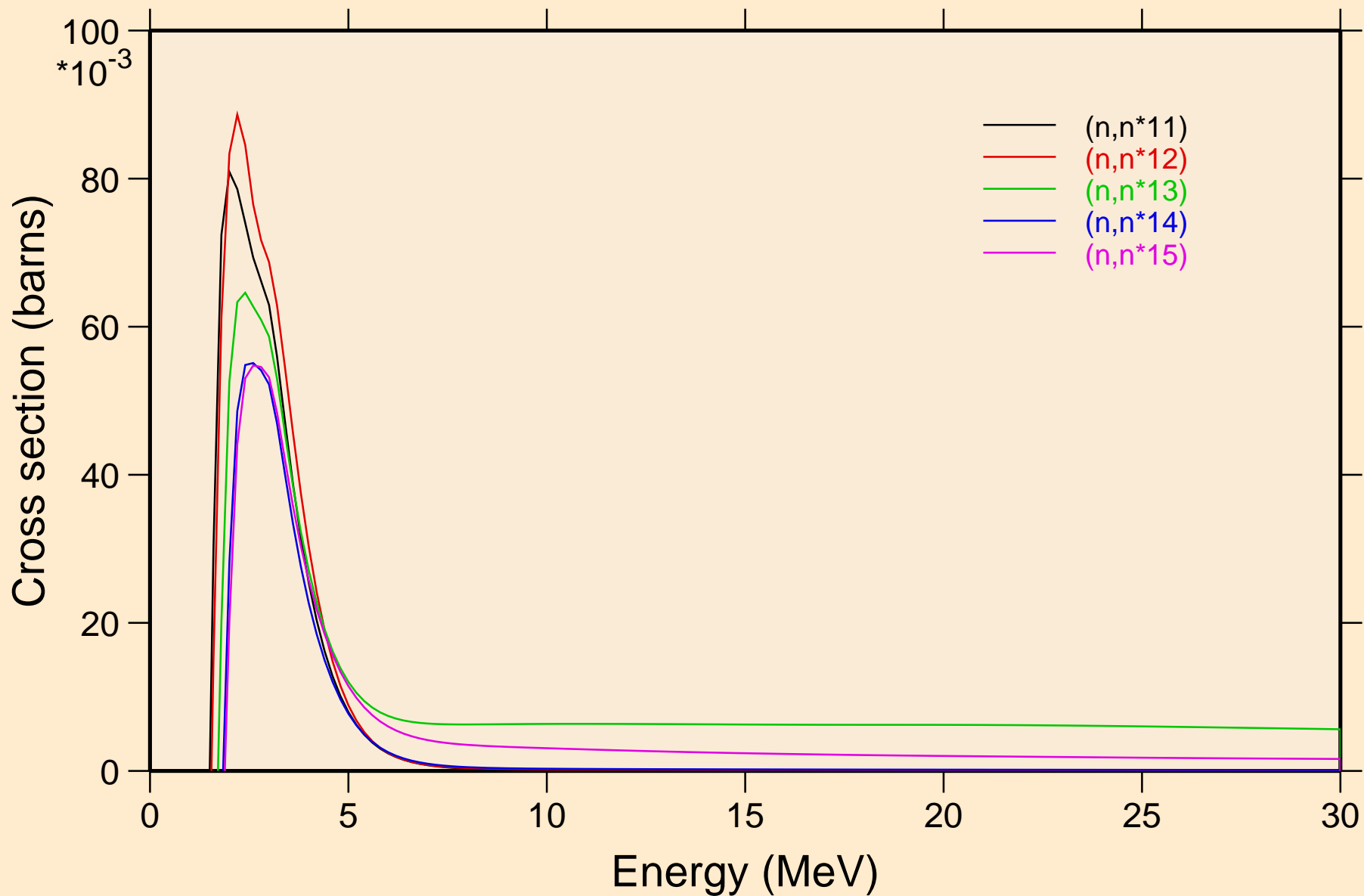

RB089 NEUTRON ACER TENDL-2019 LIBRARY; T=293.16K
Inelastic levels

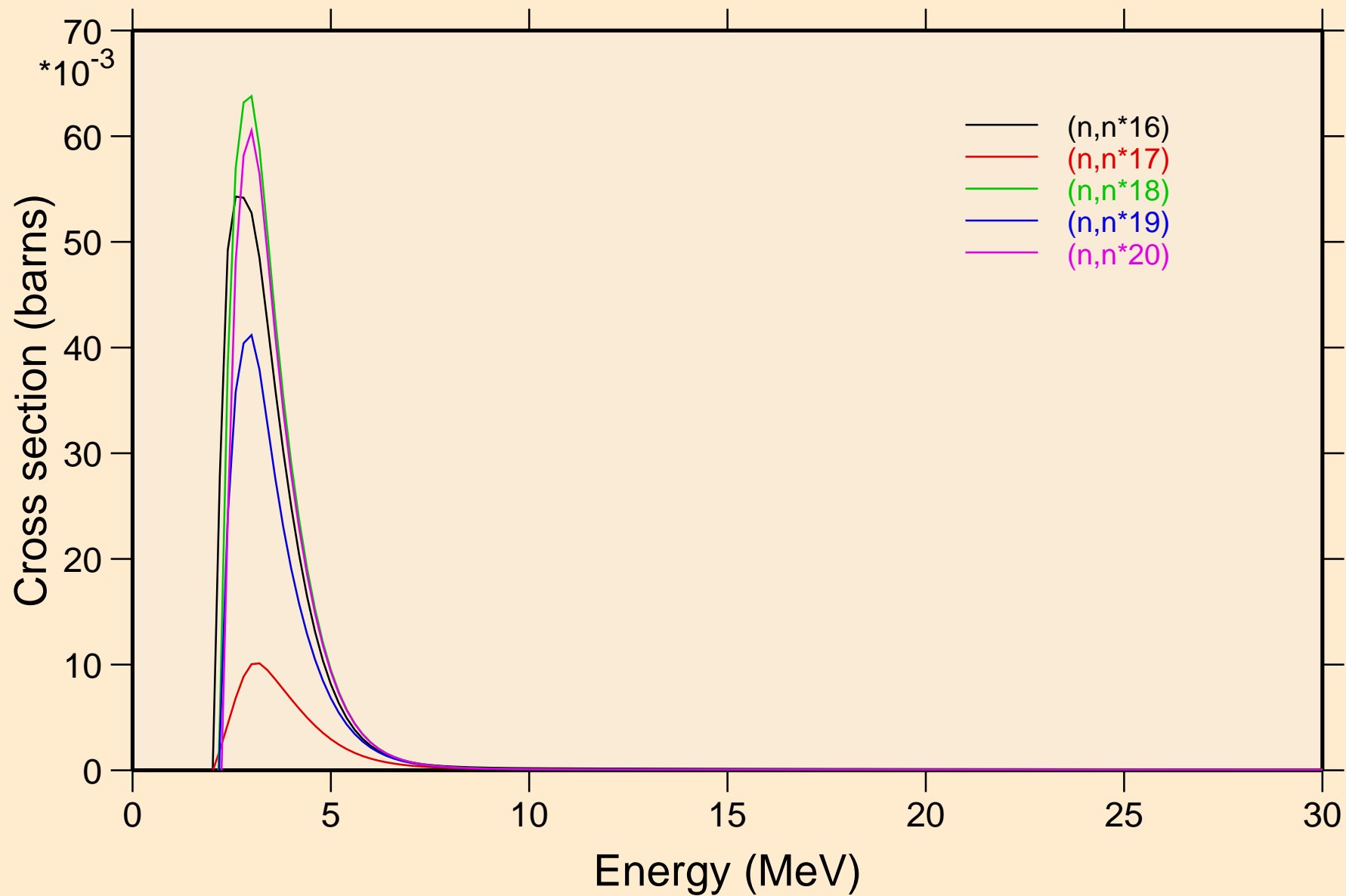

RB089 NEUTRON ACER TENDL-2019 LIBRARY; T=293.16K
Inelastic levels

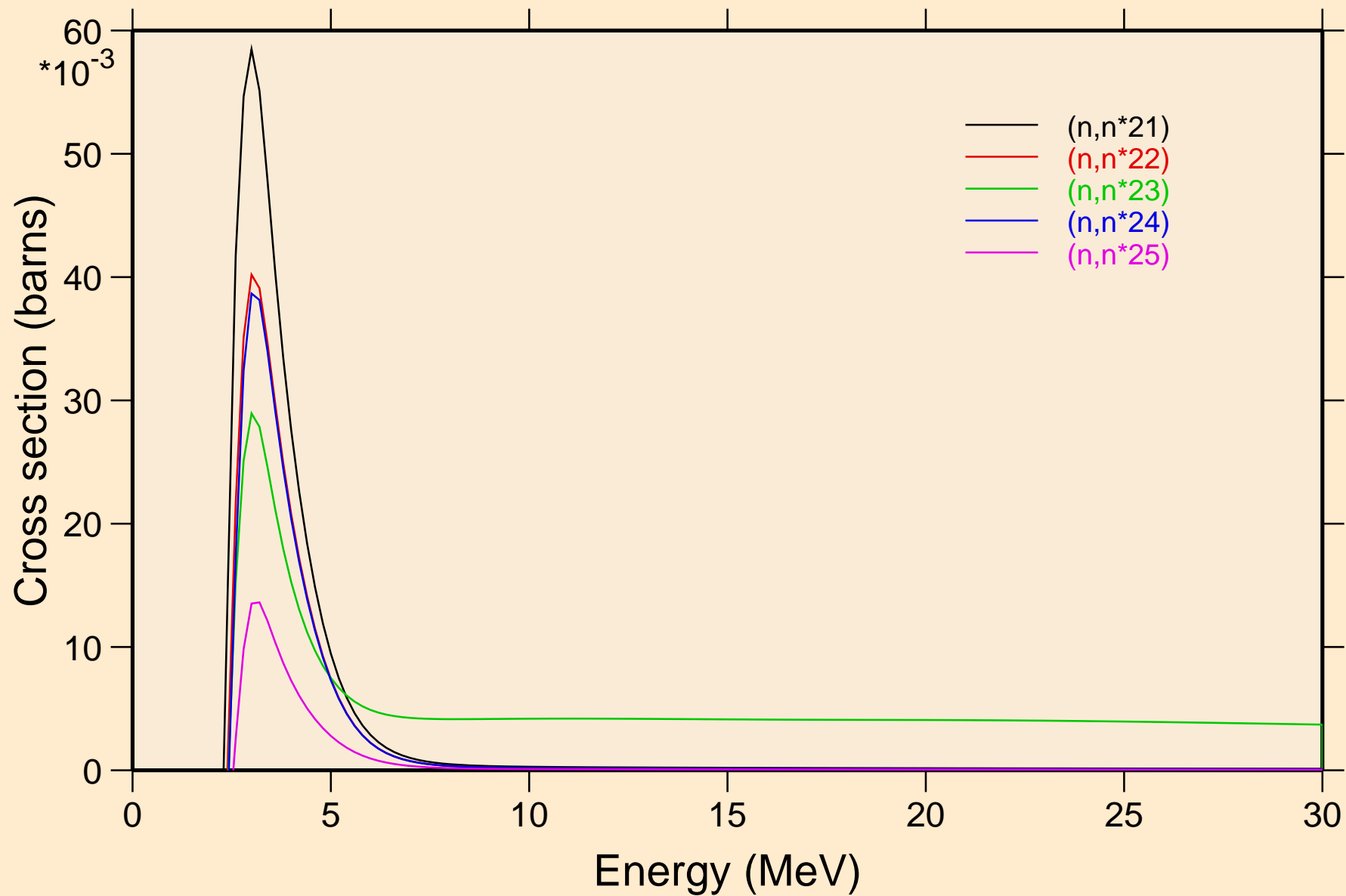

RB089 NEUTRON ACER TENDL-2019 LIBRARY; T=293.16K
Inelastic levels

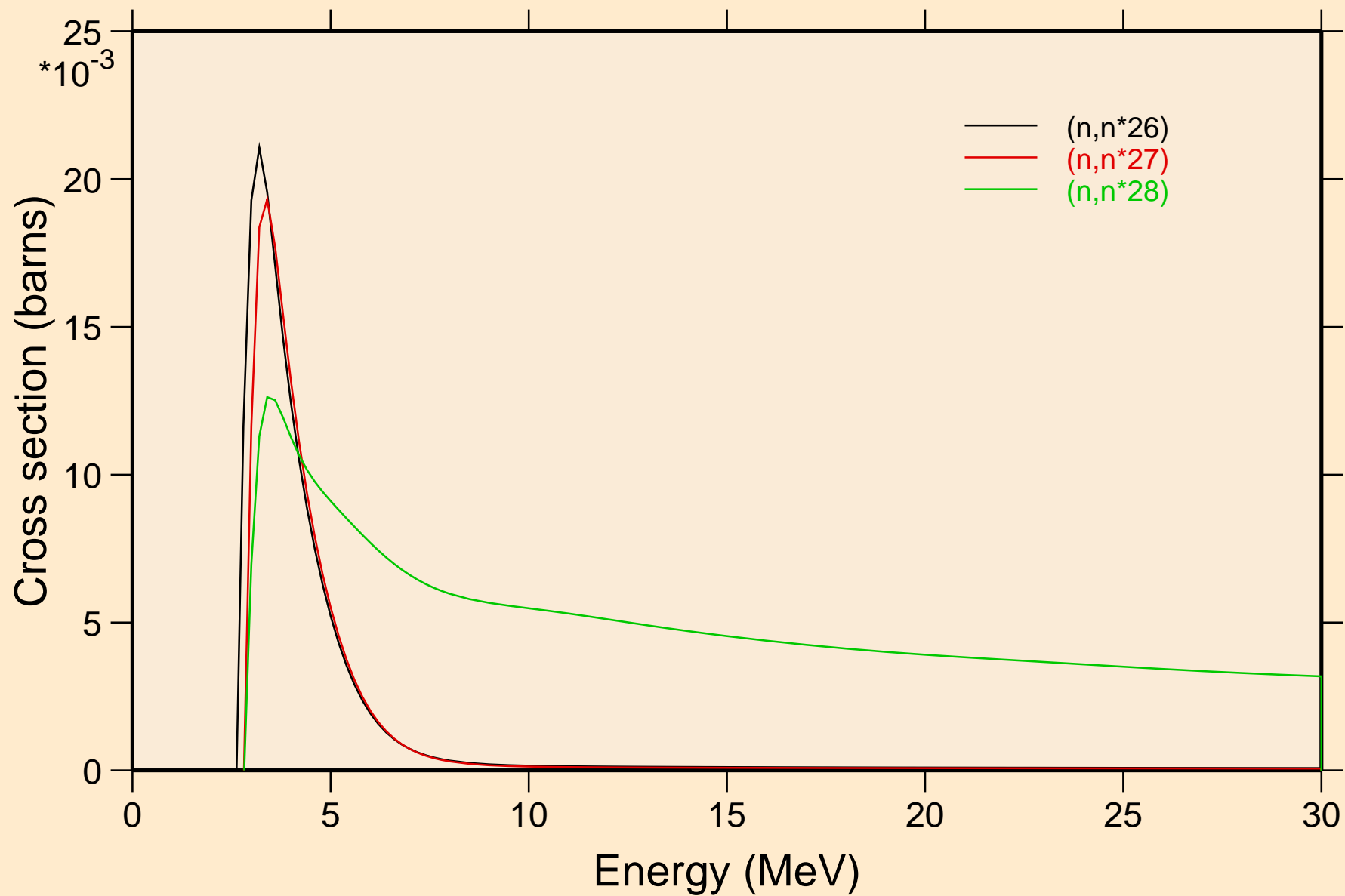

RB089 NEUTRON ACER TENDL-2019 LIBRARY; T=293.16K
Threshold reactions

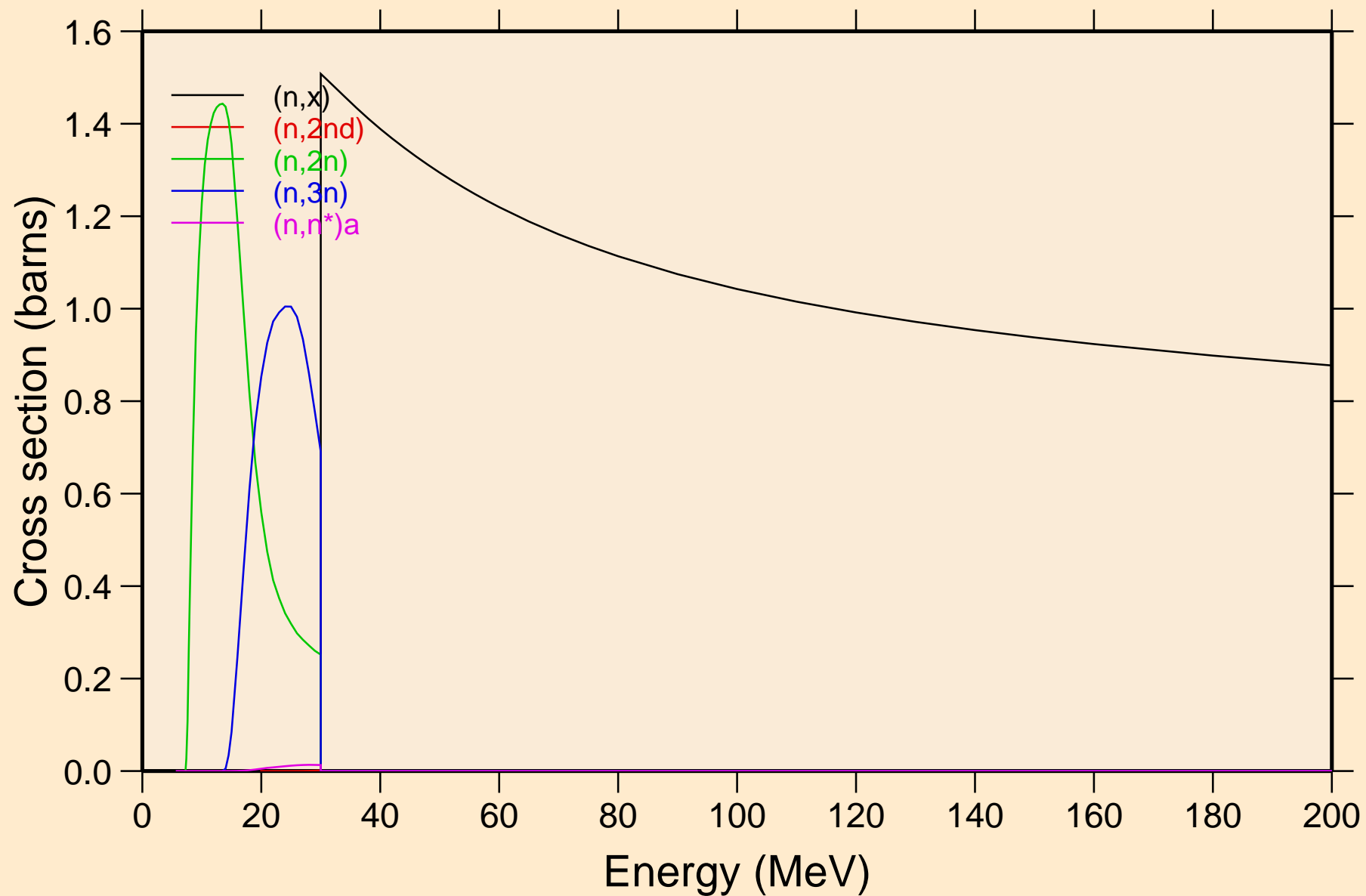

RB089 NEUTRON ACER TENDL-2019 LIBRARY; T=293.16K
Threshold reactions

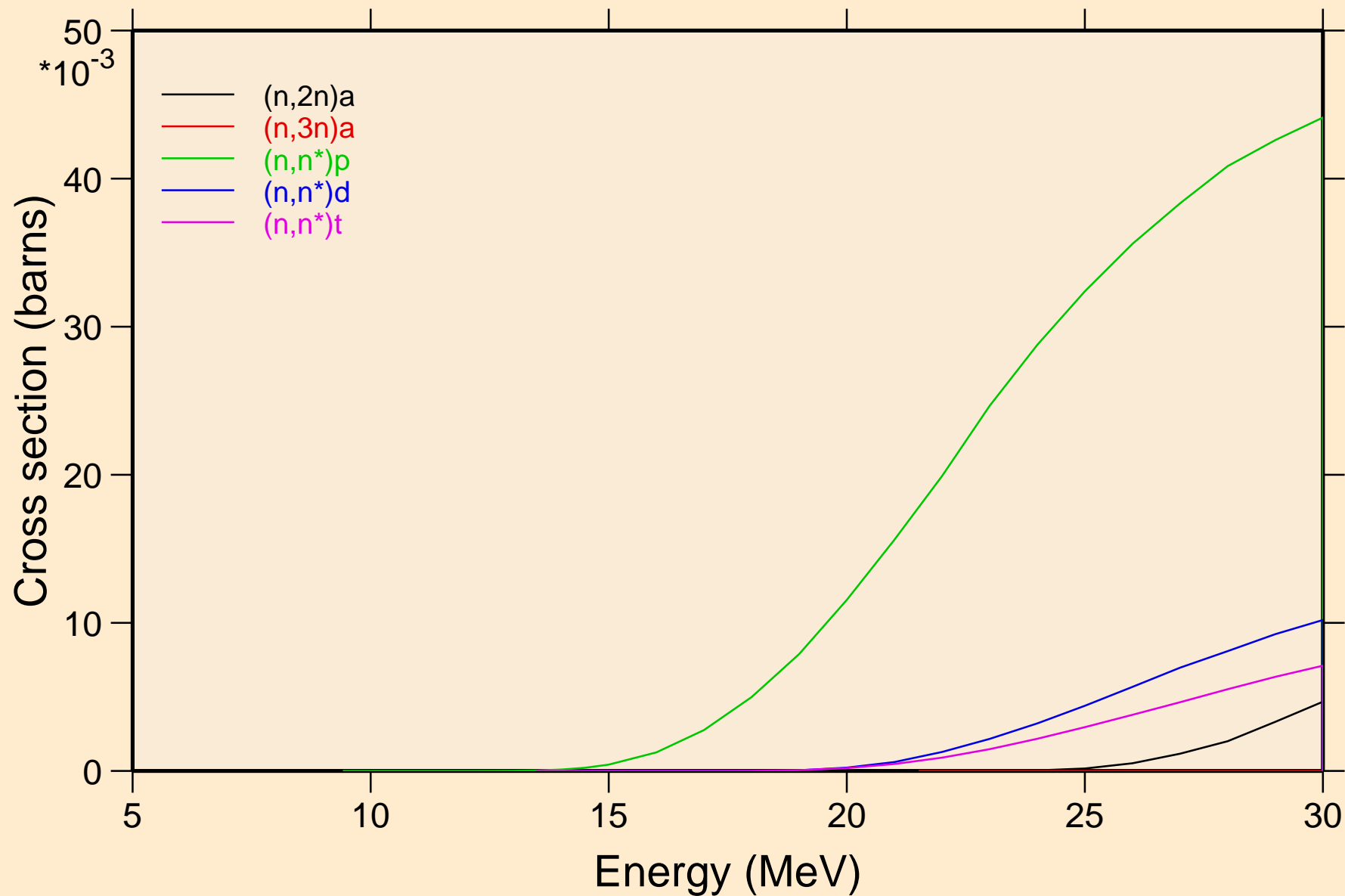

RB089 NEUTRON ACER TENDL-2019 LIBRARY; T=293.16K
Threshold reactions

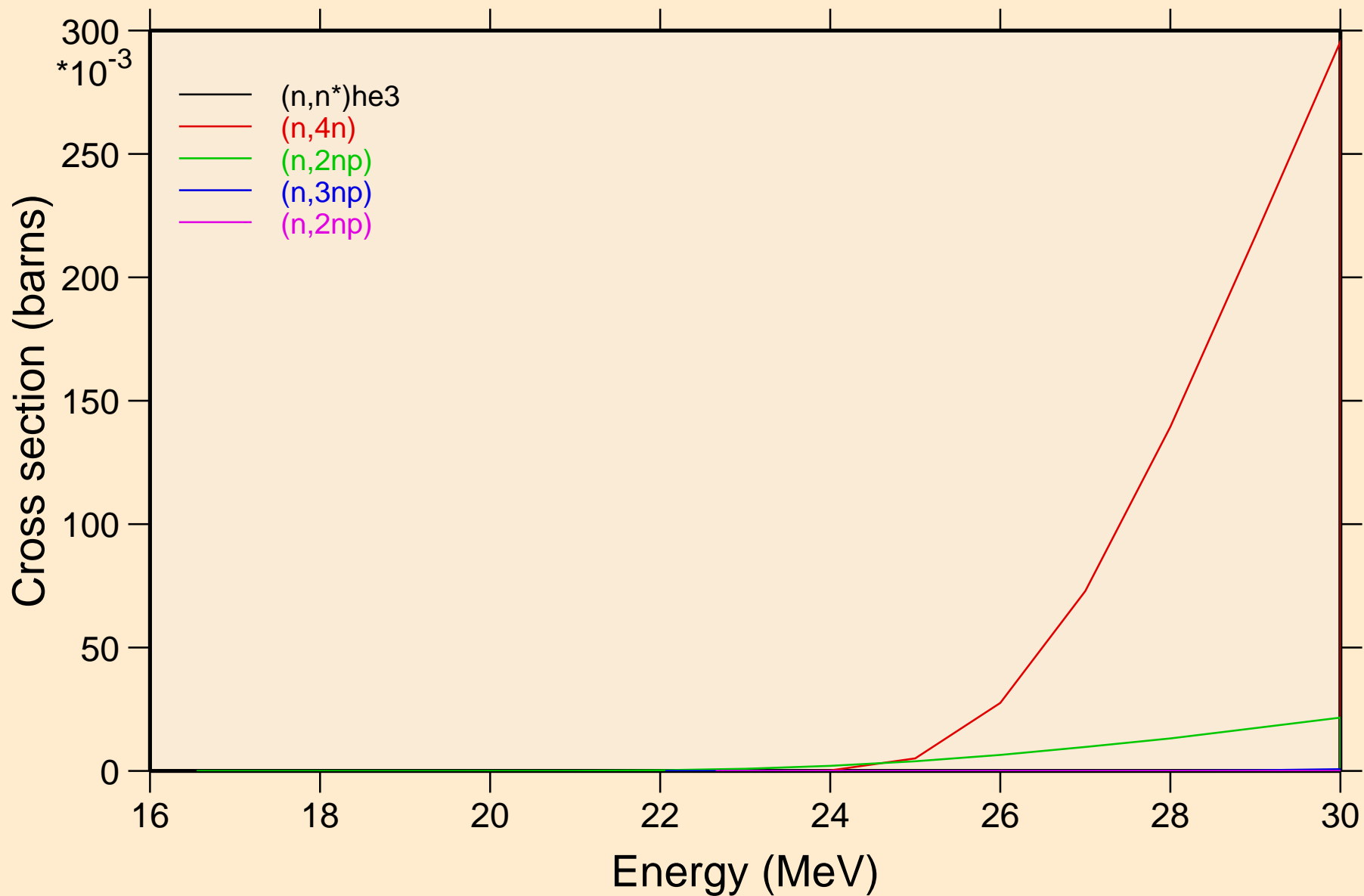

RB089 NEUTRON ACER TENDL-2019 LIBRARY; T=293.16K
Threshold reactions

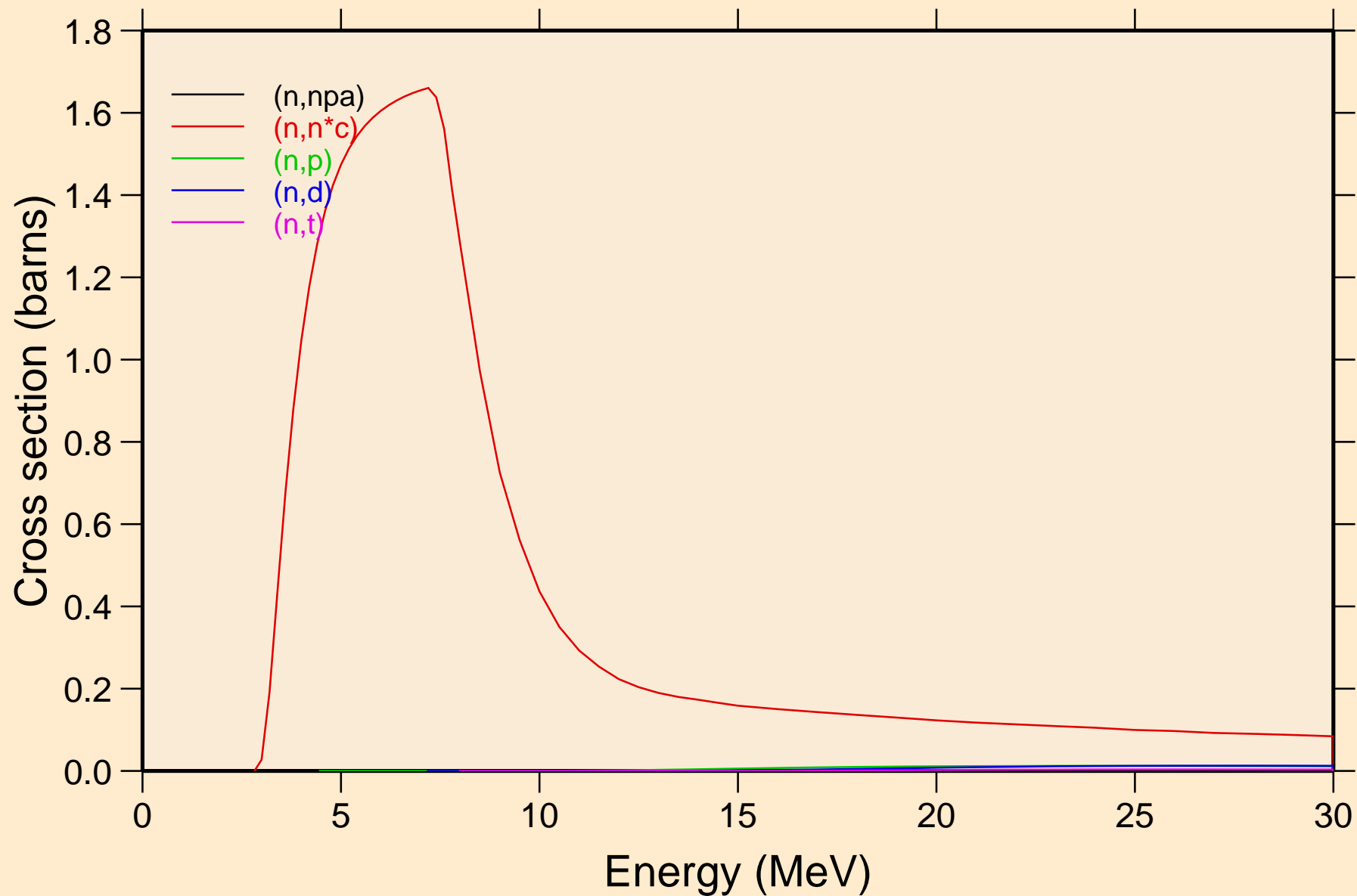

RB089 NEUTRON ACER TENDL-2019 LIBRARY; T=293.16K
Threshold reactions

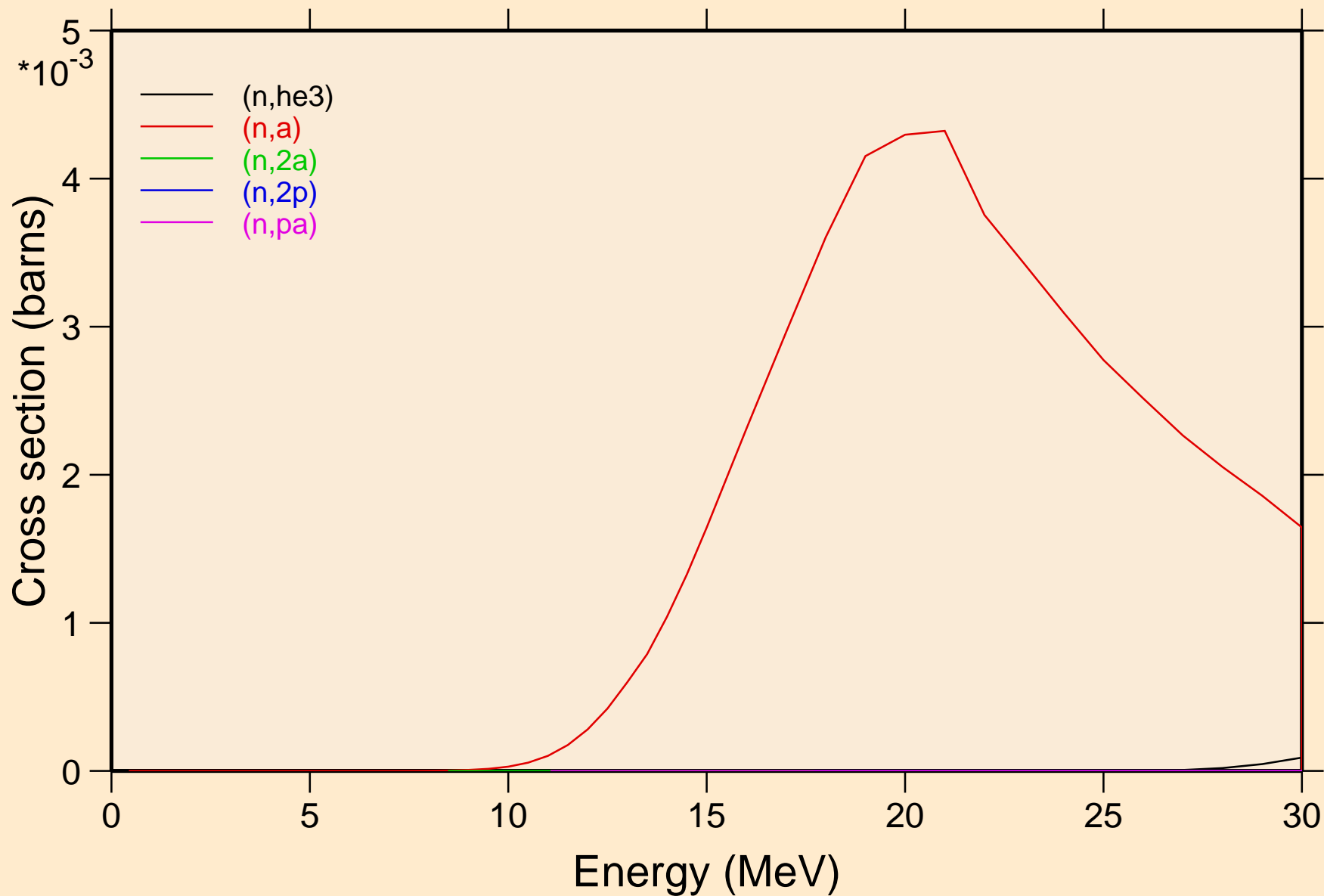

RB089 NEUTRON ACER TENDL-2019 LIBRARY; T=293.16K
Threshold reactions

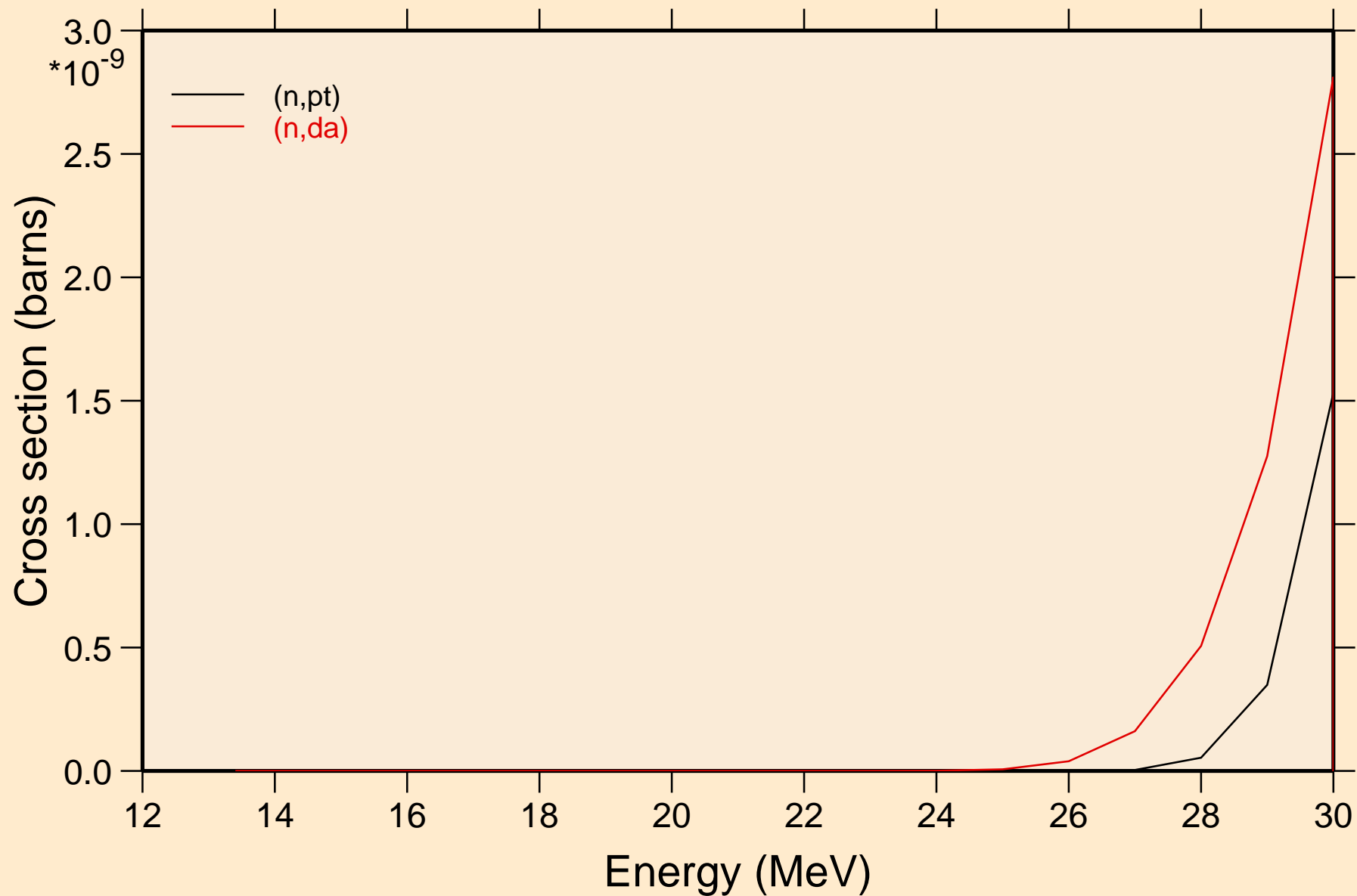

RB089 NEUTRON ACER TENDL-2019 LIBRARY; T=293.16K
Threshold reactions

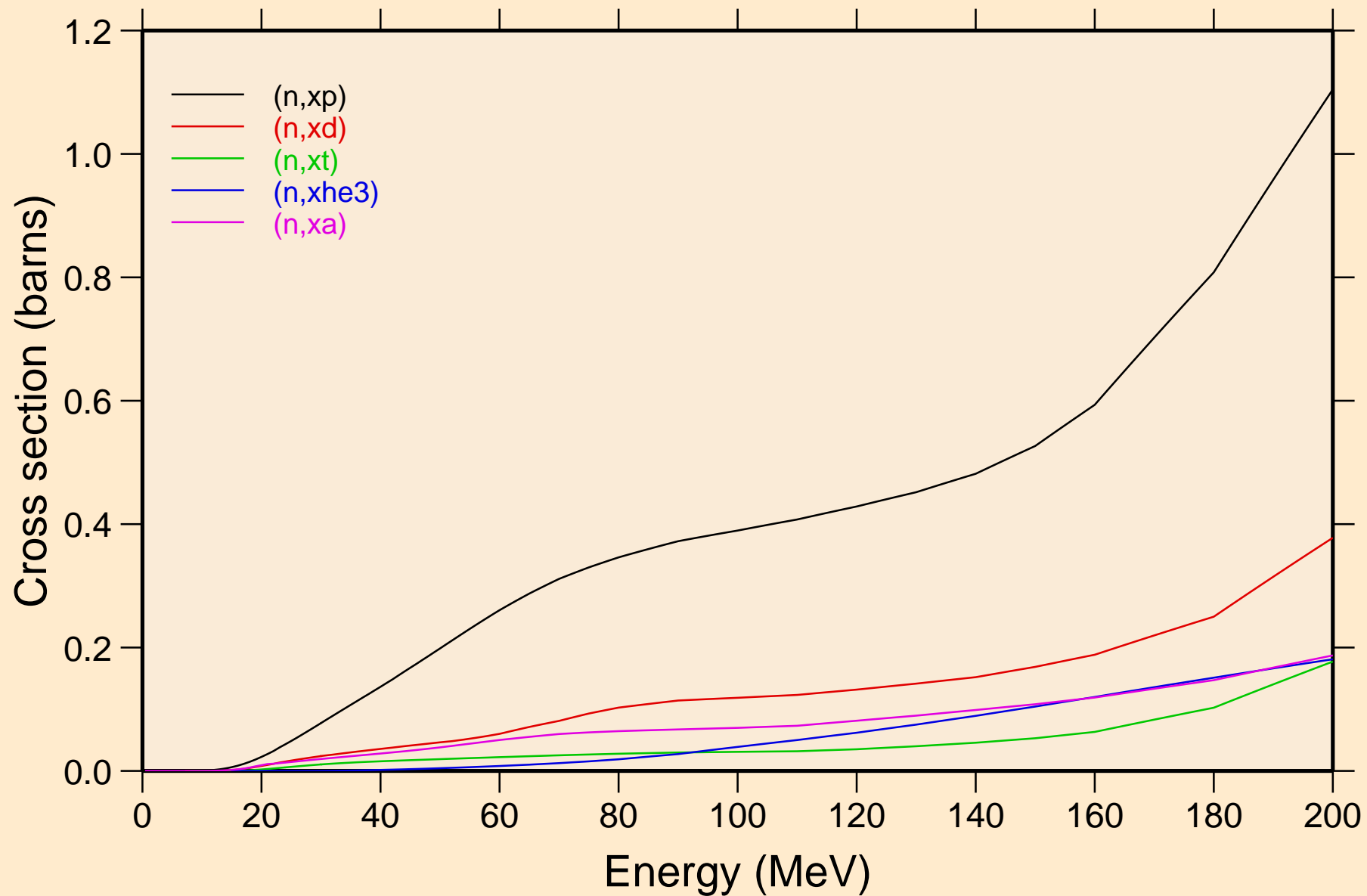

RB089 NEUTRON ACER TENDL-2019 LIBRARY; T=293.16K
angular distribution for elastic

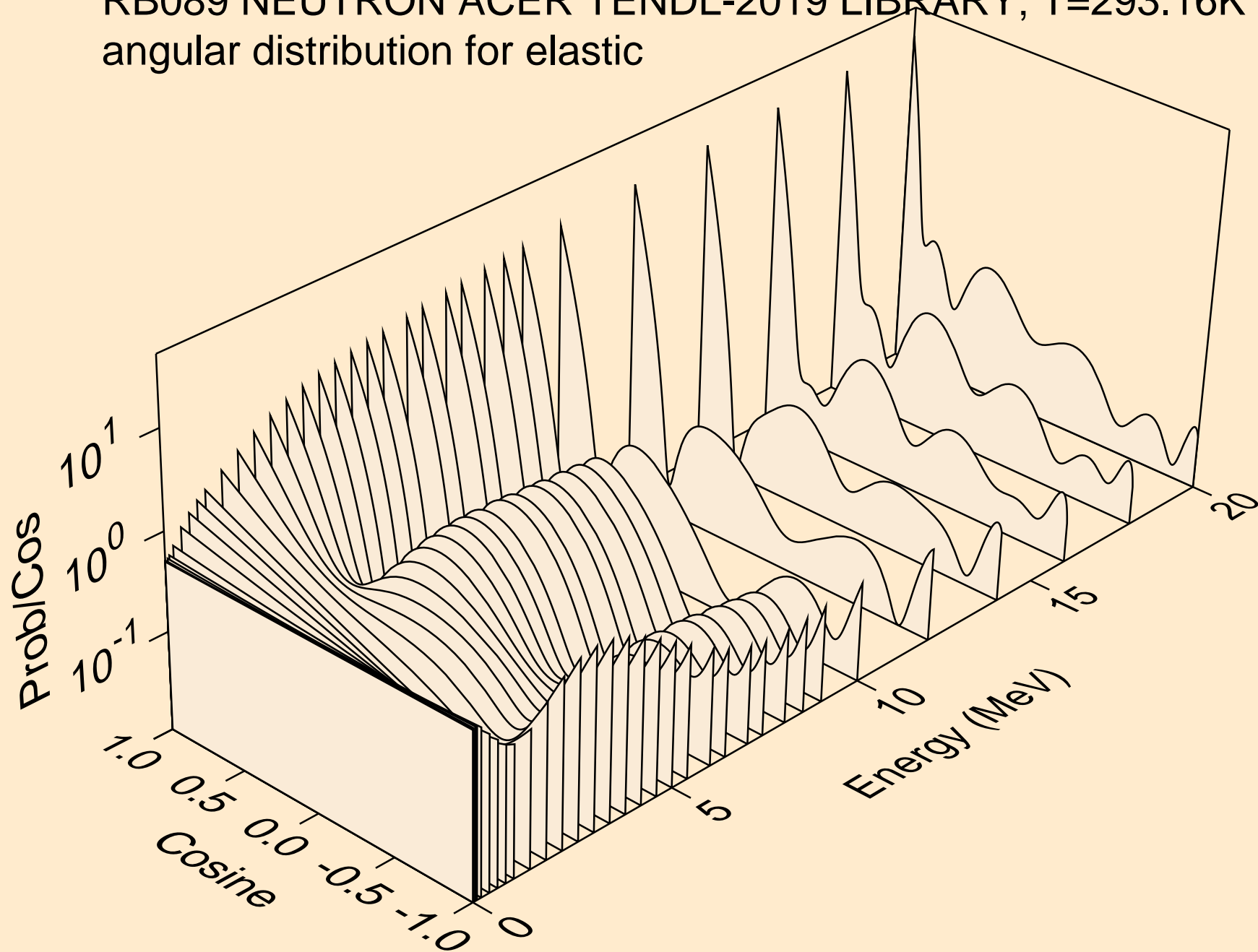

RB089 NEUTRON ACER TENDL-2019 LIBRARY; T=293.16K
angular distribution for elastic

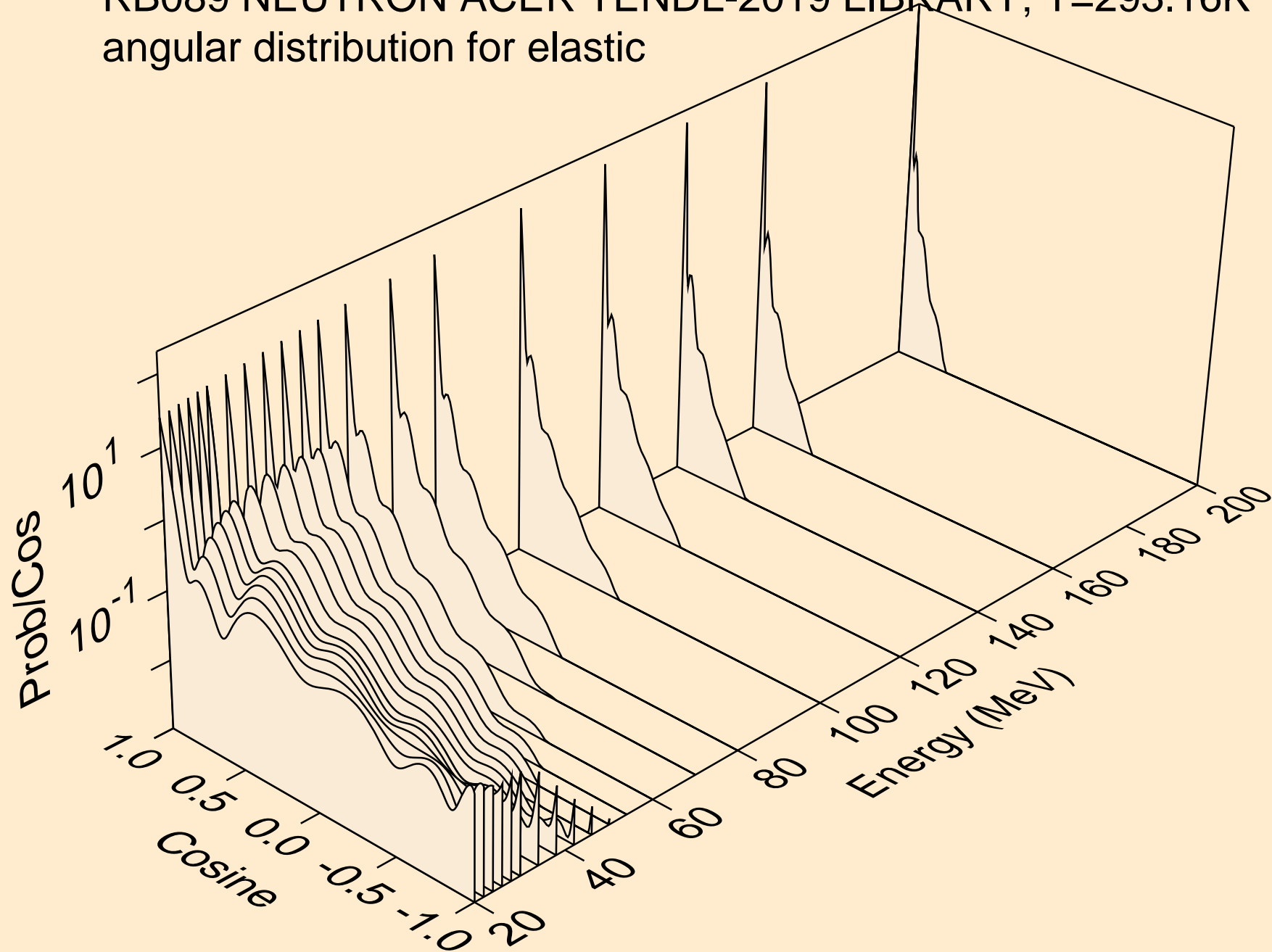

RB089 NEUTRON ACER TENDL-2019 LIBRARY; T=293.16K
angular distribution for (n,n*1)

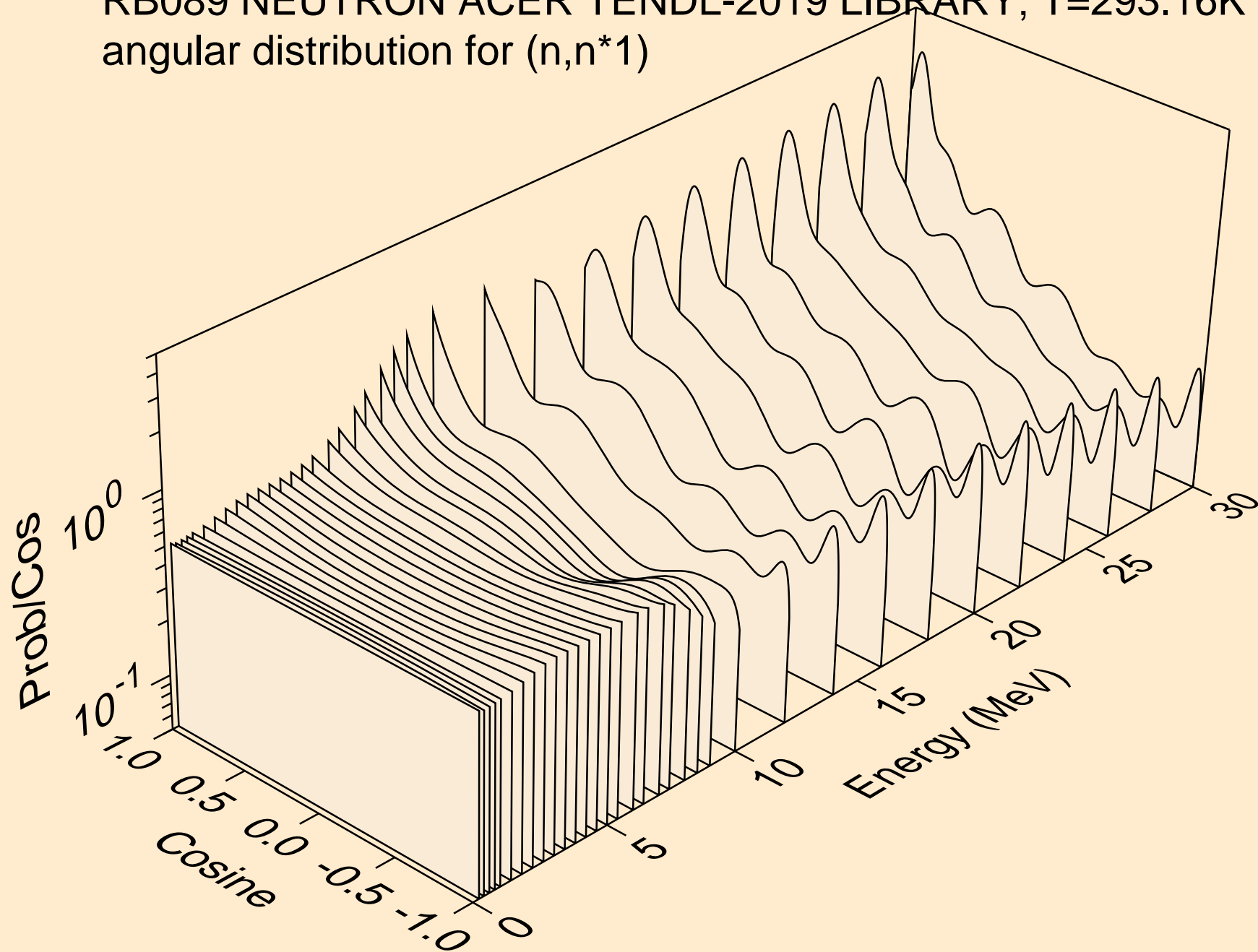

RB089 NEUTRON ACER TENDL-2019 LIBRARY; T=293.16K
angular distribution for (n,n*2)

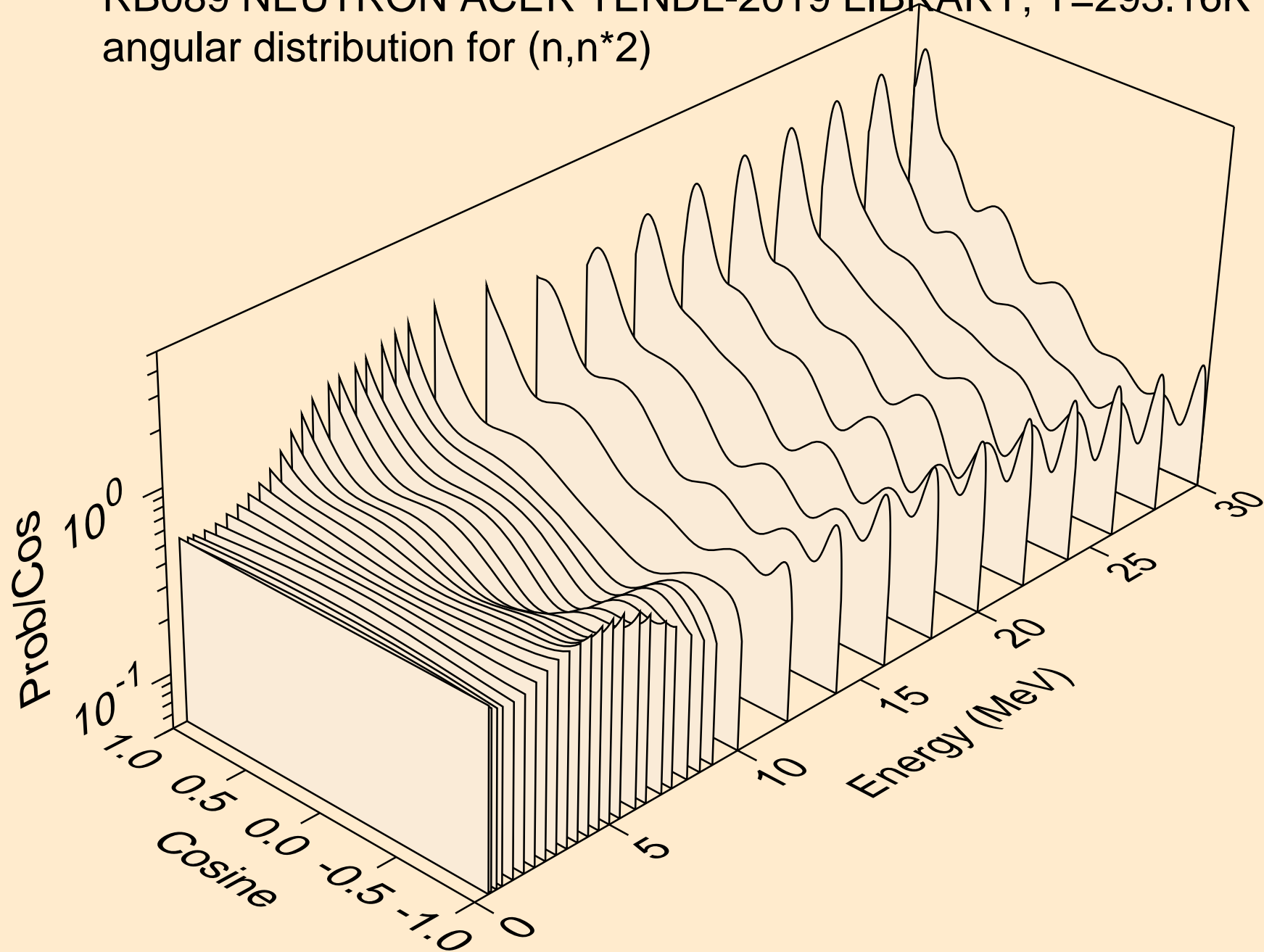

RB089 NEUTRON ACER TENDL-2019 LIBRARY; T=293.16K
angular distribution for (n,n*3)

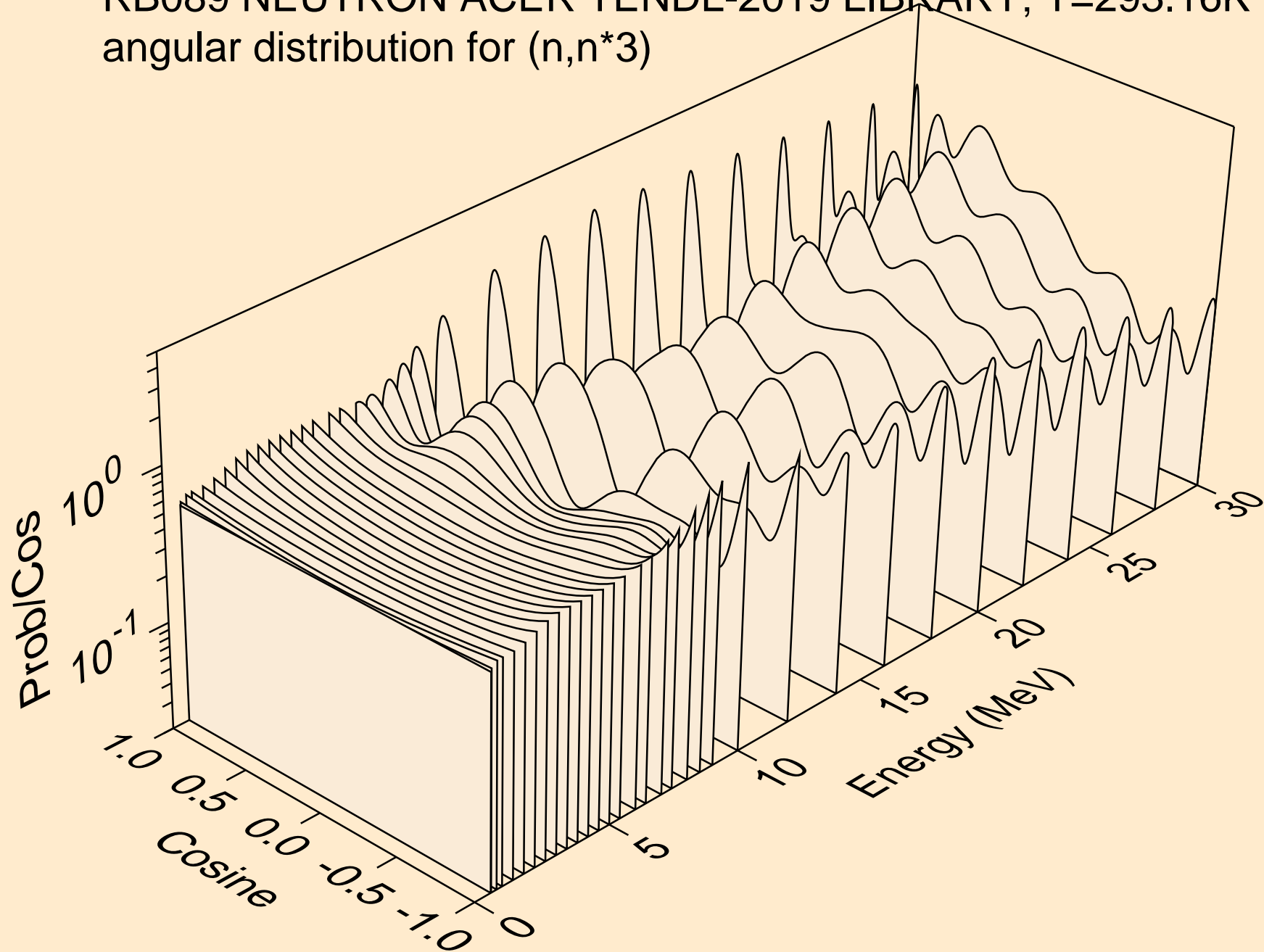

RB089 NEUTRON ACER TENDL-2019 LIBRARY; T=293.16K
angular distribution for (n,n*4)

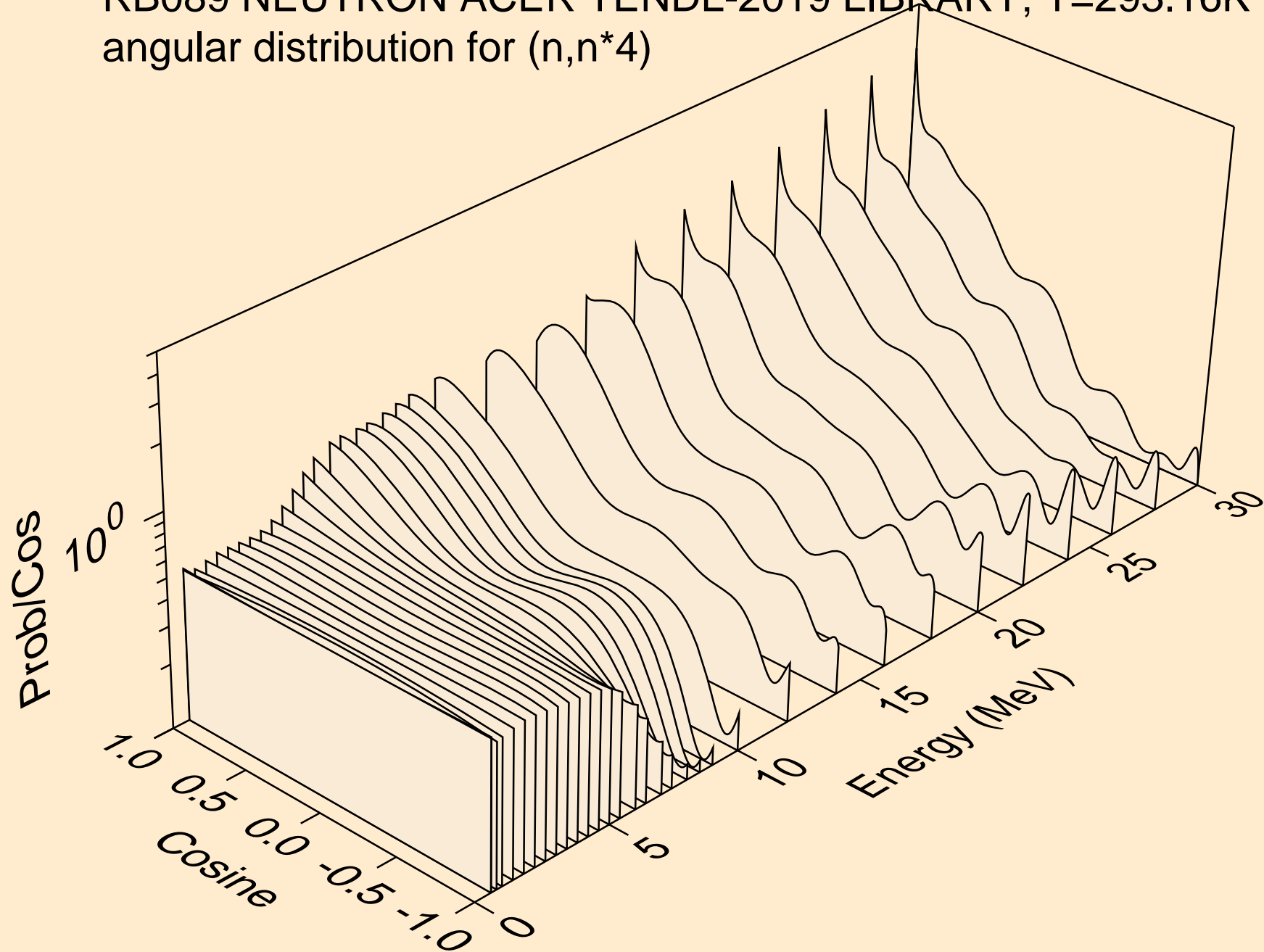

RB089 NEUTRON ACER TENDL-2019 LIBRARY; T=293.16K
angular distribution for (n,n*5)

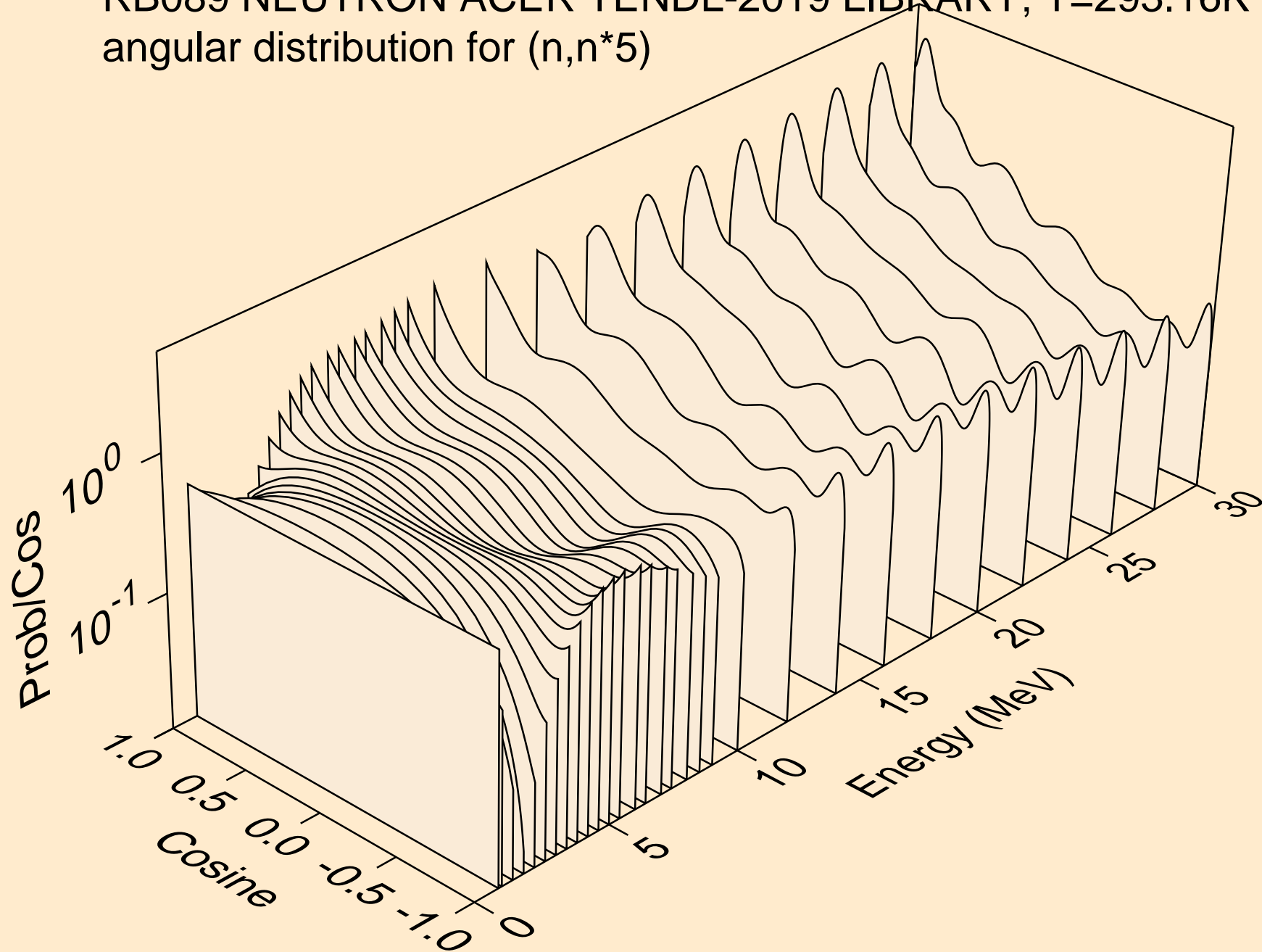

RB089 NEUTRON ACER TENDL-2019 LIBRARY; T=293.16K
angular distribution for (n,n*6)

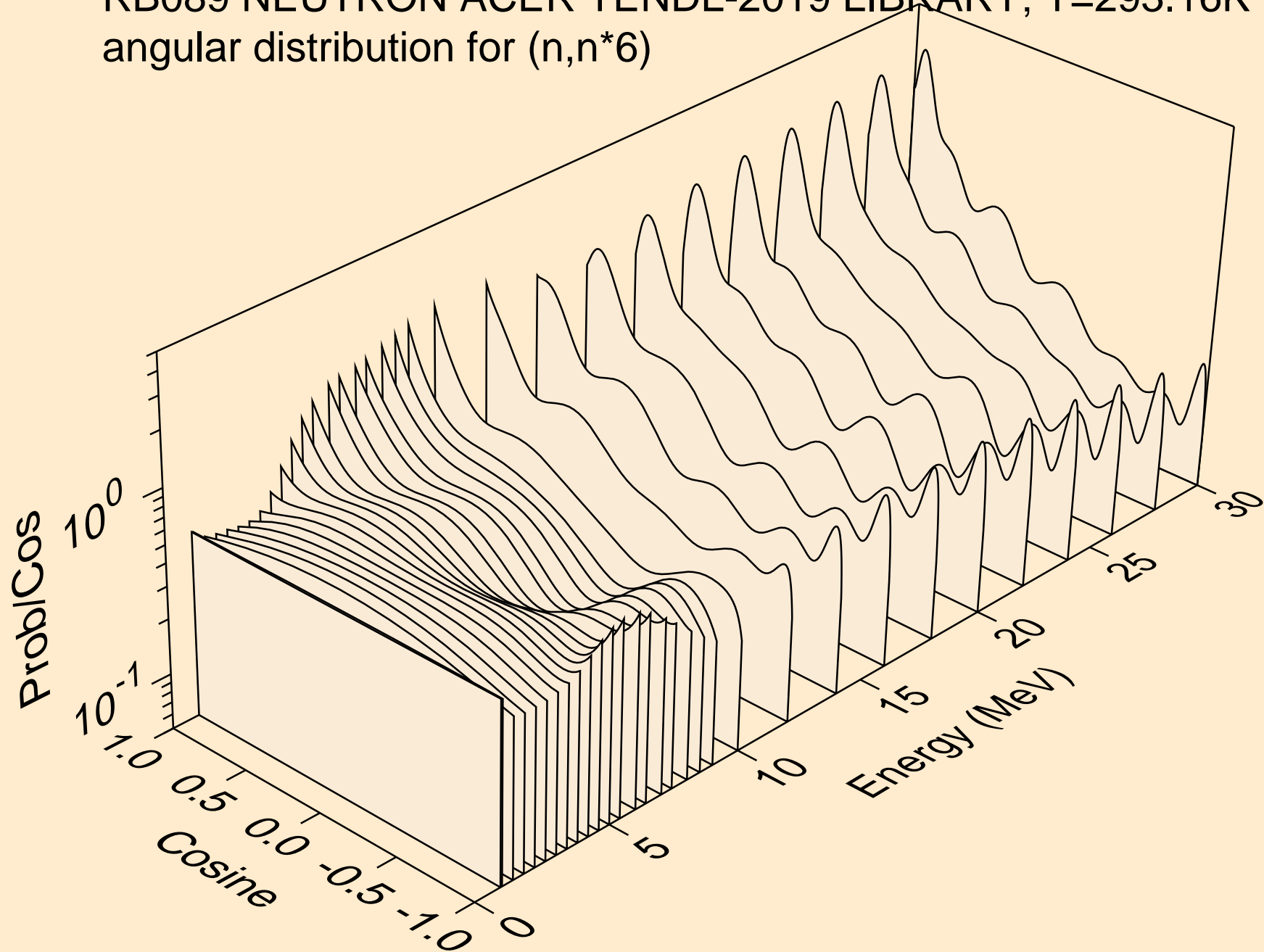

RB089 NEUTRON ACER TENDL-2019 LIBRARY; T=293.16K
angular distribution for (n,n*7)

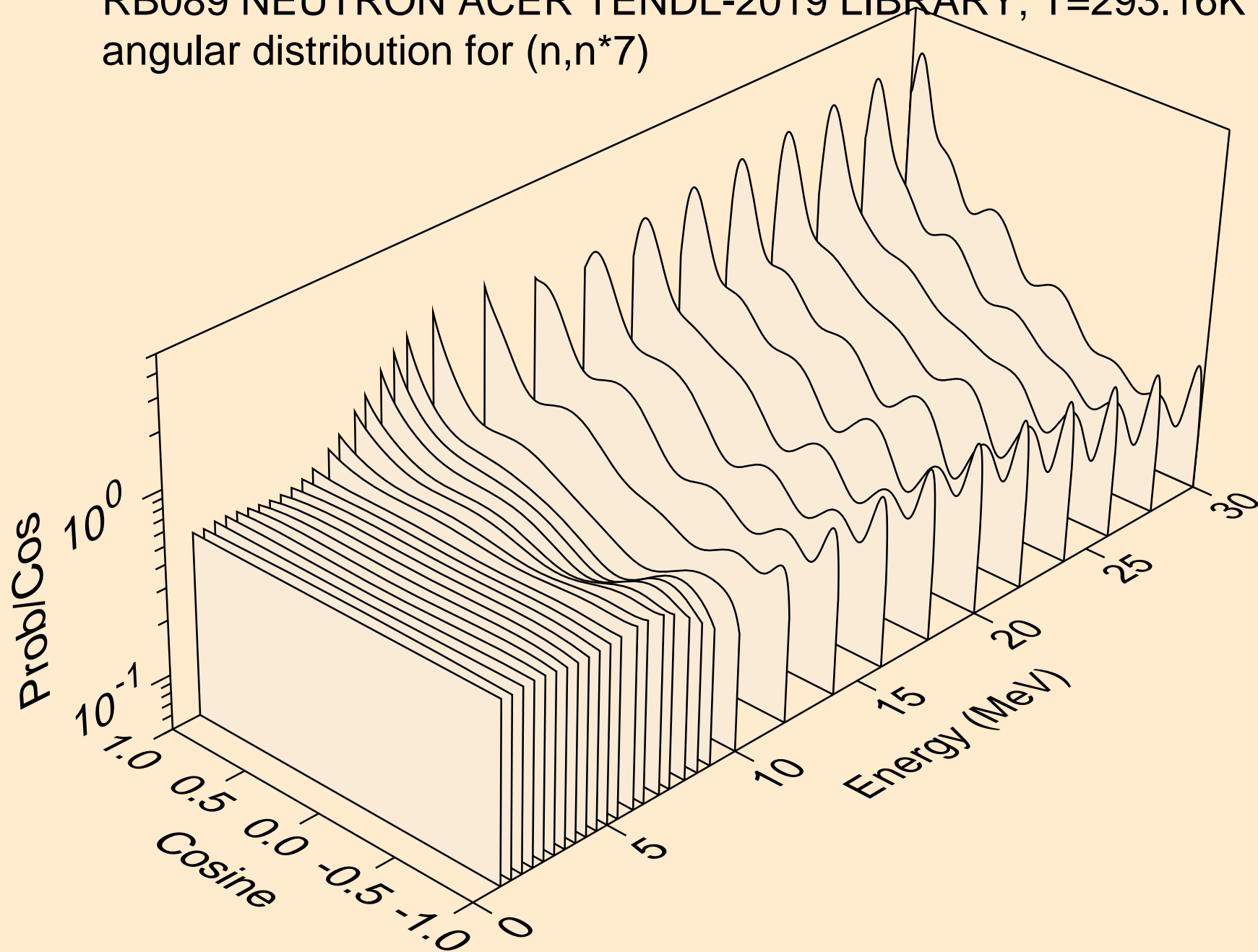

RB089 NEUTRON ACER TENDL-2019 LIBRARY; T=293.16K
angular distribution for (n,n*8)

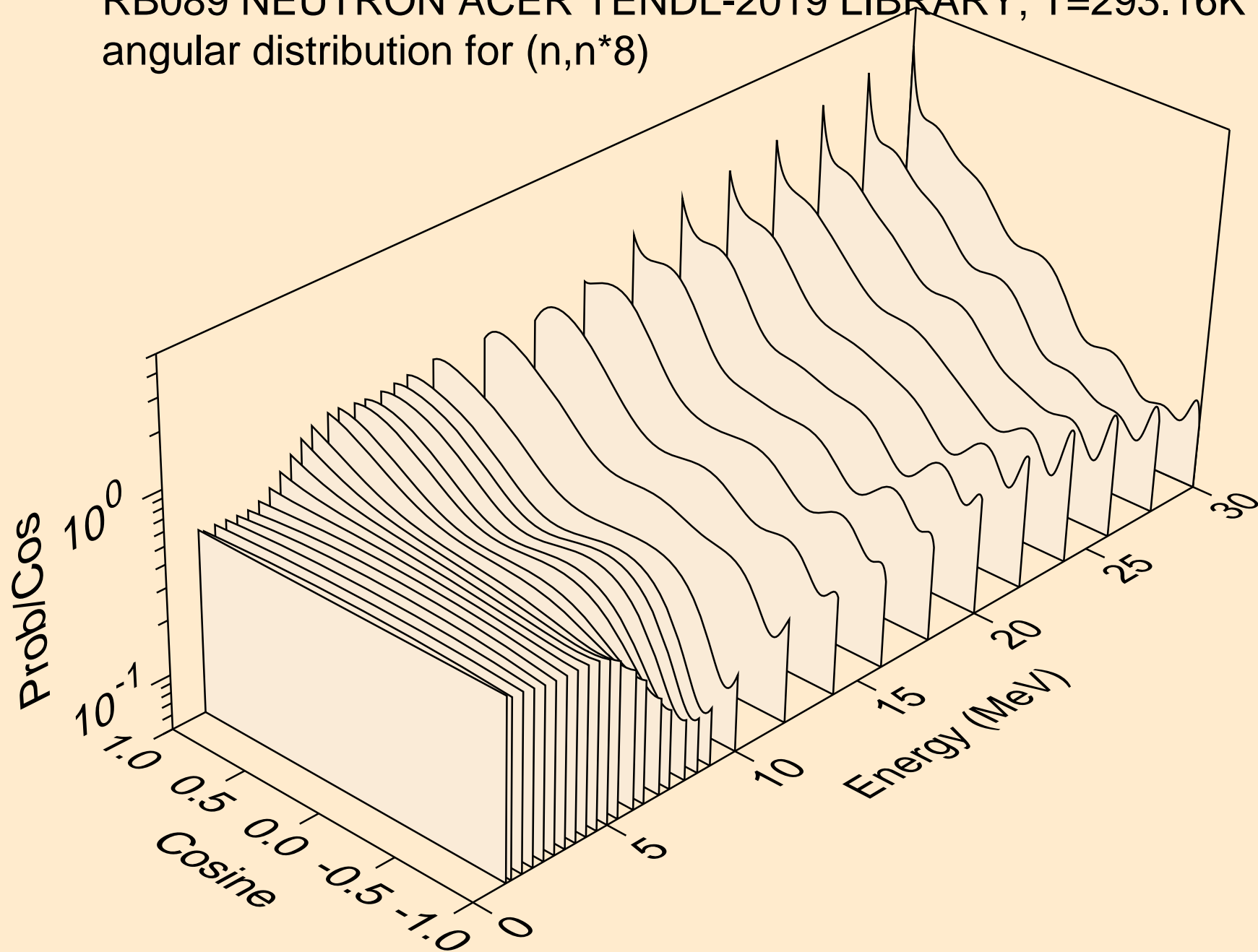

RB089 NEUTRON ACER TENDL-2019 LIBRARY; T=293.16K
angular distribution for (n,n*9)

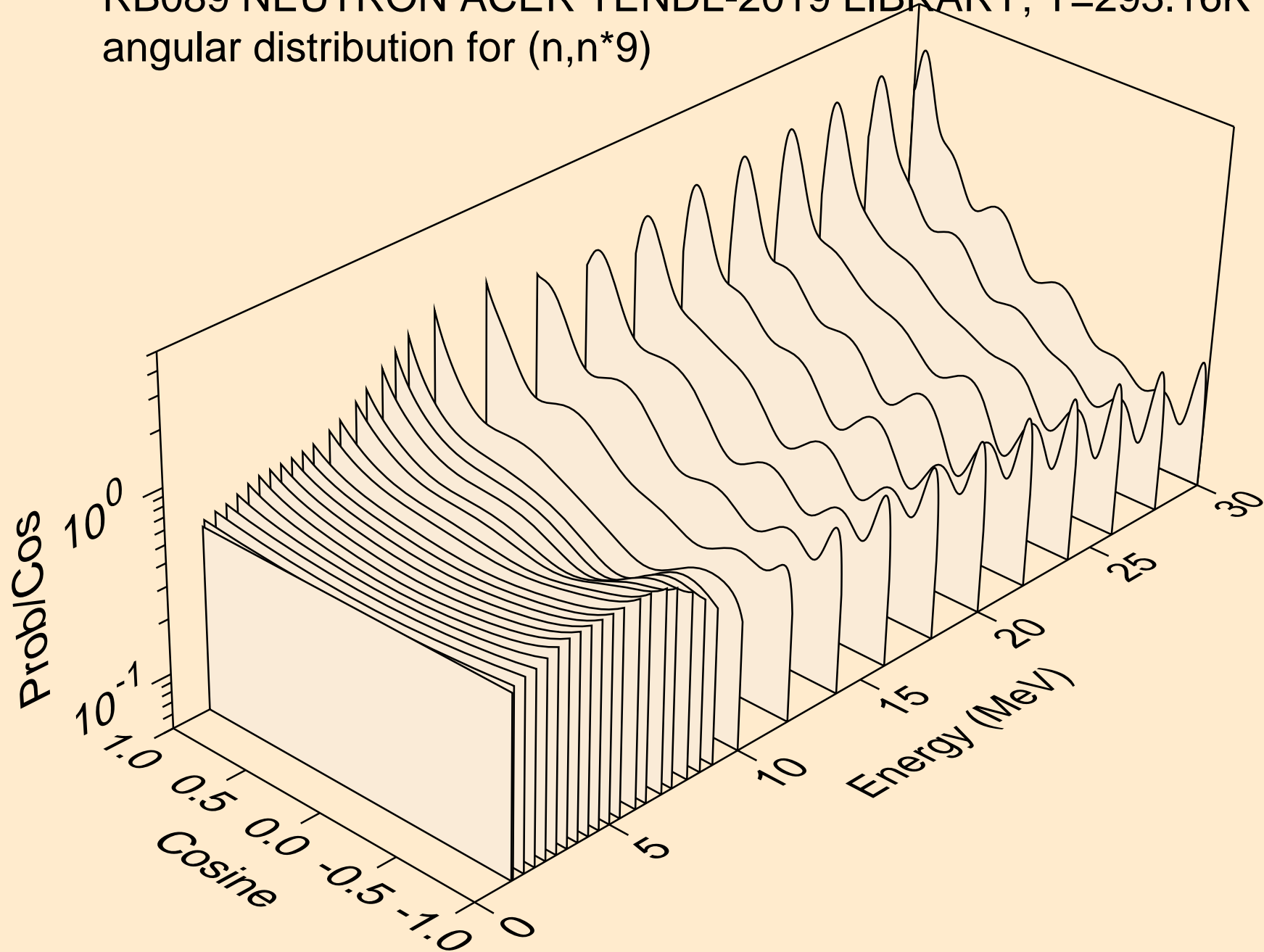

RB089 NEUTRON ACER TENDL-2019 LIBRARY; T=293.16K
angular distribution for (n,n*10)

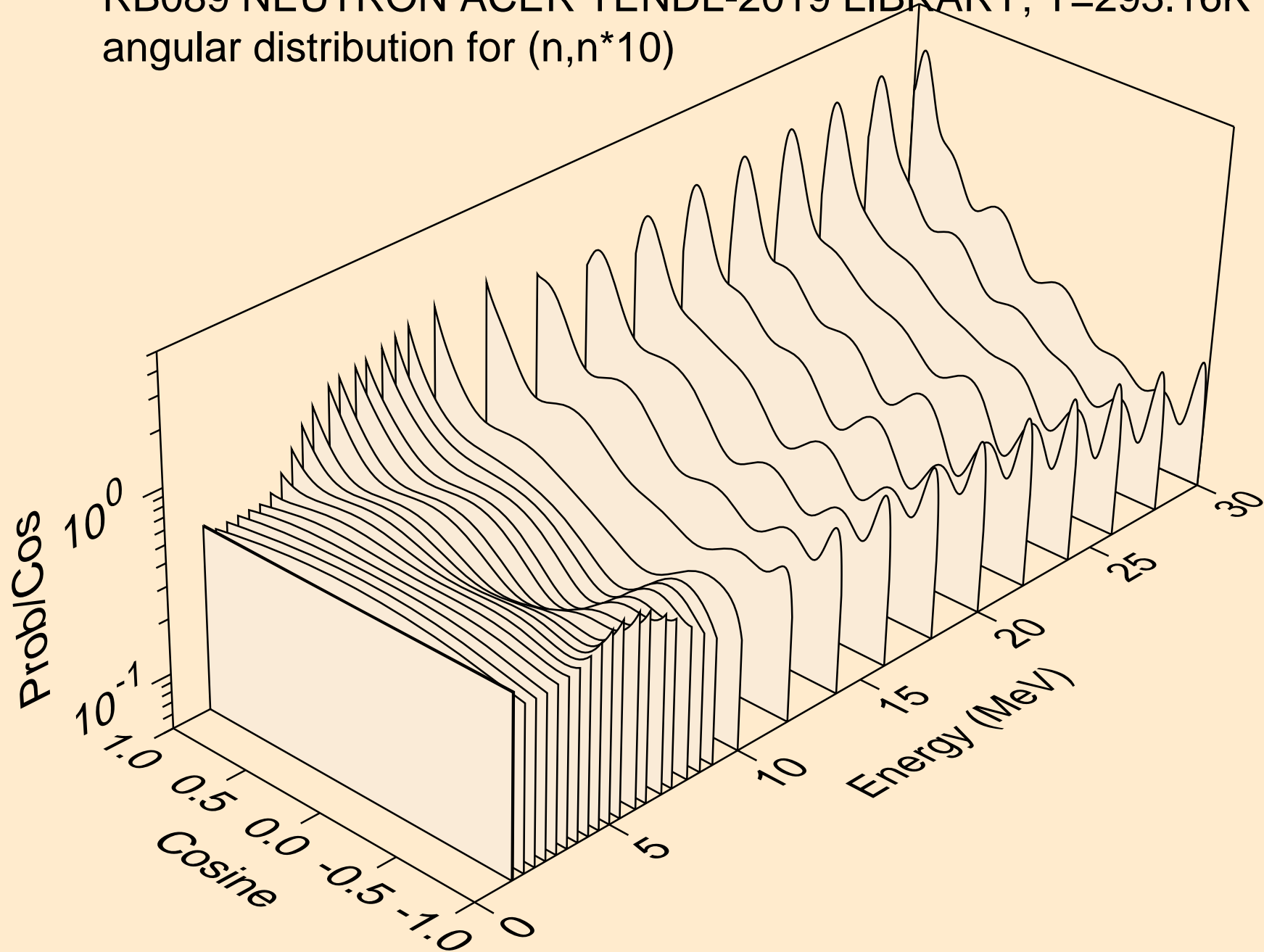

RB089 NEUTRON ACER TENDL-2019 LIBRARY; T=293.16K
angular distribution for (n,n*11)

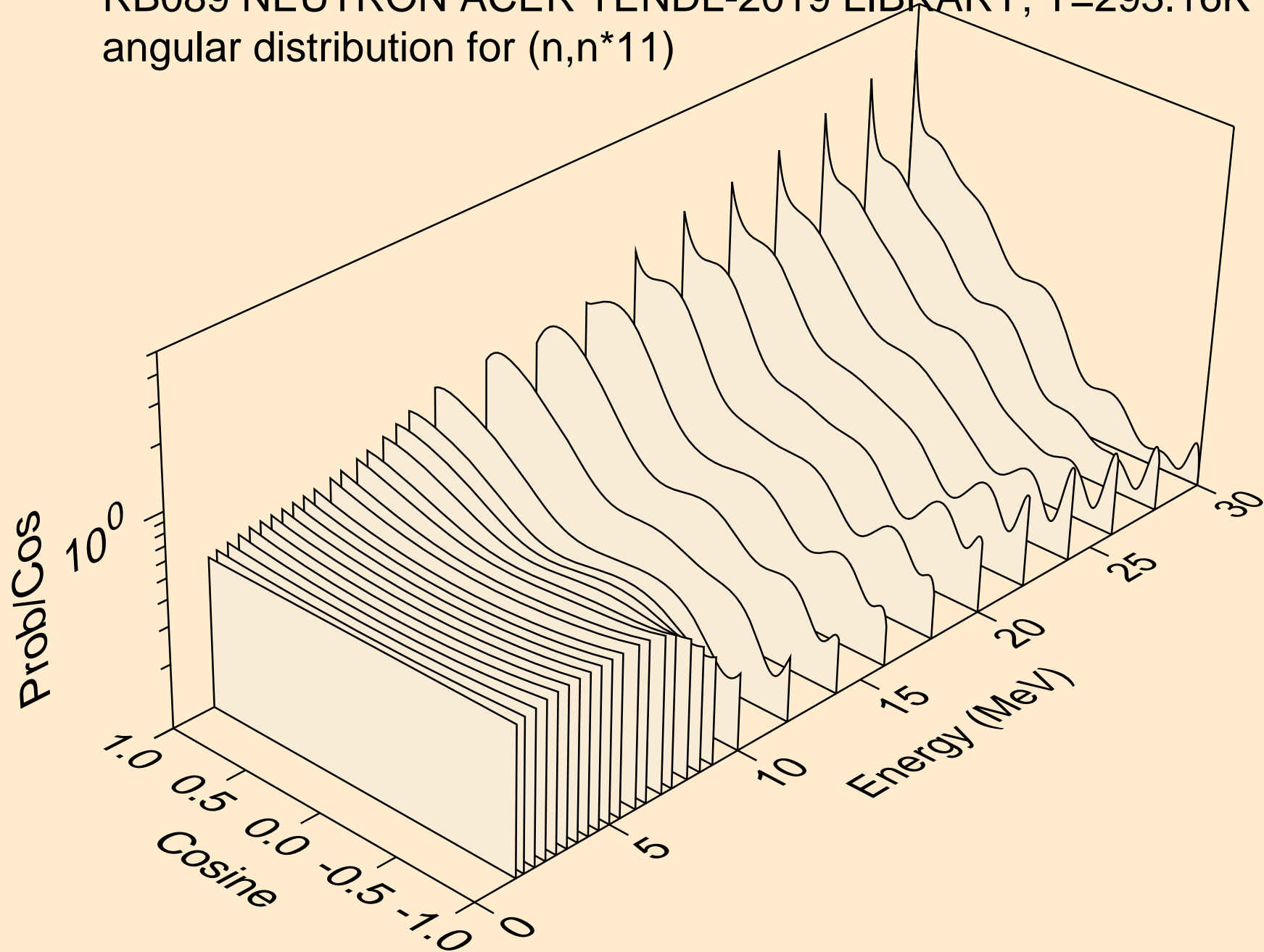

RB089 NEUTRON ACER TENDL-2019 LIBRARY; T=293.16K
angular distribution for (n,n*12)

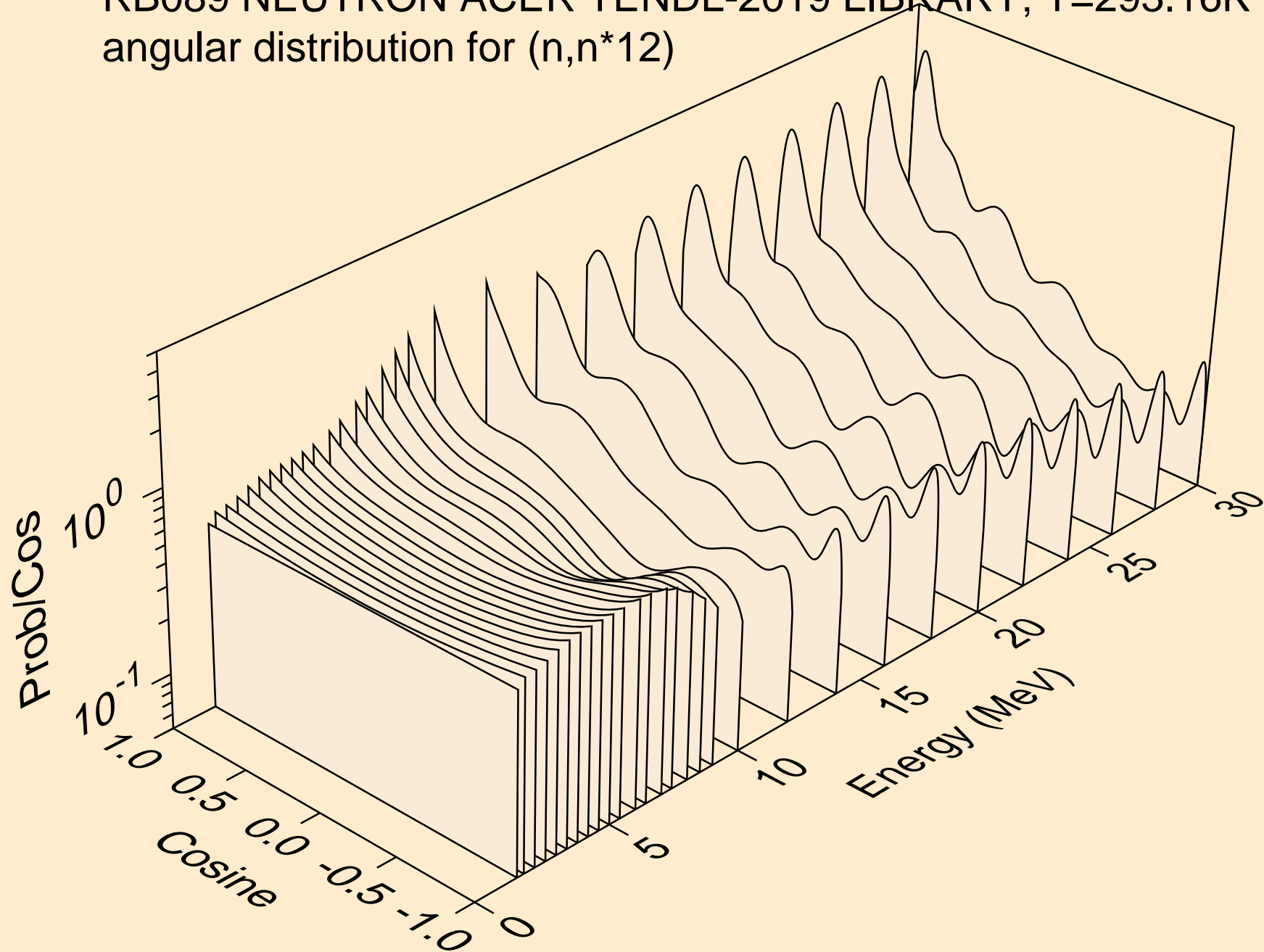

RB089 NEUTRON ACER TENDL-2019 LIBRARY; T=293.16K
angular distribution for (n,n*13)

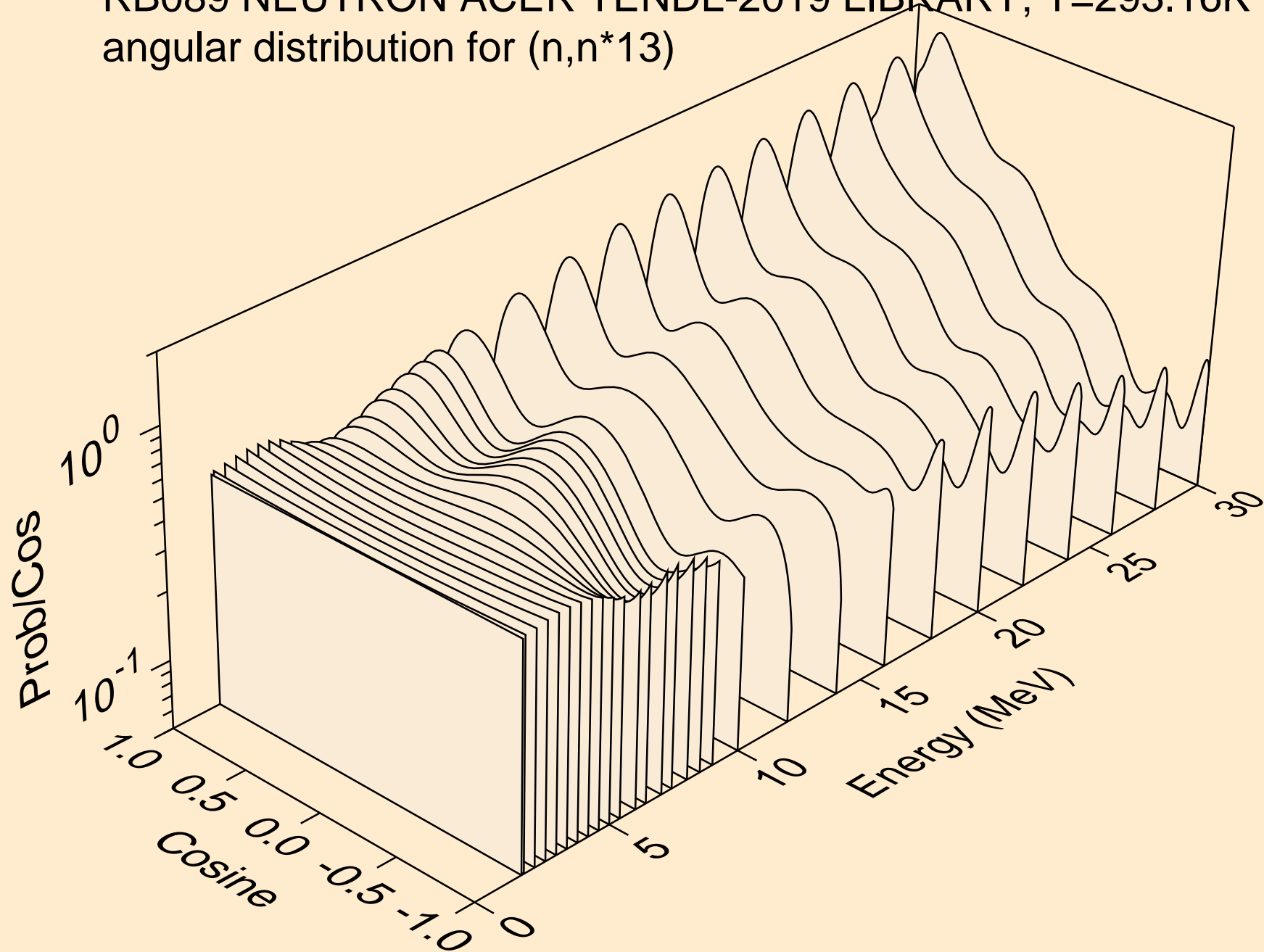

RB089 NEUTRON ACER TENDL-2019 LIBRARY; T=293.16K
angular distribution for (n,n*14)

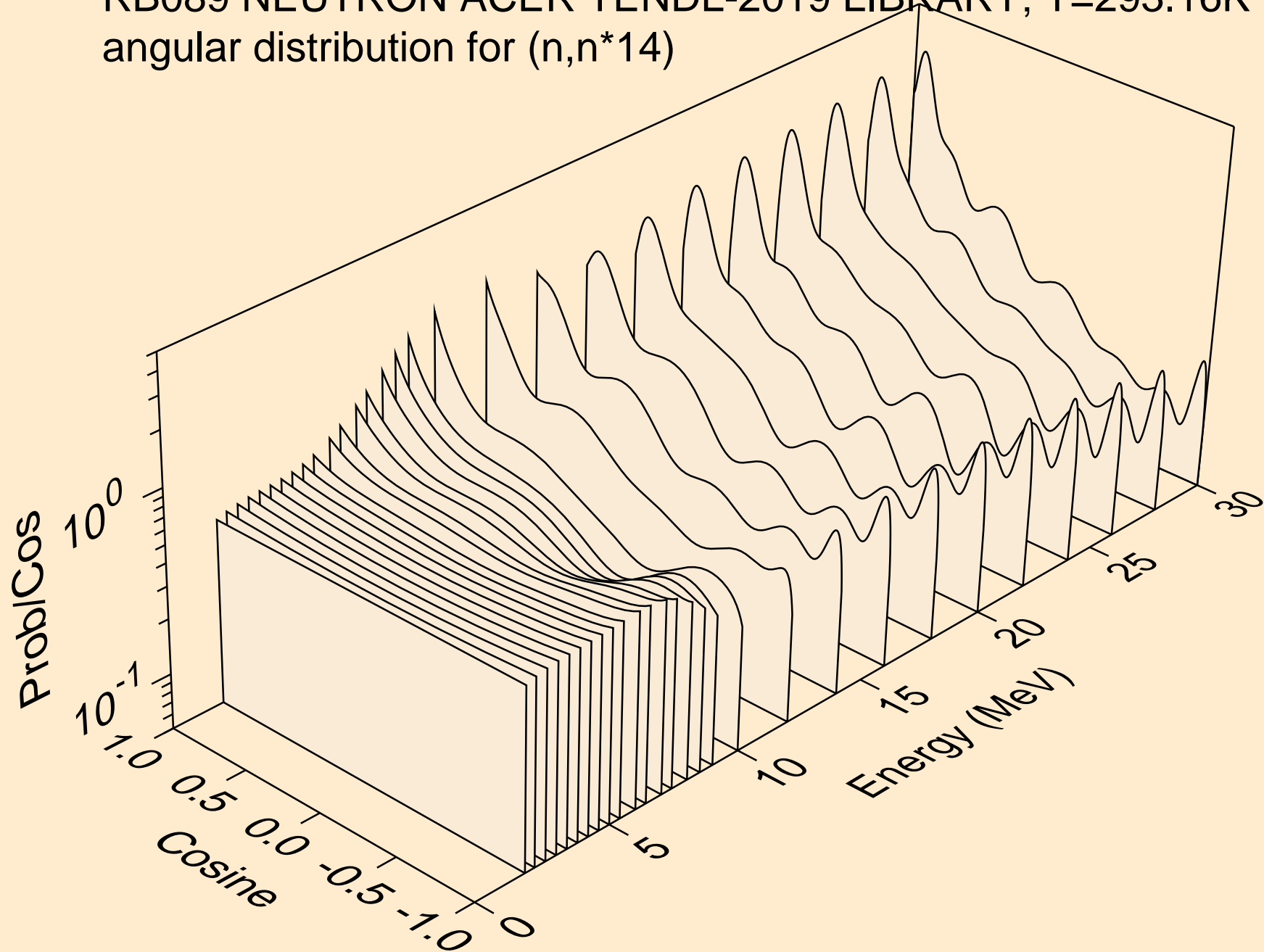

RB089 NEUTRON ACER TENDL-2019 LIBRARY; T=293.16K
angular distribution for (n,n*15)

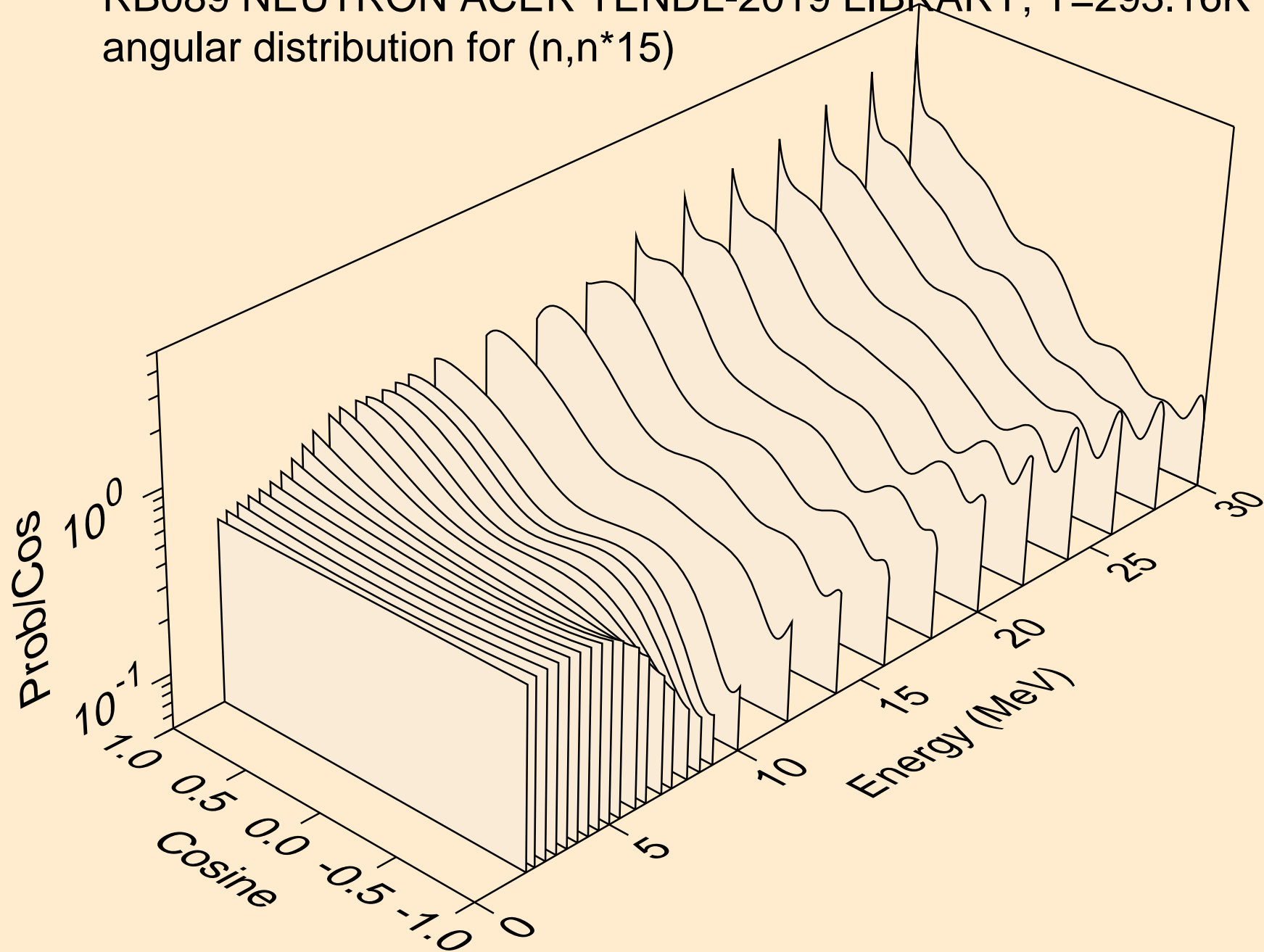

RB089 NEUTRON ACER TENDL-2019 LIBRARY; T=293.16K
angular distribution for (n,n*16)

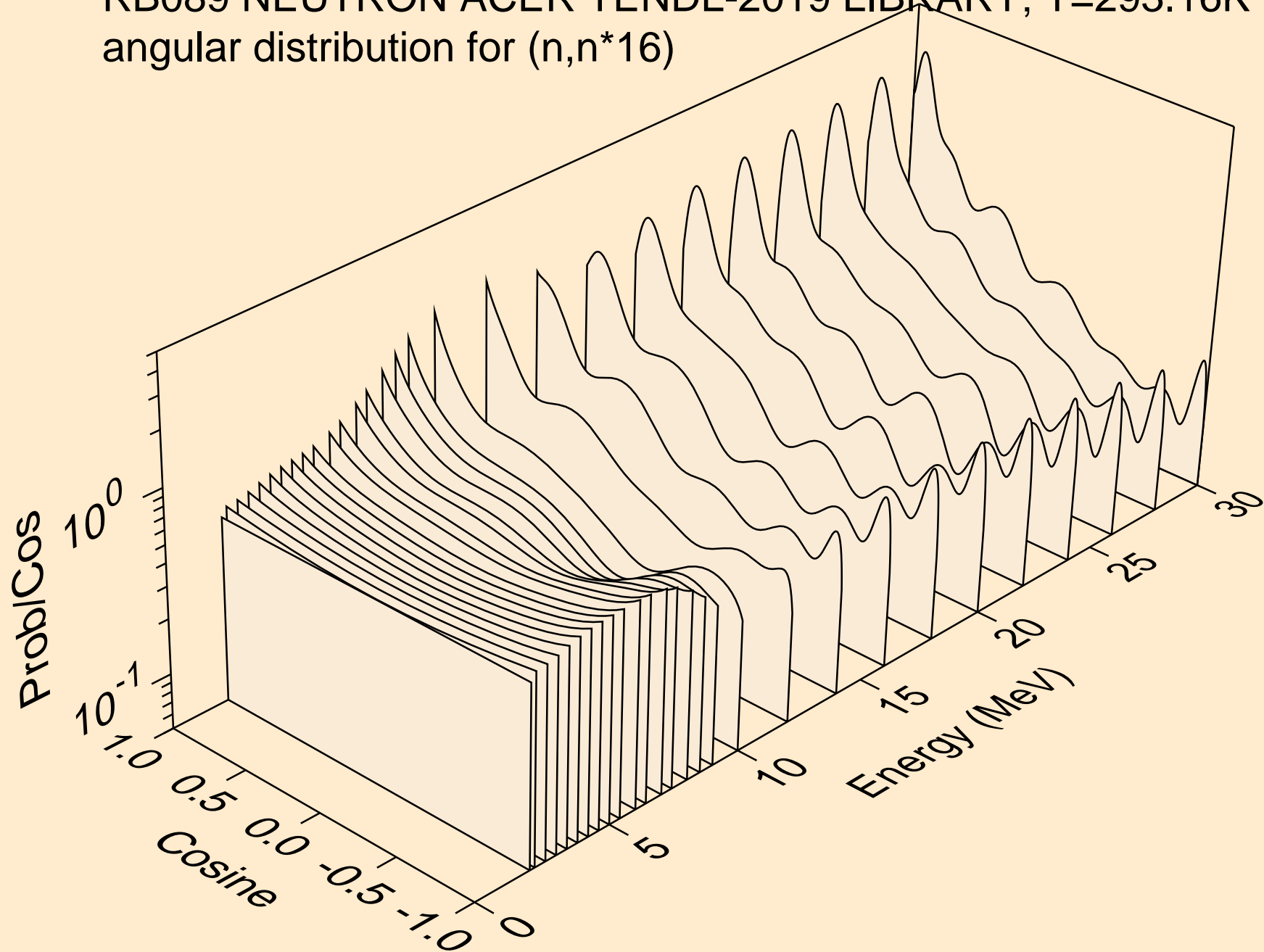

RB089 NEUTRON ACER TENDL-2019 LIBRARY; T=293.16K
angular distribution for (n,n*17)

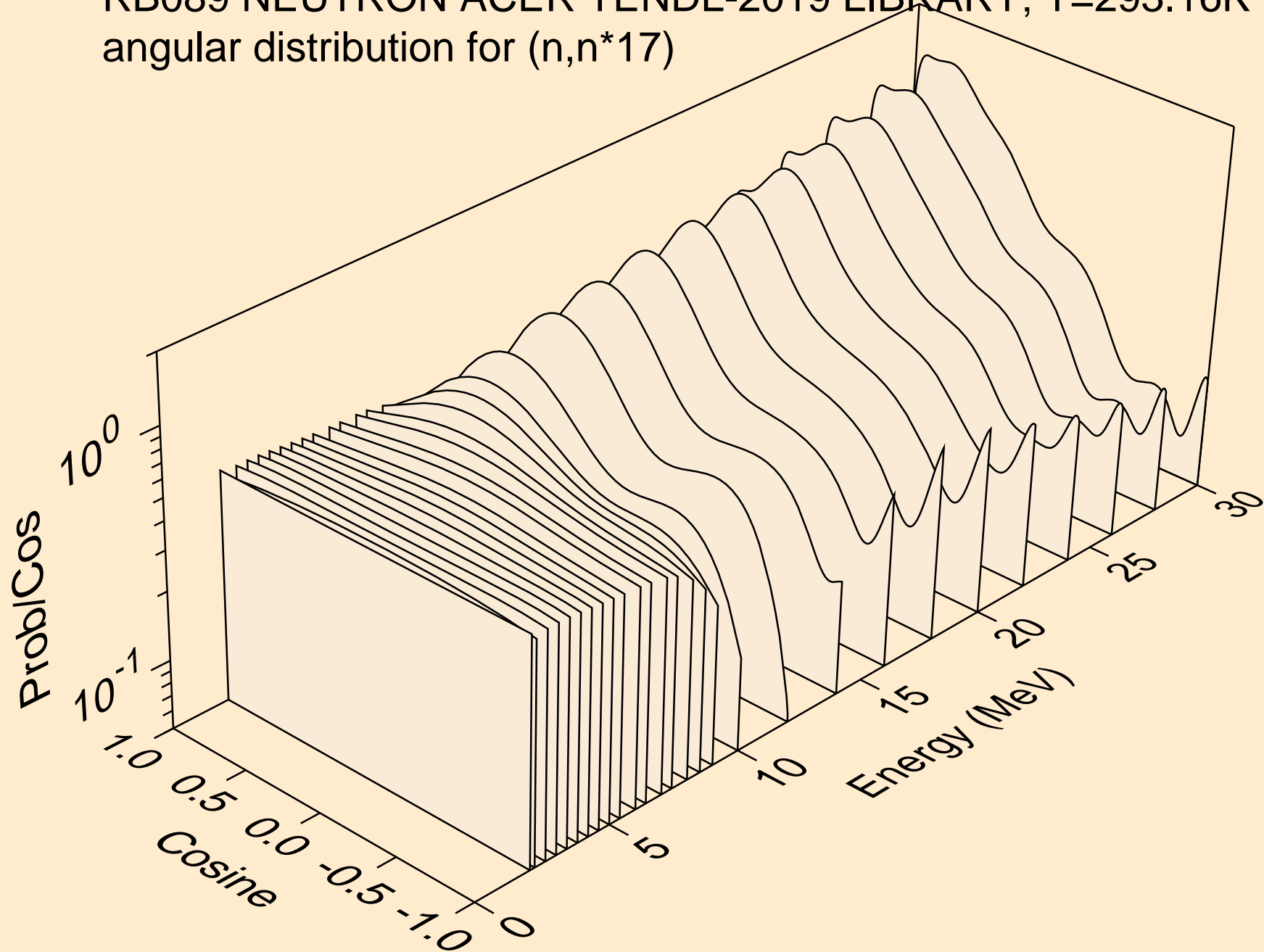

RB089 NEUTRON ACER TENDL-2019 LIBRARY; T=293.16K
angular distribution for (n,n*18)

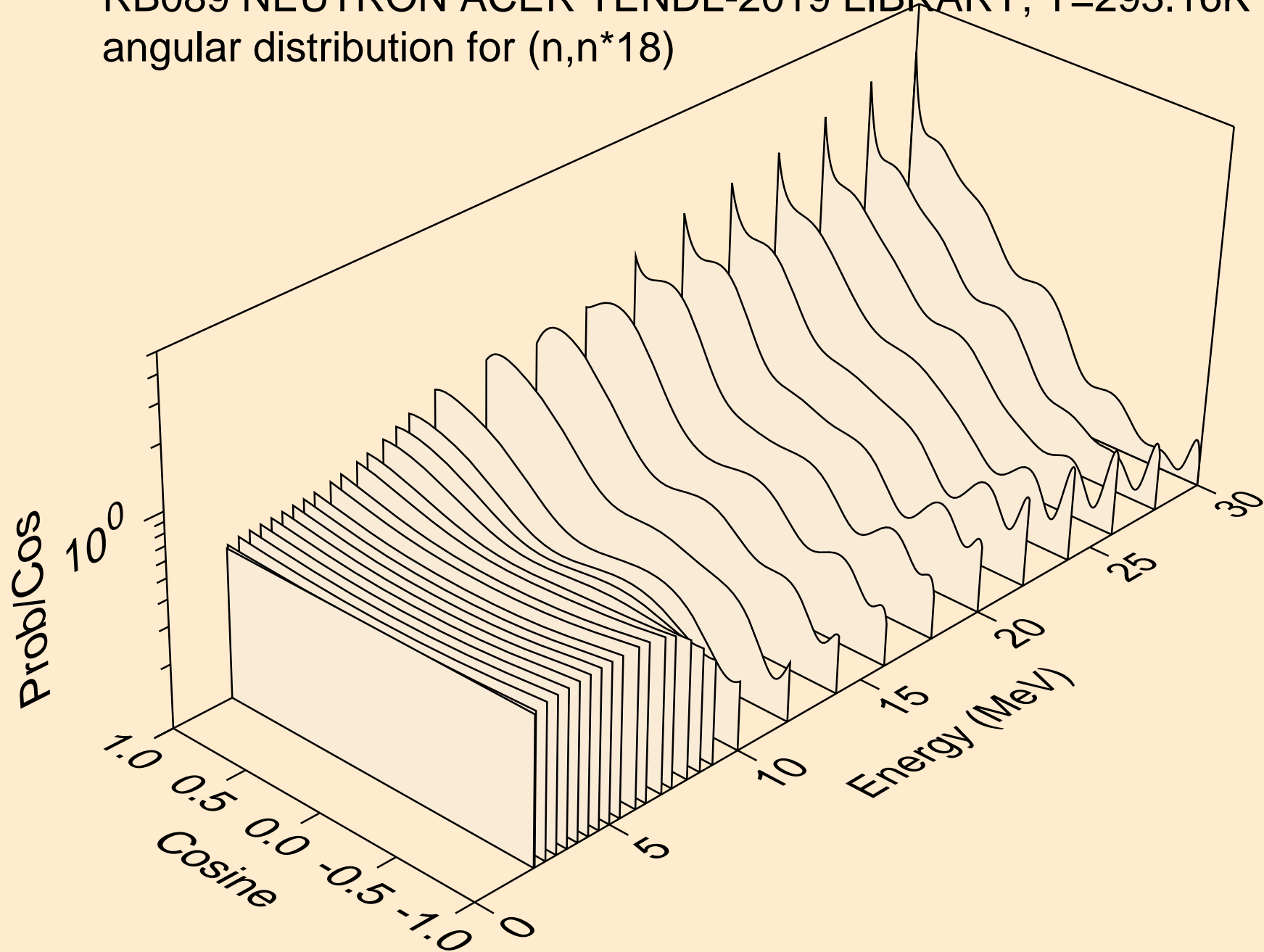

RB089 NEUTRON ACER TENDL-2019 LIBRARY; T=293.16K
angular distribution for (n,n*19)

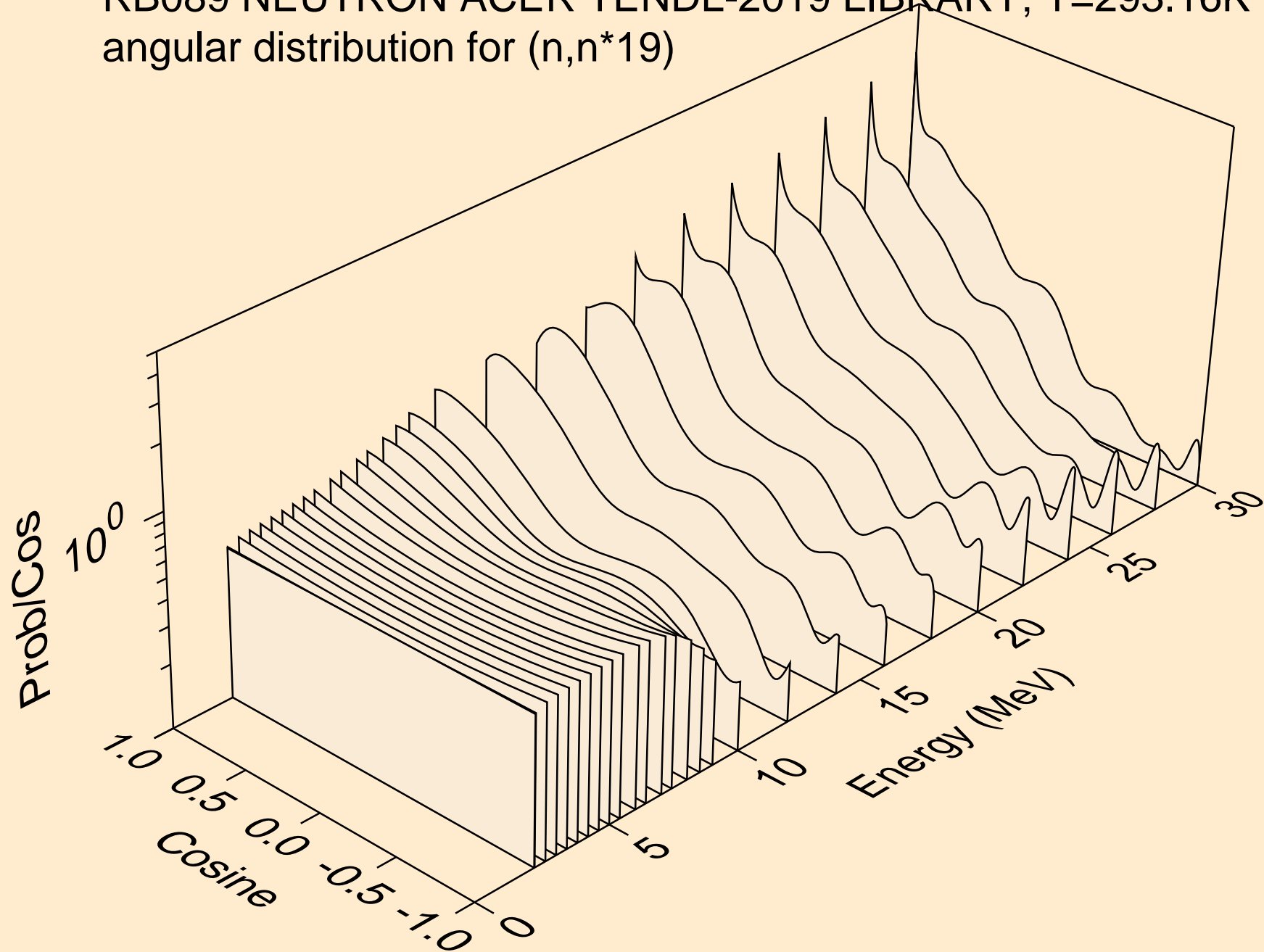

RB089 NEUTRON ACER TENDL-2019 LIBRARY; T=293.16K
angular distribution for (n,n*20)

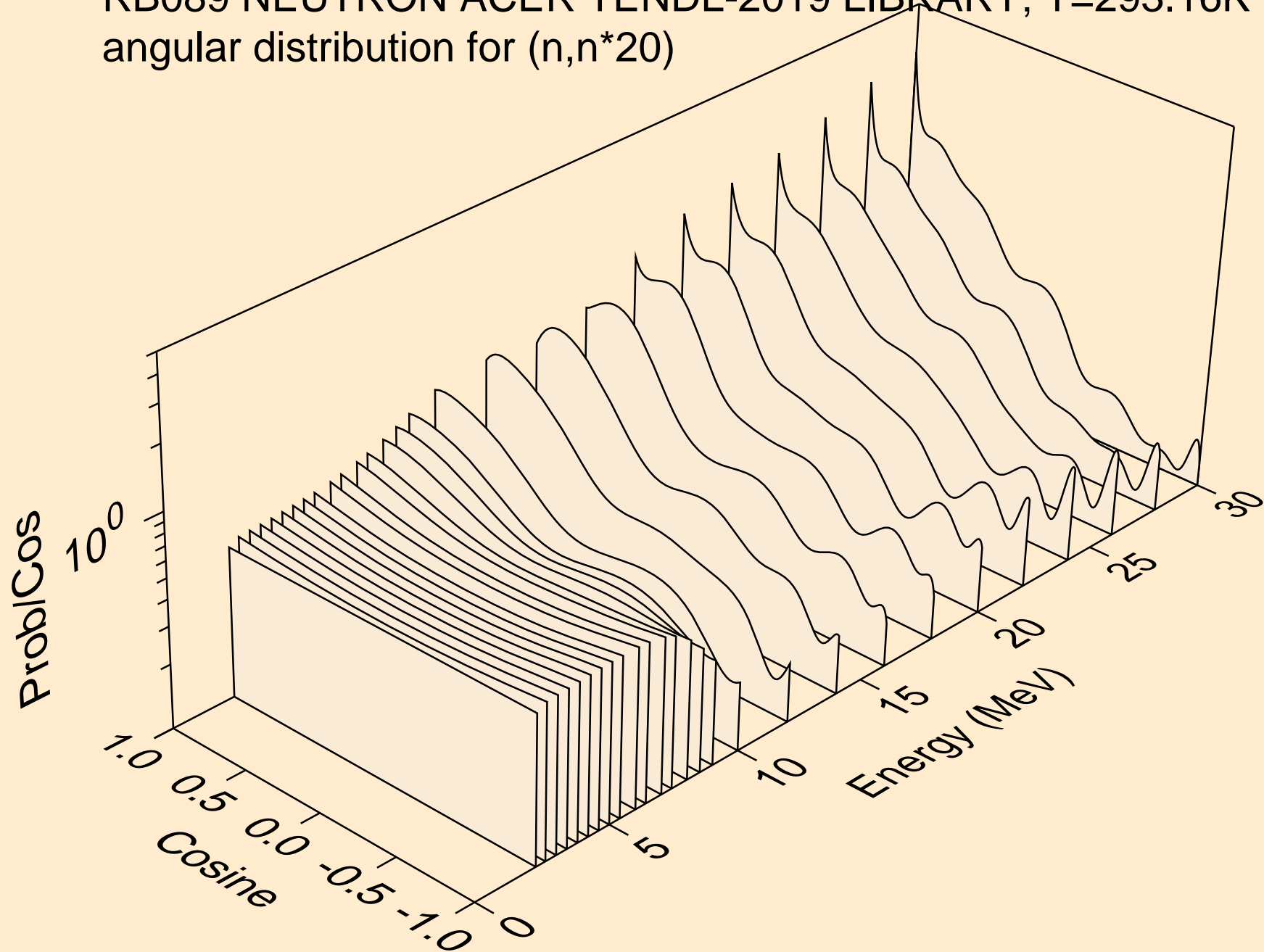

RB089 NEUTRON ACER TENDL-2019 LIBRARY; T=293.16K
angular distribution for (n,n*21)

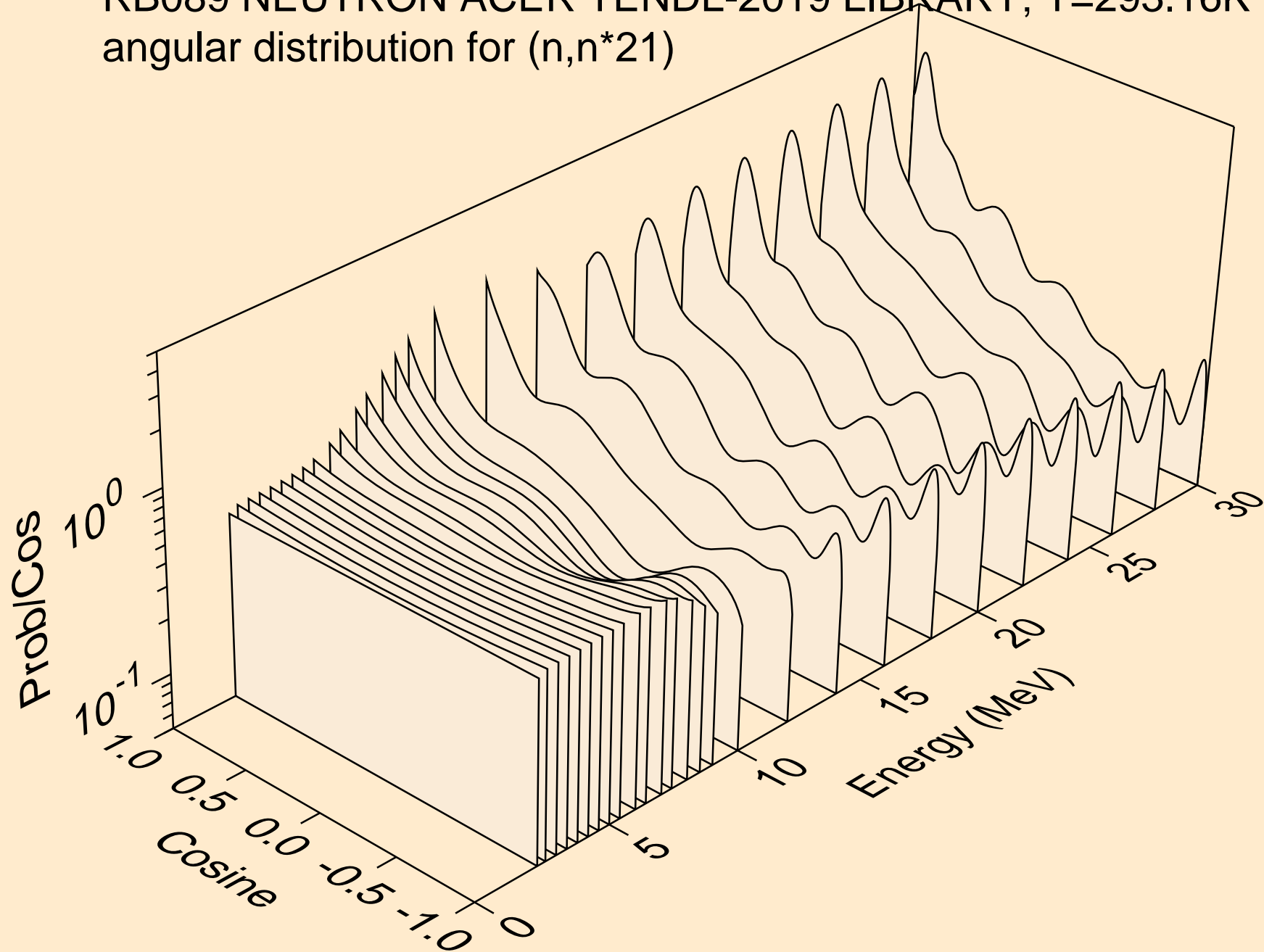

RB089 NEUTRON ACER TENDL-2019 LIBRARY; T=293.16K
angular distribution for (n,n*22)

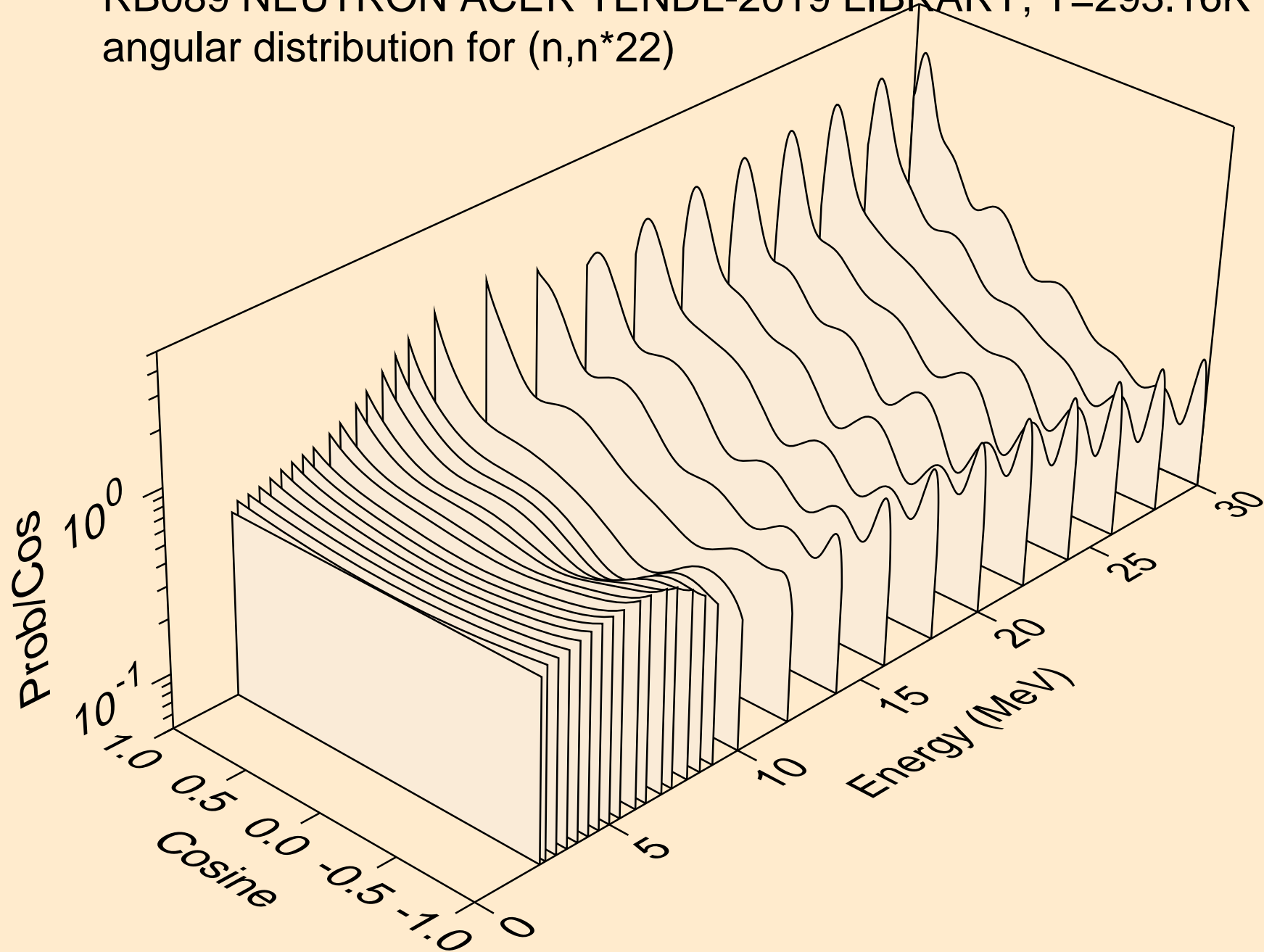

RB089 NEUTRON ACER TENDL-2019 LIBRARY; T=293.16K
angular distribution for (n,n*23)

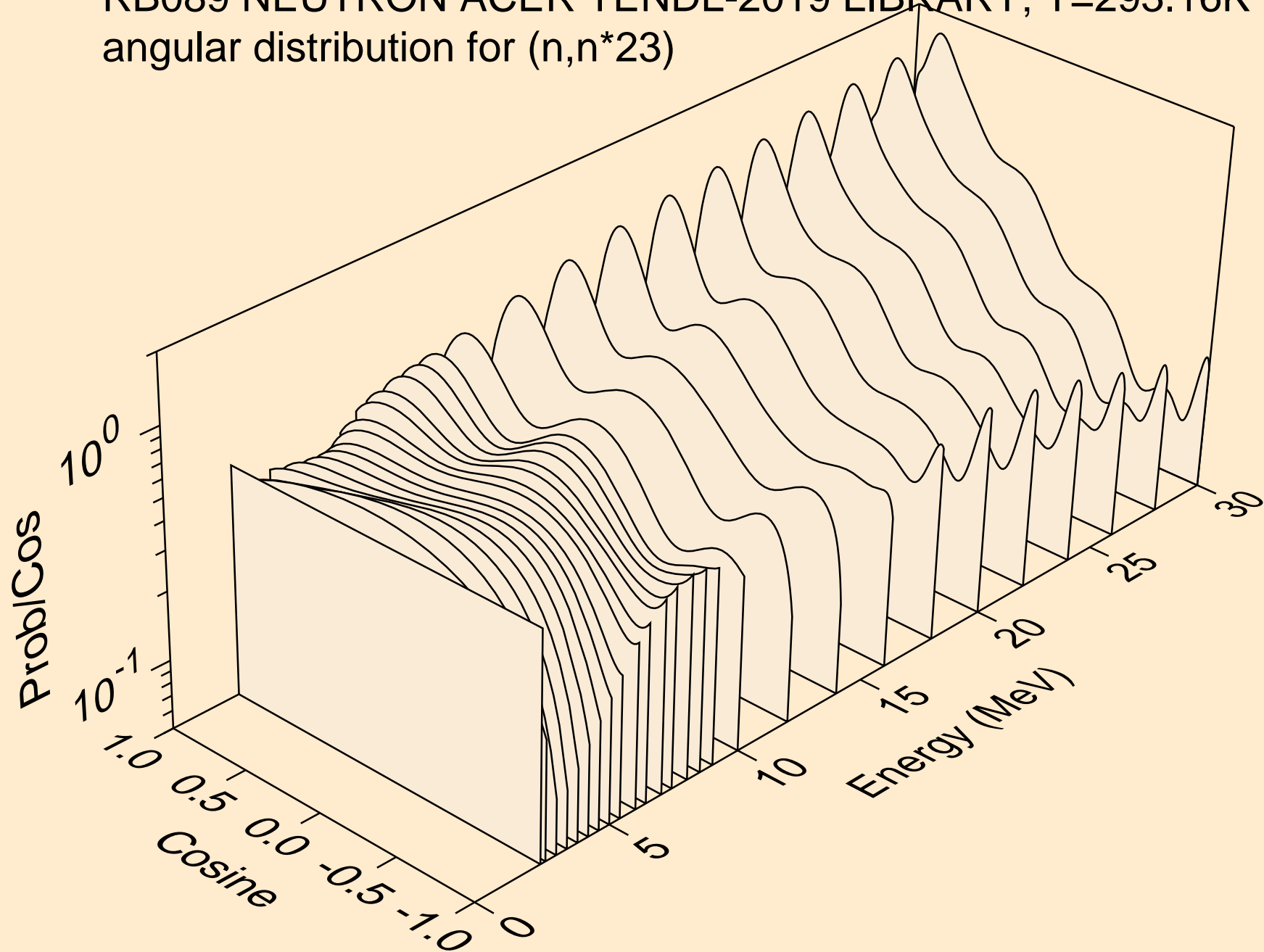

RB089 NEUTRON ACER TENDL-2019 LIBRARY; T=293.16K
angular distribution for (n,n*24)

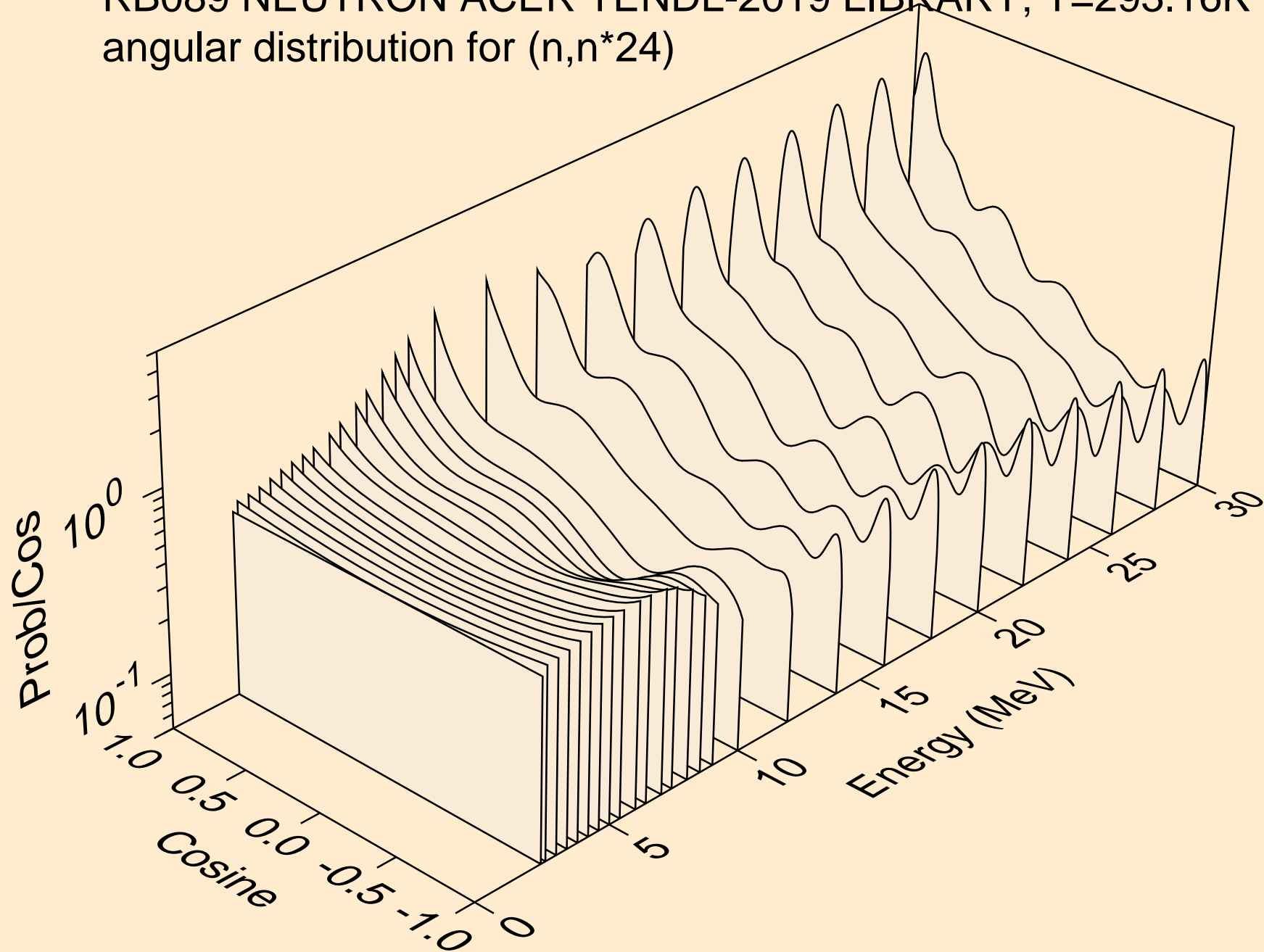

RB089 NEUTRON ACER TENDL-2019 LIBRARY; T=293.16K
angular distribution for (n,n*25)

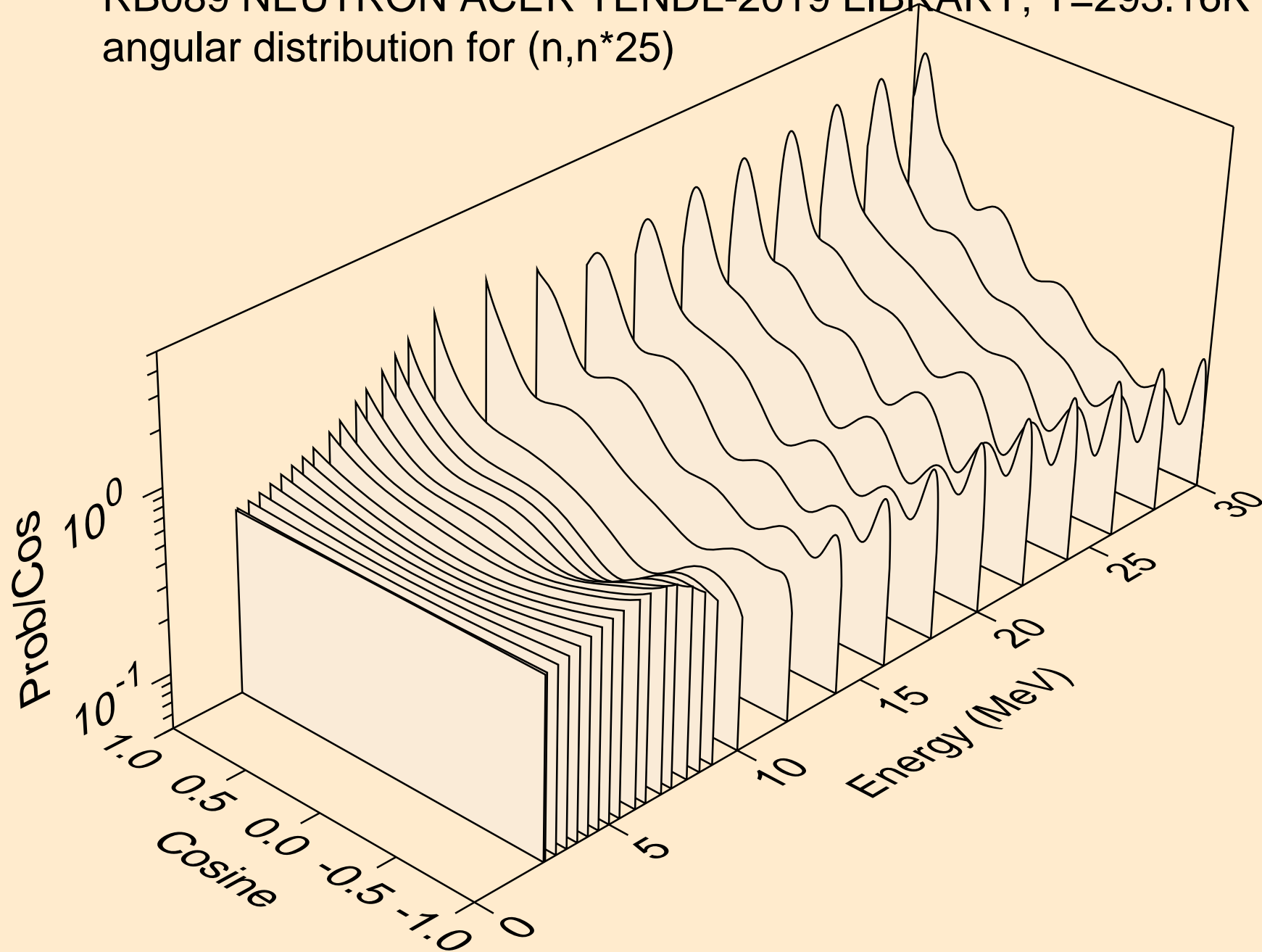

RB089 NEUTRON ACER TENDL-2019 LIBRARY; T=293.16K
angular distribution for (n,n*26)

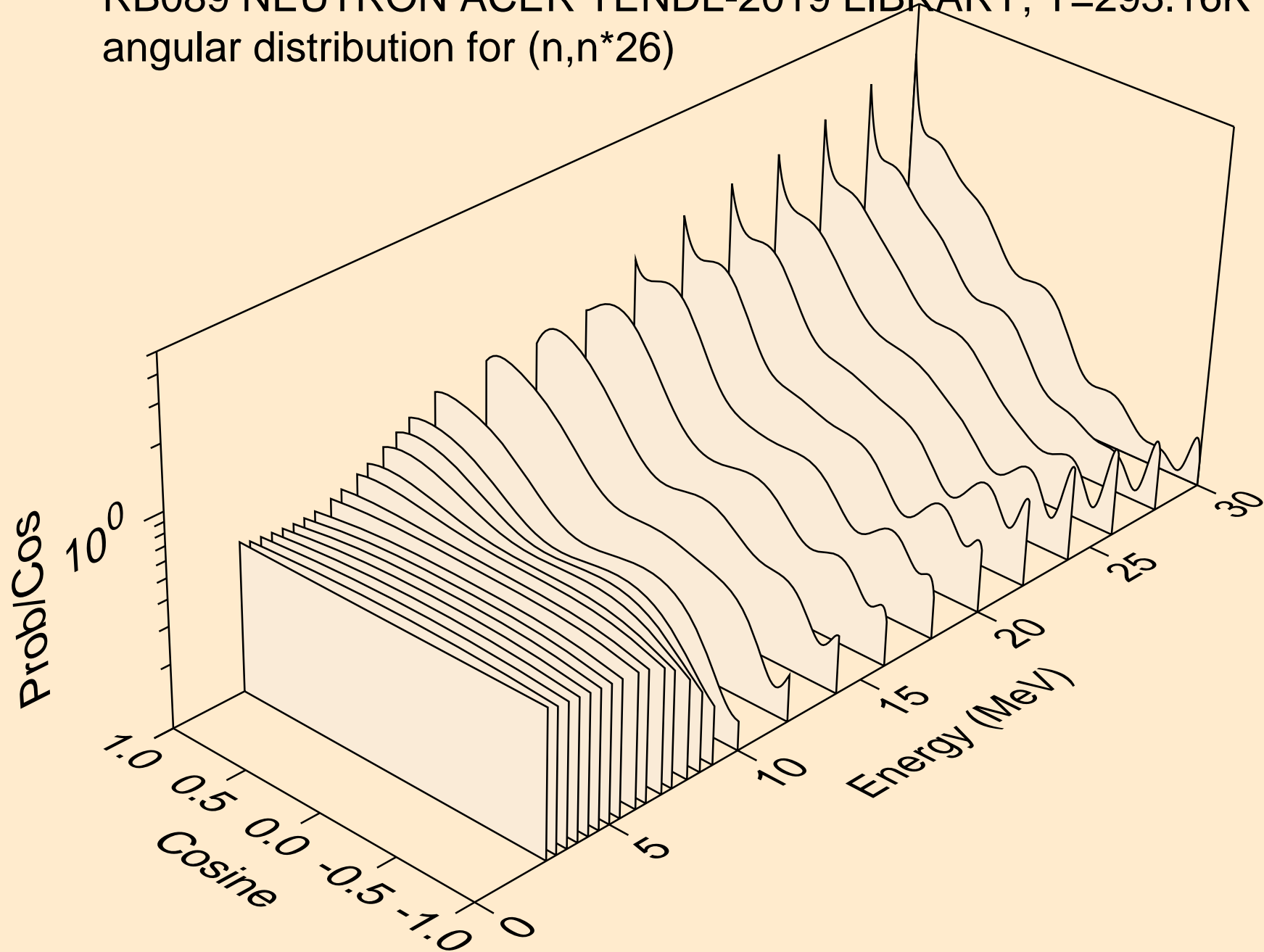

RB089 NEUTRON ACER TENDL-2019 LIBRARY; T=293.16K
angular distribution for (n,n*27)

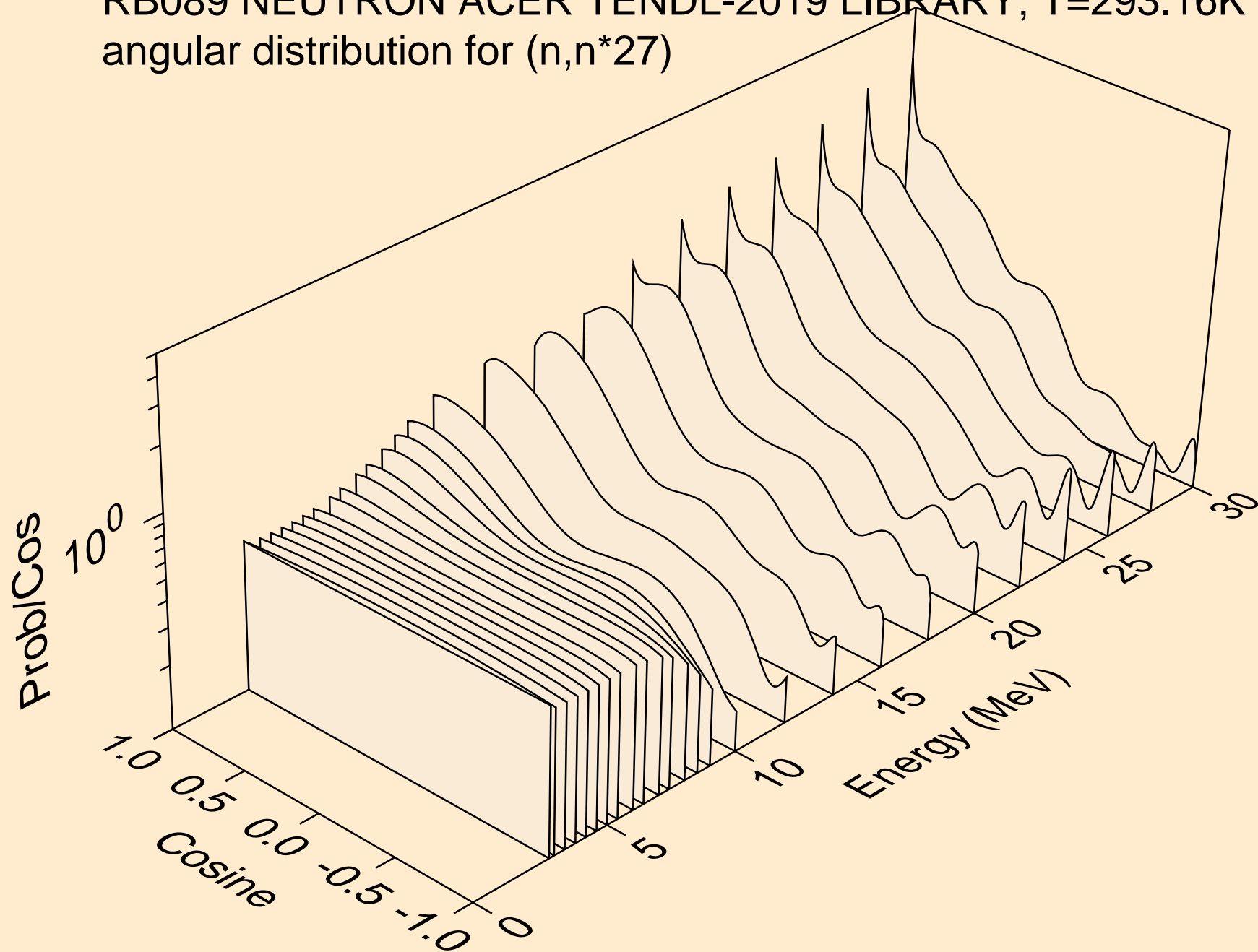

RB089 NEUTRON ACER TENDL-2019 LIBRARY; T=293.16K
angular distribution for (n,n*28)

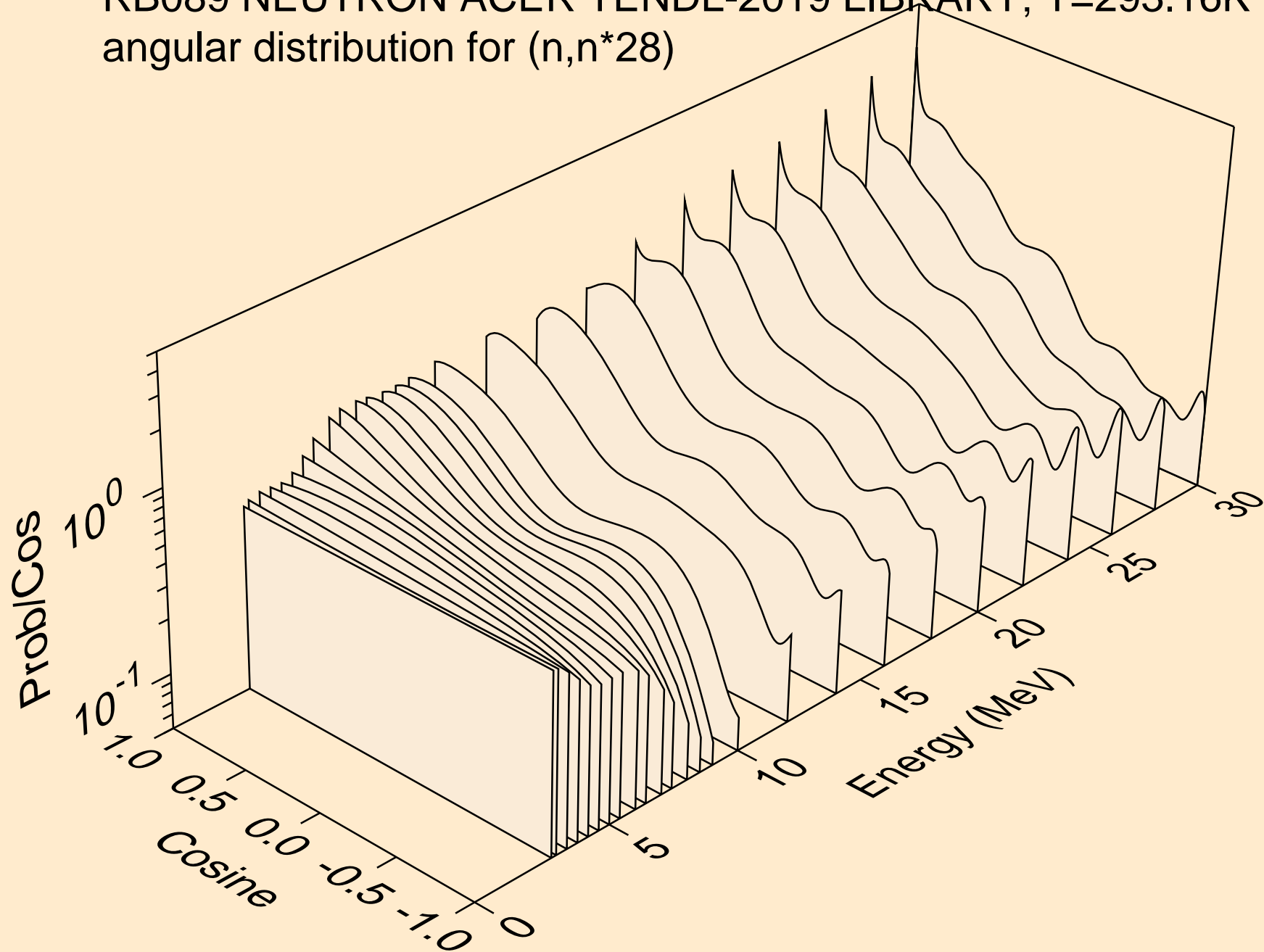

RB089 NEUTRON ACER TENDL-2019 LIBRARY; T=293.16K
Neutron emission for (n,x)

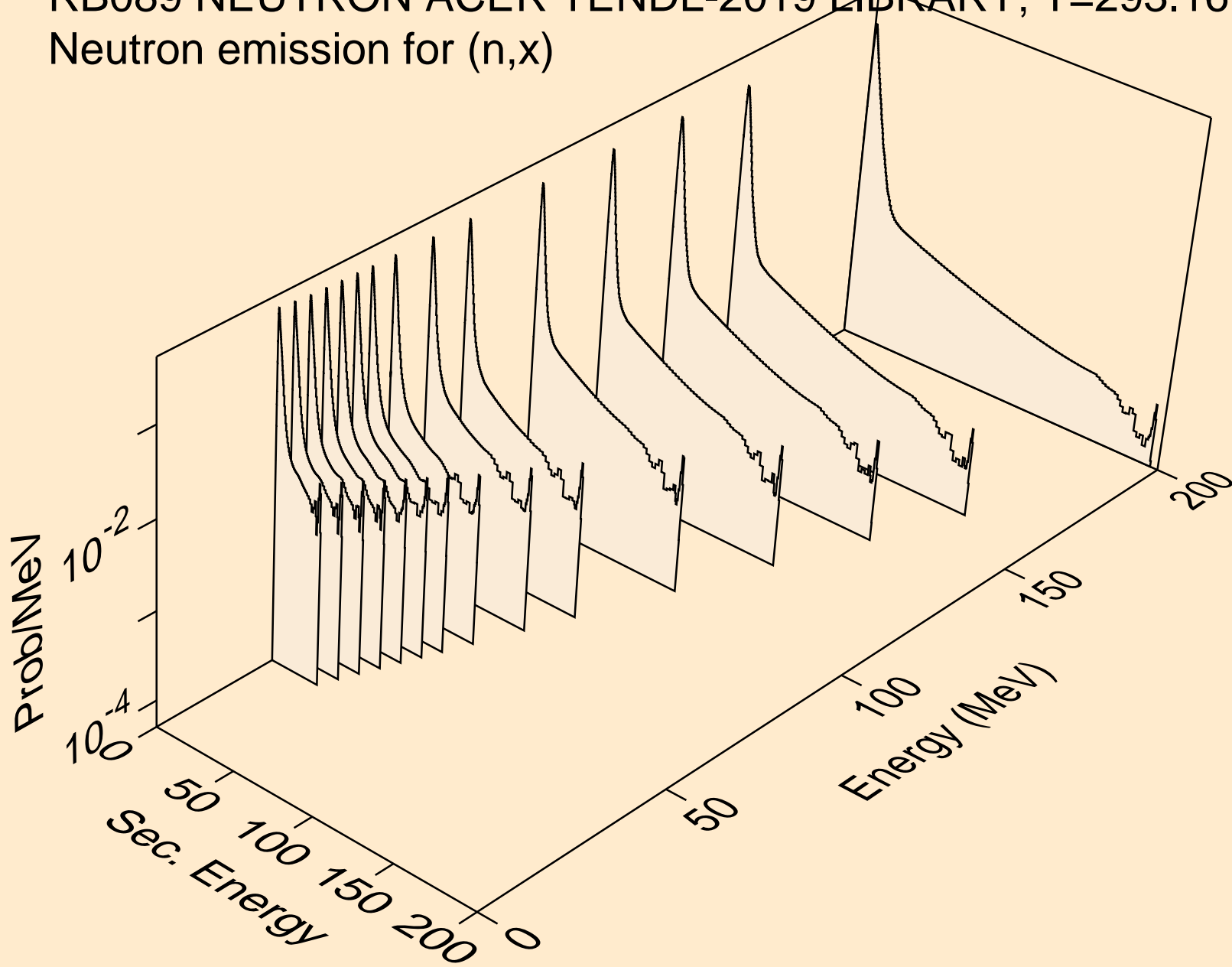

RB089 NEUTRON ACER TENDL-2019 LIBRARY; T=293.16K
Neutron emission for (n,2nd)

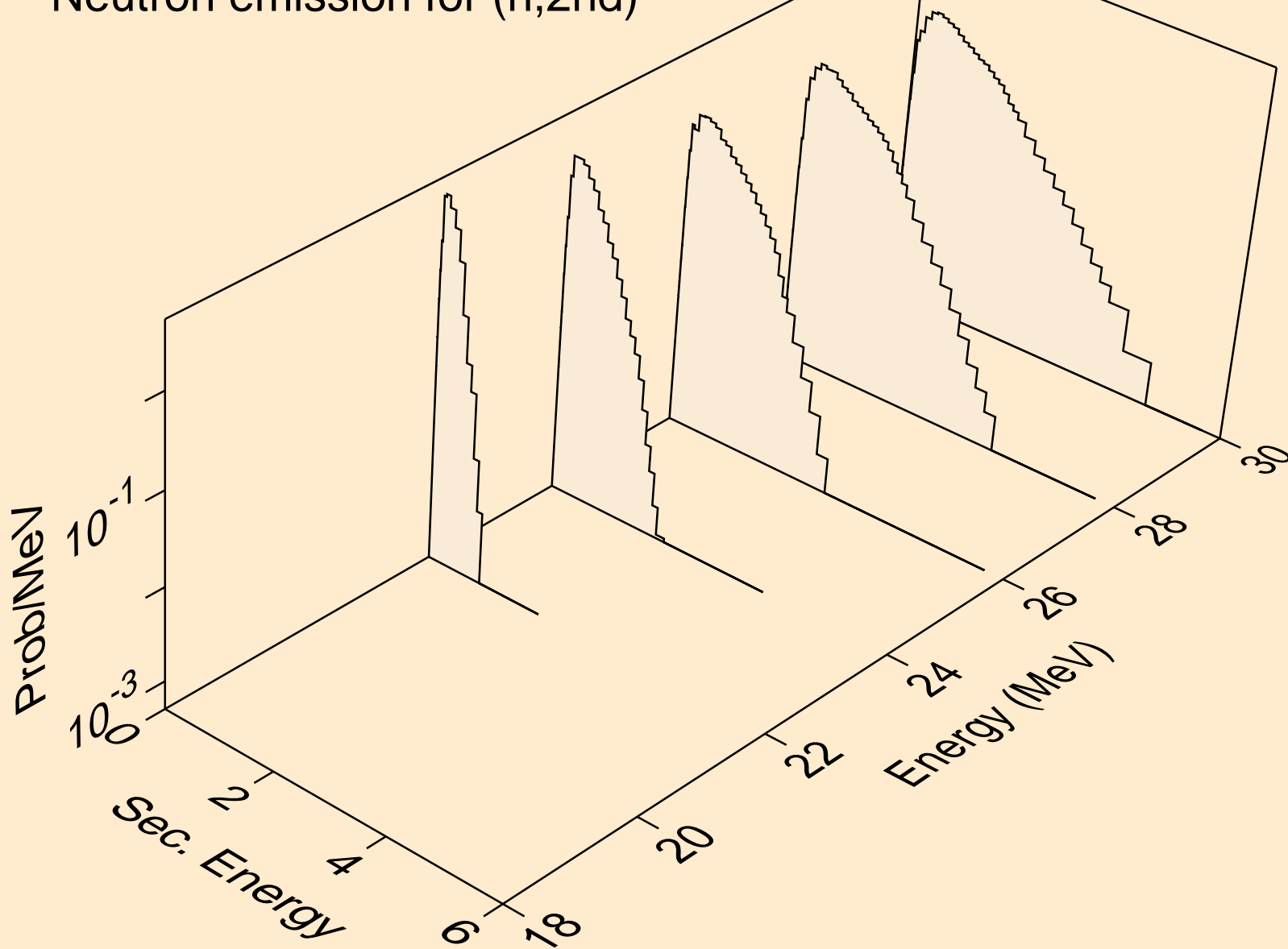

RB089 NEUTRON ACER TENDL-2019 LIBRARY; T=293.16K
Neutron emission for (n,2n)

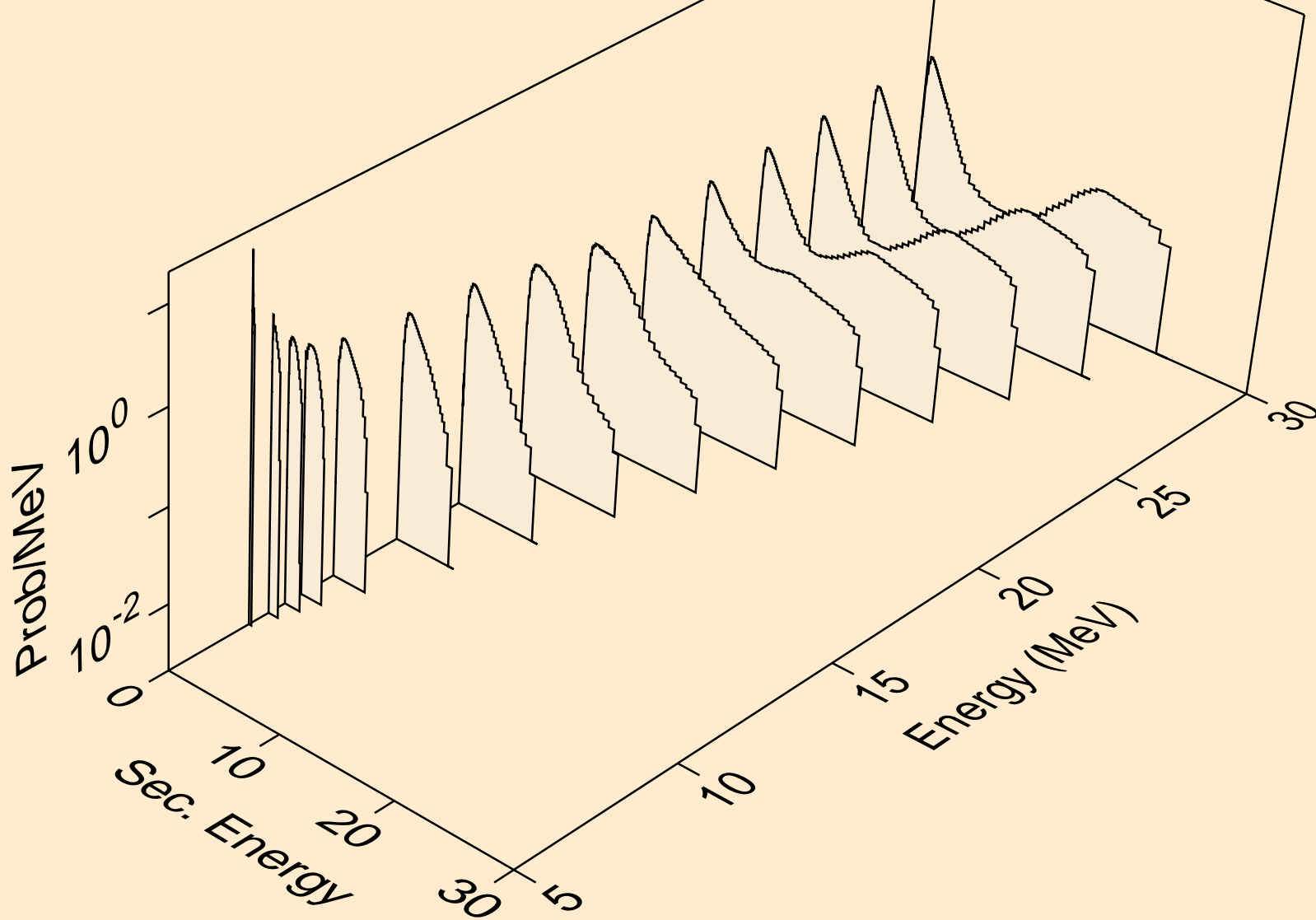

RB089 NEUTRON ACER TENDL-2019 LIBRARY; T=293.16K
Neutron emission for (n,3n)

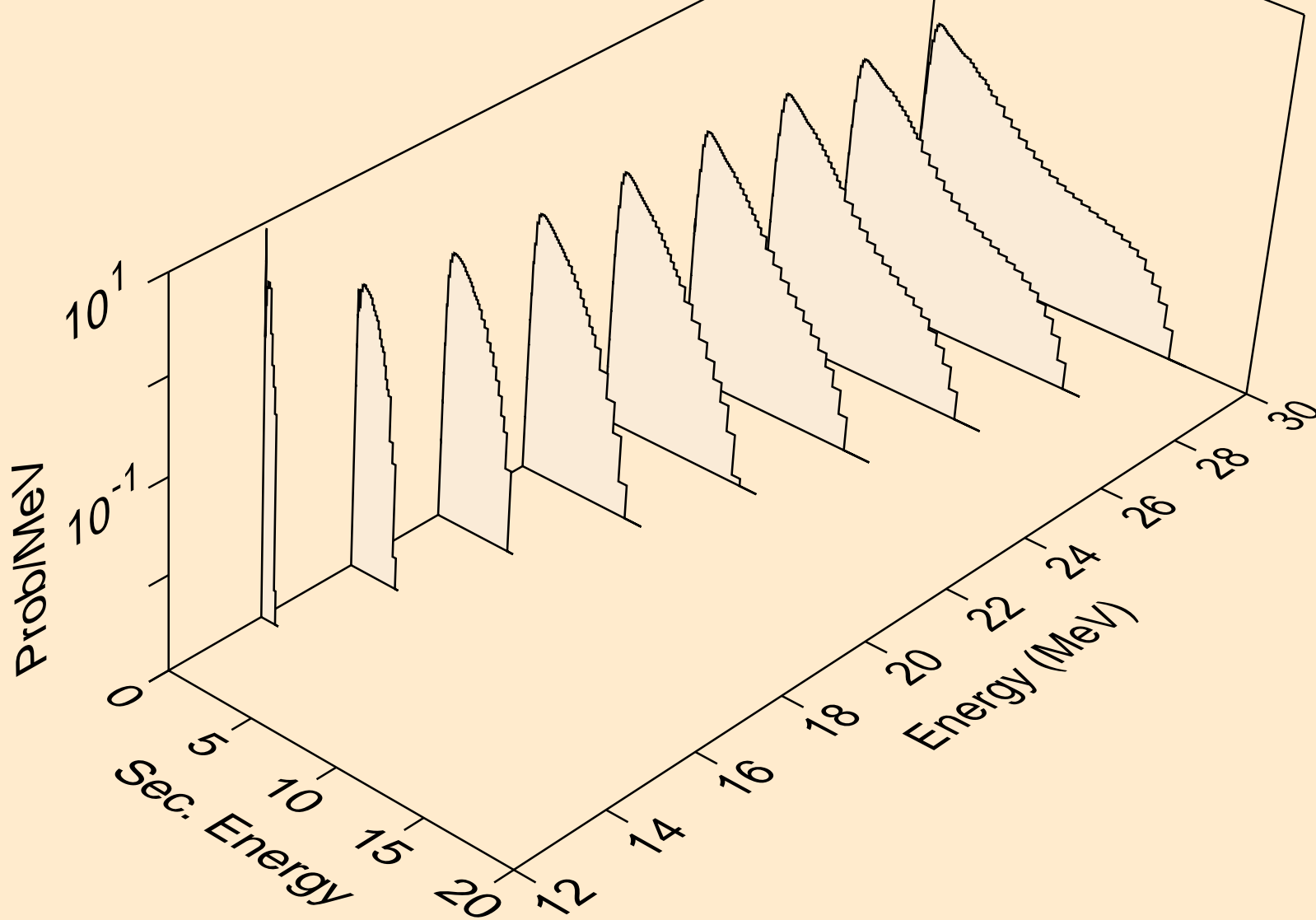

RB089 NEUTRON ACER TENDL-2019 LIBRARY; T=293.16K
Neutron emission for (n,n*)a

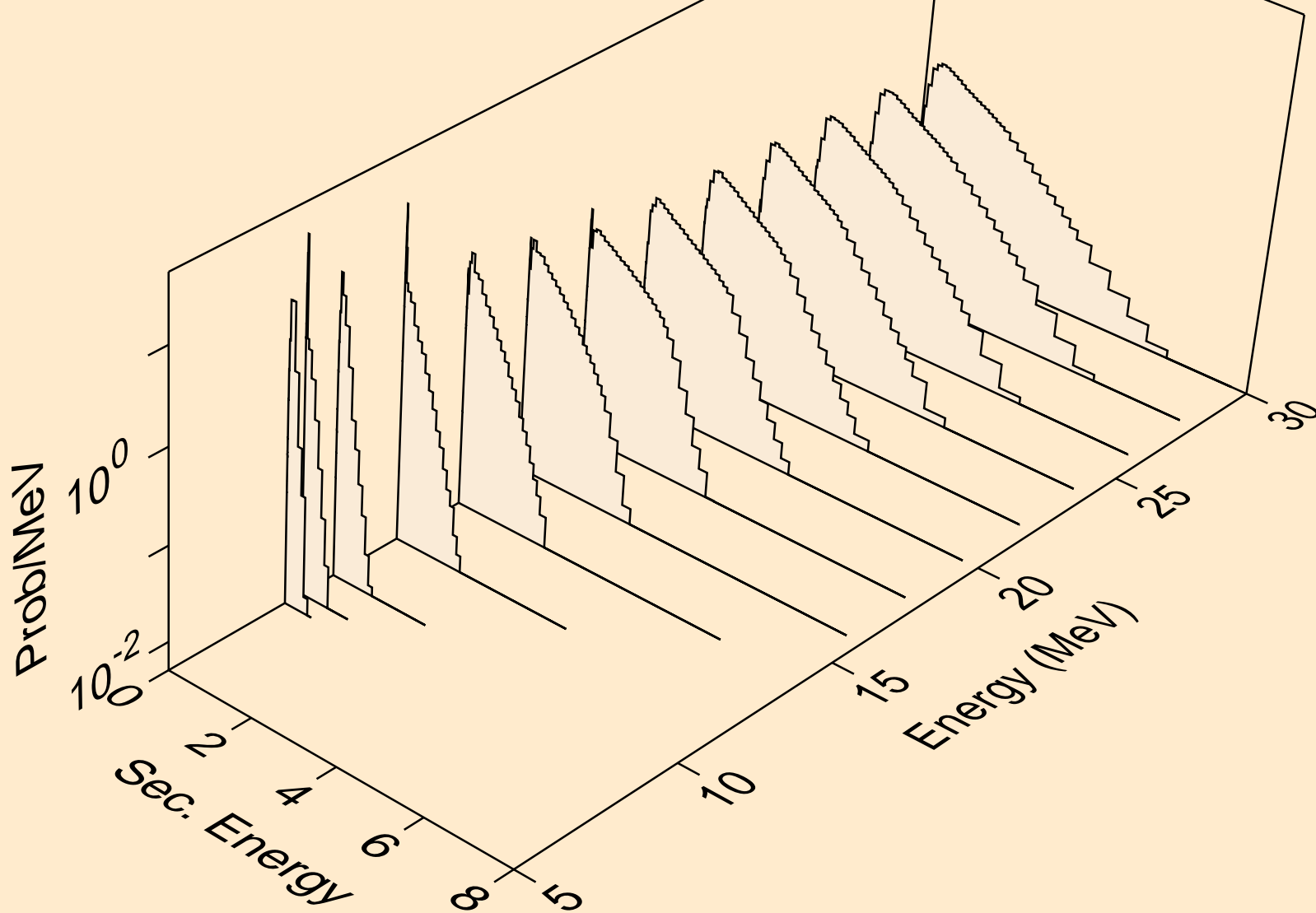

RB089 NEUTRON ACER TENDL-2019 LIBRARY; T=293.16K
Neutron emission for (n,2n)a

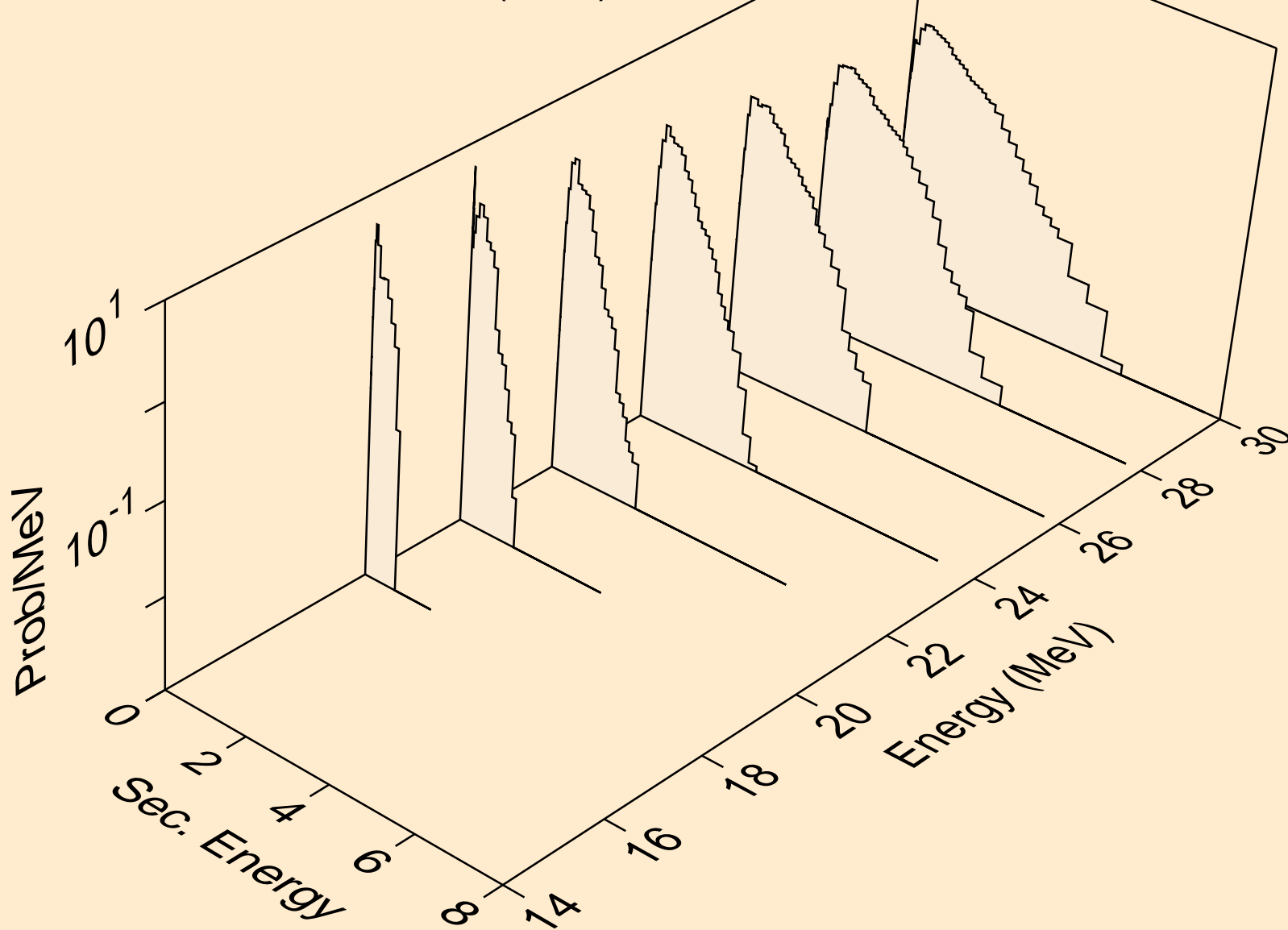

RB089 NEUTRON ACER TENDL-2019 LIBRARY; T=293.16K
Neutron emission for (n,3n)a

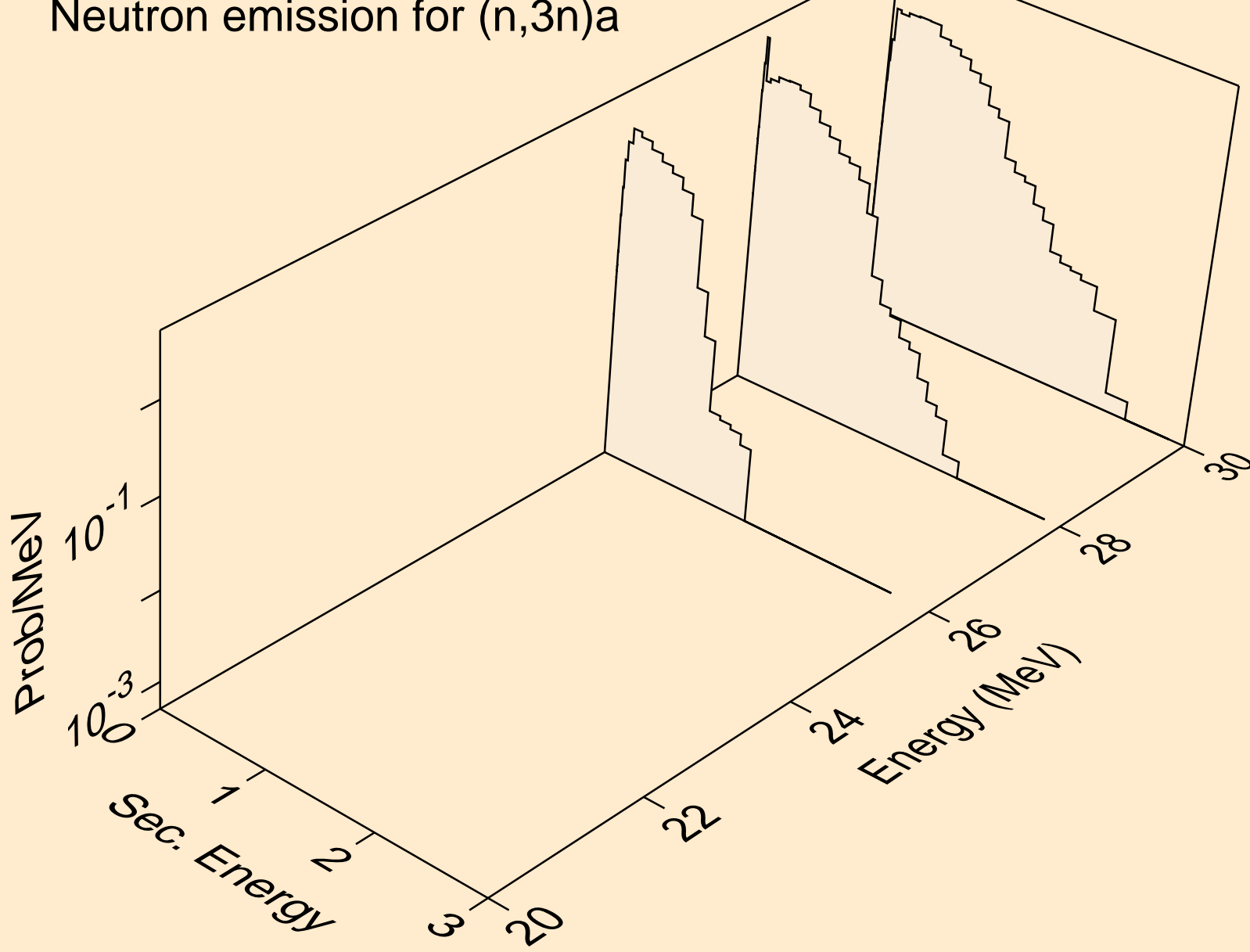

RB089 NEUTRON ACER TENDL-2019 LIBRARY; T=293.16K
Neutron emission for (n,n*)p

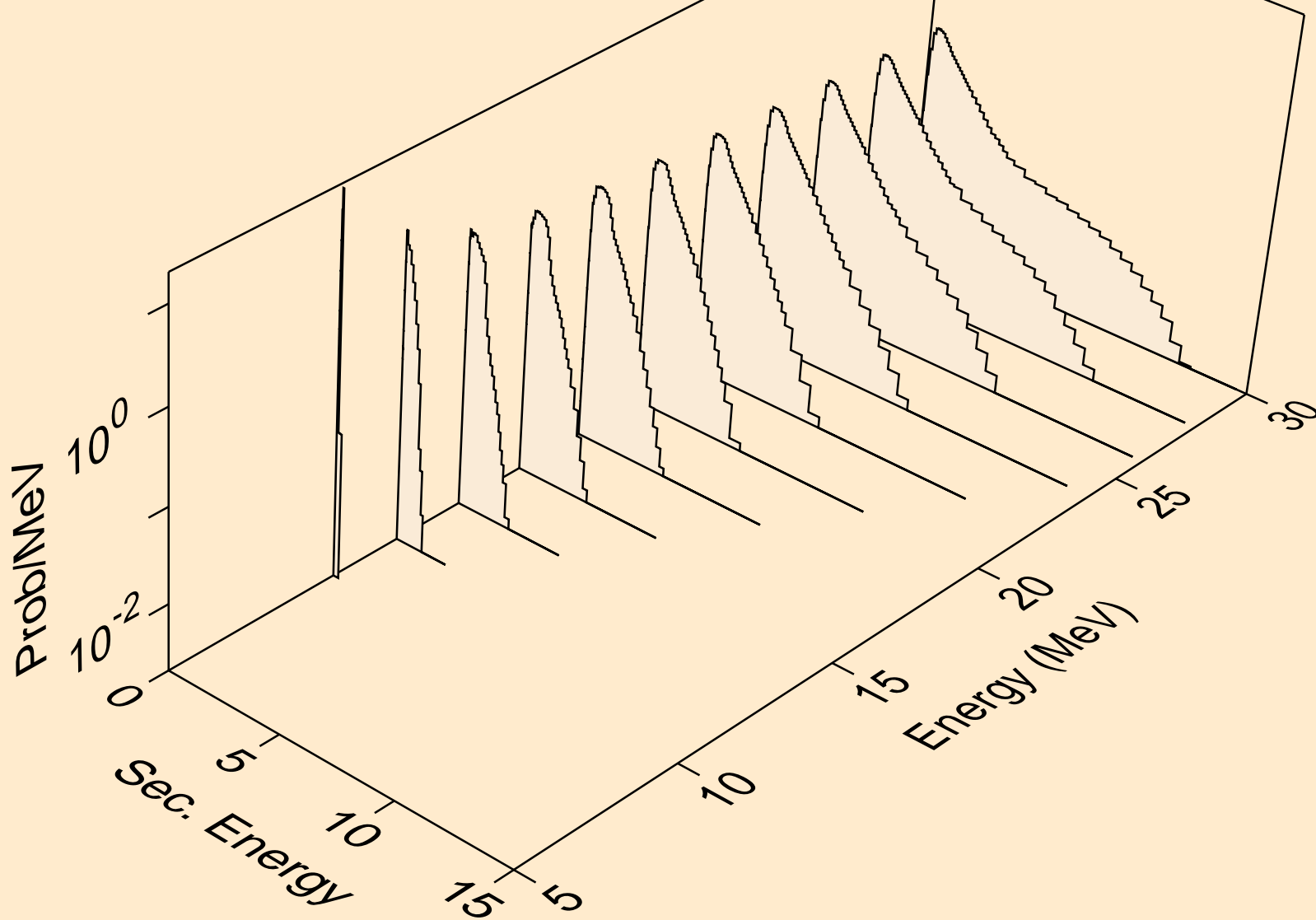

RB089 NEUTRON ACER TENDL-2019 LIBRARY; T=293.16K
Neutron emission for (n,n*)d

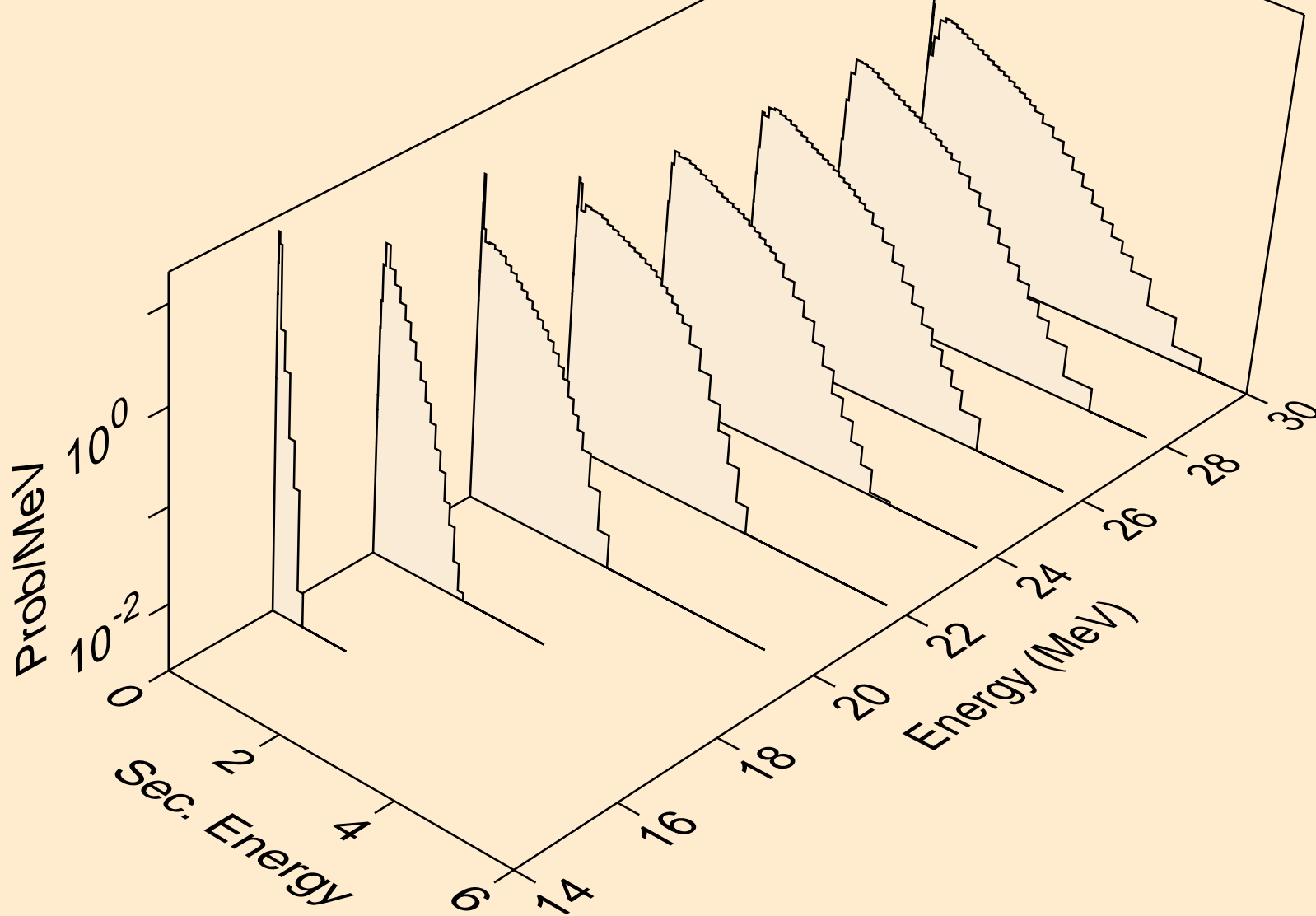

RB089 NEUTRON ACER TENDL-2019 LIBRARY; T=293.16K
Neutron emission for (n,n*)t

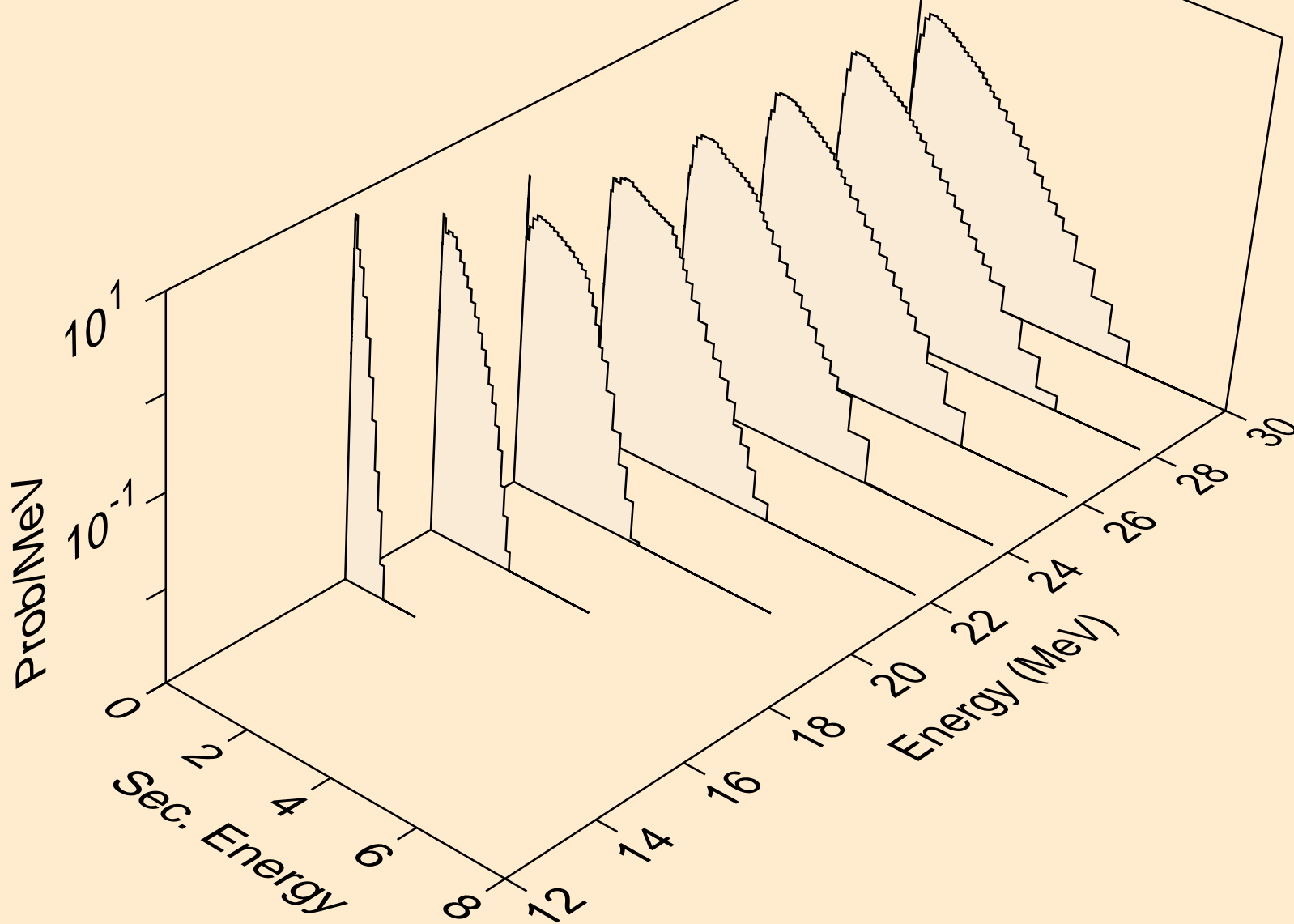

RB089 NEUTRON ACER TENDL-2019 LIBRARY; T=293.16K
Neutron emission for (n,n*)he3

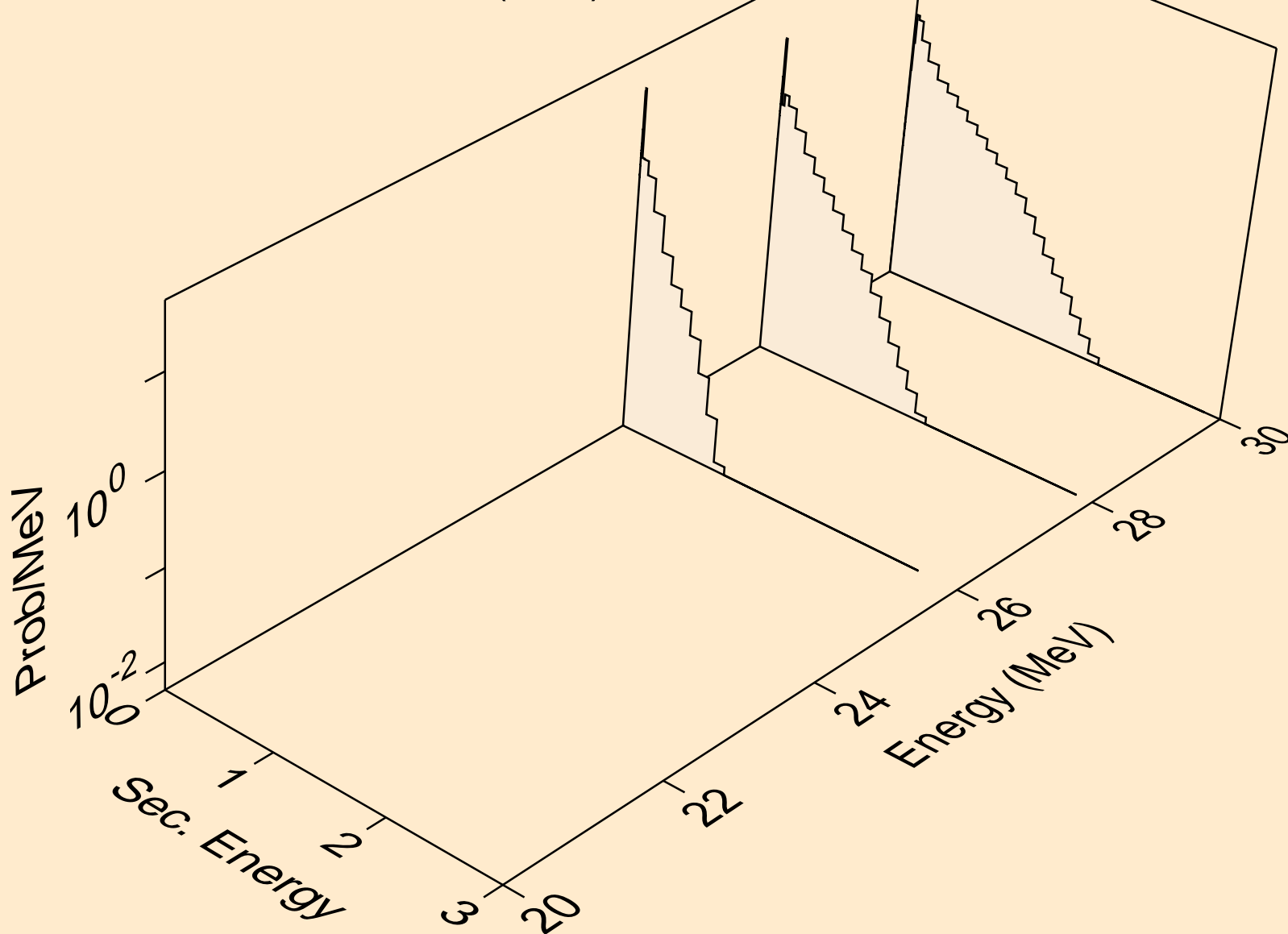

RB089 NEUTRON ACER TENDL-2019 LIBRARY; T=293.16K
Neutron emission for (n,4n)

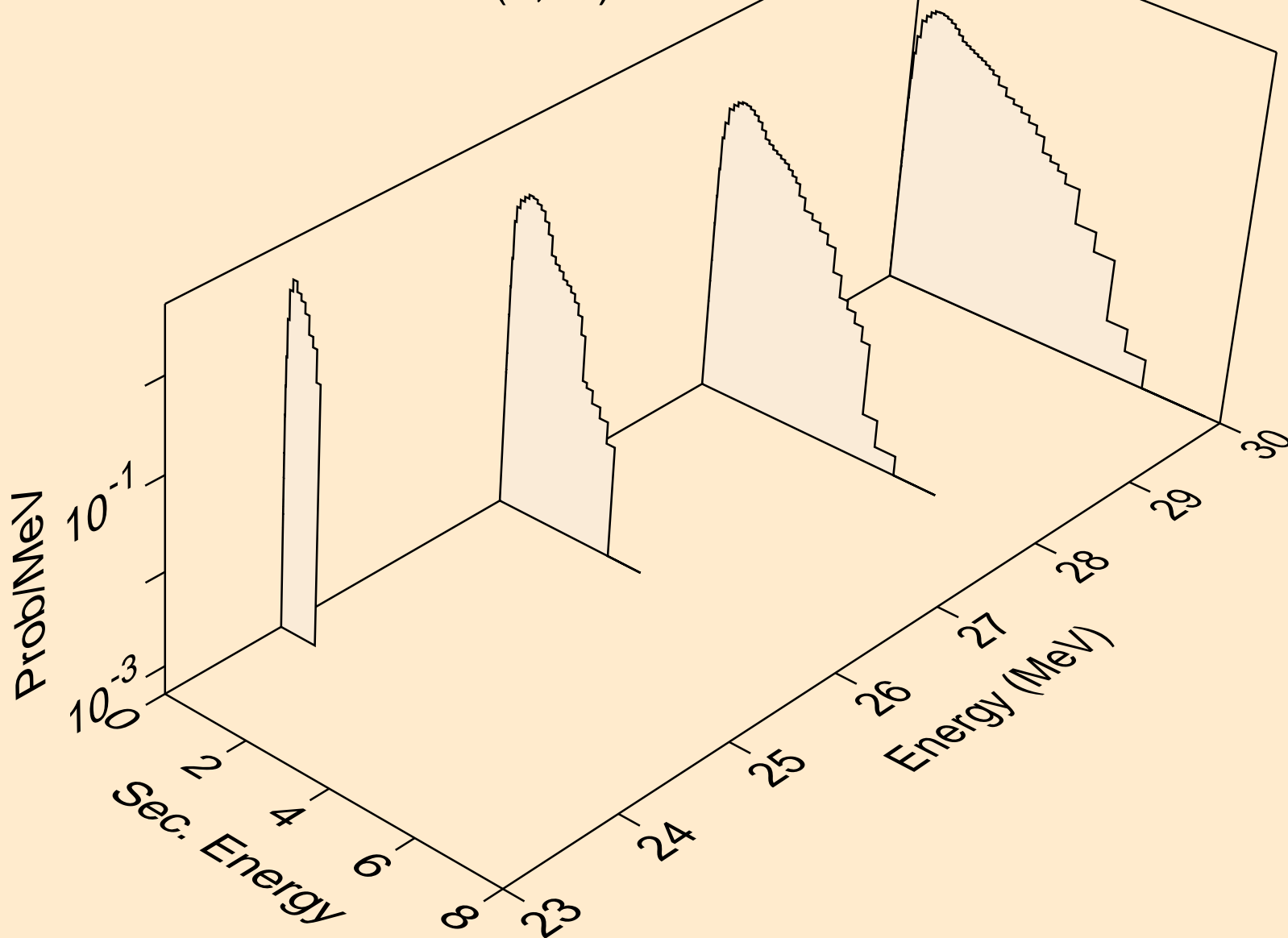

RB089 NEUTRON ACER TENDL-2019 LIBRARY; T=293.16K
Neutron emission for (n,2np)

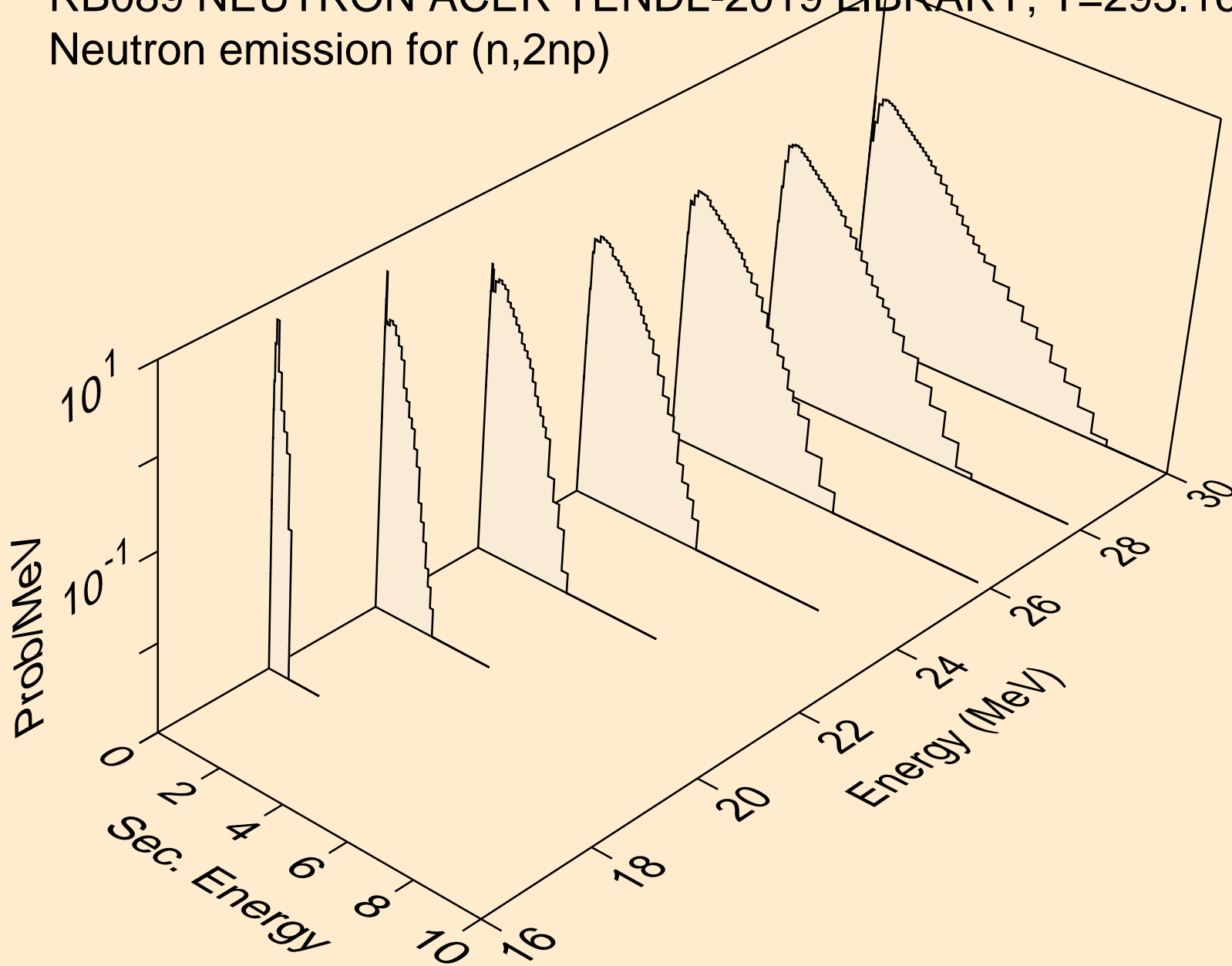

RB089 NEUTRON ACER TENDL-2019 LIBRARY; T=293.16K
Neutron emission for (n,3np)

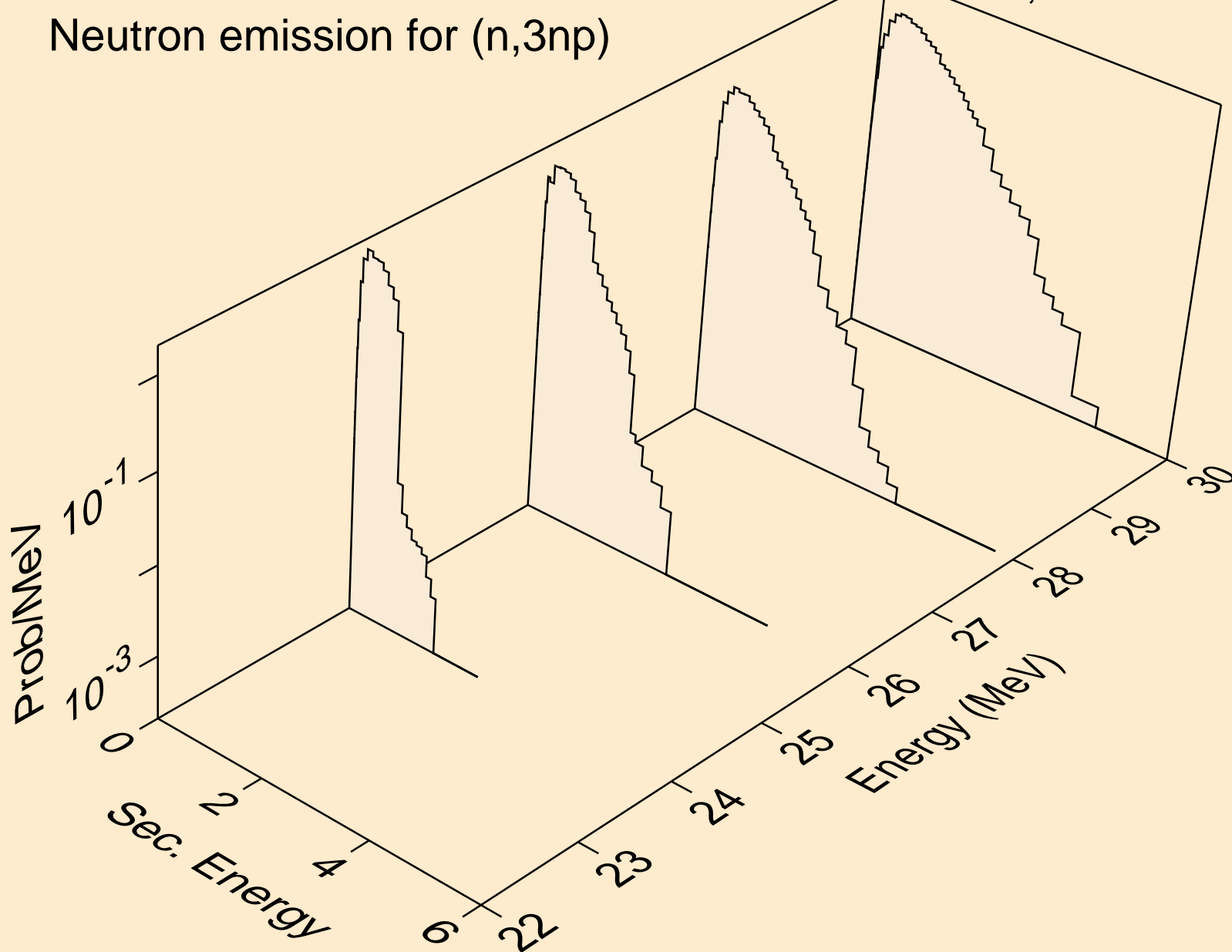

RB089 NEUTRON ACER TENDL-2019 LIBRARY; T=293.16K
Neutron emission for (n,2np)

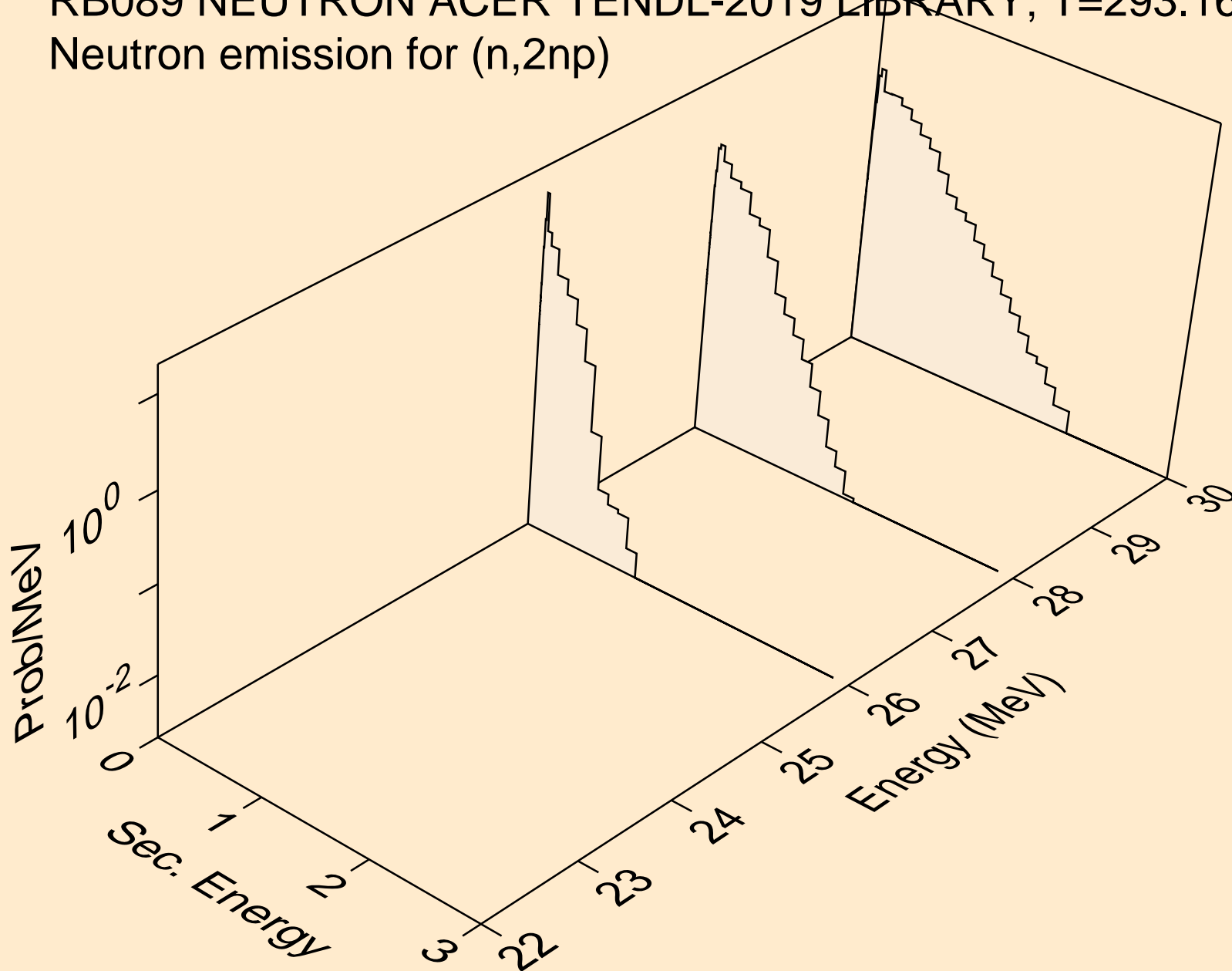

RB089 NEUTRON ACER TENDL-2019 LIBRARY; T=293.16K
Neutron emission for (n,npa)

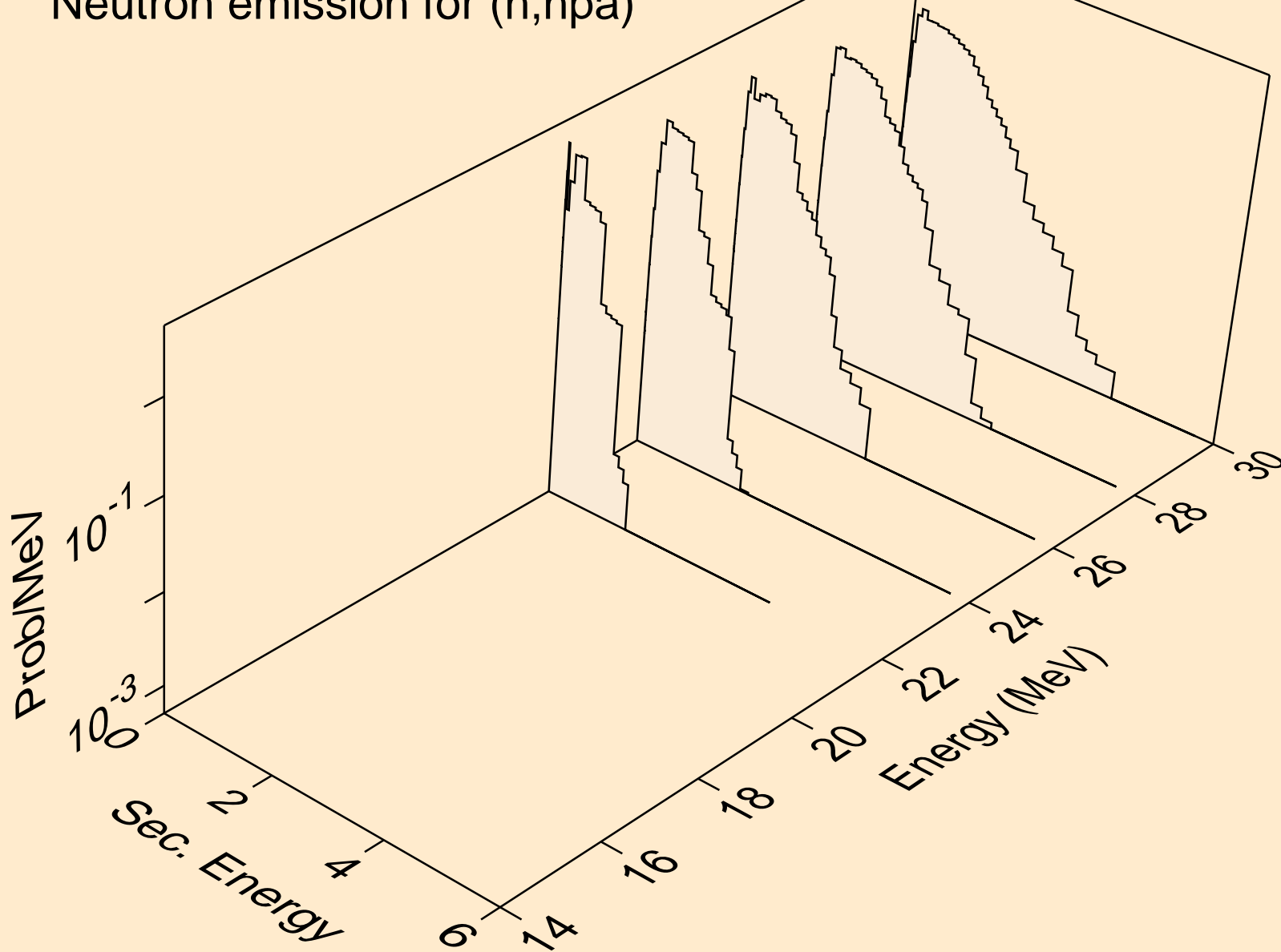

RB089 NEUTRON ACER TENDL-2019 LIBRARY; T=293.16K
Neutron emission for (n,n*c)

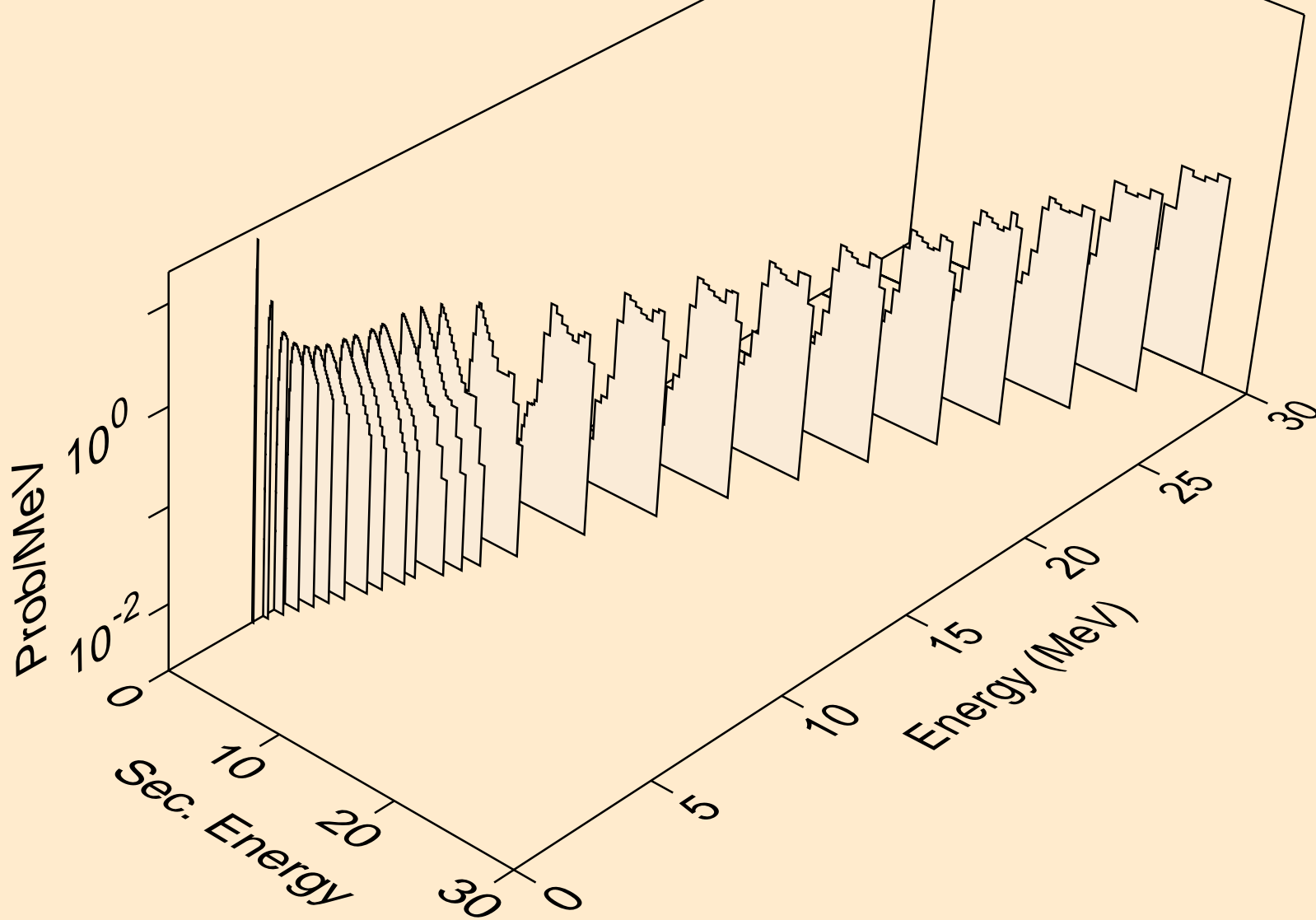

RB089 NEUTRON ACER TENDL-2019 LIBRARY; T=293.16K
Photon emission for (n,x)

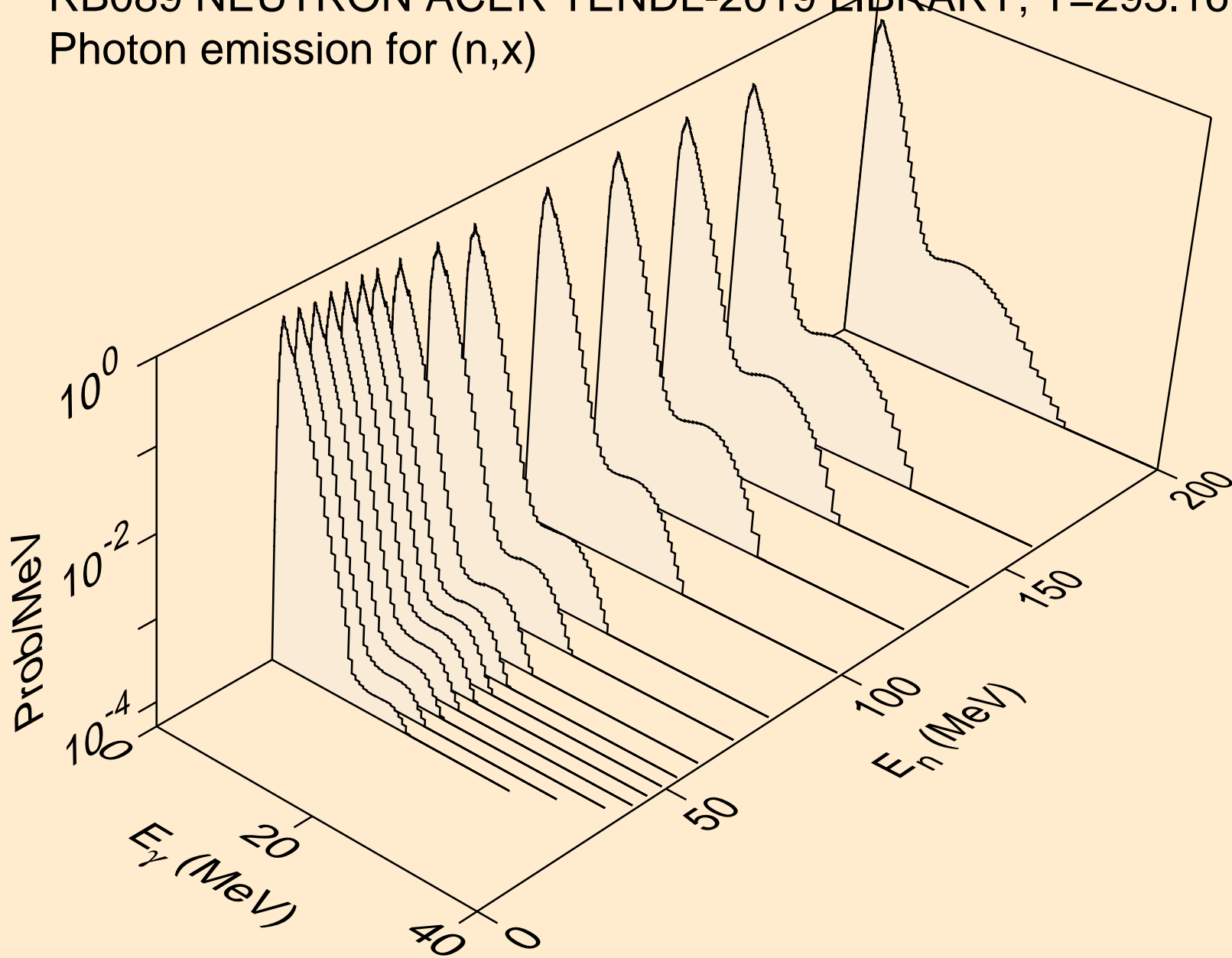

RB089 NEUTRON ACER TENDL-2019 LIBRARY; T=293.16K
Photon emission for (n,2nd)

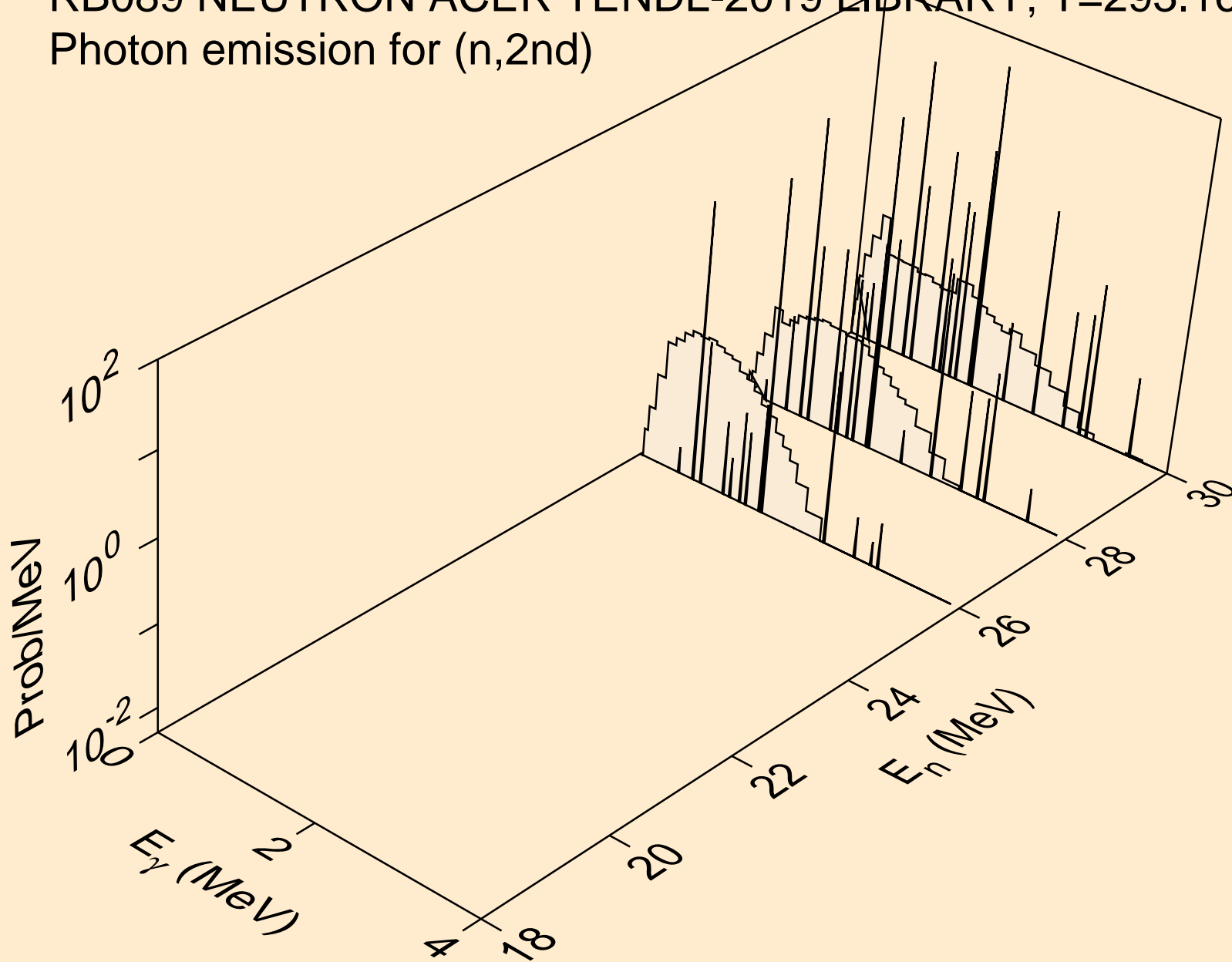

RB089 NEUTRON ACER TENDL-2019 LIBRARY; T=293.16K
Photon emission for (n,2n)

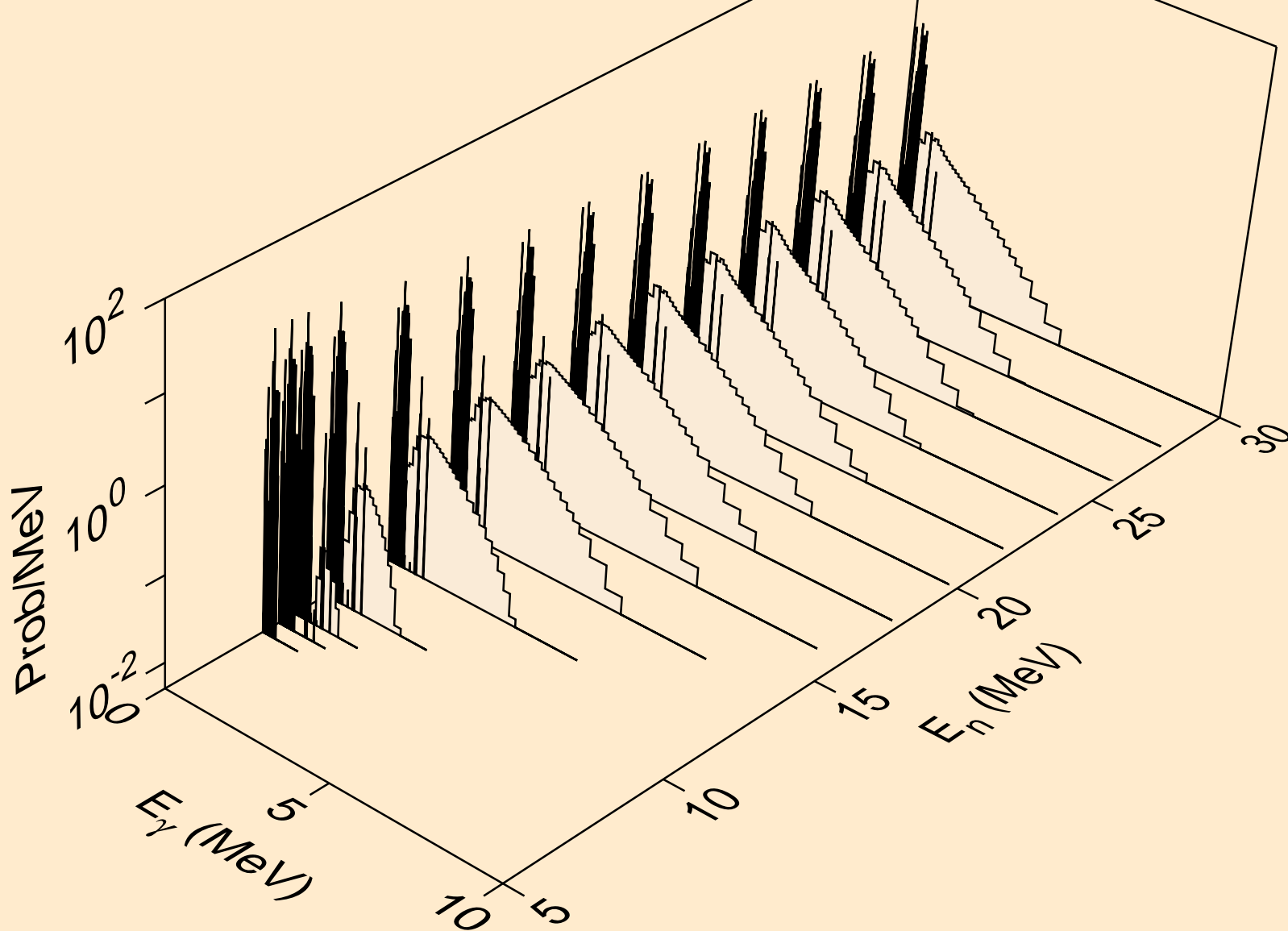

RB089 NEUTRON ACER TENDL-2019 LIBRARY; T=293.16K
Photon emission for (n,3n)

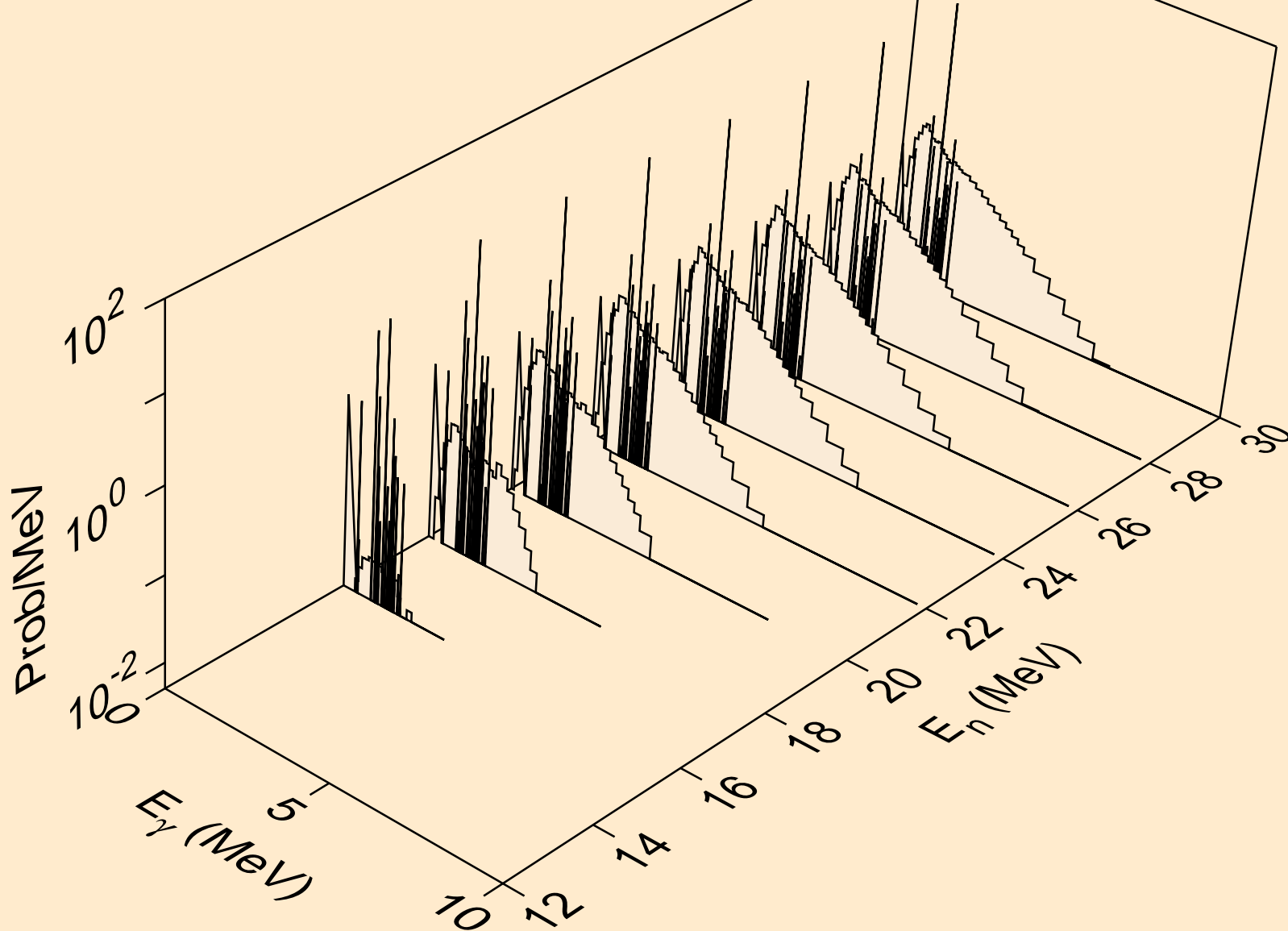

RB089 NEUTRON ACER TENDL-2019 LIBRARY; T=293.16K
Photon emission for (n,n*)a

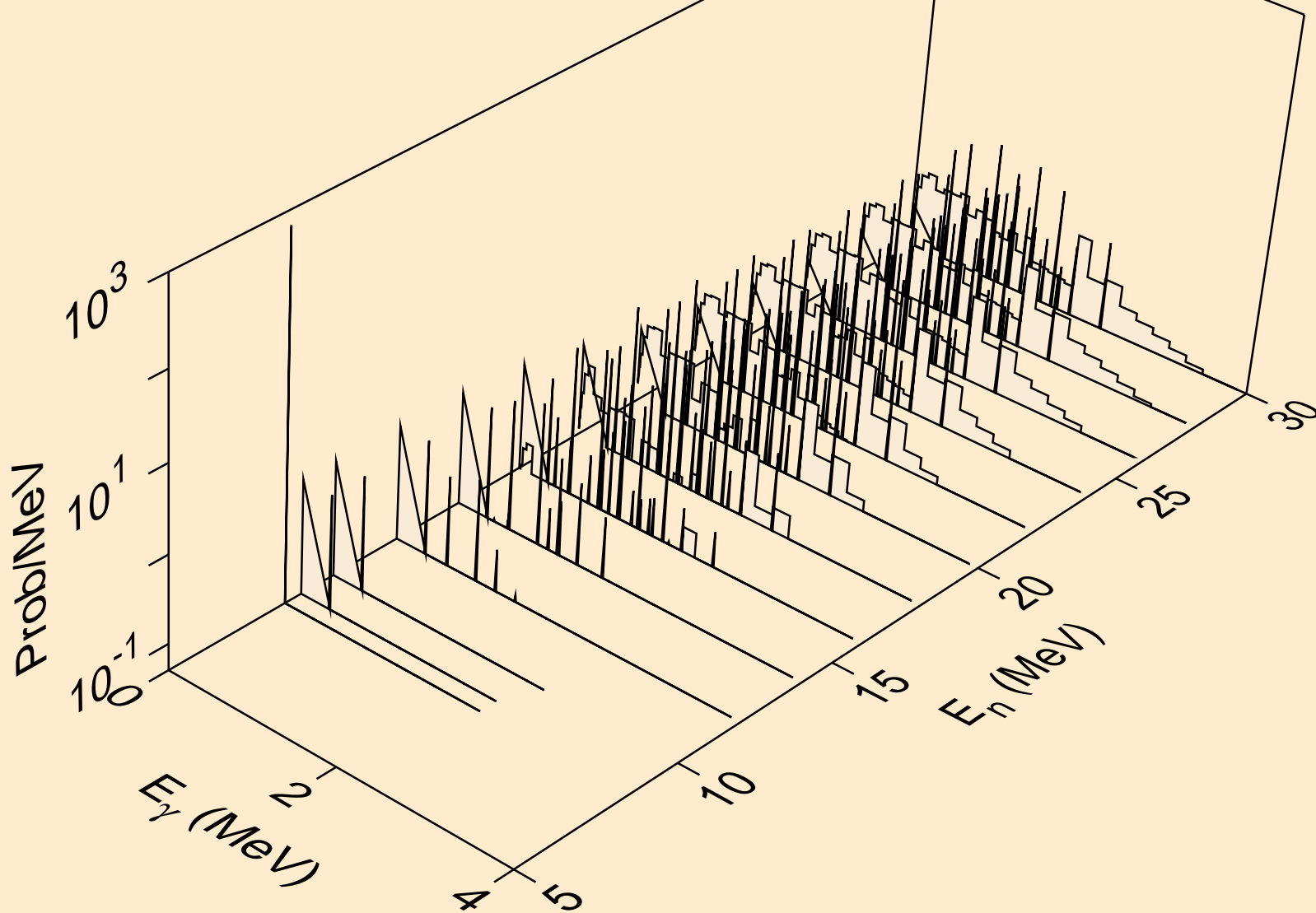

RB089 NEUTRON ACER TENDL-2019 LIBRARY; T=293.16K
Photon emission for (n,2n)a

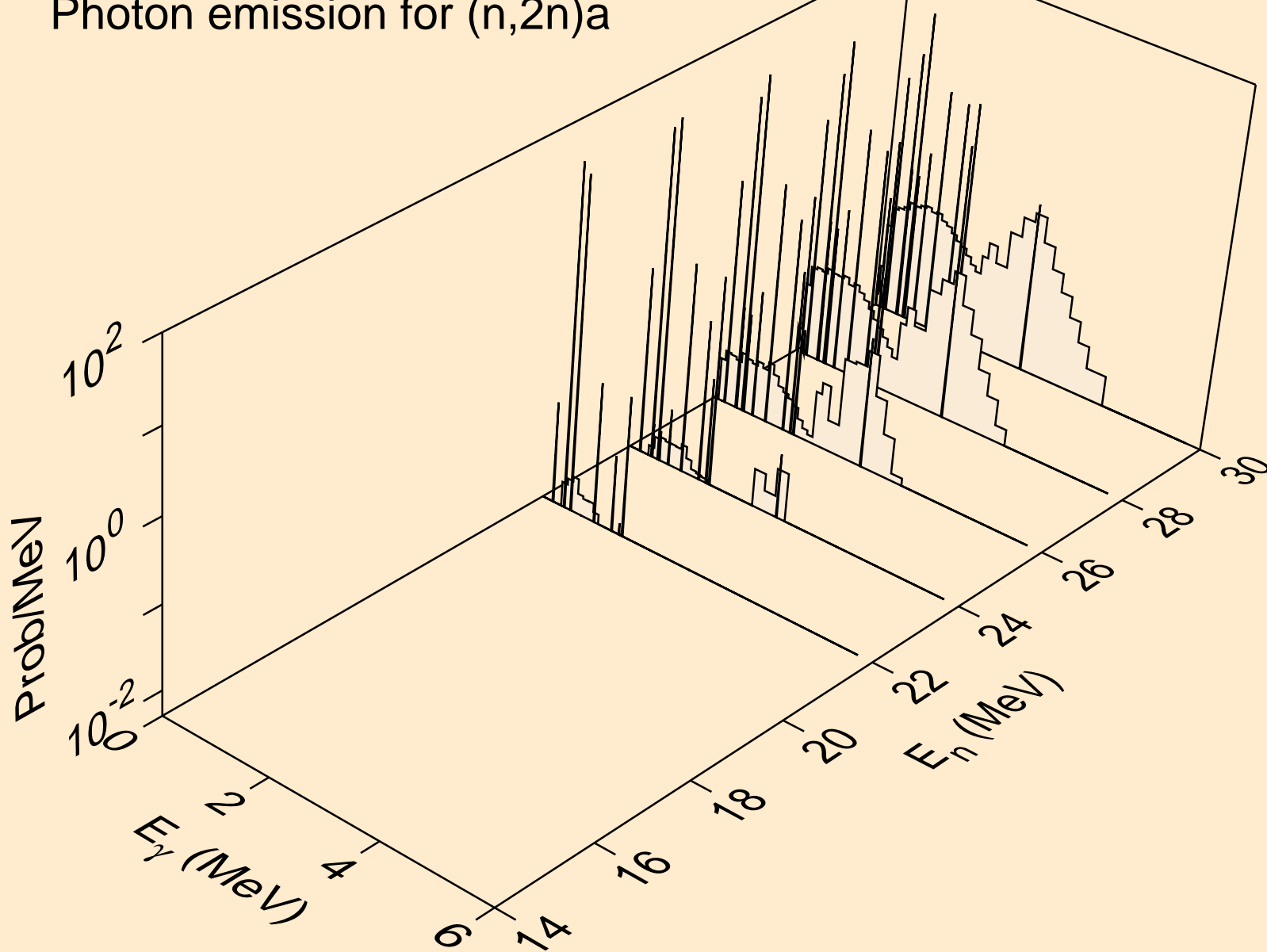

RB089 NEUTRON ACER TENDL-2019 LIBRARY; T=293.16K
Photon emission for (n,3n)a

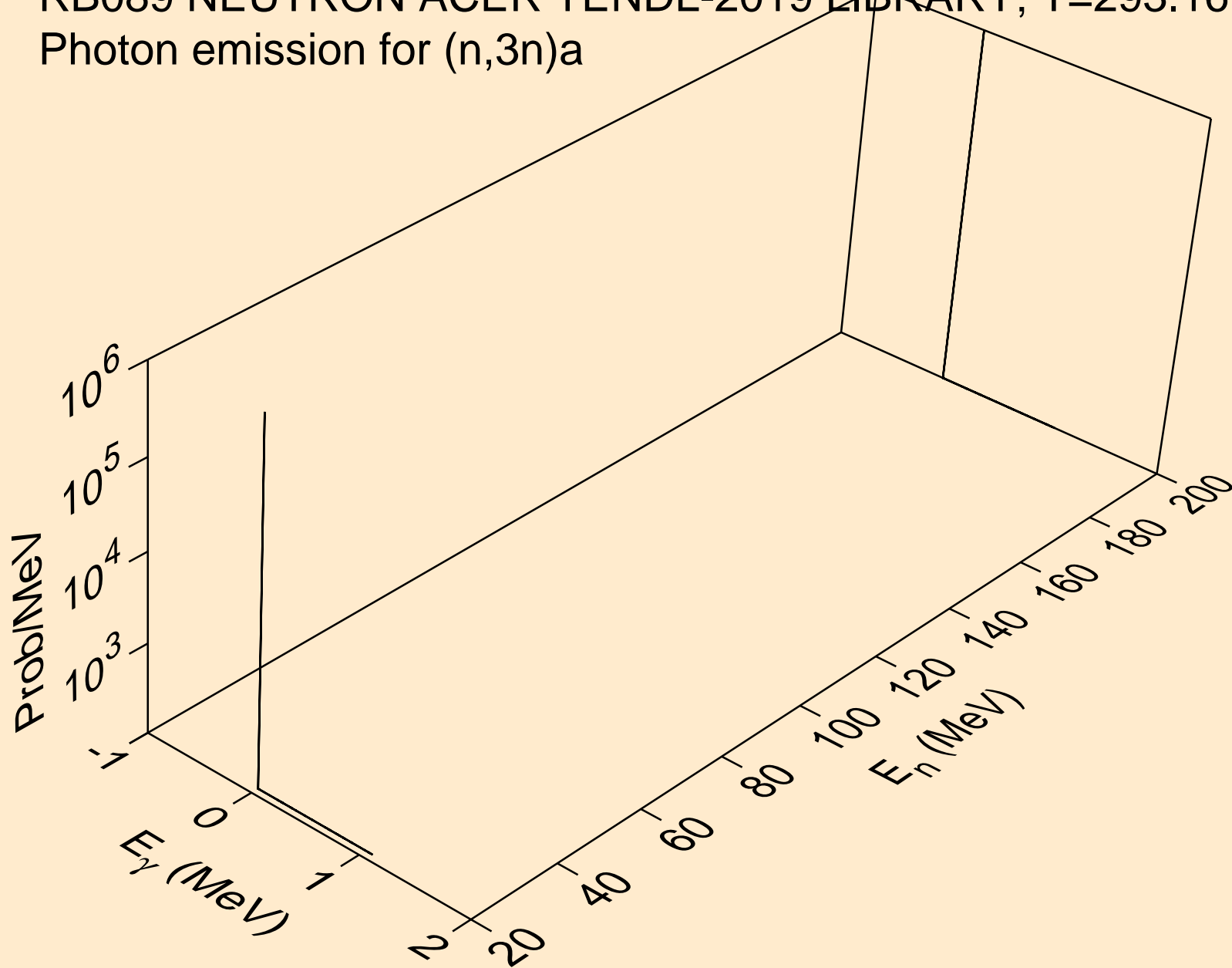

RB089 NEUTRON ACER TENDL-2019 LIBRARY; T=293.16K
Photon emission for (n,n*)p

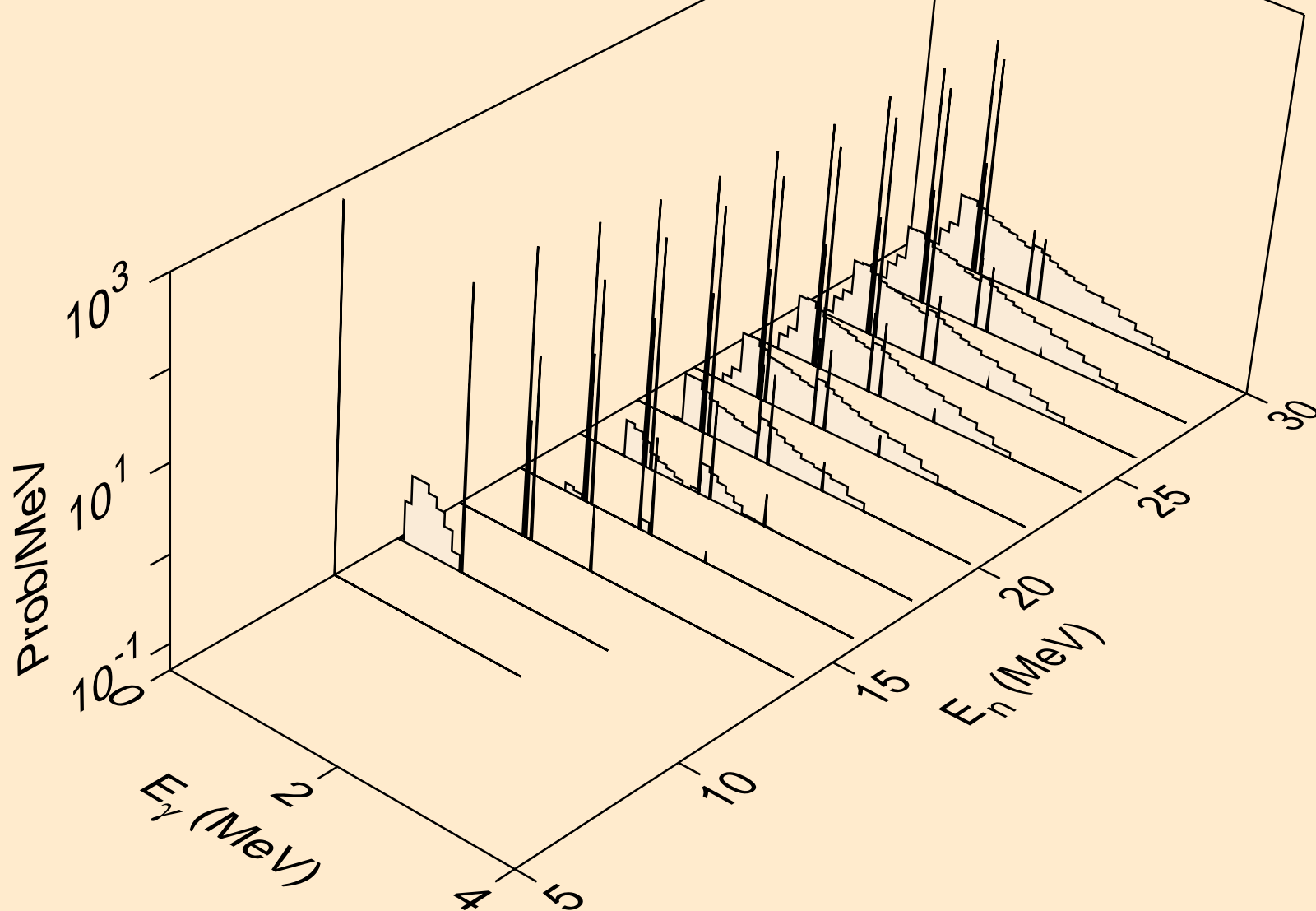

RB089 NEUTRON ACER TENDL-2019 LIBRARY; T=293.16K
Photon emission for (n,n*)d

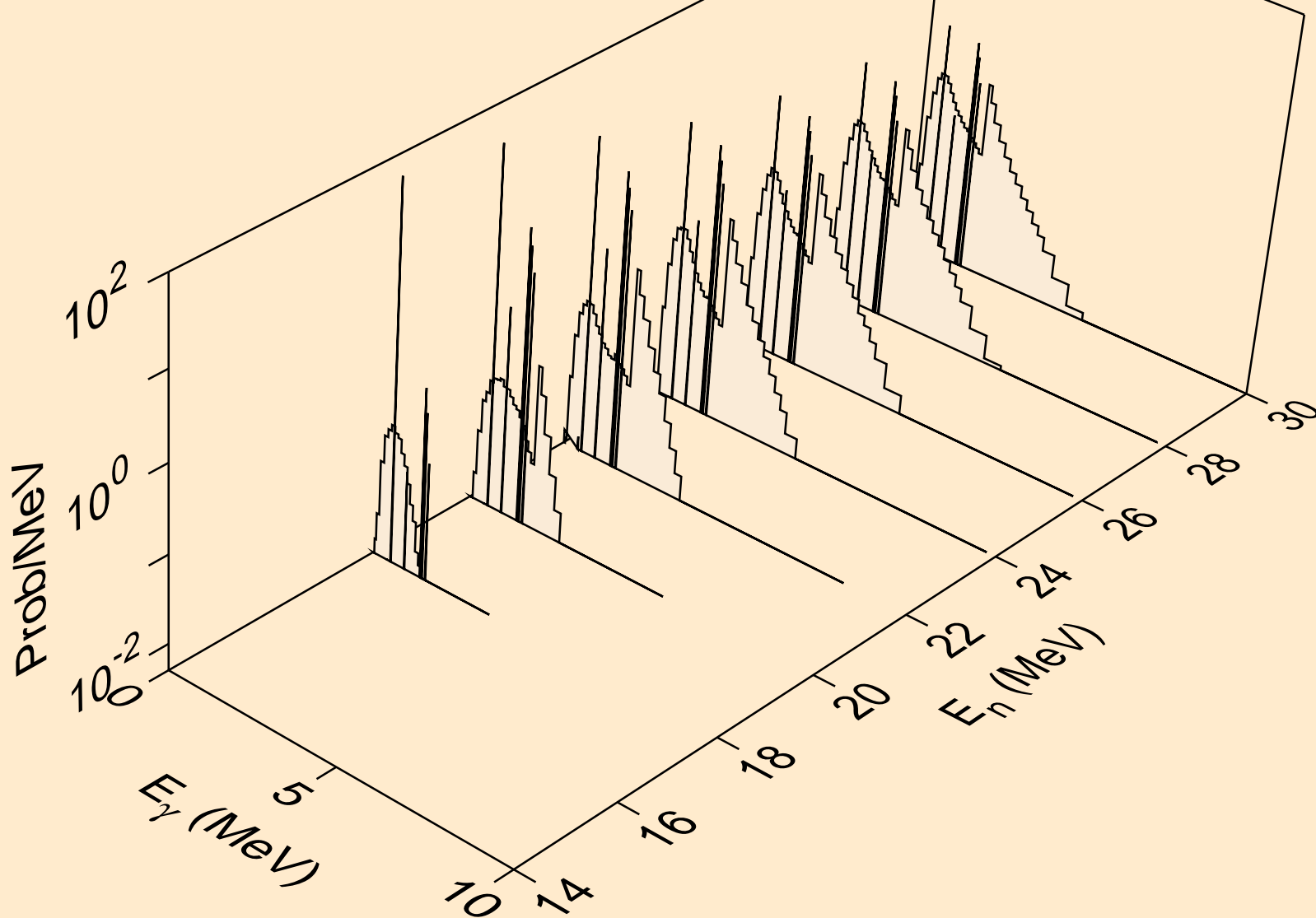

RB089 NEUTRON ACER TENDL-2019 LIBRARY; T=293.16K
Photon emission for (n,n*)t

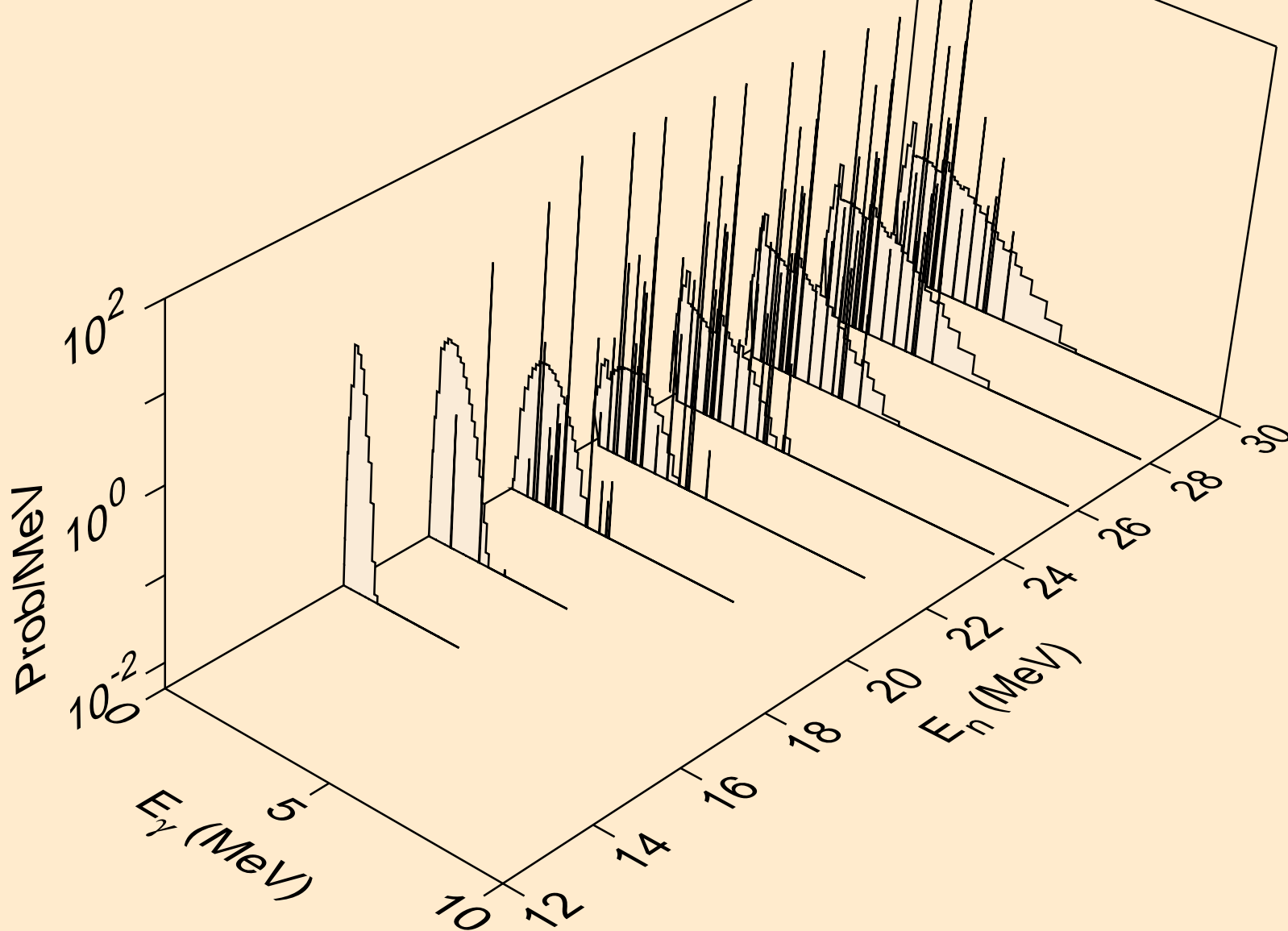

RB089 NEUTRON ACER TENDL-2019 LIBRARY; T=293.16K
Photon emission for (n,n*)he3

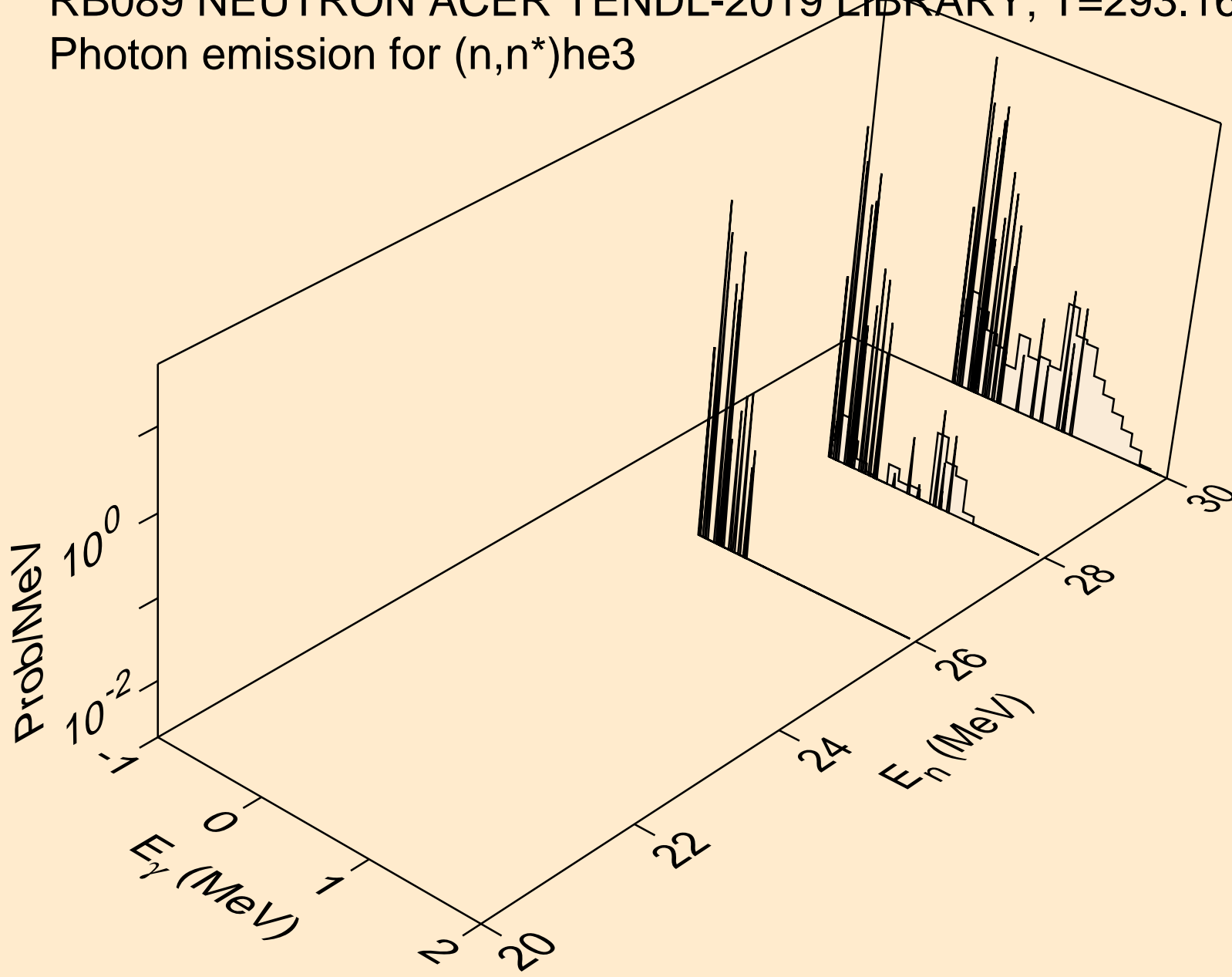

RB089 NEUTRON ACER TENDL-2019 LIBRARY; T=293.16K
Photon emission for (n,4n)

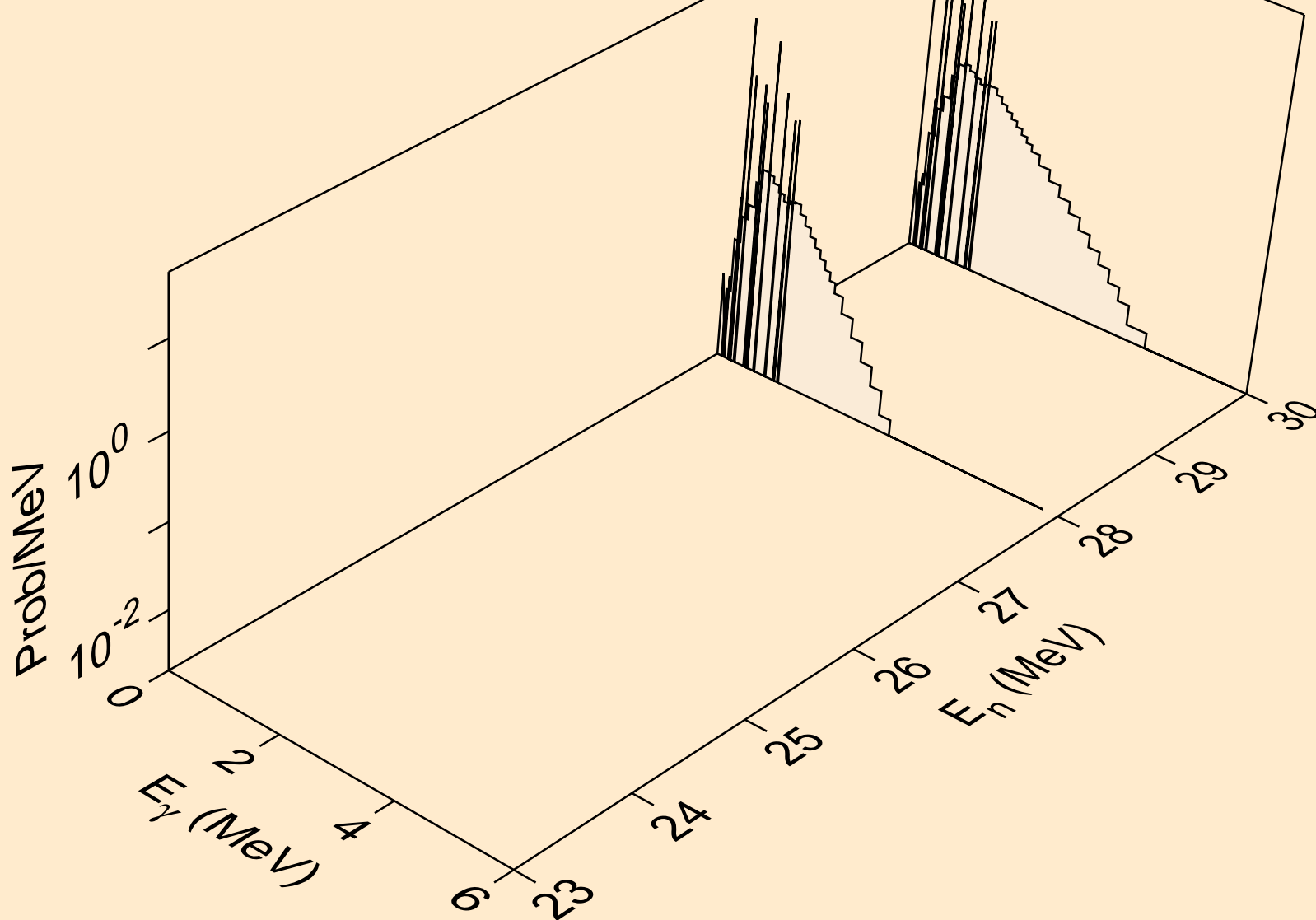

RB089 NEUTRON ACER TENDL-2019 LIBRARY; T=293.16K
Photon emission for (n,2np)

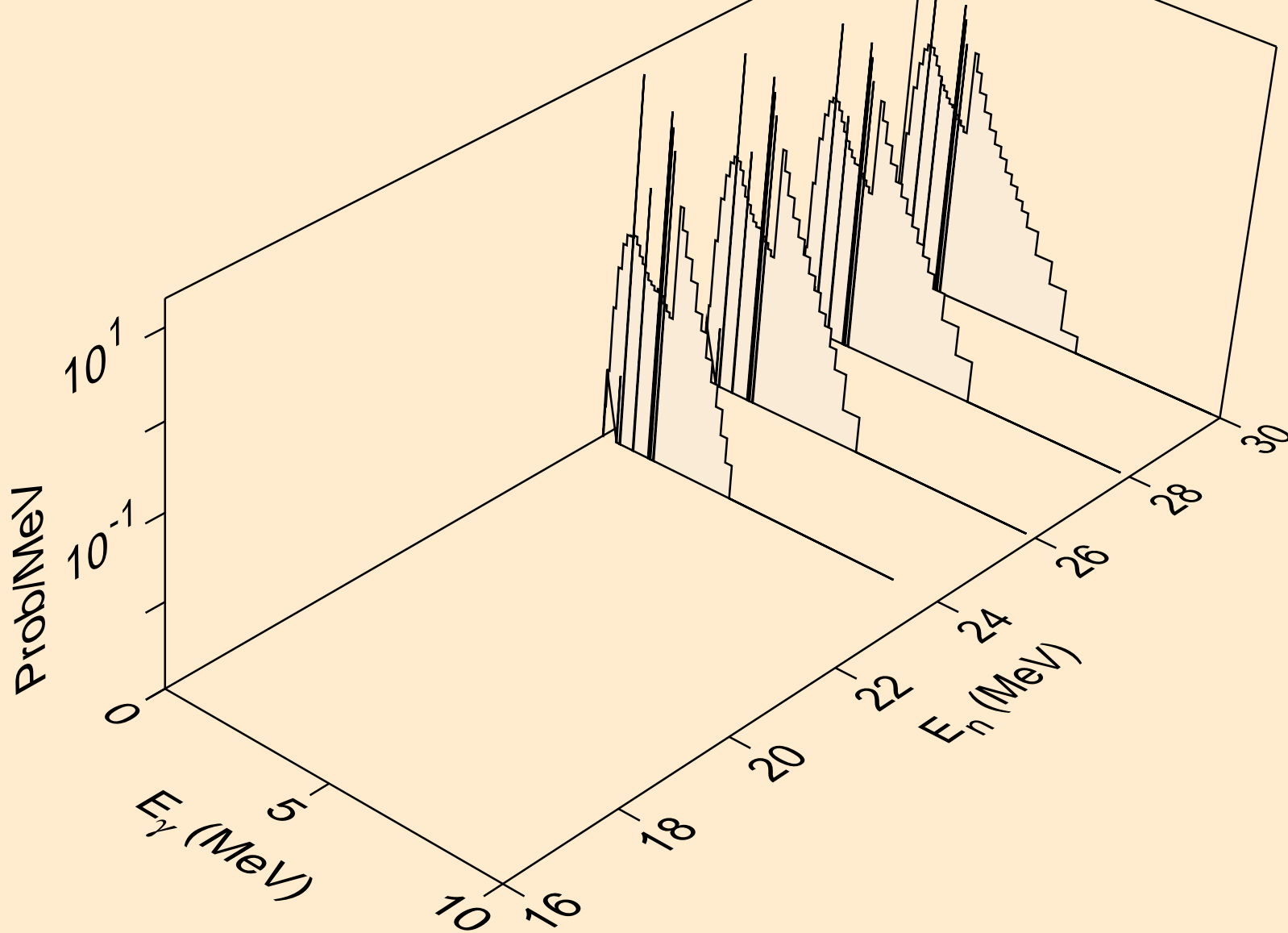

RB089 NEUTRON ACER TENDL-2019 LIBRARY; T=293.16K
Photon emission for (n,3np)

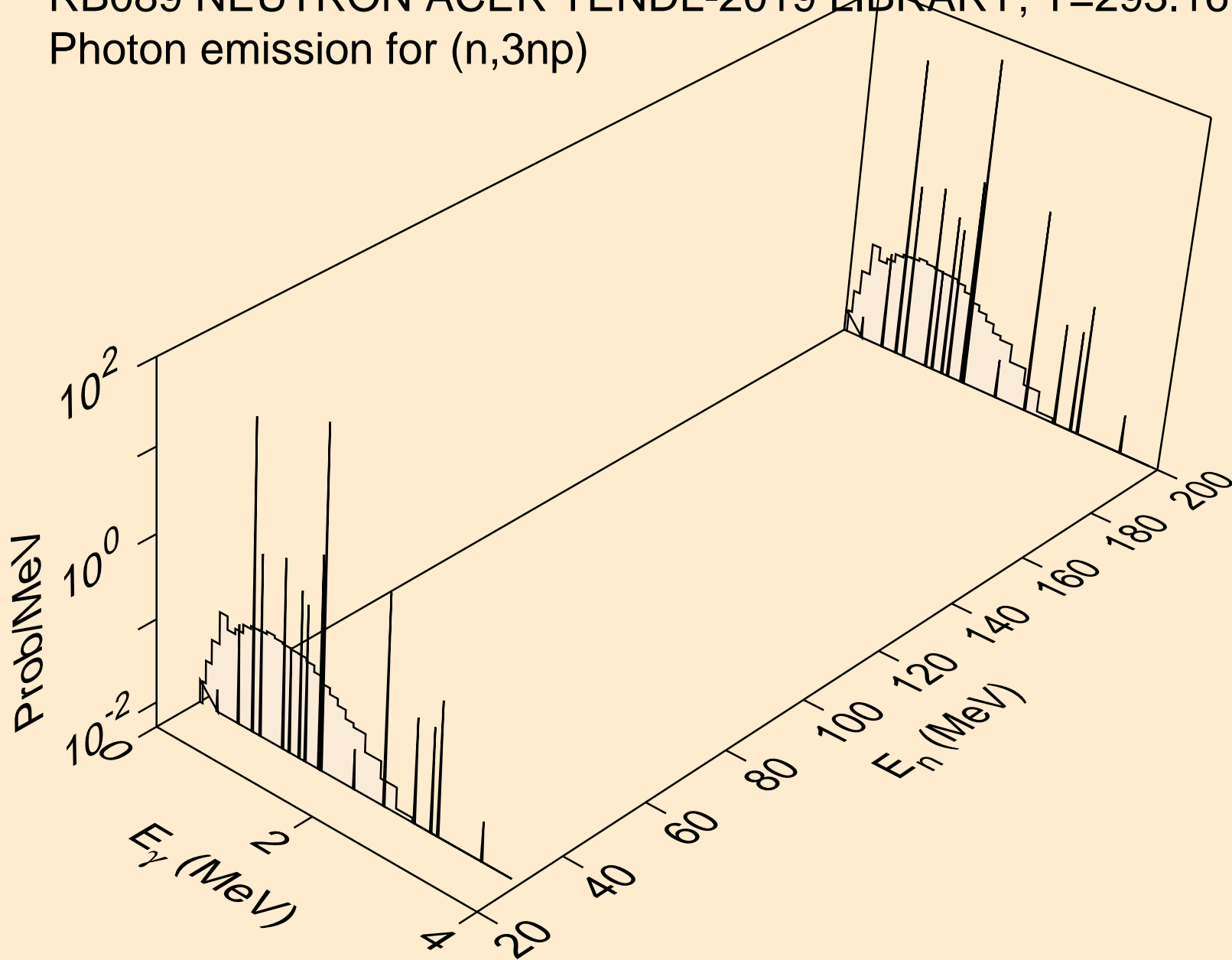

RB089 NEUTRON ACER TENDL-2019 LIBRARY; T=293.16K
Photon emission for (n,2np)

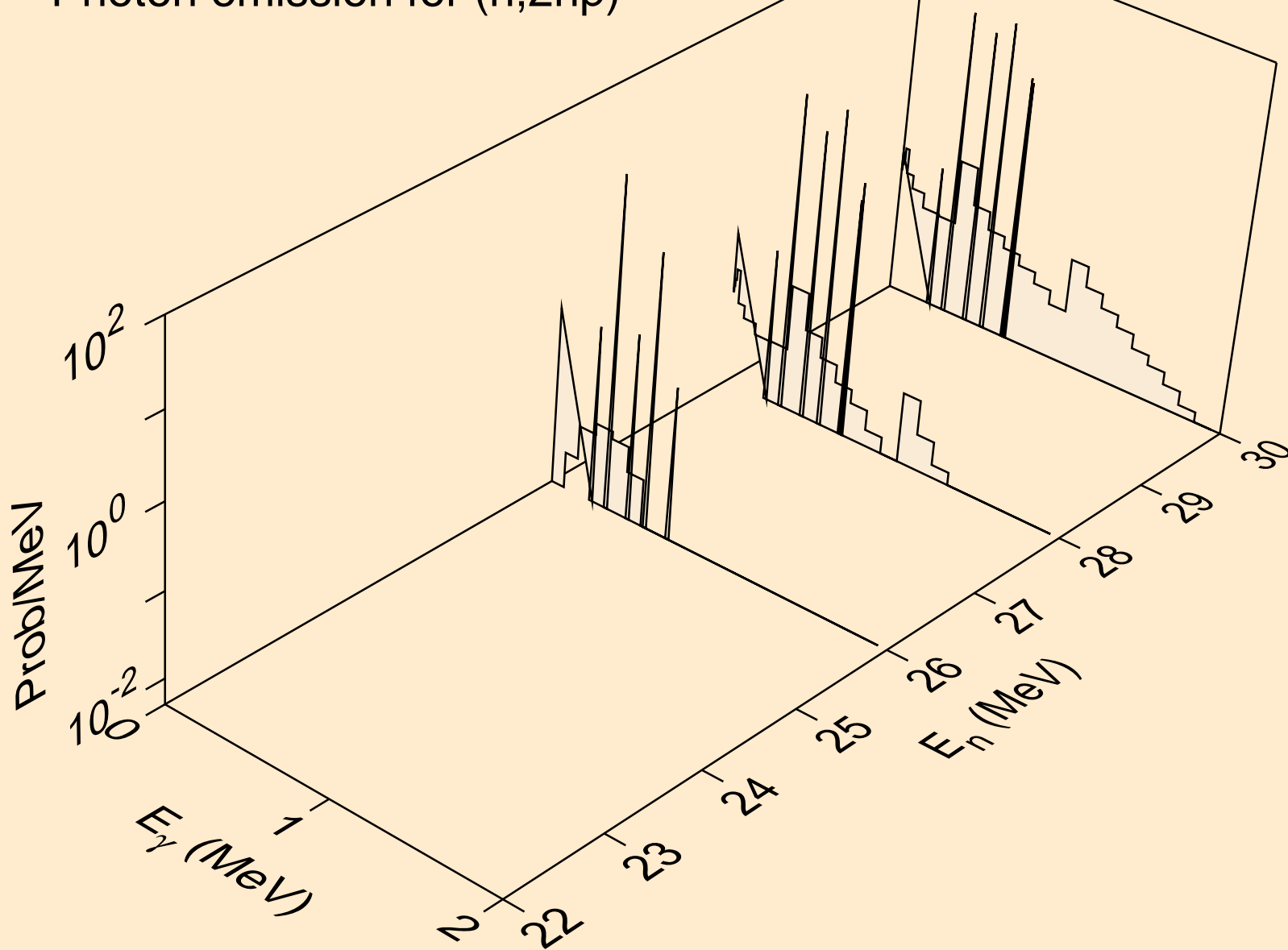

RB089 NEUTRON ACER TENDL-2019 LIBRARY; T=293.16K
Photon emission for (n,npa)

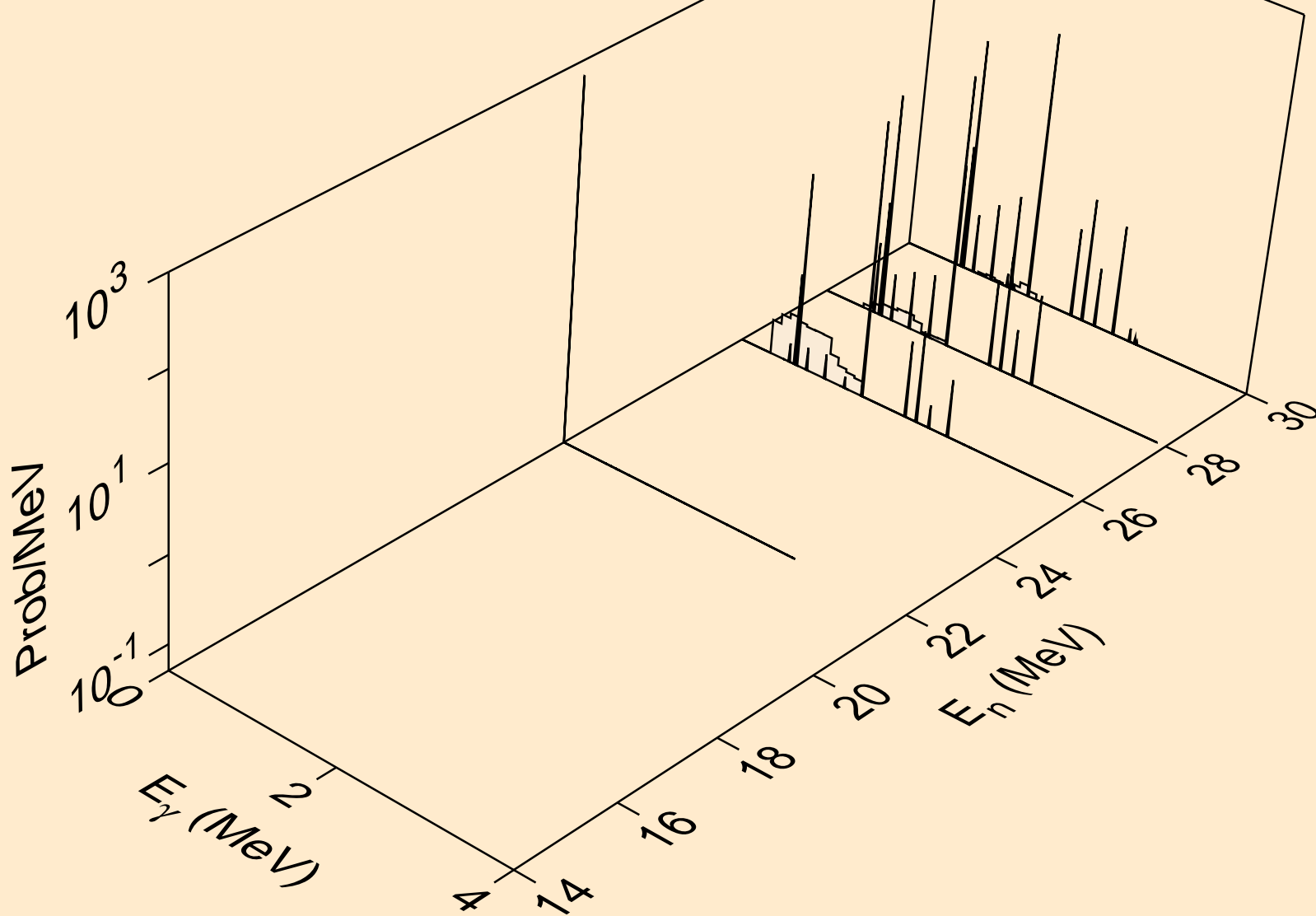

RB089 NEUTRON ACER TENDL-2019 LIBRARY; T=293.16K
Photon emission for (n,n*c)

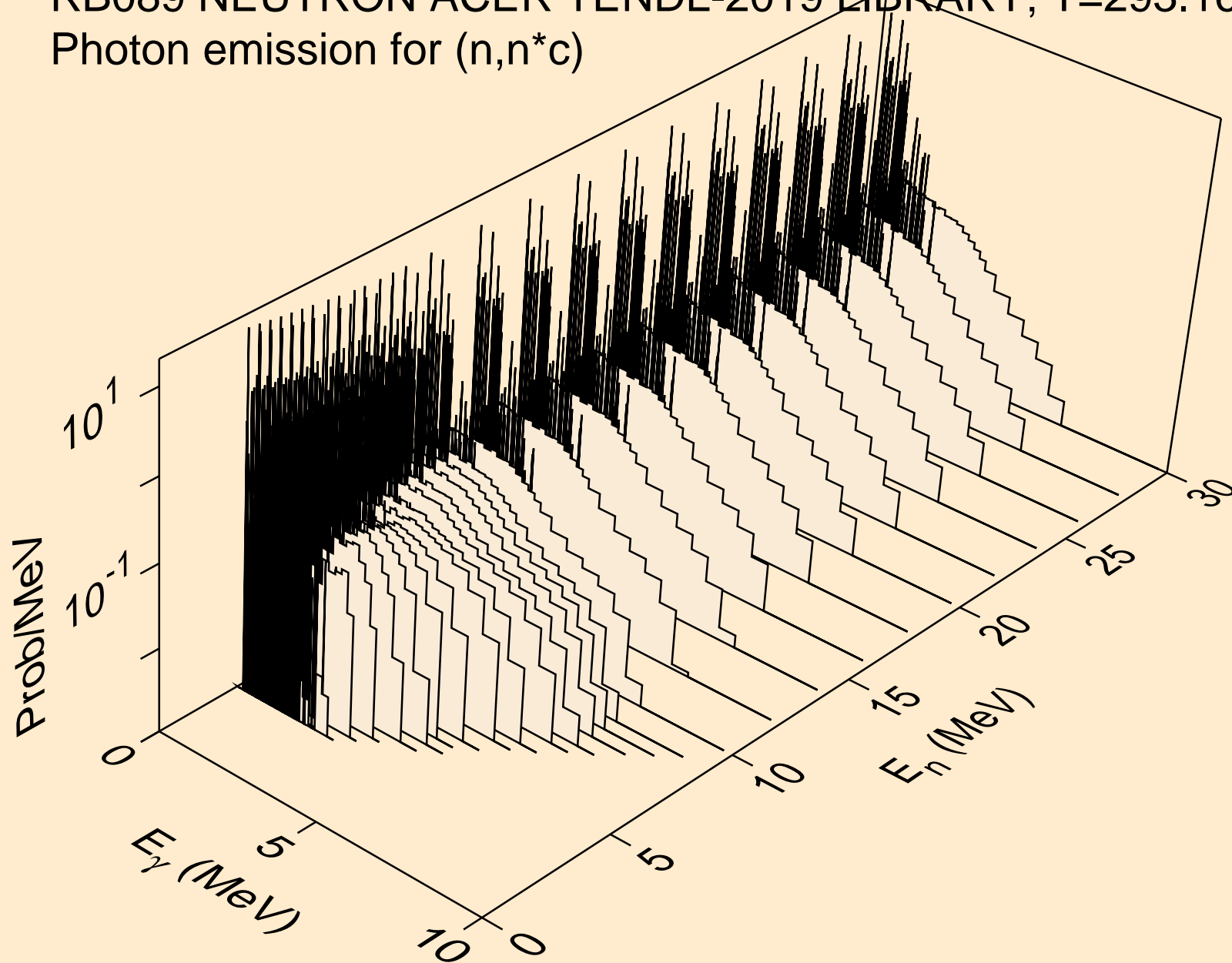

RB089 NEUTRON ACER TENDL-2019 LIBRARY; T=293.16K
Photon emission for (n,gma)

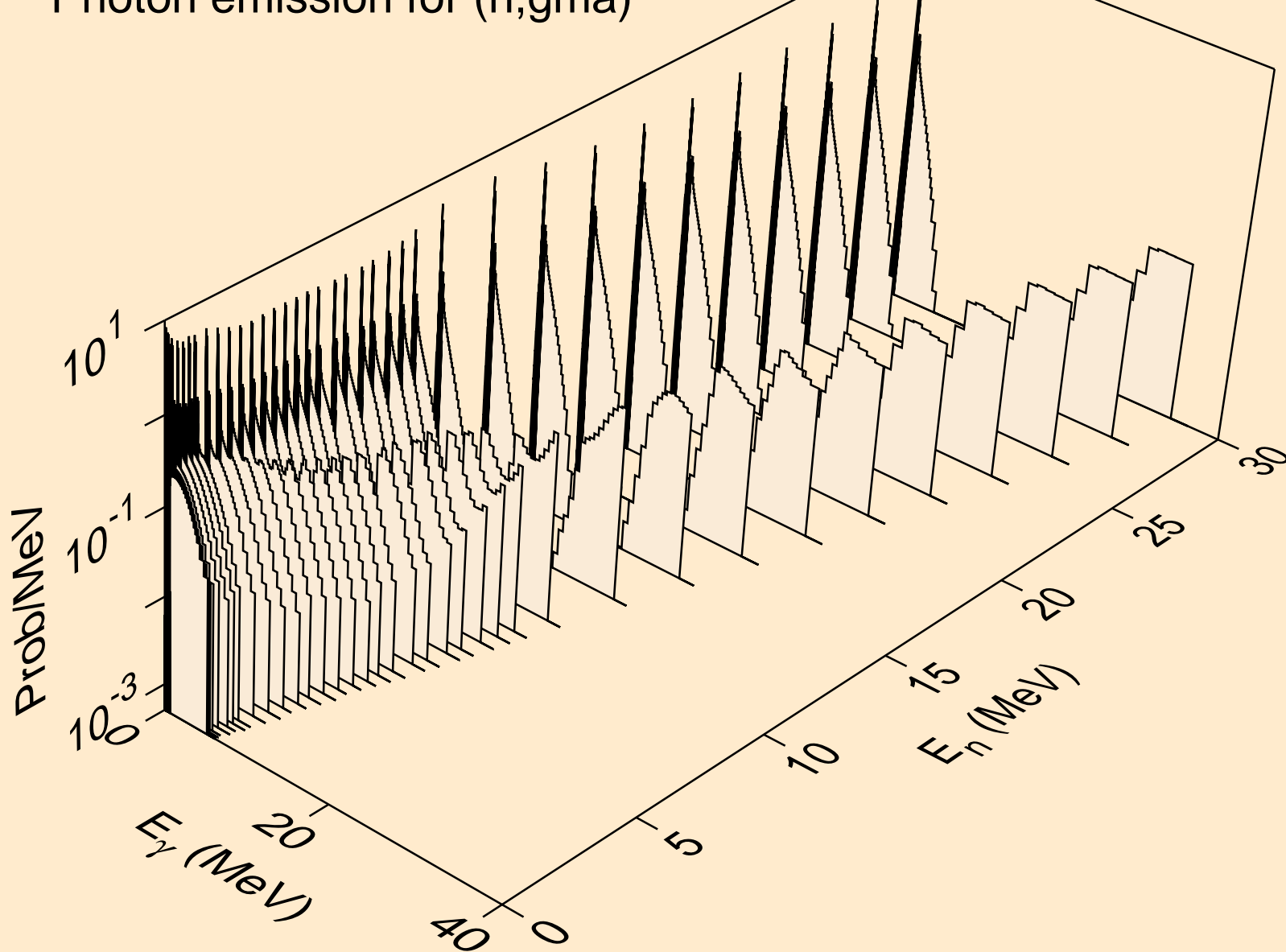

RB089 NEUTRON ACER TENDL-2019 LIBRARY; T=293.16K
Photon emission for (n,p)

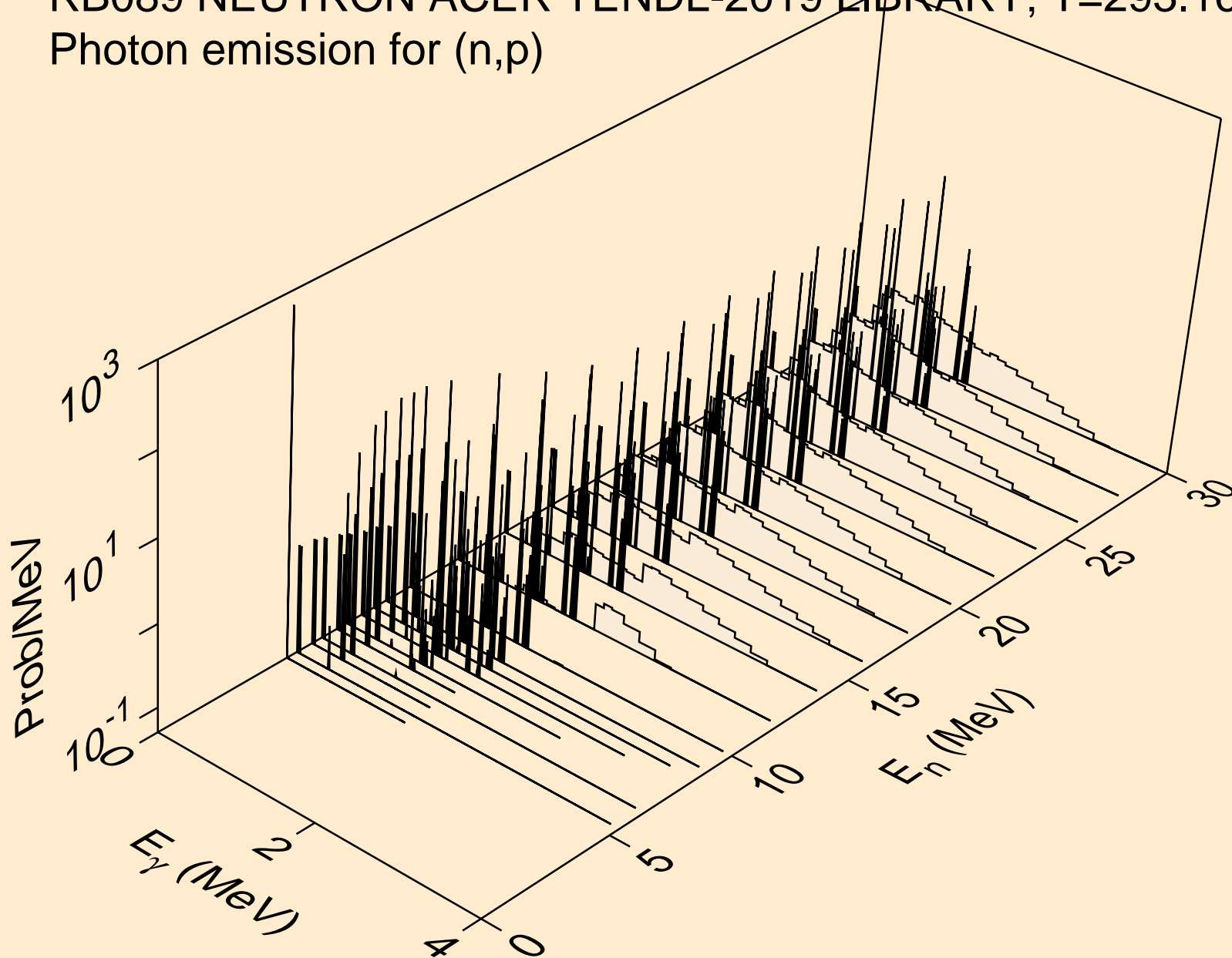

RB089 NEUTRON ACER TENDL-2019 LIBRARY; T=293.16K
Photon emission for (n,d)

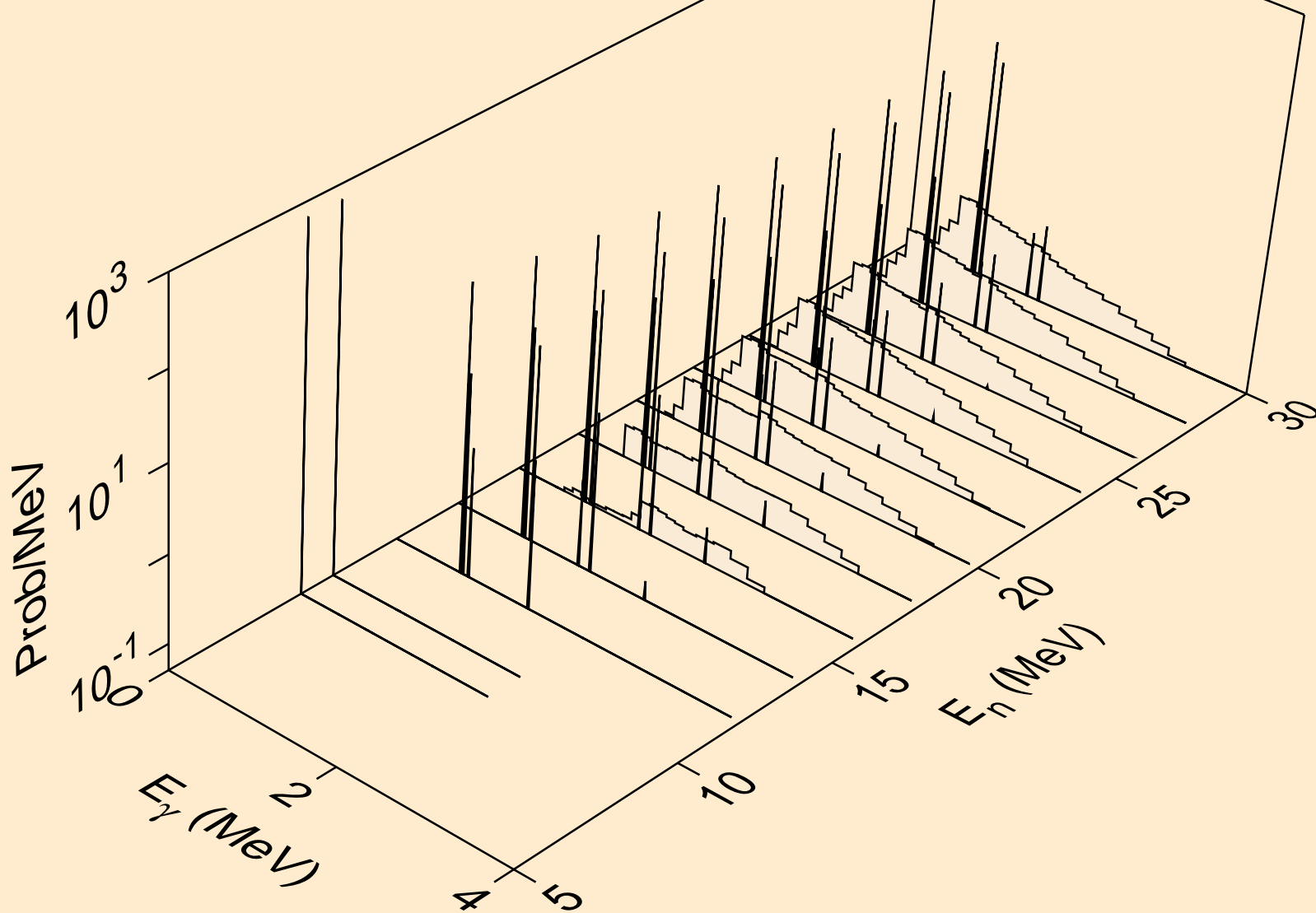

RB089 NEUTRON ACER TENDL-2019 LIBRARY; T=293.16K
Photon emission for (n,t)

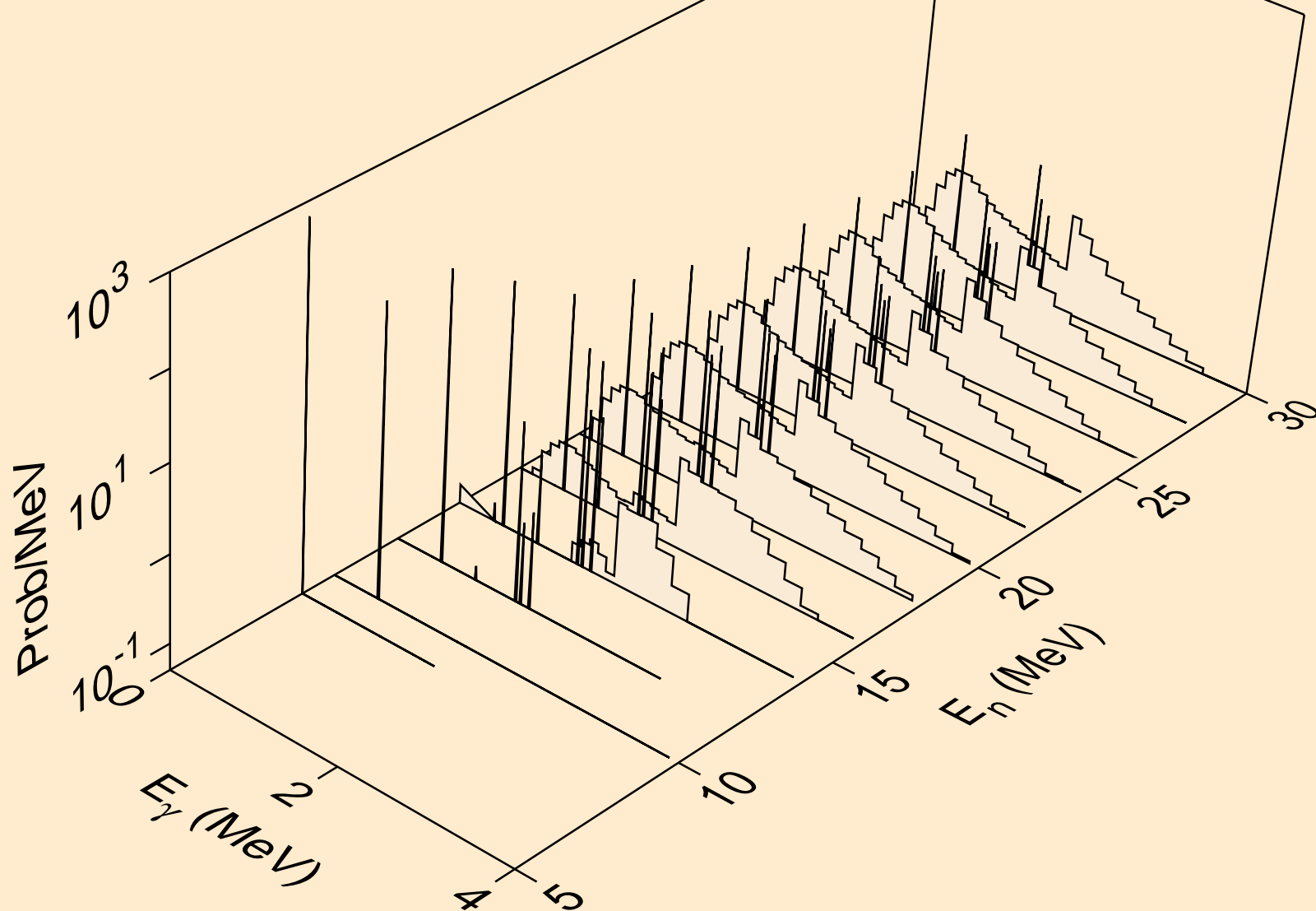

RB089 NEUTRON ACER TENDL-2019 LIBRARY; T=293.16K
Photon emission for (n,he3)

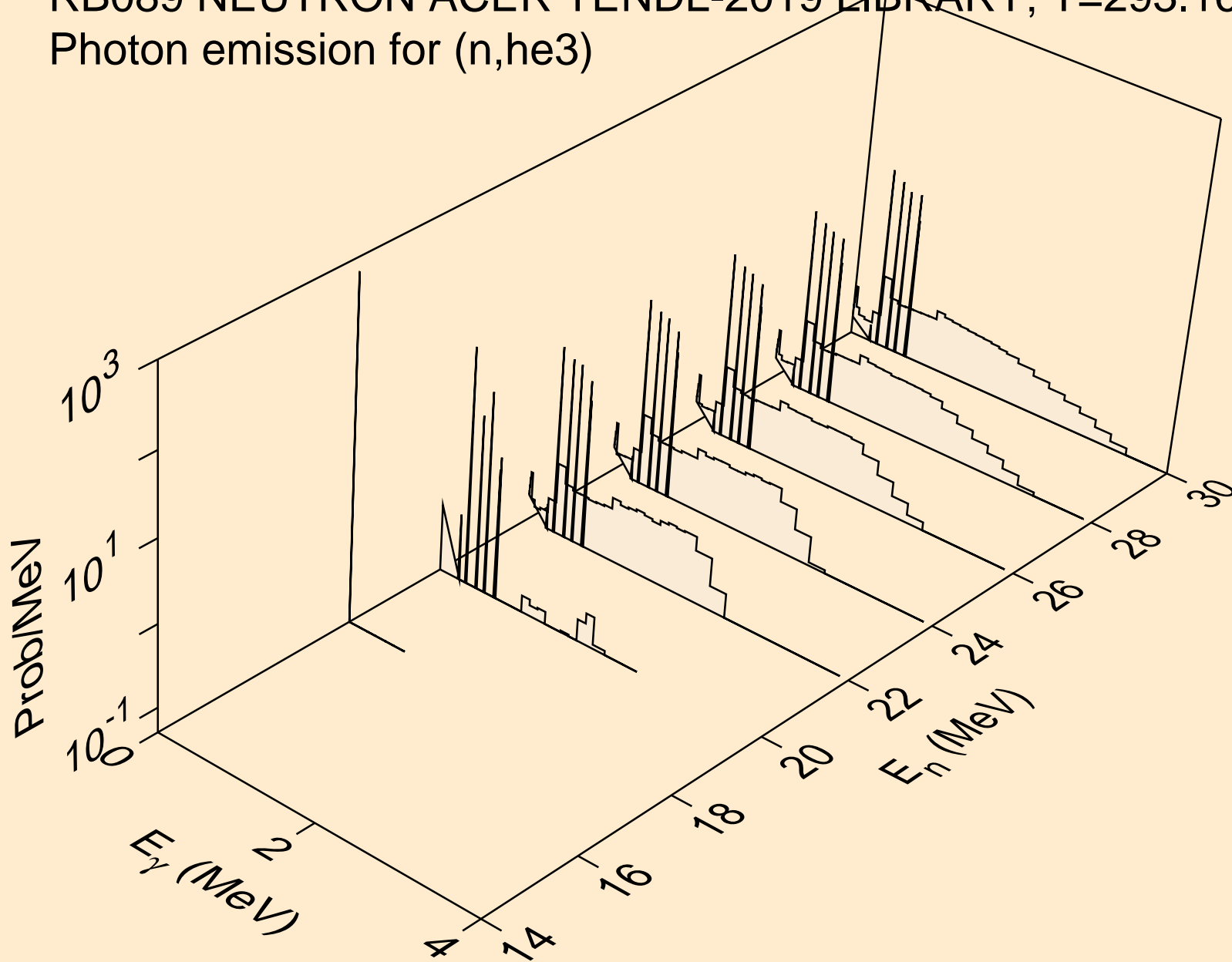

RB089 NEUTRON ACER TENDL-2019 LIBRARY; T=293.16K
Photon emission for (n,a)

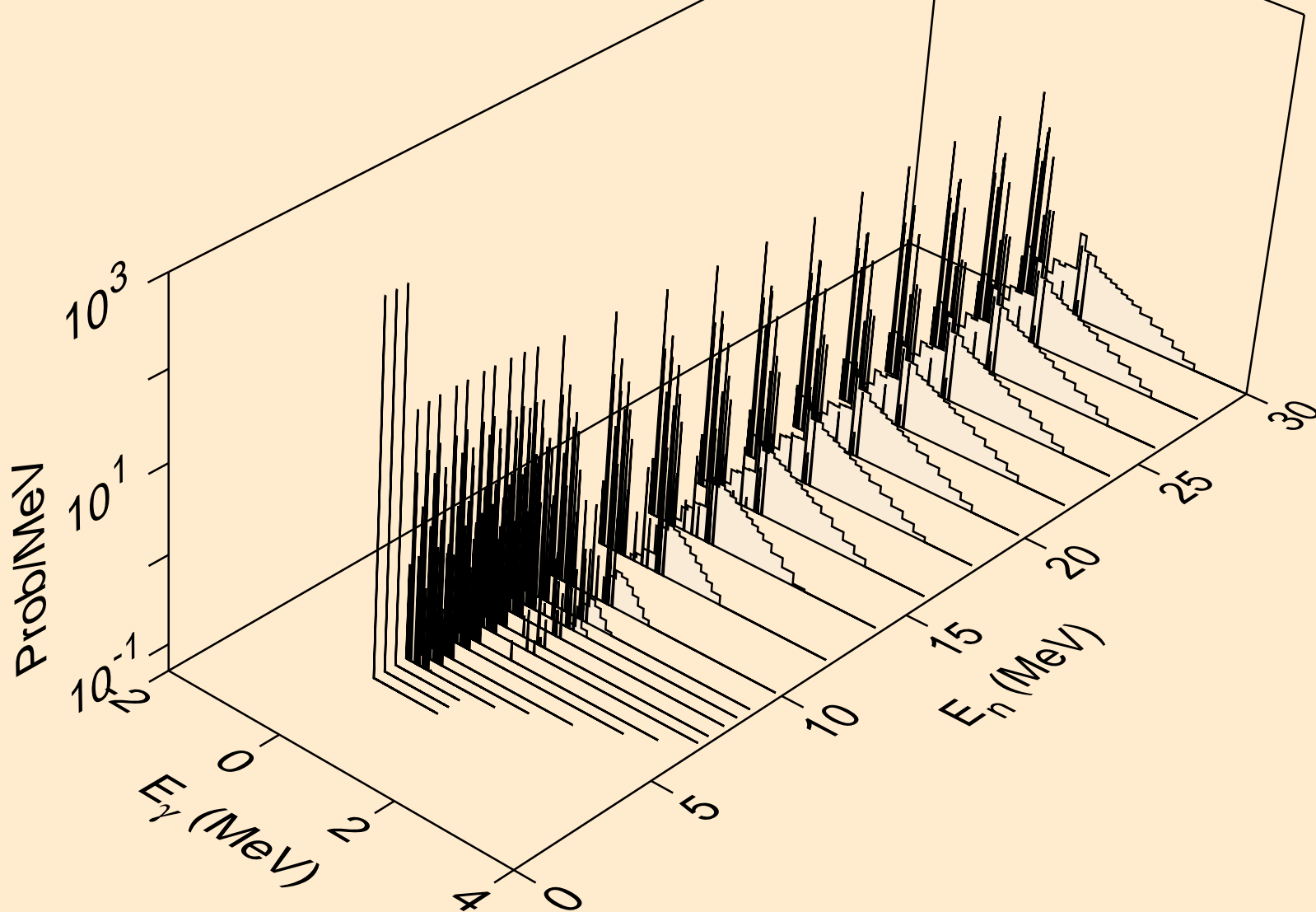

RB089 NEUTRON ACER TENDL-2019 LIBRARY; T=293.16K
Photon emission for (n,2a)

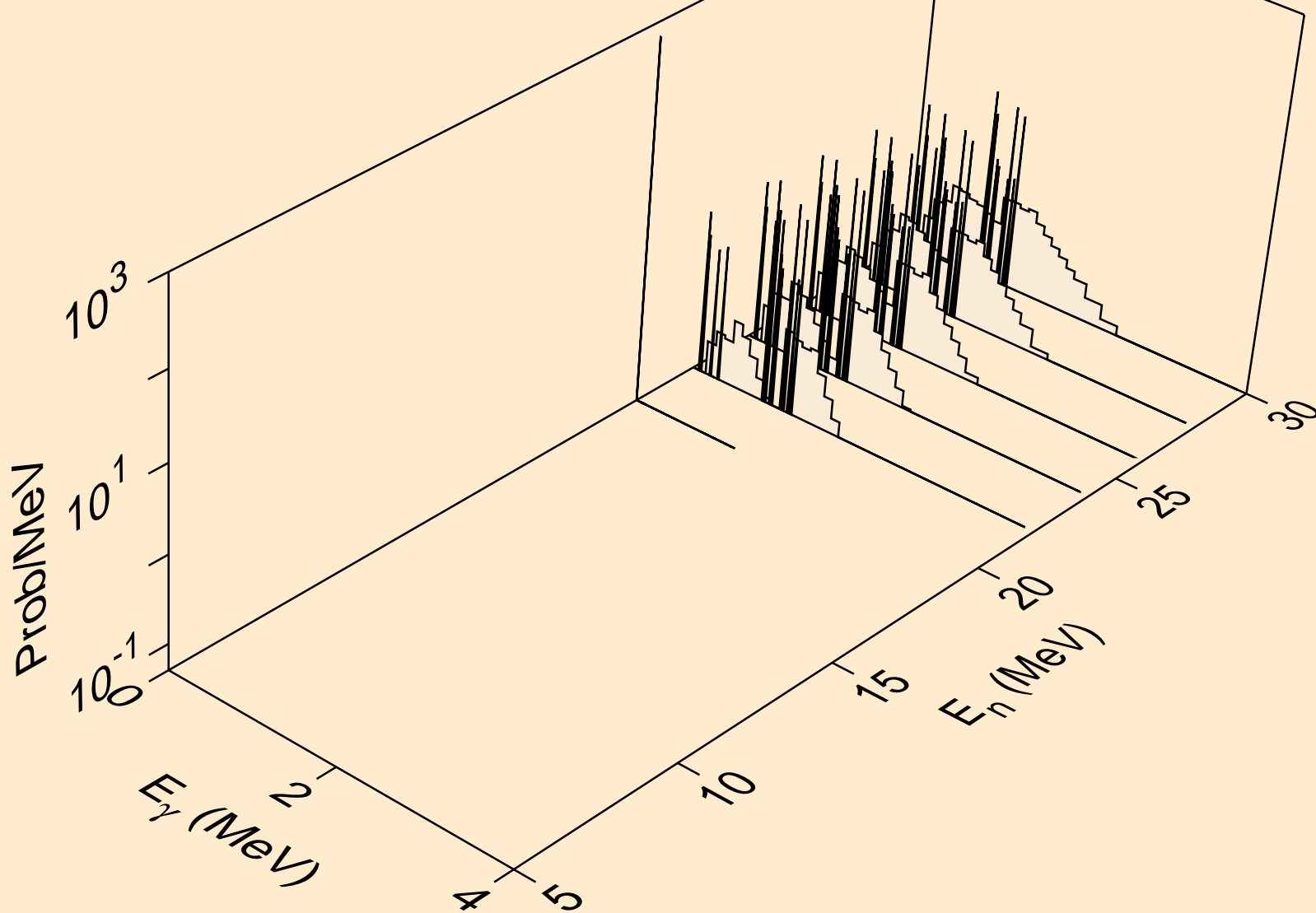

RB089 NEUTRON ACER TENDL-2019 LIBRARY; T=293.16K
Photon emission for (n,2p)

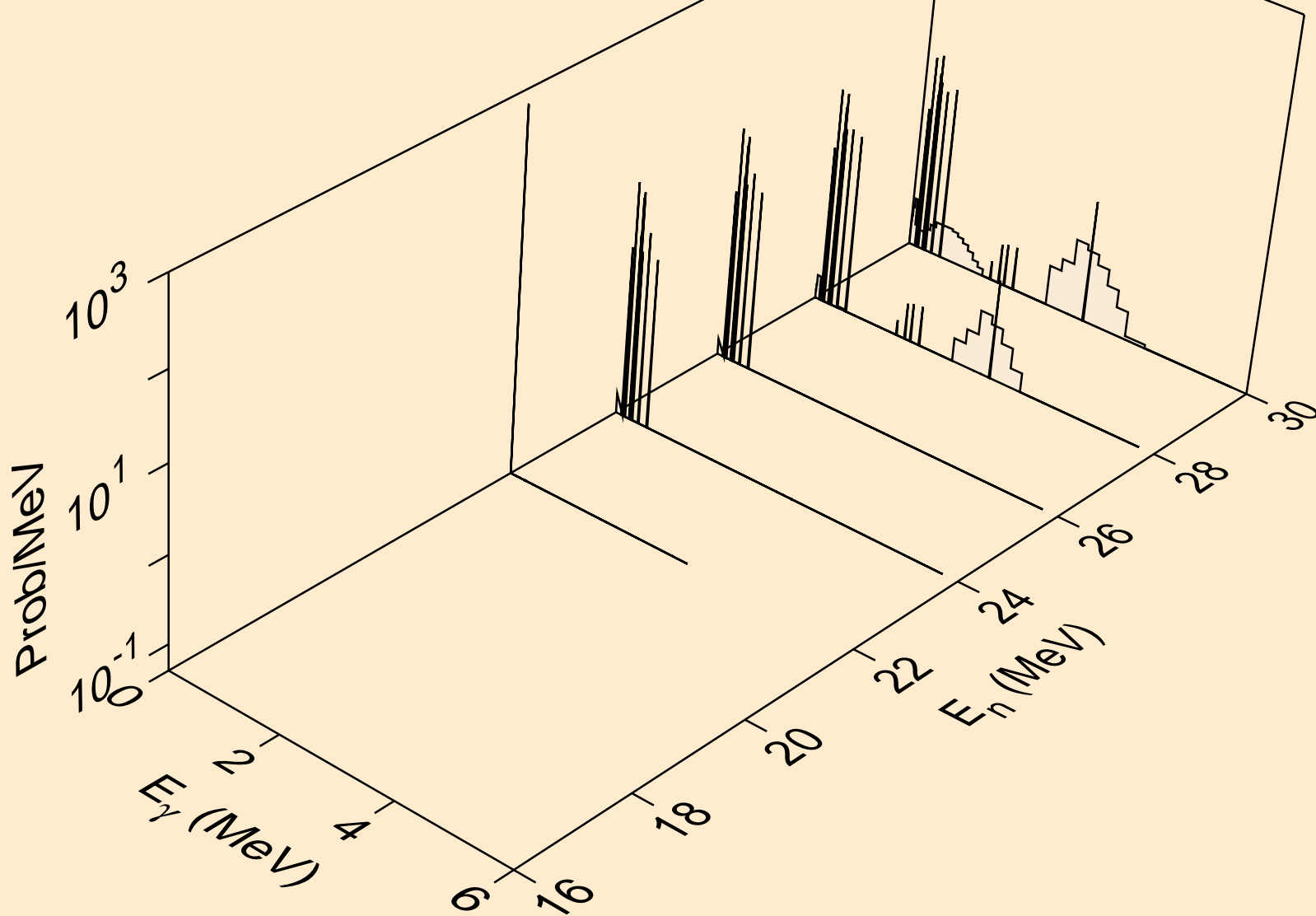

RB089 NEUTRON ACER TENDL-2019 LIBRARY; T=293.16K
Photon emission for (n,p α)

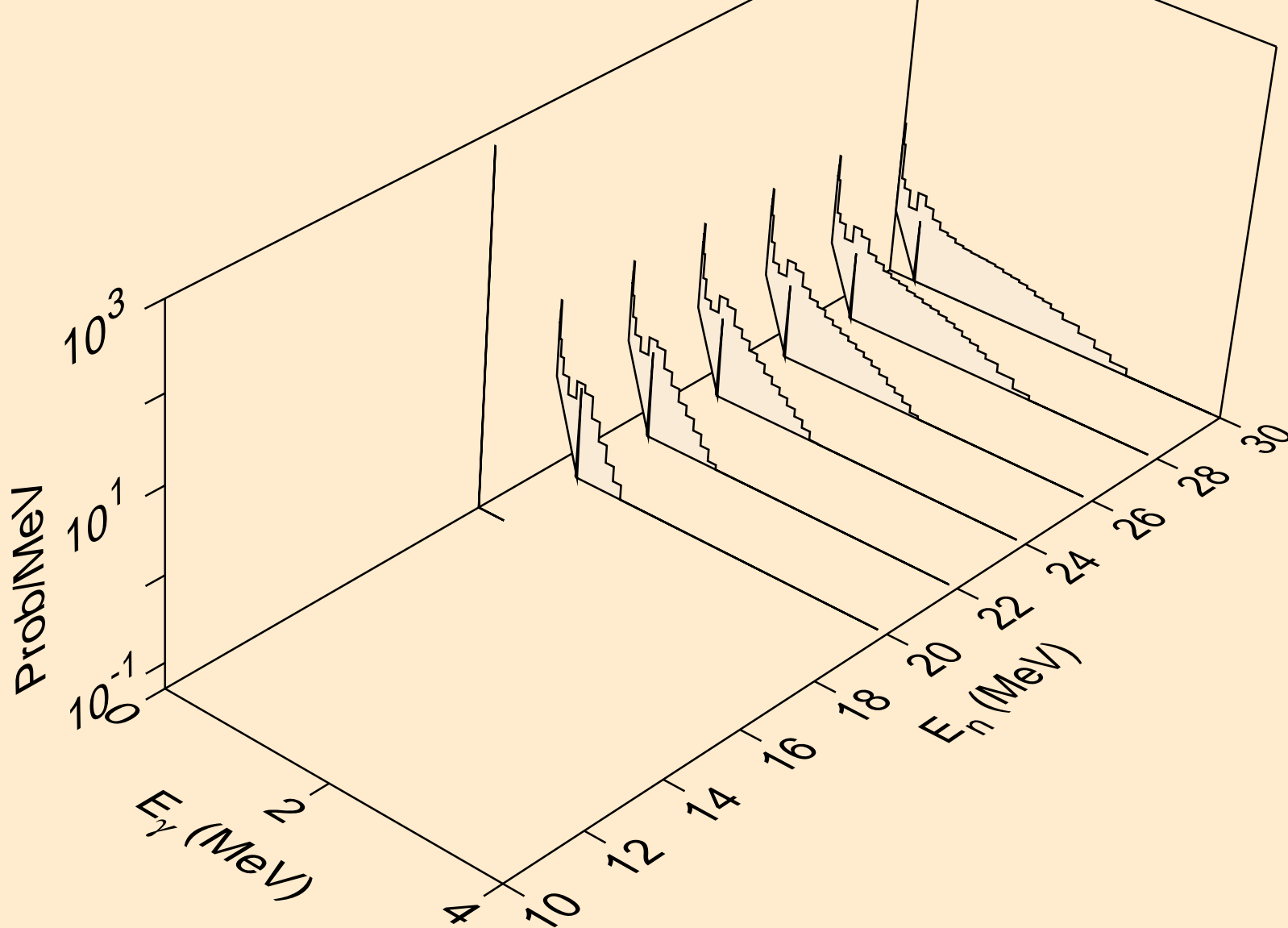

RB089 NEUTRON ACER TENDL-2019 LIBRARY; T=293.16K
Photon emission for (n,pt)

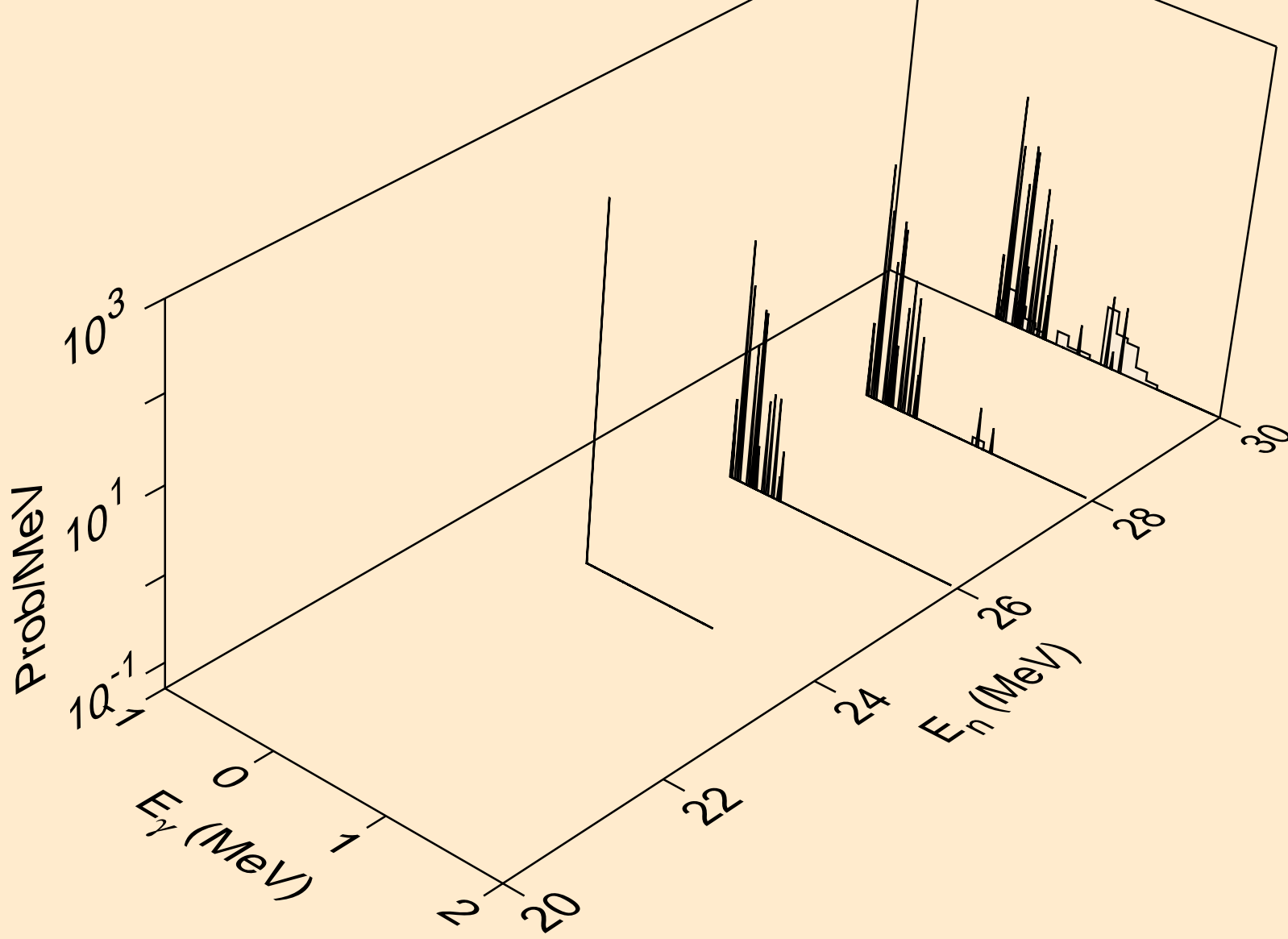

RB089 NEUTRON ACER TENDL-2019 LIBRARY; T=293.16K
Photon emission for (n,da)

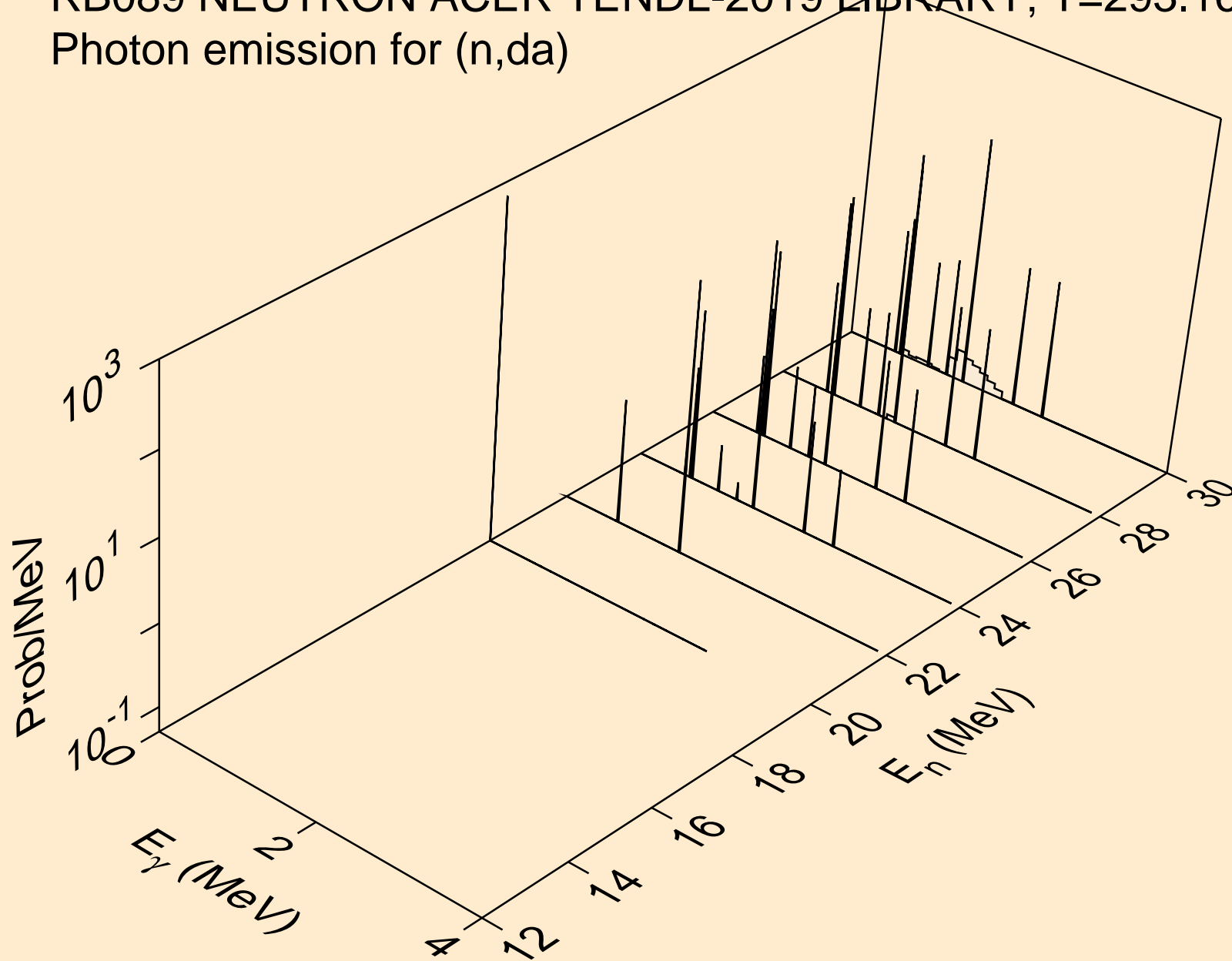

RB089 NEUTRON ACER TENDL-2019 LIBRARY; T=293.16K
thermal capture photon spectrum

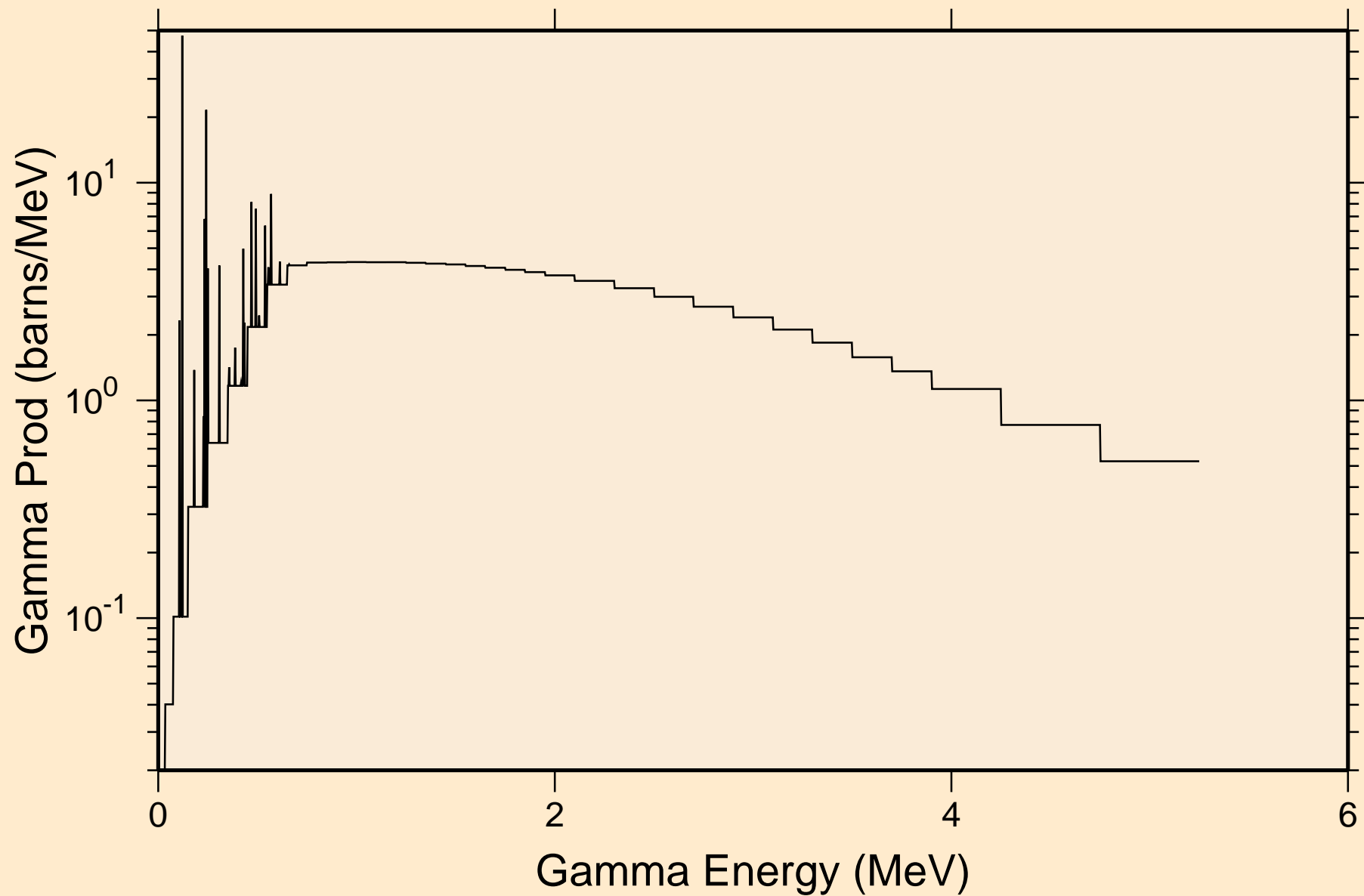

RB089 NEUTRON ACER TENDL-2019 LIBRARY; T=293.16K
14 MeV photon spectrum

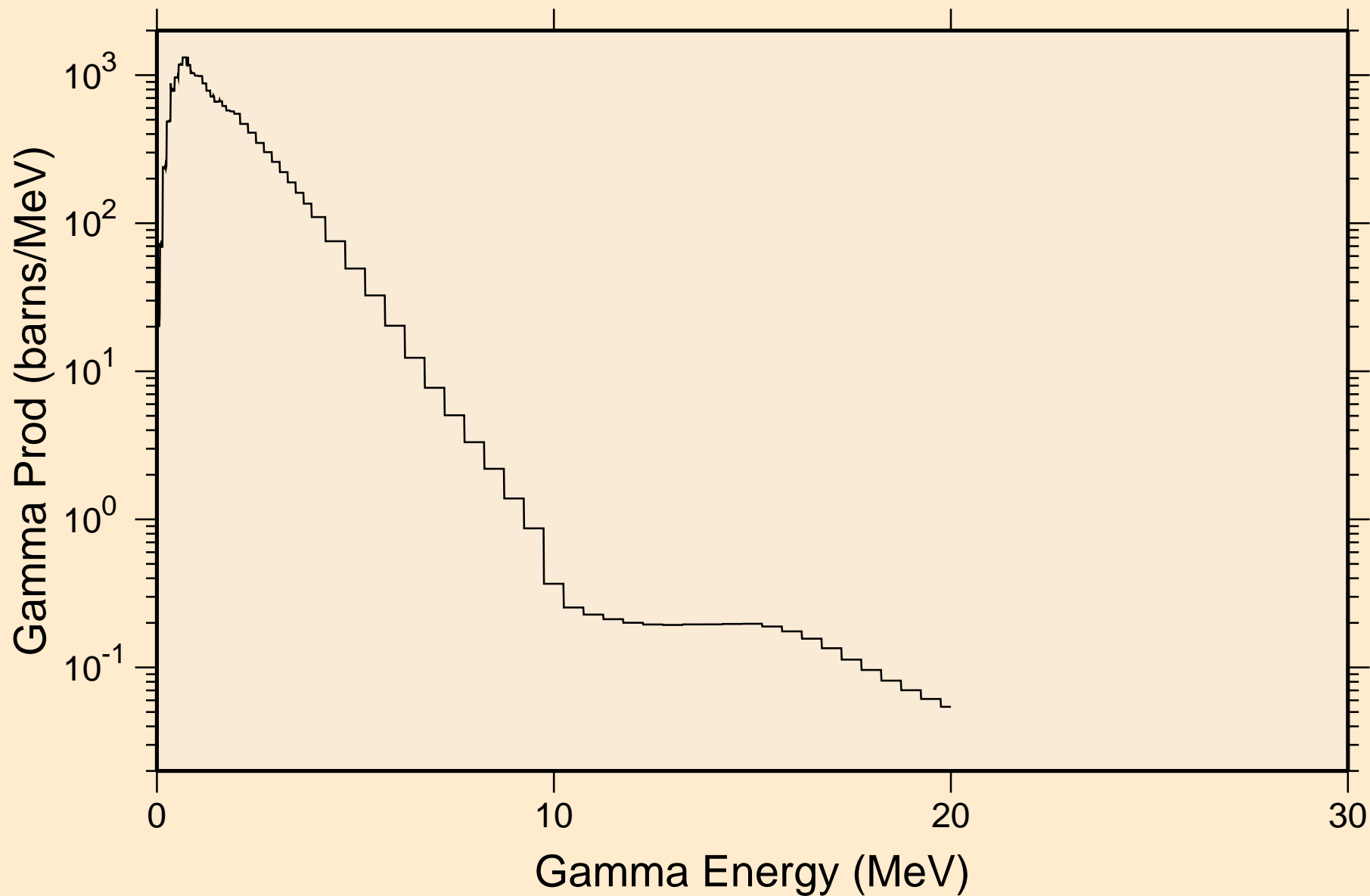

RB089 NEUTRON ACER TENDL-2019 LIBRARY; T=293.16K
Particle heating contributions

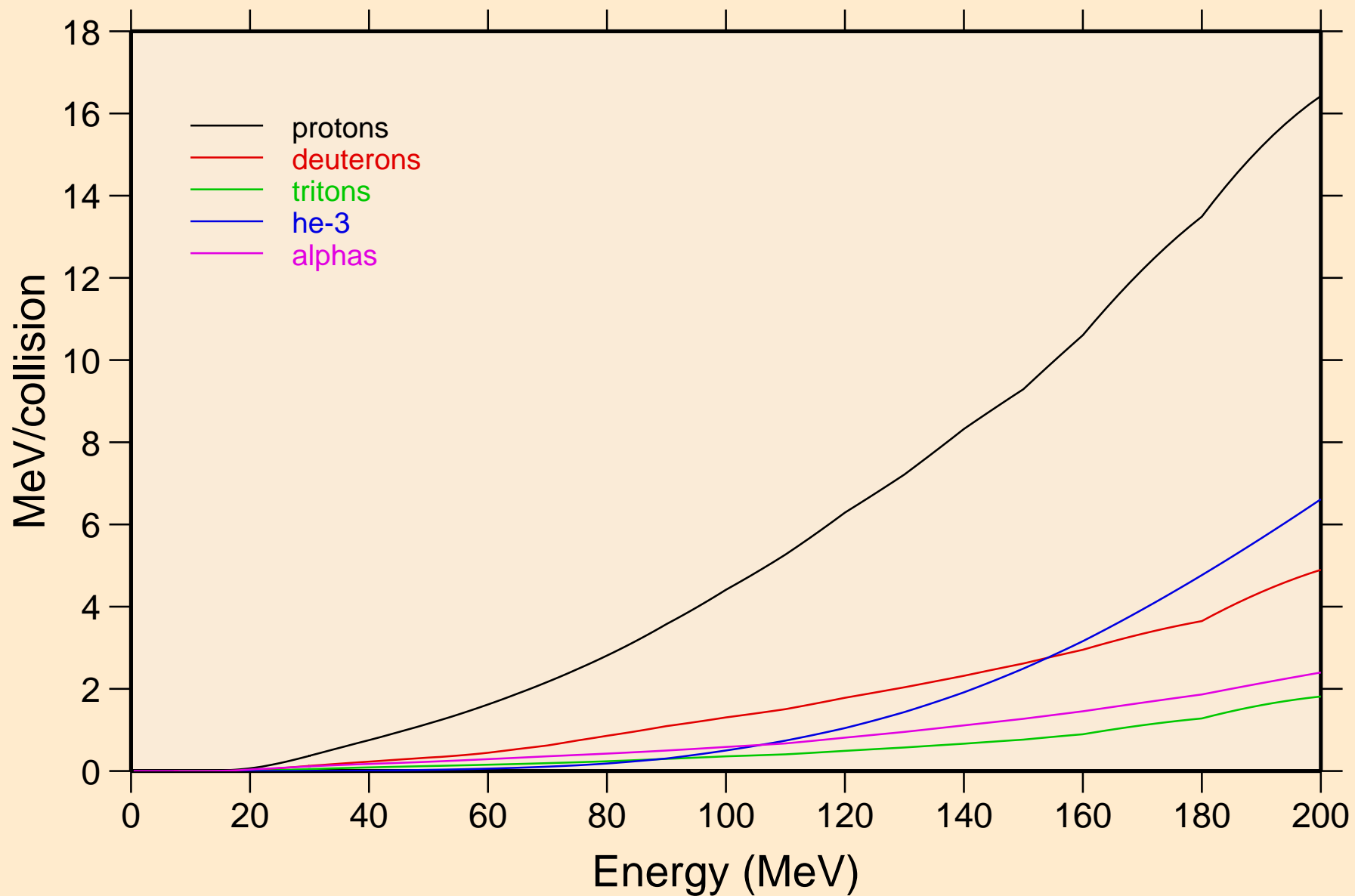

RB089 NEUTRON ACER TENDL-2019 LIBRARY; T=293.16K
Recoil Heating

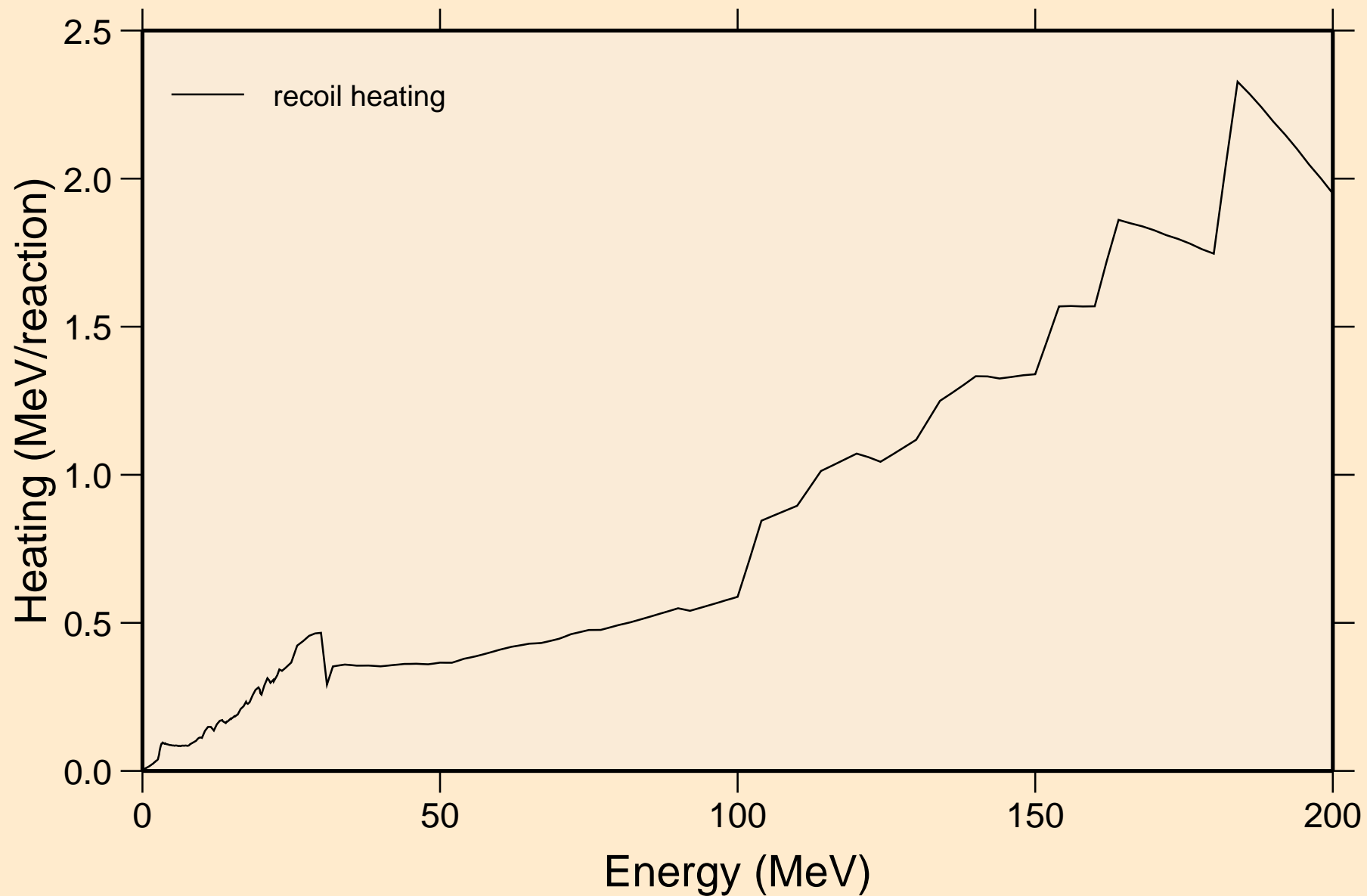

RB089 NEUTRON ACER TENDL-2019 LIBRARY; T=293.16K
Particle production cross sections

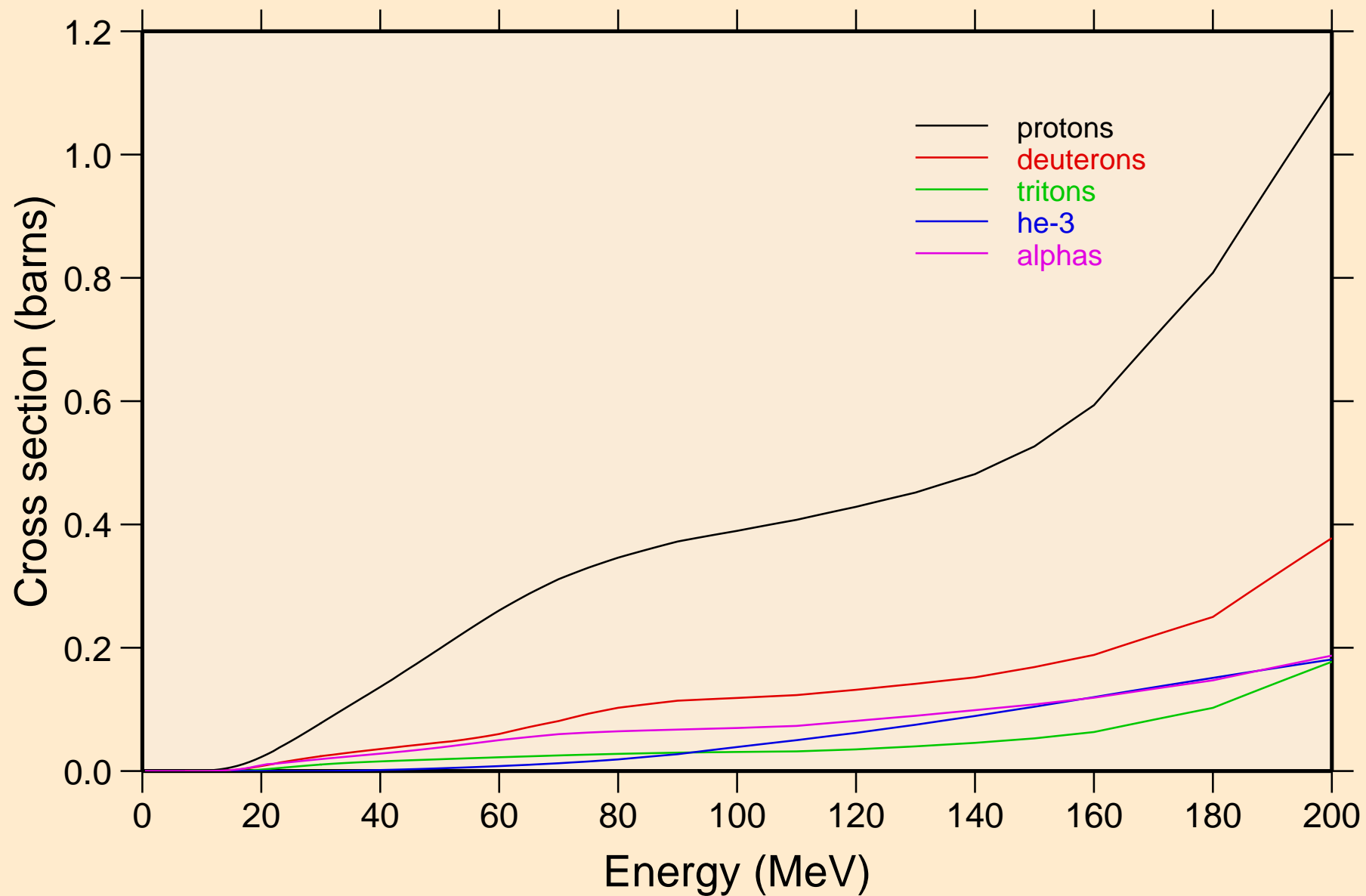

RB089 NEUTRON ACER TENDL-2019 LIBRARY; T=293.16K
protons from (n,x)

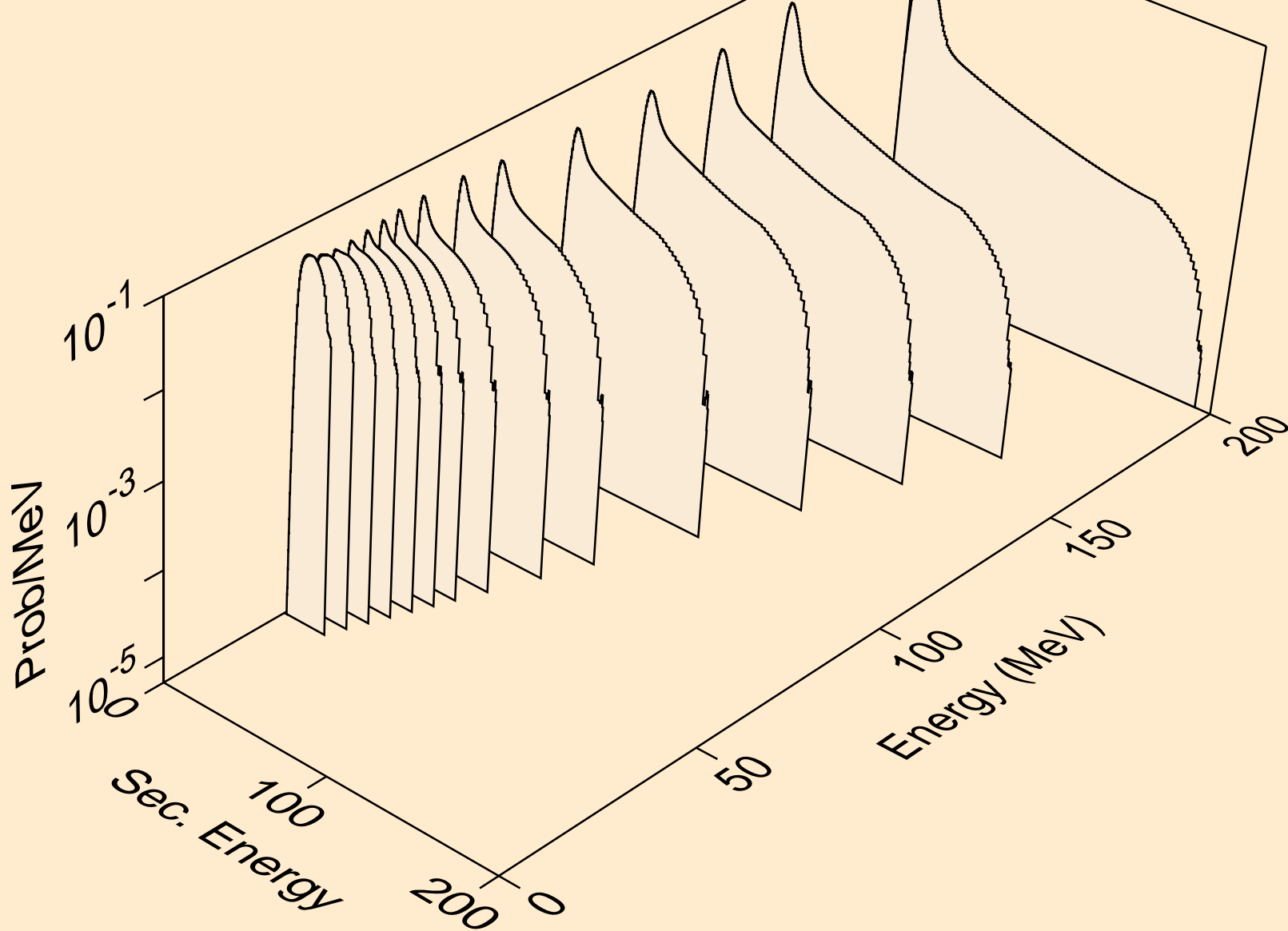

RB089 NEUTRON ACER TENDL-2019 LIBRARY; T=293.16K
protons from (n,n*)p

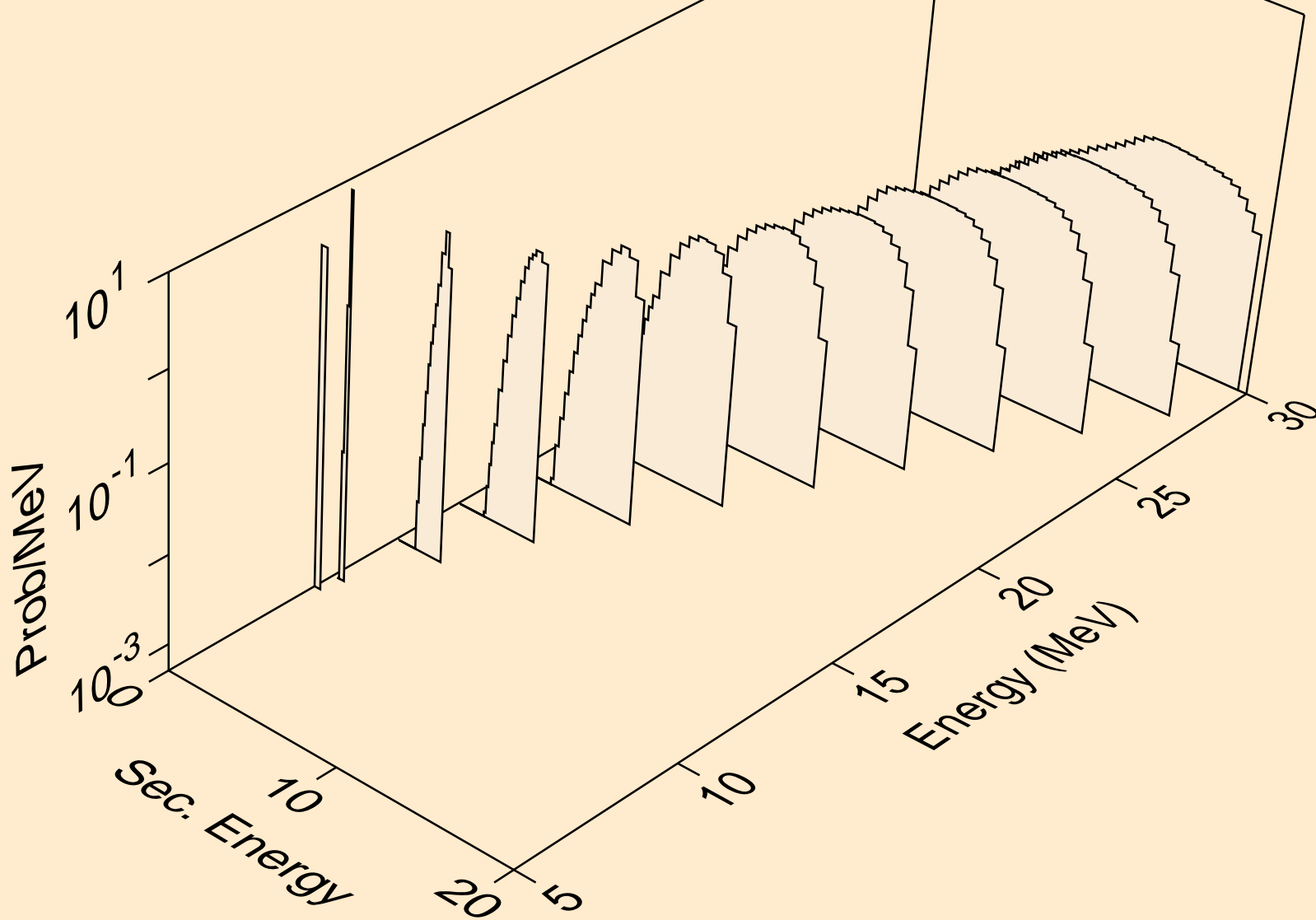

RB089 NEUTRON ACER TENDL-2019 LIBRARY; T=293.16K
protons from (n,2np)

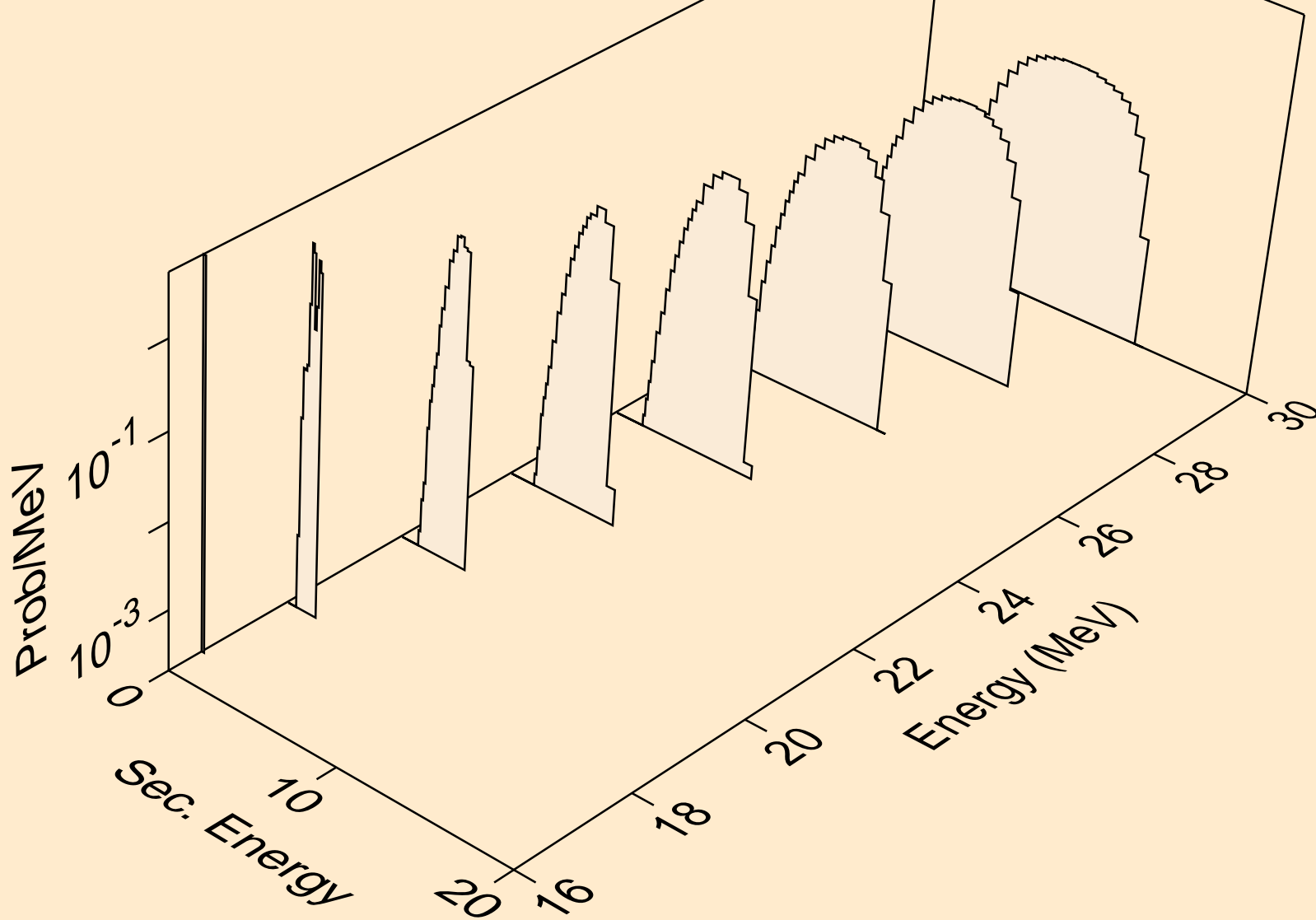

RB089 NEUTRON ACER TENDL-2019 LIBRARY; T=293.16K
protons from (n,3np)

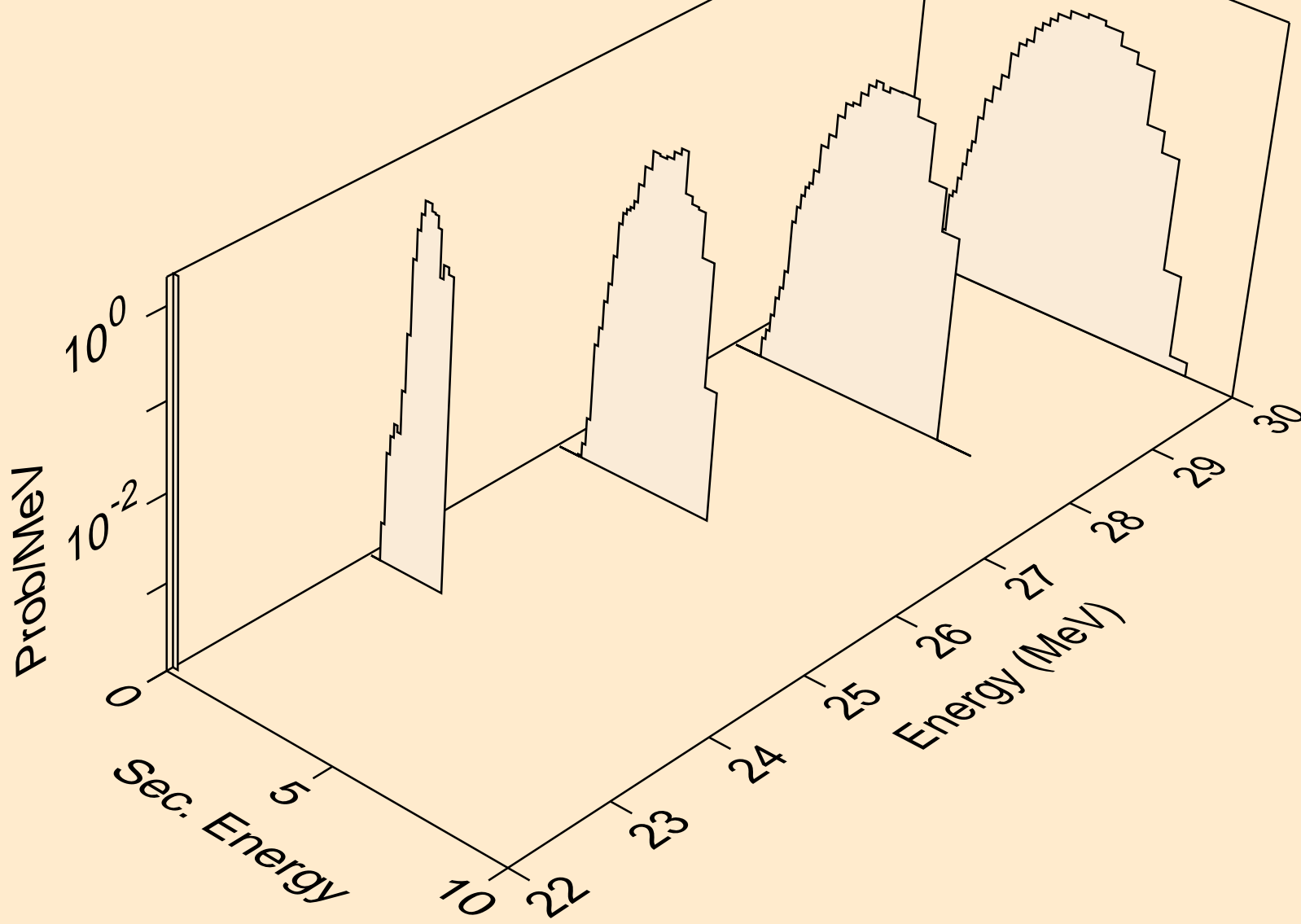

RB089 NEUTRON ACER TENDL-2019 LIBRARY; T=293.16K
protons from (n,2np)

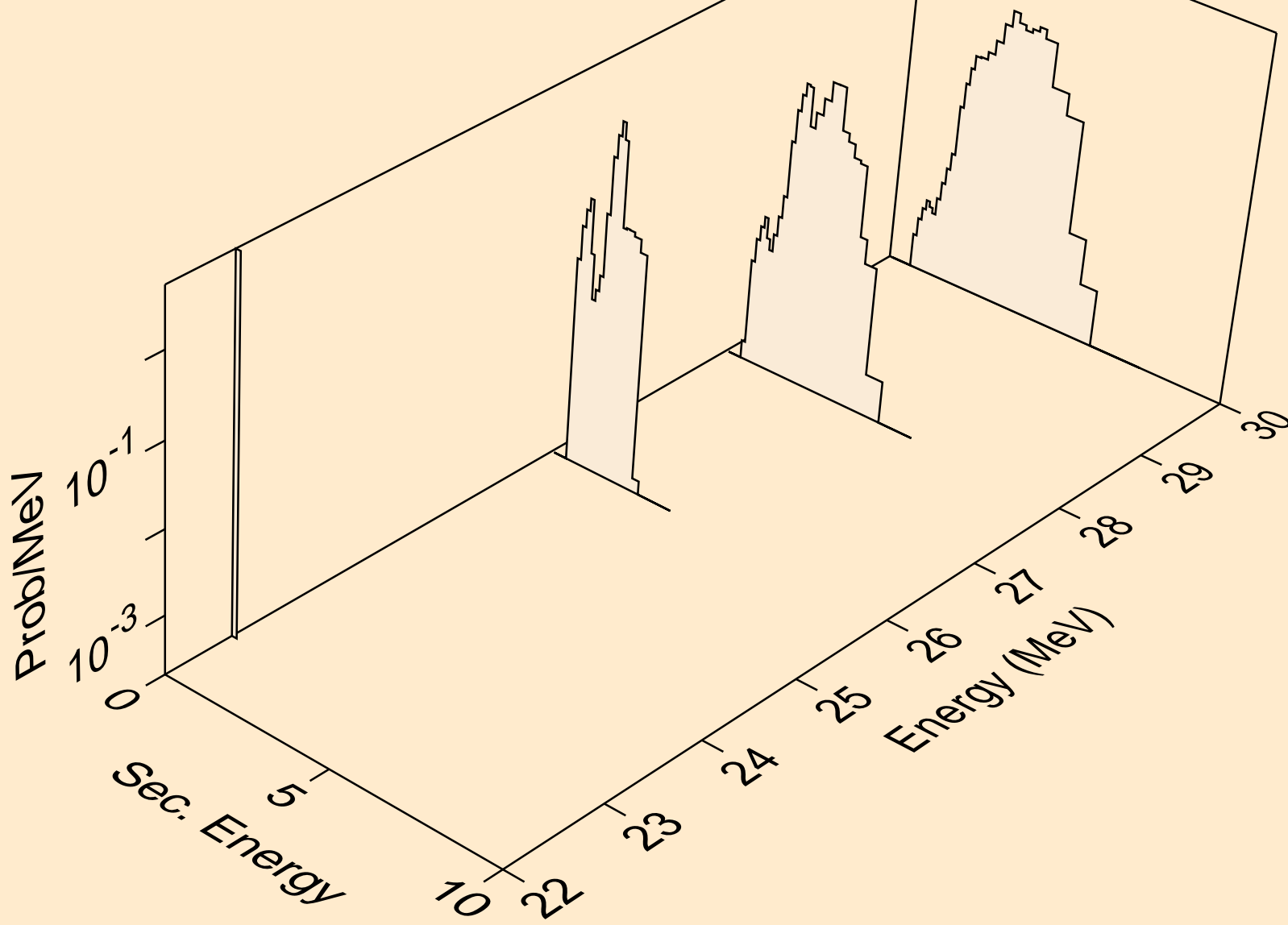

RB089 NEUTRON ACER TENDL-2019 LIBRARY; T=293.16K
protons from (n,npa)

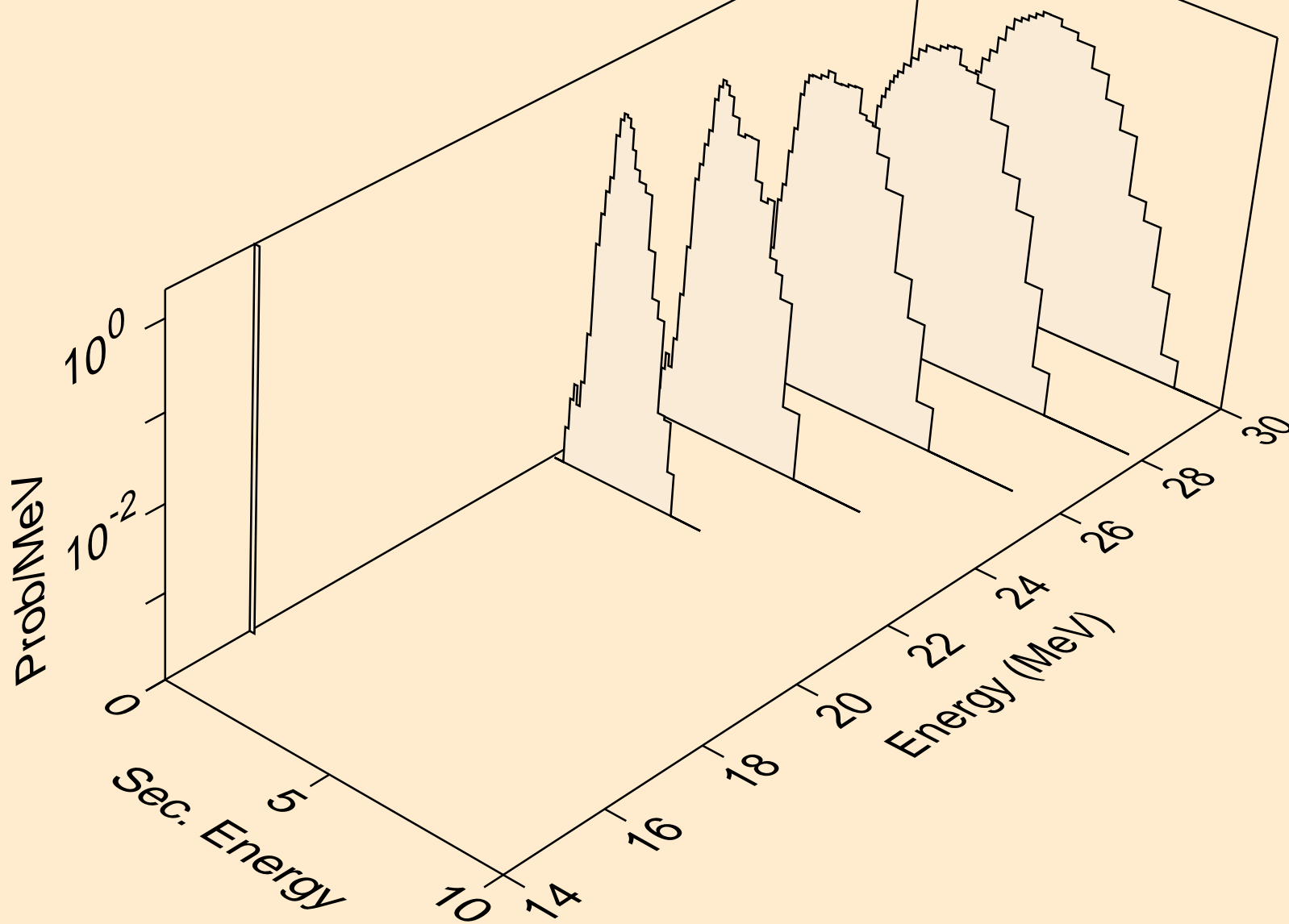

RB089 NEUTRON ACER TENDL-2019 LIBRARY; T=293.16K
protons from (n,p)

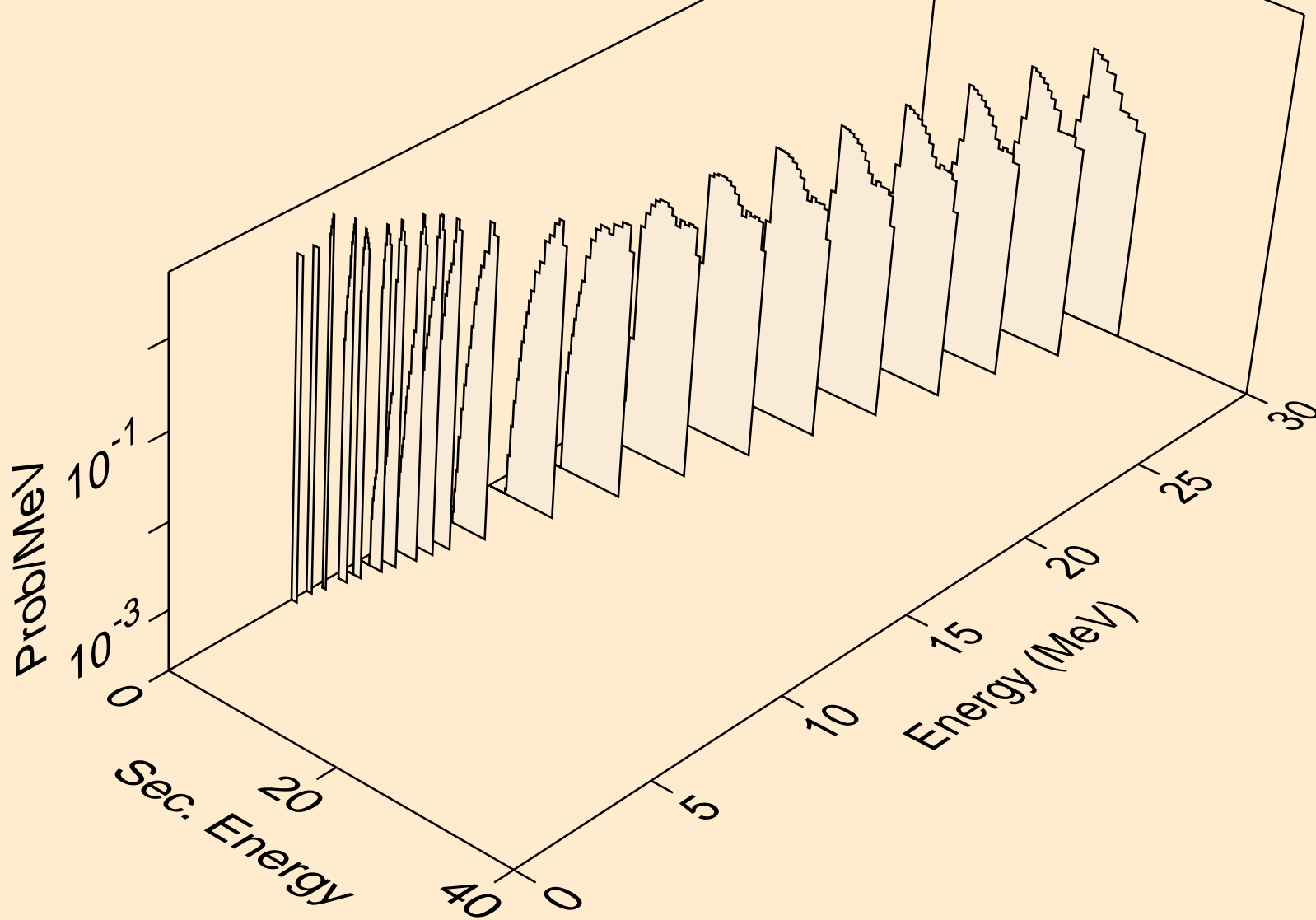

RB089 NEUTRON ACER TENDL-2019 LIBRARY; T=293.16K
protons from (n,2p)

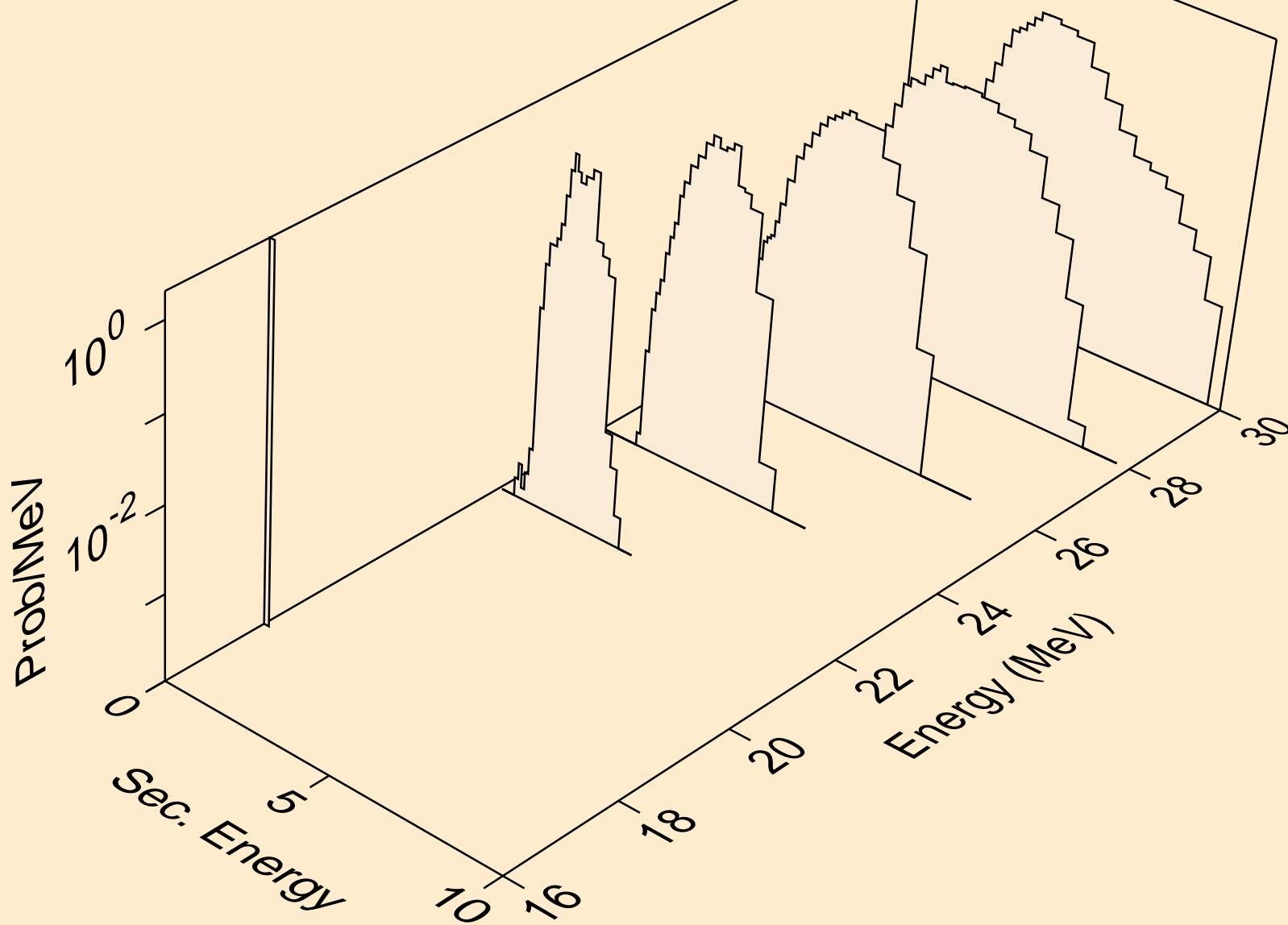

RB089 NEUTRON ACER TENDL-2019 LIBRARY; T=293.16K
protons from (n,p)

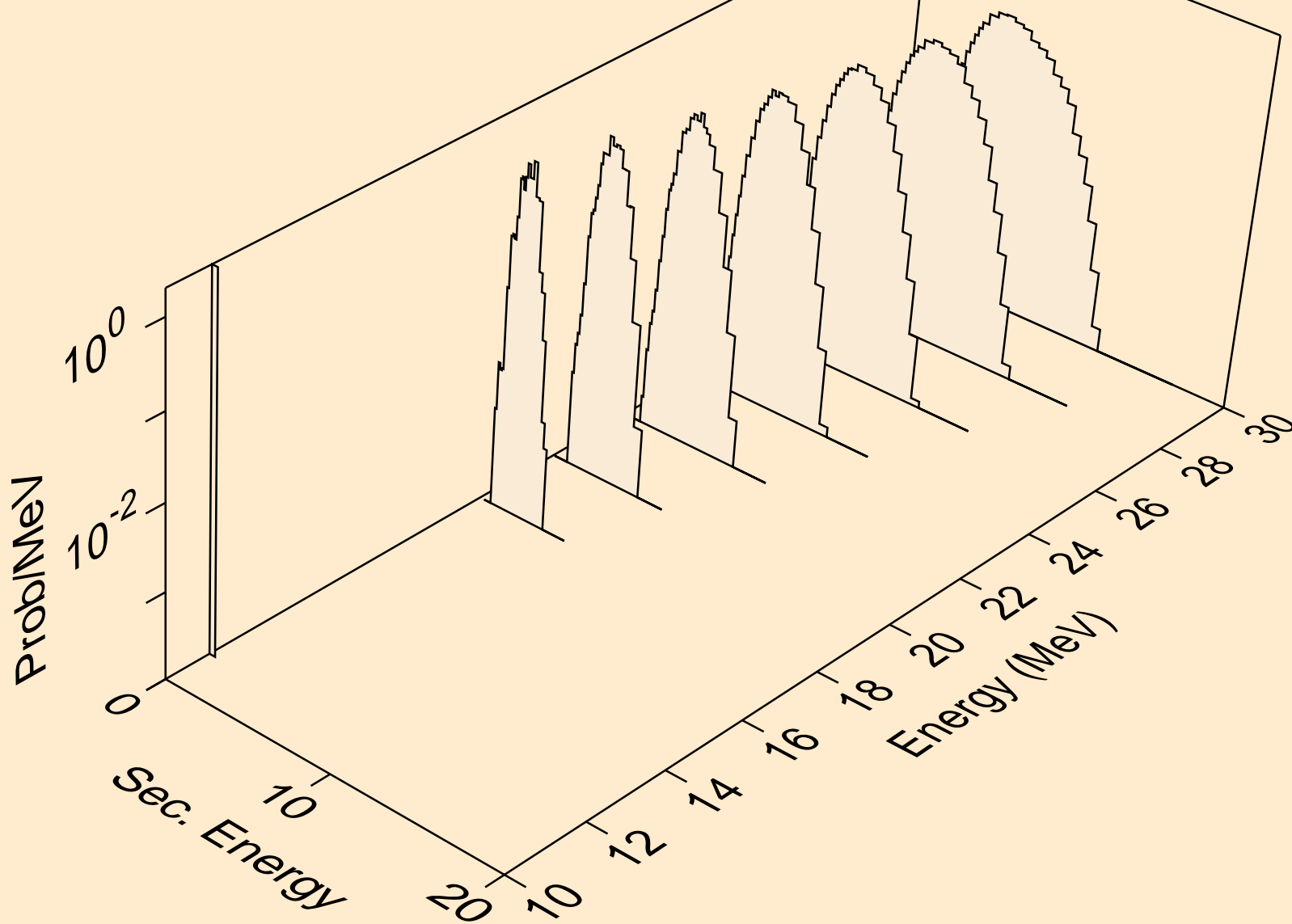

RB089 NEUTRON ACER TENDL-2019 LIBRARY; T=293.16K
protons from (n,pt)

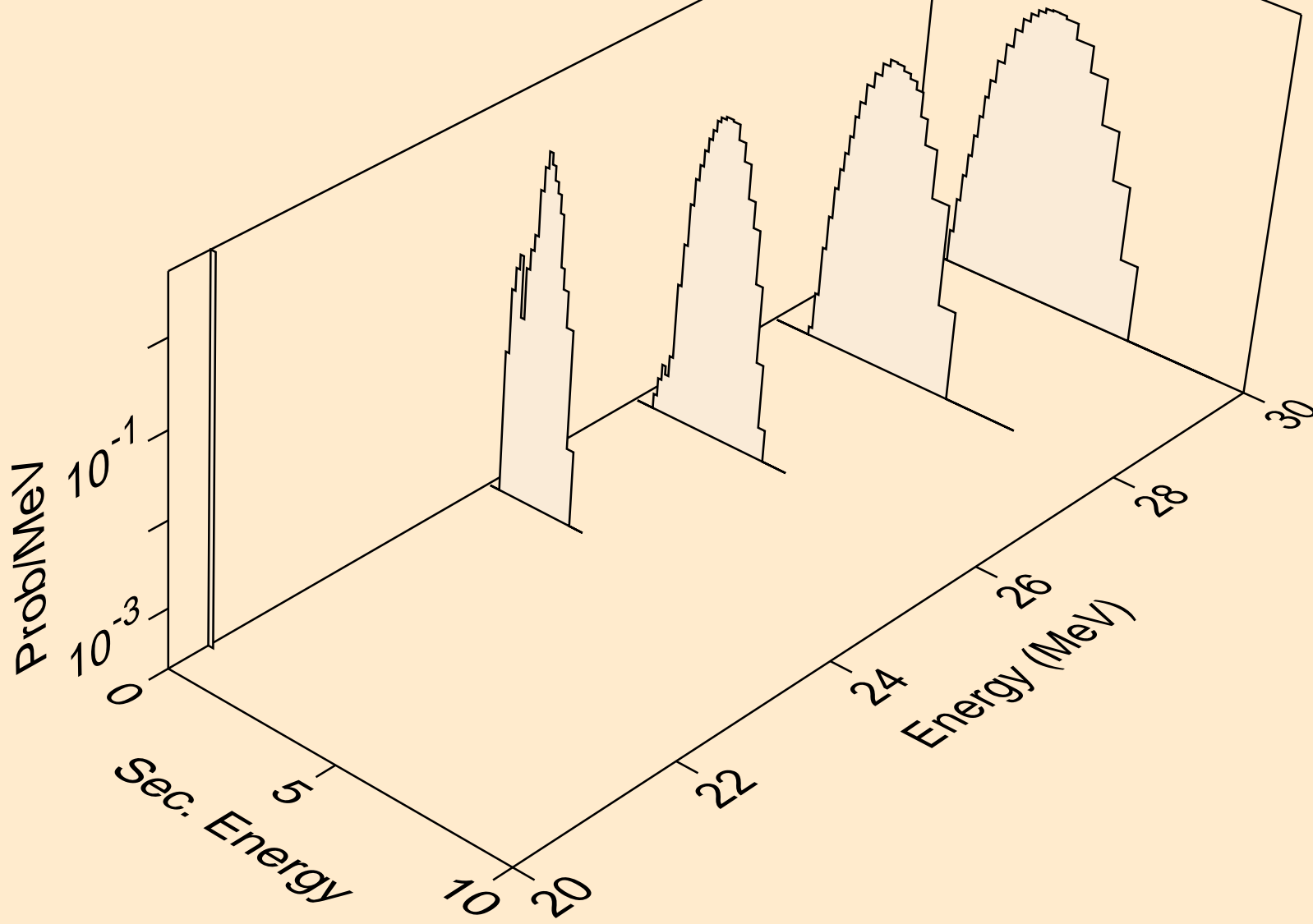

RB089 NEUTRON ACER TENDL-2019 LIBRARY; T=293.16K
deuterons from (n,x)

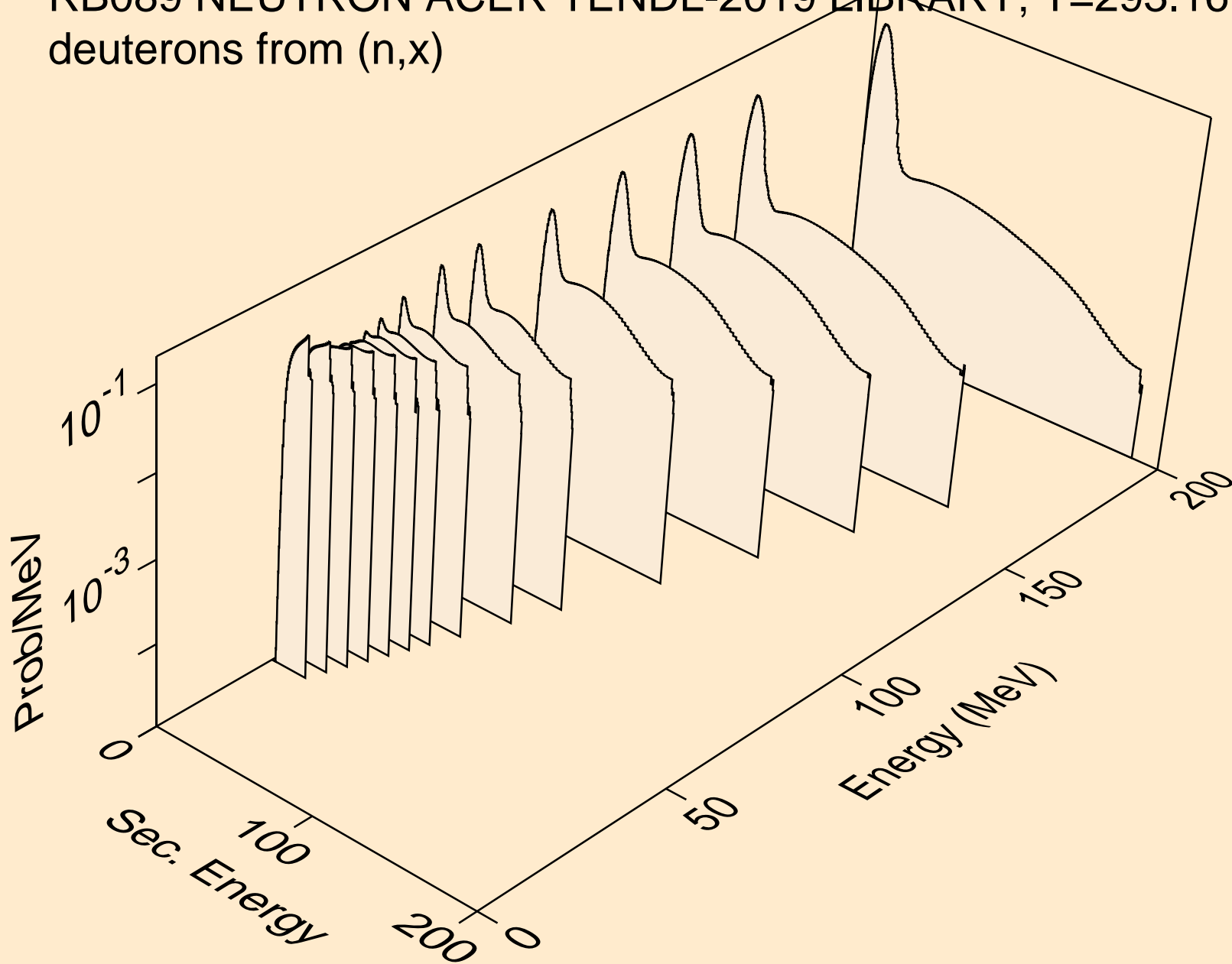

RB089 NEUTRON ACER TENDL-2019 LIBRARY; T=293.16K
deuterons from (n,2nd)

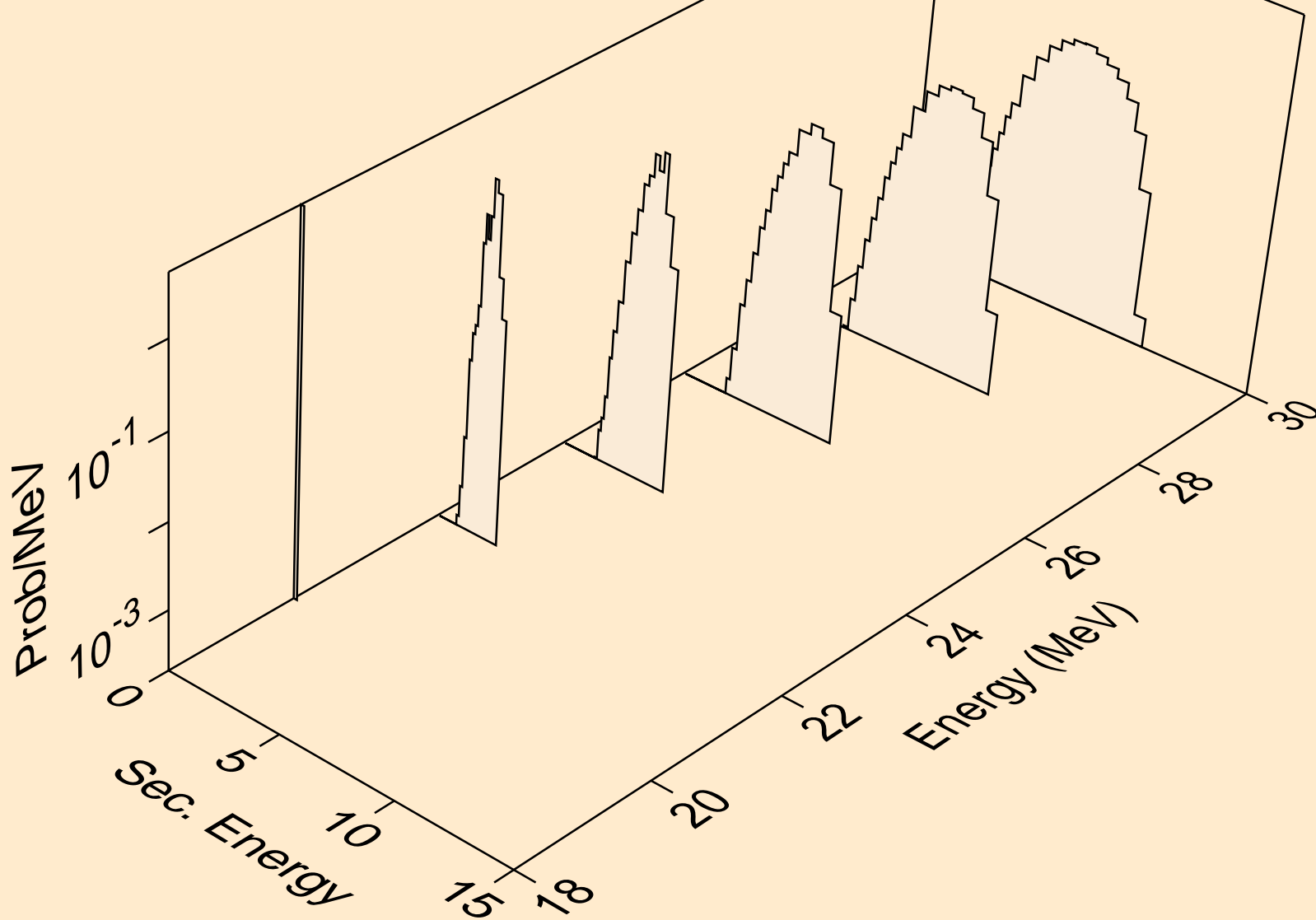

RB089 NEUTRON ACER TENDL-2019 LIBRARY; T=293.16K
deuterons from (n,n*)d

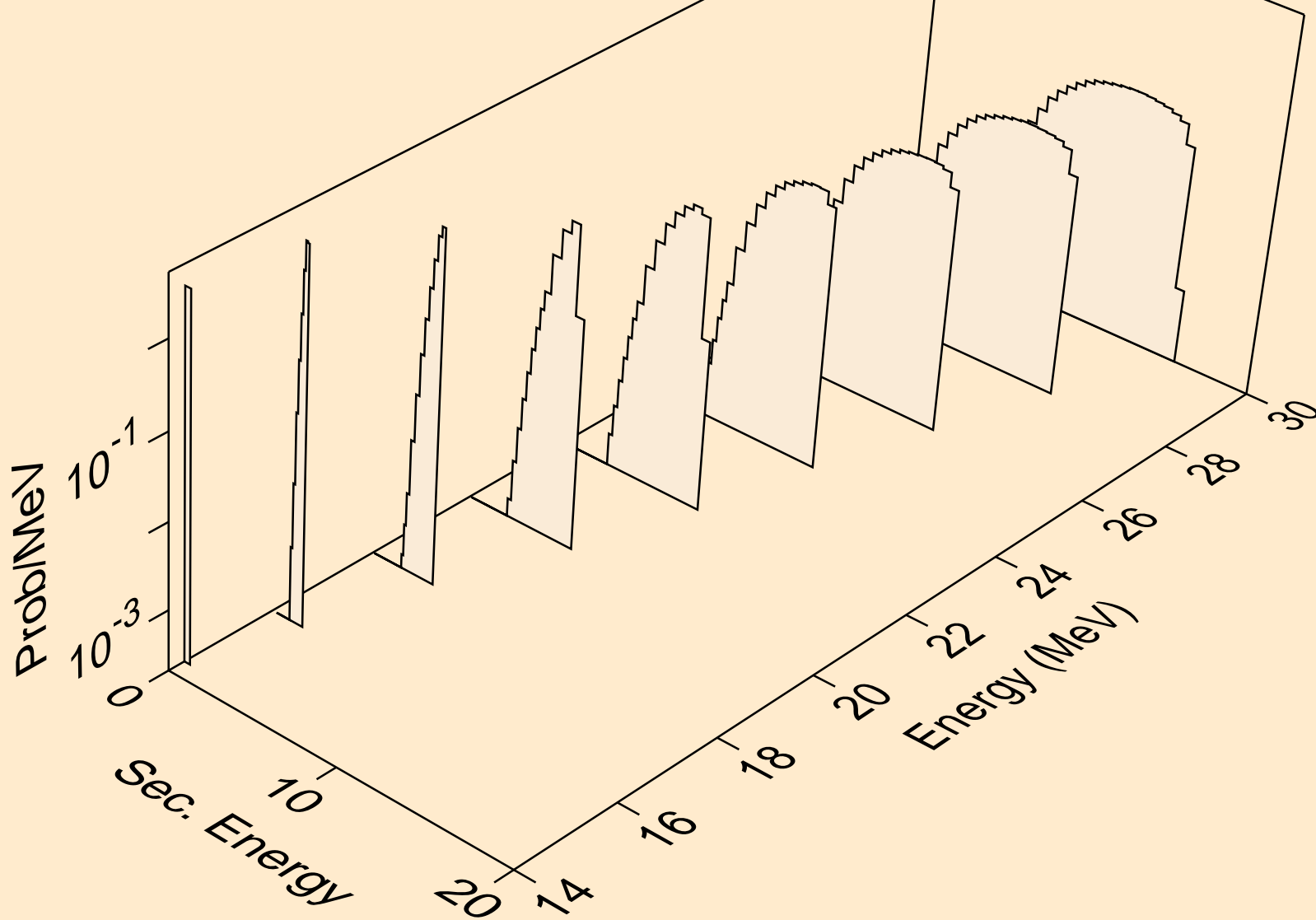

RB089 NEUTRON ACER TENDL-2019 LIBRARY; T=293.16K
deuterons from (n,d)

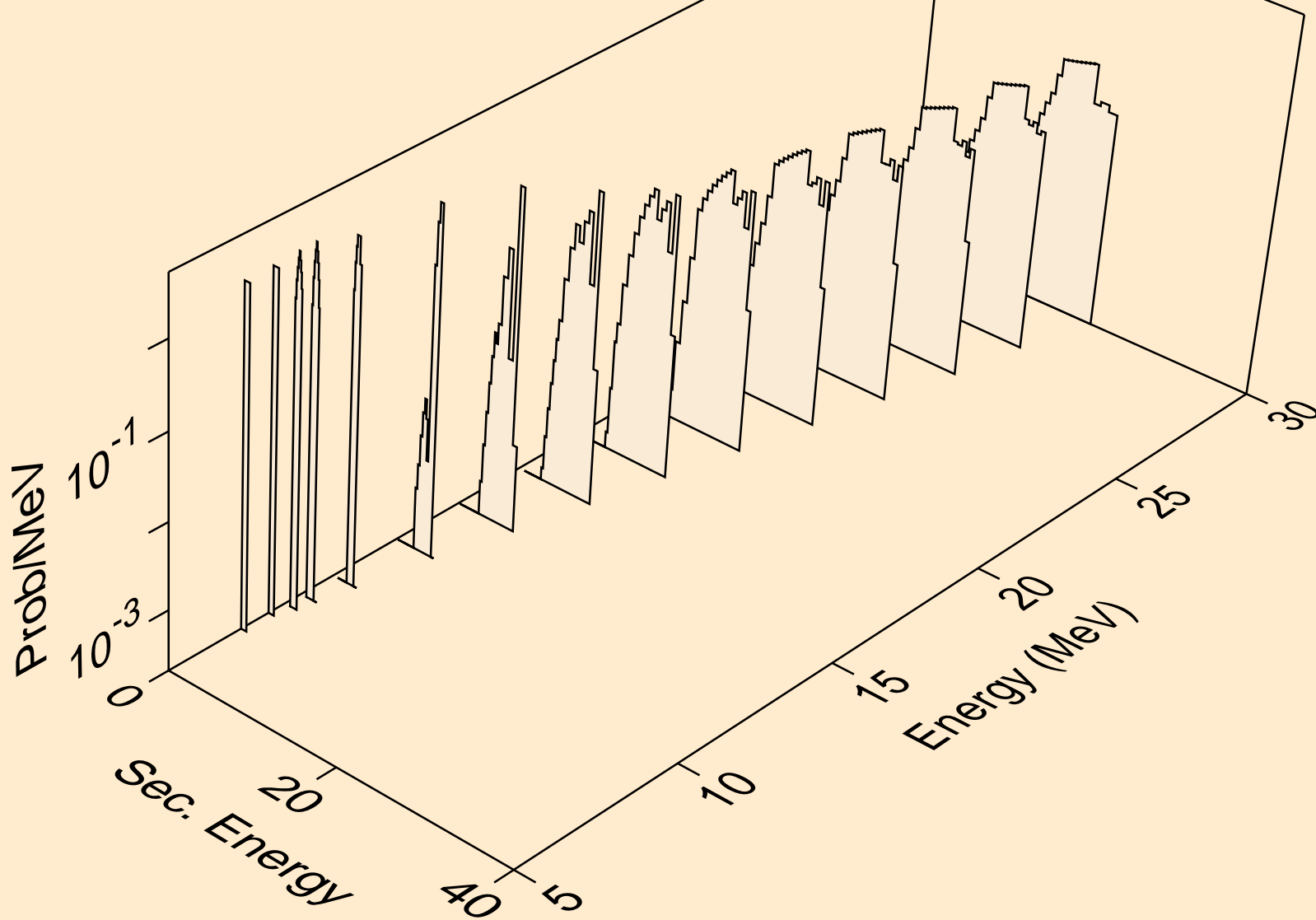

RB089 NEUTRON ACER TENDL-2019 LIBRARY; T=293.16K
deuterons from (n,da)

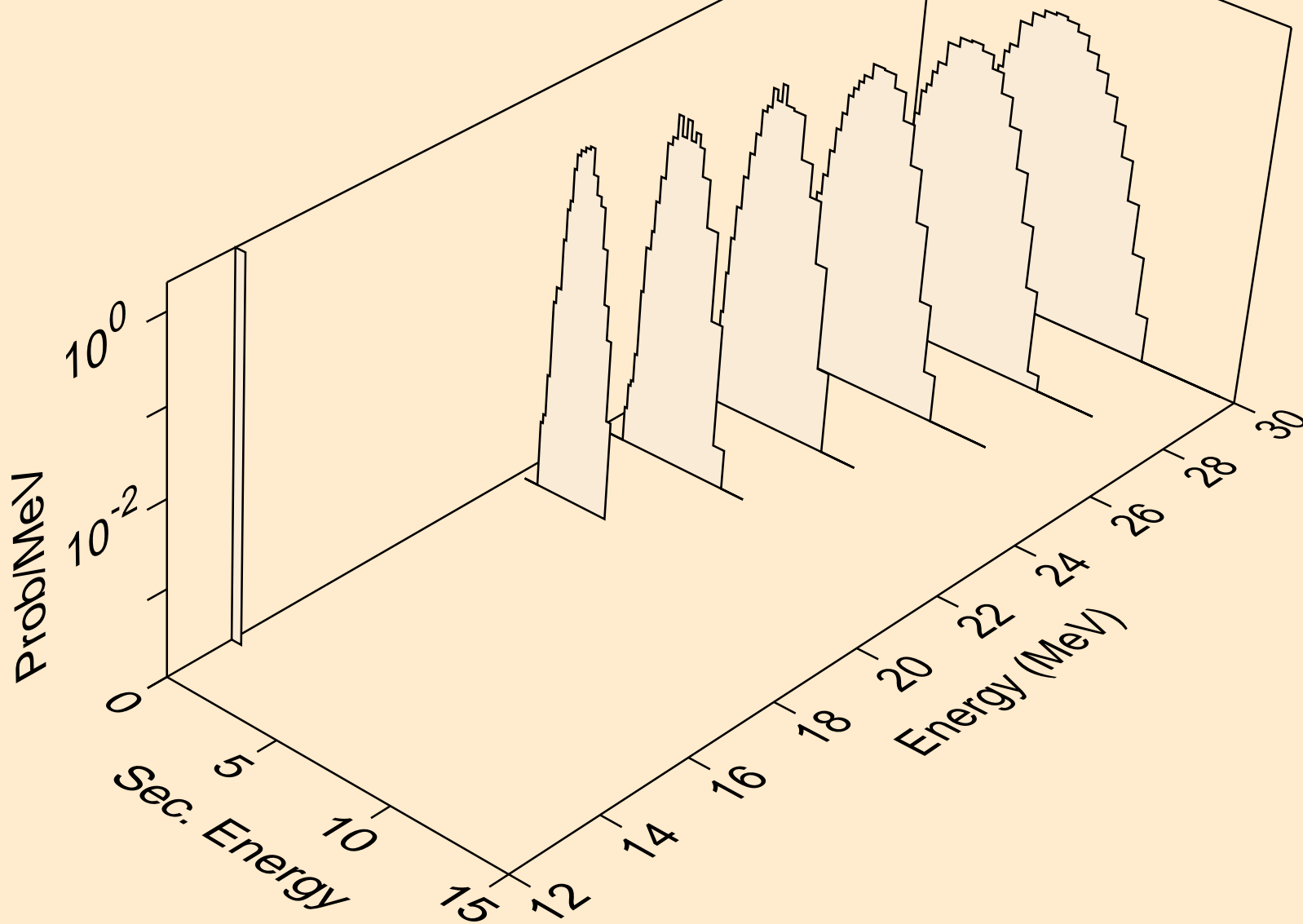

RB089 NEUTRON ACER TENDL-2019 LIBRARY; T=293.16K
tritons from (n,x)

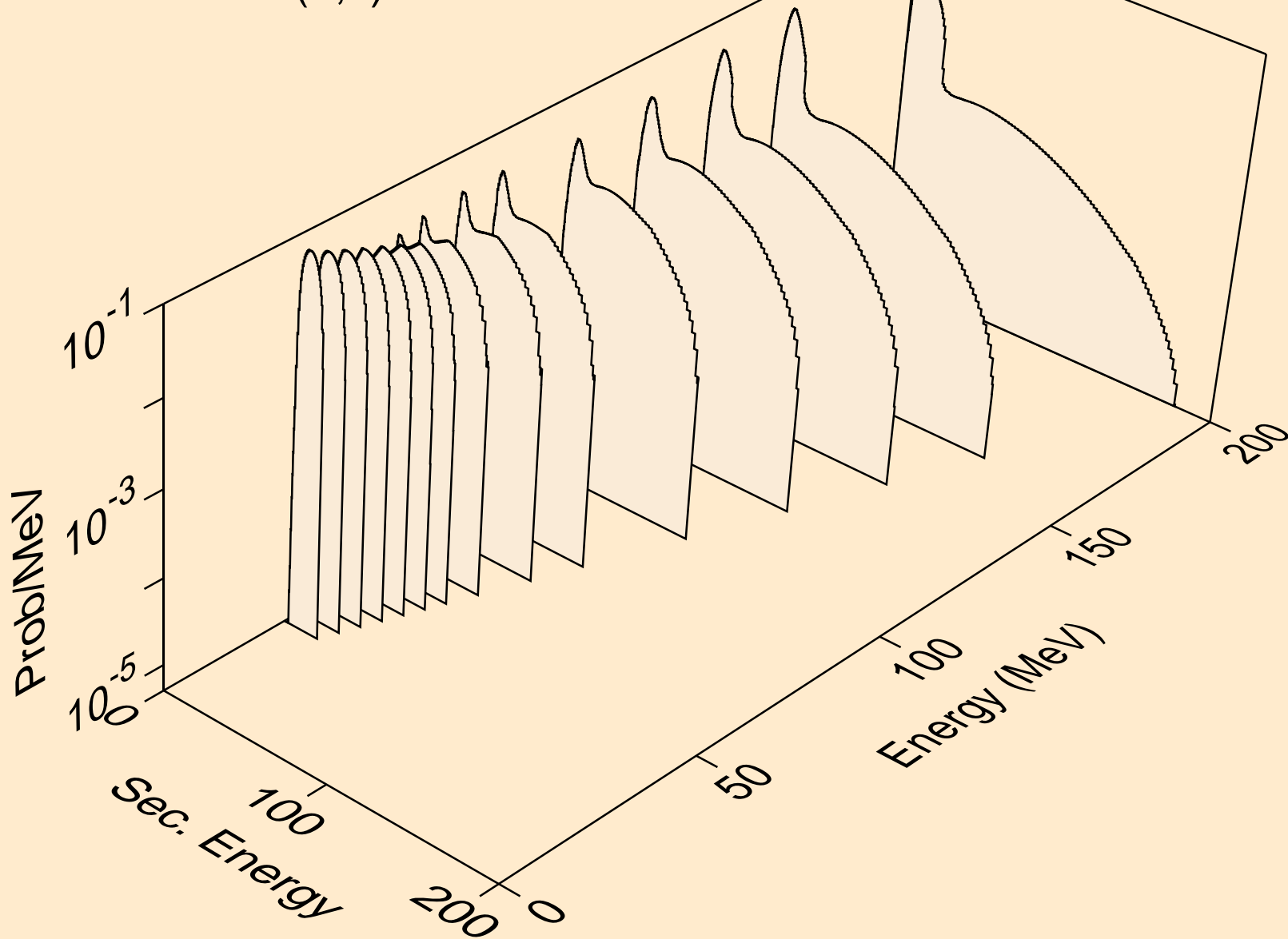

RB089 NEUTRON ACER TENDL-2019 LIBRARY; T=293.16K
tritons from (n,n*)t

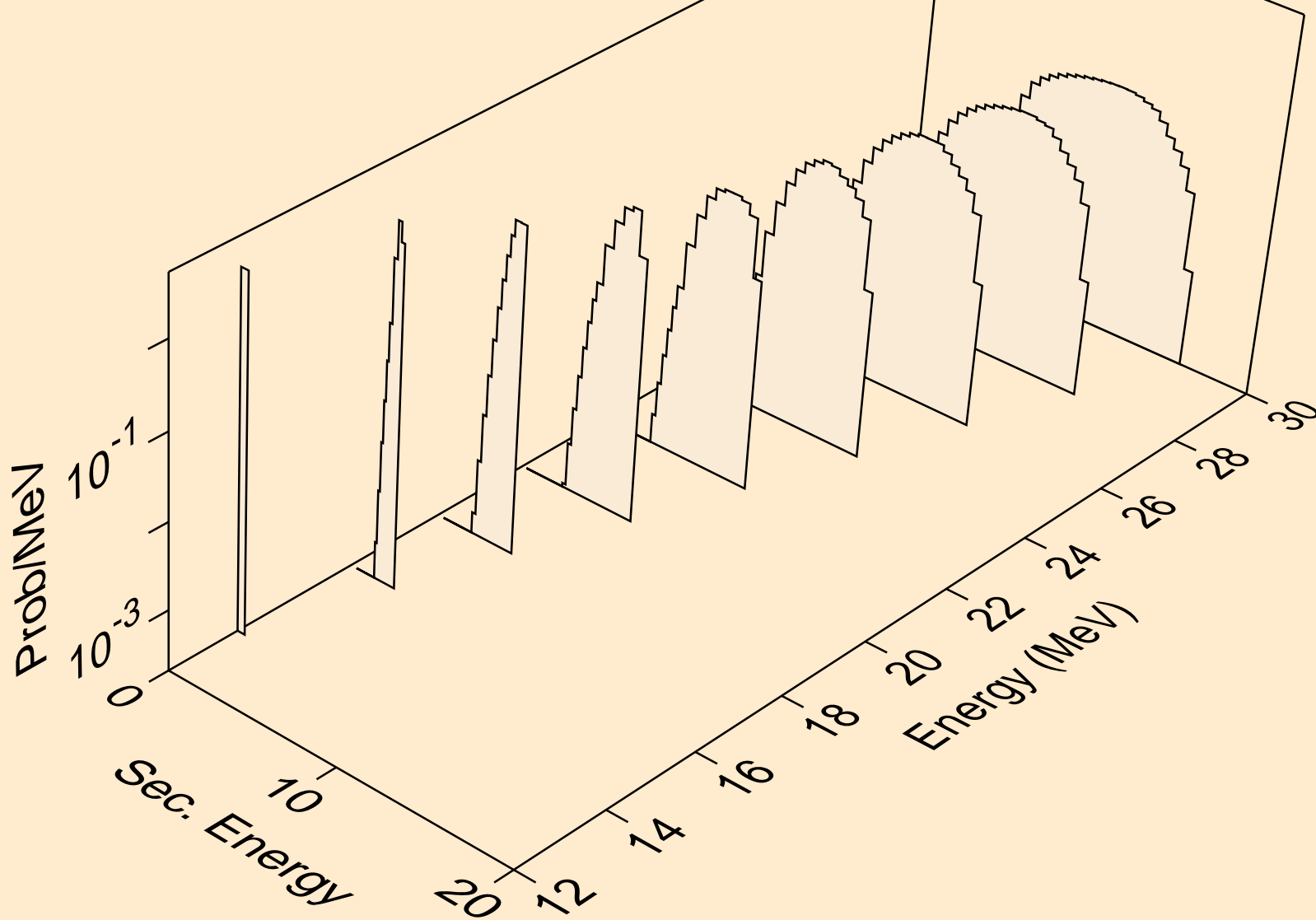

RB089 NEUTRON ACER TENDL-2019 LIBRARY; T=293.16K
tritons from (n,t)

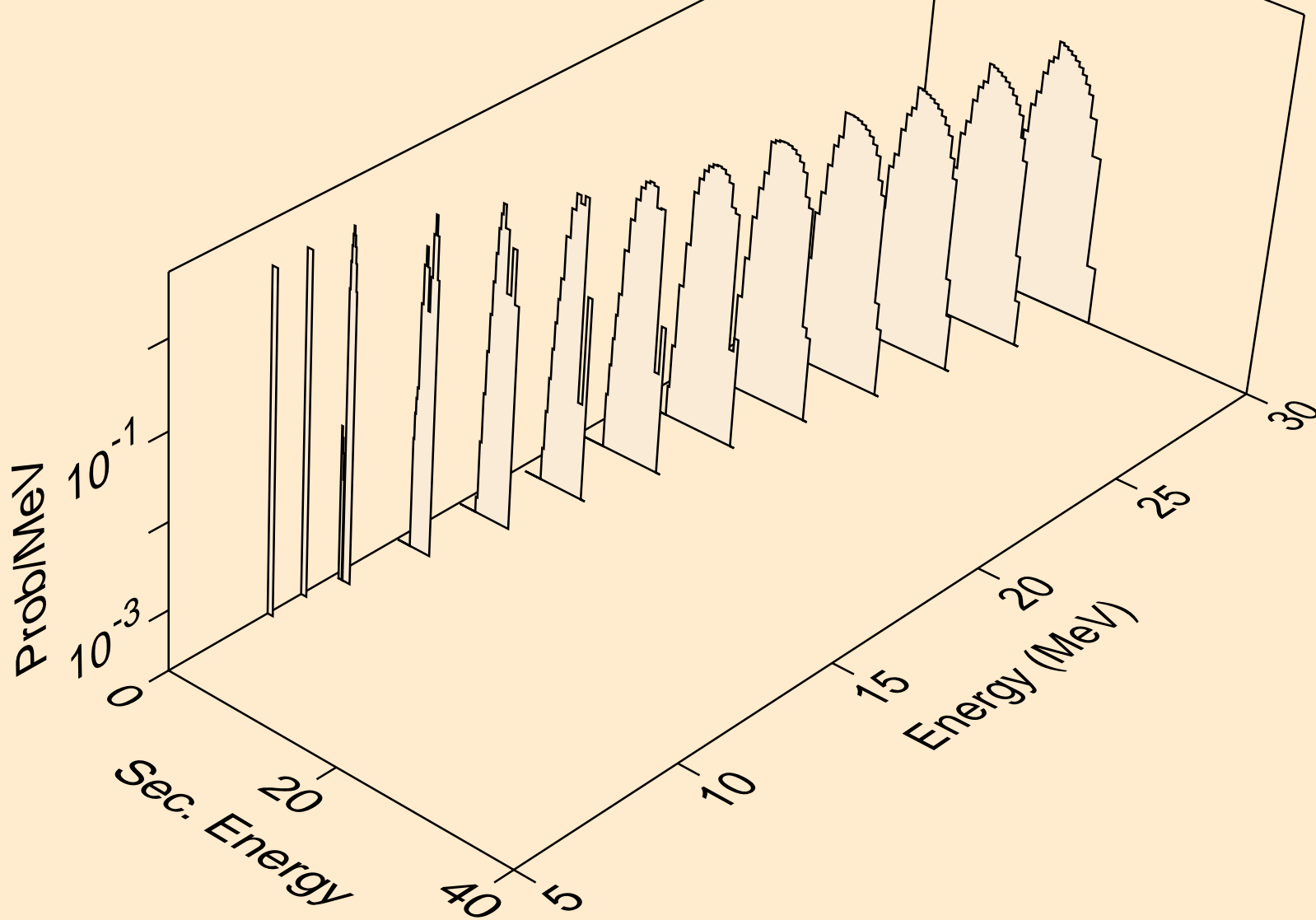

RB089 NEUTRON ACER TENDL-2019 LIBRARY; T=293.16K
tritons from (n,pt)

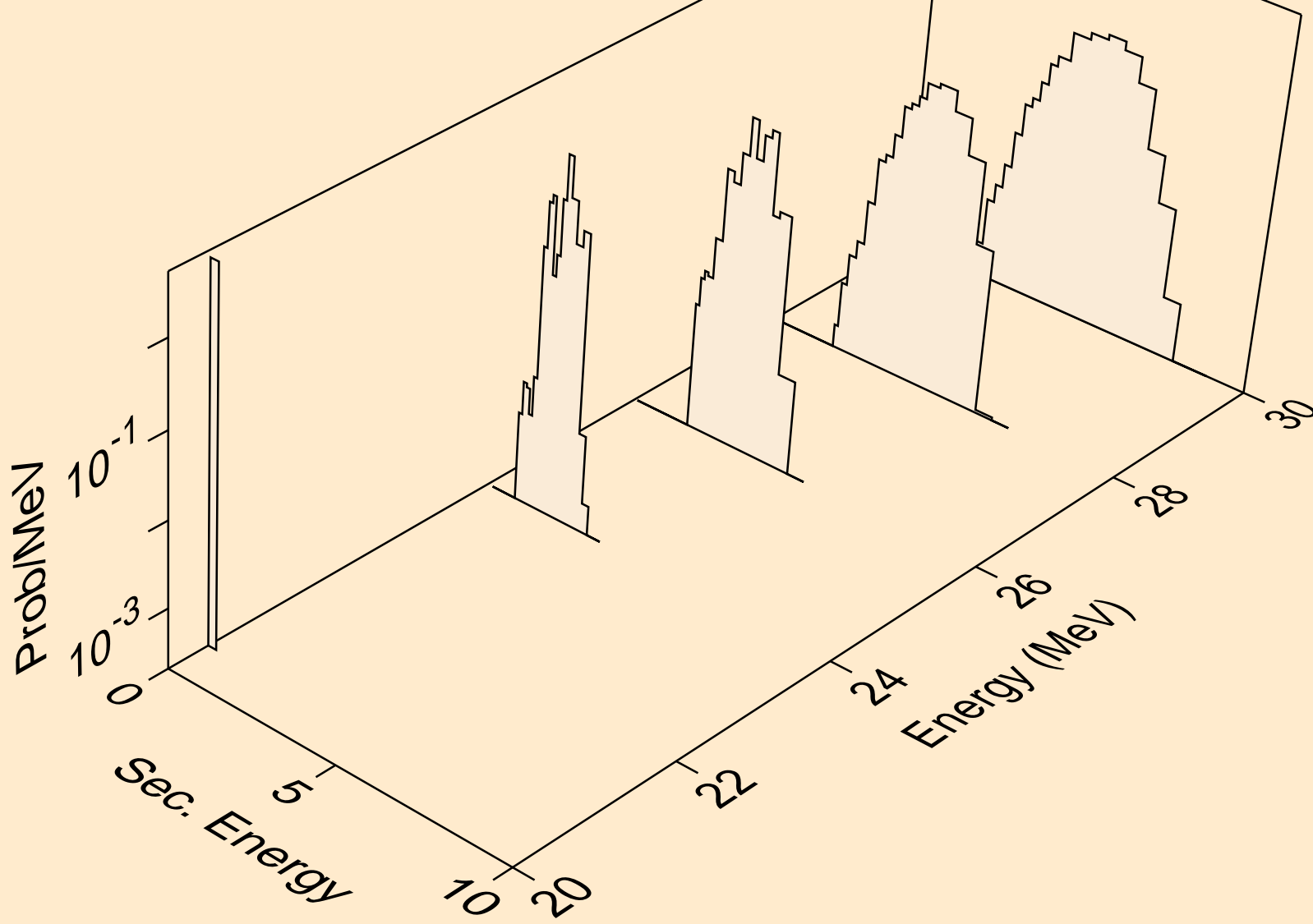

RB089 NEUTRON ACER TENDL-2019 LIBRARY; T=293.16K
he3s from (n,x)

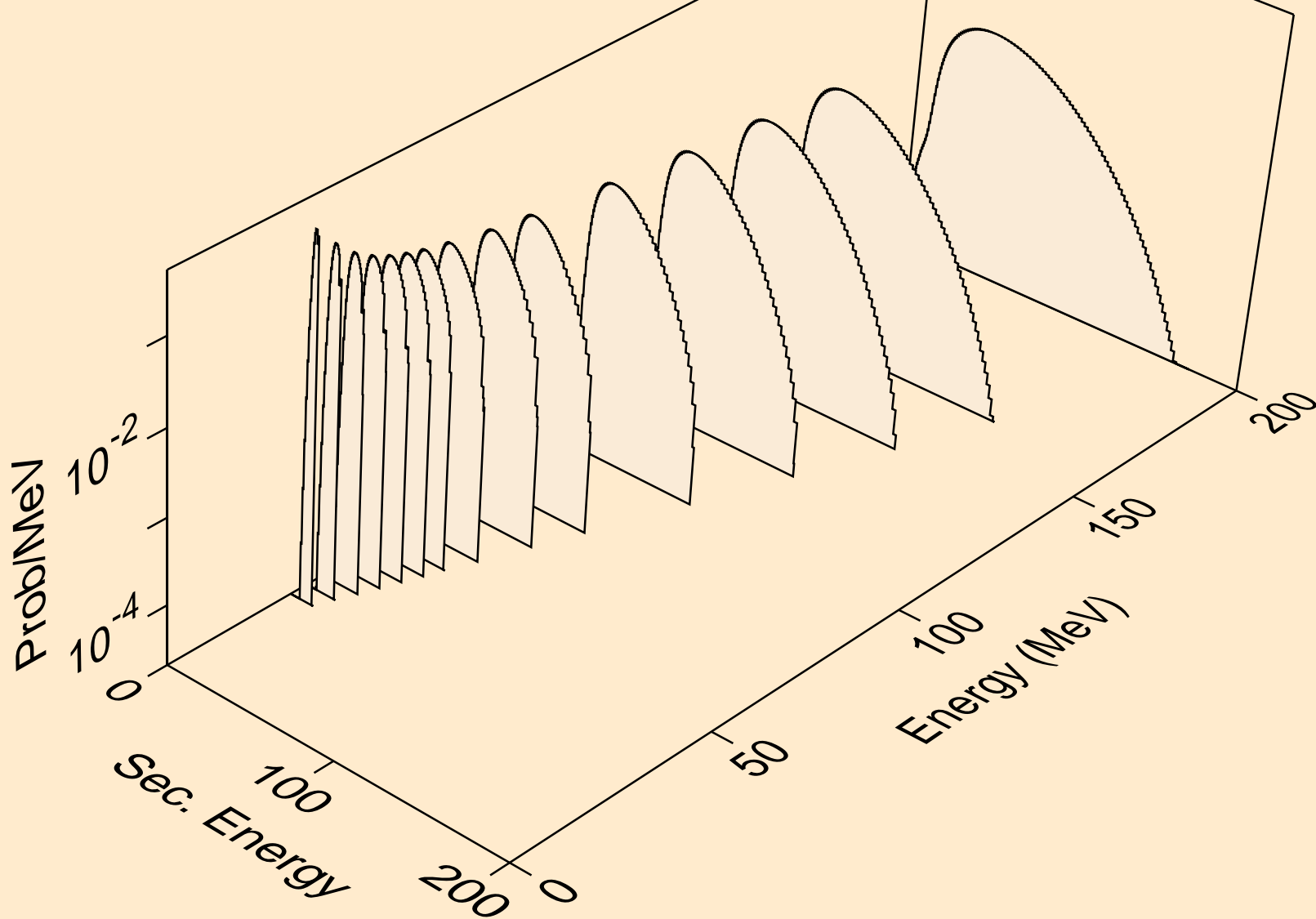

RB089 NEUTRON ACER TENDL-2019 LIBRARY; T=293.16K
he3s from (n,n*)he3

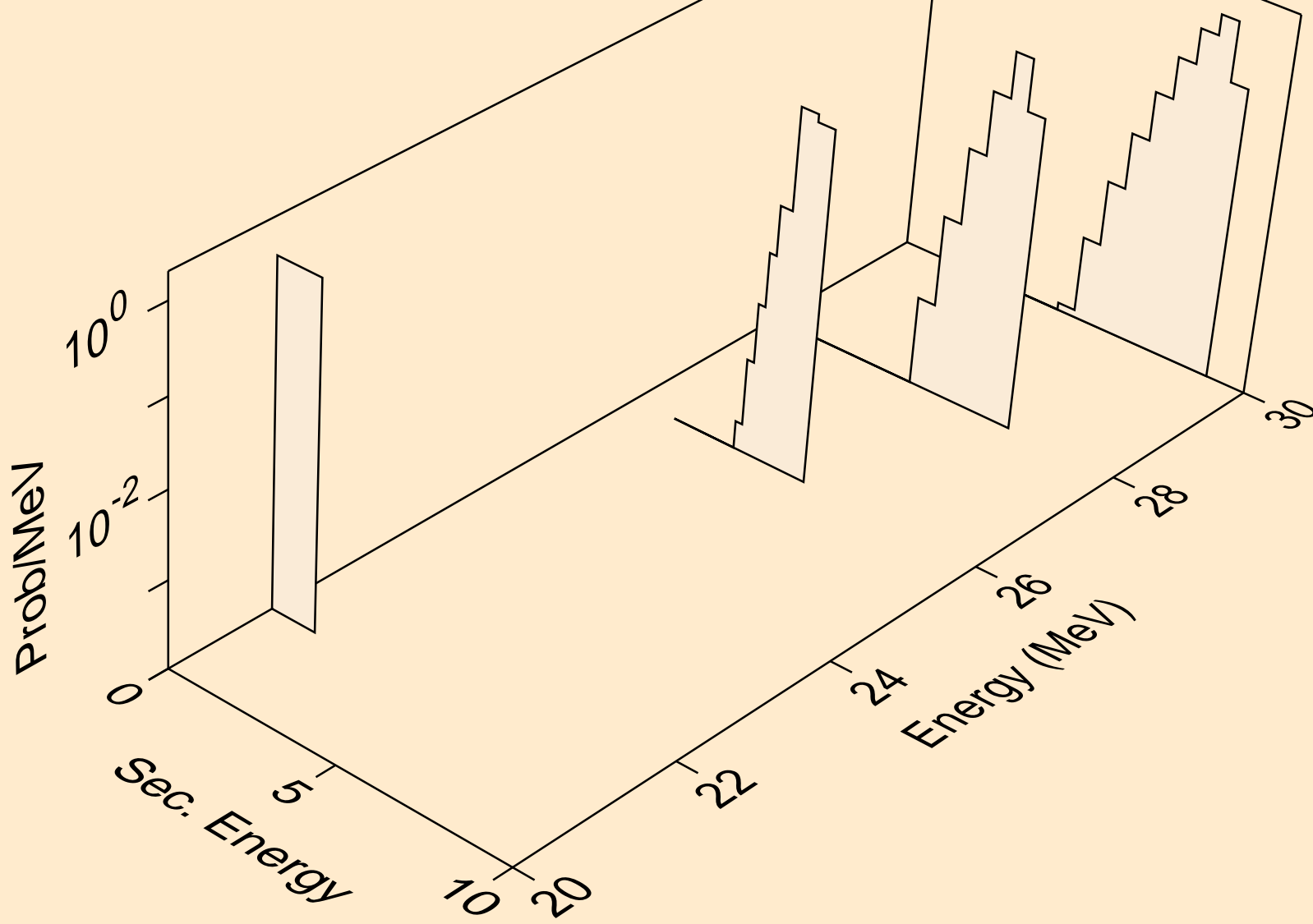

RB089 NEUTRON ACER TENDL-2019 LIBRARY; T=293.16K
he3s from (n,he3)

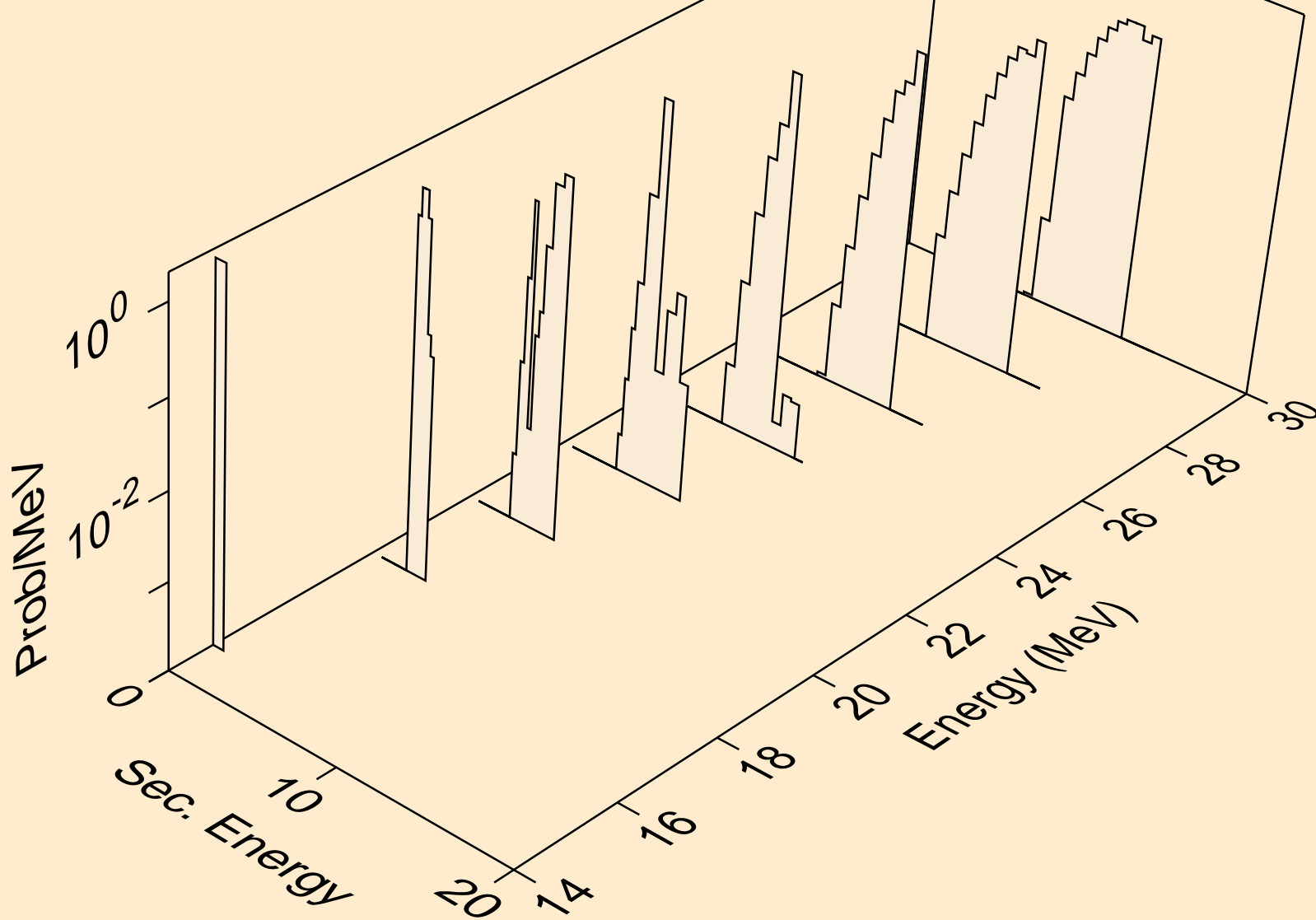

RB089 NEUTRON ACER TENDL-2019 LIBRARY; T=293.16K
alphas from (n,x)

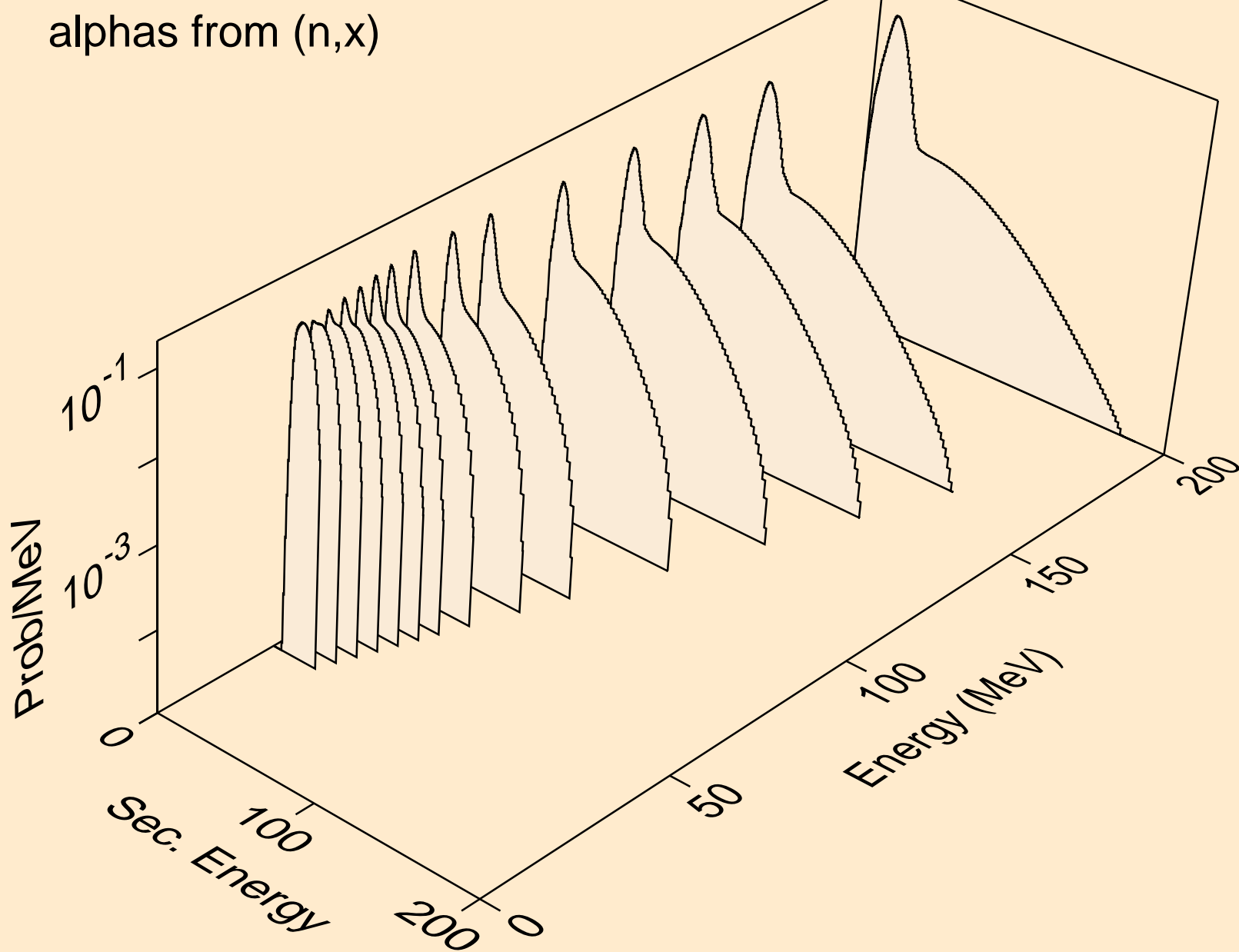

RB089 NEUTRON ACER TENDL-2019 LIBRARY; T=293.16K
alphas from (n,n*)a

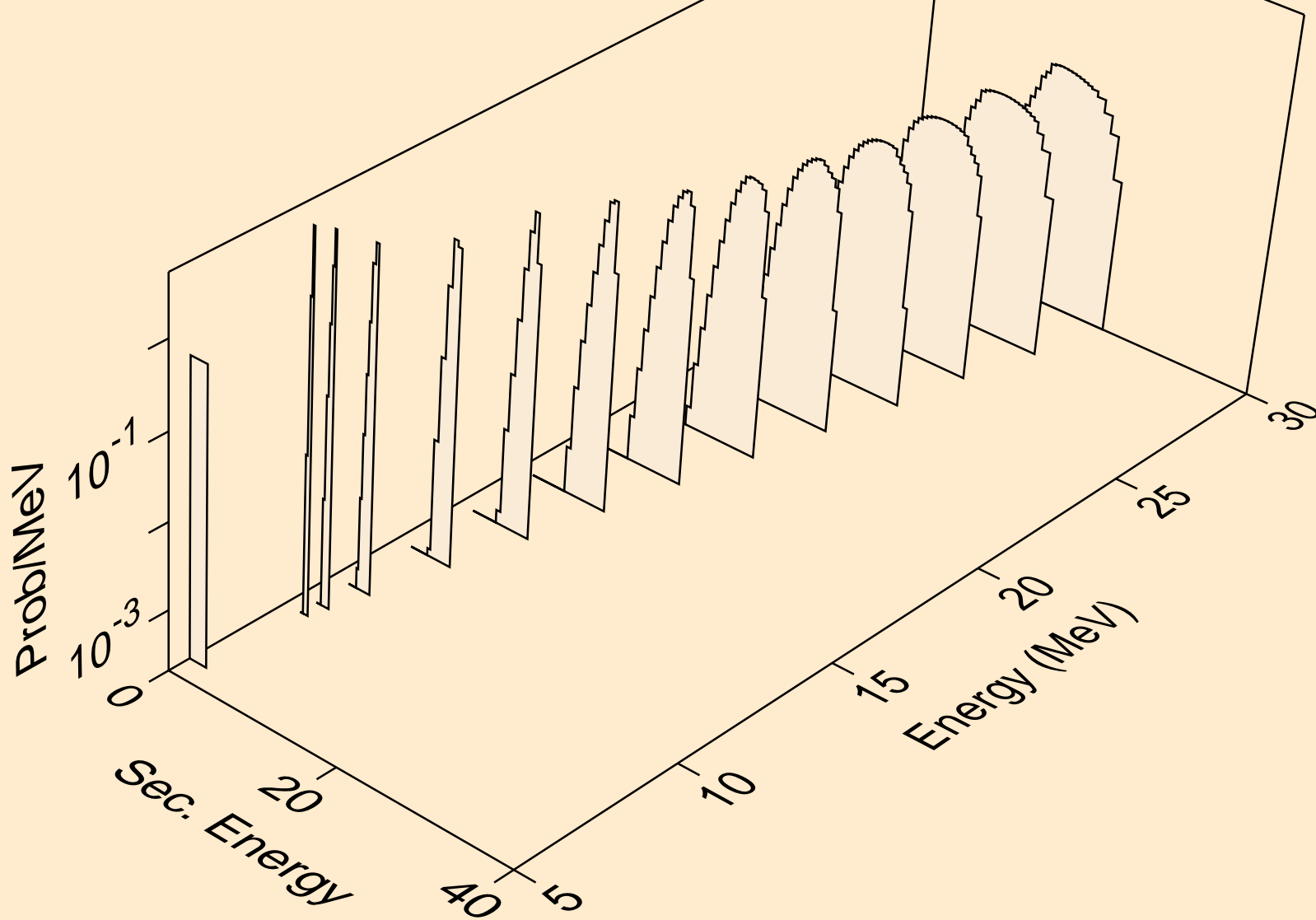

RB089 NEUTRON ACER TENDL-2019 LIBRARY; T=293.16K
alphas from (n,2n)a

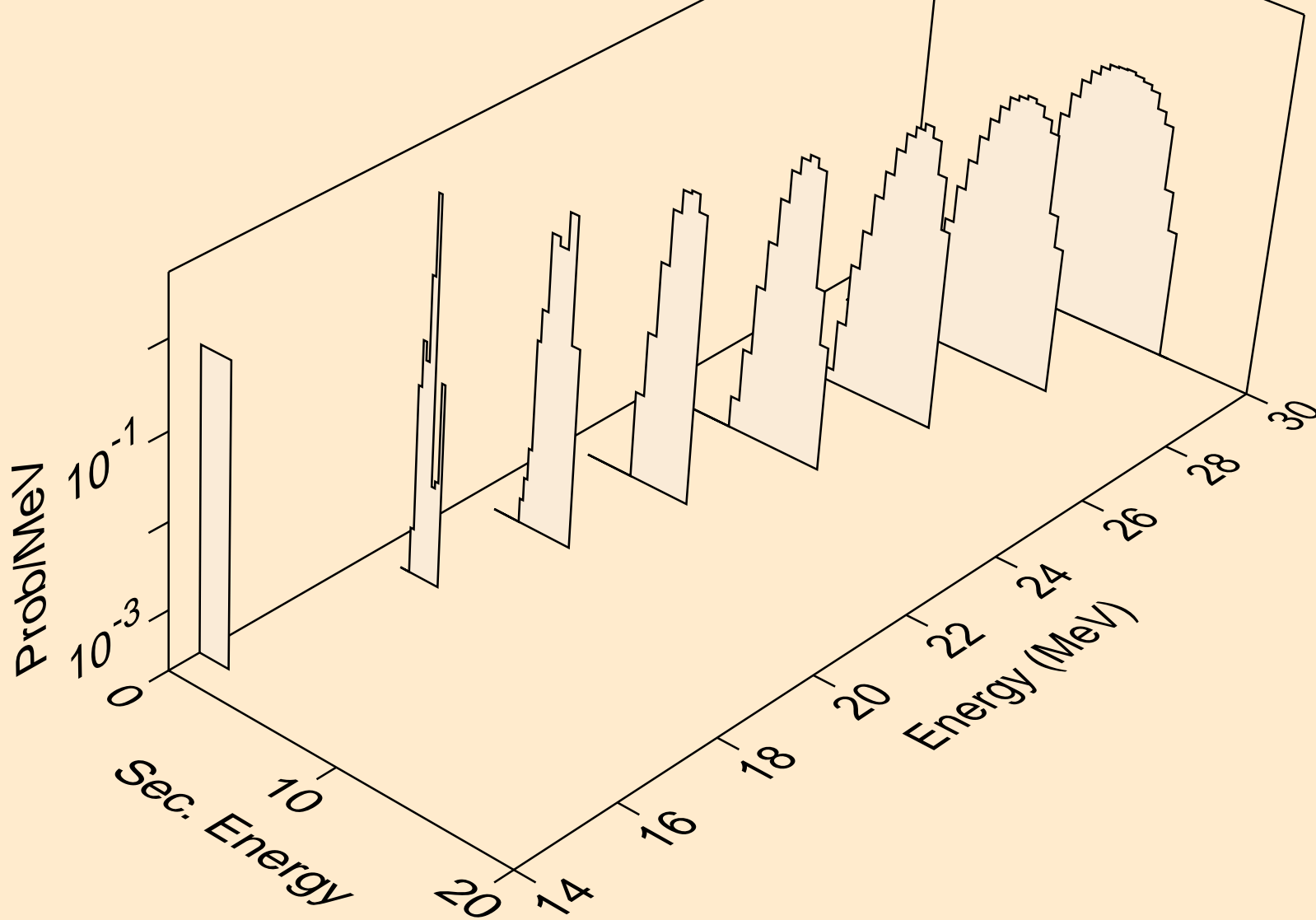

RB089 NEUTRON ACER TENDL-2019 LIBRARY; T=293.16K
alphas from (n,3n)a

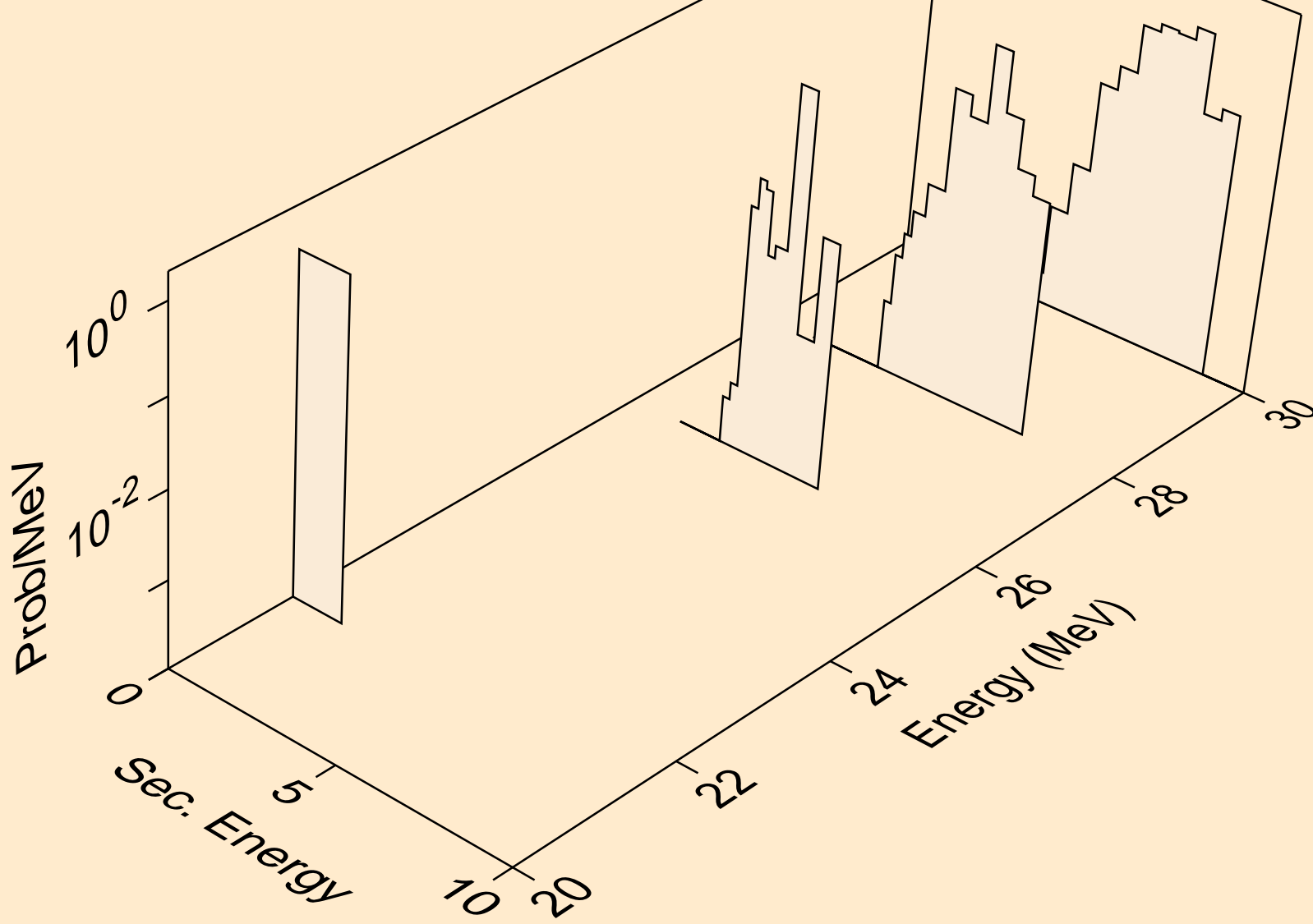

RB089 NEUTRON ACER TENDL-2019 LIBRARY; T=293.16K
alphas from (n,npa)

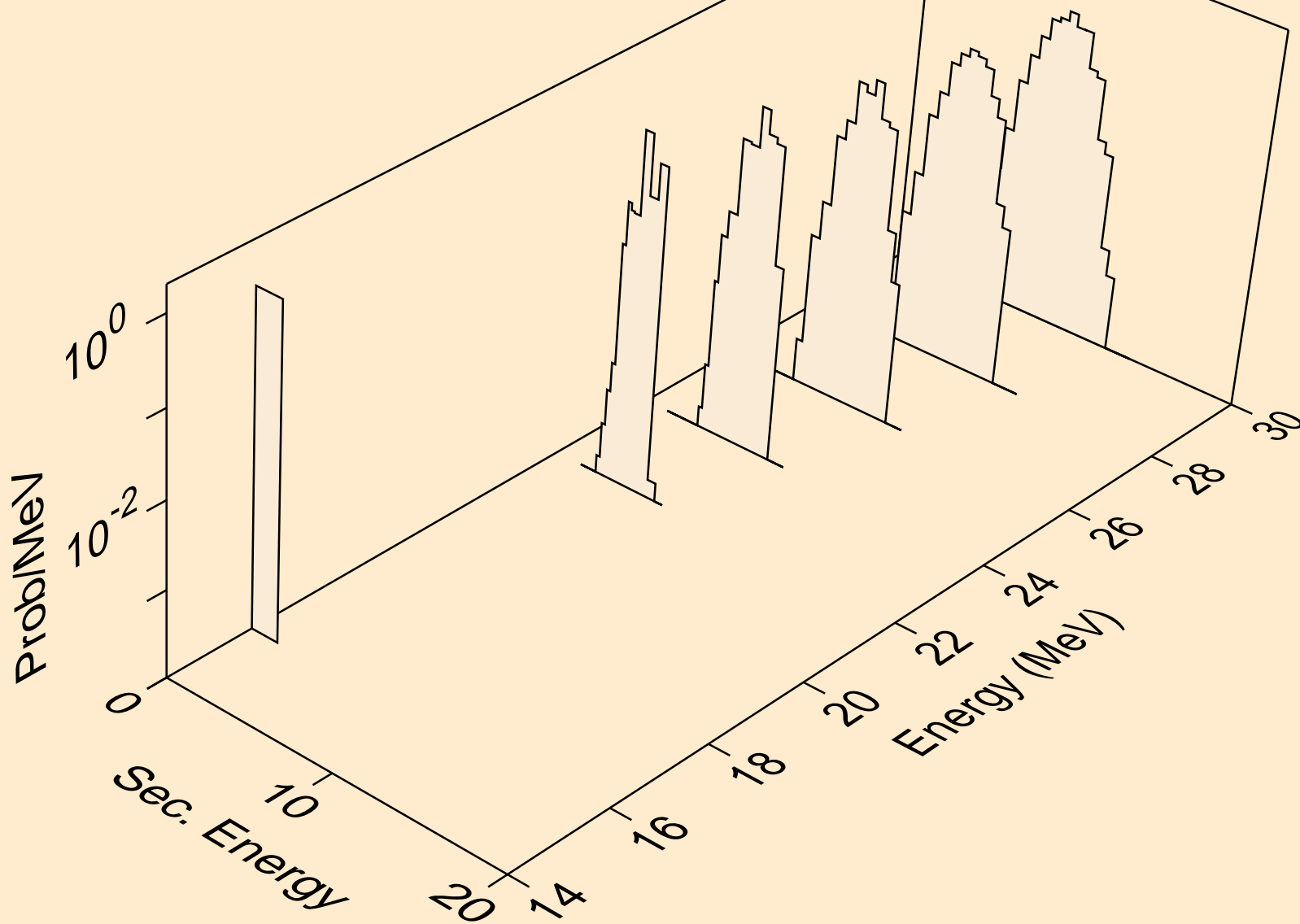

RB089 NEUTRON ACER TENDL-2019 LIBRARY; T=293.16K
alphas from (n,a)

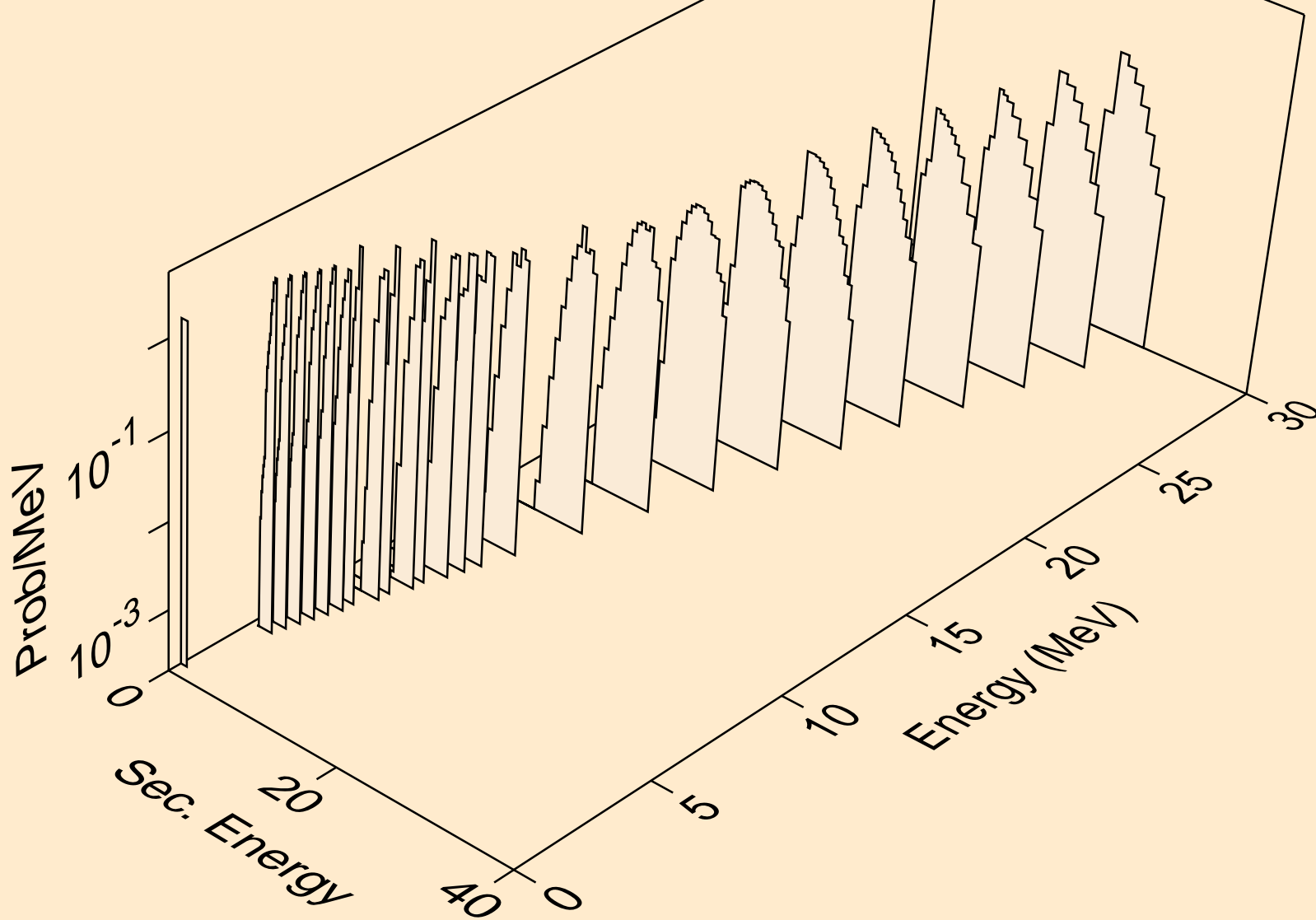

RB089 NEUTRON ACER TENDL-2019 LIBRARY; T=293.16K
alphas from (n,2a)

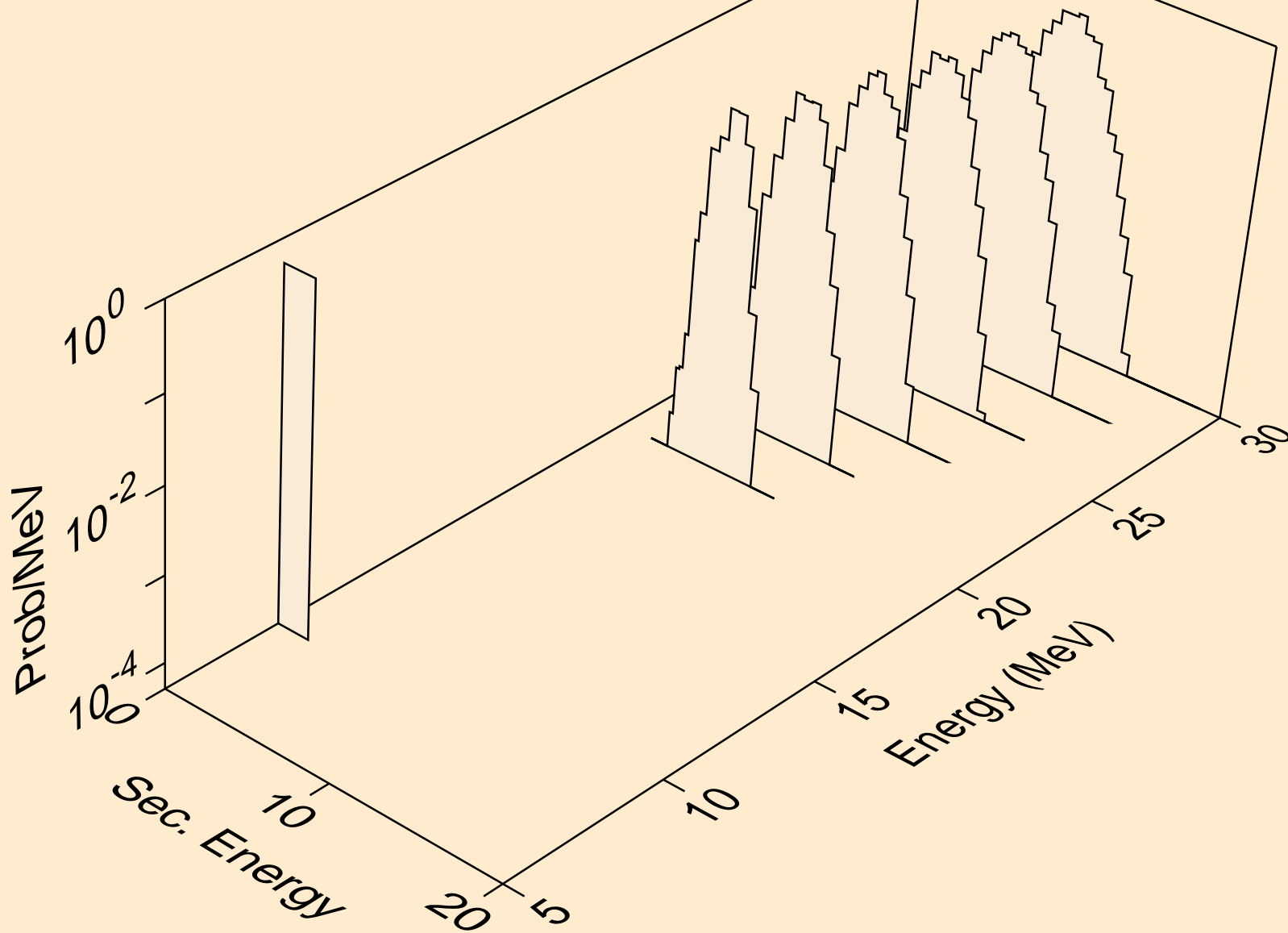

RB089 NEUTRON ACER TENDL-2019 LIBRARY; T=293.16K
alphas from (n,pa)

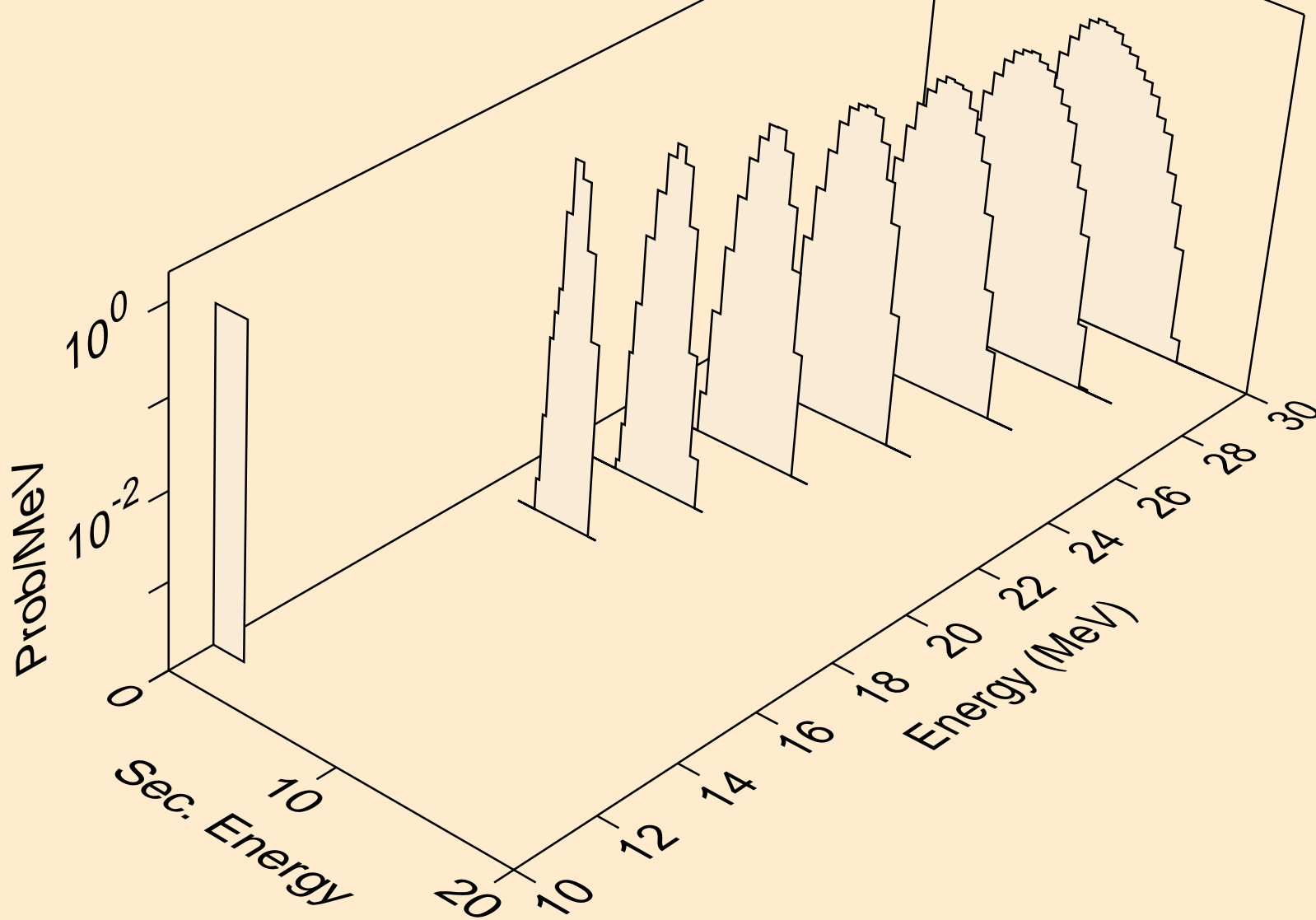

RB089 NEUTRON ACER TENDL-2019 LIBRARY; T=293.16K
alphas from (n,da)

