

RB091 NEUTRON ACER TENDL-2019 LIBRARY; T=293.16K  
Principal cross sections

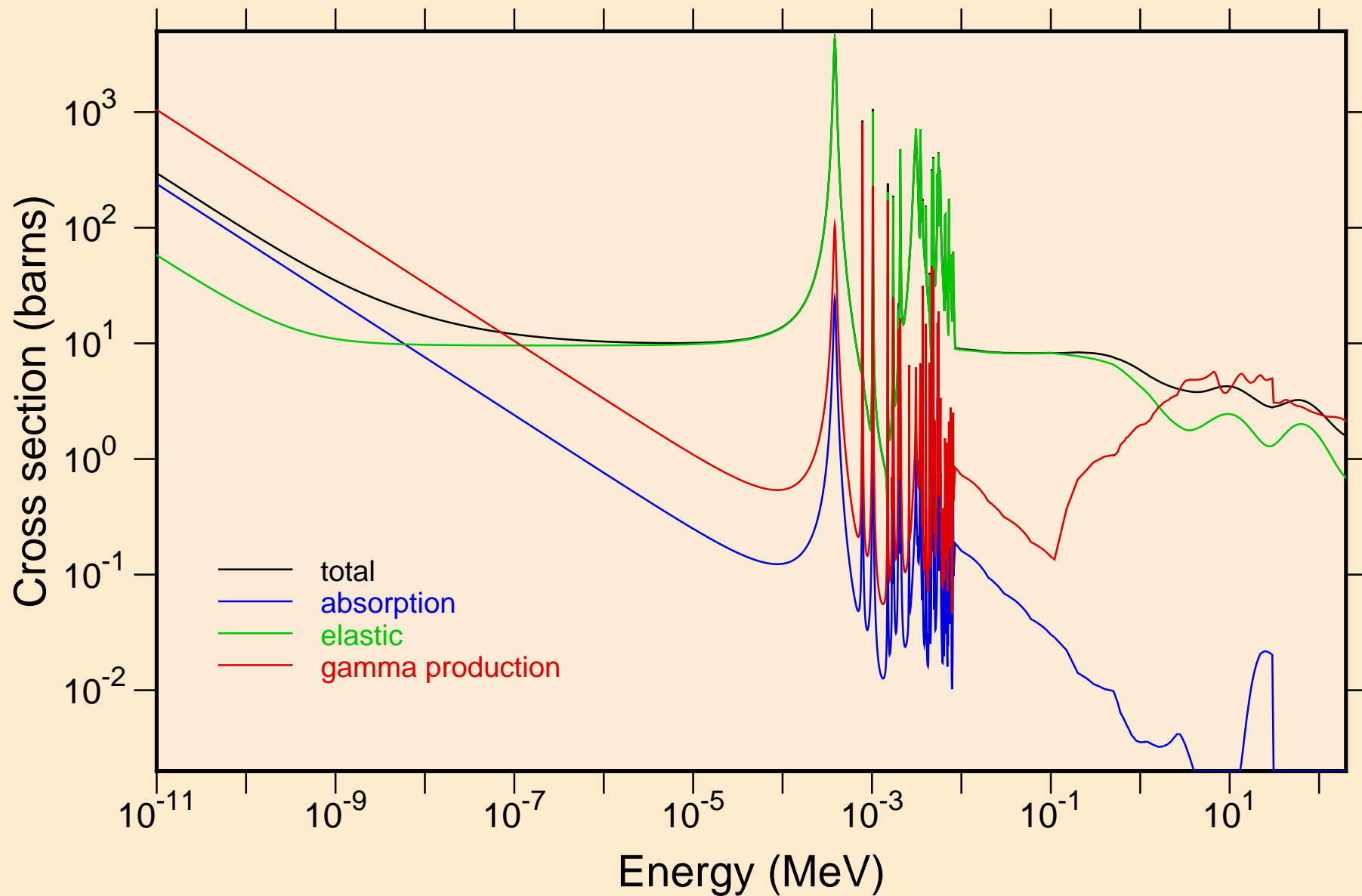

RB091 NEUTRON ACER TENDL-2019 LIBRARY; T=293.16K  
resonance total cross section

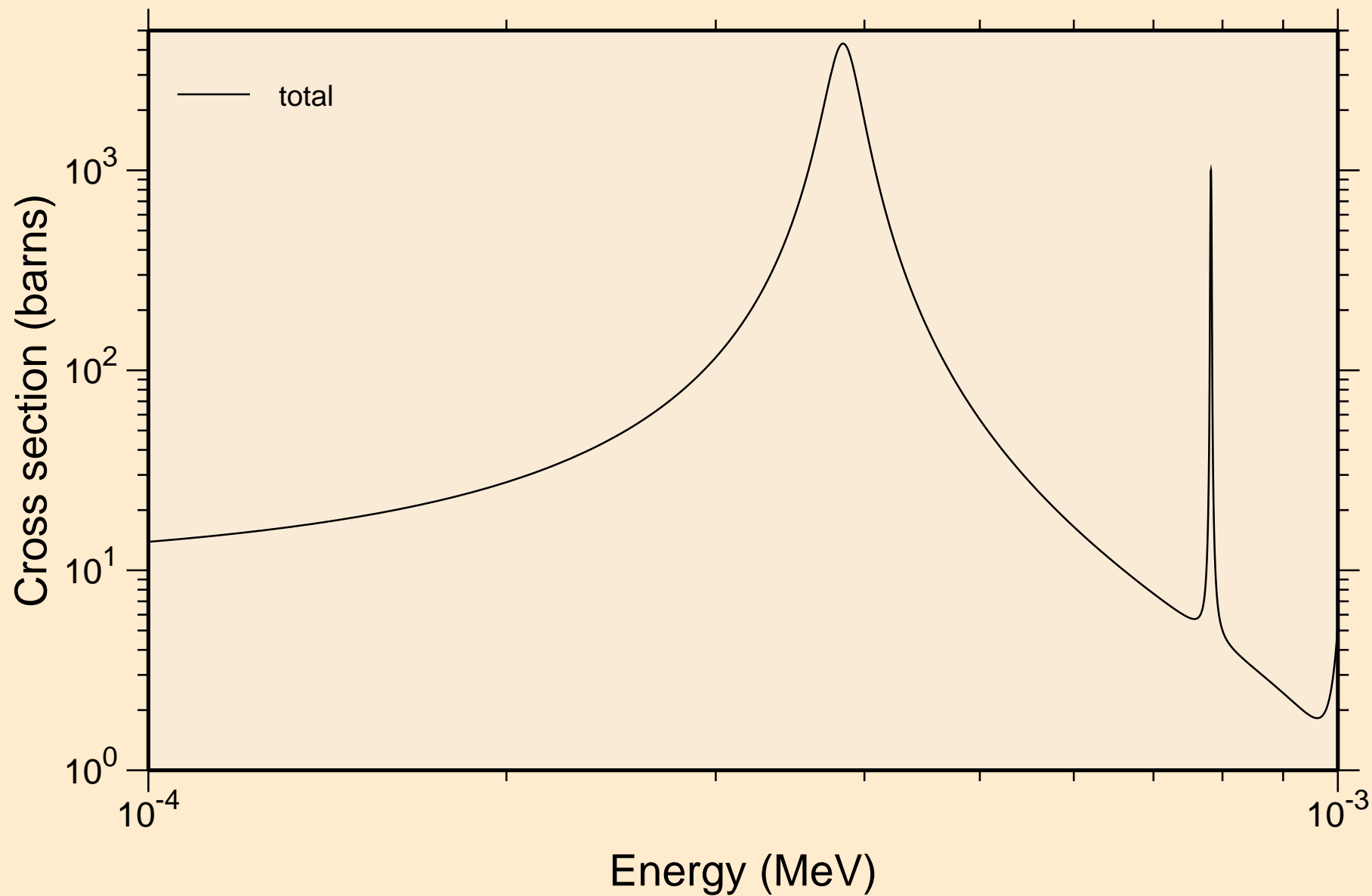

RB091 NEUTRON ACER TENDL-2019 LIBRARY; T=293.16K  
resonance total cross section

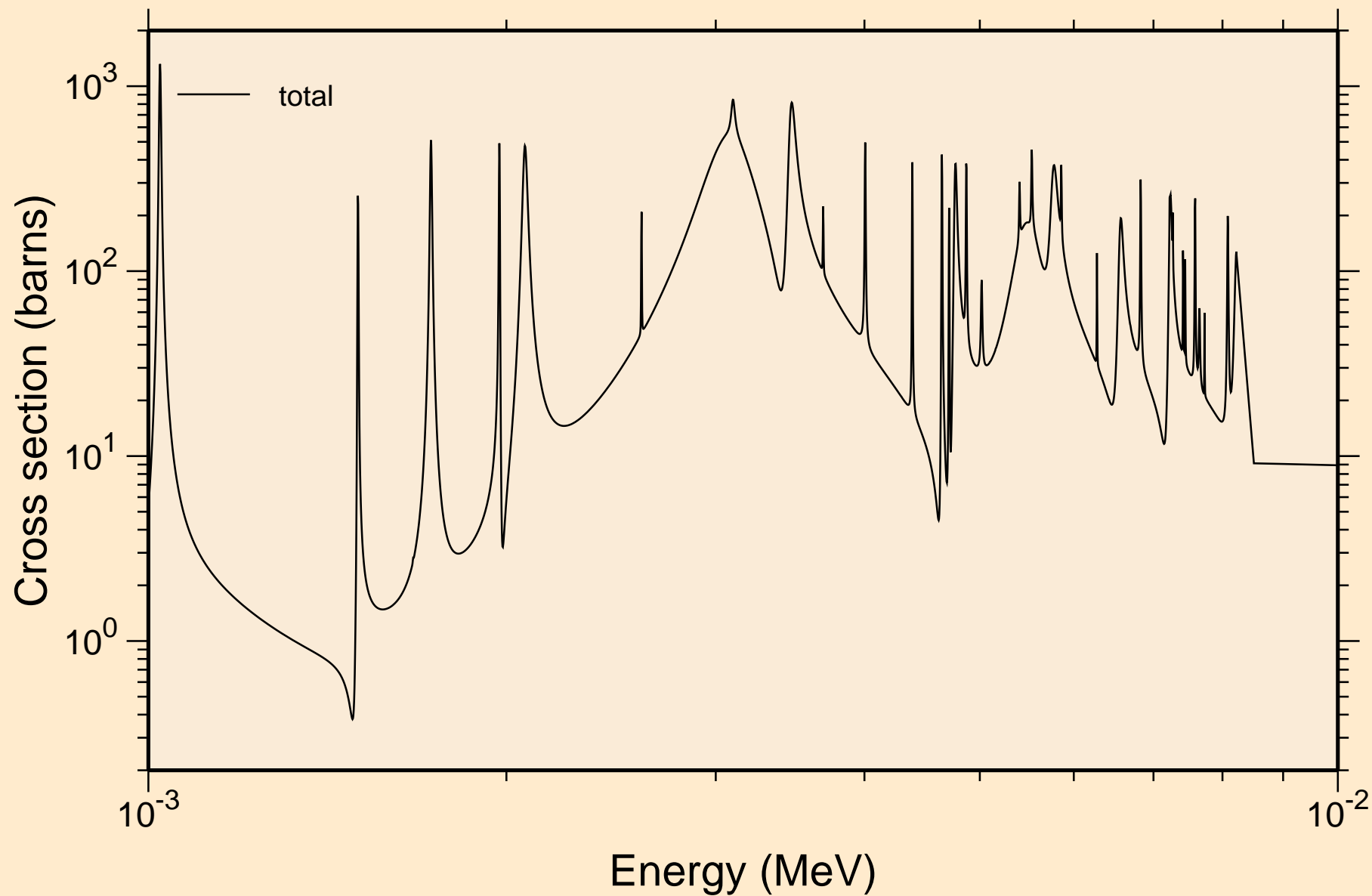

RB091 NEUTRON ACER TENDL-2019 LIBRARY; T=293.16K  
resonance total cross section

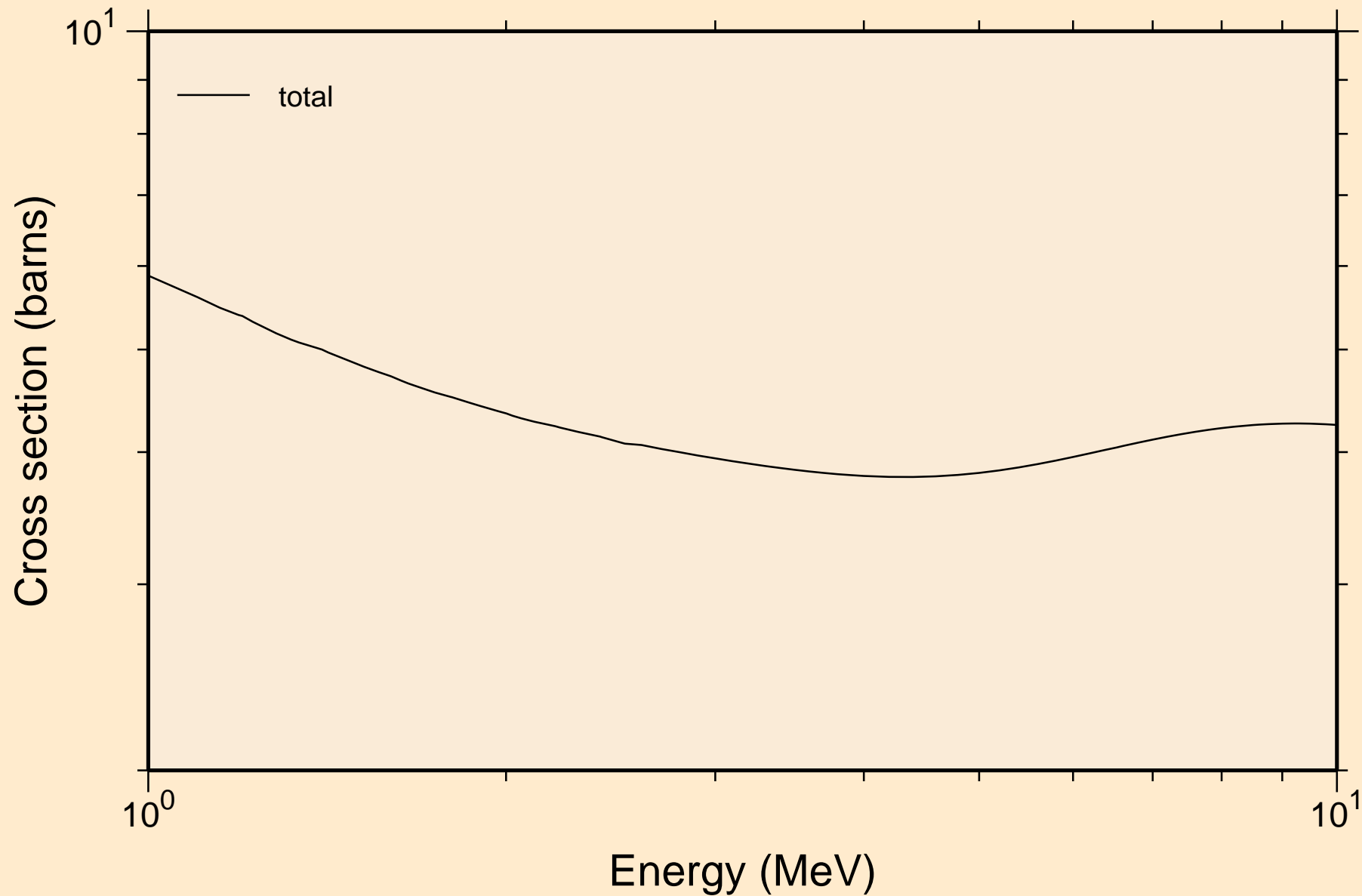

RB091 NEUTRON ACER TENDL-2019 LIBRARY; T=293.16K  
resonance absorption cross sections

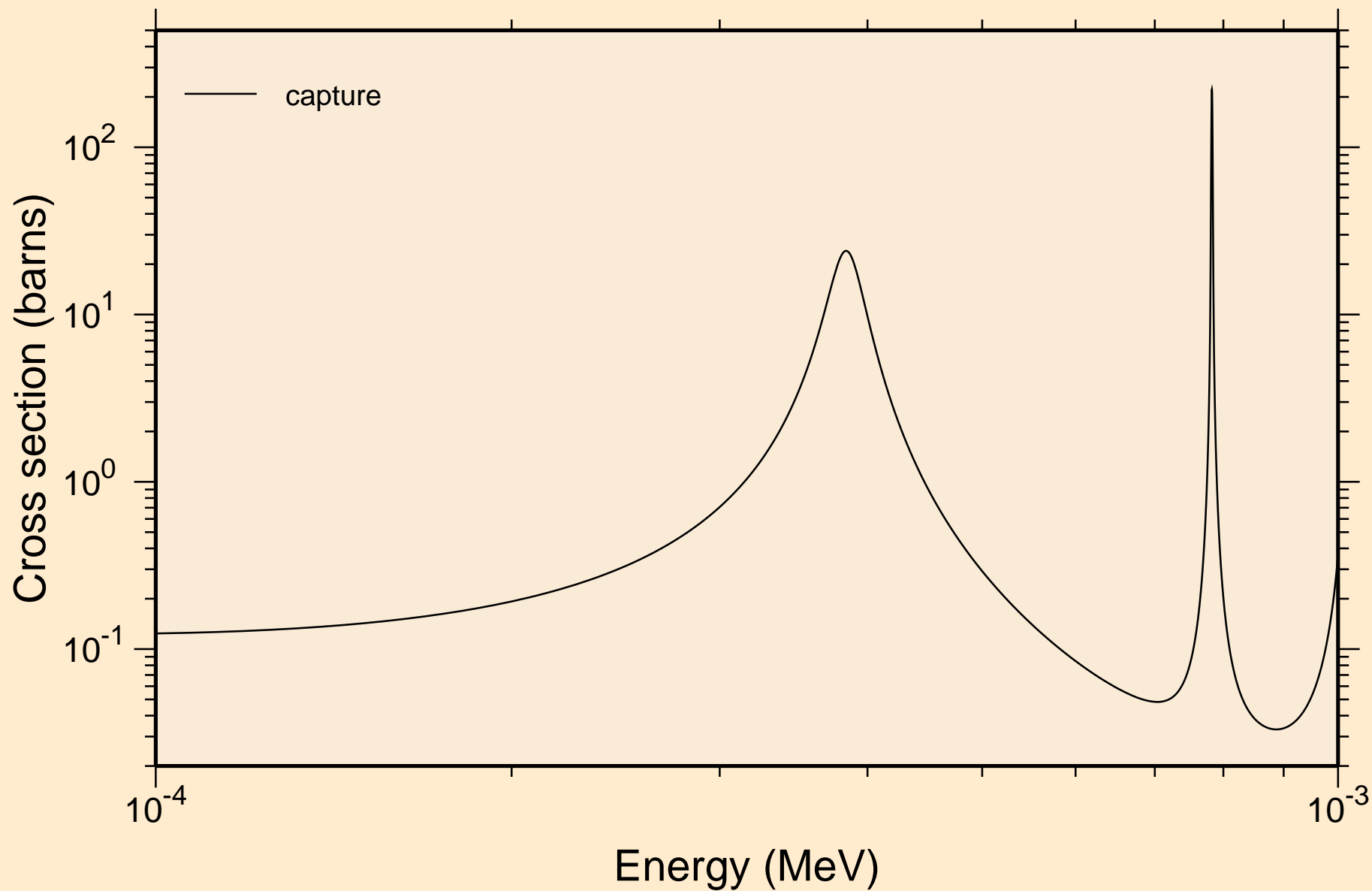

RB091 NEUTRON ACER TENDL-2019 LIBRARY; T=293.16K  
resonance absorption cross sections

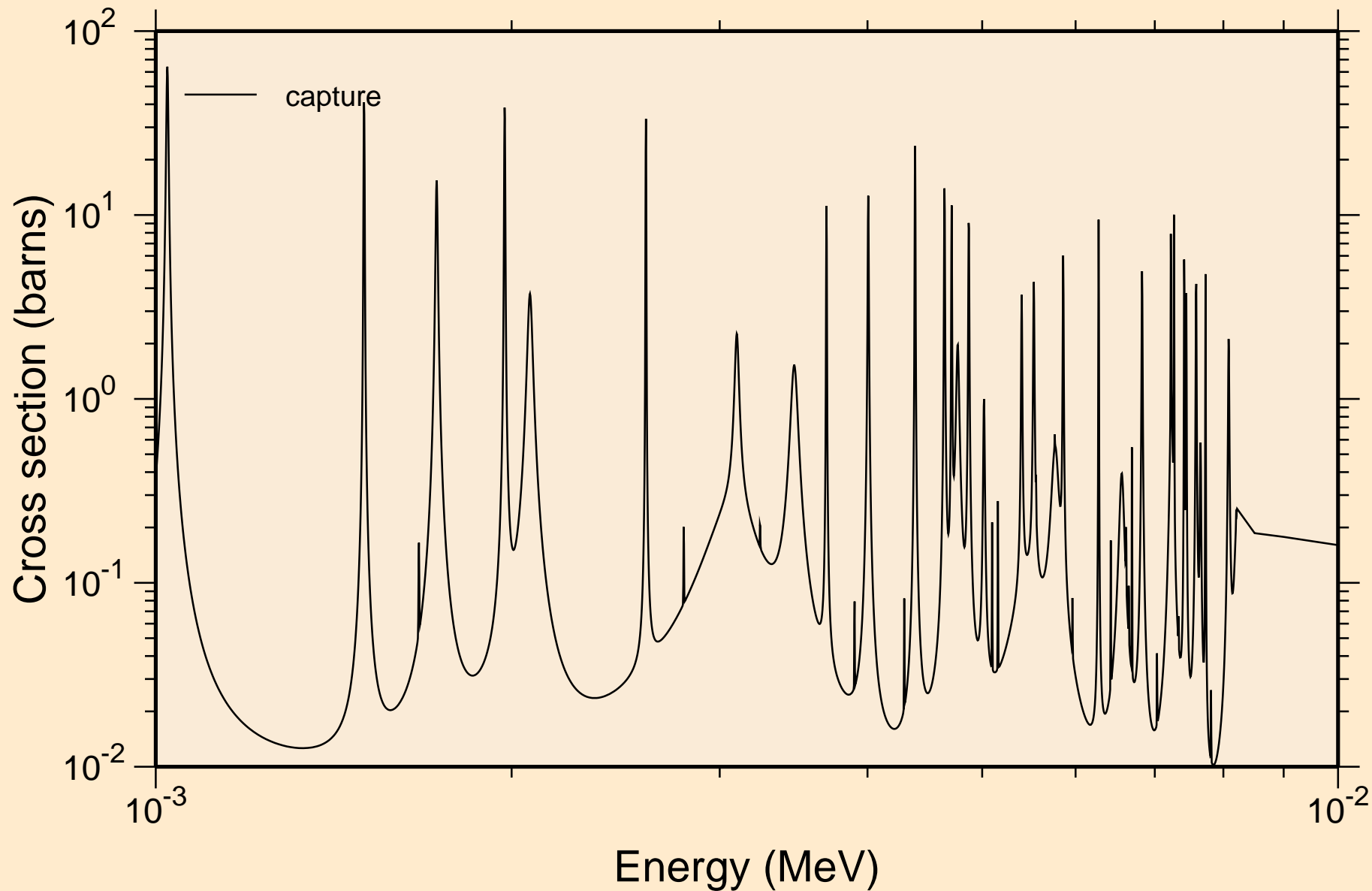

RB091 NEUTRON ACER TENDL-2019 LIBRARY; T=293.16K  
resonance absorption cross sections

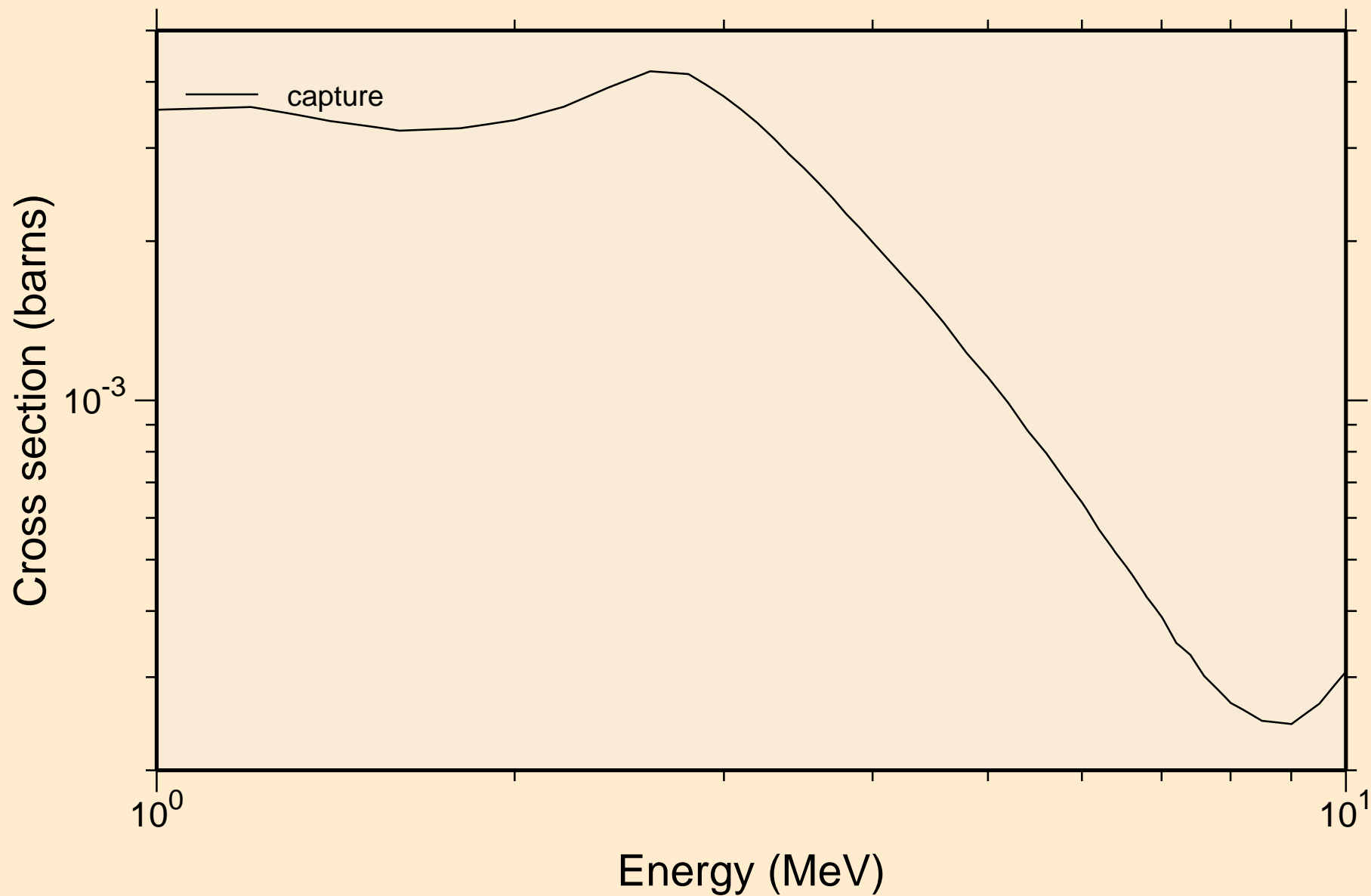

RB091 NEUTRON ACER TENDL-2019 LIBRARY; T=293.16K  
Heating

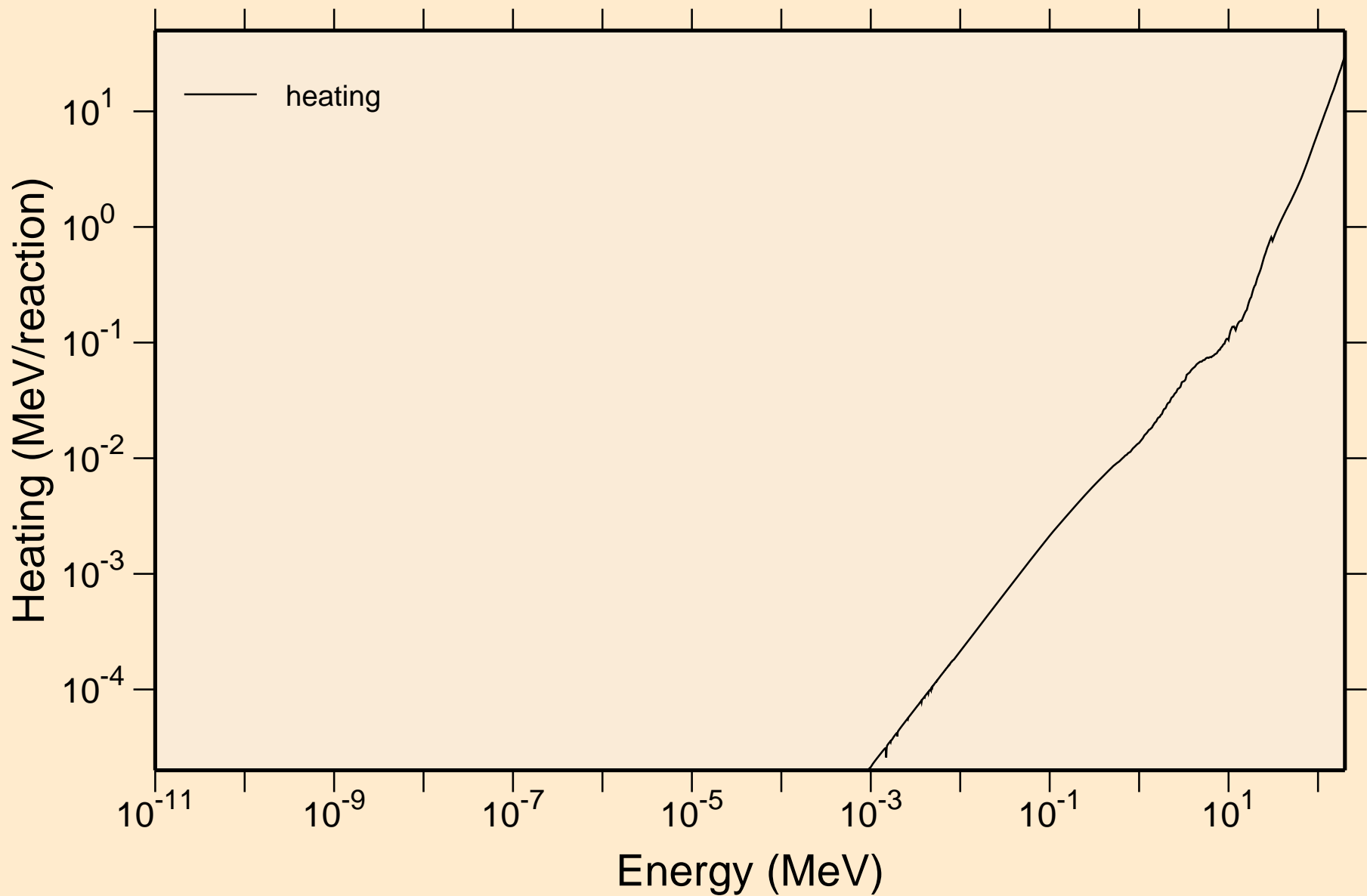



RB091 NEUTRON ACER TENDL-2019 LIBRARY; T=293.16K  
Damage

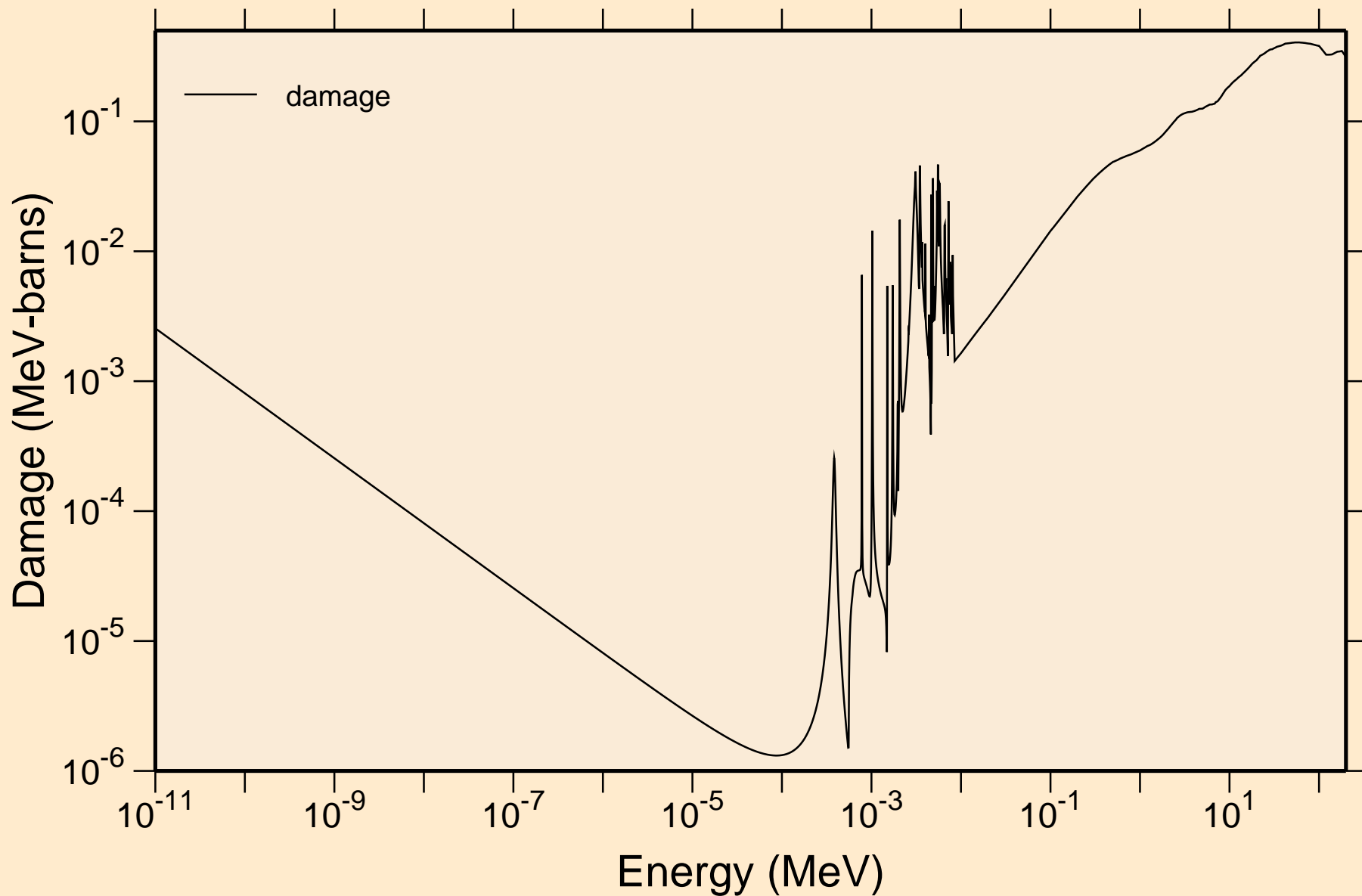

RB091 NEUTRON ACER TENDL-2019 LIBRARY; T=293.16K  
Non-threshold reactions

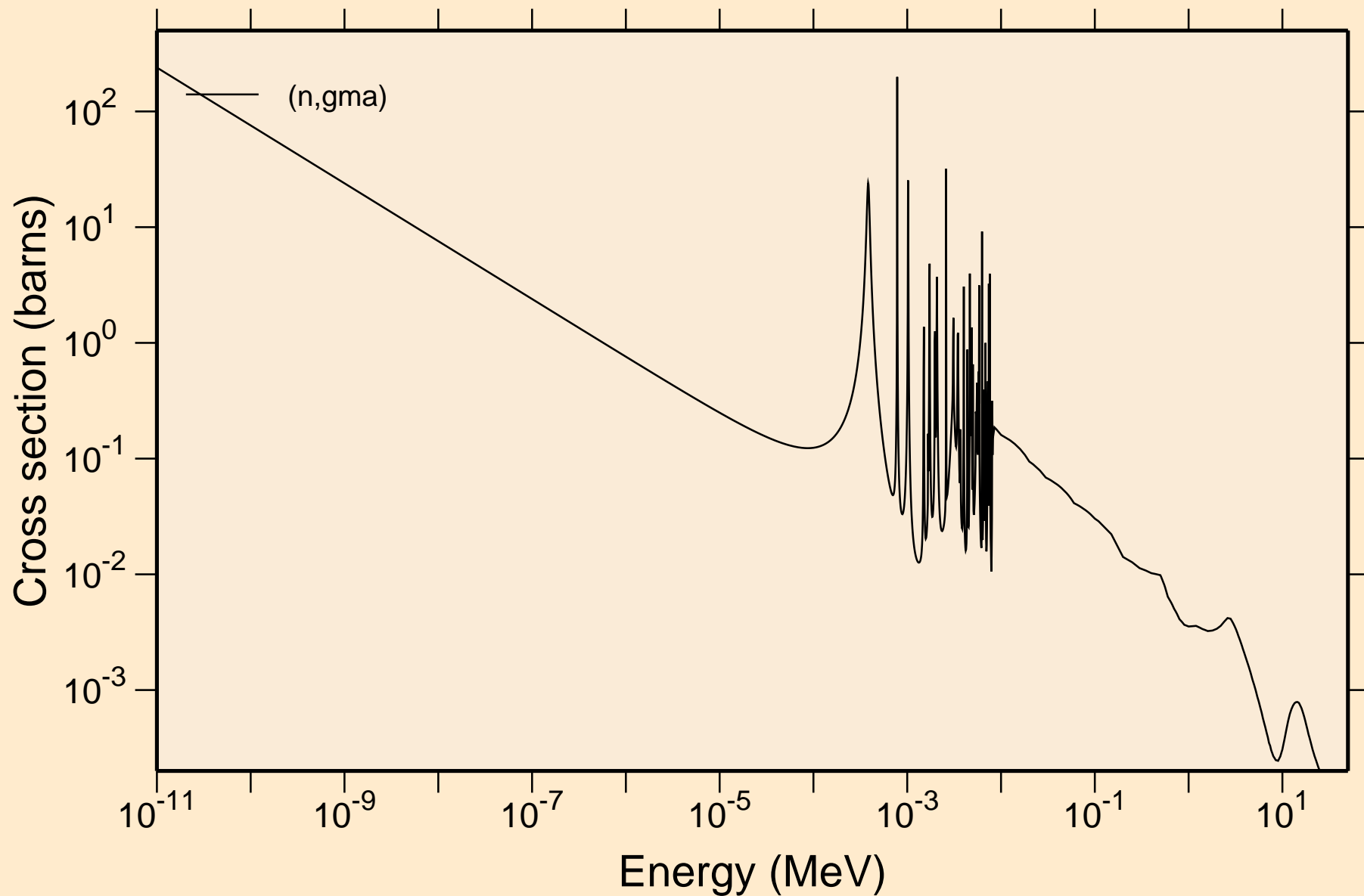

RB091 NEUTRON ACER TENDL-2019 LIBRARY; T=293.16K  
Principal cross sections

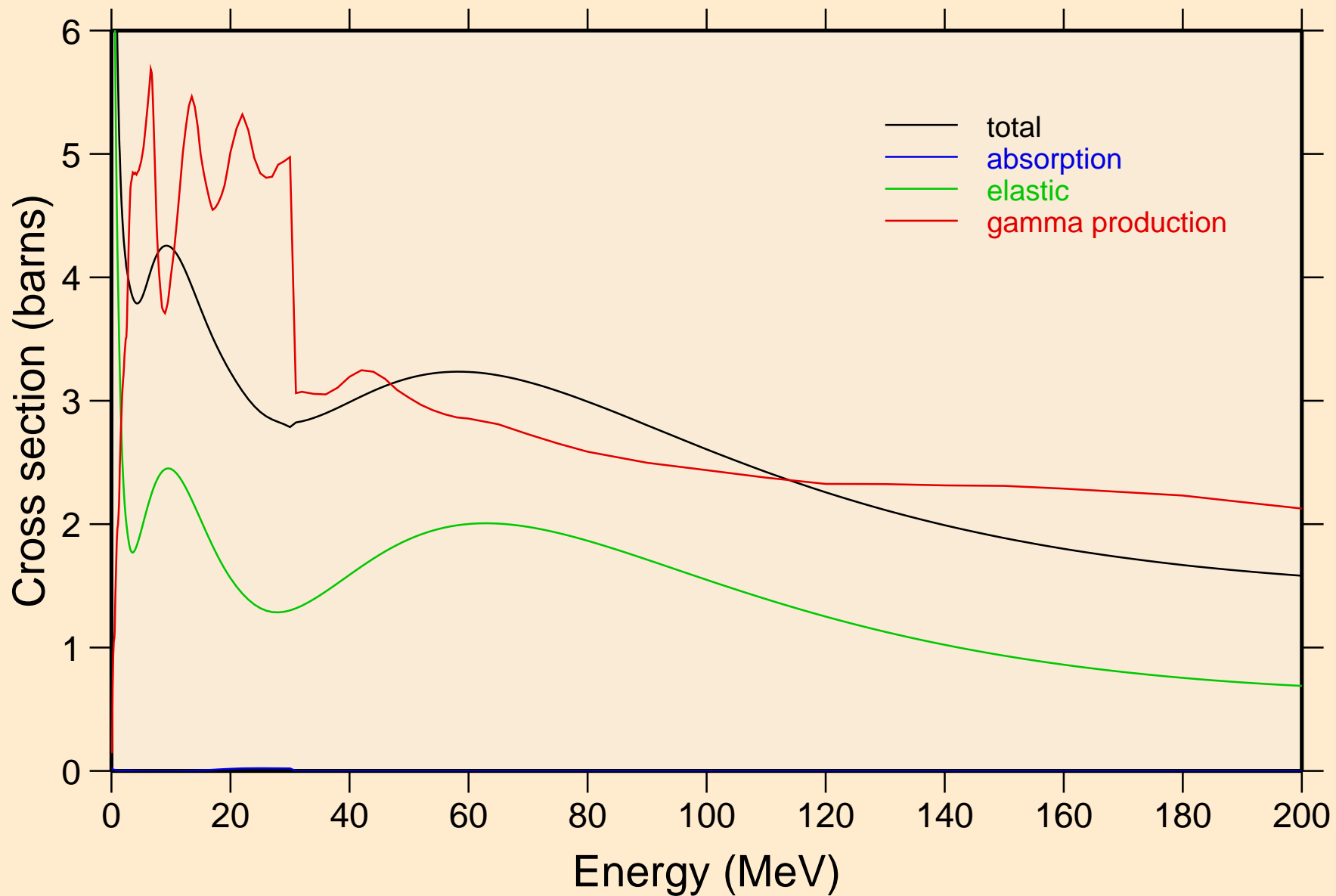

RB091 NEUTRON ACER TENDL-2019 LIBRARY; T=293.16K  
Heating

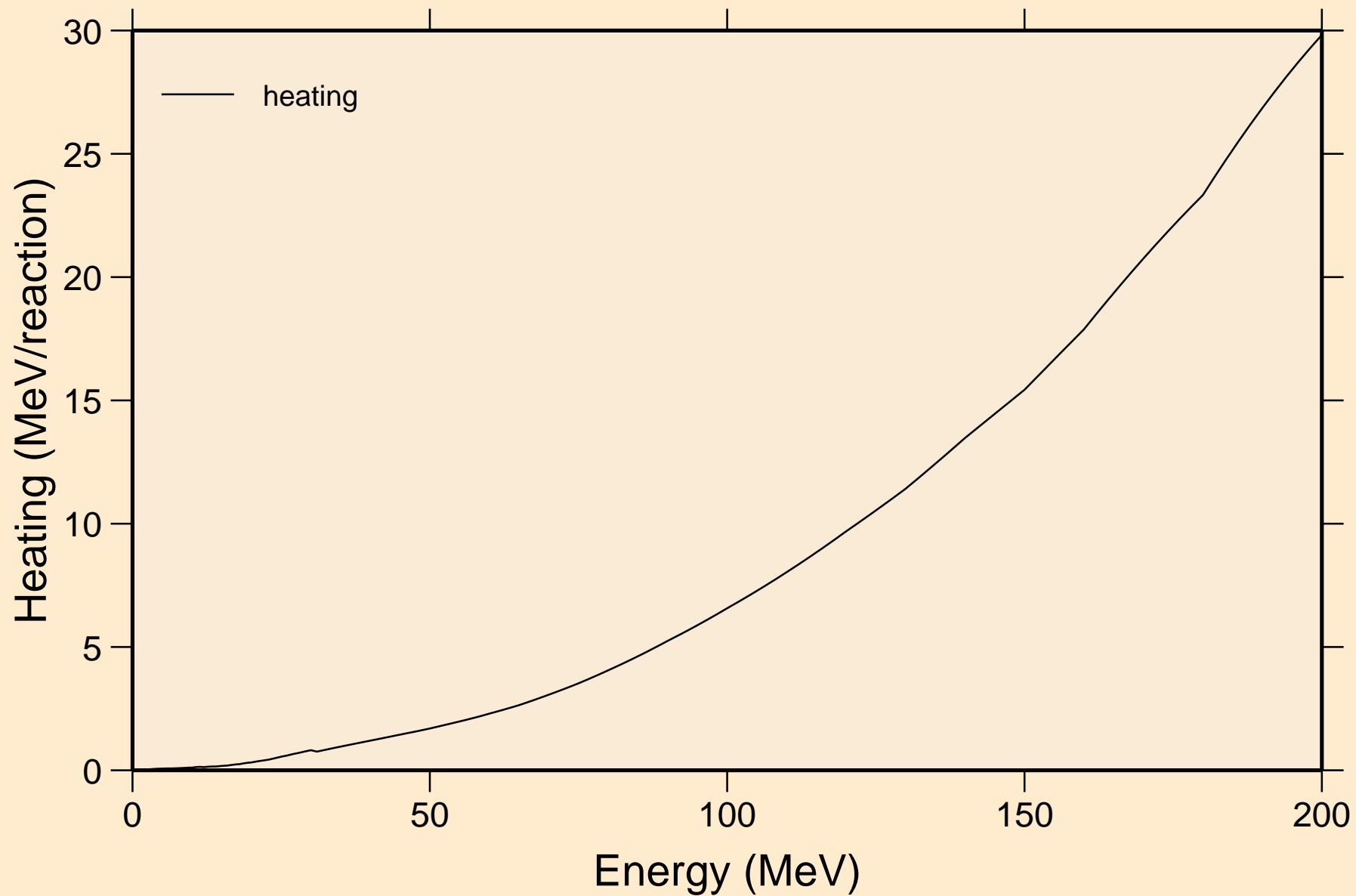

RB091 NEUTRON ACER TENDL-2019 LIBRARY; T=293.16K  
Damage

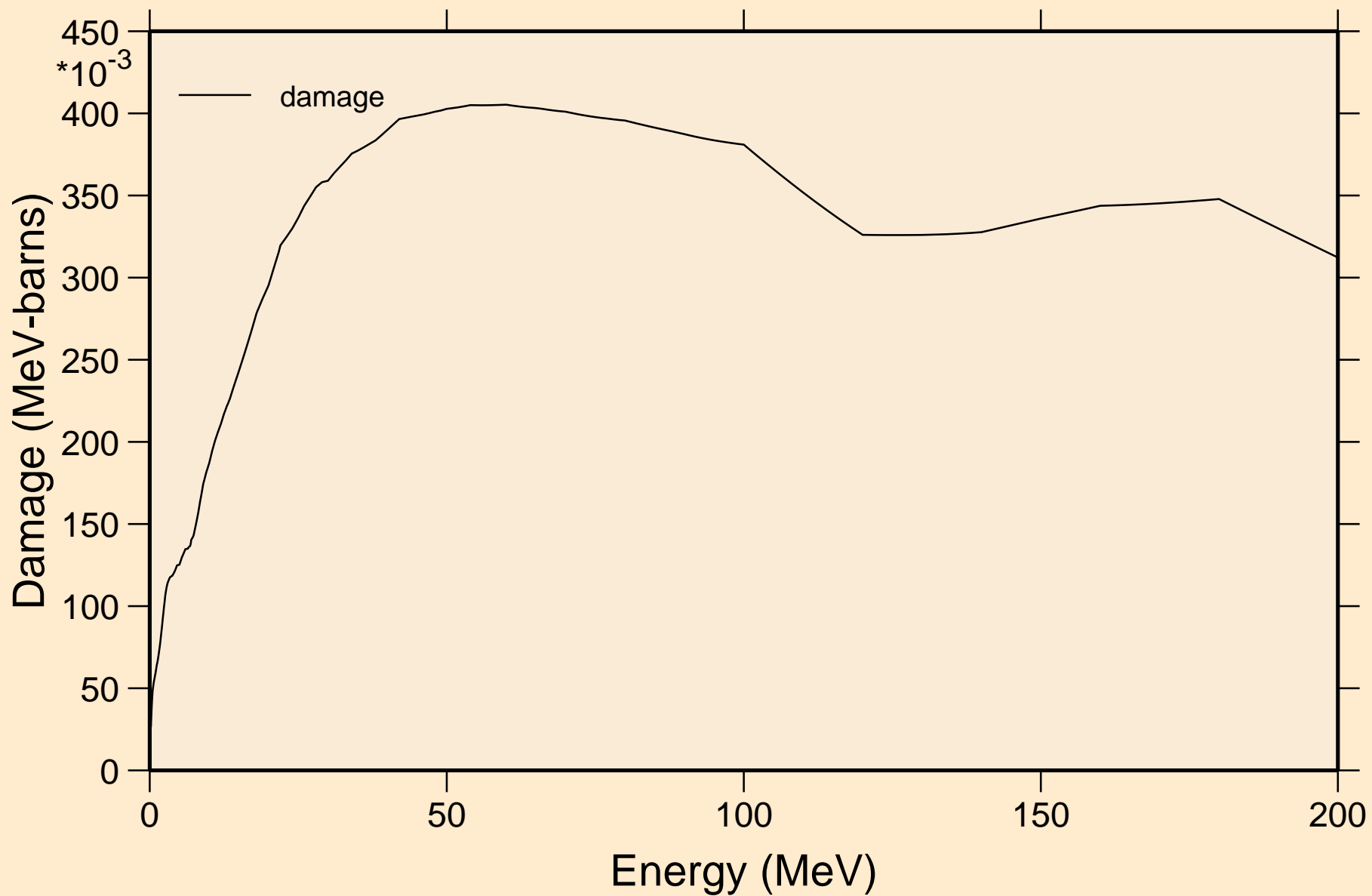

RB091 NEUTRON ACER TENDL-2019 LIBRARY; T=293.16K  
Non-threshold reactions

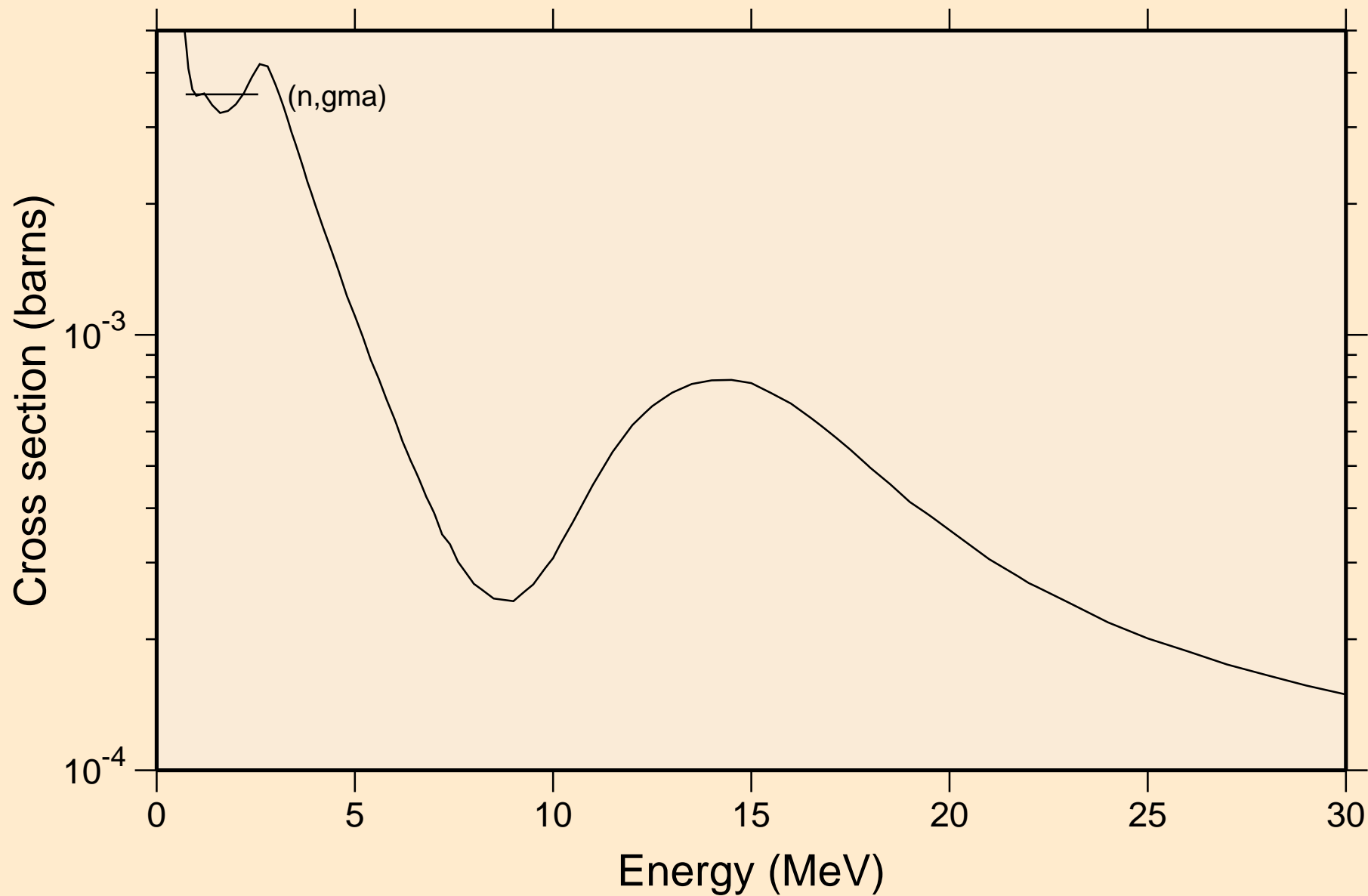

RB091 NEUTRON ACER TENDL-2019 LIBRARY; T=293.16K  
Inelastic levels

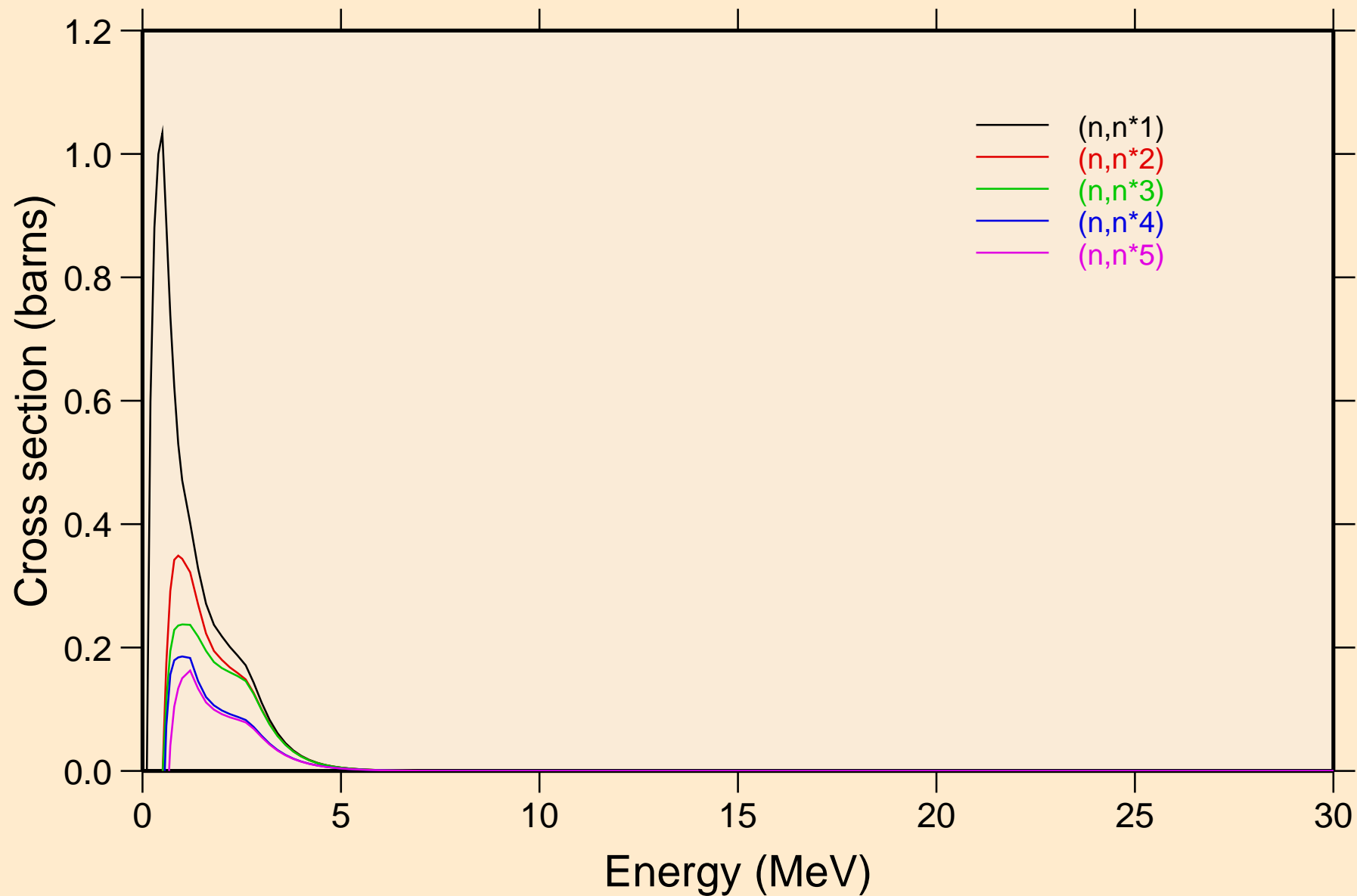

RB091 NEUTRON ACER TENDL-2019 LIBRARY; T=293.16K  
Inelastic levels

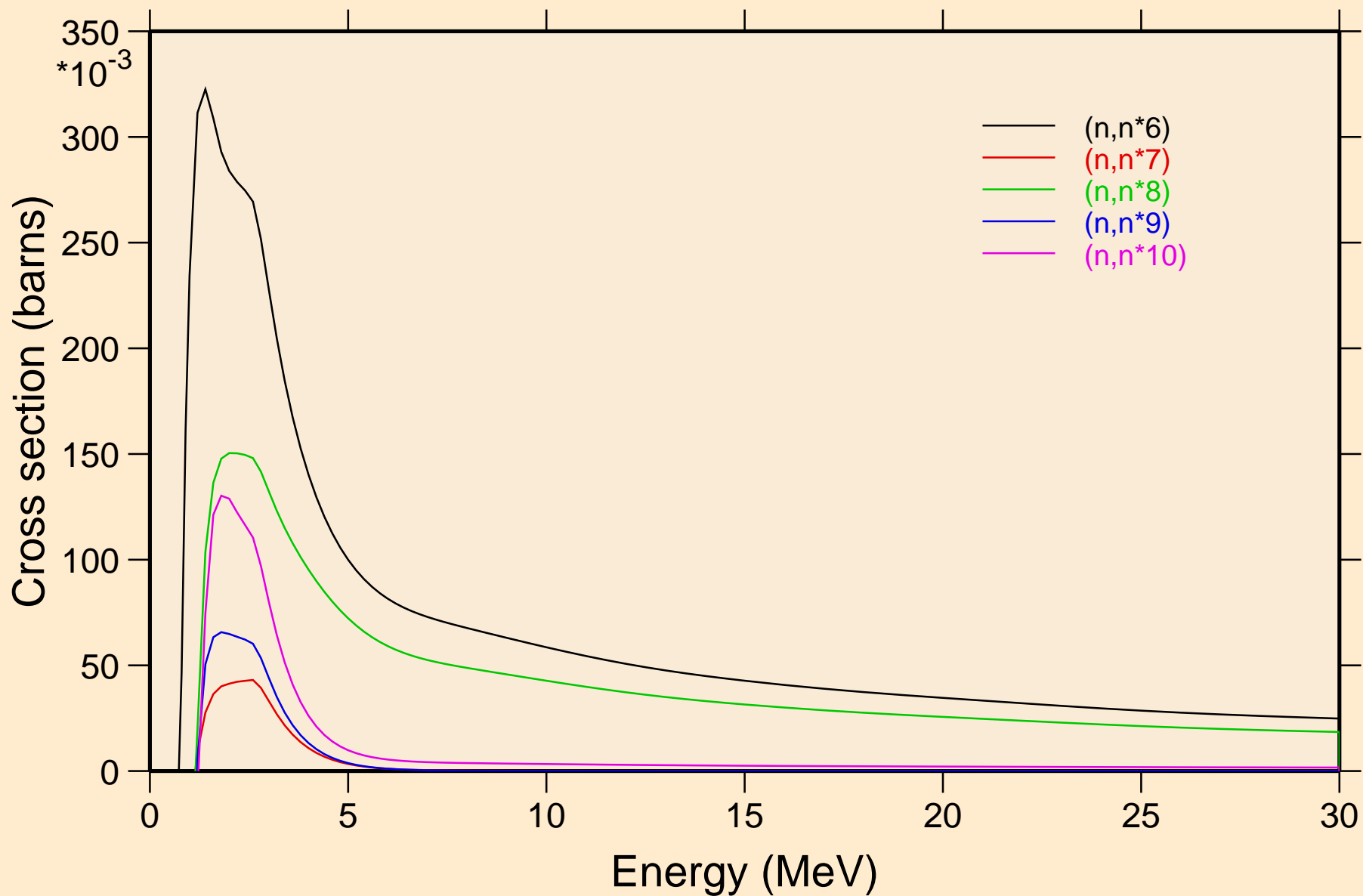



RB091 NEUTRON ACER TENDL-2019 LIBRARY; T=293.16K  
Inelastic levels

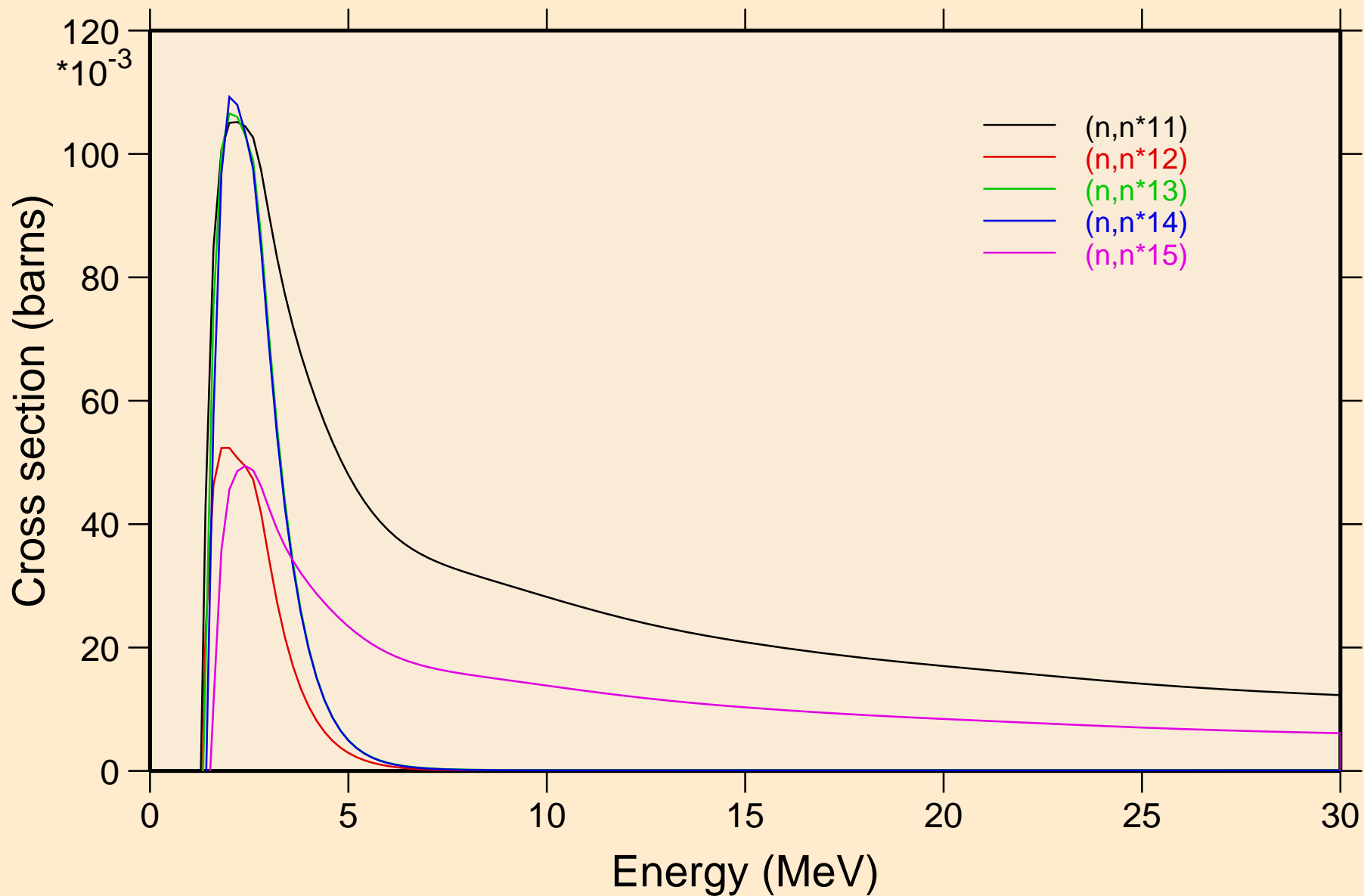

RB091 NEUTRON ACER TENDL-2019 LIBRARY; T=293.16K  
Inelastic levels

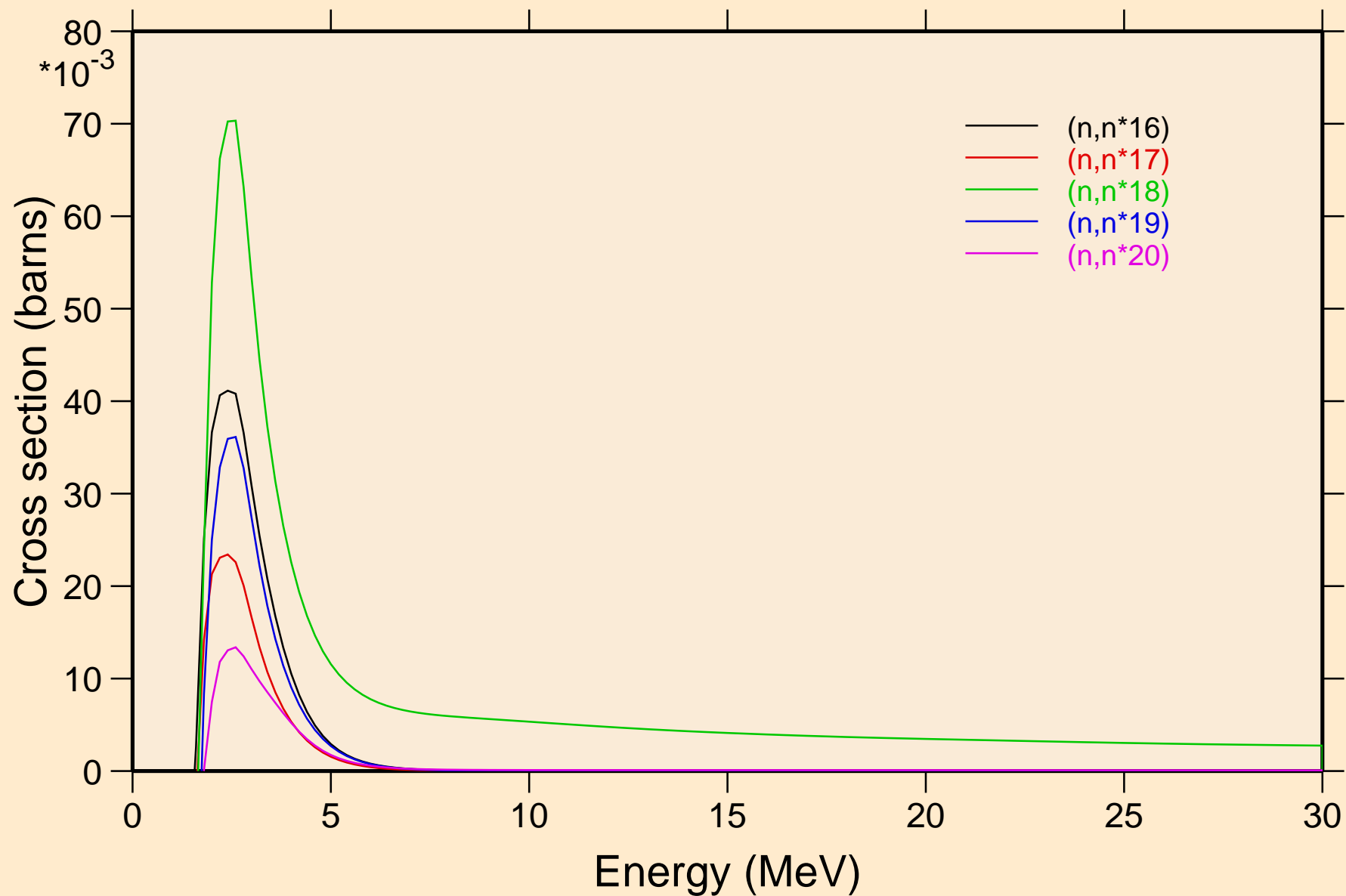

RB091 NEUTRON ACER TENDL-2019 LIBRARY; T=293.16K  
Inelastic levels

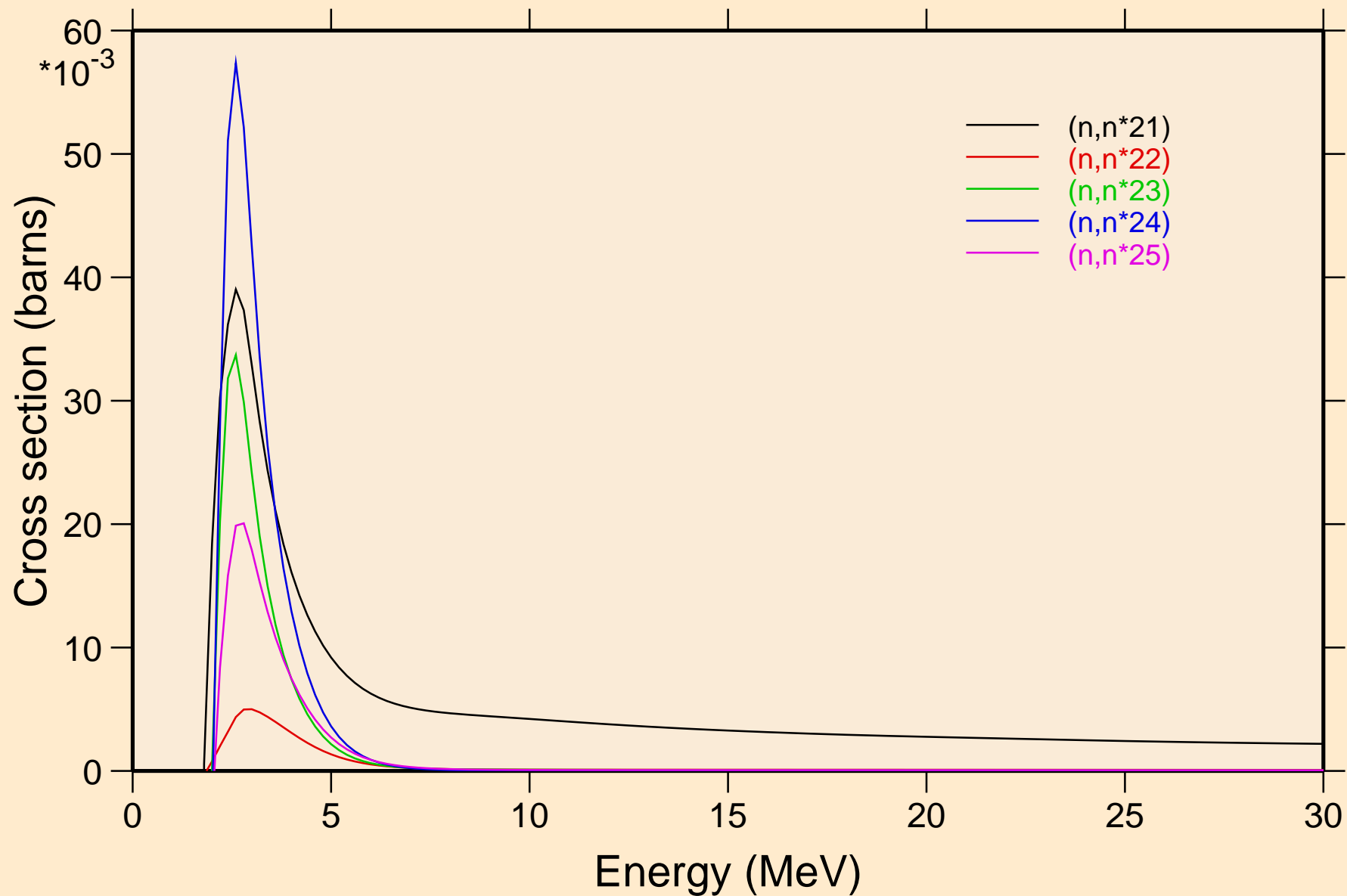

RB091 NEUTRON ACER TENDL-2019 LIBRARY; T=293.16K  
Inelastic levels

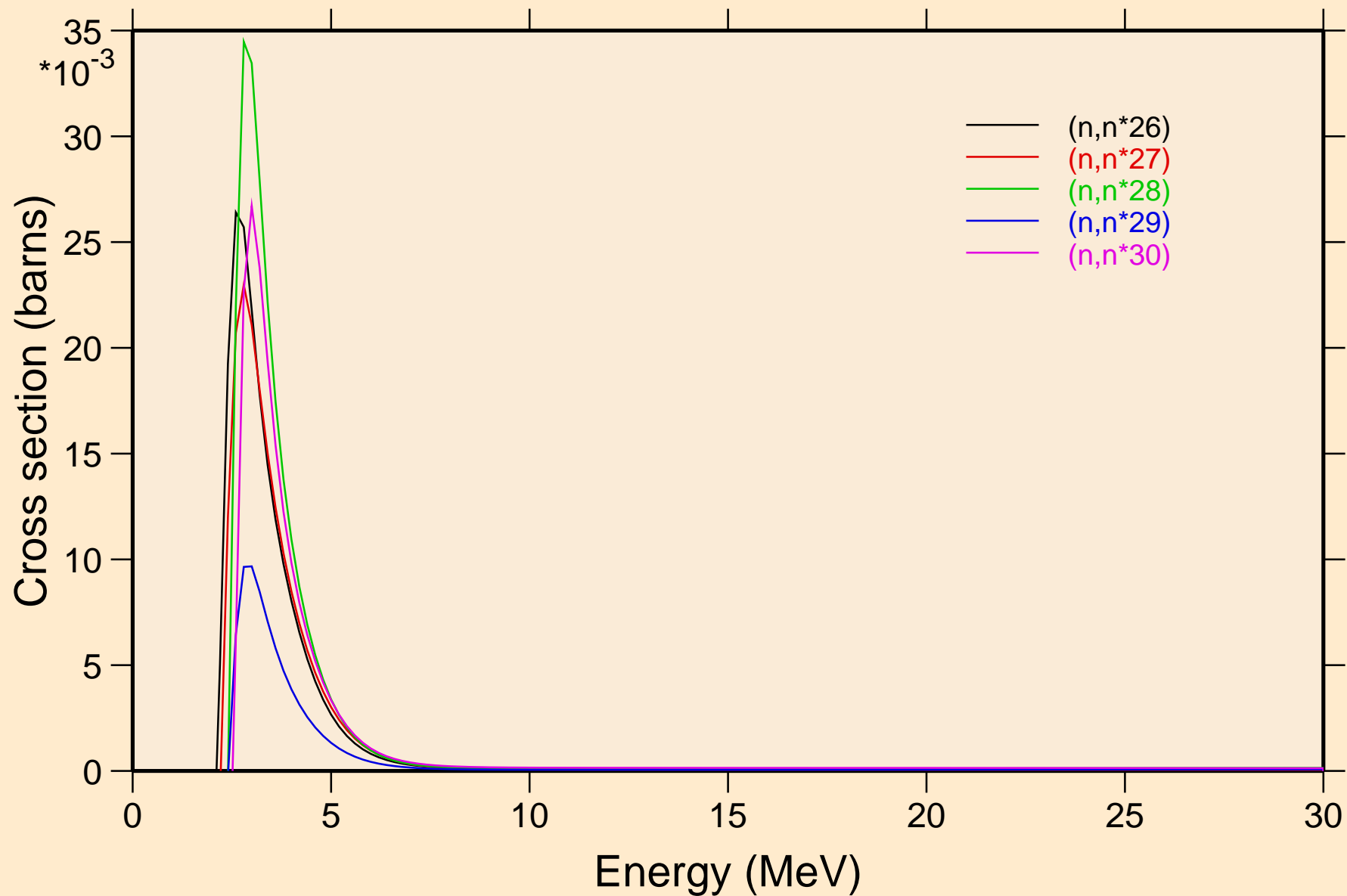

RB091 NEUTRON ACER TENDL-2019 LIBRARY; T=293.16K  
Threshold reactions

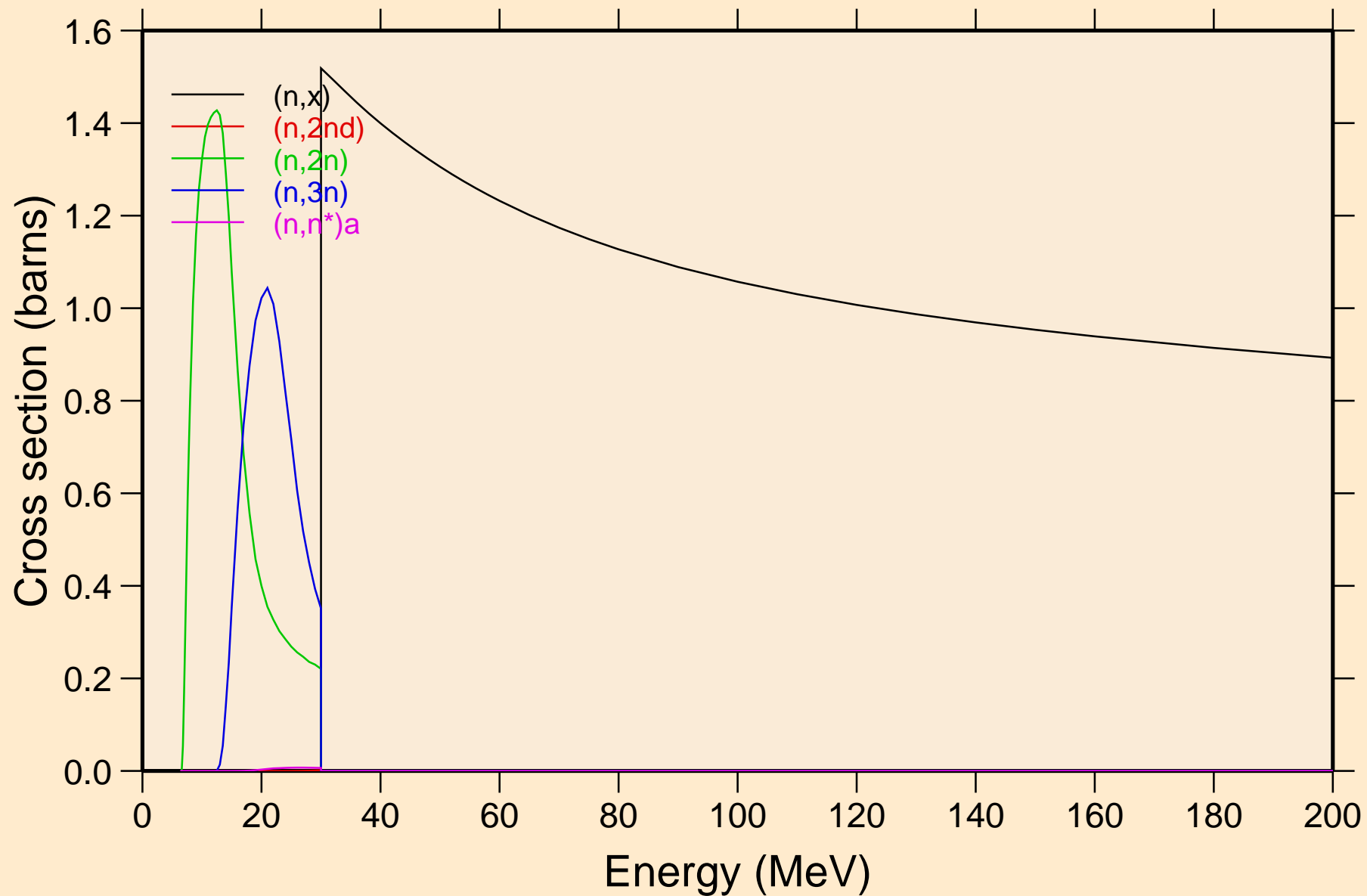

RB091 NEUTRON ACER TENDL-2019 LIBRARY; T=293.16K  
Threshold reactions

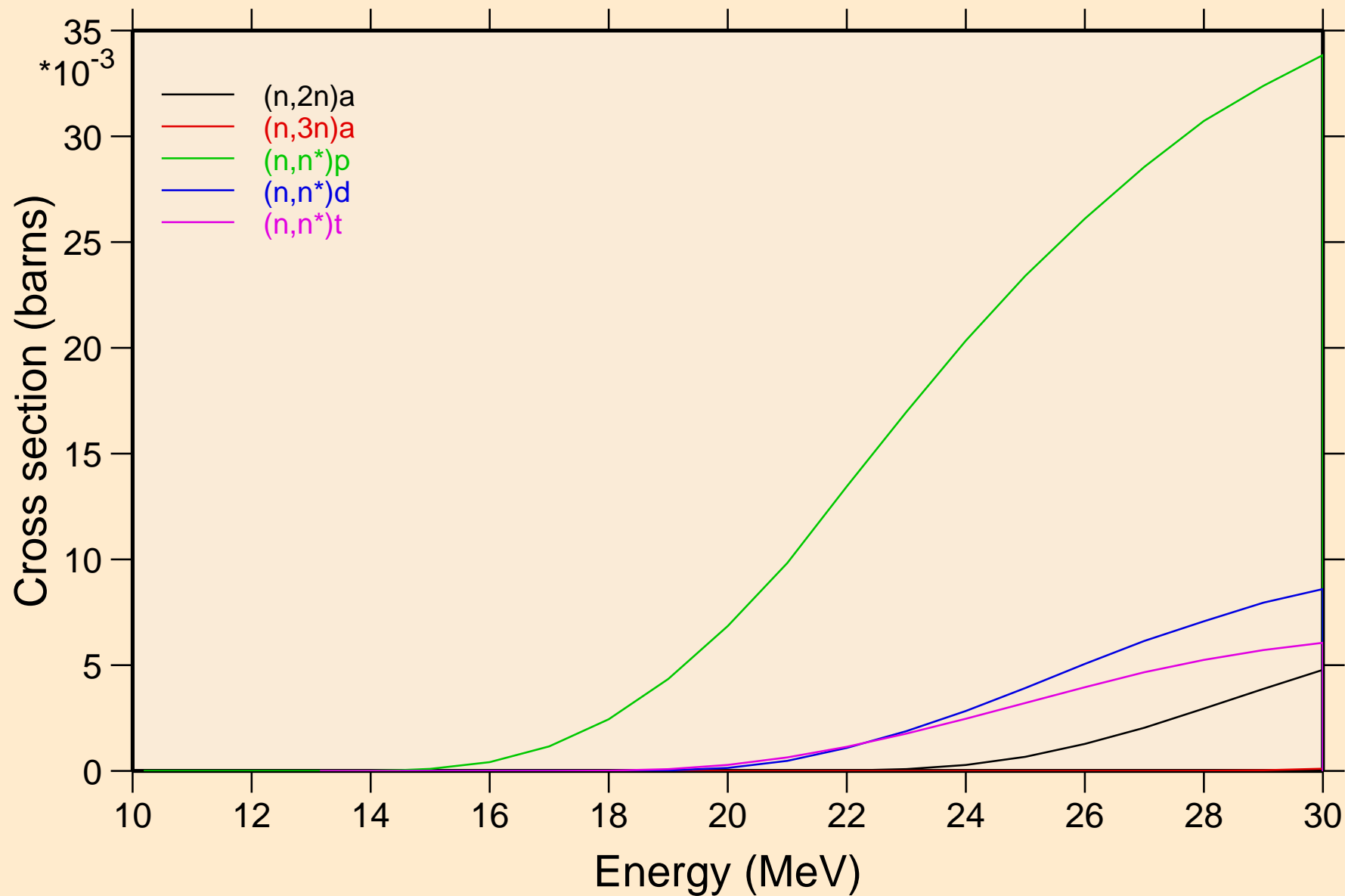

RB091 NEUTRON ACER TENDL-2019 LIBRARY; T=293.16K  
Threshold reactions

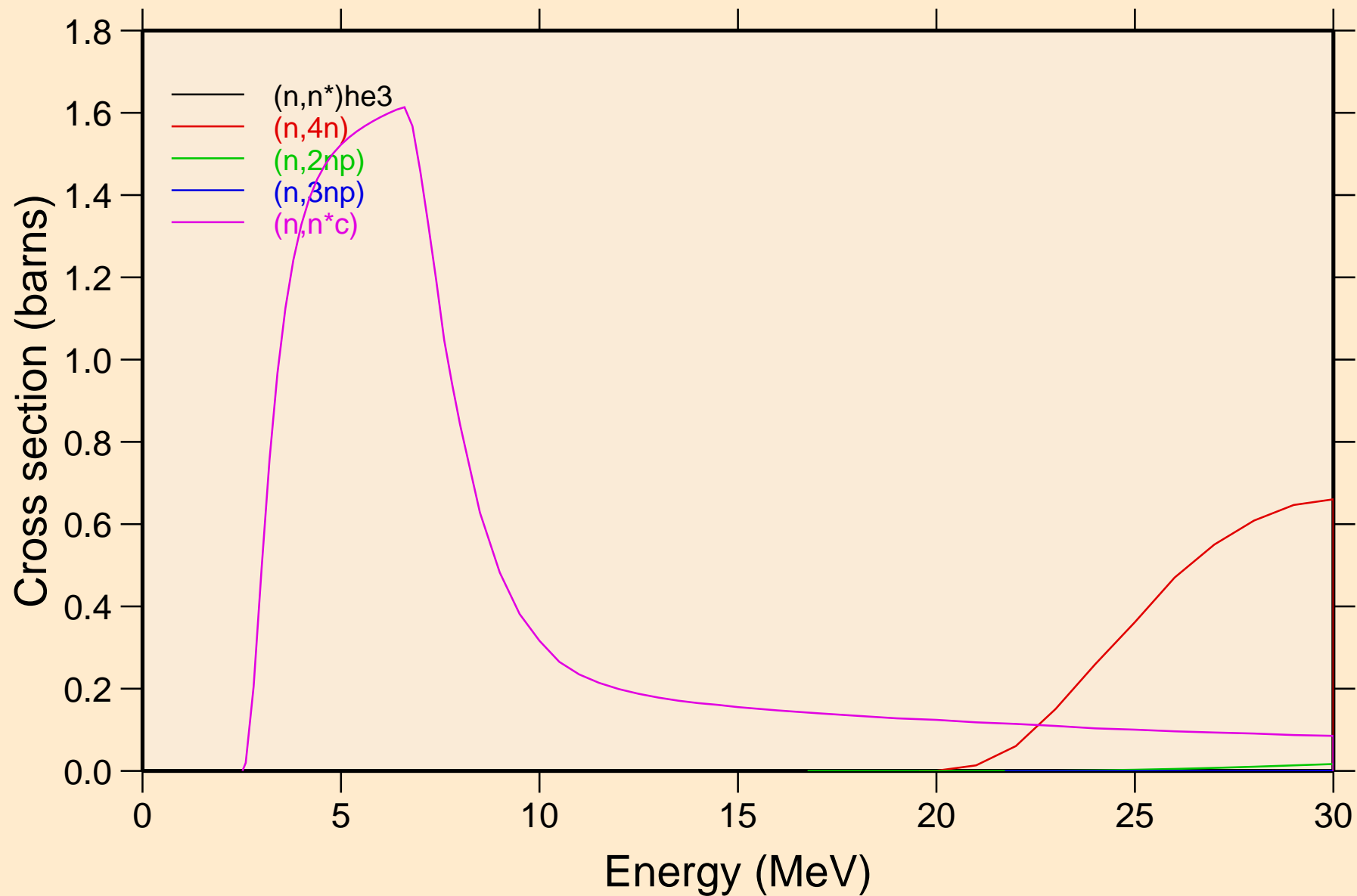

RB091 NEUTRON ACER TENDL-2019 LIBRARY; T=293.16K  
Threshold reactions

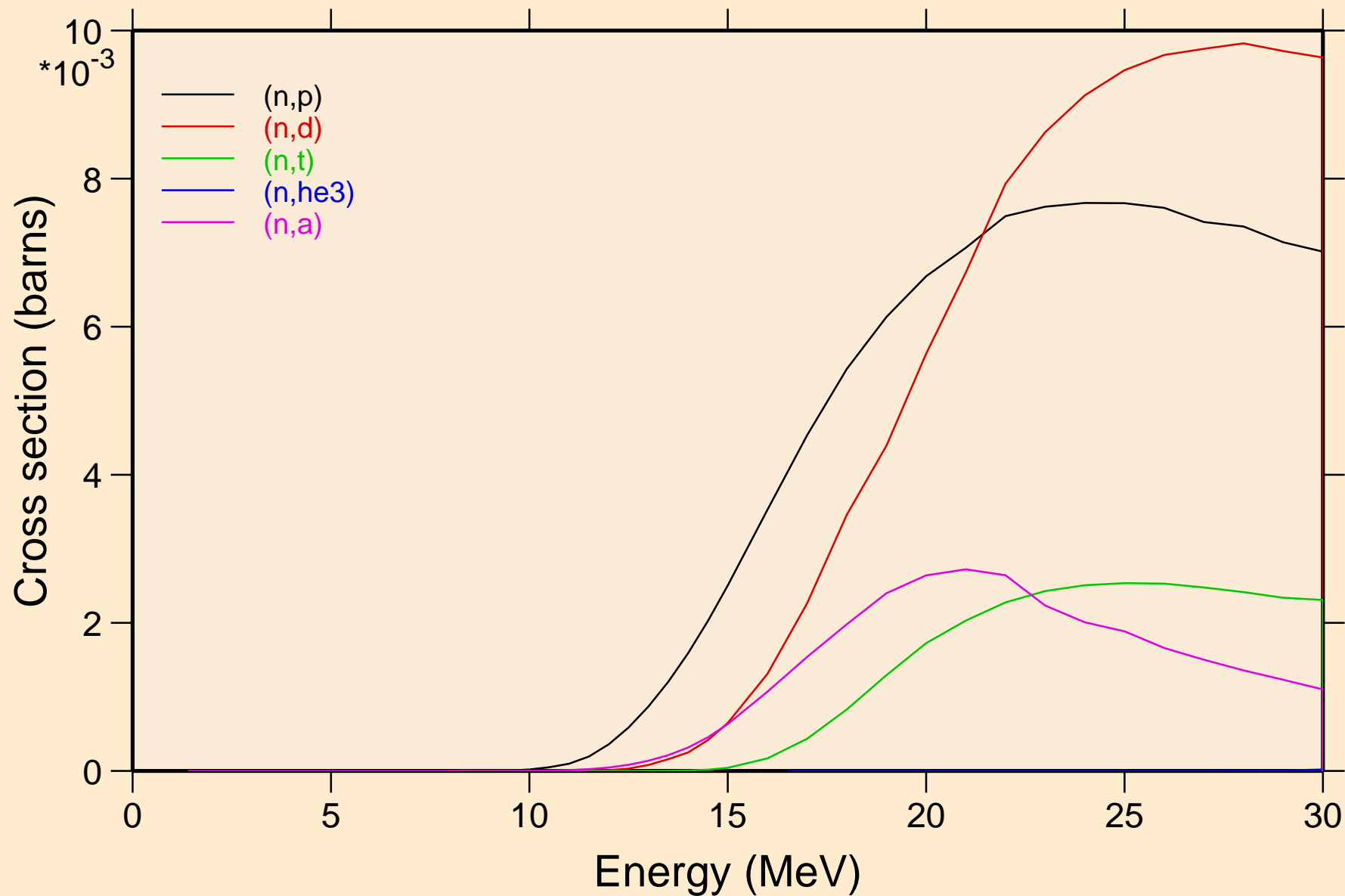



RB091 NEUTRON ACER TENDL-2019 LIBRARY; T=293.16K  
Threshold reactions

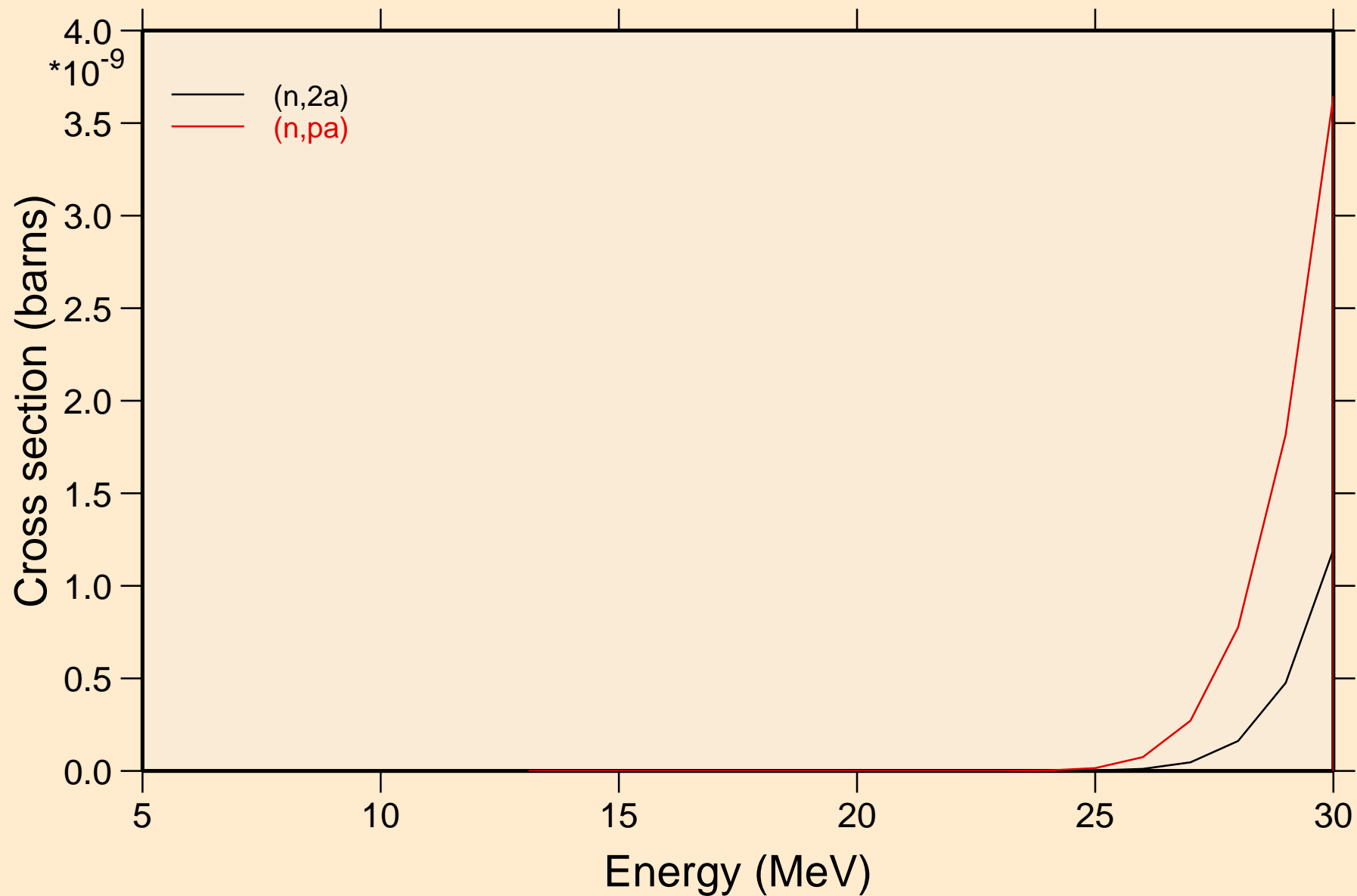

RB091 NEUTRON ACER TENDL-2019 LIBRARY; T=293.16K  
Threshold reactions

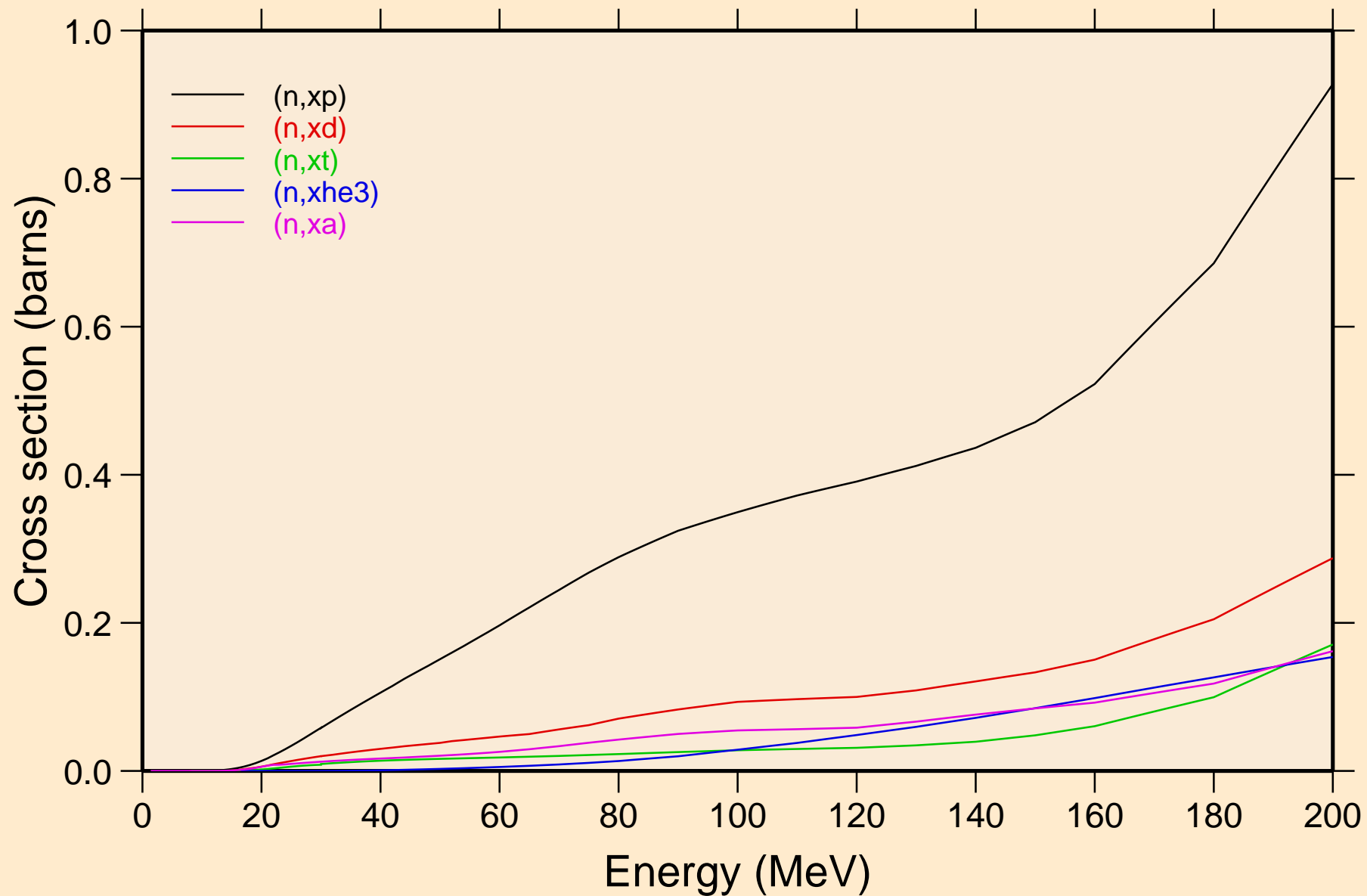

RB091 NEUTRON ACER TENDL-2019 LIBRARY; T=293.16K  
angular distribution for elastic

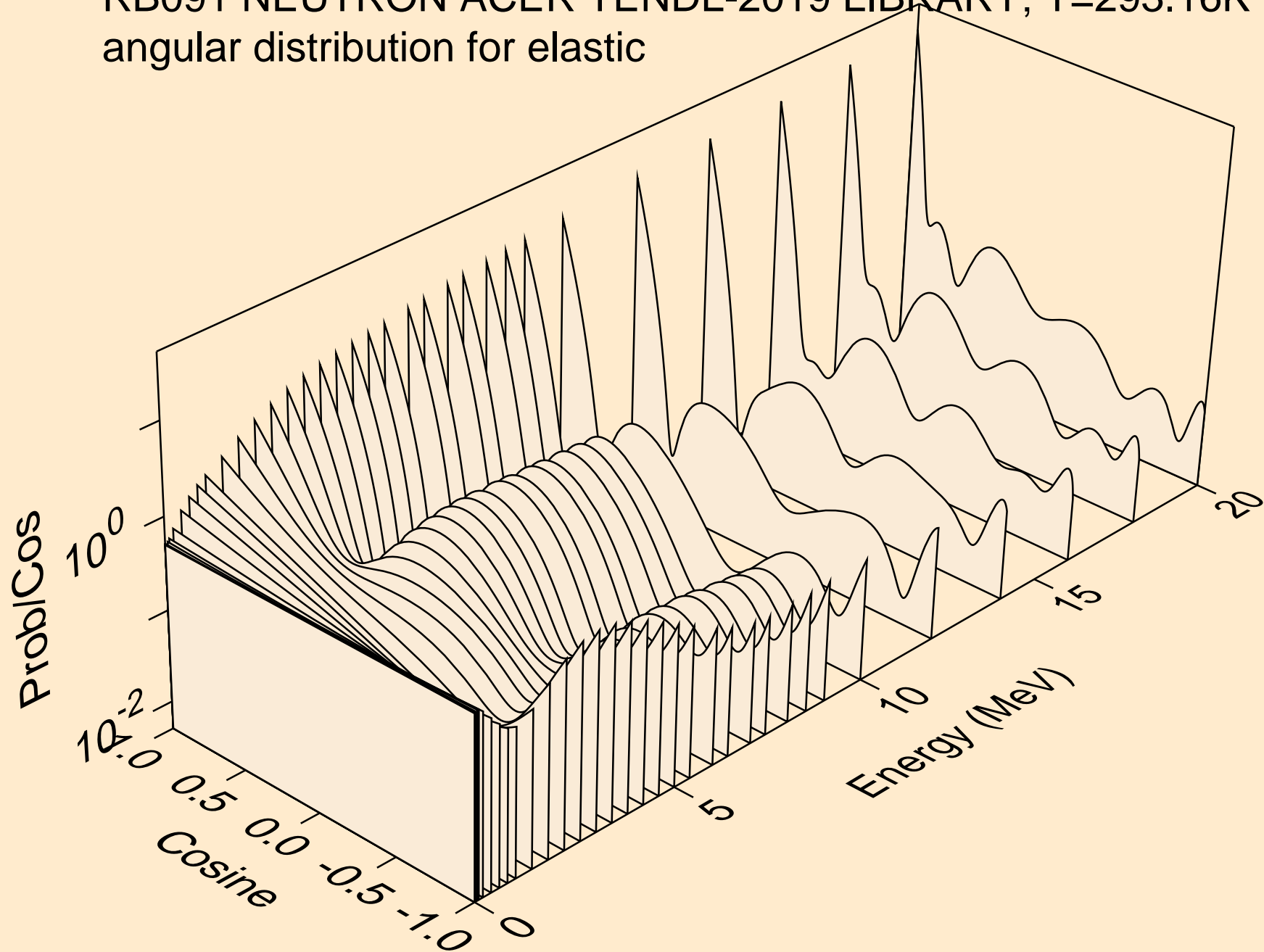

RB091 NEUTRON ACER TENDL-2019 LIBRARY; T=293.16K  
angular distribution for elastic

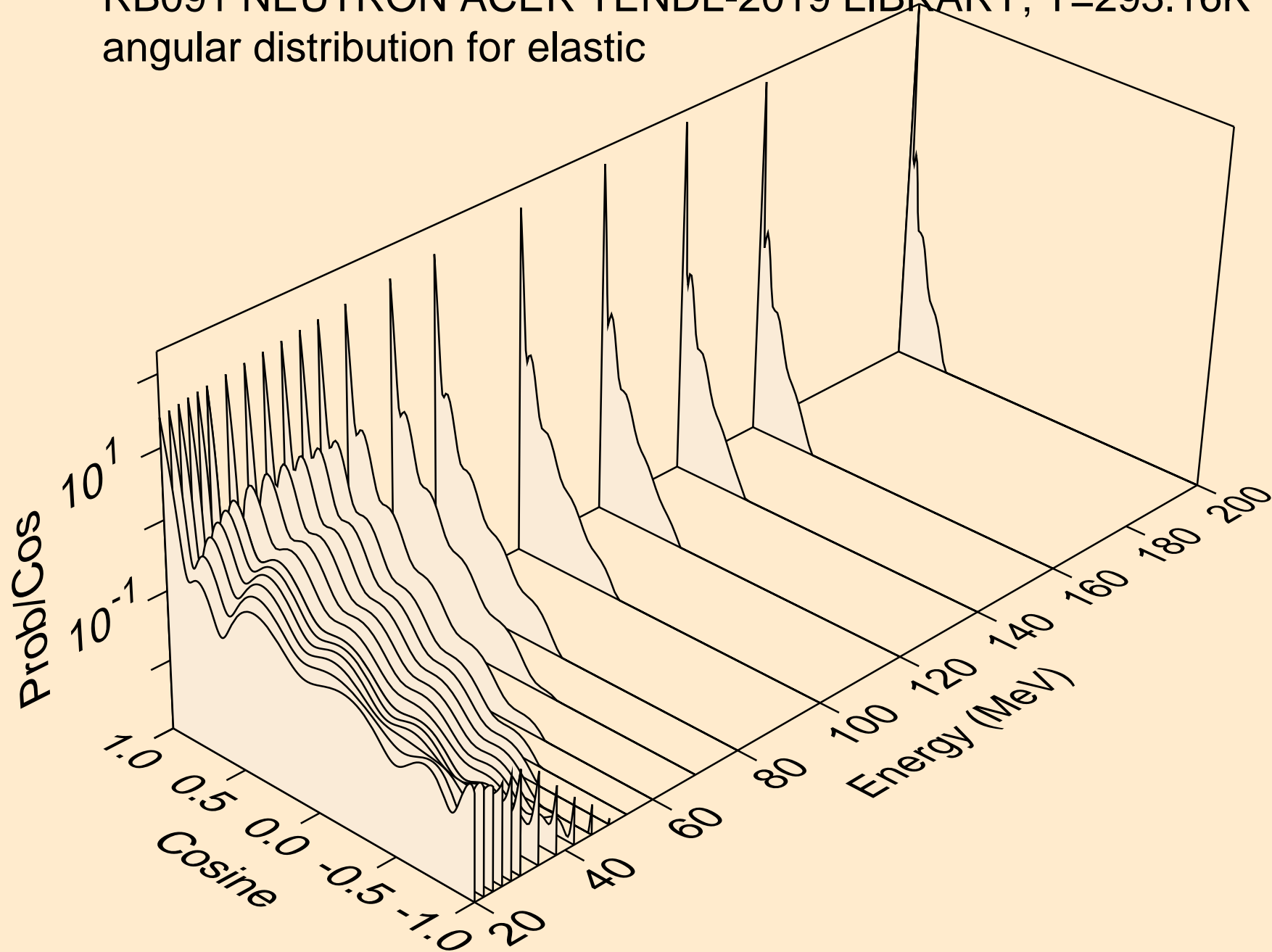

RB091 NEUTRON ACER TENDL-2019 LIBRARY; T=293.16K  
angular distribution for (n,n\*1)

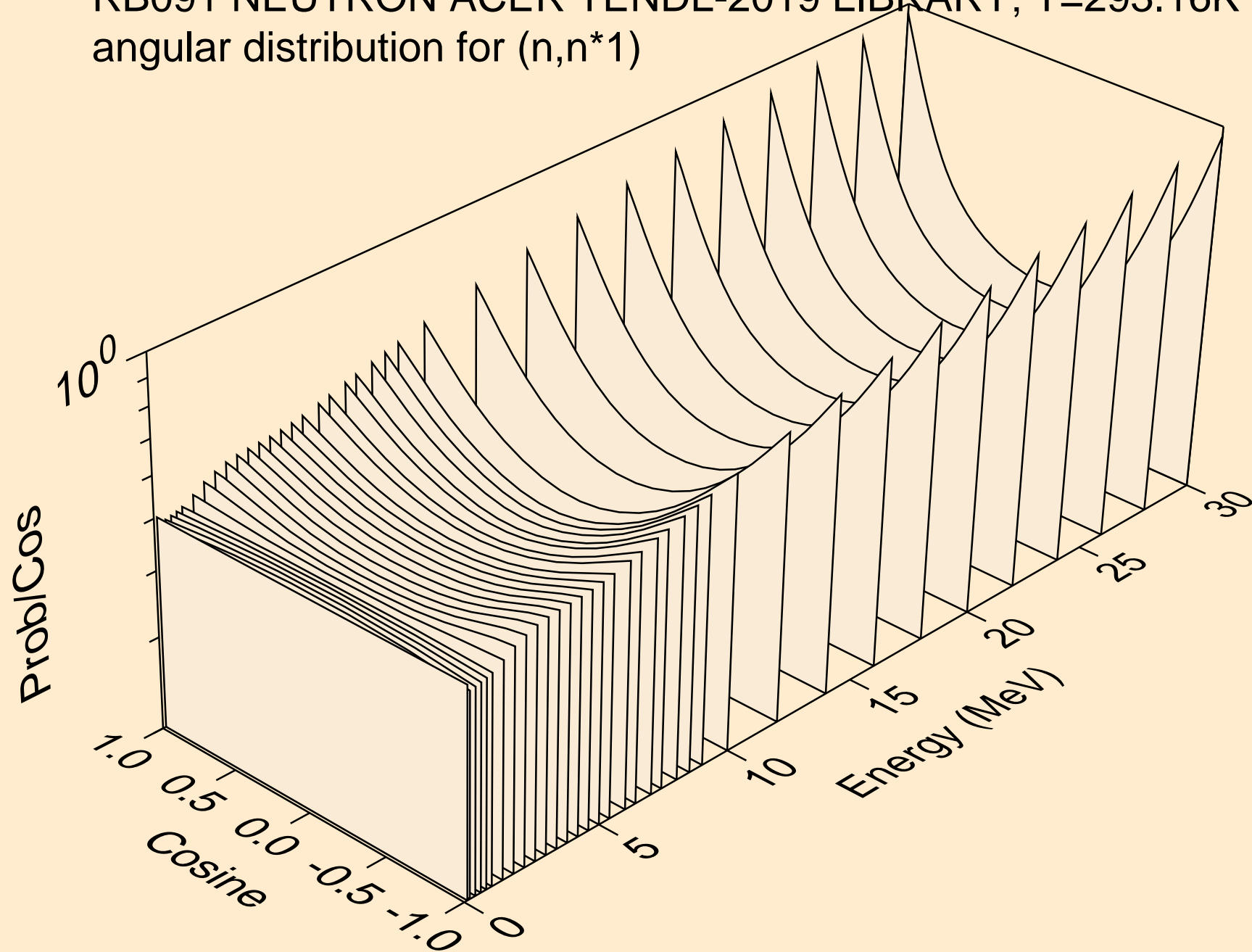

RB091 NEUTRON ACER TENDL-2019 LIBRARY; T=293.16K  
angular distribution for (n,n\*2)

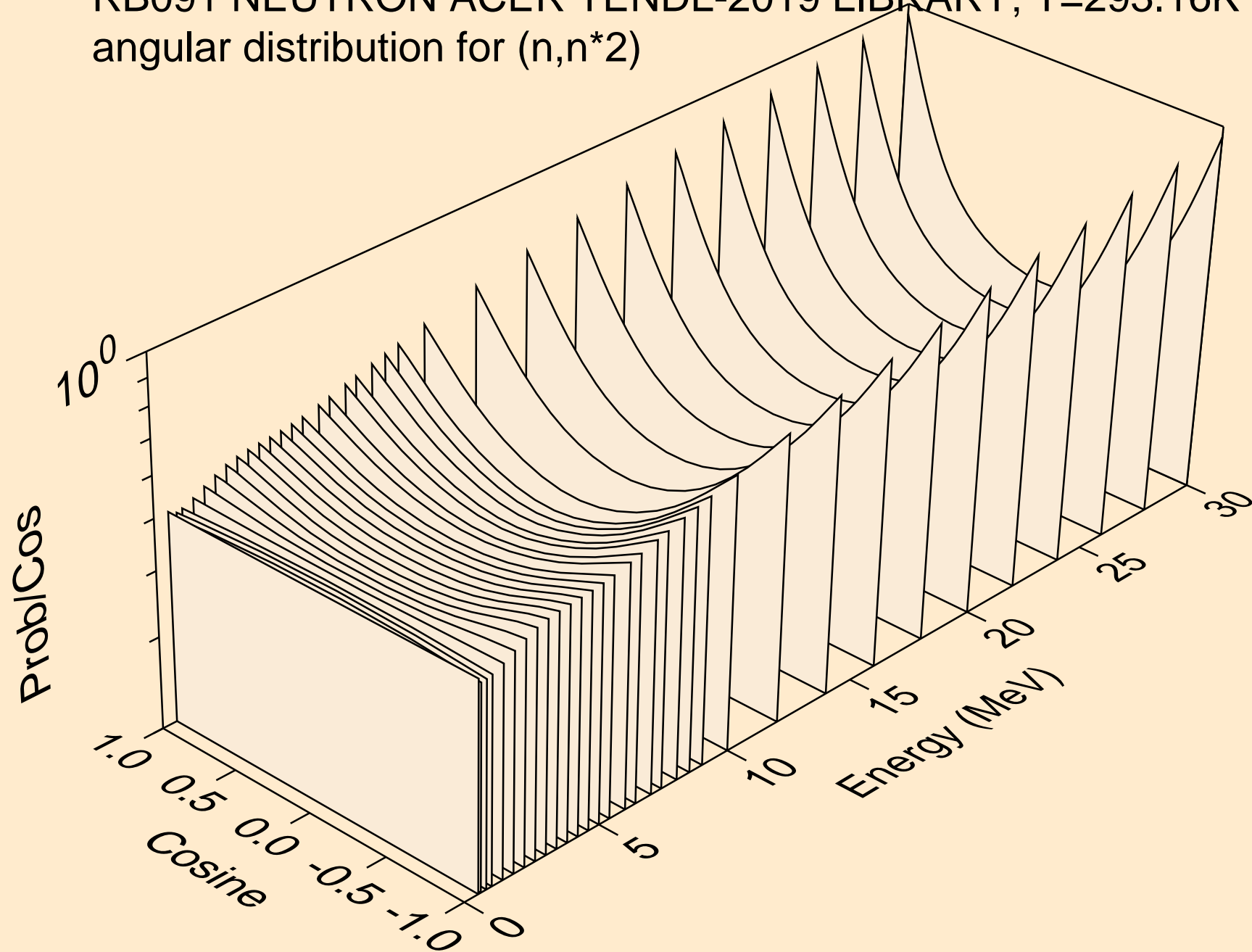

RB091 NEUTRON ACER TENDL-2019 LIBRARY; T=293.16K  
angular distribution for (n,n\*3)

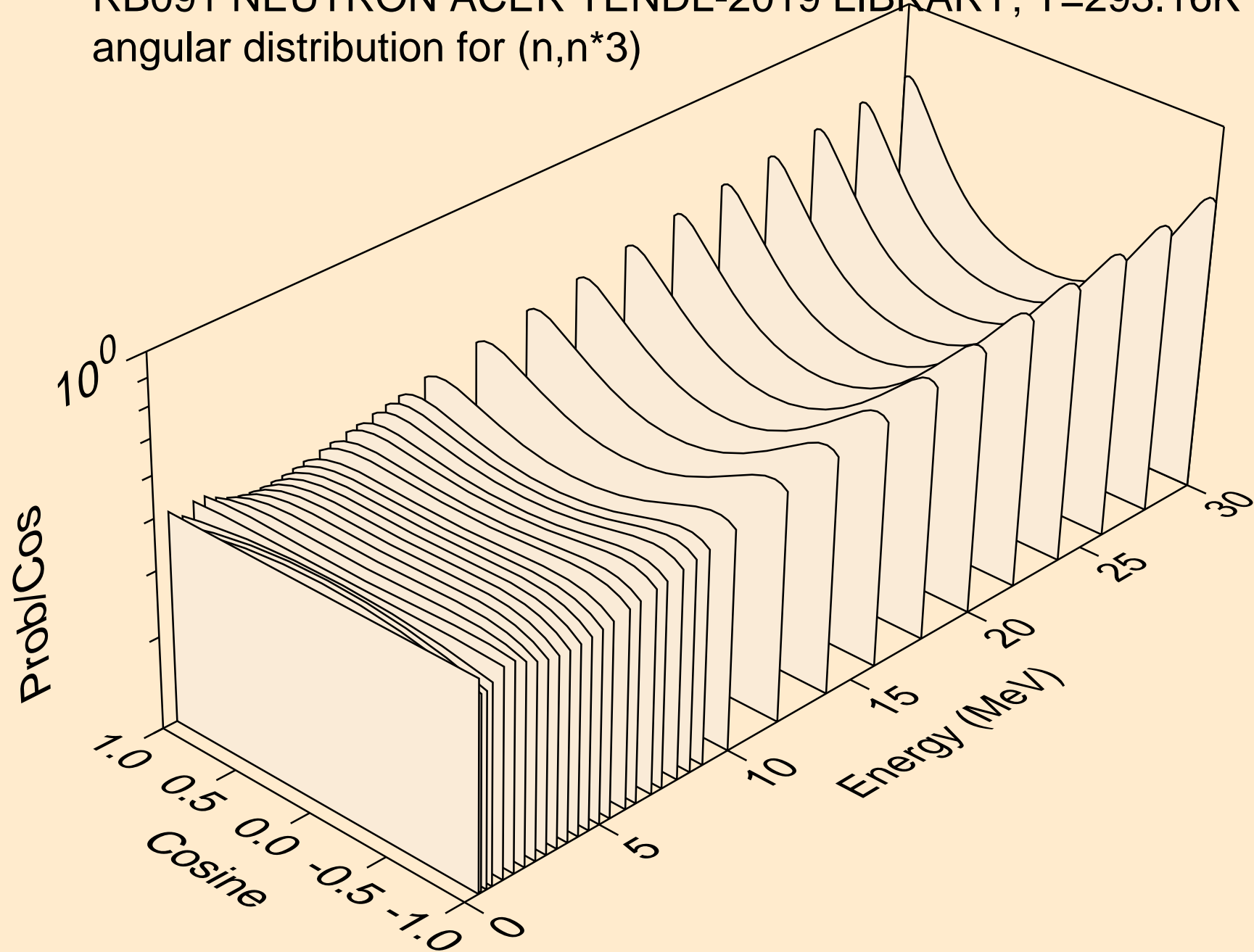

RB091 NEUTRON ACER TENDL-2019 LIBRARY; T=293.16K  
angular distribution for (n,n\*4)

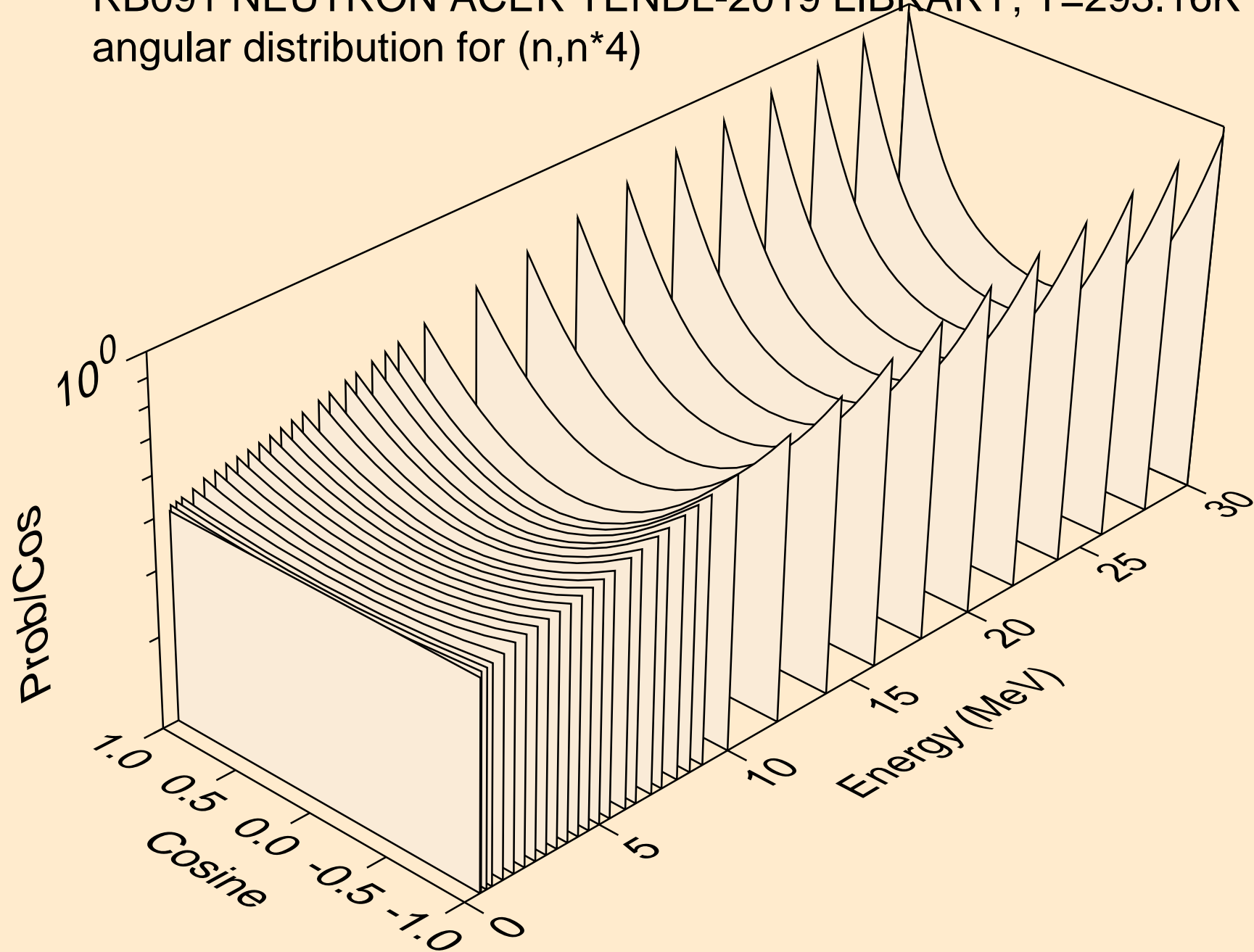



RB091 NEUTRON ACER TENDL-2019 LIBRARY; T=293.16K  
angular distribution for (n,n\*5)

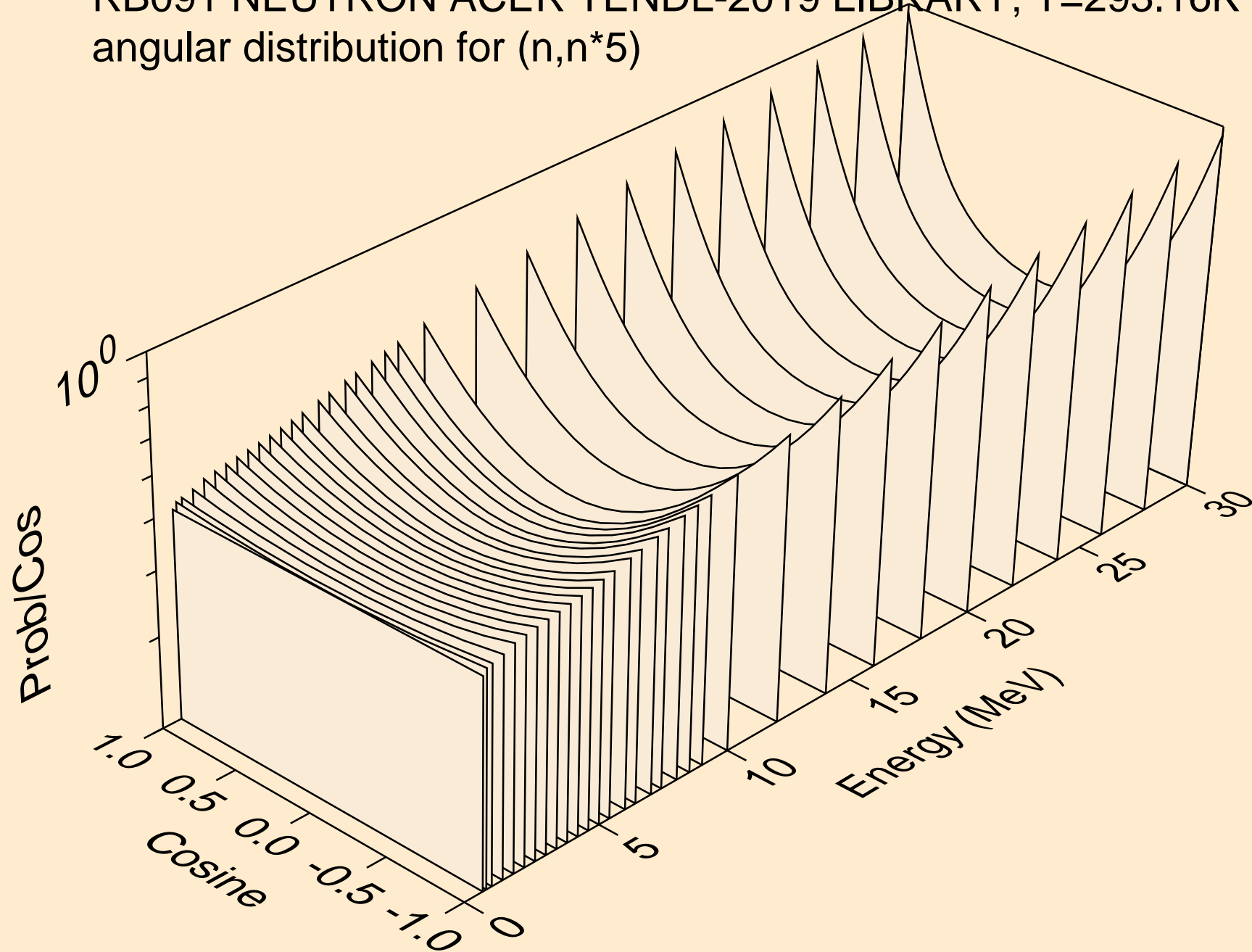

RB091 NEUTRON ACER TENDL-2019 LIBRARY; T=293.16K  
angular distribution for (n,n\*6)

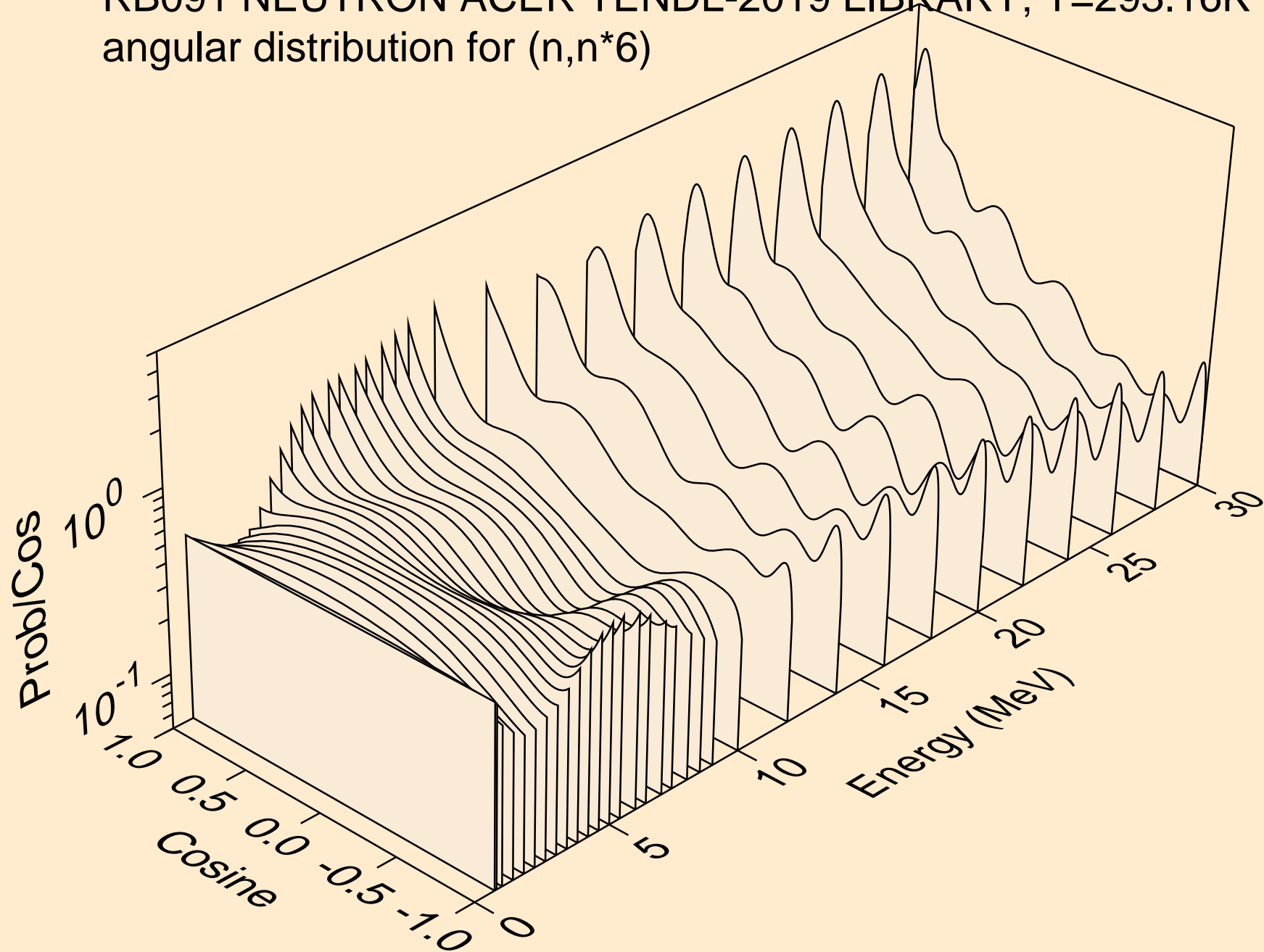

RB091 NEUTRON ACER TENDL-2019 LIBRARY; T=293.16K  
angular distribution for (n,n\*7)

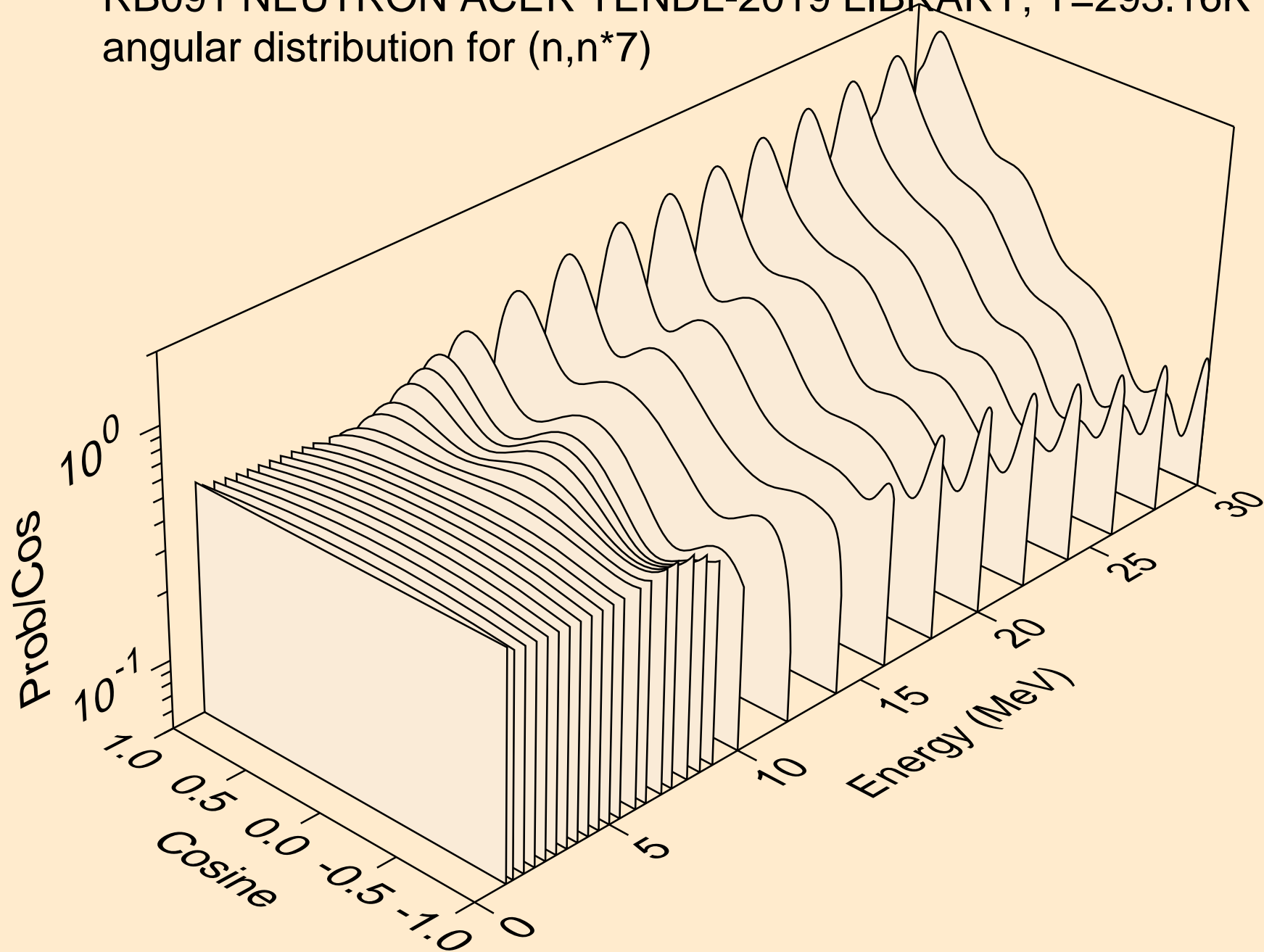

RB091 NEUTRON ACER TENDL-2019 LIBRARY; T=293.16K  
angular distribution for (n,n\*8)

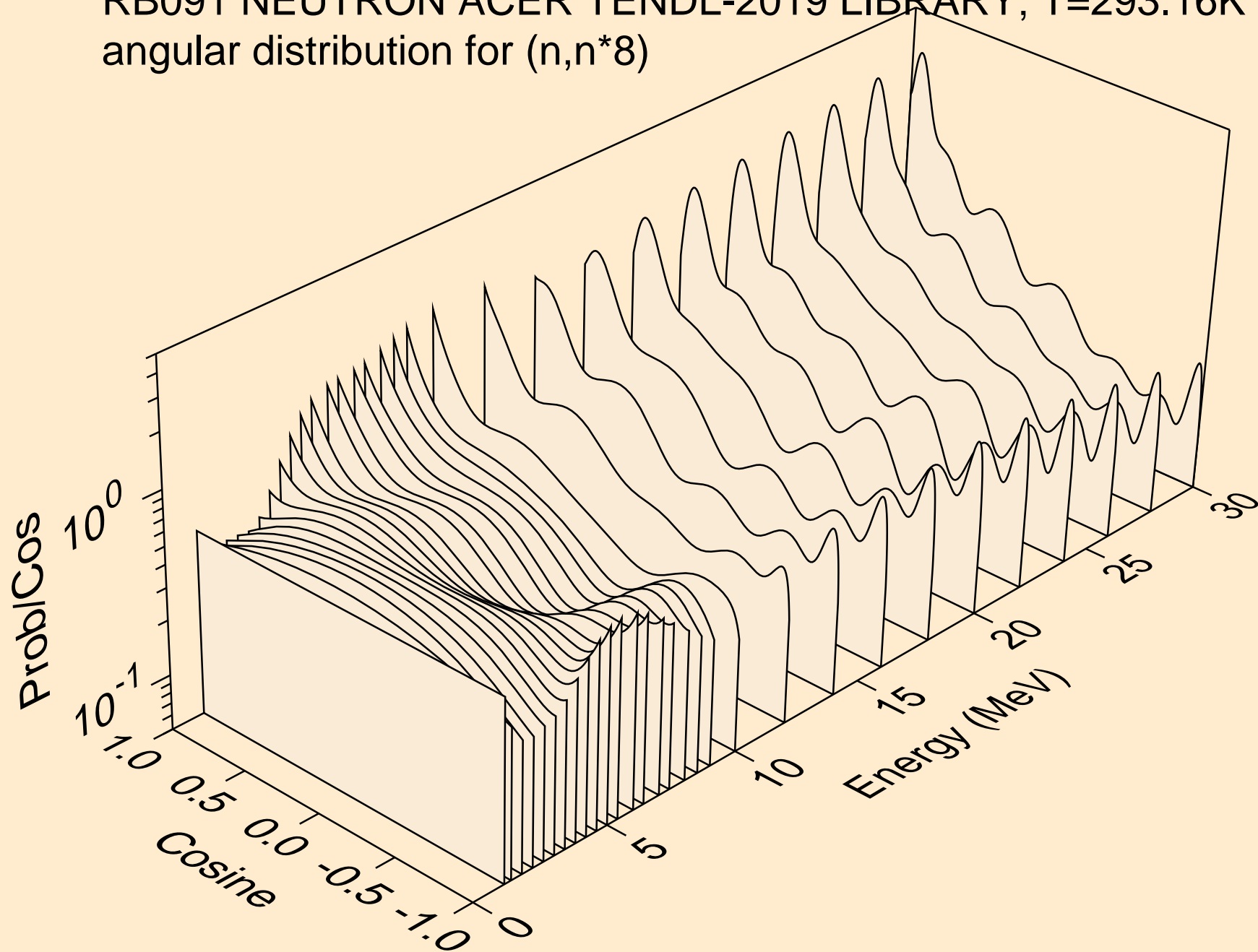

RB091 NEUTRON ACER TENDL-2019 LIBRARY; T=293.16K  
angular distribution for (n,n\*9)

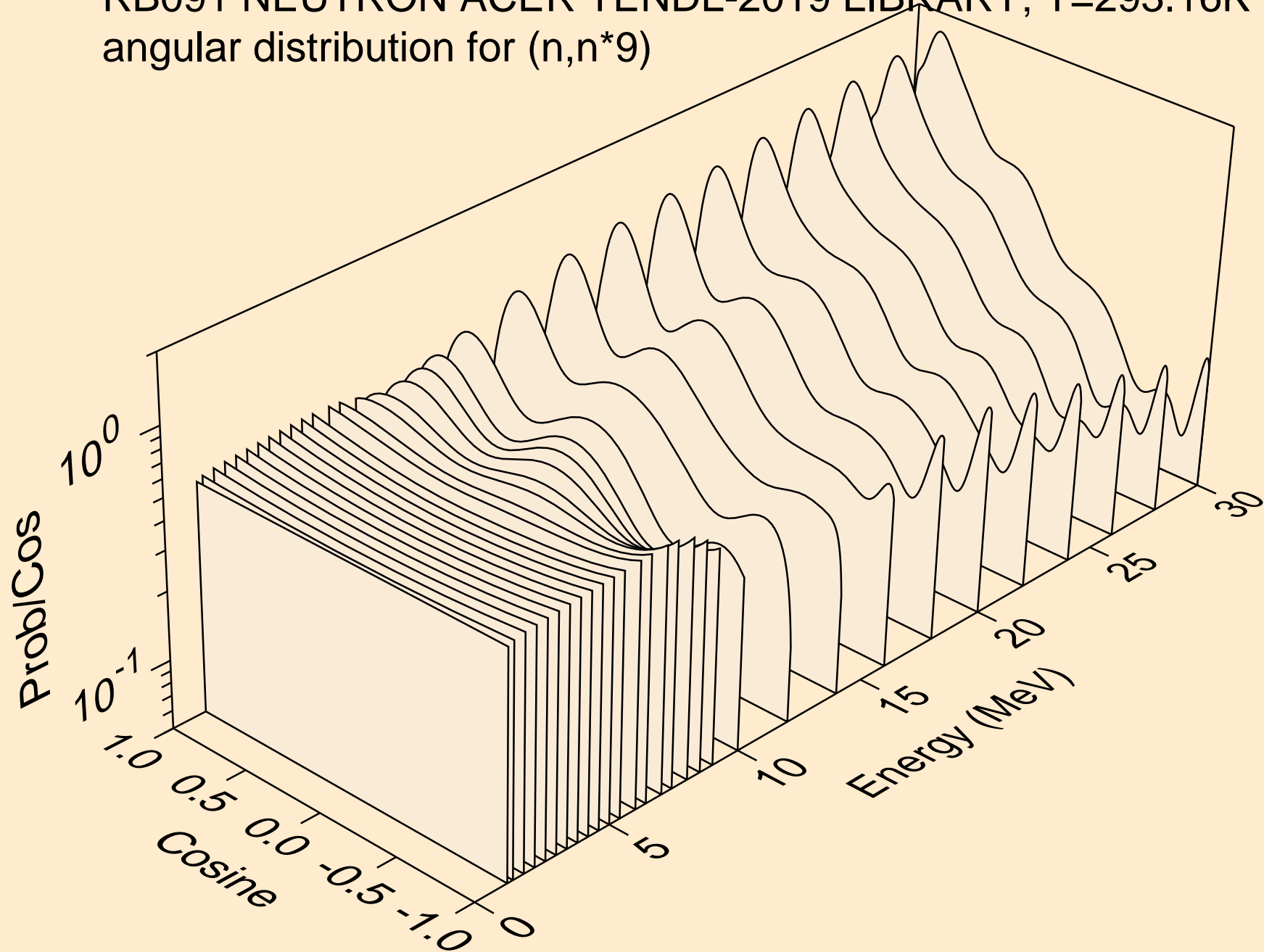

RB091 NEUTRON ACER TENDL-2019 LIBRARY; T=293.16K  
angular distribution for (n,n\*10)

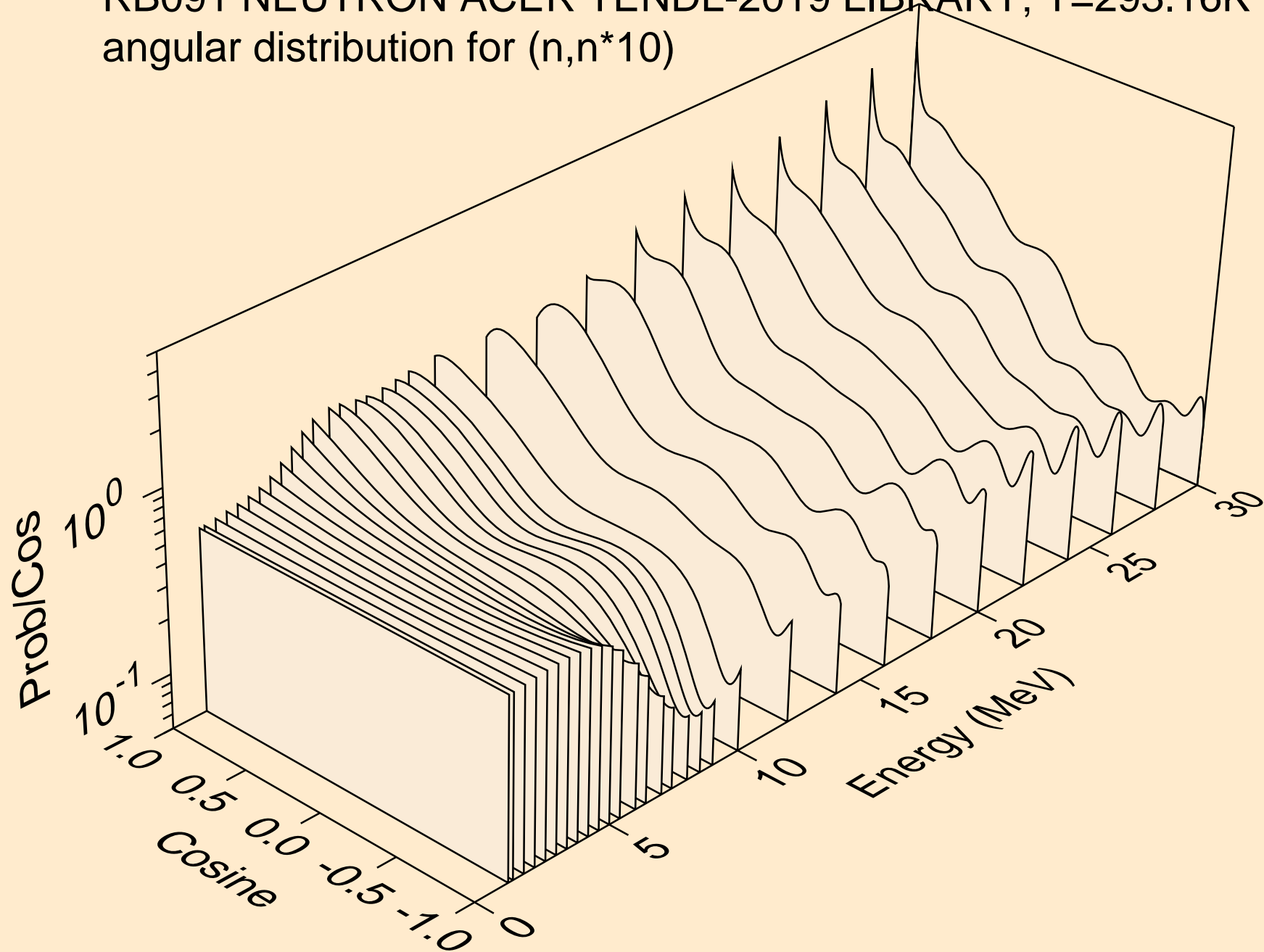

RB091 NEUTRON ACER TENDL-2019 LIBRARY; T=293.16K  
angular distribution for (n,n\*11)

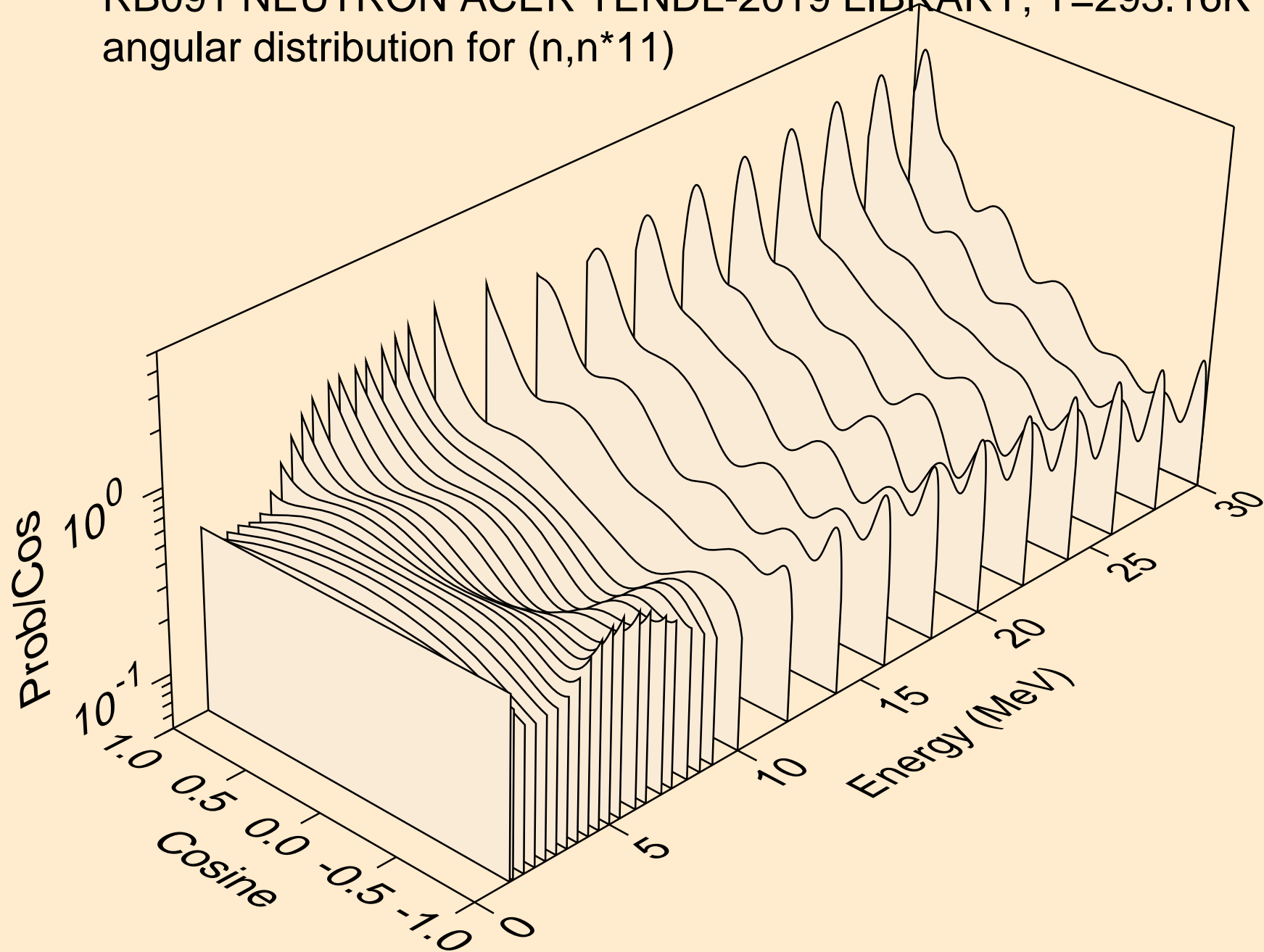

RB091 NEUTRON ACER TENDL-2019 LIBRARY; T=293.16K  
angular distribution for (n,n\*12)

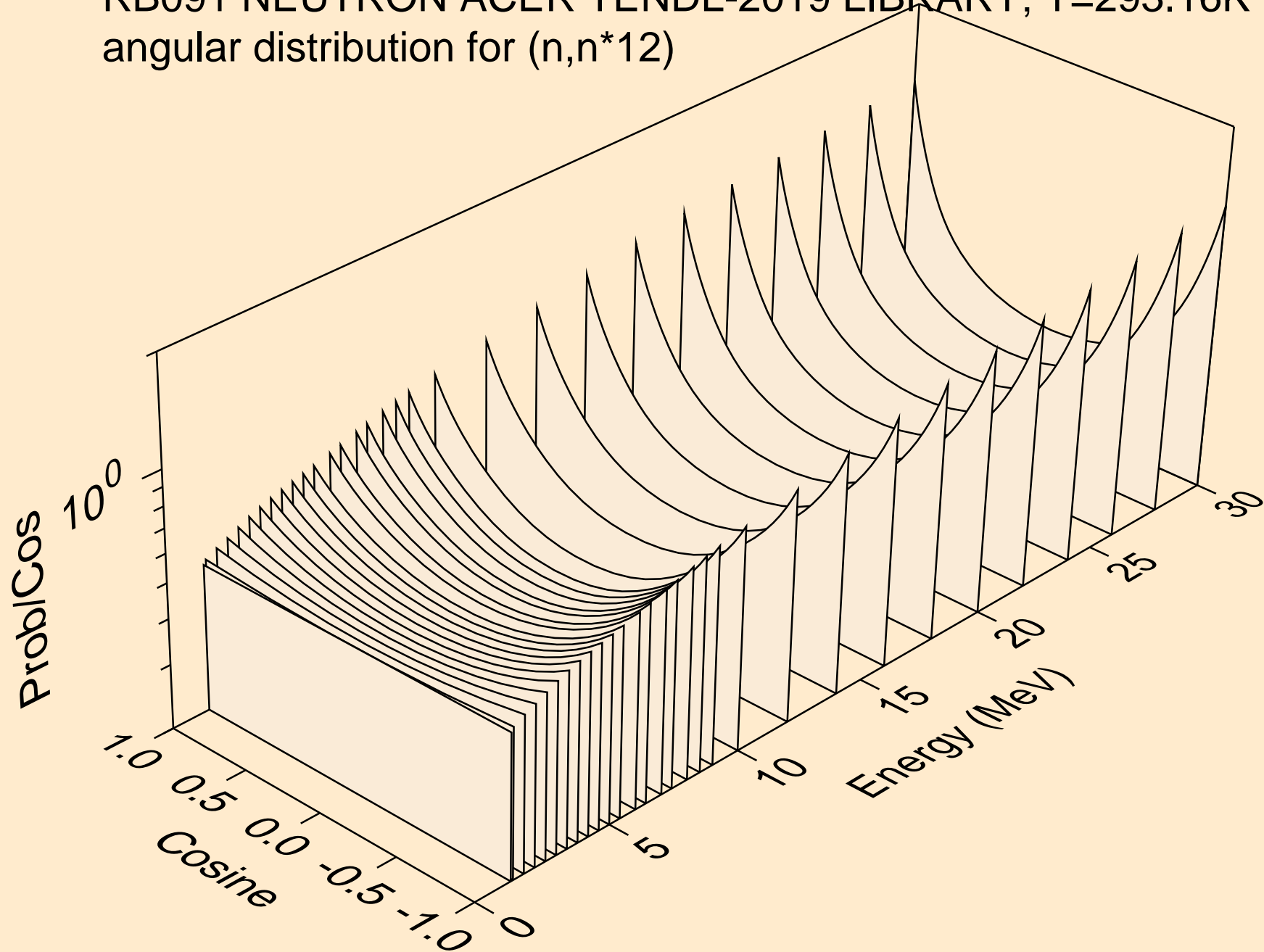



RB091 NEUTRON ACER TENDL-2019 LIBRARY; T=293.16K  
angular distribution for (n,n\*13)

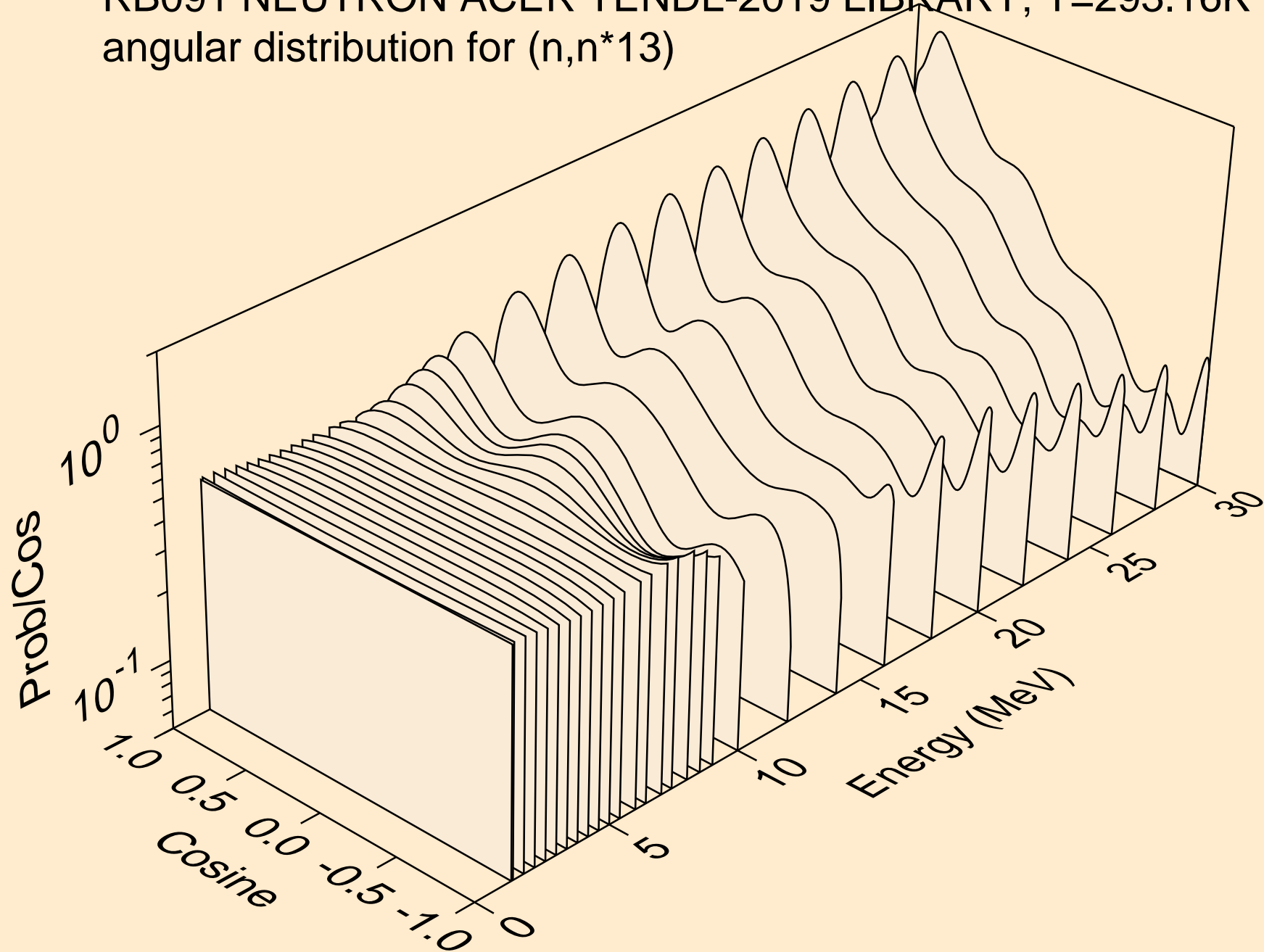

RB091 NEUTRON ACER TENDL-2019 LIBRARY; T=293.16K  
angular distribution for (n,n\*14)

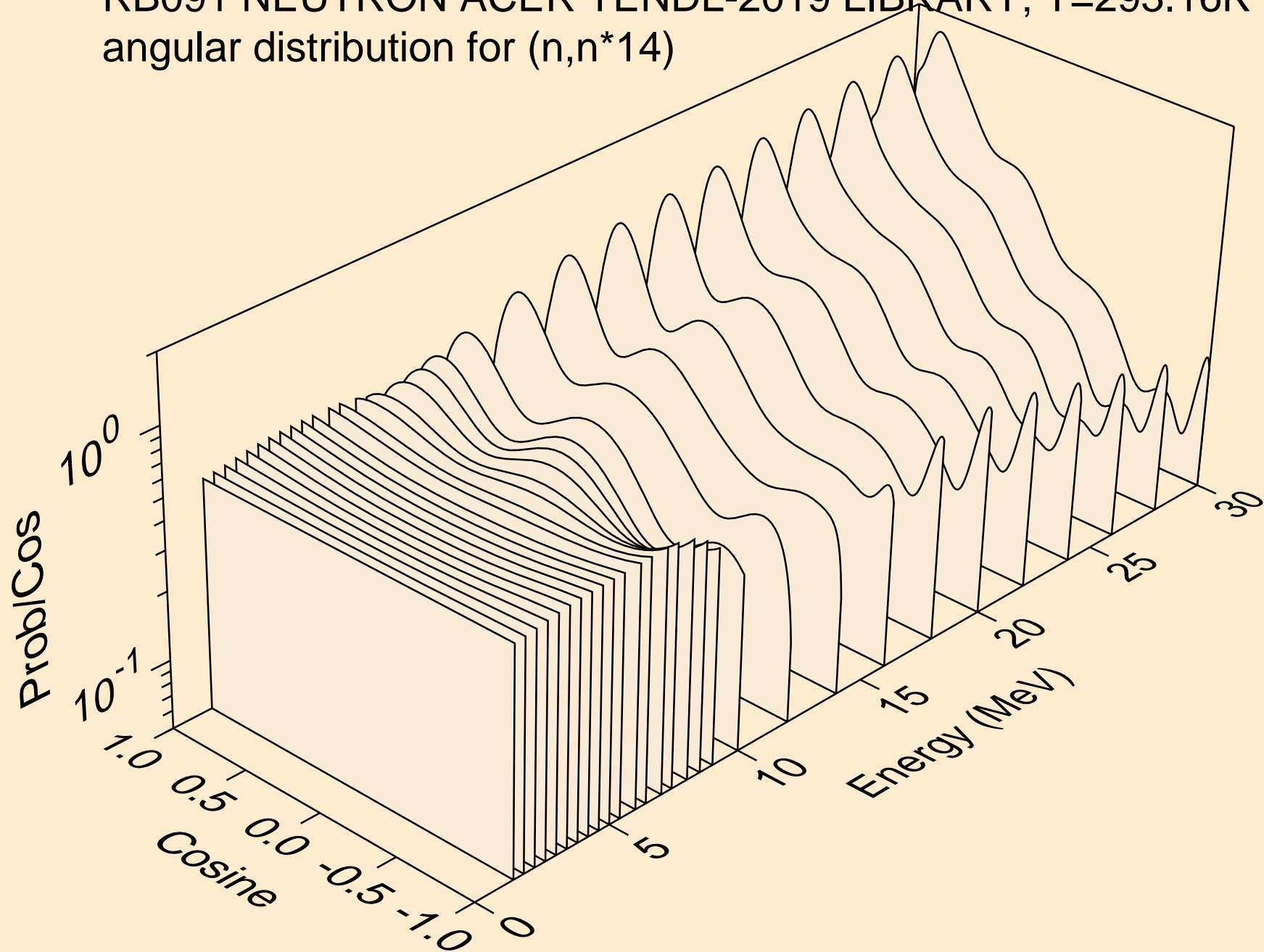

RB091 NEUTRON ACER TENDL-2019 LIBRARY; T=293.16K  
angular distribution for (n,n\*15)

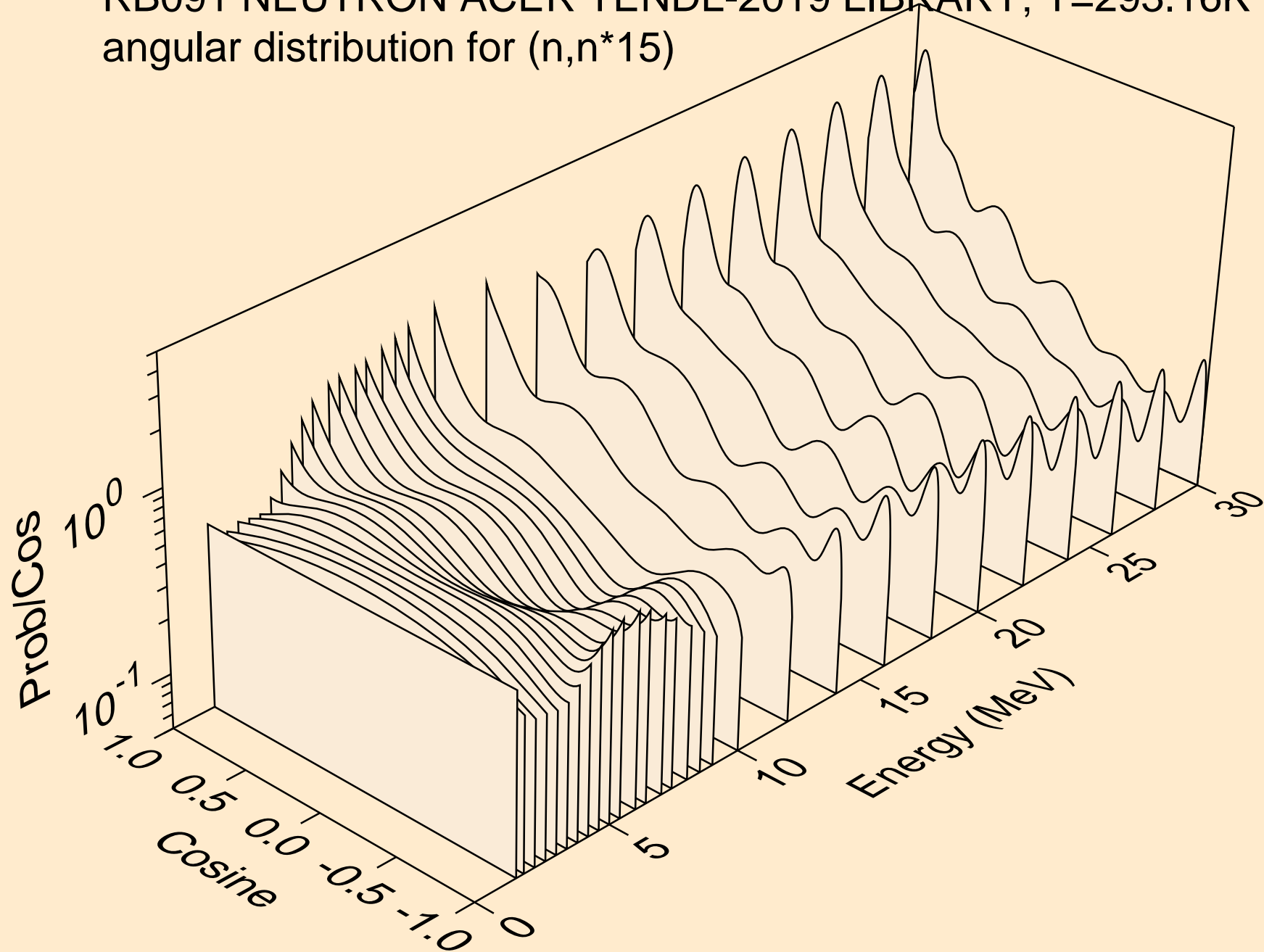

RB091 NEUTRON ACER TENDL-2019 LIBRARY; T=293.16K  
angular distribution for (n,n\*16)

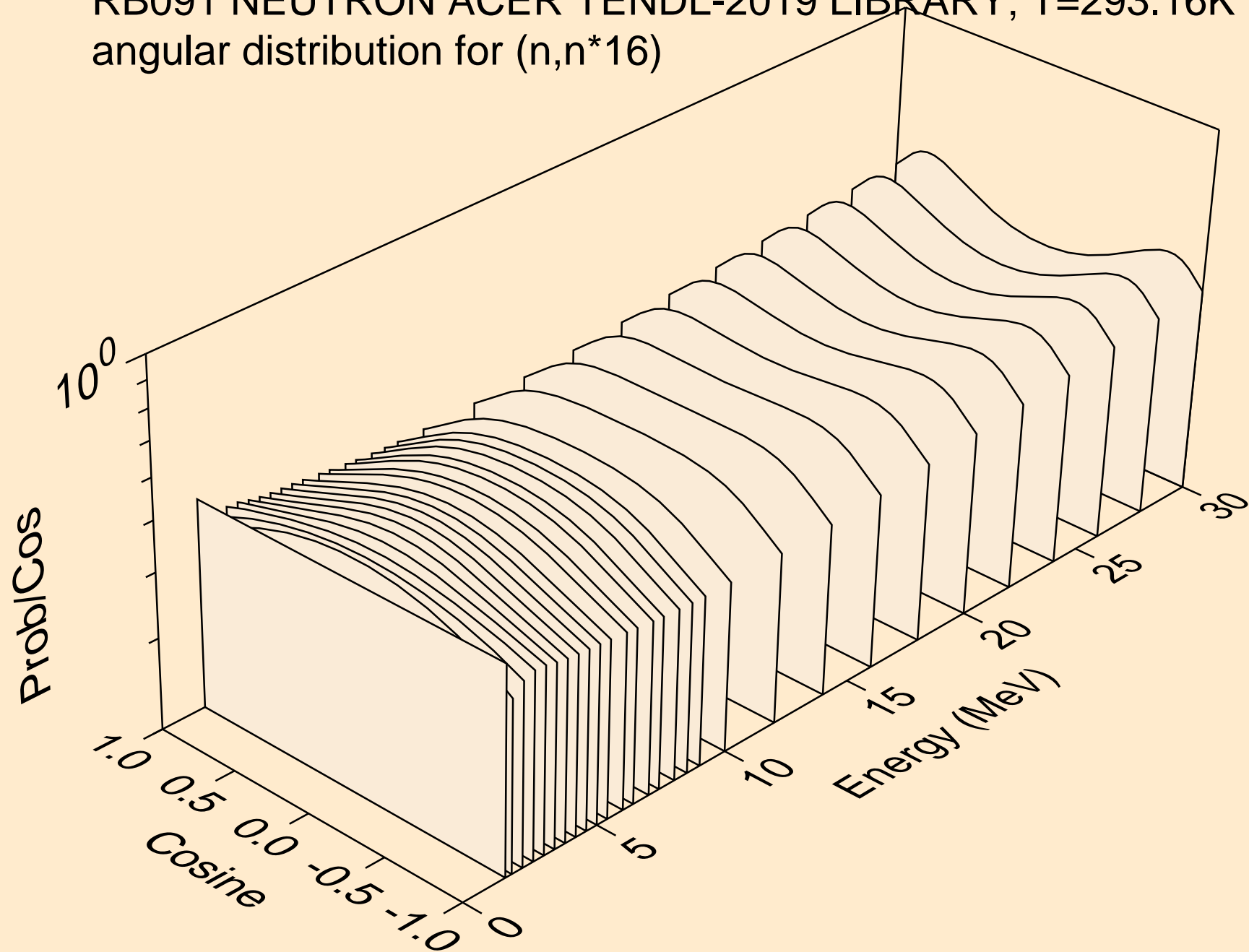

RB091 NEUTRON ACER TENDL-2019 LIBRARY; T=293.16K  
angular distribution for (n,n\*17)

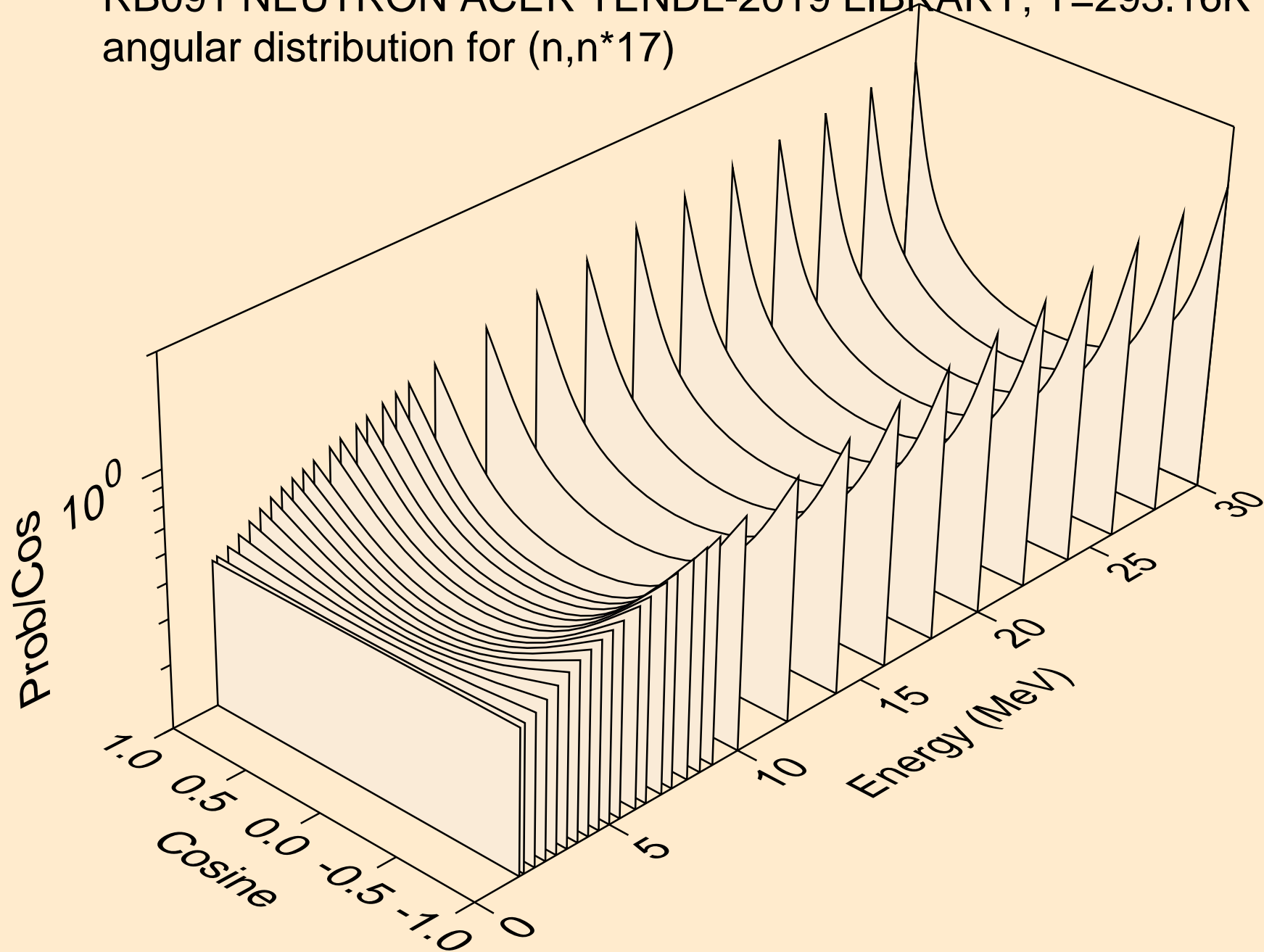

RB091 NEUTRON ACER TENDL-2019 LIBRARY; T=293.16K  
angular distribution for (n,n\*18)

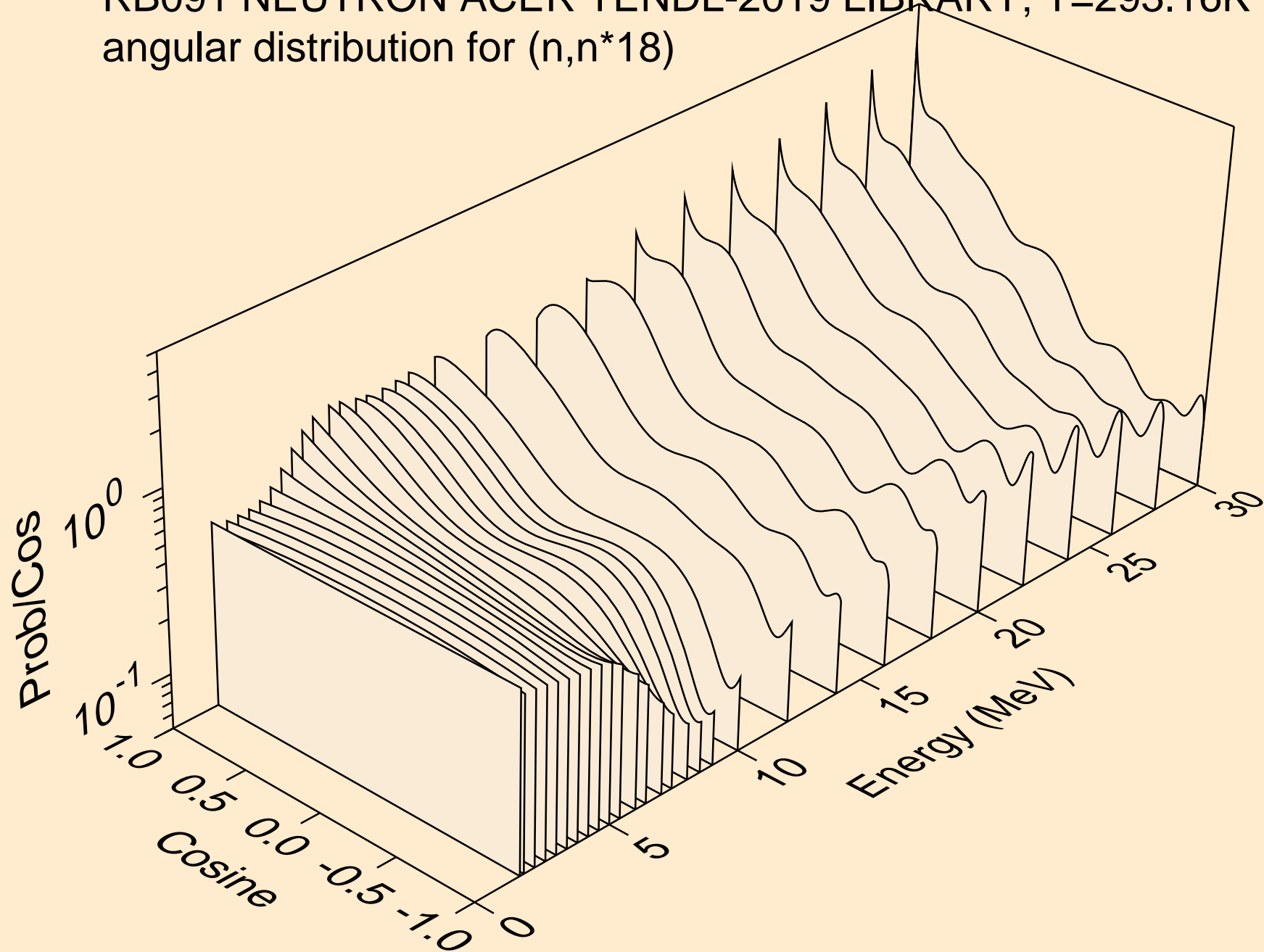

RB091 NEUTRON ACER TENDL-2019 LIBRARY; T=293.16K  
angular distribution for (n,n\*19)

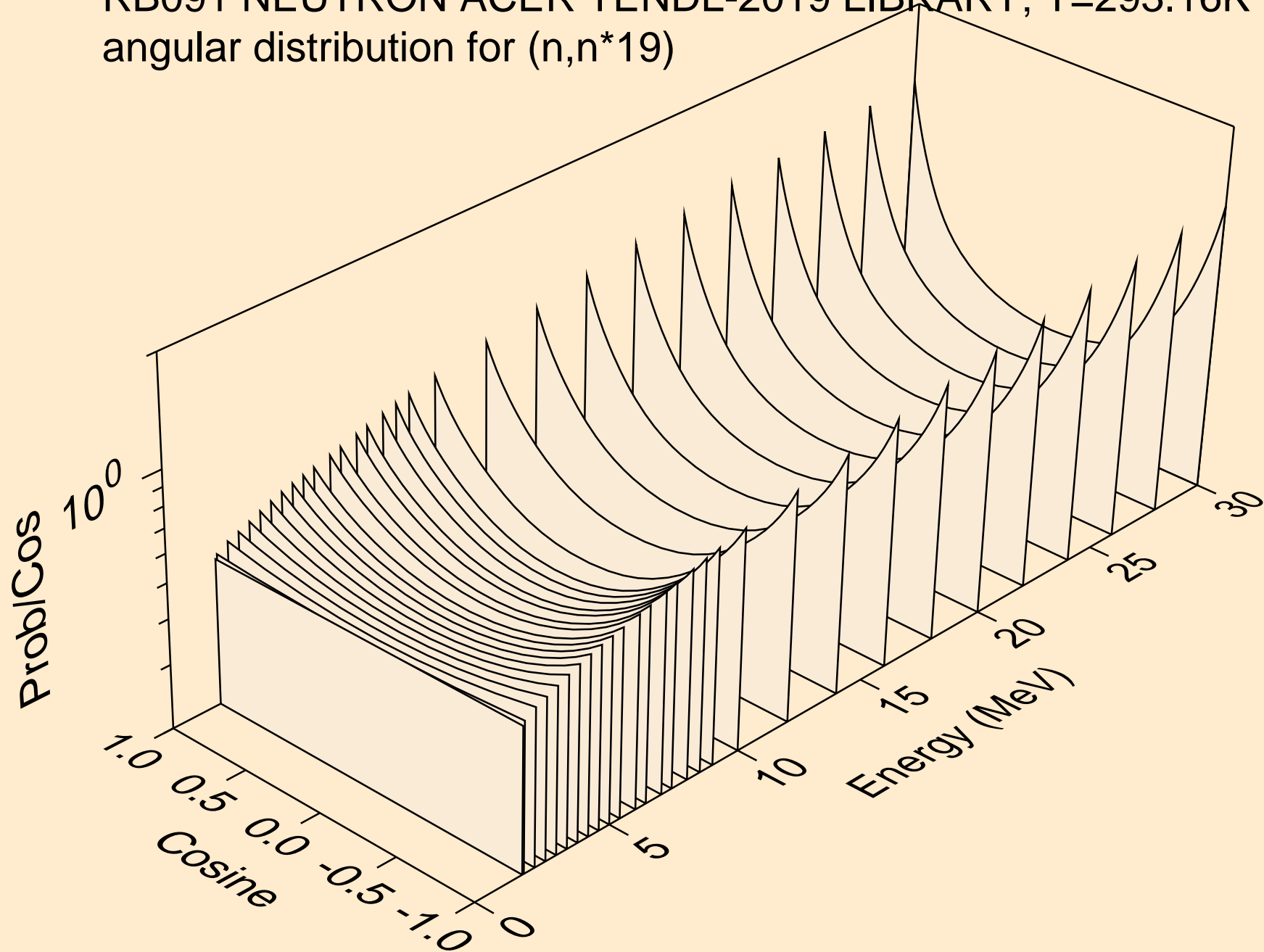

RB091 NEUTRON ACER TENDL-2019 LIBRARY; T=293.16K  
angular distribution for (n,n\*20)

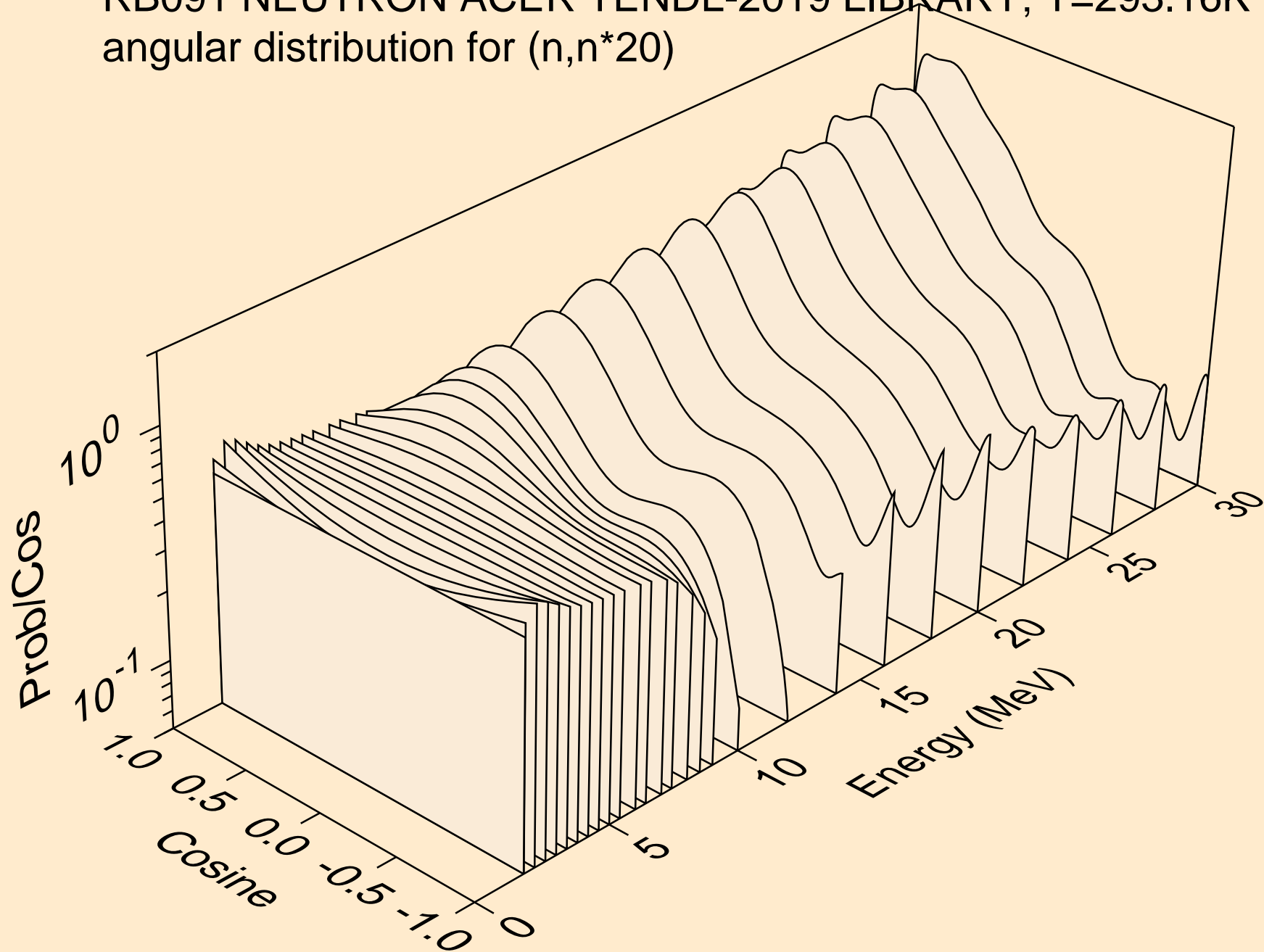



RB091 NEUTRON ACER TENDL-2019 LIBRARY; T=293.16K  
angular distribution for (n,n\*21)

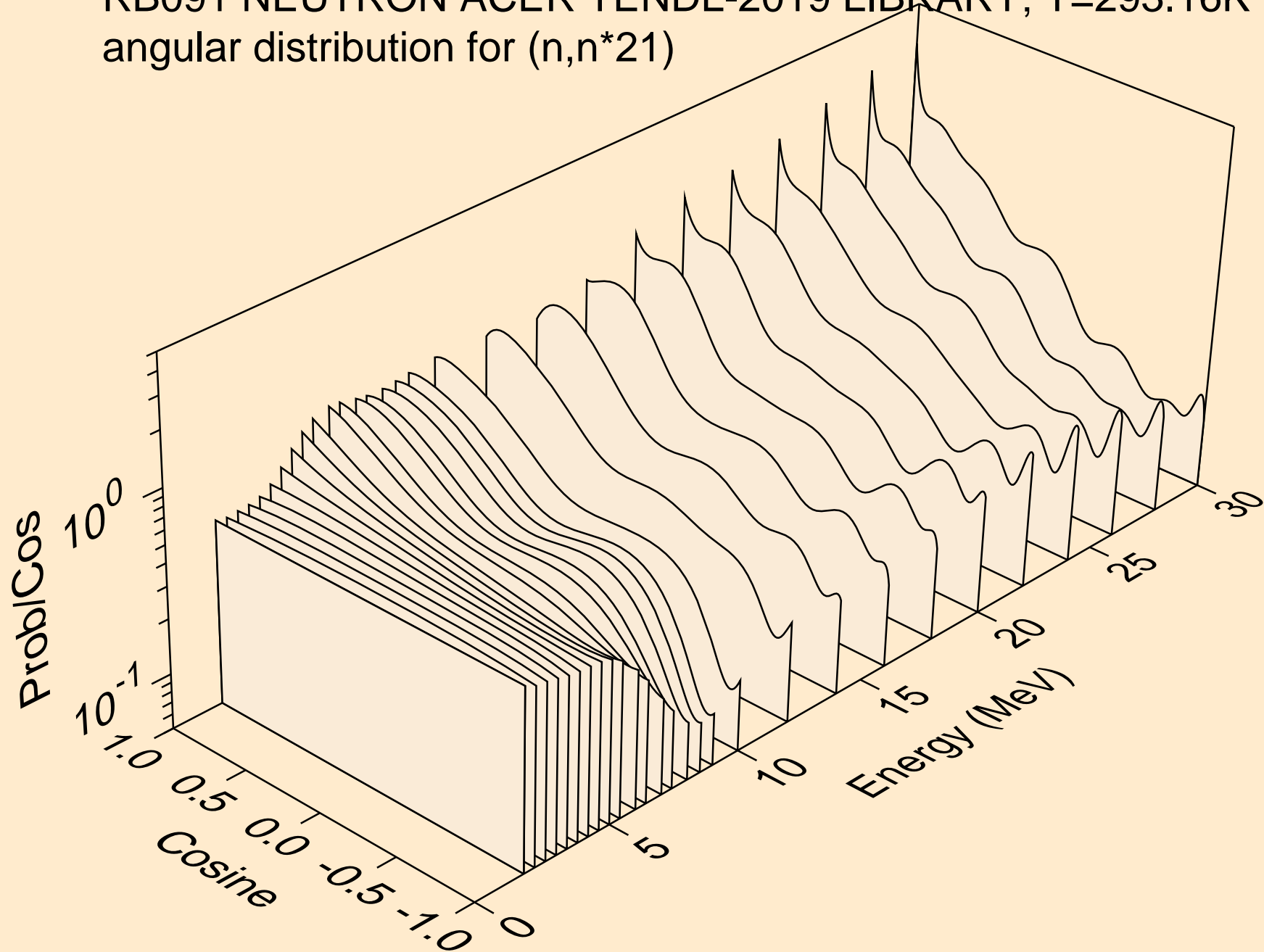

RB091 NEUTRON ACER TENDL-2019 LIBRARY; T=293.16K  
angular distribution for (n,n\*22)

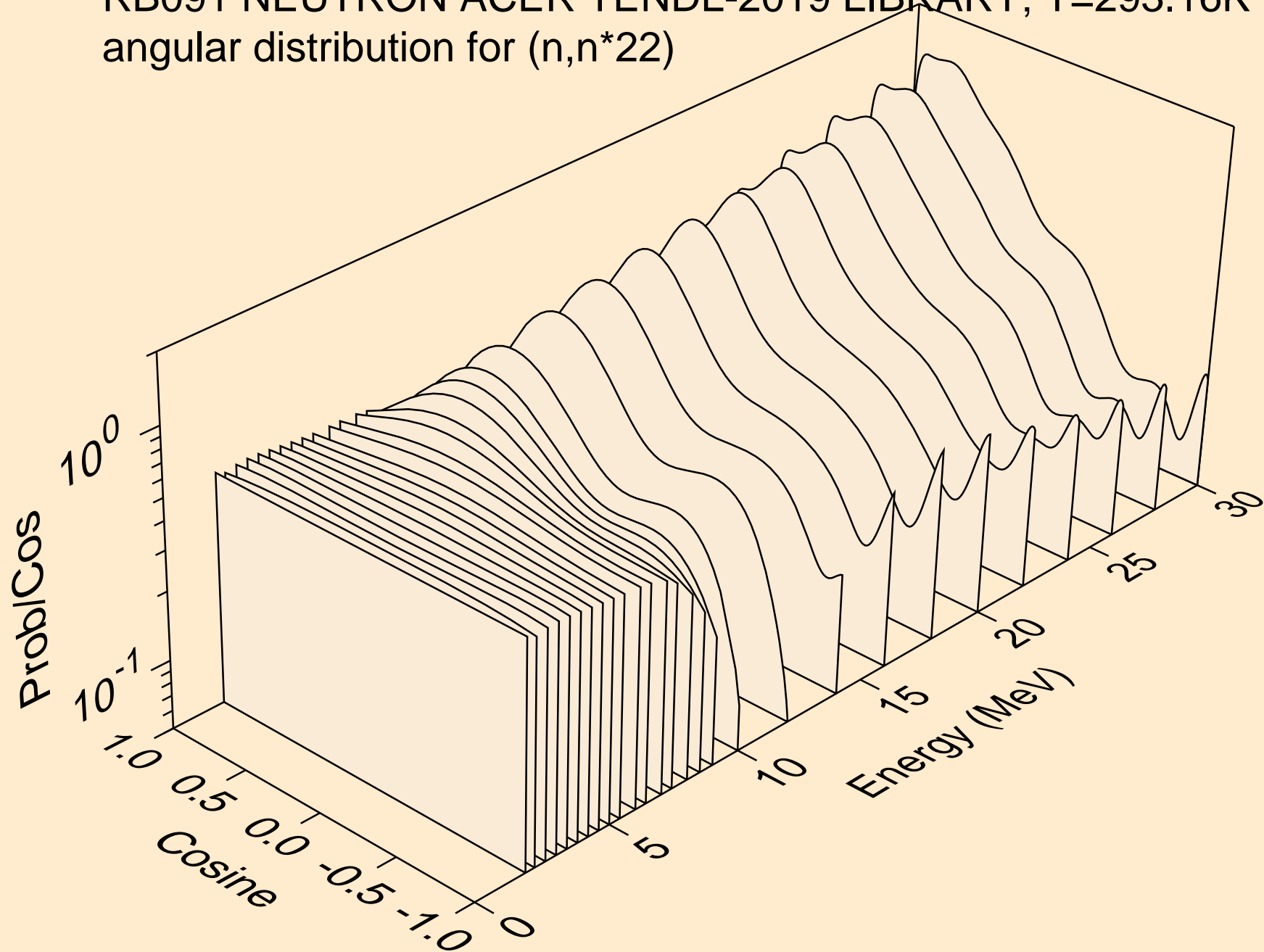

RB091 NEUTRON ACER TENDL-2019 LIBRARY; T=293.16K  
angular distribution for (n,n\*23)

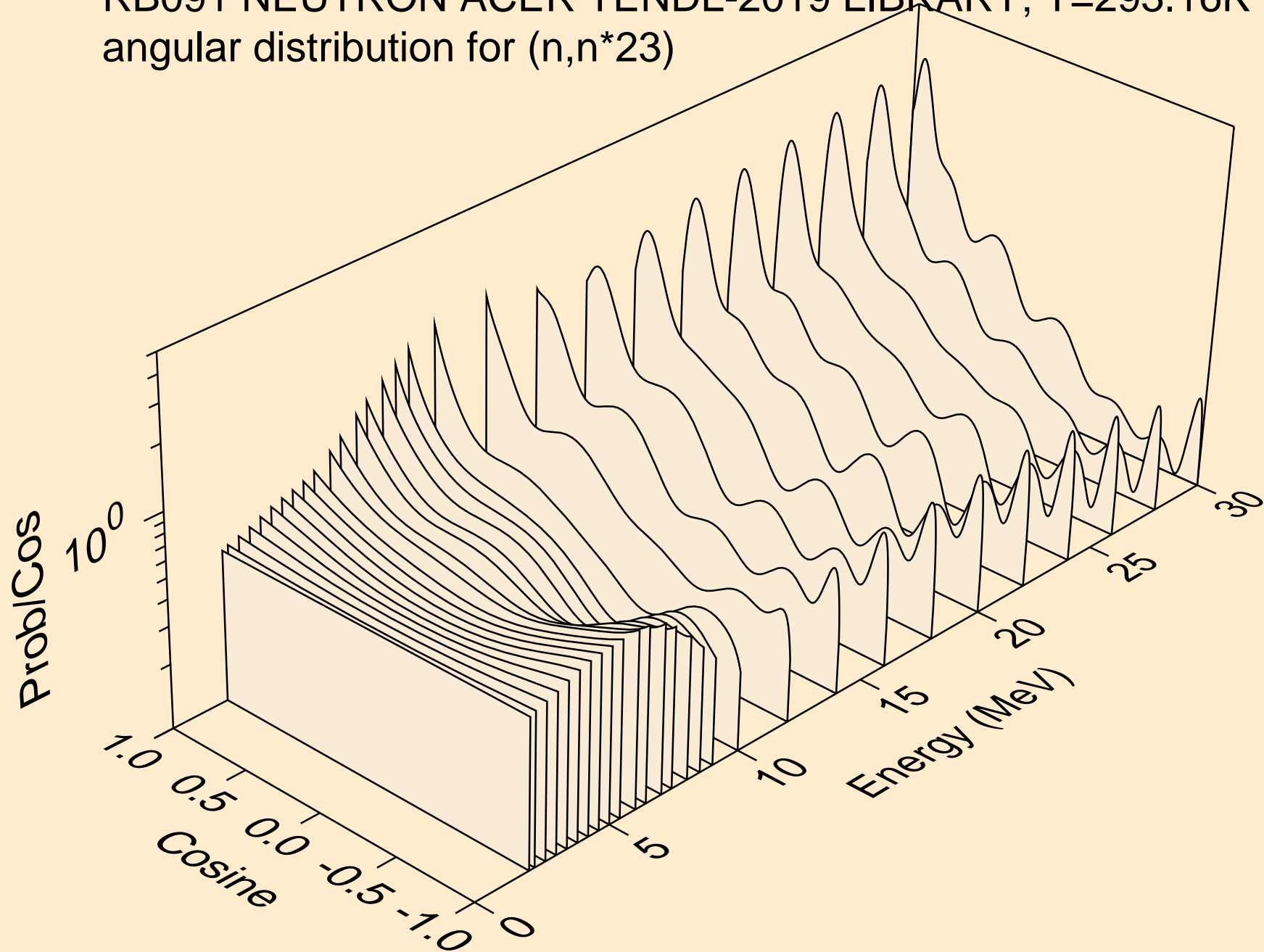

RB091 NEUTRON ACER TENDL-2019 LIBRARY; T=293.16K  
angular distribution for (n,n\*24)

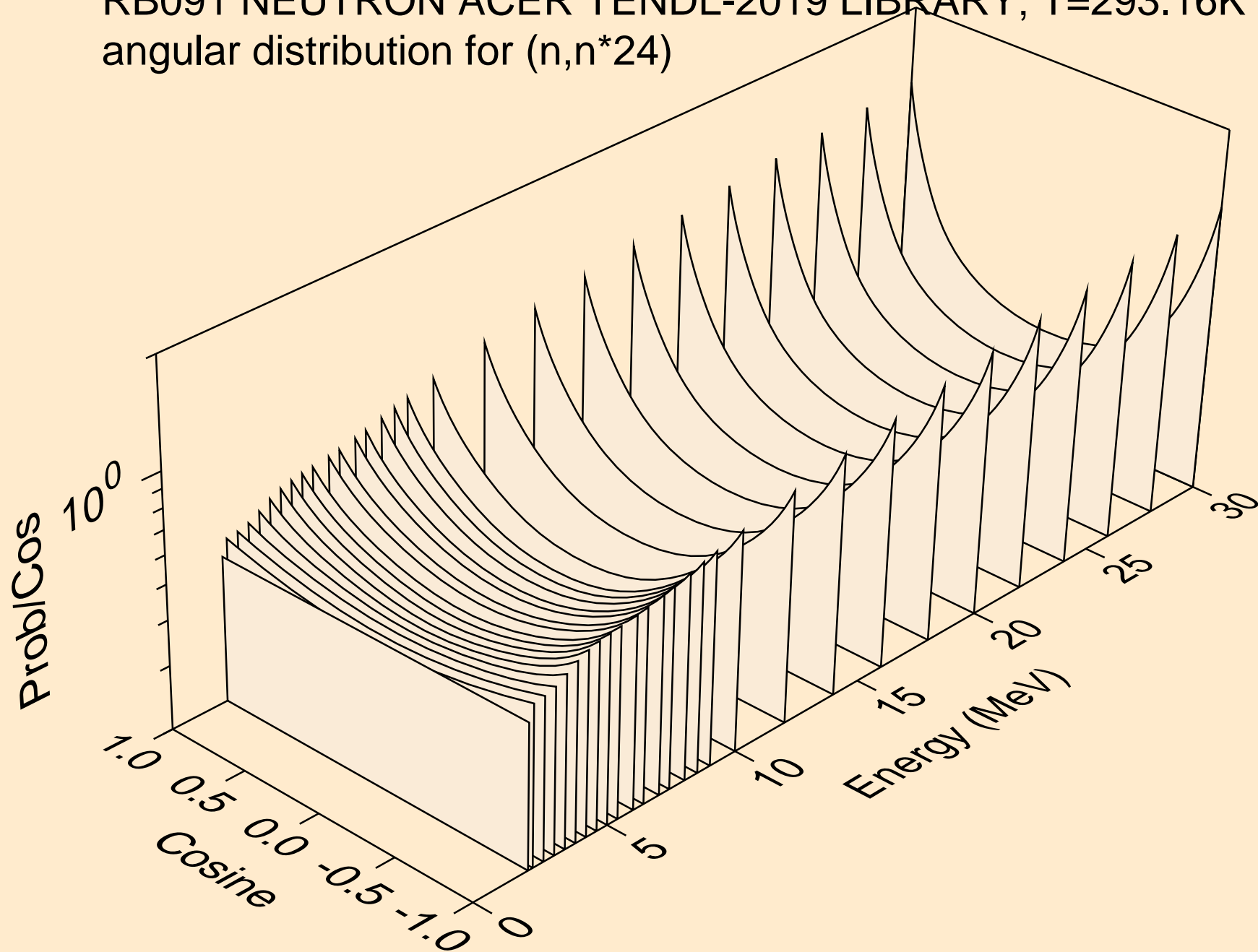

RB091 NEUTRON ACER TENDL-2019 LIBRARY; T=293.16K  
angular distribution for (n,n\*25)

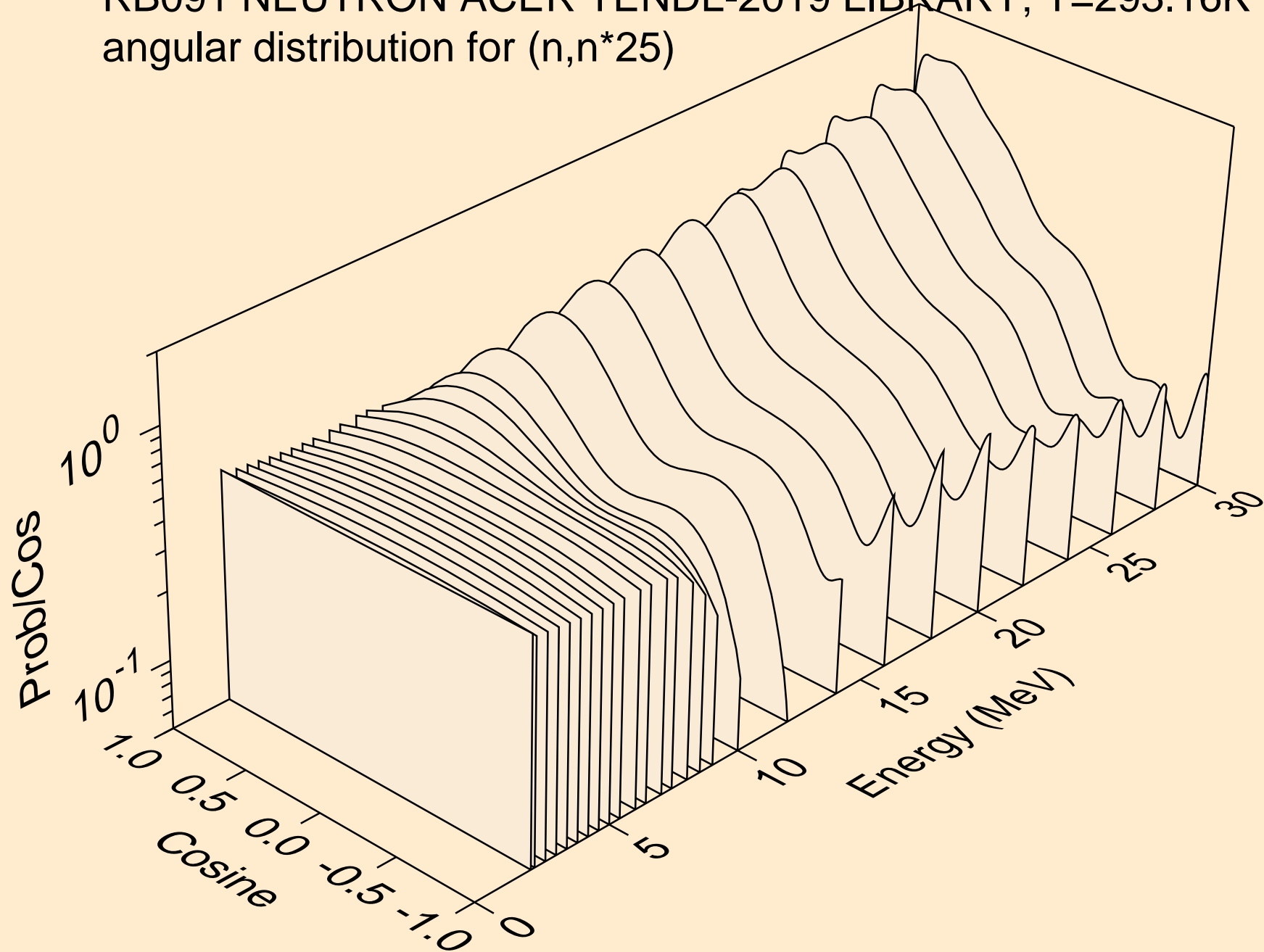

RB091 NEUTRON ACER TENDL-2019 LIBRARY; T=293.16K  
angular distribution for (n,n\*26)

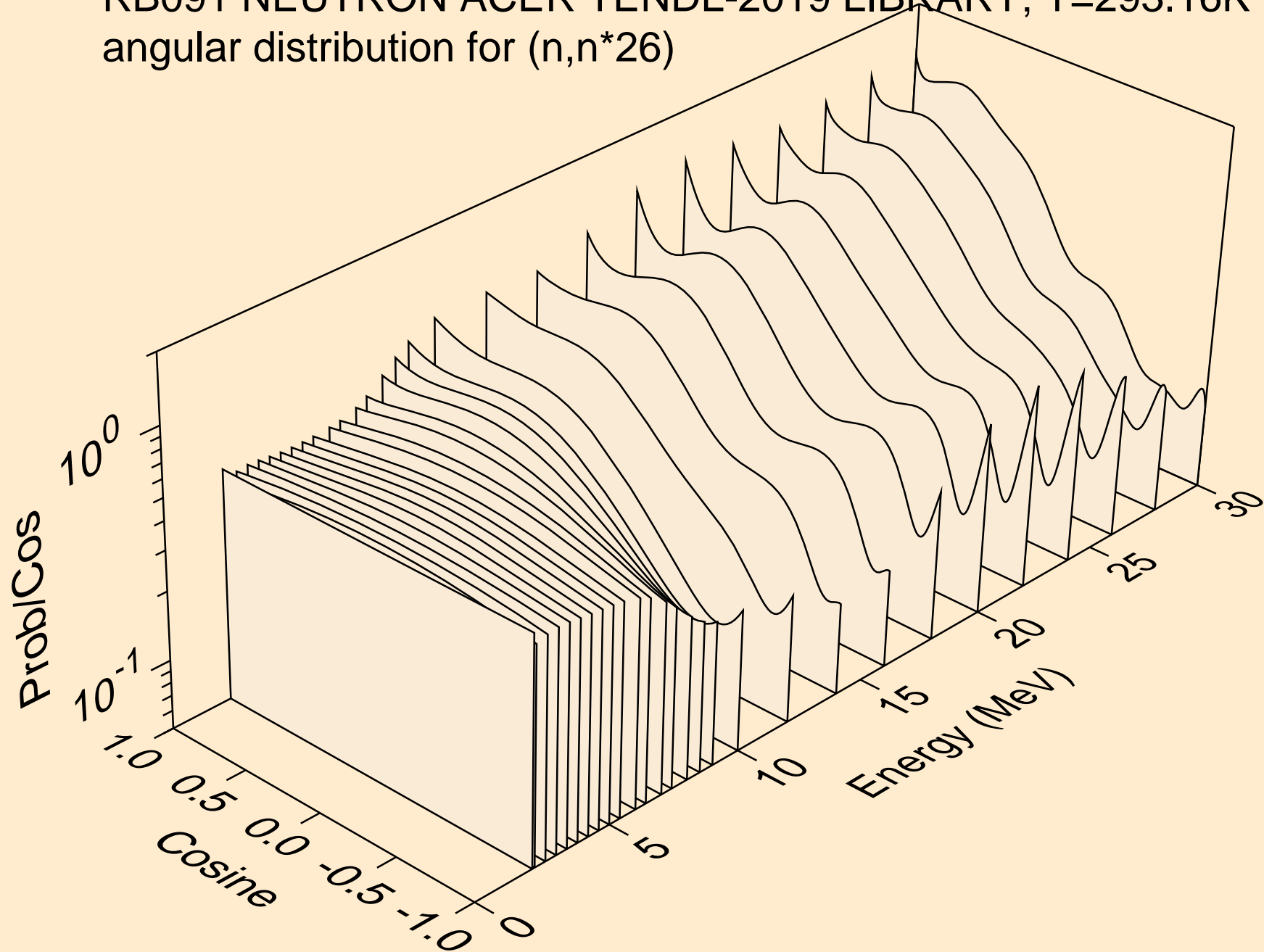

RB091 NEUTRON ACER TENDL-2019 LIBRARY; T=293.16K  
angular distribution for (n,n\*27)

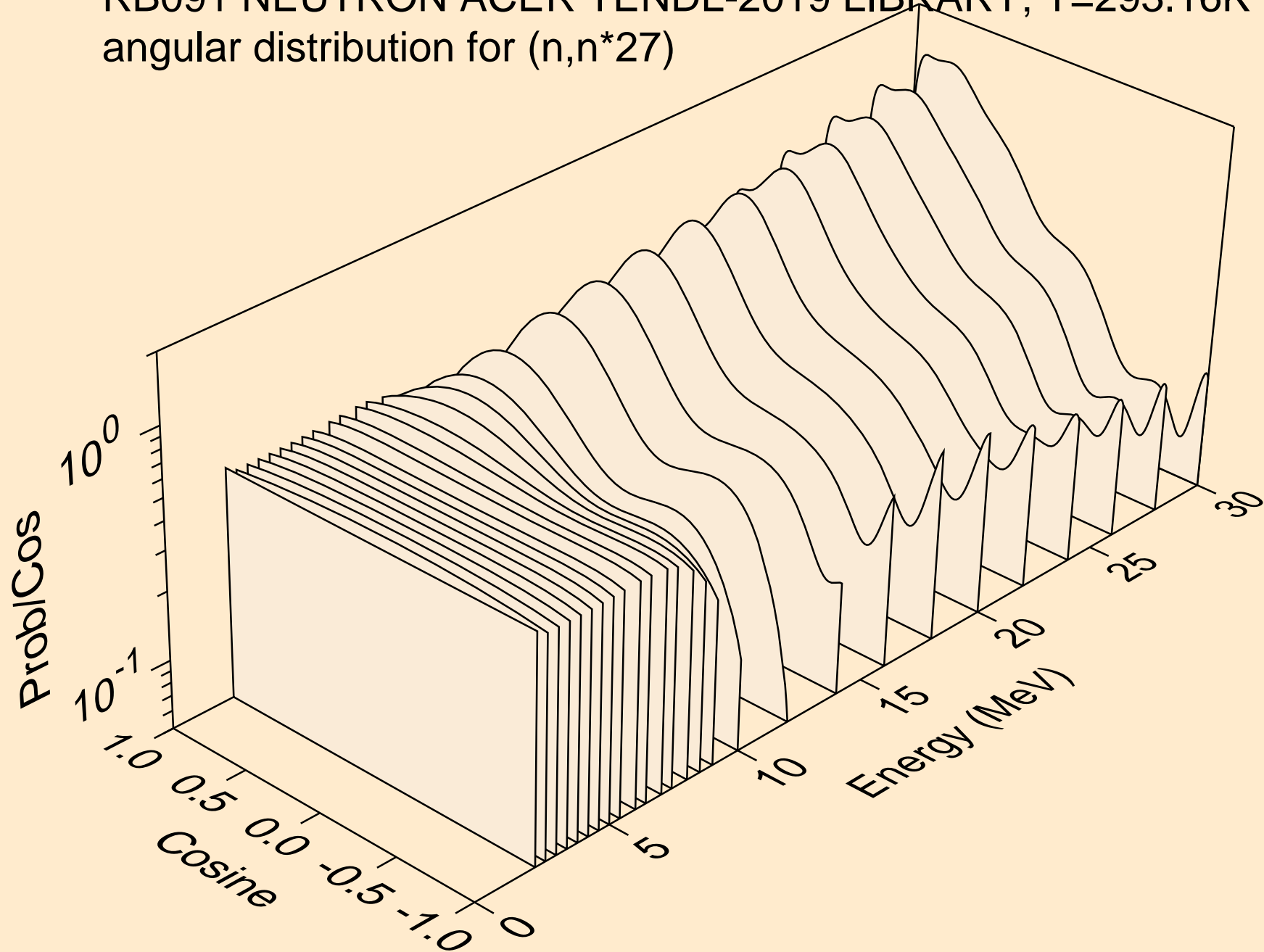

RB091 NEUTRON ACER TENDL-2019 LIBRARY; T=293.16K  
angular distribution for (n,n\*28)

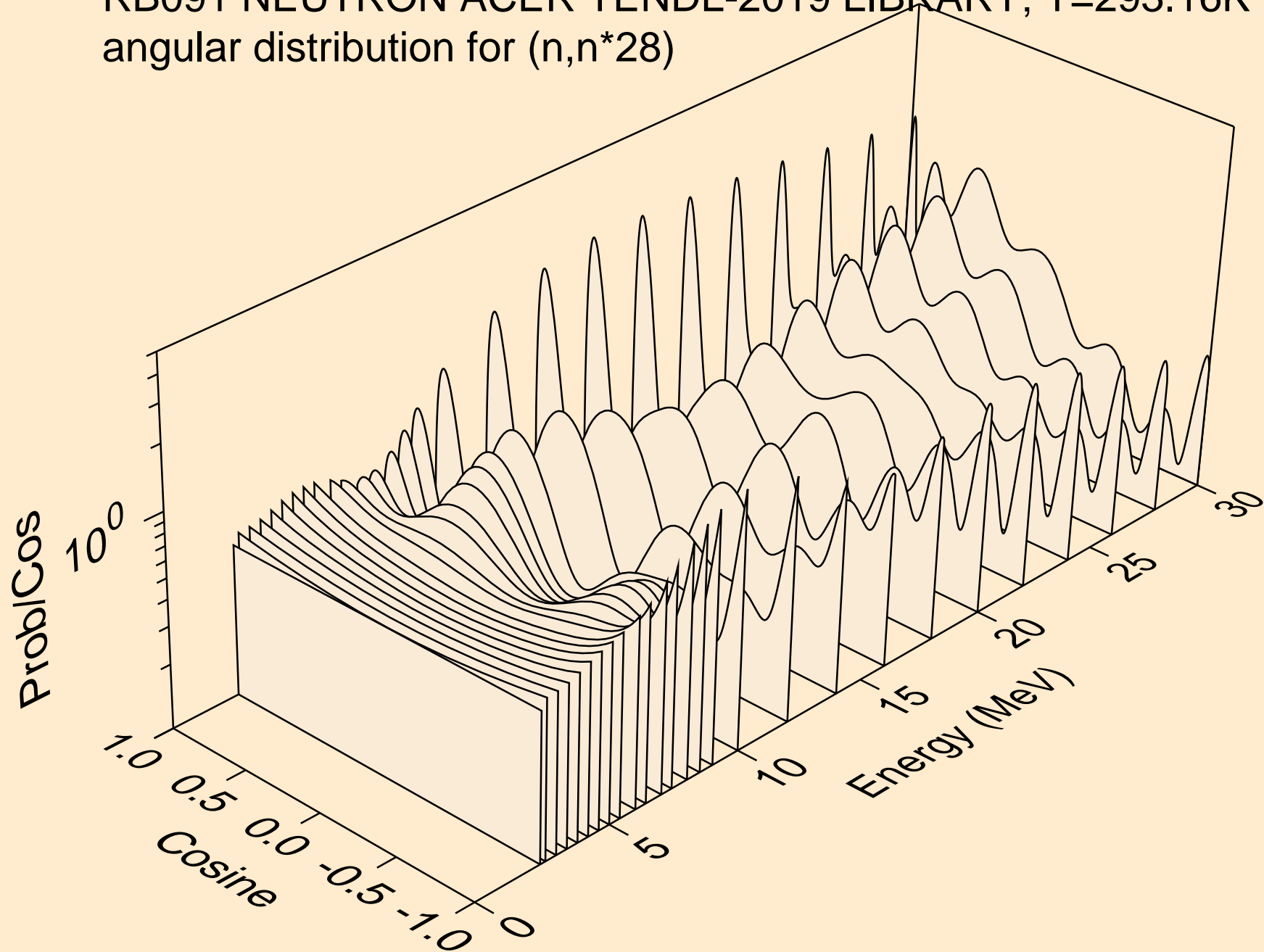



RB091 NEUTRON ACER TENDL-2019 LIBRARY; T=293.16K  
angular distribution for (n,n\*29)

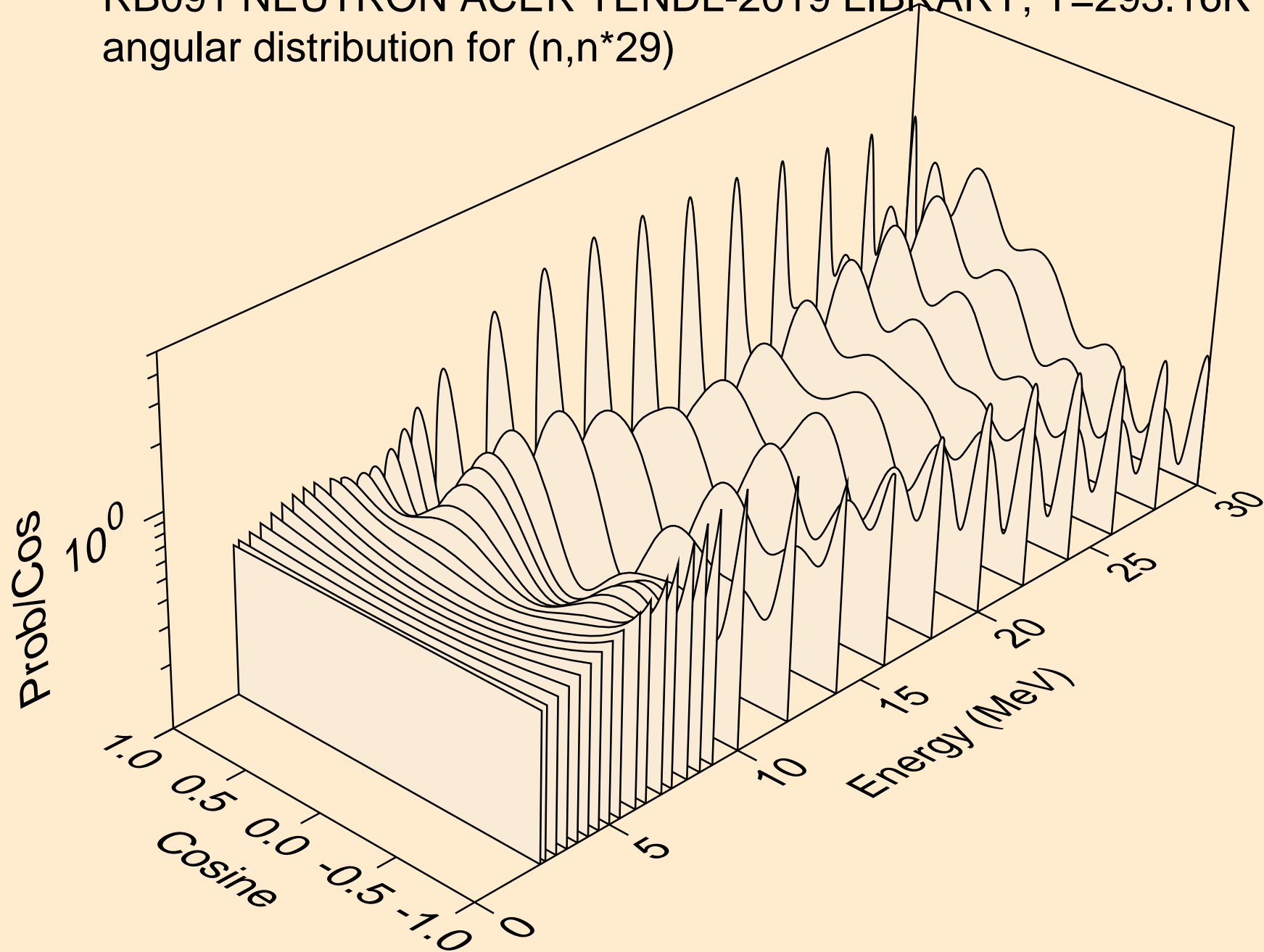

RB091 NEUTRON ACER TENDL-2019 LIBRARY; T=293.16K  
angular distribution for (n,n\*30)

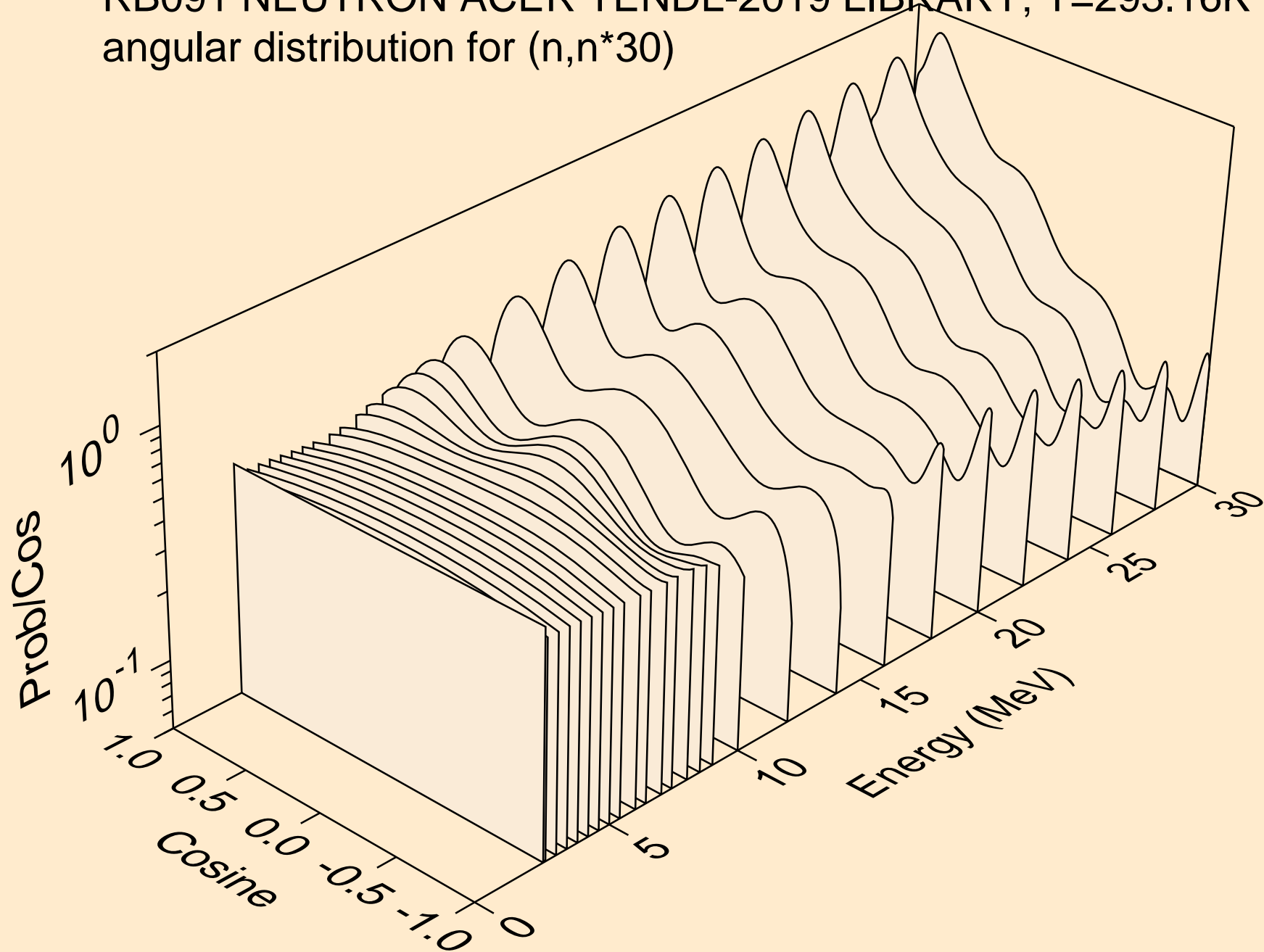

RB091 NEUTRON ACER TENDL-2019 LIBRARY; T=293.16K  
Neutron emission for (n,x)

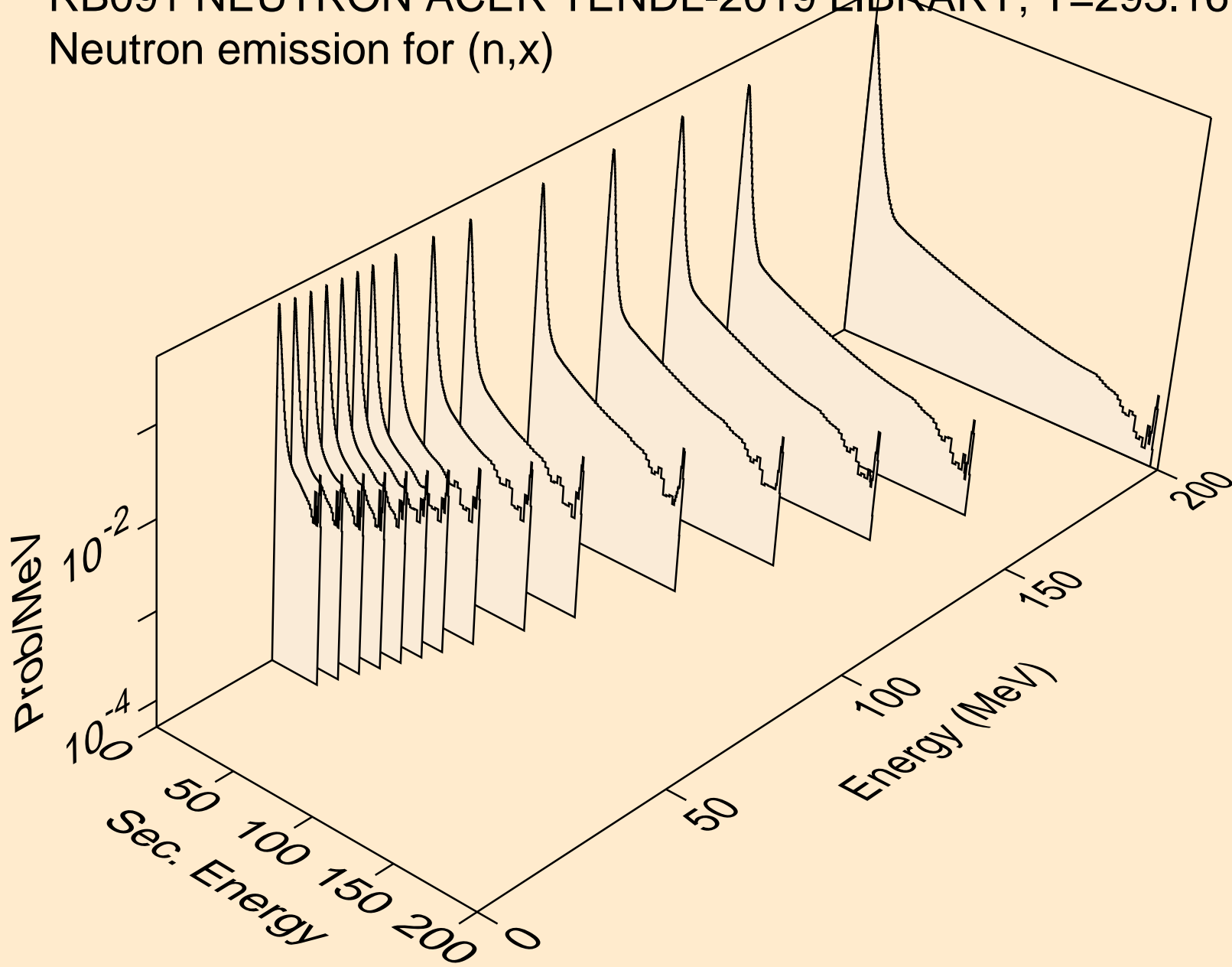

RB091 NEUTRON ACER TENDL-2019 LIBRARY; T=293.16K  
Neutron emission for (n,2nd)

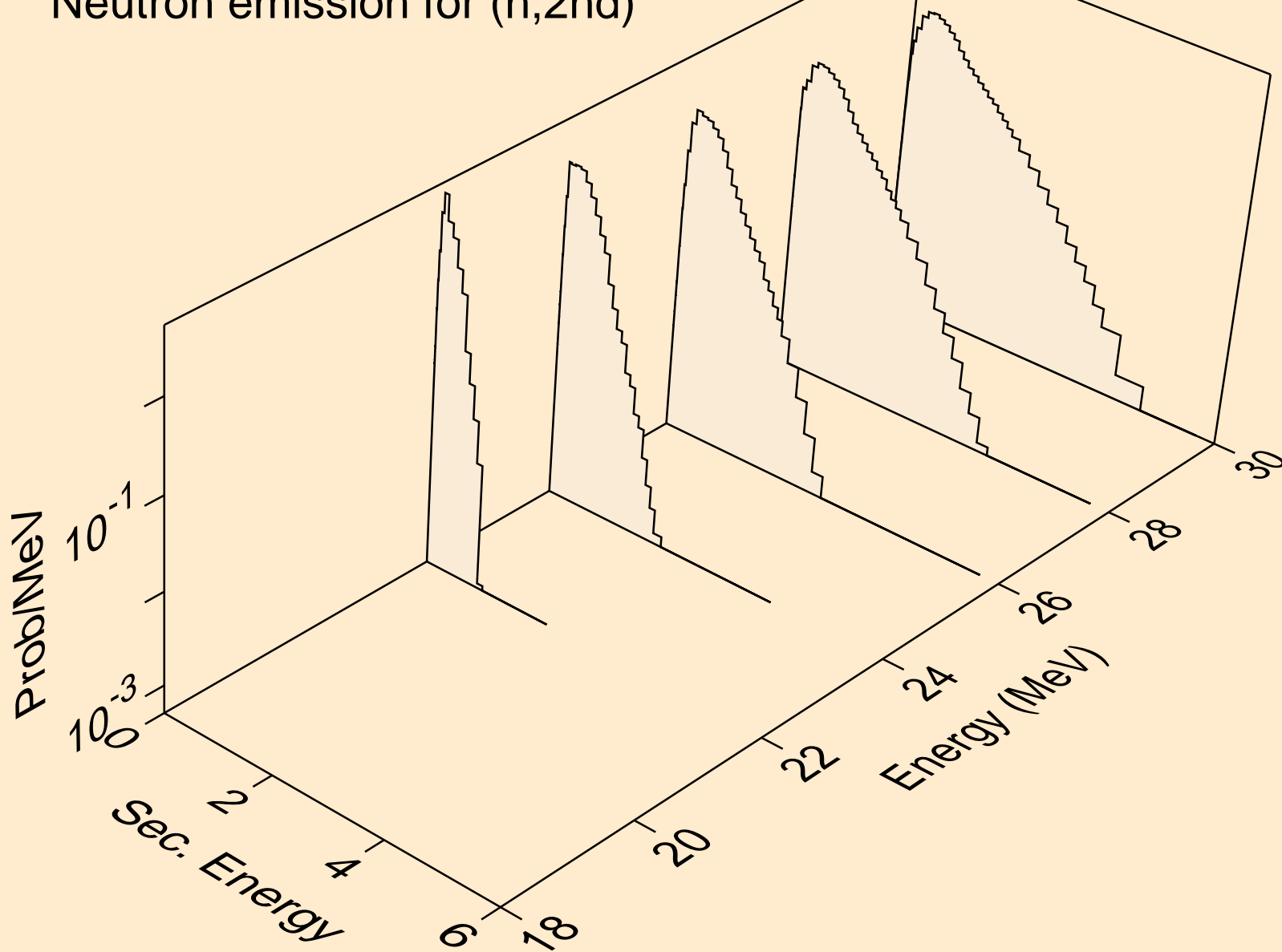

RB091 NEUTRON ACER TENDL-2019 LIBRARY; T=293.16K  
Neutron emission for (n,2n)

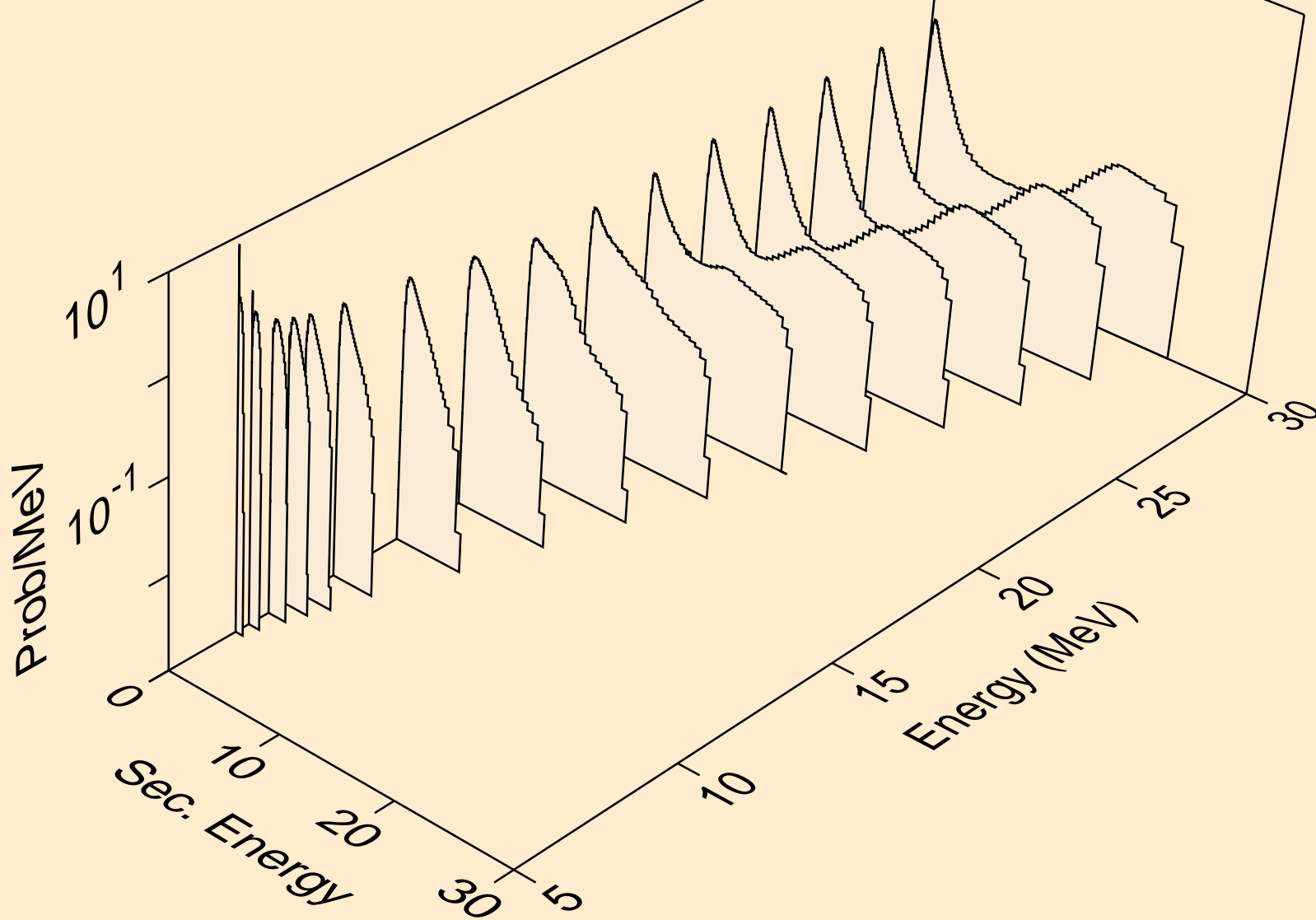

RB091 NEUTRON ACER TENDL-2019 LIBRARY; T=293.16K  
Neutron emission for (n,3n)

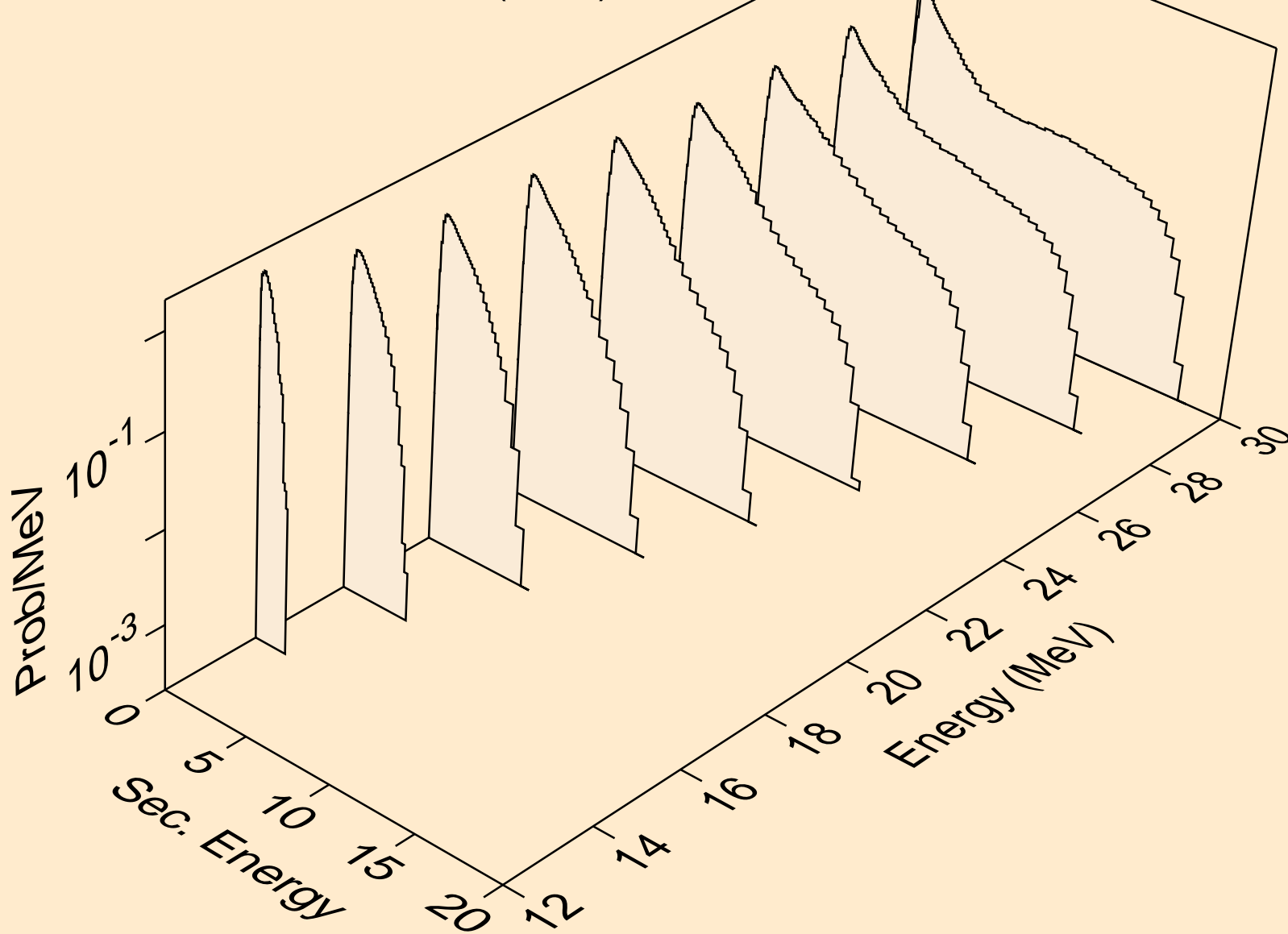

RB091 NEUTRON ACER TENDL-2019 LIBRARY; T=293.16K  
Neutron emission for (n,n\*)a

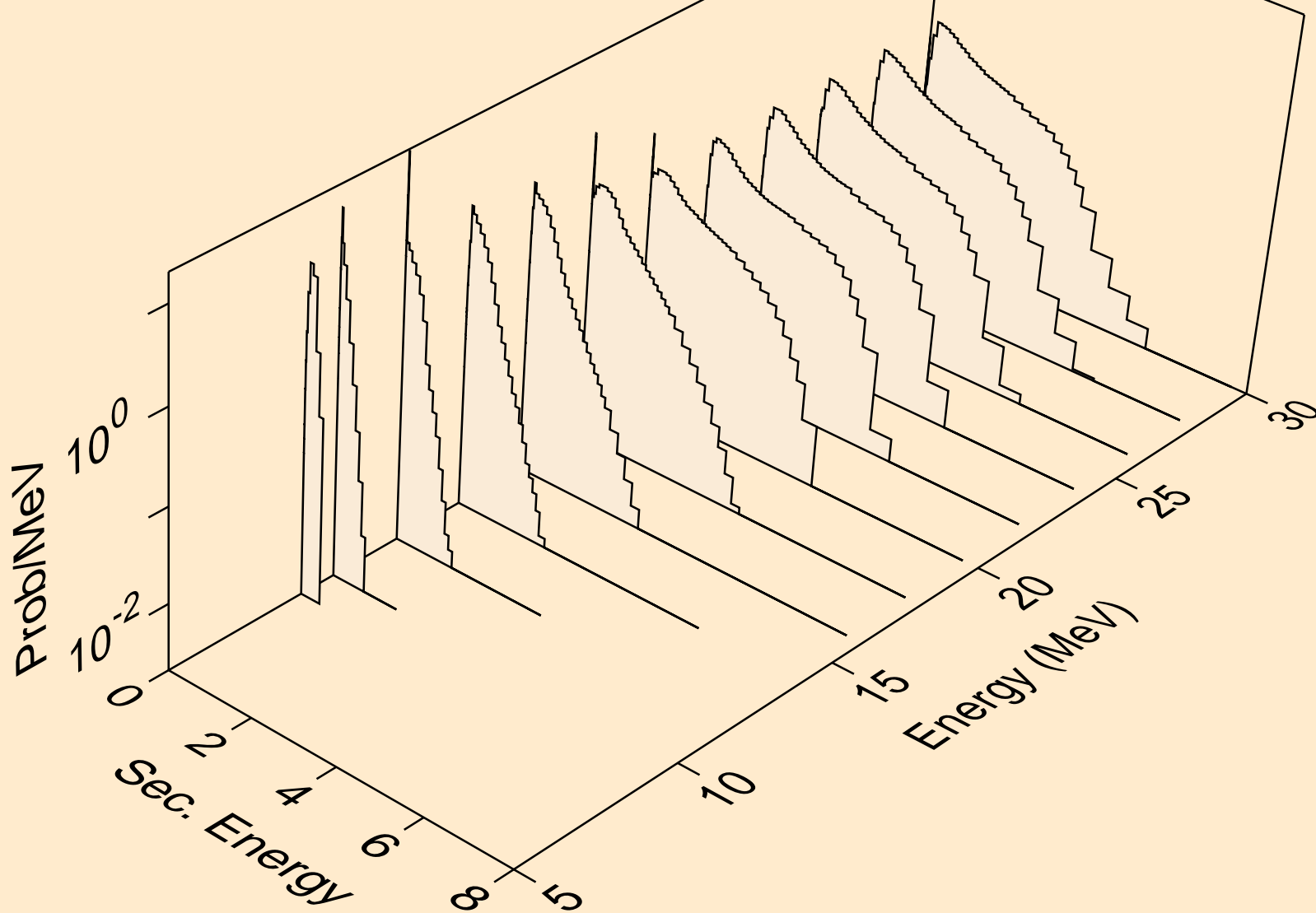

RB091 NEUTRON ACER TENDL-2019 LIBRARY; T=293.16K  
Neutron emission for (n,2n)a

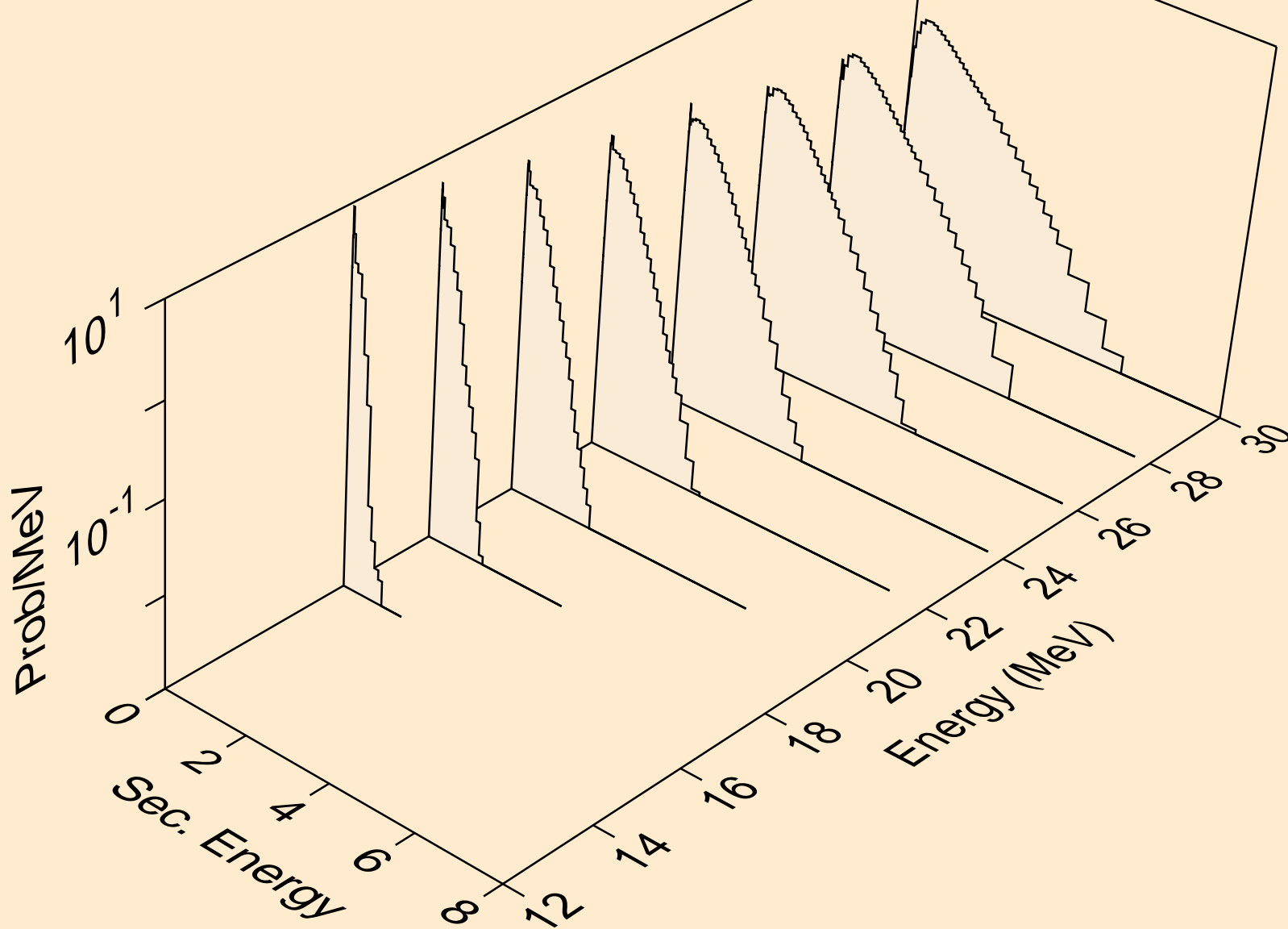



RB091 NEUTRON ACER TENDL-2019 LIBRARY; T=293.16K  
Neutron emission for (n,3n)a

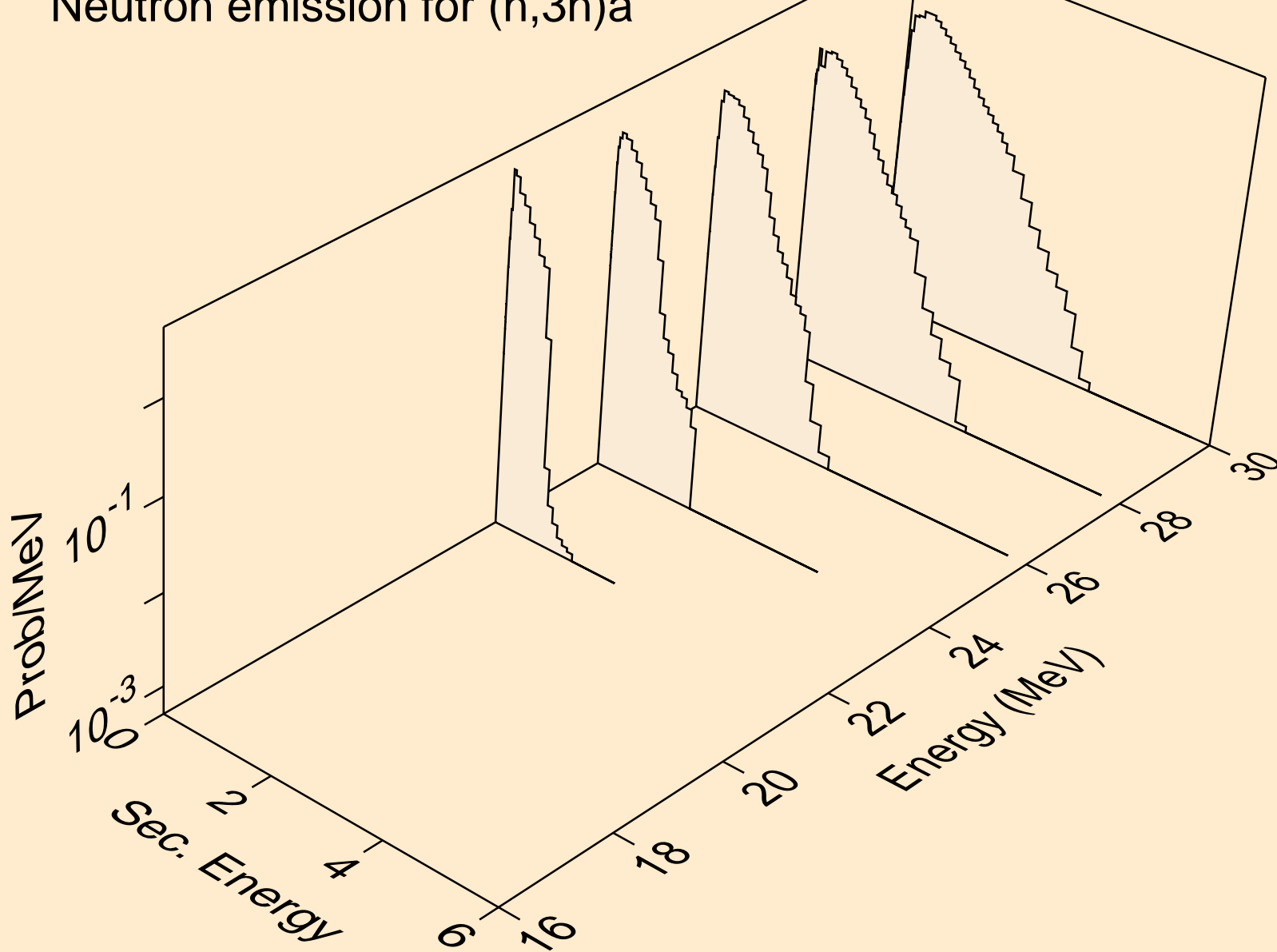

RB091 NEUTRON ACER TENDL-2019 LIBRARY; T=293.16K  
Neutron emission for (n,n\*)p

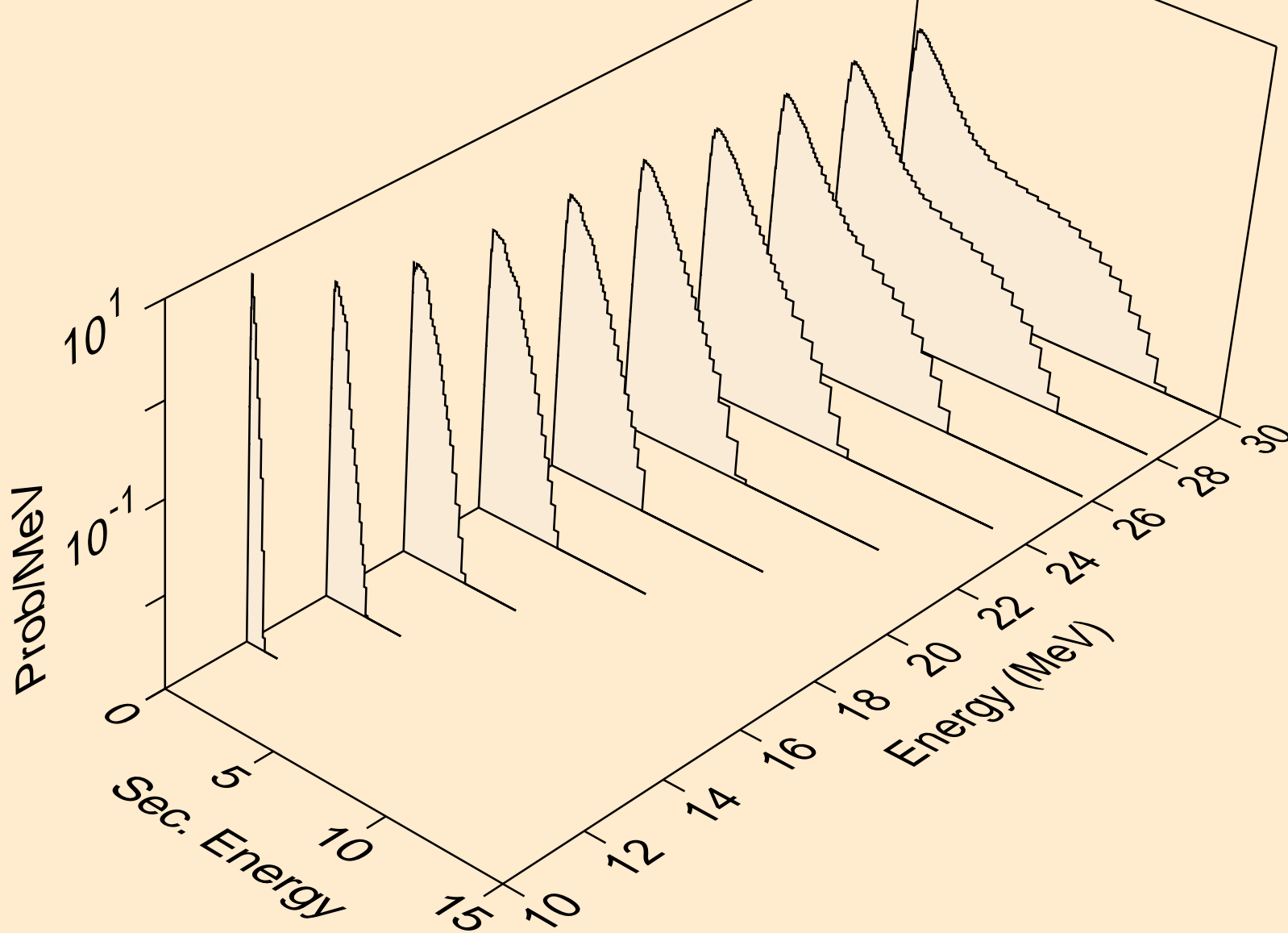

RB091 NEUTRON ACER TENDL-2019 LIBRARY; T=293.16K  
Neutron emission for (n,n\*)d

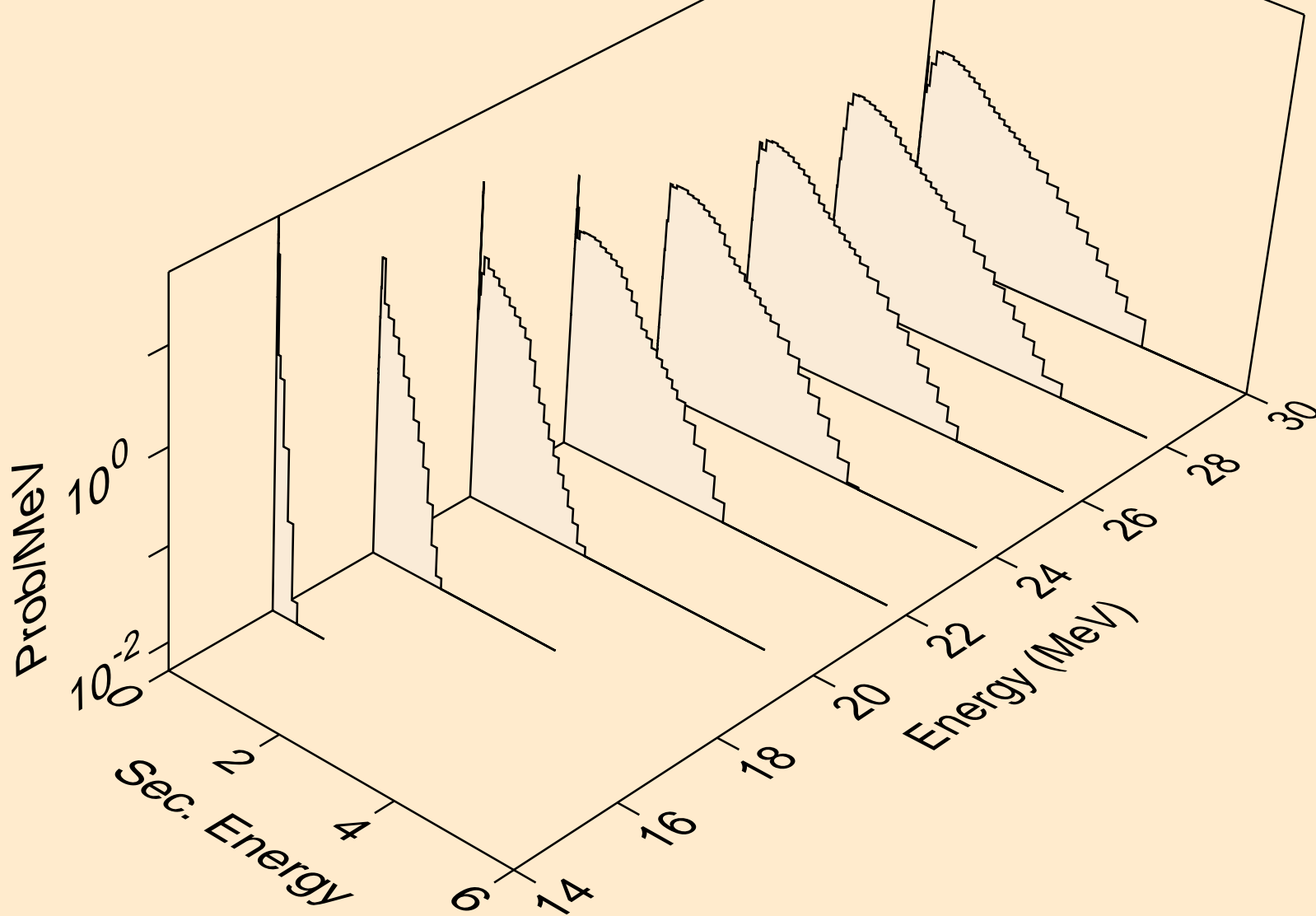

RB091 NEUTRON ACER TENDL-2019 LIBRARY; T=293.16K  
Neutron emission for (n,n\*)t

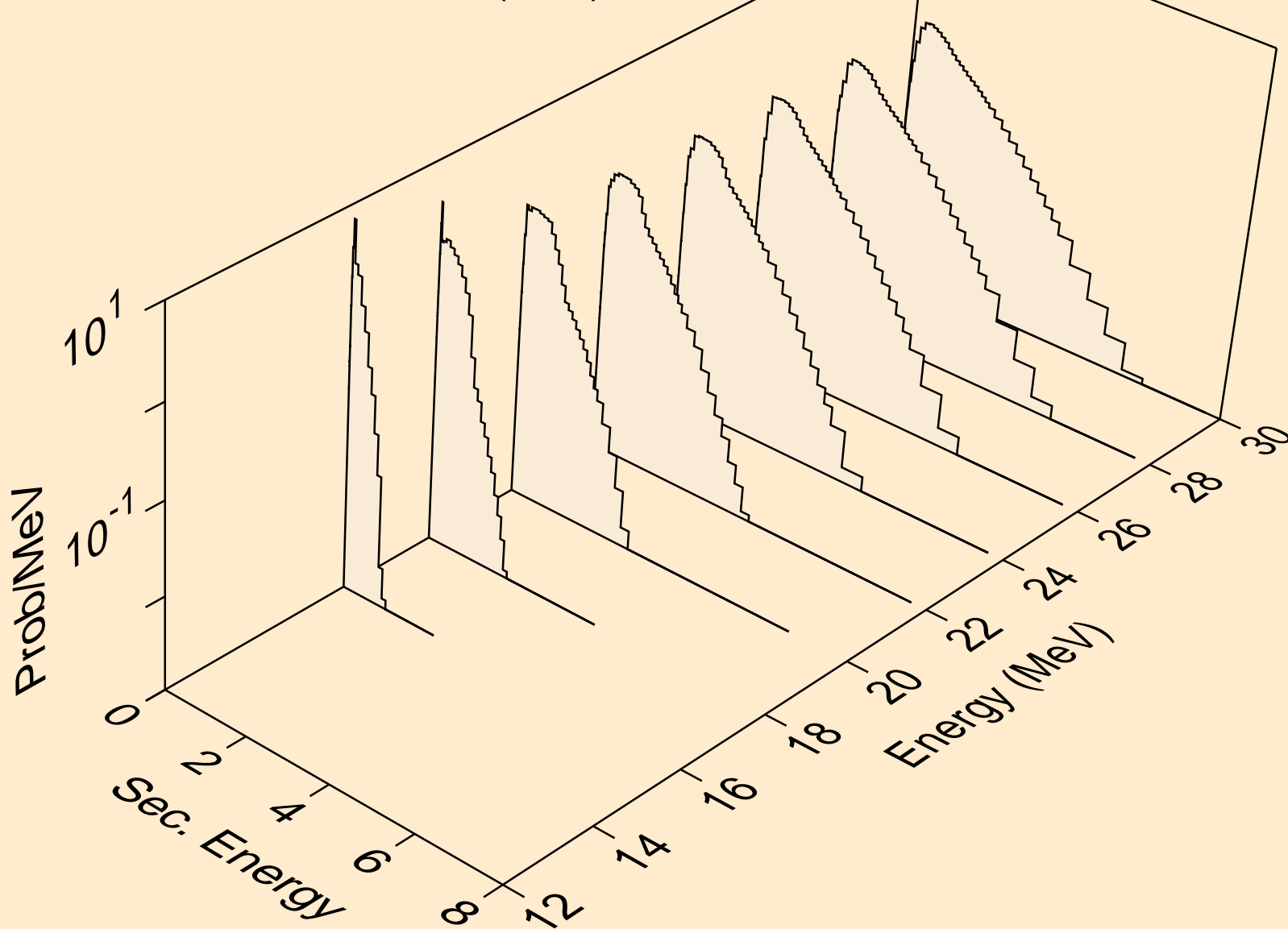

RB091 NEUTRON ACER TENDL-2019 LIBRARY; T=293.16K  
Neutron emission for (n,n\*)he3

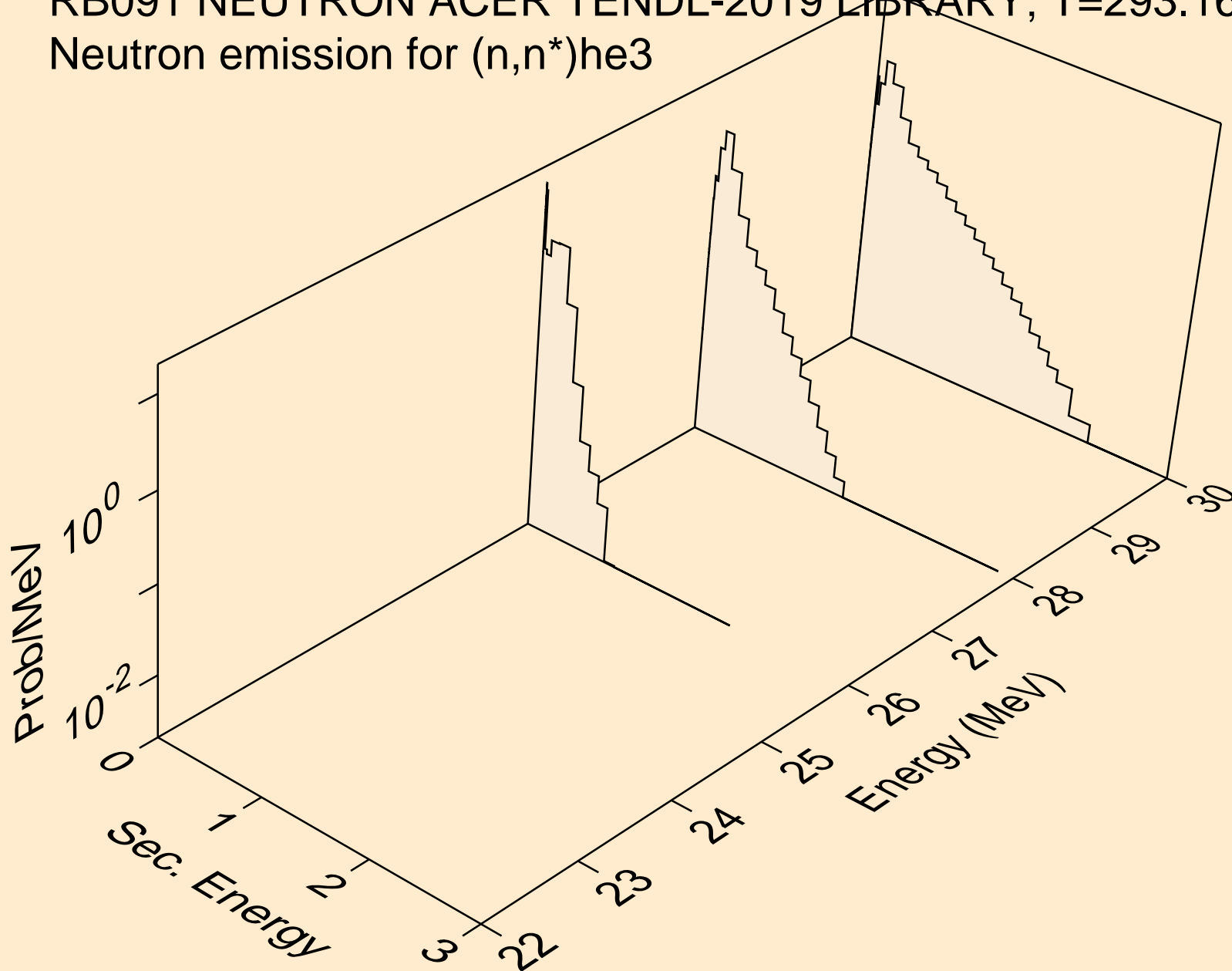

RB091 NEUTRON ACER TENDL-2019 LIBRARY; T=293.16K  
Neutron emission for (n,4n)

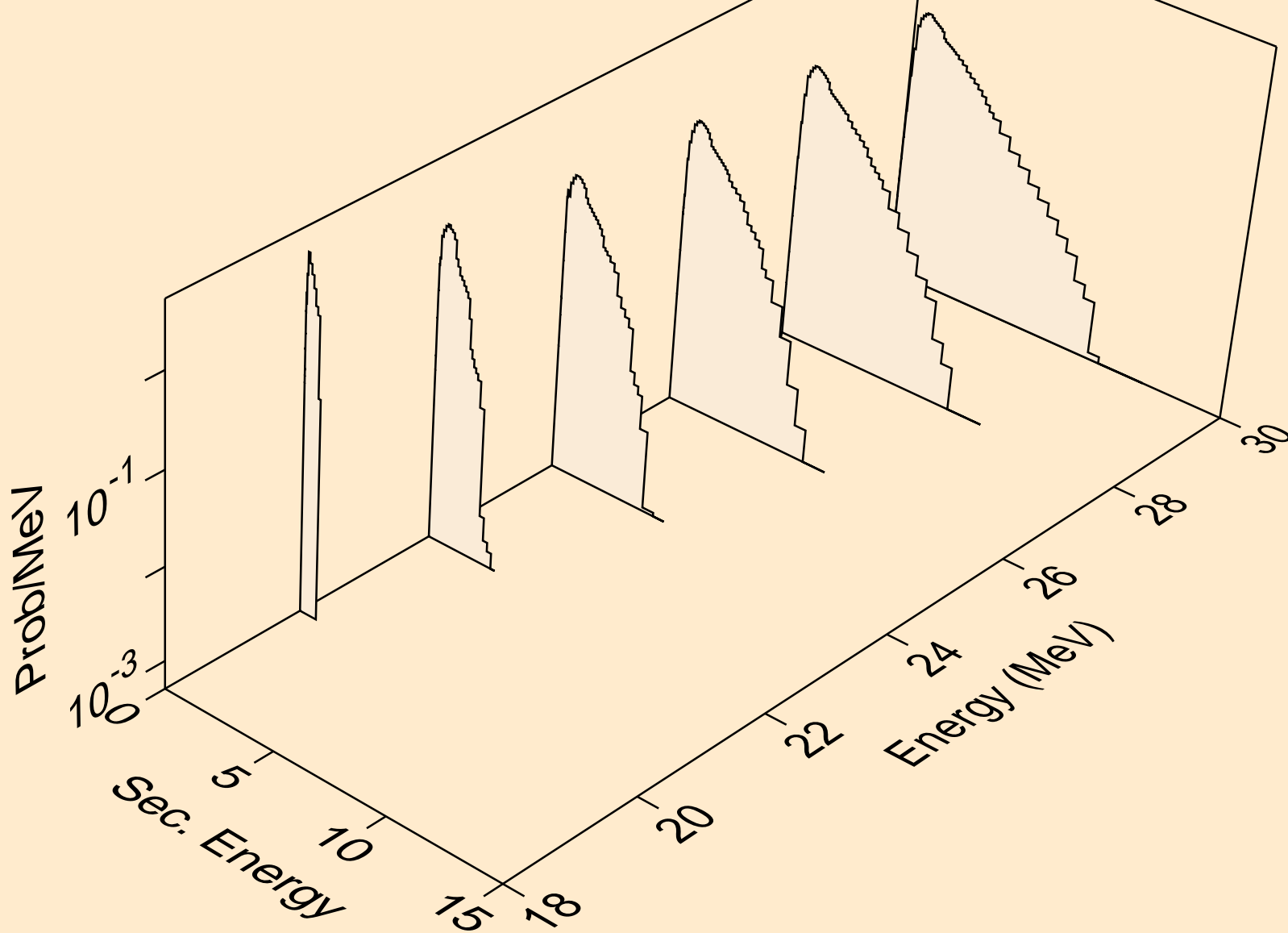

RB091 NEUTRON ACER TENDL-2019 LIBRARY; T=293.16K  
Neutron emission for (n,2np)

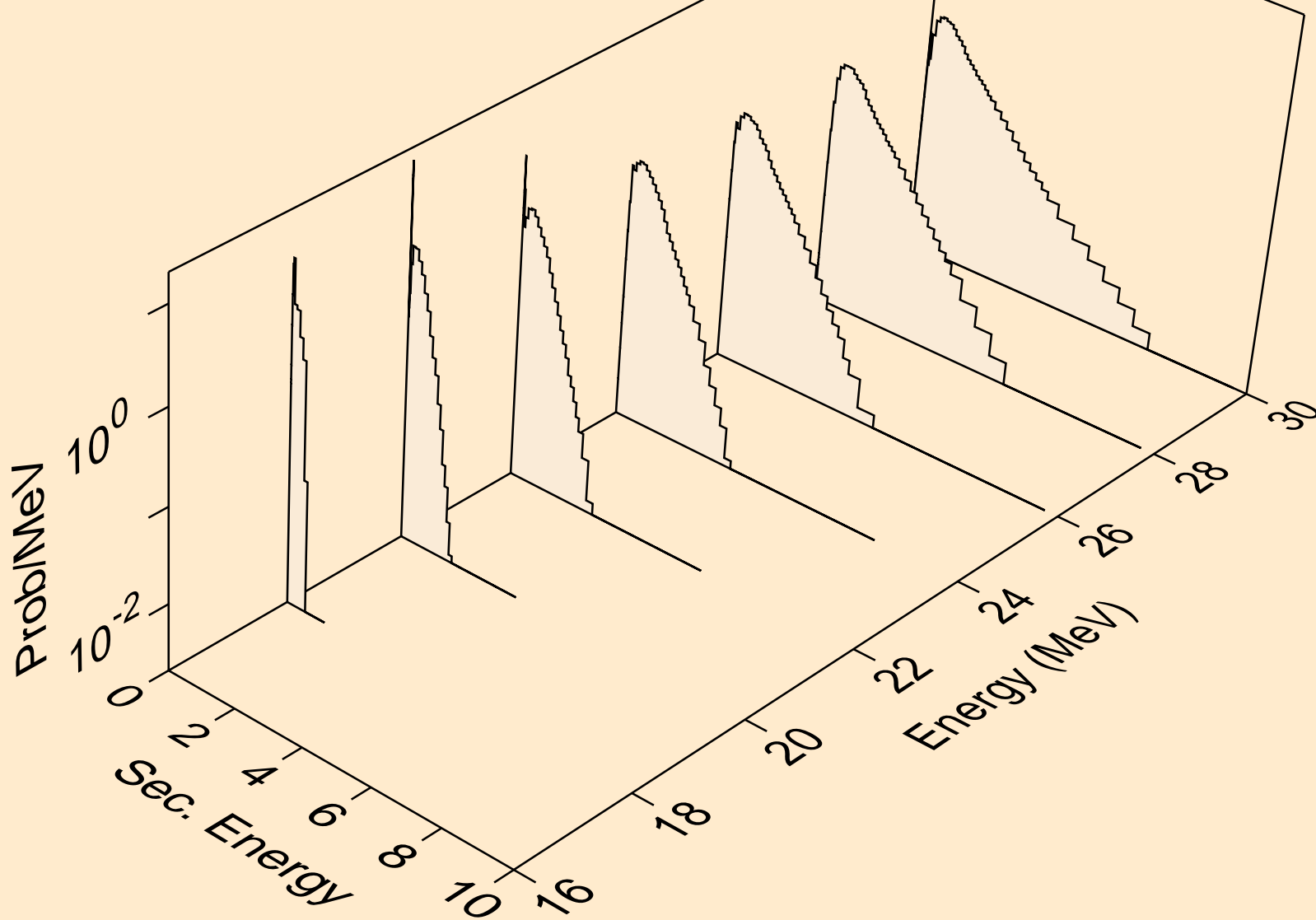

RB091 NEUTRON ACER TENDL-2019 LIBRARY; T=293.16K  
Neutron emission for (n,3np)

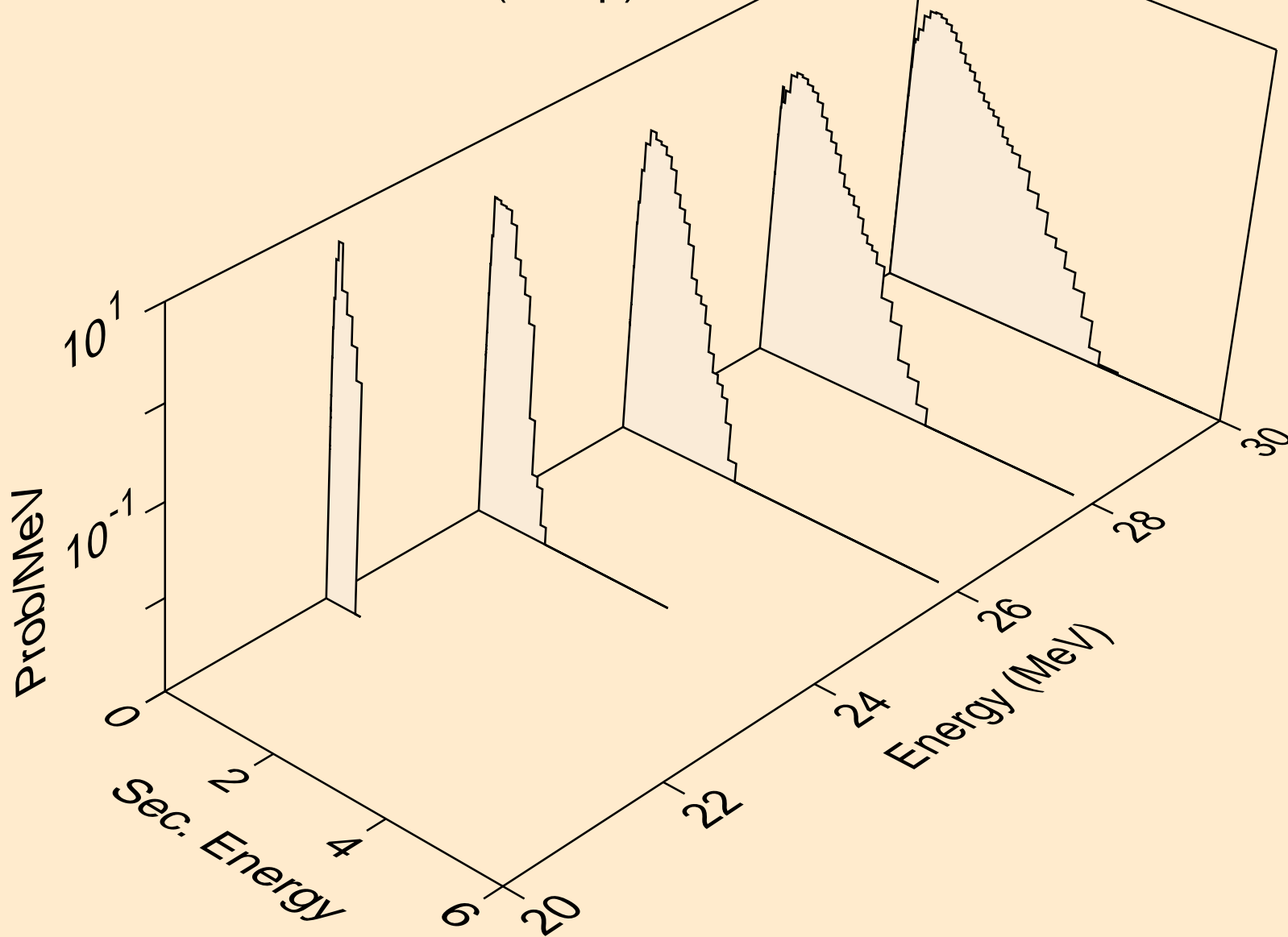



RB091 NEUTRON ACER TENDL-2019 LIBRARY; T=293.16K  
Neutron emission for (n,n\*c)

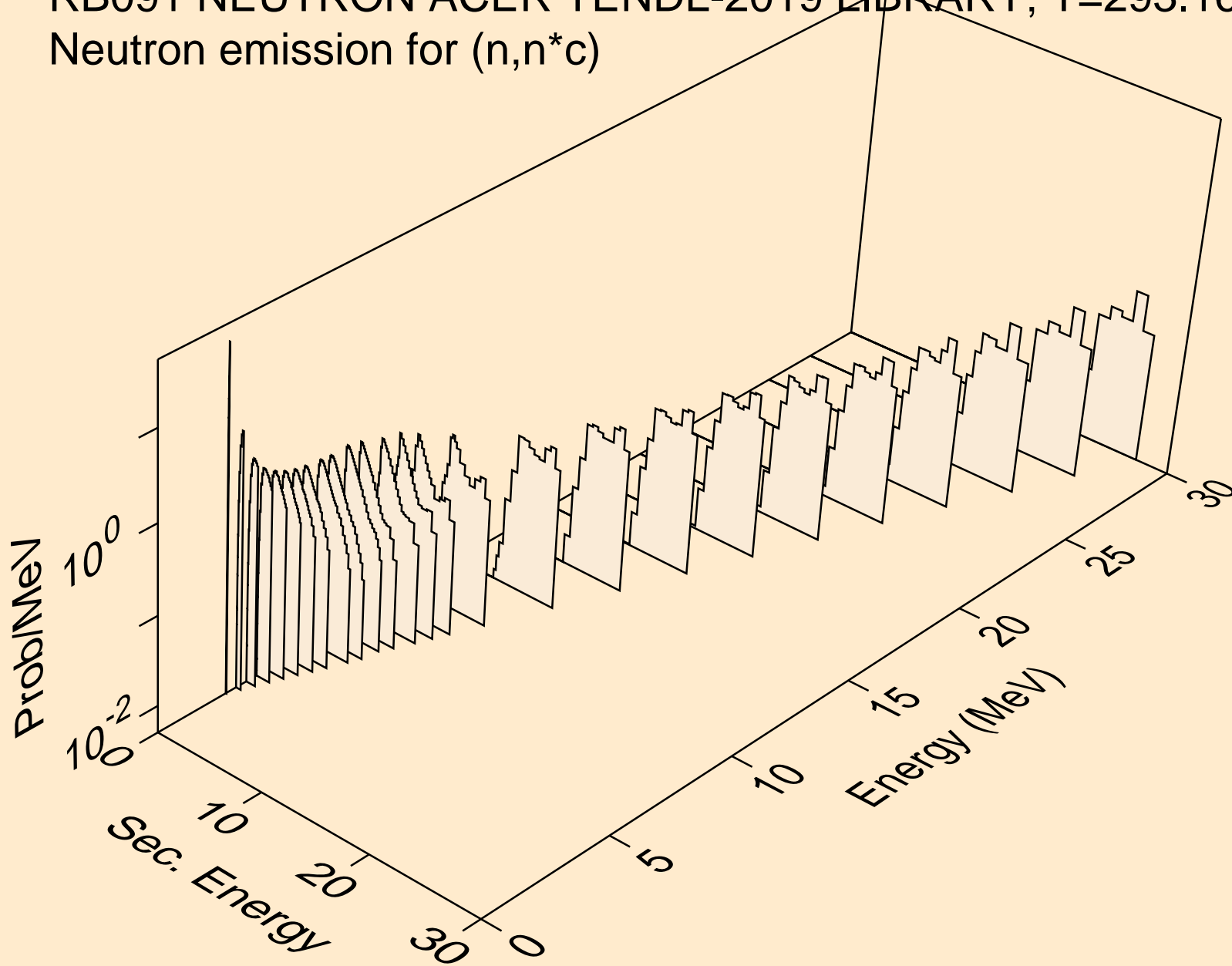

RB091 NEUTRON ACER TENDL-2019 LIBRARY; T=293.16K  
Photon emission for (n,x)

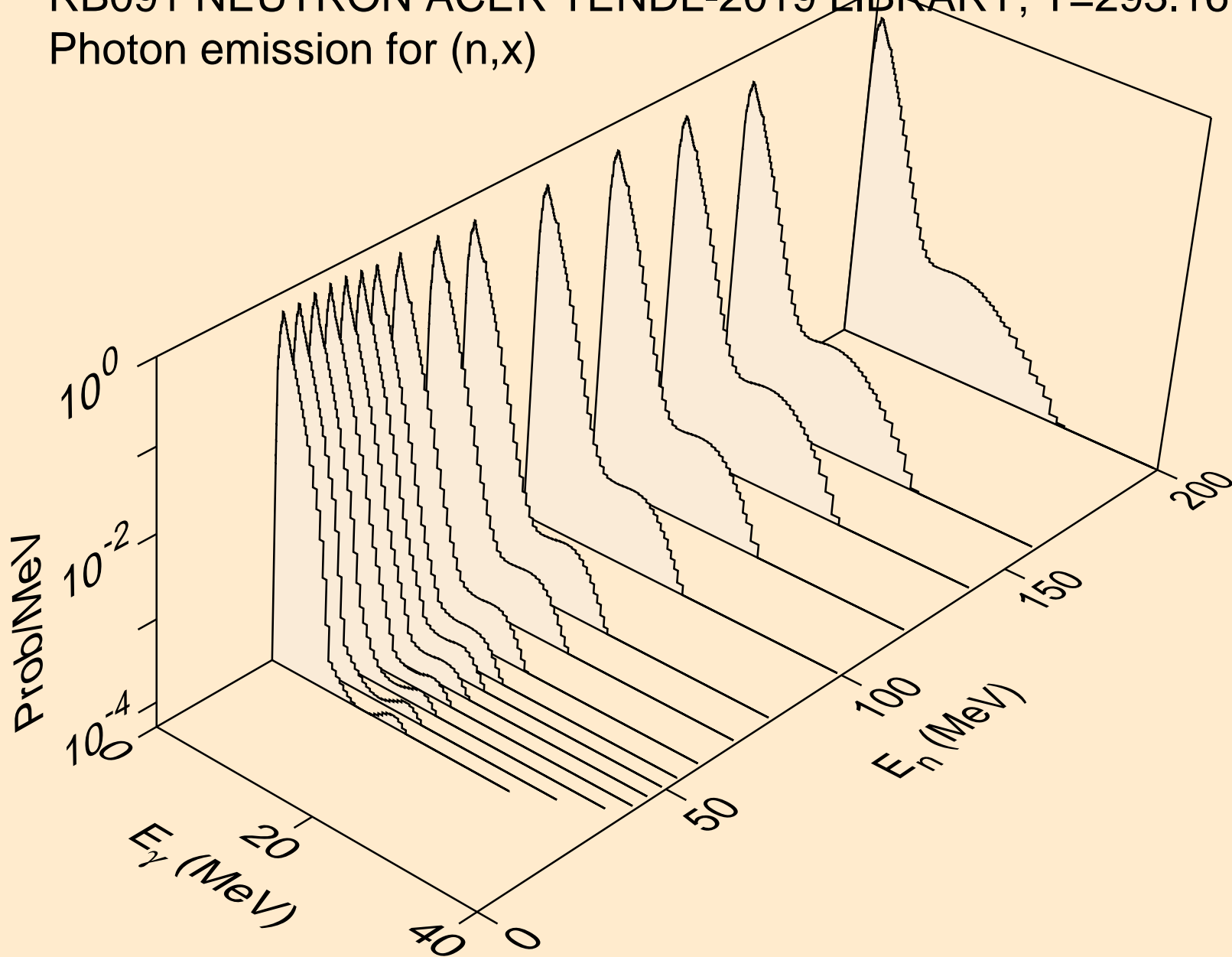

RB091 NEUTRON ACER TENDL-2019 LIBRARY; T=293.16K  
Photon emission for (n,2nd)

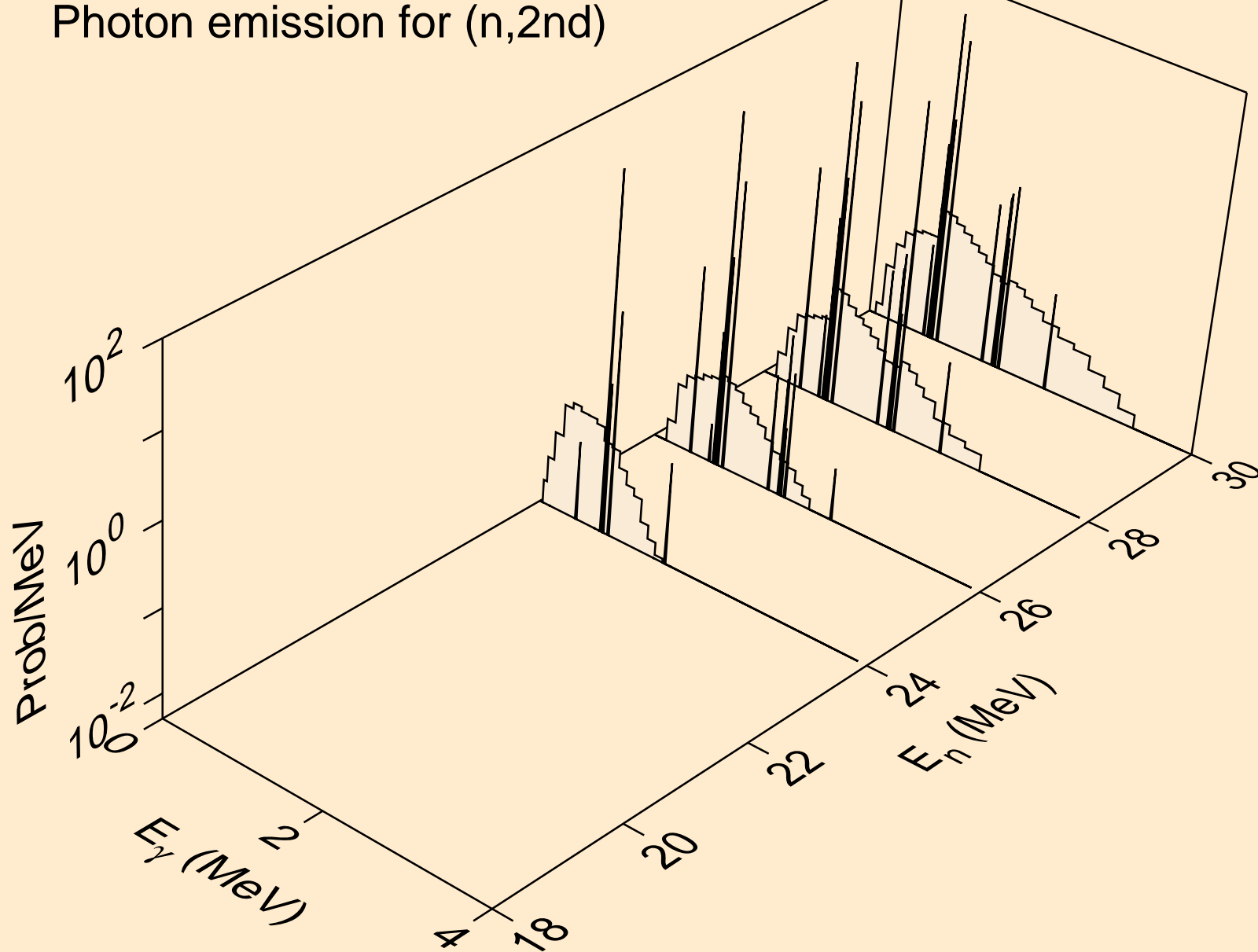

RB091 NEUTRON ACER TENDL-2019 LIBRARY; T=293.16K  
Photon emission for (n,2n)

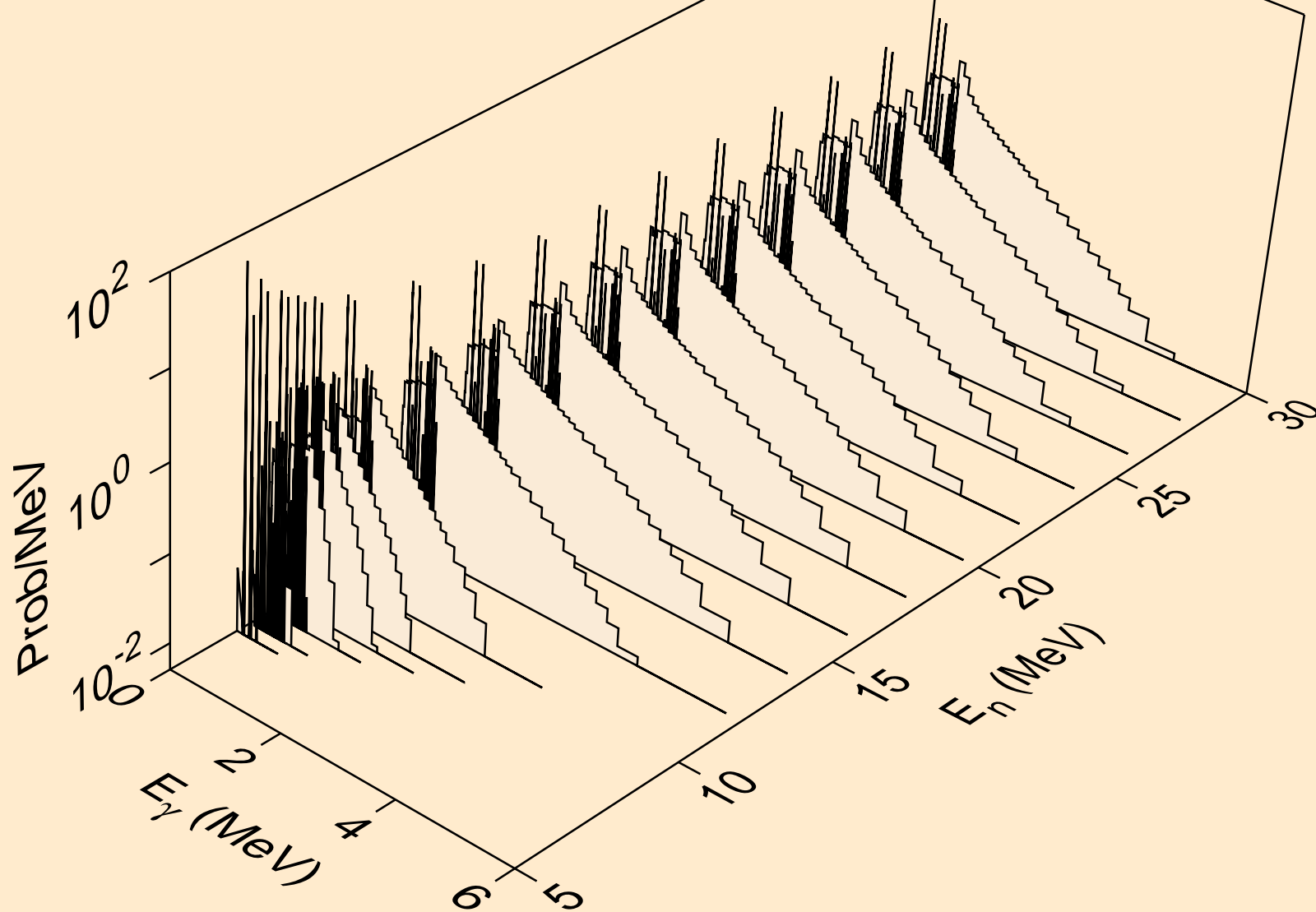

RB091 NEUTRON ACER TENDL-2019 LIBRARY; T=293.16K  
Photon emission for (n,3n)

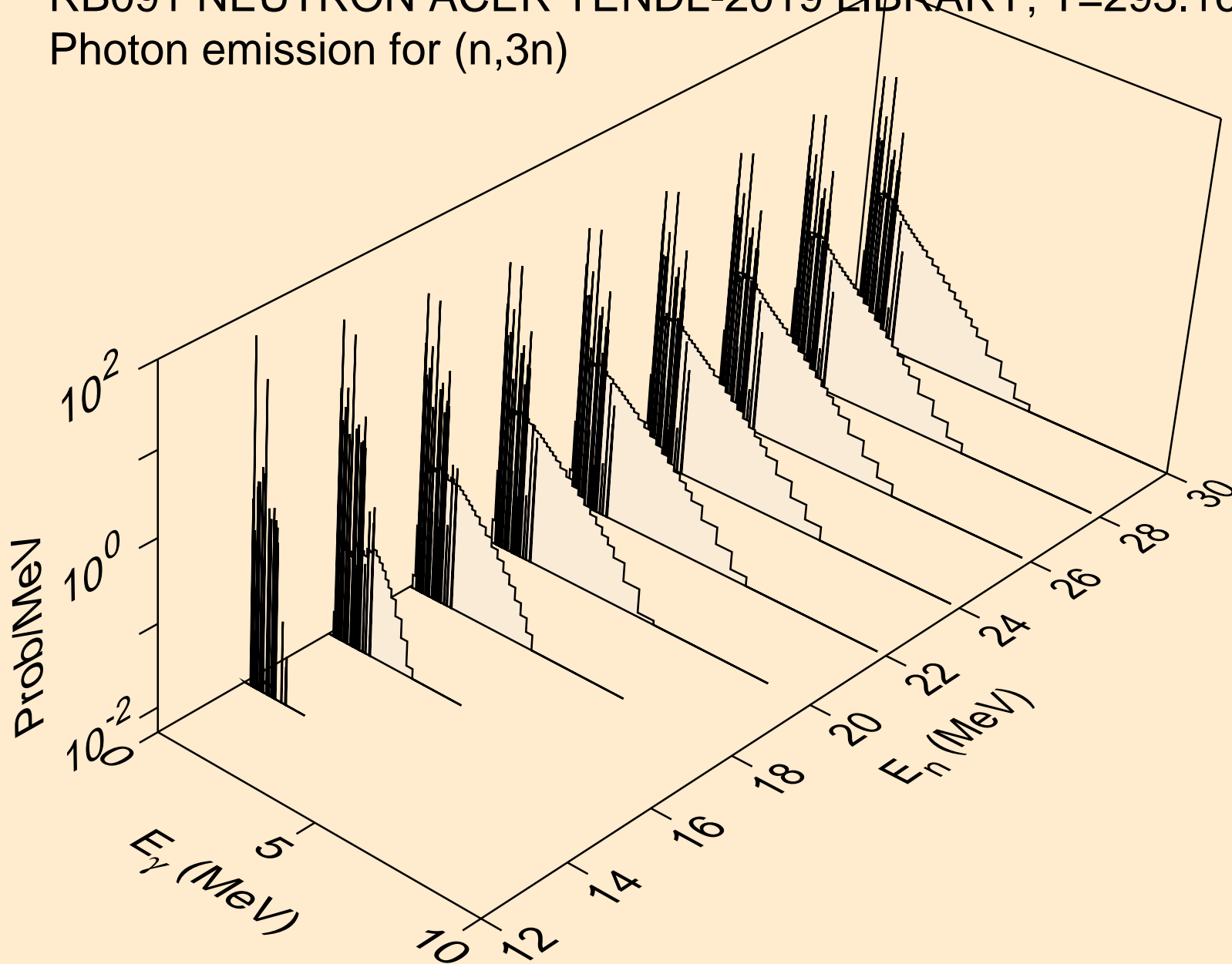

RB091 NEUTRON ACER TENDL-2019 LIBRARY; T=293.16K  
Photon emission for (n,n\*)a

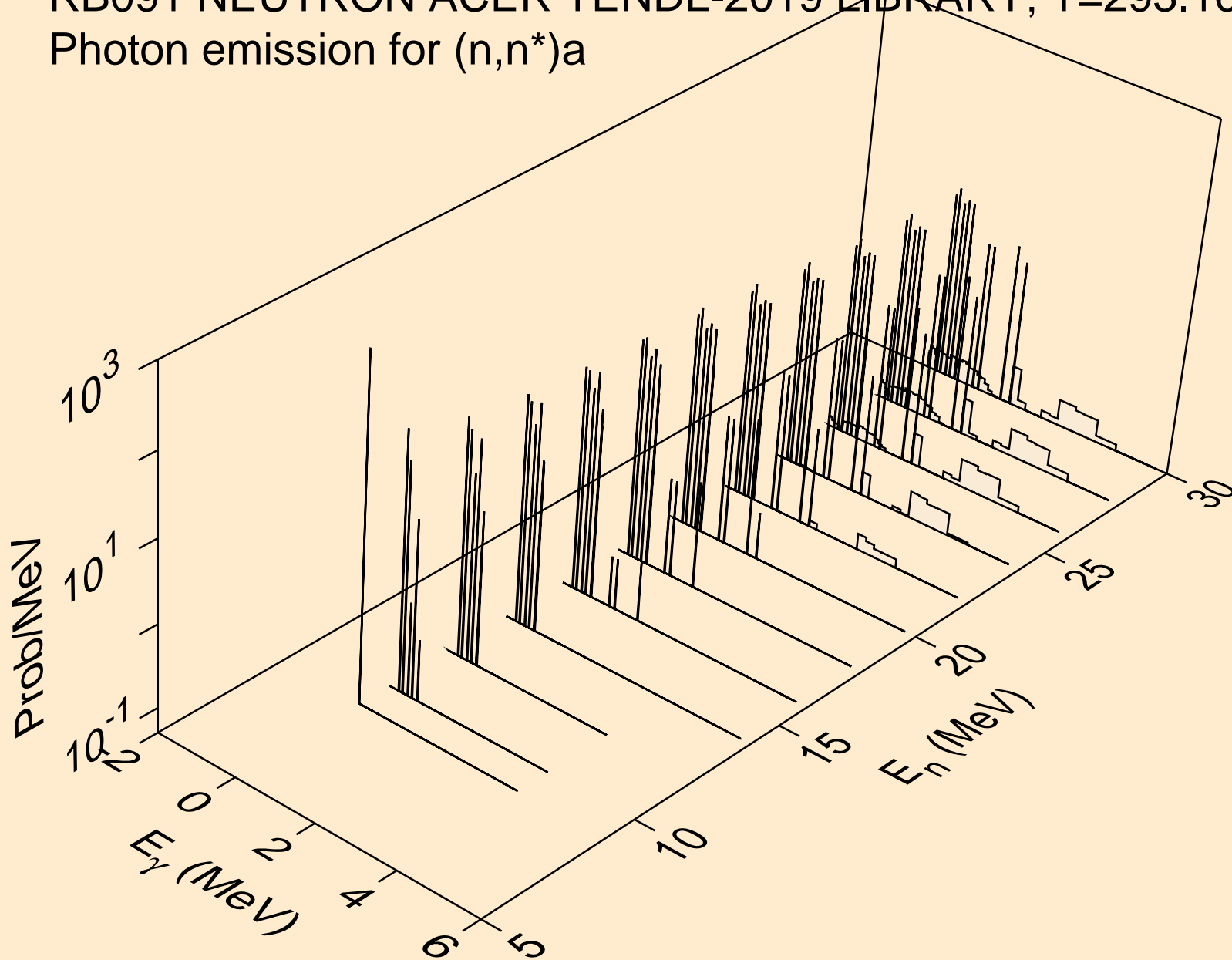

RB091 NEUTRON ACER TENDL-2019 LIBRARY; T=293.16K  
Photon emission for (n,2n)a

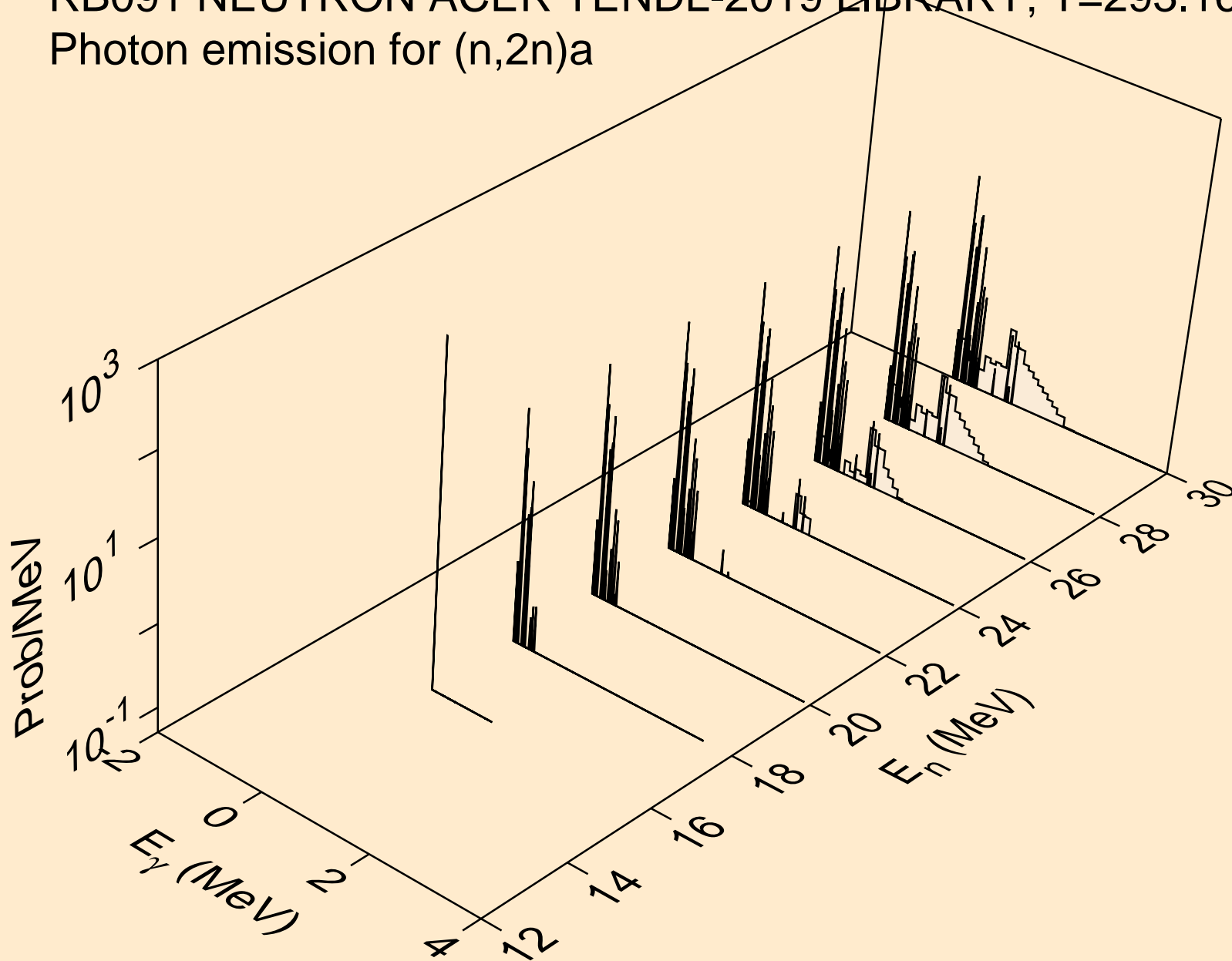

RB091 NEUTRON ACER TENDL-2019 LIBRARY; T=293.16K  
Photon emission for (n,3n)a

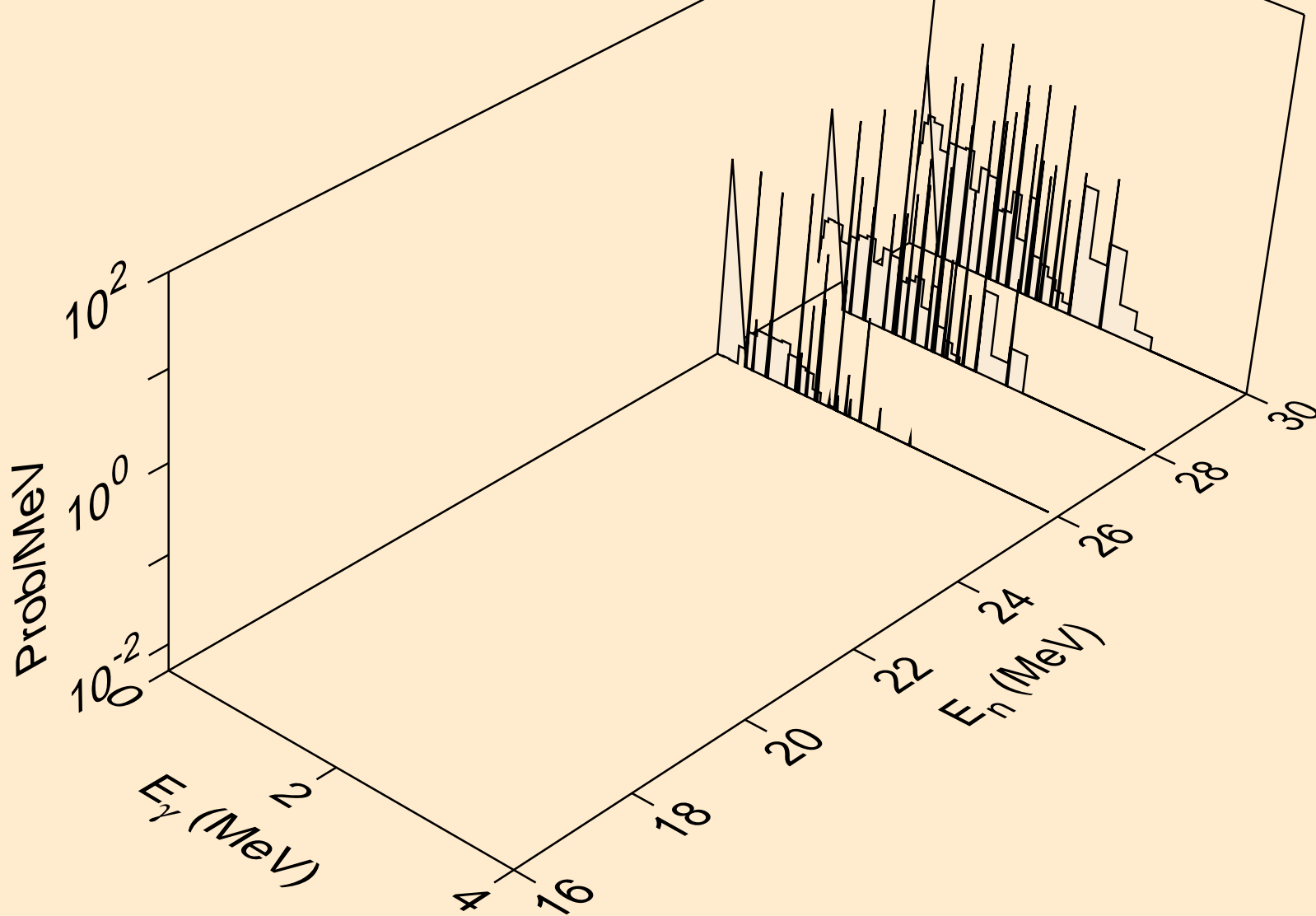



RB091 NEUTRON ACER TENDL-2019 LIBRARY; T=293.16K  
Photon emission for (n,n\*)p

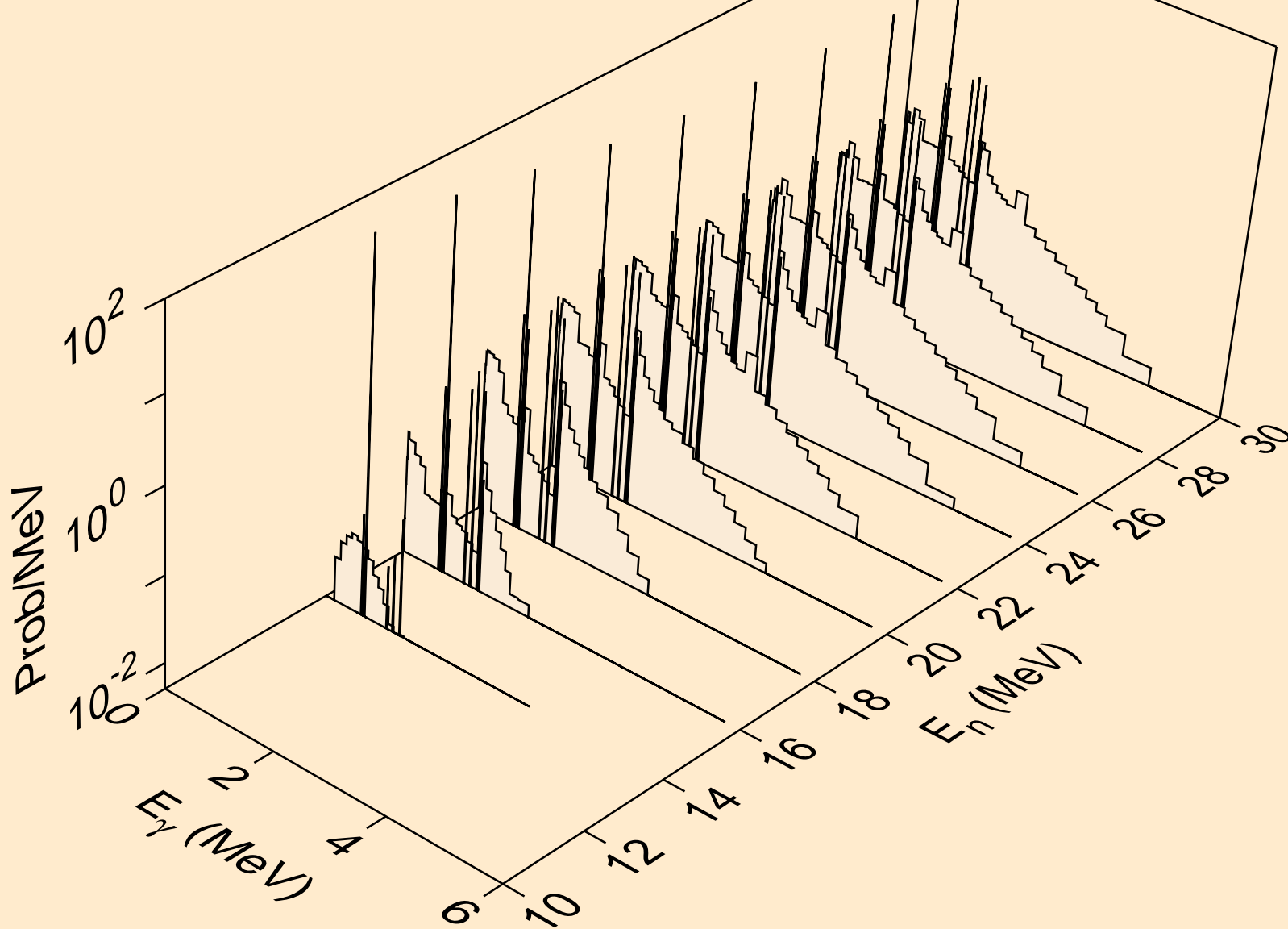

RB091 NEUTRON ACER TENDL-2019 LIBRARY; T=293.16K  
Photon emission for (n,n\*)d

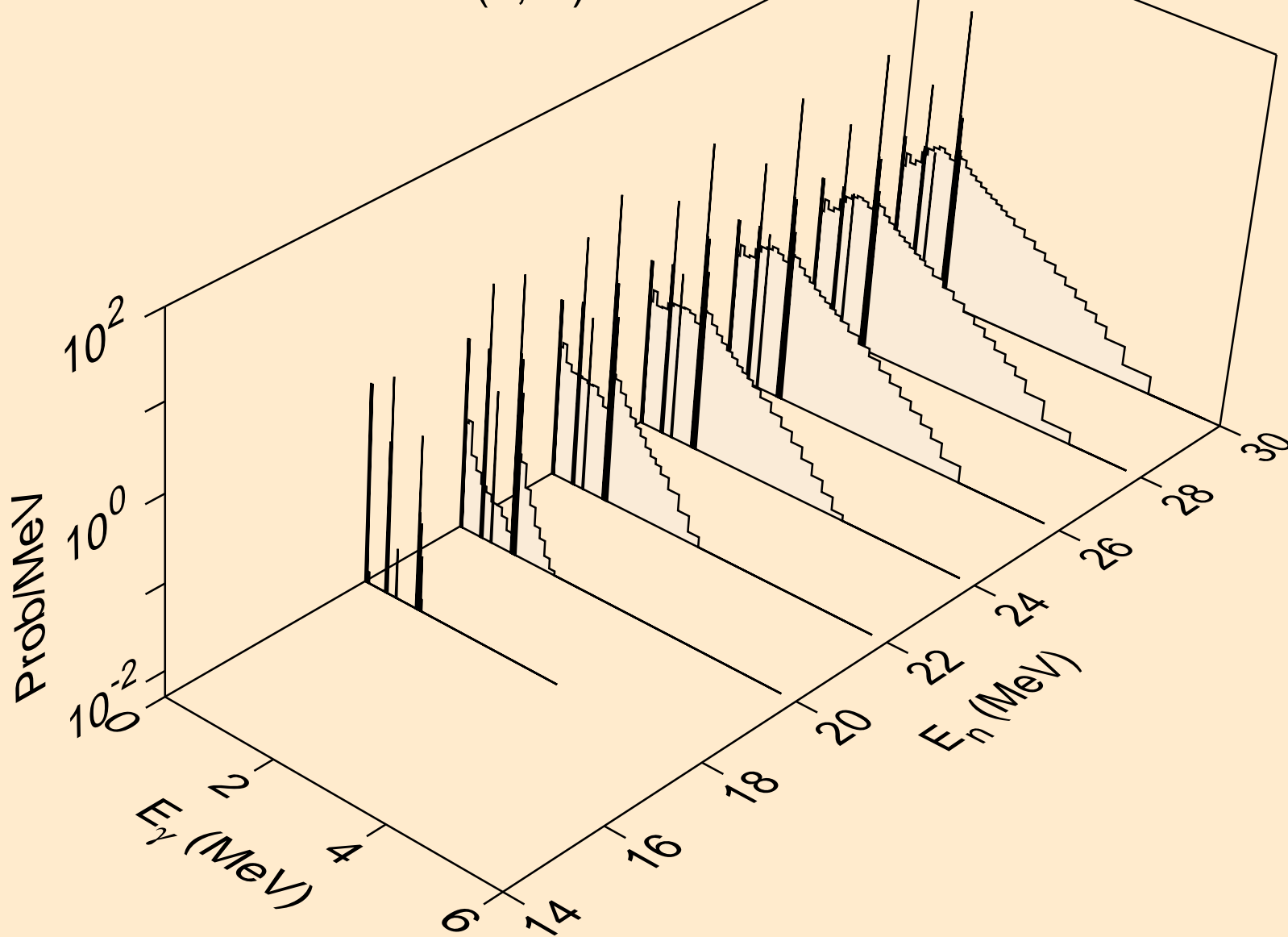

RB091 NEUTRON ACER TENDL-2019 LIBRARY; T=293.16K  
Photon emission for (n,n\*)t

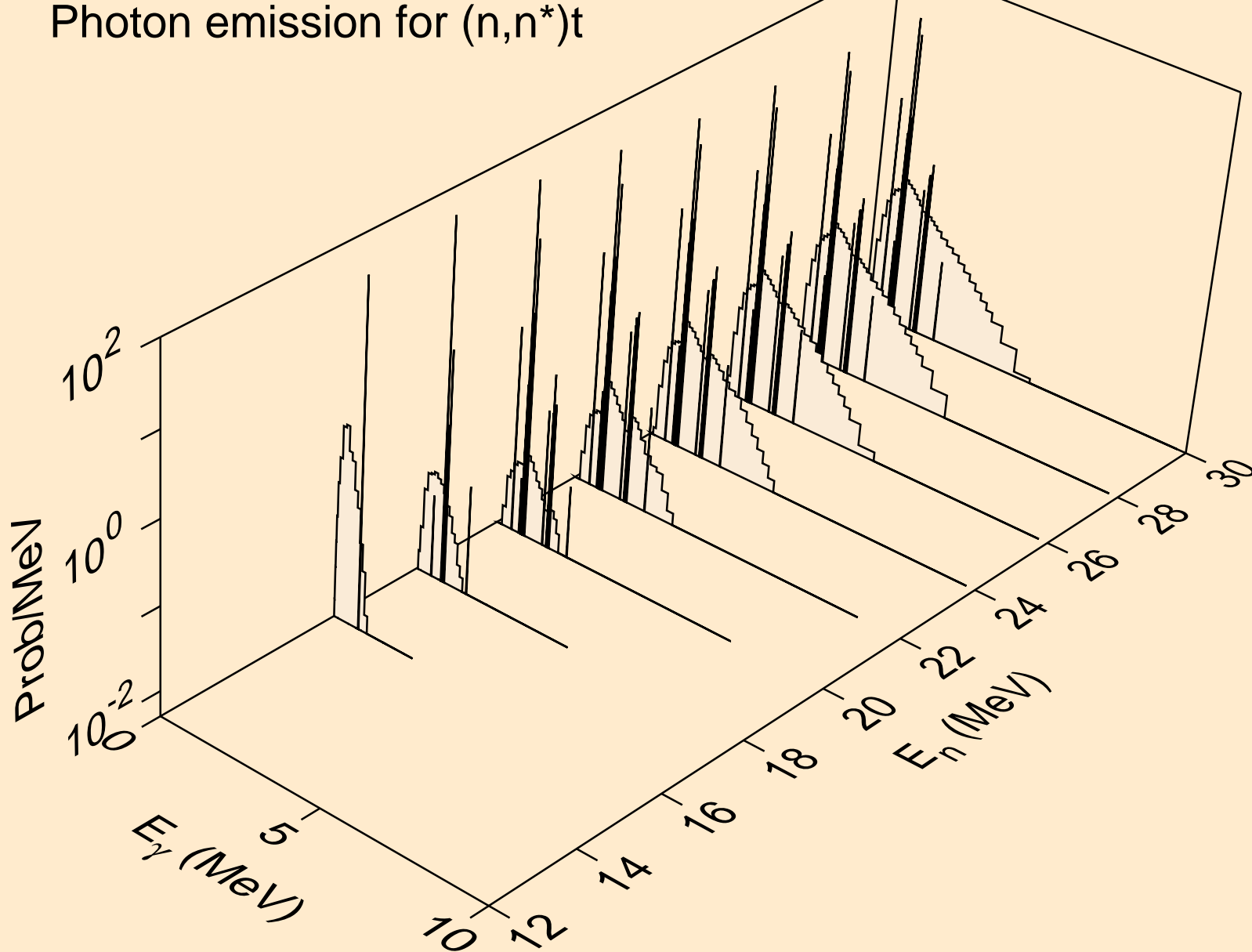

RB091 NEUTRON ACER TENDL-2019 LIBRARY; T=293.16K  
Photon emission for (n,n\*)he3

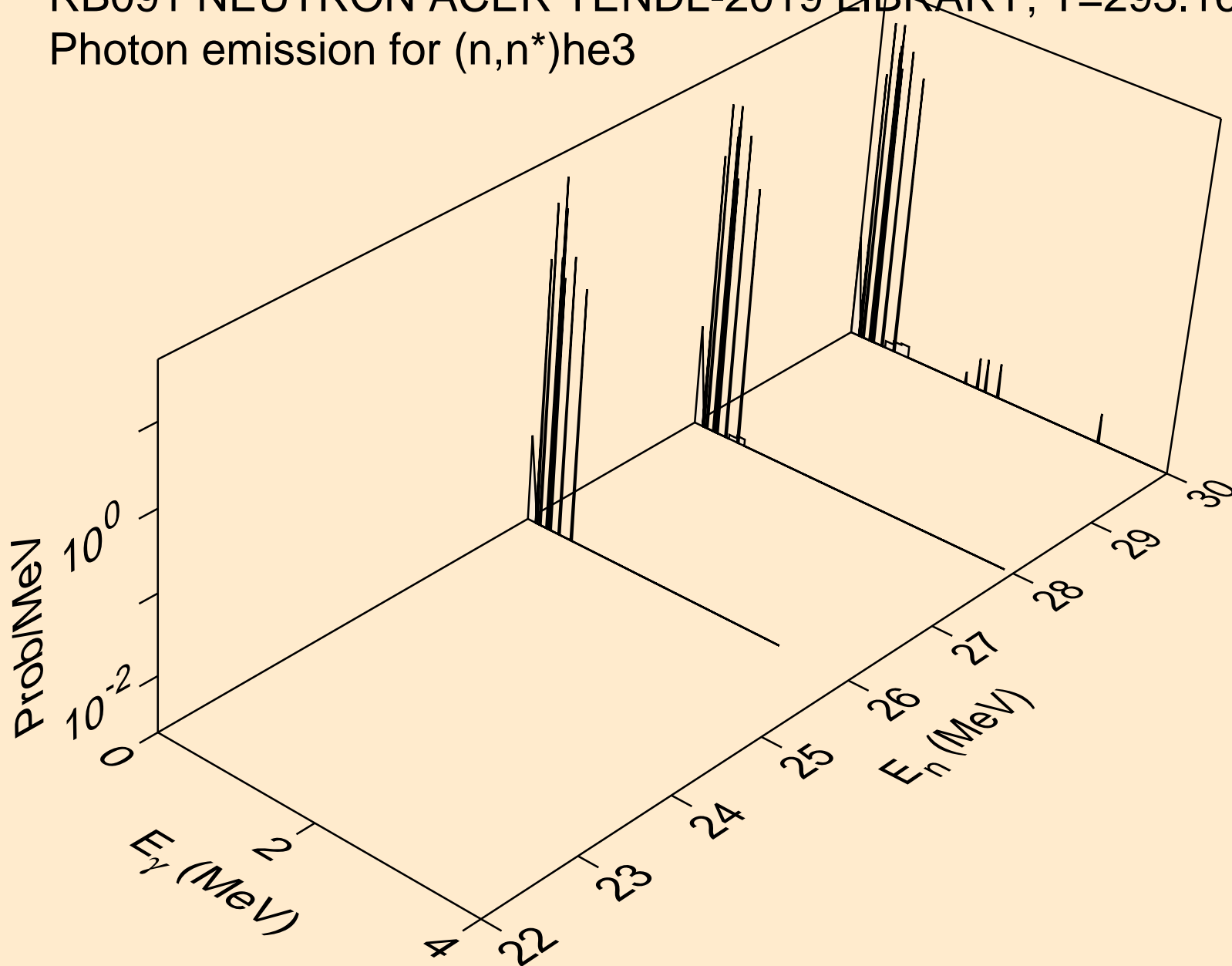

RB091 NEUTRON ACER TENDL-2019 LIBRARY; T=293.16K  
Photon emission for (n,4n)

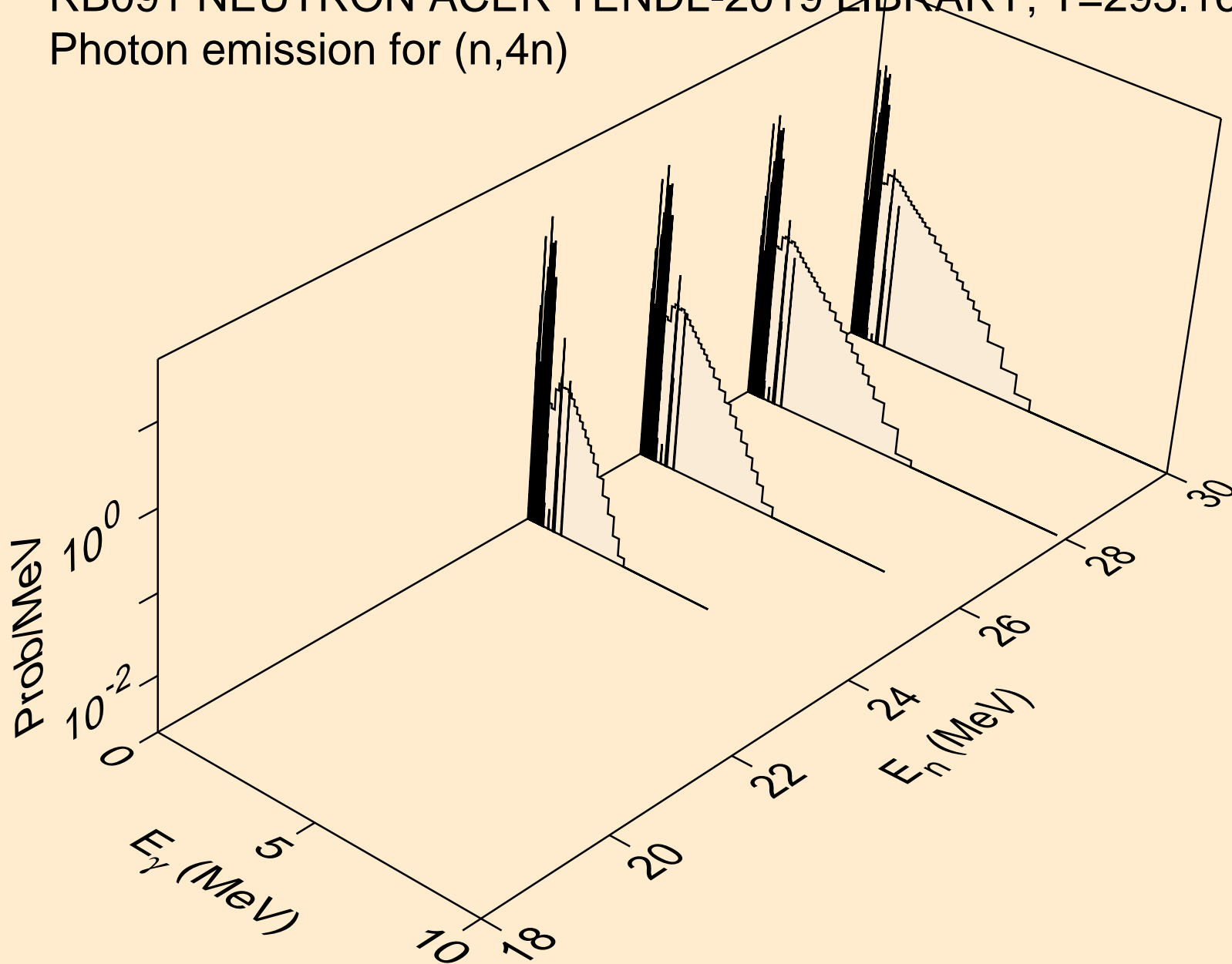

RB091 NEUTRON ACER TENDL-2019 LIBRARY; T=293.16K  
Photon emission for (n,2np)

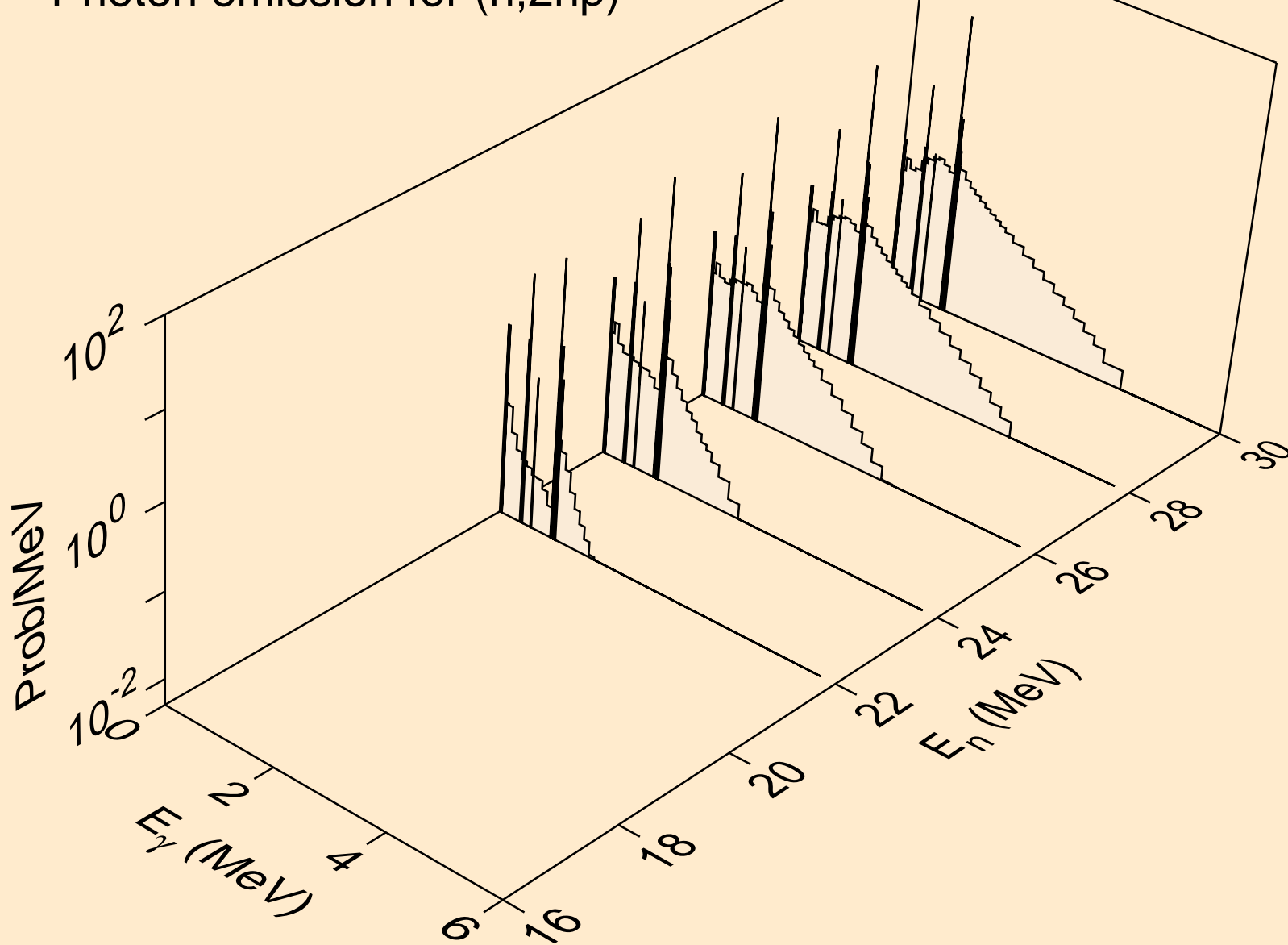

RB091 NEUTRON ACER TENDL-2019 LIBRARY; T=293.16K  
Photon emission for (n,3np)

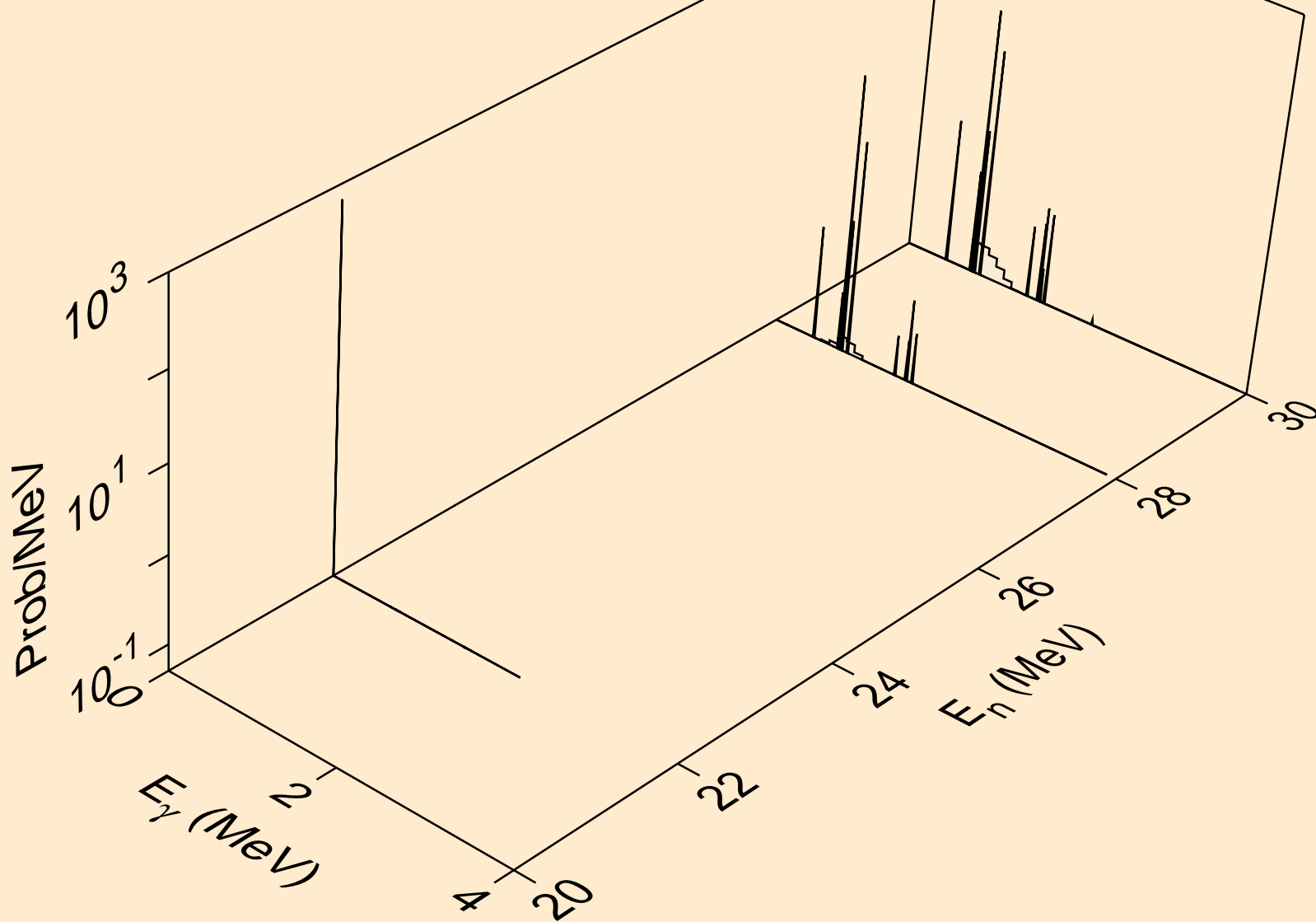

RB091 NEUTRON ACER TENDL-2019 LIBRARY; T=293.16K  
Photon emission for (n,n\*c)

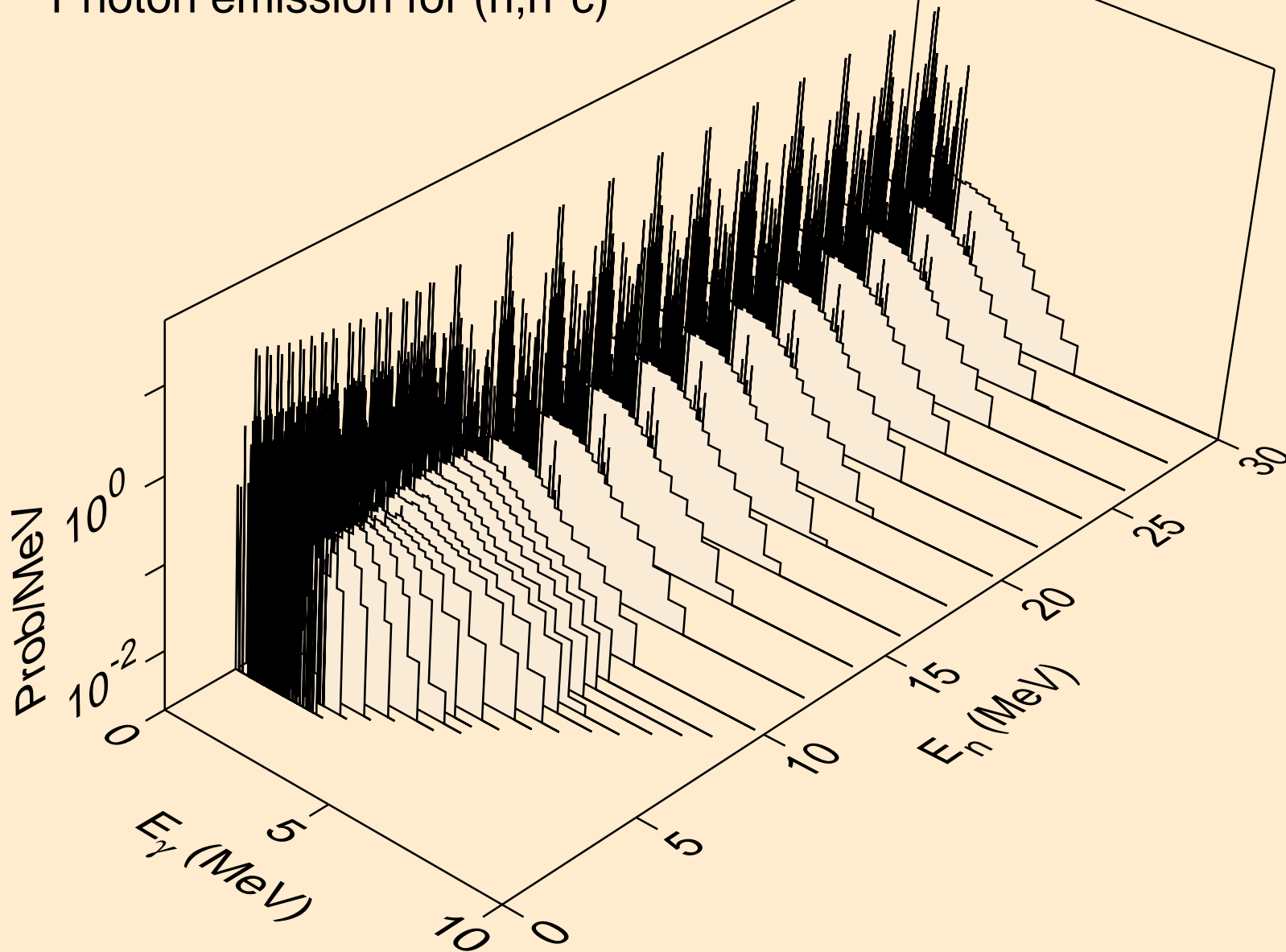



RB091 NEUTRON ACER TENDL-2019 LIBRARY; T=293.16K  
Photon emission for (n,gma)

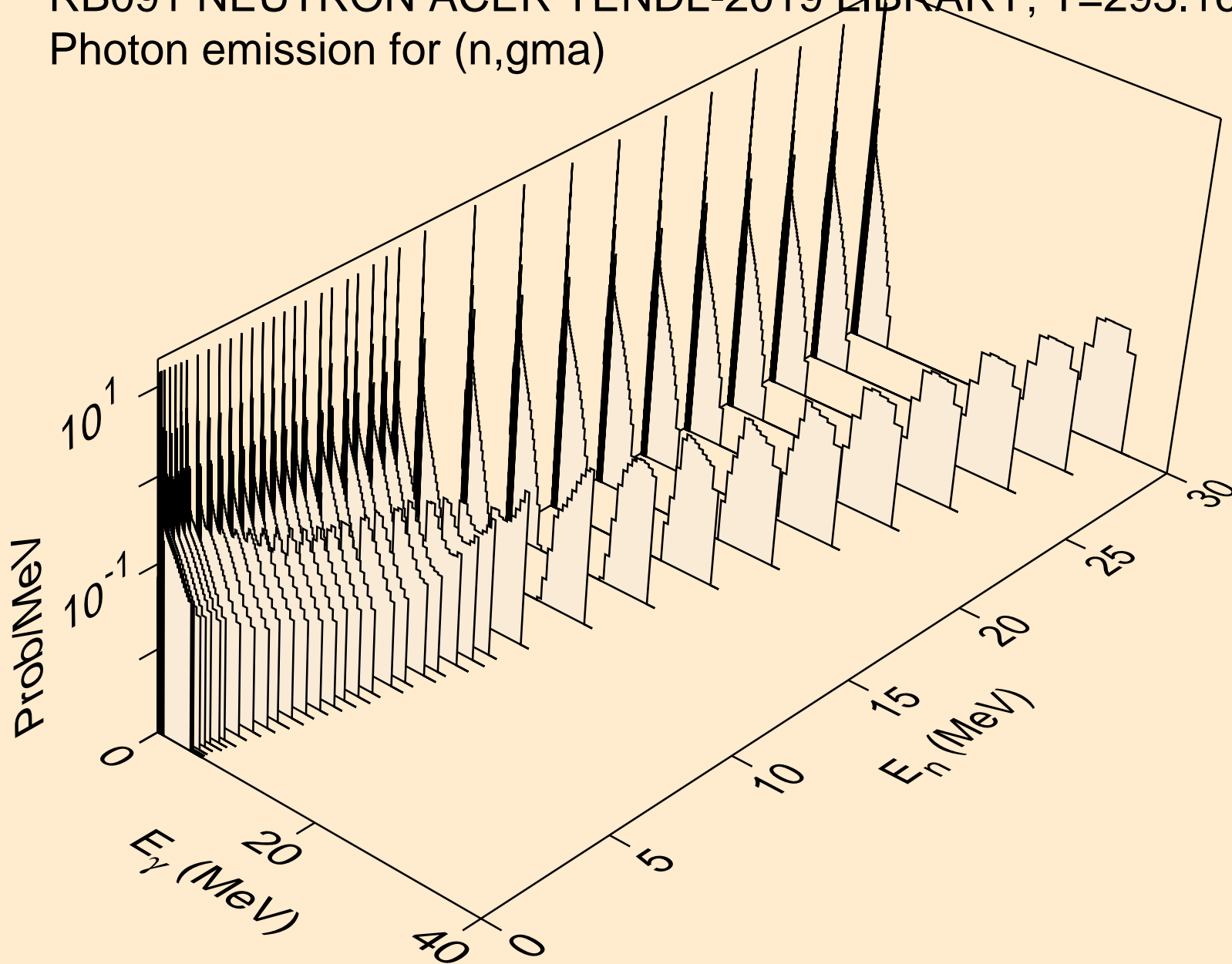

RB091 NEUTRON ACER TENDL-2019 LIBRARY; T=293.16K  
Photon emission for (n,p)

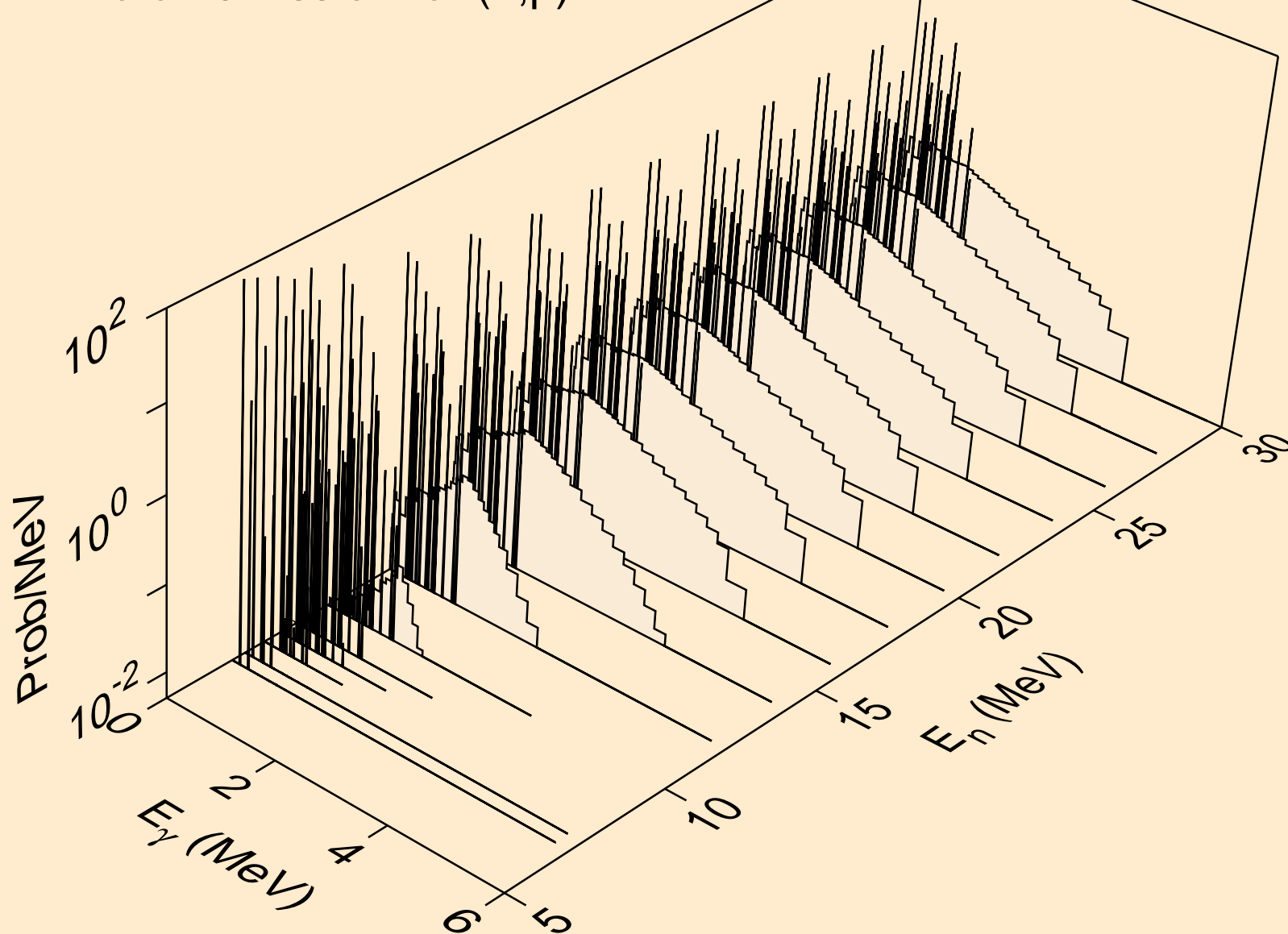

RB091 NEUTRON ACER TENDL-2019 LIBRARY; T=293.16K  
Photon emission for (n,d)

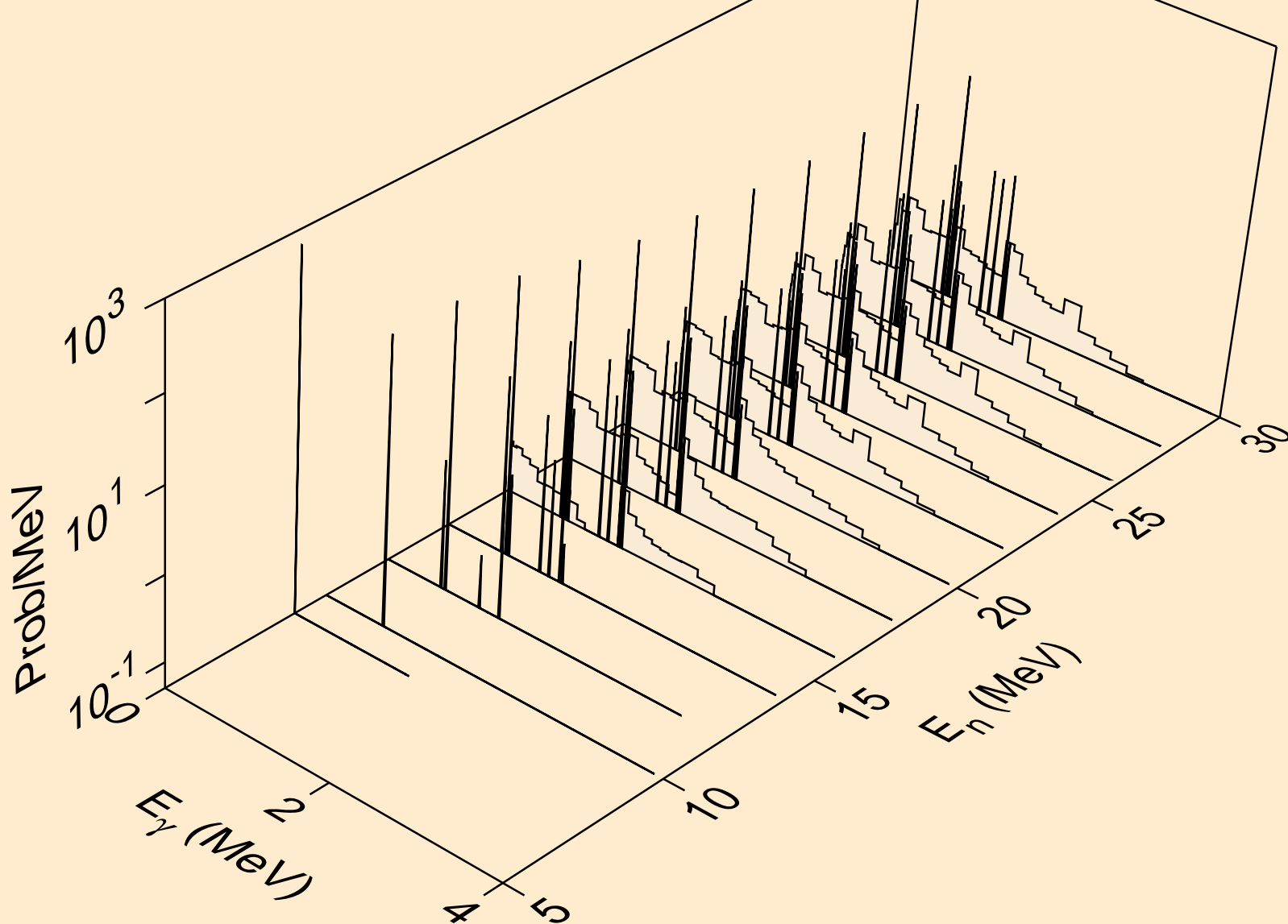

RB091 NEUTRON ACER TENDL-2019 LIBRARY; T=293.16K  
Photon emission for (n,t)

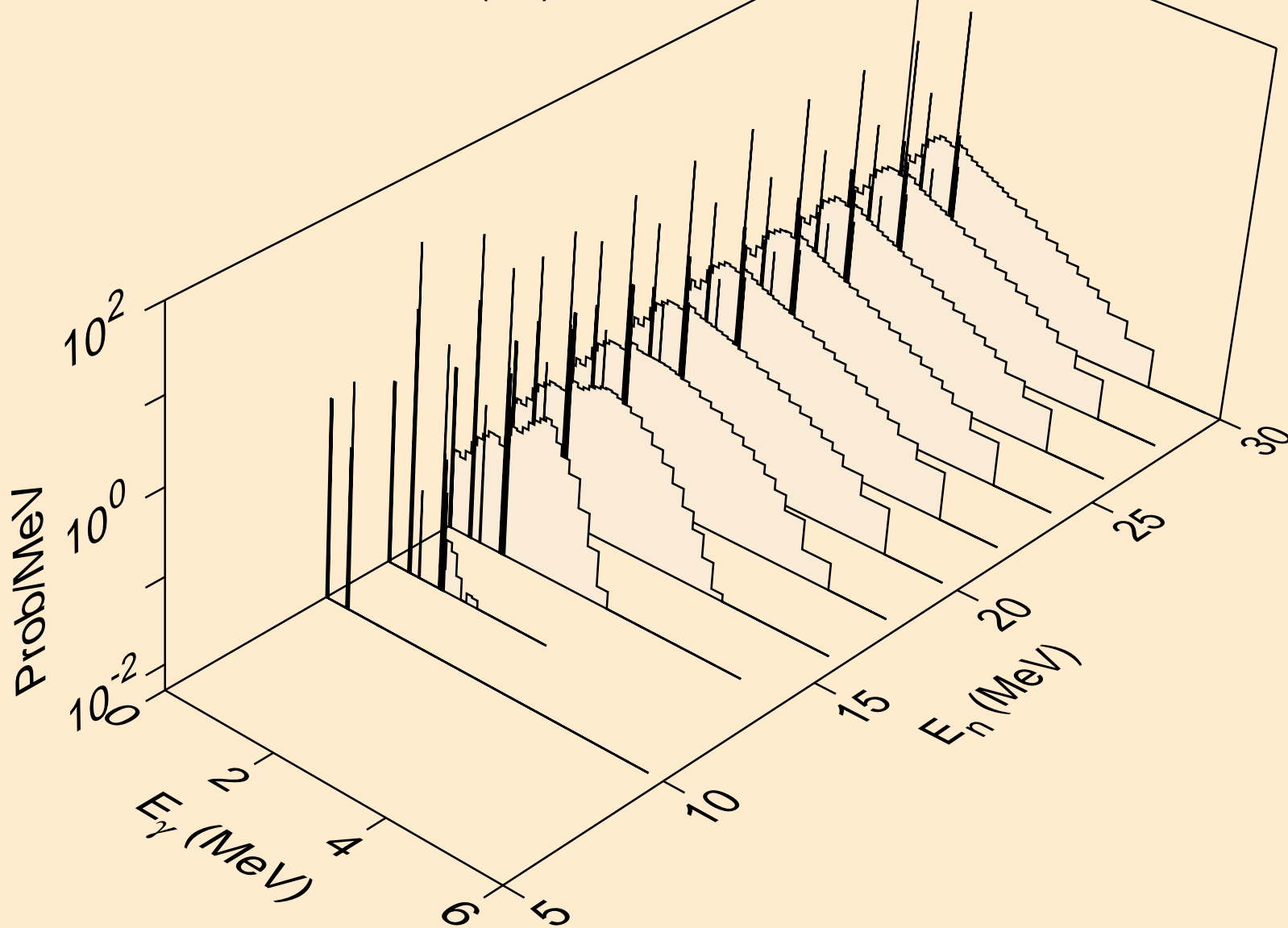

RB091 NEUTRON ACER TENDL-2019 LIBRARY; T=293.16K  
Photon emission for (n,he3)

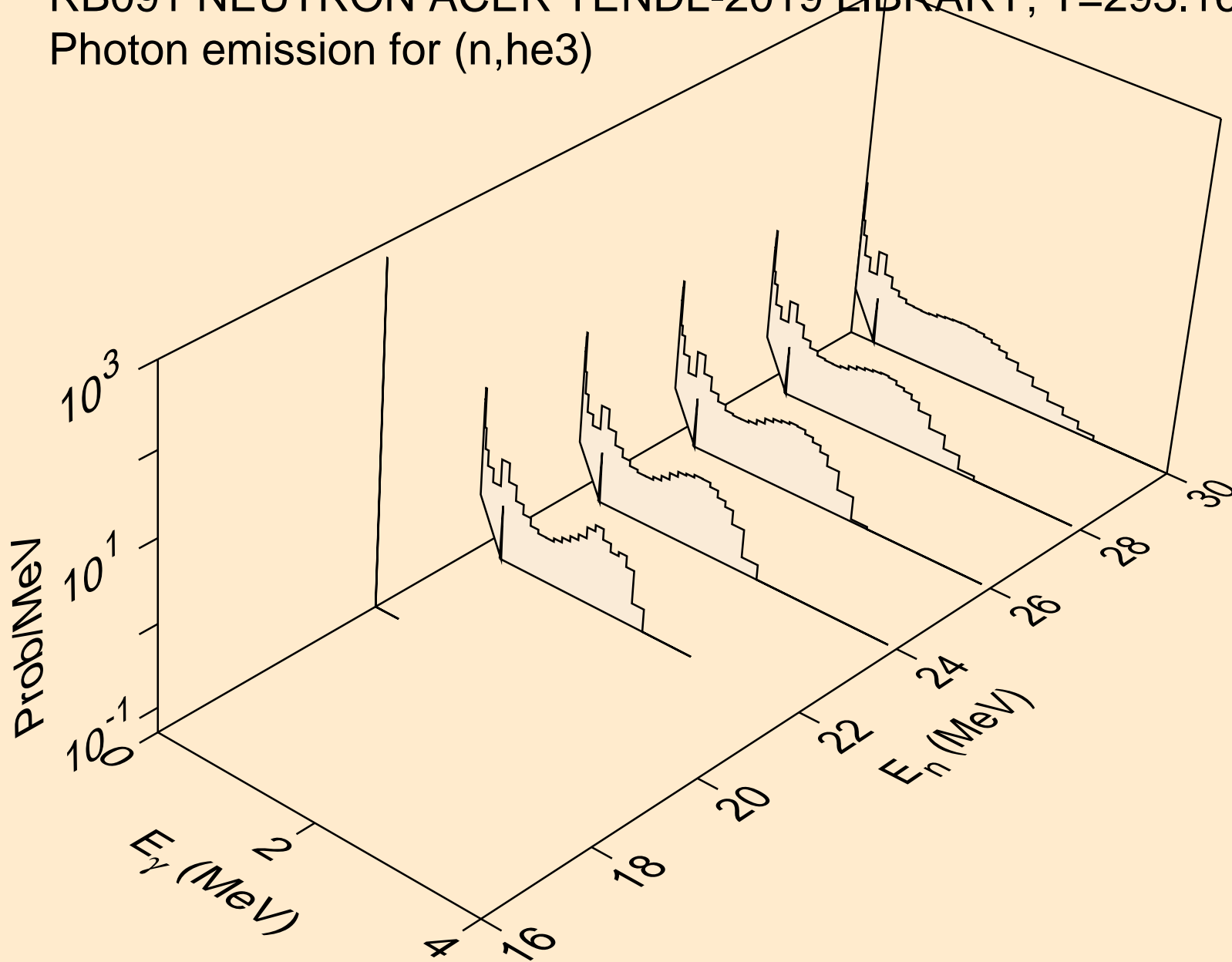

RB091 NEUTRON ACER TENDL-2019 LIBRARY; T=293.16K  
Photon emission for (n,a)

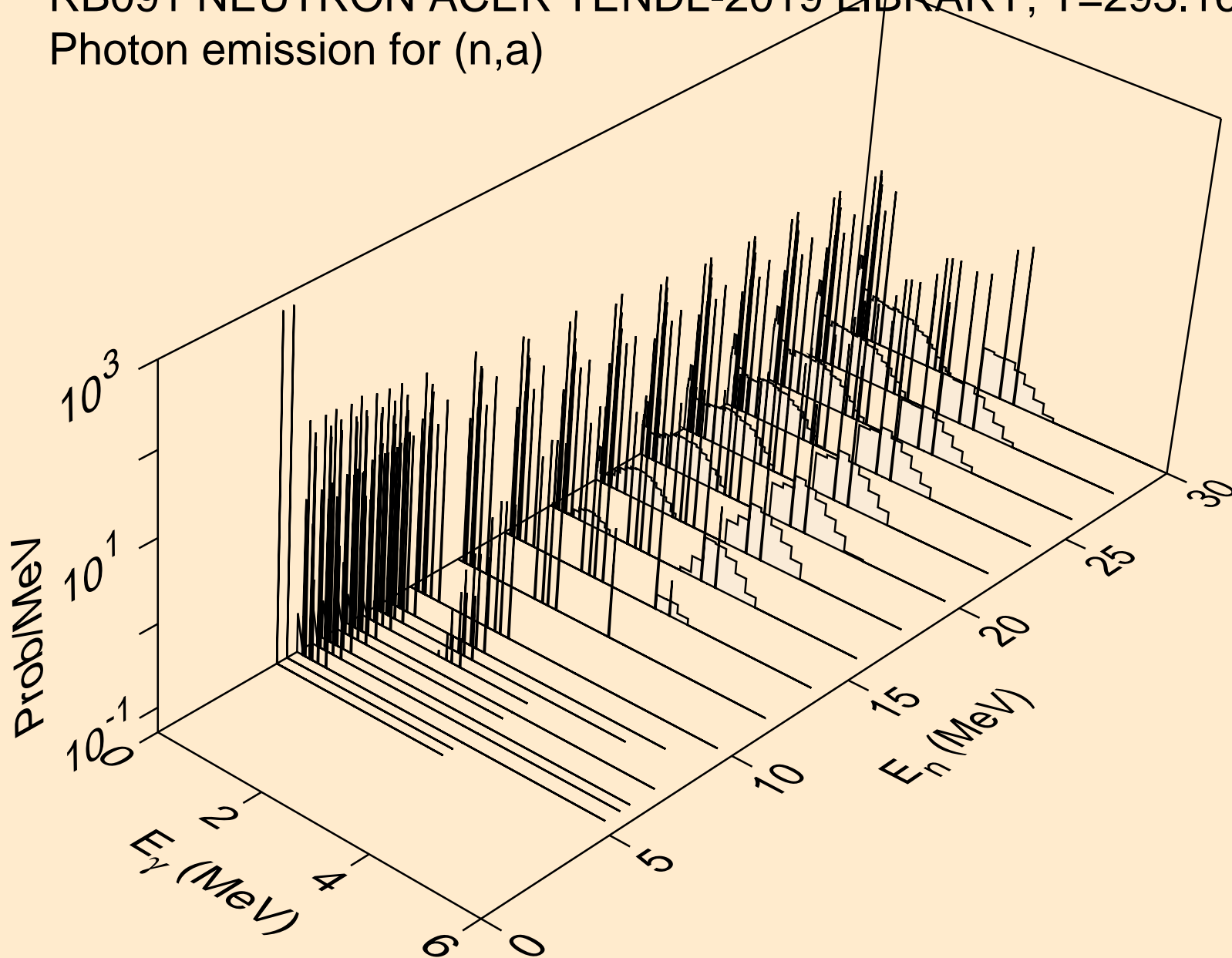

RB091 NEUTRON ACER TENDL-2019 LIBRARY; T=293.16K  
Photon emission for (n,2a)

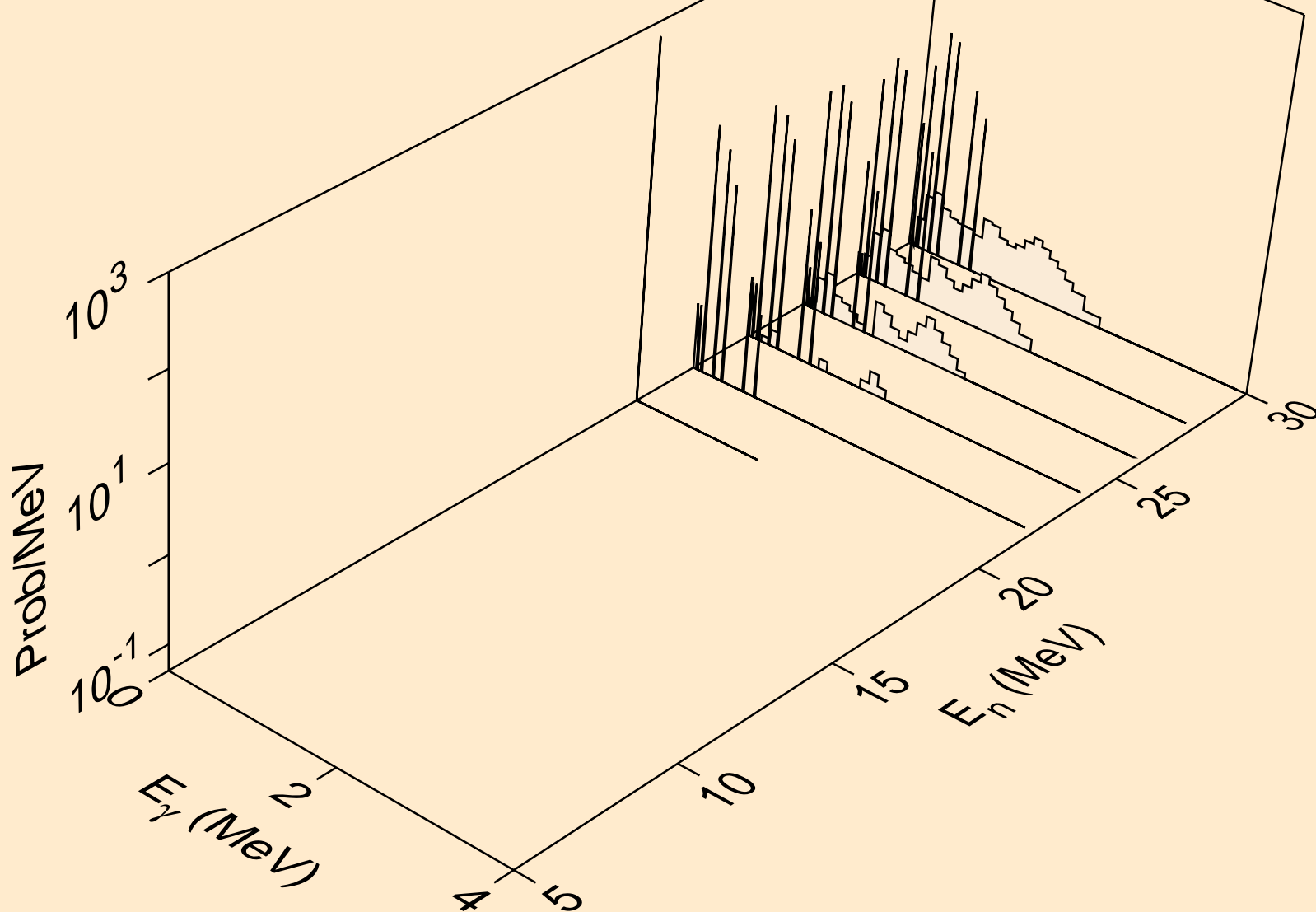

RB091 NEUTRON ACER TENDL-2019 LIBRARY; T=293.16K  
Photon emission for (n,p $\alpha$ )

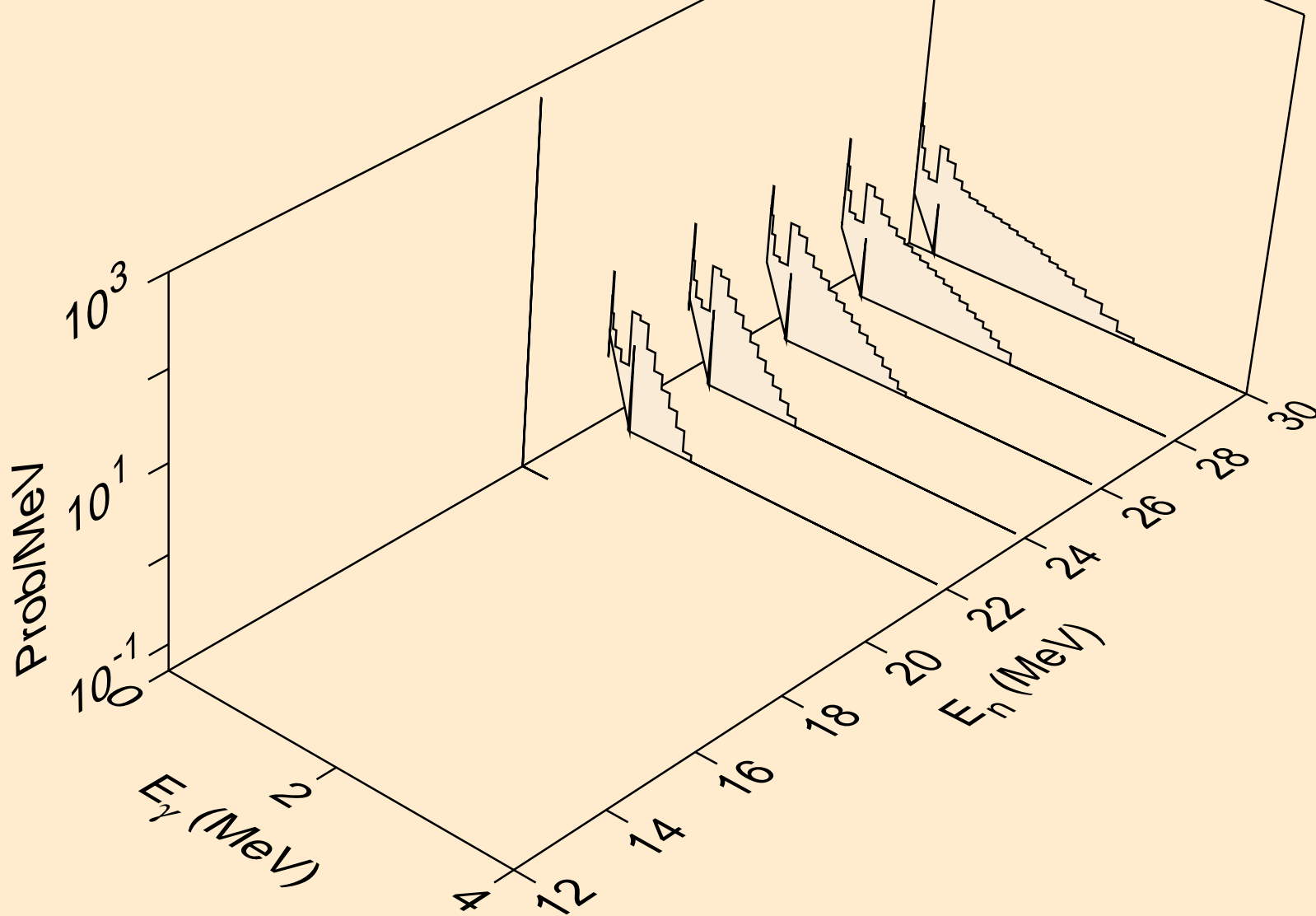



RB091 NEUTRON ACER TENDL-2019 LIBRARY; T=293.16K  
thermal capture photon spectrum

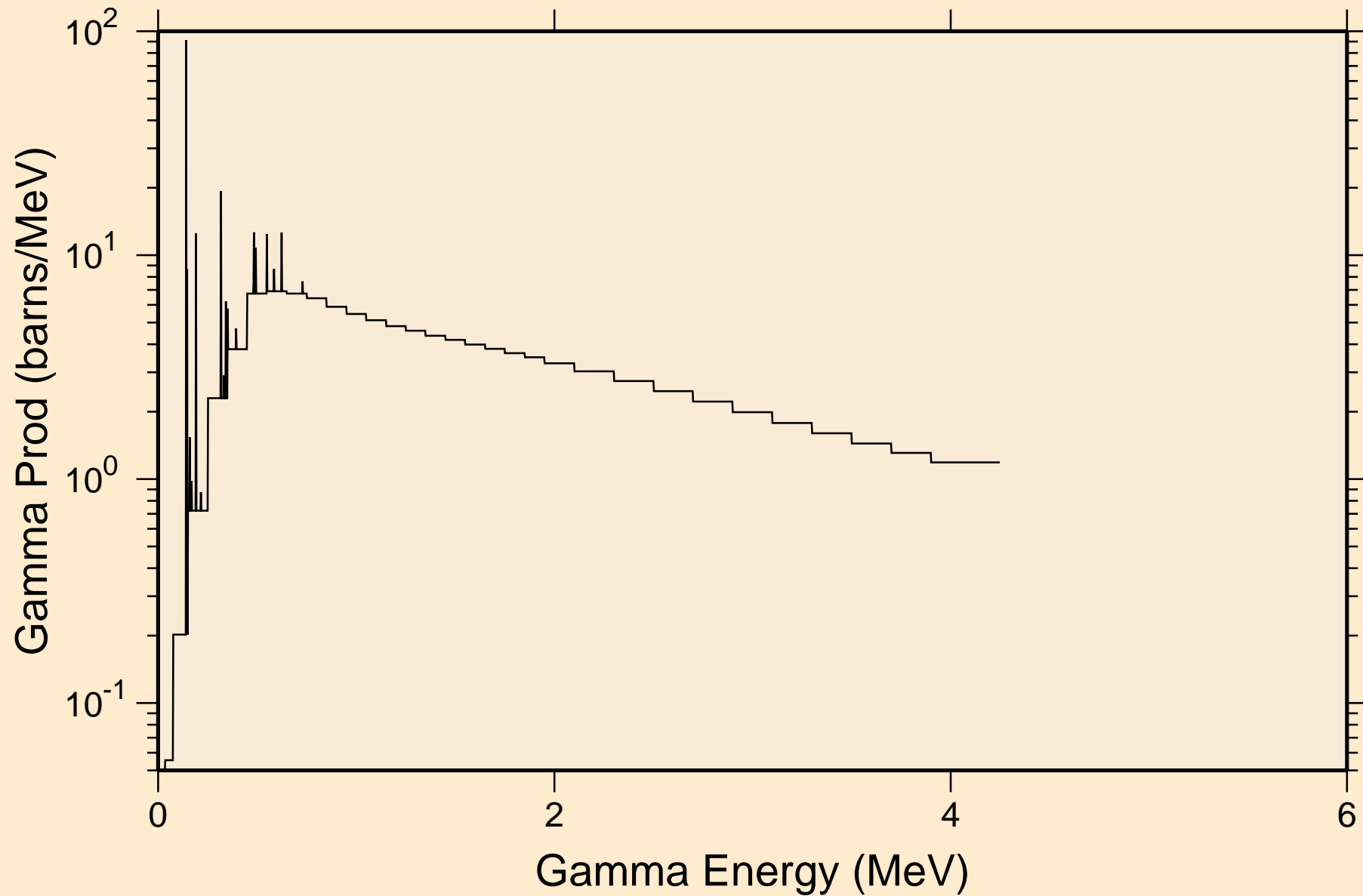

RB091 NEUTRON ACER TENDL-2019 LIBRARY; T=293.16K  
14 MeV photon spectrum

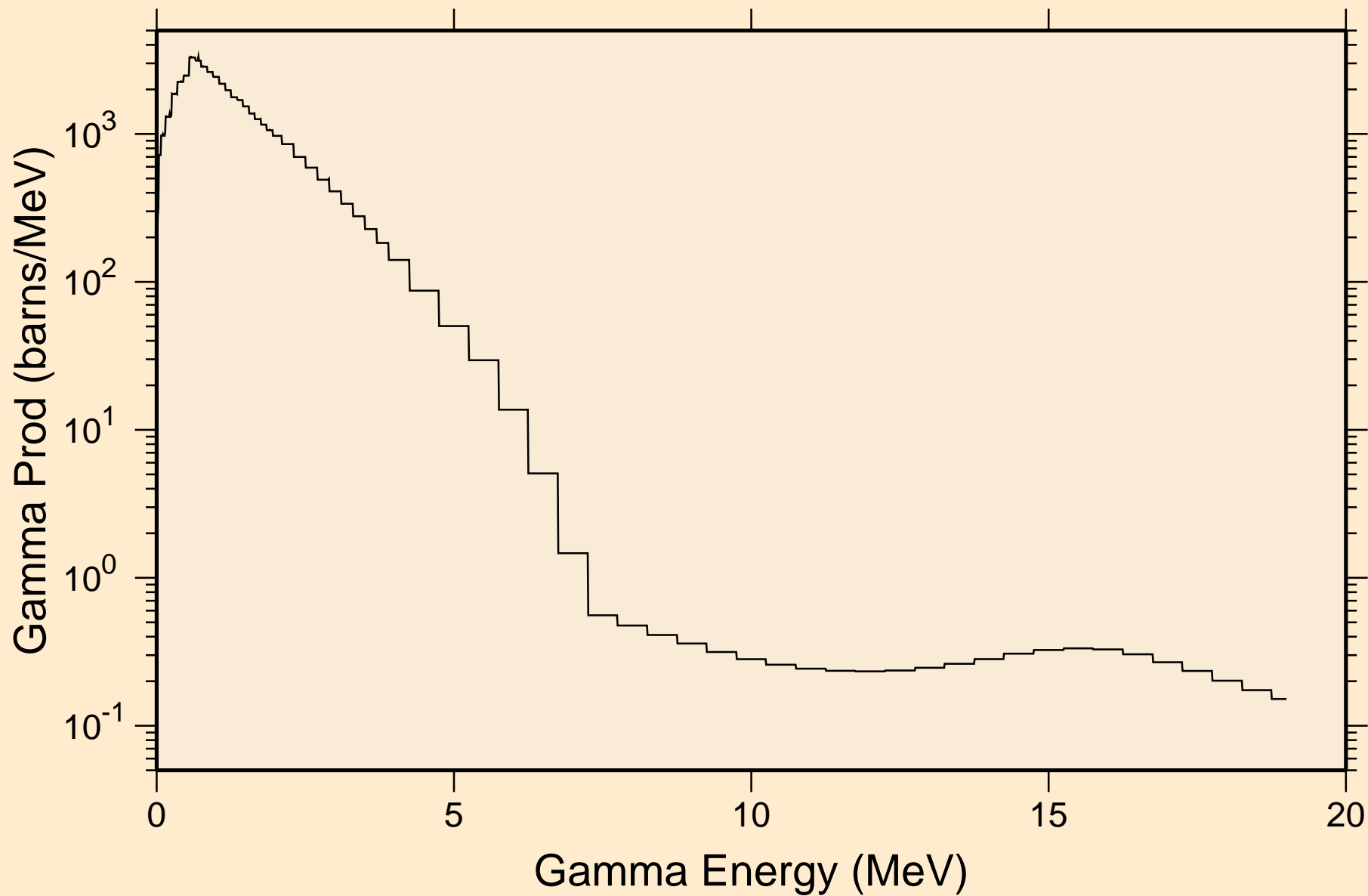

RB091 NEUTRON ACER TENDL-2019 LIBRARY; T=293.16K  
Particle heating contributions

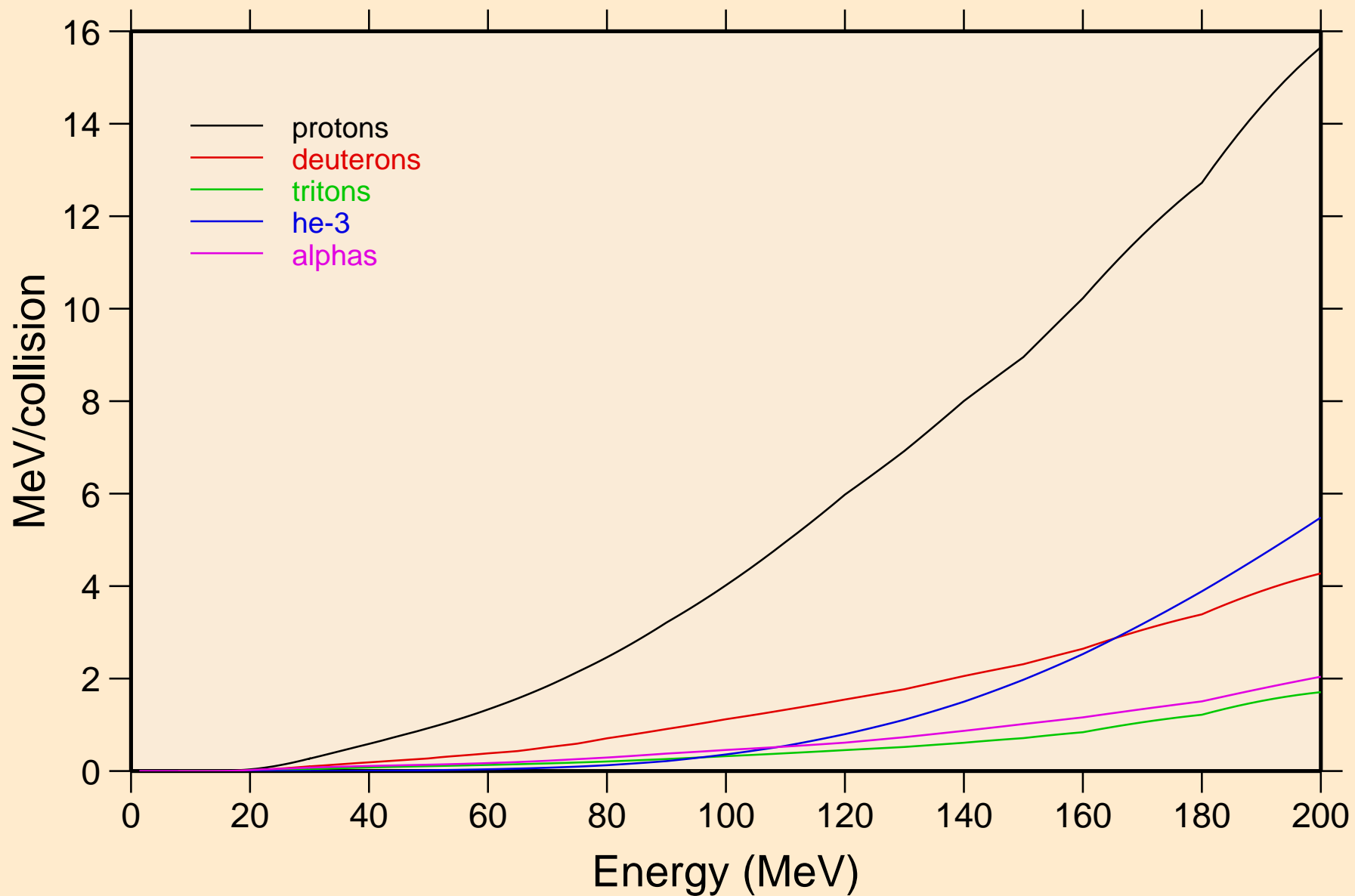

RB091 NEUTRON ACER TENDL-2019 LIBRARY; T=293.16K  
Recoil Heating

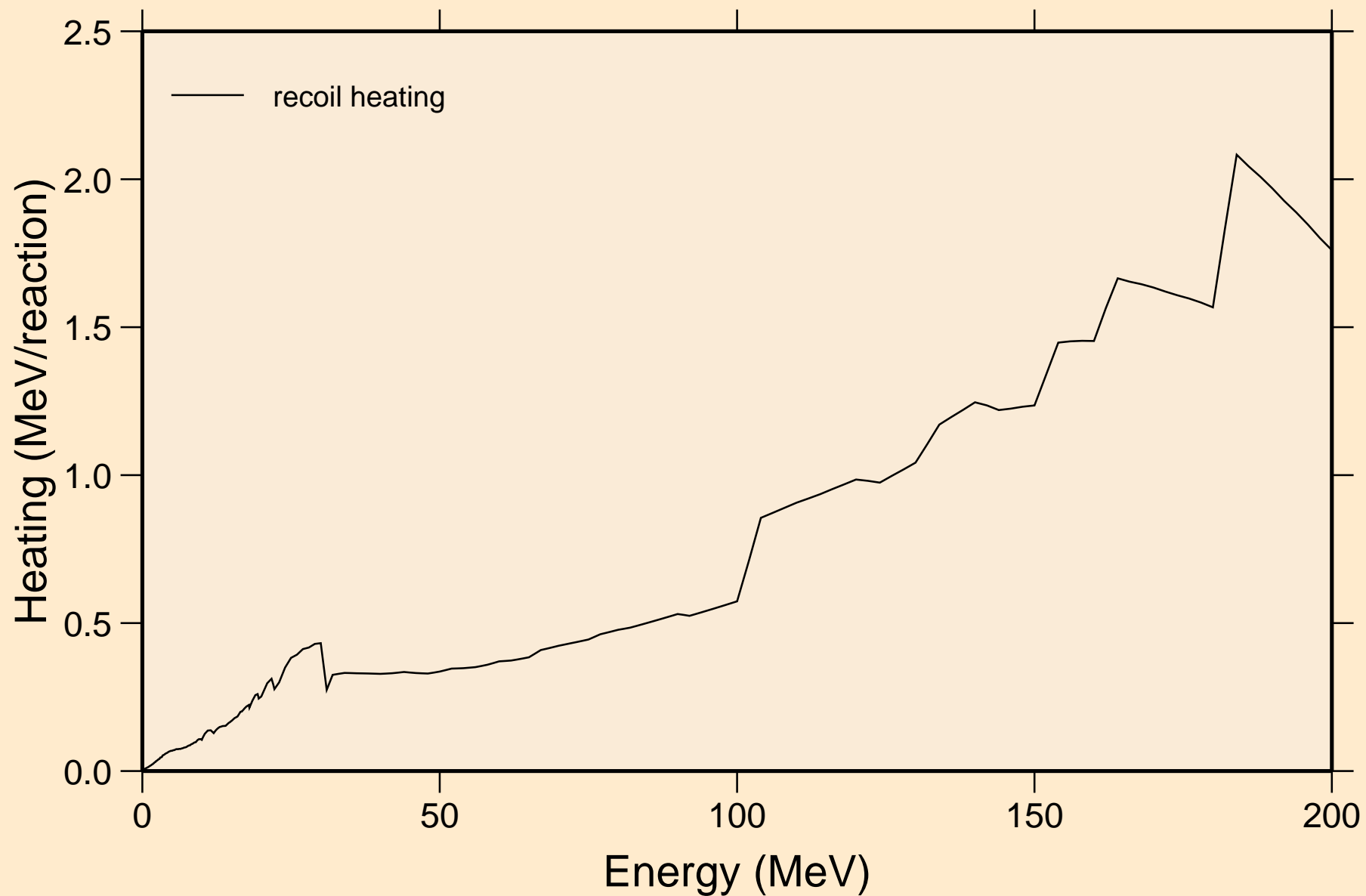

RB091 NEUTRON ACER TENDL-2019 LIBRARY; T=293.16K  
Particle production cross sections

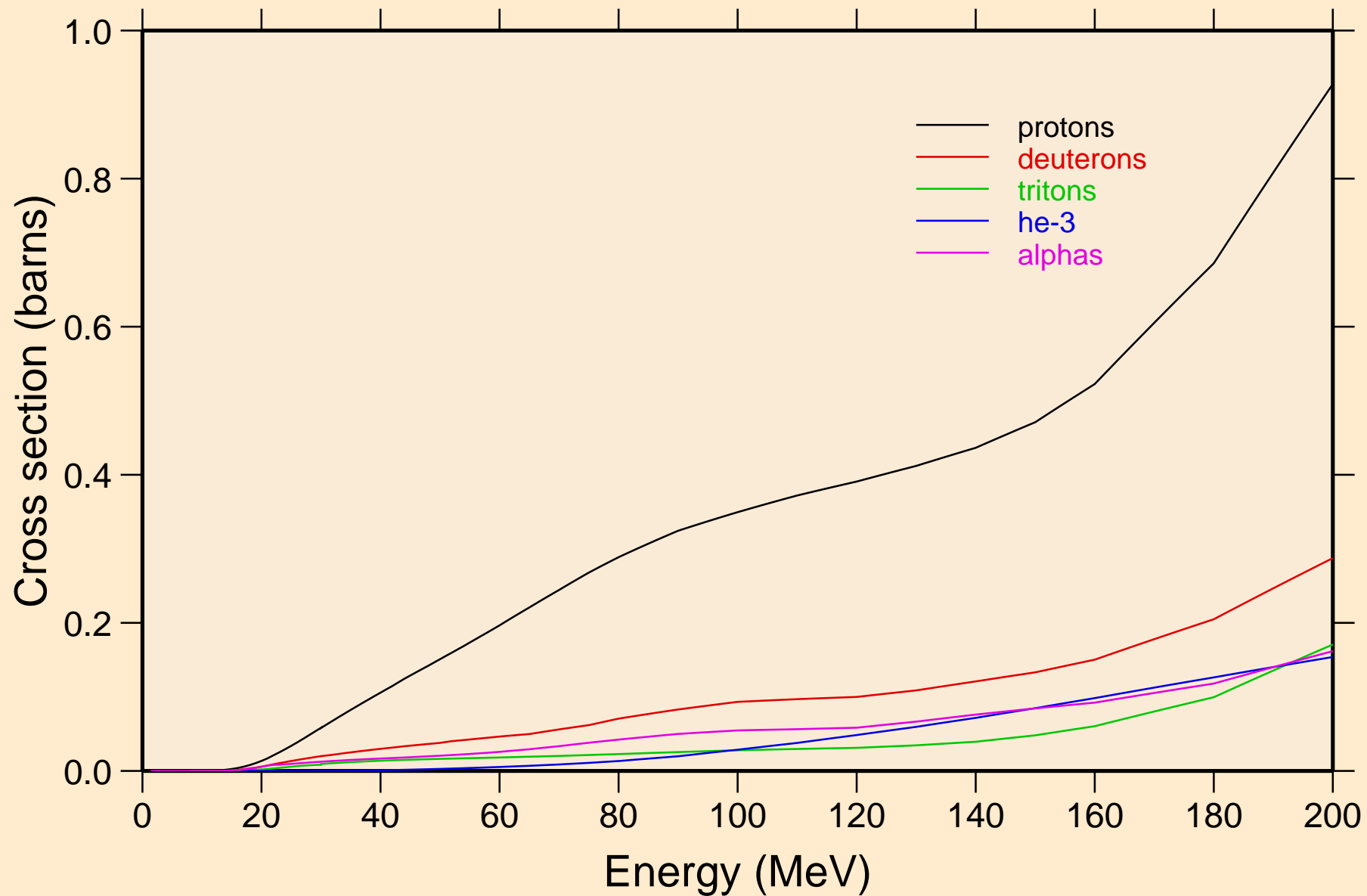

RB091 NEUTRON ACER TENDL-2019 LIBRARY; T=293.16K  
protons from (n,x)

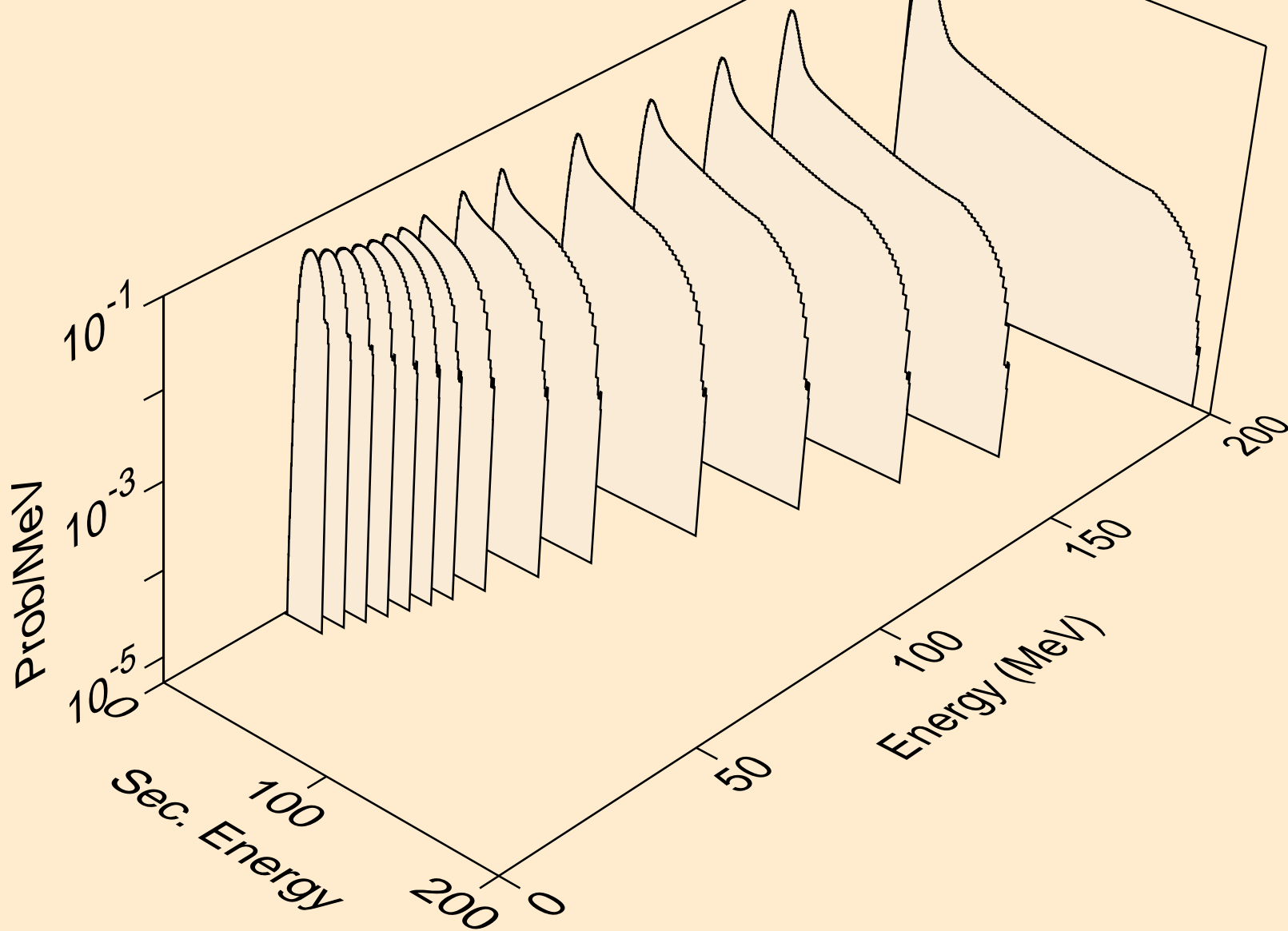

RB091 NEUTRON ACER TENDL-2019 LIBRARY; T=293.16K  
protons from (n,n\*)p

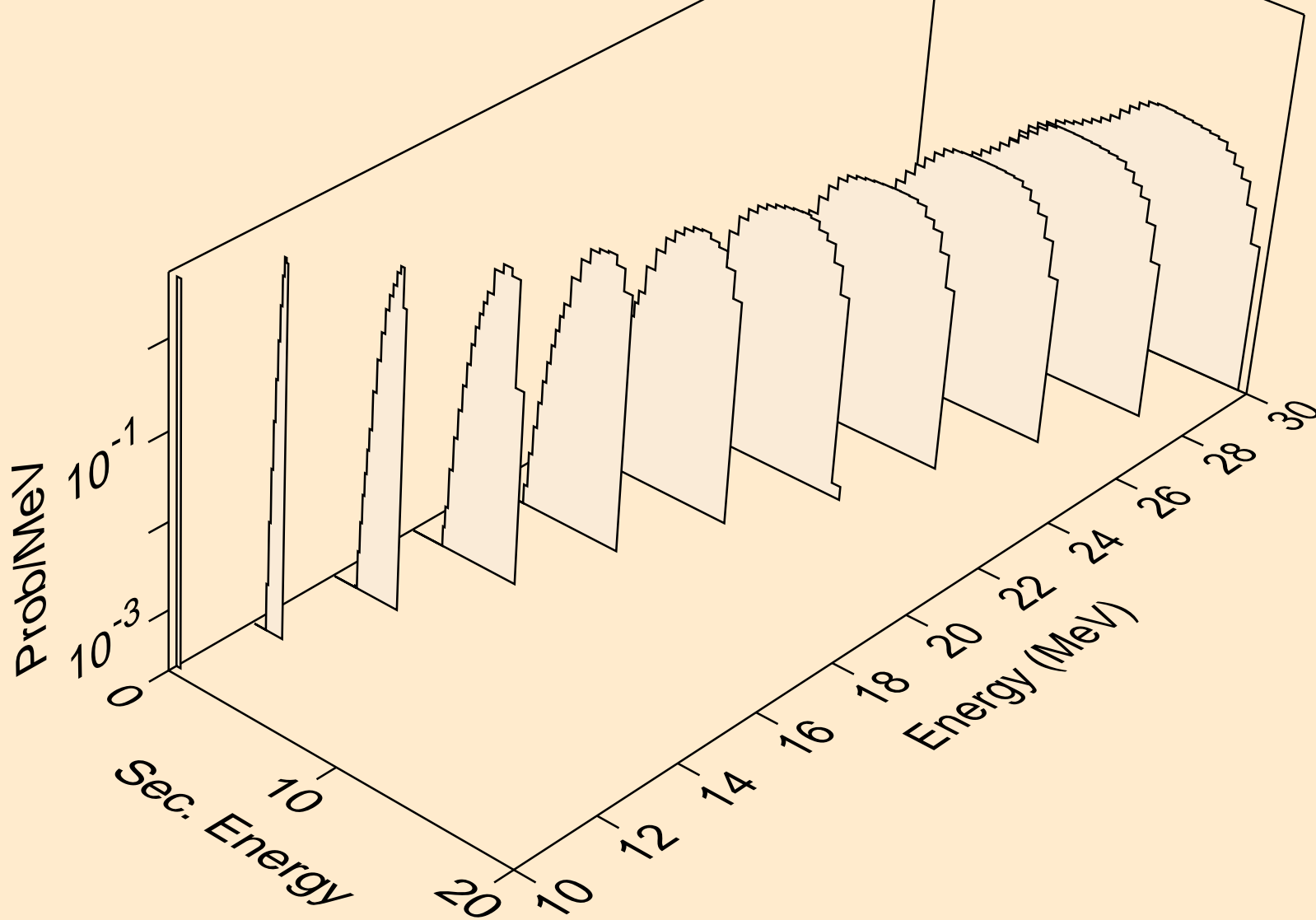

RB091 NEUTRON ACER TENDL-2019 LIBRARY; T=293.16K  
protons from (n,2np)

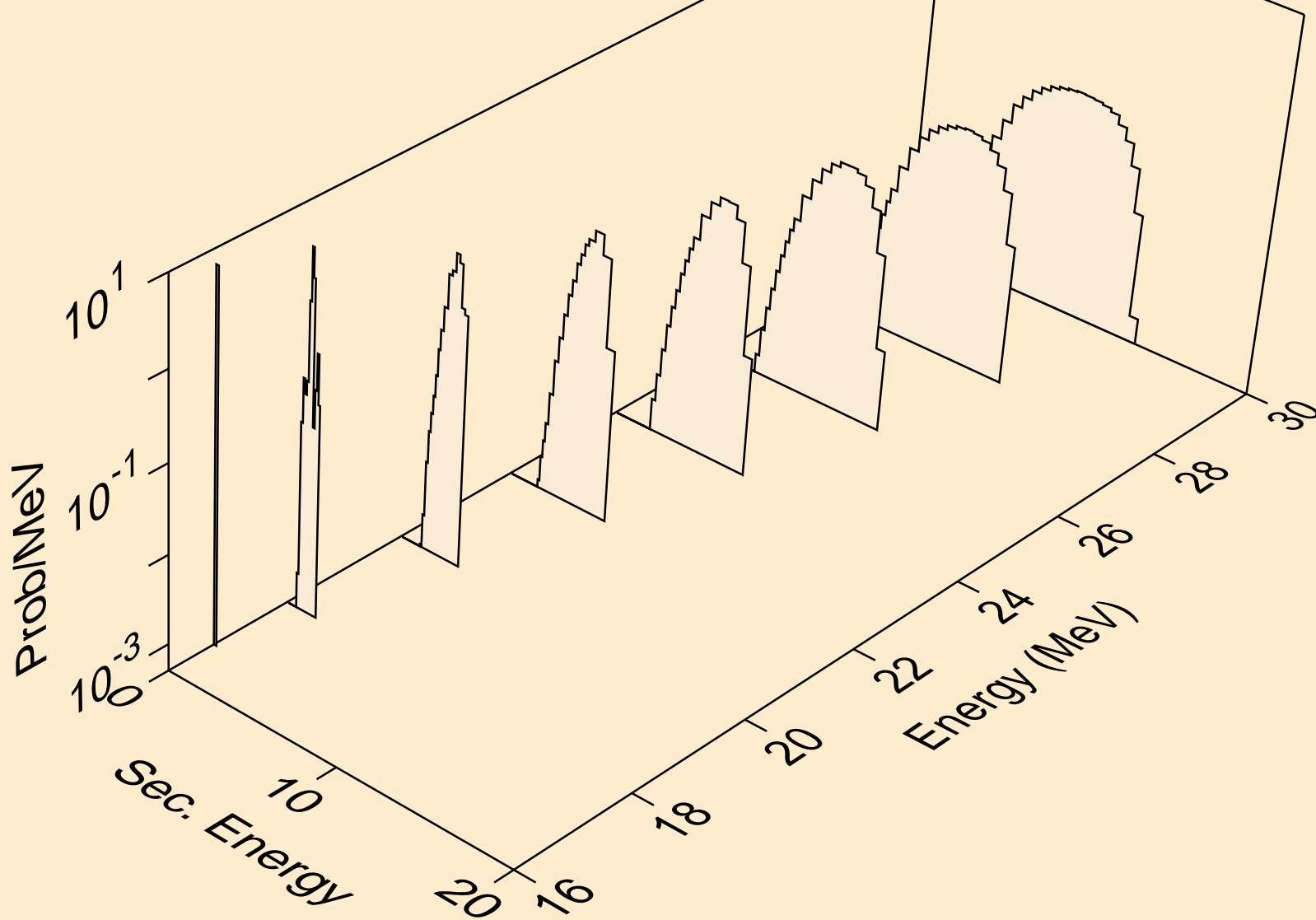



RB091 NEUTRON ACER TENDL-2019 LIBRARY; T=293.16K  
protons from (n,3np)

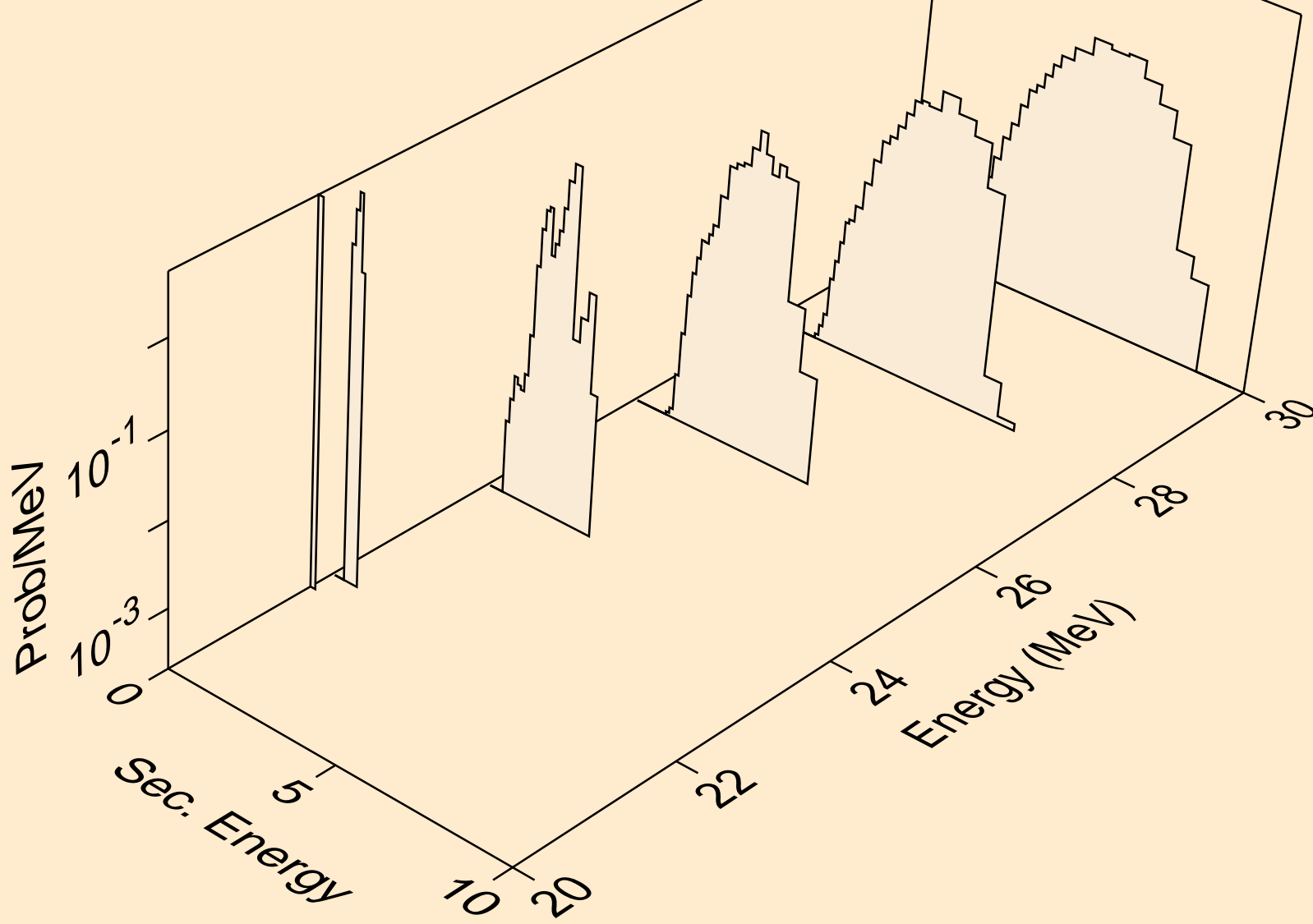

RB091 NEUTRON ACER TENDL-2019 LIBRARY; T=293.16K  
protons from (n,p)

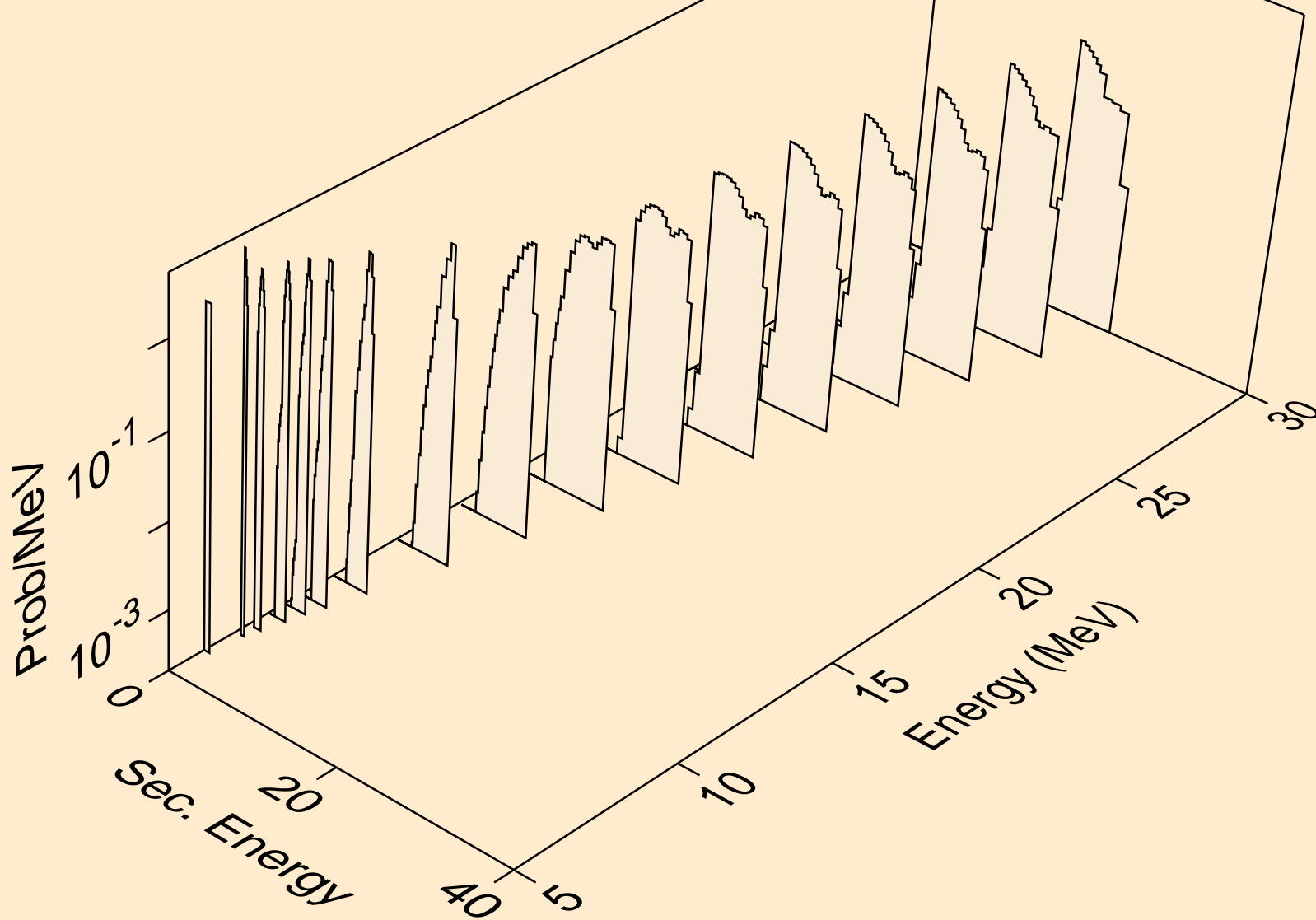

RB091 NEUTRON ACER TENDL-2019 LIBRARY; T=293.16K  
protons from (n,p)

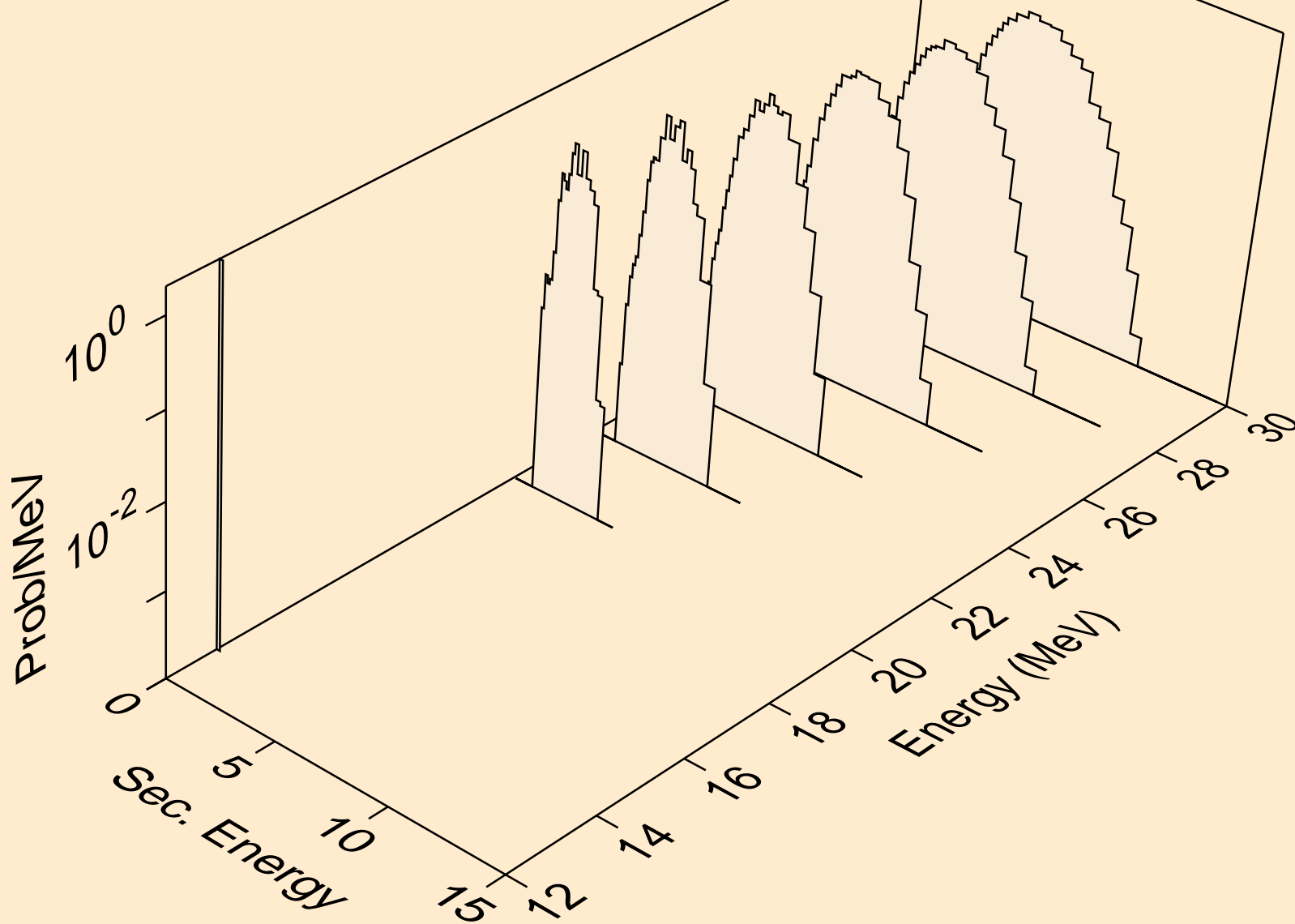

RB091 NEUTRON ACER TENDL-2019 LIBRARY; T=293.16K  
deuterons from (n,x)

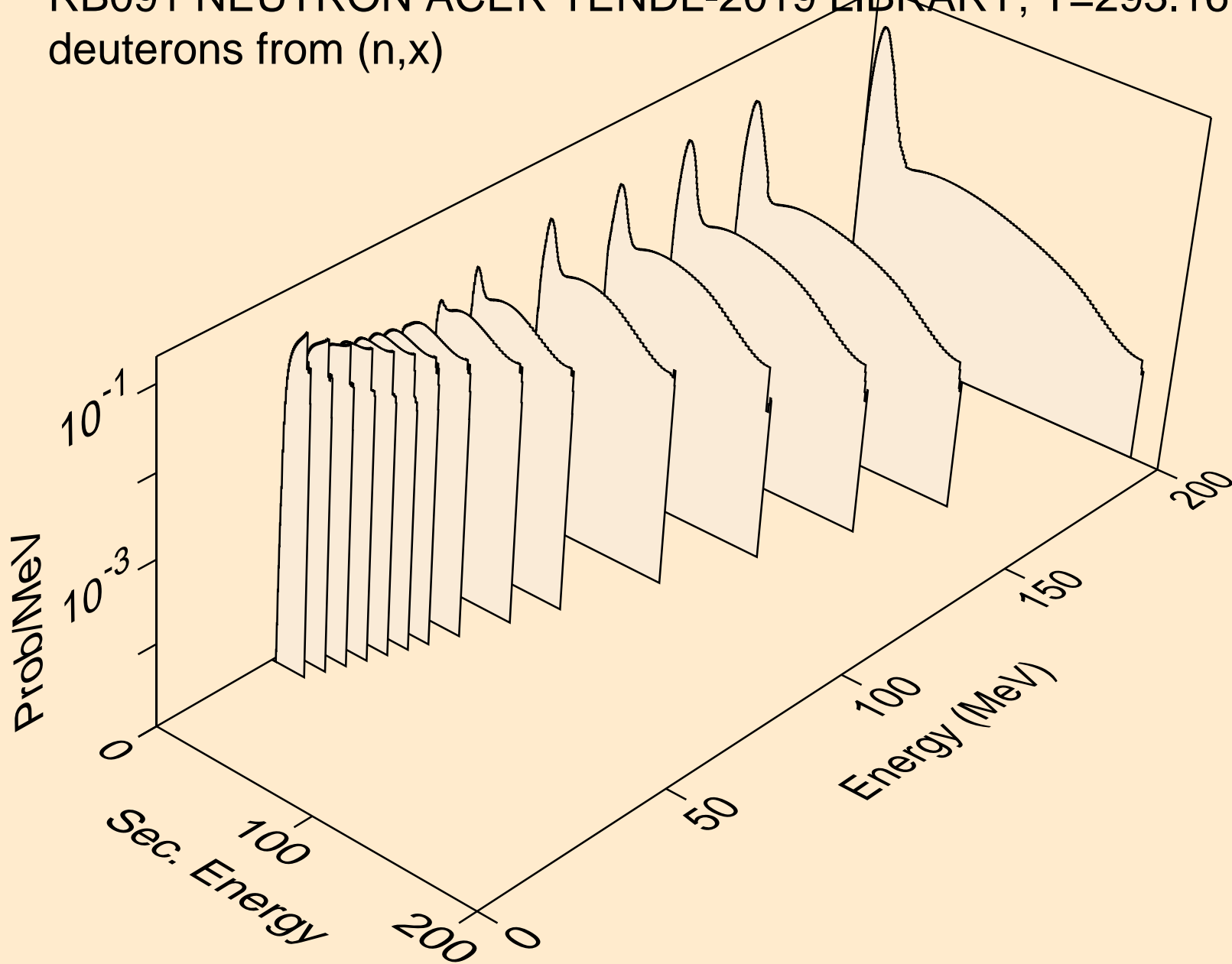

RB091 NEUTRON ACER TENDL-2019 LIBRARY; T=293.16K  
deuterons from (n,2nd)

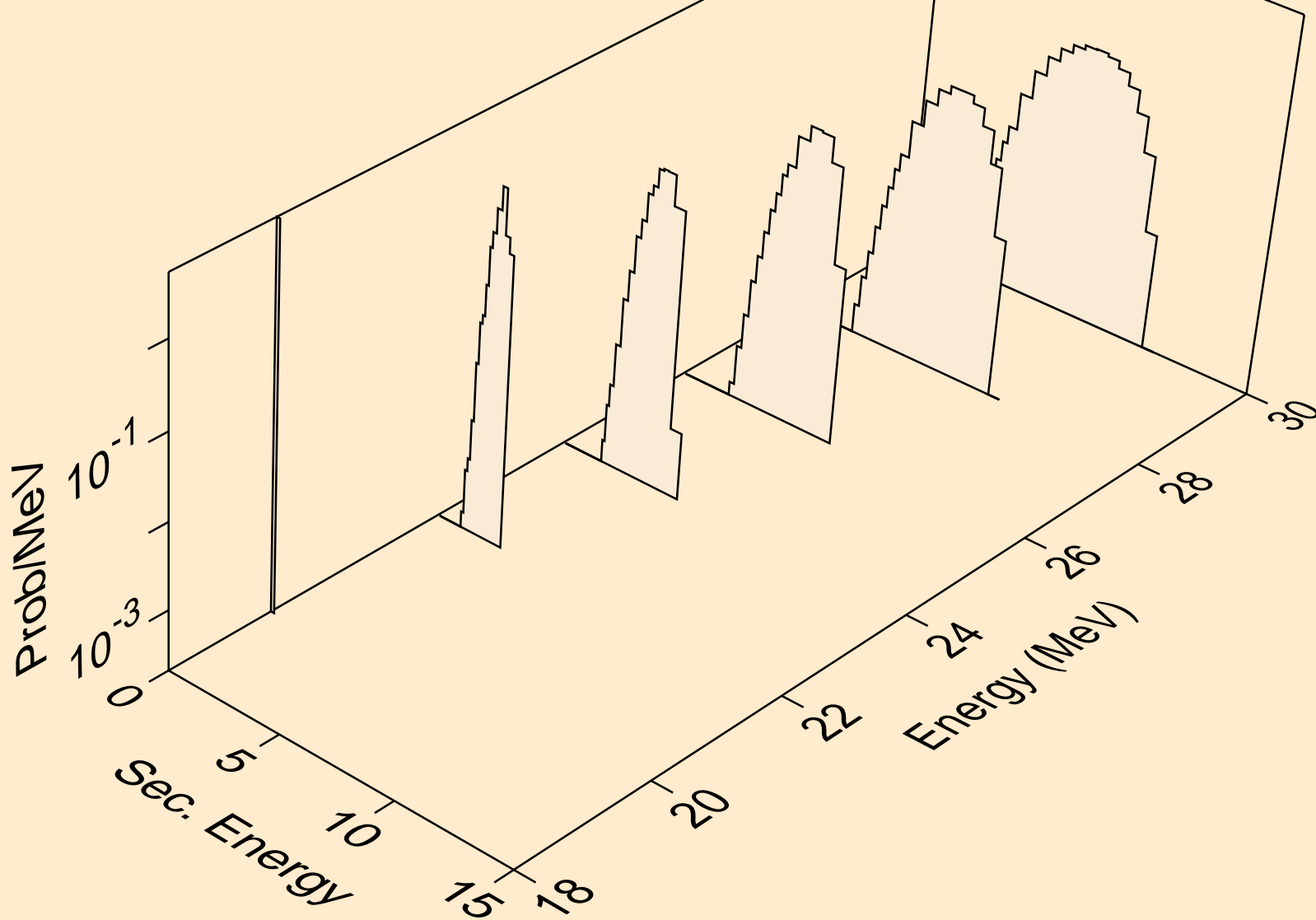

RB091 NEUTRON ACER TENDL-2019 LIBRARY; T=293.16K  
deuterons from (n,n\*)d

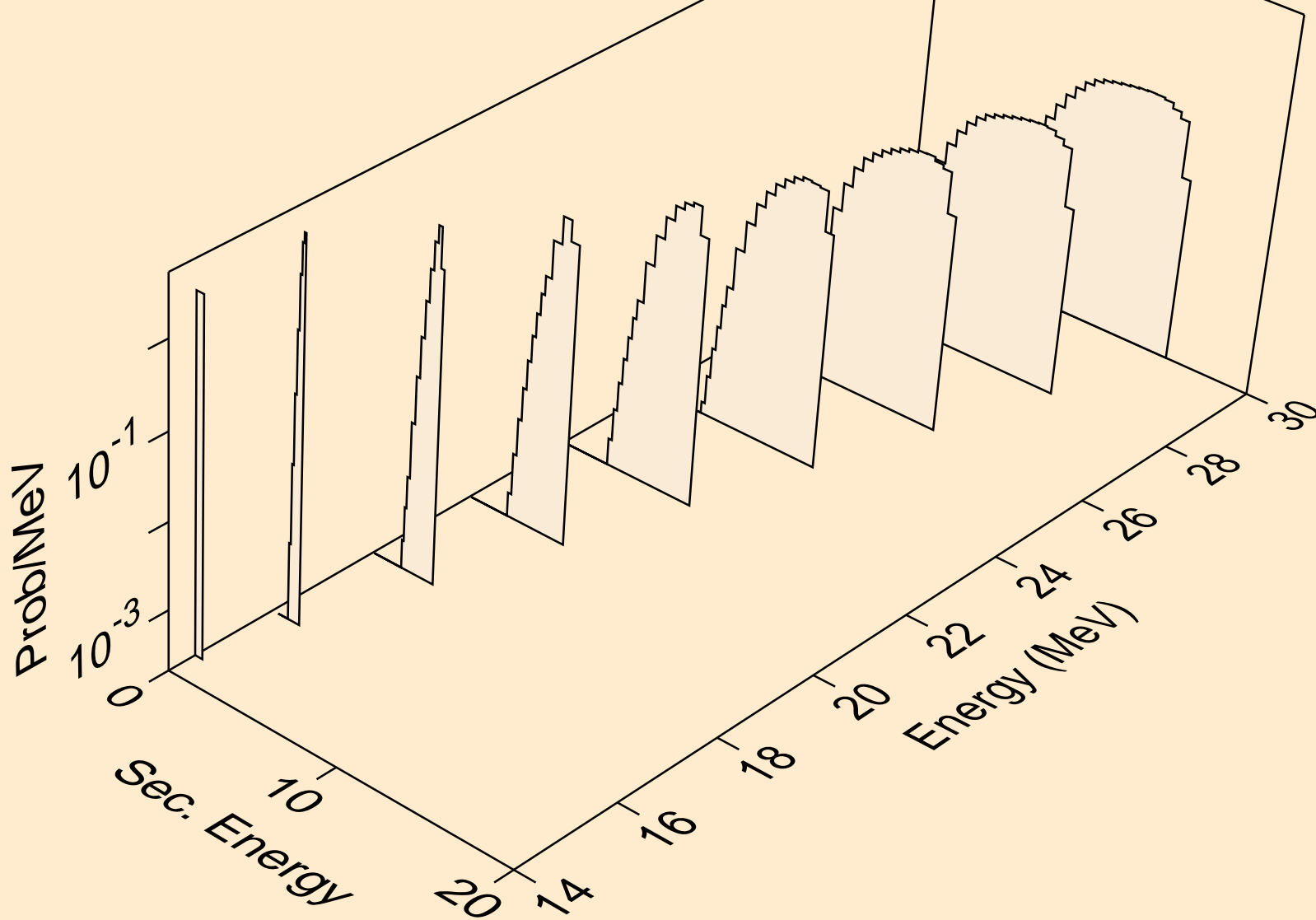

RB091 NEUTRON ACER TENDL-2019 LIBRARY; T=293.16K  
deuterons from (n,d)

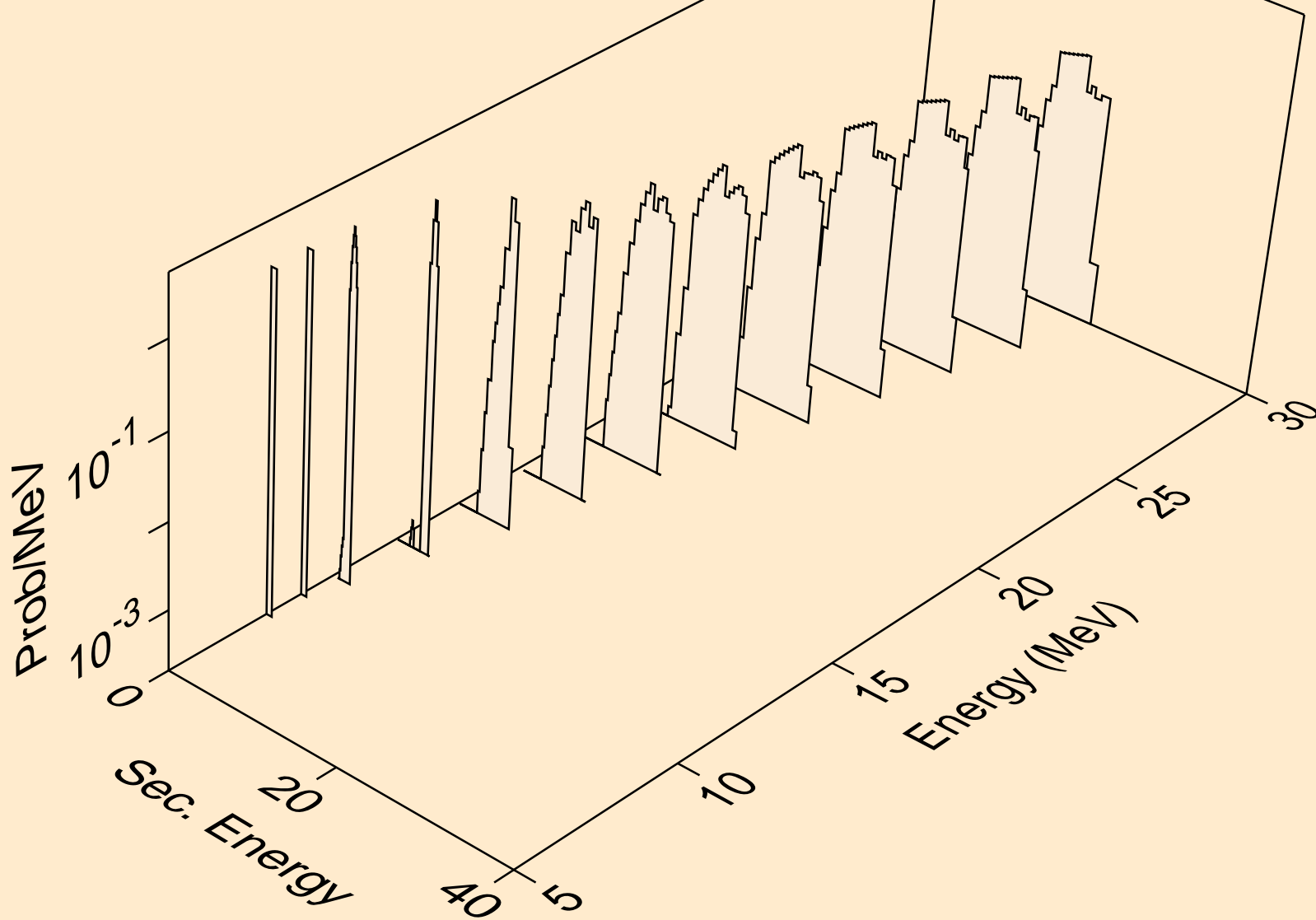

RB091 NEUTRON ACER TENDL-2019 LIBRARY; T=293.16K  
tritons from (n,x)

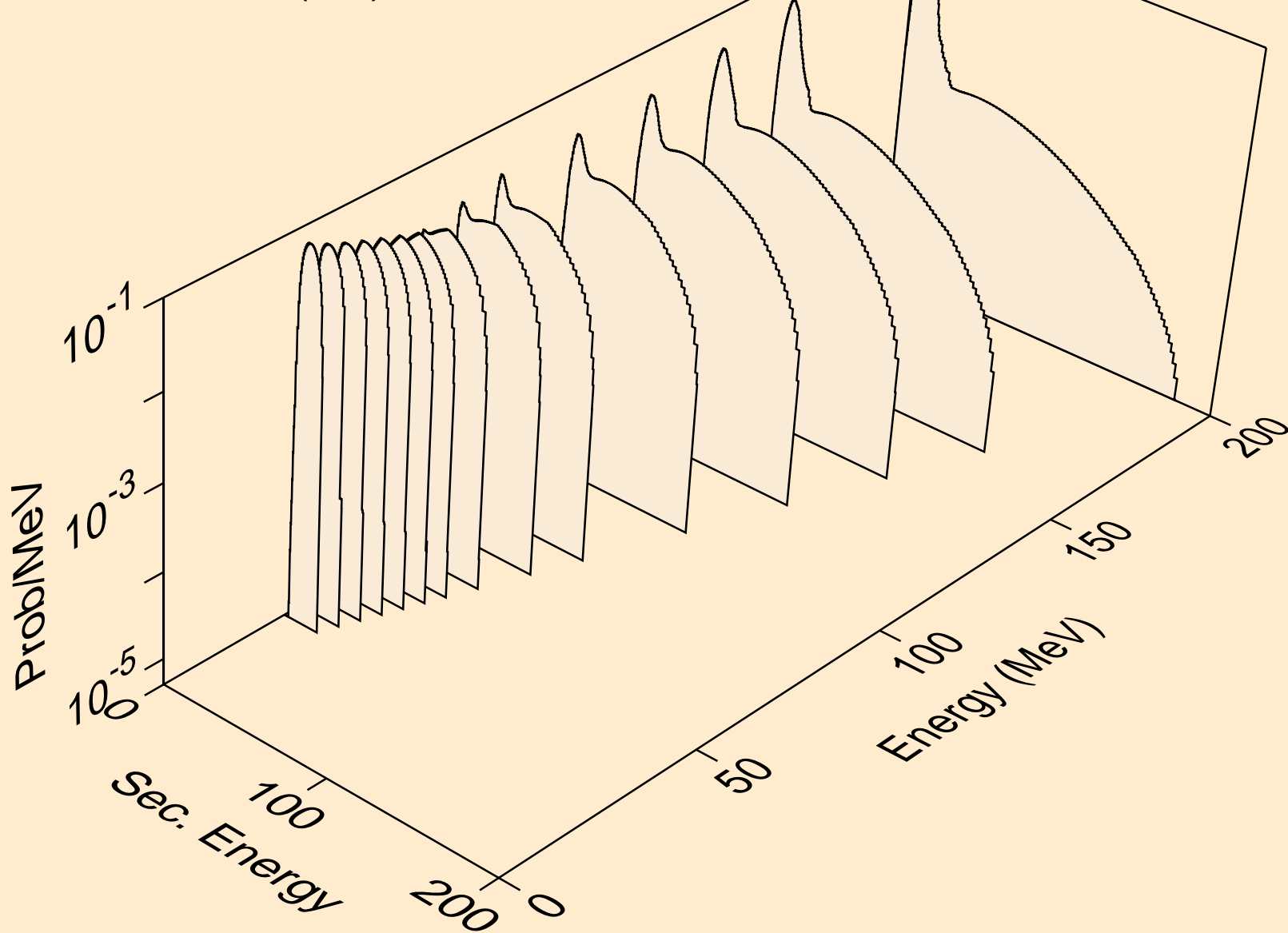



RB091 NEUTRON ACER TENDL-2019 LIBRARY; T=293.16K  
tritons from (n,n\*)t

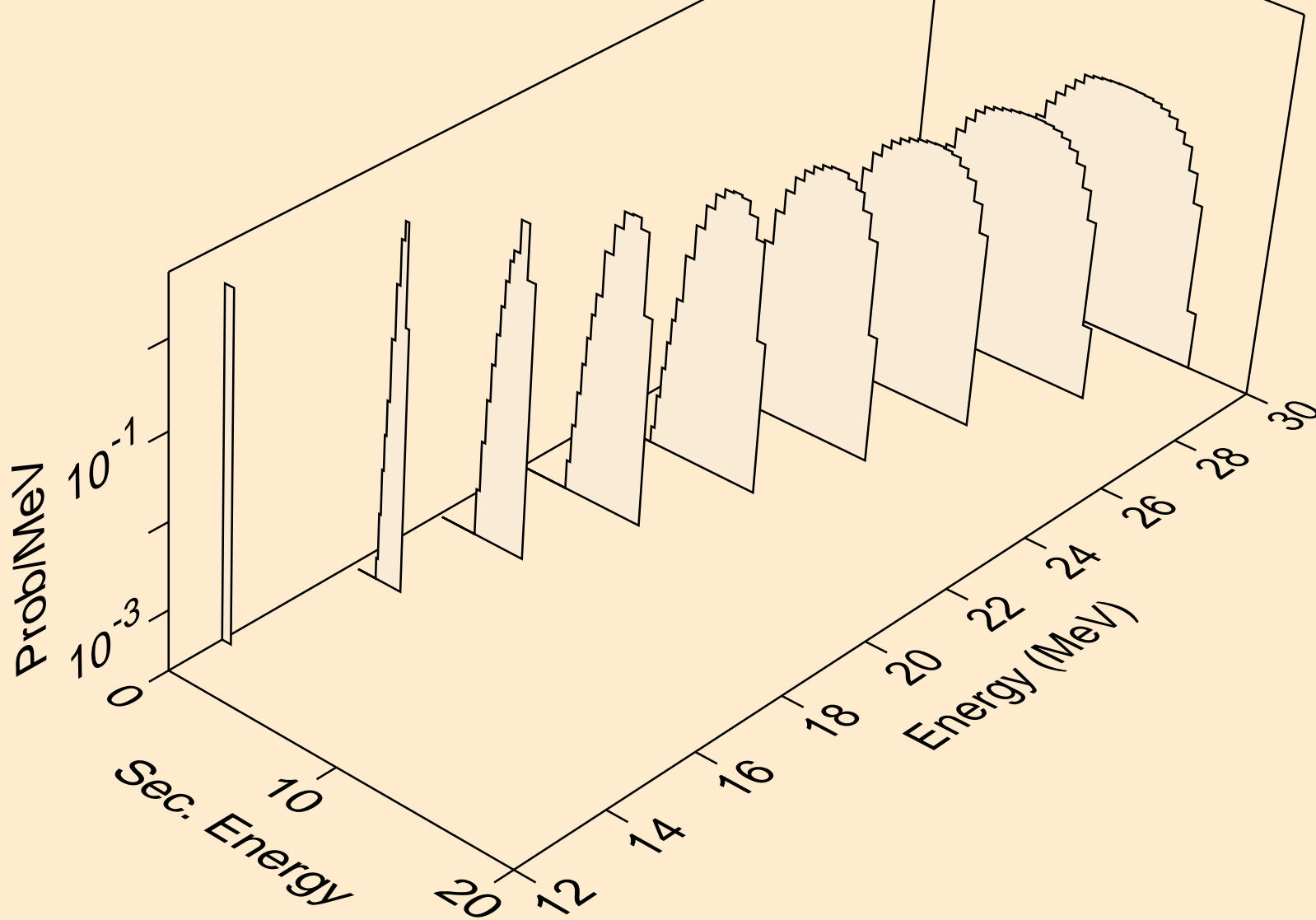

RB091 NEUTRON ACER TENDL-2019 LIBRARY; T=293.16K  
tritons from (n,t)

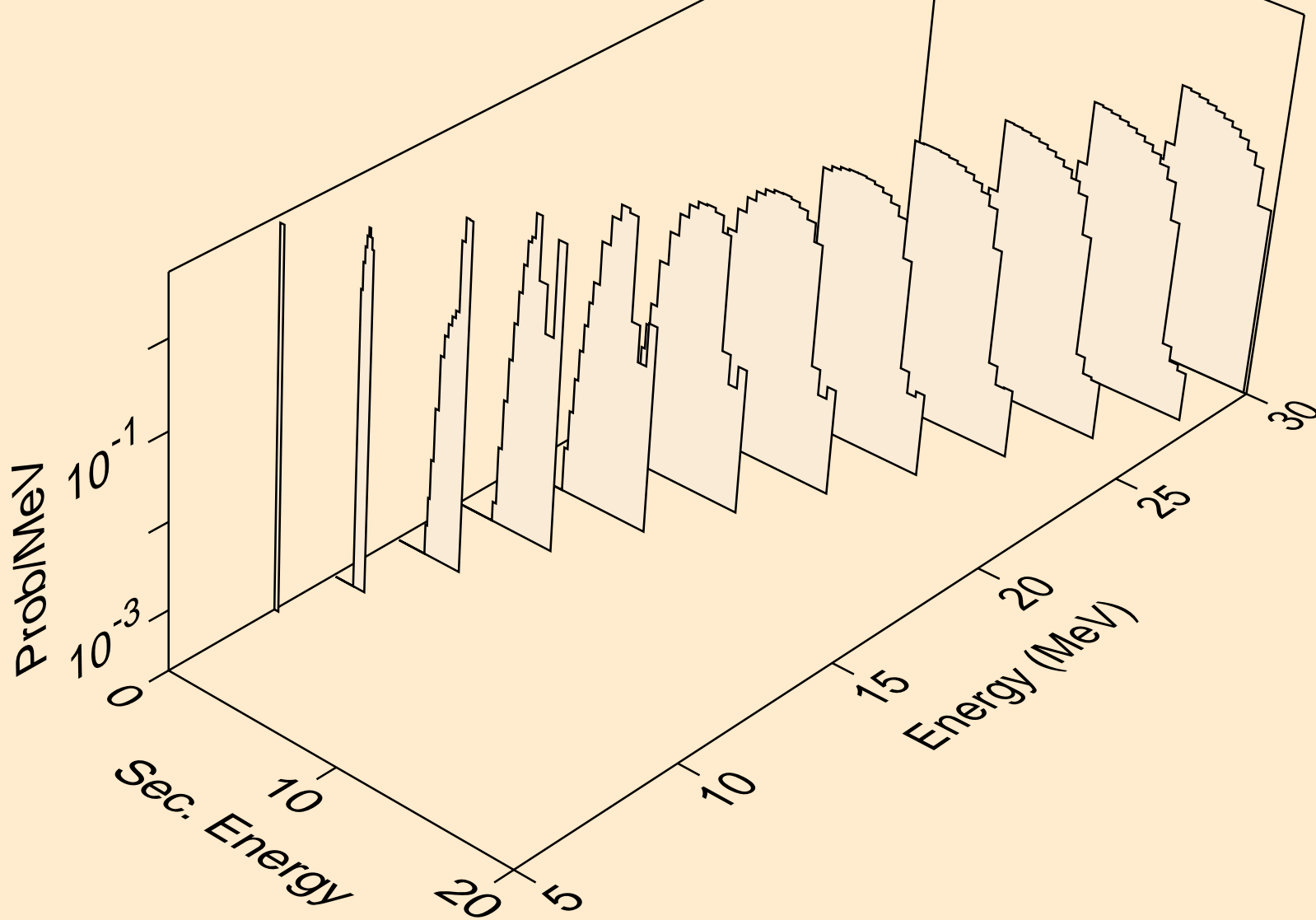

RB091 NEUTRON ACER TENDL-2019 LIBRARY; T=293.16K  
he3s from (n,x)

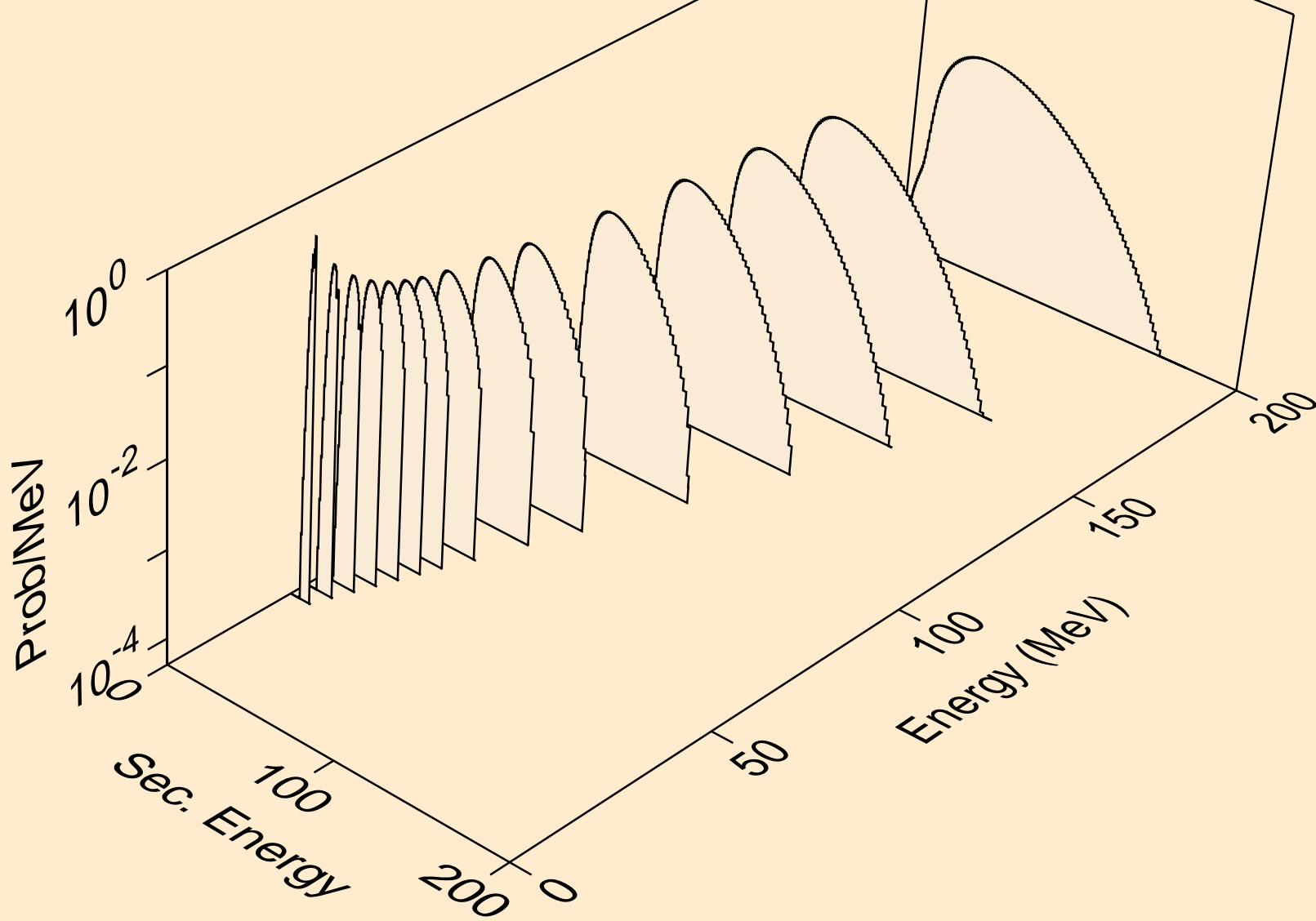

RB091 NEUTRON ACER TENDL-2019 LIBRARY; T=293.16K  
he3s from (n,n\*)he3

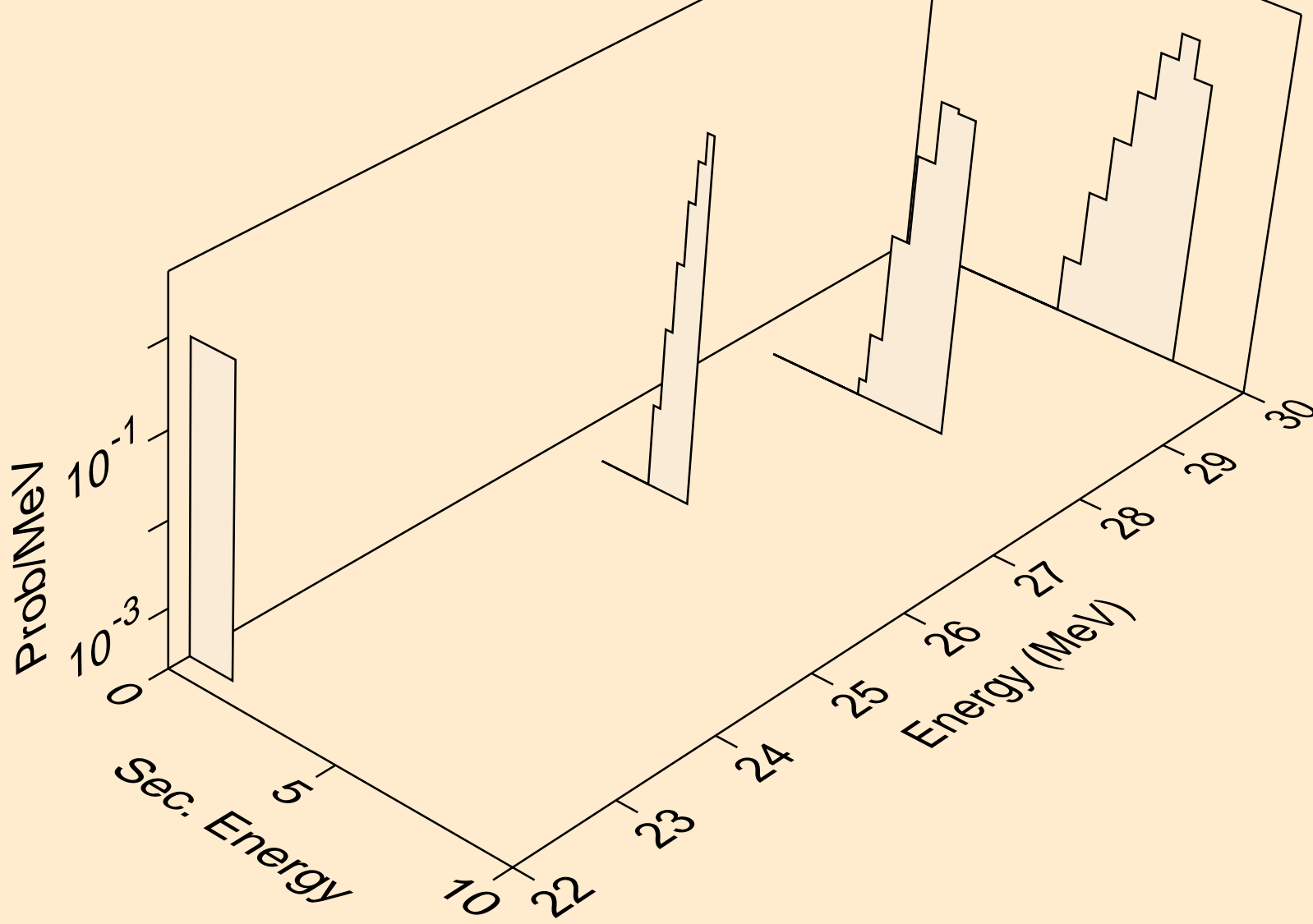

RB091 NEUTRON ACER TENDL-2019 LIBRARY; T=293.16K  
he3s from (n,he3)

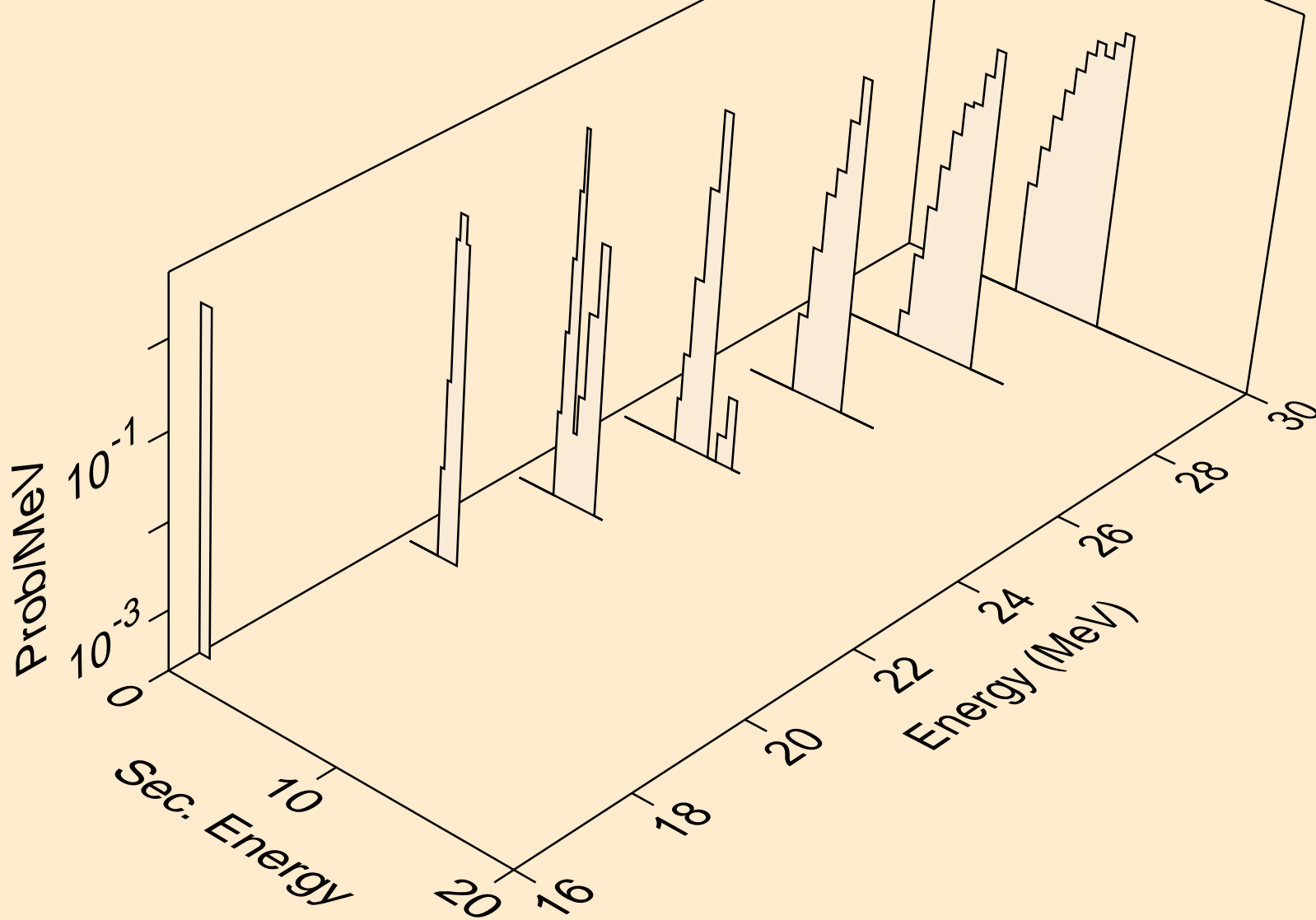

RB091 NEUTRON ACER TENDL-2019 LIBRARY; T=293.16K  
alphas from (n,x)

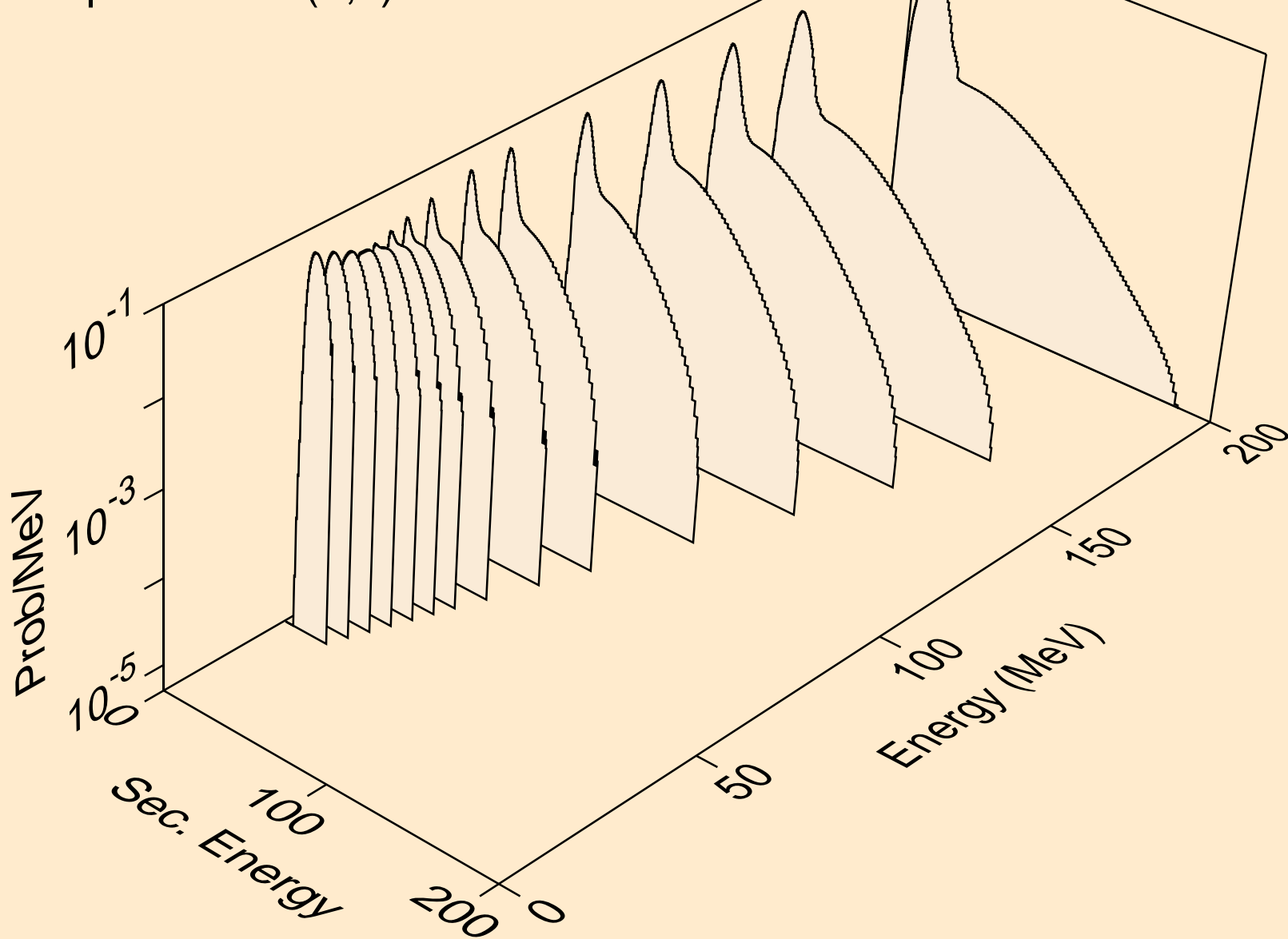

RB091 NEUTRON ACER TENDL-2019 LIBRARY; T=293.16K  
alphas from (n,n\*)a

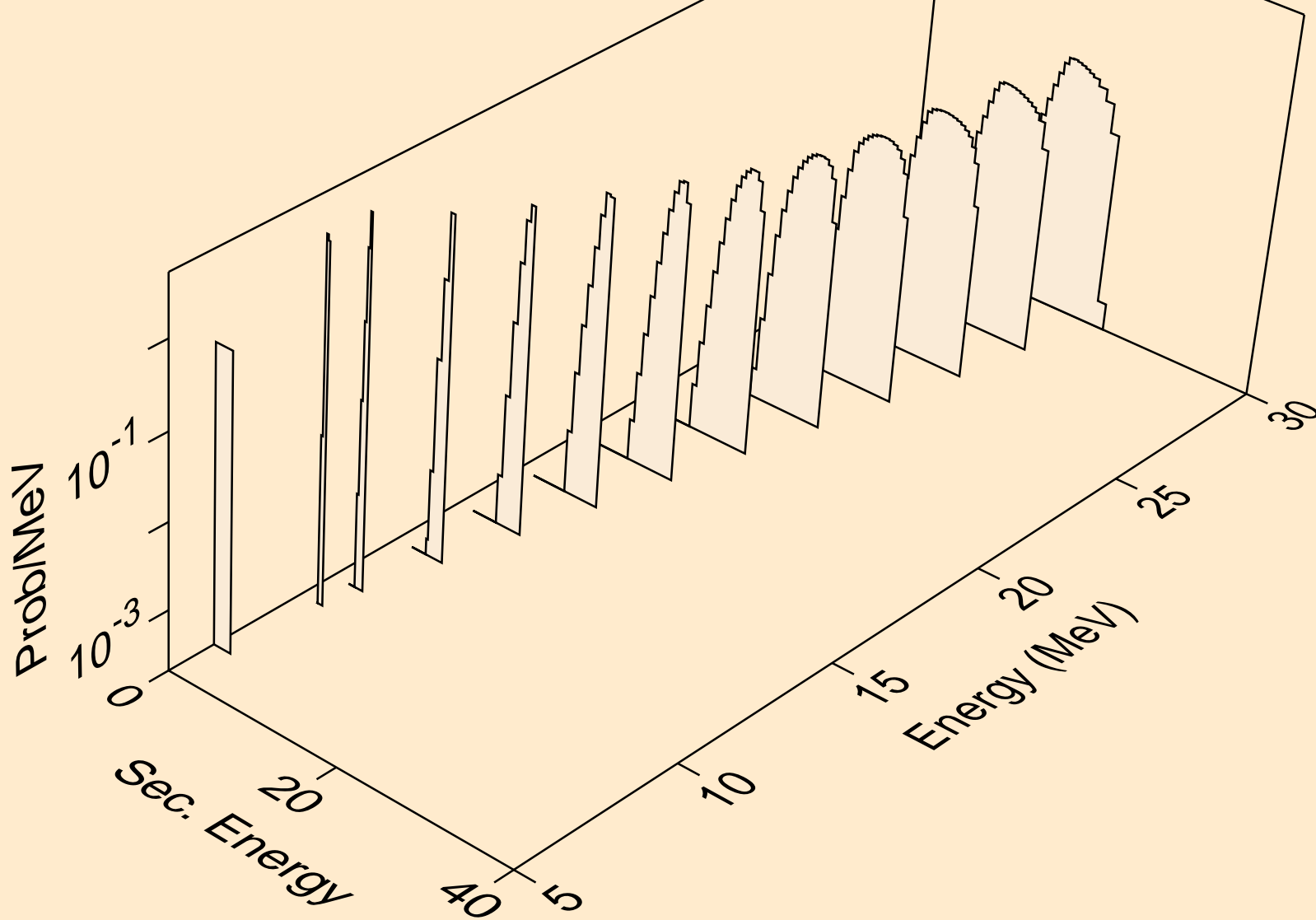

RB091 NEUTRON ACER TENDL-2019 LIBRARY; T=293.16K  
alphas from (n,2n)a

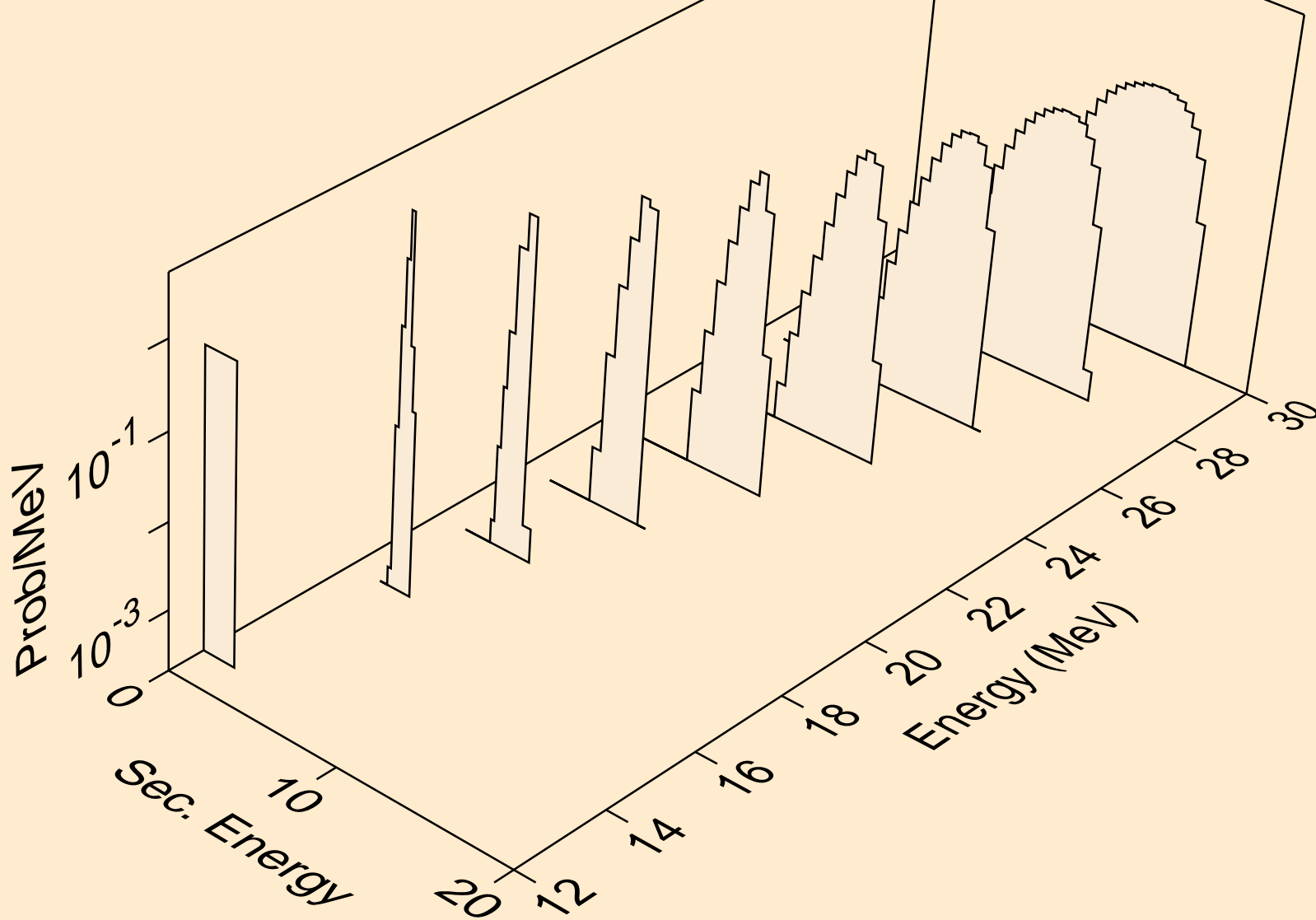



RB091 NEUTRON ACER TENDL-2019 LIBRARY; T=293.16K  
alphas from (n,3n)a

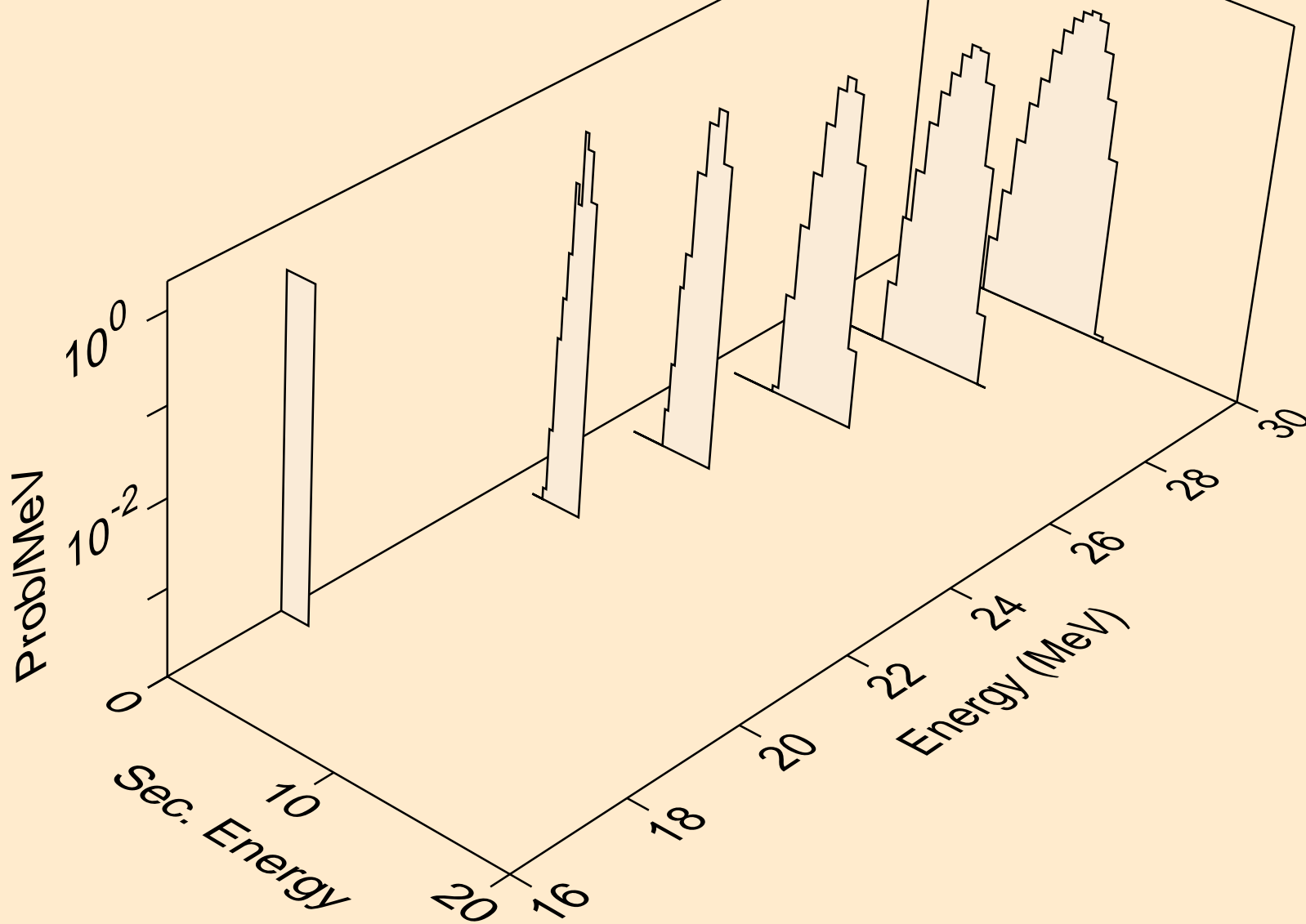

RB091 NEUTRON ACER TENDL-2019 LIBRARY; T=293.16K  
alphas from (n,a)

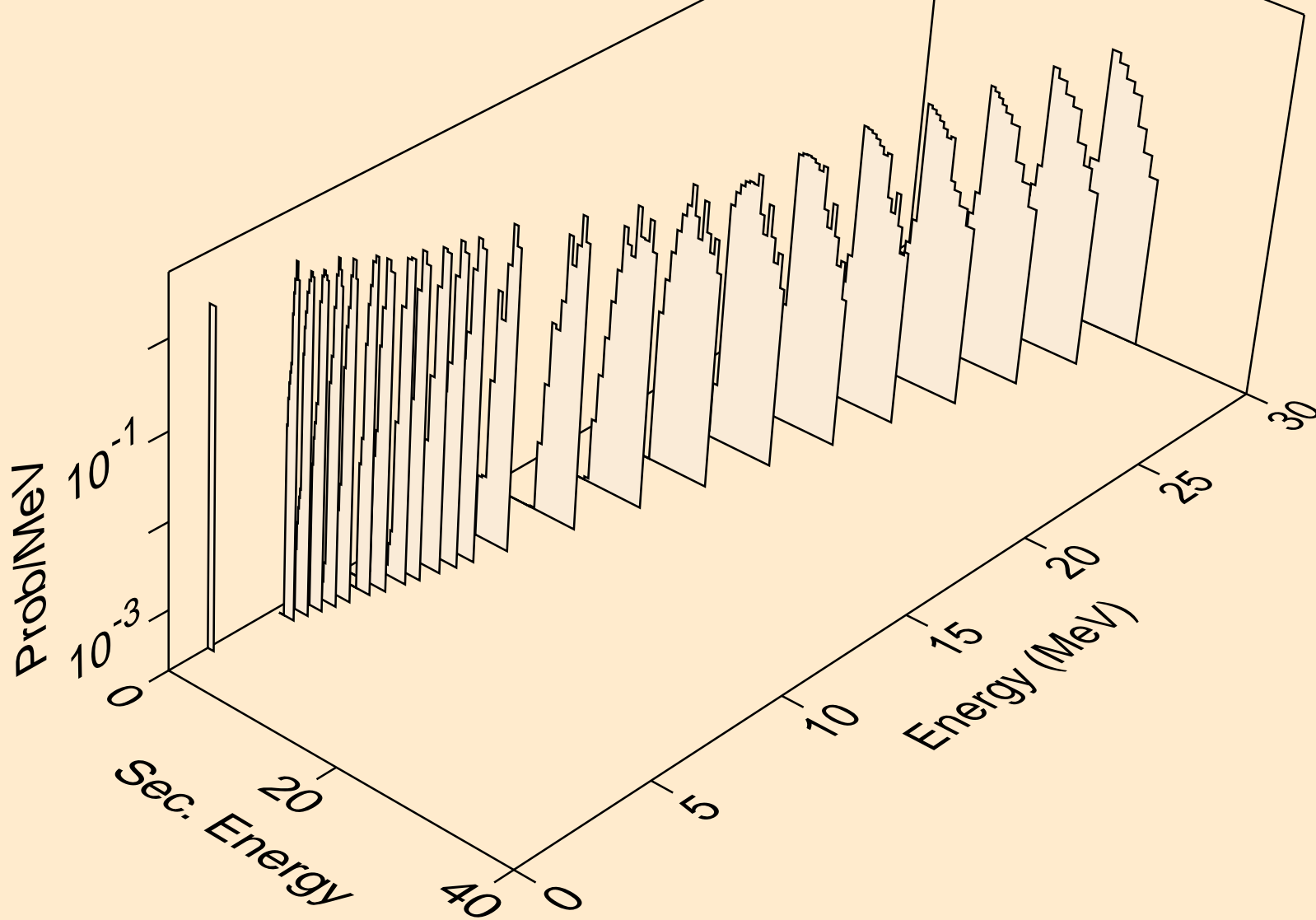

RB091 NEUTRON ACER TENDL-2019 LIBRARY; T=293.16K  
alphas from (n,2a)

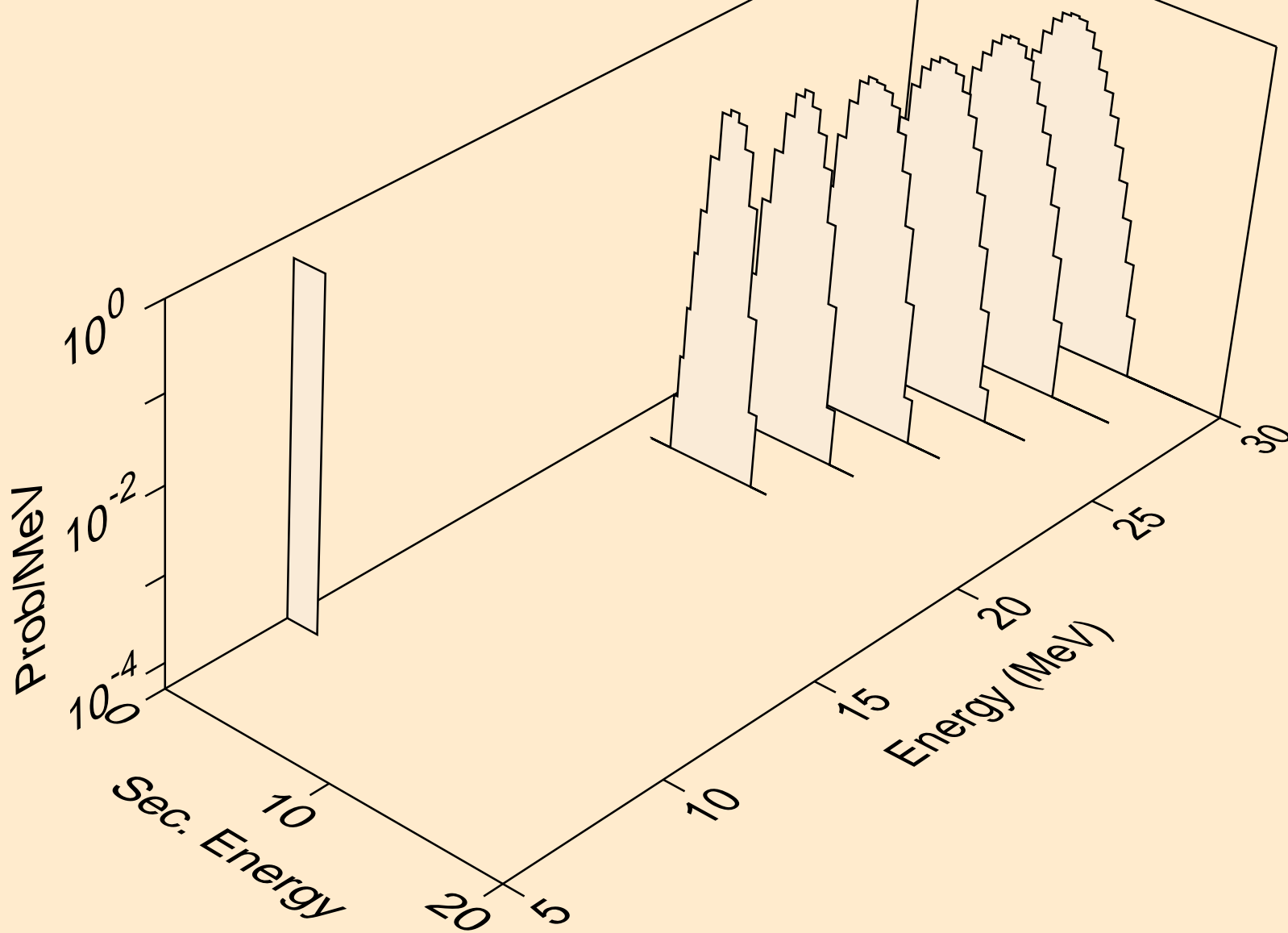

RB091 NEUTRON ACER TENDL-2019 LIBRARY; T=293.16K  
alphas from (n,pa)

