

RE167M NEUTRON ACER TENDL-2019 LIBRARY; T=293.16K
Principal cross sections

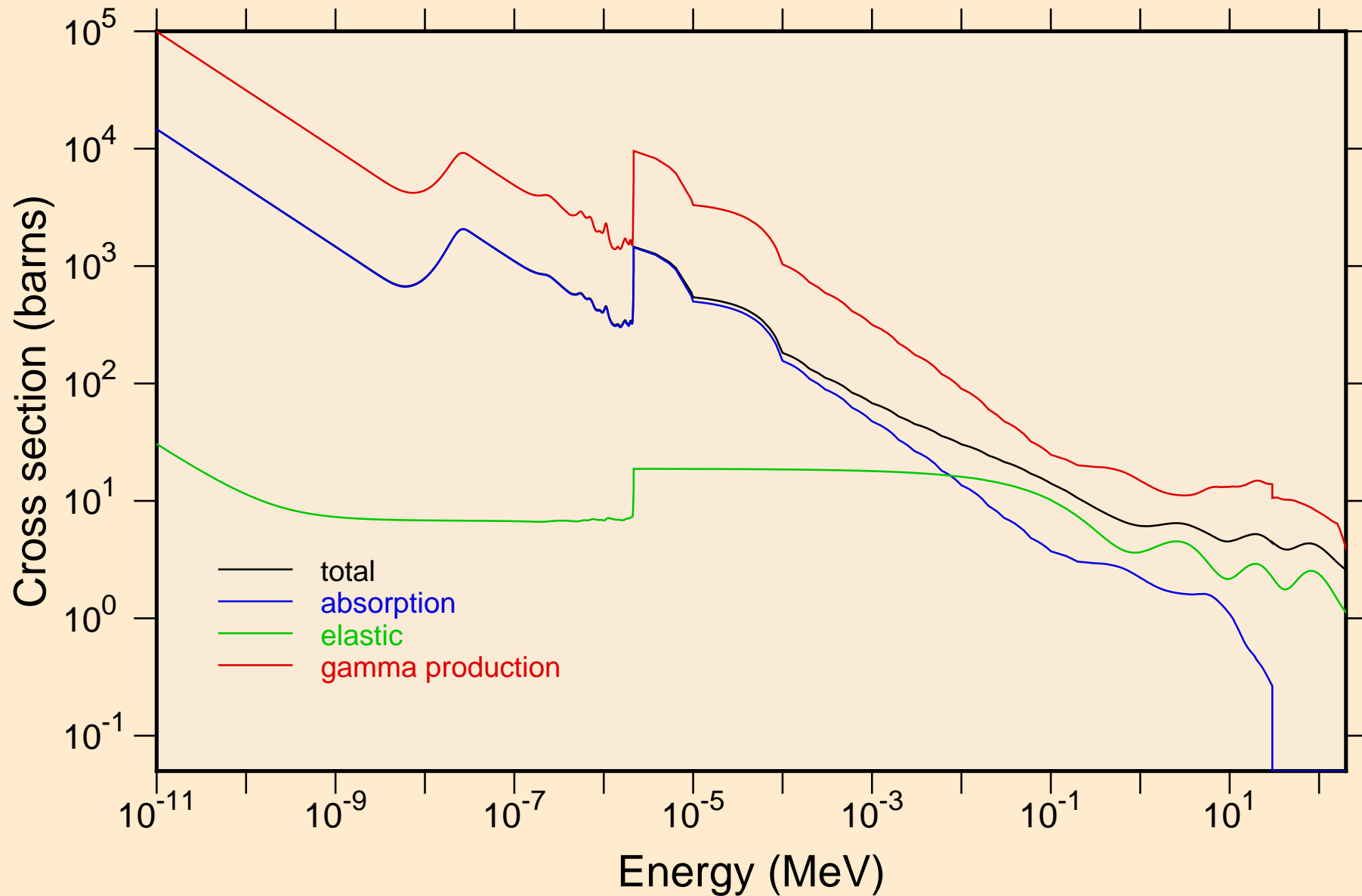

RE167M NEUTRON ACER TENDL-2019 LIBRARY; T=293.16K
Heating

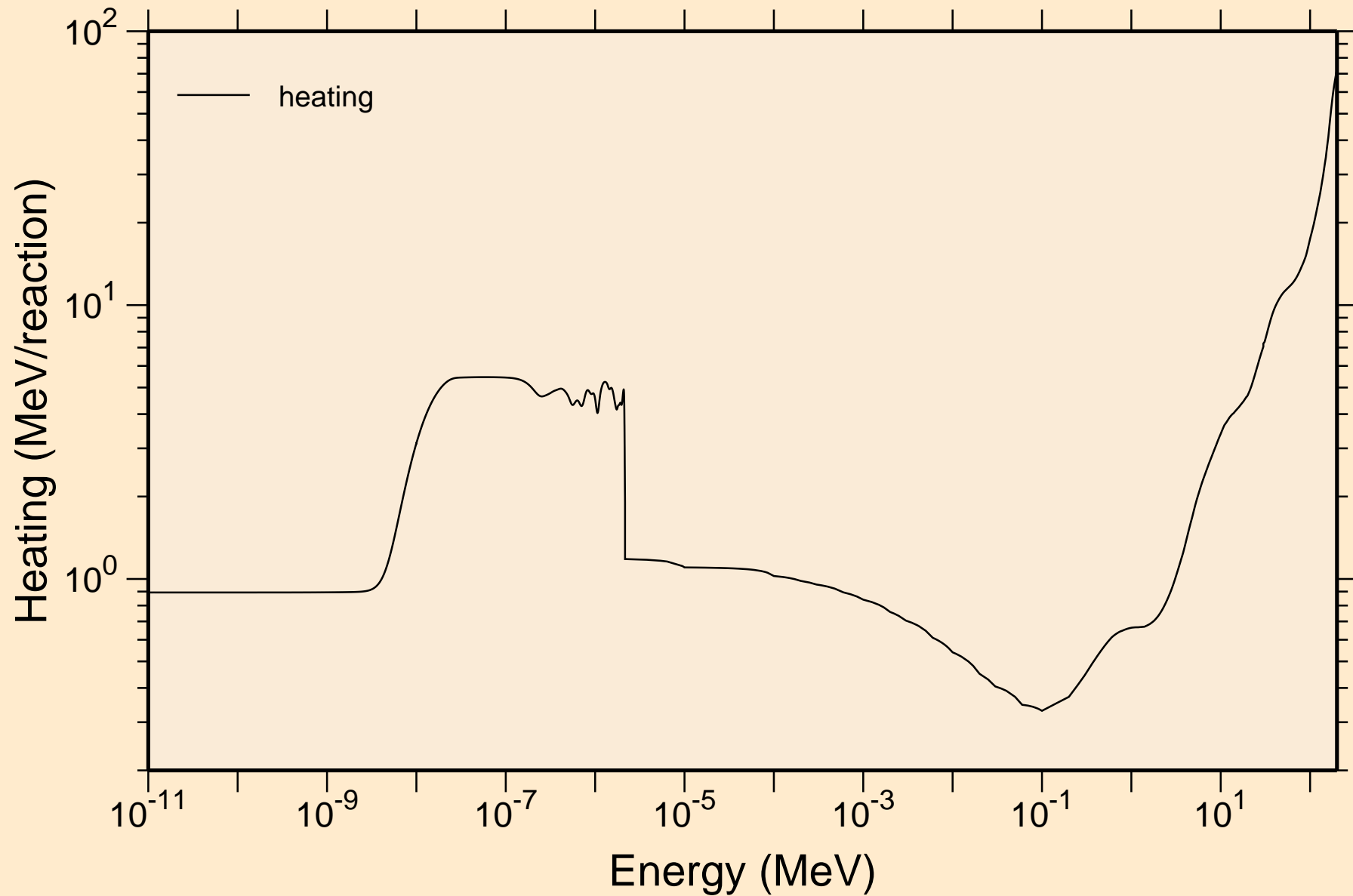

RE167M NEUTRON ACER TENDL-2019 LIBRARY; T=293.16K
Damage

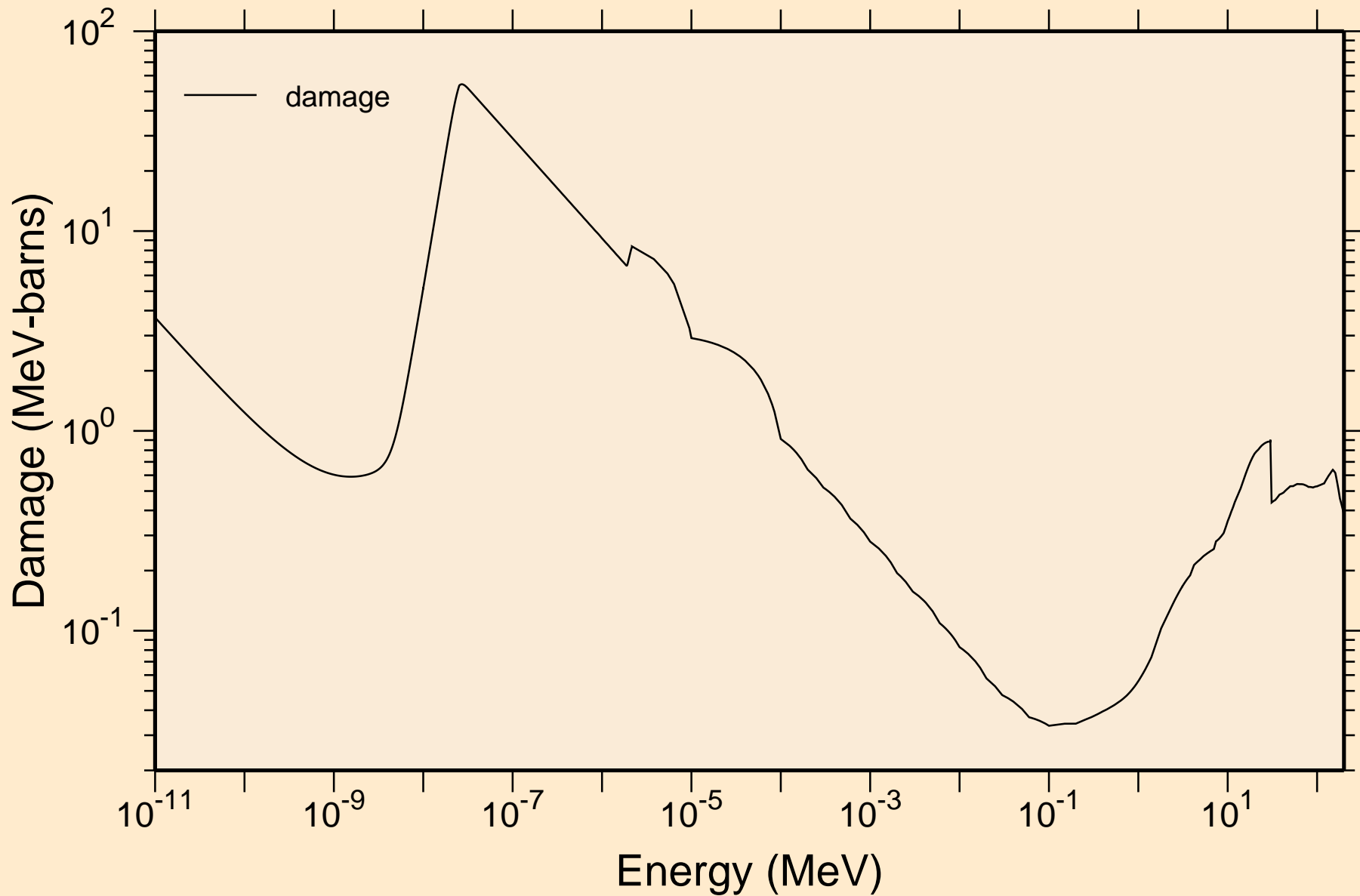

RE167M NEUTRON ACER TENDL-2019 LIBRARY; T=293.16K
Non-threshold reactions

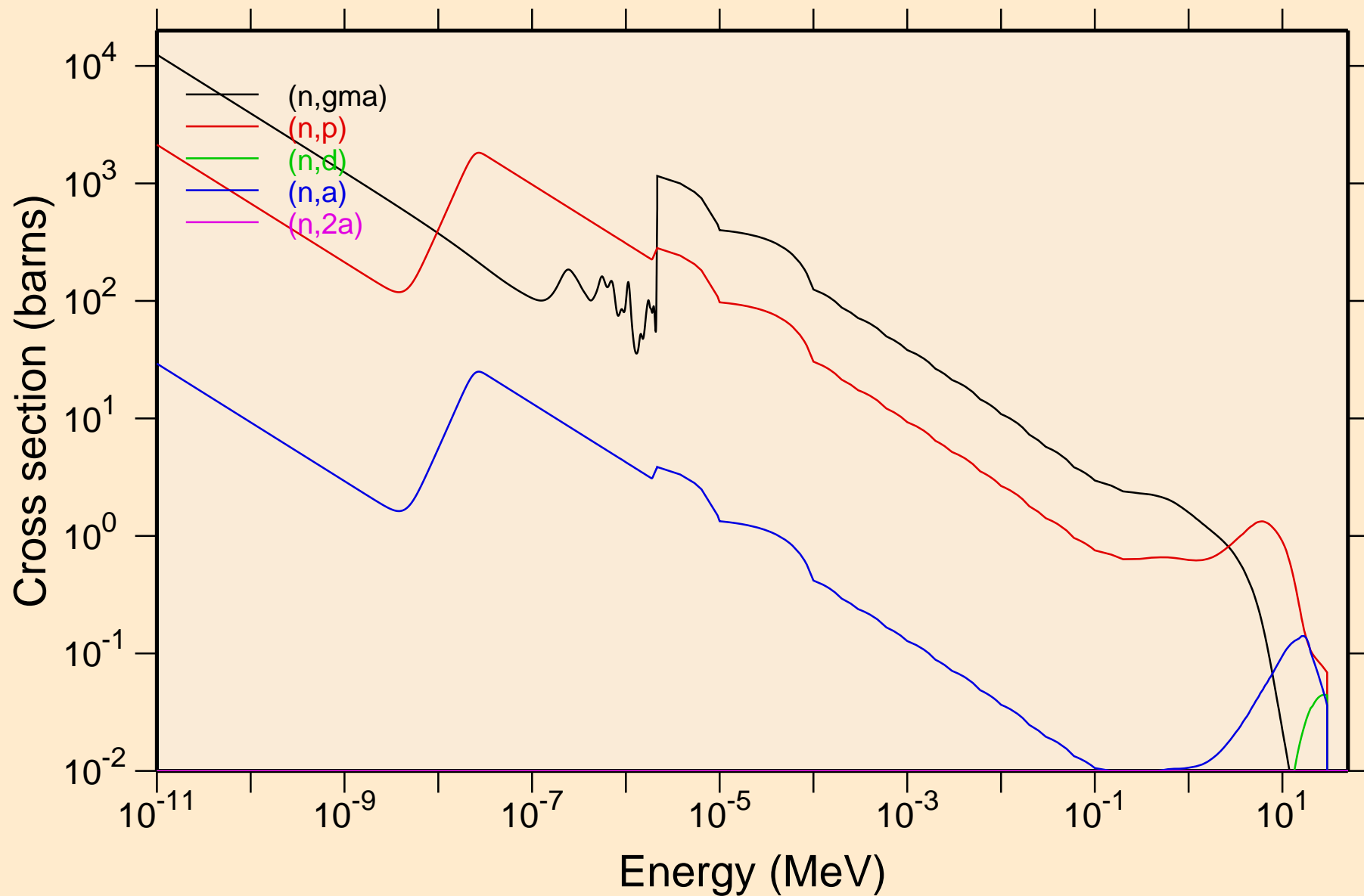

RE167M NEUTRON ACER TENDL-2019 LIBRARY; T=293.16K
Non-threshold reactions

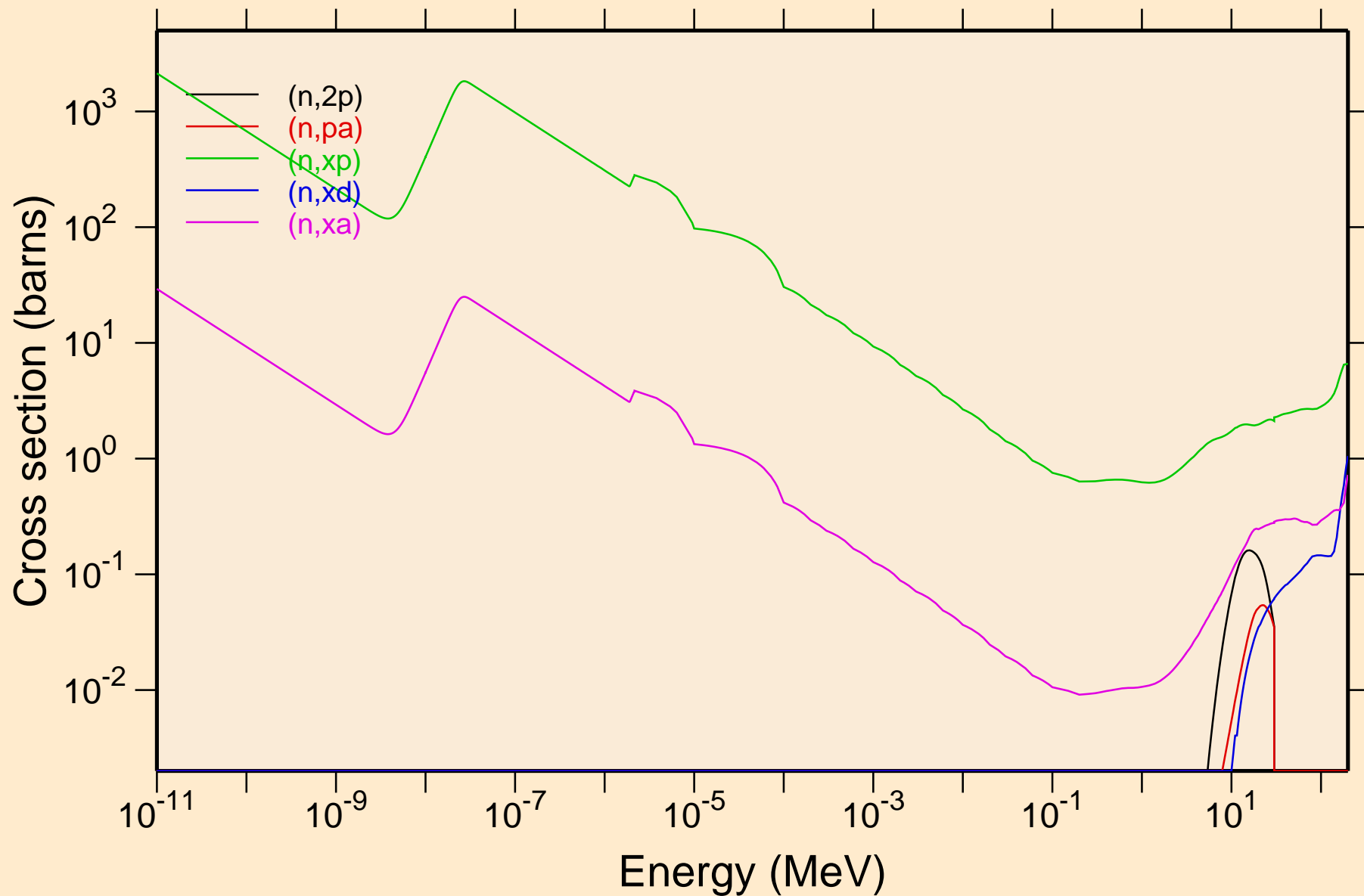

RE167M NEUTRON ACER TENDL-2019 LIBRARY; T=293.16K
Principal cross sections

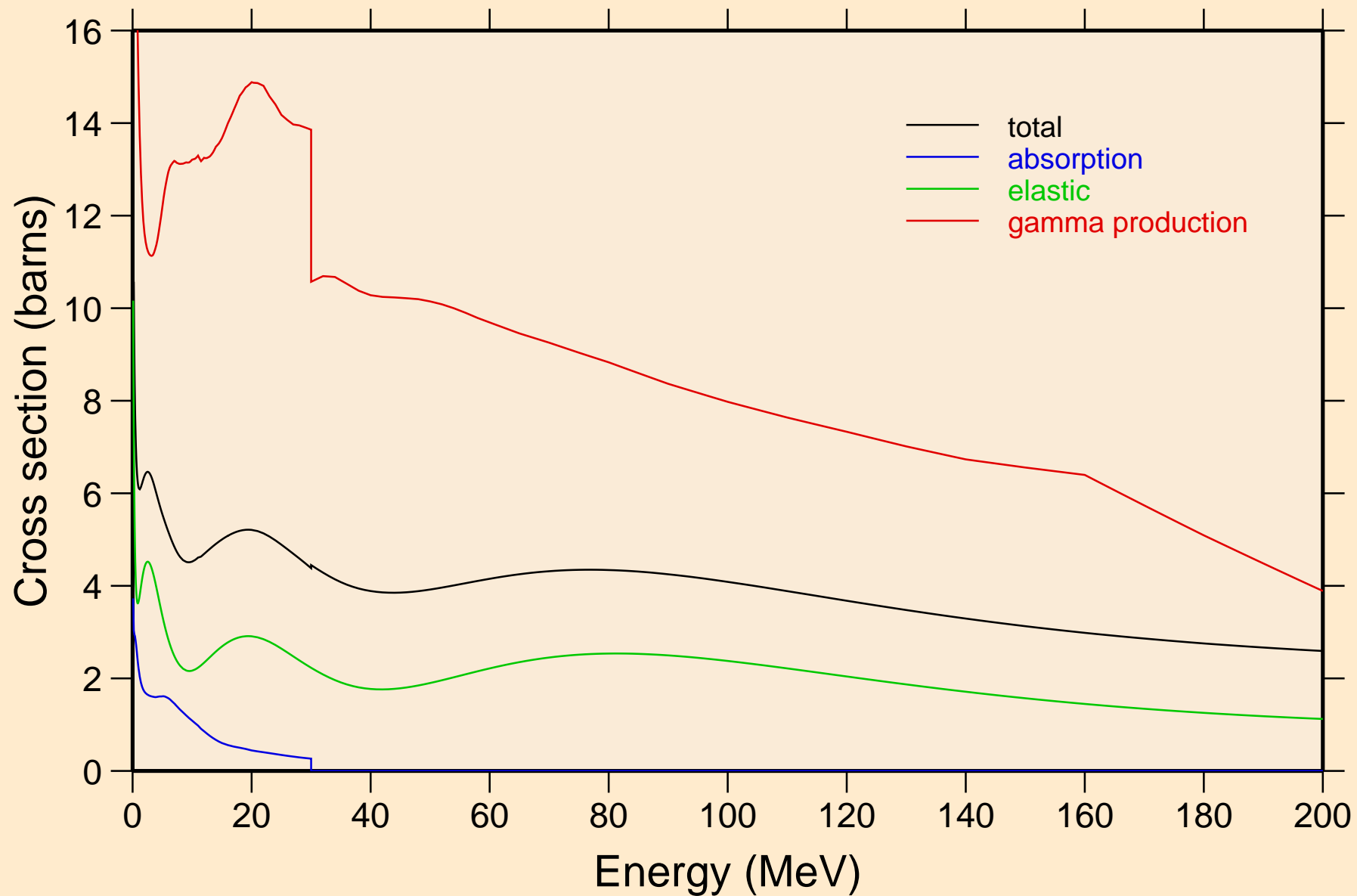

RE167M NEUTRON ACER TENDL-2019 LIBRARY; T=293.16K
Heating

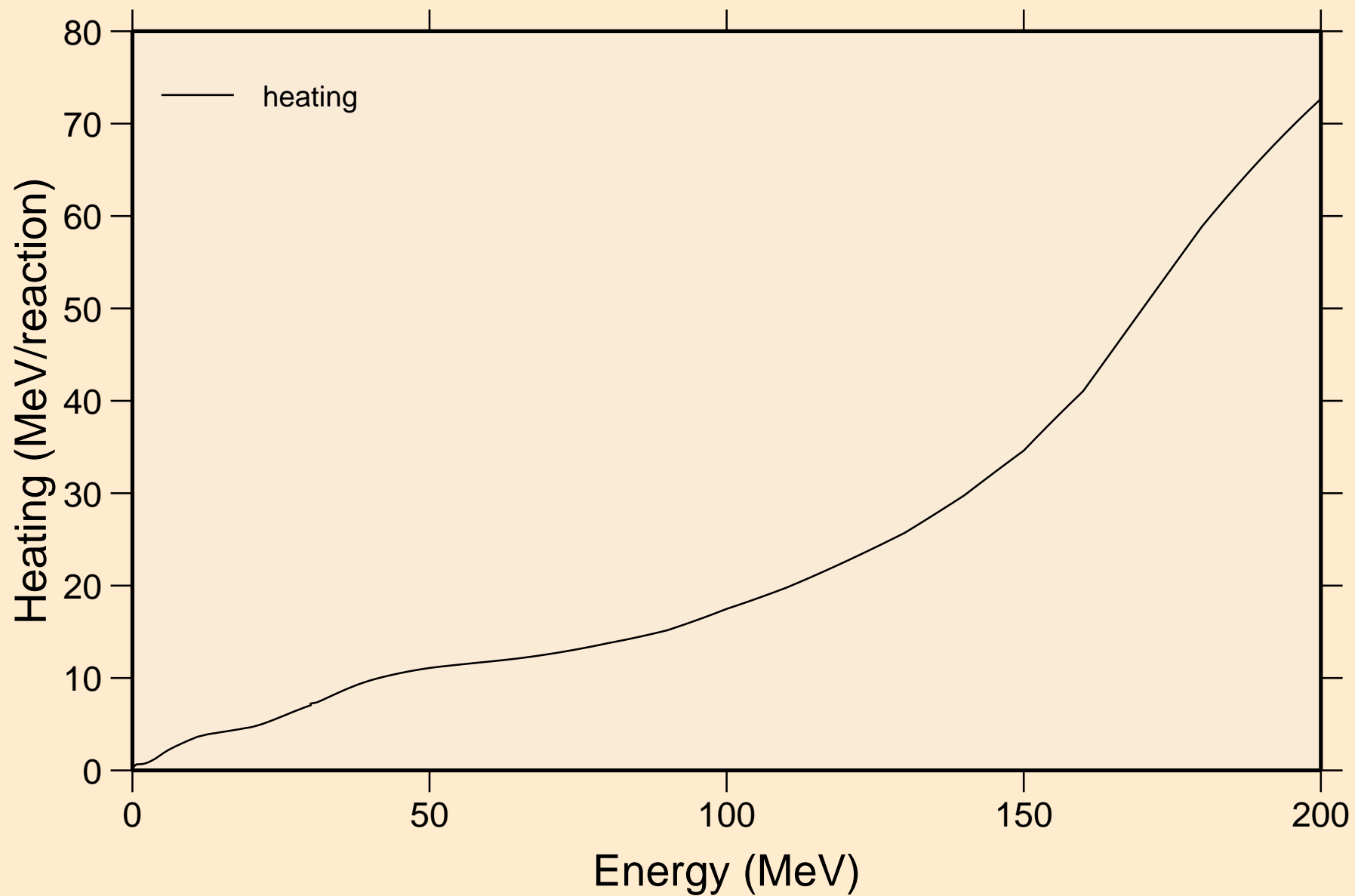

RE167M NEUTRON ACER TENDL-2019 LIBRARY; T=293.16K
Damage

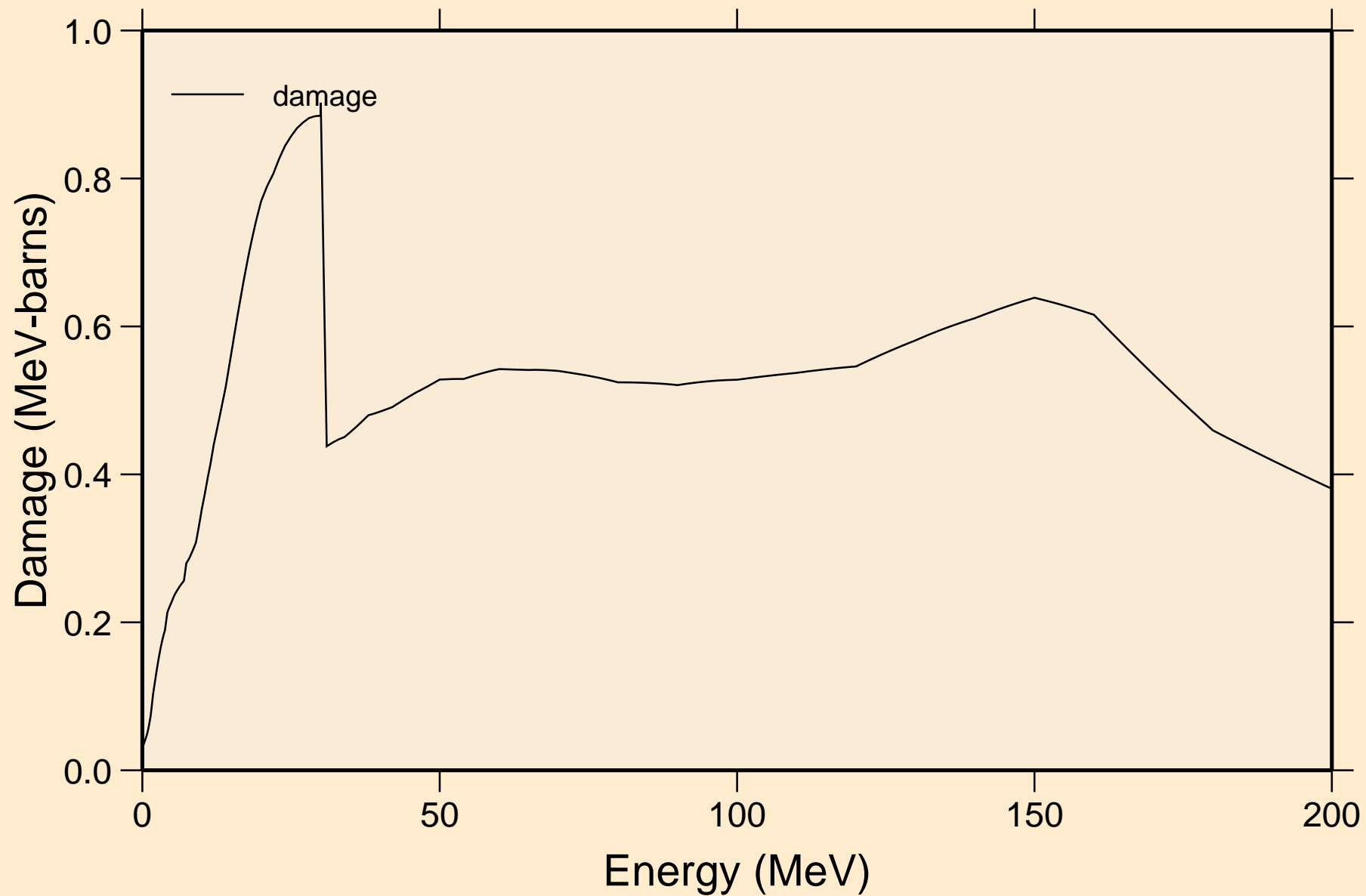

RE167M NEUTRON ACER TENDL-2019 LIBRARY; T=293.16K
Non-threshold reactions

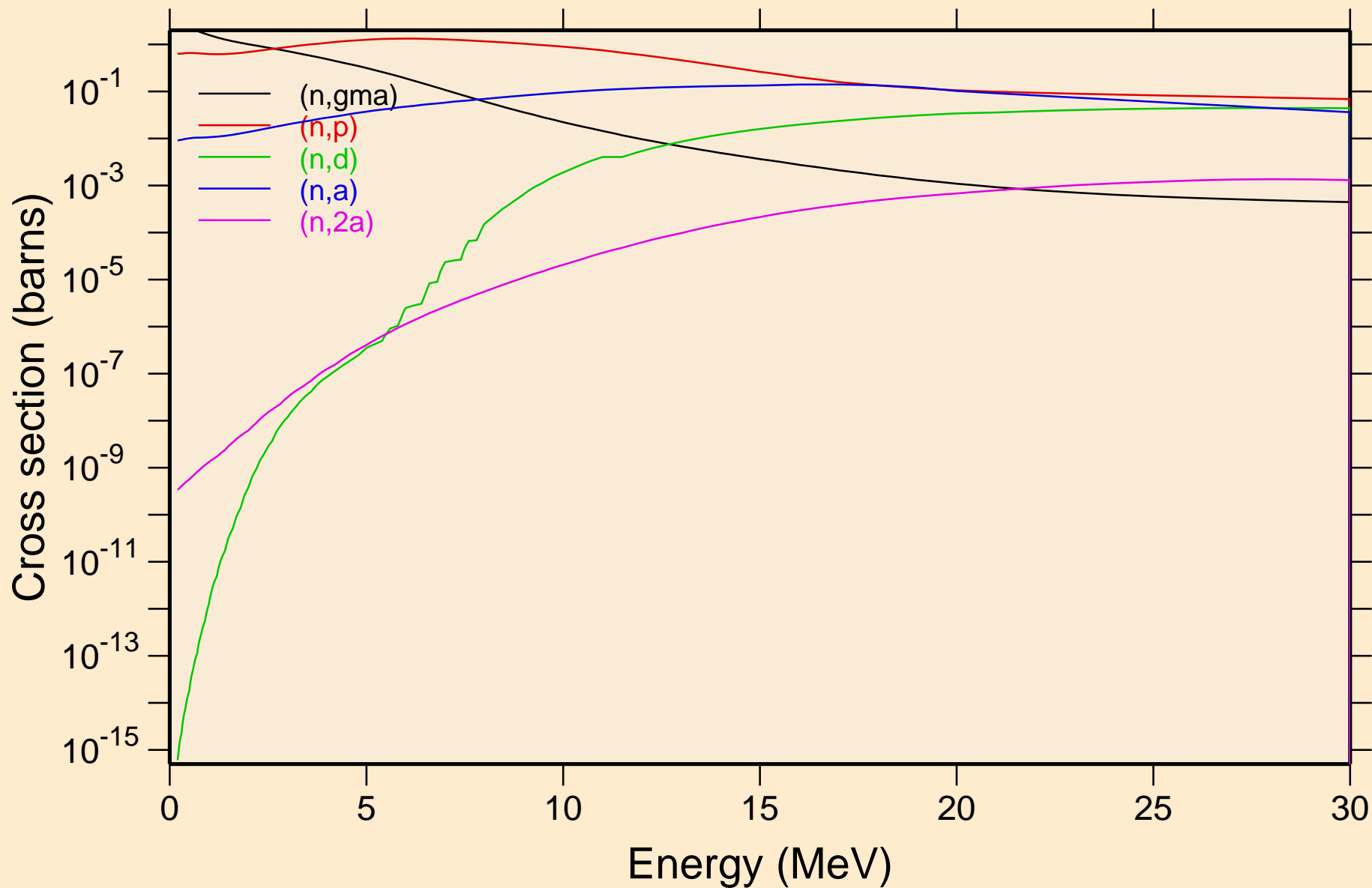

RE167M NEUTRON ACER TENDL-2019 LIBRARY; T=293.16K
Non-threshold reactions

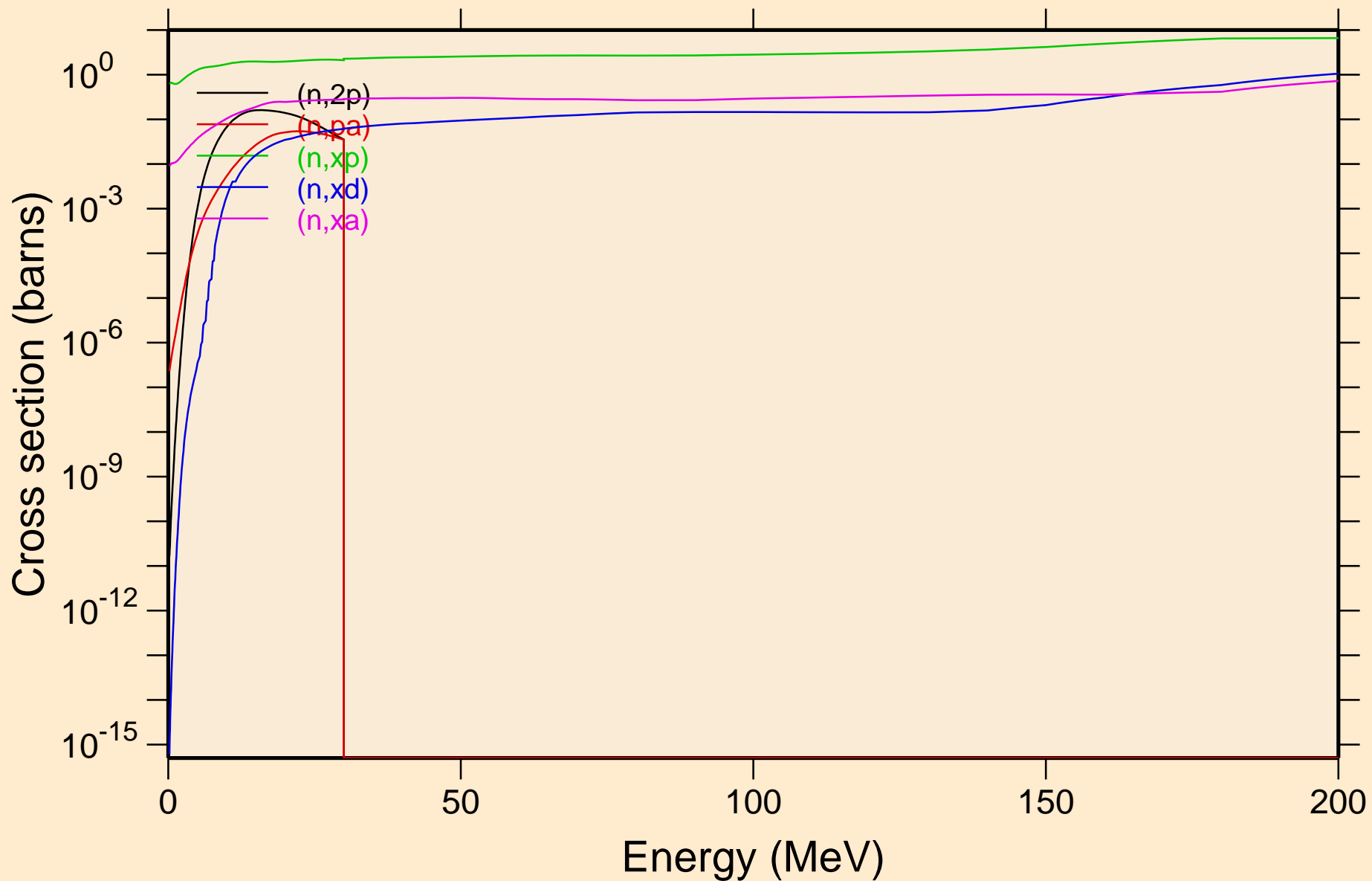

RE167M NEUTRON ACER TENDL-2019 LIBRARY; T=293.16K
Inelastic levels

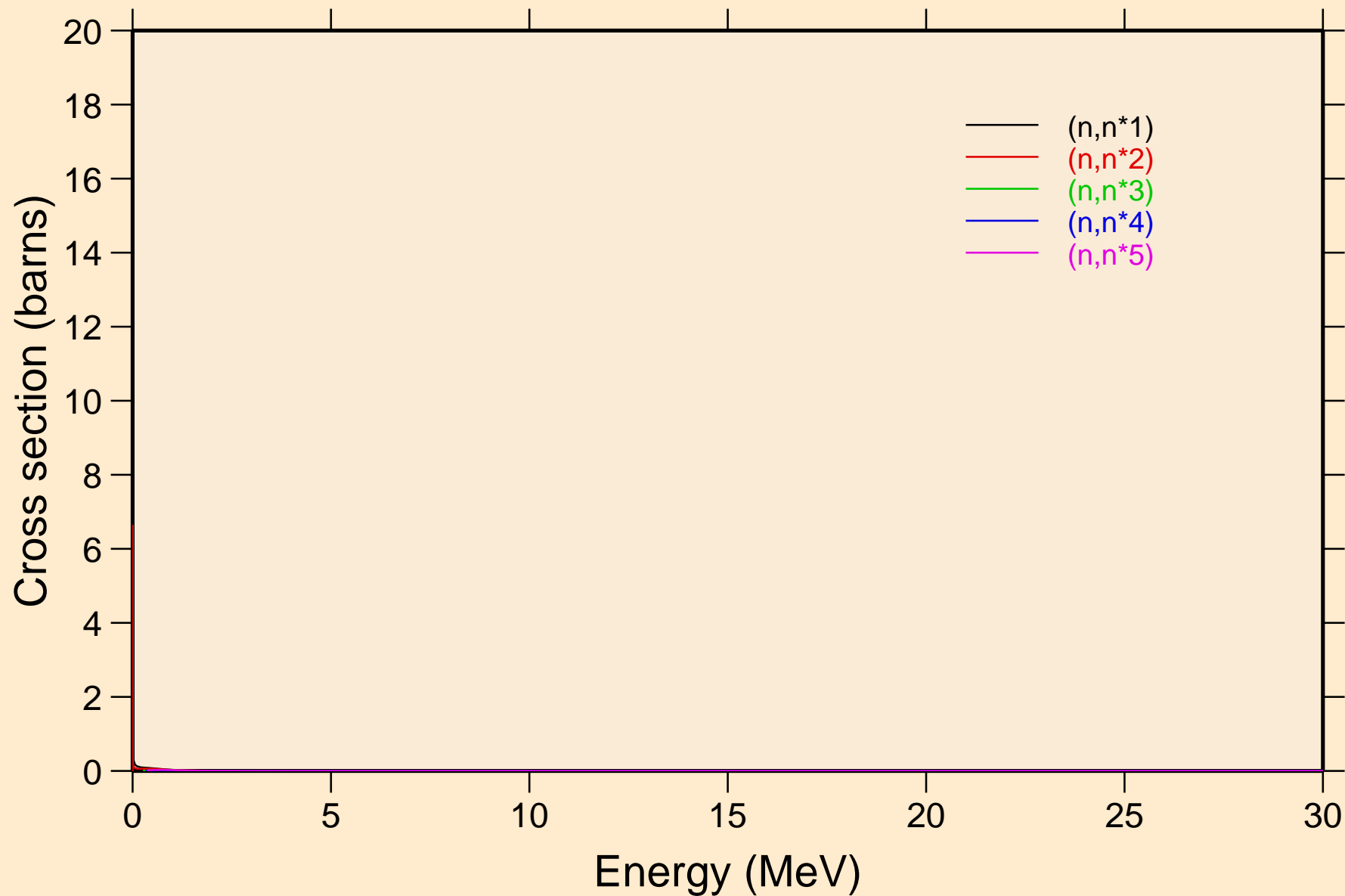

RE167M NEUTRON ACER TENDL-2019 LIBRARY; T=293.16K
Inelastic levels

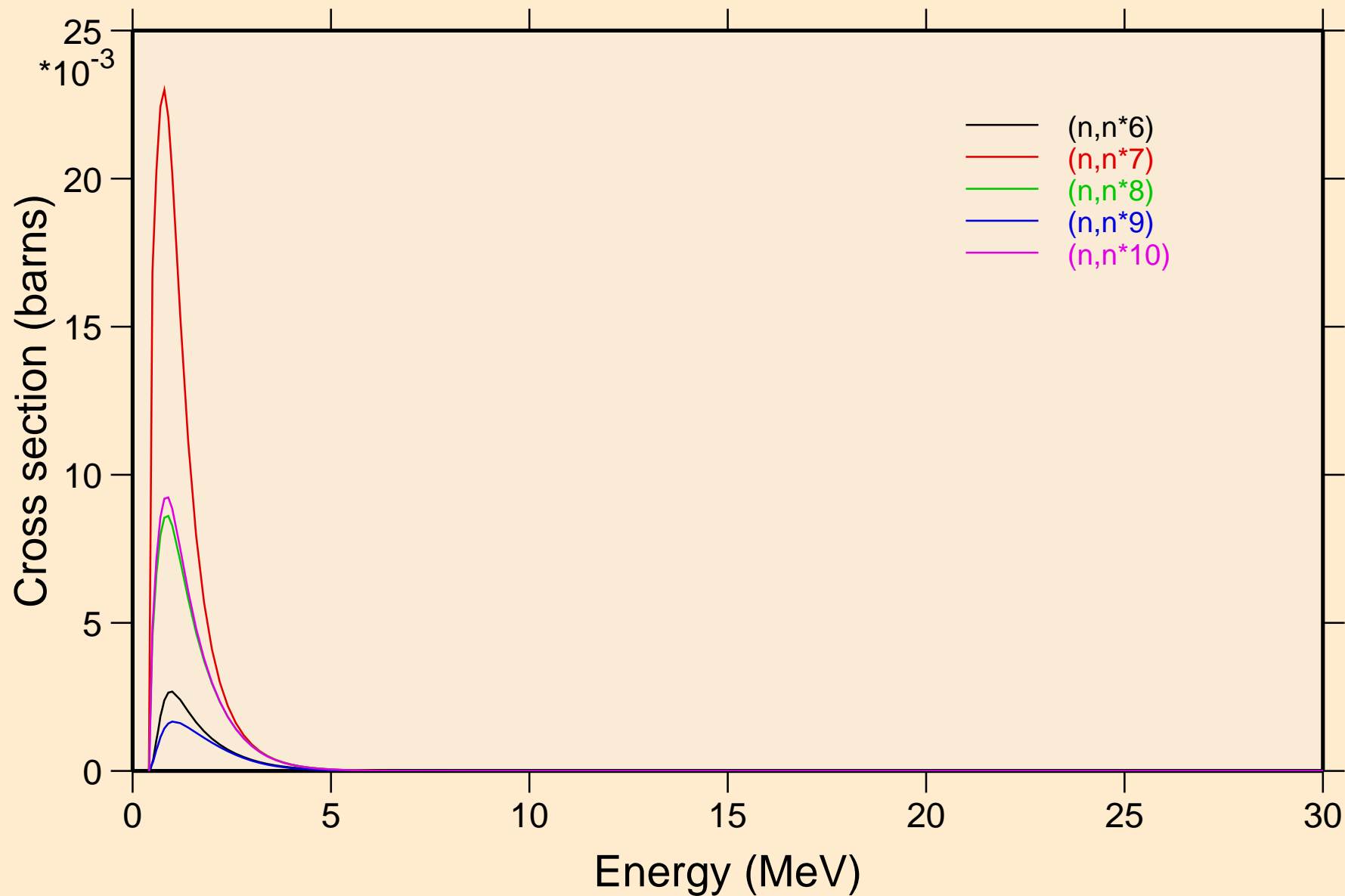

RE167M NEUTRON ACER TENDL-2019 LIBRARY; T=293.16K
Inelastic levels

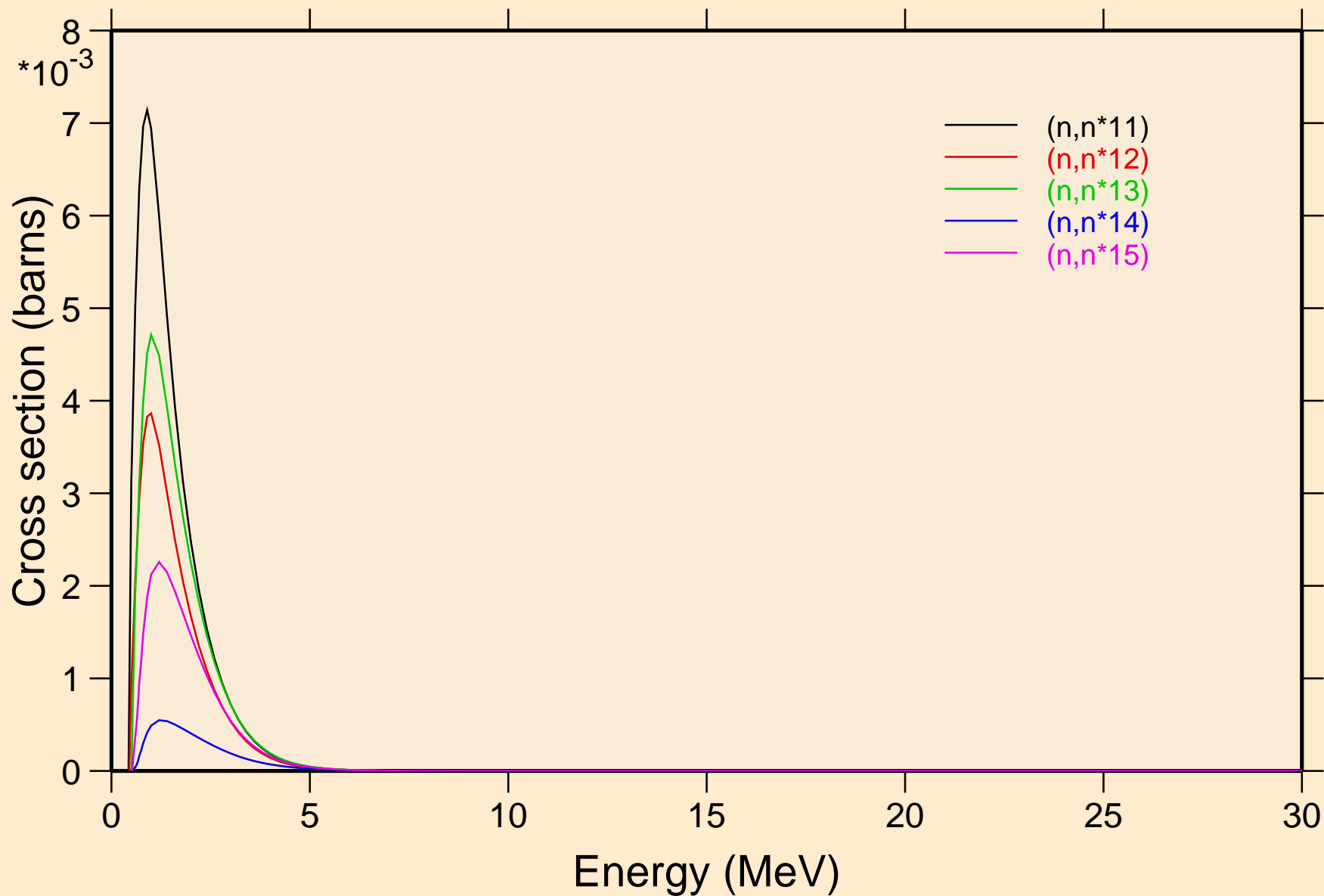

RE167M NEUTRON ACER TENDL-2019 LIBRARY; T=293.16K
Inelastic levels

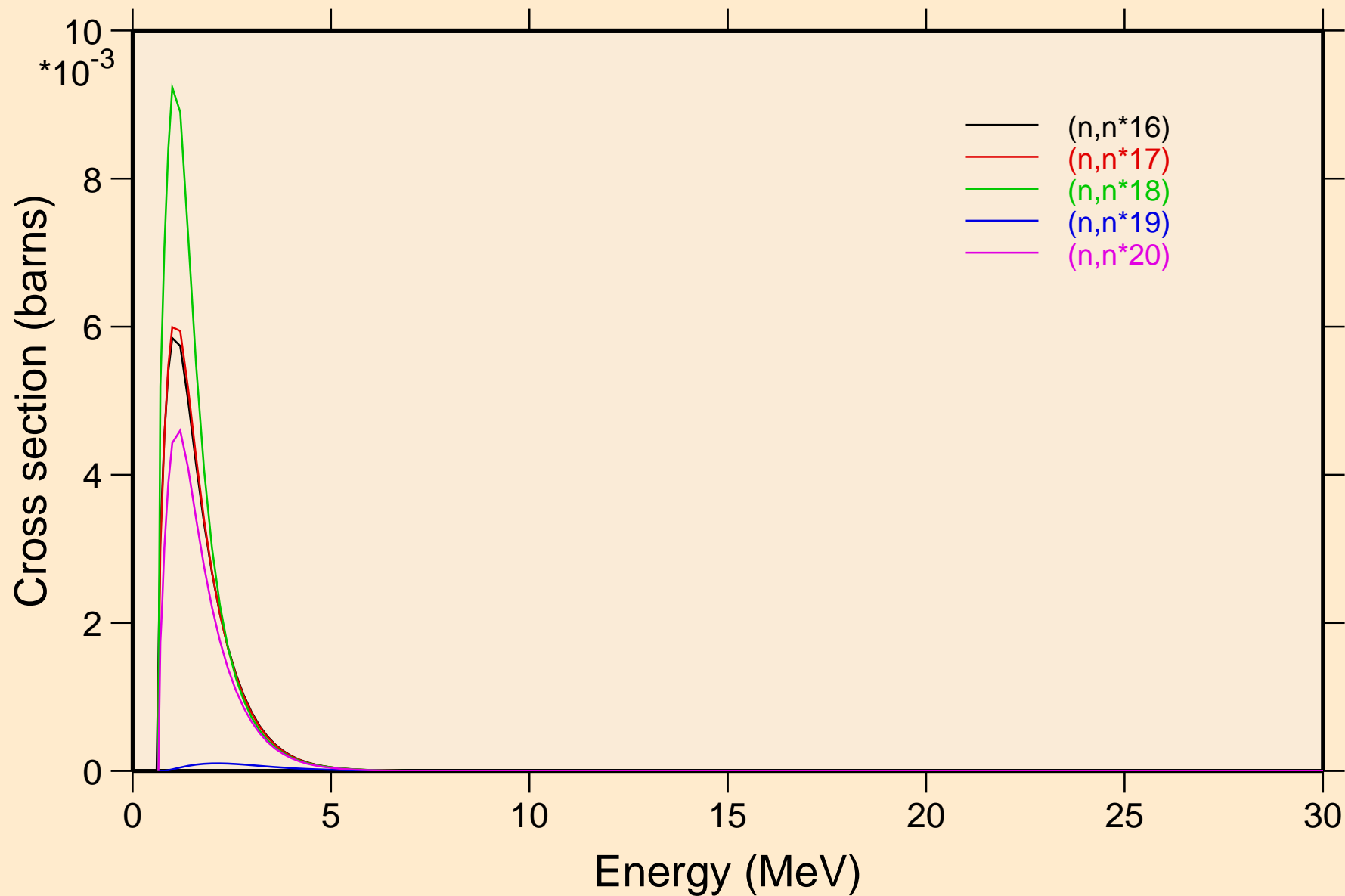

RE167M NEUTRON ACER TENDL-2019 LIBRARY; T=293.16K
Inelastic levels

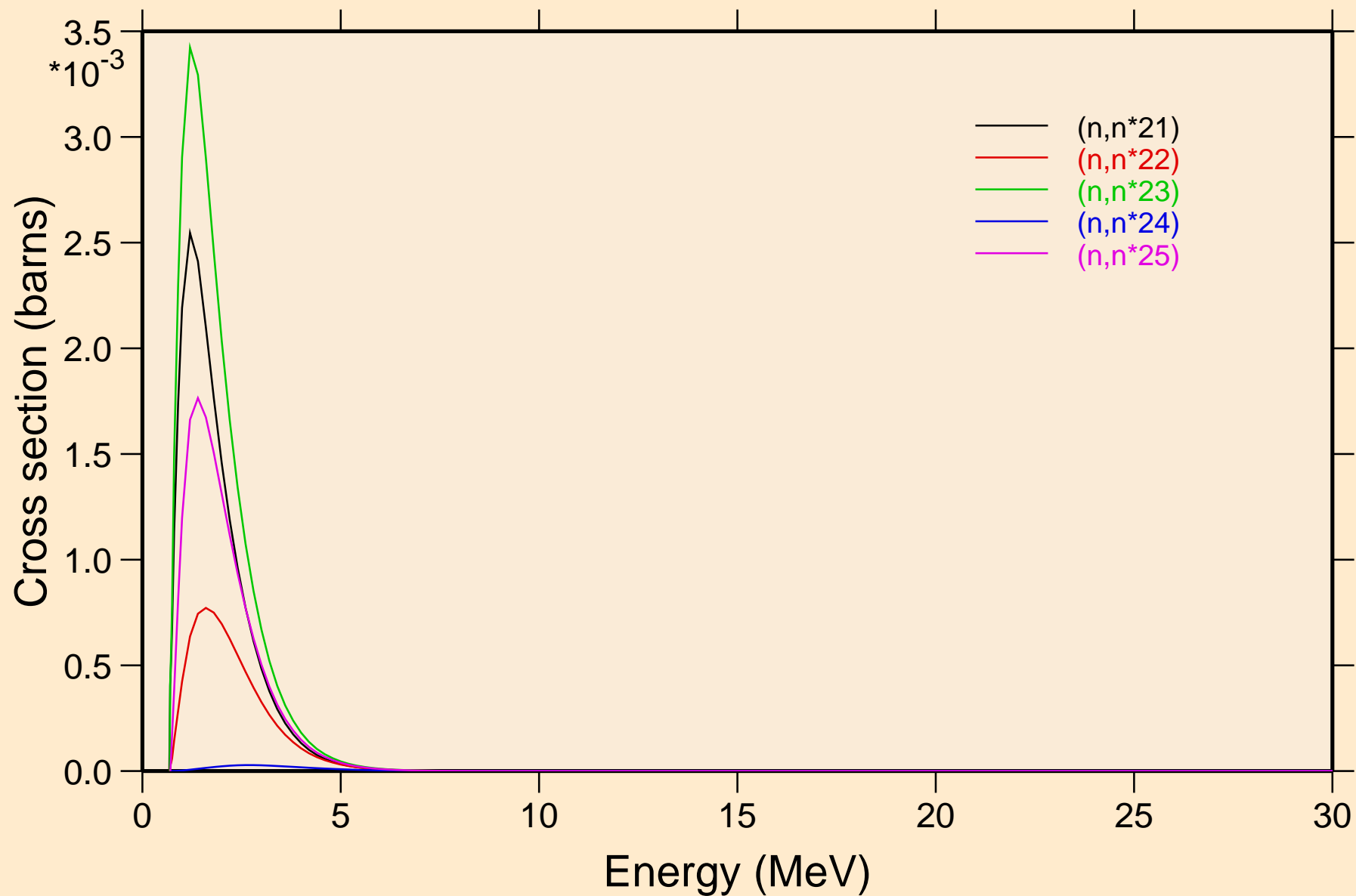

RE167M NEUTRON ACER TENDL-2019 LIBRARY; T=293.16K
Inelastic levels

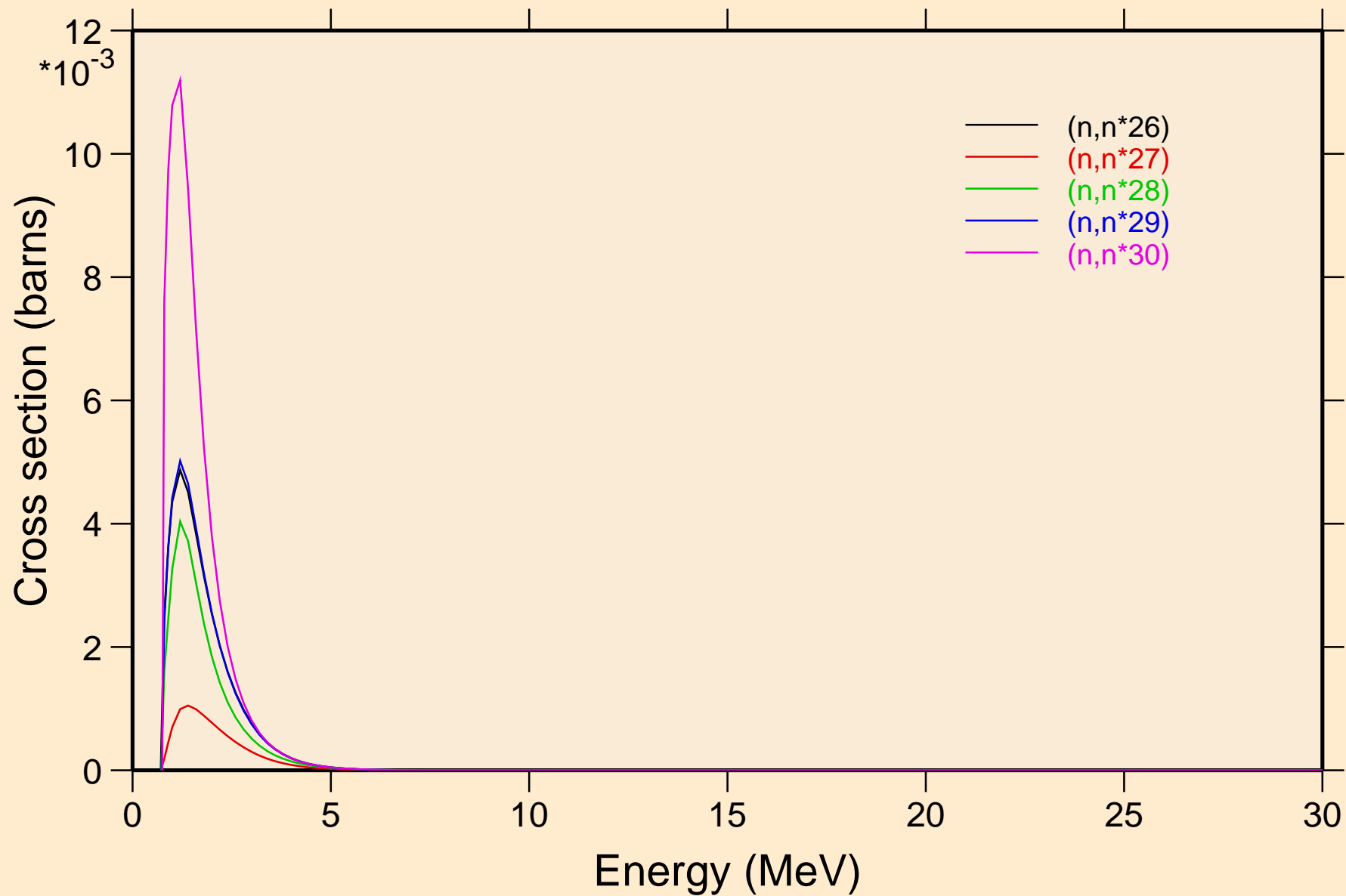

RE167M NEUTRON ACER TENDL-2019 LIBRARY; T=293.16K
Threshold reactions

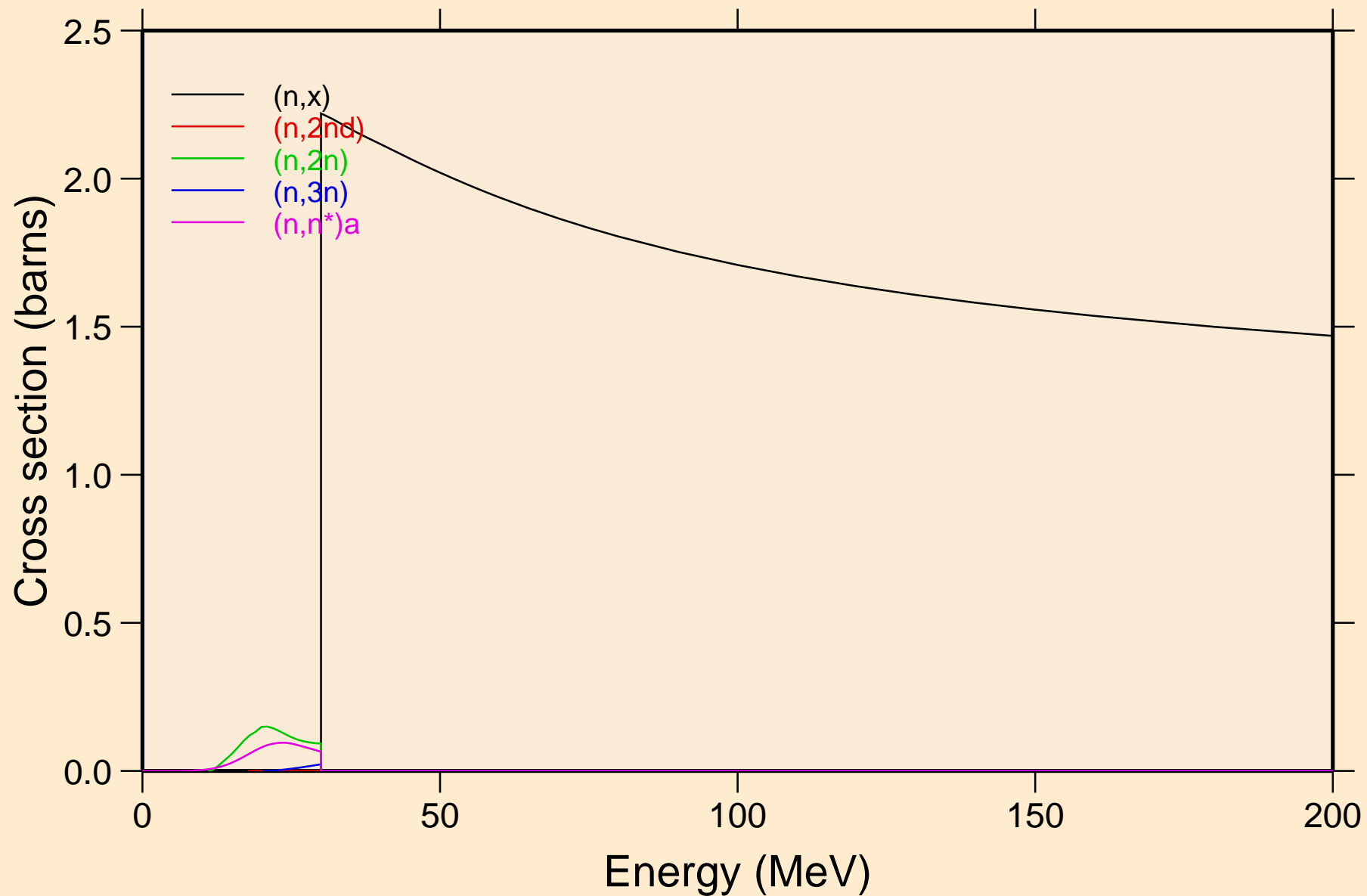

RE167M NEUTRON ACER TENDL-2019 LIBRARY; T=293.16K
Threshold reactions

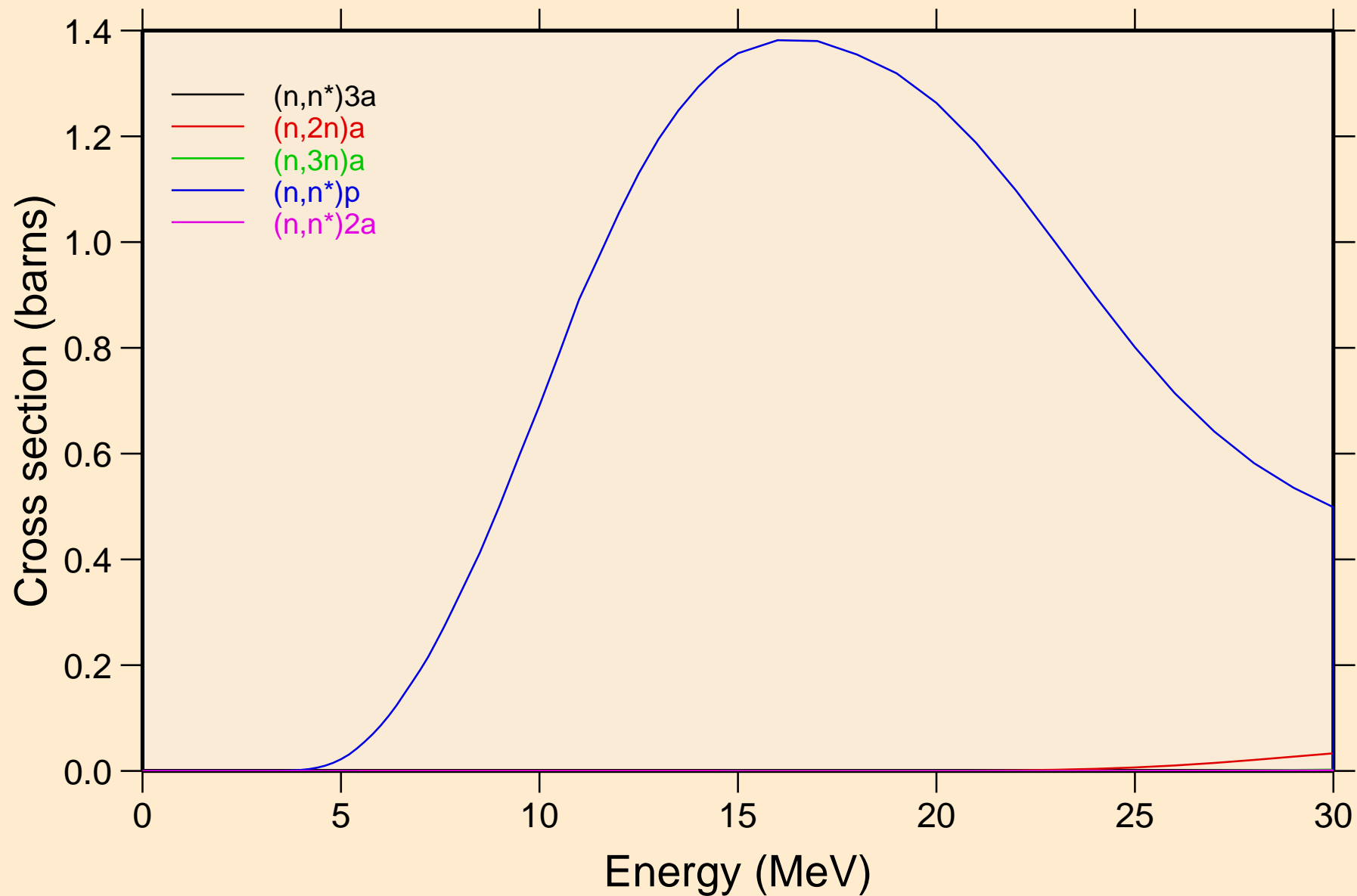

RE167M NEUTRON ACER TENDL-2019 LIBRARY; T=293.16K
Threshold reactions

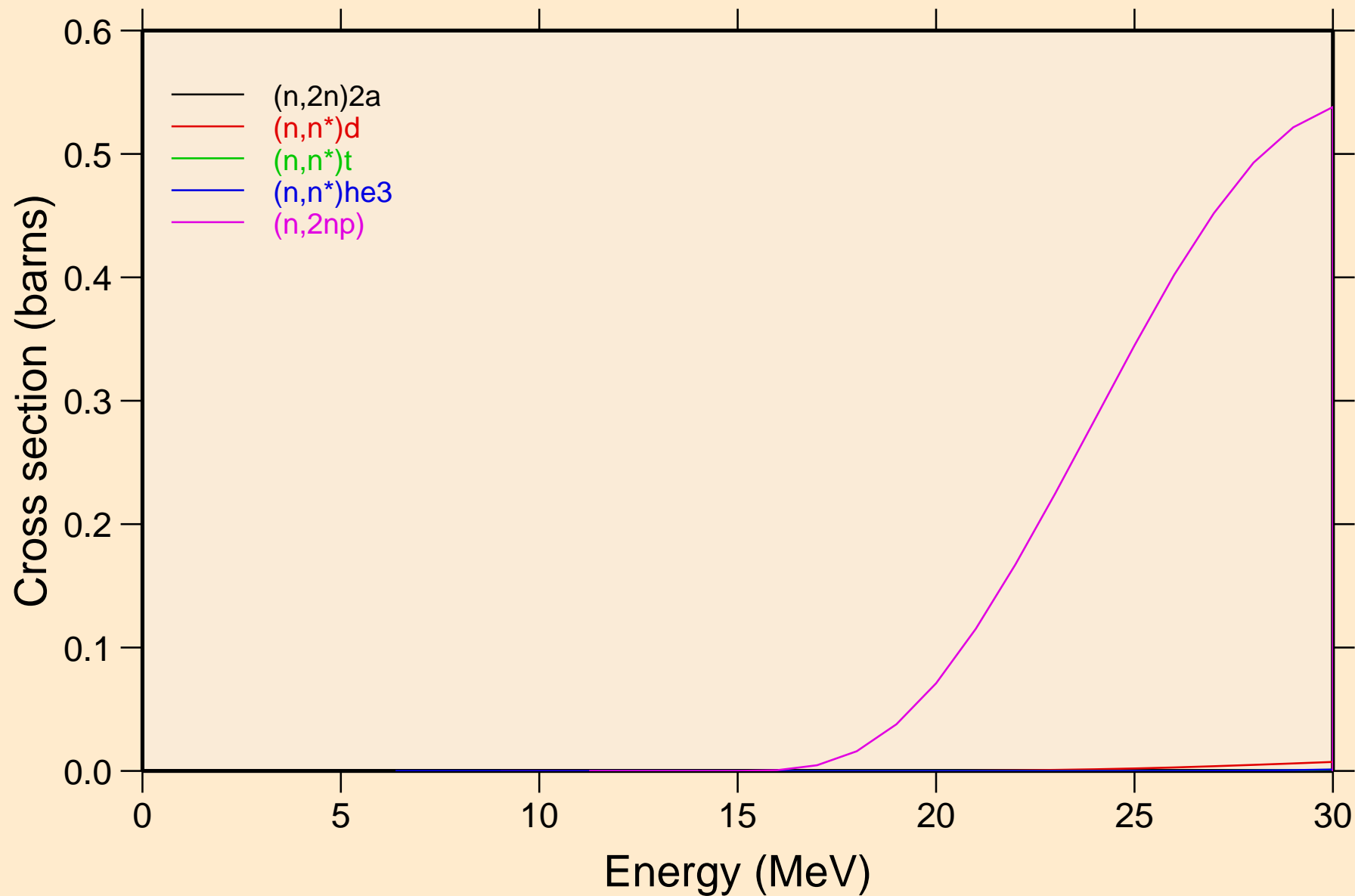

RE167M NEUTRON ACER TENDL-2019 LIBRARY; T=293.16K
Threshold reactions

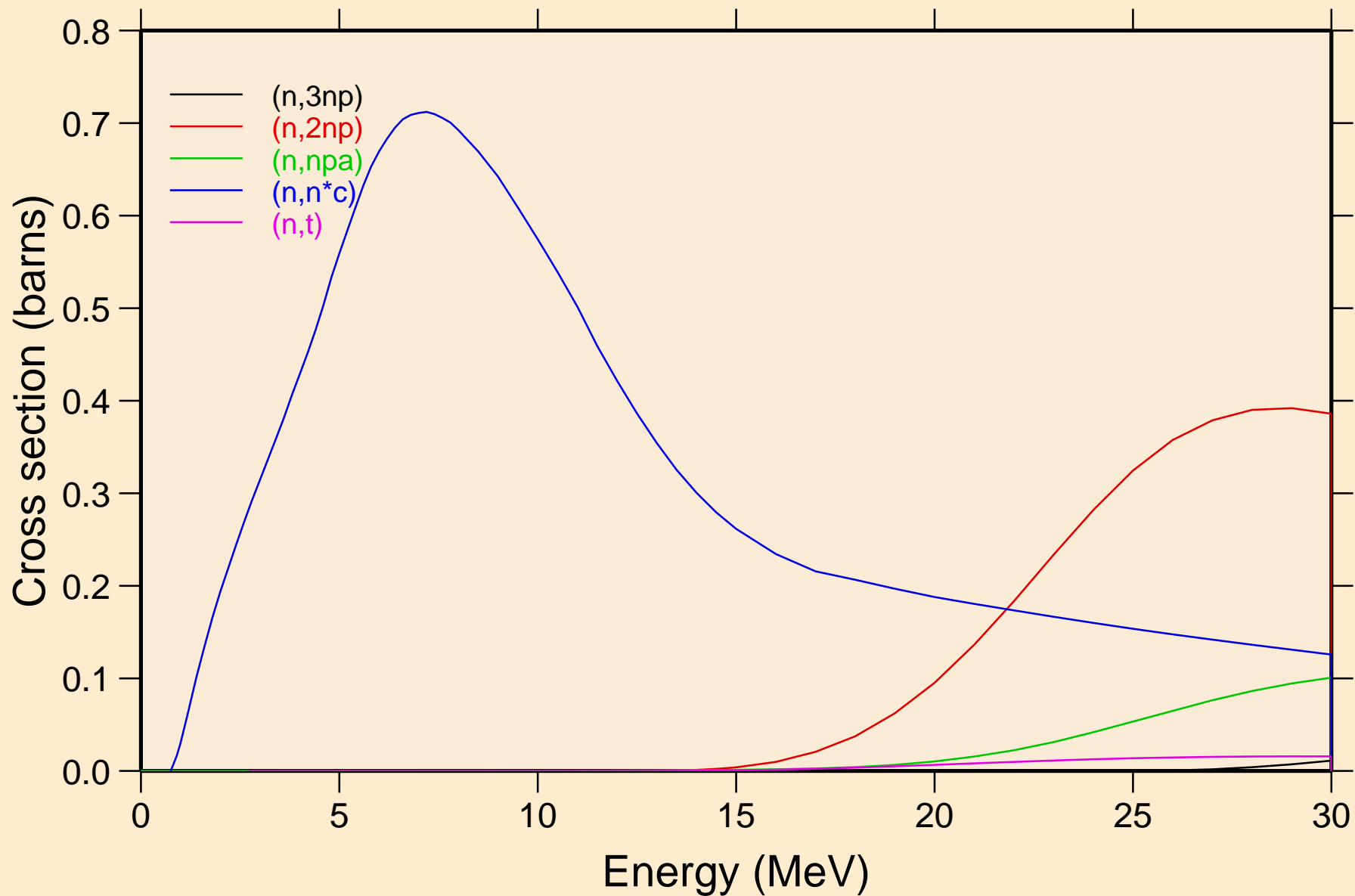

RE167M NEUTRON ACER TENDL-2019 LIBRARY; T=293.16K
Threshold reactions

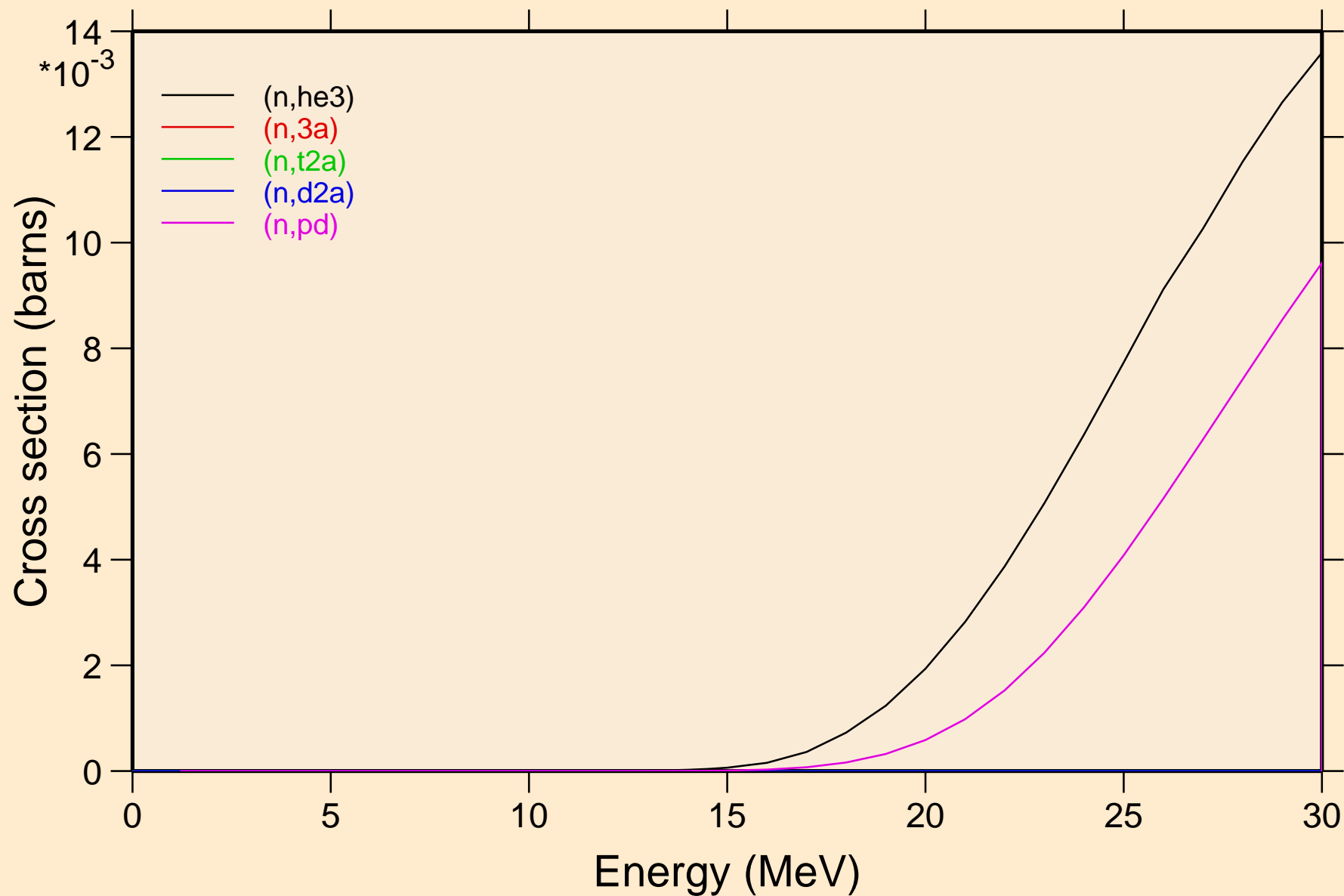

RE167M NEUTRON ACER TENDL-2019 LIBRARY; T=293.16K
Threshold reactions

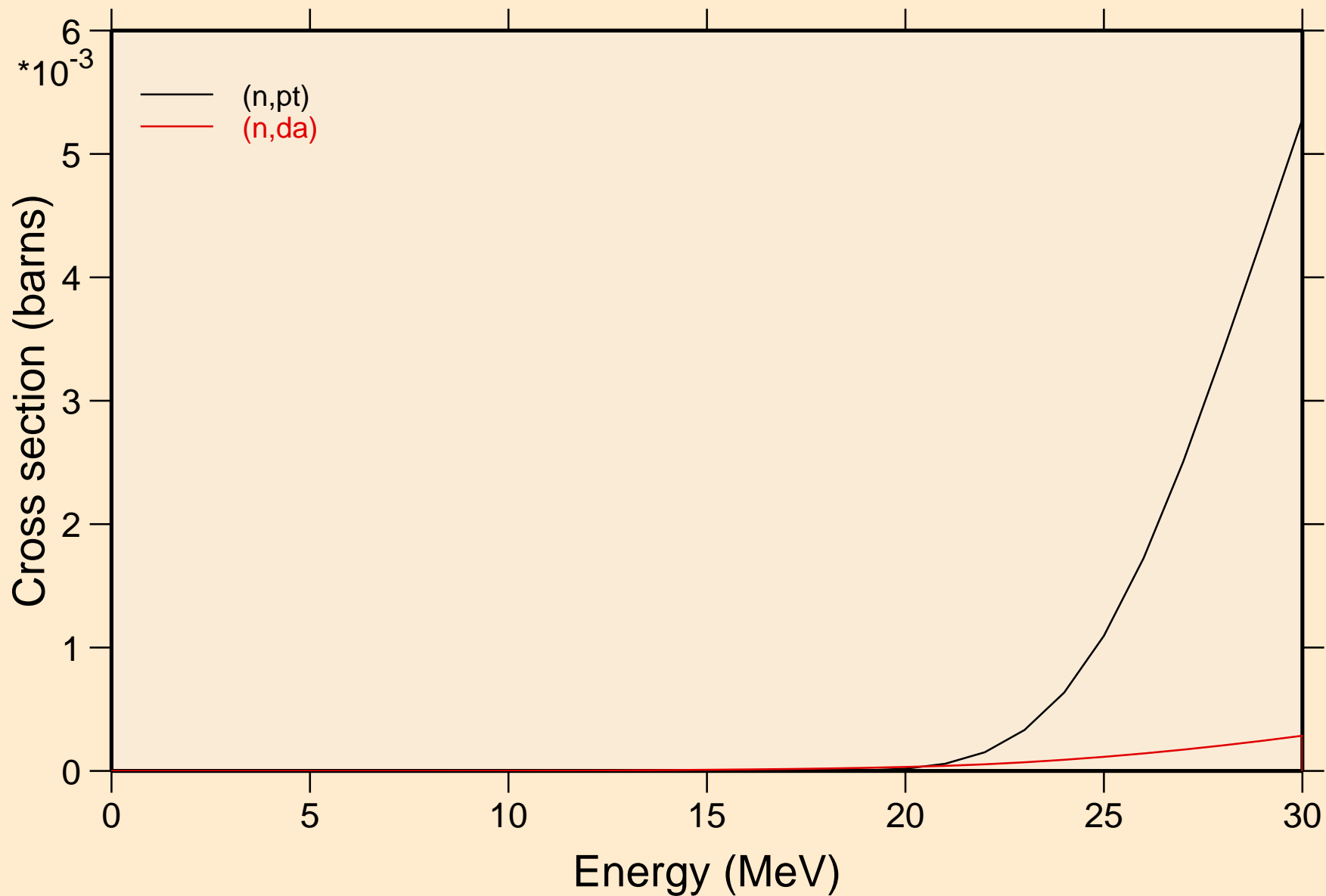

RE167M NEUTRON ACER TENDL-2019 LIBRARY; T=293.16K
Threshold reactions

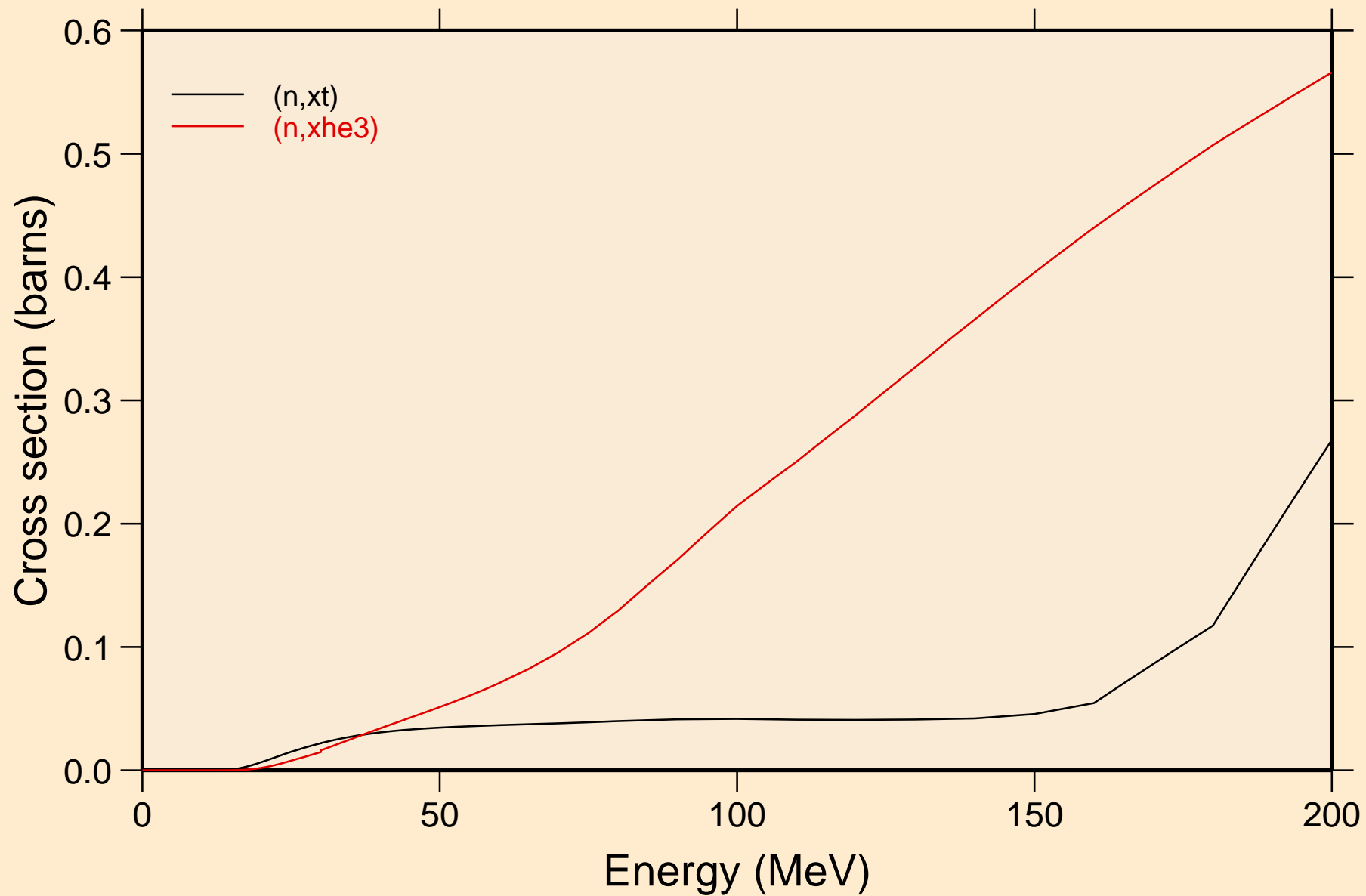

RE167M NEUTRON ACER TENDL-2019 LIBRARY; T=293.16K
angular distribution for elastic

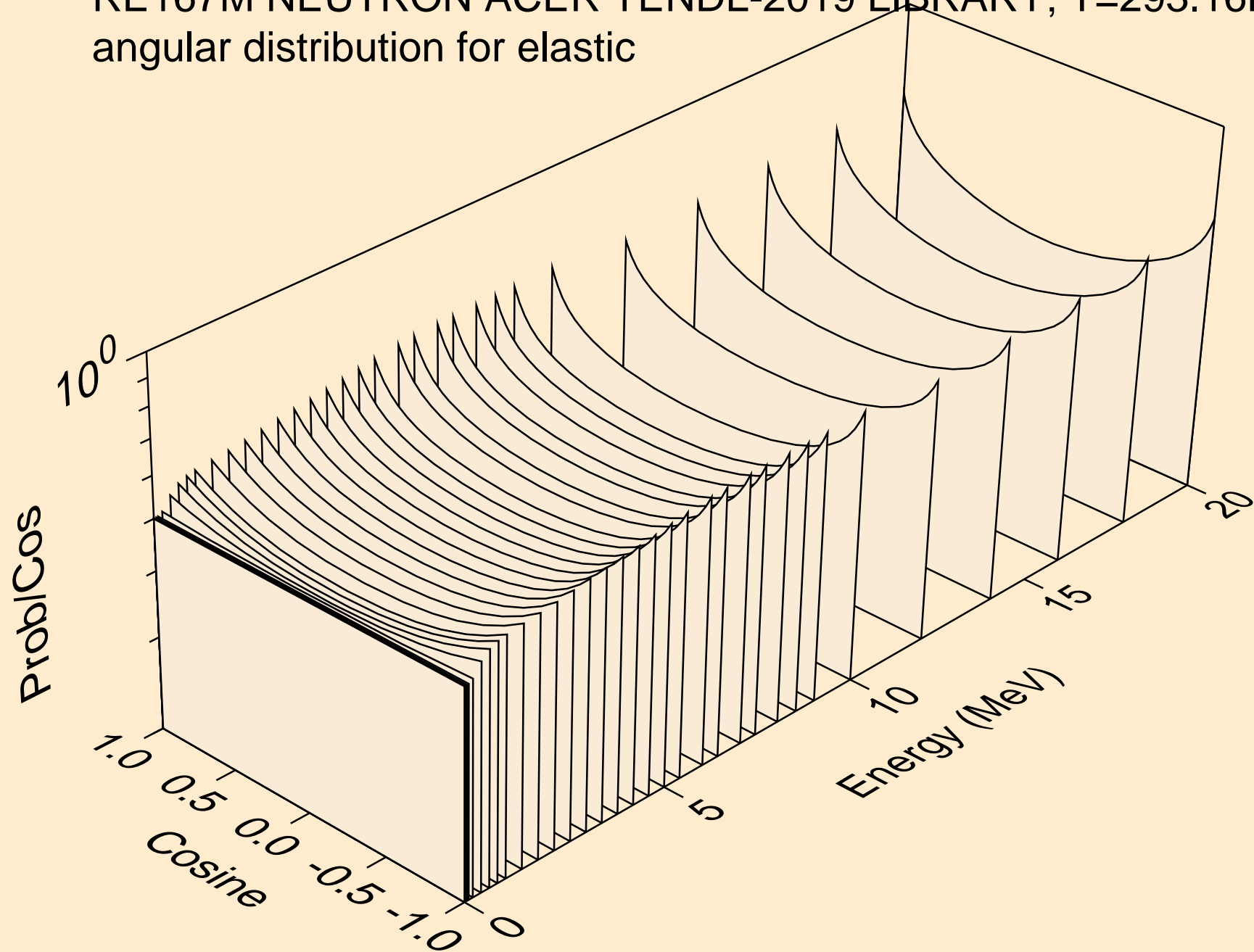

RE167M NEUTRON ACER TENDL-2019 LIBRARY; T=293.16K
angular distribution for elastic

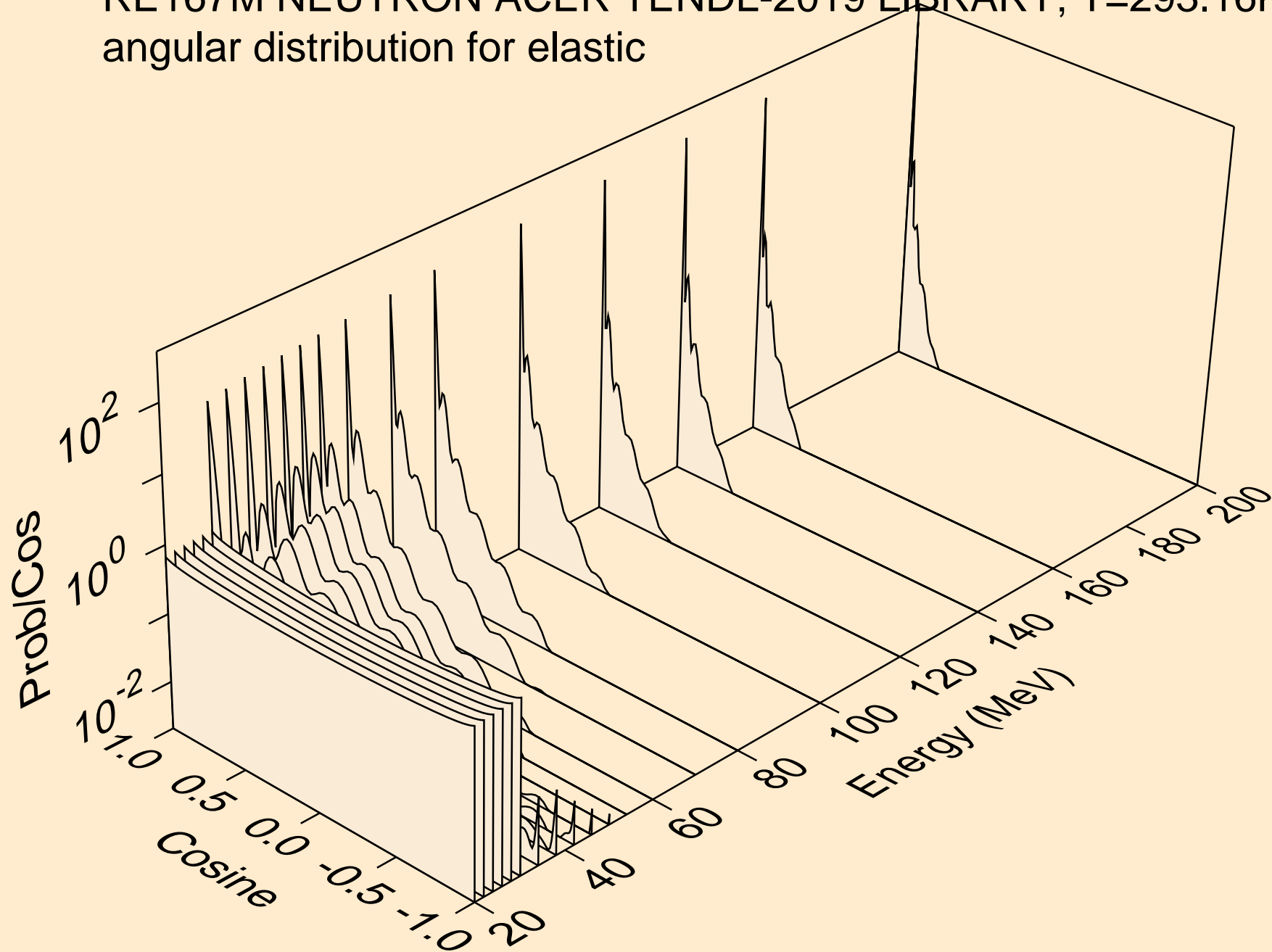

RE167M NEUTRON ACER TENDL-2019 LIBRARY; T=293.16K
angular distribution for (n,n*1)

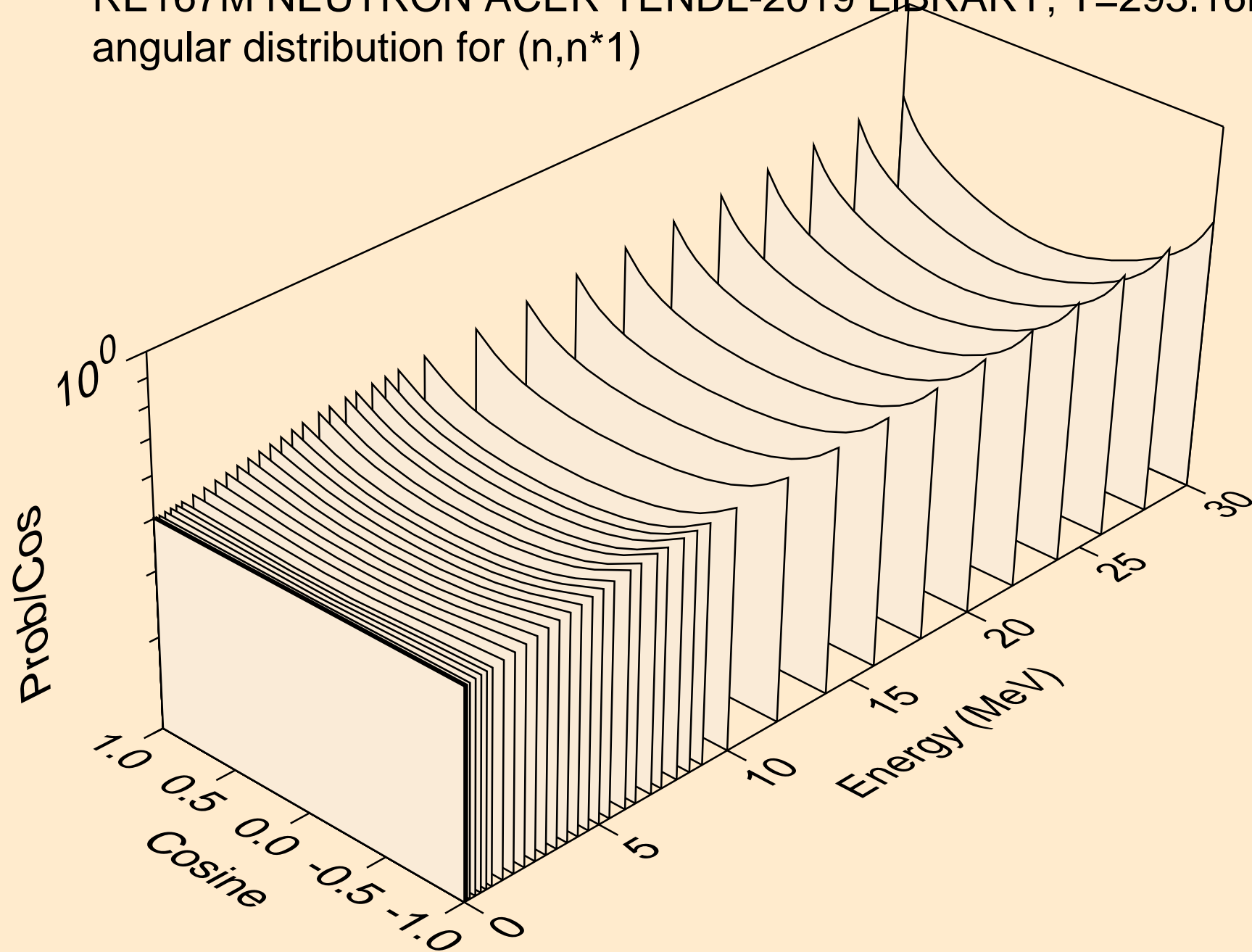

RE167M NEUTRON ACER TENDL-2019 LIBRARY; T=293.16K
angular distribution for (n,n*2)

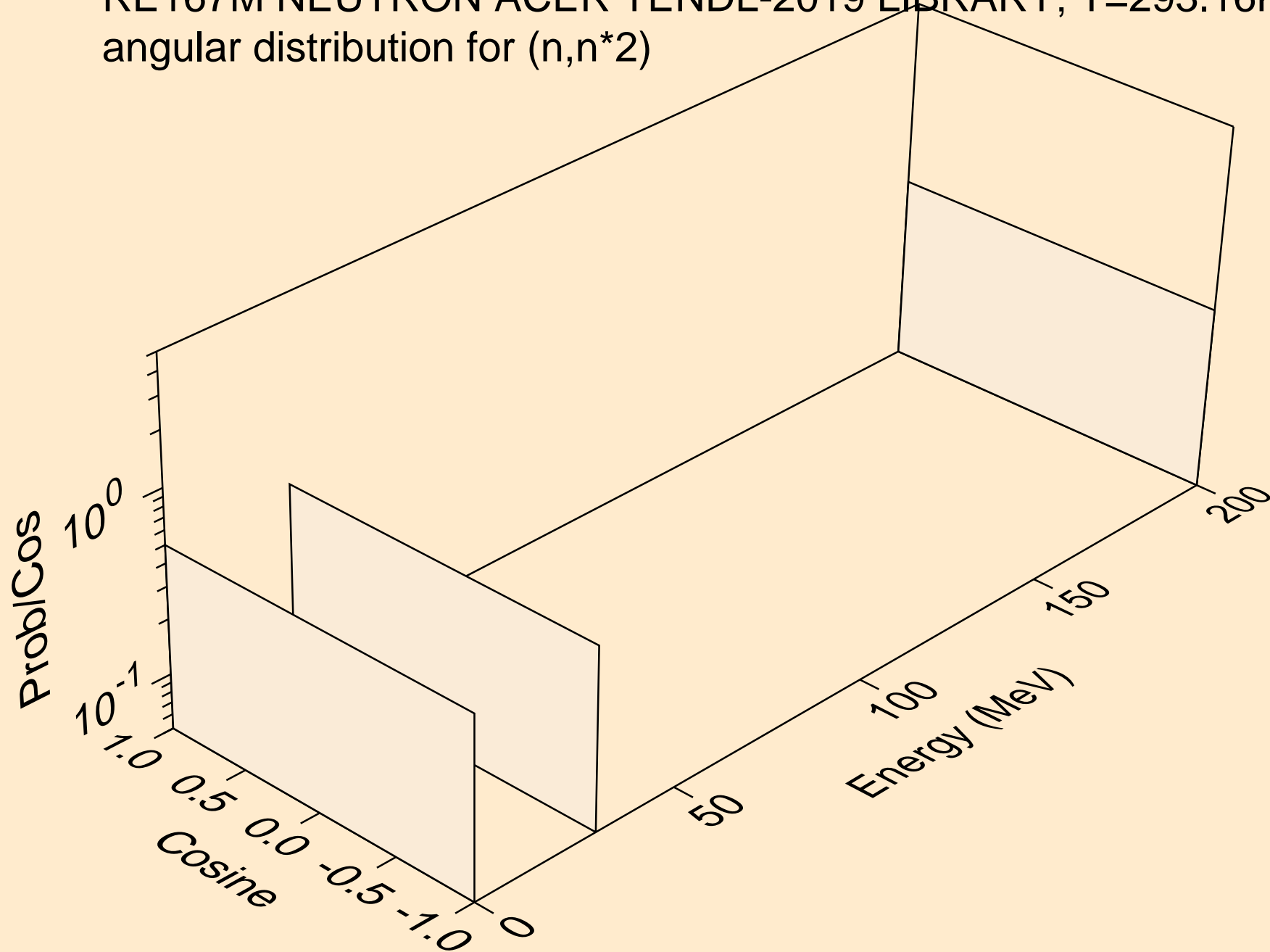

RE167M NEUTRON ACER TENDL-2019 LIBRARY; T=293.16K
angular distribution for (n,n*3)

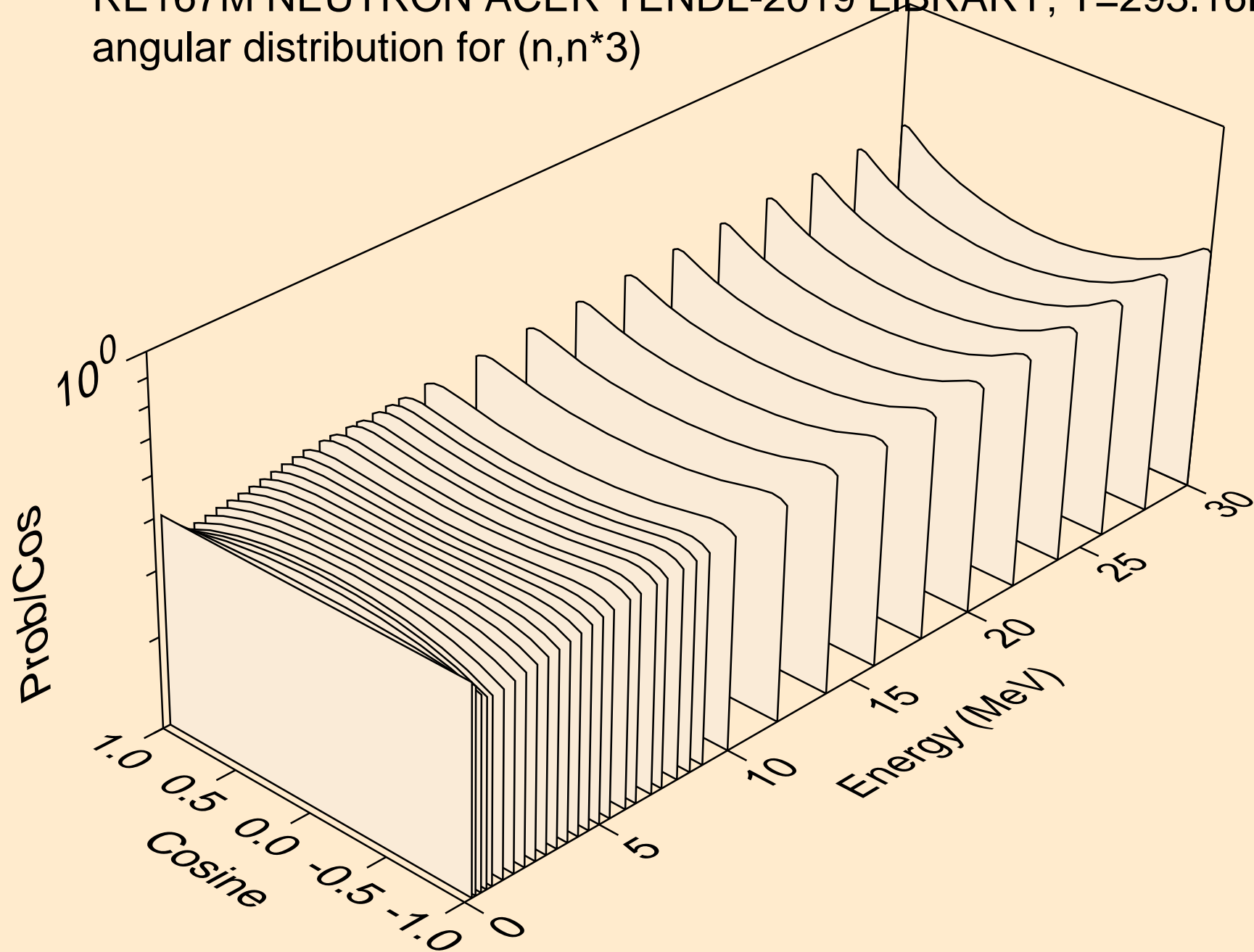

RE167M NEUTRON ACER TENDL-2019 LIBRARY; T=293.16K
angular distribution for (n,n*4)

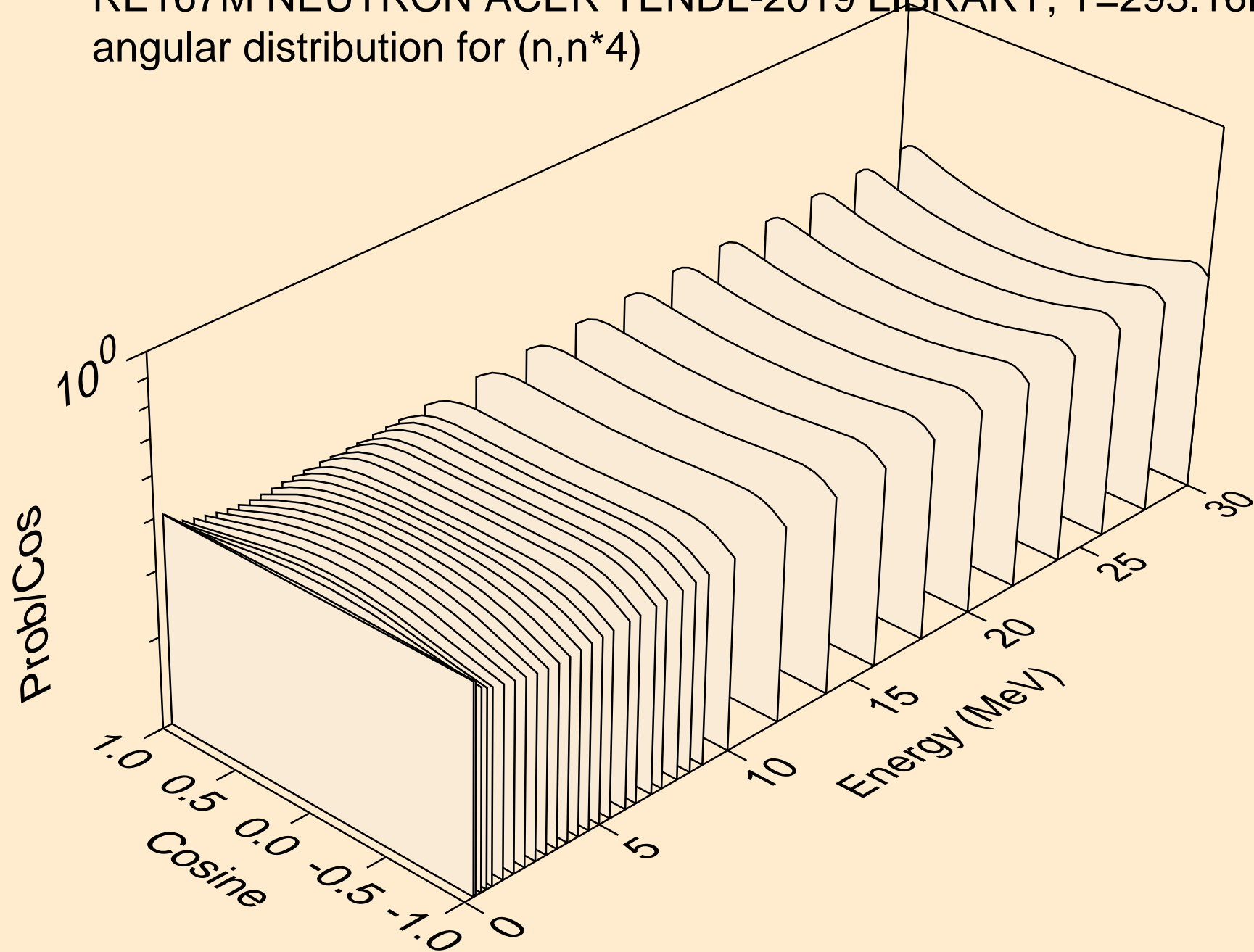

RE167M NEUTRON ACER TENDL-2019 LIBRARY; T=293.16K
angular distribution for (n,n*5)

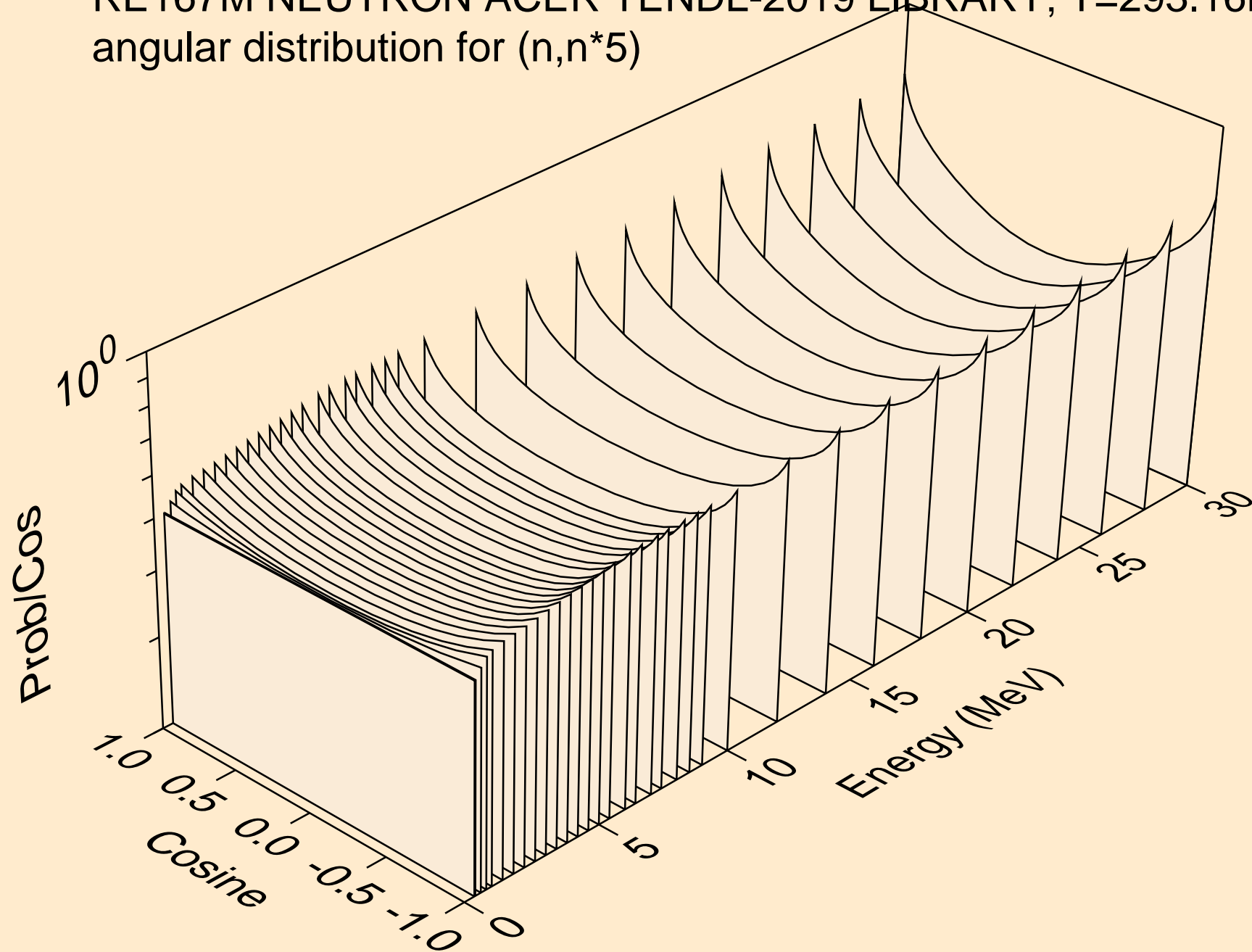

RE167M NEUTRON ACER TENDL-2019 LIBRARY; T=293.16K
angular distribution for (n,n*6)

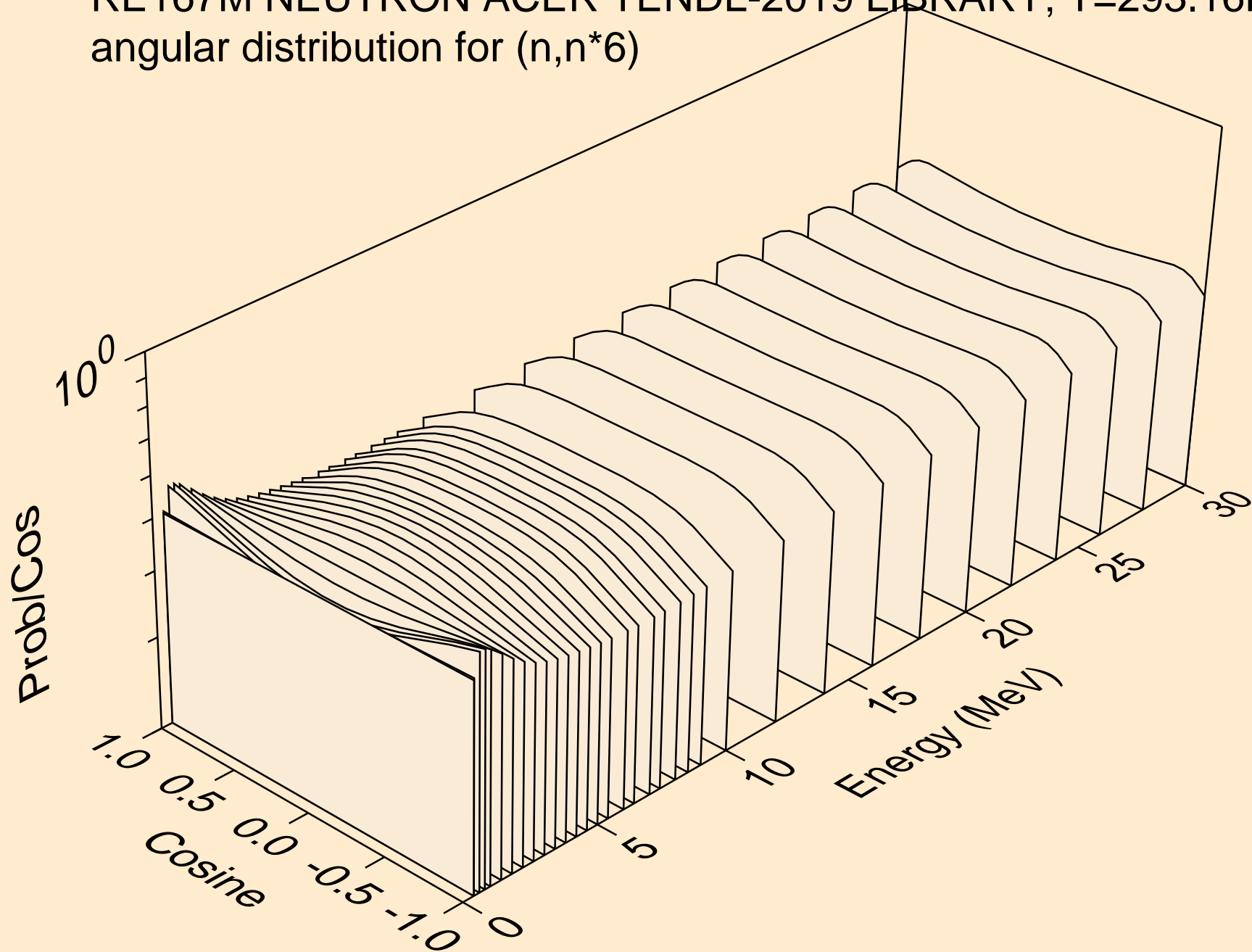

RE167M NEUTRON ACER TENDL-2019 LIBRARY; T=293.16K
angular distribution for (n,n*7)

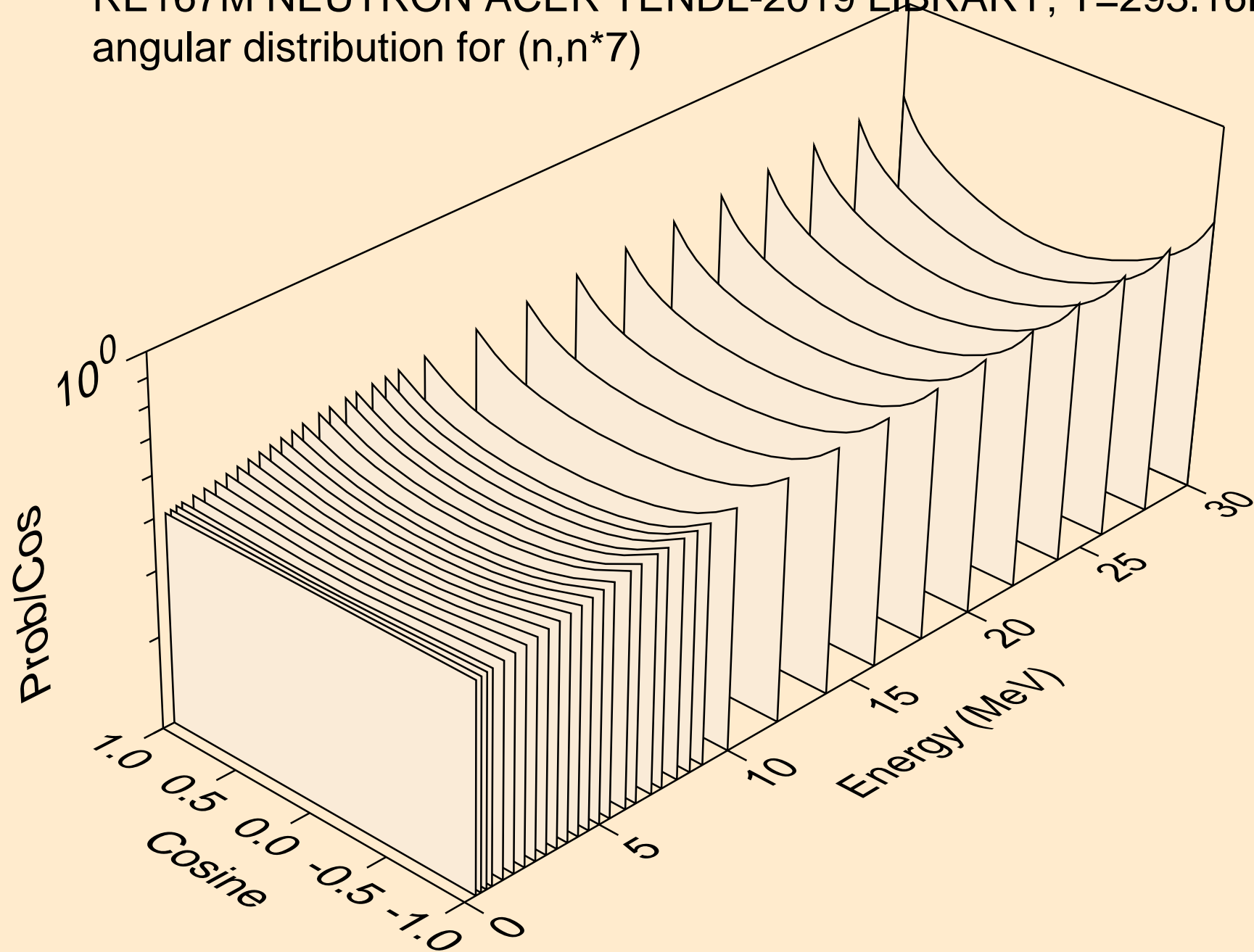

RE167M NEUTRON ACER TENDL-2019 LIBRARY; T=293.16K
angular distribution for (n,n*8)

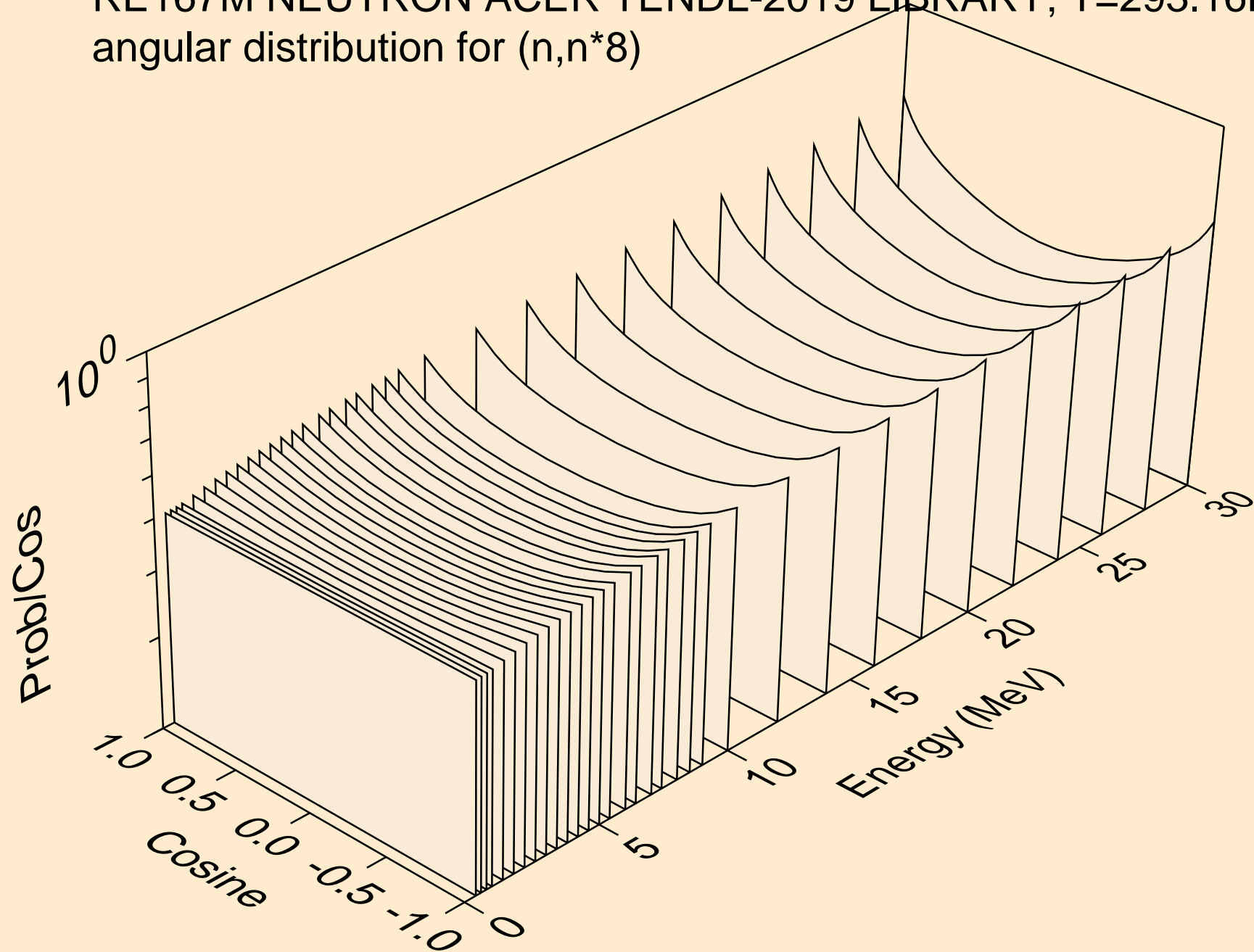

RE167M NEUTRON ACER TENDL-2019 LIBRARY; T=293.16K
angular distribution for (n,n*9)

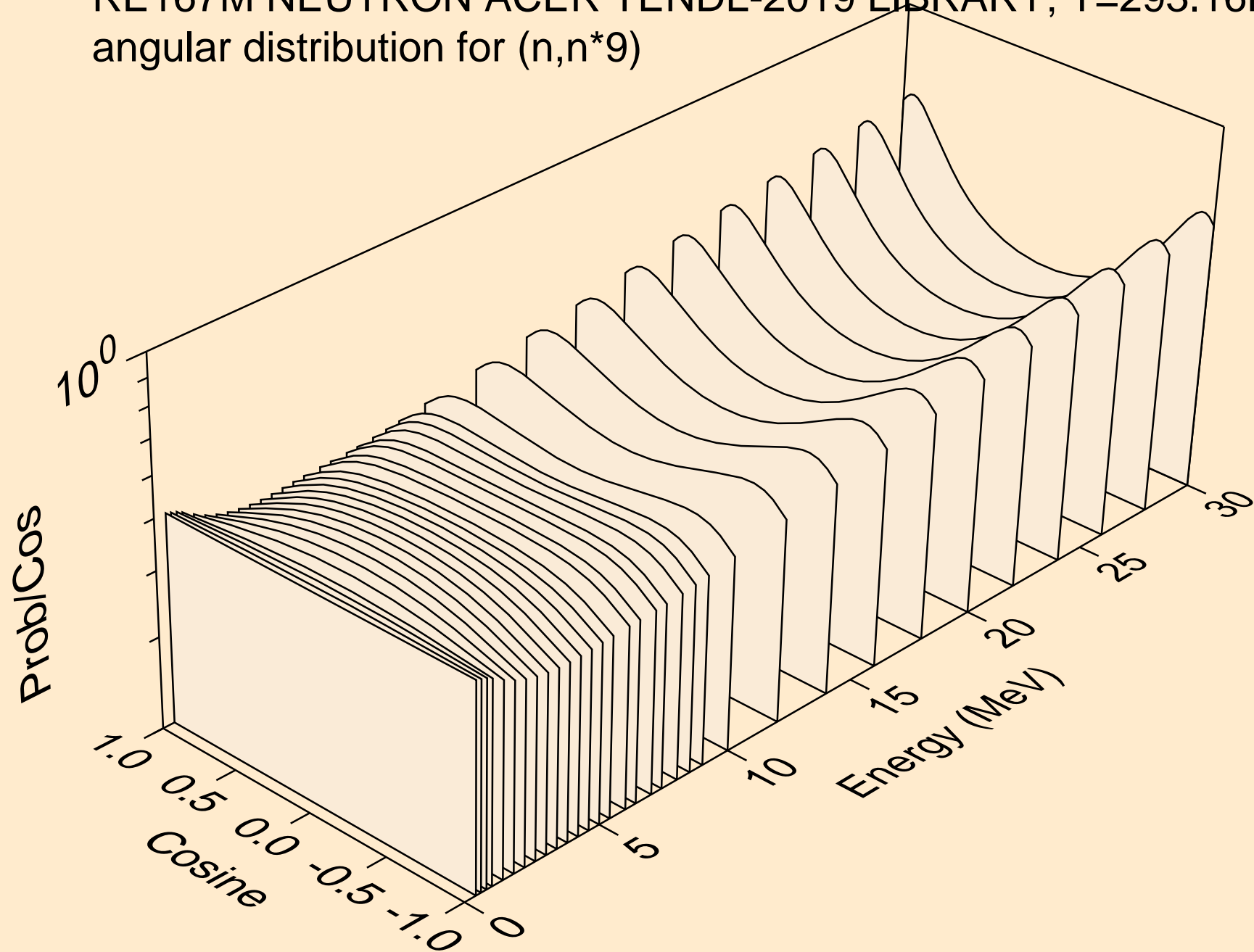

RE167M NEUTRON ACER TENDL-2019 LIBRARY; T=293.16K
angular distribution for (n,n*10)

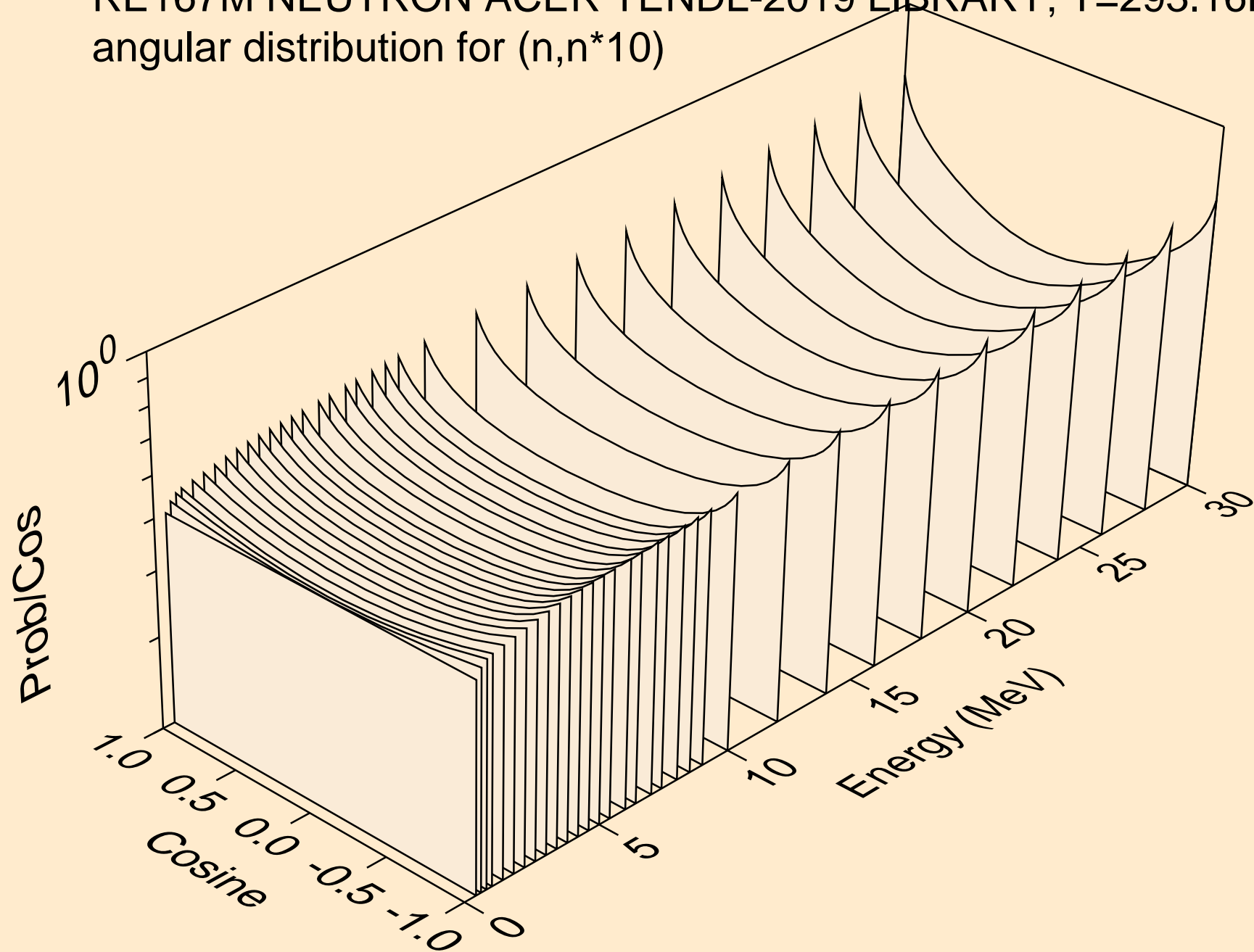

RE167M NEUTRON ACER TENDL-2019 LIBRARY; T=293.16K
angular distribution for (n,n*11)

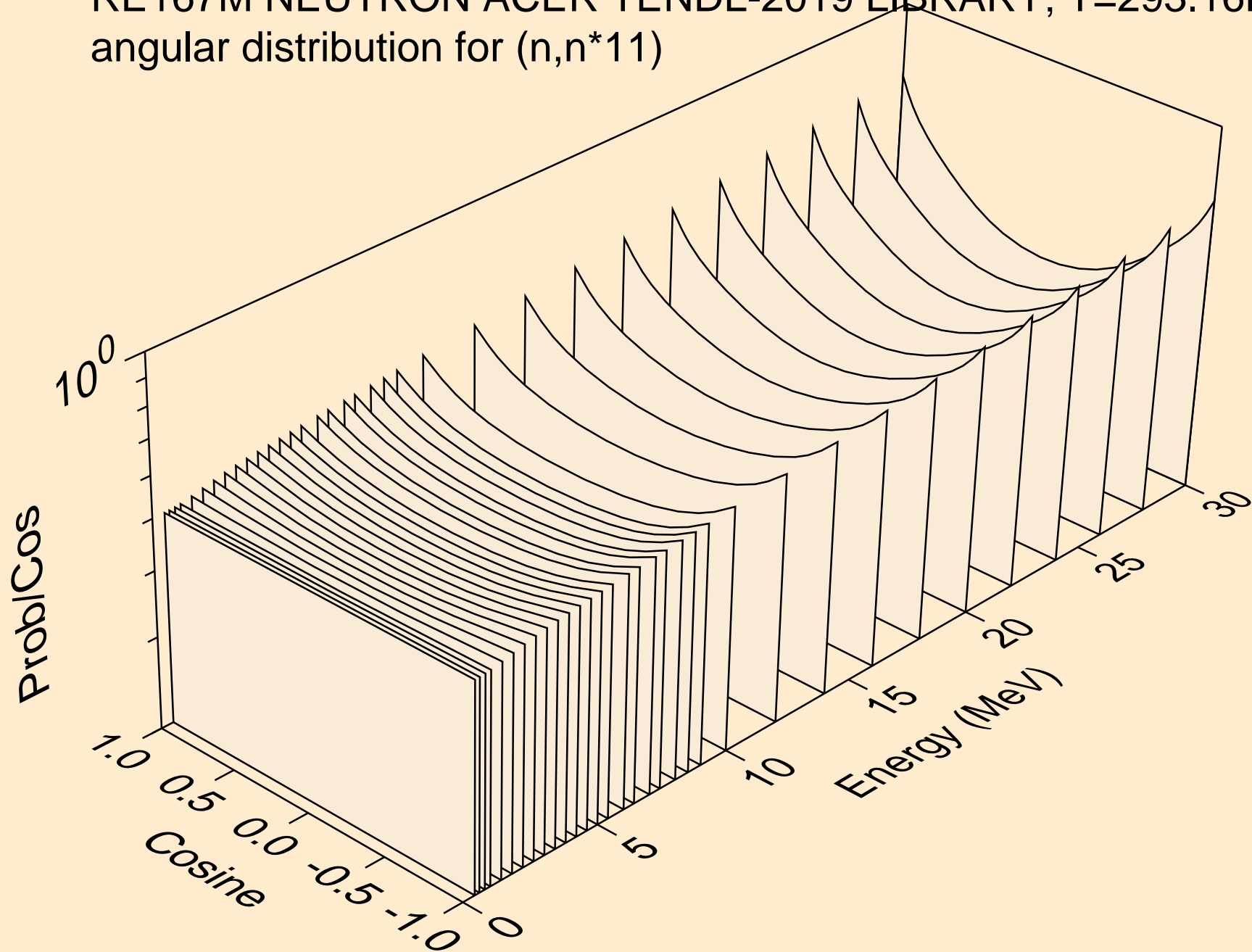

RE167M NEUTRON ACER TENDL-2019 LIBRARY; T=293.16K
angular distribution for (n,n*12)

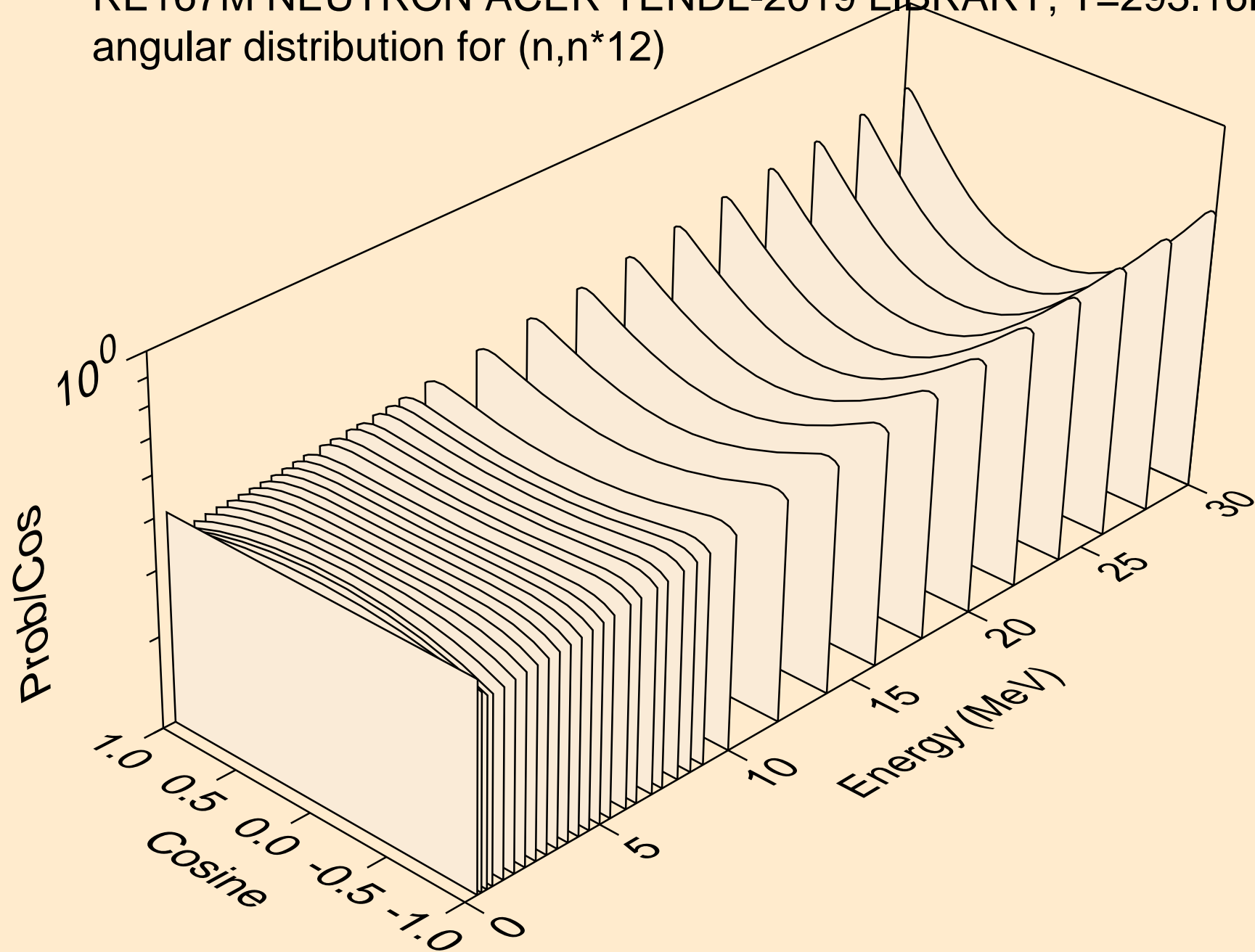

RE167M NEUTRON ACER TENDL-2019 LIBRARY; T=293.16K
angular distribution for (n,n*13)

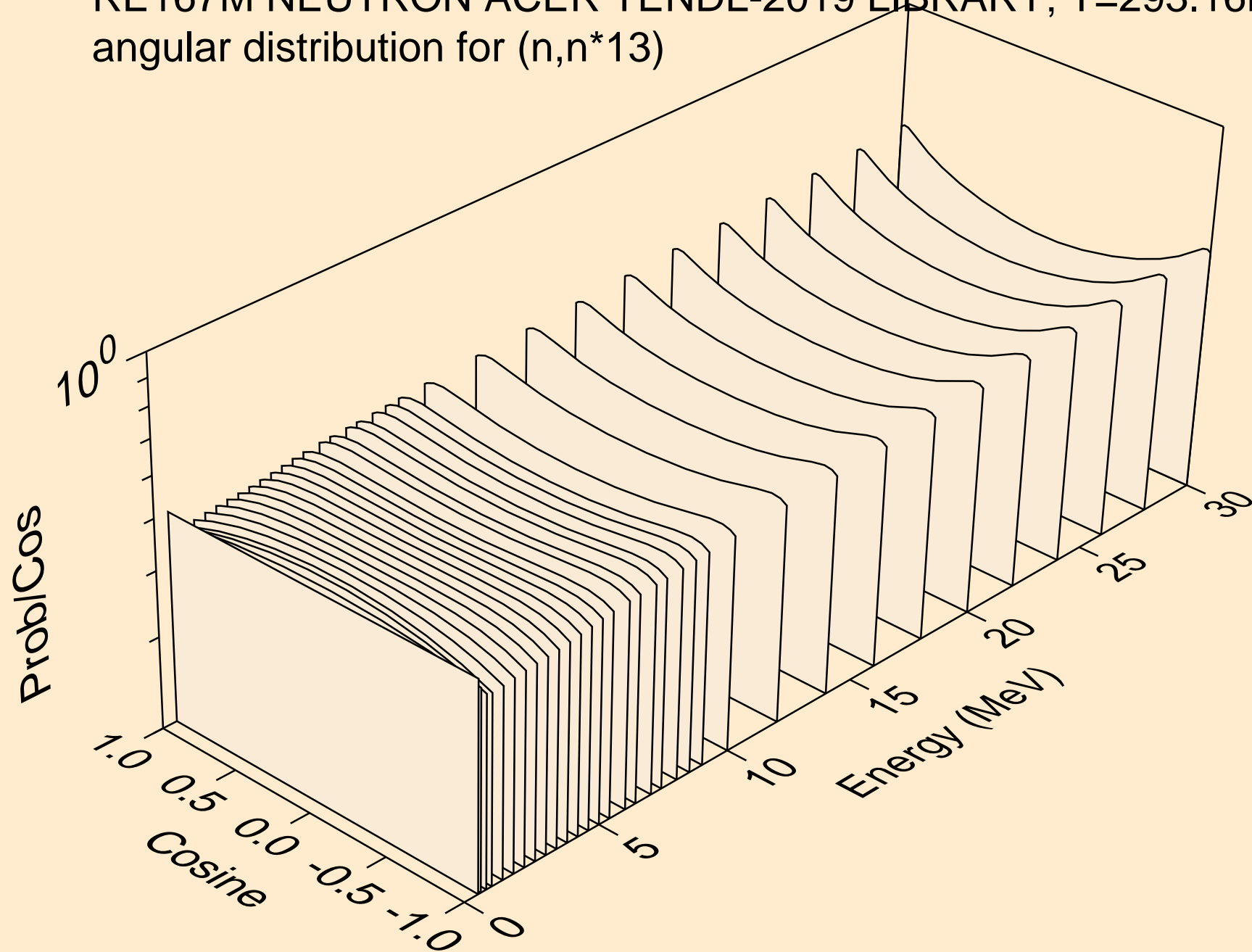

RE167M NEUTRON ACER TENDL-2019 LIBRARY; T=293.16K
angular distribution for (n,n*14)

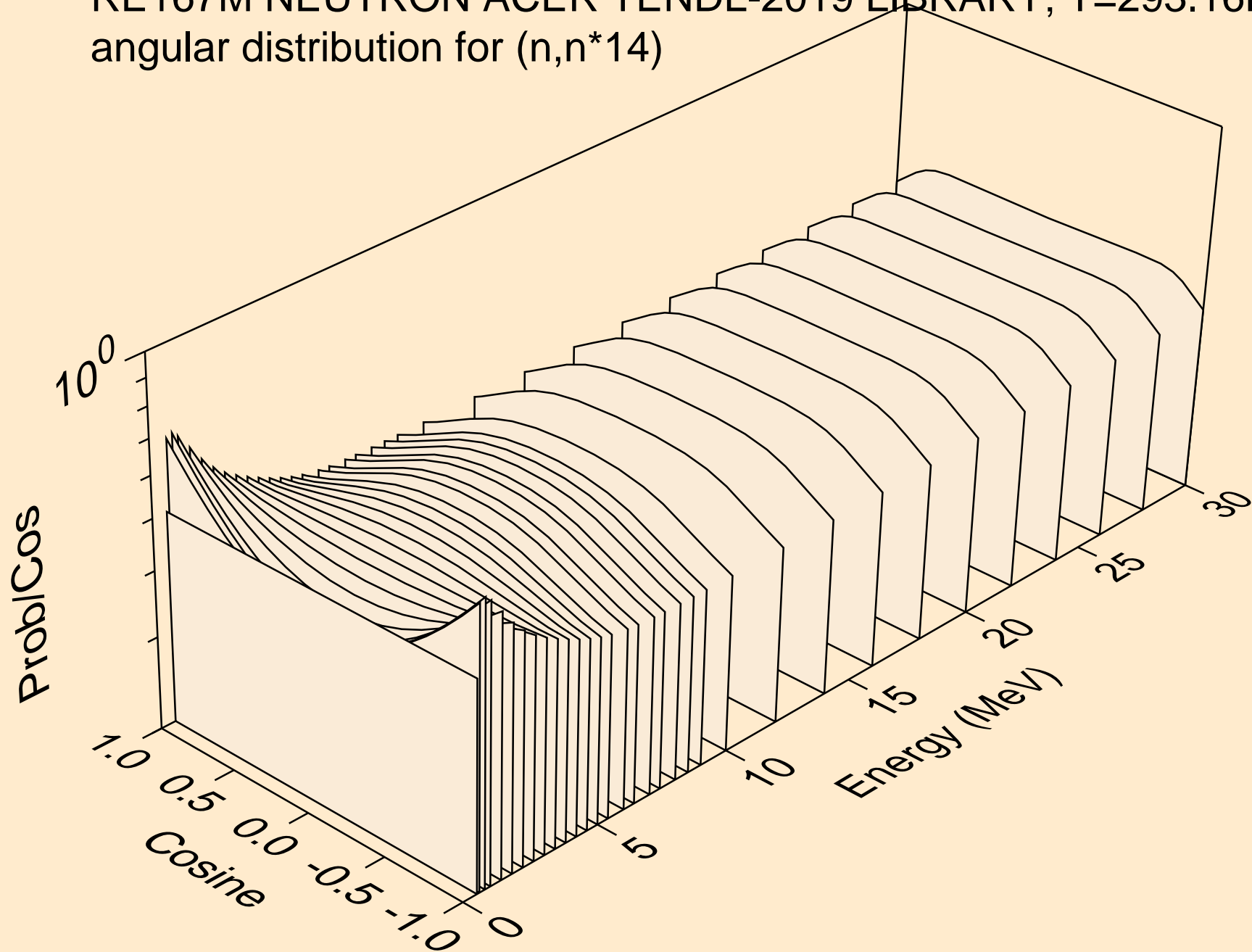

RE167M NEUTRON ACER TENDL-2019 LIBRARY; T=293.16K
angular distribution for (n,n*15)

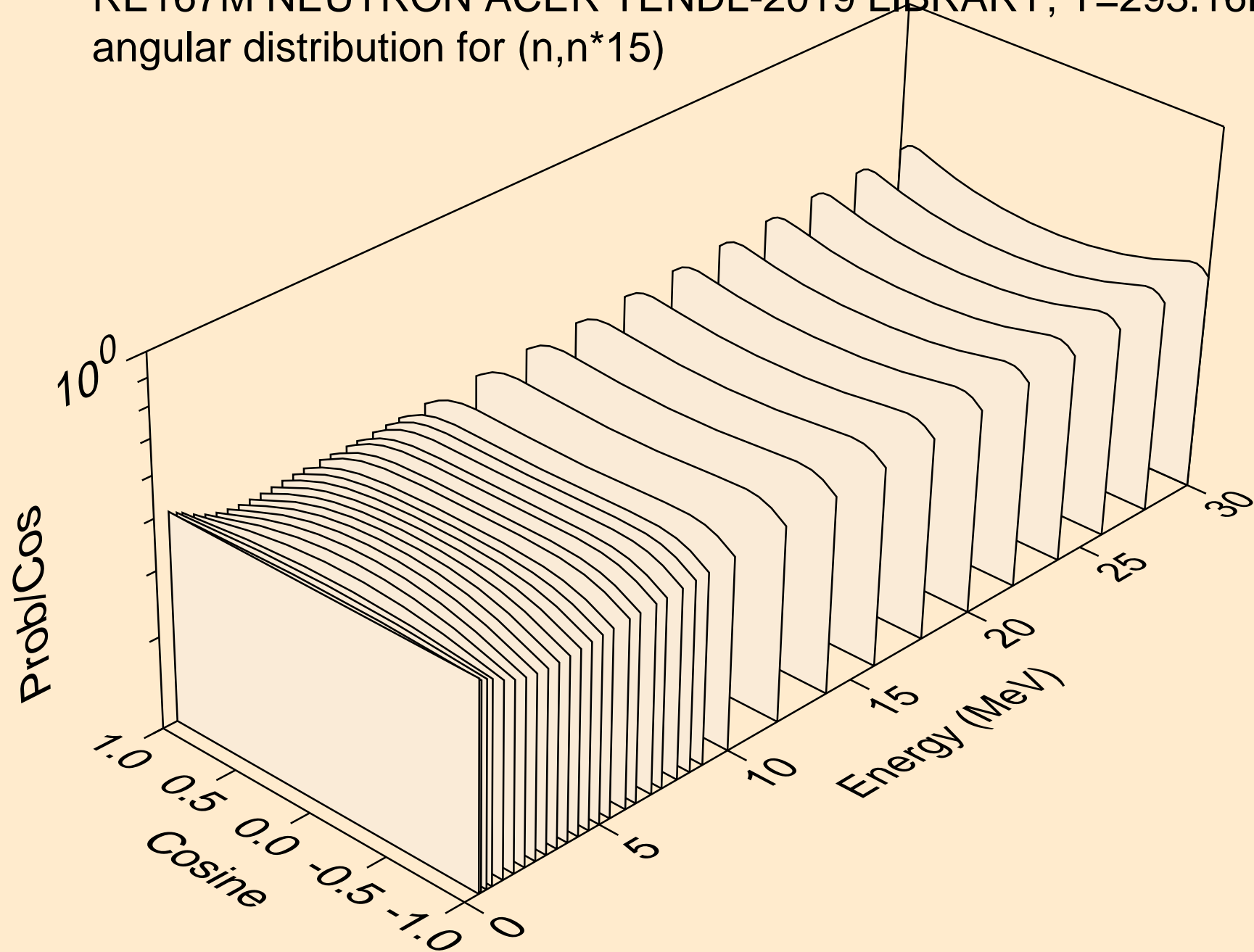

RE167M NEUTRON ACER TENDL-2019 LIBRARY; T=293.16K
angular distribution for (n,n*16)

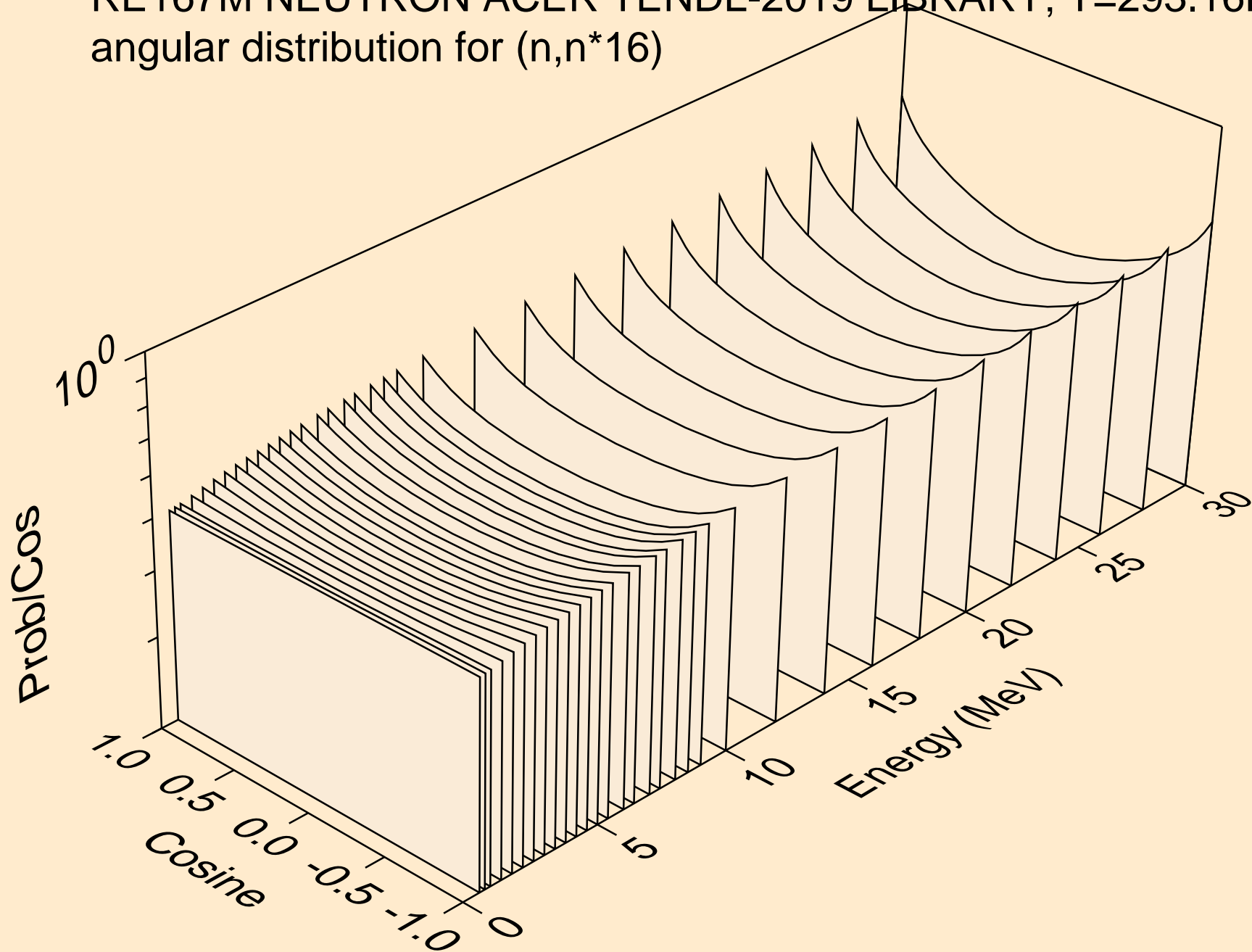

RE167M NEUTRON ACER TENDL-2019 LIBRARY; T=293.16K
angular distribution for (n,n*17)

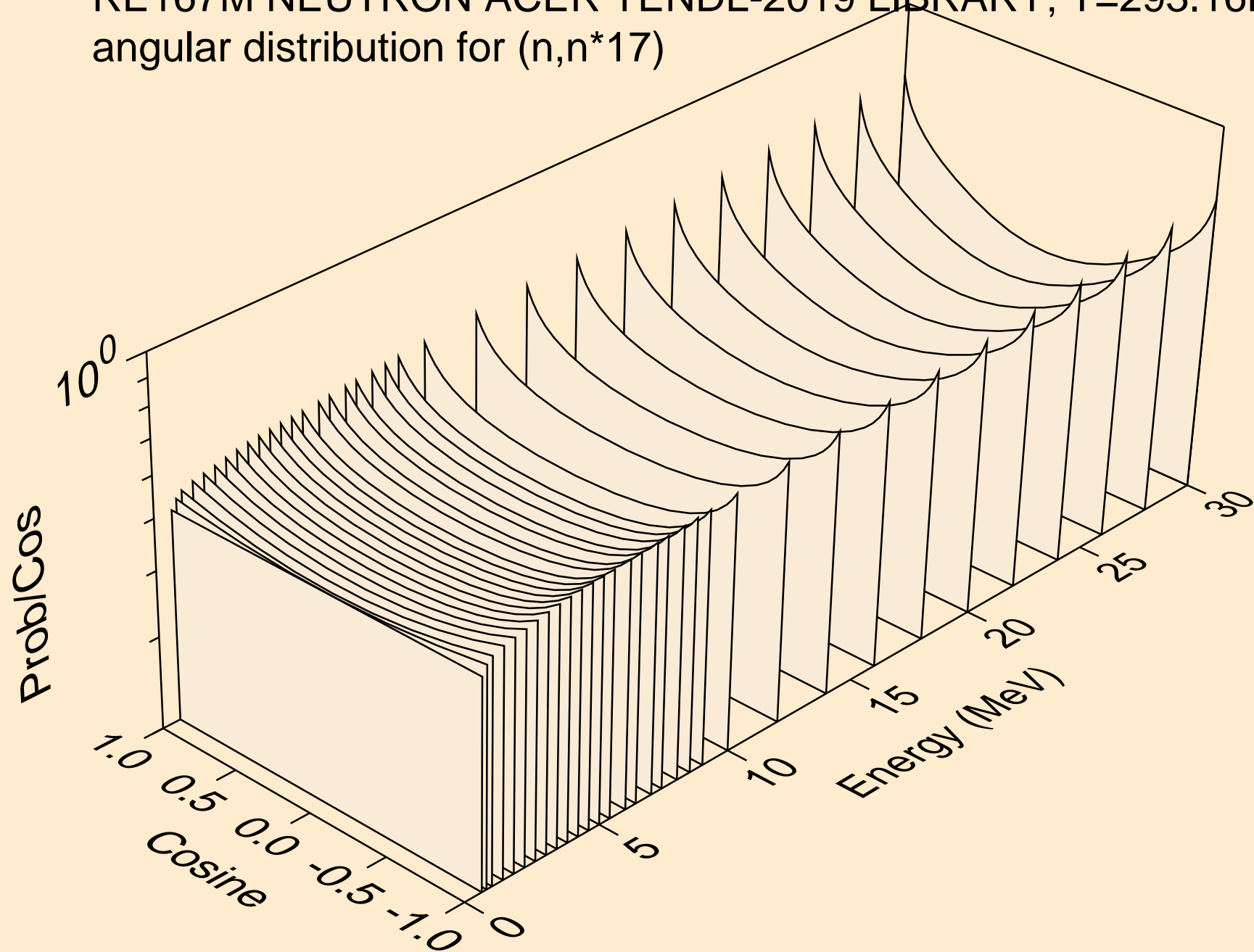

RE167M NEUTRON ACER TENDL-2019 LIBRARY; T=293.16K
angular distribution for (n,n*18)

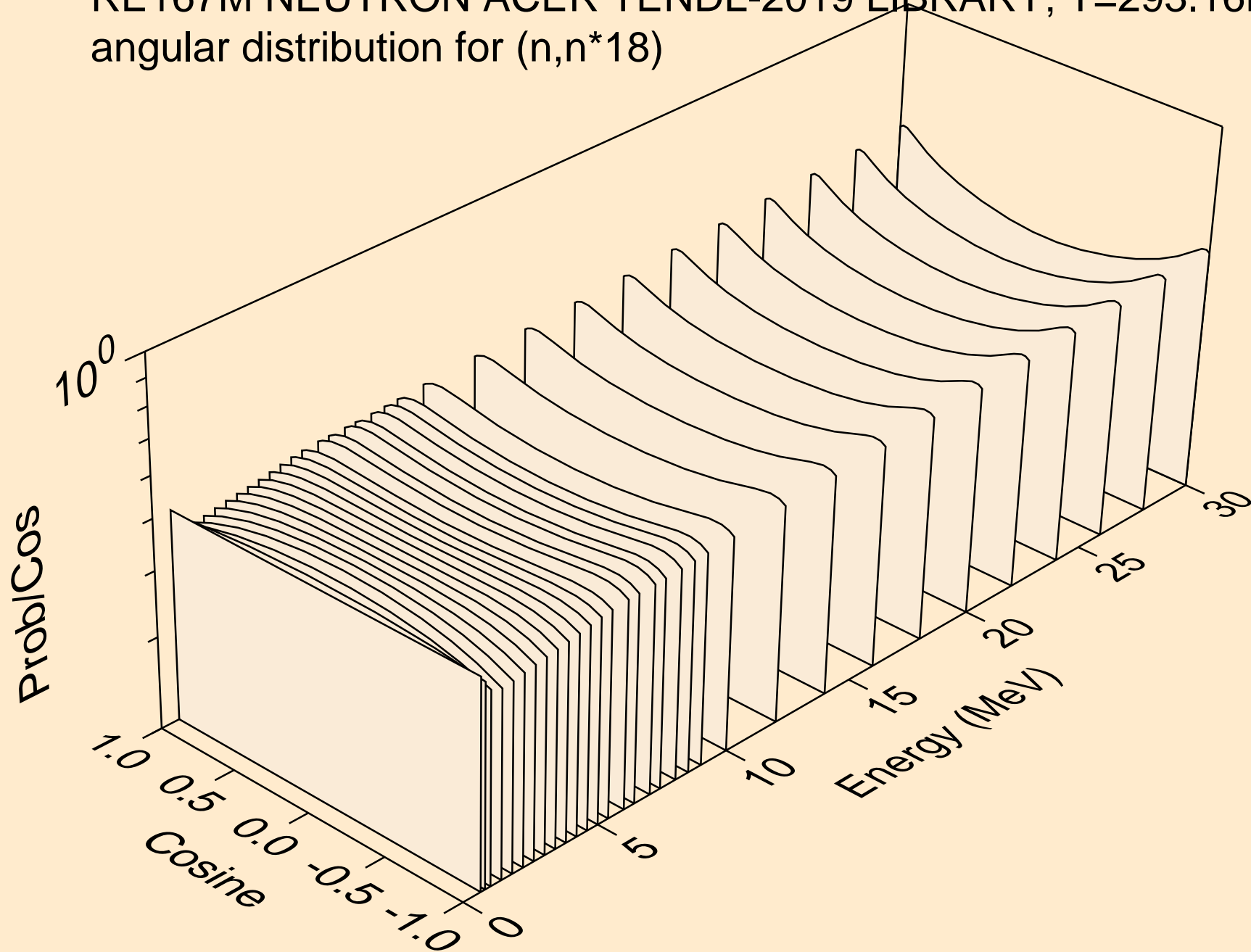

RE167M NEUTRON ACER TENDL-2019 LIBRARY; T=293.16K
angular distribution for (n,n*19)

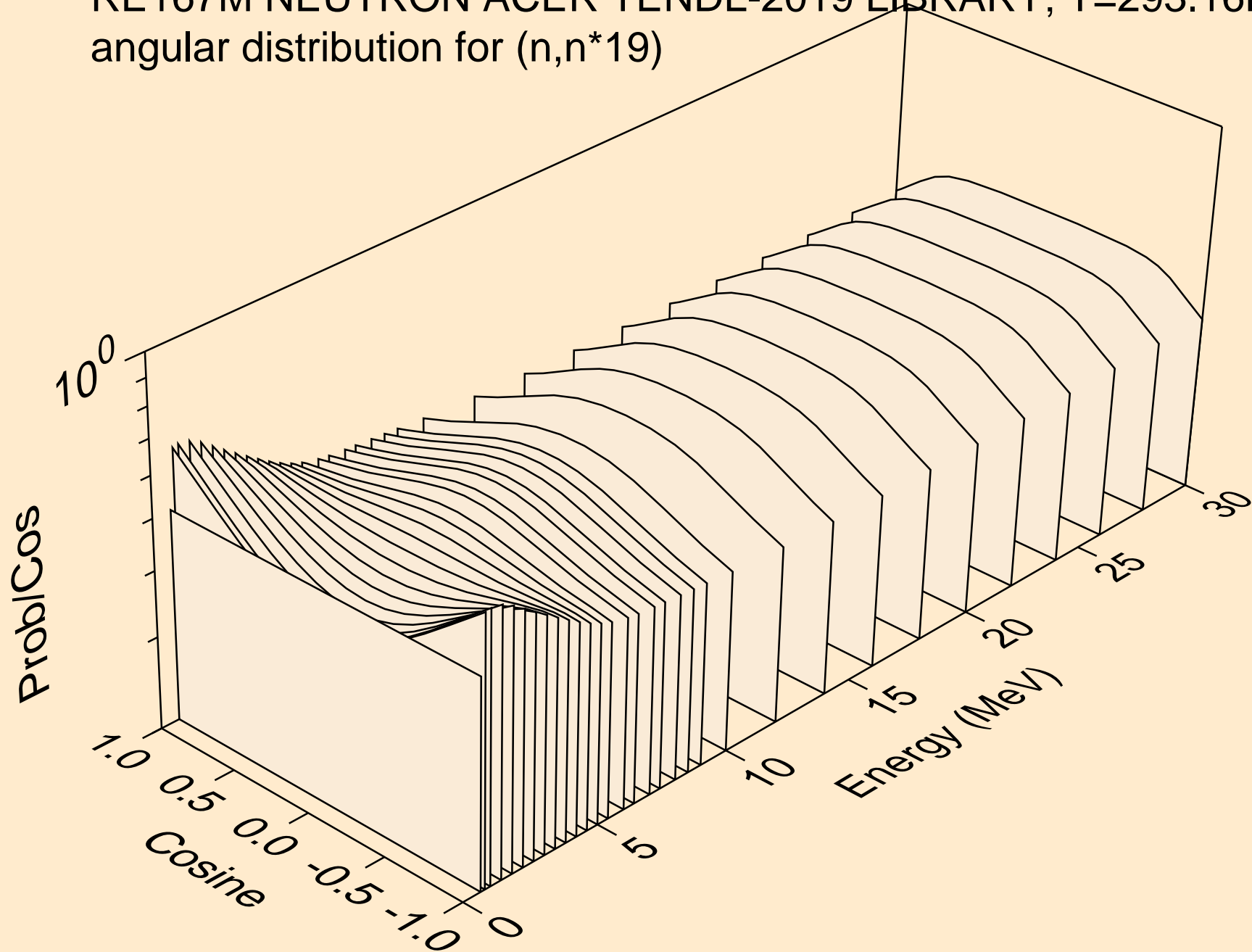

RE167M NEUTRON ACER TENDL-2019 LIBRARY; T=293.16K
angular distribution for (n,n*20)

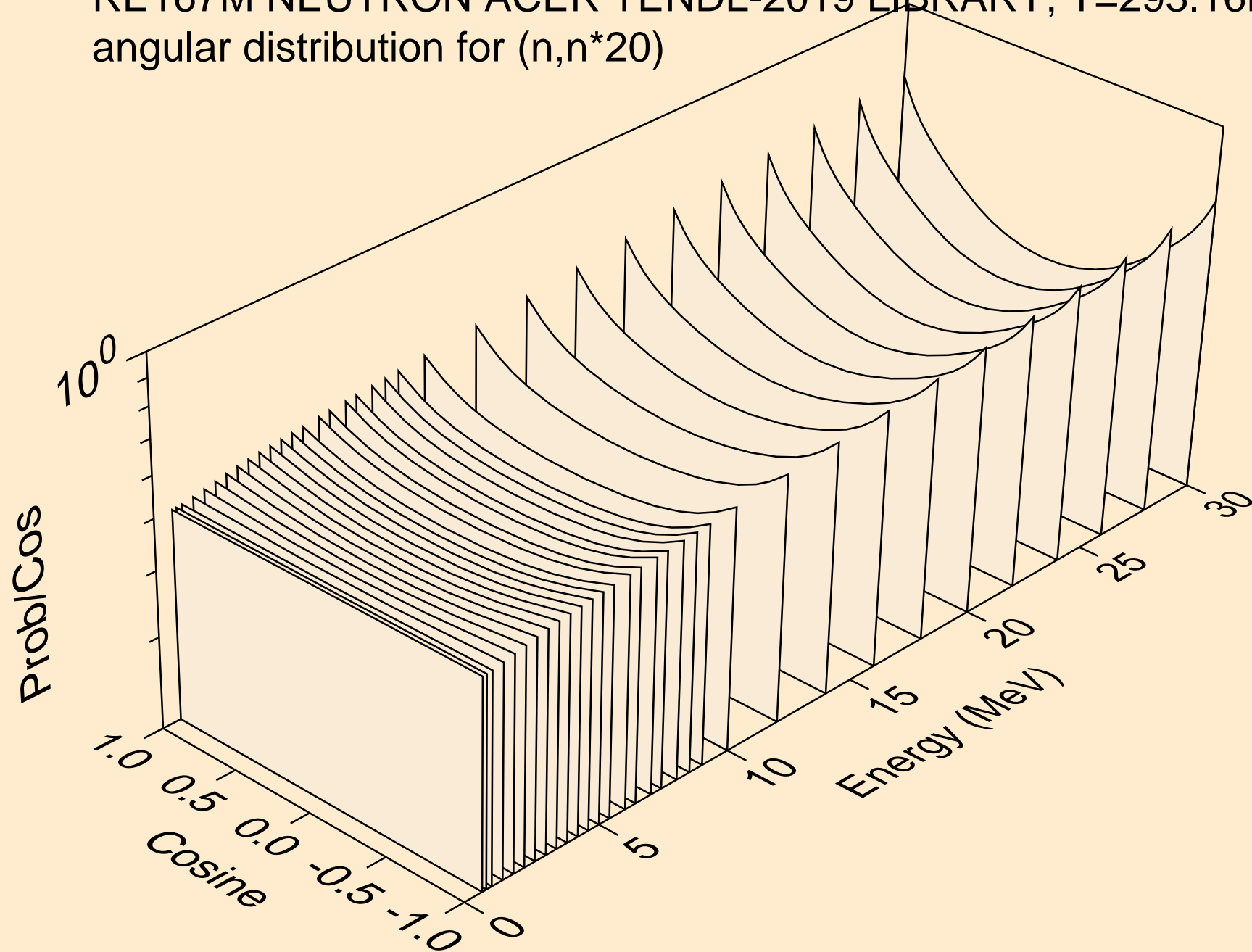

RE167M NEUTRON ACER TENDL-2019 LIBRARY; T=293.16K
angular distribution for (n,n*21)

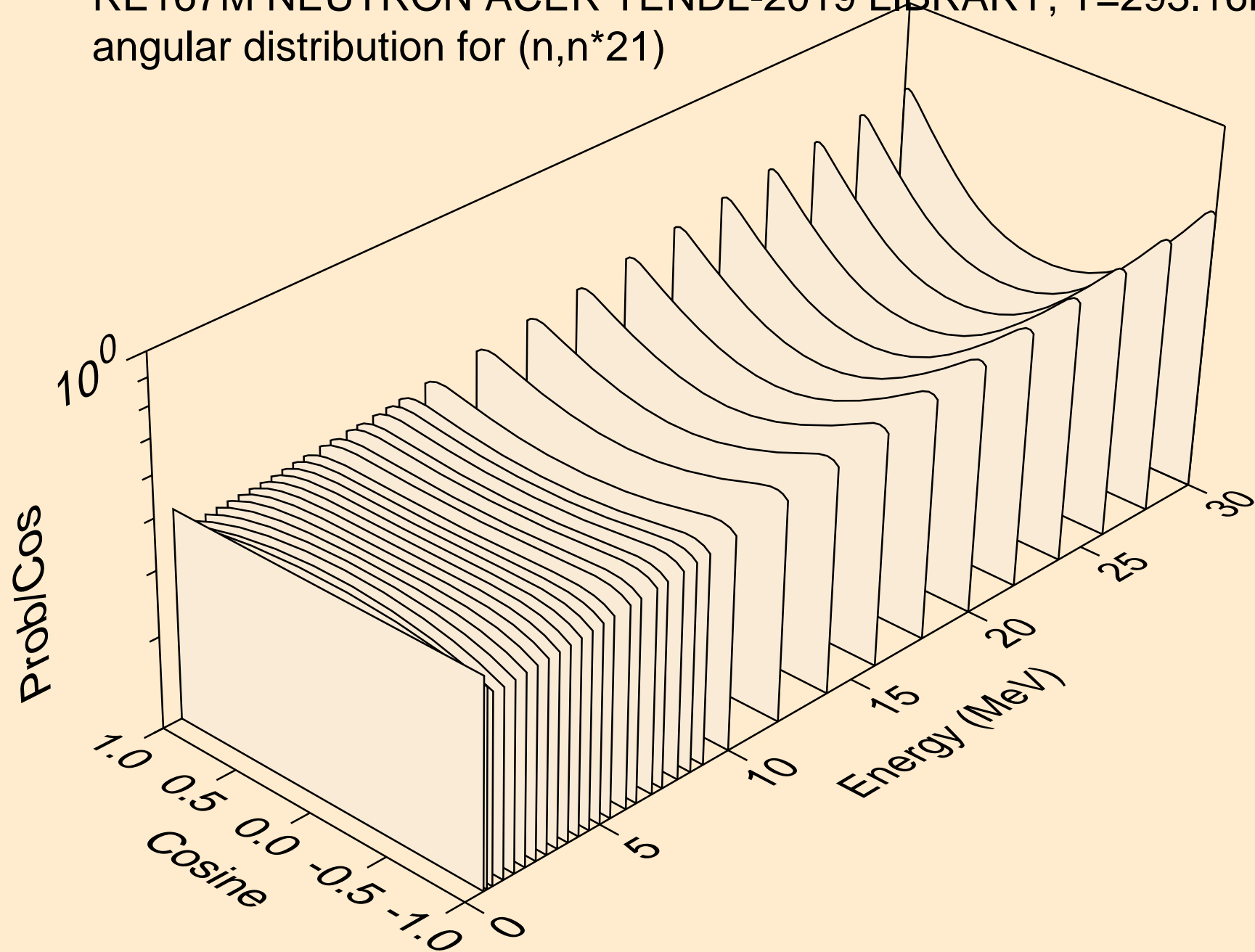

RE167M NEUTRON ACER TENDL-2019 LIBRARY; T=293.16K
angular distribution for (n,n*22)

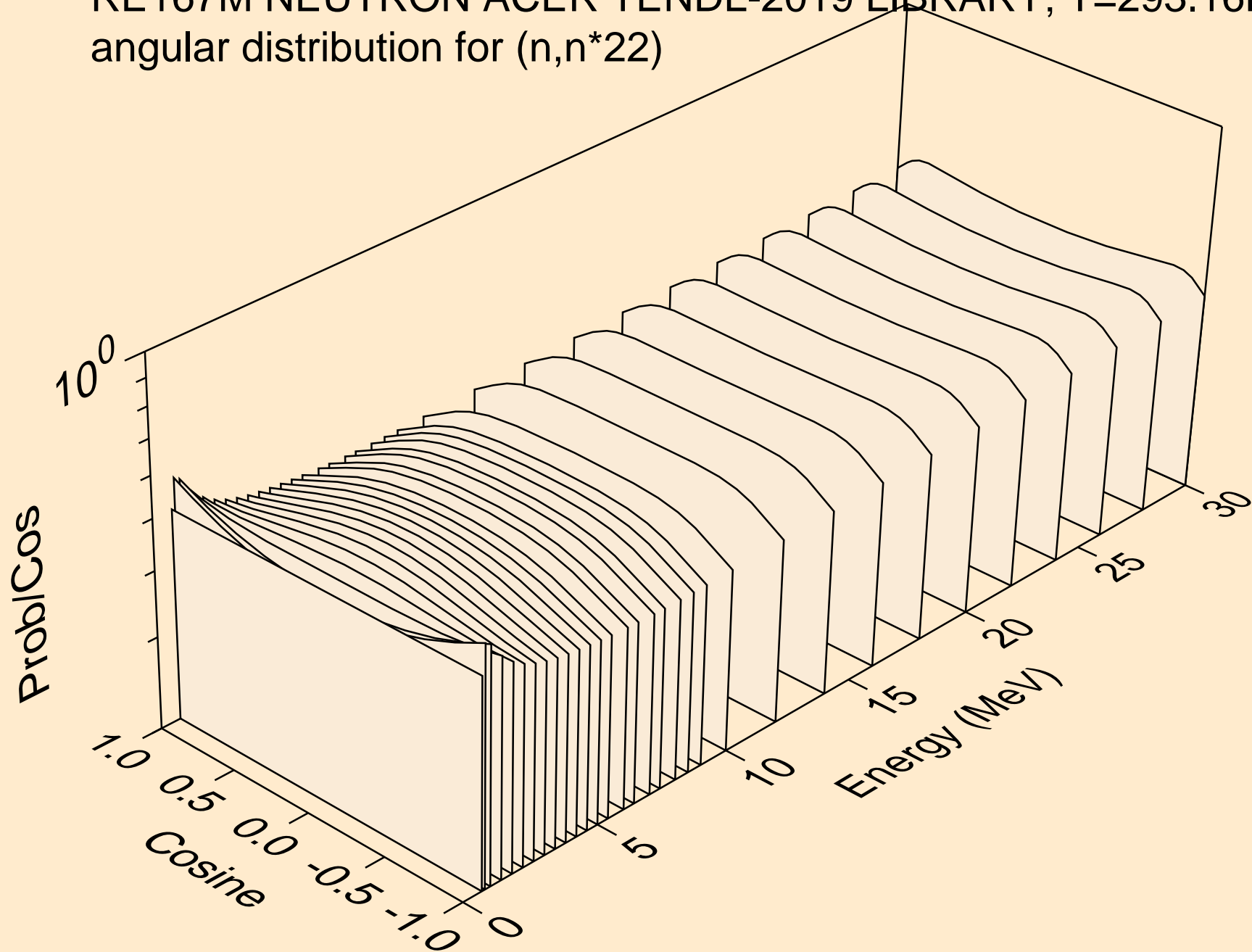

RE167M NEUTRON ACER TENDL-2019 LIBRARY; T=293.16K
angular distribution for (n,n*23)

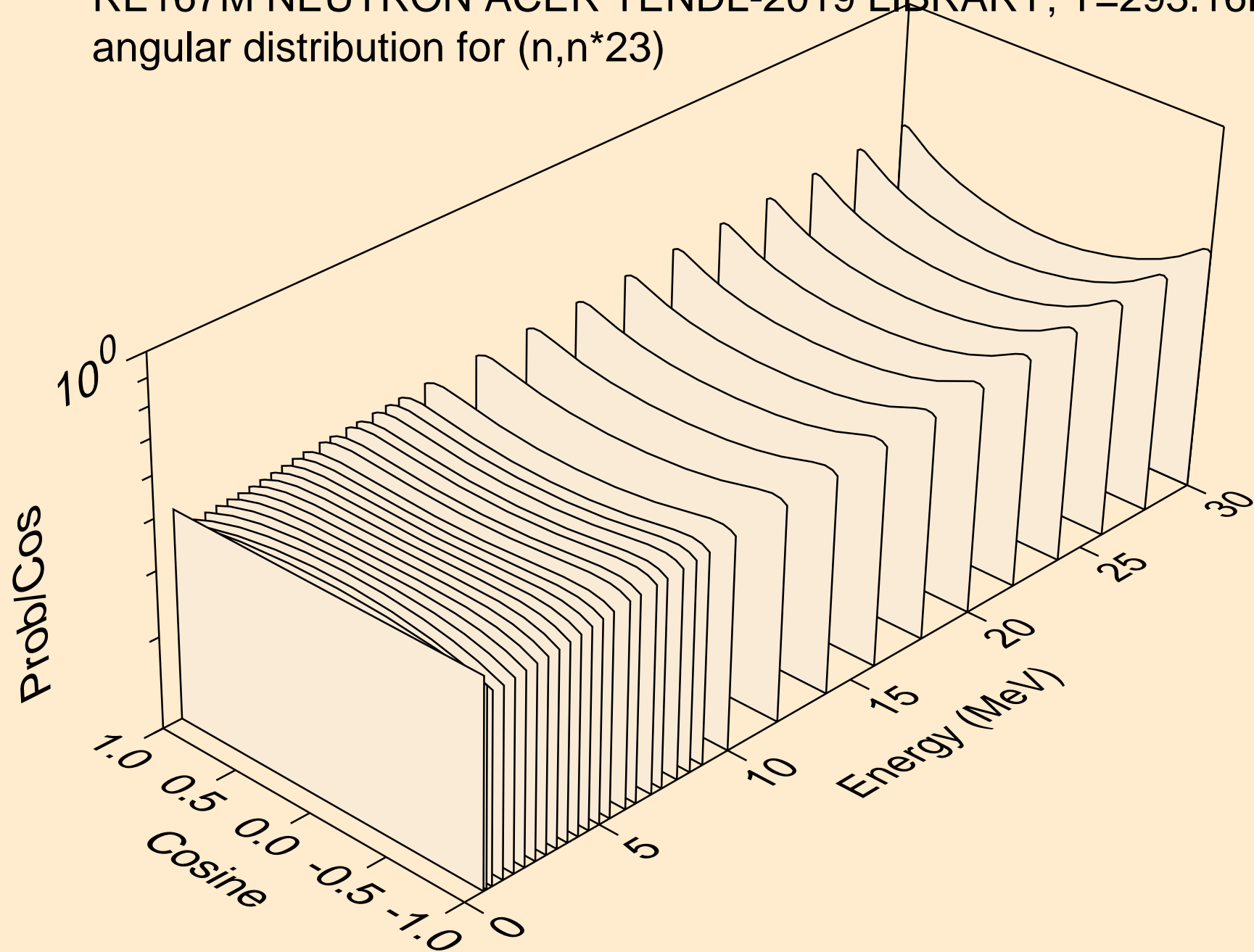

RE167M NEUTRON ACER TENDL-2019 LIBRARY; T=293.16K
angular distribution for (n,n*24)

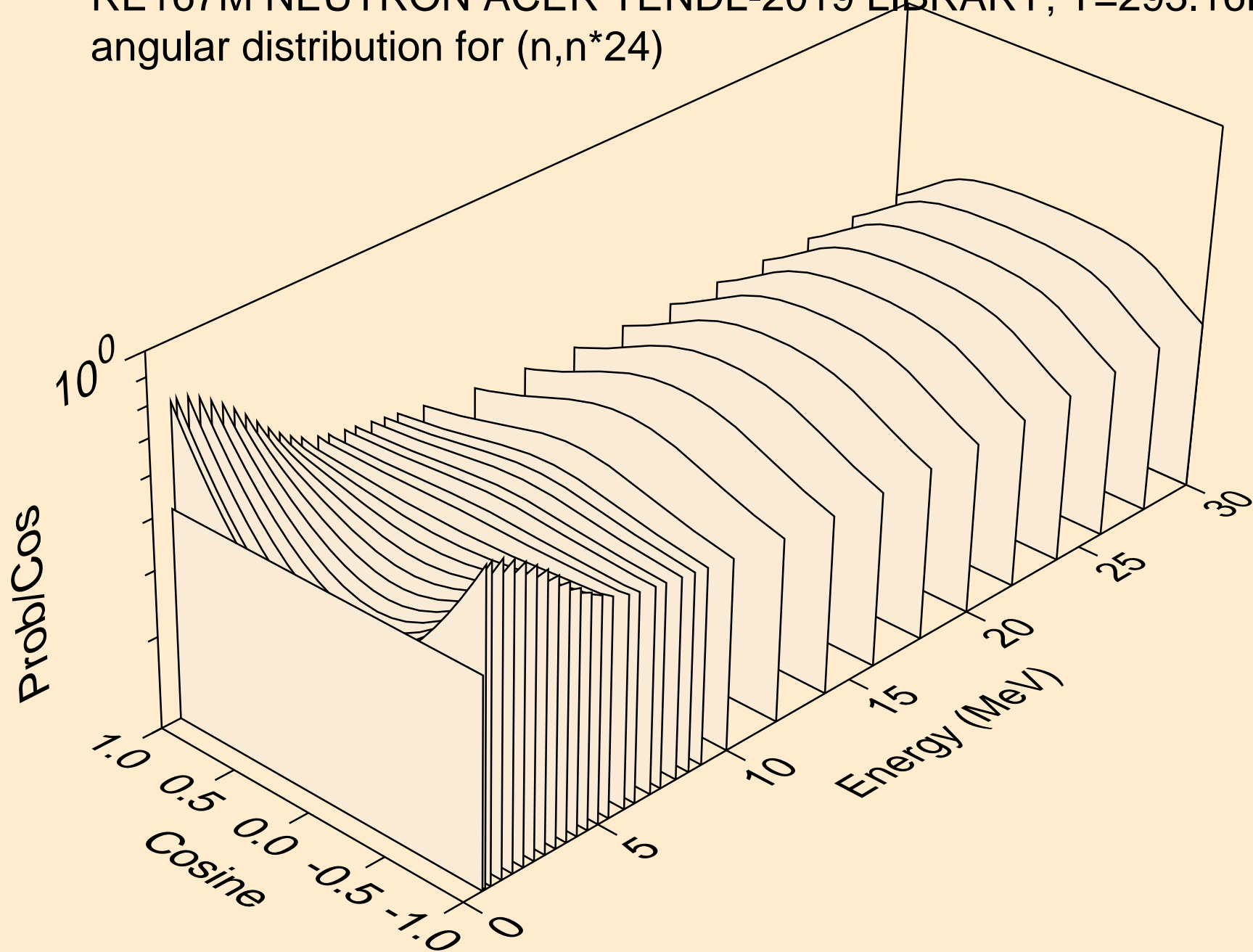

RE167M NEUTRON ACER TENDL-2019 LIBRARY; T=293.16K
angular distribution for (n,n*25)

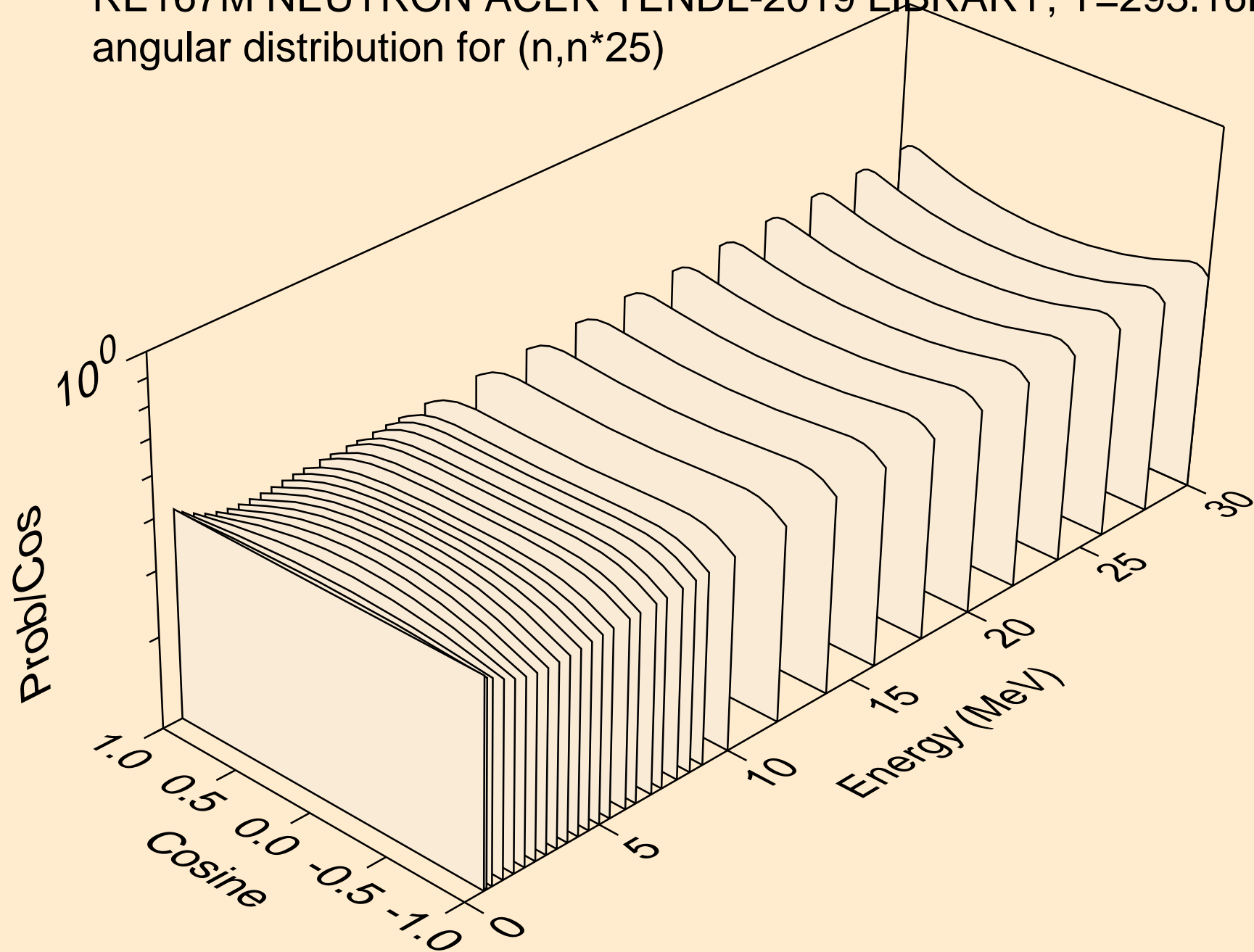

RE167M NEUTRON ACER TENDL-2019 LIBRARY; T=293.16K
angular distribution for (n,n*26)

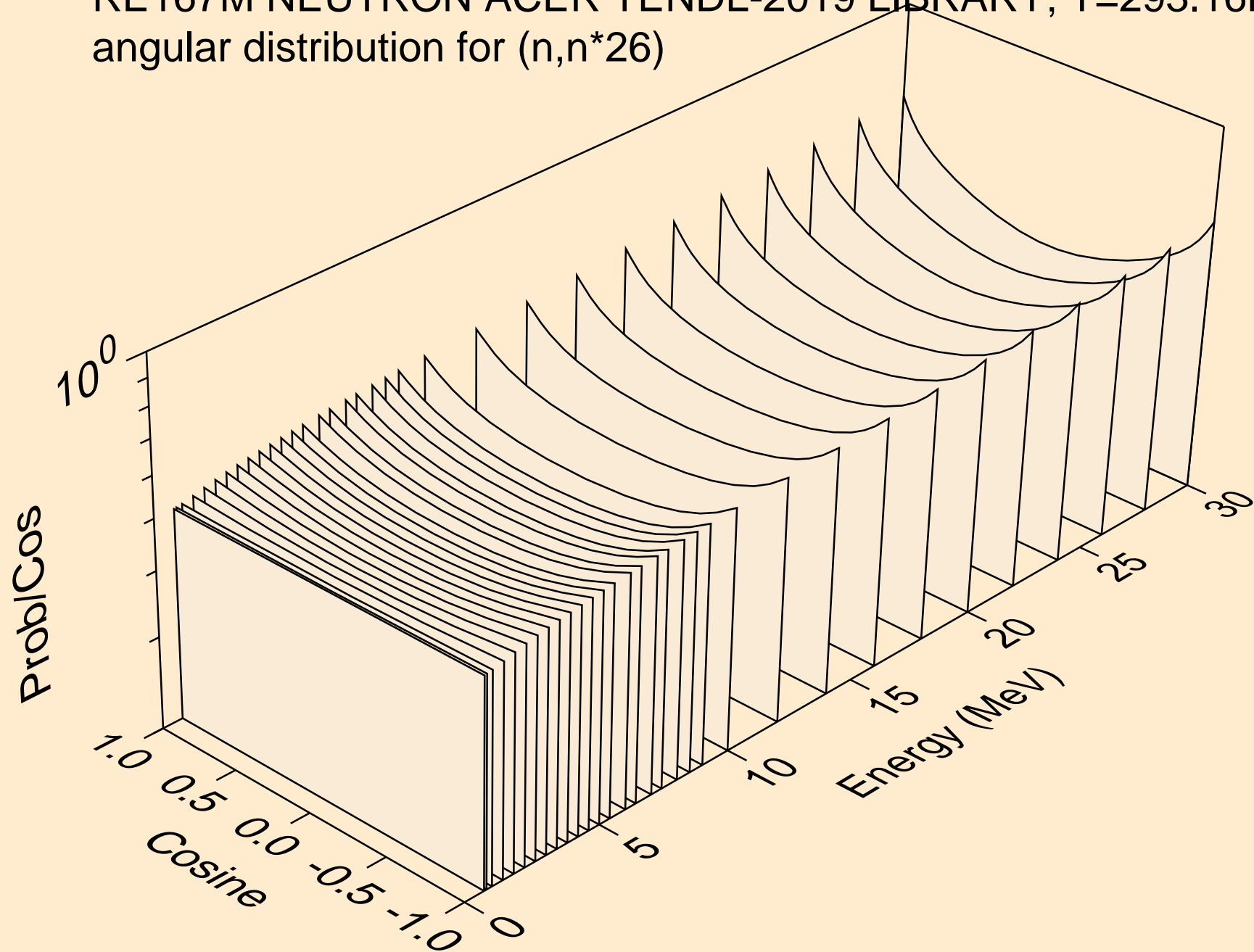

RE167M NEUTRON ACER TENDL-2019 LIBRARY; T=293.16K
angular distribution for (n,n*27)

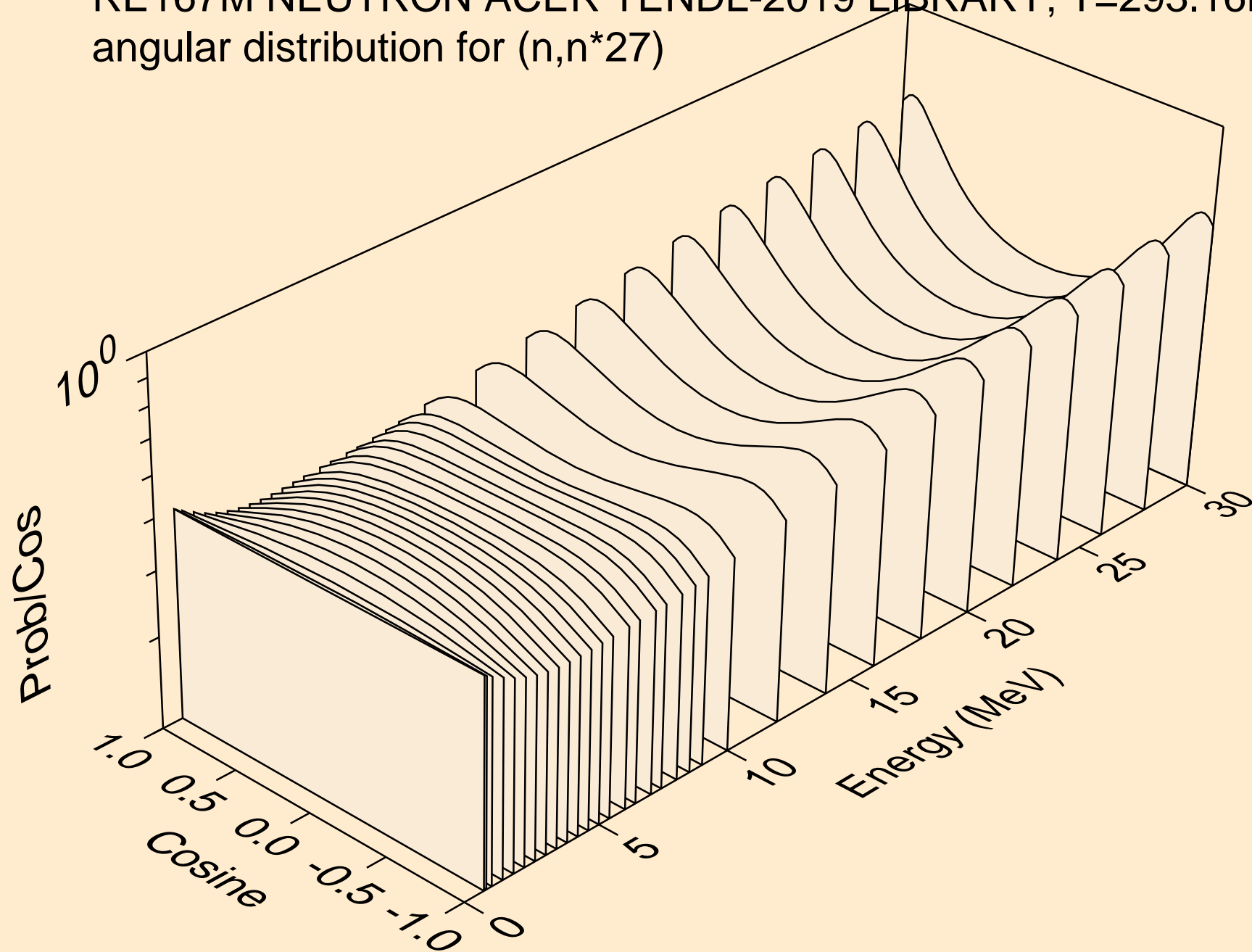

RE167M NEUTRON ACER TENDL-2019 LIBRARY; T=293.16K
angular distribution for (n,n*28)

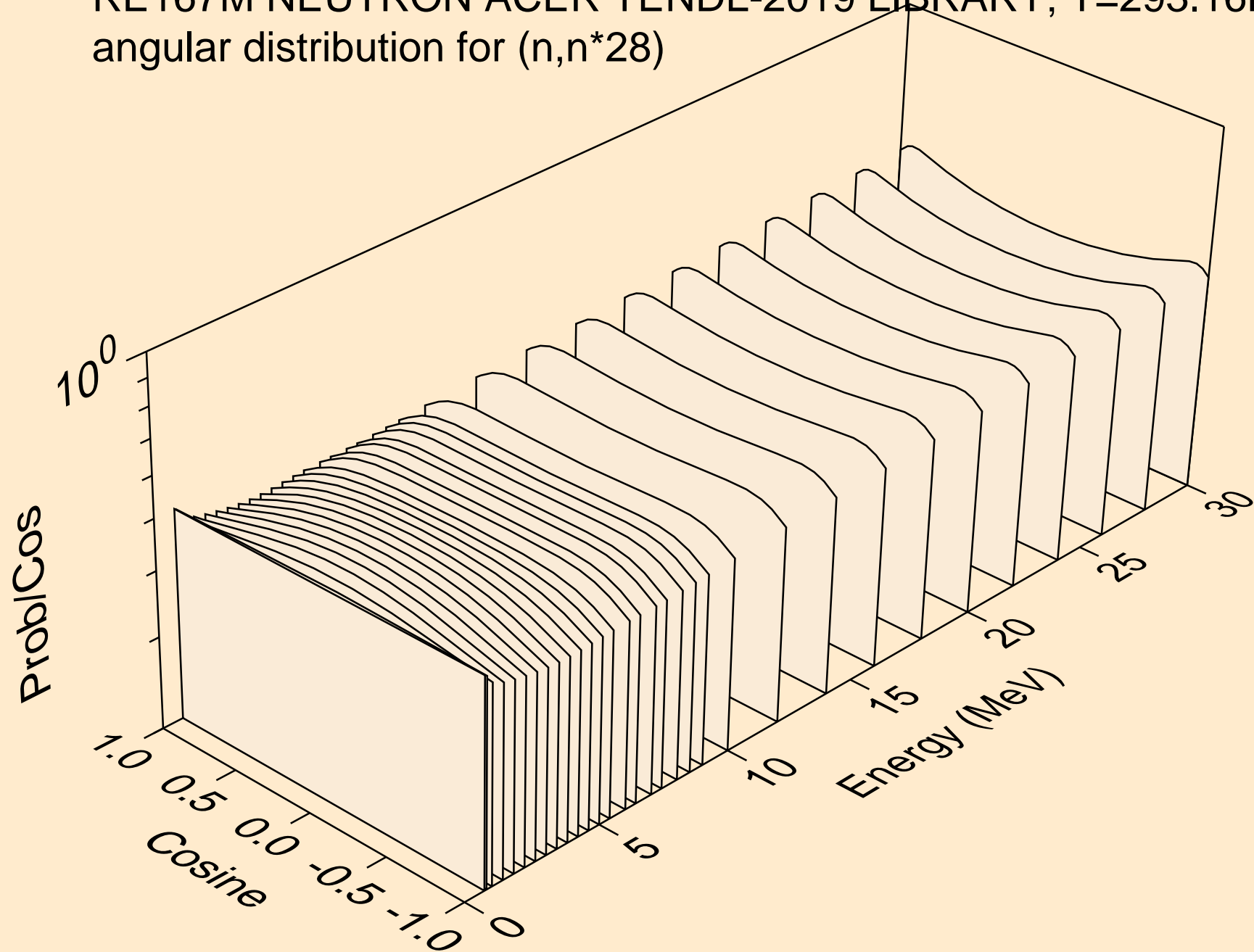

RE167M NEUTRON ACER TENDL-2019 LIBRARY; T=293.16K
angular distribution for (n,n*29)

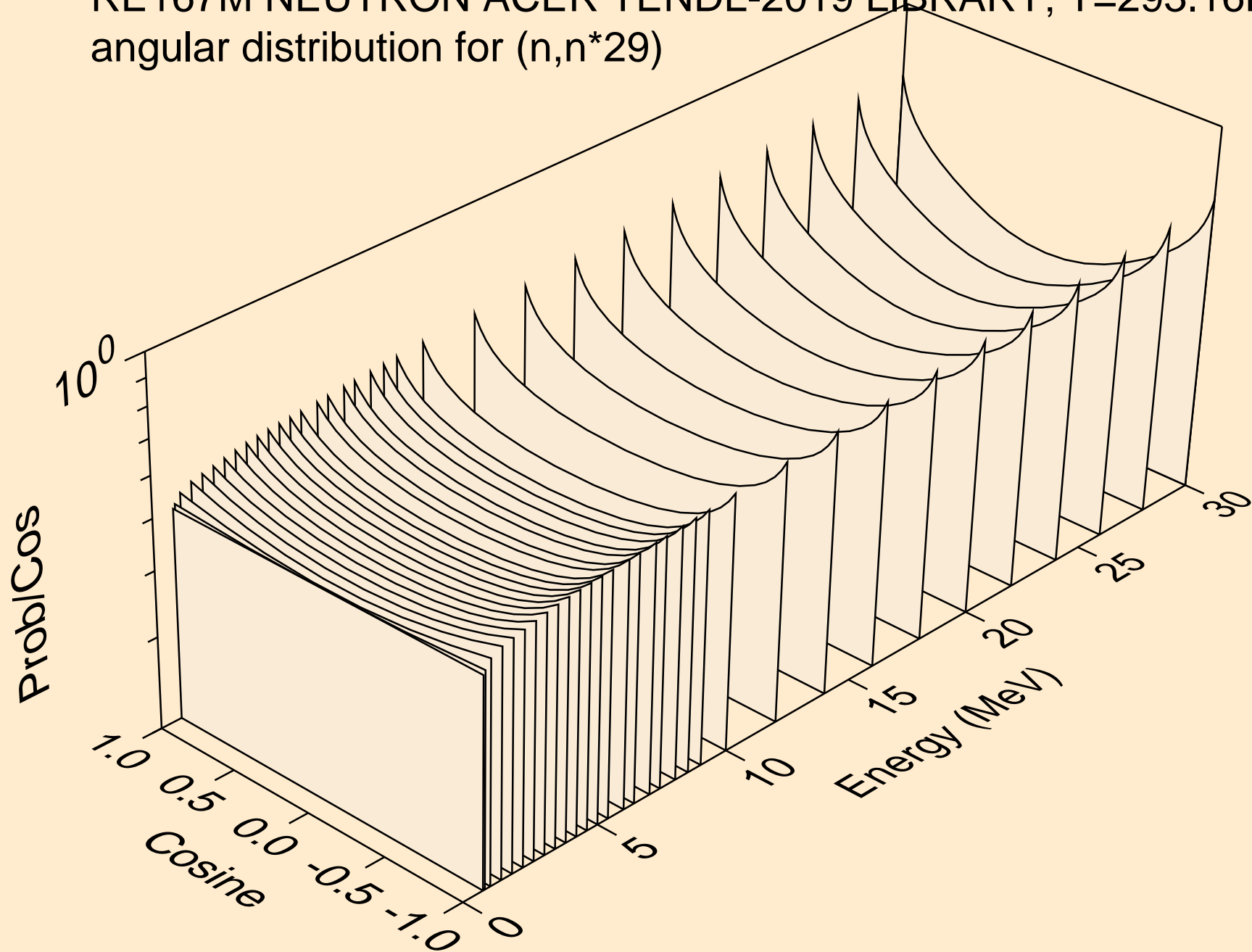

RE167M NEUTRON ACER TENDL-2019 LIBRARY; T=293.16K
angular distribution for (n,n*30)

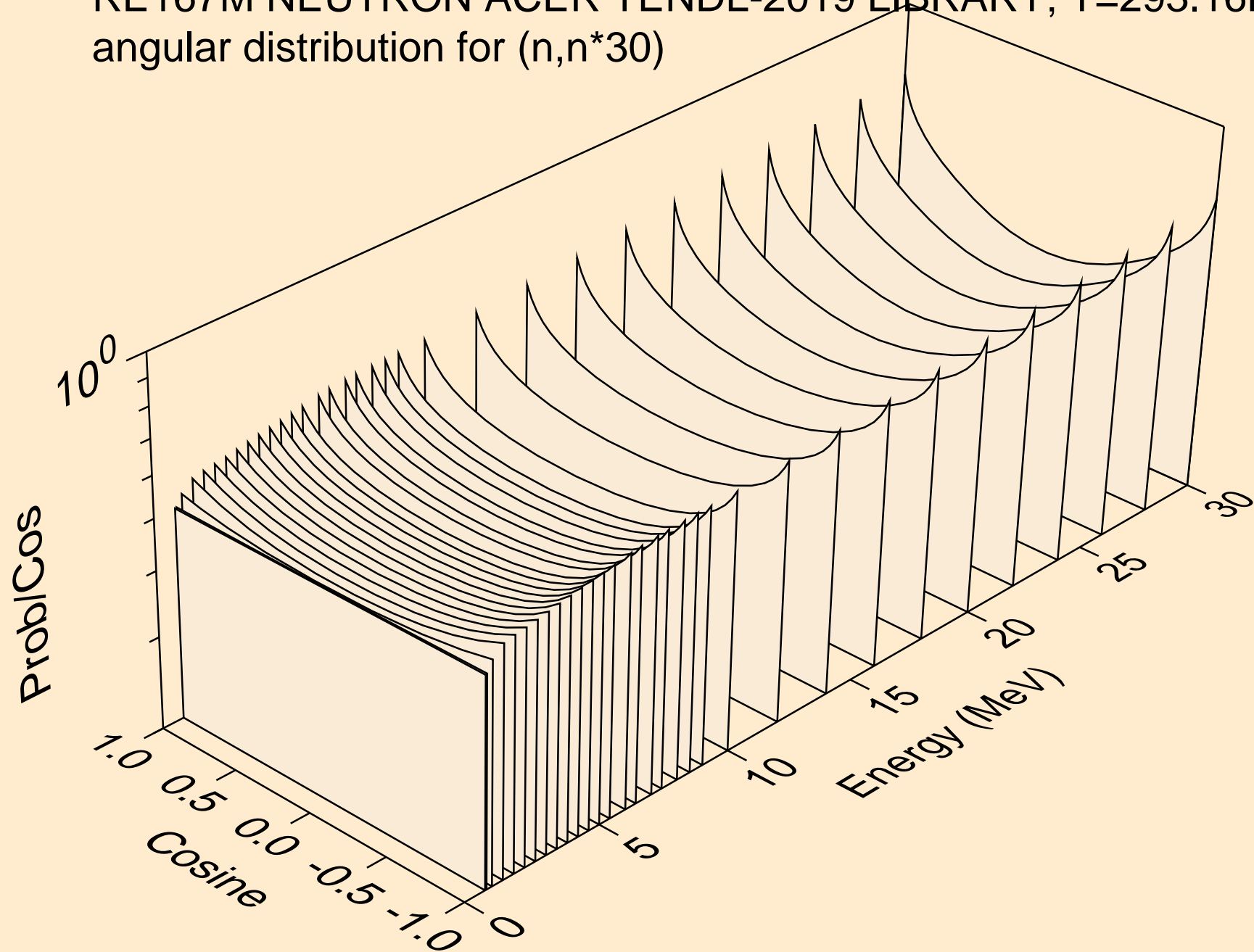

RE167M NEUTRON ACER TENDL-2019 LIBRARY; T=293.16K
Neutron emission for (n,x)

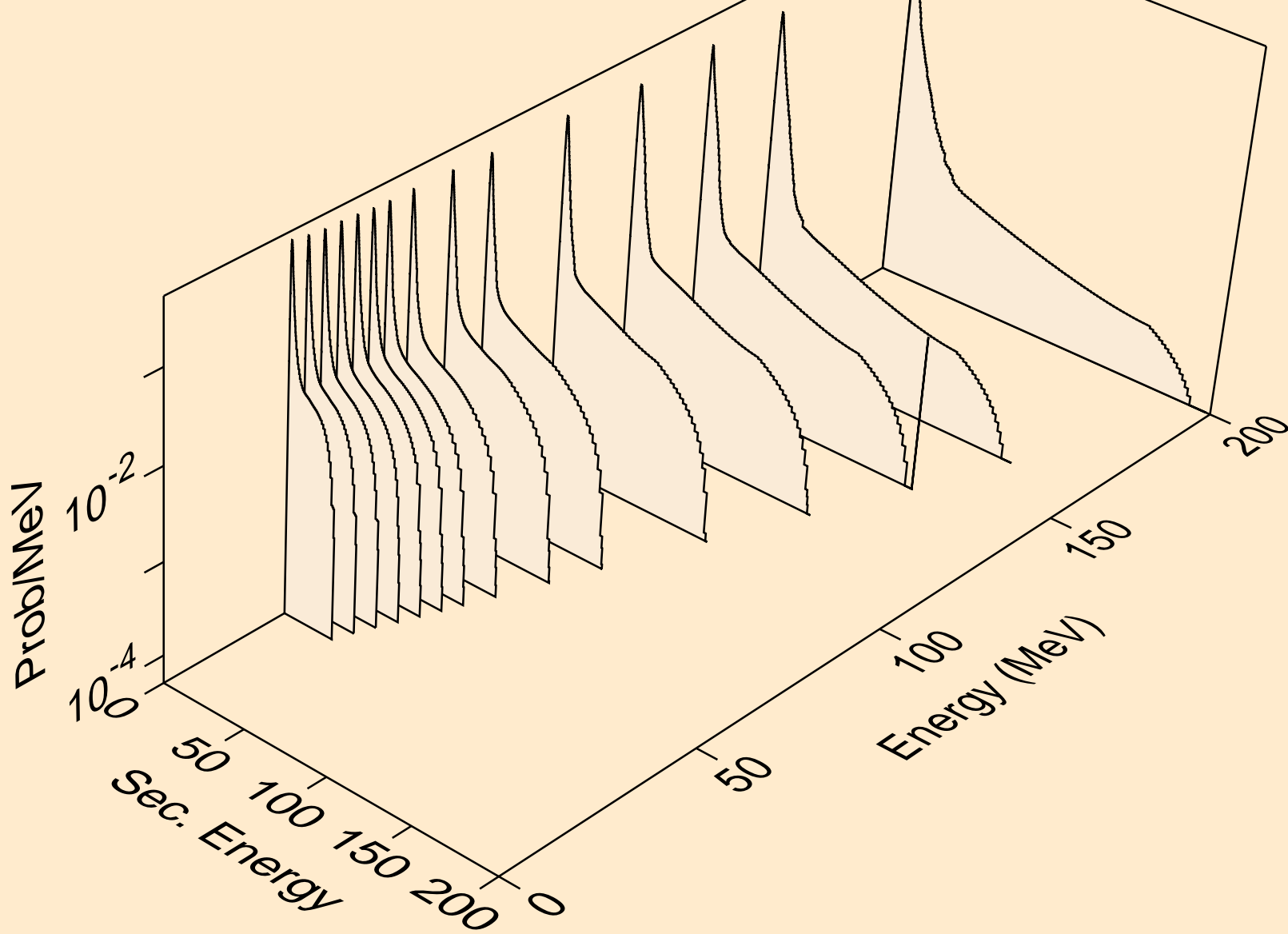

RE167M NEUTRON ACER TENDL-2019 LIBRARY; T=293.16K
Neutron emission for (n,2nd)

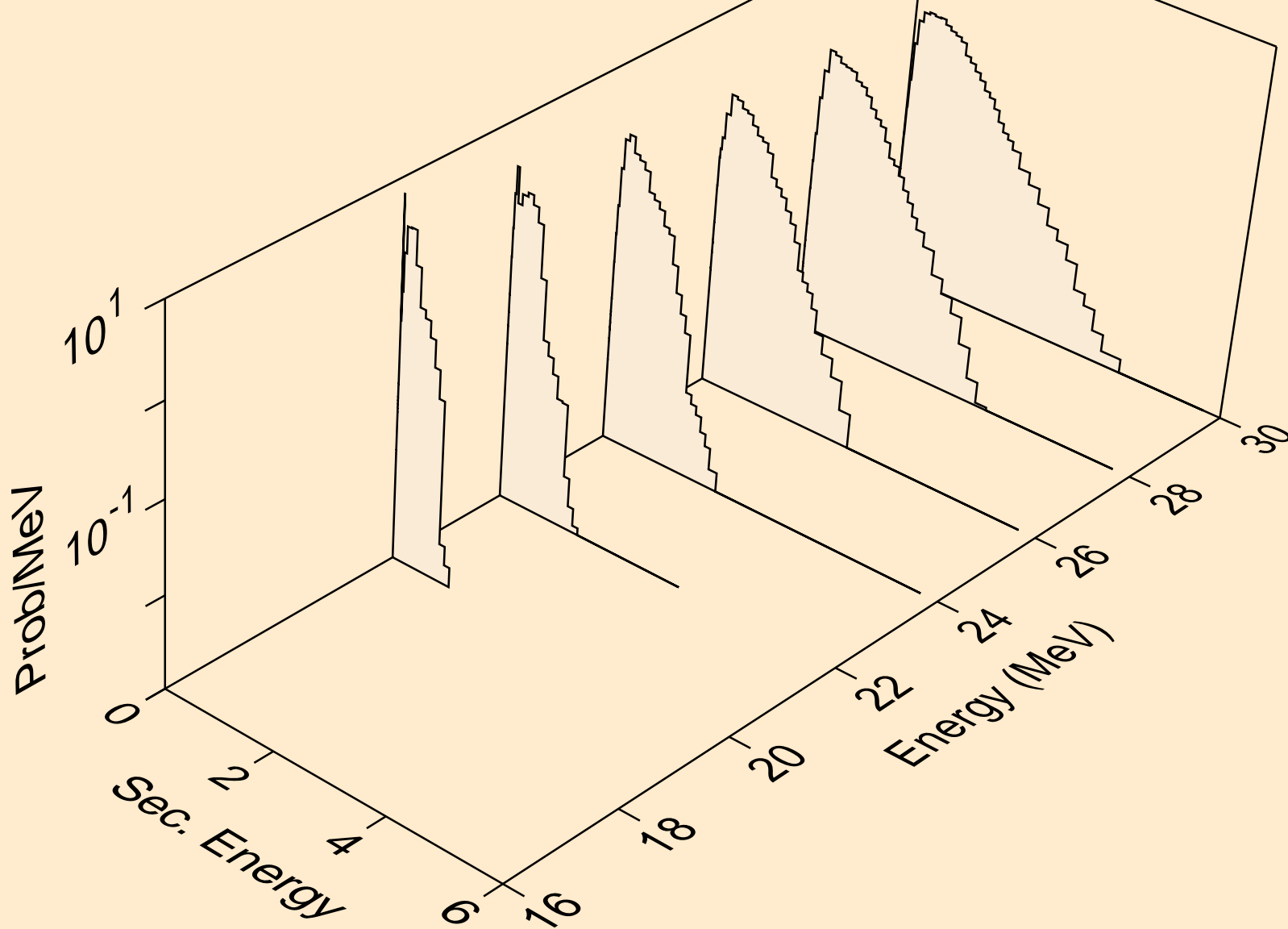

RE167M NEUTRON ACER TENDL-2019 LIBRARY; T=293.16K
Neutron emission for (n,2n)

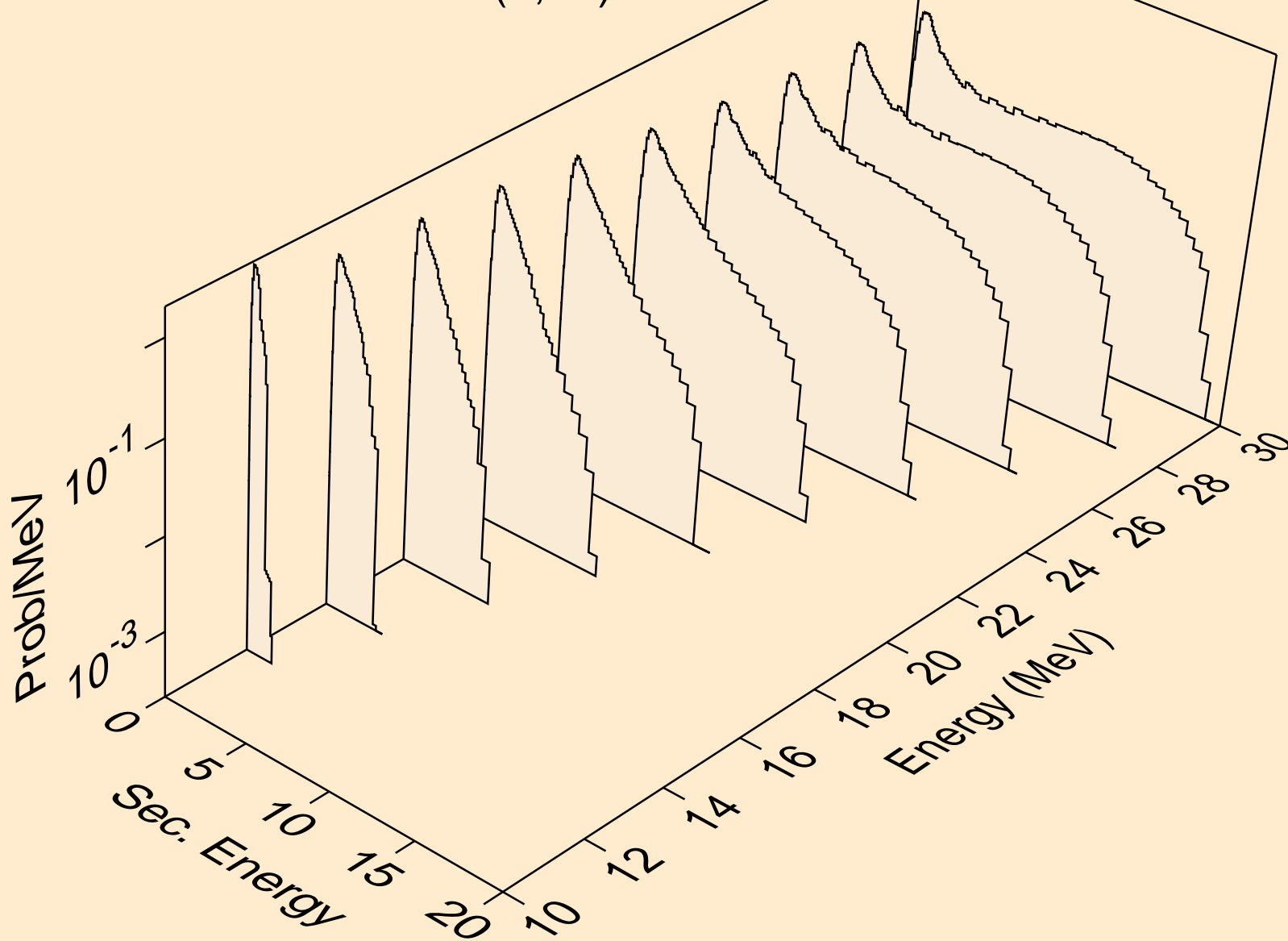

RE167M NEUTRON ACER TENDL-2019 LIBRARY; T=293.16K
Neutron emission for (n,3n)

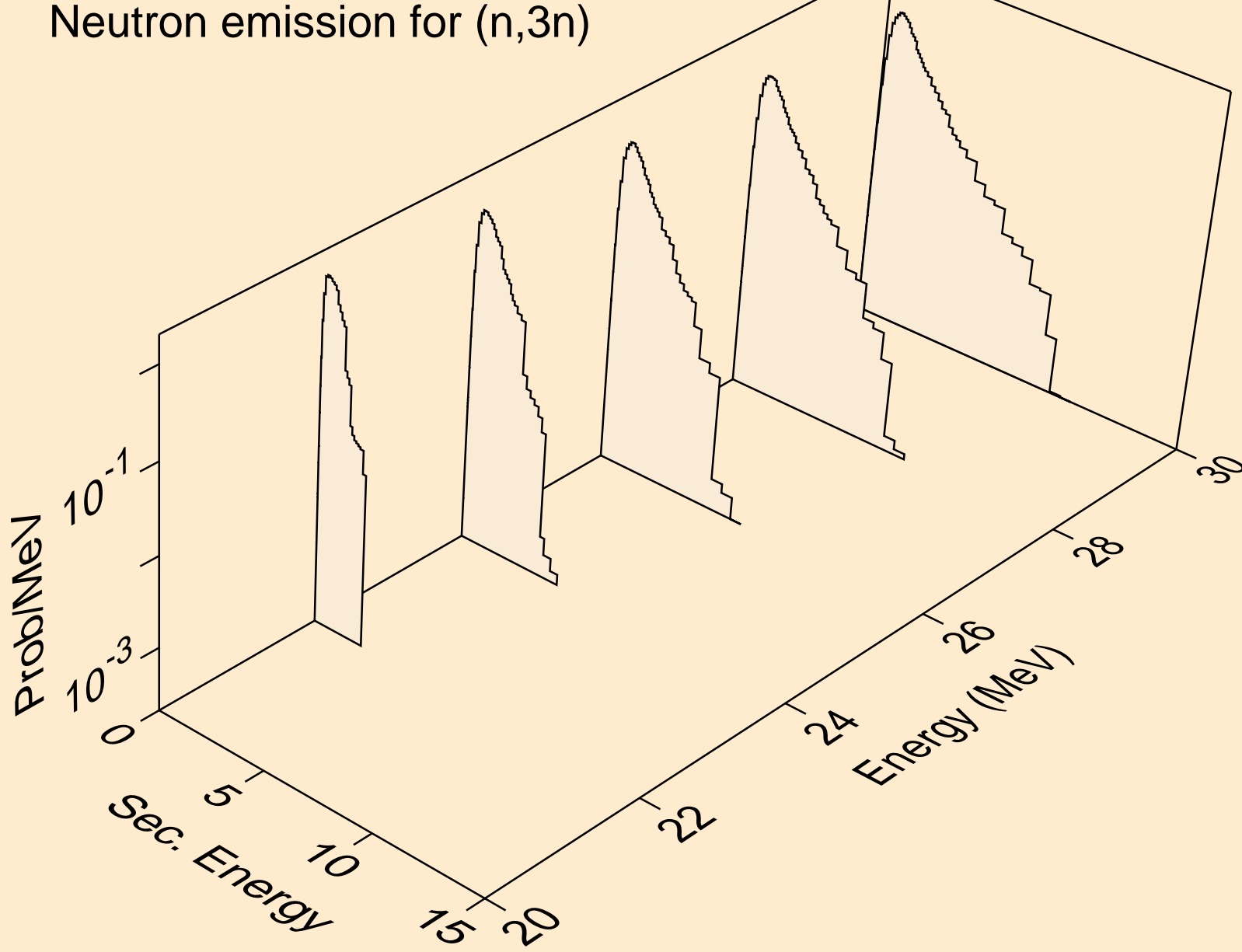

RE167M NEUTRON ACER TENDL-2019 LIBRARY; T=293.16K
Neutron emission for (n,n*)a

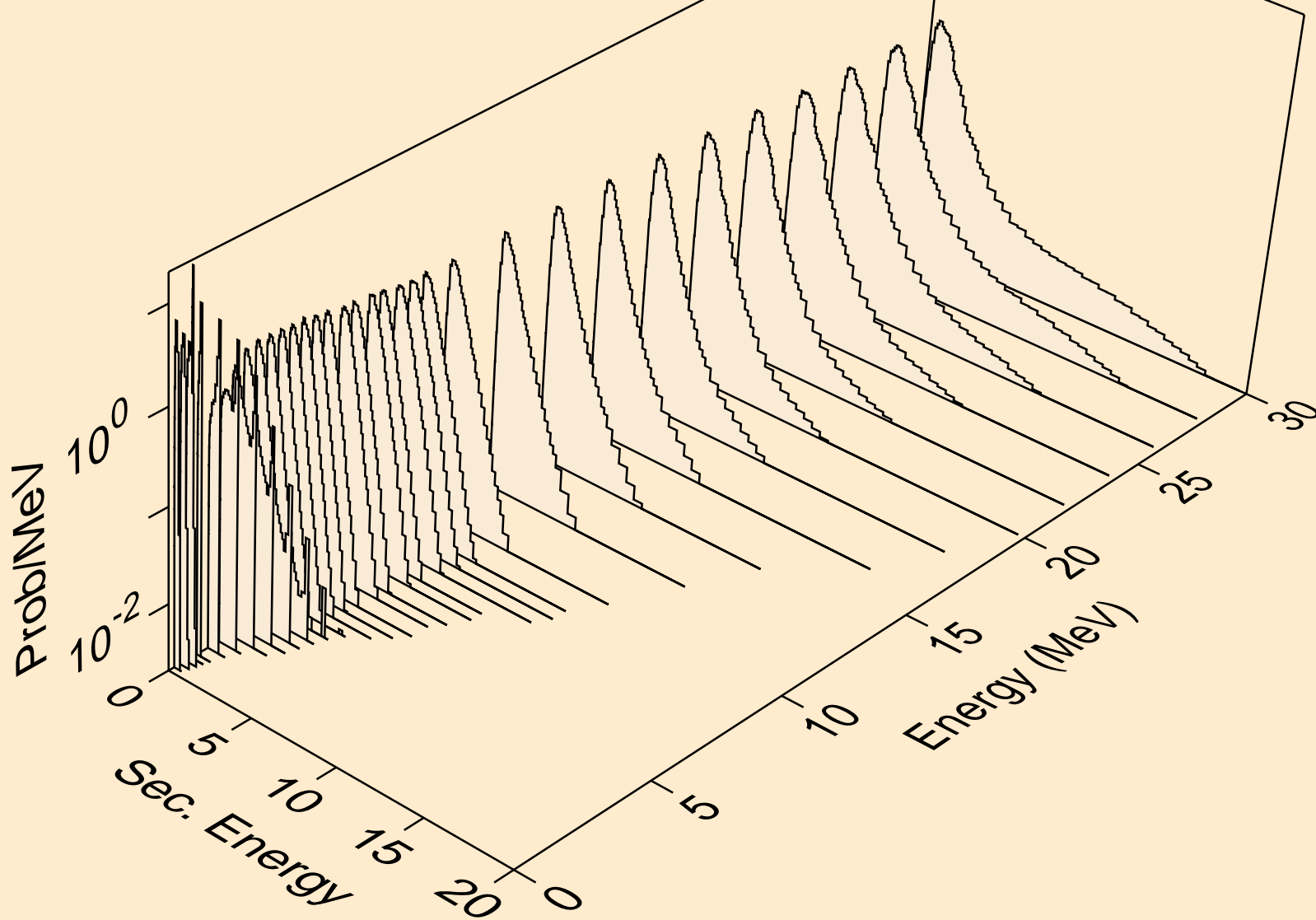

RE167M NEUTRON ACER TENDL-2019 LIBRARY; T=293.16K
Neutron emission for (n,n*)3a

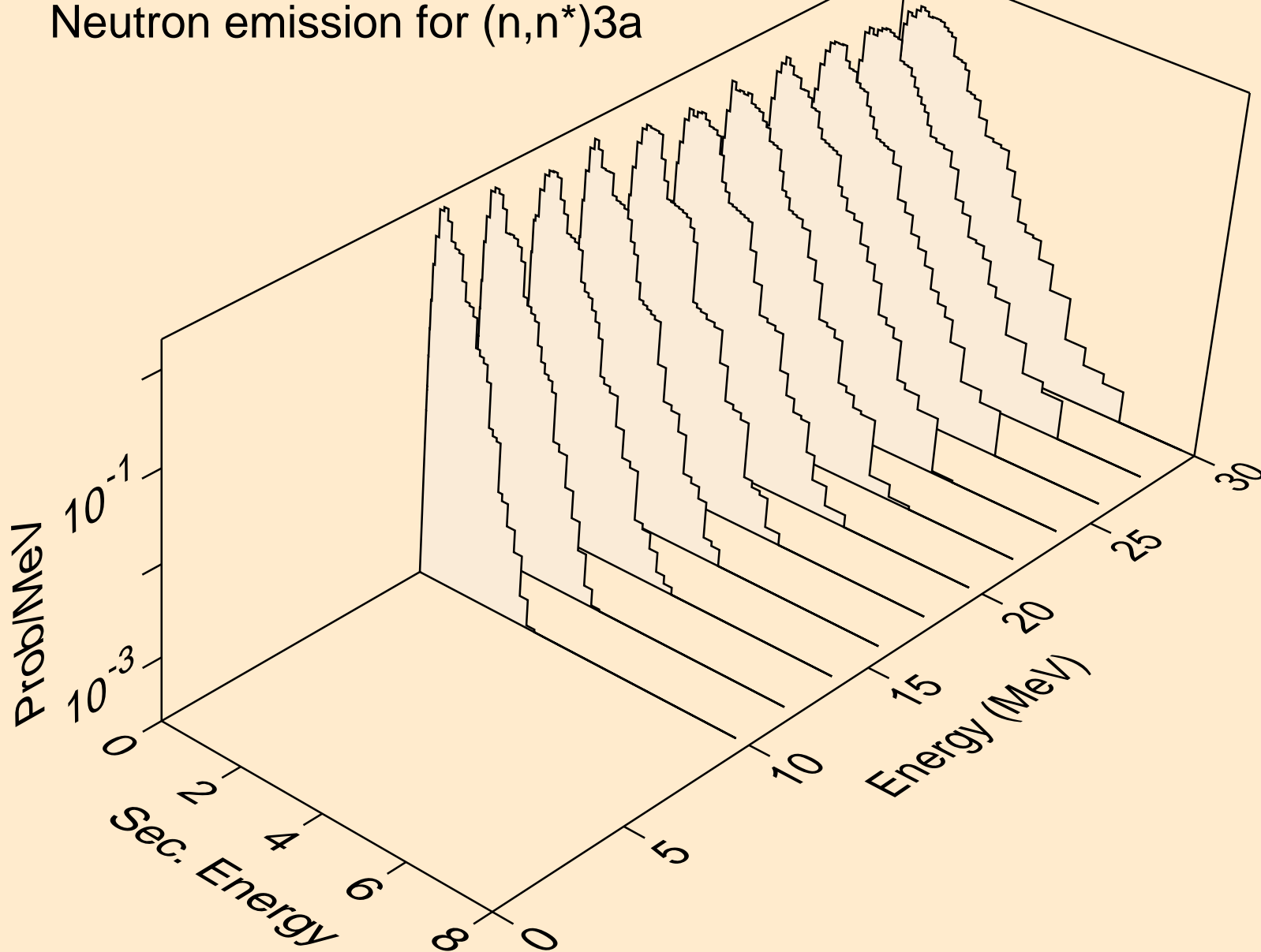

RE167M NEUTRON ACER TENDL-2019 LIBRARY; T=293.16K
Neutron emission for (n,2n)a

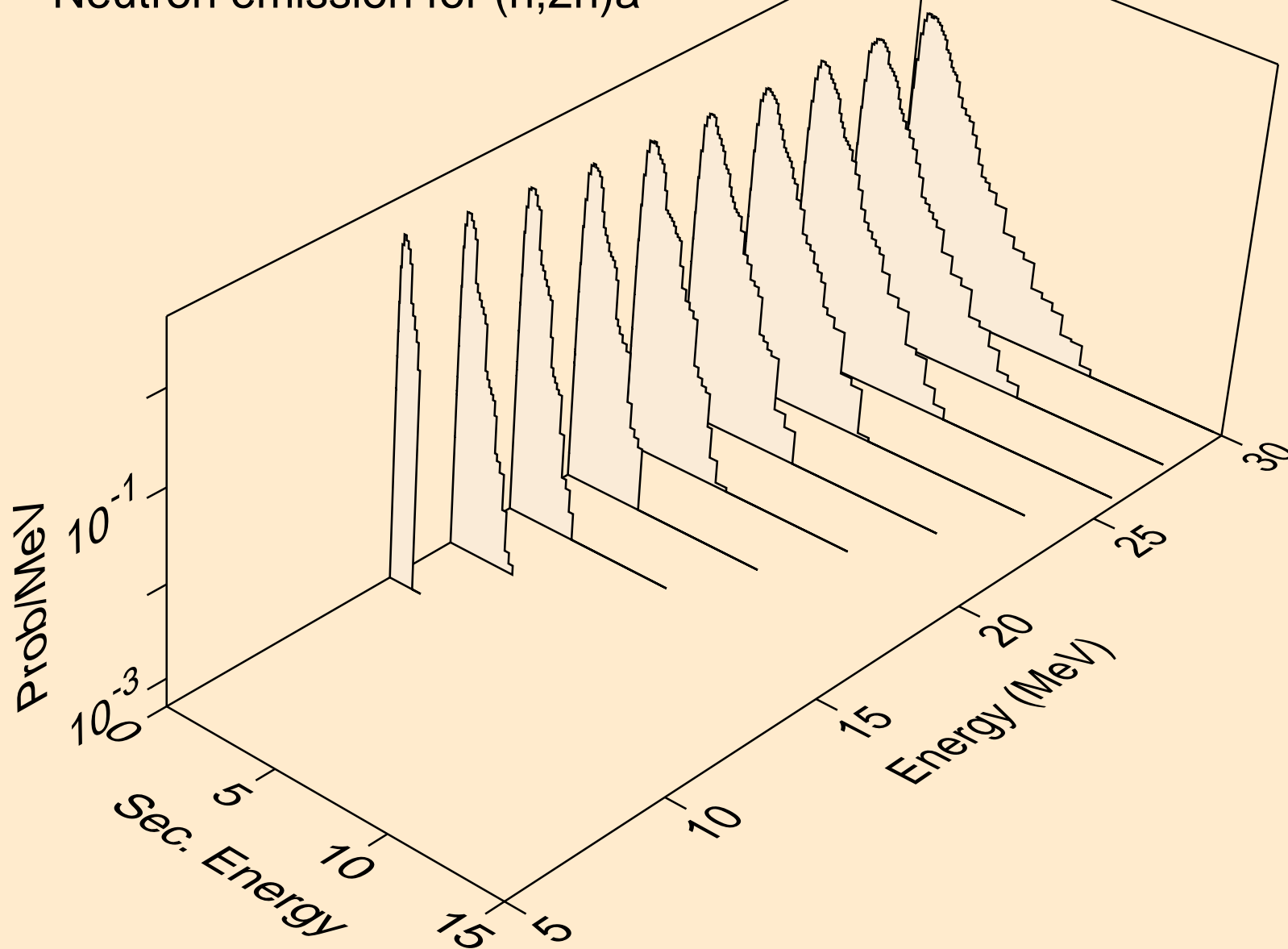

RE167M NEUTRON ACER TENDL-2019 LIBRARY; T=293.16K
Neutron emission for (n,3n)a

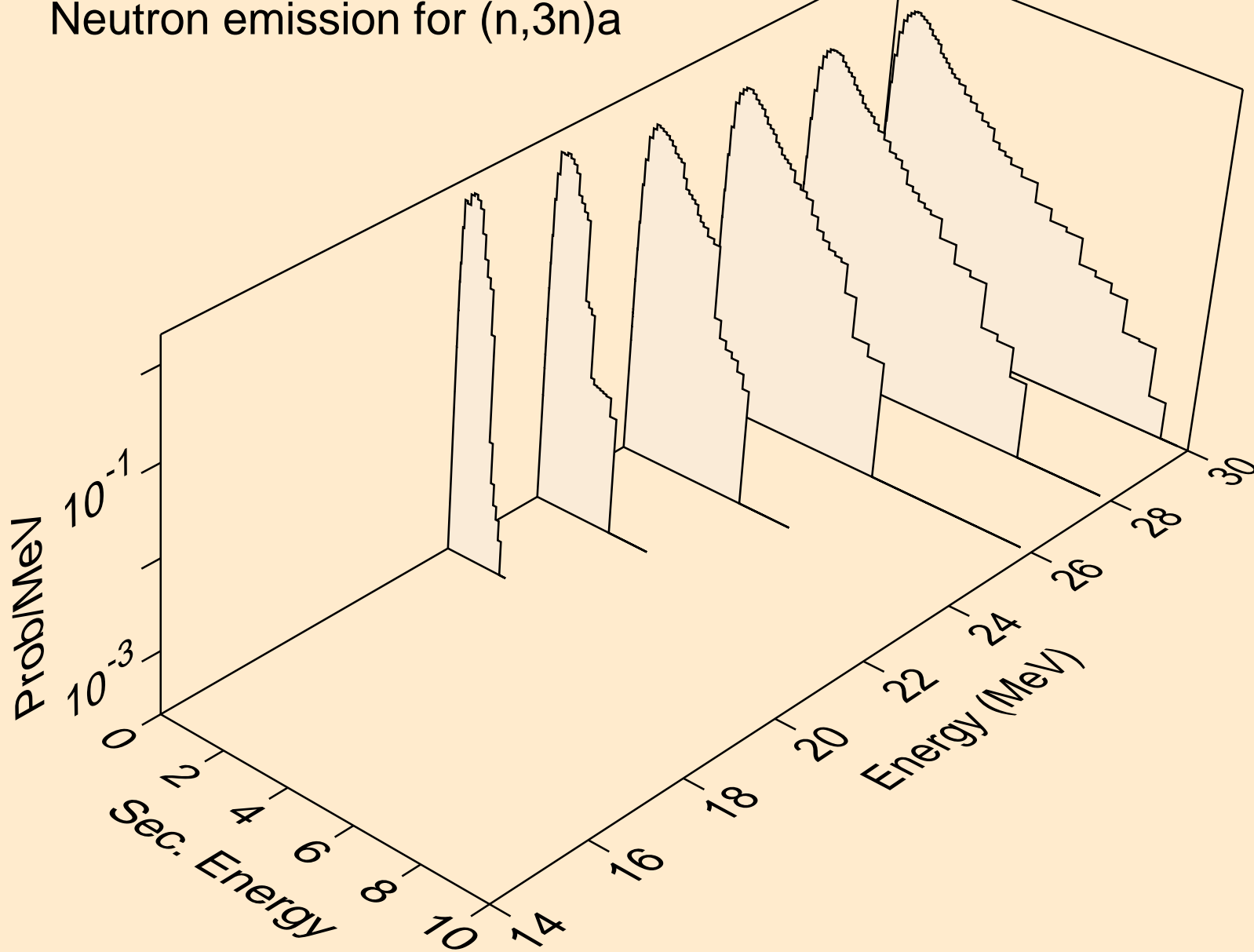

RE167M NEUTRON ACER TENDL-2019 LIBRARY; T=293.16K
Neutron emission for (n,n*)p

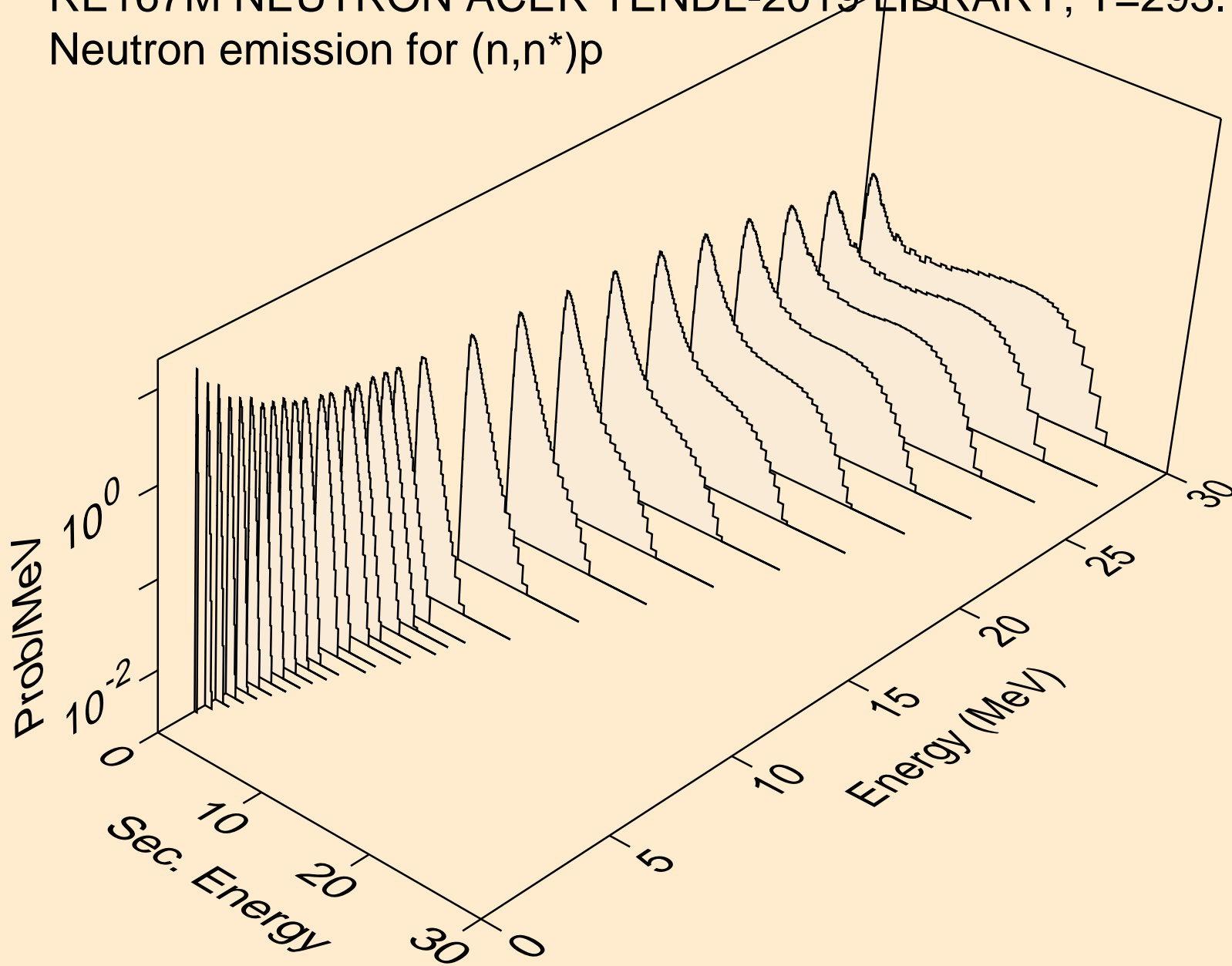

RE167M NEUTRON ACER TENDL-2019 LIBRARY; T=293.16K
Neutron emission for (n,n*)2a

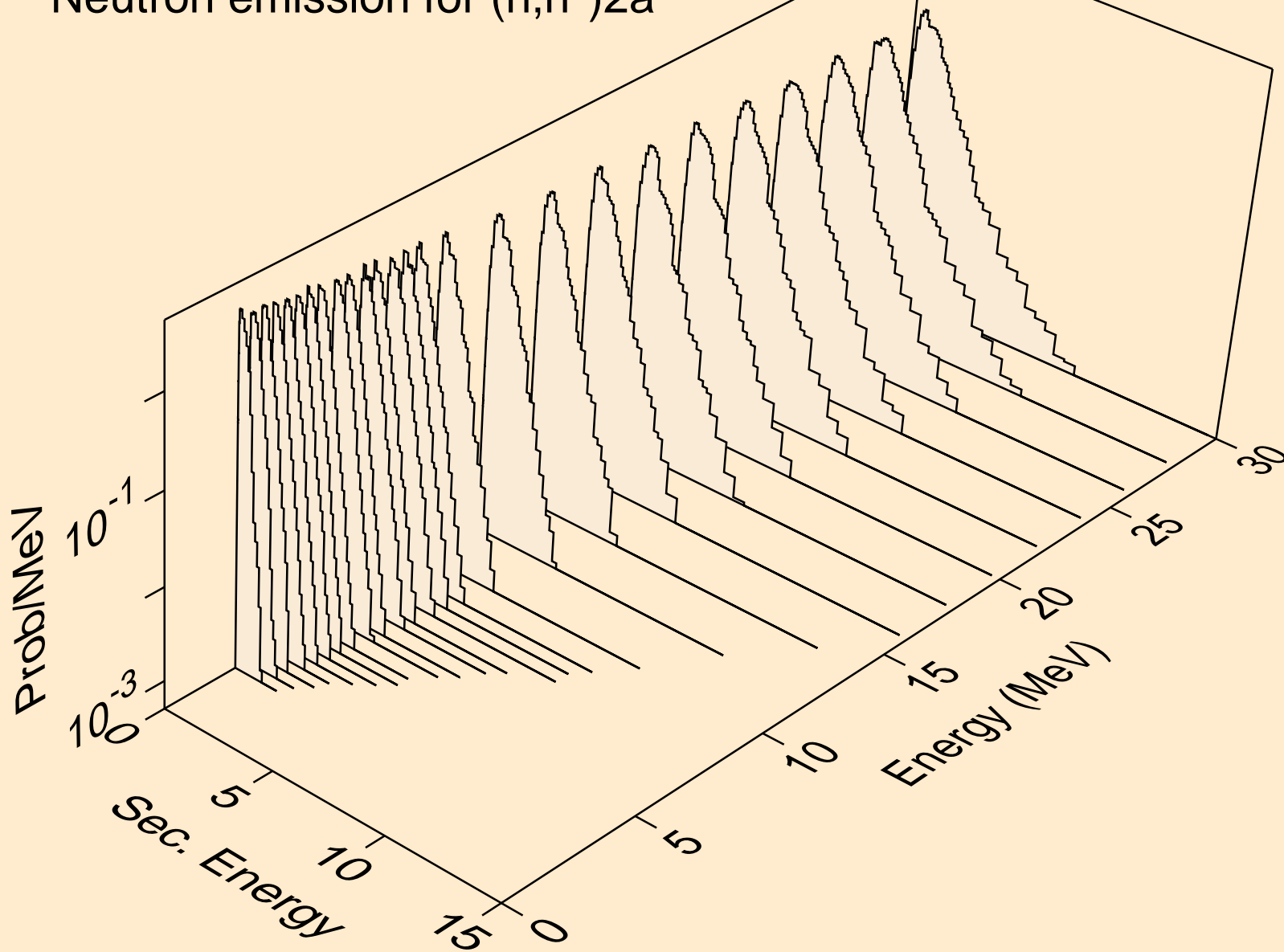

RE167M NEUTRON ACER TENDL-2019 LIBRARY; T=293.16K
Neutron emission for (n,2n)2a

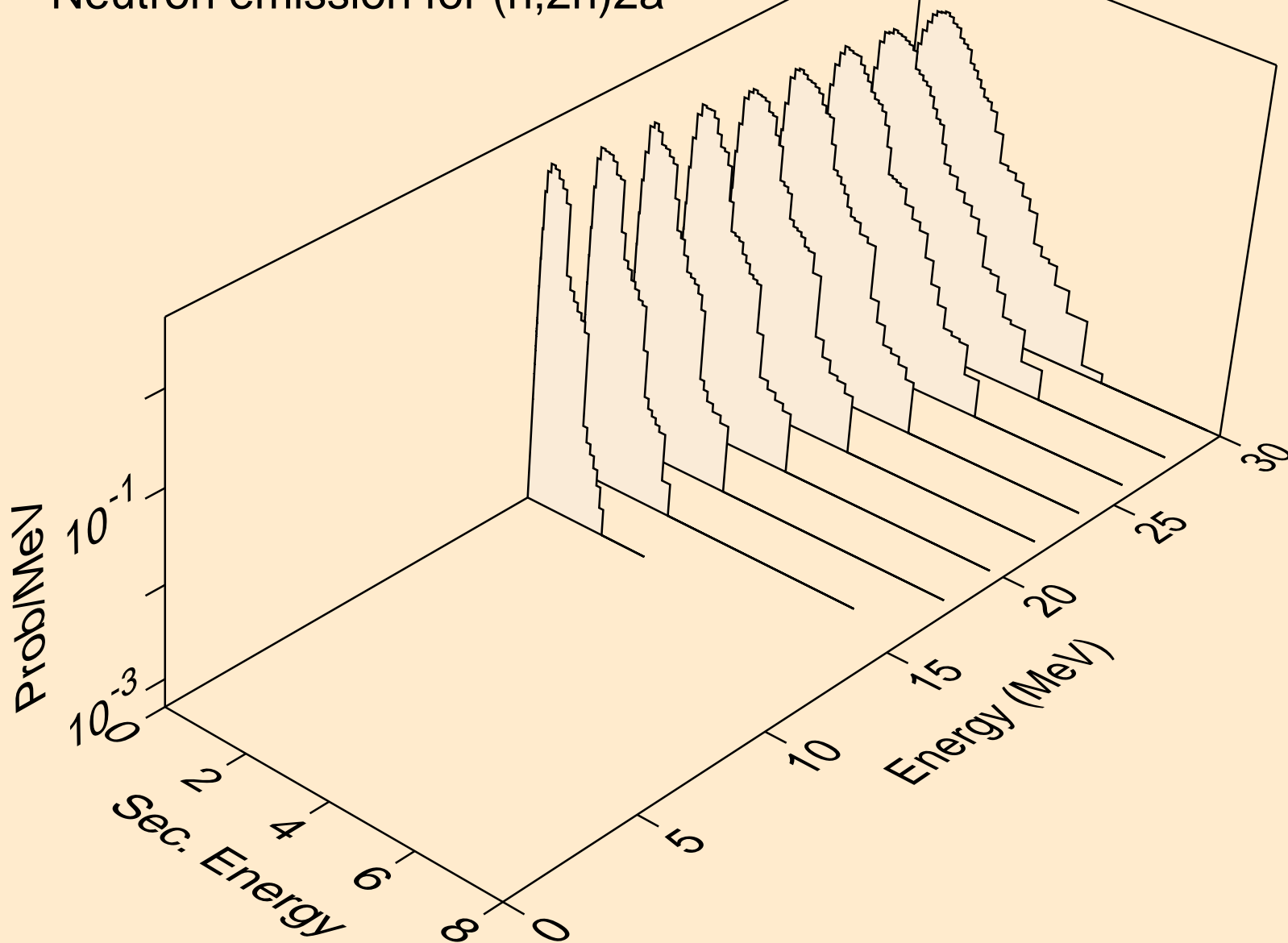

RE167M NEUTRON ACER TENDL-2019 LIBRARY; T=293.16K
Neutron emission for (n,n*)d

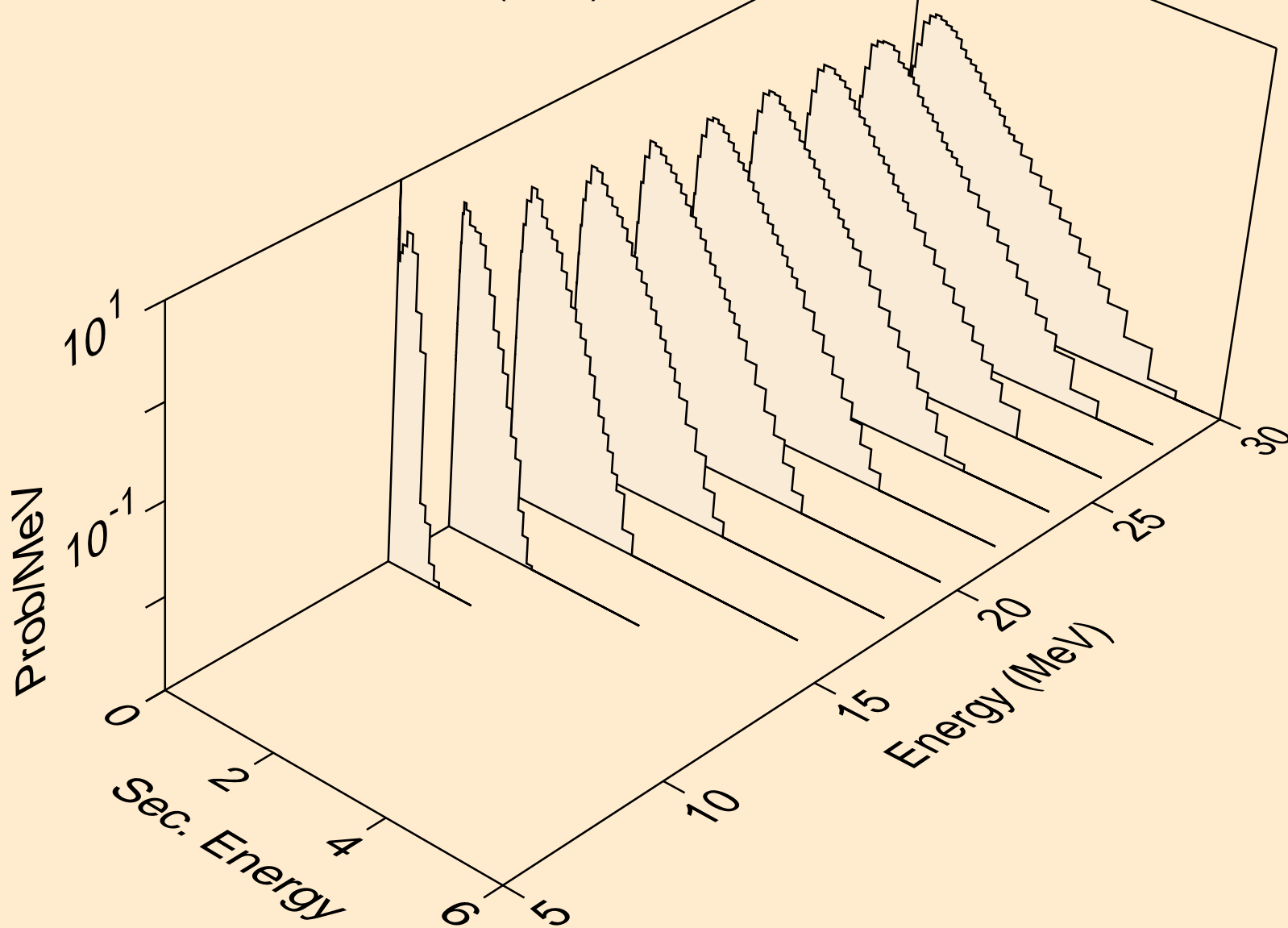

RE167M NEUTRON ACER TENDL-2019 LIBRARY; T=293.16K
Neutron emission for (n,n*)t

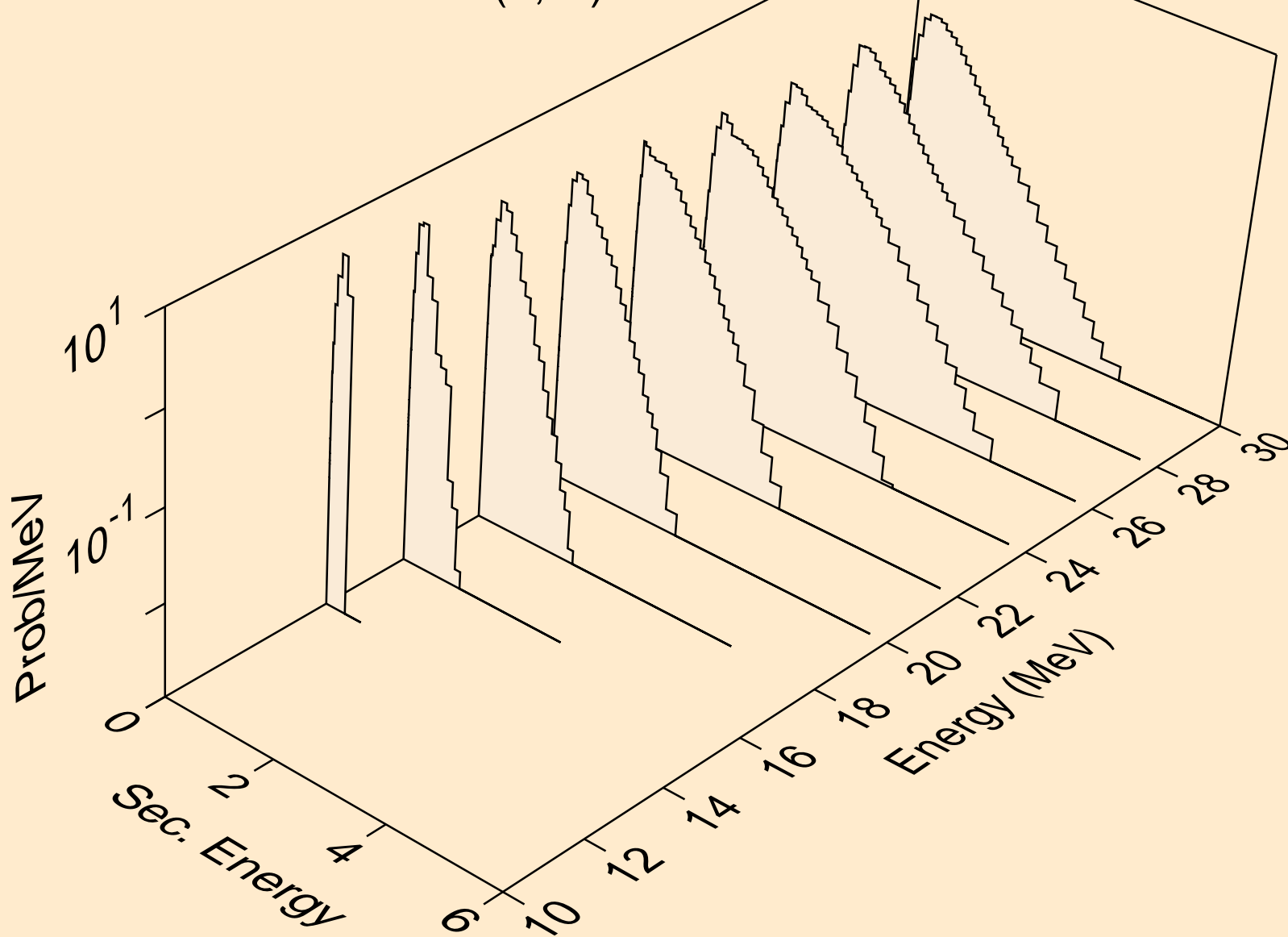

RE167M NEUTRON ACER TENDL-2019 LIBRARY; T=293.16K
Neutron emission for (n,n*)he3

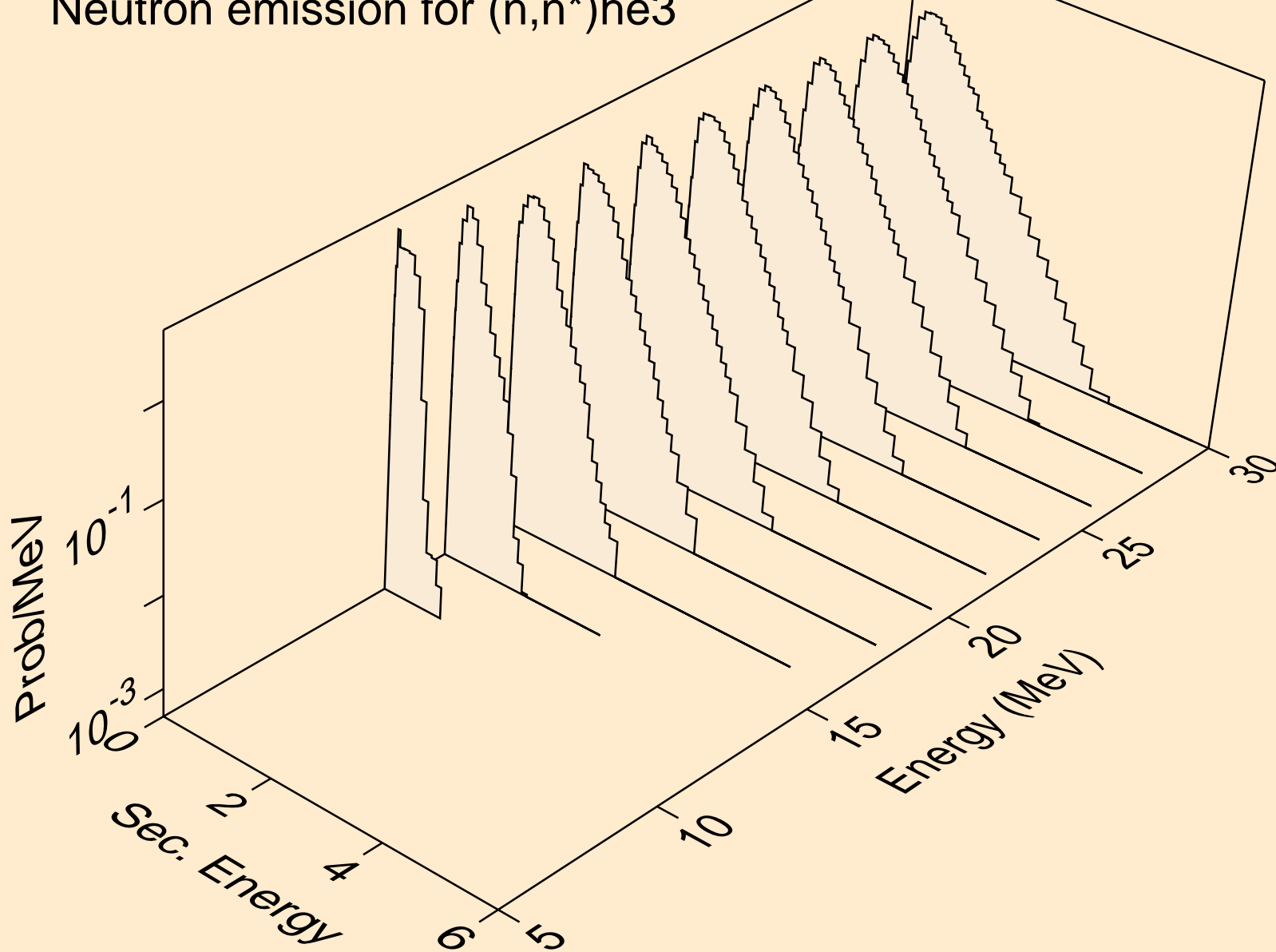

RE167M NEUTRON ACER TENDL-2019 LIBRARY; T=293.16K
Neutron emission for (n,2np)

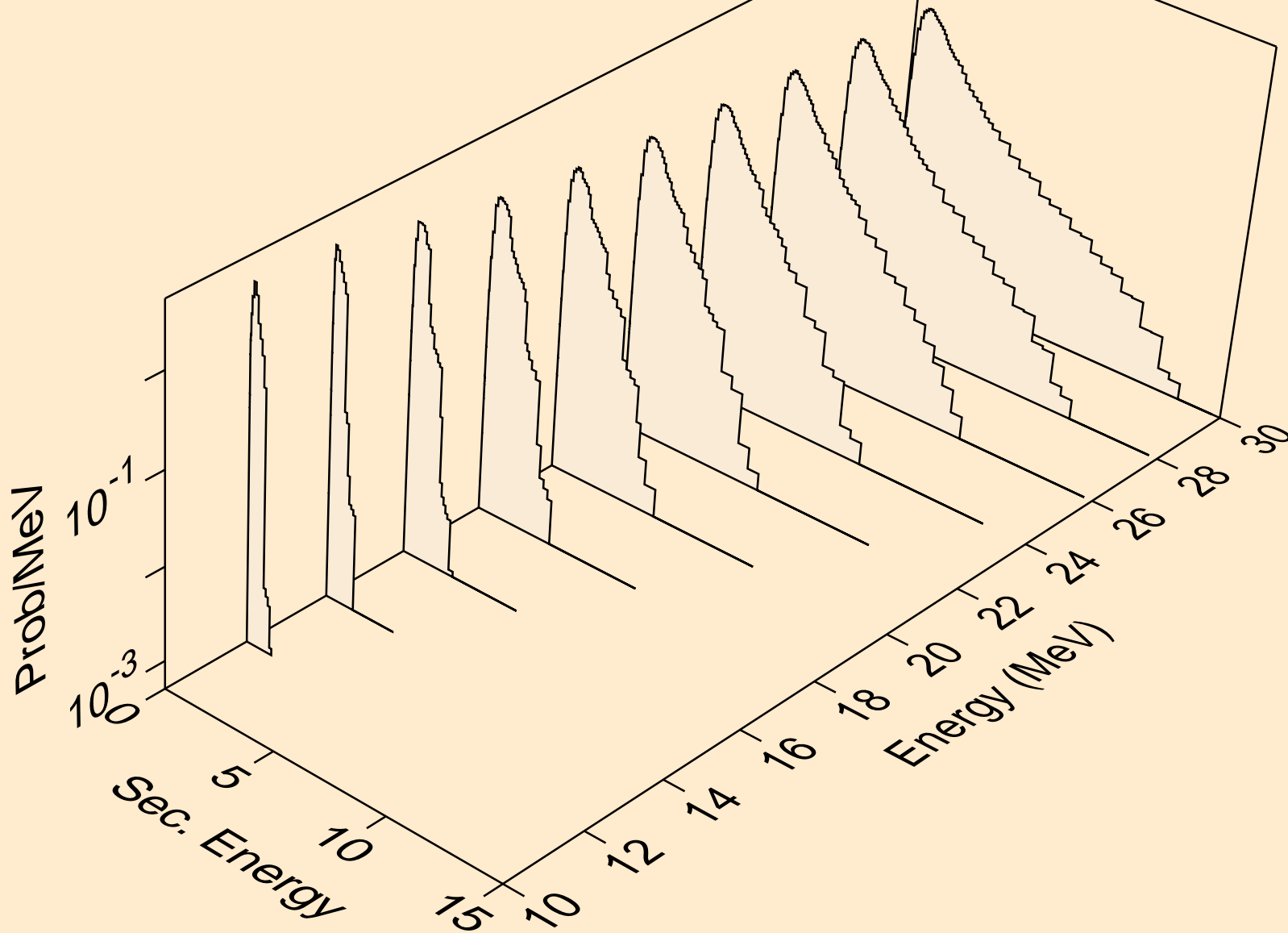

RE167M NEUTRON ACER TENDL-2019 LIBRARY; T=293.16K
Neutron emission for (n,3np)

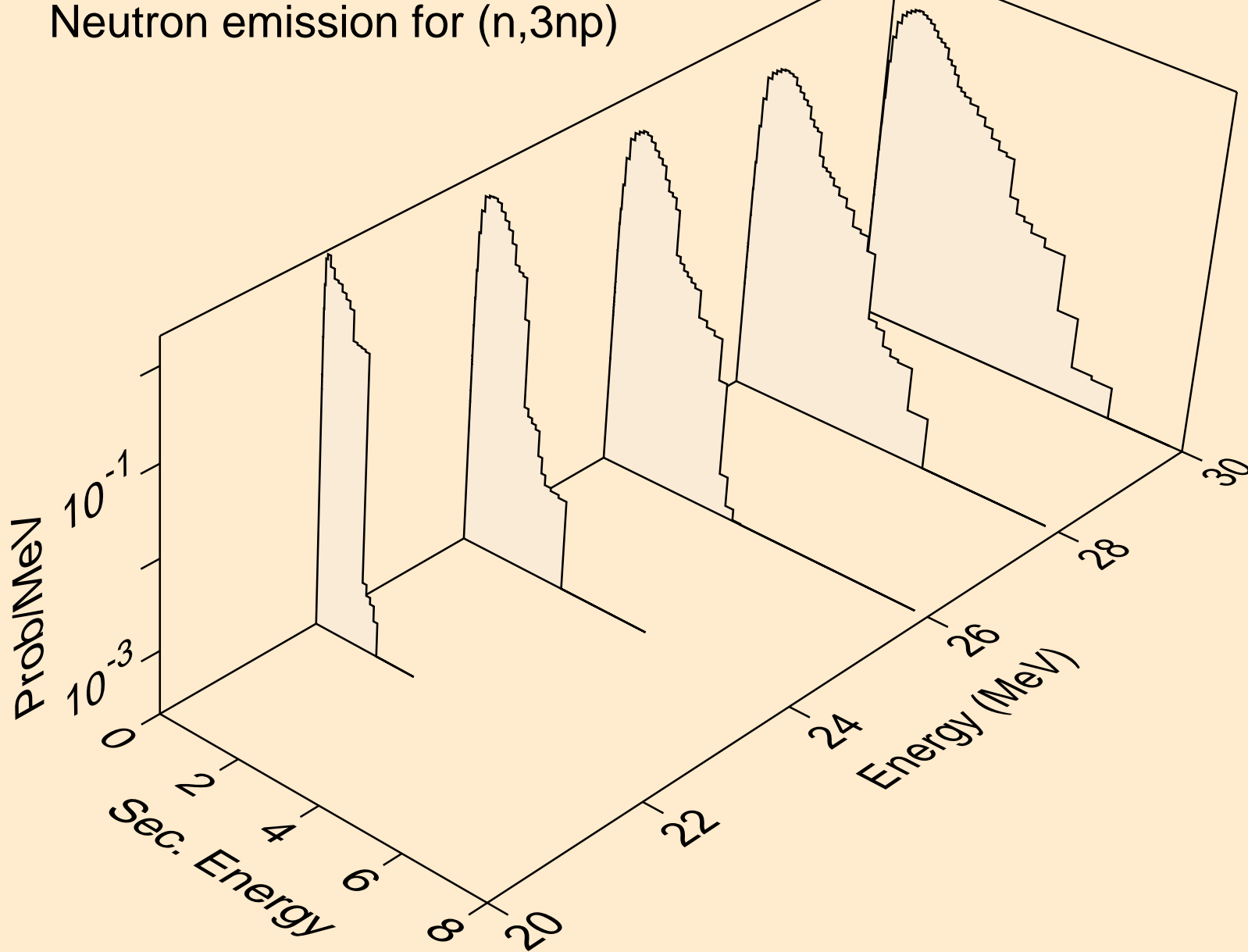

RE167M NEUTRON ACER TENDL-2019 LIBRARY; T=293.16K
Neutron emission for (n,2np)

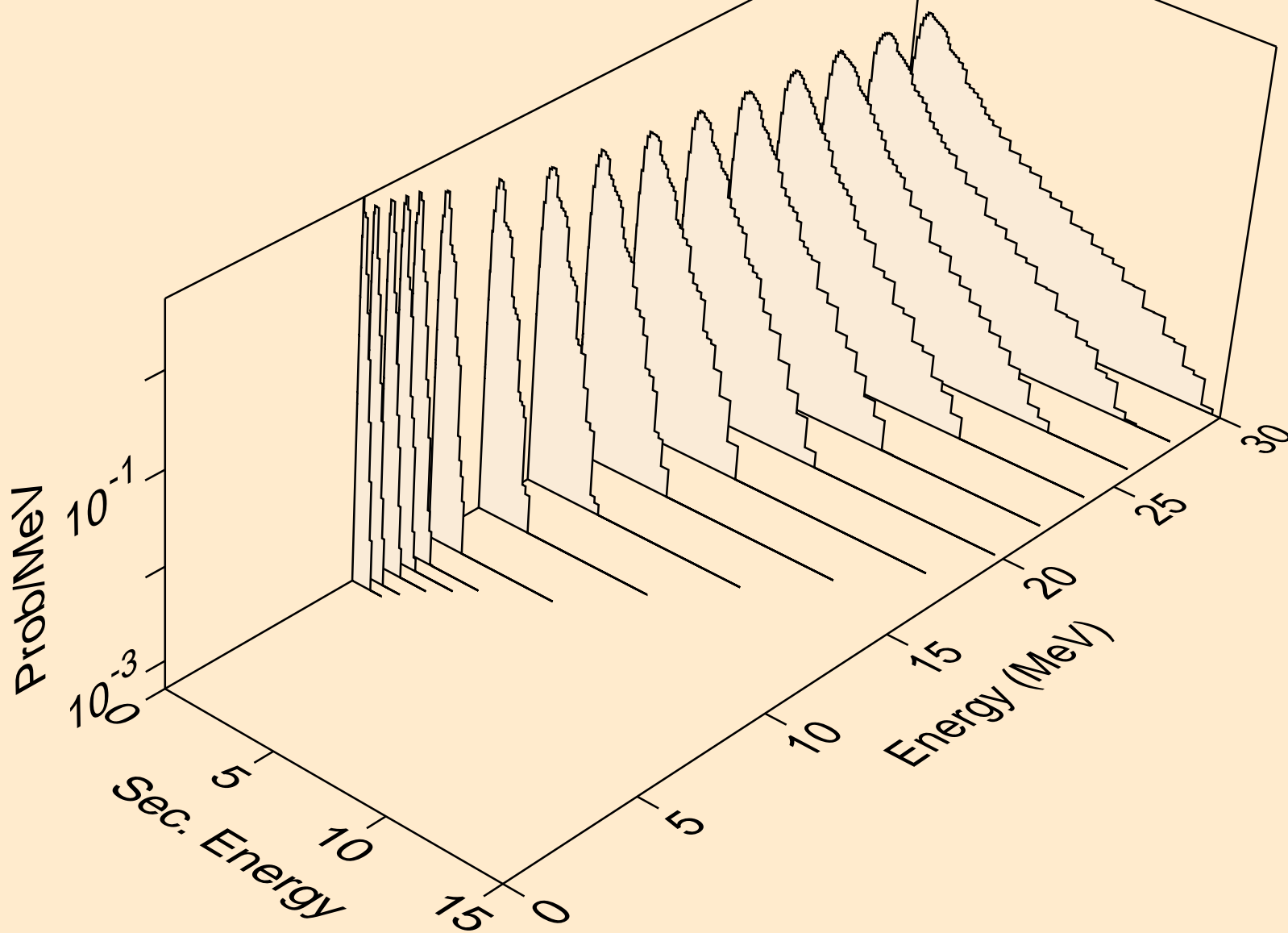

RE167M NEUTRON ACER TENDL-2019 LIBRARY; T=293.16K
Neutron emission for (n,npa)

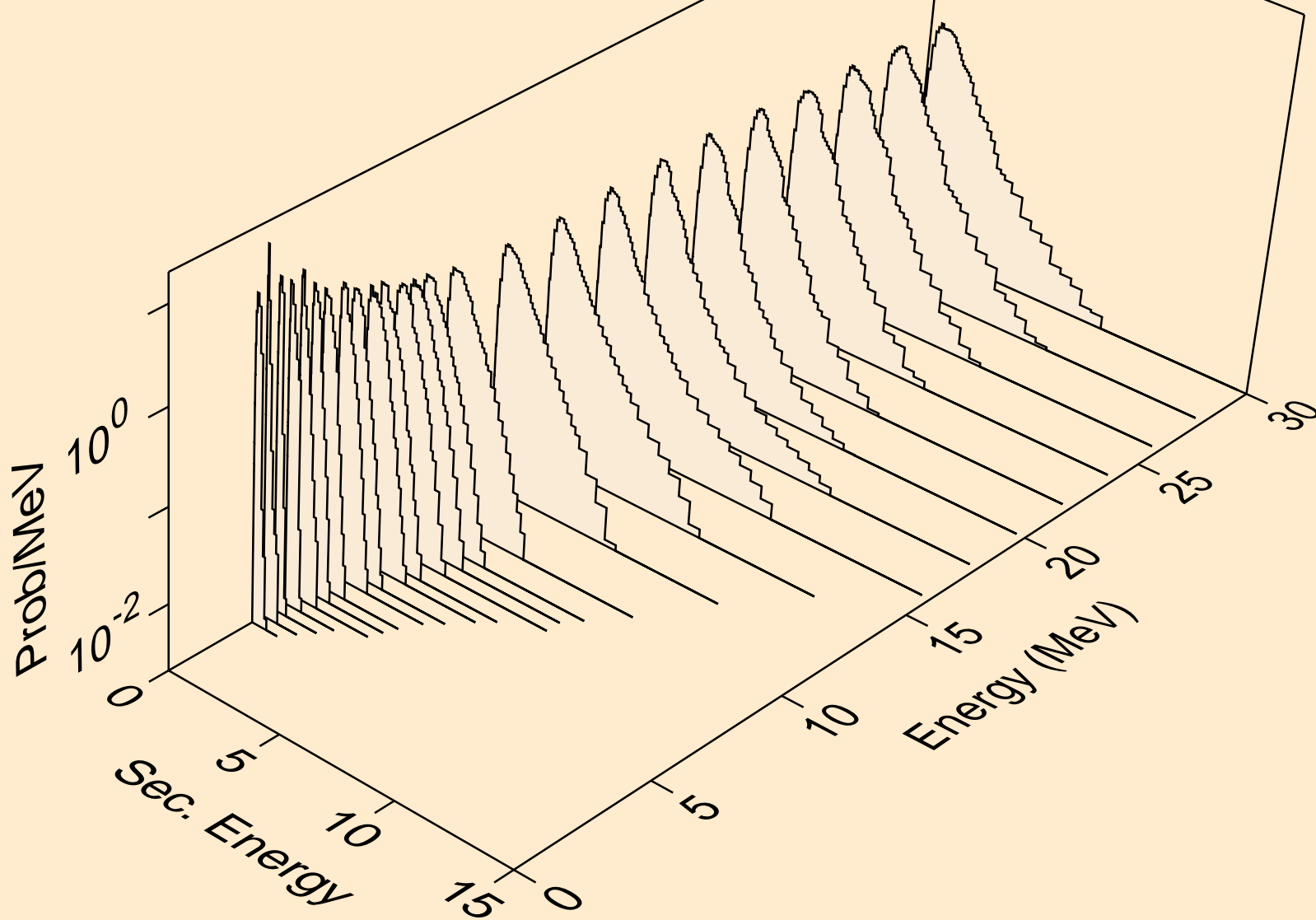

RE167M NEUTRON ACER TENDL-2019 LIBRARY; T=293.16K
Neutron emission for (n,n*c)

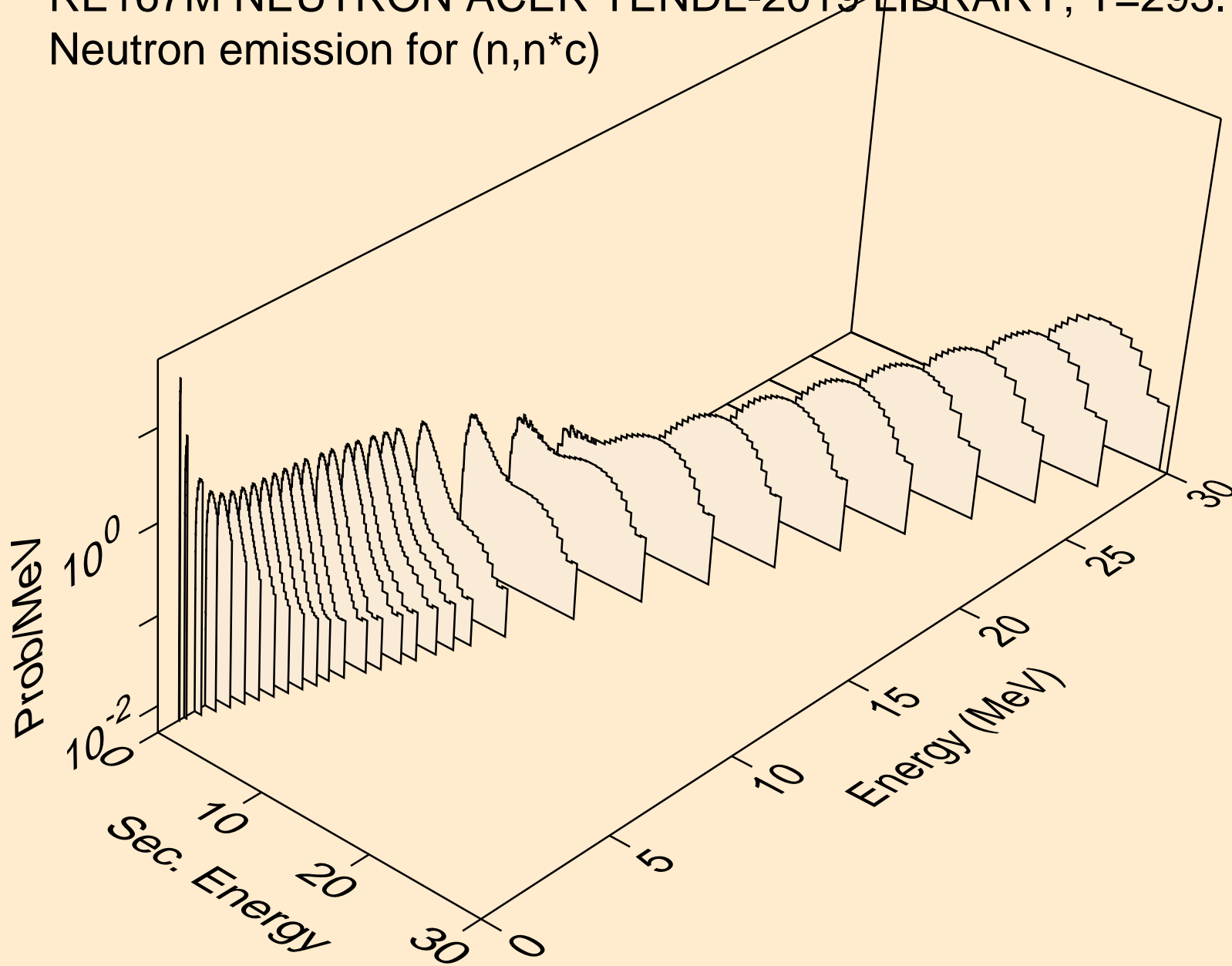

RE167M NEUTRON ACER TENDL-2019 LIBRARY; T=293.16K
Photon emission for (n,x)

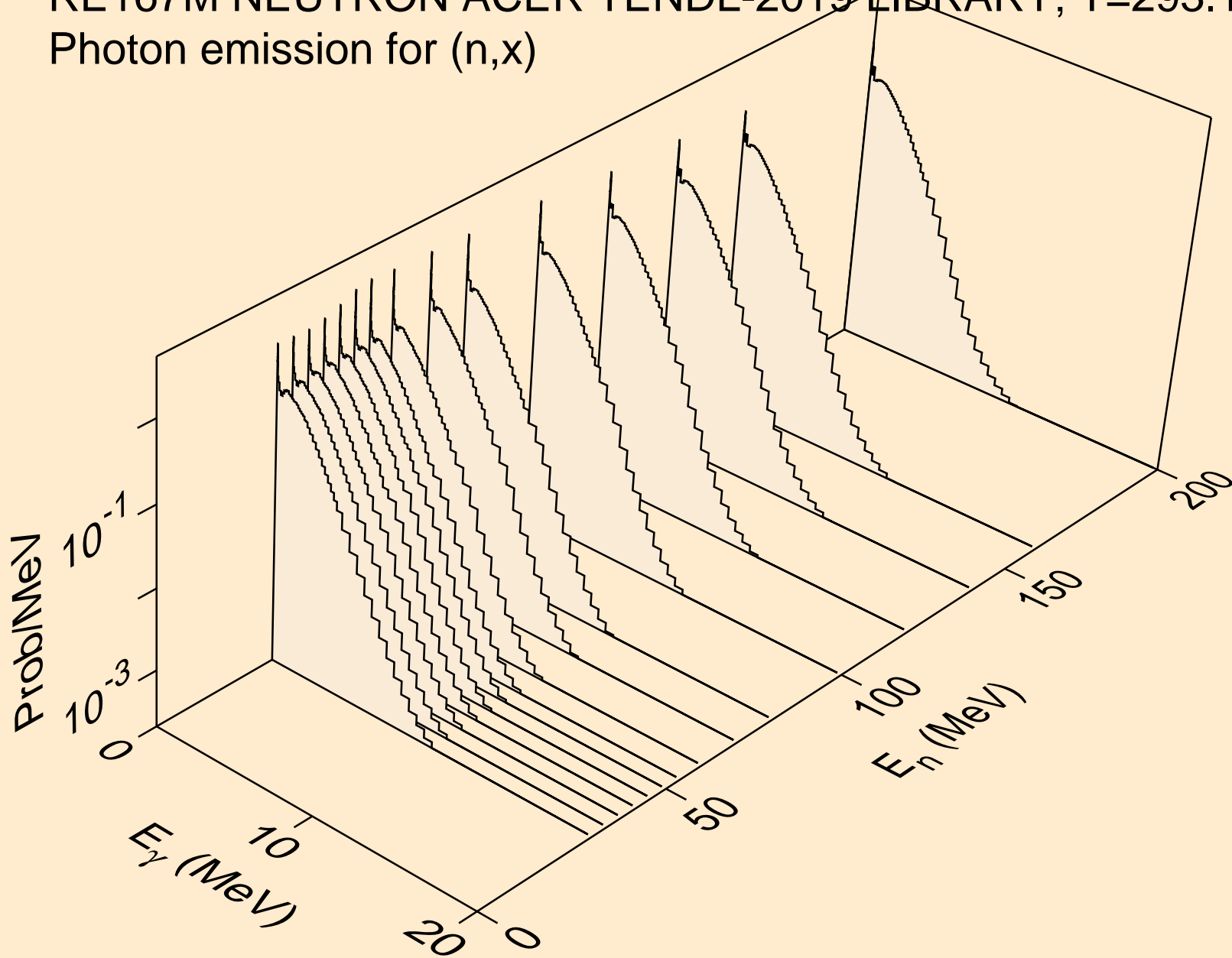

RE167M NEUTRON ACER TENDL-2019 LIBRARY; T=293.16K
Photon emission for (n,2nd)

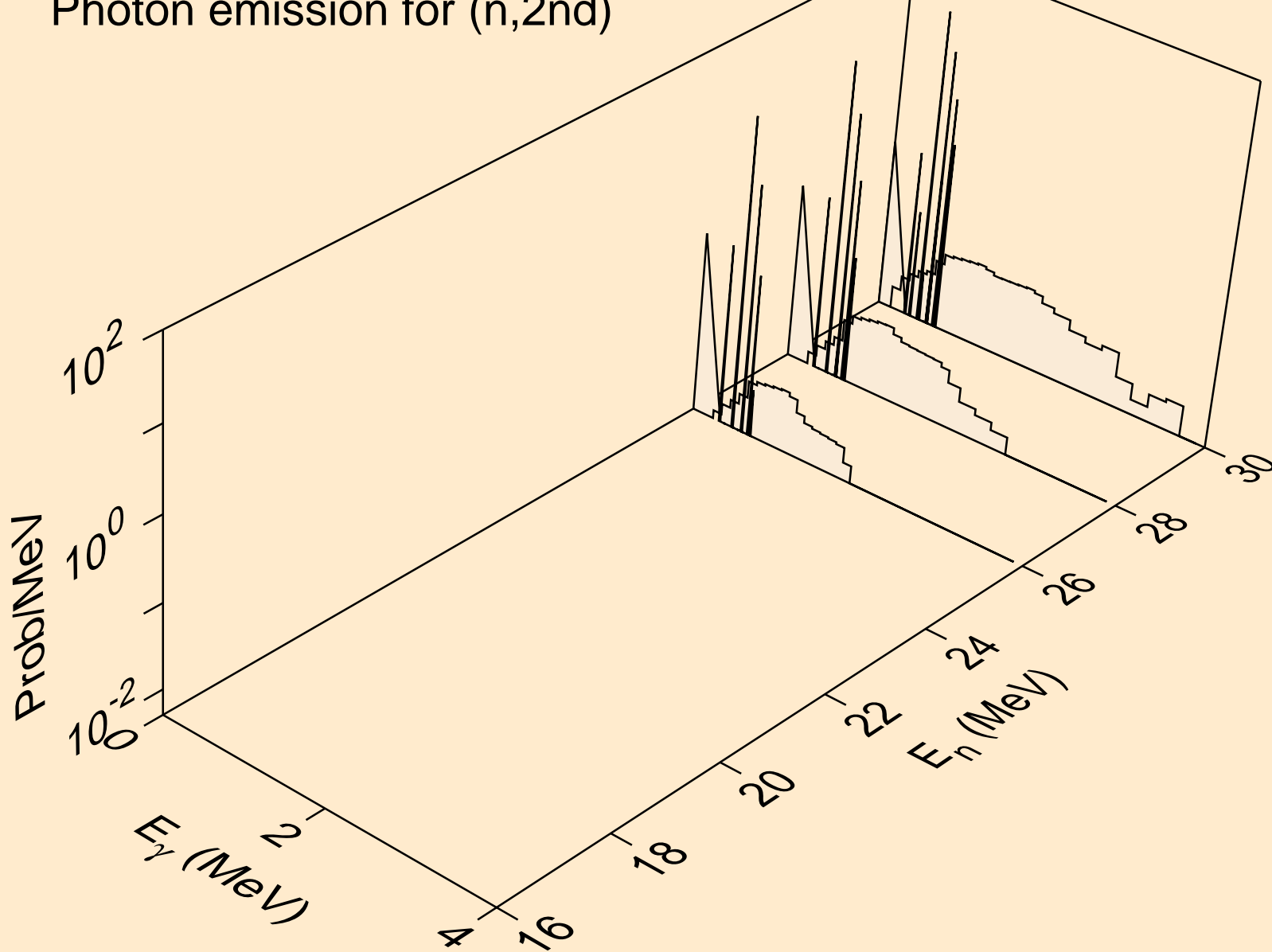

RE167M NEUTRON ACER TENDL-2019 LIBRARY; T=293.16K
Photon emission for (n,2n)

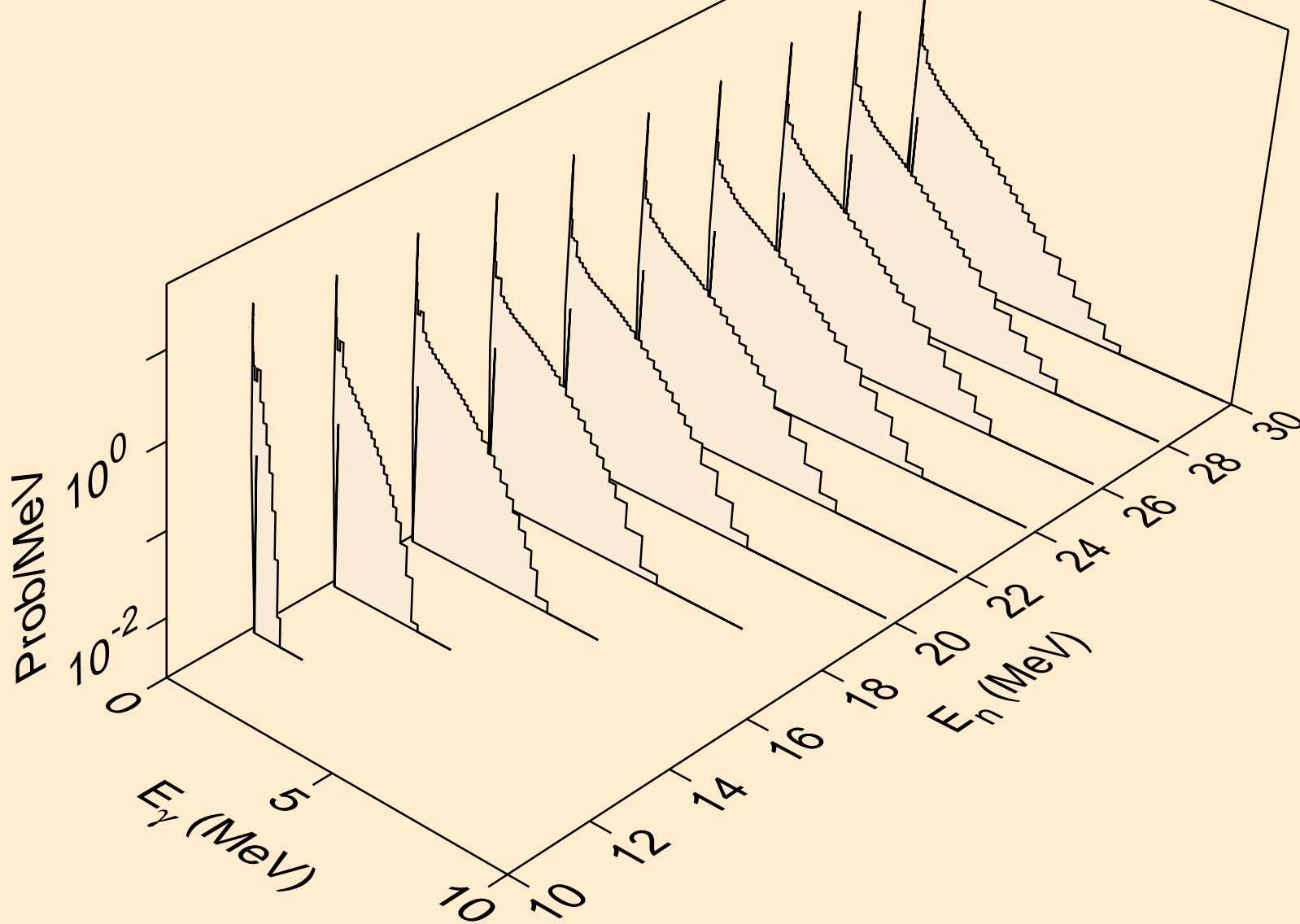

RE167M NEUTRON ACER TENDL-2019 LIBRARY; T=293.16K
Photon emission for (n,3n)

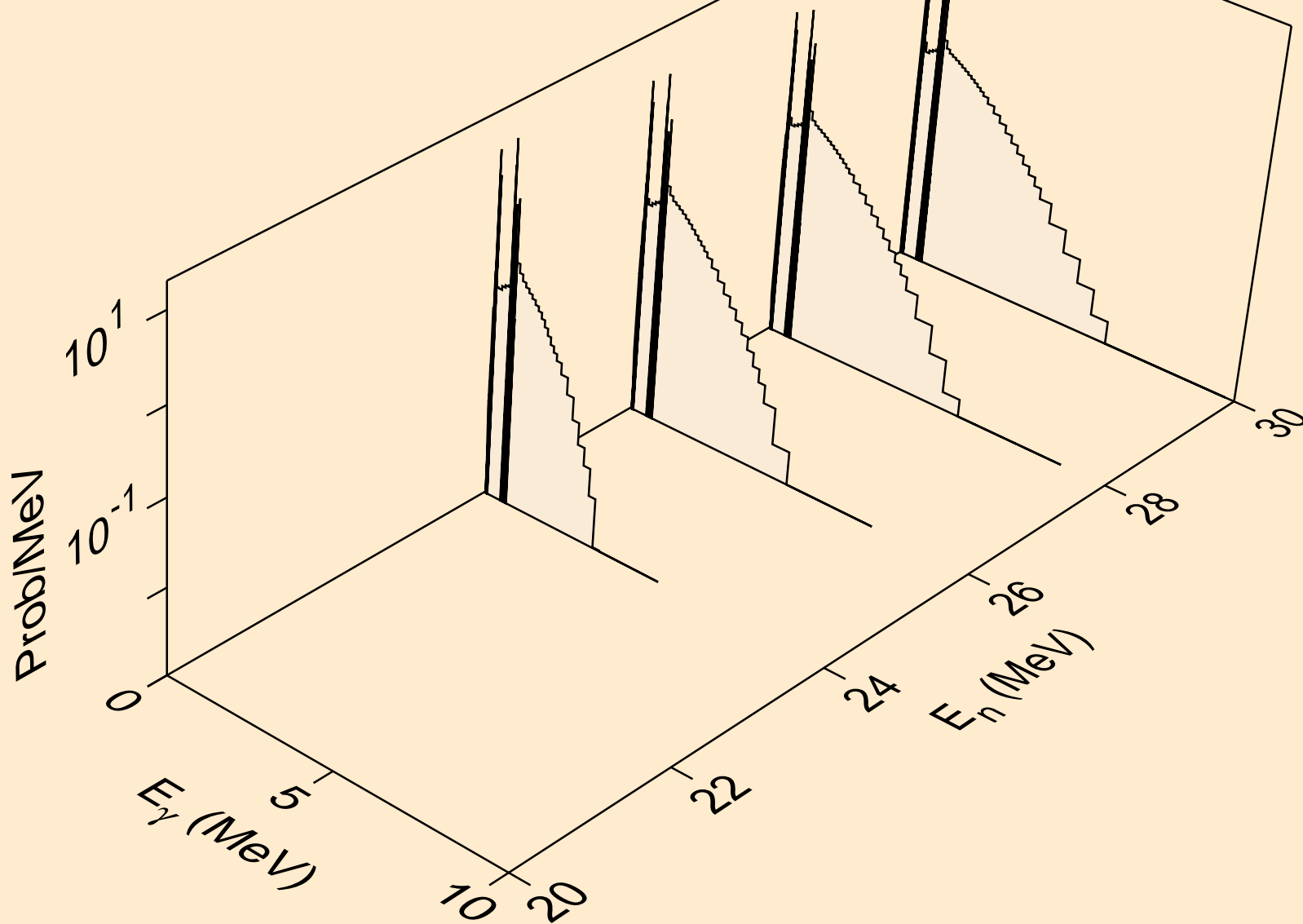

RE167M NEUTRON ACER TENDL-2019 LIBRARY; T=293.16K
Photon emission for (n,n*)a

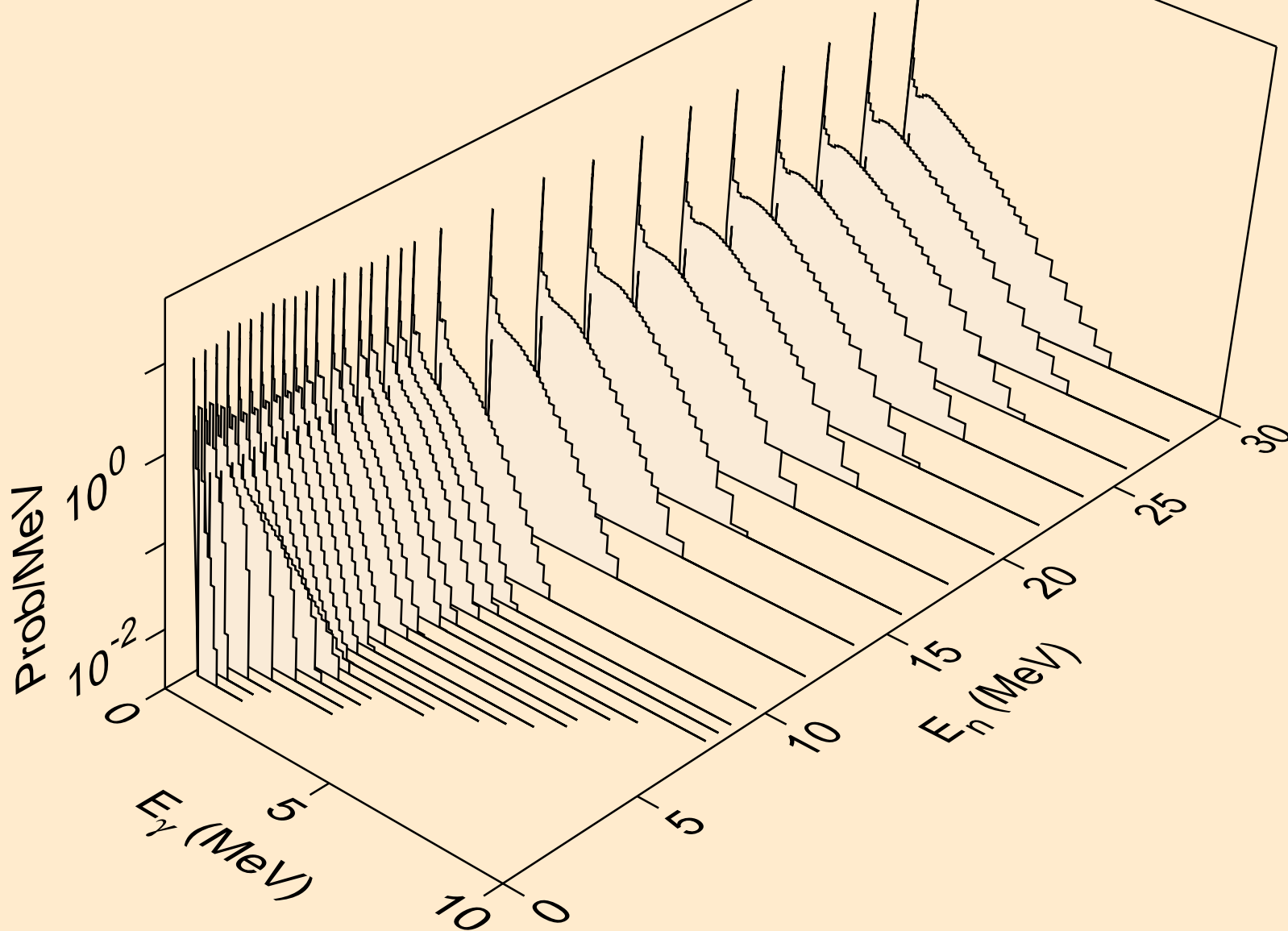

RE167M NEUTRON ACER TENDL-2019 LIBRARY; T=293.16K
Photon emission for (n,n*)3a

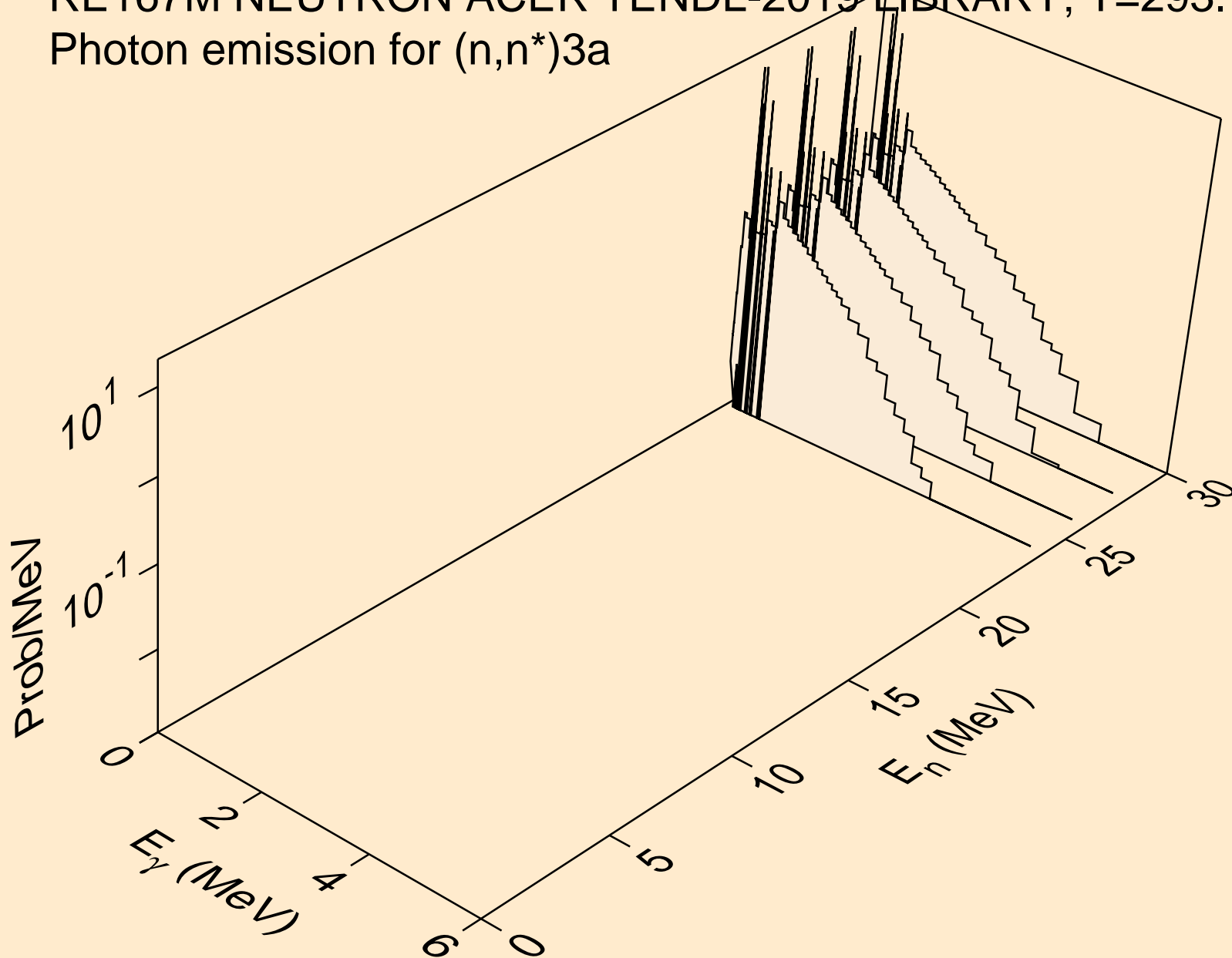

RE167M NEUTRON ACER TENDL-2019 LIBRARY; T=293.16K
Photon emission for (n,2n)a

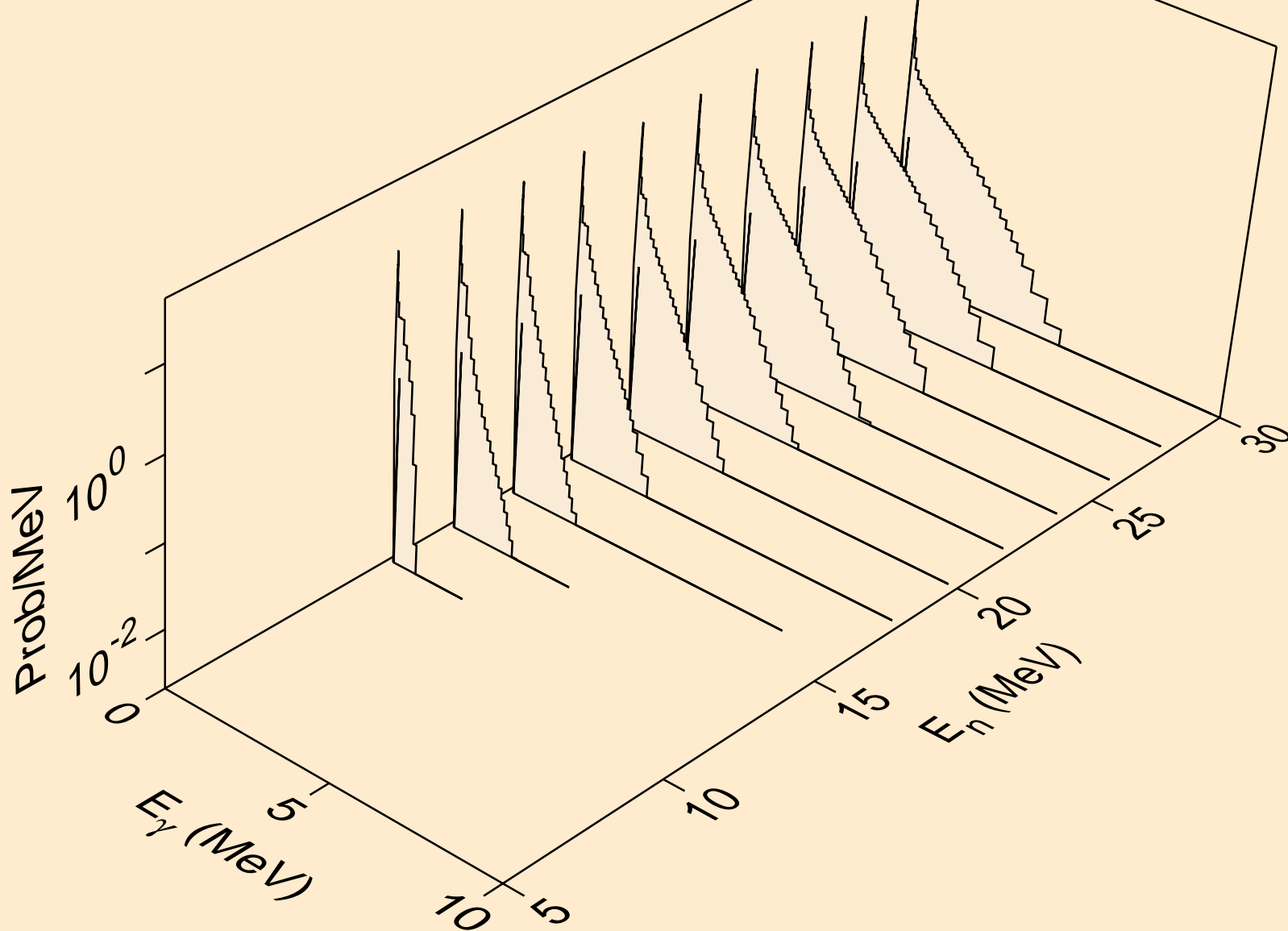

RE167M NEUTRON ACER TENDL-2019 LIBRARY; T=293.16K
Photon emission for (n,3n)a

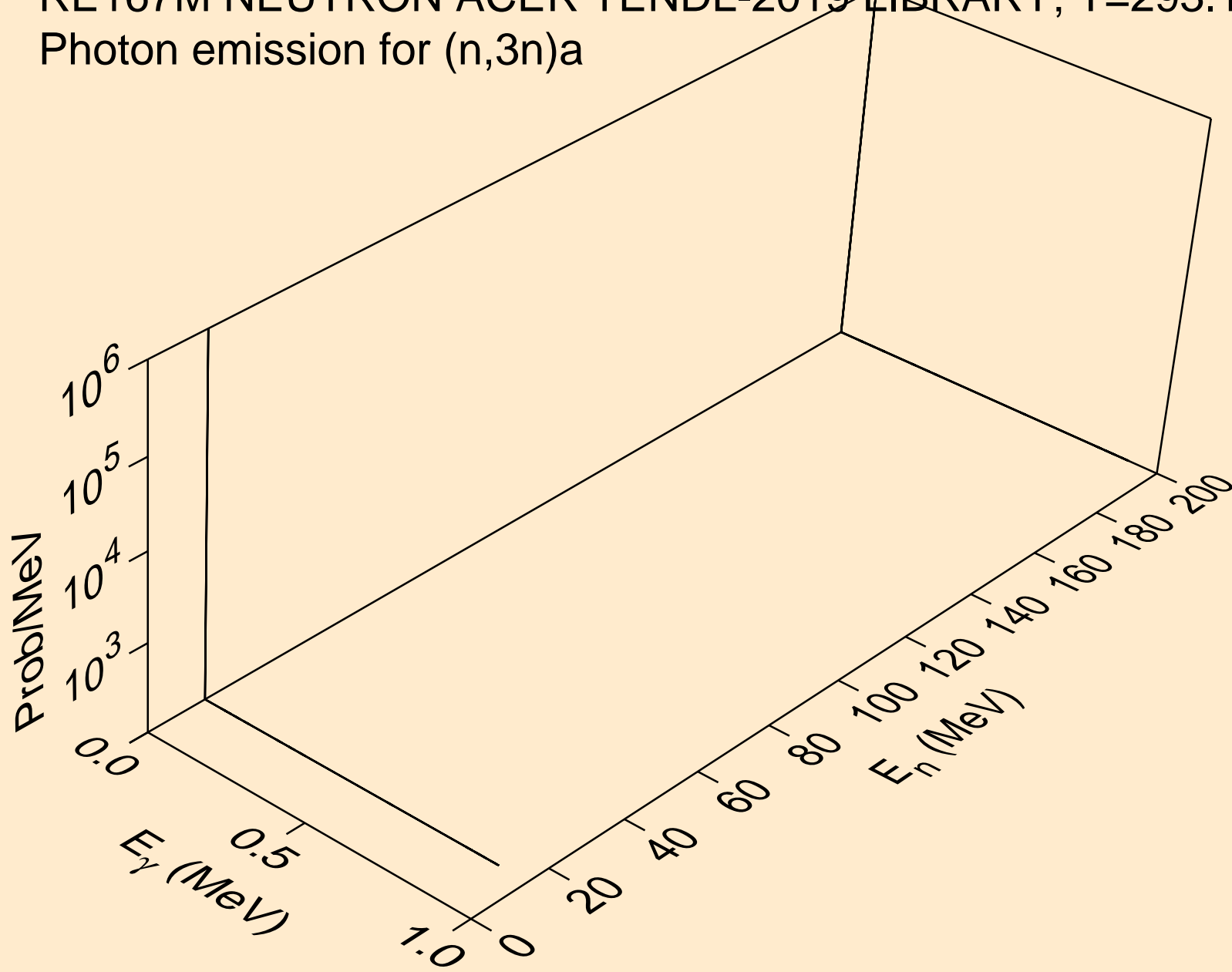

RE167M NEUTRON ACER TENDL-2019 LIBRARY; T=293.16K
Photon emission for (n,n*)p

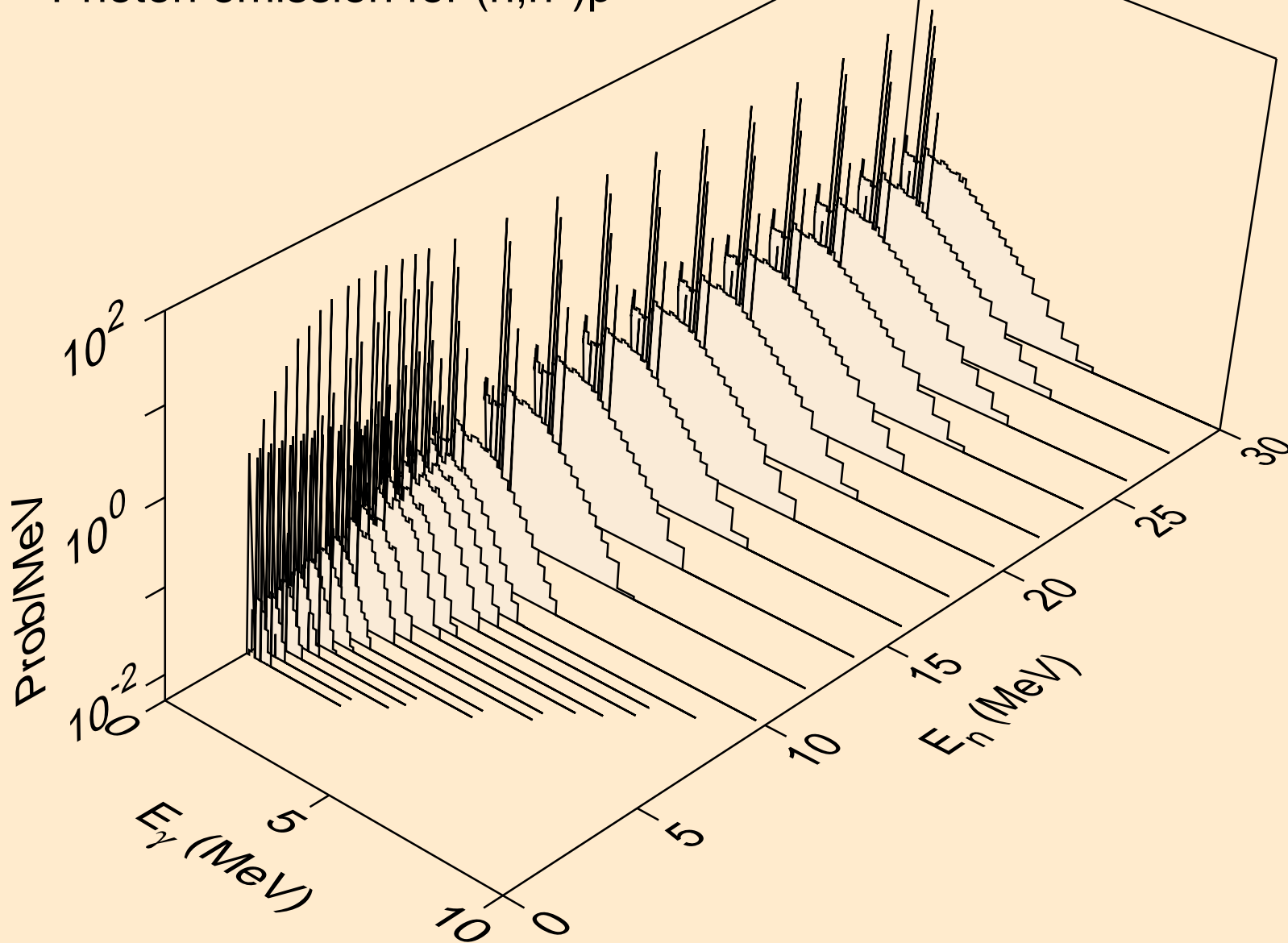

RE167M NEUTRON ACER TENDL-2019 LIBRARY; T=293.16K
Photon emission for (n,n*)2a

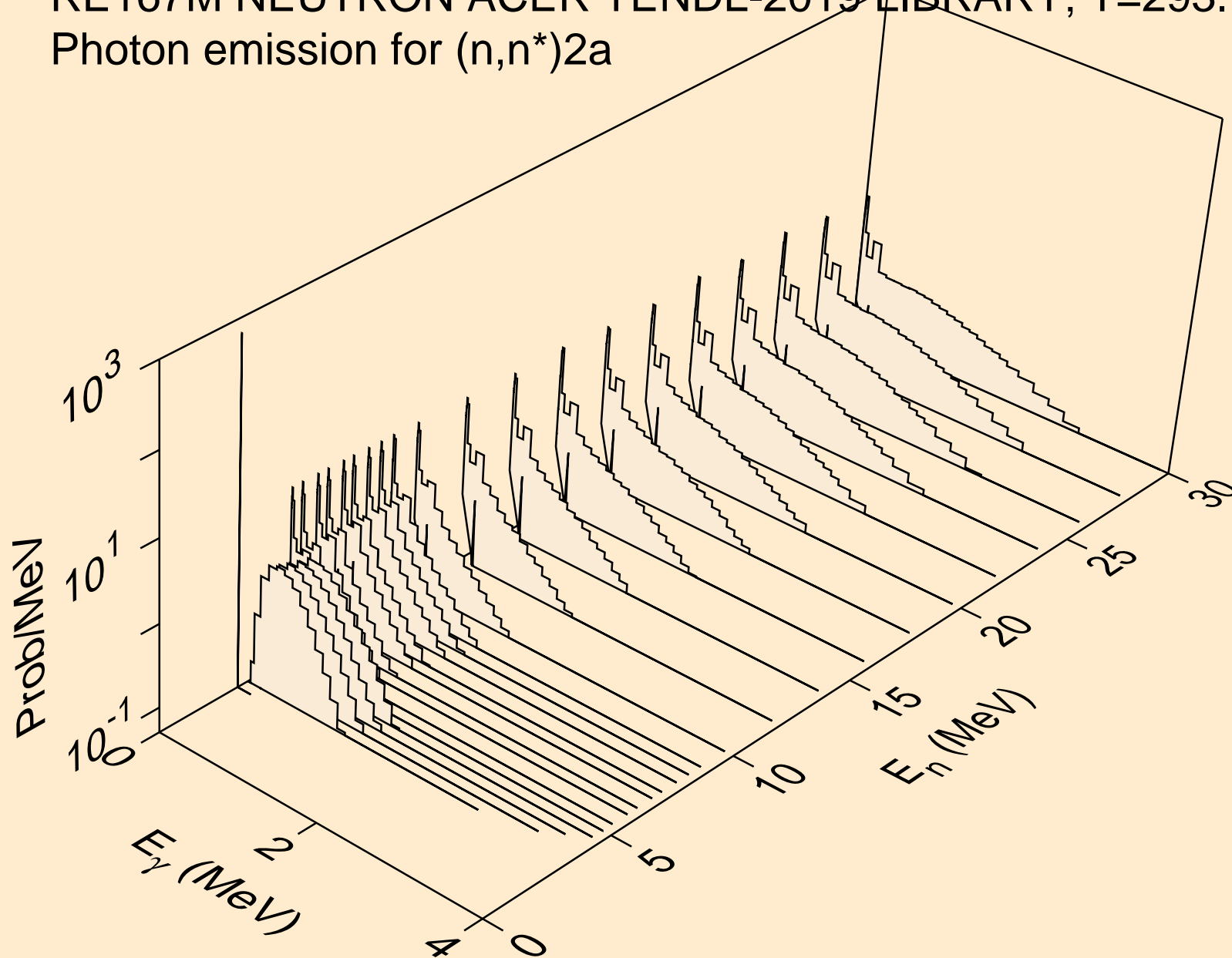

RE167M NEUTRON ACER TENDL-2019 LIBRARY; T=293.16K
Photon emission for (n,2n)2a

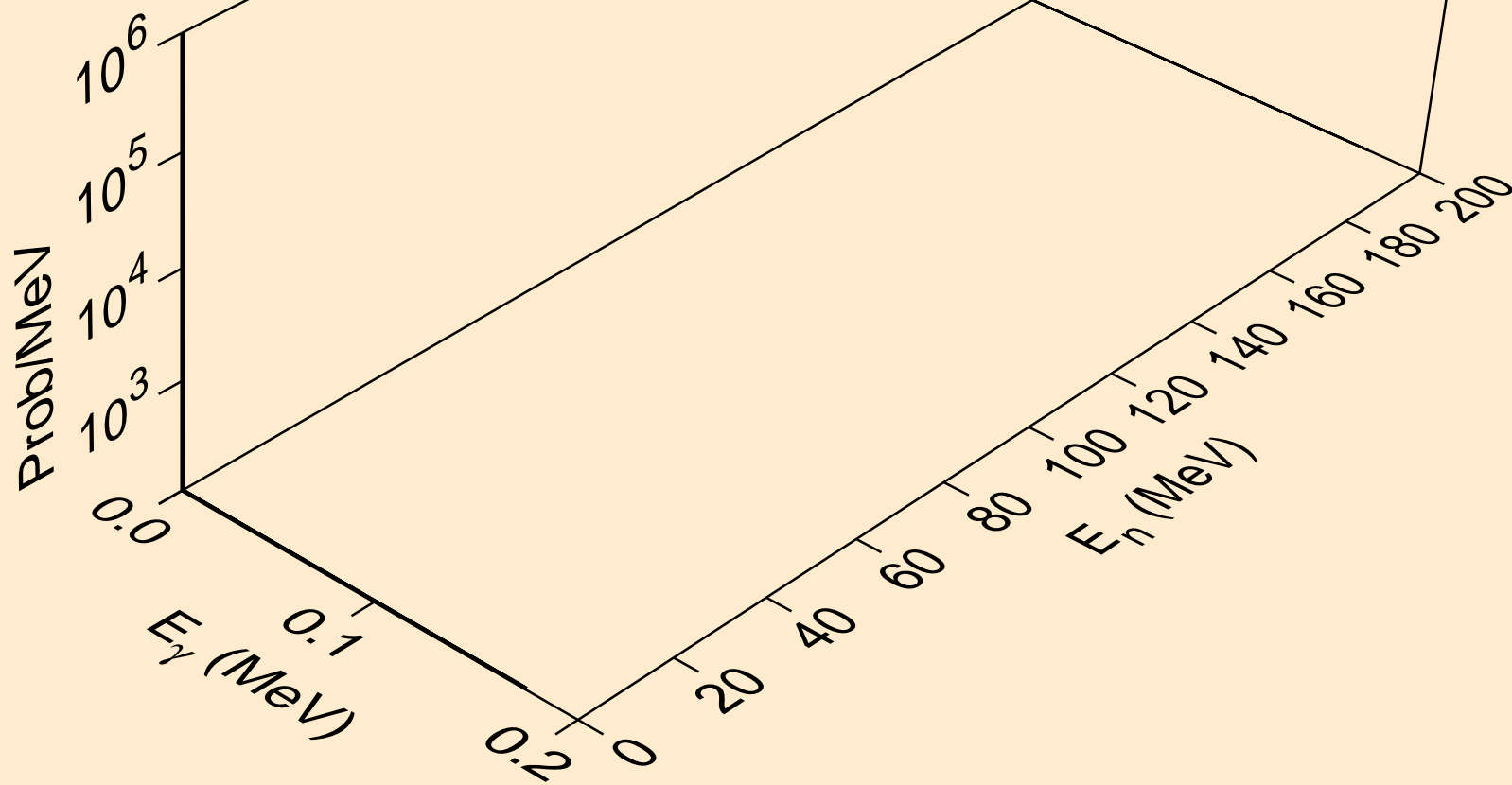

RE167M NEUTRON ACER TENDL-2019 LIBRARY; T=293.16K
Photon emission for (n,n*)d

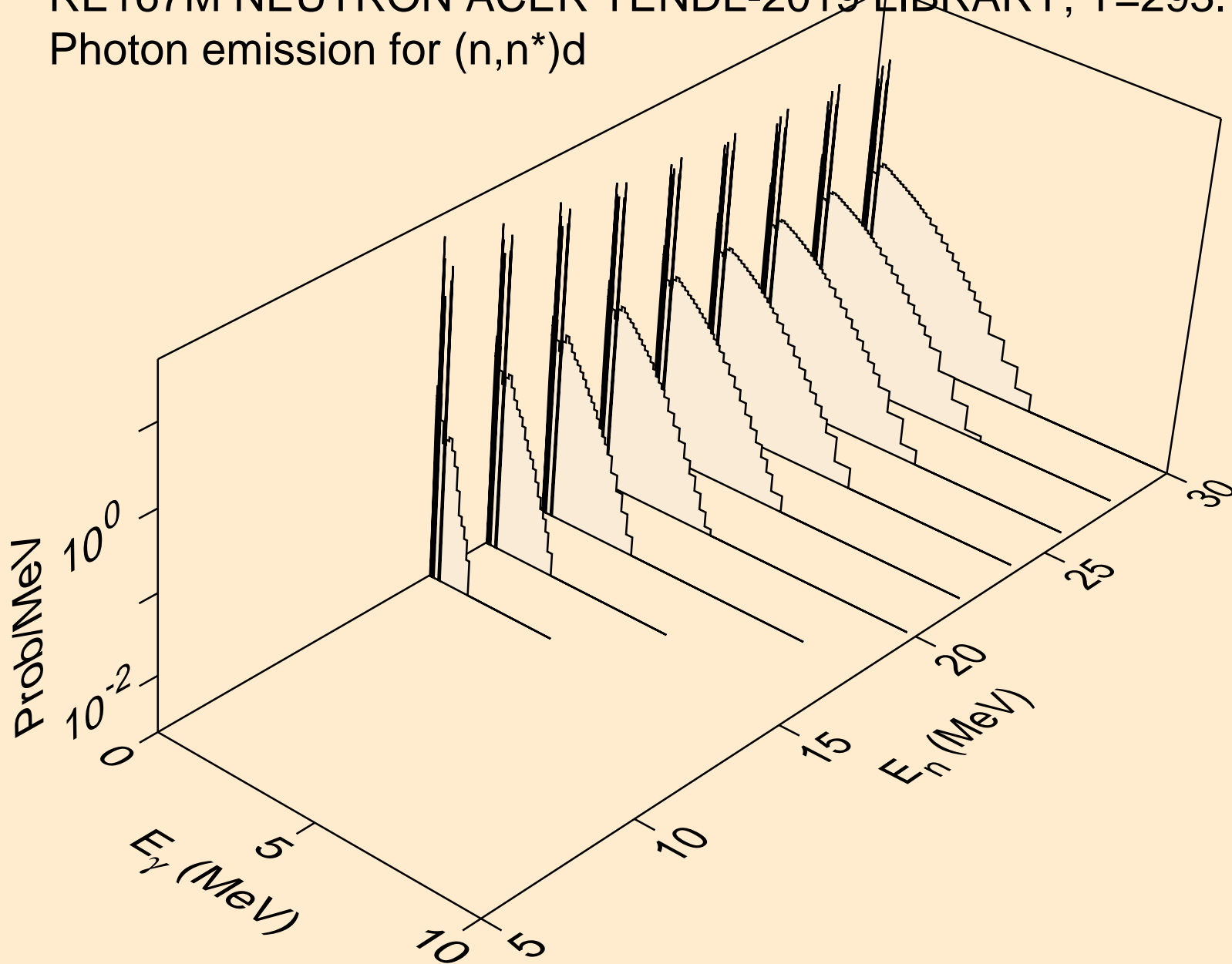

RE167M NEUTRON ACER TENDL-2019 LIBRARY; T=293.16K
Photon emission for (n,n*)t

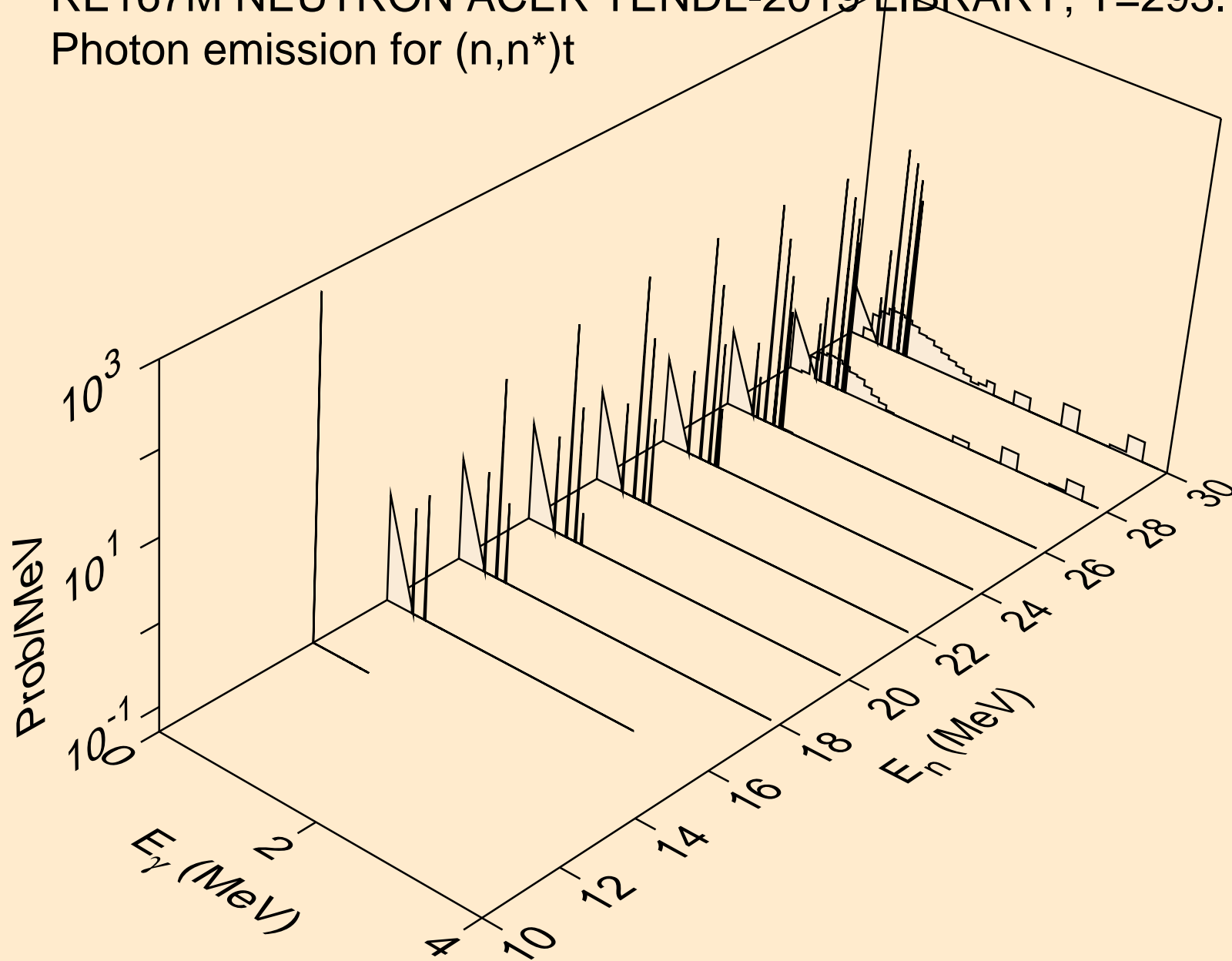

RE167M NEUTRON ACER TENDL-2019 LIBRARY; T=293.16K
Photon emission for (n,n*)he3

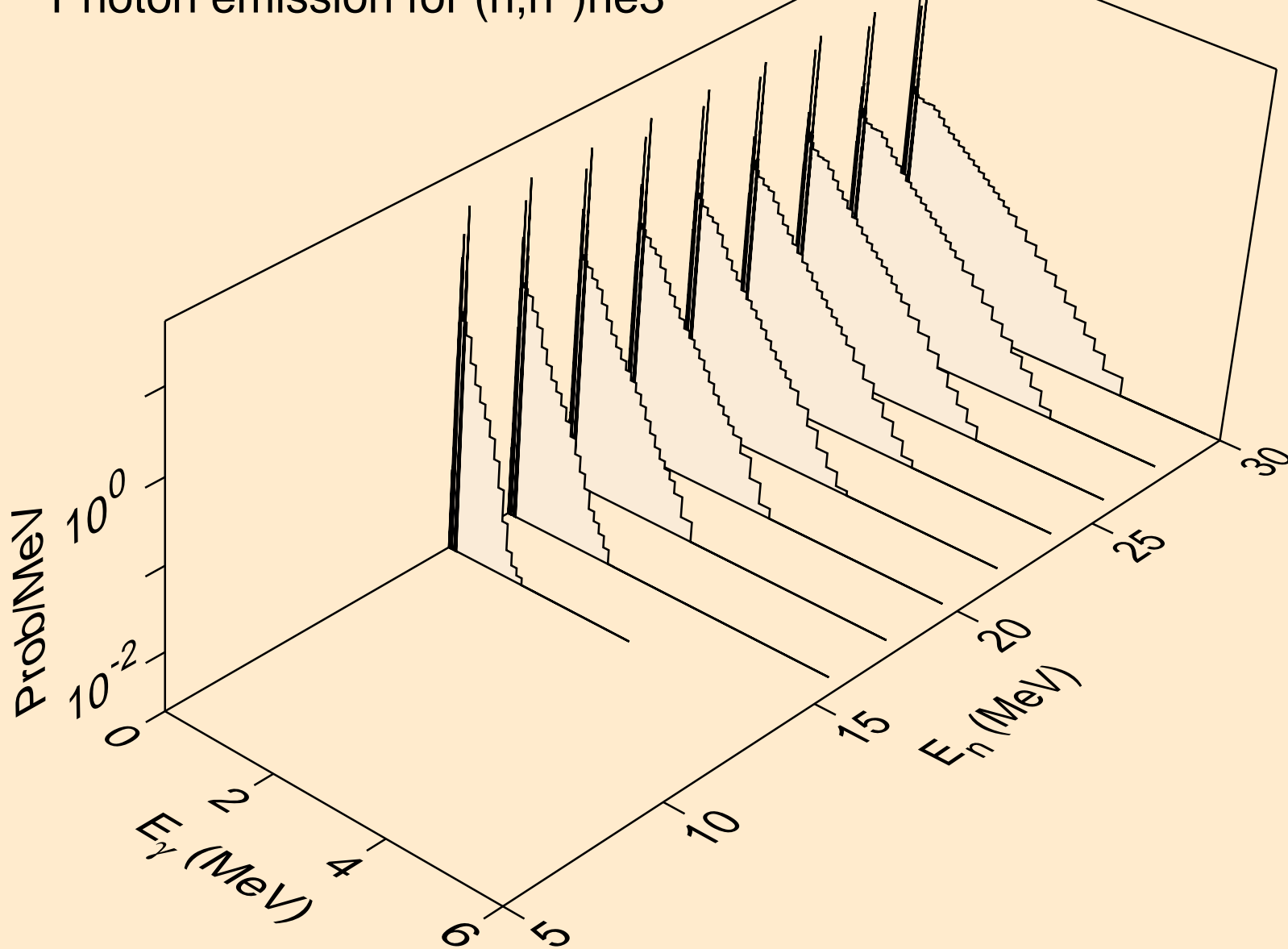

RE167M NEUTRON ACER TENDL-2019 LIBRARY; T=293.16K
Photon emission for (n,2np)

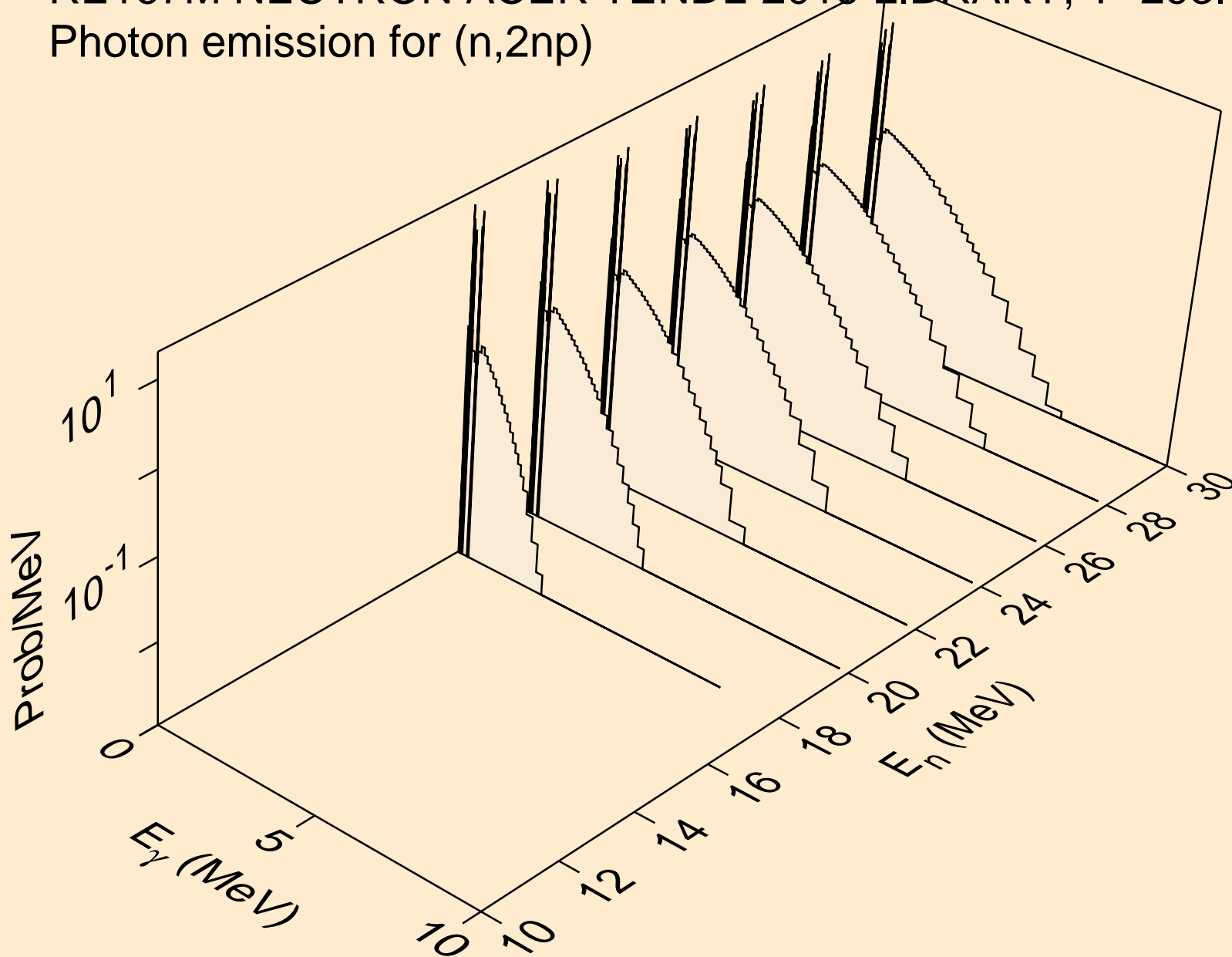

RE167M NEUTRON ACER TENDL-2019 LIBRARY; T=293.16K
Photon emission for (n,3np)

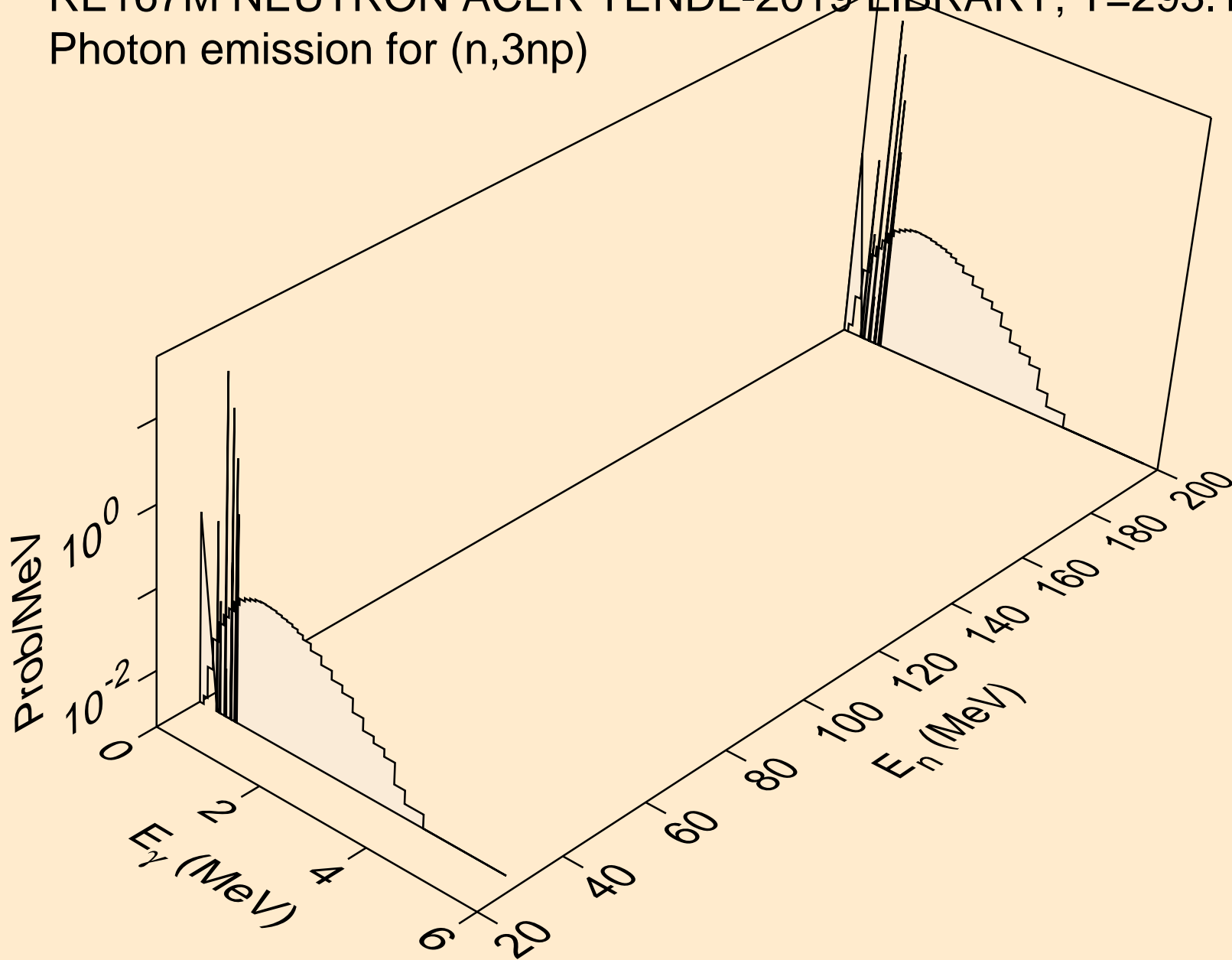

RE167M NEUTRON ACER TENDL-2019 LIBRARY; T=293.16K
Photon emission for (n,2np)

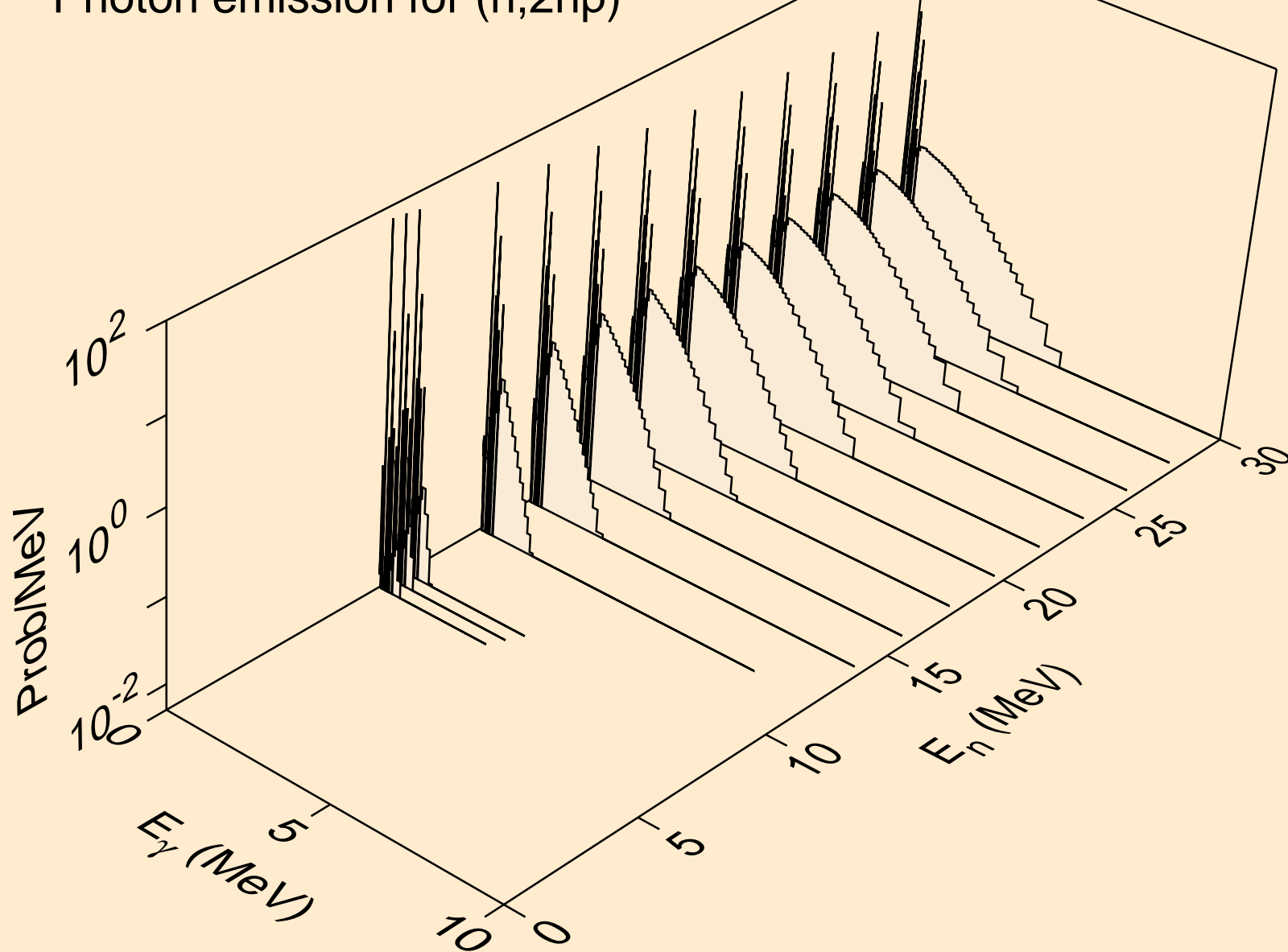

RE167M NEUTRON ACER TENDL-2019 LIBRARY; T=293.16K
Photon emission for (n,npa)

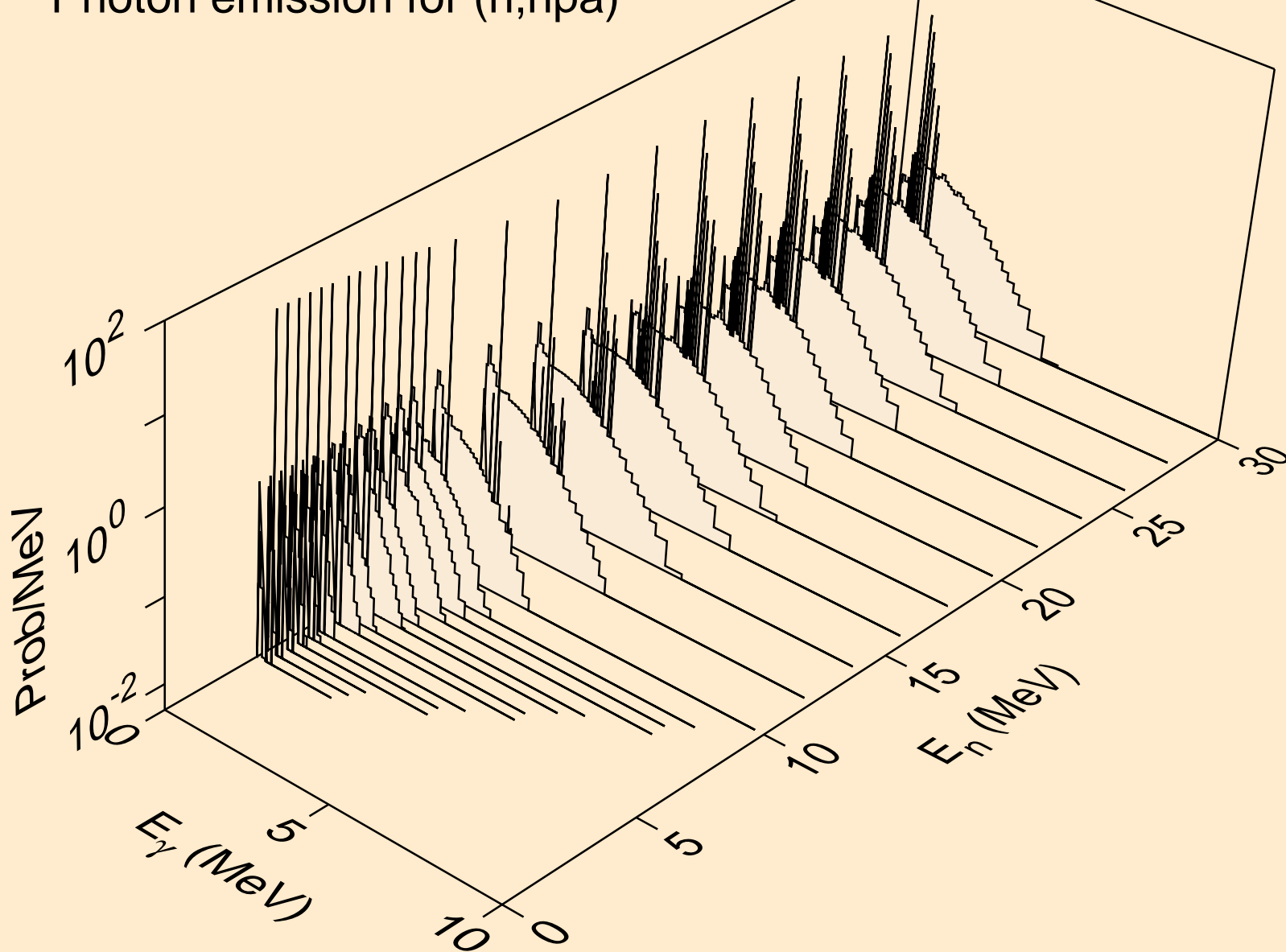

RE167M NEUTRON ACER TENDL-2019 LIBRARY; T=293.16K
Photon emission for (n,n*1)

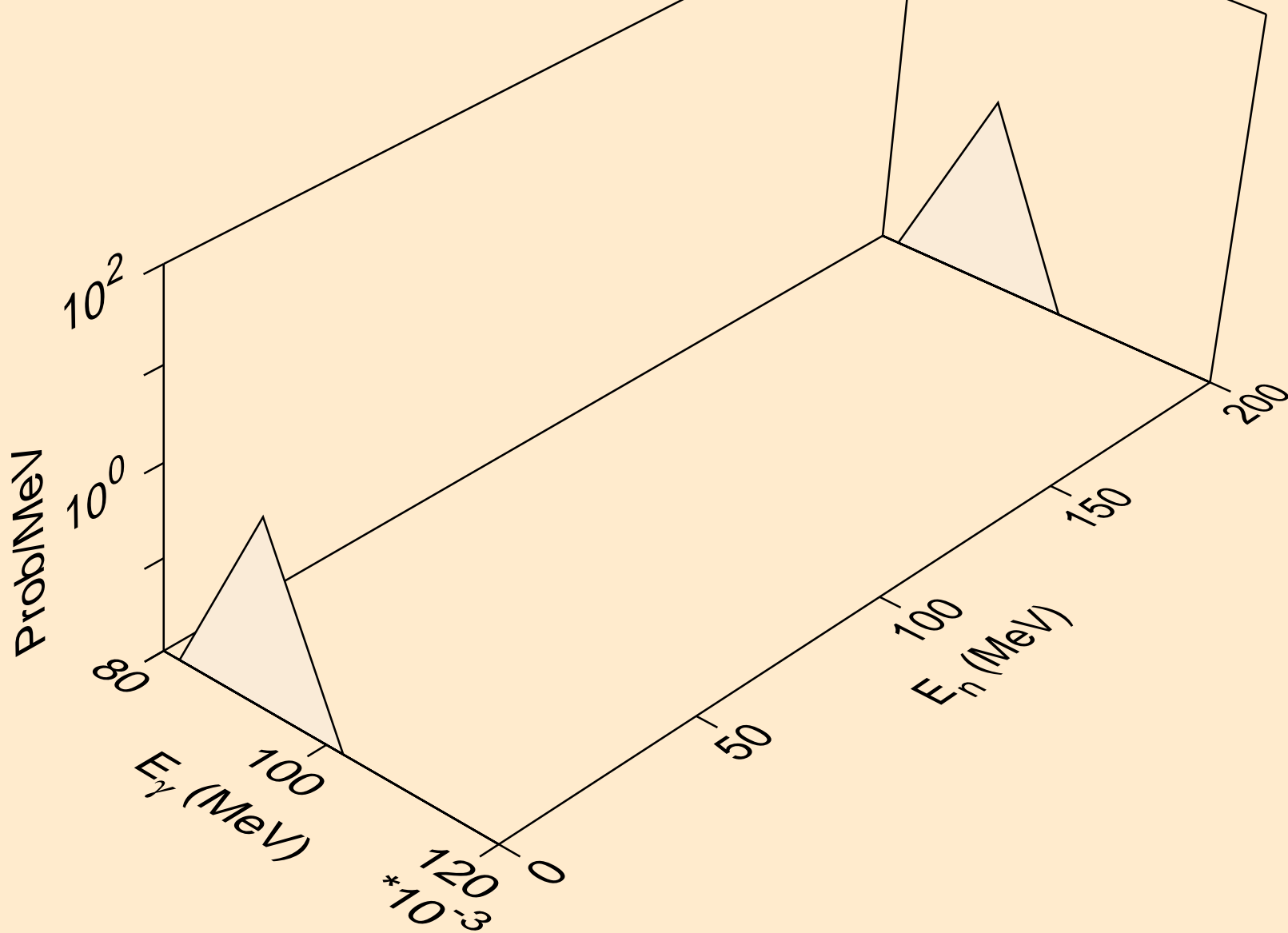

RE167M NEUTRON ACER TENDL-2019 LIBRARY; T=293.16K
Photon emission for (n,n*3)

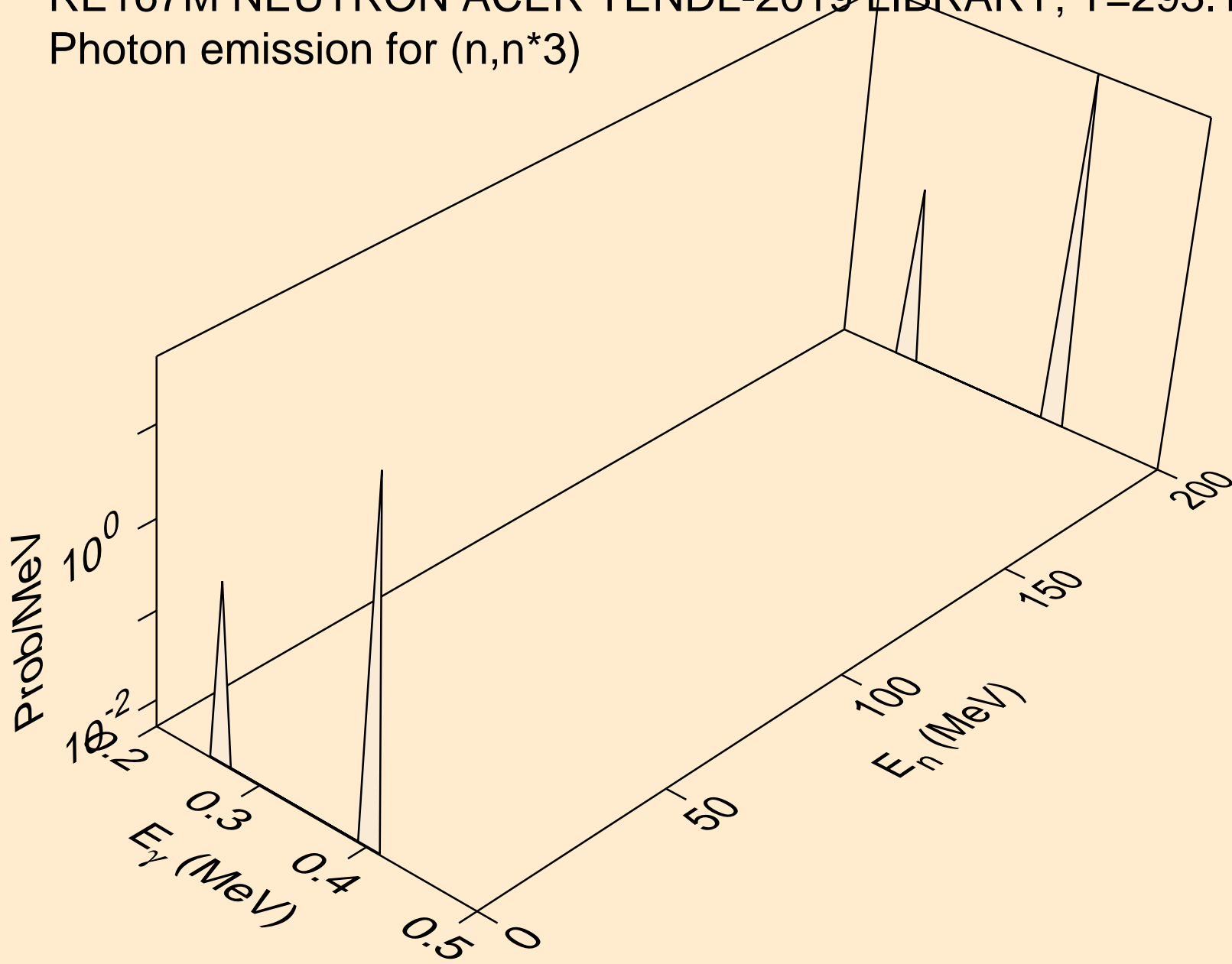

RE167M NEUTRON ACER TENDL-2019 LIBRARY; T=293.16K
Photon emission for (n,n*4)

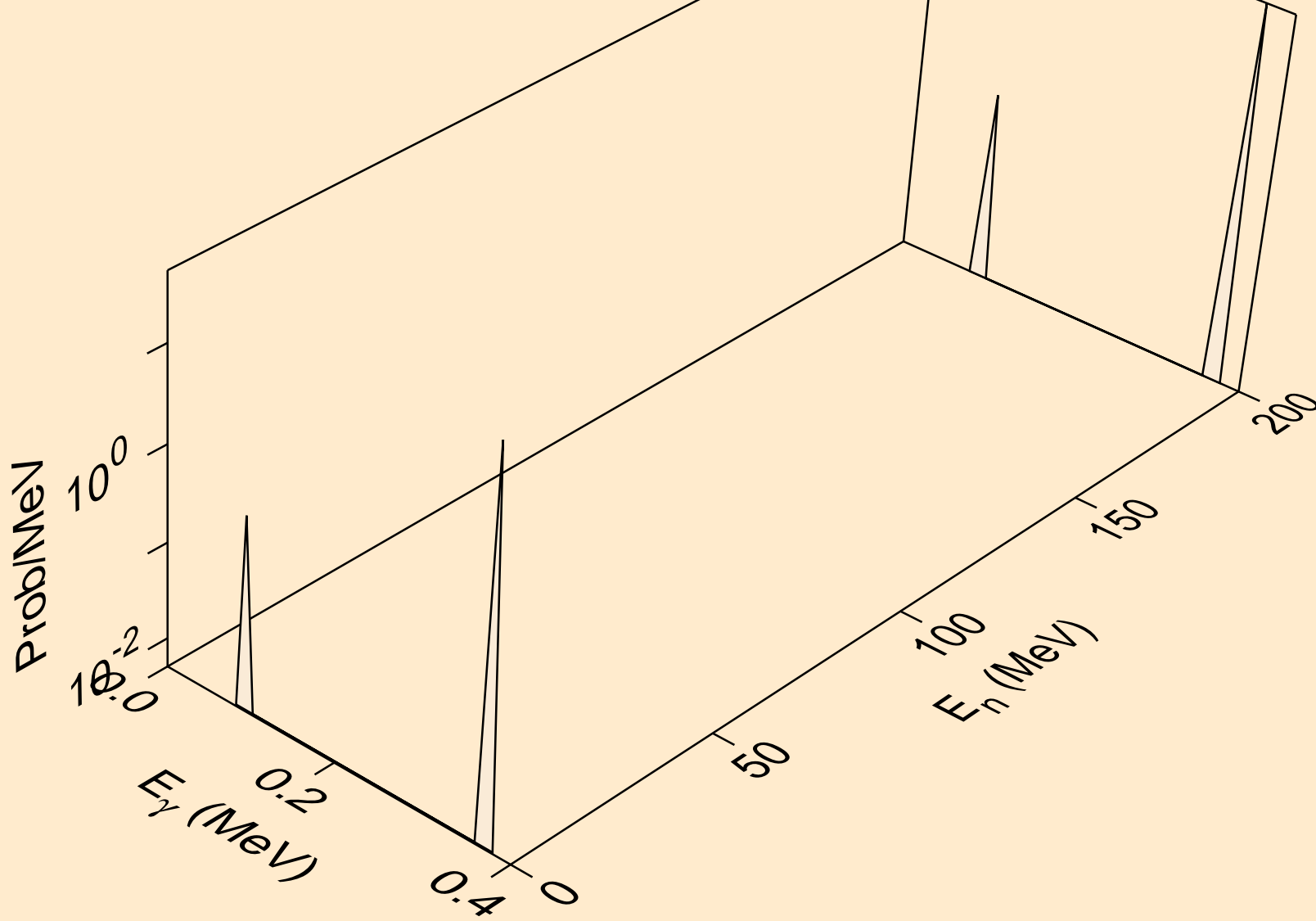

RE167M NEUTRON ACER TENDL-2019 LIBRARY; T=293.16K
Photon emission for (n,n*5)

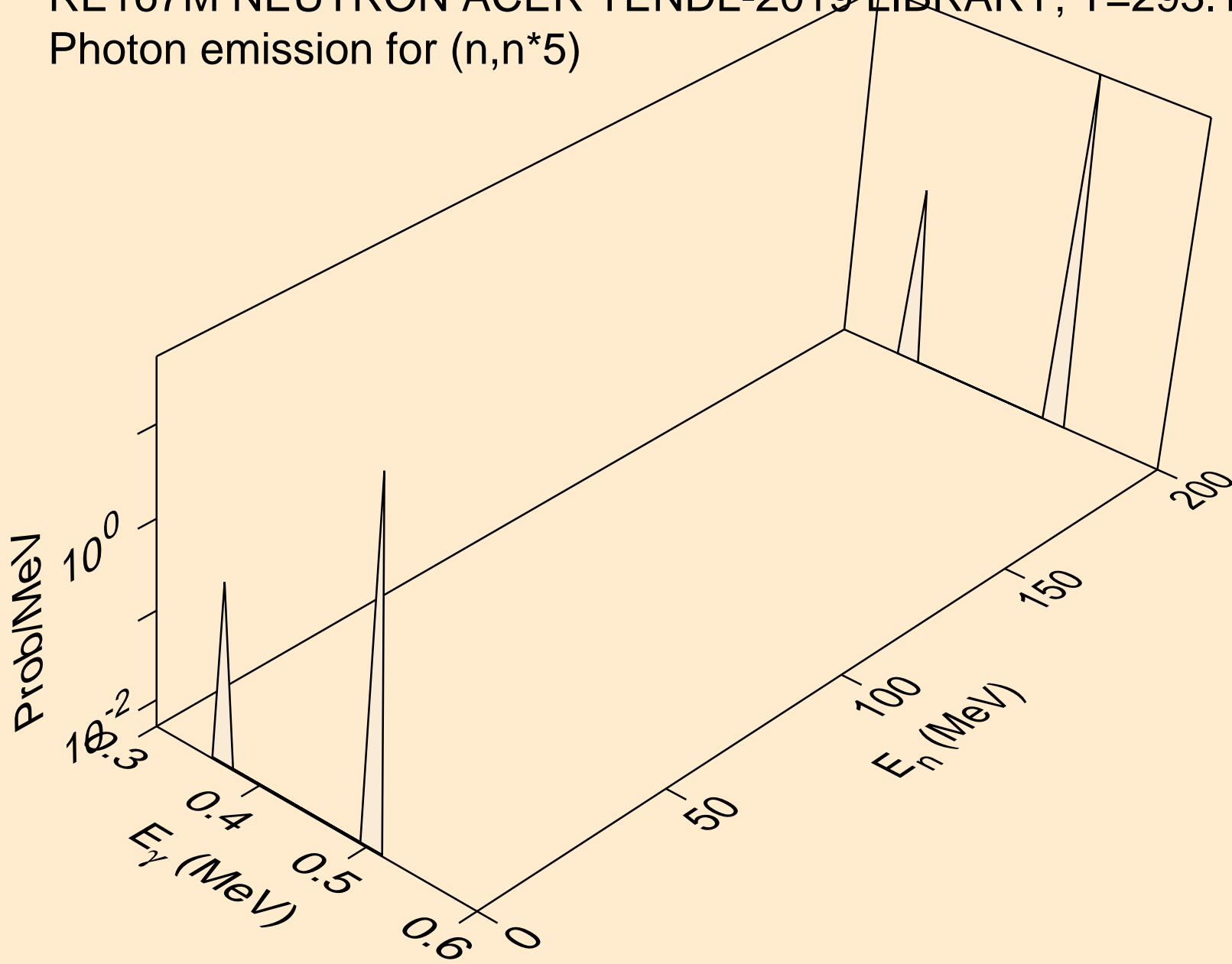

RE167M NEUTRON ACER TENDL-2019 LIBRARY; T=293.16K
Photon emission for (n,n*6)

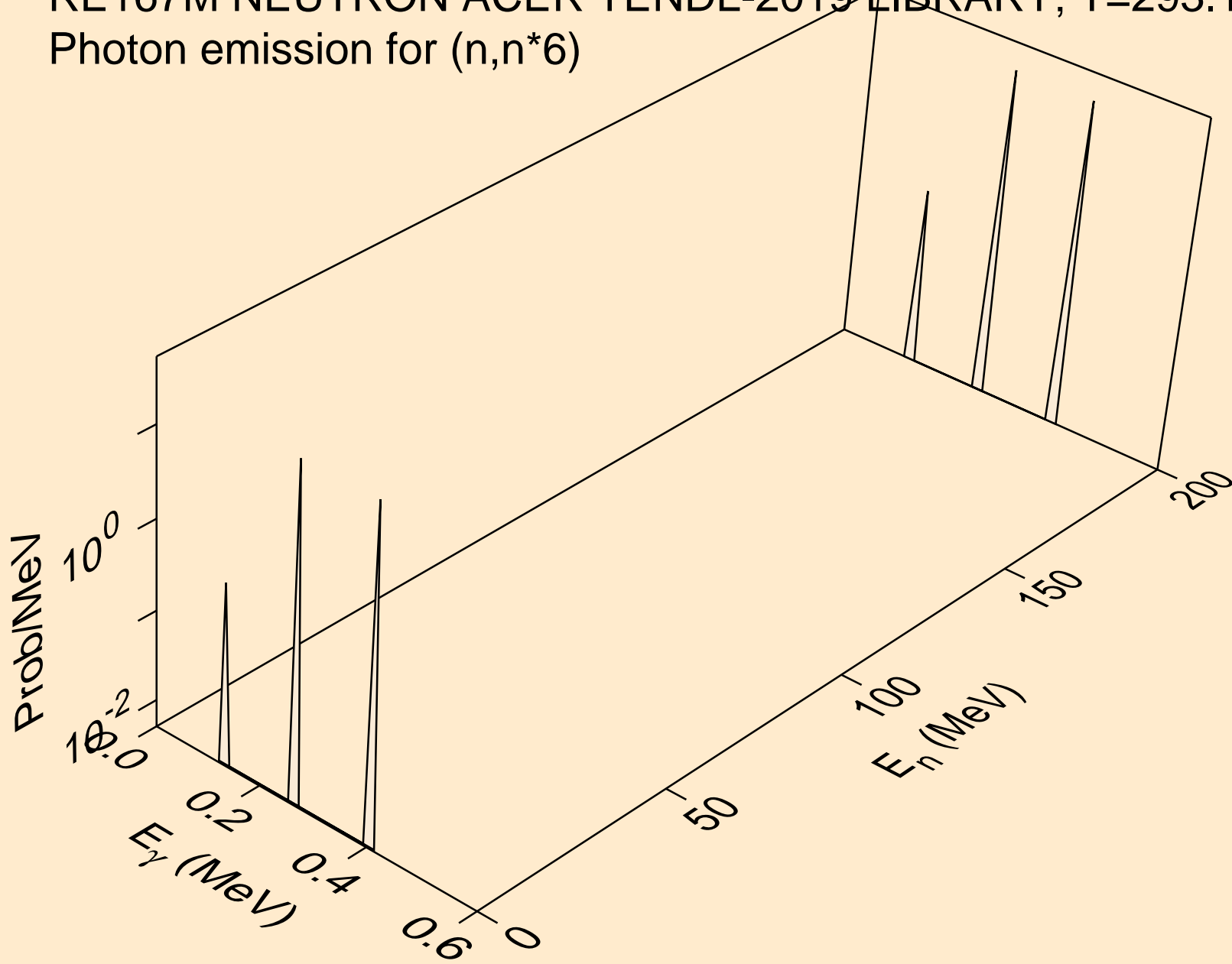

RE167M NEUTRON ACER TENDL-2019 LIBRARY; T=293.16K
Photon emission for (n,n*7)

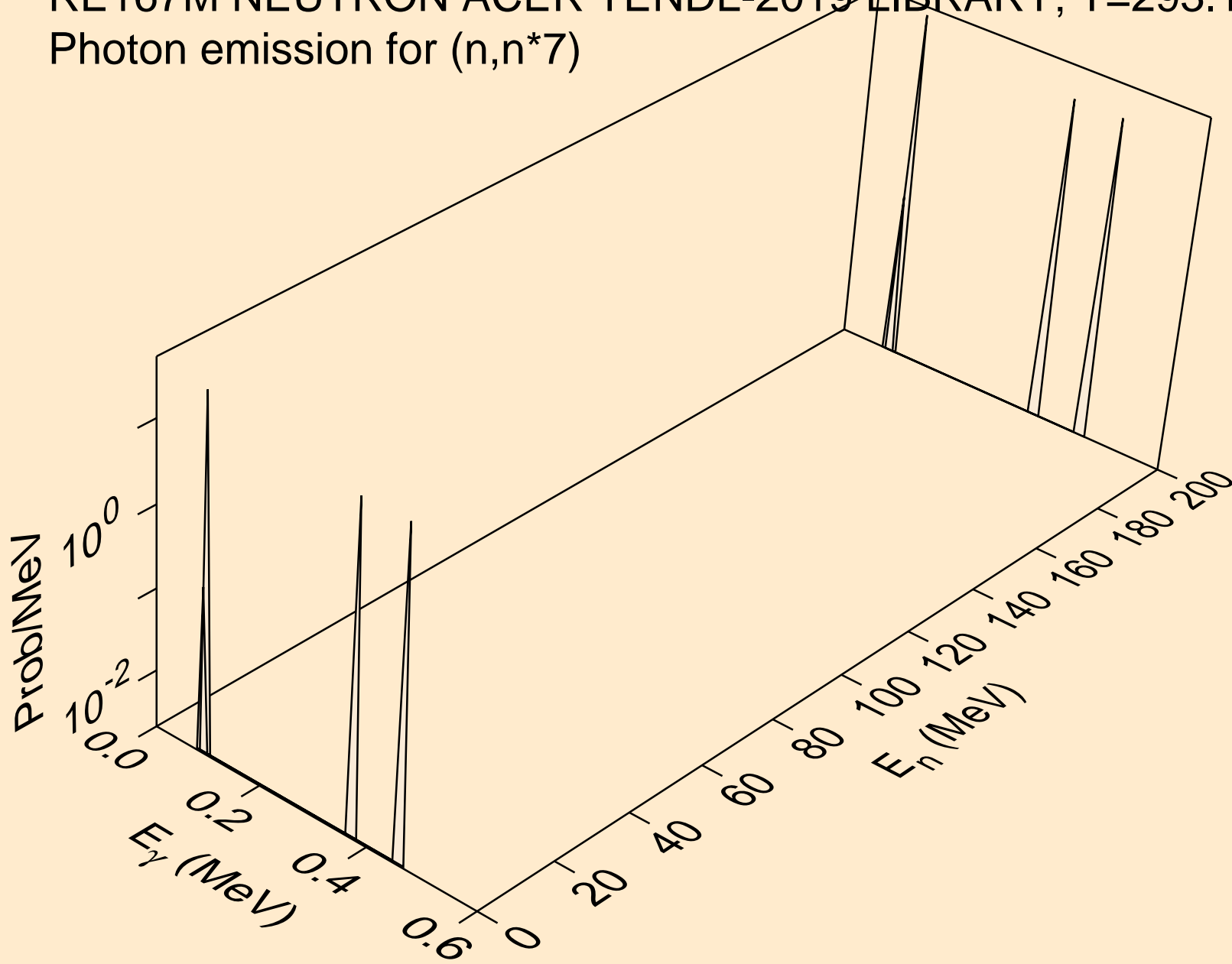

RE167M NEUTRON ACER TENDL-2019 LIBRARY; T=293.16K
Photon emission for (n,n*8)

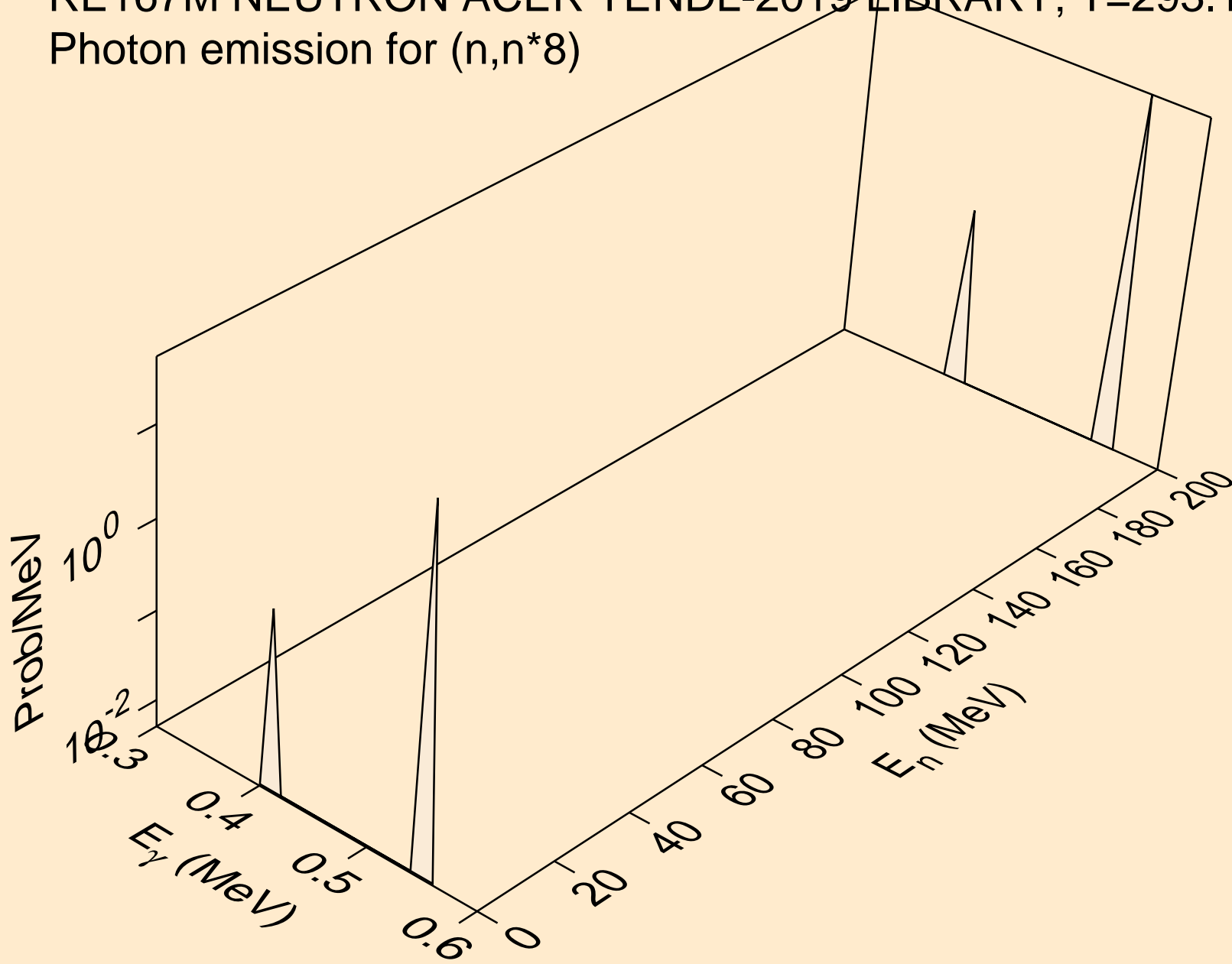

RE167M NEUTRON ACER TENDL-2019 LIBRARY; T=293.16K
Photon emission for (n,n*9)

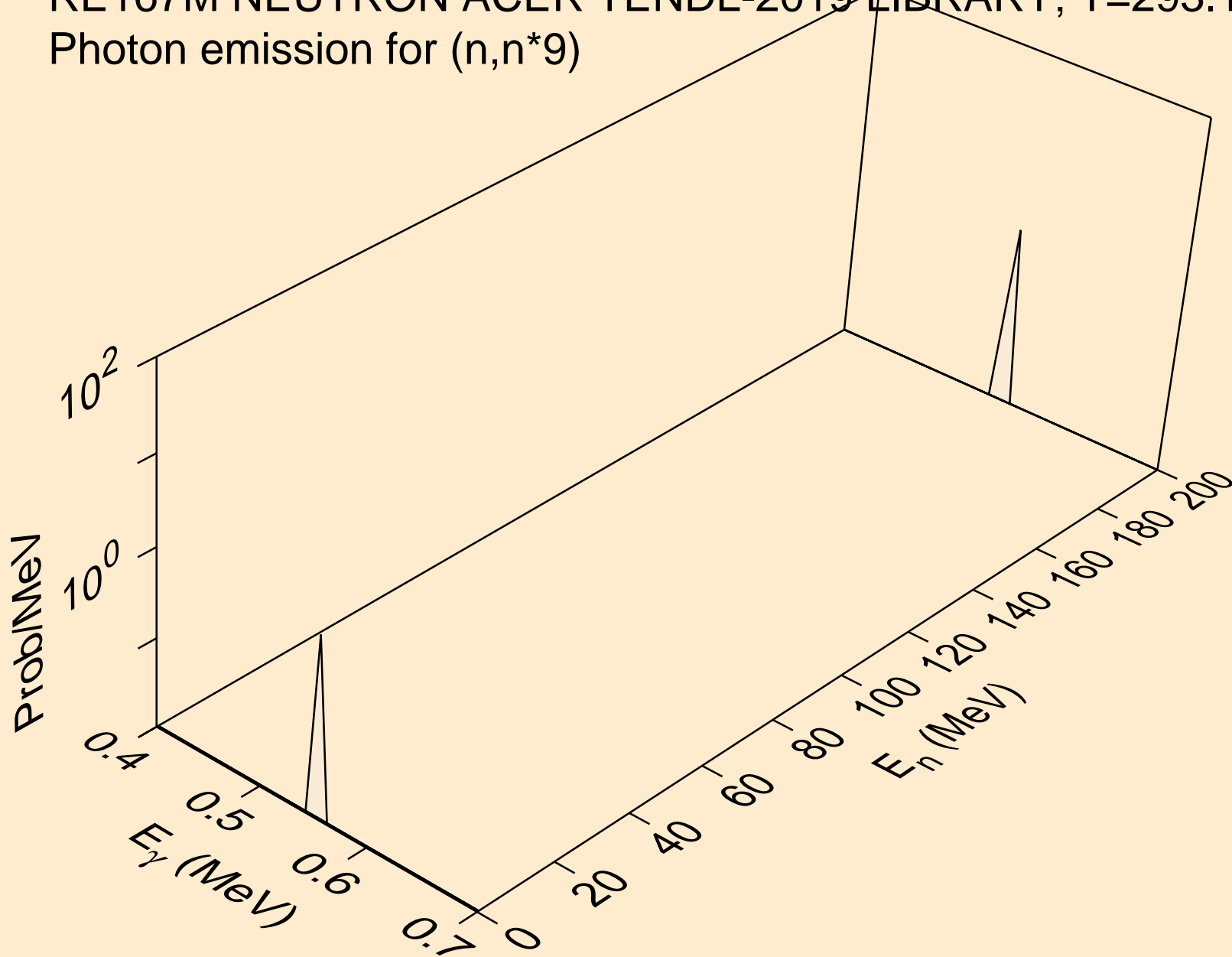

RE167M NEUTRON ACER TENDL-2019 LIBRARY; T=293.16K
Photon emission for (n,n*10)

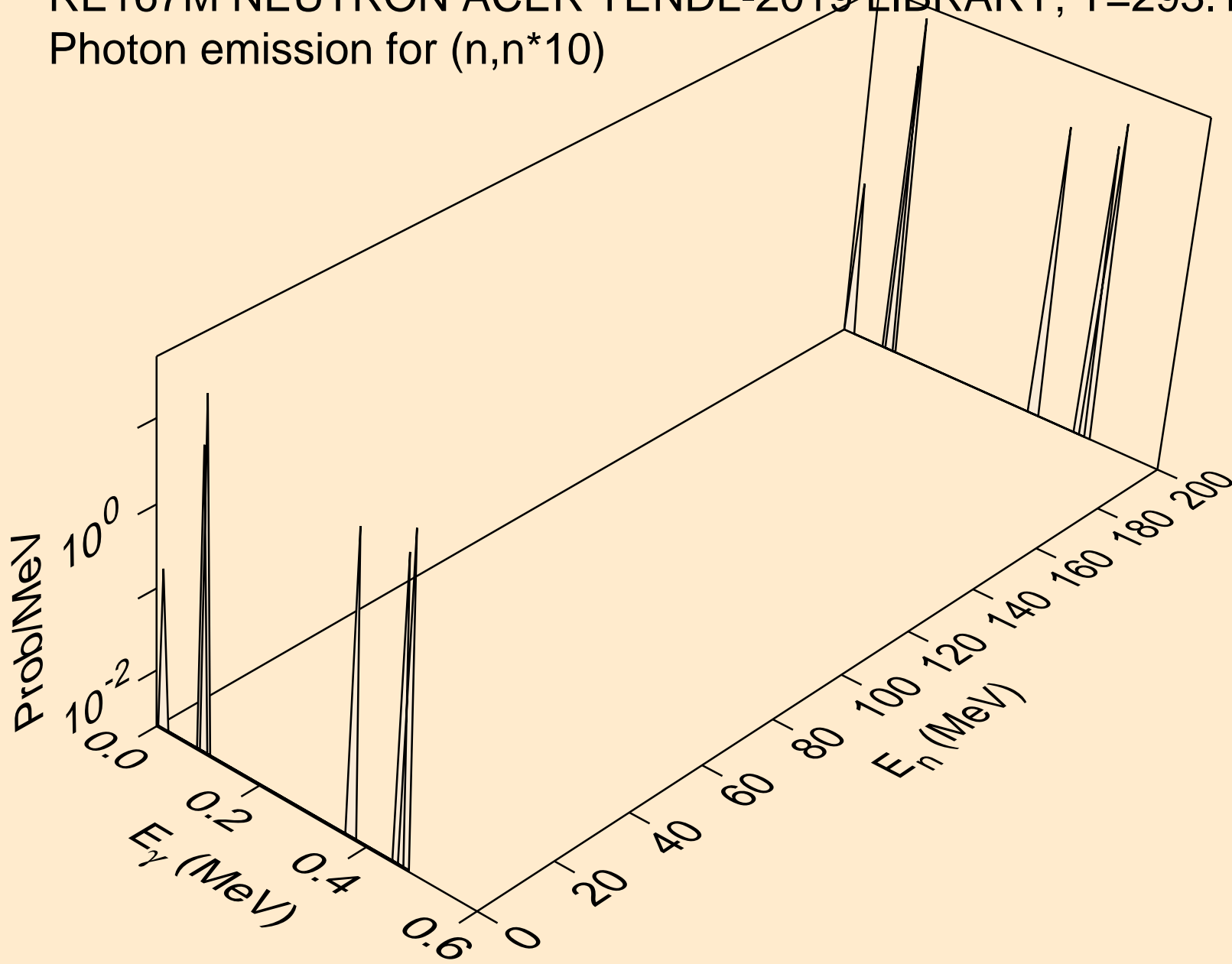

RE167M NEUTRON ACER TENDL-2019 LIBRARY; T=293.16K
Photon emission for (n,n*11)

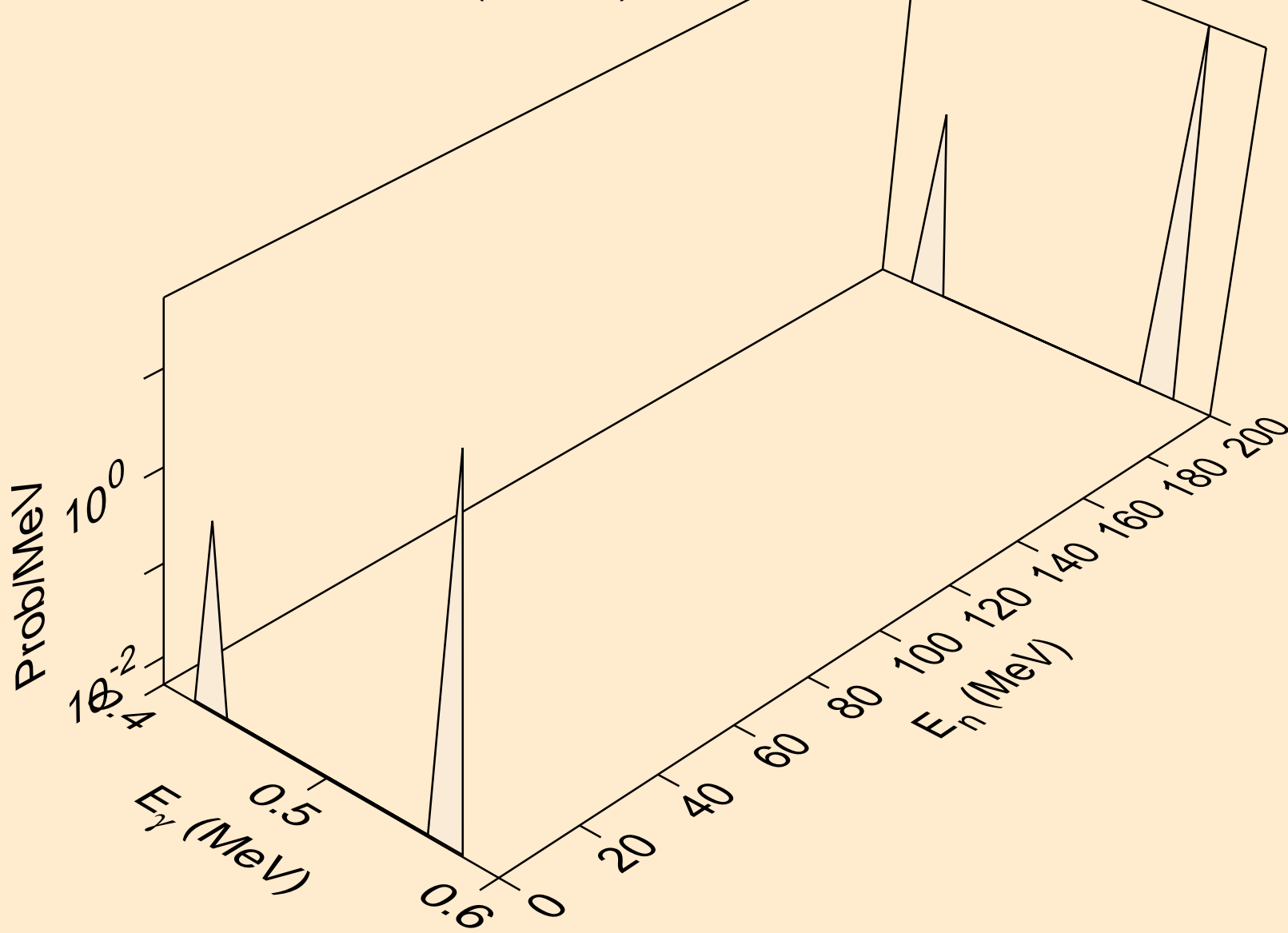

RE167M NEUTRON ACER TENDL-2019 LIBRARY; T=293.16K
Photon emission for (n,n*12)

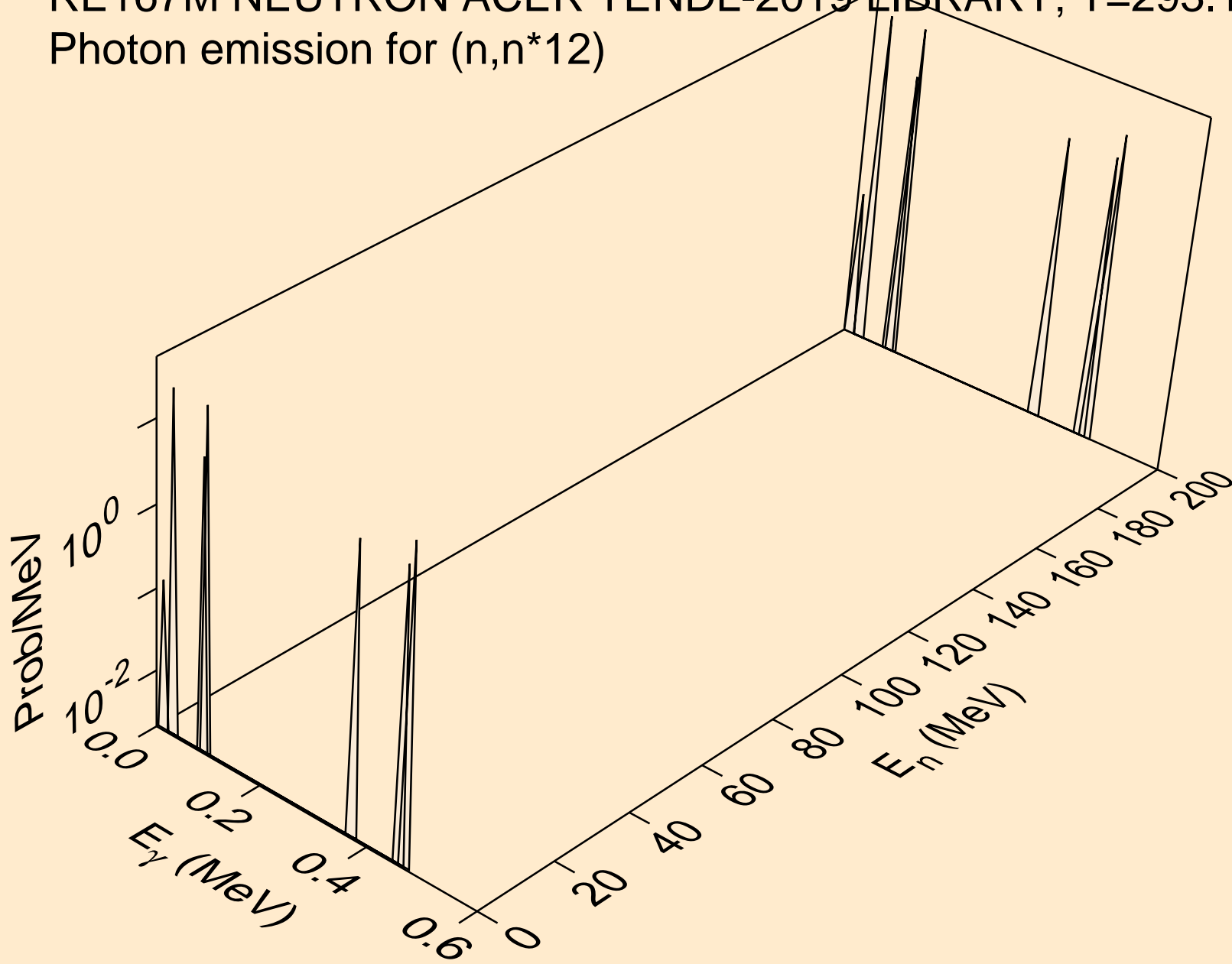

RE167M NEUTRON ACER TENDL-2019 LIBRARY; T=293.16K
Photon emission for (n,n*13)

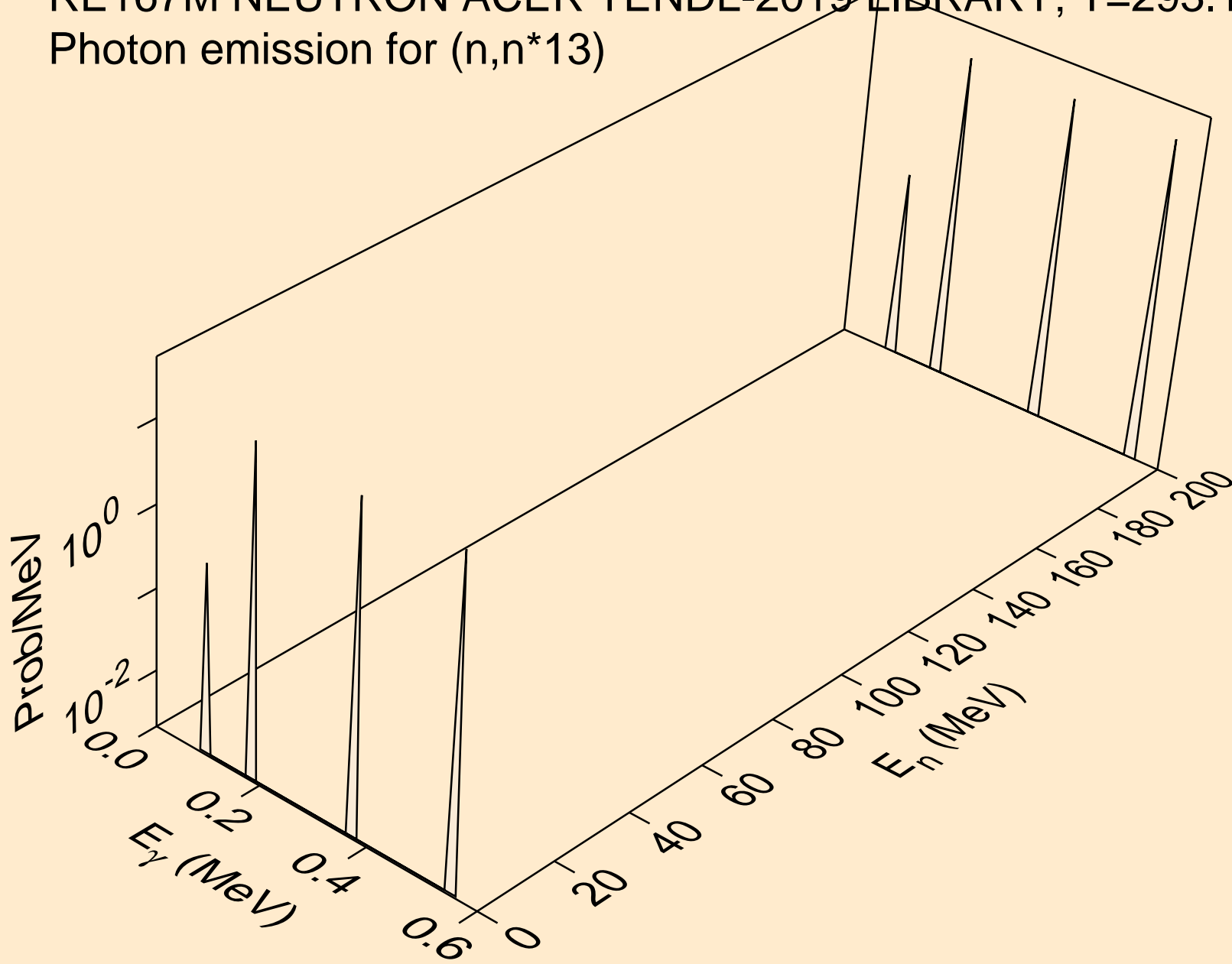

RE167M NEUTRON ACER TENDL-2019 LIBRARY; T=293.16K
Photon emission for (n,n*14)

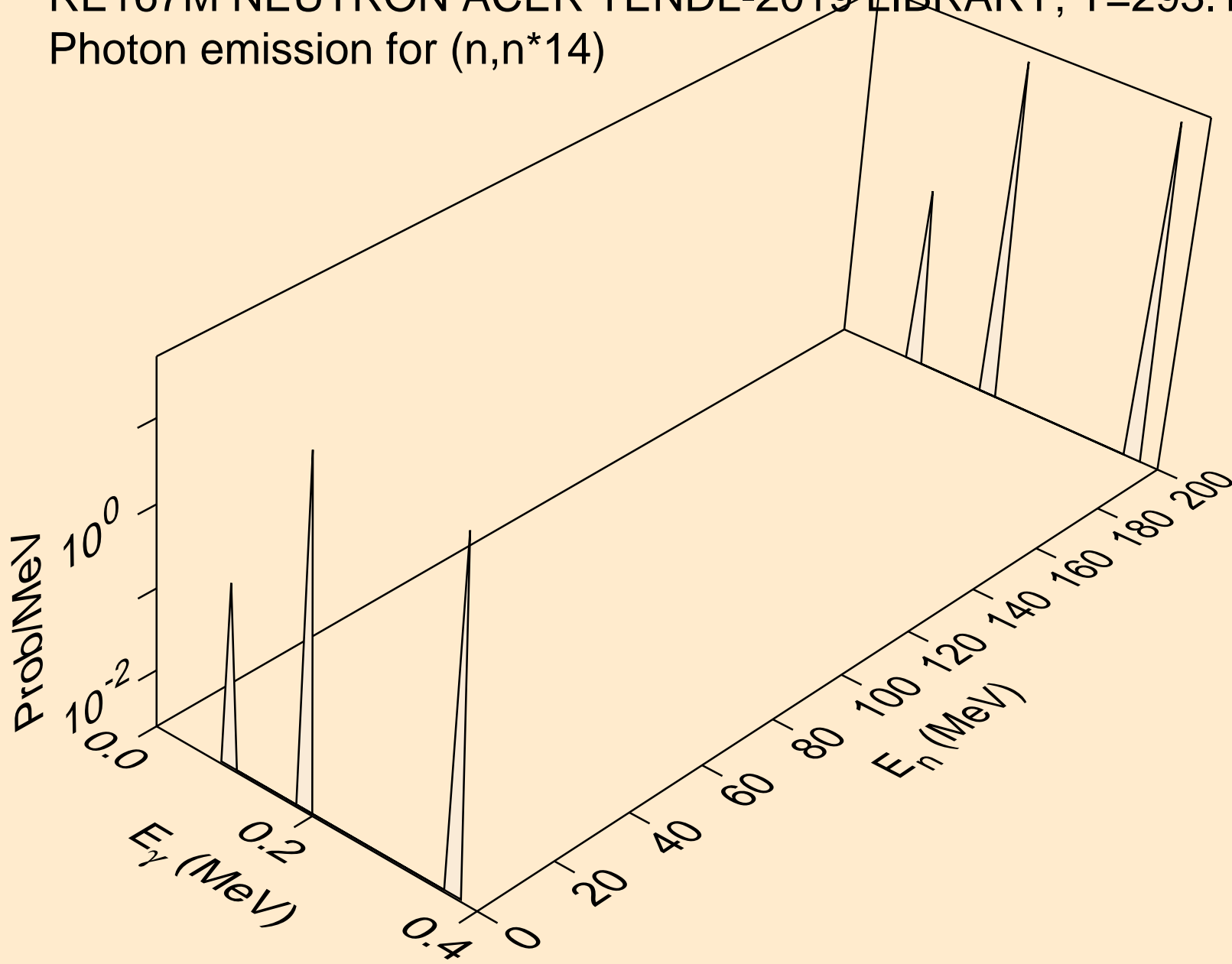

RE167M NEUTRON ACER TENDL-2019 LIBRARY; T=293.16K
Photon emission for (n,n*15)

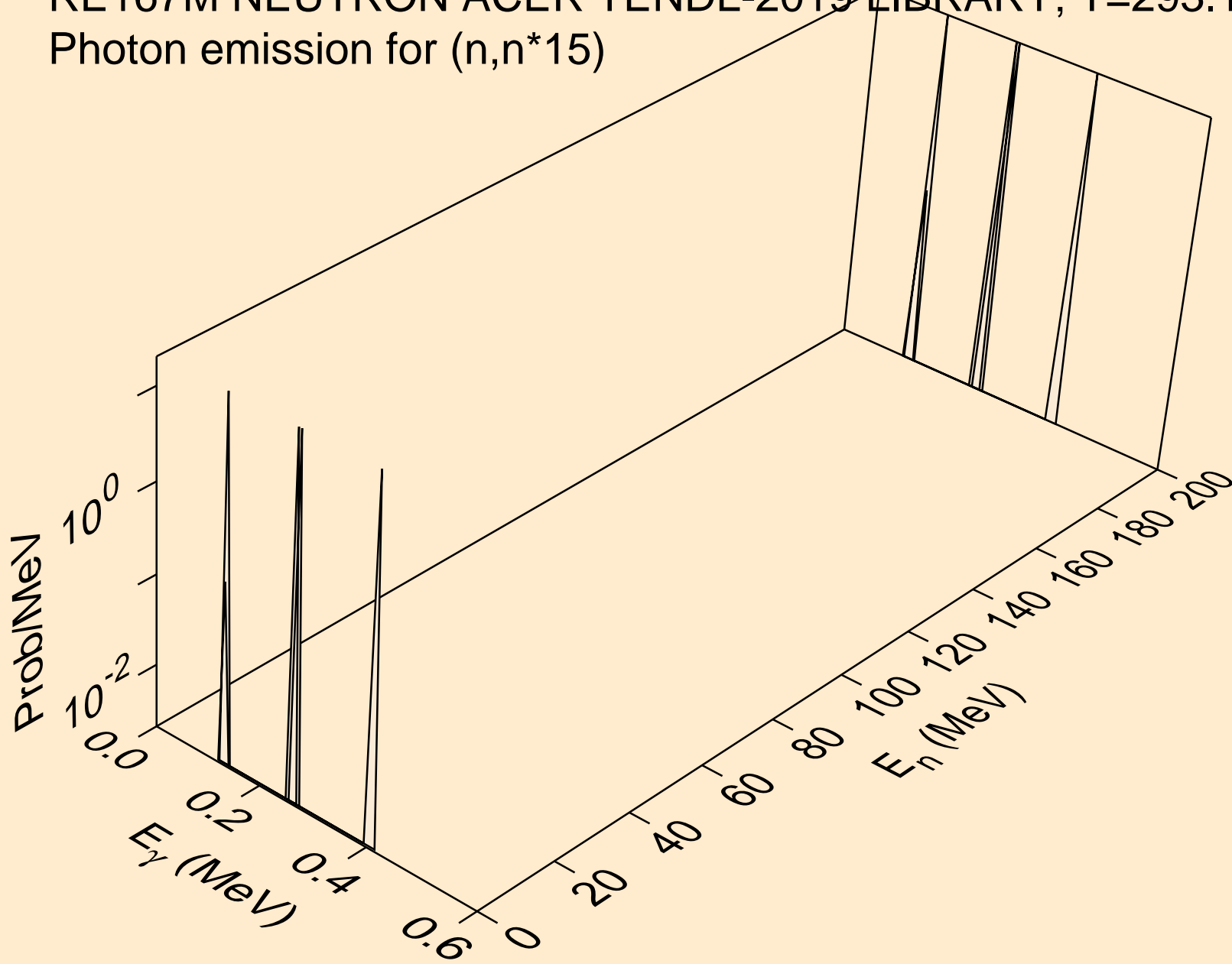

RE167M NEUTRON ACER TENDL-2019 LIBRARY; T=293.16K
Photon emission for (n,n*16)

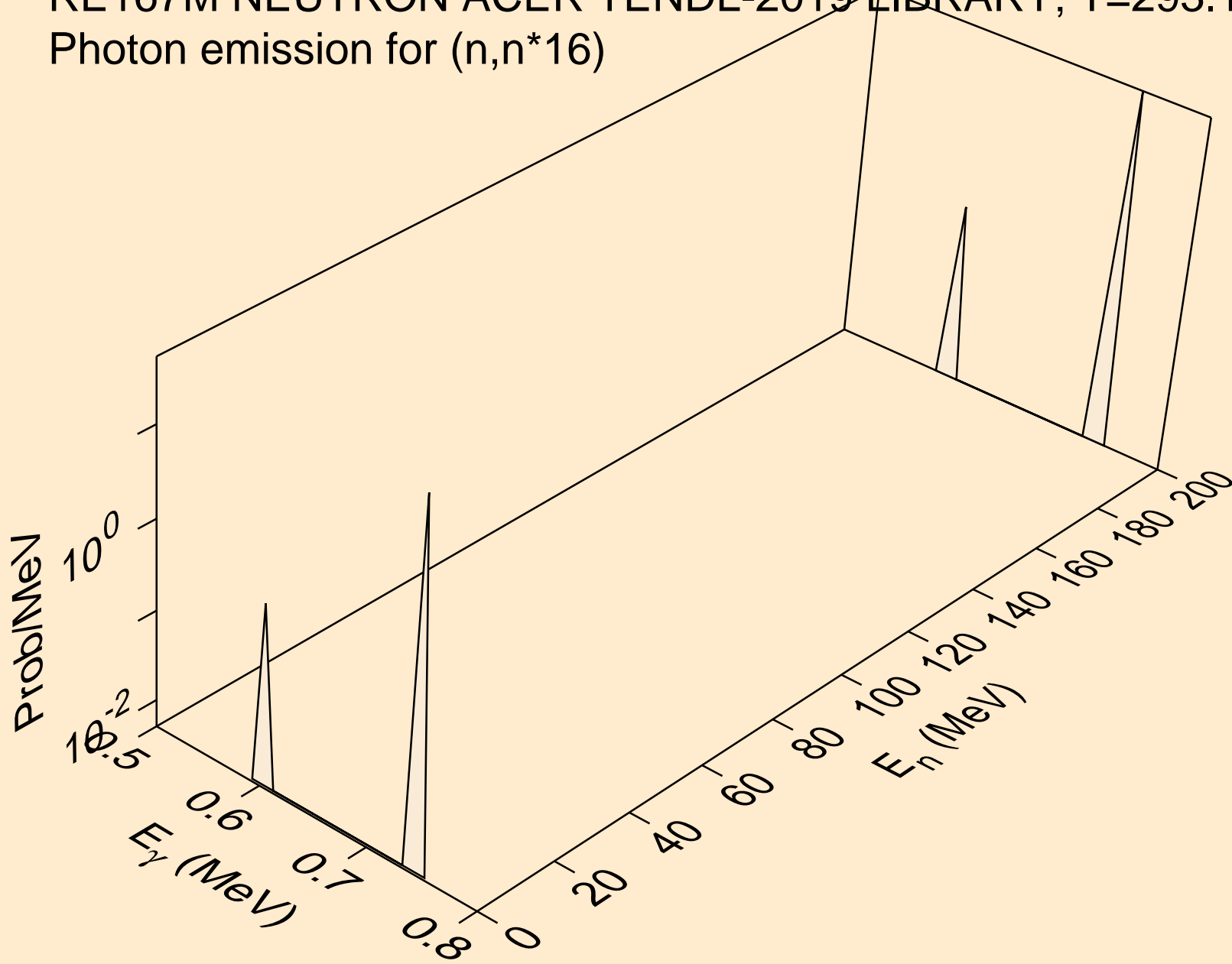

RE167M NEUTRON ACER TENDL-2019 LIBRARY; T=293.16K
Photon emission for (n,n*17)

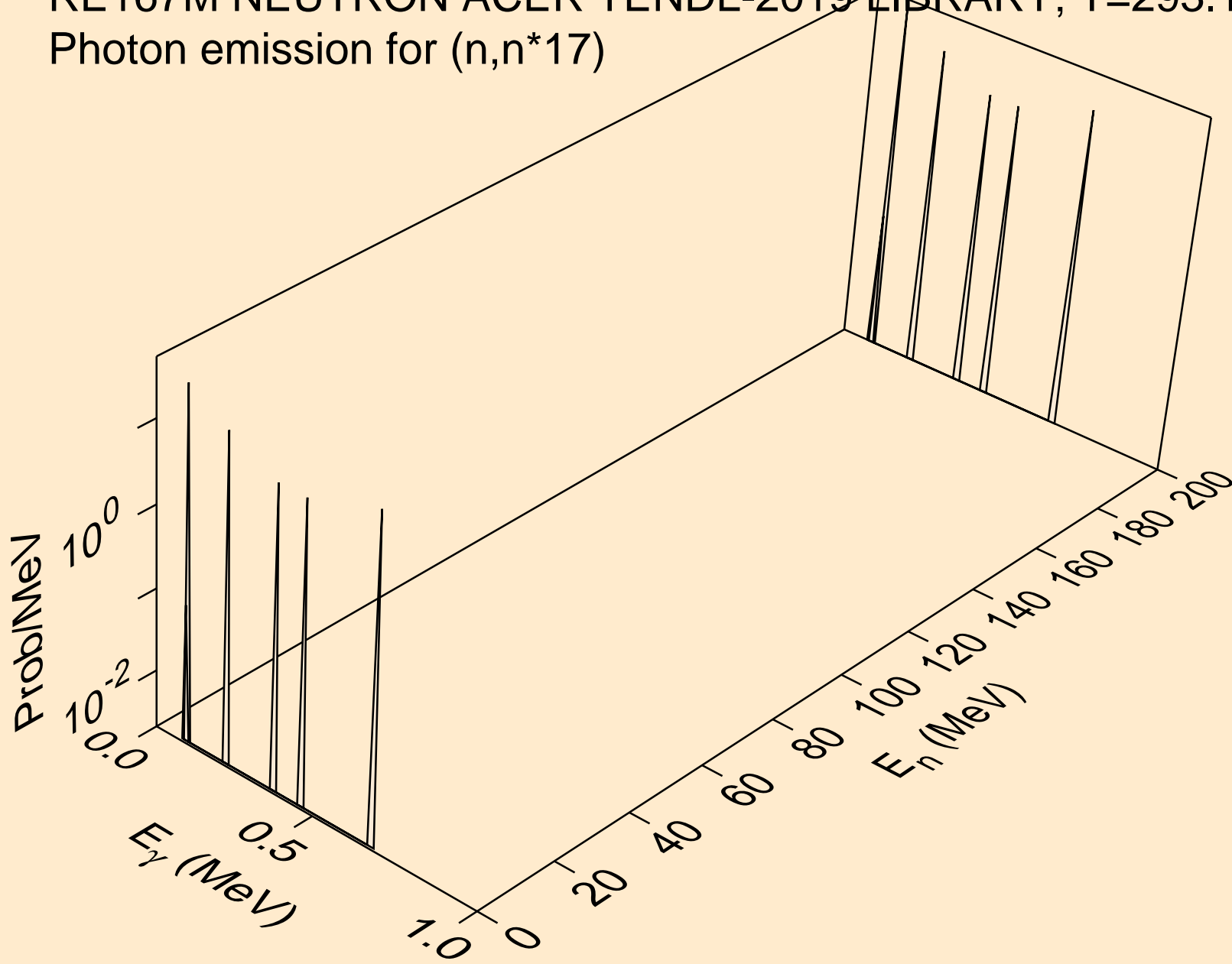

RE167M NEUTRON ACER TENDL-2019 LIBRARY; T=293.16K
Photon emission for (n,n*18)

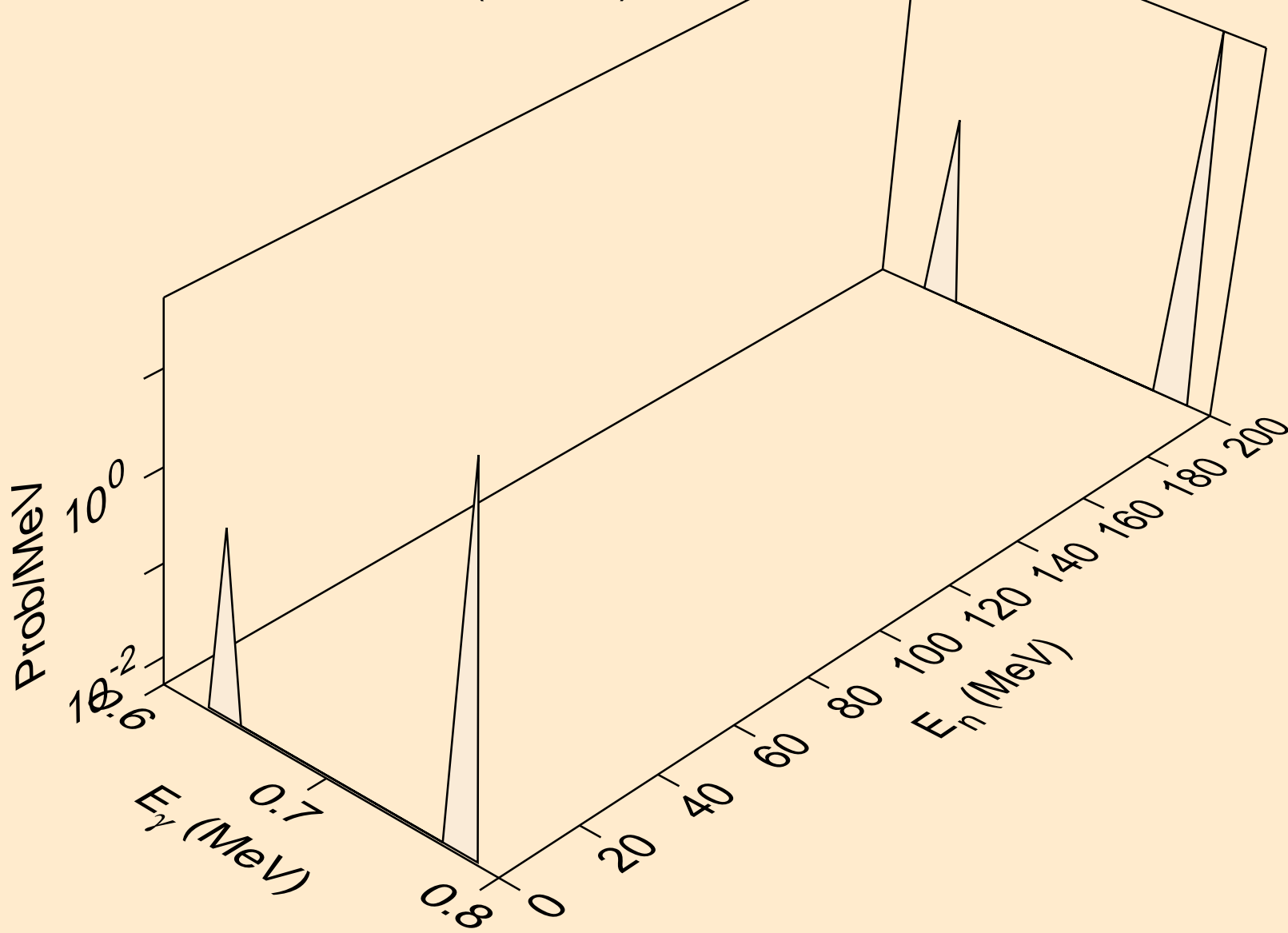

RE167M NEUTRON ACER TENDL-2019 LIBRARY; T=293.16K
Photon emission for (n,n*19)

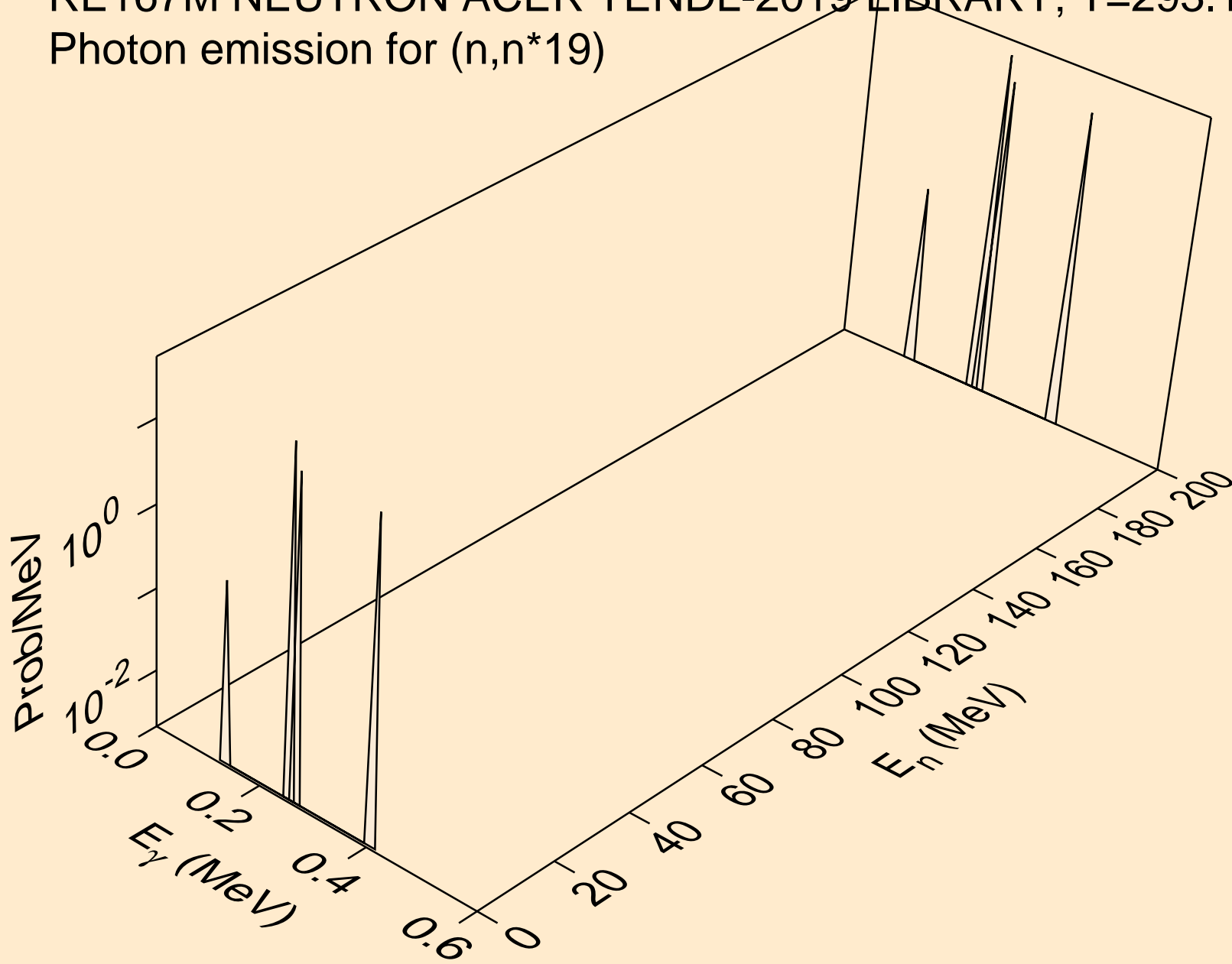

RE167M NEUTRON ACER TENDL-2019 LIBRARY; T=293.16K
Photon emission for (n,n*20)

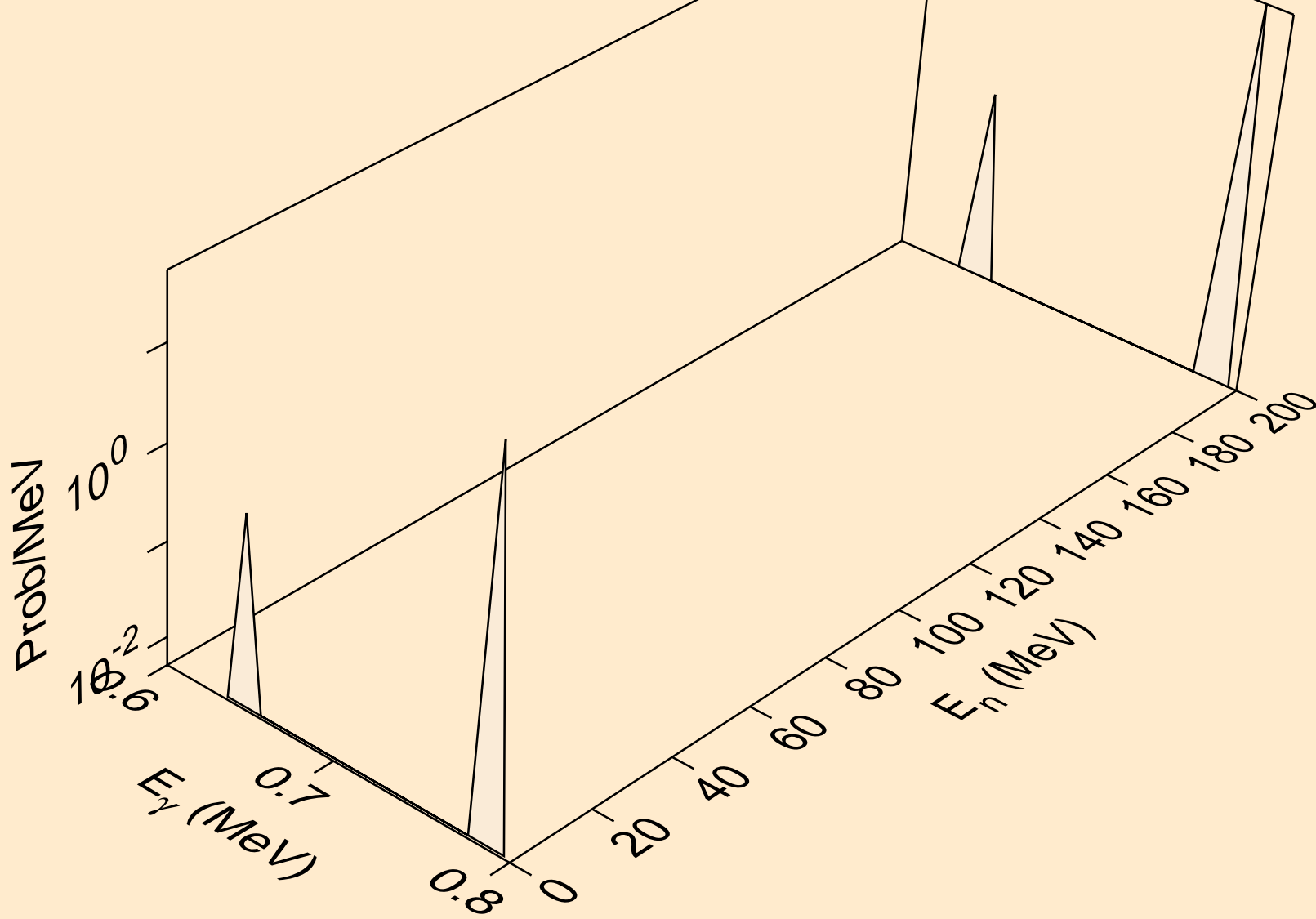

RE167M NEUTRON ACER TENDL-2019 LIBRARY; T=293.16K
Photon emission for (n,n*21)

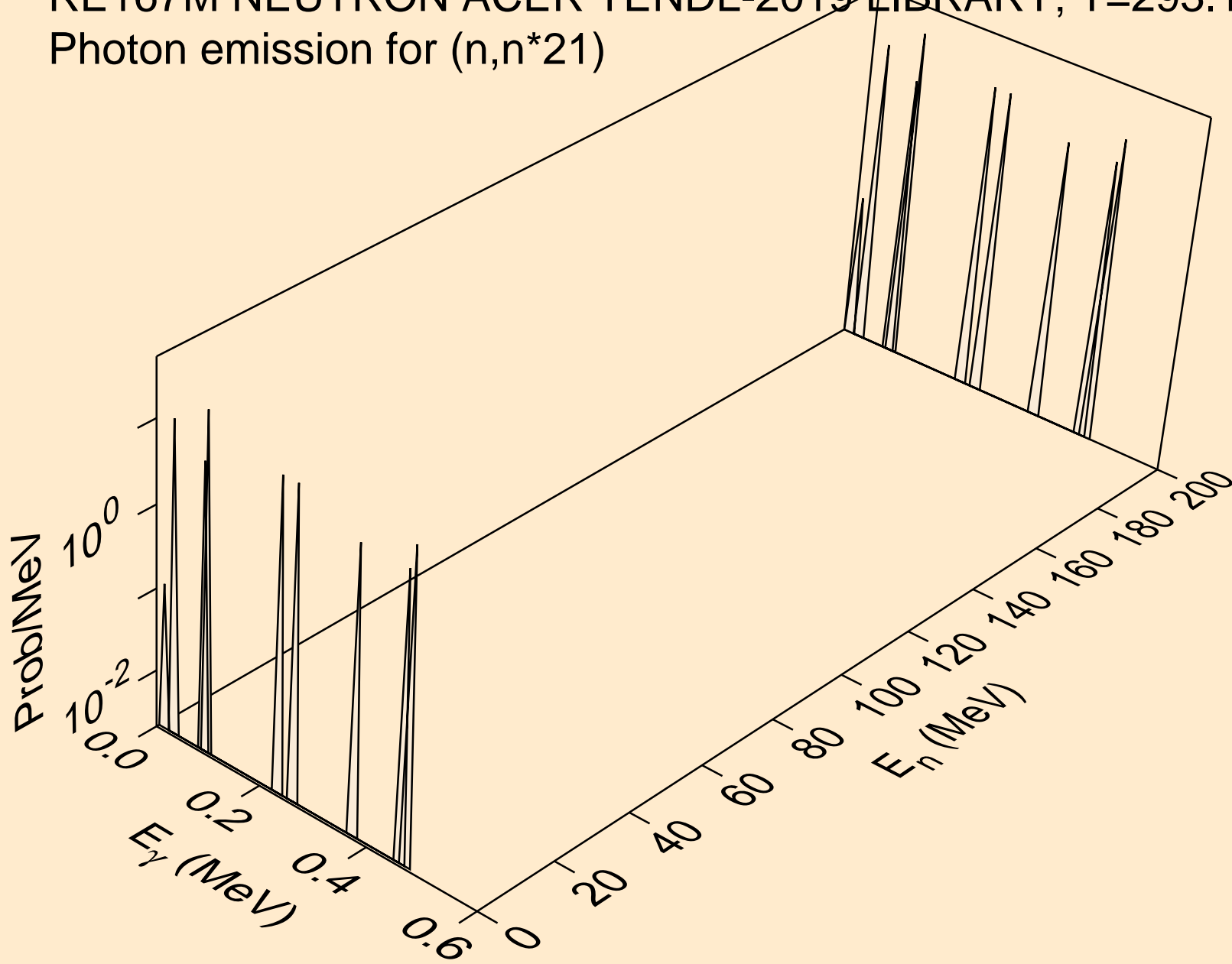

RE167M NEUTRON ACER TENDL-2019 LIBRARY; T=293.16K
Photon emission for (n,n*22)

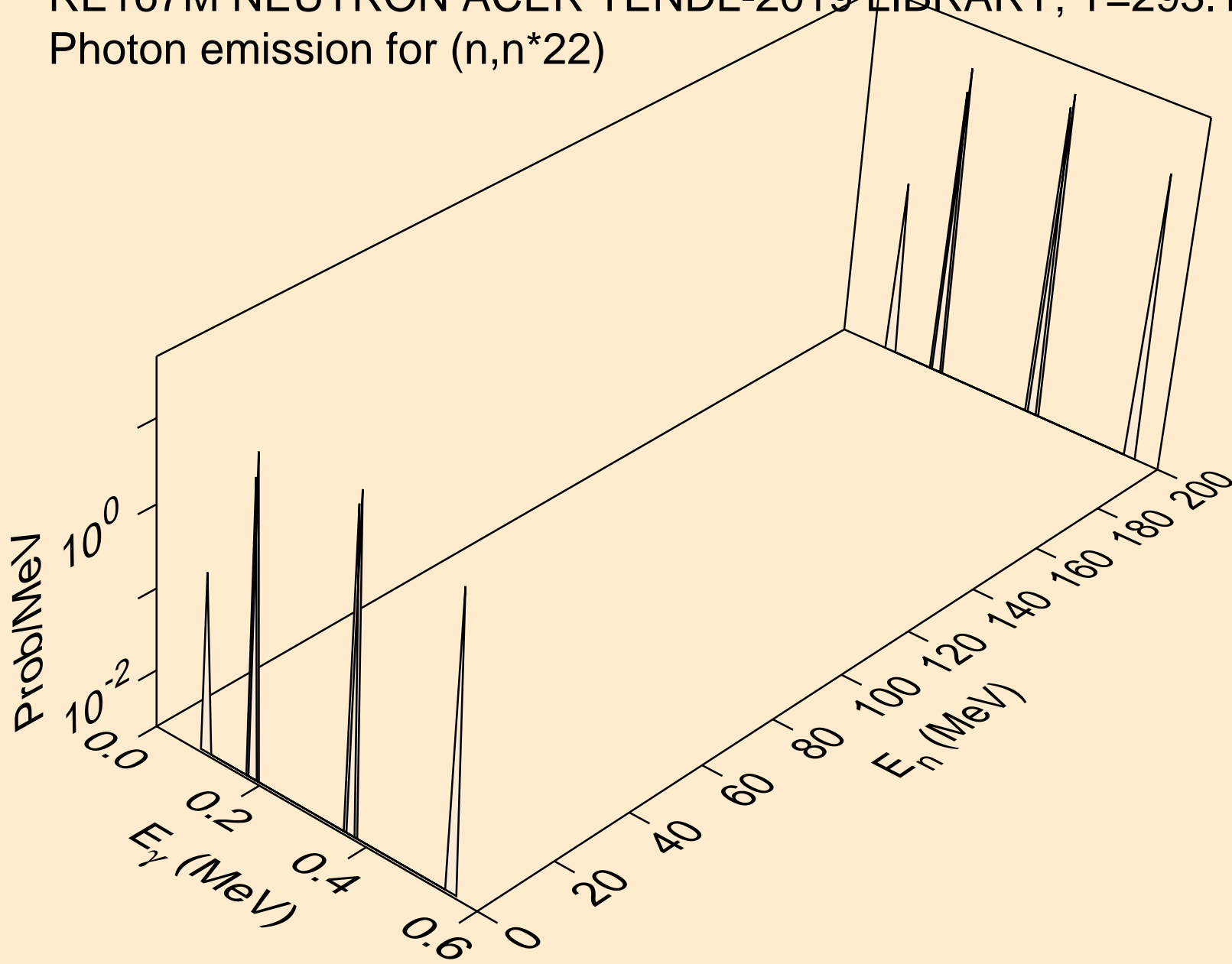

RE167M NEUTRON ACER TENDL-2019 LIBRARY; T=293.16K
Photon emission for (n,n*23)

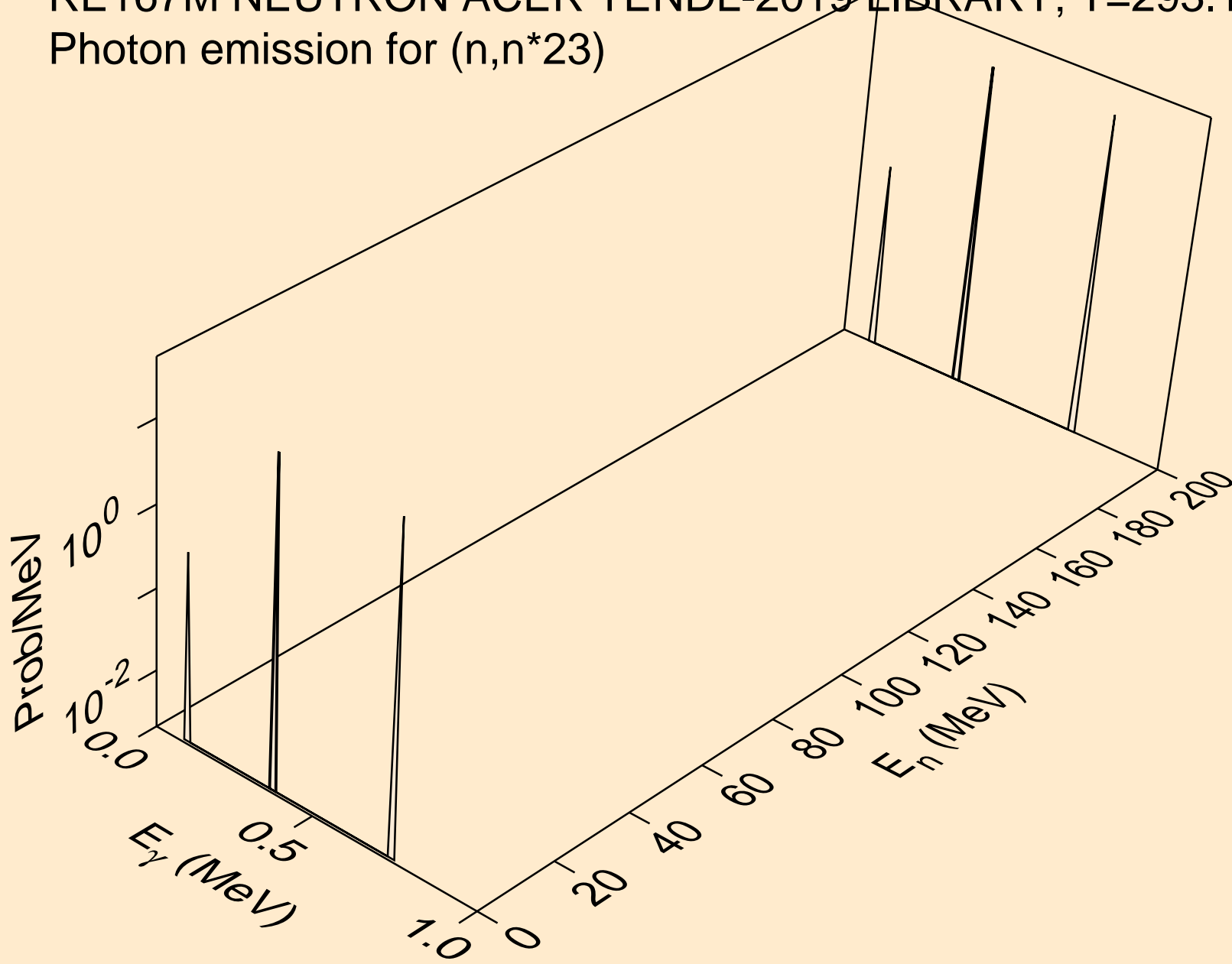

RE167M NEUTRON ACER TENDL-2019 LIBRARY; T=293.16K
Photon emission for (n,n*24)

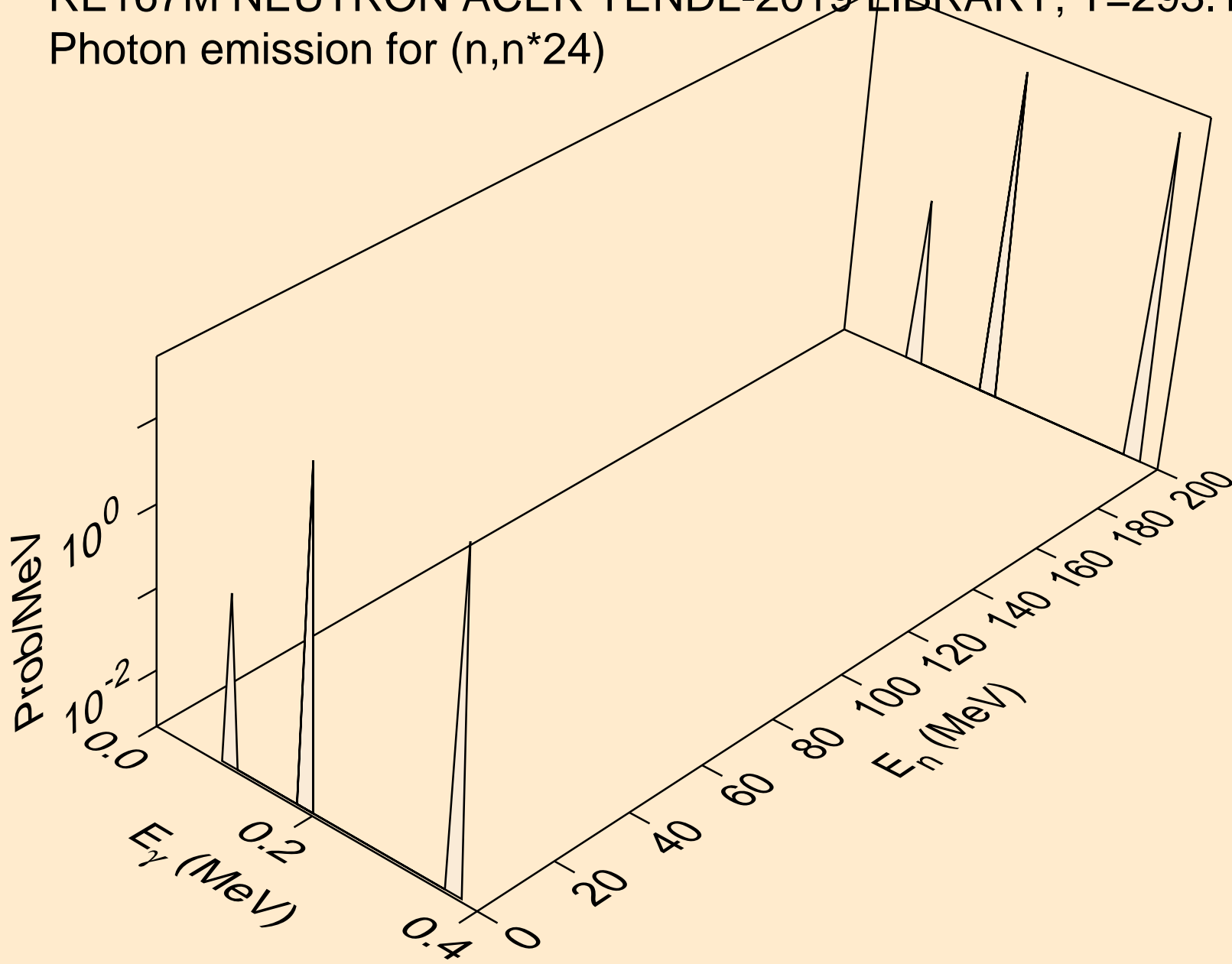

RE167M NEUTRON ACER TENDL-2019 LIBRARY; T=293.16K
Photon emission for (n,n*25)

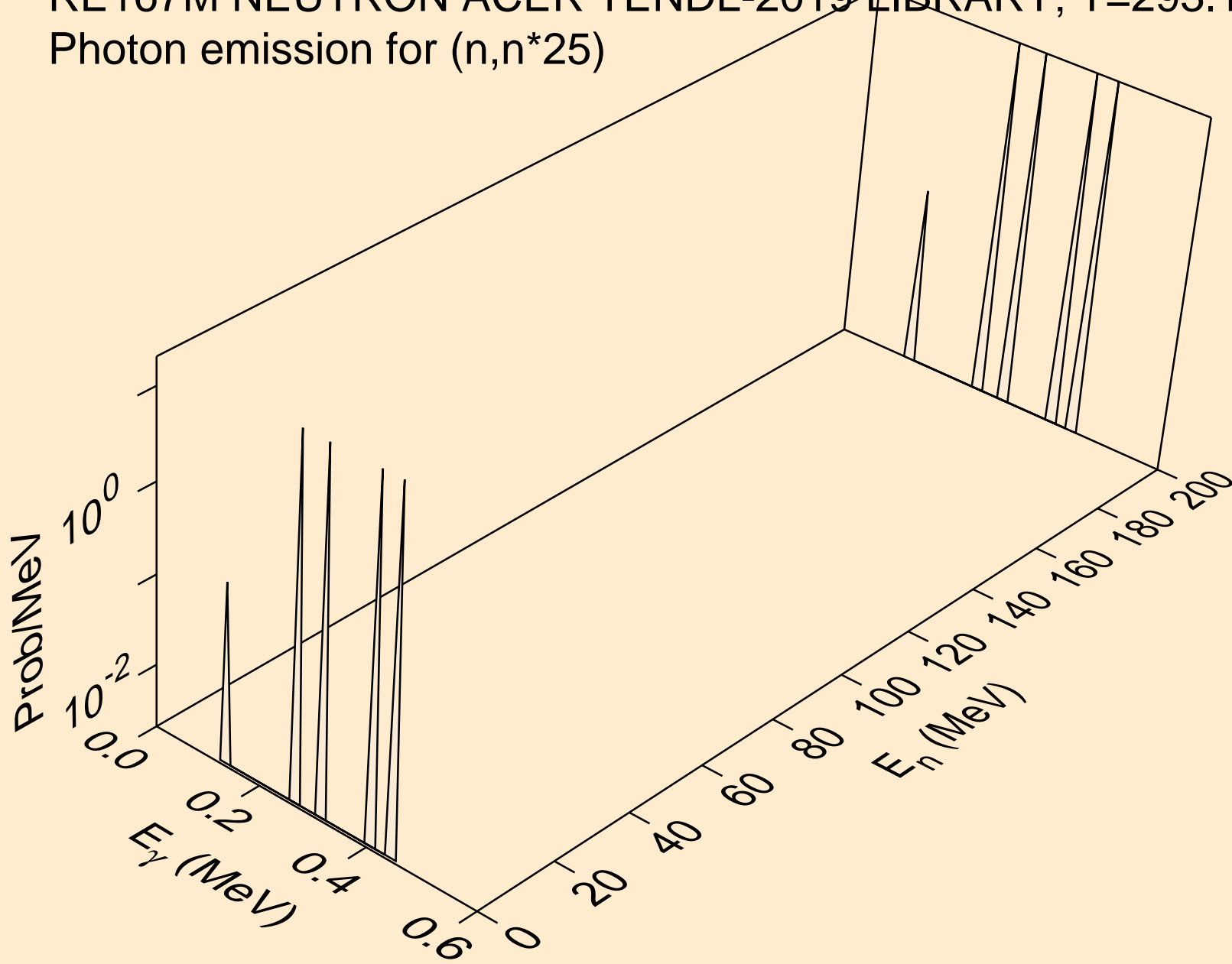

RE167M NEUTRON ACER TENDL-2019 LIBRARY; T=293.16K
Photon emission for (n,n*26)

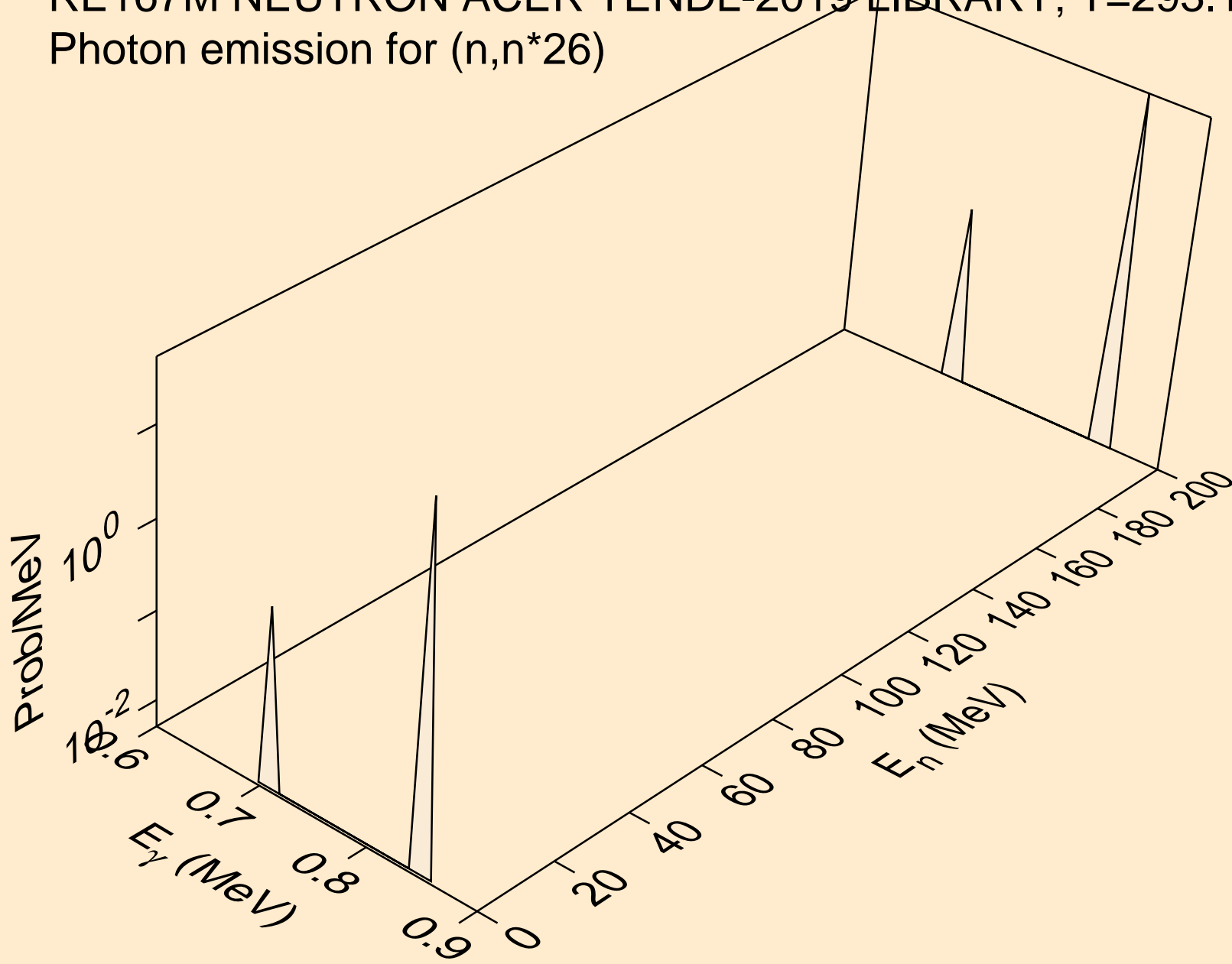

RE167M NEUTRON ACER TENDL-2019 LIBRARY; T=293.16K
Photon emission for (n,n*27)

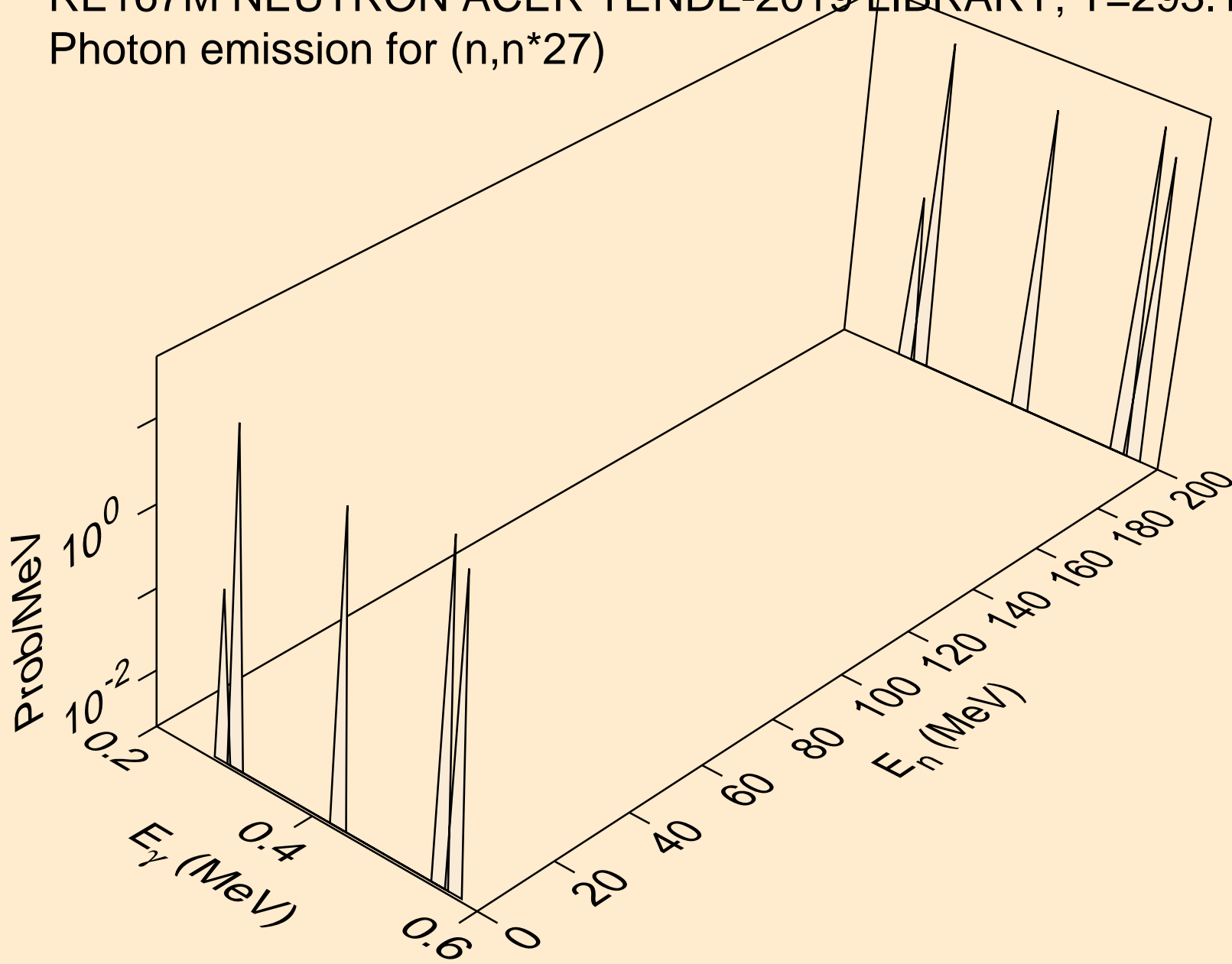

RE167M NEUTRON ACER TENDL-2019 LIBRARY; T=293.16K
Photon emission for (n,n*28)

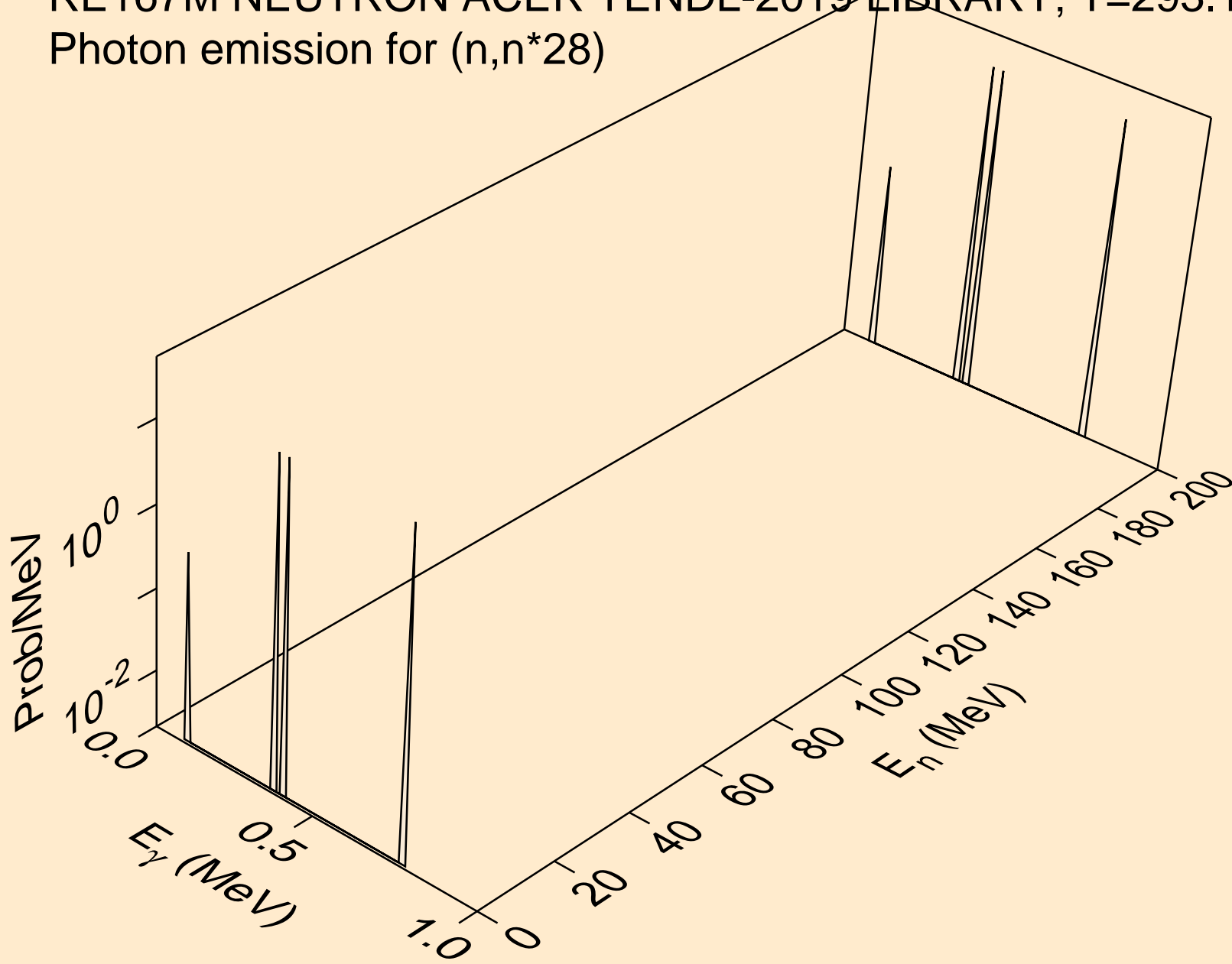

RE167M NEUTRON ACER TENDL-2019 LIBRARY; T=293.16K
Photon emission for (n,n*29)

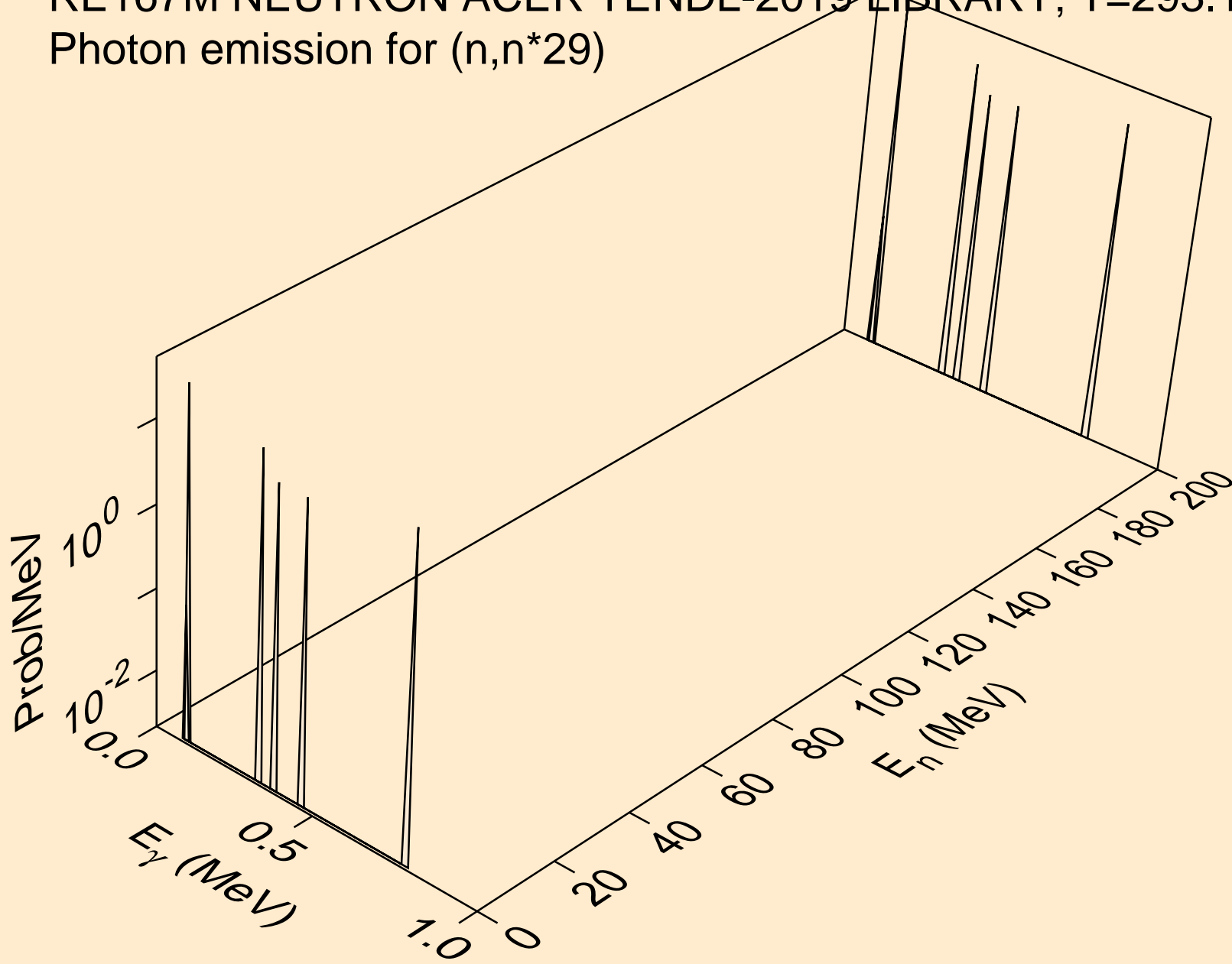

RE167M NEUTRON ACER TENDL-2019 LIBRARY; T=293.16K
Photon emission for (n,n*30)

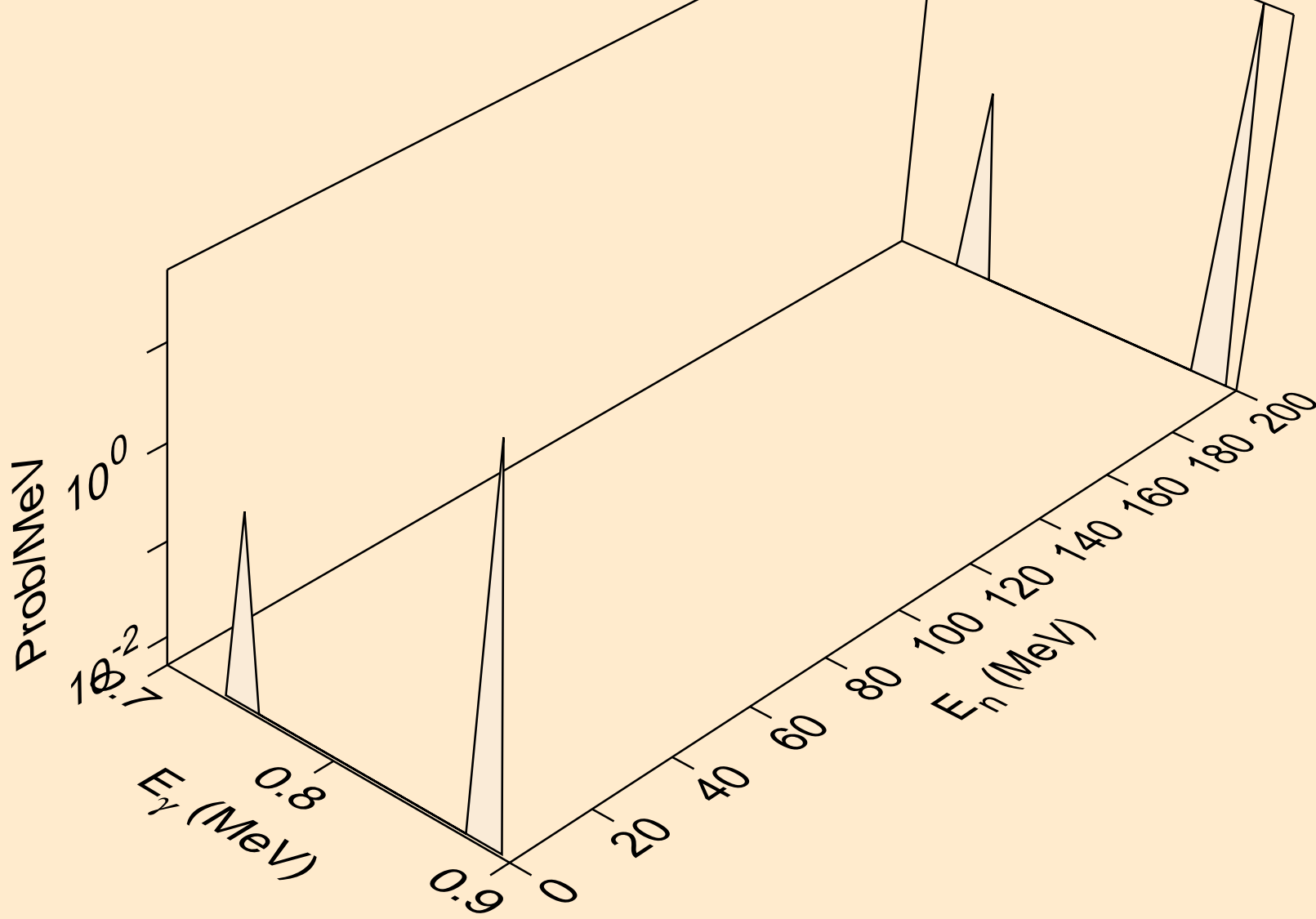

RE167M NEUTRON ACER TENDL-2019 LIBRARY; T=293.16K
Photon emission for (n,n*c)

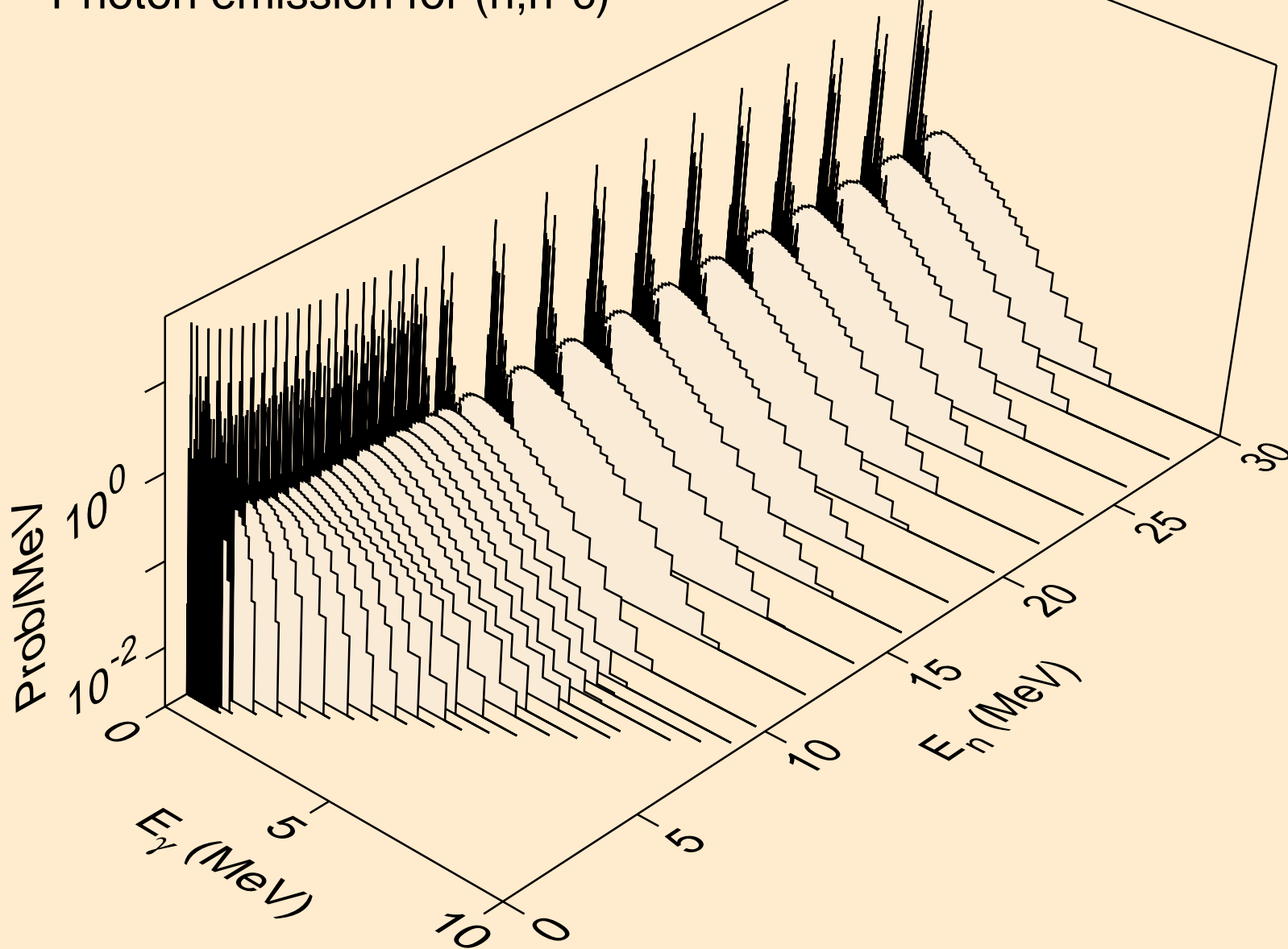

RE167M NEUTRON ACER TENDL-2019 LIBRARY; T=293.16K
Photon emission for (n,gma)

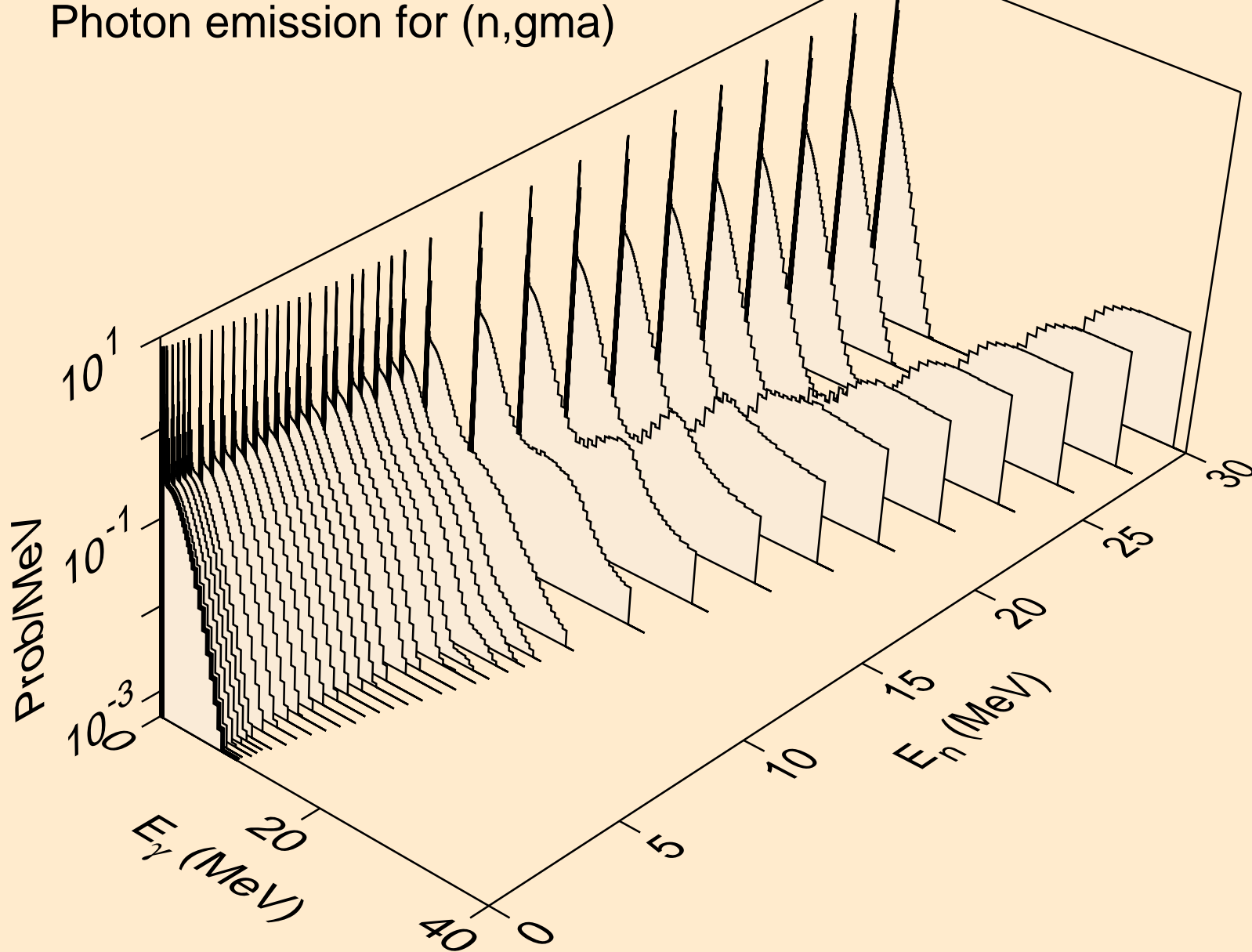

RE167M NEUTRON ACER TENDL-2019 LIBRARY; T=293.16K
Photon emission for (n,p)

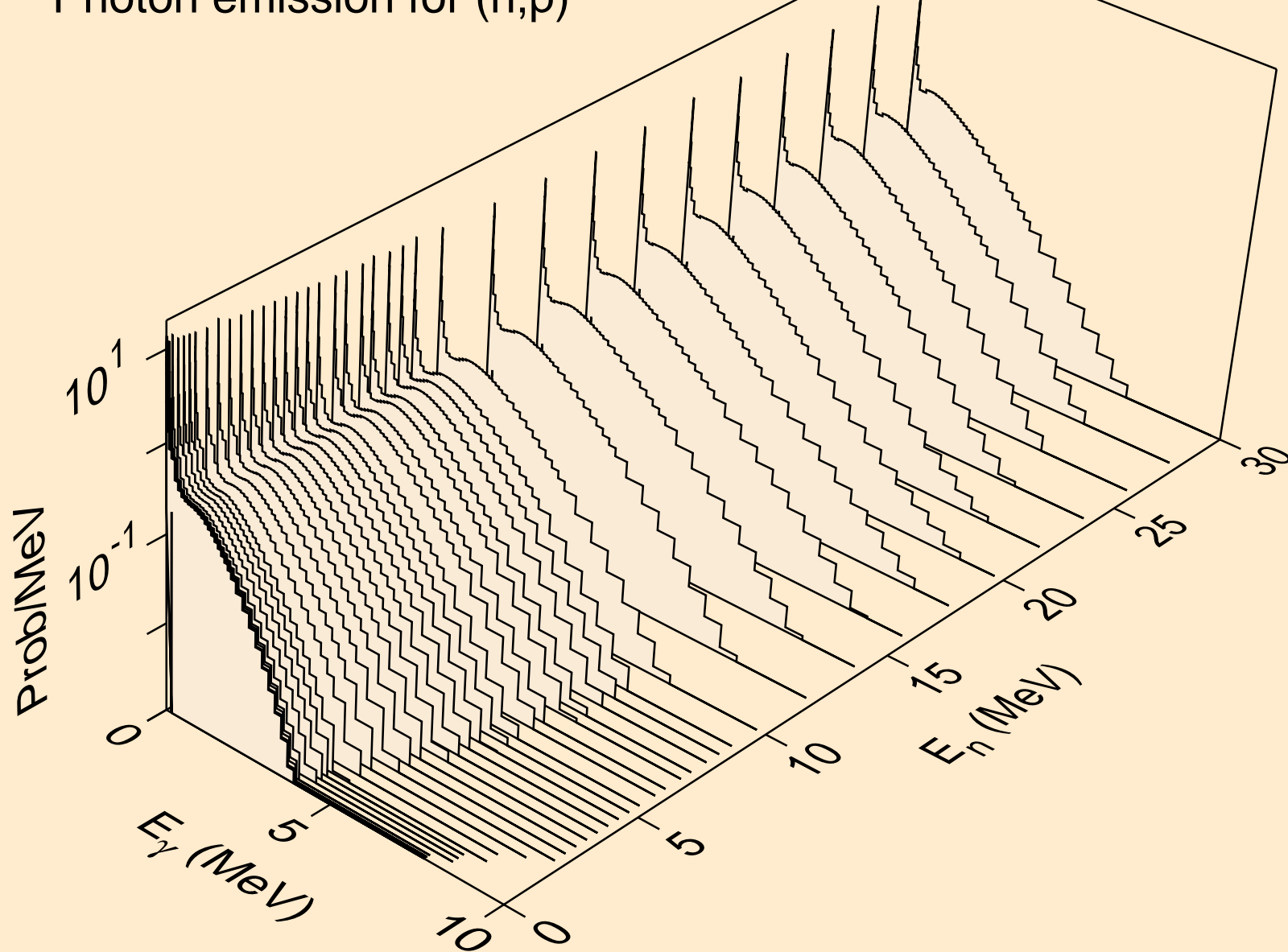

RE167M NEUTRON ACER TENDL-2019 LIBRARY; T=293.16K
Photon emission for (n,d)

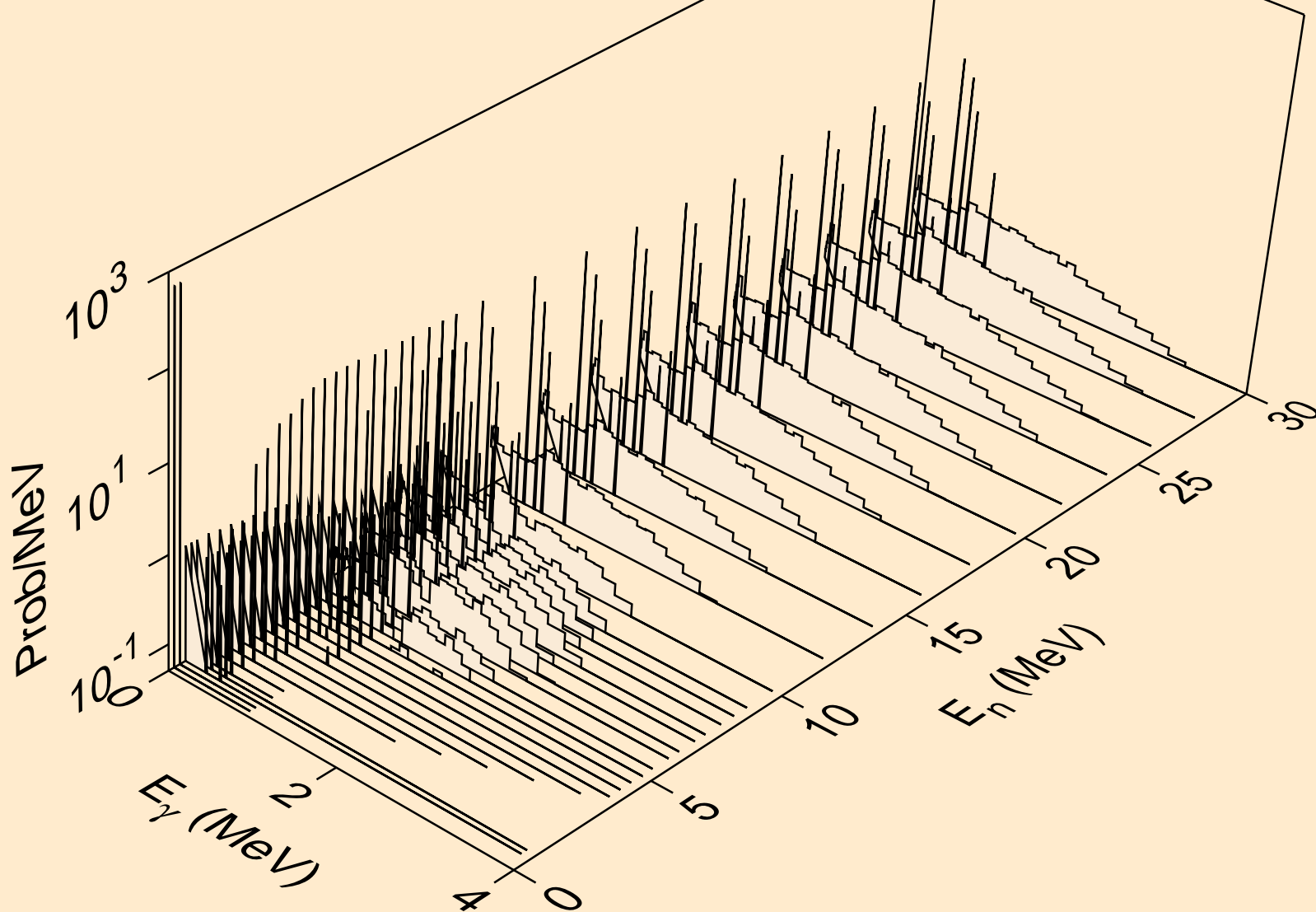

RE167M NEUTRON ACER TENDL-2019 LIBRARY; T=293.16K
Photon emission for (n,t)

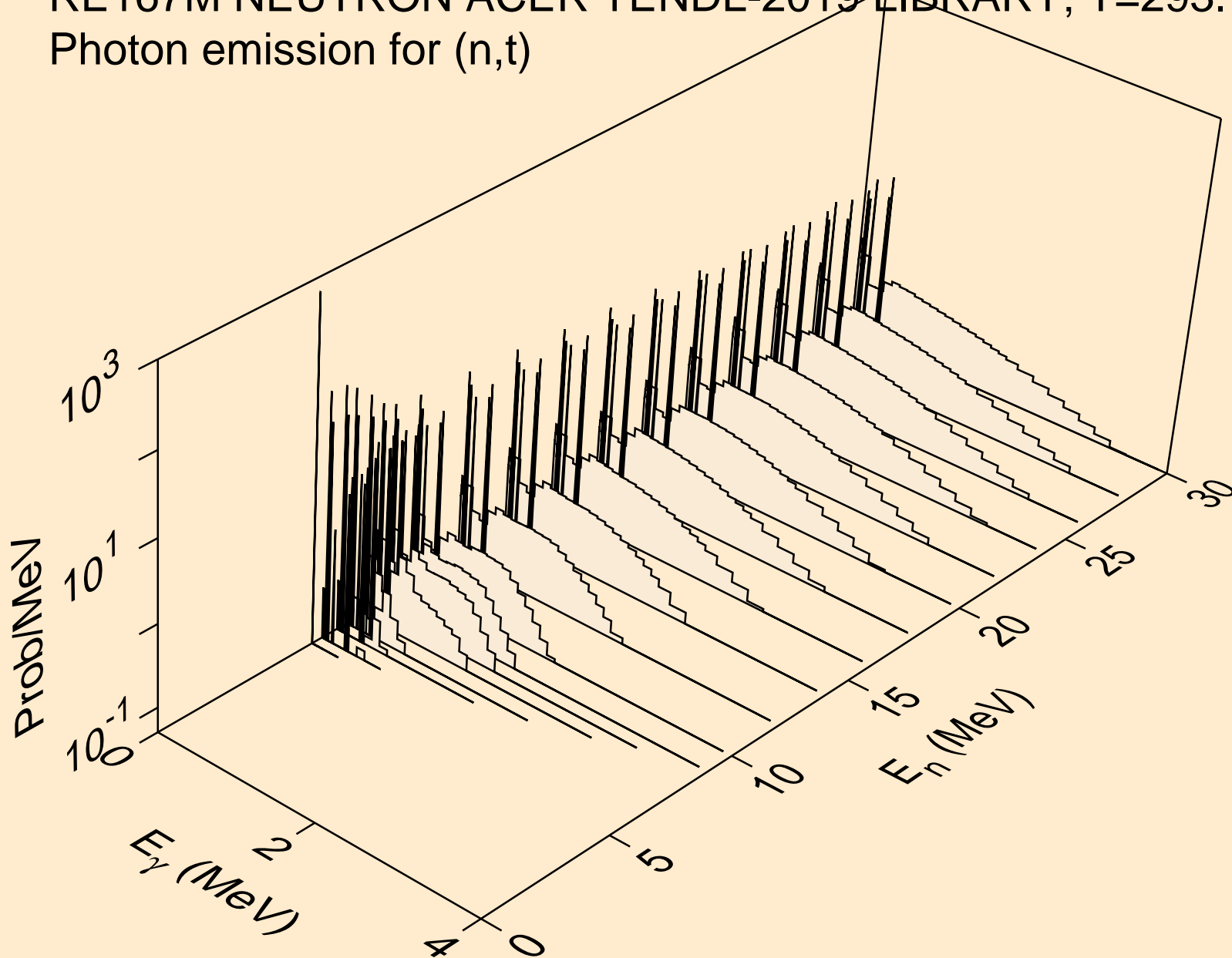

RE167M NEUTRON ACER TENDL-2019 LIBRARY; T=293.16K
Photon emission for (n,he3)

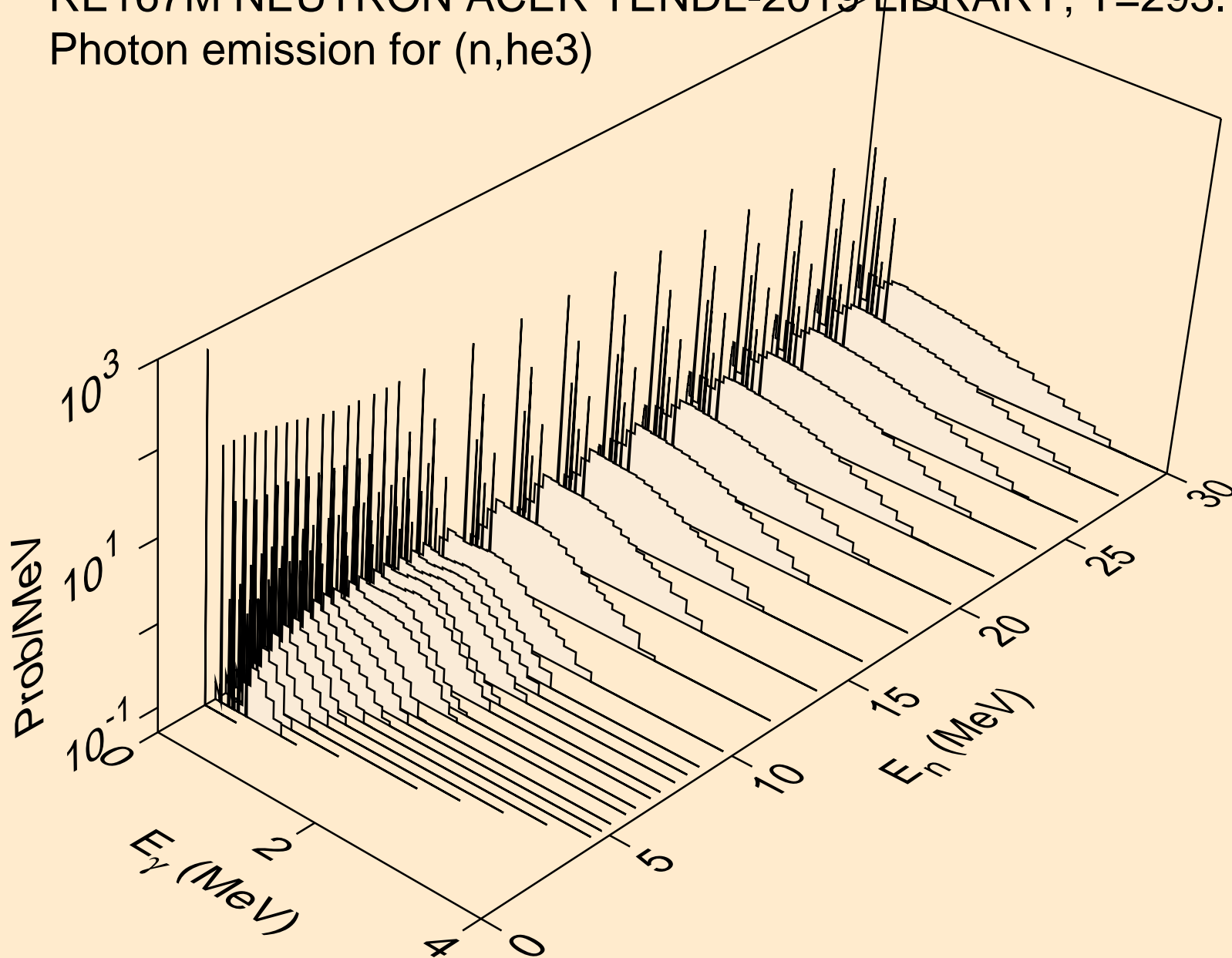

RE167M NEUTRON ACER TENDL-2019 LIBRARY; T=293.16K
Photon emission for (n,a)

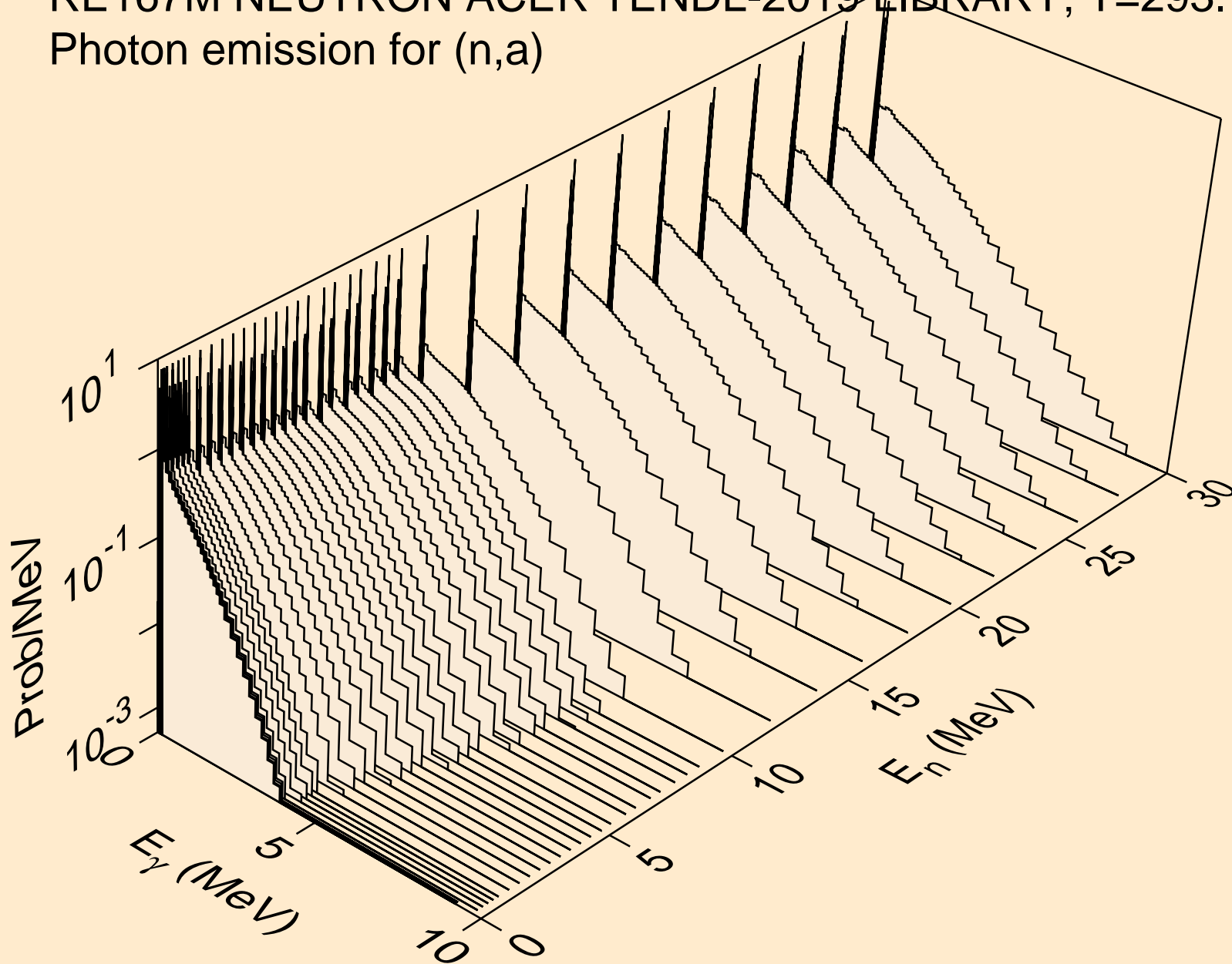

RE167M NEUTRON ACER TENDL-2019 LIBRARY; T=293.16K
Photon emission for (n,2a)

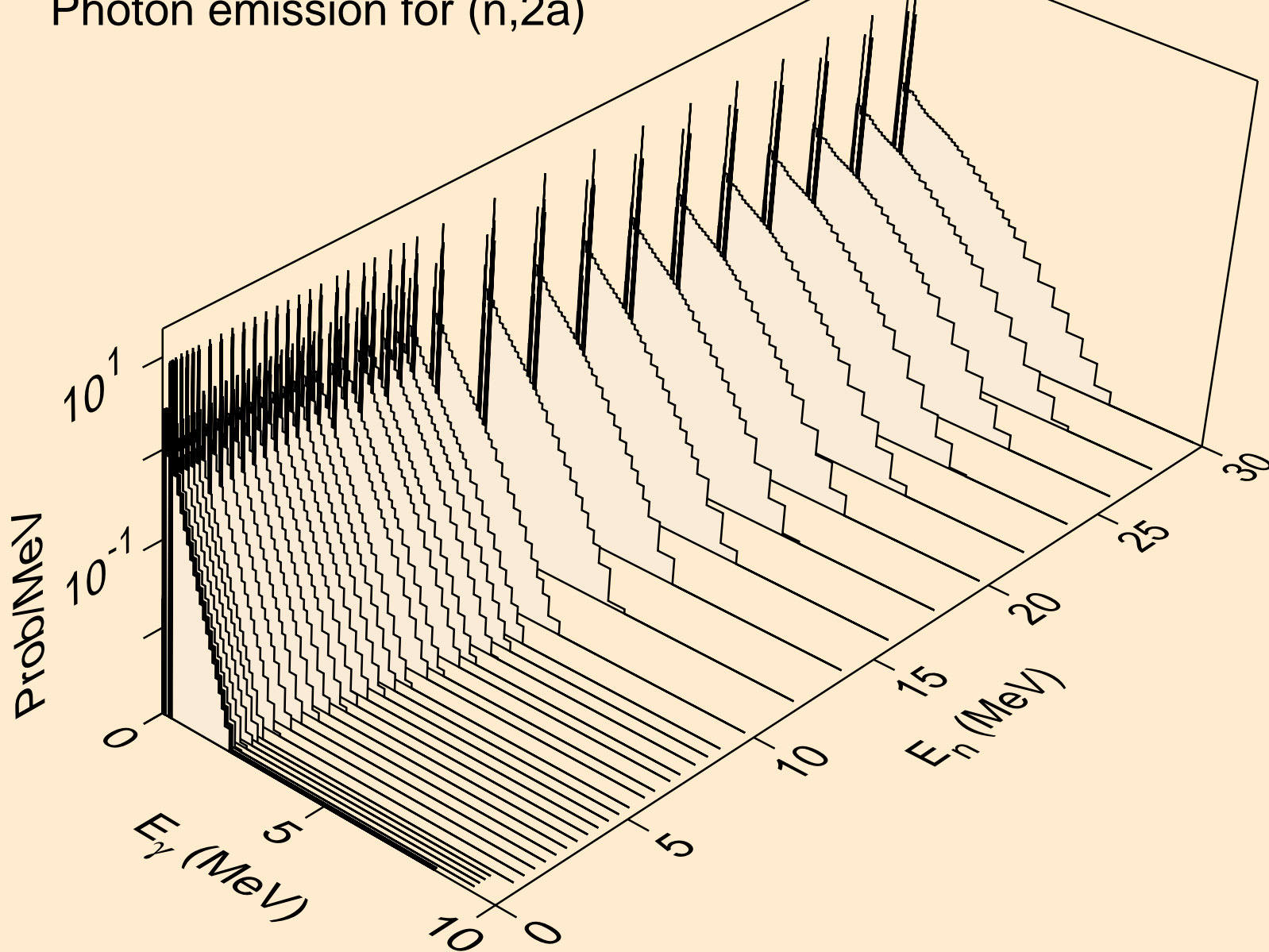

RE167M NEUTRON ACER TENDL-2019 LIBRARY; T=293.16K
Photon emission for (n,3a)

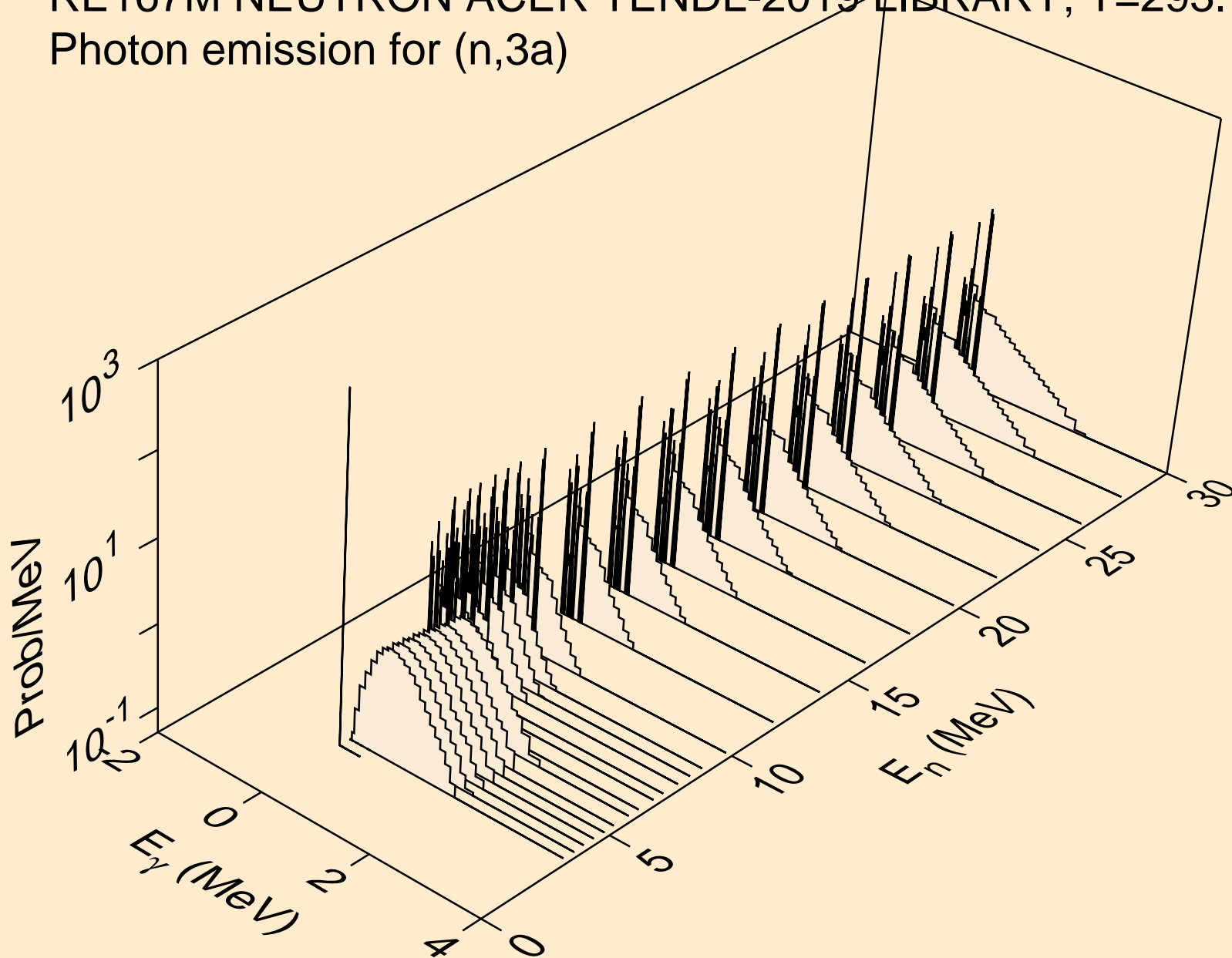

RE167M NEUTRON ACER TENDL-2019 LIBRARY; T=293.16K
Photon emission for (n,2p)

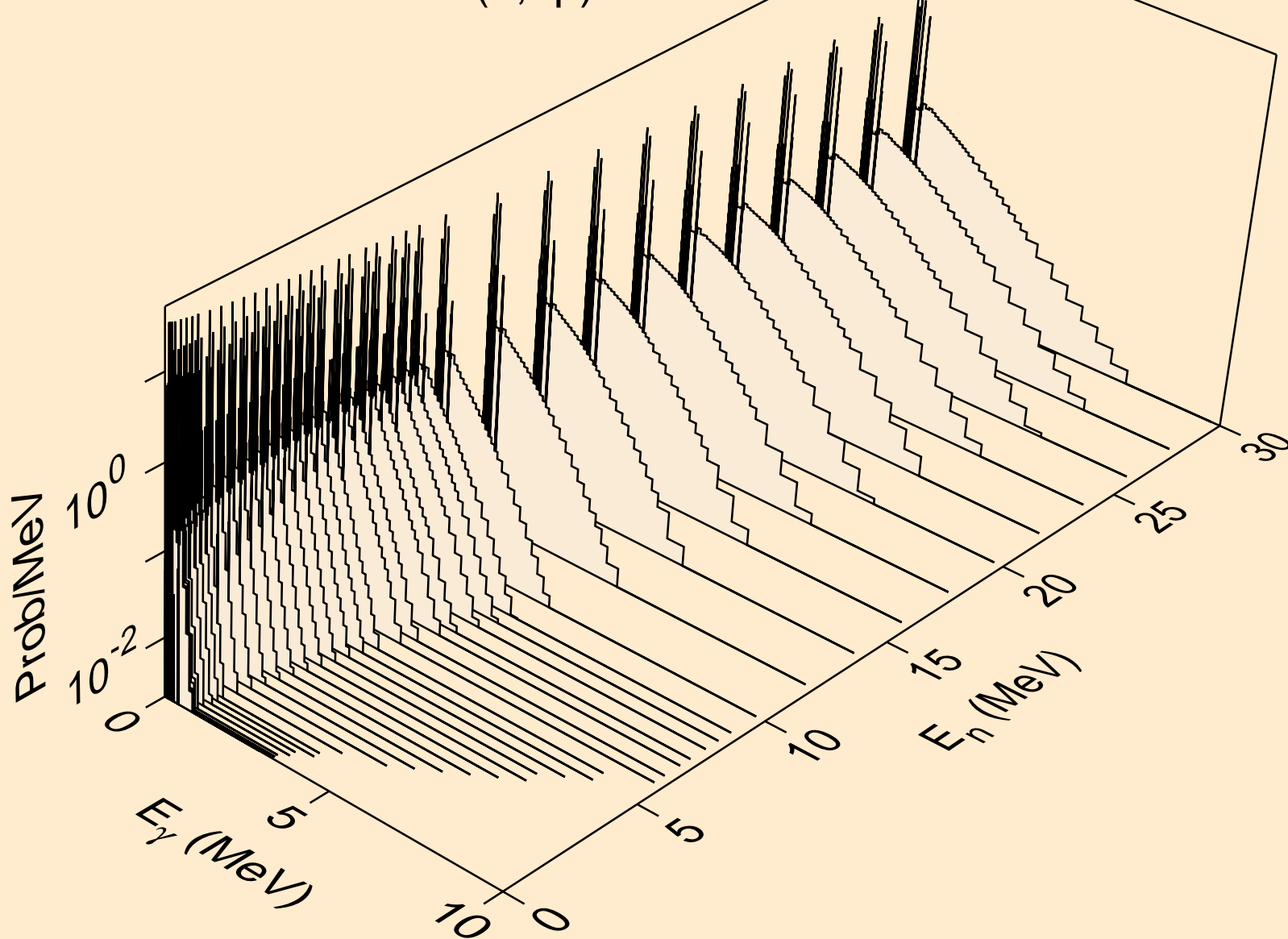

RE167M NEUTRON ACER TENDL-2019 LIBRARY; T=293.16K
Photon emission for (n,pa)

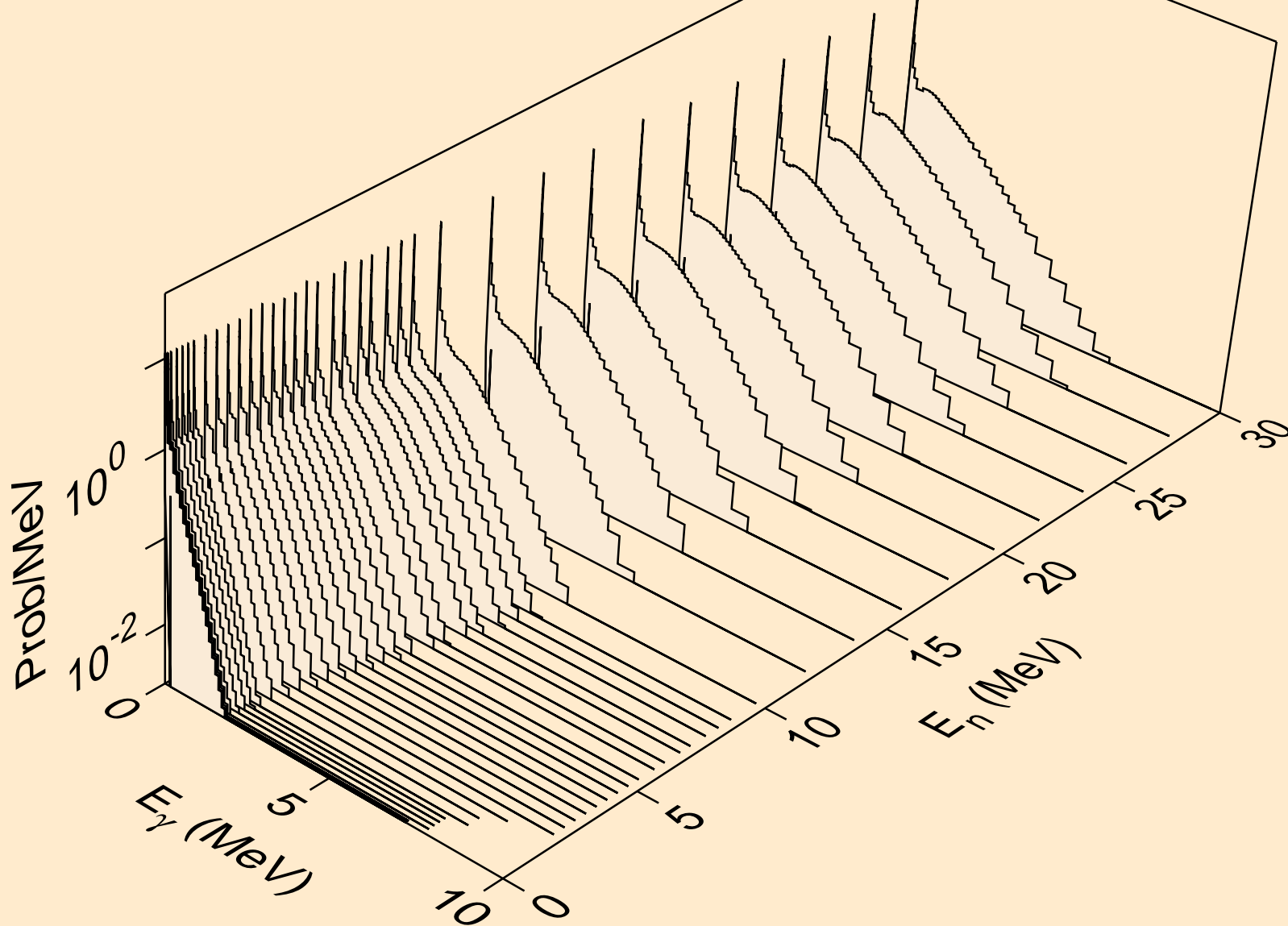

RE167M NEUTRON ACER TENDL-2019 LIBRARY; T=293.16K
Photon emission for (n,t2a)

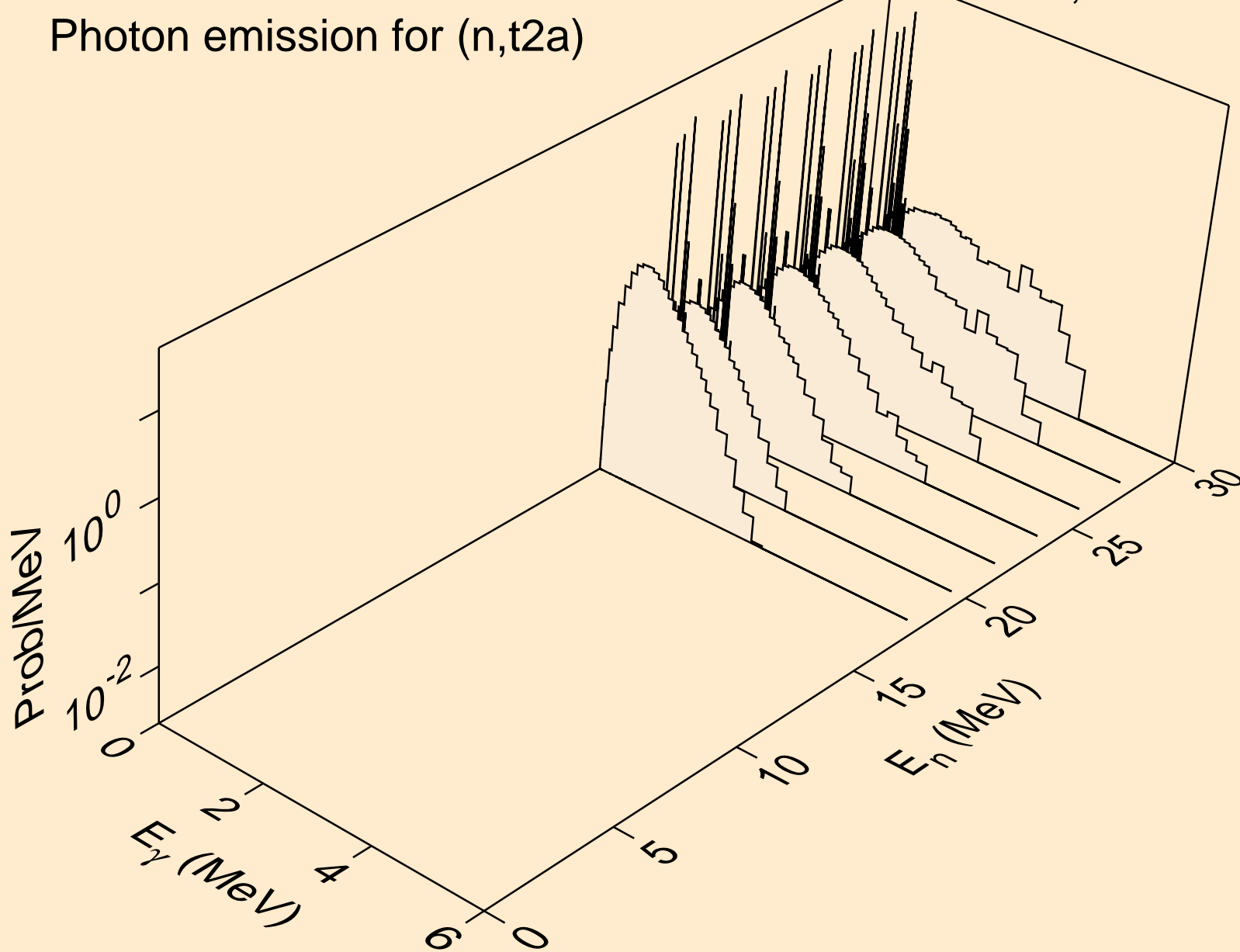

RE167M NEUTRON ACER TENDL-2019 LIBRARY; T=293.16K
Photon emission for (n,d2a)

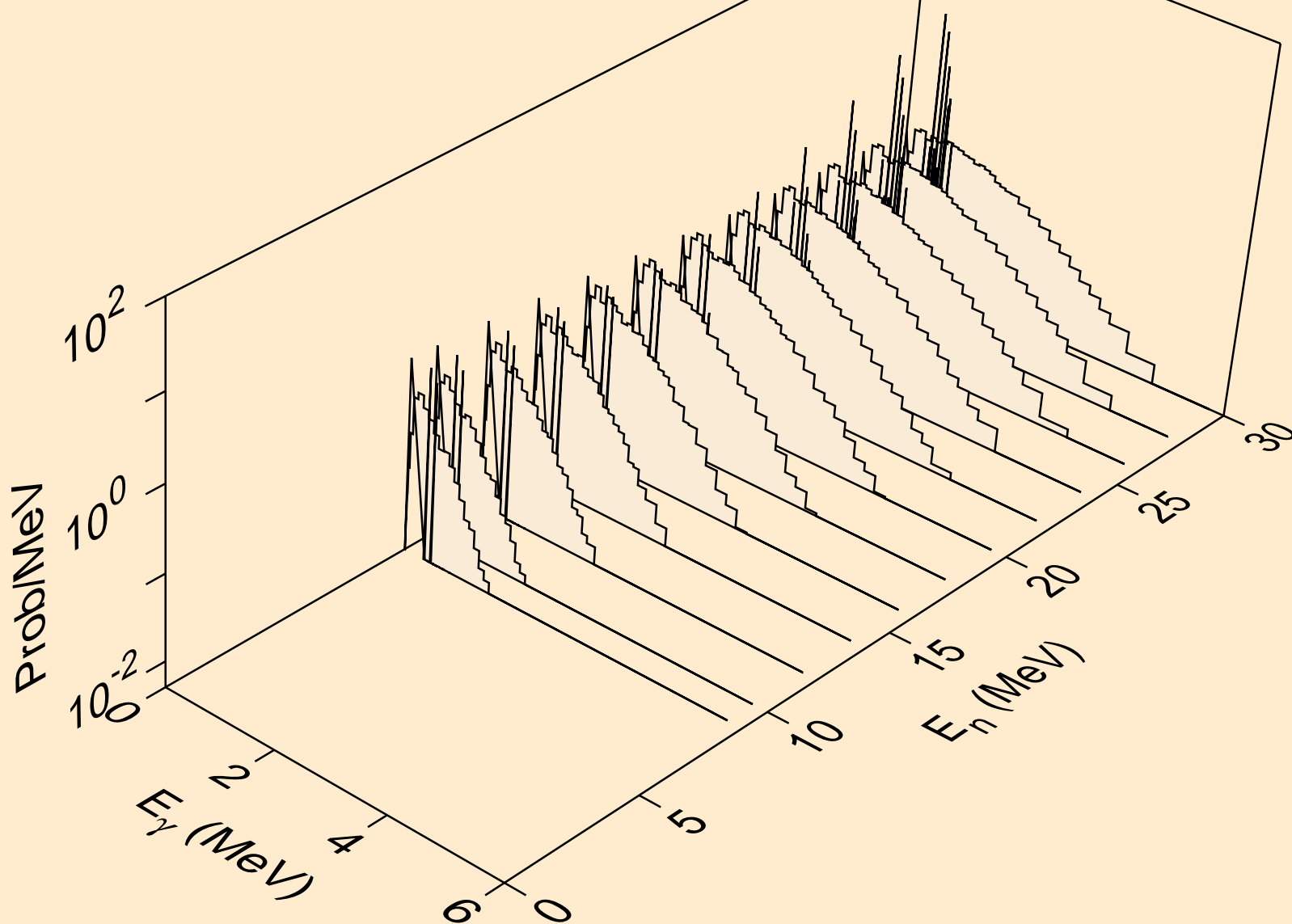

RE167M NEUTRON ACER TENDL-2019 LIBRARY; T=293.16K
Photon emission for (n,pd)

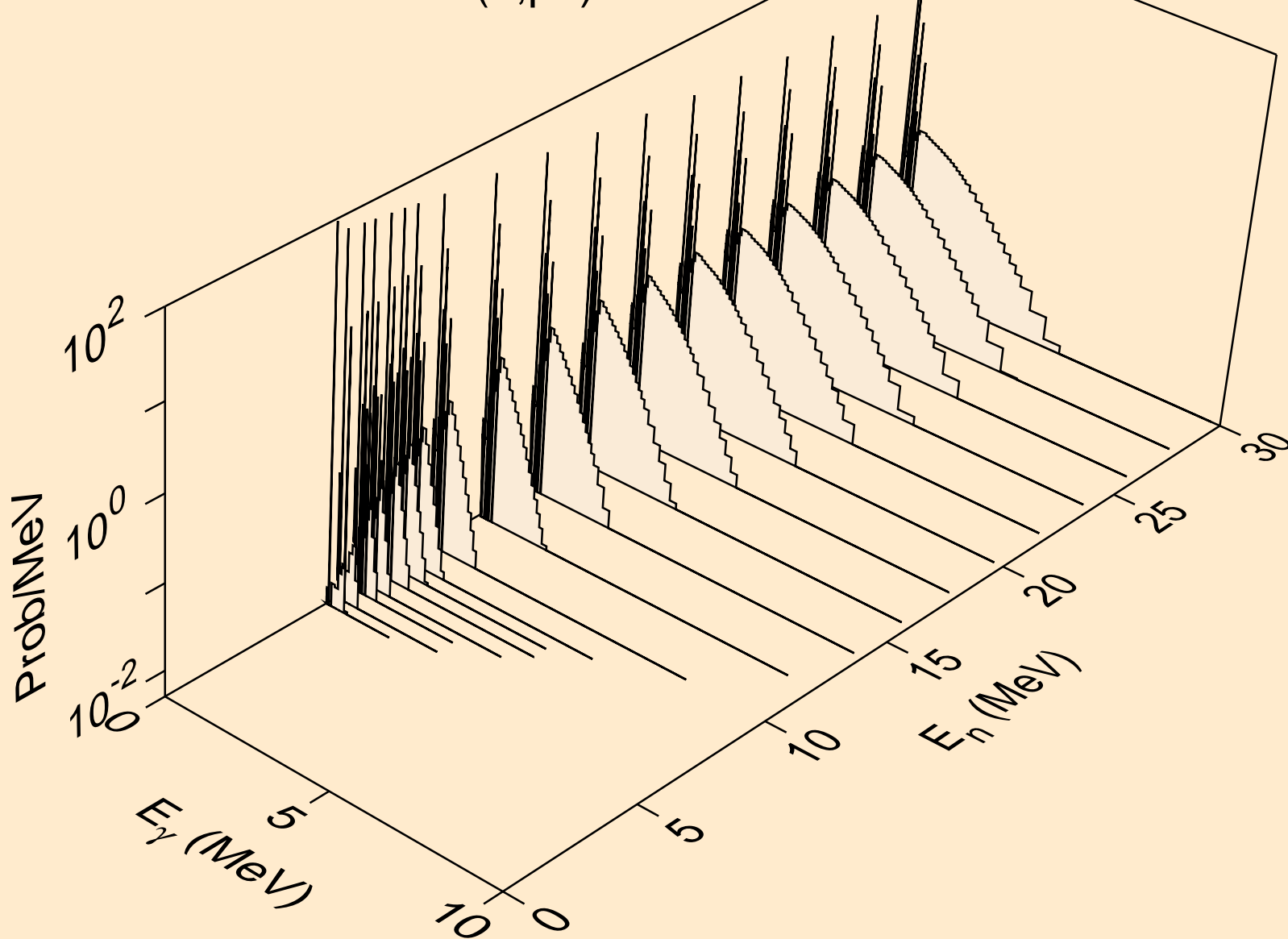

RE167M NEUTRON ACER TENDL-2019 LIBRARY; T=293.16K
Photon emission for (n,pt)

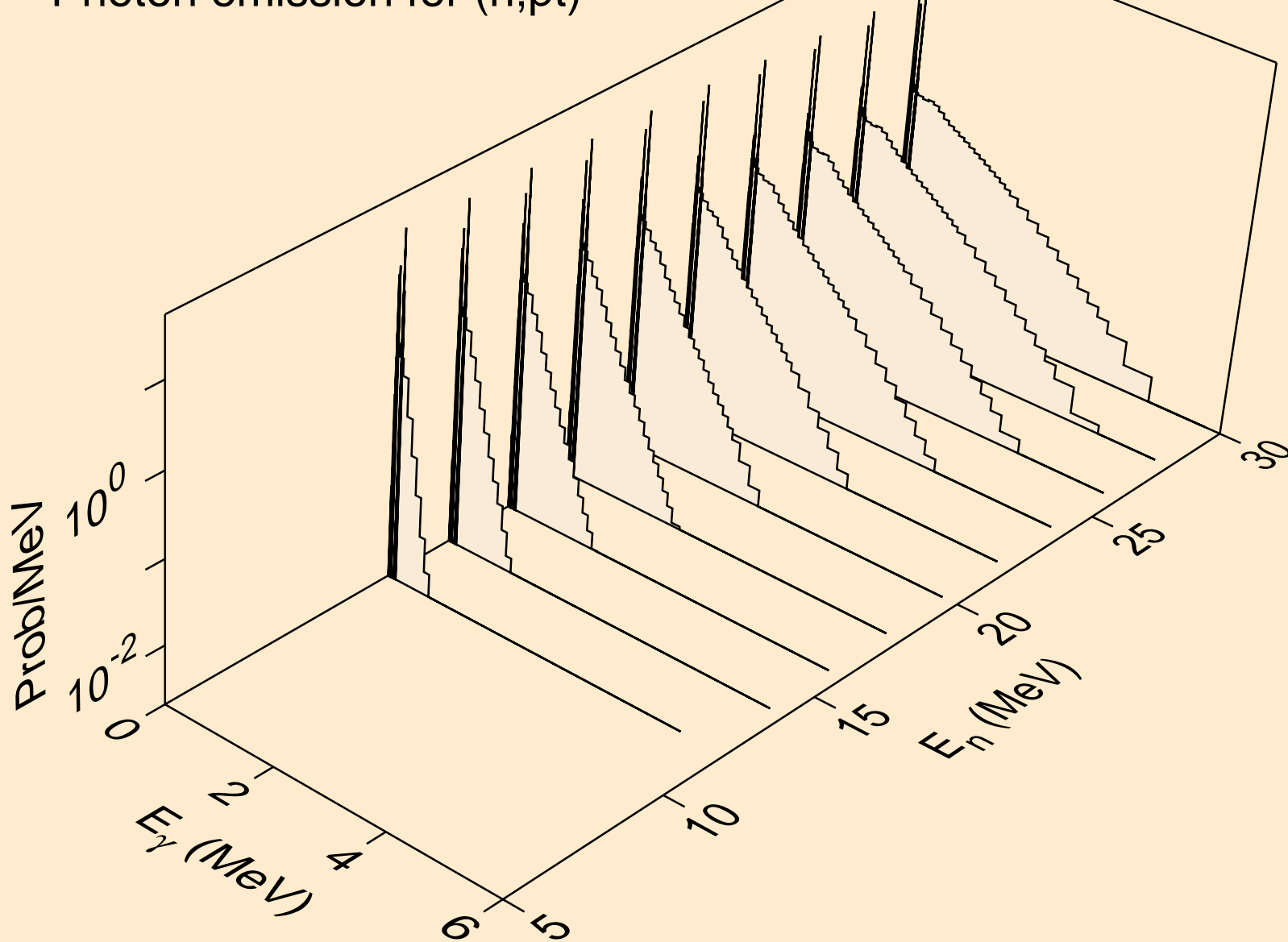

RE167M NEUTRON ACER TENDL-2019 LIBRARY; T=293.16K
Photon emission for (n,da)

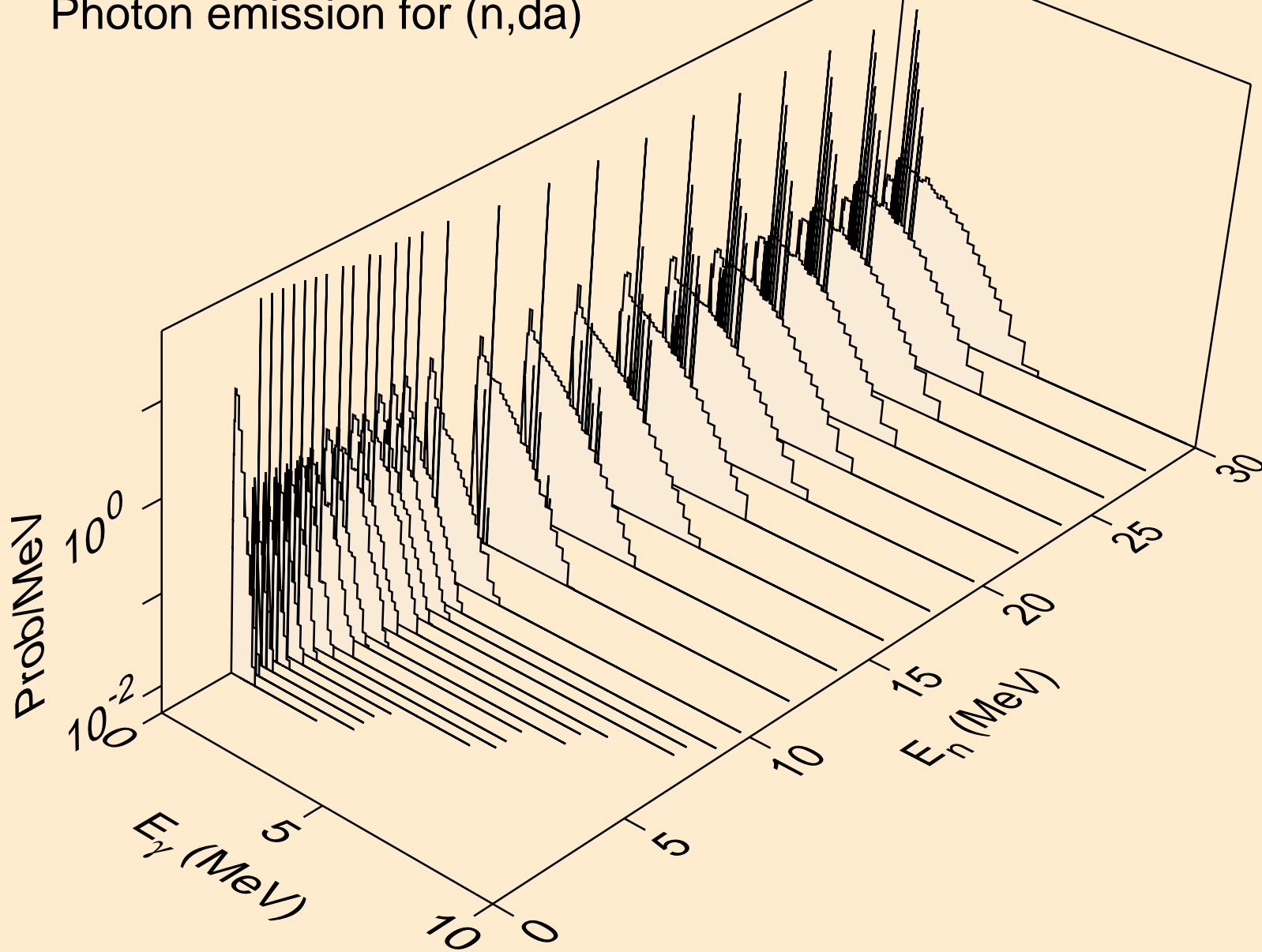

RE167M NEUTRON ACER TENDL-2019 LIBRARY; T=293.16K
thermal capture photon spectrum

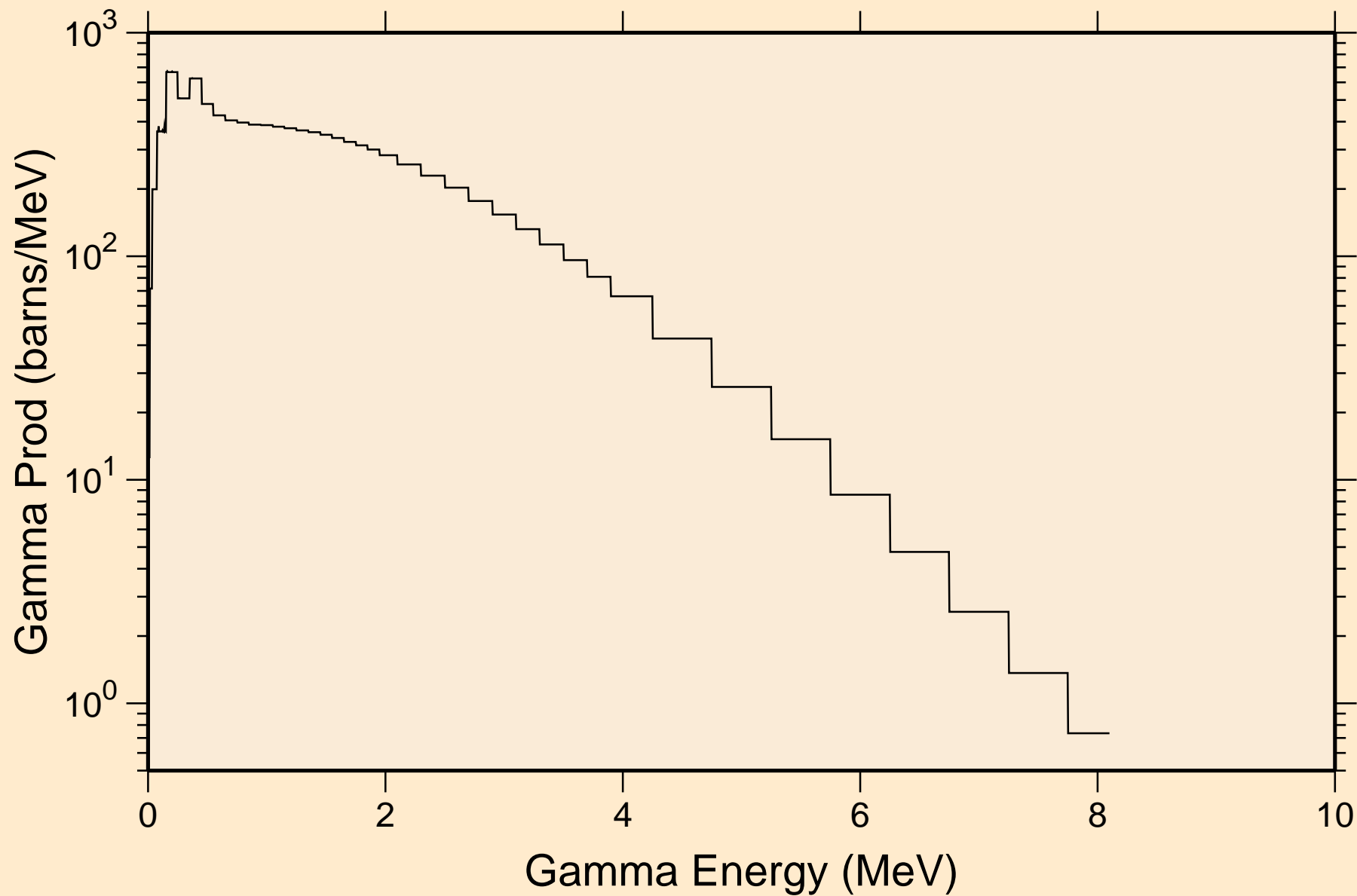

RE167M NEUTRON ACER TENDL-2019 LIBRARY; T=293.16K
14 MeV photon spectrum

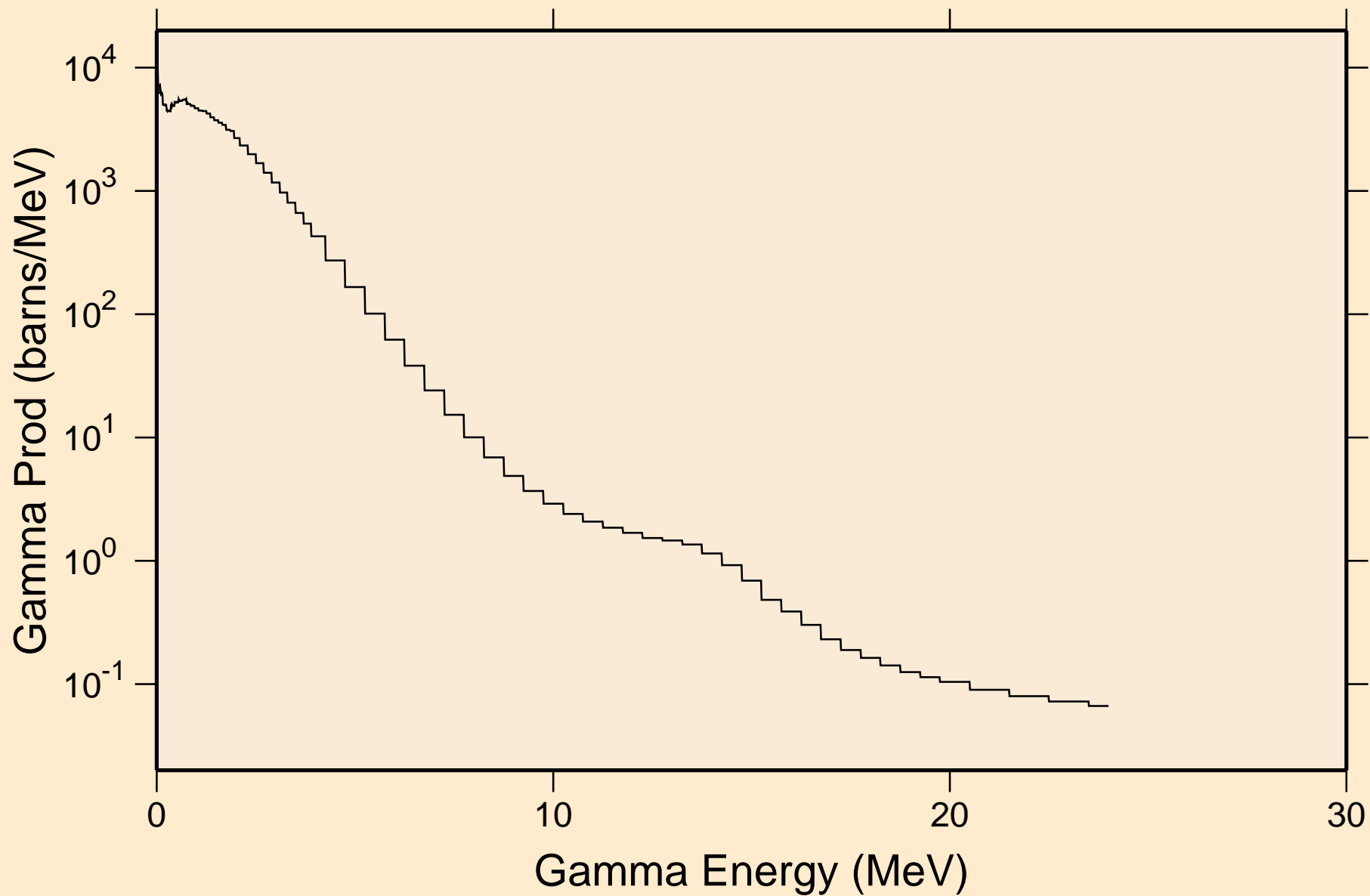

RE167M NEUTRON ACER TENDL-2019 LIBRARY; T=293.16K
Particle heating contributions

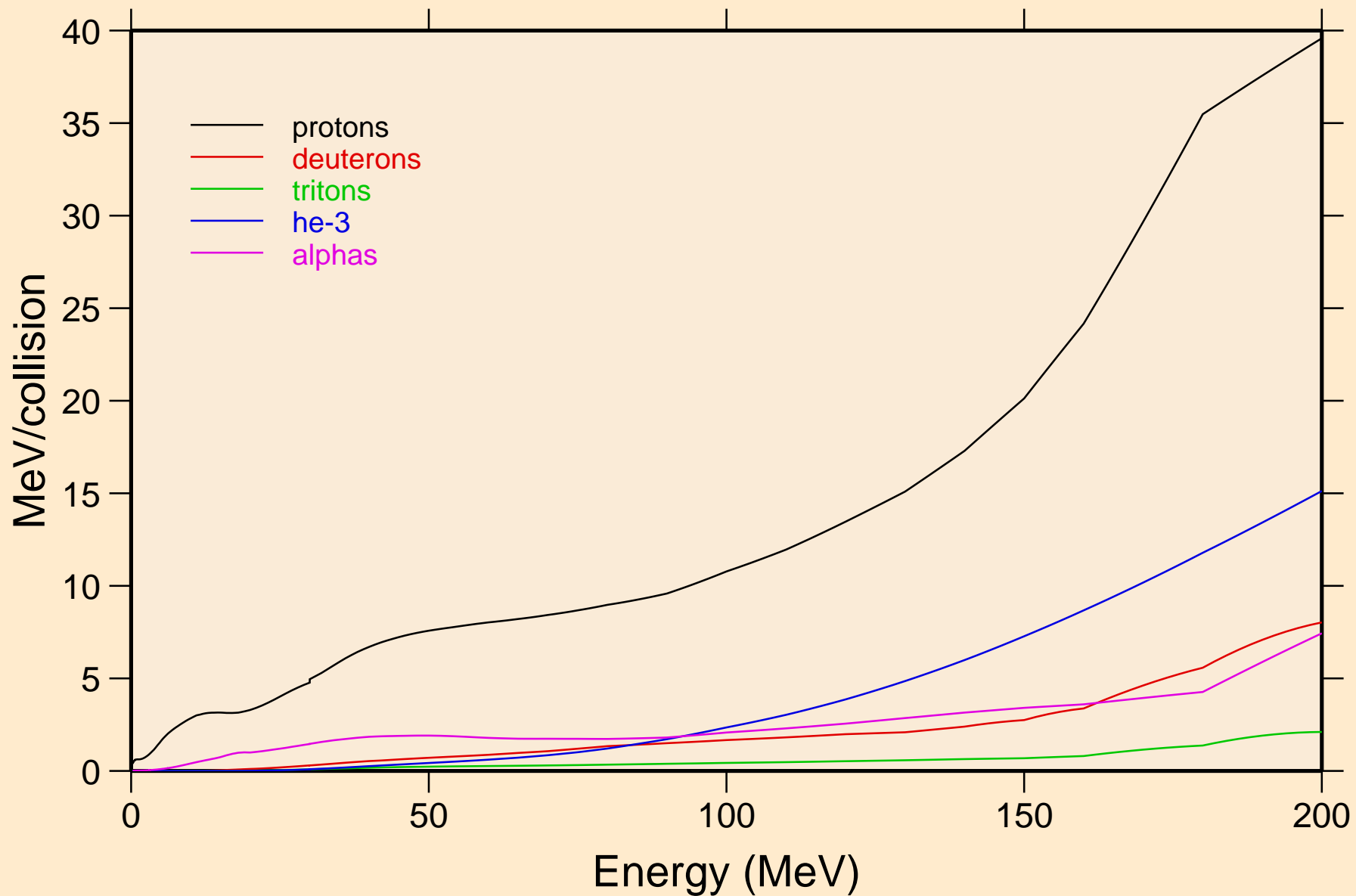

RE167M NEUTRON ACER TENDL-2019 LIBRARY; T=293.16K
Recoil Heating

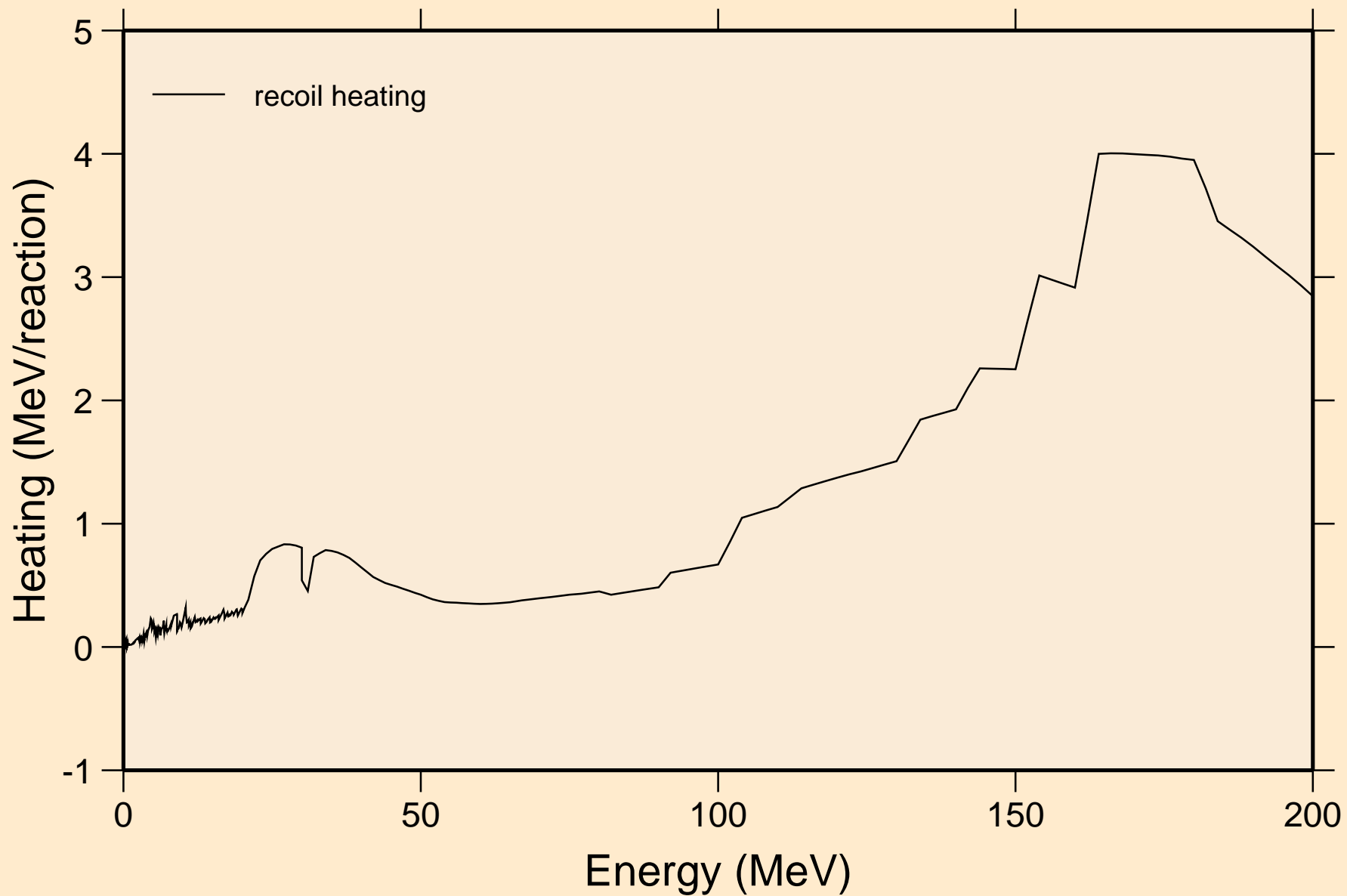

RE167M NEUTRON ACER TENDL-2019 LIBRARY; T=293.16K
Particle production cross sections

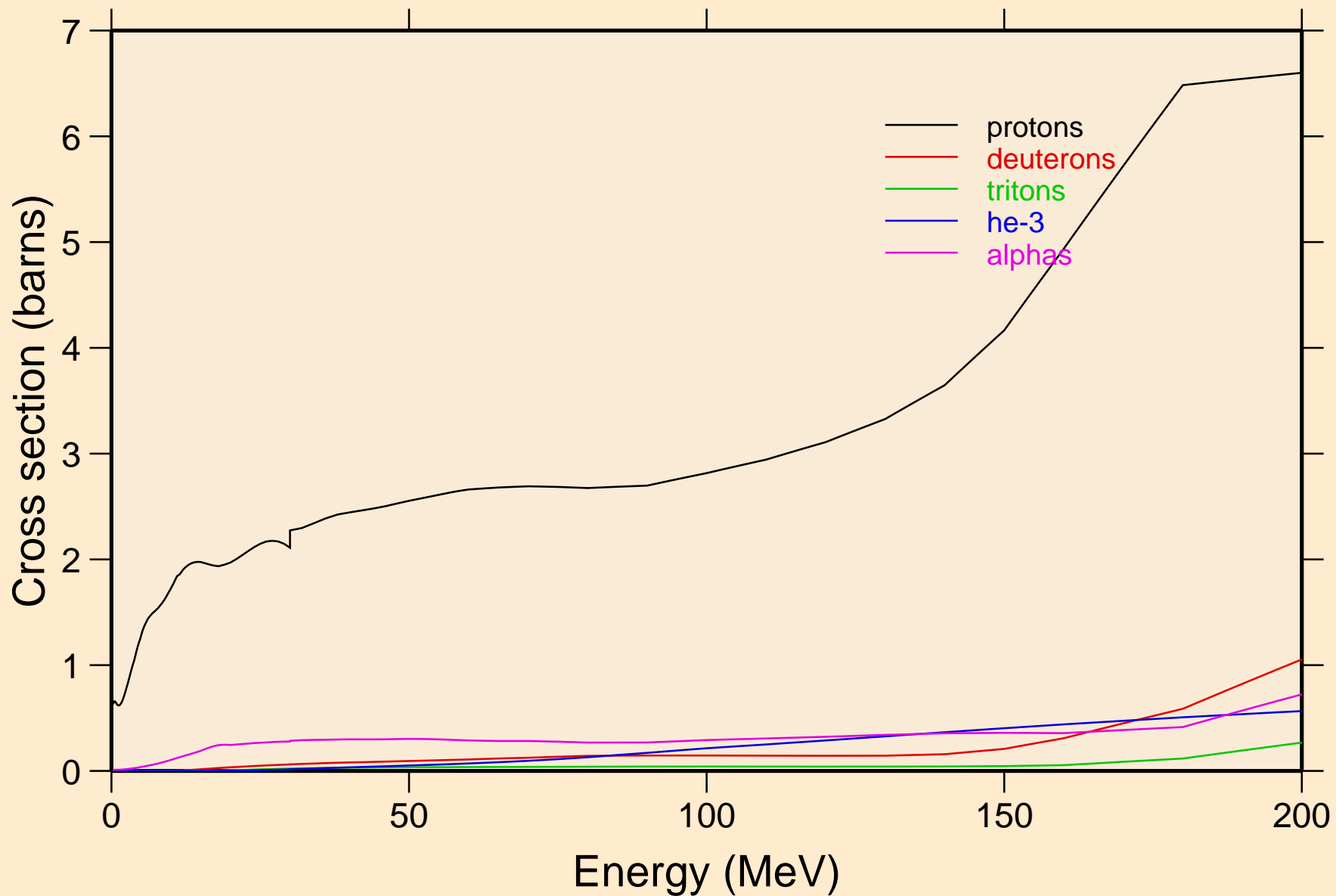

RE167M NEUTRON ACER TENDL-2019 LIBRARY; T=293.16K
protons from (n,x)

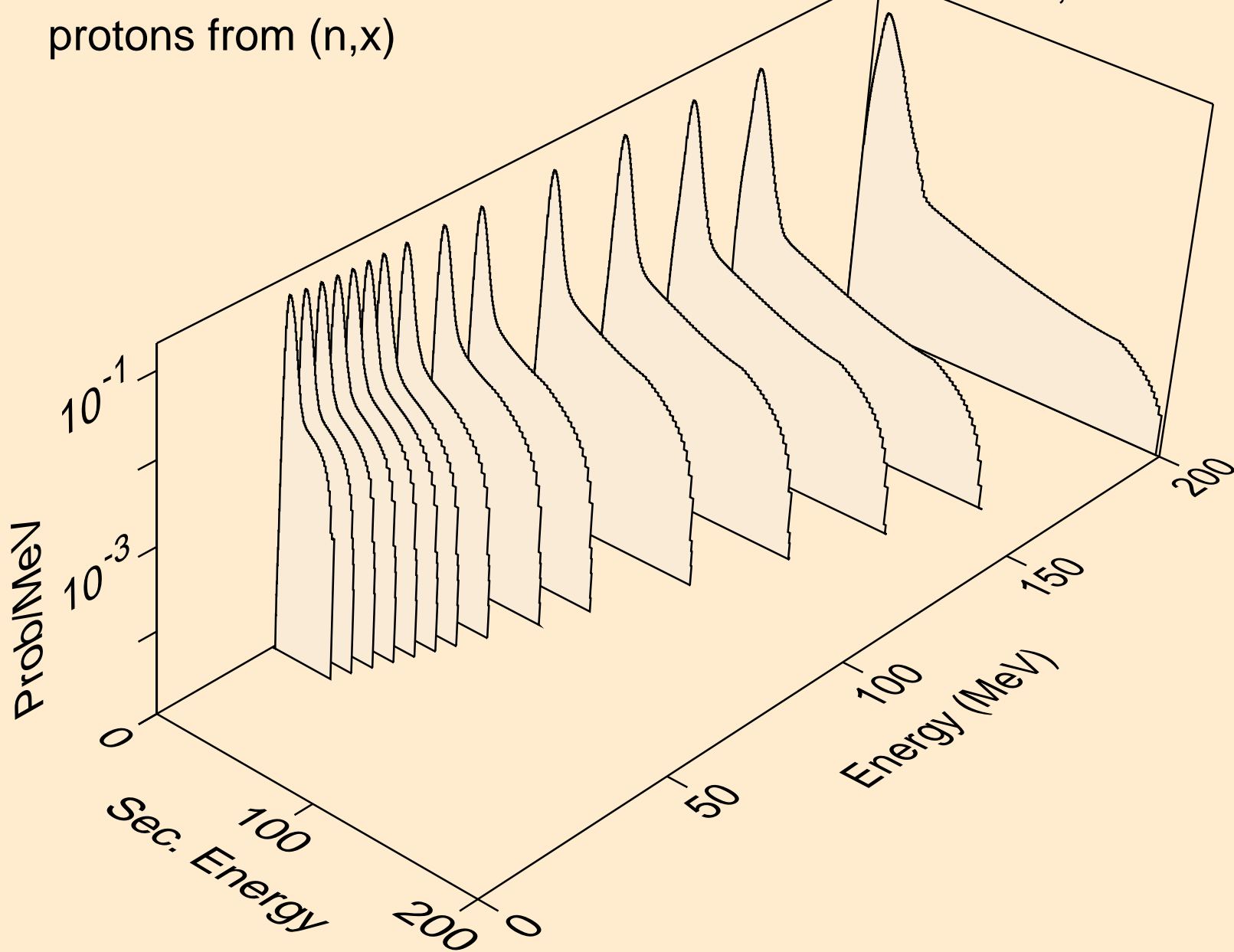

RE167M NEUTRON ACER TENDL-2019 LIBRARY; T=293.16K
protons from (n,n*)p

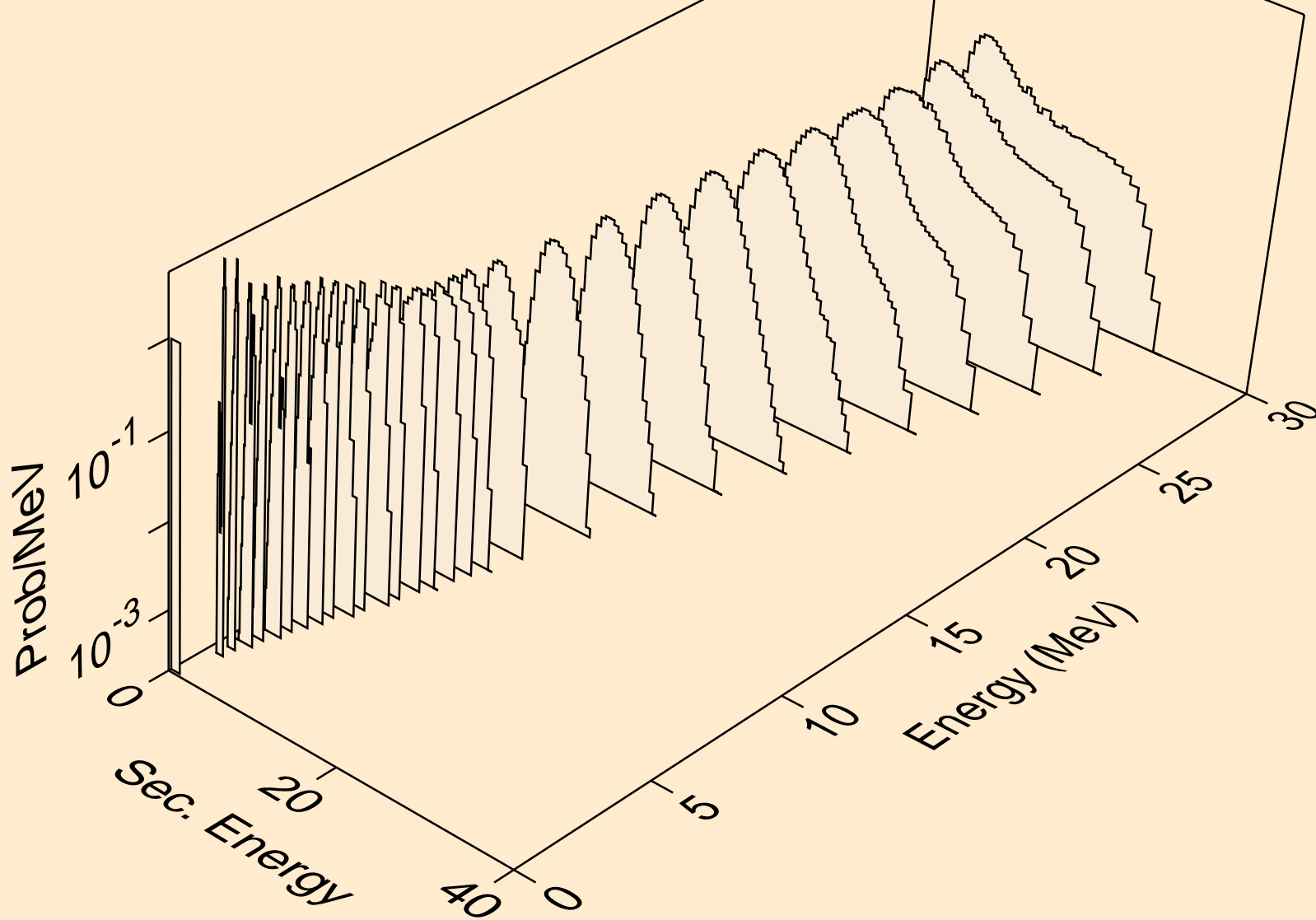

RE167M NEUTRON ACER TENDL-2019 LIBRARY; T=293.16K
protons from (n,2np)

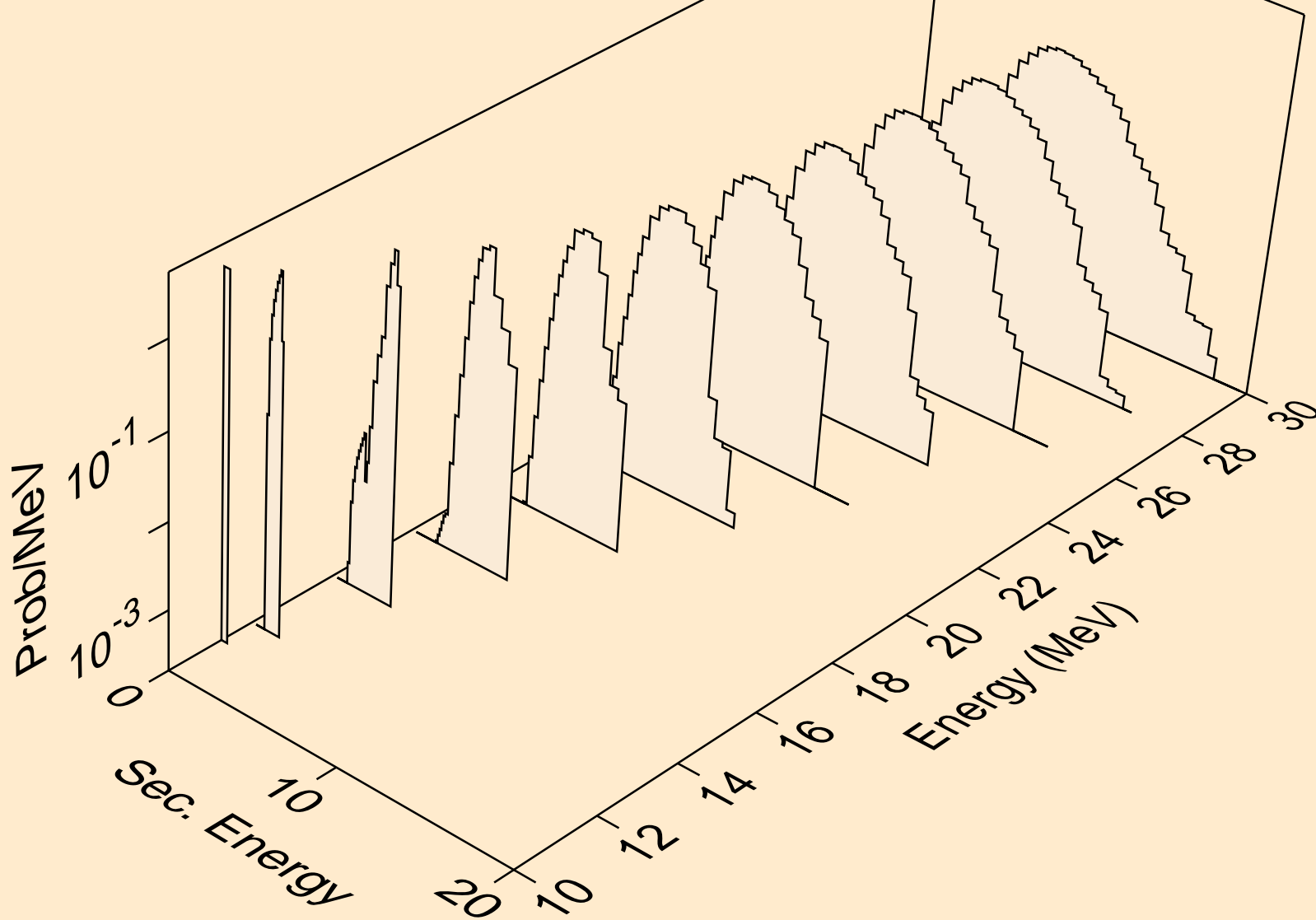

RE167M NEUTRON ACER TENDL-2019 LIBRARY; T=293.16K
protons from (n,3np)

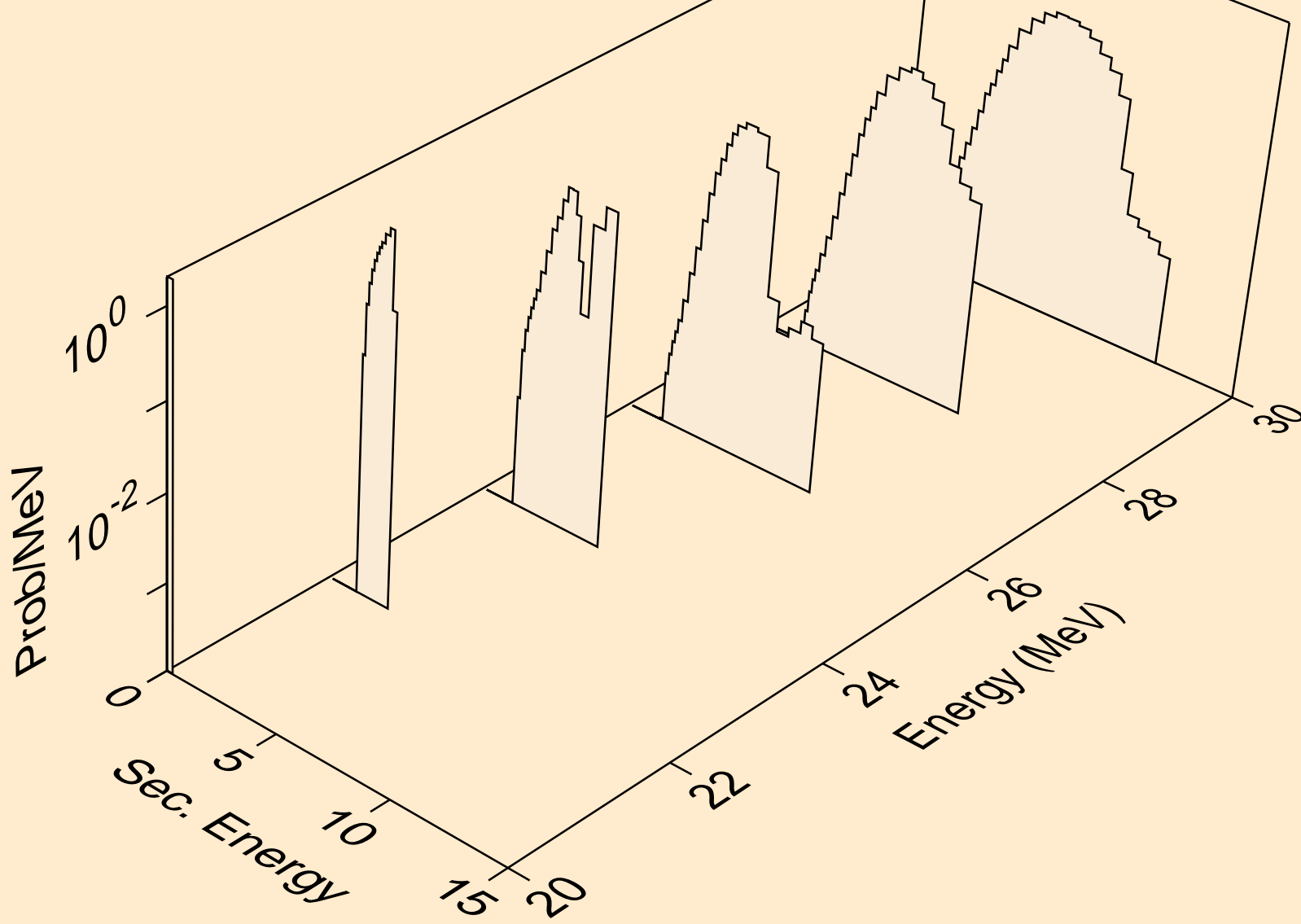

RE167M NEUTRON ACER TENDL-2019 LIBRARY; T=293.16K
protons from (n,2np)

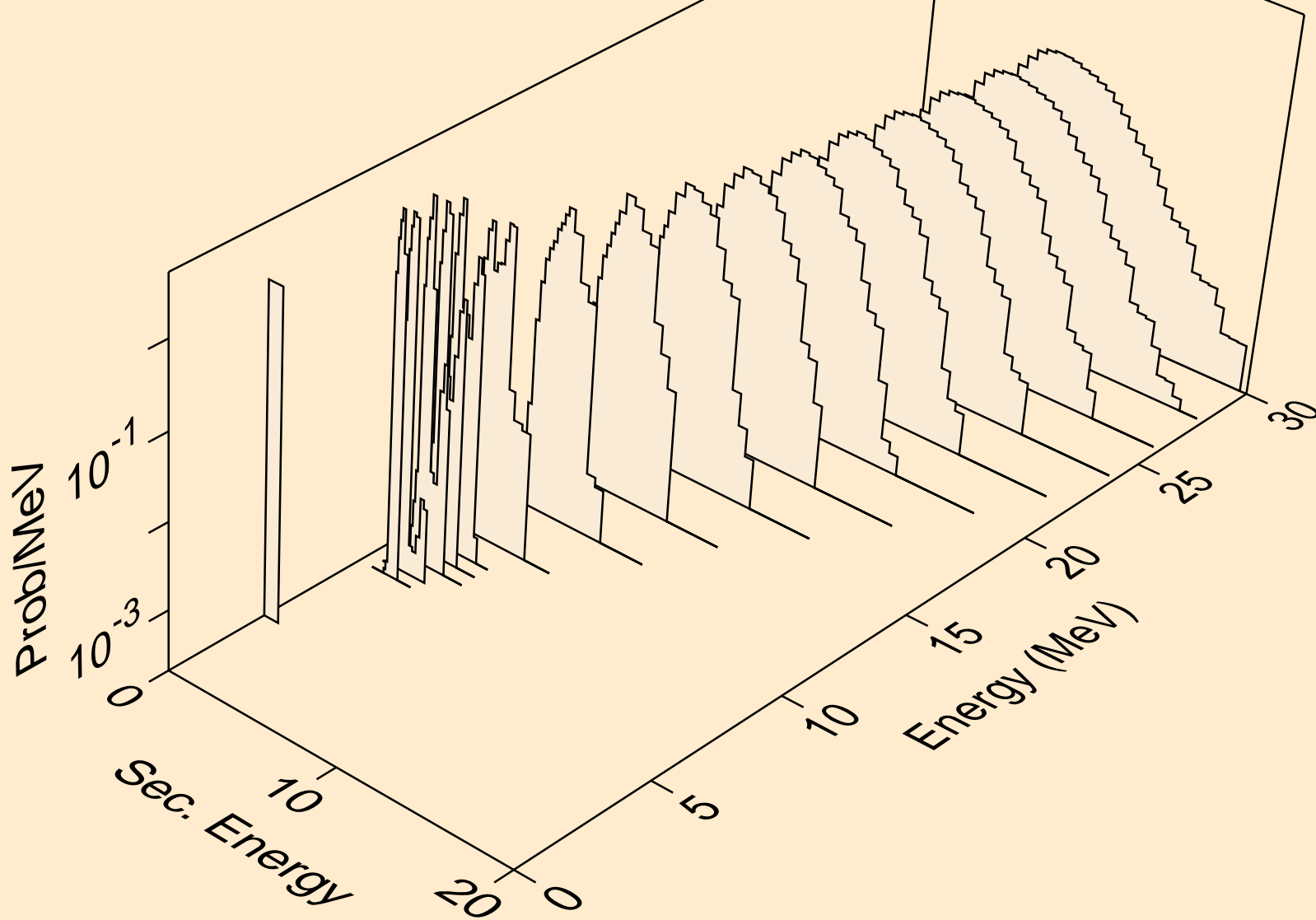

RE167M NEUTRON ACER TENDL-2019 LIBRARY; T=293.16K
protons from (n,npa)

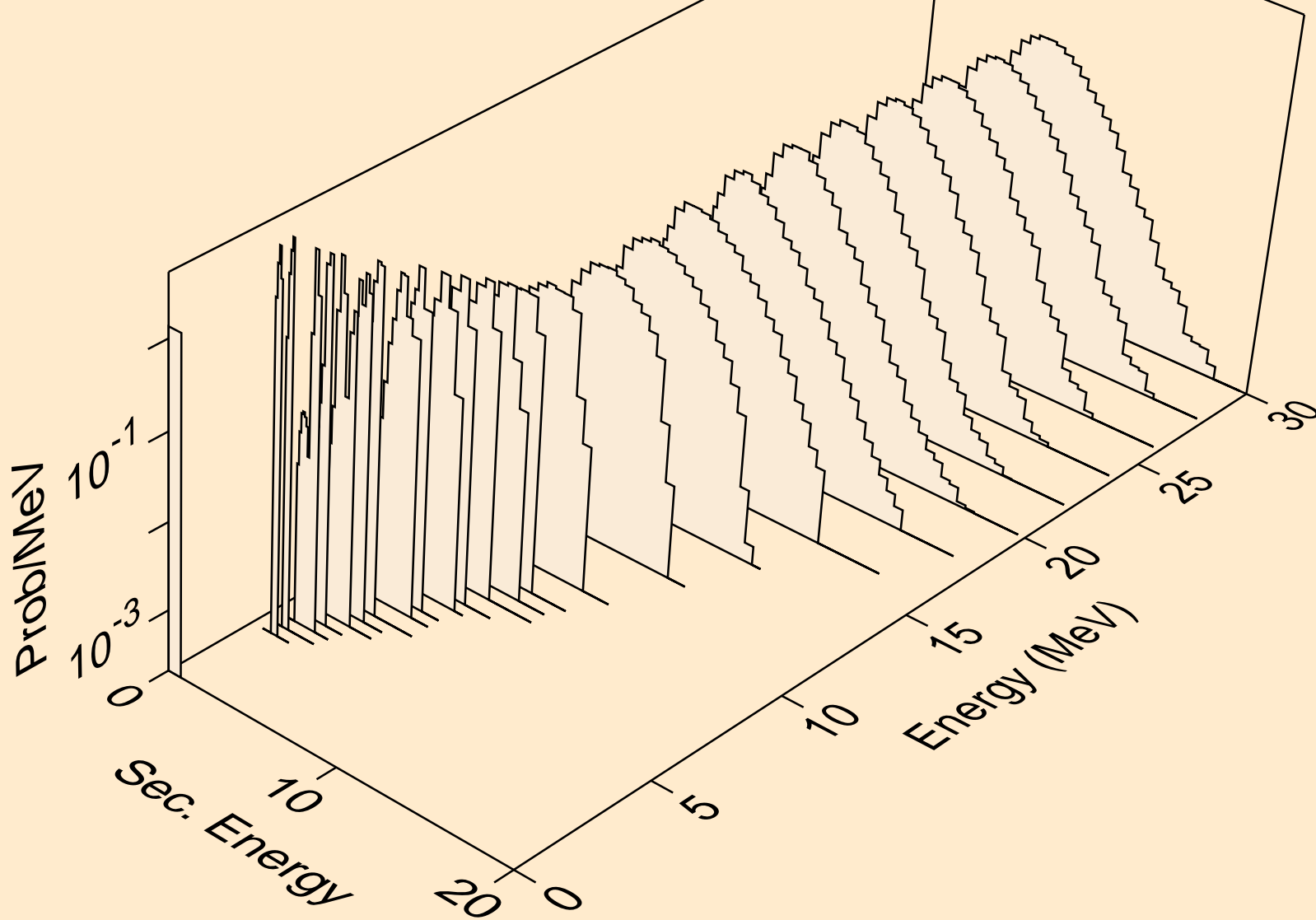

RE167M NEUTRON ACER TENDL-2019 LIBRARY; T=293.16K
protons from (n,p)

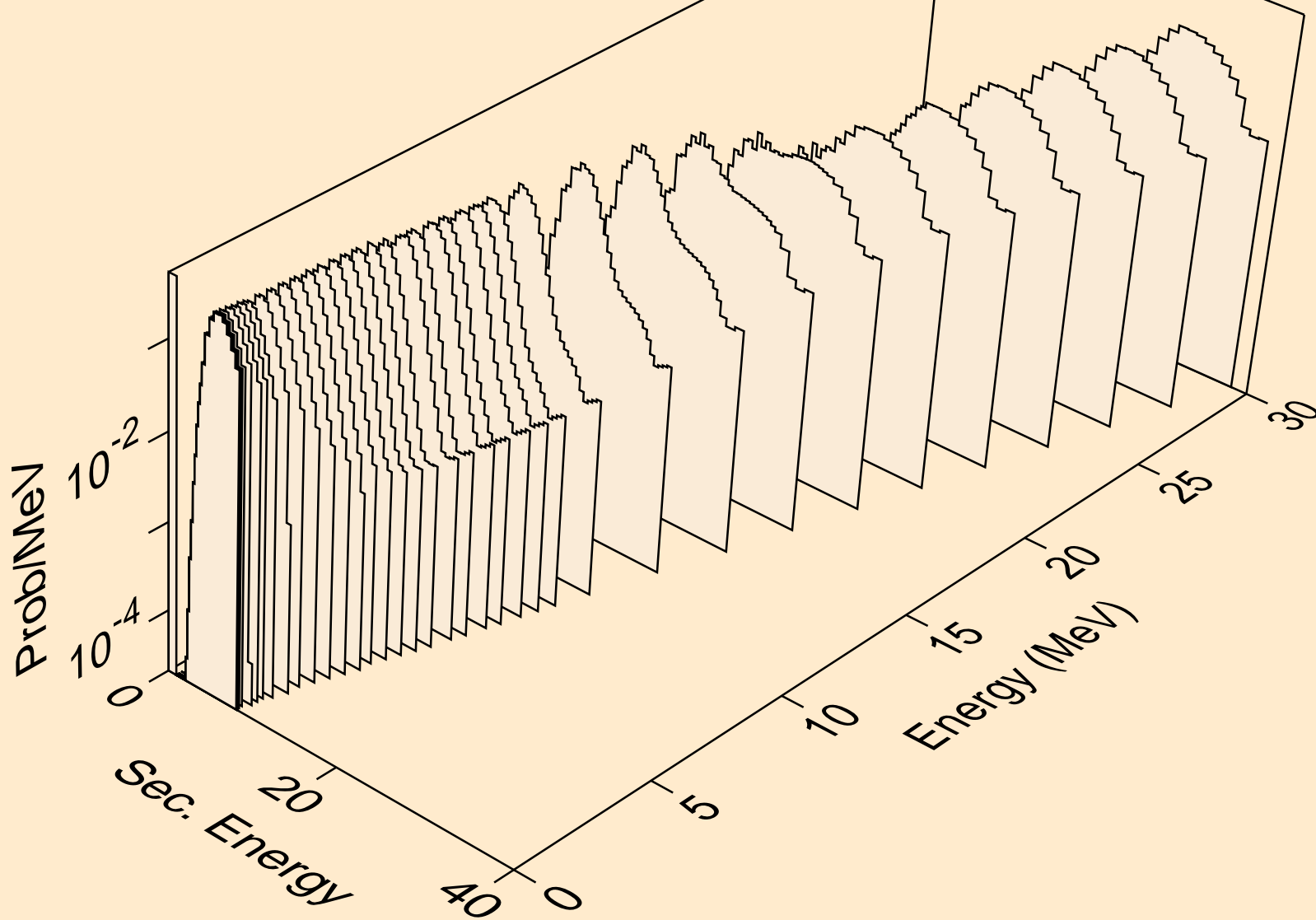

RE167M NEUTRON ACER TENDL-2019 LIBRARY; T=293.16K
protons from (n,2p)

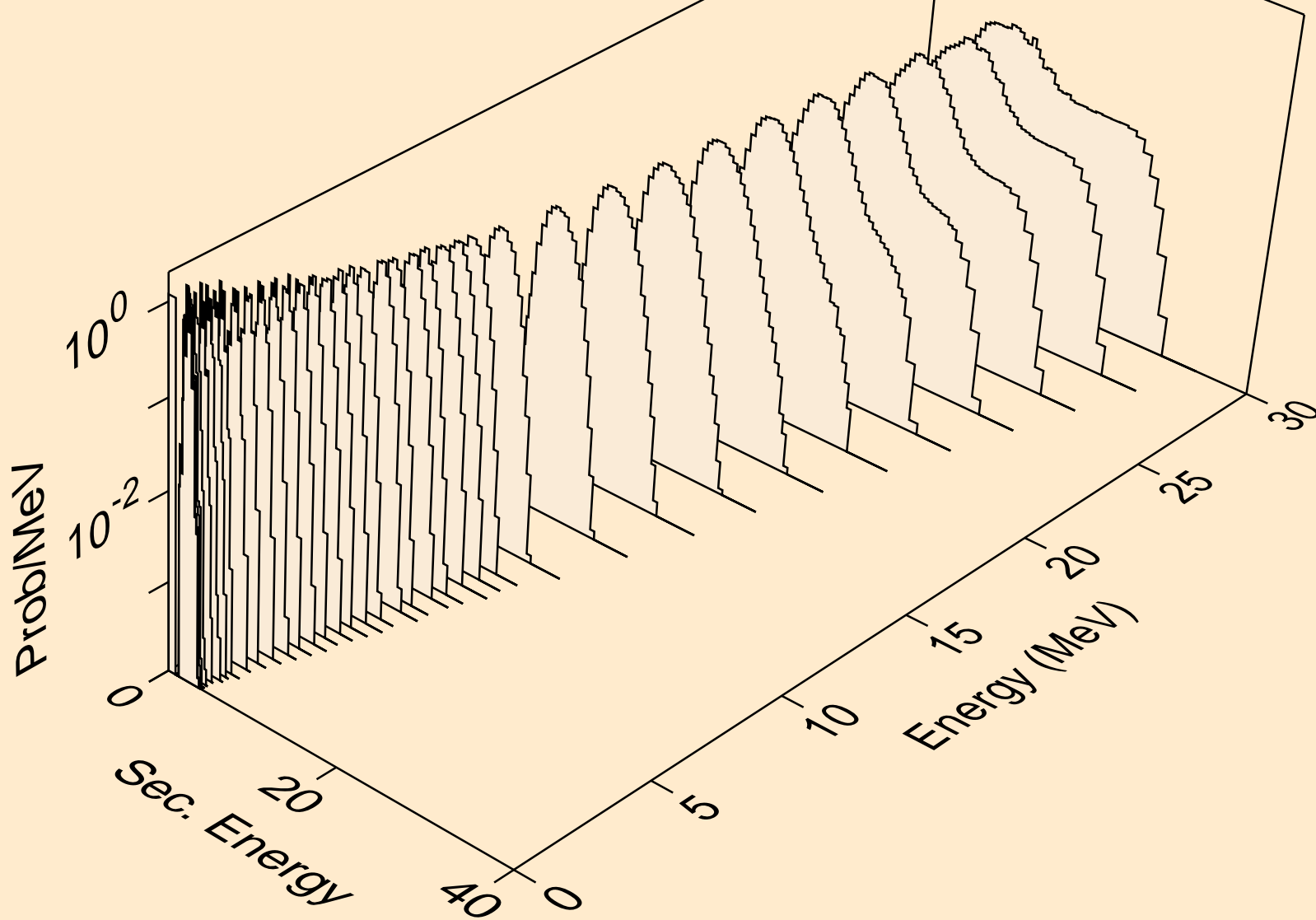

RE167M NEUTRON ACER TENDL-2019 LIBRARY; T=293.16K
protons from (n,p)

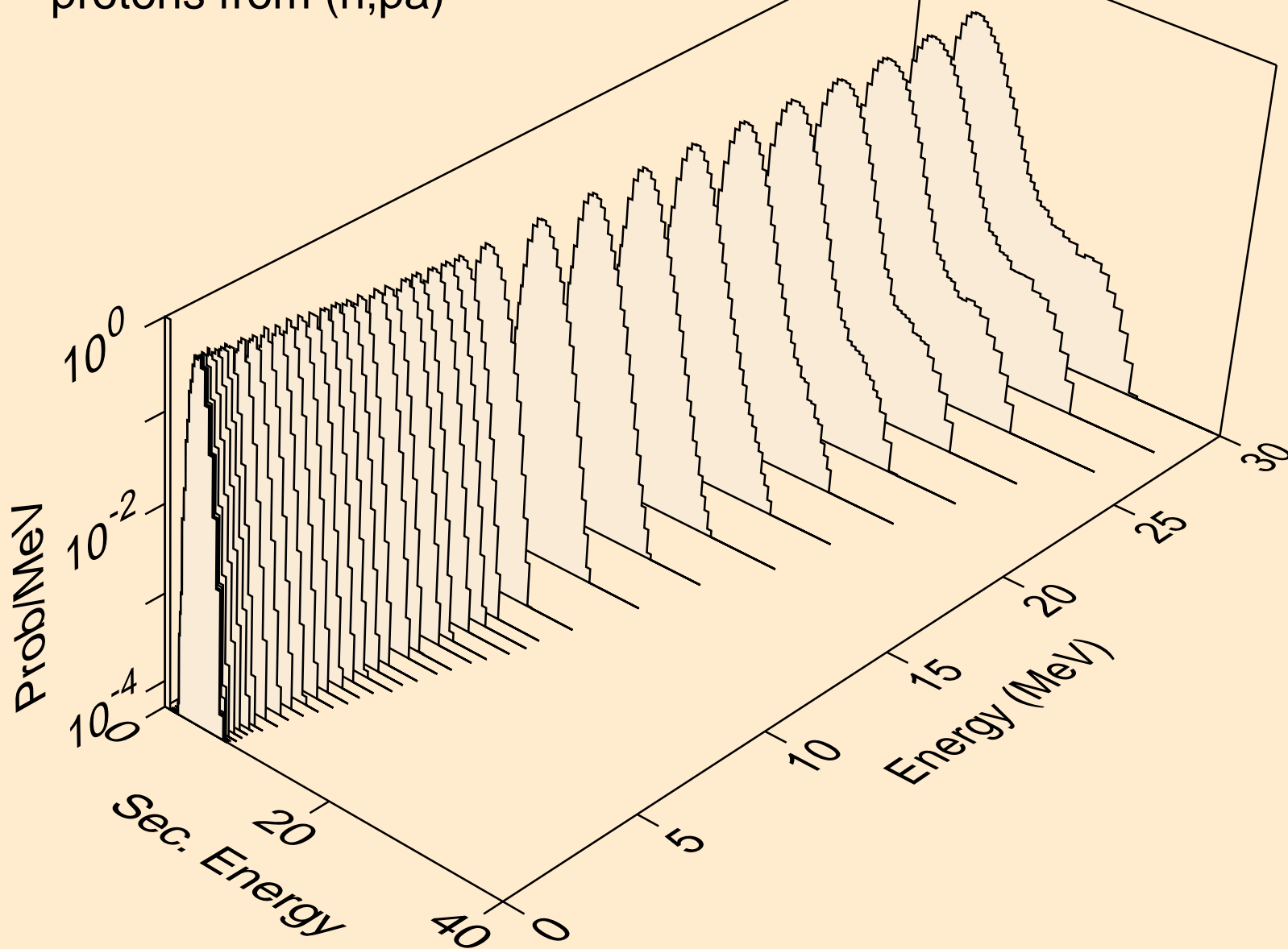

RE167M NEUTRON ACER TENDL-2019 LIBRARY; T=293.16K
protons from (n,pd)

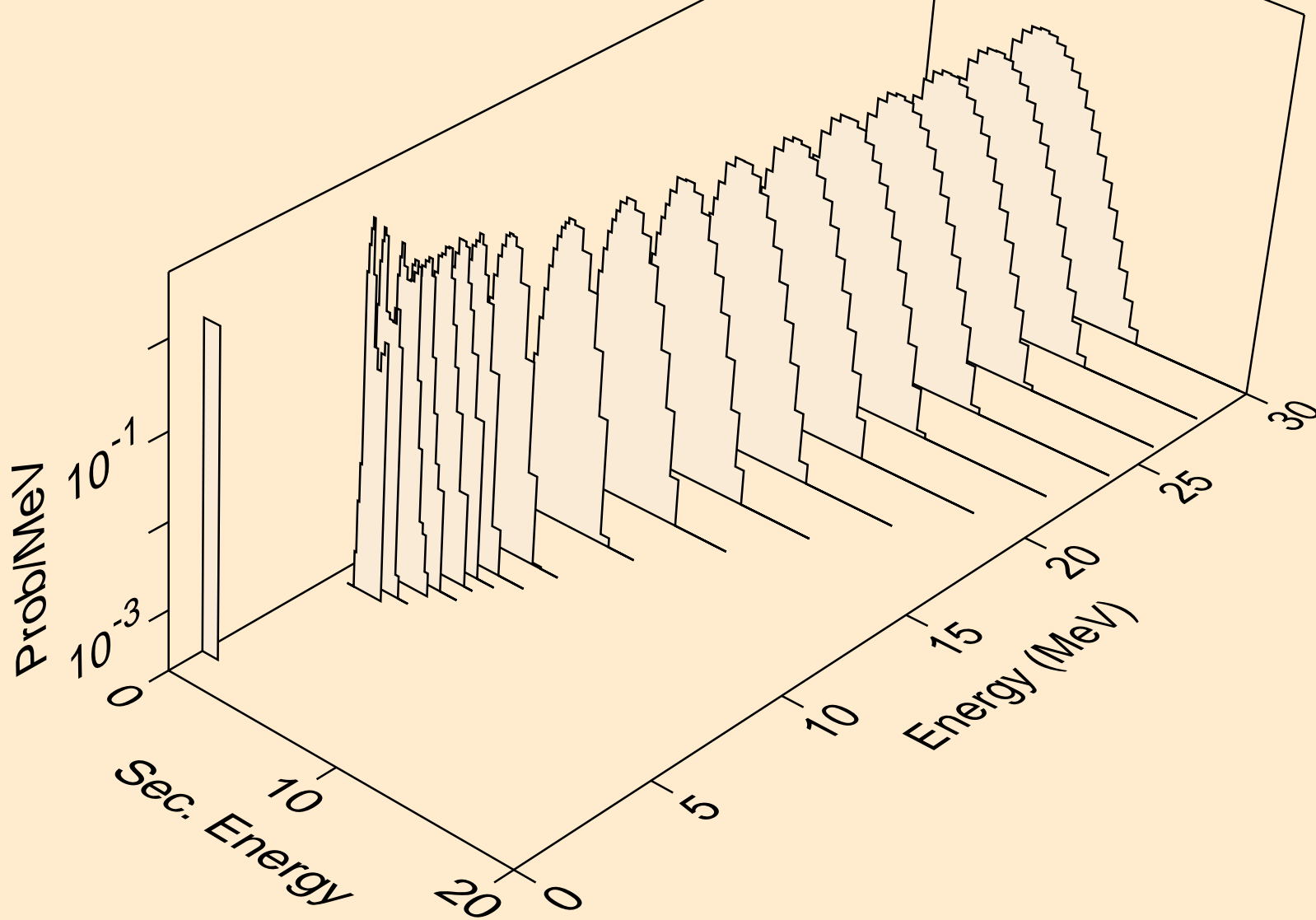

RE167M NEUTRON ACER TENDL-2019 LIBRARY; T=293.16K
protons from (n,pt)

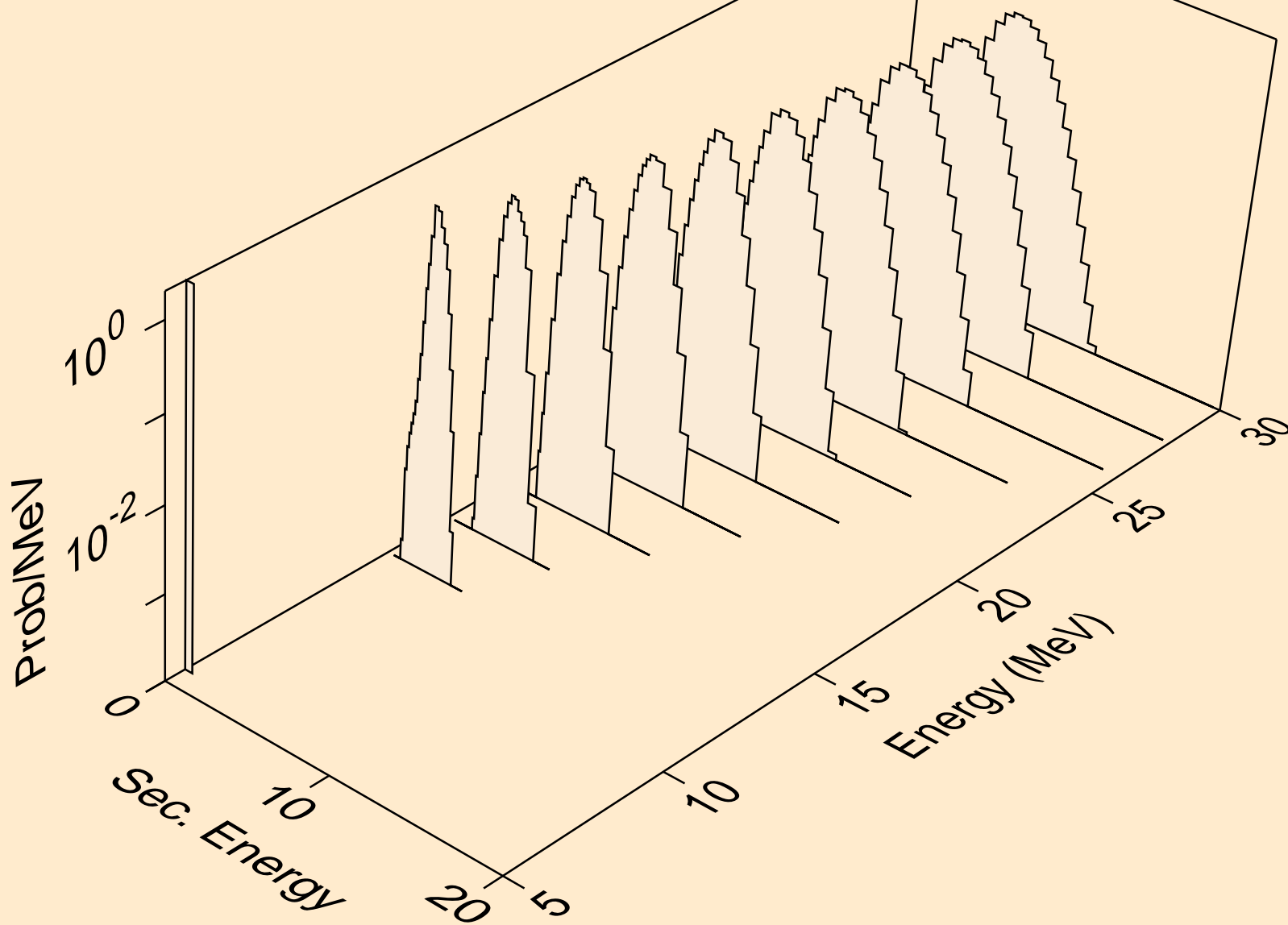

RE167M NEUTRON ACER TENDL-2019 LIBRARY; T=293.16K
deuterons from (n,x)

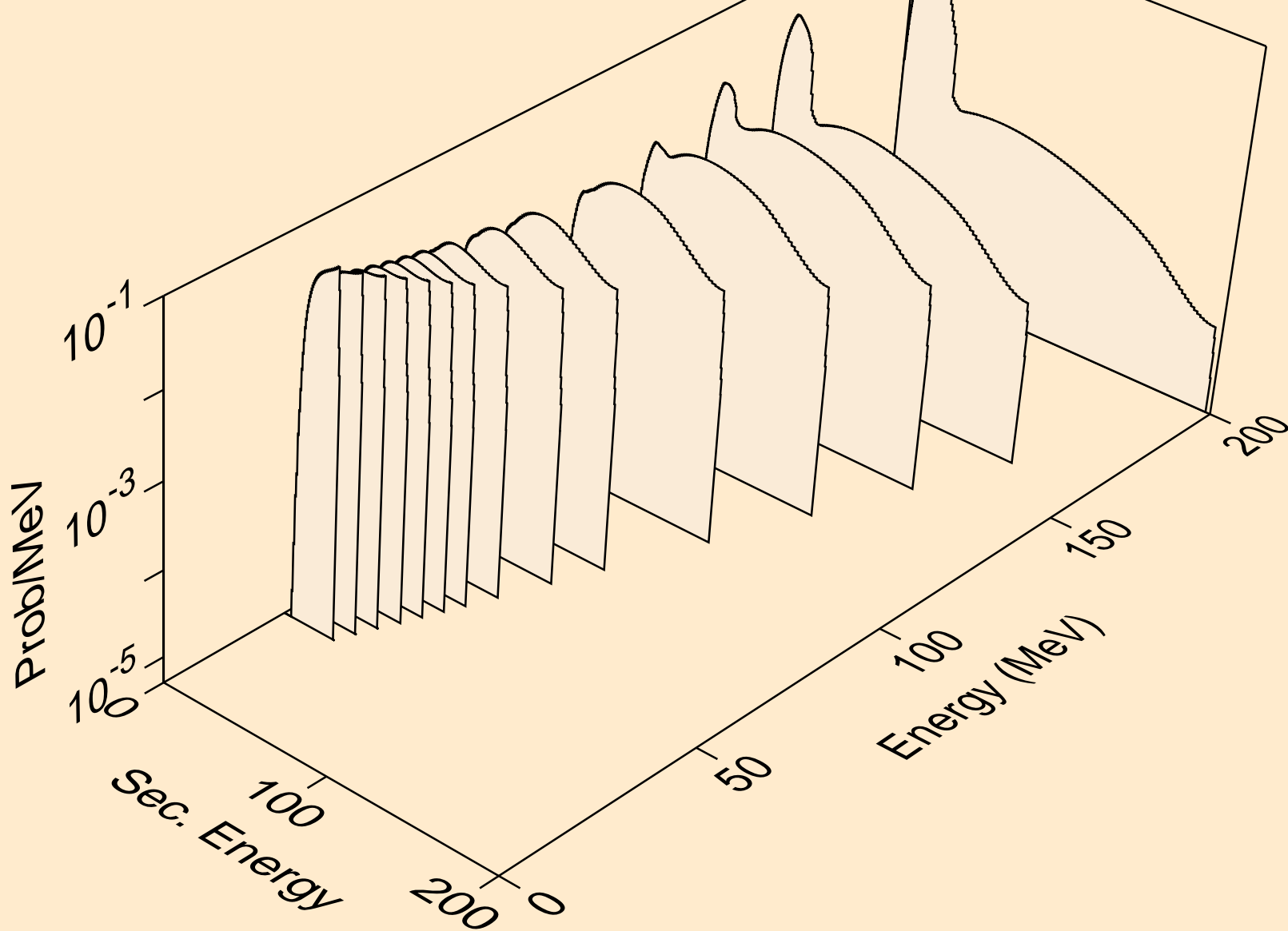

RE167M NEUTRON ACER TENDL-2019 LIBRARY; T=293.16K
deuterons from (n,2nd)

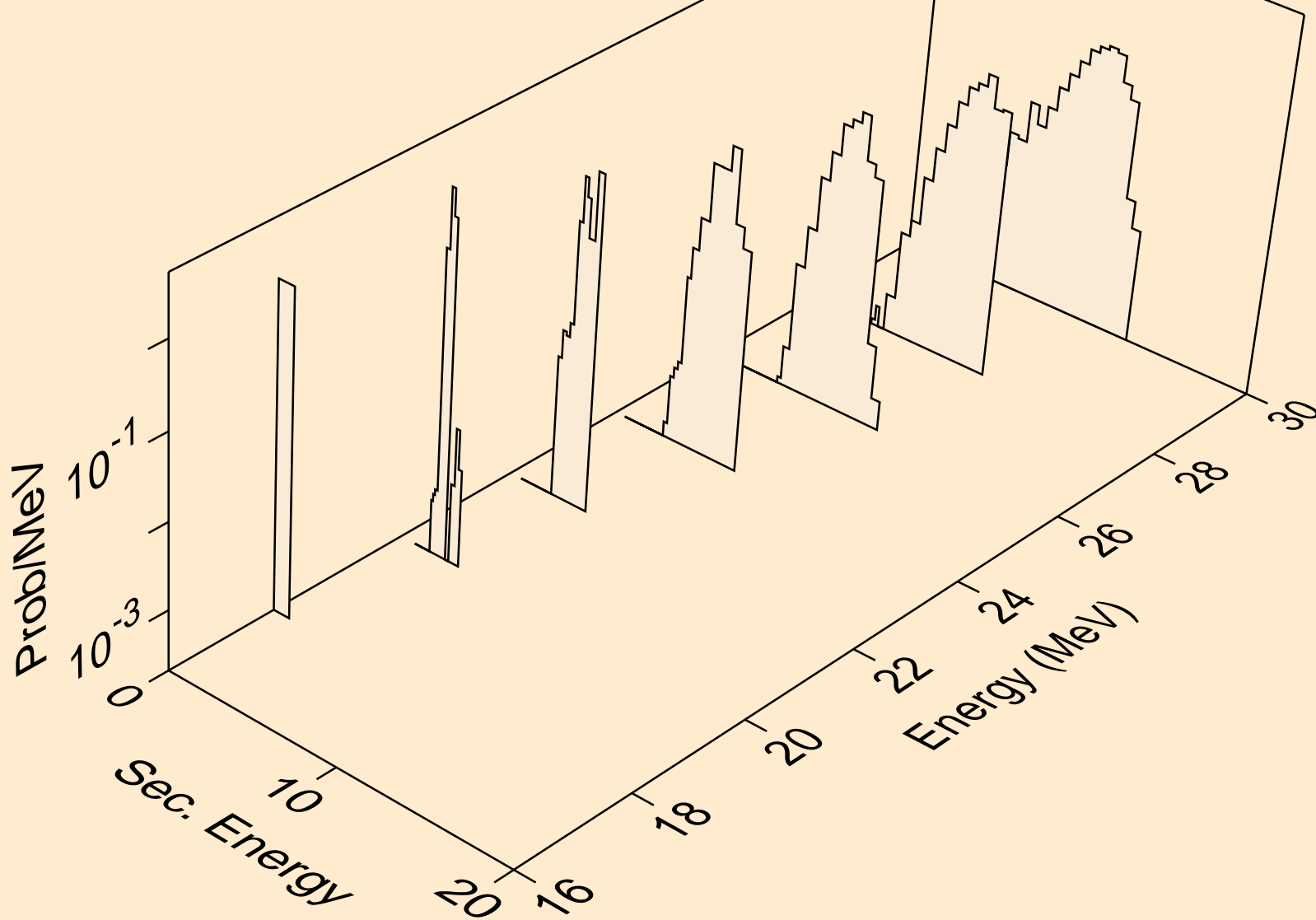

RE167M NEUTRON ACER TENDL-2019 LIBRARY; T=293.16K
deuterons from (n,n*)d

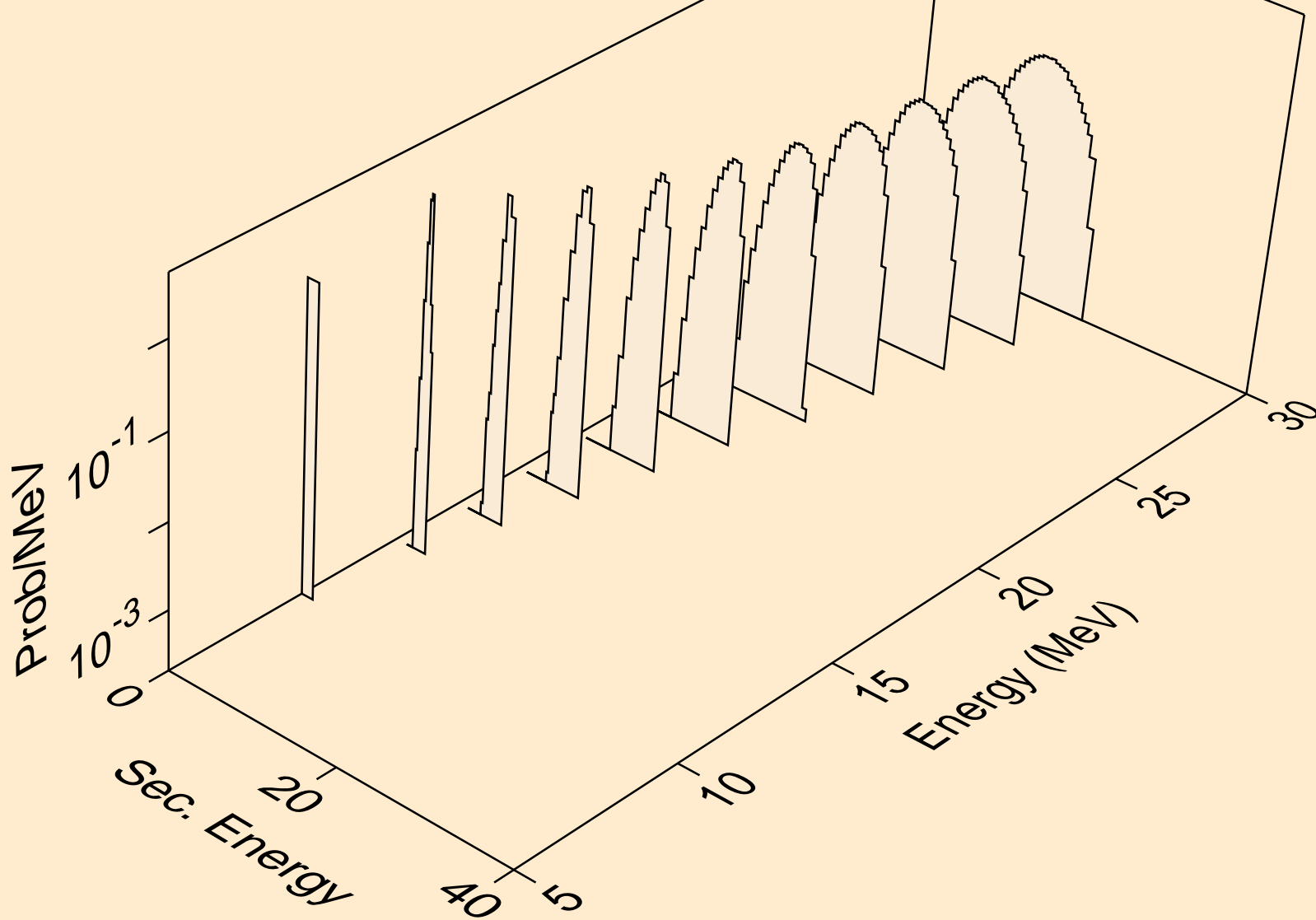

RE167M NEUTRON ACER TENDL-2019 LIBRARY; T=293.16K
deuterons from (n,d)

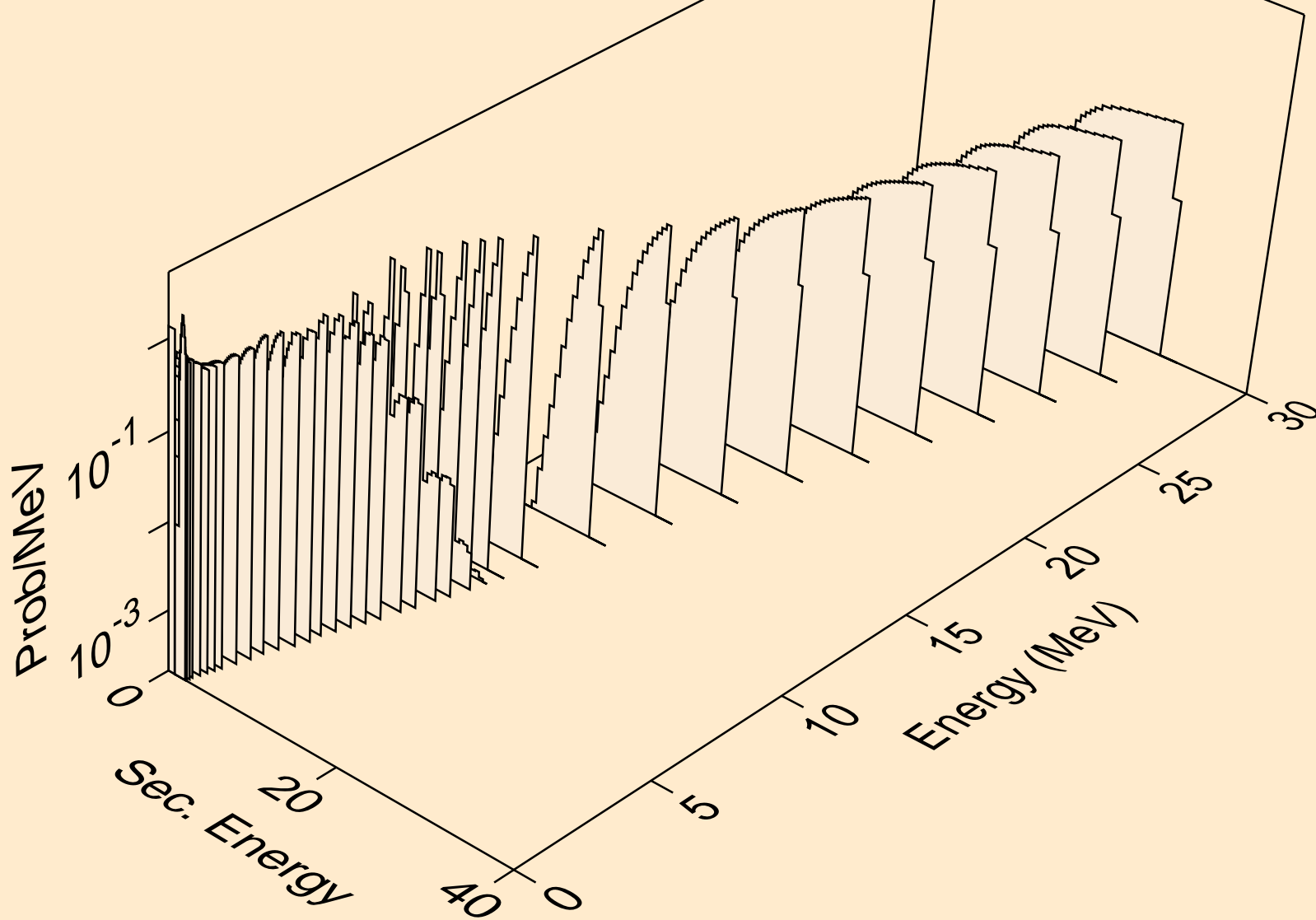

RE167M NEUTRON ACER TENDL-2019 LIBRARY; T=293.16K
deuterons from (n,d2a)

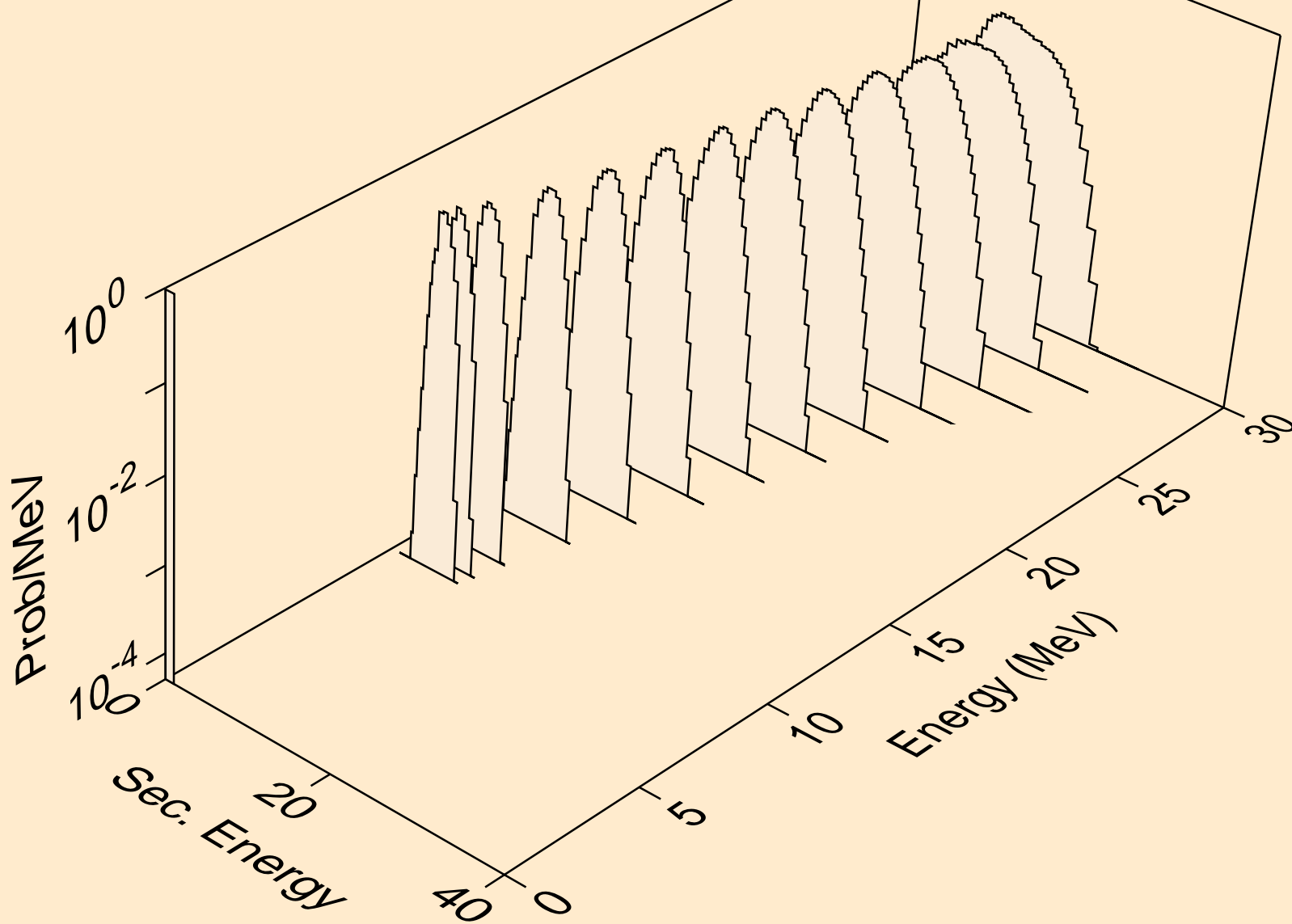

RE167M NEUTRON ACER TENDL-2019 LIBRARY; T=293.16K
deuterons from (n,pd)

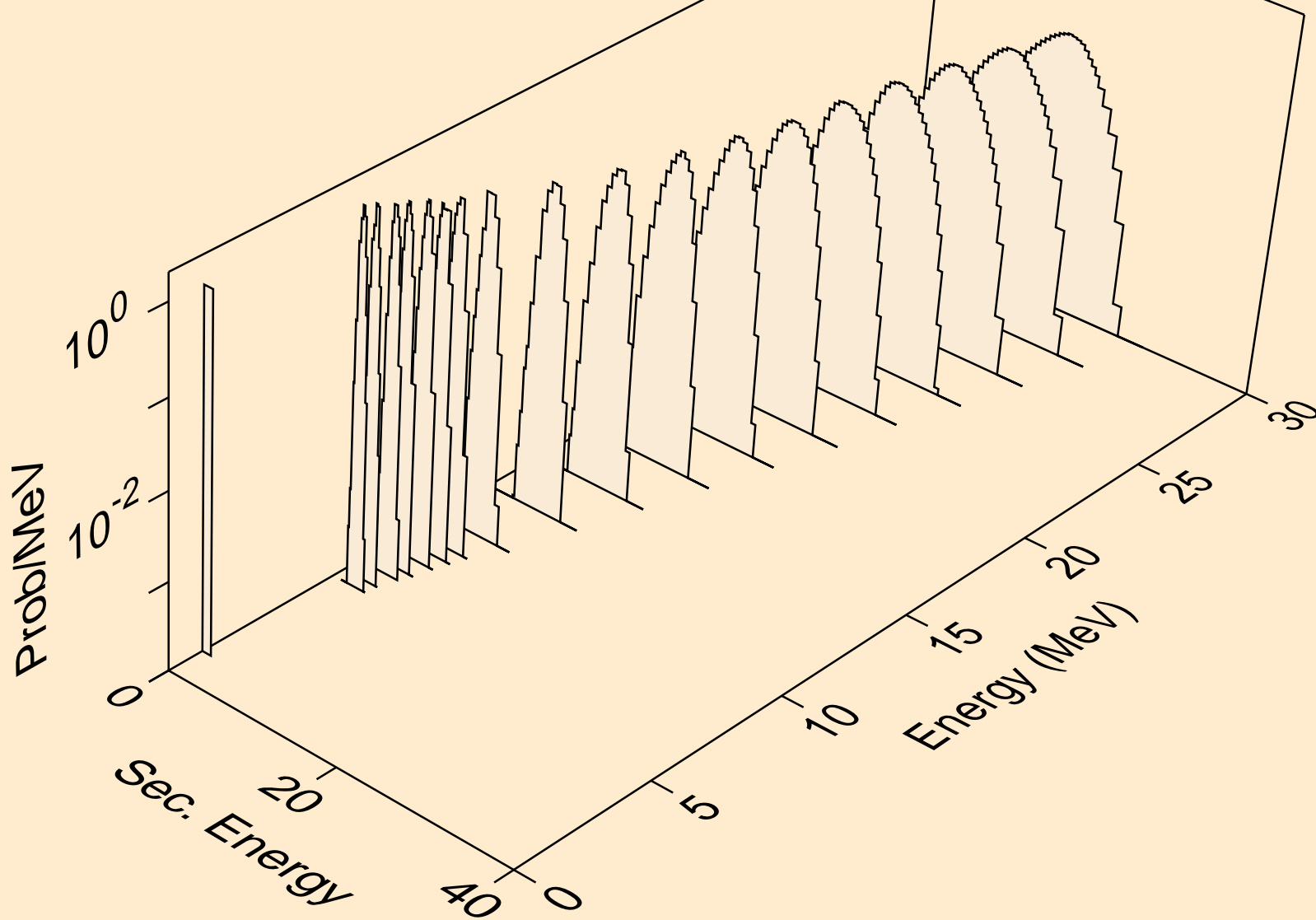

RE167M NEUTRON ACER TENDL-2019 LIBRARY; T=293.16K
deuterons from (n,da)

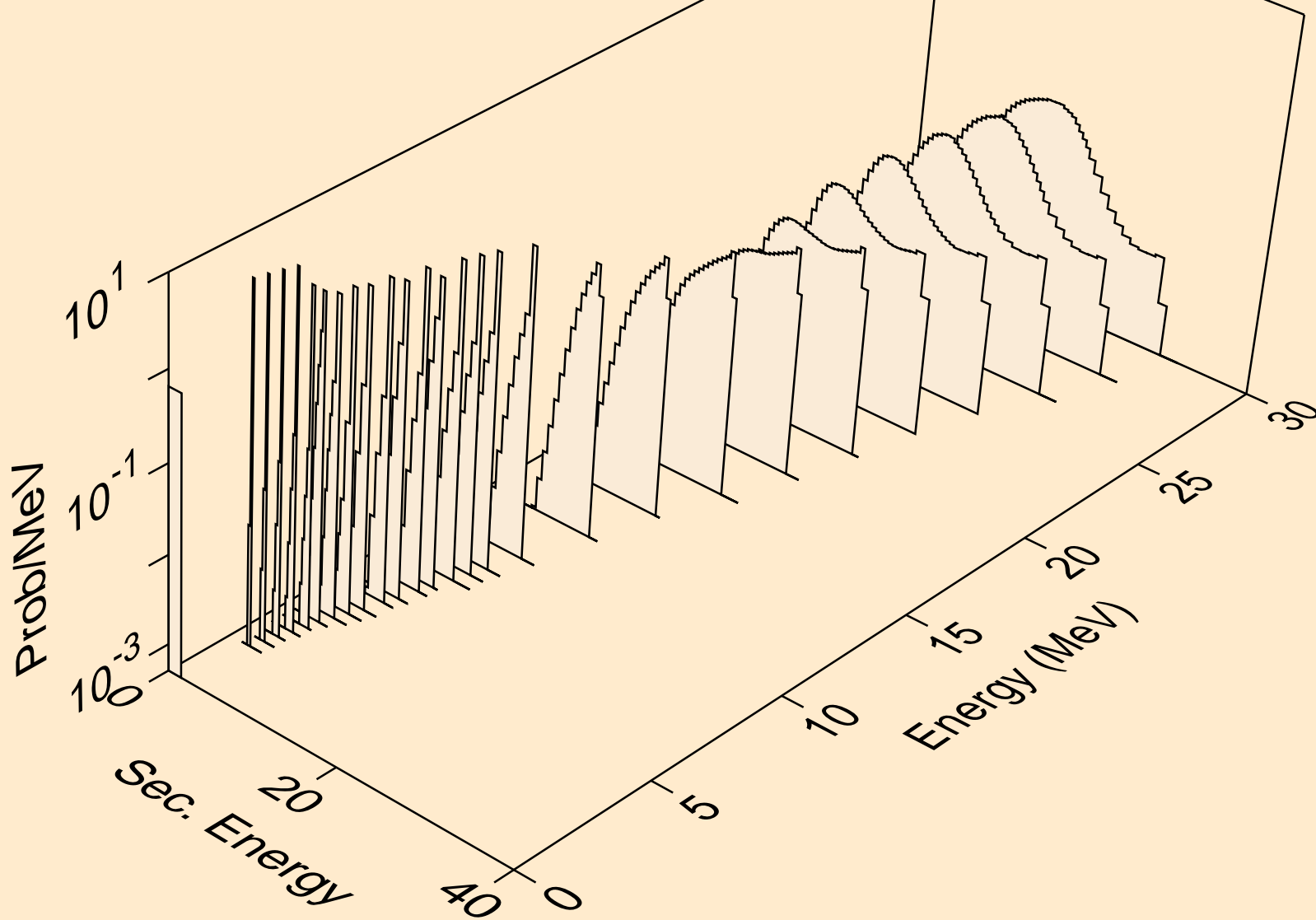

RE167M NEUTRON ACER TENDL-2019 LIBRARY; T=293.16K
tritons from (n,x)

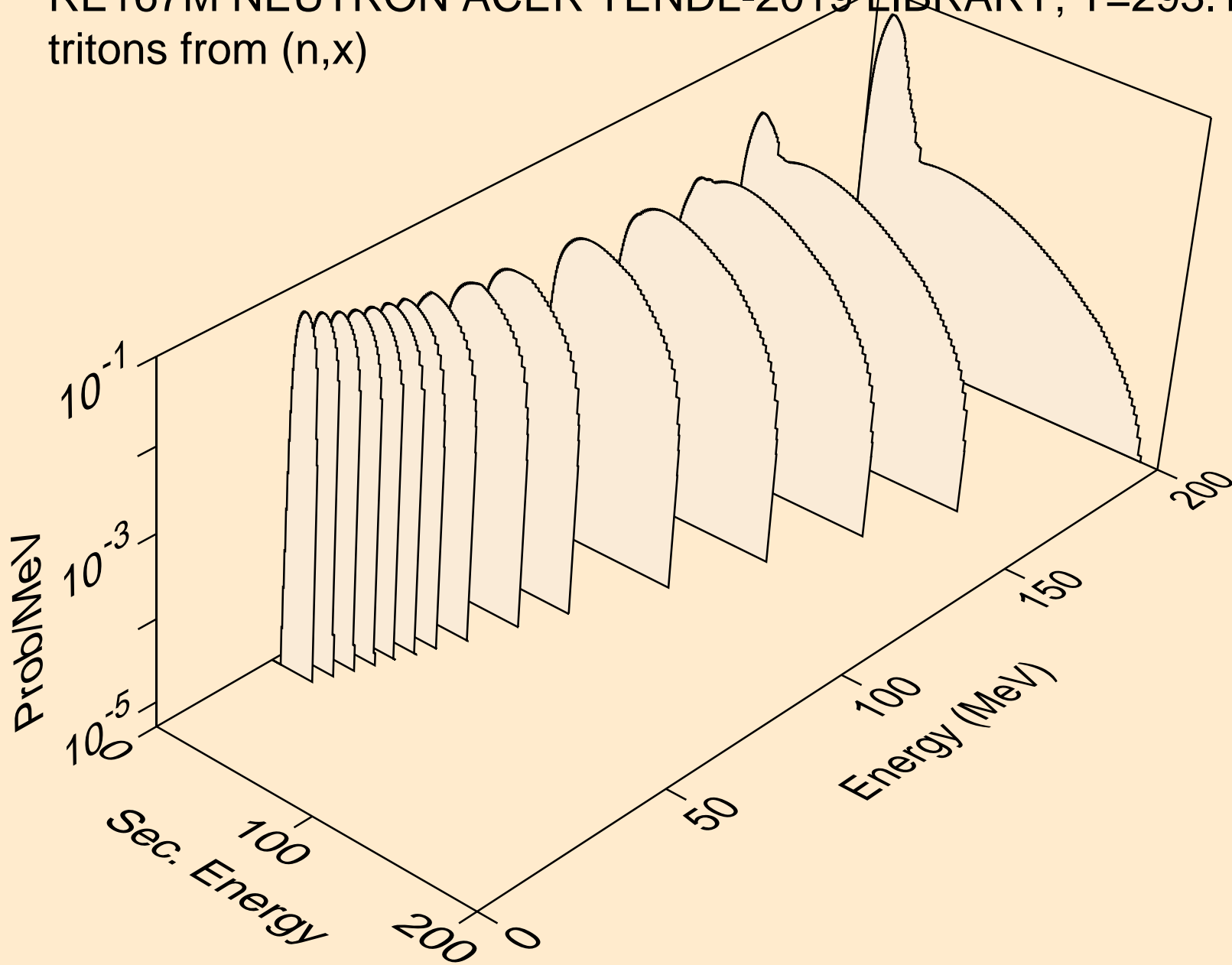

RE167M NEUTRON ACER TENDL-2019 LIBRARY; T=293.16K
tritons from (n,n*)t

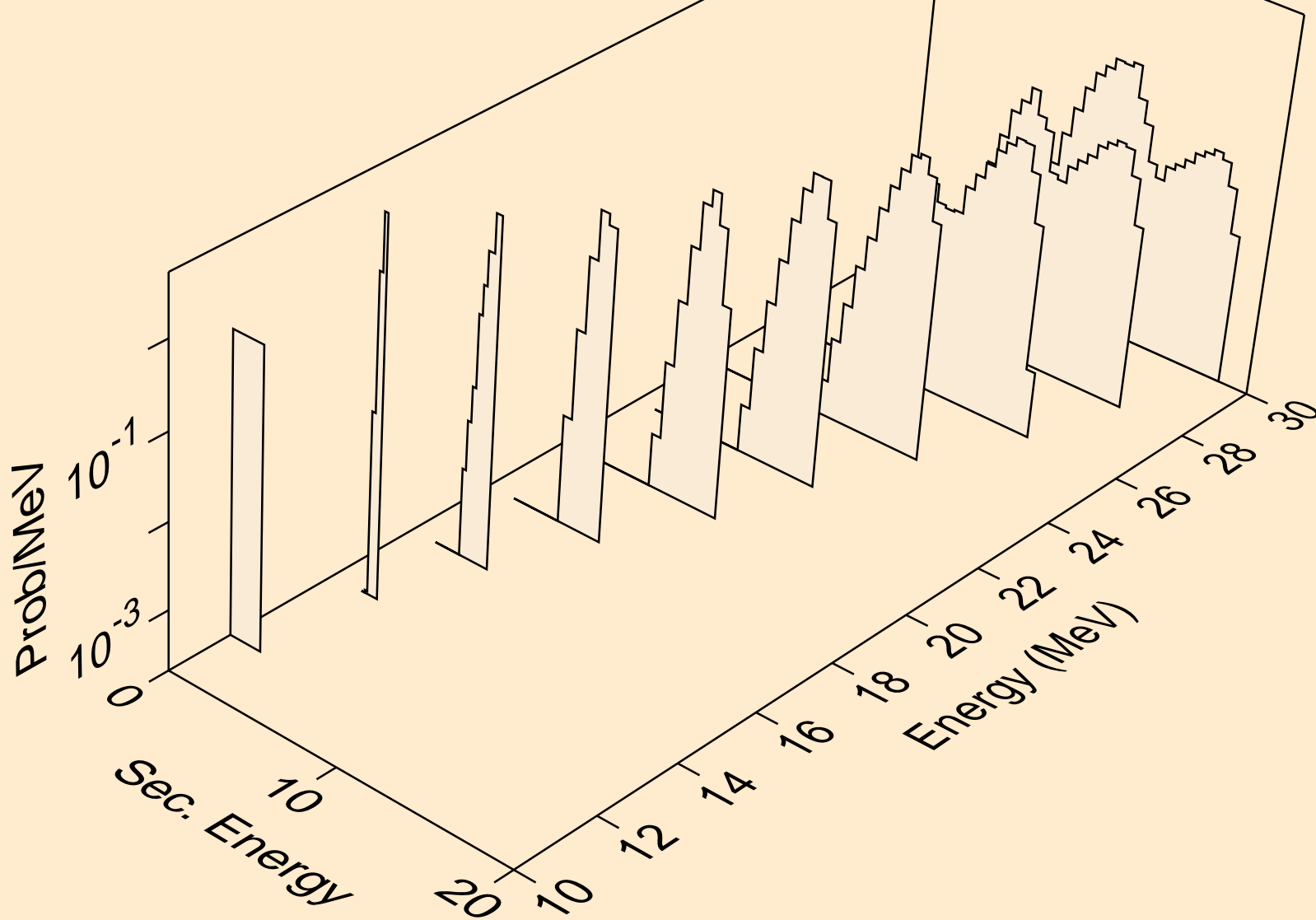

RE167M NEUTRON ACER TENDL-2019 LIBRARY; T=293.16K
tritons from (n,t)

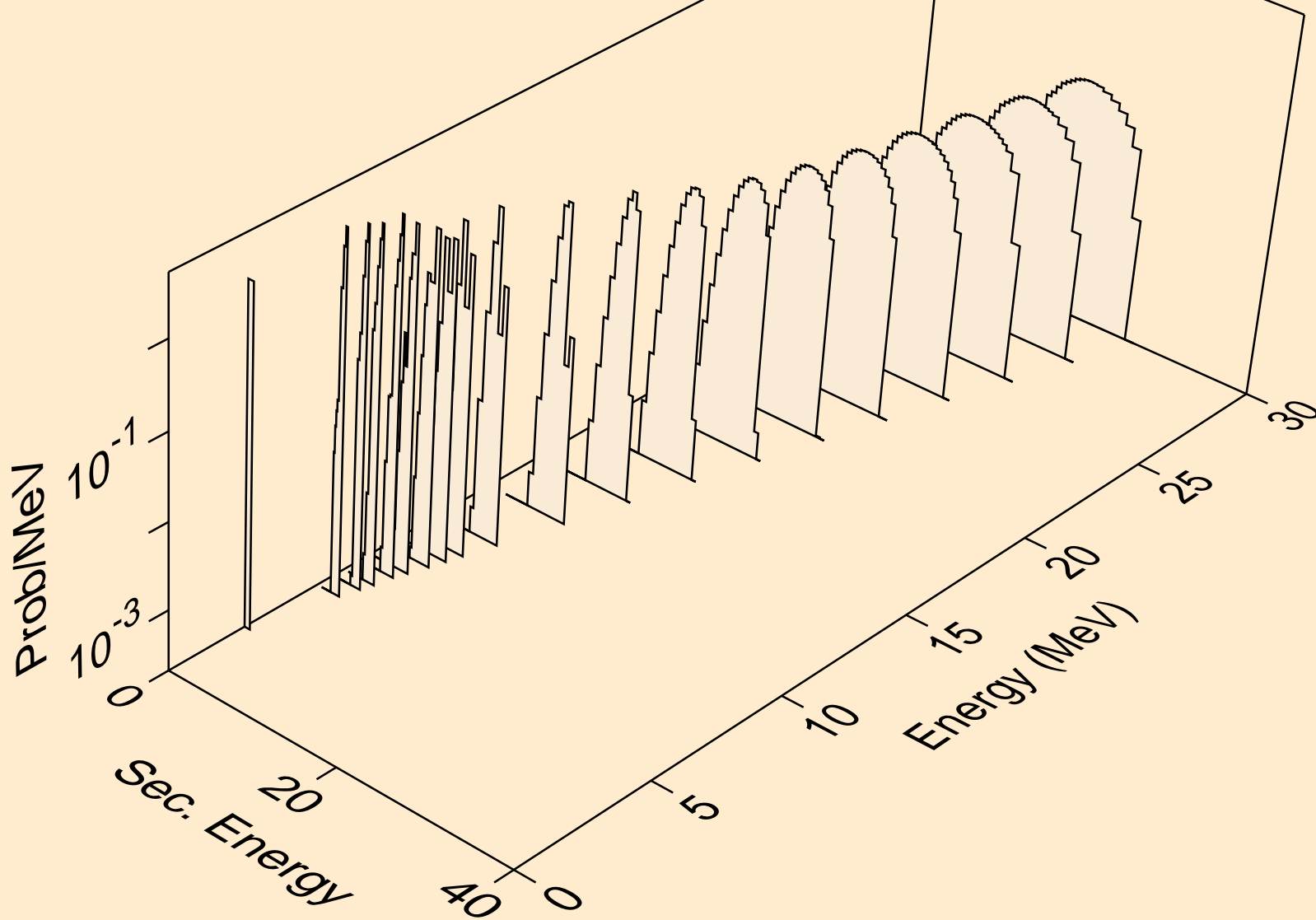

RE167M NEUTRON ACER TENDL-2019 LIBRARY; T=293.16K
tritons from (n,t2a)

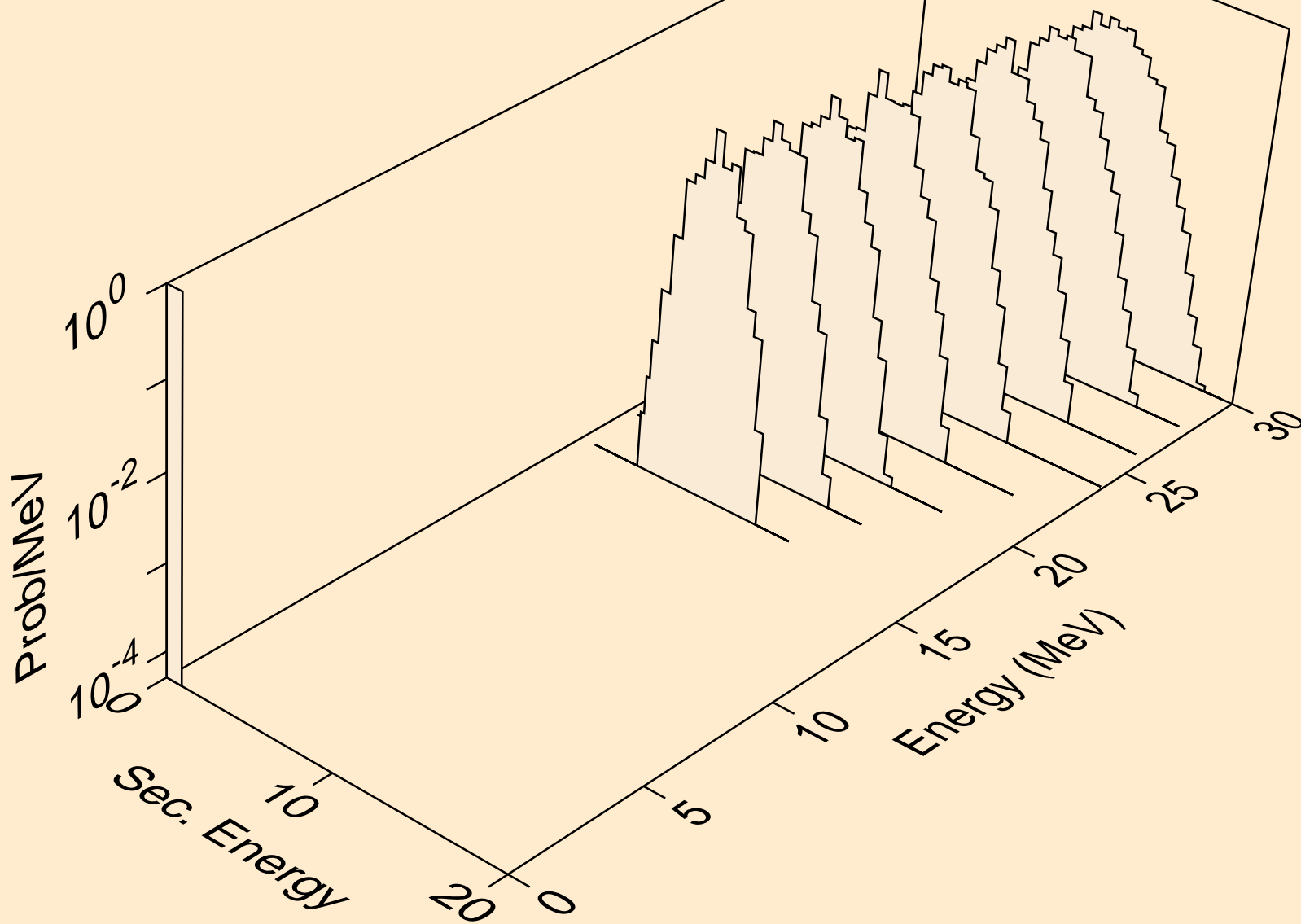

RE167M NEUTRON ACER TENDL-2019 LIBRARY; T=293.16K
tritons from (n,pt)

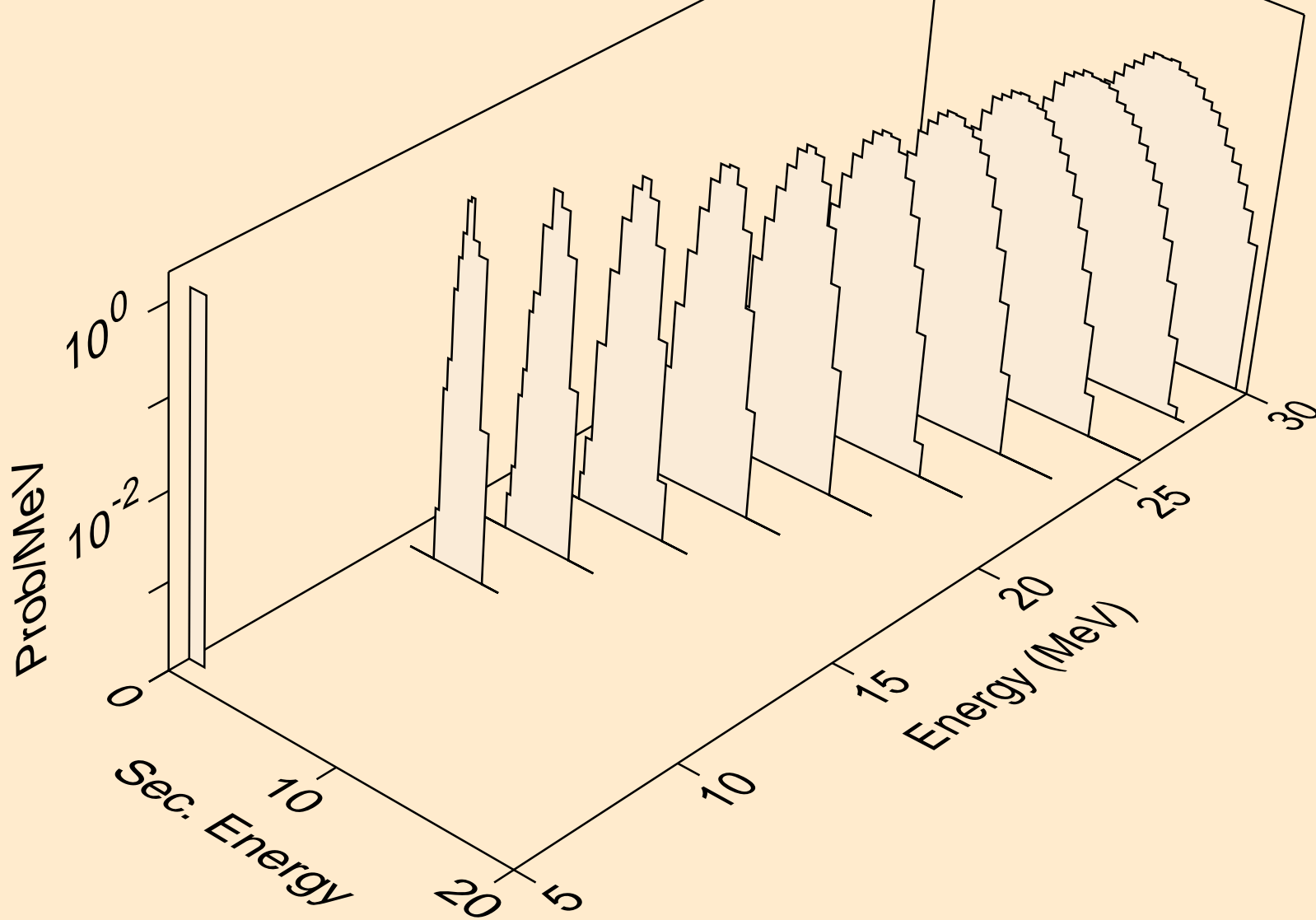

RE167M NEUTRON ACER TENDL-2019 LIBRARY; T=293.16K
he3s from (n,x)

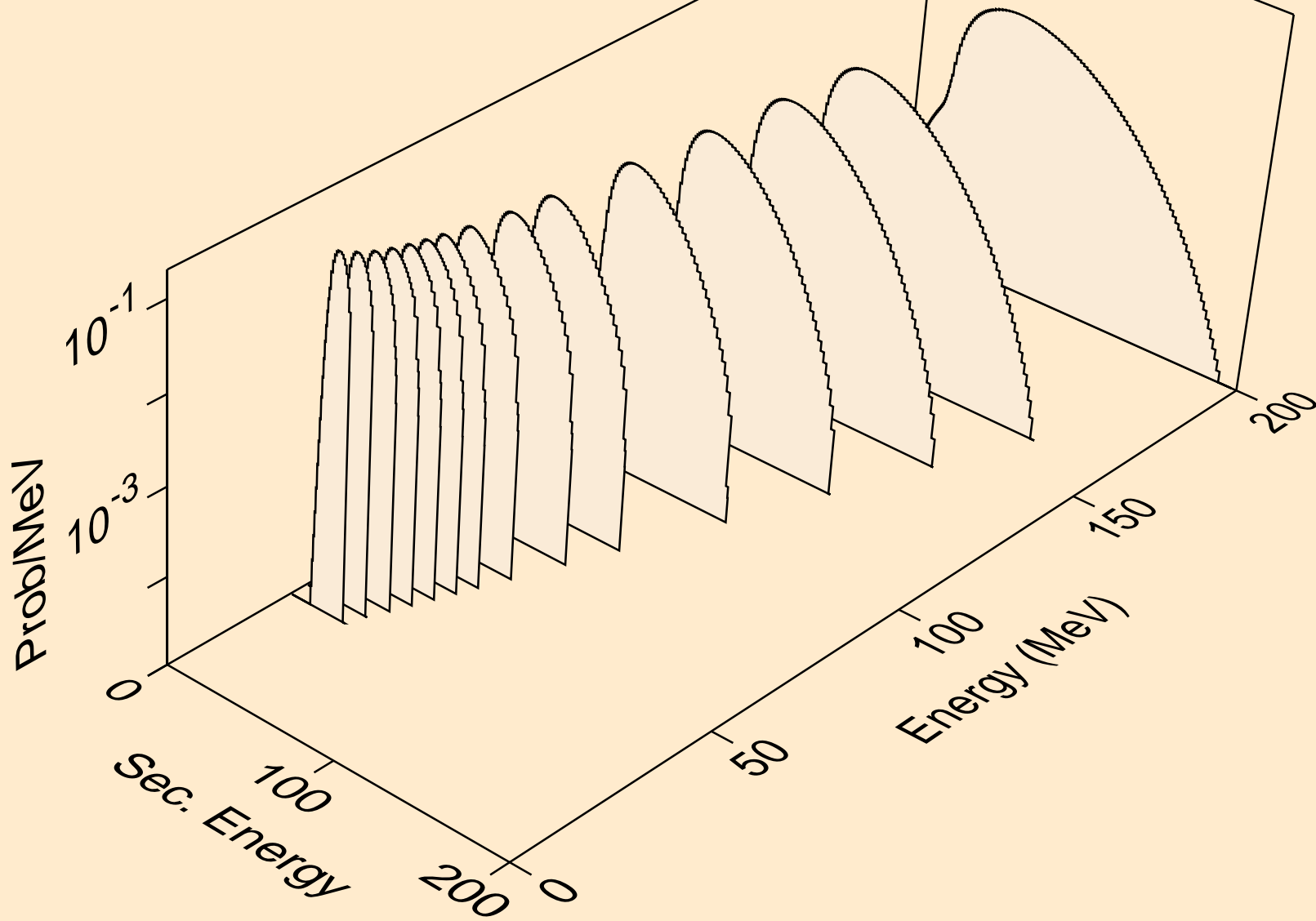

RE167M NEUTRON ACER TENDL-2019 LIBRARY; T=293.16K
he3s from (n,n*)he3

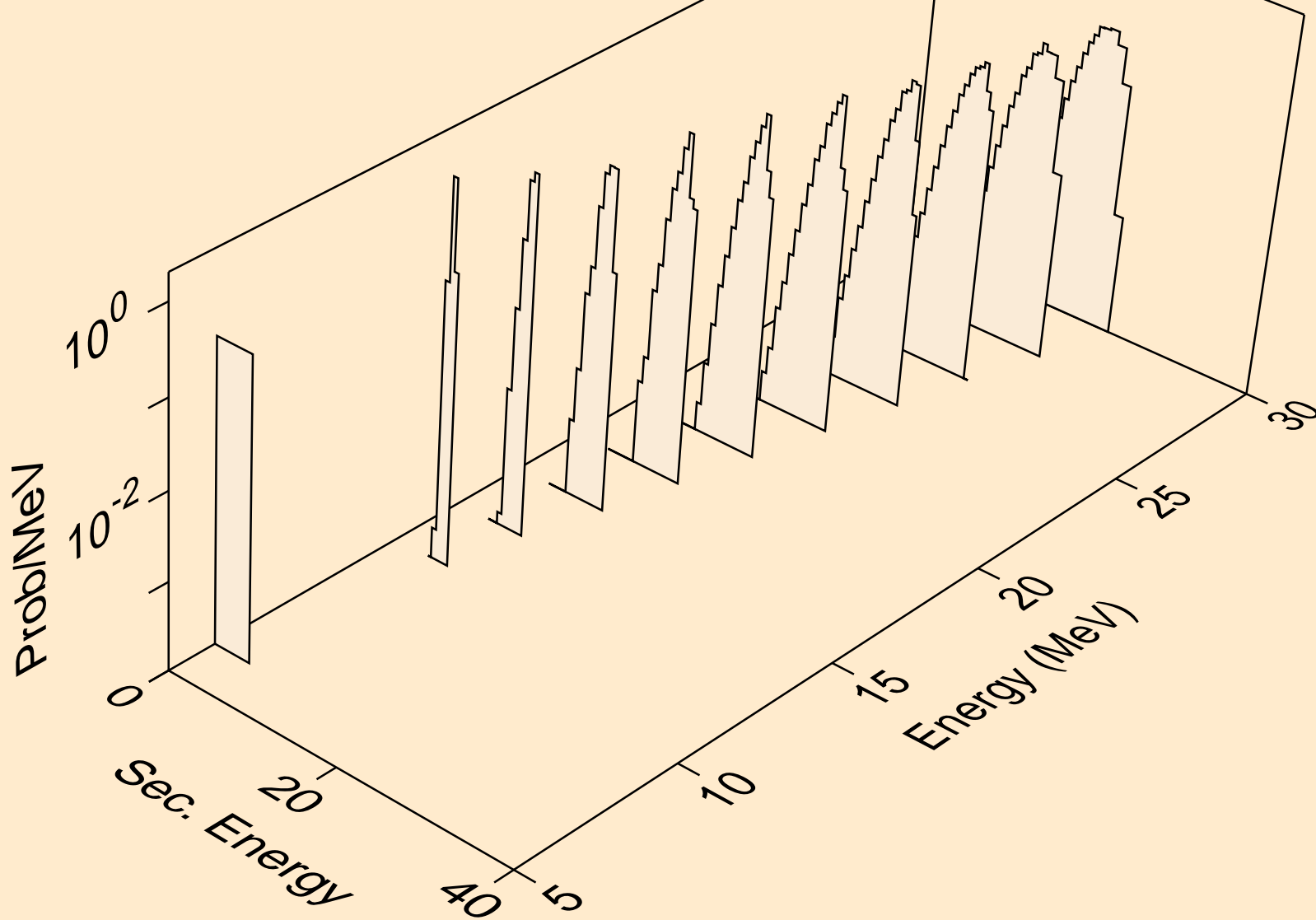

RE167M NEUTRON ACER TENDL-2019 LIBRARY; T=293.16K
he3s from (n,he3)

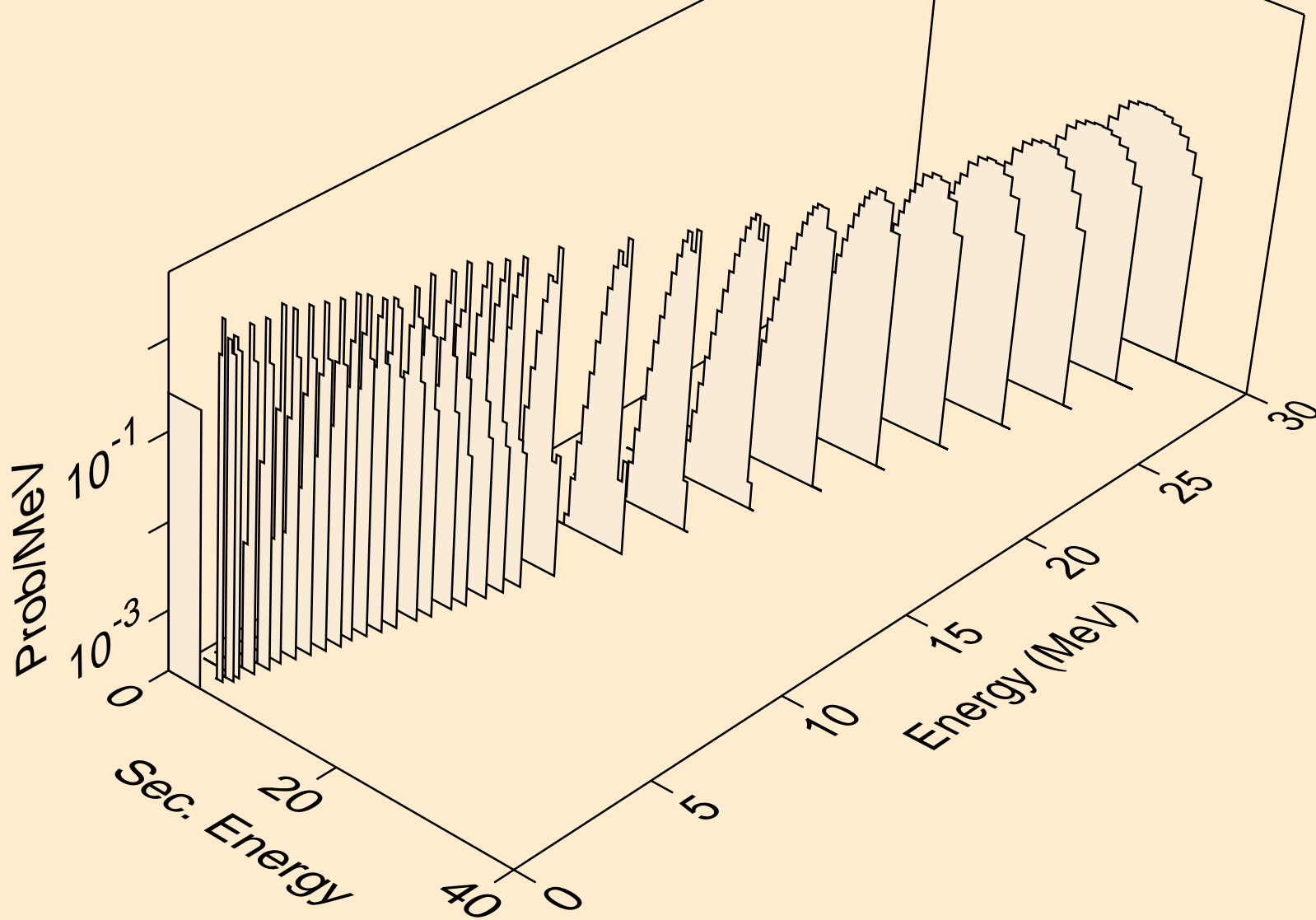

RE167M NEUTRON ACER TENDL-2019 LIBRARY; T=293.16K
alphas from (n,x)

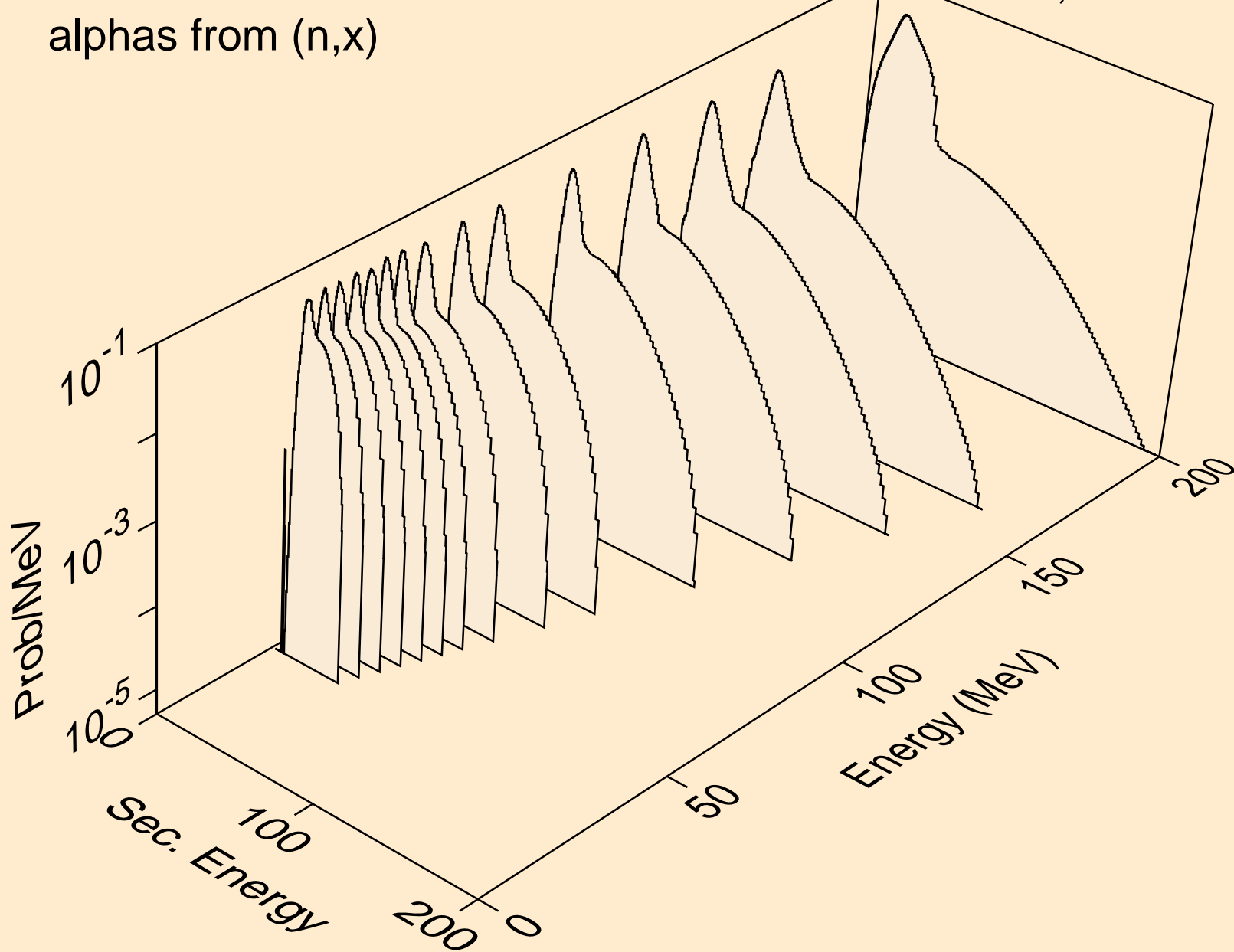

RE167M NEUTRON ACER TENDL-2019 LIBRARY; T=293.16K
alphas from (n,n*)a

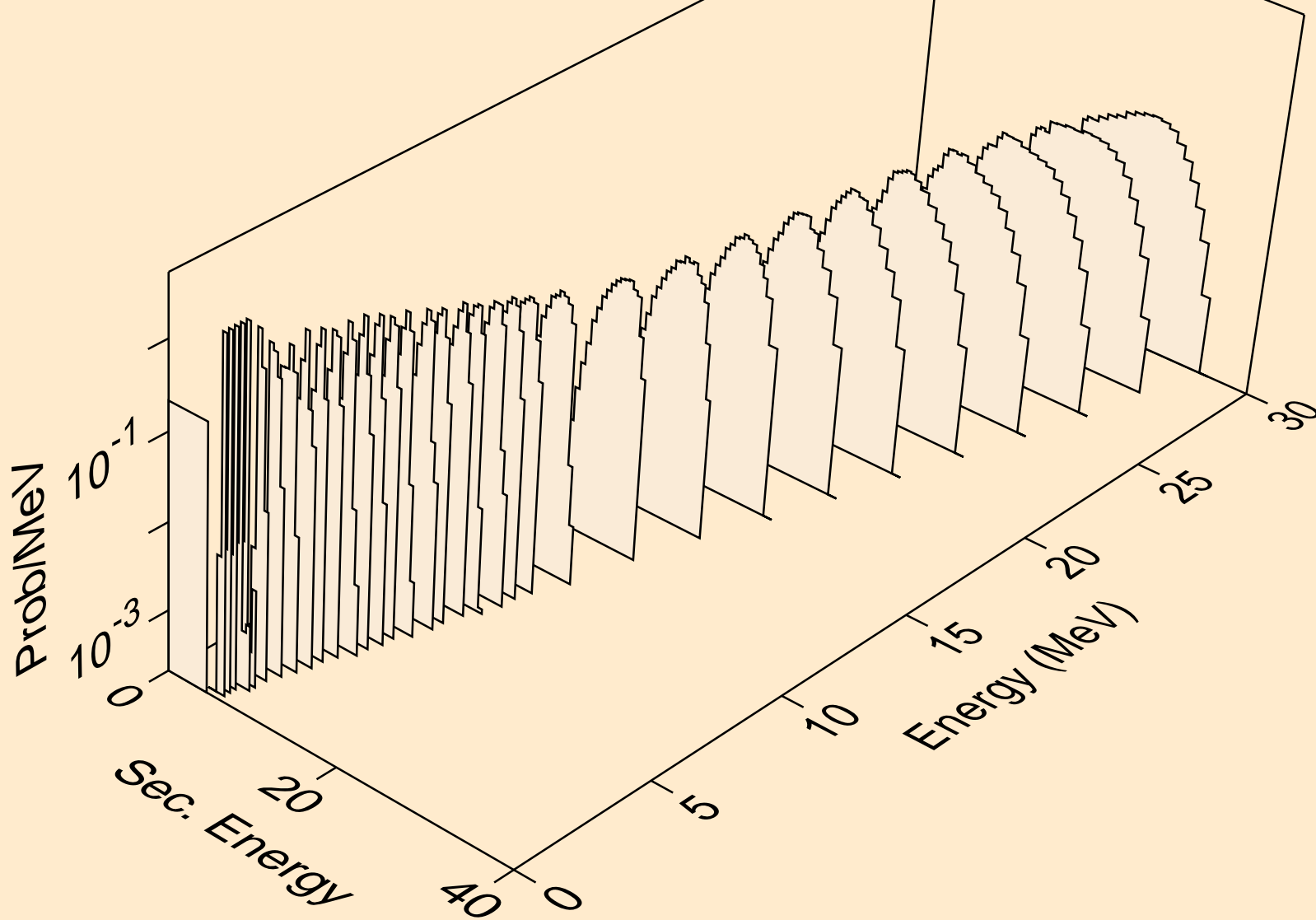

RE167M NEUTRON ACER TENDL-2019 LIBRARY; T=293.16K
alphas from (n,n*)3a

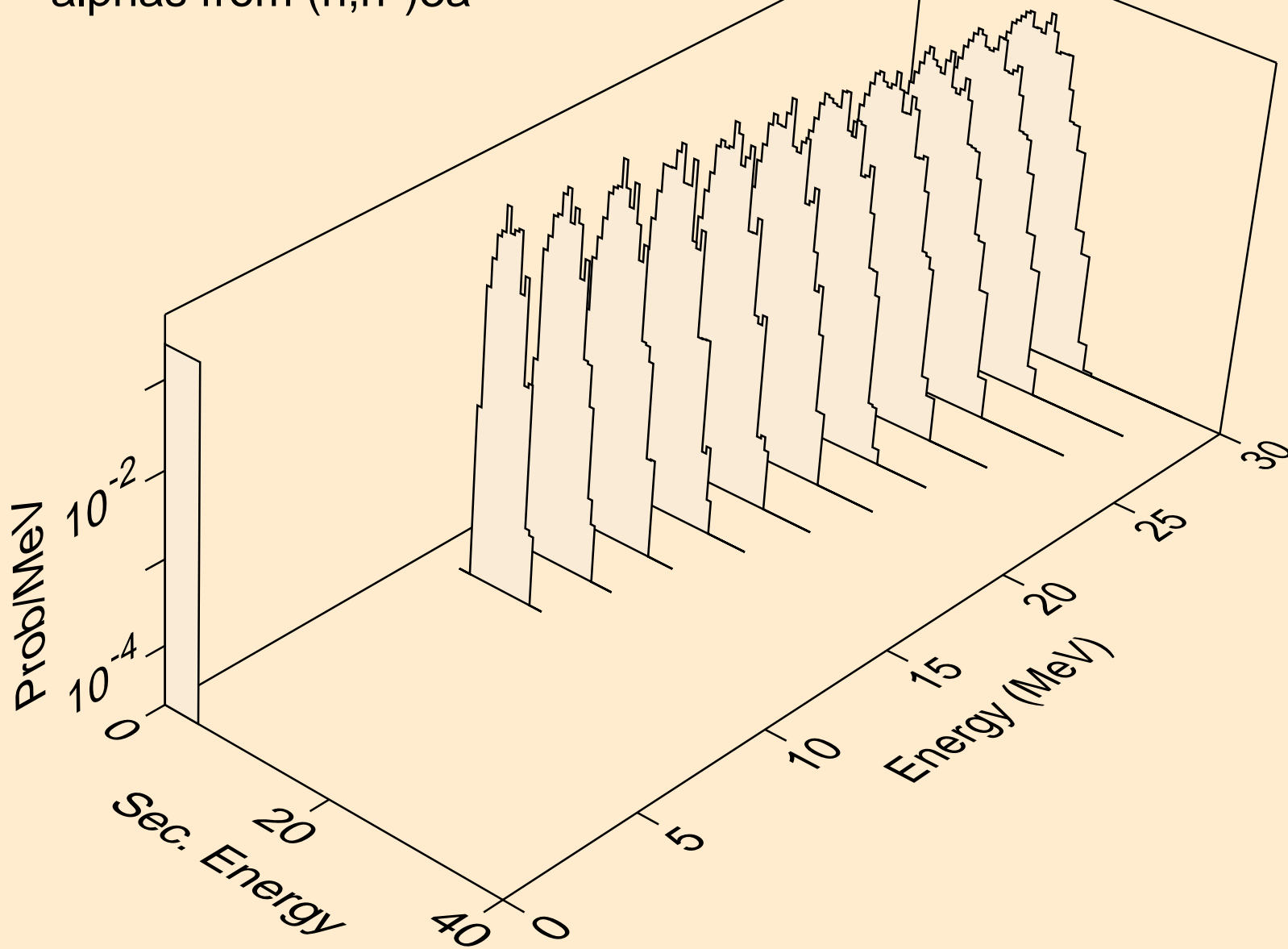

RE167M NEUTRON ACER TENDL-2019 LIBRARY; T=293.16K
alphas from (n,2n)a

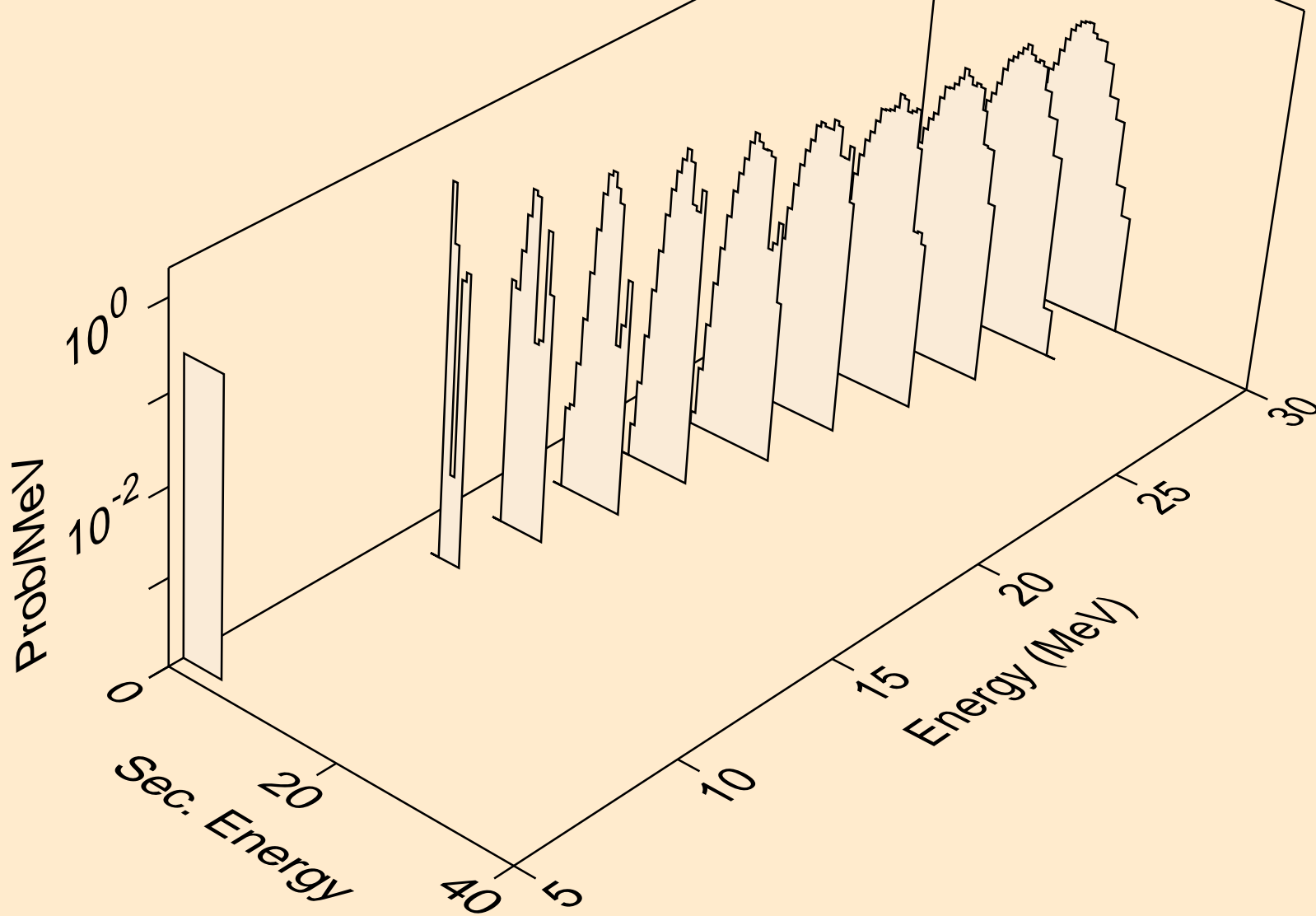

RE167M NEUTRON ACER TENDL-2019 LIBRARY; T=293.16K
alphas from (n,3n)a

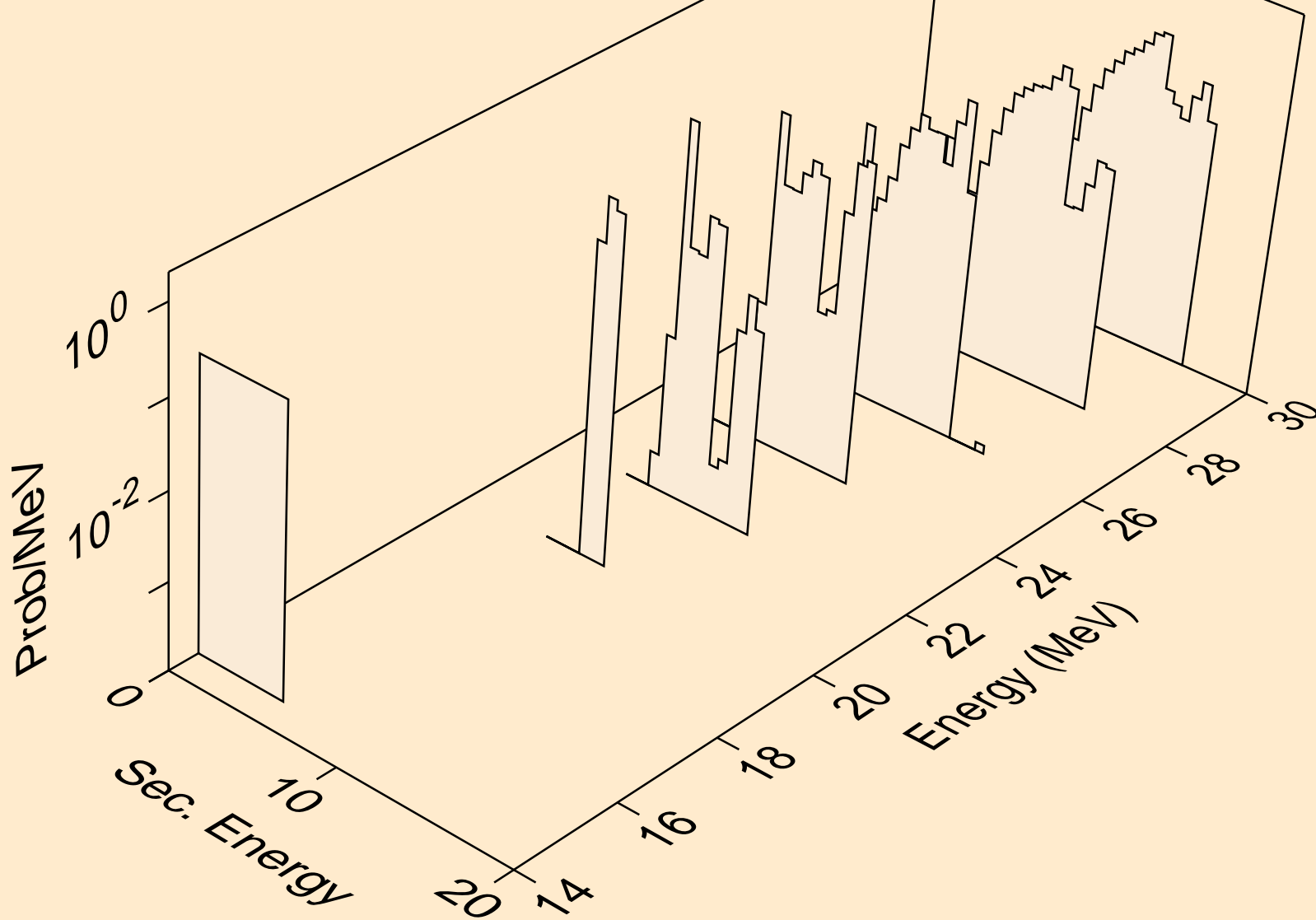

RE167M NEUTRON ACER TENDL-2019 LIBRARY; T=293.16K
alphas from (n,n*)2a

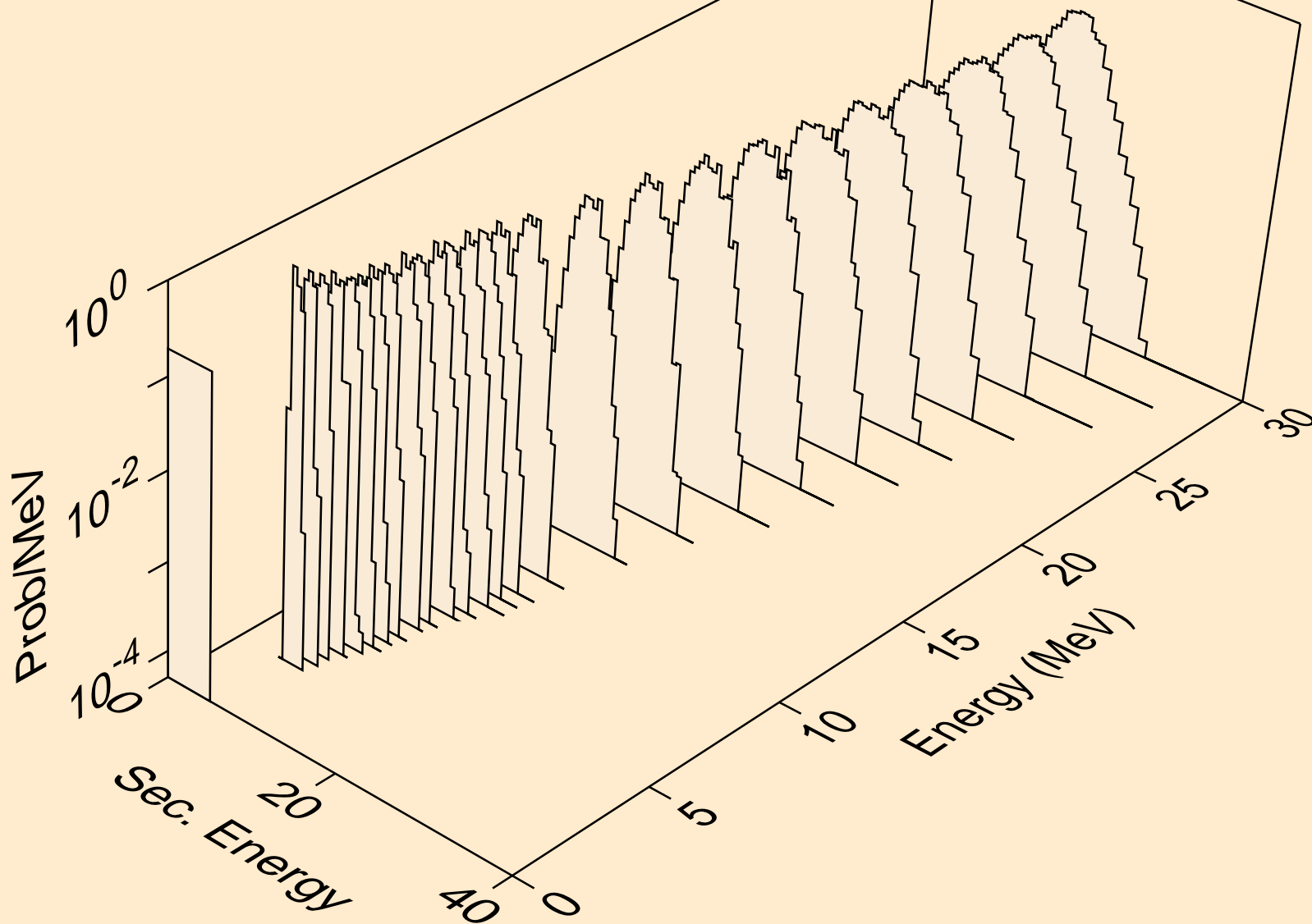

RE167M NEUTRON ACER TENDL-2019 LIBRARY; T=293.16K
alphas from (n,2n)2a

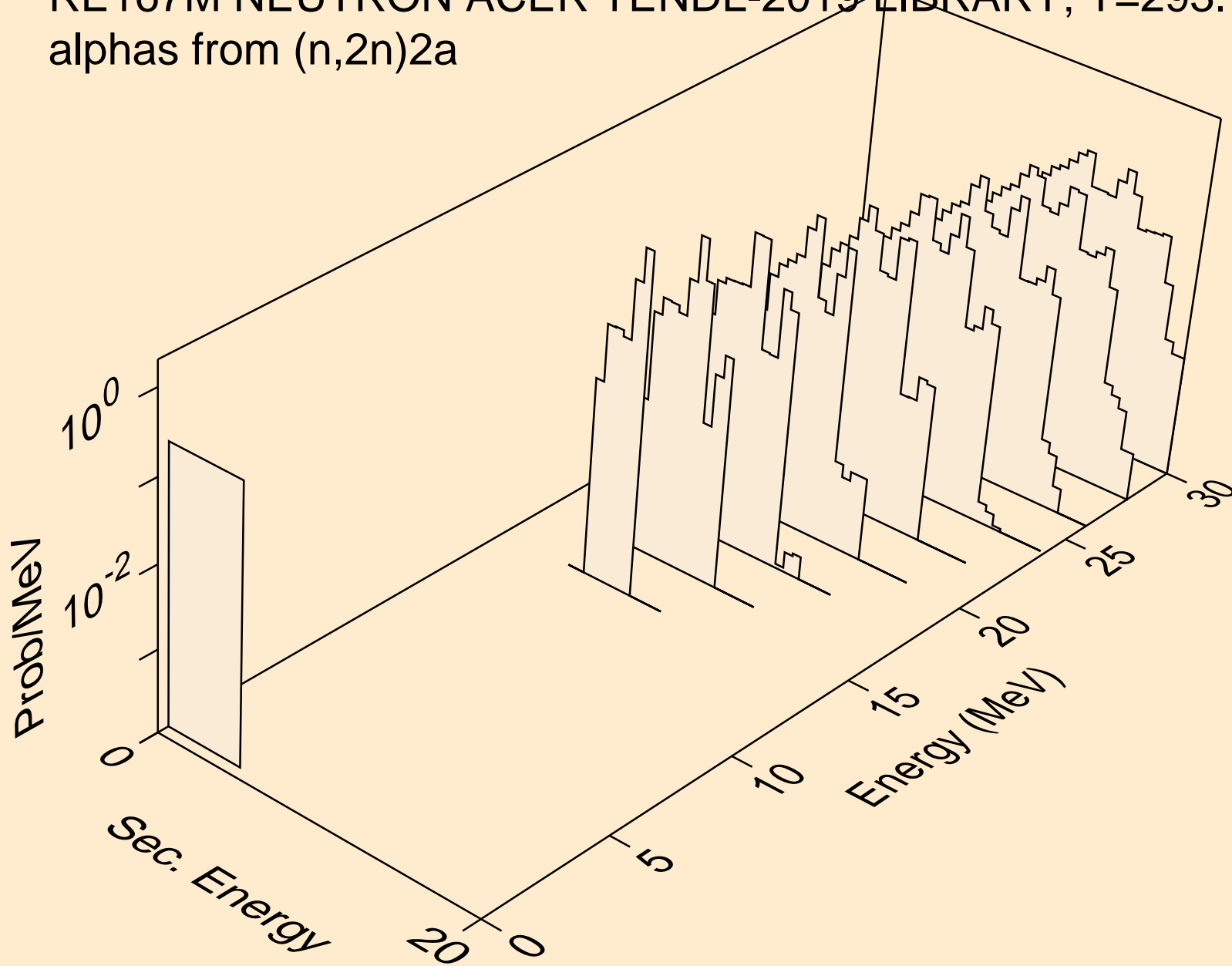

RE167M NEUTRON ACER TENDL-2019 LIBRARY; T=293.16K
alphas from (n,npa)

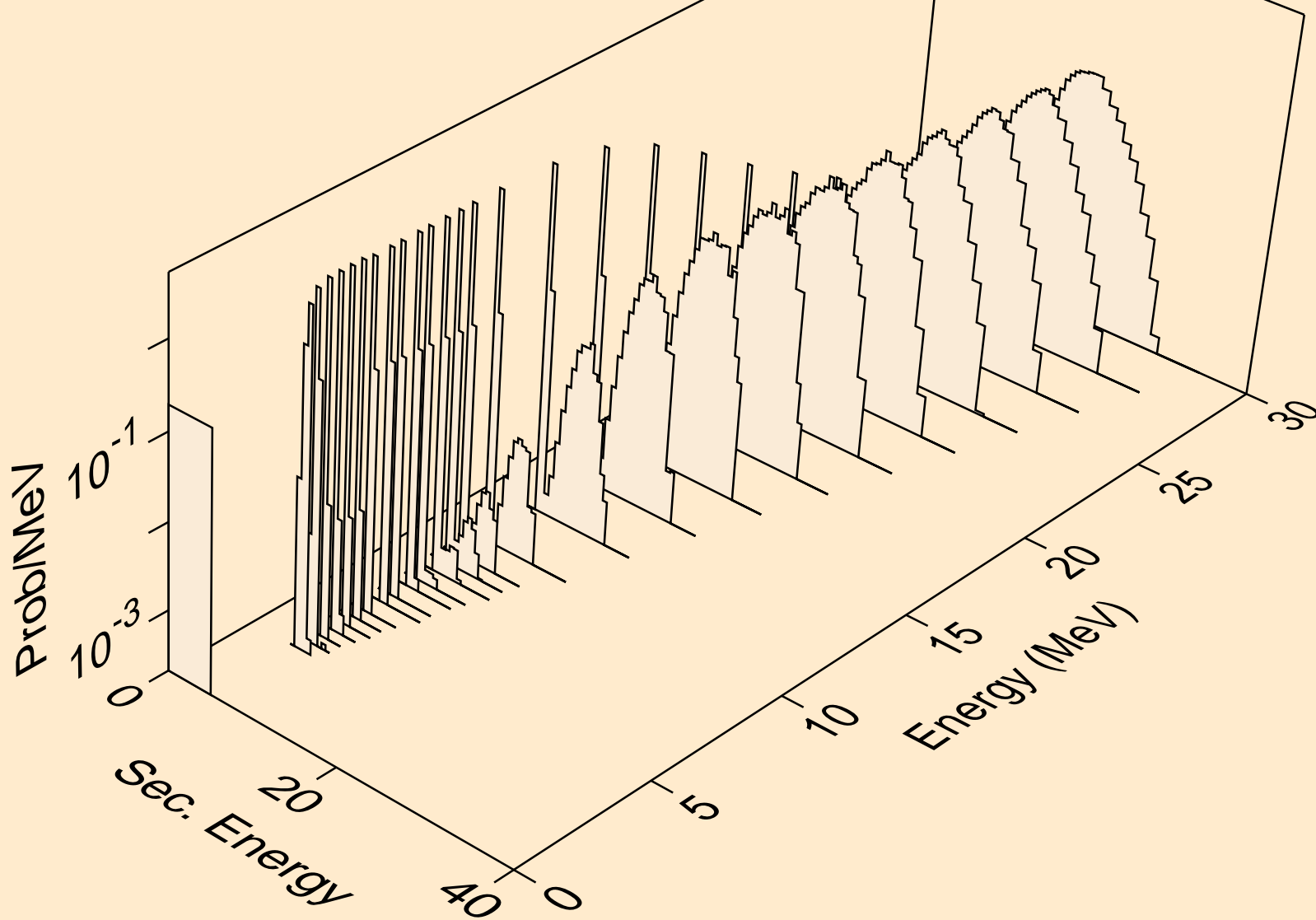

RE167M NEUTRON ACER TENDL-2019 LIBRARY; T=293.16K
alphas from (n,a)

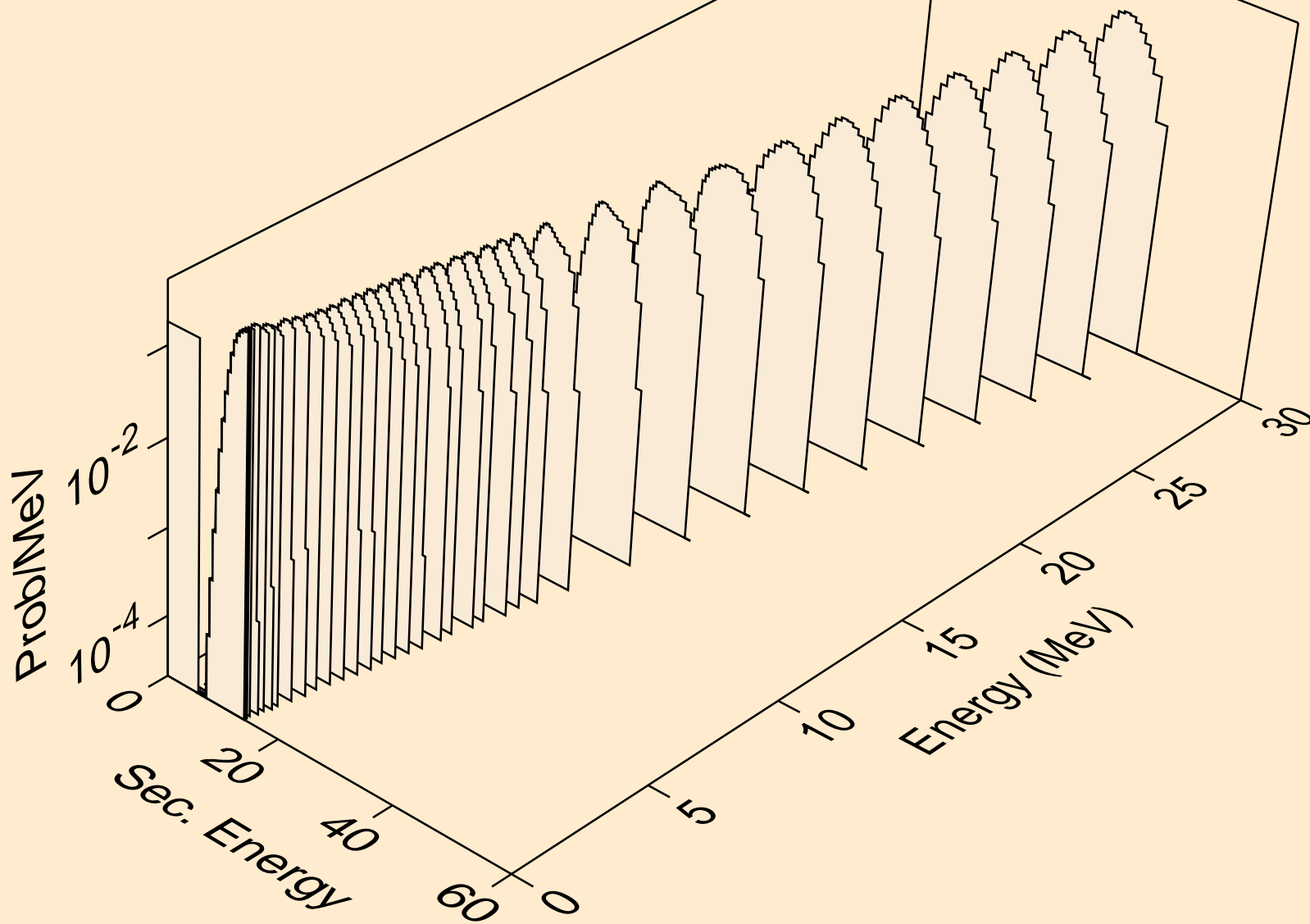

RE167M NEUTRON ACER TENDL-2019 LIBRARY; T=293.16K
alphas from (n,2a)

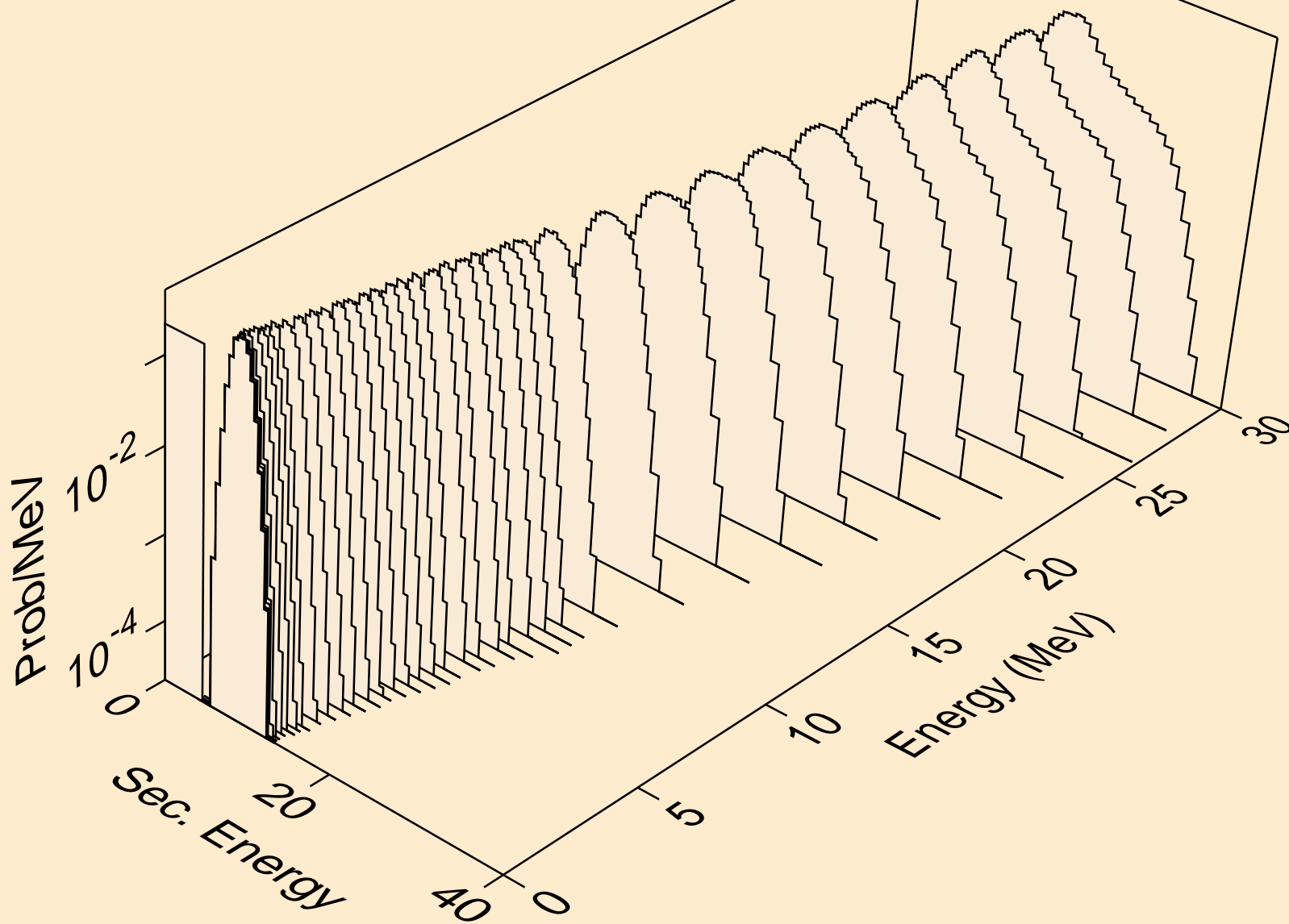

RE167M NEUTRON ACER TENDL-2019 LIBRARY; T=293.16K
alphas from (n,3a)

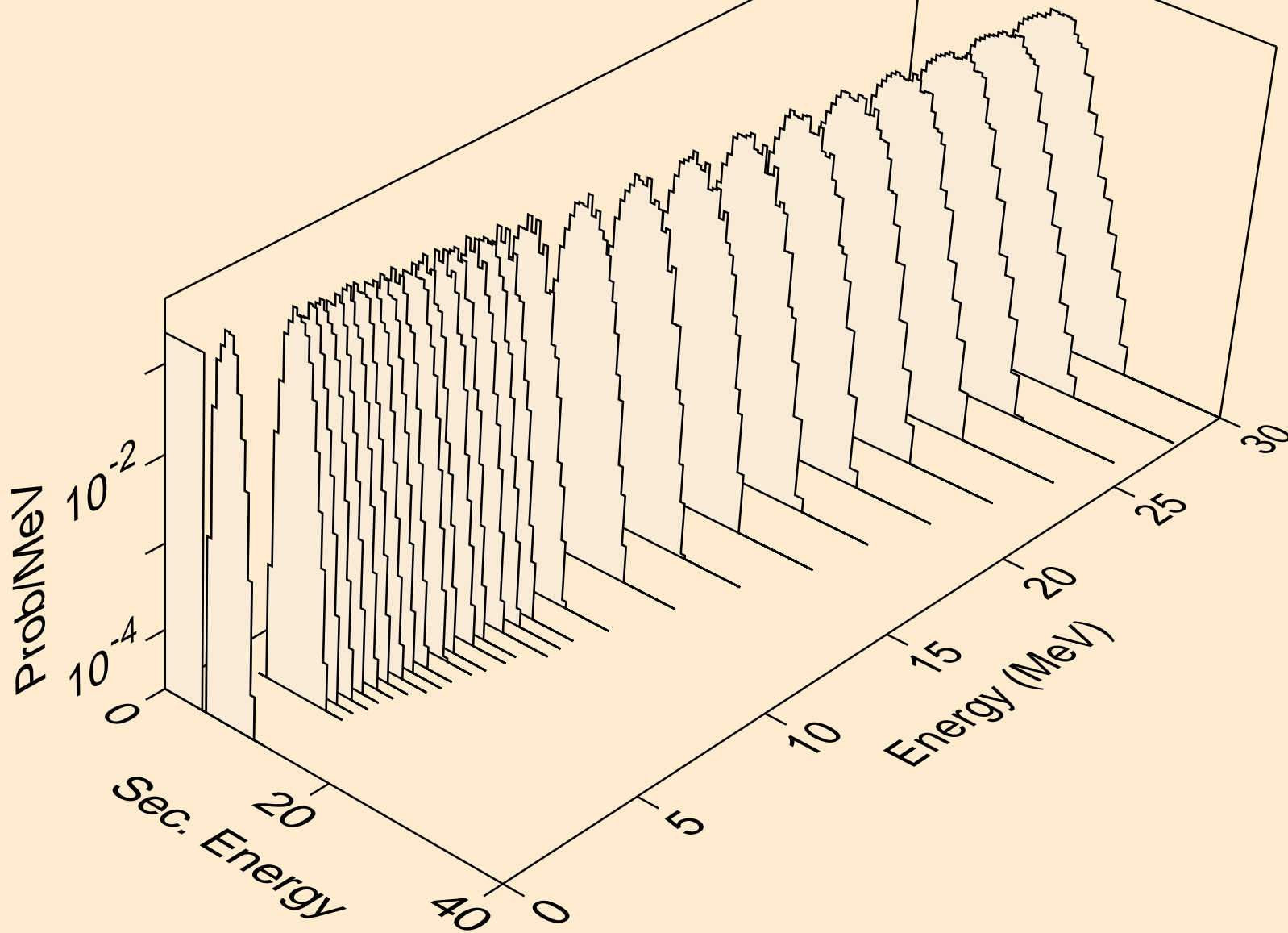

RE167M NEUTRON ACER TENDL-2019 LIBRARY; T=293.16K
alphas from (n,pa)

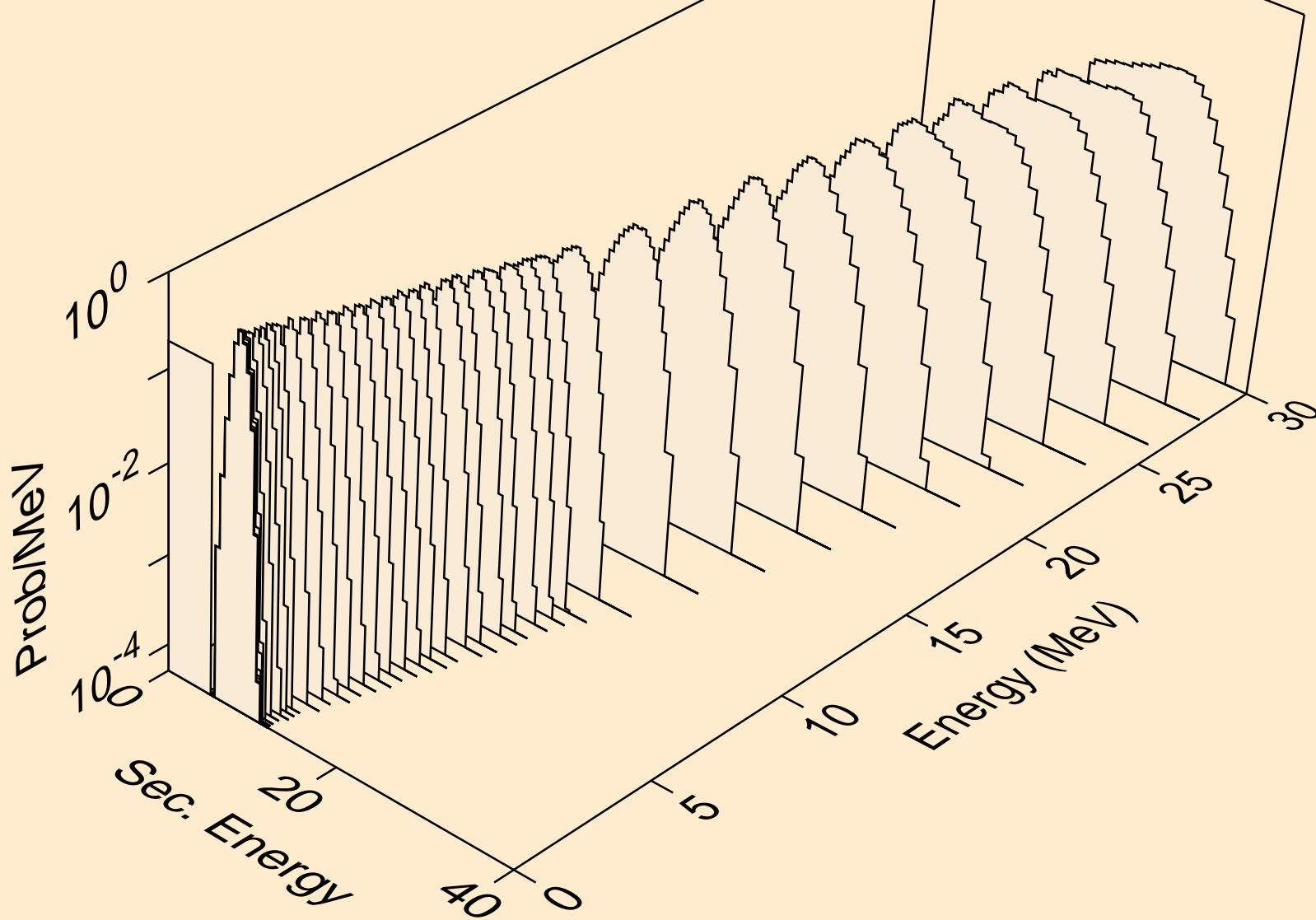

RE167M NEUTRON ACER TENDL-2019 LIBRARY; T=293.16K
alphas from (n,t2a)

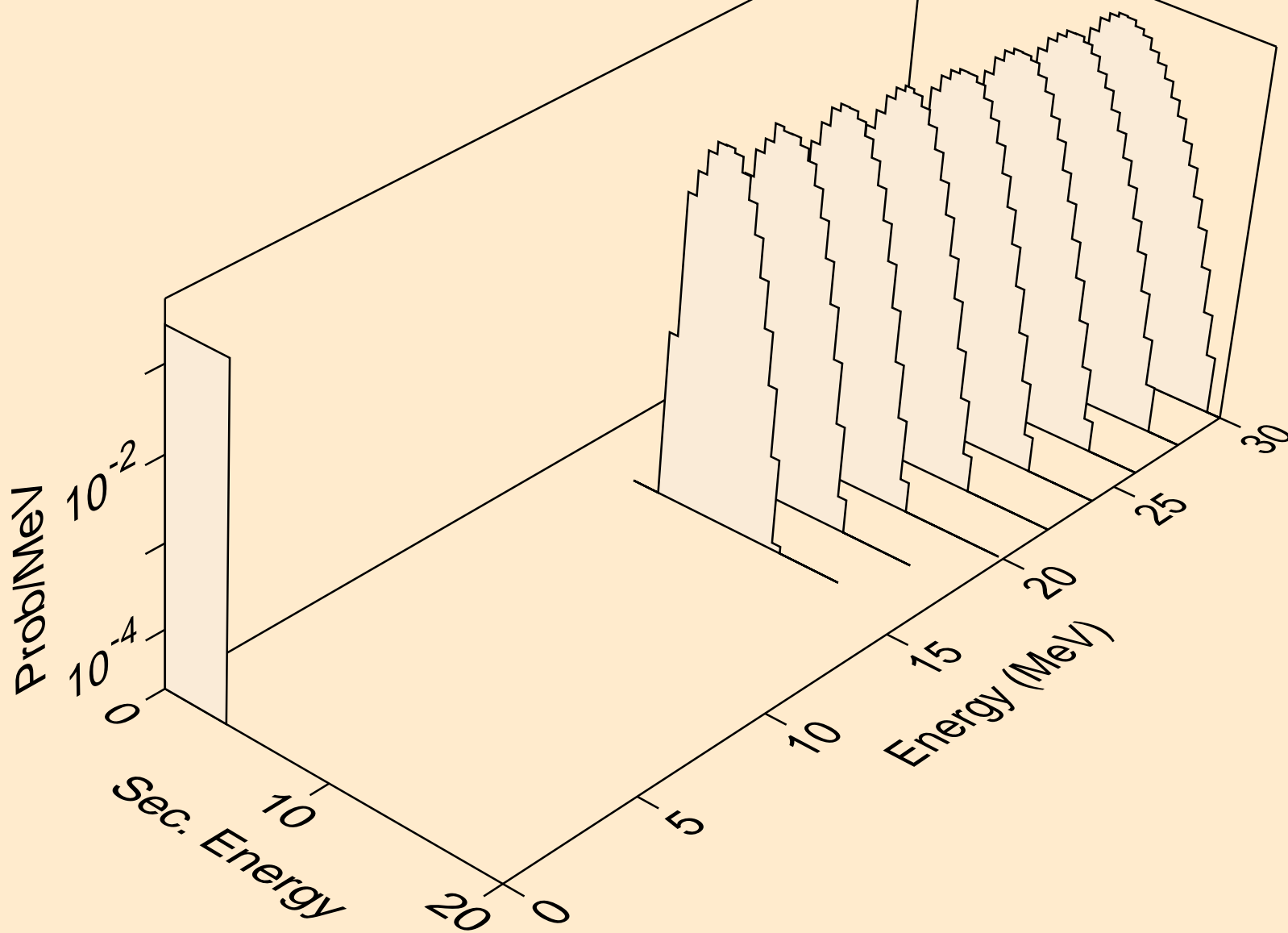

RE167M NEUTRON ACER TENDL-2019 LIBRARY; T=293.16K
alphas from (n,d2a)

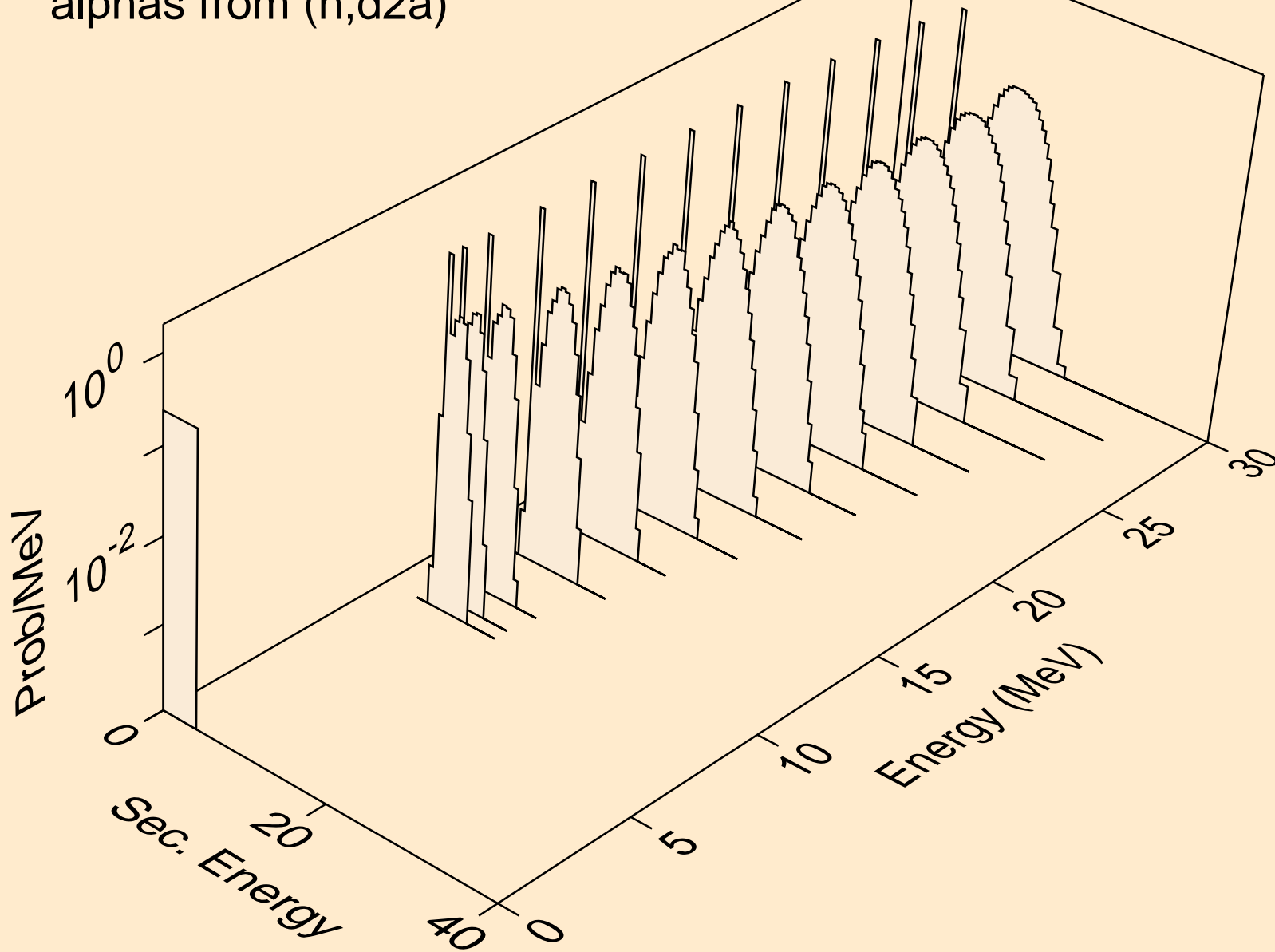

RE167M NEUTRON ACER TENDL-2019 LIBRARY; T=293.16K
alphas from (n,da)

