

RE184 NEUTRON ACER TENDL-2019 LIBRARY; T=293.16K
Principal cross sections

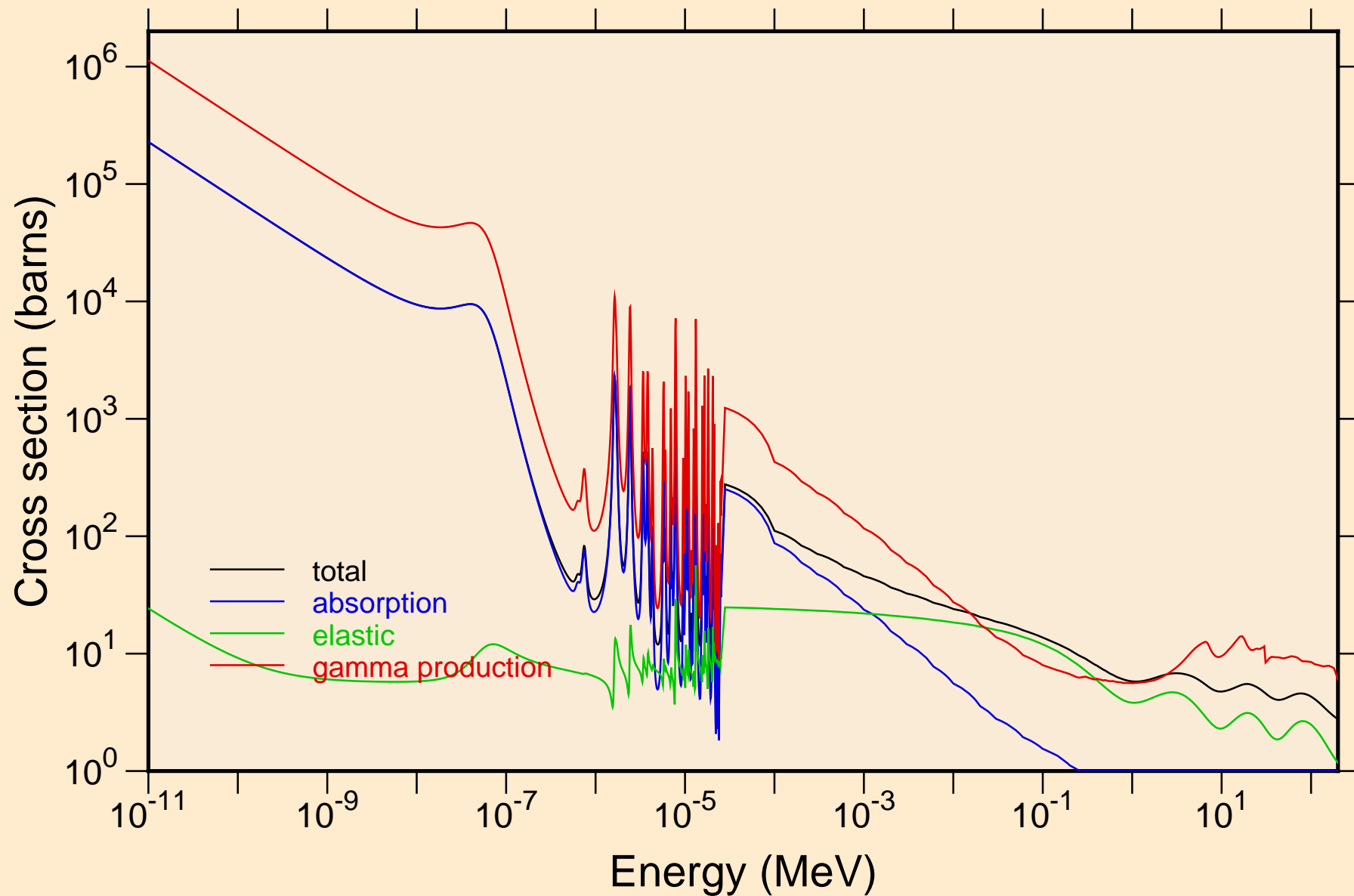

RE184 NEUTRON ACER TENDL-2019 LIBRARY; T=293.16K
resonance total cross section

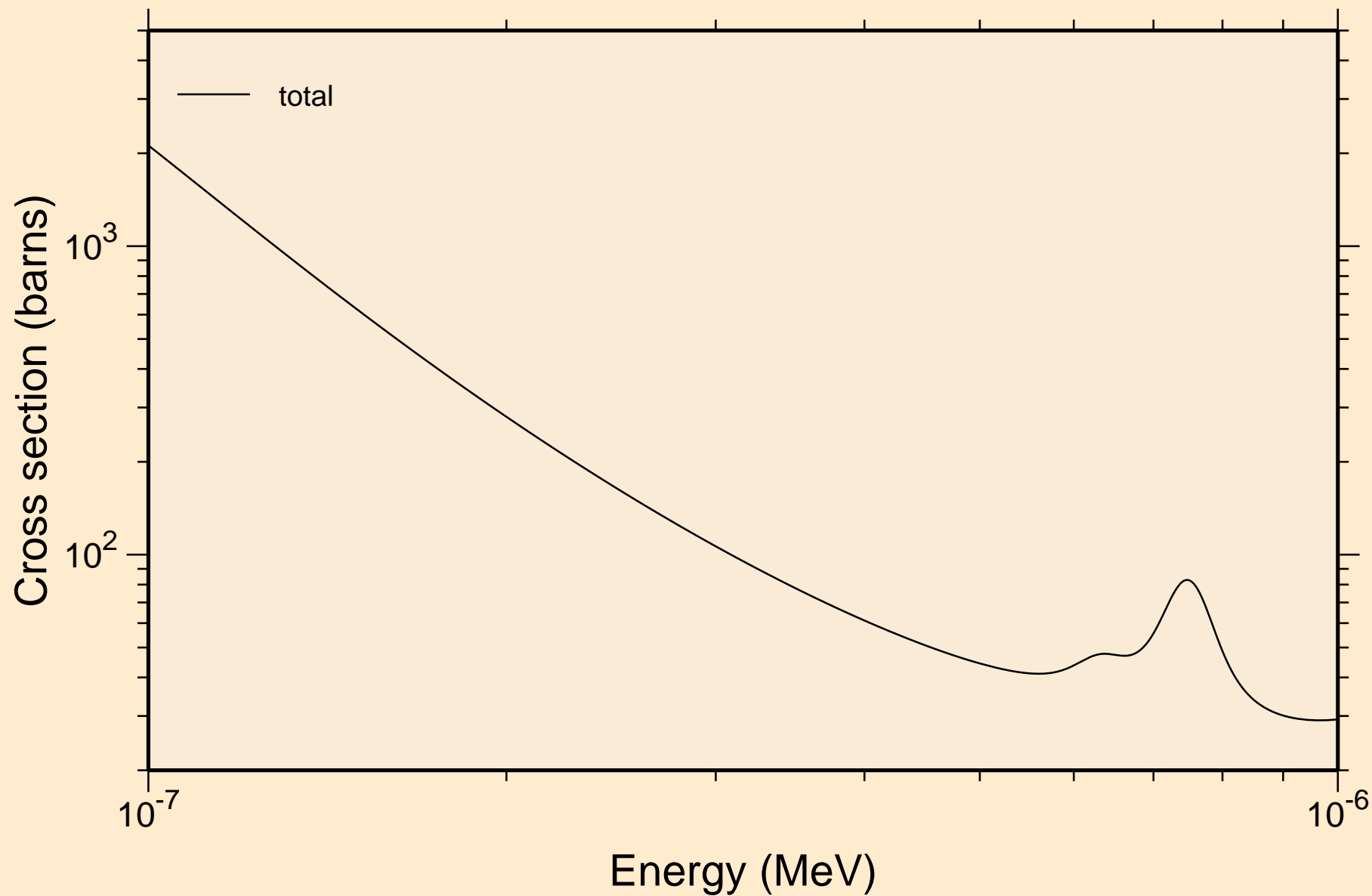

RE184 NEUTRON ACER TENDL-2019 LIBRARY; T=293.16K
resonance total cross section

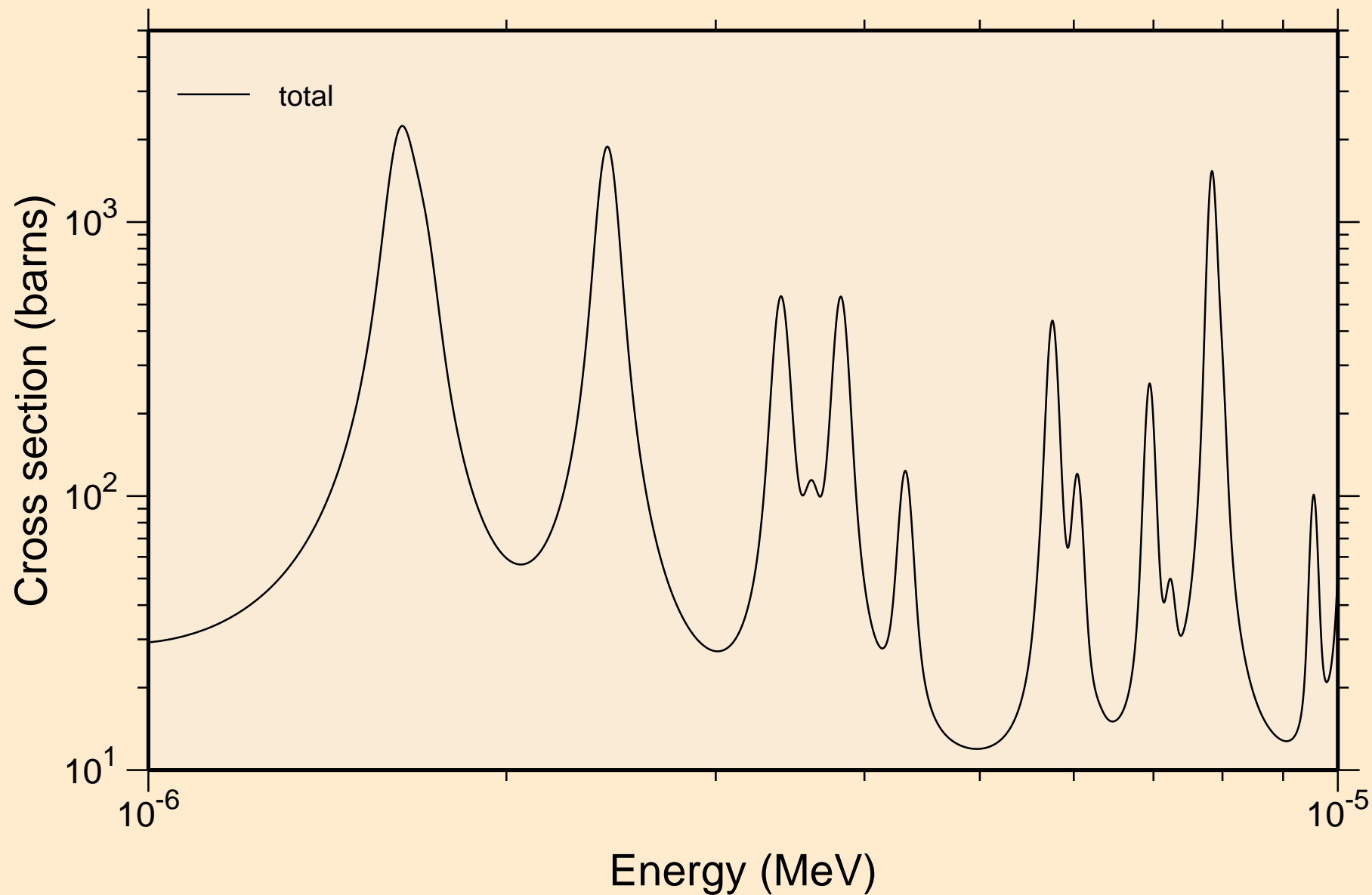

RE184 NEUTRON ACER TENDL-2019 LIBRARY; T=293.16K
resonance total cross section

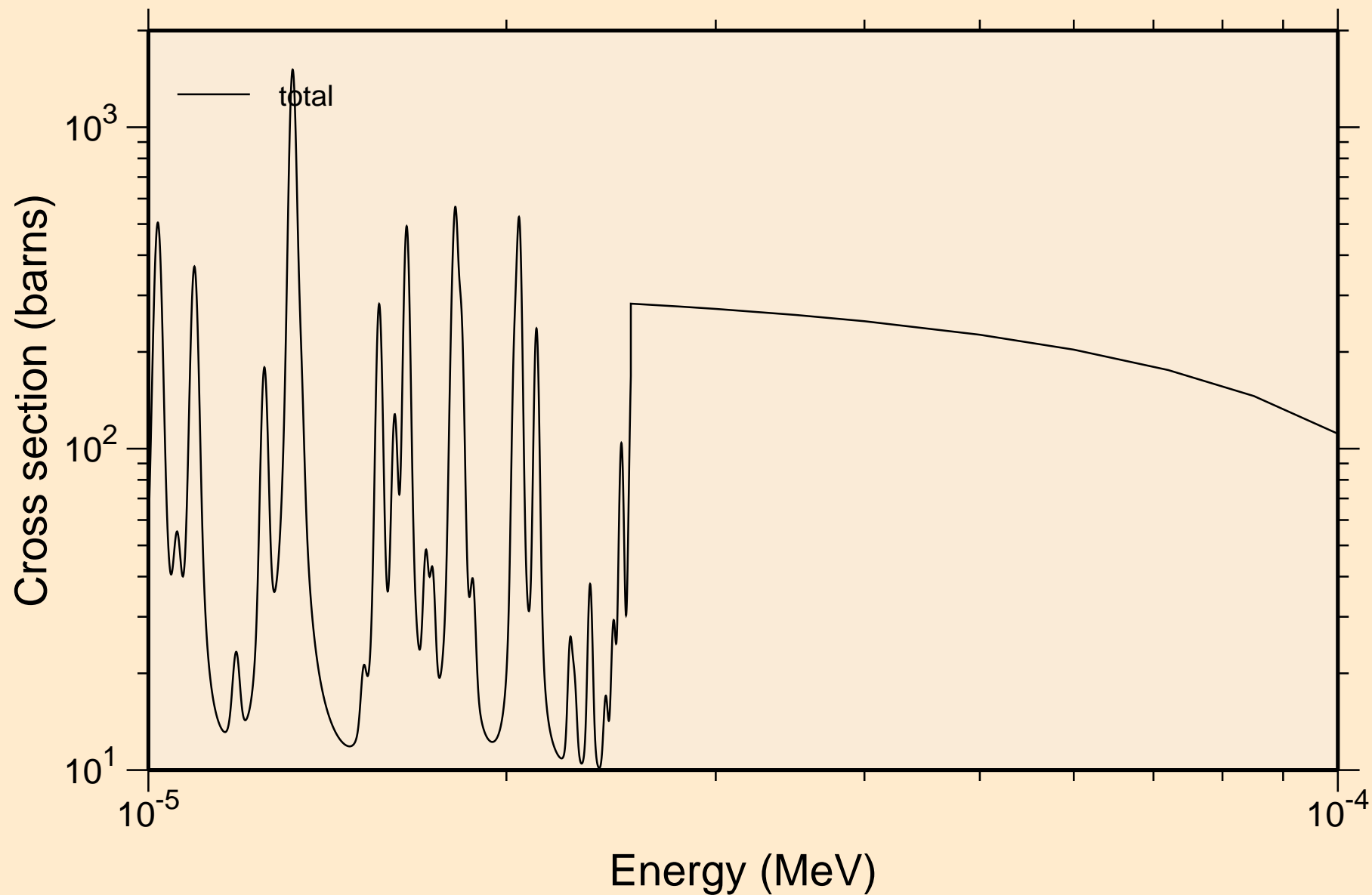

RE184 NEUTRON ACER TENDL-2019 LIBRARY; T=293.16K
resonance total cross section

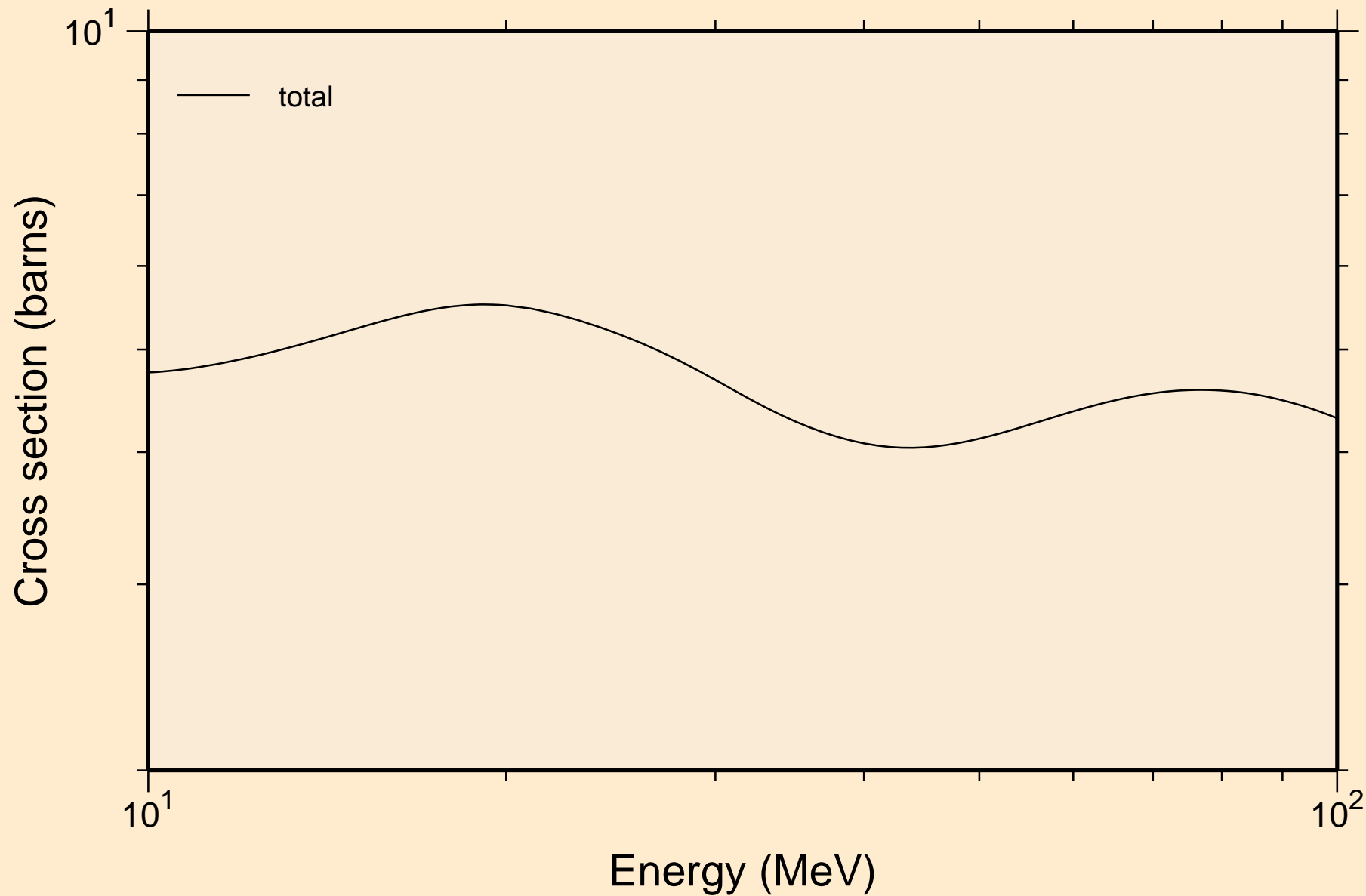

RE184 NEUTRON ACER TENDL-2019 LIBRARY; T=293.16K
resonance absorption cross sections

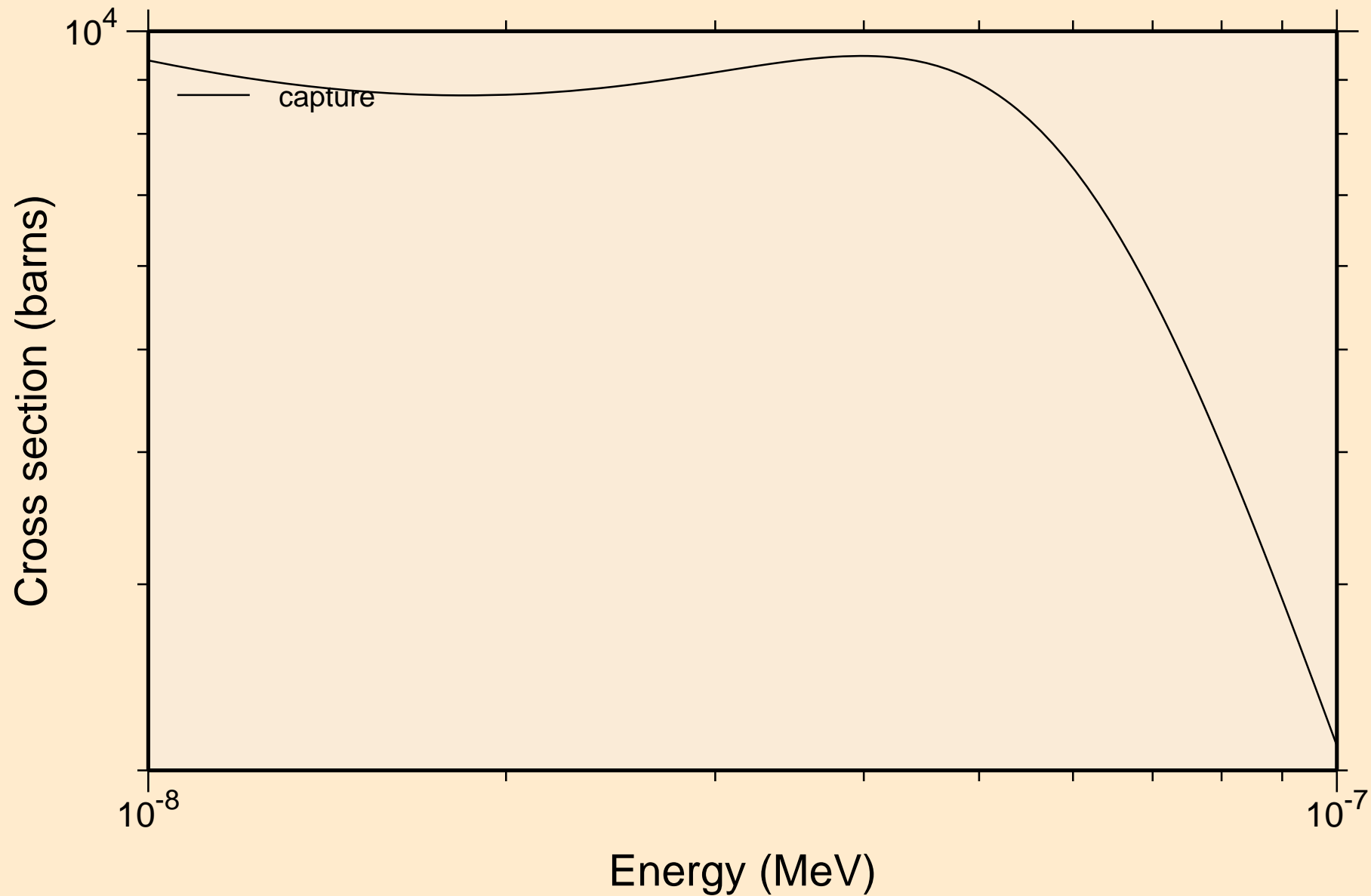

RE184 NEUTRON ACER TENDL-2019 LIBRARY; T=293.16K
resonance absorption cross sections

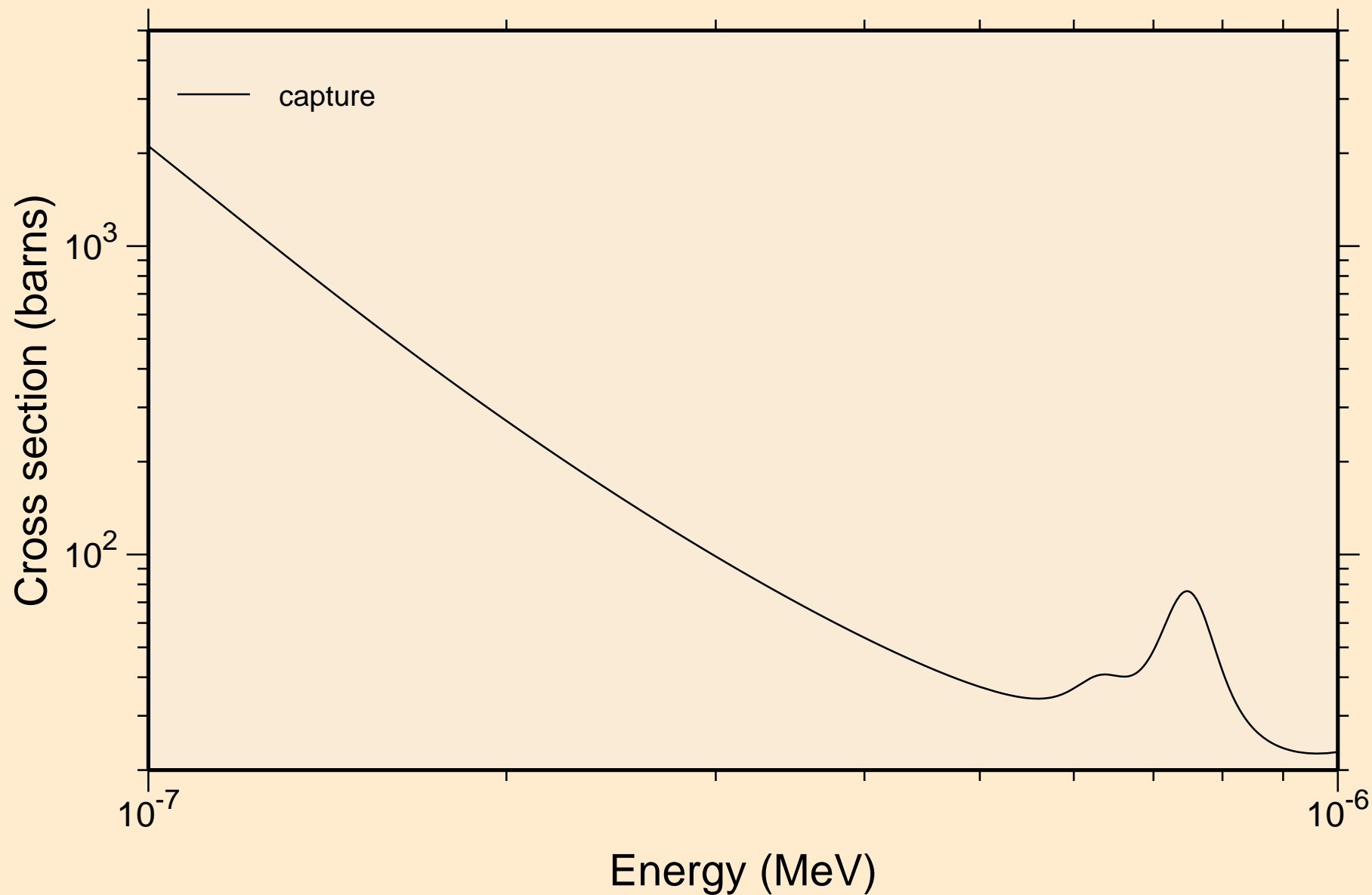

RE184 NEUTRON ACER TENDL-2019 LIBRARY; T=293.16K
resonance absorption cross sections

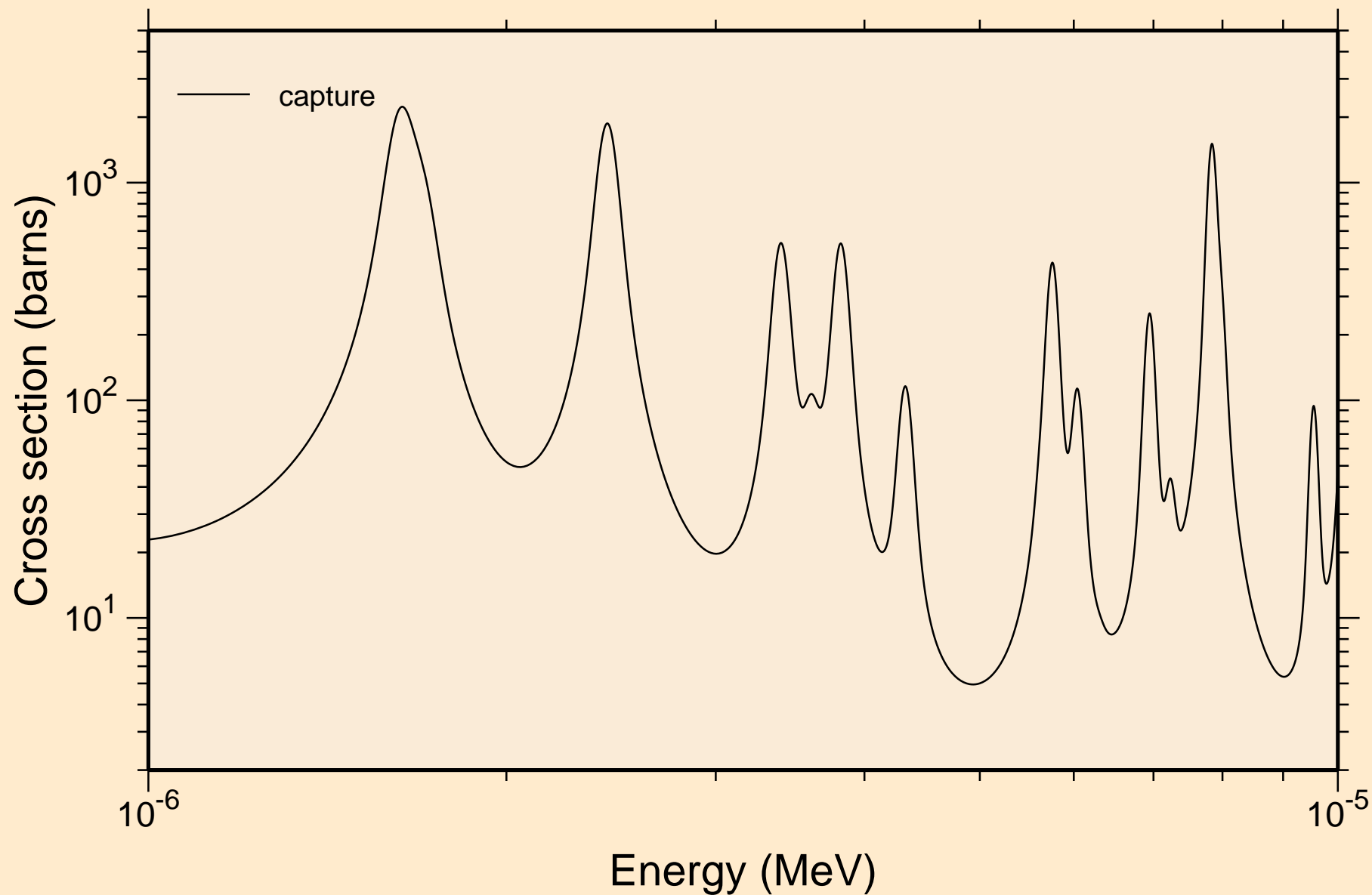

RE184 NEUTRON ACER TENDL-2019 LIBRARY; T=293.16K
resonance absorption cross sections

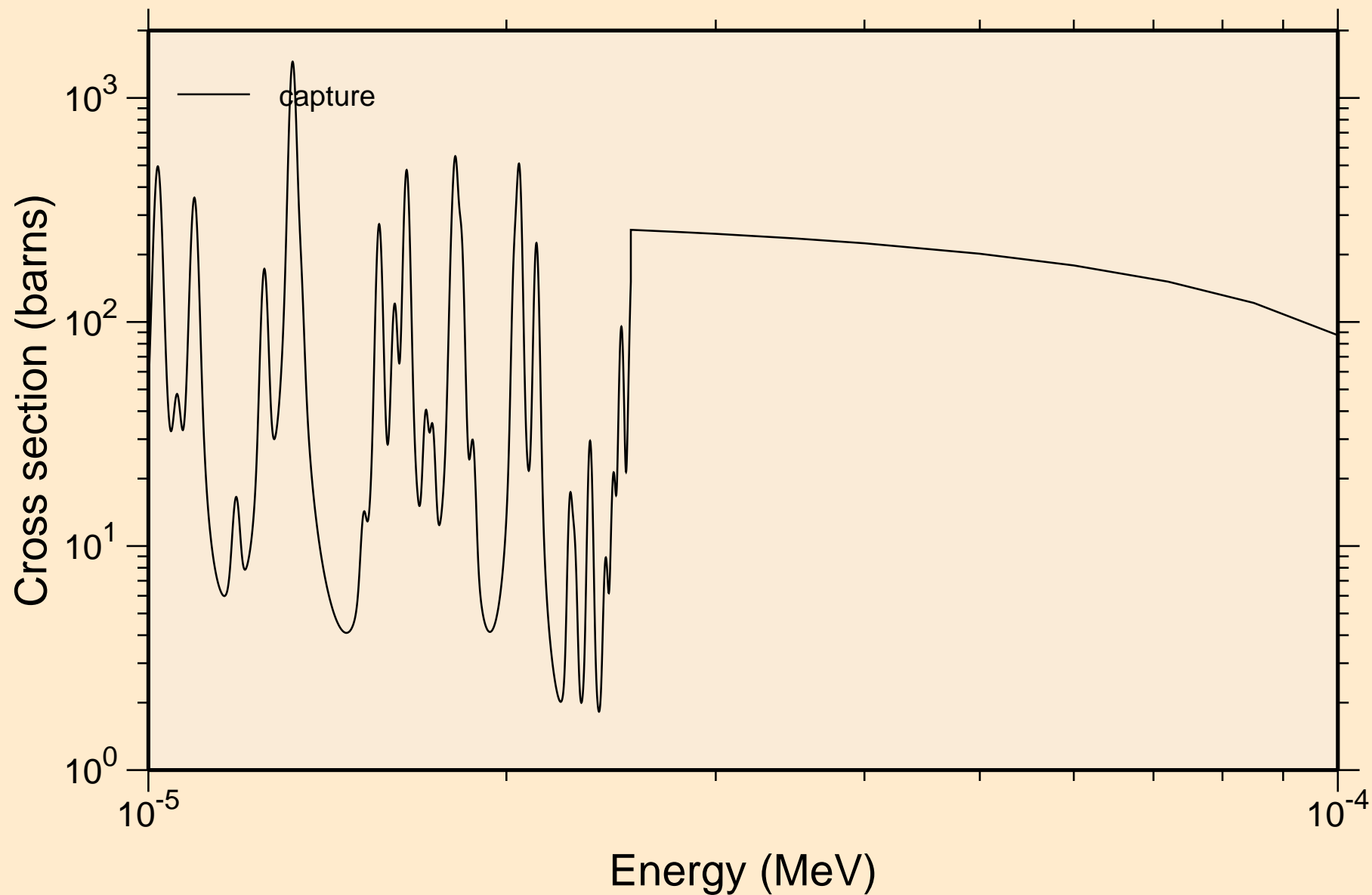

RE184 NEUTRON ACER TENDL-2019 LIBRARY; T=293.16K
resonance absorption cross sections

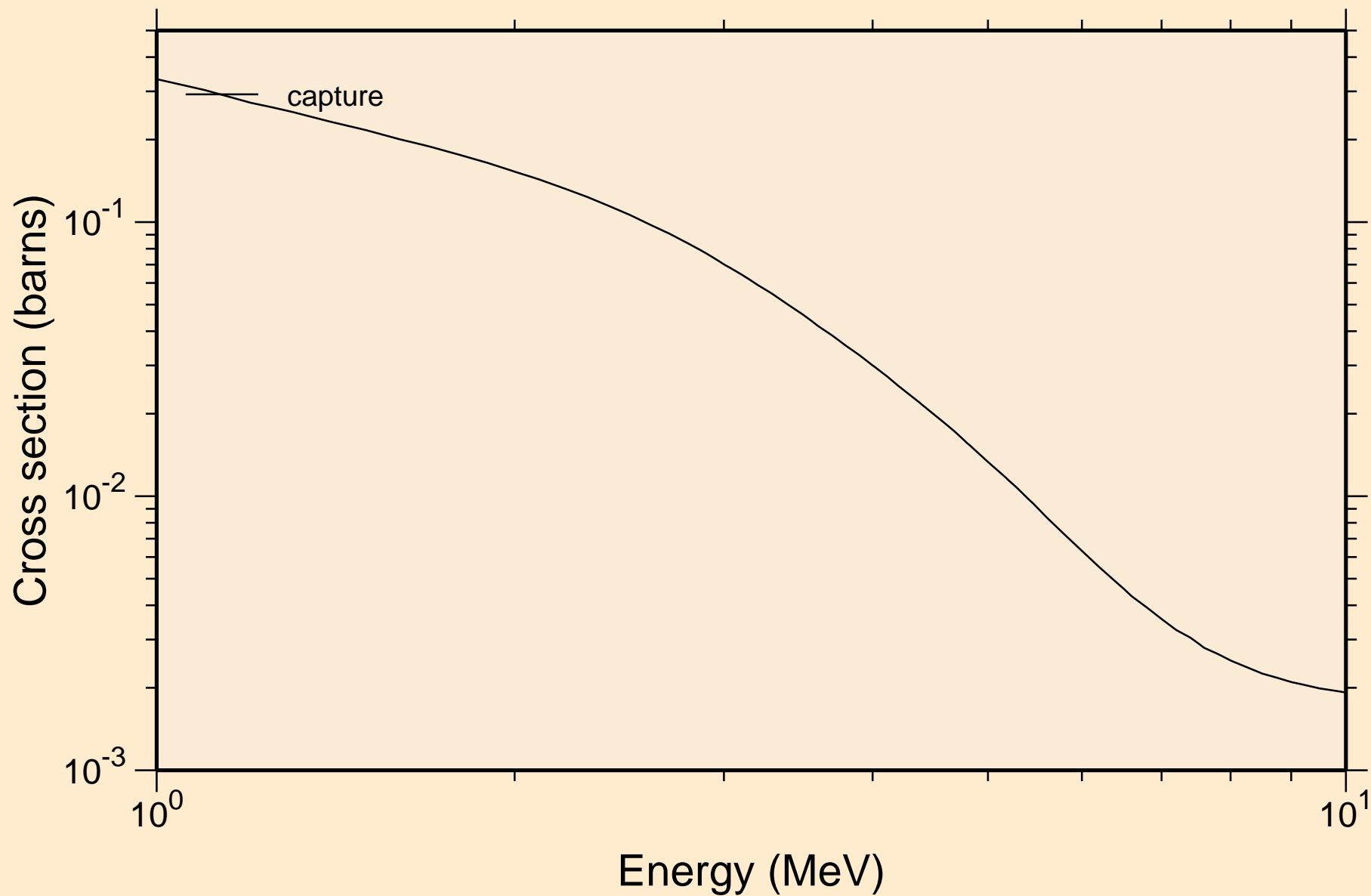

RE184 NEUTRON ACER TENDL-2019 LIBRARY; T=293.16K
Heating

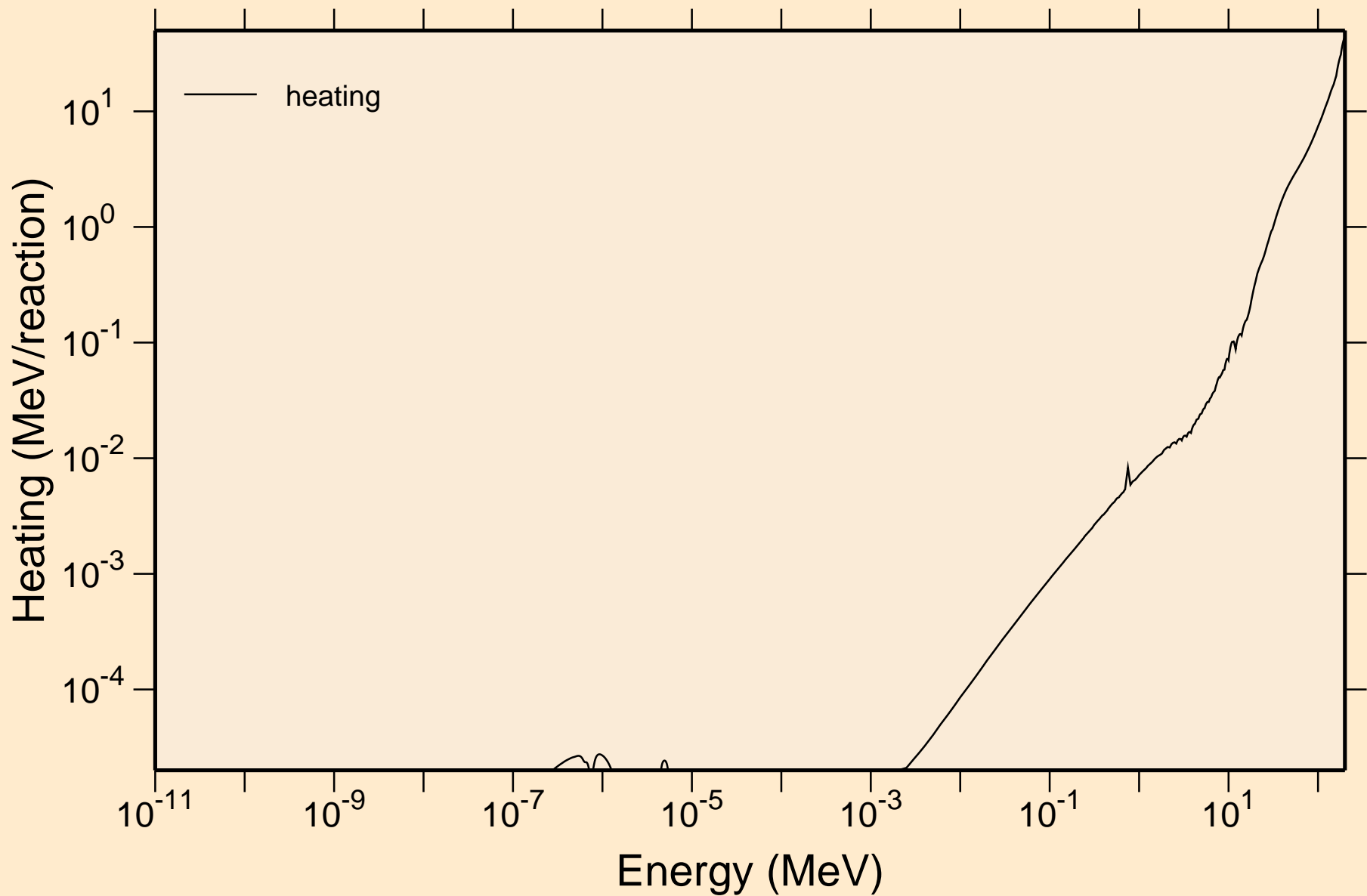

RE184 NEUTRON ACER TENDL-2019 LIBRARY; T=293.16K
Damage

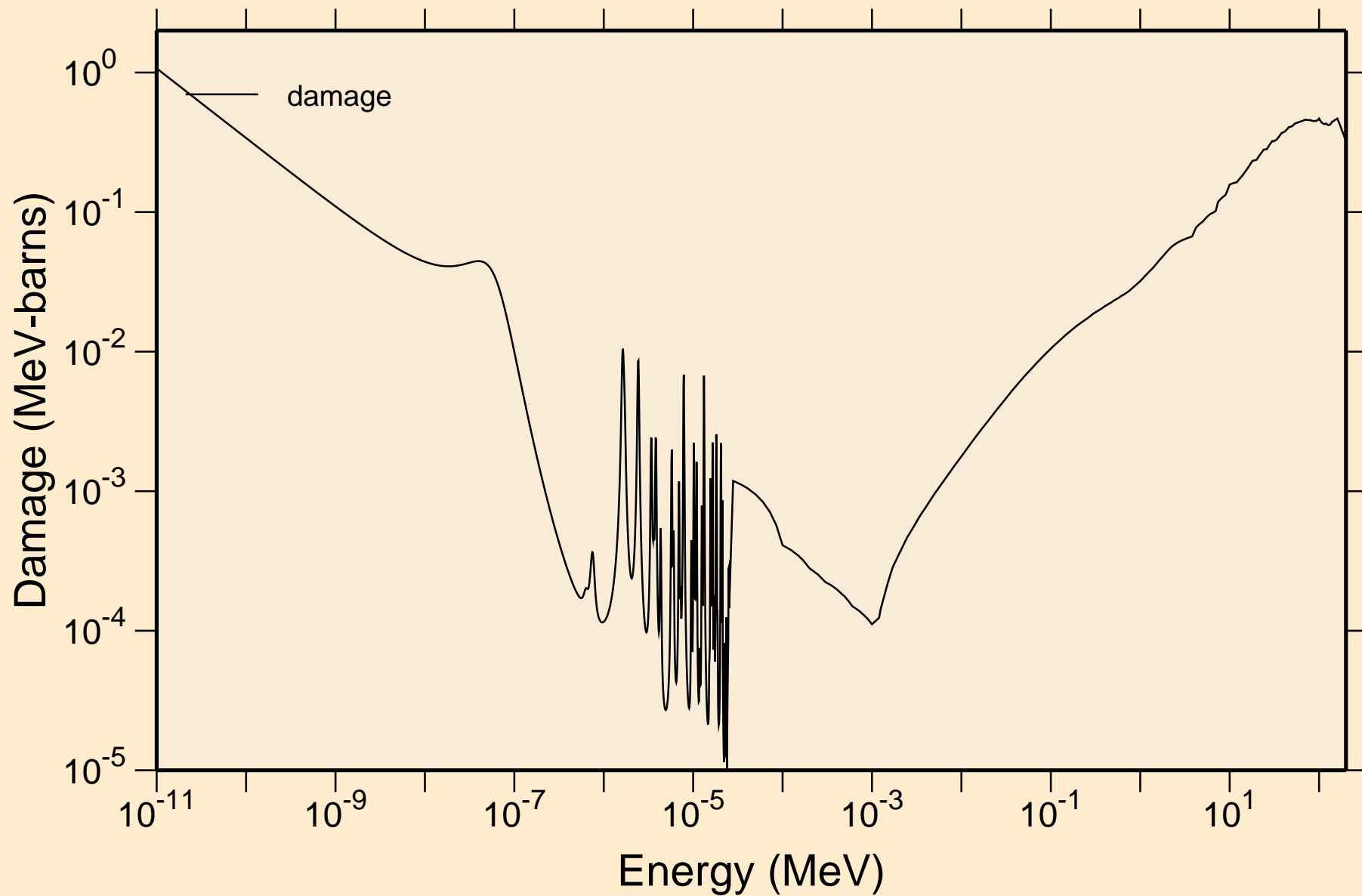

RE184 NEUTRON ACER TENDL-2019 LIBRARY; T=293.16K
Non-threshold reactions

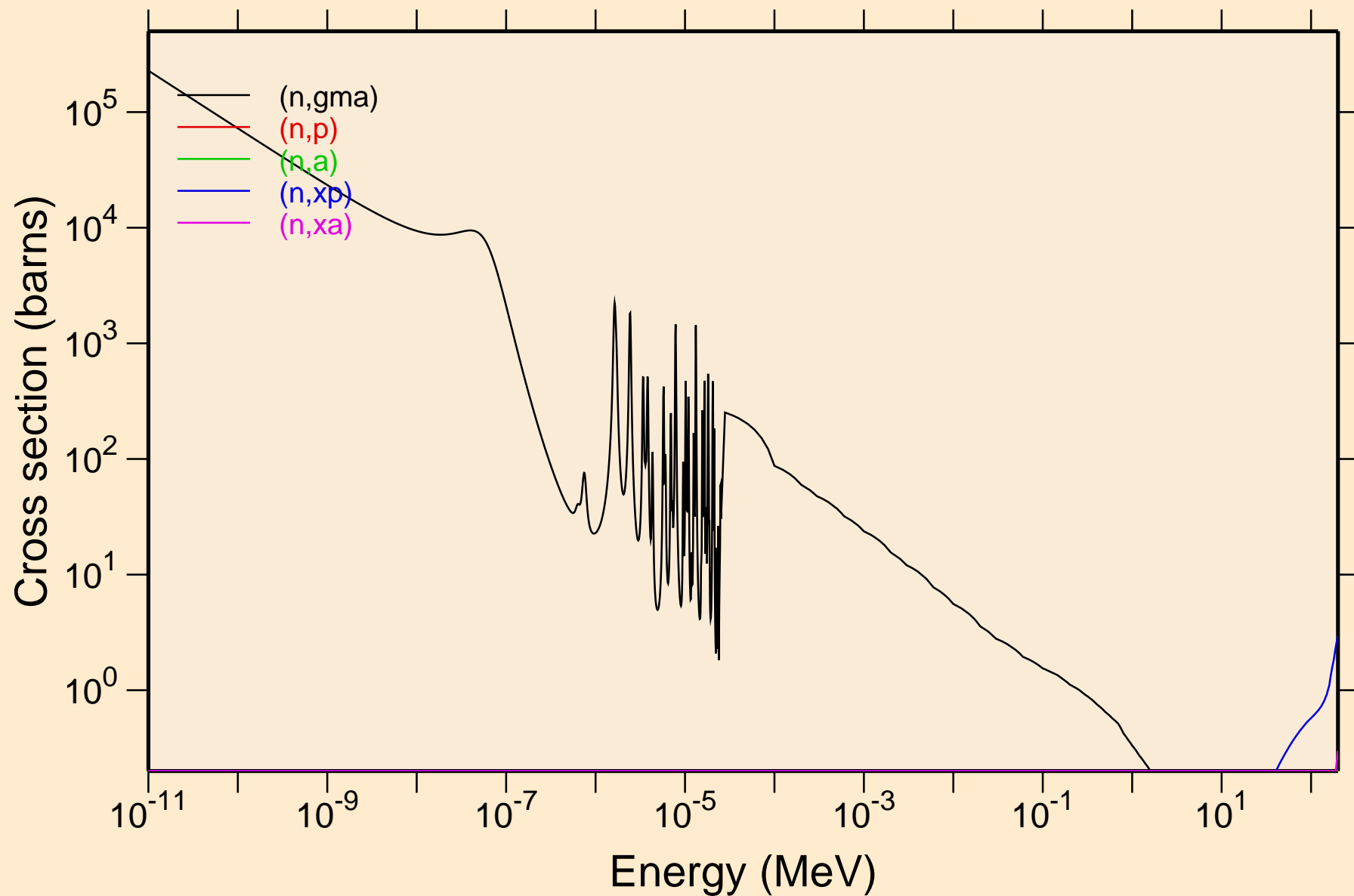

RE184 NEUTRON ACER TENDL-2019 LIBRARY; T=293.16K
Principal cross sections

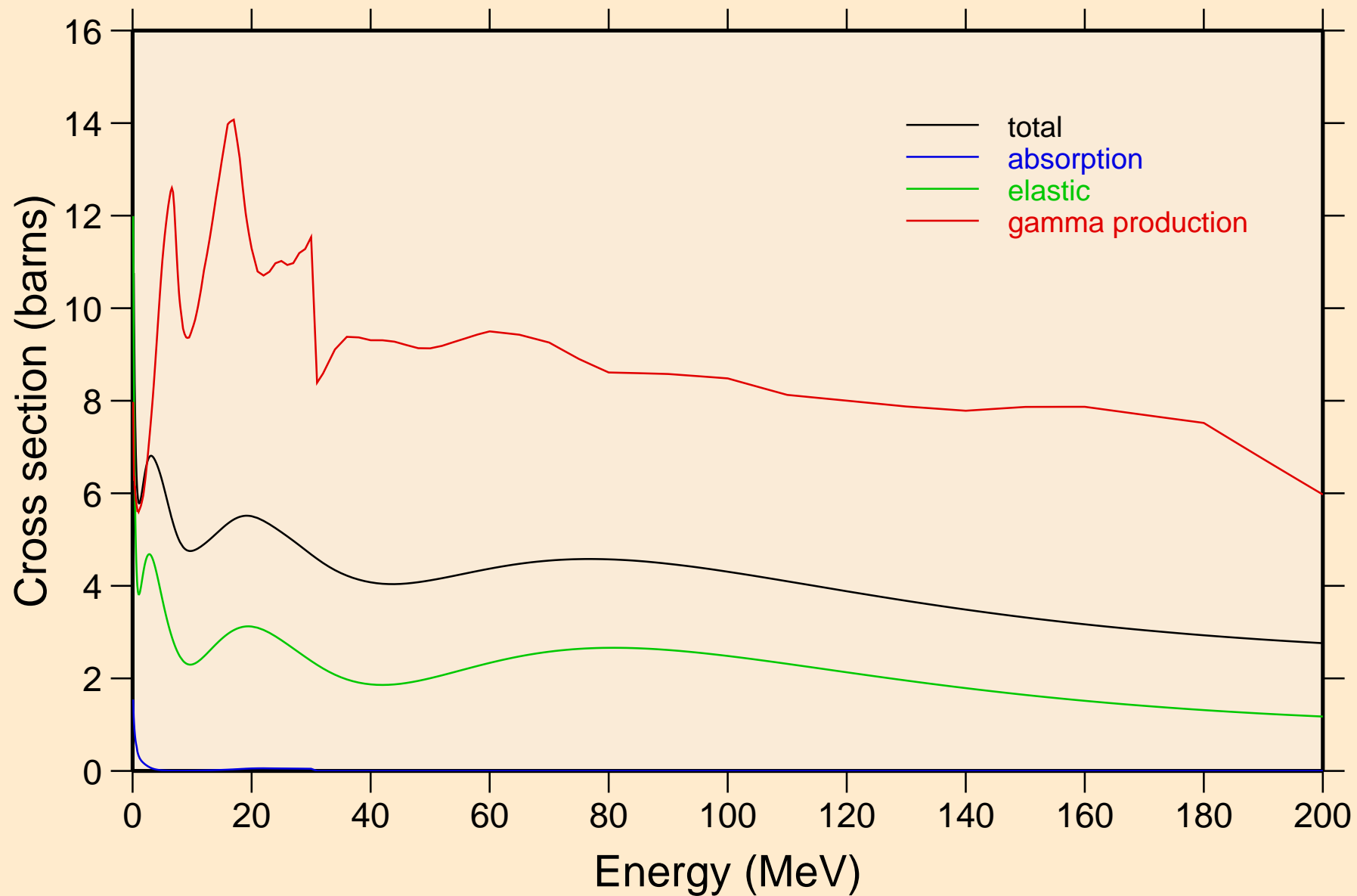

RE184 NEUTRON ACER TENDL-2019 LIBRARY; T=293.16K
Heating

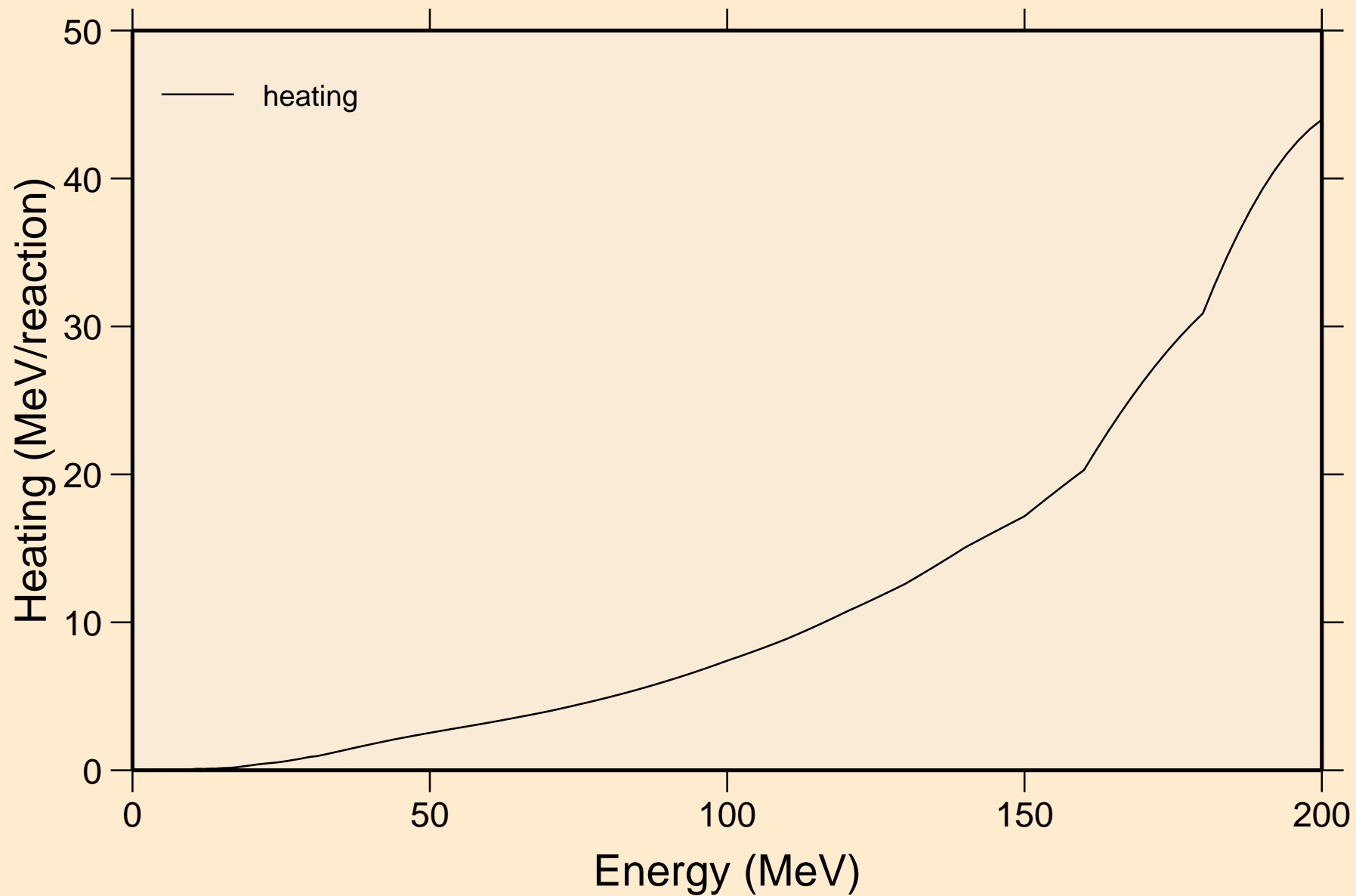

RE184 NEUTRON ACER TENDL-2019 LIBRARY; T=293.16K
Damage

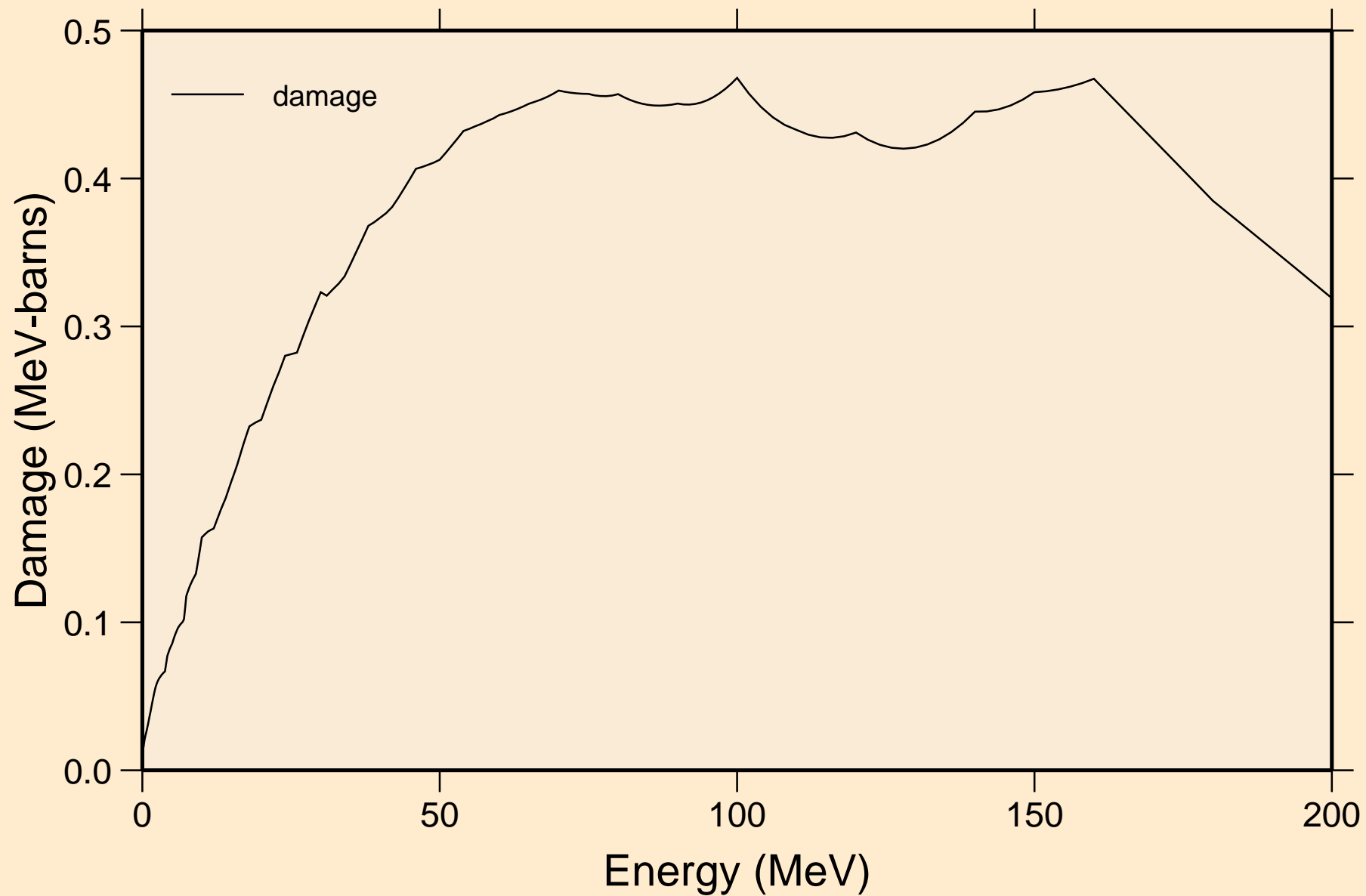

RE184 NEUTRON ACER TENDL-2019 LIBRARY; T=293.16K
Non-threshold reactions

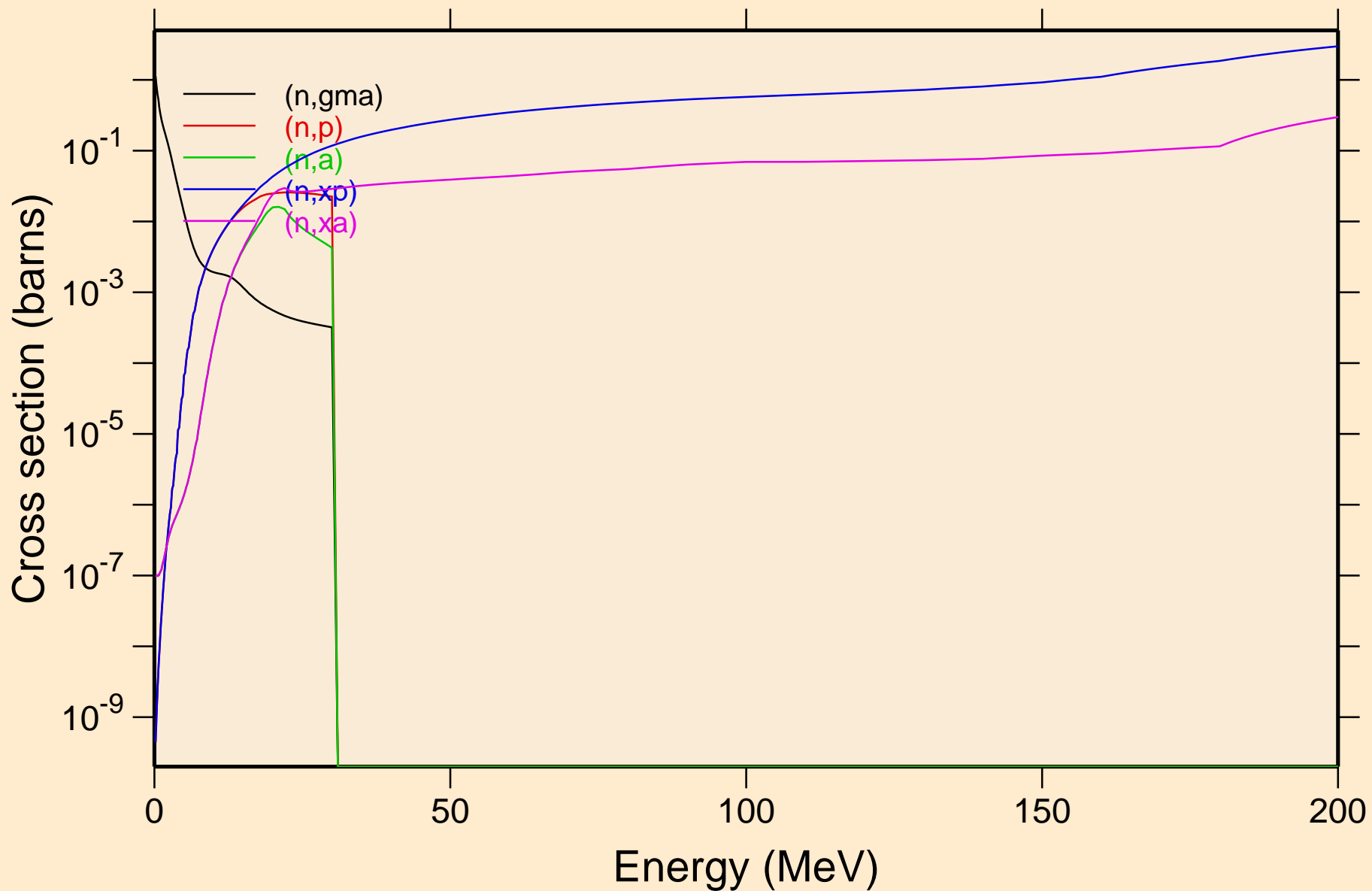

RE184 NEUTRON ACER TENDL-2019 LIBRARY; T=293.16K
Inelastic levels

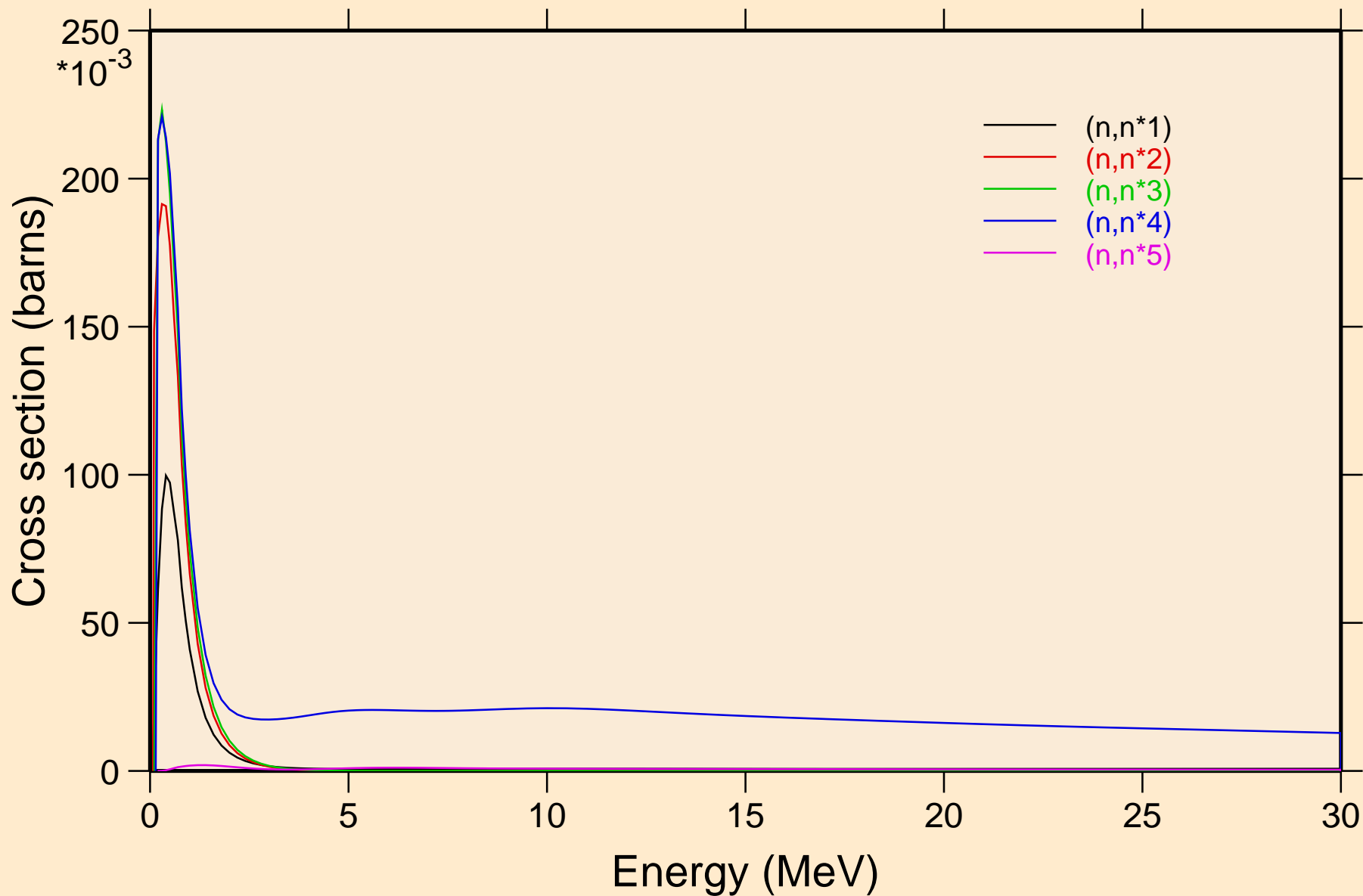

RE184 NEUTRON ACER TENDL-2019 LIBRARY; T=293.16K
Inelastic levels

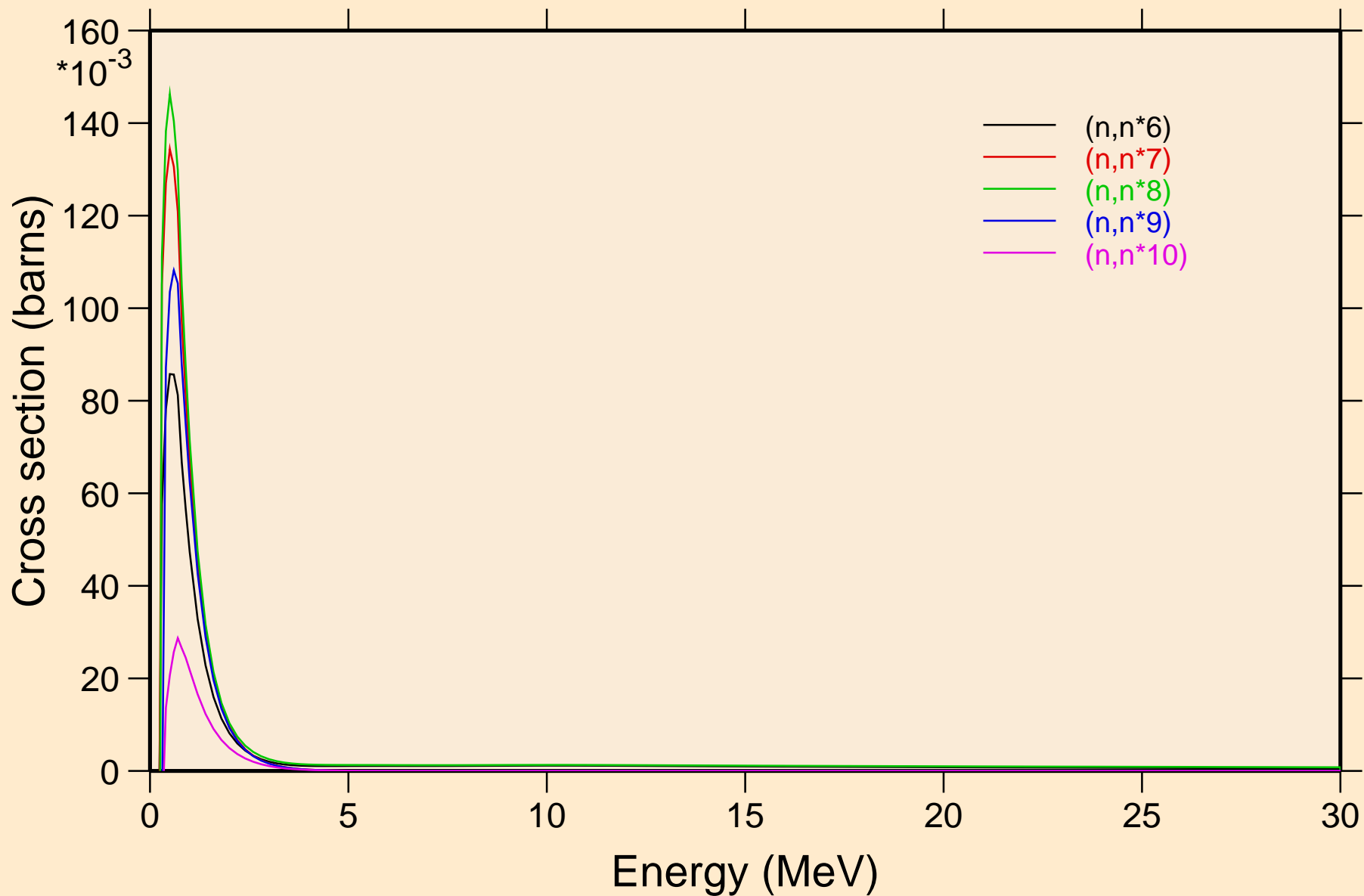

RE184 NEUTRON ACER TENDL-2019 LIBRARY; T=293.16K
Inelastic levels

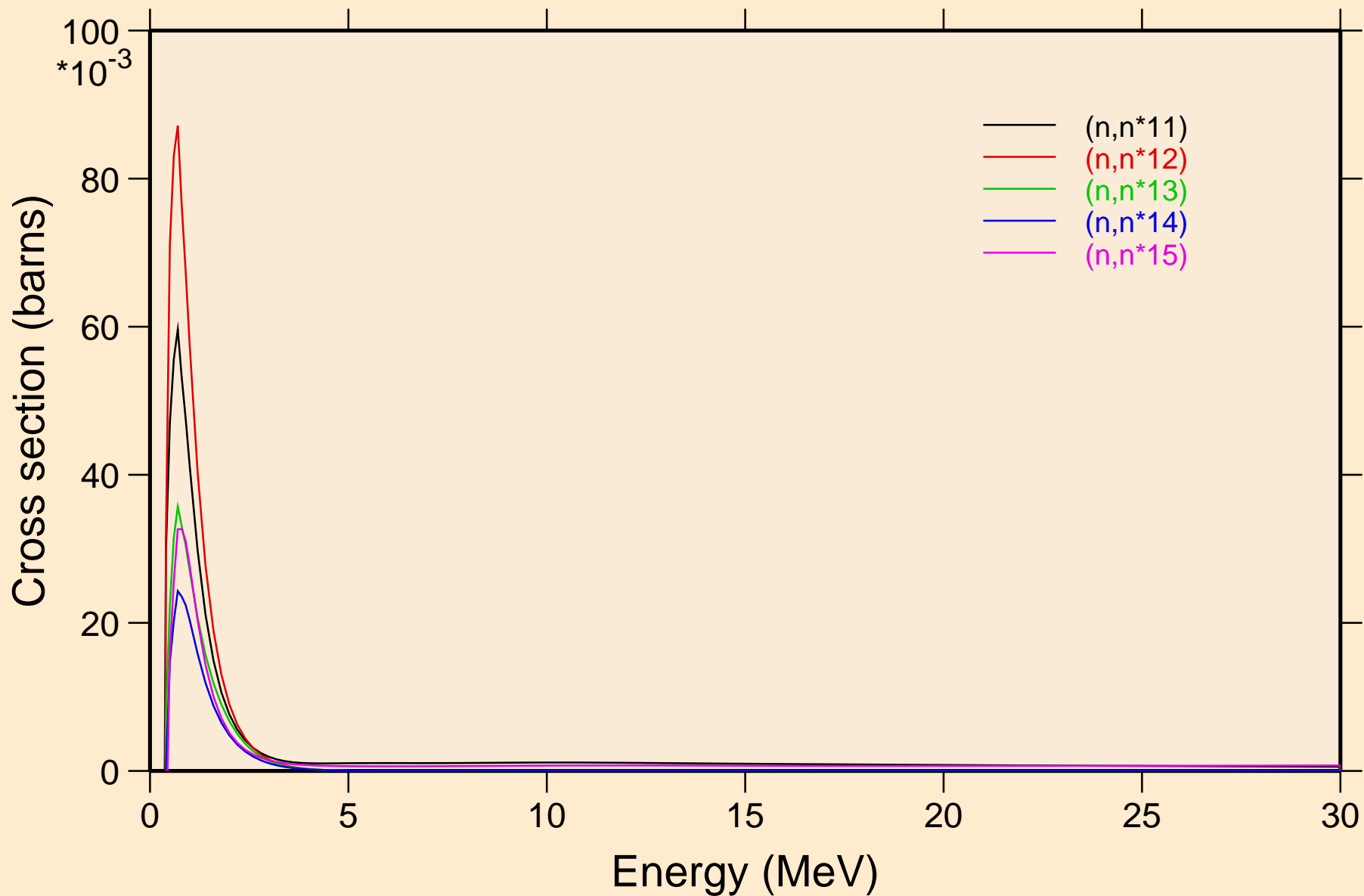

RE184 NEUTRON ACER TENDL-2019 LIBRARY; T=293.16K
Inelastic levels

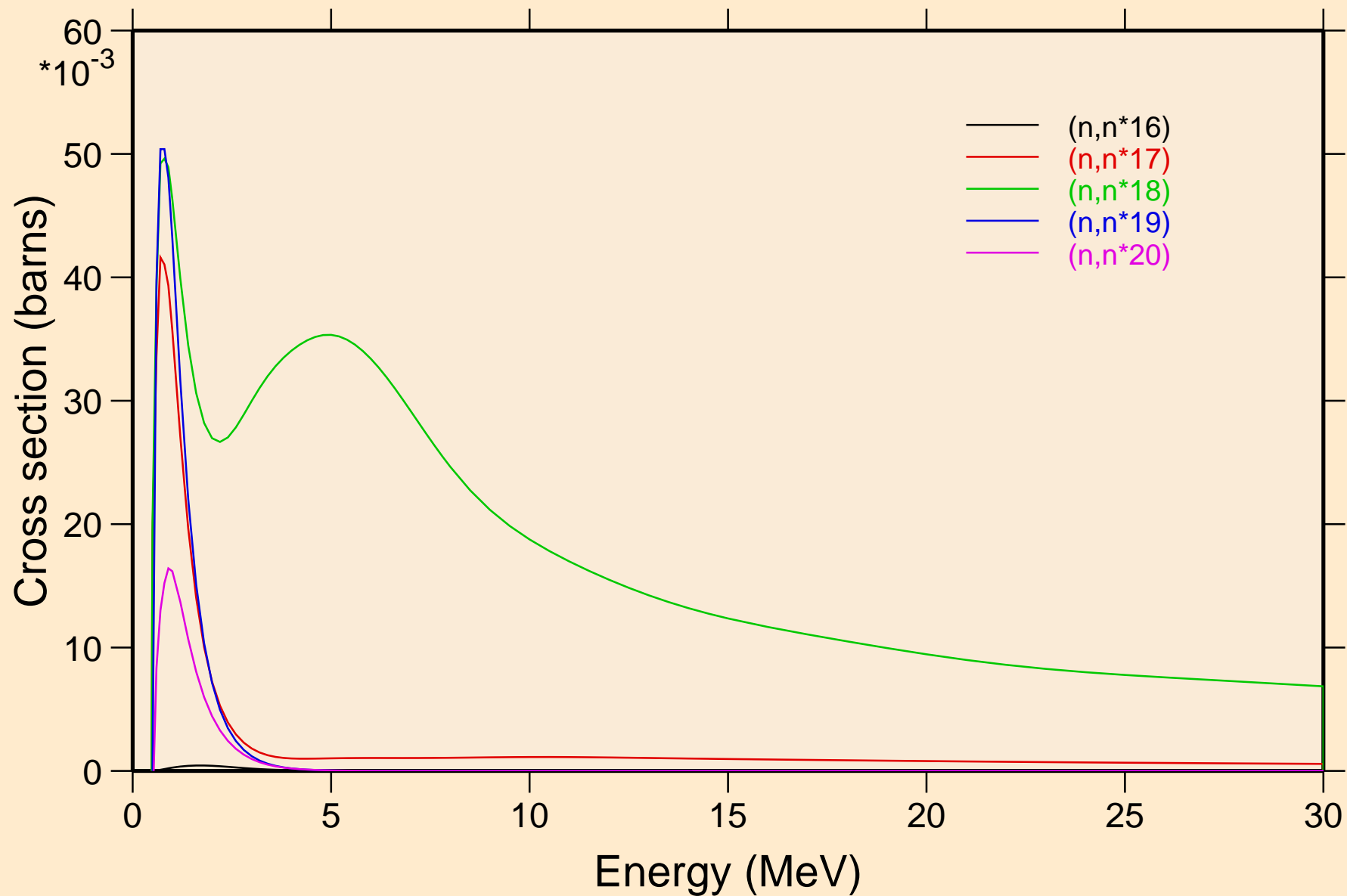

RE184 NEUTRON ACER TENDL-2019 LIBRARY; T=293.16K
Inelastic levels

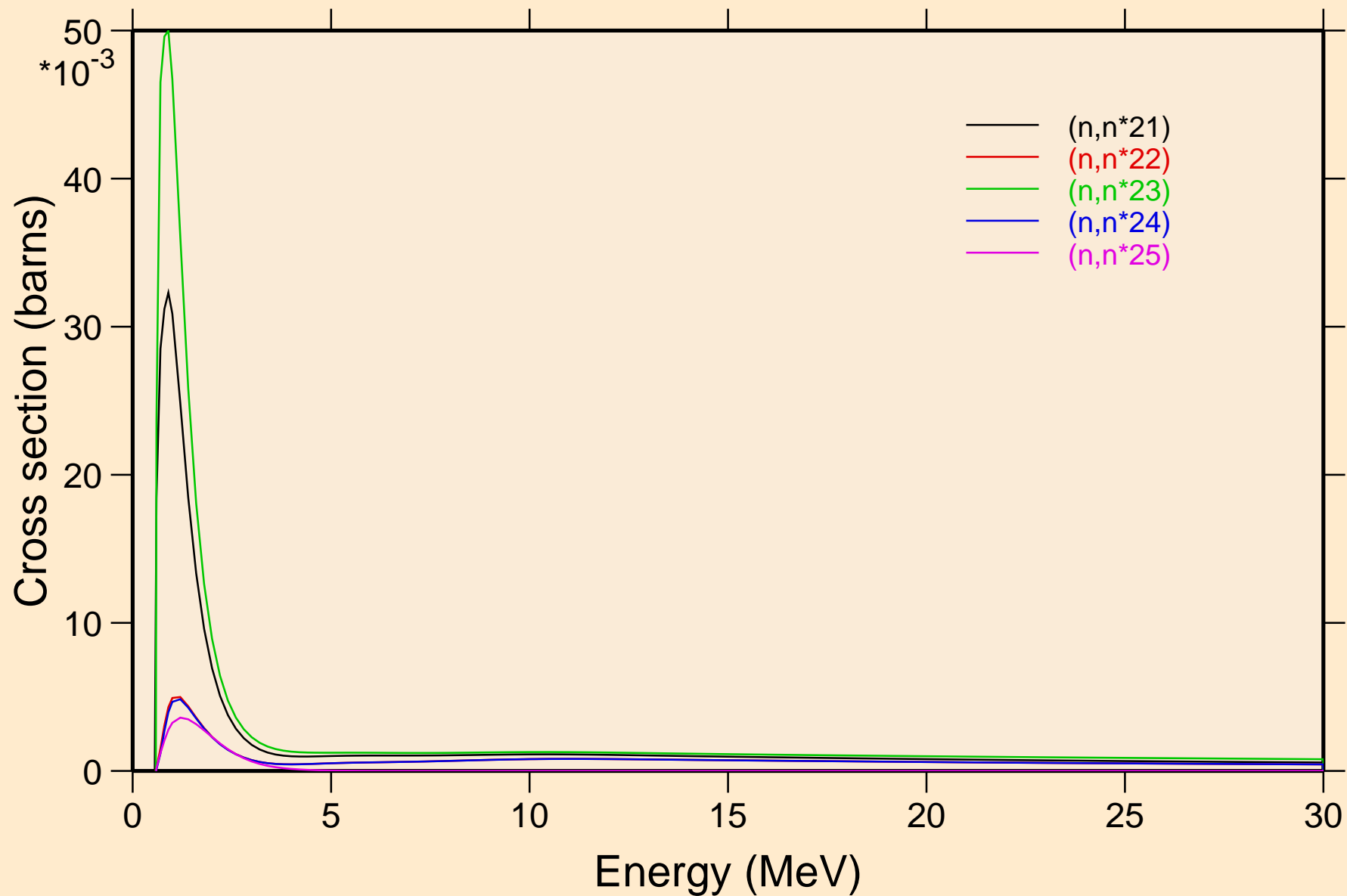

RE184 NEUTRON ACER TENDL-2019 LIBRARY; T=293.16K
Inelastic levels

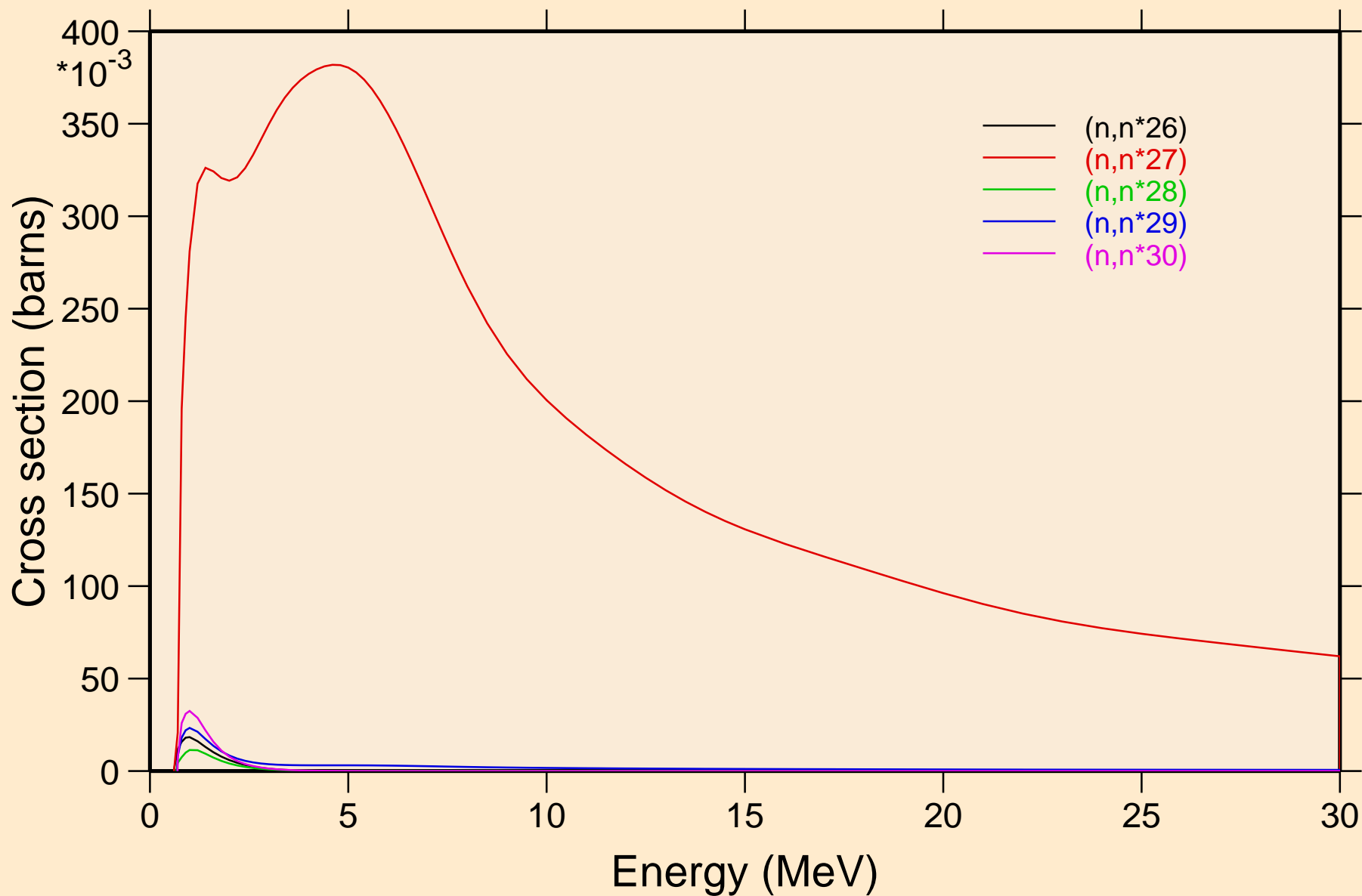

RE184 NEUTRON ACER TENDL-2019 LIBRARY; T=293.16K
Threshold reactions

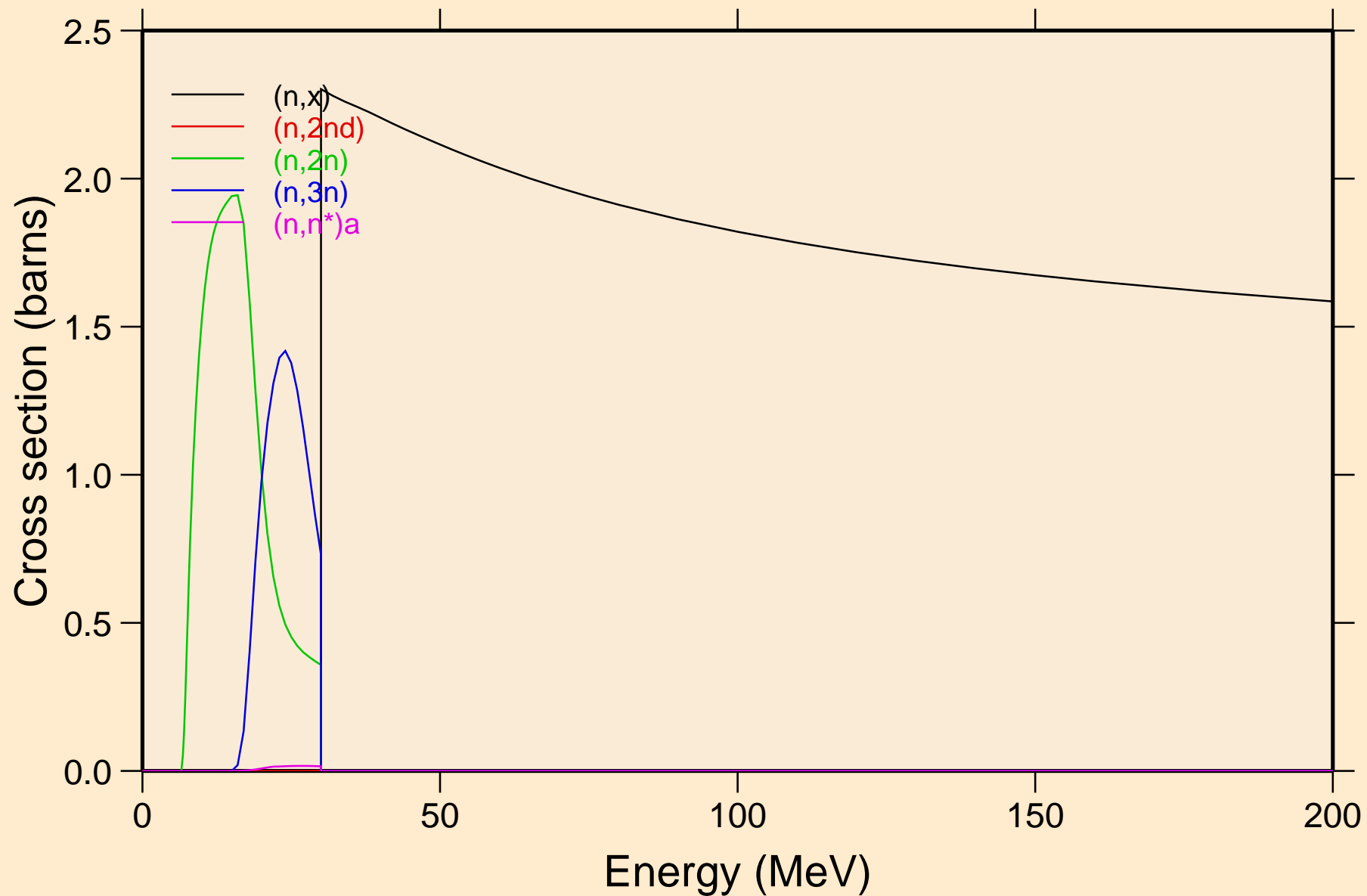

RE184 NEUTRON ACER TENDL-2019 LIBRARY; T=293.16K
Threshold reactions

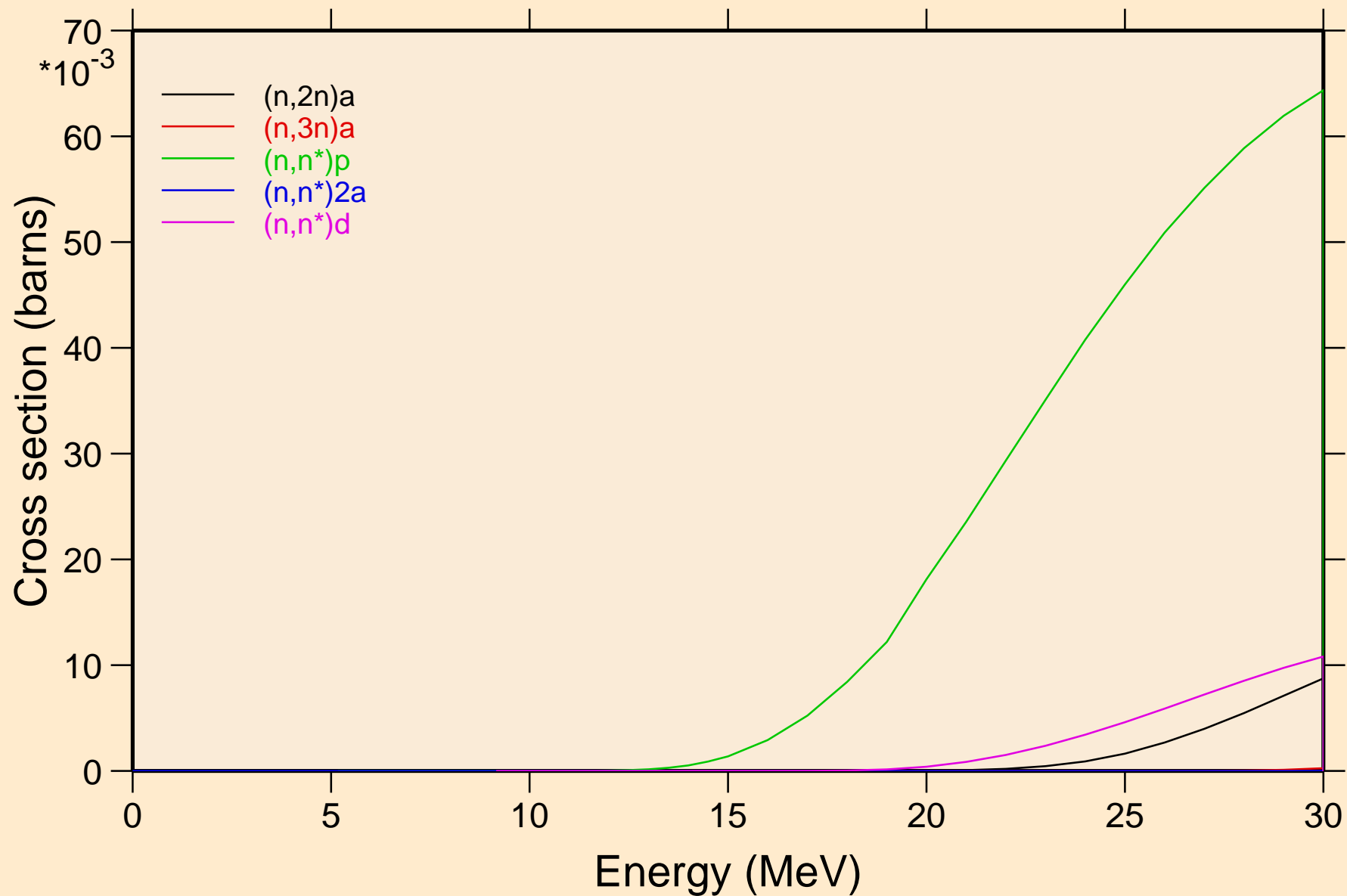

RE184 NEUTRON ACER TENDL-2019 LIBRARY; T=293.16K
Threshold reactions

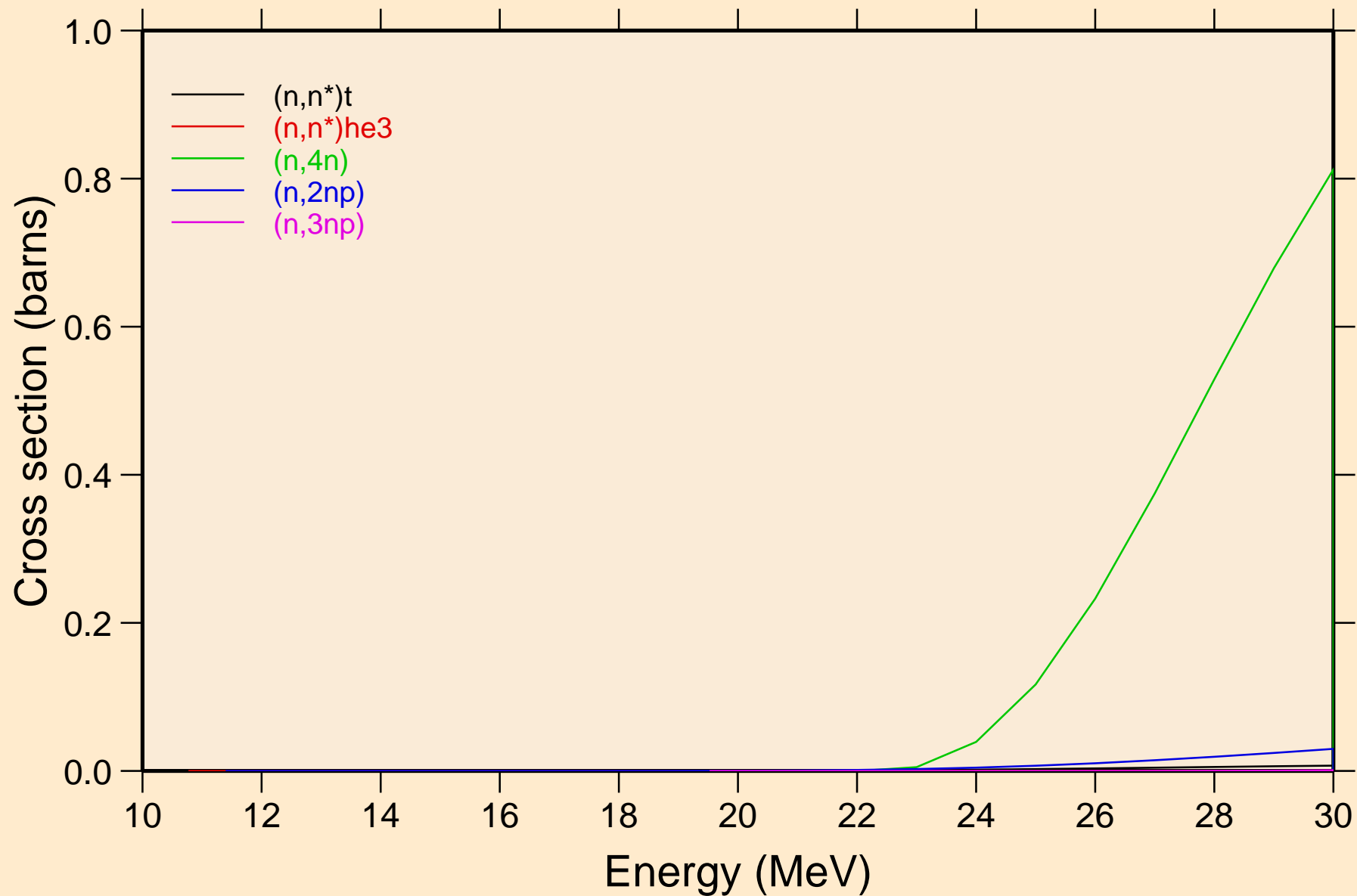

RE184 NEUTRON ACER TENDL-2019 LIBRARY; T=293.16K
Threshold reactions

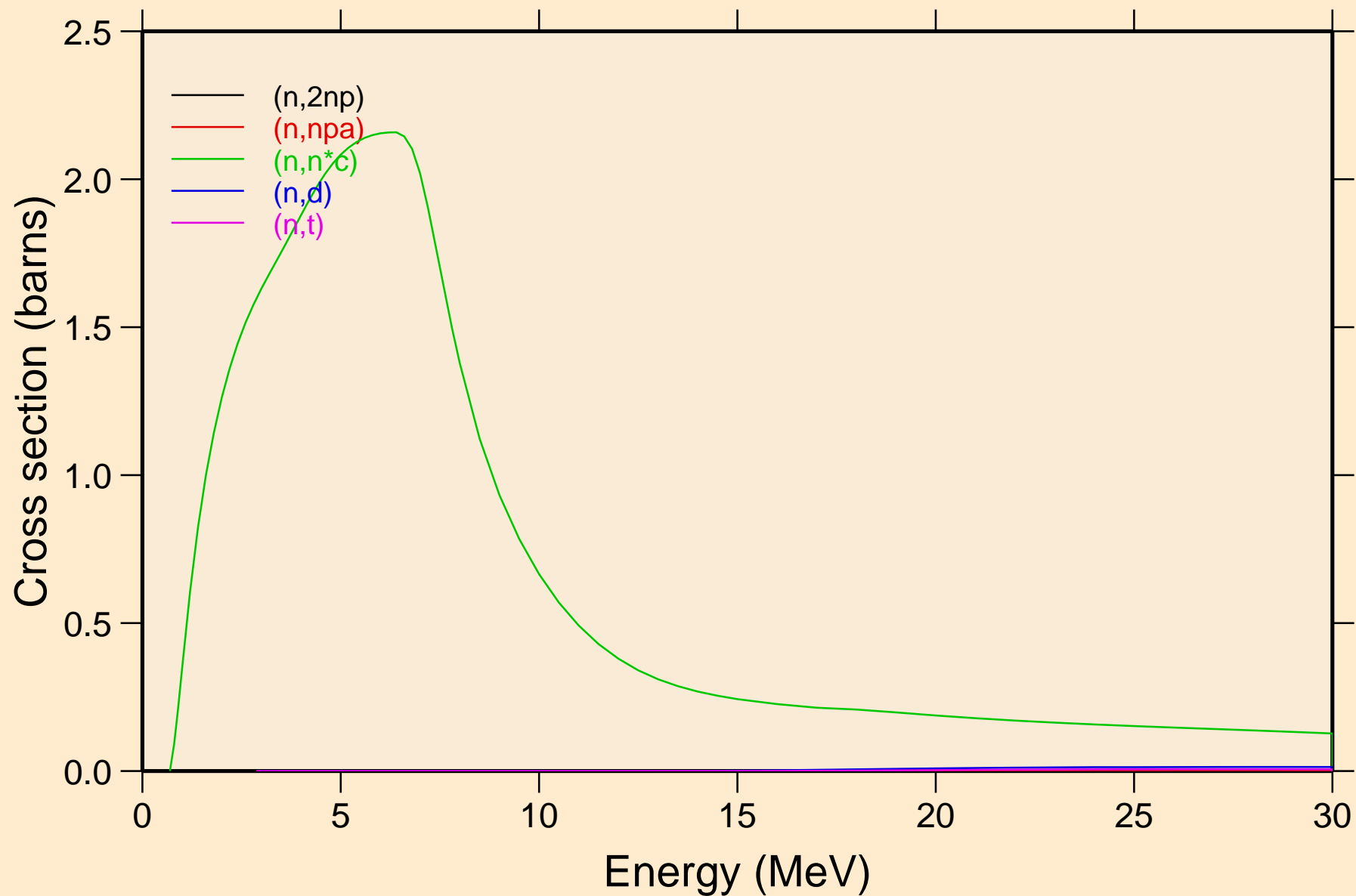

RE184 NEUTRON ACER TENDL-2019 LIBRARY; T=293.16K
Threshold reactions

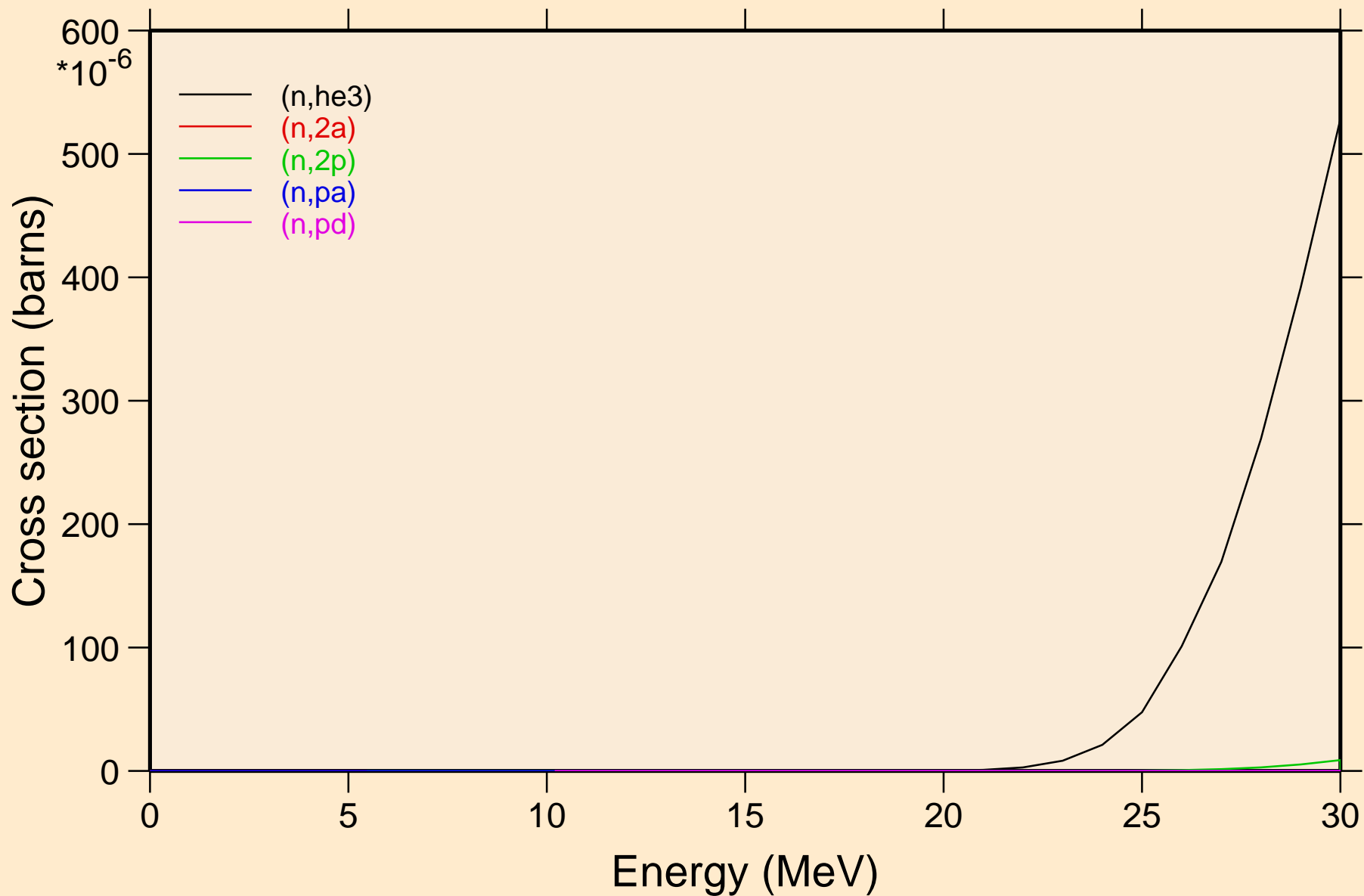

RE184 NEUTRON ACER TENDL-2019 LIBRARY; T=293.16K
Threshold reactions

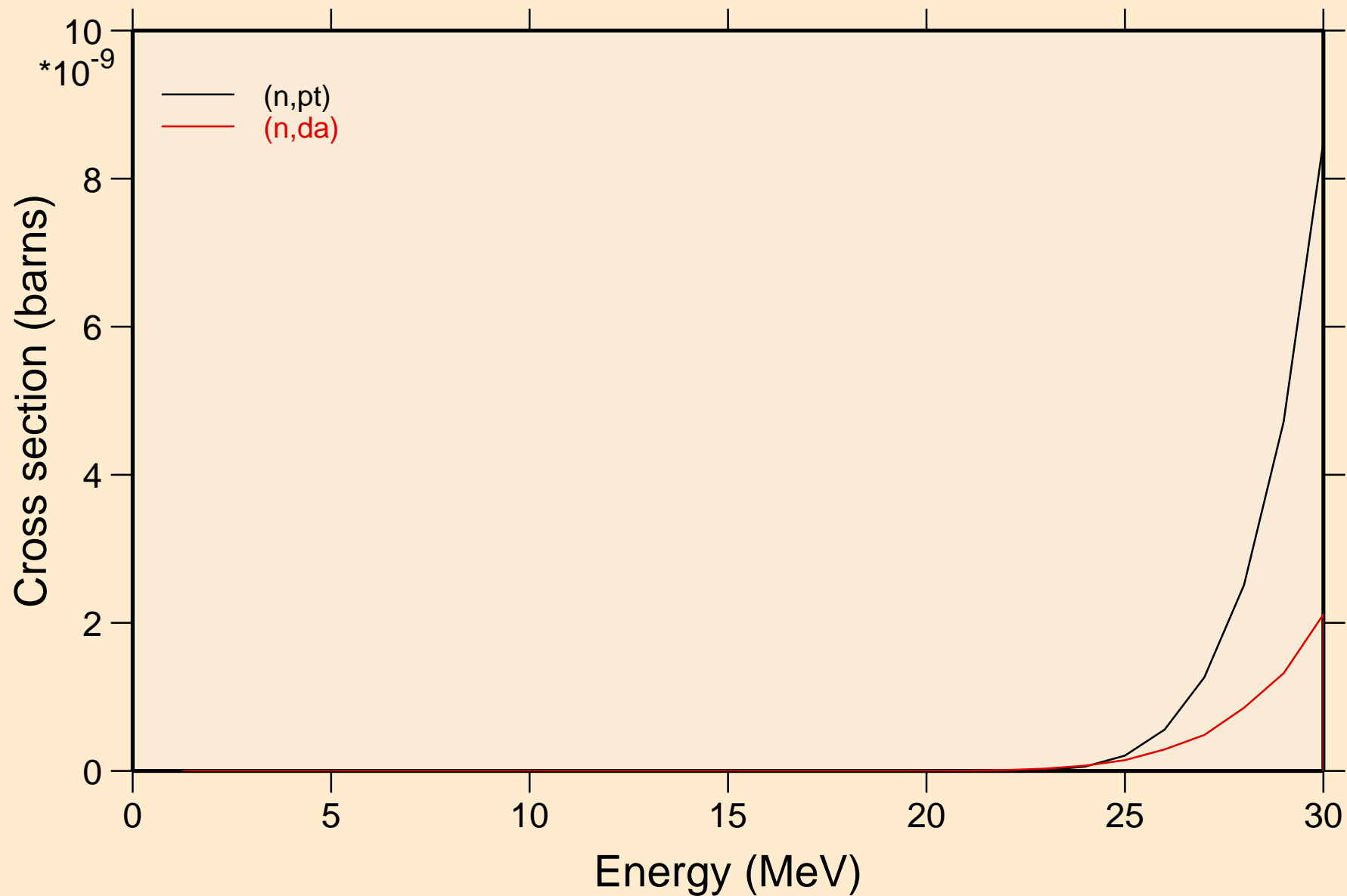

RE184 NEUTRON ACER TENDL-2019 LIBRARY; T=293.16K
Threshold reactions

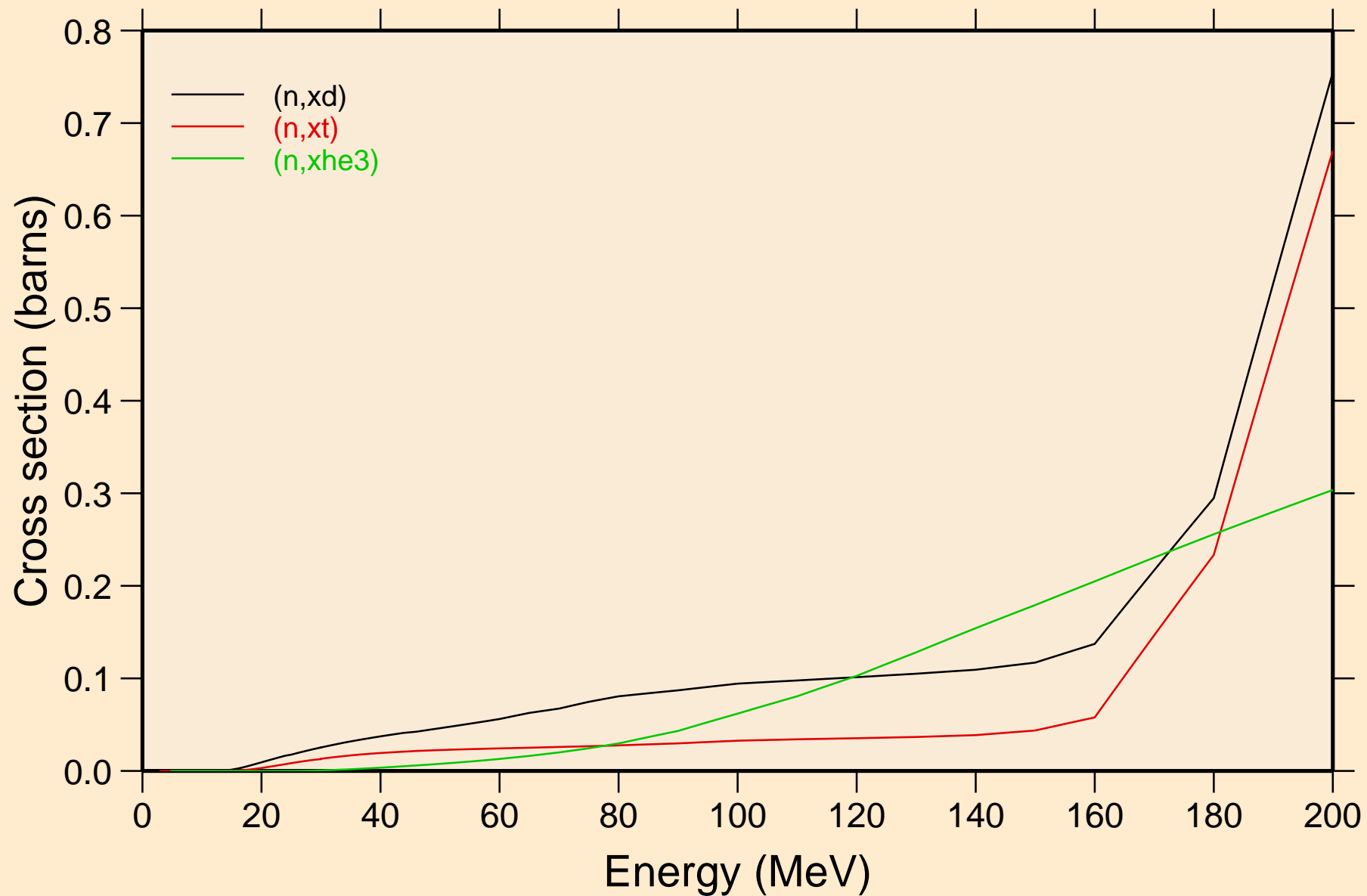

RE184 NEUTRON ACER TENDL-2019 LIBRARY; T=293.16K
angular distribution for elastic

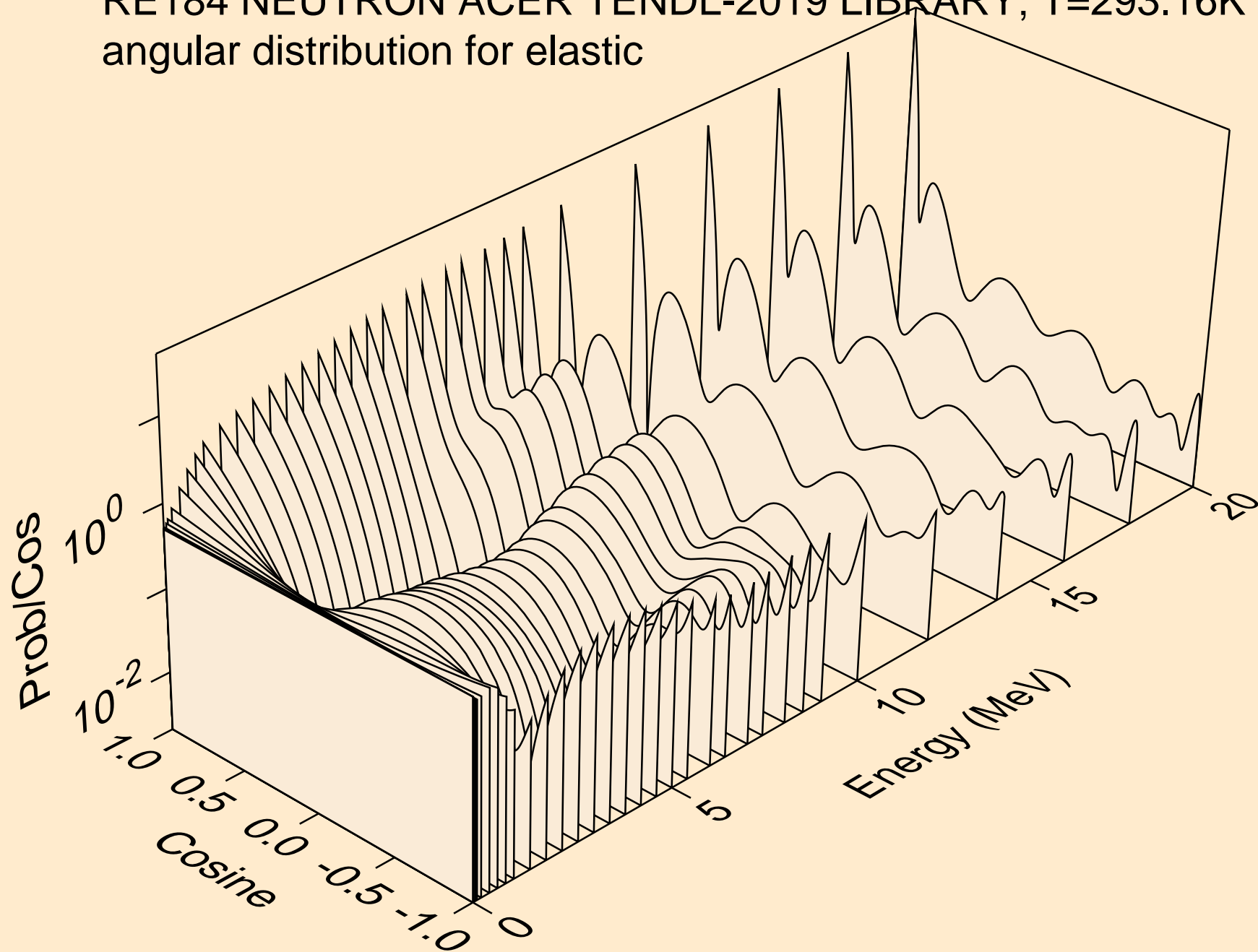

RE184 NEUTRON ACER TENDL-2019 LIBRARY; T=293.16K
angular distribution for elastic

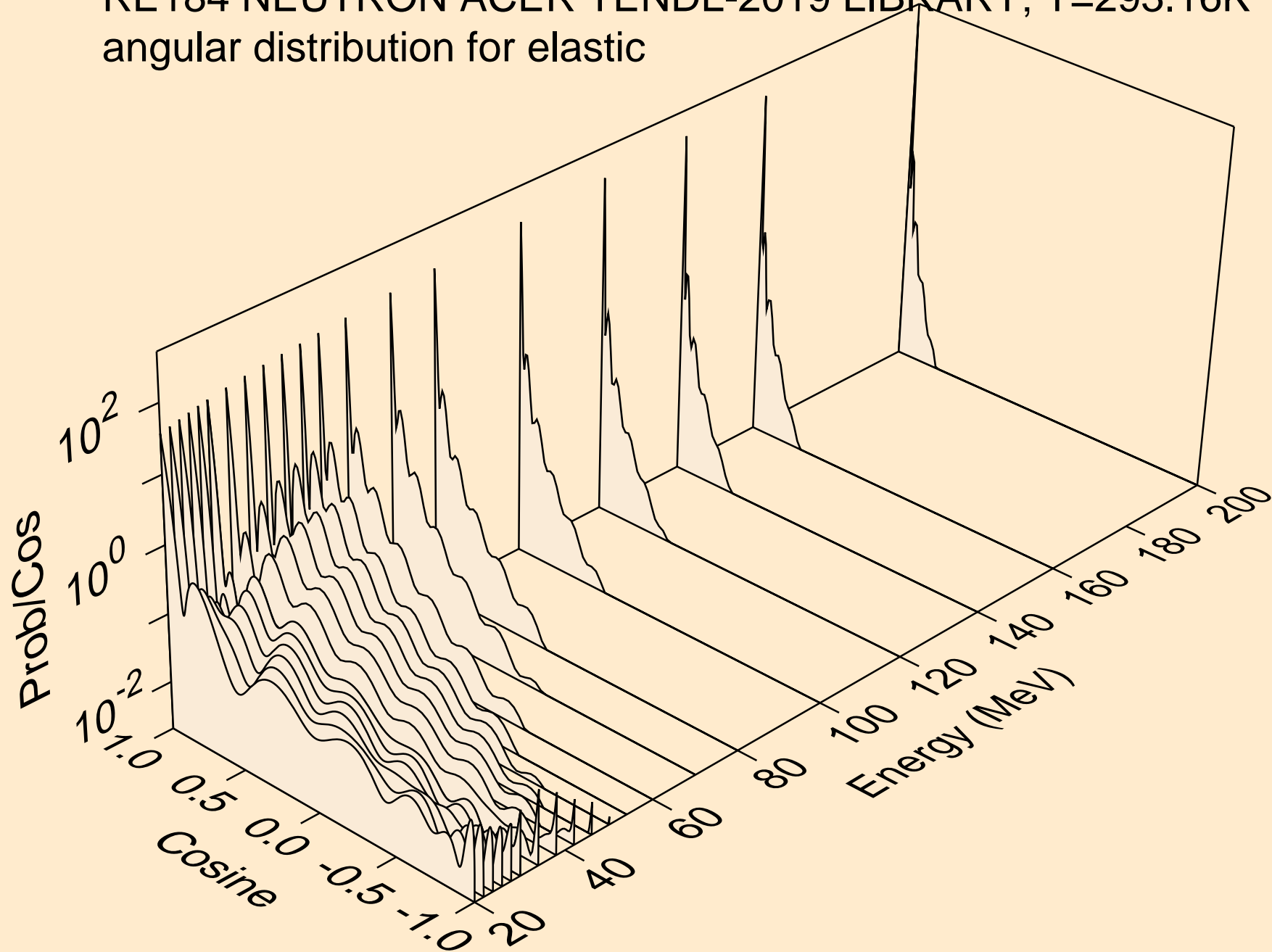

RE184 NEUTRON ACER TENDL-2019 LIBRARY; T=293.16K
angular distribution for (n,n*1)

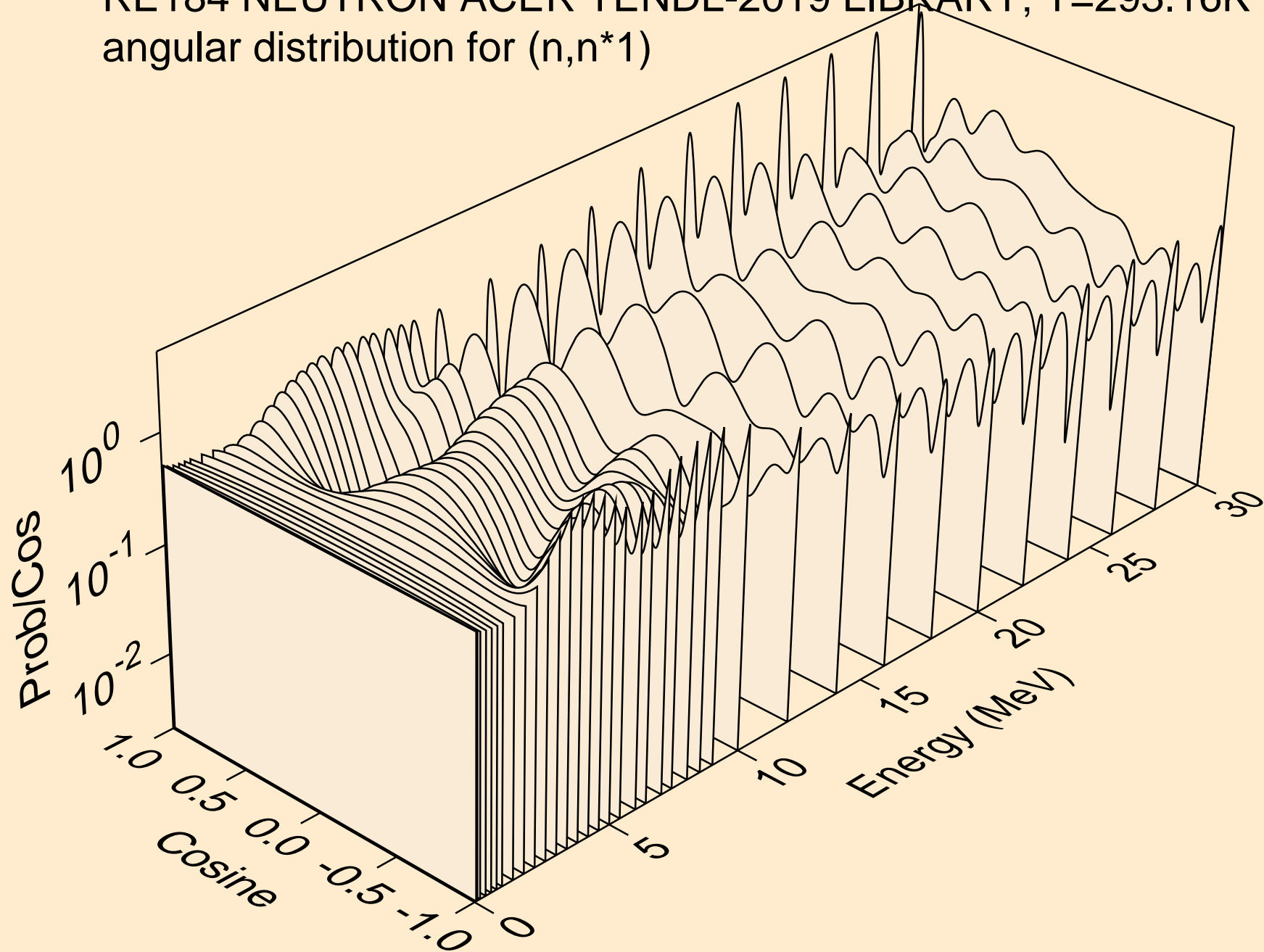

RE184 NEUTRON ACER TENDL-2019 LIBRARY; T=293.16K
angular distribution for (n,n*2)

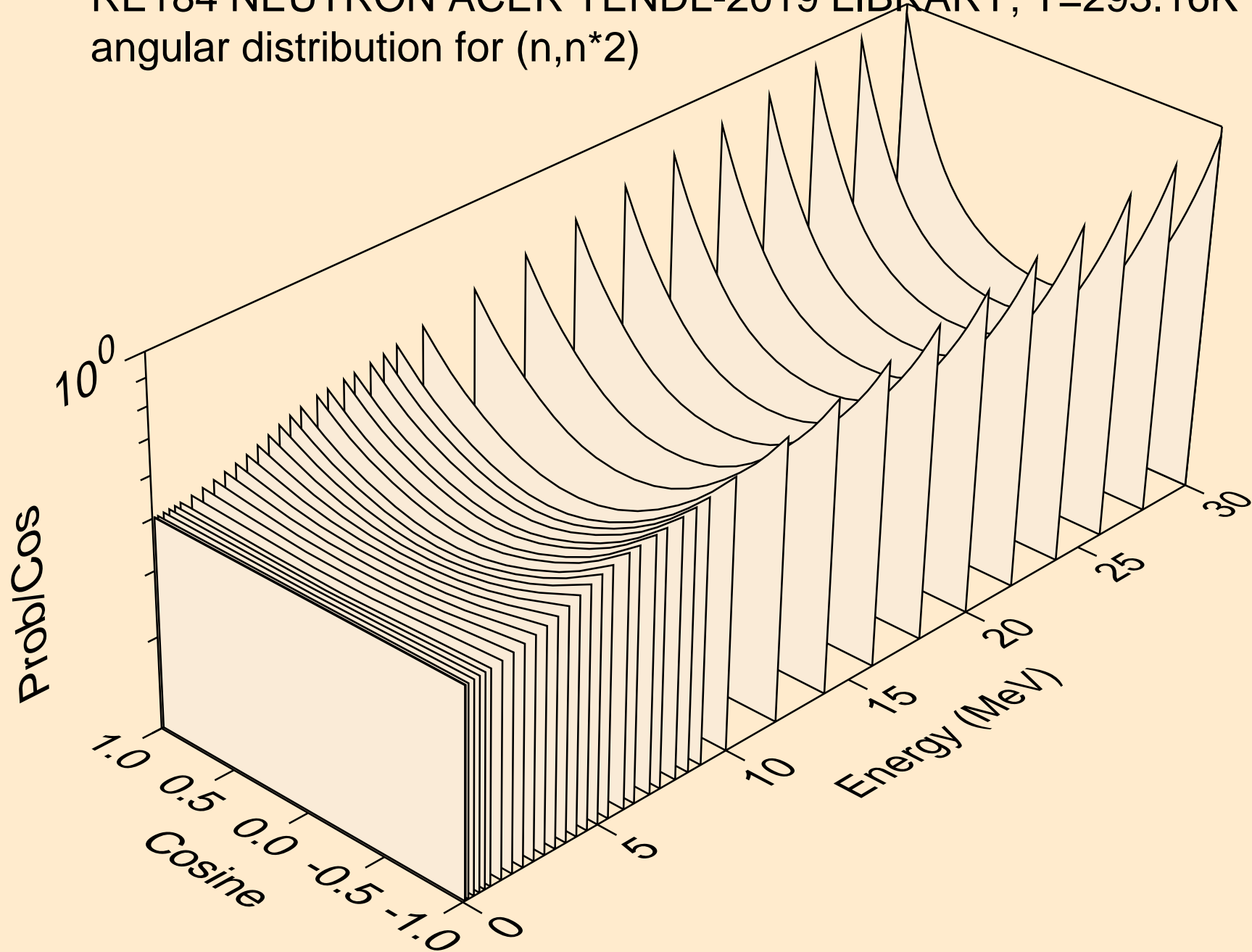

RE184 NEUTRON ACER TENDL-2019 LIBRARY; T=293.16K
angular distribution for (n,n*3)

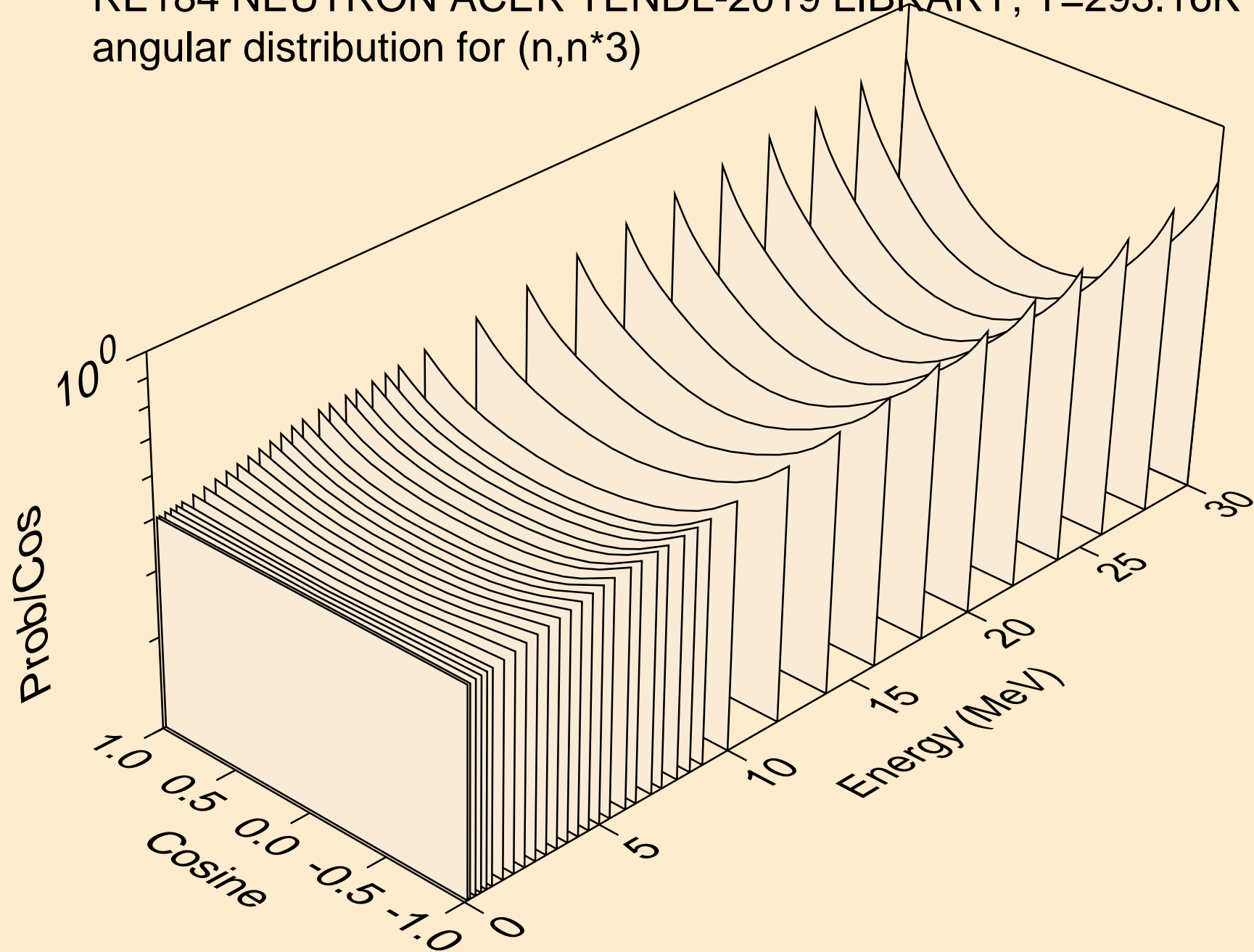

RE184 NEUTRON ACER TENDL-2019 LIBRARY; T=293.16K
angular distribution for (n,n*4)

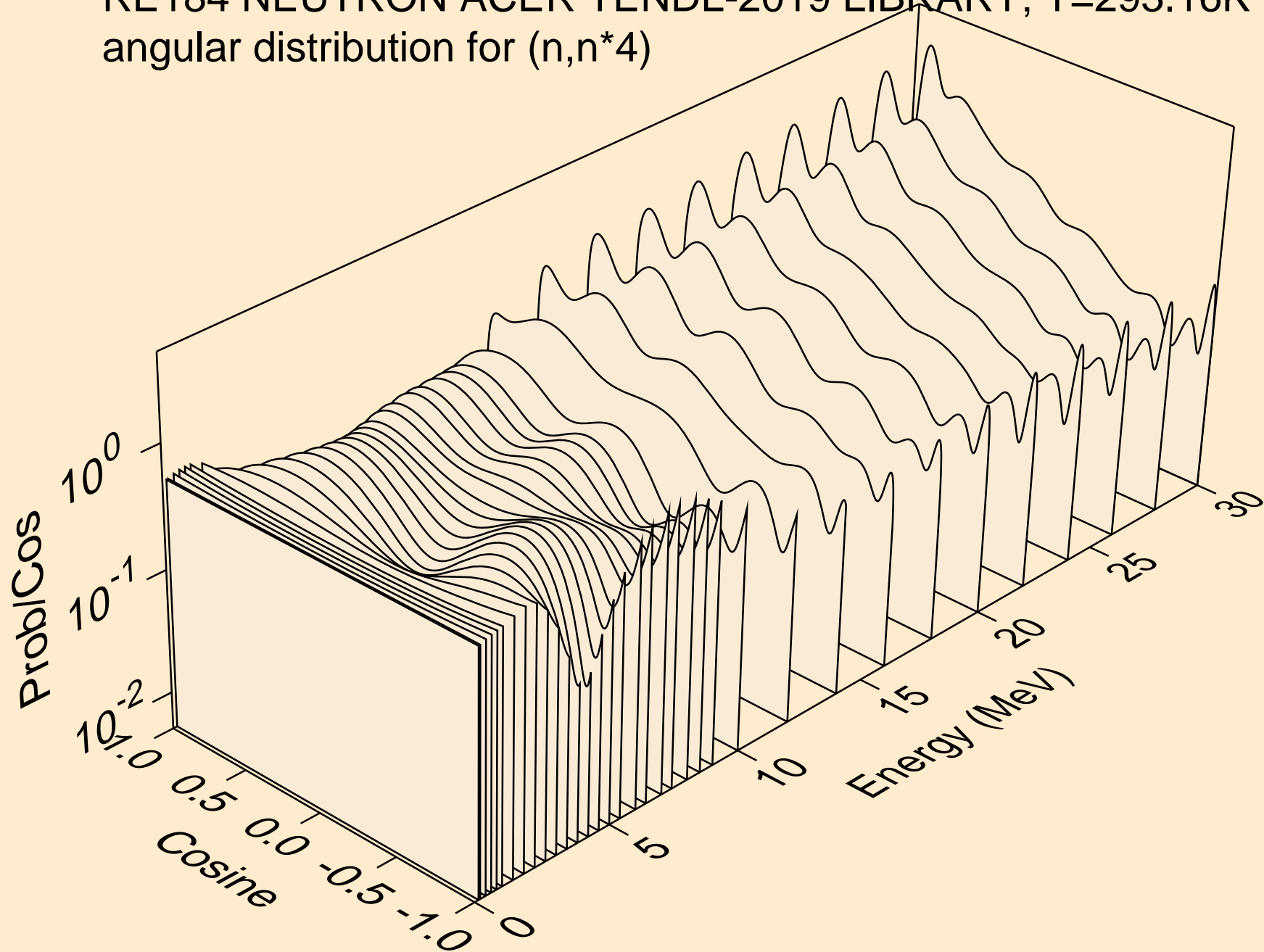

RE184 NEUTRON ACER TENDL-2019 LIBRARY; T=293.16K
angular distribution for (n,n*5)

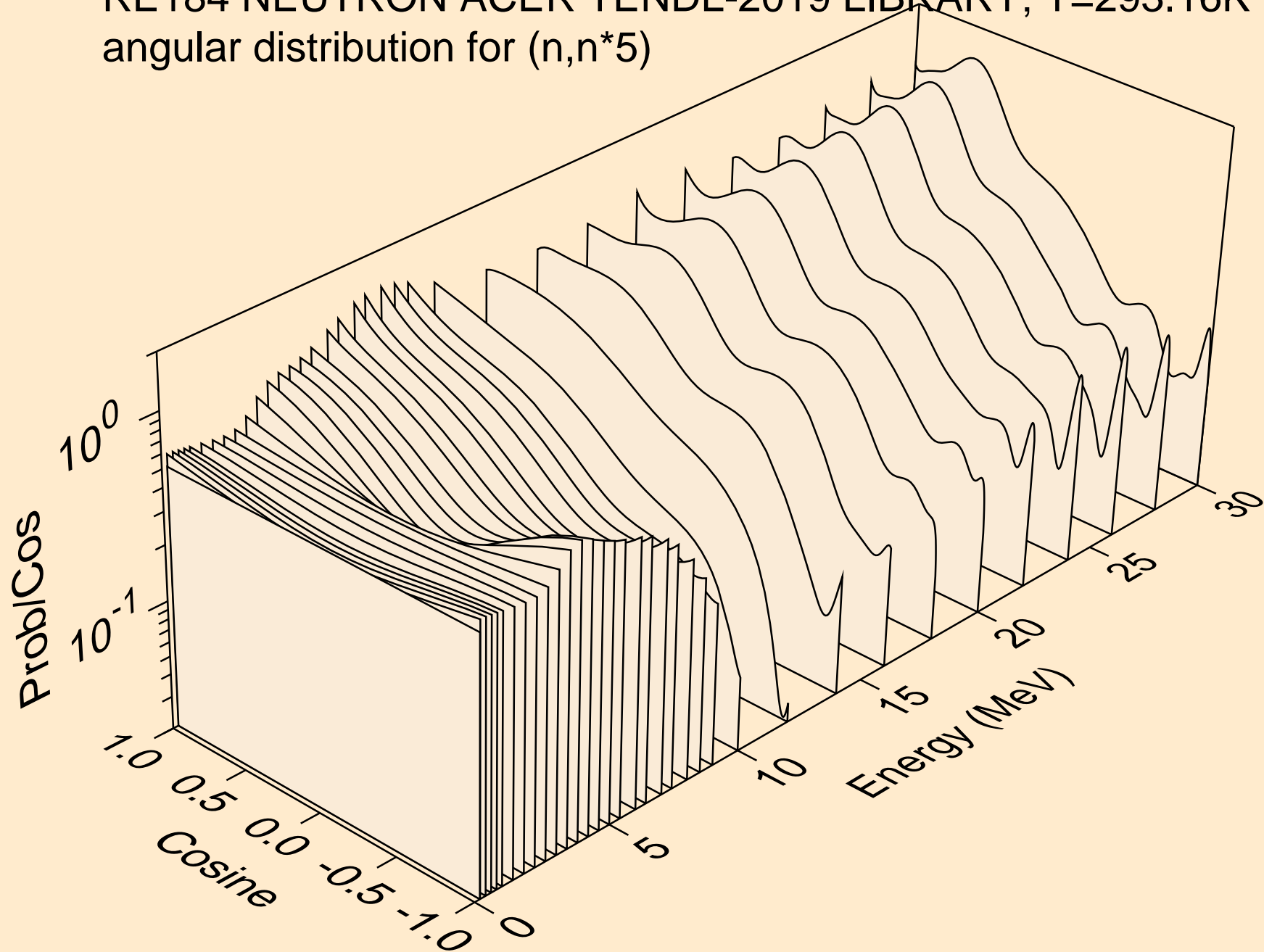

RE184 NEUTRON ACER TENDL-2019 LIBRARY; T=293.16K
angular distribution for (n,n*6)

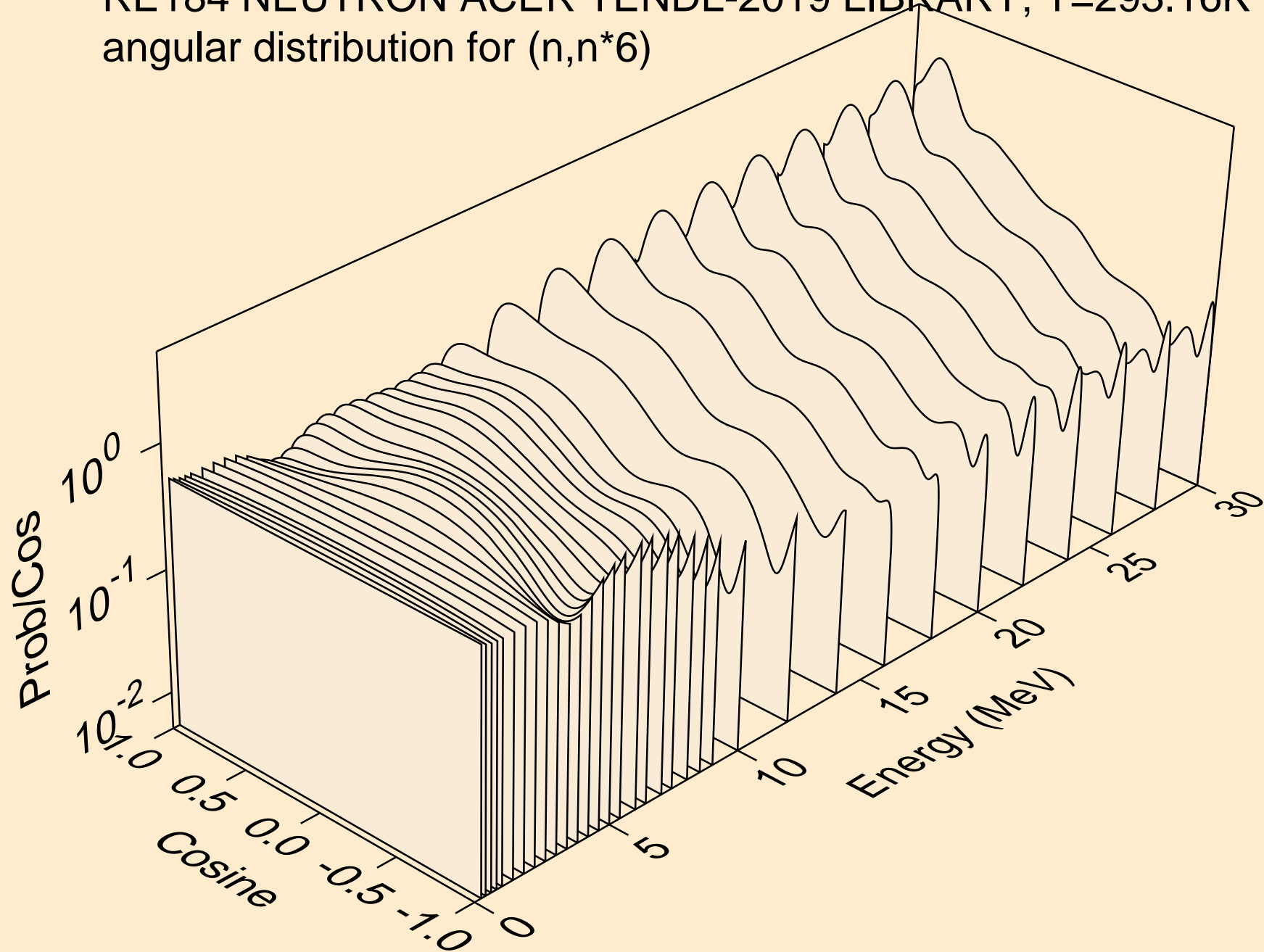

RE184 NEUTRON ACER TENDL-2019 LIBRARY; T=293.16K
angular distribution for (n,n*7)

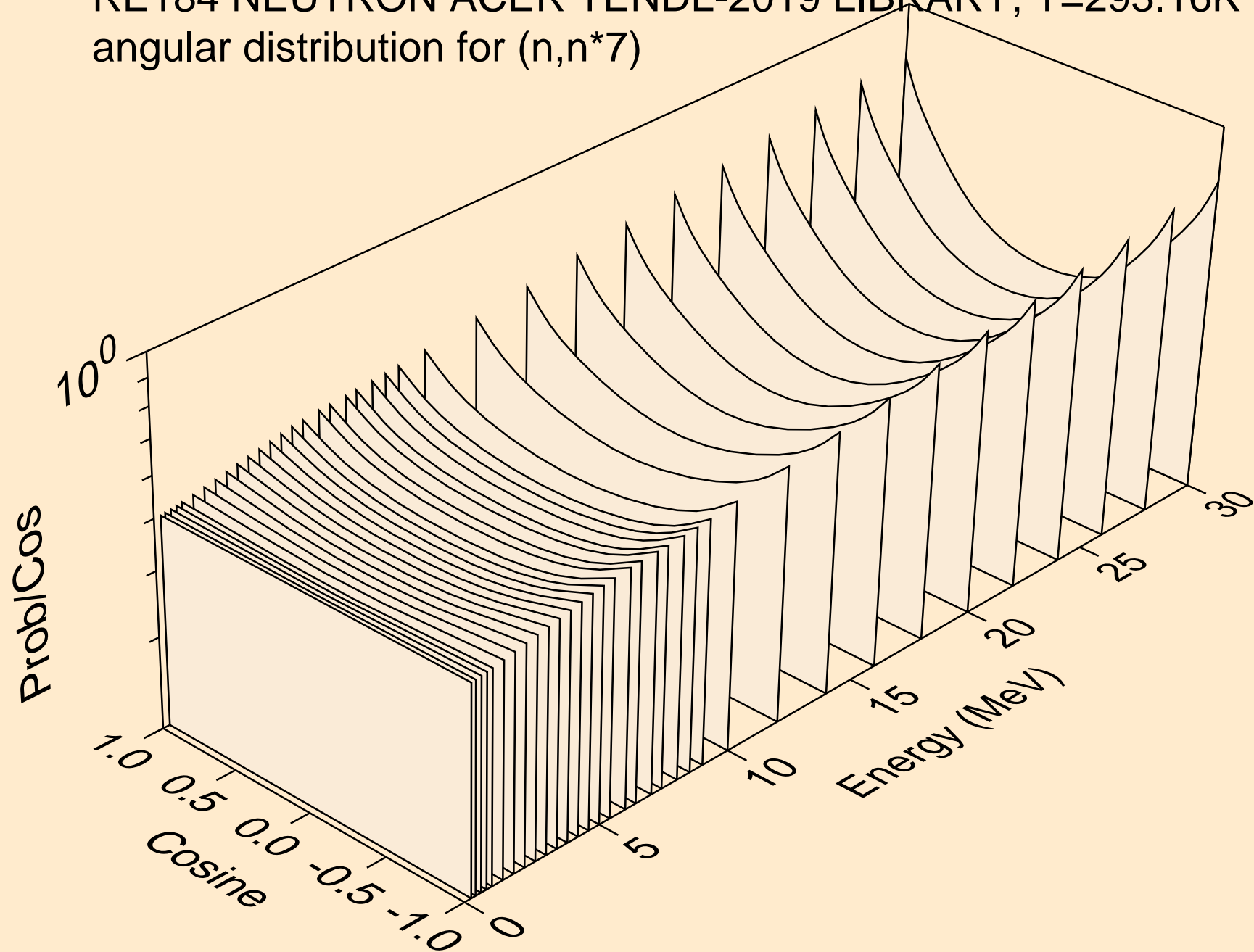

RE184 NEUTRON ACER TENDL-2019 LIBRARY; T=293.16K
angular distribution for (n,n*8)

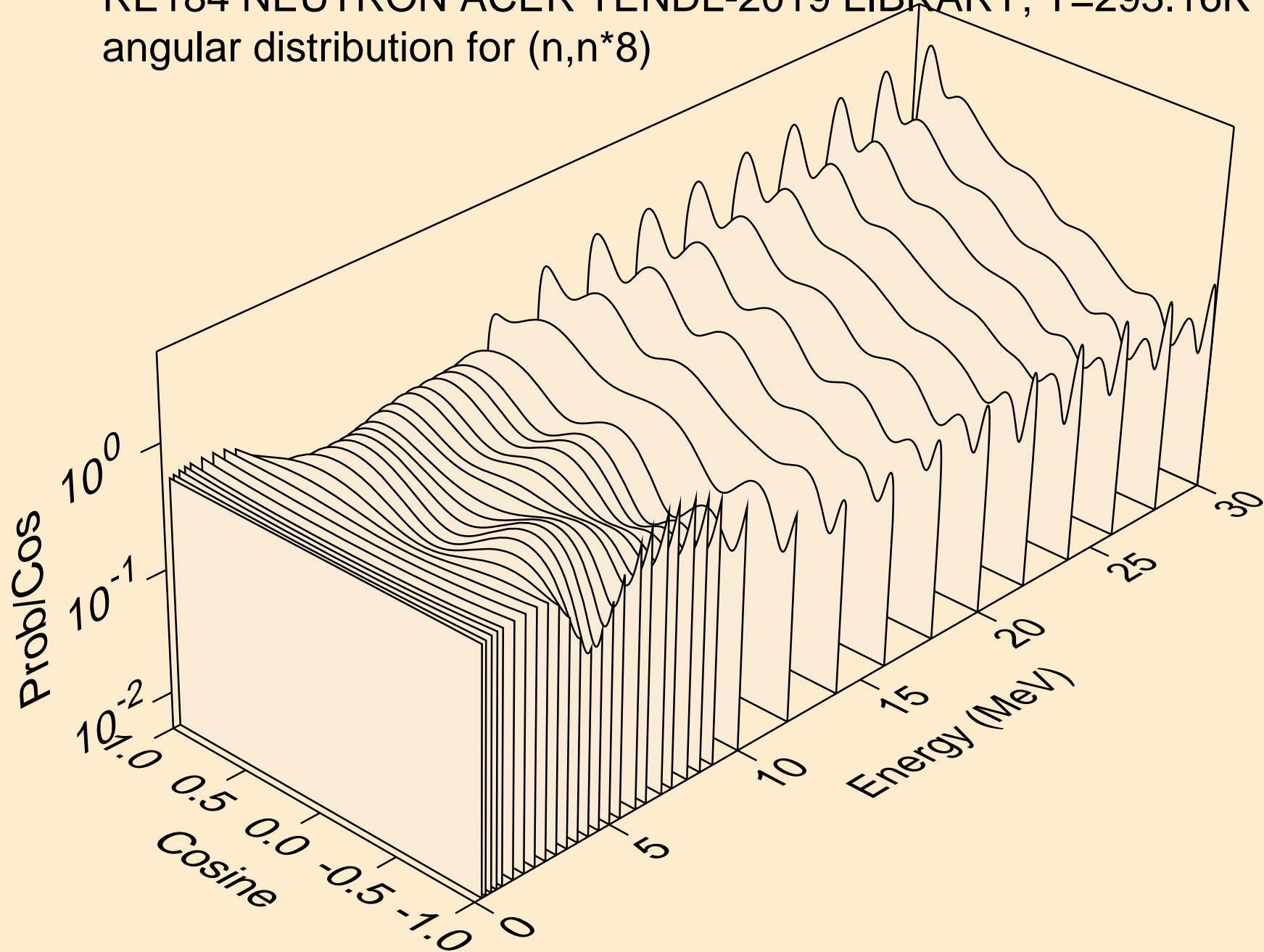

RE184 NEUTRON ACER TENDL-2019 LIBRARY; T=293.16K
angular distribution for (n,n*9)

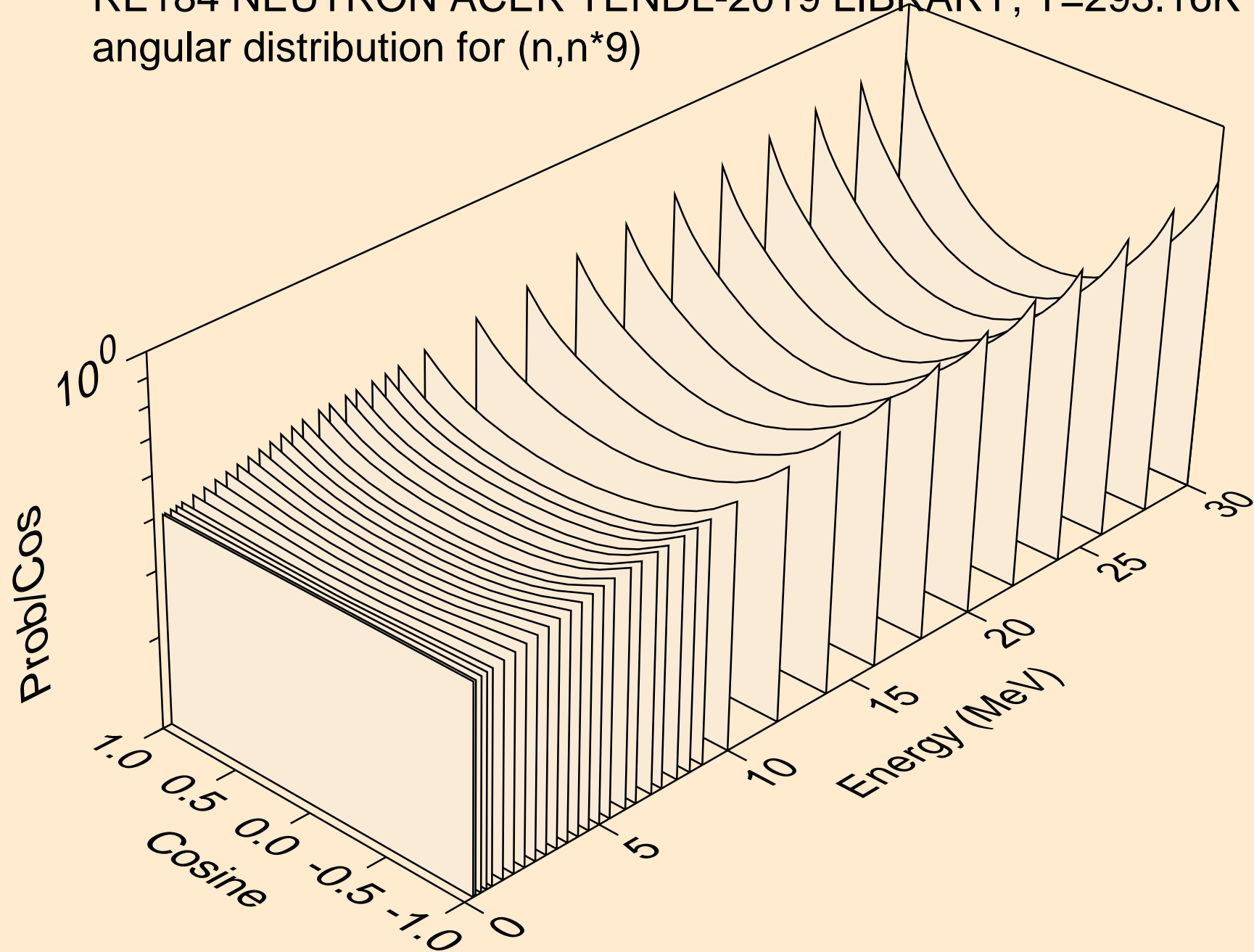

RE184 NEUTRON ACER TENDL-2019 LIBRARY; T=293.16K
angular distribution for (n,n*10)

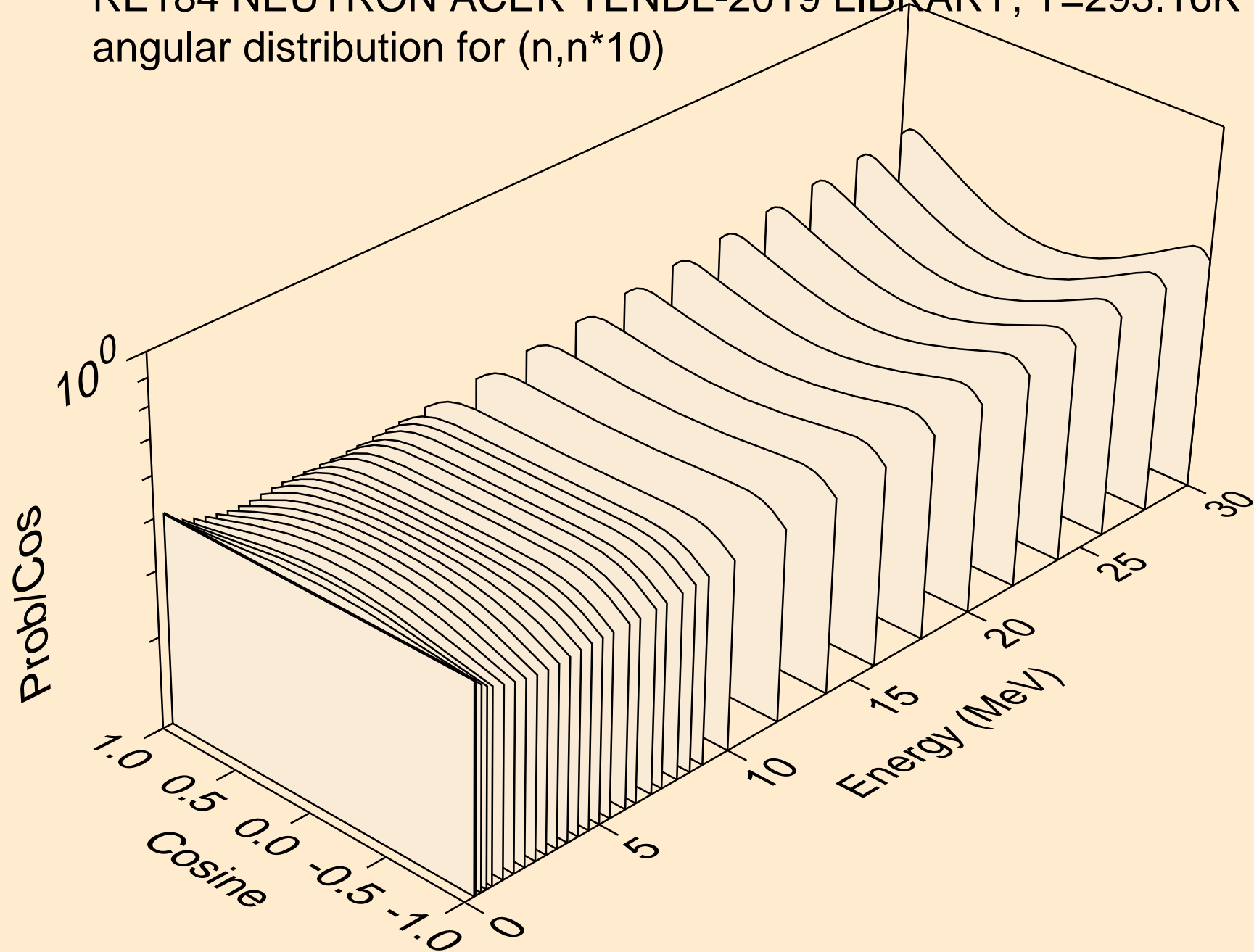

RE184 NEUTRON ACER TENDL-2019 LIBRARY; T=293.16K
angular distribution for (n,n*11)

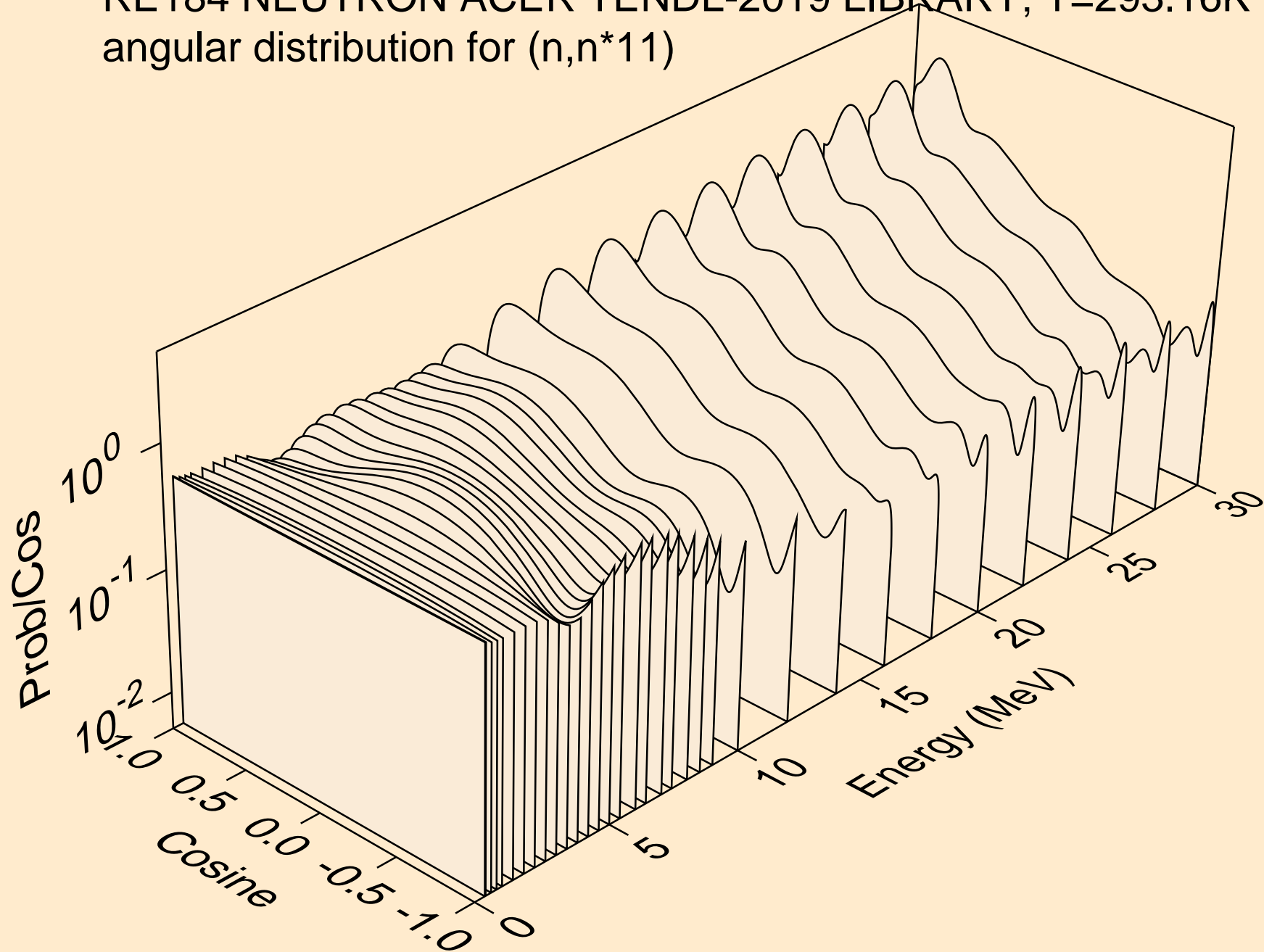

RE184 NEUTRON ACER TENDL-2019 LIBRARY; T=293.16K
angular distribution for (n,n*12)

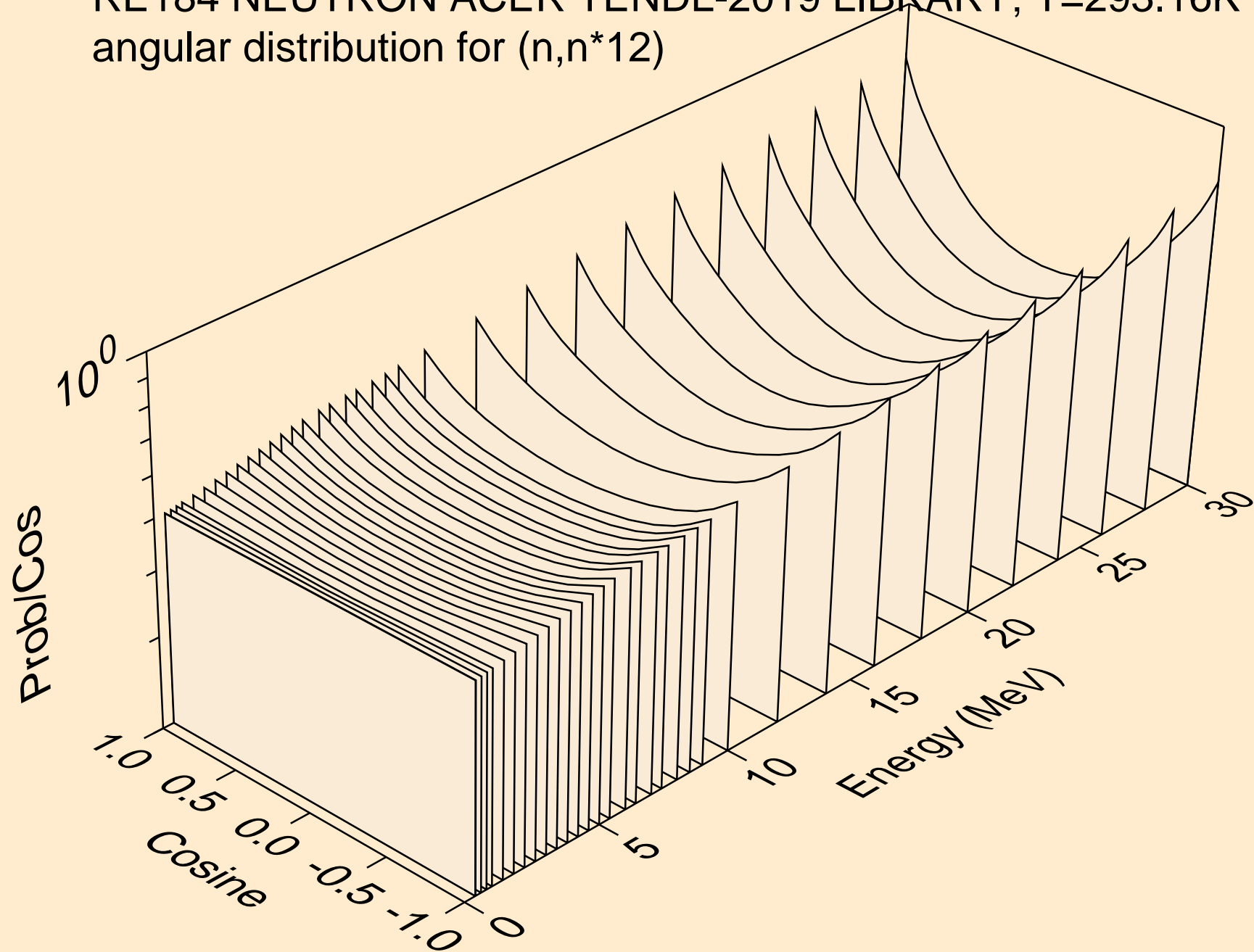

RE184 NEUTRON ACER TENDL-2019 LIBRARY; T=293.16K
angular distribution for (n,n*13)

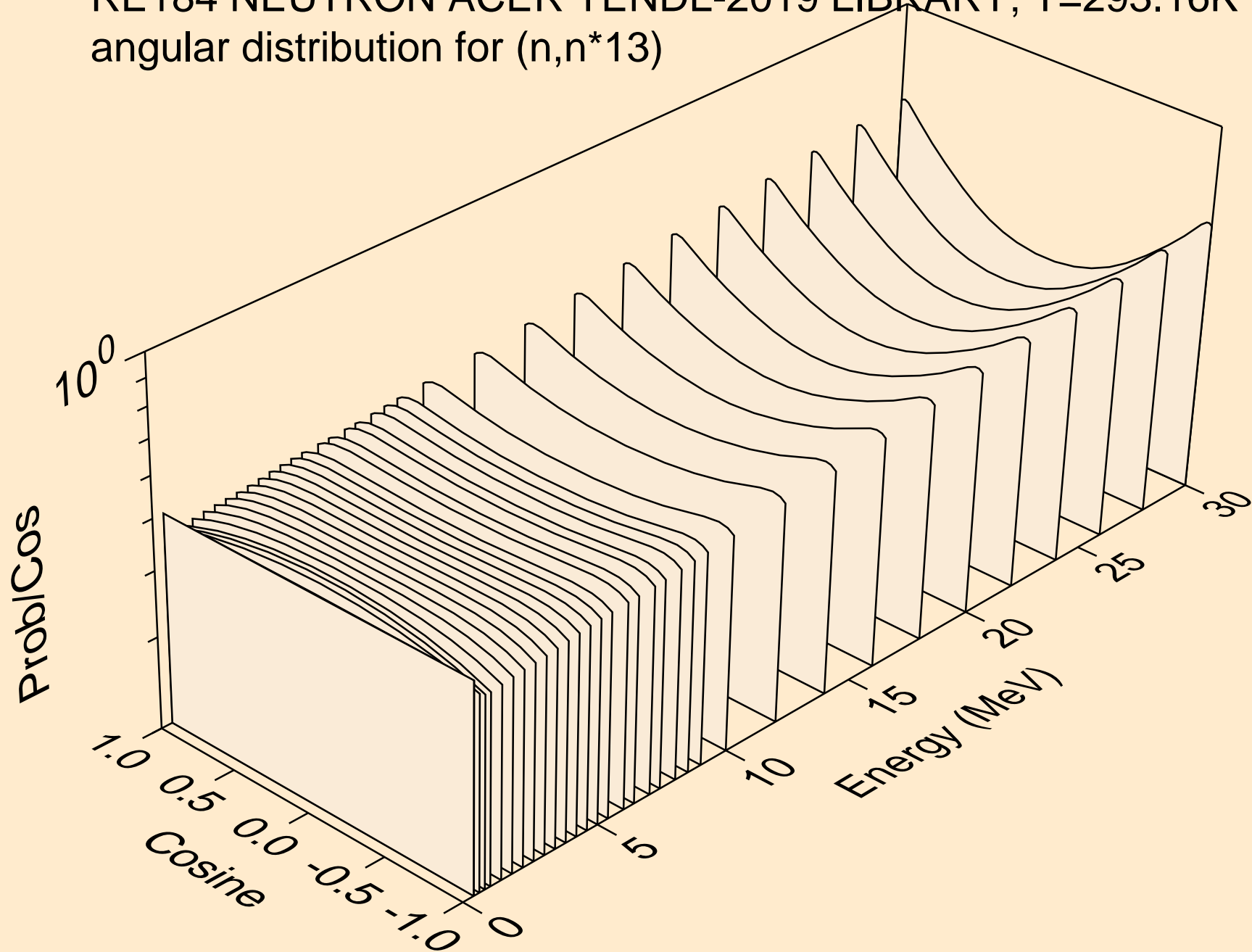

RE184 NEUTRON ACER TENDL-2019 LIBRARY; T=293.16K
angular distribution for (n,n*14)

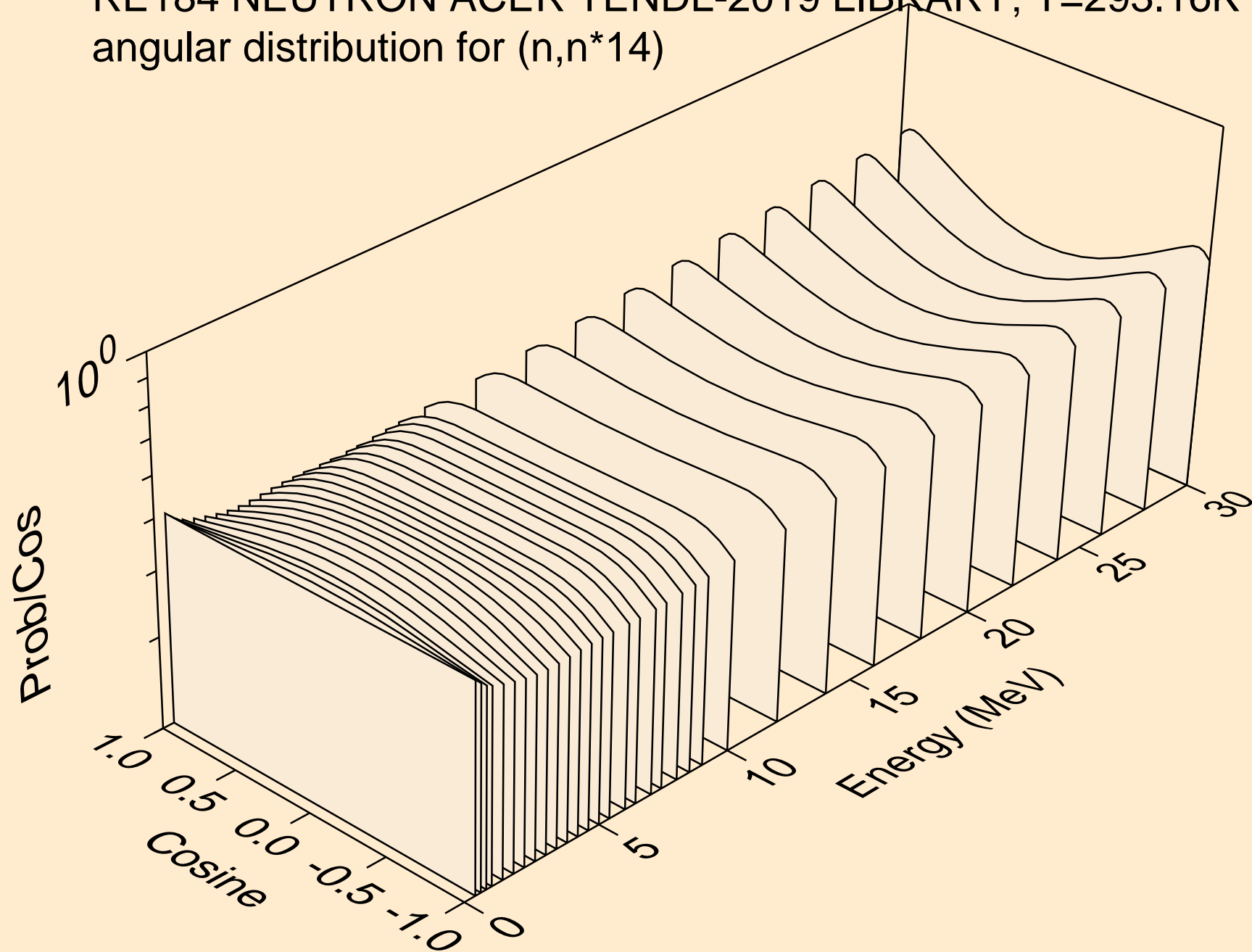

RE184 NEUTRON ACER TENDL-2019 LIBRARY; T=293.16K
angular distribution for (n,n*15)

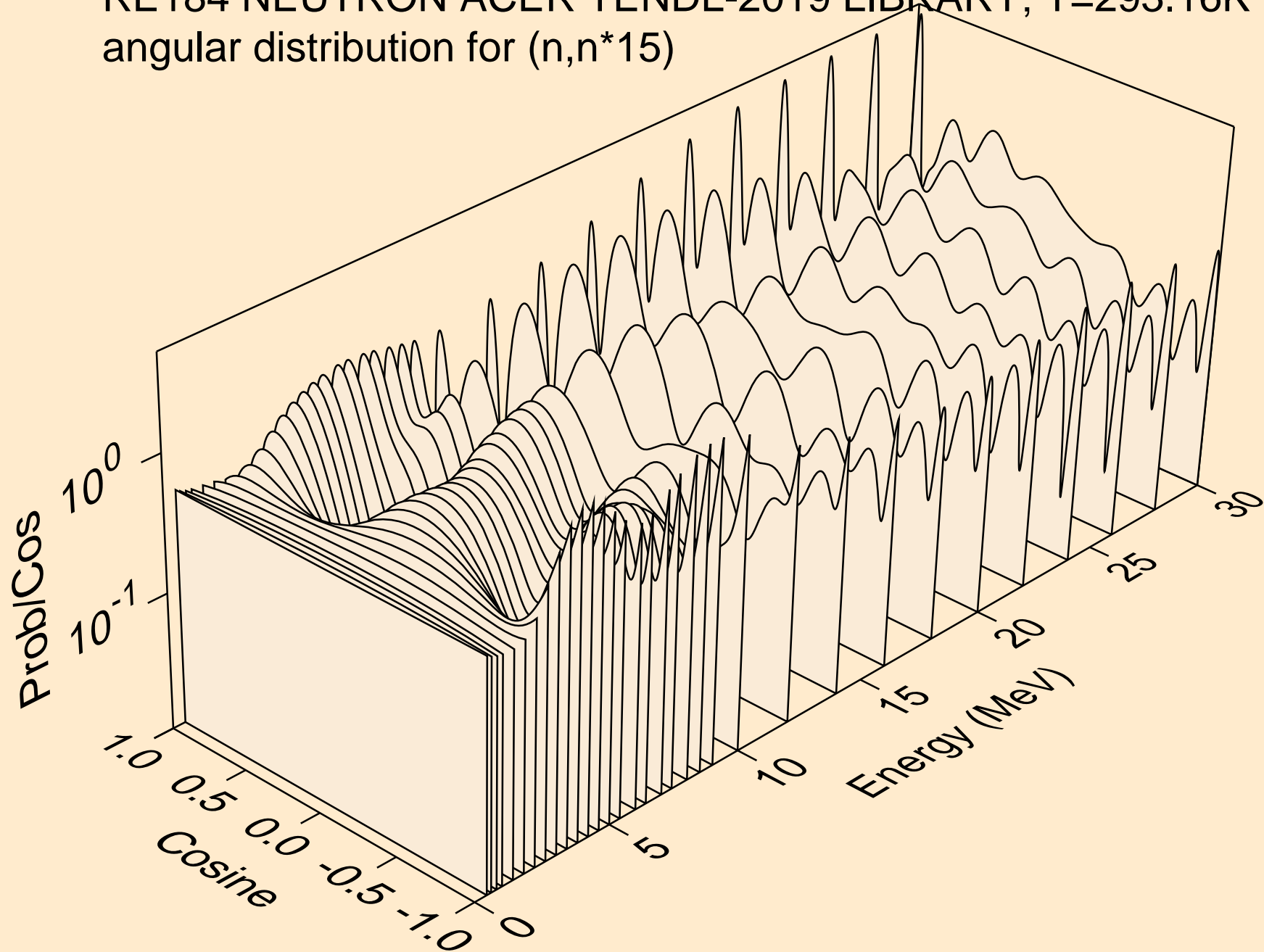

RE184 NEUTRON ACER TENDL-2019 LIBRARY; T=293.16K
angular distribution for (n,n*16)

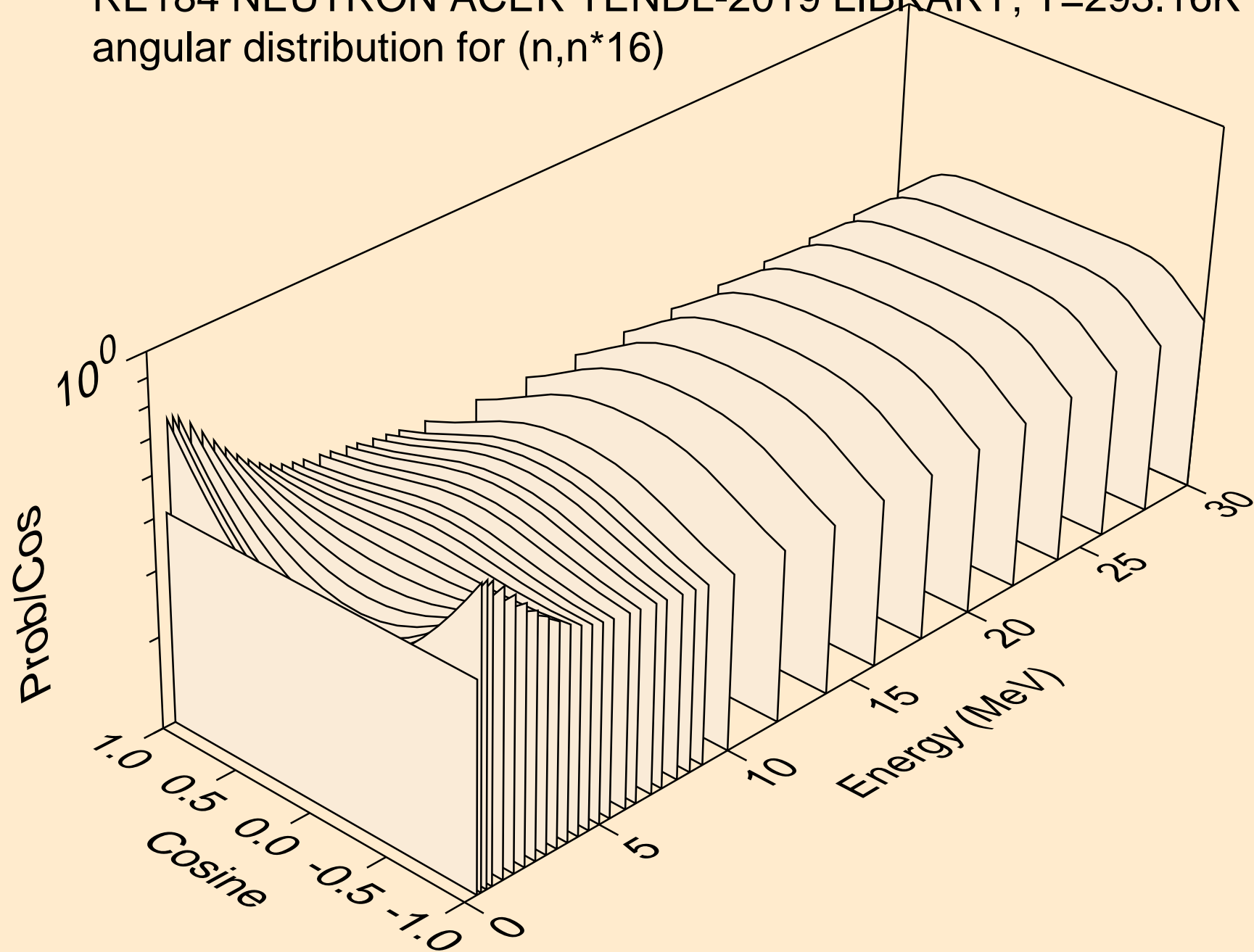

RE184 NEUTRON ACER TENDL-2019 LIBRARY; T=293.16K
angular distribution for (n,n*17)

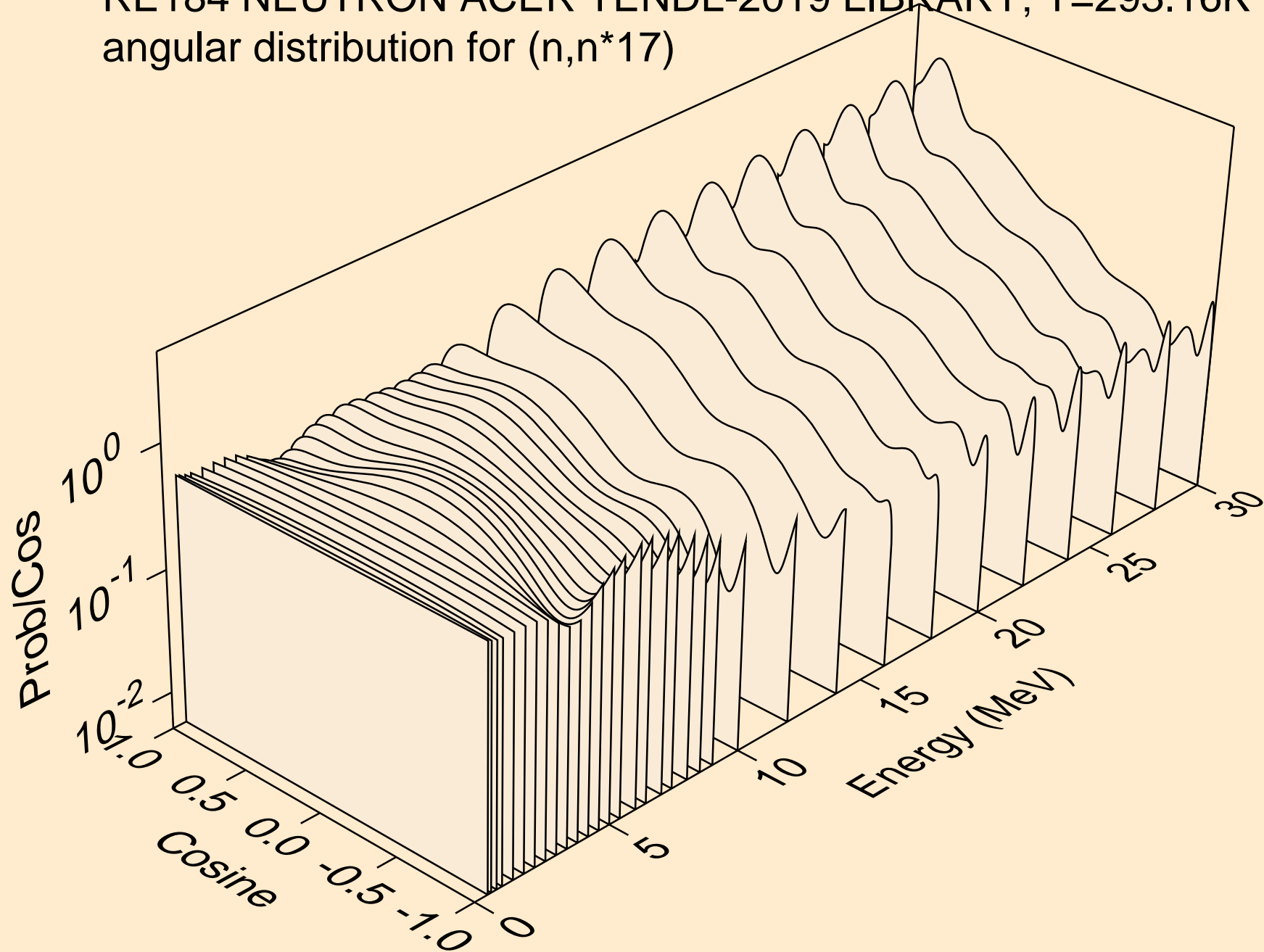

RE184 NEUTRON ACER TENDL-2019 LIBRARY; T=293.16K
angular distribution for (n,n*18)

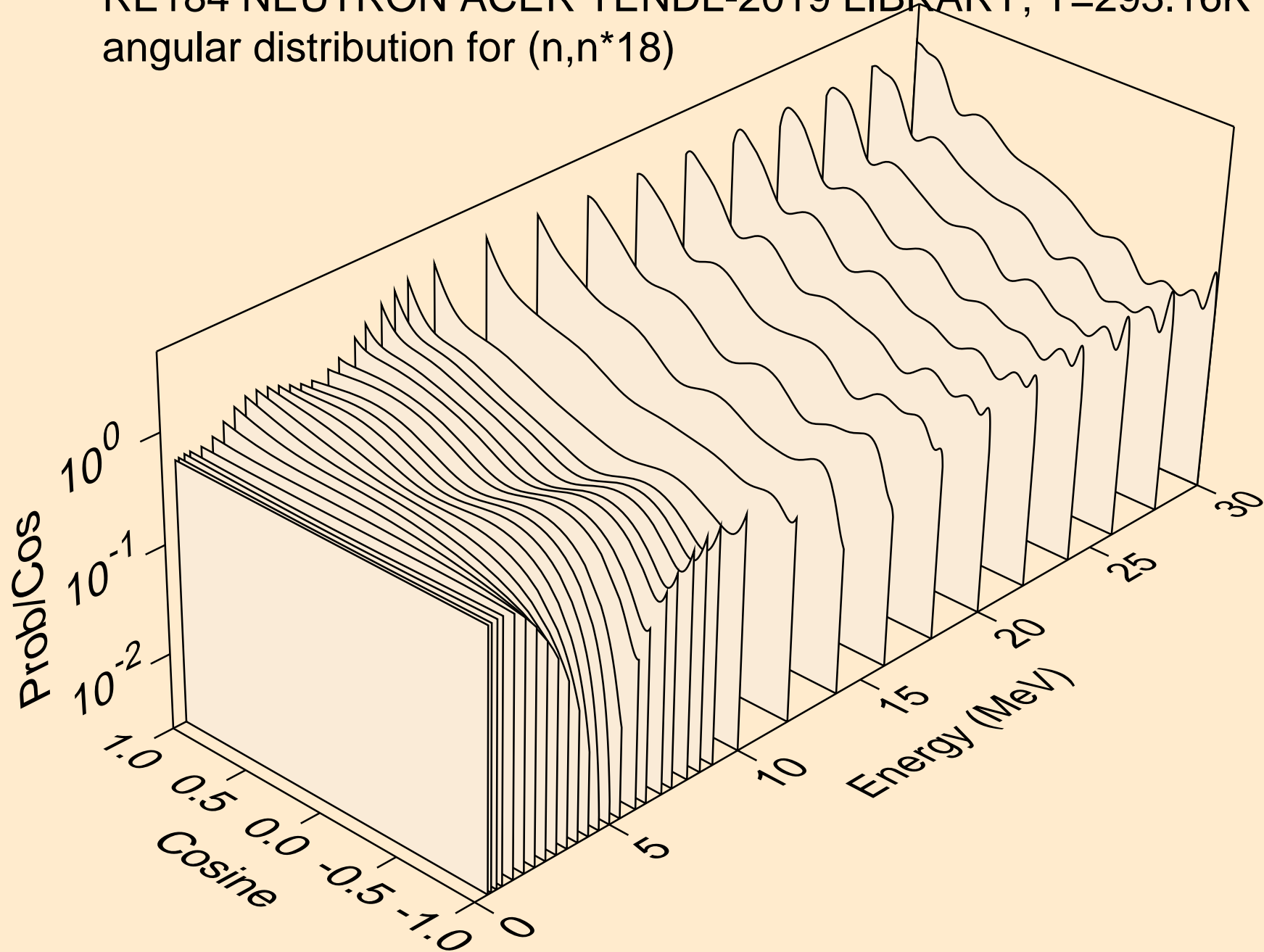

RE184 NEUTRON ACER TENDL-2019 LIBRARY; T=293.16K
angular distribution for (n,n*19)

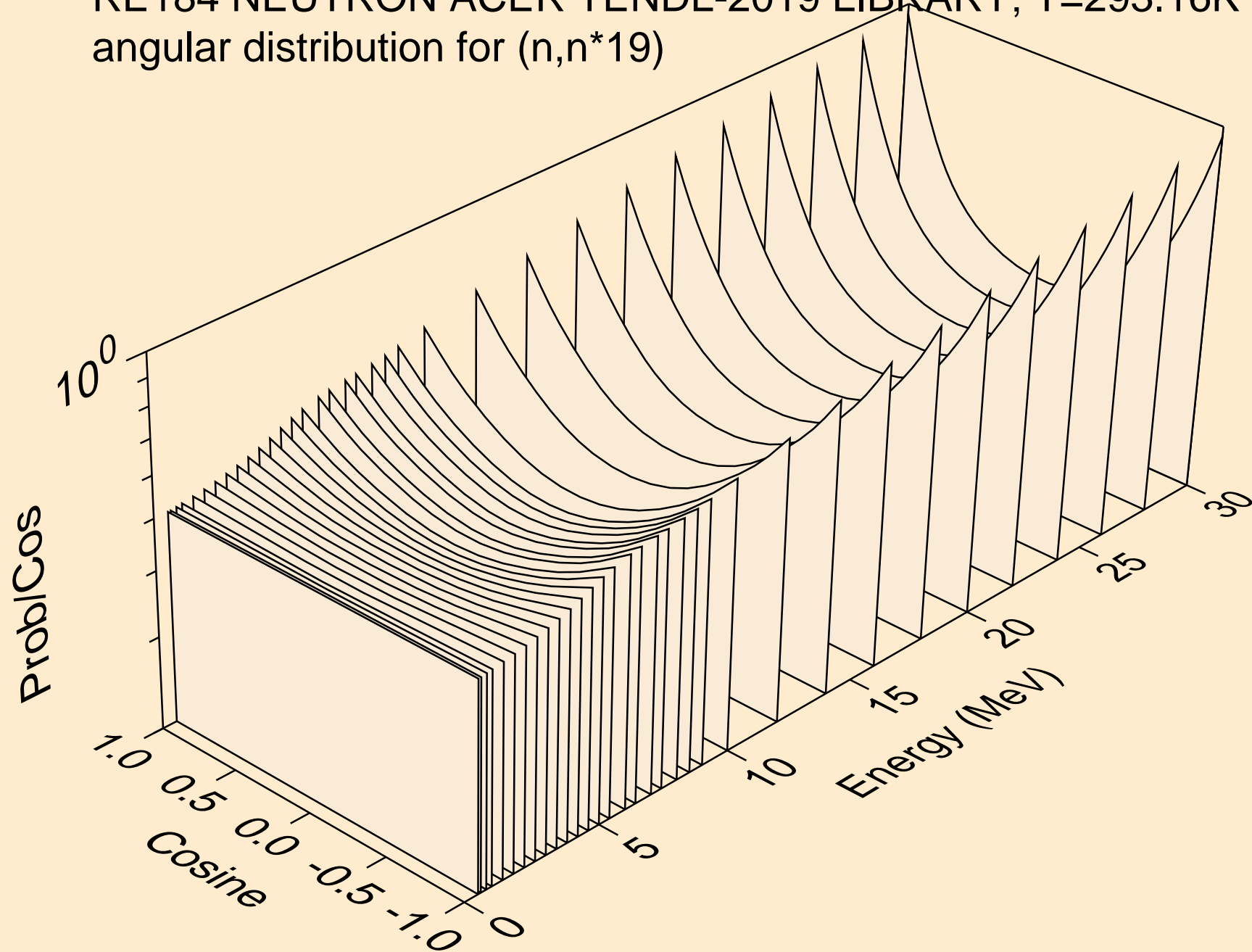

RE184 NEUTRON ACER TENDL-2019 LIBRARY; T=293.16K
angular distribution for (n,n*20)

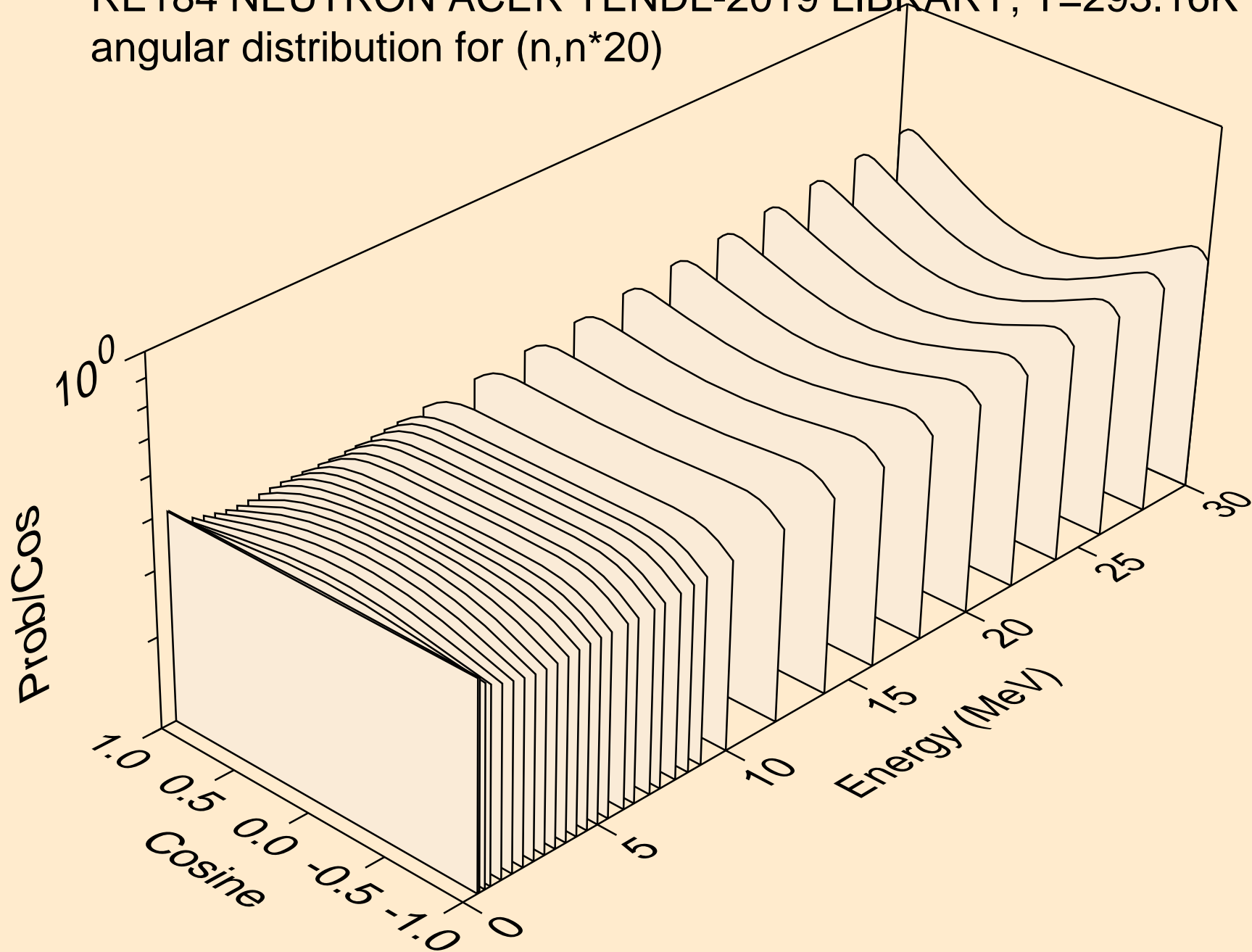

RE184 NEUTRON ACER TENDL-2019 LIBRARY; T=293.16K
angular distribution for (n,n*21)

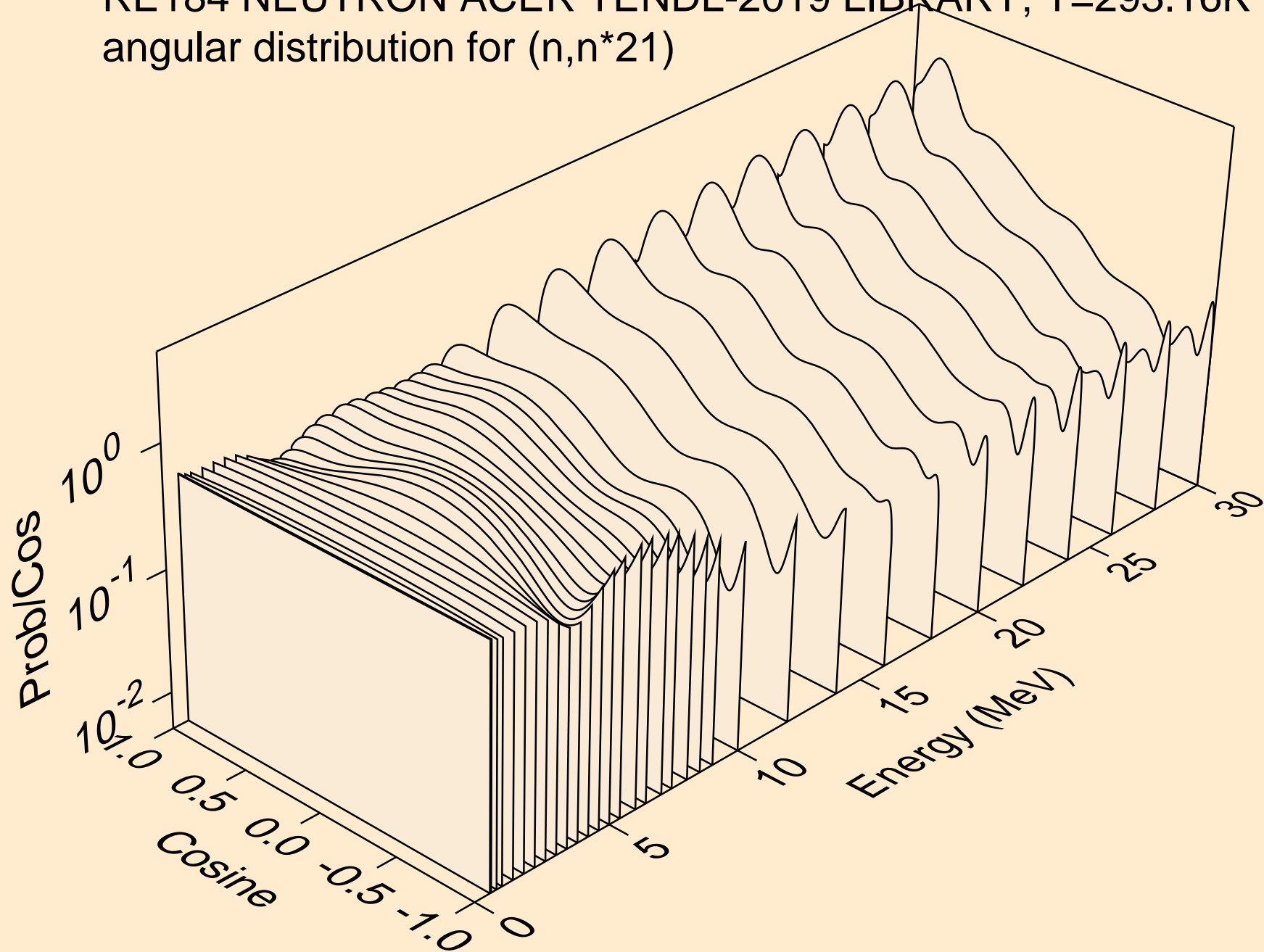

RE184 NEUTRON ACER TENDL-2019 LIBRARY; T=293.16K
angular distribution for (n,n*22)

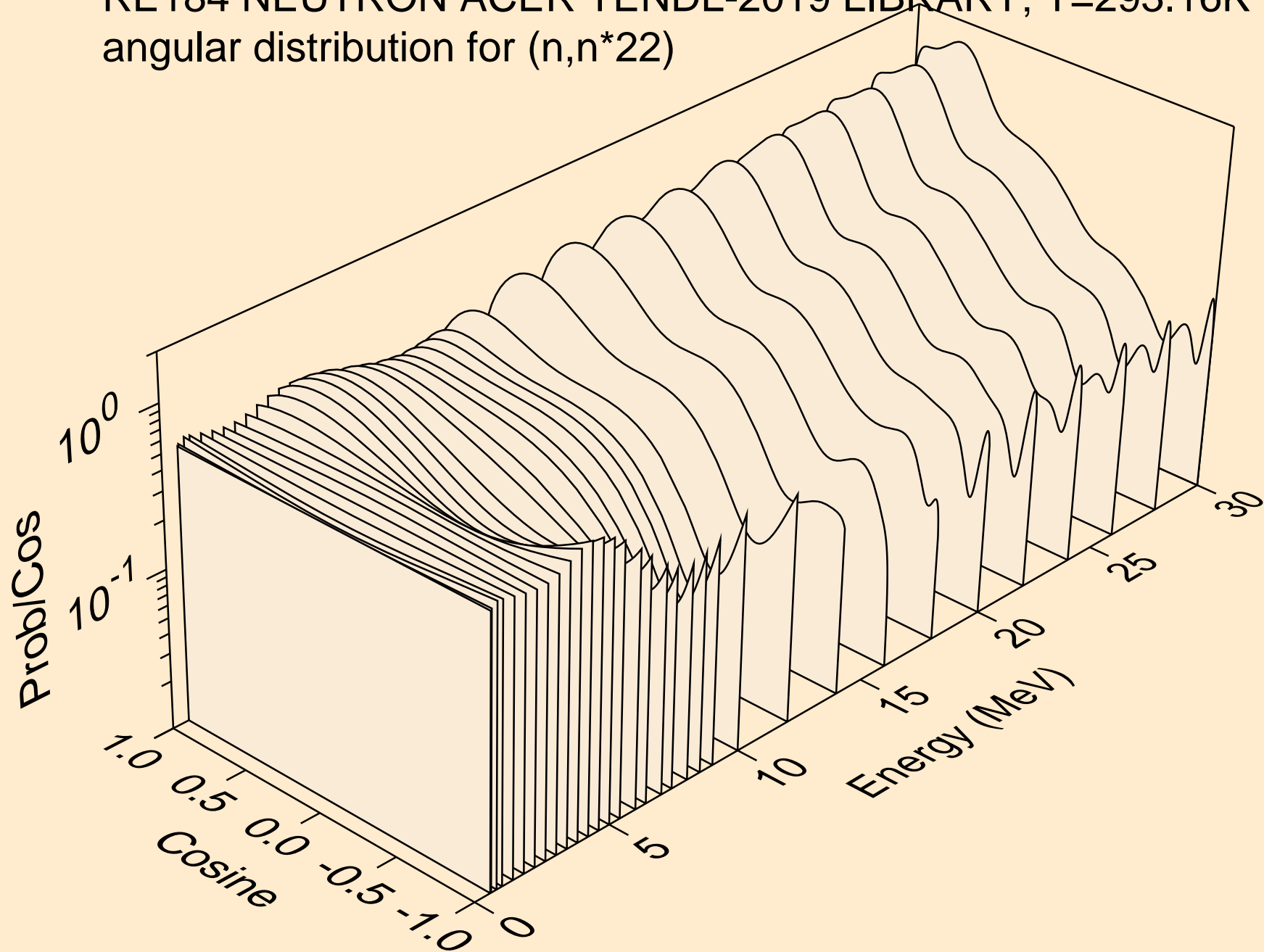

RE184 NEUTRON ACER TENDL-2019 LIBRARY; T=293.16K
angular distribution for (n,n*23)

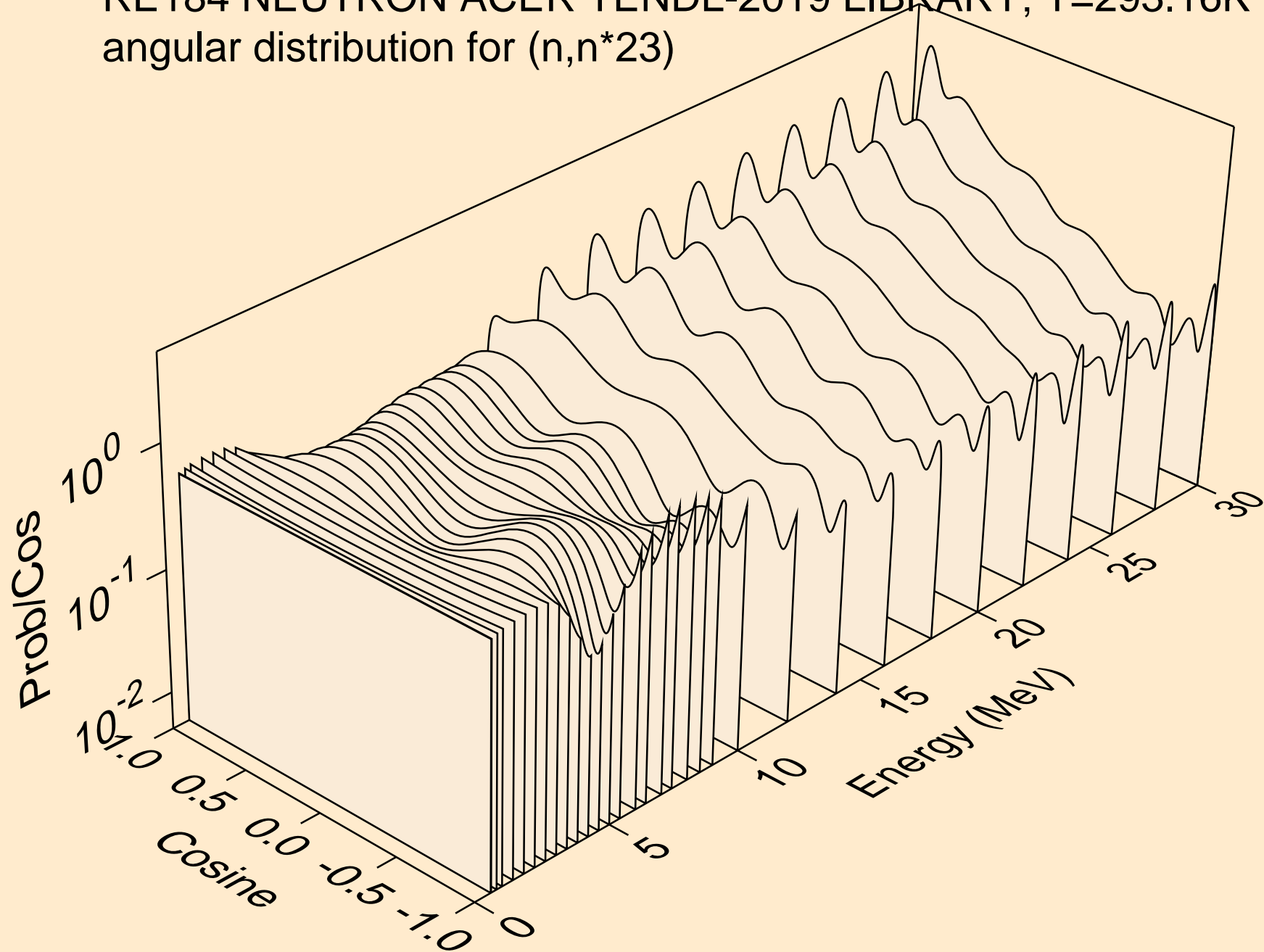

RE184 NEUTRON ACER TENDL-2019 LIBRARY; T=293.16K
angular distribution for (n,n*24)

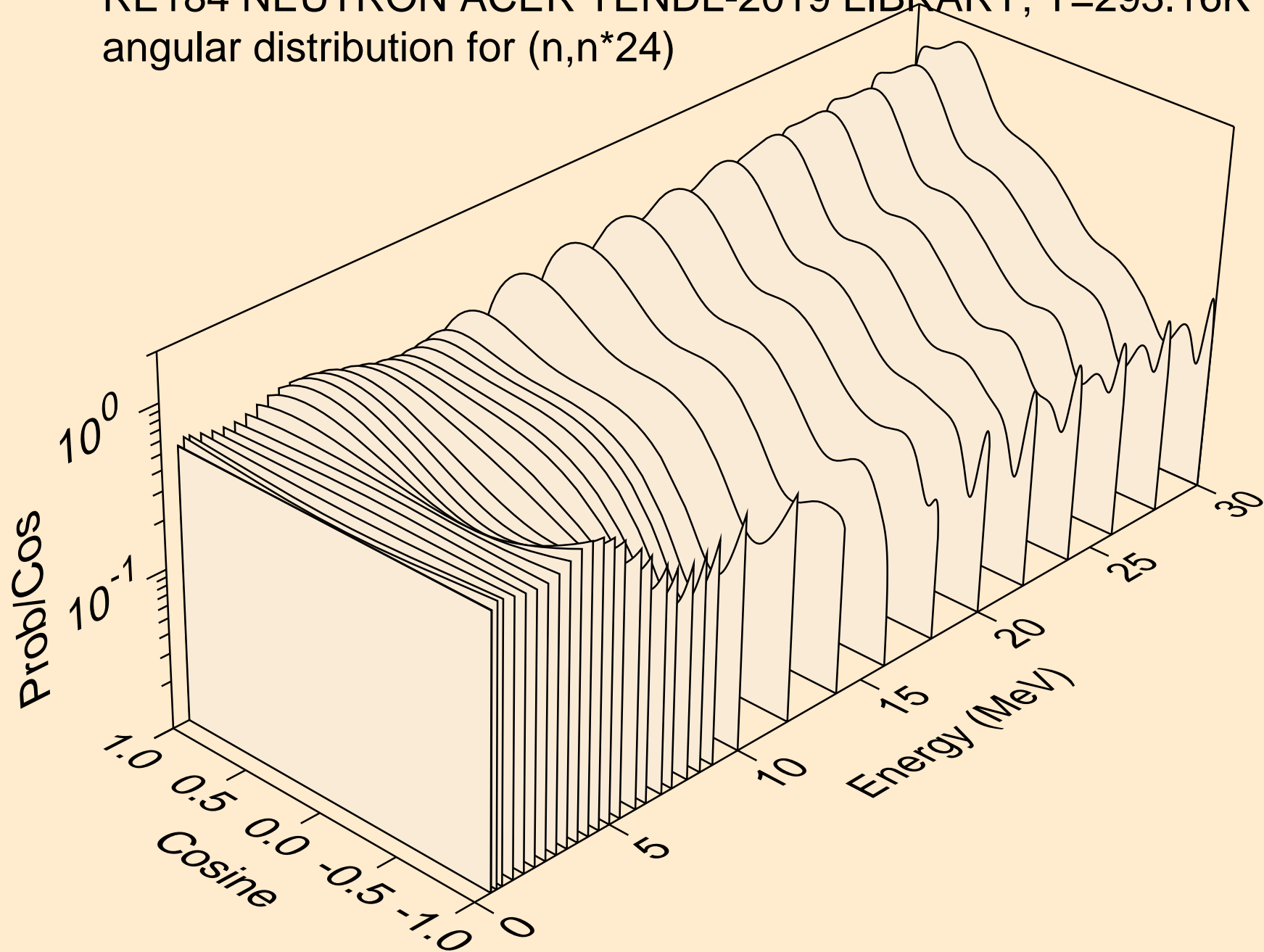

RE184 NEUTRON ACER TENDL-2019 LIBRARY; T=293.16K
angular distribution for (n,n*25)

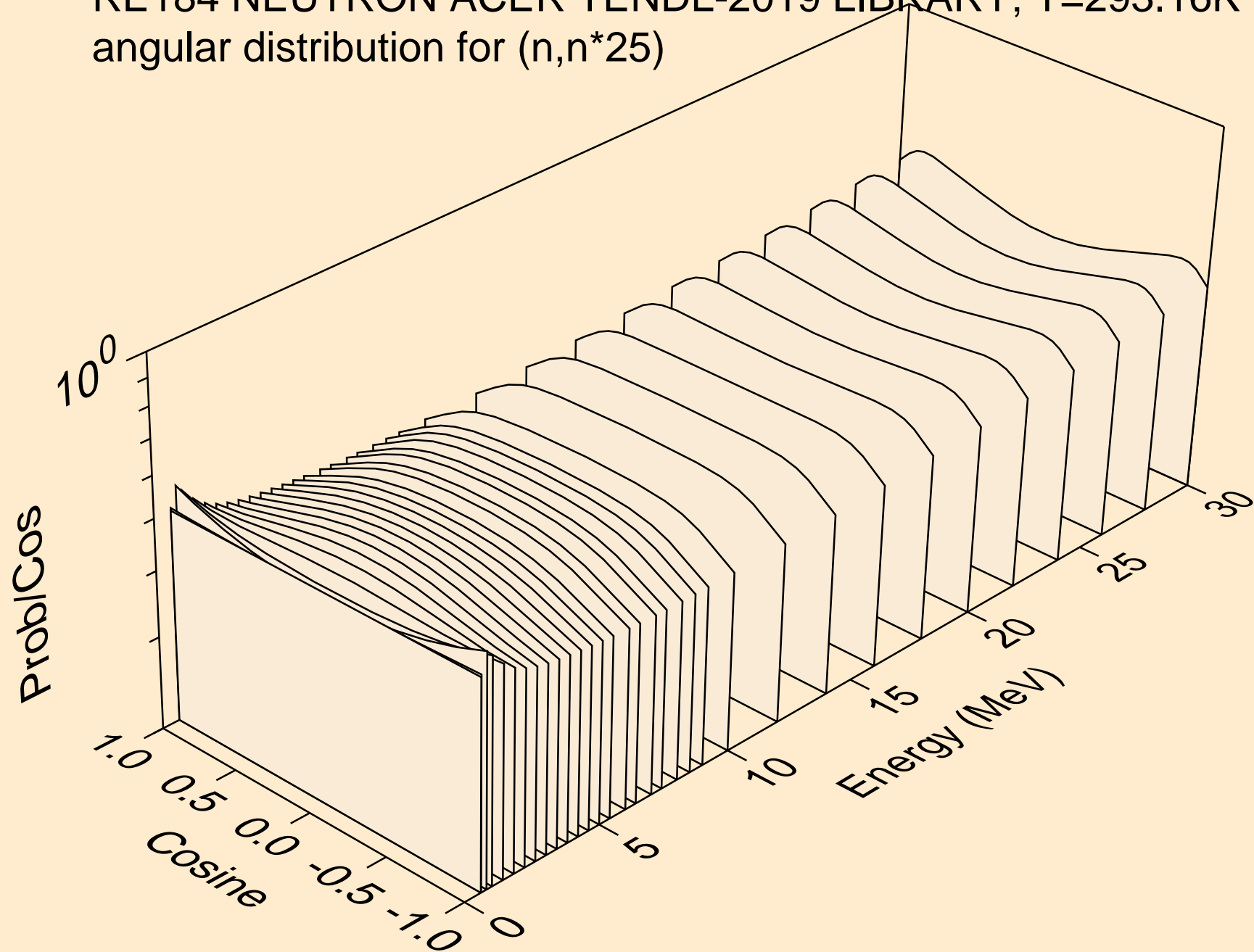

RE184 NEUTRON ACER TENDL-2019 LIBRARY; T=293.16K
angular distribution for (n,n*26)

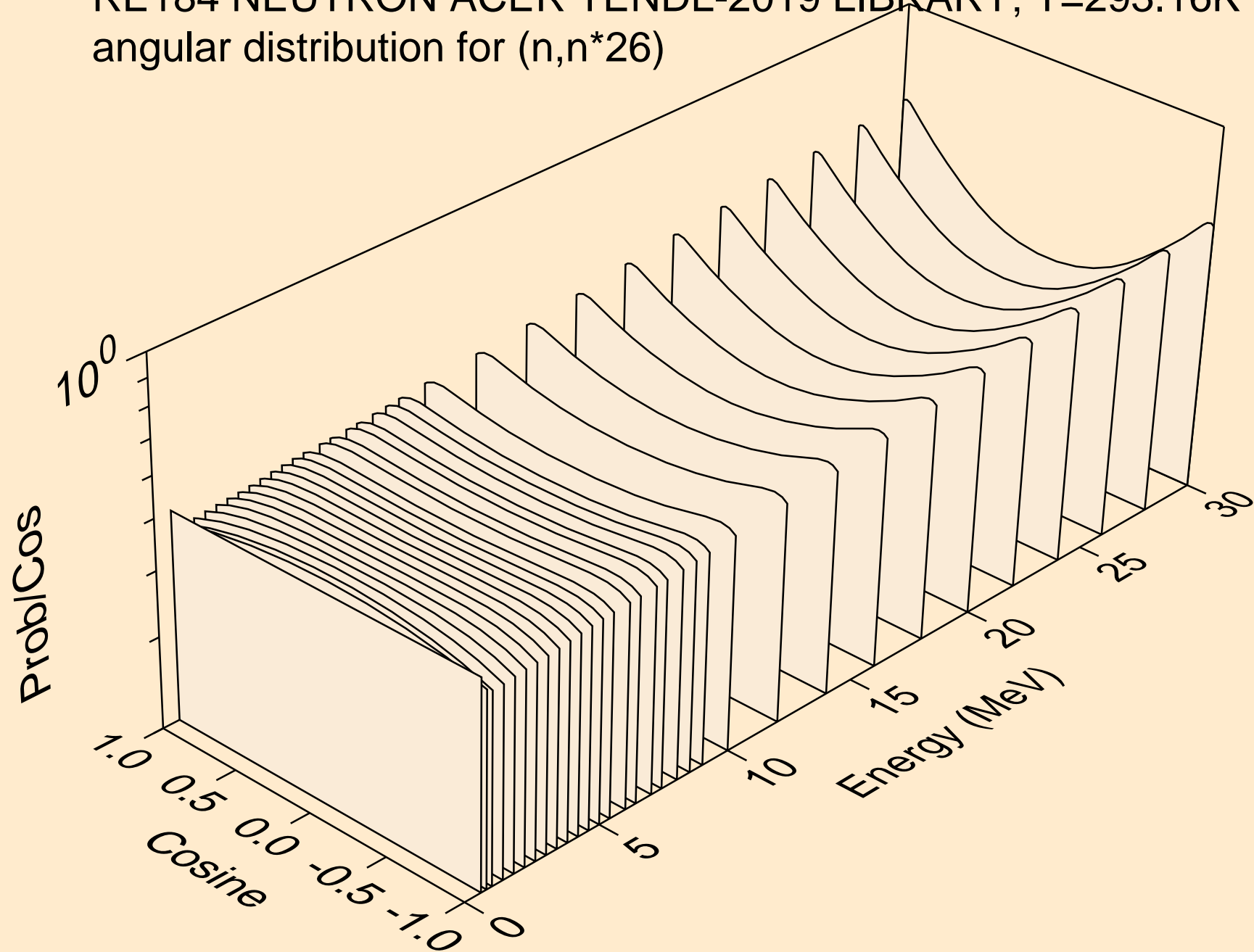

RE184 NEUTRON ACER TENDL-2019 LIBRARY; T=293.16K
angular distribution for (n,n*27)

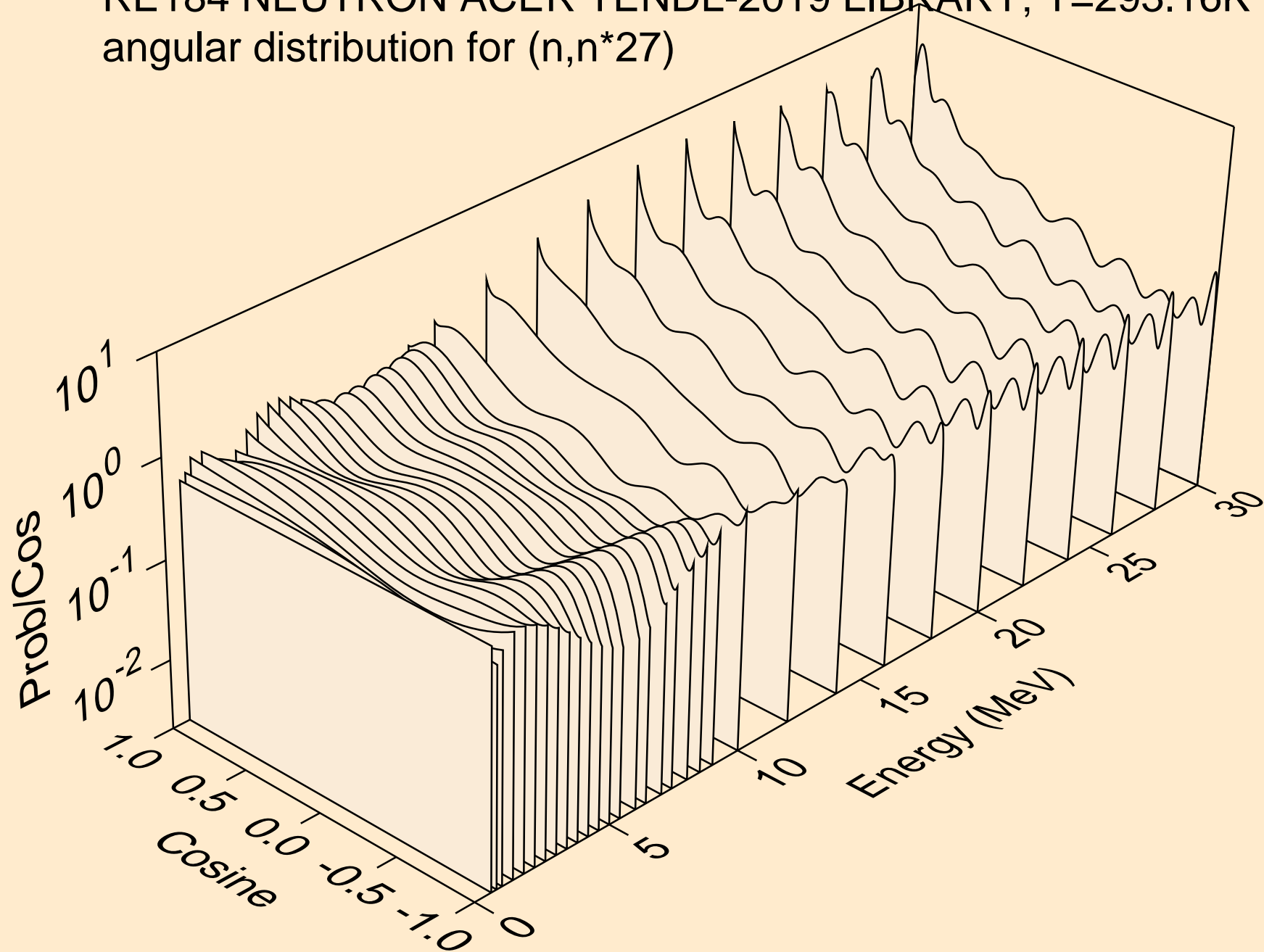

RE184 NEUTRON ACER TENDL-2019 LIBRARY; T=293.16K
angular distribution for (n,n*28)

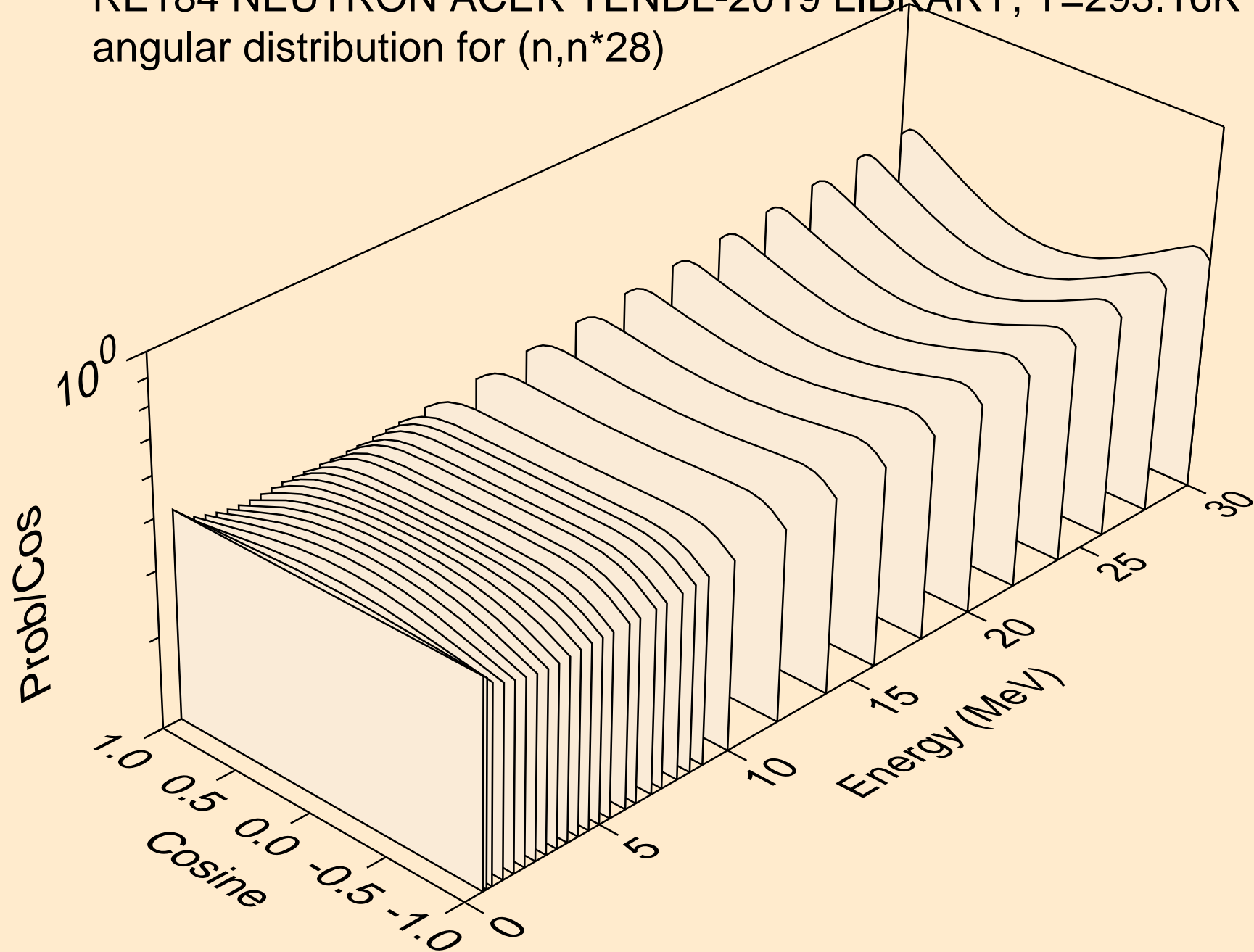

RE184 NEUTRON ACER TENDL-2019 LIBRARY; T=293.16K
angular distribution for (n,n*29)

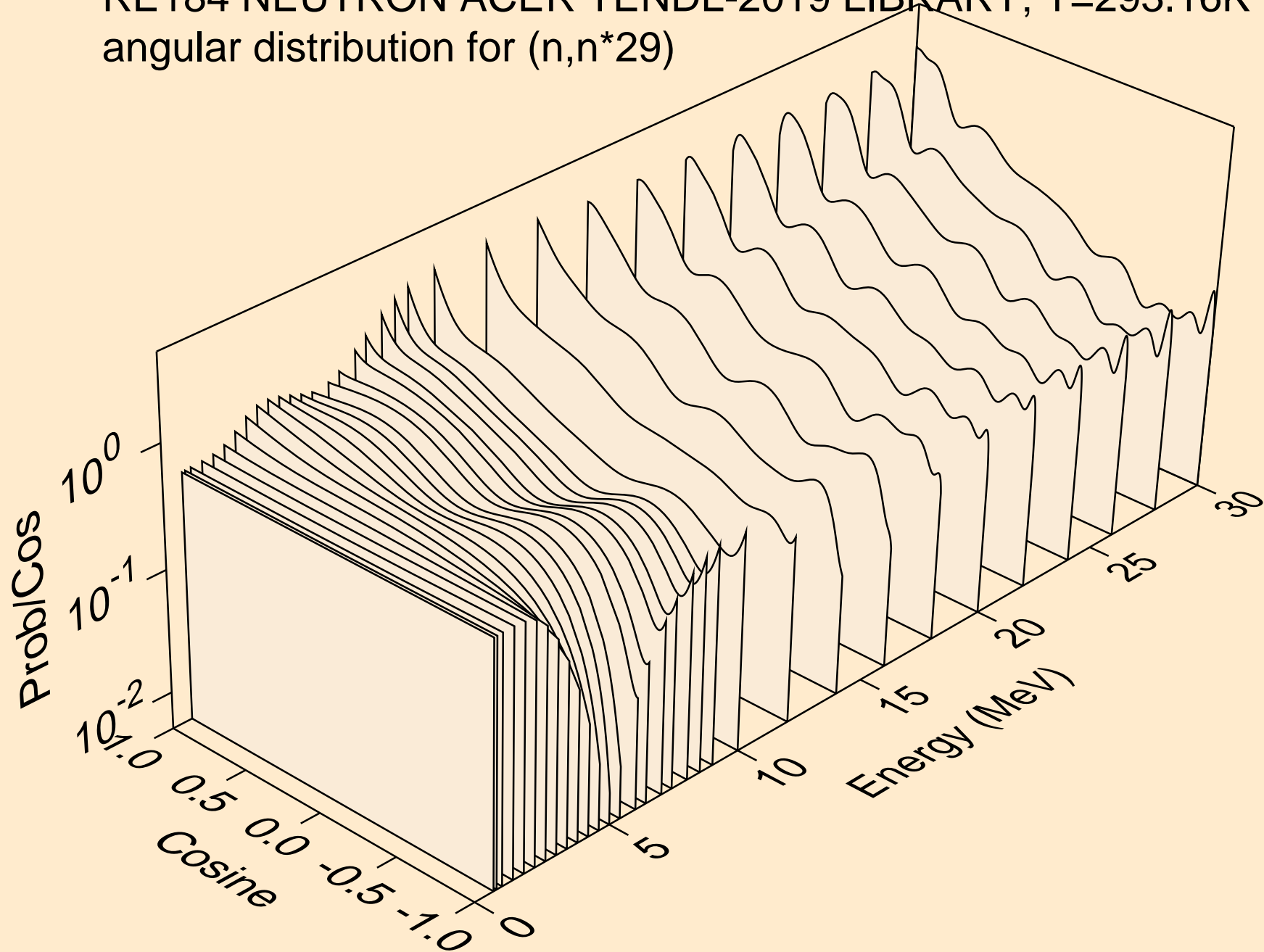

RE184 NEUTRON ACER TENDL-2019 LIBRARY; T=293.16K
angular distribution for (n,n*30)

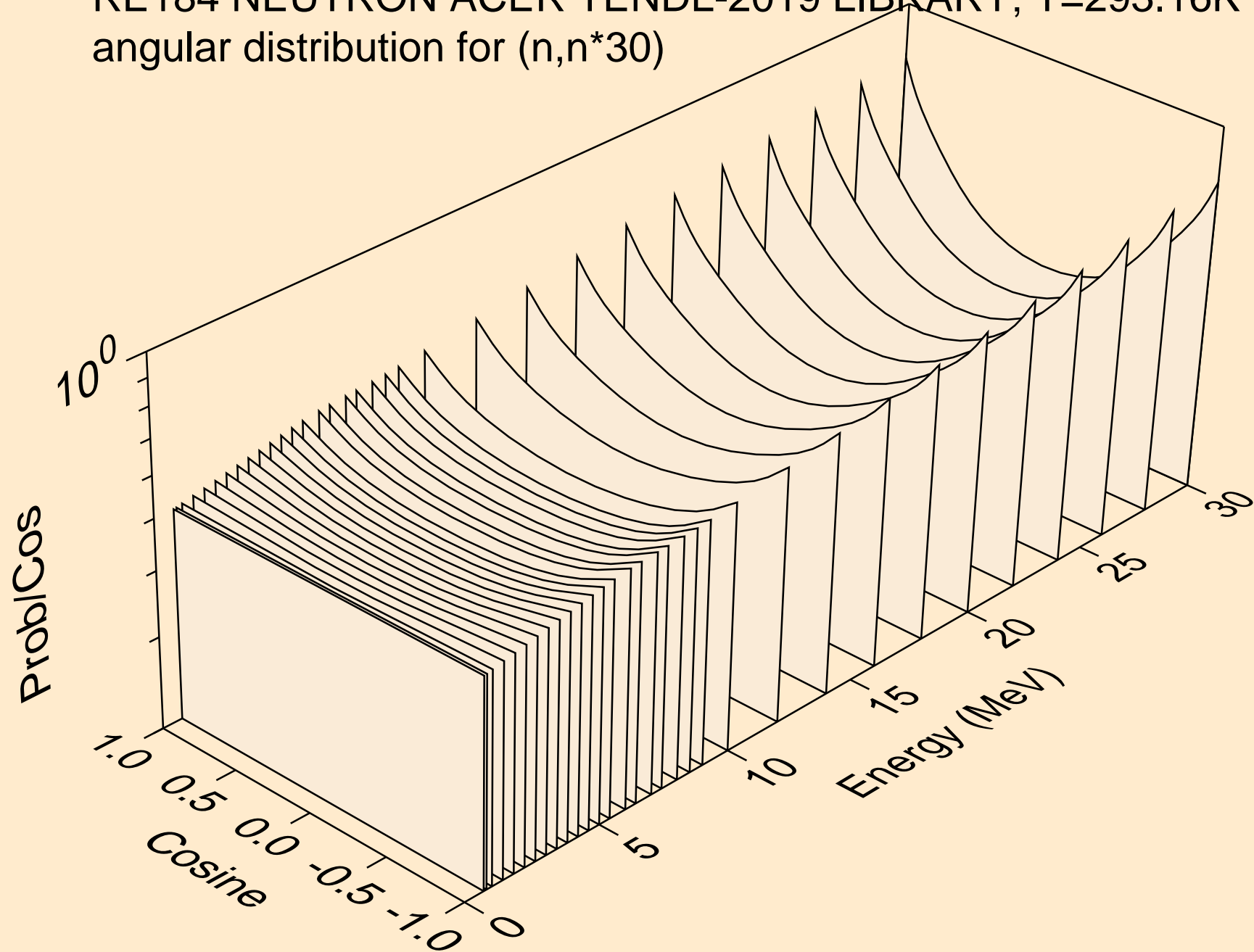

RE184 NEUTRON ACER TENDL-2019 LIBRARY; T=293.16K
Neutron emission for (n,x)

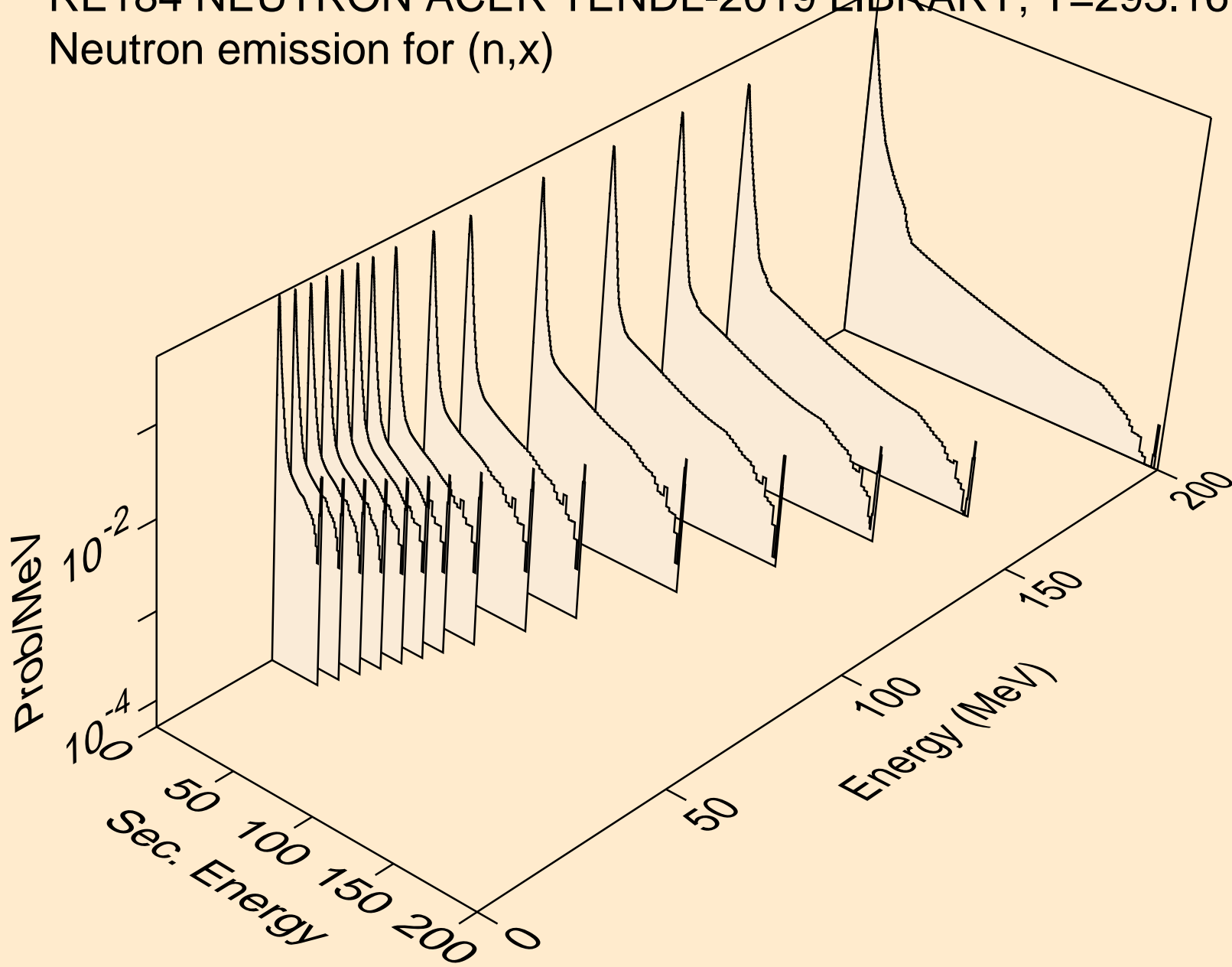

RE184 NEUTRON ACER TENDL-2019 LIBRARY; T=293.16K
Neutron emission for (n,2nd)

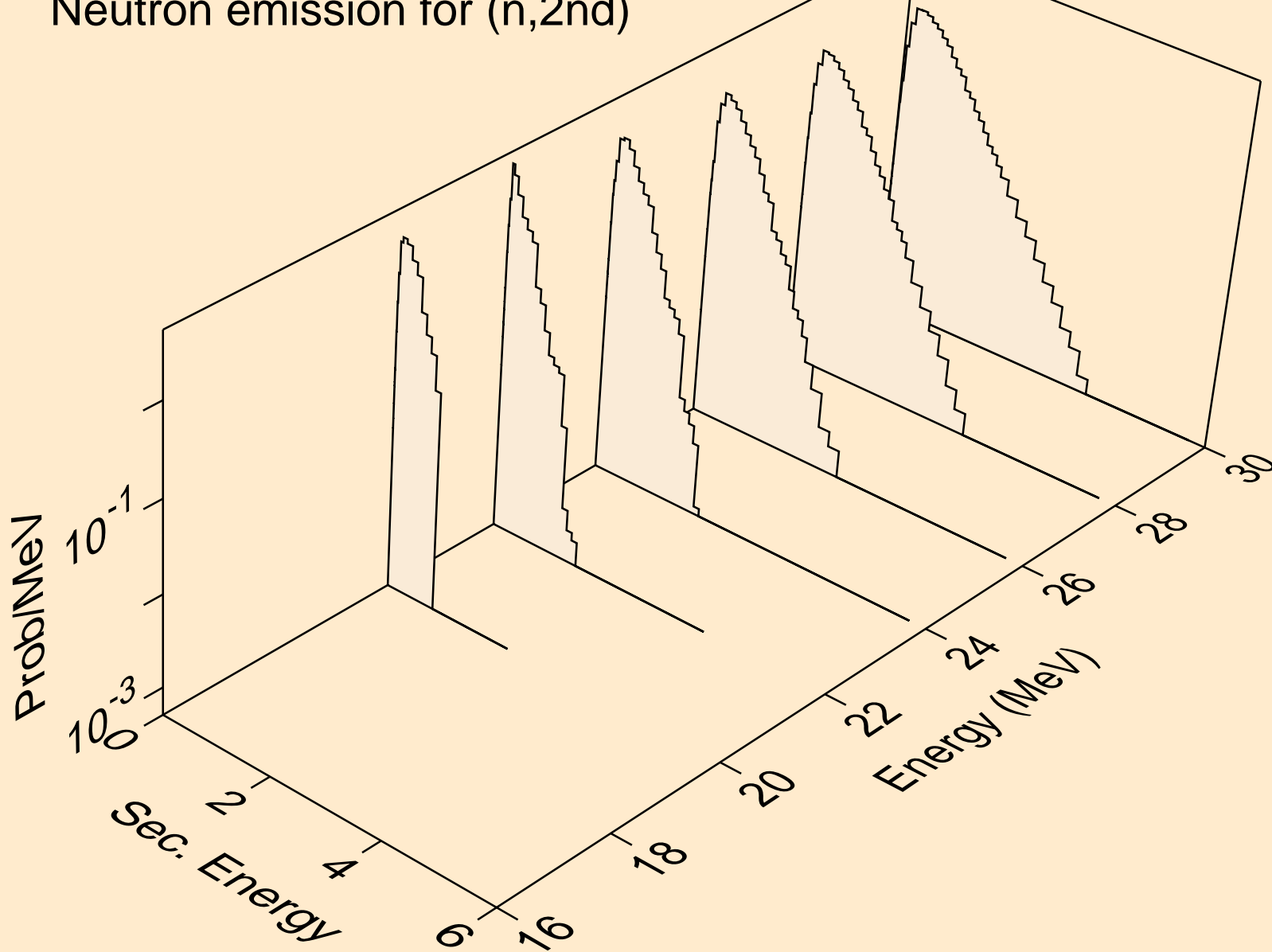

RE184 NEUTRON ACER TENDL-2019 LIBRARY; T=293.16K
Neutron emission for (n,2n)

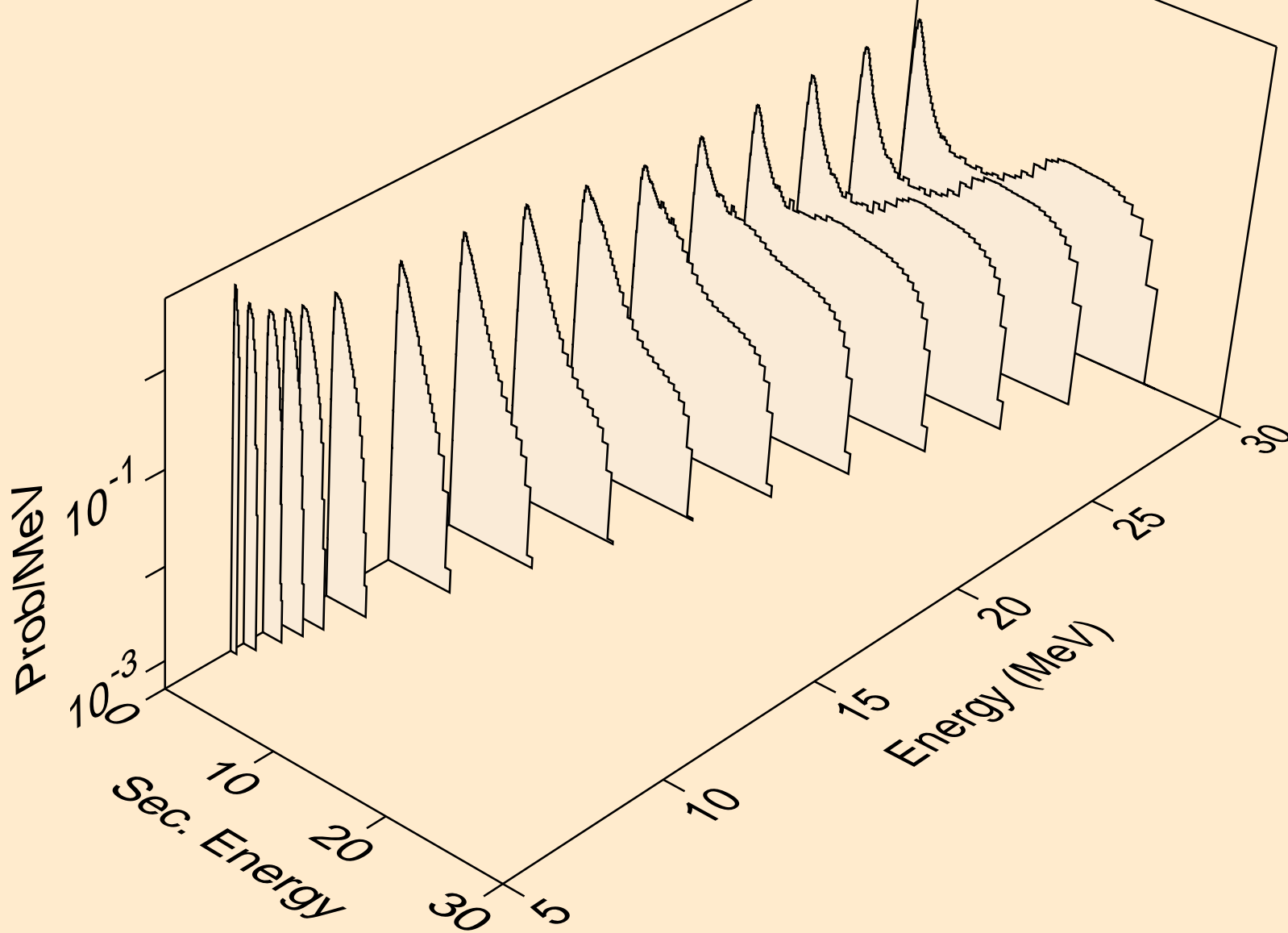

RE184 NEUTRON ACER TENDL-2019 LIBRARY; T=293.16K
Neutron emission for (n,3n)

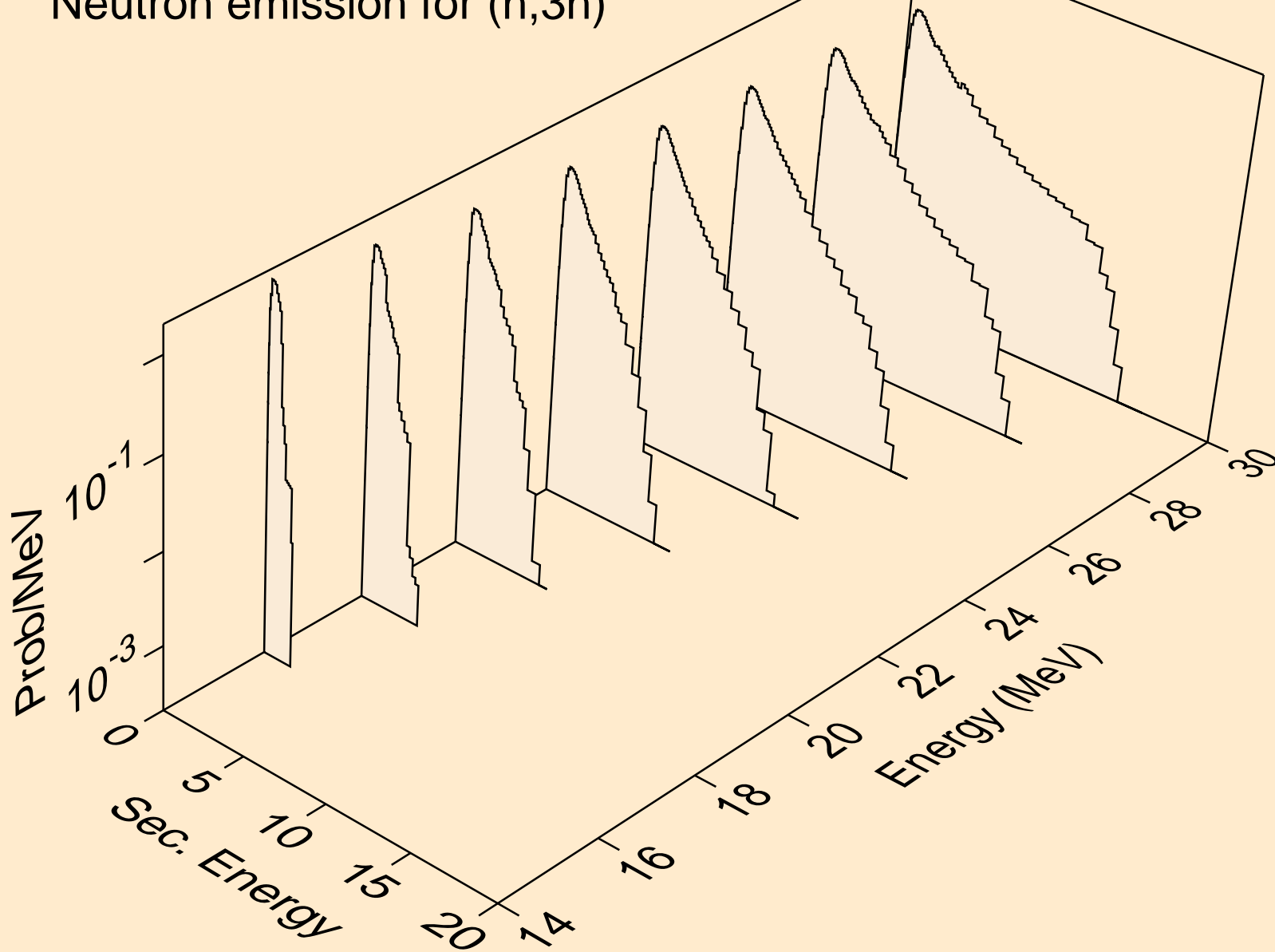

RE184 NEUTRON ACER TENDL-2019 LIBRARY; T=293.16K
Neutron emission for (n,n*)a

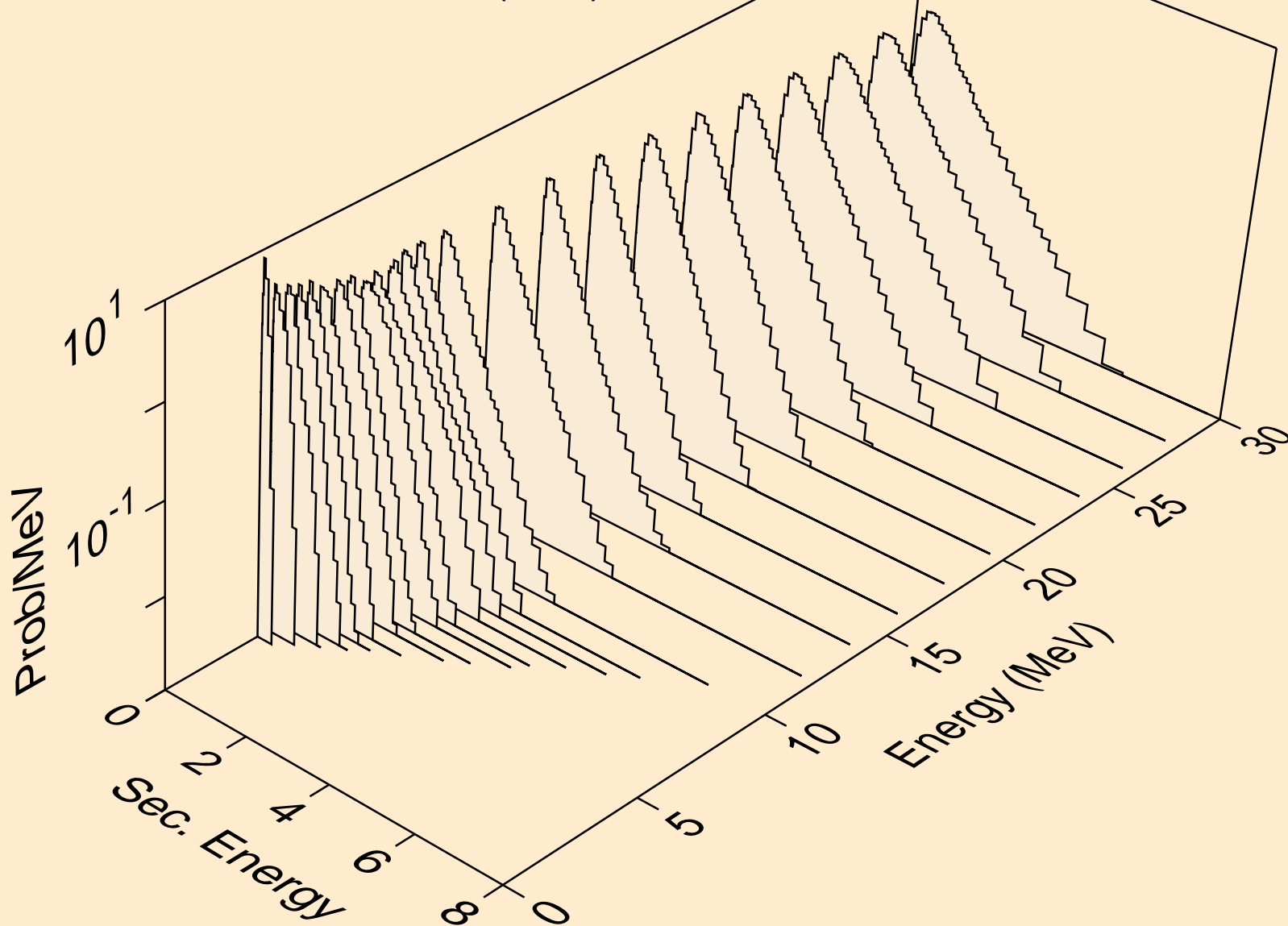

RE184 NEUTRON ACER TENDL-2019 LIBRARY; T=293.16K
Neutron emission for (n,2n)a

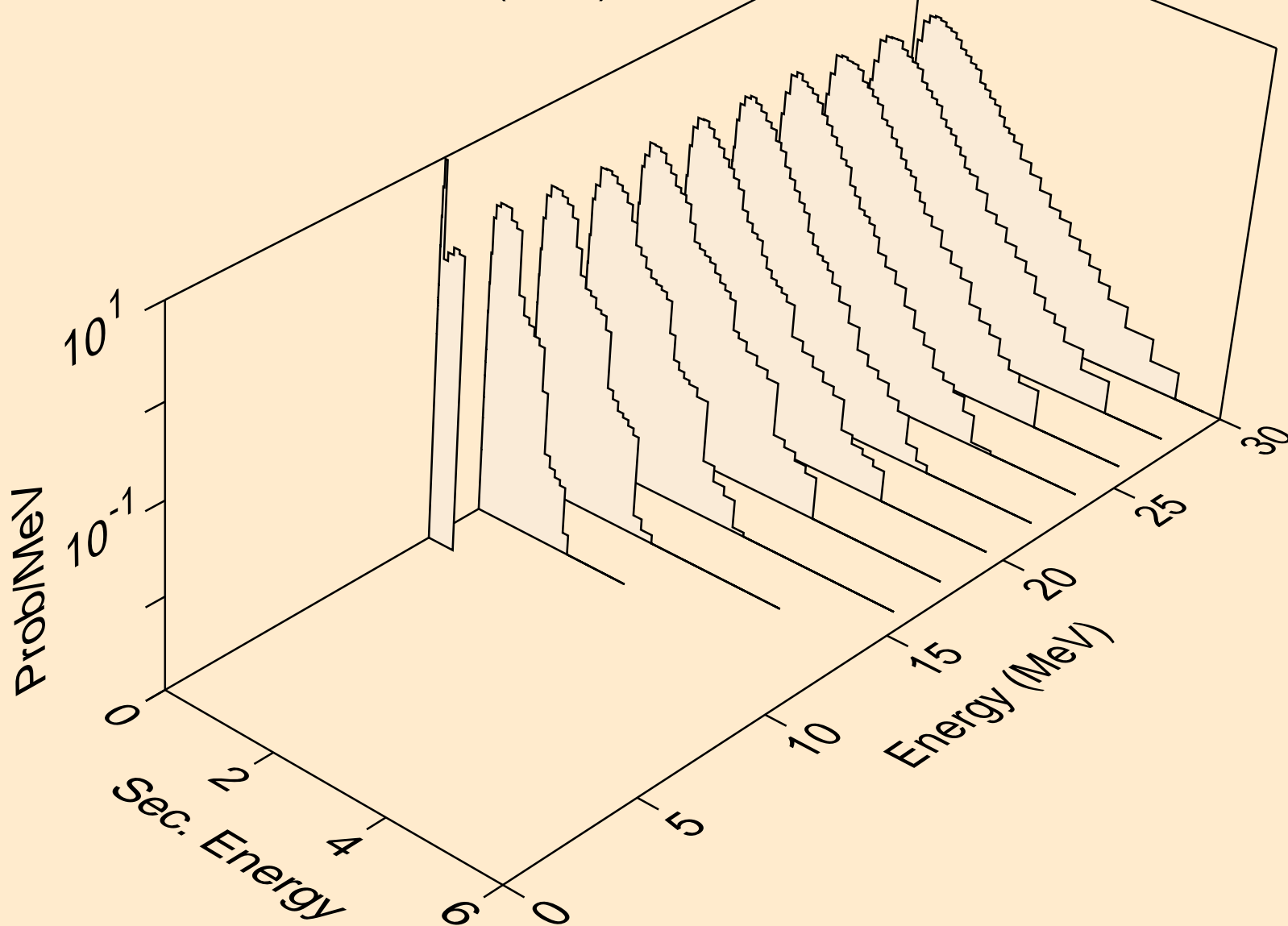

RE184 NEUTRON ACER TENDL-2019 LIBRARY; T=293.16K
Neutron emission for (n,3n)a

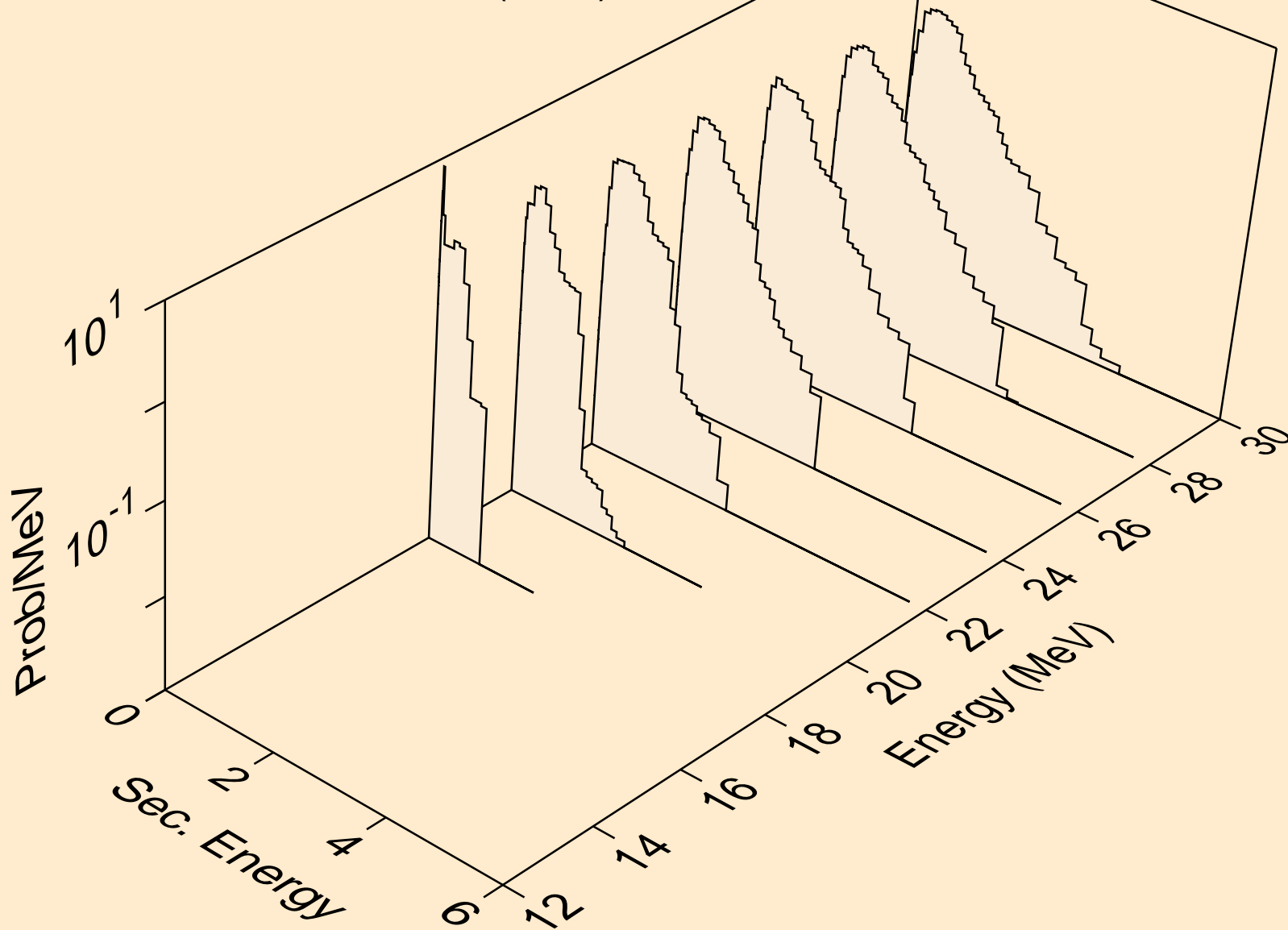

RE184 NEUTRON ACER TENDL-2019 LIBRARY; T=293.16K
Neutron emission for (n,n*)p

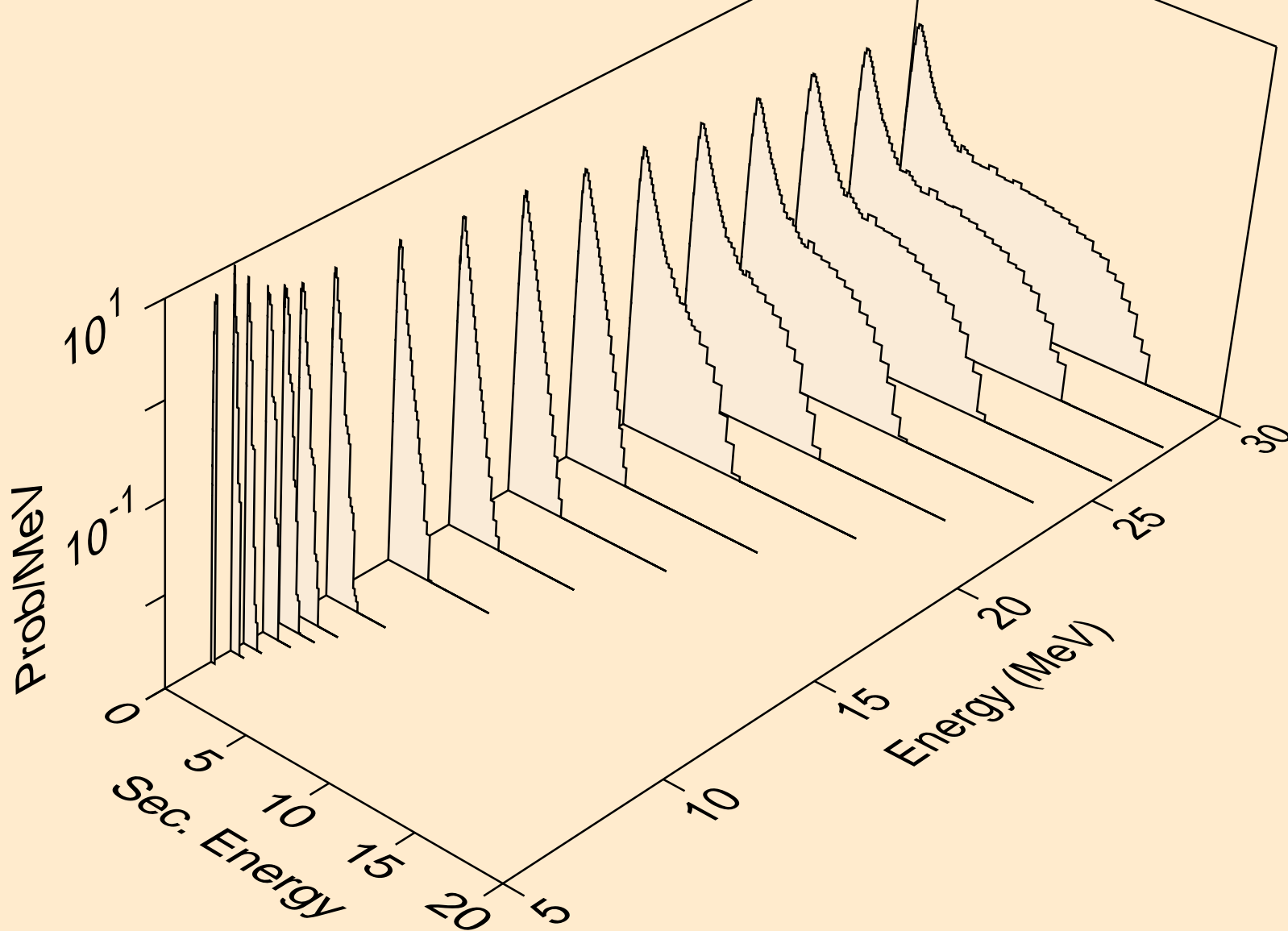

RE184 NEUTRON ACER TENDL-2019 LIBRARY; T=293.16K
Neutron emission for (n,n*)2a

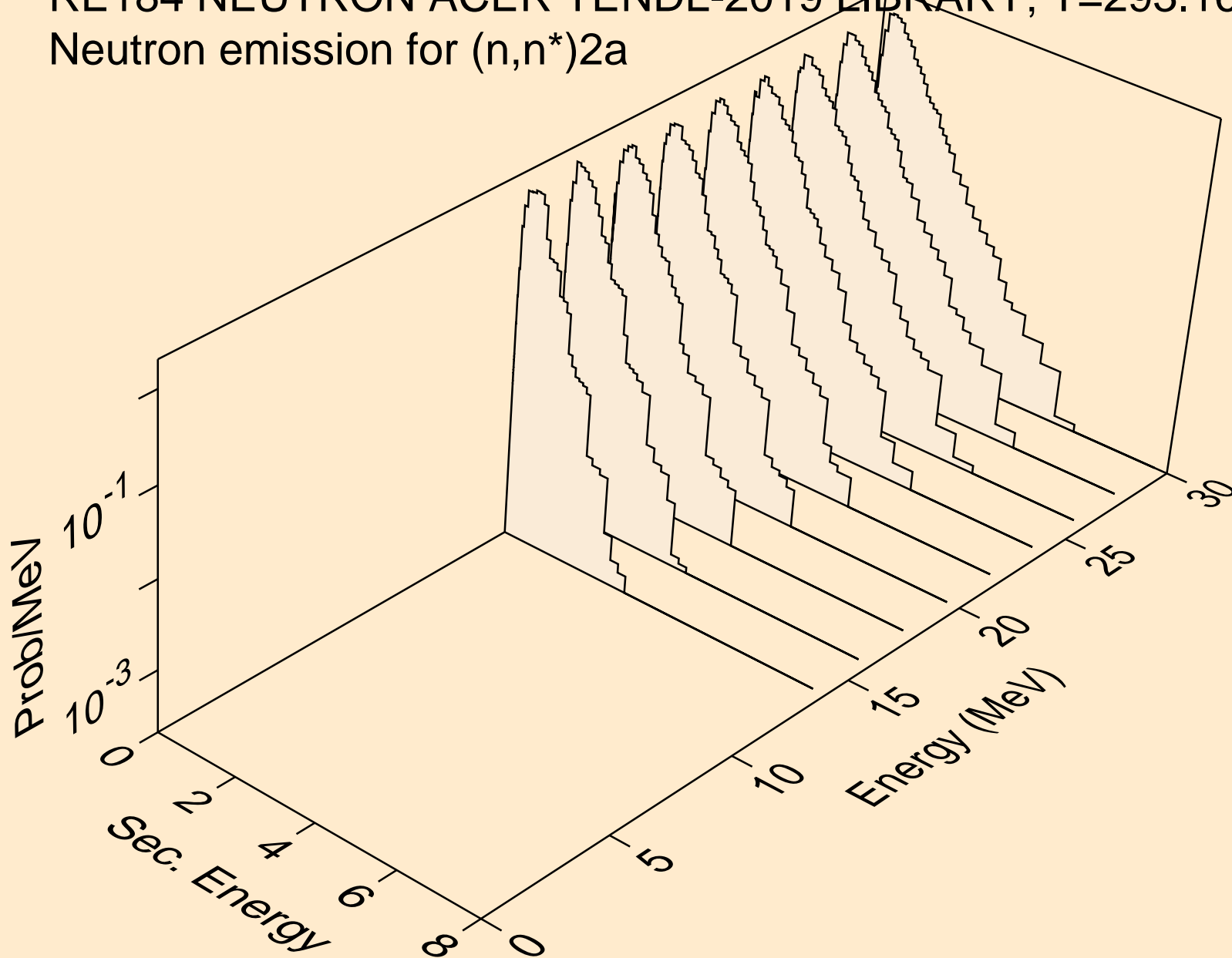

RE184 NEUTRON ACER TENDL-2019 LIBRARY; T=293.16K
Neutron emission for (n,n*)d

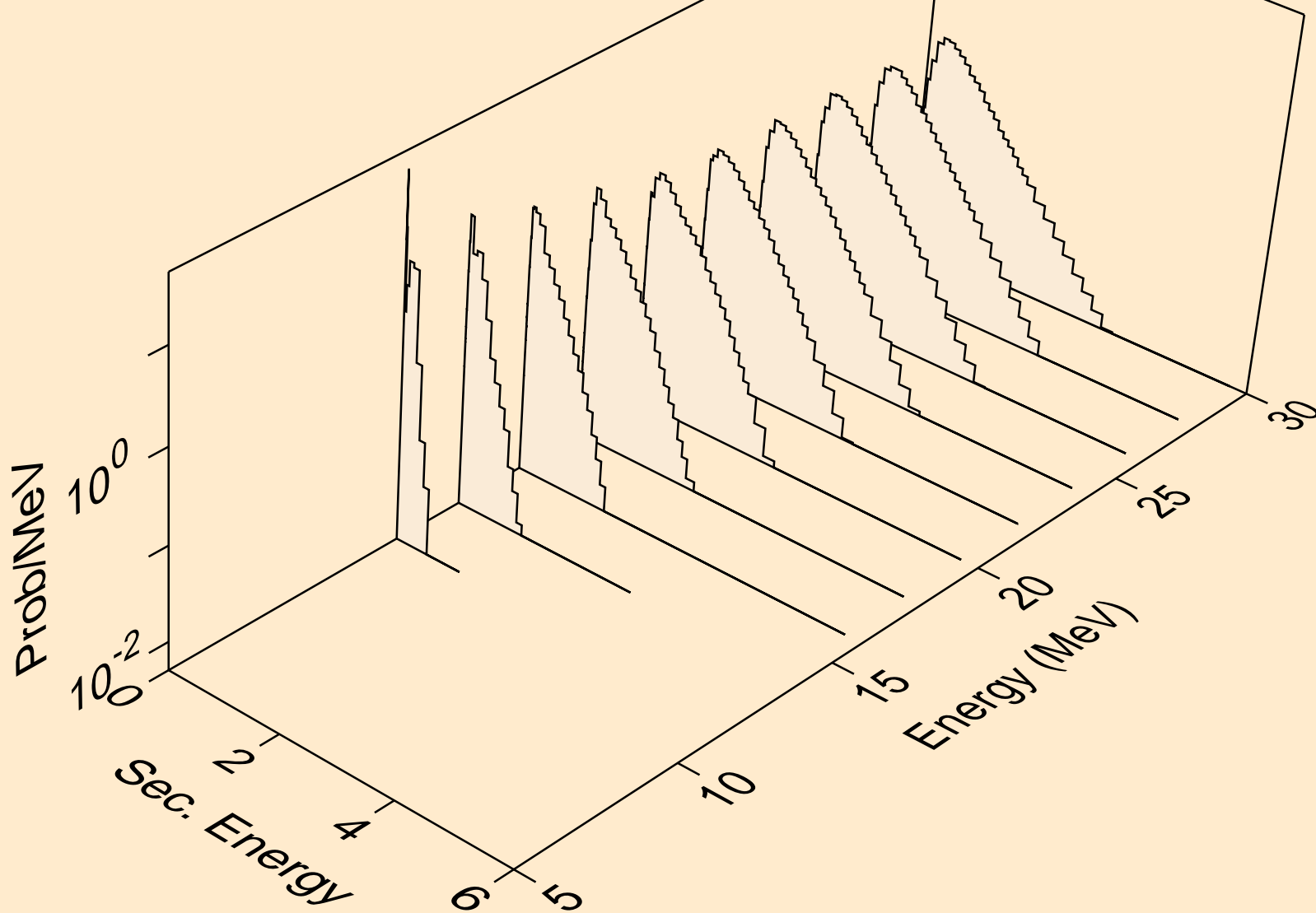

RE184 NEUTRON ACER TENDL-2019 LIBRARY; T=293.16K
Neutron emission for (n,n*)t

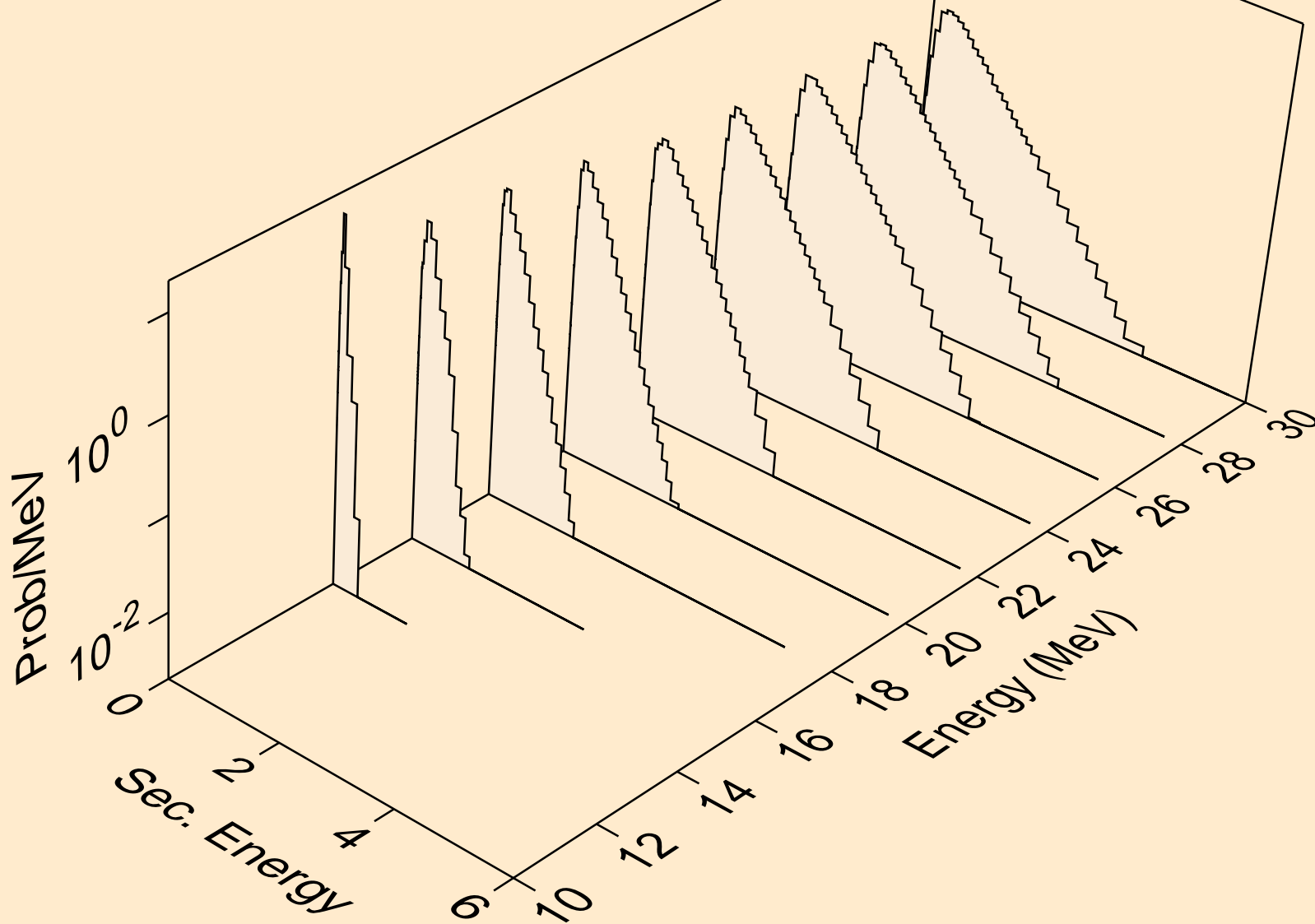

RE184 NEUTRON ACER TENDL-2019 LIBRARY; T=293.16K
Neutron emission for (n,n*)he3

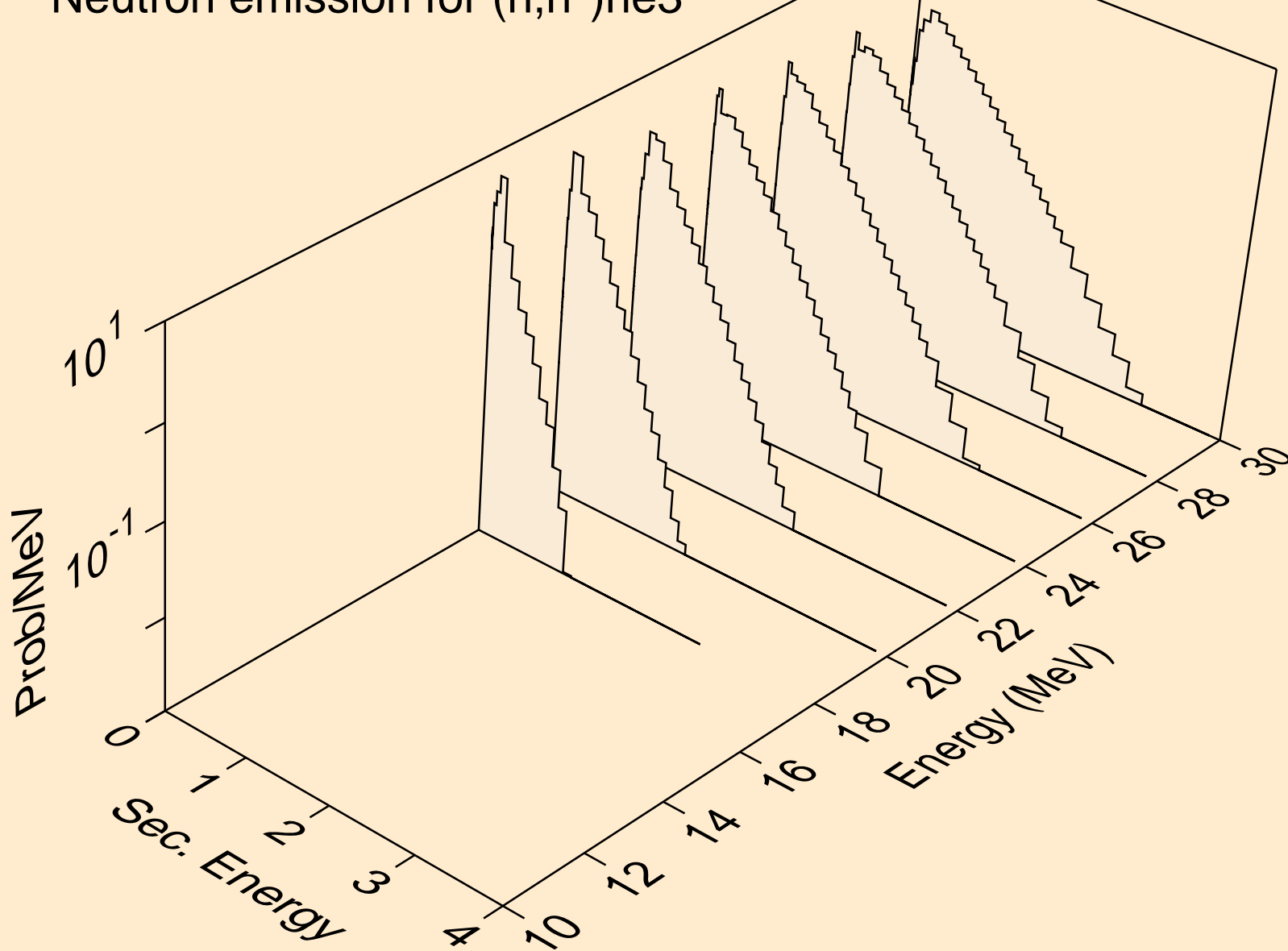

RE184 NEUTRON ACER TENDL-2019 LIBRARY; T=293.16K
Neutron emission for (n,4n)

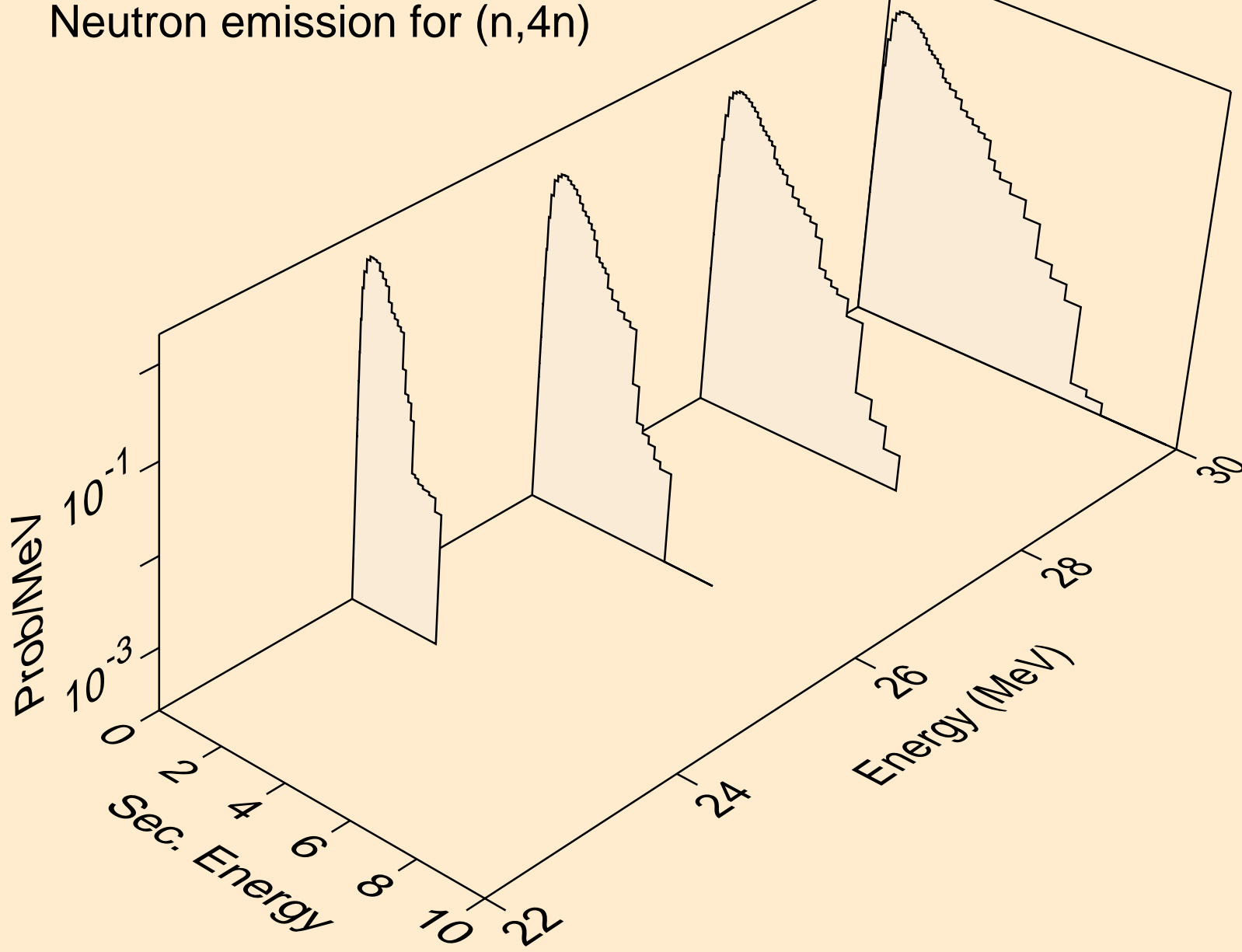

RE184 NEUTRON ACER TENDL-2019 LIBRARY; T=293.16K
Neutron emission for (n,2np)

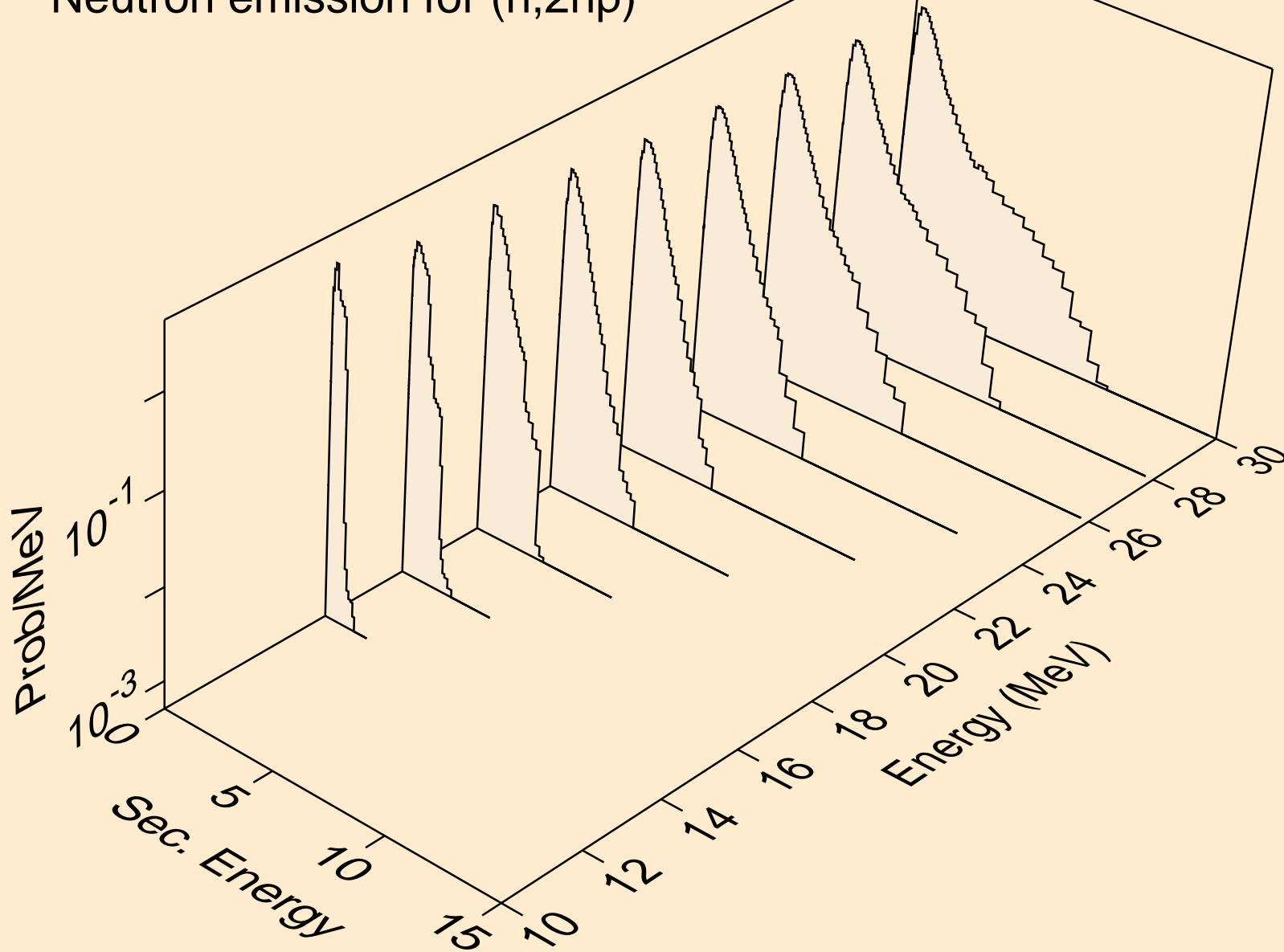

RE184 NEUTRON ACER TENDL-2019 LIBRARY; T=293.16K
Neutron emission for (n,3np)

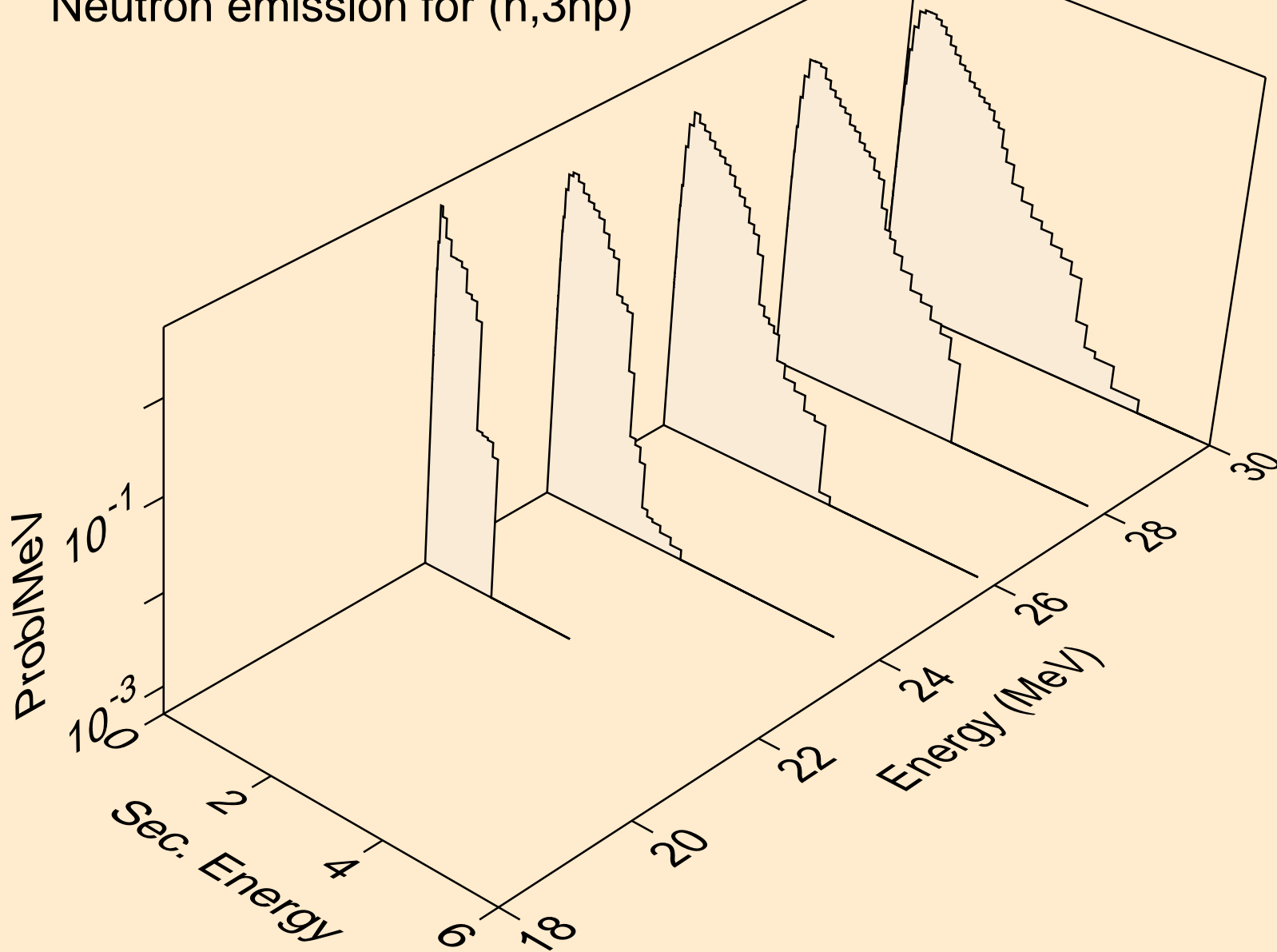

RE184 NEUTRON ACER TENDL-2019 LIBRARY; T=293.16K
Neutron emission for (n,2np)

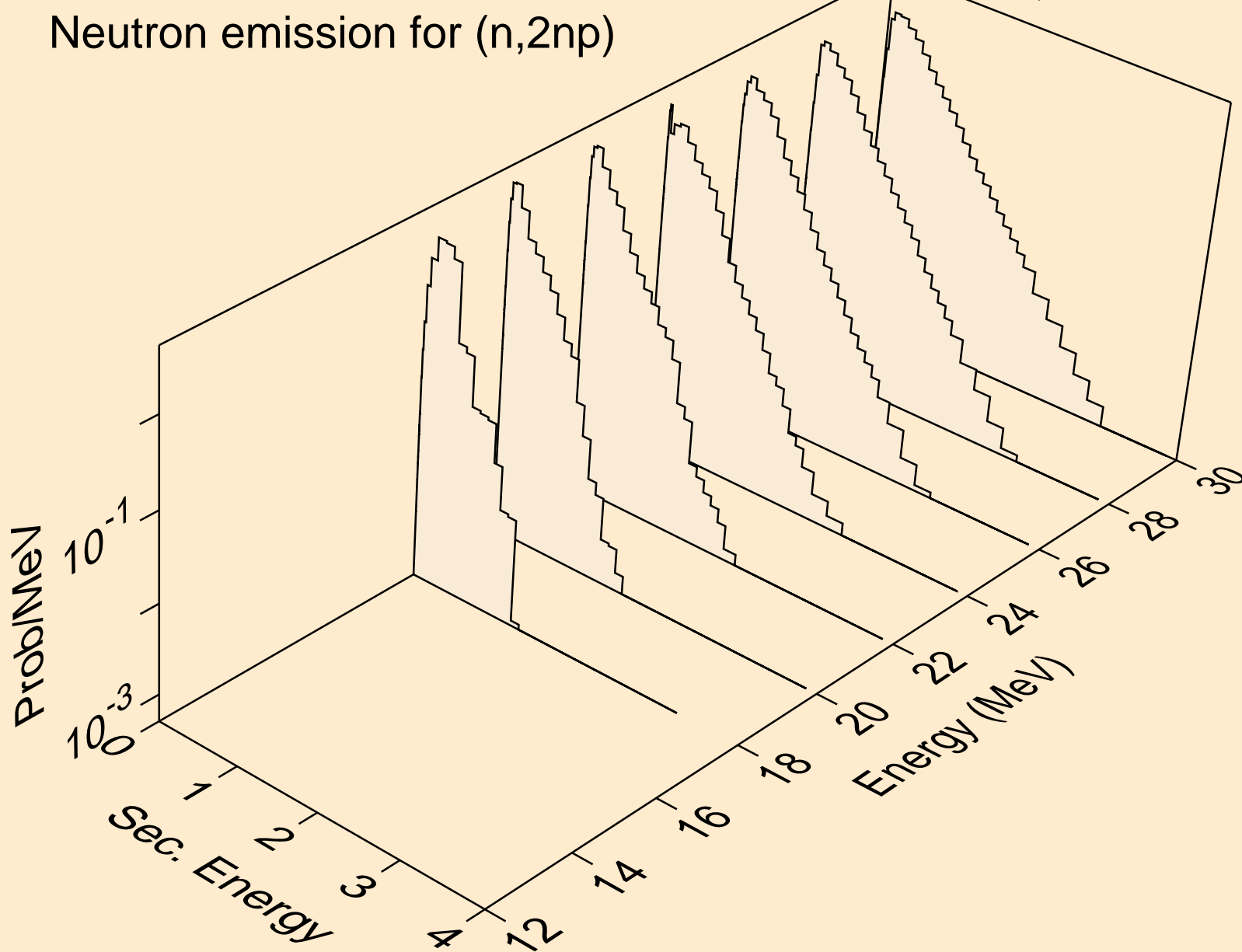

RE184 NEUTRON ACER TENDL-2019 LIBRARY; T=293.16K
Neutron emission for (n,npa)

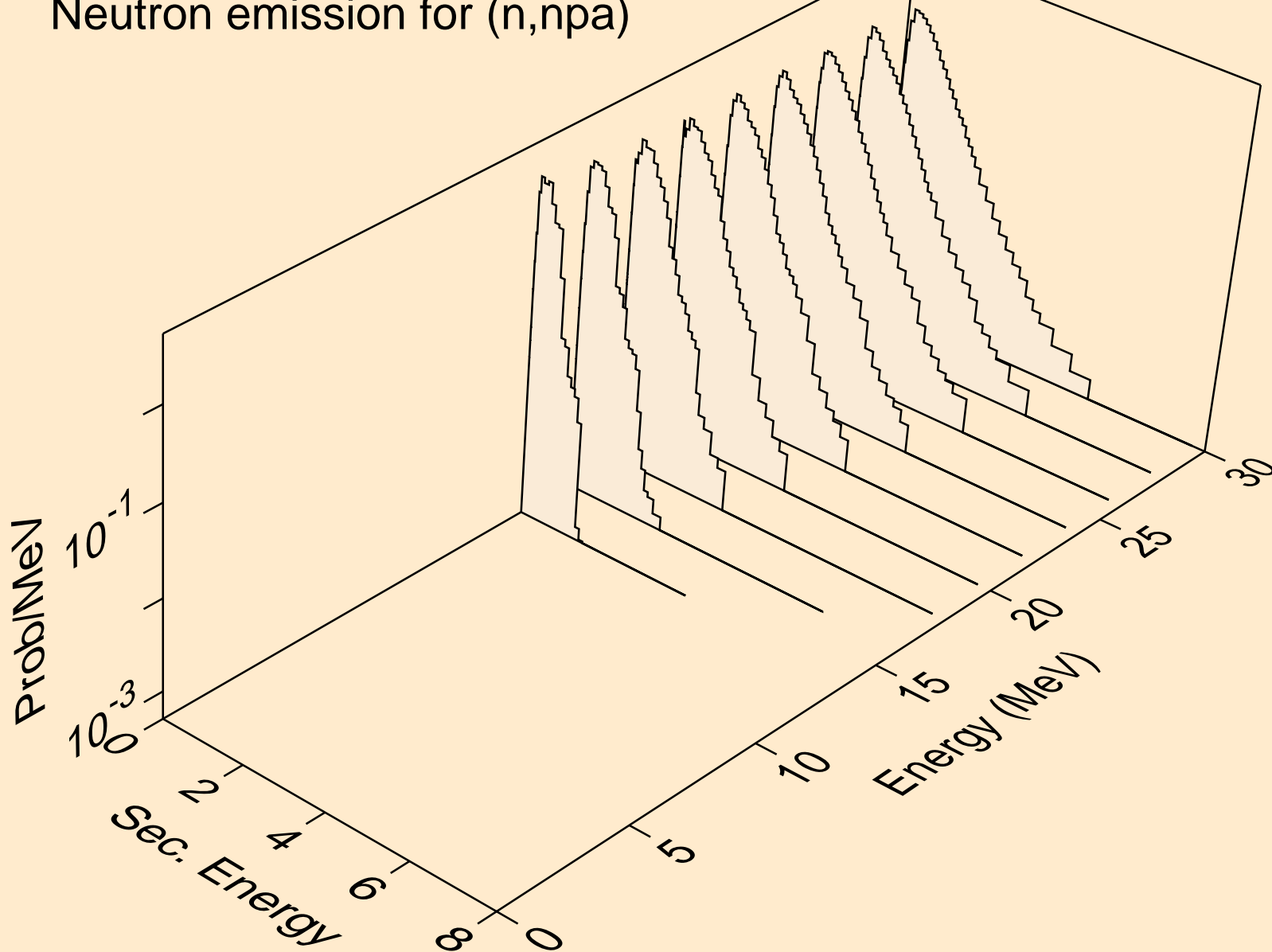

RE184 NEUTRON ACER TENDL-2019 LIBRARY; T=293.16K
Neutron emission for (n,n*c)

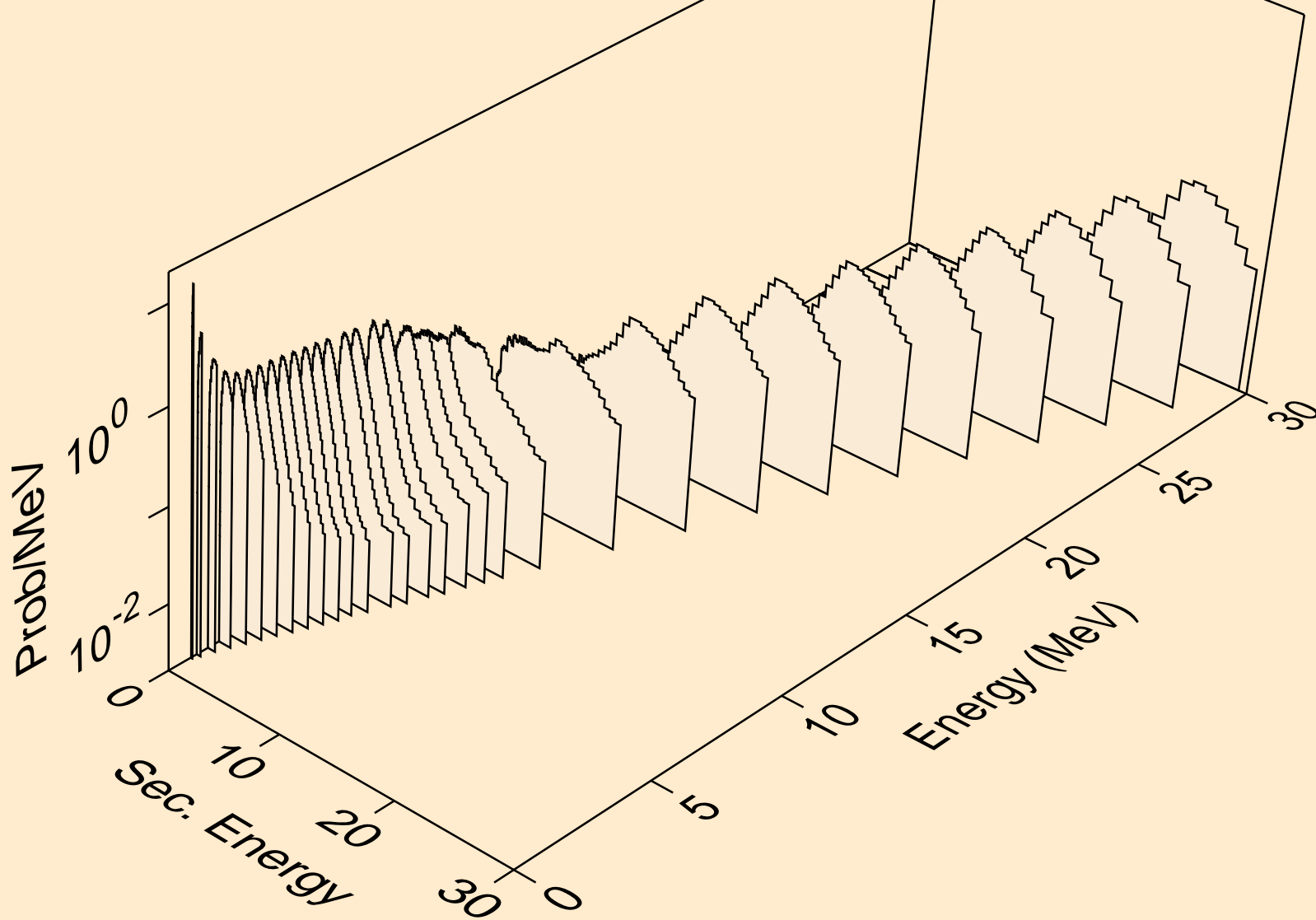

RE184 NEUTRON ACER TENDL-2019 LIBRARY; T=293.16K
Photon emission for (n,x)

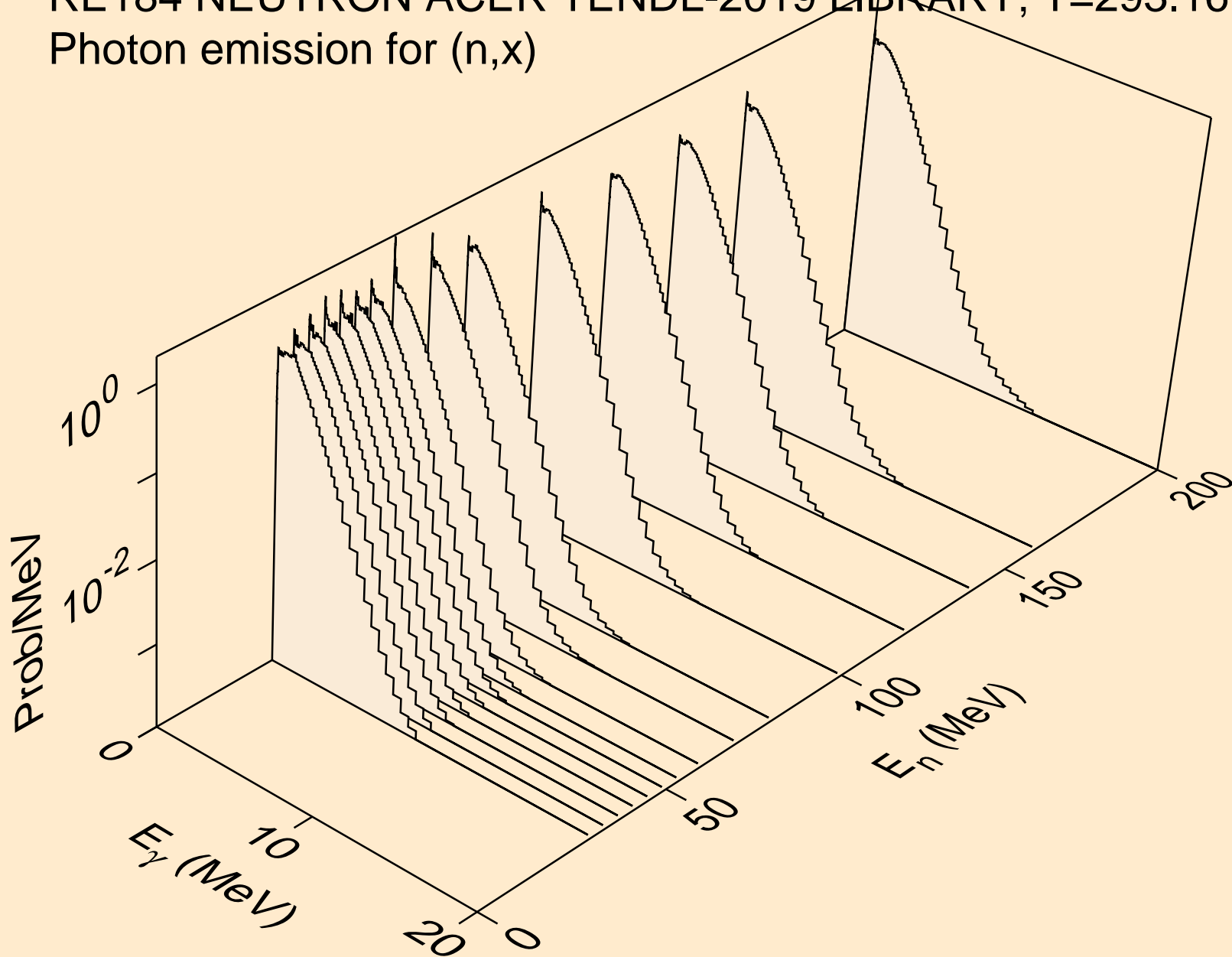

RE184 NEUTRON ACER TENDL-2019 LIBRARY; T=293.16K
Photon emission for (n,2nd)

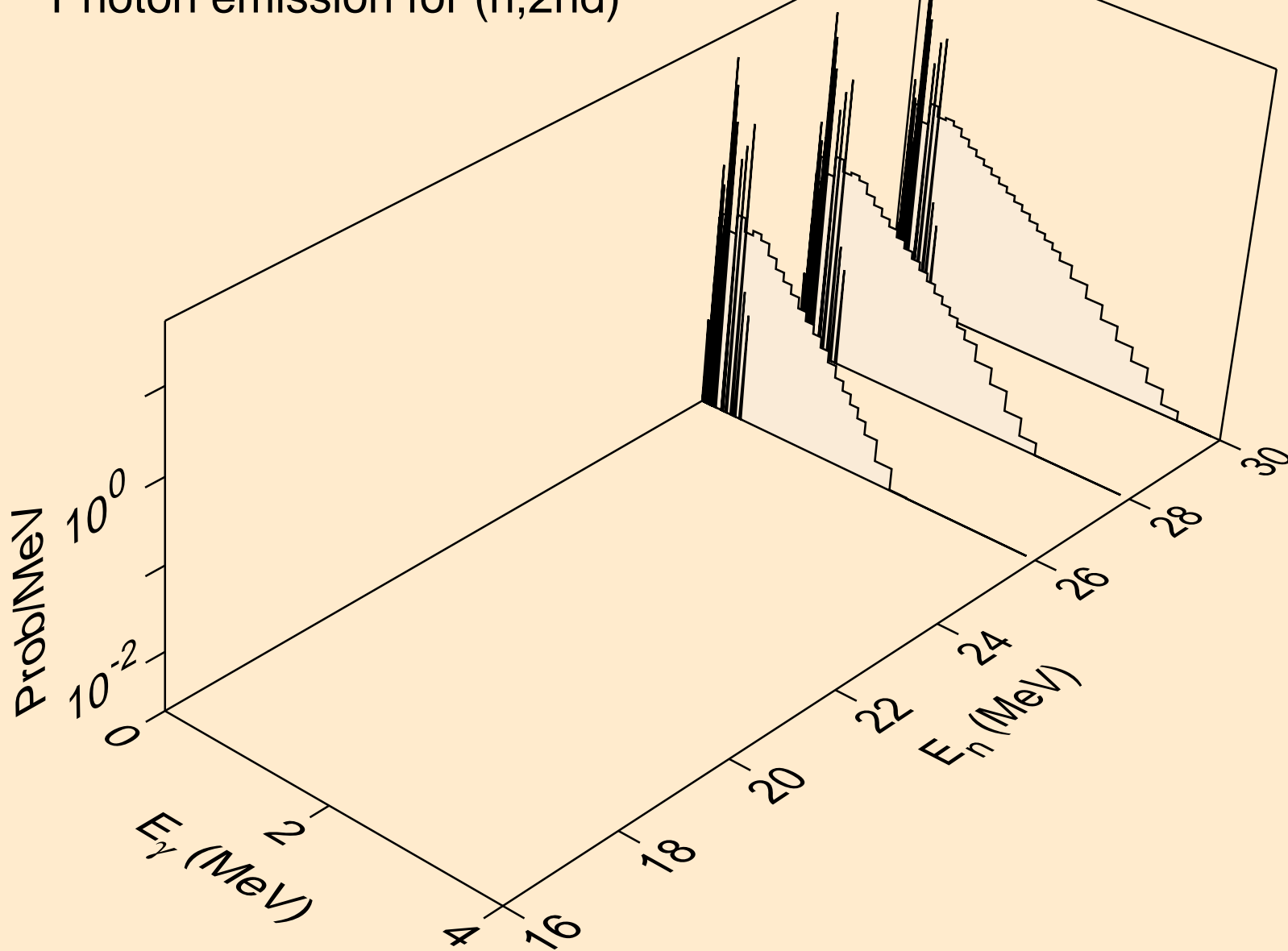

RE184 NEUTRON ACER TENDL-2019 LIBRARY; T=293.16K
Photon emission for (n,2n)

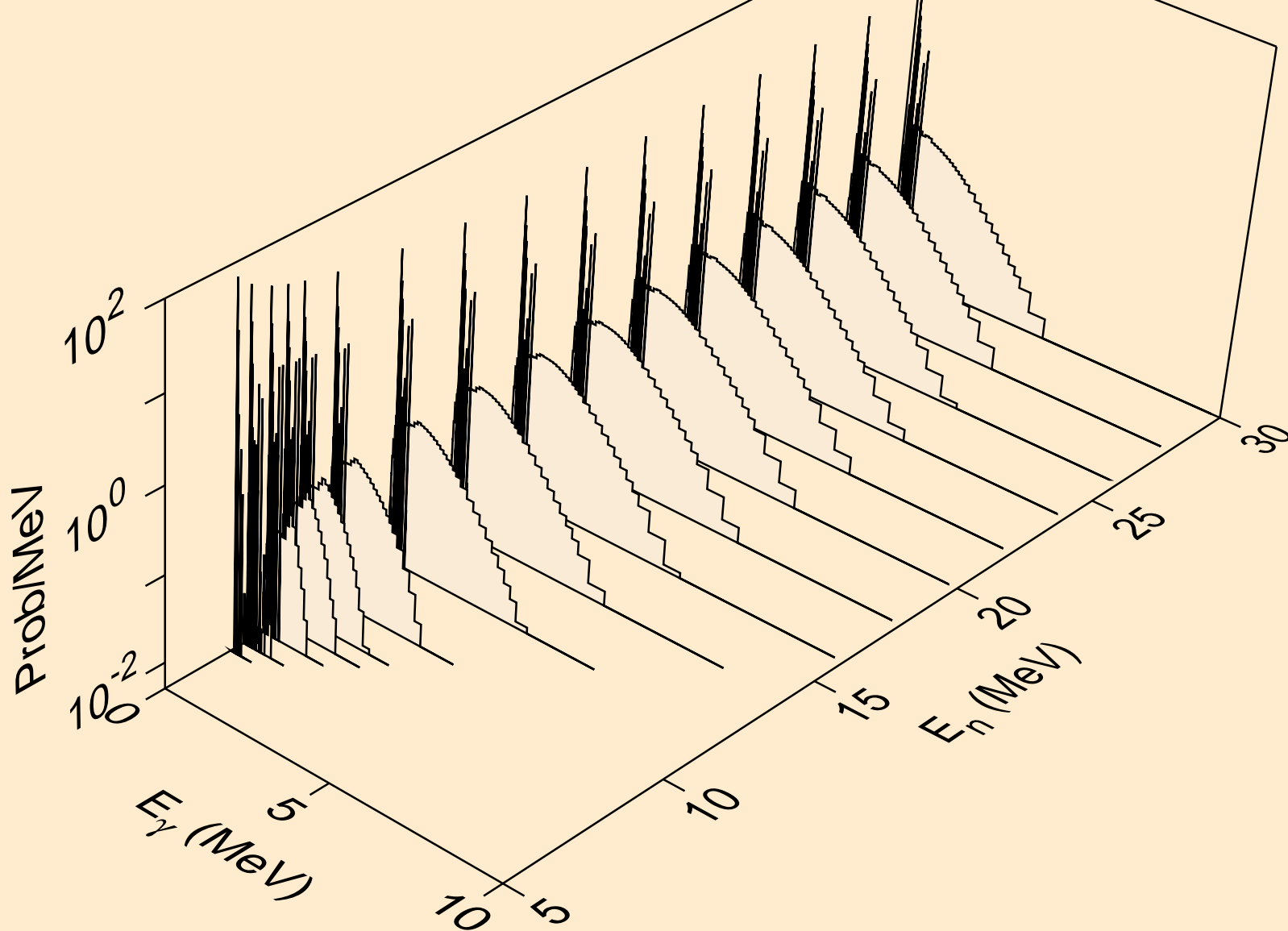

RE184 NEUTRON ACER TENDL-2019 LIBRARY; T=293.16K
Photon emission for (n,3n)

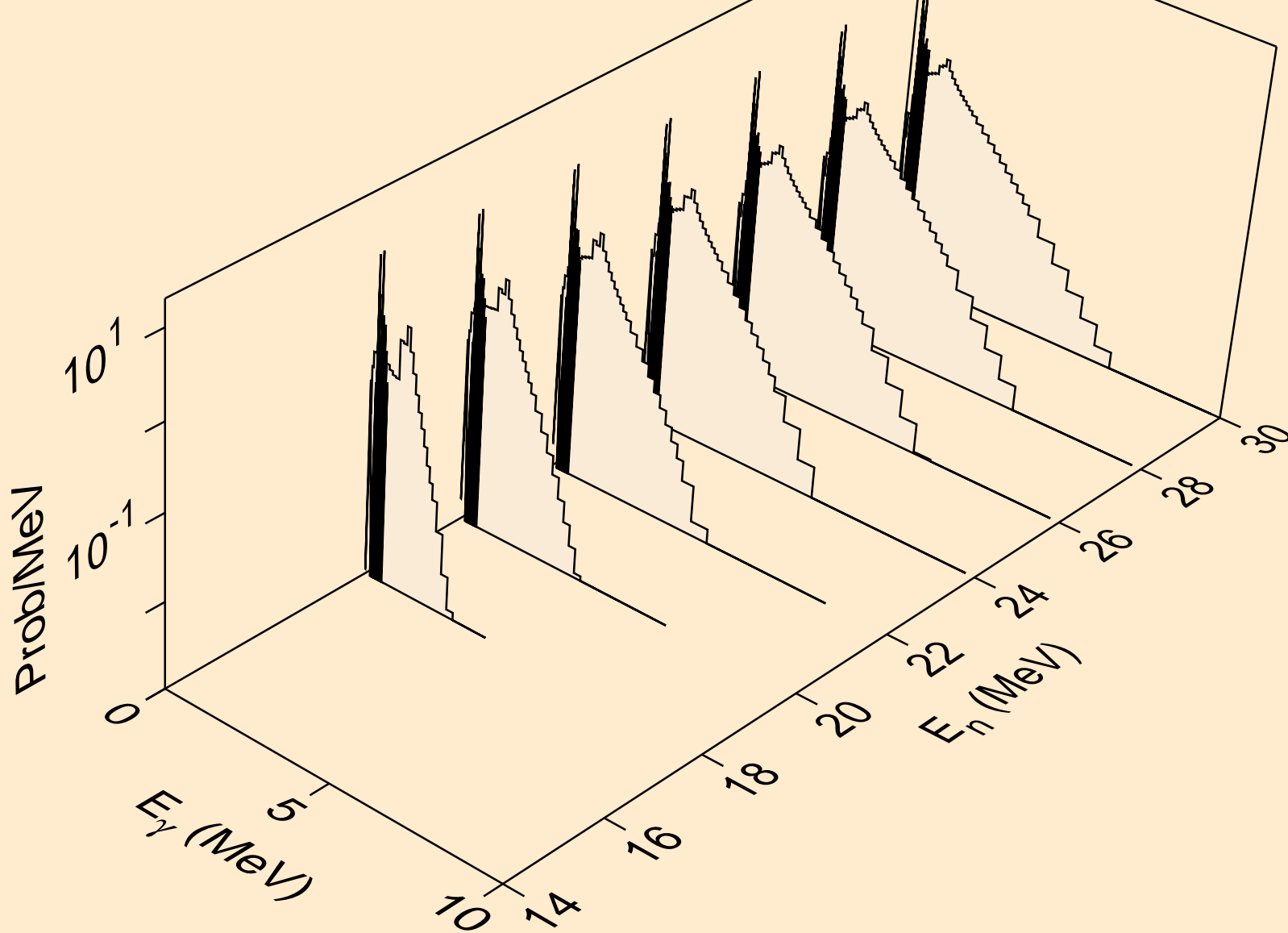

RE184 NEUTRON ACER TENDL-2019 LIBRARY; T=293.16K
Photon emission for (n,n*)a

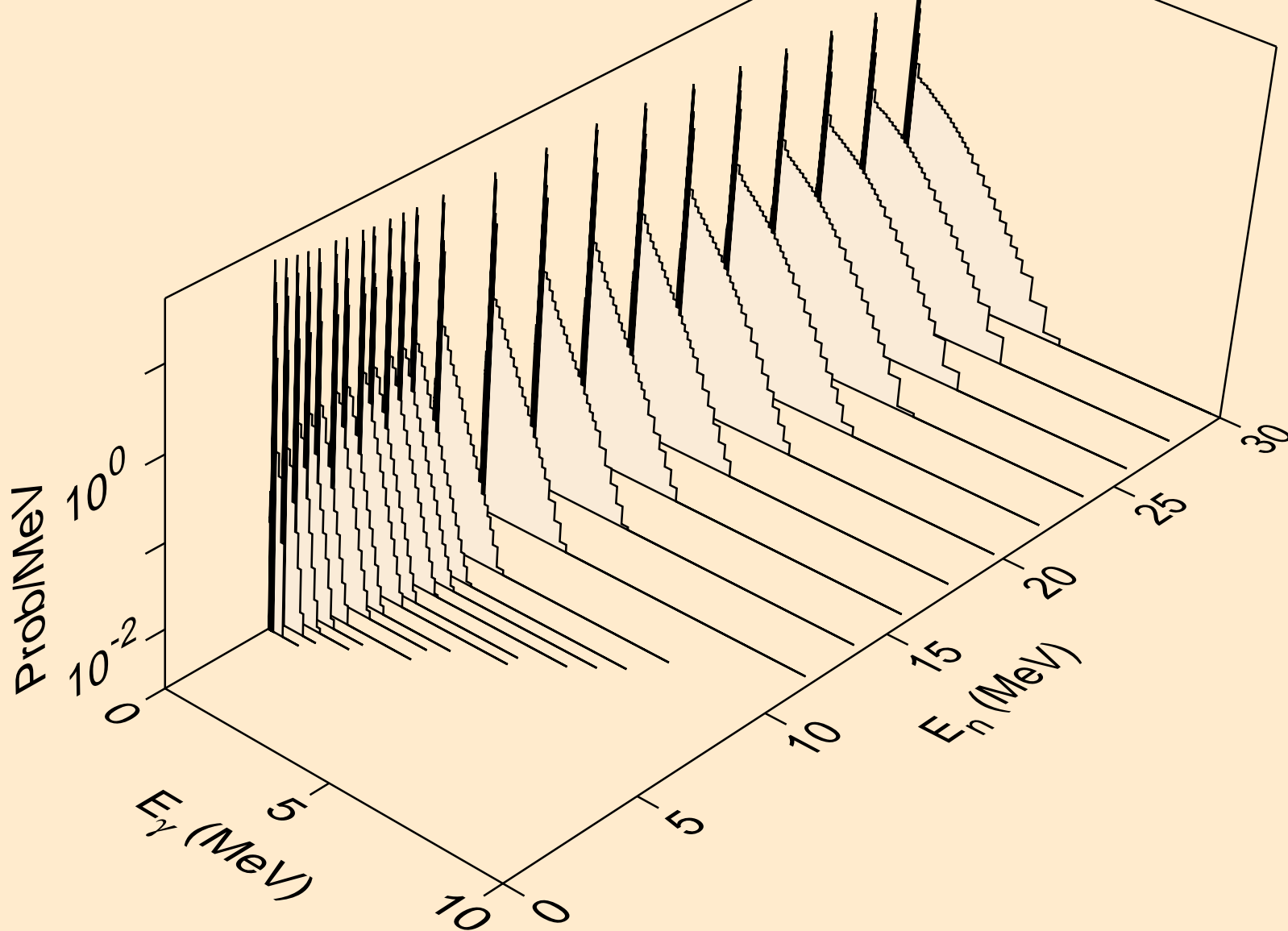

RE184 NEUTRON ACER TENDL-2019 LIBRARY; T=293.16K
Photon emission for (n,2n)a

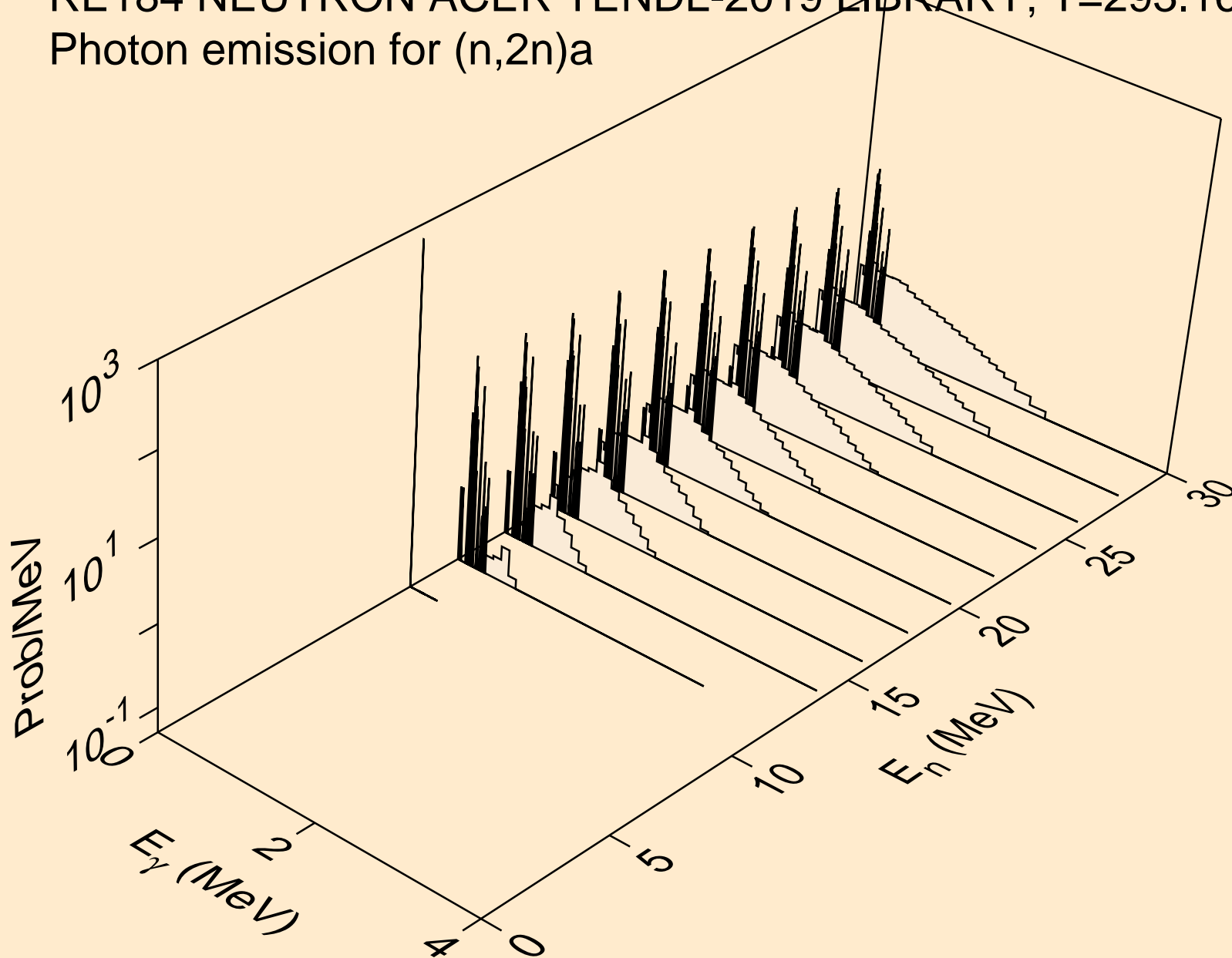

RE184 NEUTRON ACER TENDL-2019 LIBRARY; T=293.16K
Photon emission for (n,3n)a

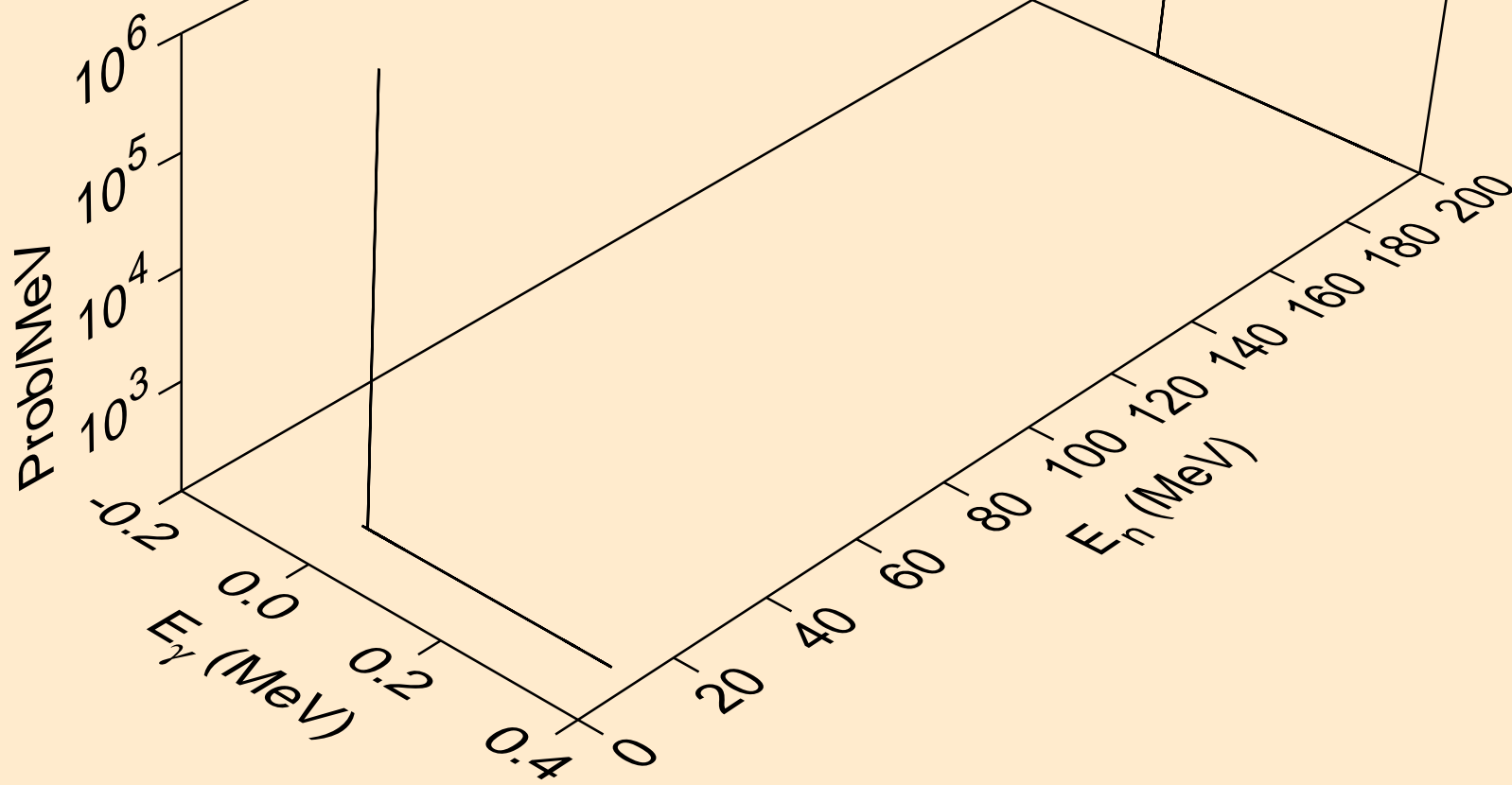

RE184 NEUTRON ACER TENDL-2019 LIBRARY; T=293.16K
Photon emission for (n,n*)p

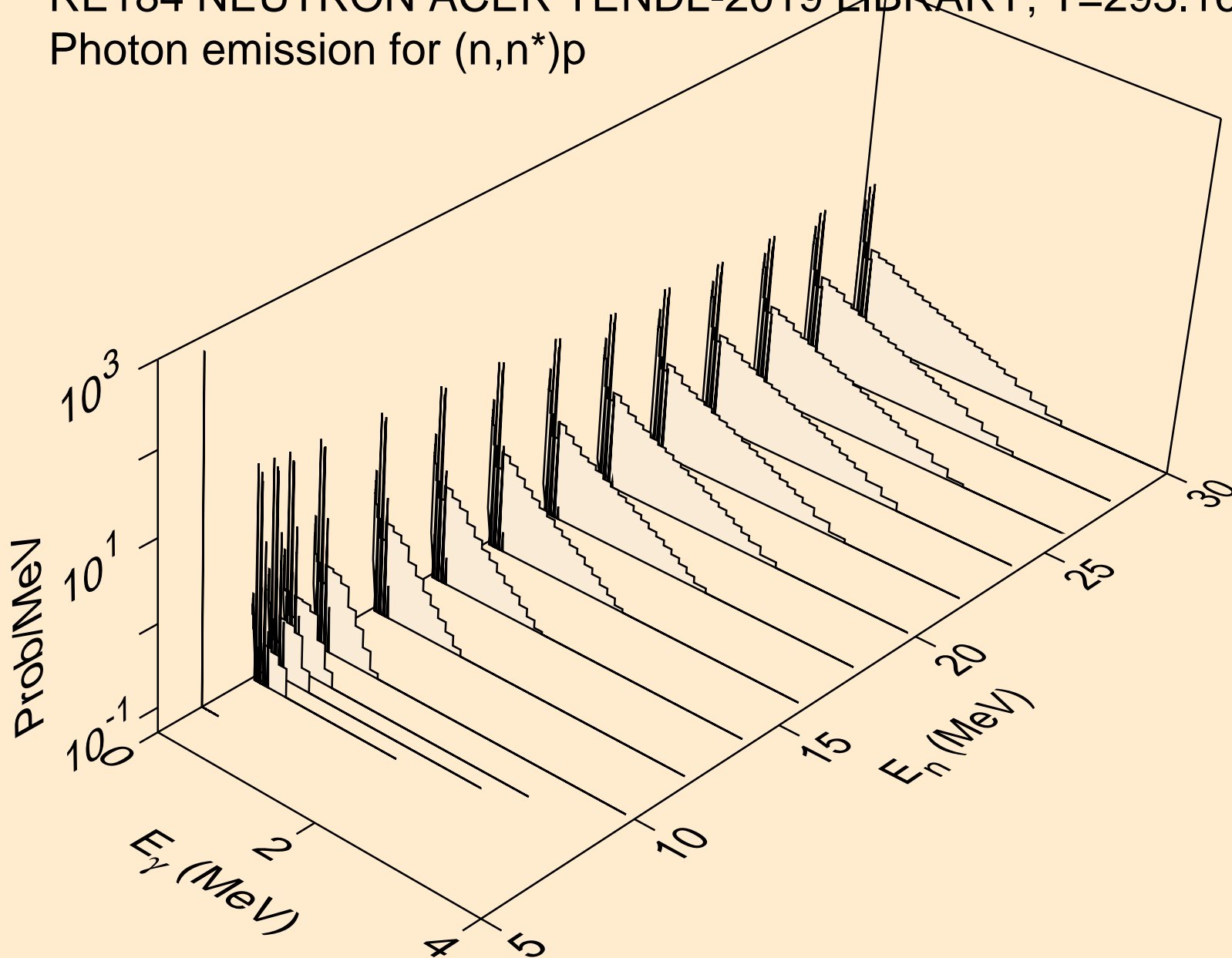

RE184 NEUTRON ACER TENDL-2019 LIBRARY; T=293.16K
Photon emission for (n,n*)2a

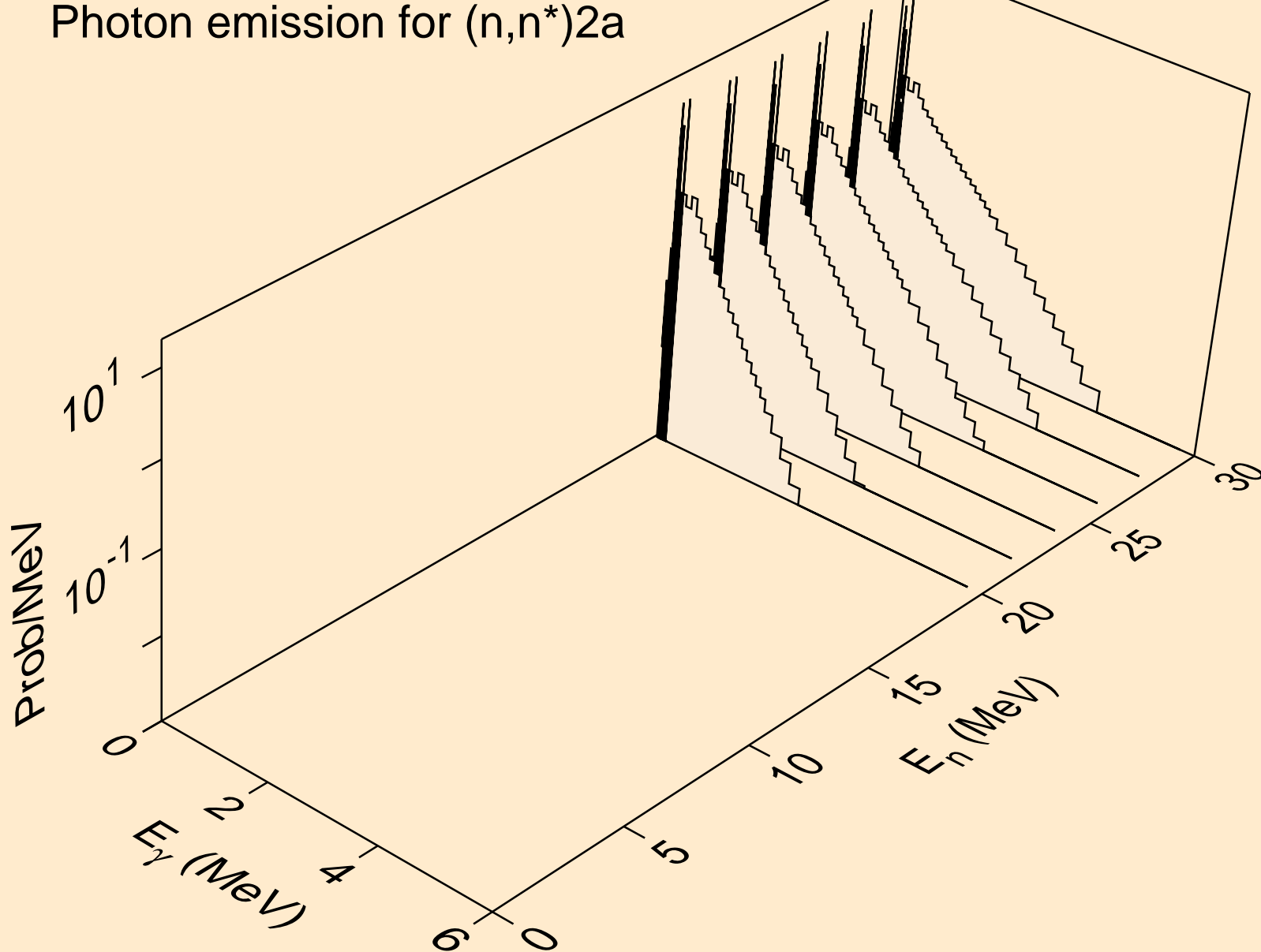

RE184 NEUTRON ACER TENDL-2019 LIBRARY; T=293.16K
Photon emission for (n,n*)d

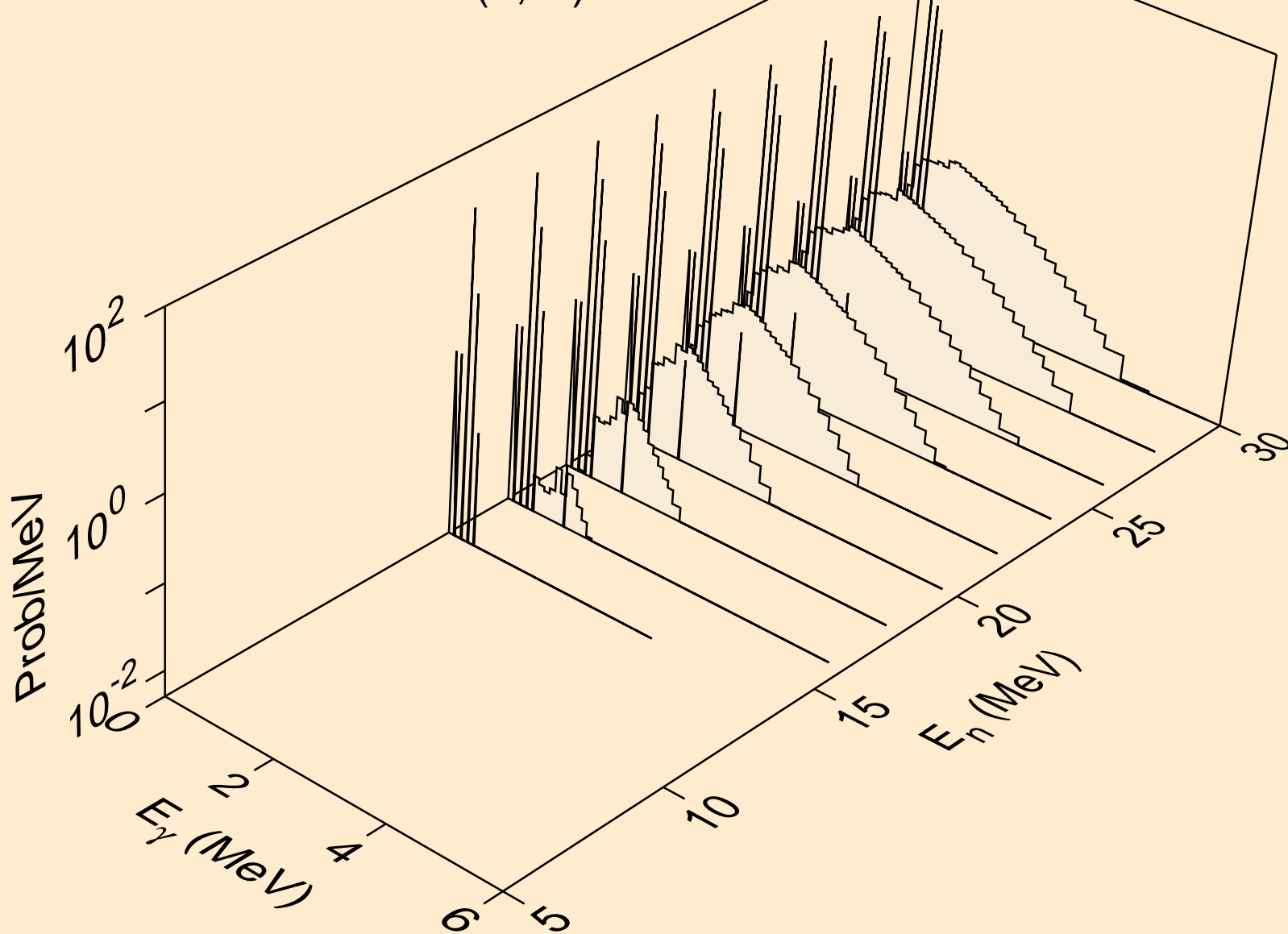

RE184 NEUTRON ACER TENDL-2019 LIBRARY; T=293.16K
Photon emission for (n,n*)t

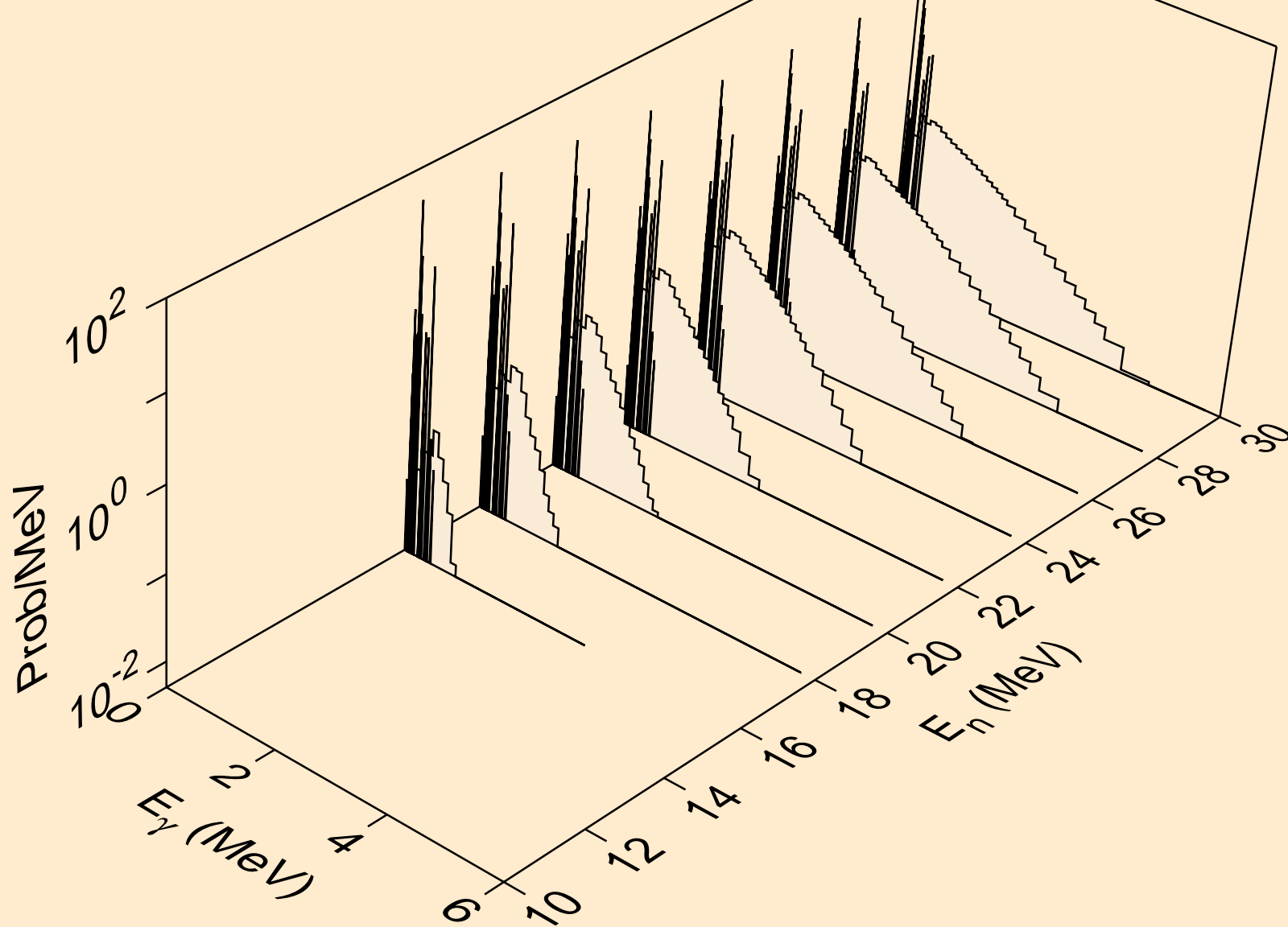

RE184 NEUTRON ACER TENDL-2019 LIBRARY; T=293.16K
Photon emission for (n,n*)he3

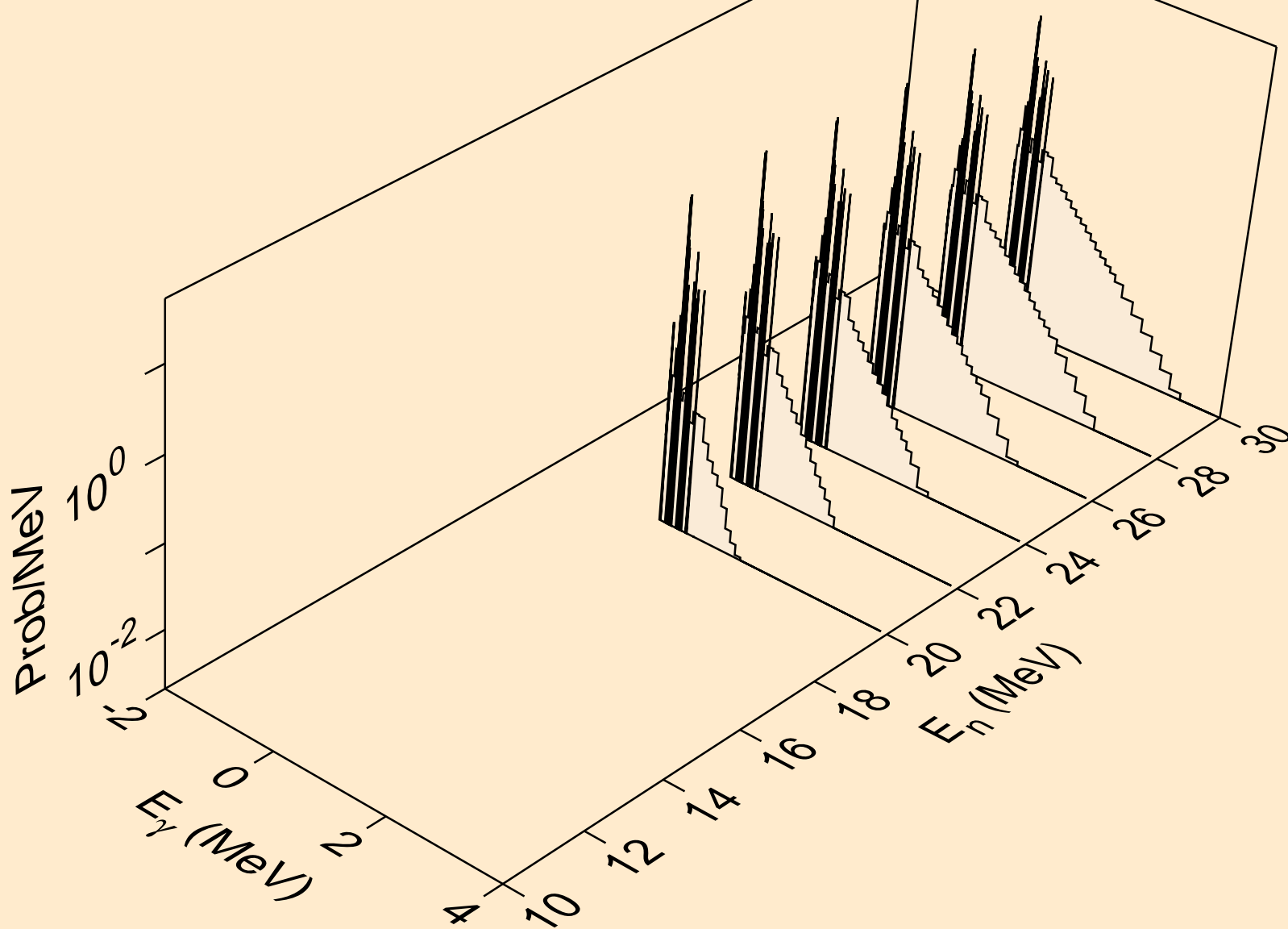

RE184 NEUTRON ACER TENDL-2019 LIBRARY; T=293.16K
Photon emission for (n,4n)

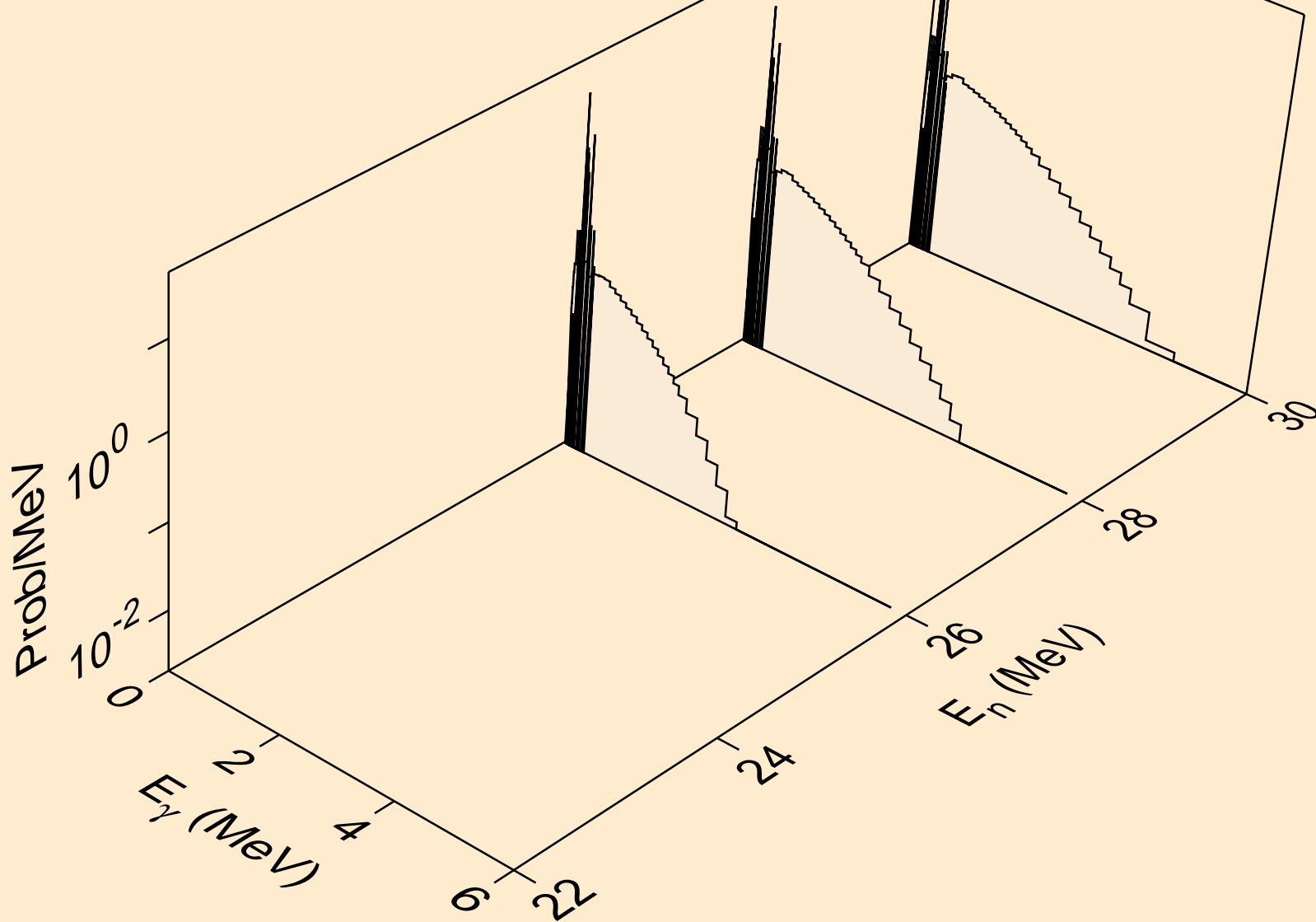

RE184 NEUTRON ACER TENDL-2019 LIBRARY; T=293.16K
Photon emission for (n,2np)

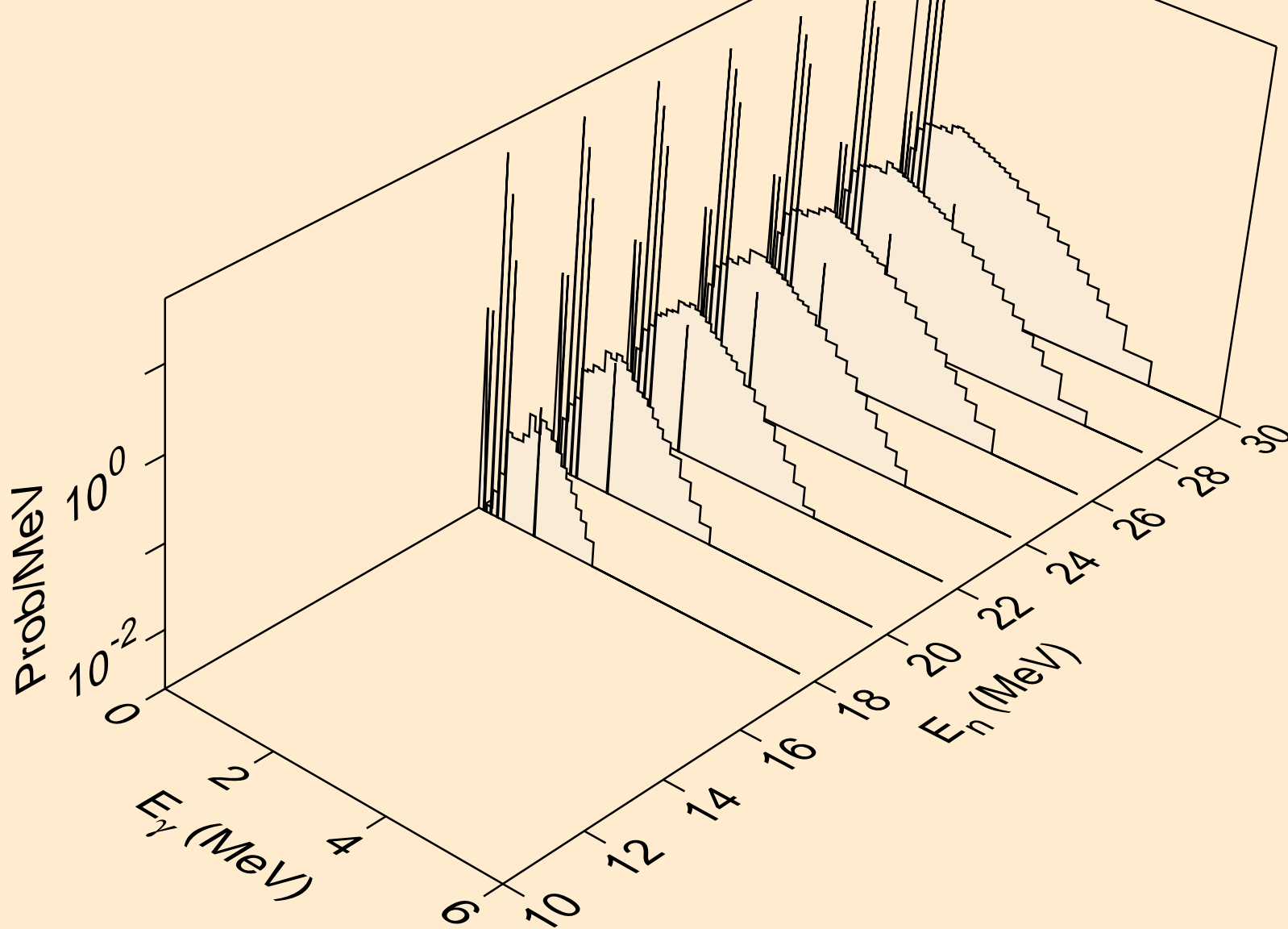

RE184 NEUTRON ACER TENDL-2019 LIBRARY; T=293.16K
Photon emission for (n,3np)

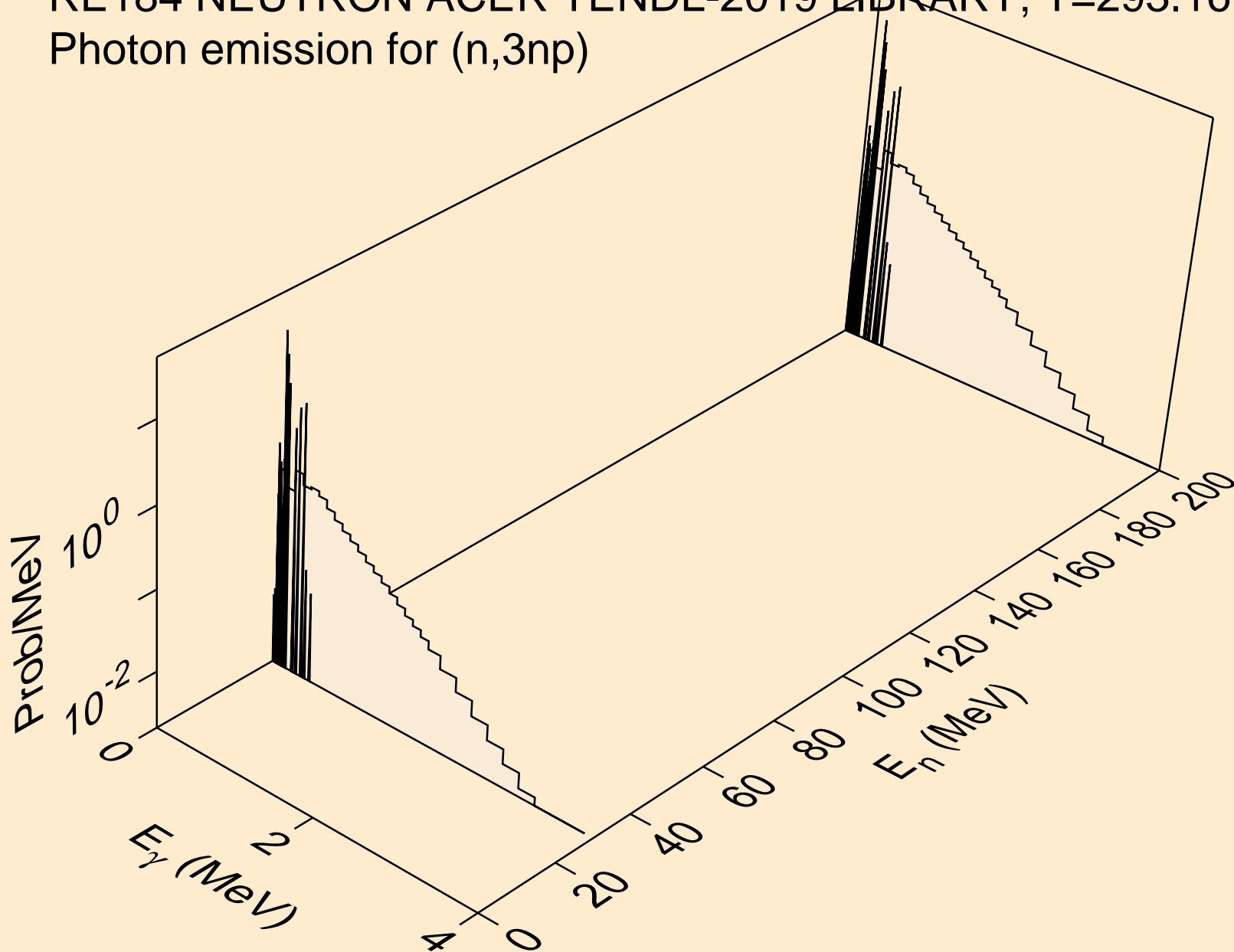

RE184 NEUTRON ACER TENDL-2019 LIBRARY; T=293.16K
Photon emission for (n,2np)

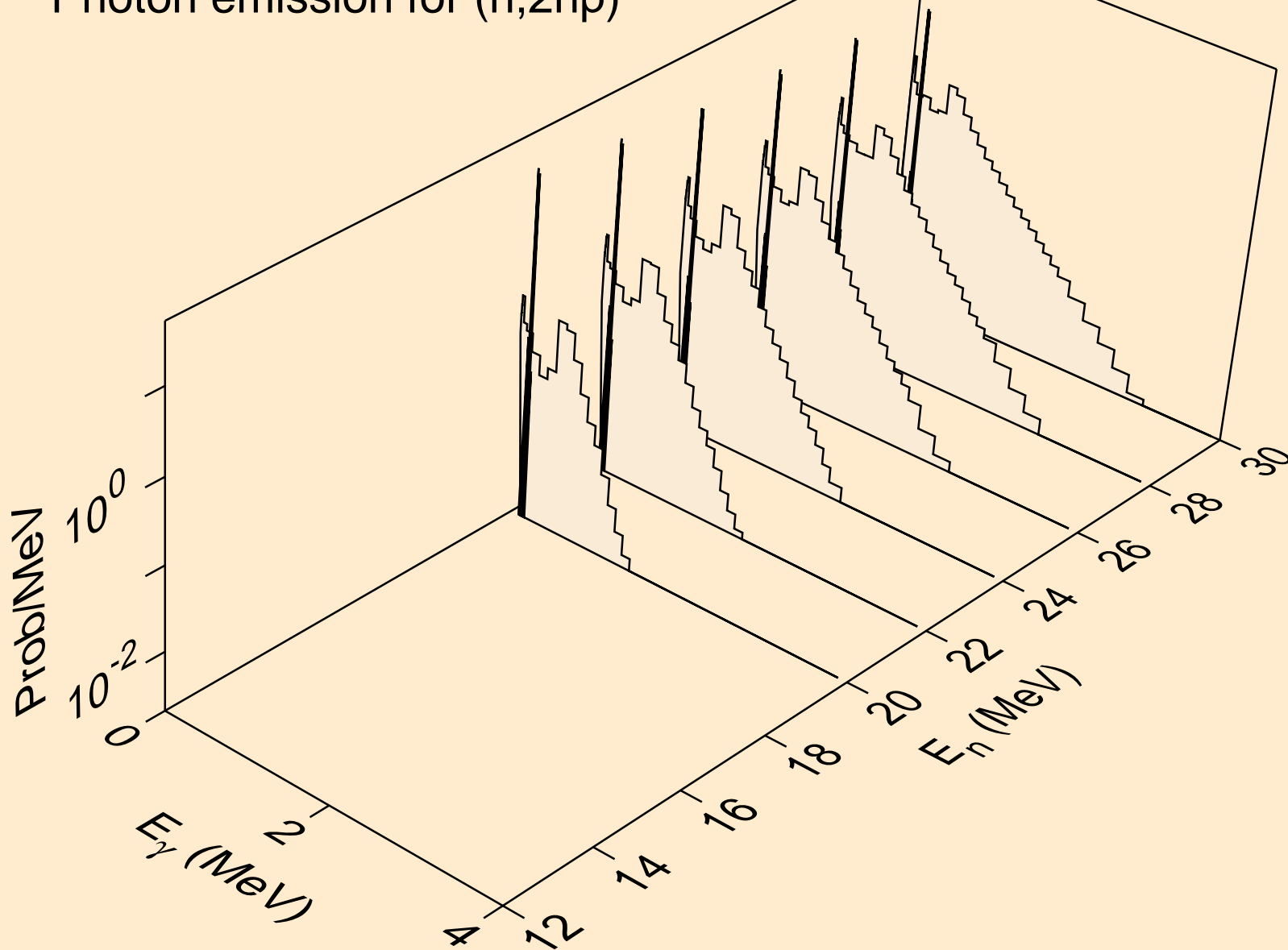

RE184 NEUTRON ACER TENDL-2019 LIBRARY; T=293.16K
Photon emission for (n,npa)

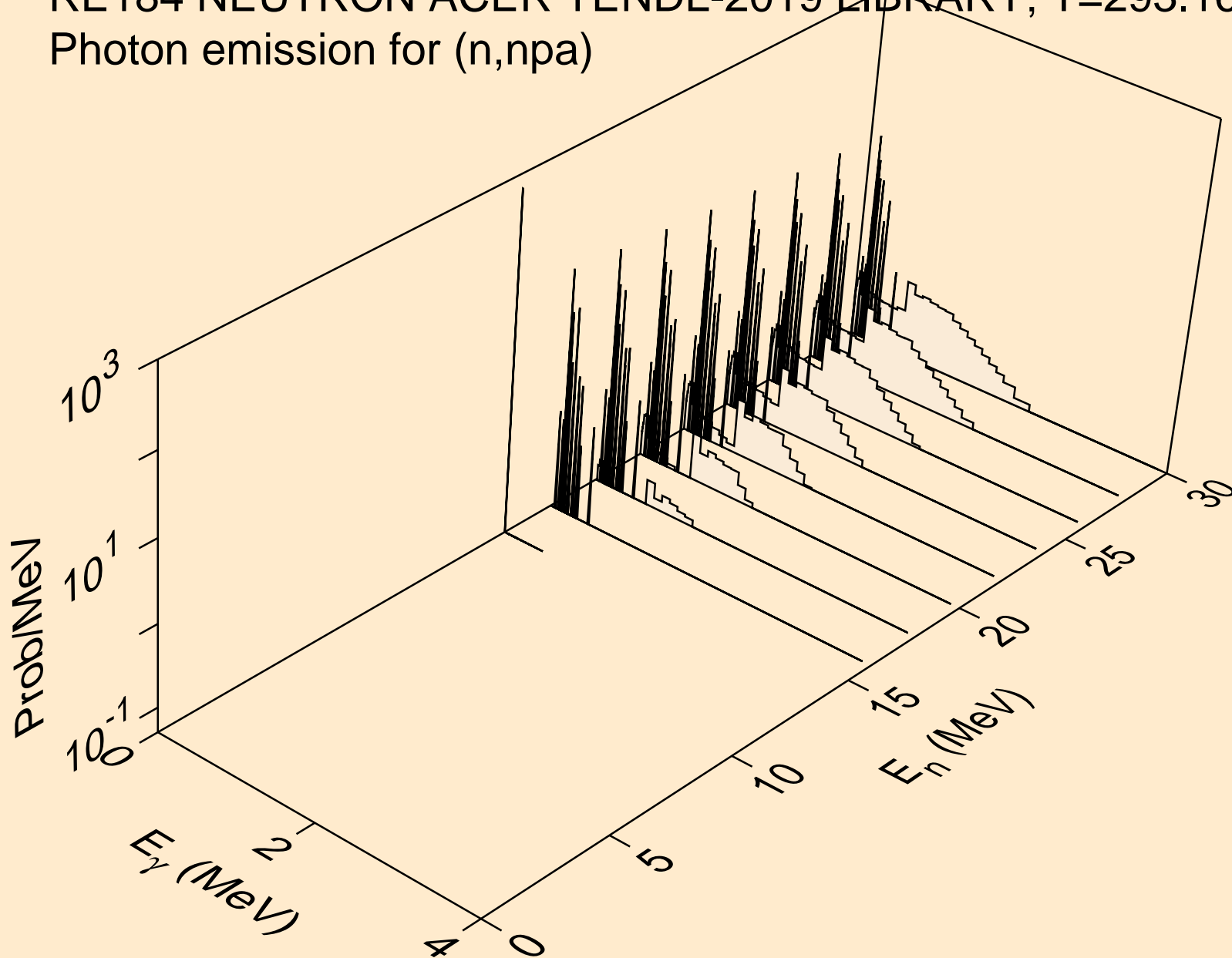

RE184 NEUTRON ACER TENDL-2019 LIBRARY; T=293.16K
Photon emission for (n,n*c)

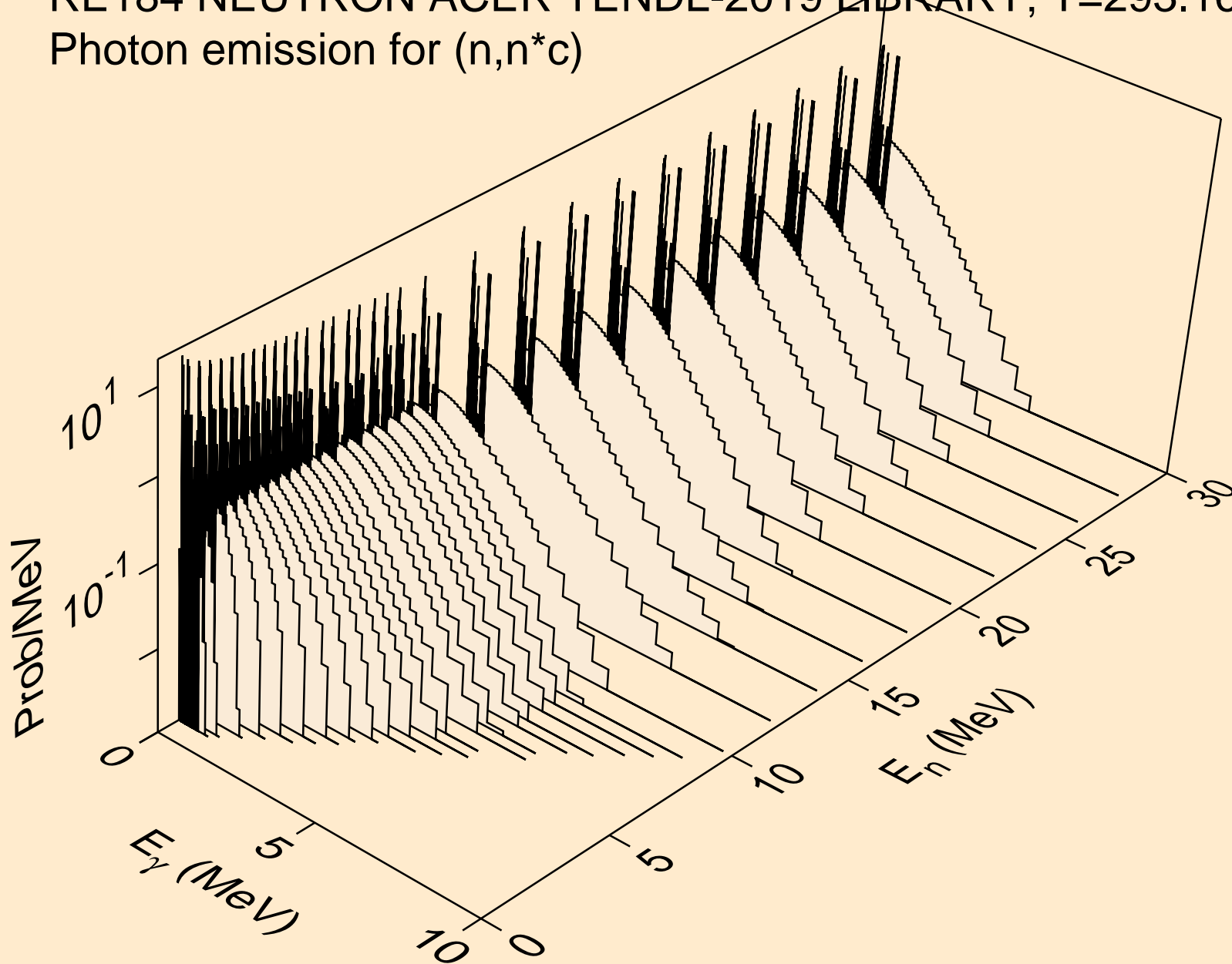

RE184 NEUTRON ACER TENDL-2019 LIBRARY; T=293.16K
Photon emission for (n,gma)

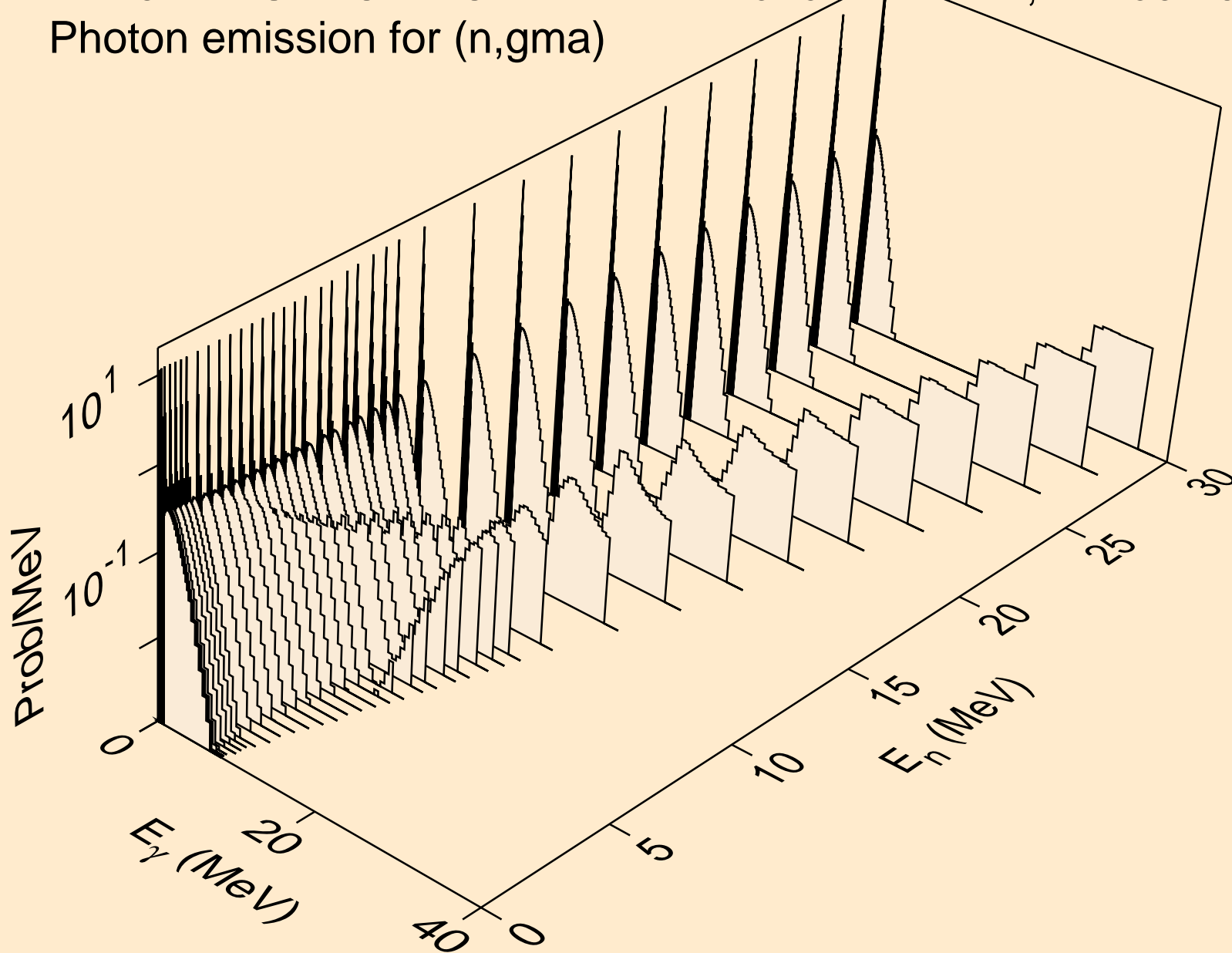

RE184 NEUTRON ACER TENDL-2019 LIBRARY; T=293.16K
Photon emission for (n,p)

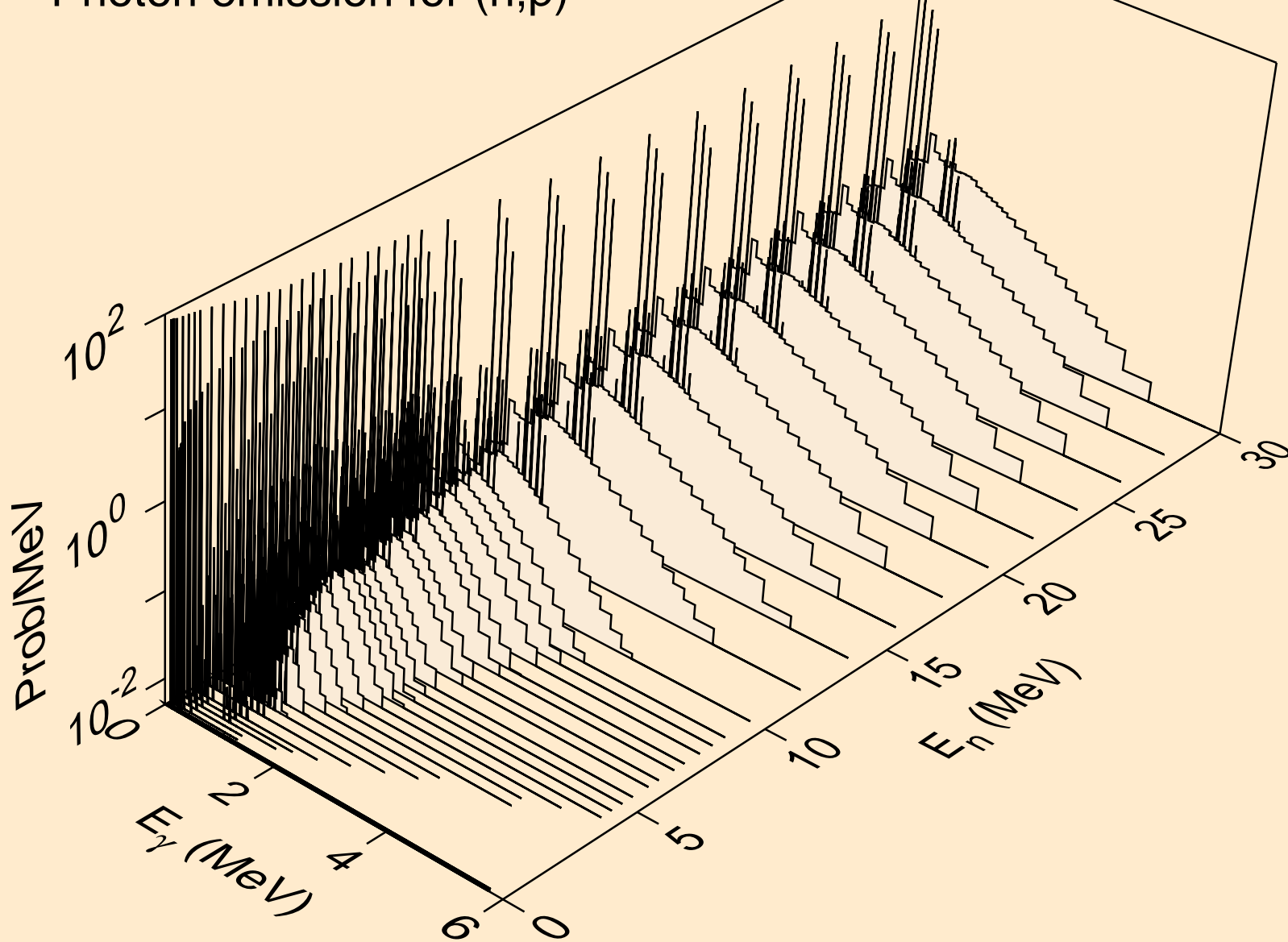

RE184 NEUTRON ACER TENDL-2019 LIBRARY; T=293.16K
Photon emission for (n,d)

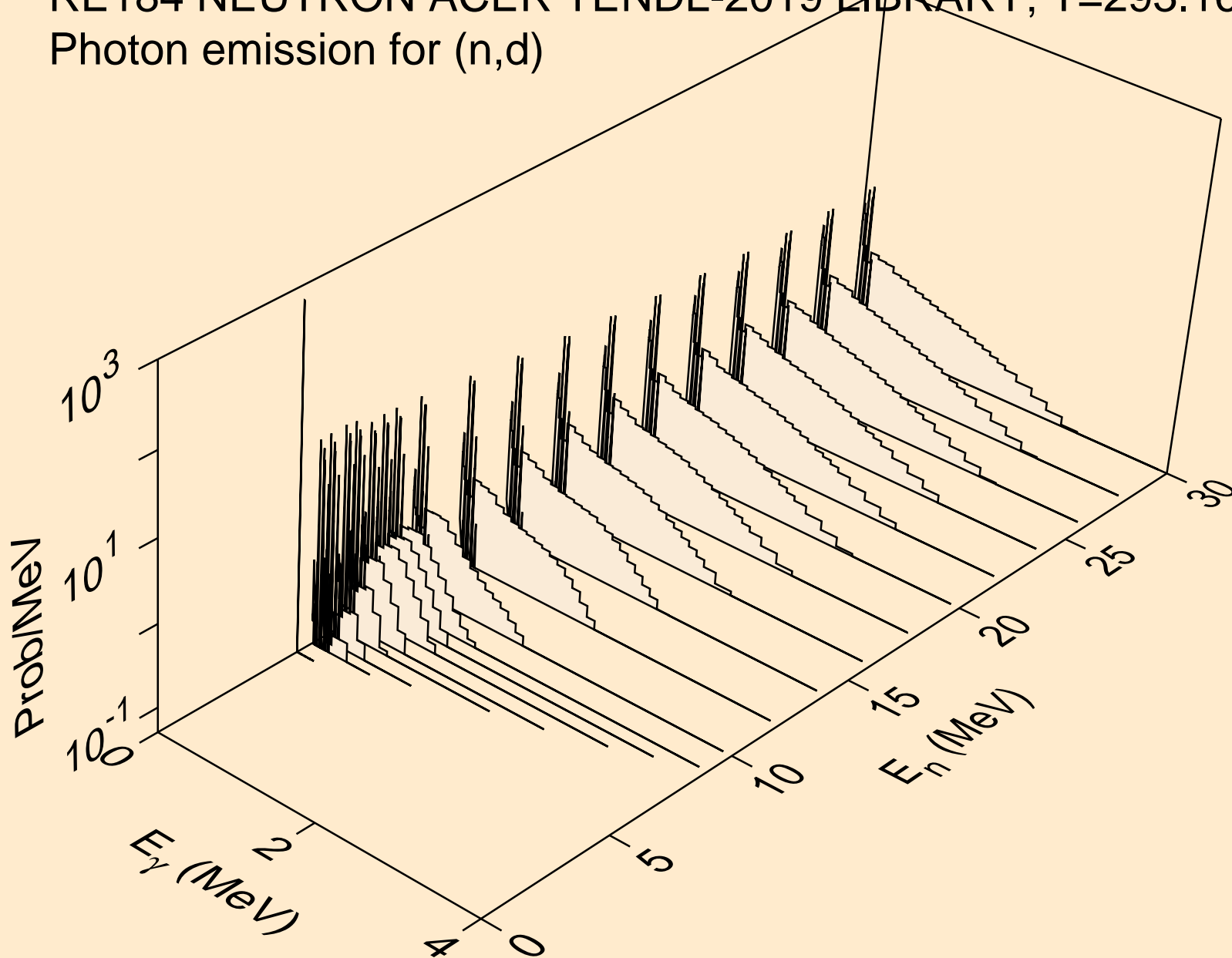

RE184 NEUTRON ACER TENDL-2019 LIBRARY; T=293.16K
Photon emission for (n,t)

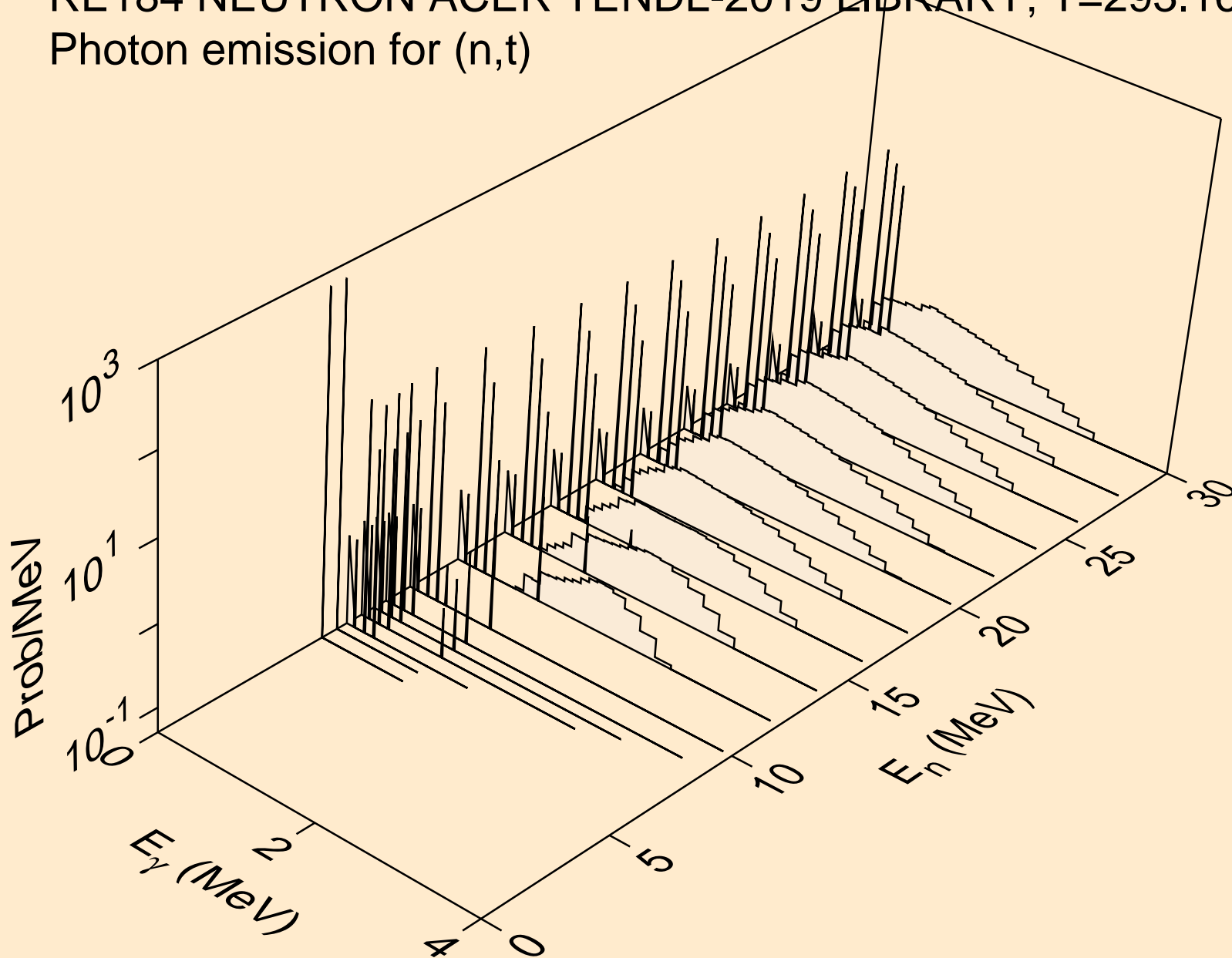

RE184 NEUTRON ACER TENDL-2019 LIBRARY; T=293.16K
Photon emission for (n,he3)

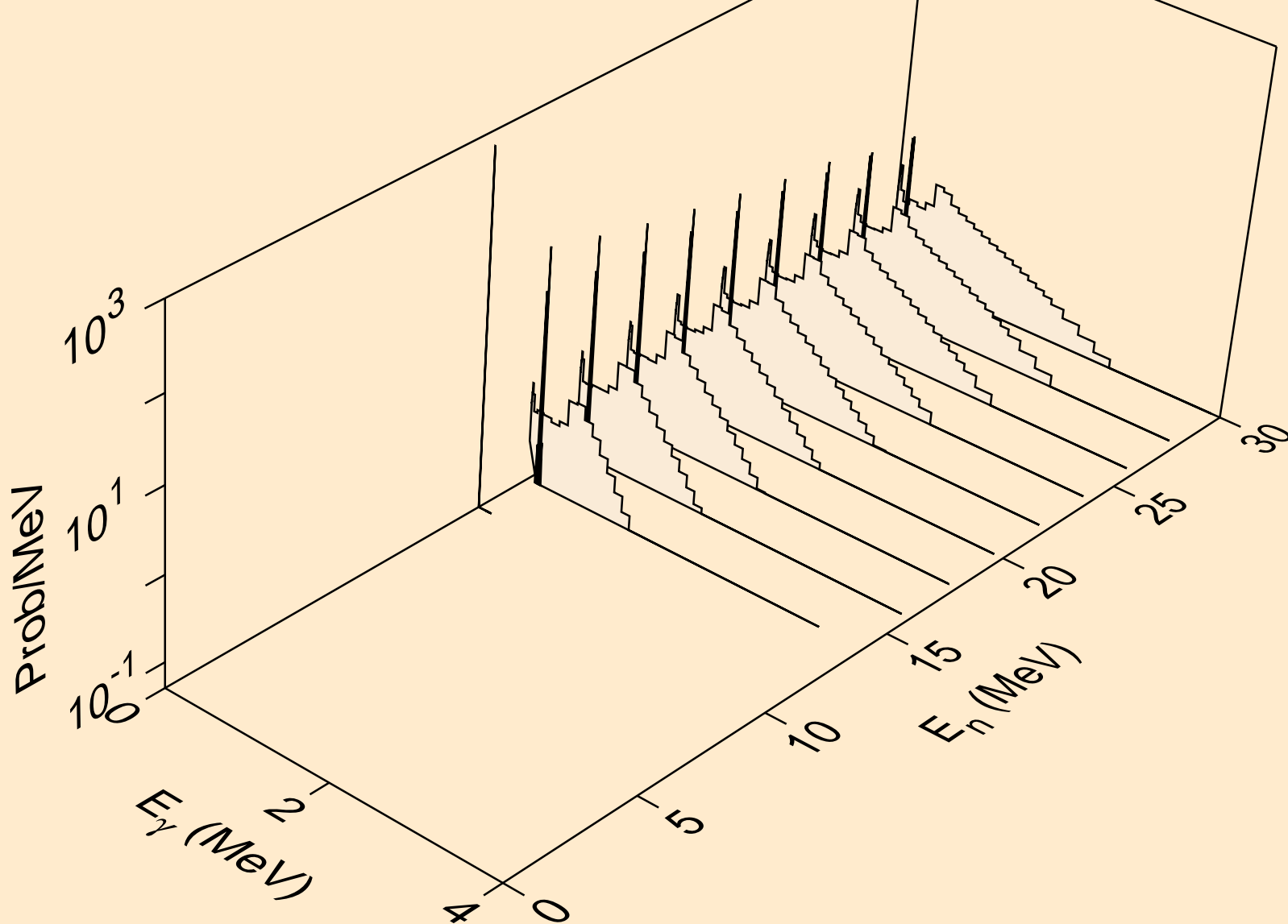

RE184 NEUTRON ACER TENDL-2019 LIBRARY; T=293.16K
Photon emission for (n,a)

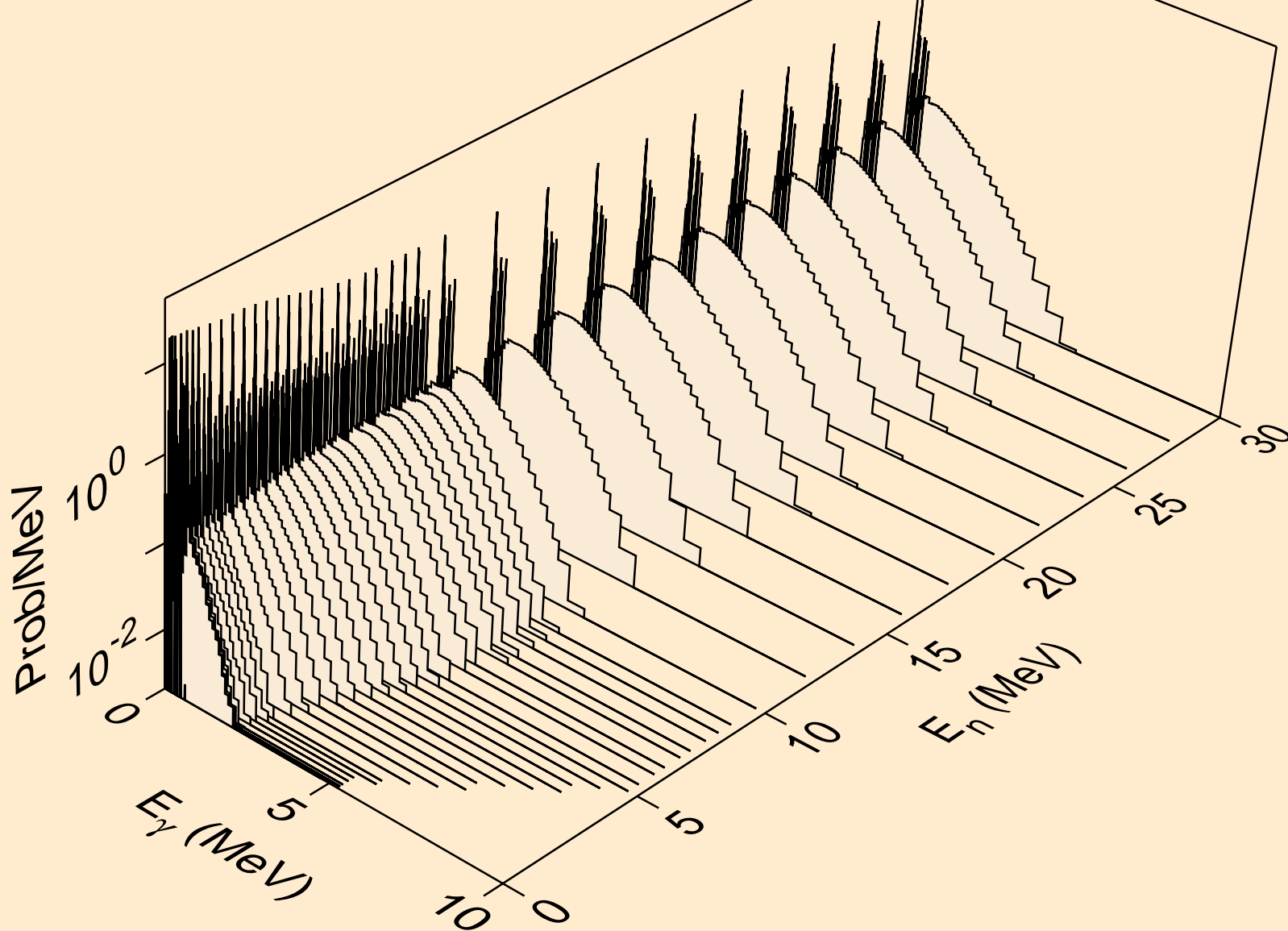

RE184 NEUTRON ACER TENDL-2019 LIBRARY; T=293.16K
Photon emission for (n,2a)

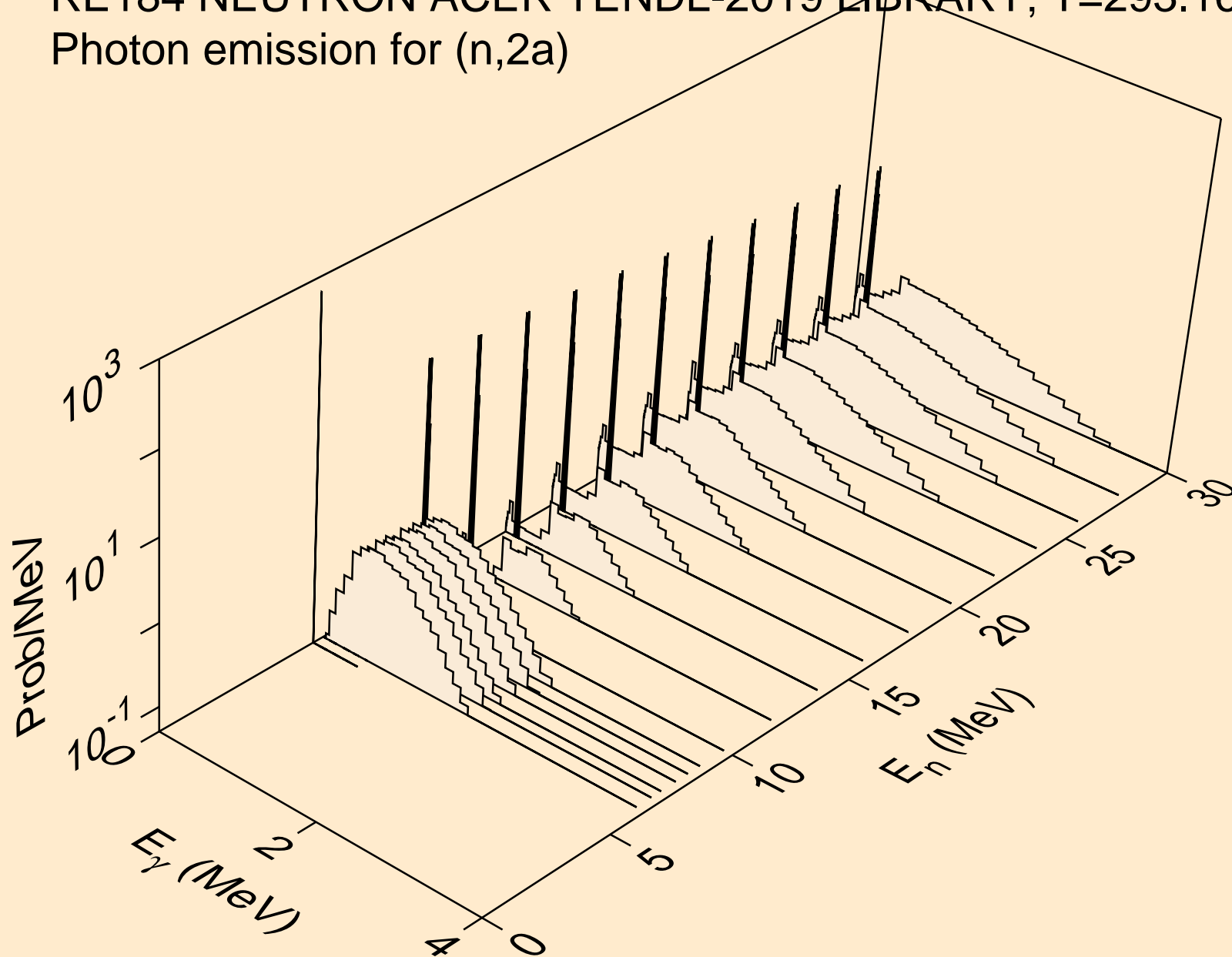

RE184 NEUTRON ACER TENDL-2019 LIBRARY; T=293.16K
Photon emission for (n,2p)

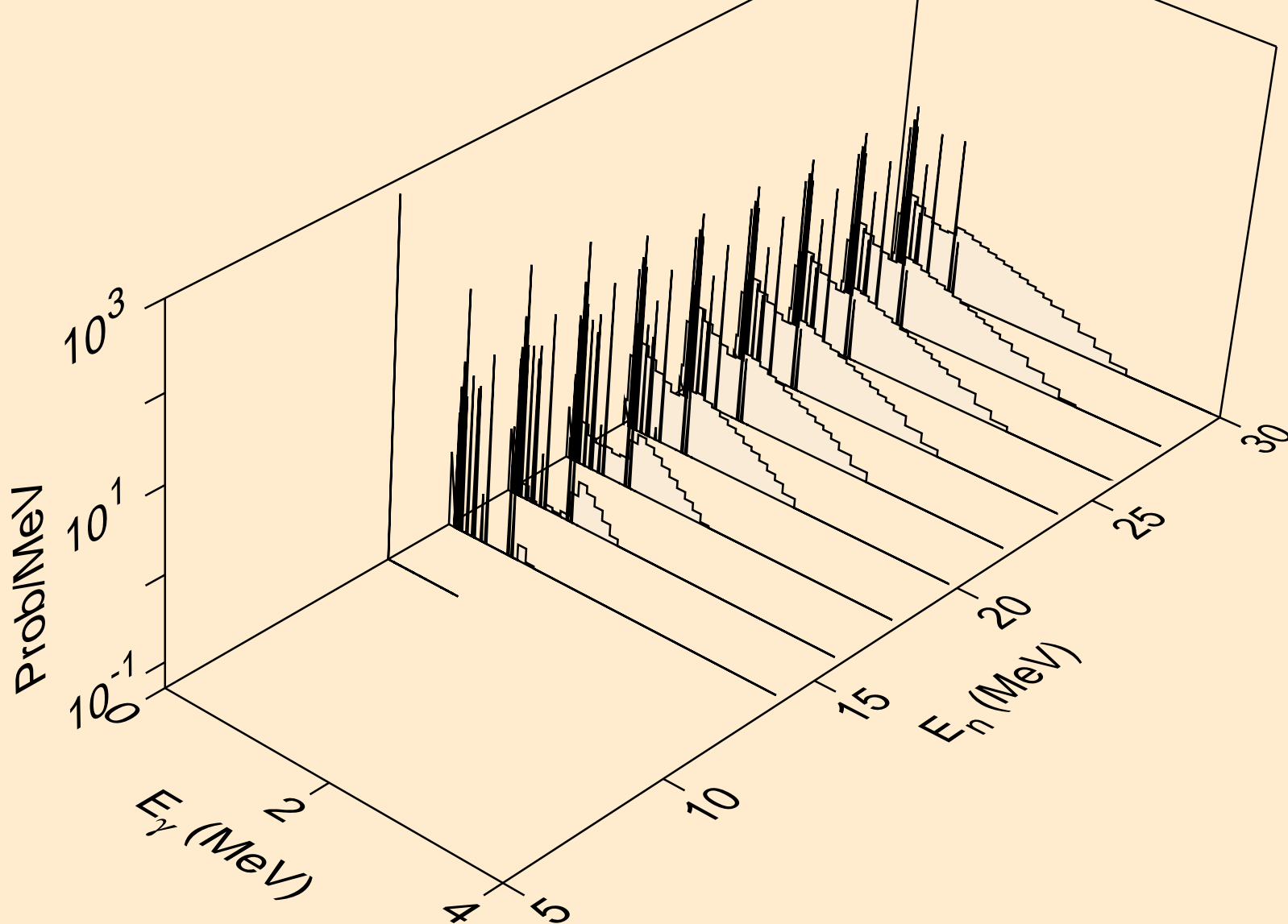

RE184 NEUTRON ACER TENDL-2019 LIBRARY; T=293.16K
Photon emission for (n,p α)

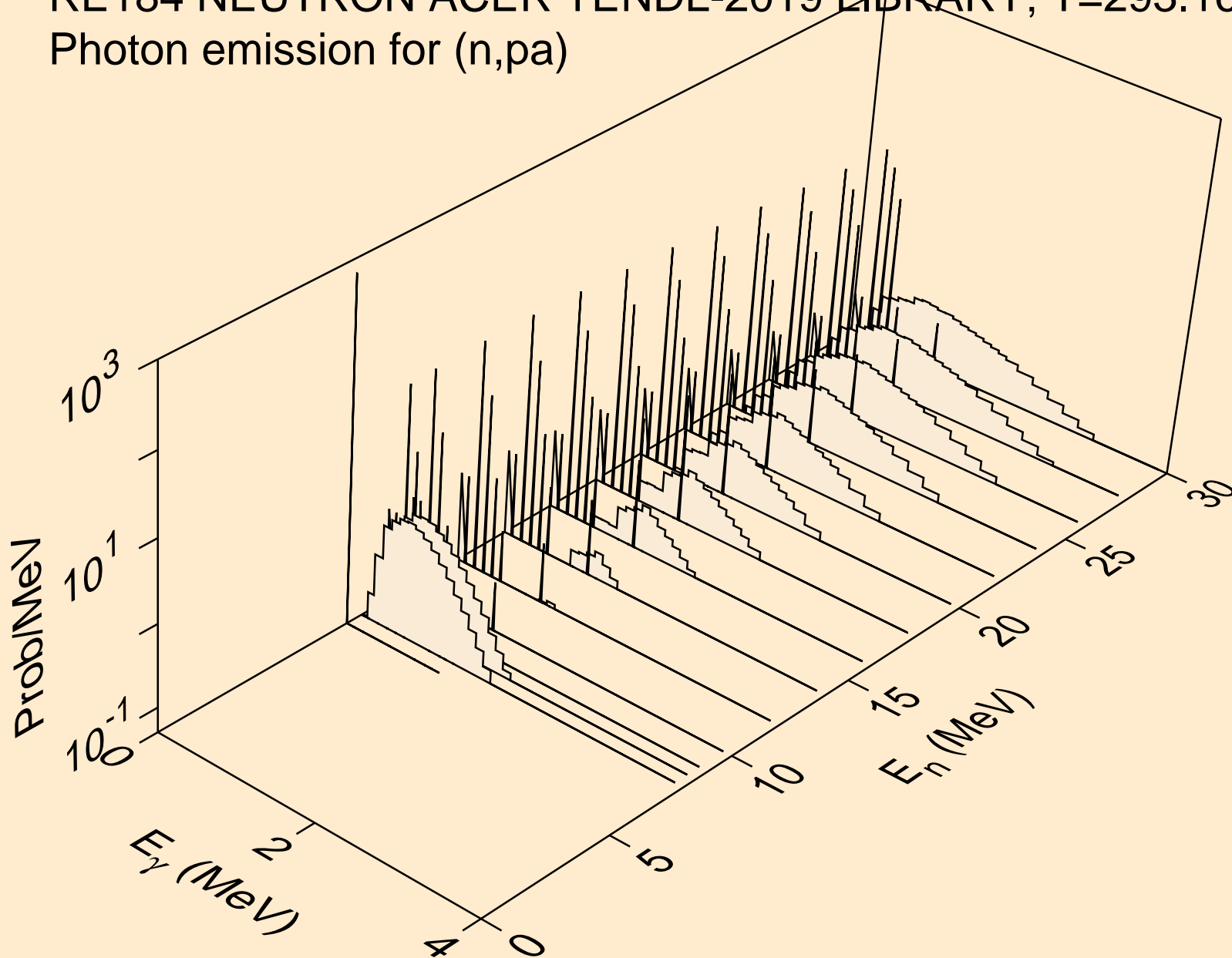

RE184 NEUTRON ACER TENDL-2019 LIBRARY; T=293.16K
Photon emission for (n,pd)

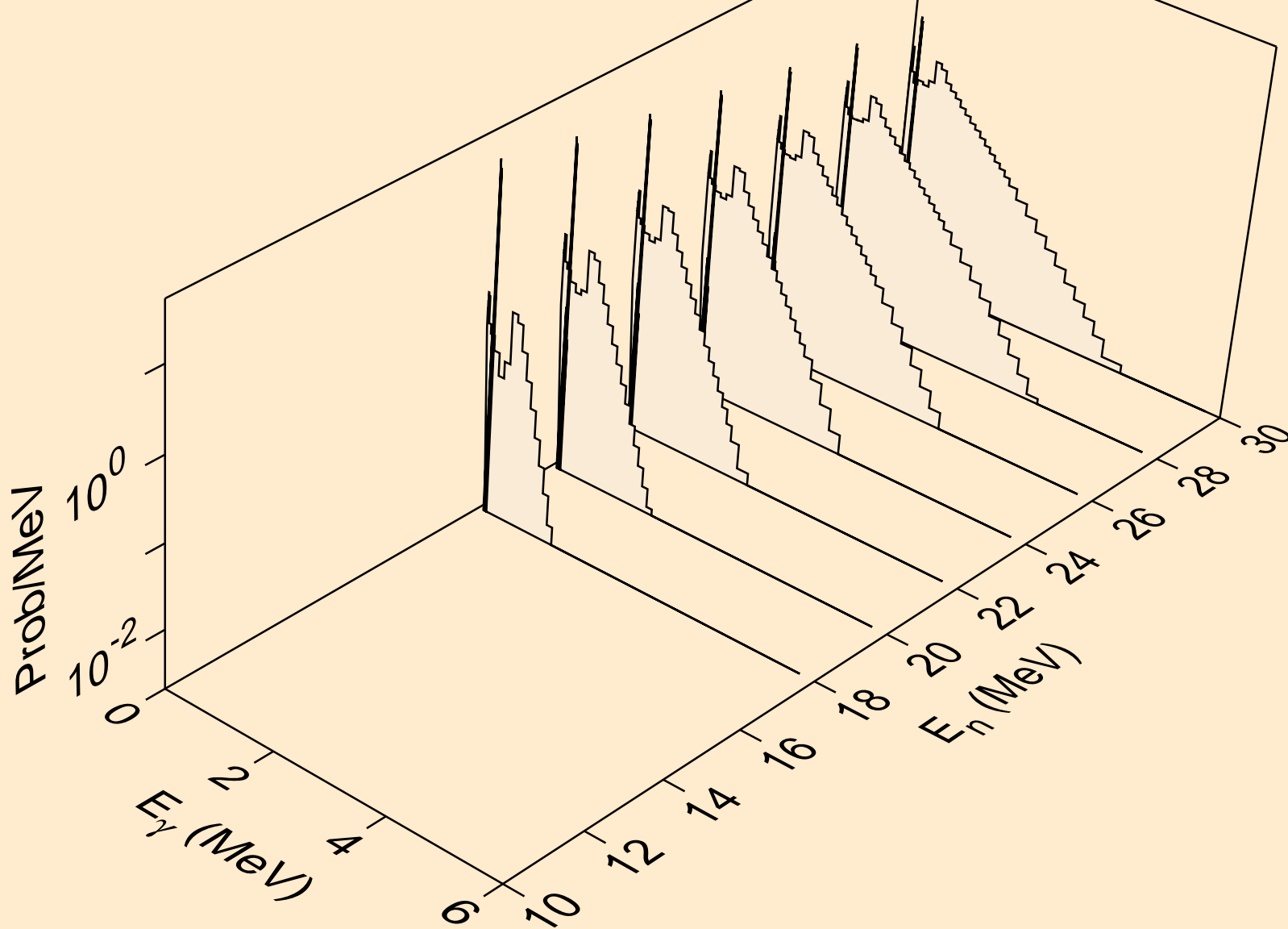

RE184 NEUTRON ACER TENDL-2019 LIBRARY; T=293.16K
Photon emission for (n,pt)

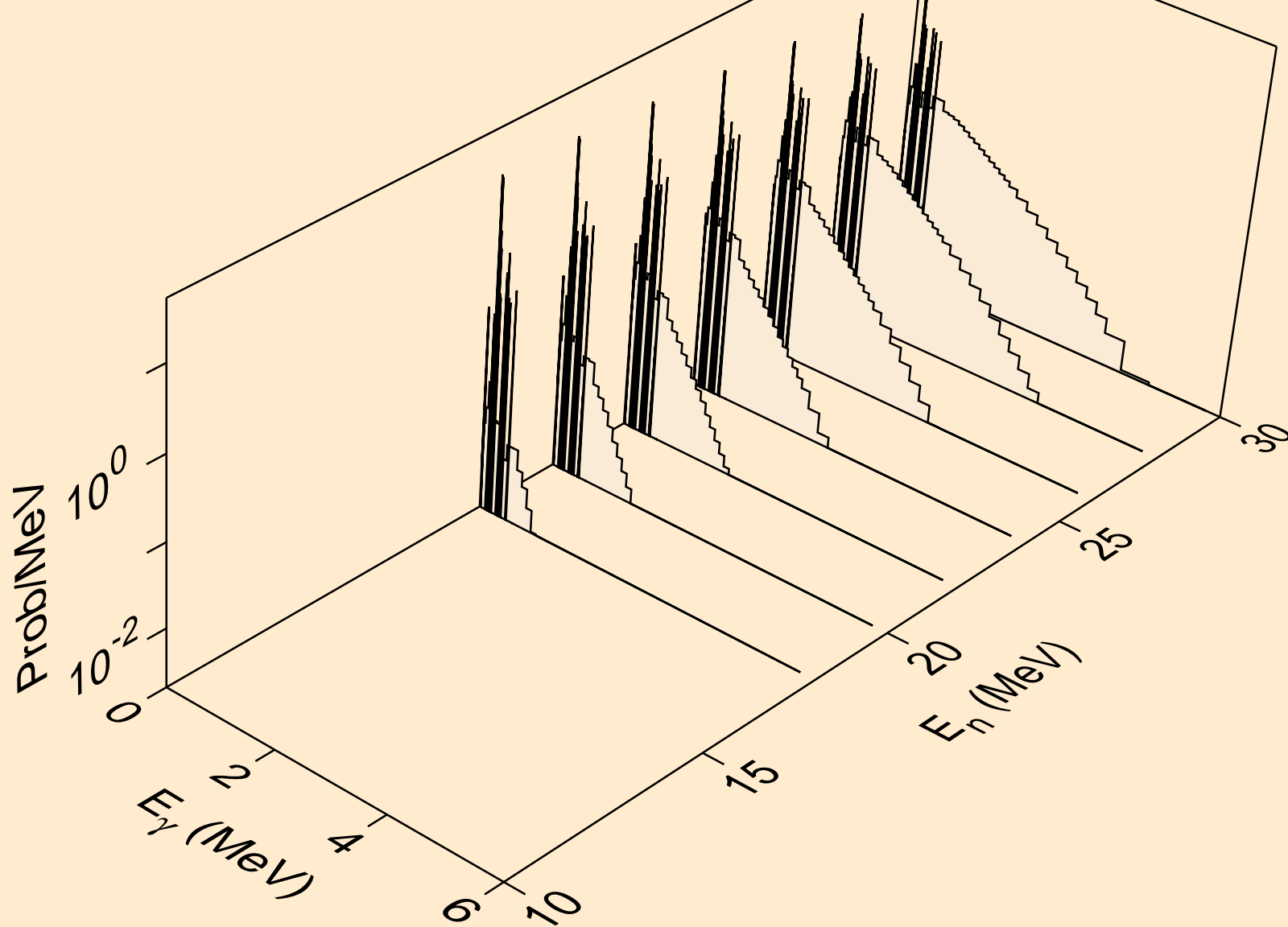

RE184 NEUTRON ACER TENDL-2019 LIBRARY; T=293.16K
Photon emission for (n,da)

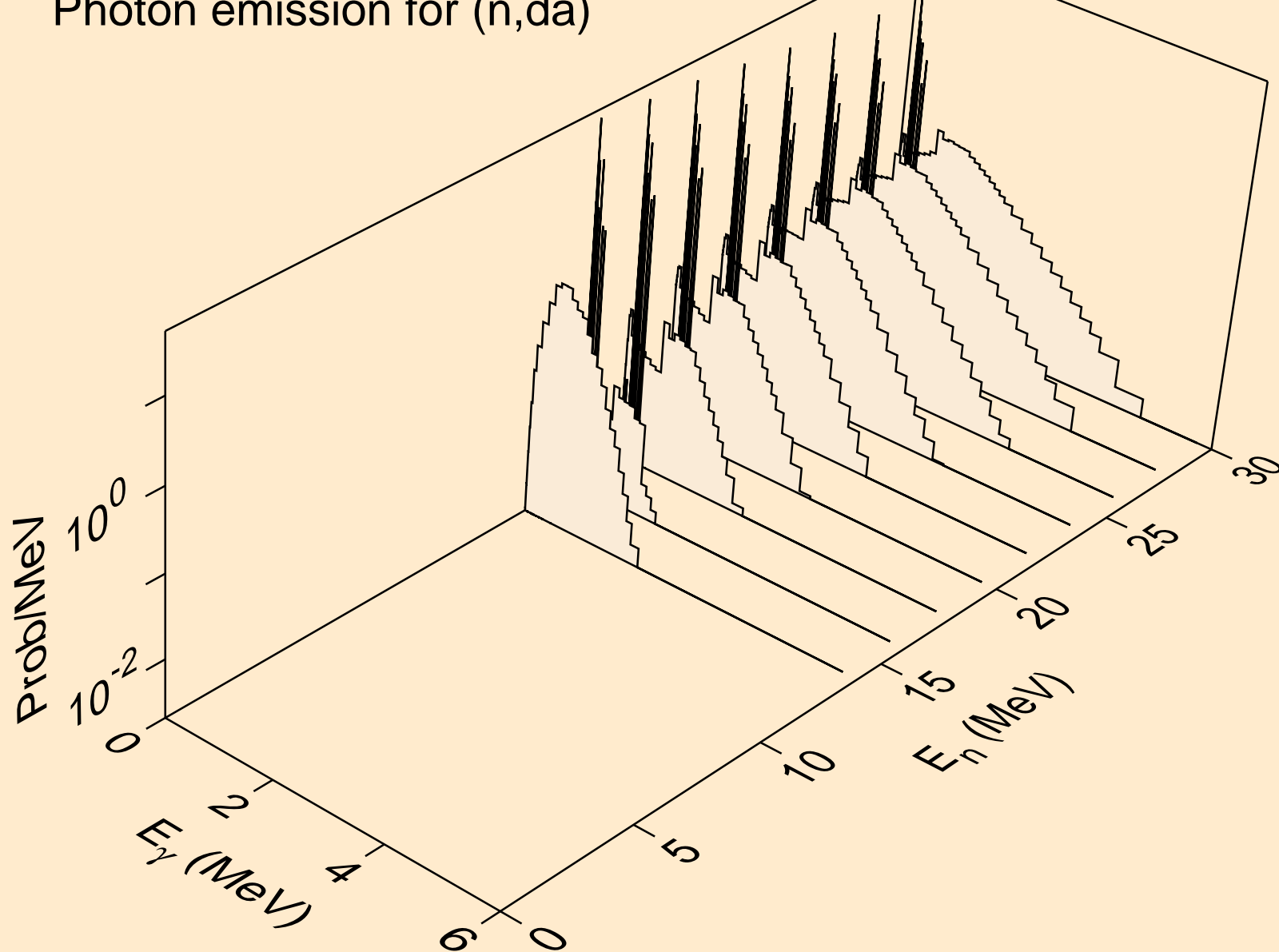

RE184 NEUTRON ACER TENDL-2019 LIBRARY; T=293.16K
thermal capture photon spectrum

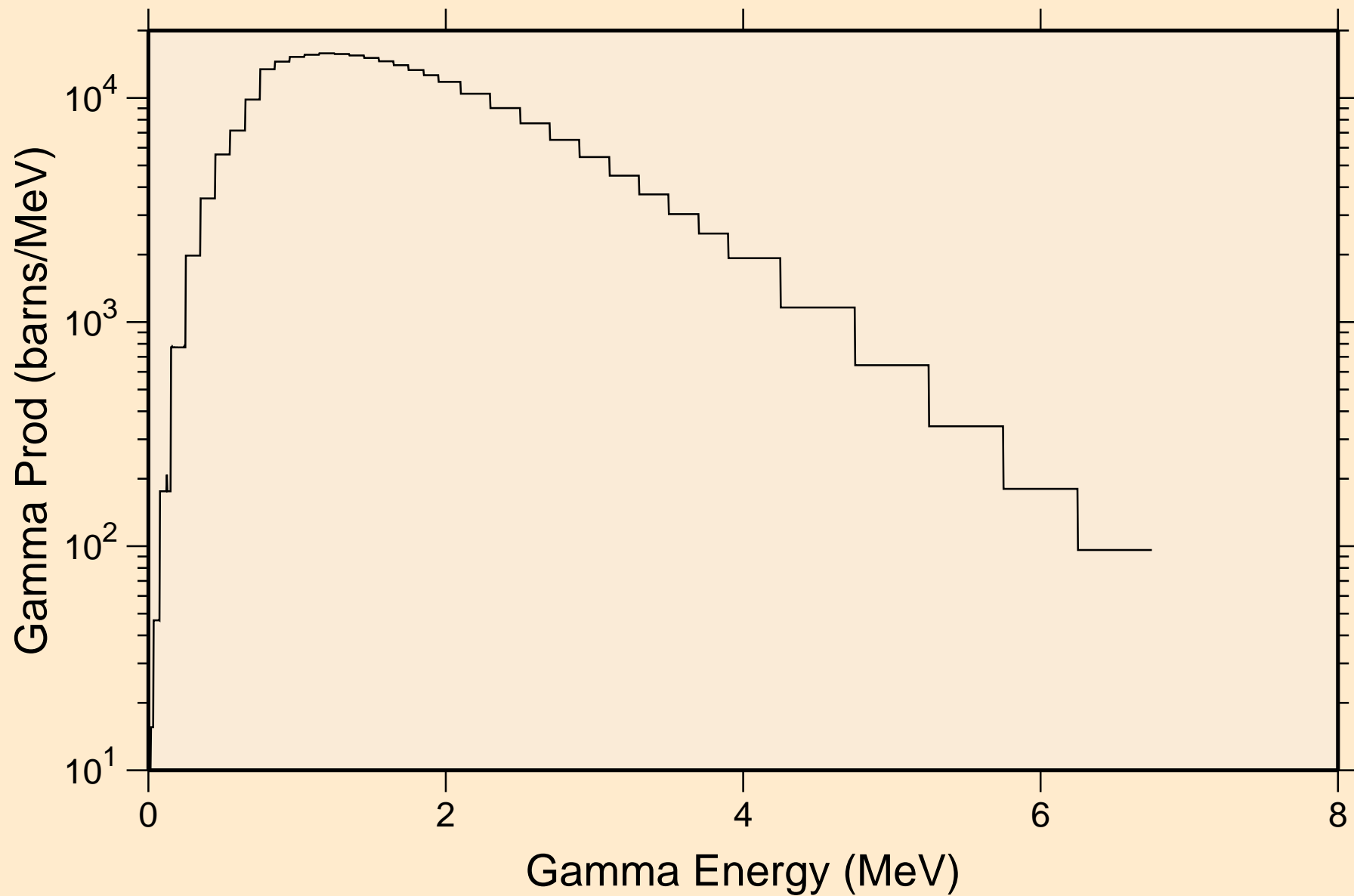

RE184 NEUTRON ACER TENDL-2019 LIBRARY; T=293.16K
14 MeV photon spectrum

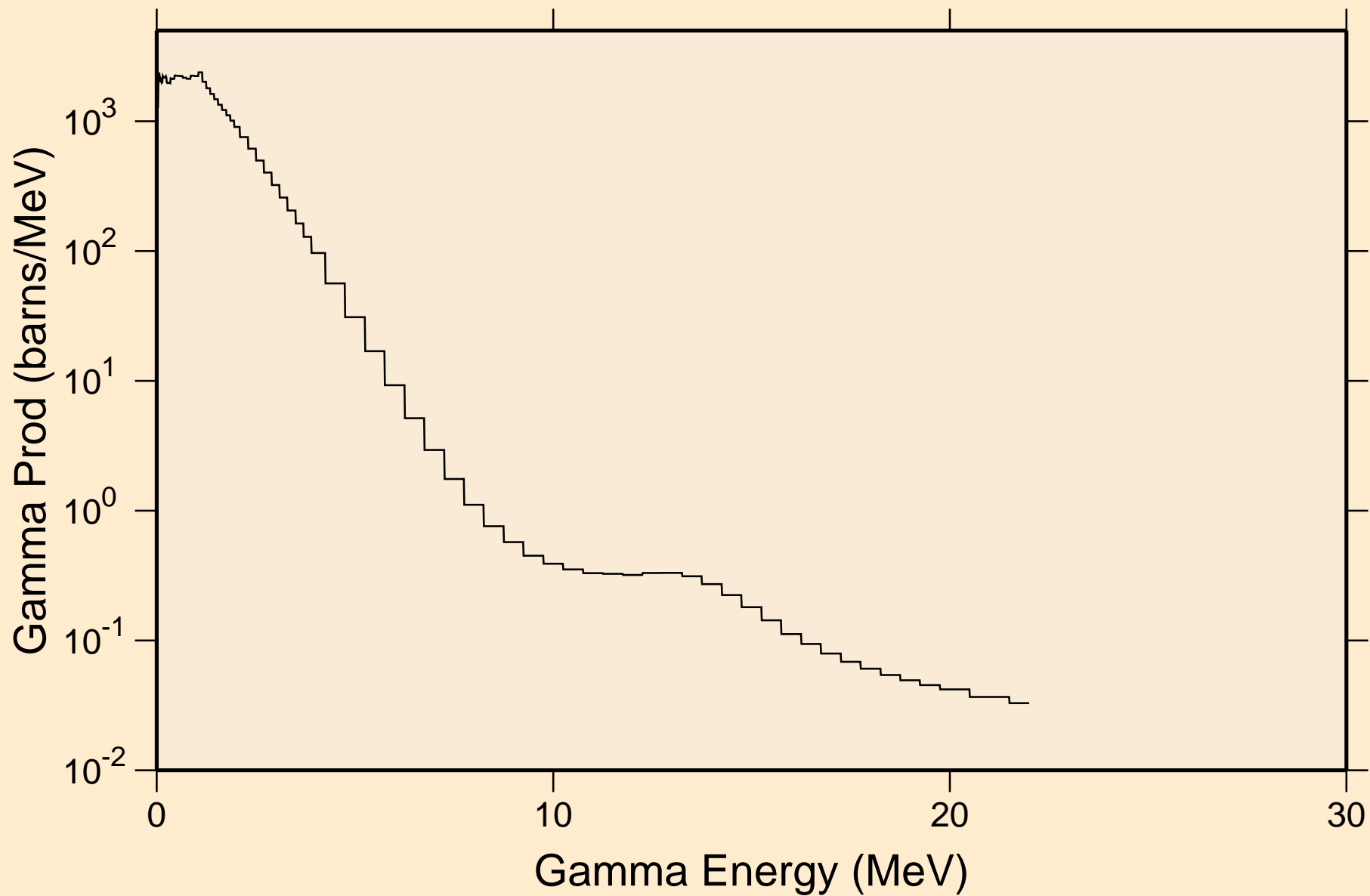

RE184 NEUTRON ACER TENDL-2019 LIBRARY; T=293.16K
Particle heating contributions

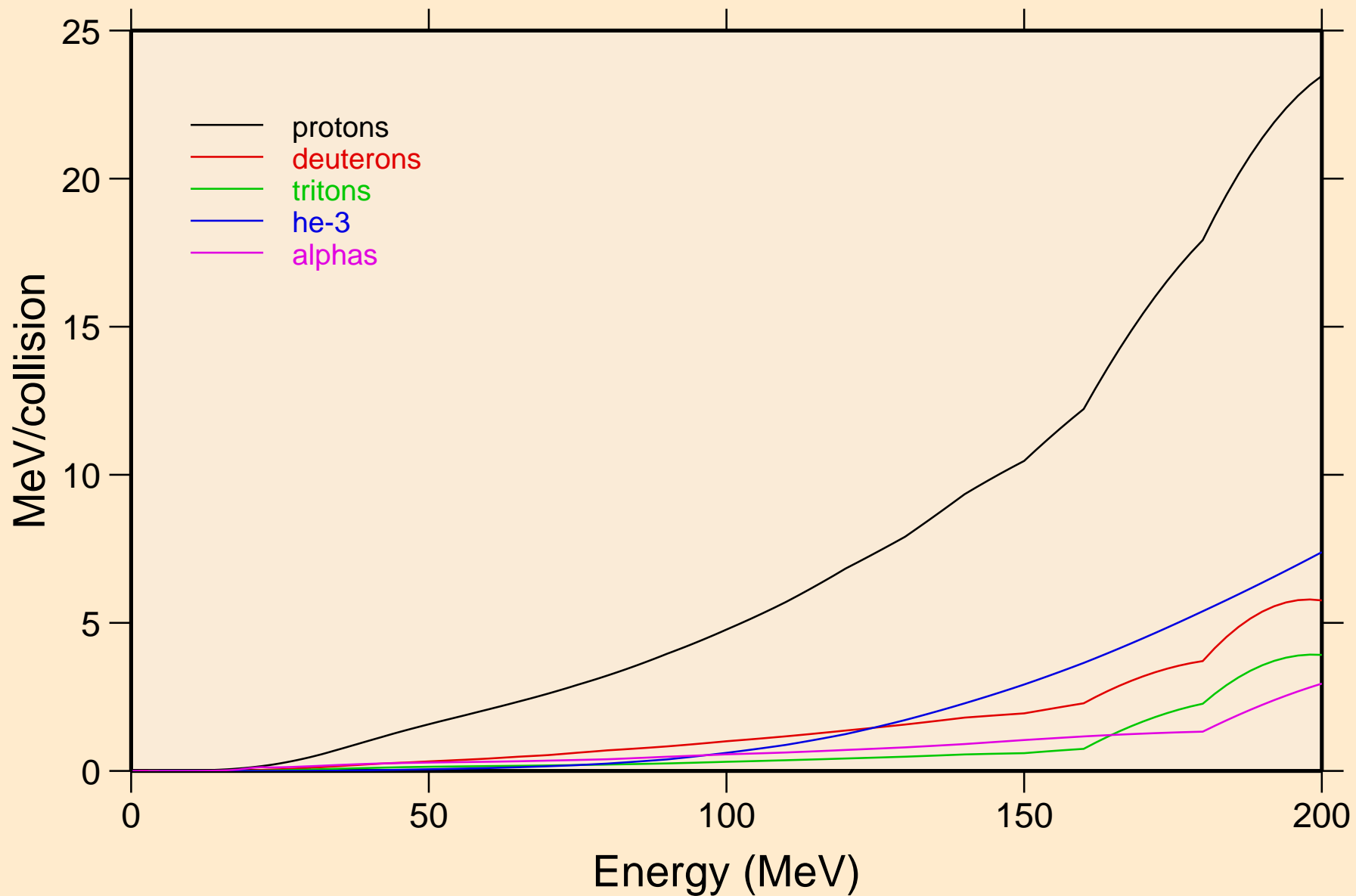

RE184 NEUTRON ACER TENDL-2019 LIBRARY; T=293.16K
Recoil Heating

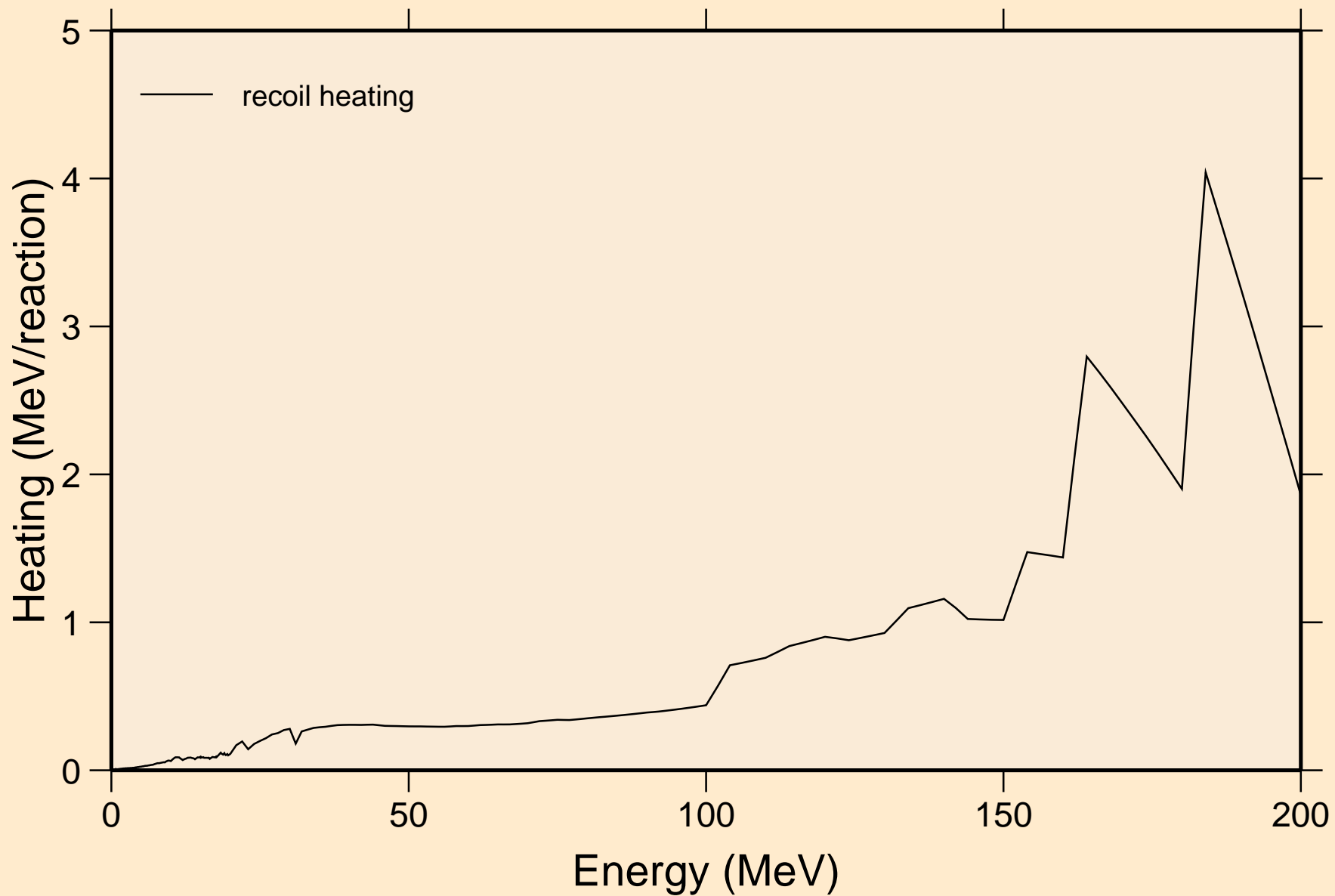

RE184 NEUTRON ACER TENDL-2019 LIBRARY; T=293.16K
Particle production cross sections

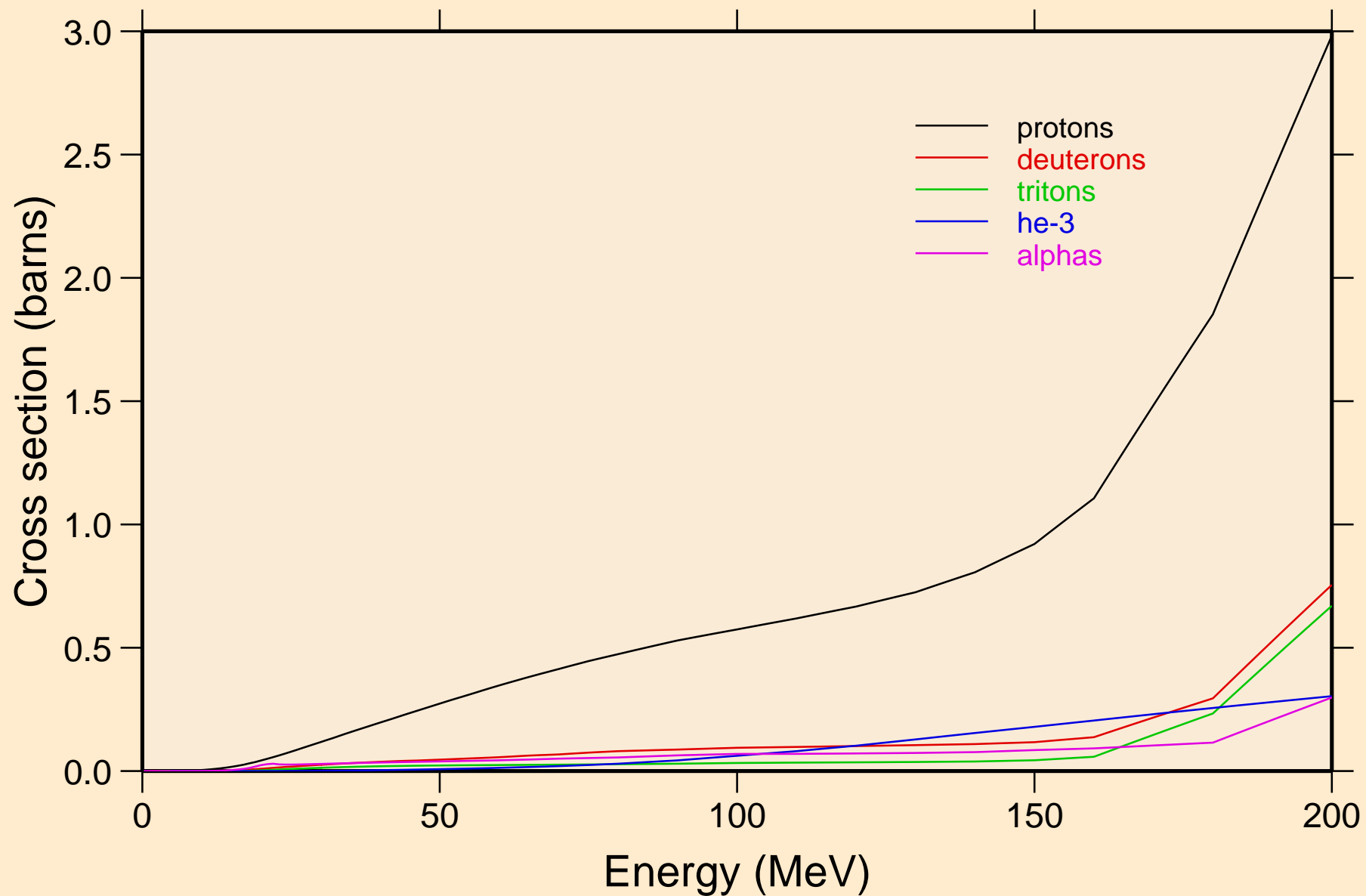

RE184 NEUTRON ACER TENDL-2019 LIBRARY; T=293.16K
protons from (n,x)

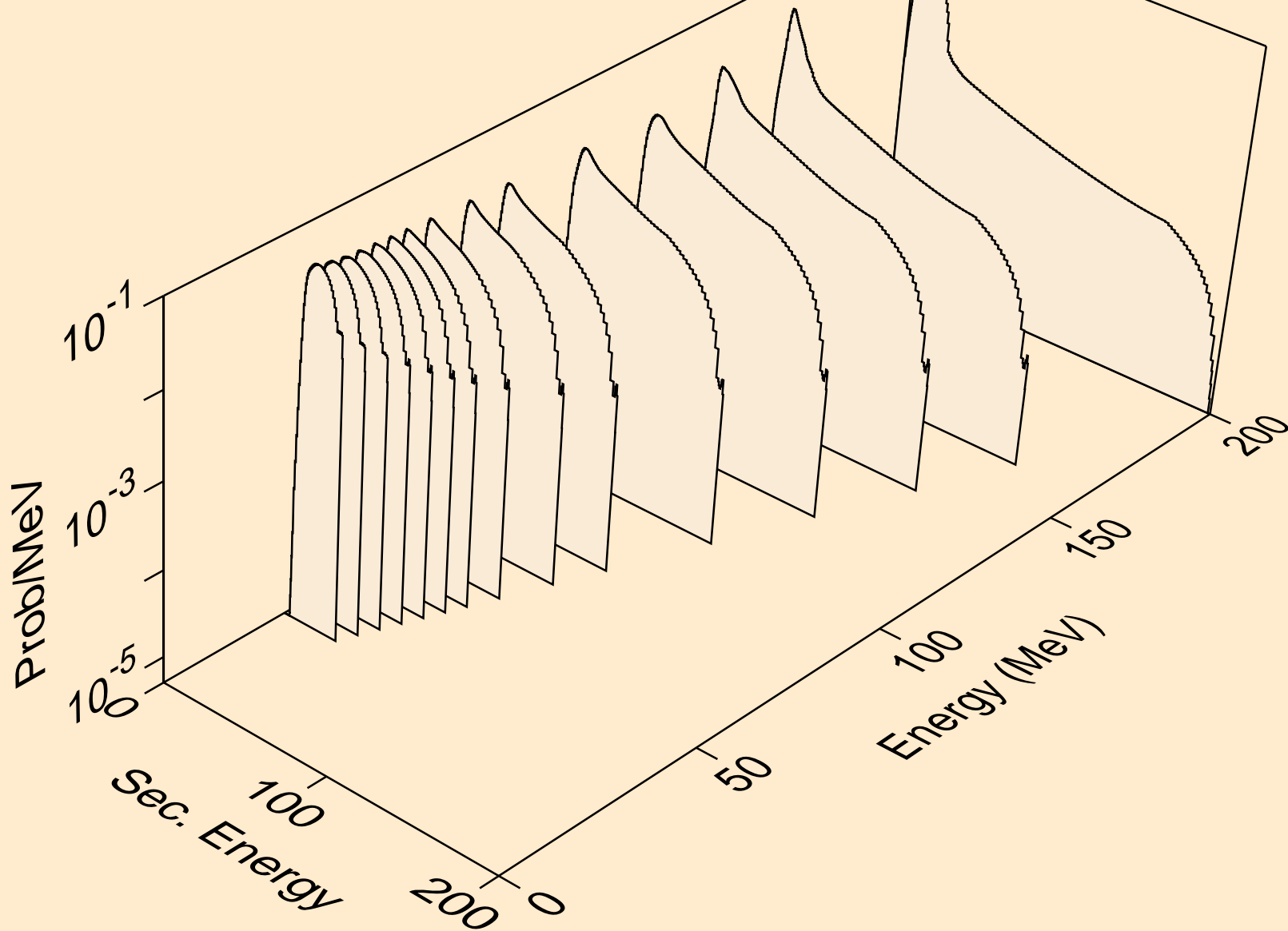

RE184 NEUTRON ACER TENDL-2019 LIBRARY; T=293.16K
protons from (n,n*)p

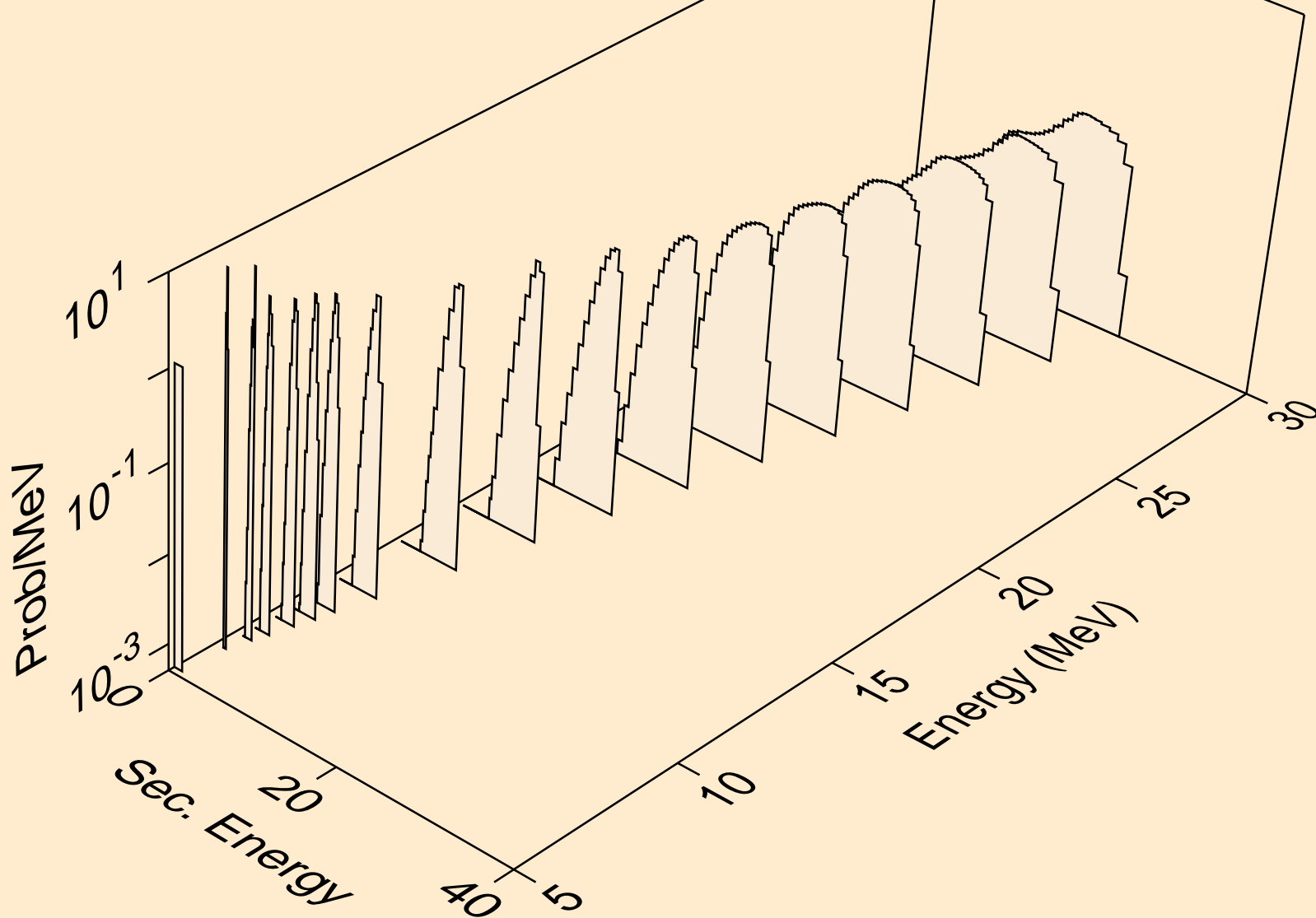

RE184 NEUTRON ACER TENDL-2019 LIBRARY; T=293.16K
protons from (n,2np)

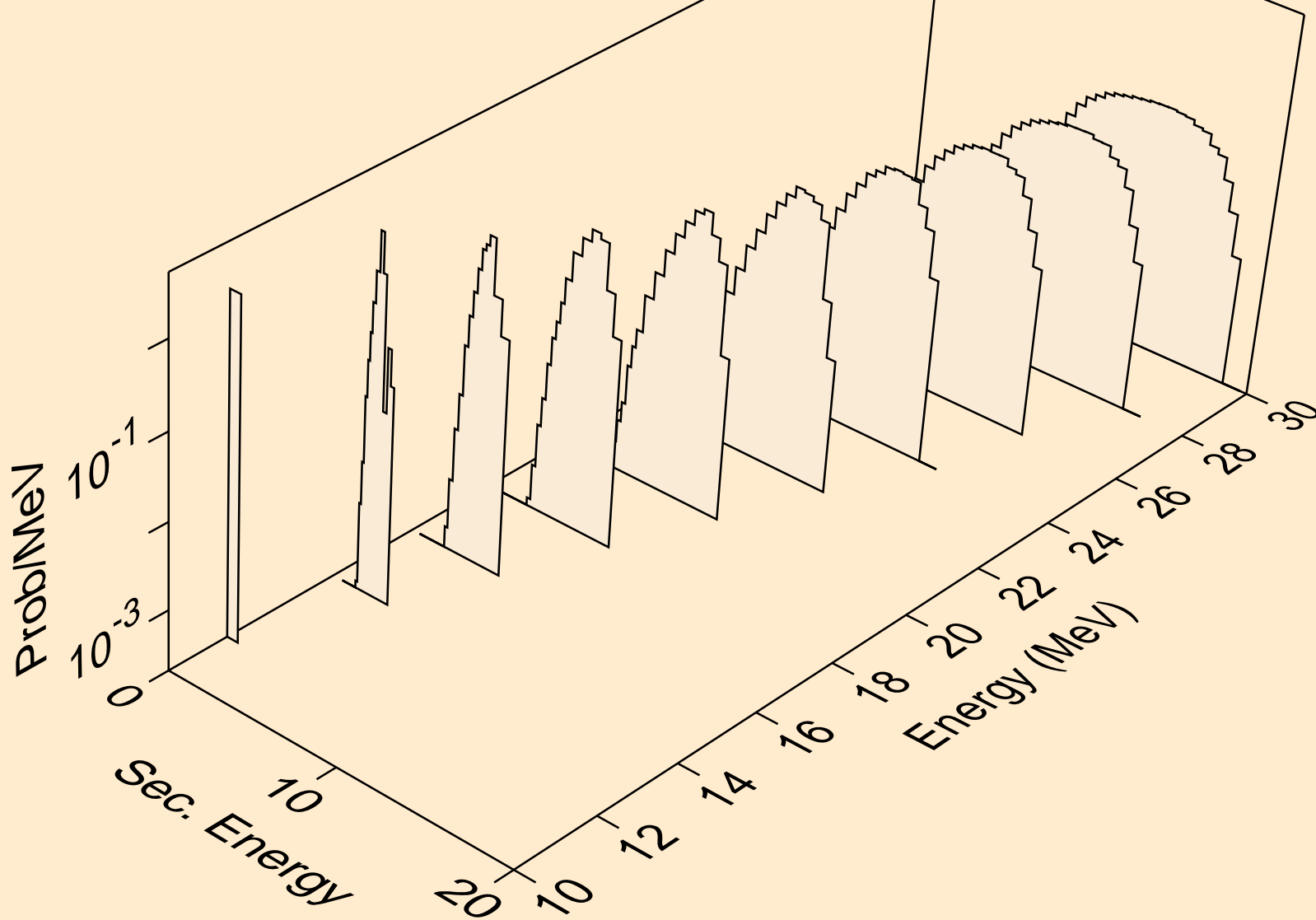

RE184 NEUTRON ACER TENDL-2019 LIBRARY; T=293.16K
protons from (n,3np)

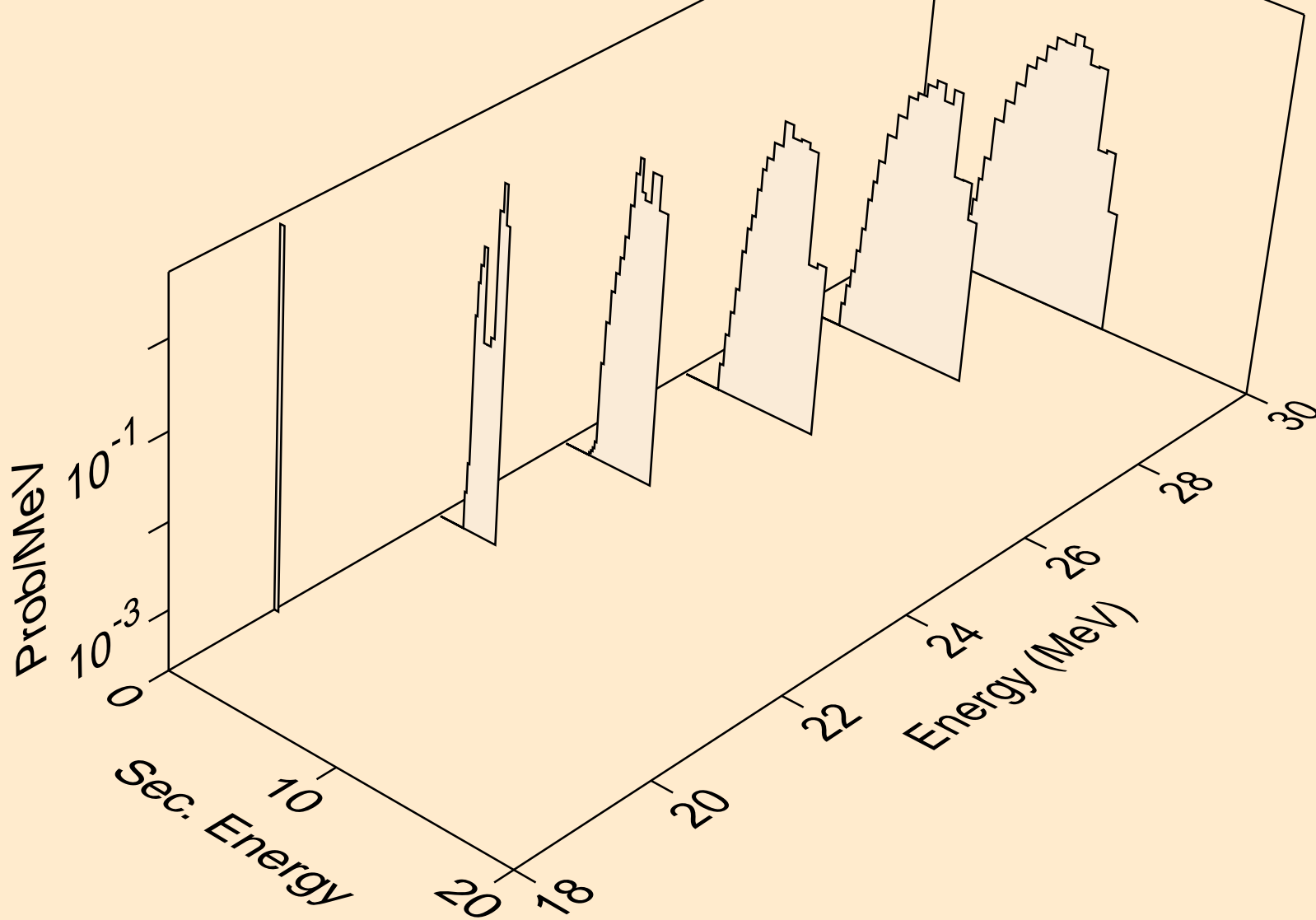

RE184 NEUTRON ACER TENDL-2019 LIBRARY; T=293.16K
protons from (n,2np)

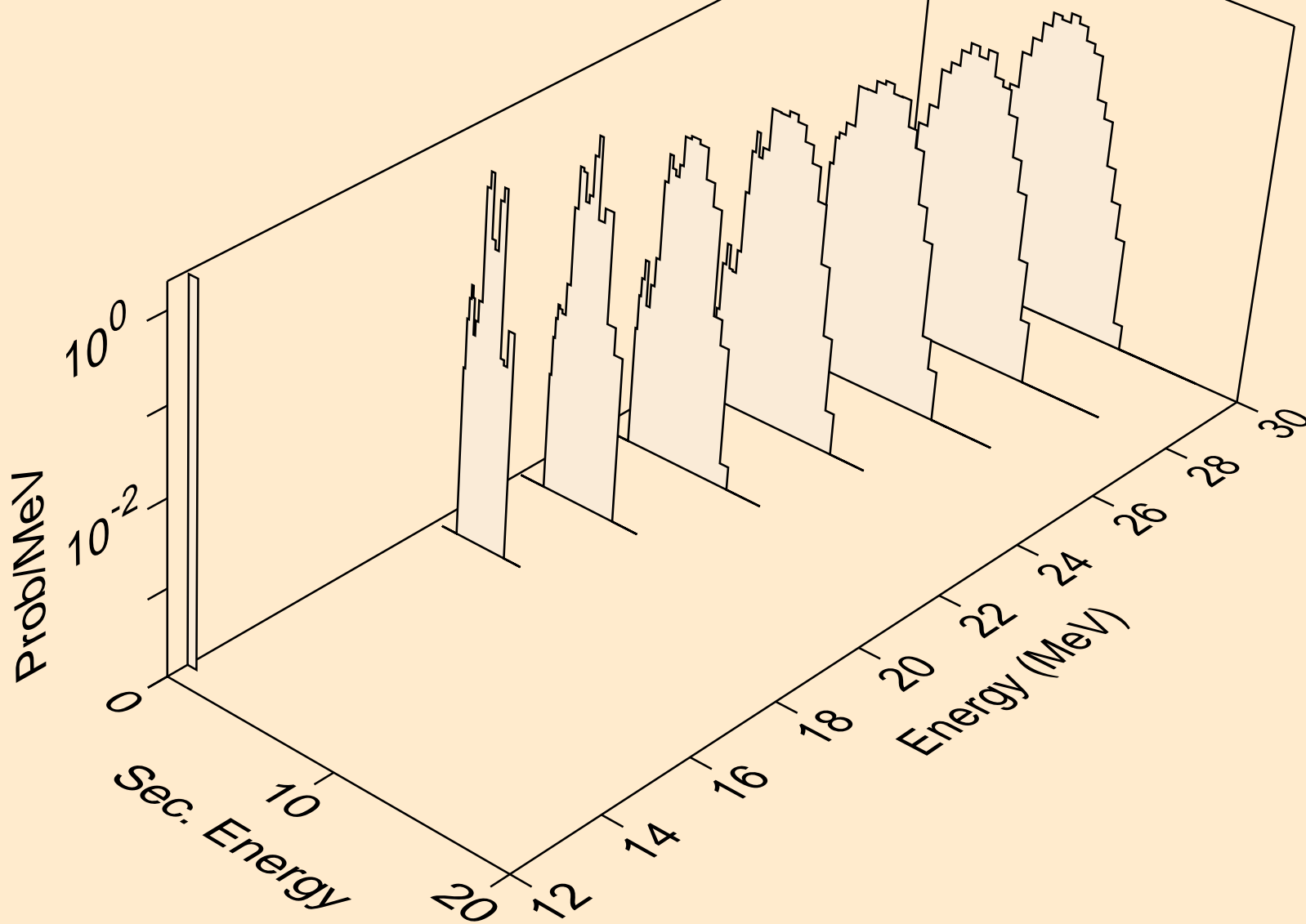

RE184 NEUTRON ACER TENDL-2019 LIBRARY; T=293.16K
protons from (n,npa)

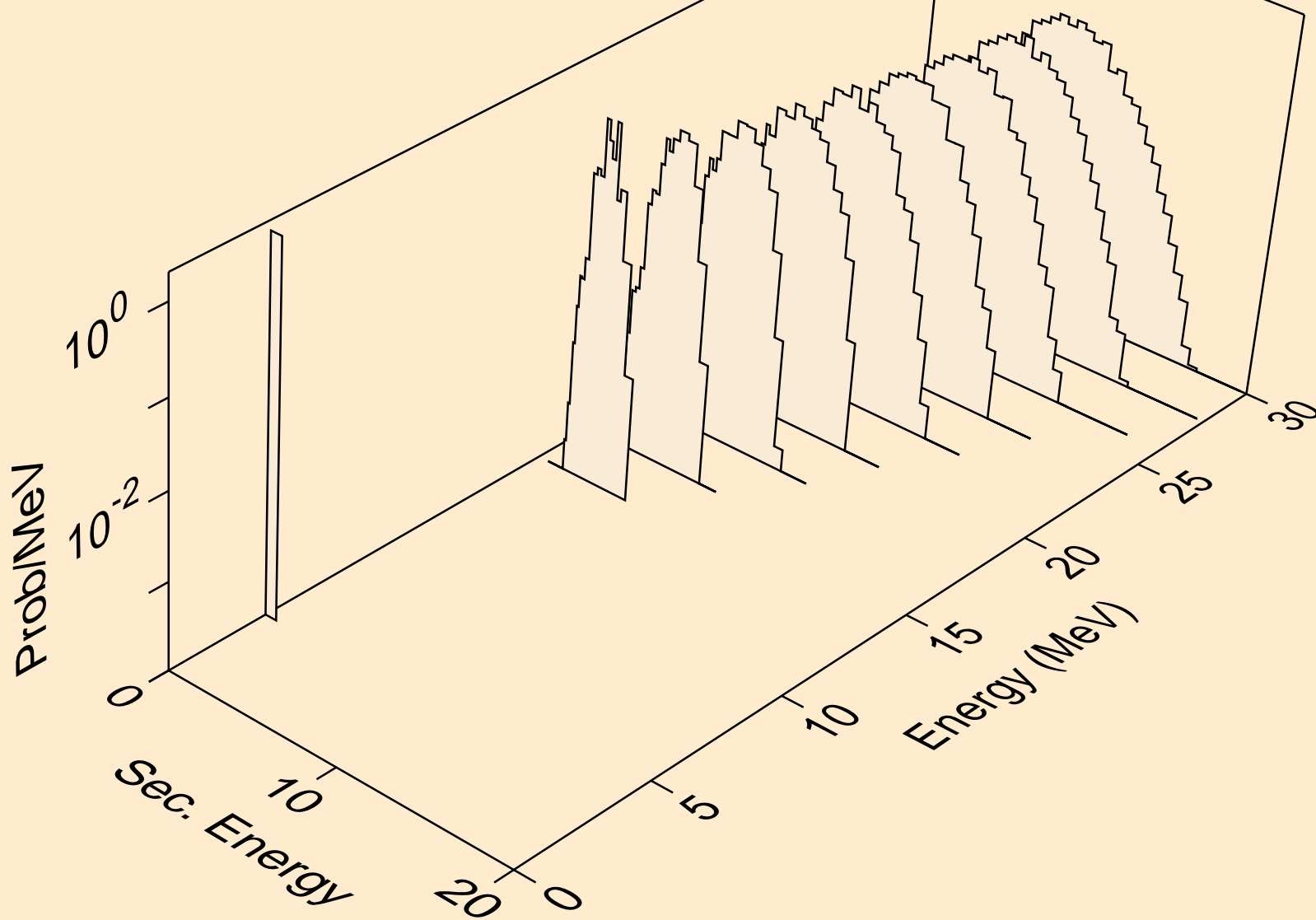

RE184 NEUTRON ACER TENDL-2019 LIBRARY; T=293.16K
protons from (n,p)

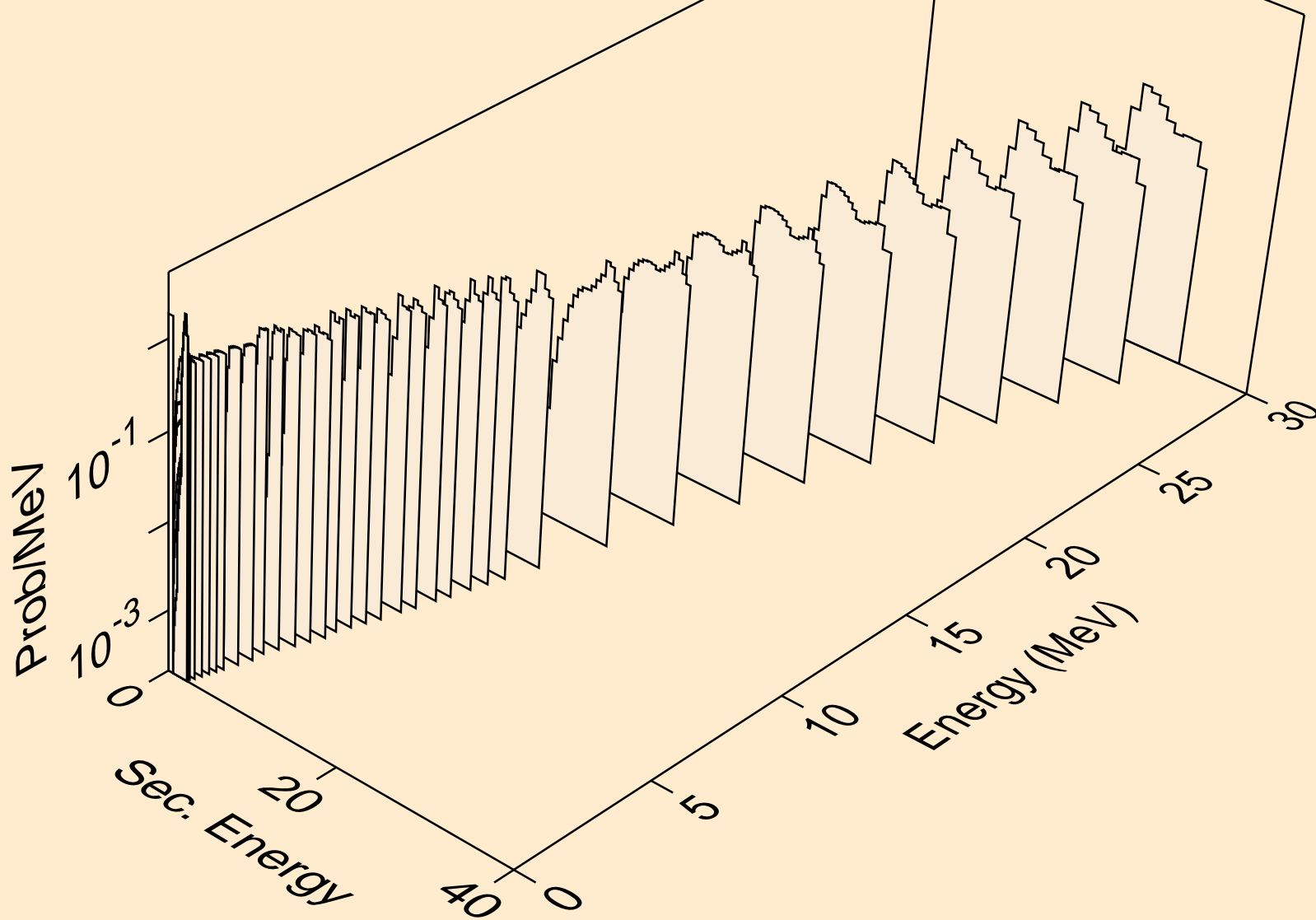

RE184 NEUTRON ACER TENDL-2019 LIBRARY; T=293.16K
protons from (n,2p)

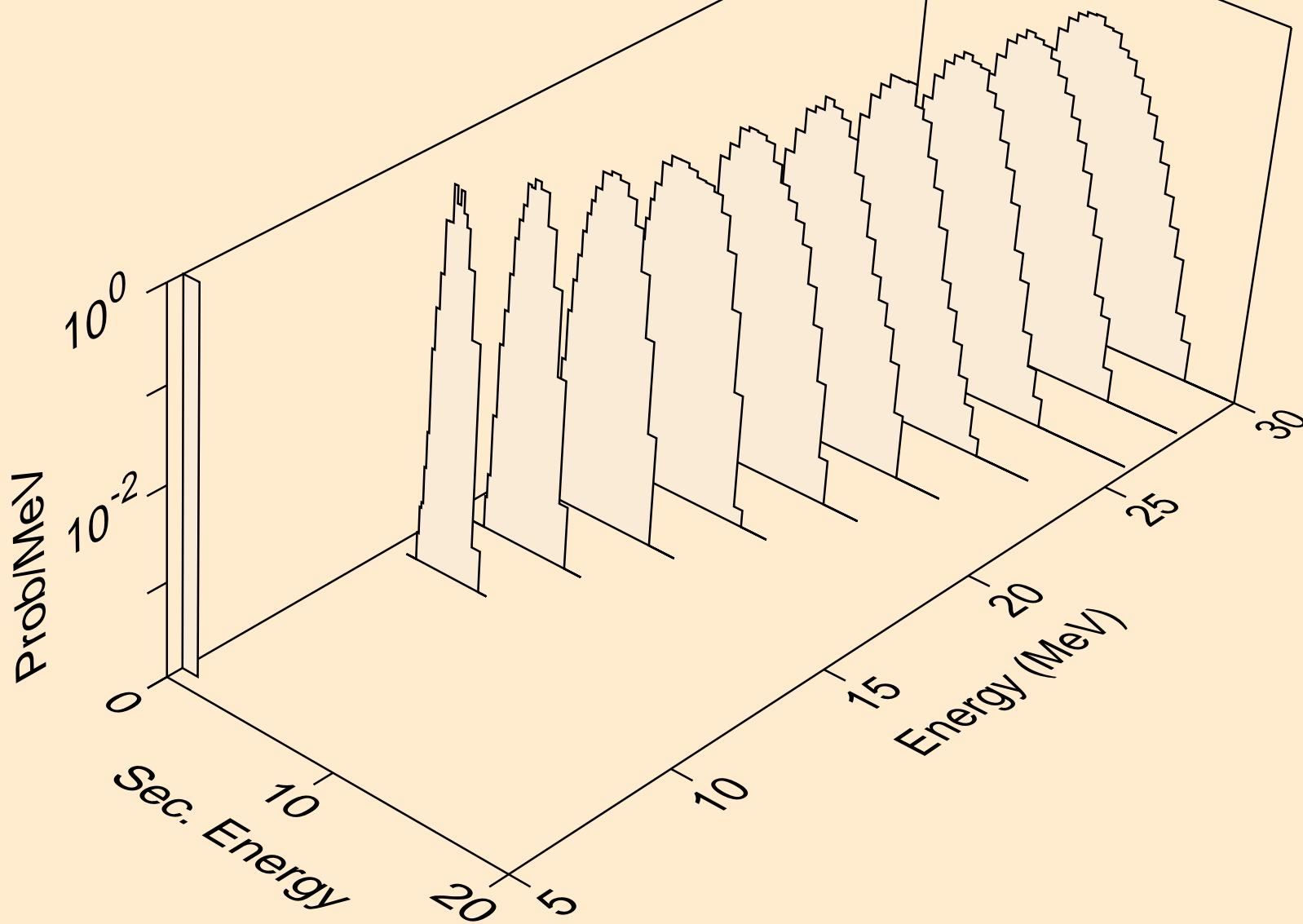

RE184 NEUTRON ACER TENDL-2019 LIBRARY; T=293.16K
protons from (n,p)

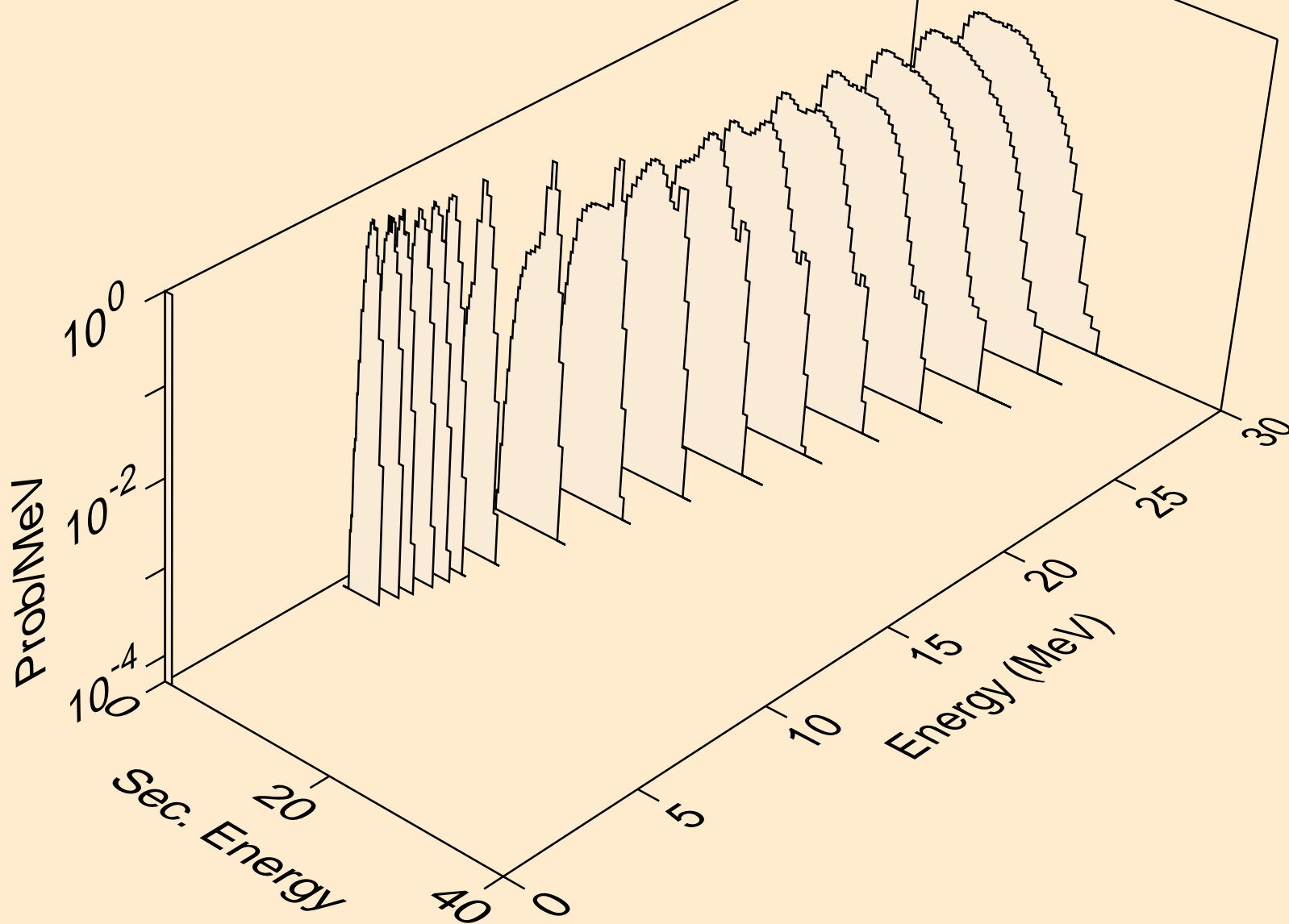

RE184 NEUTRON ACER TENDL-2019 LIBRARY; T=293.16K
protons from (n,pd)

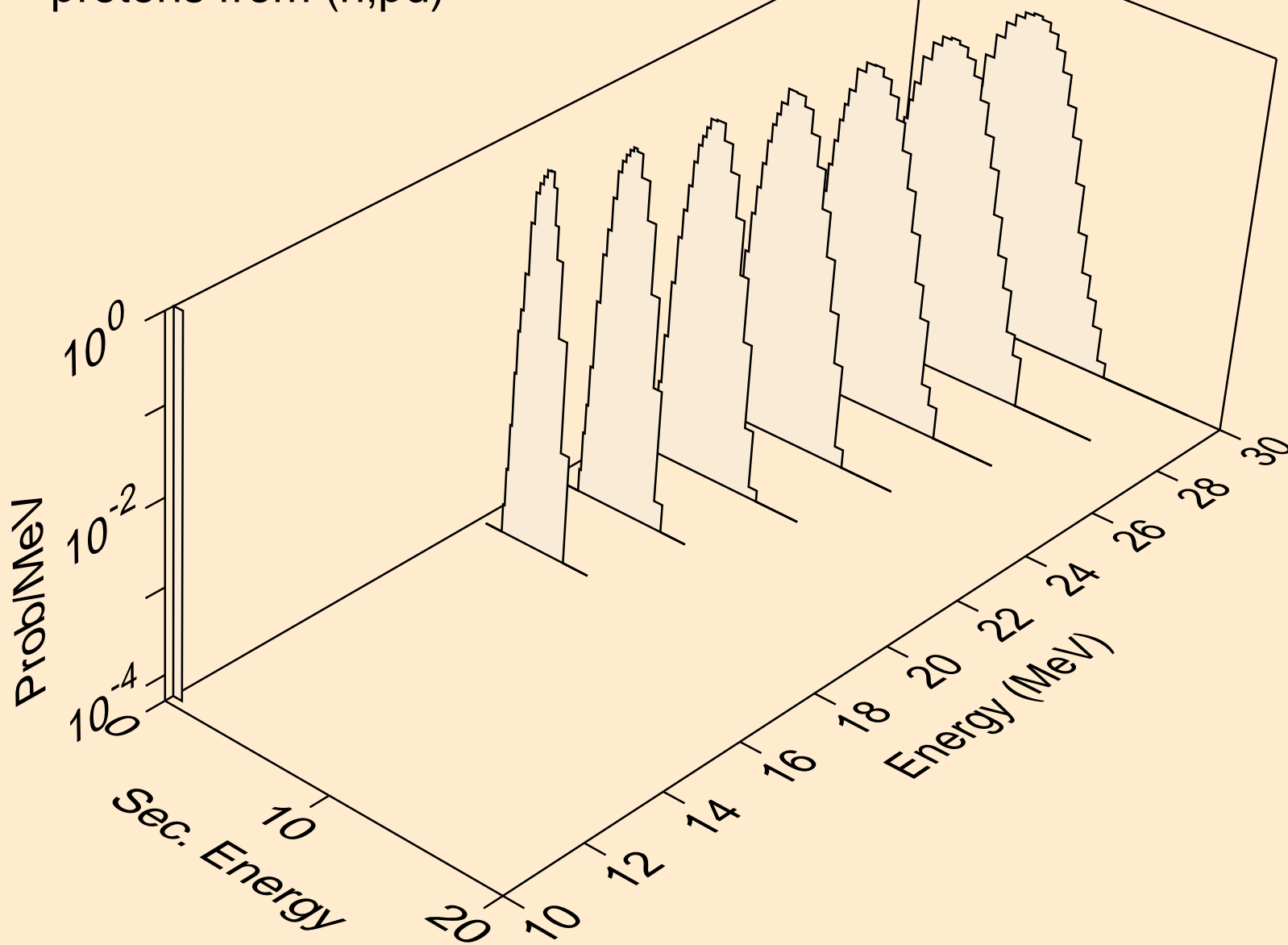

RE184 NEUTRON ACER TENDL-2019 LIBRARY; T=293.16K
protons from (n,pt)

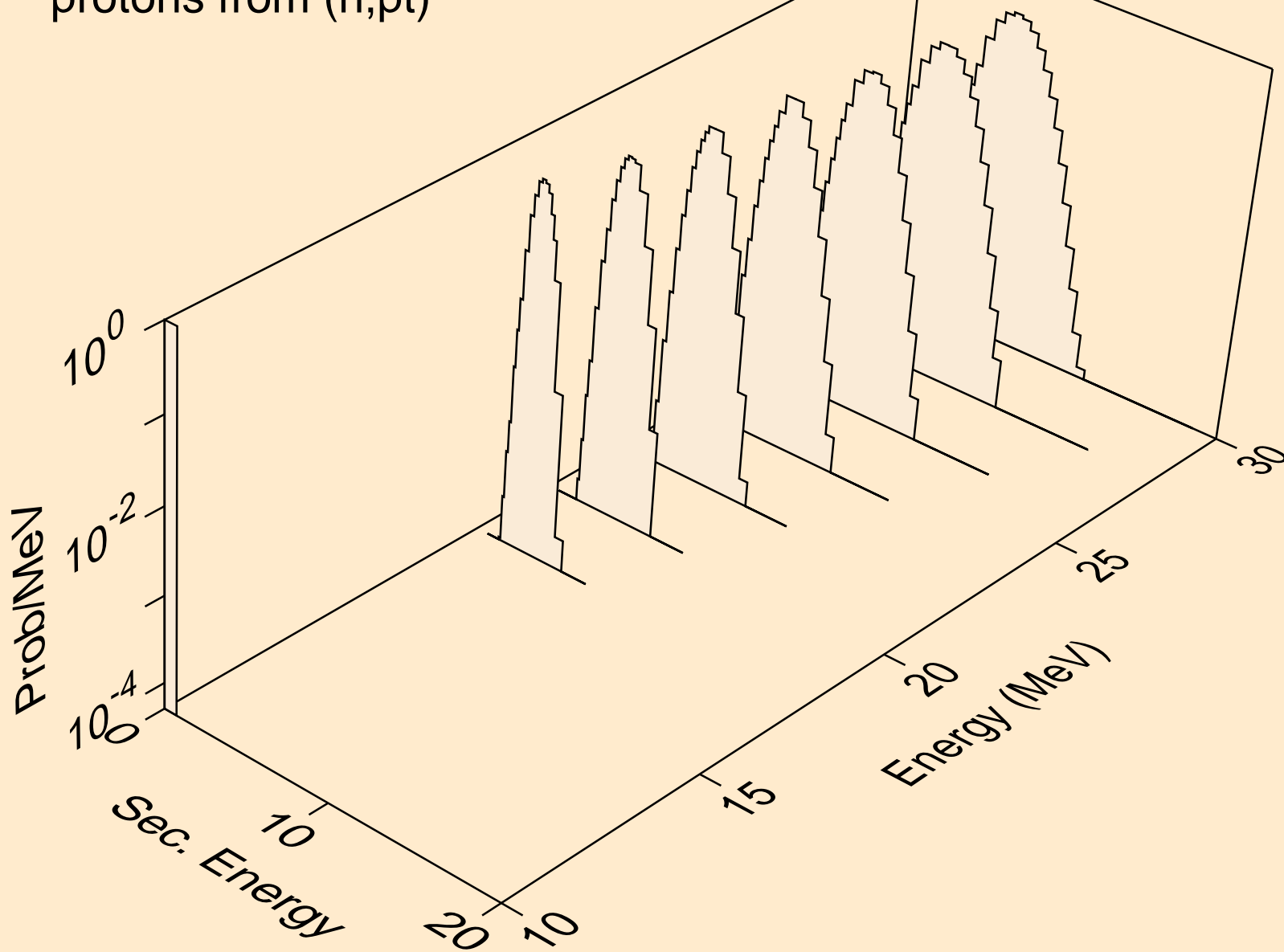

RE184 NEUTRON ACER TENDL-2019 LIBRARY; T=293.16K
deuterons from (n,x)

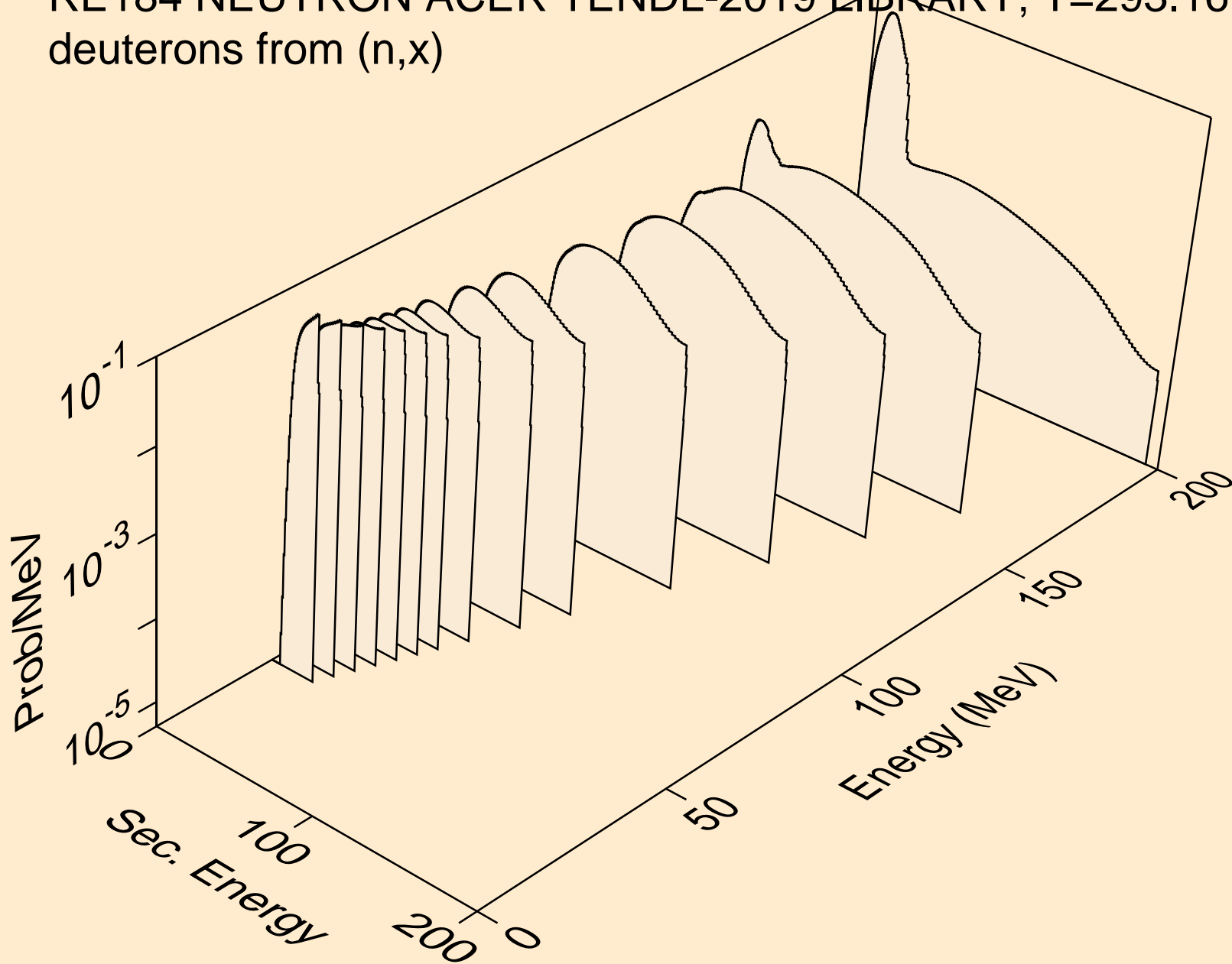

RE184 NEUTRON ACER TENDL-2019 LIBRARY; T=293.16K
deuterons from (n,2nd)

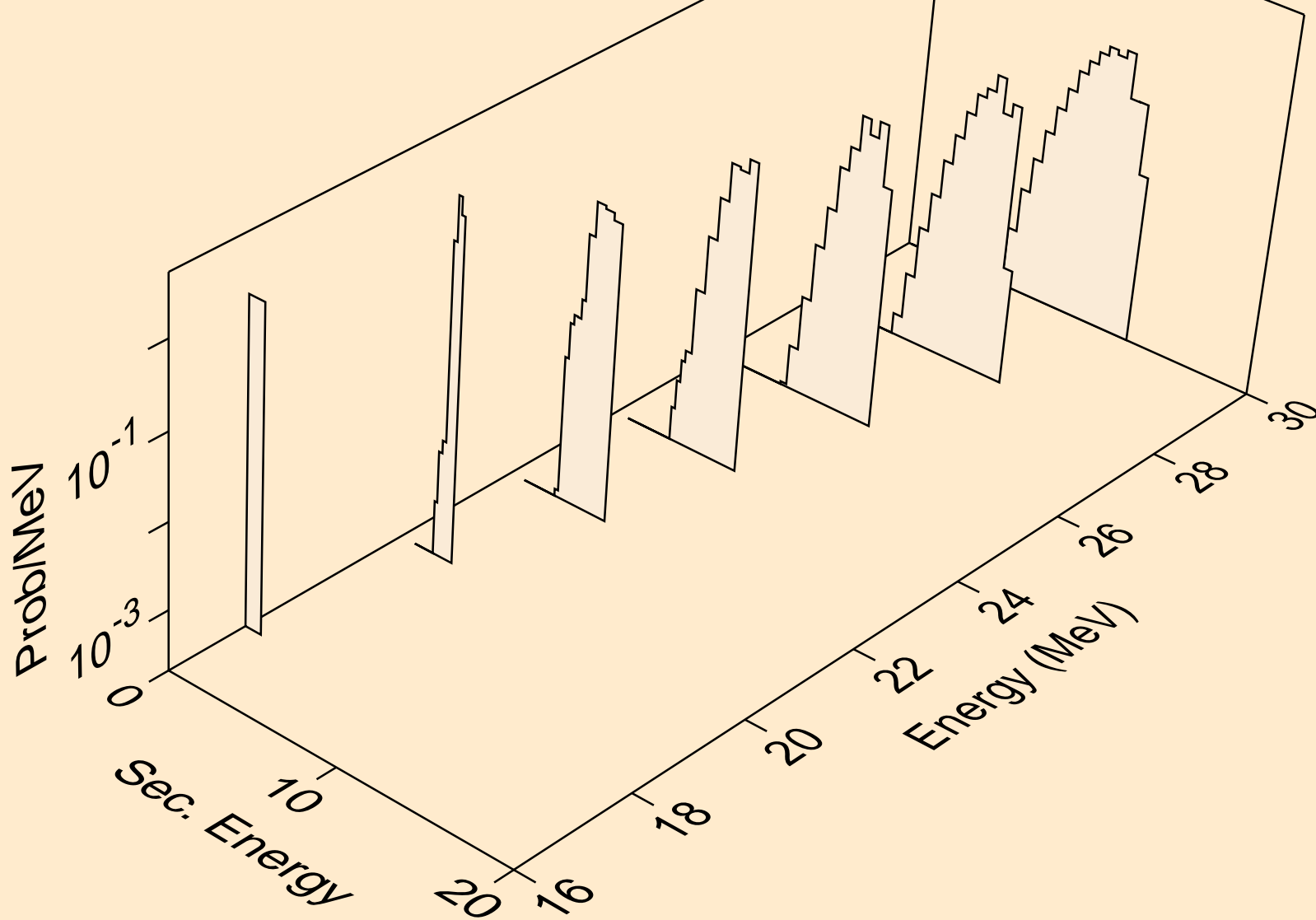

RE184 NEUTRON ACER TENDL-2019 LIBRARY; T=293.16K
deuterons from (n,n*)d

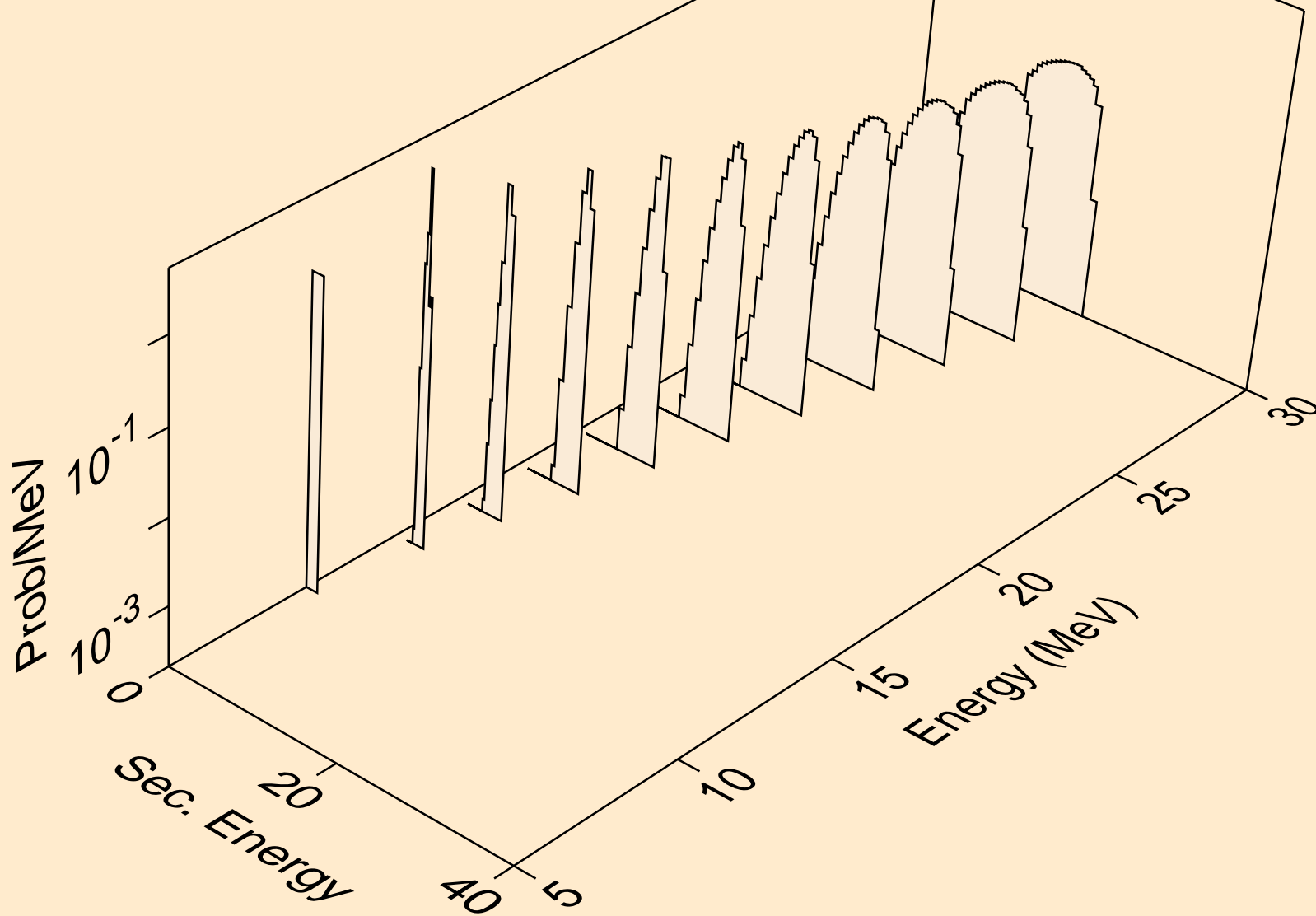

RE184 NEUTRON ACER TENDL-2019 LIBRARY; T=293.16K
deuterons from (n,d)

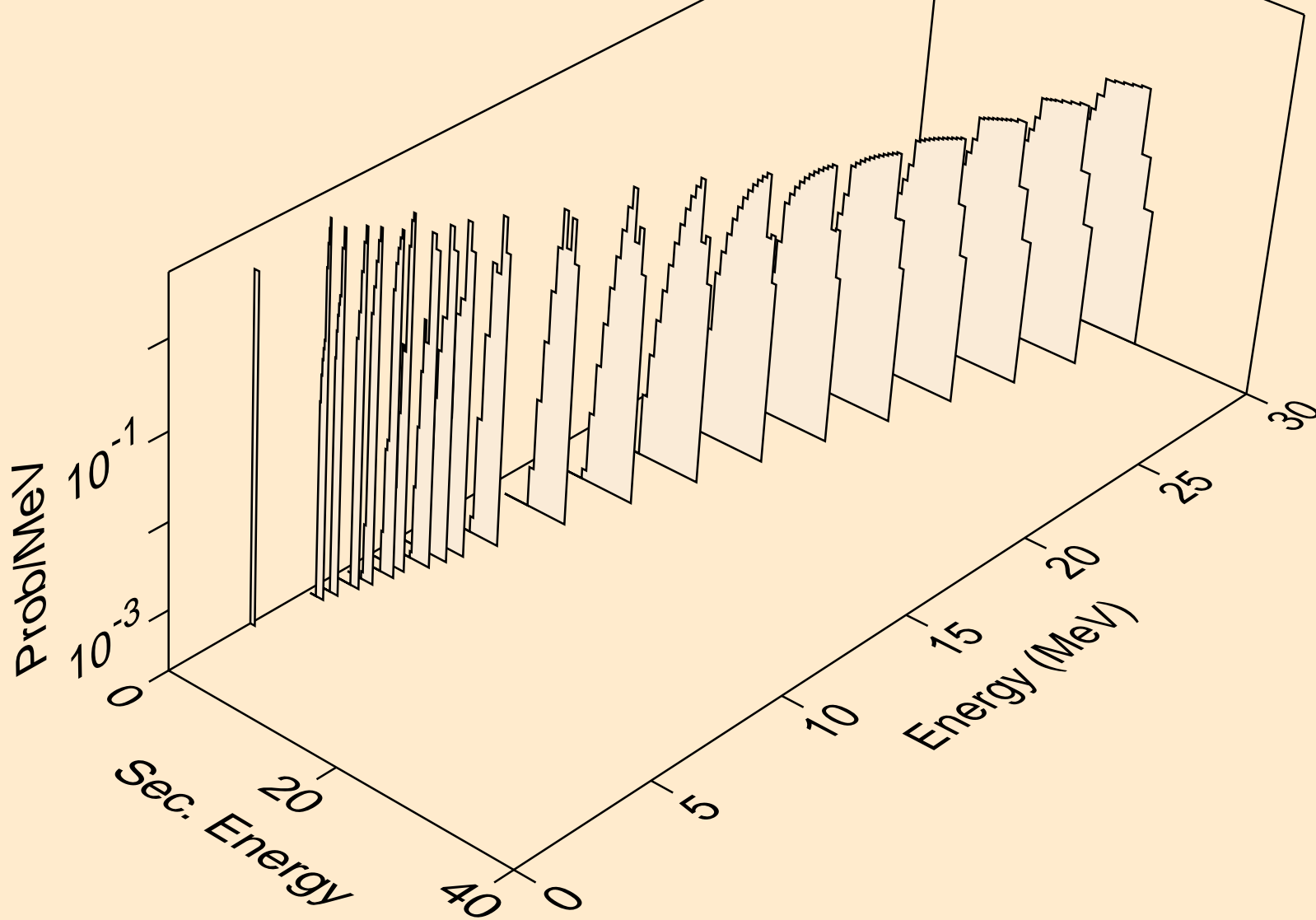

RE184 NEUTRON ACER TENDL-2019 LIBRARY; T=293.16K
deuterons from (n,pd)

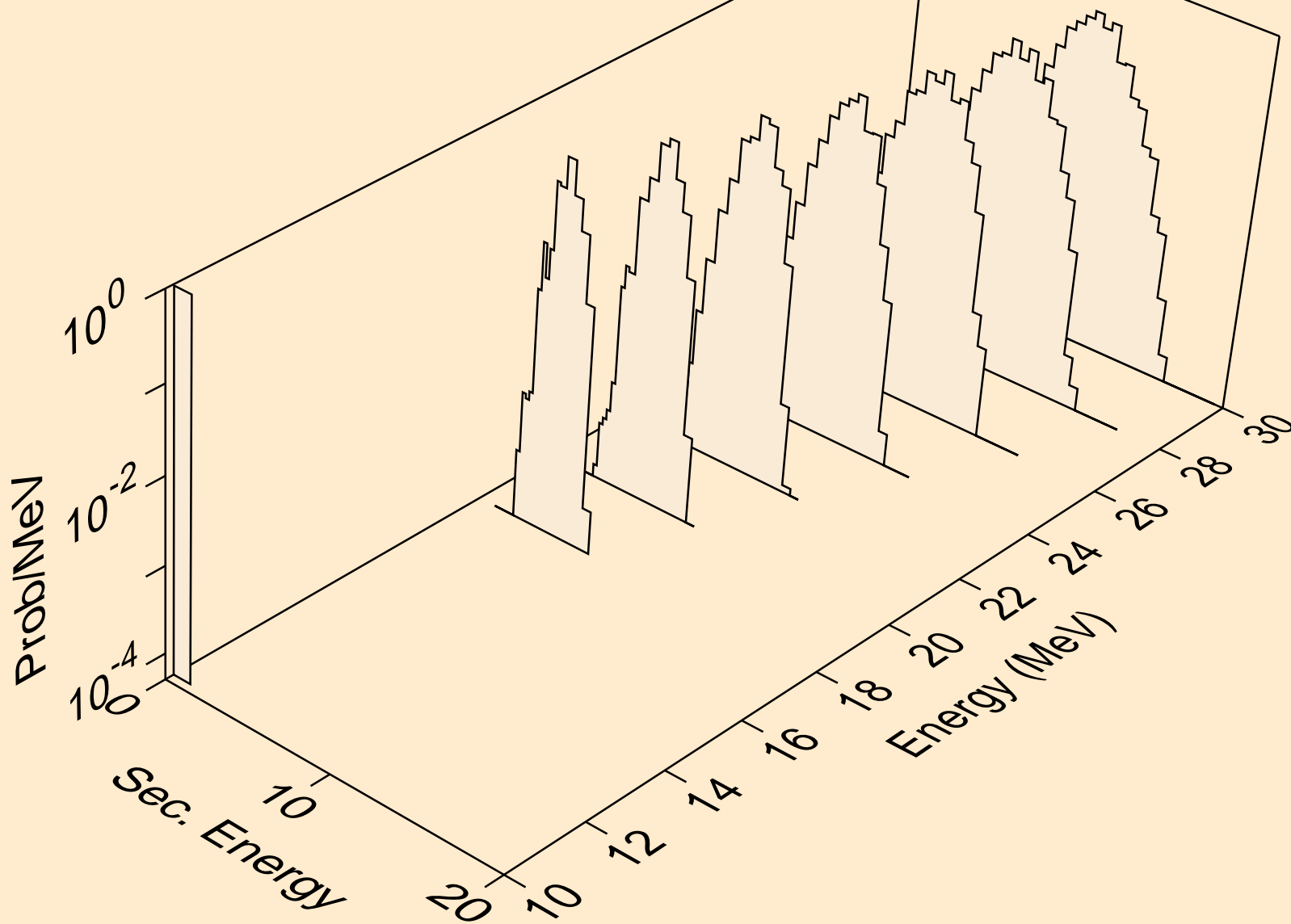

RE184 NEUTRON ACER TENDL-2019 LIBRARY; T=293.16K
deuterons from (n,da)

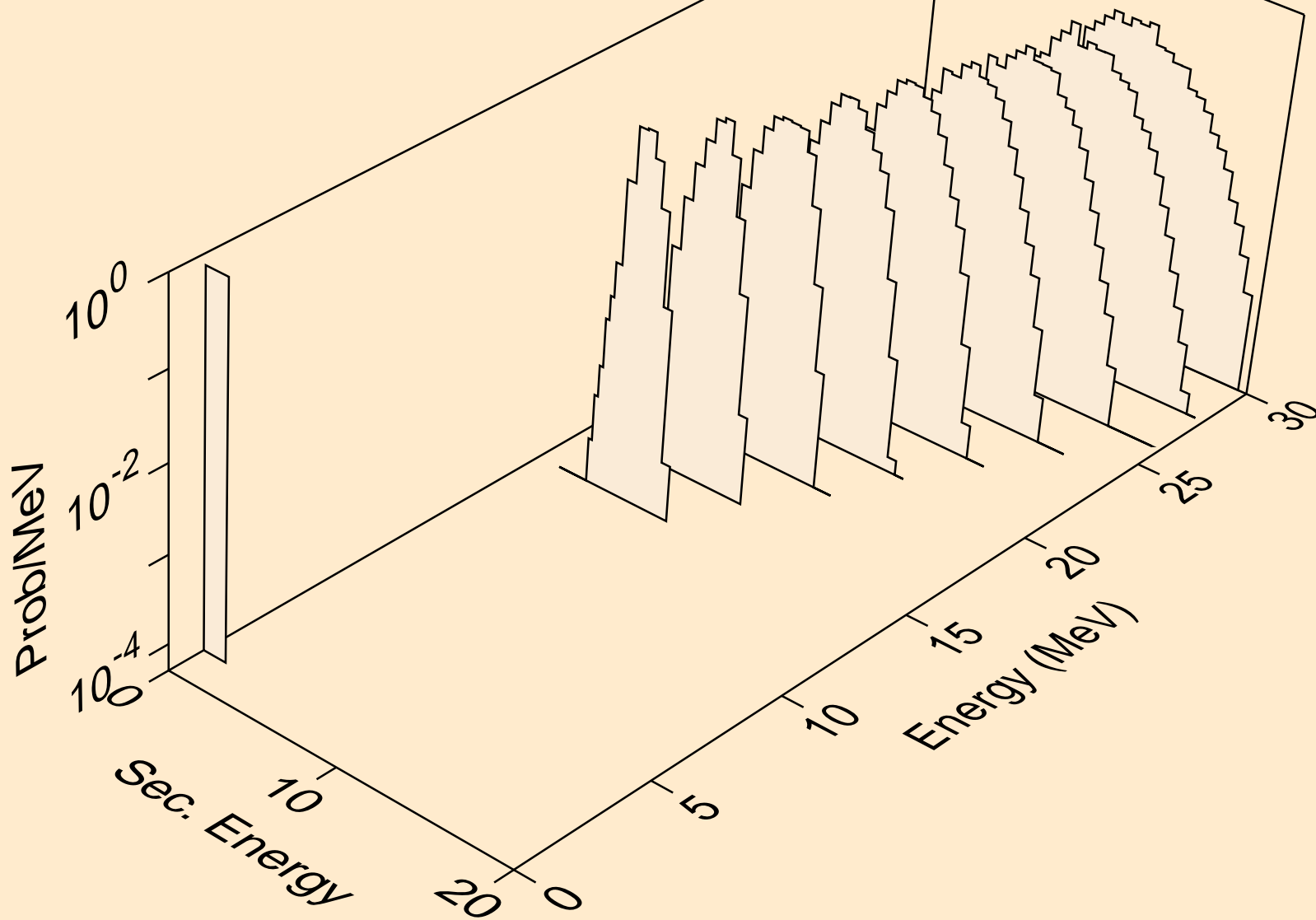

RE184 NEUTRON ACER TENDL-2019 LIBRARY; T=293.16K
tritons from (n,x)

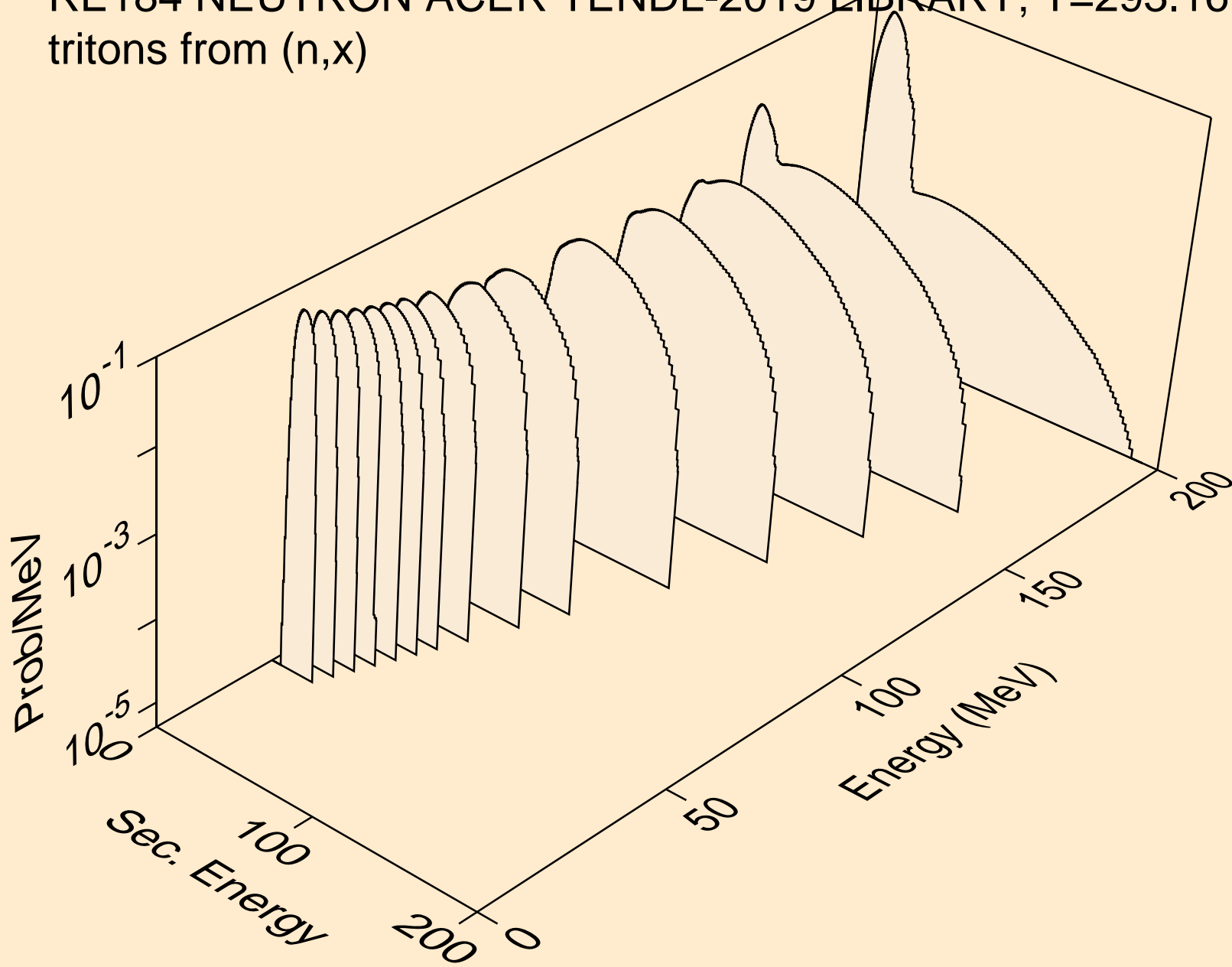

RE184 NEUTRON ACER TENDL-2019 LIBRARY; T=293.16K
tritons from (n,n*)t

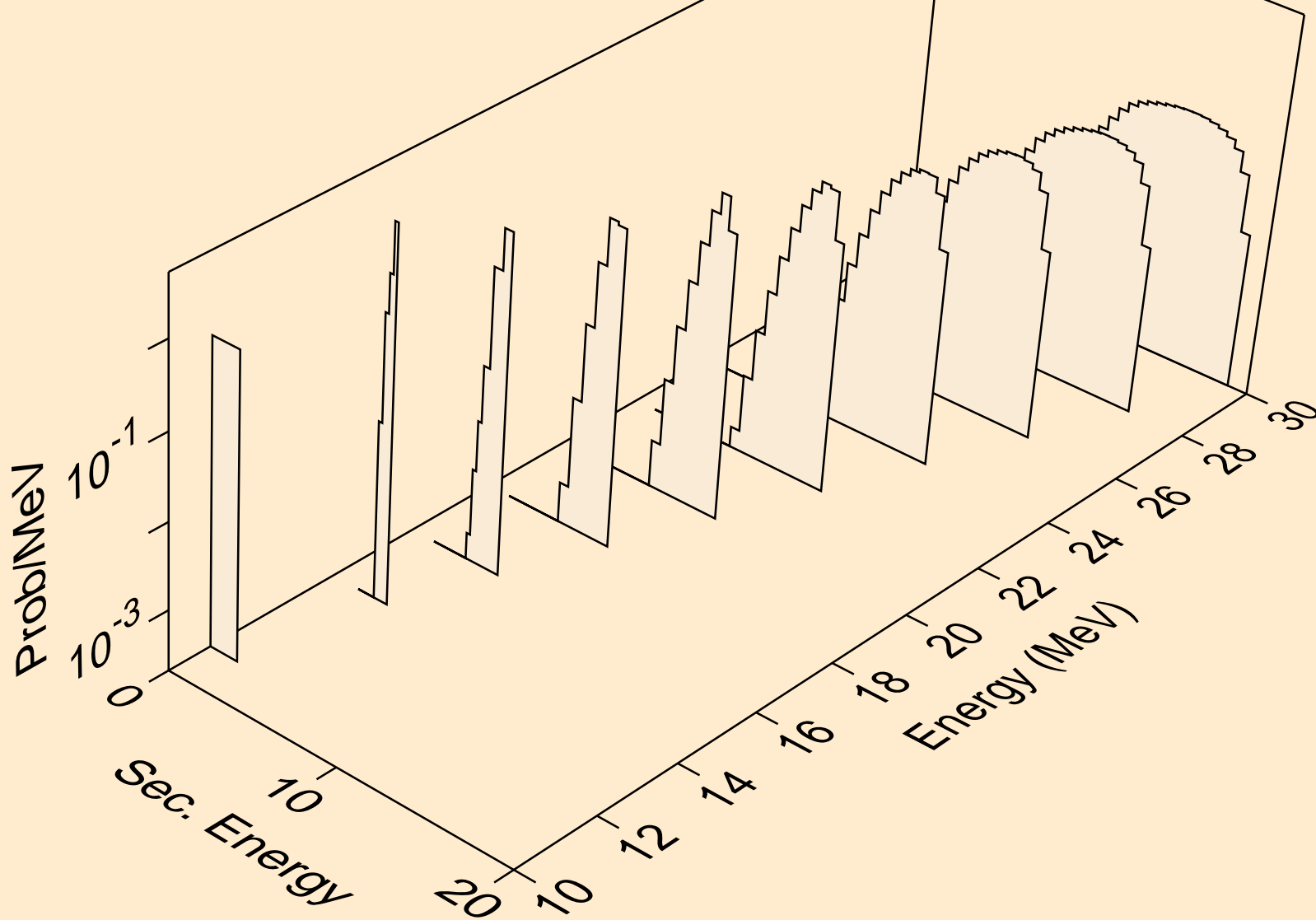

RE184 NEUTRON ACER TENDL-2019 LIBRARY; T=293.16K
tritons from (n,t)

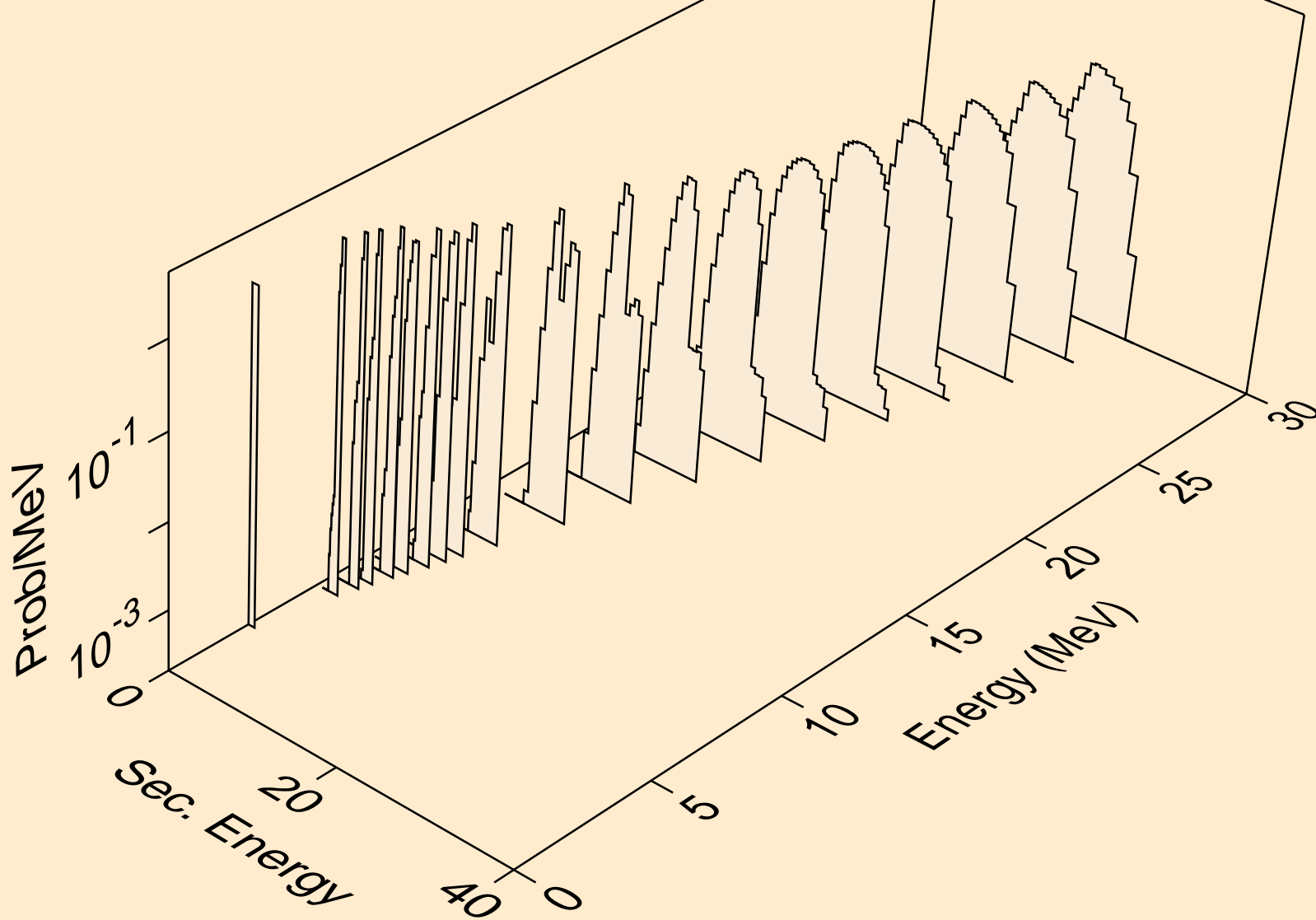

RE184 NEUTRON ACER TENDL-2019 LIBRARY; T=293.16K
tritons from (n,pt)

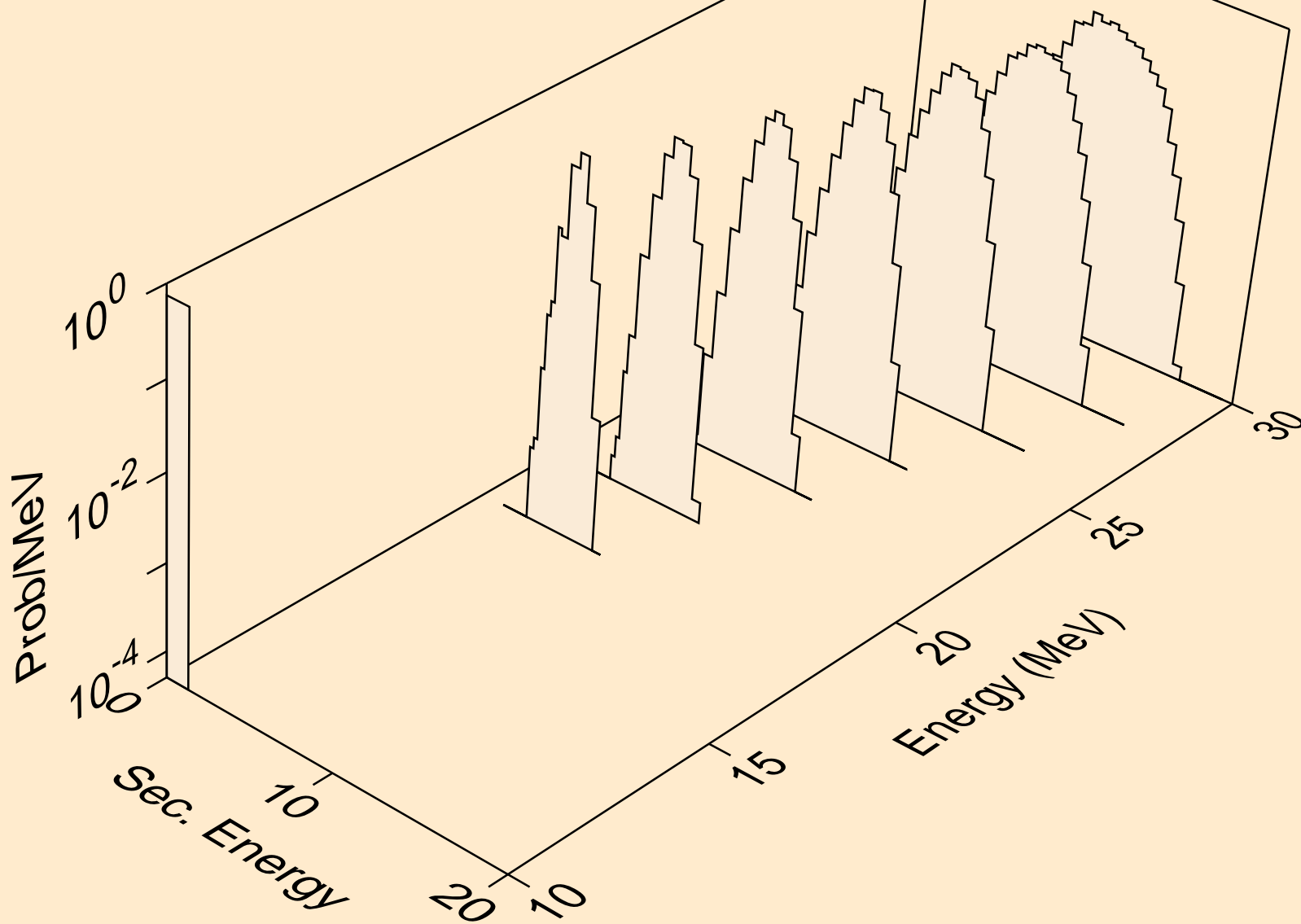

RE184 NEUTRON ACER TENDL-2019 LIBRARY; T=293.16K
he3s from (n,x)

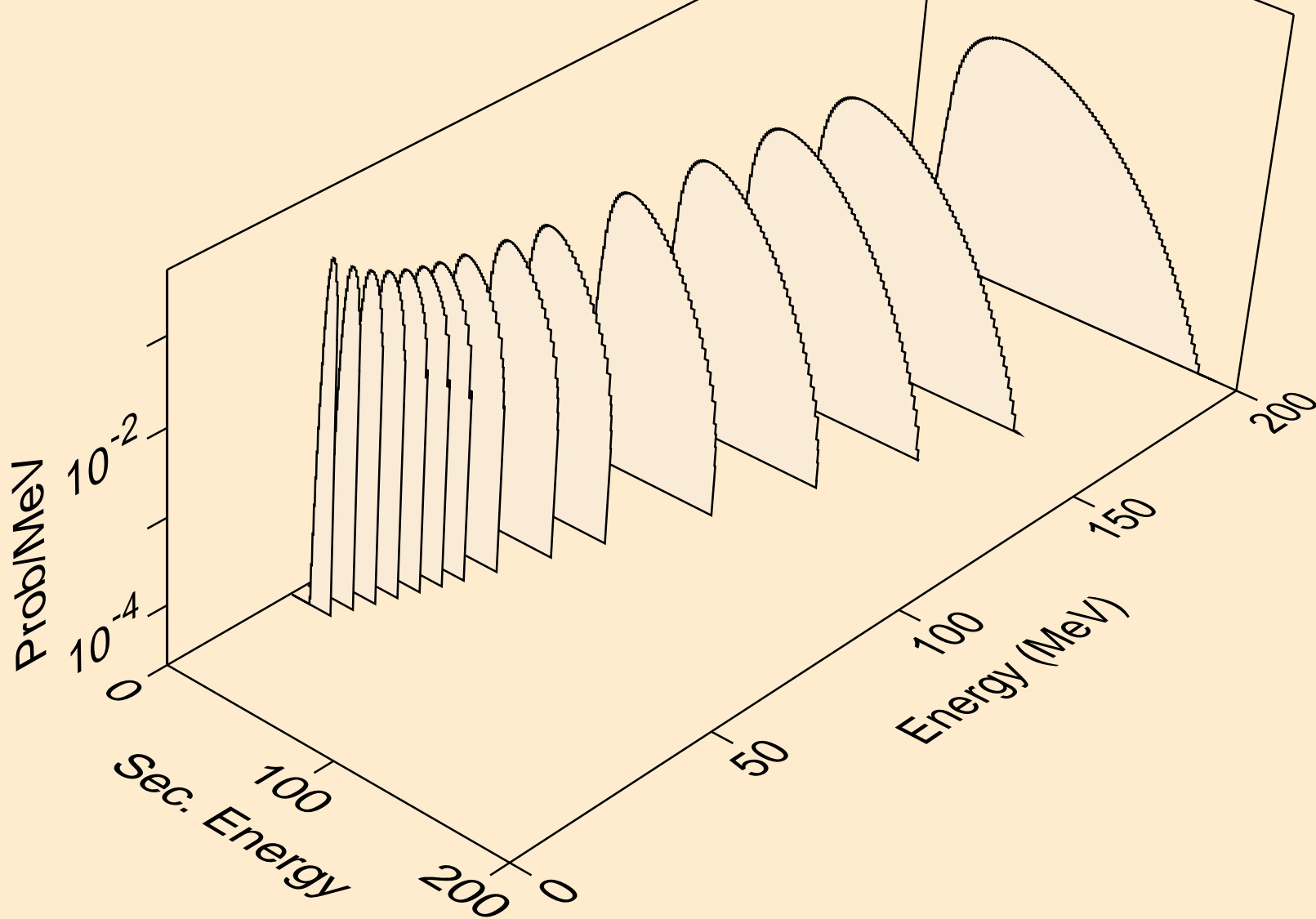

RE184 NEUTRON ACER TENDL-2019 LIBRARY; T=293.16K
he3s from (n,n*)he3

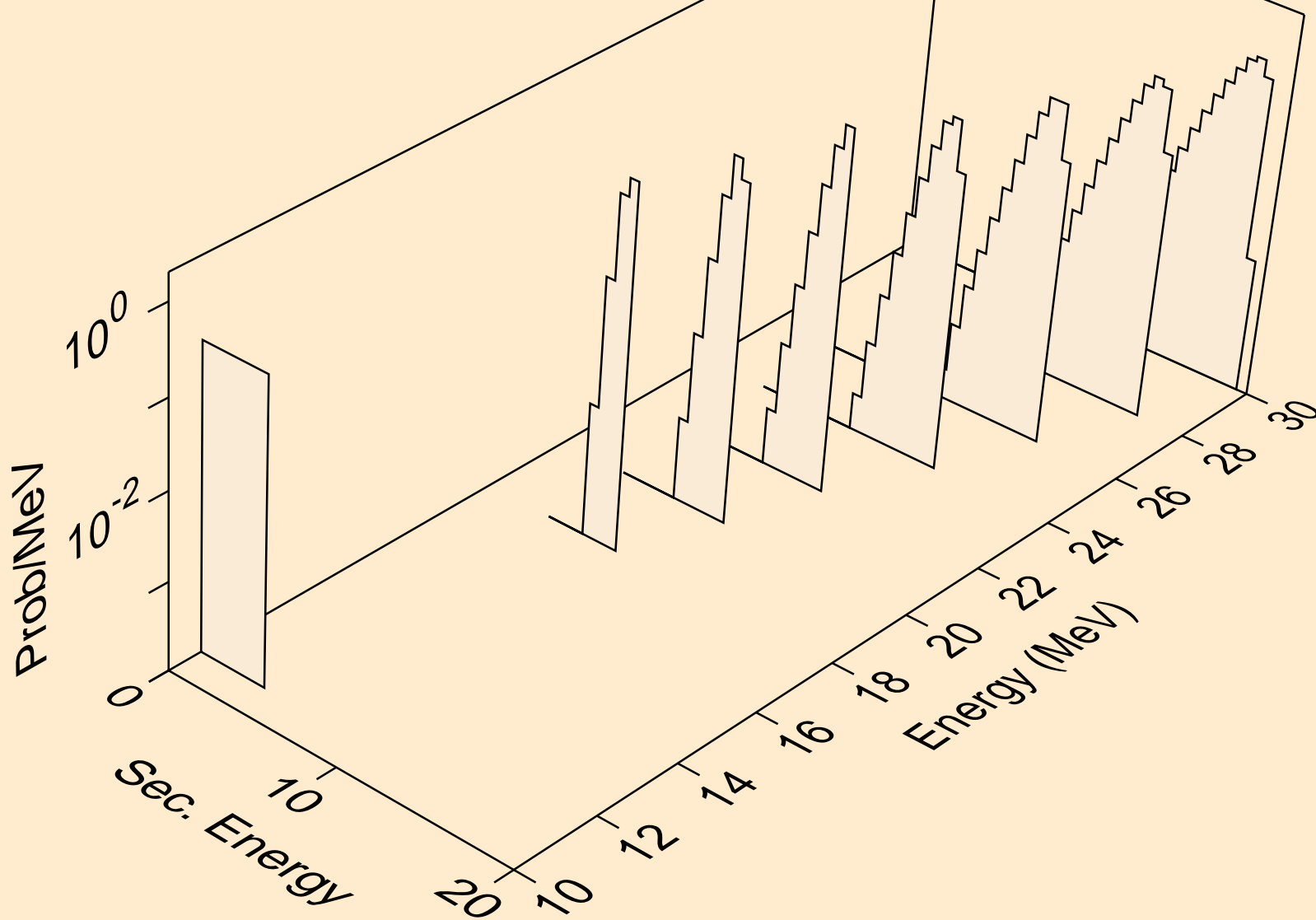

RE184 NEUTRON ACER TENDL-2019 LIBRARY; T=293.16K
he3s from (n,he3)

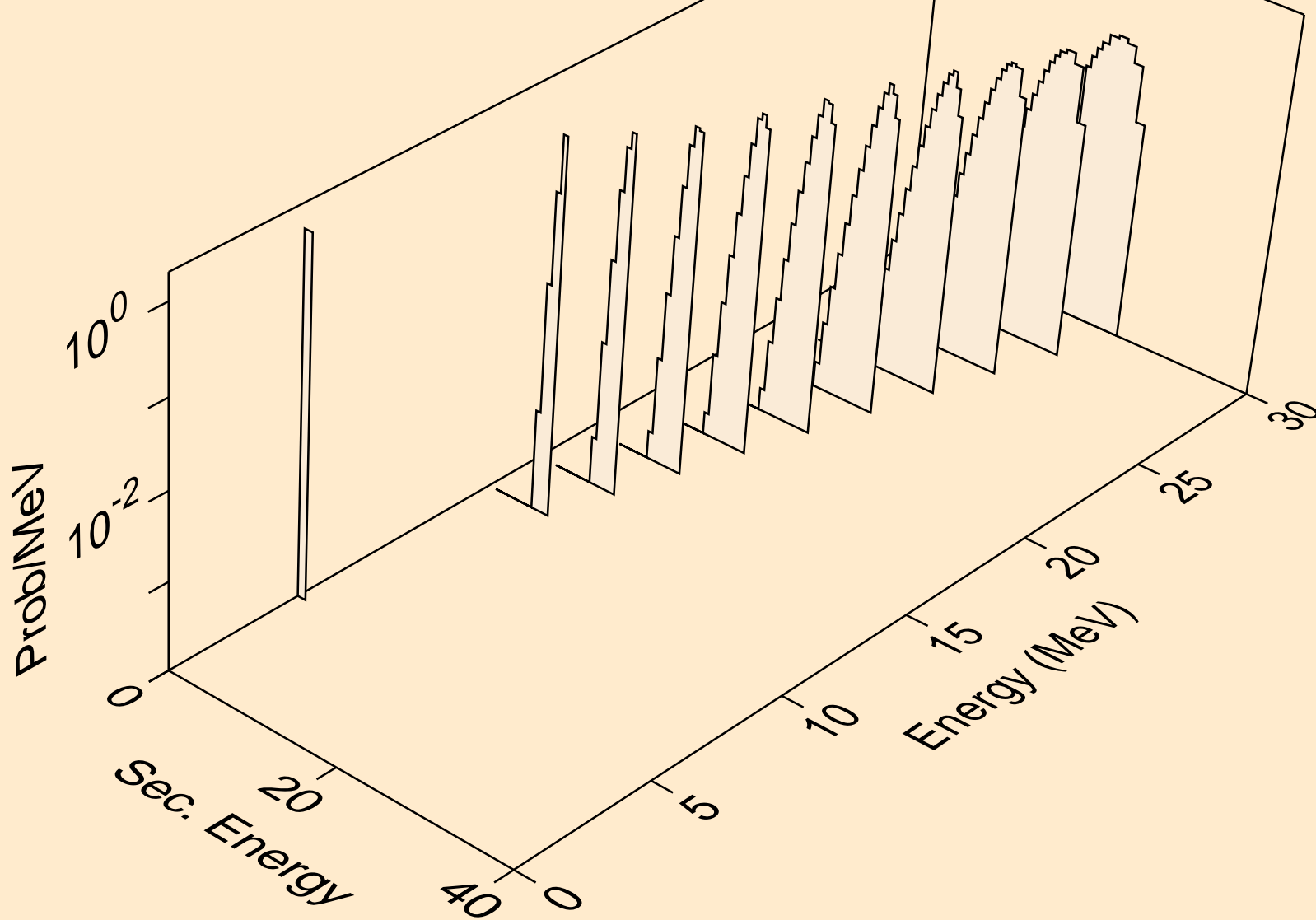

RE184 NEUTRON ACER TENDL-2019 LIBRARY; T=293.16K
alphas from (n,x)

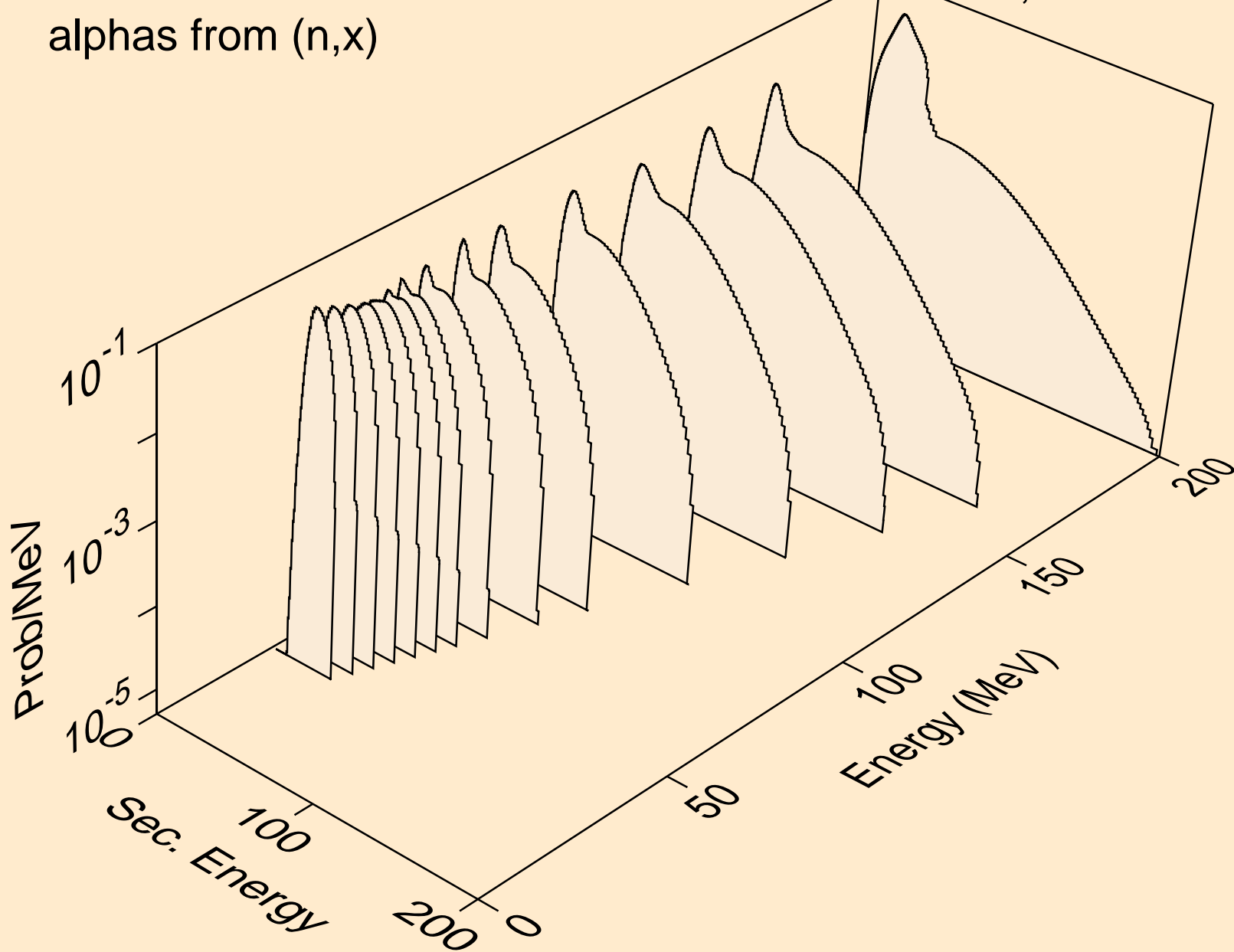

RE184 NEUTRON ACER TENDL-2019 LIBRARY; T=293.16K
alphas from (n,n*)a

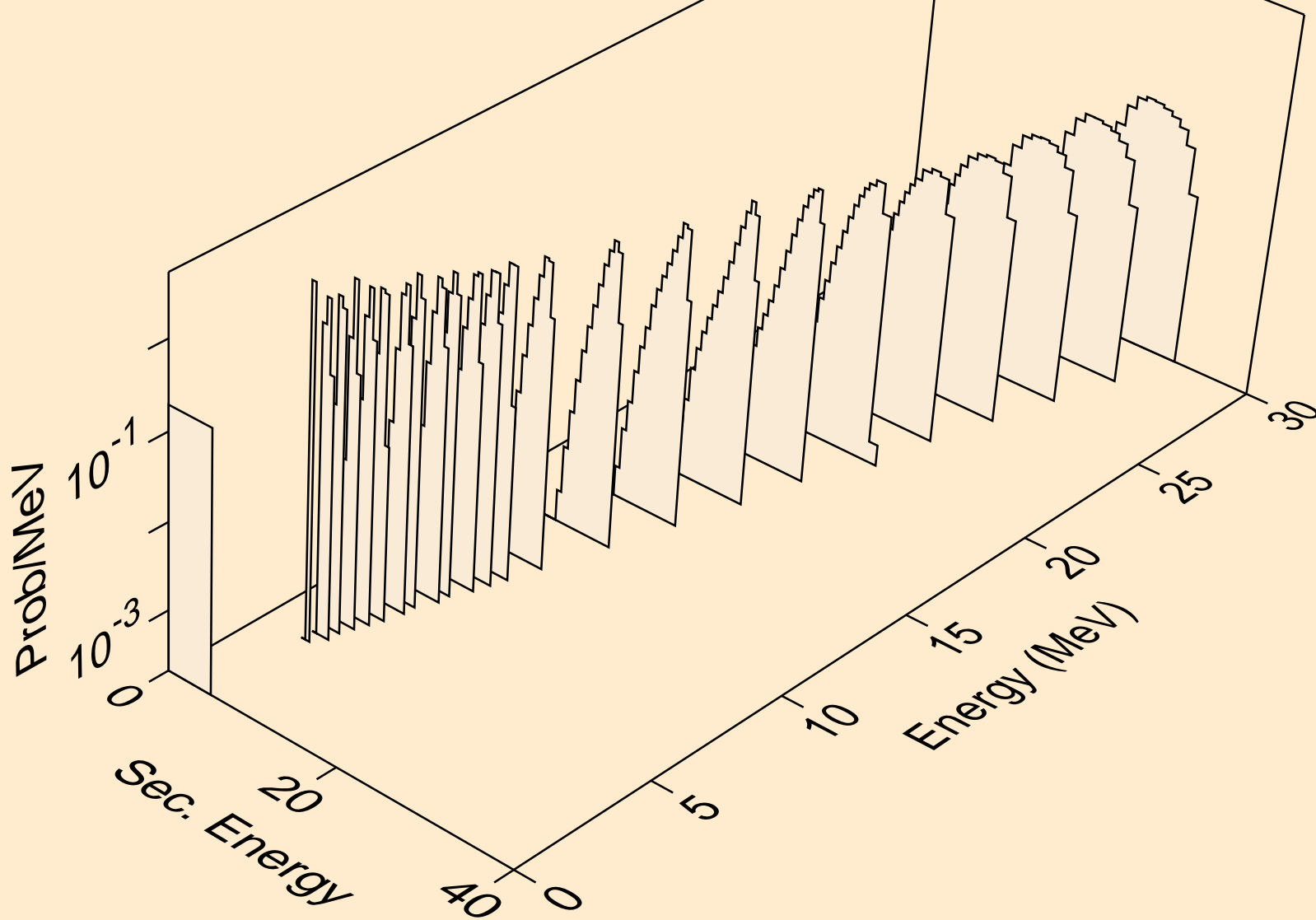

RE184 NEUTRON ACER TENDL-2019 LIBRARY; T=293.16K
alphas from (n,2n)a

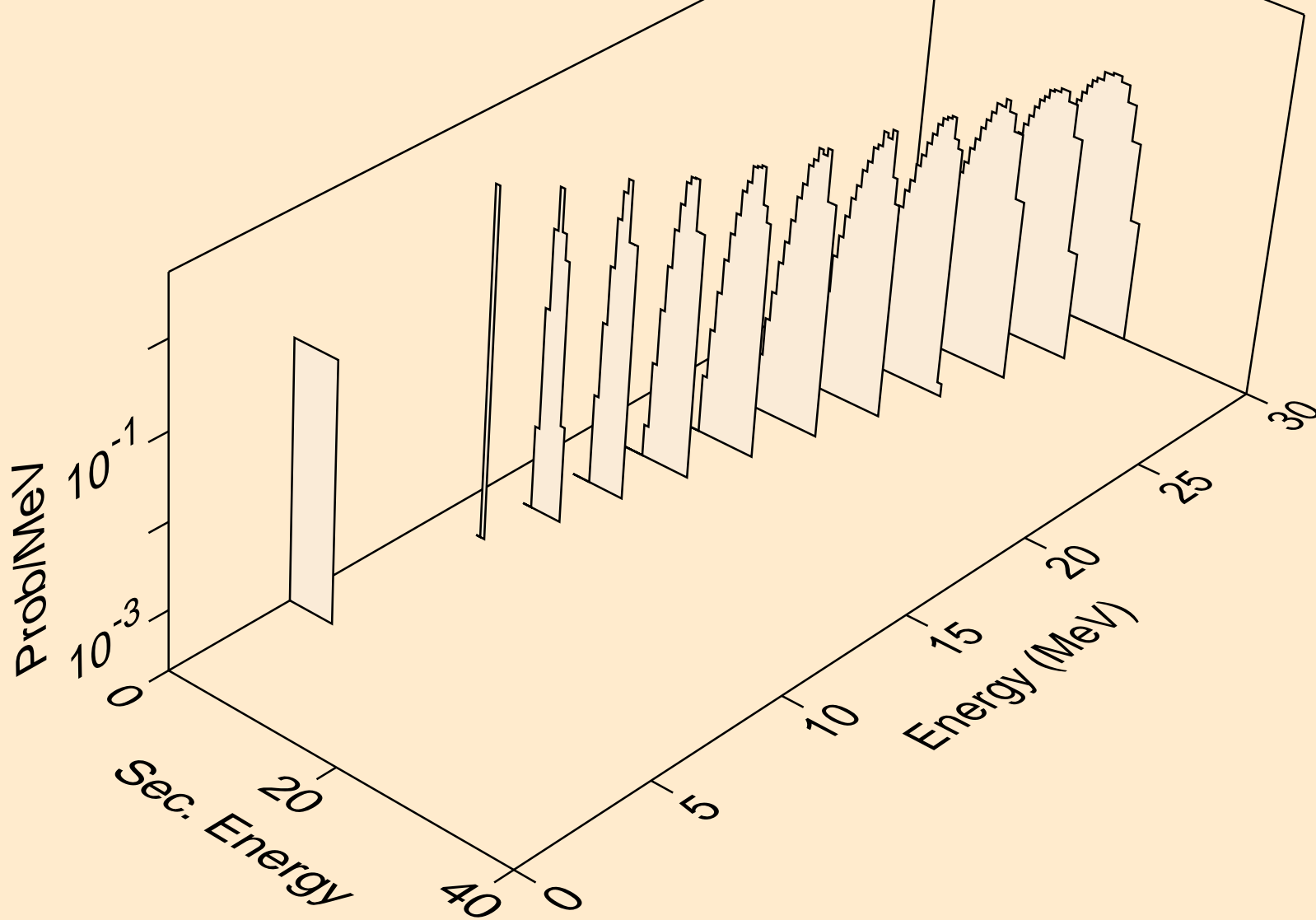

RE184 NEUTRON ACER TENDL-2019 LIBRARY; T=293.16K
alphas from (n,3n)a

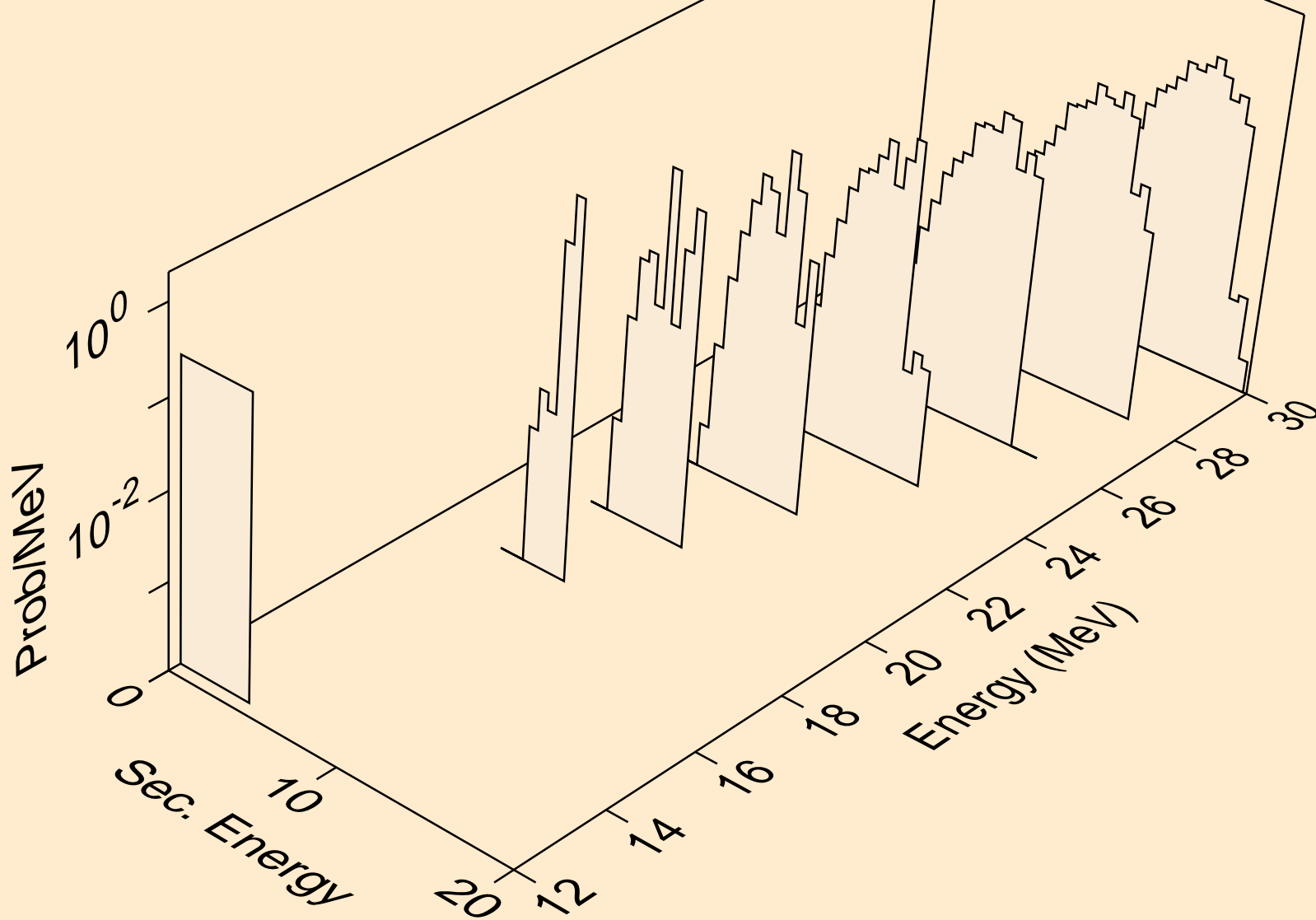

RE184 NEUTRON ACER TENDL-2019 LIBRARY; T=293.16K
alphas from (n,n*)2a

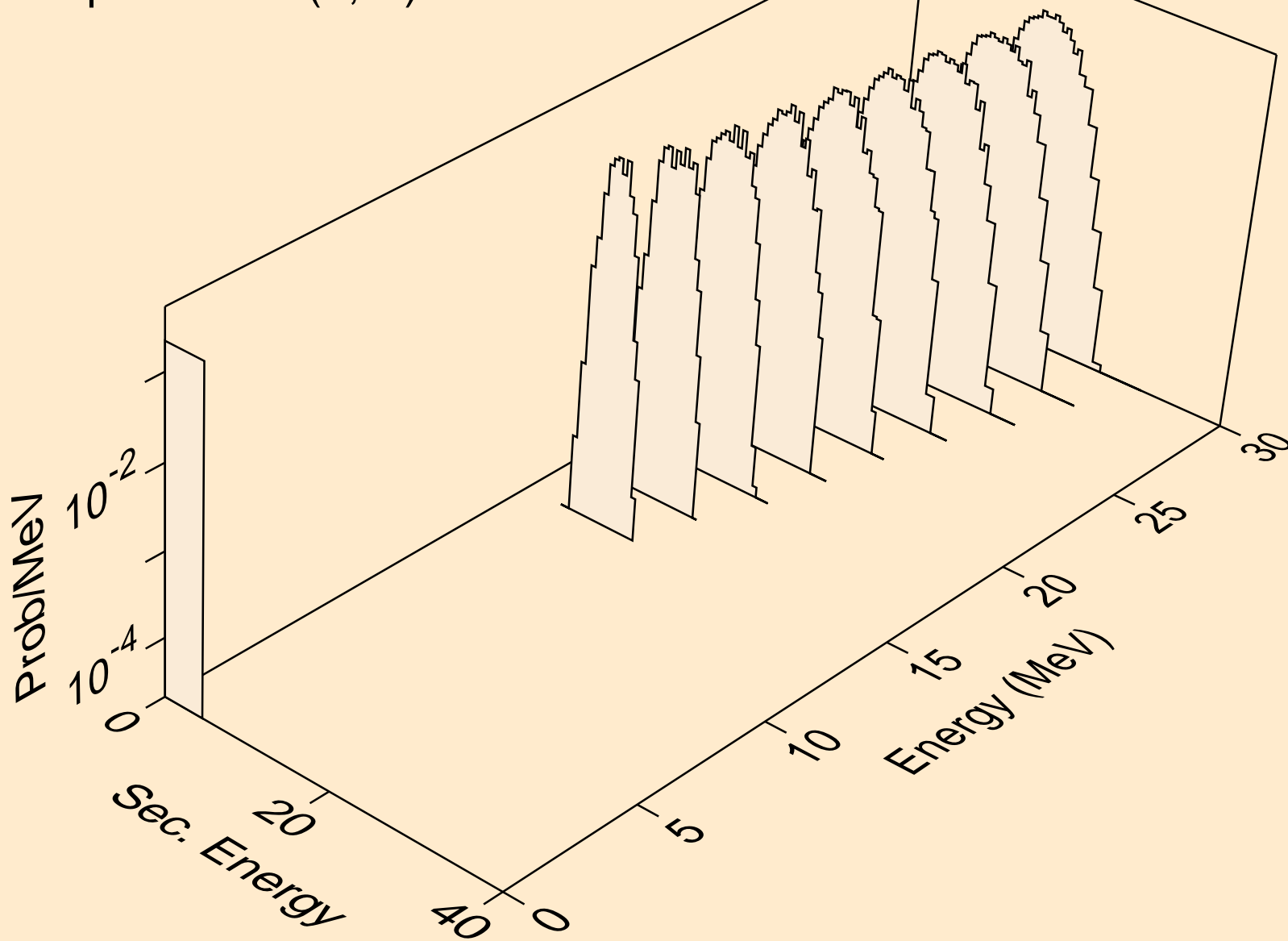

RE184 NEUTRON ACER TENDL-2019 LIBRARY; T=293.16K
alphas from (n,npa)

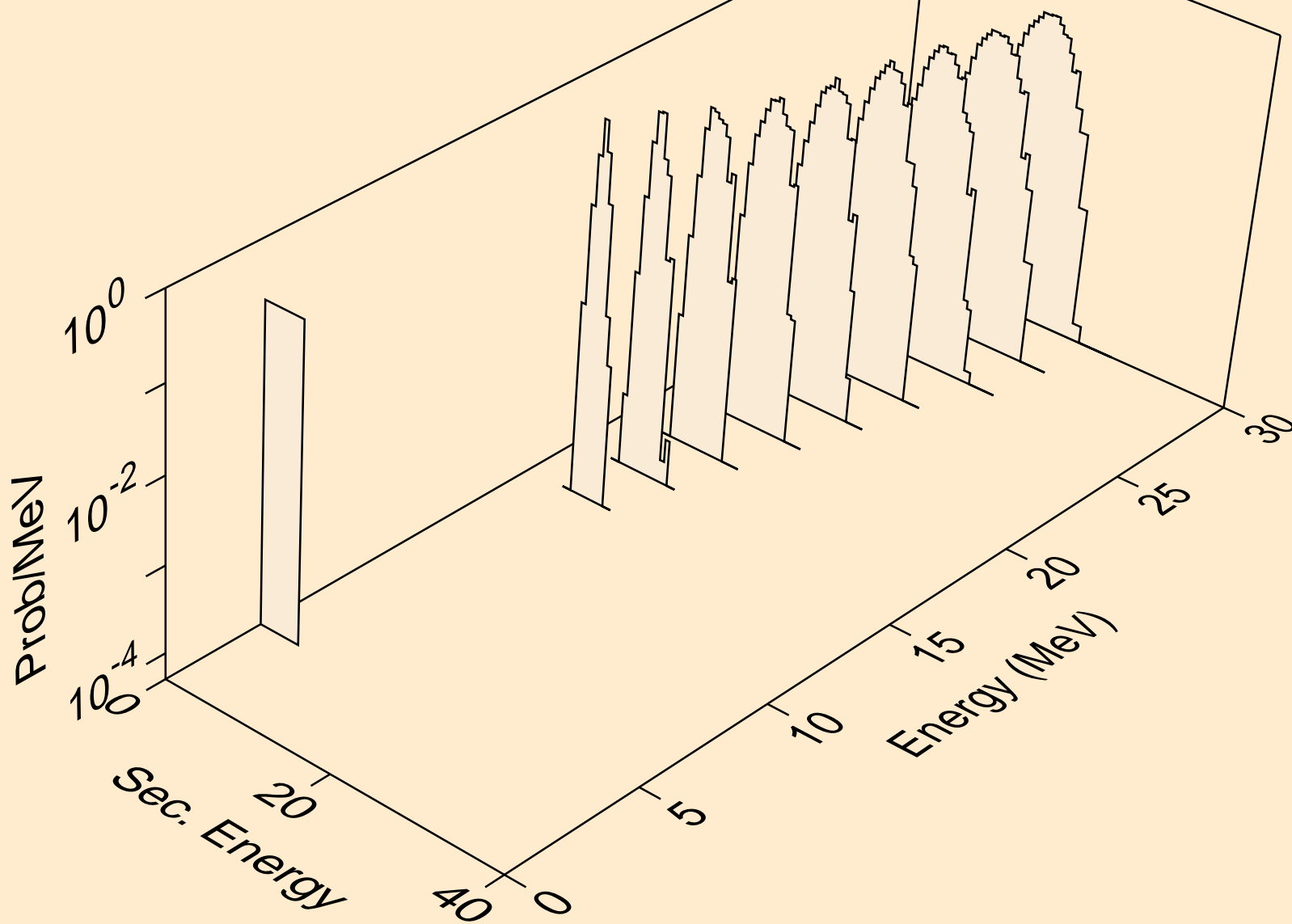

RE184 NEUTRON ACER TENDL-2019 LIBRARY; T=293.16K
alphas from (n,a)

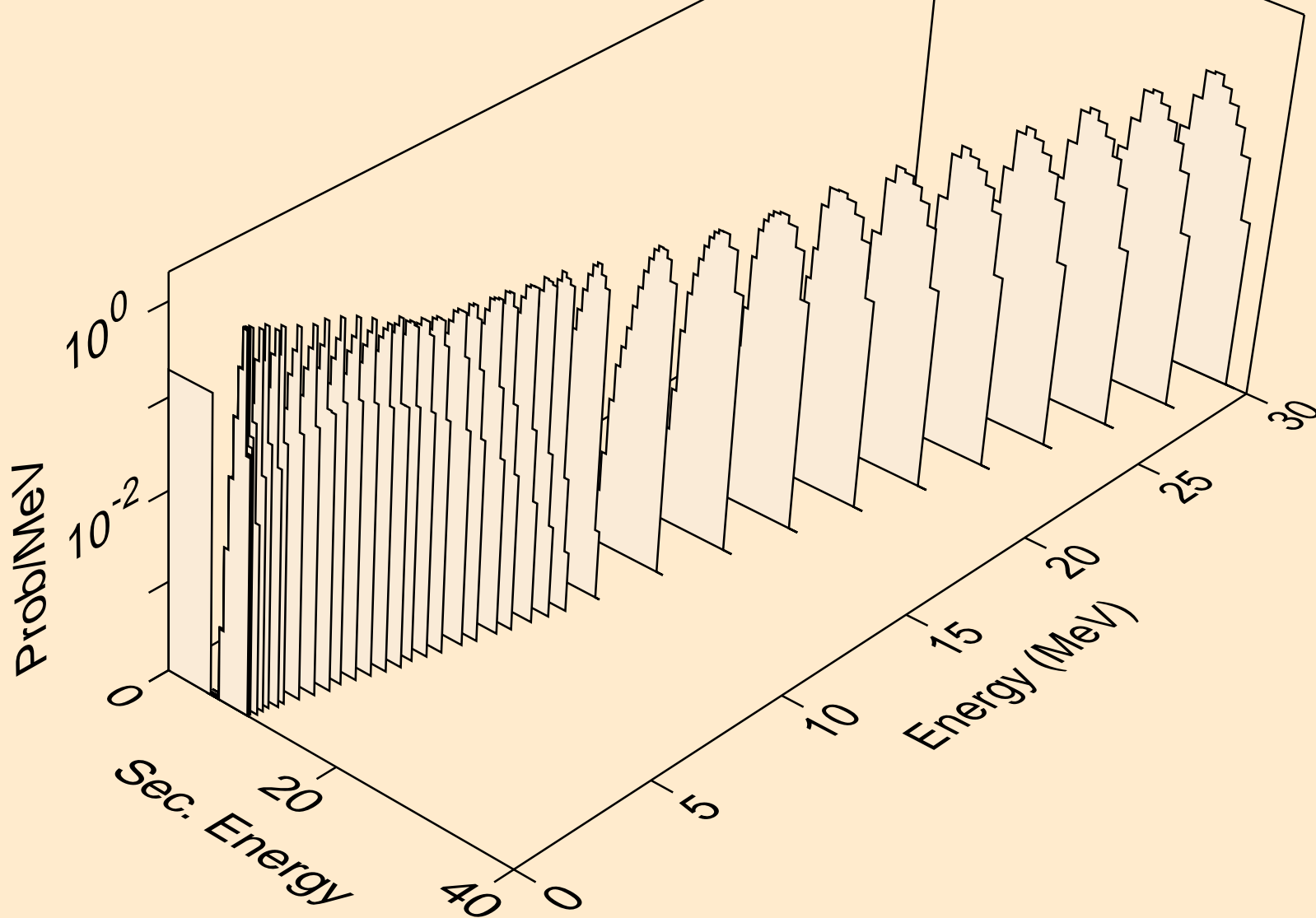

RE184 NEUTRON ACER TENDL-2019 LIBRARY; T=293.16K
alphas from (n,2a)

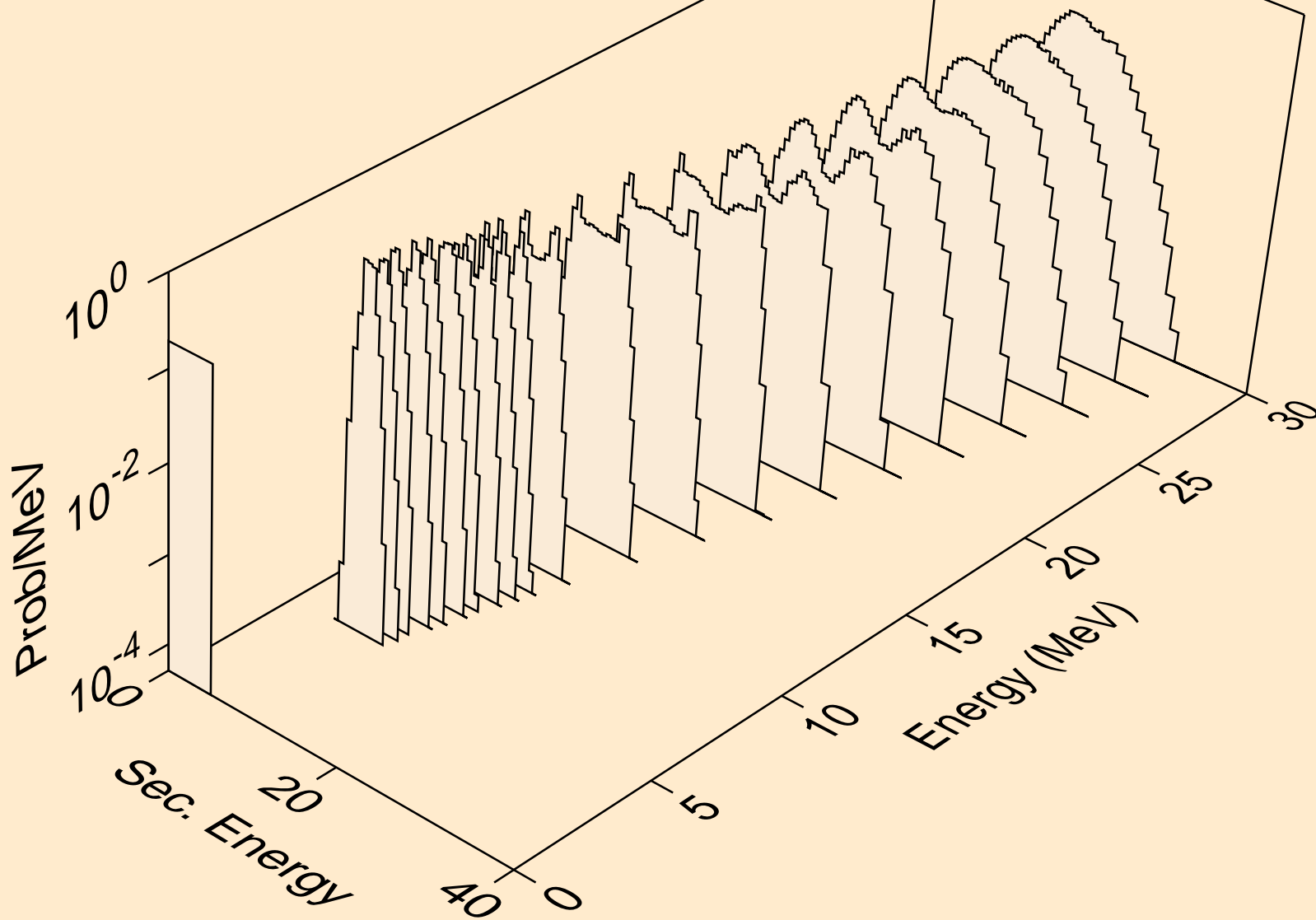

RE184 NEUTRON ACER TENDL-2019 LIBRARY; T=293.16K
alphas from (n,pa)

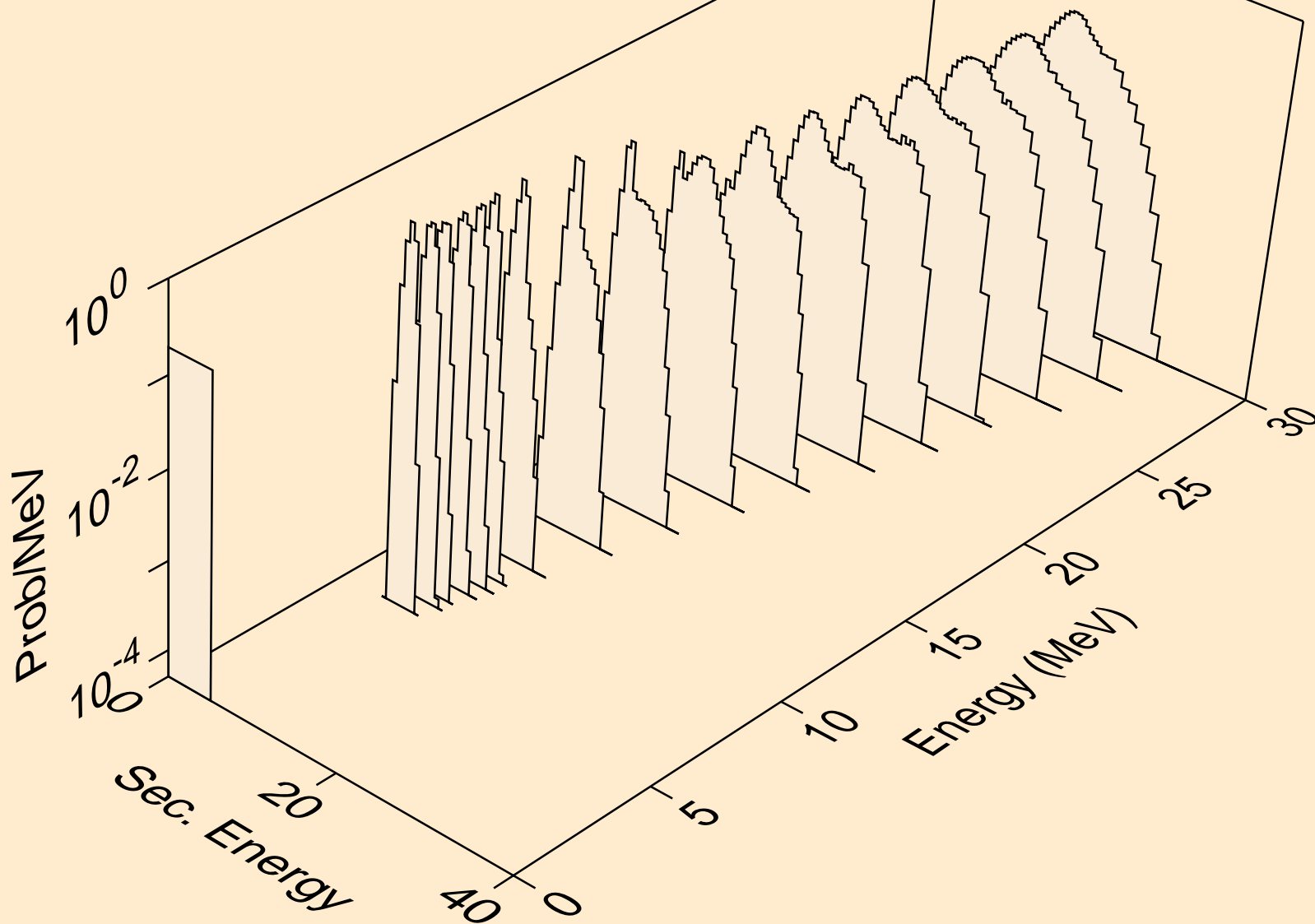

RE184 NEUTRON ACER TENDL-2019 LIBRARY; T=293.16K
alphas from (n,da)

