

RE195 NEUTRON ACER TENDL-2019 LIBRARY; T=293.16K
Principal cross sections

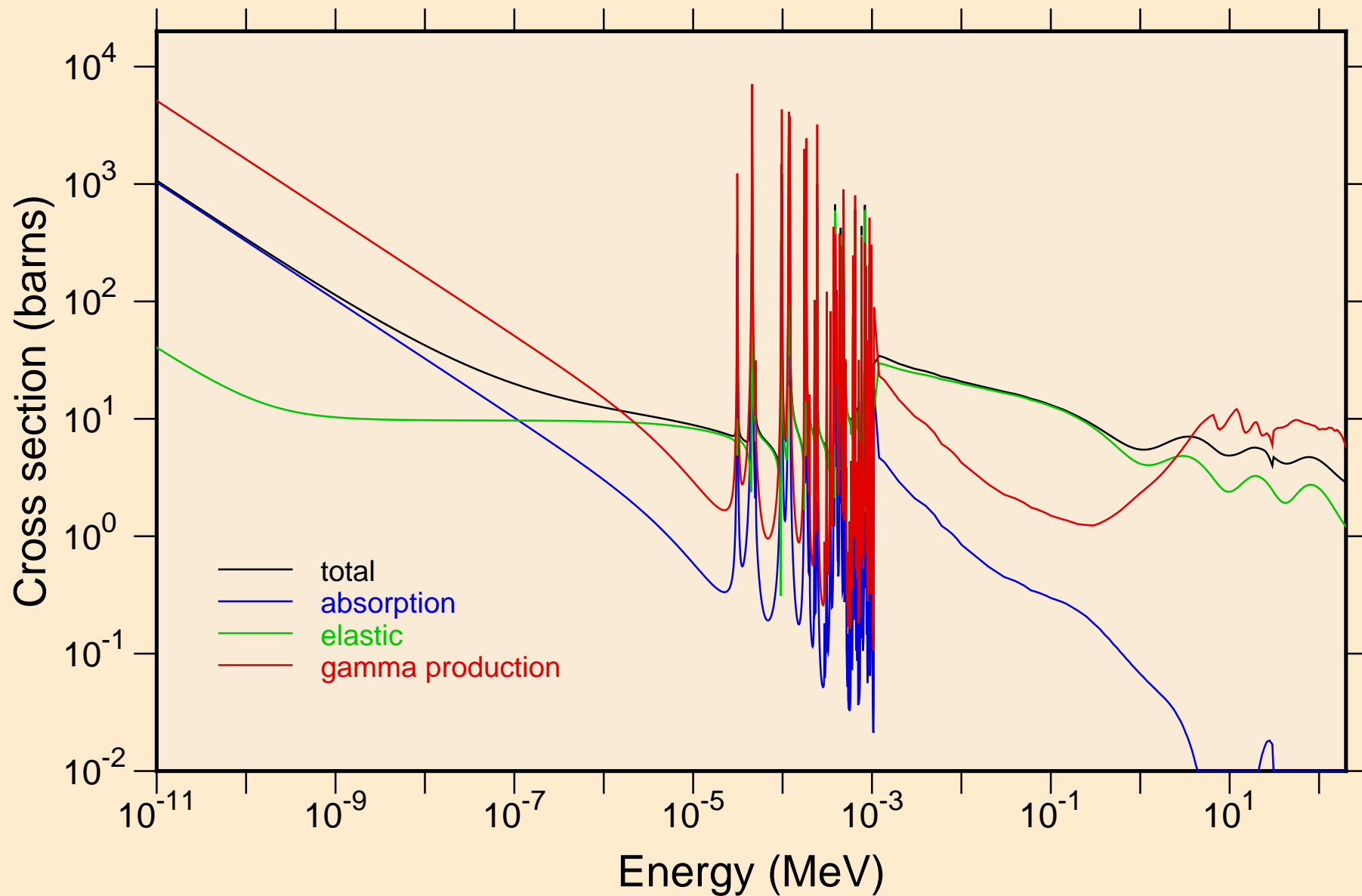

RE195 NEUTRON ACER TENDL-2019 LIBRARY; T=293.16K
resonance total cross section

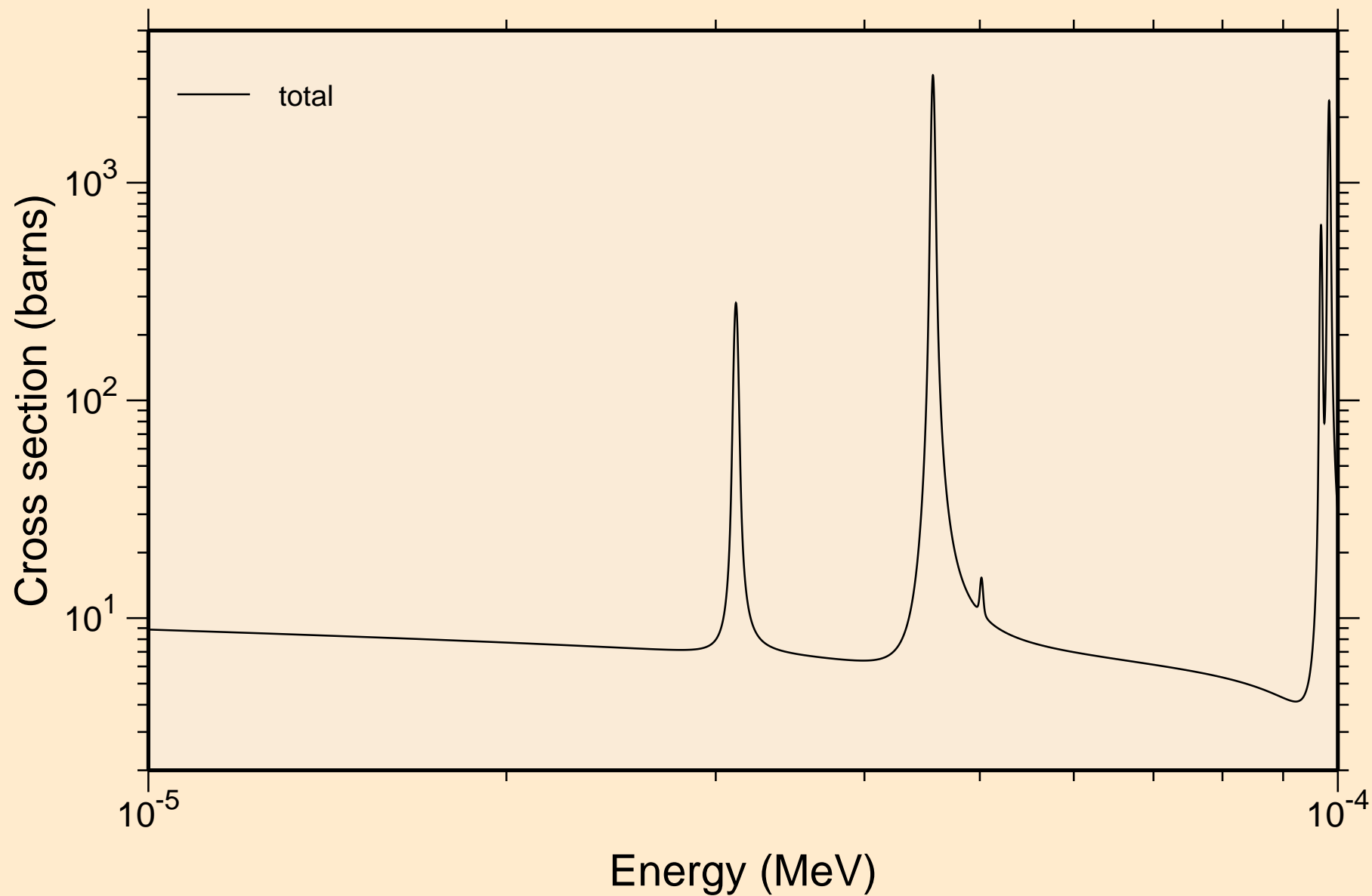

RE195 NEUTRON ACER TENDL-2019 LIBRARY; T=293.16K
resonance total cross section

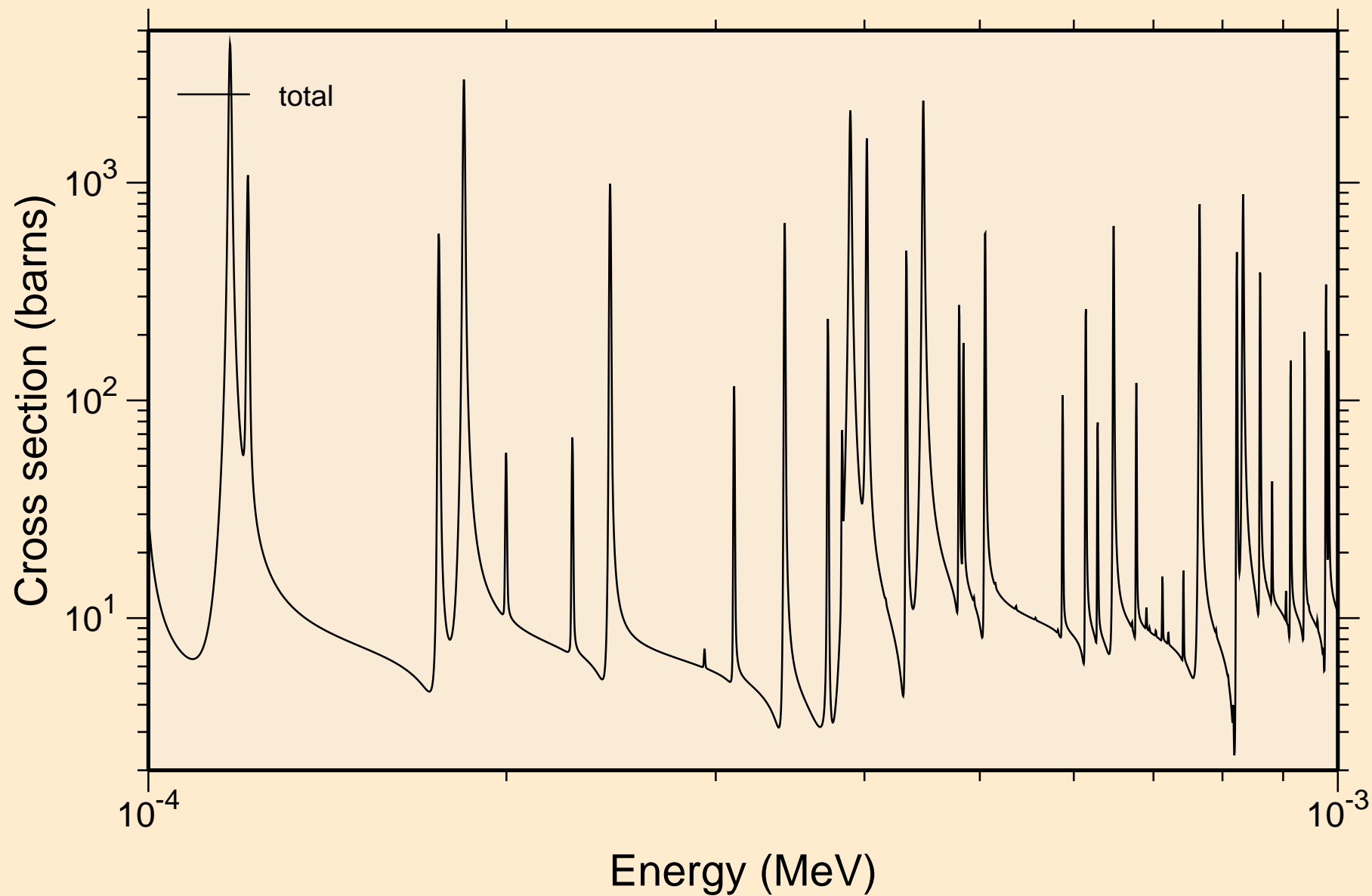

RE195 NEUTRON ACER TENDL-2019 LIBRARY; T=293.16K
resonance total cross section

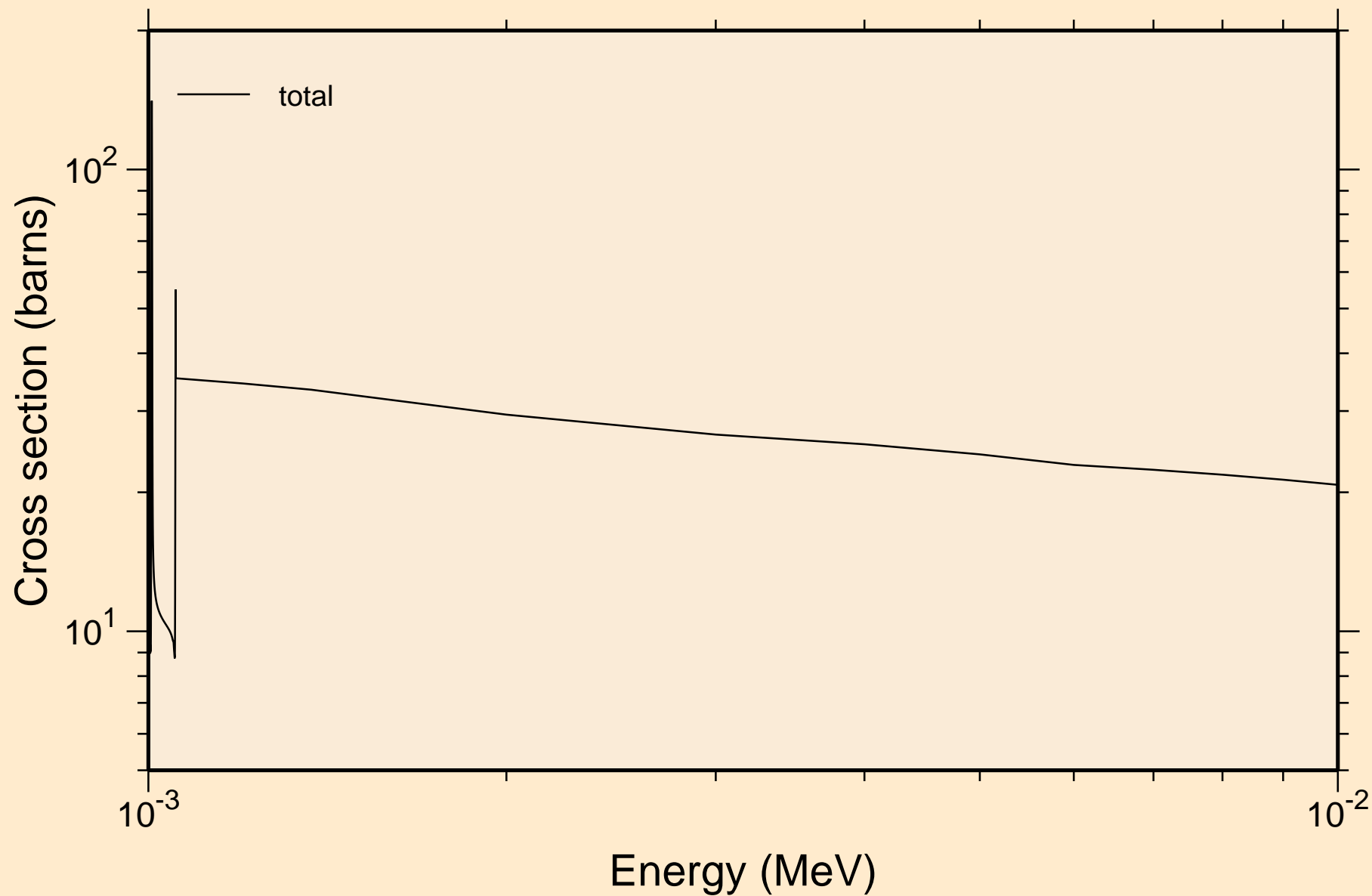

RE195 NEUTRON ACER TENDL-2019 LIBRARY; T=293.16K
resonance total cross section

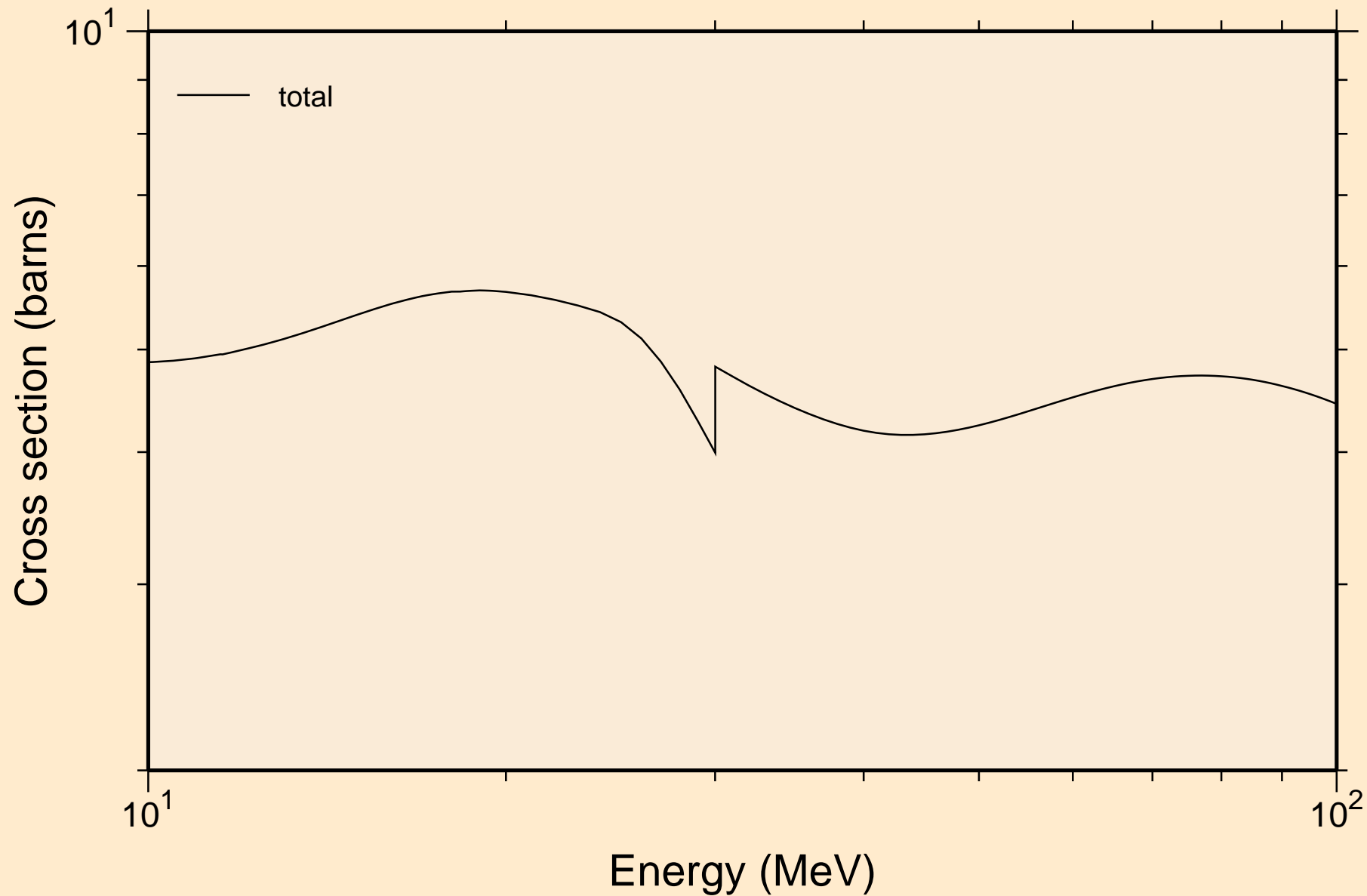

RE195 NEUTRON ACER TENDL-2019 LIBRARY; T=293.16K
resonance absorption cross sections

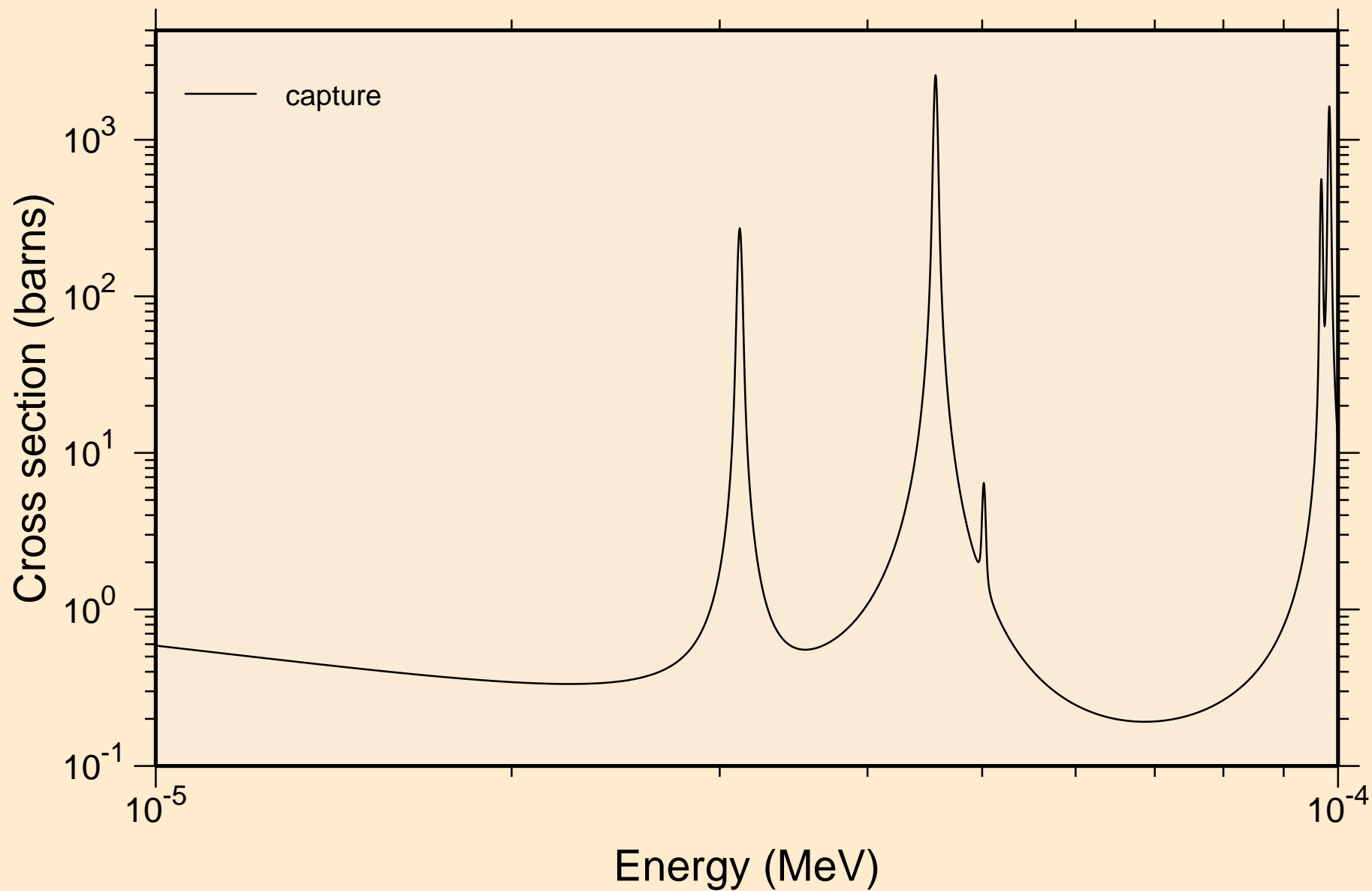

RE195 NEUTRON ACER TENDL-2019 LIBRARY; T=293.16K
resonance absorption cross sections

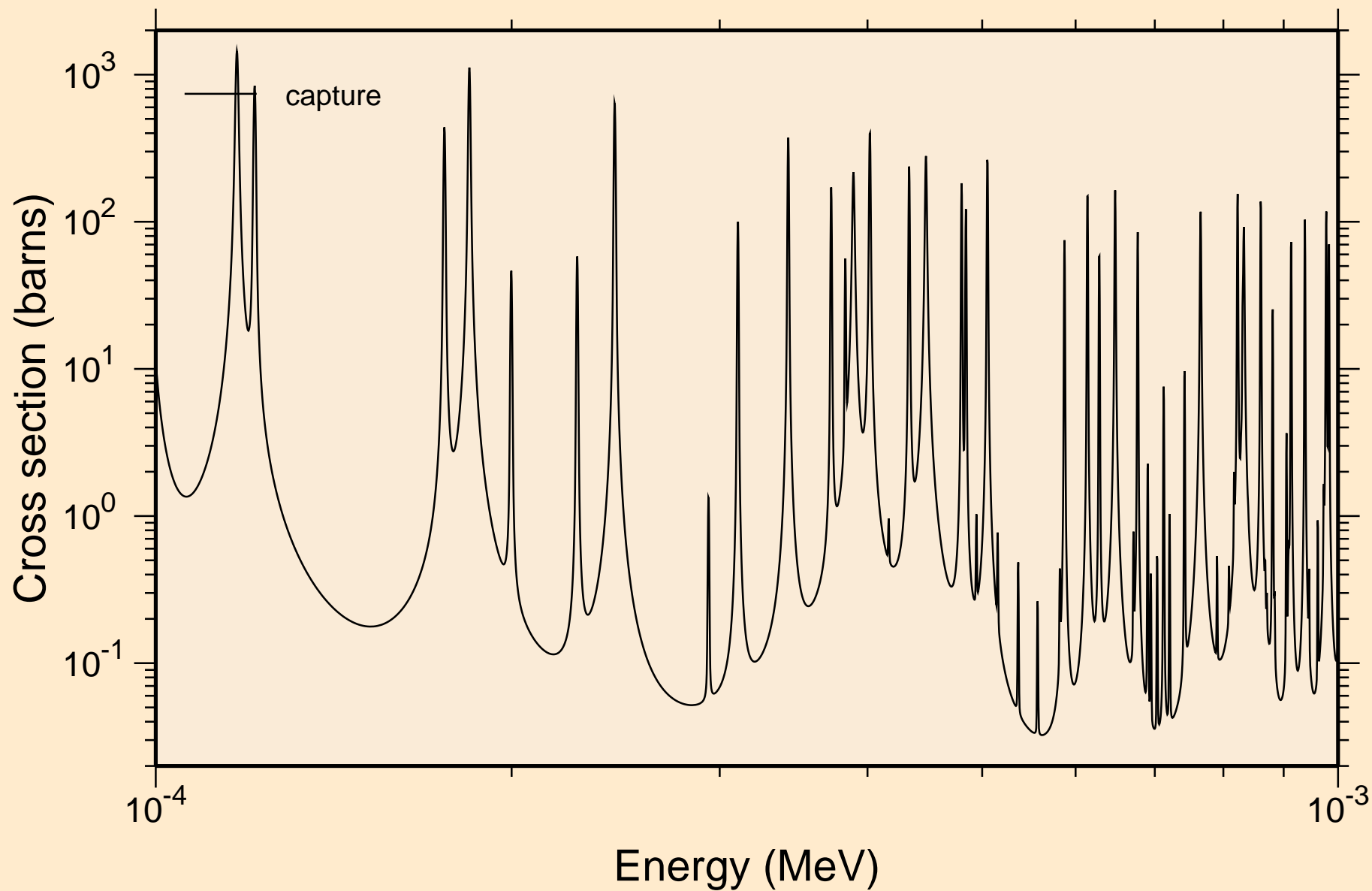

RE195 NEUTRON ACER TENDL-2019 LIBRARY; T=293.16K
resonance absorption cross sections

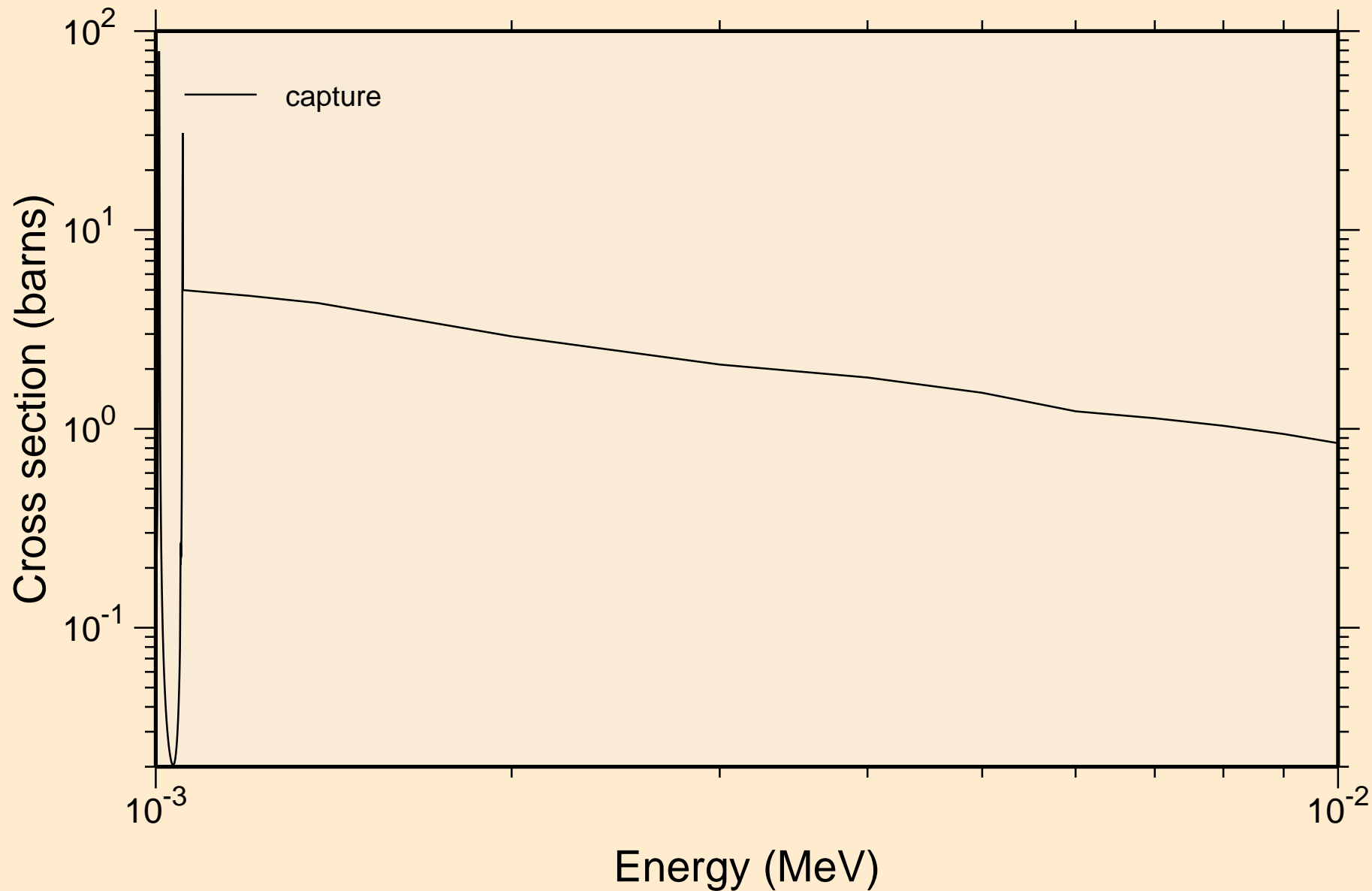

RE195 NEUTRON ACER TENDL-2019 LIBRARY; T=293.16K
resonance absorption cross sections

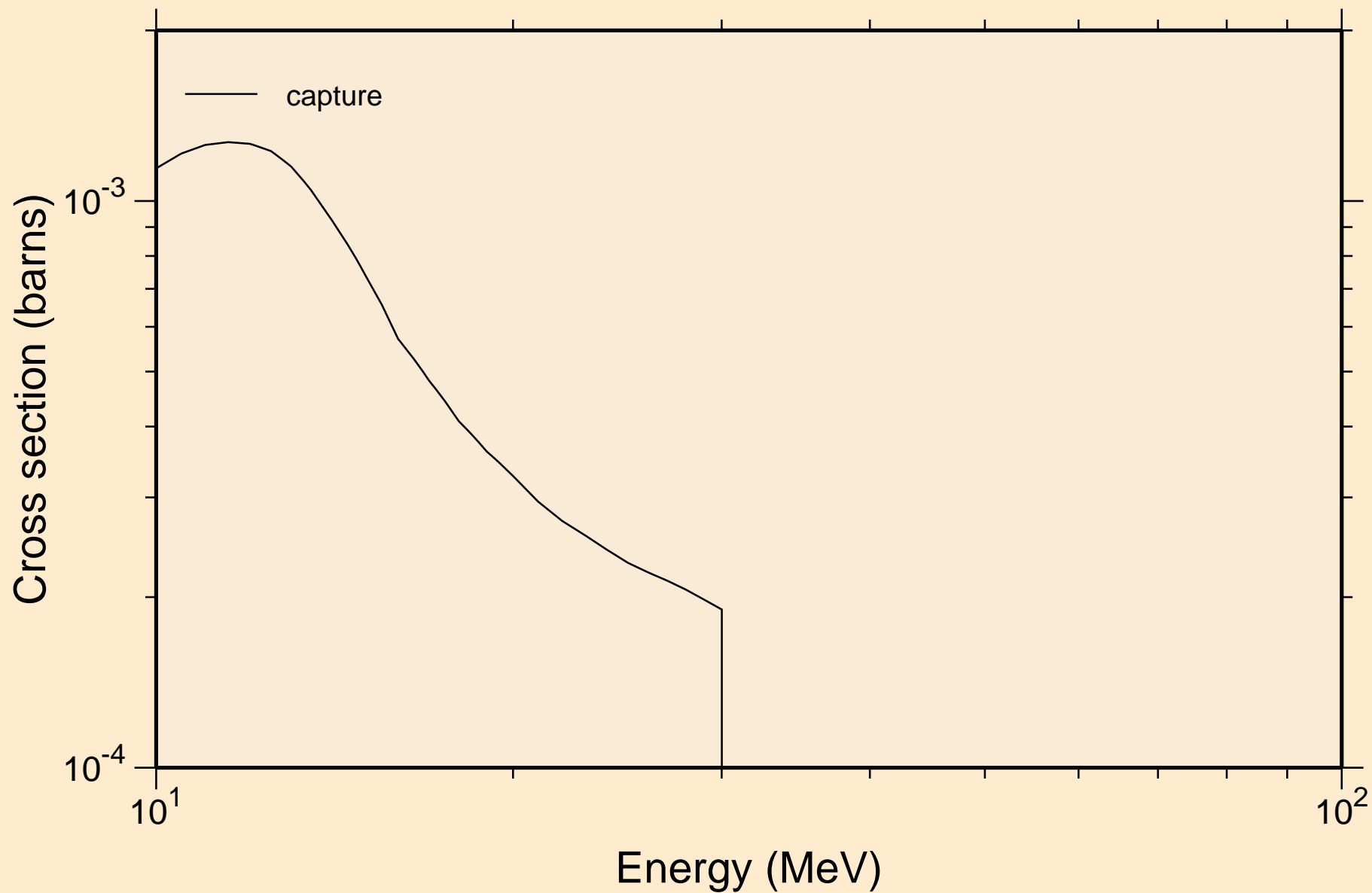

RE195 NEUTRON ACER TENDL-2019 LIBRARY; T=293.16K
Heating

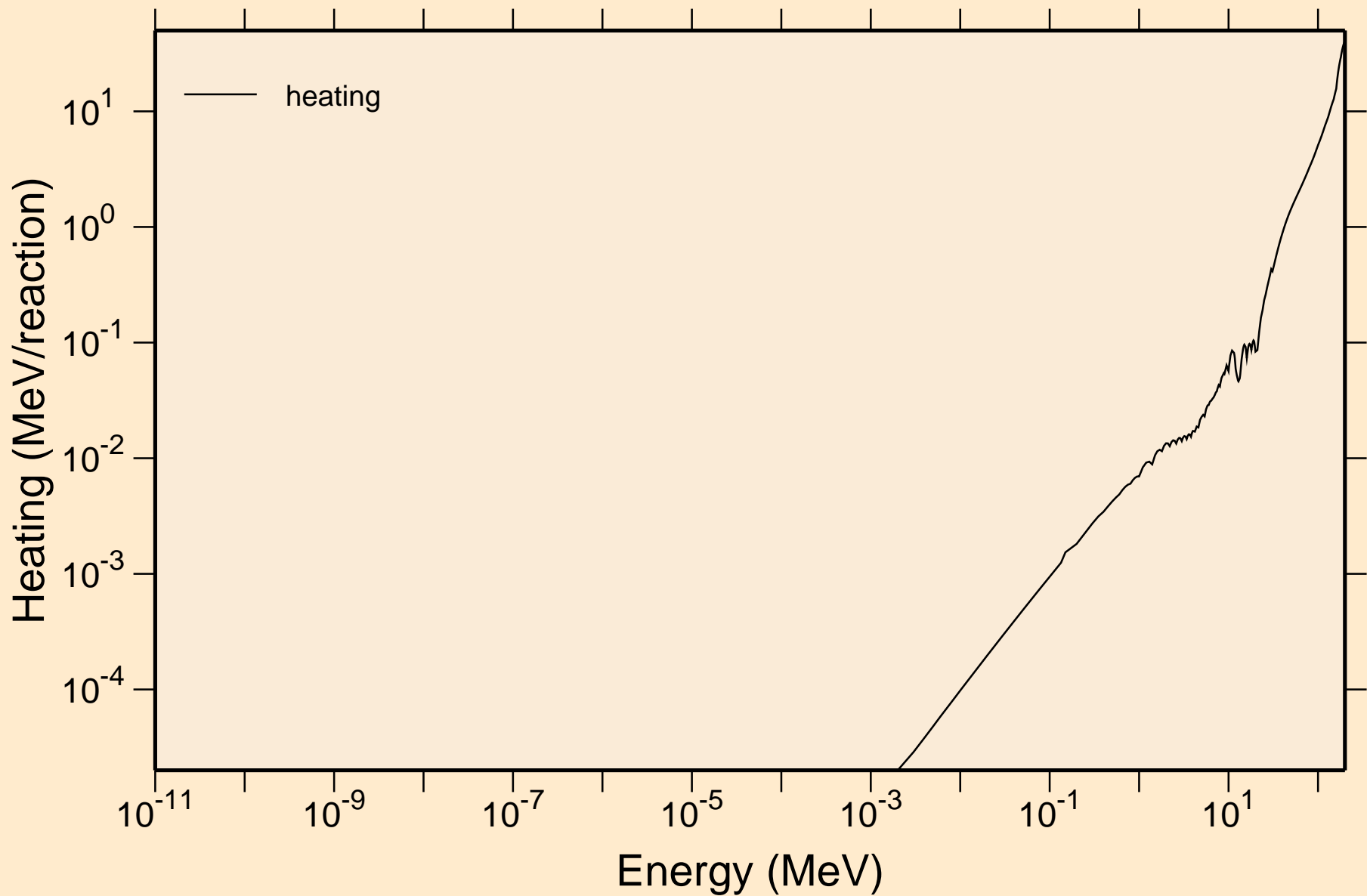

RE195 NEUTRON ACER TENDL-2019 LIBRARY; T=293.16K
Damage

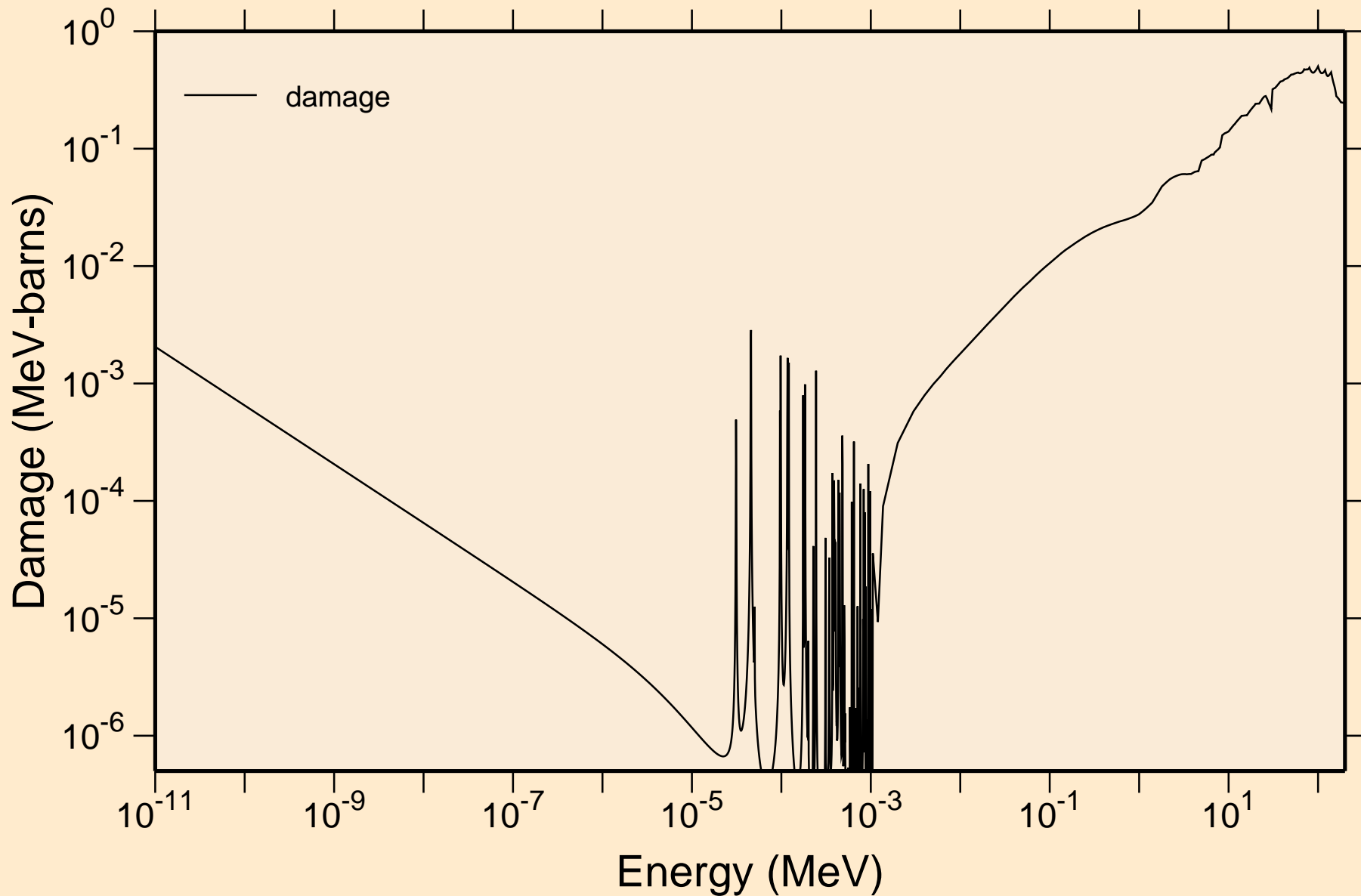

RE195 NEUTRON ACER TENDL-2019 LIBRARY; T=293.16K
Non-threshold reactions

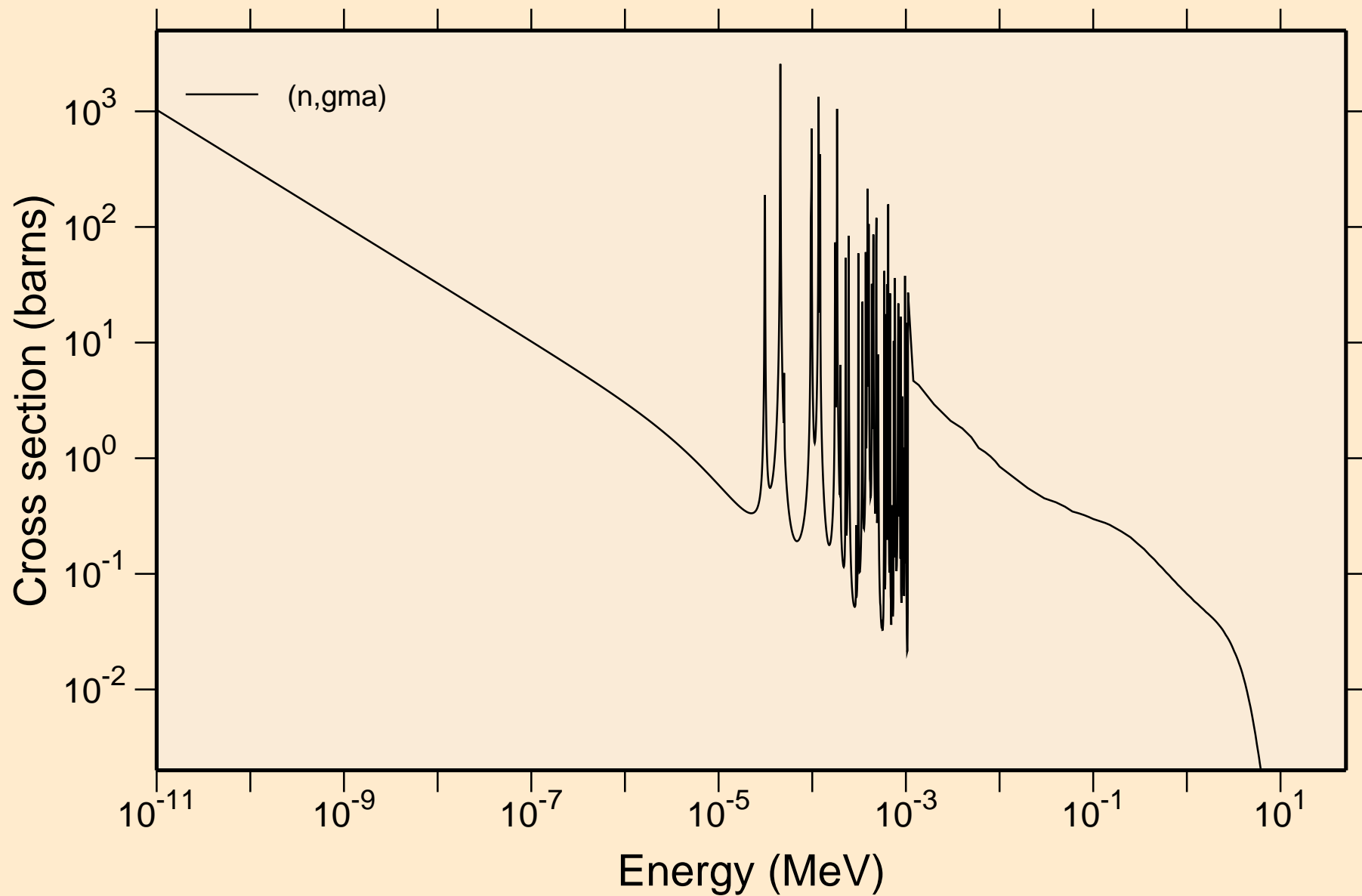

RE195 NEUTRON ACER TENDL-2019 LIBRARY; T=293.16K
Principal cross sections

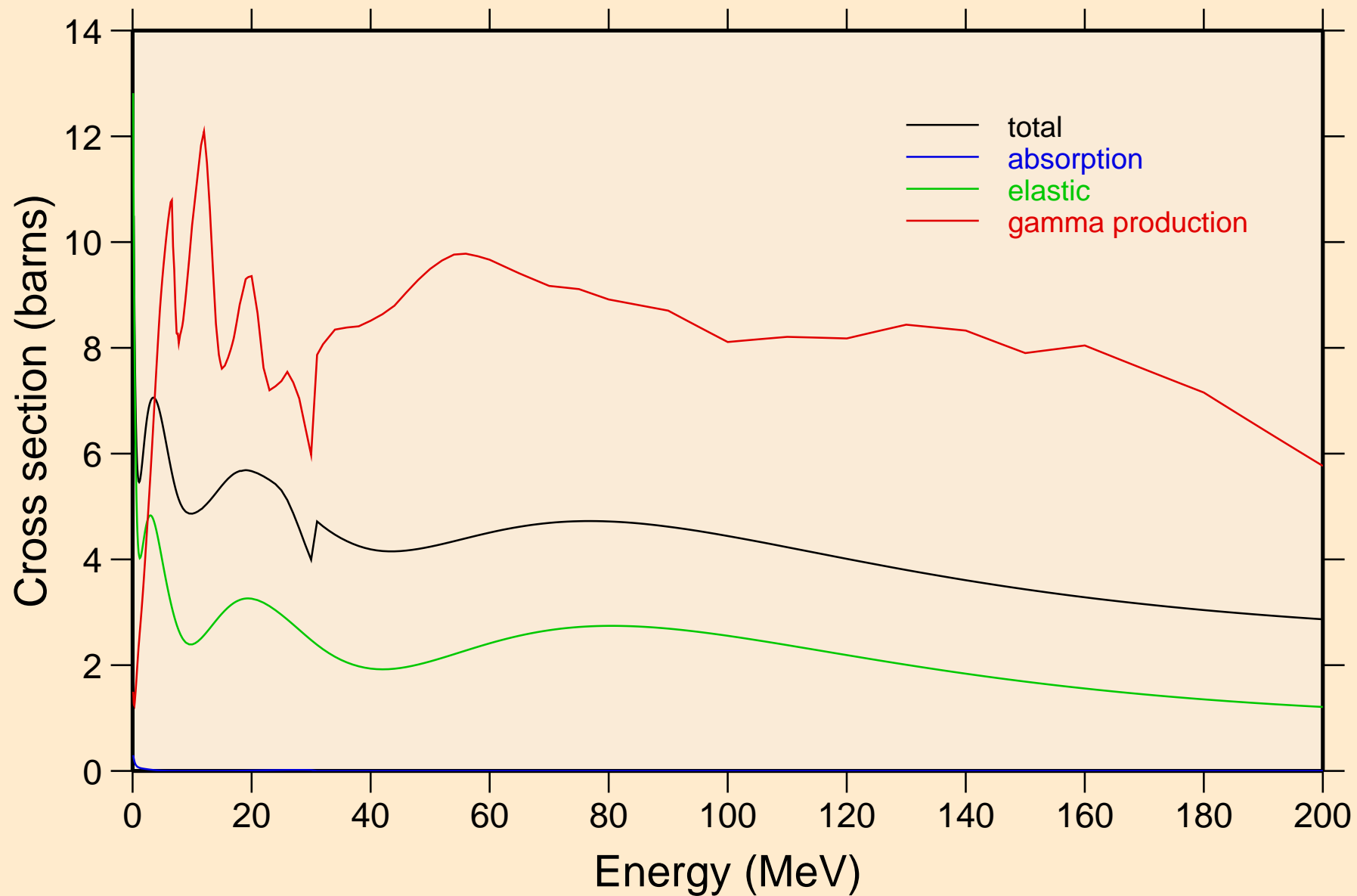

RE195 NEUTRON ACER TENDL-2019 LIBRARY; T=293.16K
Heating

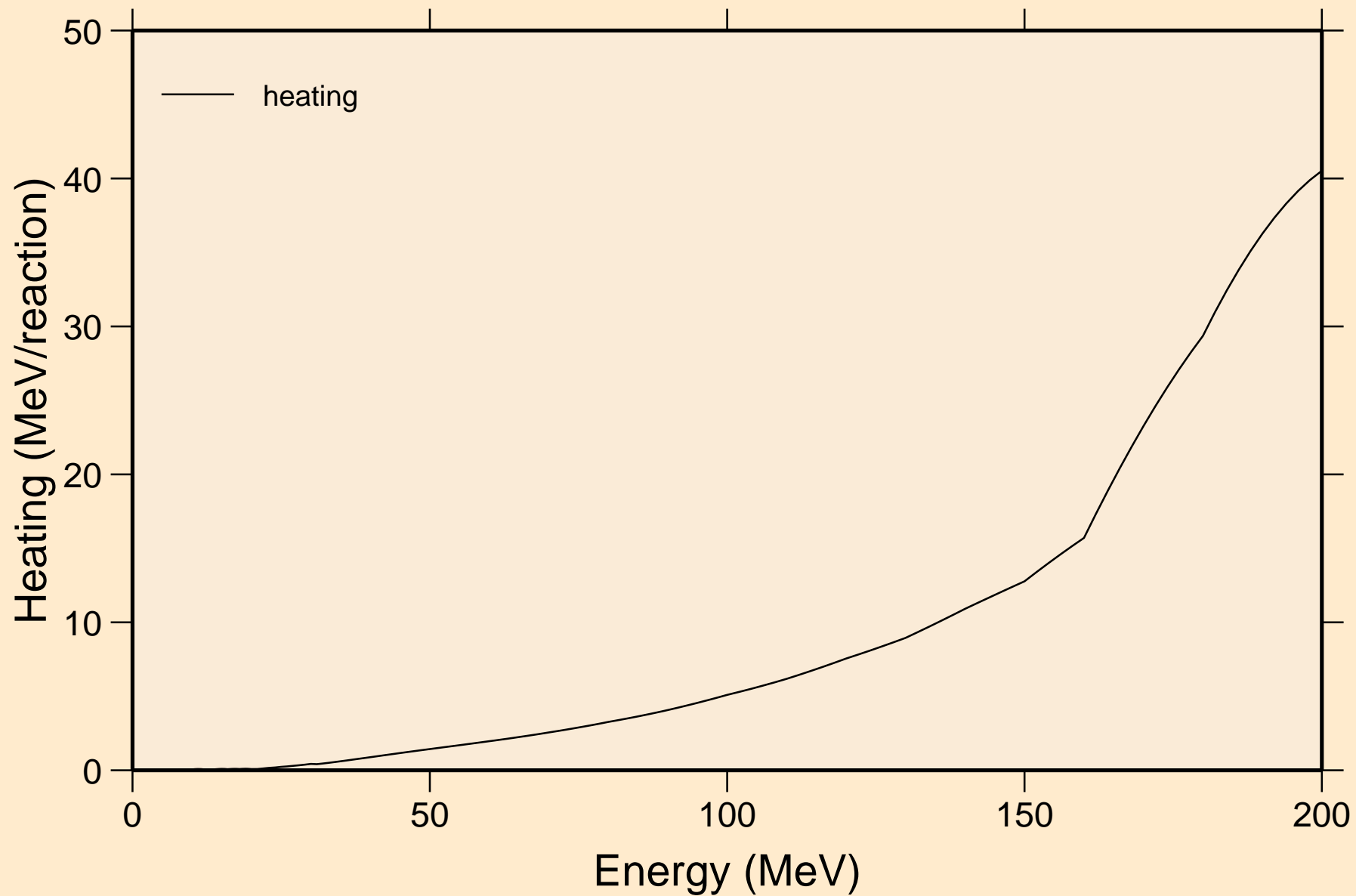

RE195 NEUTRON ACER TENDL-2019 LIBRARY; T=293.16K
Damage

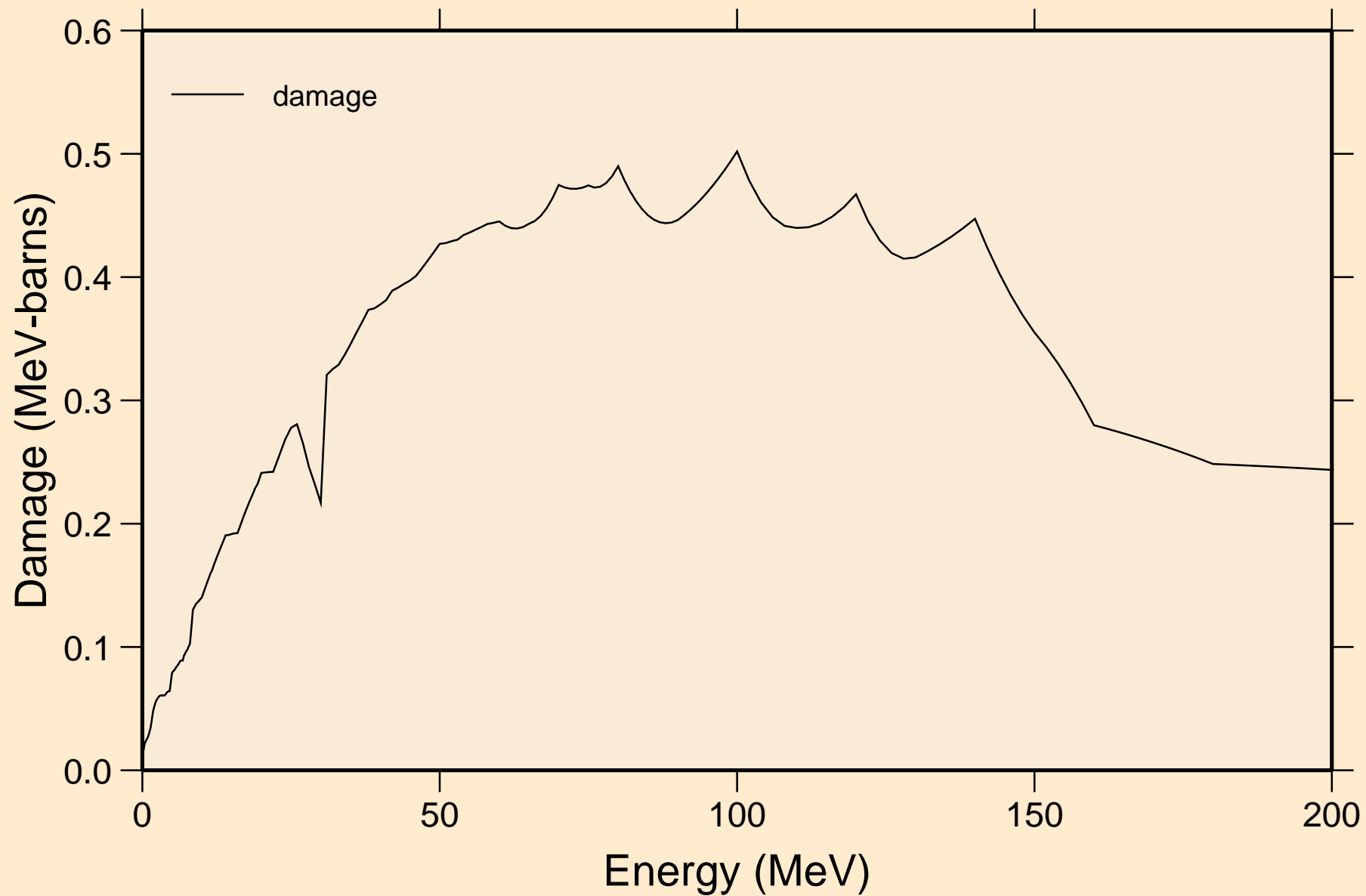

RE195 NEUTRON ACER TENDL-2019 LIBRARY; T=293.16K
Non-threshold reactions

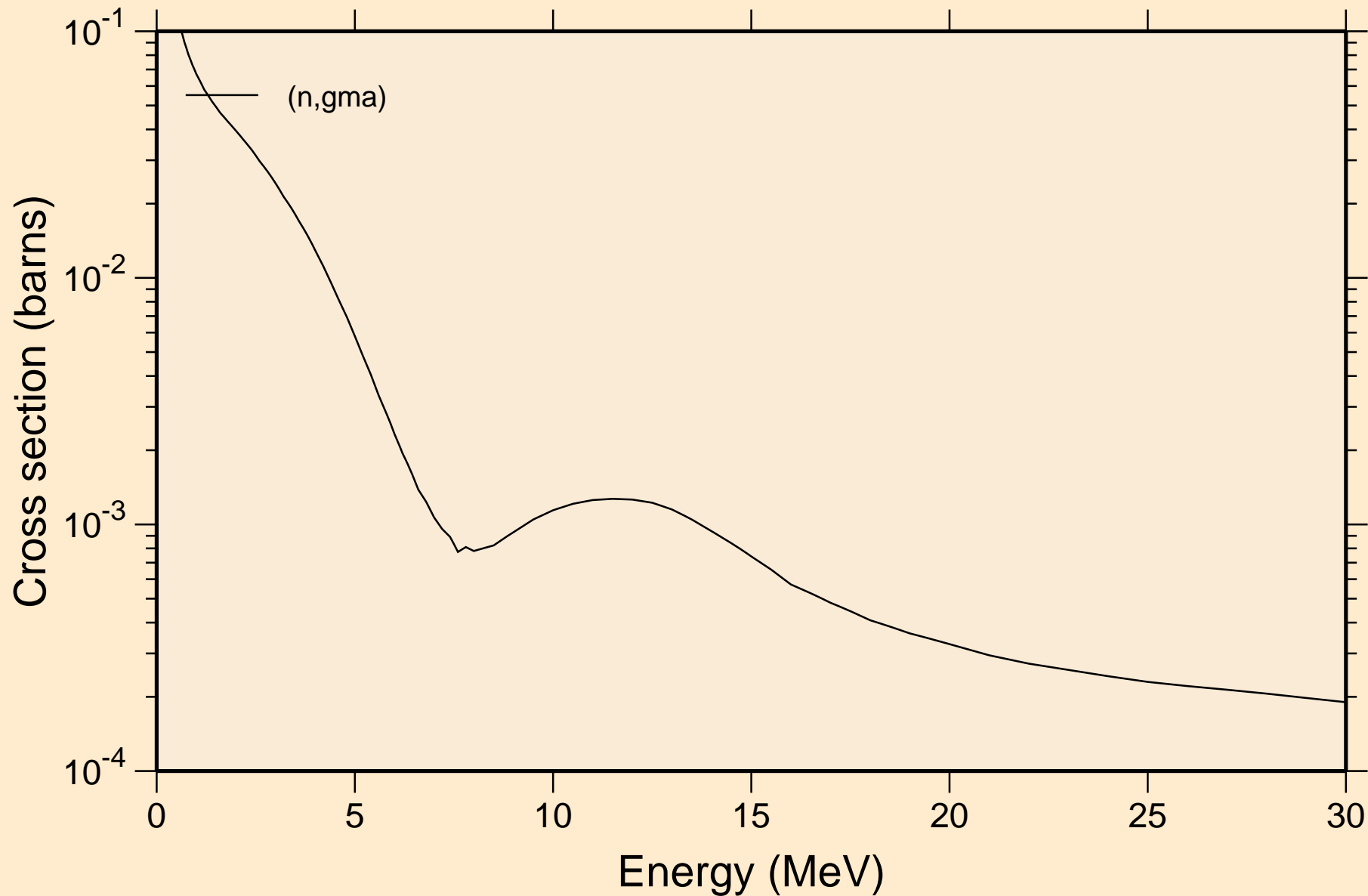

RE195 NEUTRON ACER TENDL-2019 LIBRARY; T=293.16K
Inelastic levels

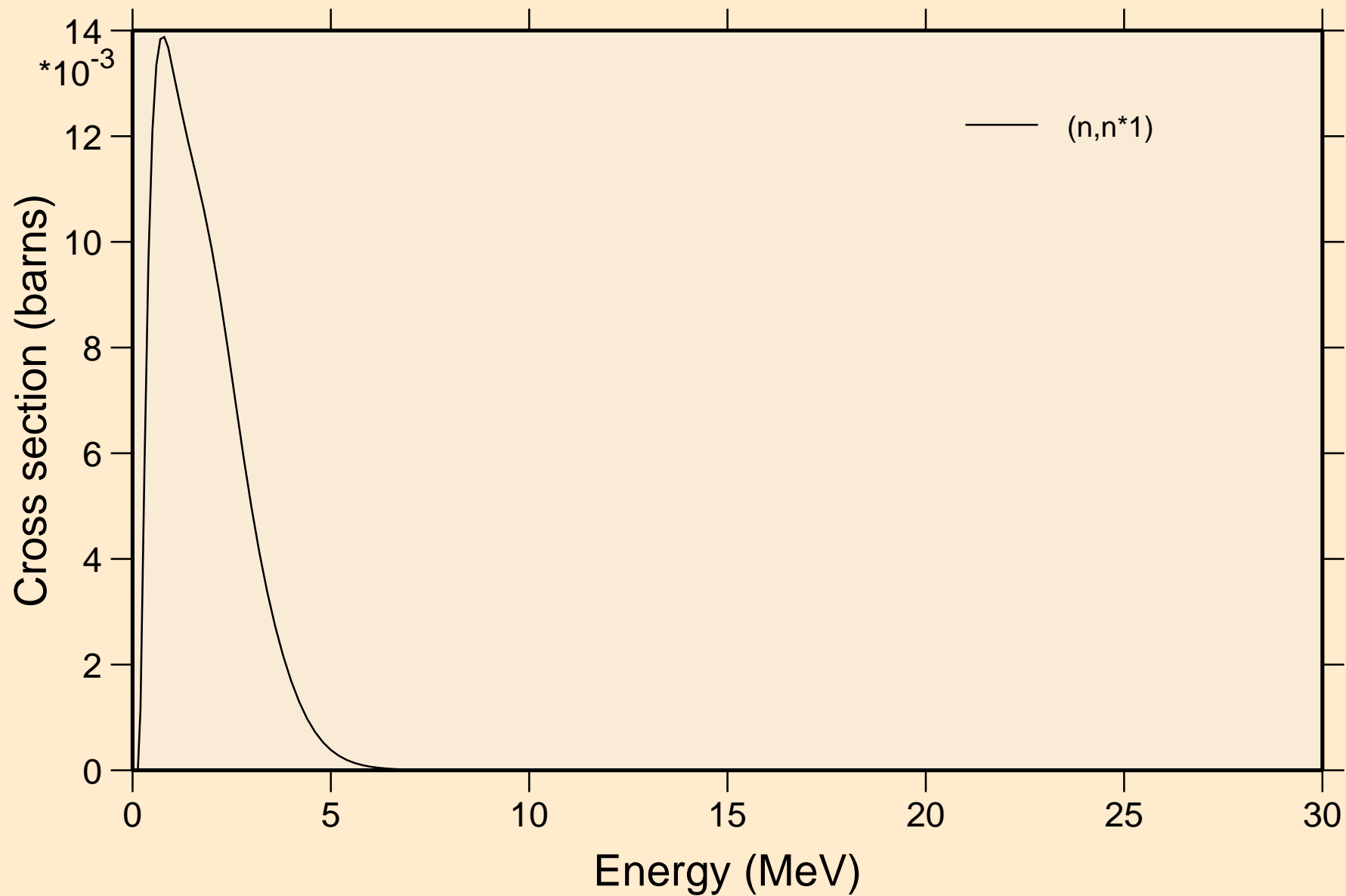

RE195 NEUTRON ACER TENDL-2019 LIBRARY; T=293.16K
Threshold reactions

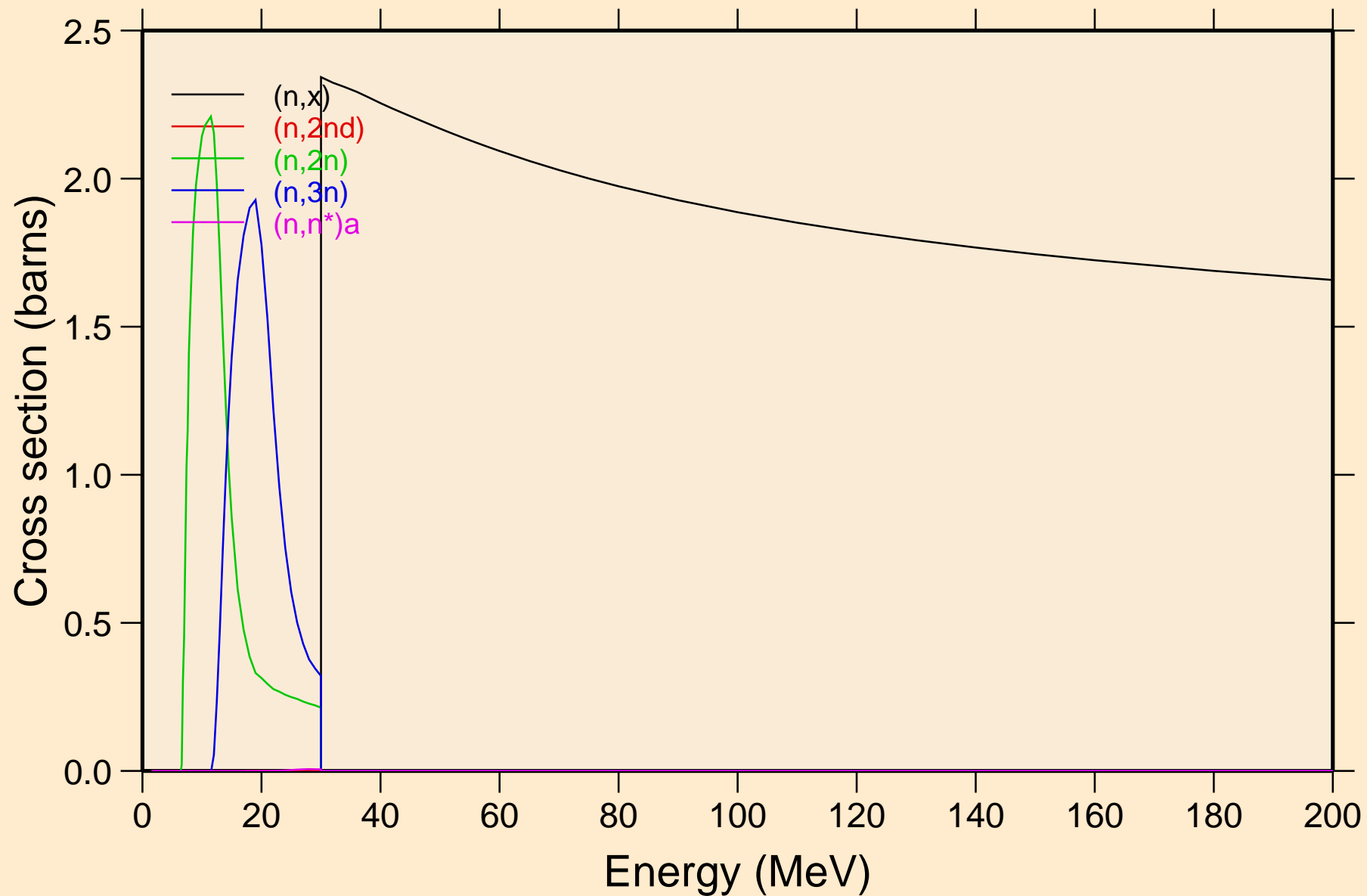

RE195 NEUTRON ACER TENDL-2019 LIBRARY; T=293.16K
Threshold reactions

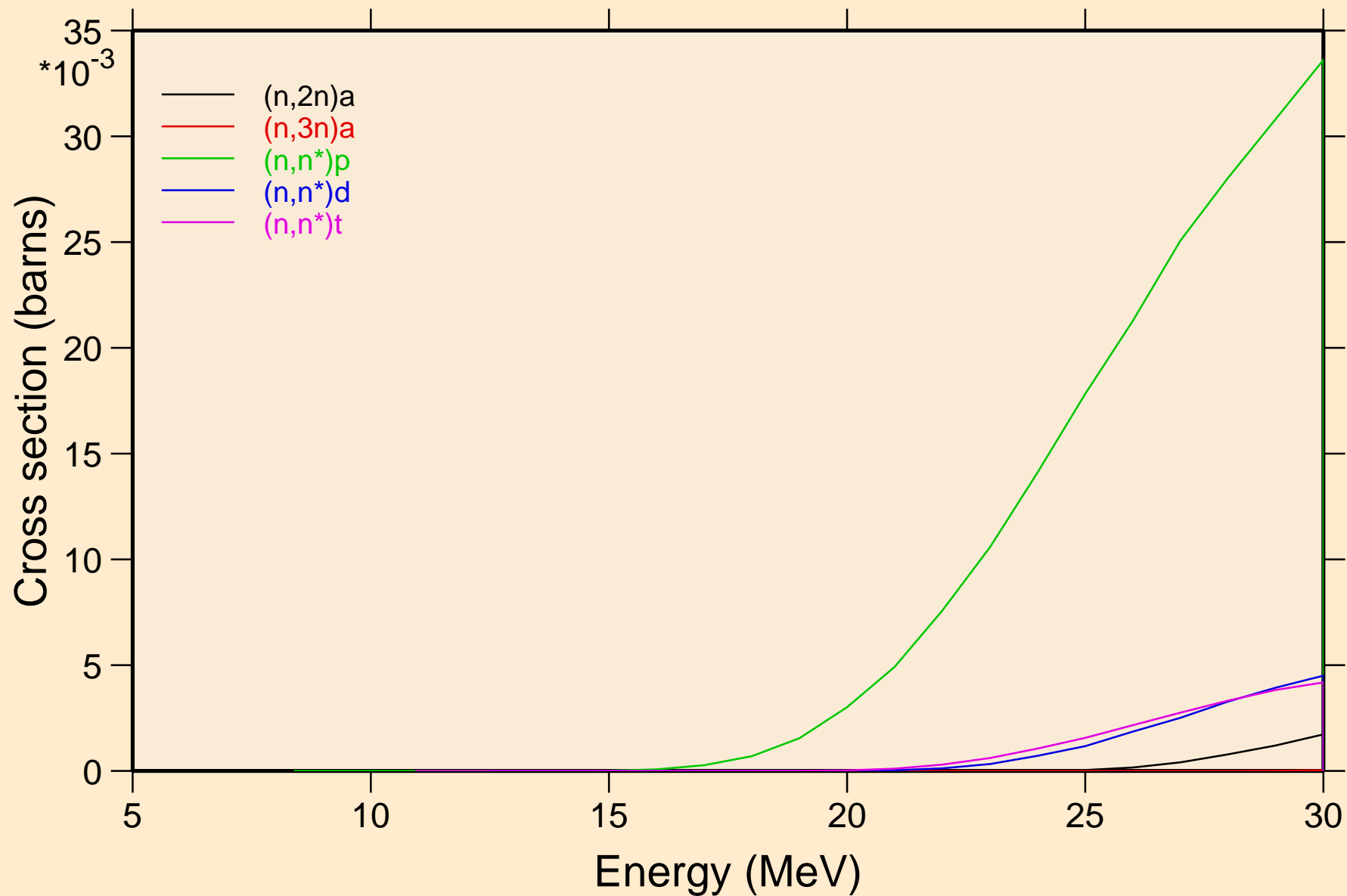

RE195 NEUTRON ACER TENDL-2019 LIBRARY; T=293.16K
Threshold reactions

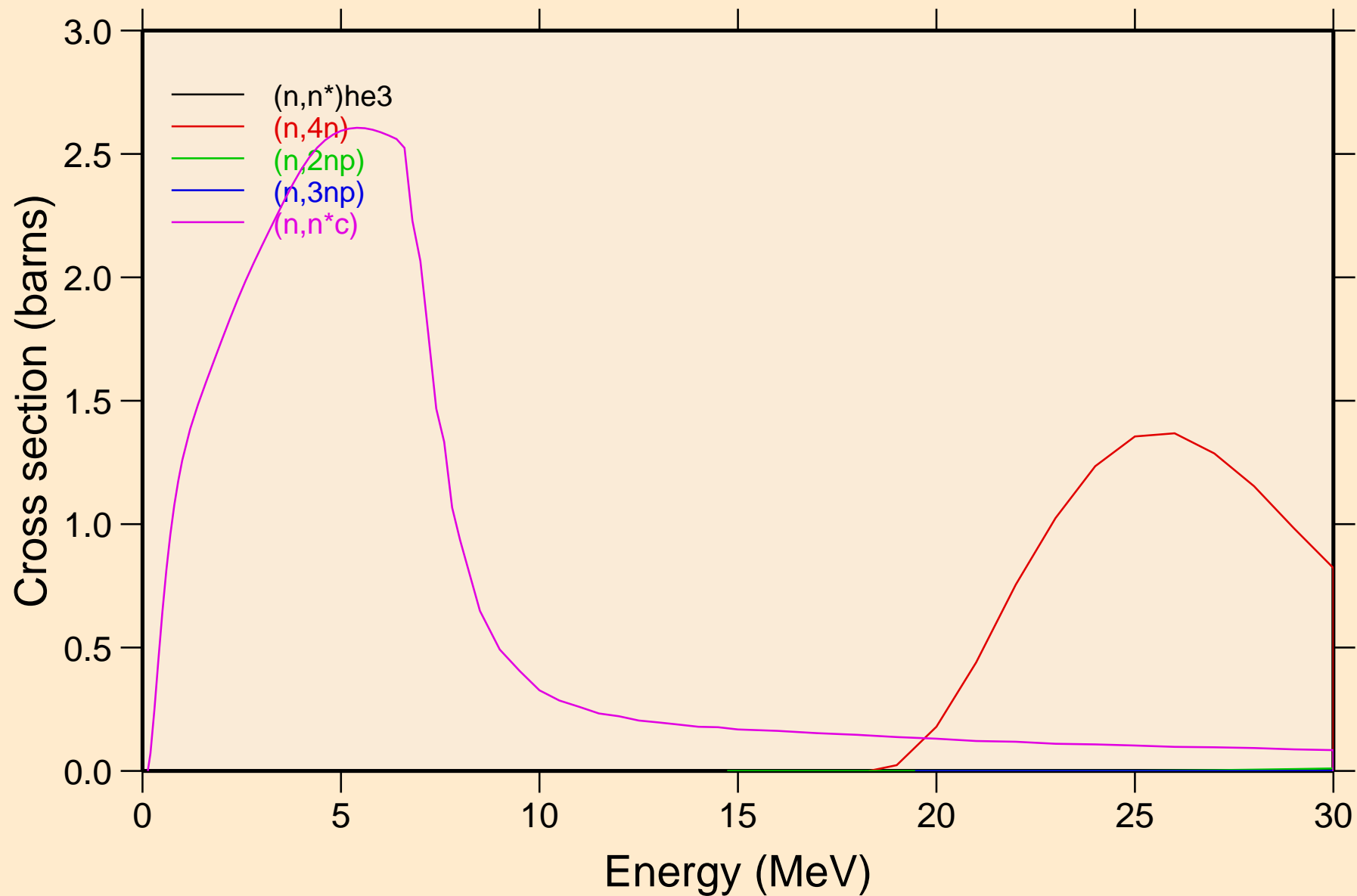

RE195 NEUTRON ACER TENDL-2019 LIBRARY; T=293.16K
Threshold reactions

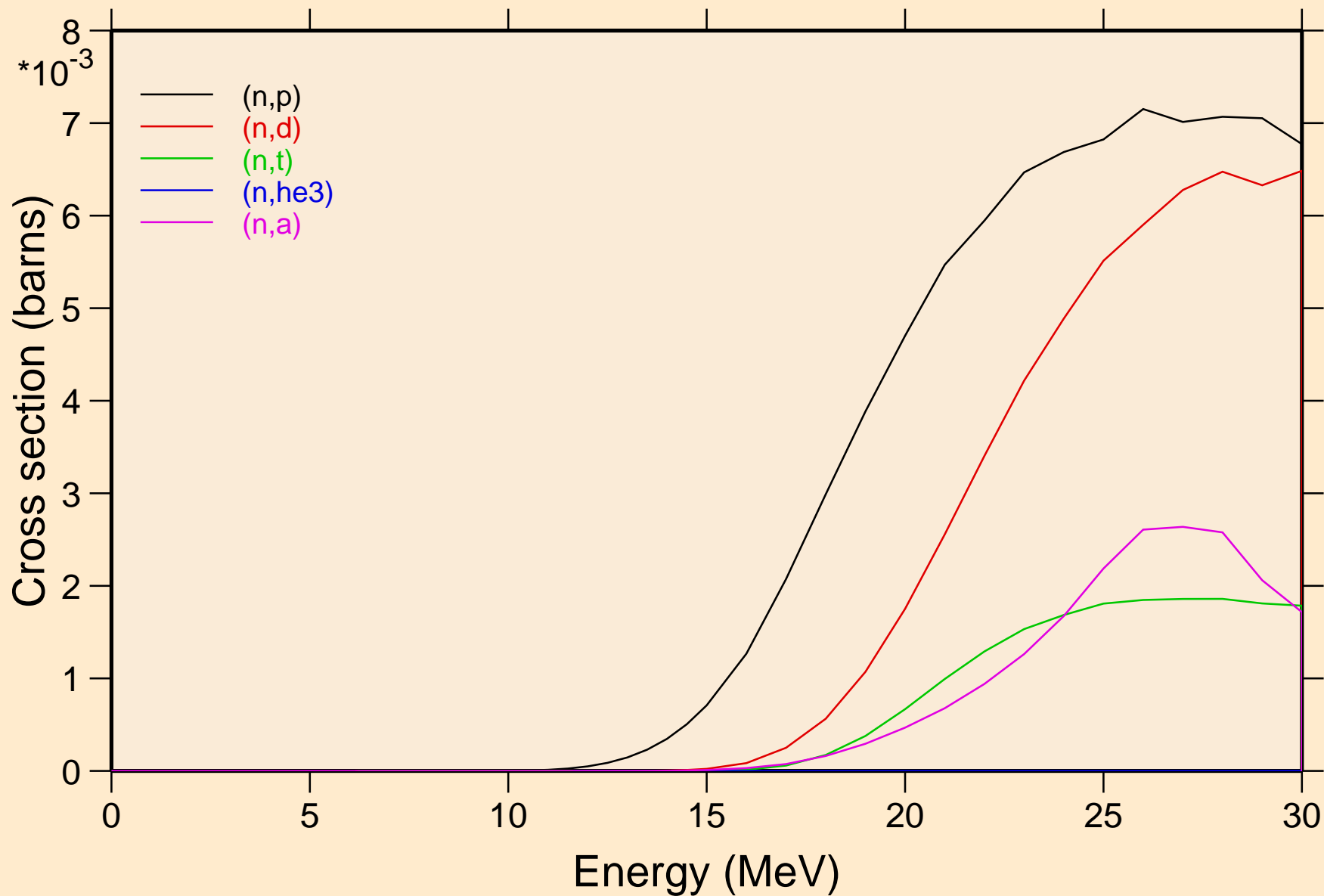

RE195 NEUTRON ACER TENDL-2019 LIBRARY; T=293.16K
Threshold reactions

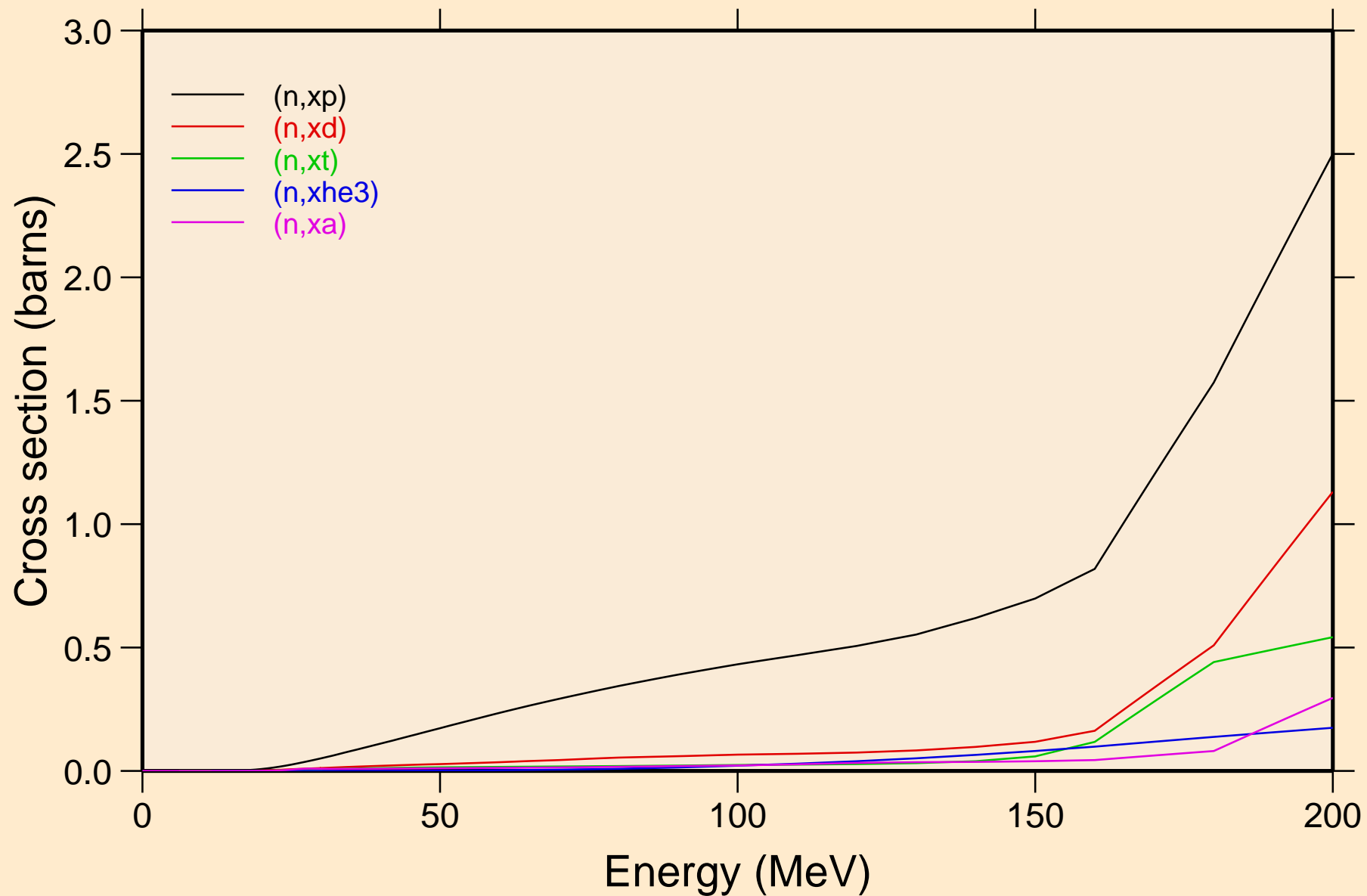

RE195 NEUTRON ACER TENDL-2019 LIBRARY; T=293.16K
angular distribution for elastic

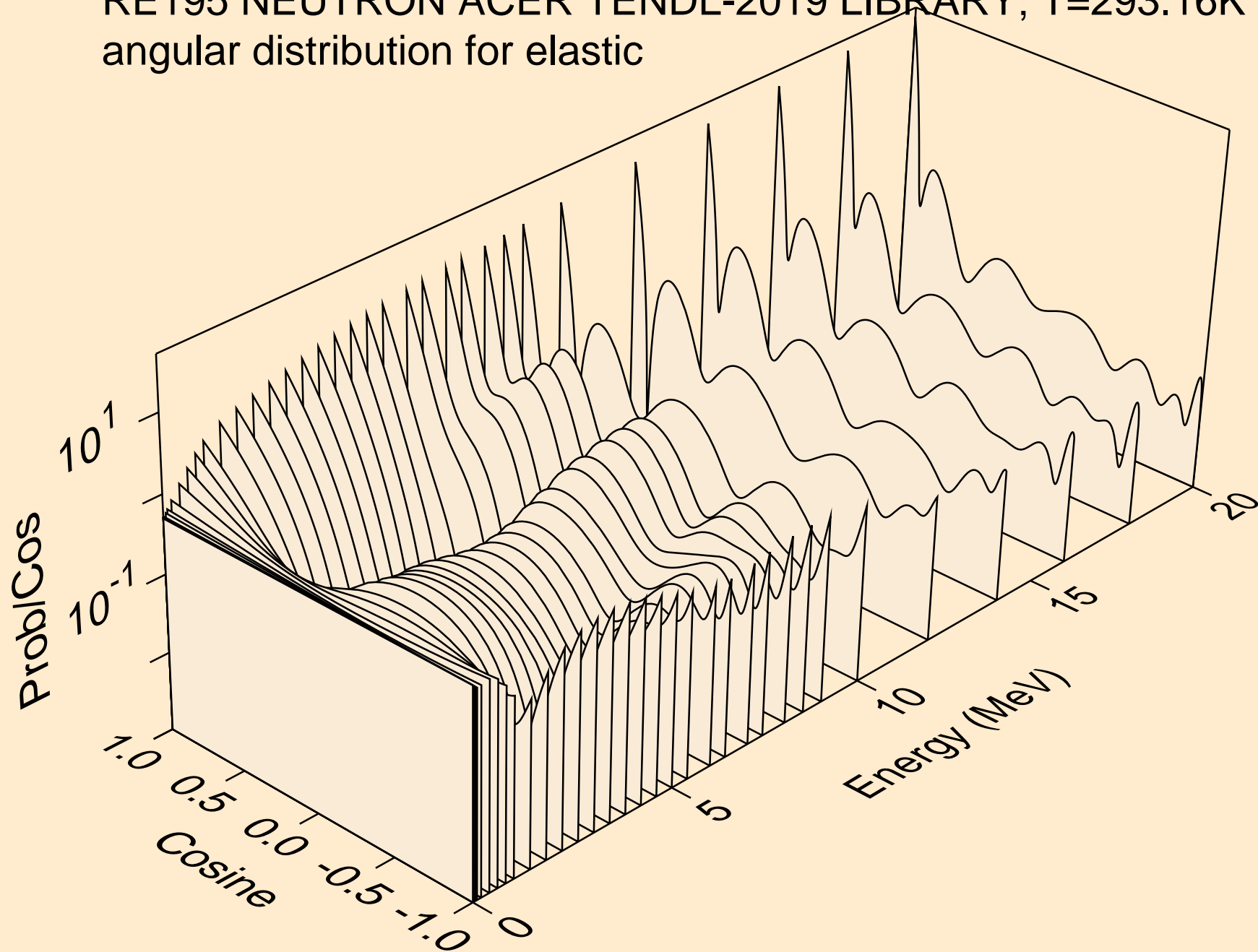

RE195 NEUTRON ACER TENDL-2019 LIBRARY; T=293.16K
angular distribution for elastic

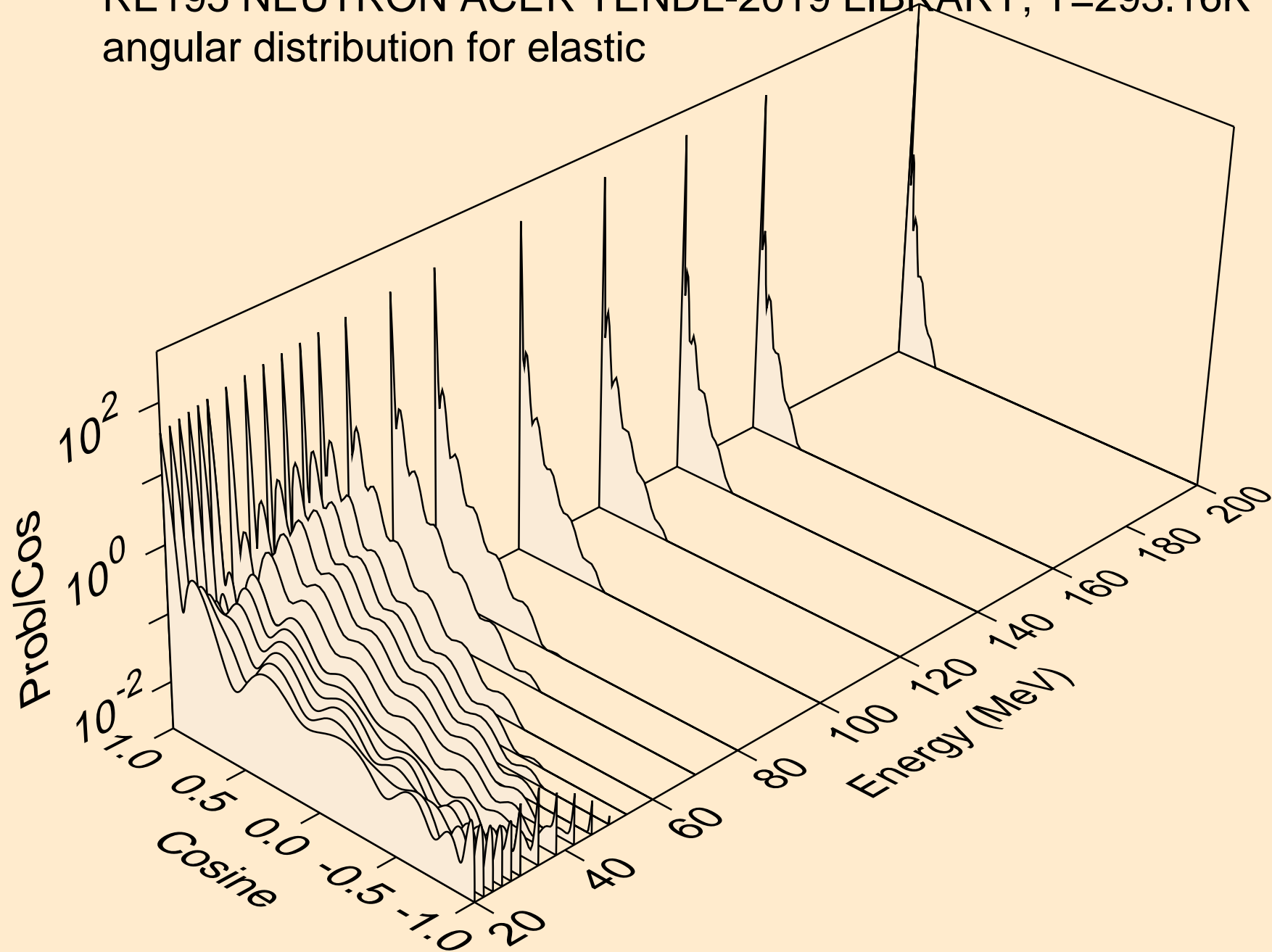

RE195 NEUTRON ACER TENDL-2019 LIBRARY; T=293.16K
angular distribution for (n,n*1)

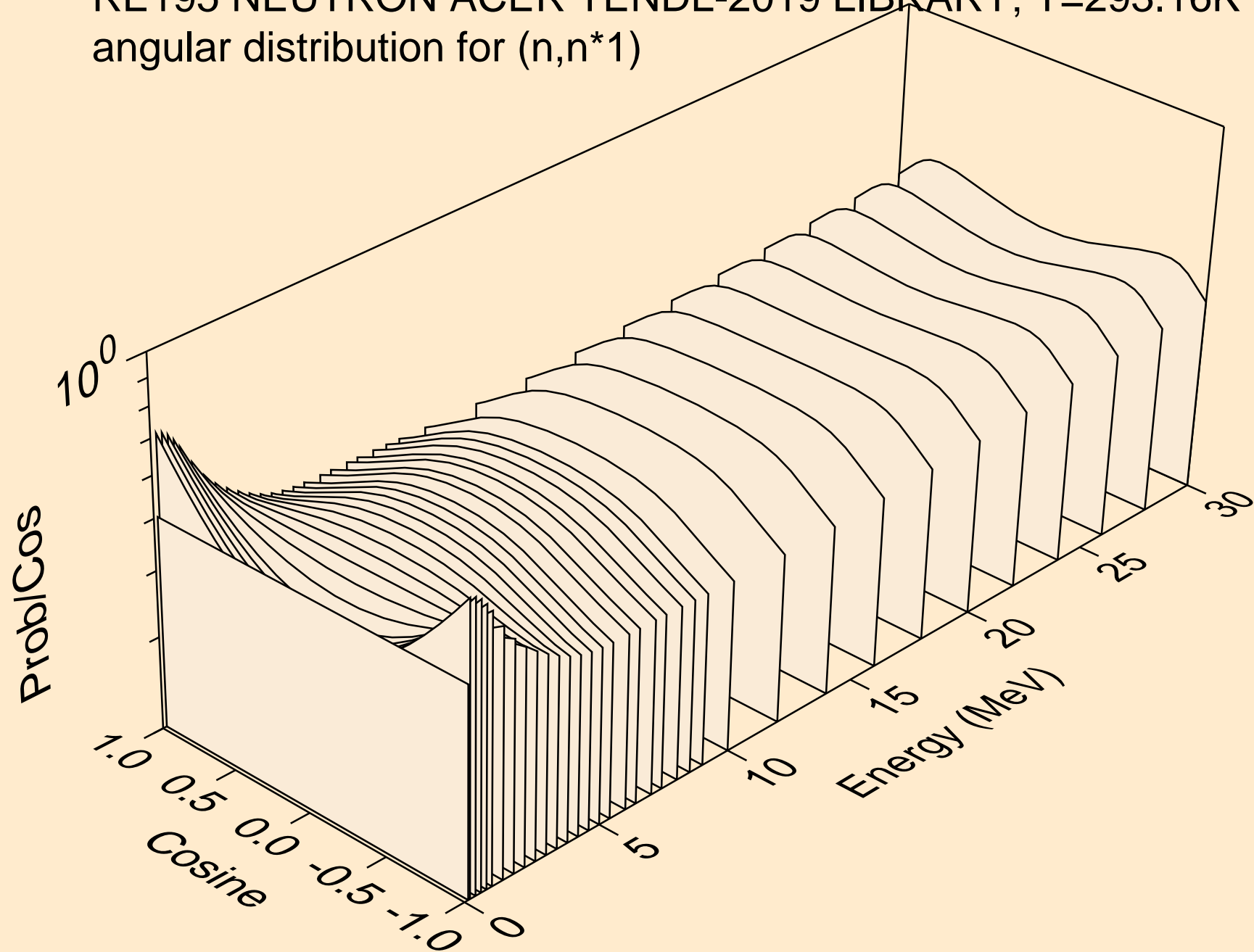

RE195 NEUTRON ACER TENDL-2019 LIBRARY; T=293.16K
Neutron emission for (n,x)

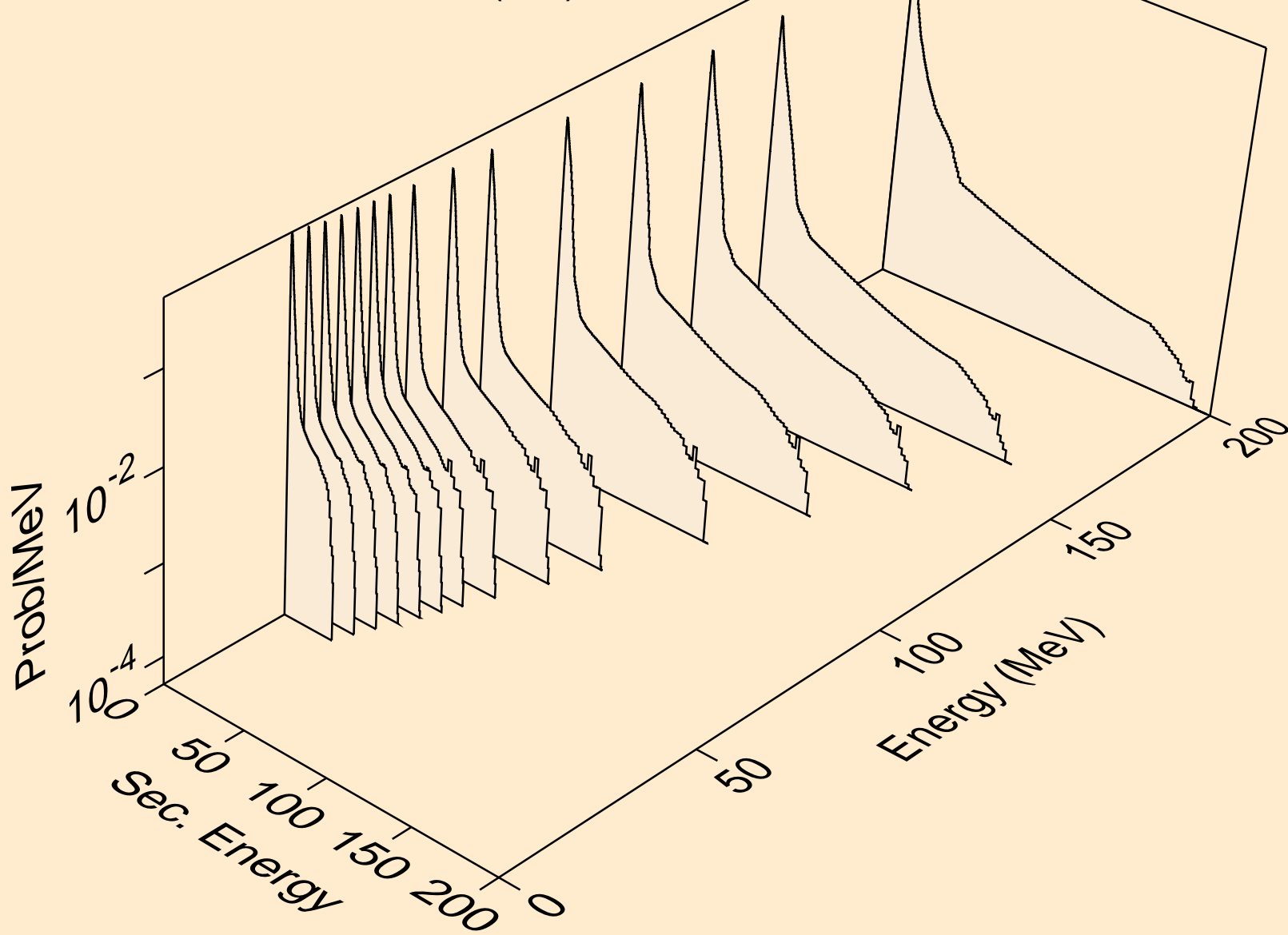

RE195 NEUTRON ACER TENDL-2019 LIBRARY; T=293.16K
Neutron emission for (n,2nd)

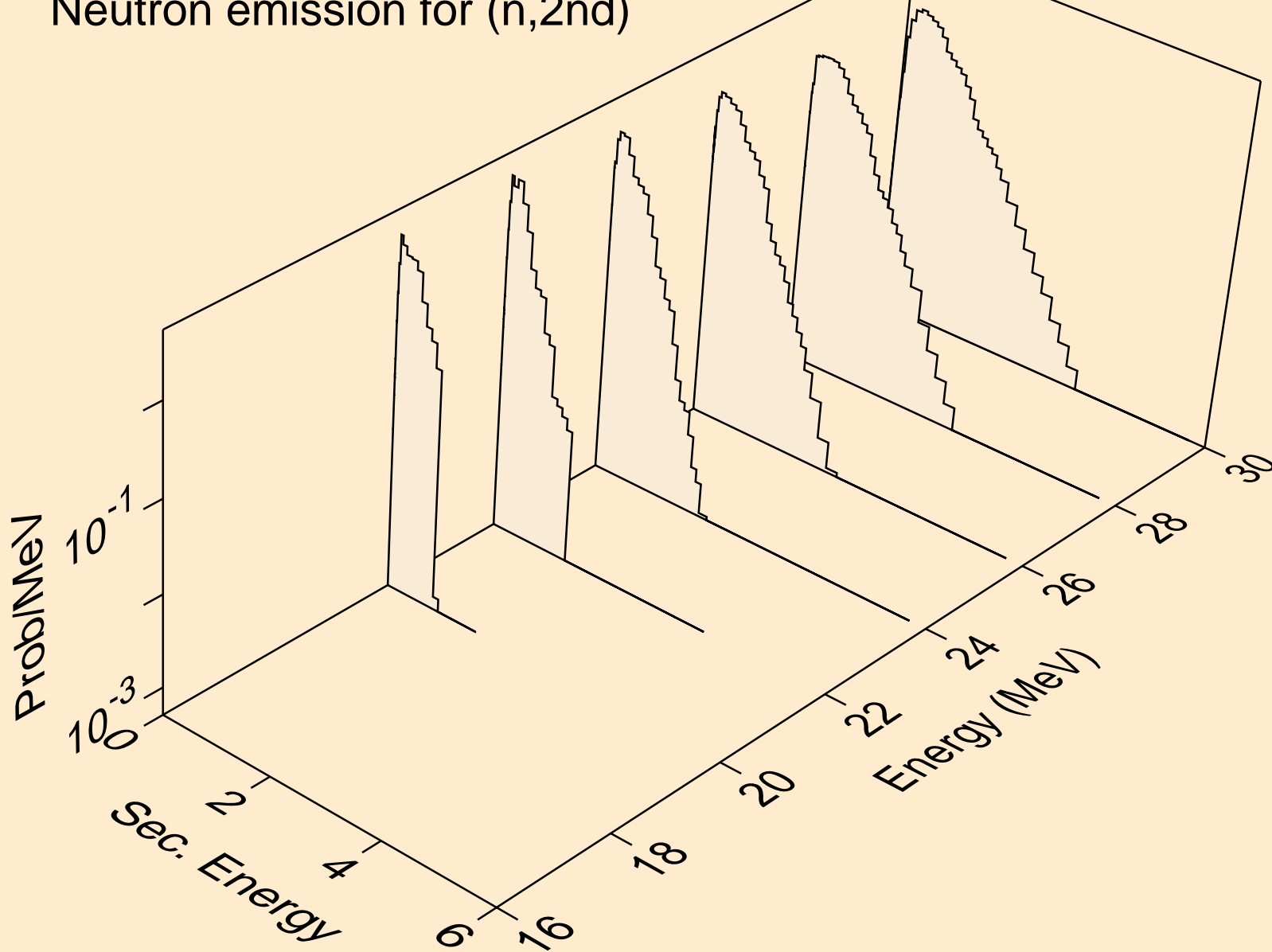

RE195 NEUTRON ACER TENDL-2019 LIBRARY; T=293.16K
Neutron emission for (n,2n)

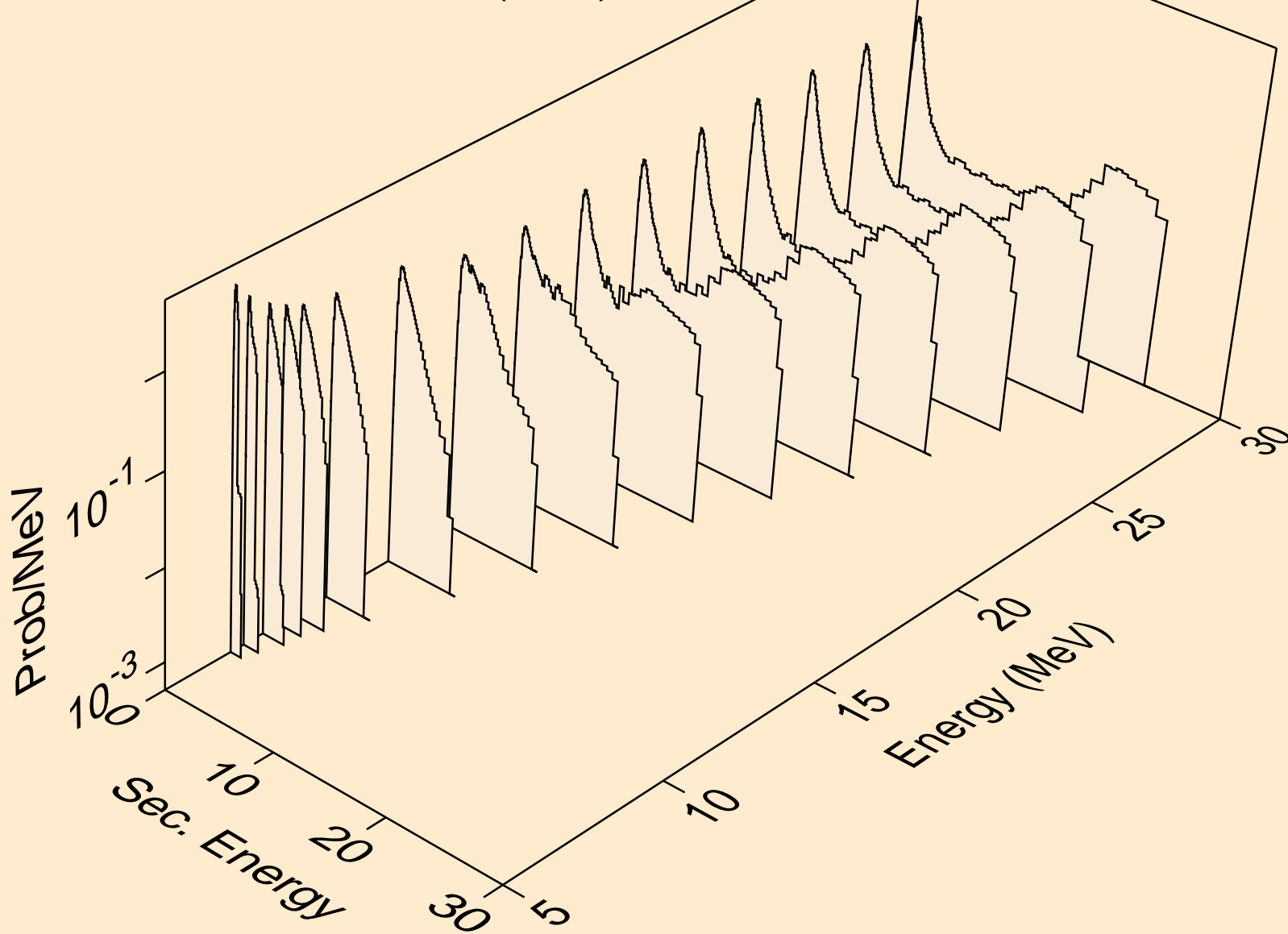

RE195 NEUTRON ACER TENDL-2019 LIBRARY; T=293.16K
Neutron emission for (n,3n)

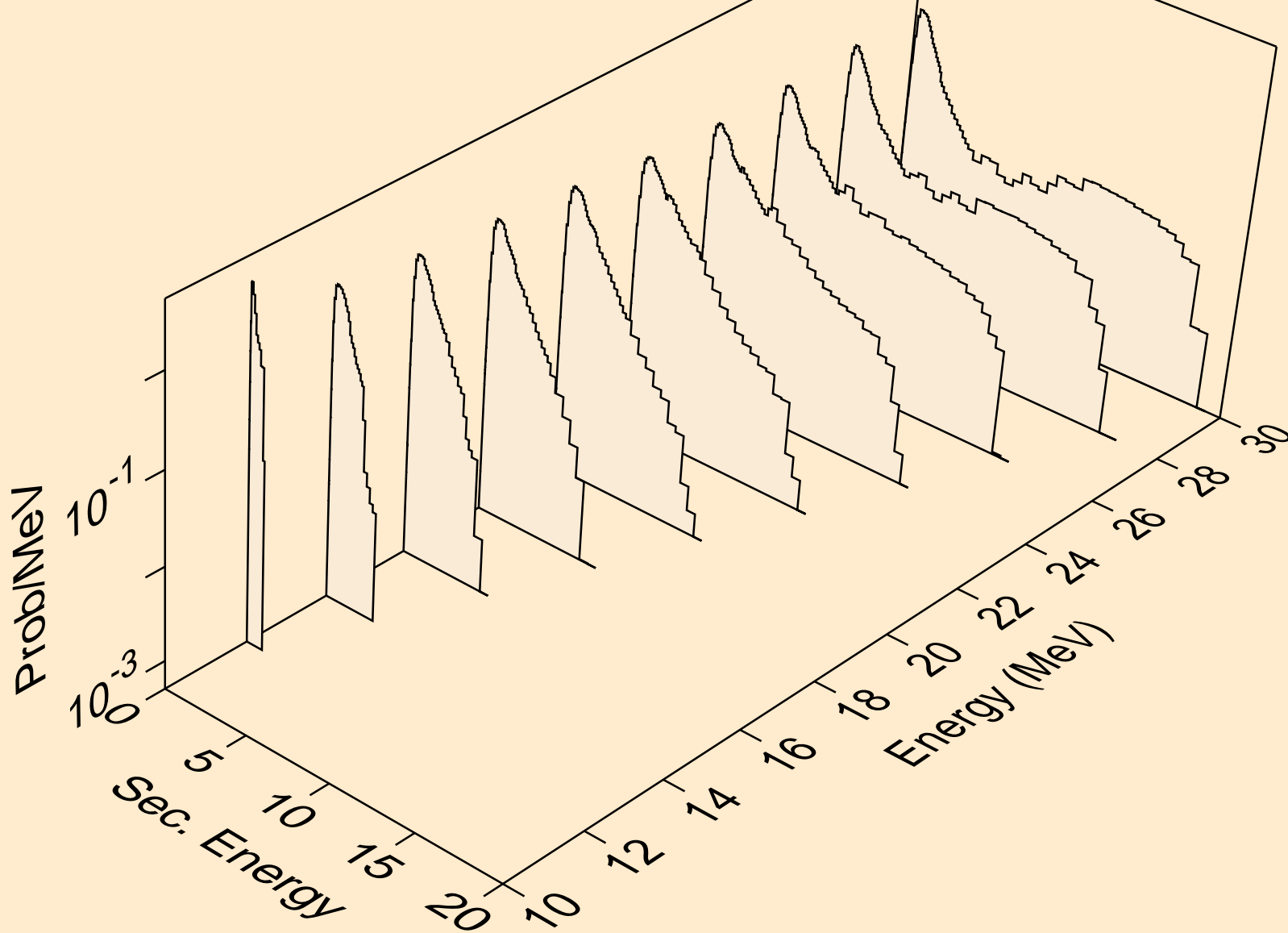

RE195 NEUTRON ACER TENDL-2019 LIBRARY; T=293.16K
Neutron emission for (n,n*)a

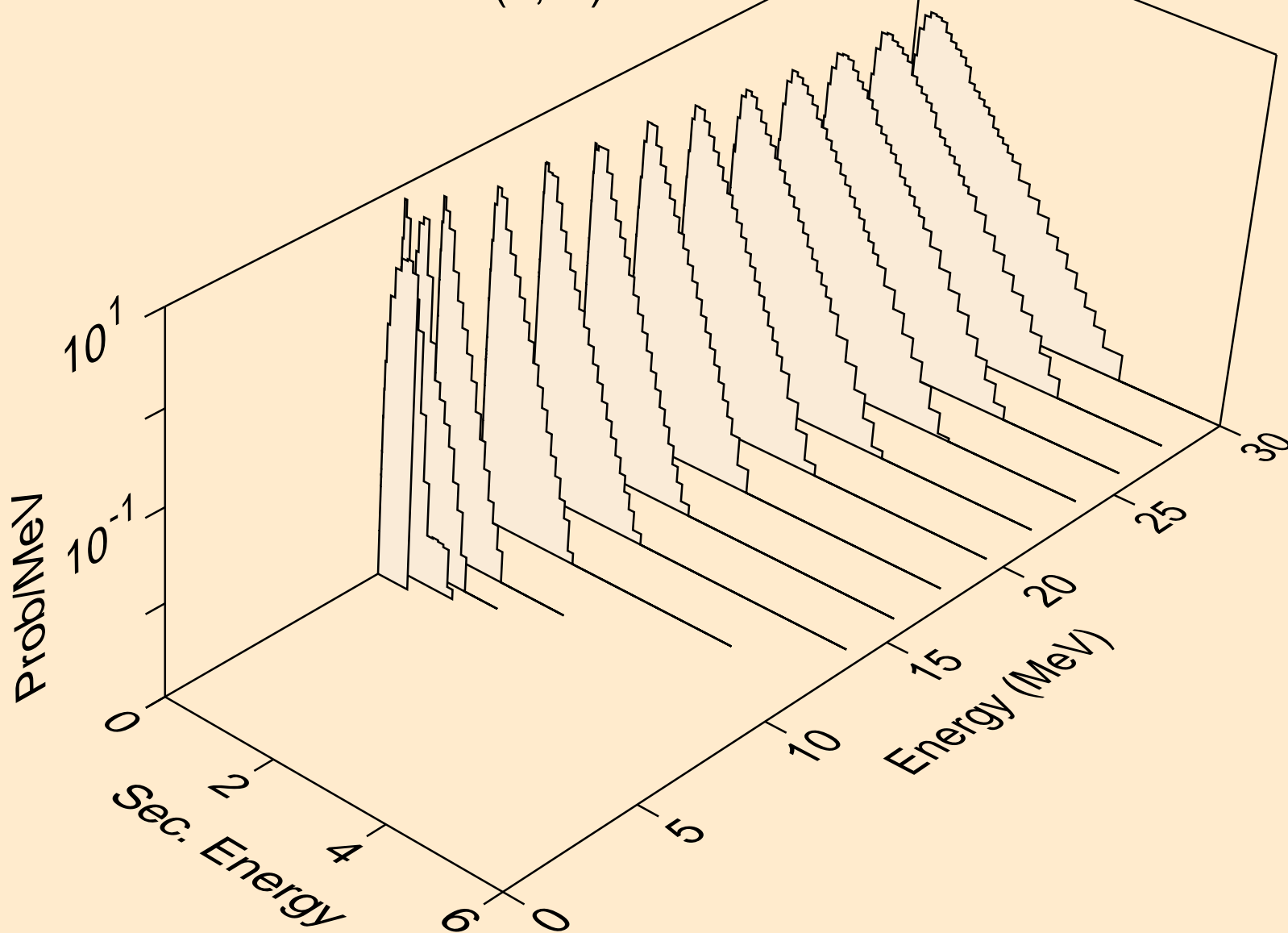

RE195 NEUTRON ACER TENDL-2019 LIBRARY; T=293.16K
Neutron emission for (n,2n)a

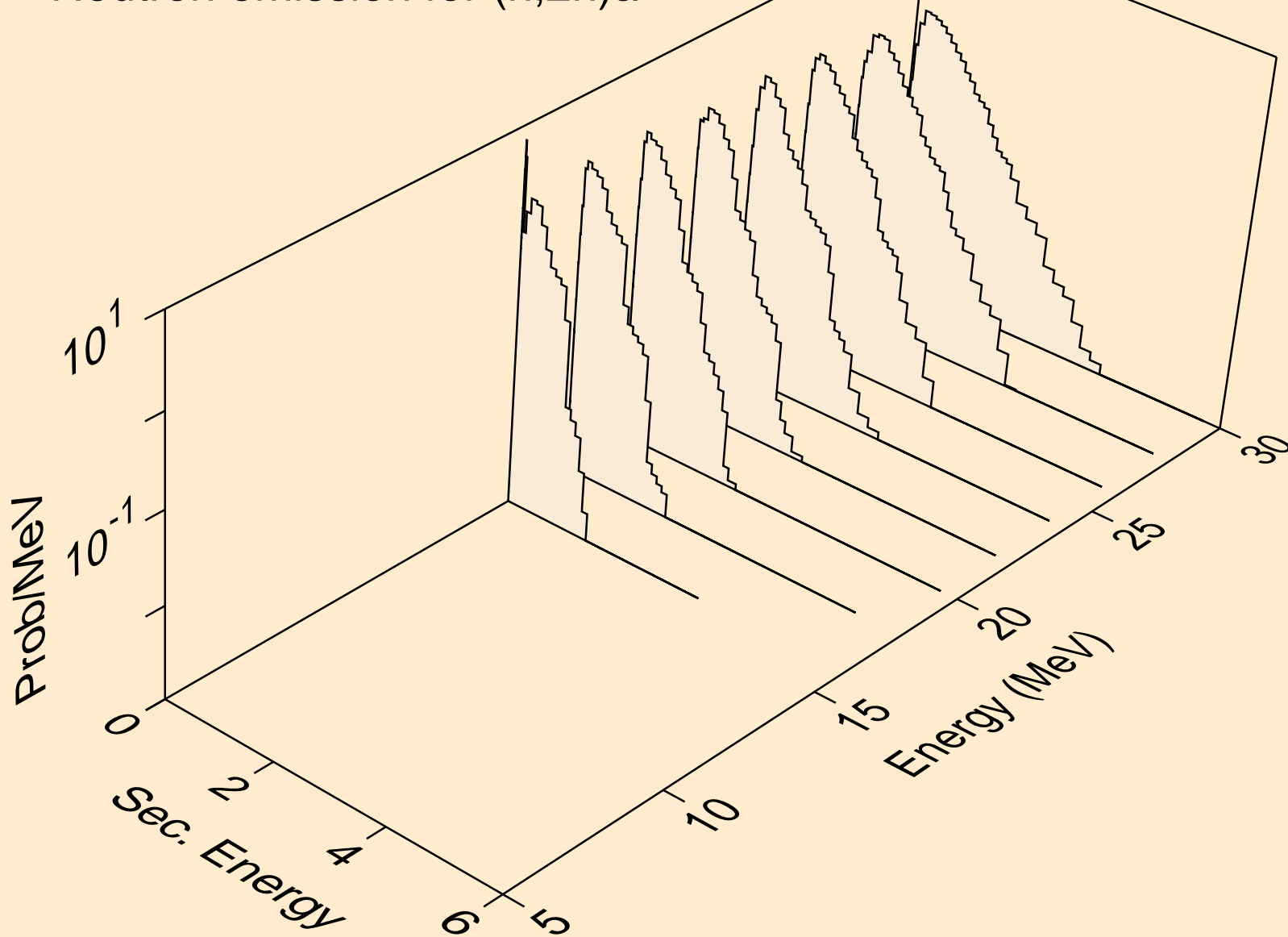

RE195 NEUTRON ACER TENDL-2019 LIBRARY; T=293.16K
Neutron emission for (n,3n)a

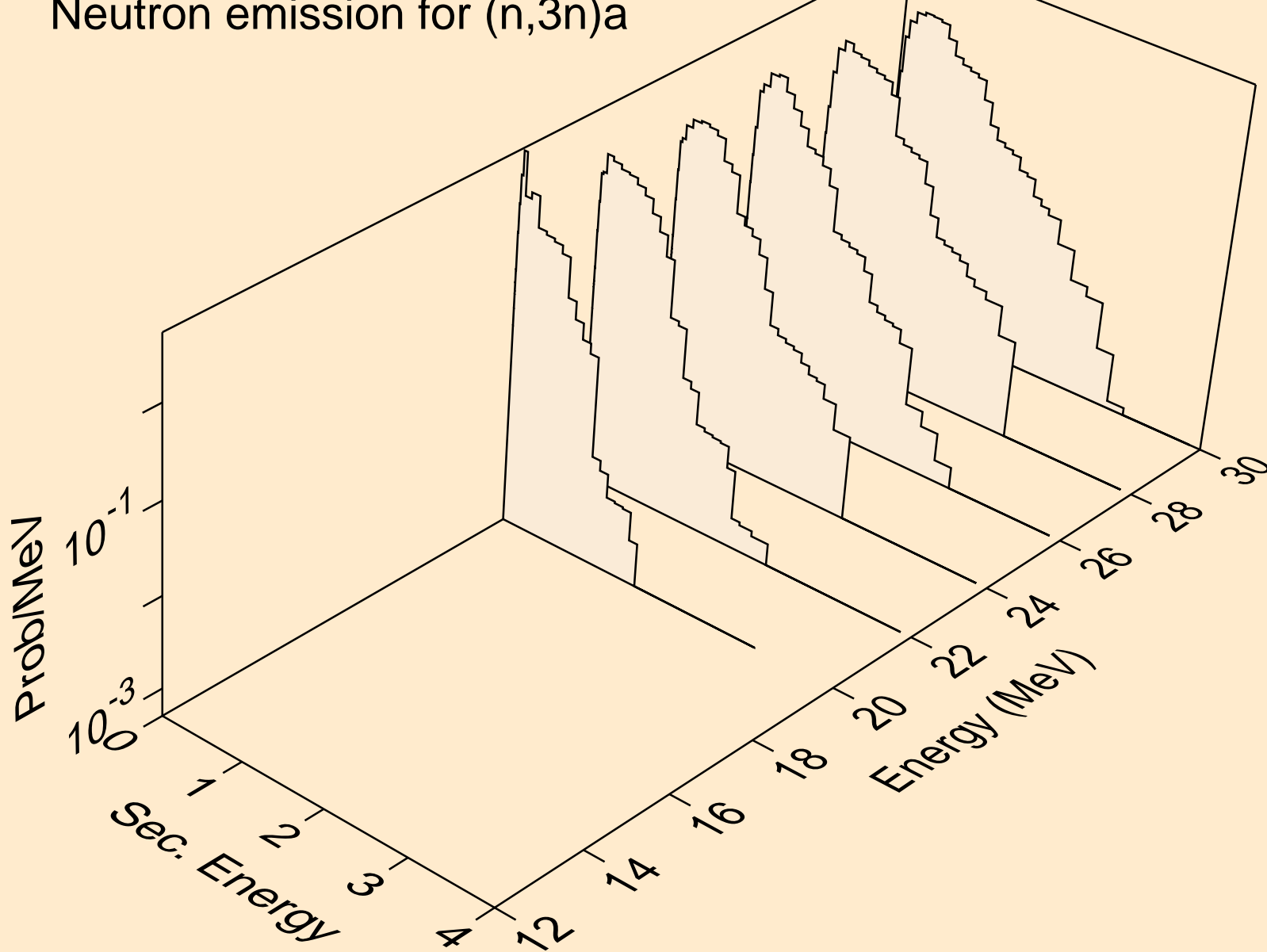

RE195 NEUTRON ACER TENDL-2019 LIBRARY; T=293.16K
Neutron emission for (n,n*)p

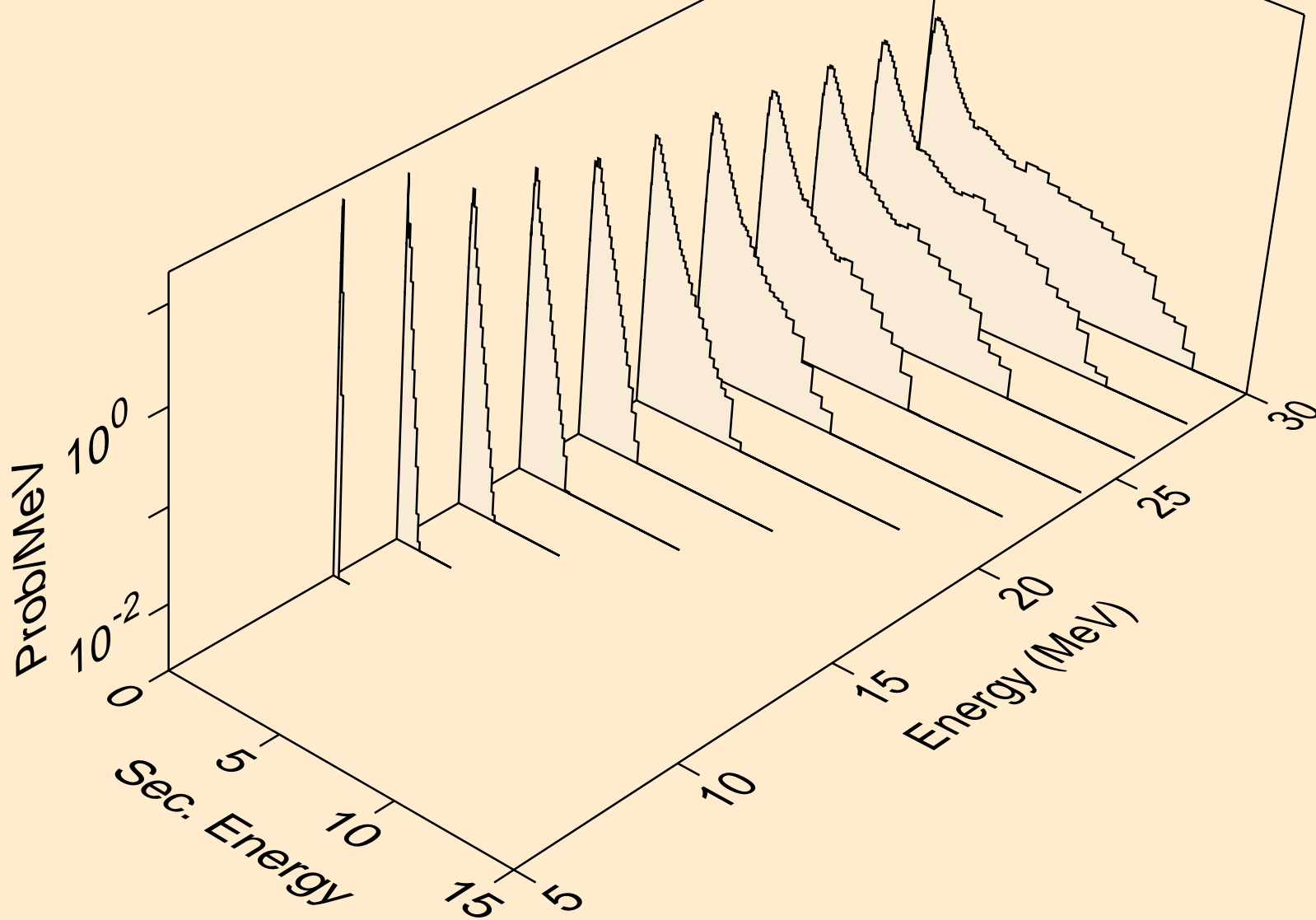

RE195 NEUTRON ACER TENDL-2019 LIBRARY; T=293.16K
Neutron emission for (n,n*)d

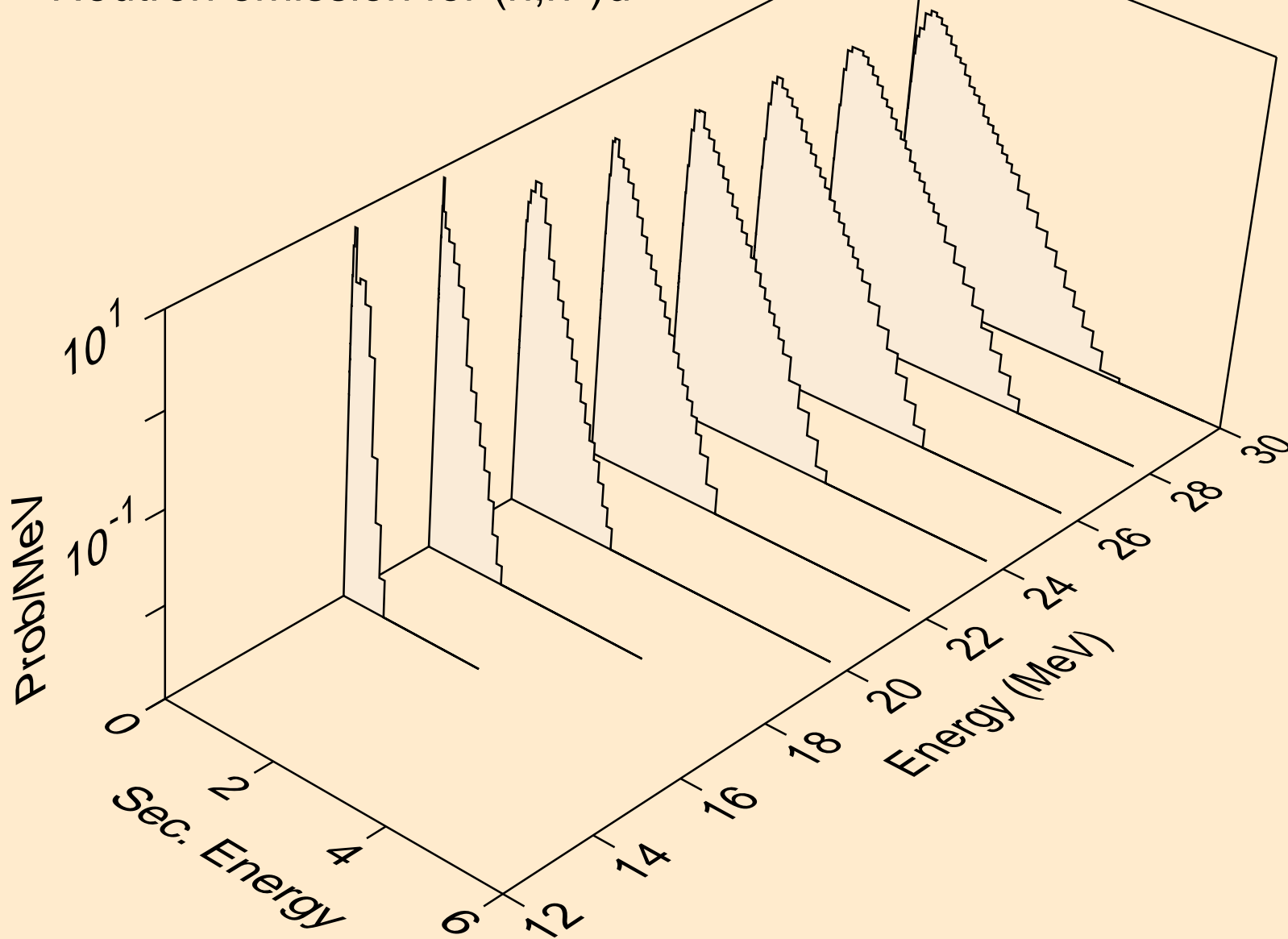

RE195 NEUTRON ACER TENDL-2019 LIBRARY; T=293.16K
Neutron emission for (n,n*)t

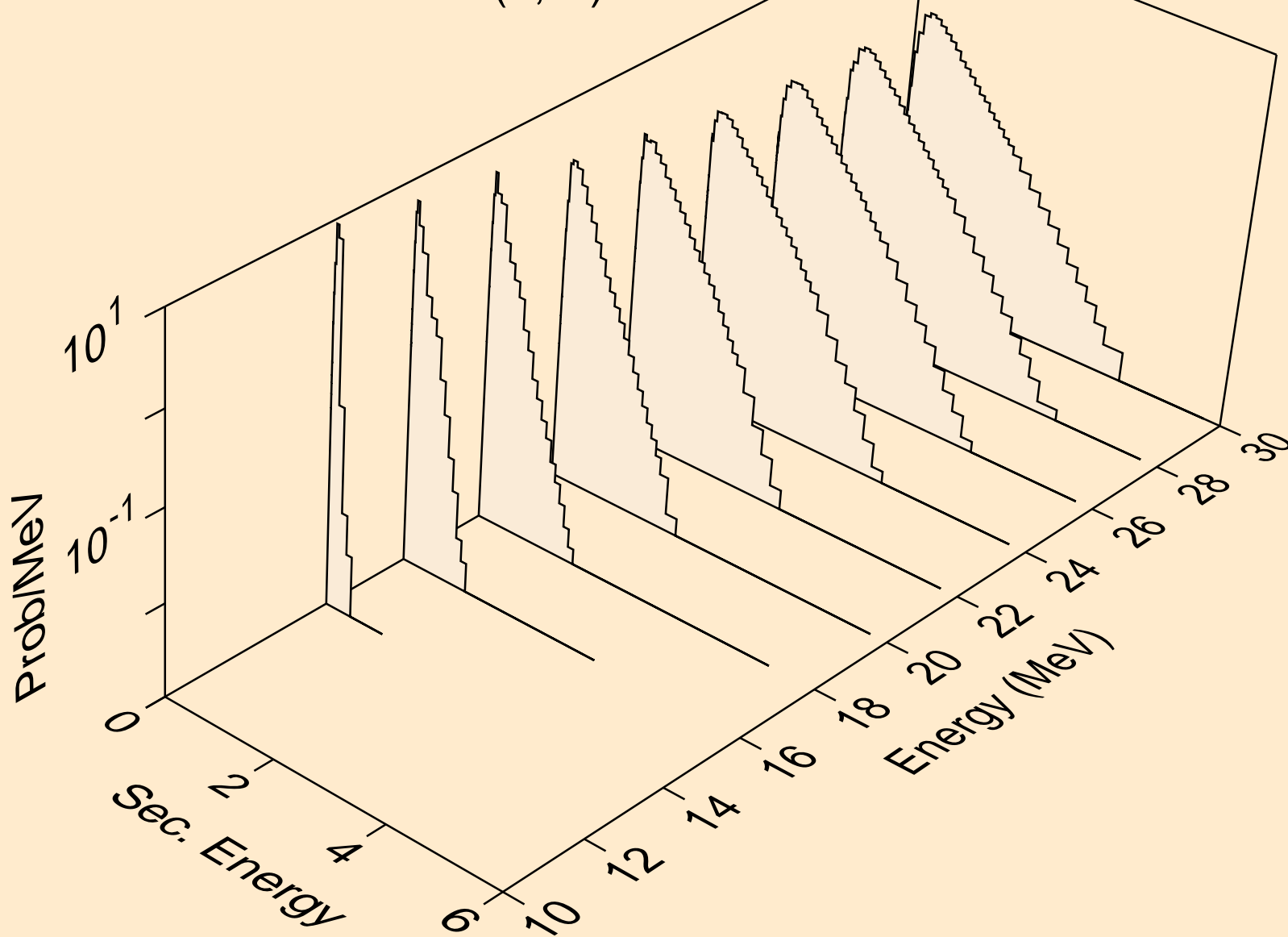

RE195 NEUTRON ACER TENDL-2019 LIBRARY; T=293.16K
Neutron emission for (n,n*)he3

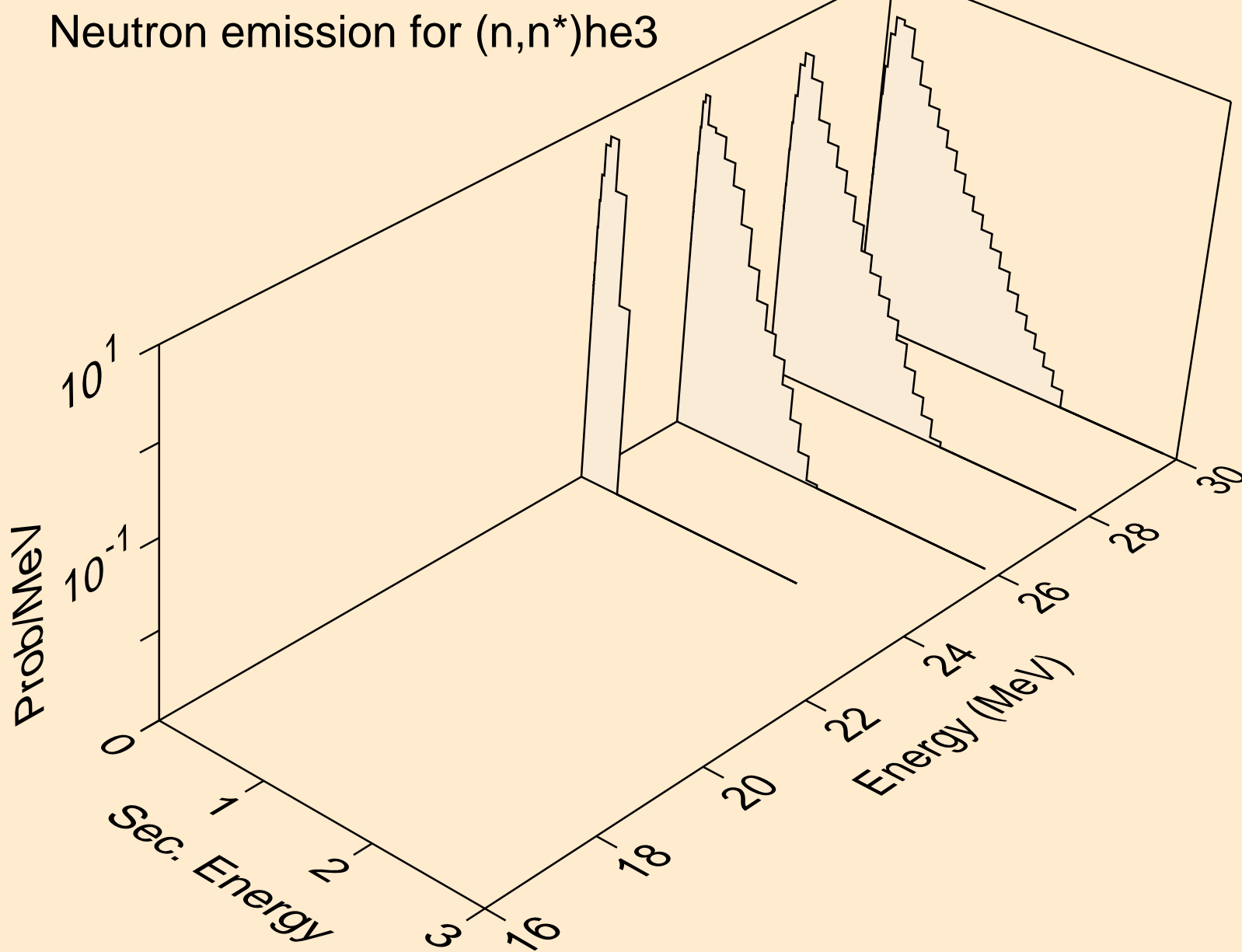

RE195 NEUTRON ACER TENDL-2019 LIBRARY; T=293.16K
Neutron emission for (n,4n)

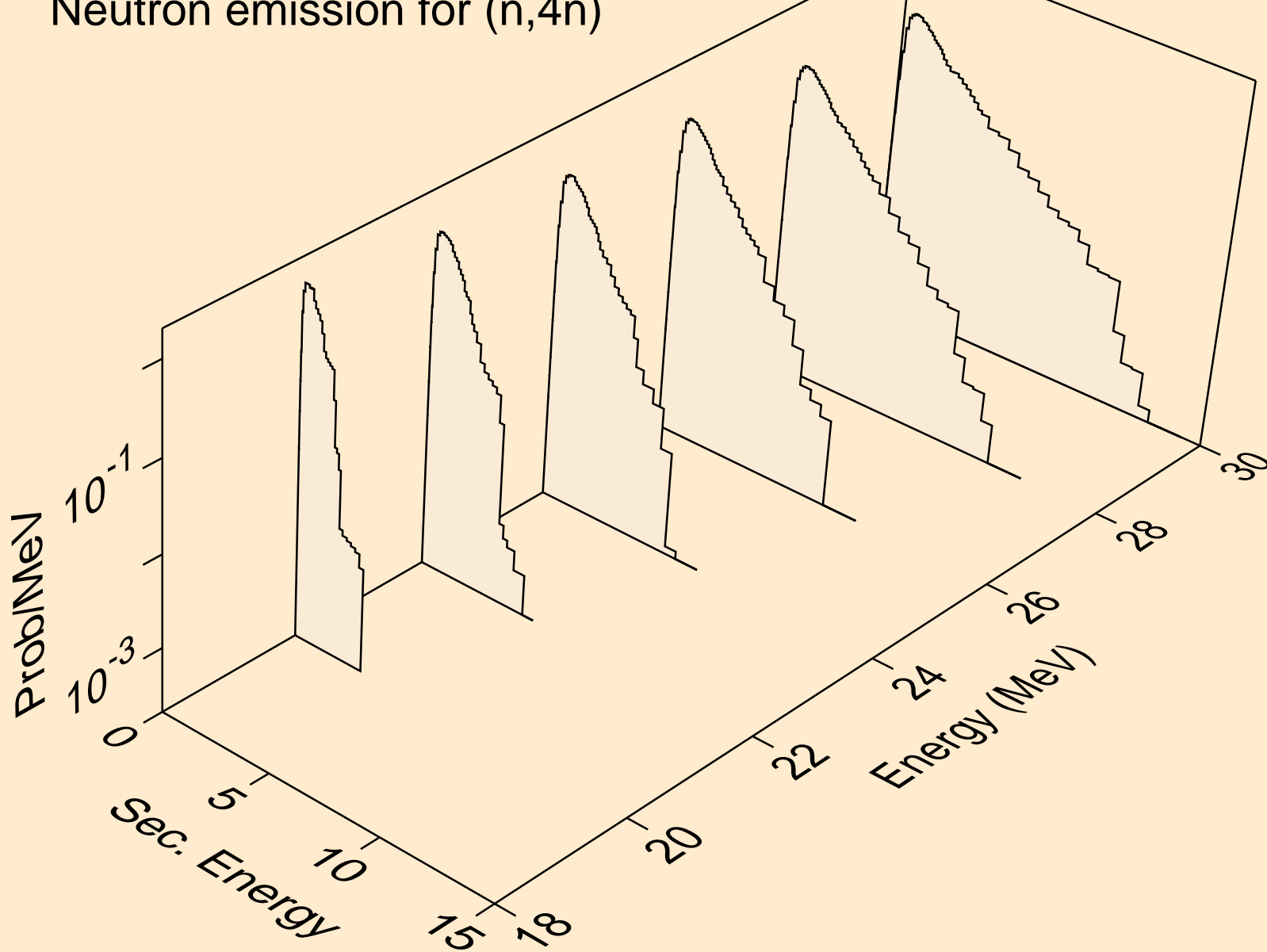

RE195 NEUTRON ACER TENDL-2019 LIBRARY; T=293.16K
Neutron emission for (n,2np)

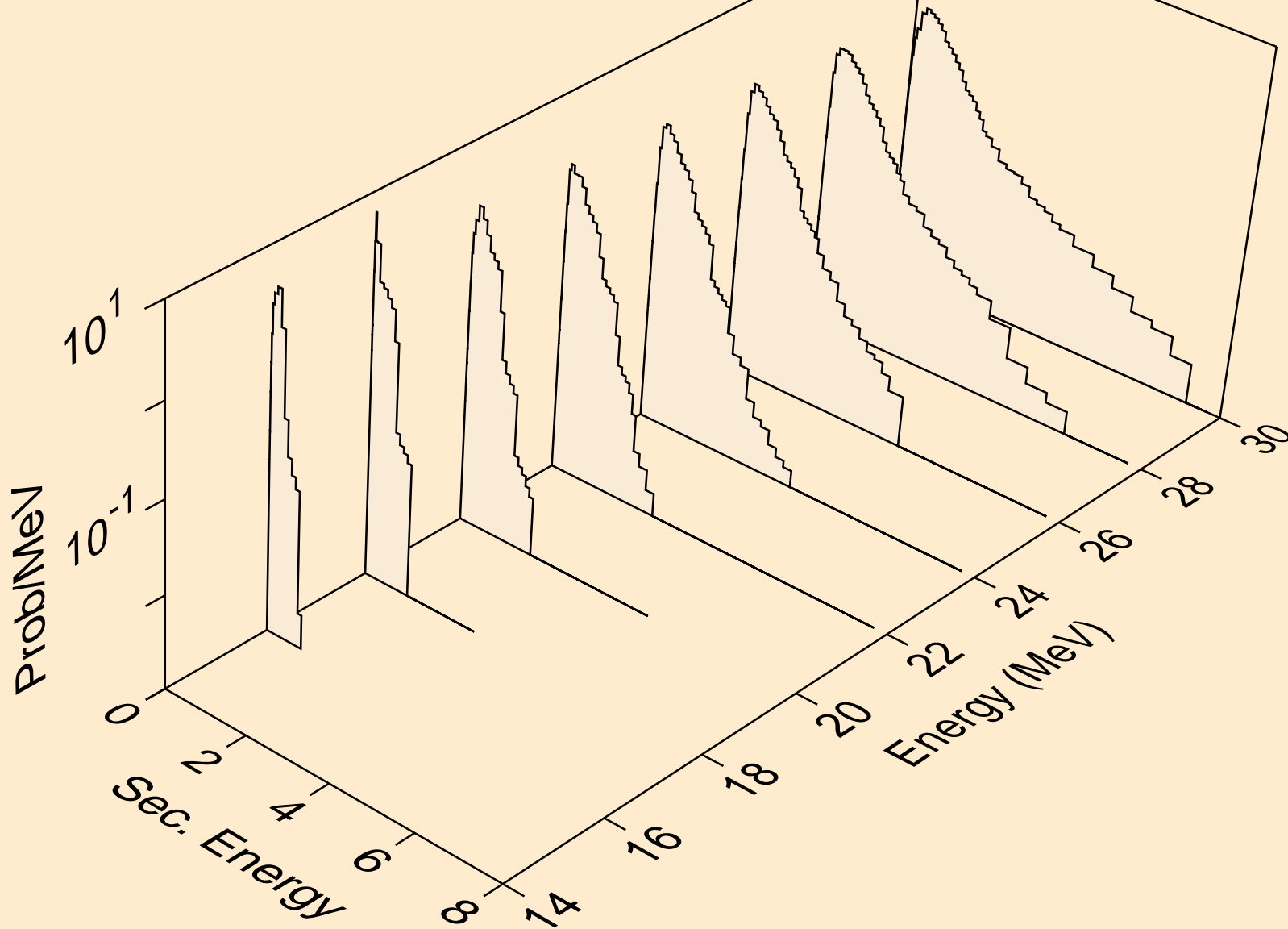

RE195 NEUTRON ACER TENDL-2019 LIBRARY; T=293.16K
Neutron emission for (n,3np)

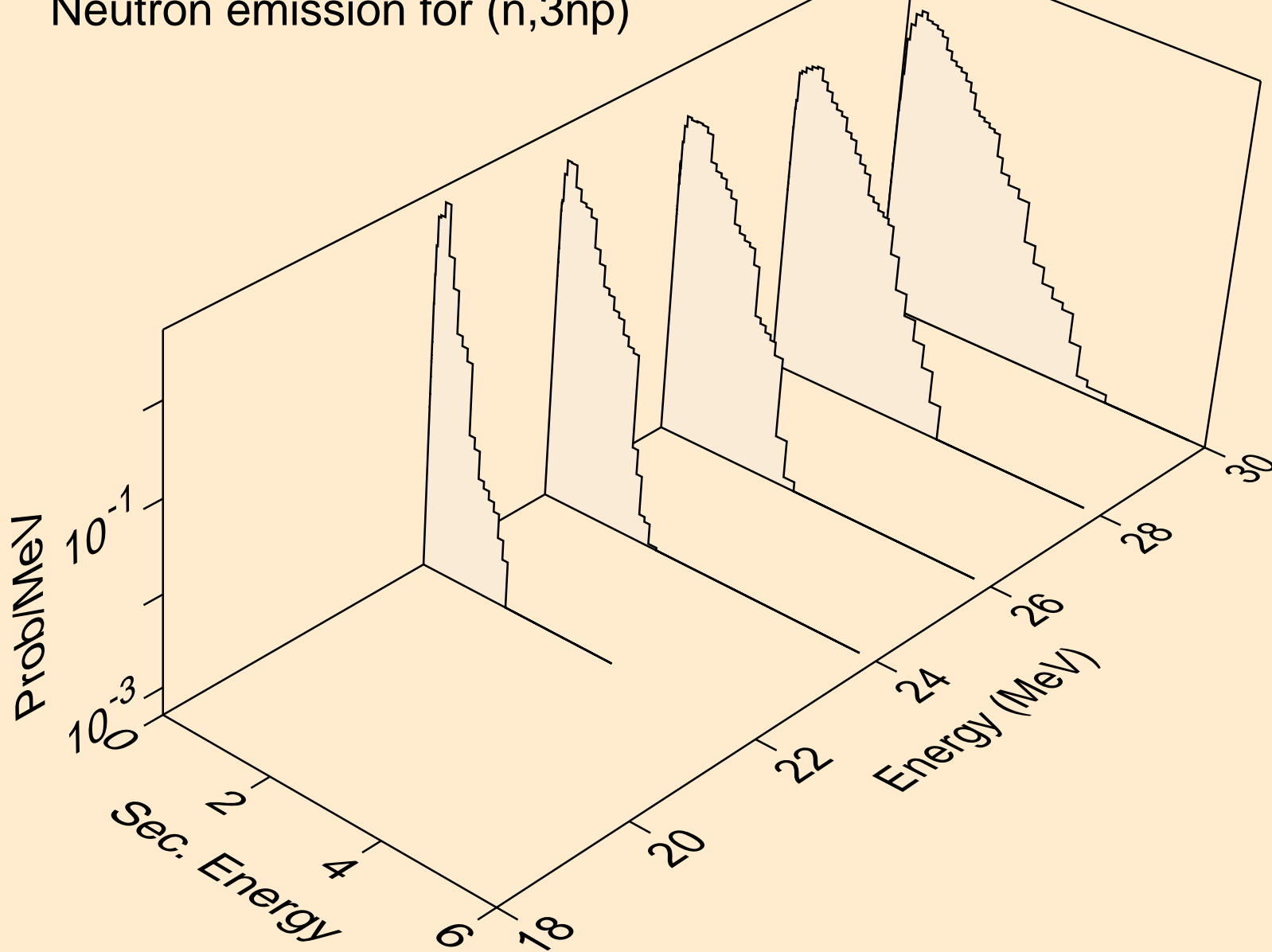

RE195 NEUTRON ACER TENDL-2019 LIBRARY; T=293.16K
Neutron emission for (n,n*c)

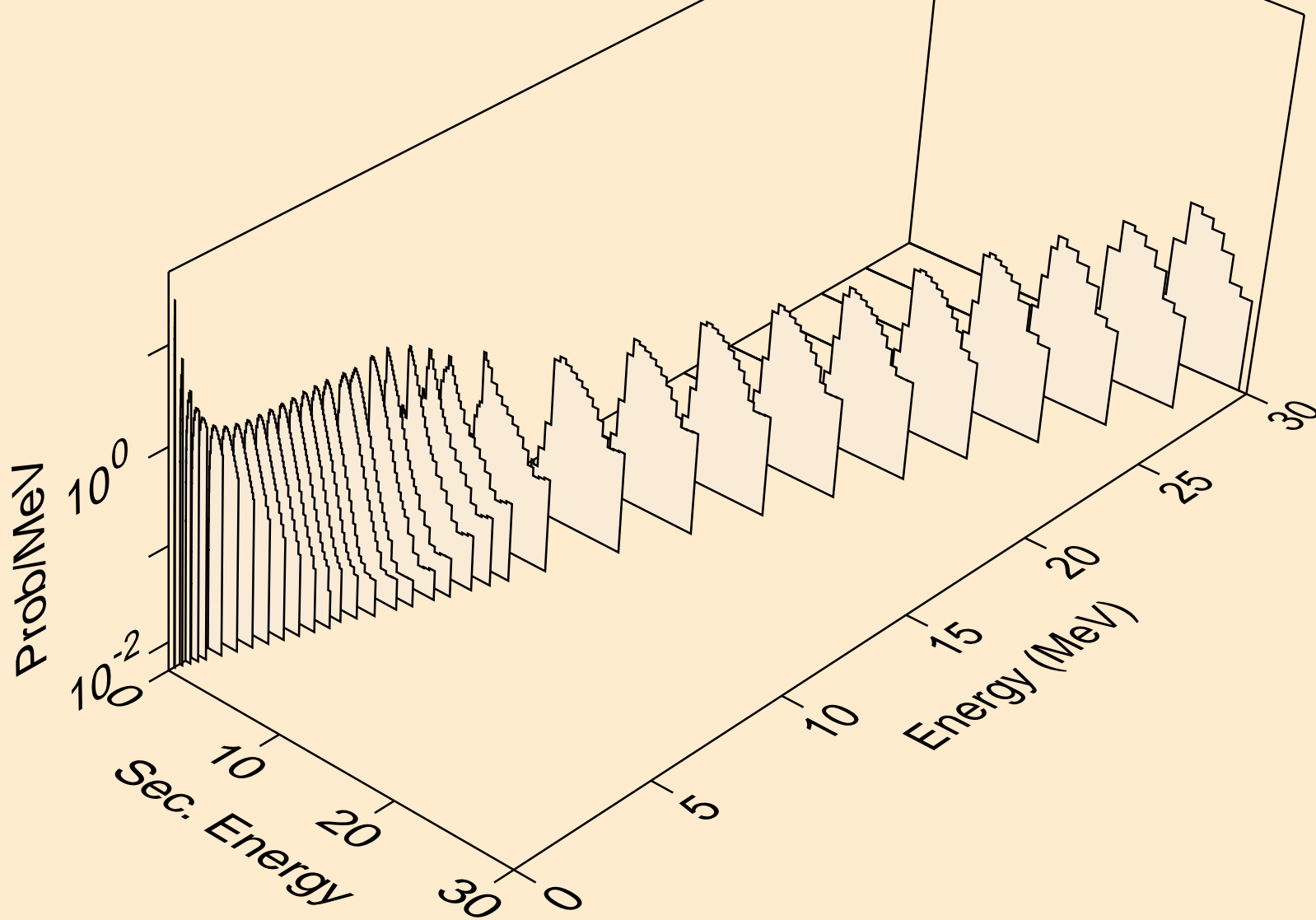

RE195 NEUTRON ACER TENDL-2019 LIBRARY; T=293.16K
Photon emission for (n,x)

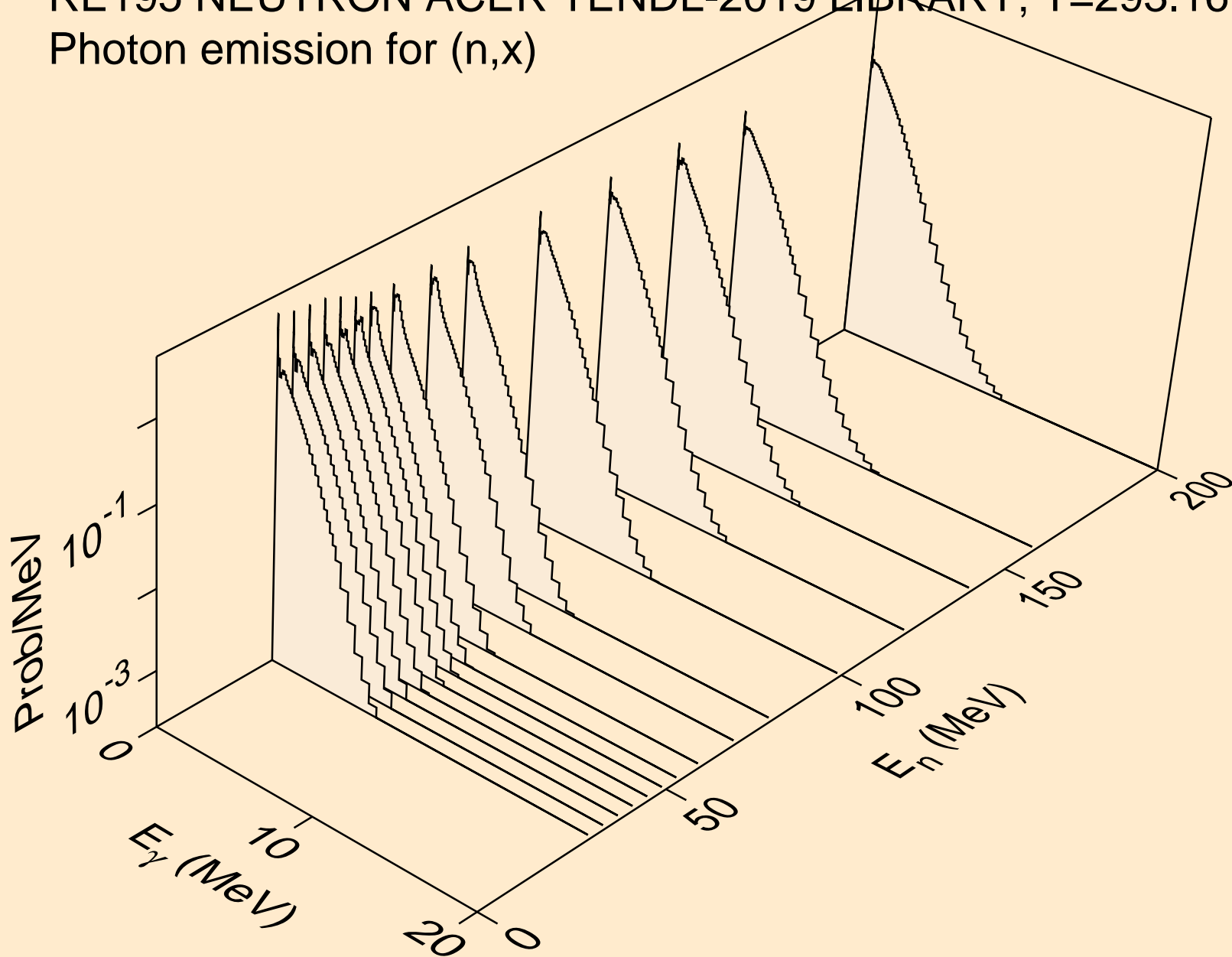

RE195 NEUTRON ACER TENDL-2019 LIBRARY; T=293.16K
Photon emission for (n,2nd)

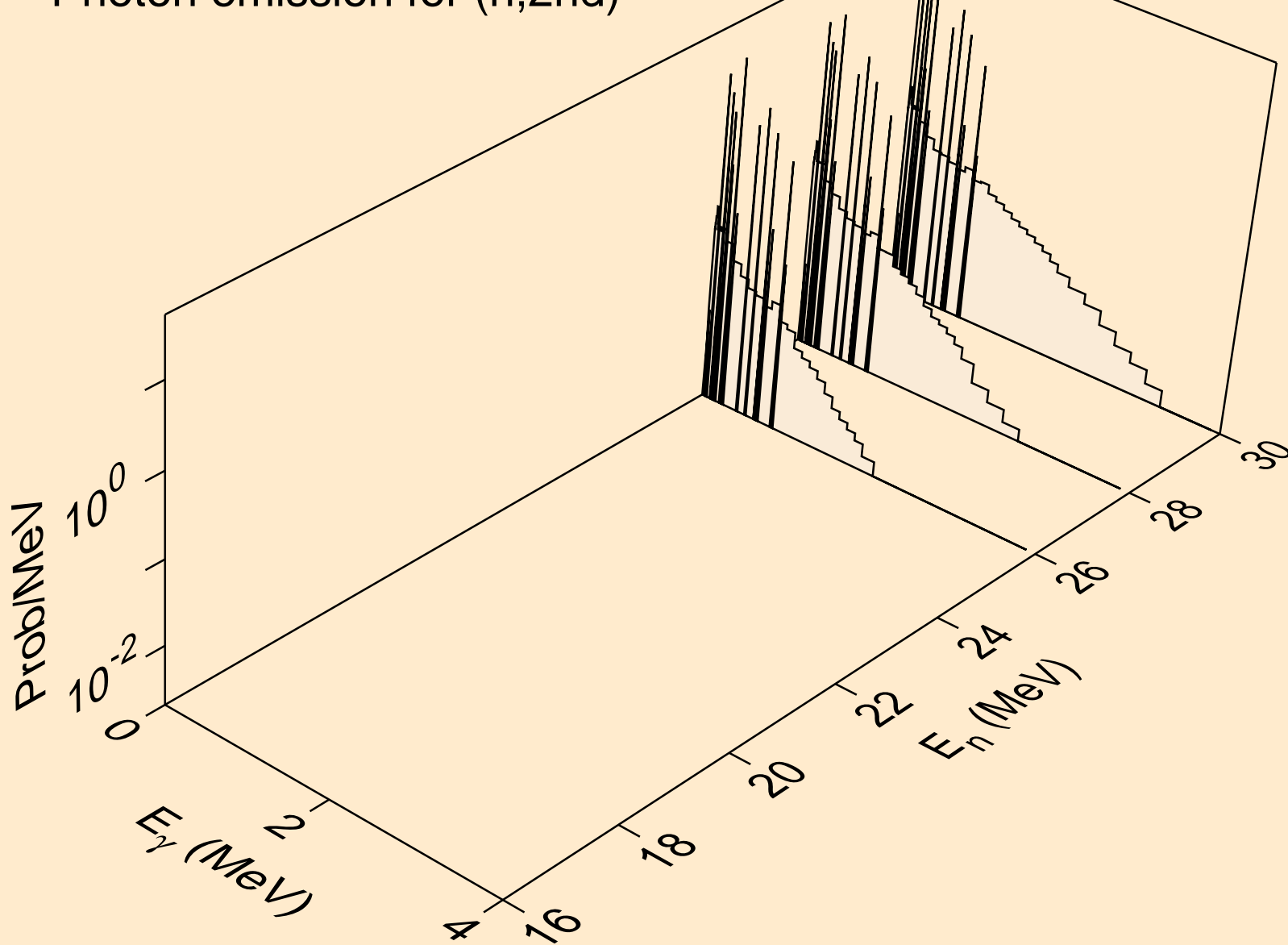

RE195 NEUTRON ACER TENDL-2019 LIBRARY; T=293.16K
Photon emission for (n,2n)

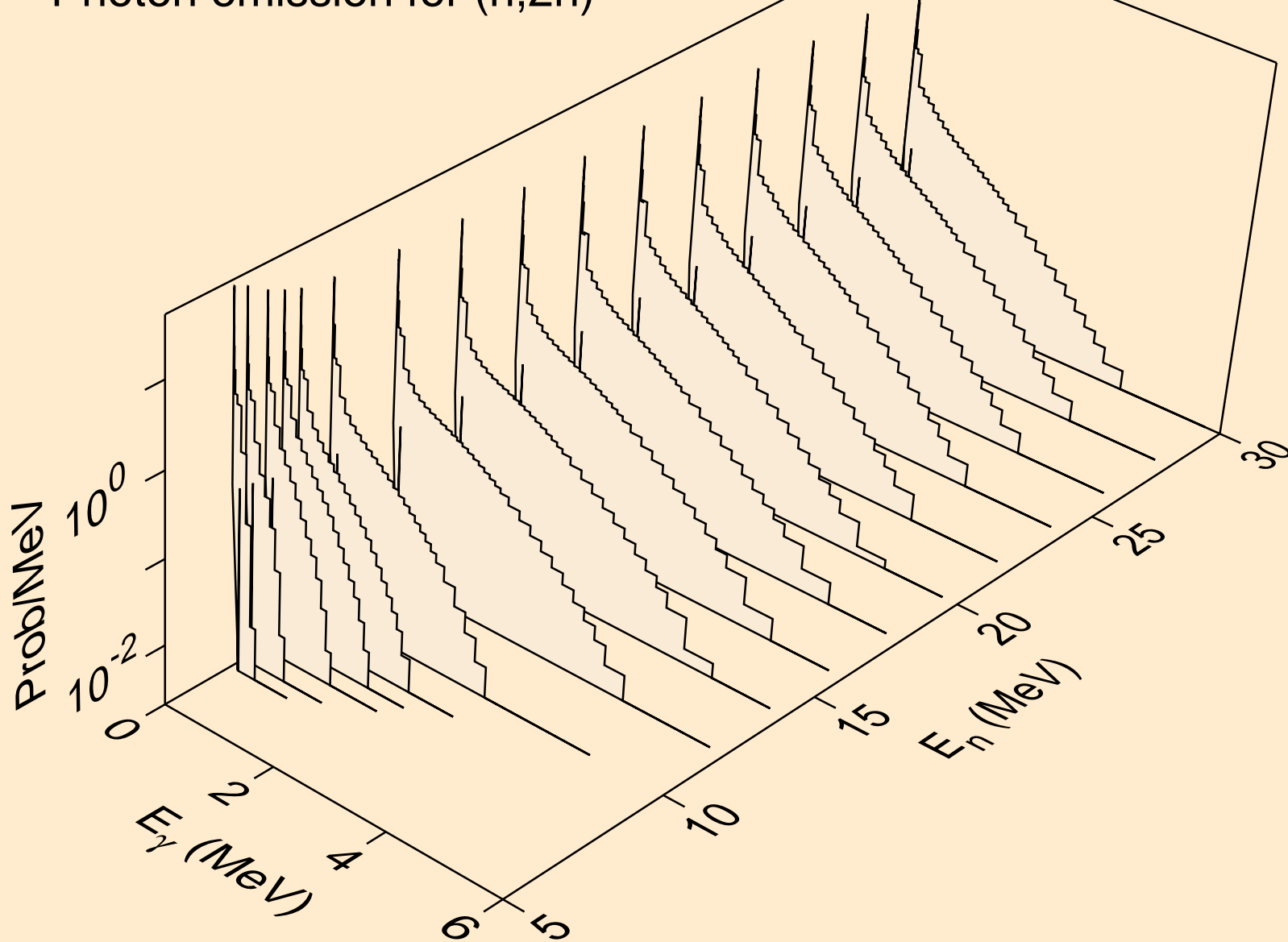

RE195 NEUTRON ACER TENDL-2019 LIBRARY; T=293.16K
Photon emission for (n,3n)

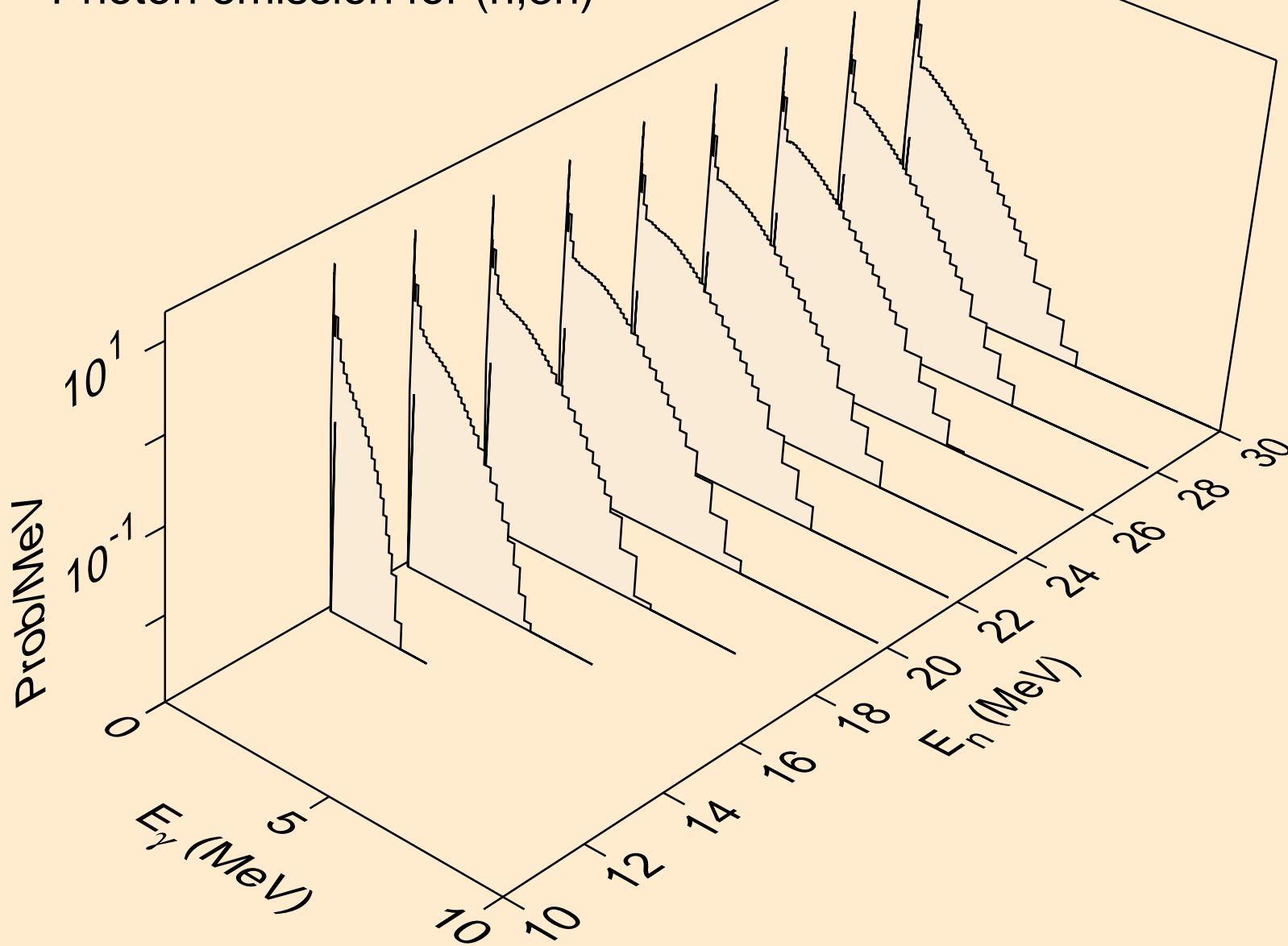

RE195 NEUTRON ACER TENDL-2019 LIBRARY; T=293.16K
Photon emission for (n,n*)a

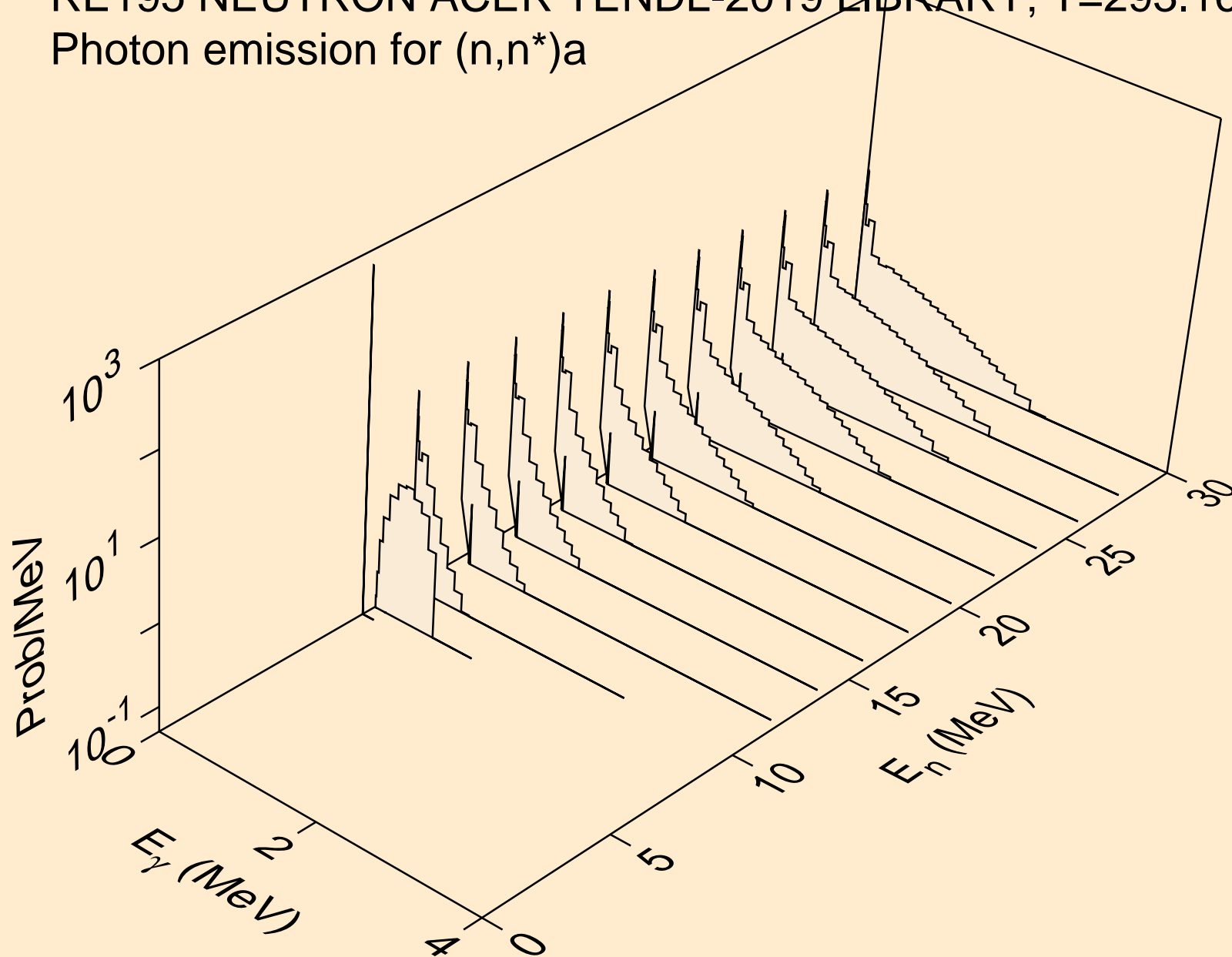

RE195 NEUTRON ACER TENDL-2019 LIBRARY; T=293.16K
Photon emission for (n,2n)a

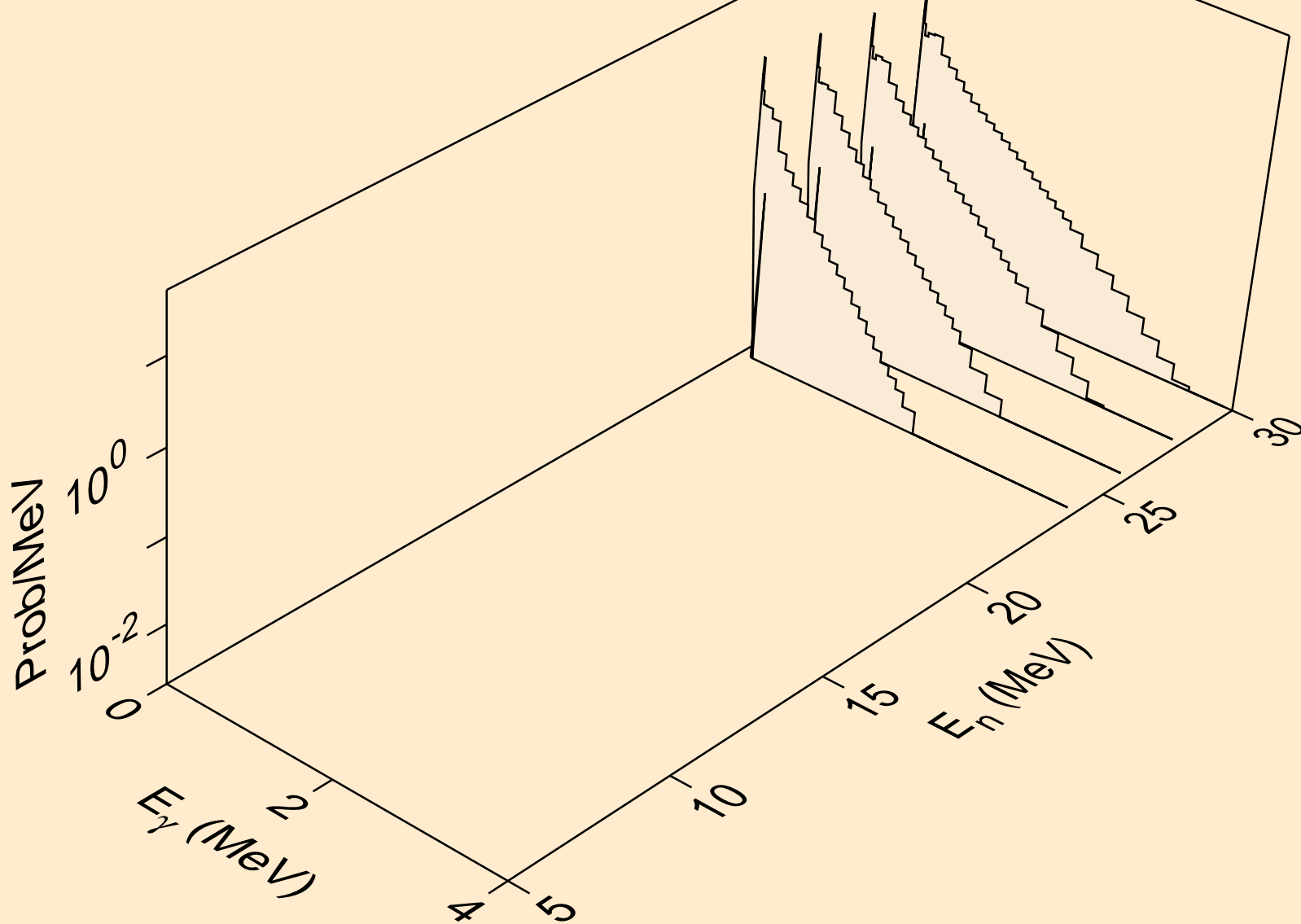

RE195 NEUTRON ACER TENDL-2019 LIBRARY; T=293.16K
Photon emission for (n,3n)a

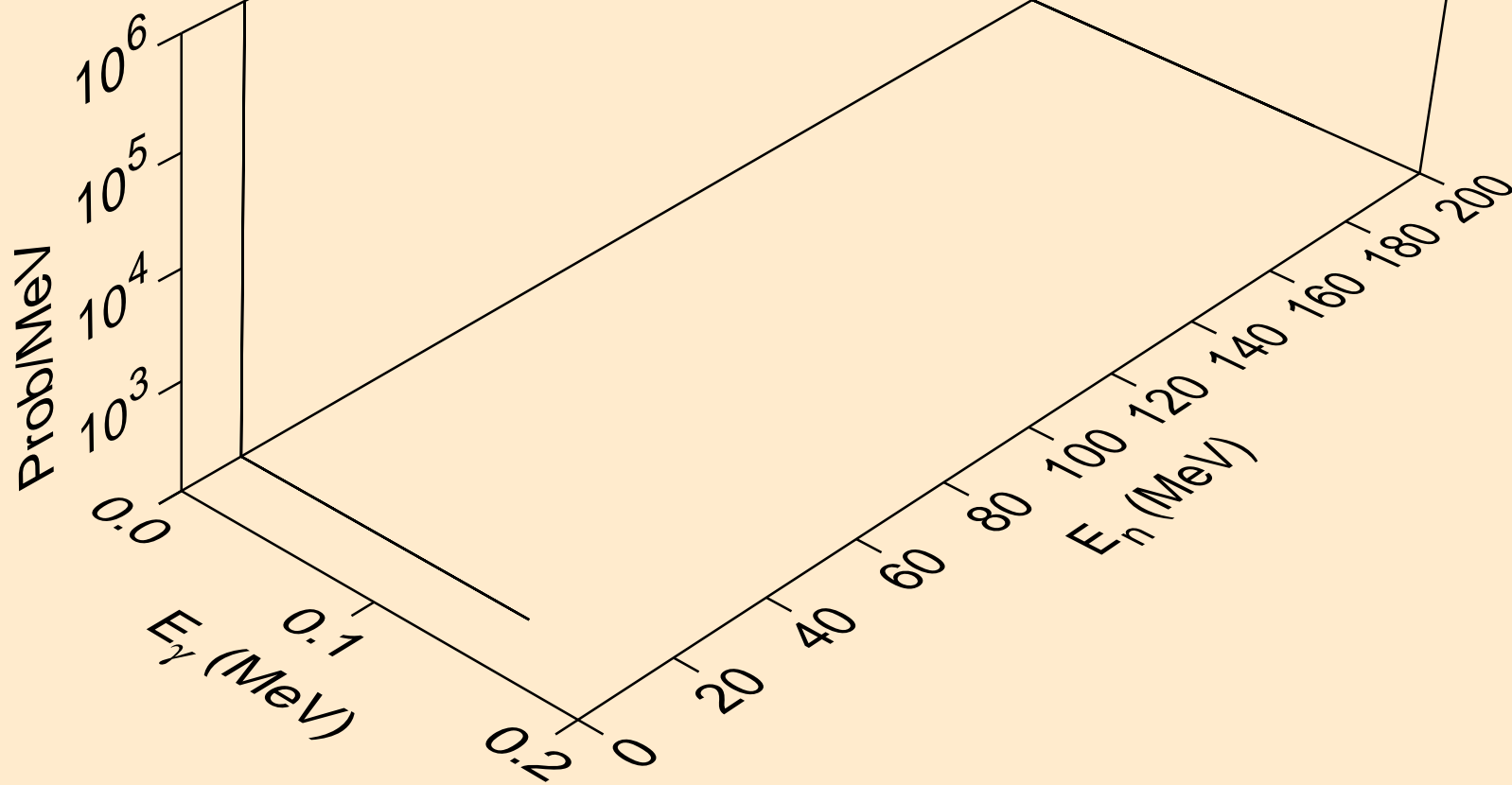

RE195 NEUTRON ACER TENDL-2019 LIBRARY; T=293.16K
Photon emission for (n,n*)p

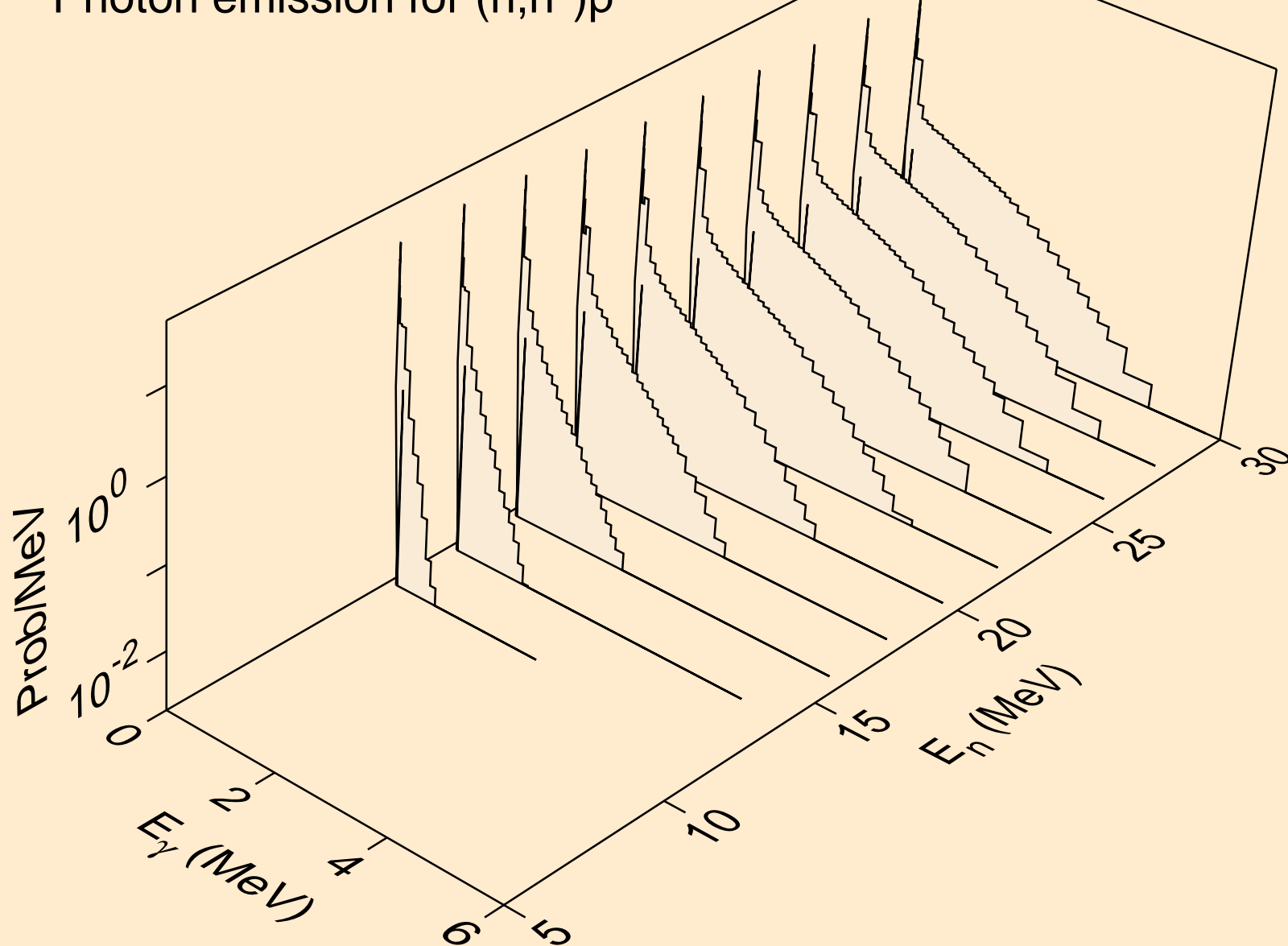

RE195 NEUTRON ACER TENDL-2019 LIBRARY; T=293.16K
Photon emission for (n,n*)d

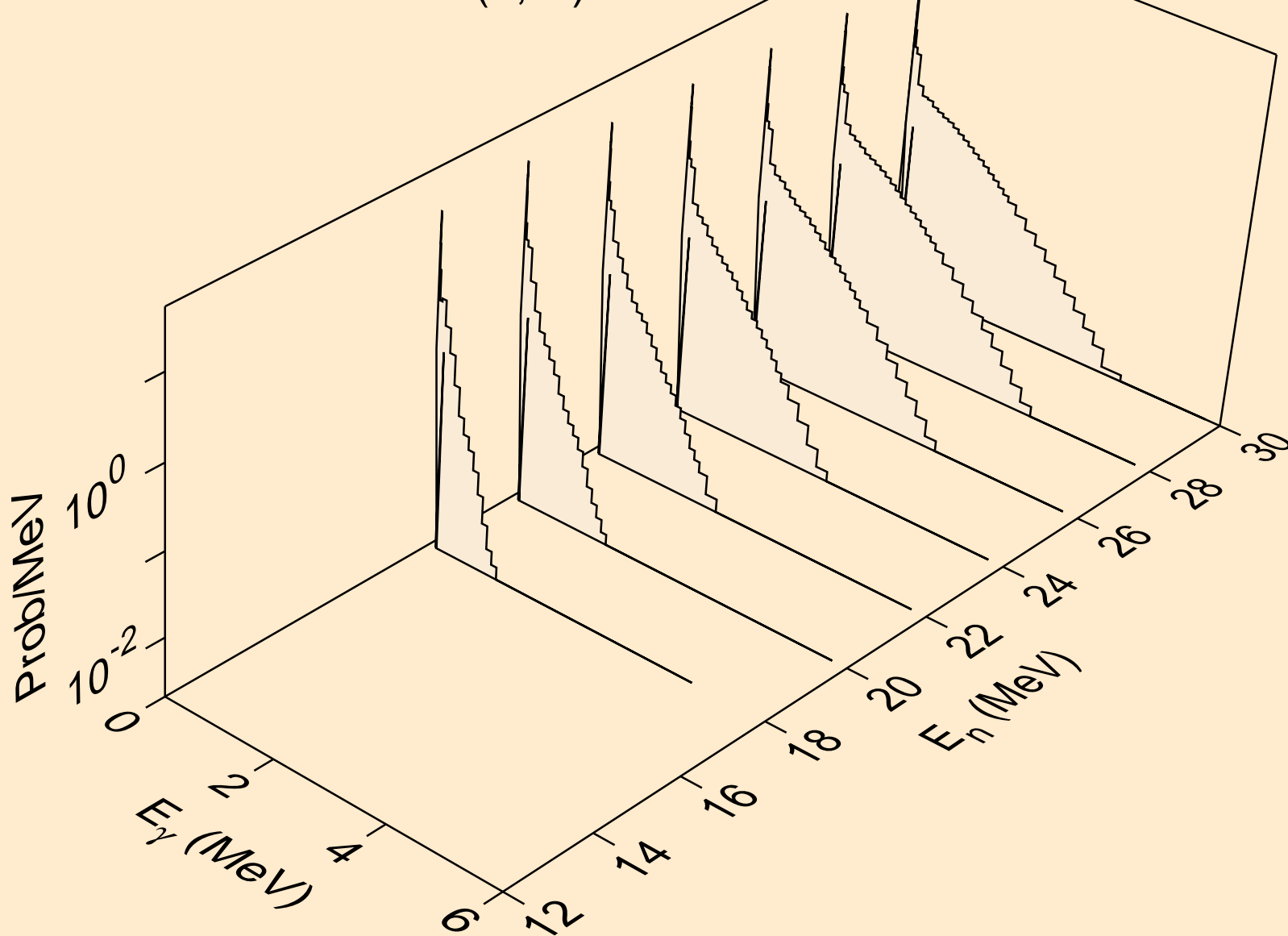

RE195 NEUTRON ACER TENDL-2019 LIBRARY; T=293.16K
Photon emission for (n,n*)t

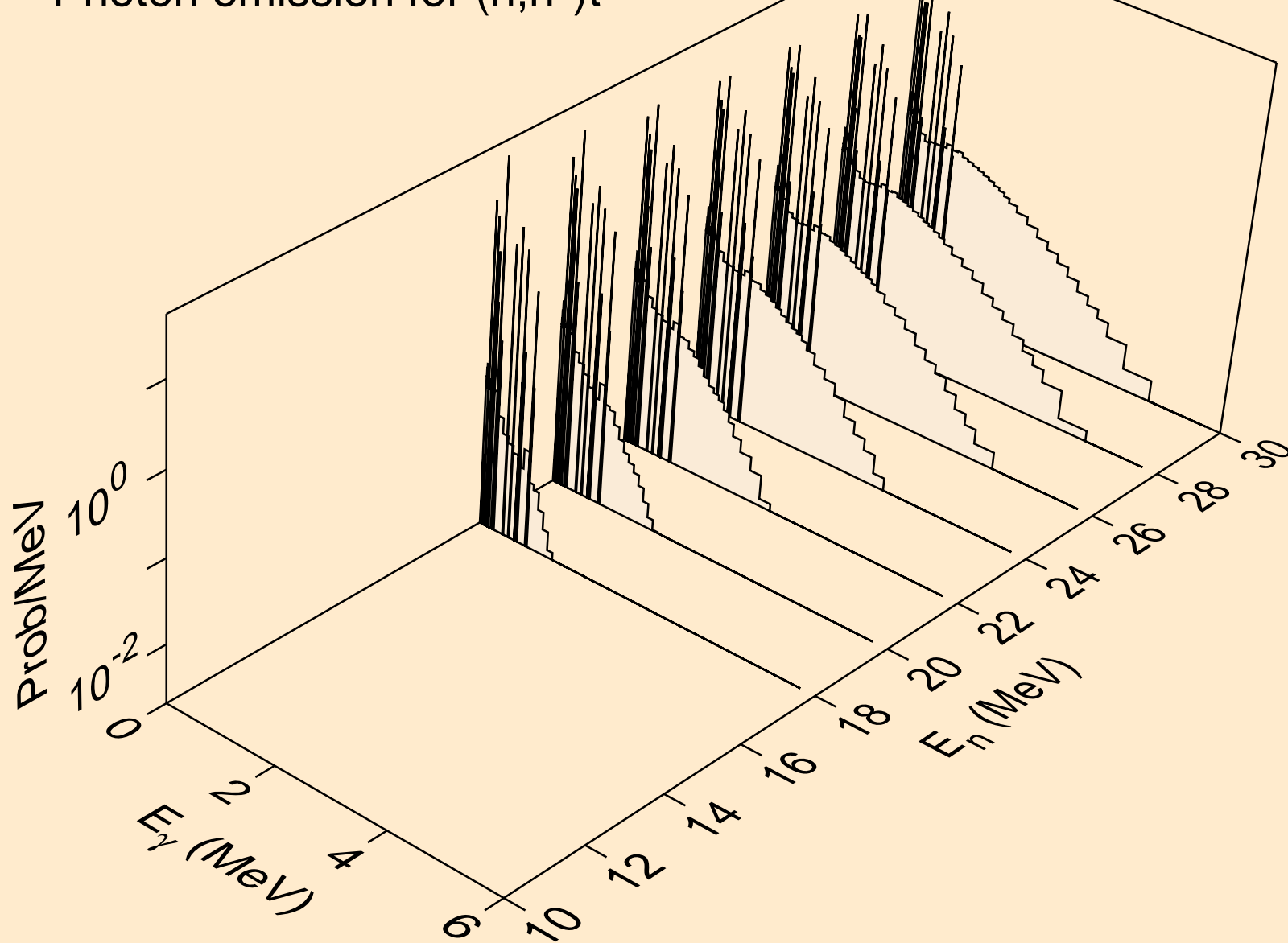

RE195 NEUTRON ACER TENDL-2019 LIBRARY; T=293.16K
Photon emission for (n,n*)he3

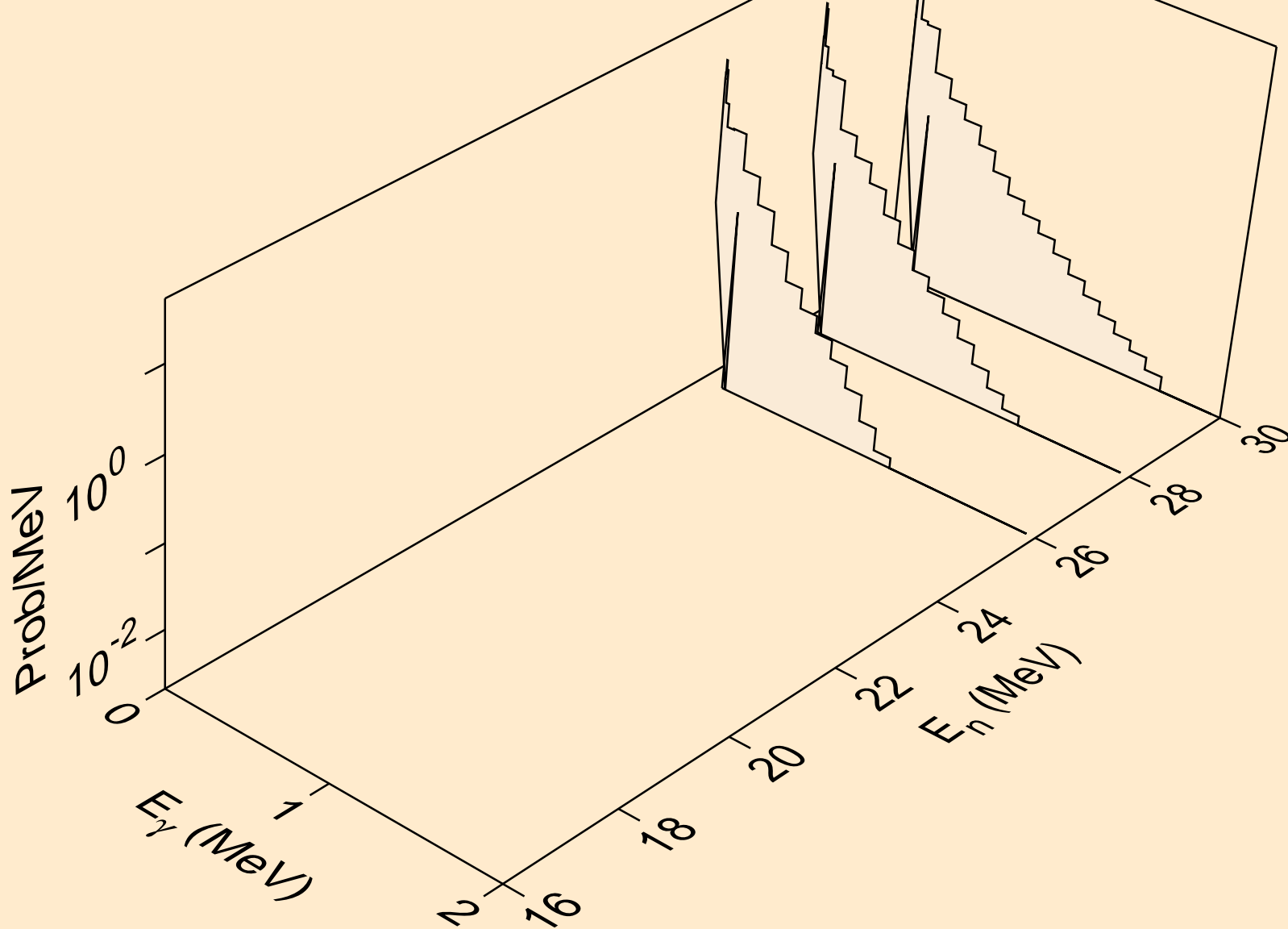

RE195 NEUTRON ACER TENDL-2019 LIBRARY; T=293.16K
Photon emission for (n,4n)

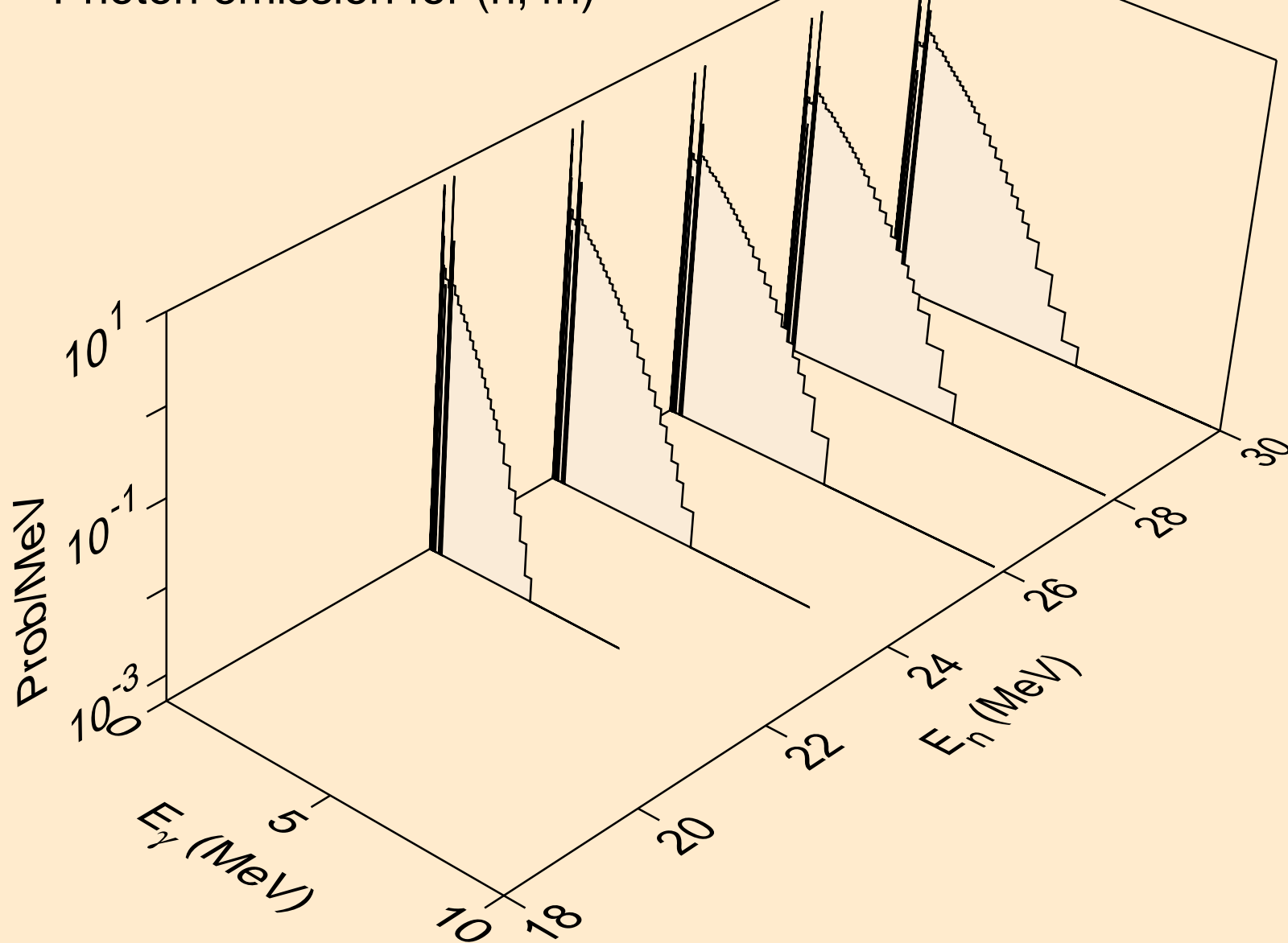

RE195 NEUTRON ACER TENDL-2019 LIBRARY; T=293.16K
Photon emission for (n,2np)

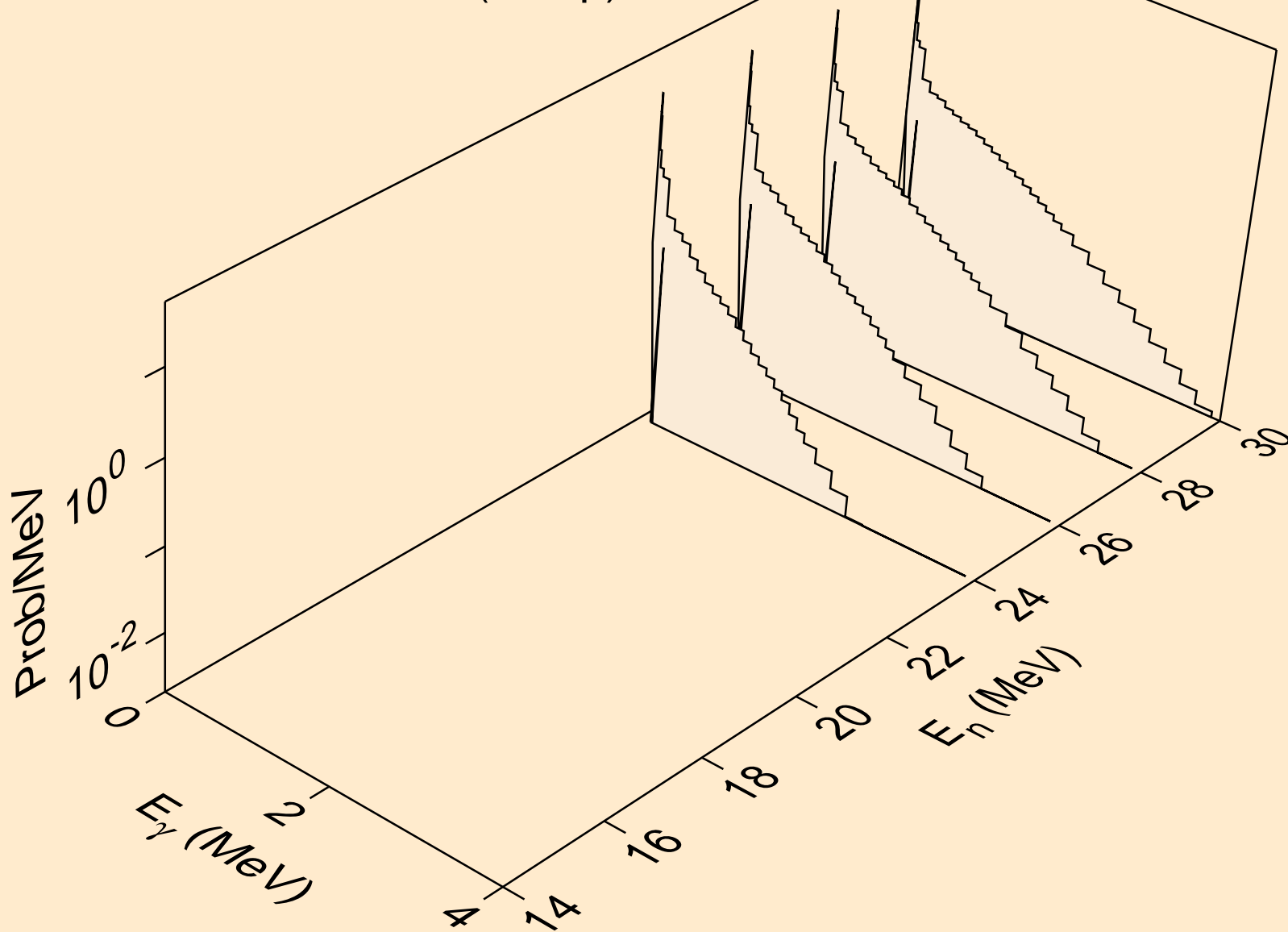

RE195 NEUTRON ACER TENDL-2019 LIBRARY; T=293.16K
Photon emission for (n,3np)

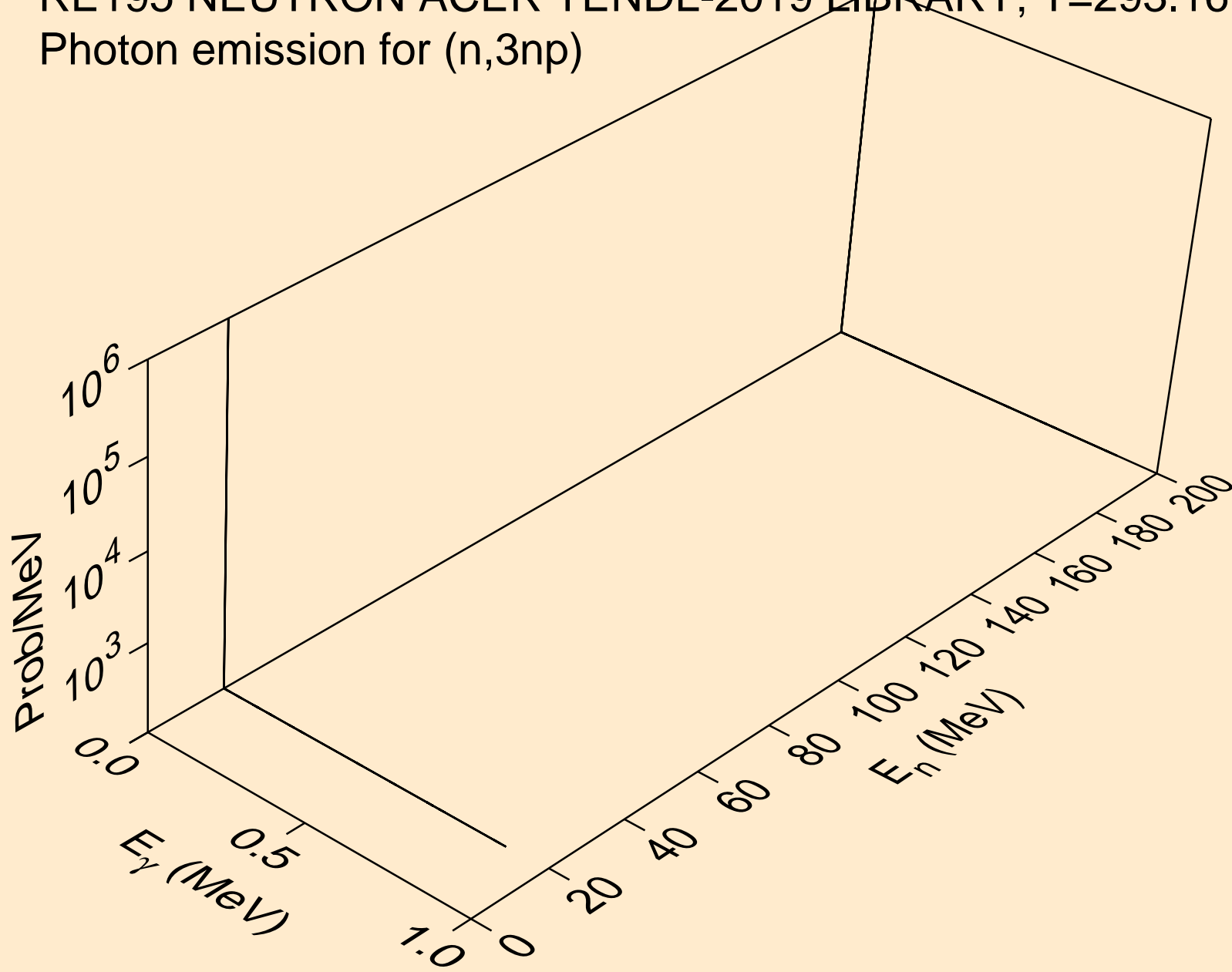

RE195 NEUTRON ACER TENDL-2019 LIBRARY; T=293.16K
Photon emission for (n,n*c)

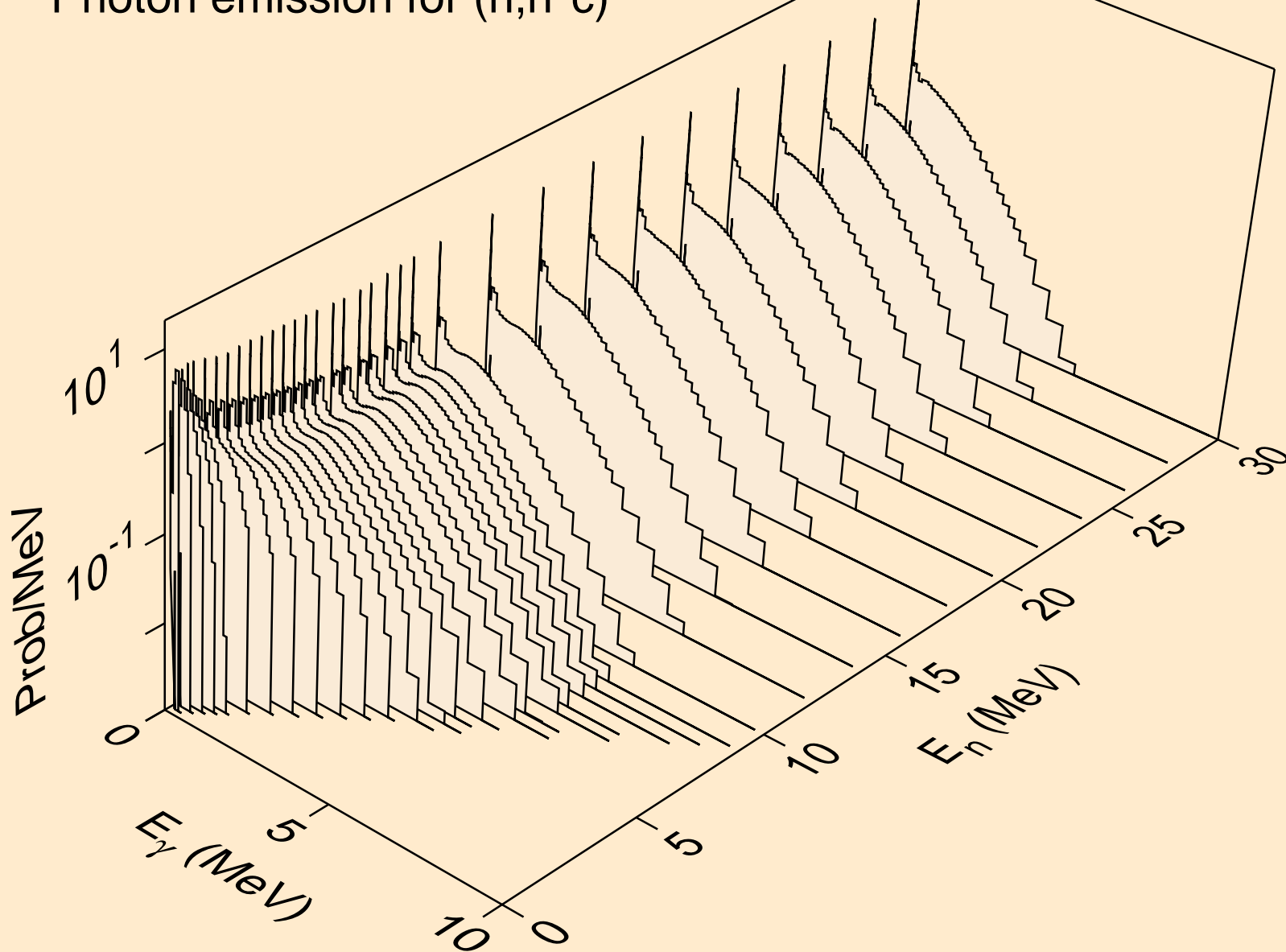

RE195 NEUTRON ACER TENDL-2019 LIBRARY; T=293.16K
Photon emission for (n,gma)

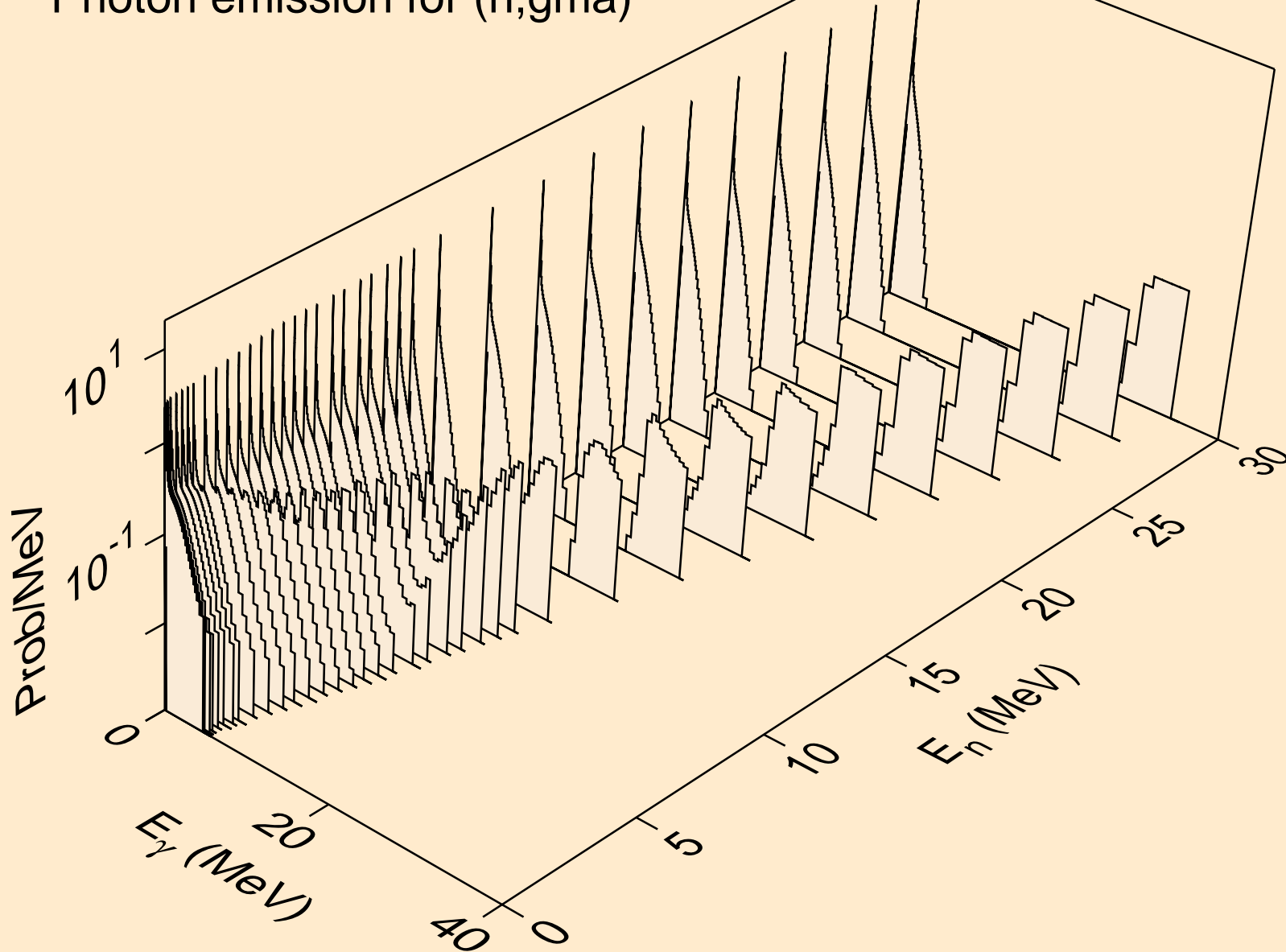

RE195 NEUTRON ACER TENDL-2019 LIBRARY; T=293.16K
Photon emission for (n,p)

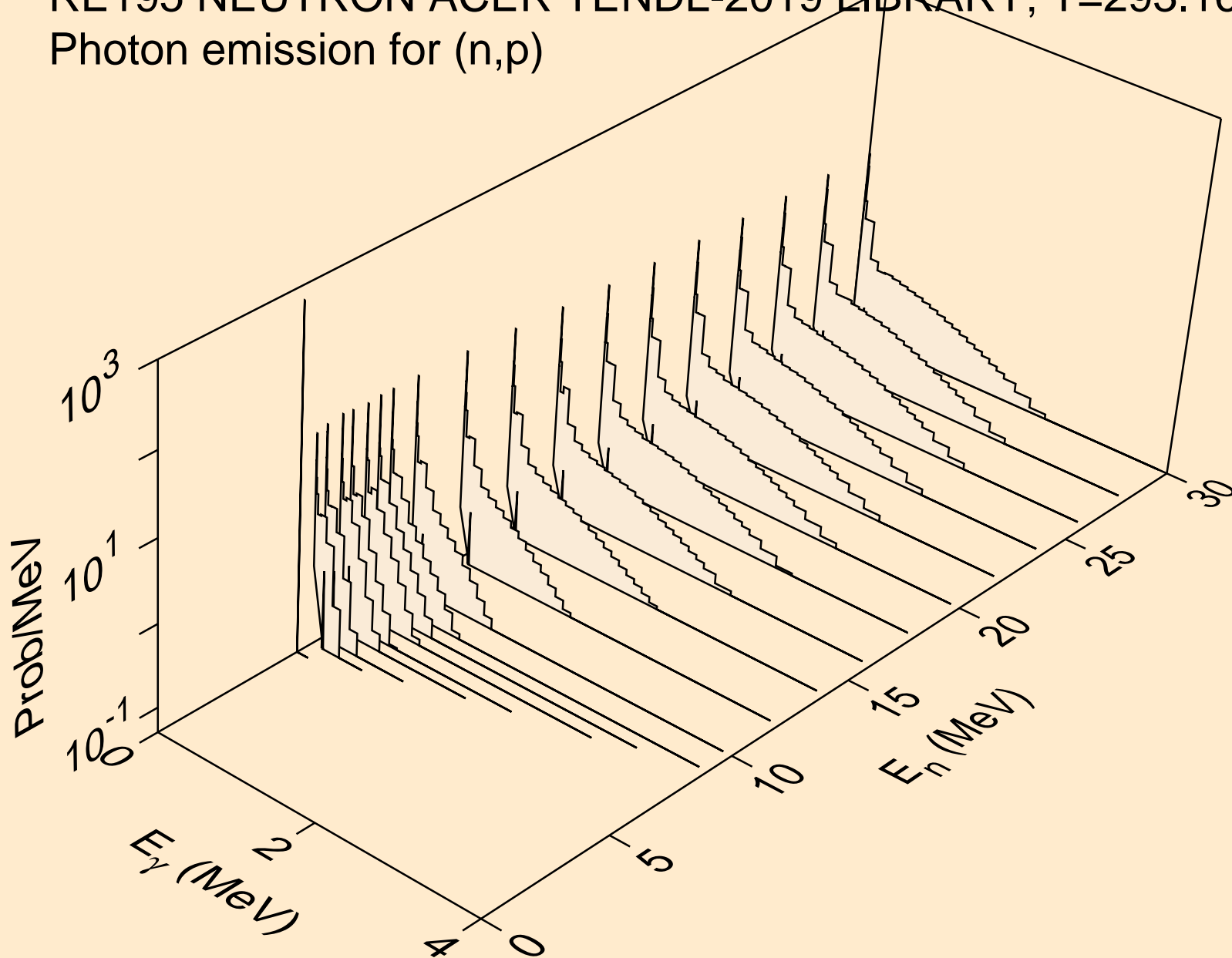

RE195 NEUTRON ACER TENDL-2019 LIBRARY; T=293.16K
Photon emission for (n,d)

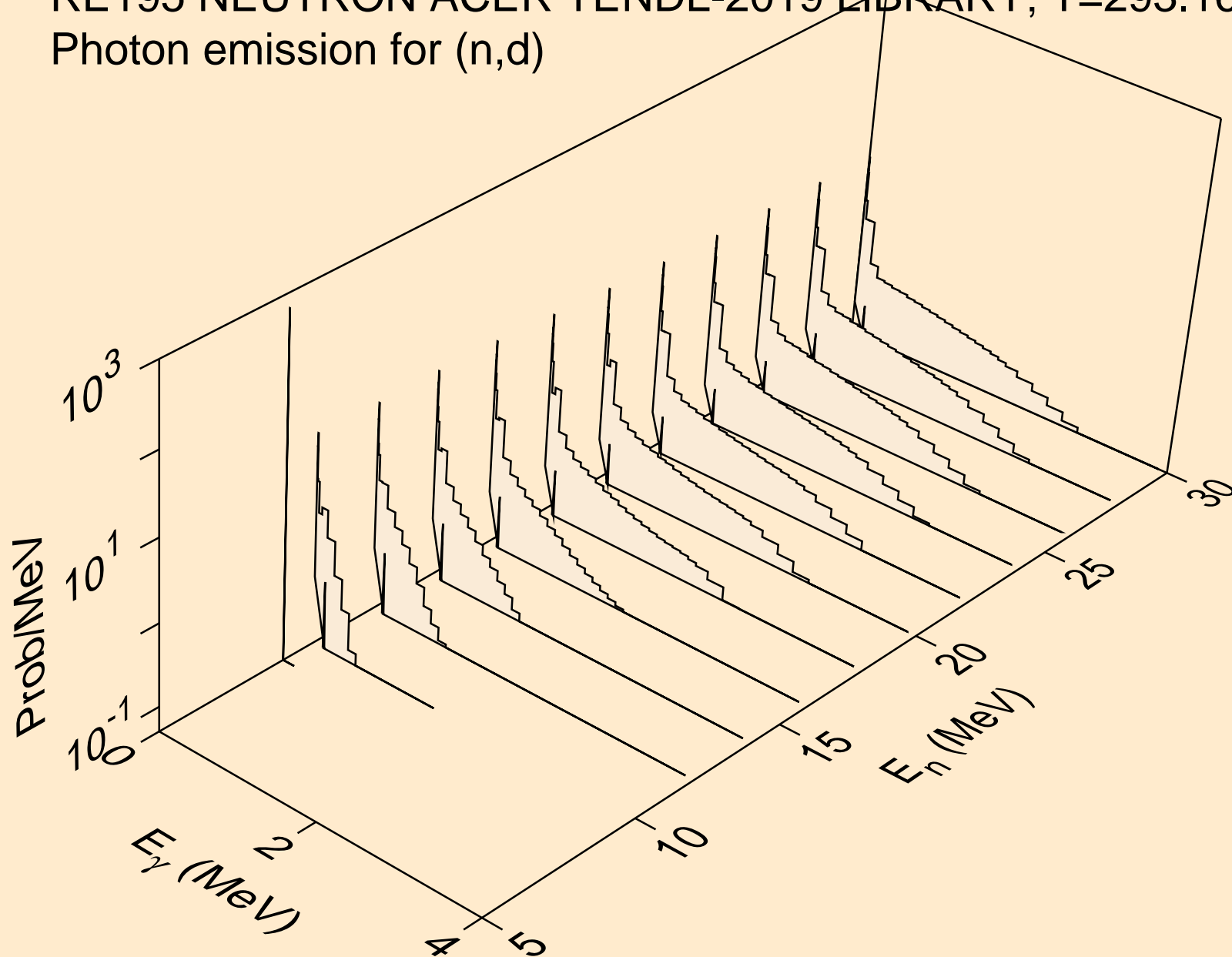

RE195 NEUTRON ACER TENDL-2019 LIBRARY; T=293.16K
Photon emission for (n,t)

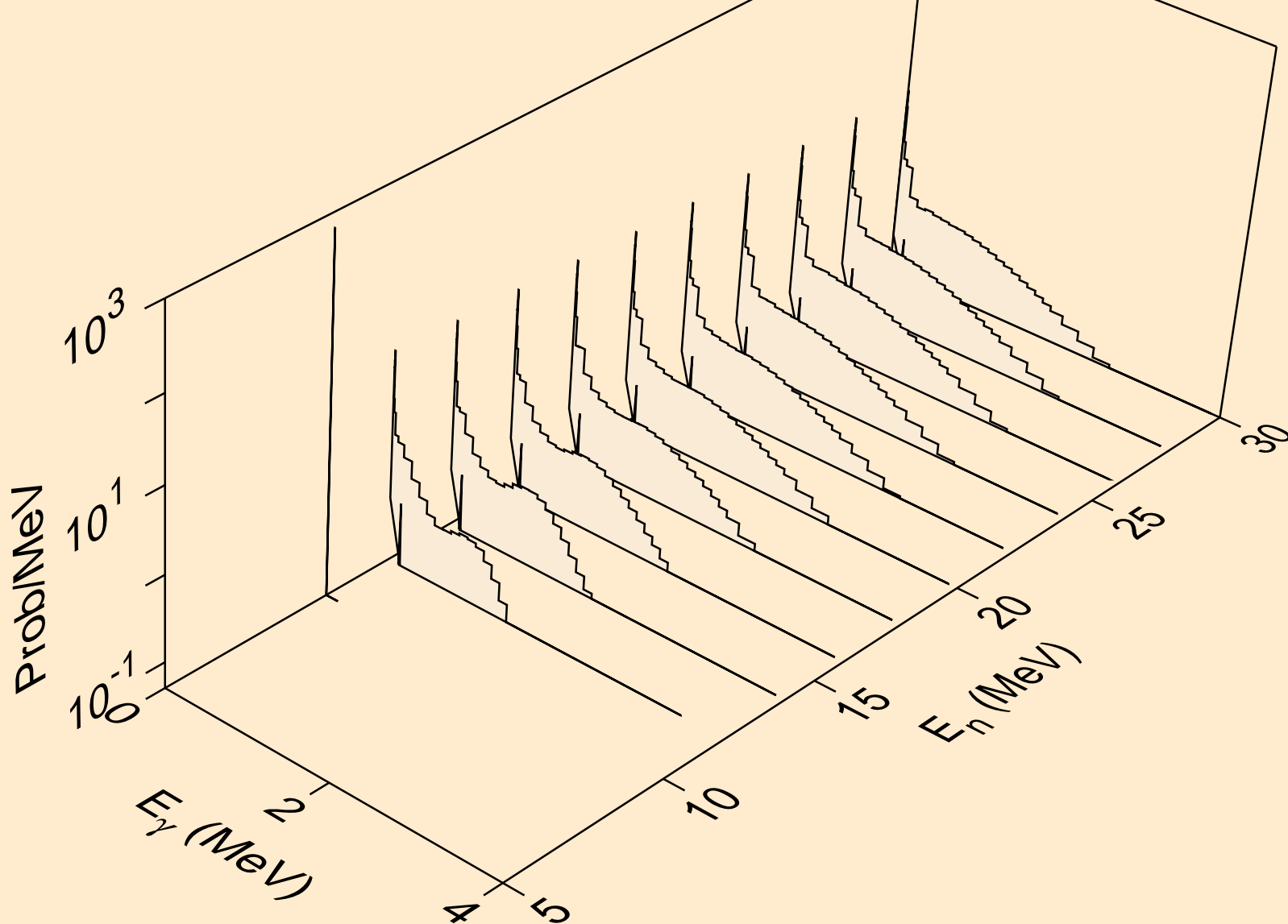

RE195 NEUTRON ACER TENDL-2019 LIBRARY; T=293.16K
Photon emission for (n,he3)

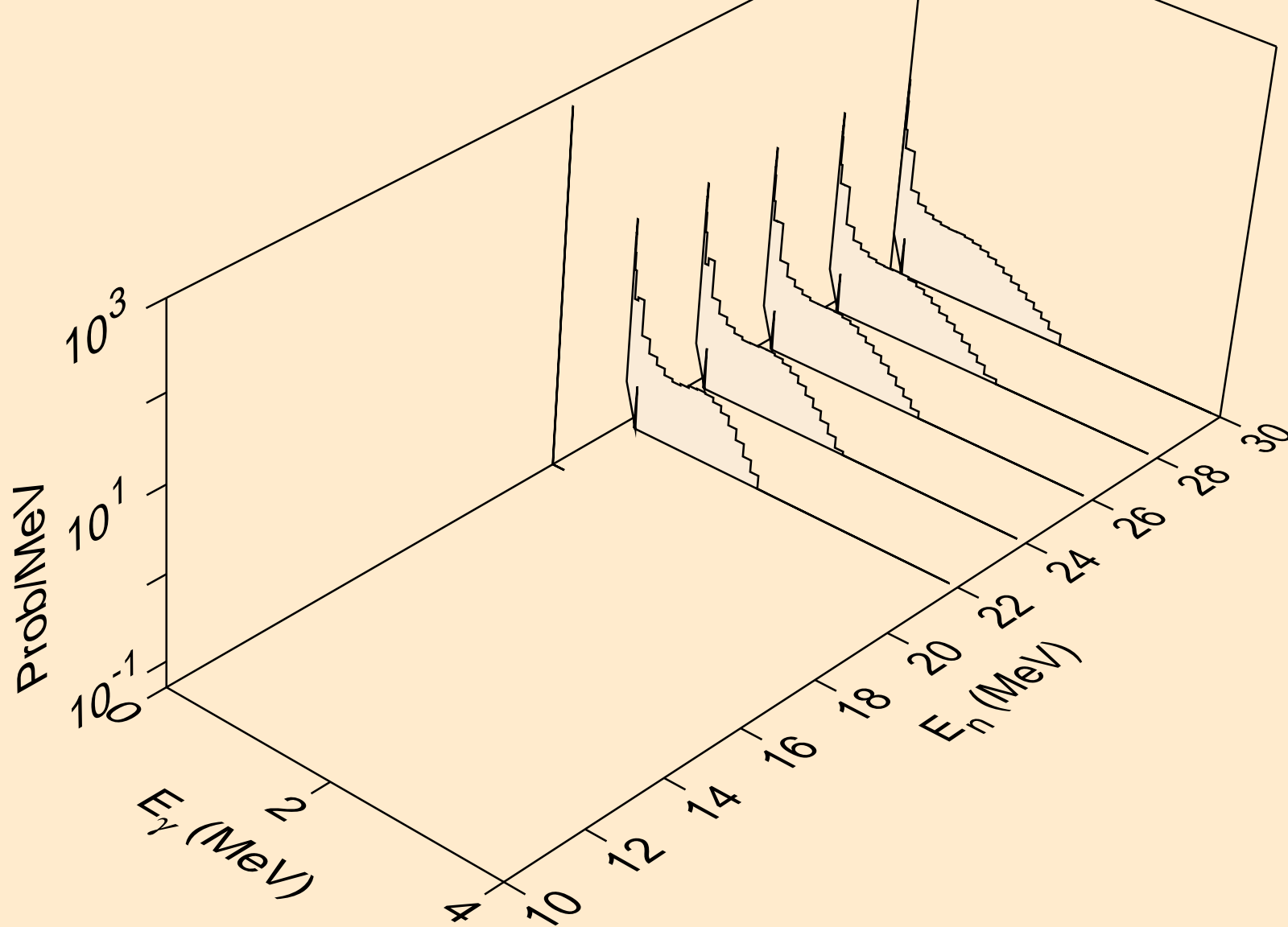

RE195 NEUTRON ACER TENDL-2019 LIBRARY; T=293.16K
Photon emission for (n,a)

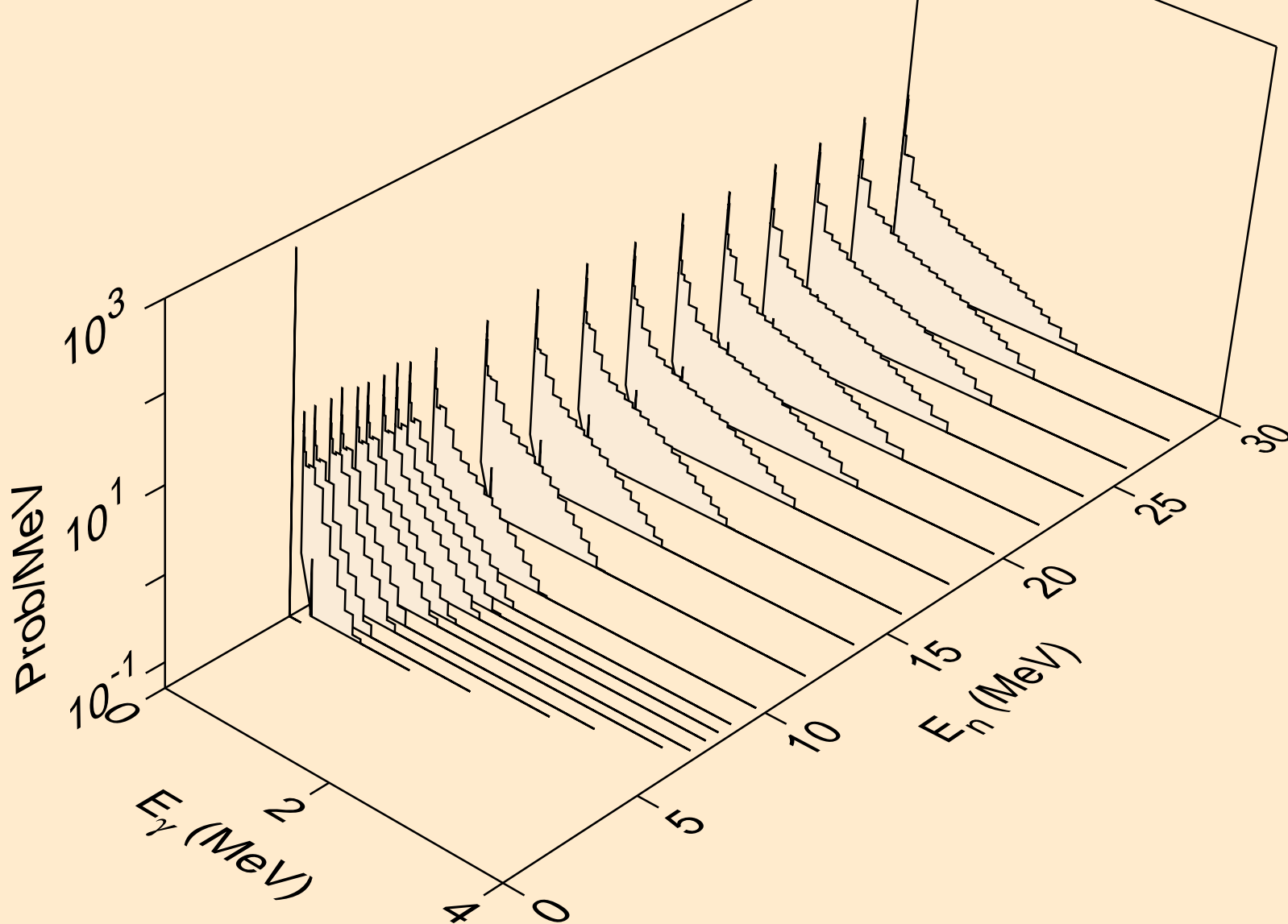

RE195 NEUTRON ACER TENDL-2019 LIBRARY; T=293.16K
thermal capture photon spectrum

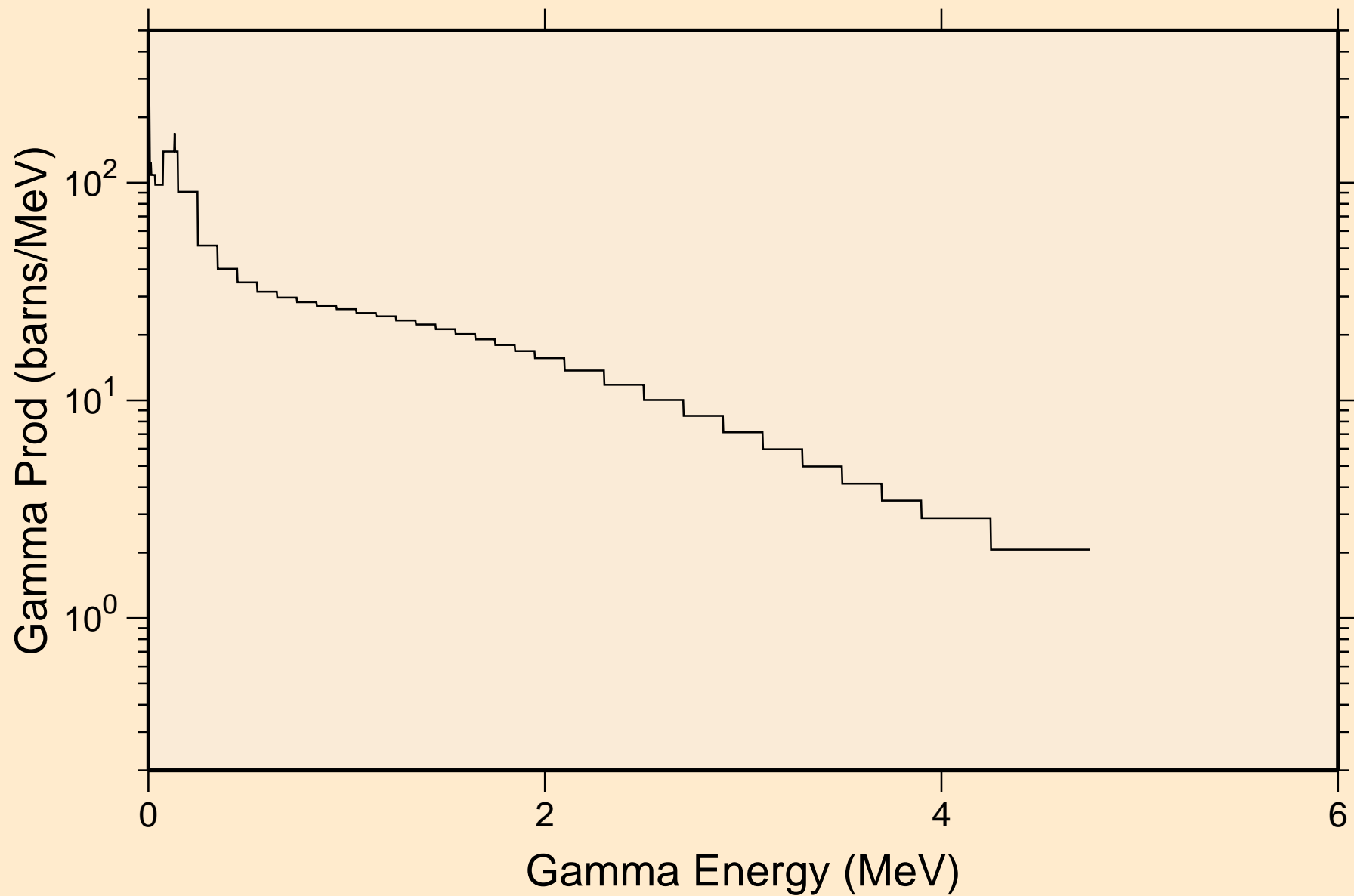

RE195 NEUTRON ACER TENDL-2019 LIBRARY; T=293.16K
14 MeV photon spectrum

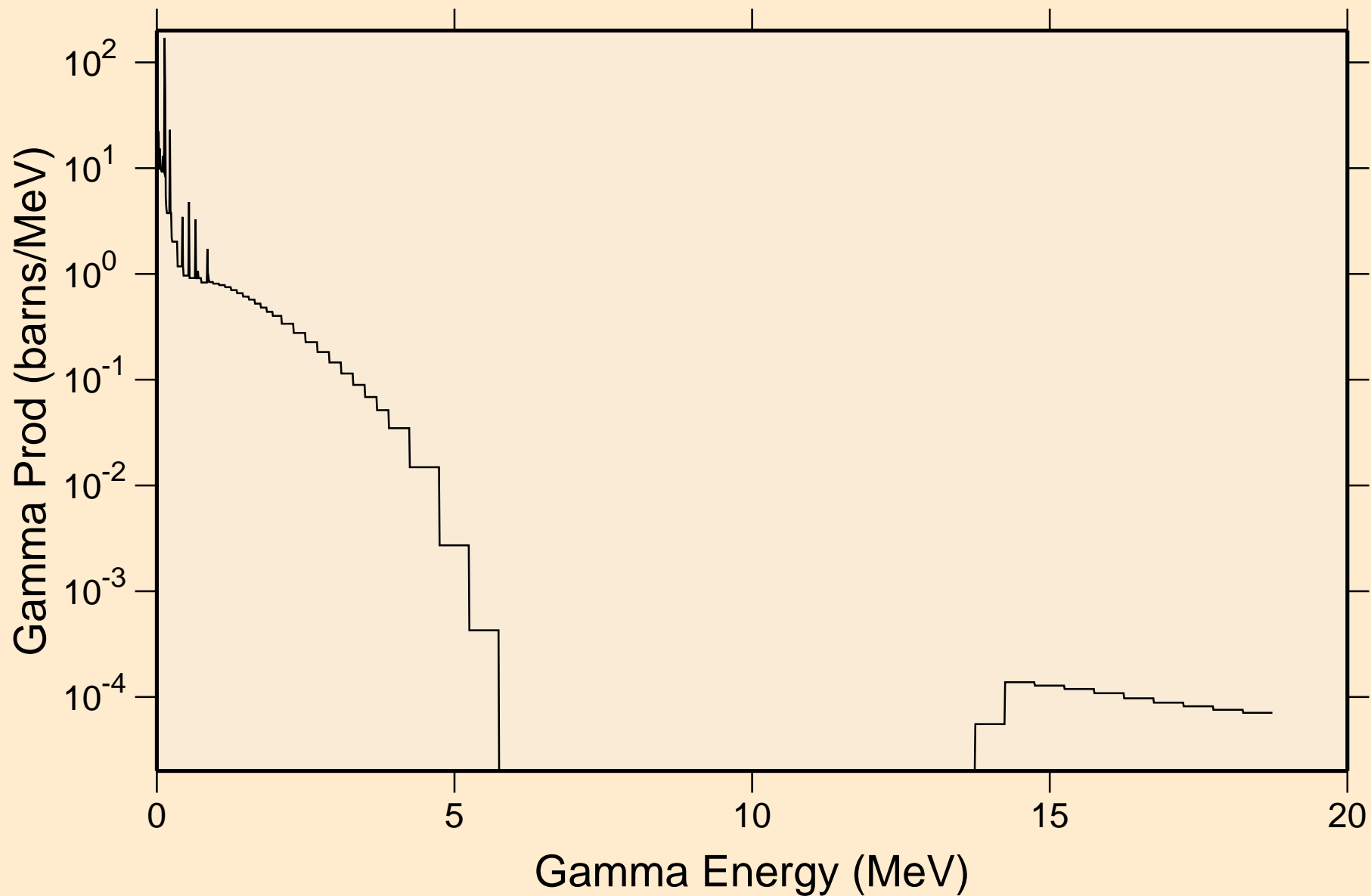

RE195 NEUTRON ACER TENDL-2019 LIBRARY; T=293.16K
Particle heating contributions

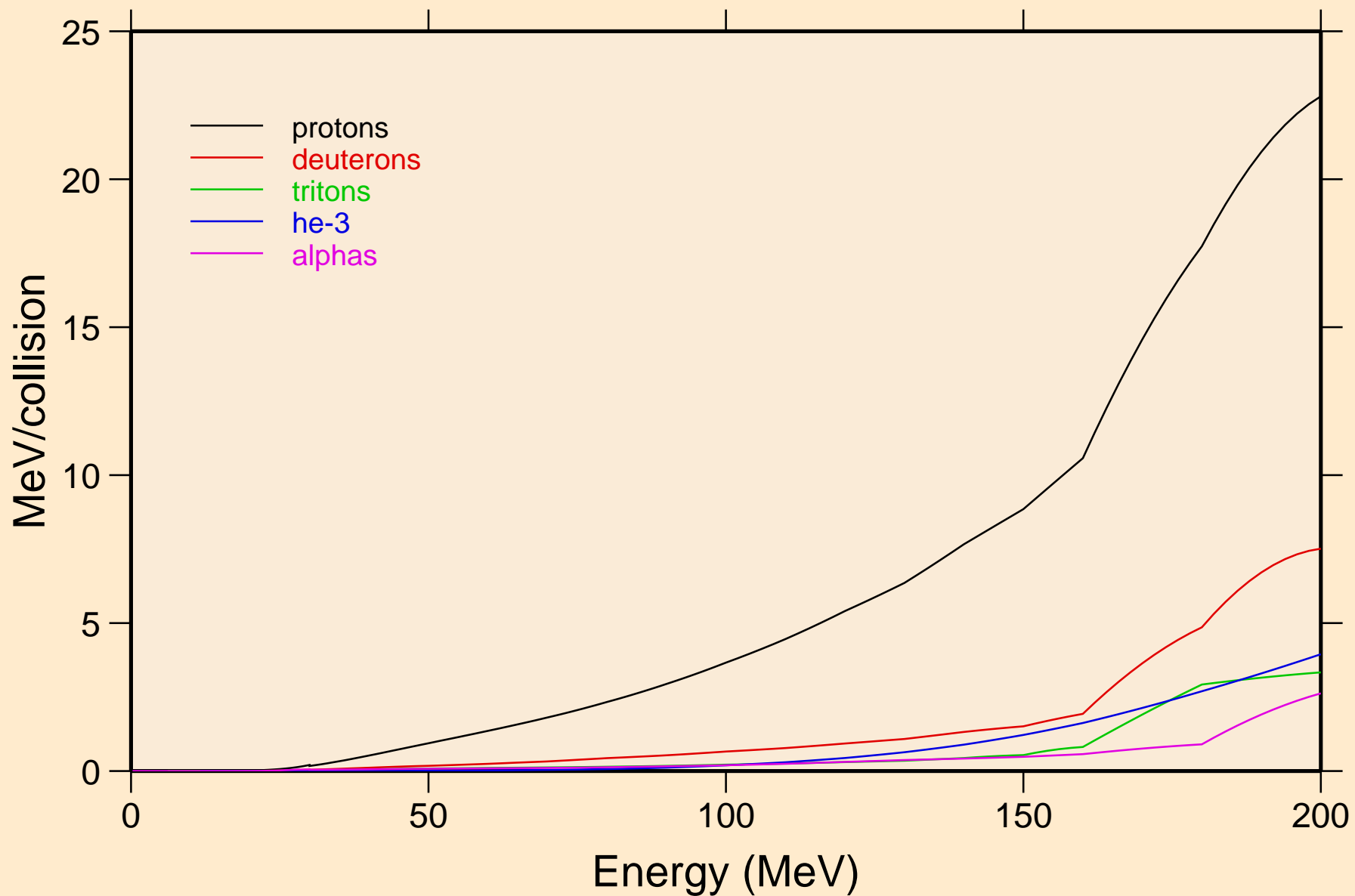

RE195 NEUTRON ACER TENDL-2019 LIBRARY; T=293.16K
Recoil Heating

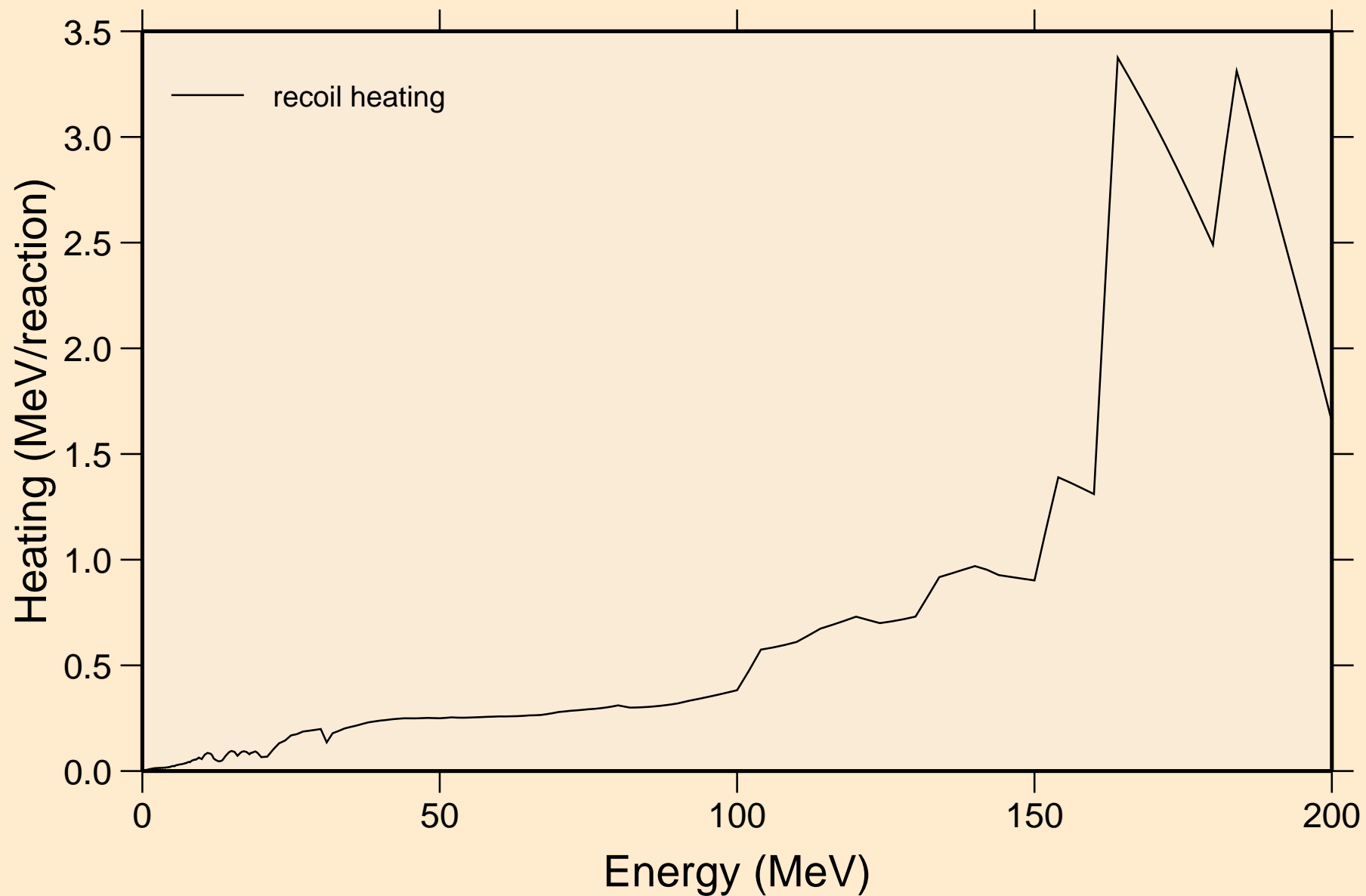

RE195 NEUTRON ACER TENDL-2019 LIBRARY; T=293.16K
Particle production cross sections

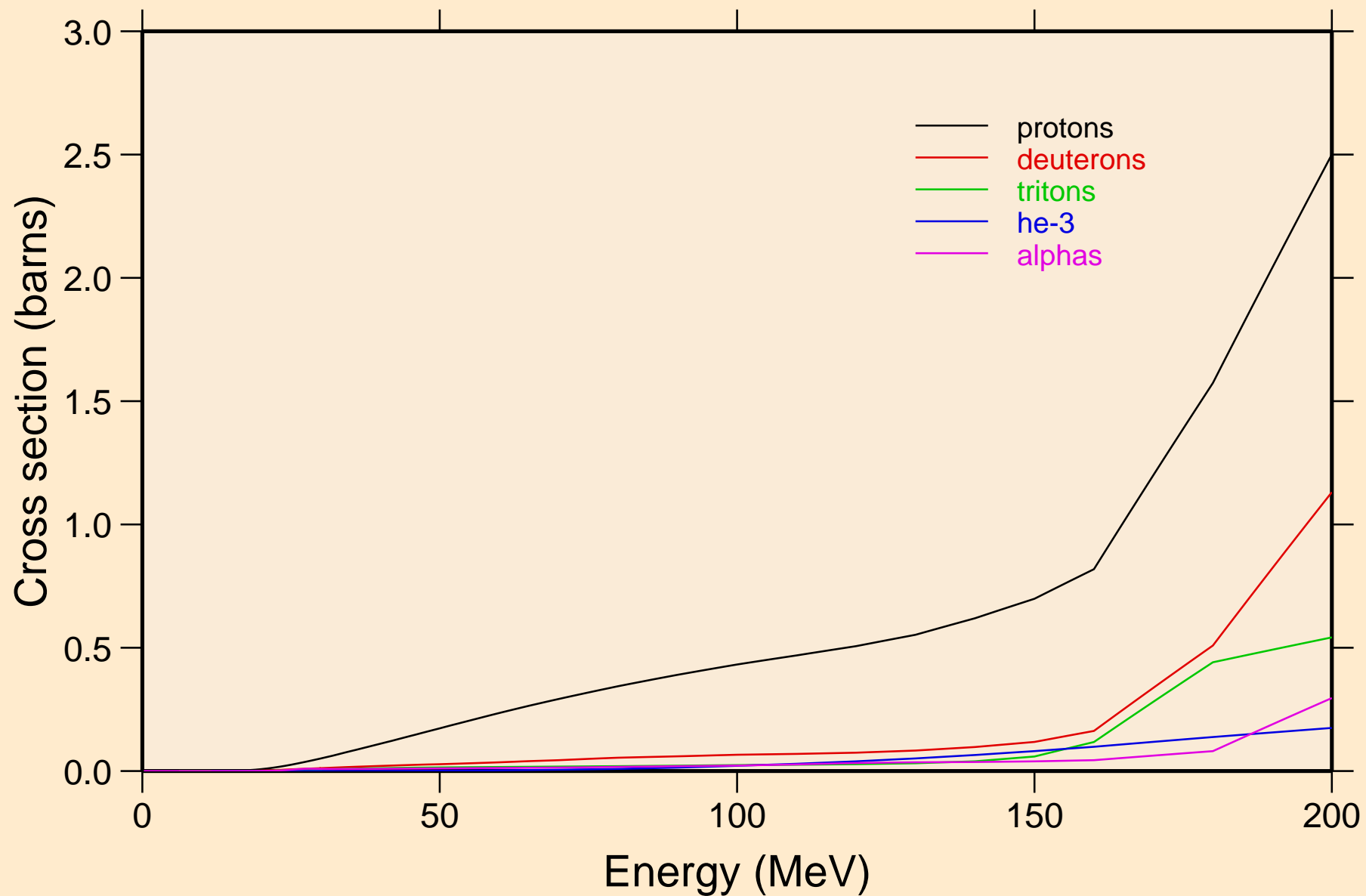

RE195 NEUTRON ACER TENDL-2019 LIBRARY; T=293.16K
protons from (n,x)

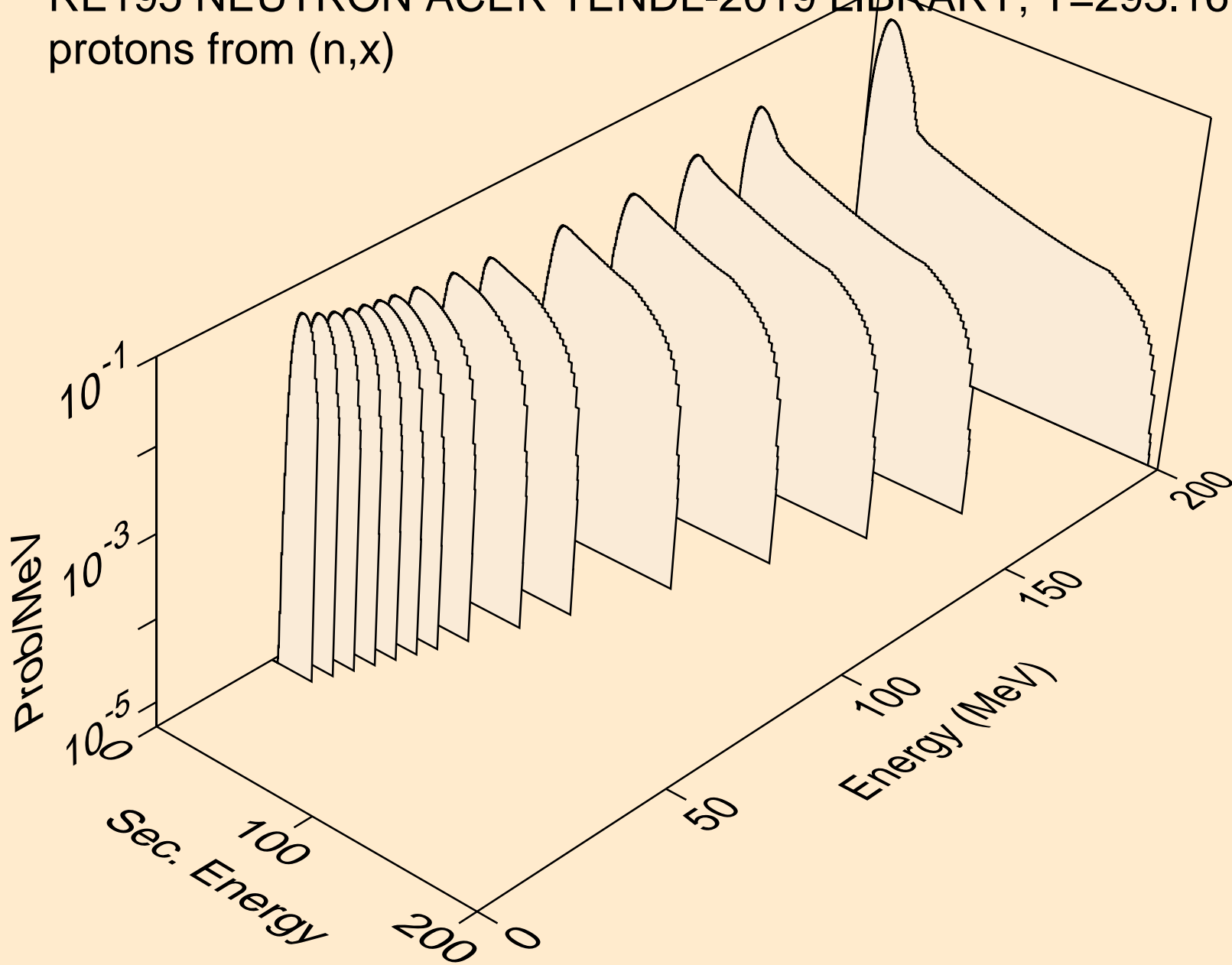

RE195 NEUTRON ACER TENDL-2019 LIBRARY; T=293.16K
protons from (n,n*)p

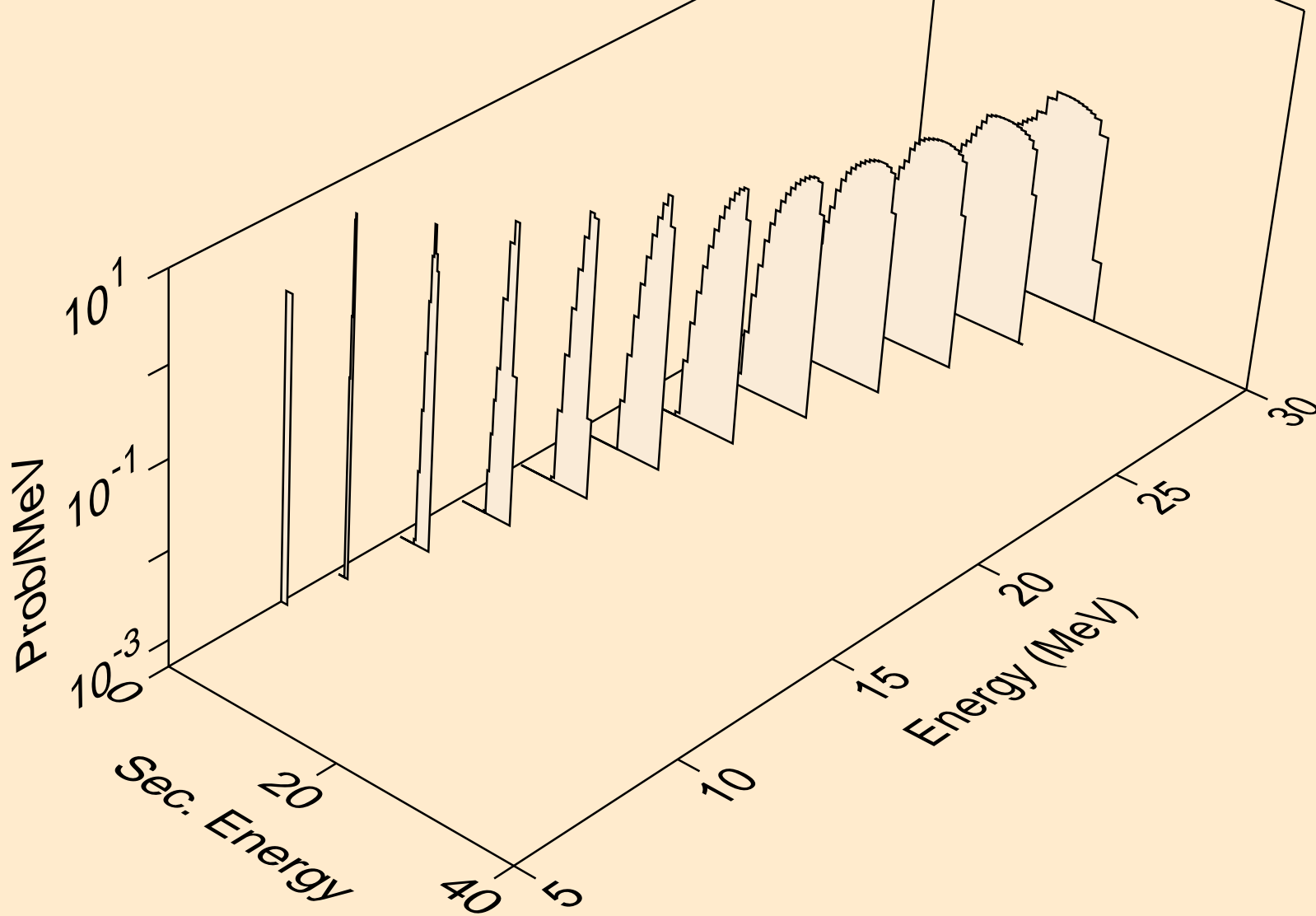

RE195 NEUTRON ACER TENDL-2019 LIBRARY; T=293.16K
protons from (n,2np)

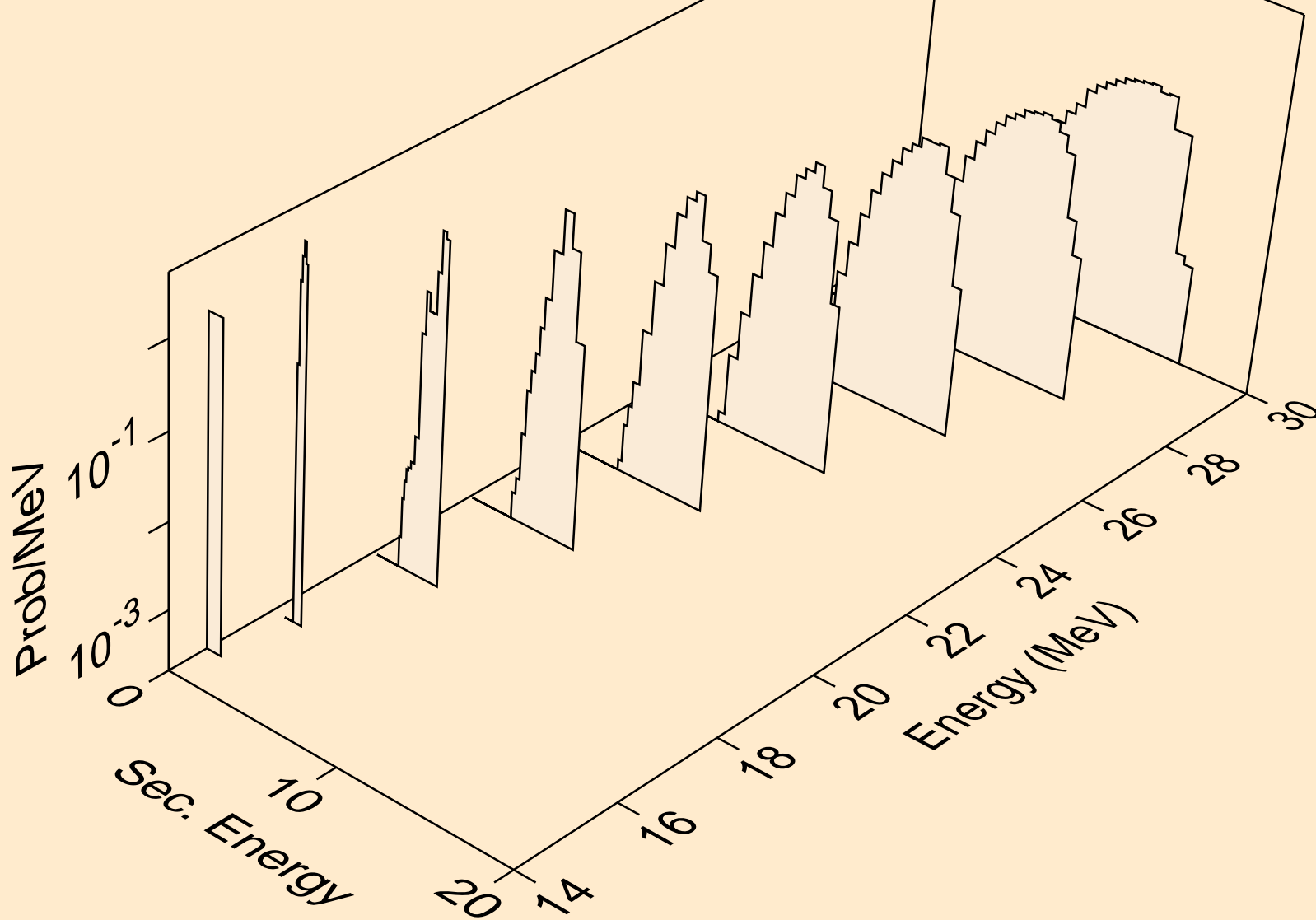

RE195 NEUTRON ACER TENDL-2019 LIBRARY; T=293.16K
protons from (n,3np)

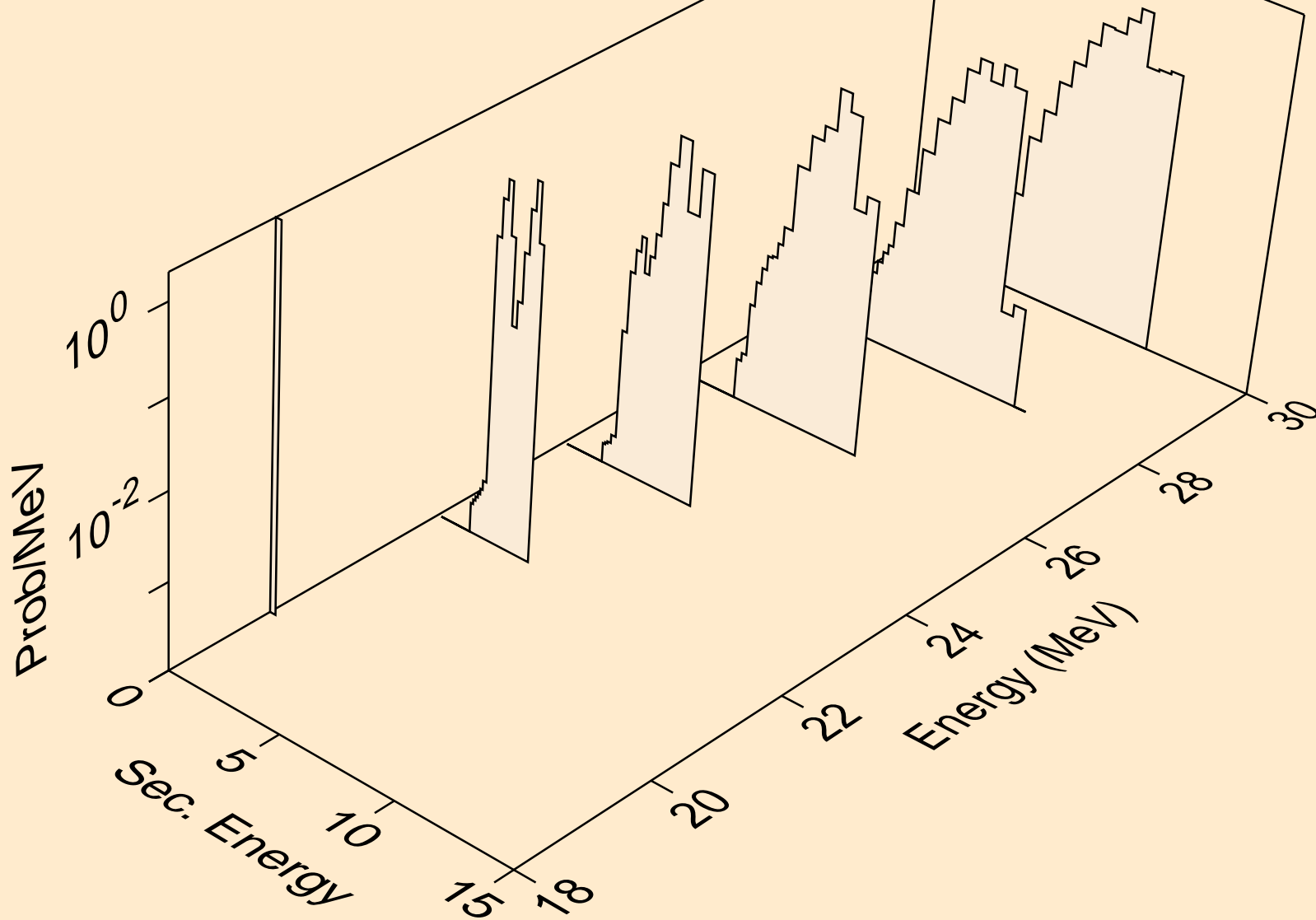

RE195 NEUTRON ACER TENDL-2019 LIBRARY; T=293.16K
protons from (n,p)

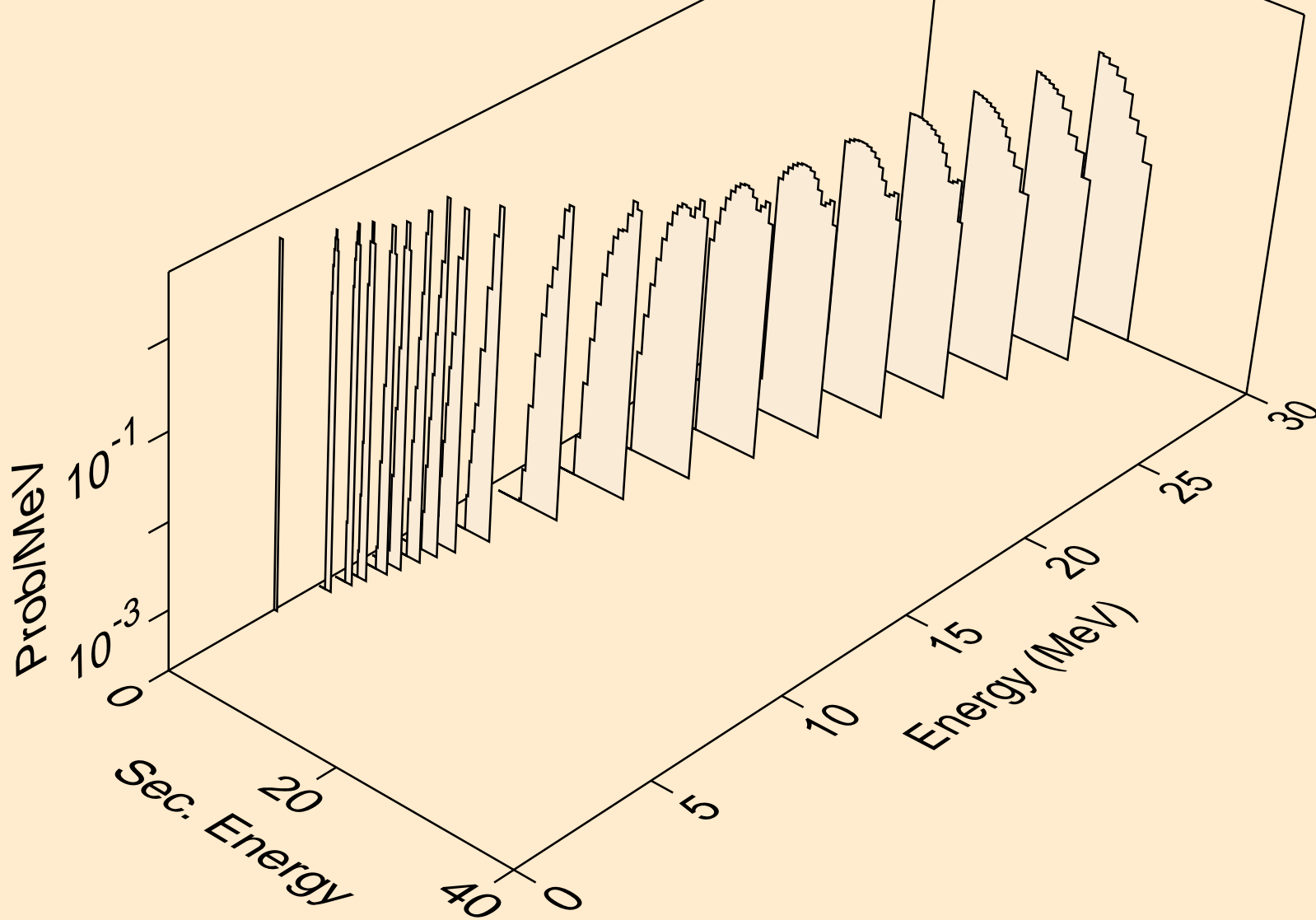

RE195 NEUTRON ACER TENDL-2019 LIBRARY; T=293.16K
deuterons from (n,x)

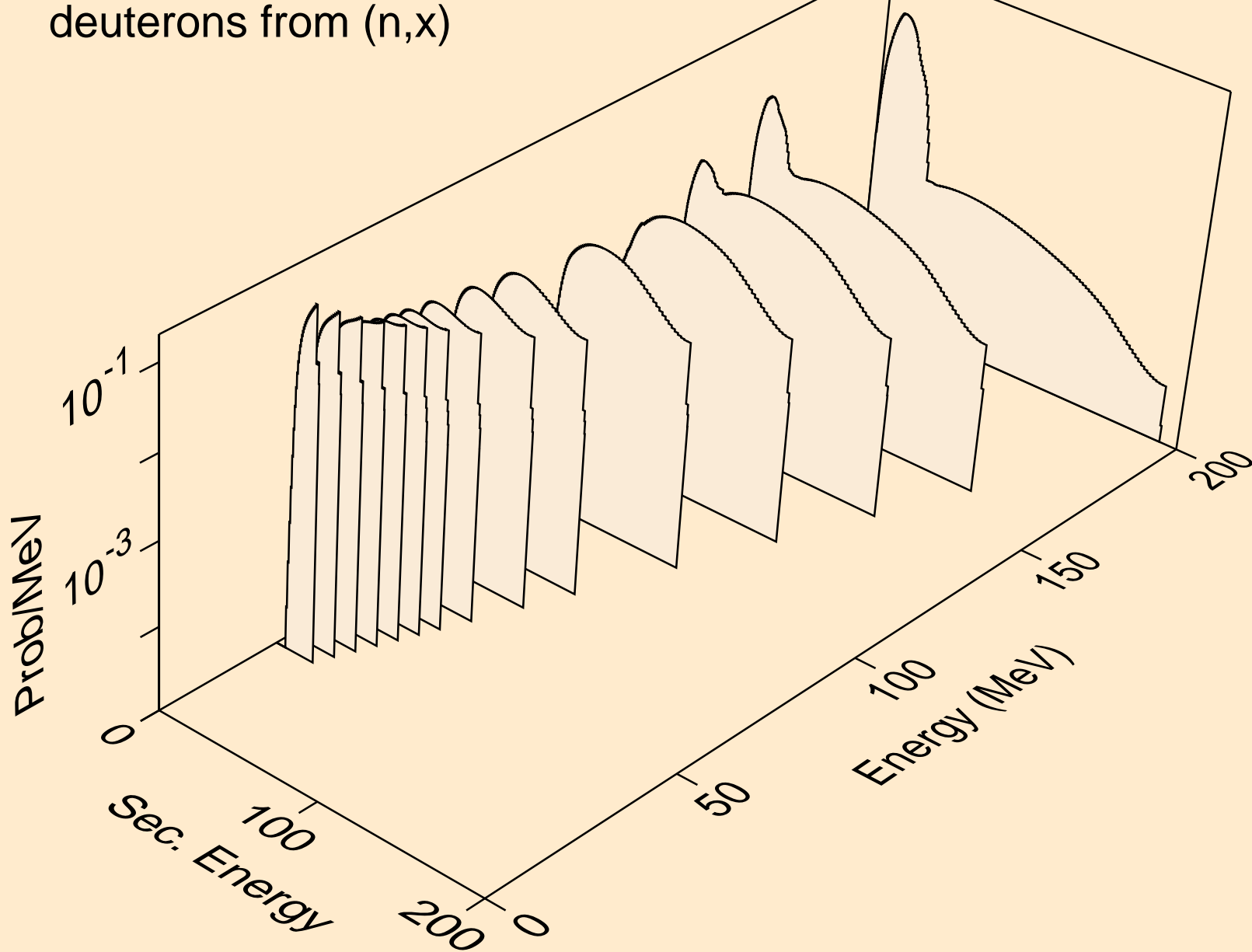

RE195 NEUTRON ACER TENDL-2019 LIBRARY; T=293.16K
deuterons from (n,2nd)

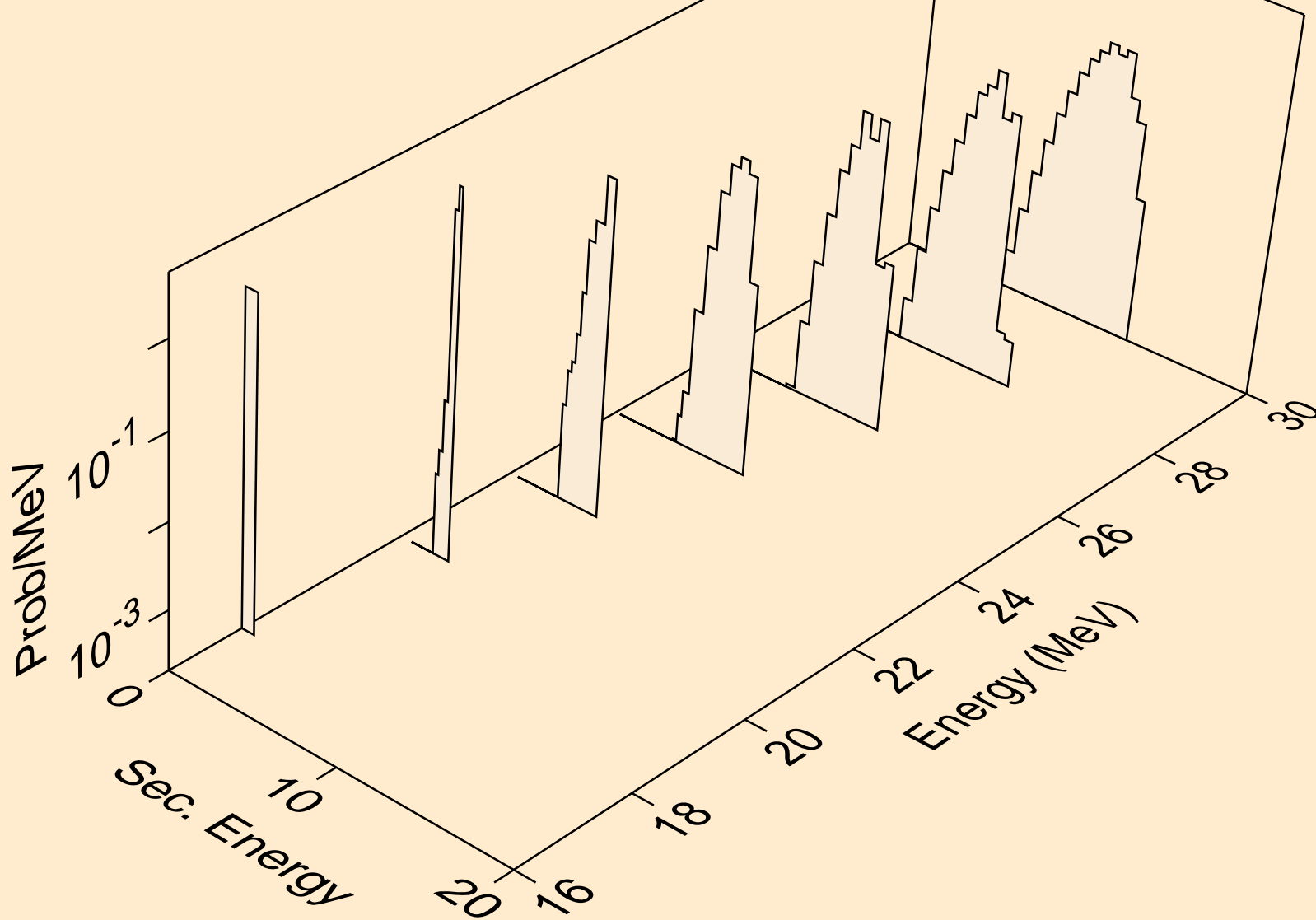

RE195 NEUTRON ACER TENDL-2019 LIBRARY; T=293.16K
deuterons from (n,n*)d

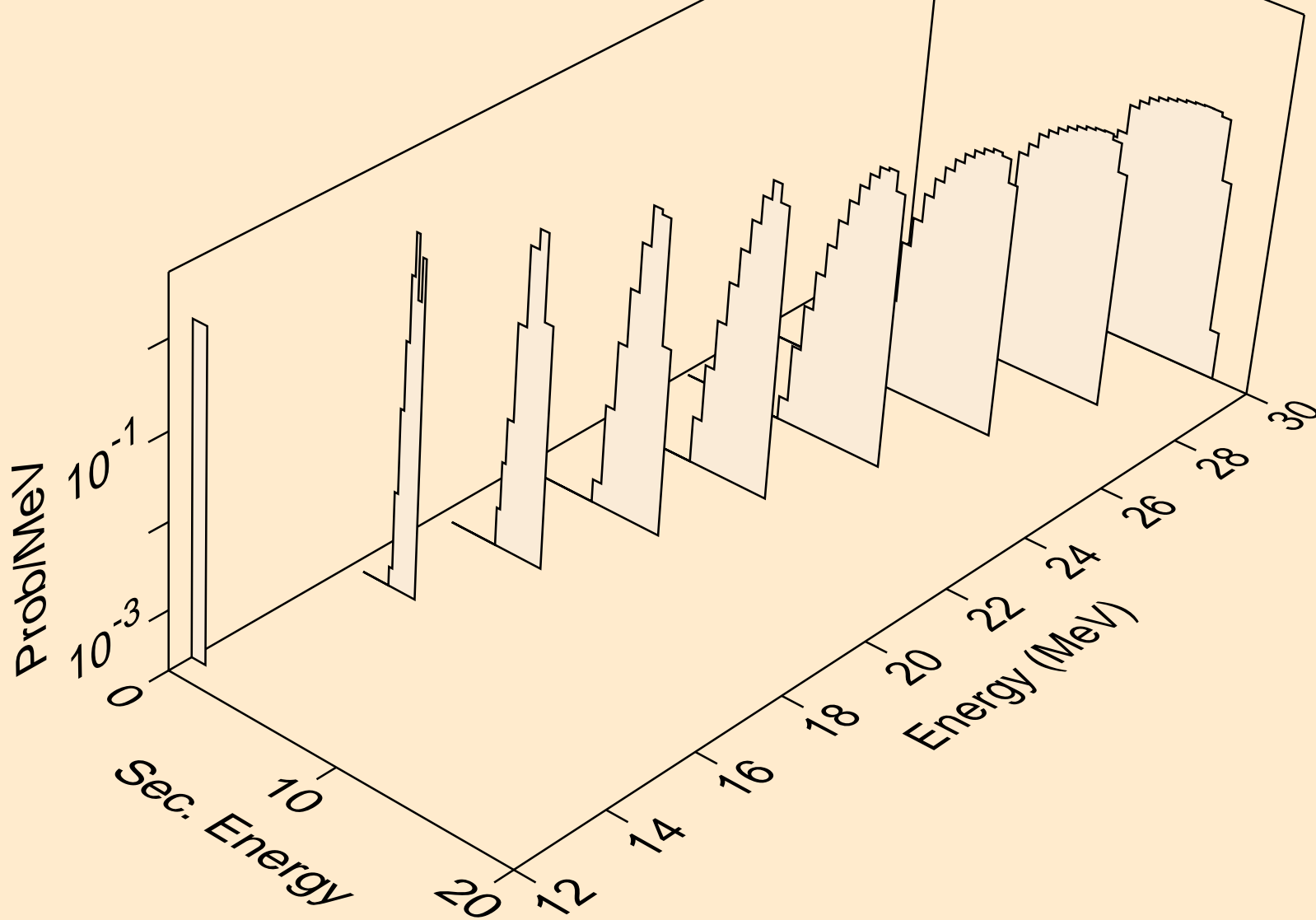

RE195 NEUTRON ACER TENDL-2019 LIBRARY; T=293.16K
deuterons from (n,d)

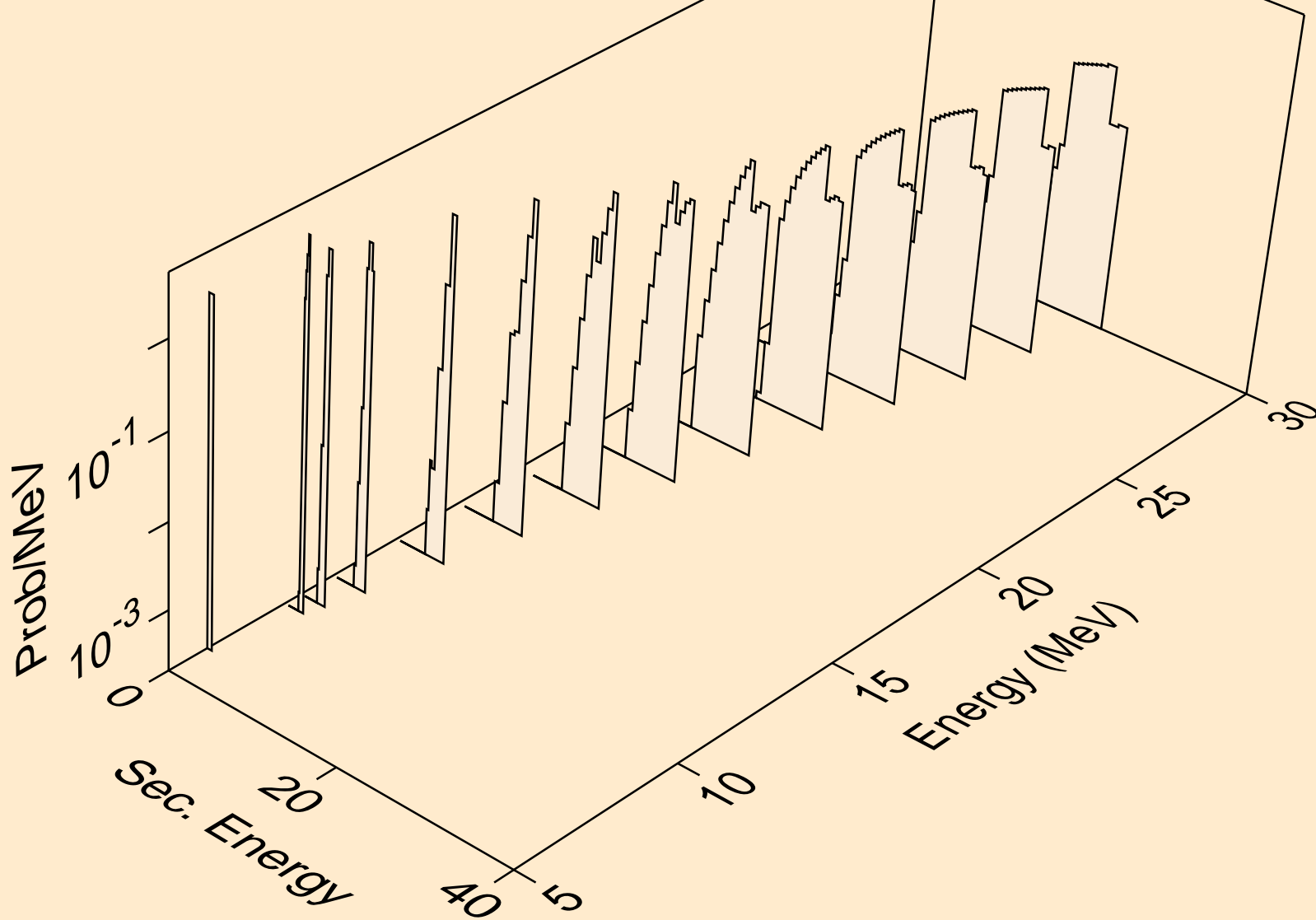

RE195 NEUTRON ACER TENDL-2019 LIBRARY; T=293.16K
tritons from (n,x)

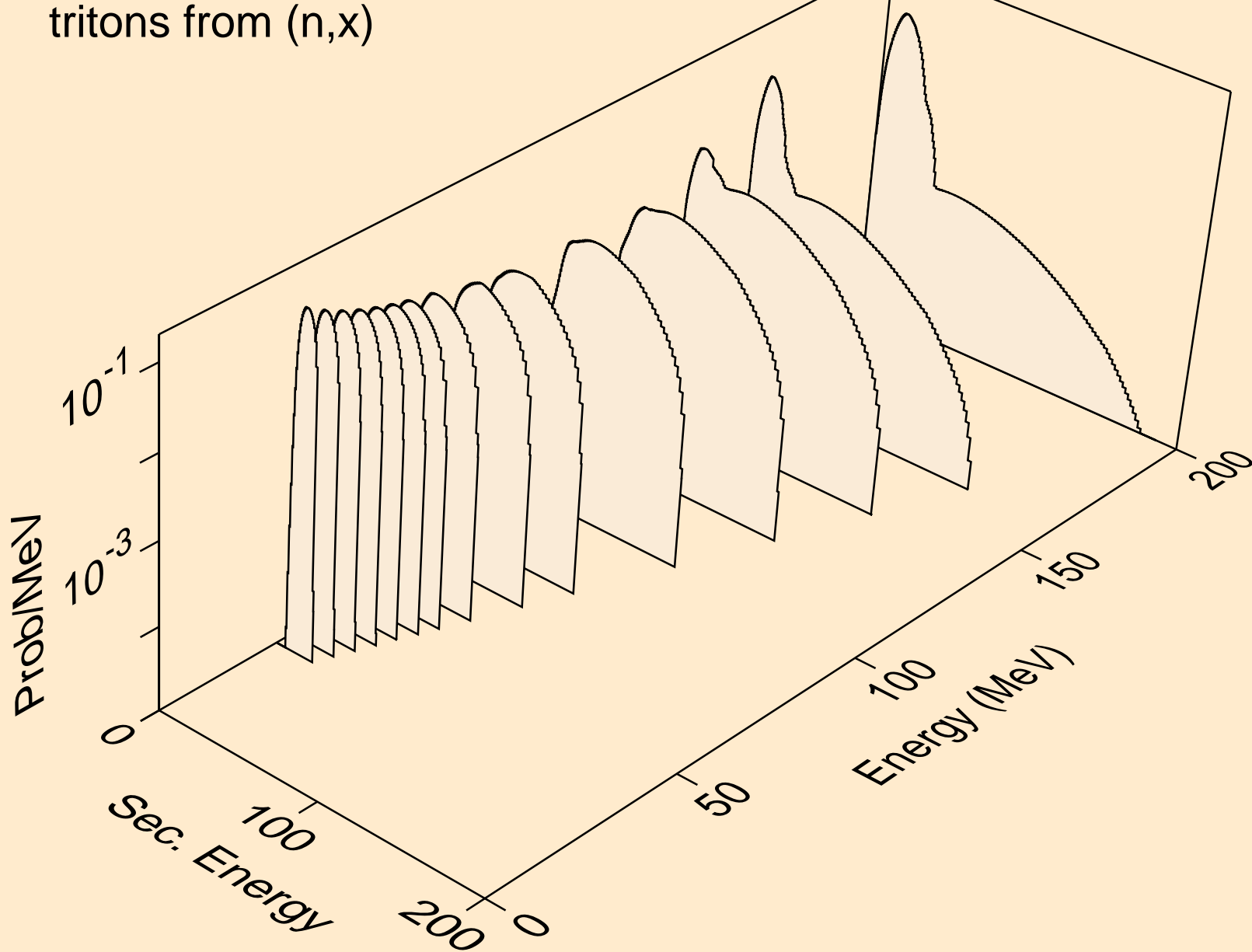

RE195 NEUTRON ACER TENDL-2019 LIBRARY; T=293.16K
tritons from (n,n*)t

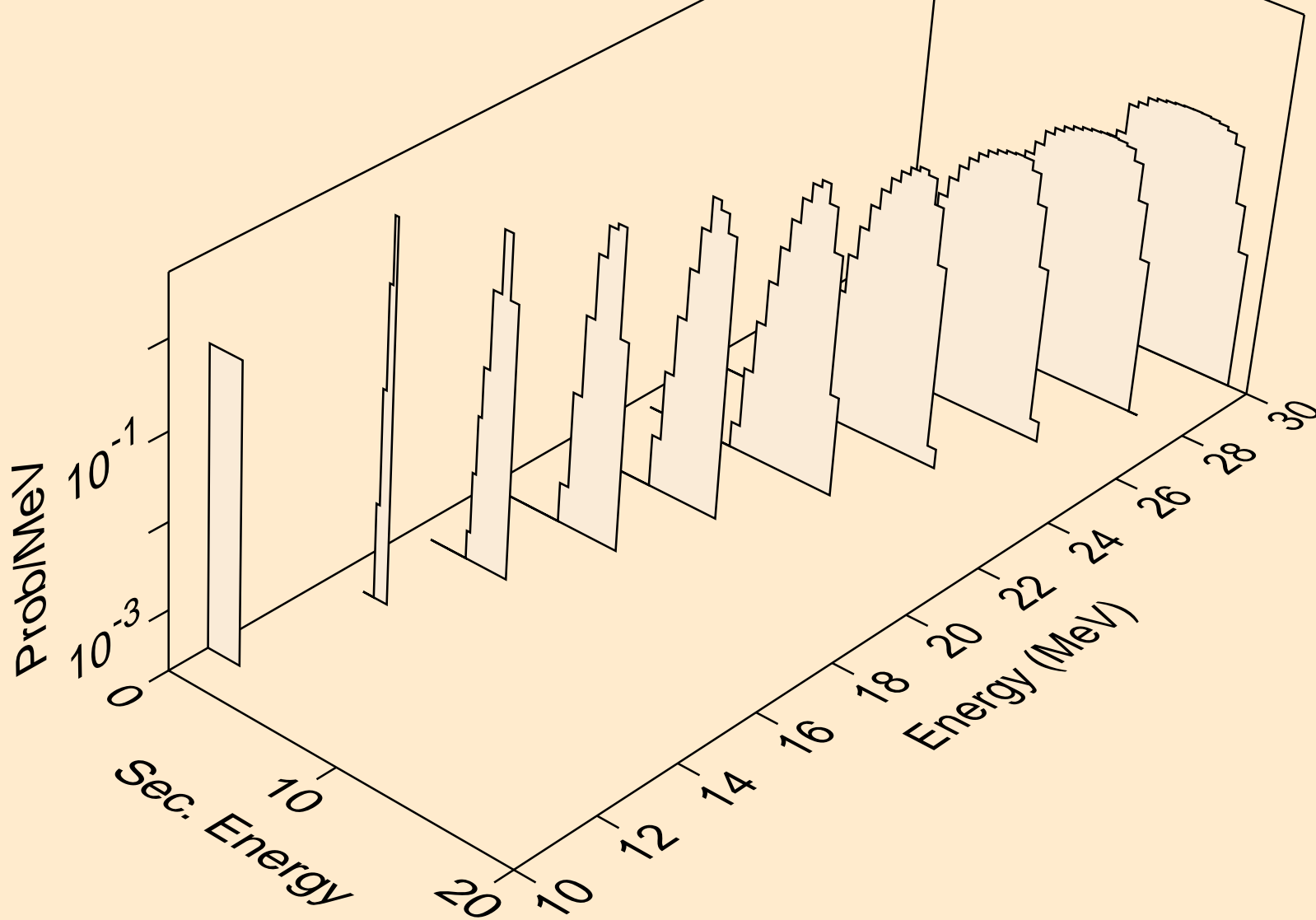

RE195 NEUTRON ACER TENDL-2019 LIBRARY; T=293.16K
tritons from (n,t)

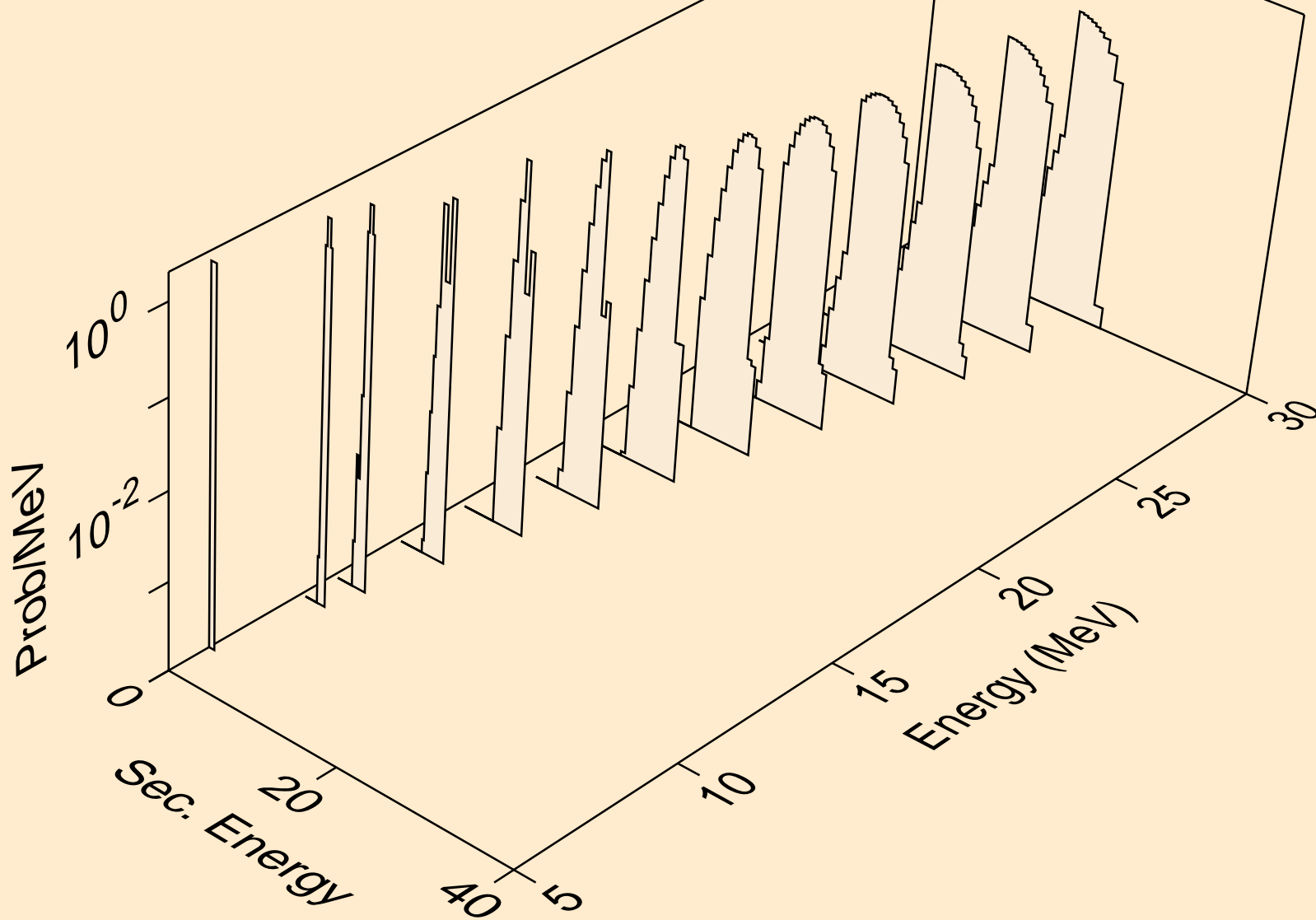

RE195 NEUTRON ACER TENDL-2019 LIBRARY; T=293.16K
he3s from (n,x)

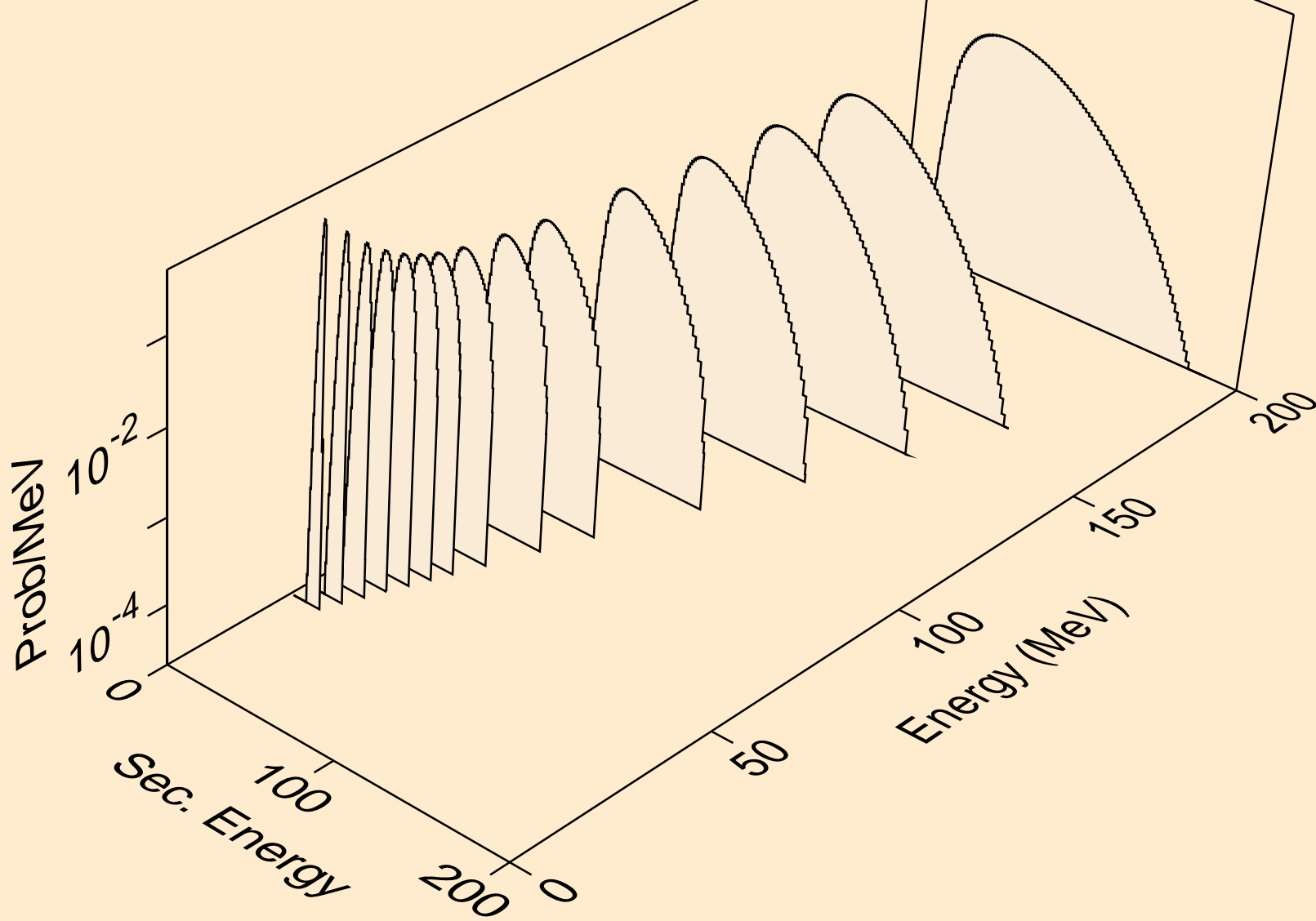

RE195 NEUTRON ACER TENDL-2019 LIBRARY; T=293.16K
he3s from (n,n*)he3

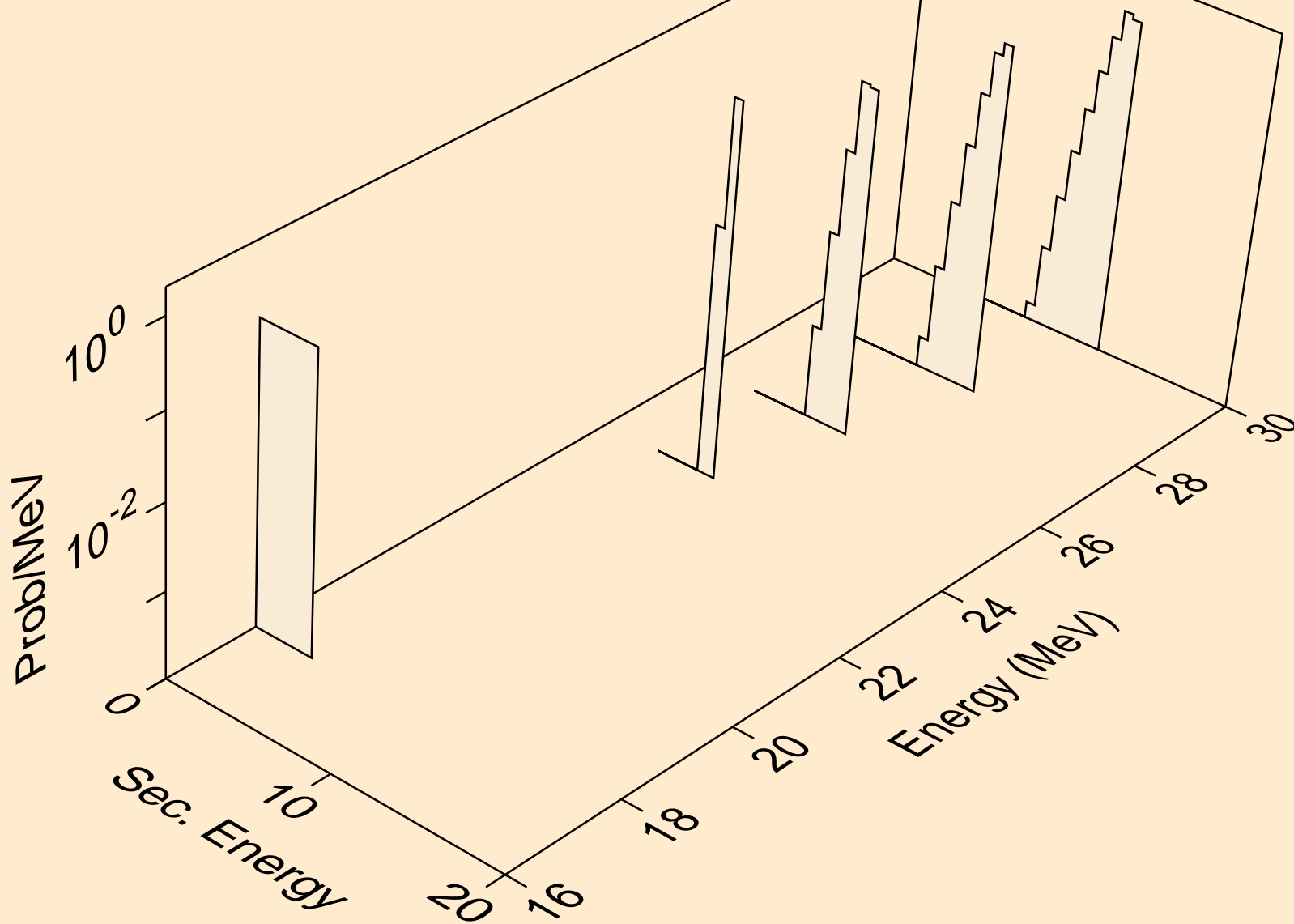

RE195 NEUTRON ACER TENDL-2019 LIBRARY; T=293.16K
he3s from (n,he3)

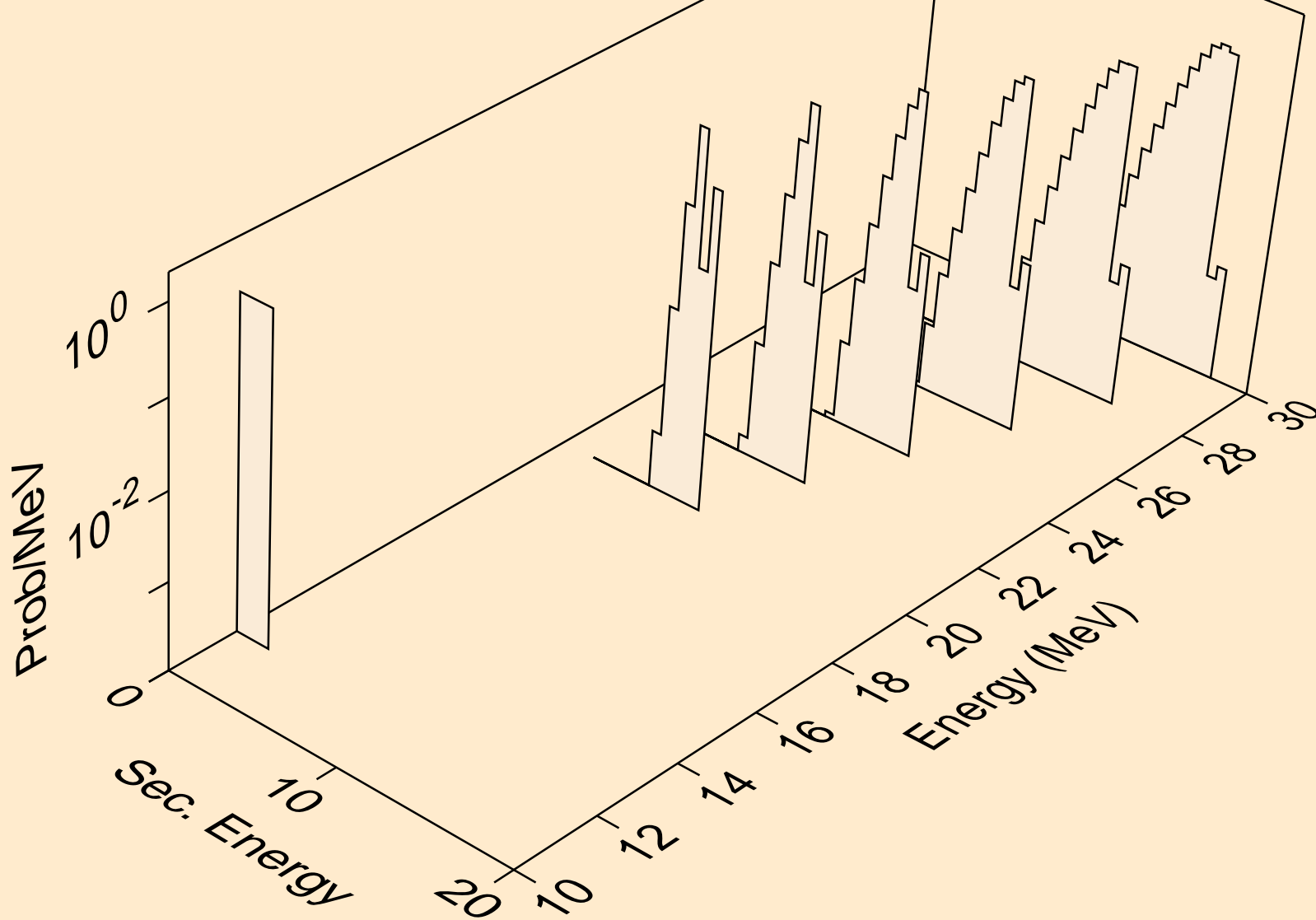

RE195 NEUTRON ACER TENDL-2019 LIBRARY; T=293.16K
alphas from (n,x)

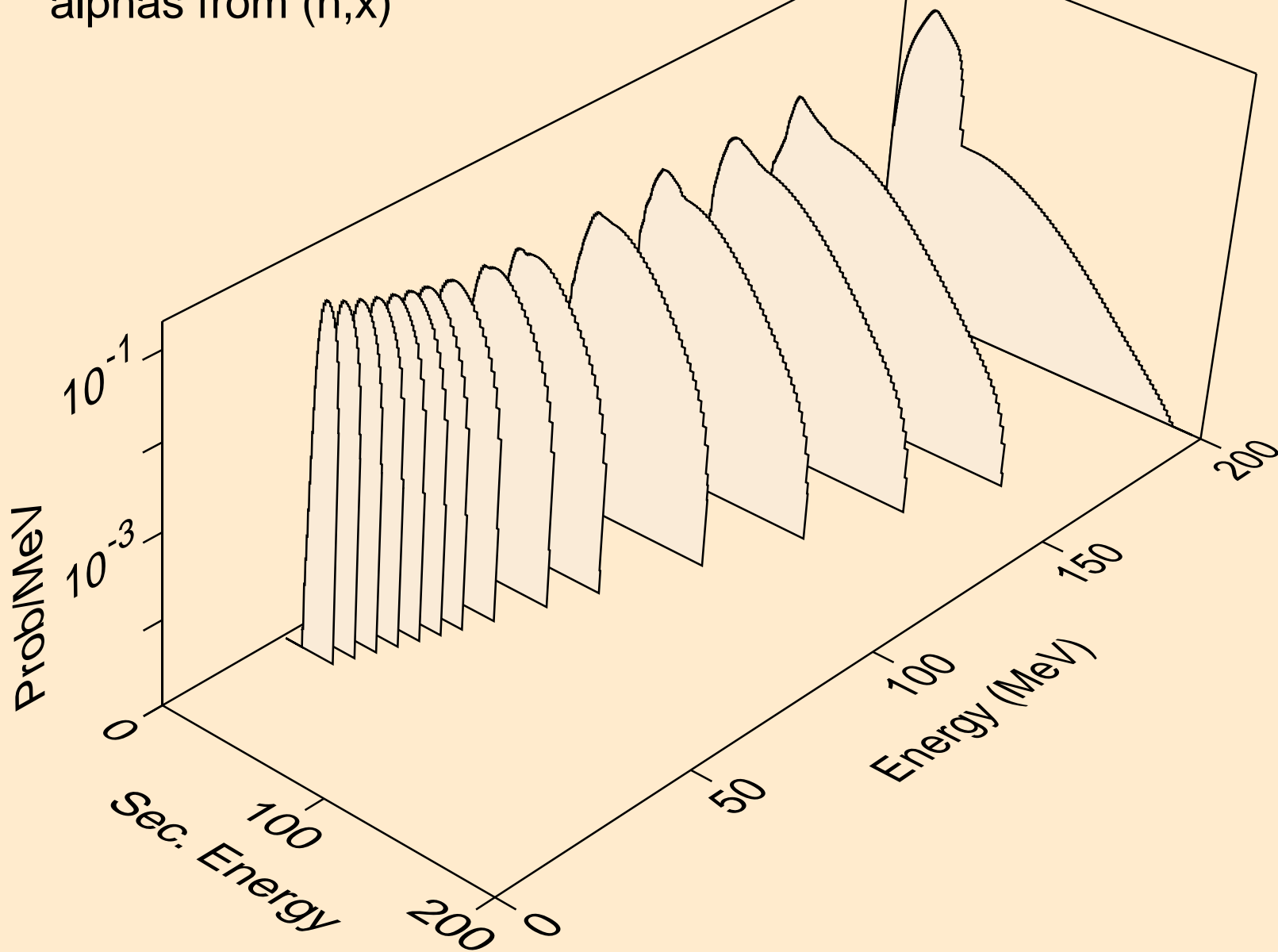

RE195 NEUTRON ACER TENDL-2019 LIBRARY; T=293.16K
alphas from (n,n*)a

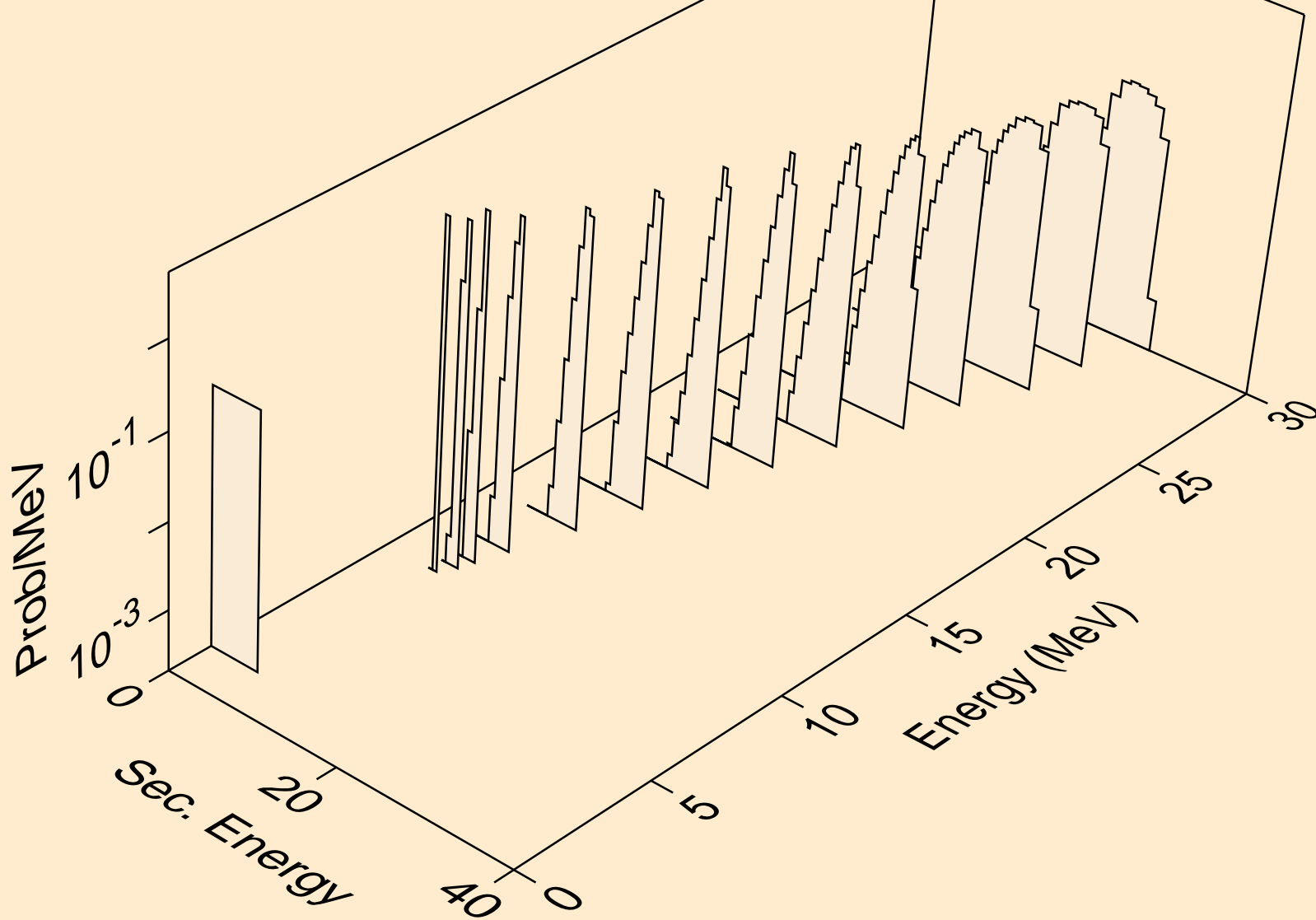

RE195 NEUTRON ACER TENDL-2019 LIBRARY; T=293.16K
alphas from (n,2n)a

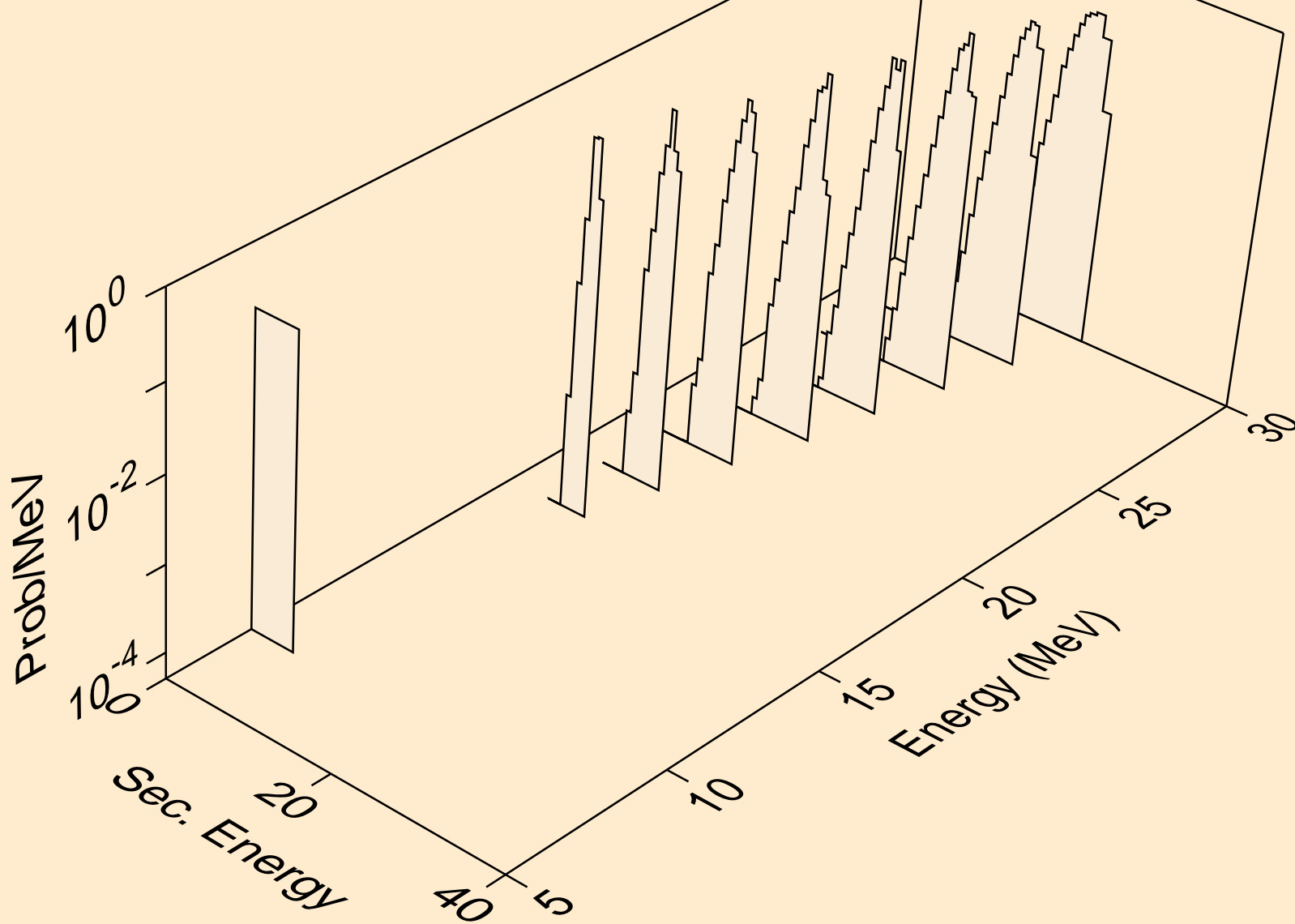

RE195 NEUTRON ACER TENDL-2019 LIBRARY; T=293.16K
alphas from (n,3n)a

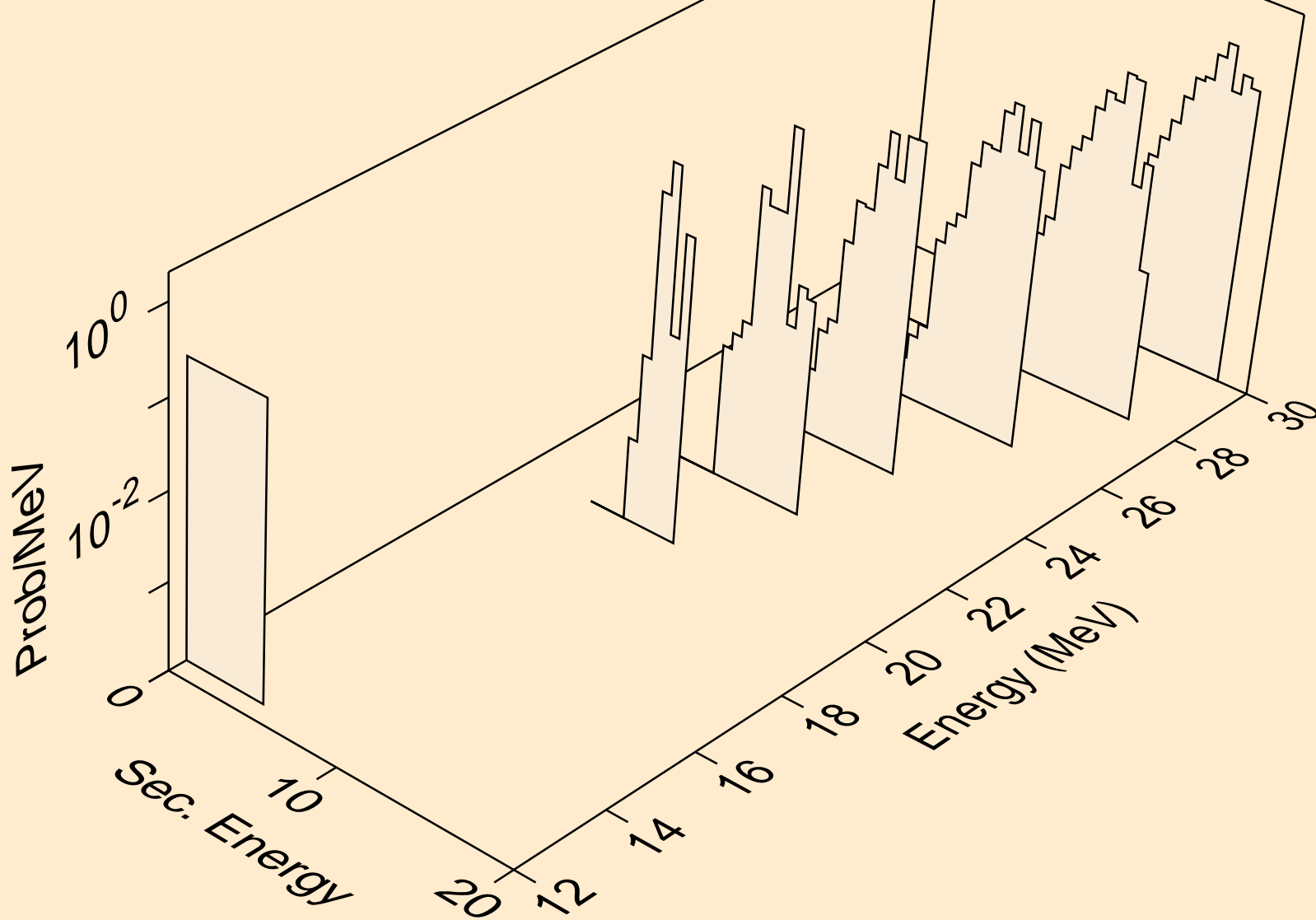

RE195 NEUTRON ACER TENDL-2019 LIBRARY; T=293.16K
alphas from (n,a)

