

RF257M NEUTRON ACER TENDL-2019 LIBRARY; T=293.16K
Principal cross sections

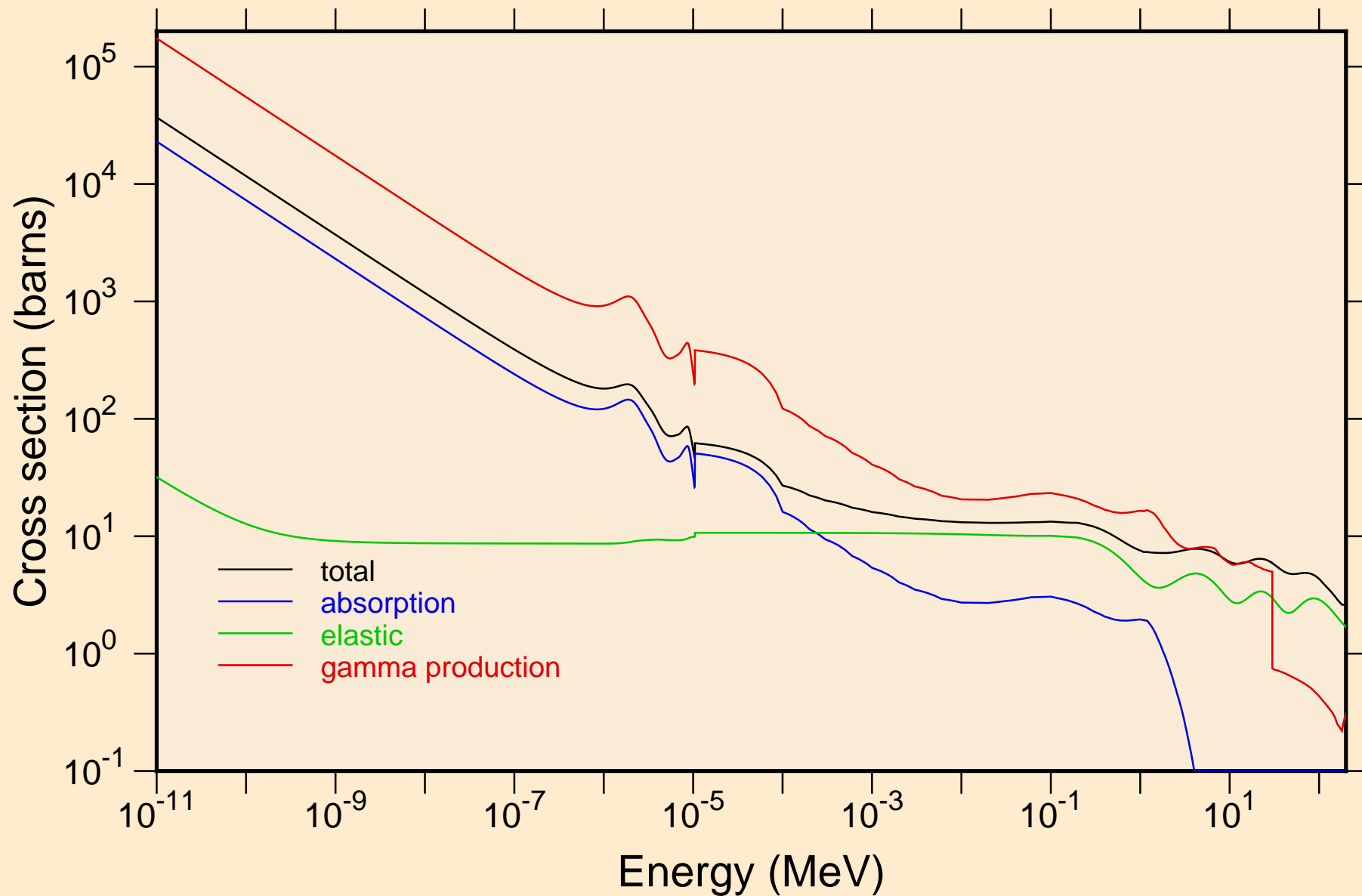

RF257M NEUTRON ACER TENDL-2019 LIBRARY; T=293.16K
Heating

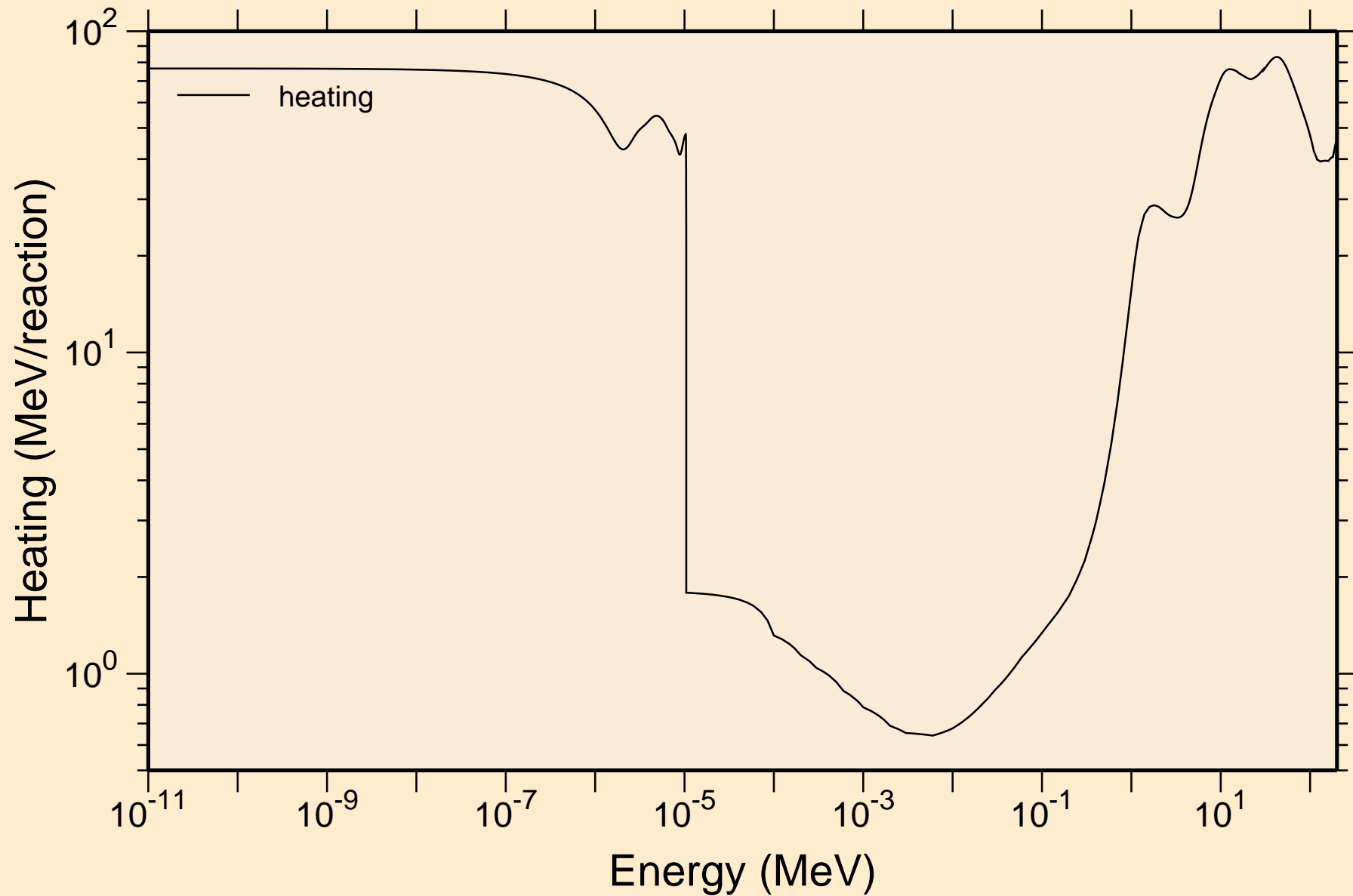

RF257M NEUTRON ACER TENDL-2019 LIBRARY; T=293.16K
Damage

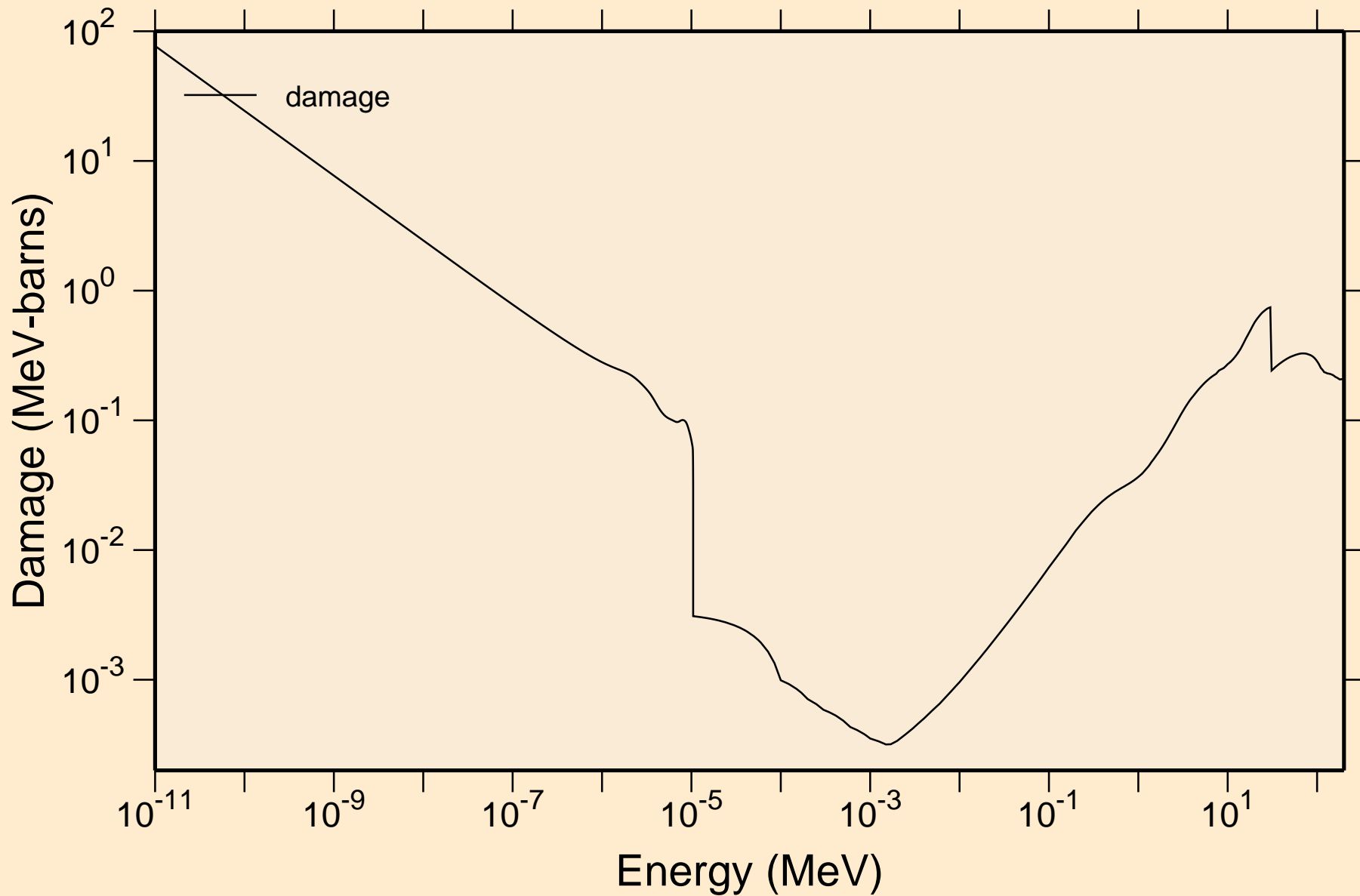

RF257M NEUTRON ACER TENDL-2019 LIBRARY; T=293.16K
Non-threshold reactions

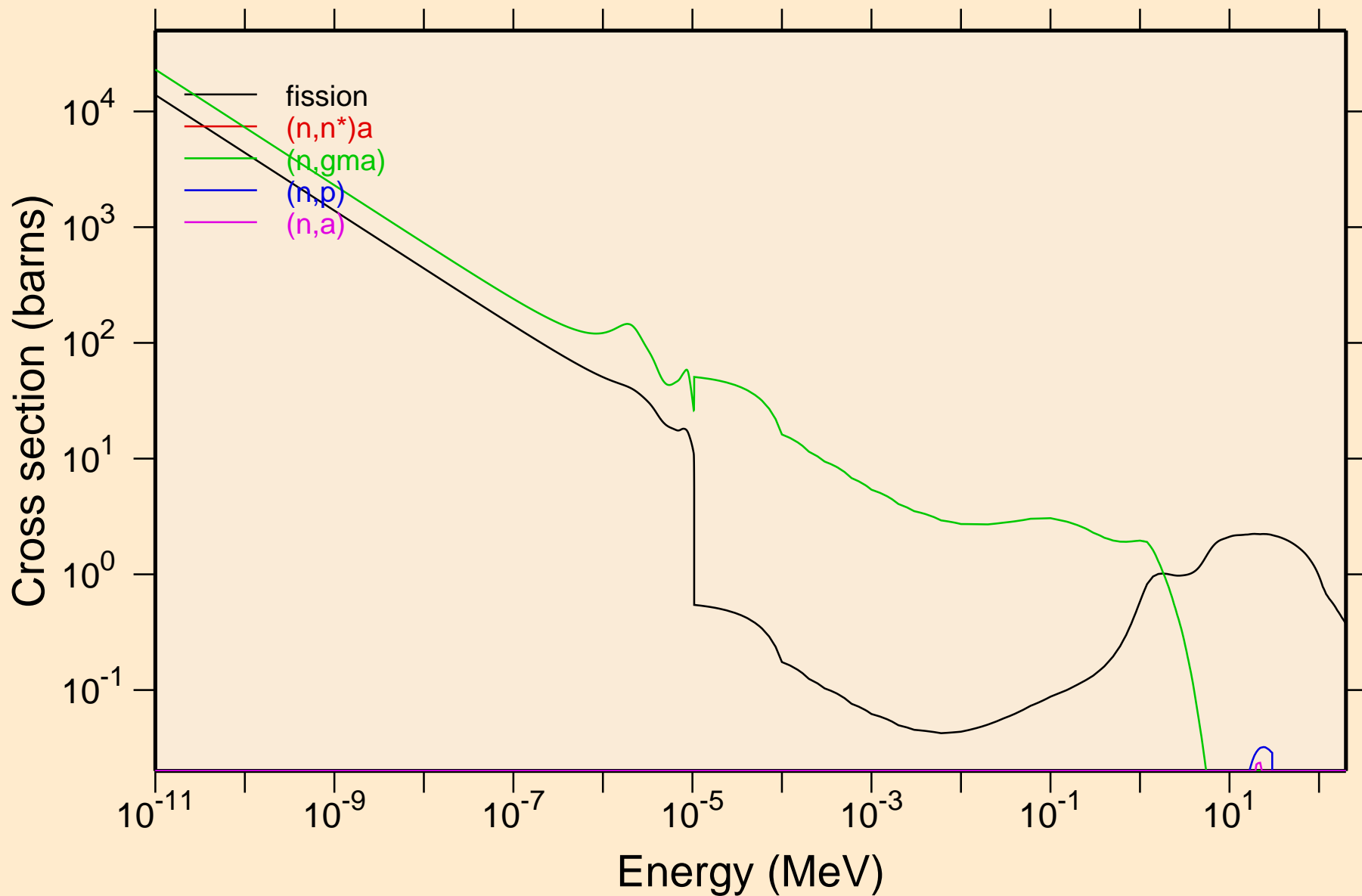

RF257M NEUTRON ACER TENDL-2019 LIBRARY; T=293.16K
Non-threshold reactions

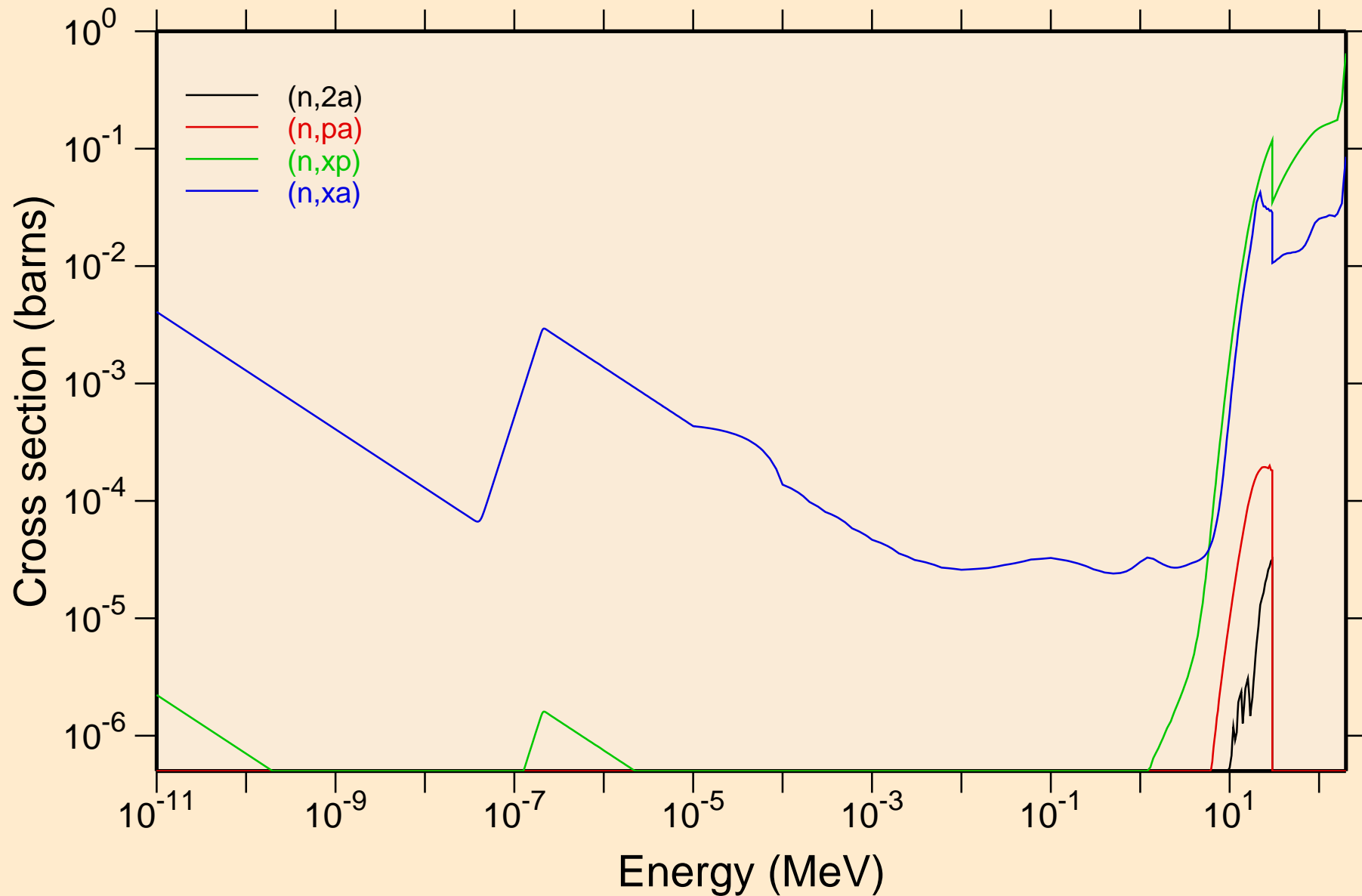

RF257M NEUTRON ACER TENDL-2019 LIBRARY; T=293.16K
Principal cross sections

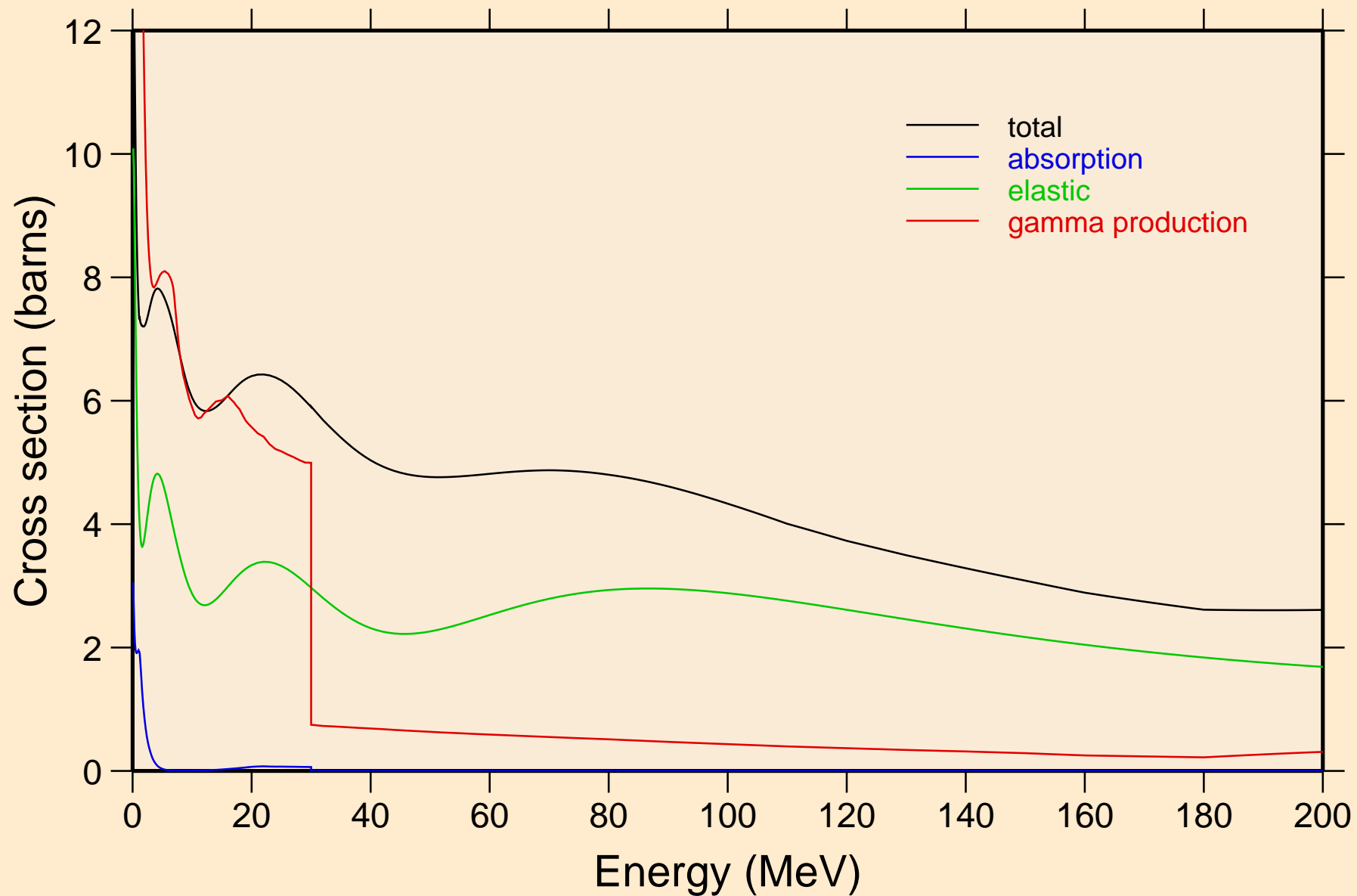

RF257M NEUTRON ACER TENDL-2019 LIBRARY; T=293.16K
Heating

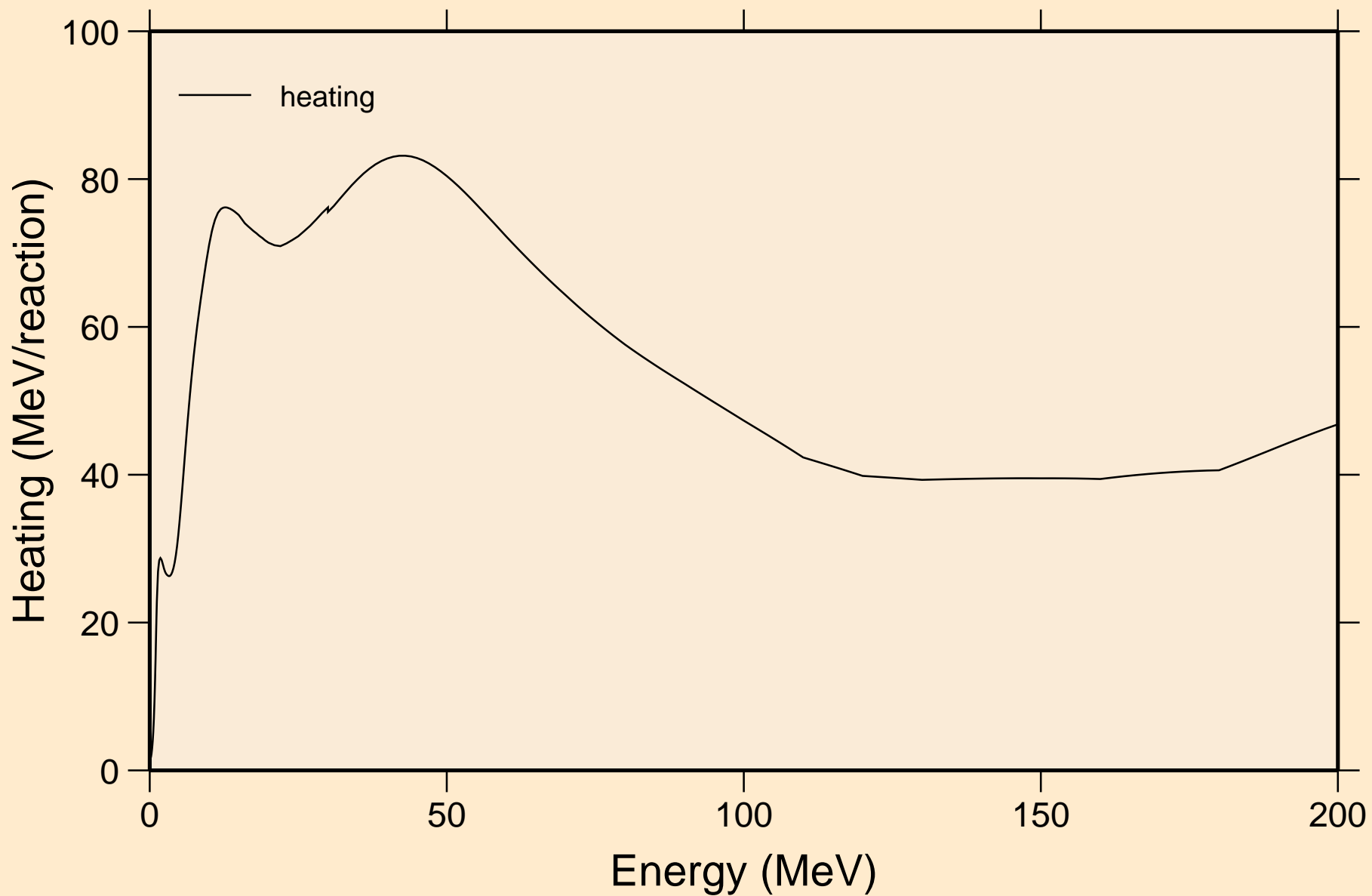

RF257M NEUTRON ACER TENDL-2019 LIBRARY; T=293.16K
Damage

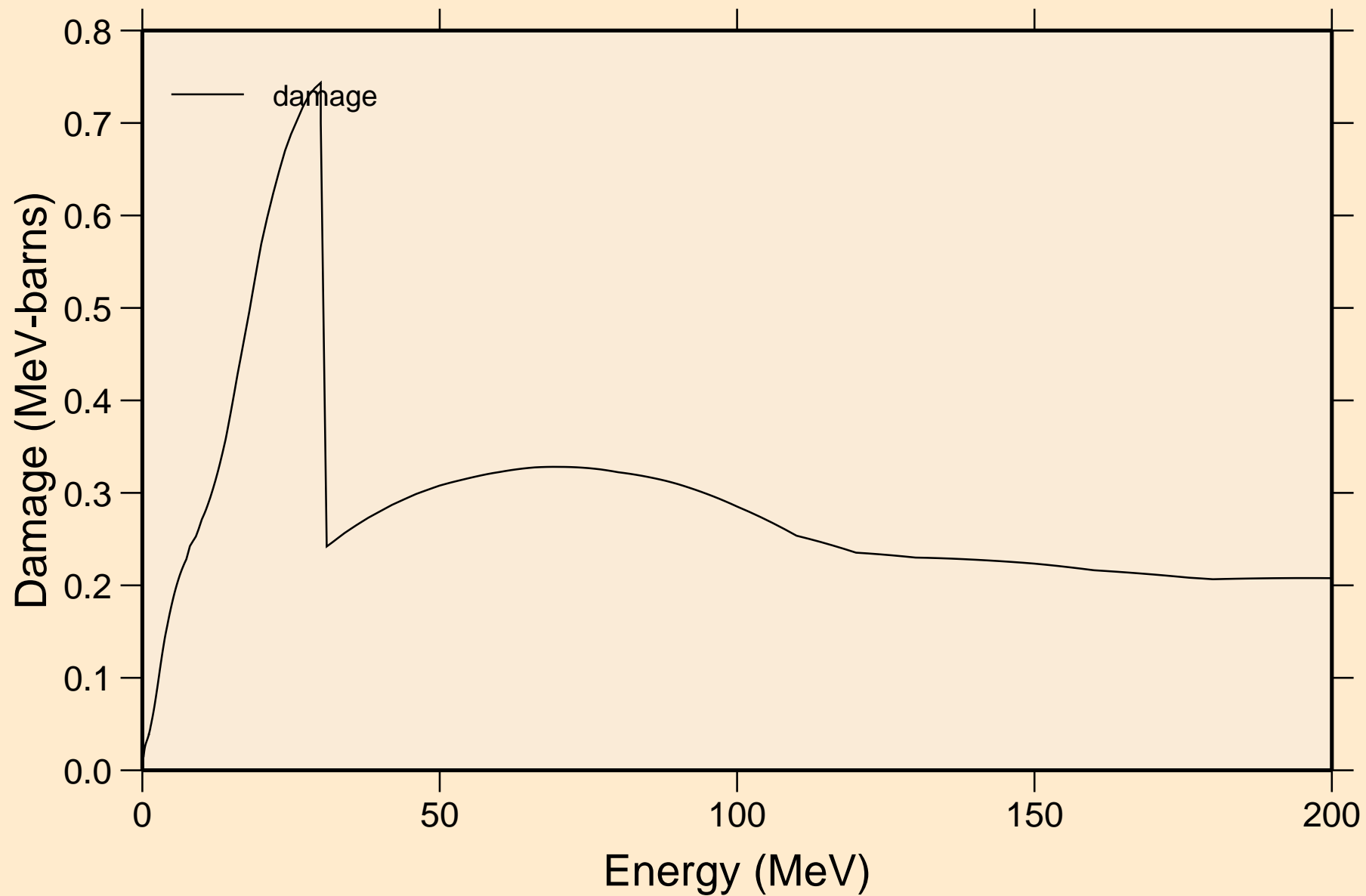

RF257M NEUTRON ACER TENDL-2019 LIBRARY; T=293.16K
Non-threshold reactions

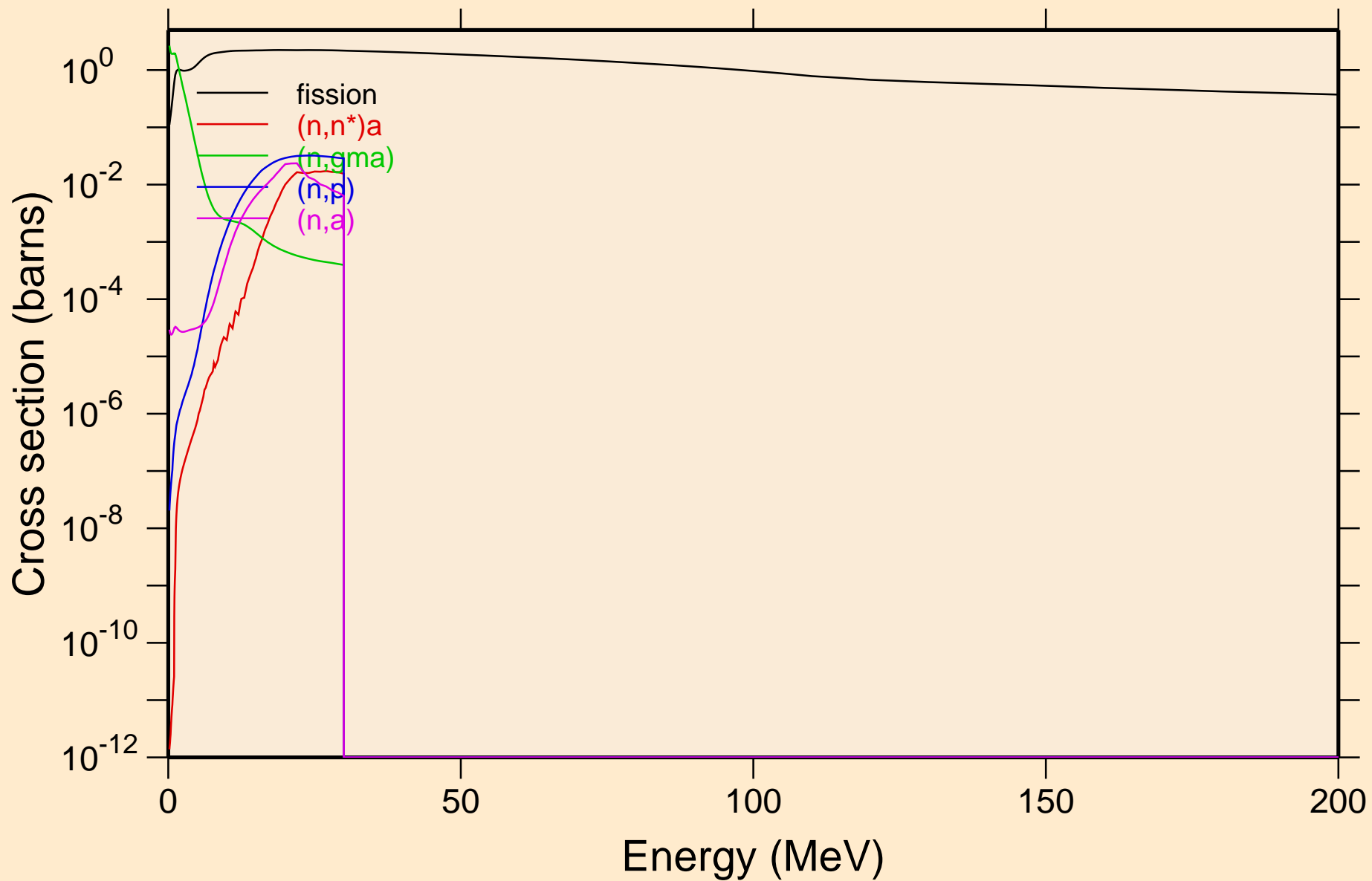

RF257M NEUTRON ACER TENDL-2019 LIBRARY; T=293.16K
Non-threshold reactions

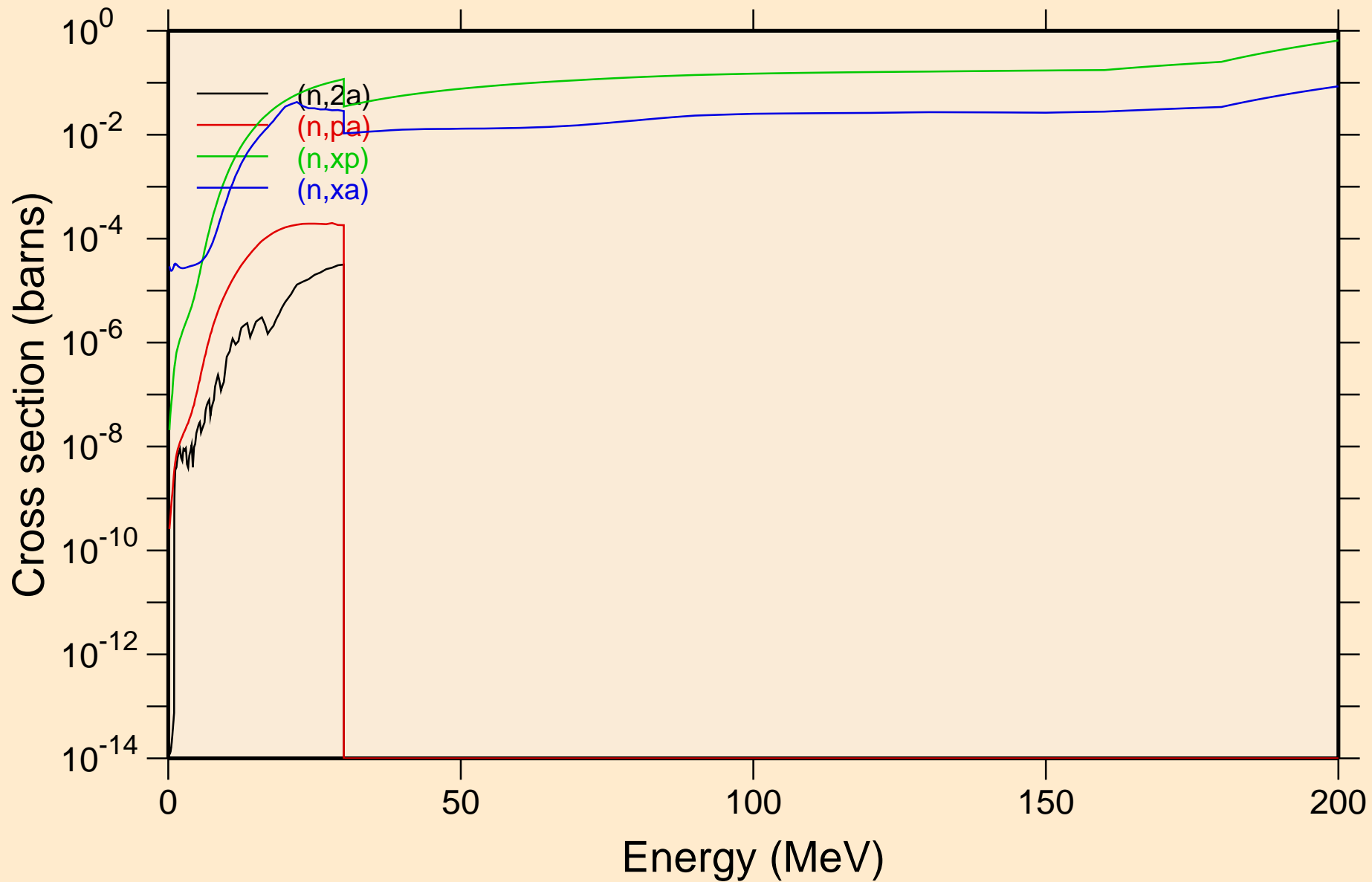

RF257M NEUTRON ACER TENDL-2019 LIBRARY; T=293.16K
Inelastic levels

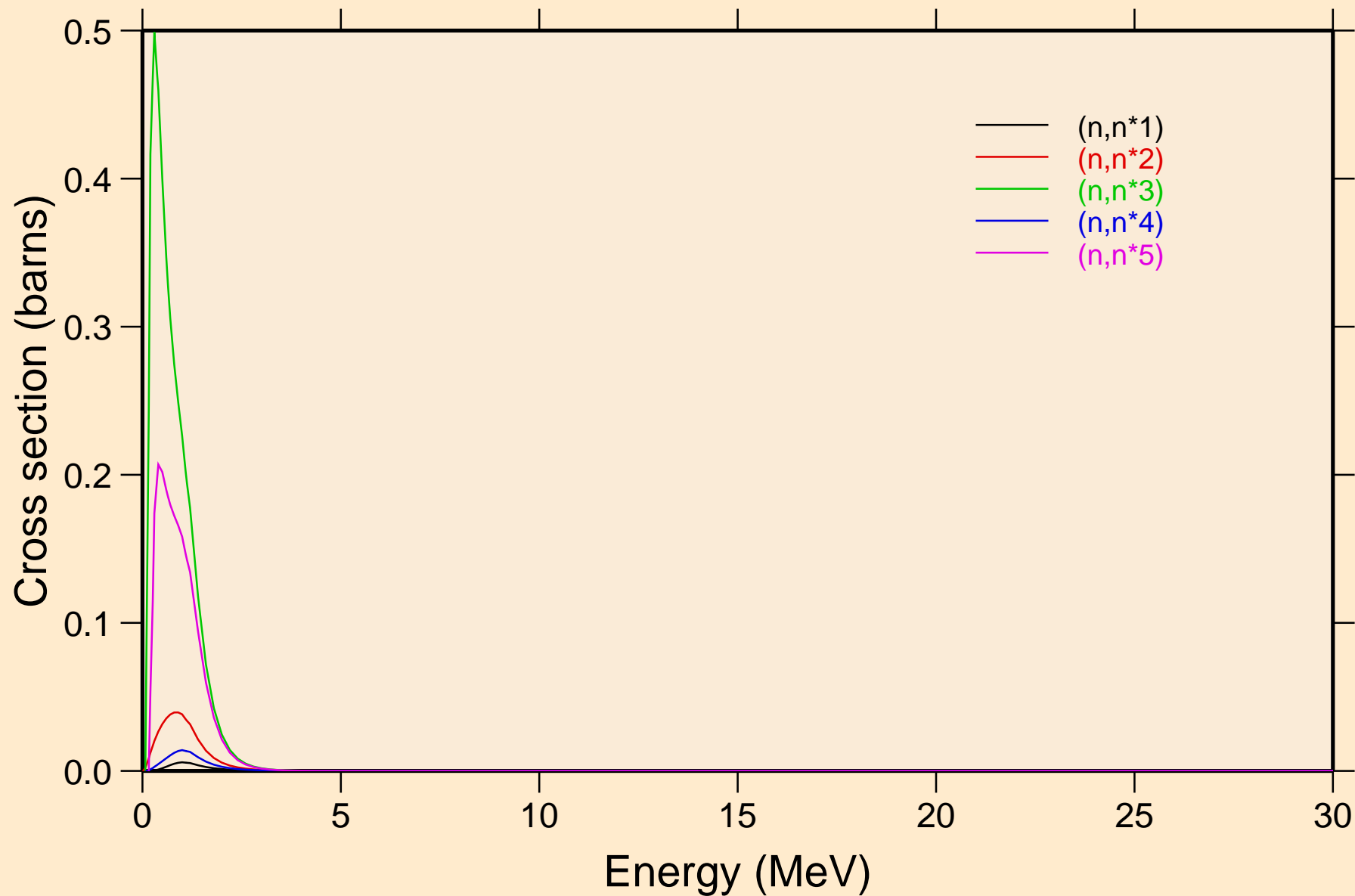

RF257M NEUTRON ACER TENDL-2019 LIBRARY; T=293.16K
Inelastic levels

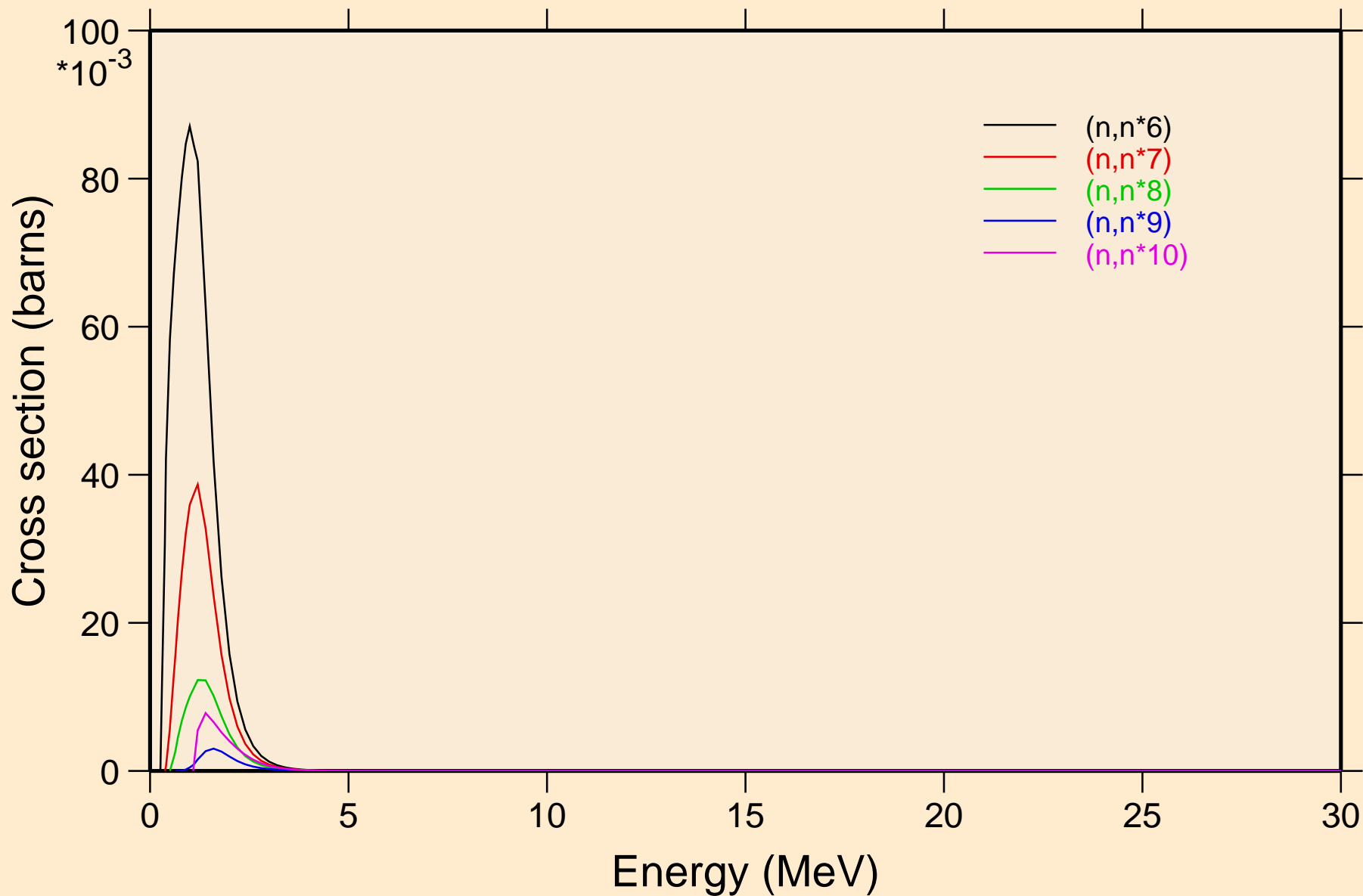

RF257M NEUTRON ACER TENDL-2019 LIBRARY; T=293.16K
Inelastic levels

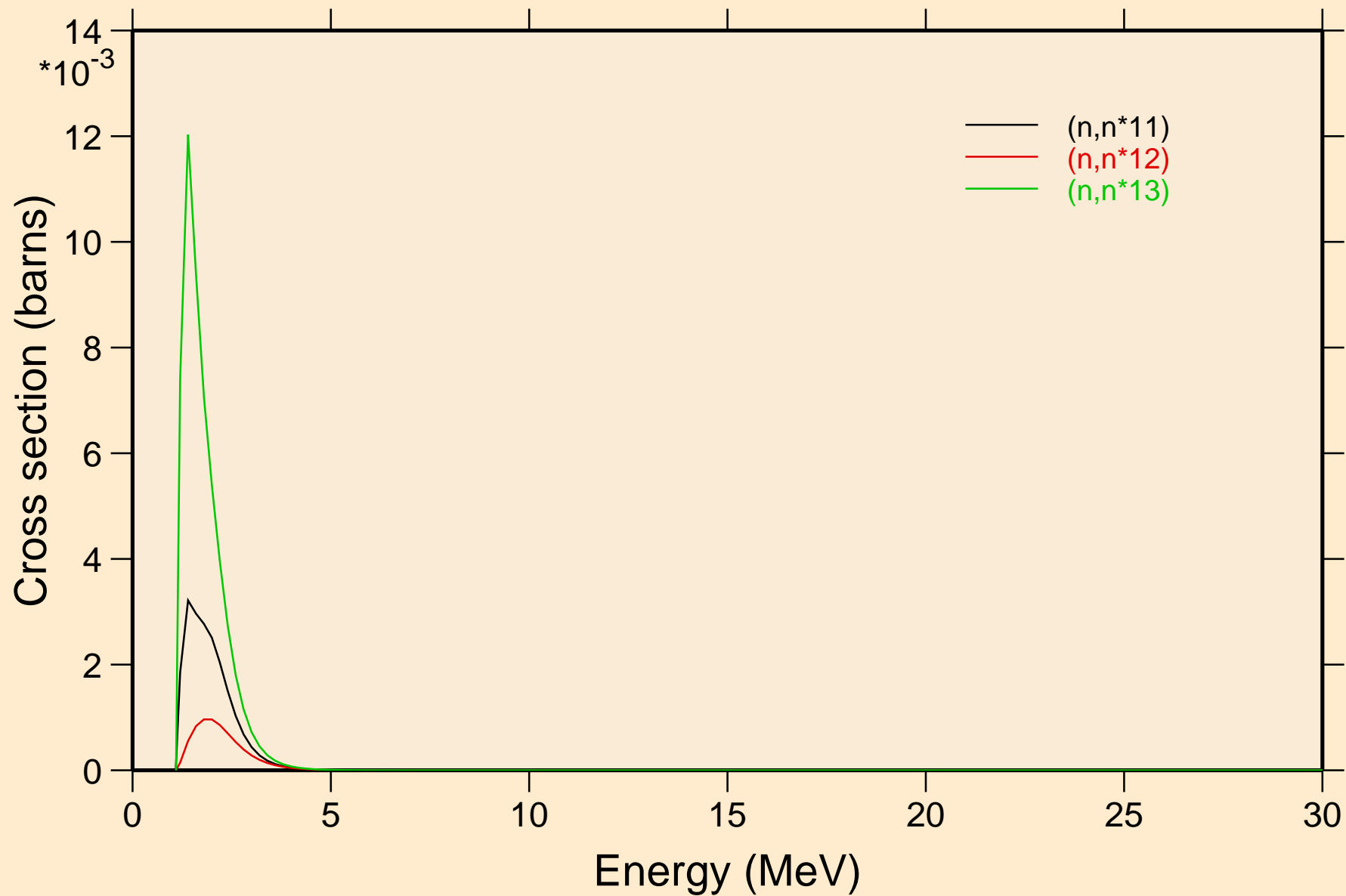

RF257M NEUTRON ACER TENDL-2019 LIBRARY; T=293.16K
Threshold reactions

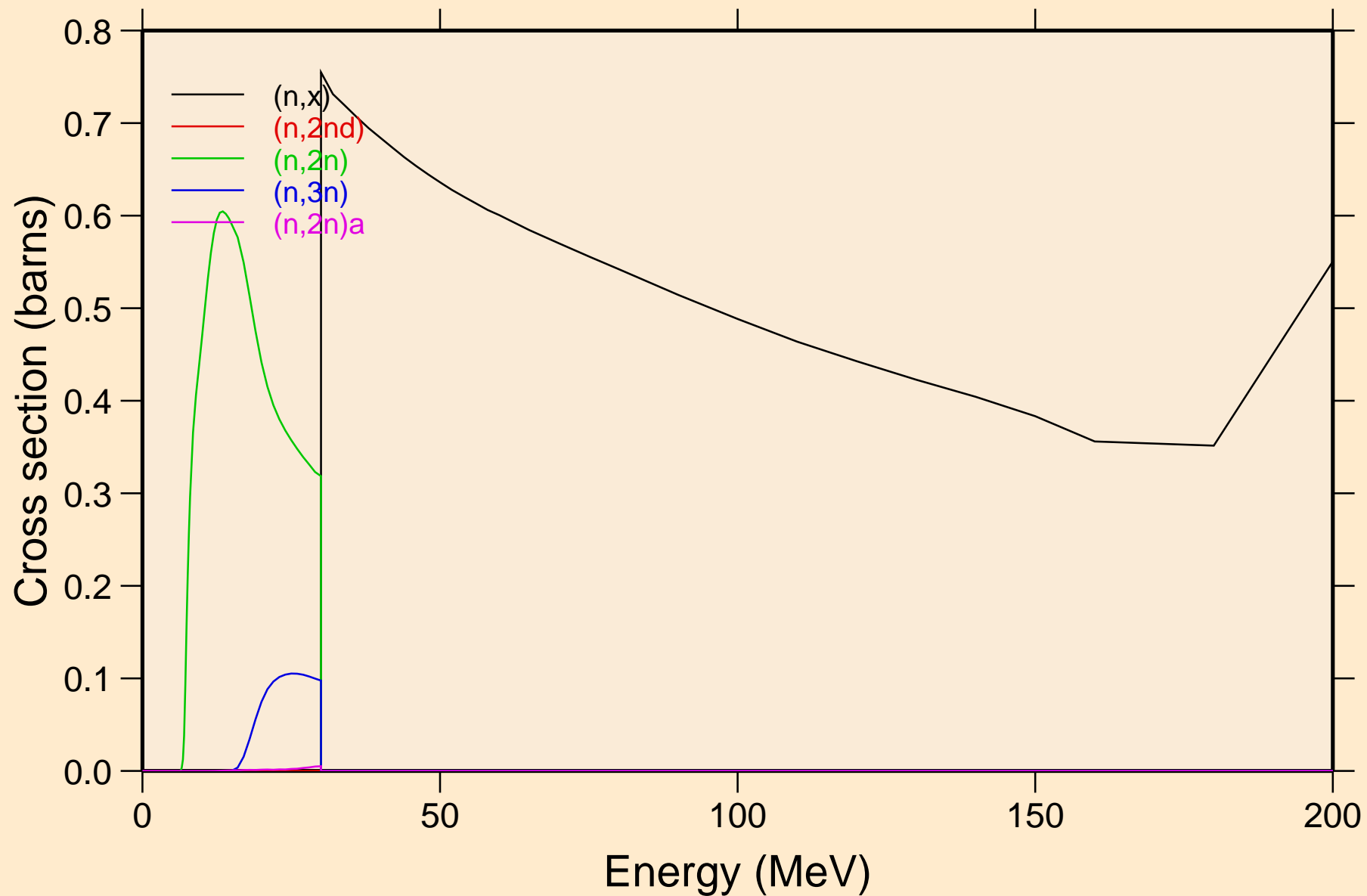

RF257M NEUTRON ACER TENDL-2019 LIBRARY; T=293.16K
Threshold reactions

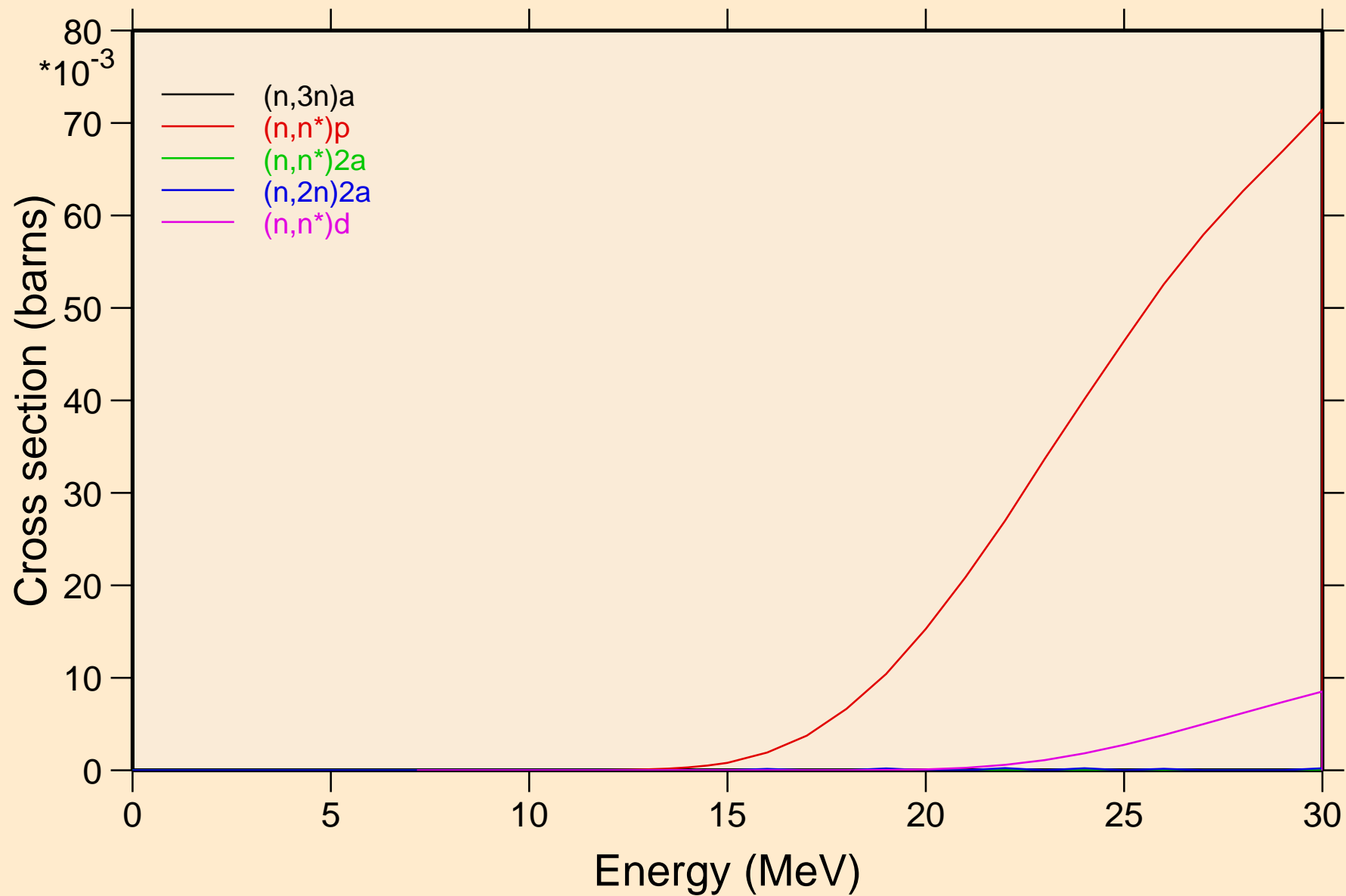

RF257M NEUTRON ACER TENDL-2019 LIBRARY; T=293.16K
Threshold reactions

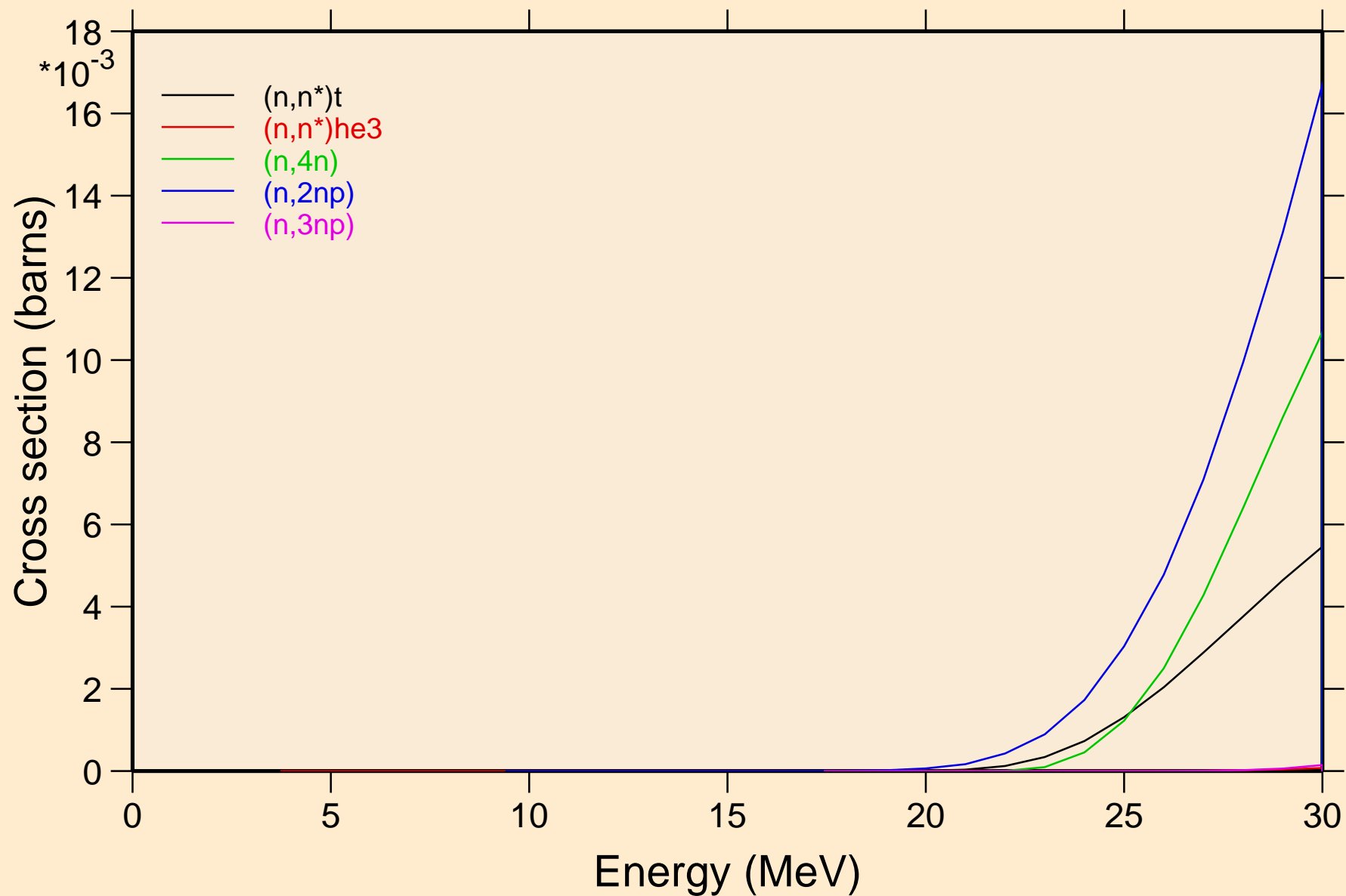

RF257M NEUTRON ACER TENDL-2019 LIBRARY; T=293.16K
Threshold reactions

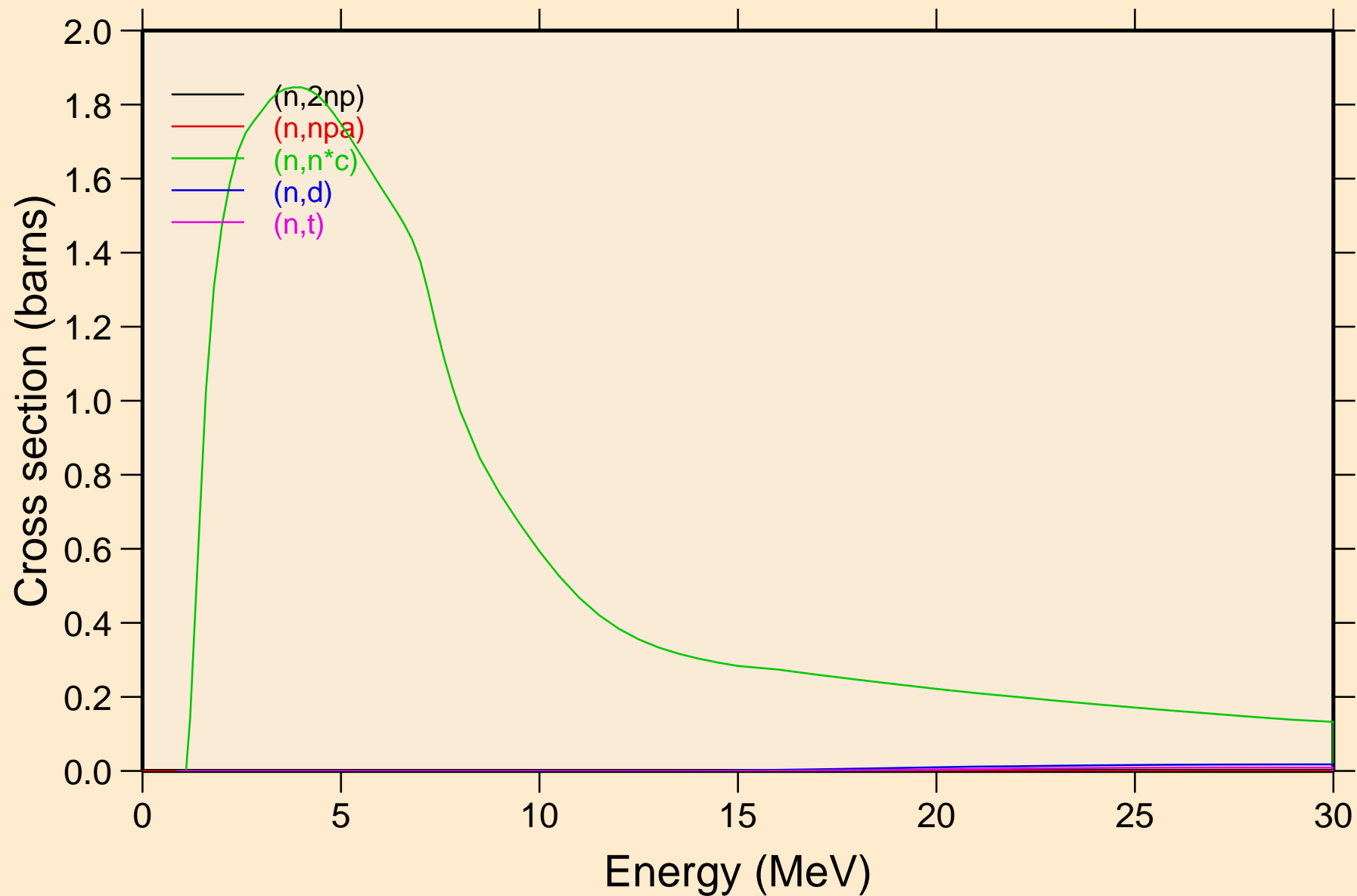

RF257M NEUTRON ACER TENDL-2019 LIBRARY; T=293.16K
Threshold reactions

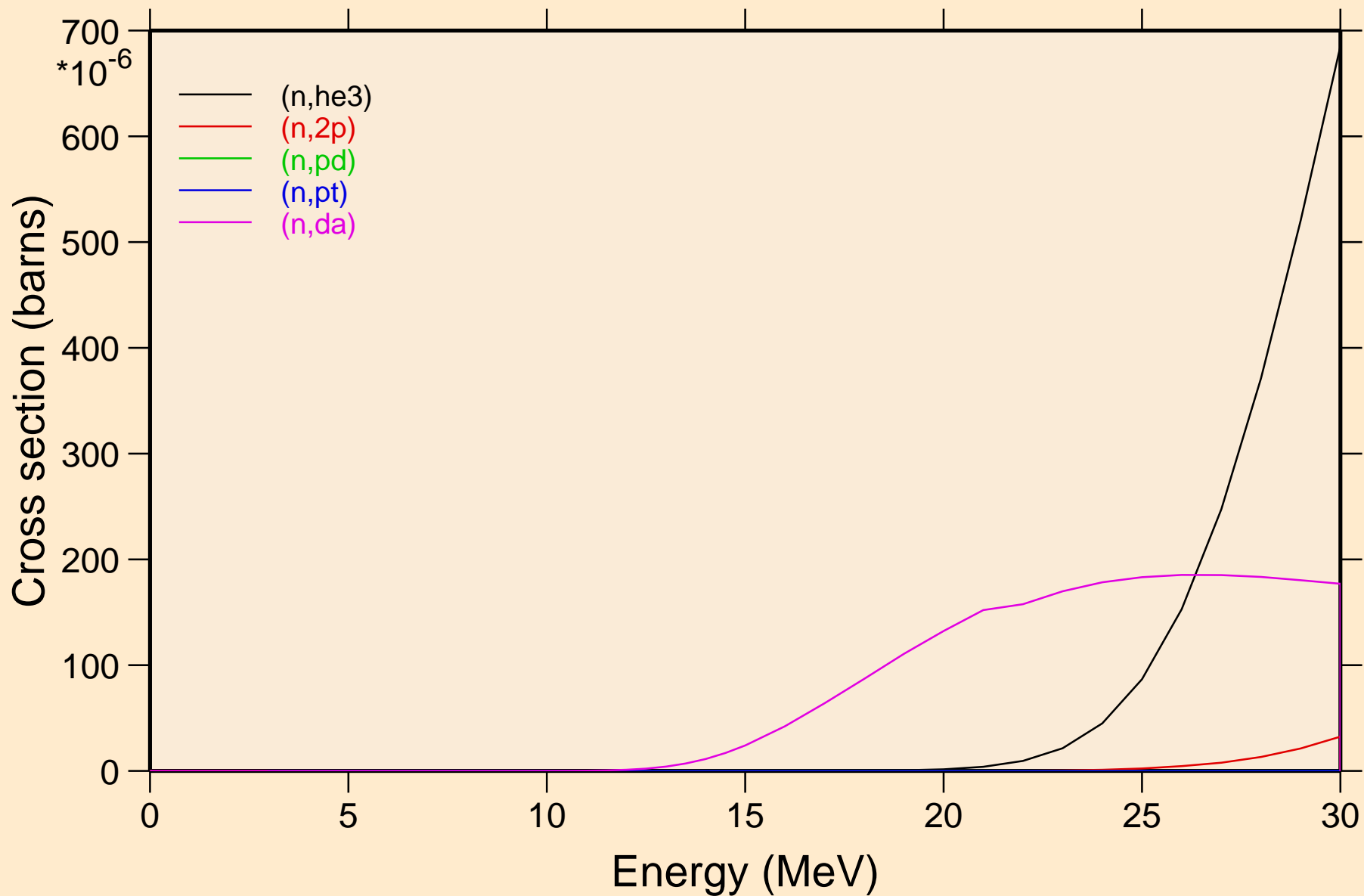

RF257M NEUTRON ACER TENDL-2019 LIBRARY; T=293.16K
Threshold reactions

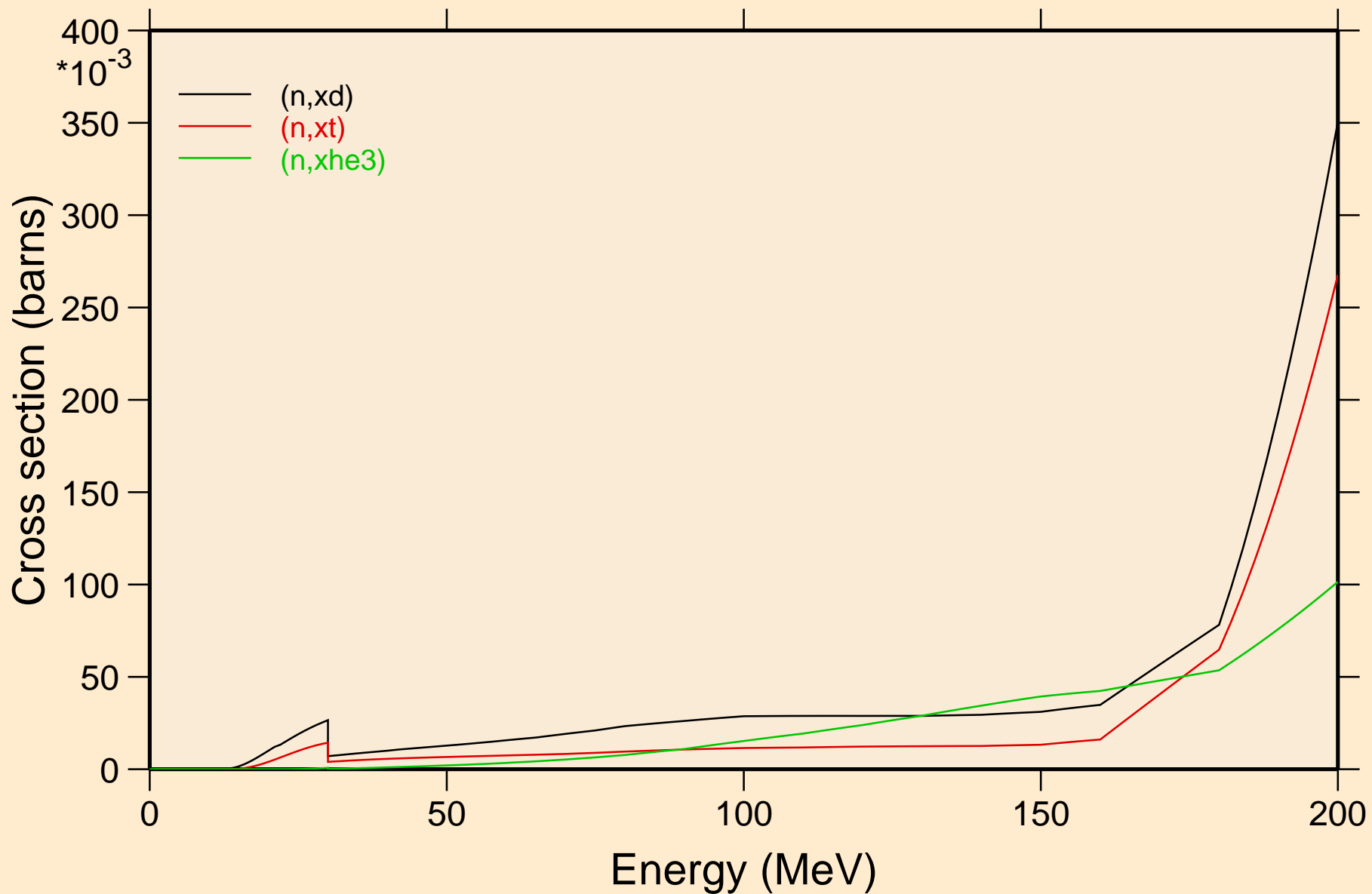

RF257M NEUTRON ACER TENDL-2019 LIBRARY; T=293.16K
angular distribution for elastic

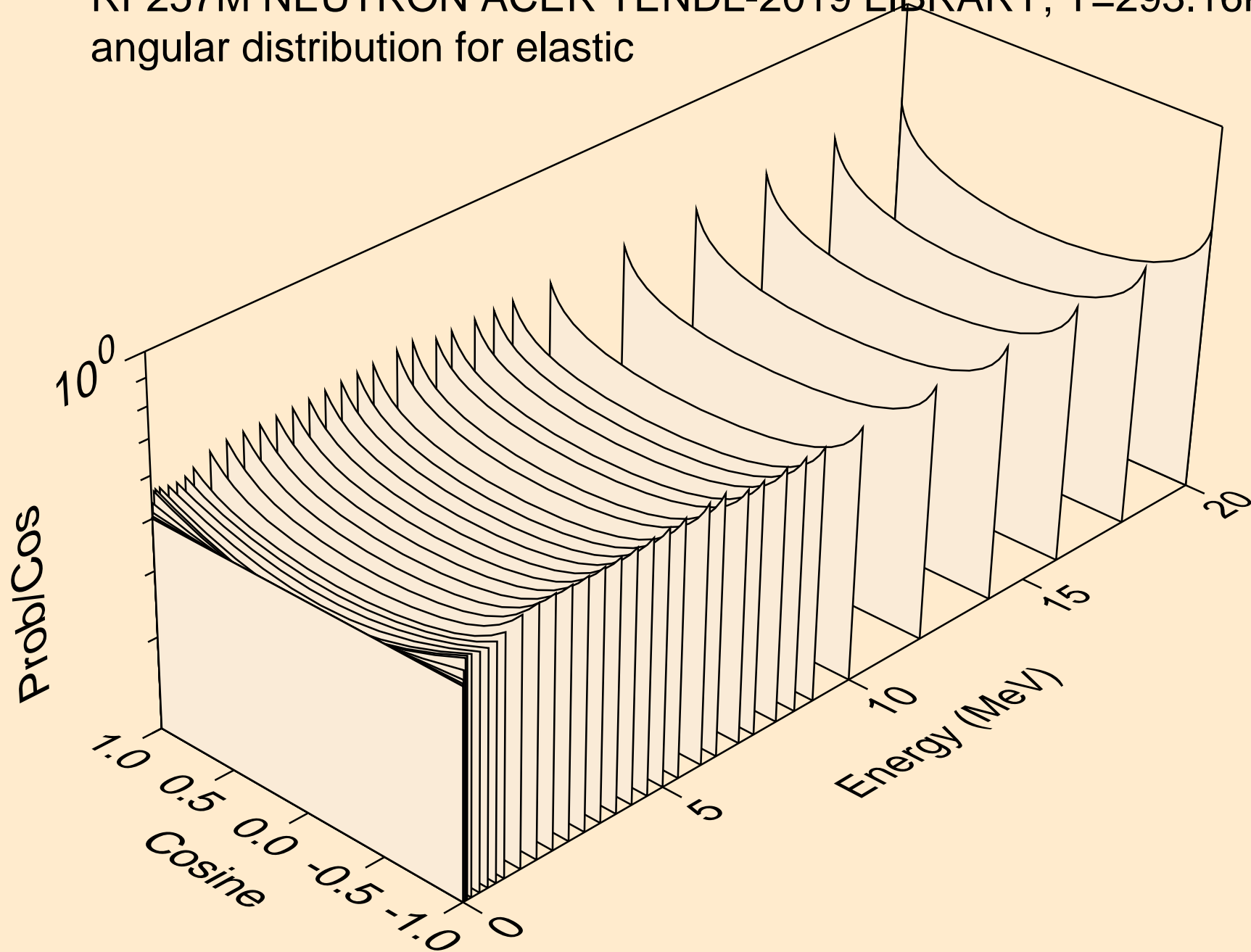

RF257M NEUTRON ACER TENDL-2019 LIBRARY; T=293.16K
angular distribution for elastic

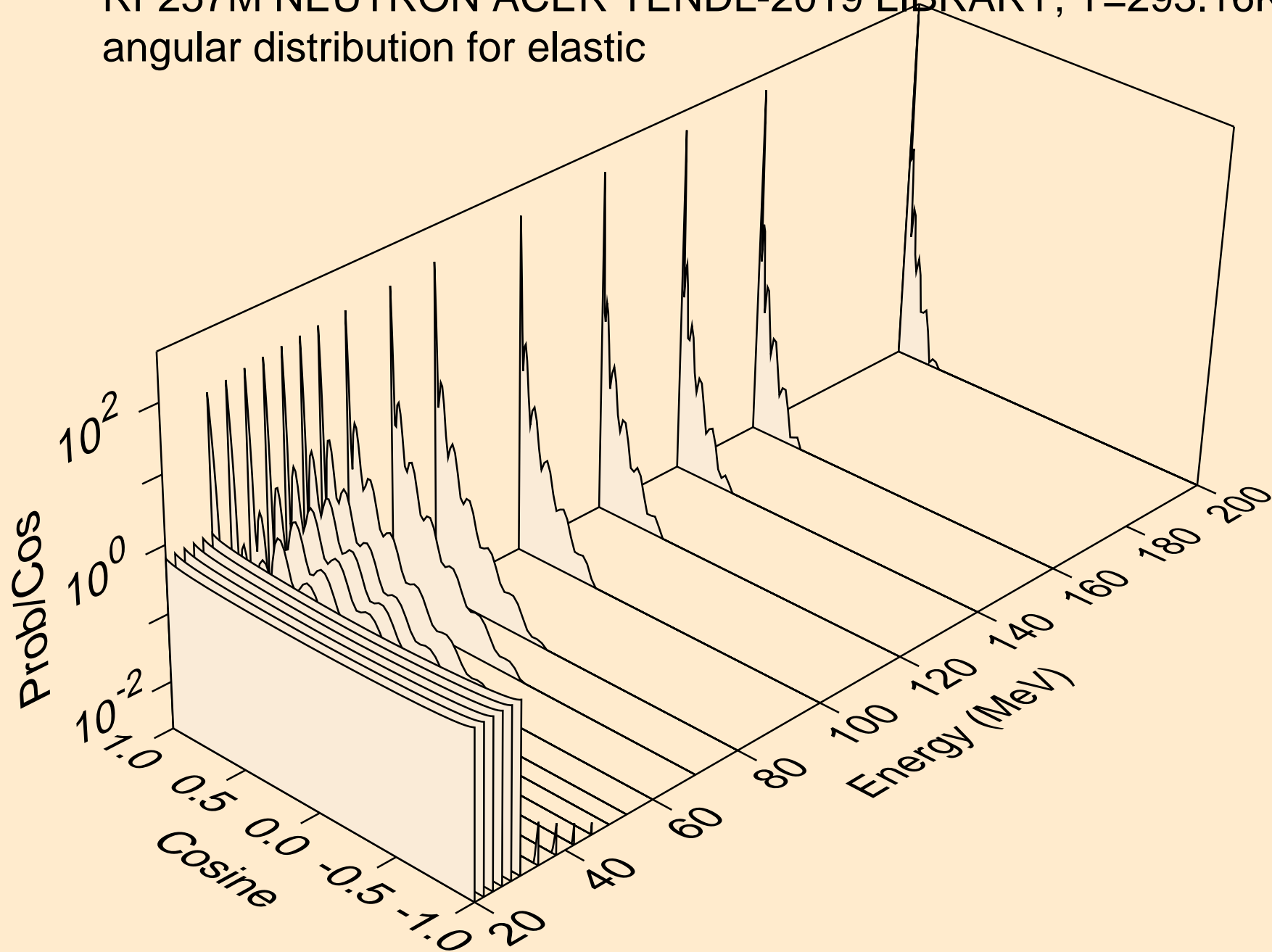

RF257M NEUTRON ACER TENDL-2019 LIBRARY; T=293.16K
angular distribution for (n,n*1)

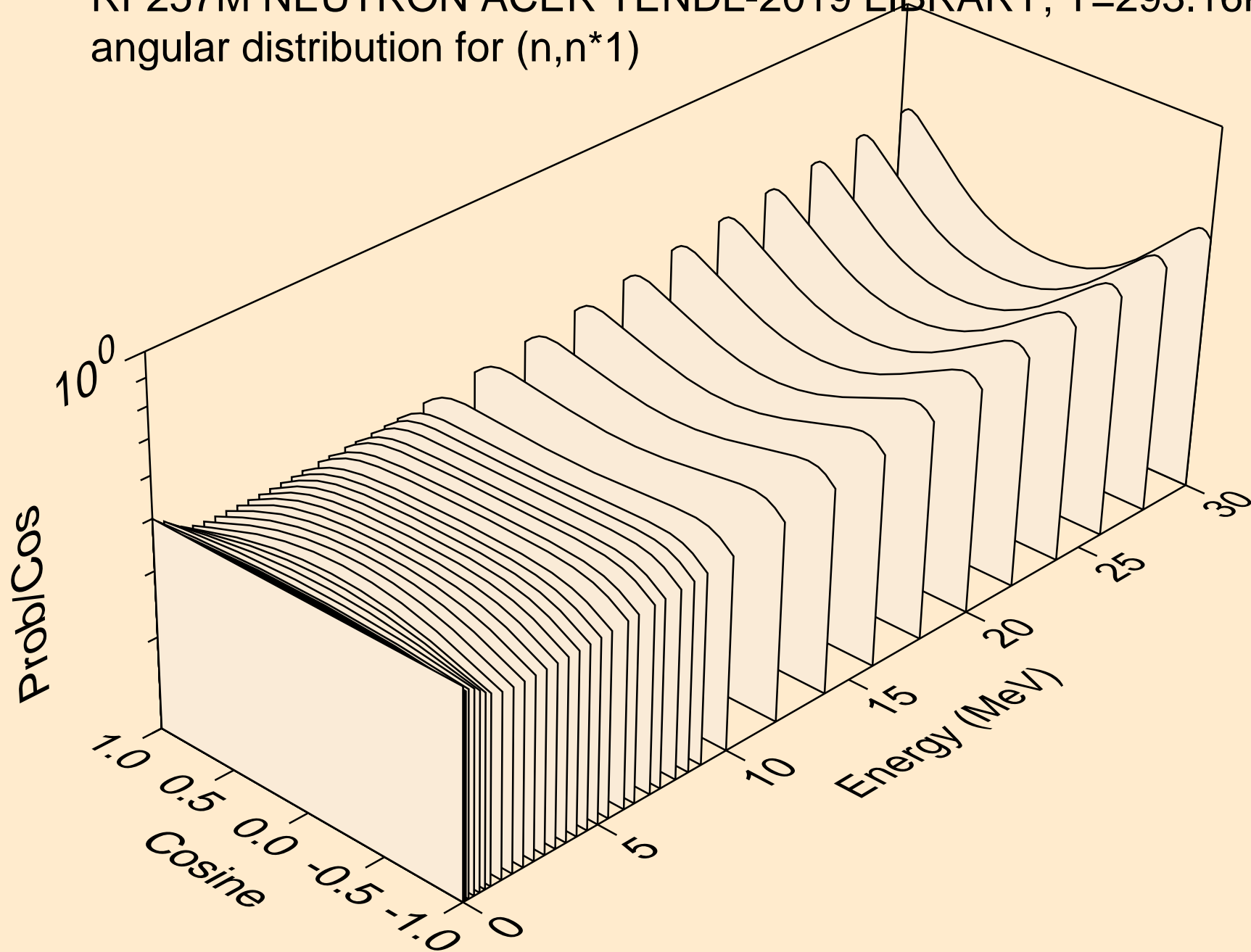

RF257M NEUTRON ACER TENDL-2019 LIBRARY; T=293.16K
angular distribution for (n,n*2)

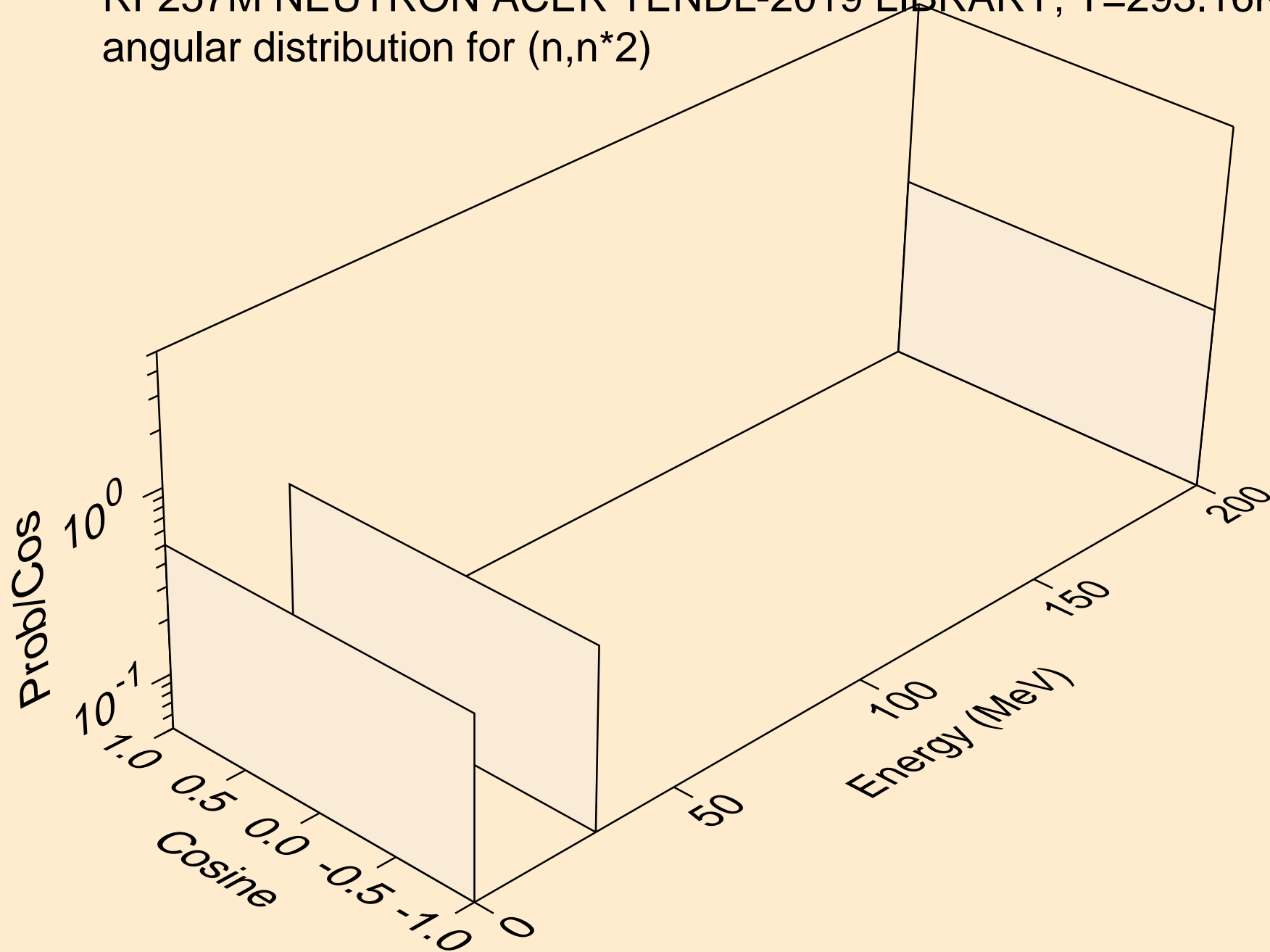

RF257M NEUTRON ACER TENDL-2019 LIBRARY; T=293.16K
angular distribution for (n,n*3)

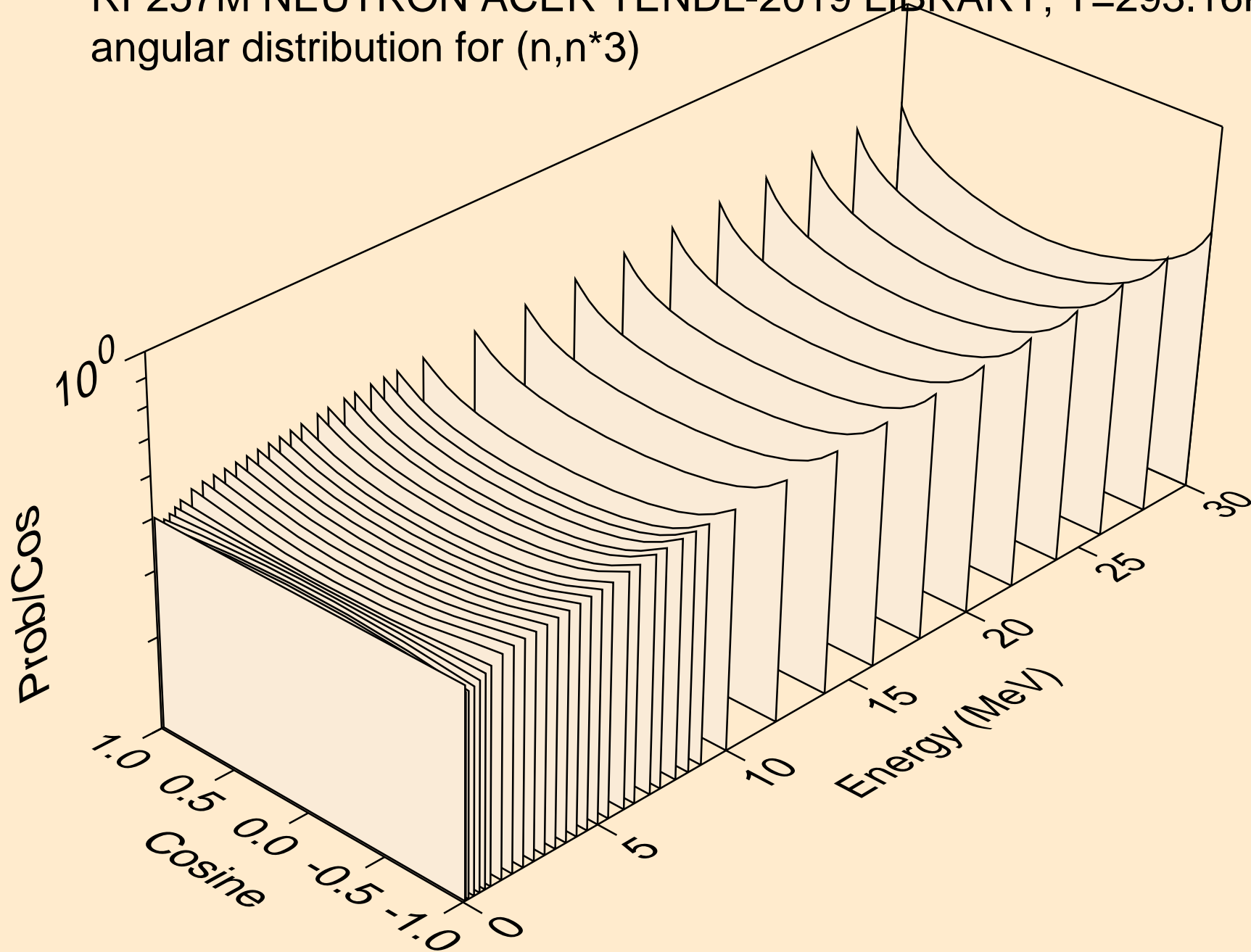

RF257M NEUTRON ACER TENDL-2019 LIBRARY; T=293.16K
angular distribution for (n,n*4)

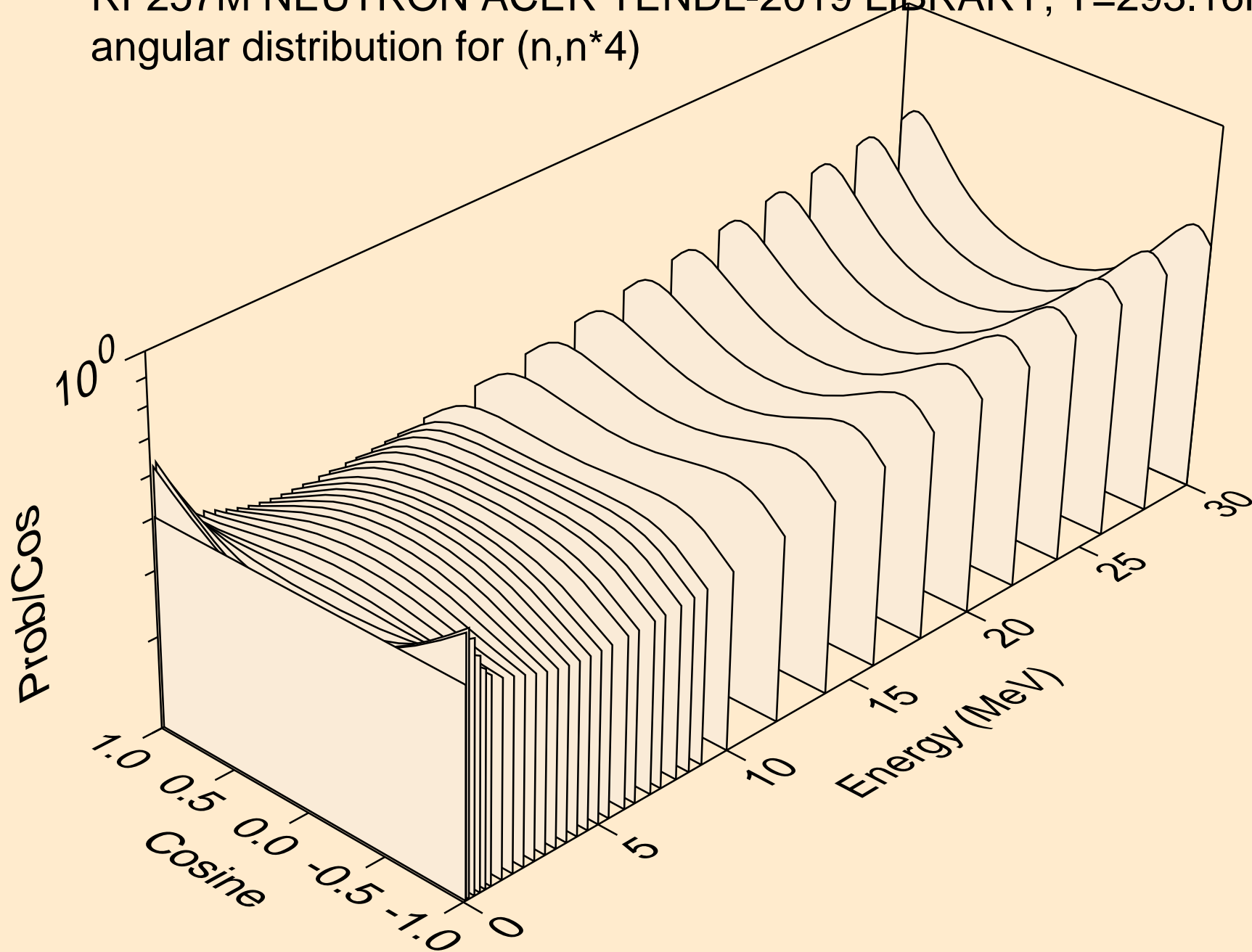

RF257M NEUTRON ACER TENDL-2019 LIBRARY; T=293.16K
angular distribution for (n,n*5)

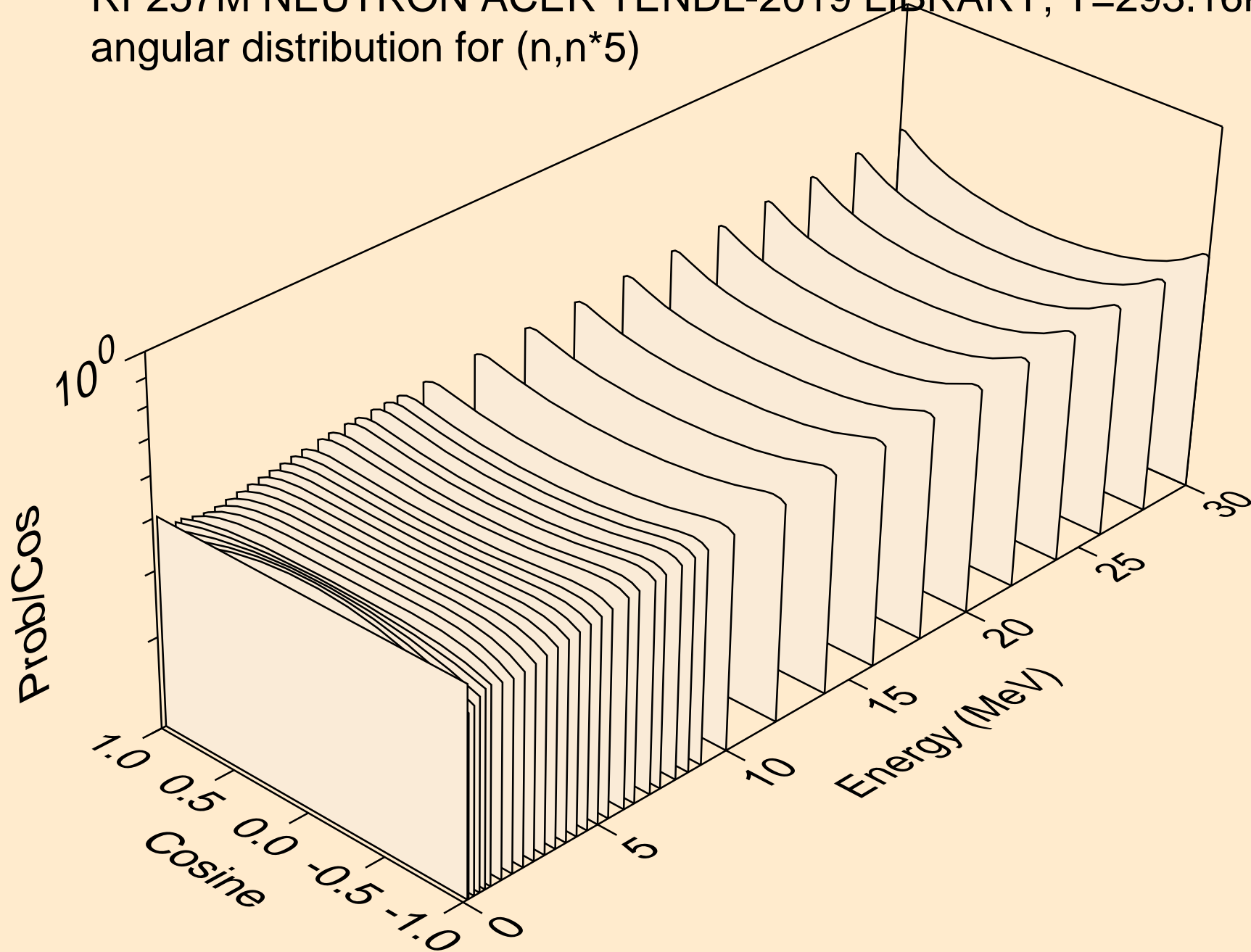

RF257M NEUTRON ACER TENDL-2019 LIBRARY; T=293.16K
angular distribution for (n,n*6)

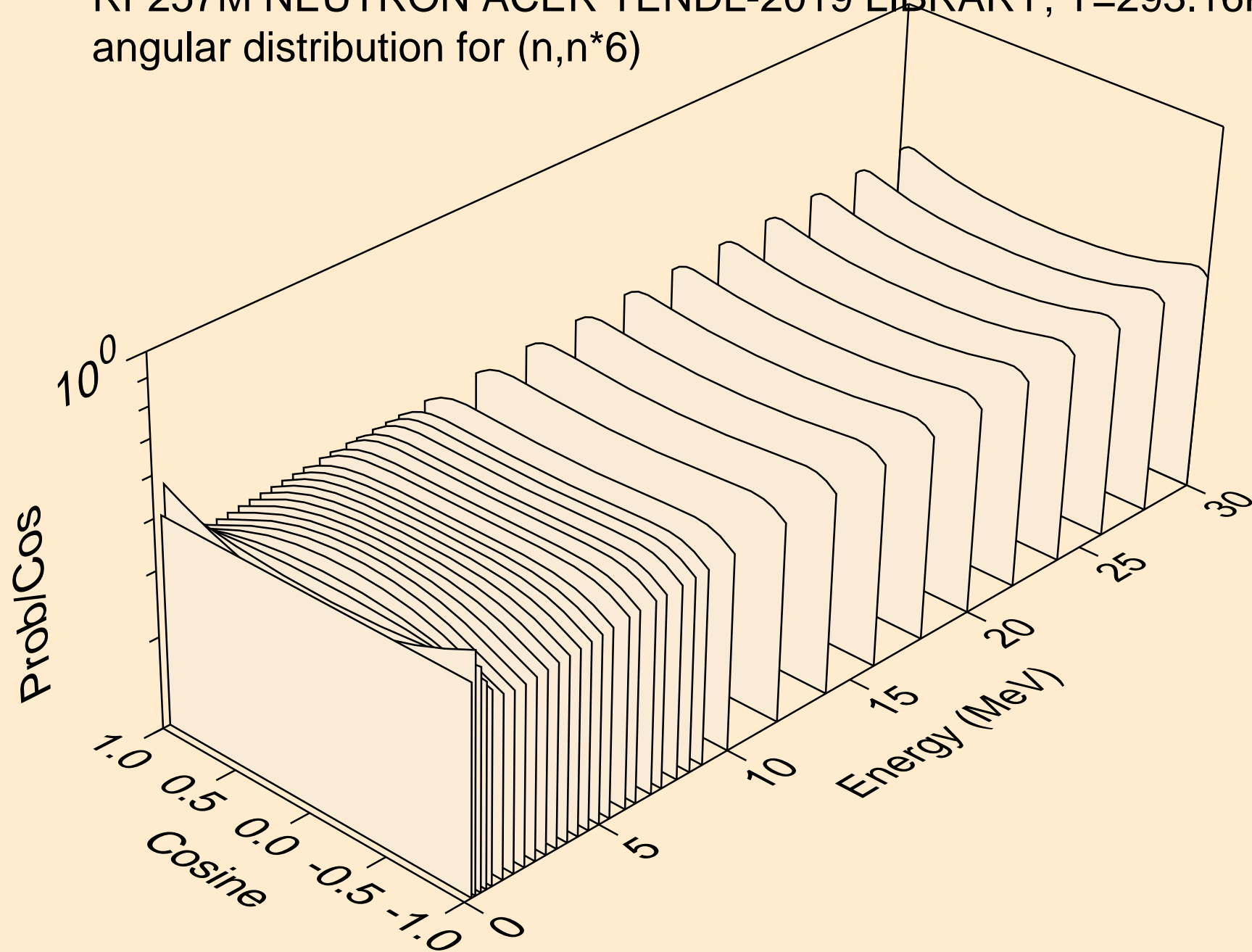

RF257M NEUTRON ACER TENDL-2019 LIBRARY; T=293.16K
angular distribution for (n,n*7)

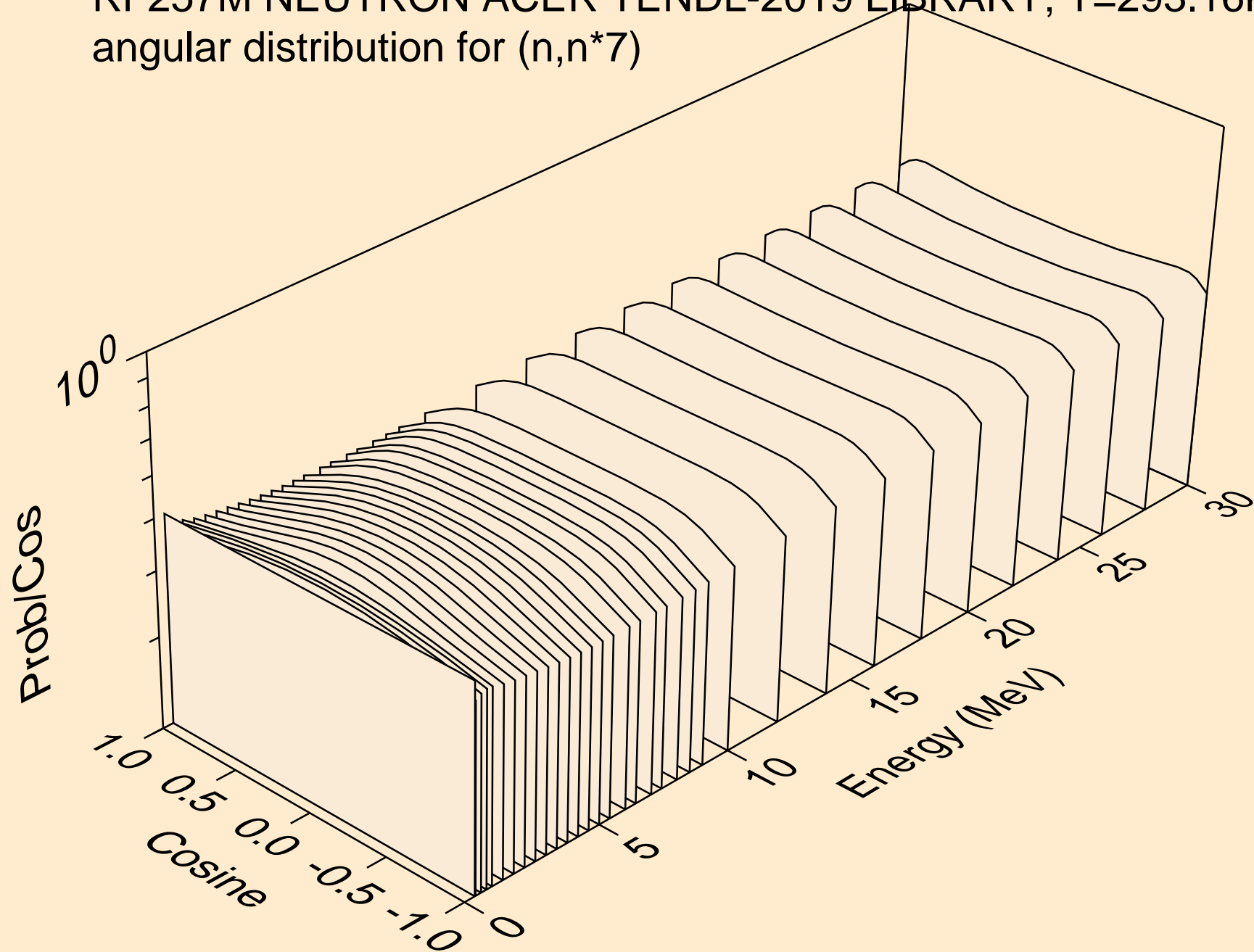

RF257M NEUTRON ACER TENDL-2019 LIBRARY; T=293.16K
angular distribution for (n,n*8)

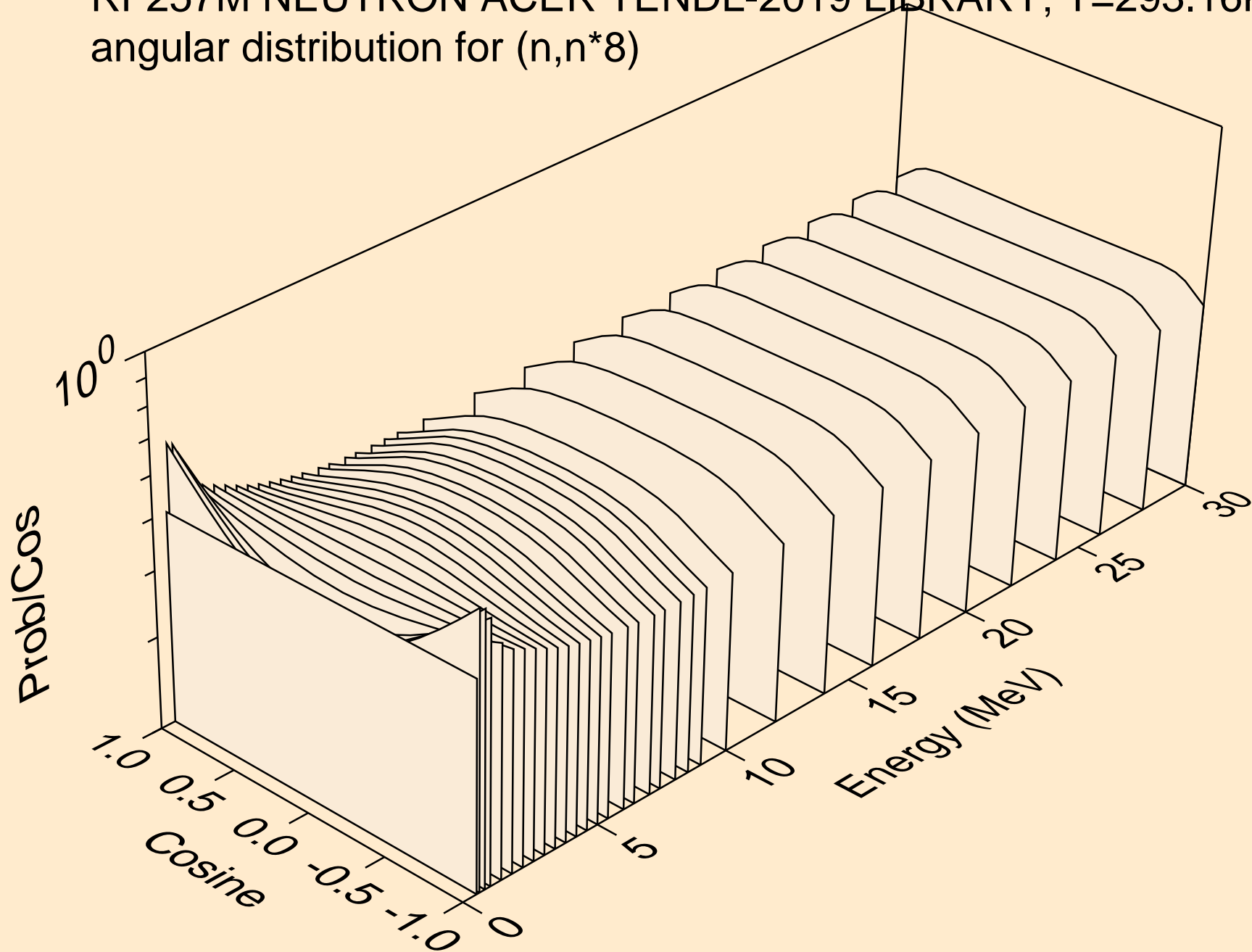

RF257M NEUTRON ACER TENDL-2019 LIBRARY; T=293.16K
angular distribution for (n,n*9)

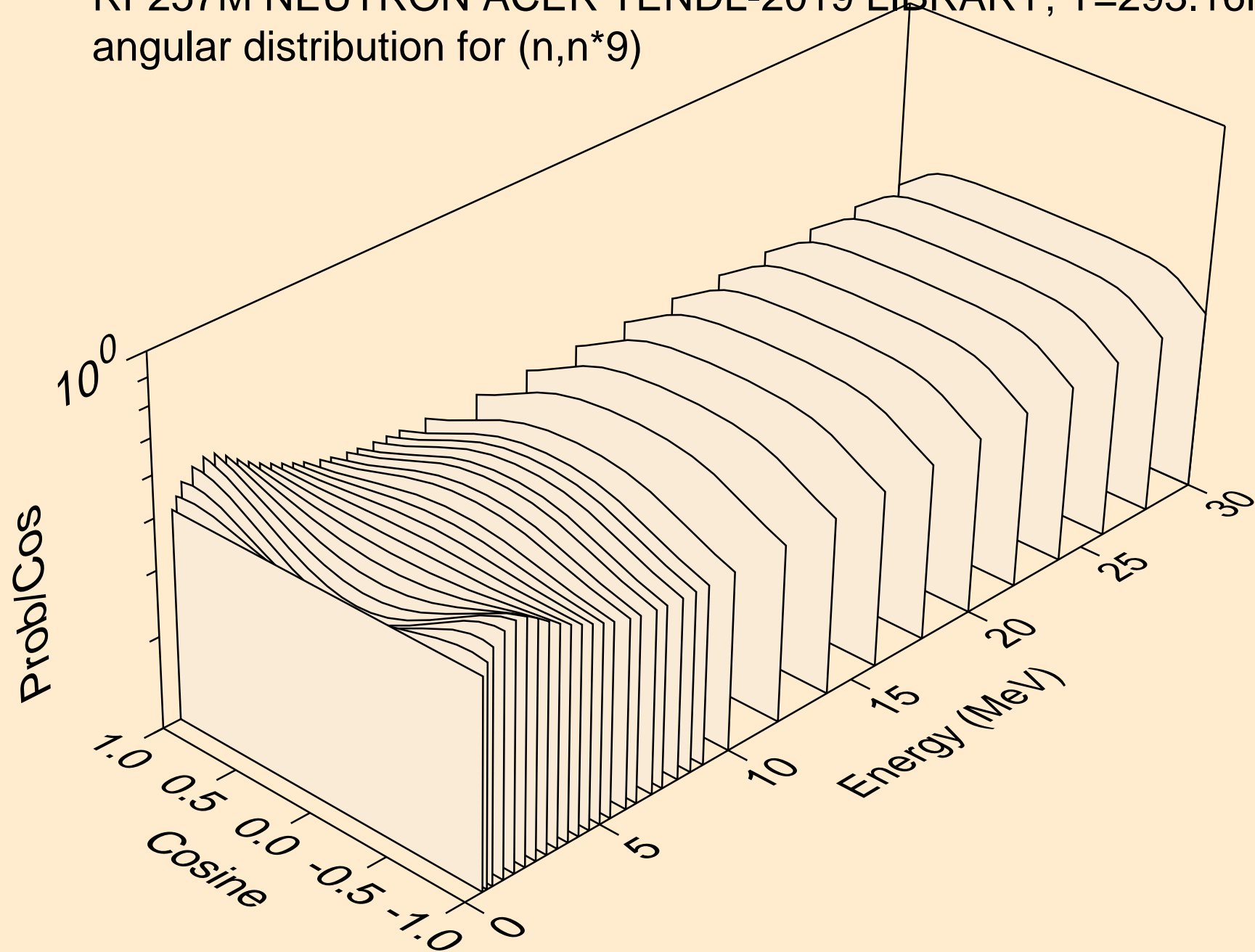

RF257M NEUTRON ACER TENDL-2019 LIBRARY; T=293.16K
angular distribution for (n,n*10)

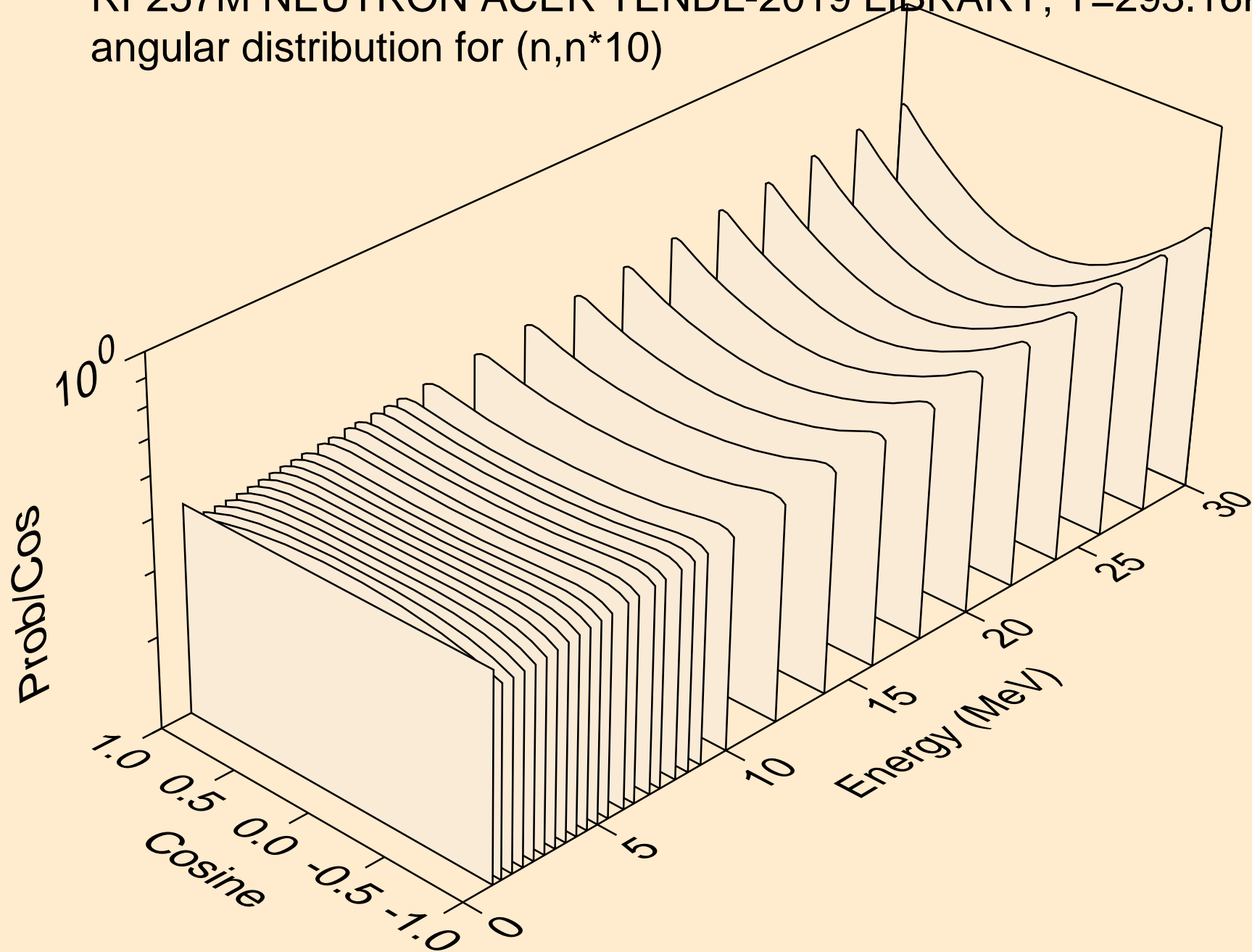

RF257M NEUTRON ACER TENDL-2019 LIBRARY; T=293.16K
angular distribution for (n,n*11)

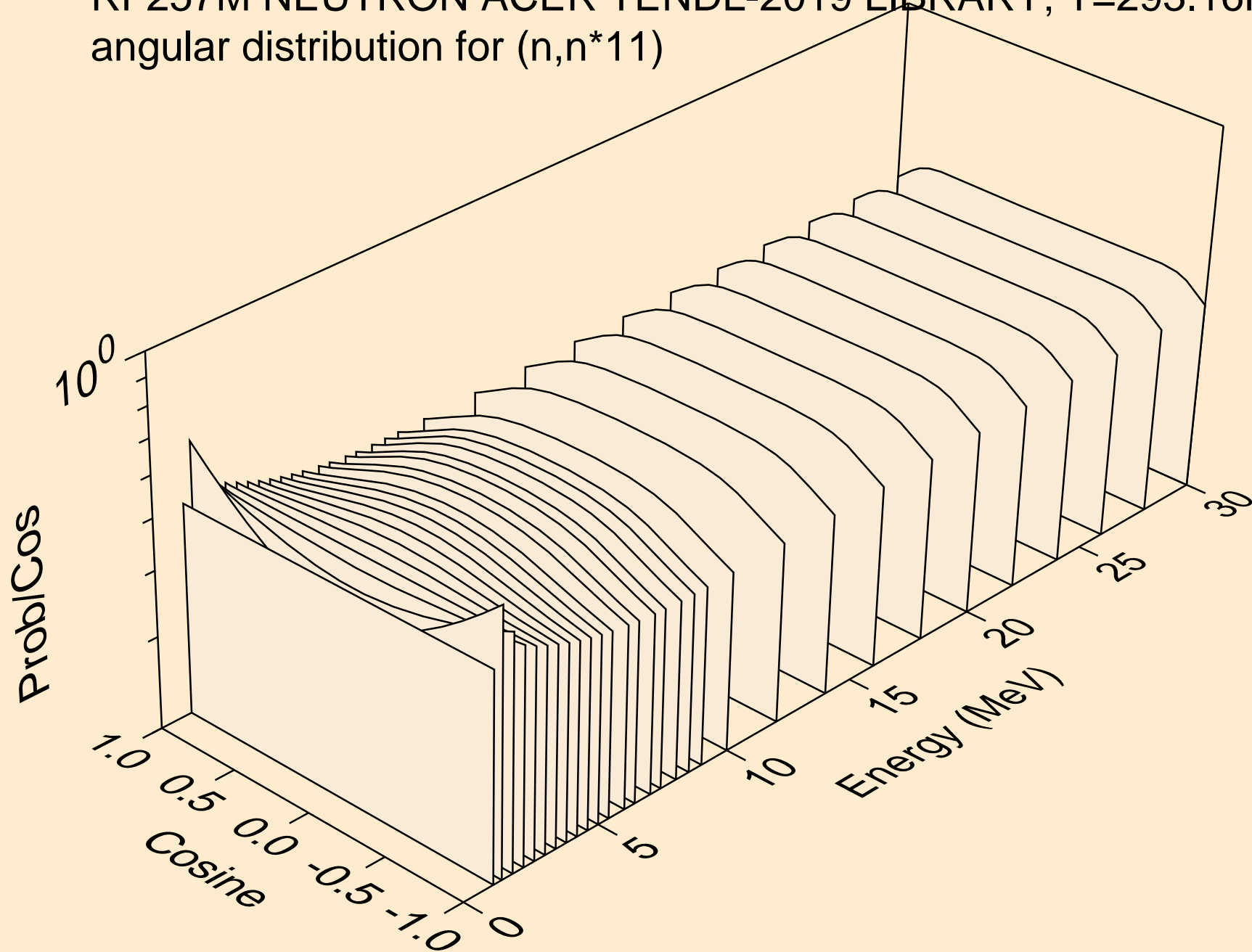

RF257M NEUTRON ACER TENDL-2019 LIBRARY; T=293.16K
angular distribution for (n,n*12)

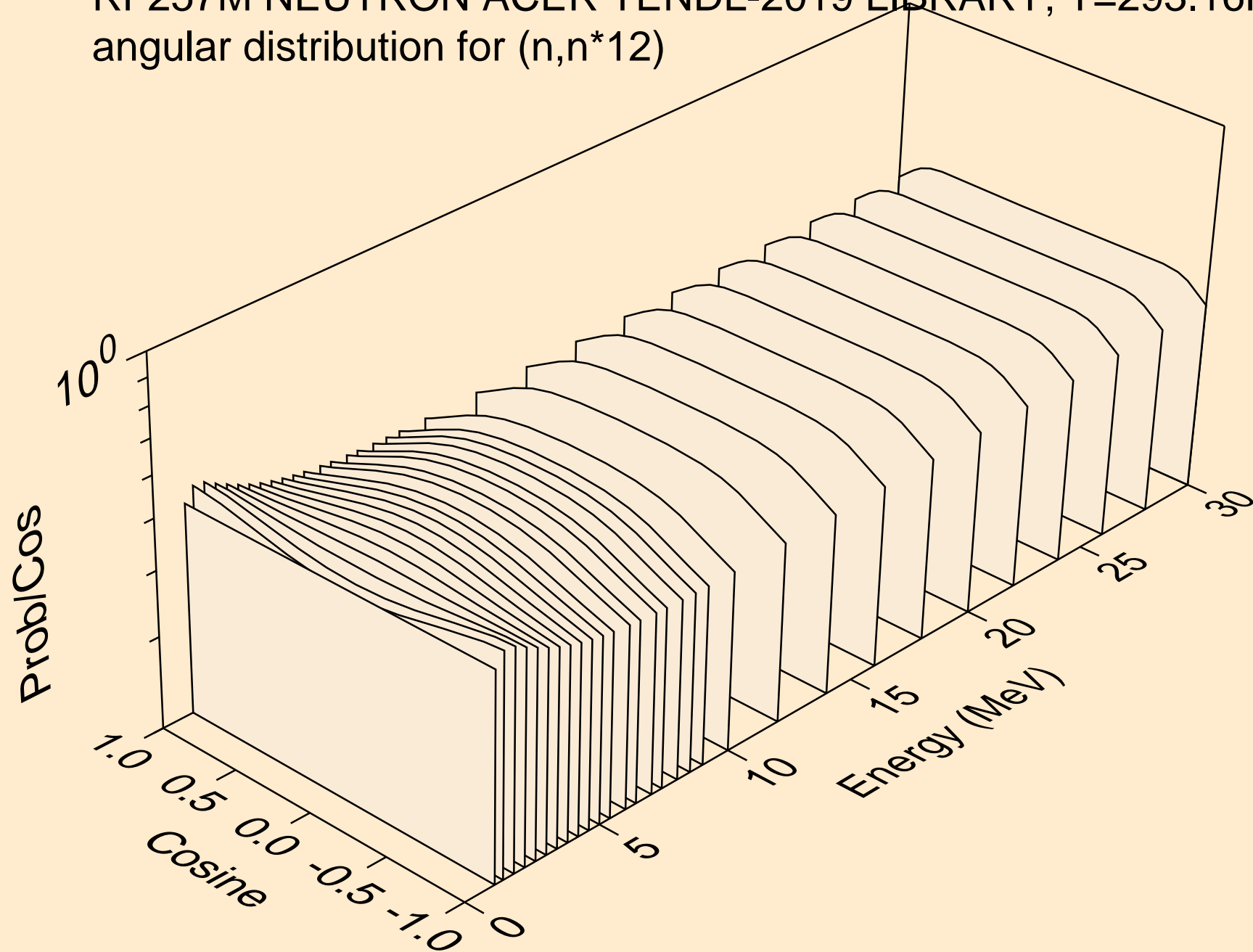

RF257M NEUTRON ACER TENDL-2019 LIBRARY; T=293.16K
angular distribution for (n,n*13)

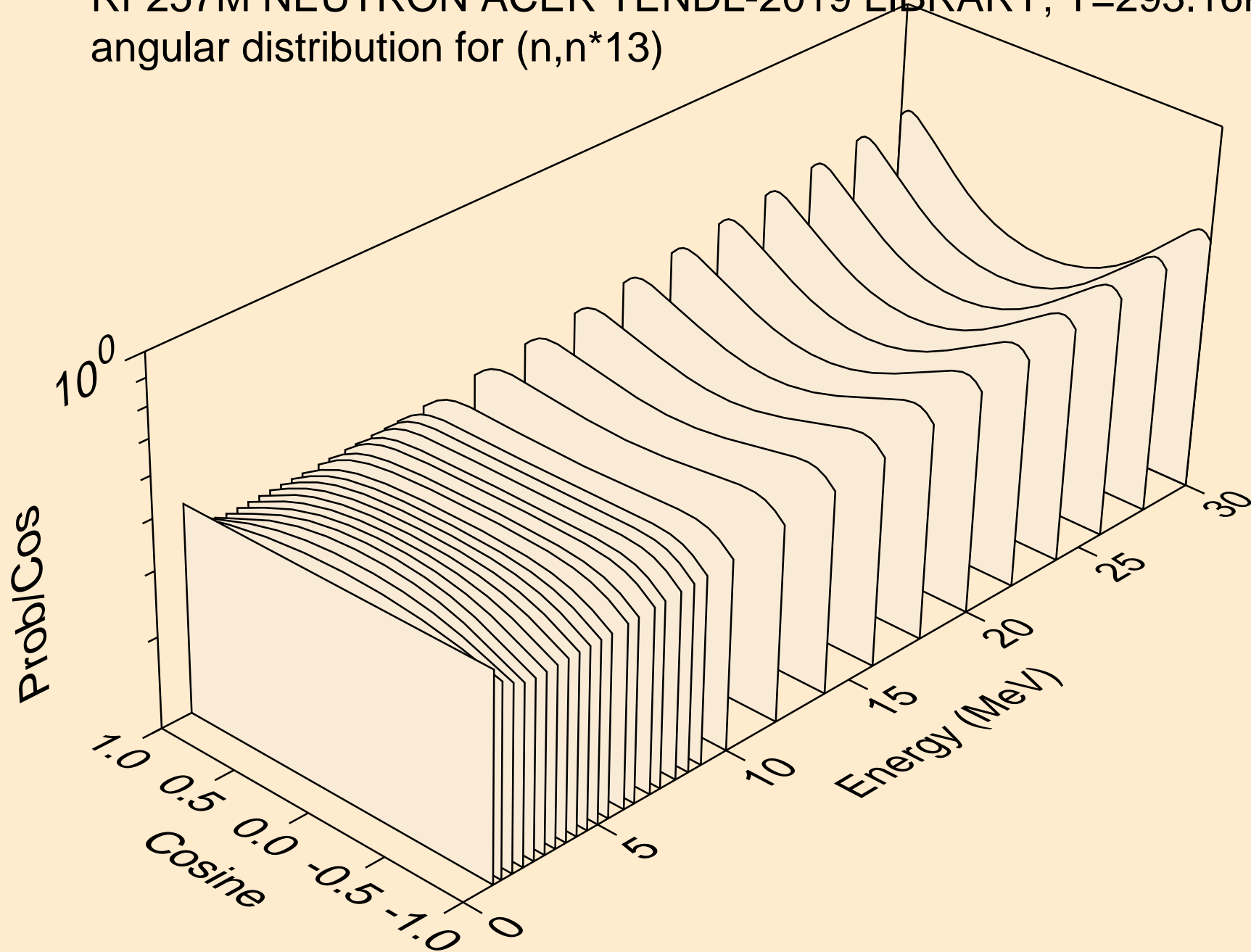

RF257M NEUTRON ACER TENDL-2019 LIBRARY; T=293.16K
Total fission nubar

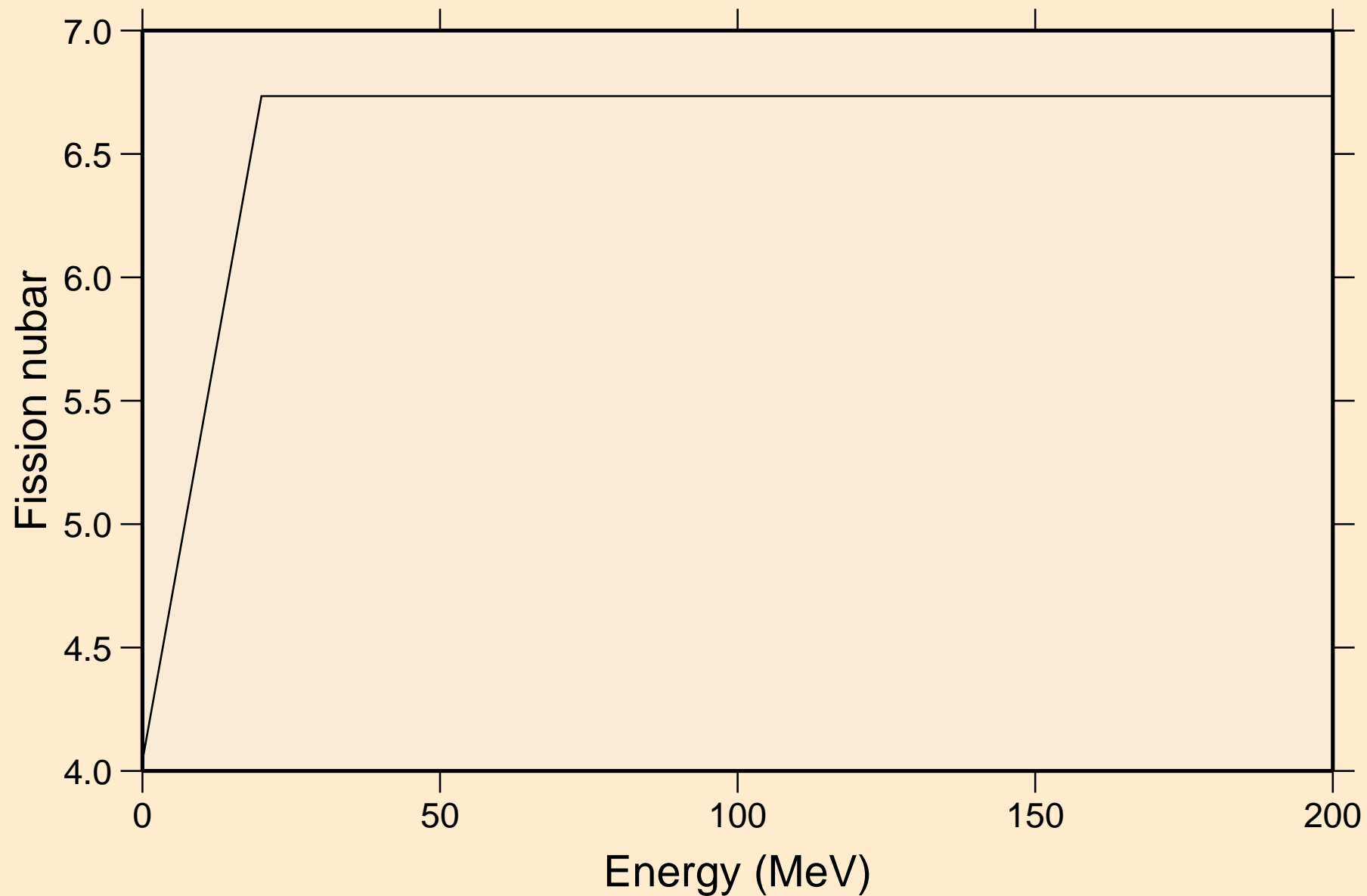

RF257M NEUTRON ACER TENDL-2019 LIBRARY; T=293.16K
Neutron emission for (n,x)

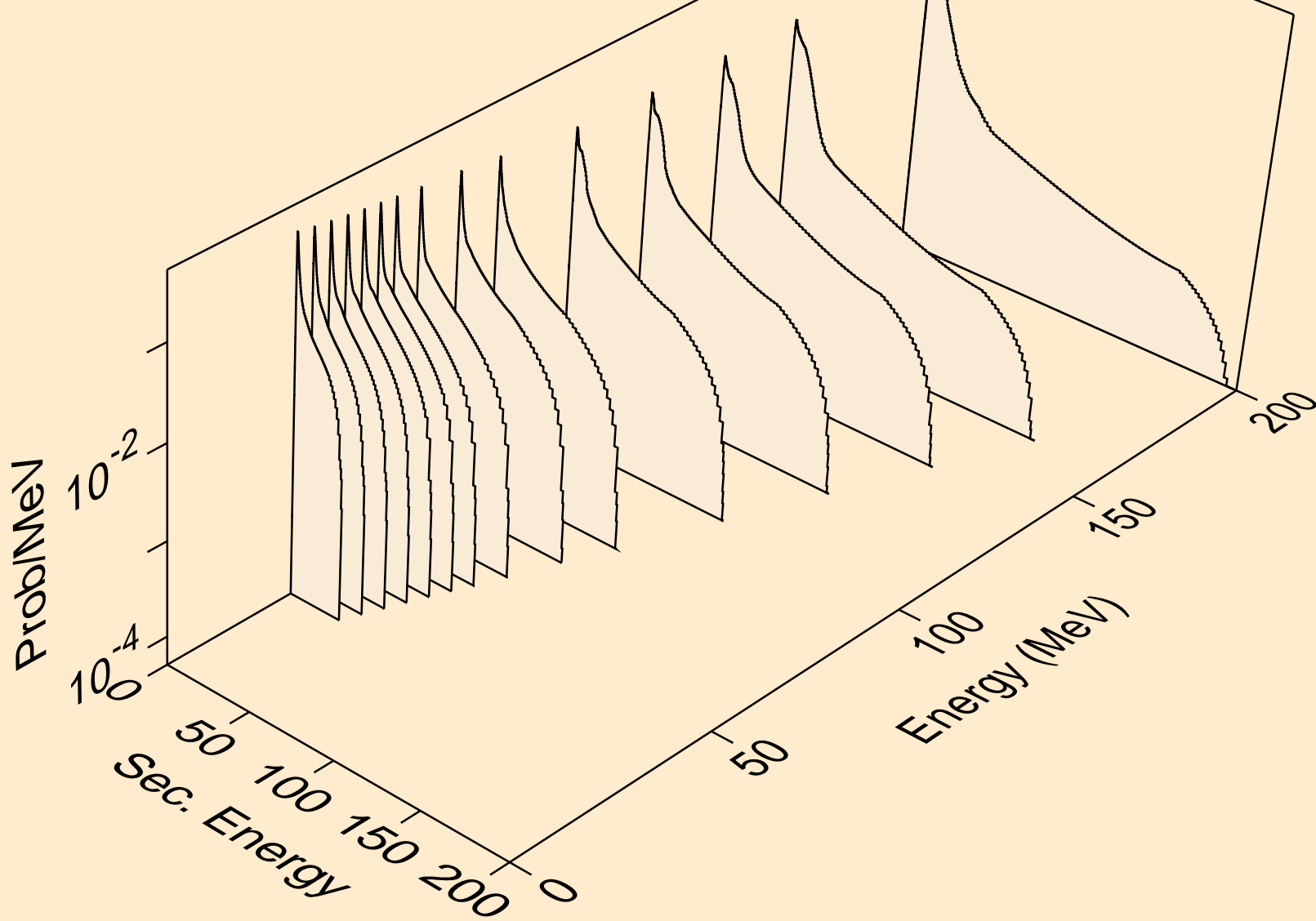

RF257M NEUTRON ACER TENDL-2019 LIBRARY; T=293.16K
Neutron emission for (n,2nd)

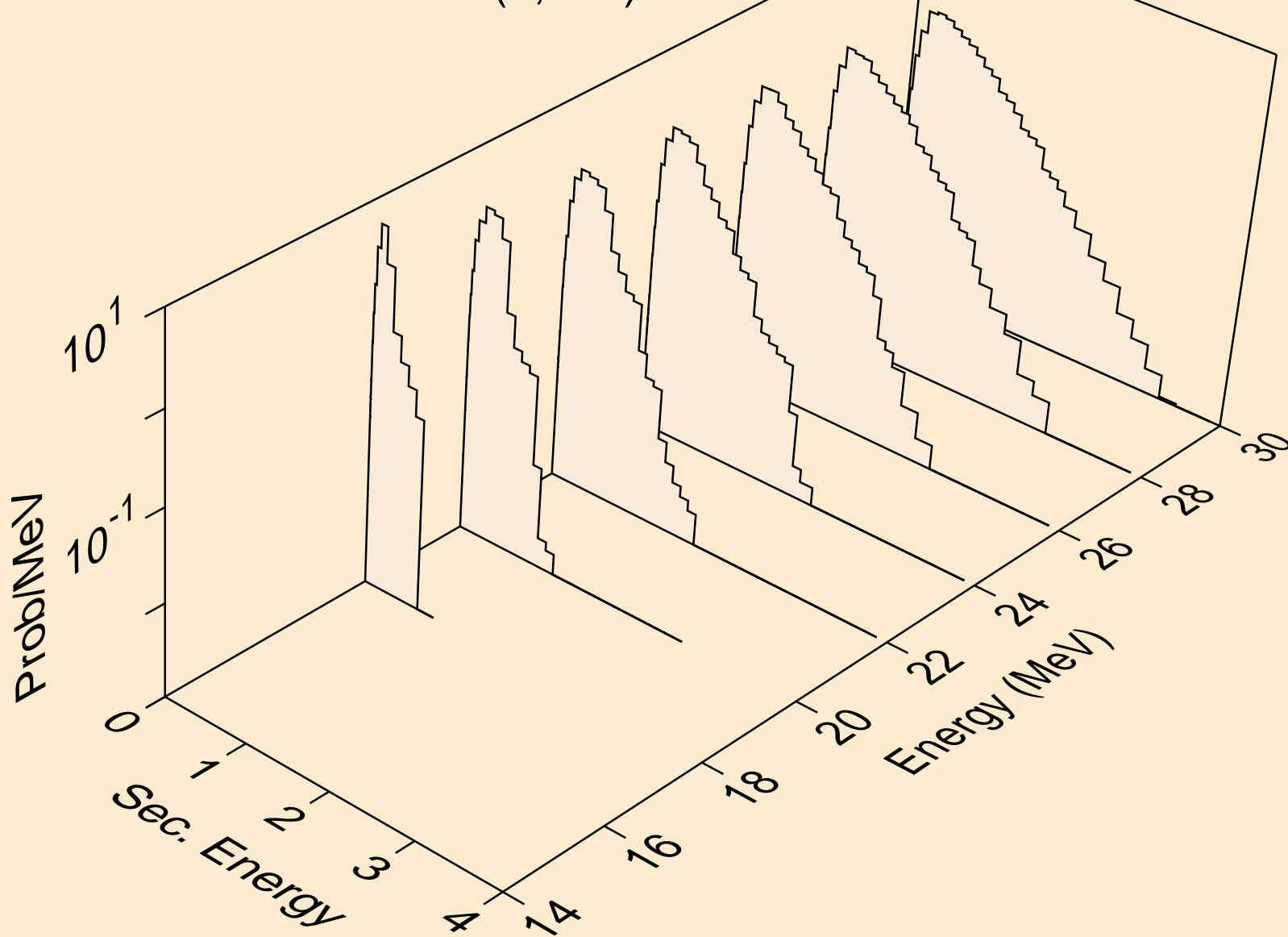

RF257M NEUTRON ACER TENDL-2019 LIBRARY; T=293.16K
Neutron emission for (n,2n)

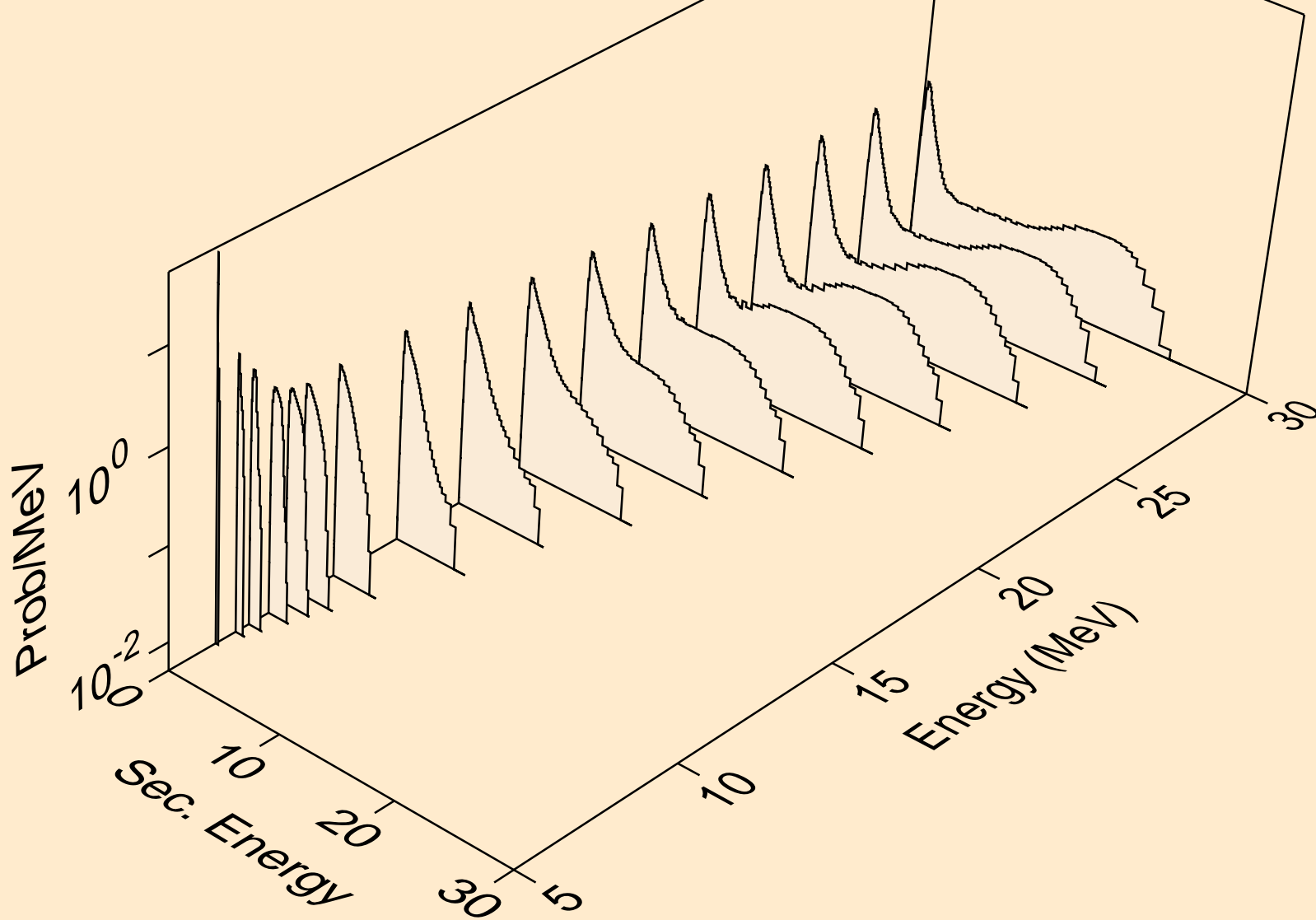

RF257M NEUTRON ACER TENDL-2019 LIBRARY; T=293.16K
Neutron emission for (n,3n)

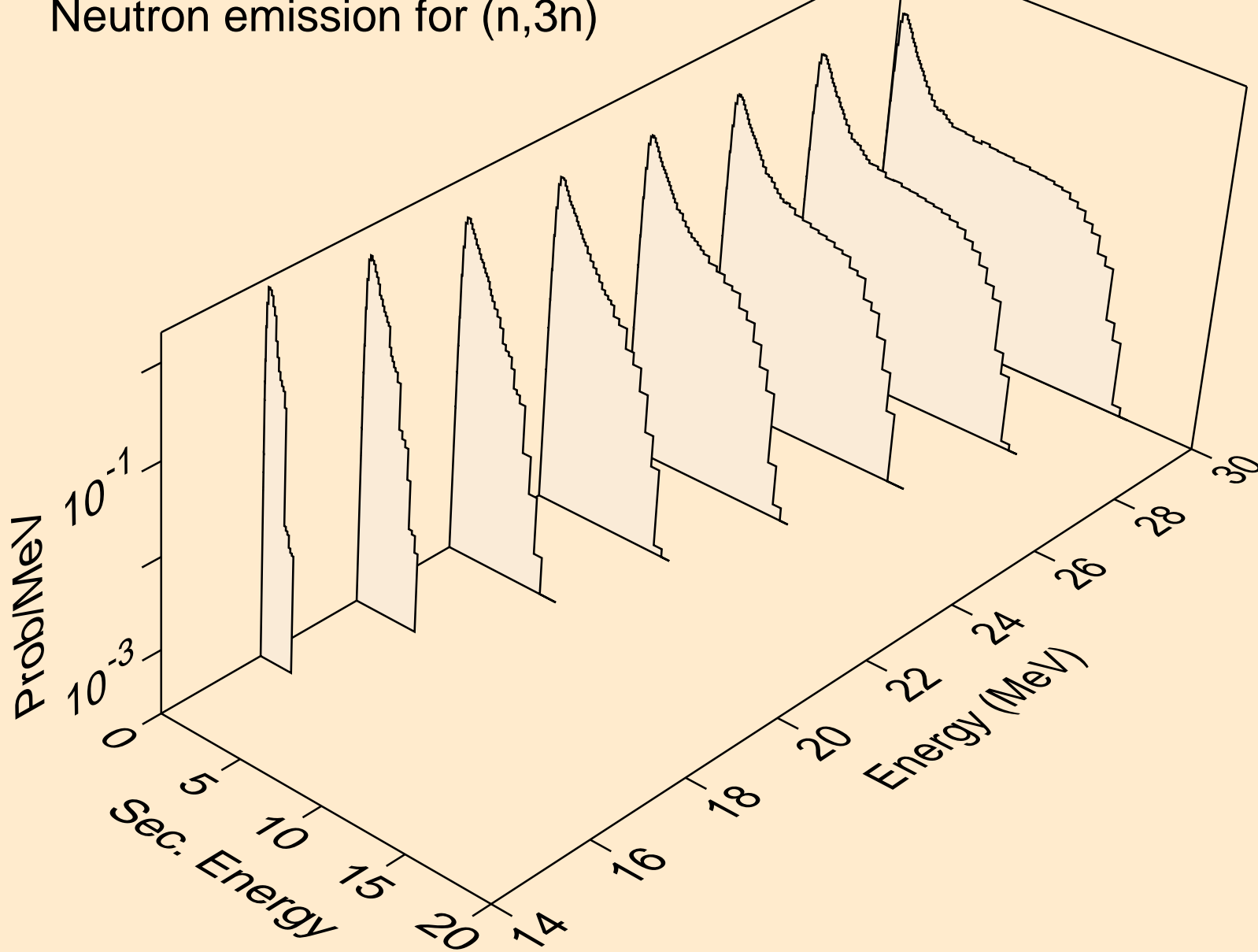

RF257M NEUTRON ACER TENDL-2019 LIBRARY; T=293.16K
Neutron emission for fission

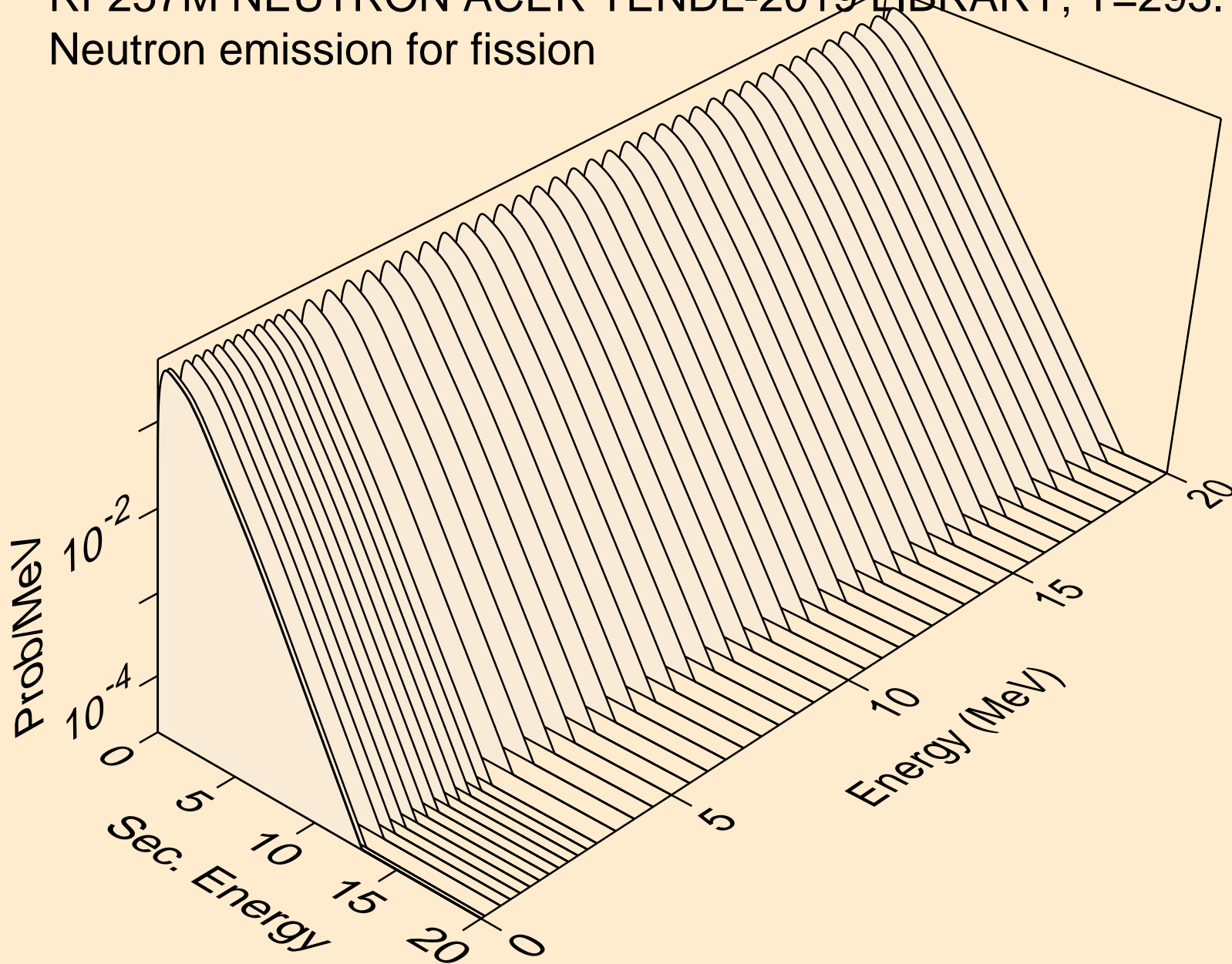

RF257M NEUTRON ACER TENDL-2019 LIBRARY; T=293.16K
Neutron emission for (n,n*)a

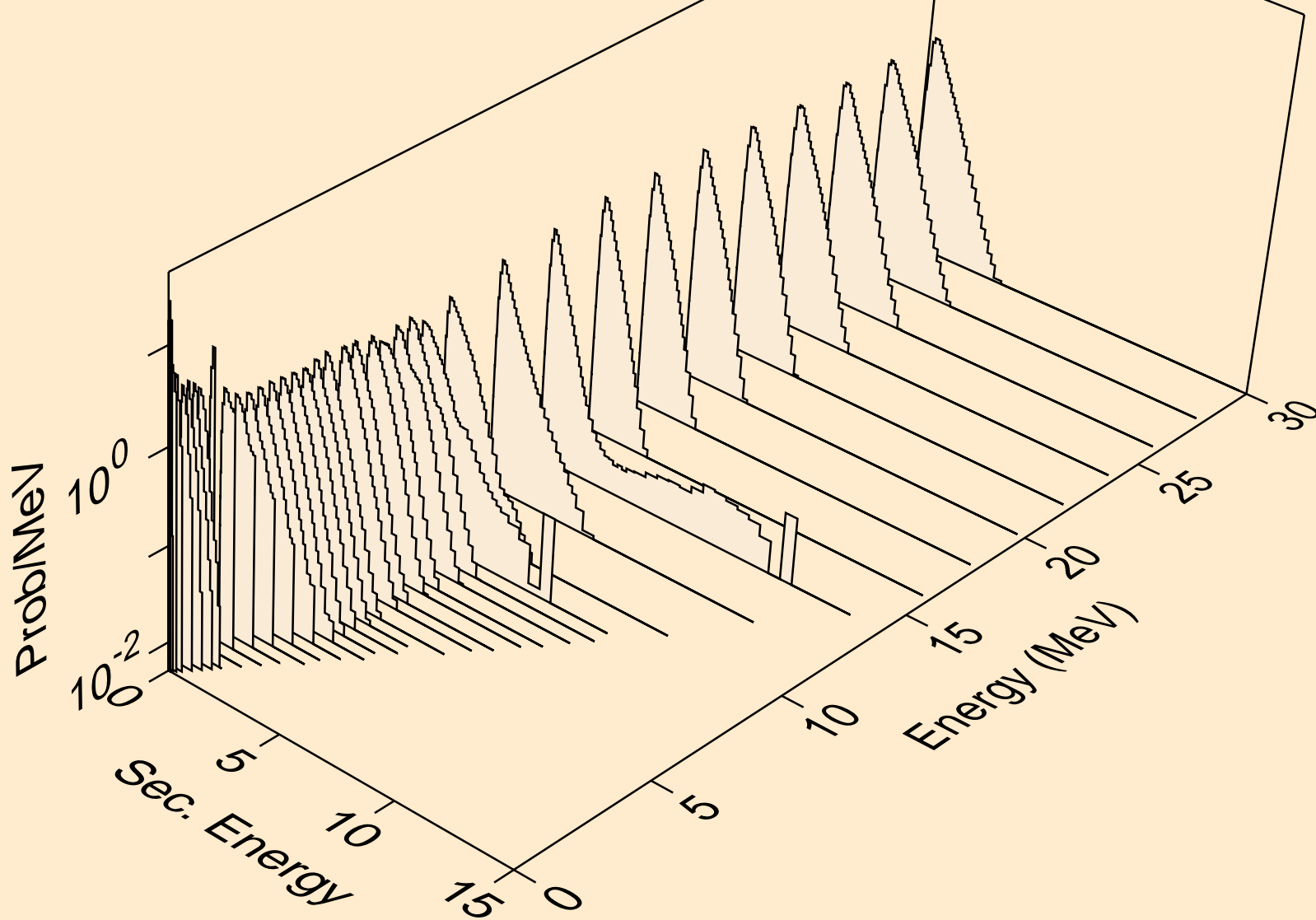

RF257M NEUTRON ACER TENDL-2019 LIBRARY; T=293.16K
Neutron emission for (n,2n)a

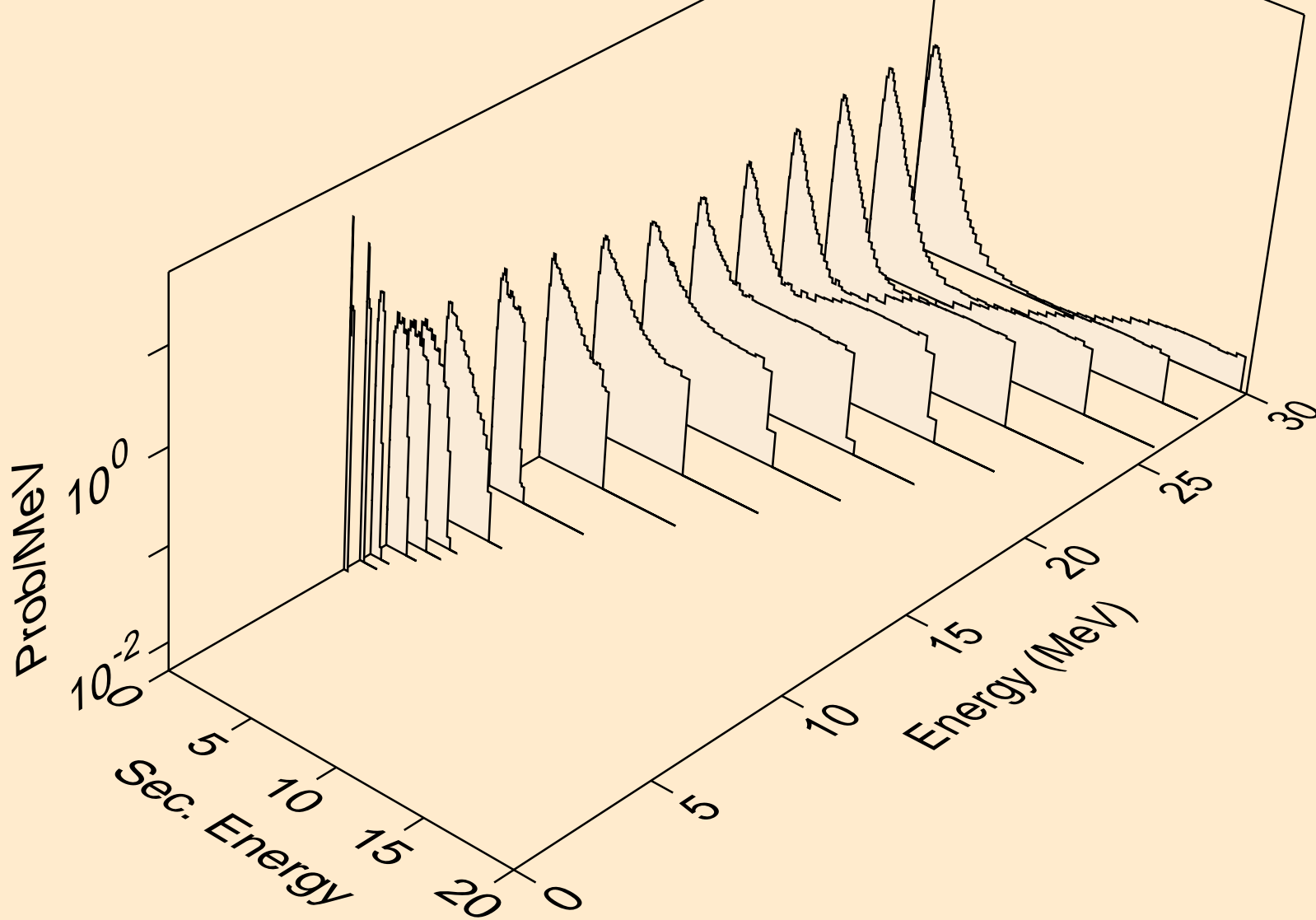

RF257M NEUTRON ACER TENDL-2019 LIBRARY; T=293.16K
Neutron emission for (n,3n)a

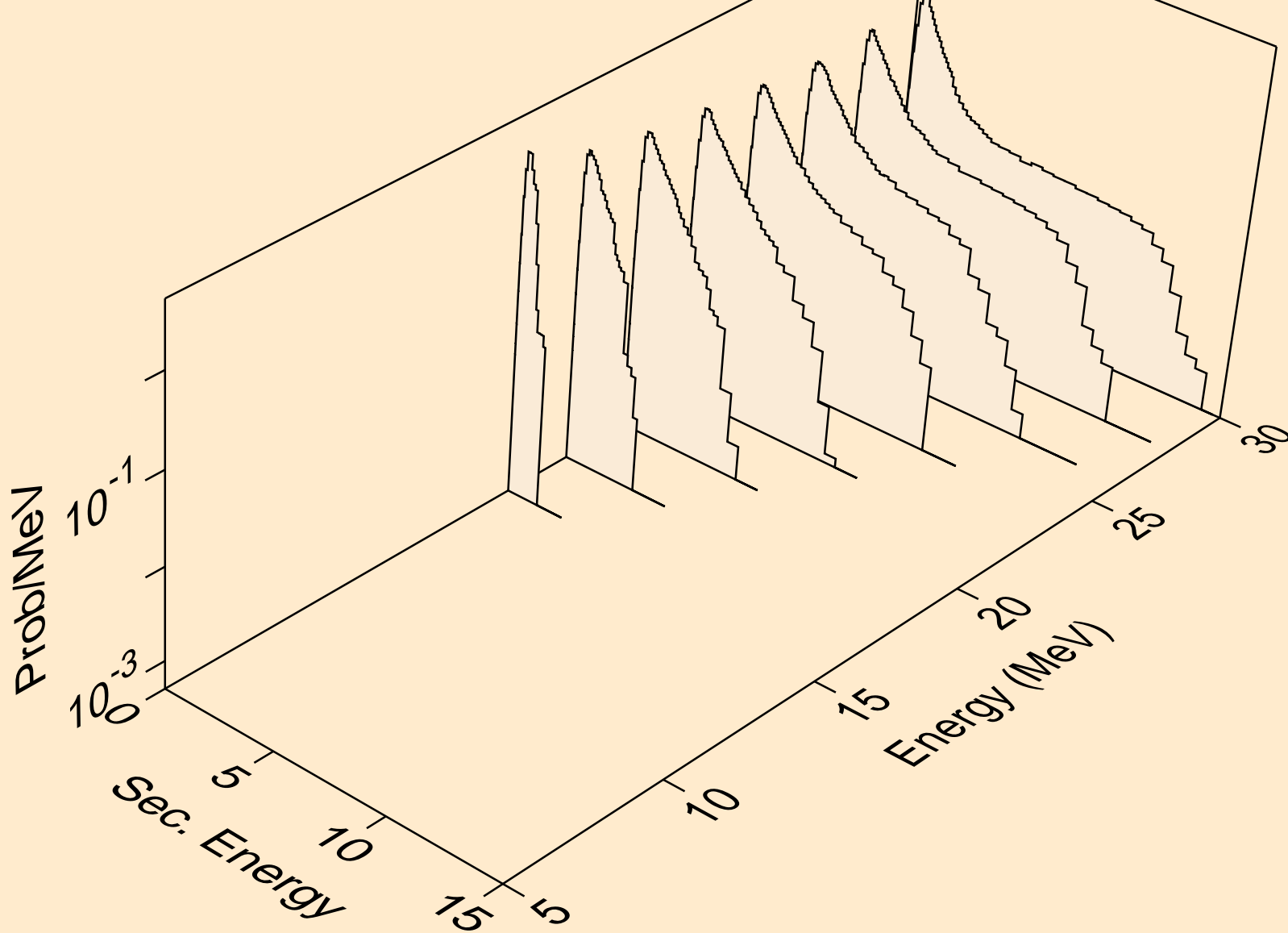

RF257M NEUTRON ACER TENDL-2019 LIBRARY; T=293.16K
Neutron emission for (n,n*)p

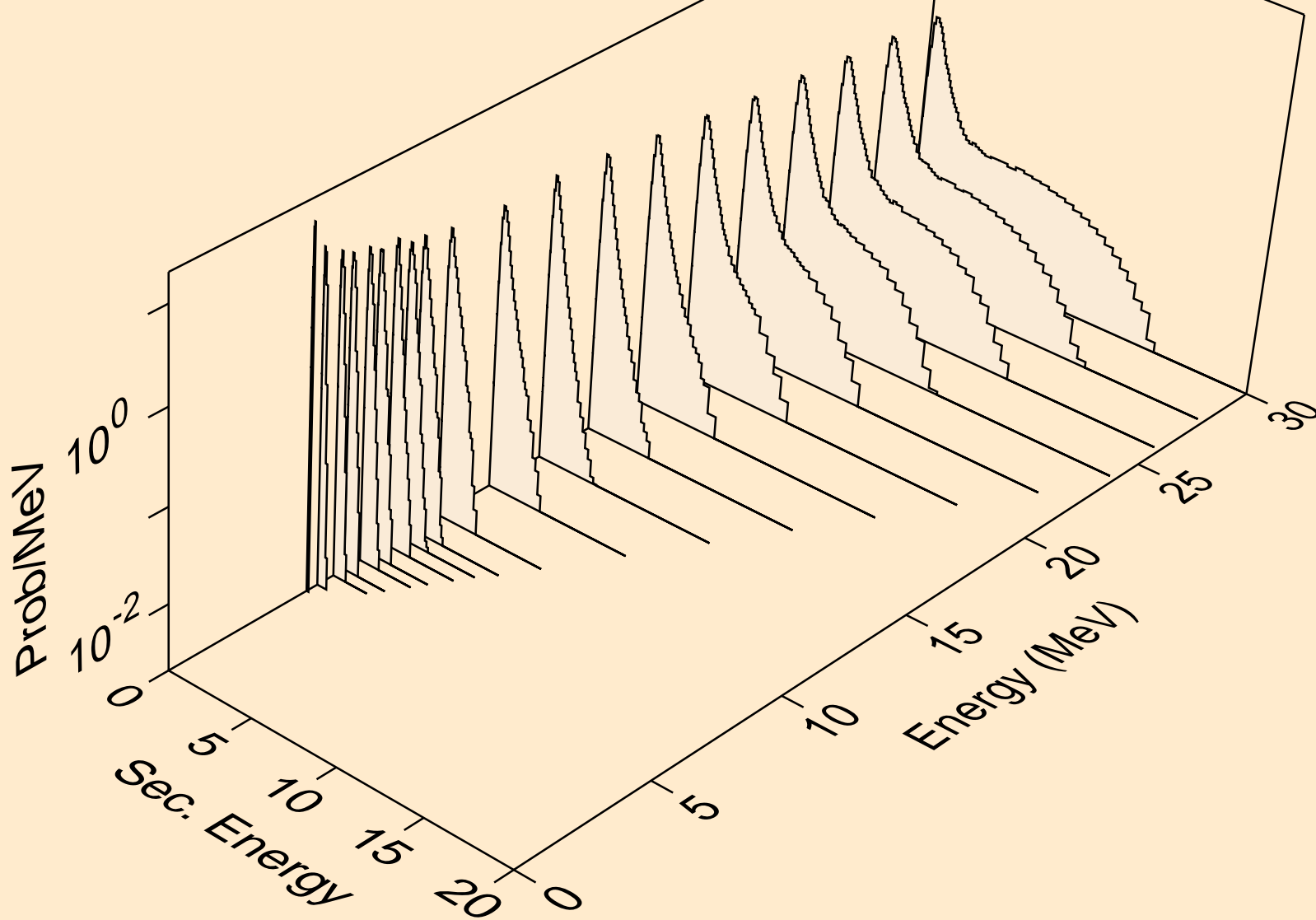

RF257M NEUTRON ACER TENDL-2019 LIBRARY; T=293.16K
Neutron emission for (n,n*)2a

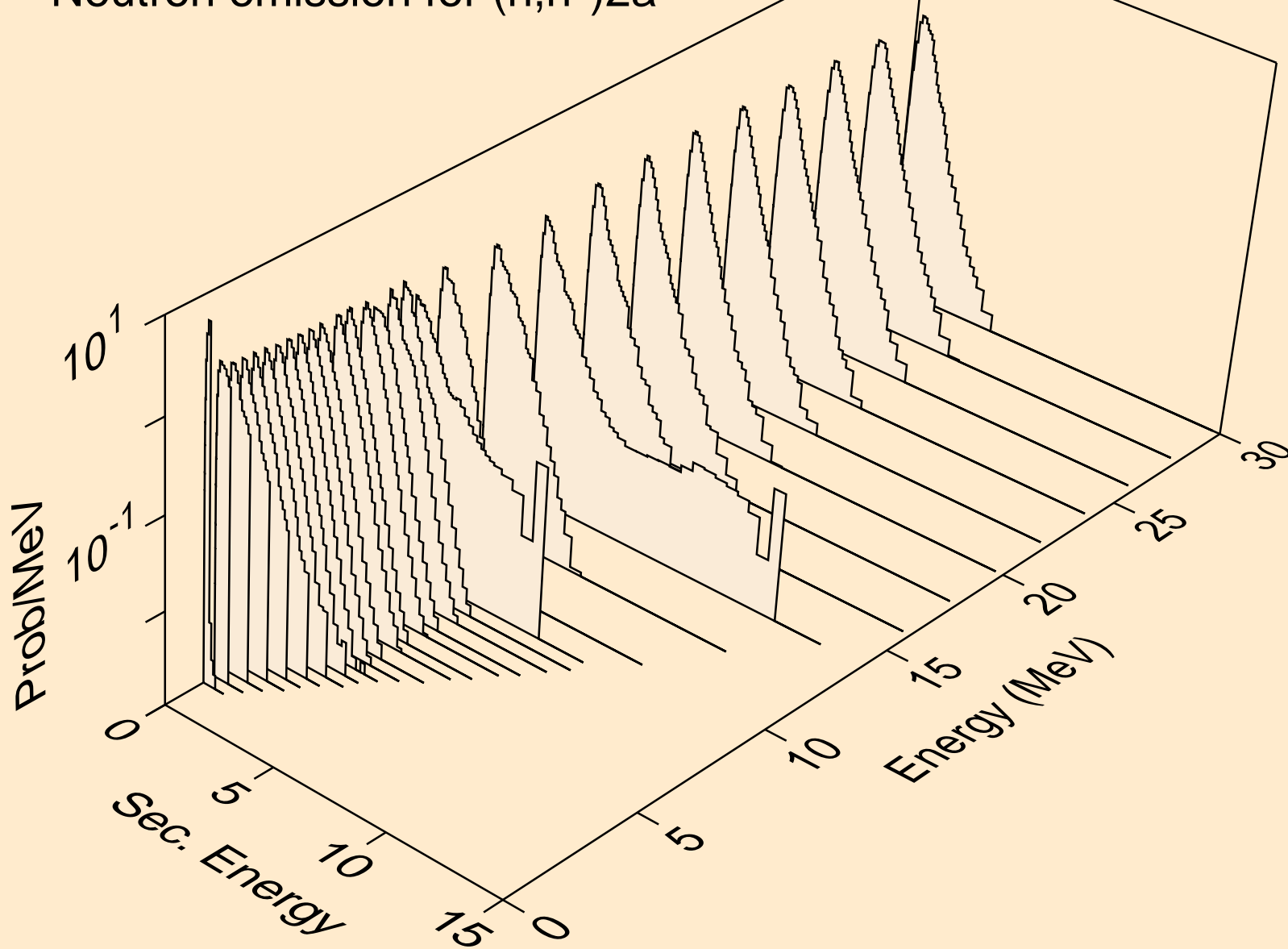

RF257M NEUTRON ACER TENDL-2019 LIBRARY; T=293.16K
Neutron emission for (n,2n)2a

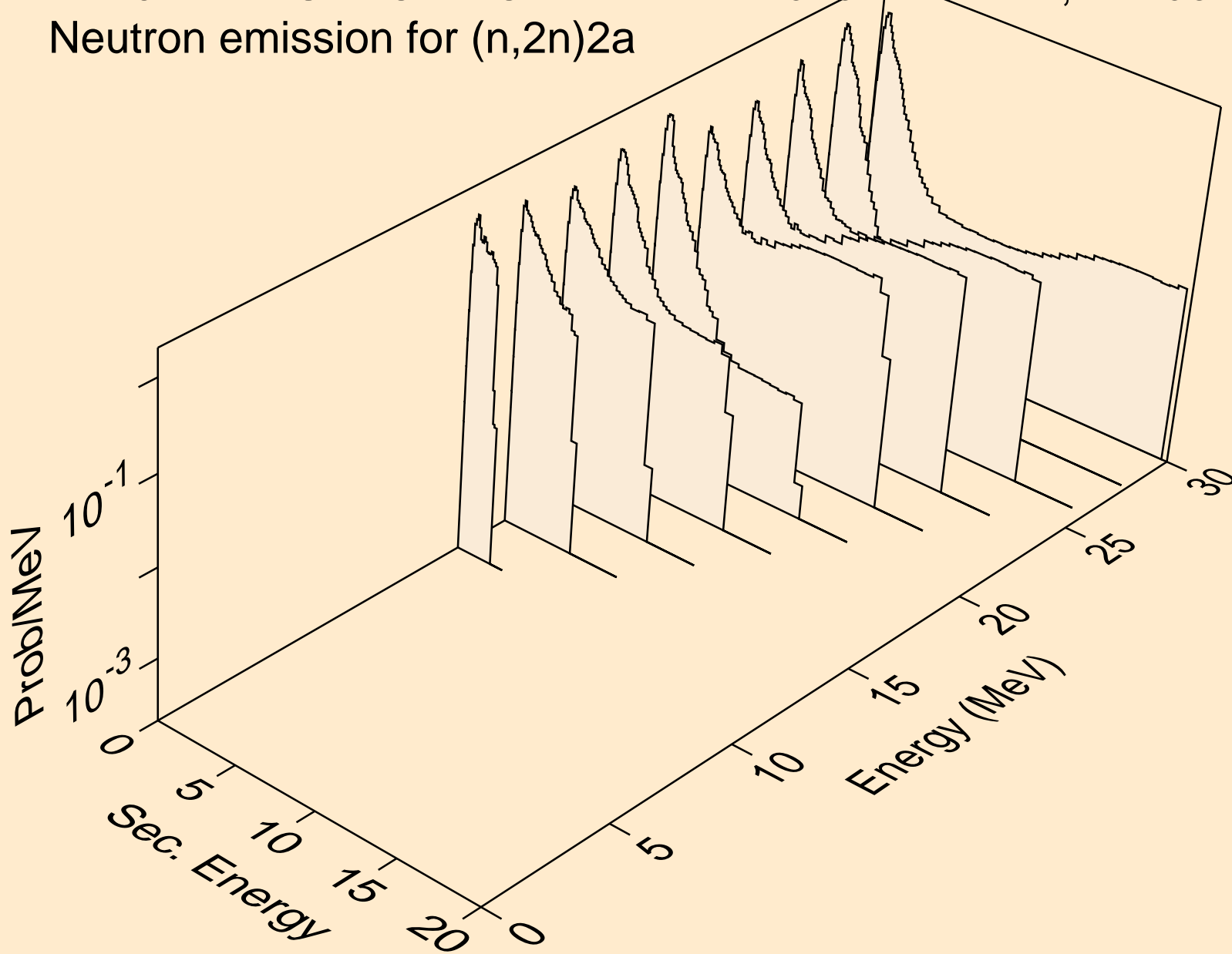

RF257M NEUTRON ACER TENDL-2019 LIBRARY; T=293.16K
Neutron emission for (n,n*)d

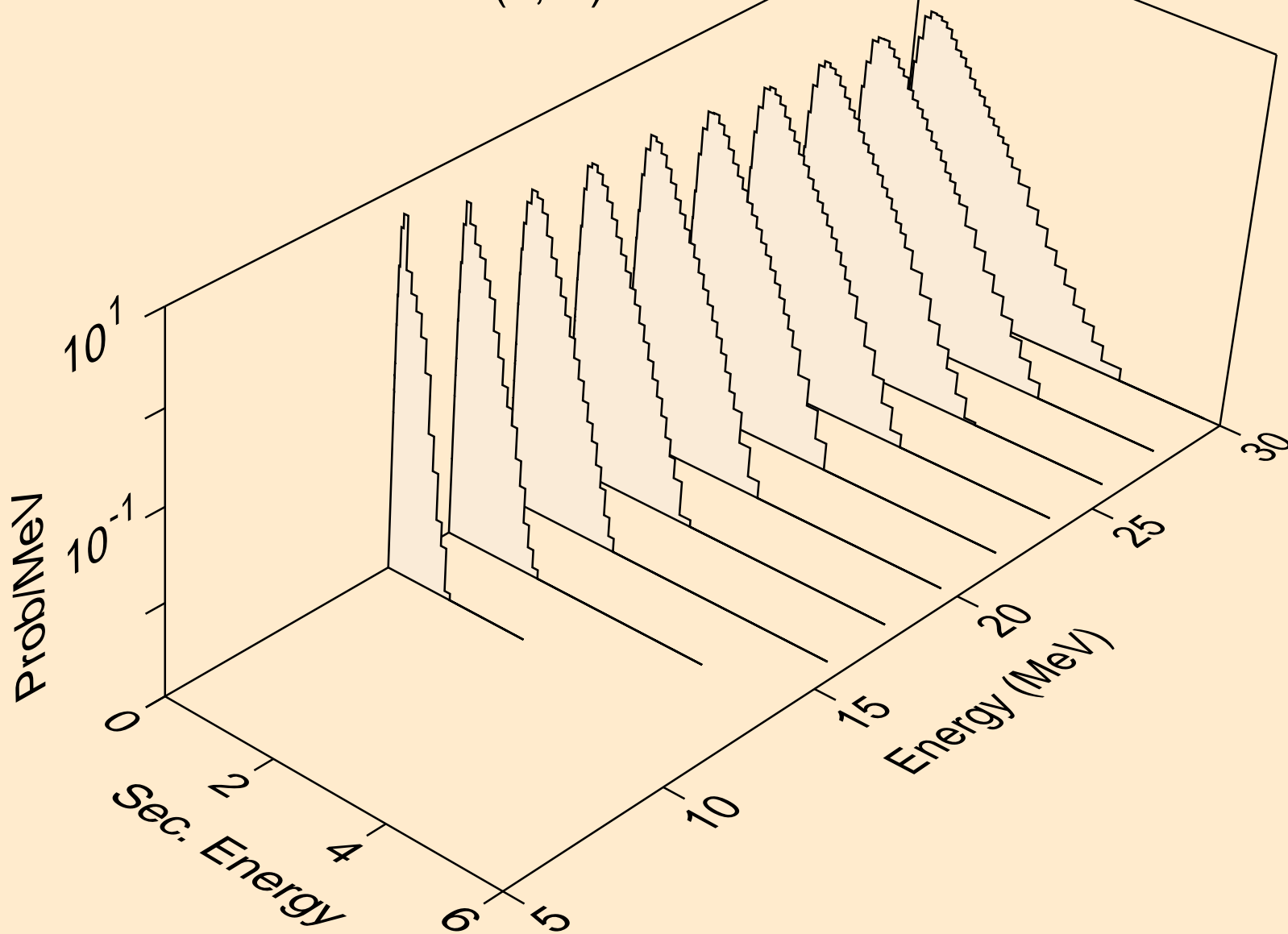

RF257M NEUTRON ACER TENDL-2019 LIBRARY; T=293.16K
Neutron emission for (n,n*)t

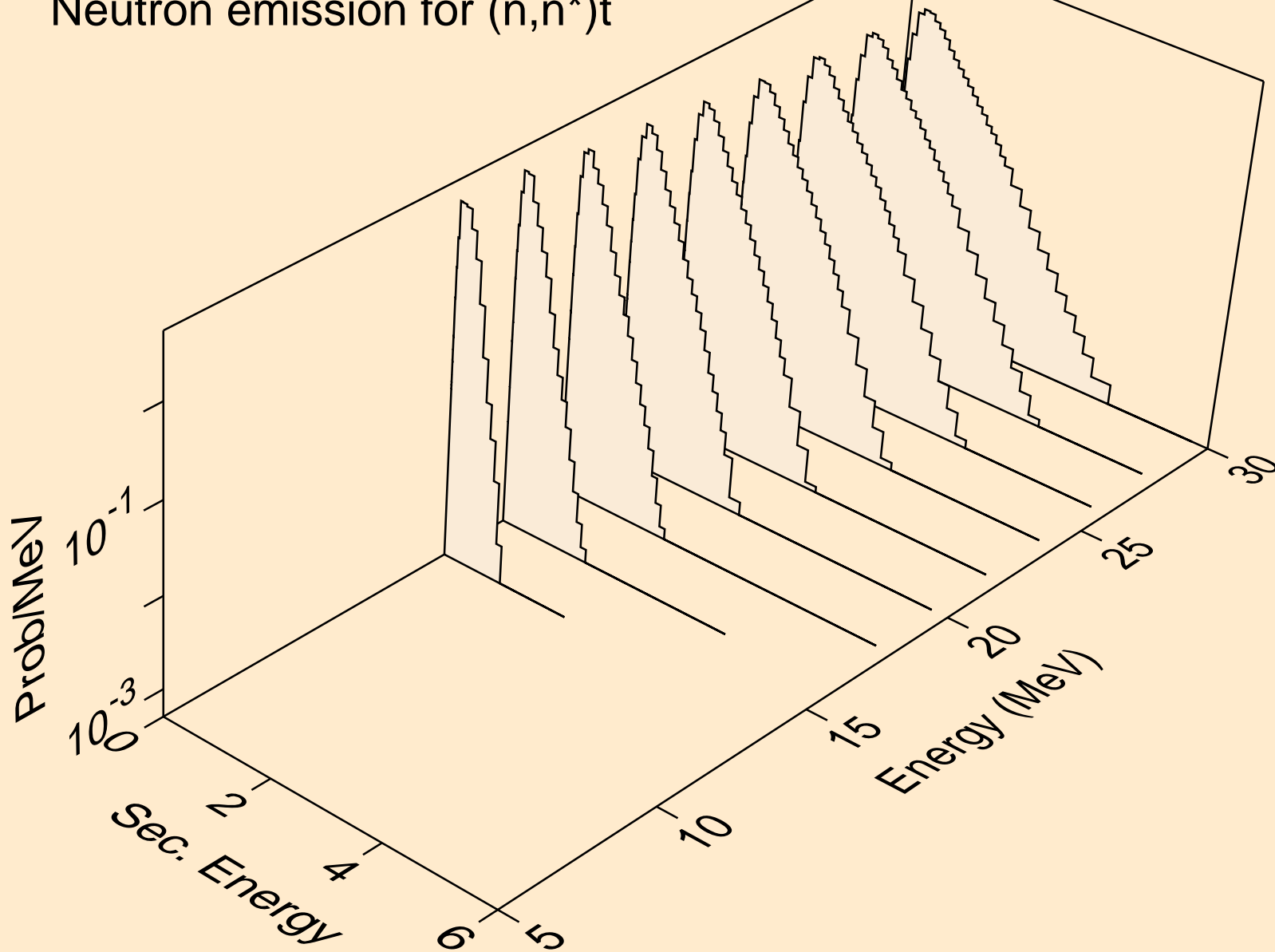

RF257M NEUTRON ACER TENDL-2019 LIBRARY; T=293.16K
Neutron emission for (n,n*)he3

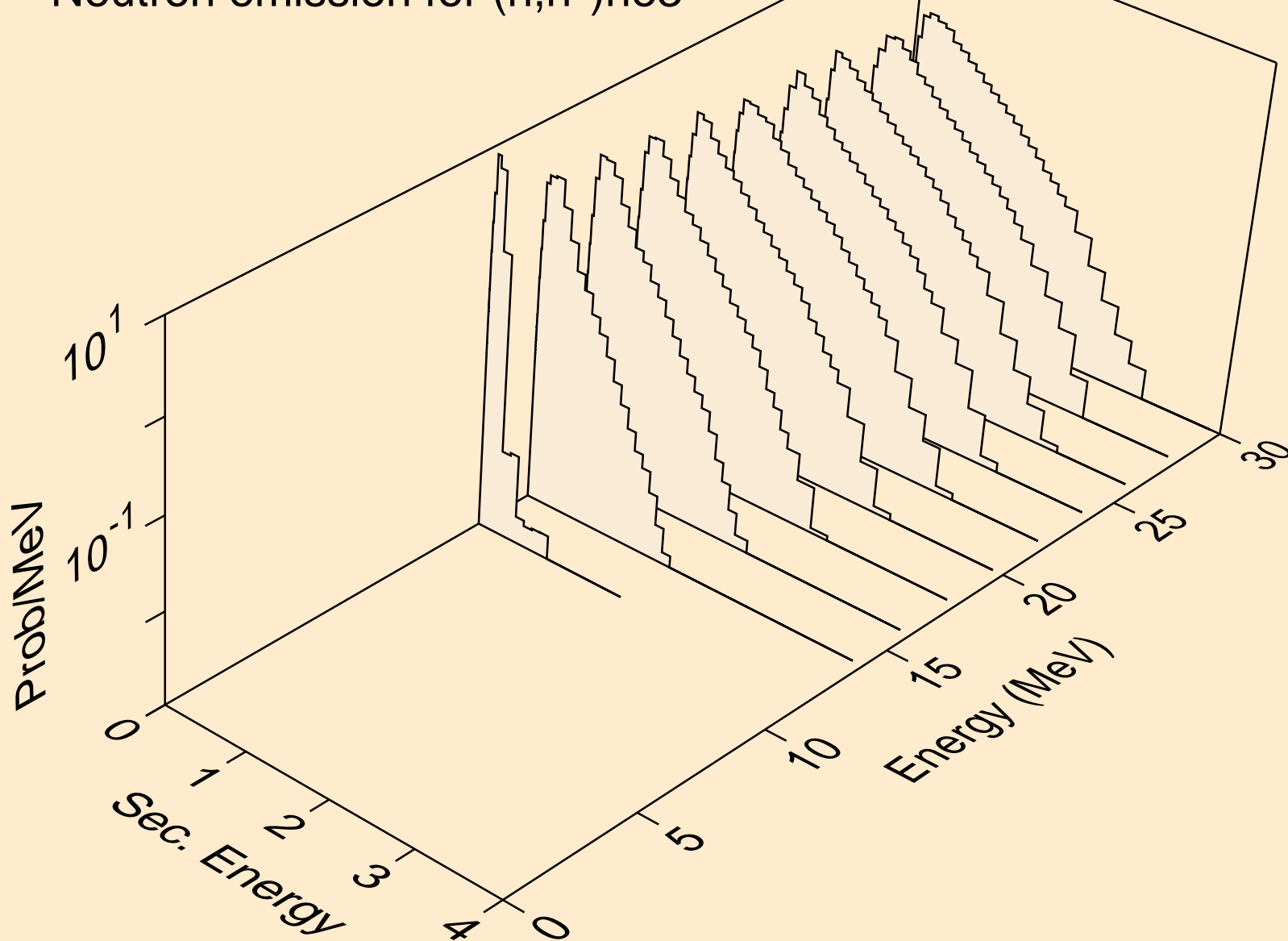

RF257M NEUTRON ACER TENDL-2019 LIBRARY; T=293.16K
Neutron emission for (n,4n)

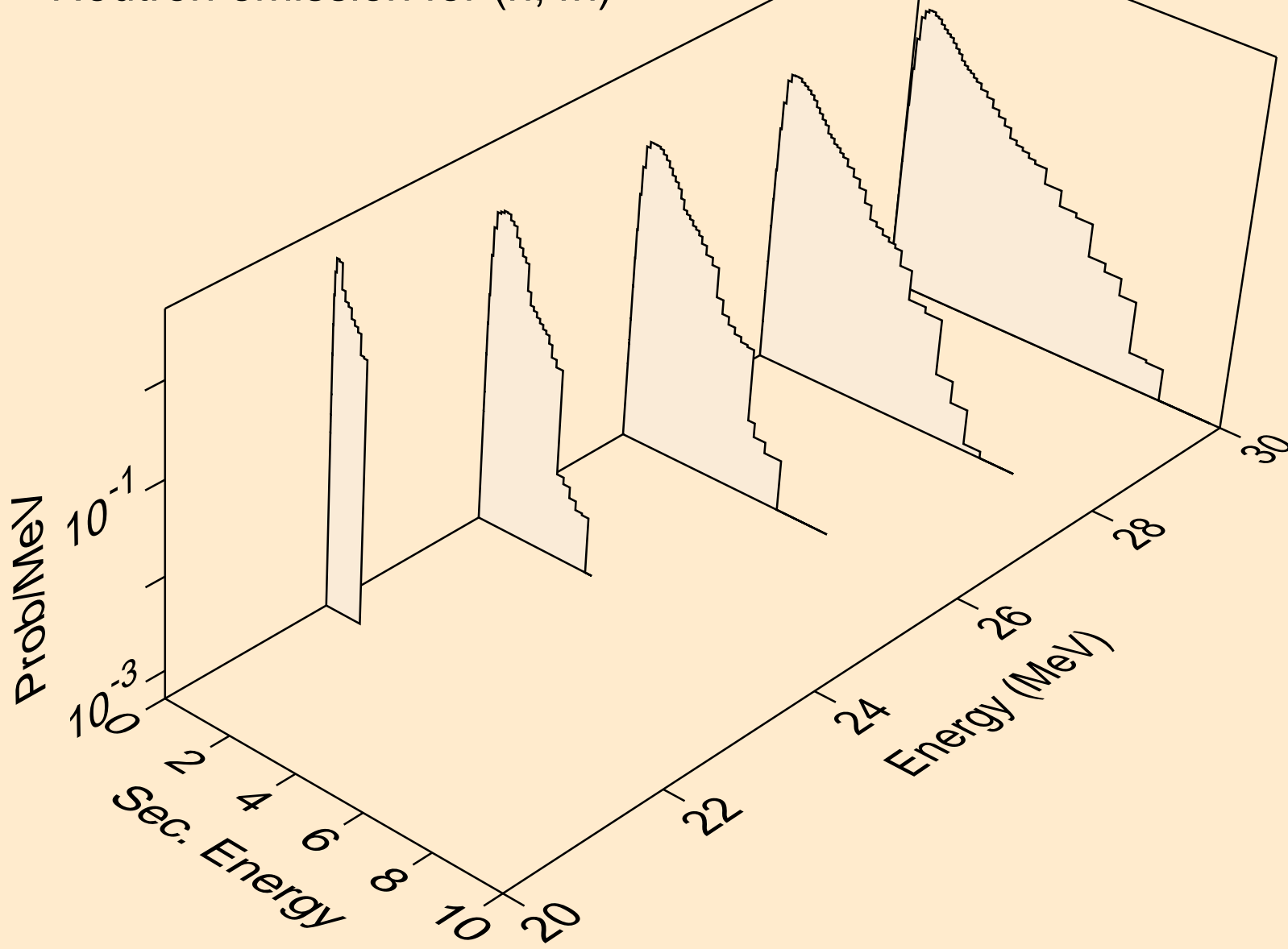

RF257M NEUTRON ACER TENDL-2019 LIBRARY; T=293.16K
Neutron emission for (n,2np)

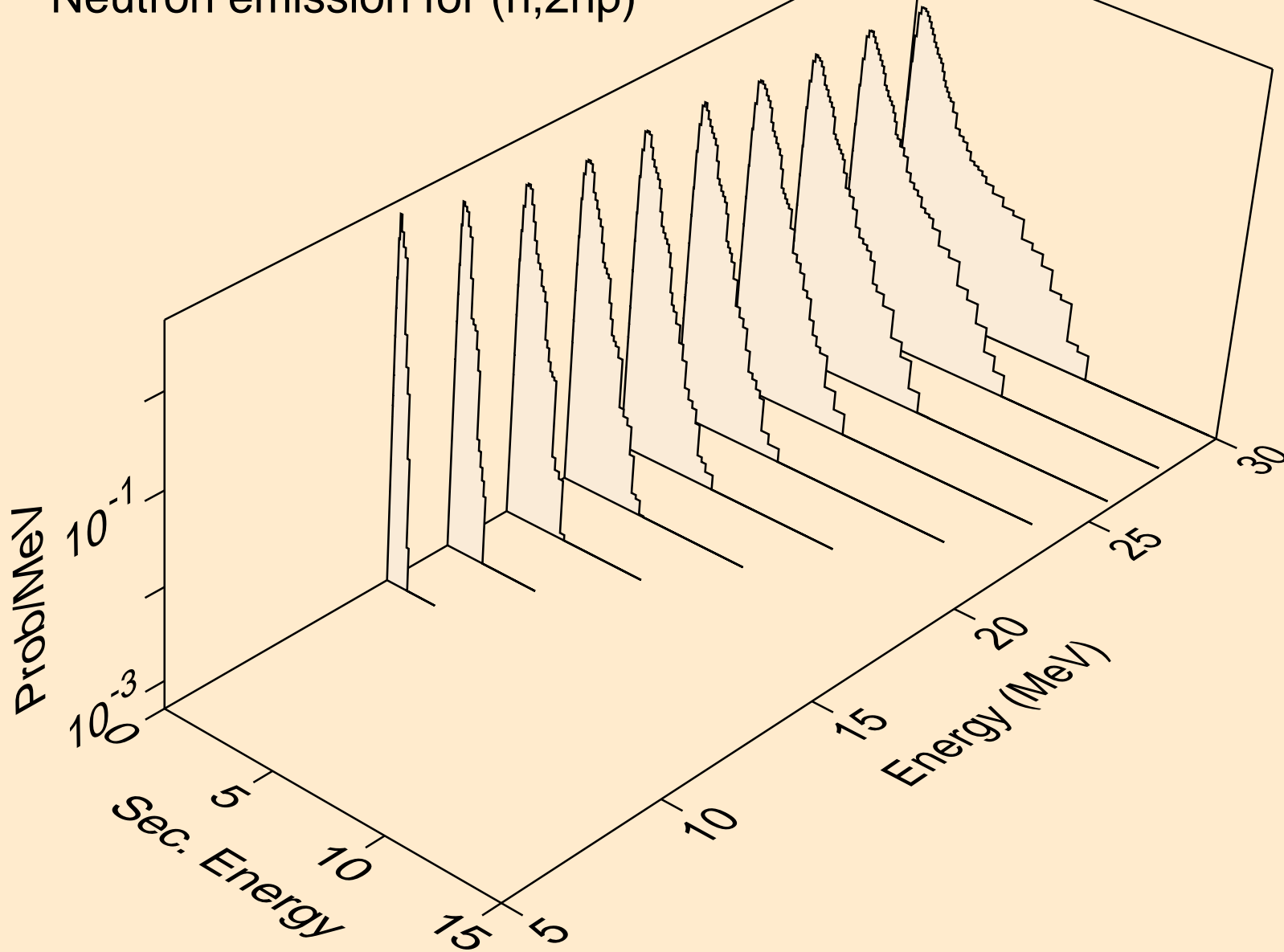

RF257M NEUTRON ACER TENDL-2019 LIBRARY; T=293.16K
Neutron emission for (n,3np)

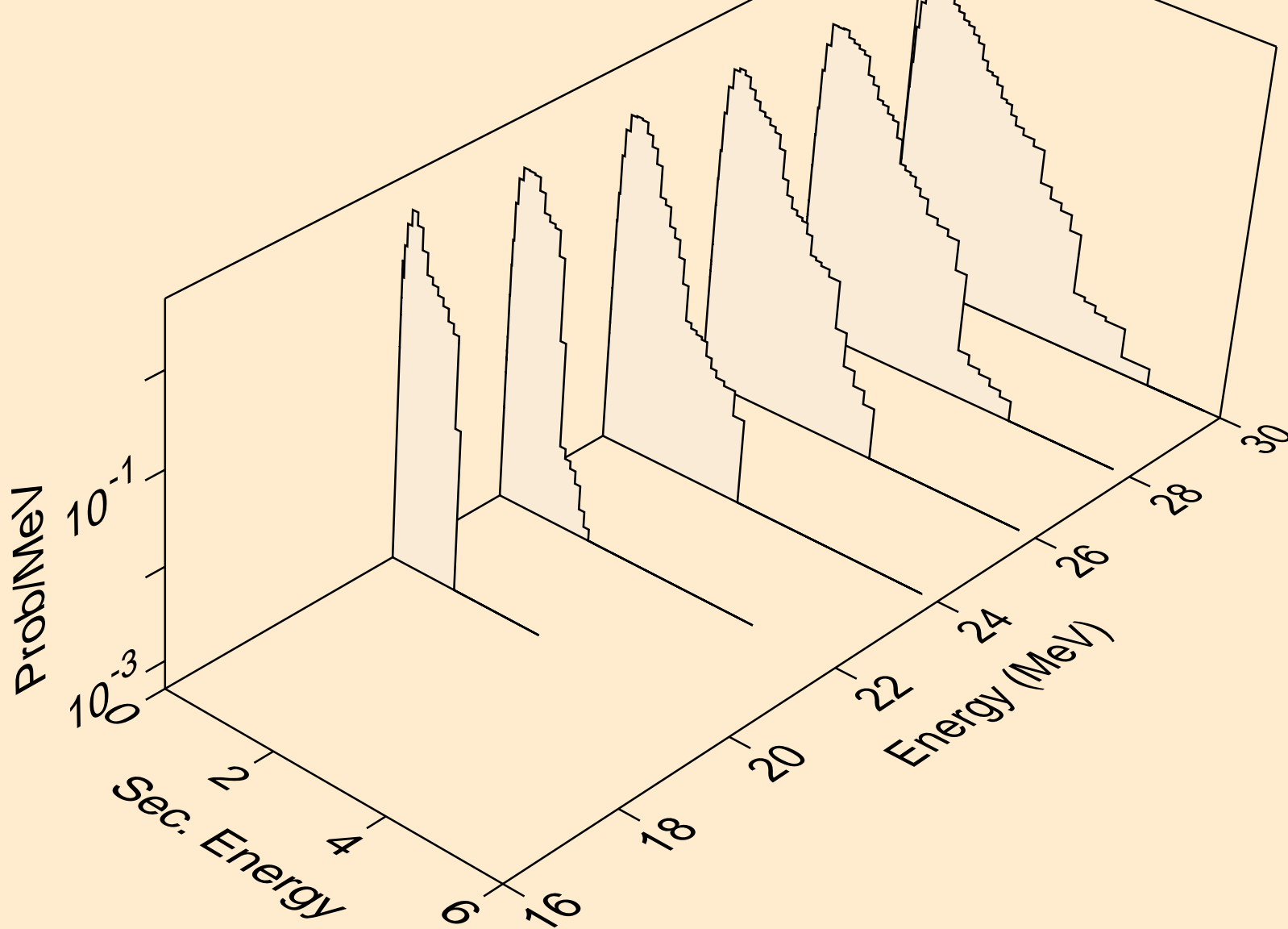

RF257M NEUTRON ACER TENDL-2019 LIBRARY; T=293.16K
Neutron emission for (n,2np)

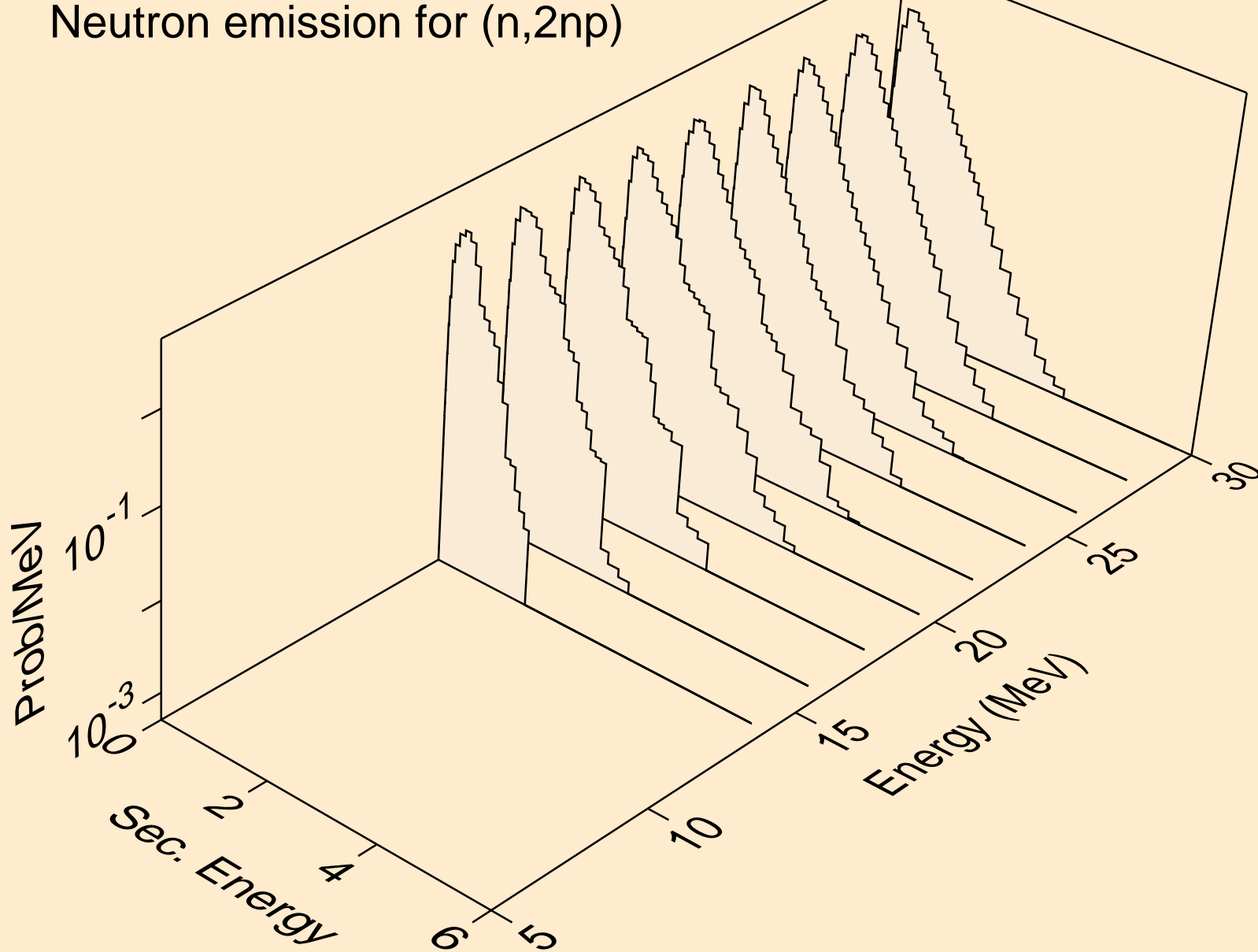

RF257M NEUTRON ACER TENDL-2019 LIBRARY; T=293.16K
Neutron emission for (n,npa)

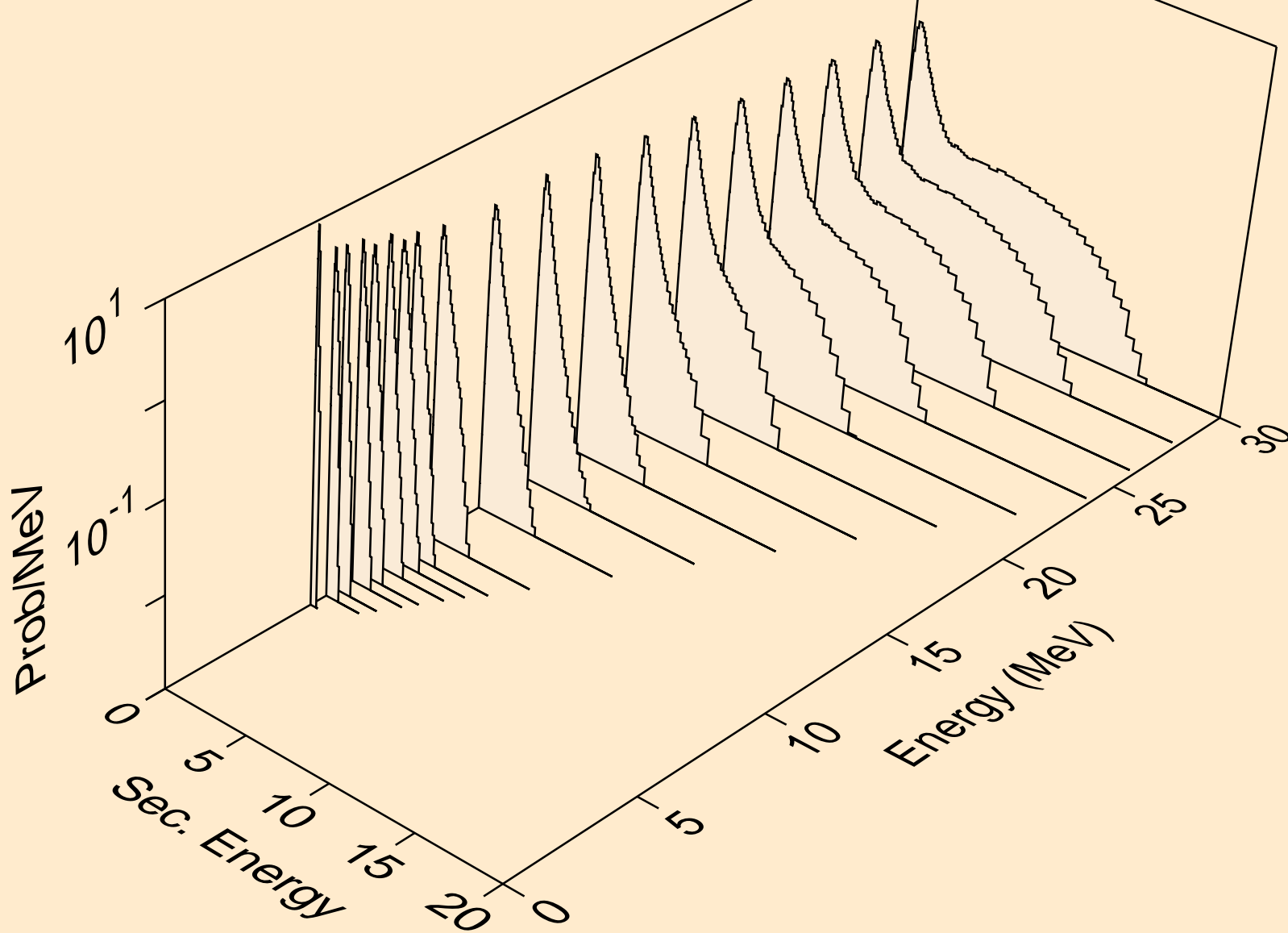

RF257M NEUTRON ACER TENDL-2019 LIBRARY; T=293.16K
Neutron emission for (n,n*c)

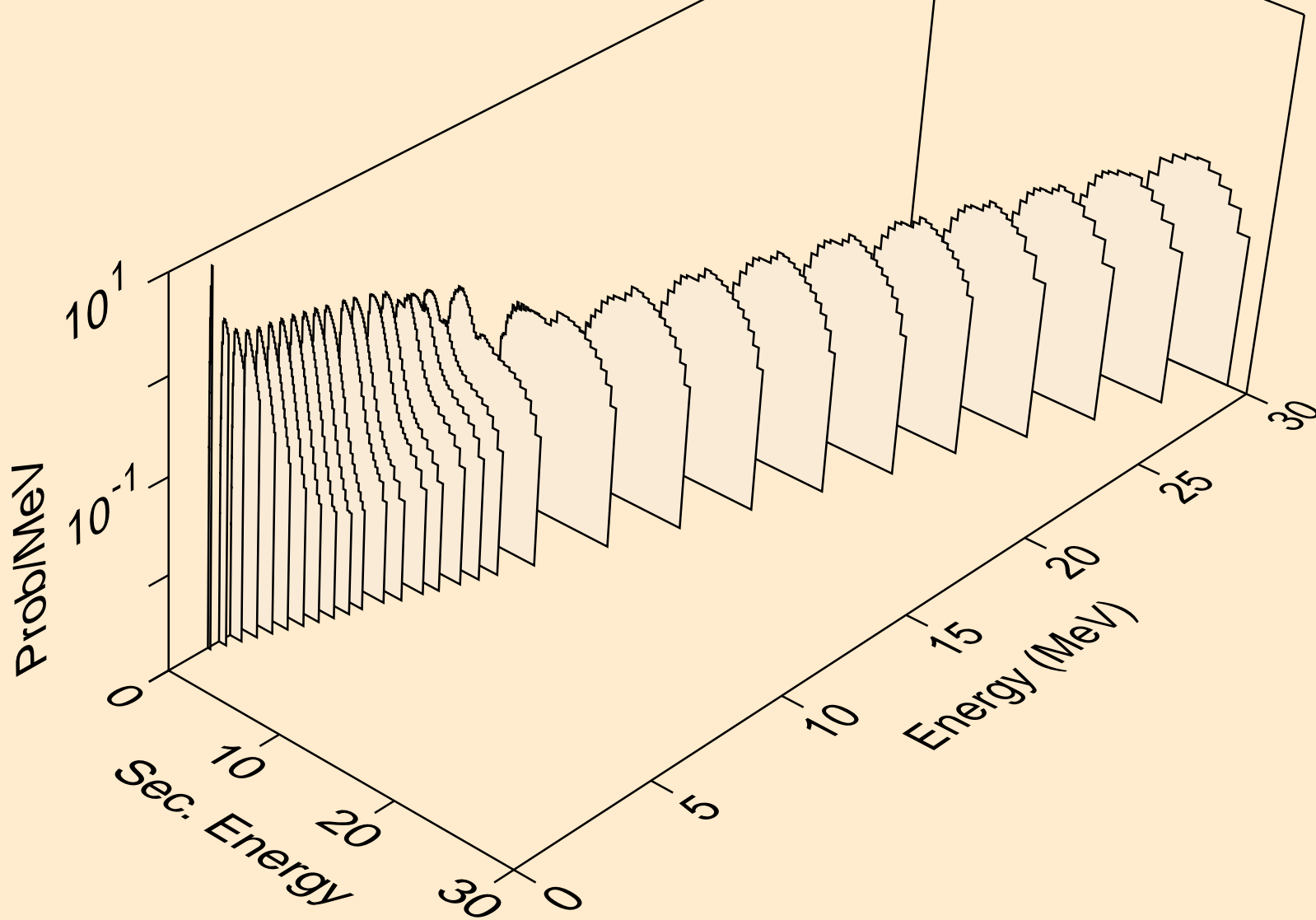

RF257M NEUTRON ACER TENDL-2019 LIBRARY; T=293.16K

Delayed nubar

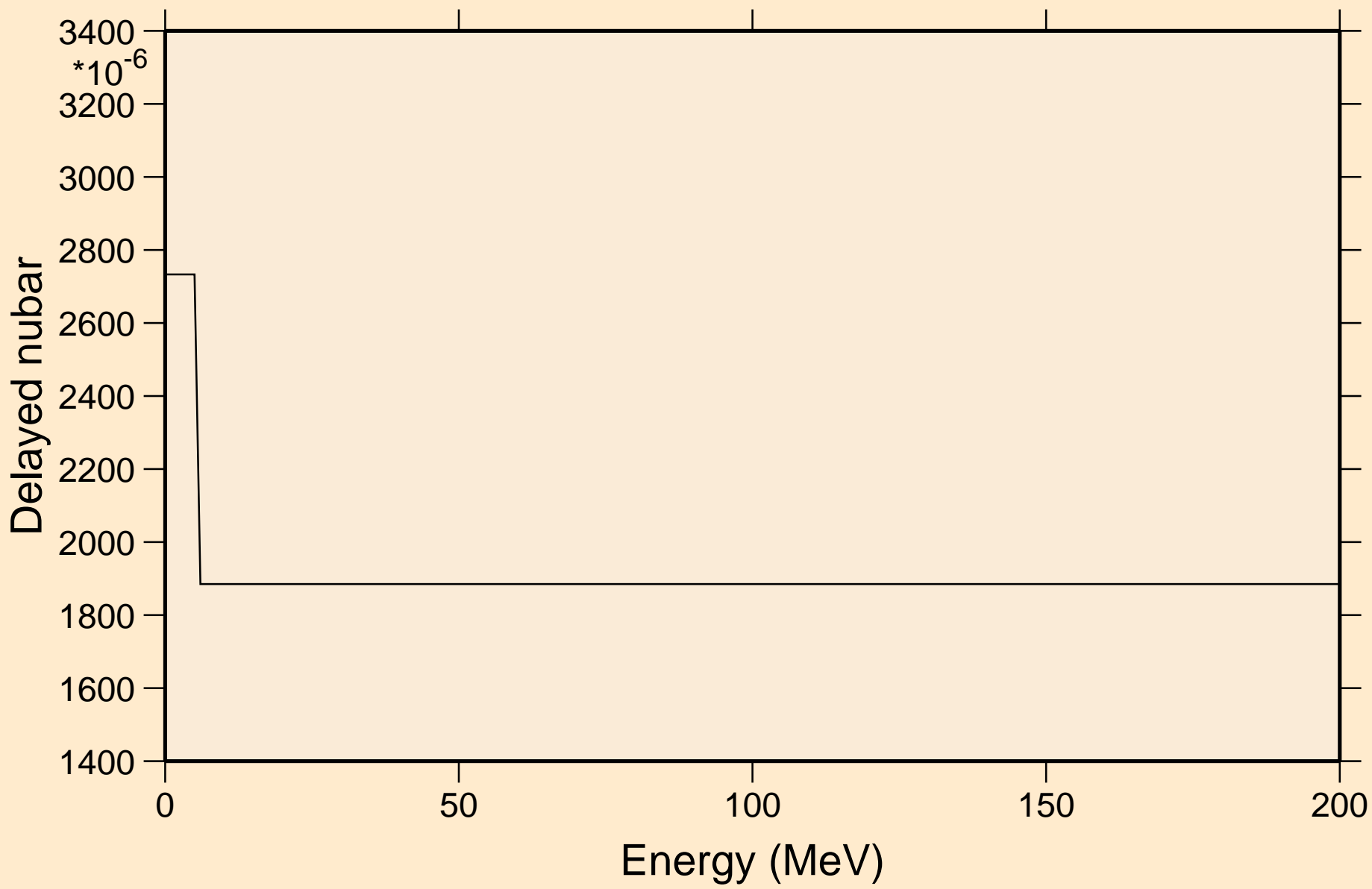

RF257M NEUTRON ACER TENDL-2019 LIBRARY; T=293.16K

Delayed neutron spectra

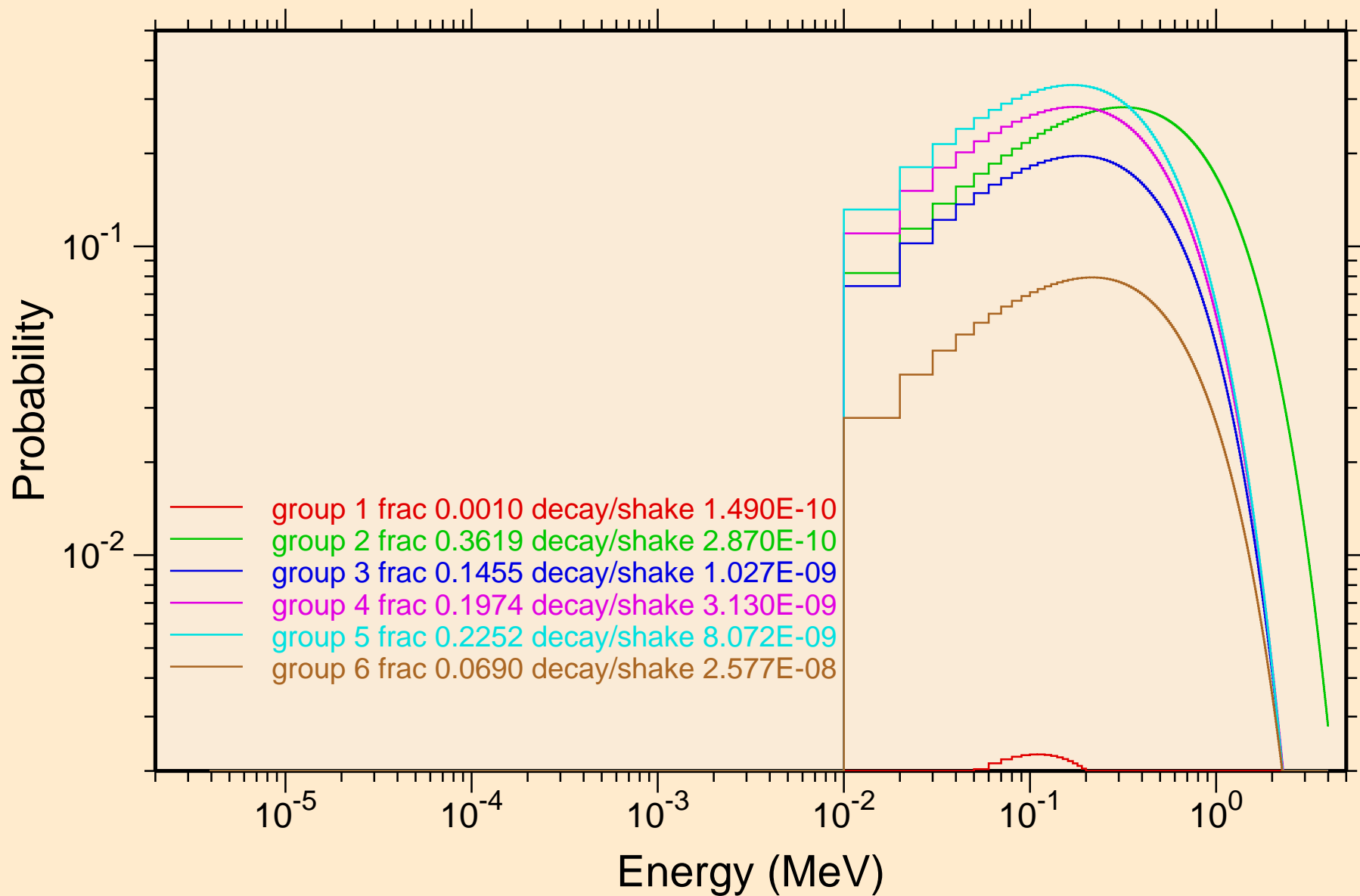

RF257M NEUTRON ACER TENDL-2019 LIBRARY; T=293.16K
Photon emission for (n,x)

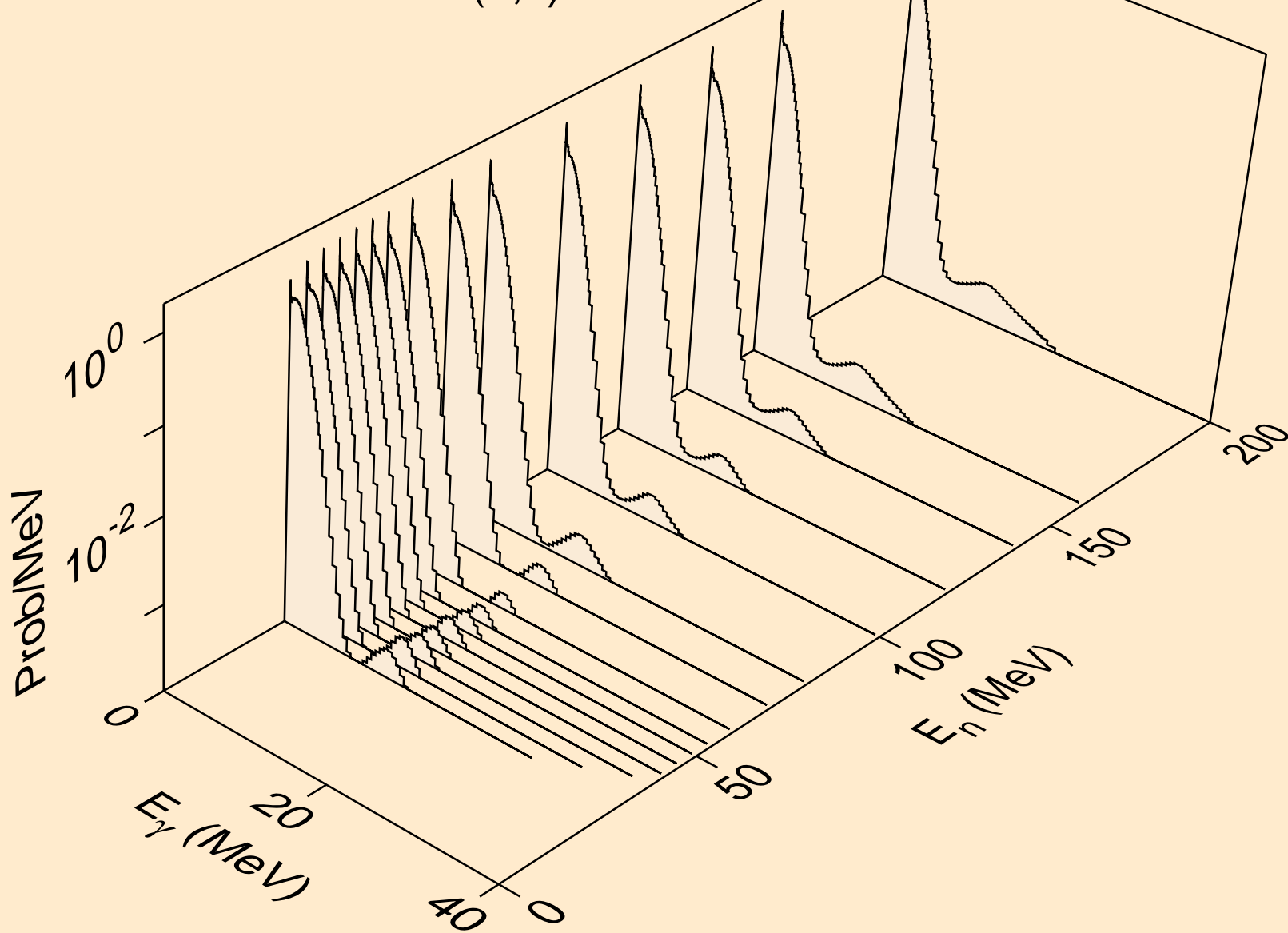

RF257M NEUTRON ACER TENDL-2019 LIBRARY; T=293.16K
Photon emission for (n,2nd)

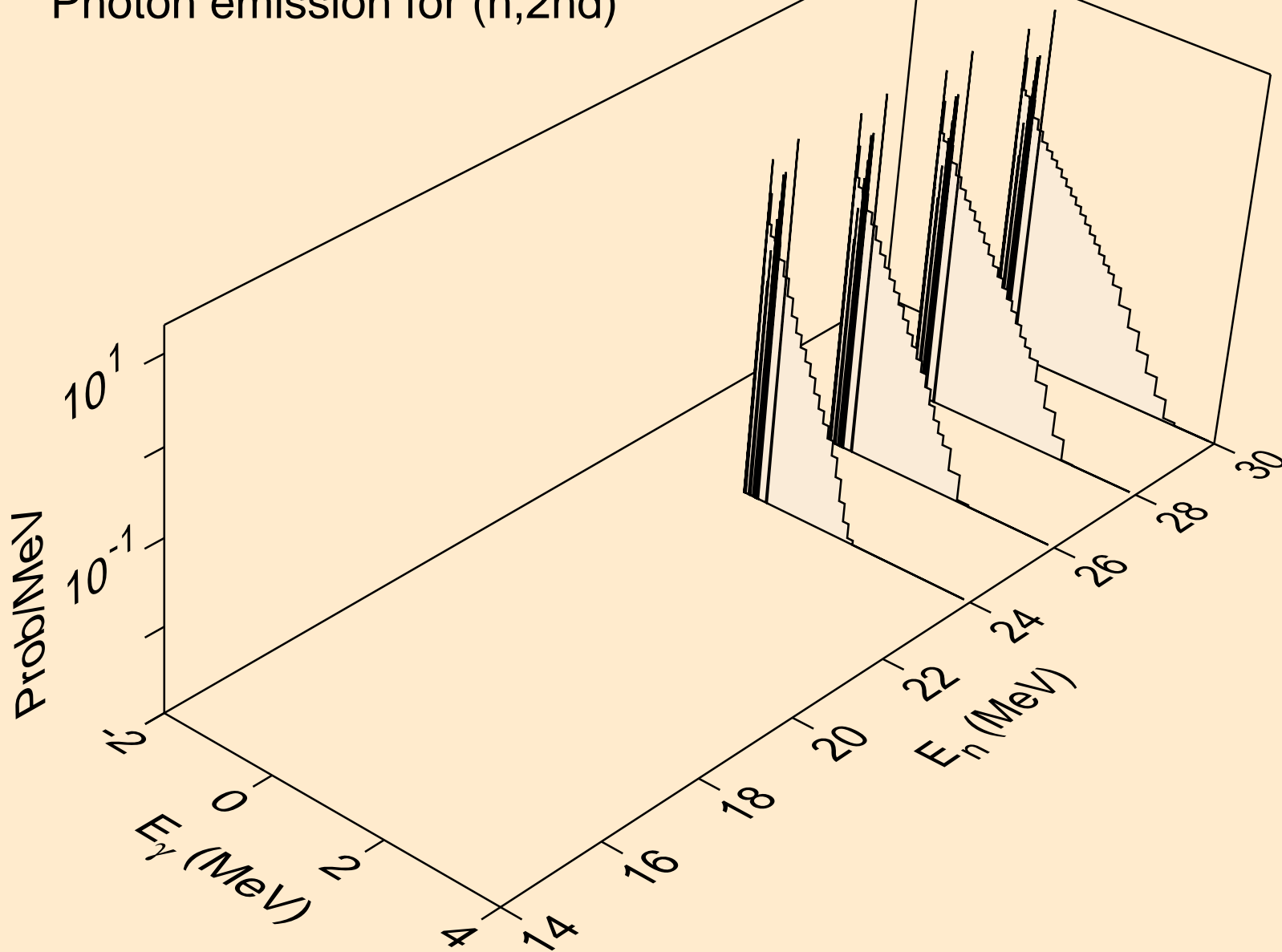

RF257M NEUTRON ACER TENDL-2019 LIBRARY; T=293.16K
Photon emission for (n,2n)

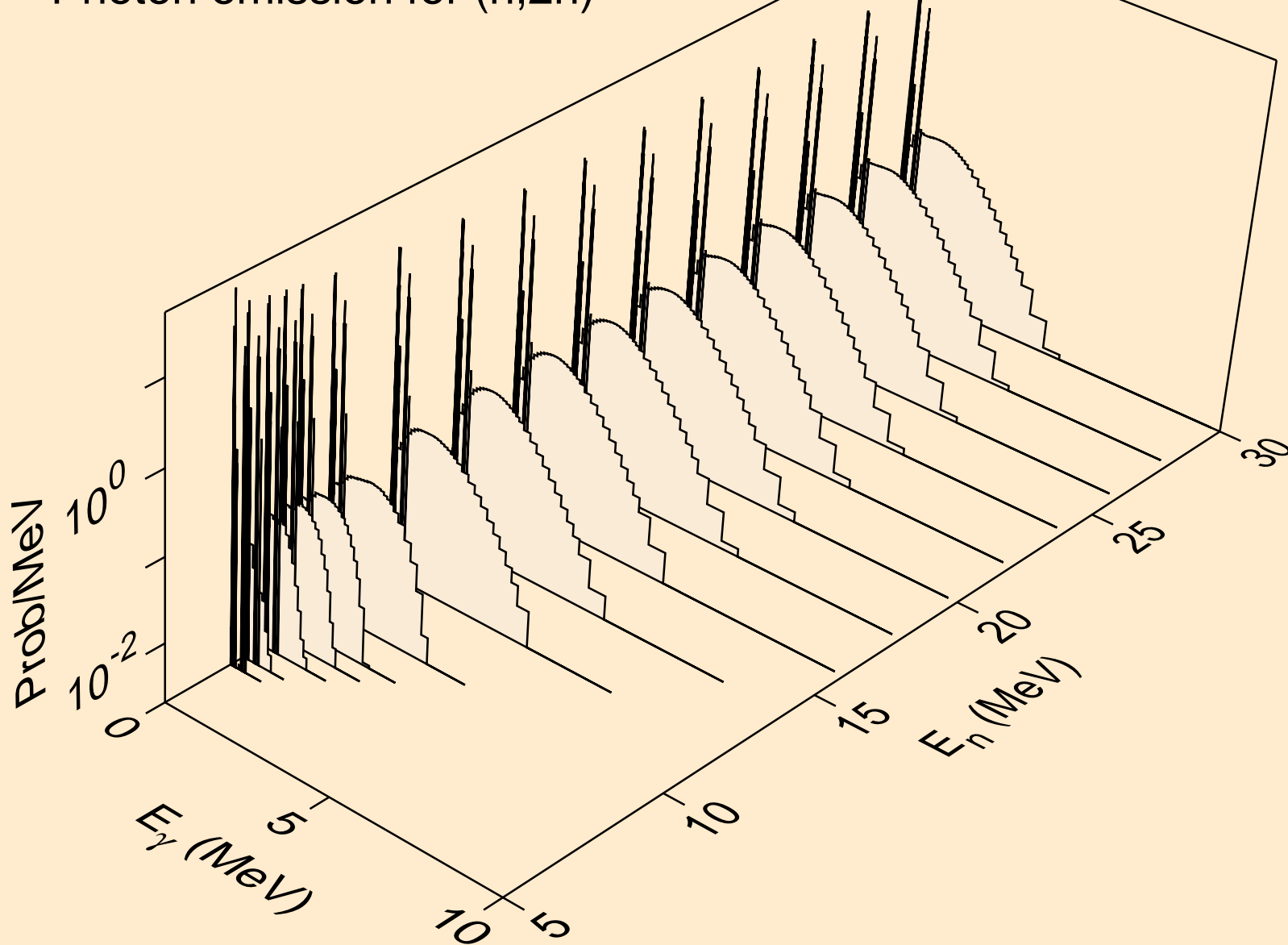

RF257M NEUTRON ACER TENDL-2019 LIBRARY; T=293.16K
Photon emission for (n,3n)

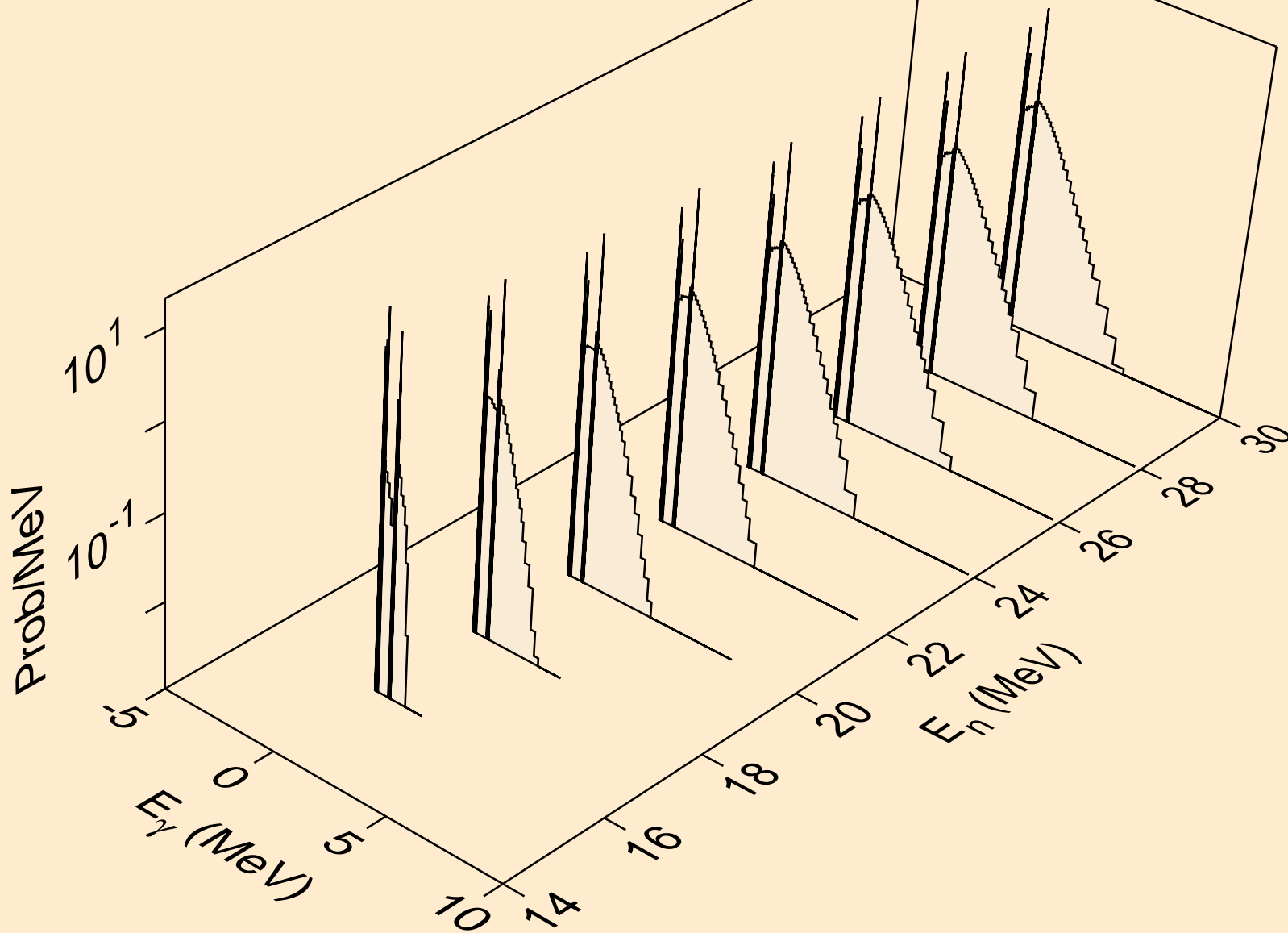

RF257M NEUTRON ACER TENDL-2019 LIBRARY; T=293.16K
Photon emission for (n,n*)a

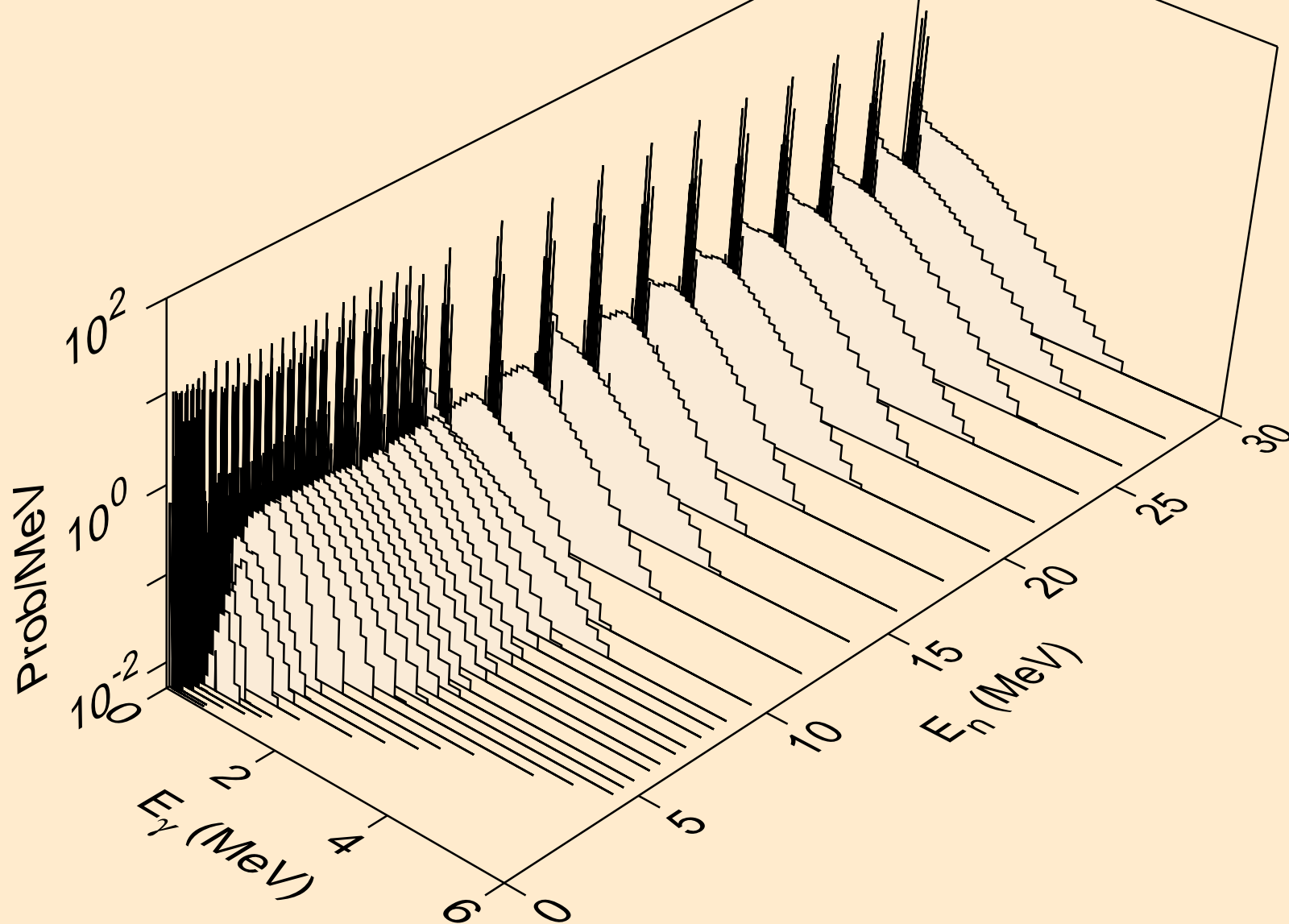

RF257M NEUTRON ACER TENDL-2019 LIBRARY; T=293.16K
Photon emission for (n,2n)a

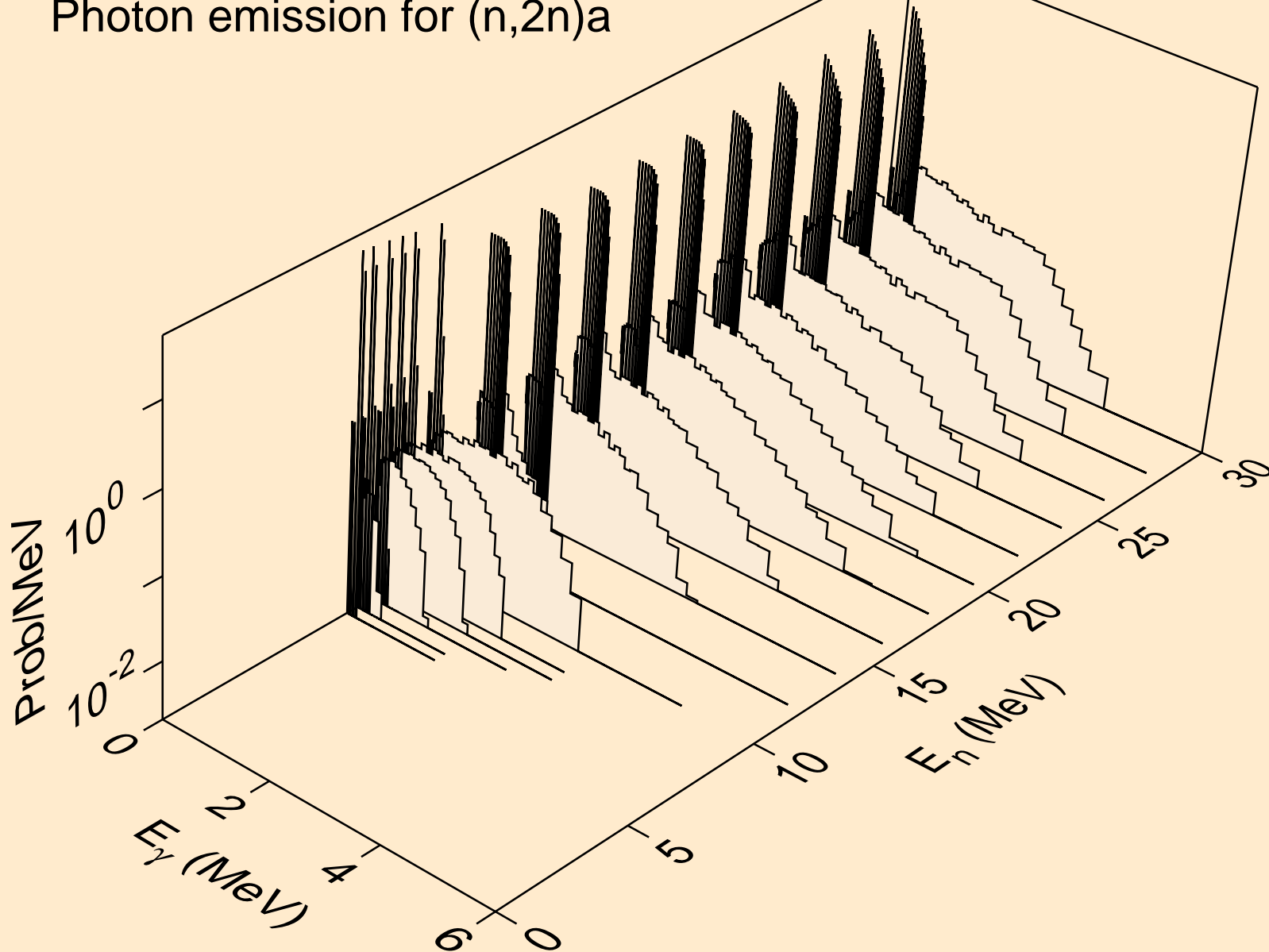

RF257M NEUTRON ACER TENDL-2019 LIBRARY; T=293.16K
Photon emission for (n,3n)a

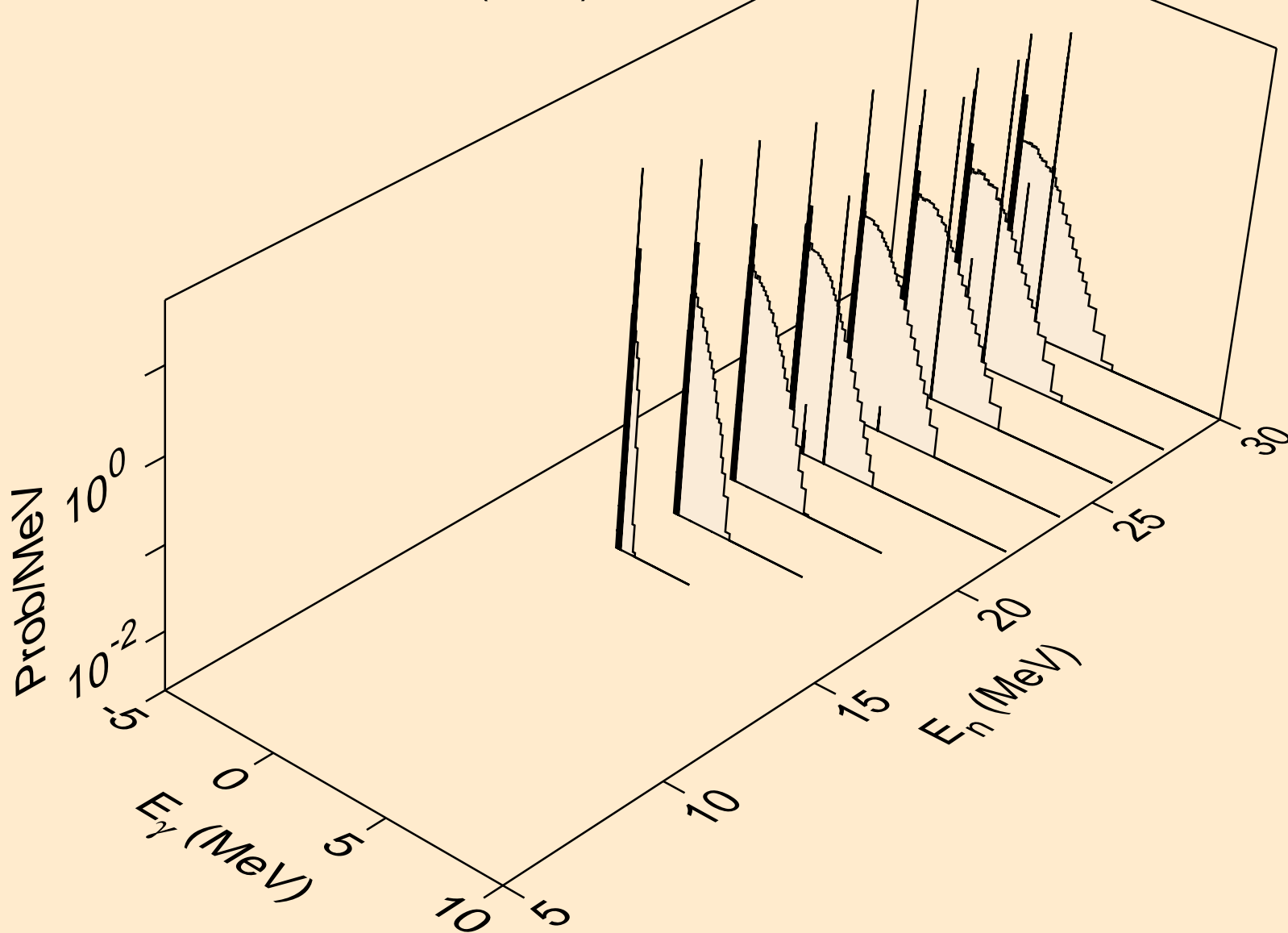

RF257M NEUTRON ACER TENDL-2019 LIBRARY; T=293.16K
Photon emission for (n,n*)p

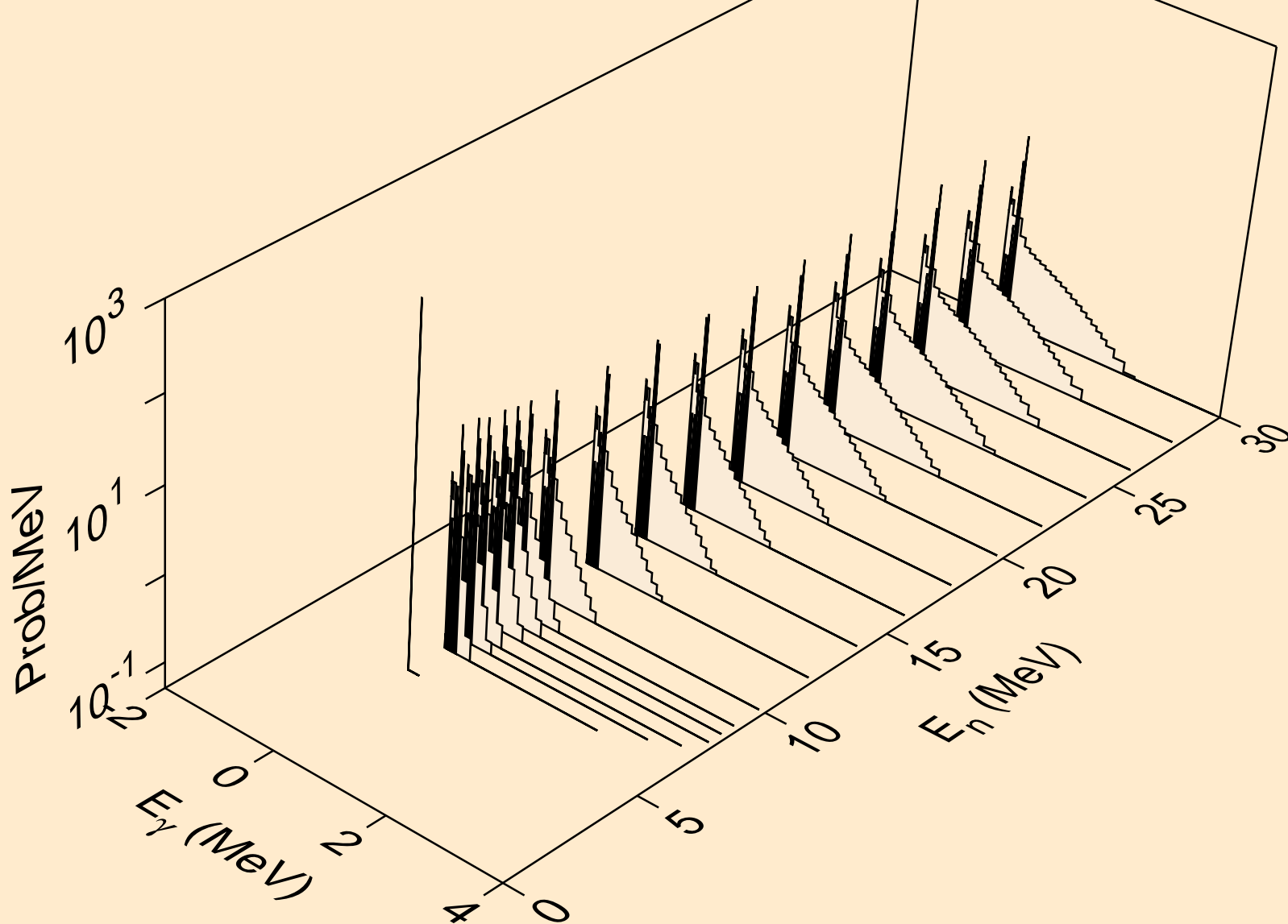

RF257M NEUTRON ACER TENDL-2019 LIBRARY; T=293.16K
Photon emission for (n,n*)2a

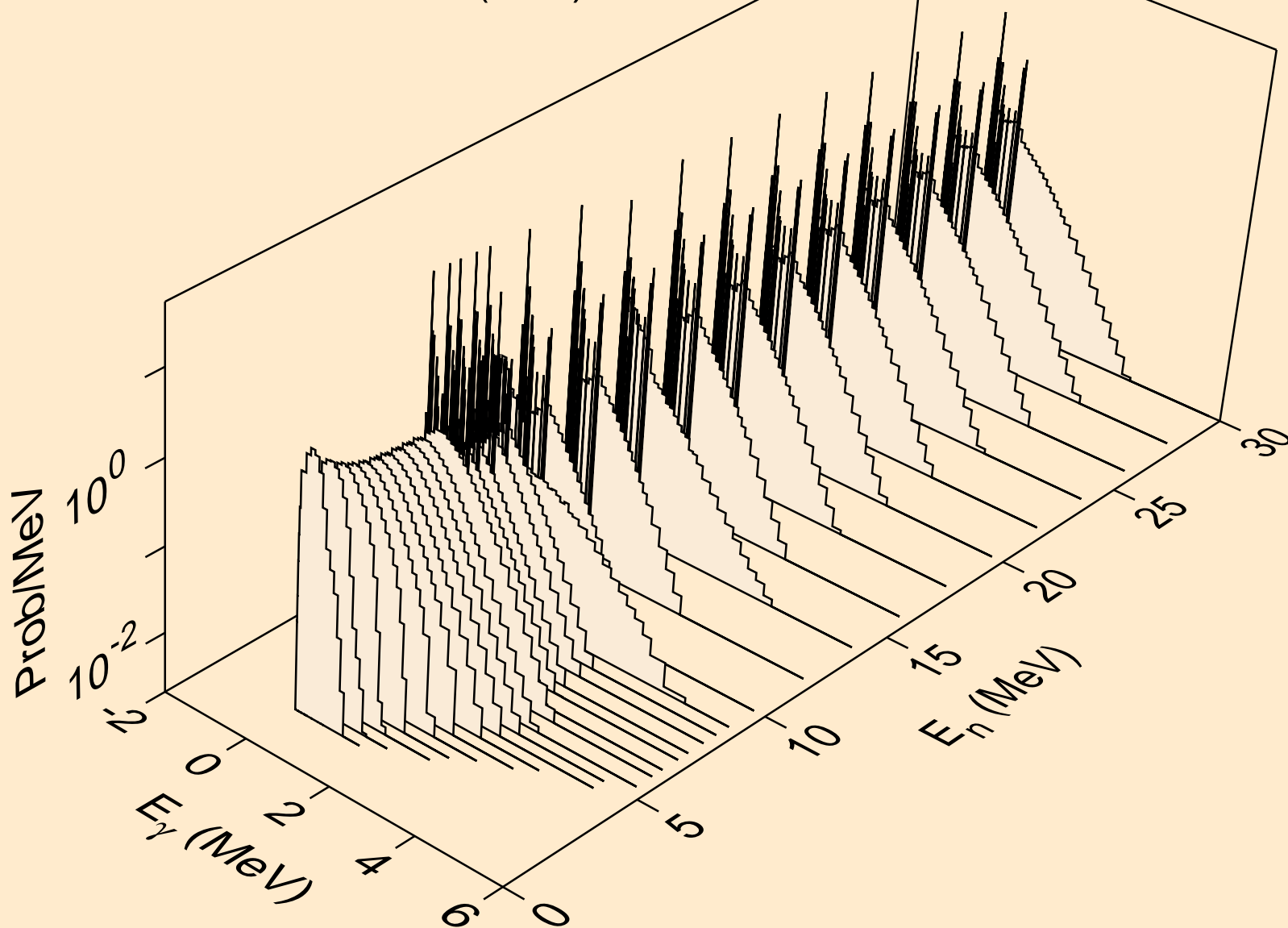

RF257M NEUTRON ACER TENDL-2019 LIBRARY; T=293.16K
Photon emission for (n,2n)2a

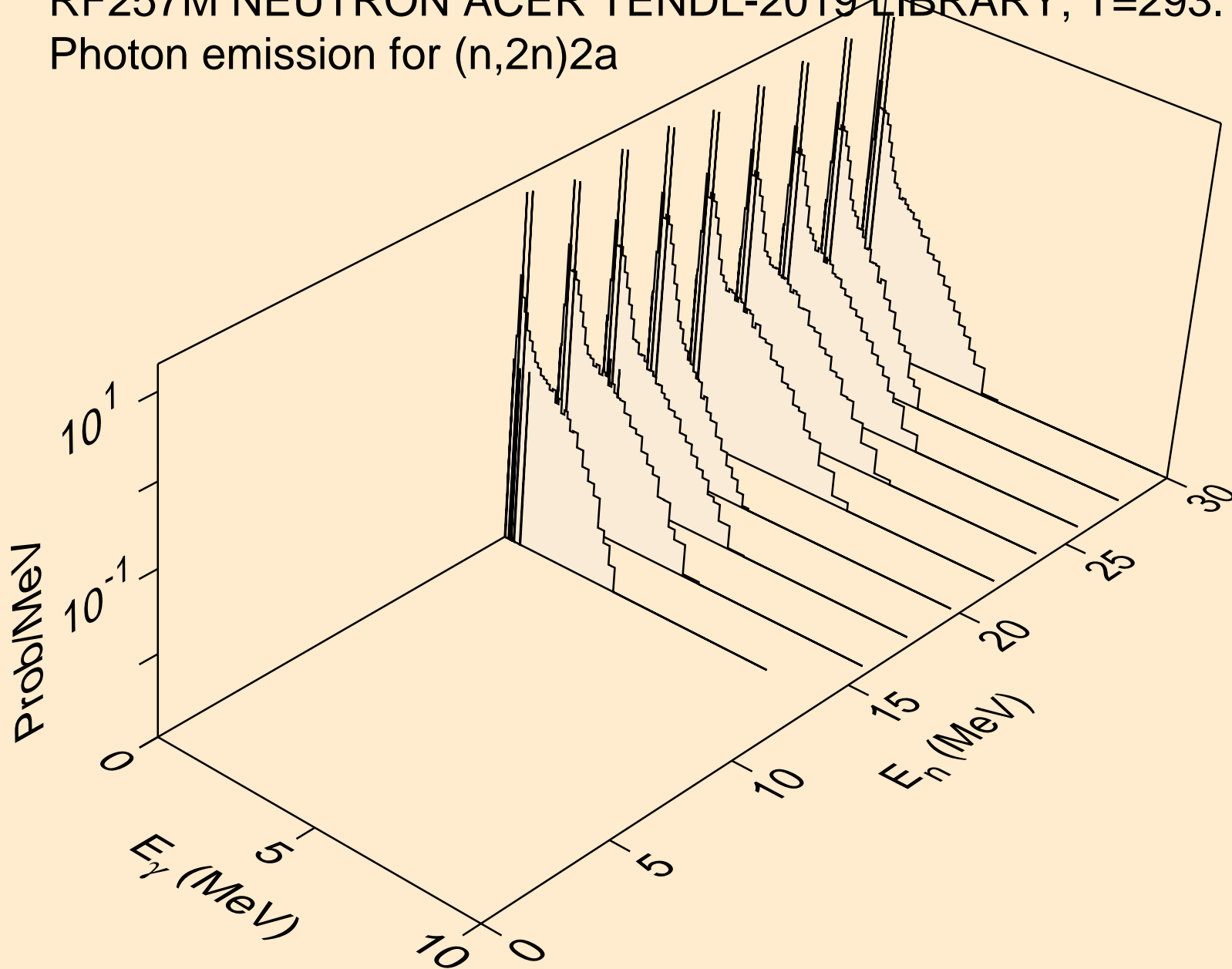

RF257M NEUTRON ACER TENDL-2019 LIBRARY; T=293.16K
Photon emission for (n,n*)d

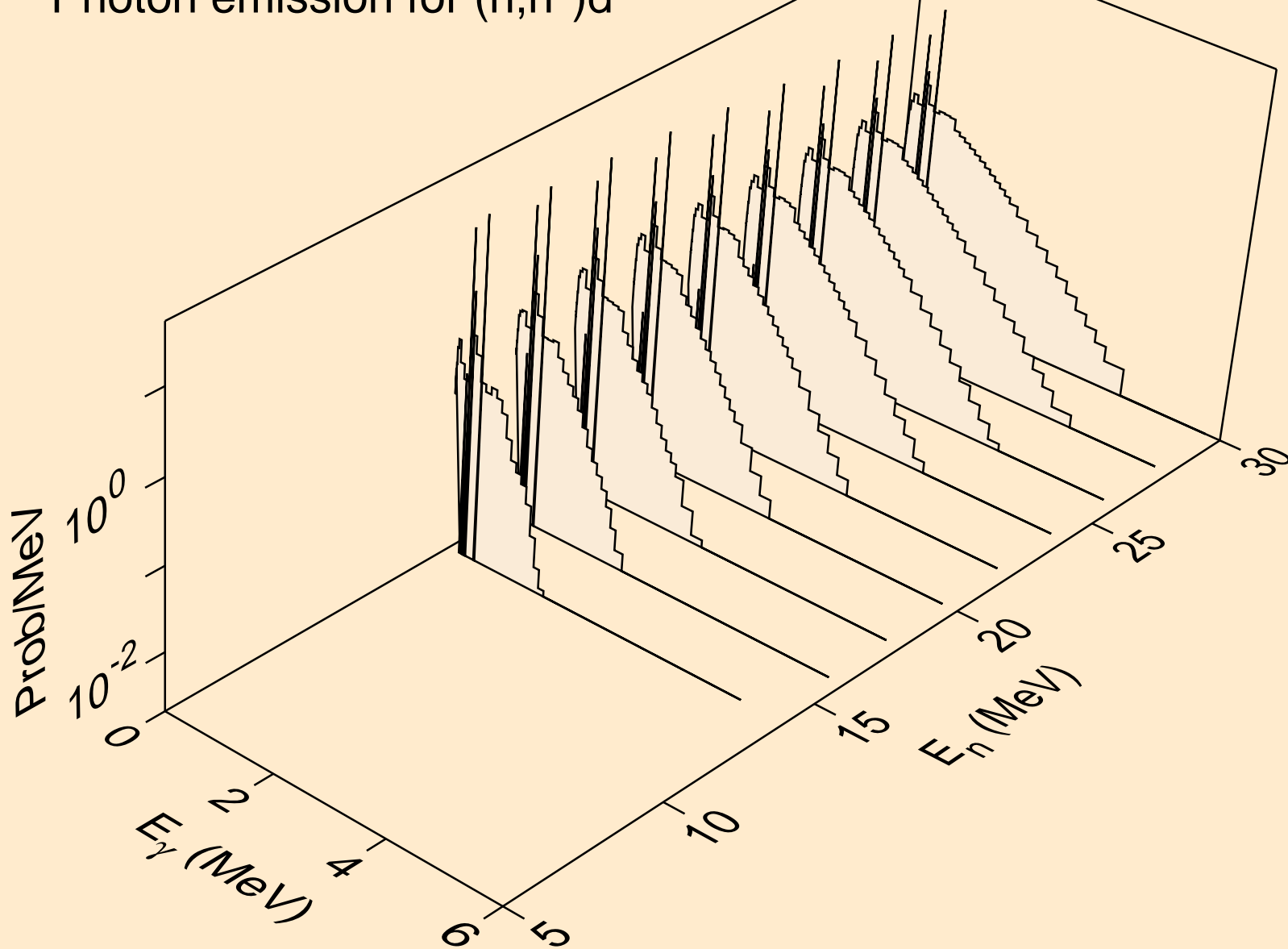

RF257M NEUTRON ACER TENDL-2019 LIBRARY; T=293.16K
Photon emission for (n,n*)t

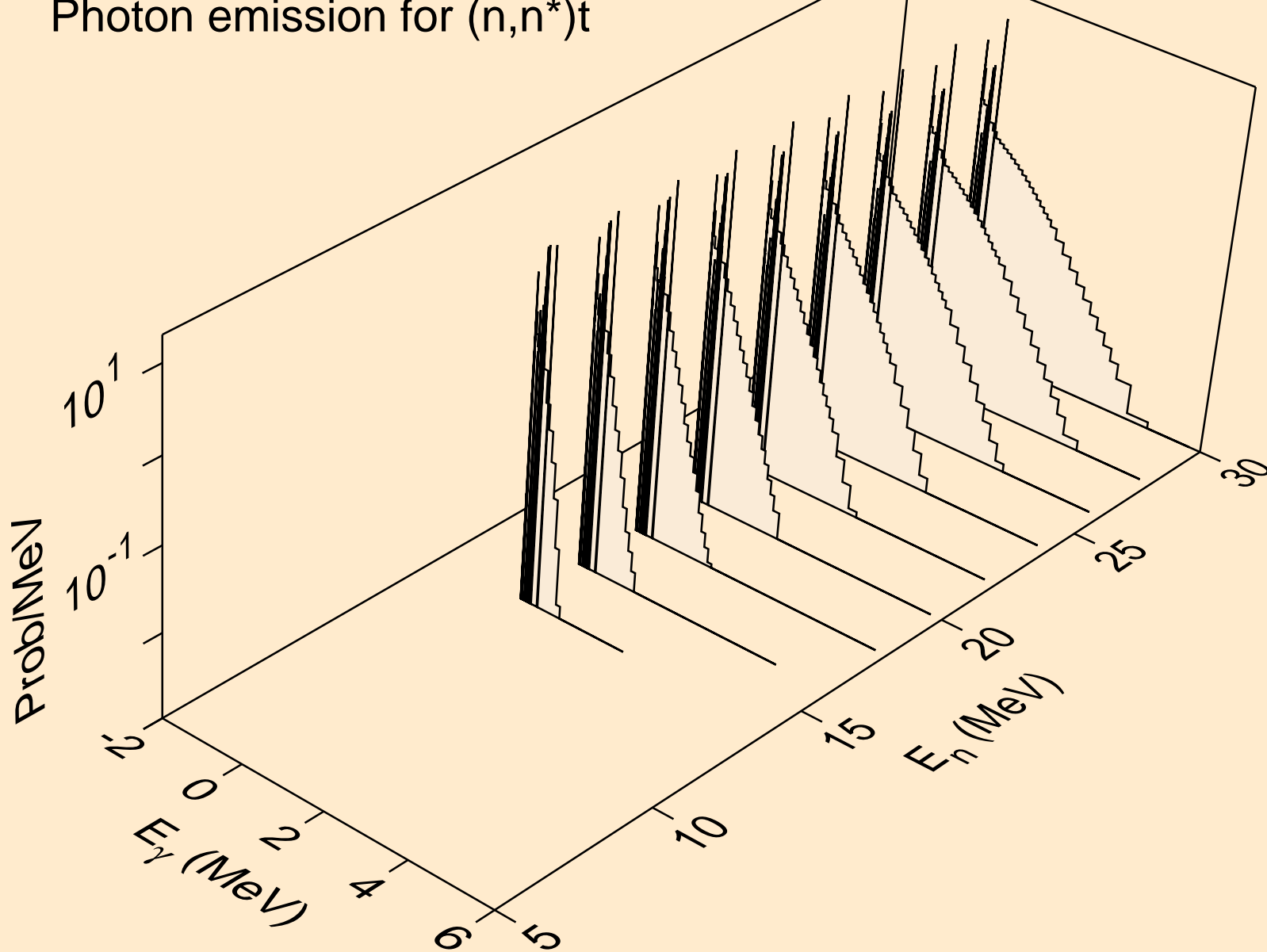

RF257M NEUTRON ACER TENDL-2019 LIBRARY; T=293.16K
Photon emission for (n,n*)he3

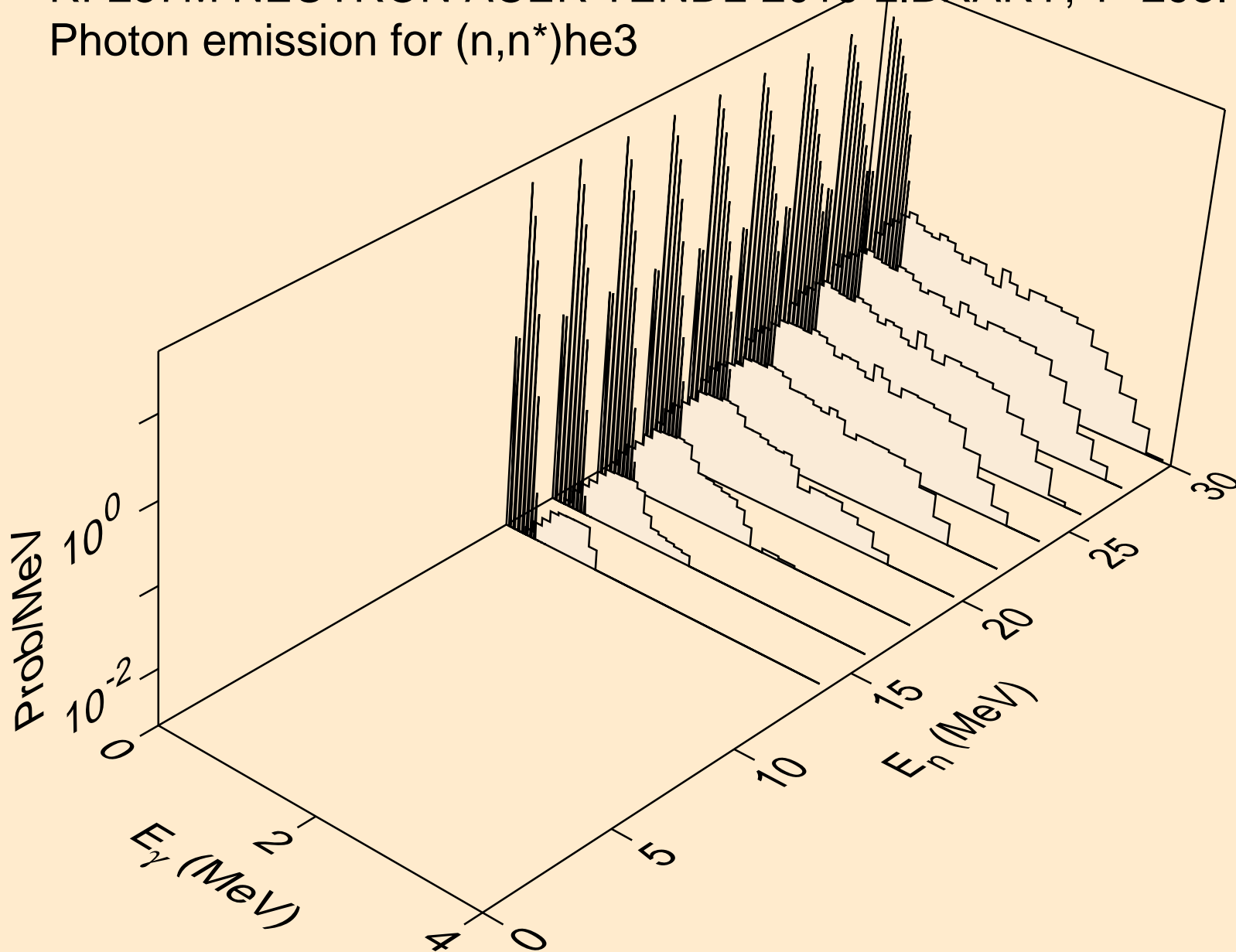

RF257M NEUTRON ACER TENDL-2019 LIBRARY; T=293.16K
Photon emission for (n,4n)

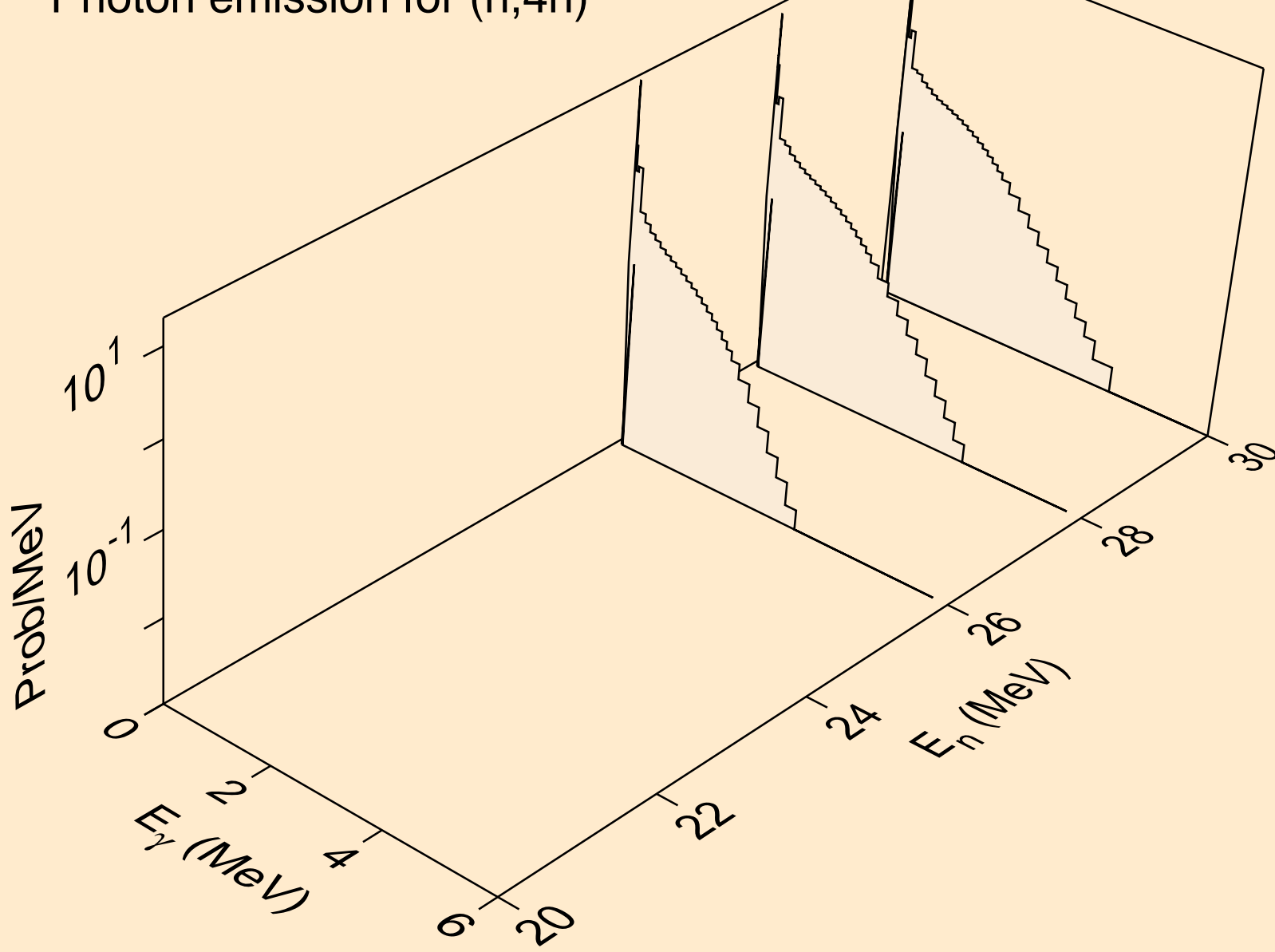

RF257M NEUTRON ACER TENDL-2019 LIBRARY; T=293.16K
Photon emission for (n,2np)

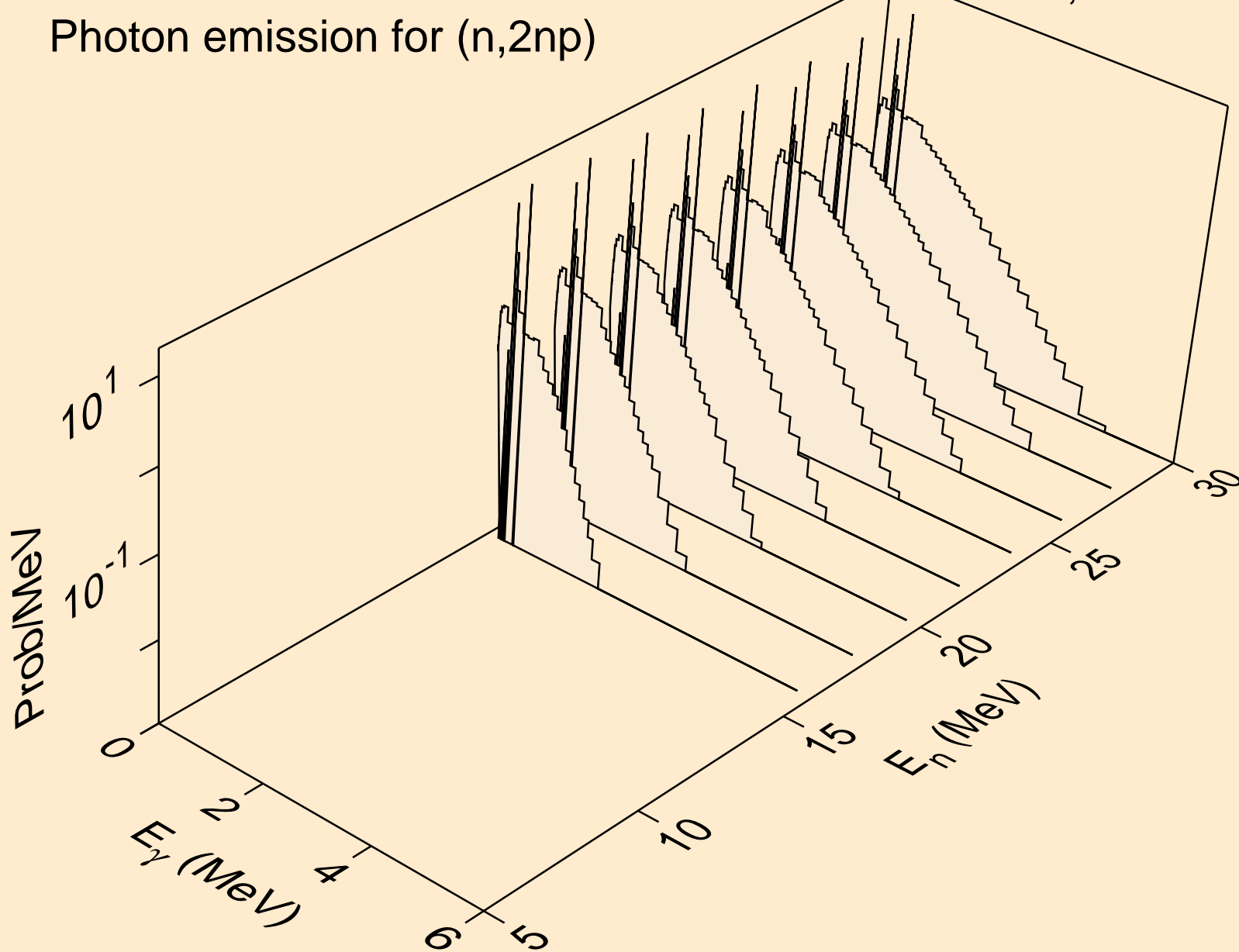

RF257M NEUTRON ACER TENDL-2019 LIBRARY; T=293.16K
Photon emission for (n,3np)

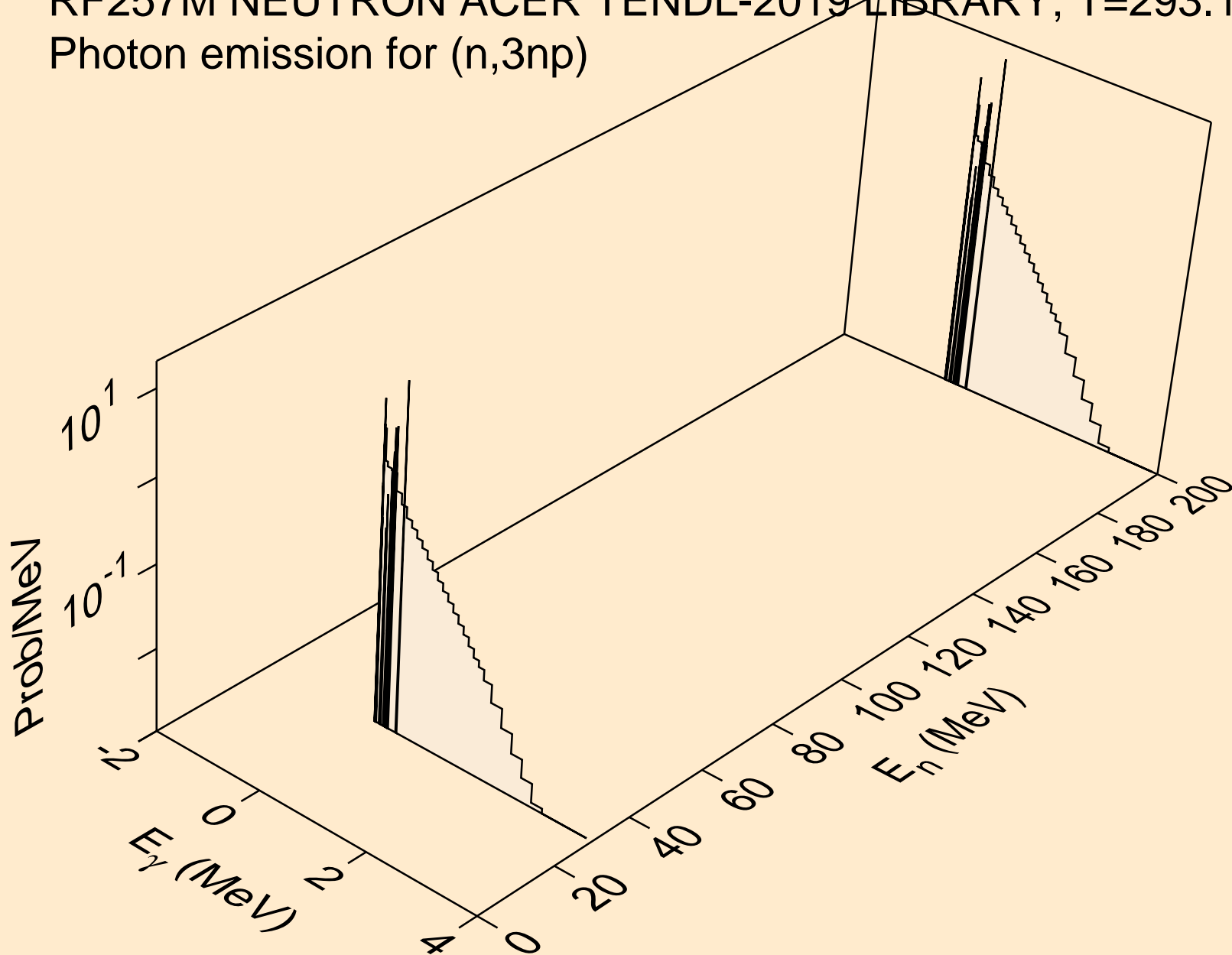

RF257M NEUTRON ACER TENDL-2019 LIBRARY; T=293.16K
Photon emission for (n,2np)

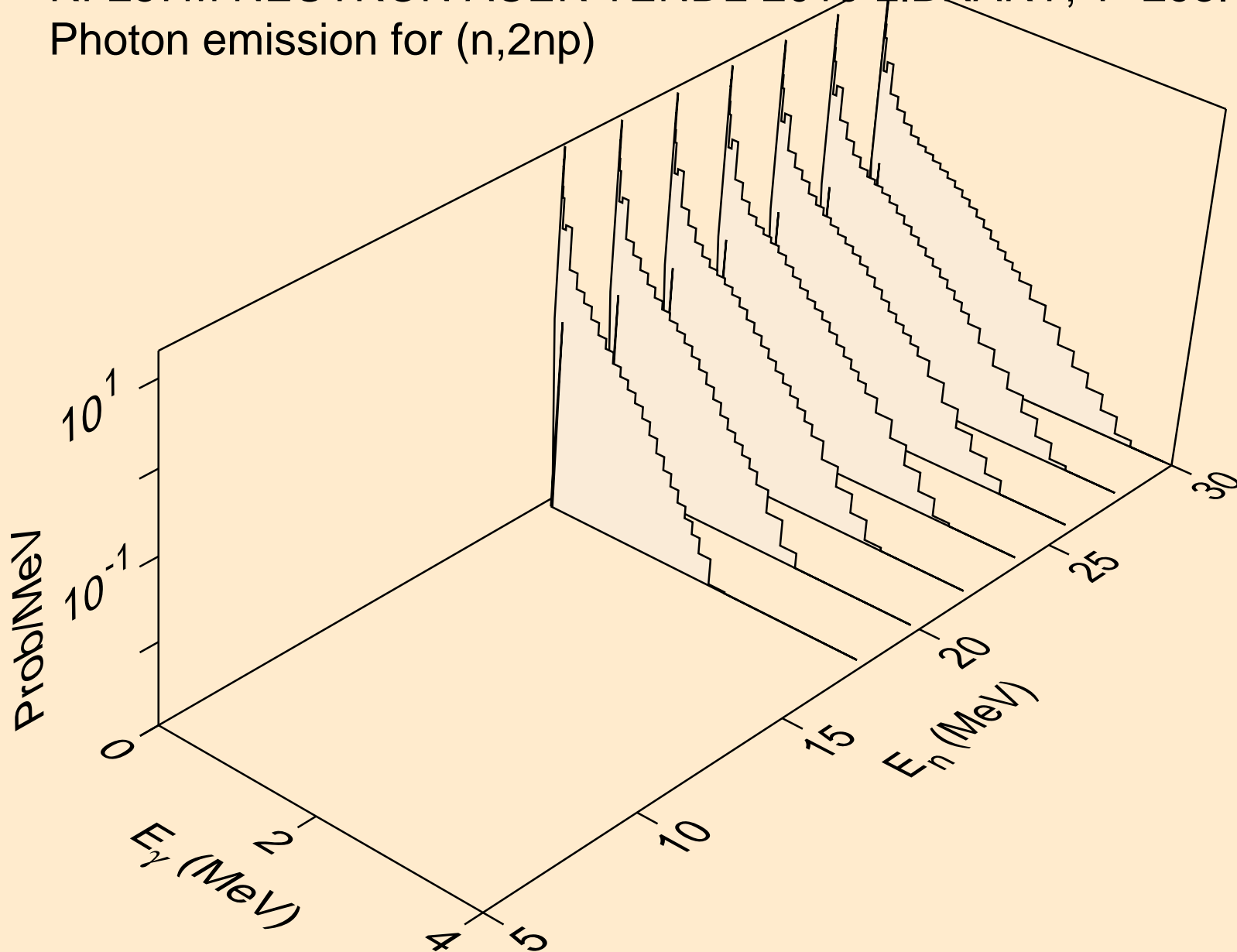

RF257M NEUTRON ACER TENDL-2019 LIBRARY; T=293.16K
Photon emission for (n,npa)

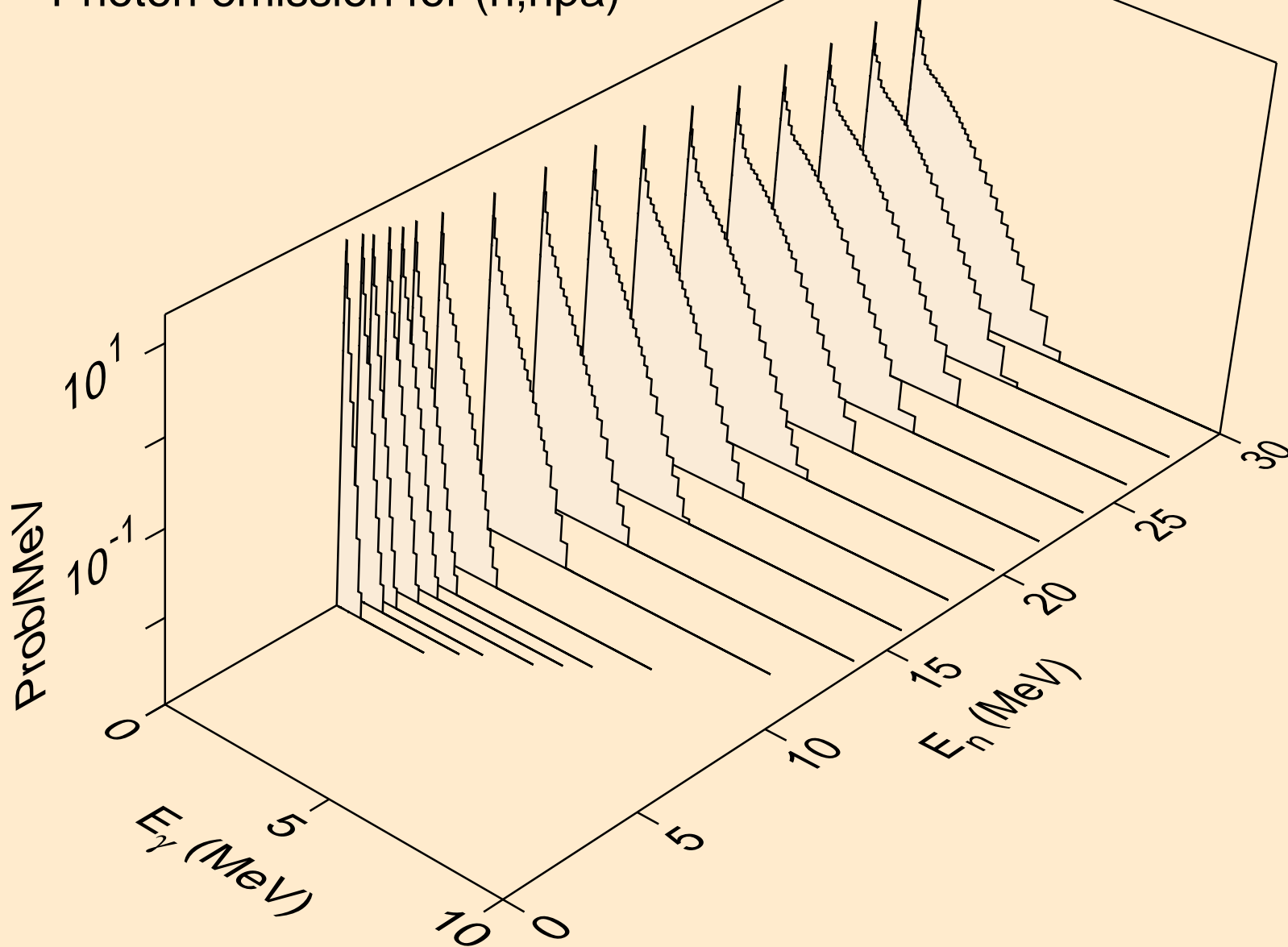

RF257M NEUTRON ACER TENDL-2019 LIBRARY; T=293.16K
Photon emission for (n,n*1)

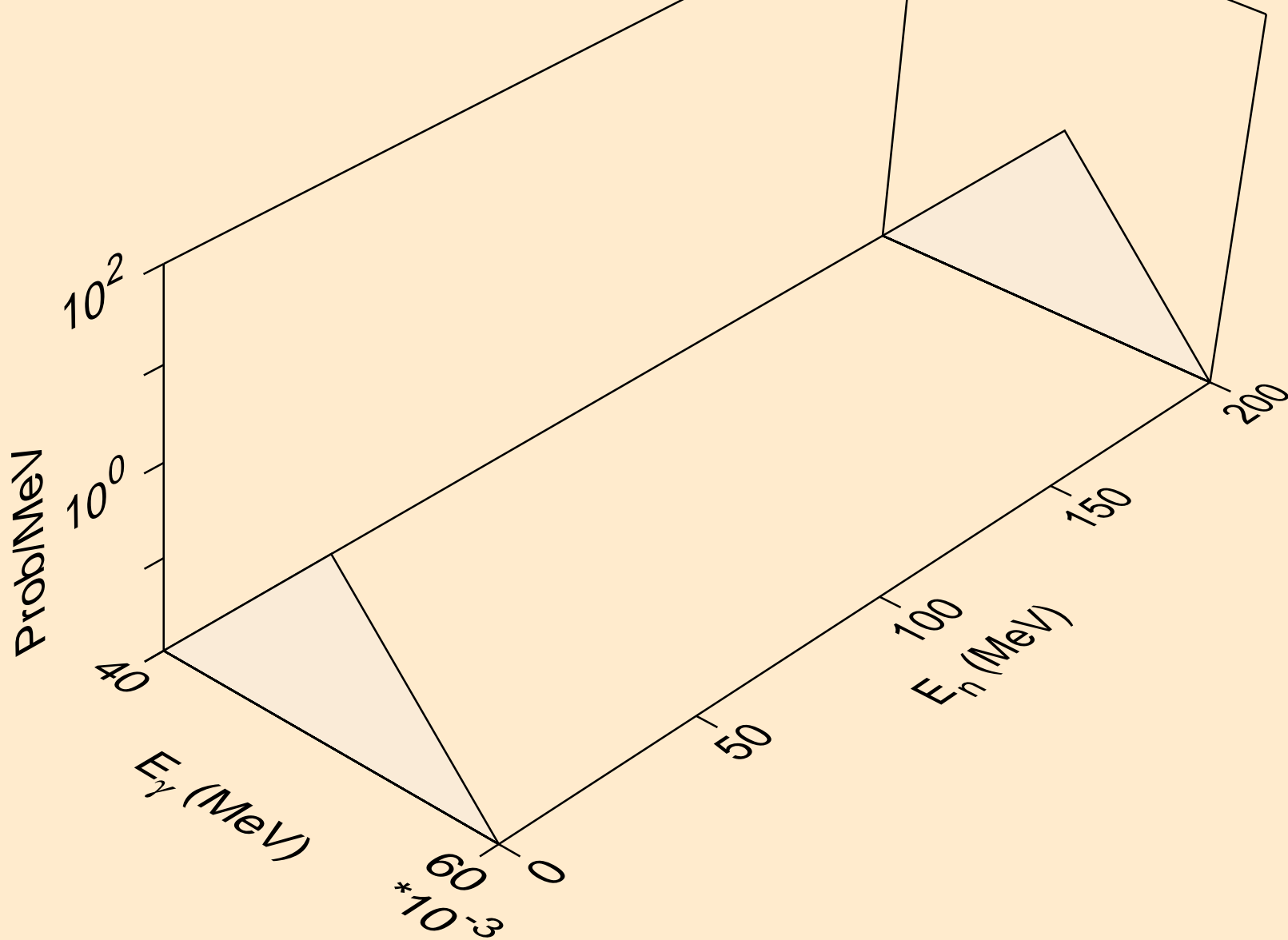

RF257M NEUTRON ACER TENDL-2019 LIBRARY; T=293.16K
Photon emission for (n,n*3)

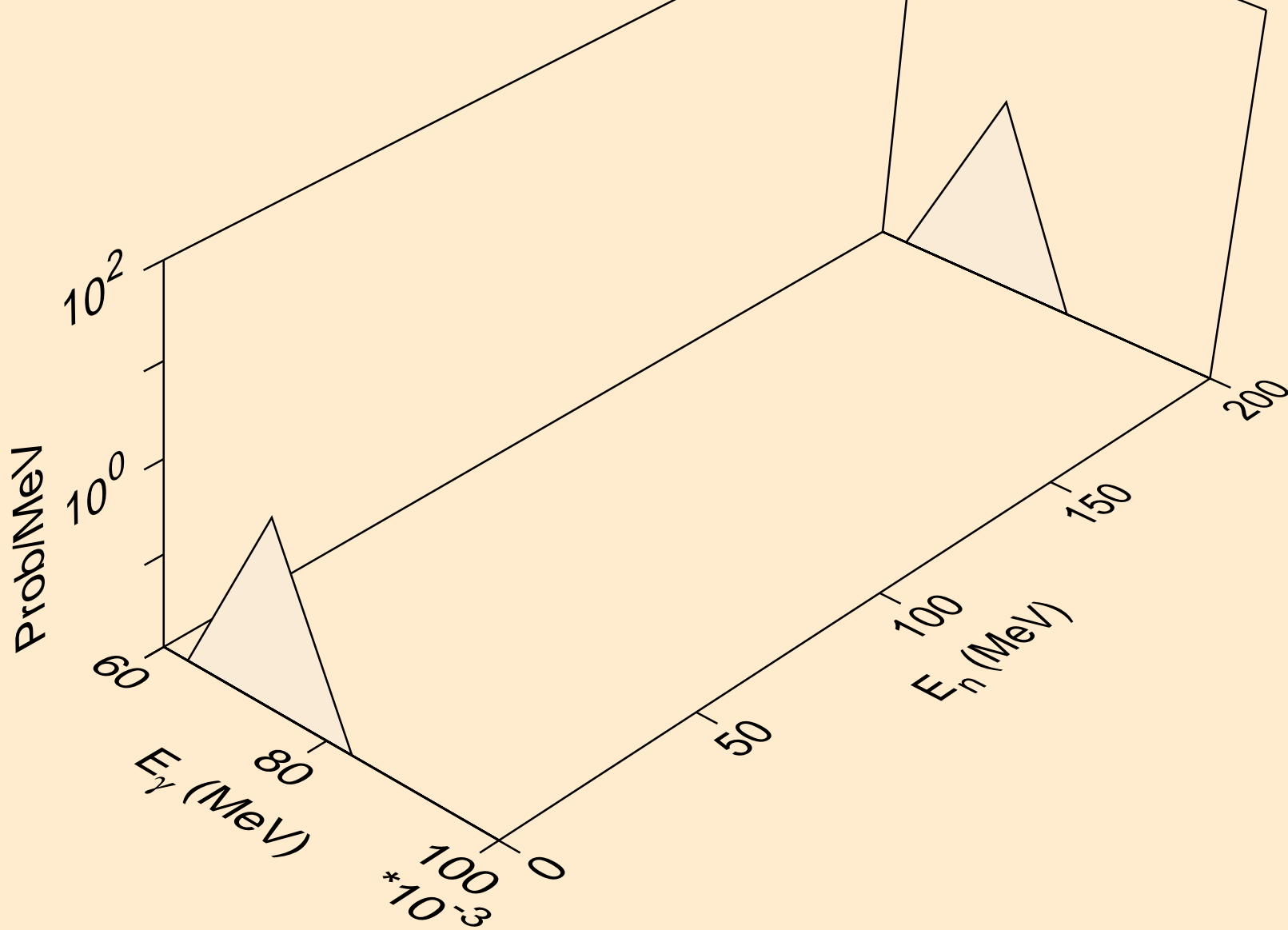

RF257M NEUTRON ACER TENDL-2019 LIBRARY; T=293.16K
Photon emission for (n,n*4)

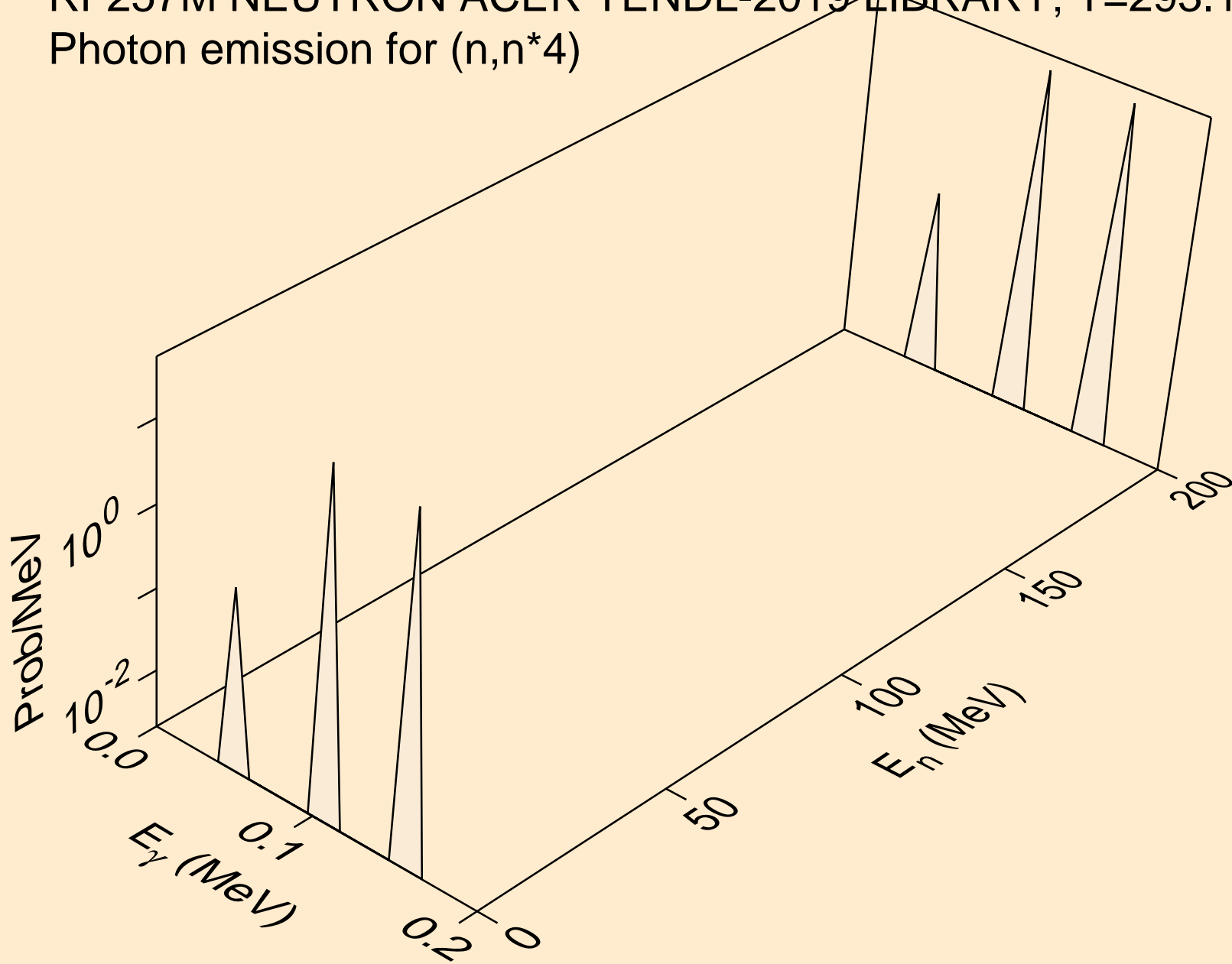

RF257M NEUTRON ACER TENDL-2019 LIBRARY; T=293.16K
Photon emission for (n,n*5)

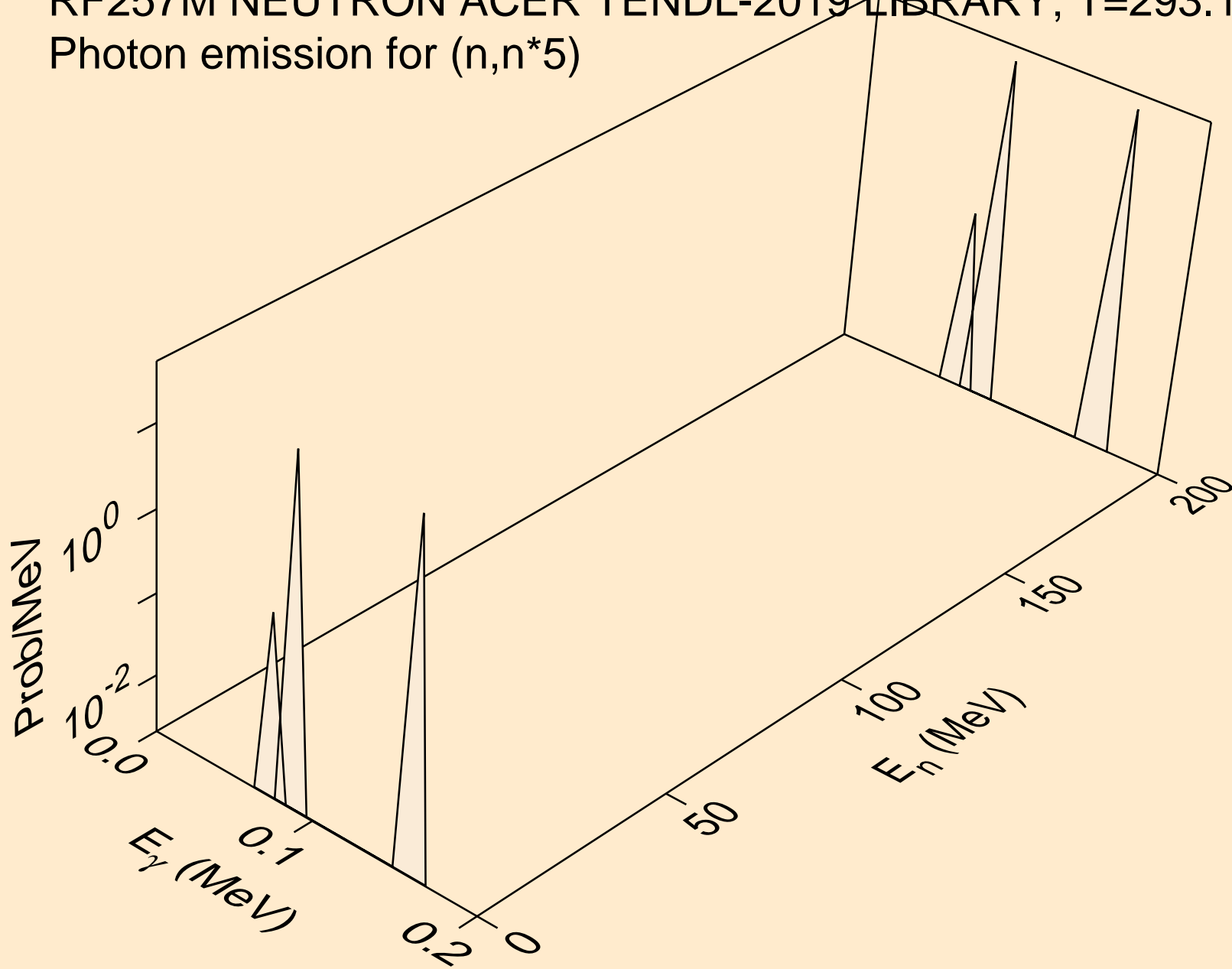

RF257M NEUTRON ACER TENDL-2019 LIBRARY; T=293.16K
Photon emission for (n,n*6)

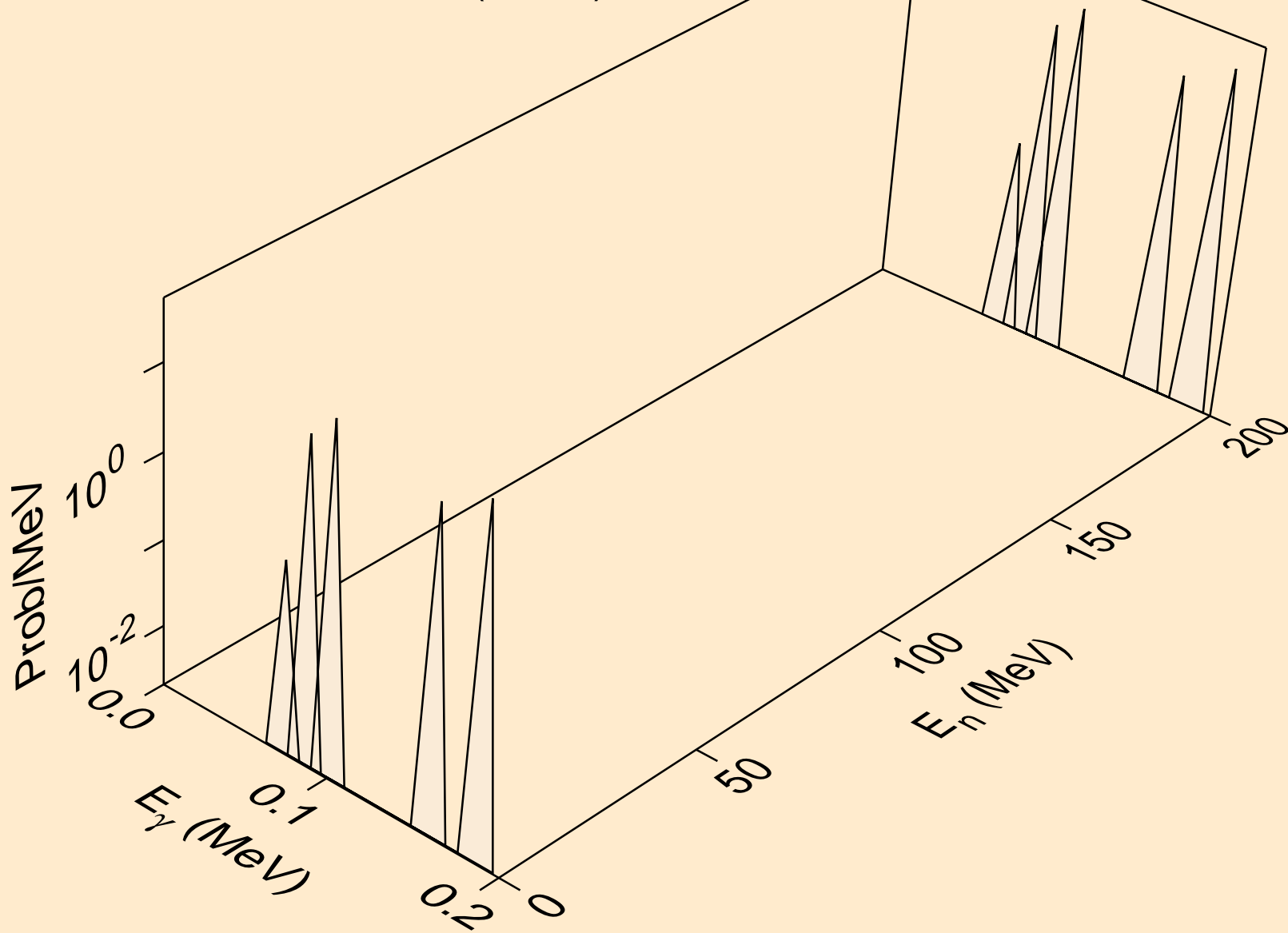

RF257M NEUTRON ACER TENDL-2019 LIBRARY; T=293.16K
Photon emission for (n,n*7)

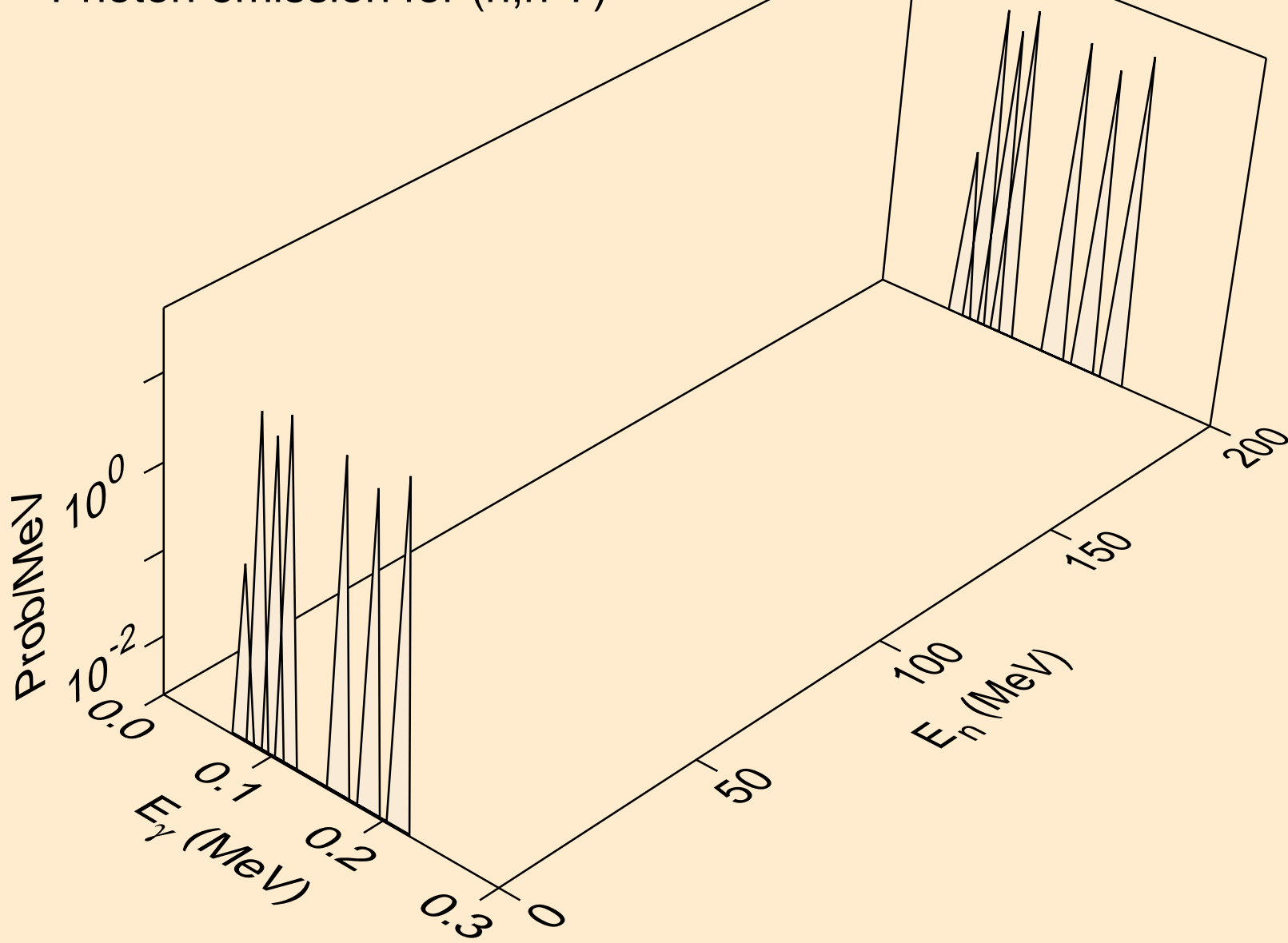

RF257M NEUTRON ACER TENDL-2019 LIBRARY; T=293.16K
Photon emission for (n,n*8)

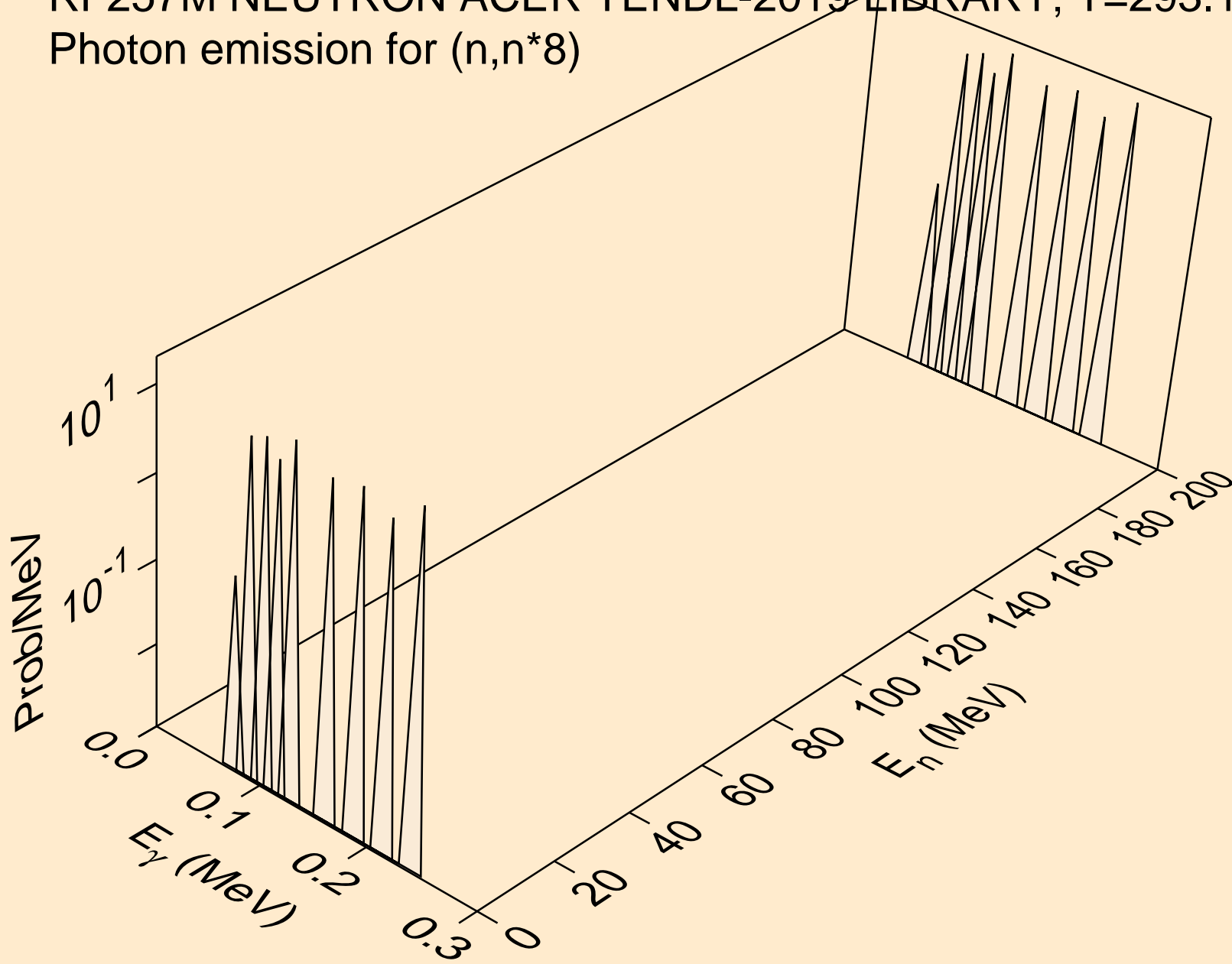

RF257M NEUTRON ACER TENDL-2019 LIBRARY; T=293.16K
Photon emission for (n,n*9)

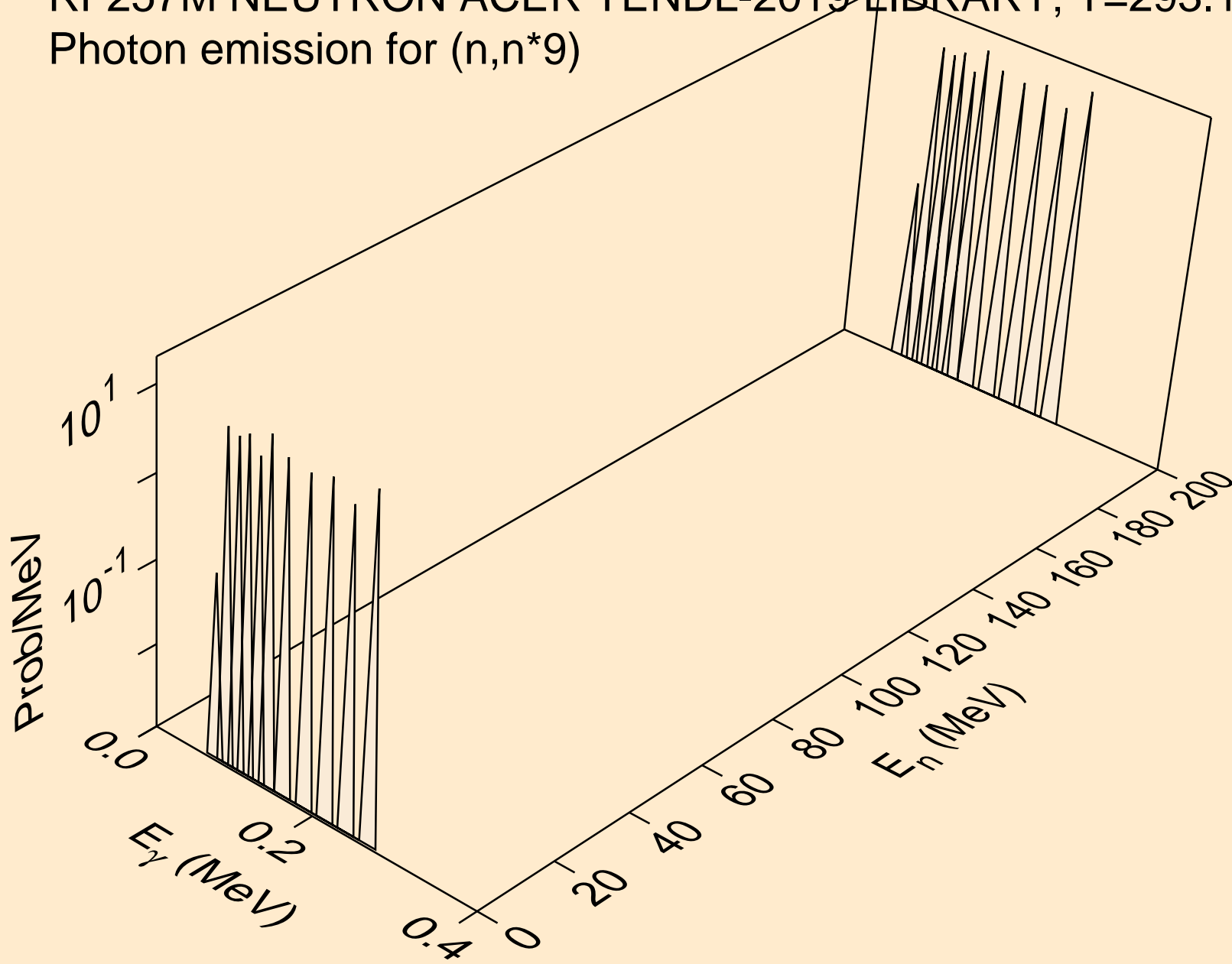

RF257M NEUTRON ACER TENDL-2019 LIBRARY; T=293.16K
Photon emission for (n,n*10)

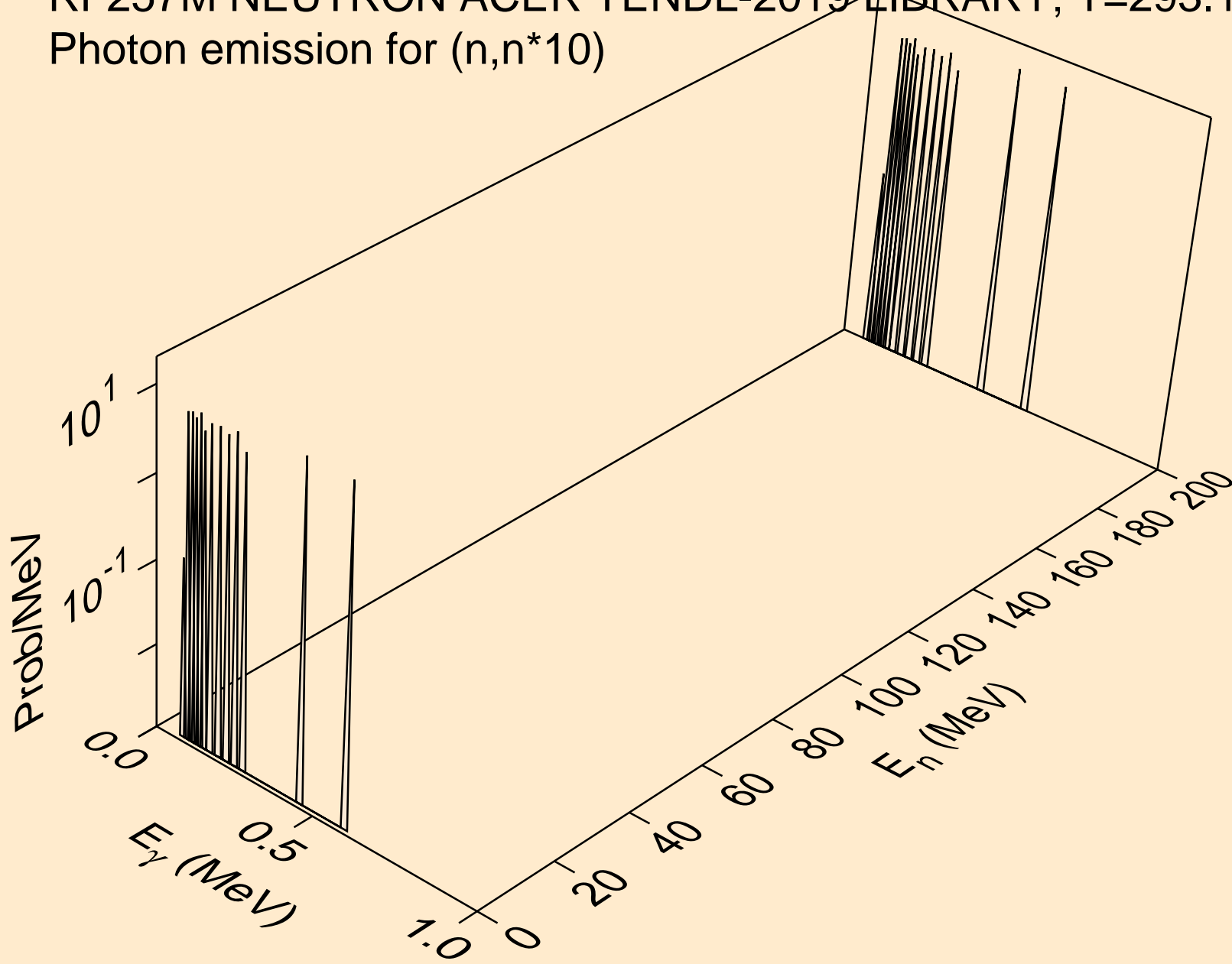

RF257M NEUTRON ACER TENDL-2019 LIBRARY; T=293.16K
Photon emission for (n,n*11)

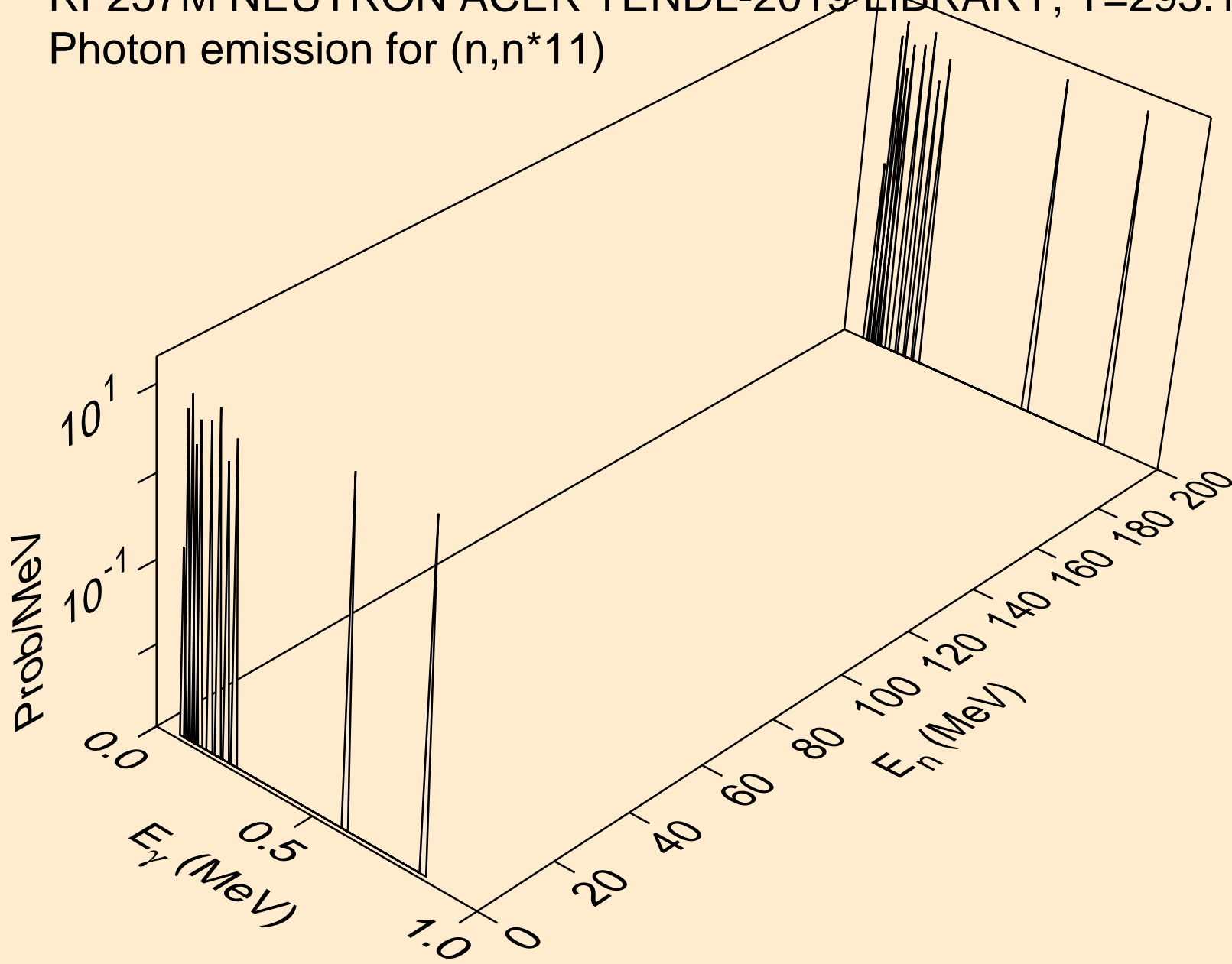

RF257M NEUTRON ACER TENDL-2019 LIBRARY; T=293.16K
Photon emission for (n,n*12)

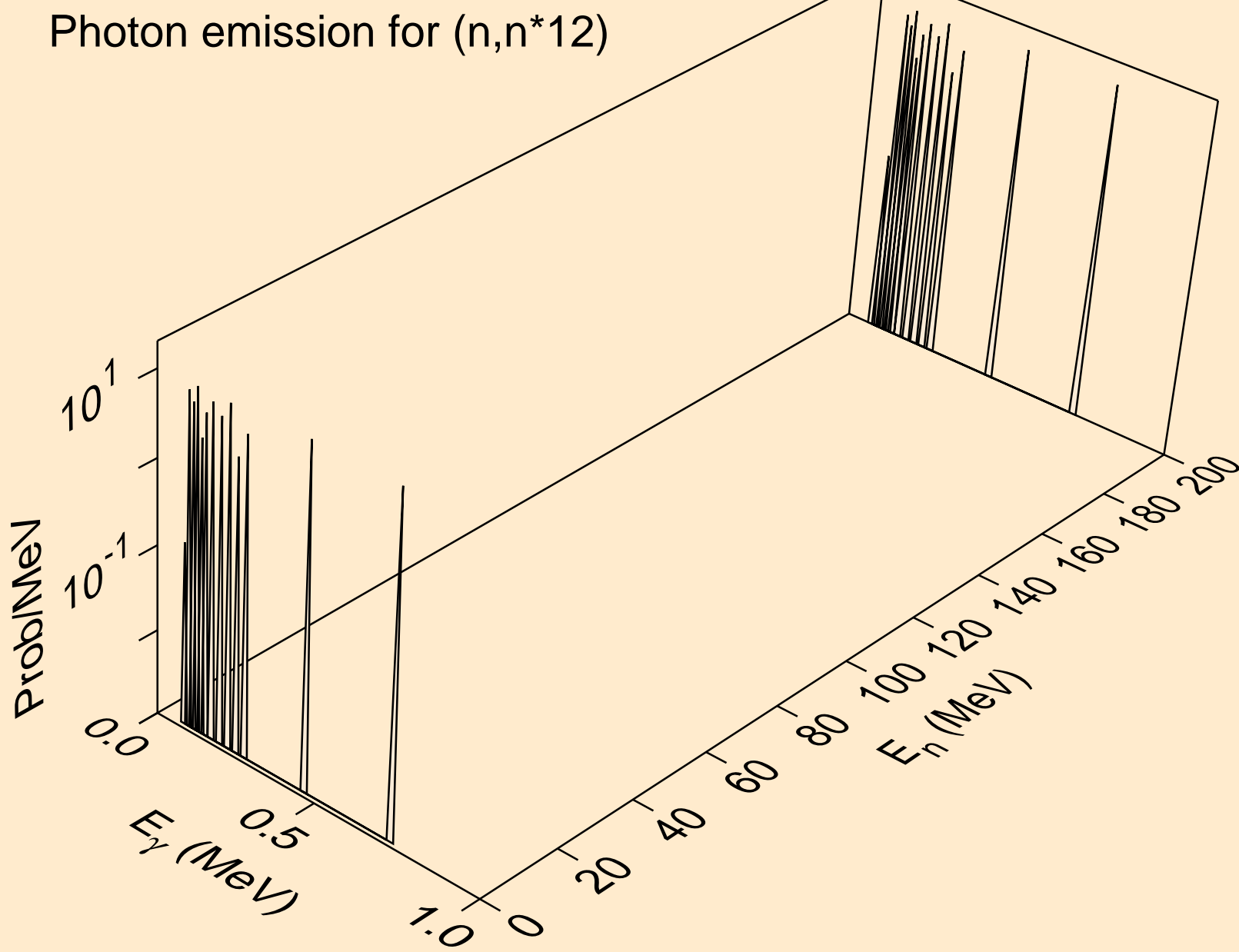

RF257M NEUTRON ACER TENDL-2019 LIBRARY; T=293.16K
Photon emission for (n,n*13)

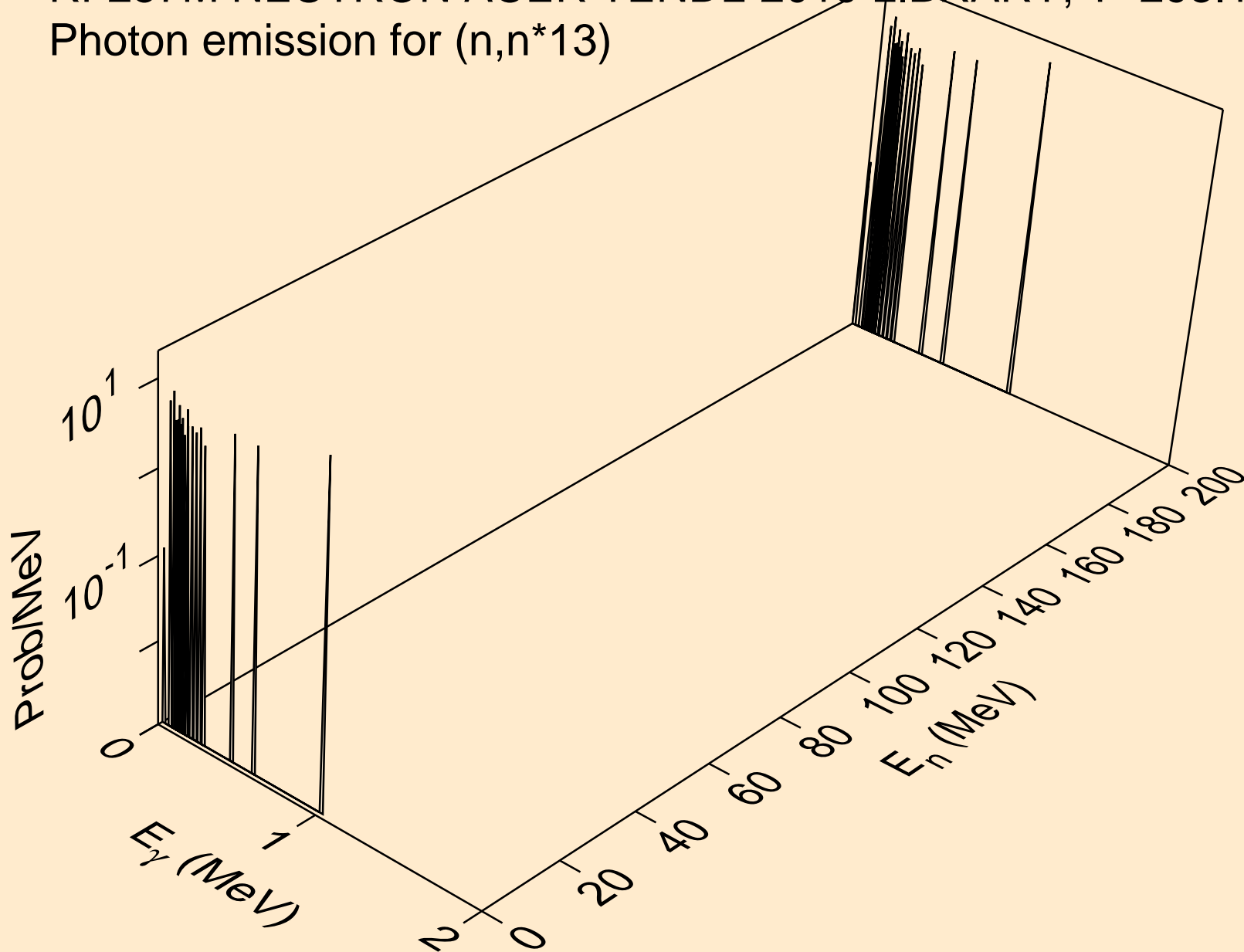

RF257M NEUTRON ACER TENDL-2019 LIBRARY; T=293.16K
Photon emission for (n,n*c)

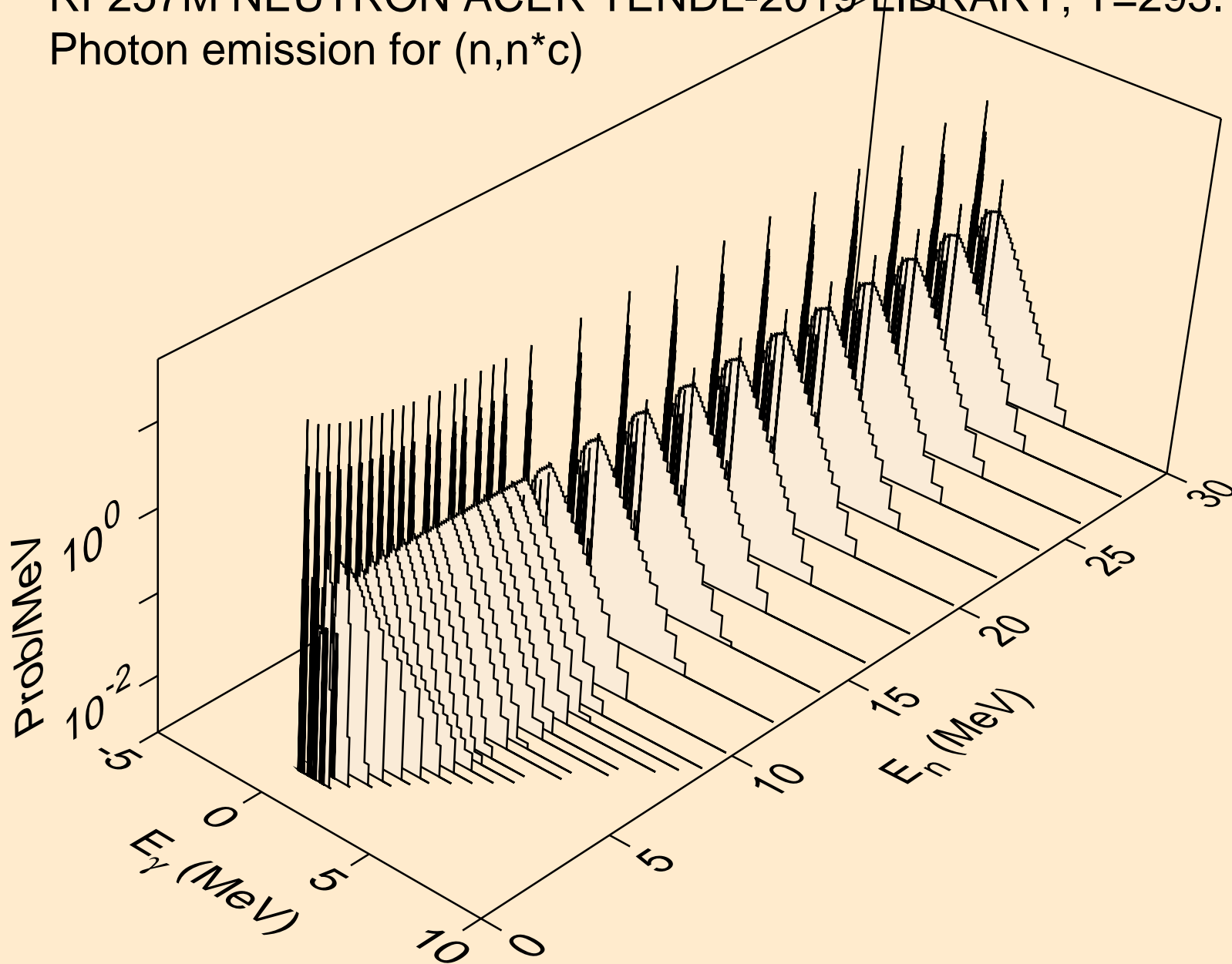

RF257M NEUTRON ACER TENDL-2019 LIBRARY; T=293.16K
Photon emission for (n,gma)

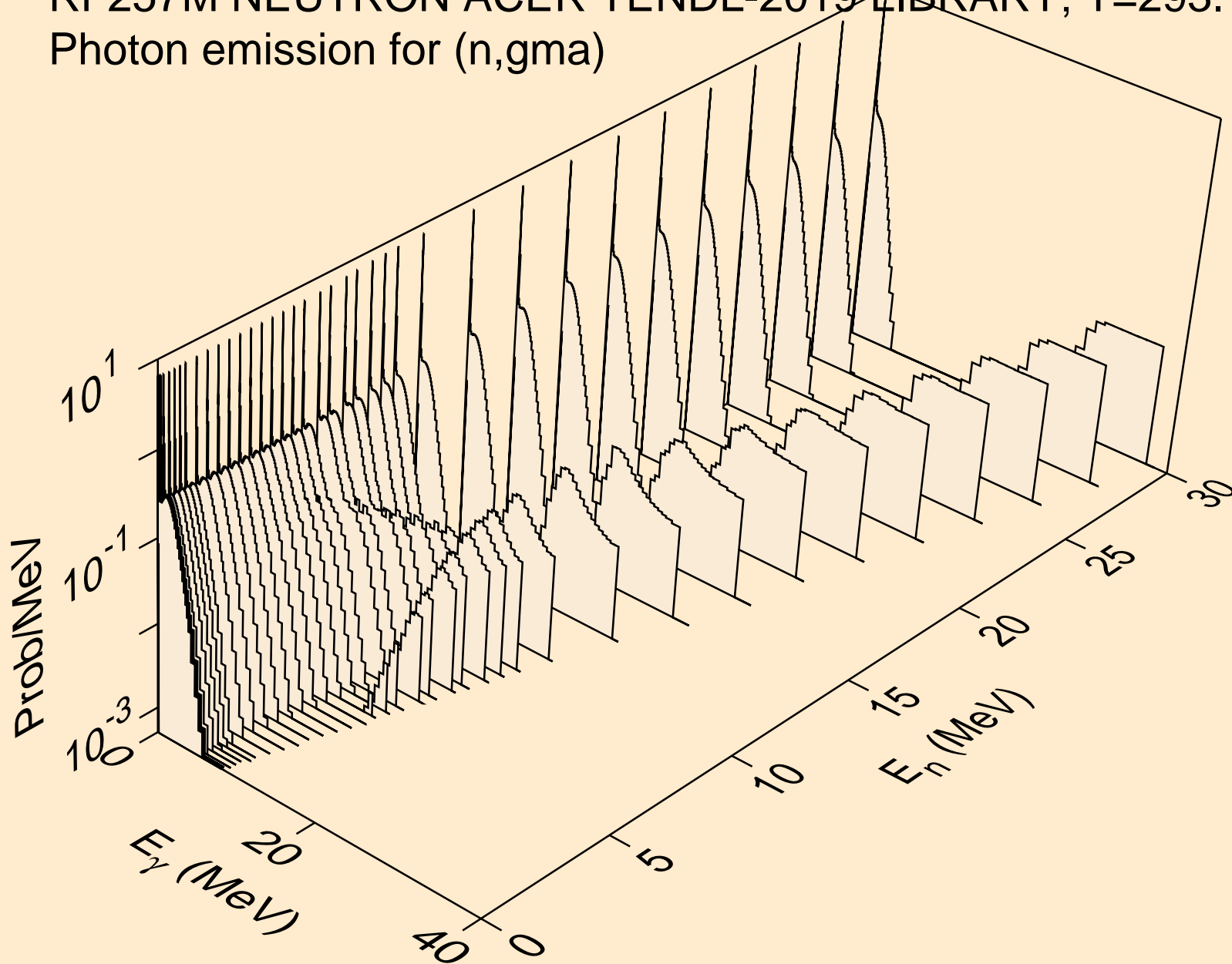

RF257M NEUTRON ACER TENDL-2019 LIBRARY; T=293.16K
Photon emission for (n,p)

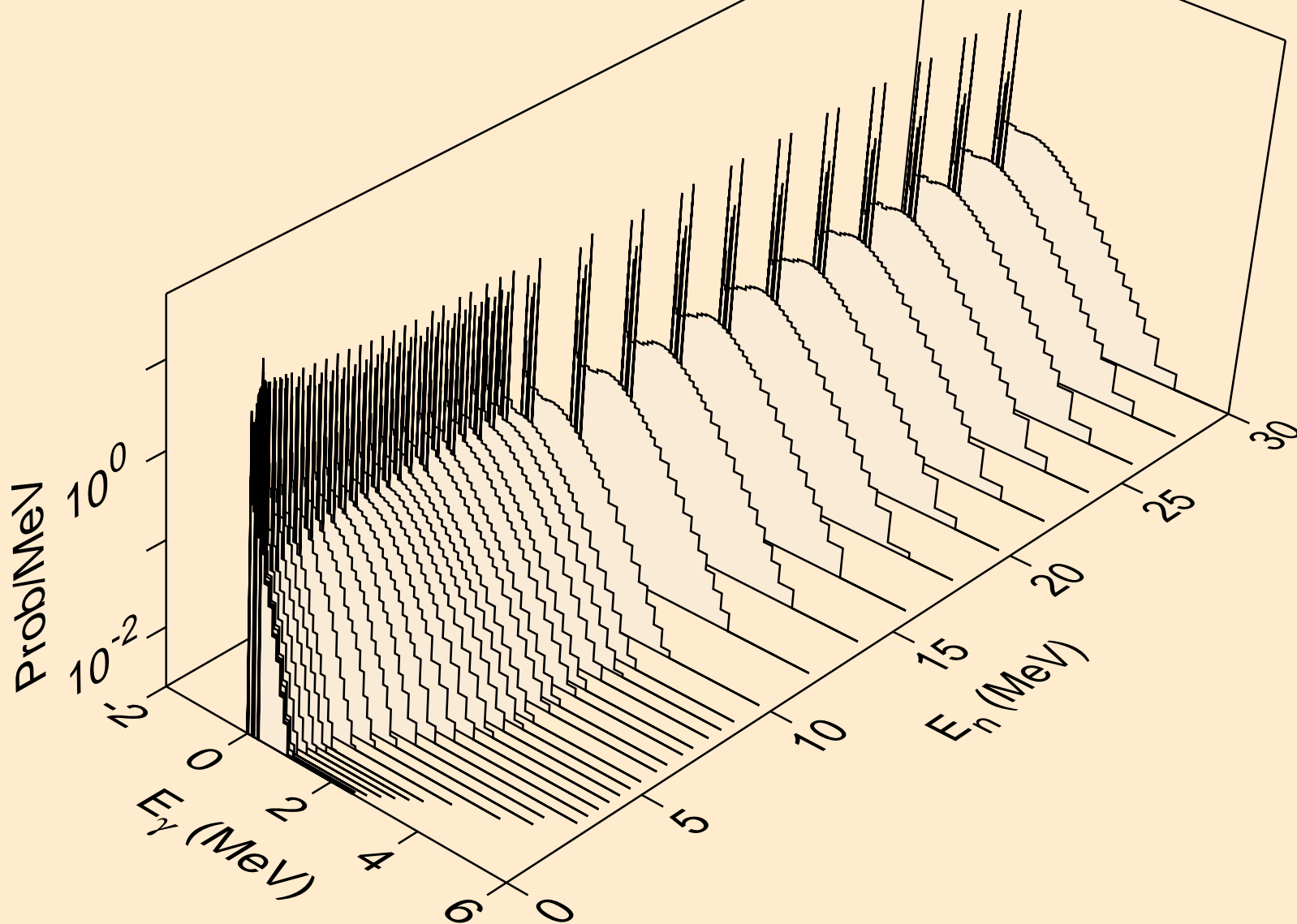

RF257M NEUTRON ACER TENDL-2019 LIBRARY; T=293.16K
Photon emission for (n,d)

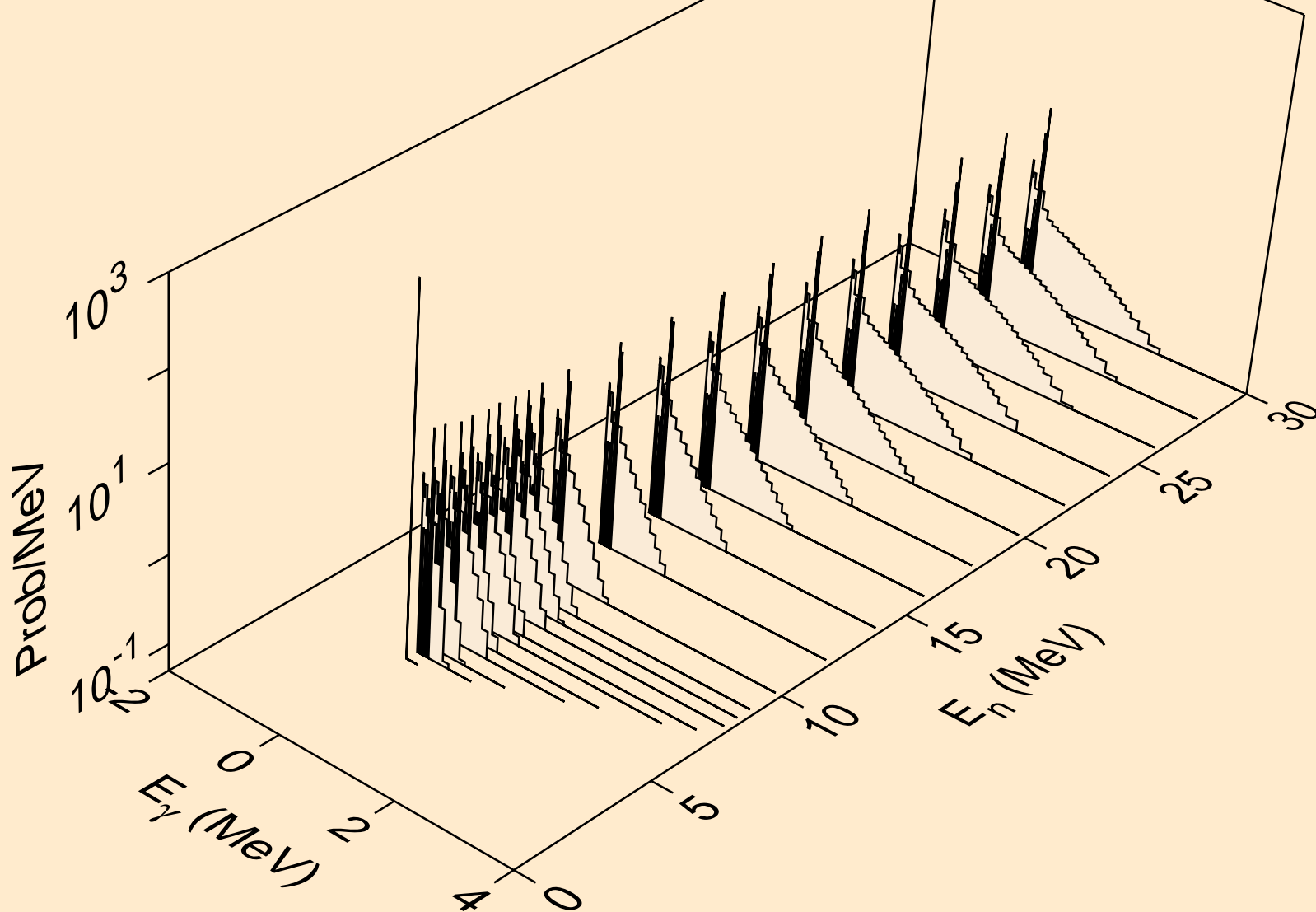

RF257M NEUTRON ACER TENDL-2019 LIBRARY; T=293.16K
Photon emission for (n,t)

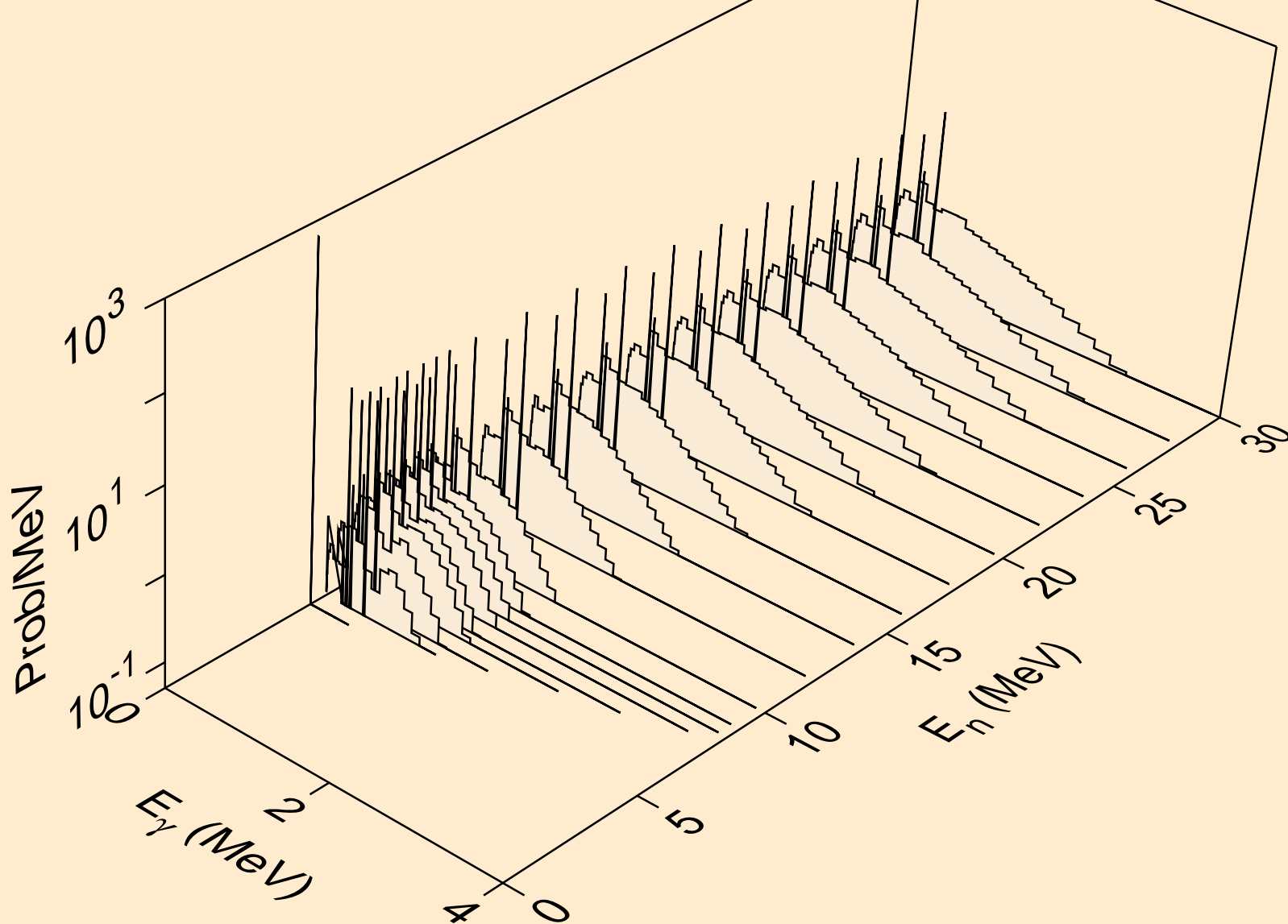

RF257M NEUTRON ACER TENDL-2019 LIBRARY; T=293.16K
Photon emission for (n,he3)

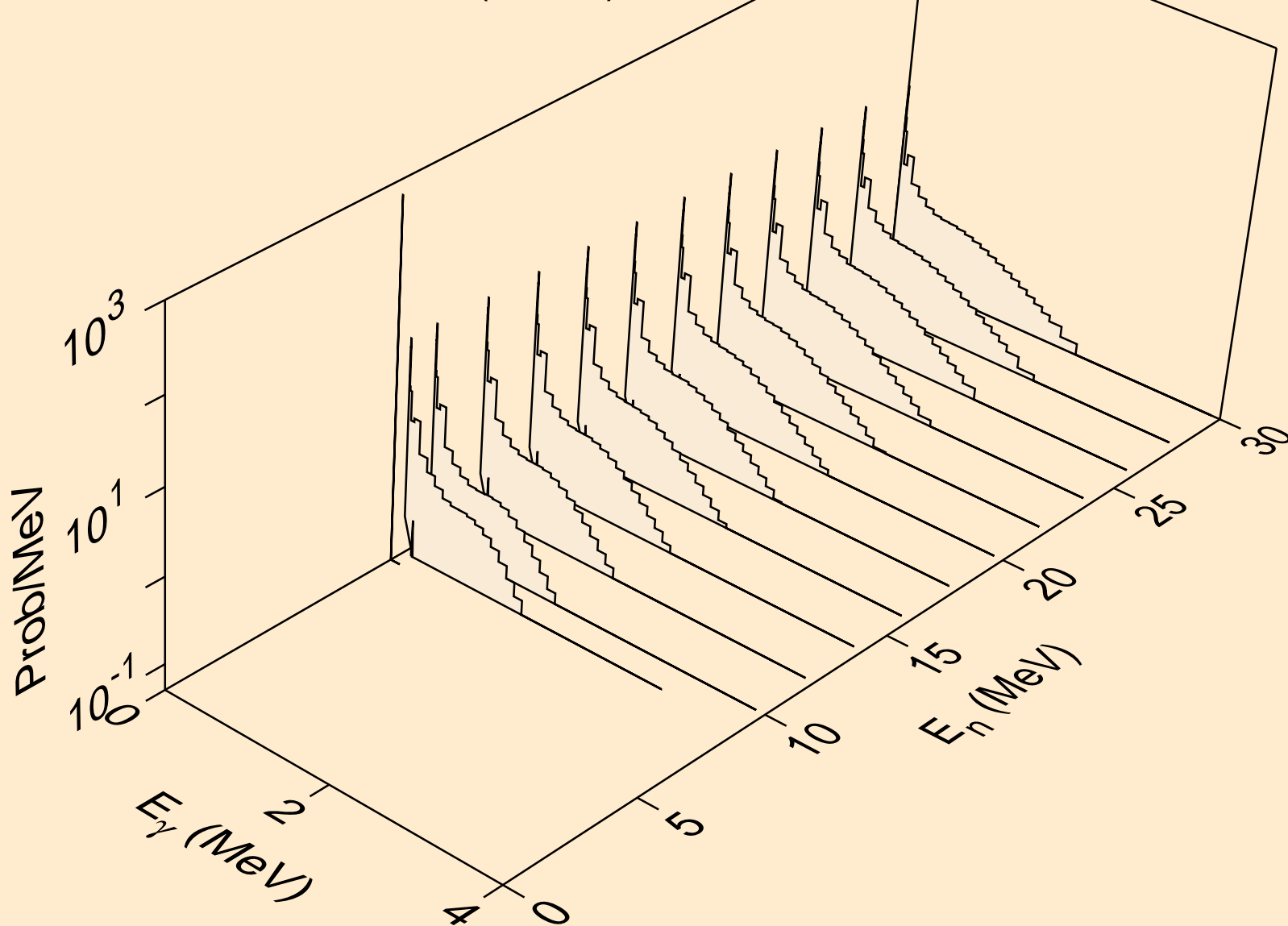

RF257M NEUTRON ACER TENDL-2019 LIBRARY; T=293.16K
Photon emission for (n,a)

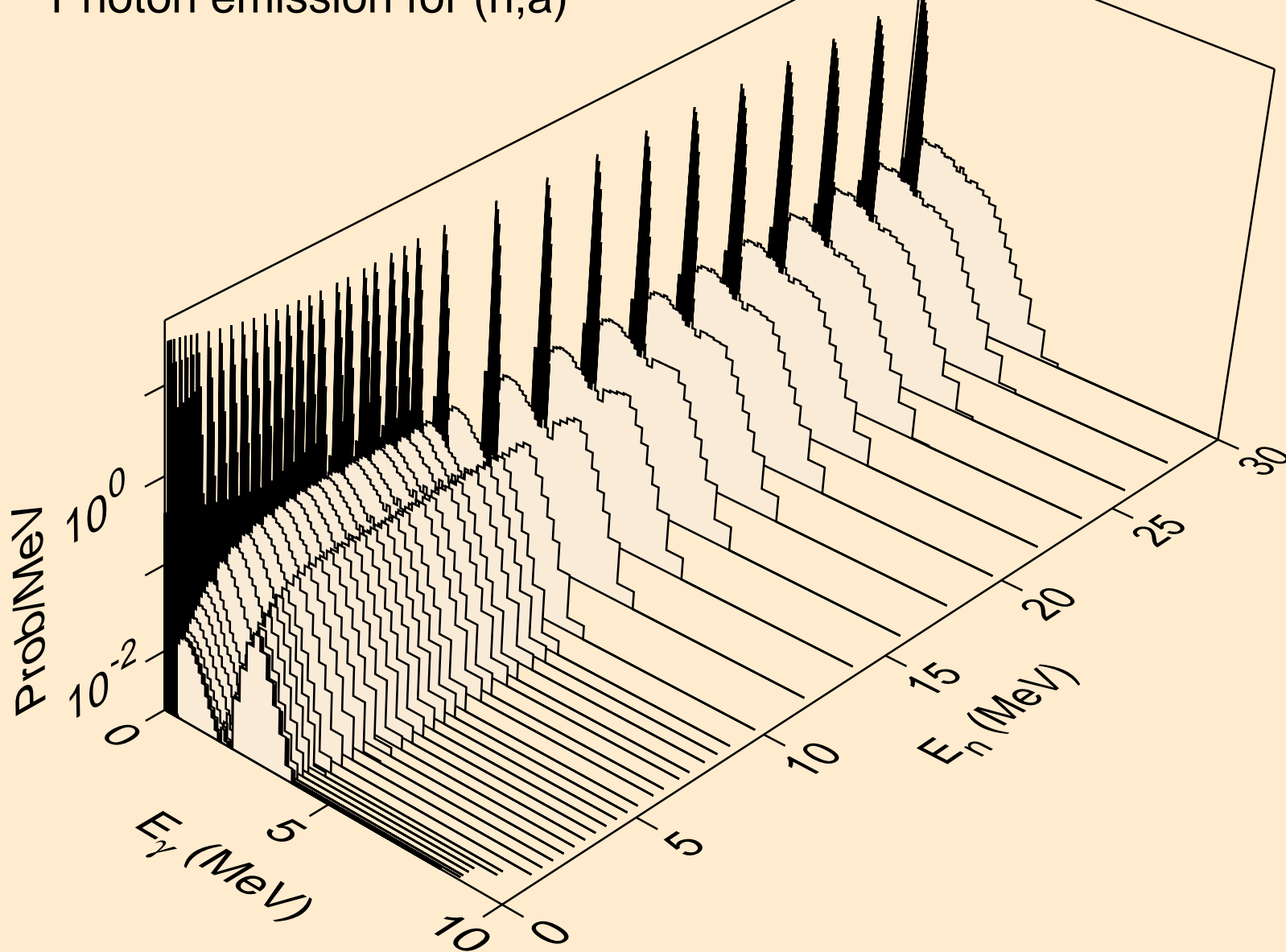

RF257M NEUTRON ACER TENDL-2019 LIBRARY; T=293.16K
Photon emission for (n,2a)

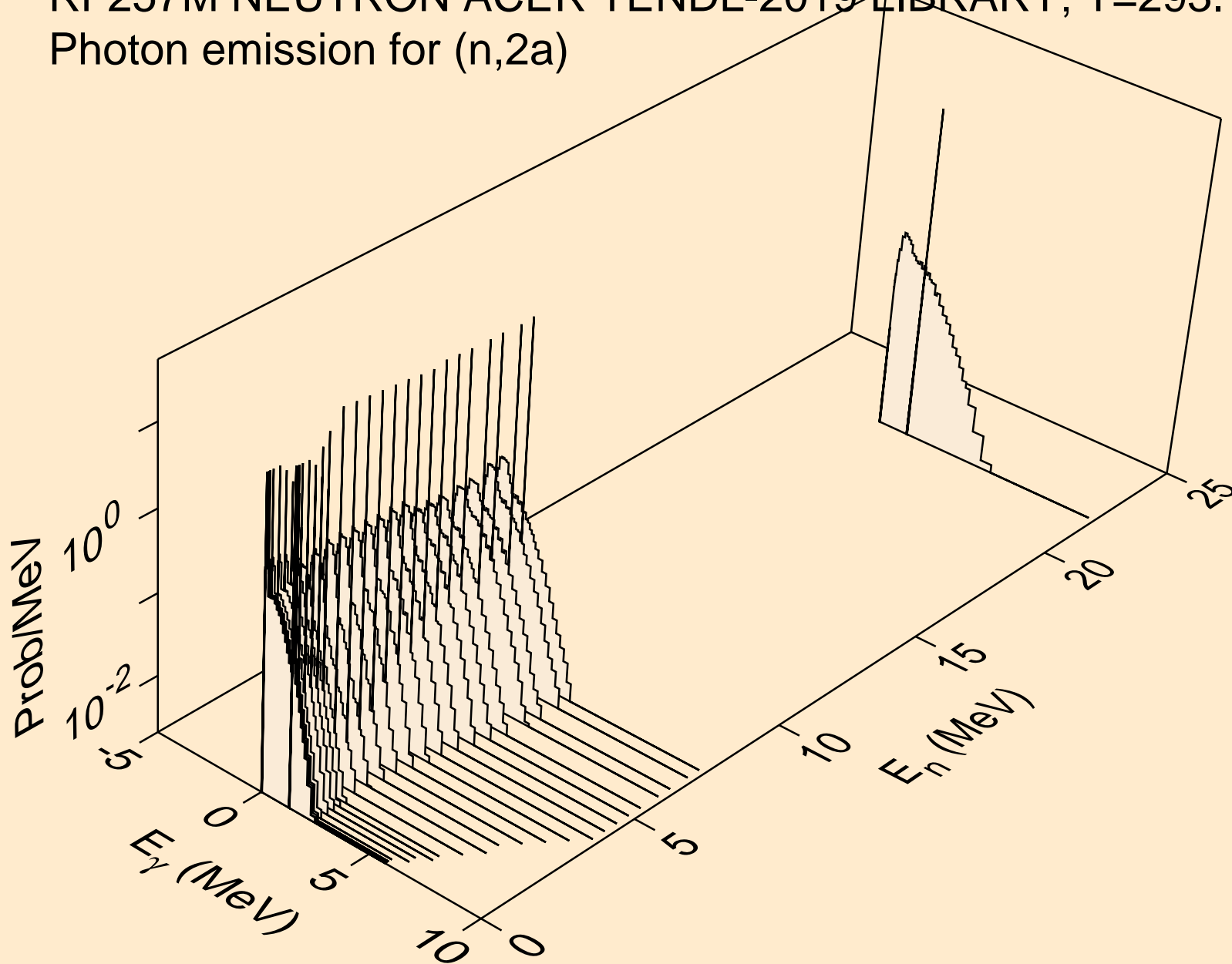

RF257M NEUTRON ACER TENDL-2019 LIBRARY; T=293.16K
Photon emission for (n,2p)

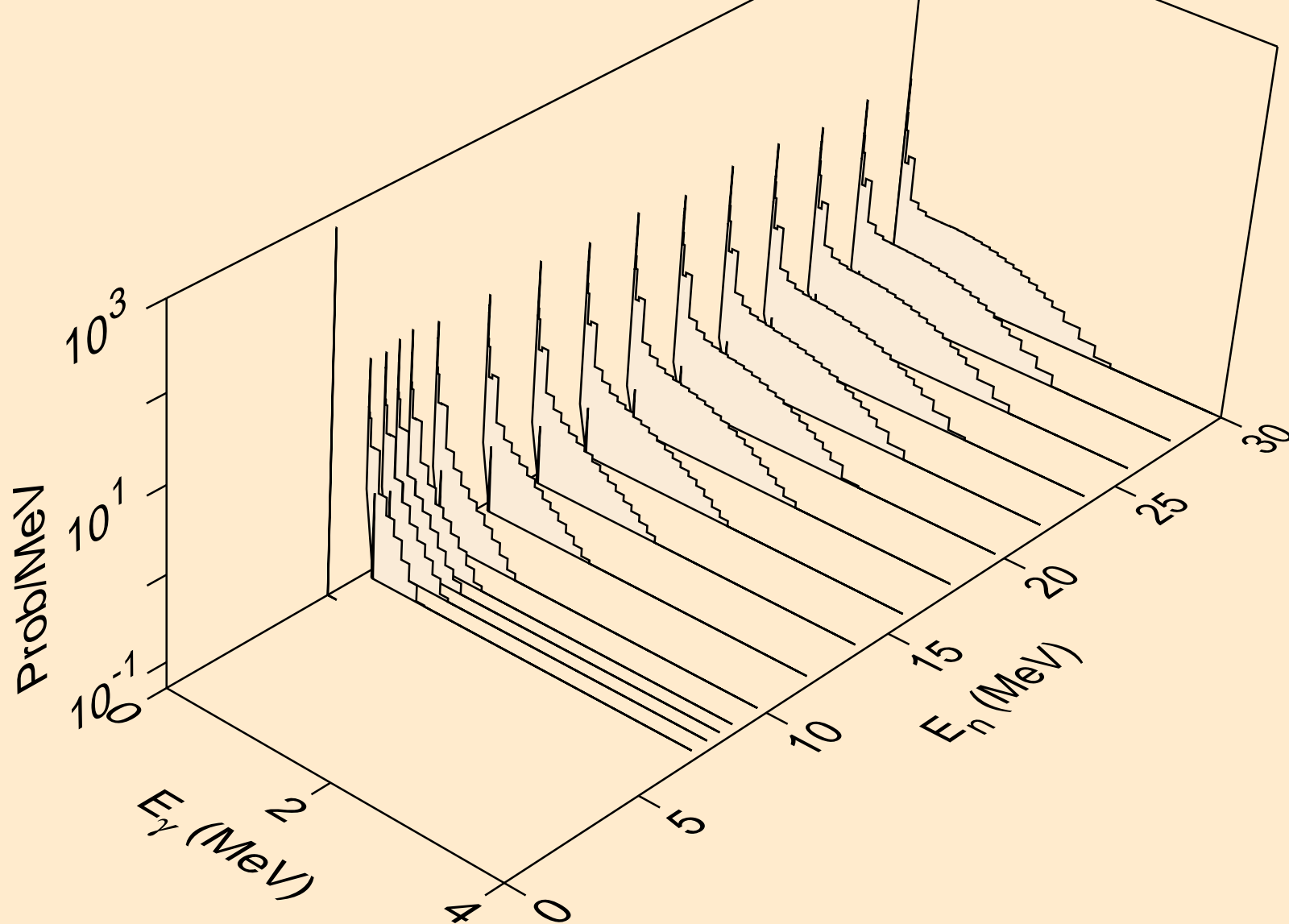

RF257M NEUTRON ACER TENDL-2019 LIBRARY; T=293.16K
Photon emission for (n,p α)

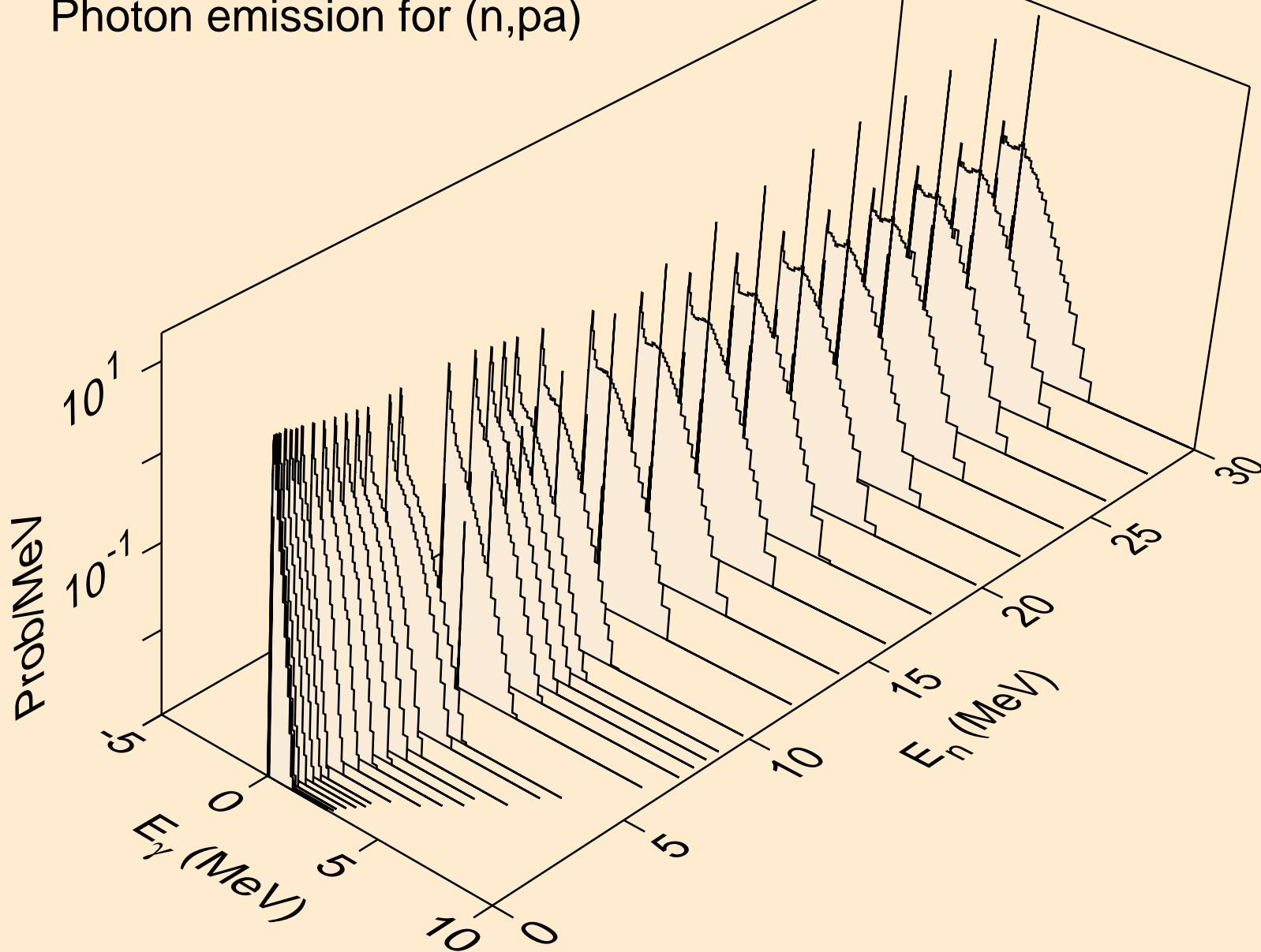

RF257M NEUTRON ACER TENDL-2019 LIBRARY; T=293.16K
Photon emission for (n,pd)

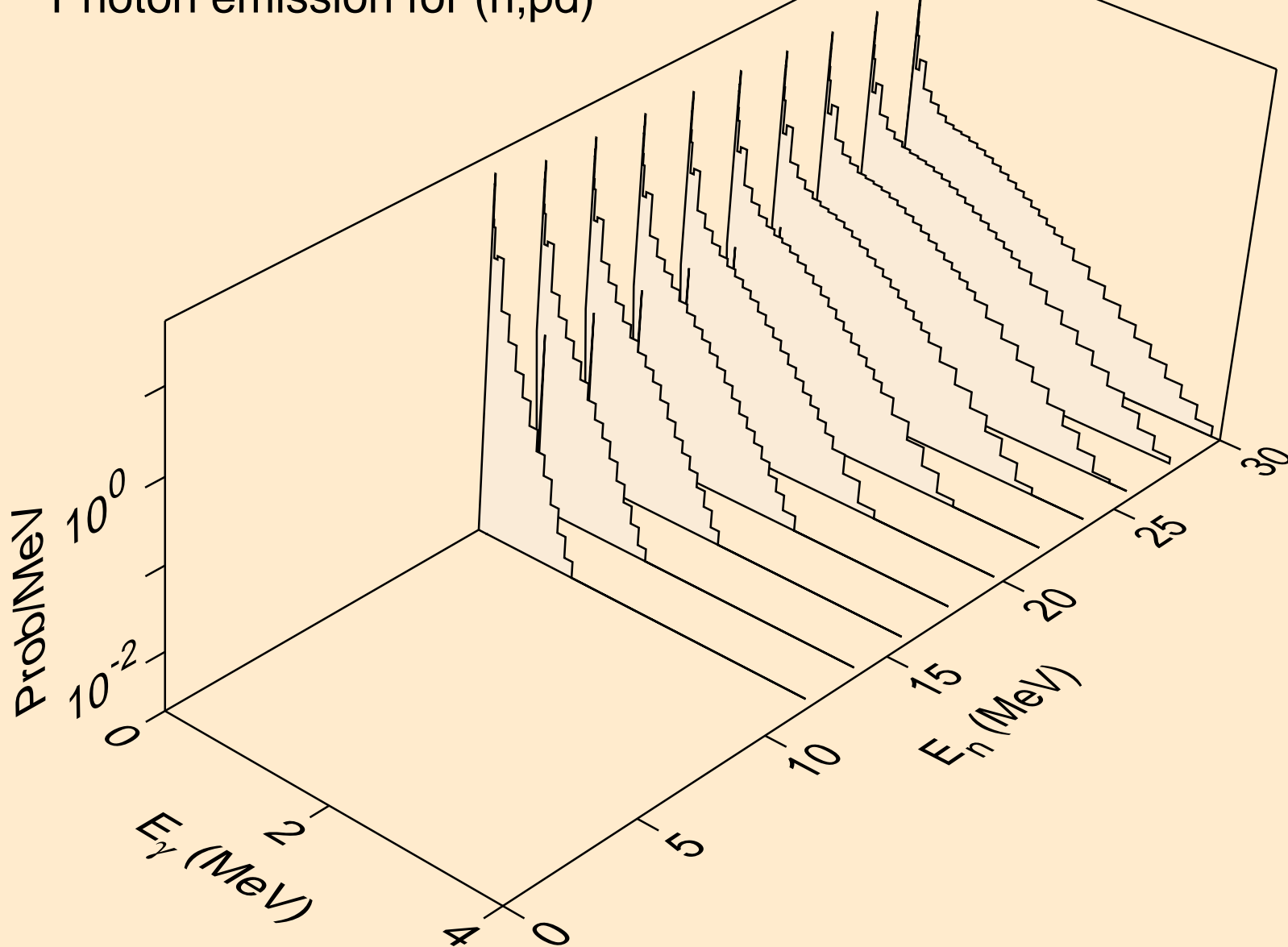

RF257M NEUTRON ACER TENDL-2019 LIBRARY; T=293.16K
Photon emission for (n,pt)

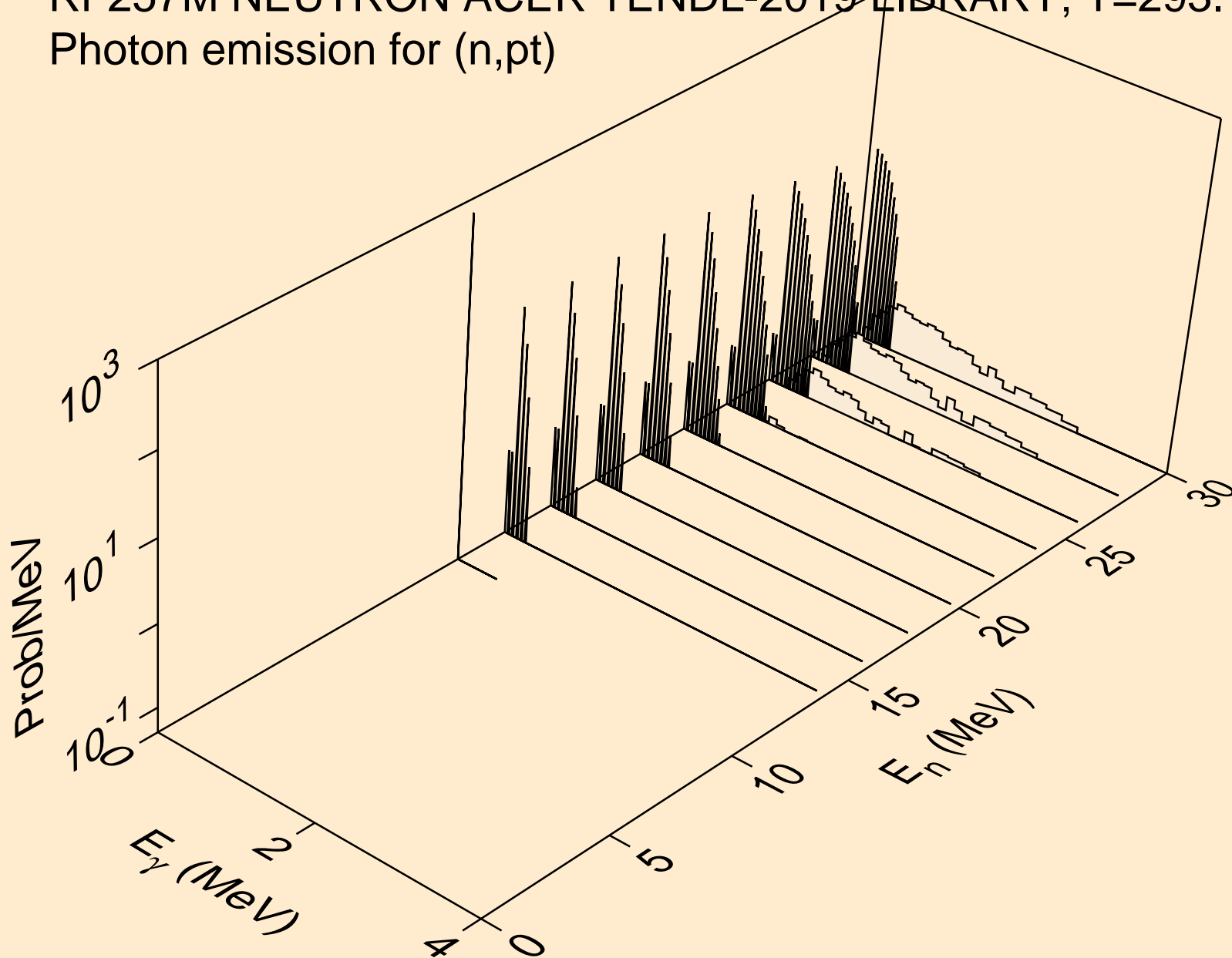

RF257M NEUTRON ACER TENDL-2019 LIBRARY; T=293.16K
Photon emission for (n,da)

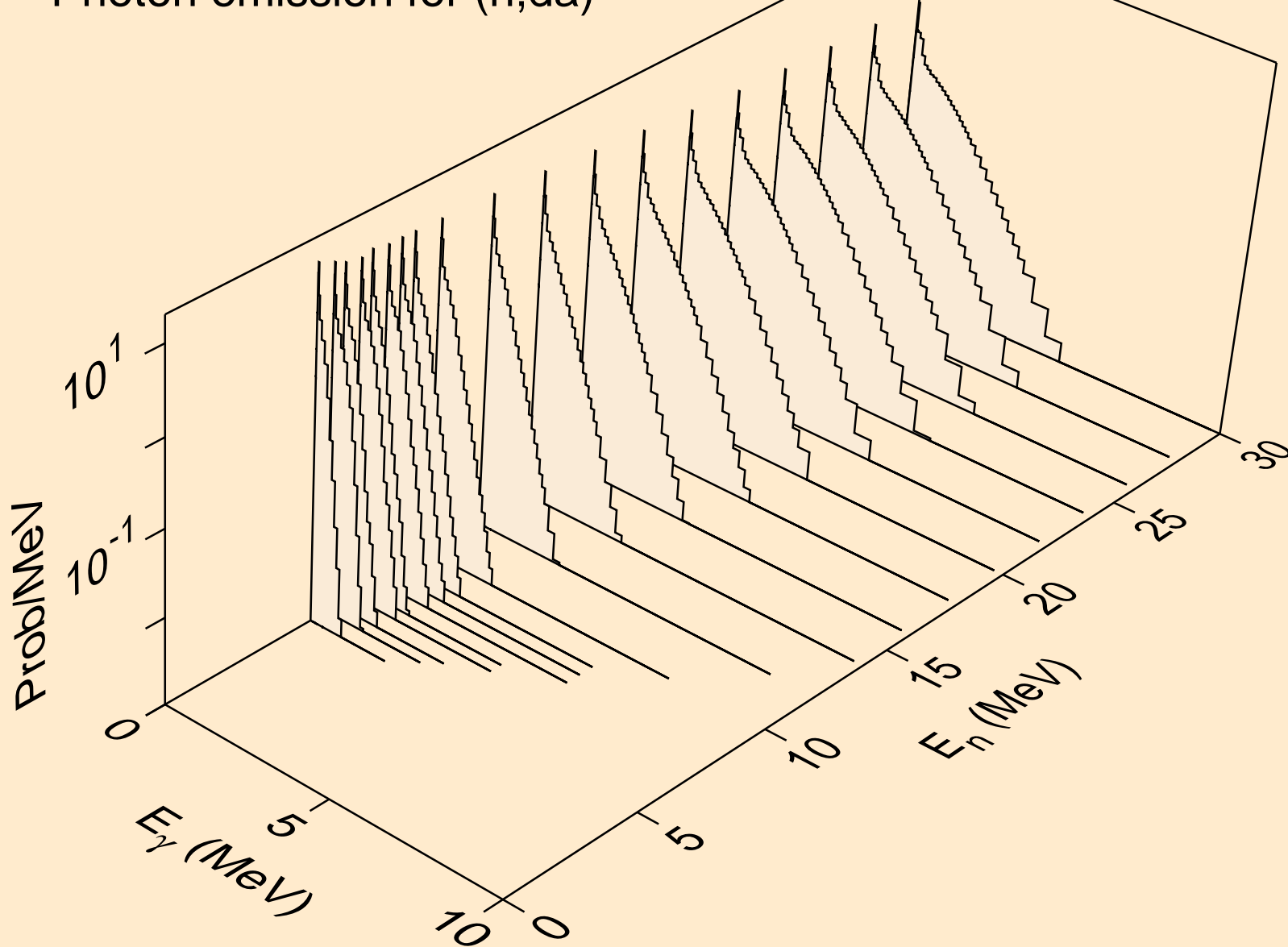

RF257M NEUTRON ACER TENDL-2019 LIBRARY; T=293.16K
thermal capture photon spectrum

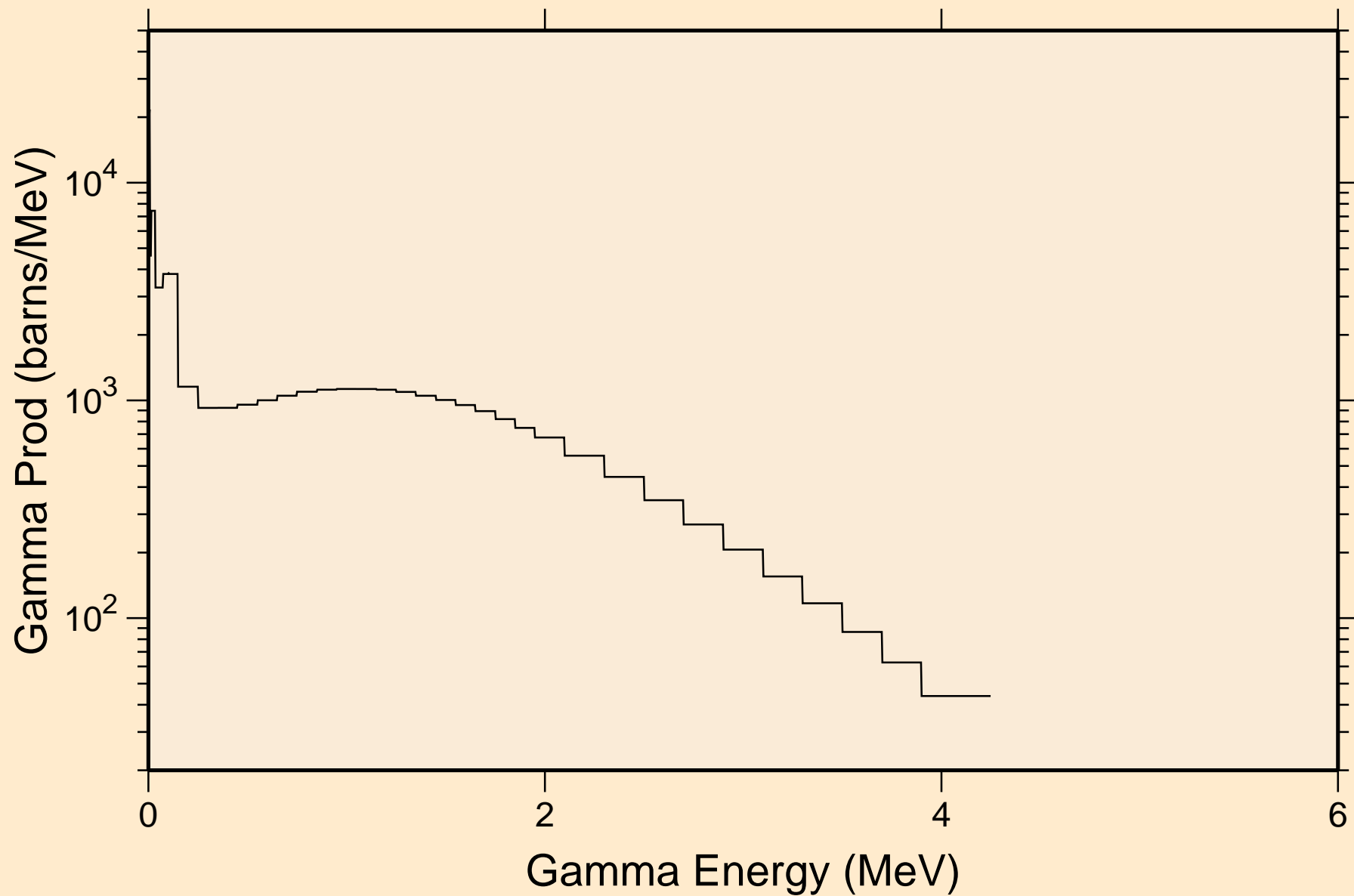

RF257M NEUTRON ACER TENDL-2019 LIBRARY; T=293.16K
14 MeV photon spectrum

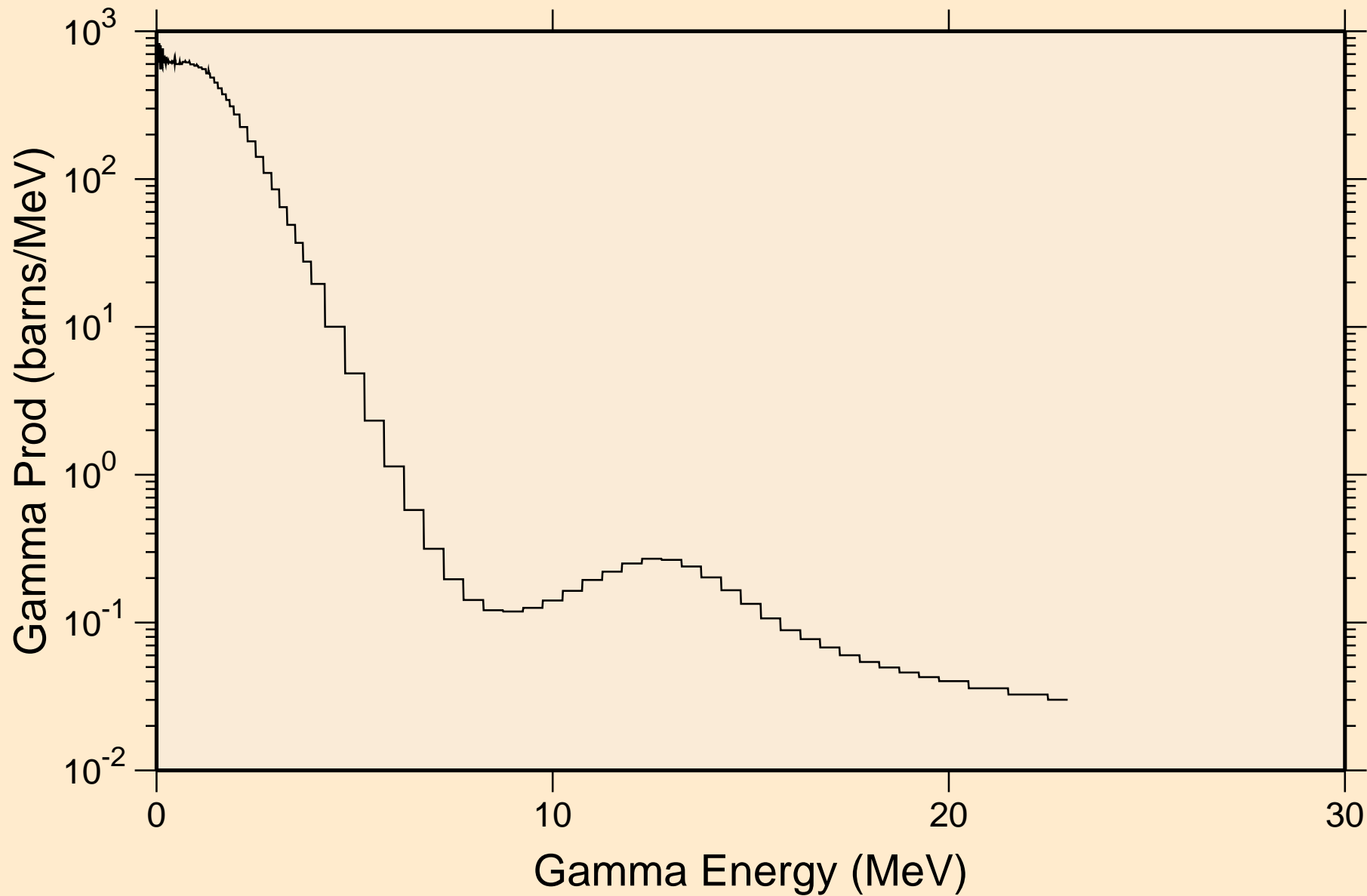

RF257M NEUTRON ACER TENDL-2019 LIBRARY; T=293.16K
Particle heating contributions

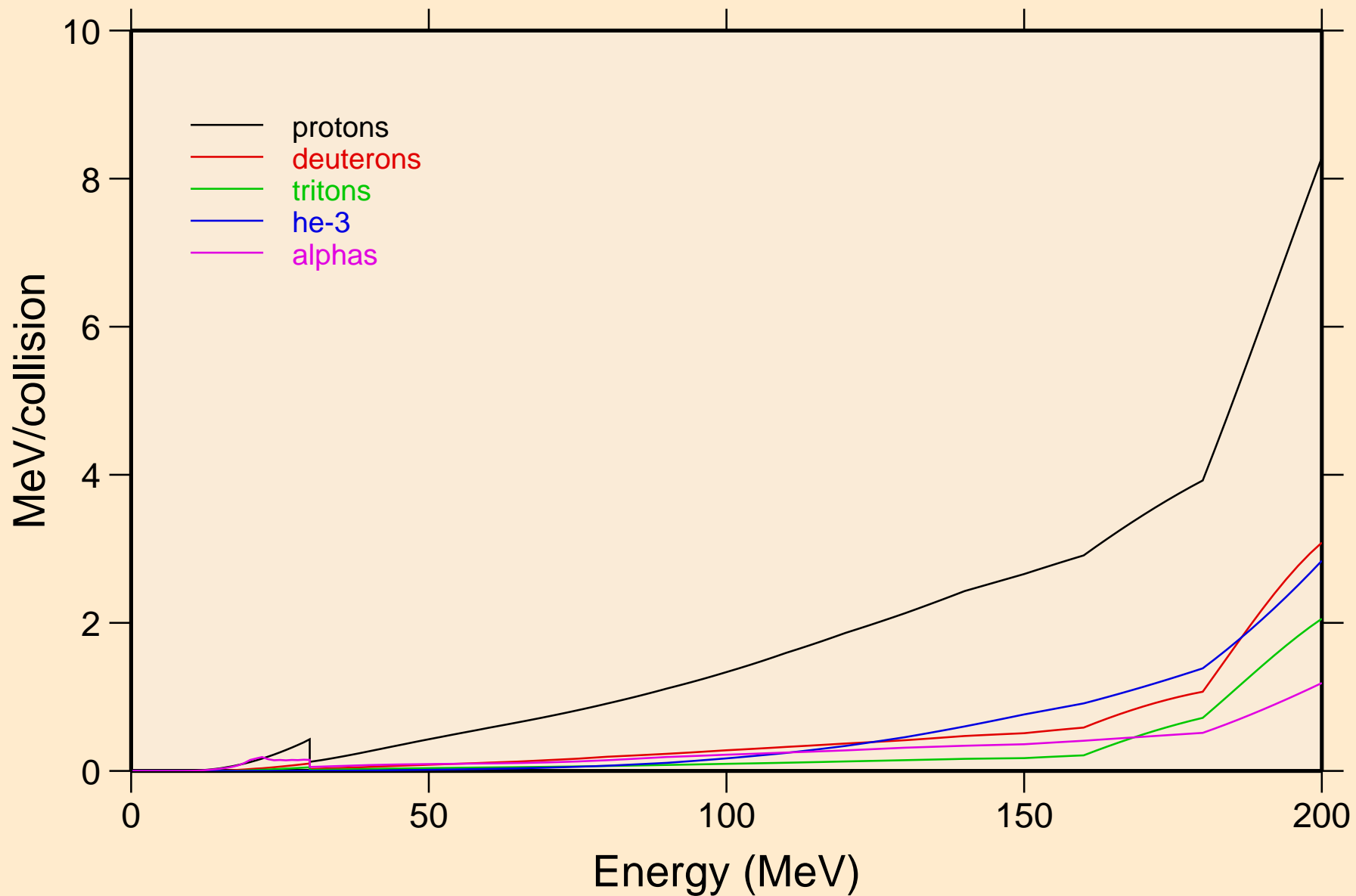

RF257M NEUTRON ACER TENDL-2019 LIBRARY; T=293.16K
Recoil Heating

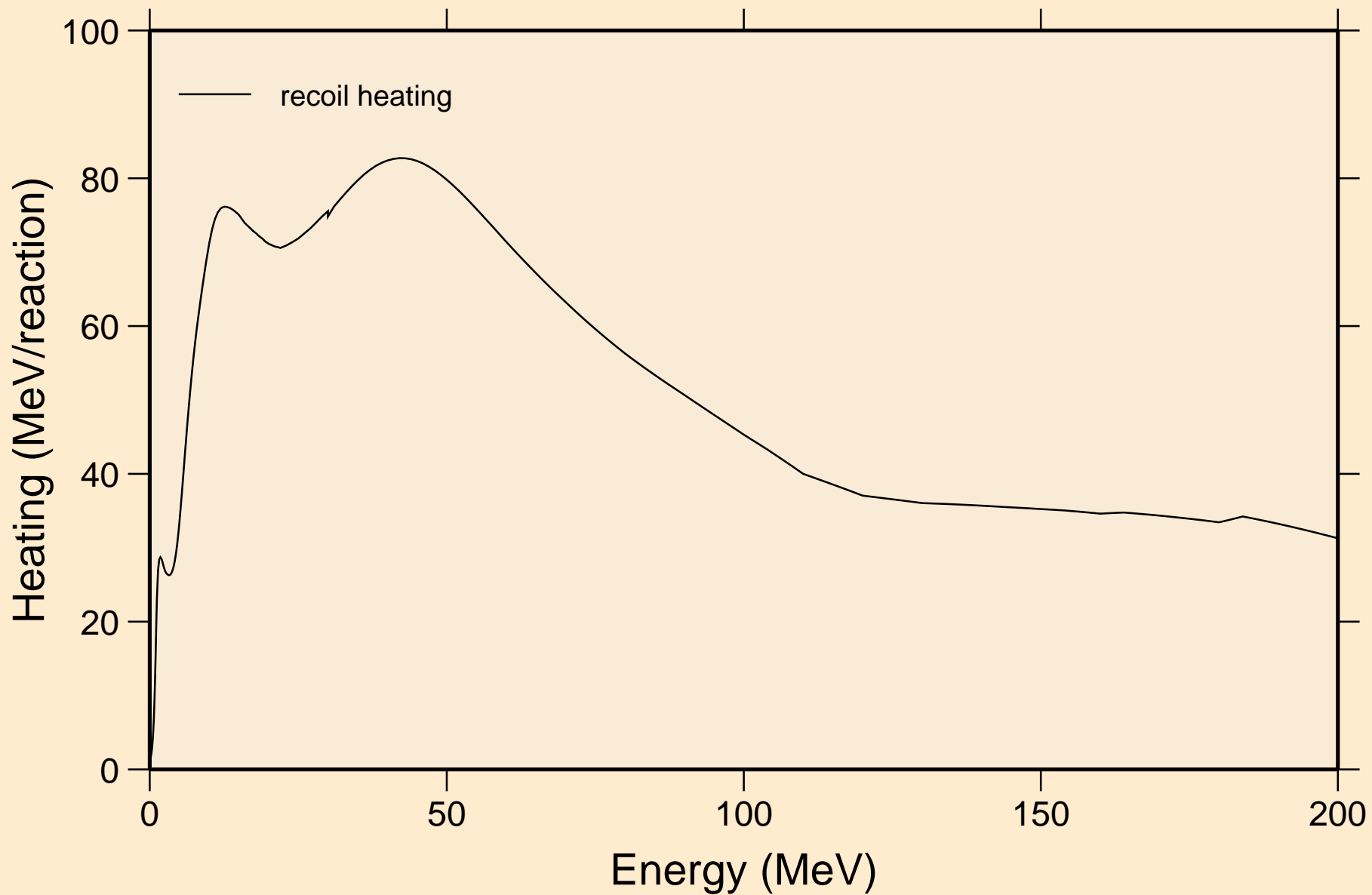

RF257M NEUTRON ACER TENDL-2019 LIBRARY; T=293.16K
Particle production cross sections

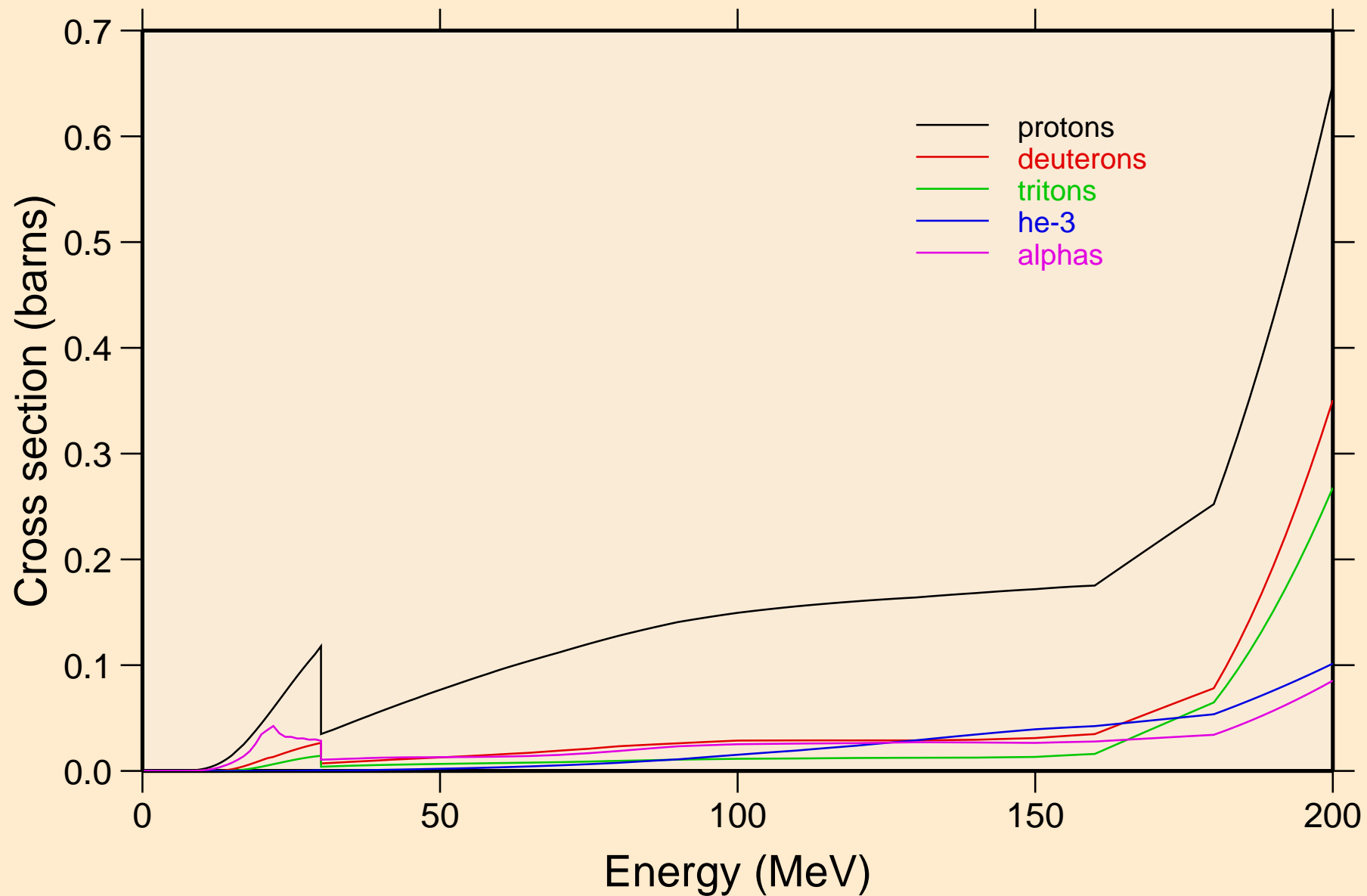

RF257M NEUTRON ACER TENDL-2019 LIBRARY; T=293.16K
protons from (n,x)

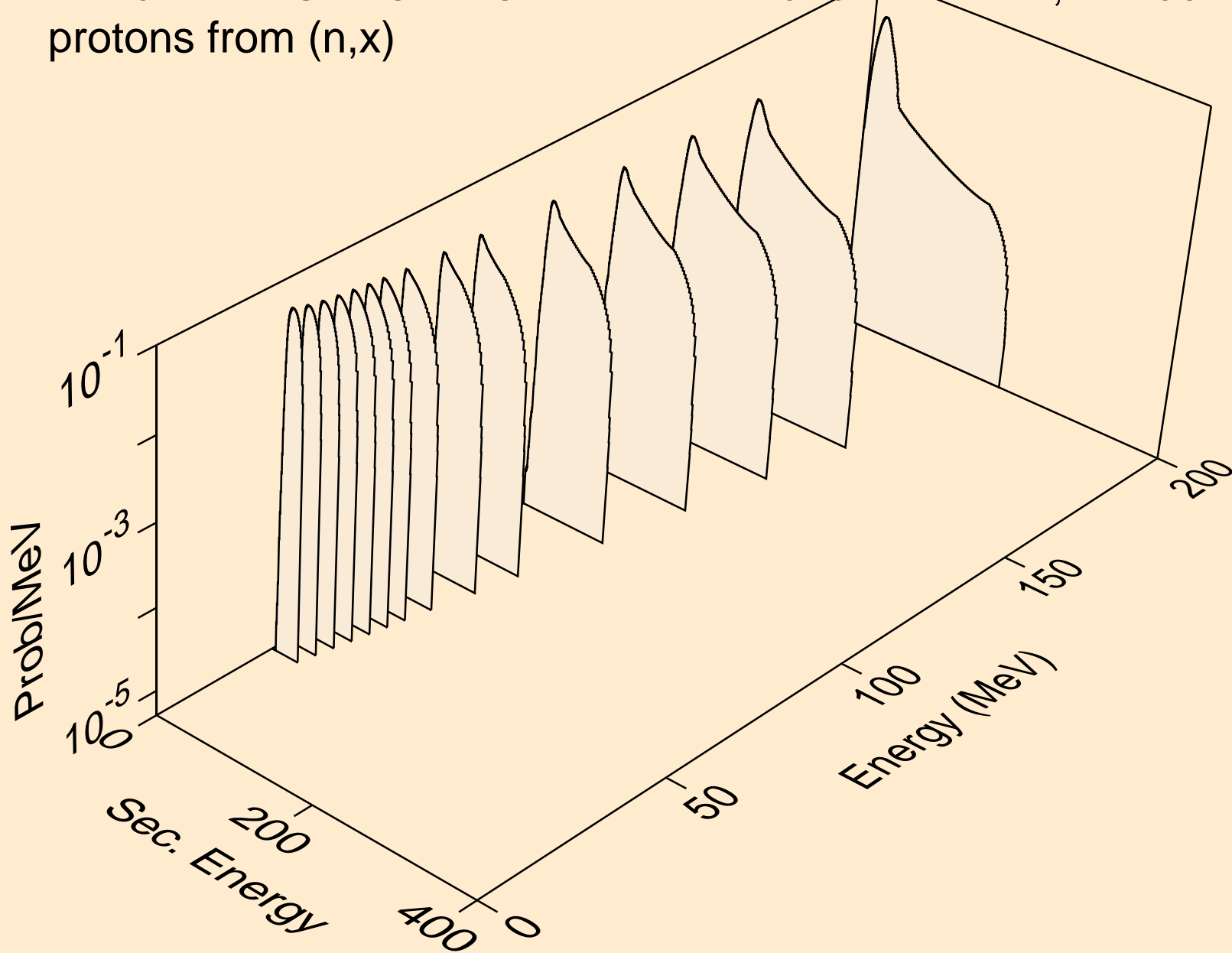

RF257M NEUTRON ACER TENDL-2019 LIBRARY; T=293.16K
protons from (n,n*)p

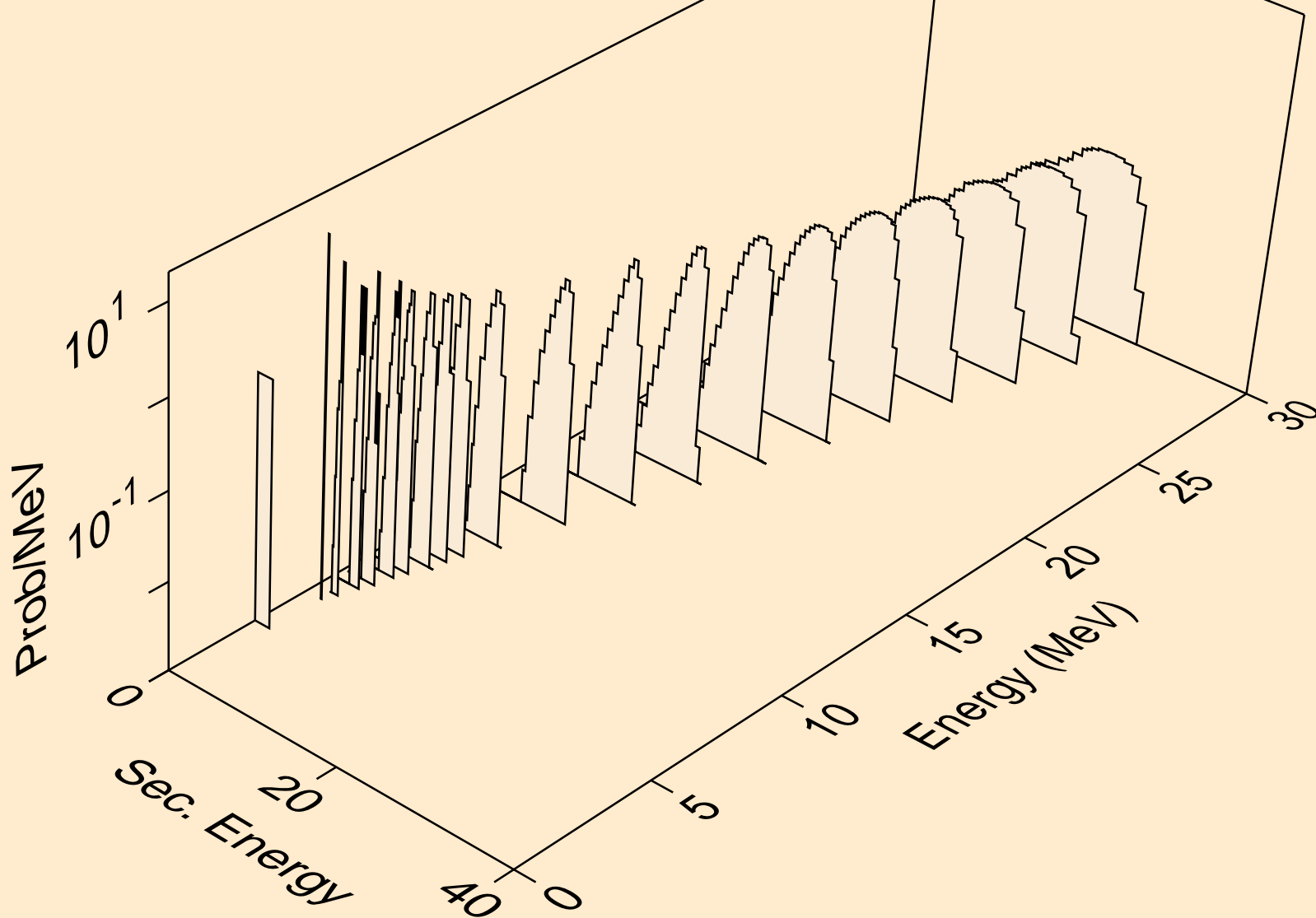

RF257M NEUTRON ACER TENDL-2019 LIBRARY; T=293.16K
protons from (n,2np)

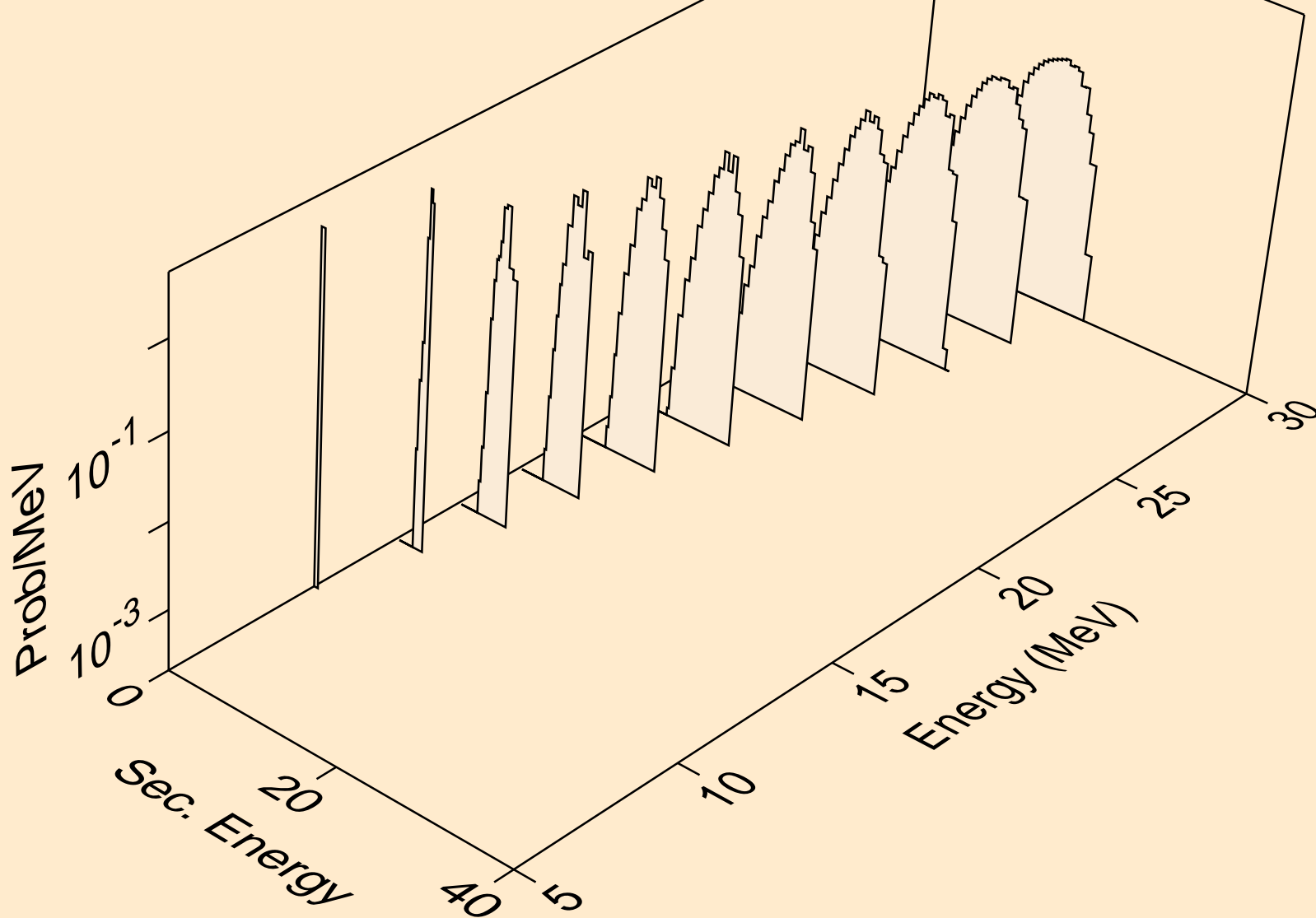

RF257M NEUTRON ACER TENDL-2019 LIBRARY; T=293.16K
protons from (n,3np)

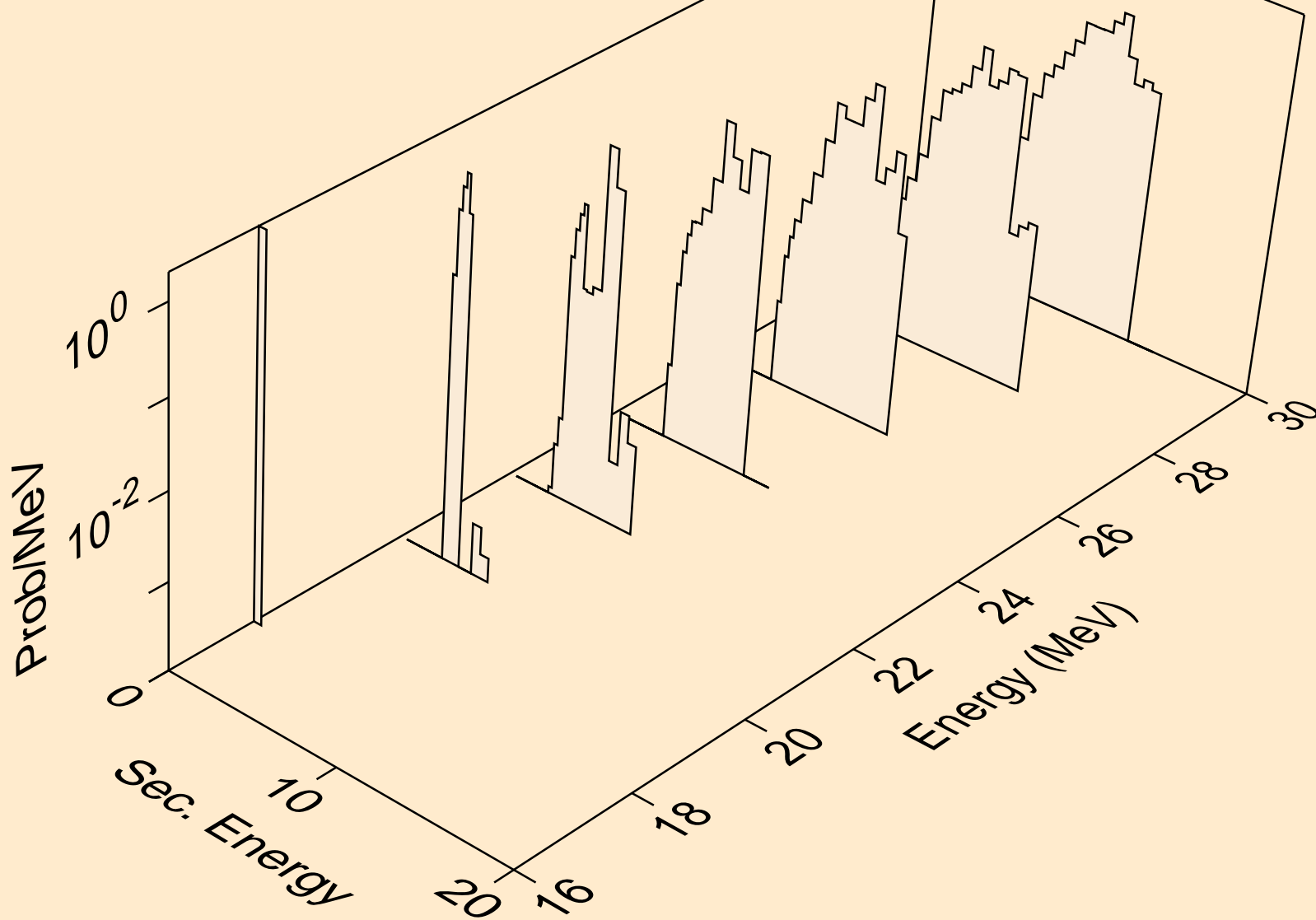

RF257M NEUTRON ACER TENDL-2019 LIBRARY; T=293.16K
protons from (n,2np)

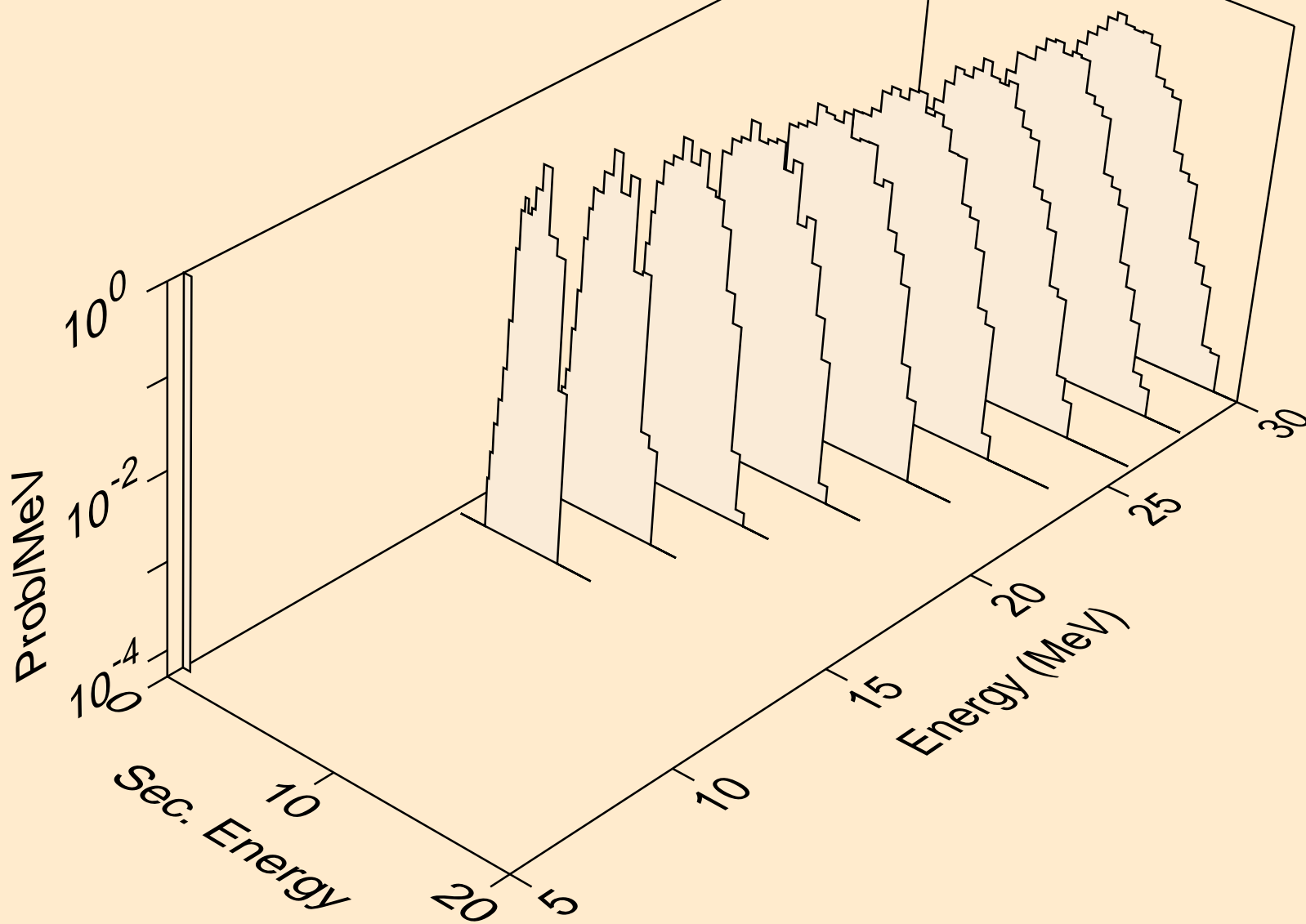

RF257M NEUTRON ACER TENDL-2019 LIBRARY; T=293.16K
protons from (n,npa)

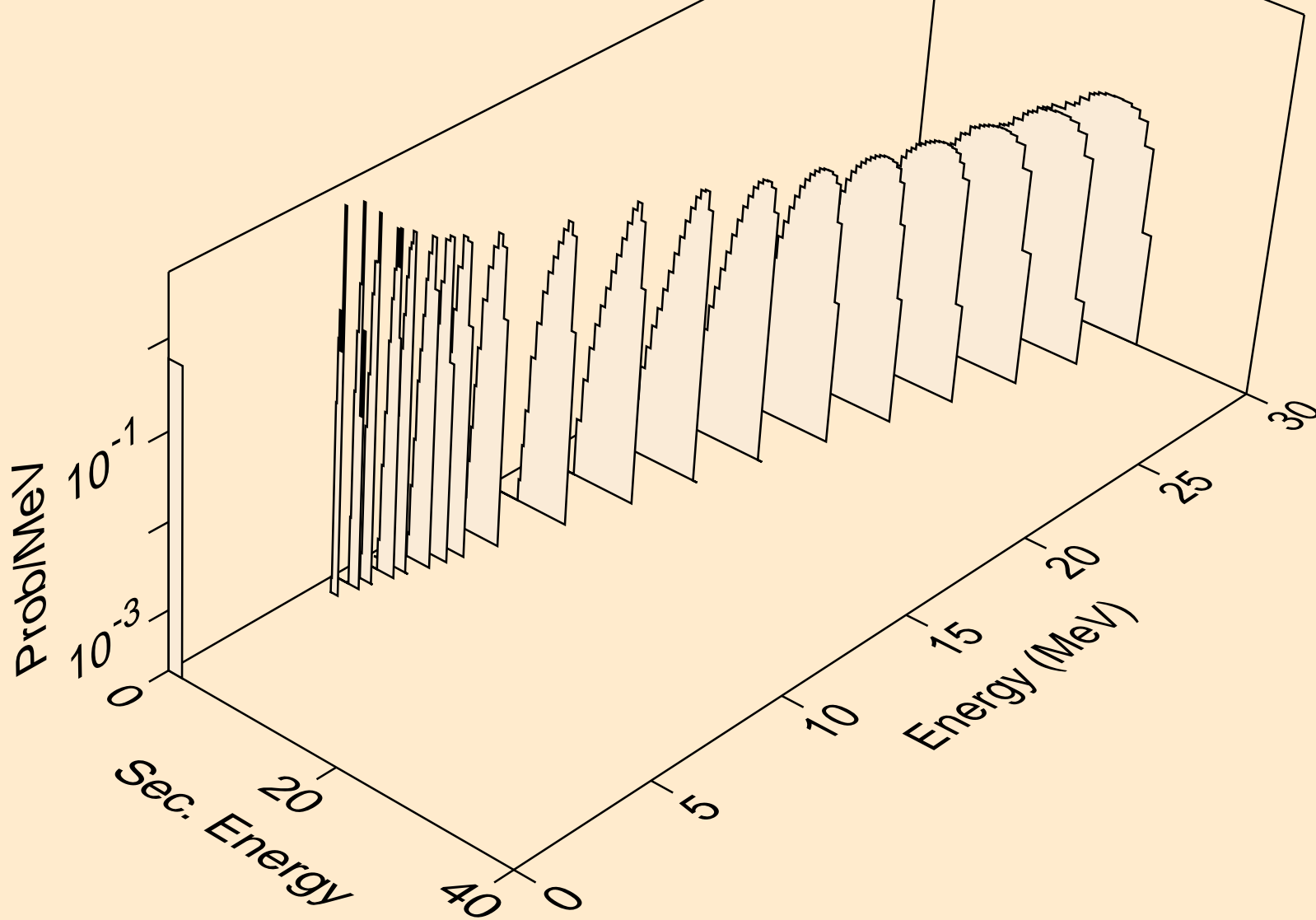

RF257M NEUTRON ACER TENDL-2019 LIBRARY; T=293.16K
protons from (n,p)

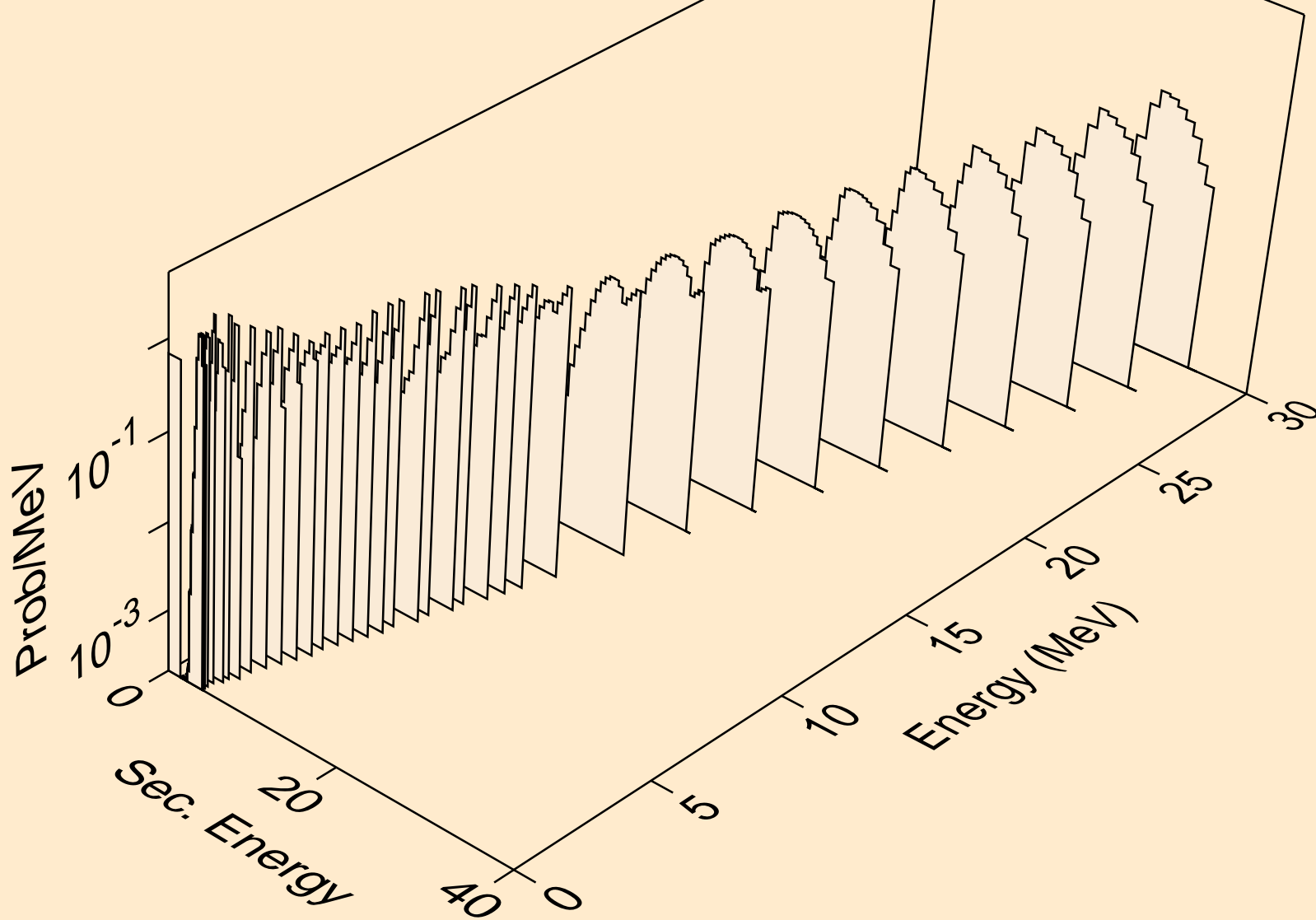

RF257M NEUTRON ACER TENDL-2019 LIBRARY; T=293.16K
protons from (n,2p)

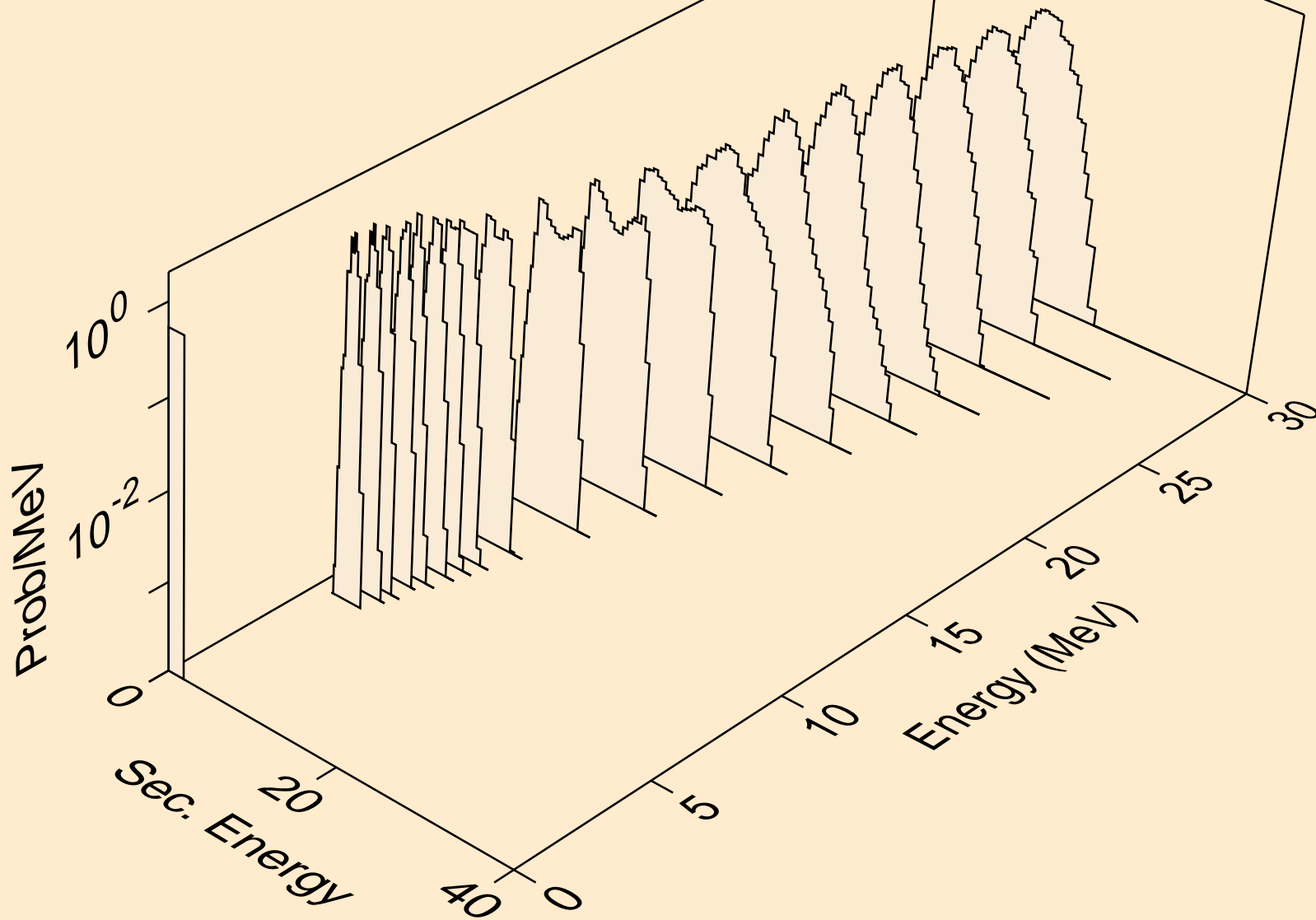

RF257M NEUTRON ACER TENDL-2019 LIBRARY; T=293.16K
protons from (n,p)

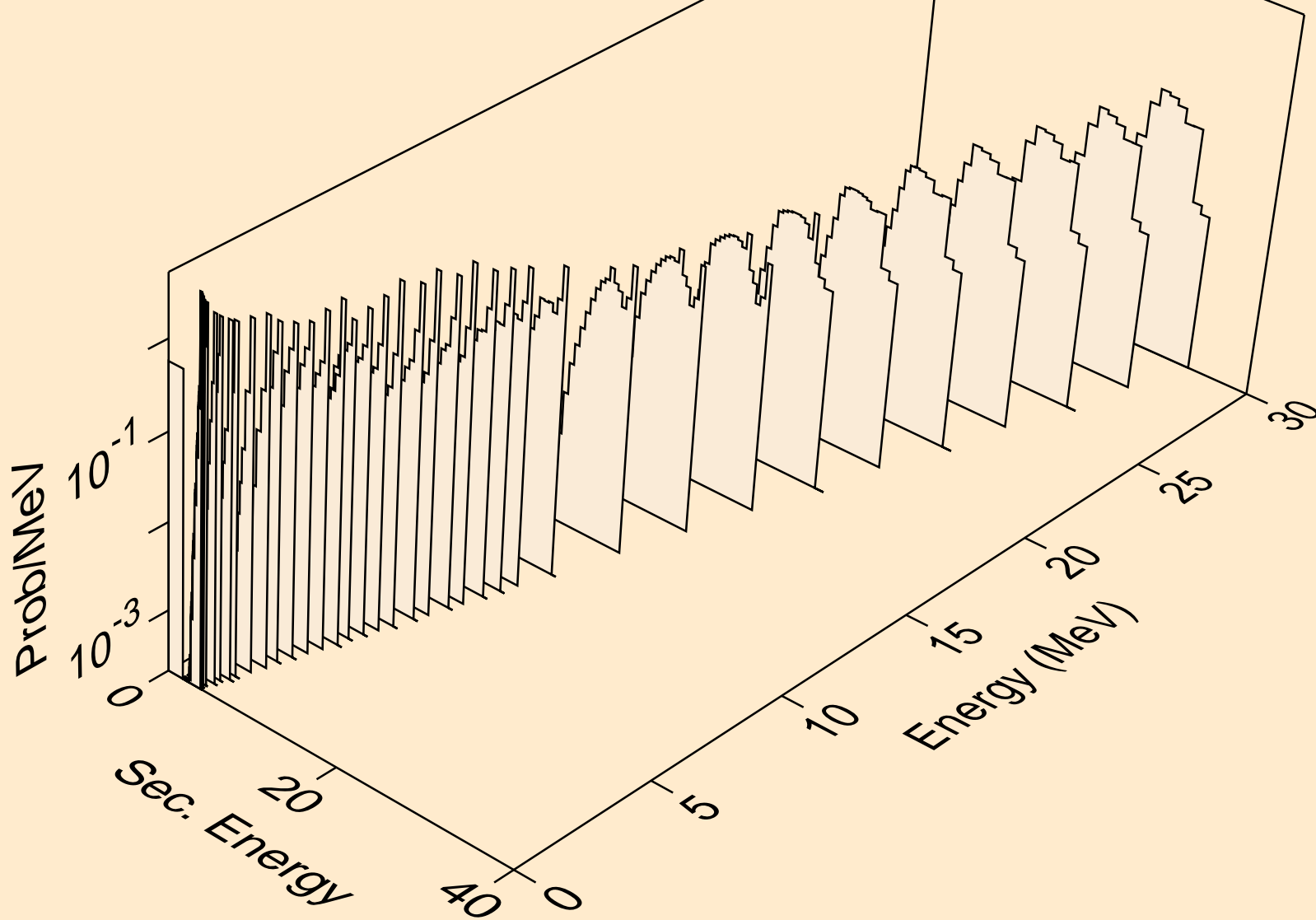

RF257M NEUTRON ACER TENDL-2019 LIBRARY; T=293.16K
protons from (n,pd)

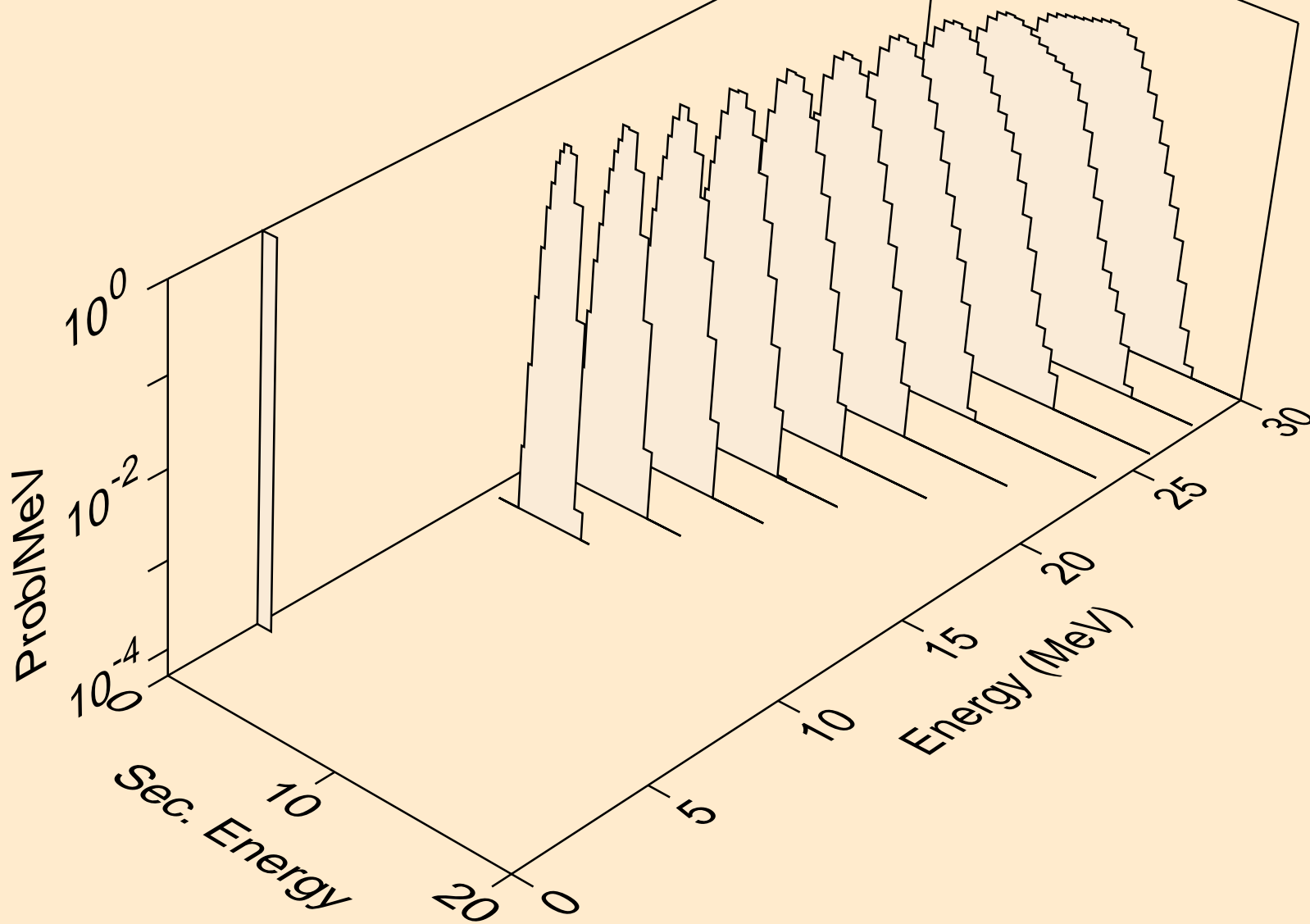

RF257M NEUTRON ACER TENDL-2019 LIBRARY; T=293.16K
protons from (n,pt)

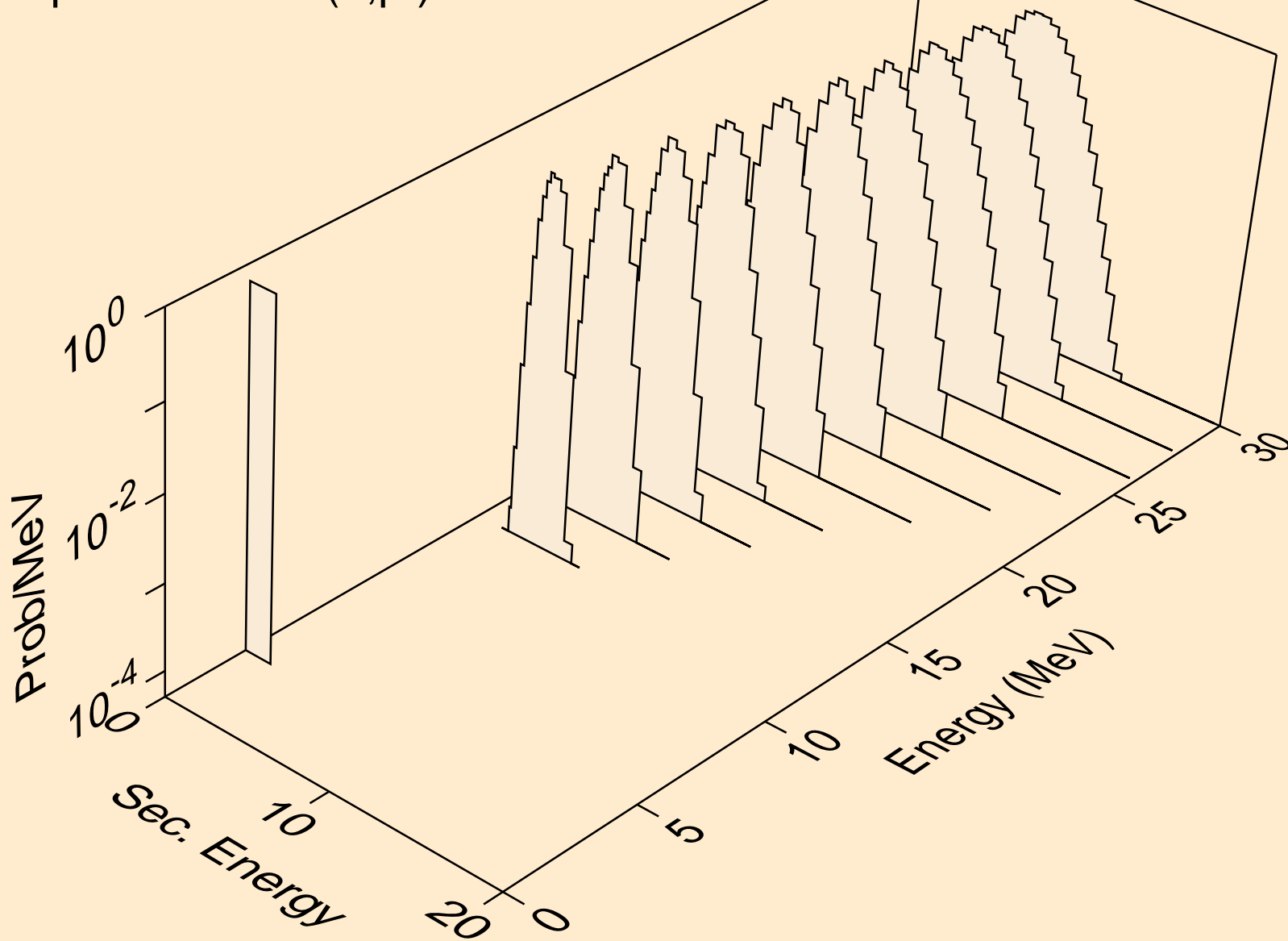

RF257M NEUTRON ACER TENDL-2019 LIBRARY; T=293.16K
deuterons from (n,x)

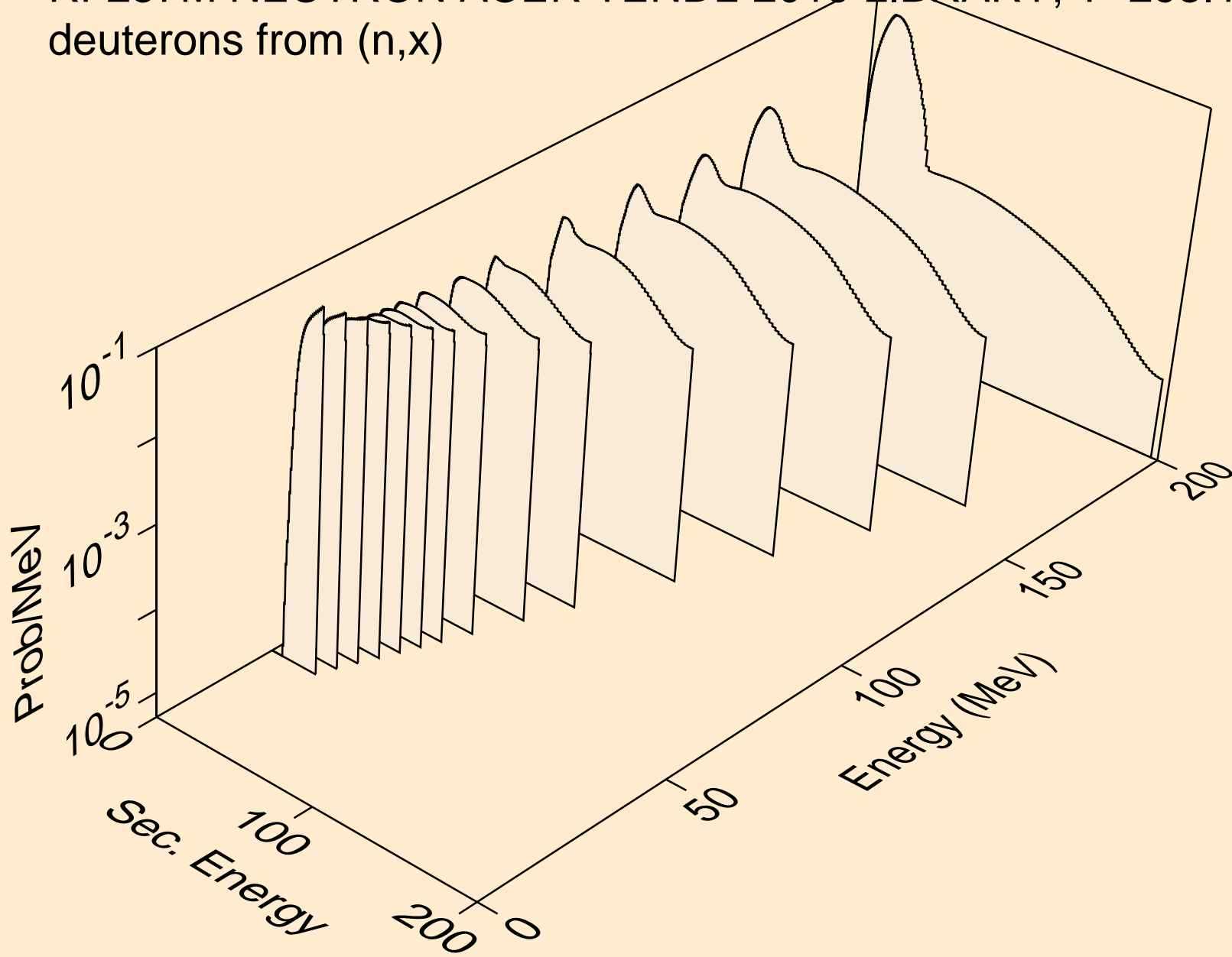

RF257M NEUTRON ACER TENDL-2019 LIBRARY; T=293.16K
deuterons from (n,2nd)

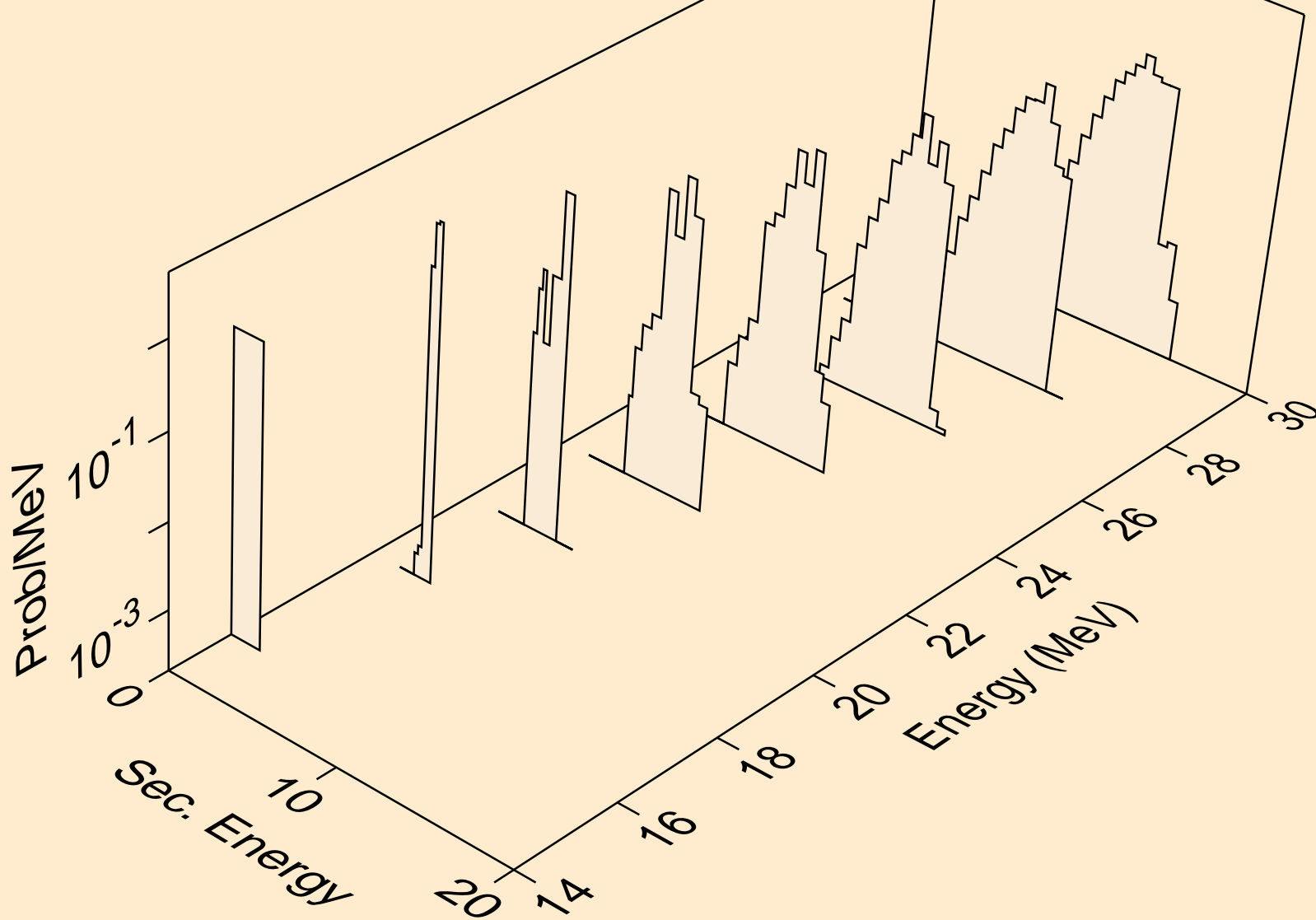

RF257M NEUTRON ACER TENDL-2019 LIBRARY; T=293.16K
deuterons from (n,n*)d

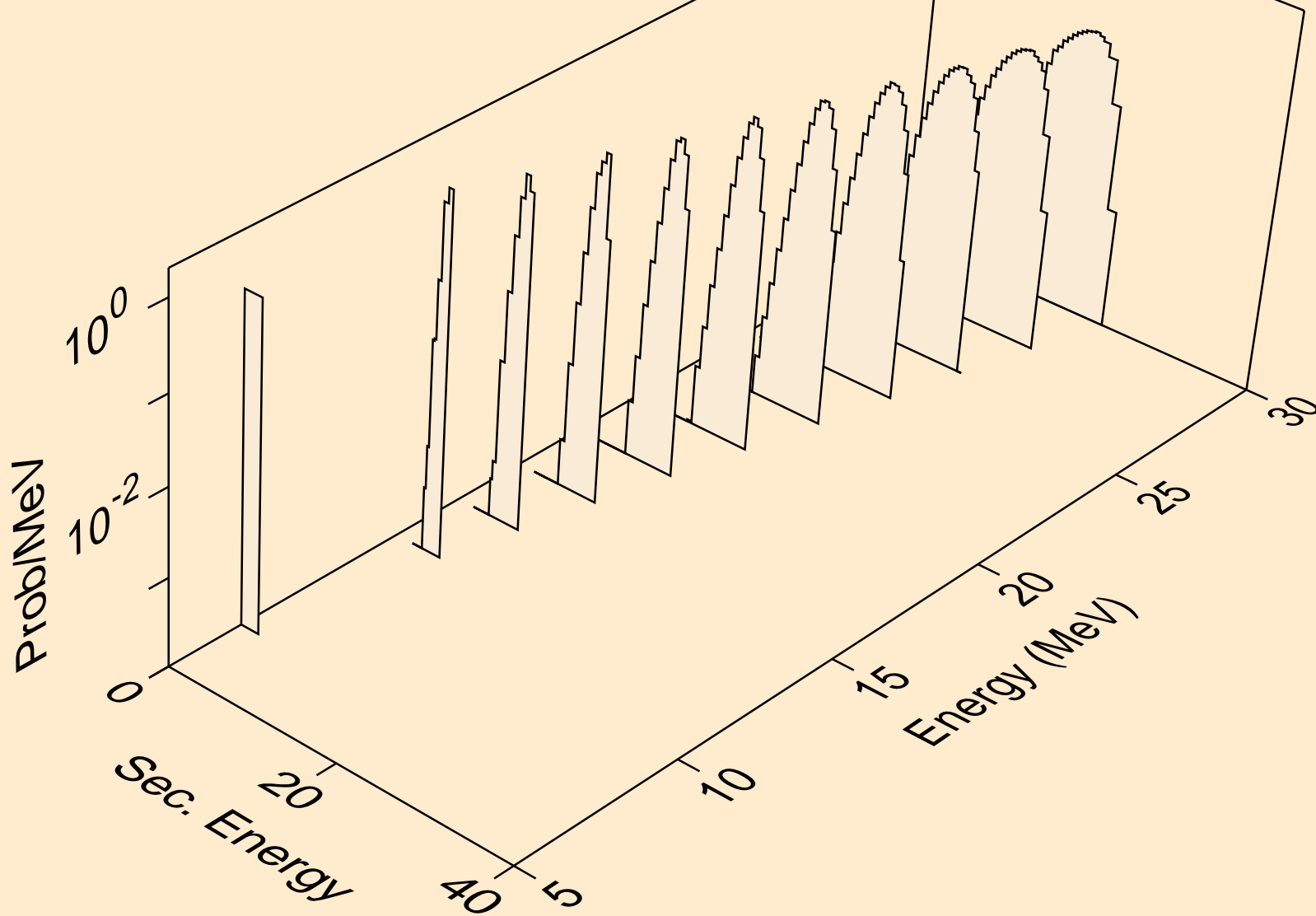

RF257M NEUTRON ACER TENDL-2019 LIBRARY; T=293.16K
deuterons from (n,d)

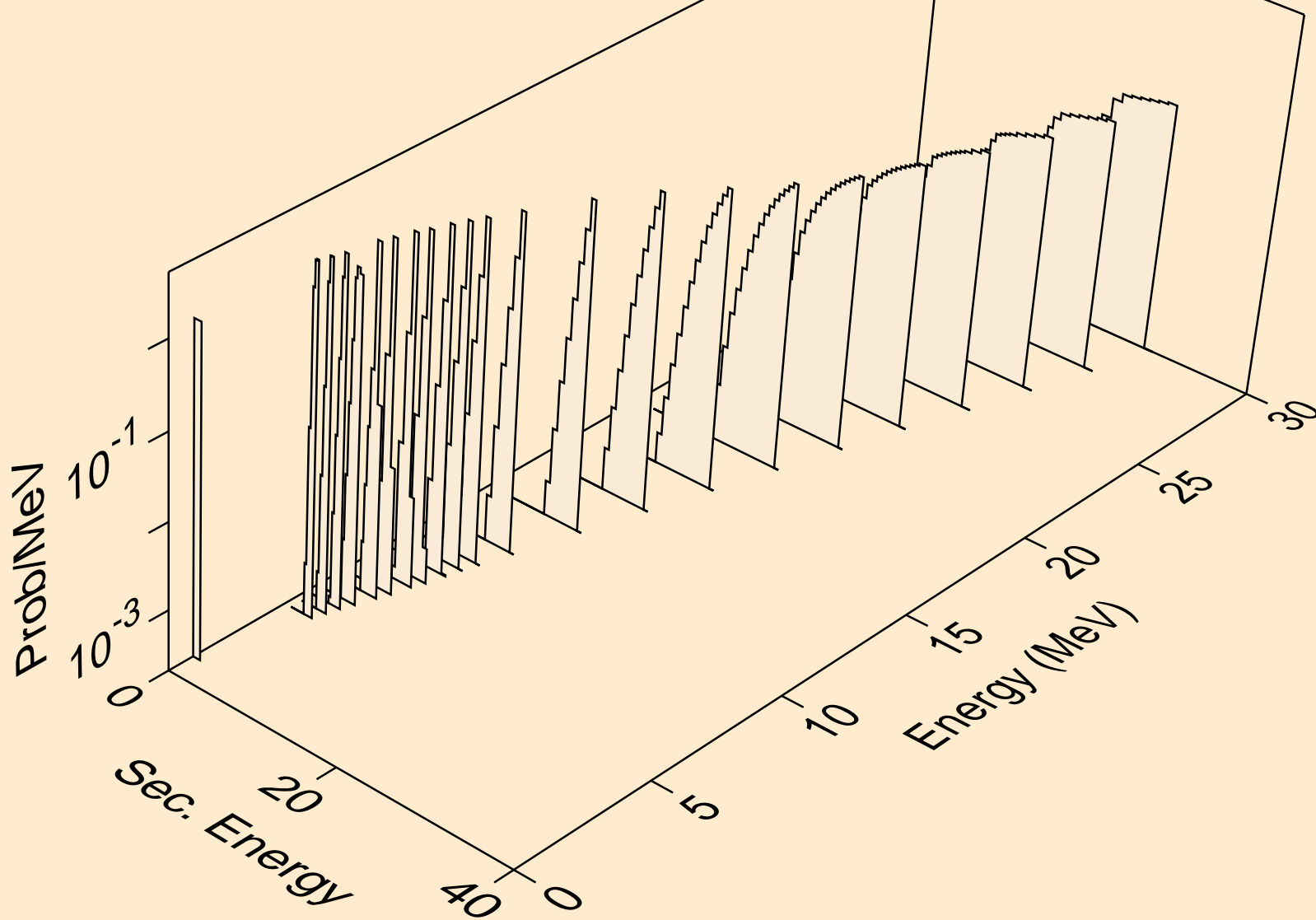

RF257M NEUTRON ACER TENDL-2019 LIBRARY; T=293.16K
deuterons from (n,pd)

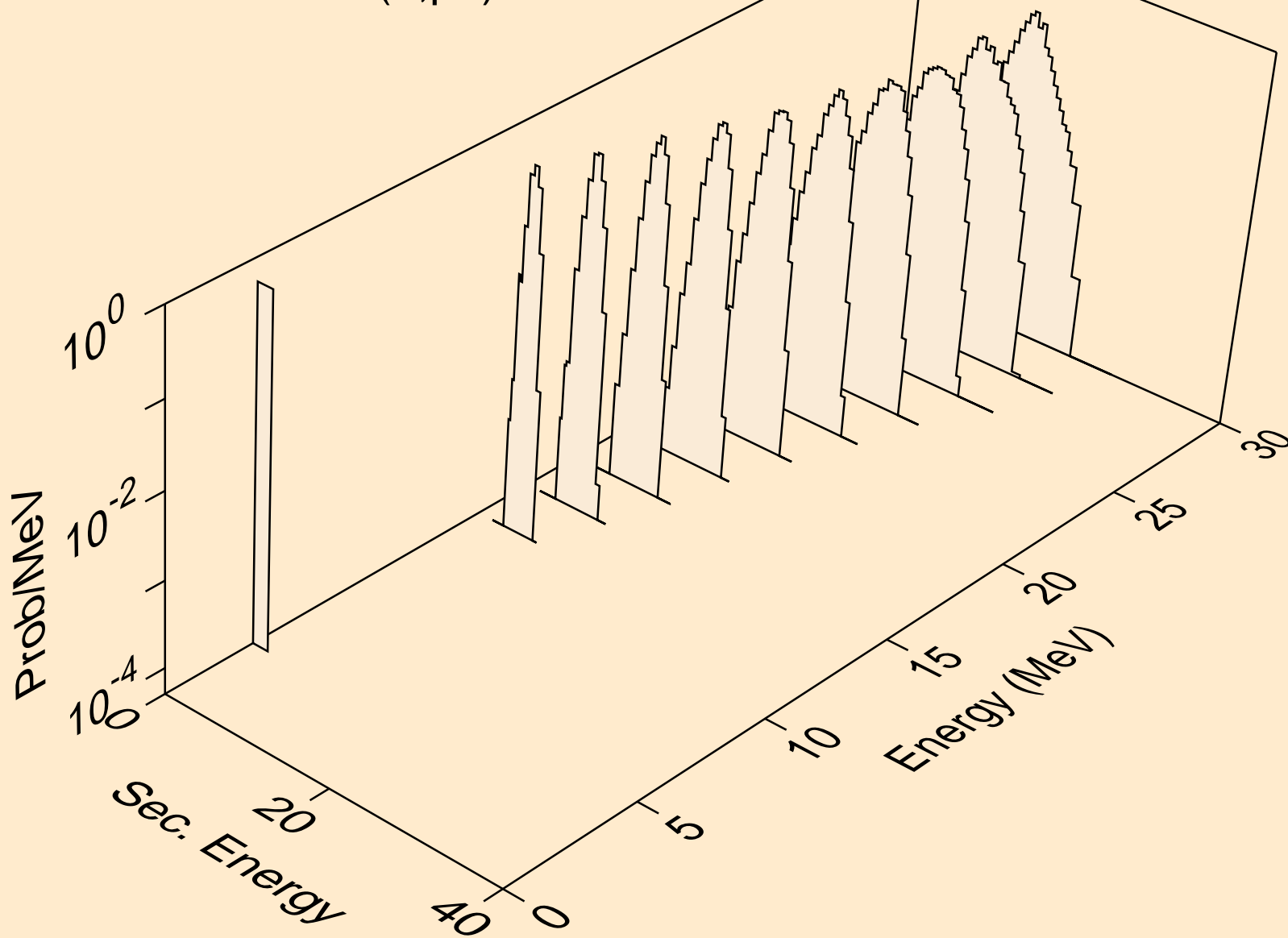

RF257M NEUTRON ACER TENDL-2019 LIBRARY; T=293.16K
deuterons from (n,da)

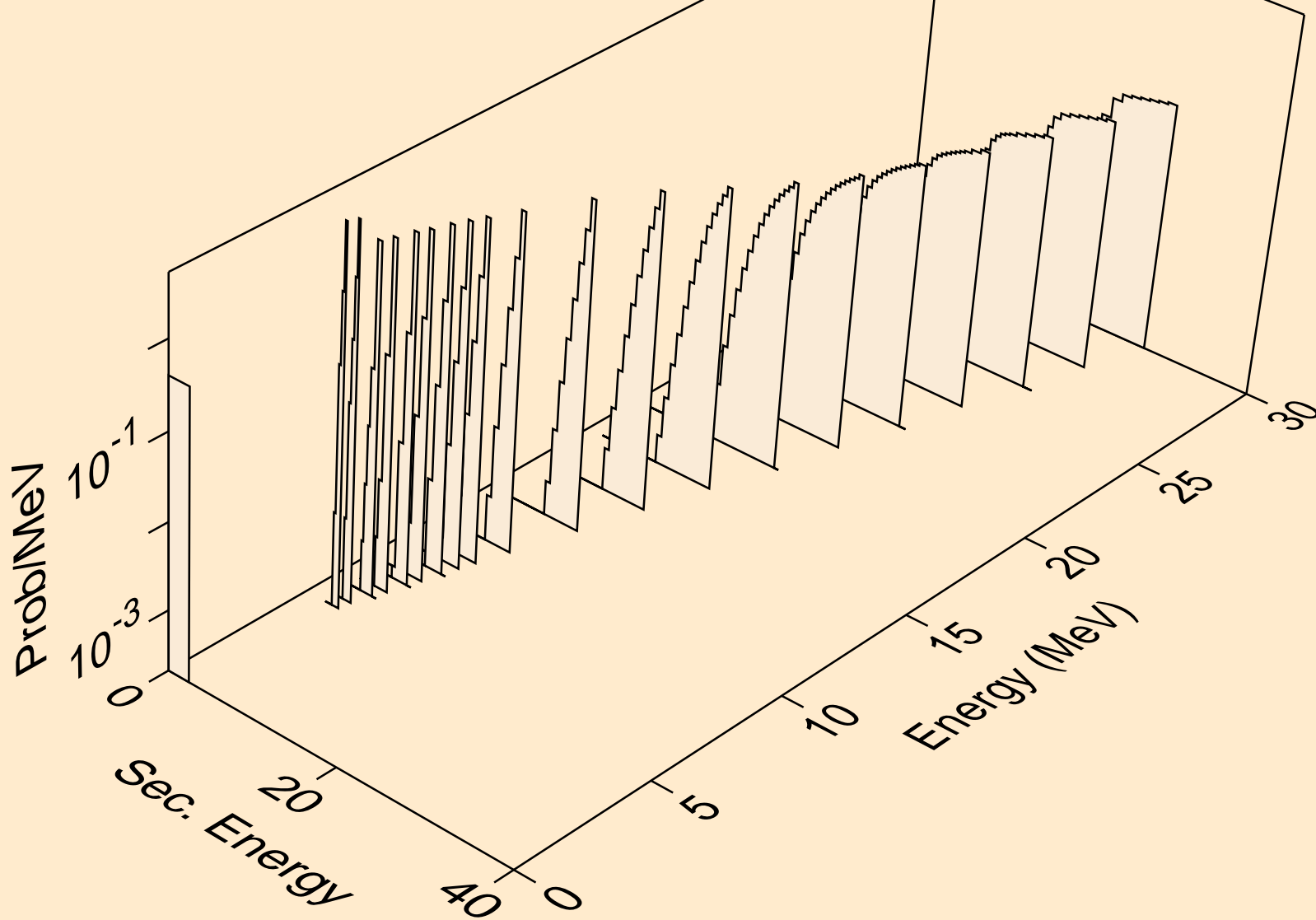

RF257M NEUTRON ACER TENDL-2019 LIBRARY; T=293.16K
tritons from (n,x)

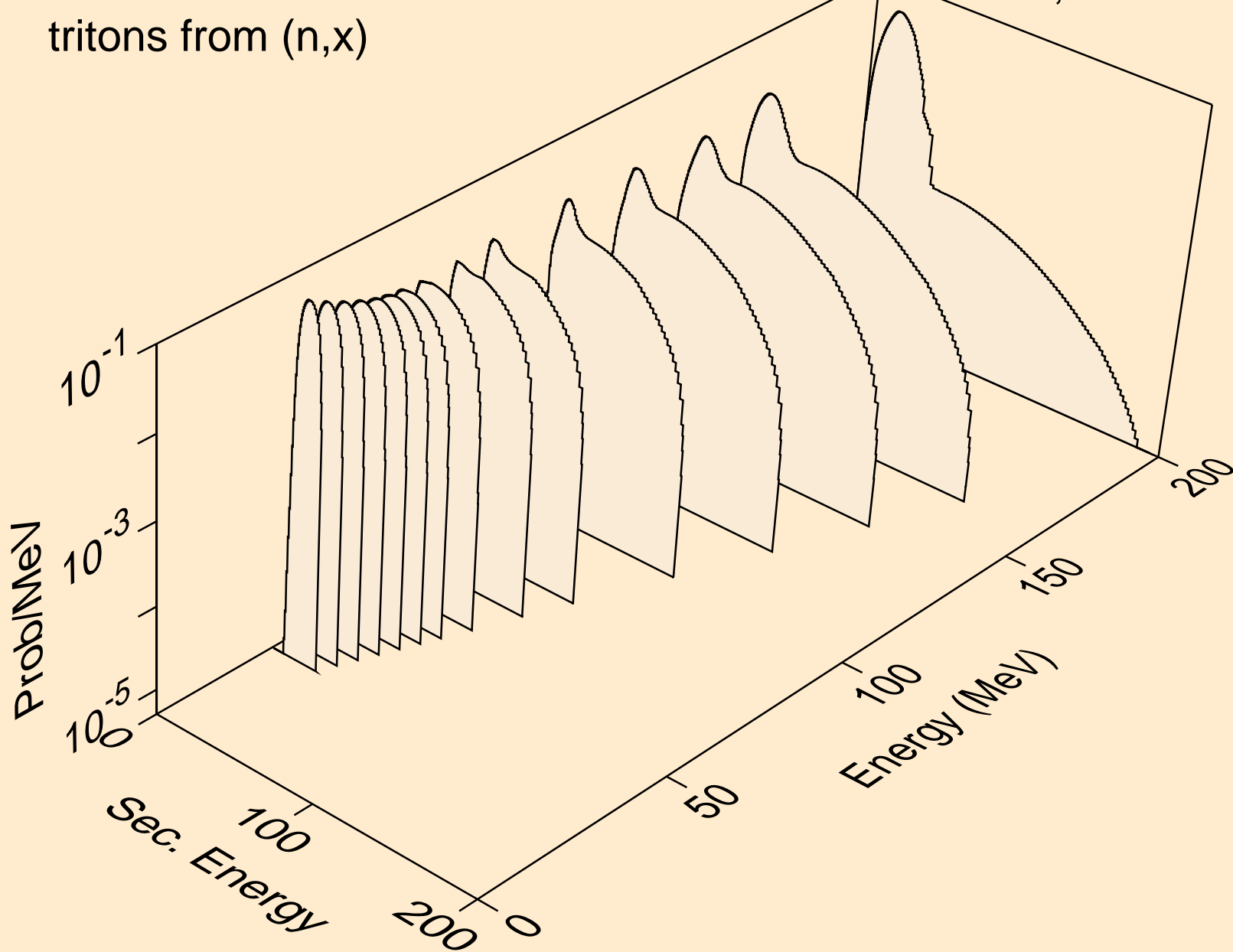

RF257M NEUTRON ACER TENDL-2019 LIBRARY; T=293.16K
tritons from (n,n*)t

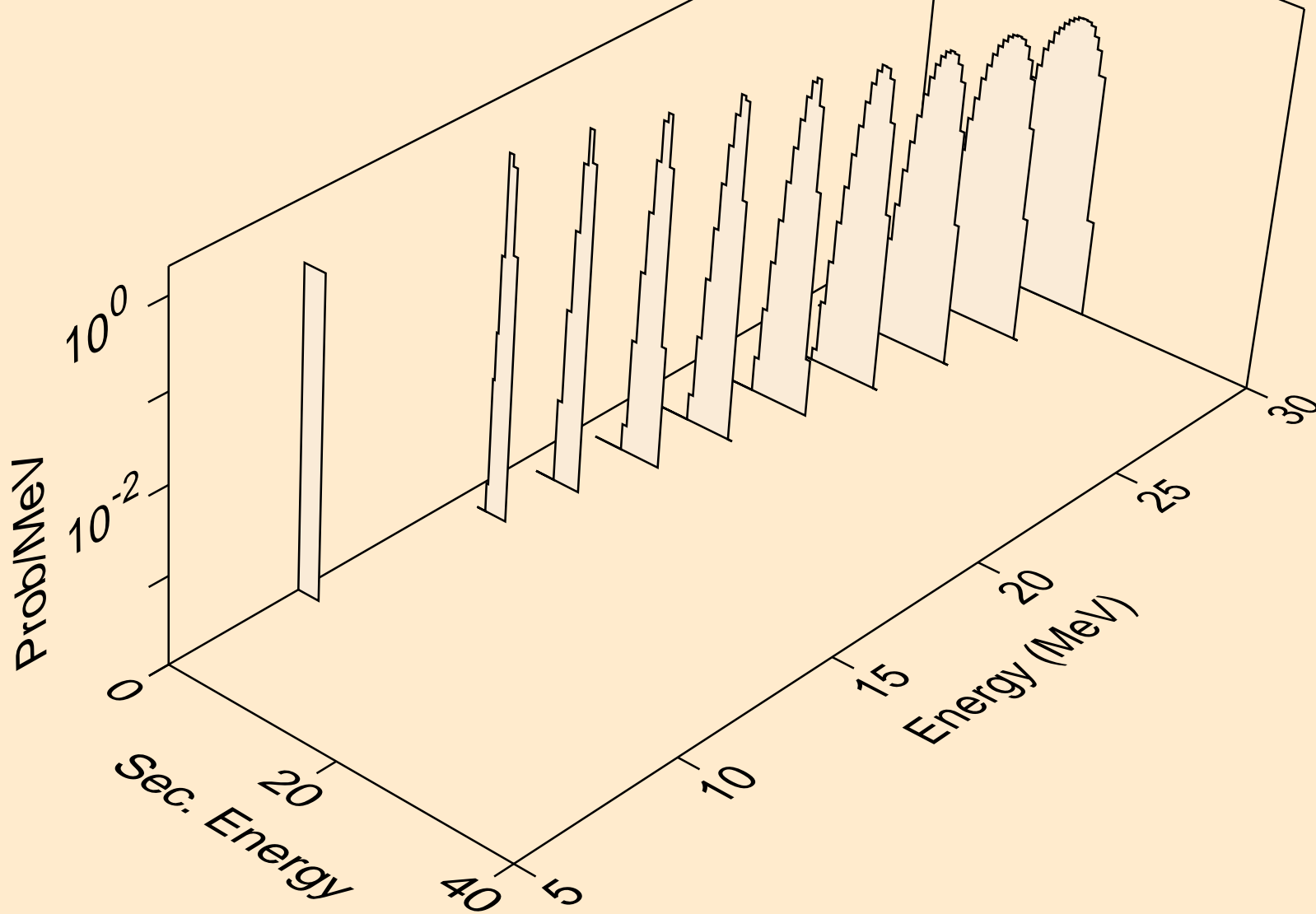

RF257M NEUTRON ACER TENDL-2019 LIBRARY; T=293.16K
tritons from (n,t)

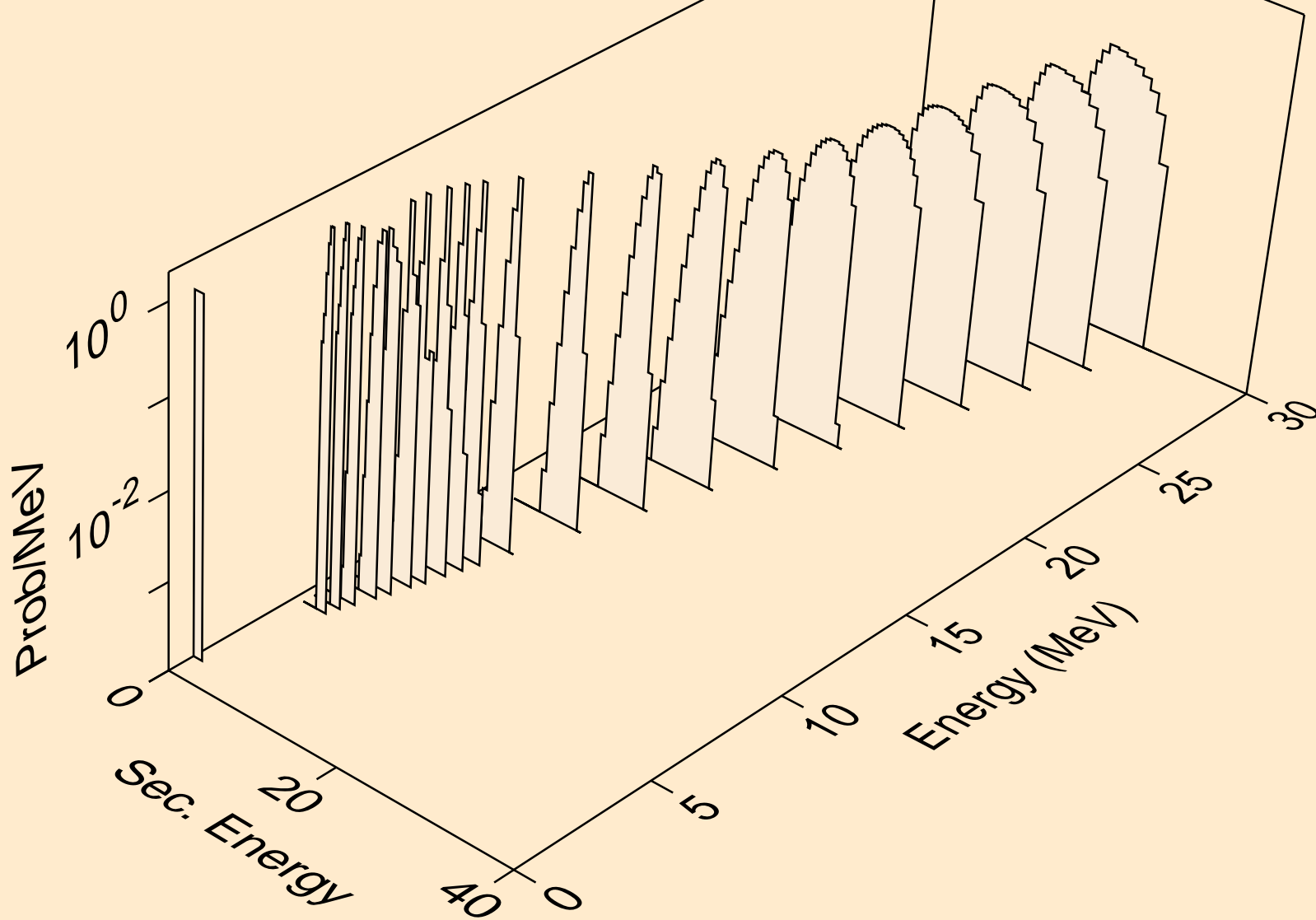

RF257M NEUTRON ACER TENDL-2019 LIBRARY; T=293.16K
tritons from (n,pt)

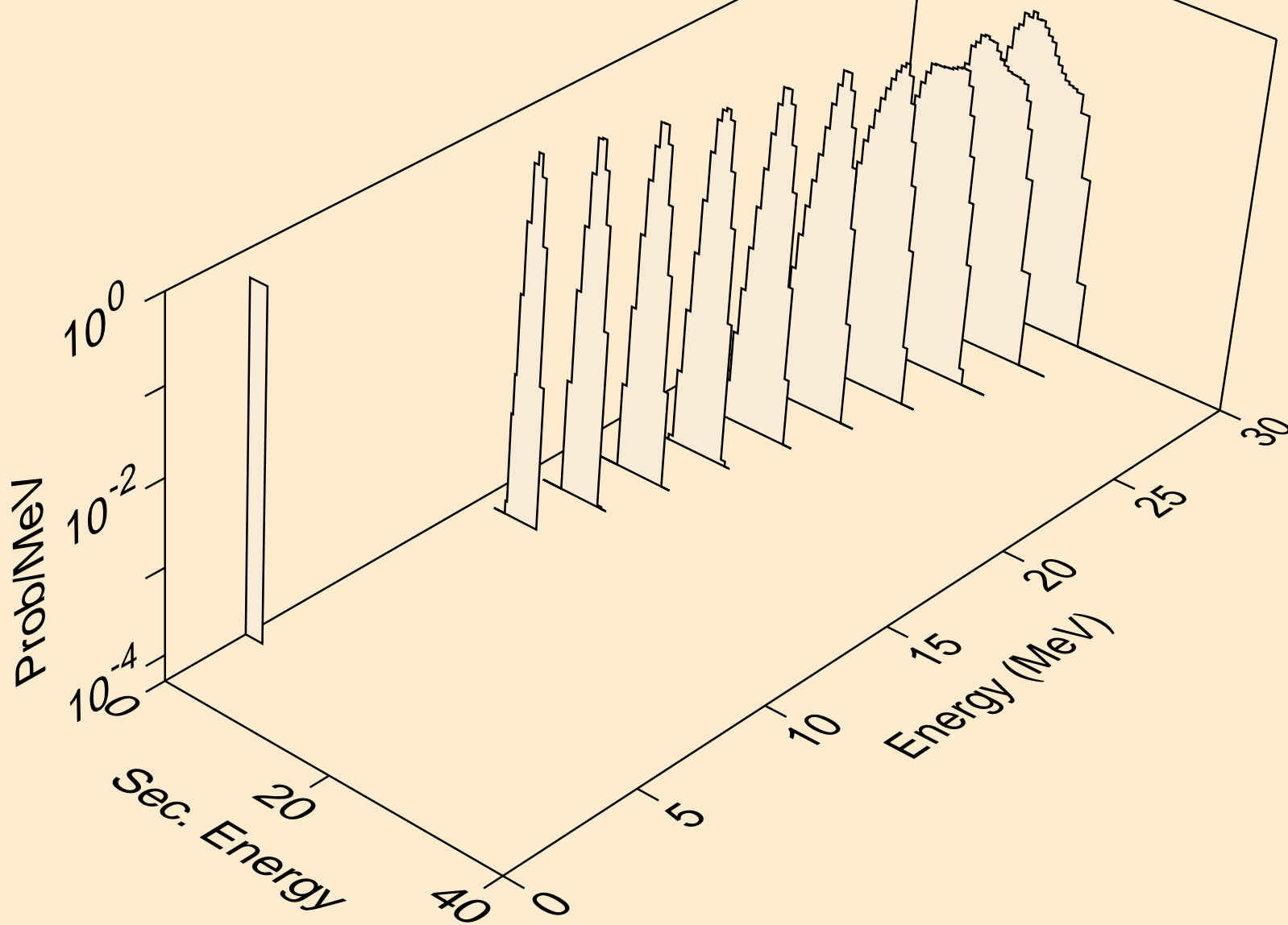

RF257M NEUTRON ACER TENDL-2019 LIBRARY; T=293.16K
he3s from (n,x)

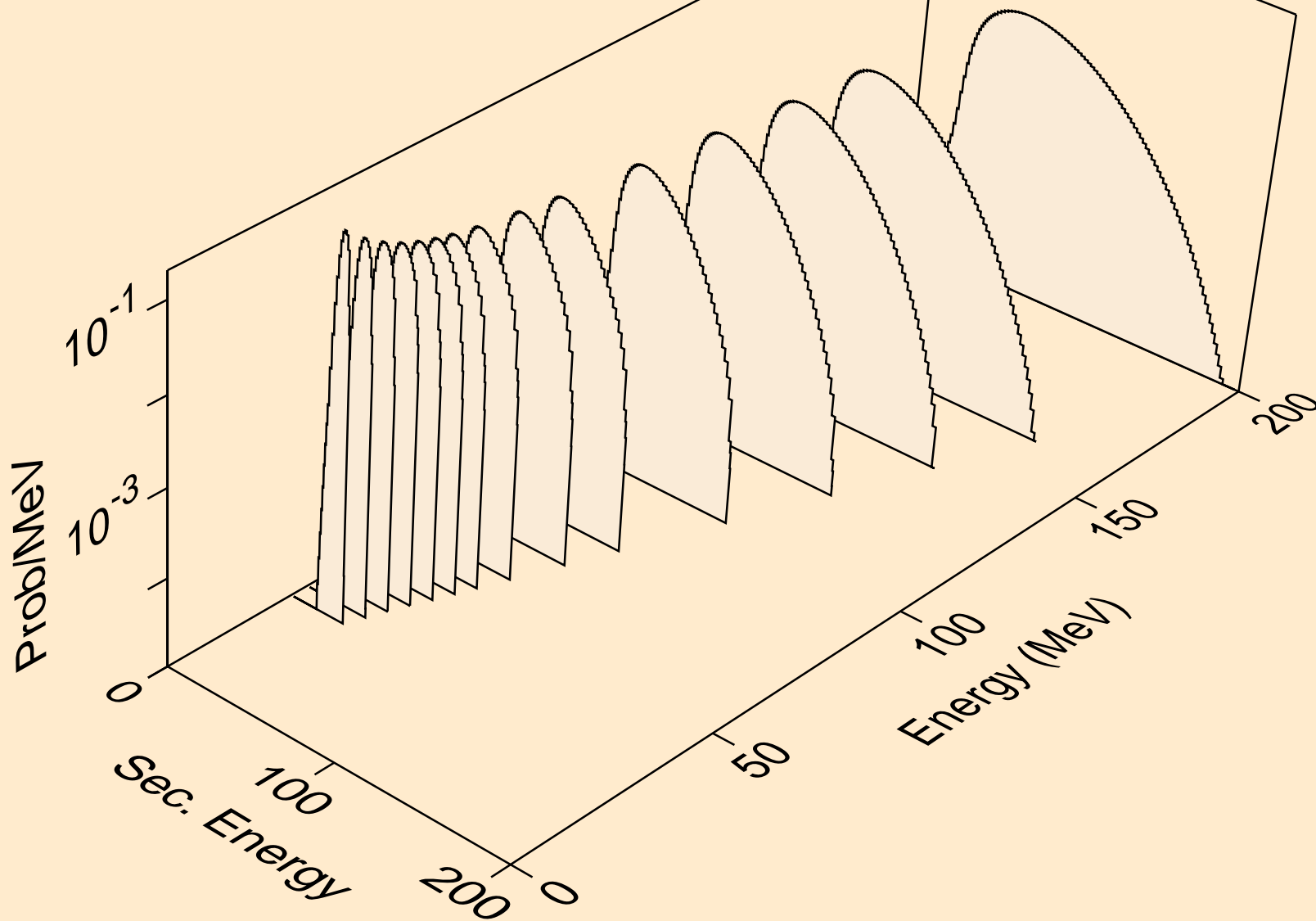

RF257M NEUTRON ACER TENDL-2019 LIBRARY; T=293.16K
he3s from (n,n*)he3

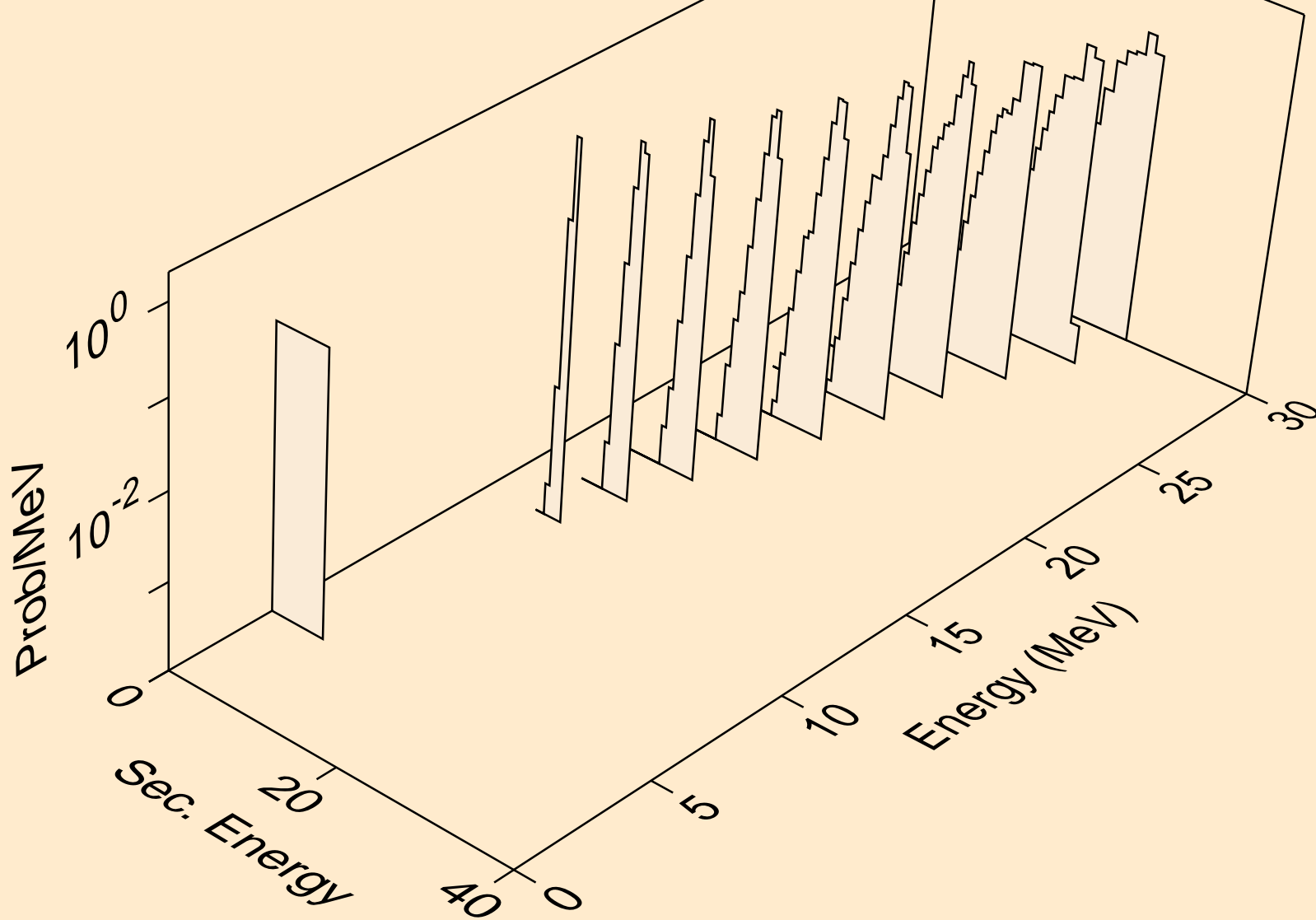

RF257M NEUTRON ACER TENDL-2019 LIBRARY; T=293.16K
he3s from (n,he3)

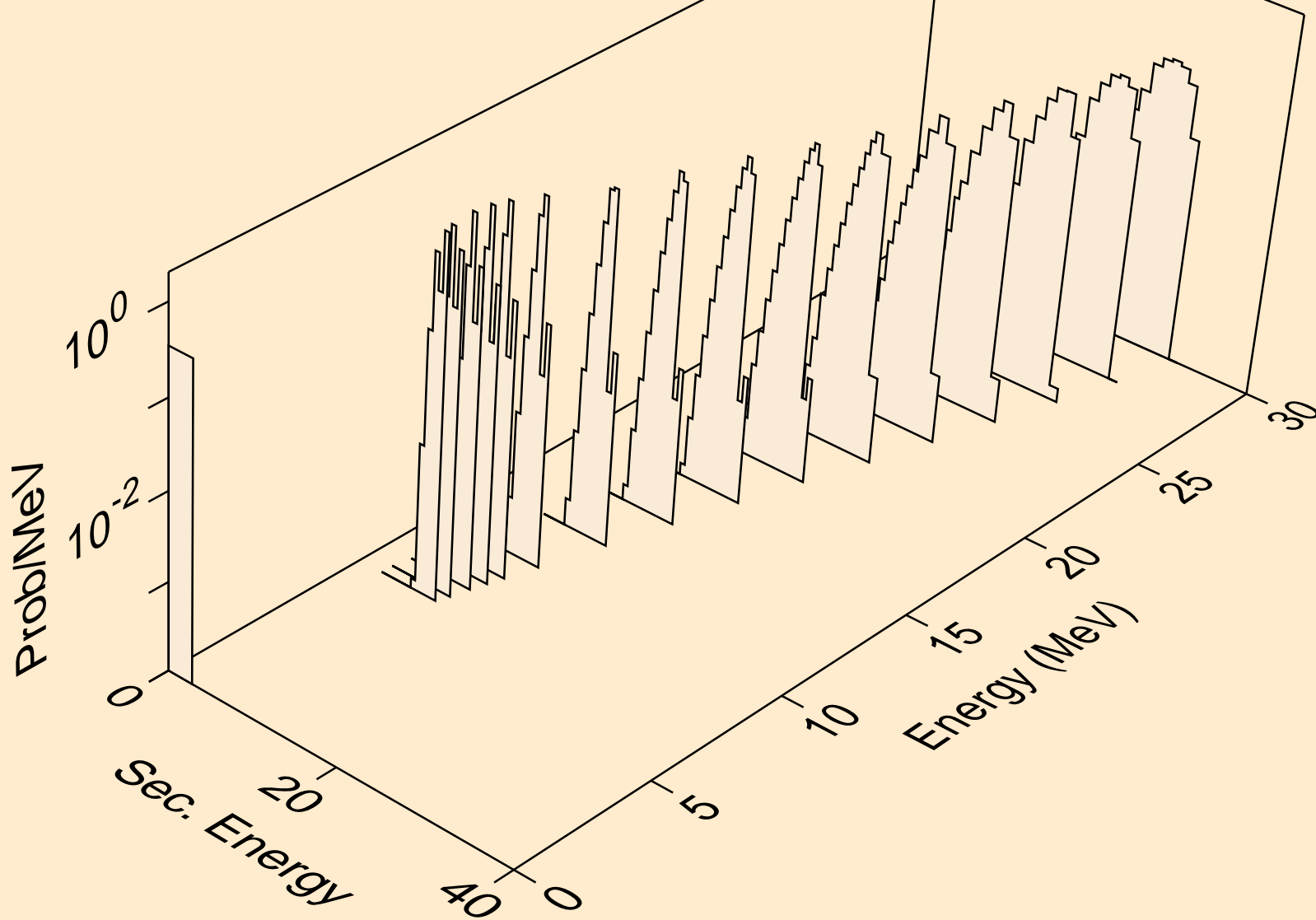

RF257M NEUTRON ACER TENDL-2019 LIBRARY; T=293.16K
alphas from (n,x)

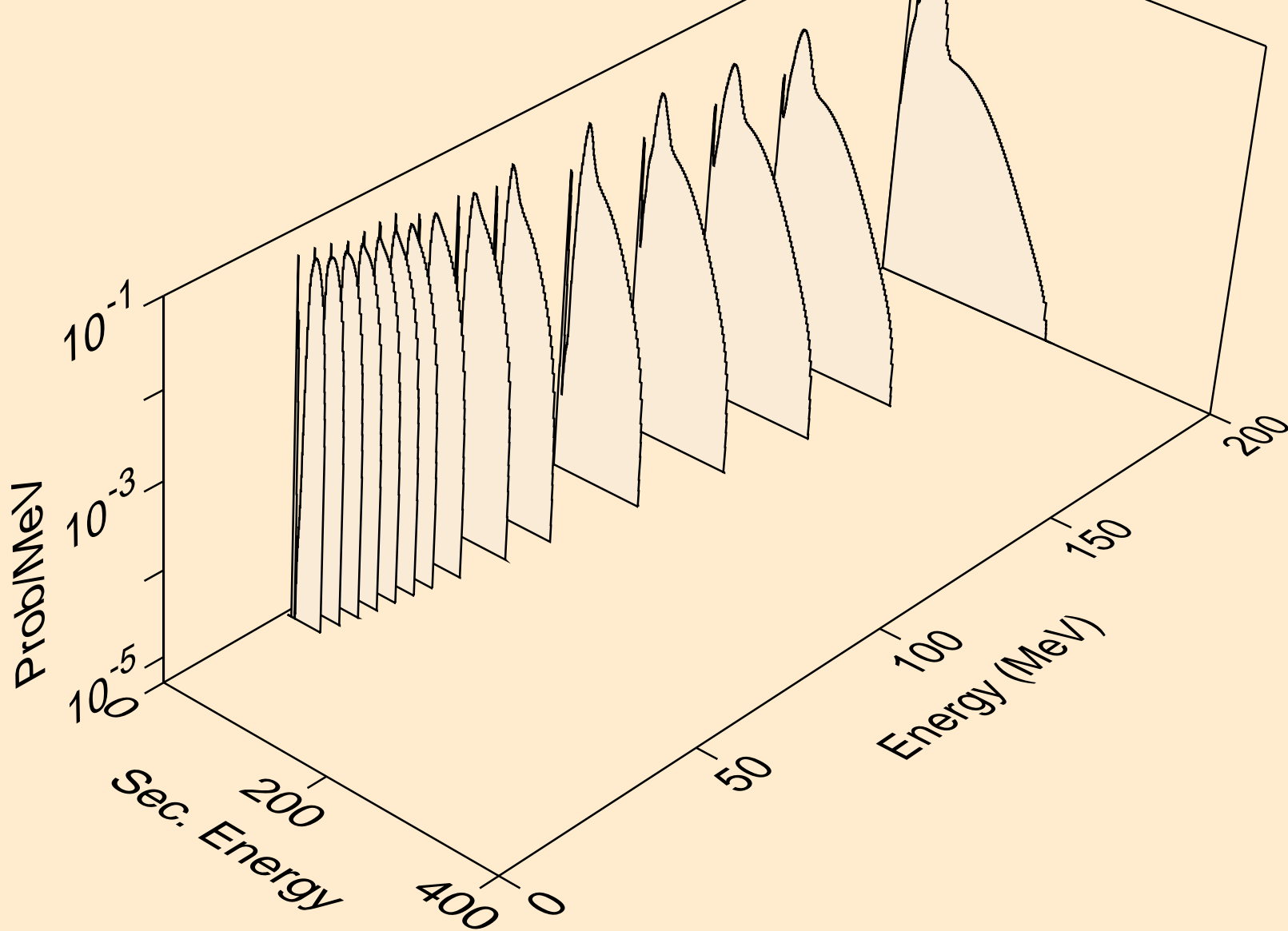

RF257M NEUTRON ACER TENDL-2019 LIBRARY; T=293.16K
alphas from (n,n*)a

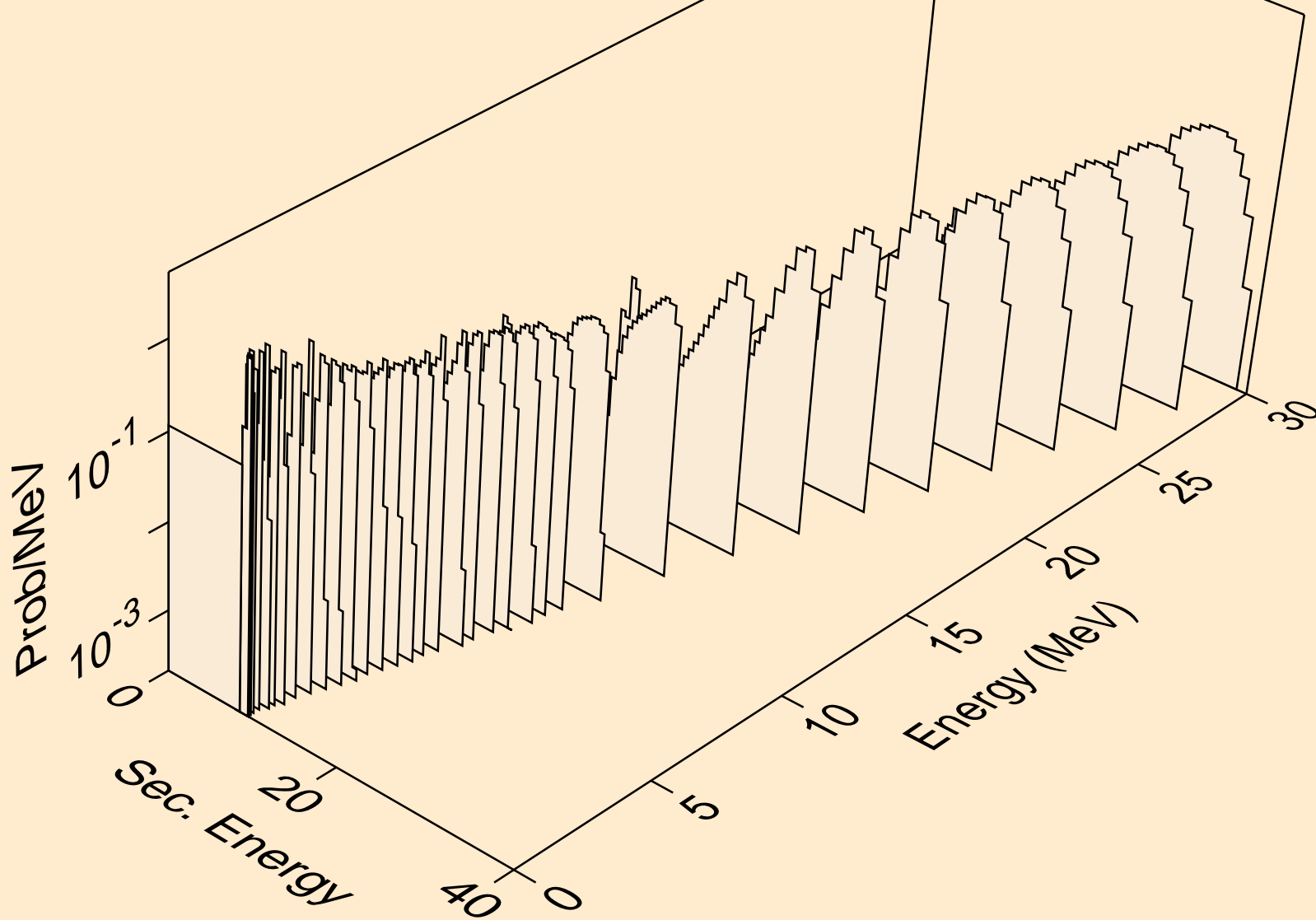

RF257M NEUTRON ACER TENDL-2019 LIBRARY; T=293.16K
alphas from (n,2n)a

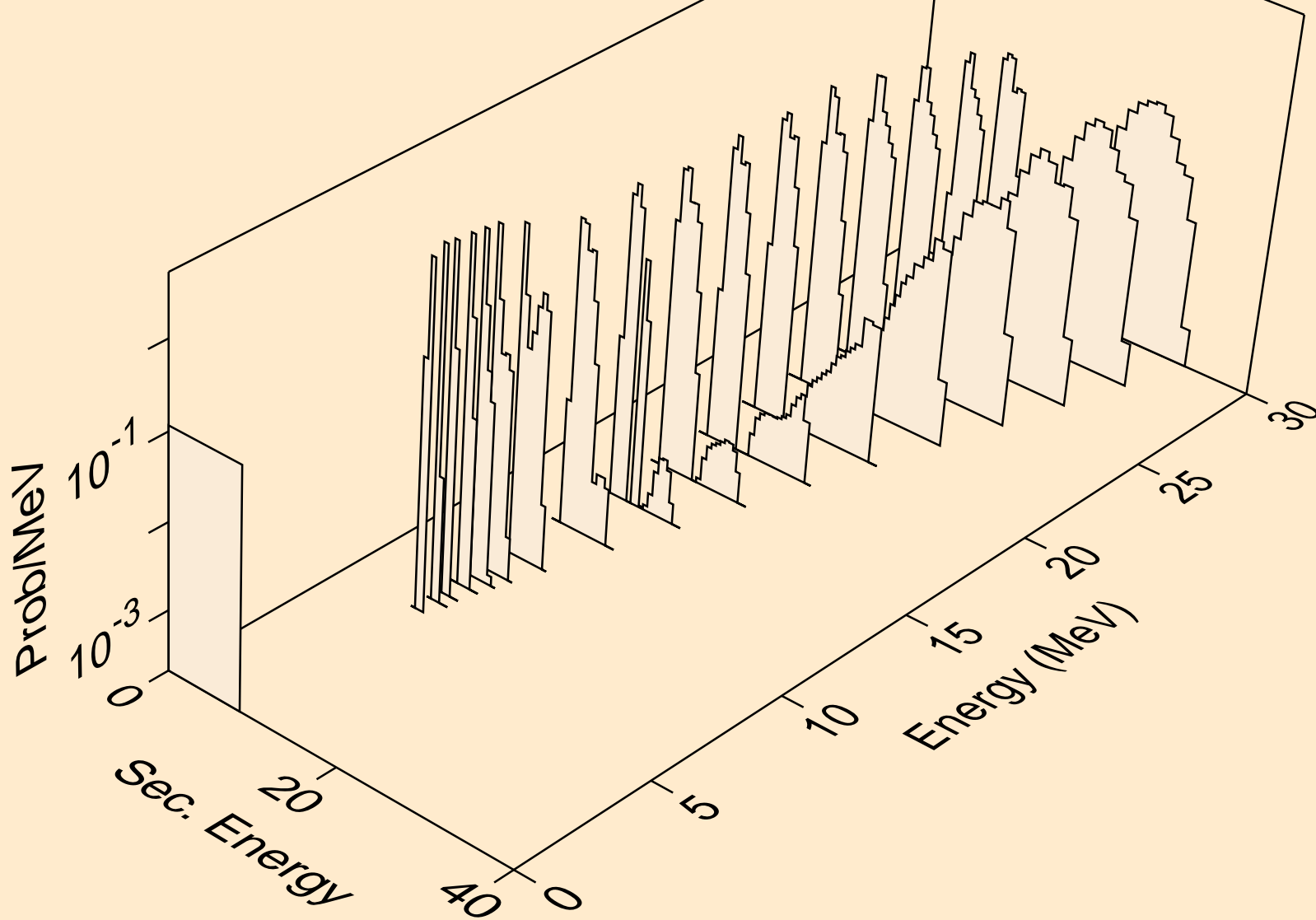

RF257M NEUTRON ACER TENDL-2019 LIBRARY; T=293.16K
alphas from (n,3n)a

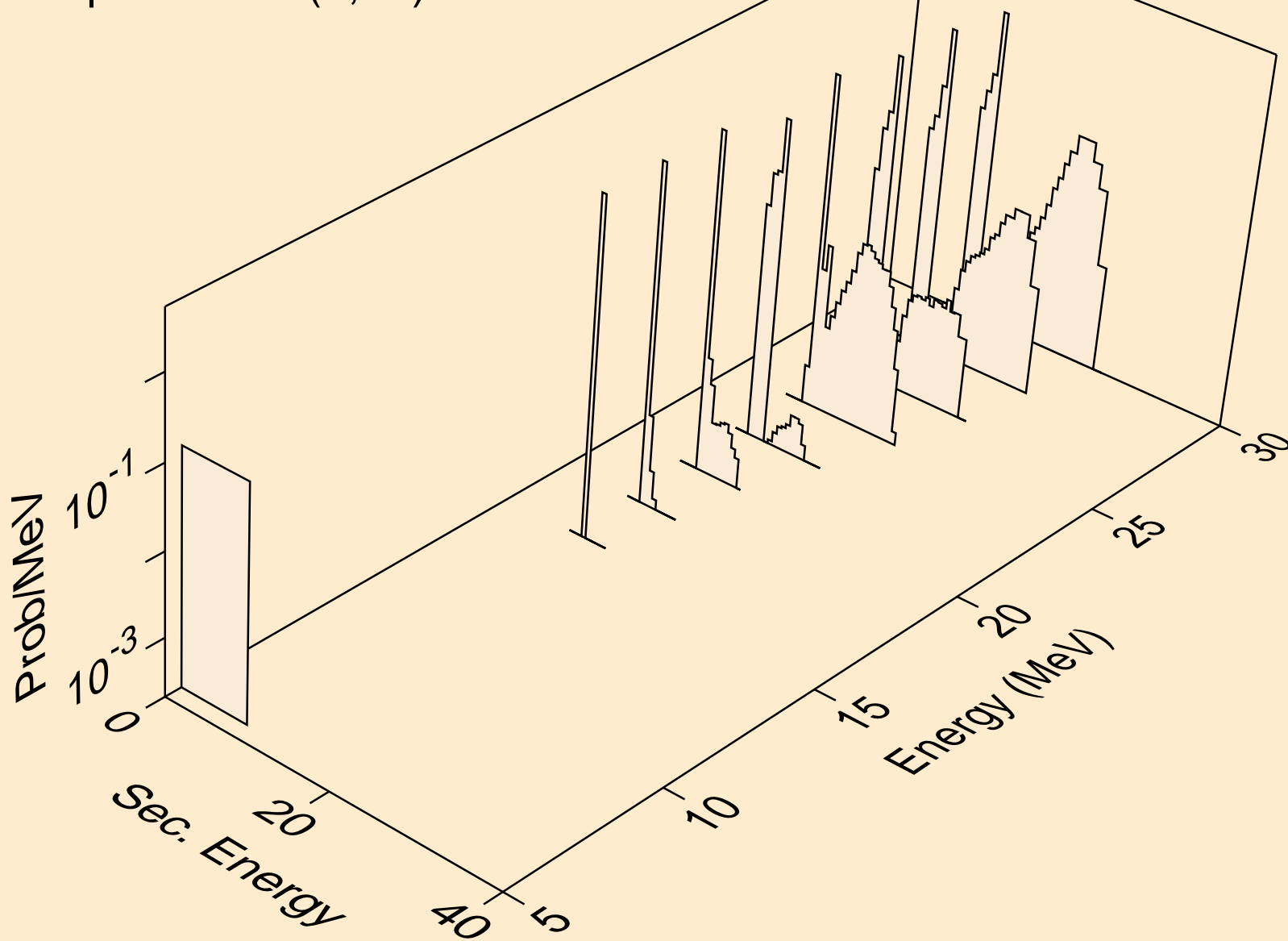

RF257M NEUTRON ACER TENDL-2019 LIBRARY; T=293.16K
alphas from (n,n*)2a

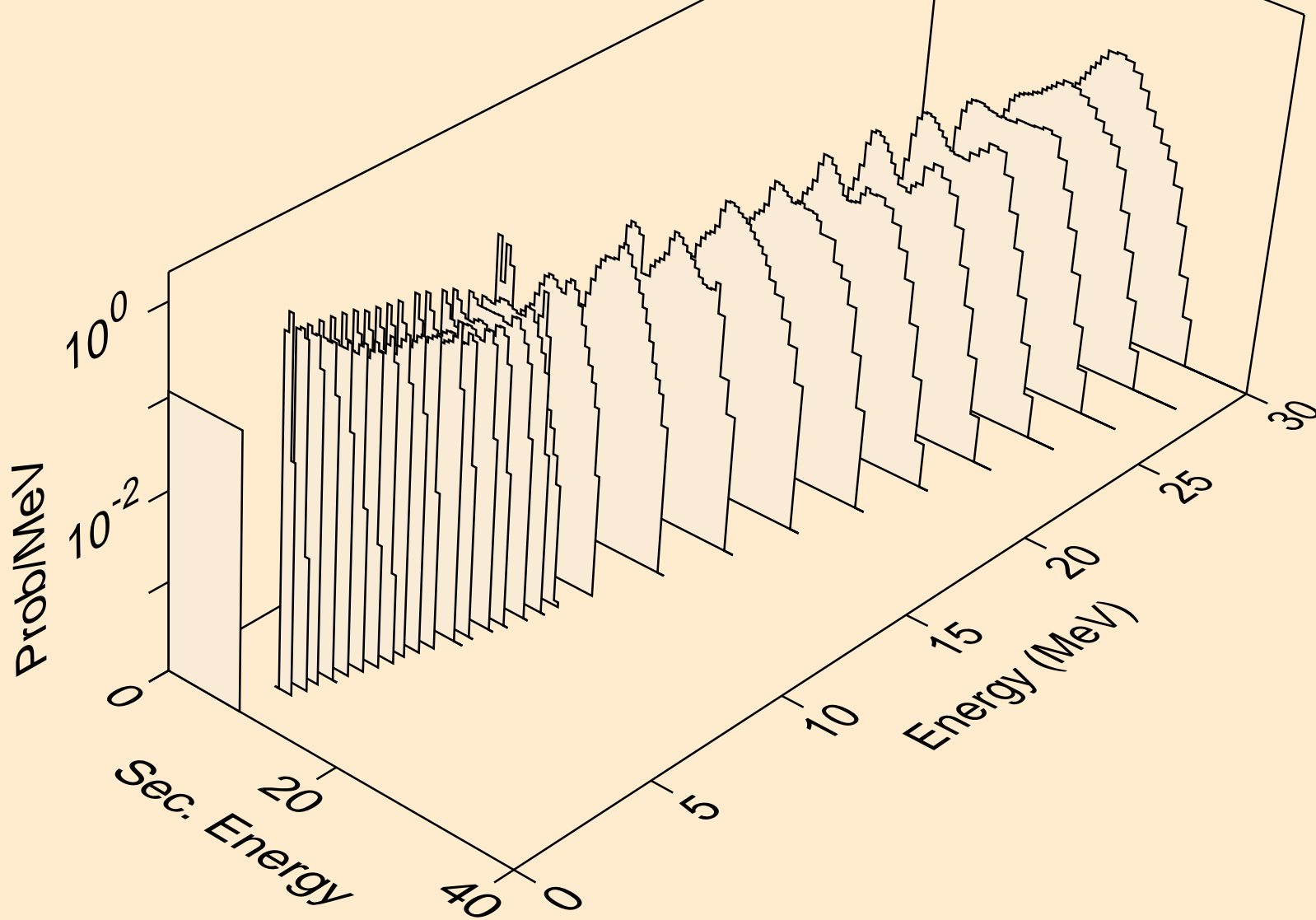

RF257M NEUTRON ACER TENDL-2019 LIBRARY; T=293.16K
alphas from (n,2n)2a

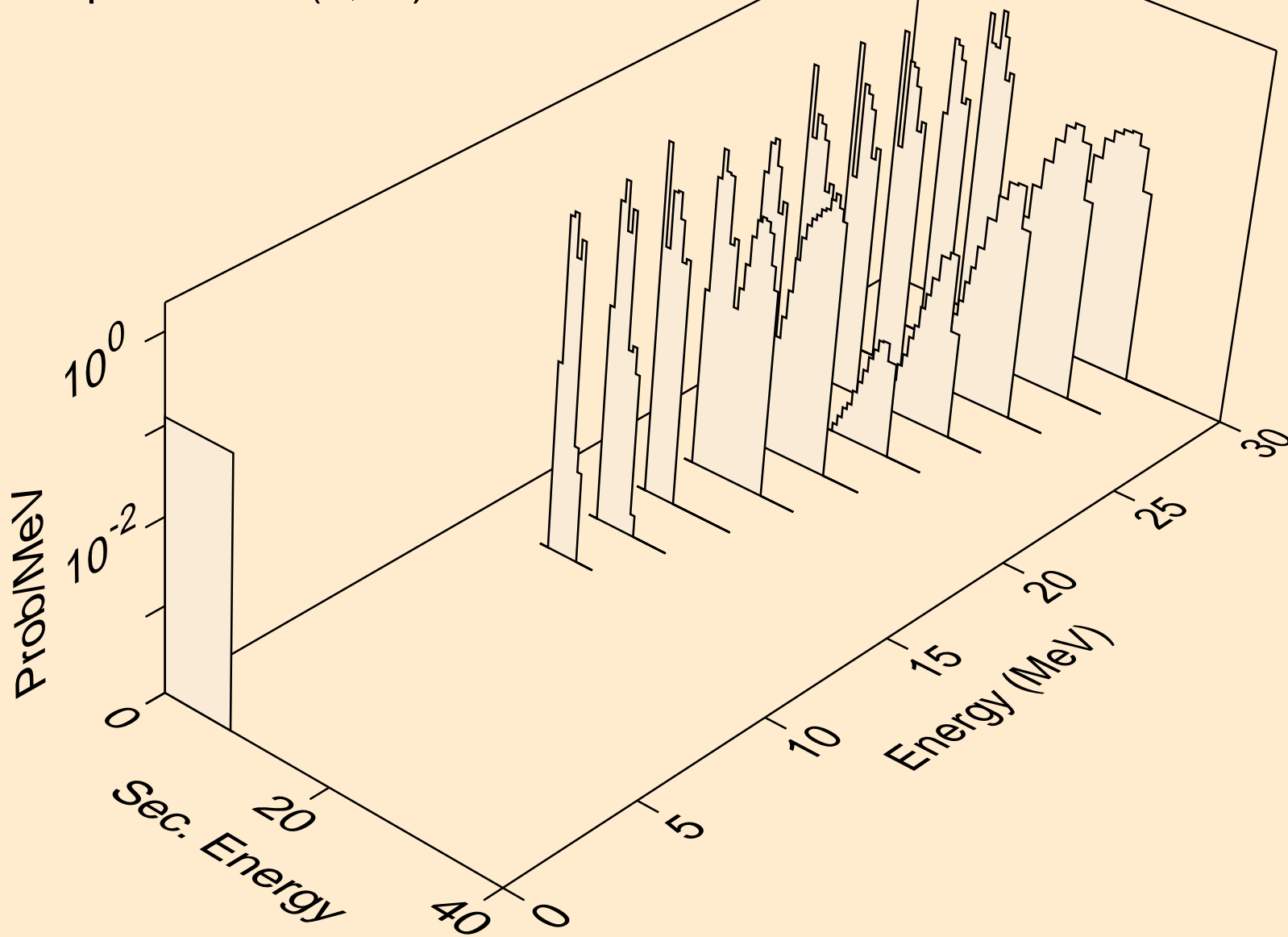

RF257M NEUTRON ACER TENDL-2019 LIBRARY; T=293.16K
alphas from (n,npa)

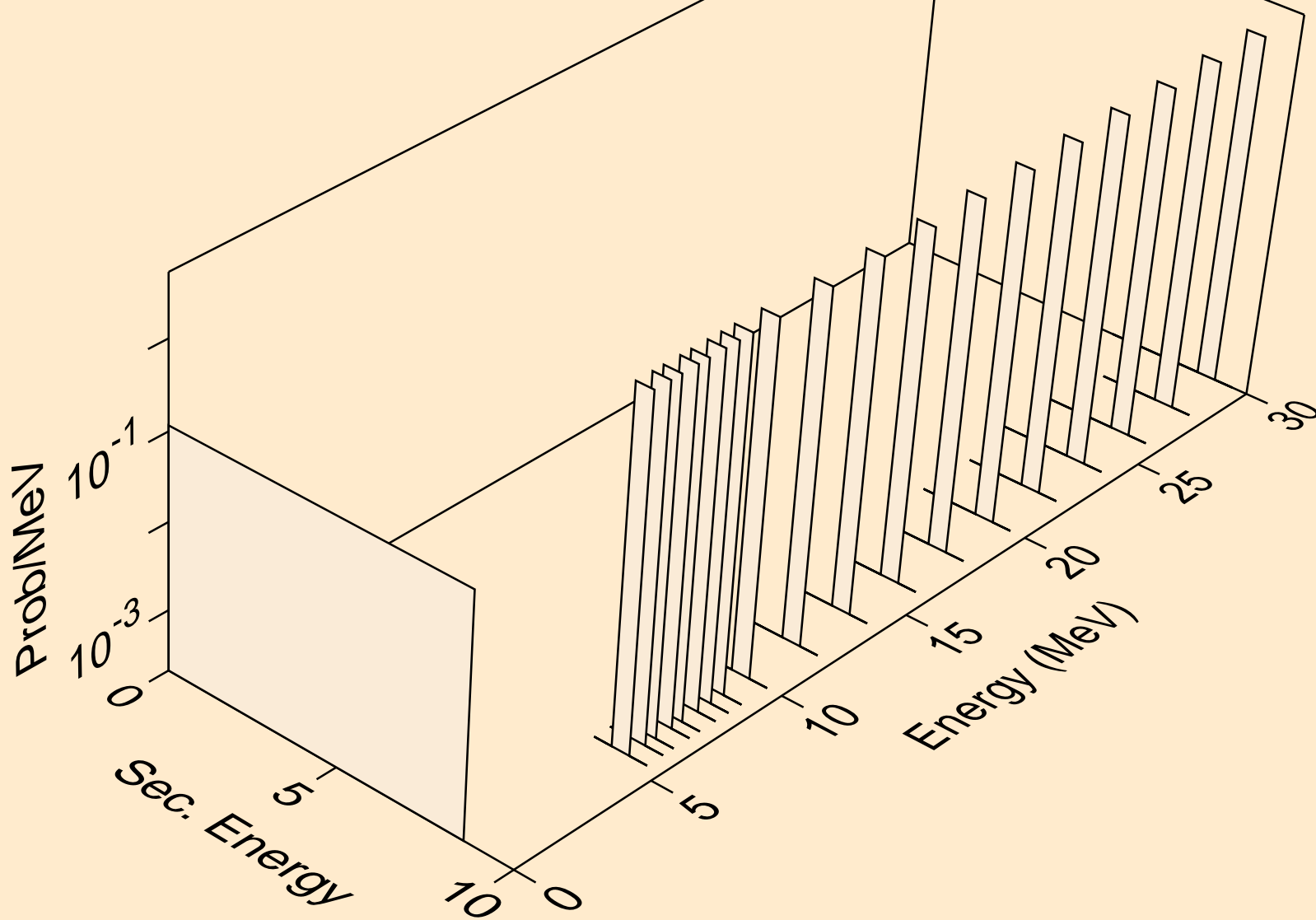

RF257M NEUTRON ACER TENDL-2019 LIBRARY; T=293.16K
alphas from (n,a)

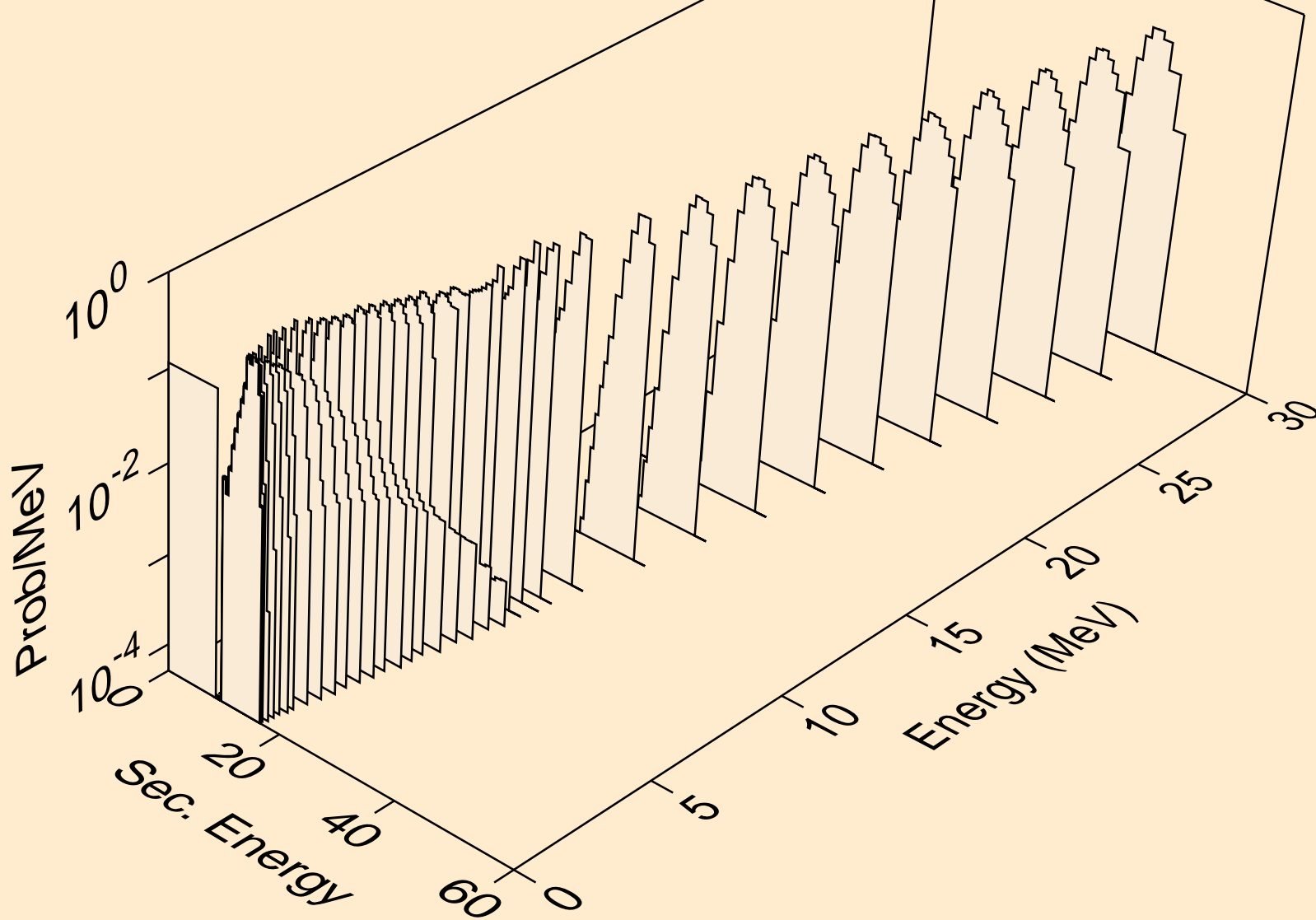

RF257M NEUTRON ACER TENDL-2019 LIBRARY; T=293.16K
alphas from (n,2a)

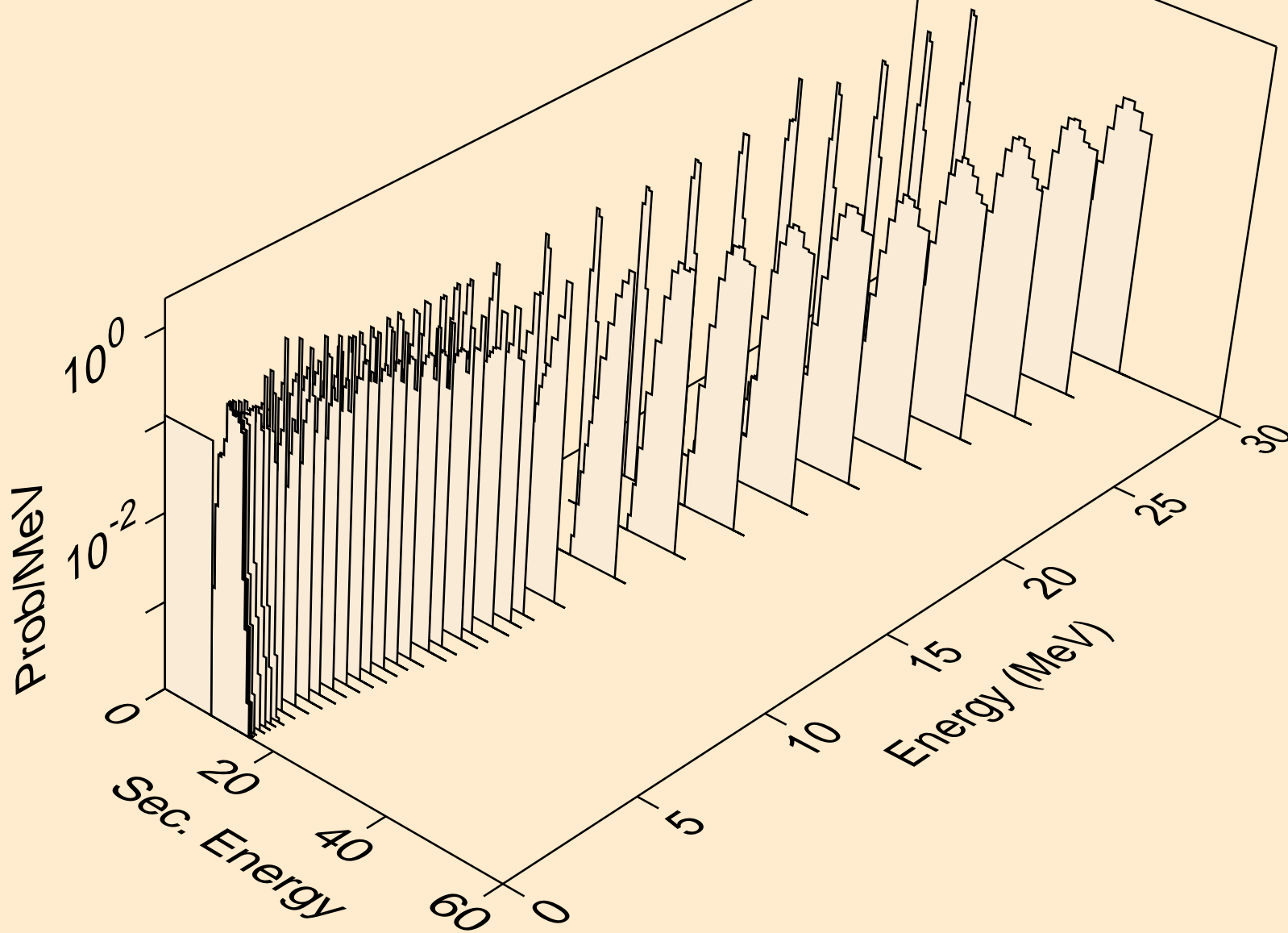

RF257M NEUTRON ACER TENDL-2019 LIBRARY; T=293.16K
alphas from (n,pa)

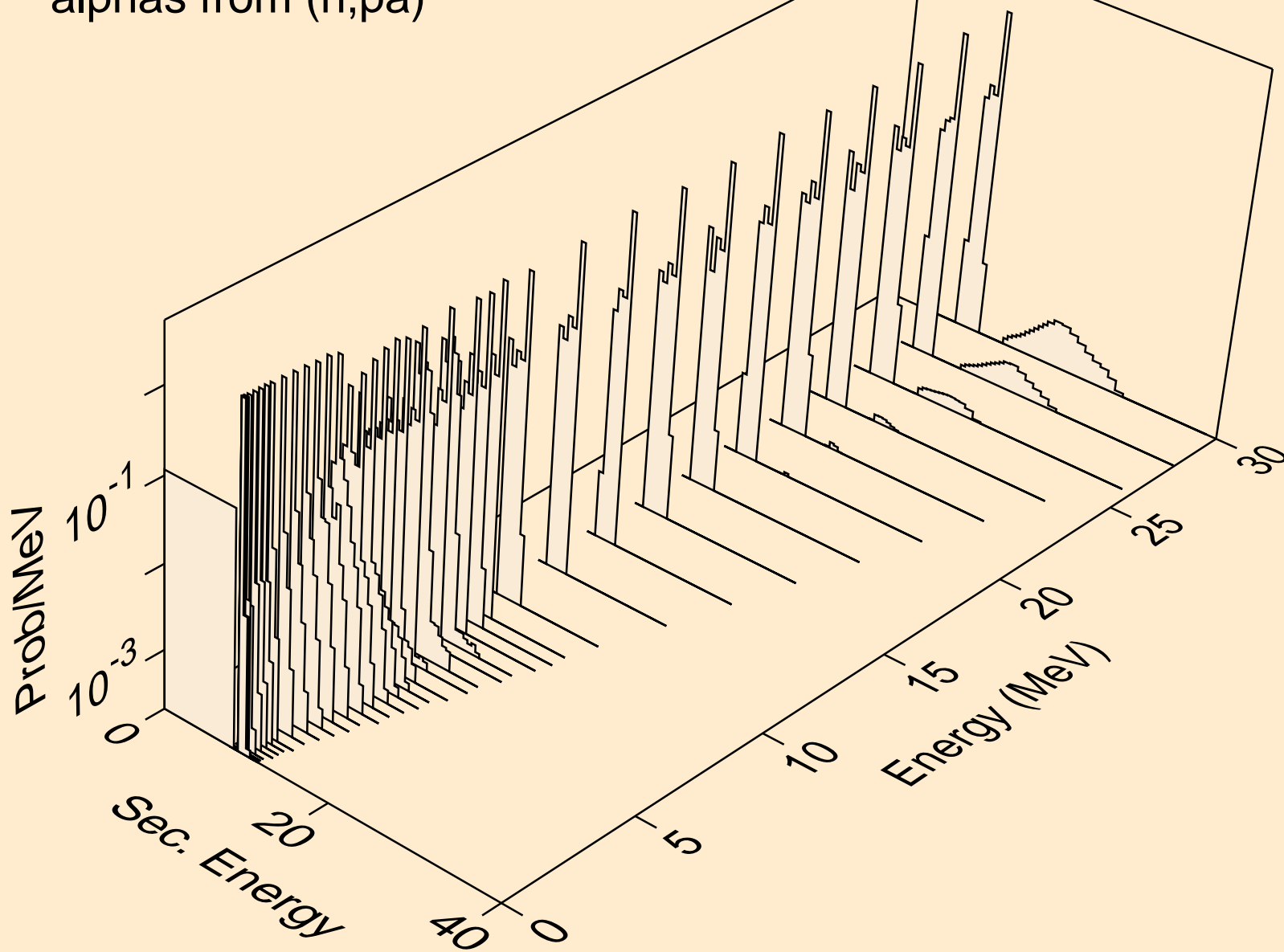

RF257M NEUTRON ACER TENDL-2019 LIBRARY; T=293.16K
alphas from (n,da)

