

RF259 NEUTRON ACER TENDL-2019 LIBRARY; T=293.16K  
Principal cross sections

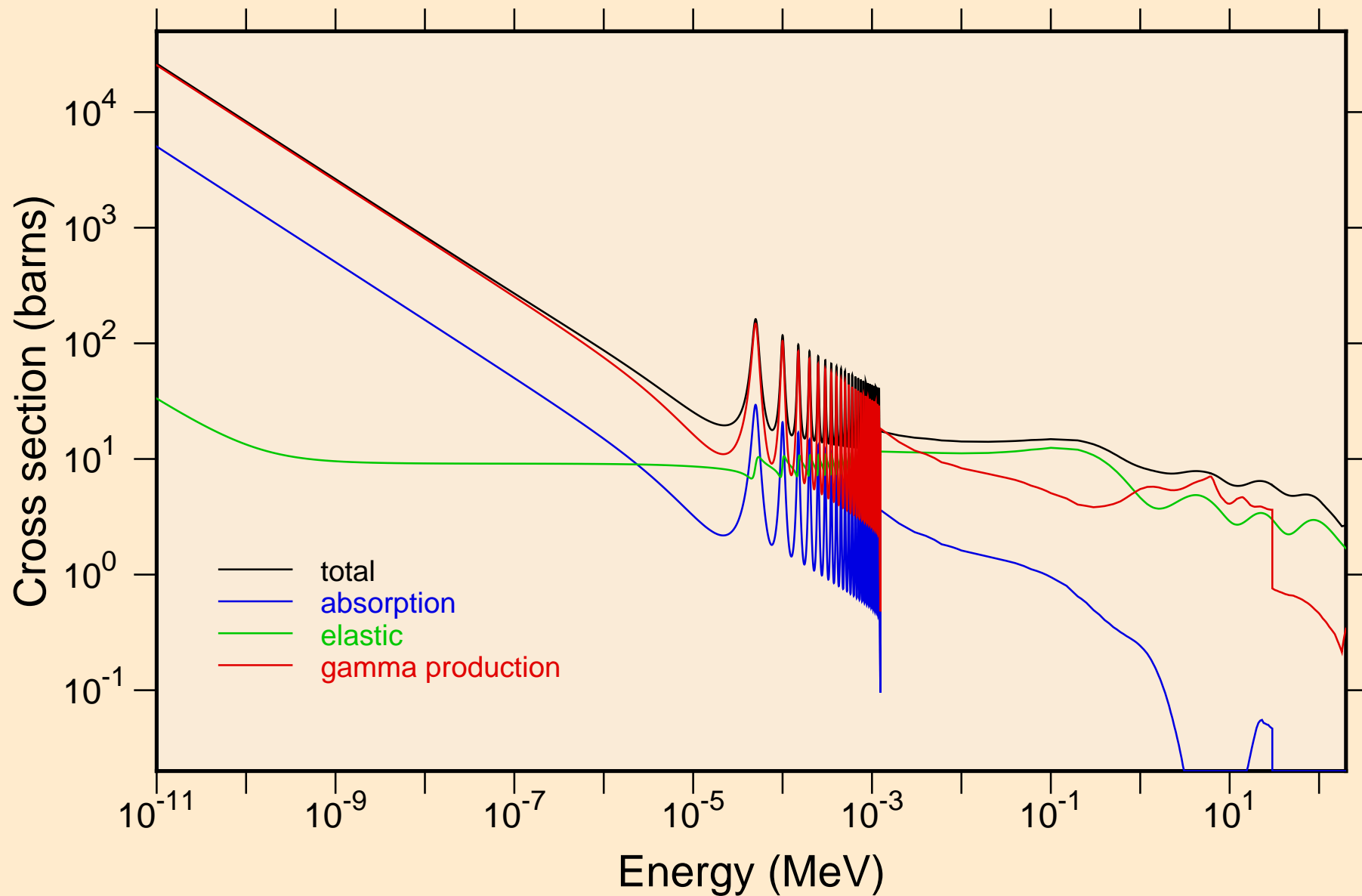

RF259 NEUTRON ACER TENDL-2019 LIBRARY; T=293.16K  
resonance total cross section

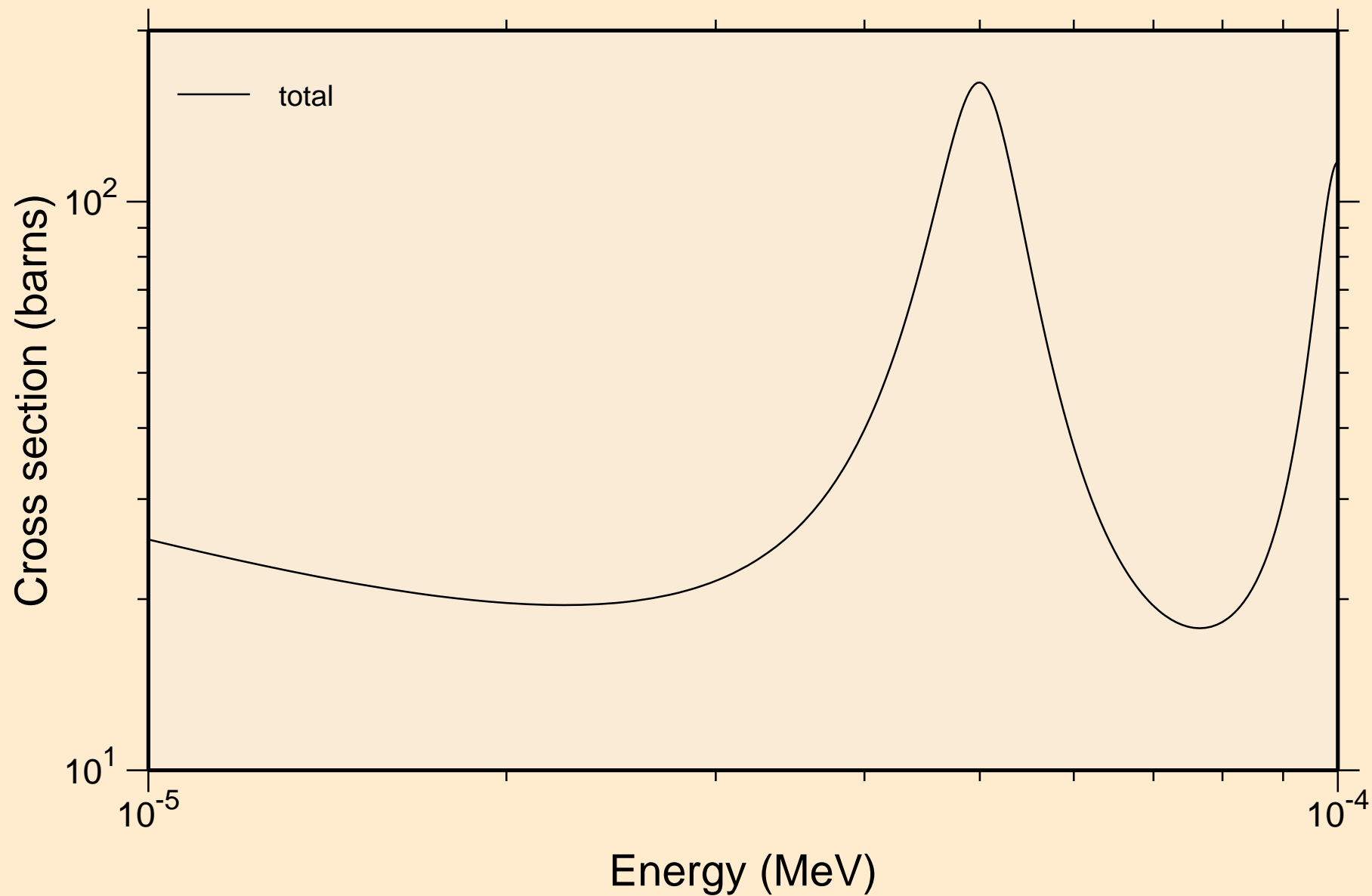

RF259 NEUTRON ACER TENDL-2019 LIBRARY; T=293.16K  
resonance total cross section

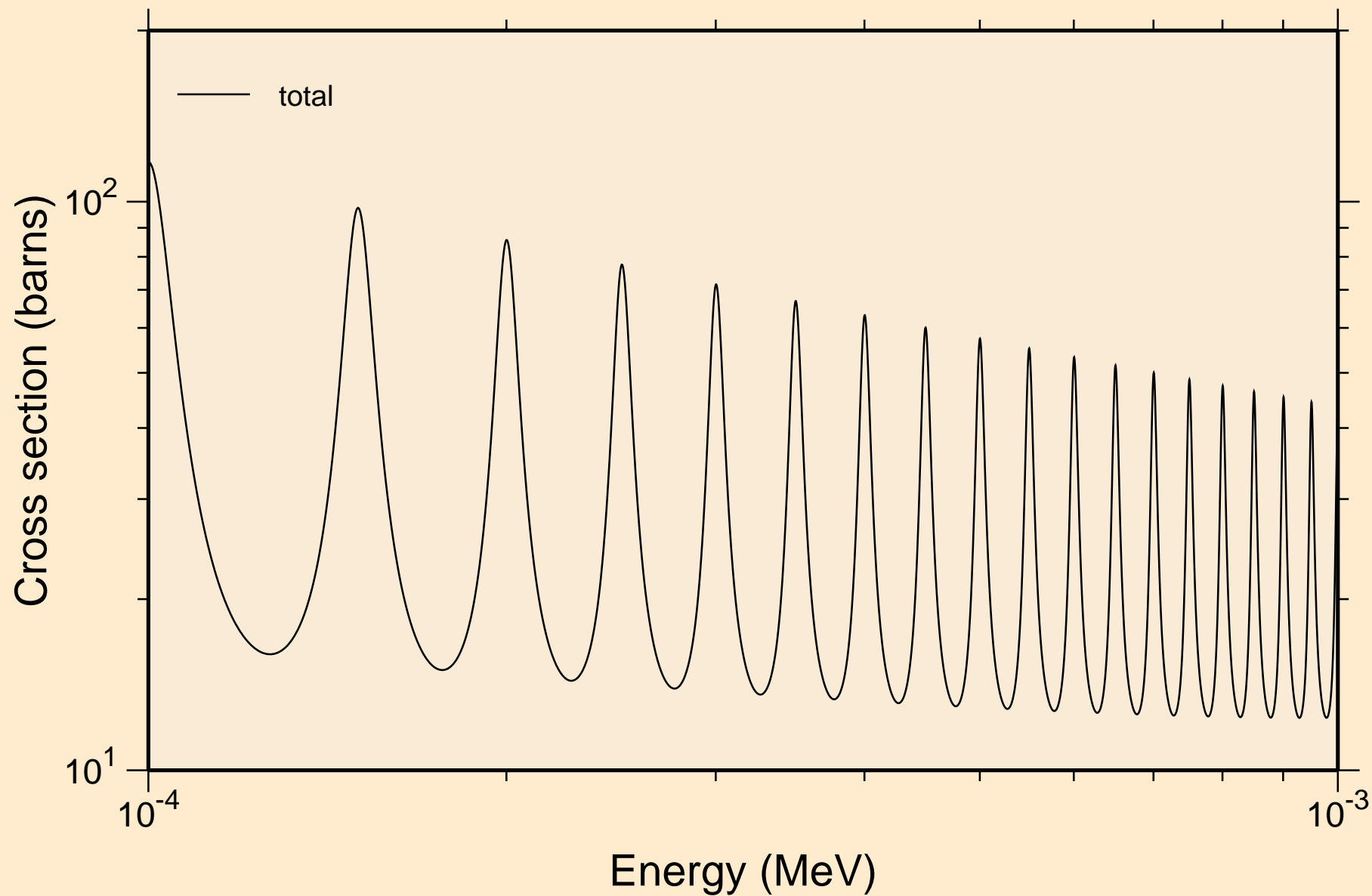

RF259 NEUTRON ACER TENDL-2019 LIBRARY; T=293.16K  
resonance total cross section

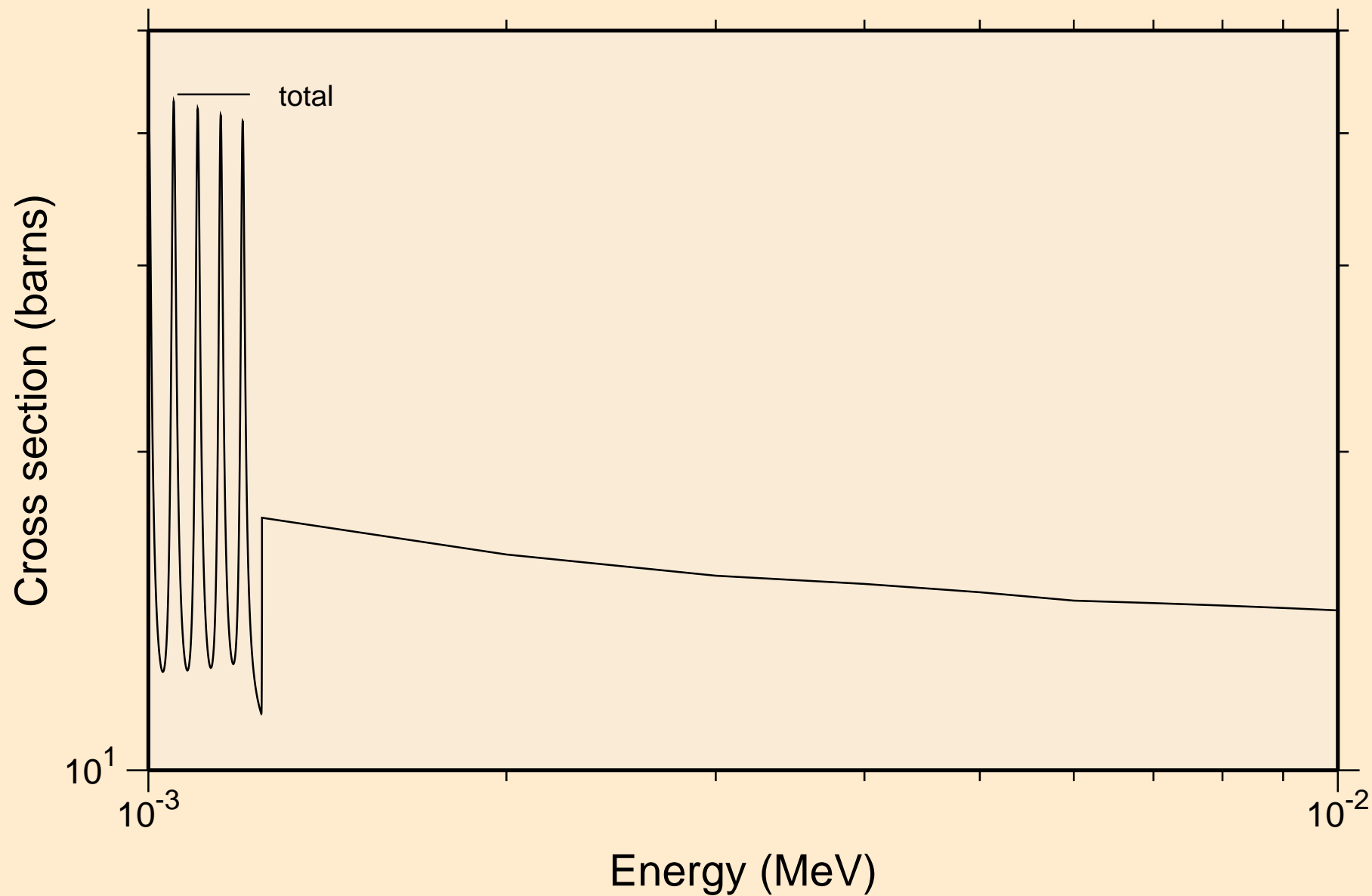

RF259 NEUTRON ACER TENDL-2019 LIBRARY; T=293.16K  
resonance total cross section

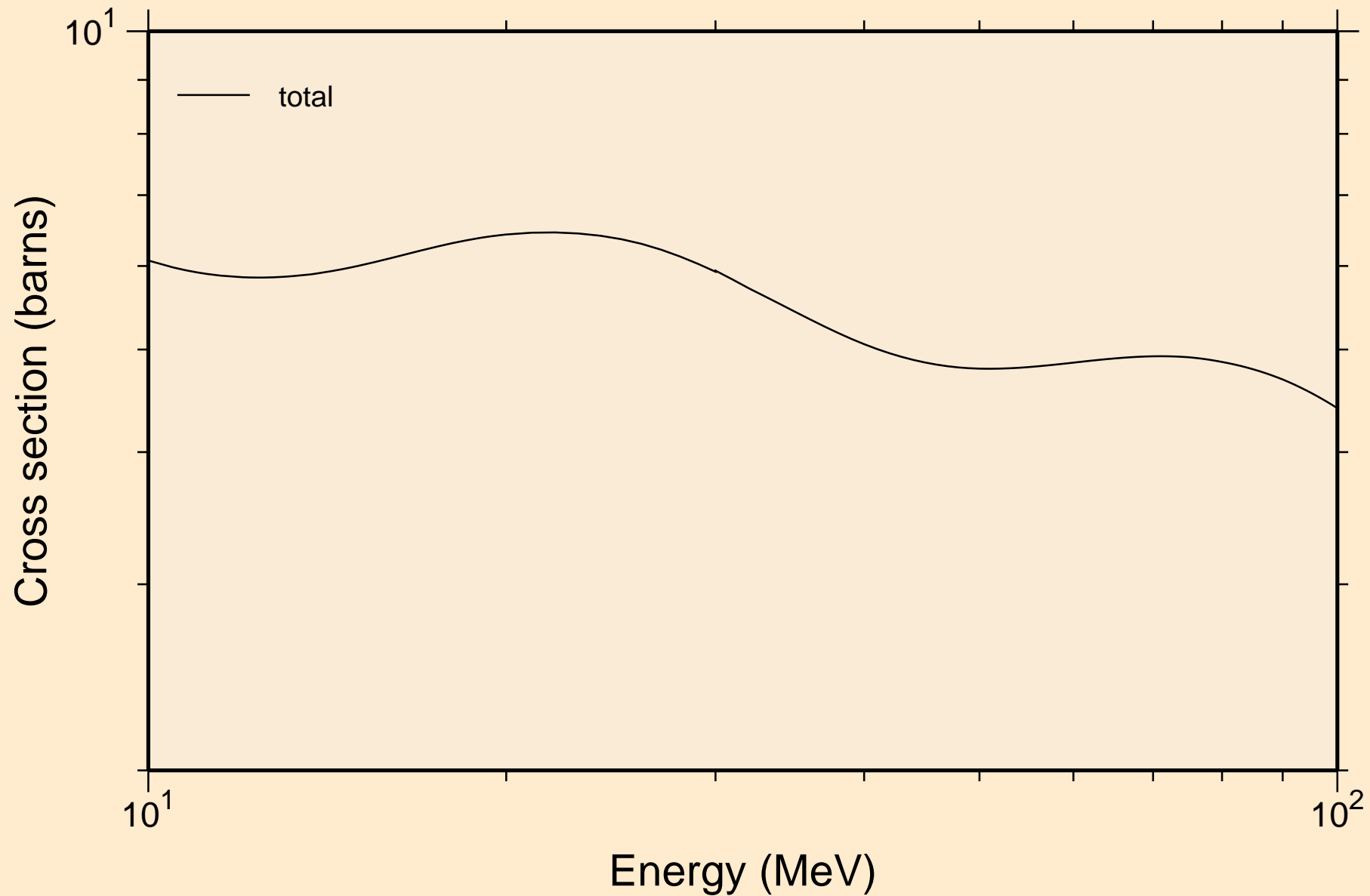

RF259 NEUTRON ACER TENDL-2019 LIBRARY; T=293.16K  
resonance absorption cross sections

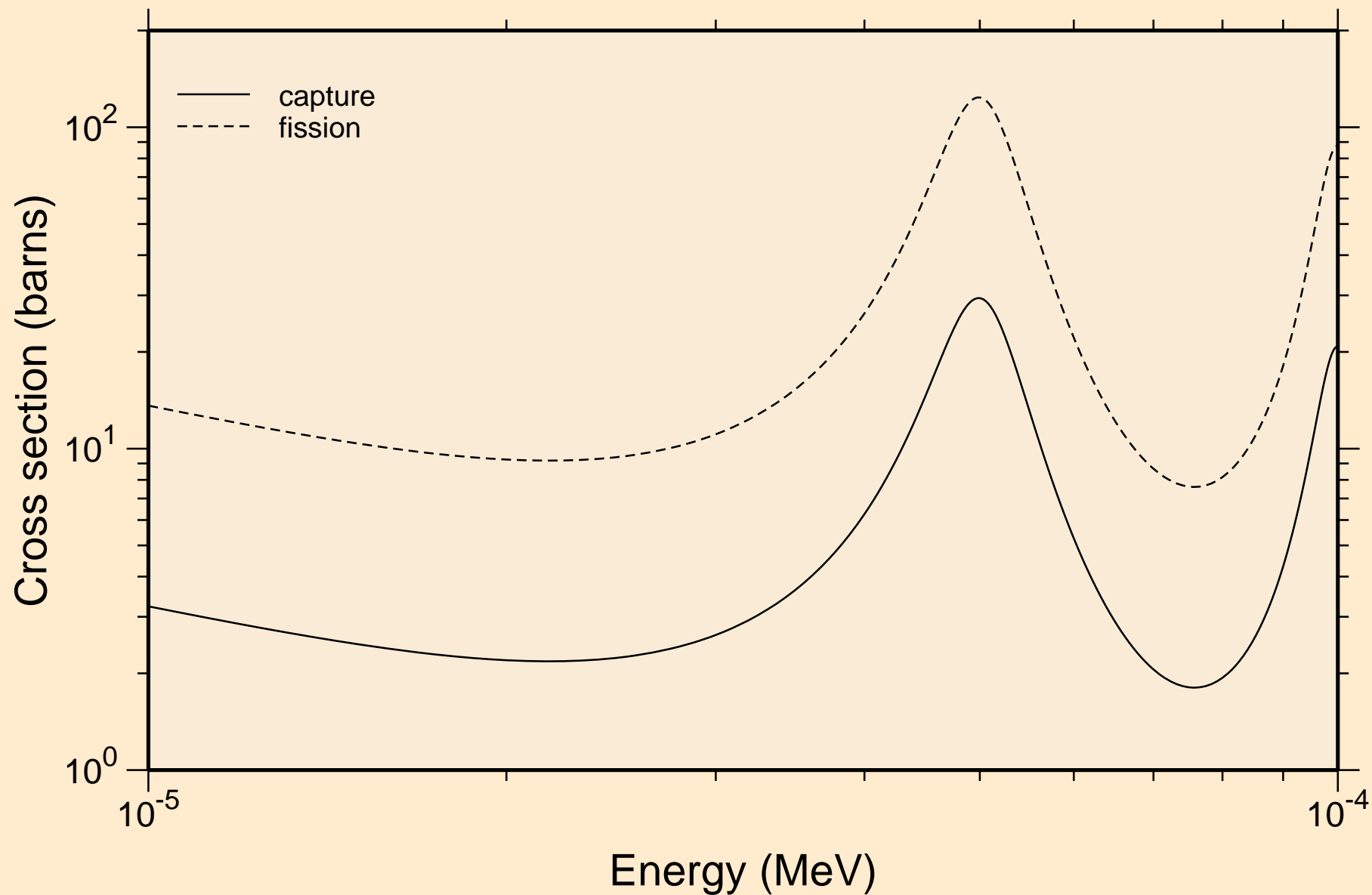

RF259 NEUTRON ACER TENDL-2019 LIBRARY; T=293.16K  
resonance absorption cross sections

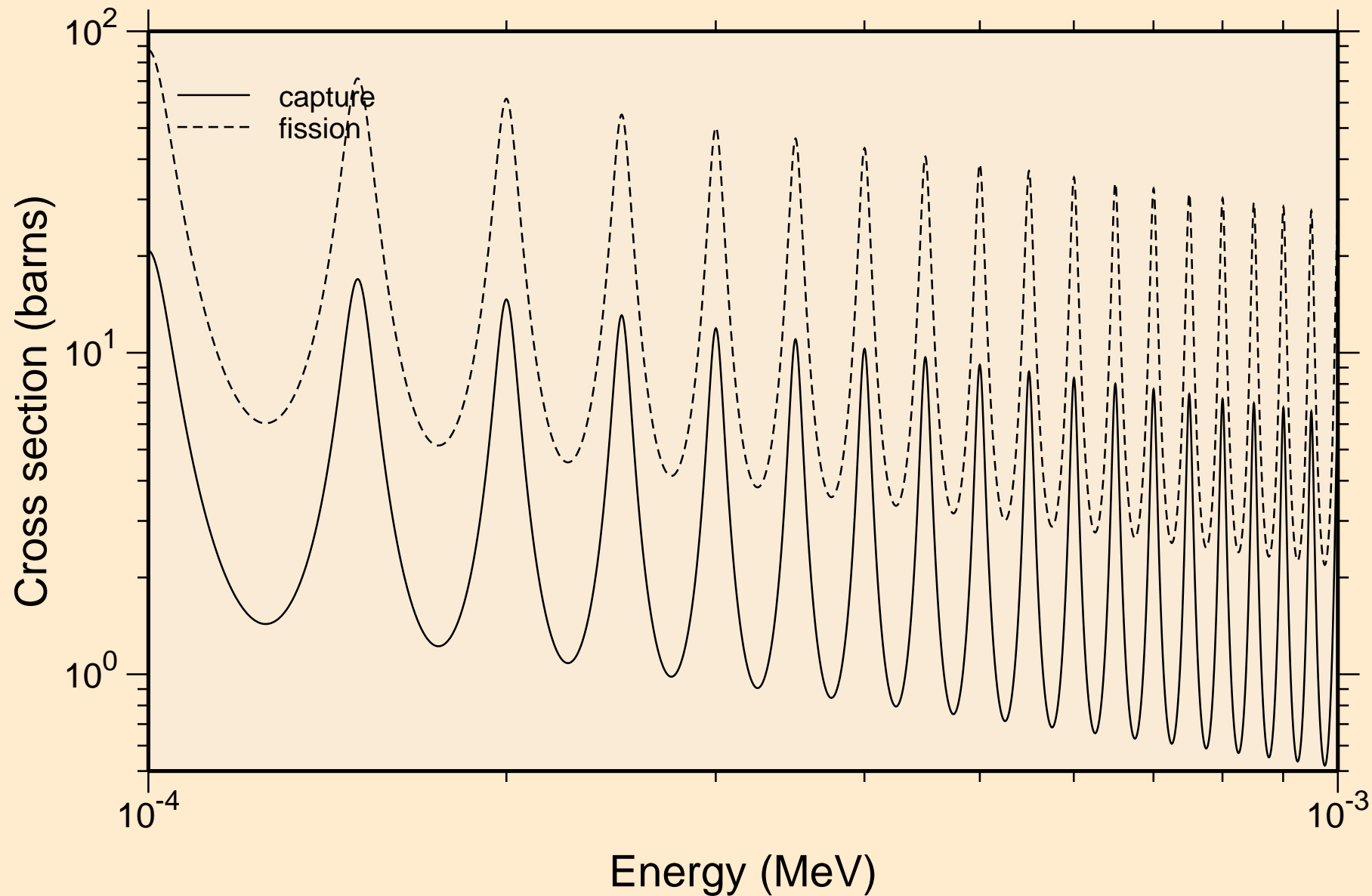

RF259 NEUTRON ACER TENDL-2019 LIBRARY; T=293.16K  
resonance absorption cross sections

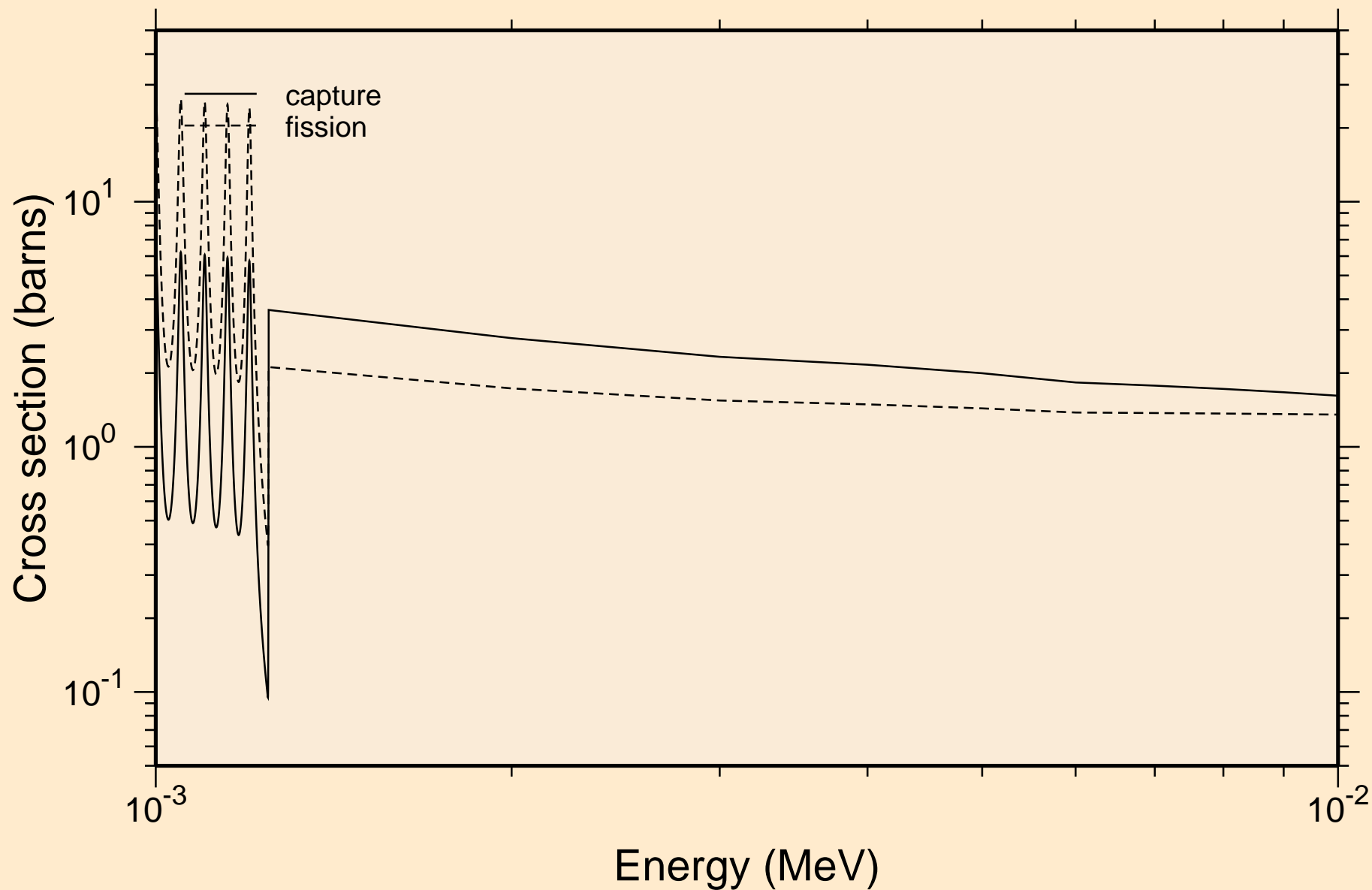



RF259 NEUTRON ACER TENDL-2019 LIBRARY; T=293.16K  
resonance absorption cross sections

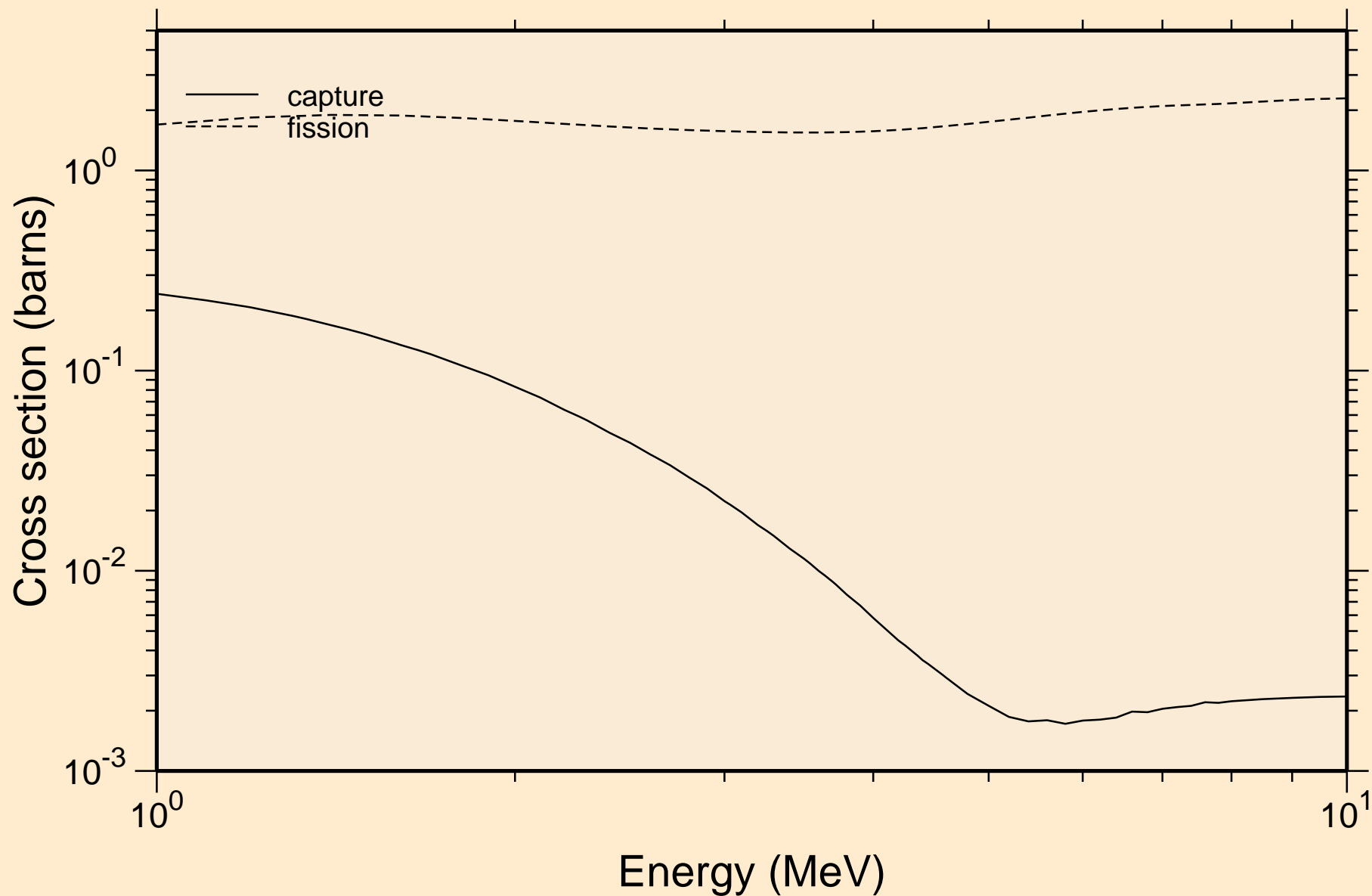

RF259 NEUTRON ACER TENDL-2019 LIBRARY; T=293.16K  
Heating

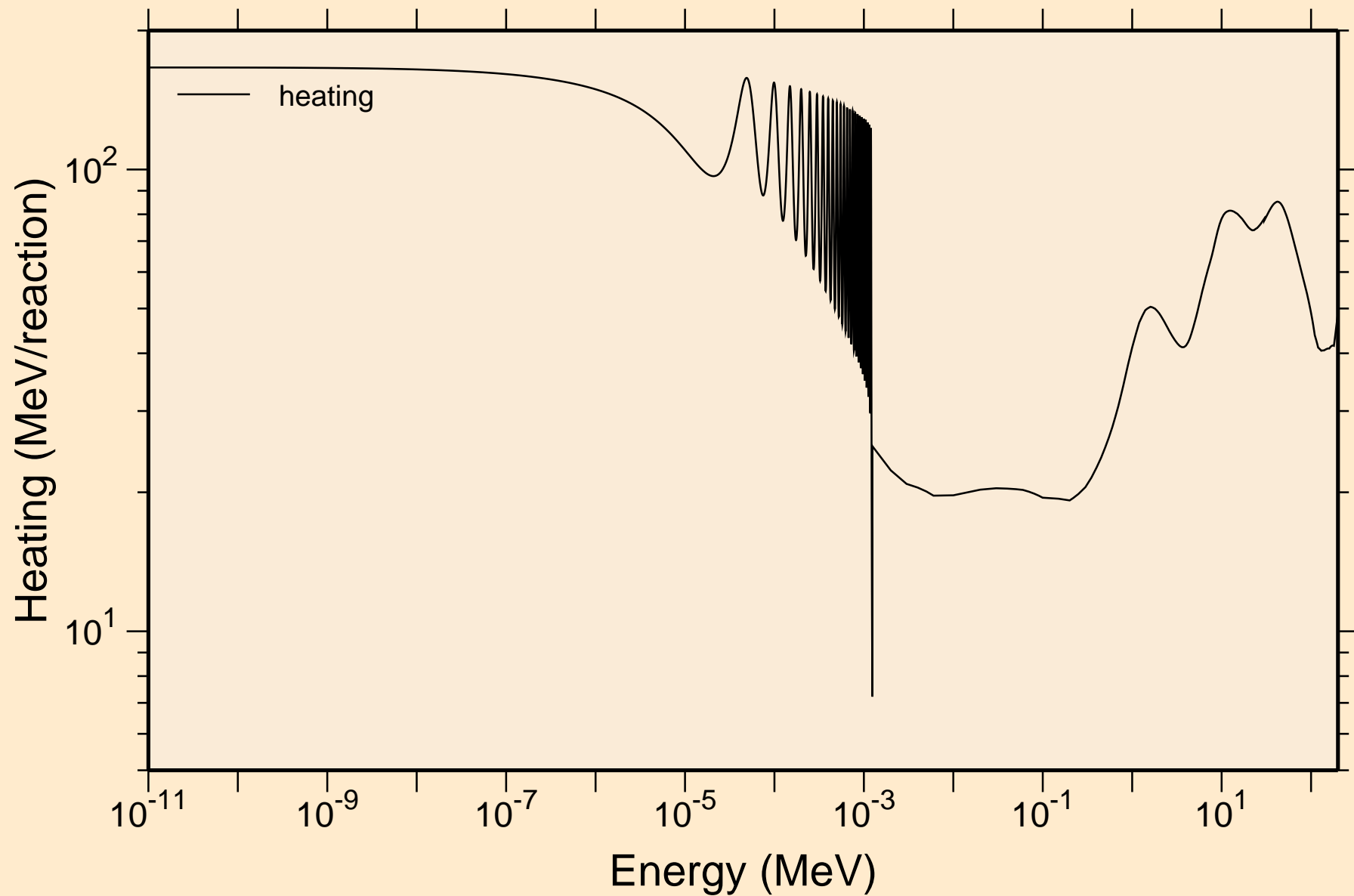

RF259 NEUTRON ACER TENDL-2019 LIBRARY; T=293.16K  
Damage

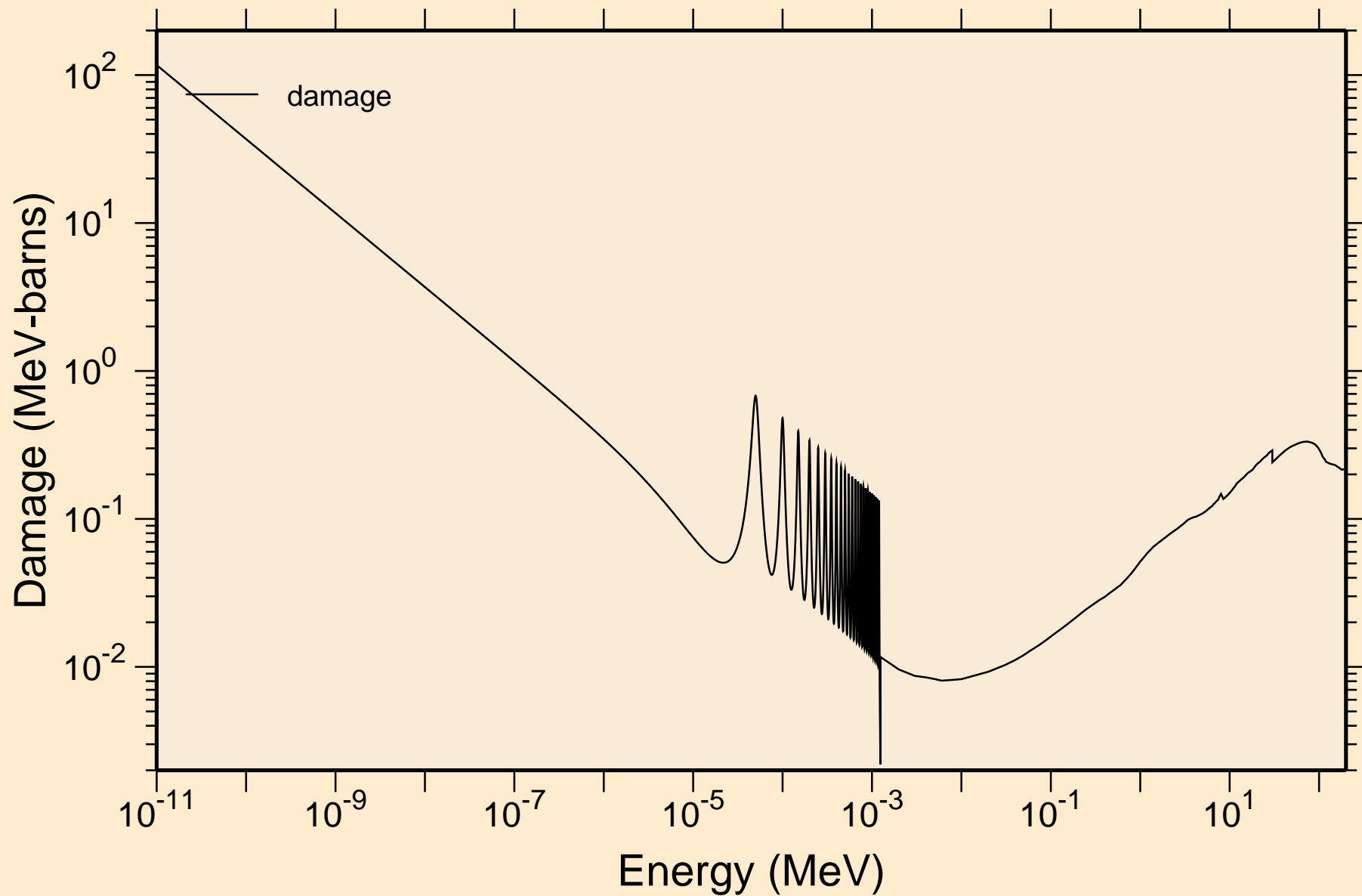

# RF259 NEUTRON ACER TENDL-2019 LIBRARY; T=293.16K

## Non-threshold reactions

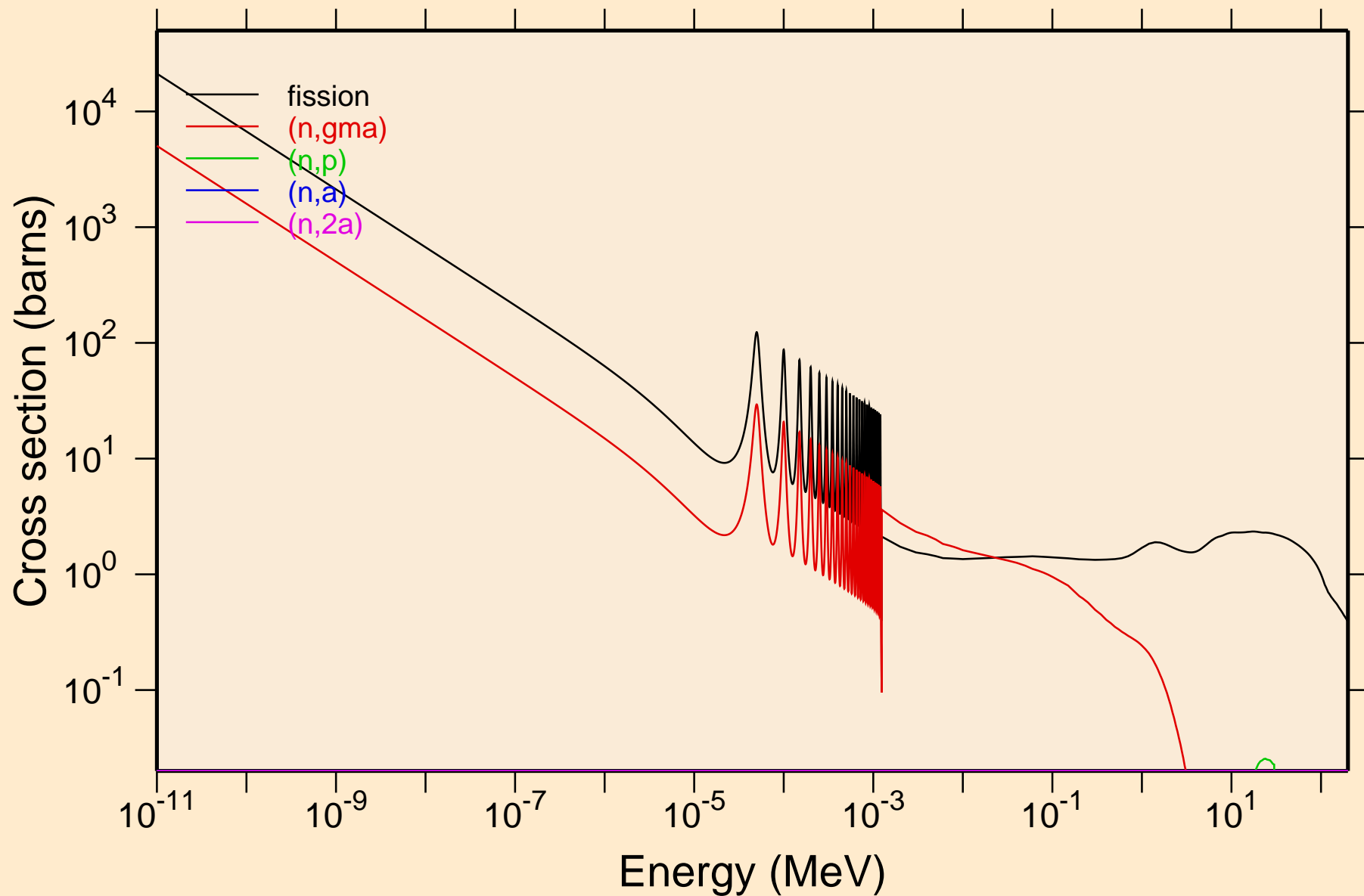

RF259 NEUTRON ACER TENDL-2019 LIBRARY; T=293.16K  
Non-threshold reactions

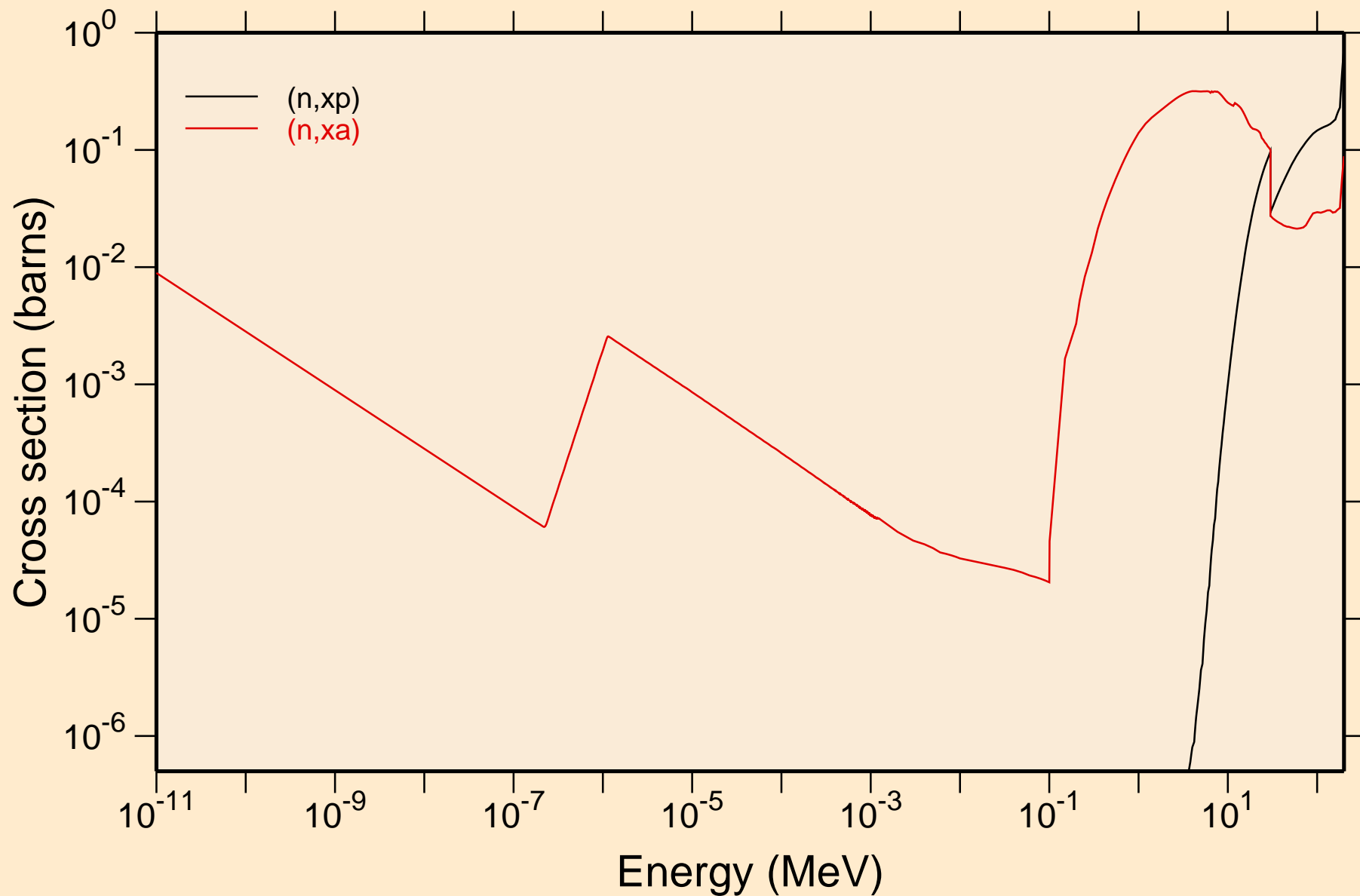

RF259 NEUTRON ACER TENDL-2019 LIBRARY; T=293.16K  
Principal cross sections

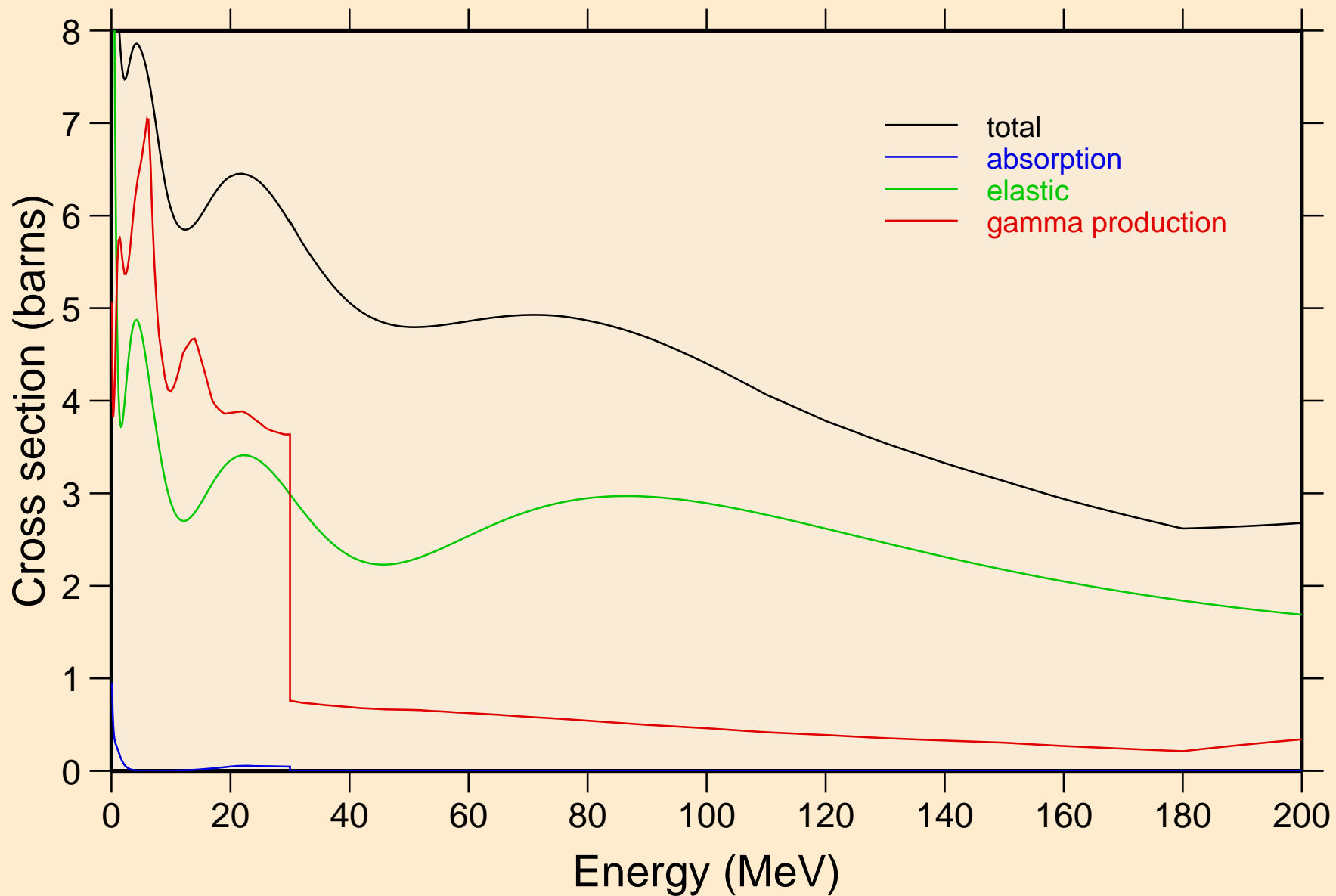

RF259 NEUTRON ACER TENDL-2019 LIBRARY; T=293.16K  
Heating

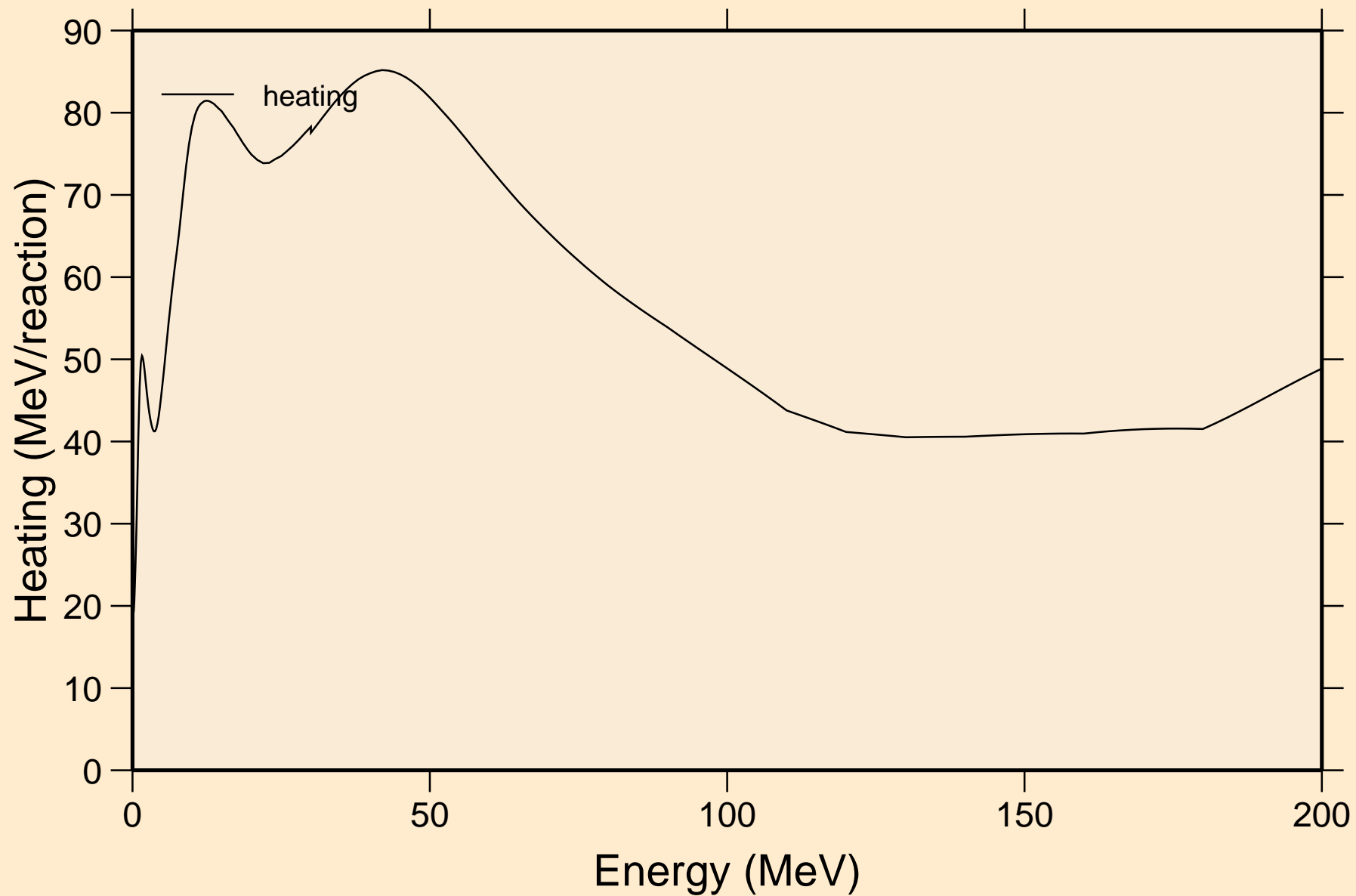

RF259 NEUTRON ACER TENDL-2019 LIBRARY; T=293.16K  
Damage

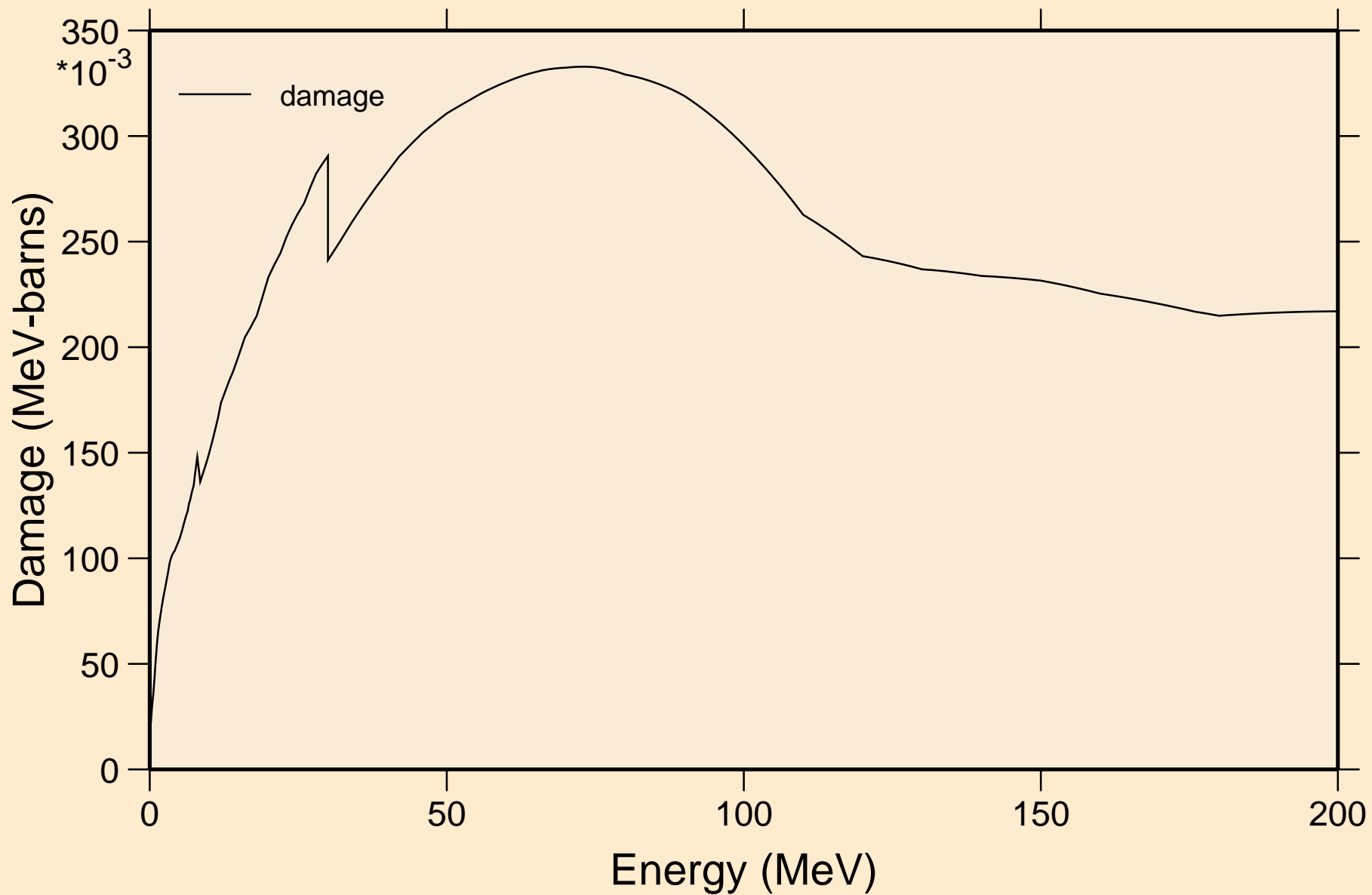



RF259 NEUTRON ACER TENDL-2019 LIBRARY; T=293.16K  
Non-threshold reactions

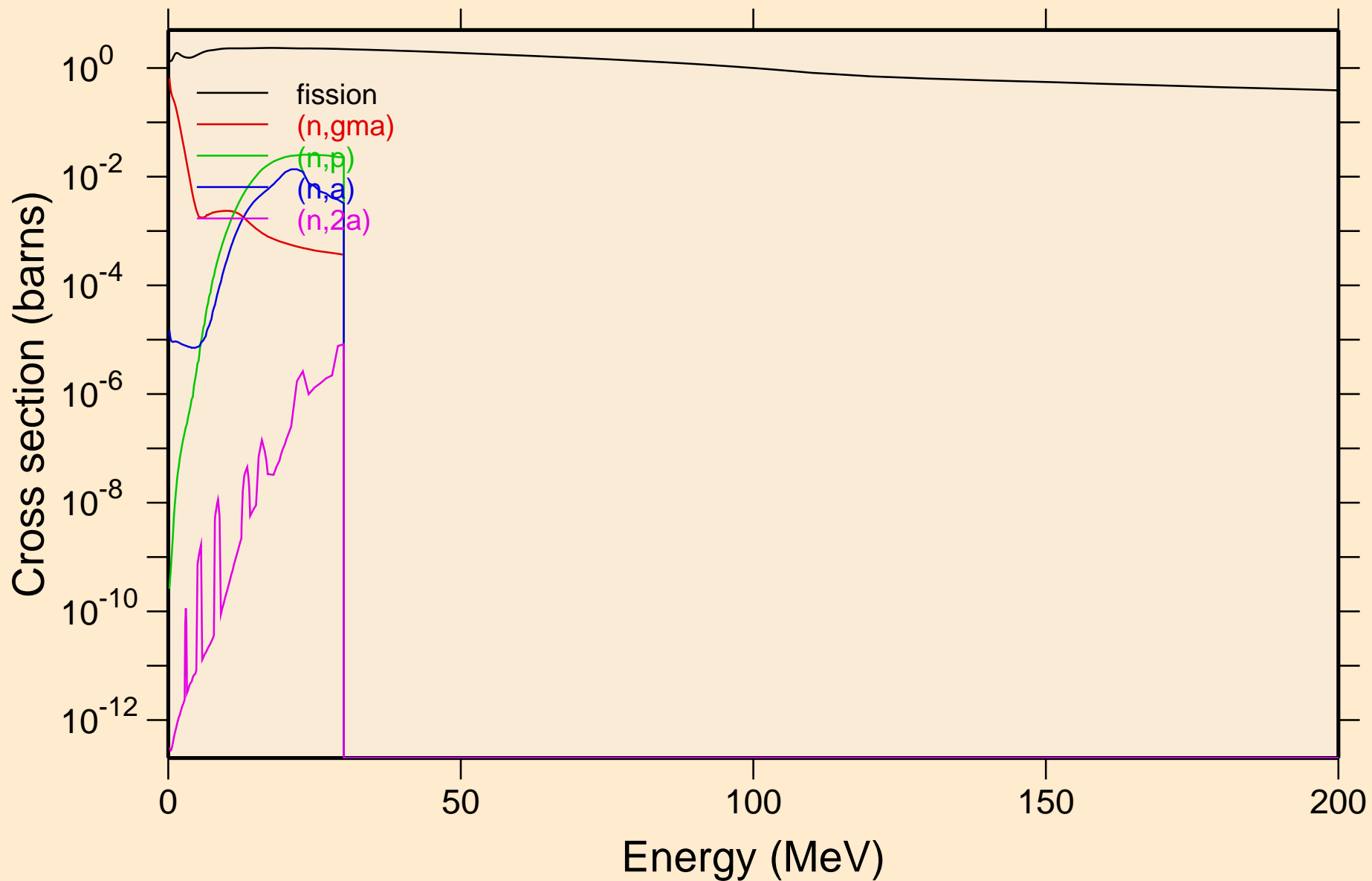

RF259 NEUTRON ACER TENDL-2019 LIBRARY; T=293.16K  
Non-threshold reactions

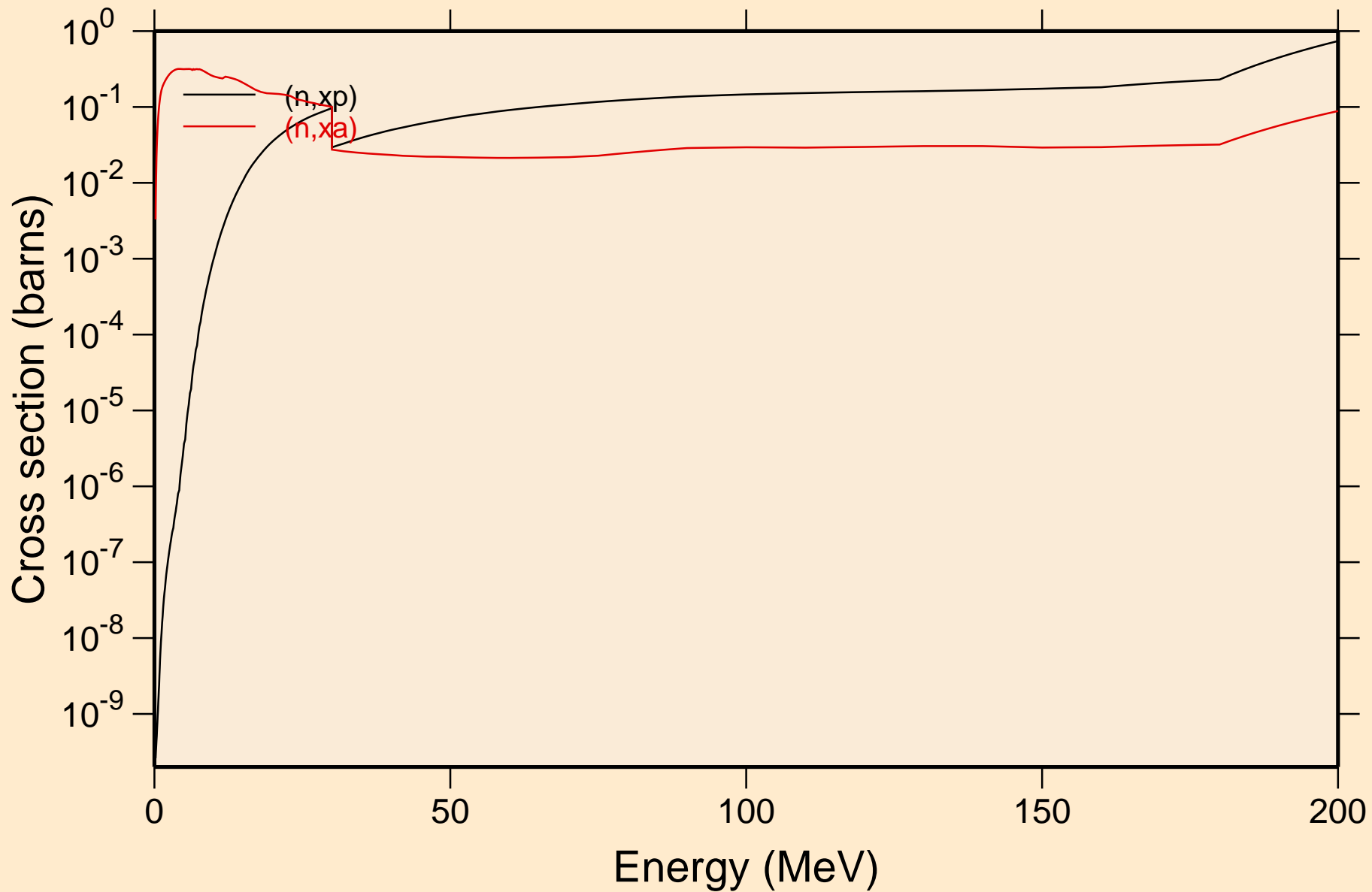

RF259 NEUTRON ACER TENDL-2019 LIBRARY; T=293.16K  
Inelastic levels

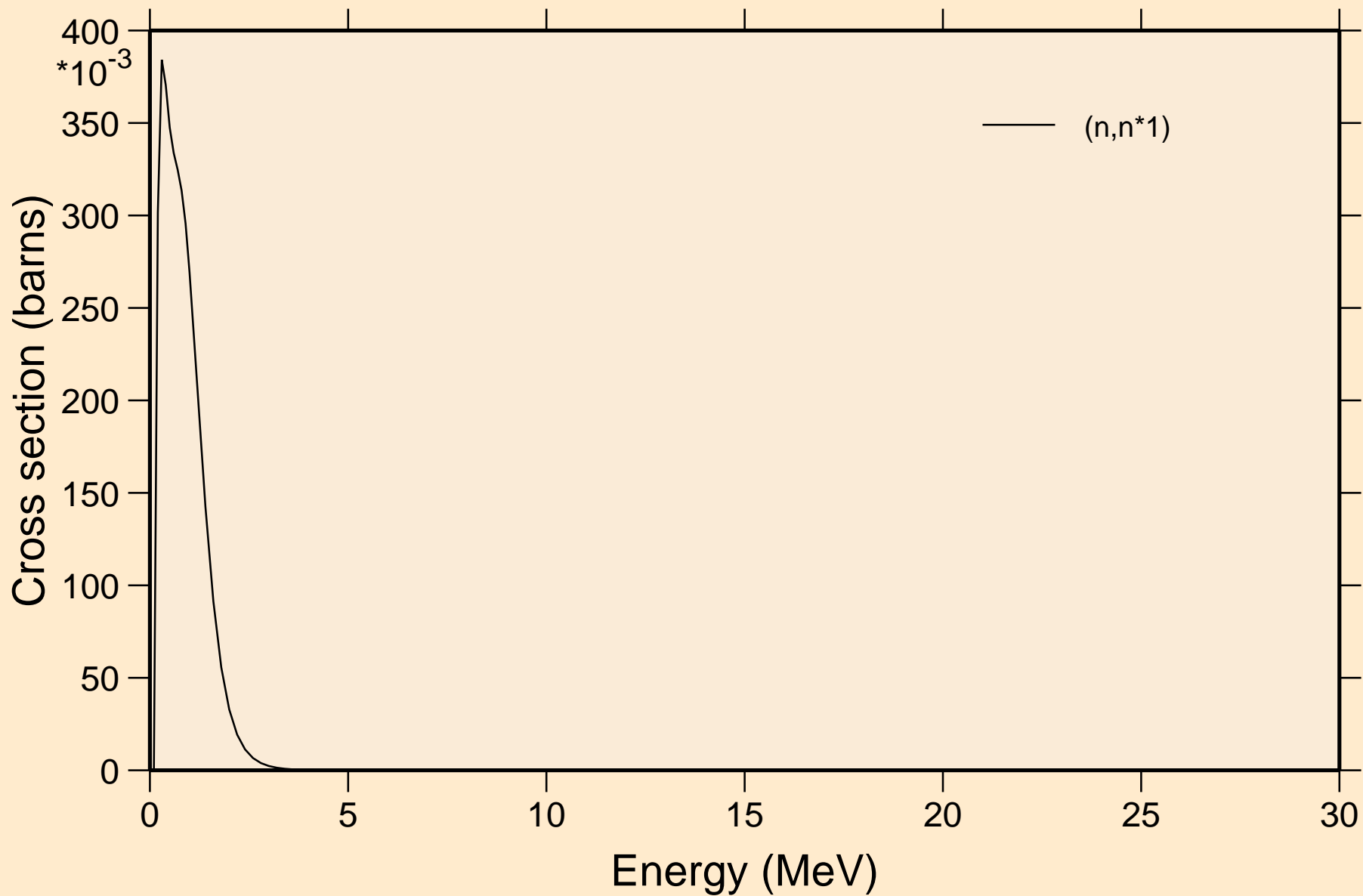

RF259 NEUTRON ACER TENDL-2019 LIBRARY; T=293.16K  
Threshold reactions

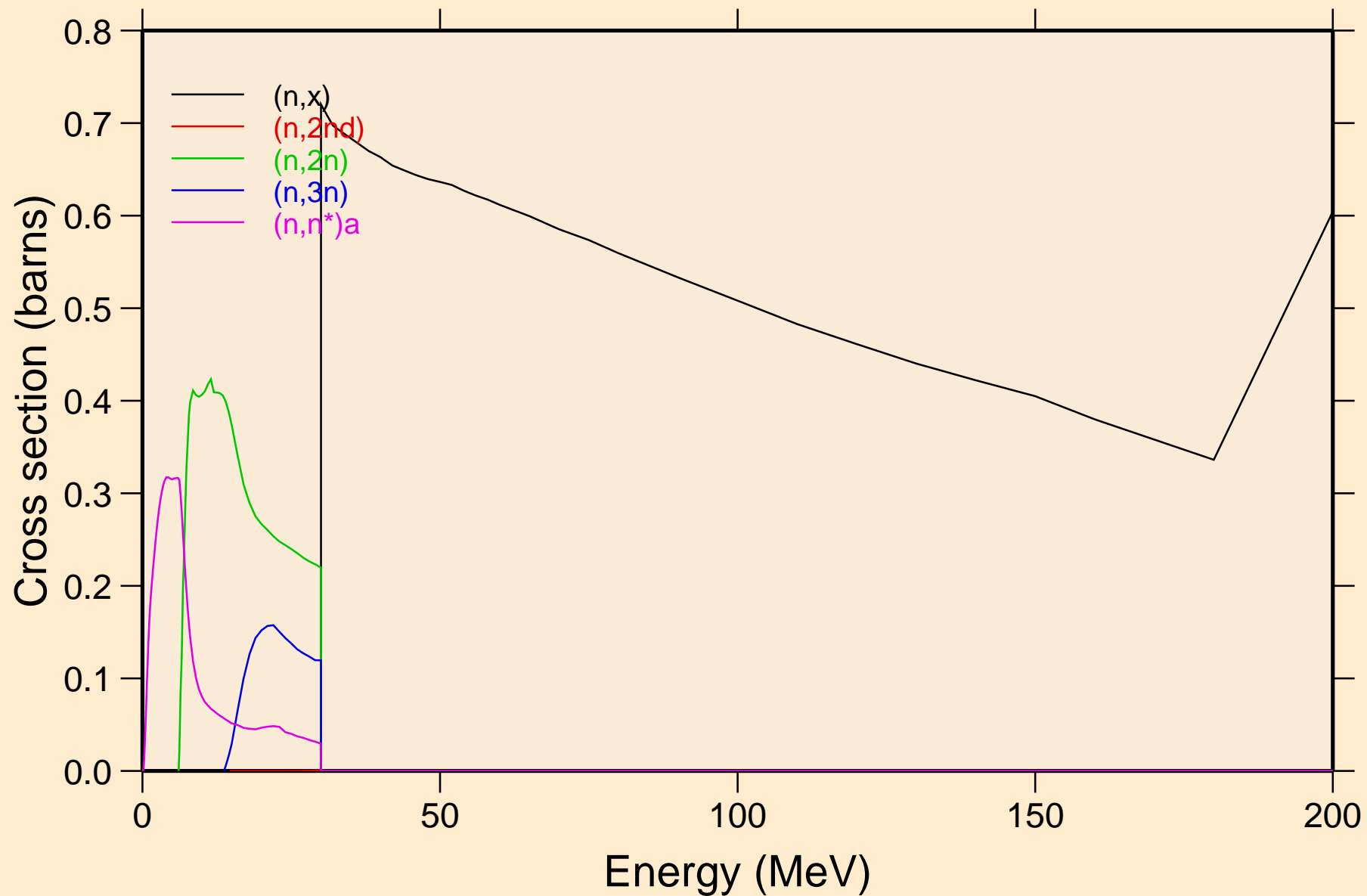

RF259 NEUTRON ACER TENDL-2019 LIBRARY; T=293.16K  
Threshold reactions

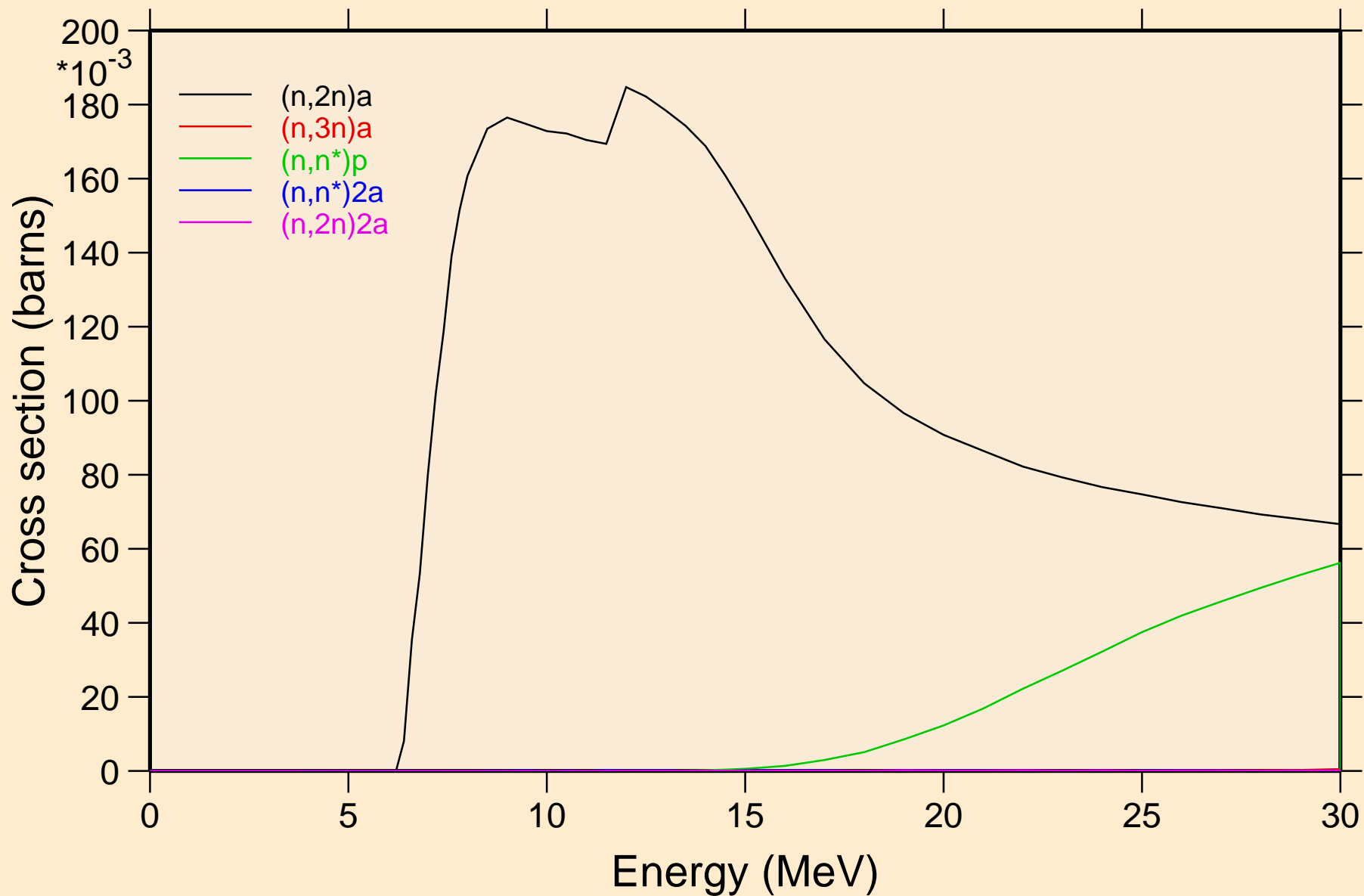

RF259 NEUTRON ACER TENDL-2019 LIBRARY; T=293.16K  
Threshold reactions

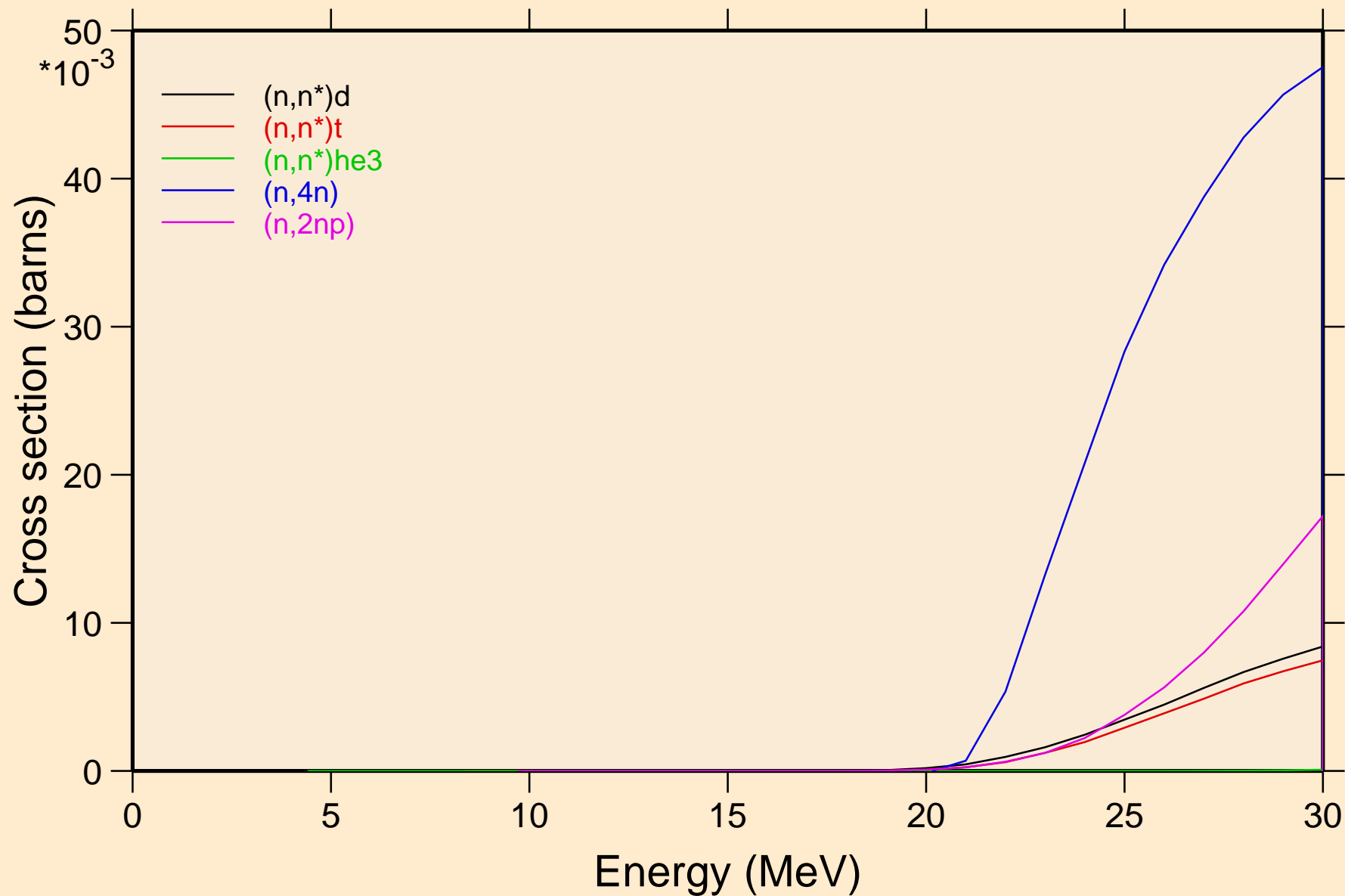

RF259 NEUTRON ACER TENDL-2019 LIBRARY; T=293.16K  
Threshold reactions

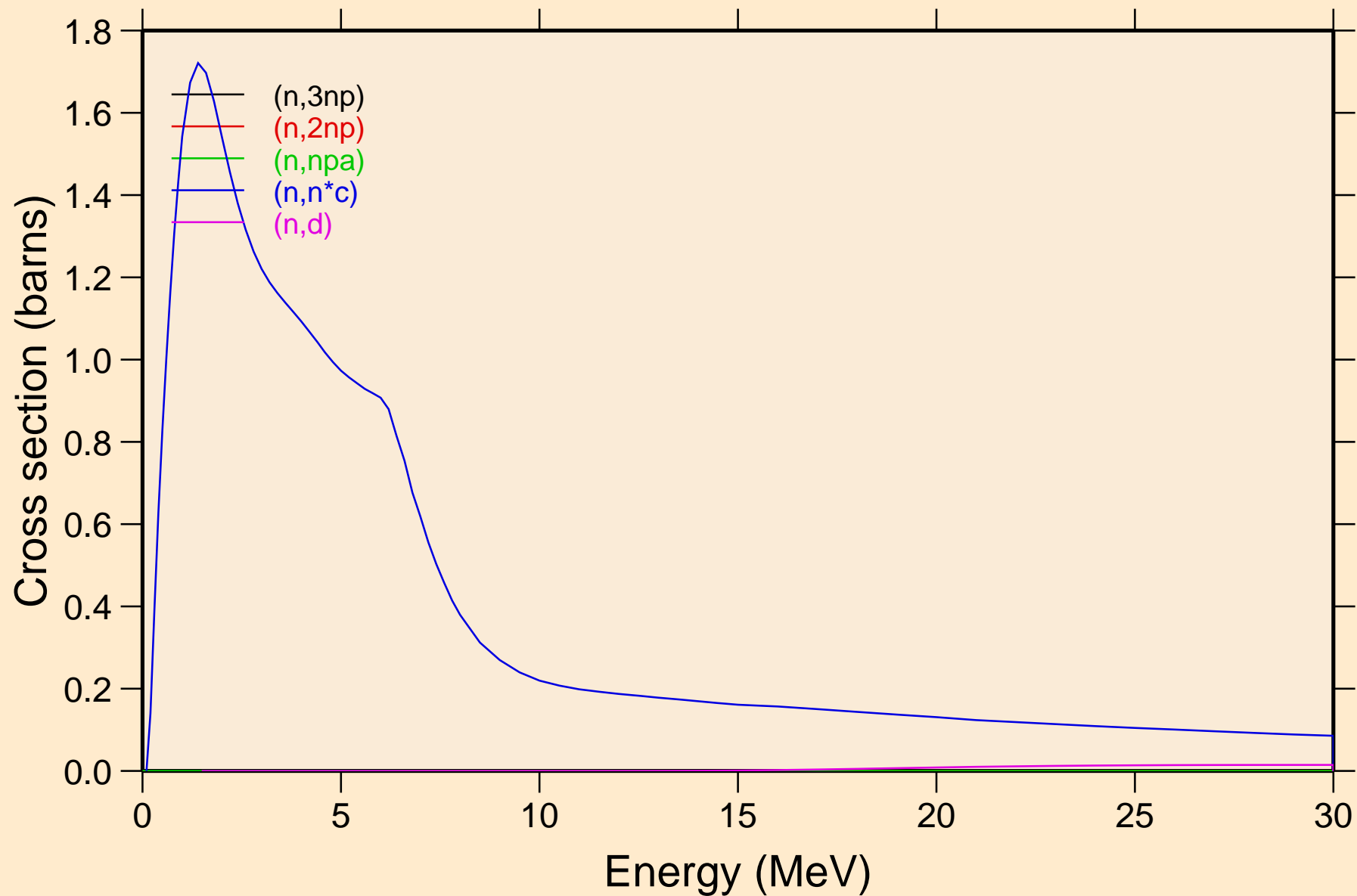

RF259 NEUTRON ACER TENDL-2019 LIBRARY; T=293.16K  
Threshold reactions

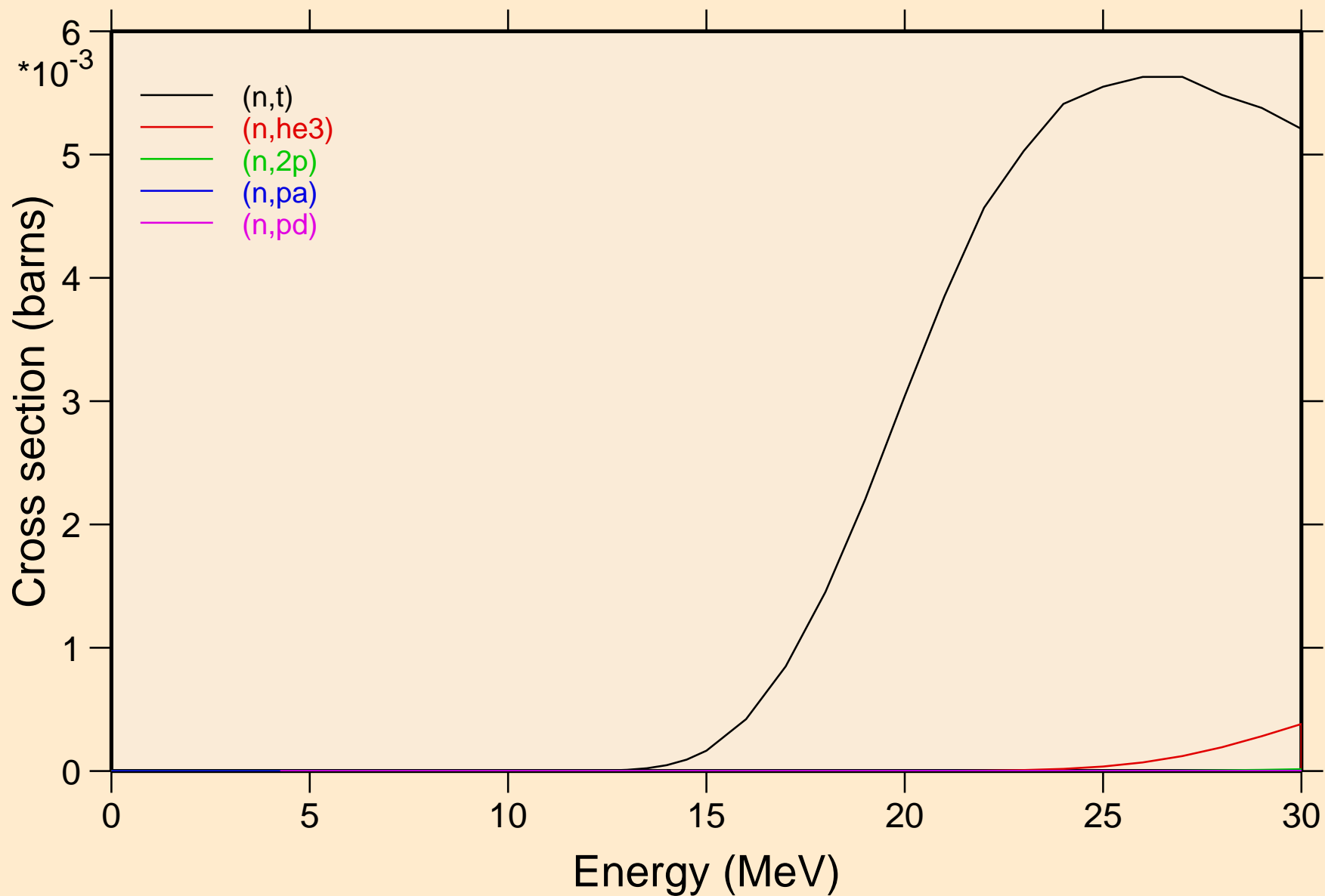



RF259 NEUTRON ACER TENDL-2019 LIBRARY; T=293.16K  
Threshold reactions

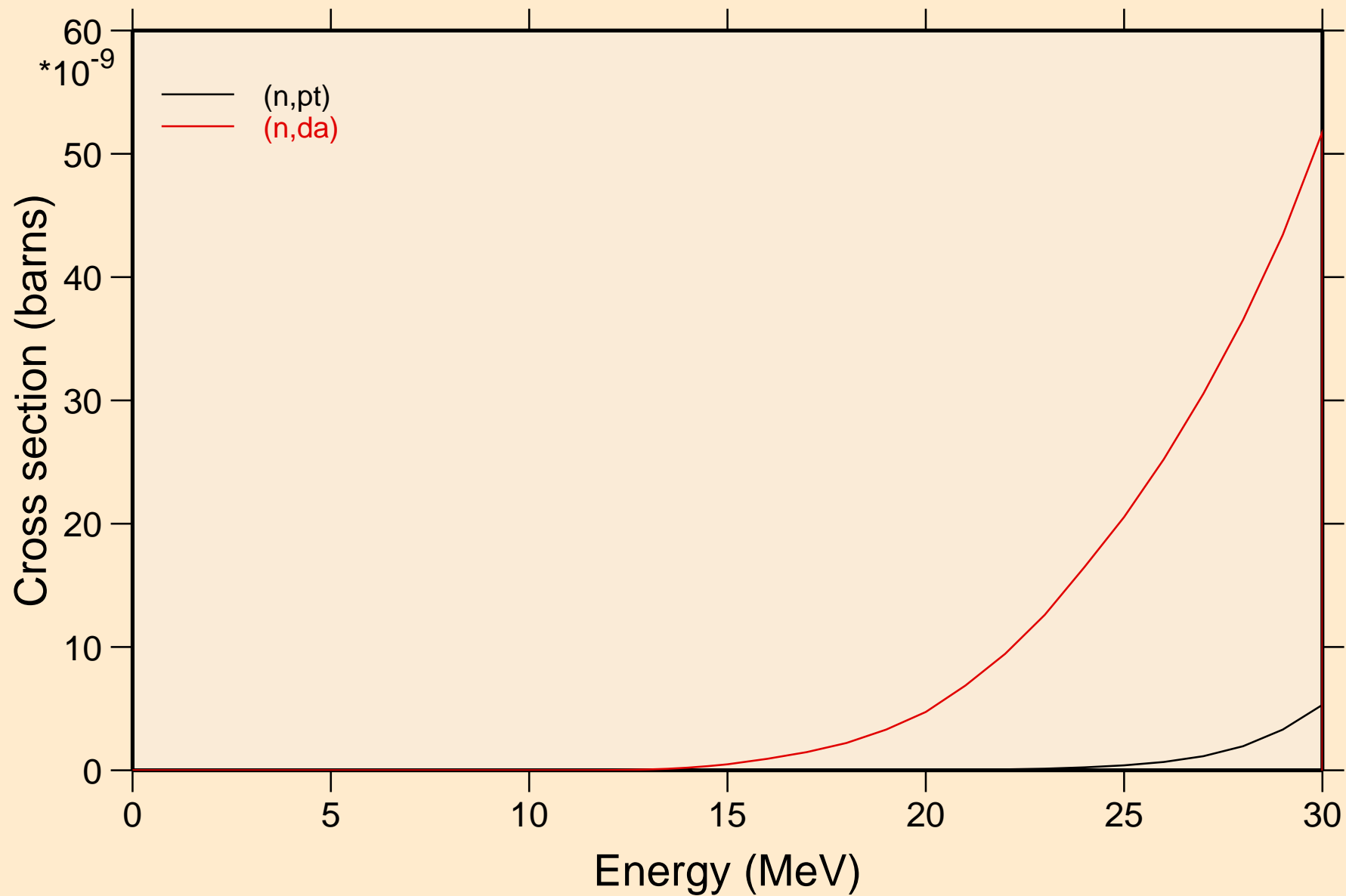

RF259 NEUTRON ACER TENDL-2019 LIBRARY; T=293.16K  
Threshold reactions

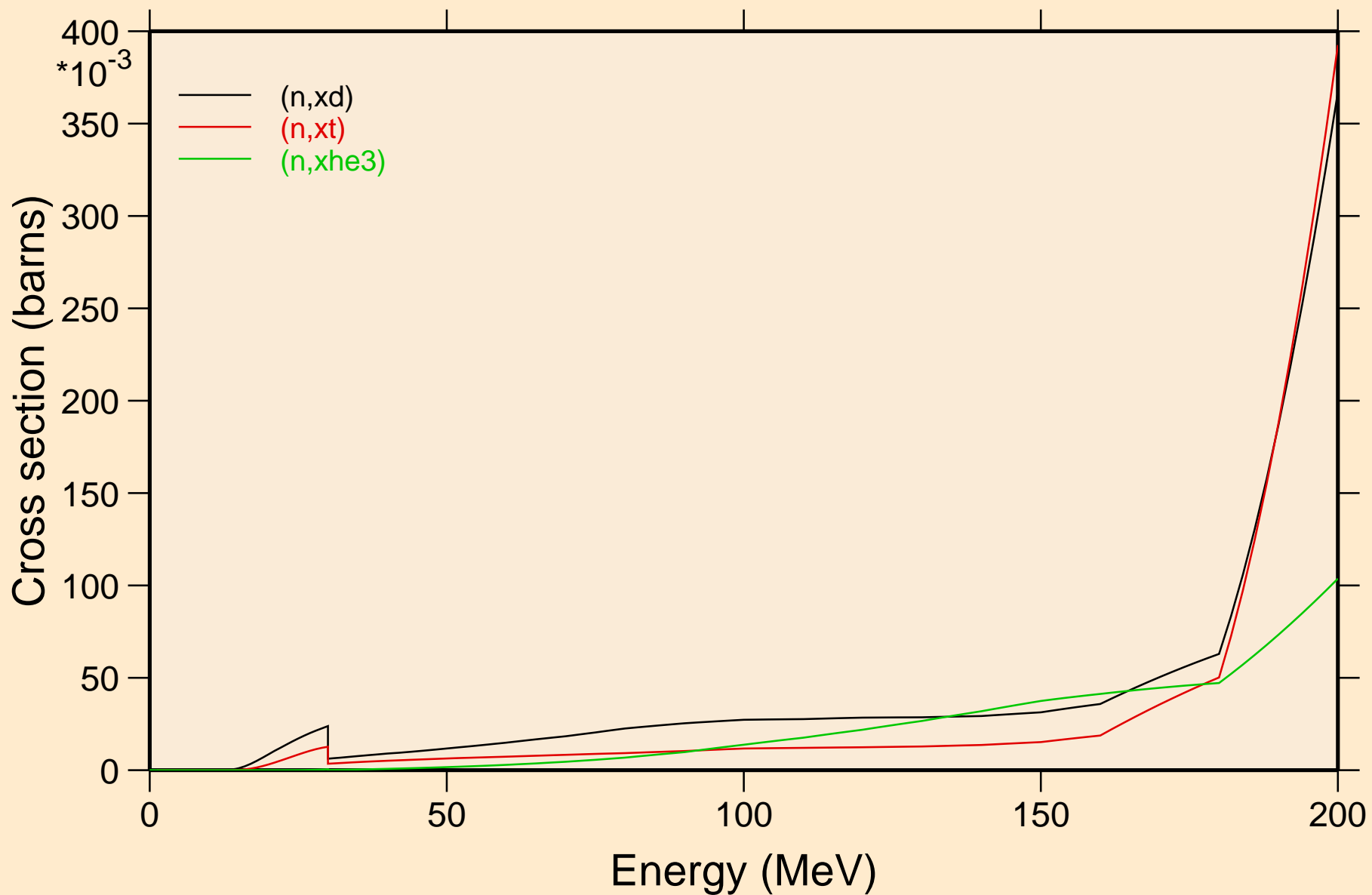

RF259 NEUTRON ACER TENDL-2019 LIBRARY; T=293.16K  
angular distribution for elastic

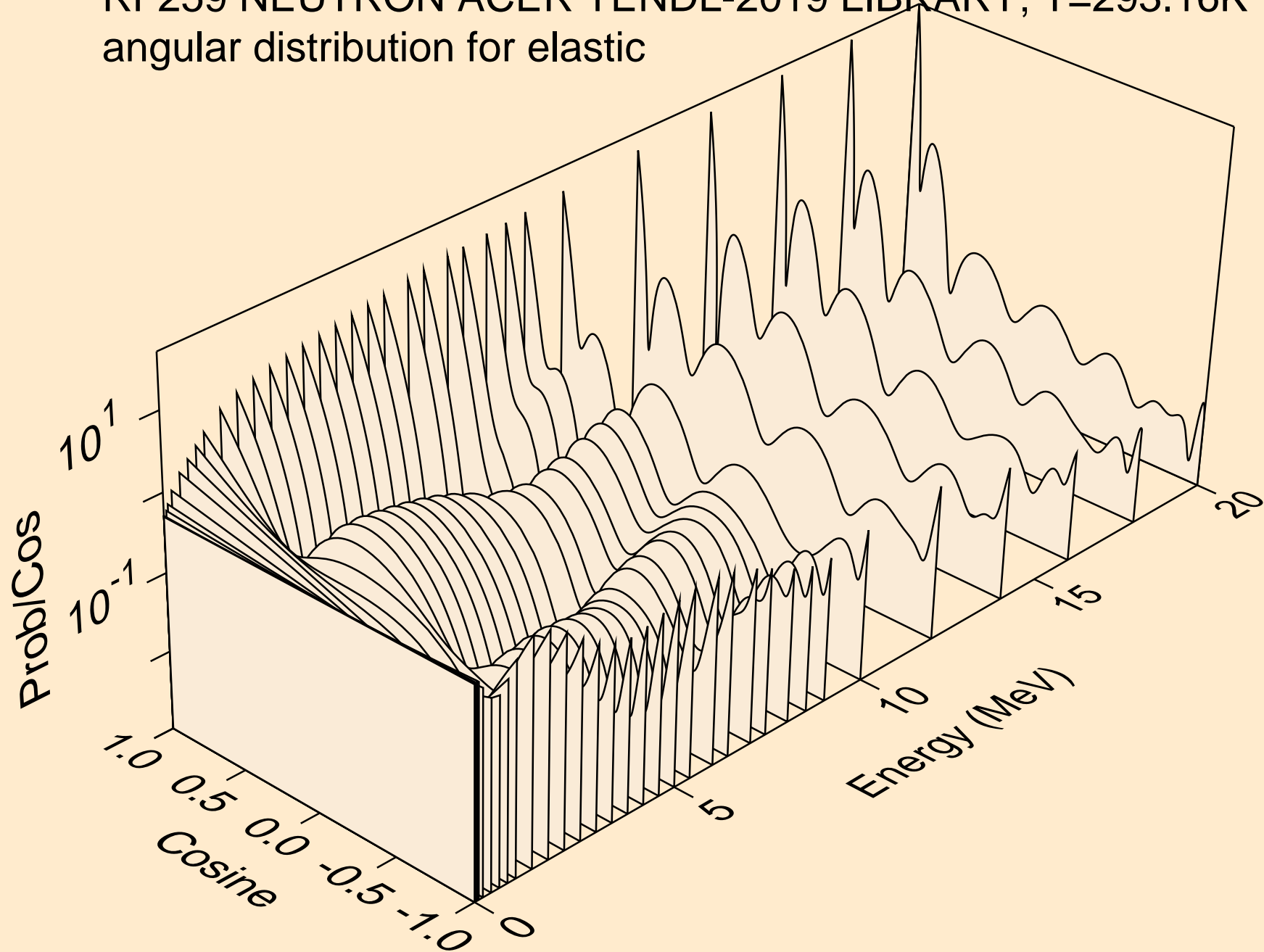

RF259 NEUTRON ACER TENDL-2019 LIBRARY; T=293.16K  
angular distribution for elastic

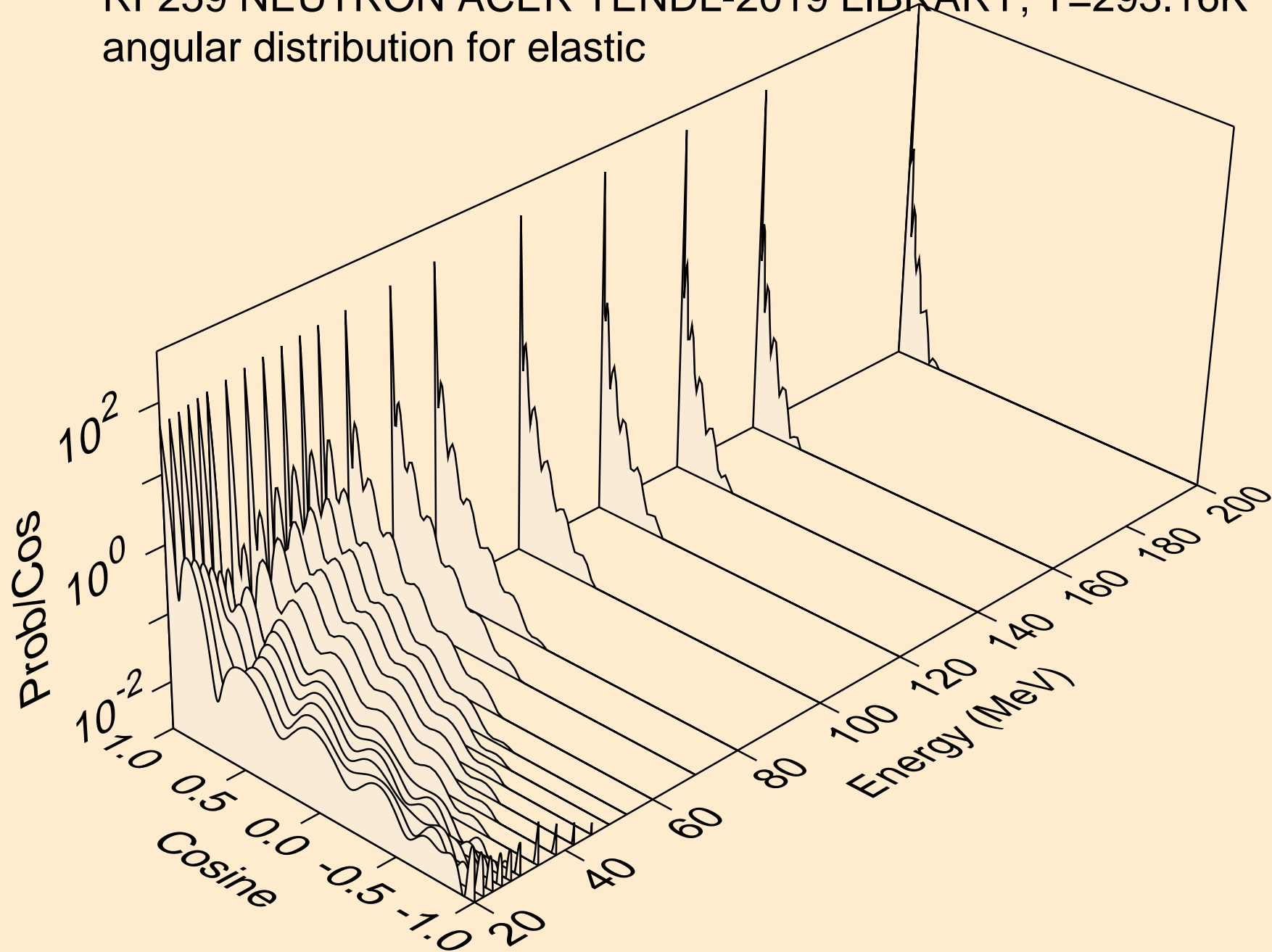

RF259 NEUTRON ACER TENDL-2019 LIBRARY; T=293.16K  
angular distribution for (n,n\*1)

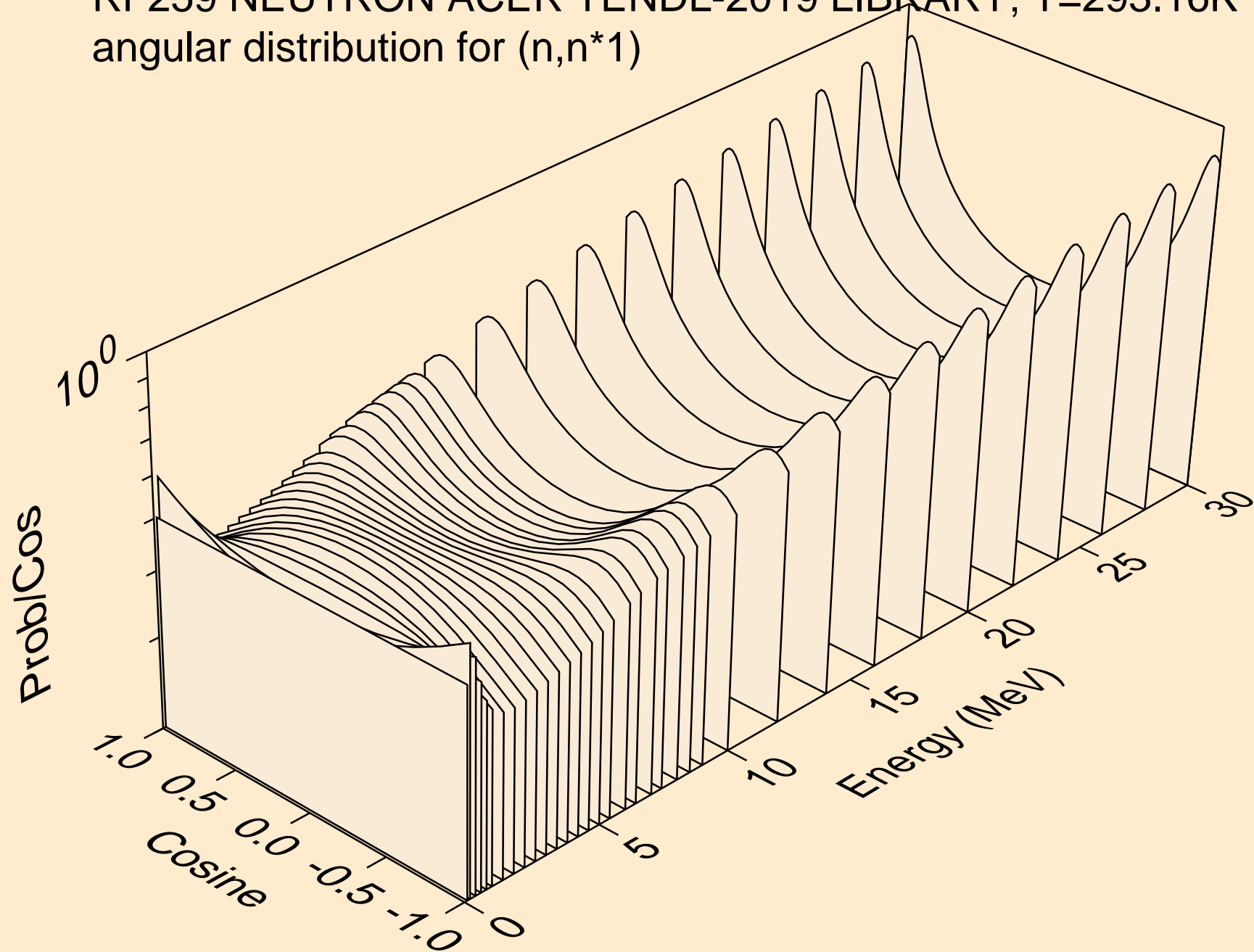

RF259 NEUTRON ACER TENDL-2019 LIBRARY; T=293.16K  
Total fission nubar

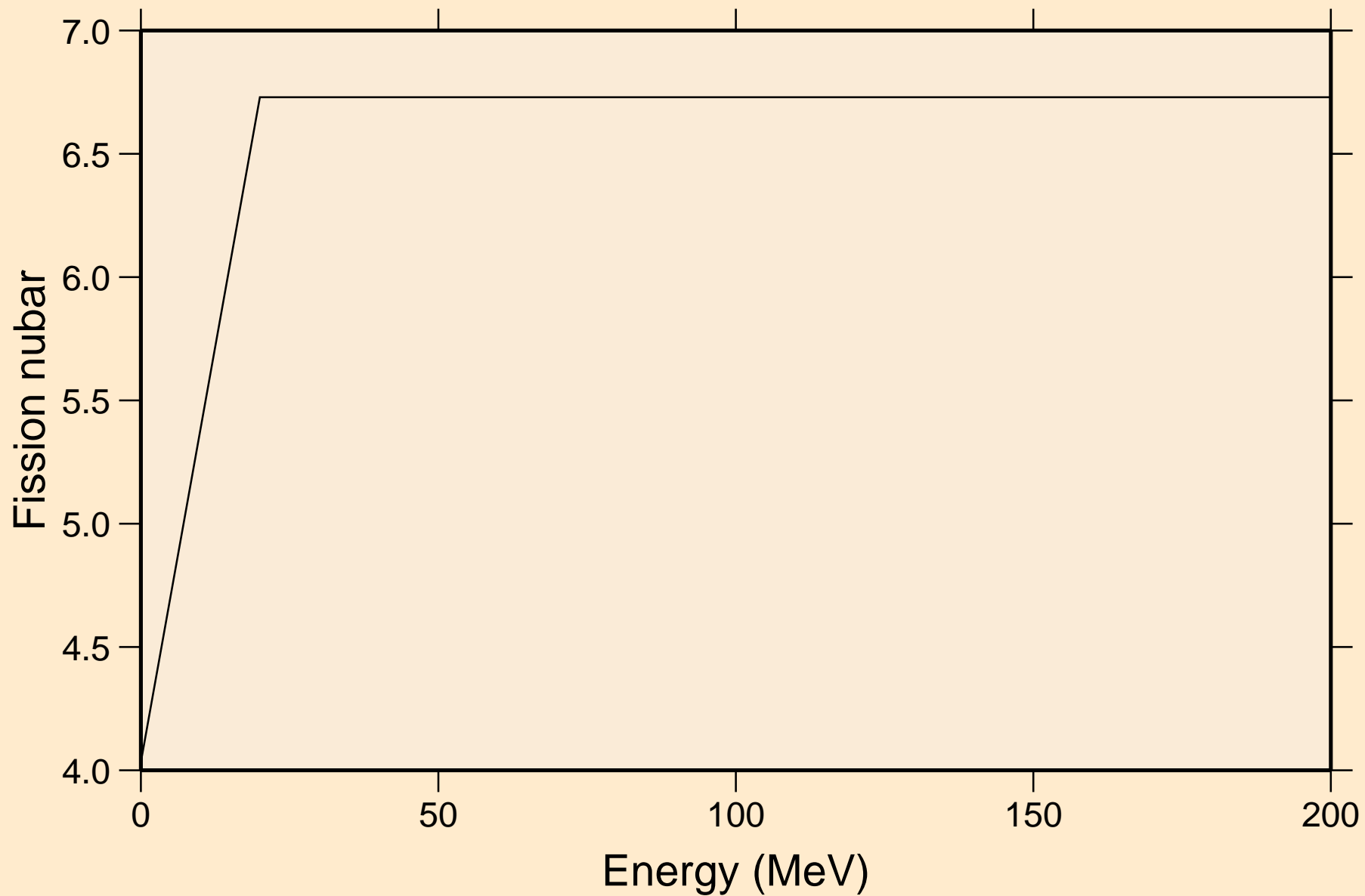

RF259 NEUTRON ACER TENDL-2019 LIBRARY; T=293.16K  
Neutron emission for (n,x)

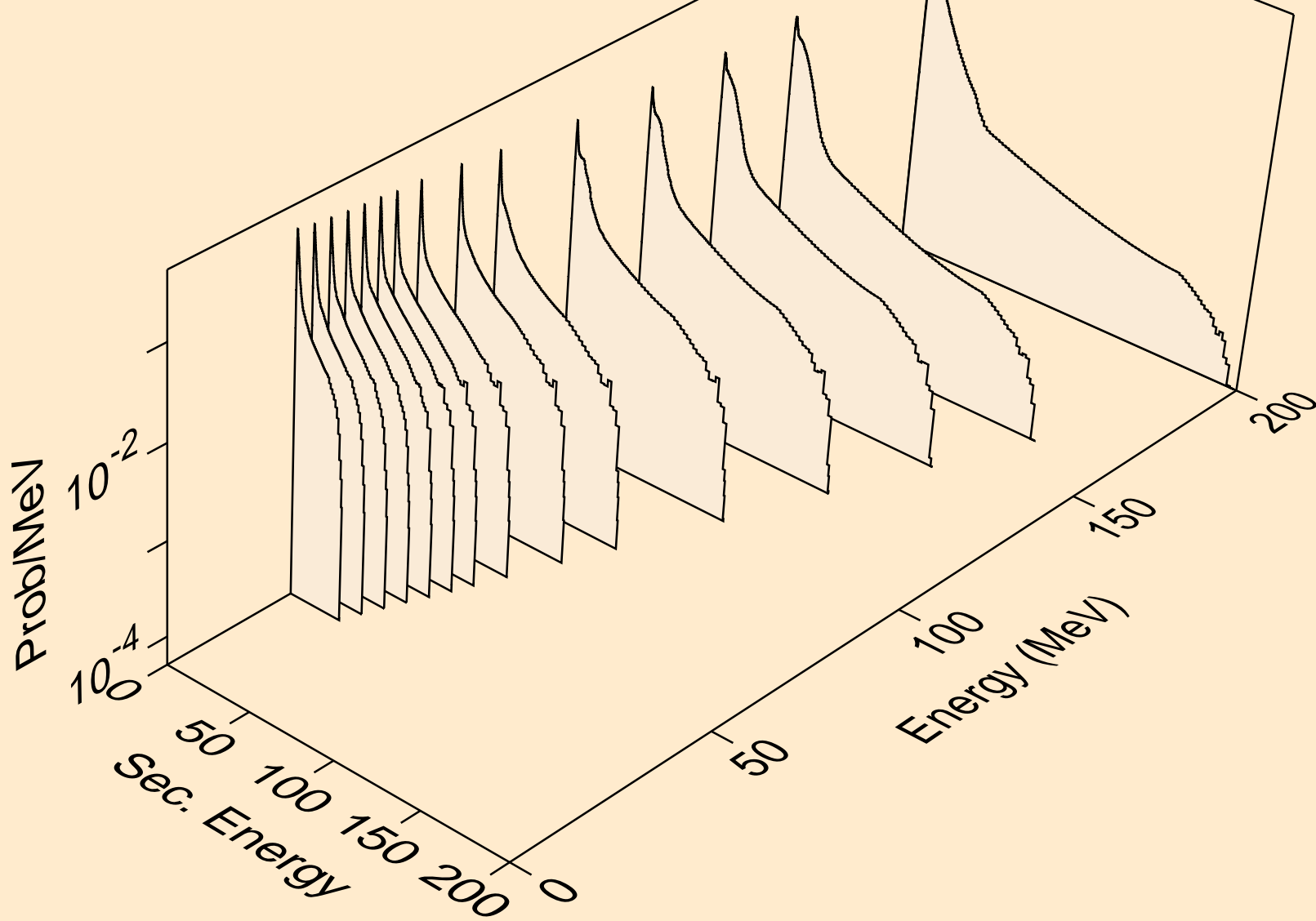

RF259 NEUTRON ACER TENDL-2019 LIBRARY; T=293.16K  
Neutron emission for (n,2nd)

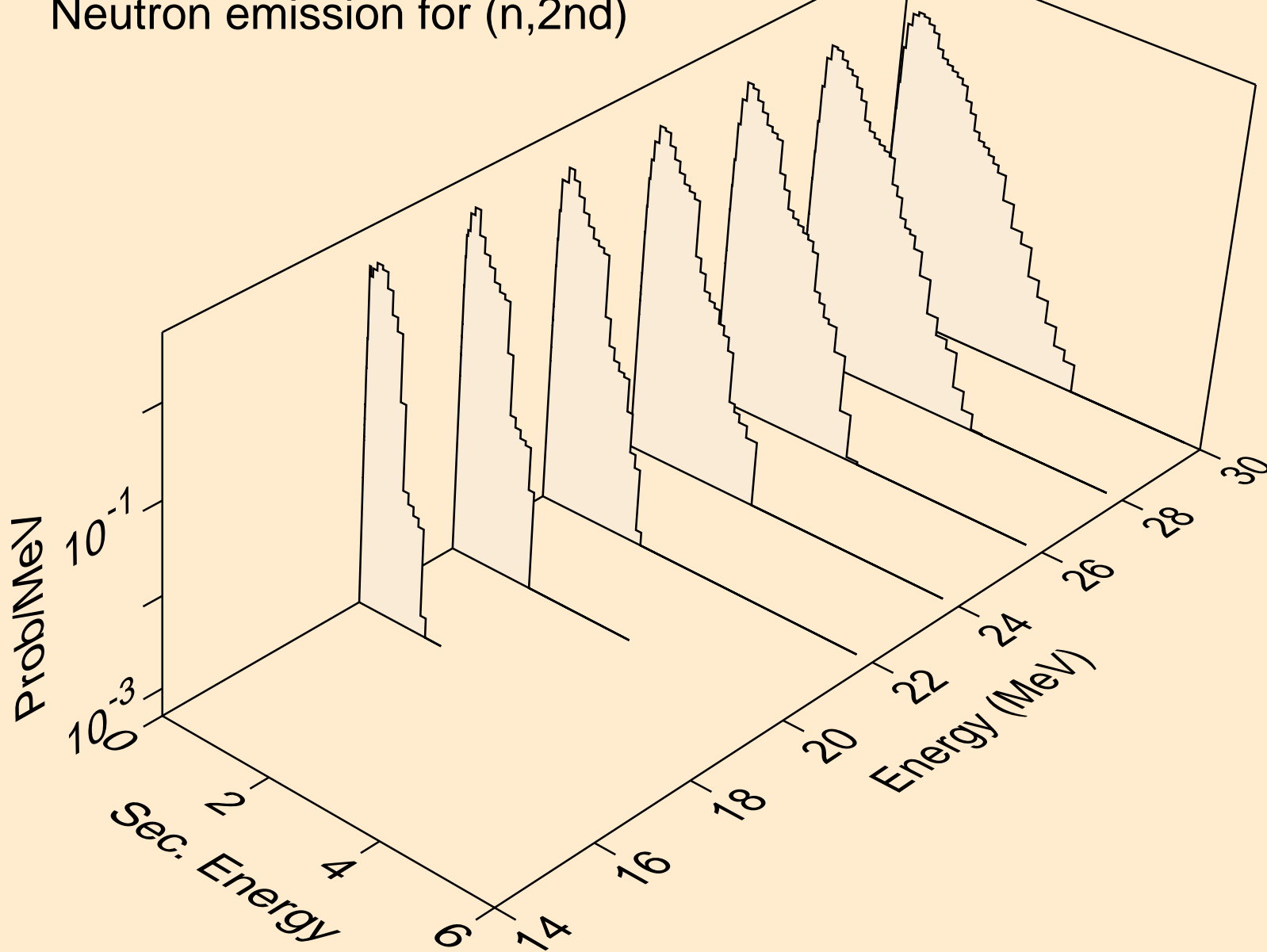



RF259 NEUTRON ACER TENDL-2019 LIBRARY; T=293.16K  
Neutron emission for (n,2n)

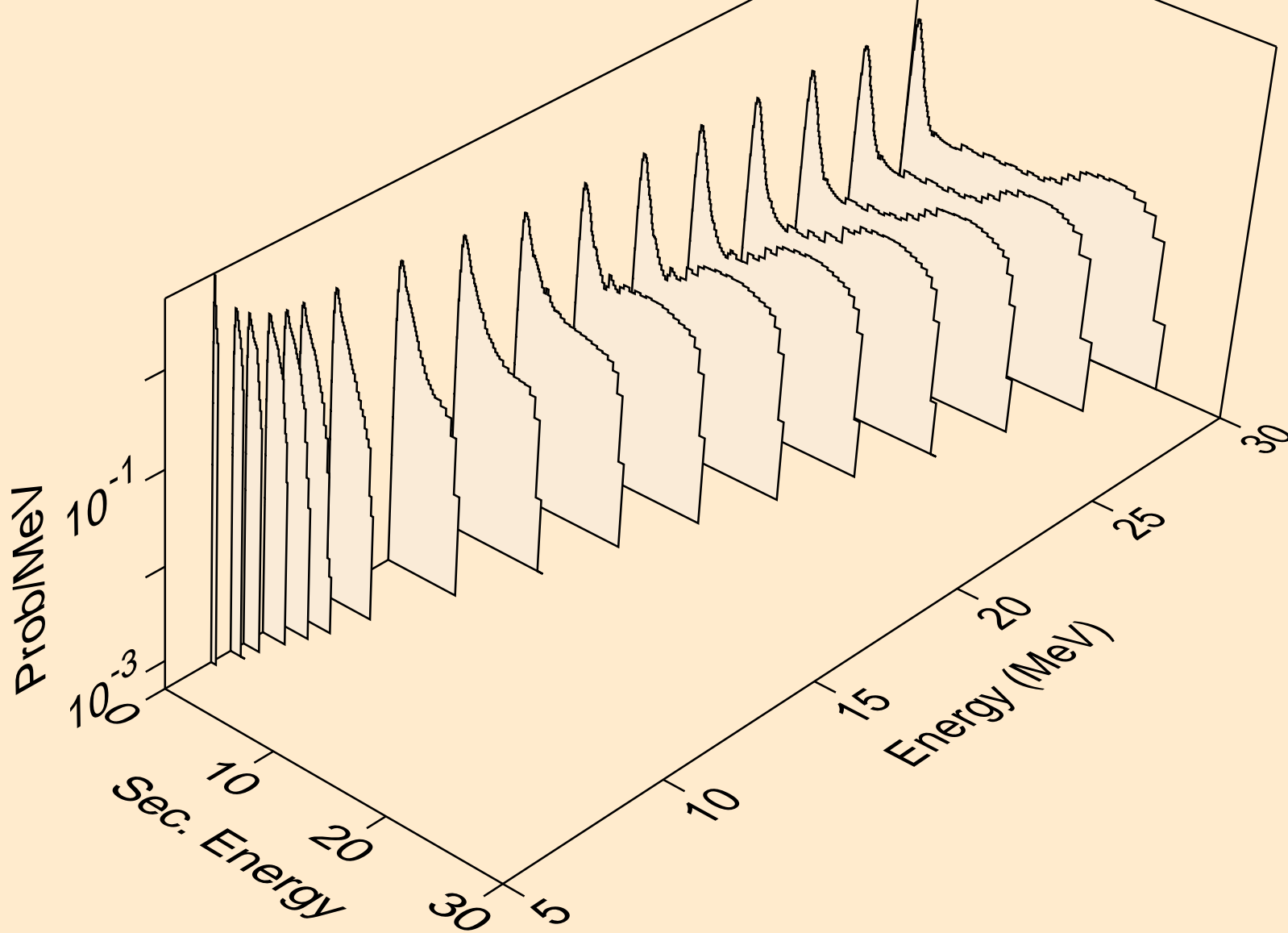

RF259 NEUTRON ACER TENDL-2019 LIBRARY; T=293.16K  
Neutron emission for (n,3n)

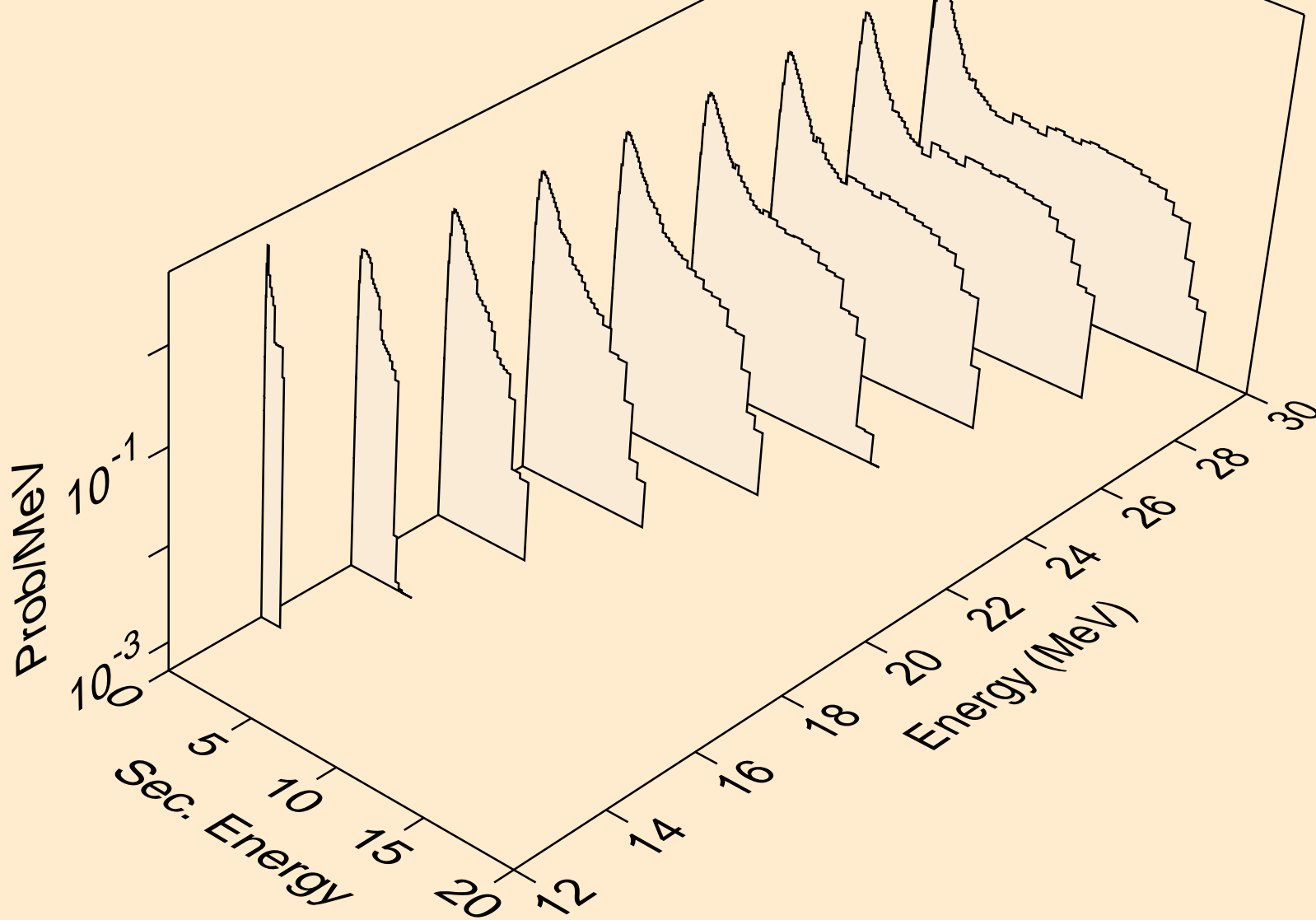

RF259 NEUTRON ACER TENDL-2019 LIBRARY; T=293.16K  
Neutron emission for fission

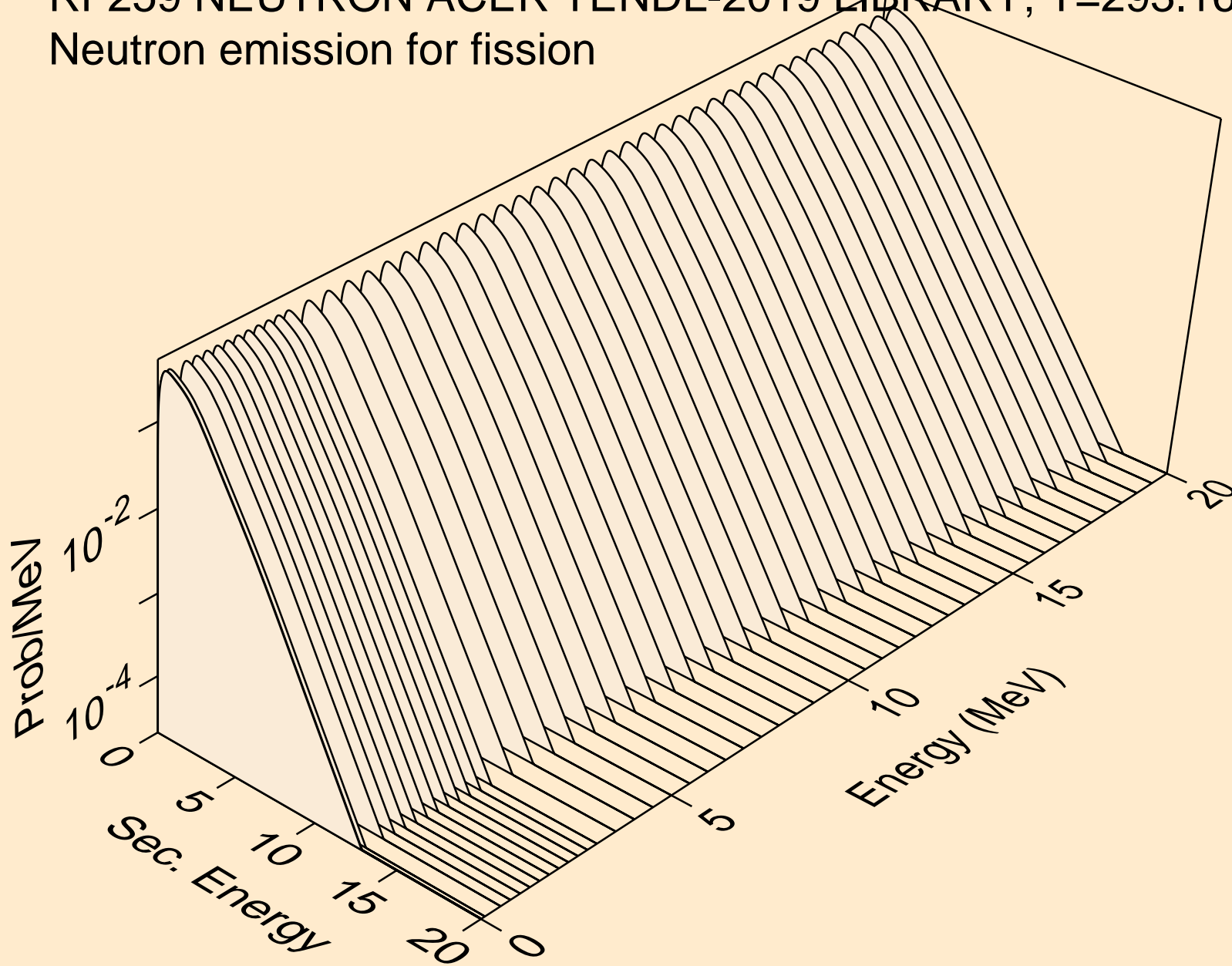

RF259 NEUTRON ACER TENDL-2019 LIBRARY; T=293.16K  
Neutron emission for (n,n\*)a

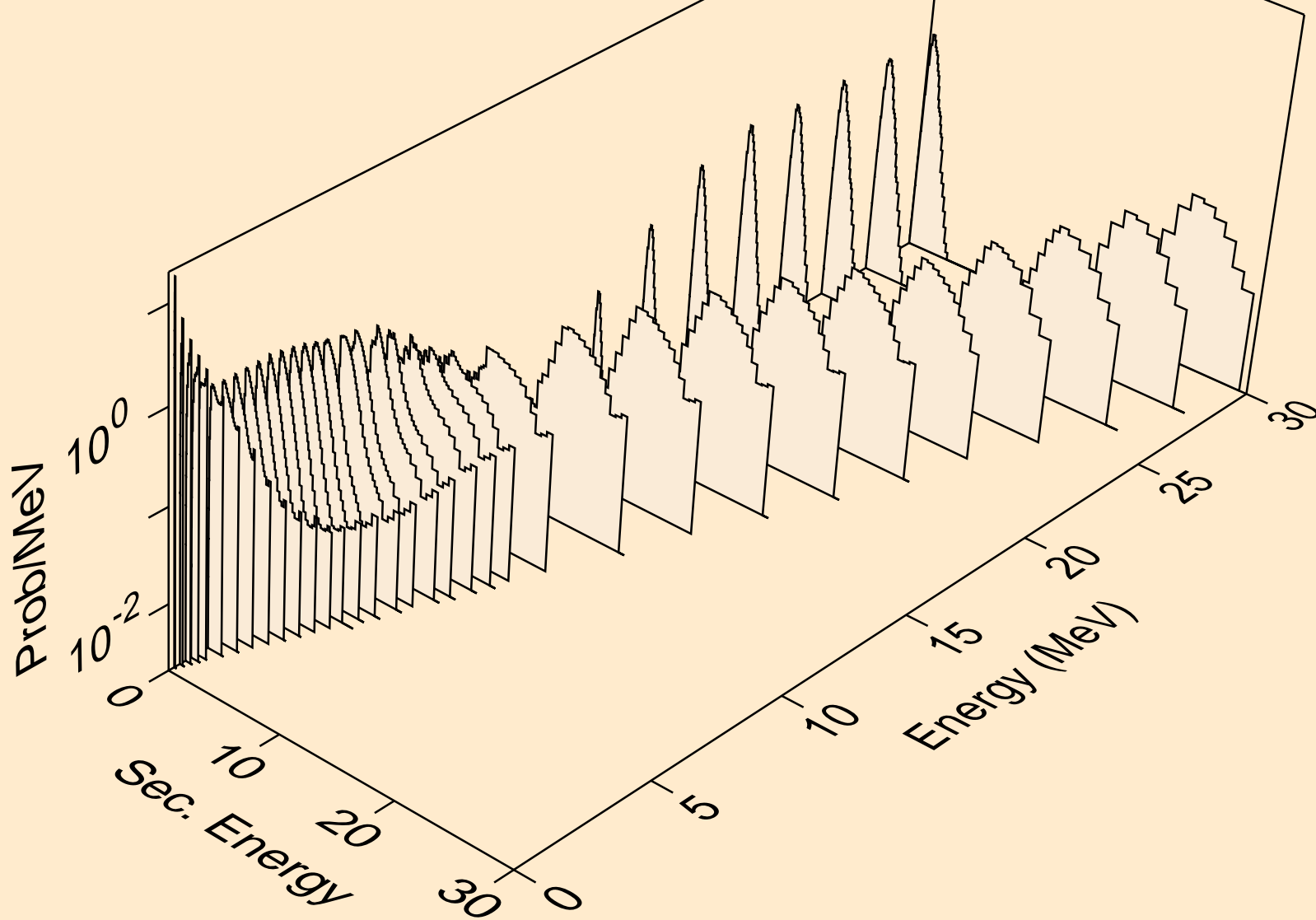

RF259 NEUTRON ACER TENDL-2019 LIBRARY; T=293.16K  
Neutron emission for (n,2n)a

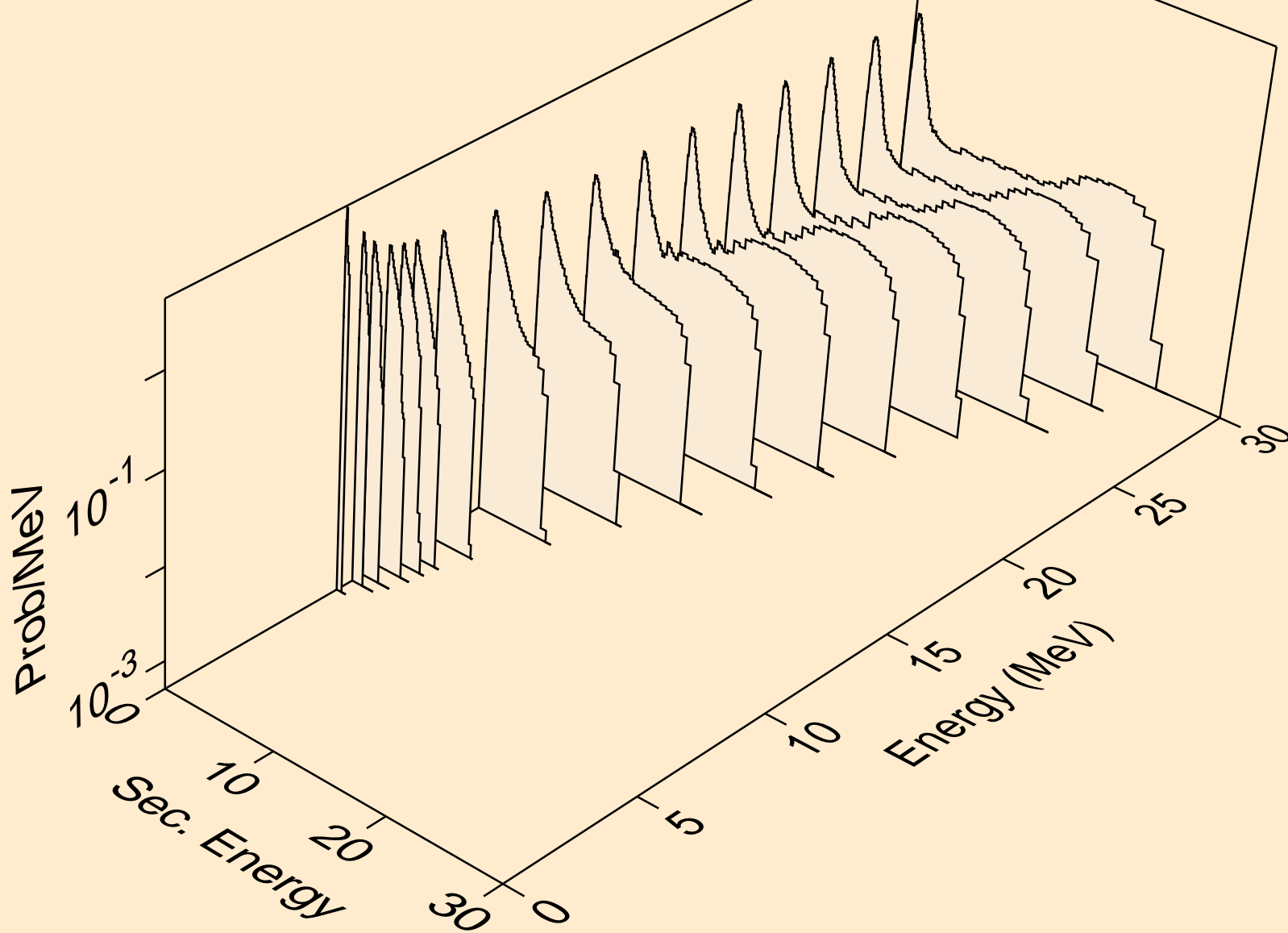

RF259 NEUTRON ACER TENDL-2019 LIBRARY; T=293.16K  
Neutron emission for (n,3n)a

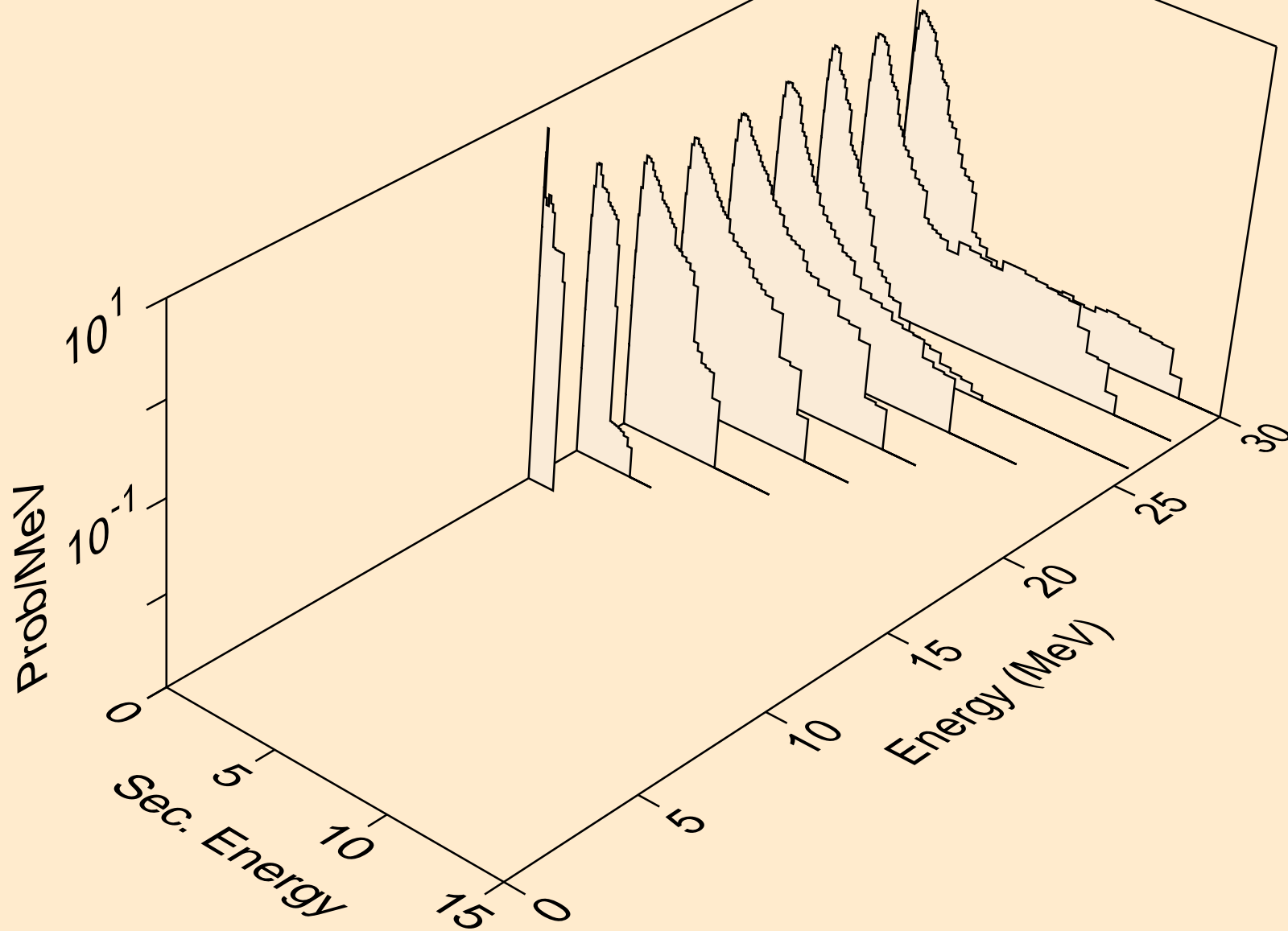

RF259 NEUTRON ACER TENDL-2019 LIBRARY; T=293.16K  
Neutron emission for (n,n\*)p

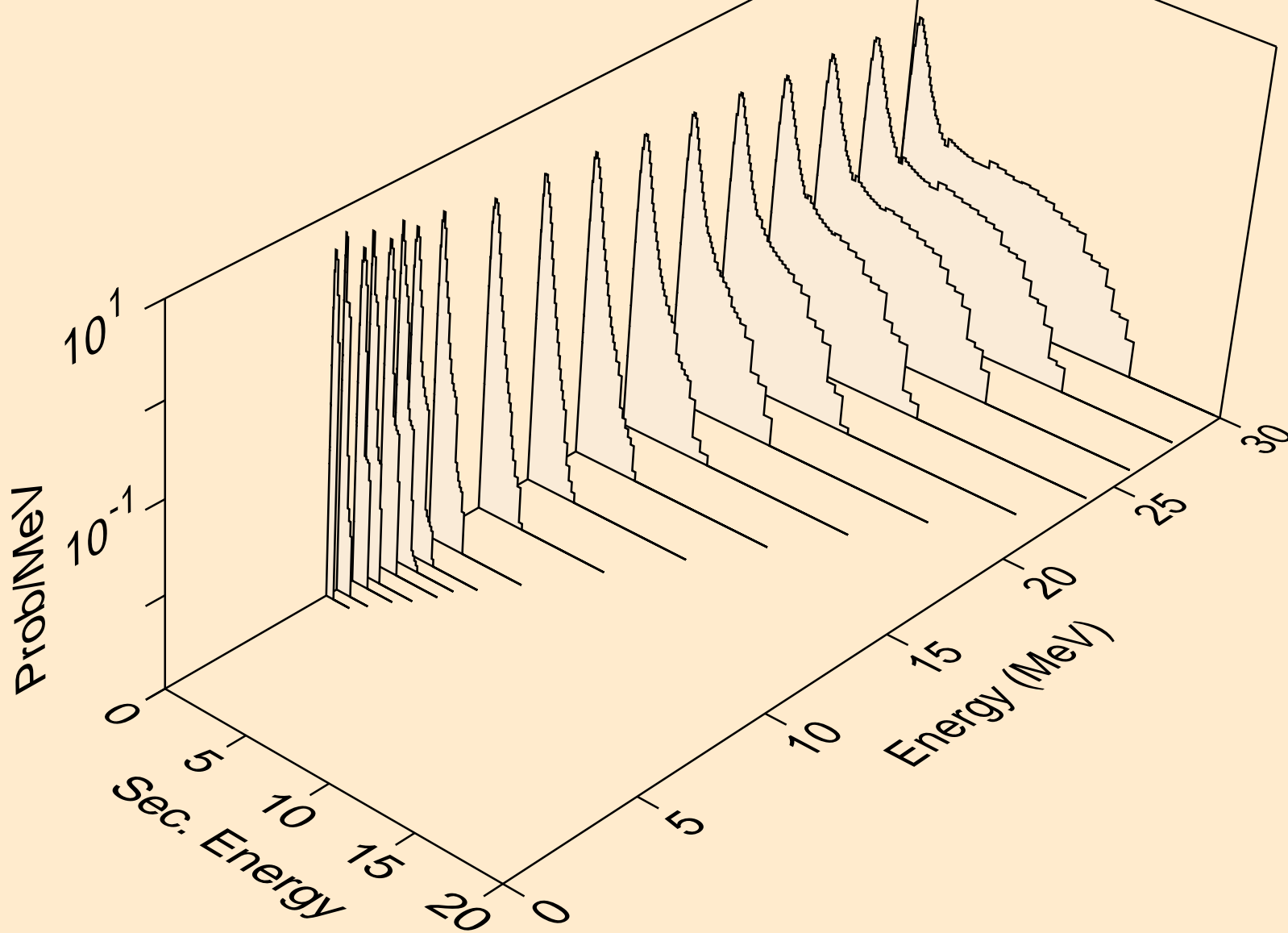

RF259 NEUTRON ACER TENDL-2019 LIBRARY; T=293.16K  
Neutron emission for (n,n\*)2a

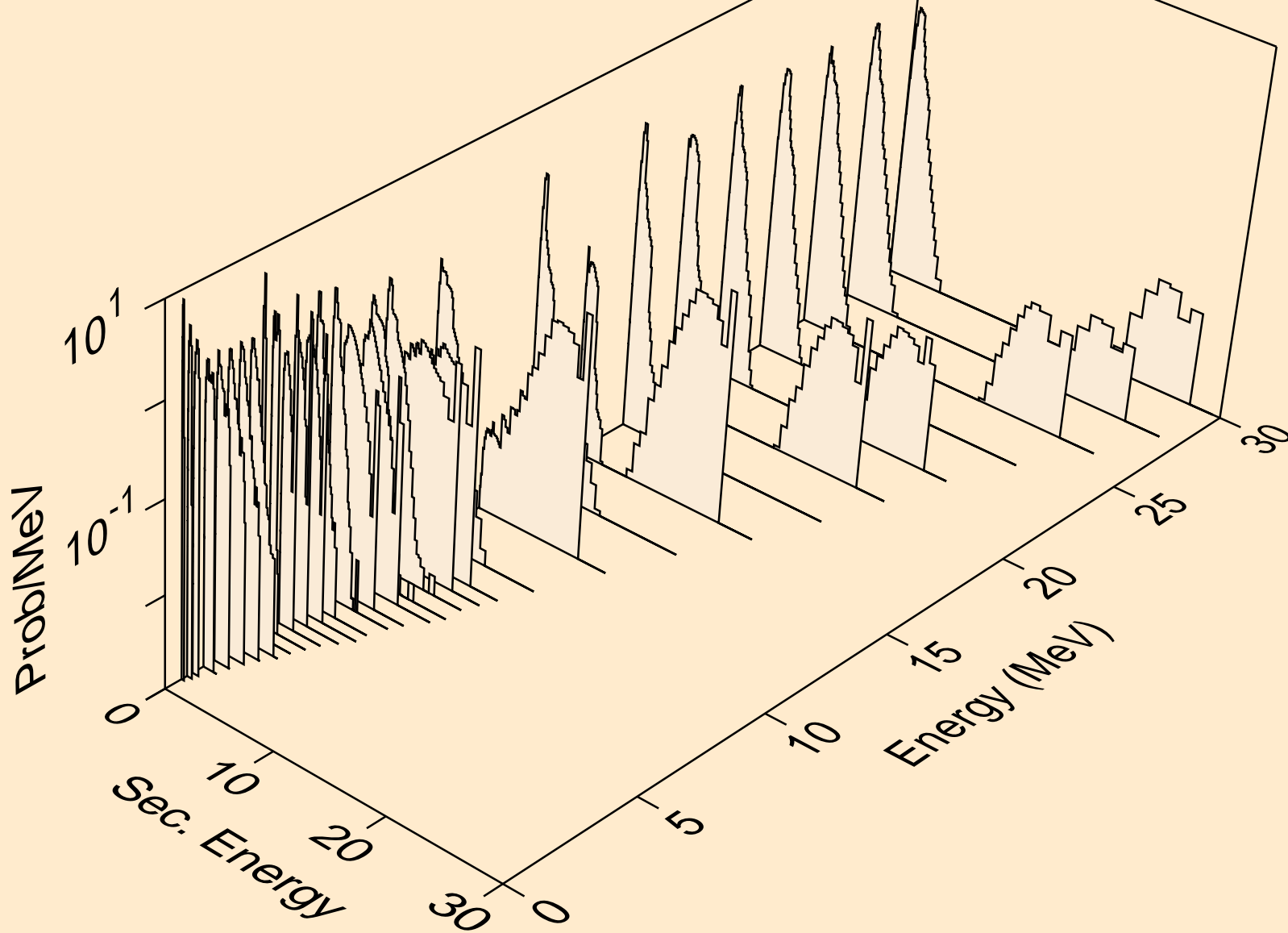



RF259 NEUTRON ACER TENDL-2019 LIBRARY; T=293.16K  
Neutron emission for (n,2n)2a

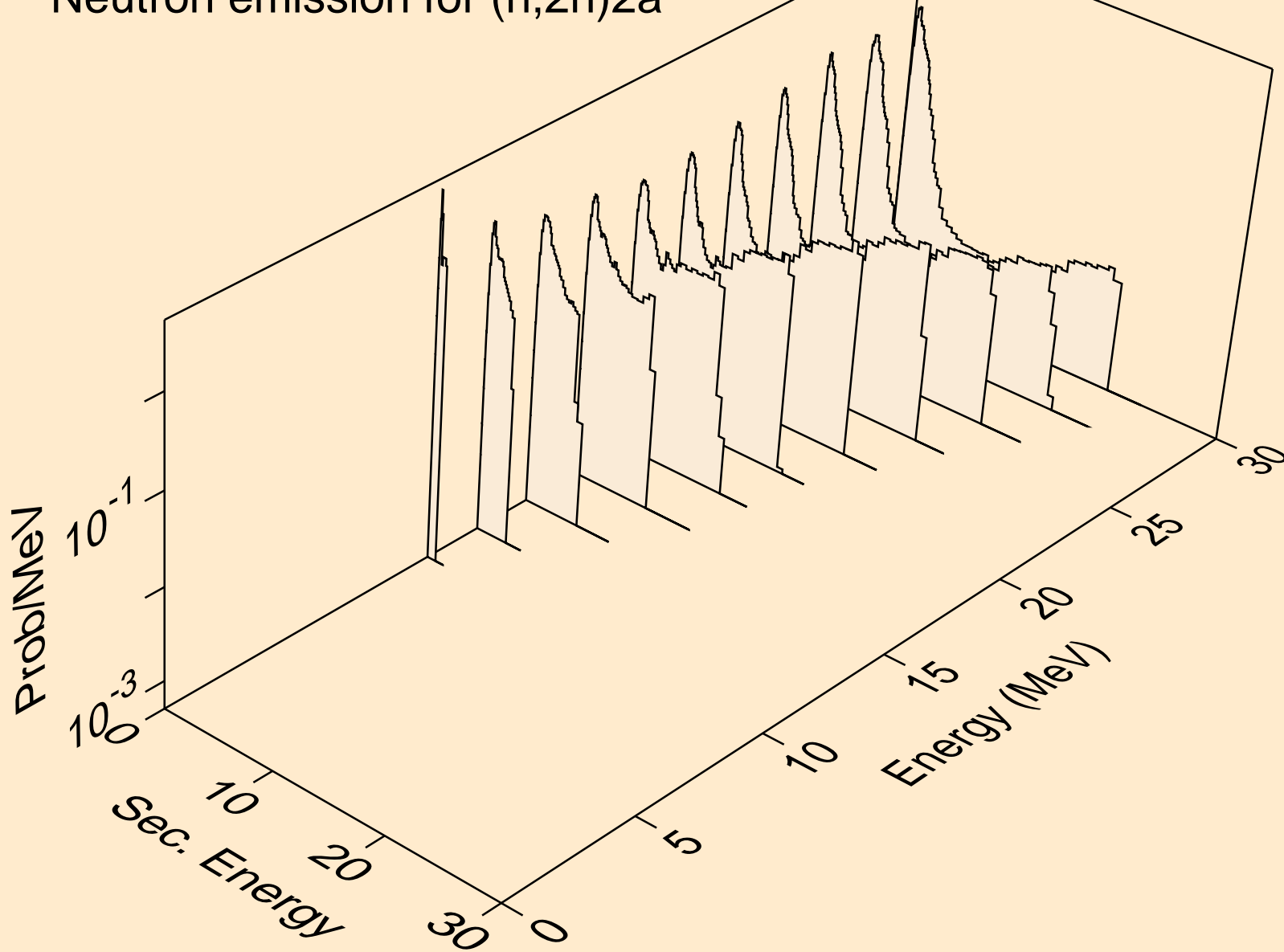

RF259 NEUTRON ACER TENDL-2019 LIBRARY; T=293.16K  
Neutron emission for (n,n\*)d

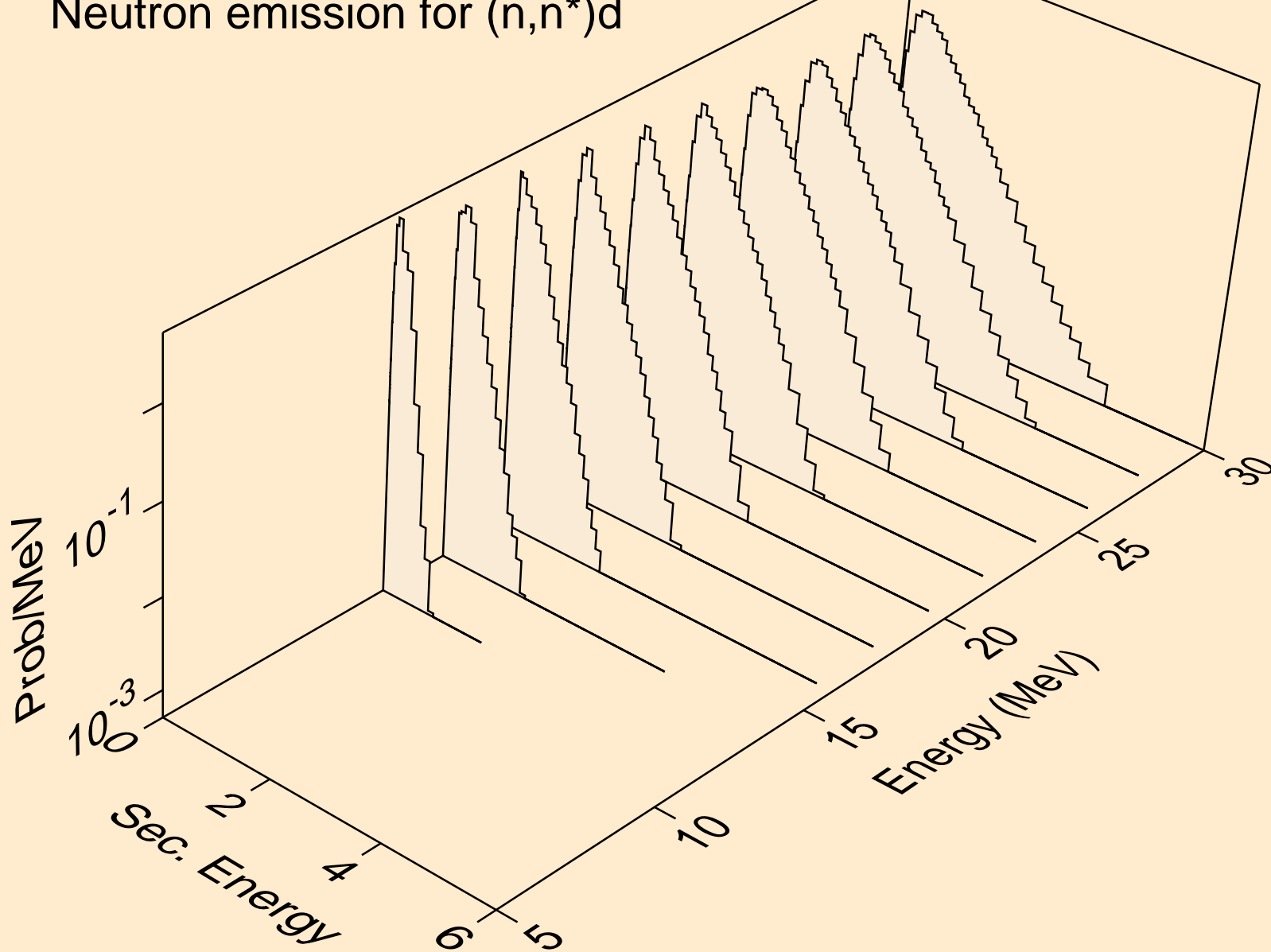

RF259 NEUTRON ACER TENDL-2019 LIBRARY; T=293.16K  
Neutron emission for (n,n\*)t

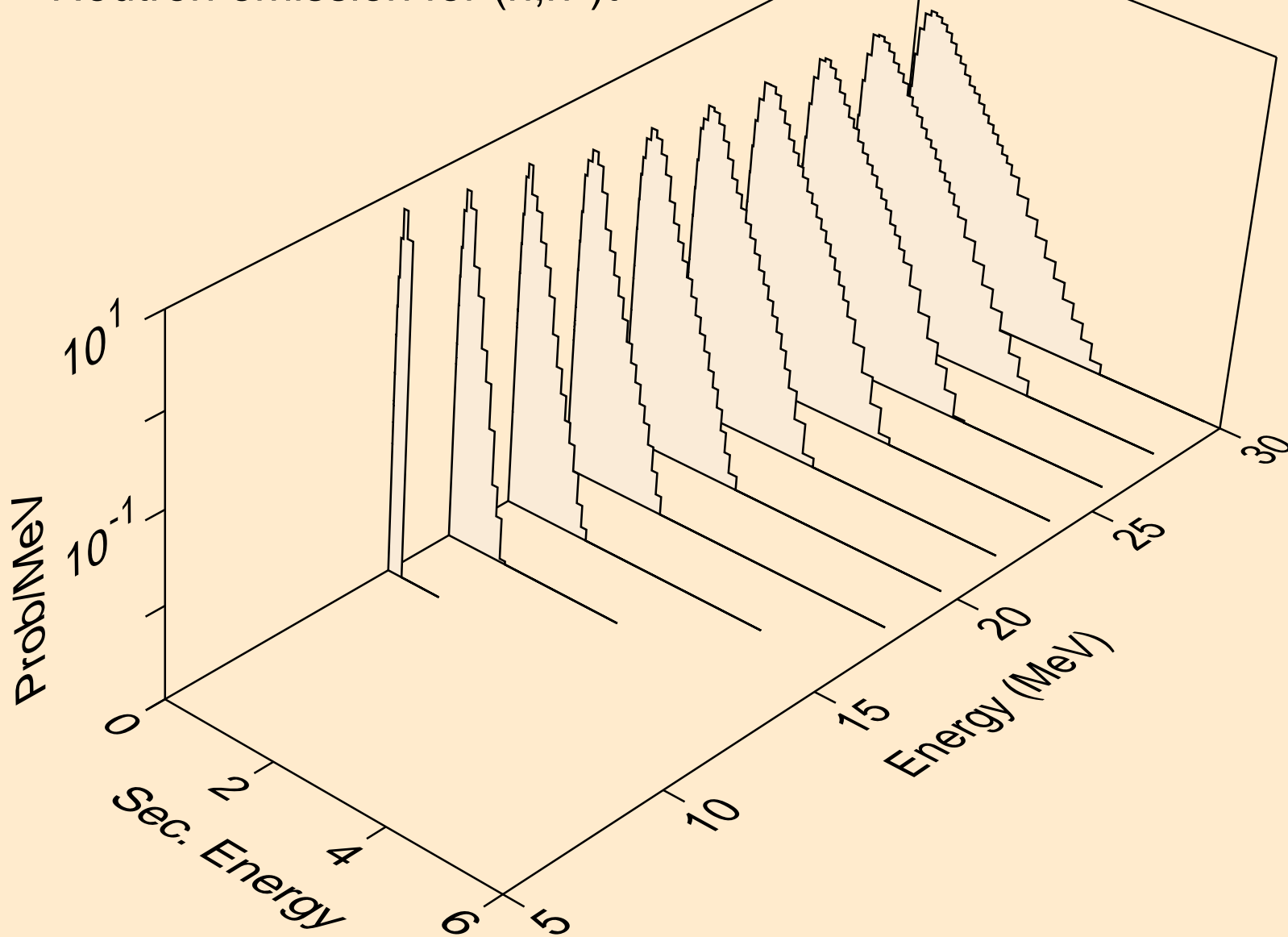

RF259 NEUTRON ACER TENDL-2019 LIBRARY; T=293.16K  
Neutron emission for (n,n\*)he3

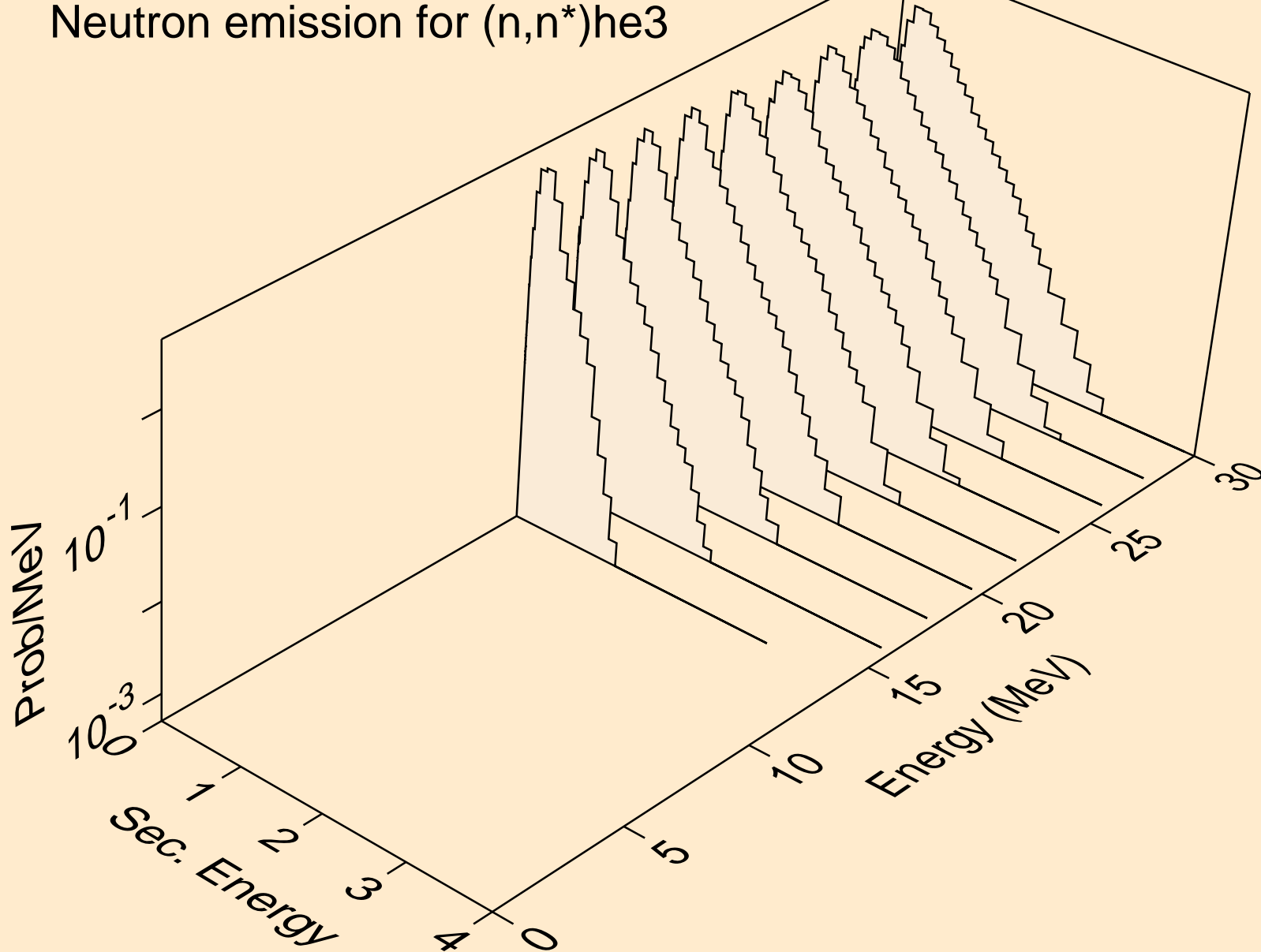

RF259 NEUTRON ACER TENDL-2019 LIBRARY; T=293.16K  
Neutron emission for (n,4n)

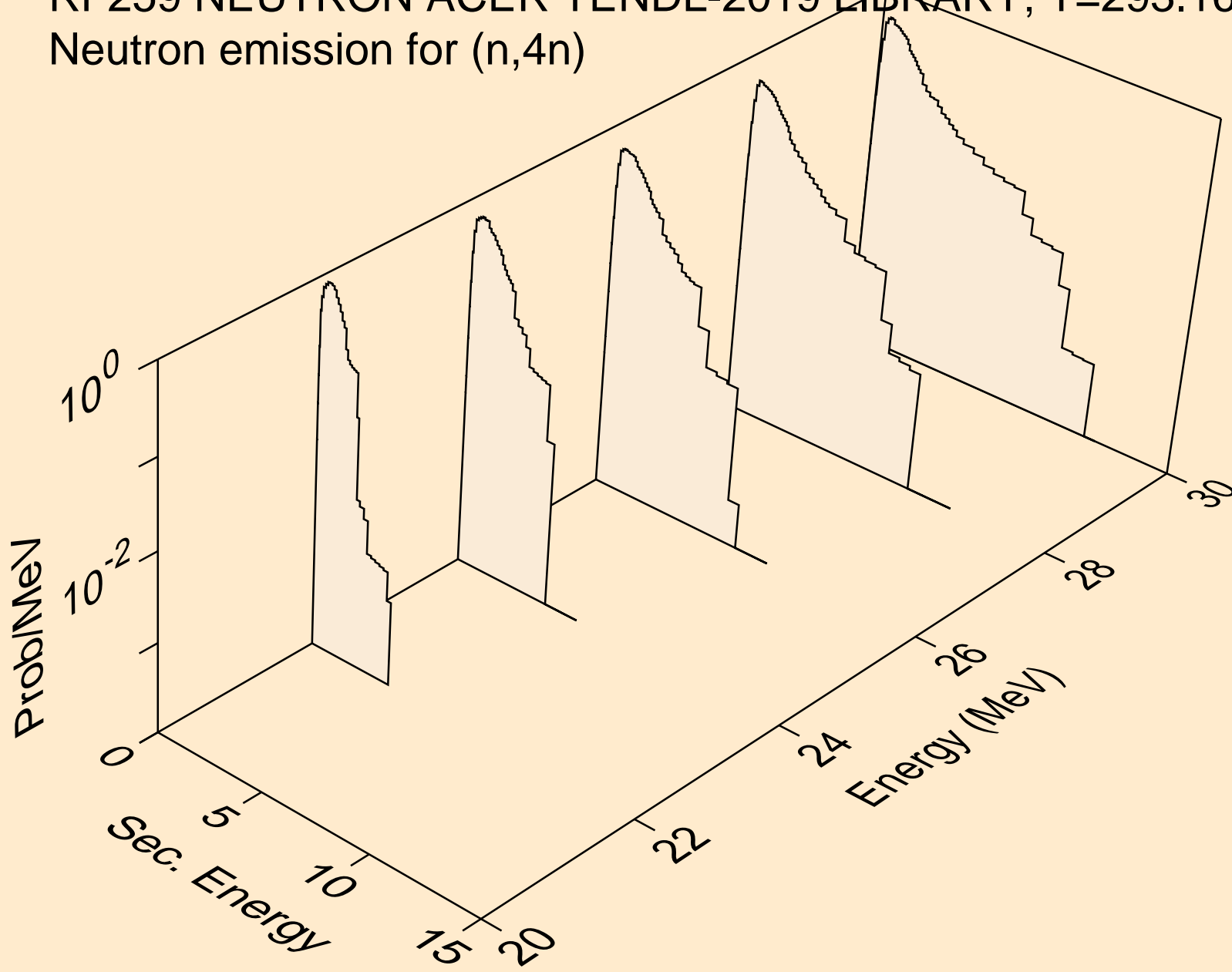

RF259 NEUTRON ACER TENDL-2019 LIBRARY; T=293.16K  
Neutron emission for (n,2np)

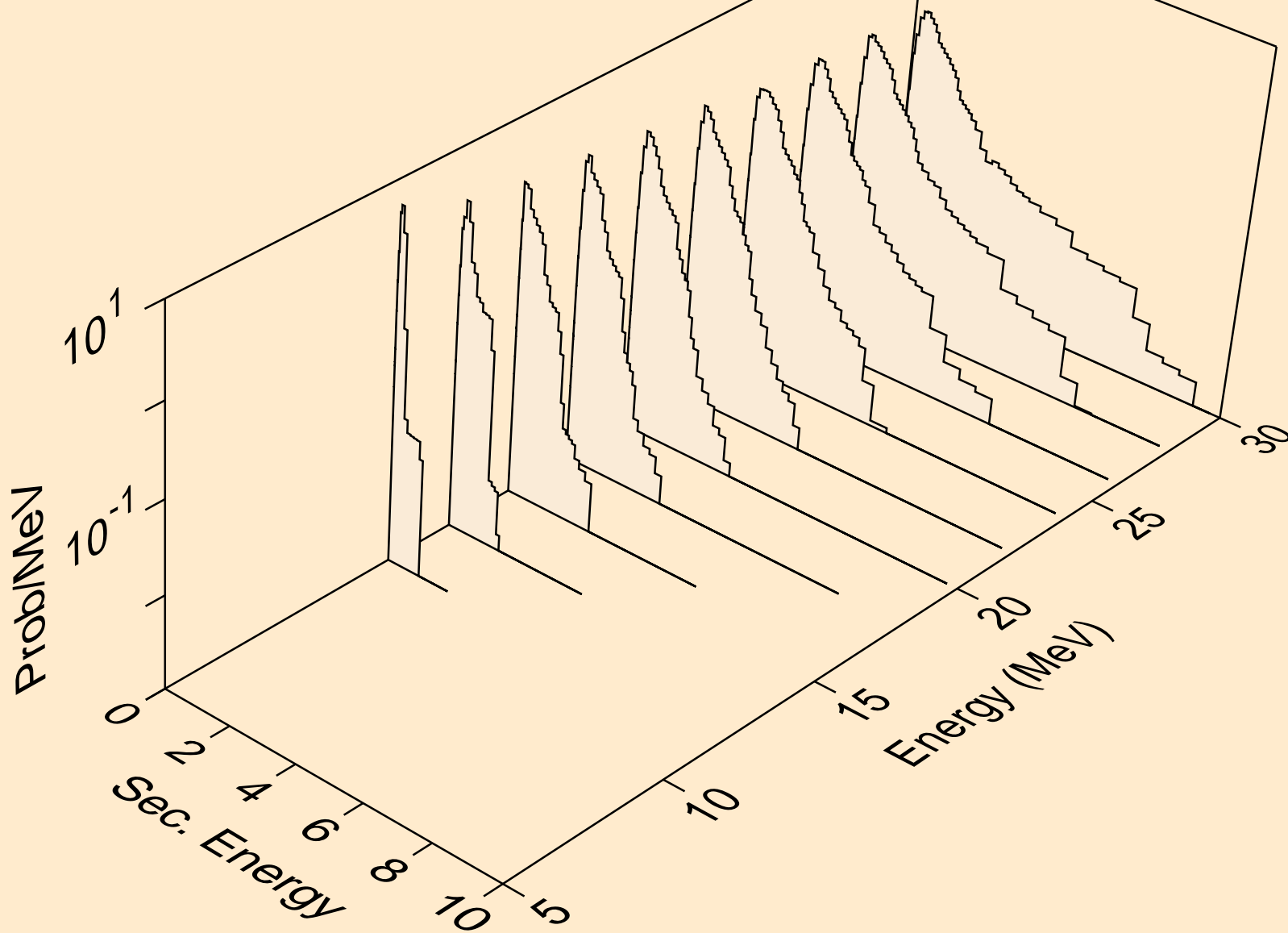

RF259 NEUTRON ACER TENDL-2019 LIBRARY; T=293.16K  
Neutron emission for (n,3np)

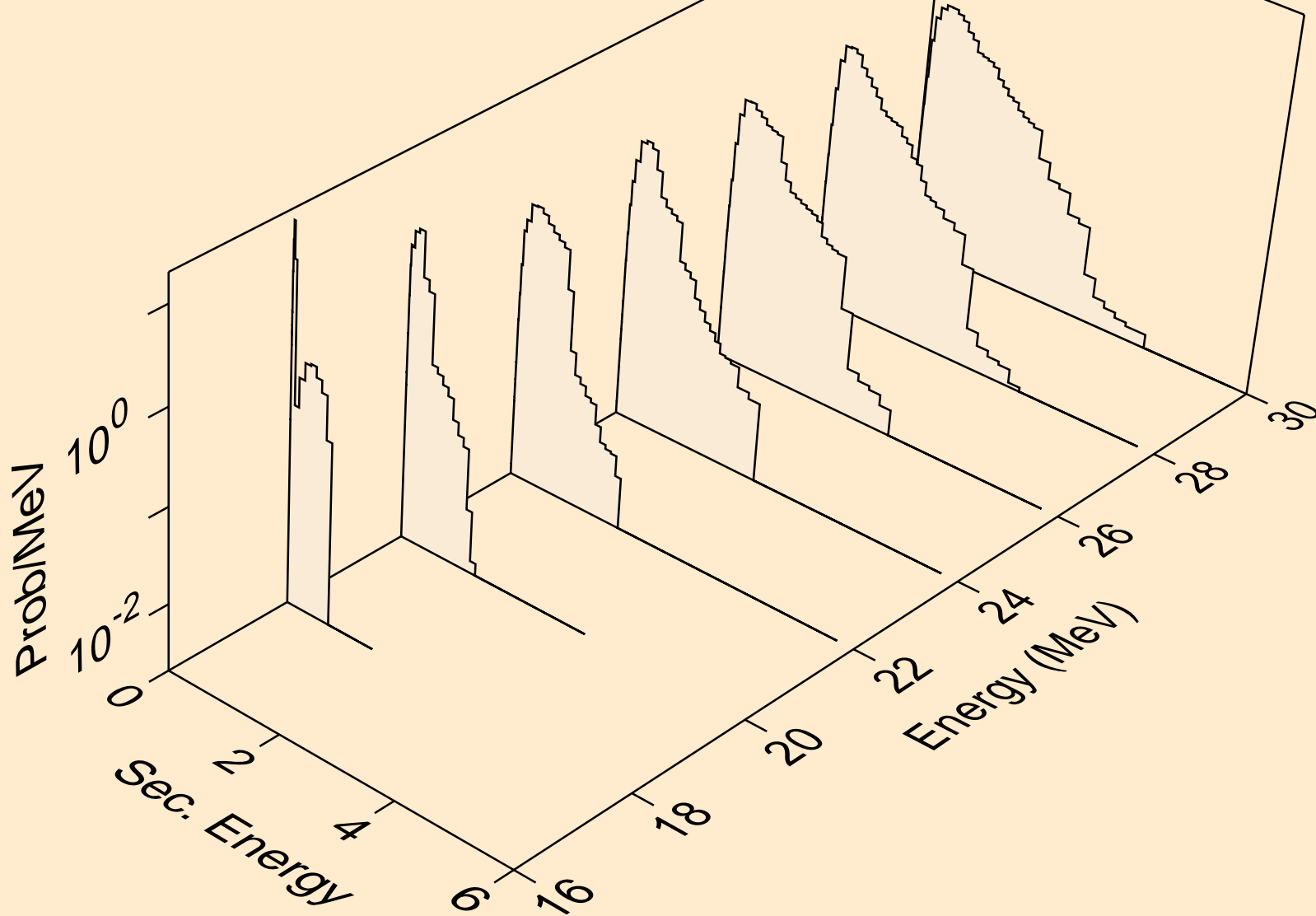

RF259 NEUTRON ACER TENDL-2019 LIBRARY; T=293.16K  
Neutron emission for (n,2np)

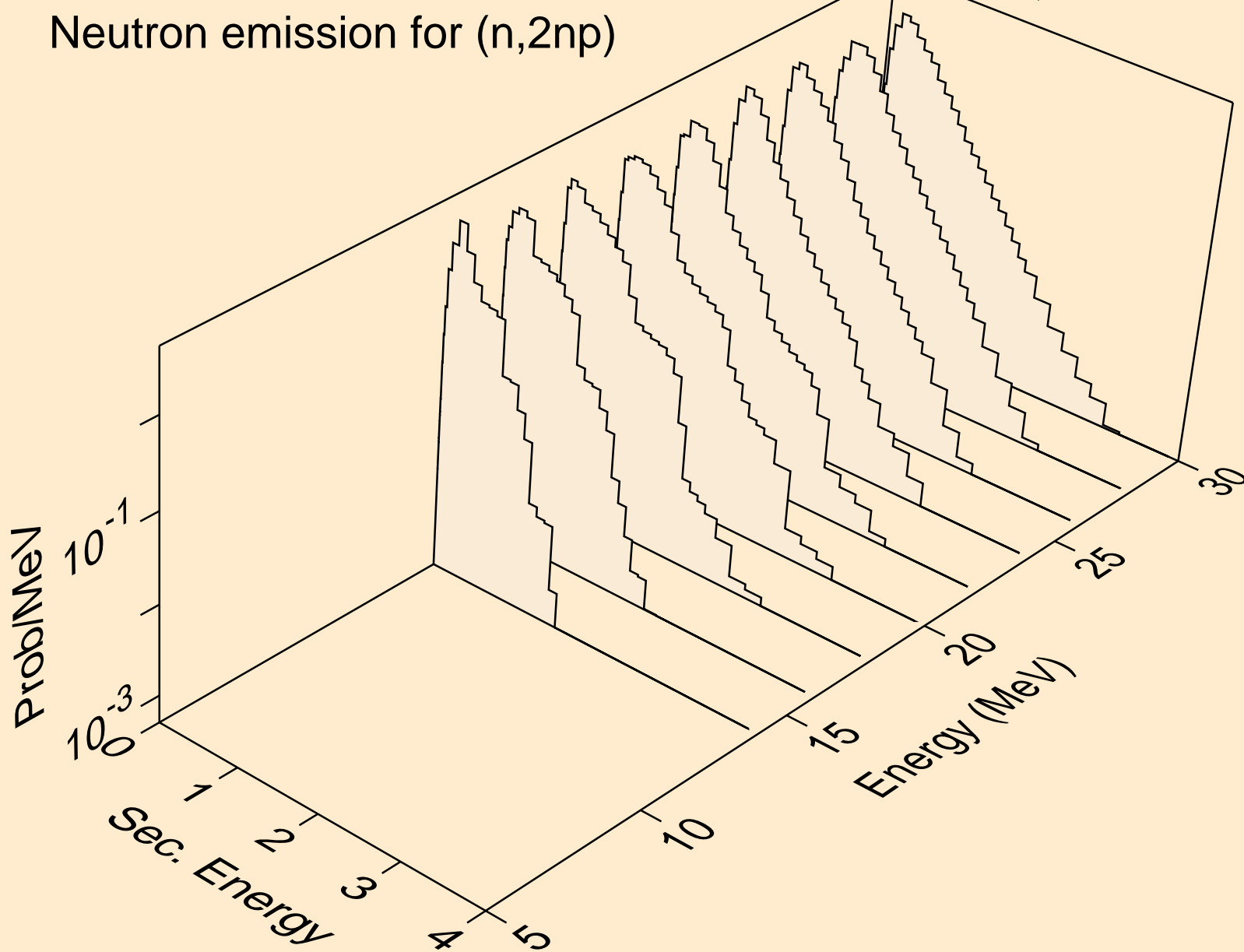



RF259 NEUTRON ACER TENDL-2019 LIBRARY; T=293.16K  
Neutron emission for (n,npa)

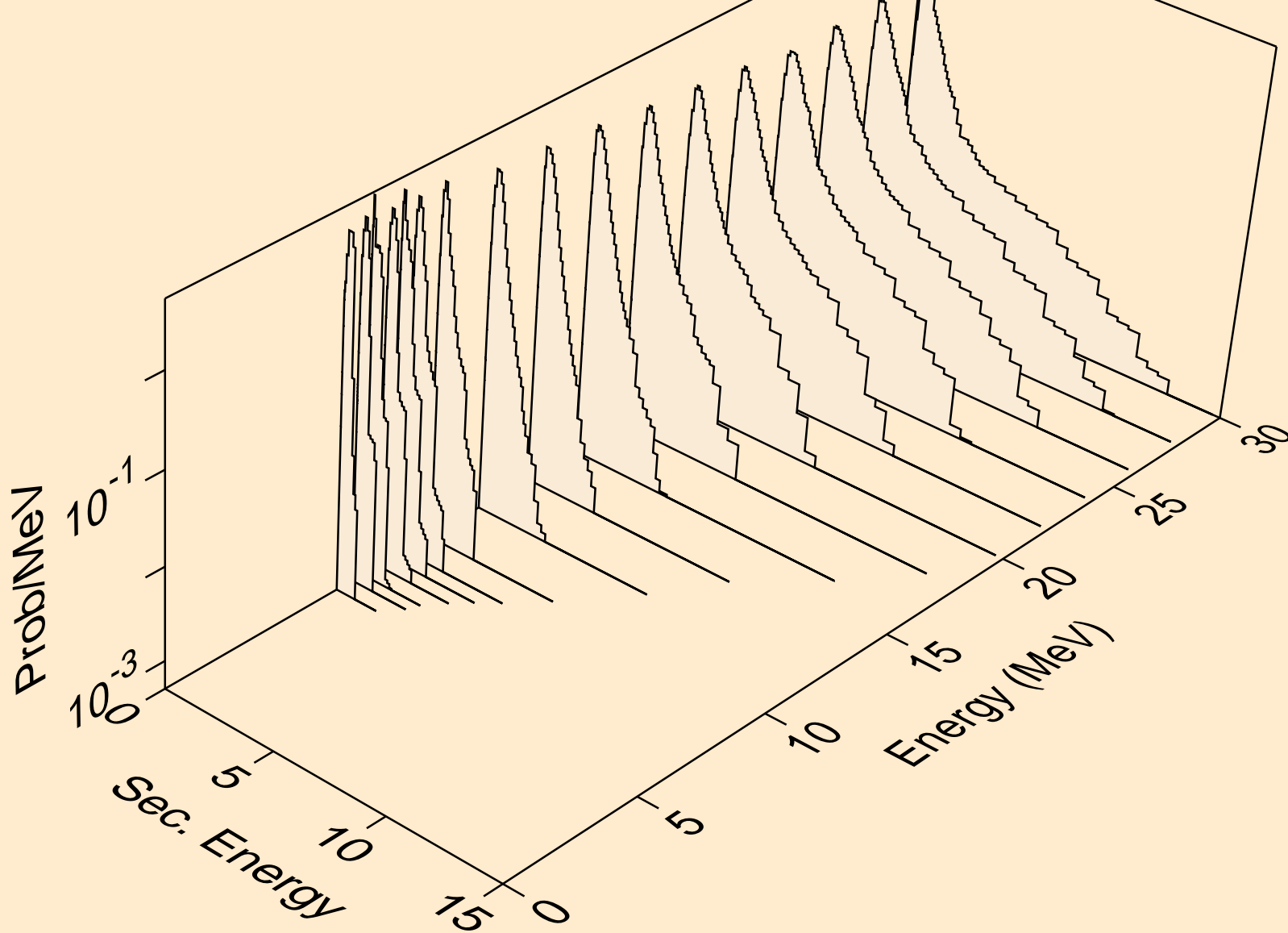

RF259 NEUTRON ACER TENDL-2019 LIBRARY; T=293.16K  
Neutron emission for (n,n\*c)

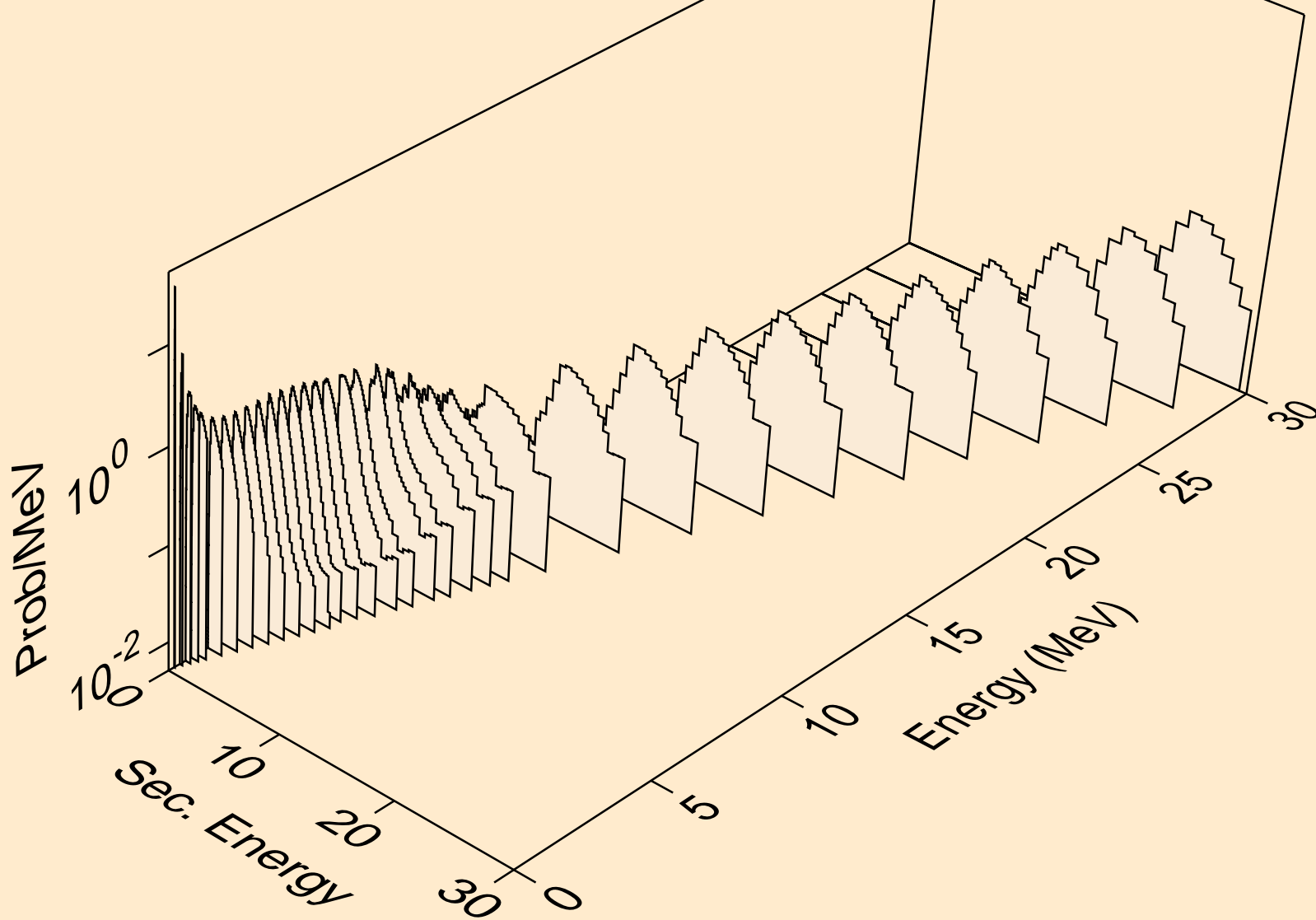

RF259 NEUTRON ACER TENDL-2019 LIBRARY; T=293.16K  
Delayed nubar

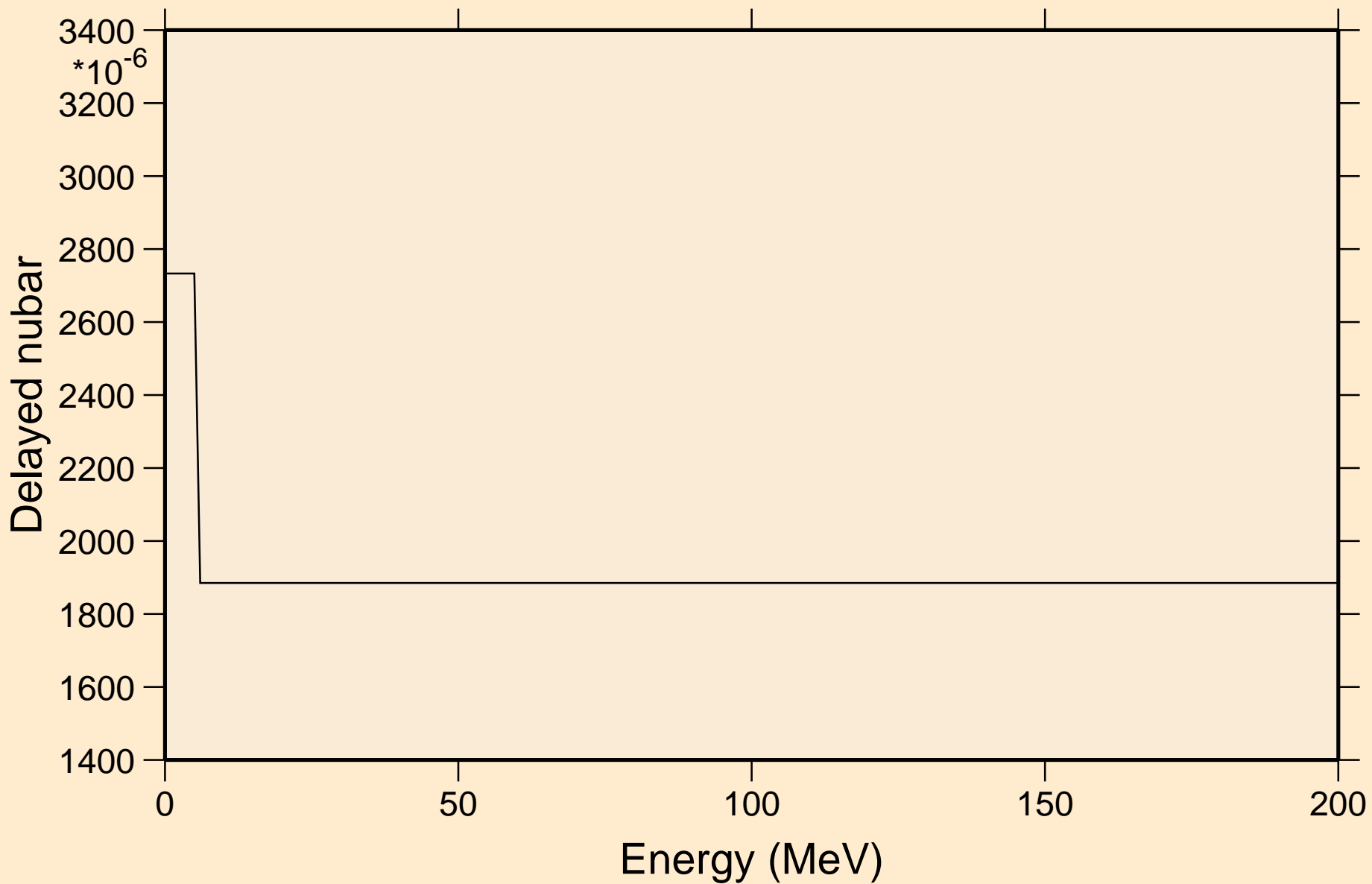

# RF259 NEUTRON ACER TENDL-2019 LIBRARY; T=293.16K

## Delayed neutron spectra

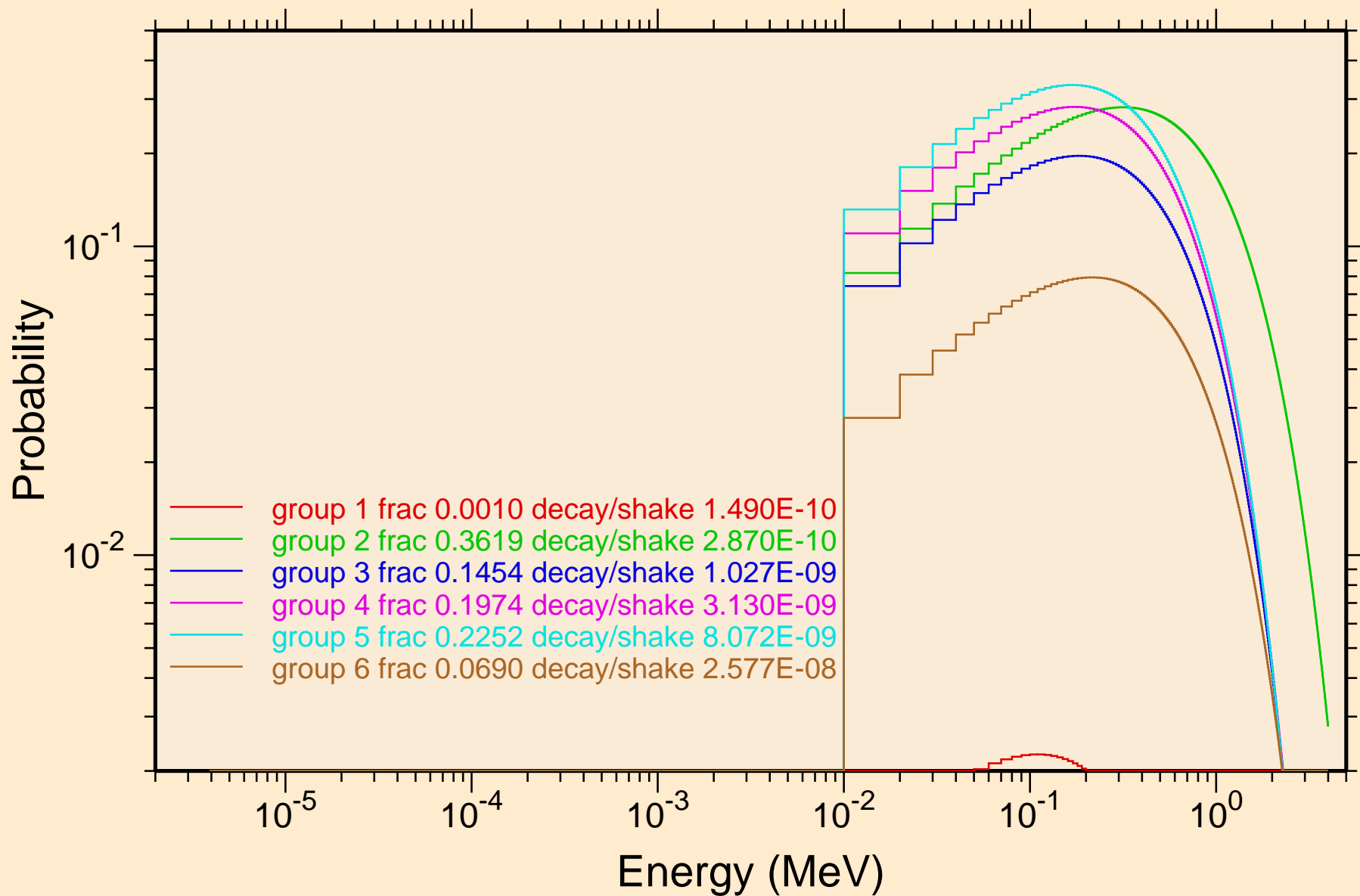

RF259 NEUTRON ACER TENDL-2019 LIBRARY; T=293.16K  
Photon emission for (n,x)

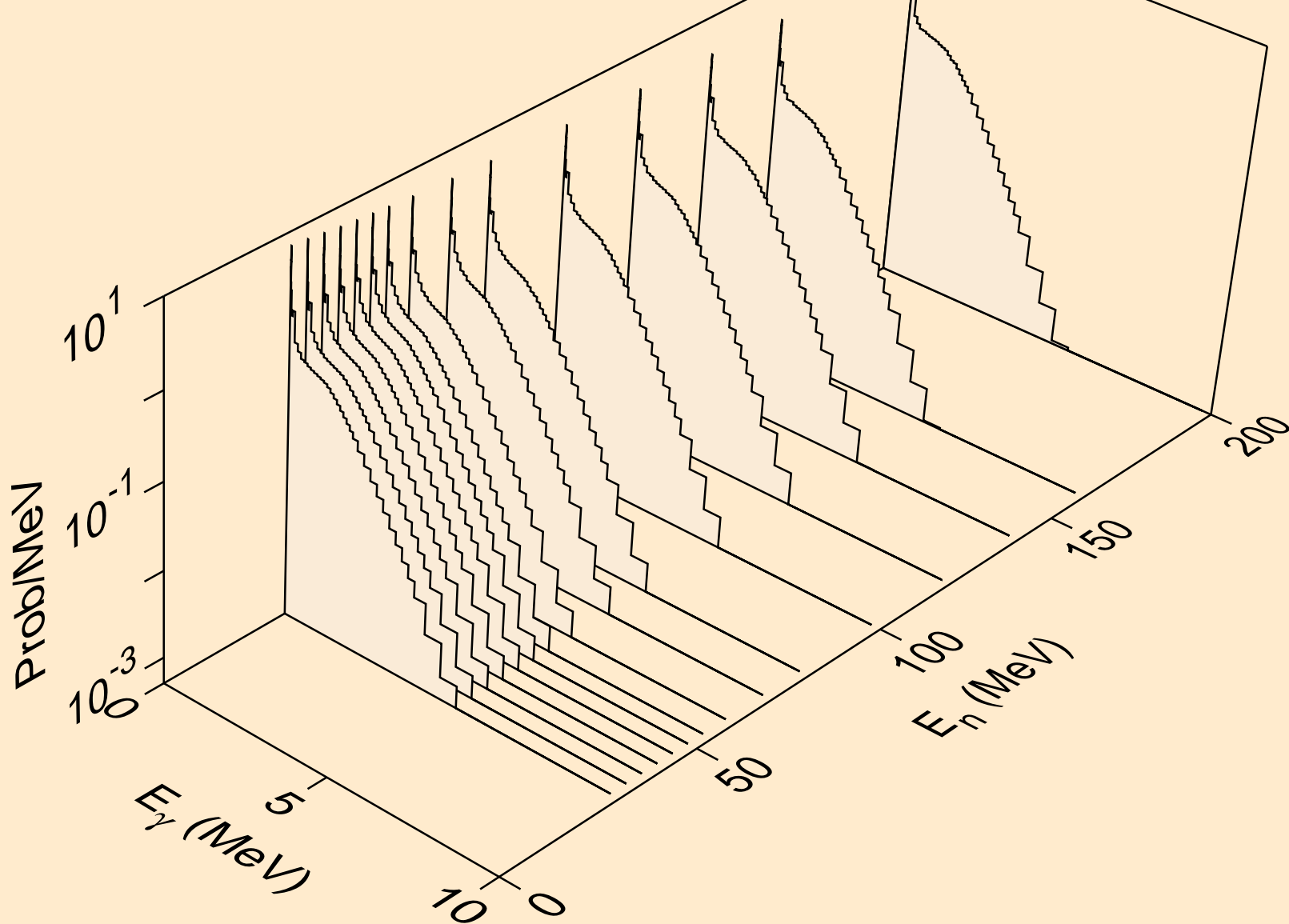

RF259 NEUTRON ACER TENDL-2019 LIBRARY; T=293.16K  
Photon emission for (n,2nd)

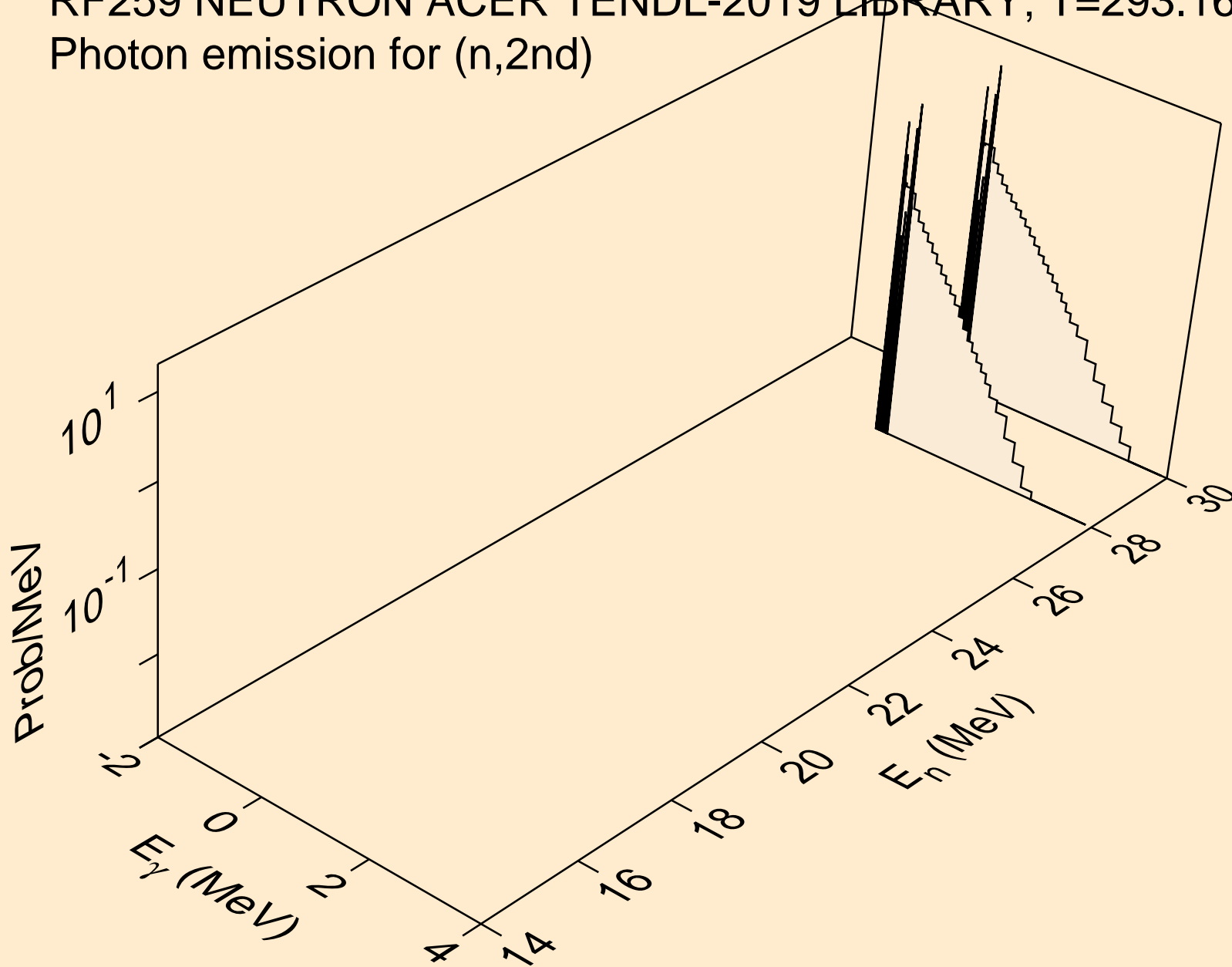

RF259 NEUTRON ACER TENDL-2019 LIBRARY; T=293.16K  
Photon emission for (n,2n)

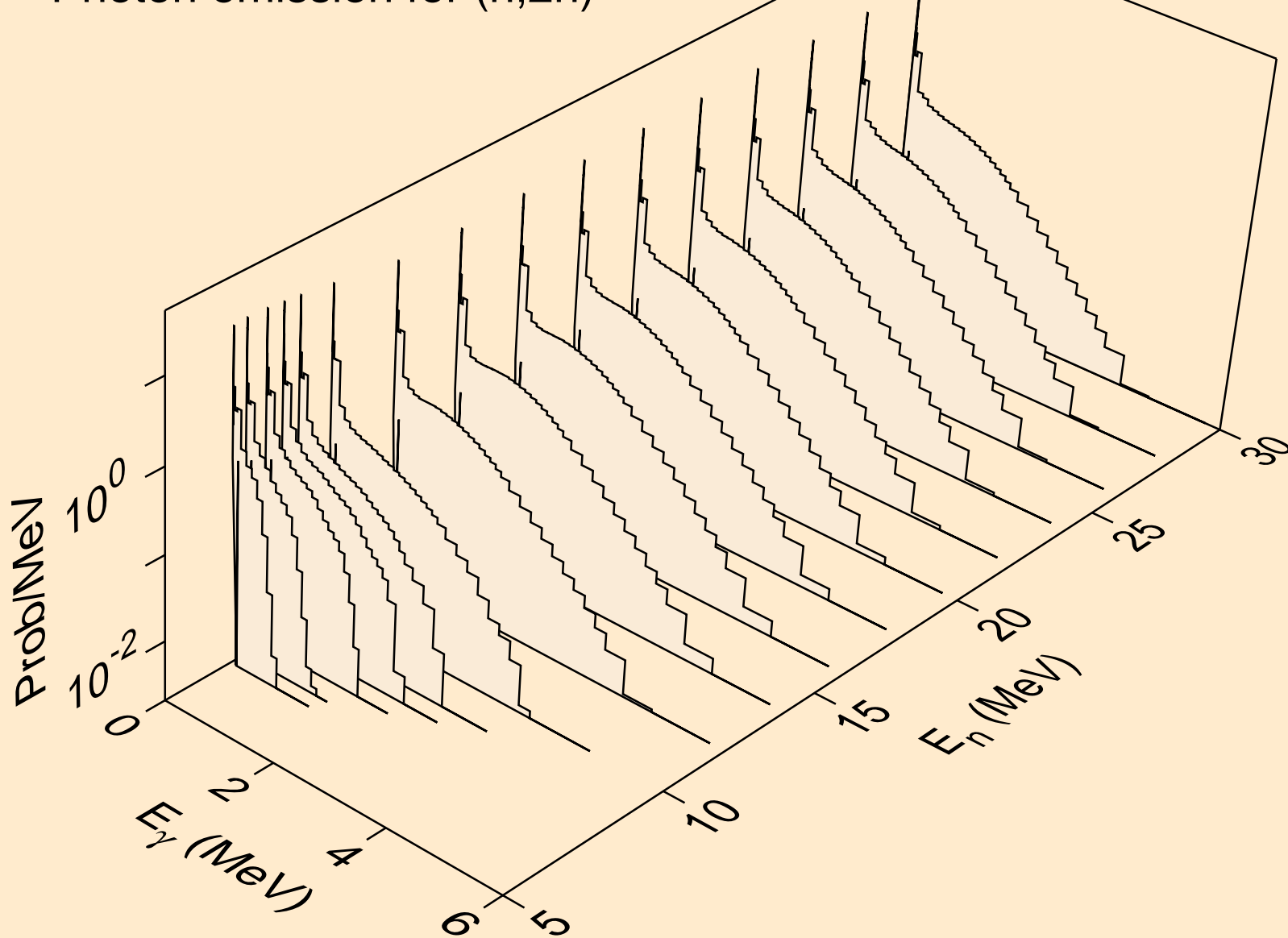

RF259 NEUTRON ACER TENDL-2019 LIBRARY; T=293.16K  
Photon emission for (n,3n)

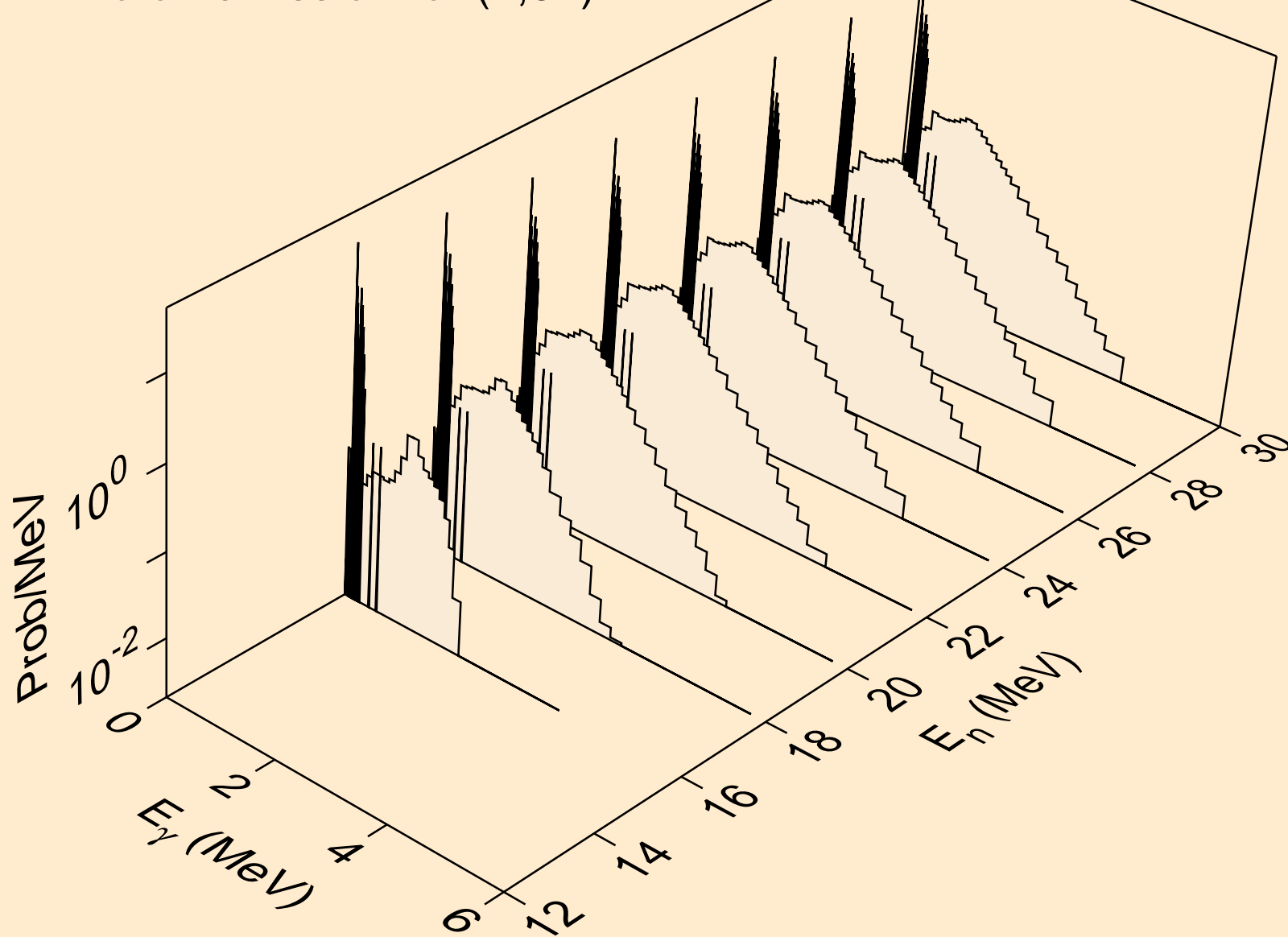



RF259 NEUTRON ACER TENDL-2019 LIBRARY; T=293.16K  
Photon emission for (n,n\*)a

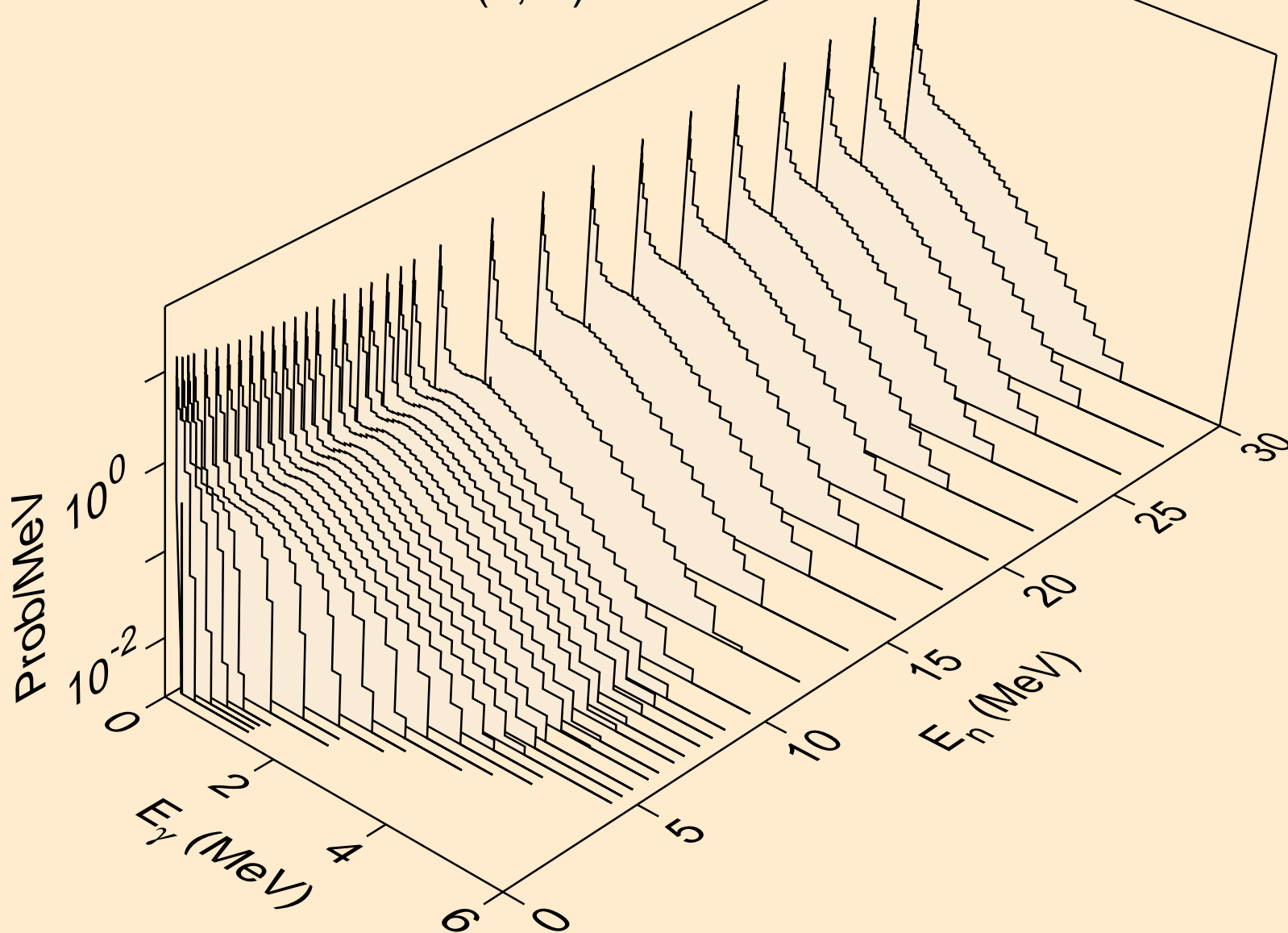

RF259 NEUTRON ACER TENDL-2019 LIBRARY; T=293.16K  
Photon emission for (n,2n)a

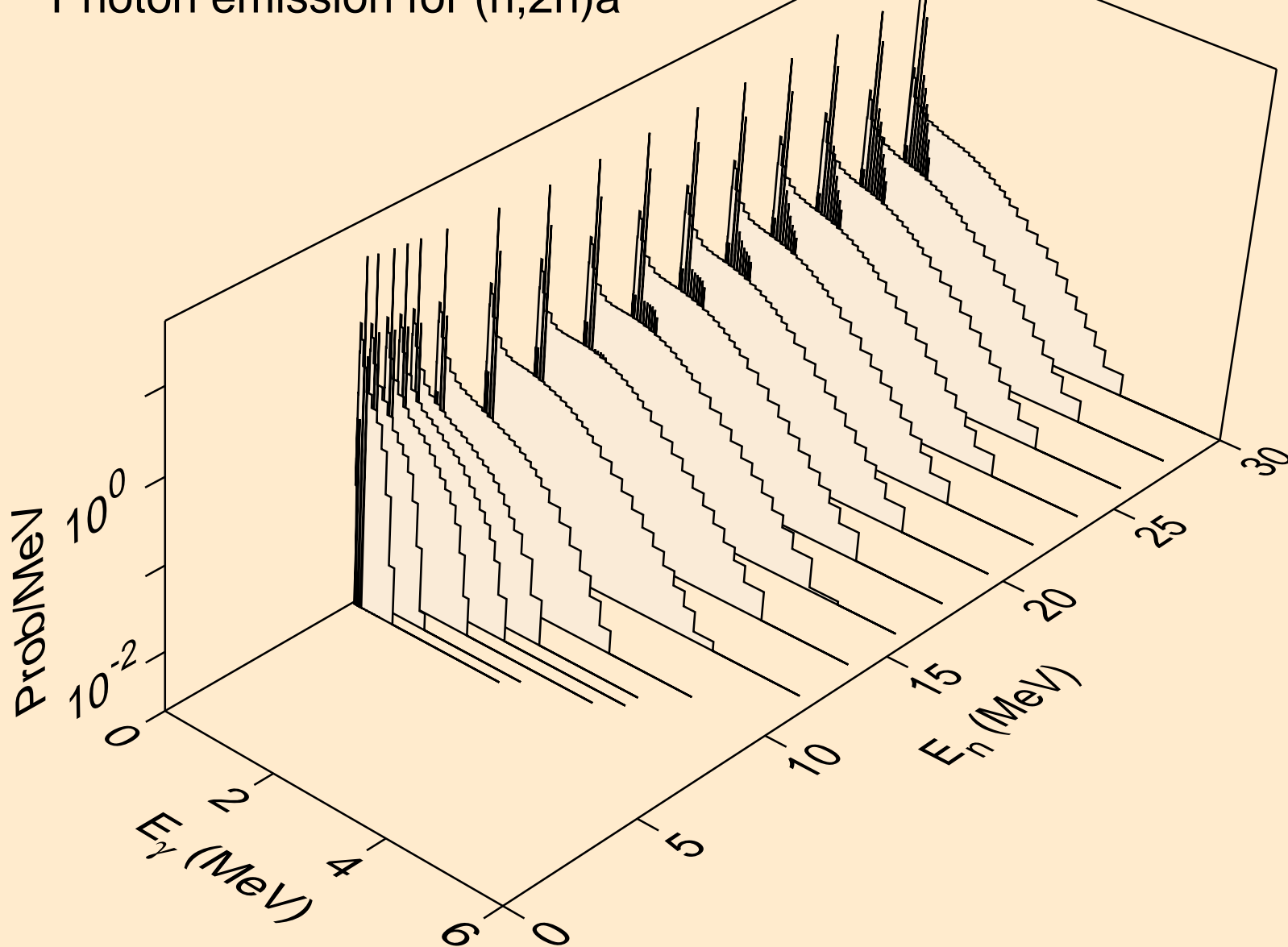

RF259 NEUTRON ACER TENDL-2019 LIBRARY; T=293.16K  
Photon emission for (n,3n)a

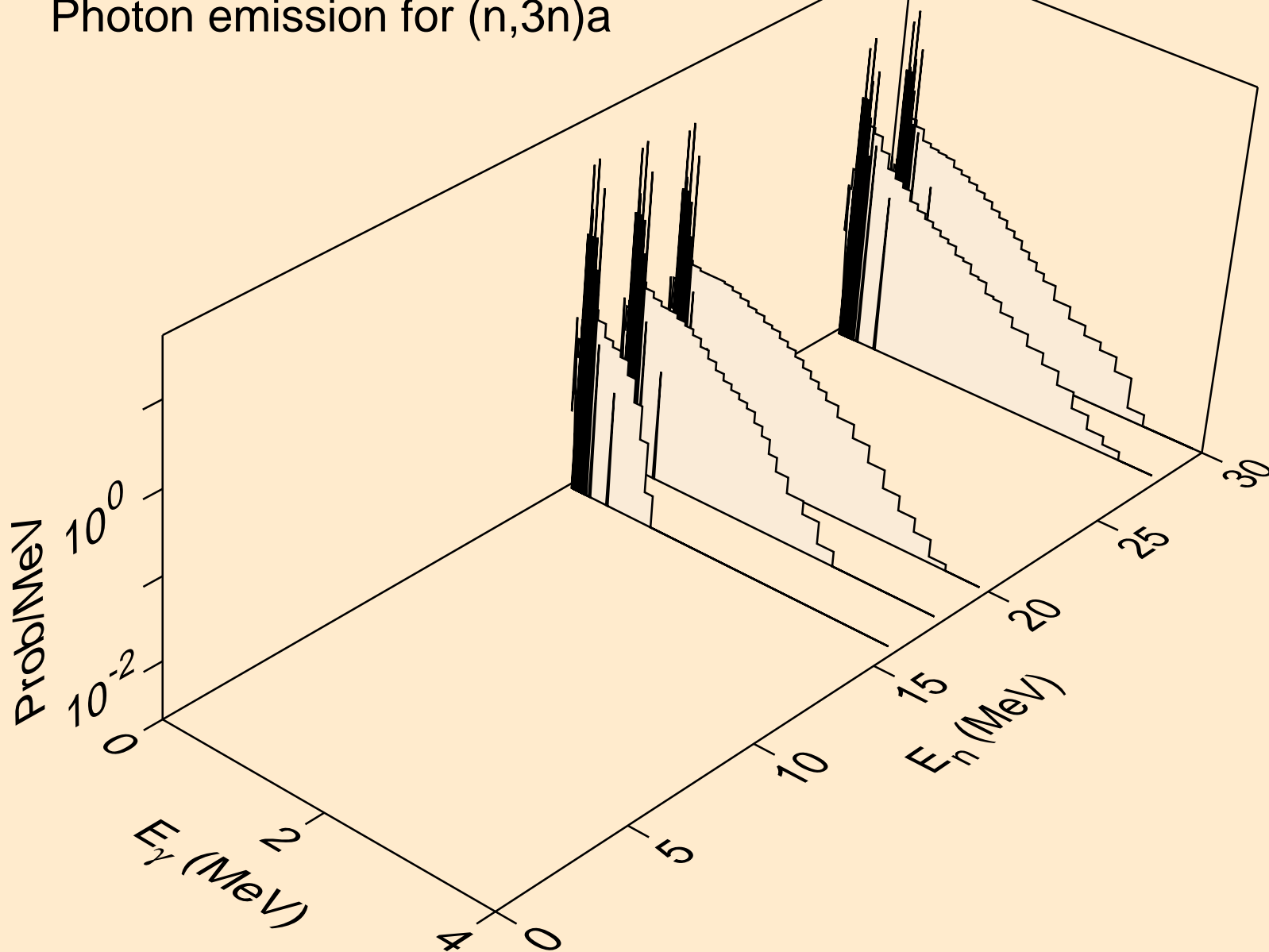

RF259 NEUTRON ACER TENDL-2019 LIBRARY; T=293.16K  
Photon emission for (n,n\*)p

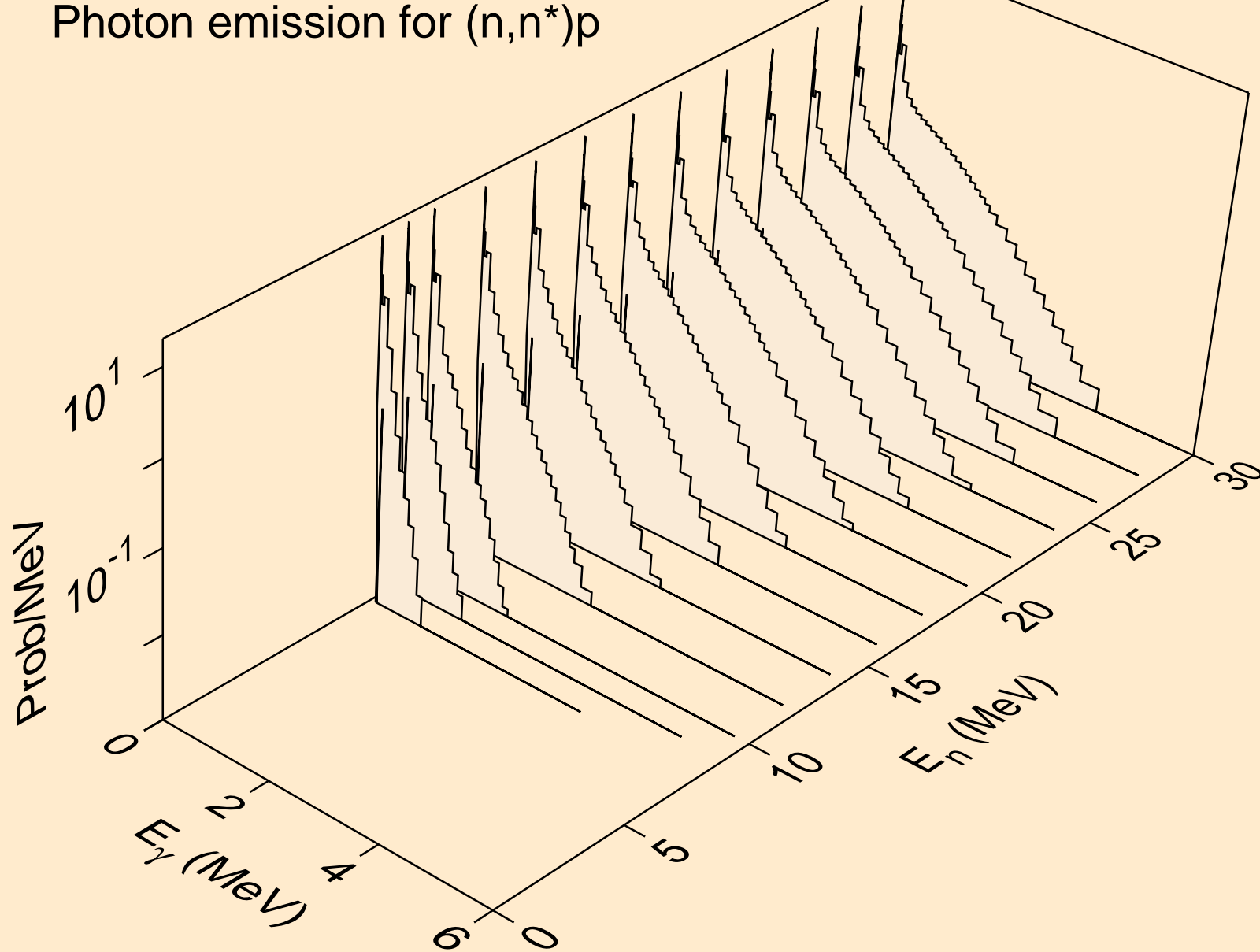

RF259 NEUTRON ACER TENDL-2019 LIBRARY; T=293.16K  
Photon emission for (n,n\*)2a

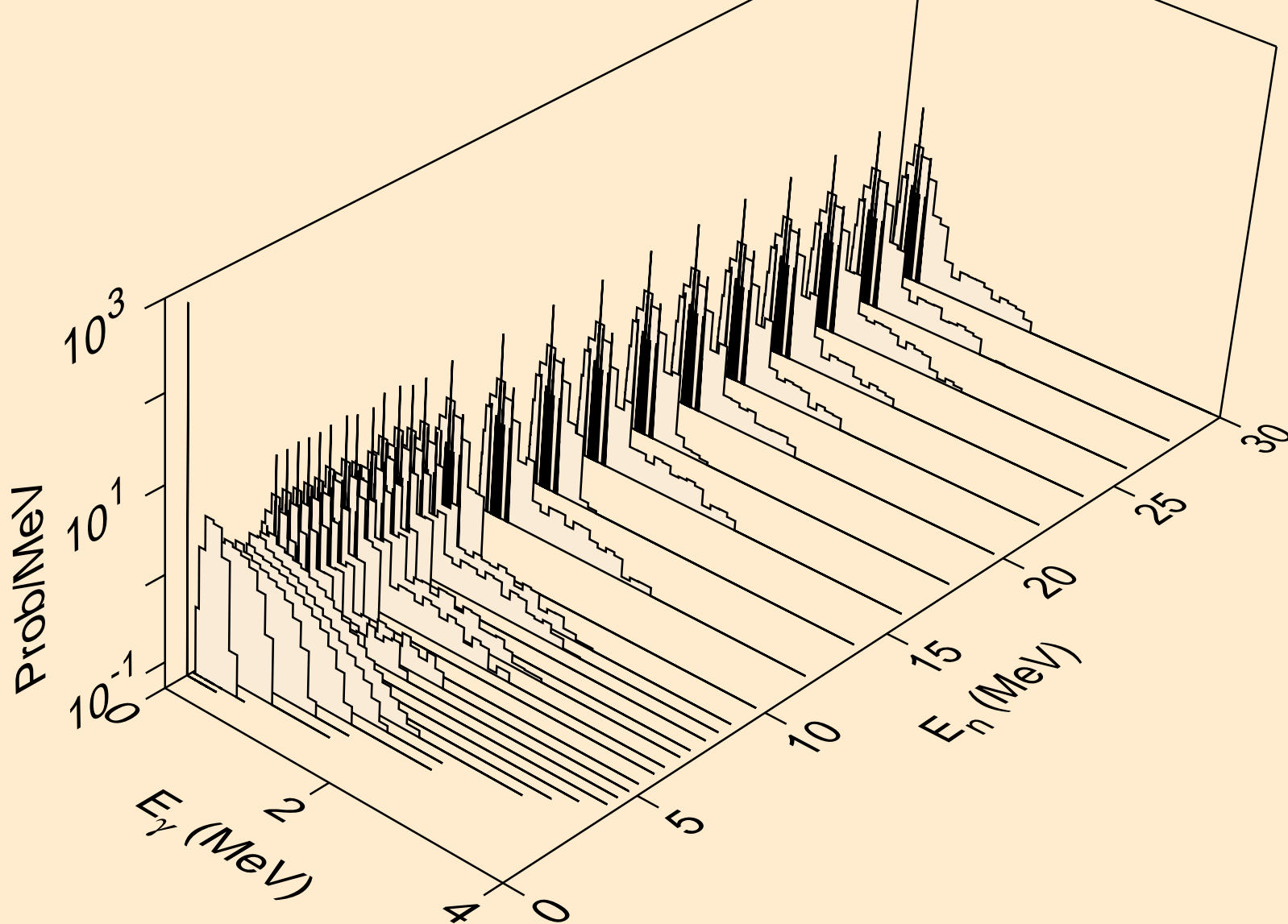

RF259 NEUTRON ACER TENDL-2019 LIBRARY; T=293.16K  
Photon emission for (n,2n)2a

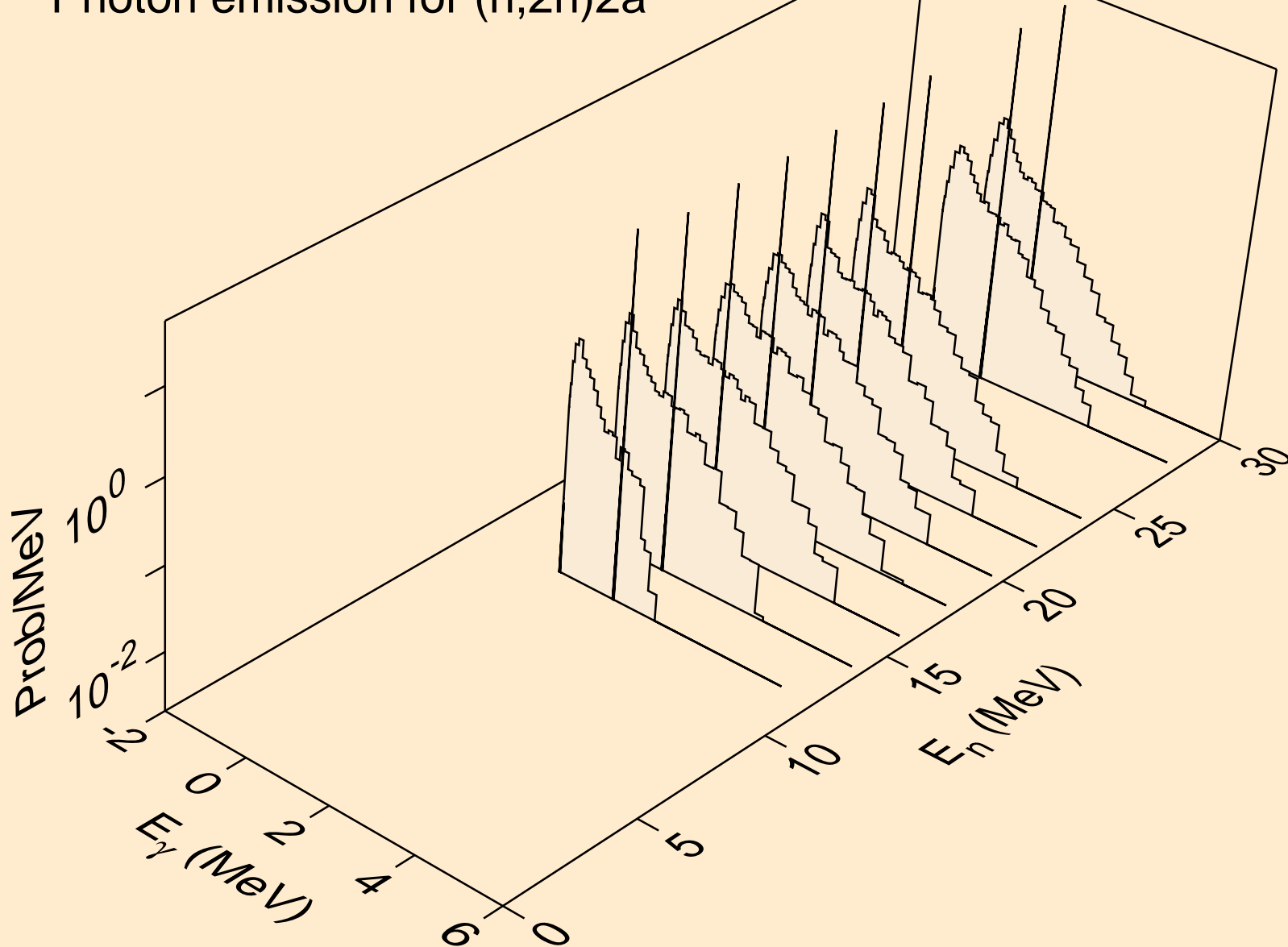

RF259 NEUTRON ACER TENDL-2019 LIBRARY; T=293.16K  
Photon emission for (n,n\*)d

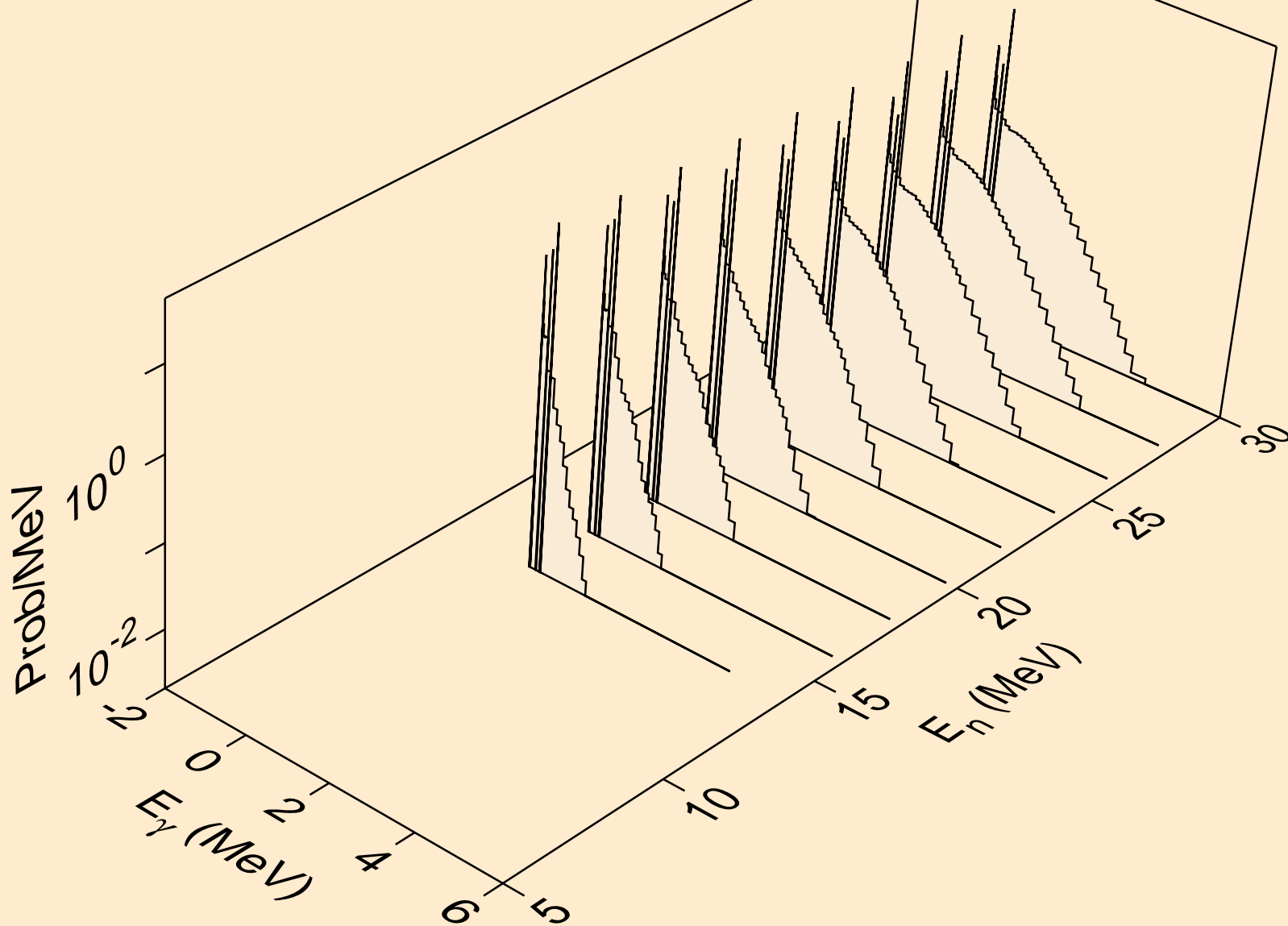

RF259 NEUTRON ACER TENDL-2019 LIBRARY; T=293.16K  
Photon emission for (n,n\*)t

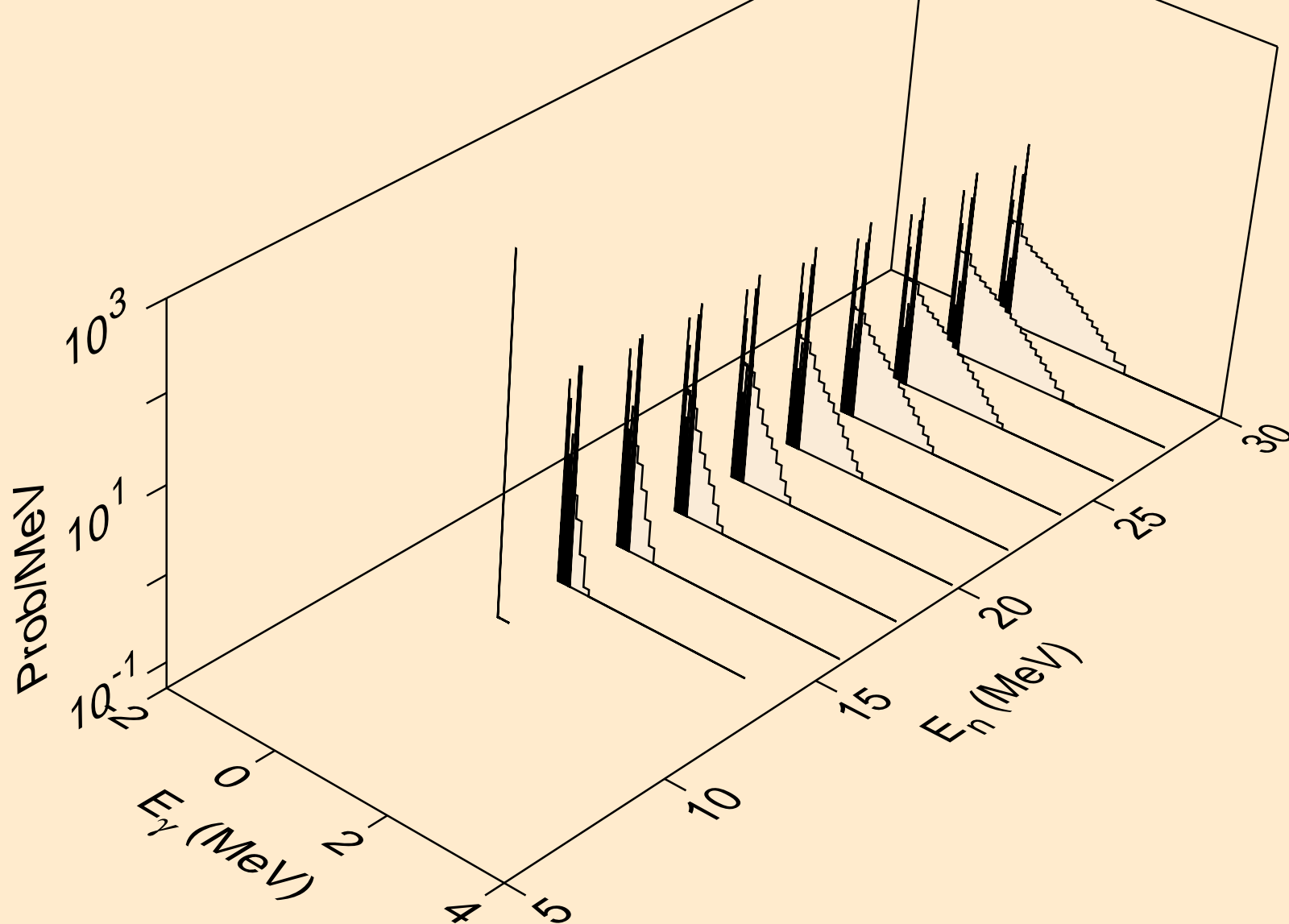



RF259 NEUTRON ACER TENDL-2019 LIBRARY; T=293.16K  
Photon emission for (n,n\*)he3

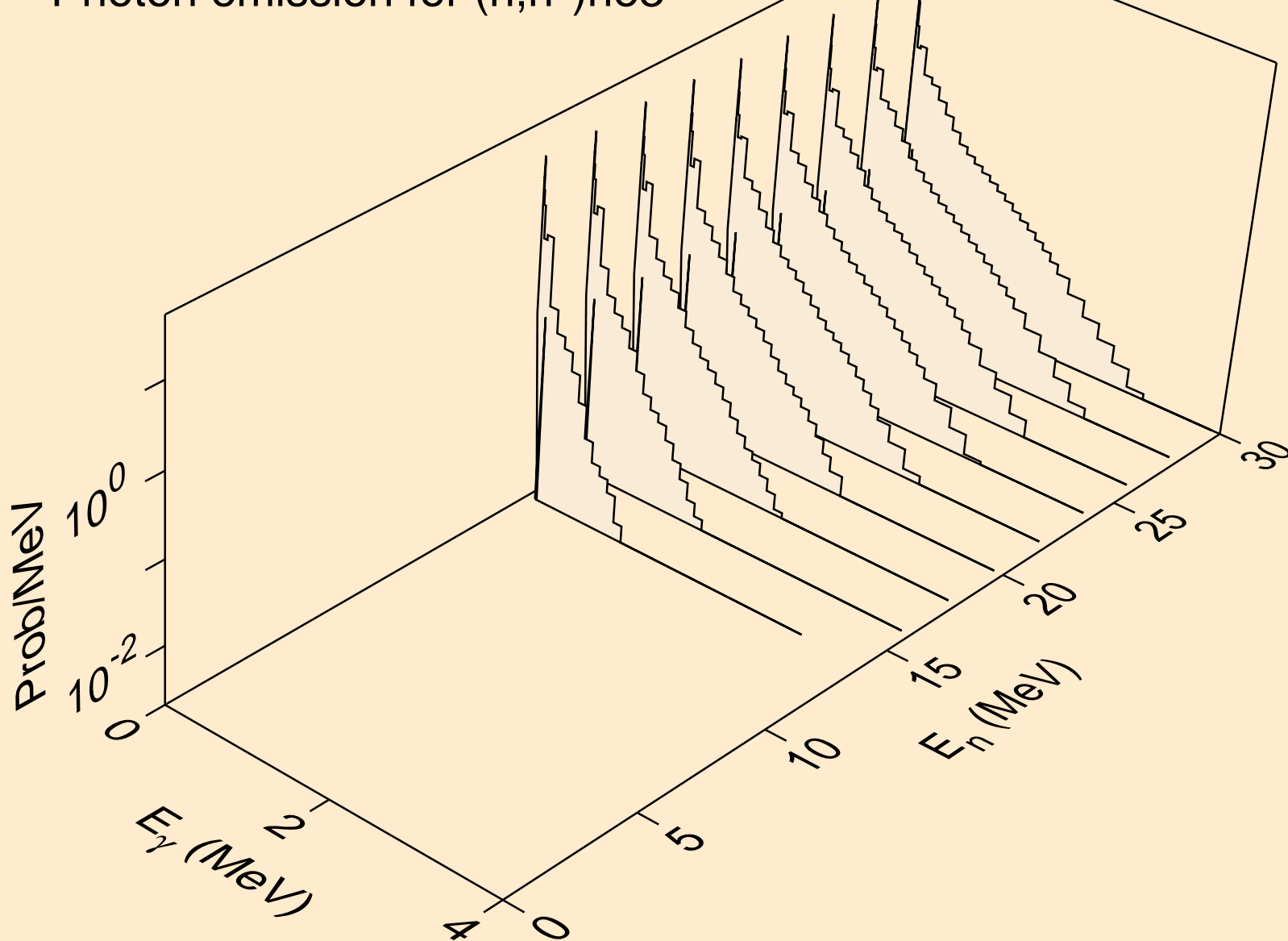

RF259 NEUTRON ACER TENDL-2019 LIBRARY; T=293.16K  
Photon emission for (n,4n)

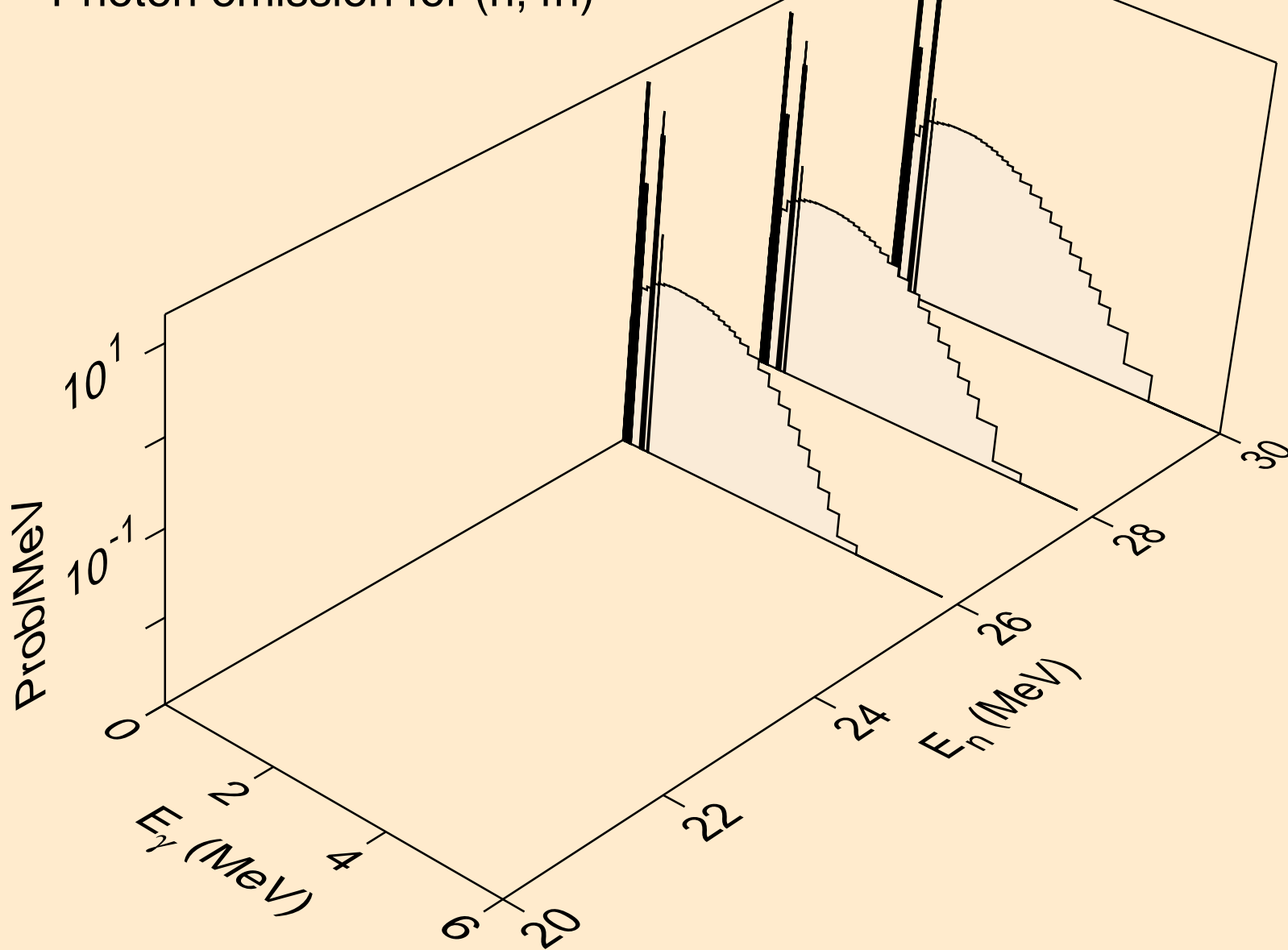

RF259 NEUTRON ACER TENDL-2019 LIBRARY; T=293.16K  
Photon emission for (n,2np)

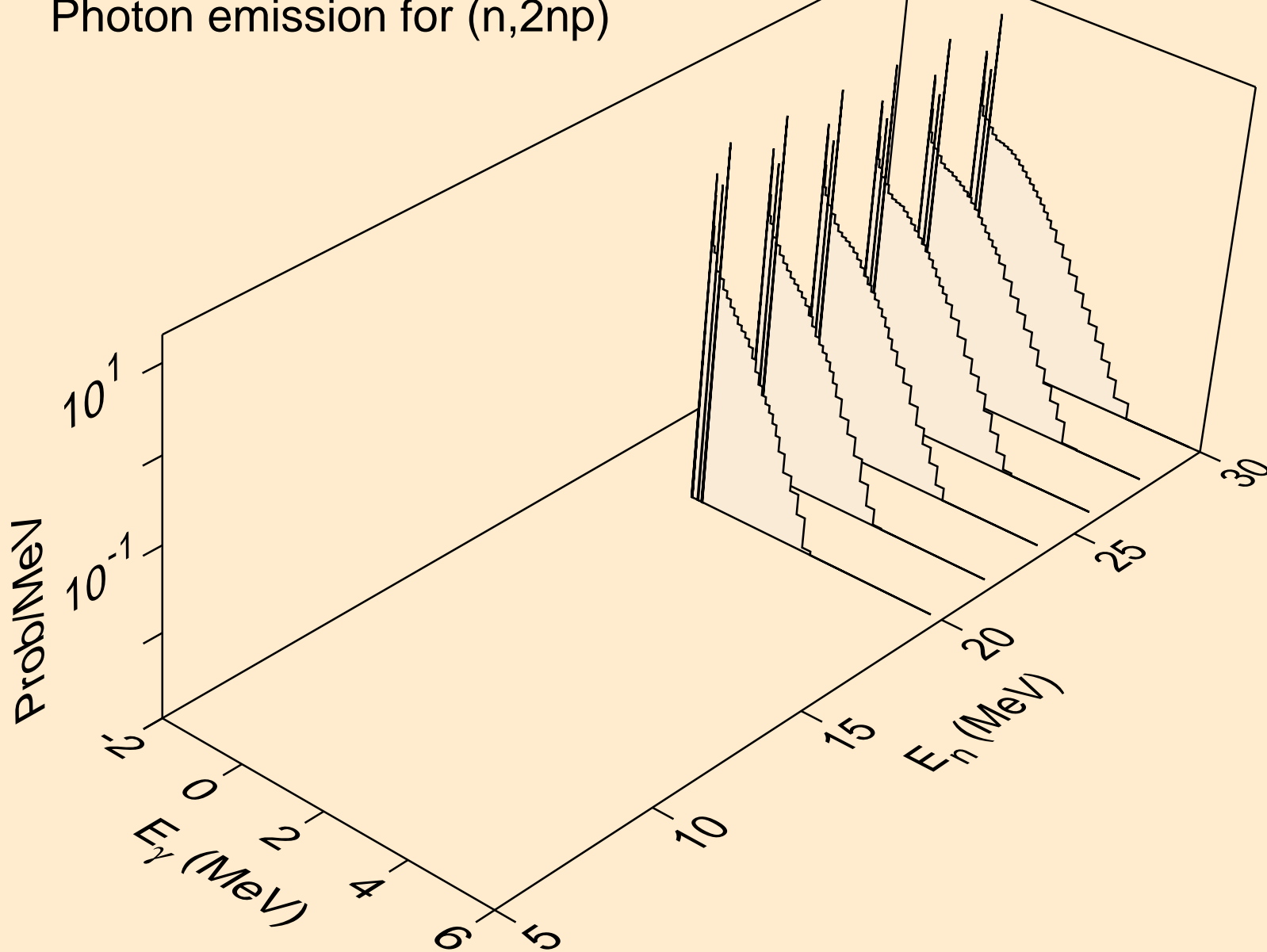

RF259 NEUTRON ACER TENDL-2019 LIBRARY; T=293.16K  
Photon emission for (n,3np)

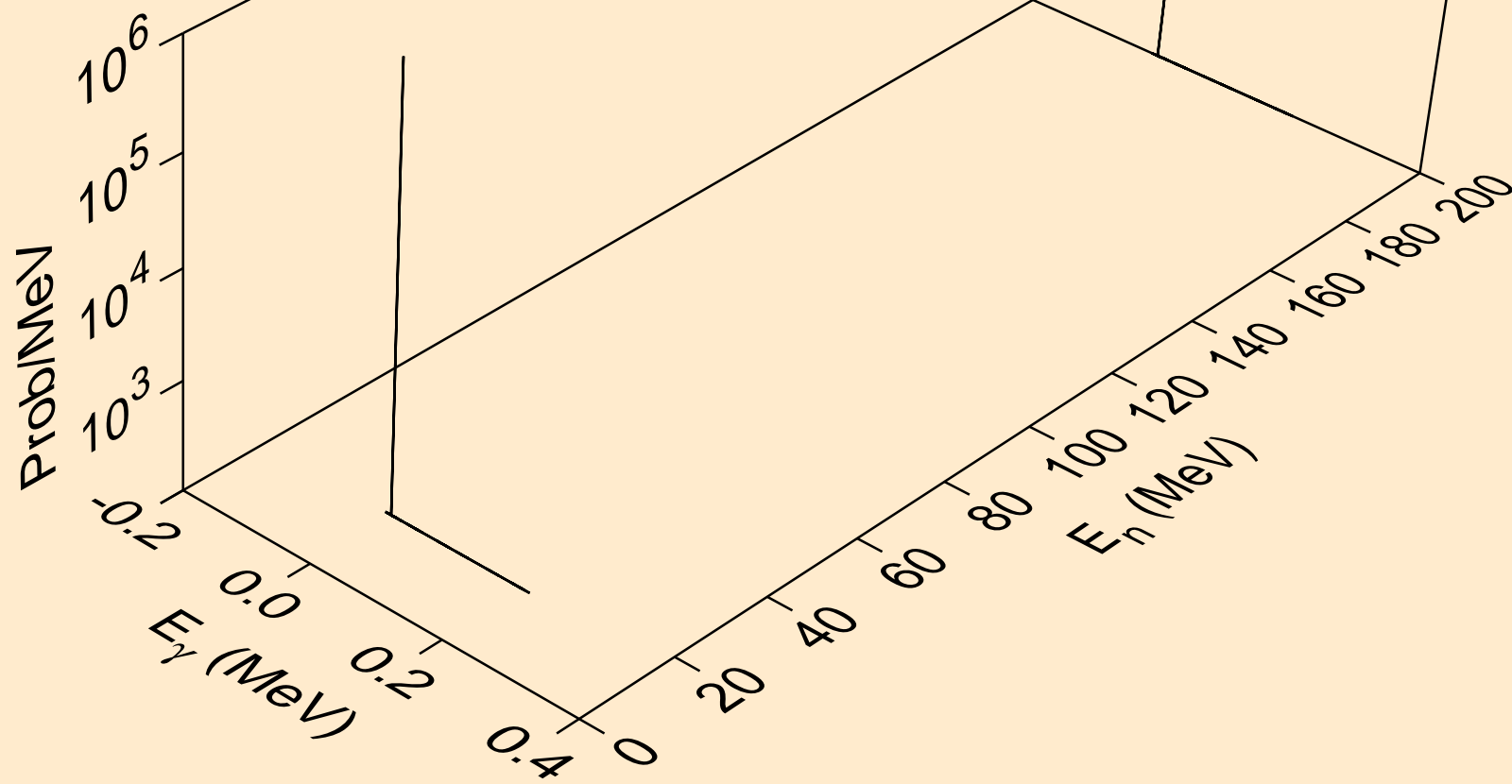

RF259 NEUTRON ACER TENDL-2019 LIBRARY; T=293.16K  
Photon emission for (n,2np)

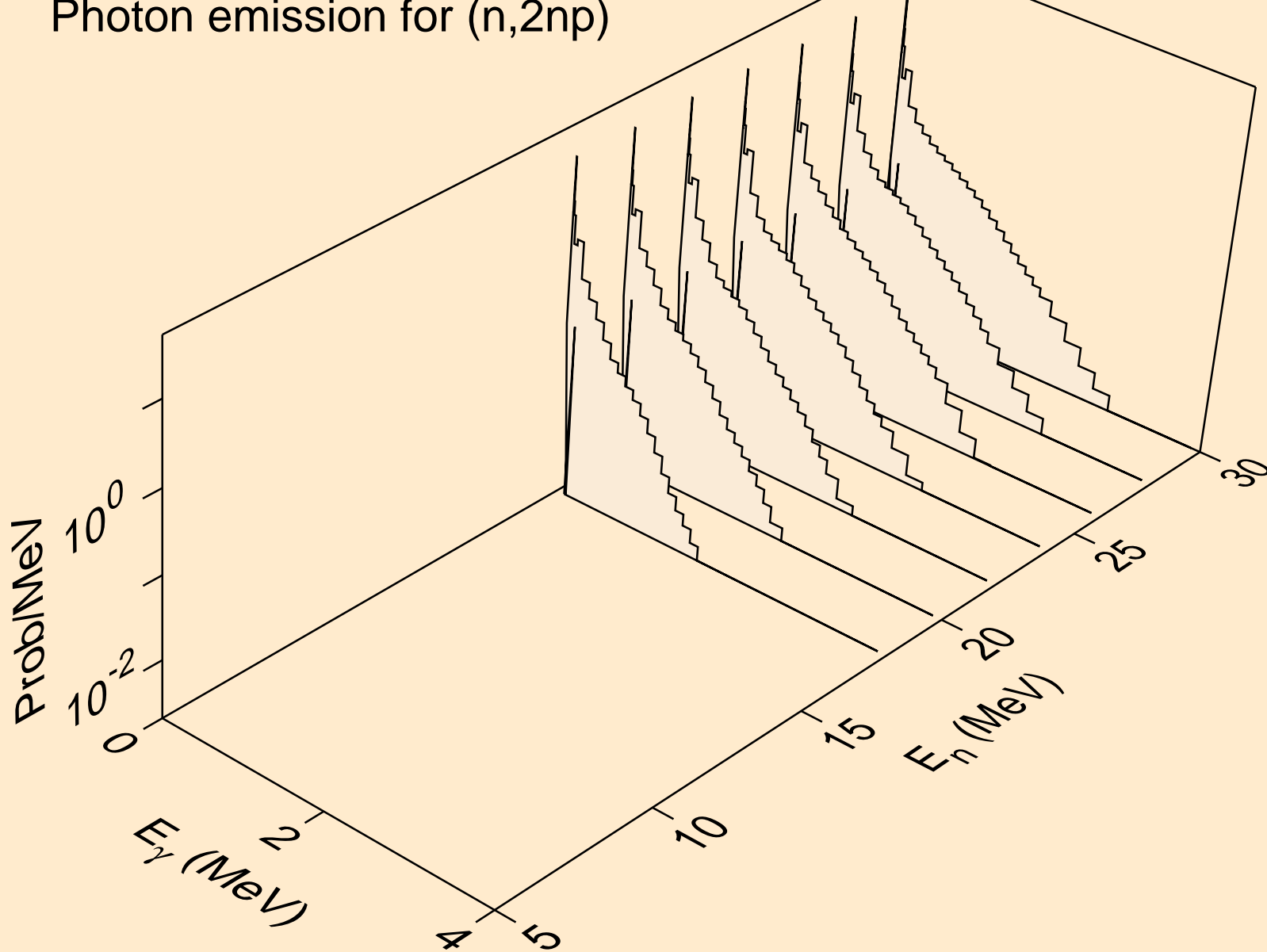

RF259 NEUTRON ACER TENDL-2019 LIBRARY; T=293.16K  
Photon emission for (n,npa)

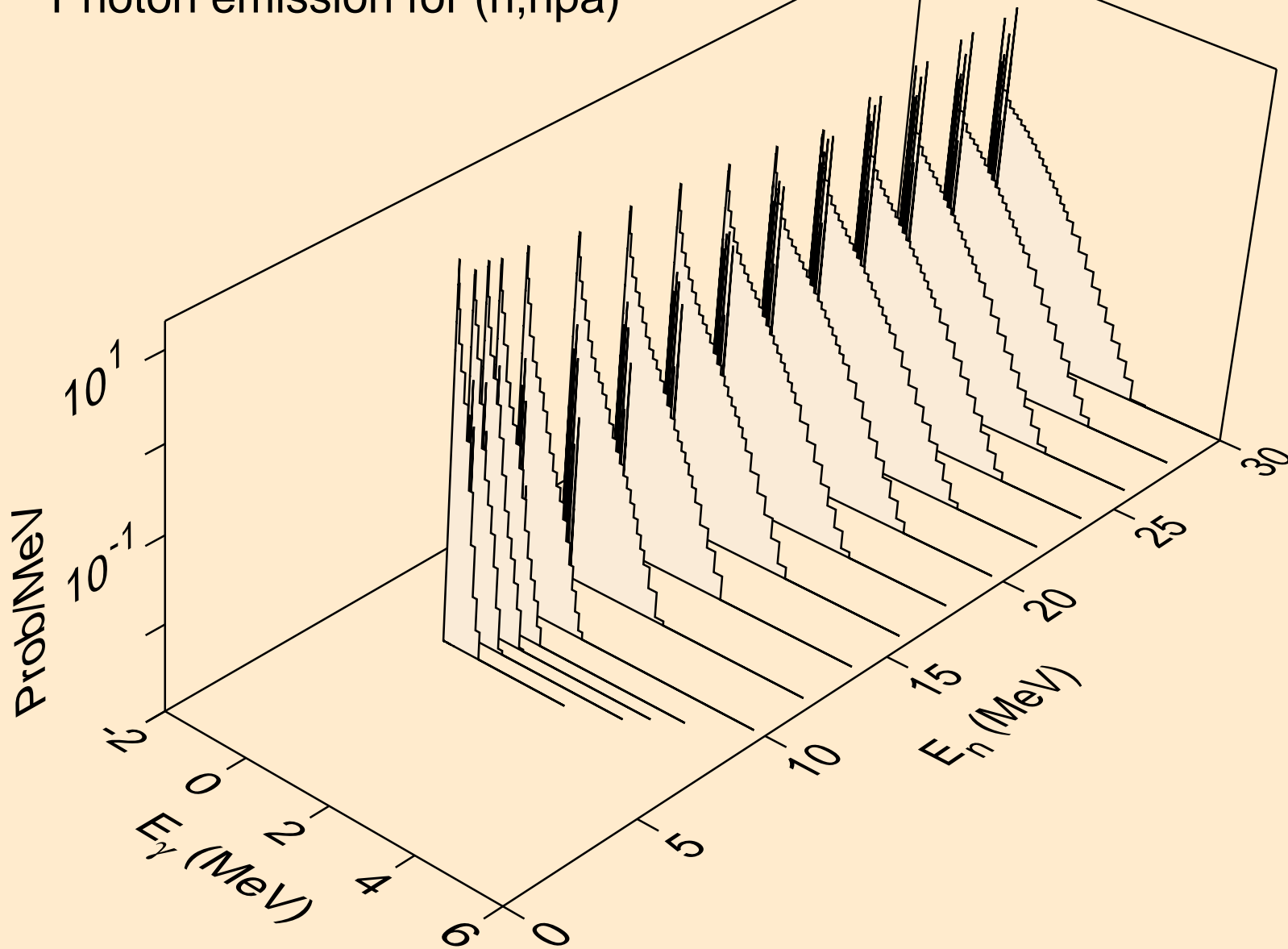

RF259 NEUTRON ACER TENDL-2019 LIBRARY; T=293.16K  
Photon emission for (n,n\*c)

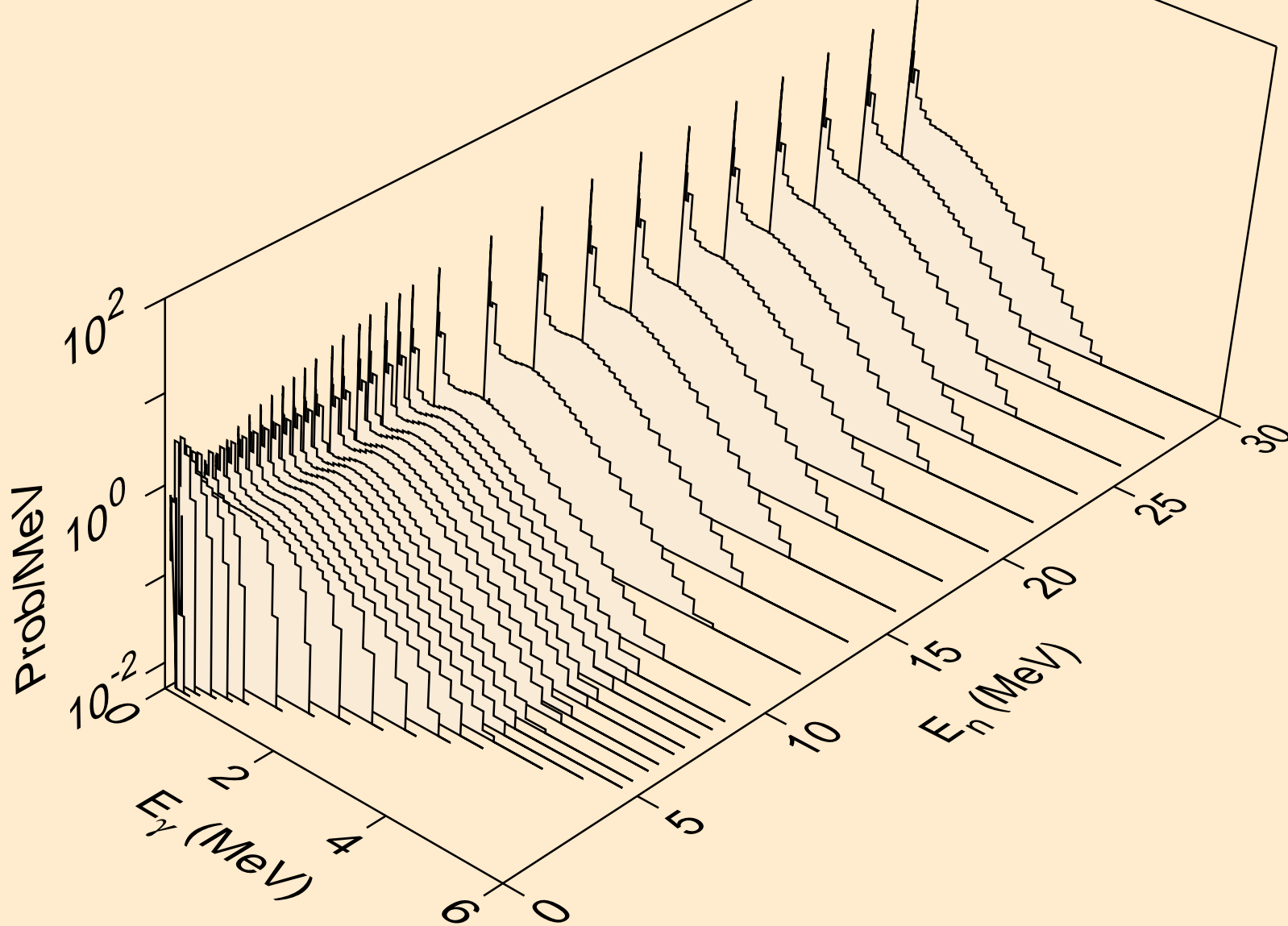

RF259 NEUTRON ACER TENDL-2019 LIBRARY; T=293.16K  
Photon emission for (n,gma)

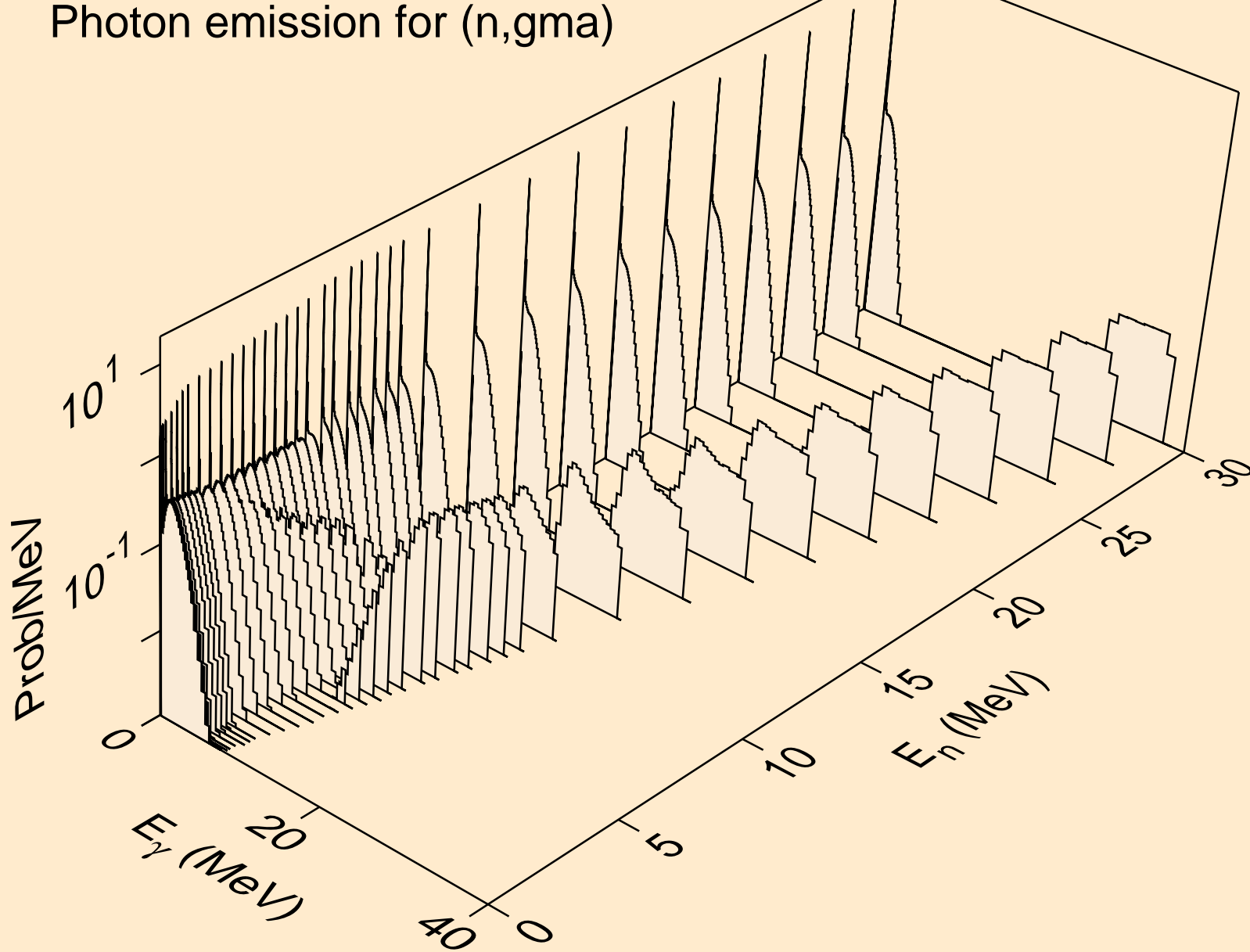



RF259 NEUTRON ACER TENDL-2019 LIBRARY; T=293.16K  
Photon emission for (n,p)

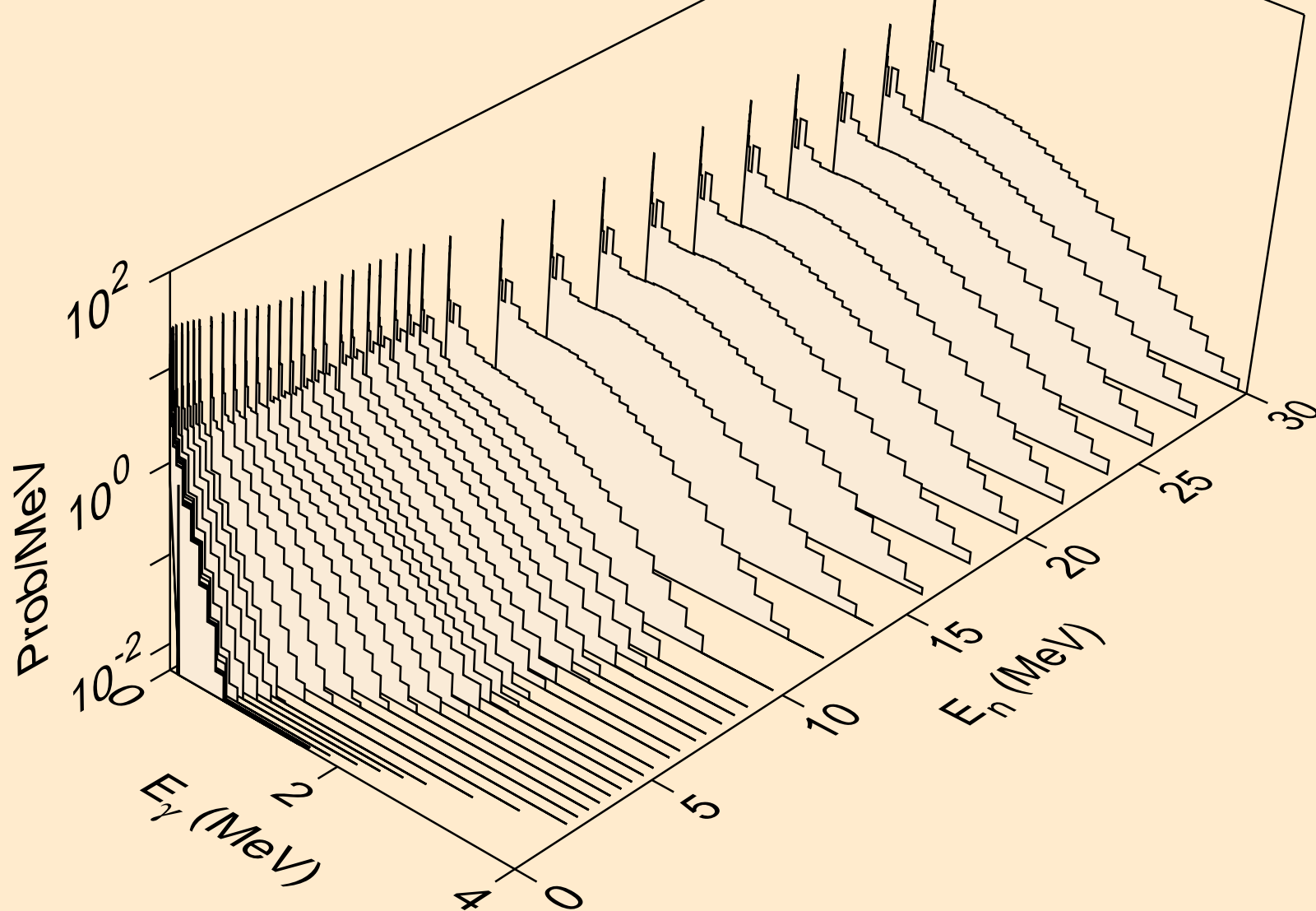

RF259 NEUTRON ACER TENDL-2019 LIBRARY; T=293.16K  
Photon emission for (n,d)

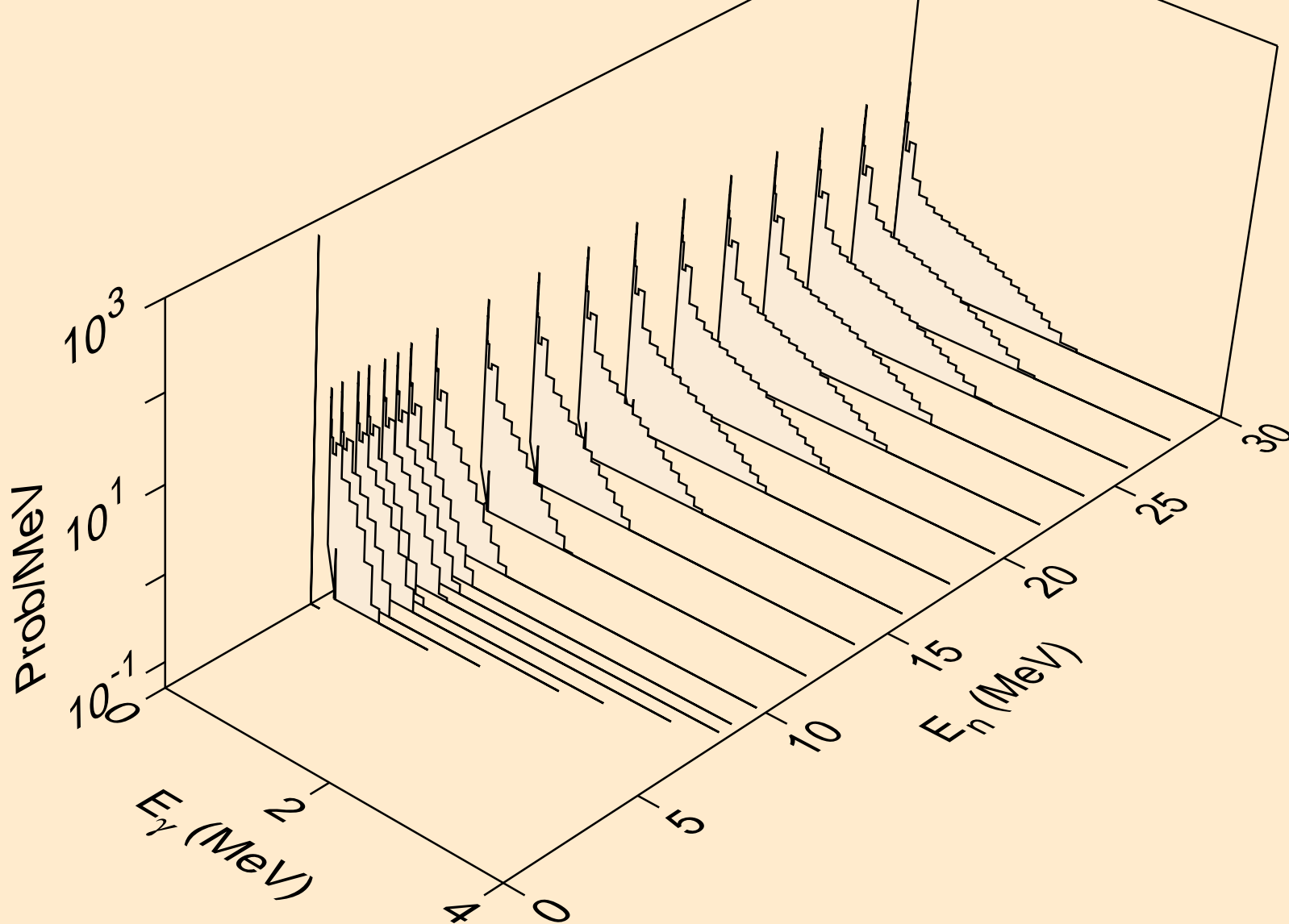

RF259 NEUTRON ACER TENDL-2019 LIBRARY; T=293.16K  
Photon emission for (n,t)

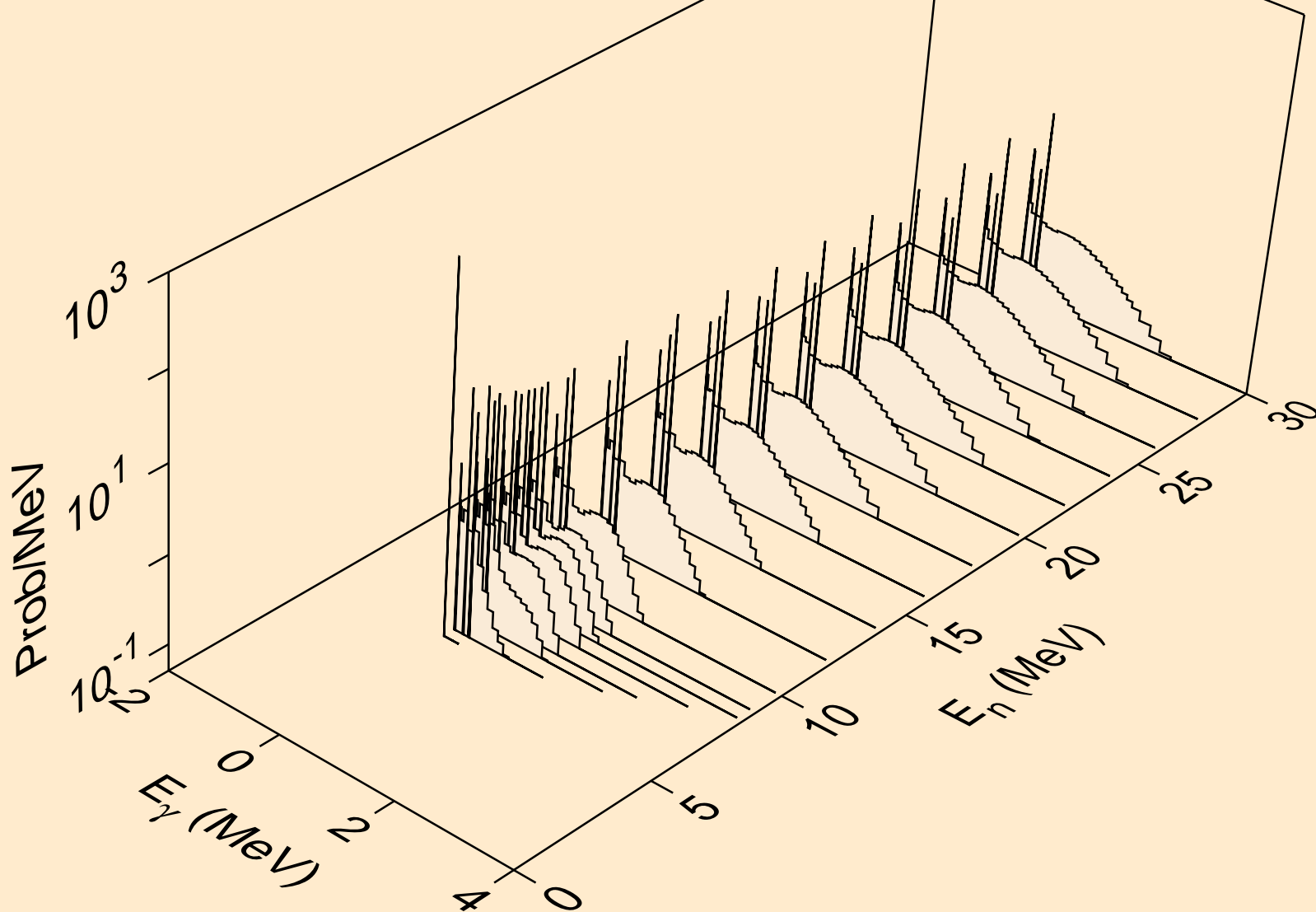

RF259 NEUTRON ACER TENDL-2019 LIBRARY; T=293.16K  
Photon emission for (n,he3)

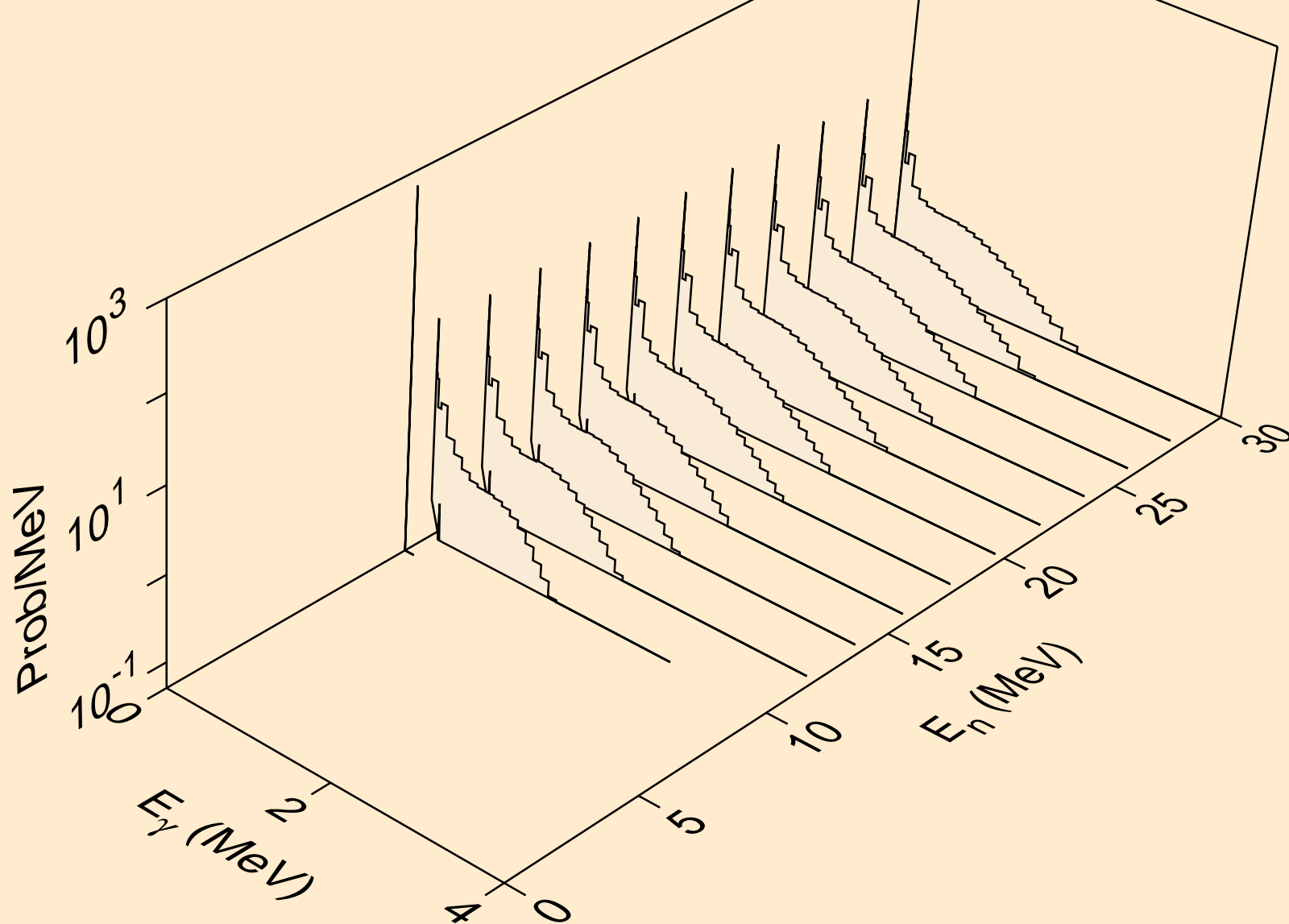

RF259 NEUTRON ACER TENDL-2019 LIBRARY; T=293.16K  
Photon emission for (n,a)

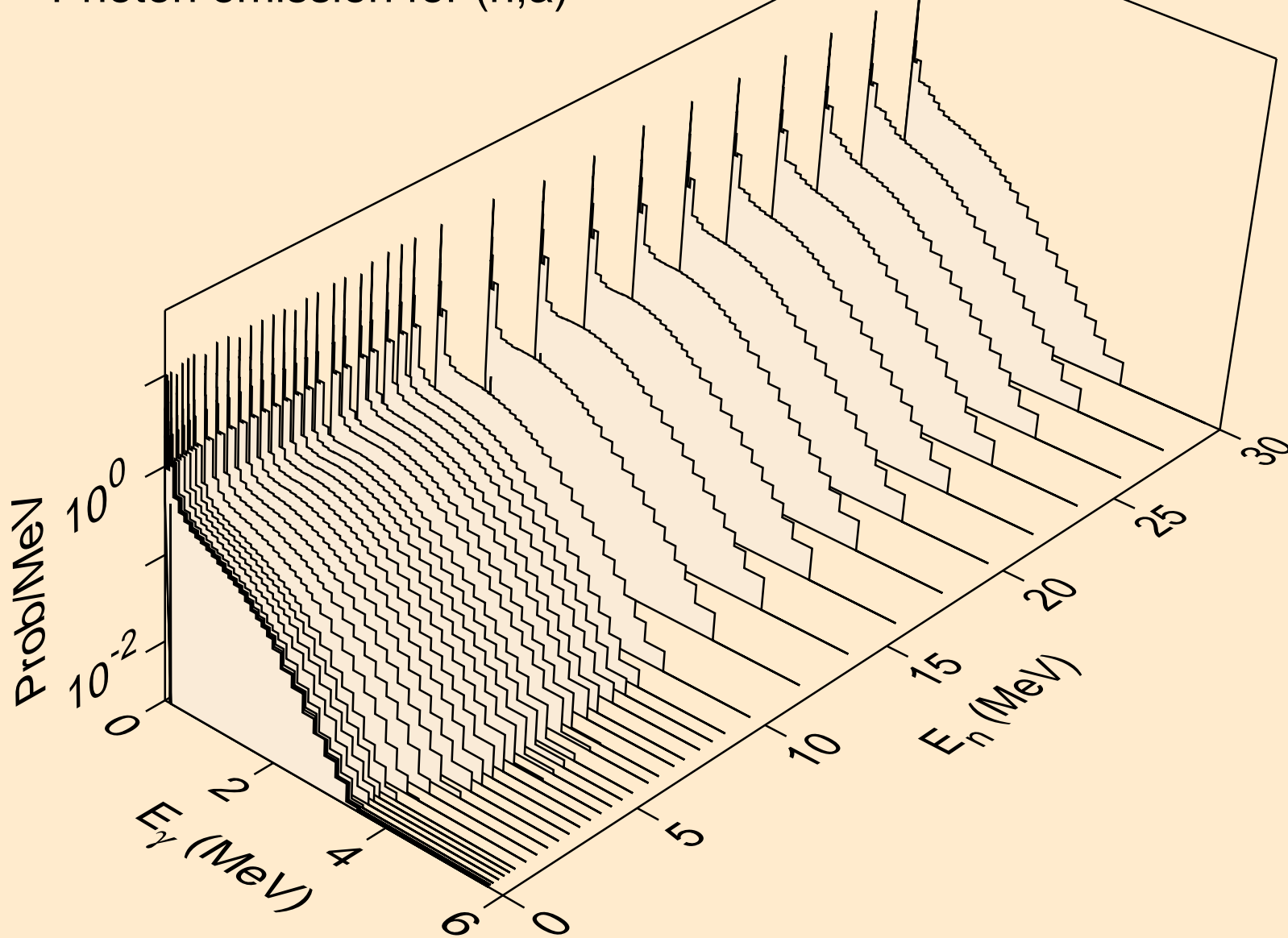

RF259 NEUTRON ACER TENDL-2019 LIBRARY; T=293.16K  
Photon emission for (n,2a)

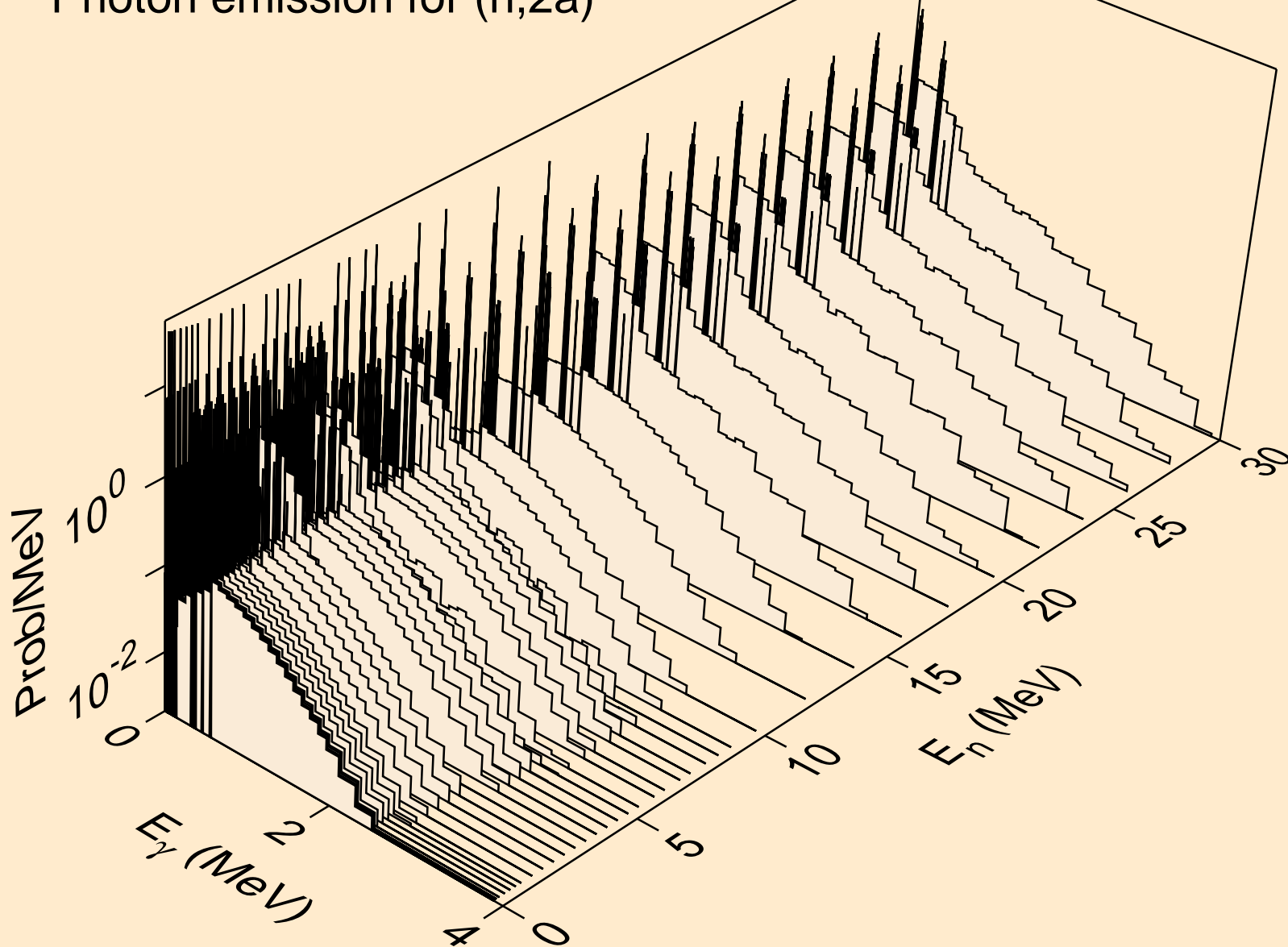

RF259 NEUTRON ACER TENDL-2019 LIBRARY; T=293.16K  
Photon emission for (n,2p)

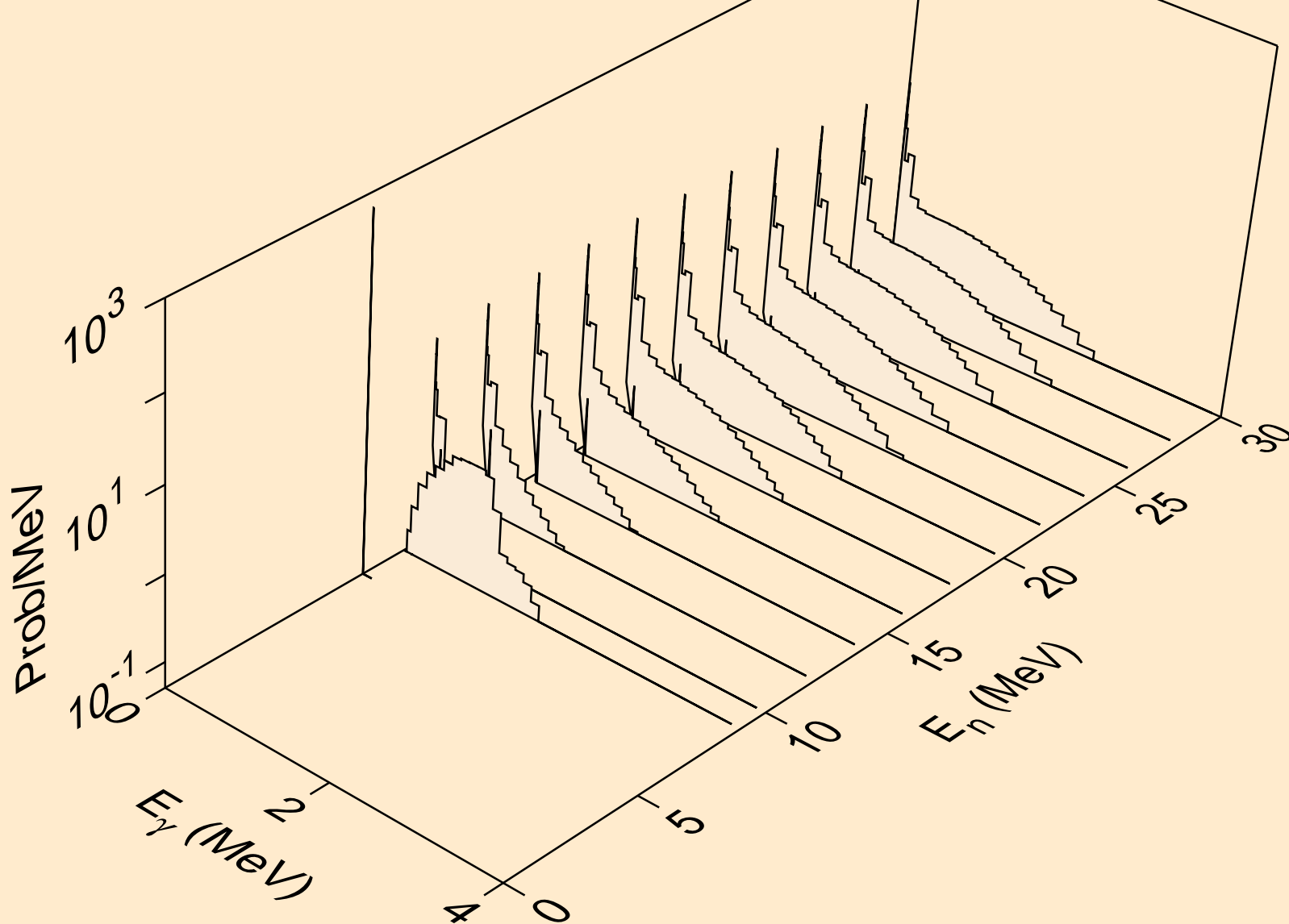

RF259 NEUTRON ACER TENDL-2019 LIBRARY; T=293.16K  
Photon emission for (n,p)

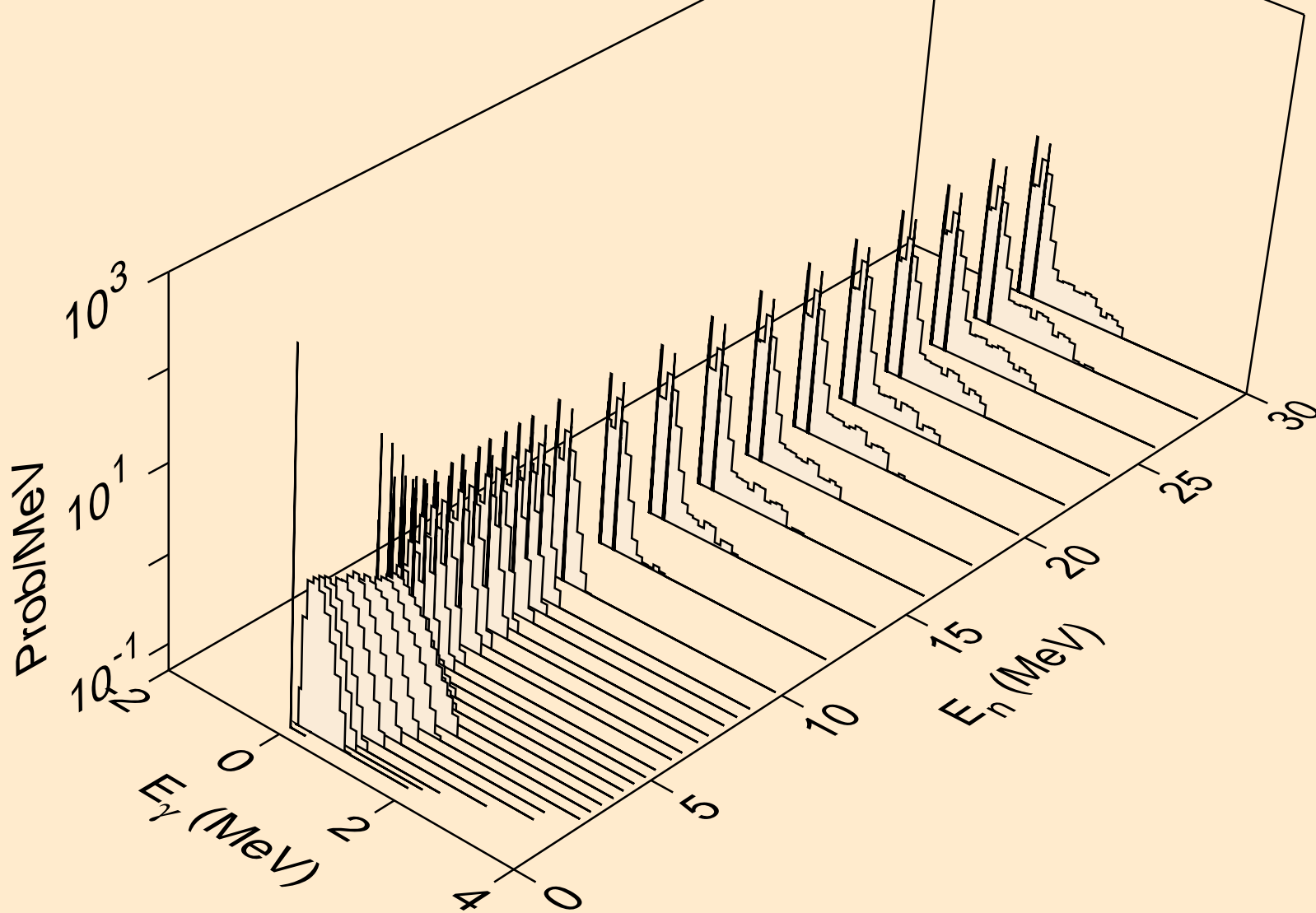



RF259 NEUTRON ACER TENDL-2019 LIBRARY; T=293.16K  
Photon emission for (n,pd)

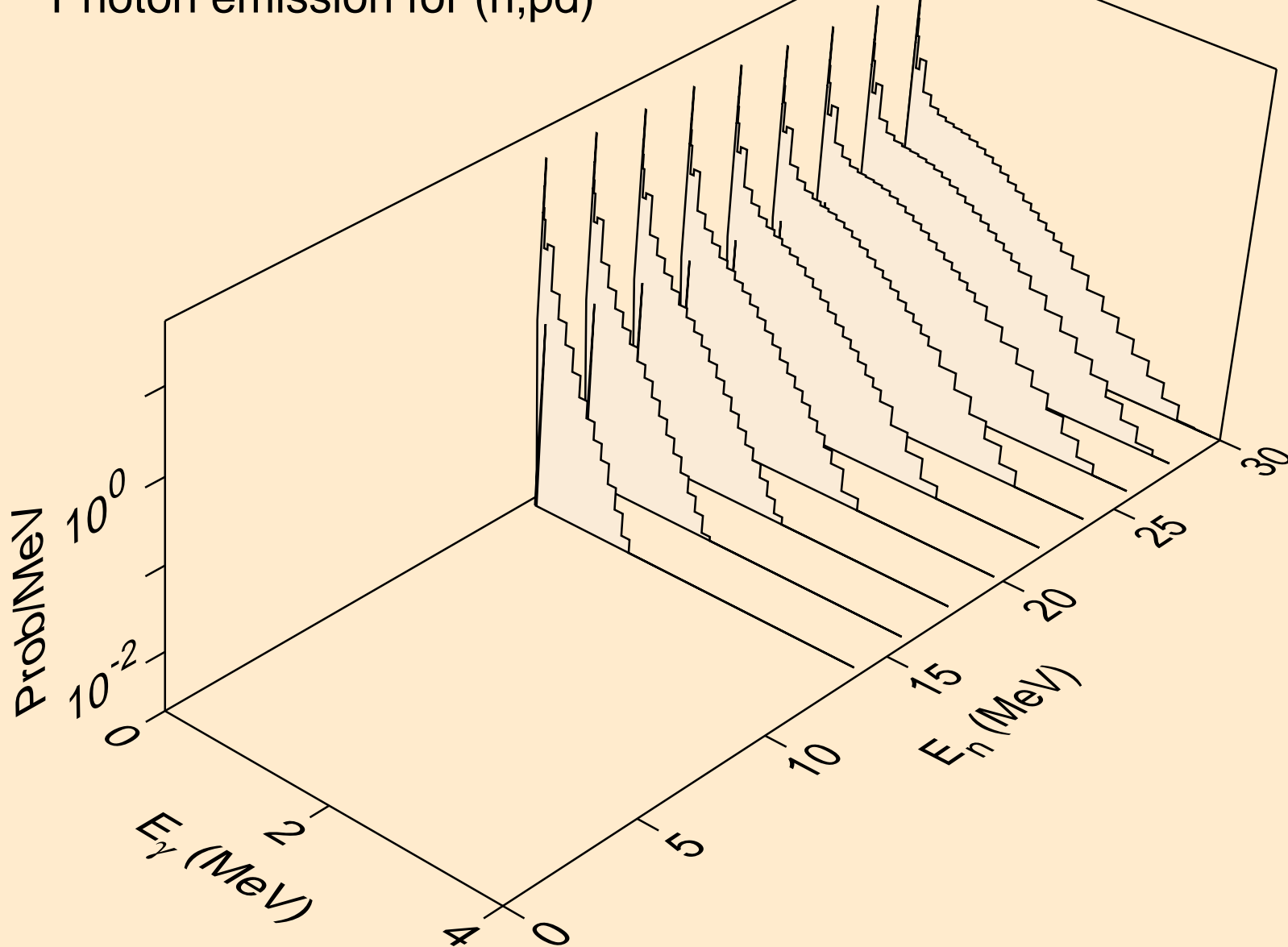

RF259 NEUTRON ACER TENDL-2019 LIBRARY; T=293.16K  
Photon emission for (n,pt)

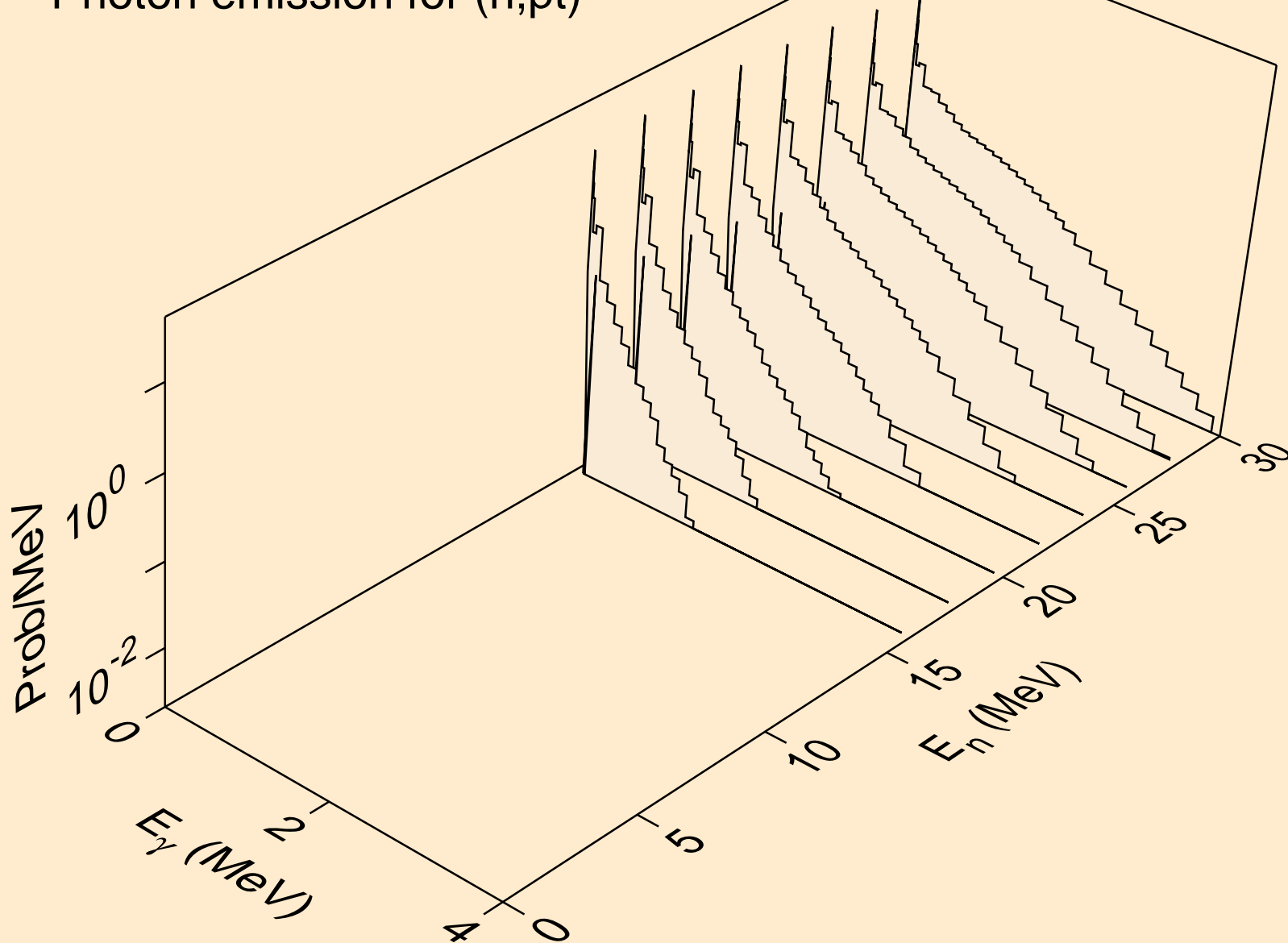

RF259 NEUTRON ACER TENDL-2019 LIBRARY; T=293.16K  
Photon emission for (n,da)

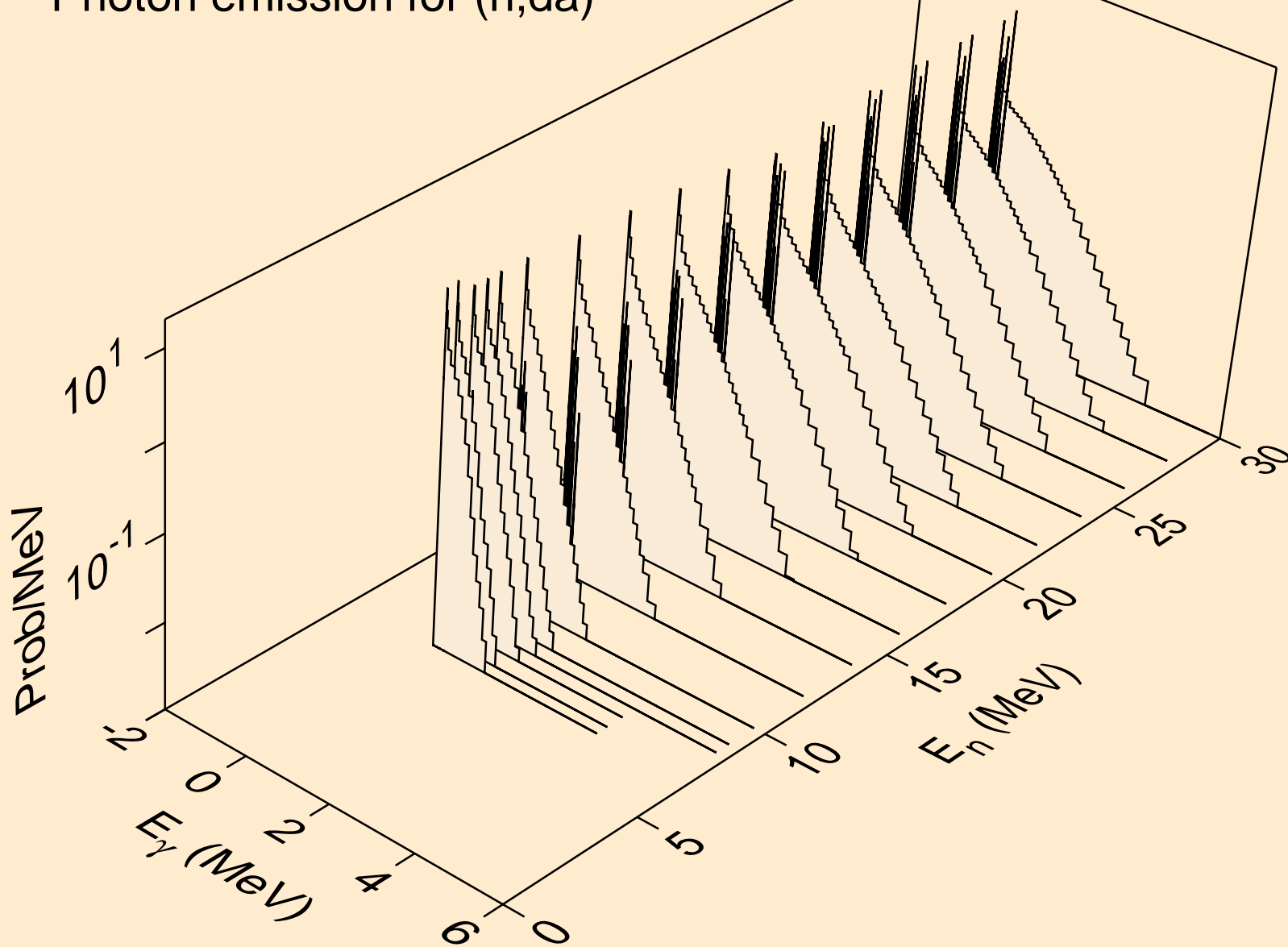

RF259 NEUTRON ACER TENDL-2019 LIBRARY; T=293.16K  
thermal capture photon spectrum

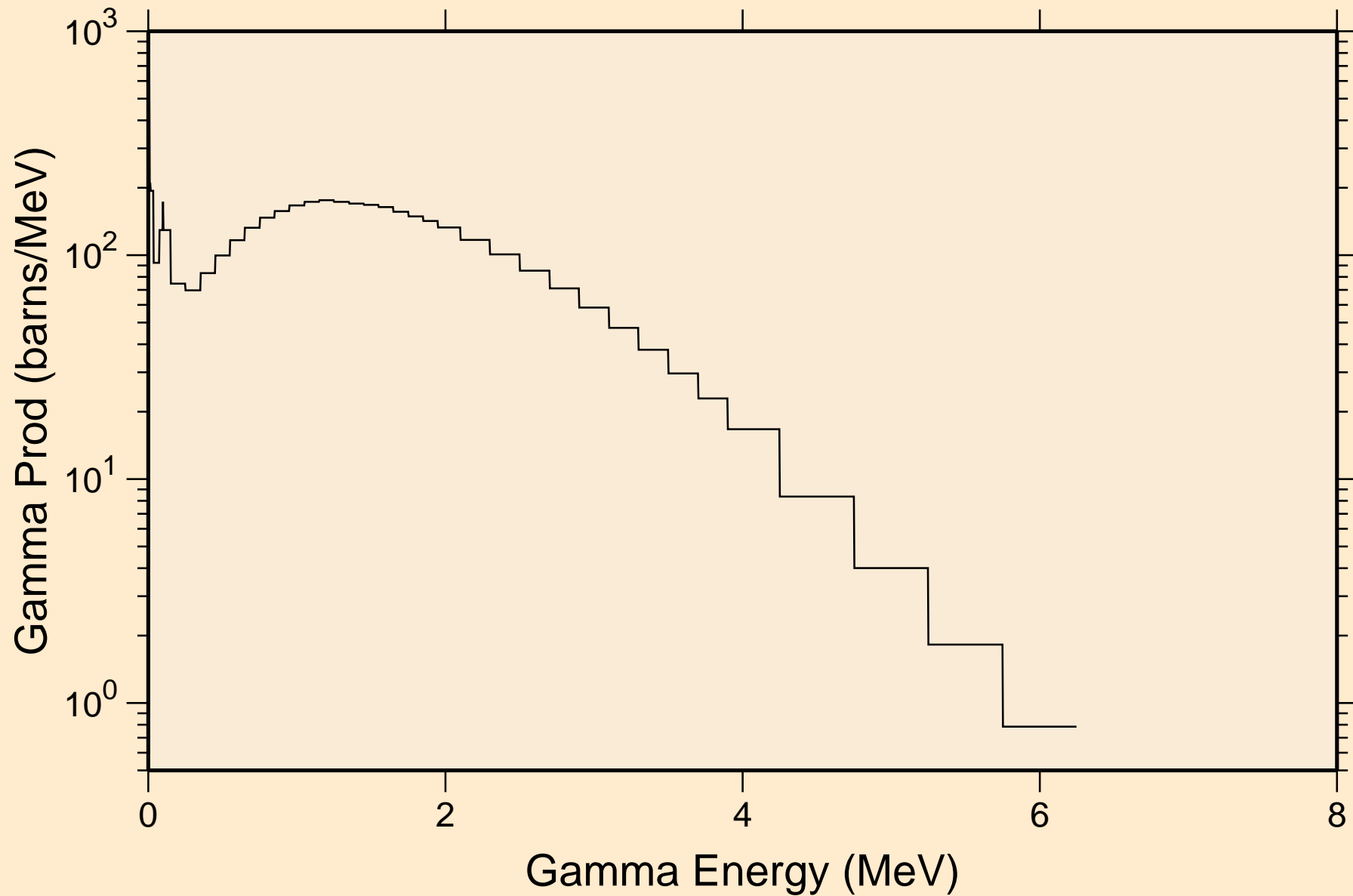

RF259 NEUTRON ACER TENDL-2019 LIBRARY; T=293.16K  
14 MeV photon spectrum

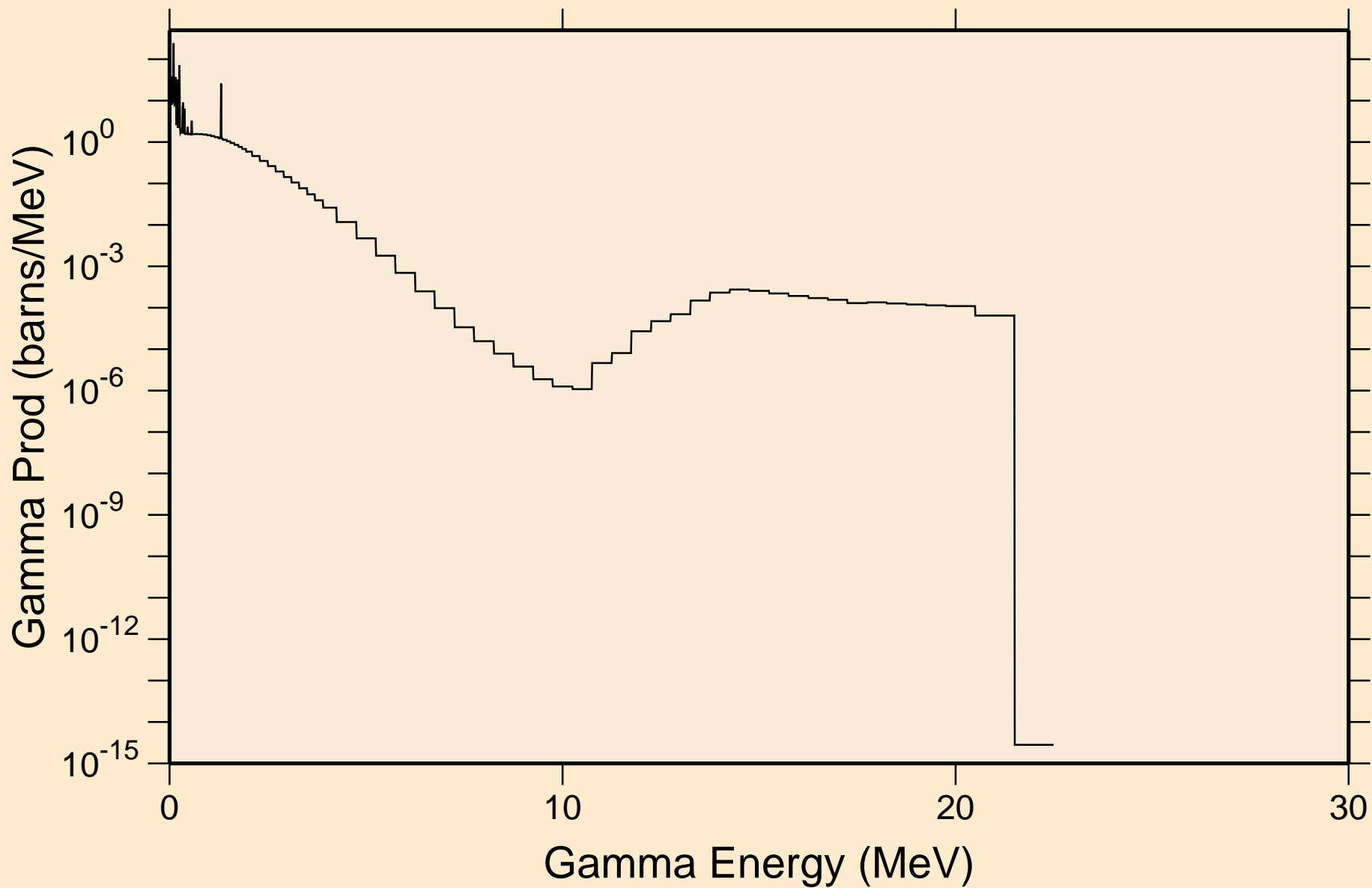

RF259 NEUTRON ACER TENDL-2019 LIBRARY; T=293.16K  
Particle heating contributions

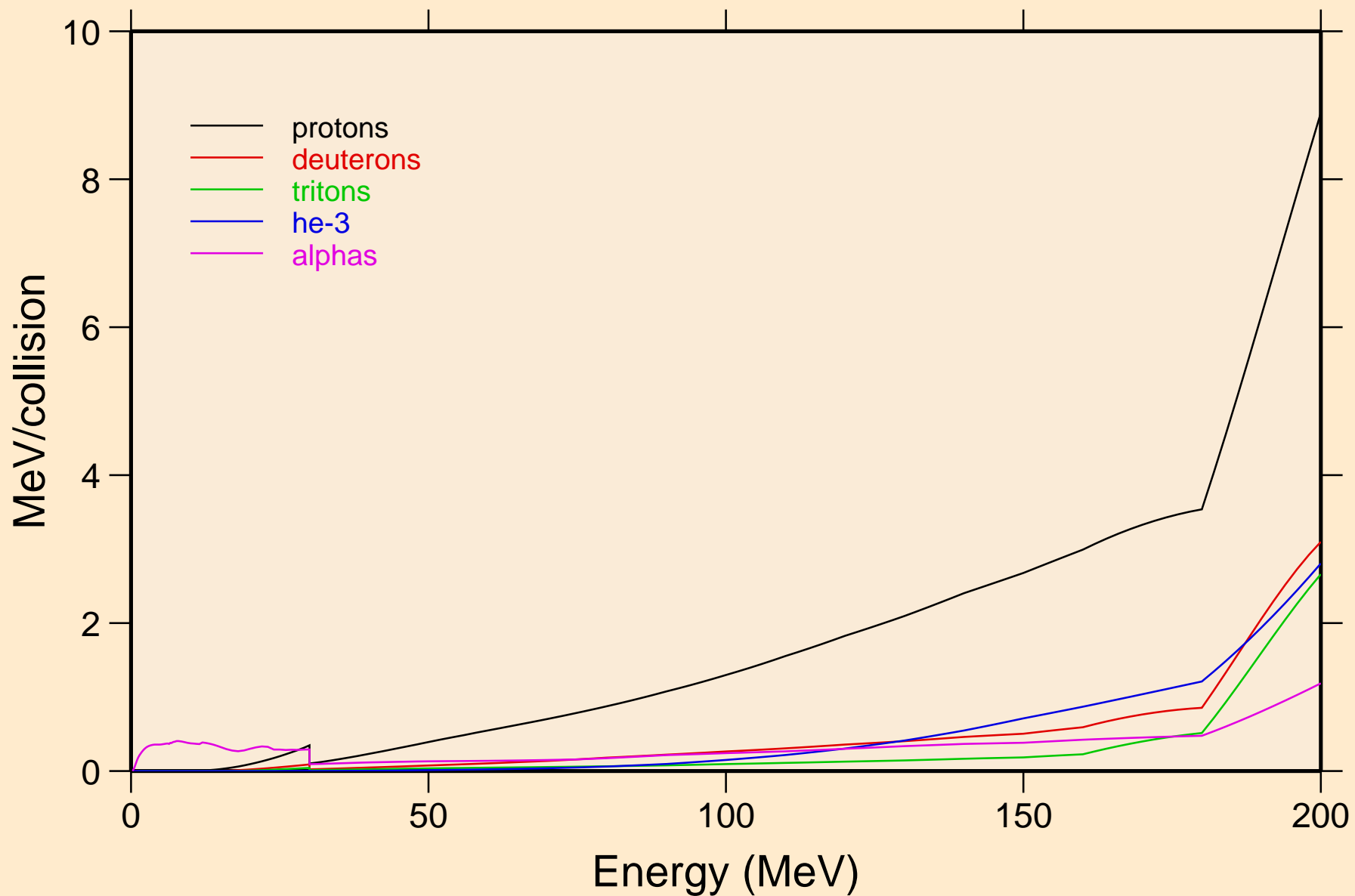

RF259 NEUTRON ACER TENDL-2019 LIBRARY; T=293.16K  
Recoil Heating

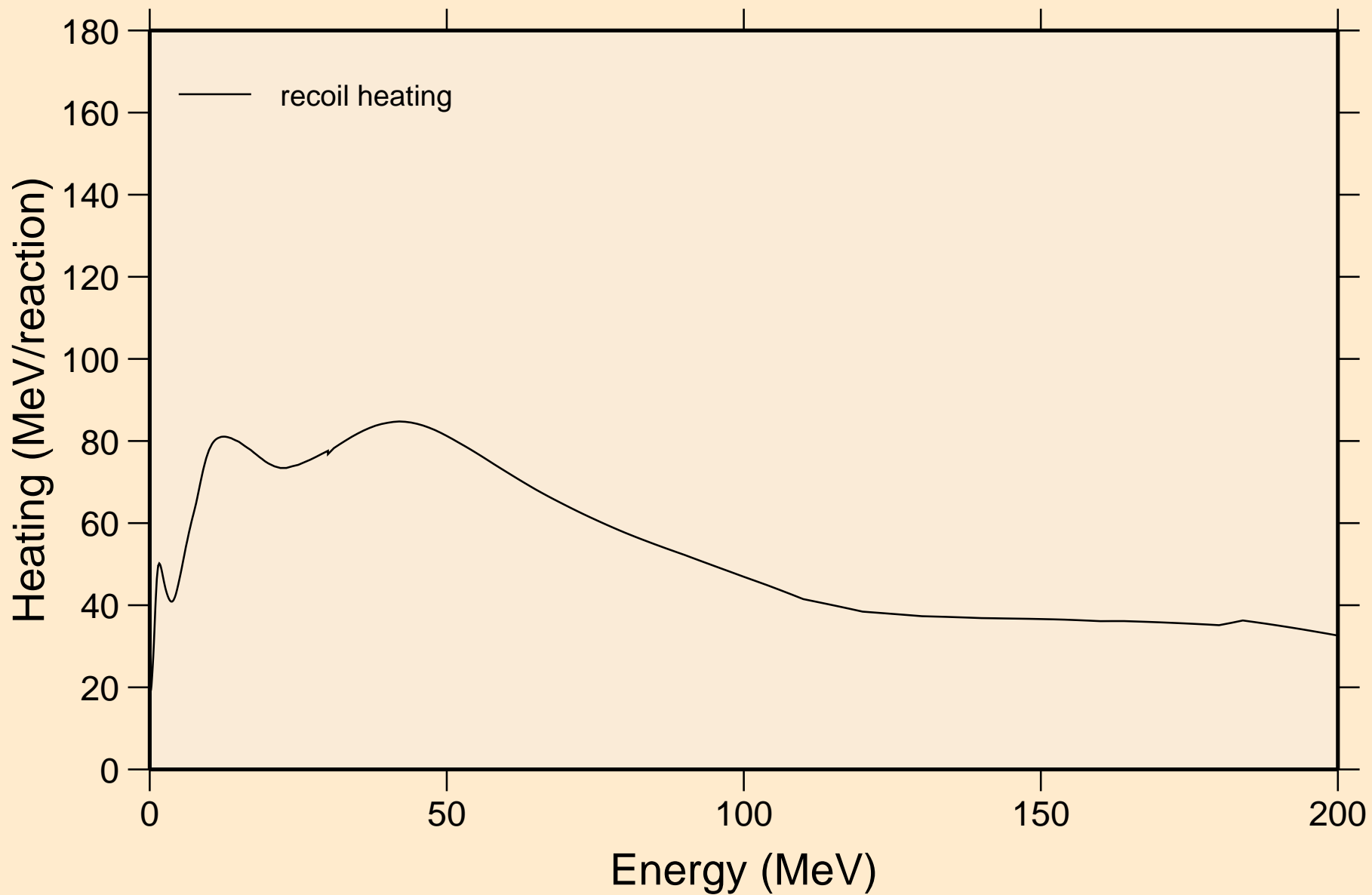

RF259 NEUTRON ACER TENDL-2019 LIBRARY; T=293.16K  
Particle production cross sections

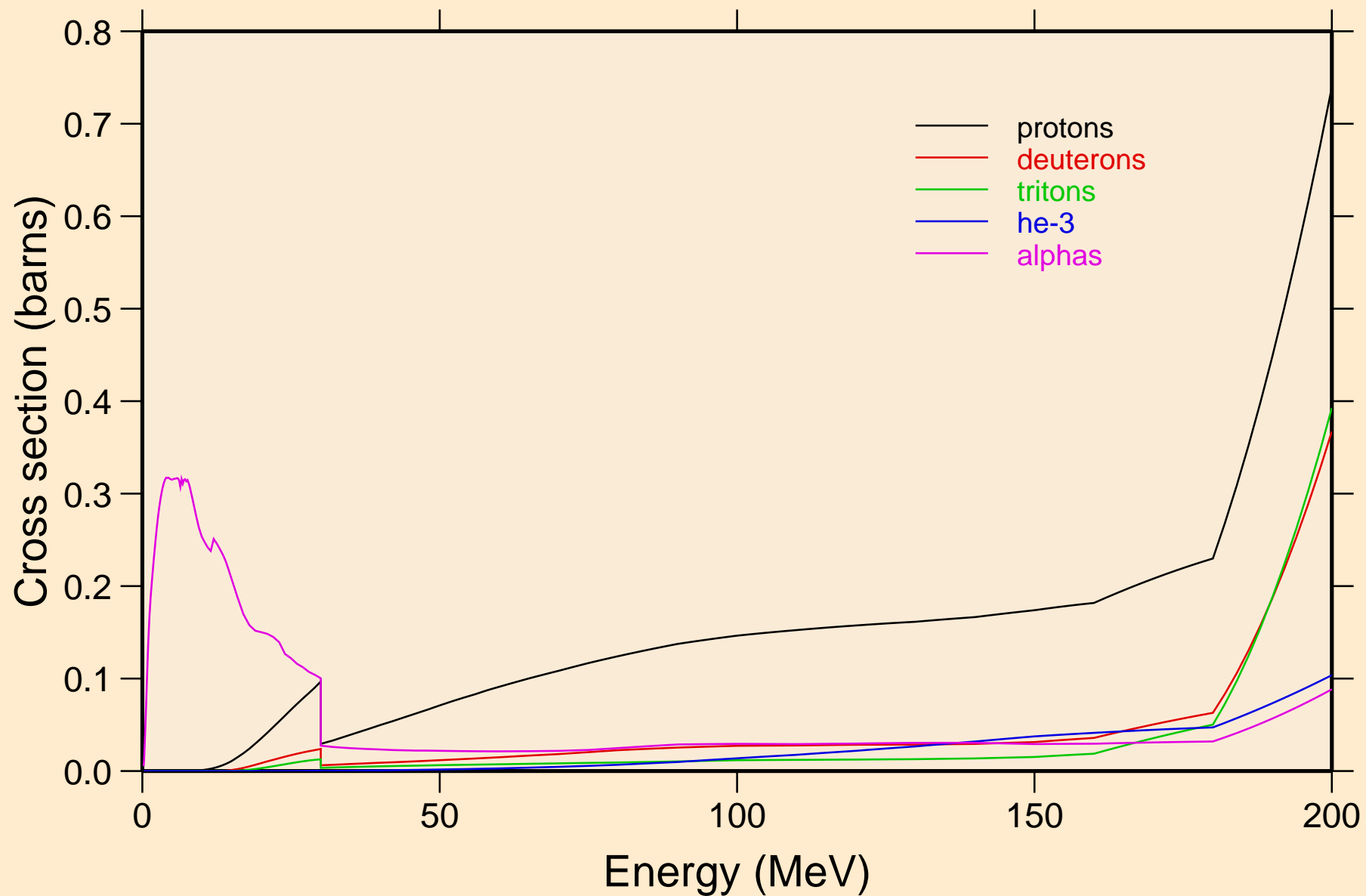



RF259 NEUTRON ACER TENDL-2019 LIBRARY; T=293.16K  
protons from (n,x)

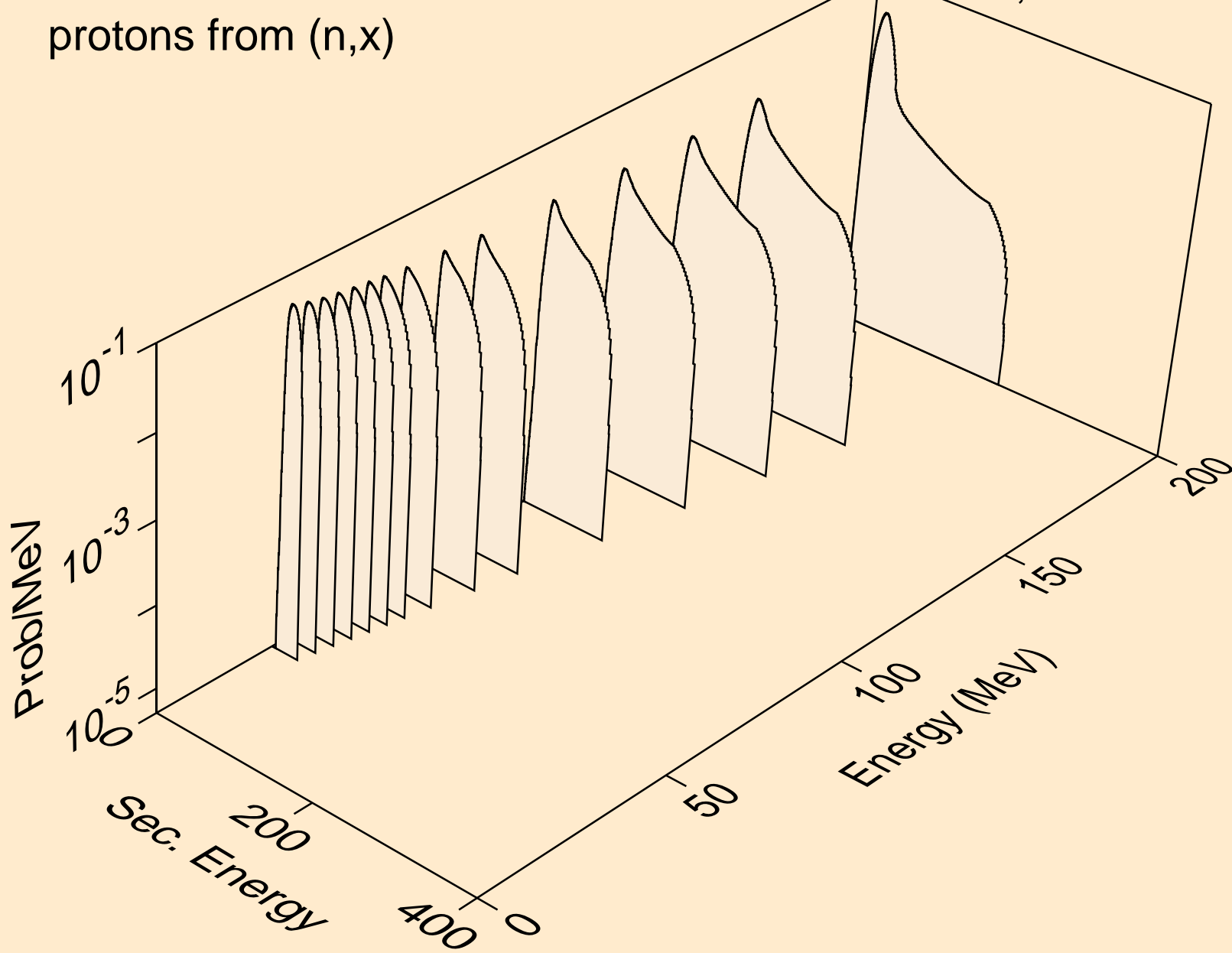

RF259 NEUTRON ACER TENDL-2019 LIBRARY; T=293.16K  
protons from (n,n\*)p

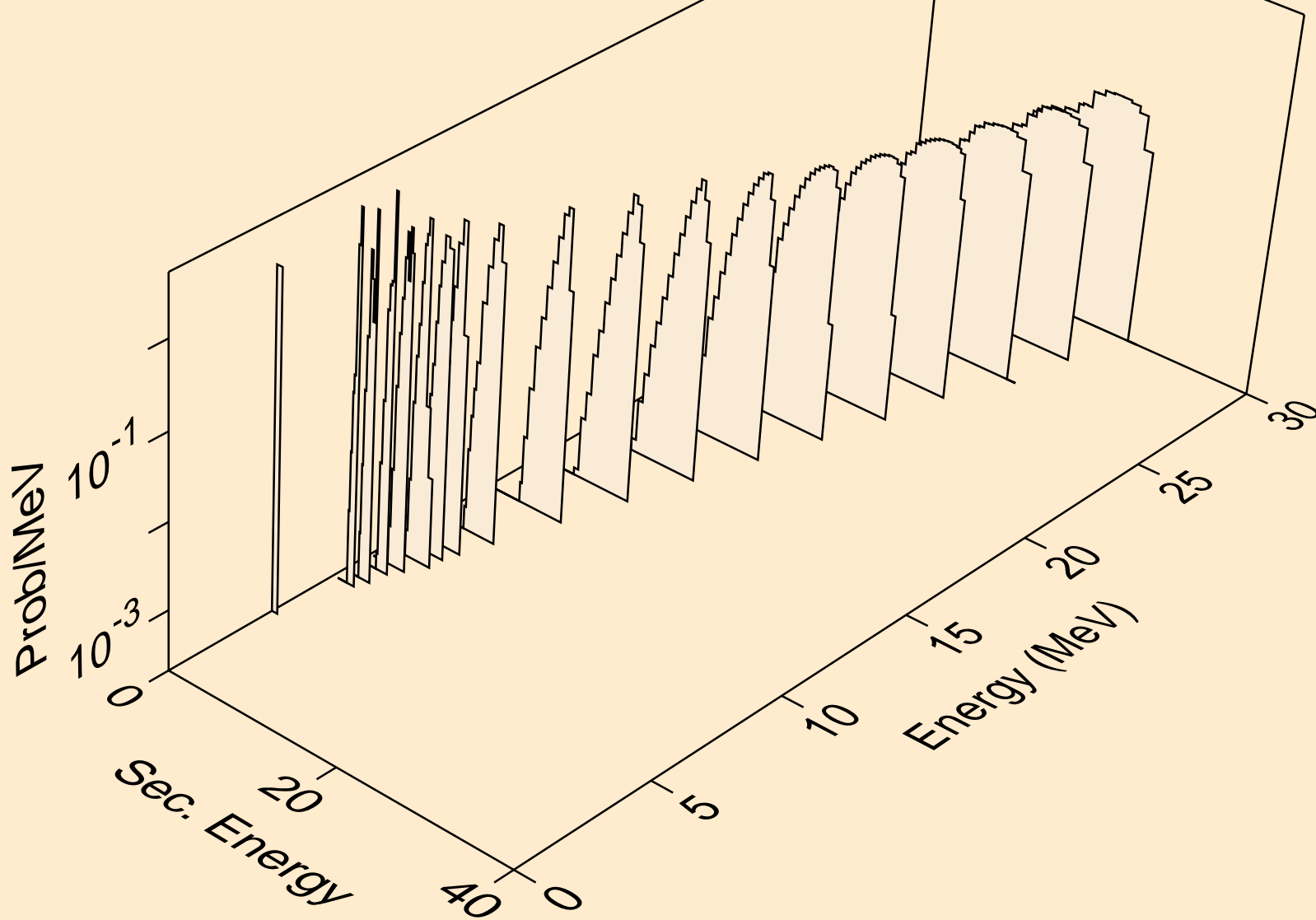

RF259 NEUTRON ACER TENDL-2019 LIBRARY; T=293.16K  
protons from (n,2np)

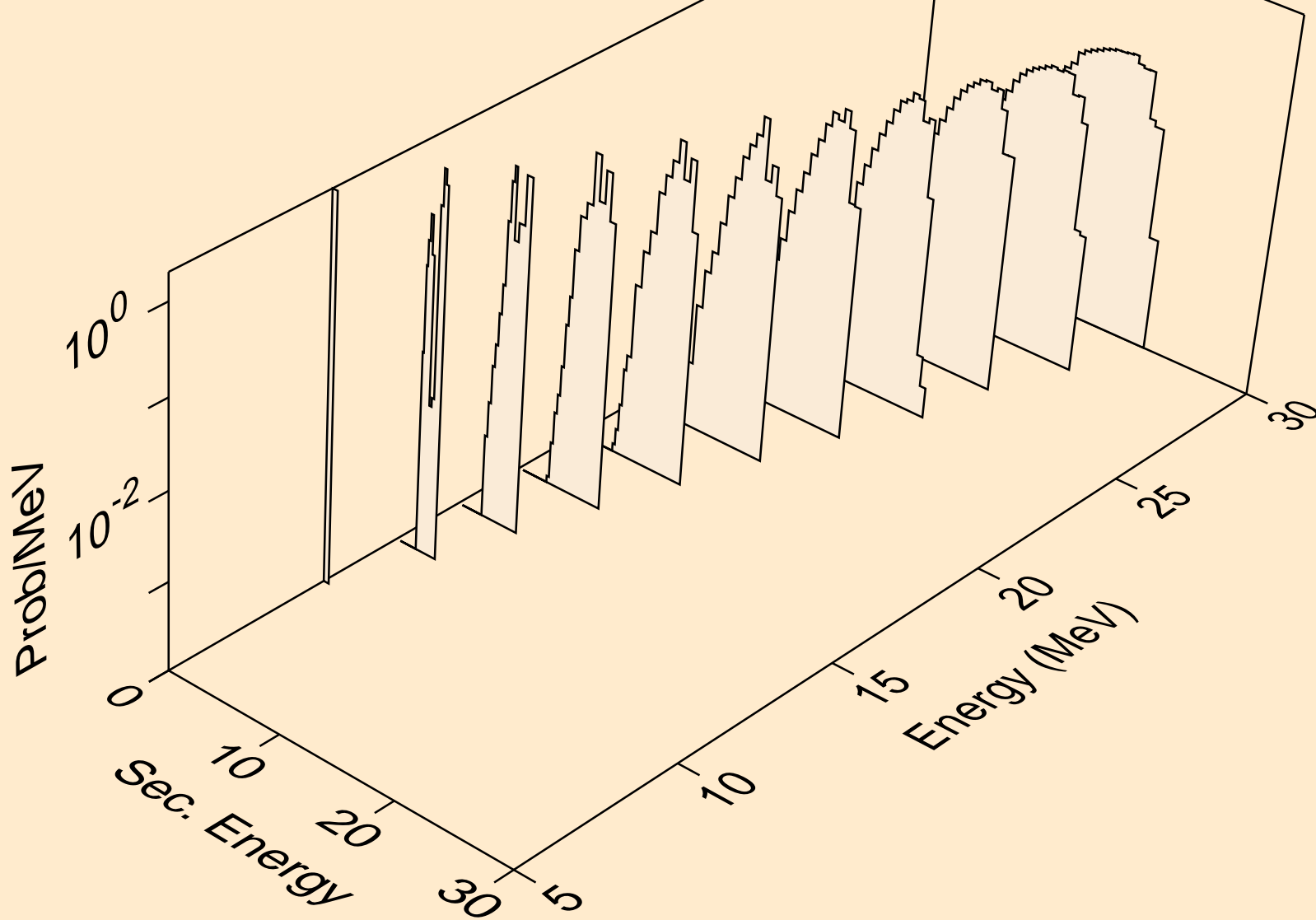

RF259 NEUTRON ACER TENDL-2019 LIBRARY; T=293.16K  
protons from (n,3np)

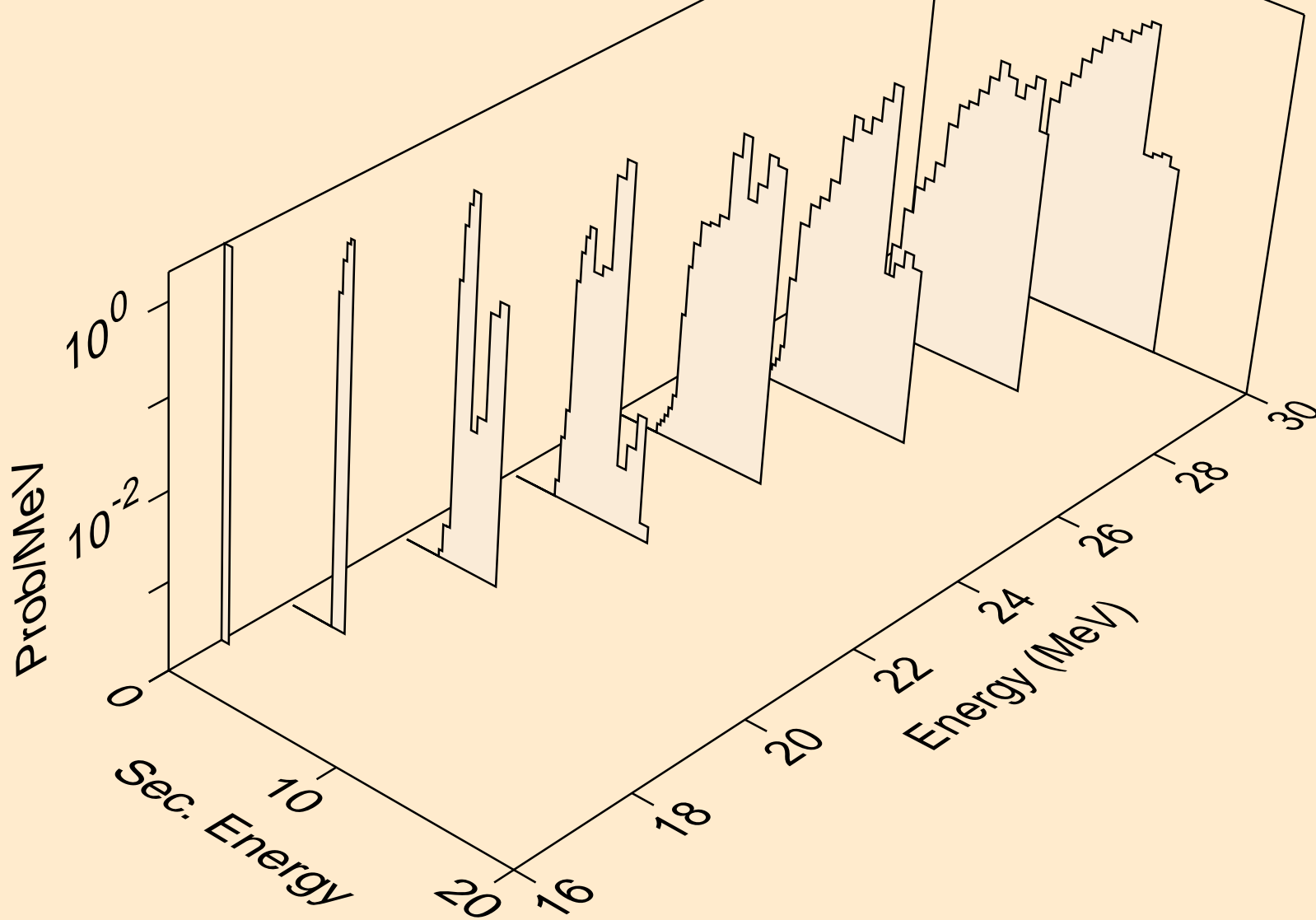

RF259 NEUTRON ACER TENDL-2019 LIBRARY; T=293.16K  
protons from (n,2np)

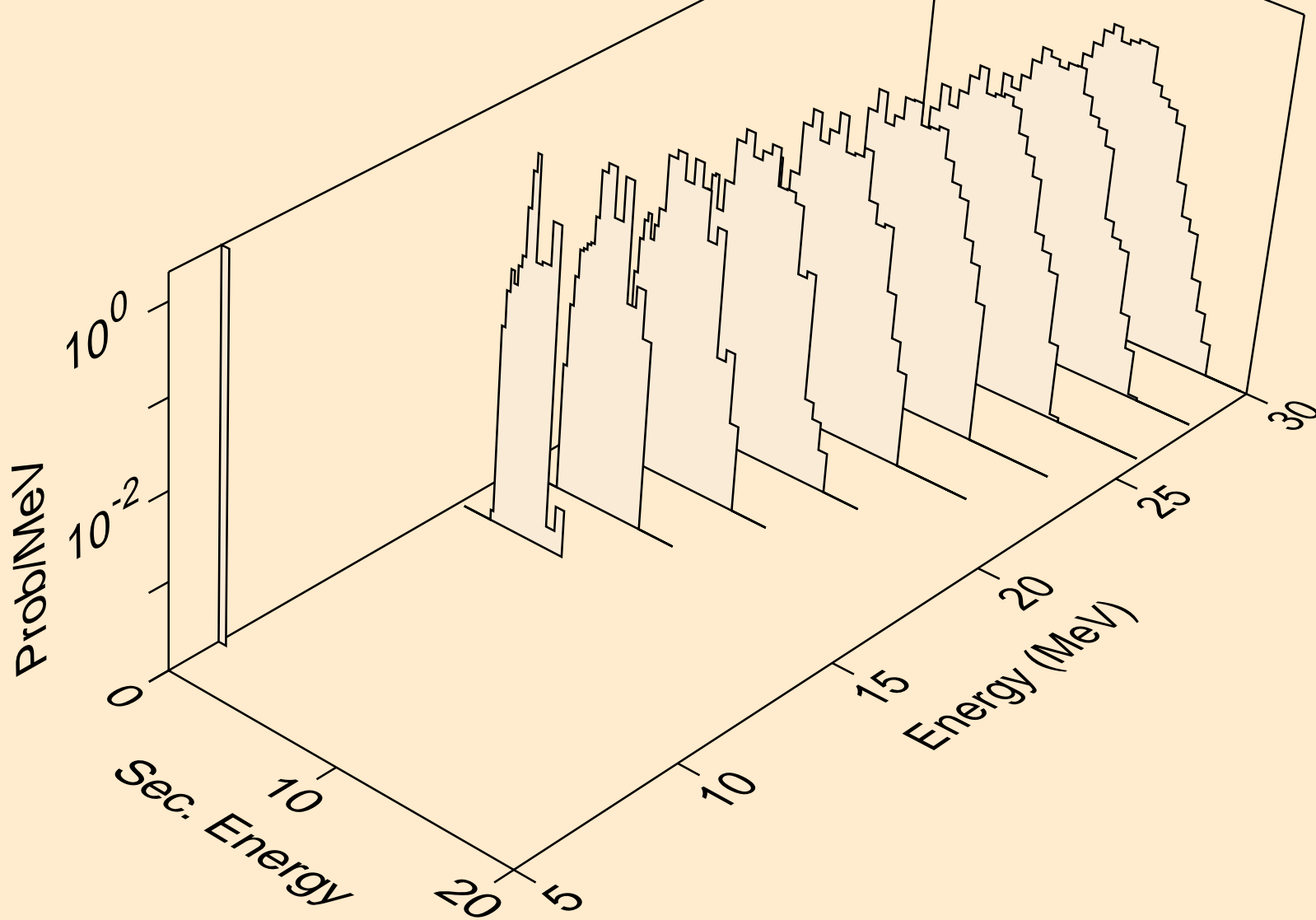

RF259 NEUTRON ACER TENDL-2019 LIBRARY; T=293.16K  
protons from (n,npa)

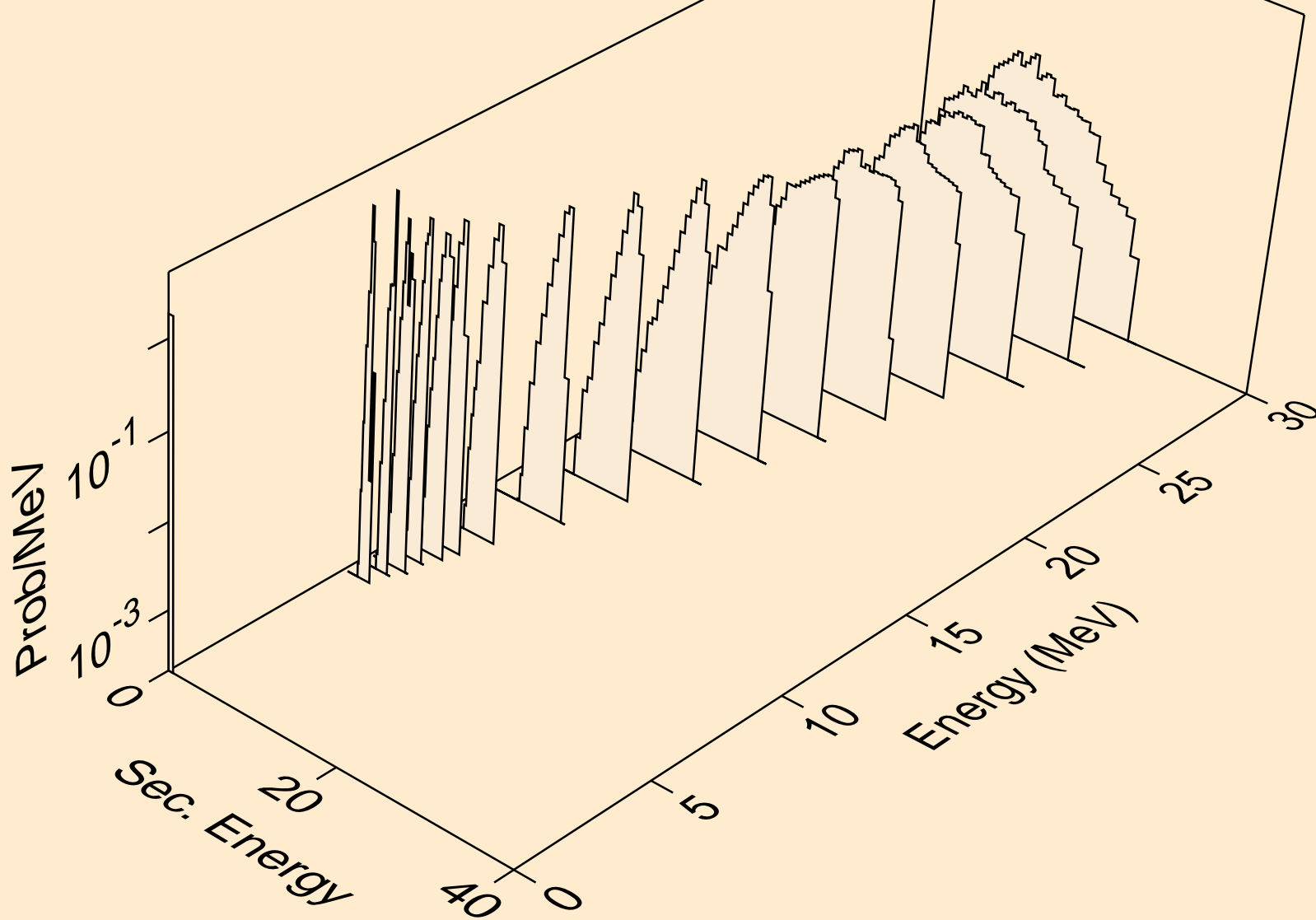

RF259 NEUTRON ACER TENDL-2019 LIBRARY; T=293.16K  
protons from (n,p)

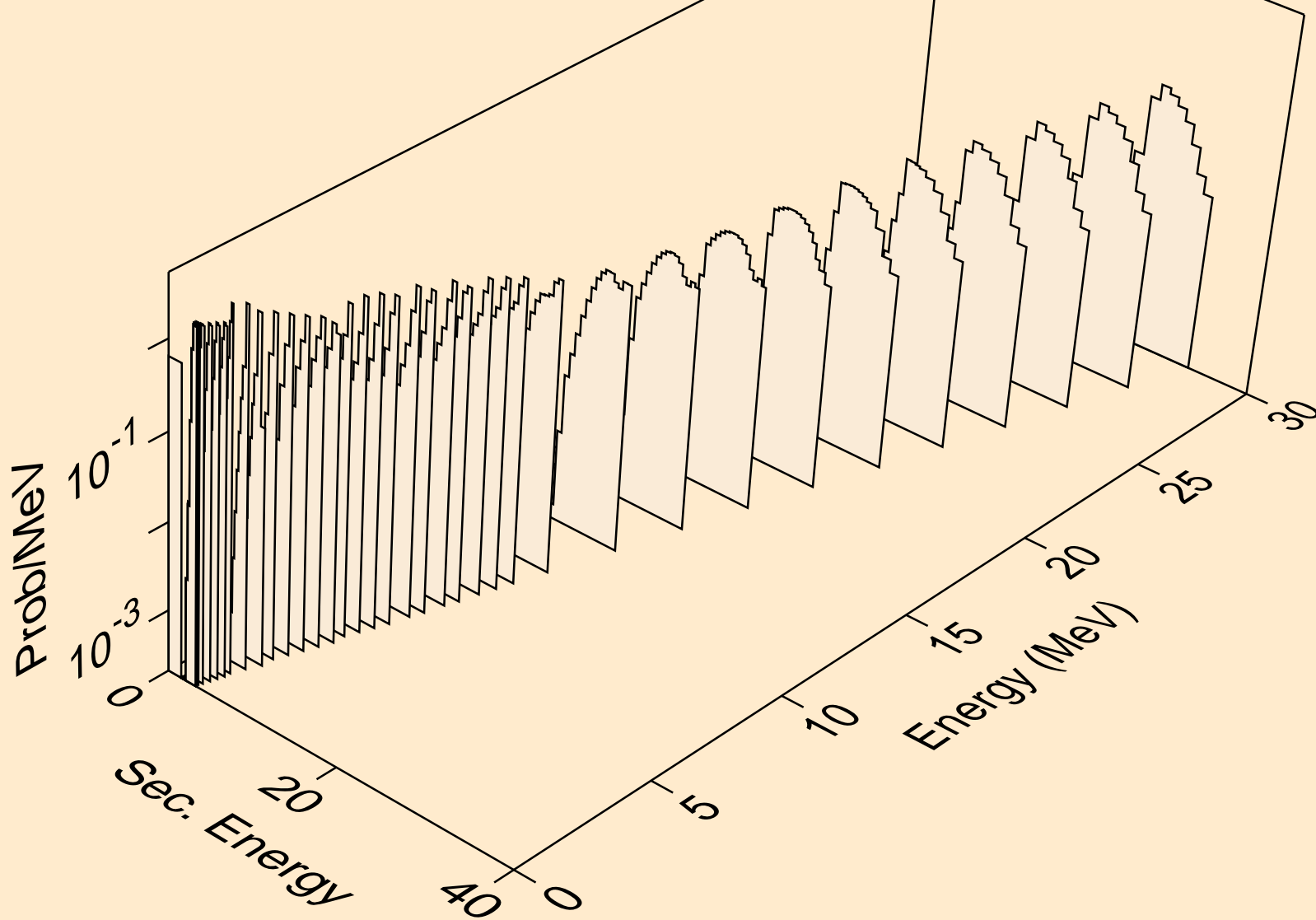

RF259 NEUTRON ACER TENDL-2019 LIBRARY; T=293.16K  
protons from (n,2p)

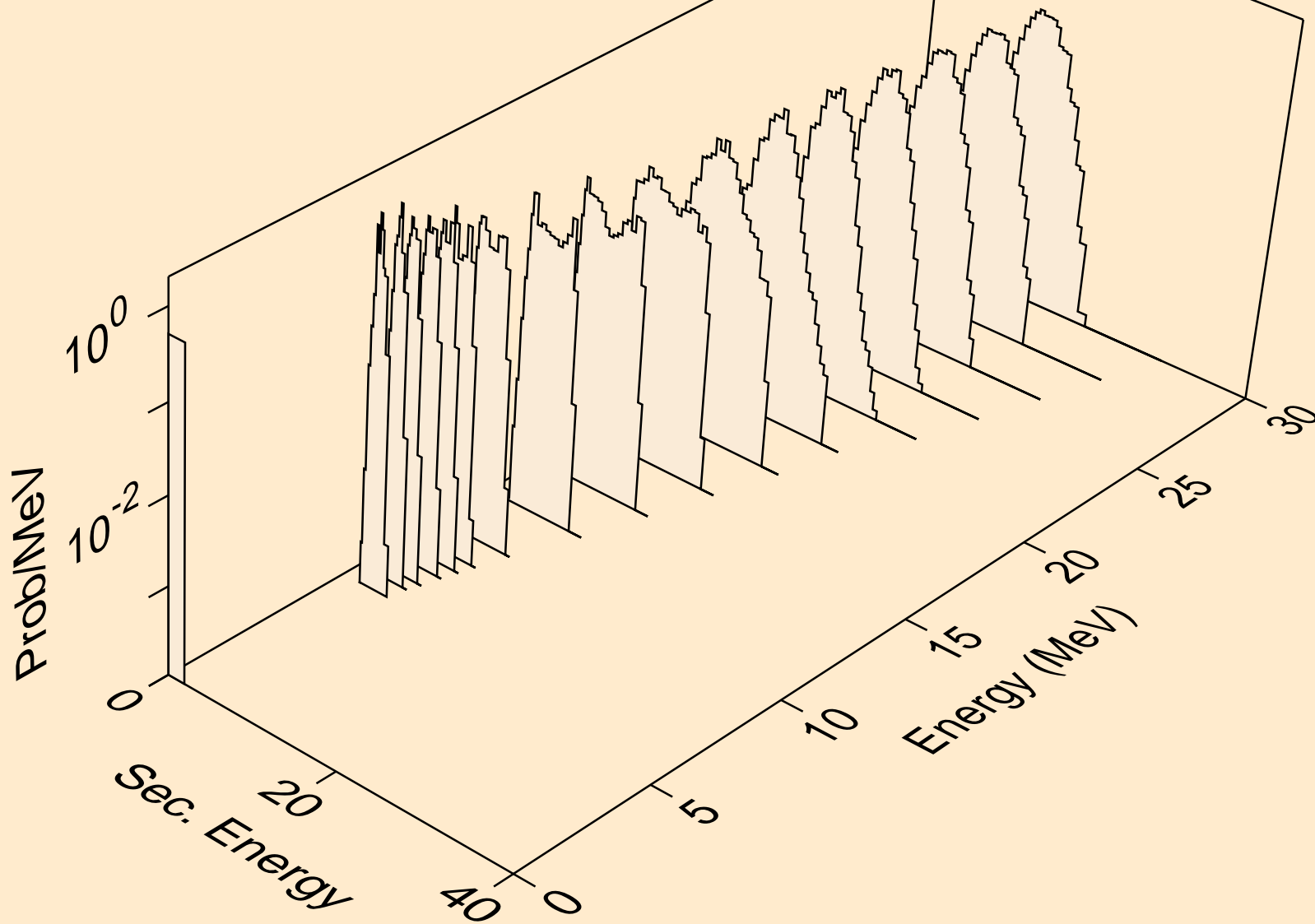



RF259 NEUTRON ACER TENDL-2019 LIBRARY; T=293.16K  
protons from (n,p)

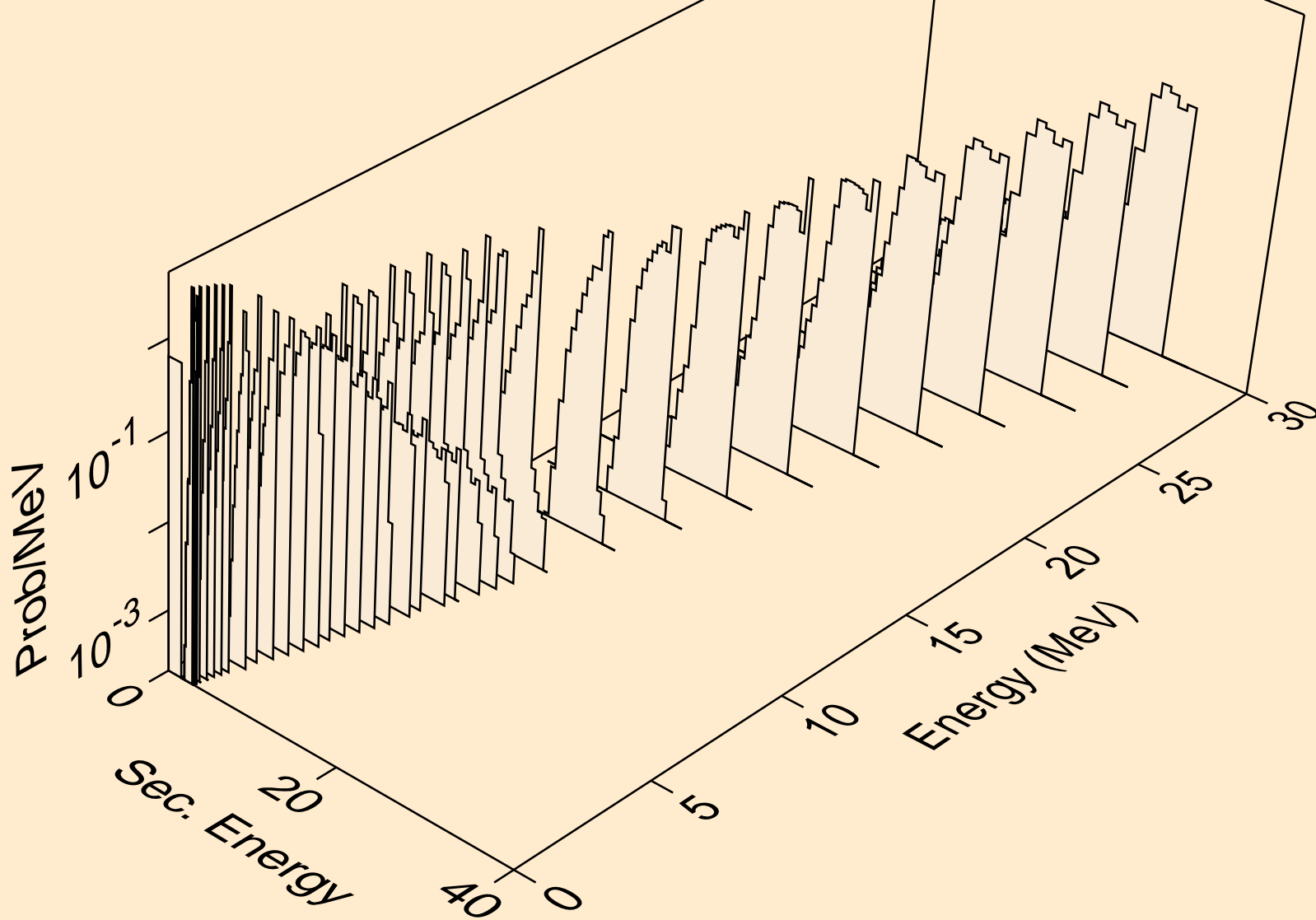

RF259 NEUTRON ACER TENDL-2019 LIBRARY; T=293.16K  
protons from (n,pd)

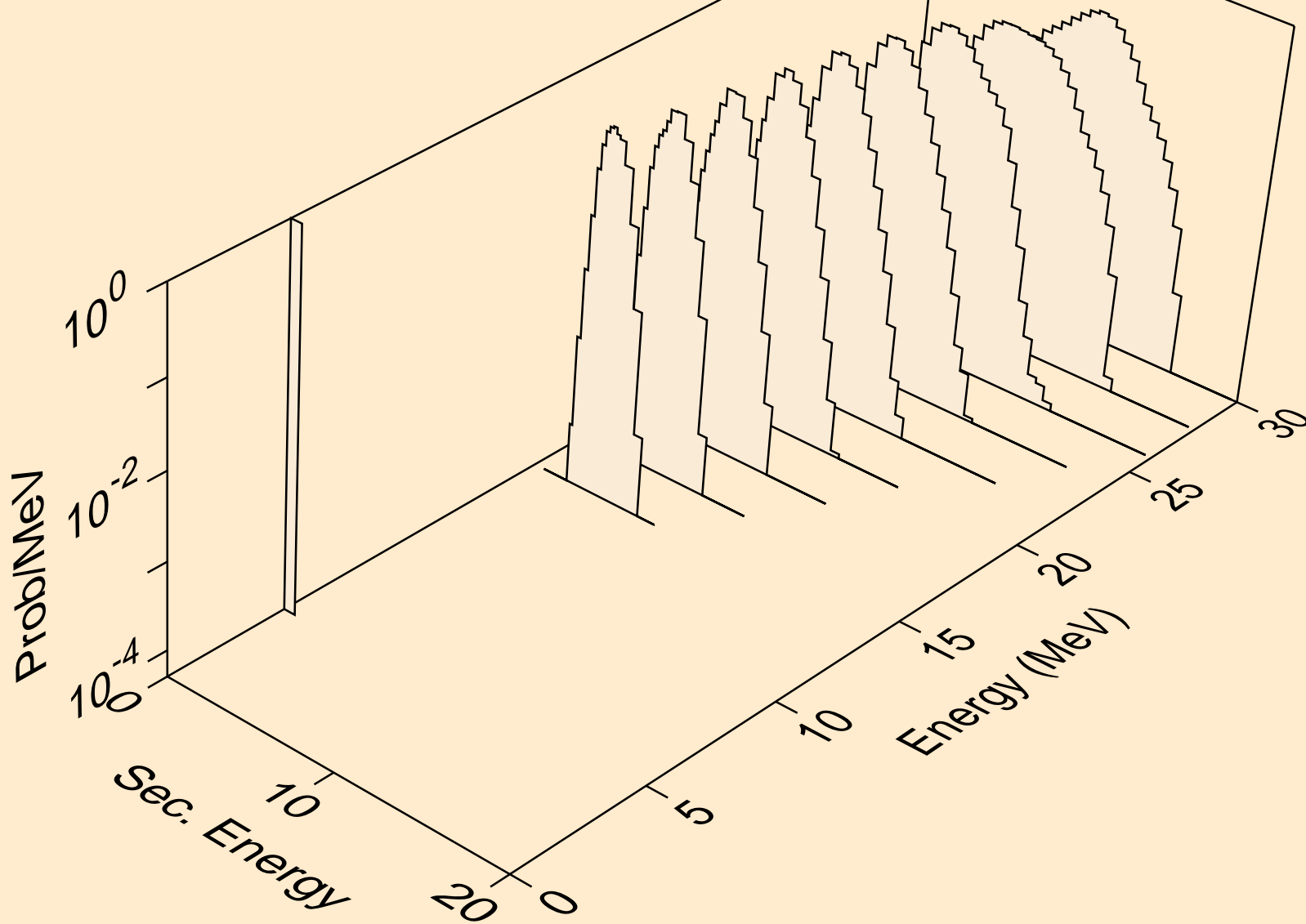

RF259 NEUTRON ACER TENDL-2019 LIBRARY; T=293.16K  
protons from (n,pt)

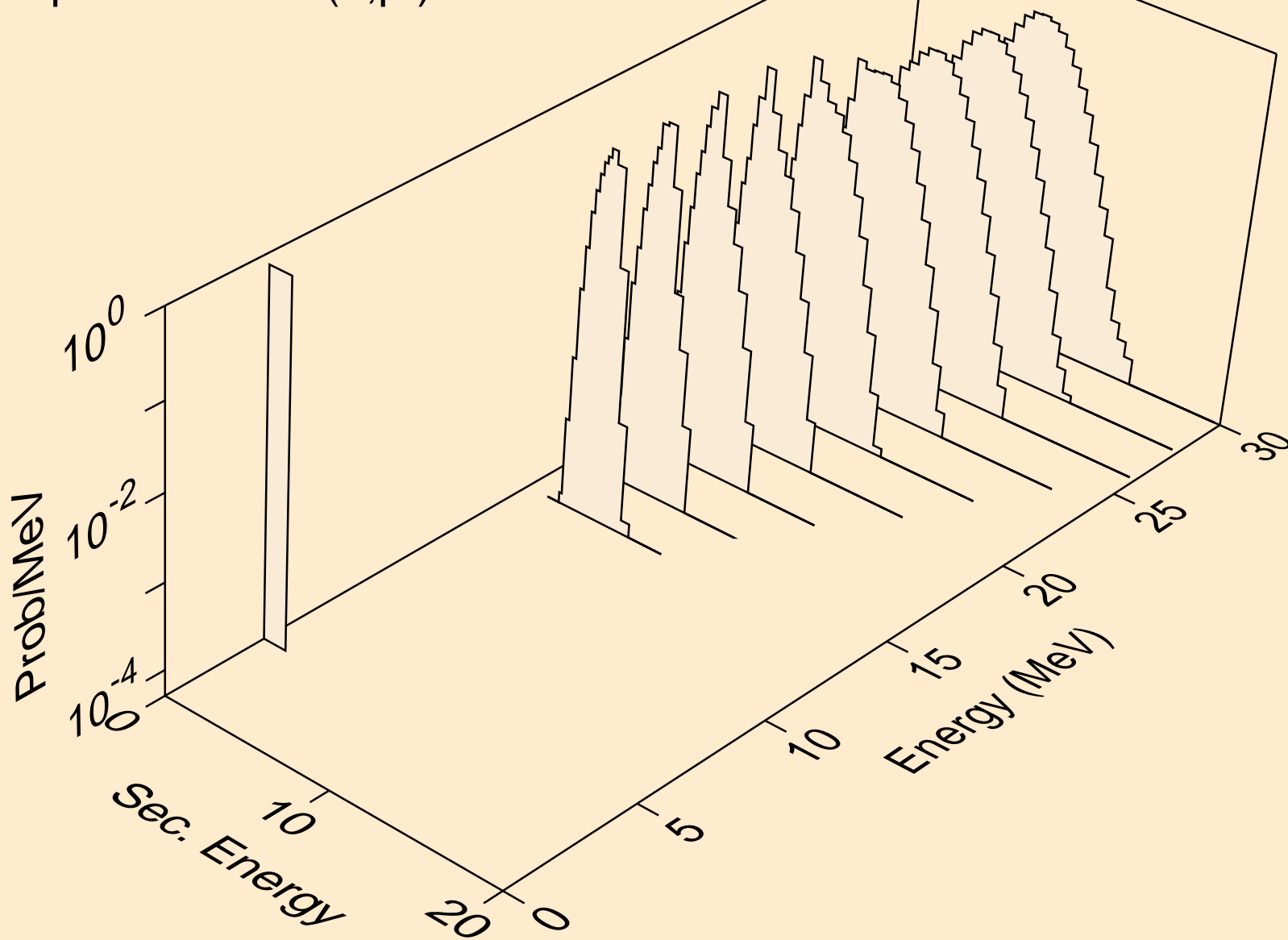

RF259 NEUTRON ACER TENDL-2019 LIBRARY; T=293.16K  
deuterons from (n,x)

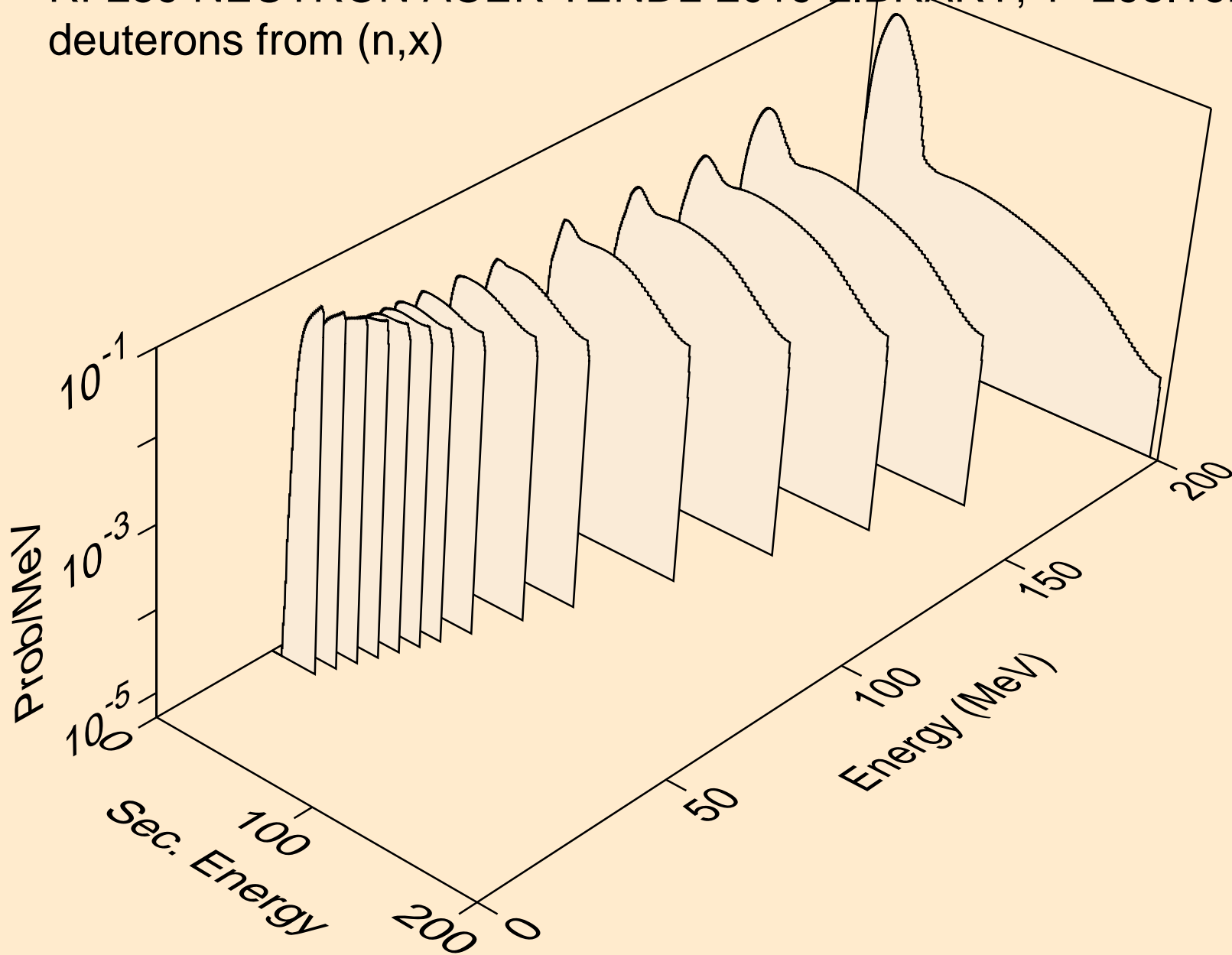

RF259 NEUTRON ACER TENDL-2019 LIBRARY; T=293.16K  
deuterons from (n,2nd)

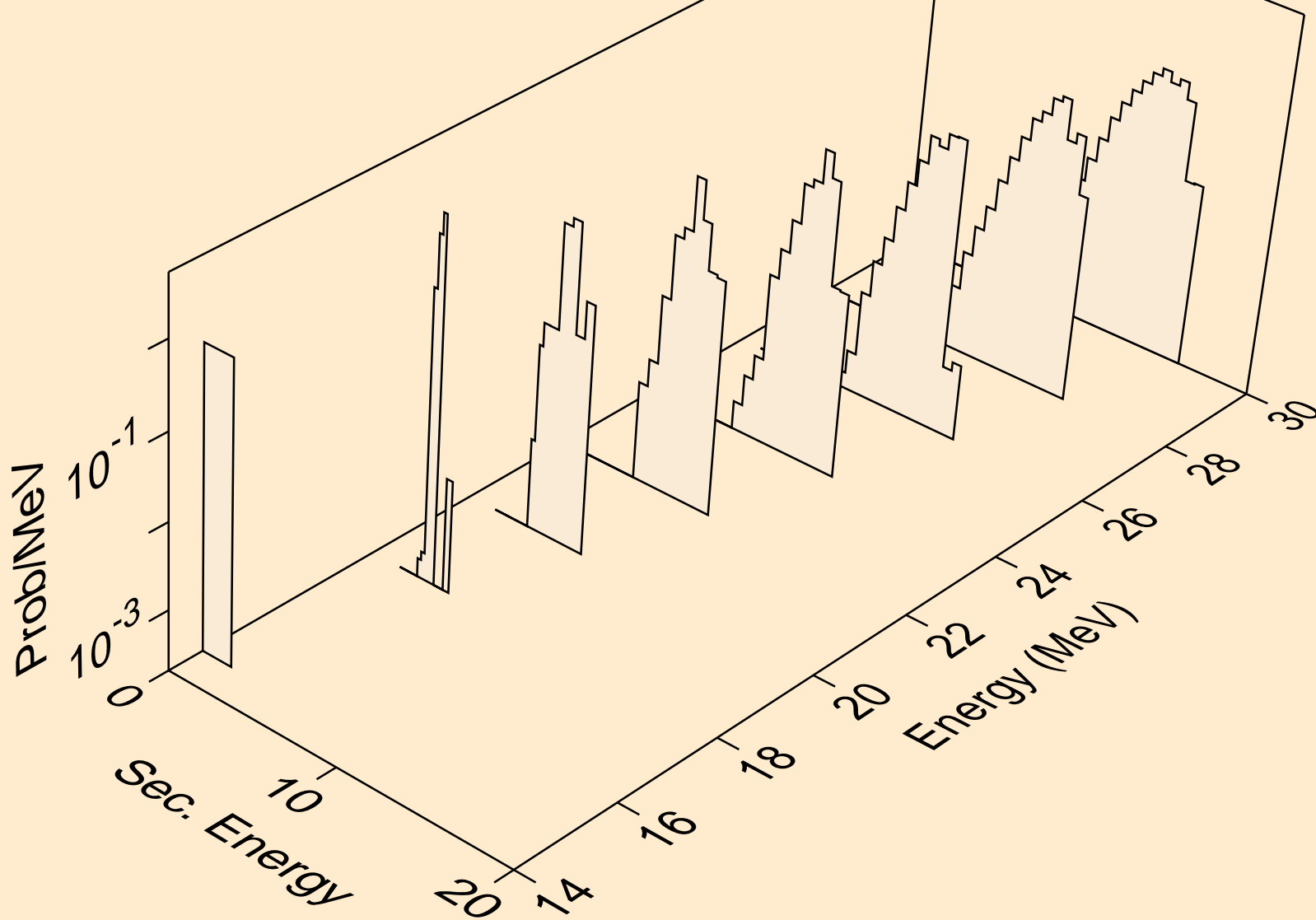

RF259 NEUTRON ACER TENDL-2019 LIBRARY; T=293.16K  
deuterons from (n,n\*)d

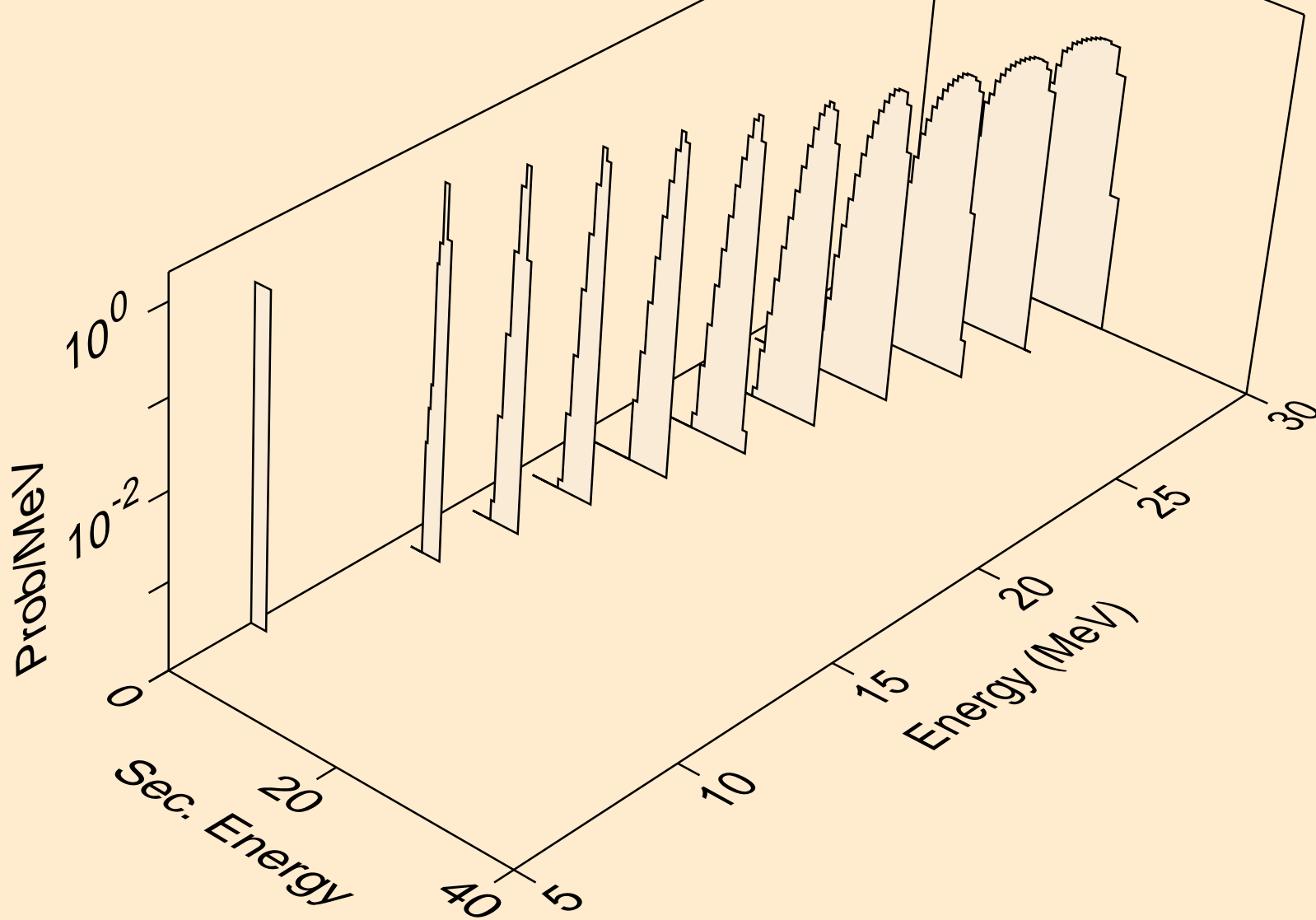

RF259 NEUTRON ACER TENDL-2019 LIBRARY; T=293.16K  
deuterons from (n,d)

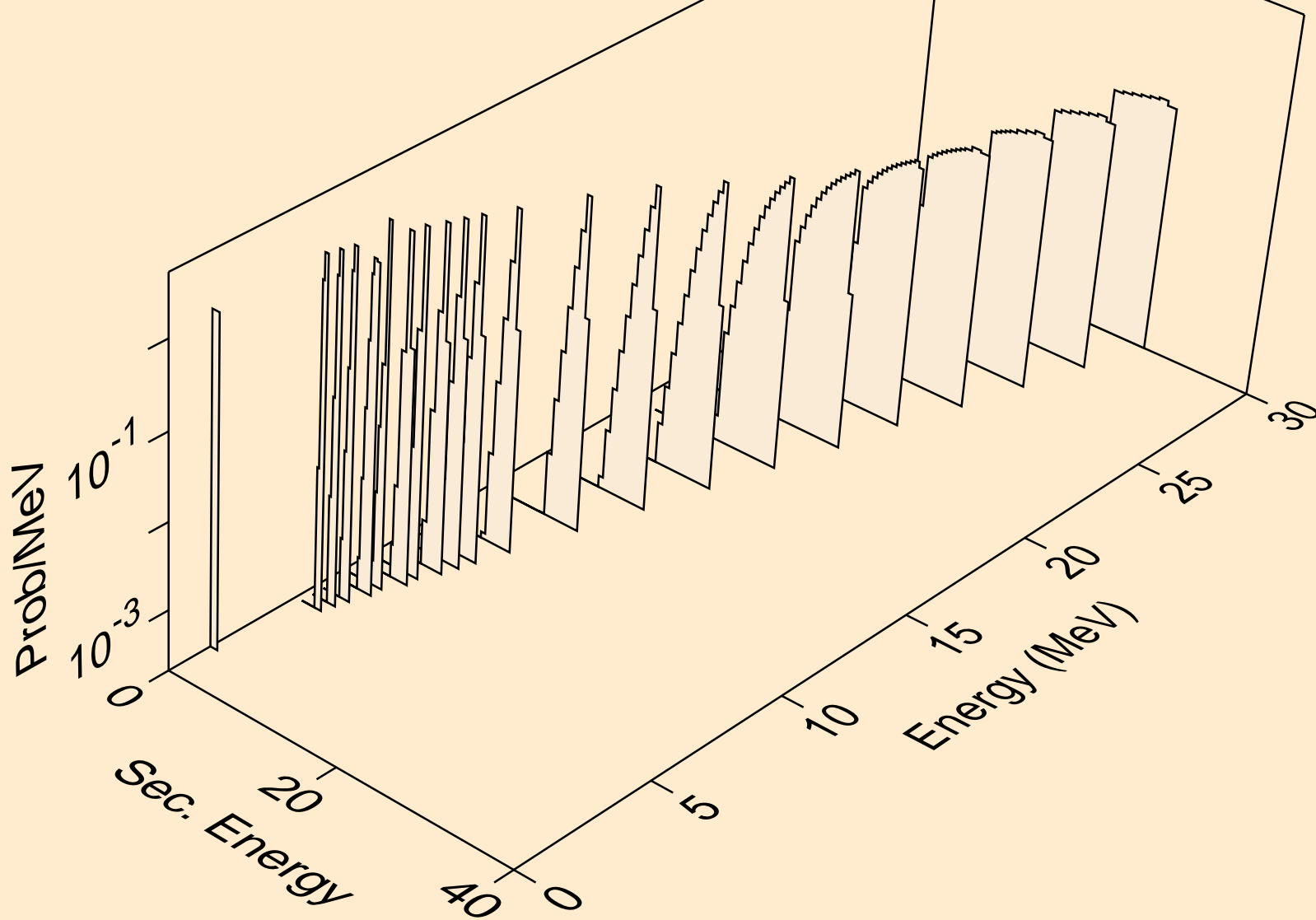

RF259 NEUTRON ACER TENDL-2019 LIBRARY; T=293.16K  
deuterons from (n,pd)

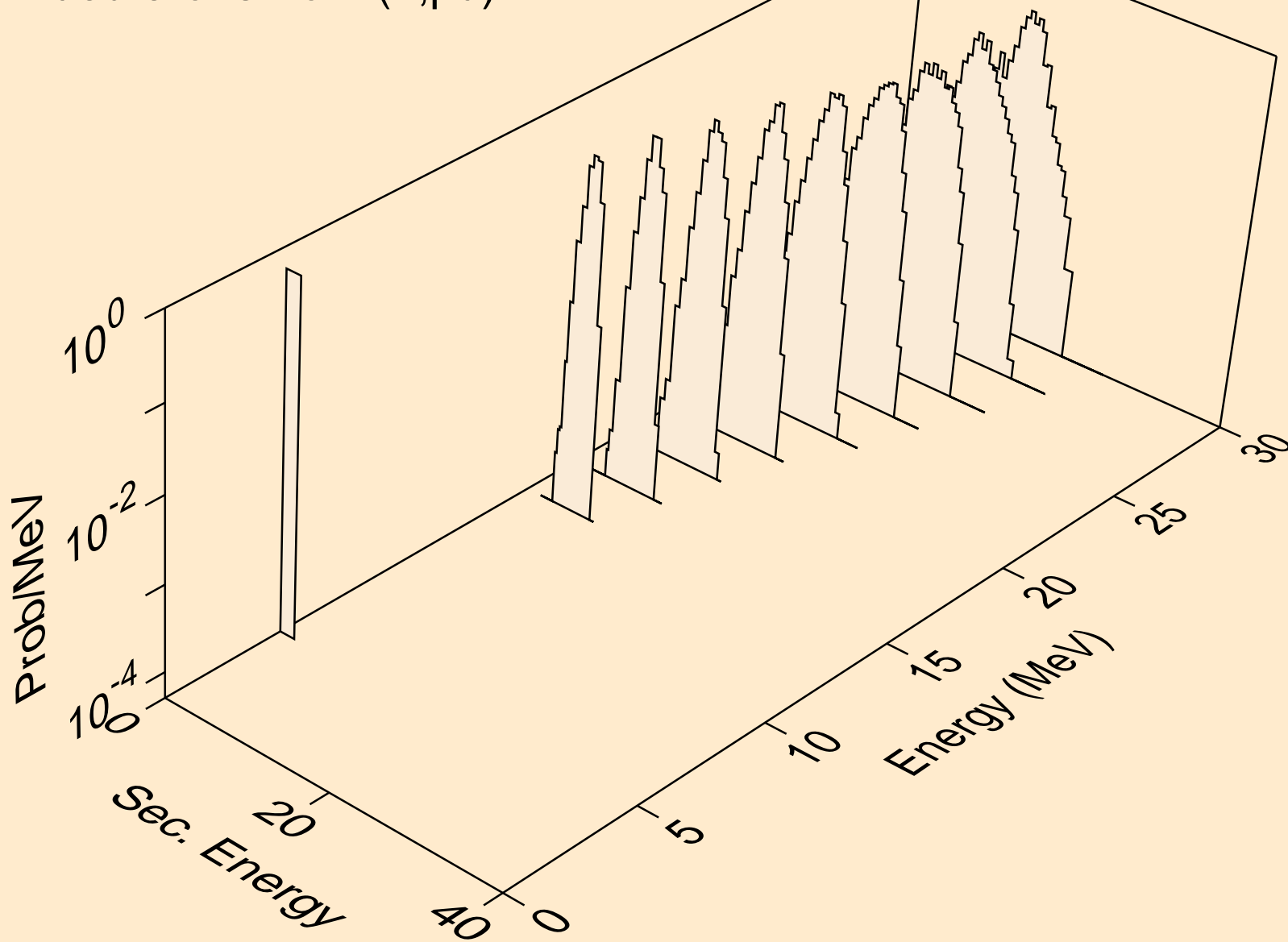



RF259 NEUTRON ACER TENDL-2019 LIBRARY; T=293.16K  
deuterons from (n,da)

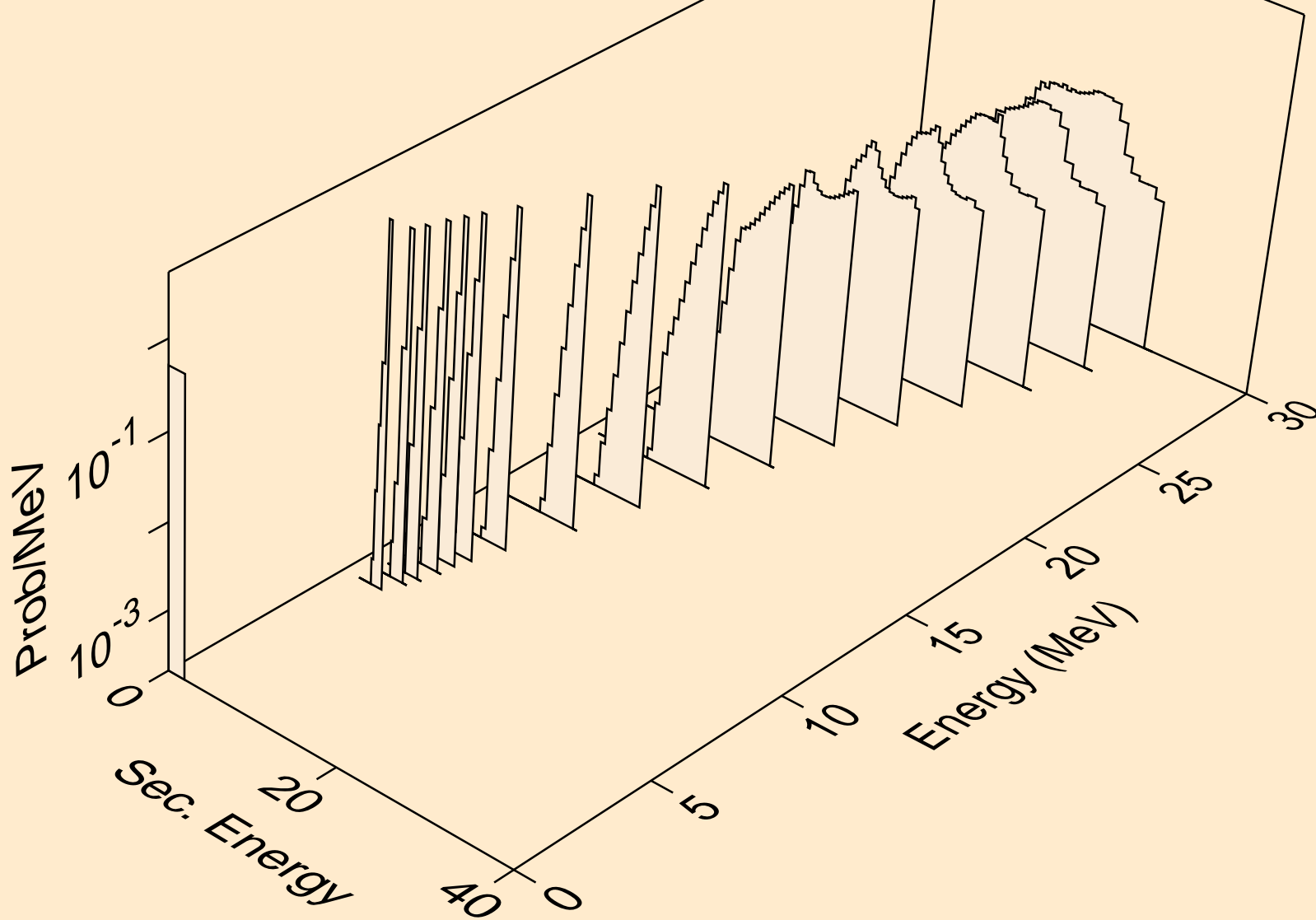

RF259 NEUTRON ACER TENDL-2019 LIBRARY; T=293.16K  
tritons from (n,x)

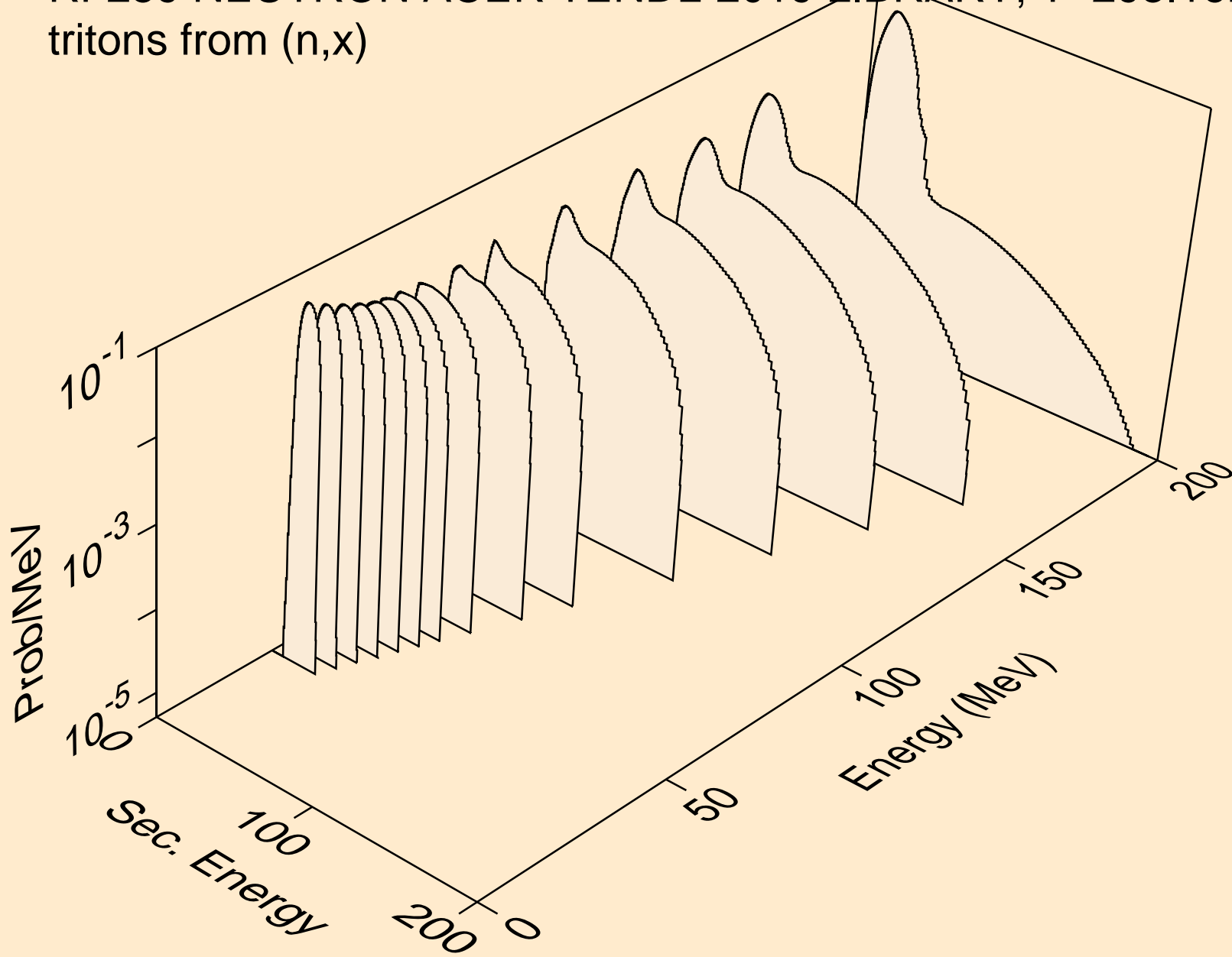

RF259 NEUTRON ACER TENDL-2019 LIBRARY; T=293.16K  
tritons from (n,n\*)t

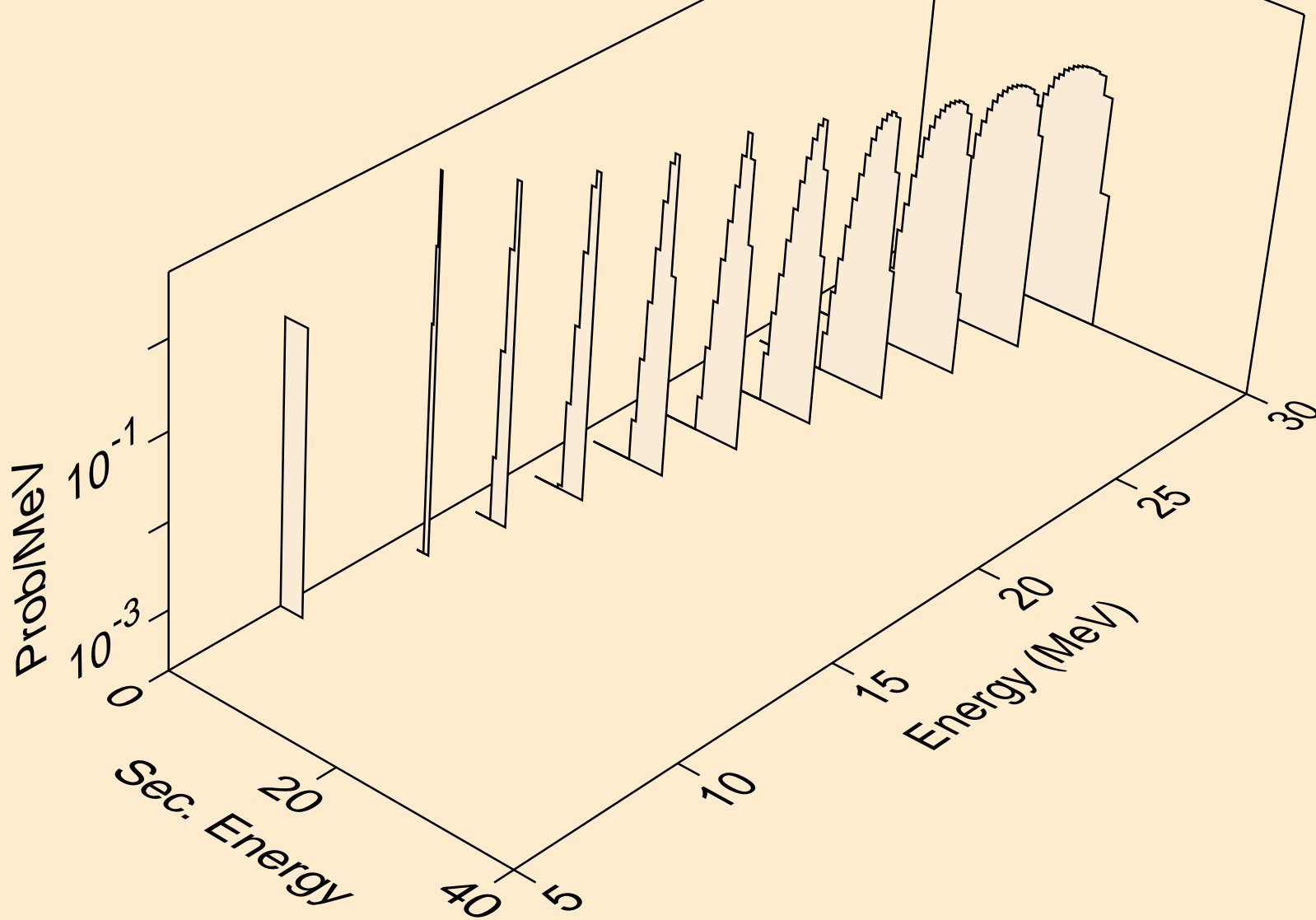

RF259 NEUTRON ACER TENDL-2019 LIBRARY; T=293.16K  
tritons from (n,t)

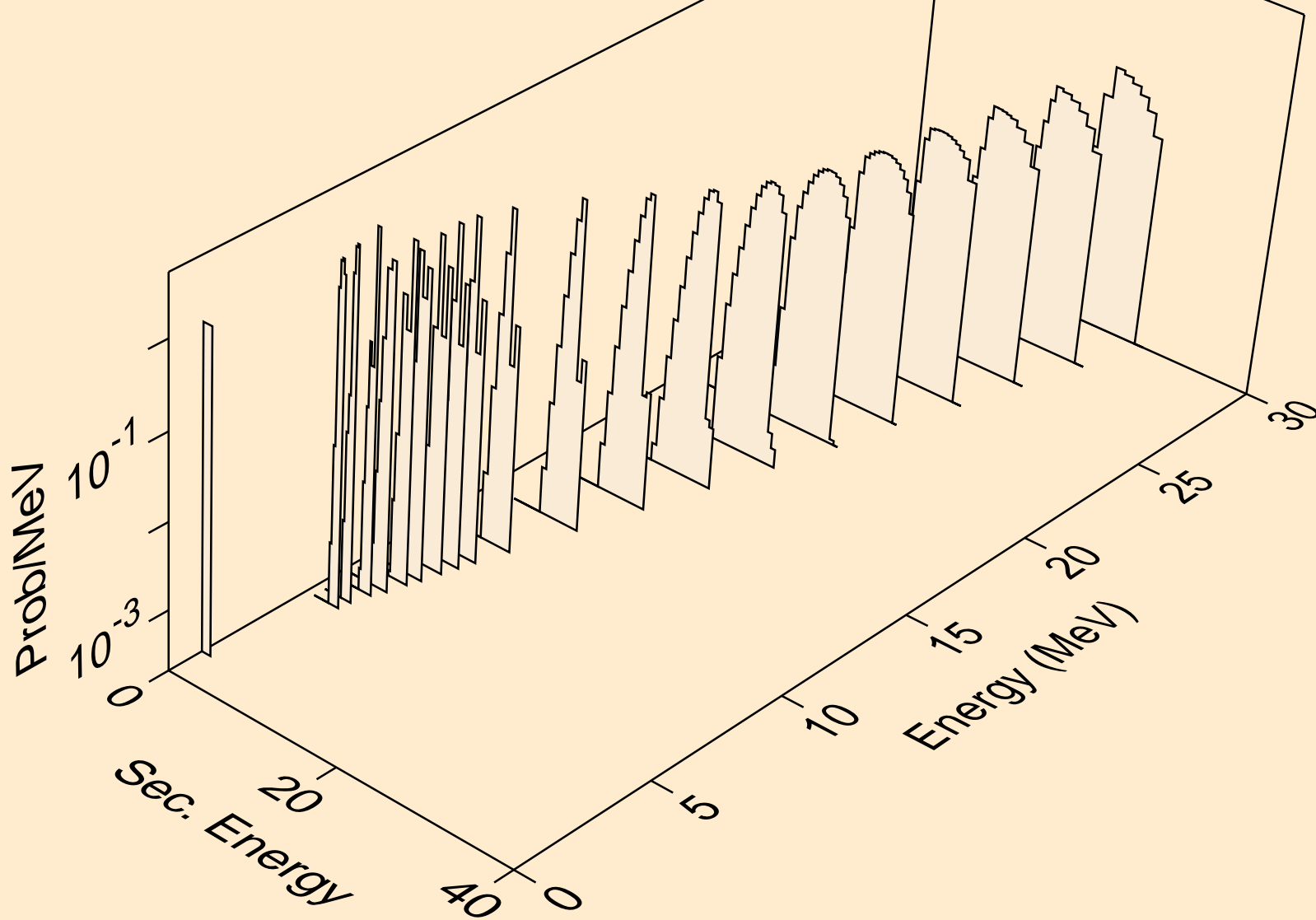

RF259 NEUTRON ACER TENDL-2019 LIBRARY; T=293.16K  
tritons from (n,pt)

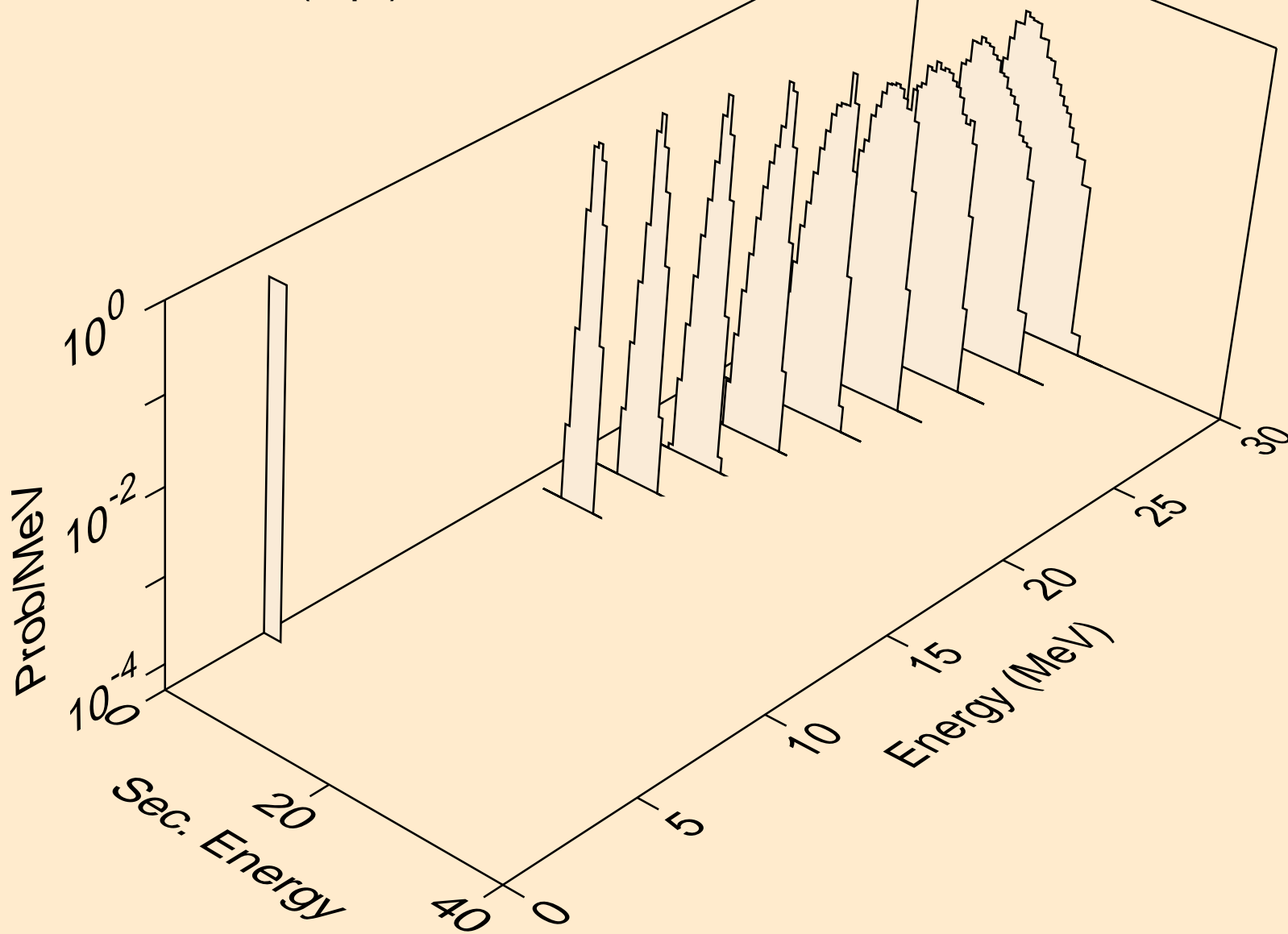

RF259 NEUTRON ACER TENDL-2019 LIBRARY; T=293.16K  
he3s from (n,x)

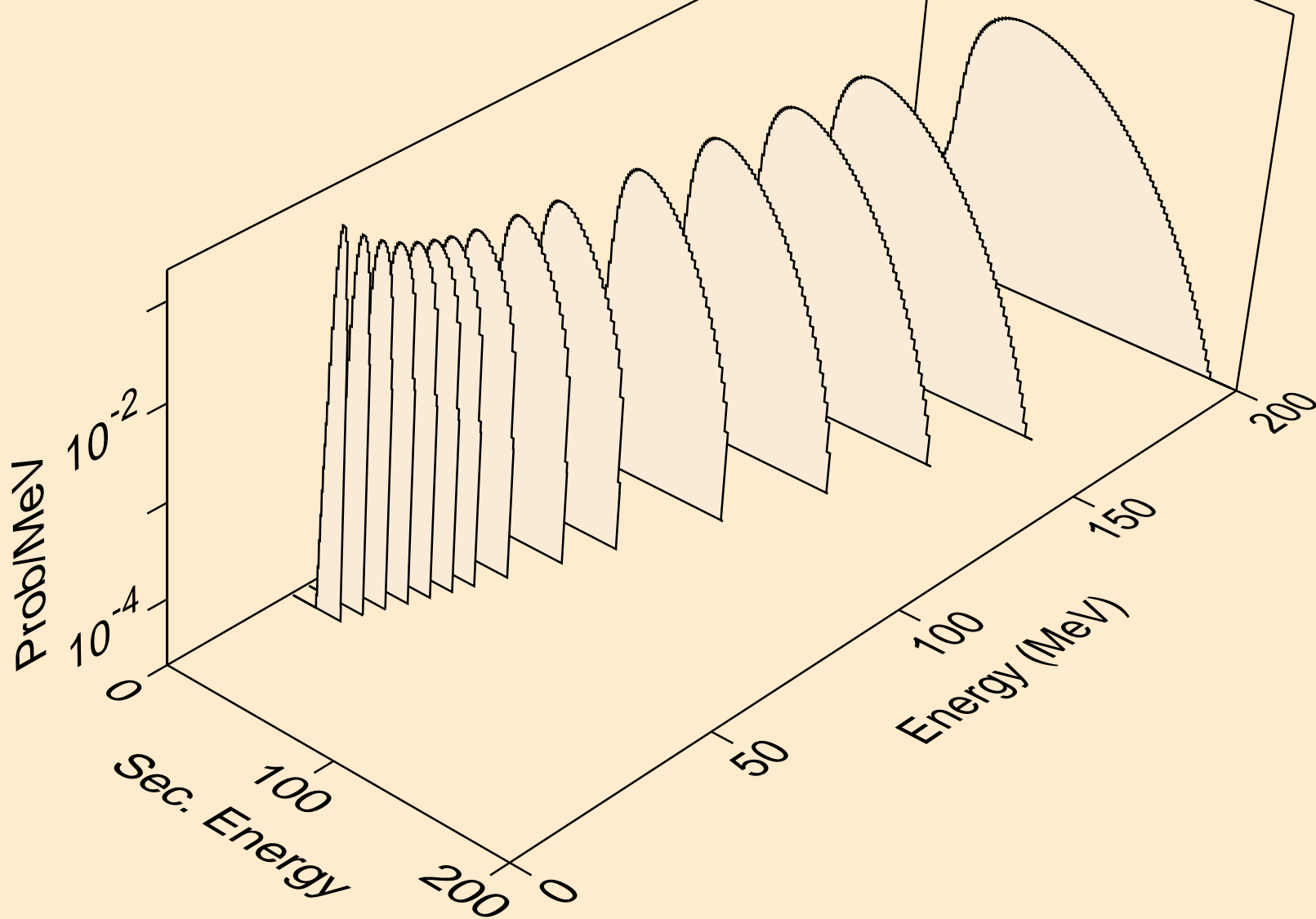

RF259 NEUTRON ACER TENDL-2019 LIBRARY; T=293.16K  
he3s from (n,n\*)he3

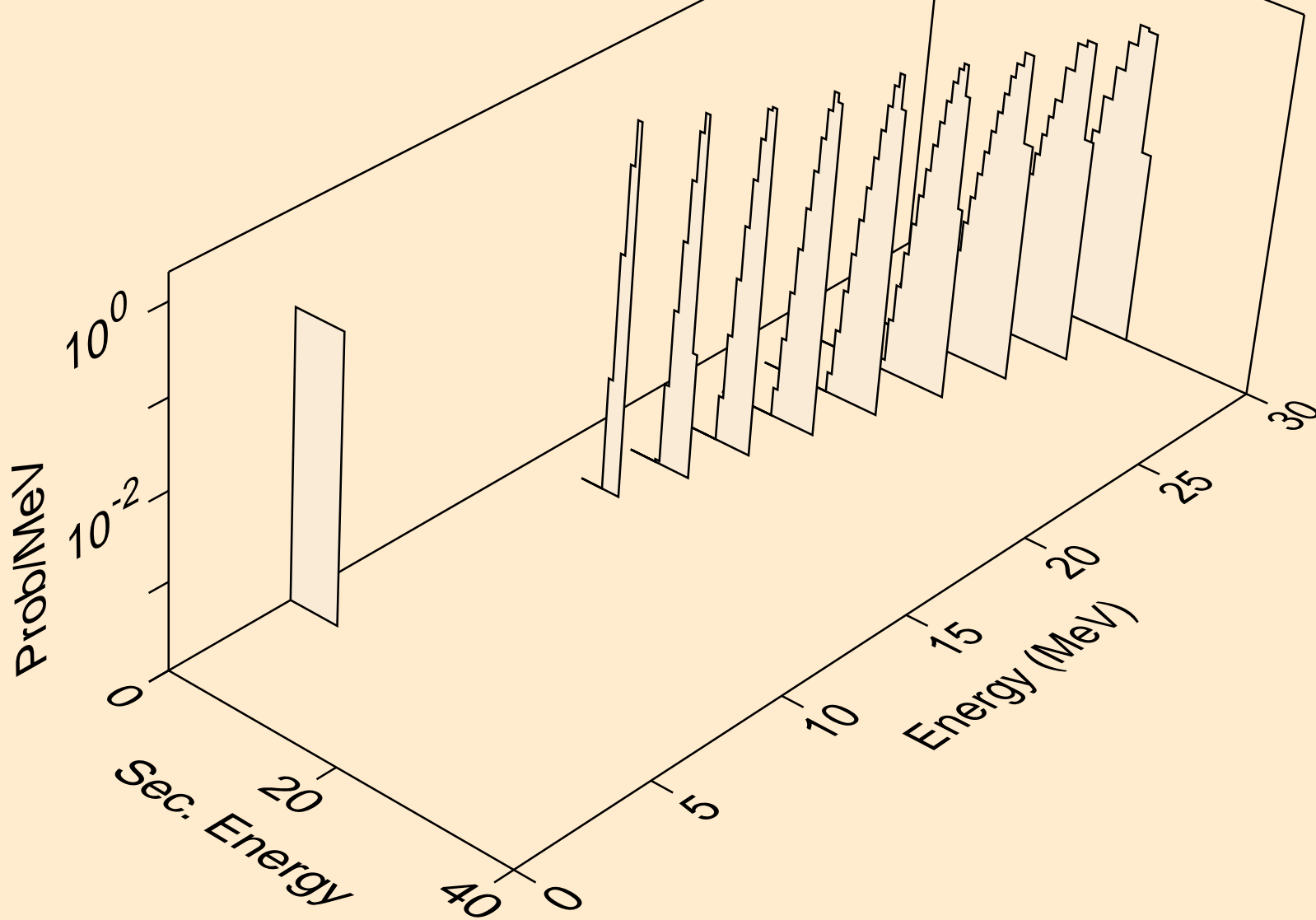

RF259 NEUTRON ACER TENDL-2019 LIBRARY; T=293.16K  
he3s from (n,he3)

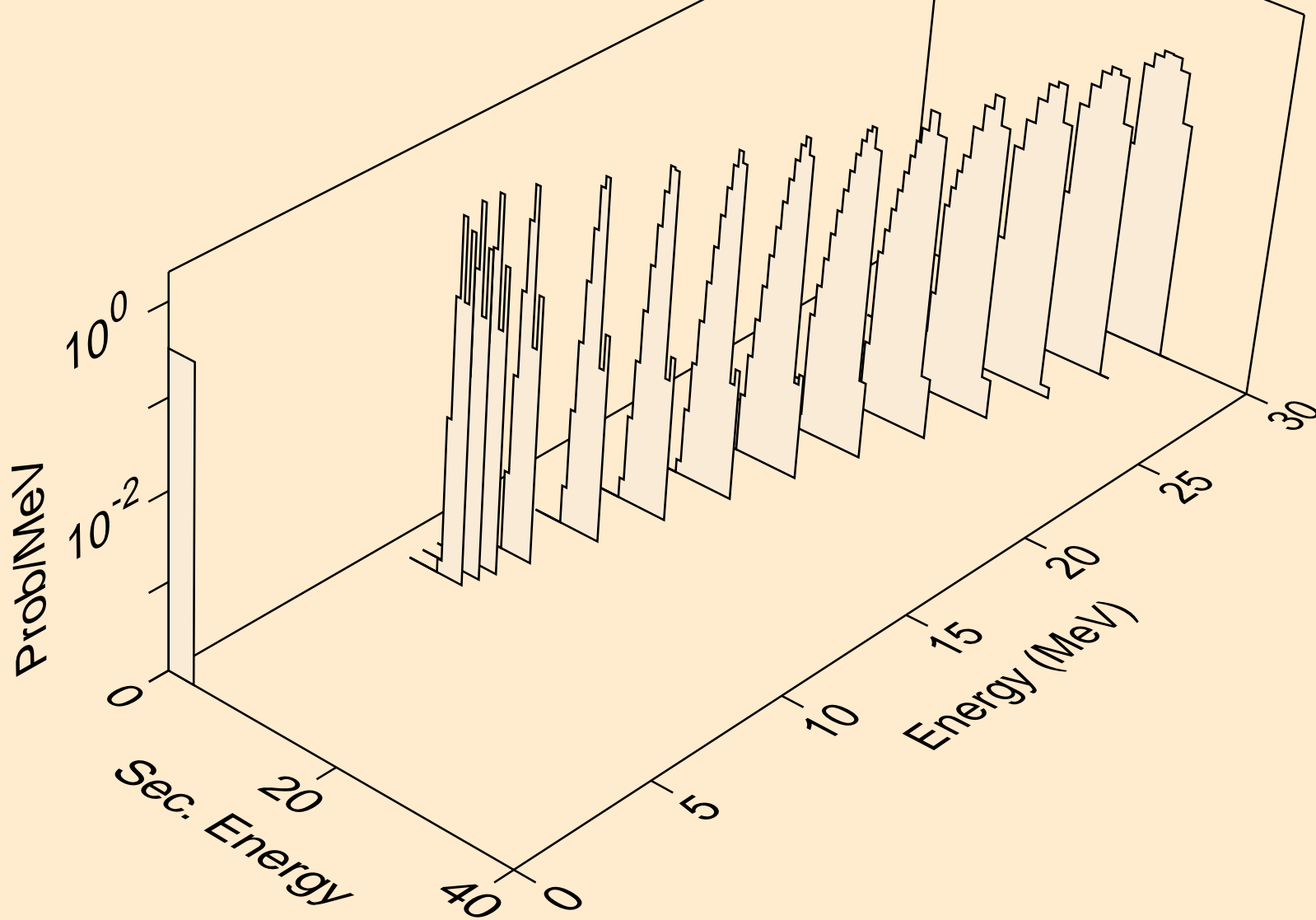



RF259 NEUTRON ACER TENDL-2019 LIBRARY; T=293.16K  
alphas from (n,x)

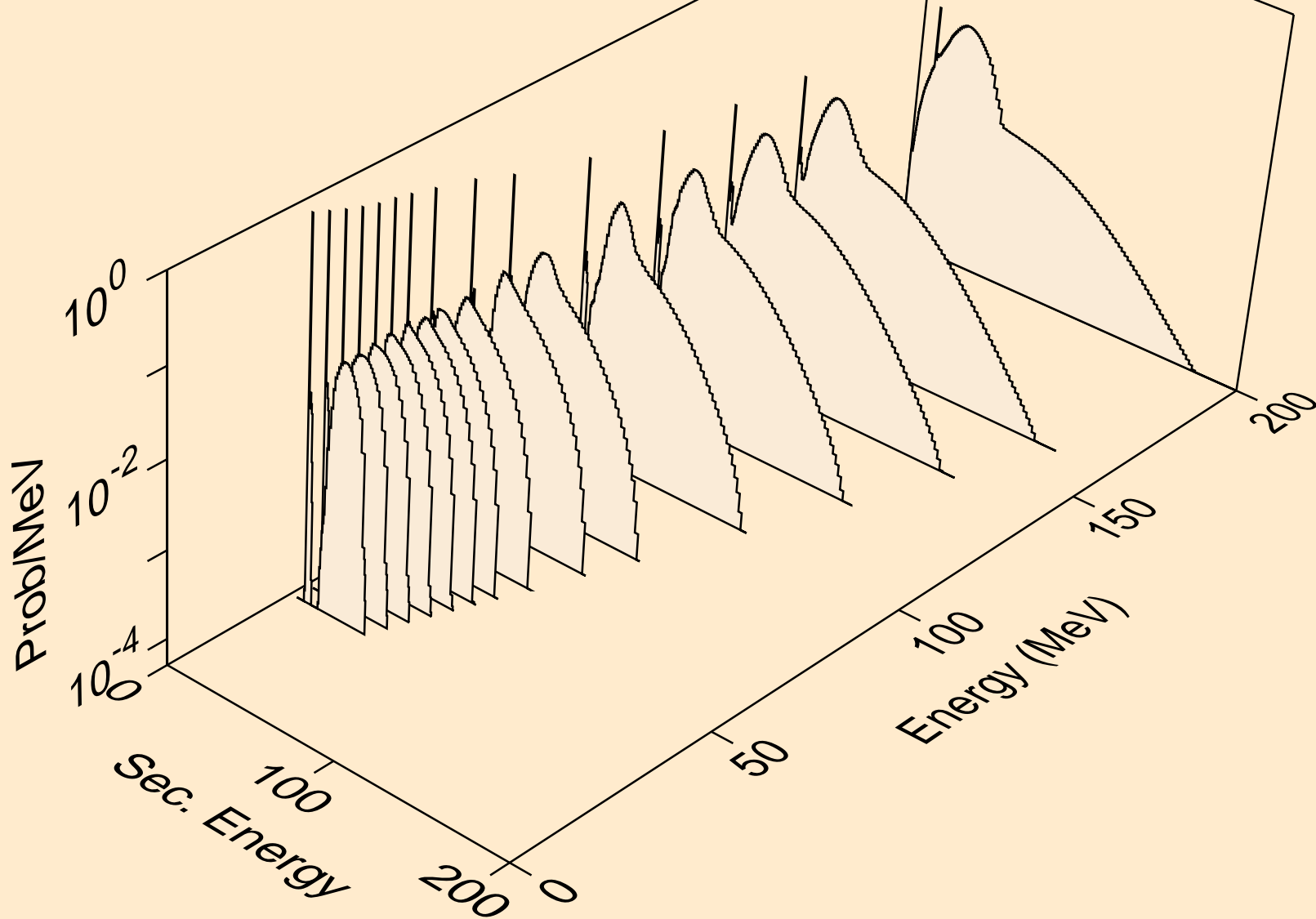

RF259 NEUTRON ACER TENDL-2019 LIBRARY; T=293.16K  
alphas from (n,n\*)a

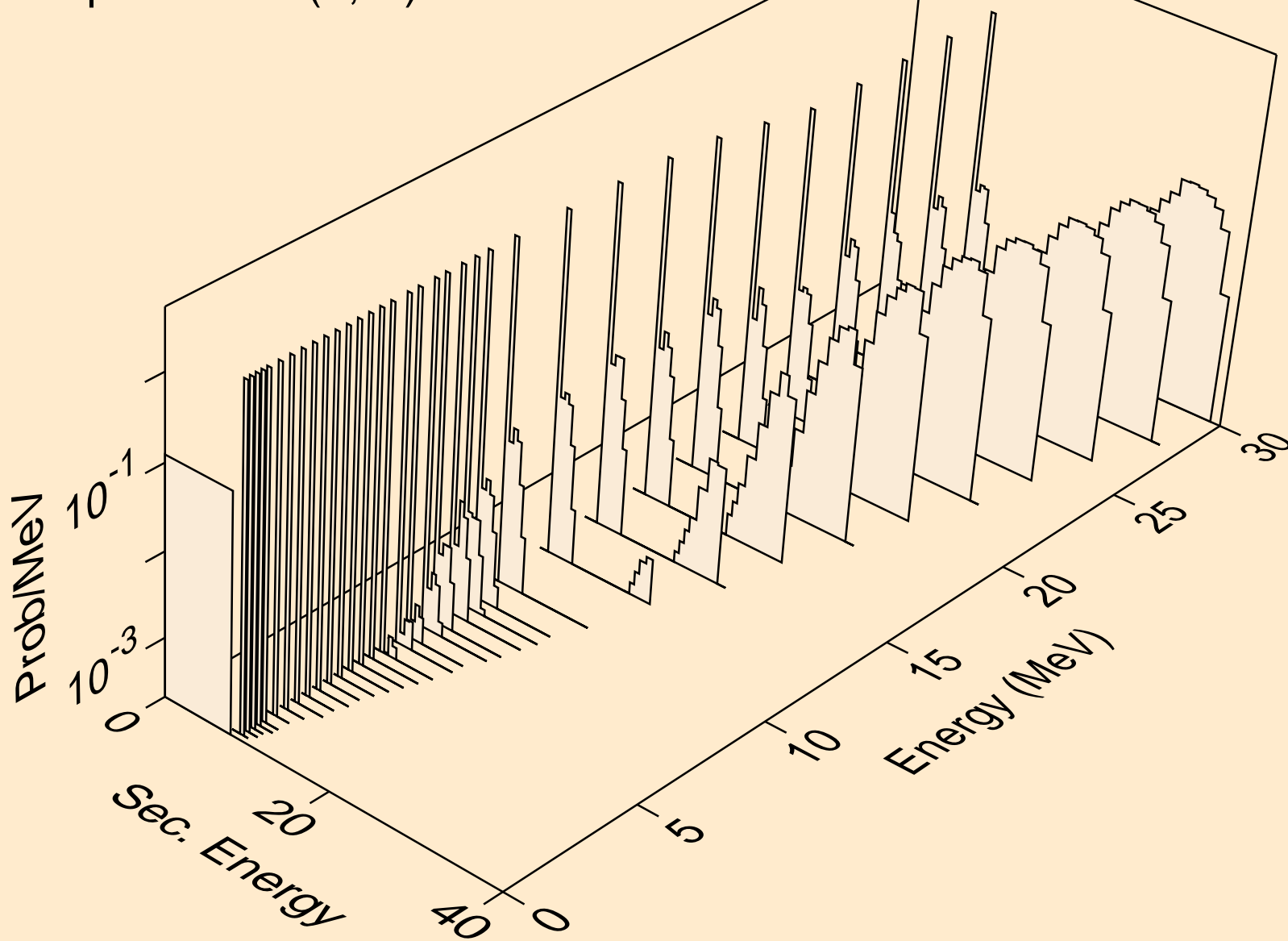

RF259 NEUTRON ACER TENDL-2019 LIBRARY; T=293.16K  
alphas from (n,2n)a

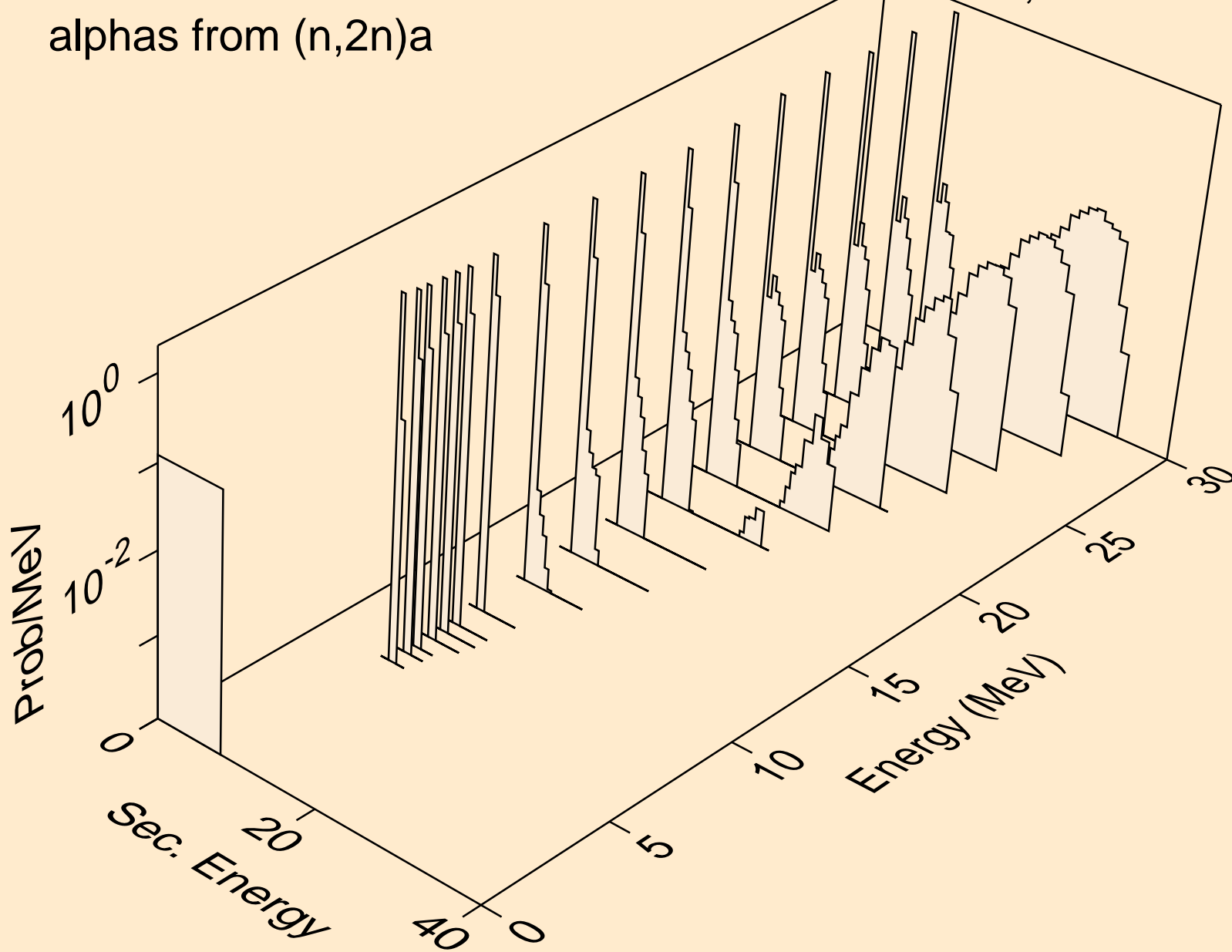

RF259 NEUTRON ACER TENDL-2019 LIBRARY; T=293.16K  
alphas from (n,3n)a

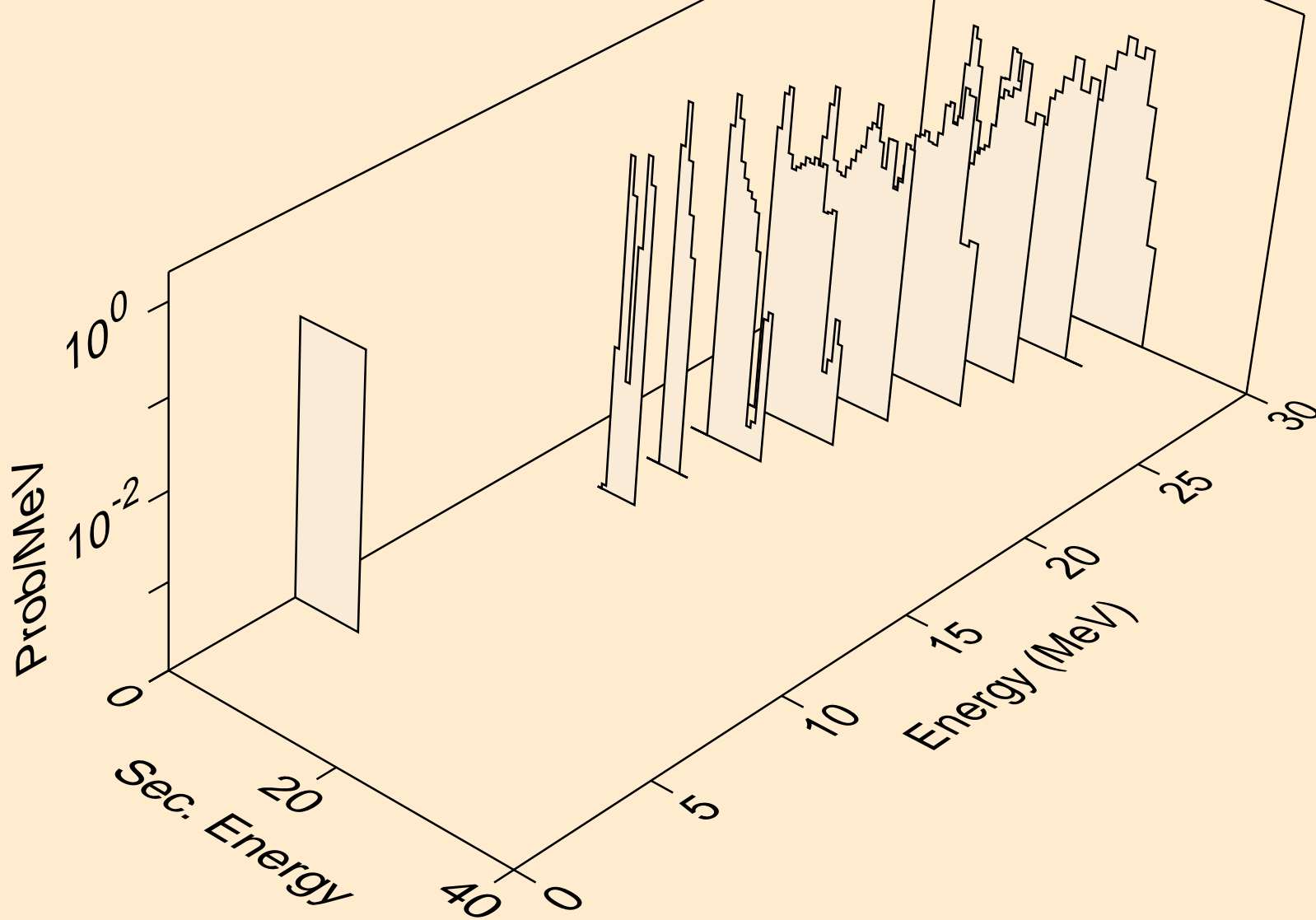

RF259 NEUTRON ACER TENDL-2019 LIBRARY; T=293.16K  
alphas from (n,n\*)2a

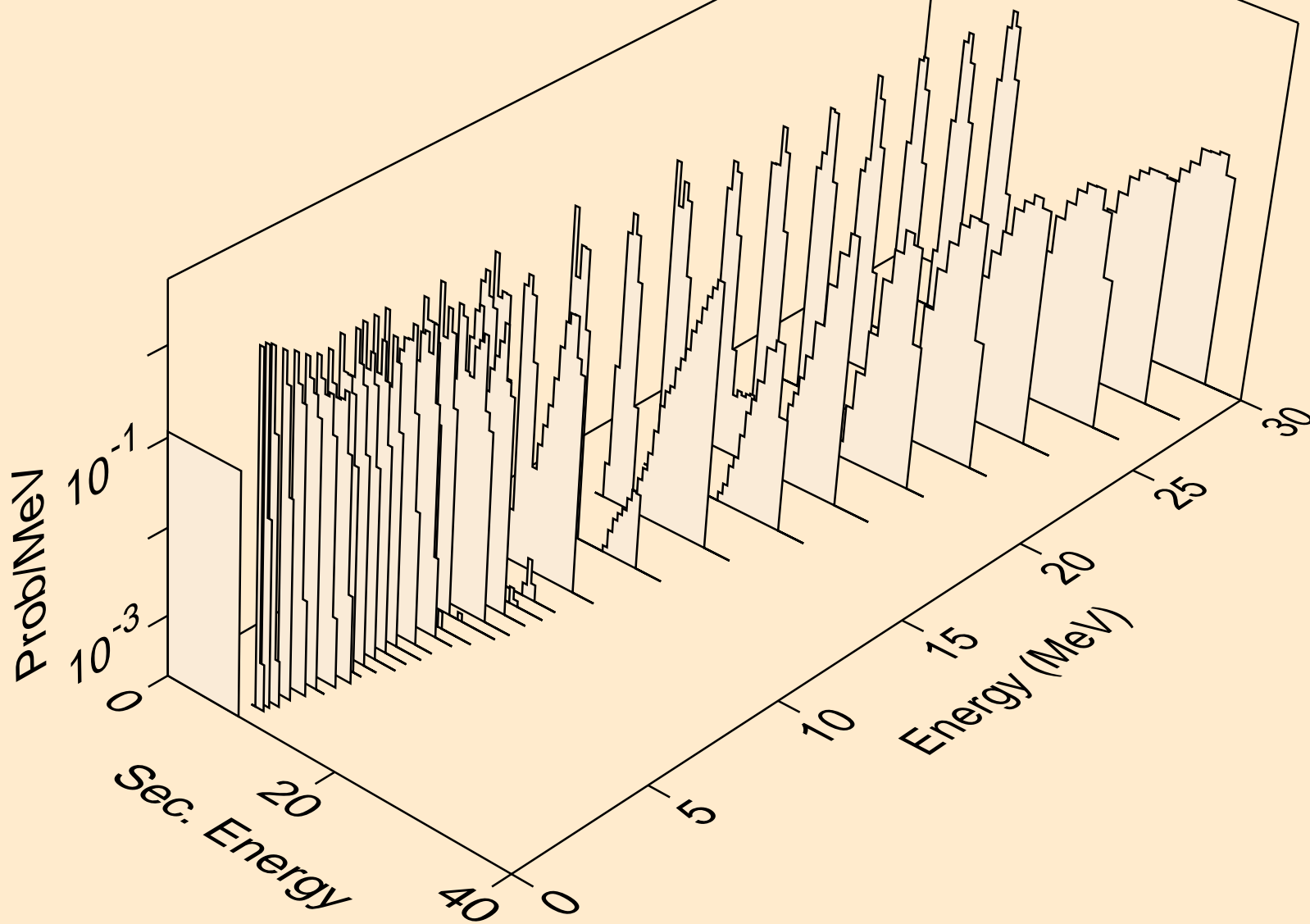

RF259 NEUTRON ACER TENDL-2019 LIBRARY; T=293.16K  
alphas from (n,2n)2a

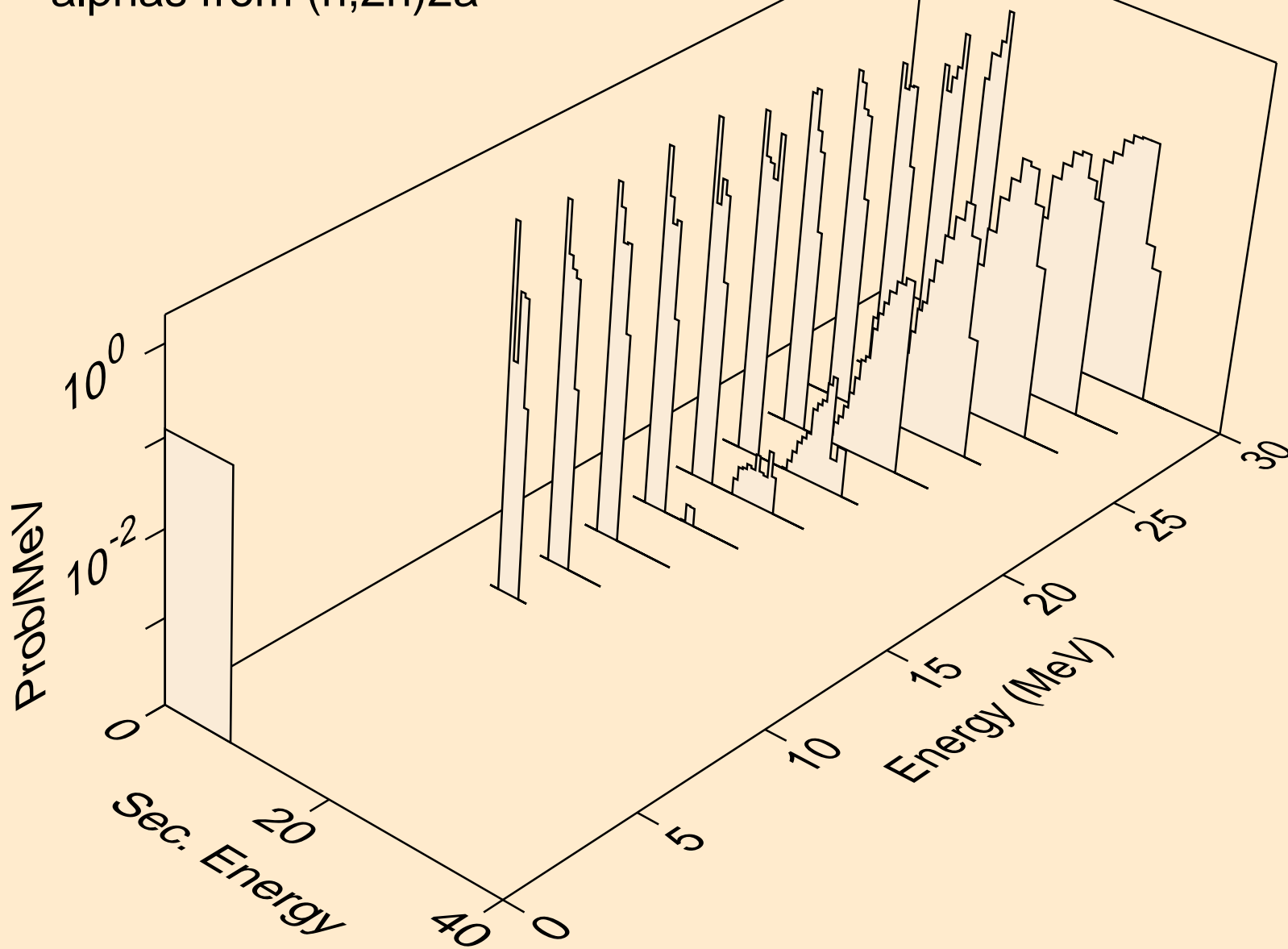

RF259 NEUTRON ACER TENDL-2019 LIBRARY; T=293.16K  
alphas from (n,npa)

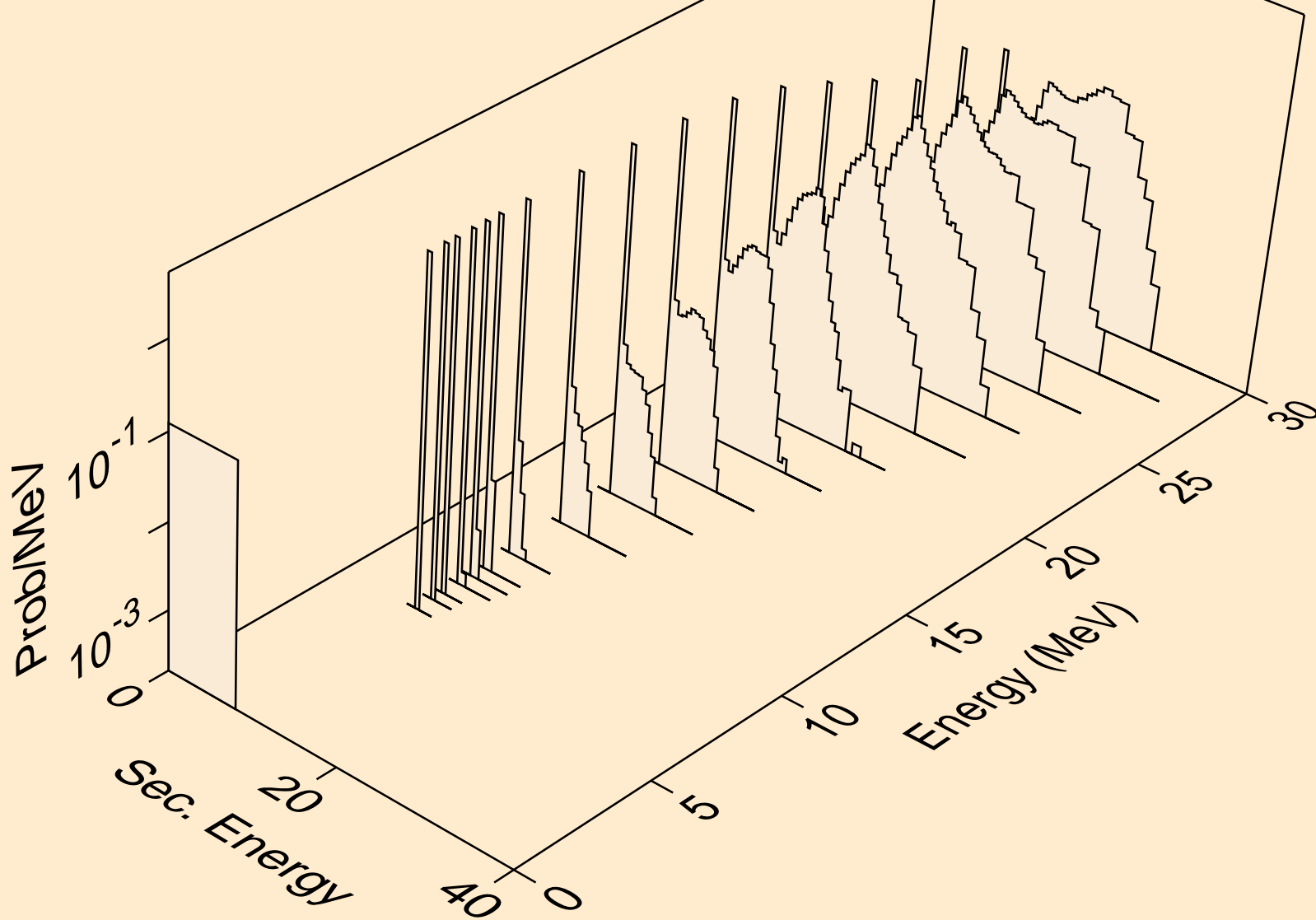

RF259 NEUTRON ACER TENDL-2019 LIBRARY; T=293.16K  
alphas from (n,a)

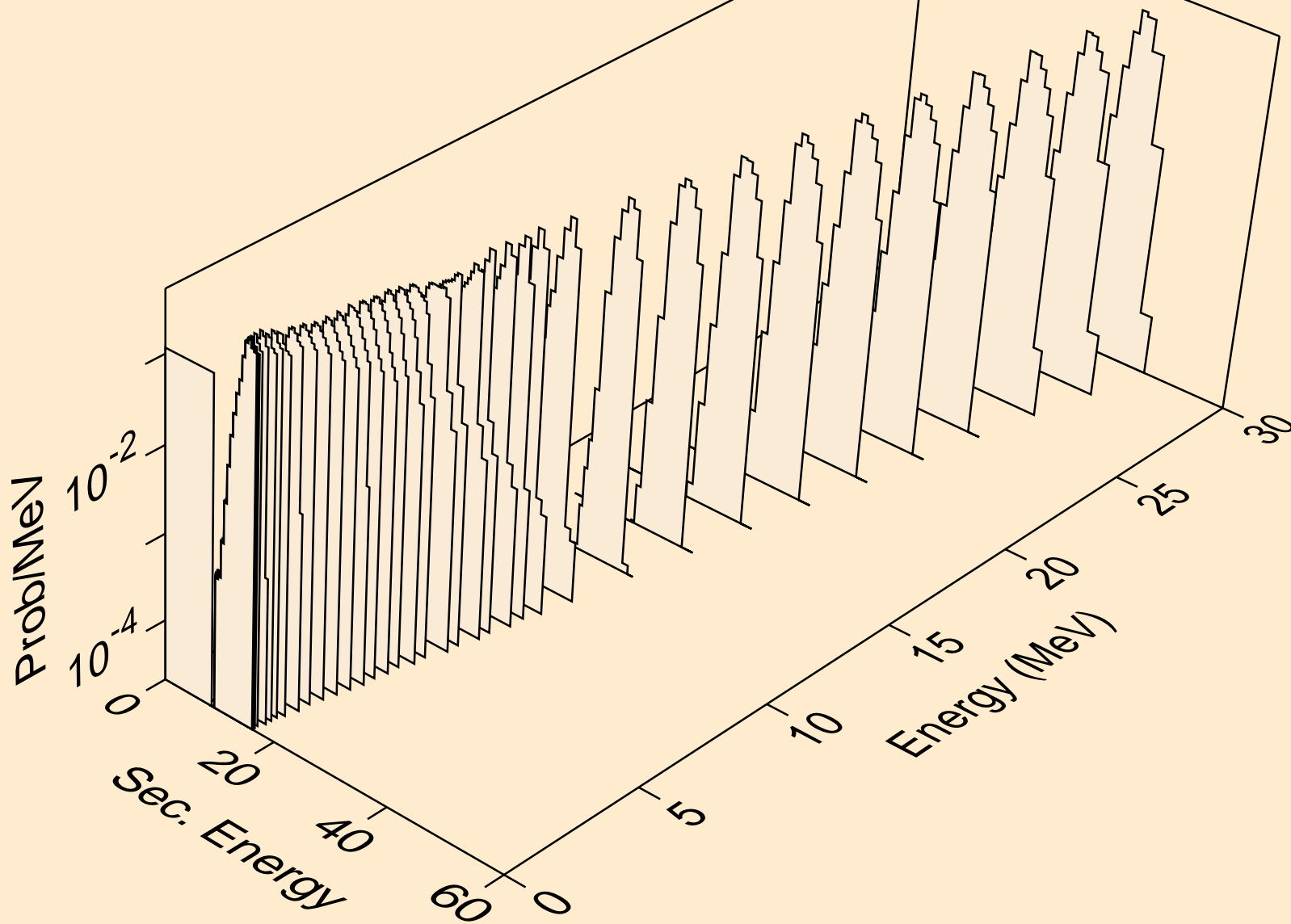



RF259 NEUTRON ACER TENDL-2019 LIBRARY; T=293.16K  
alphas from (n,2a)

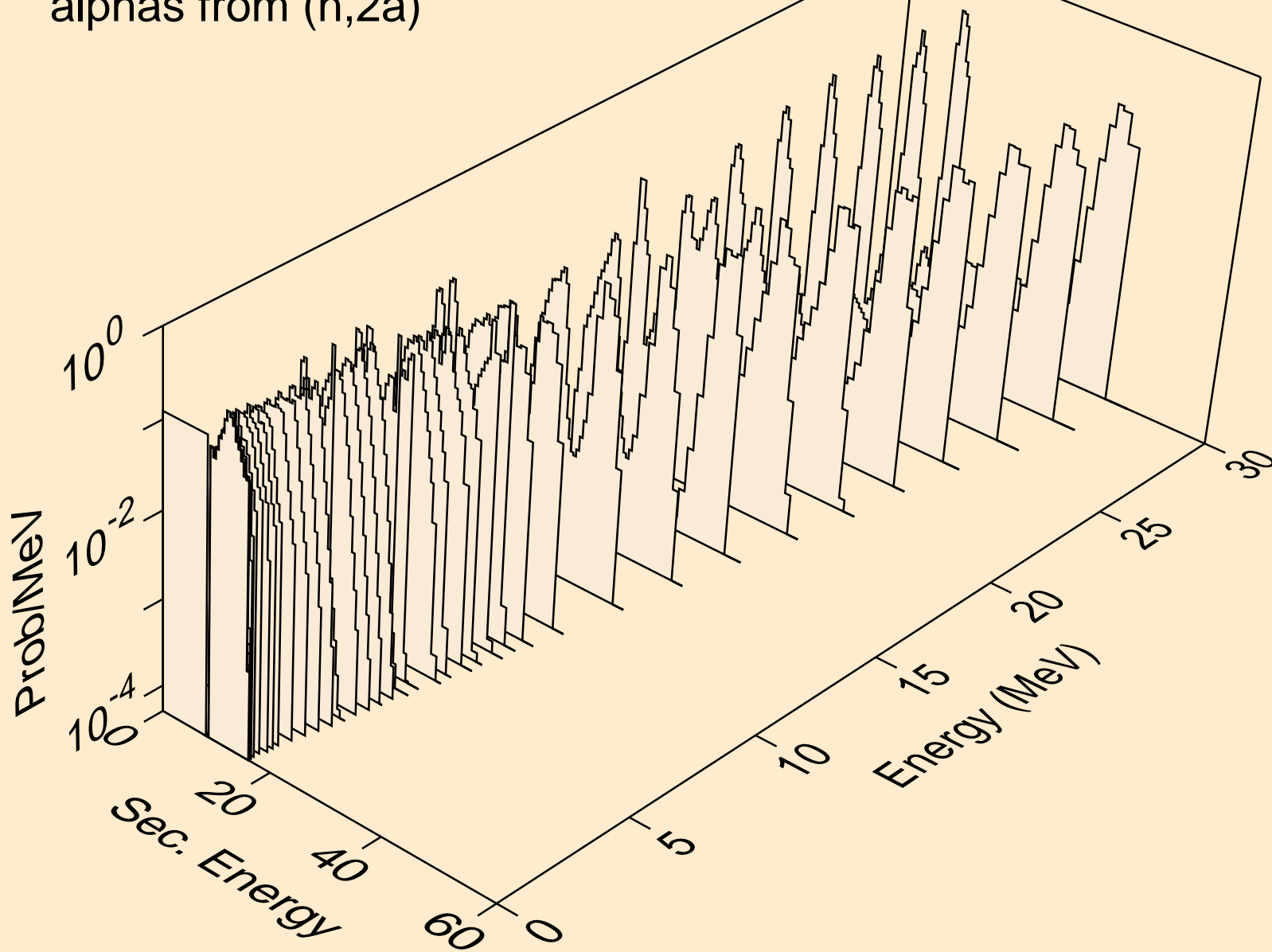

RF259 NEUTRON ACER TENDL-2019 LIBRARY; T=293.16K  
alphas from (n,pa)

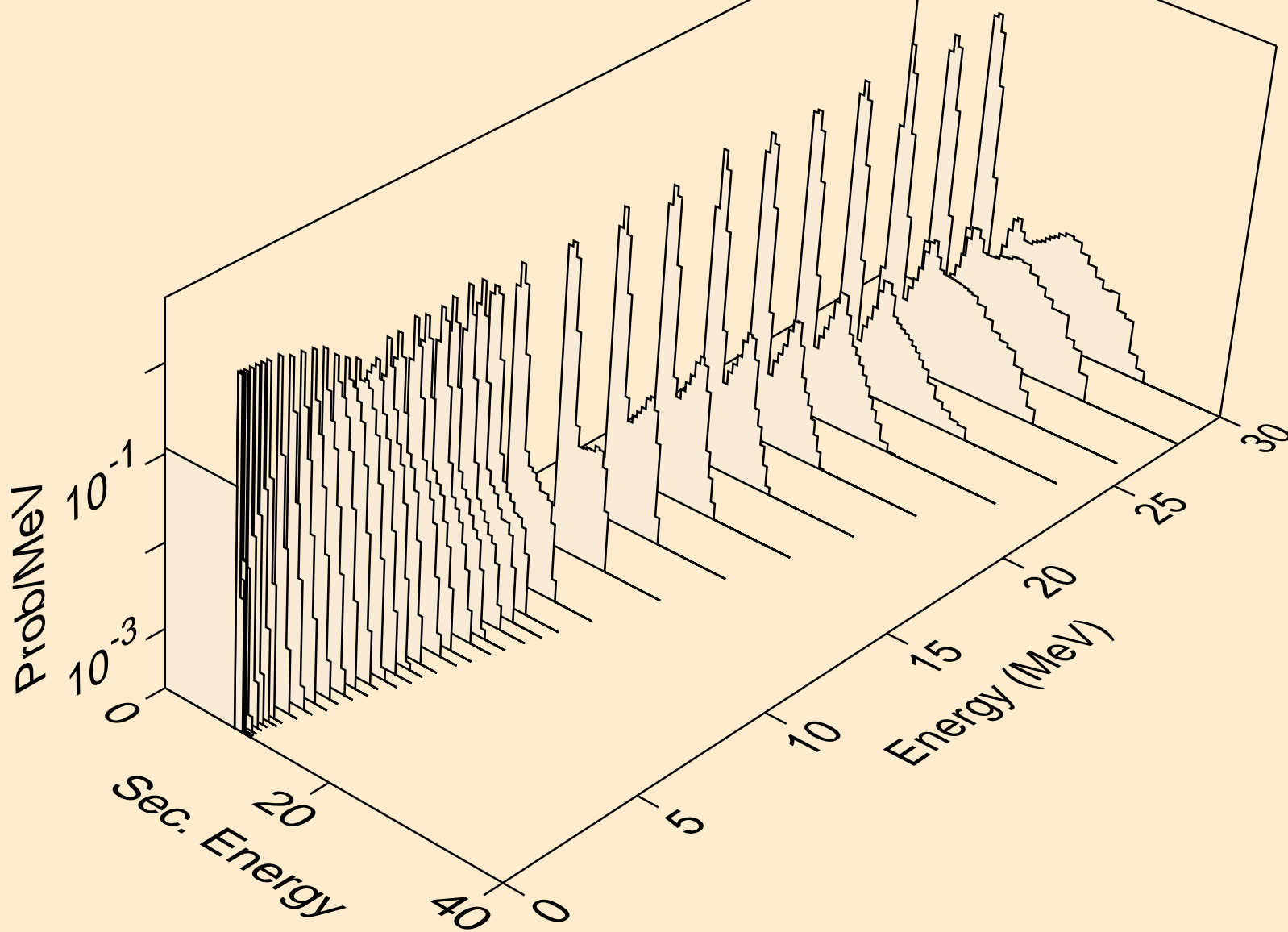

RF259 NEUTRON ACER TENDL-2019 LIBRARY; T=293.16K  
alphas from (n,da)

