

RF261 NEUTRON ACER TENDL-2019 LIBRARY; T=293.16K

Principal cross sections

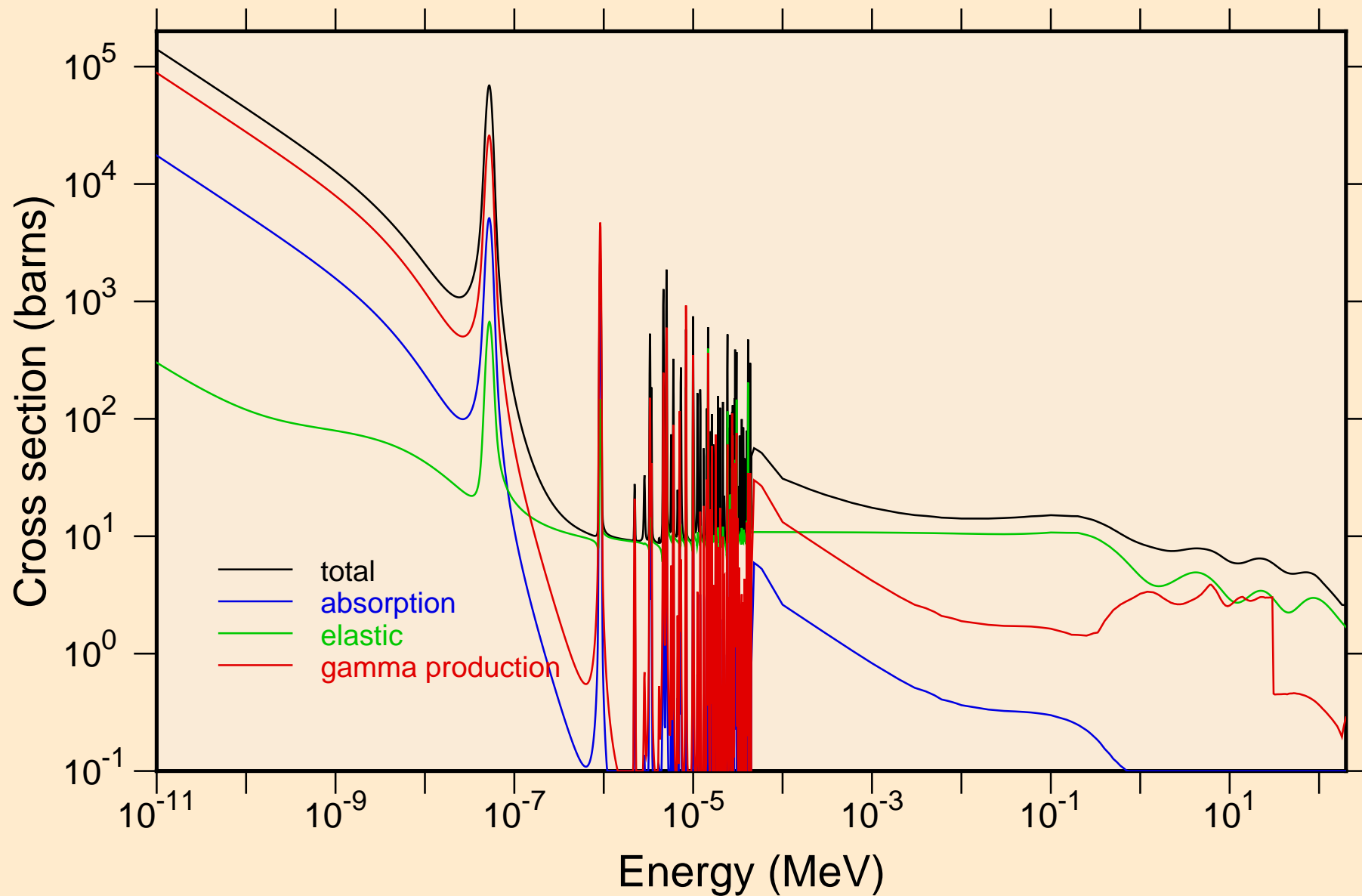

RF261 NEUTRON ACER TENDL-2019 LIBRARY; T=293.16K
resonance total cross section

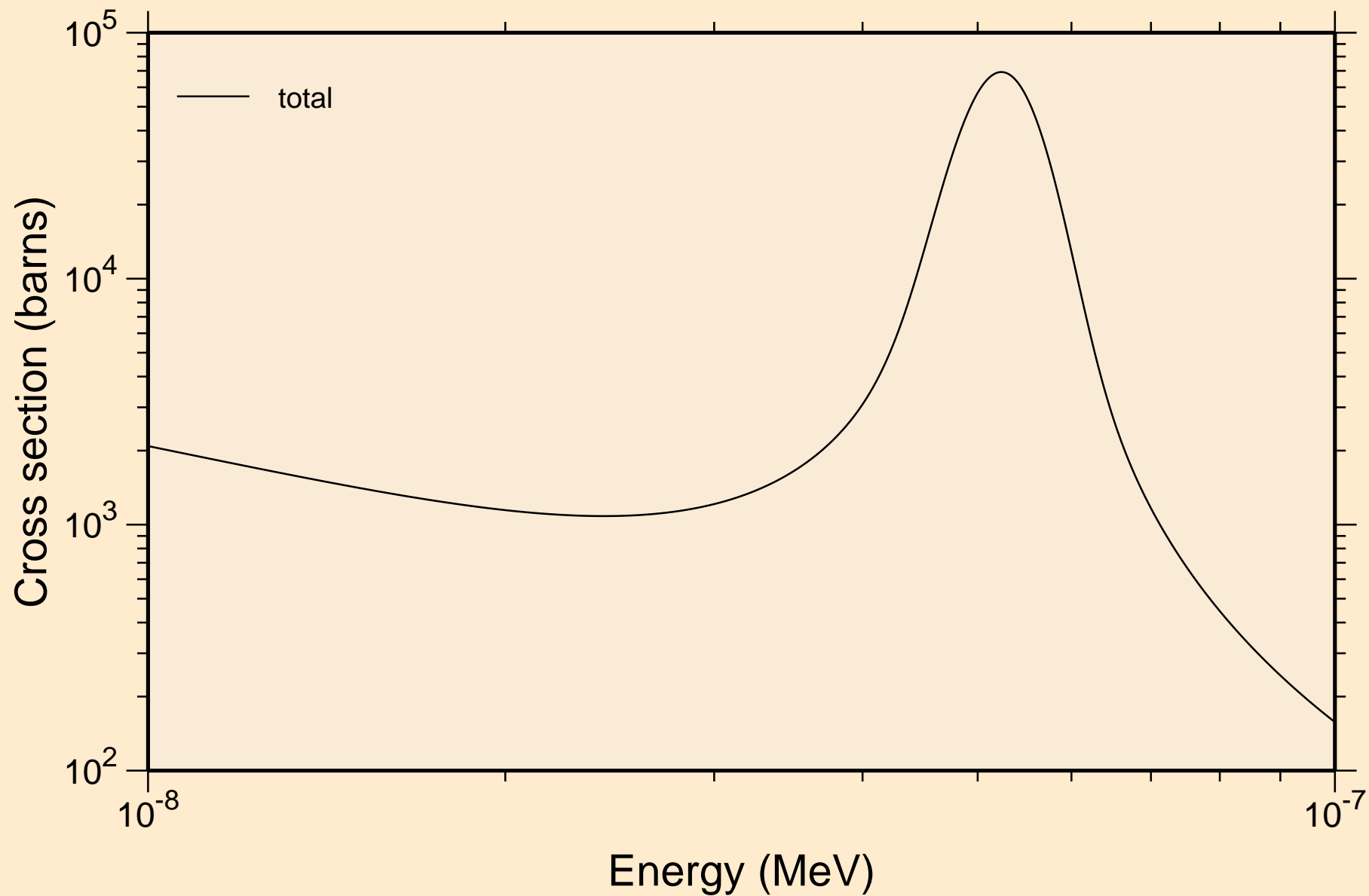

RF261 NEUTRON ACER TENDL-2019 LIBRARY; T=293.16K
resonance total cross section

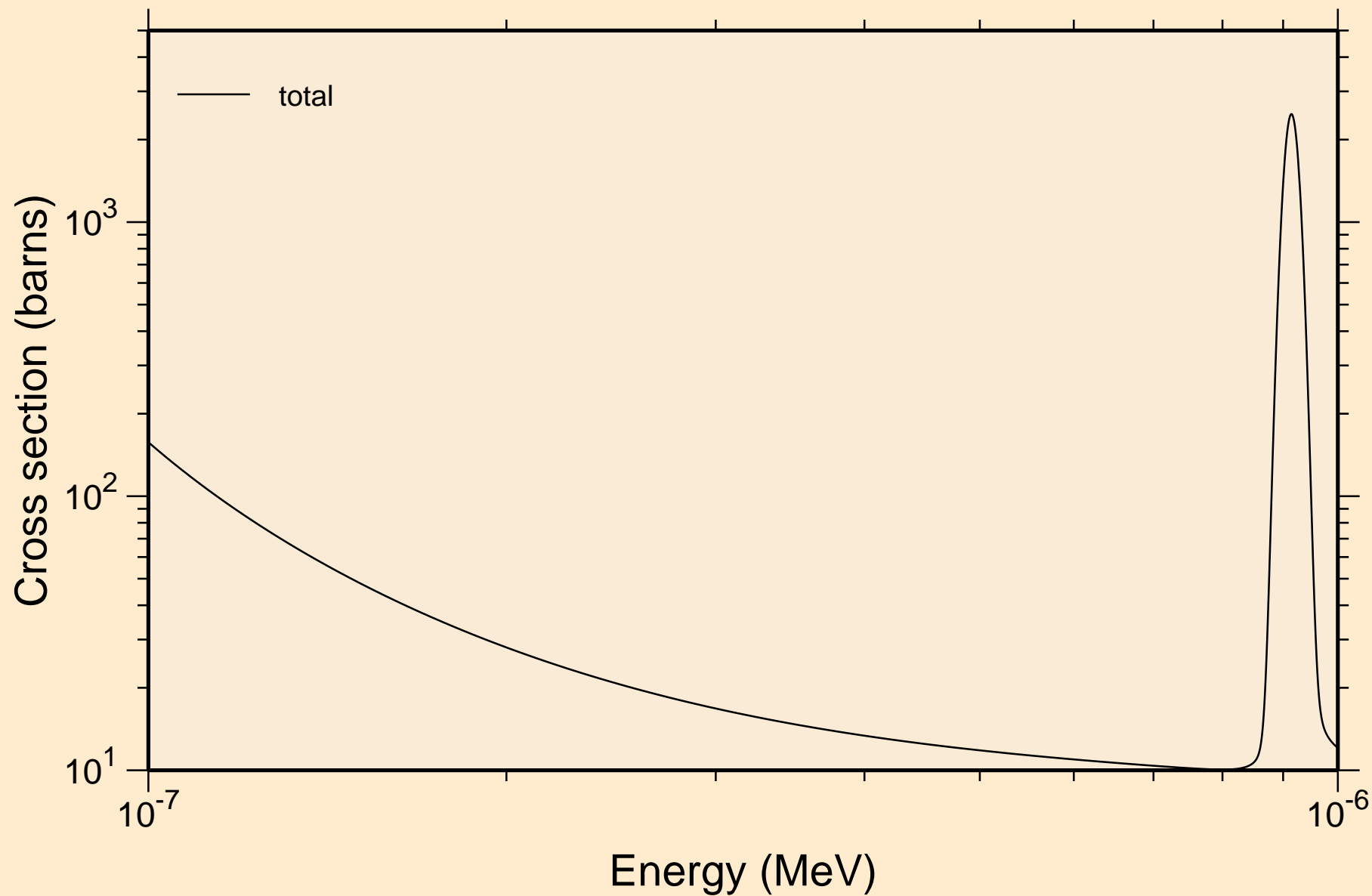

RF261 NEUTRON ACER TENDL-2019 LIBRARY; T=293.16K
resonance total cross section

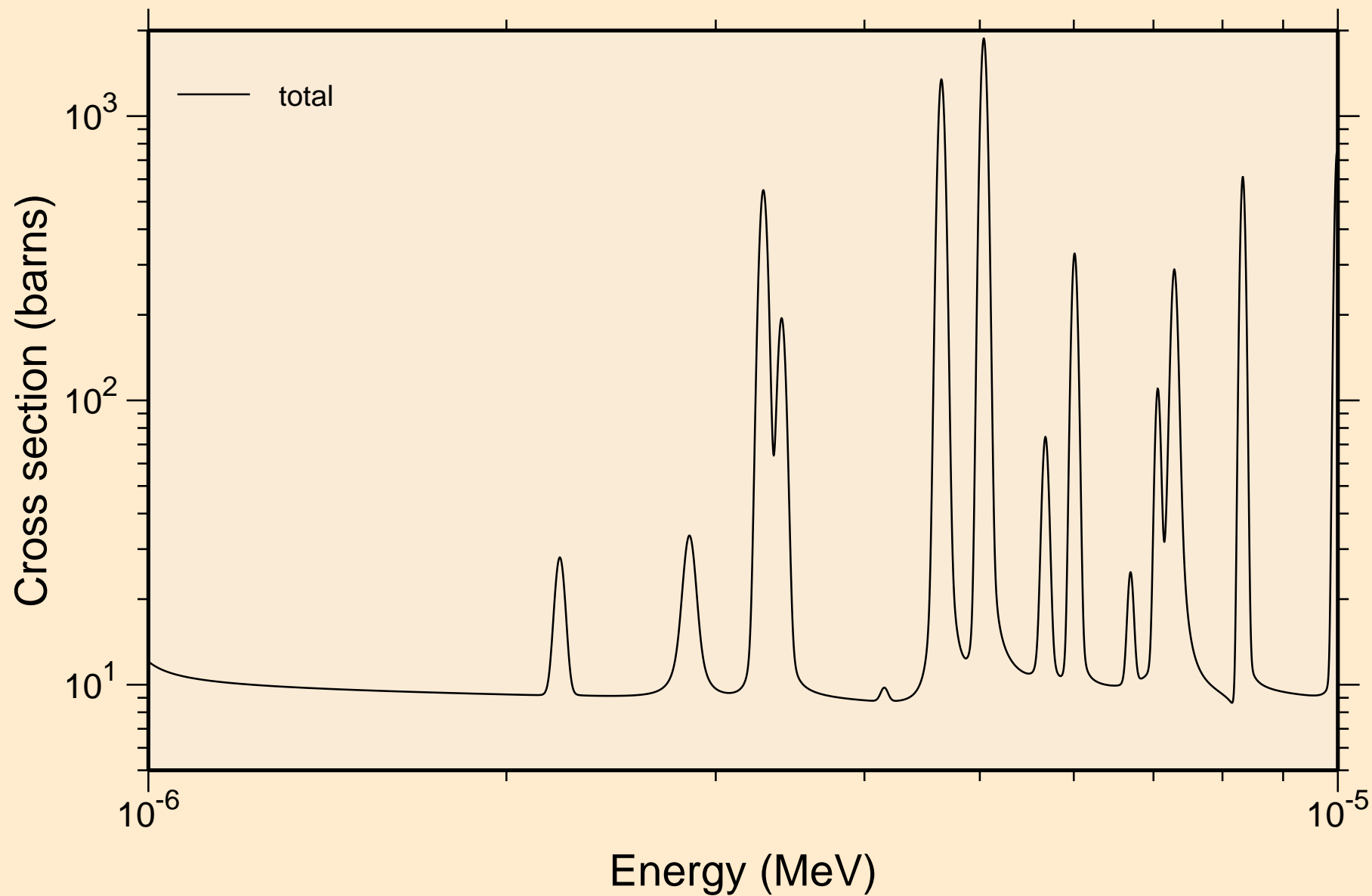

RF261 NEUTRON ACER TENDL-2019 LIBRARY; T=293.16K
resonance total cross section

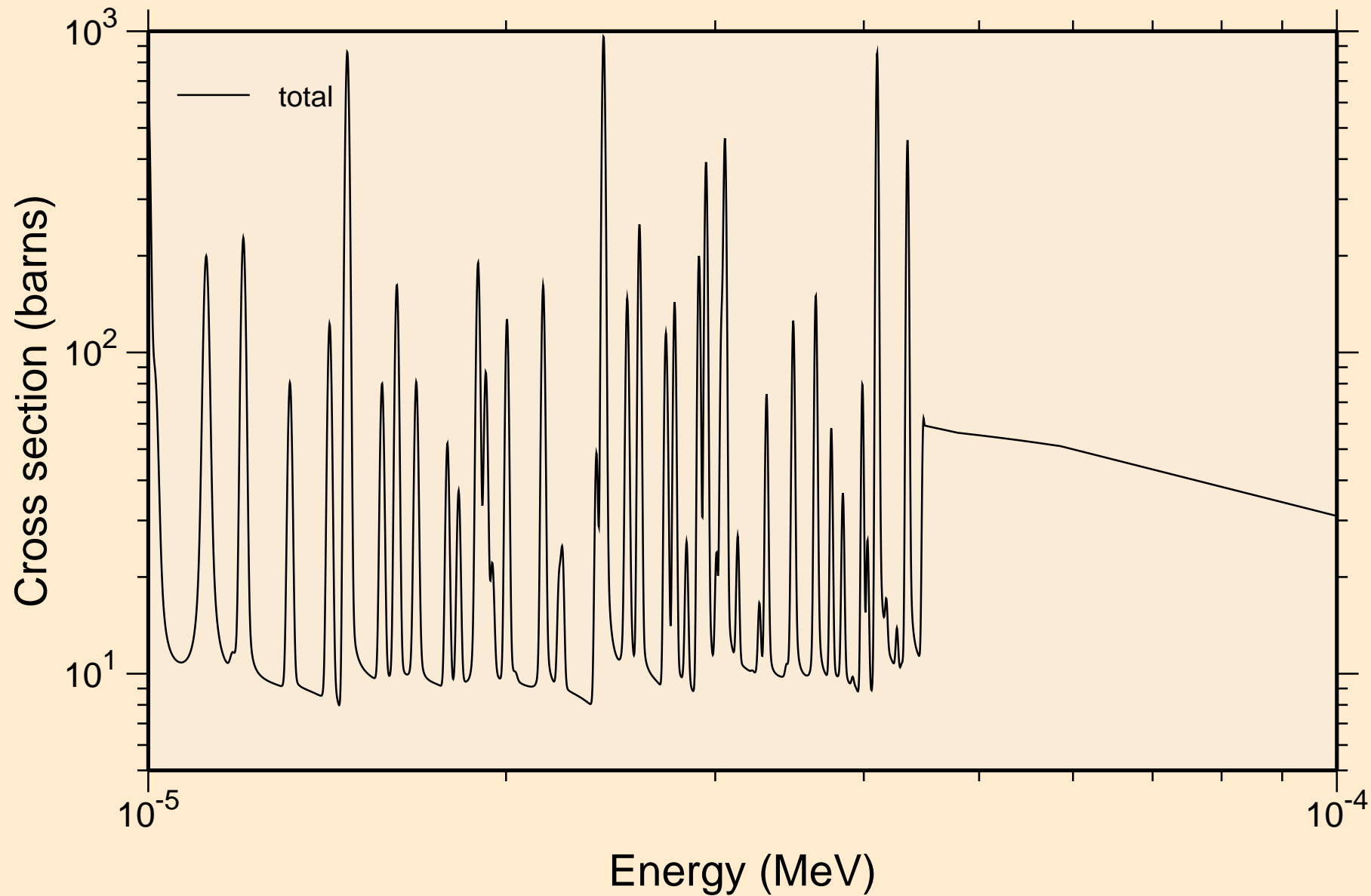

RF261 NEUTRON ACER TENDL-2019 LIBRARY; T=293.16K
resonance total cross section

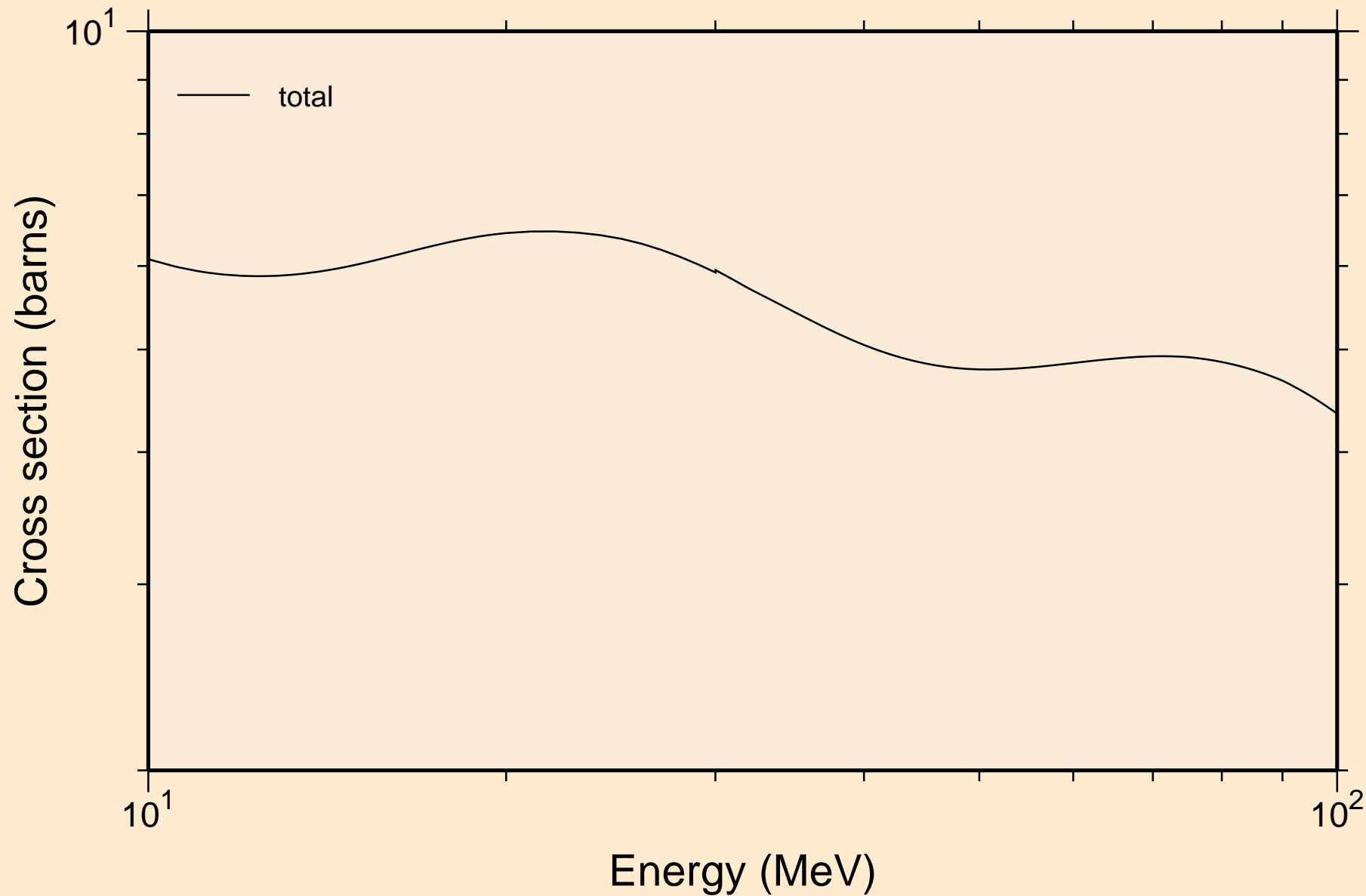

RF261 NEUTRON ACER TENDL-2019 LIBRARY; T=293.16K
resonance absorption cross sections

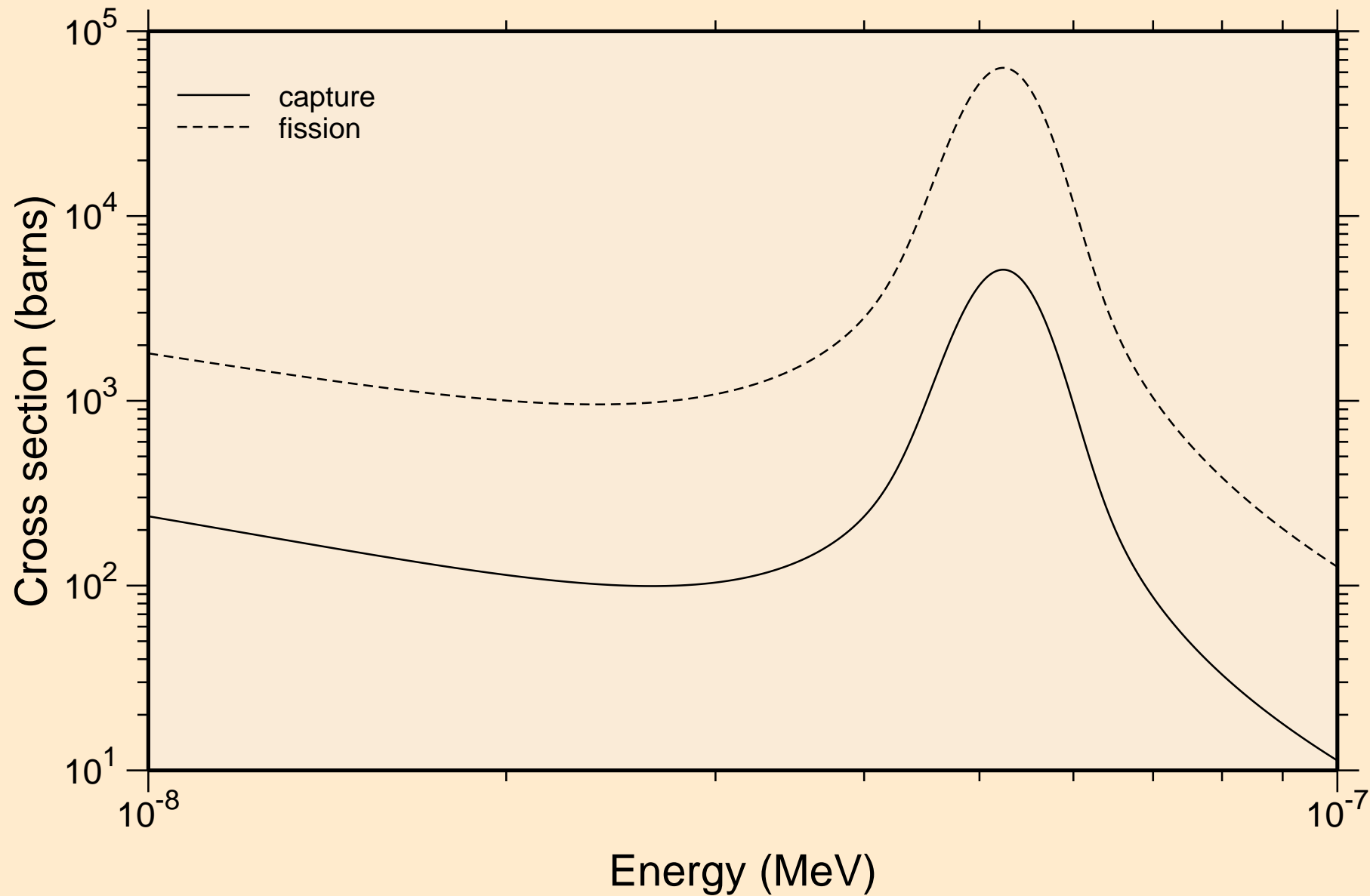

RF261 NEUTRON ACER TENDL-2019 LIBRARY; T=293.16K
resonance absorption cross sections

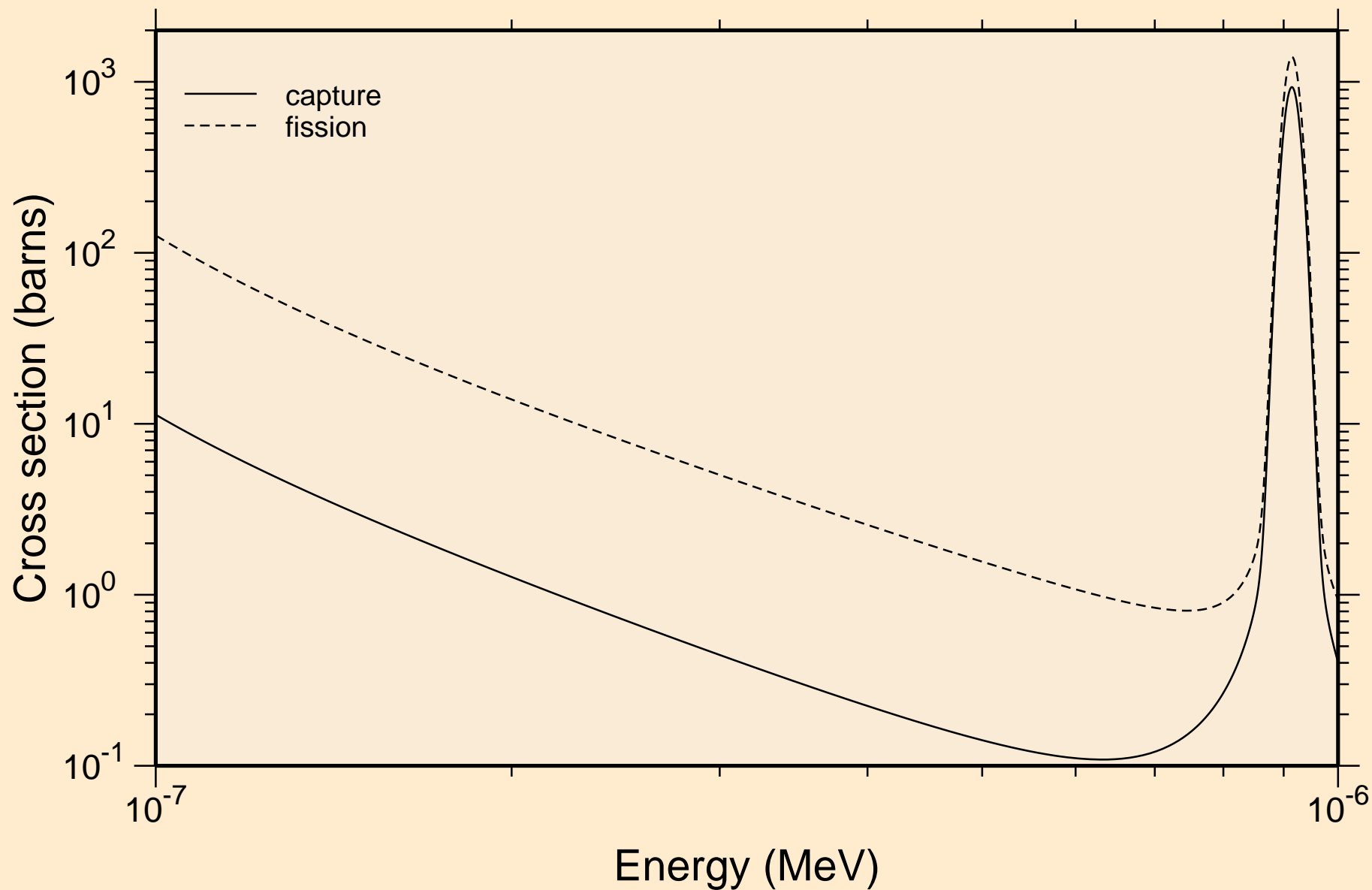

RF261 NEUTRON ACER TENDL-2019 LIBRARY; T=293.16K
resonance absorption cross sections

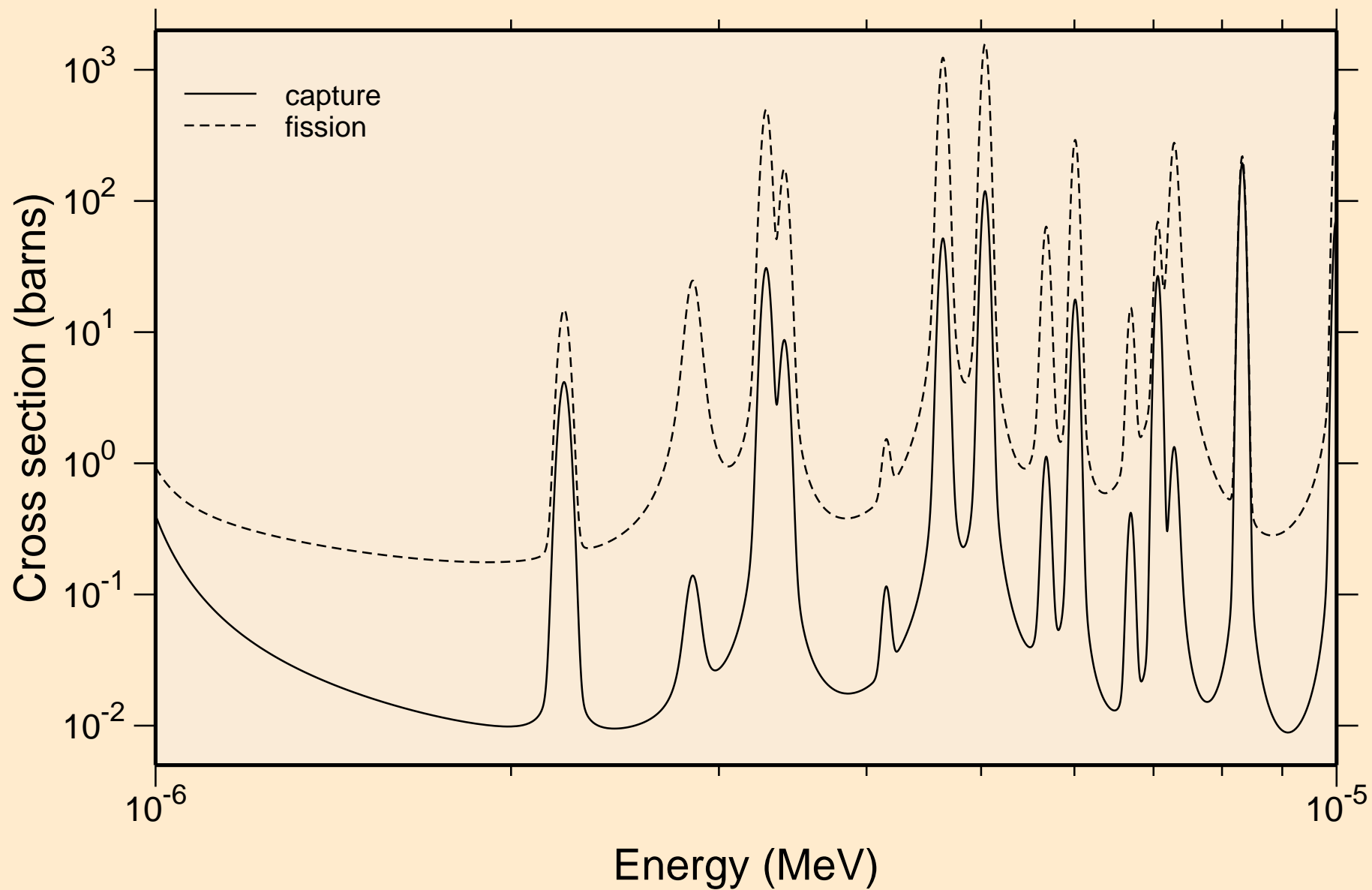

RF261 NEUTRON ACER TENDL-2019 LIBRARY; T=293.16K
resonance absorption cross sections

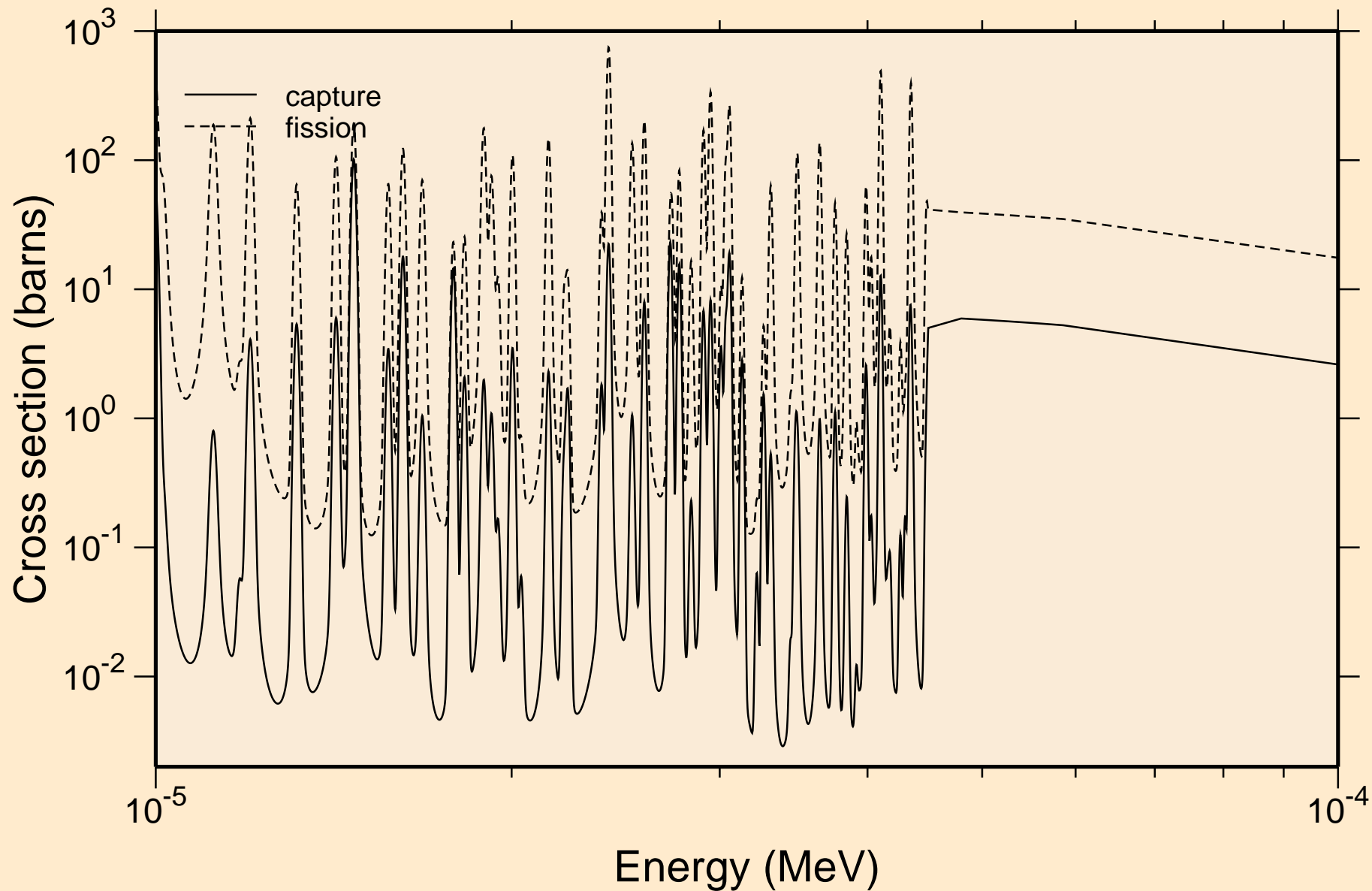

RF261 NEUTRON ACER TENDL-2019 LIBRARY; T=293.16K
resonance absorption cross sections

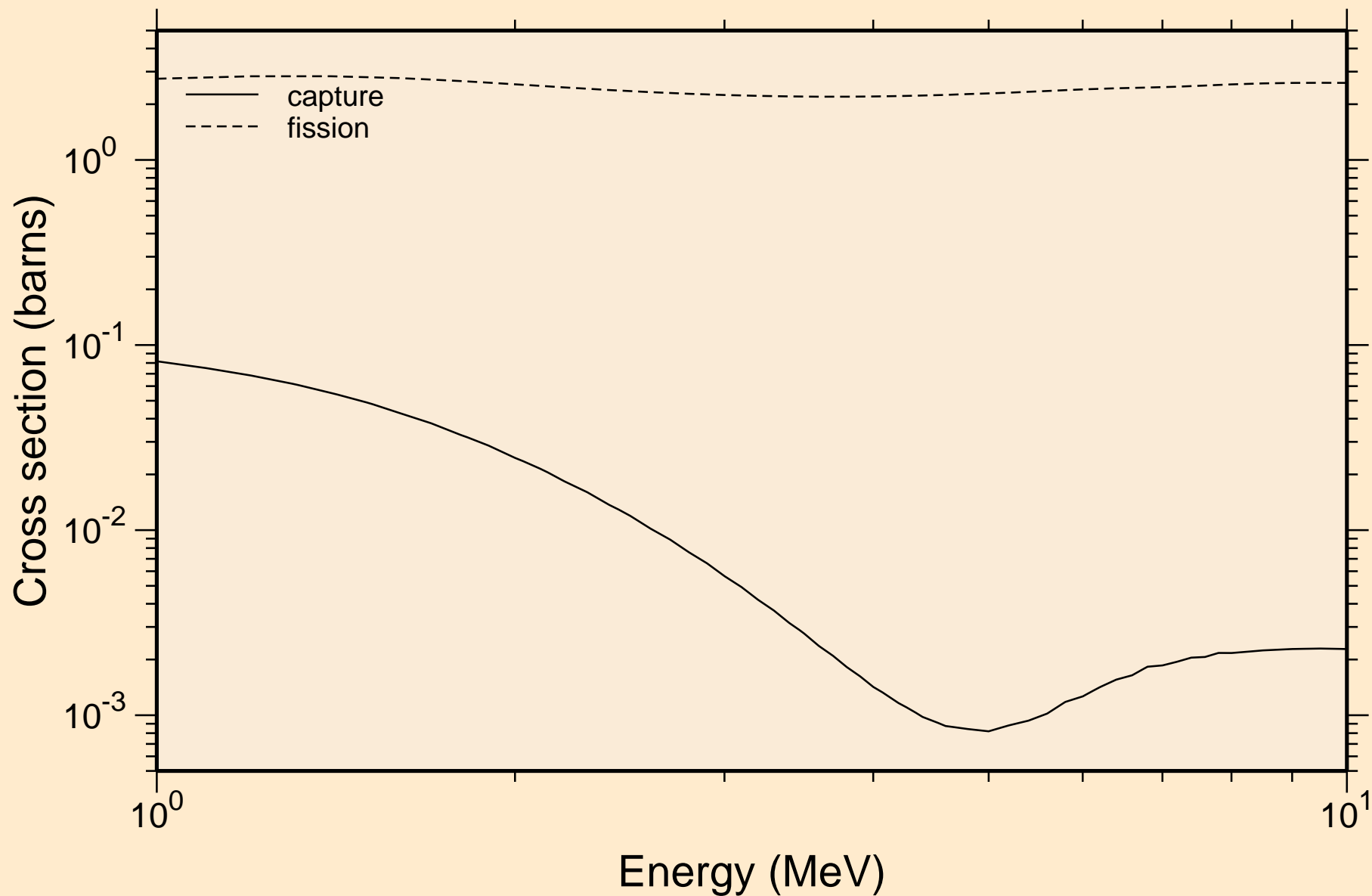

RF261 NEUTRON ACER TENDL-2019 LIBRARY; T=293.16K
Heating

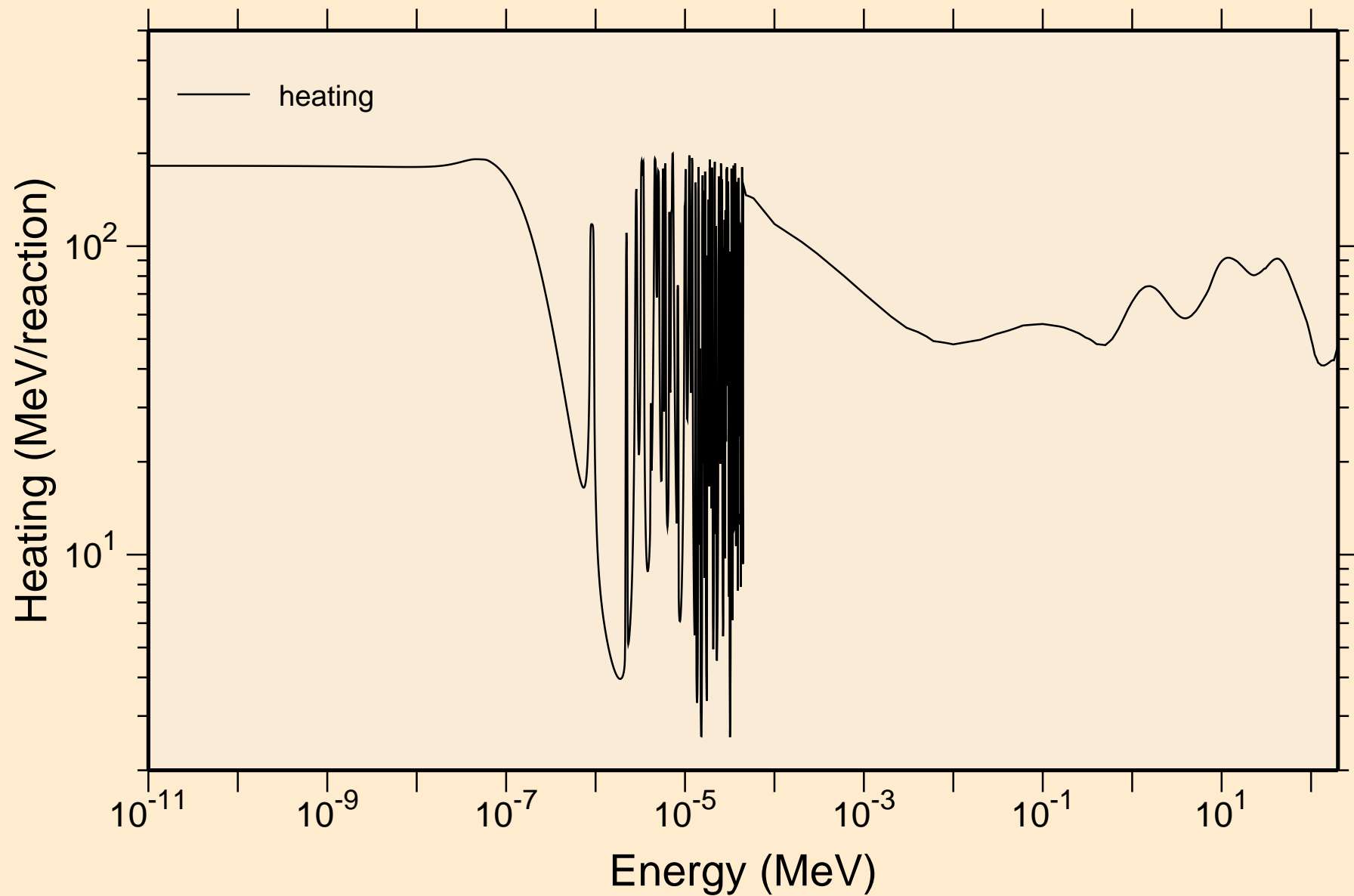

RF261 NEUTRON ACER TENDL-2019 LIBRARY; T=293.16K
Damage

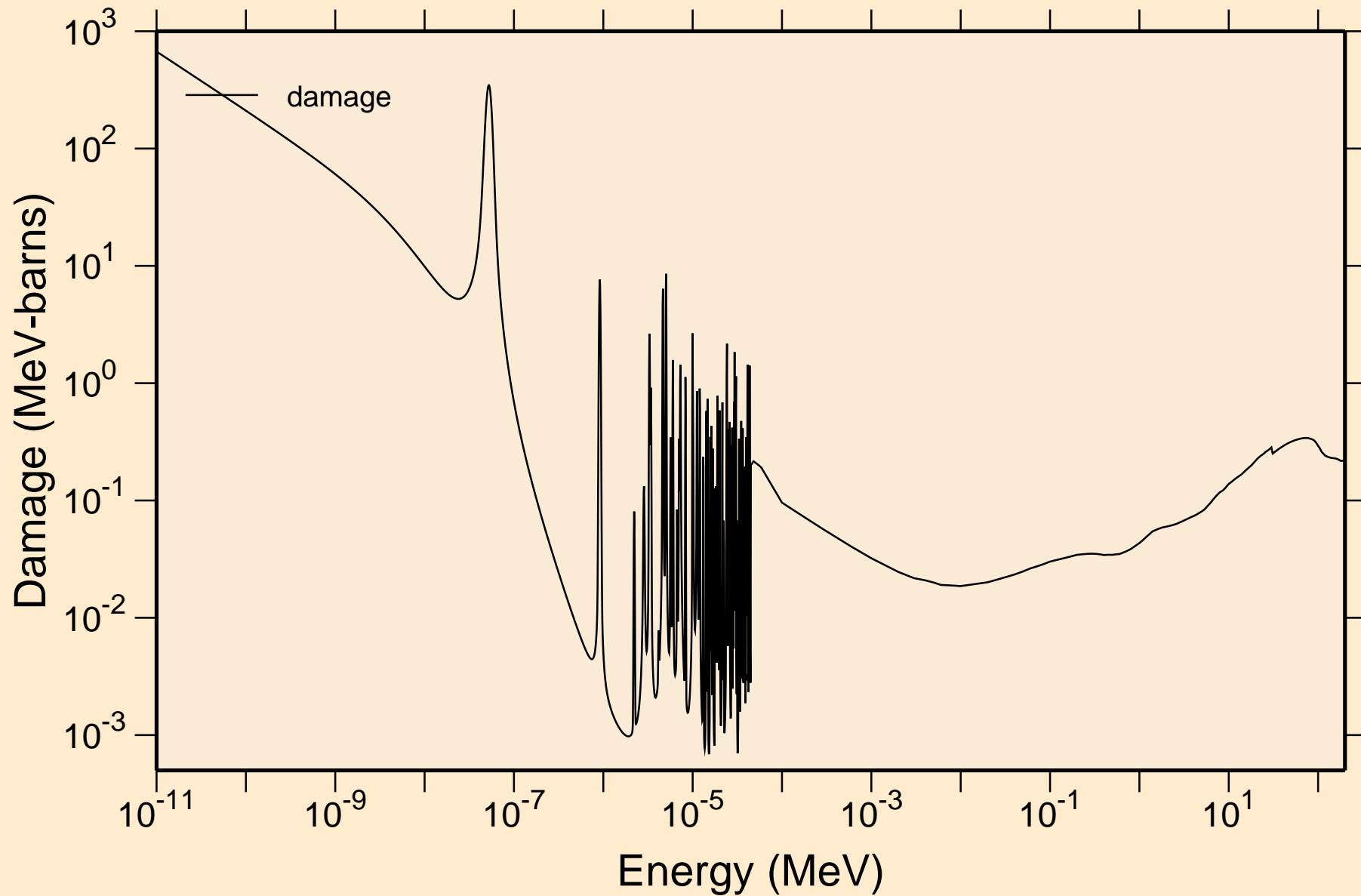

RF261 NEUTRON ACER TENDL-2019 LIBRARY; T=293.16K
Non-threshold reactions

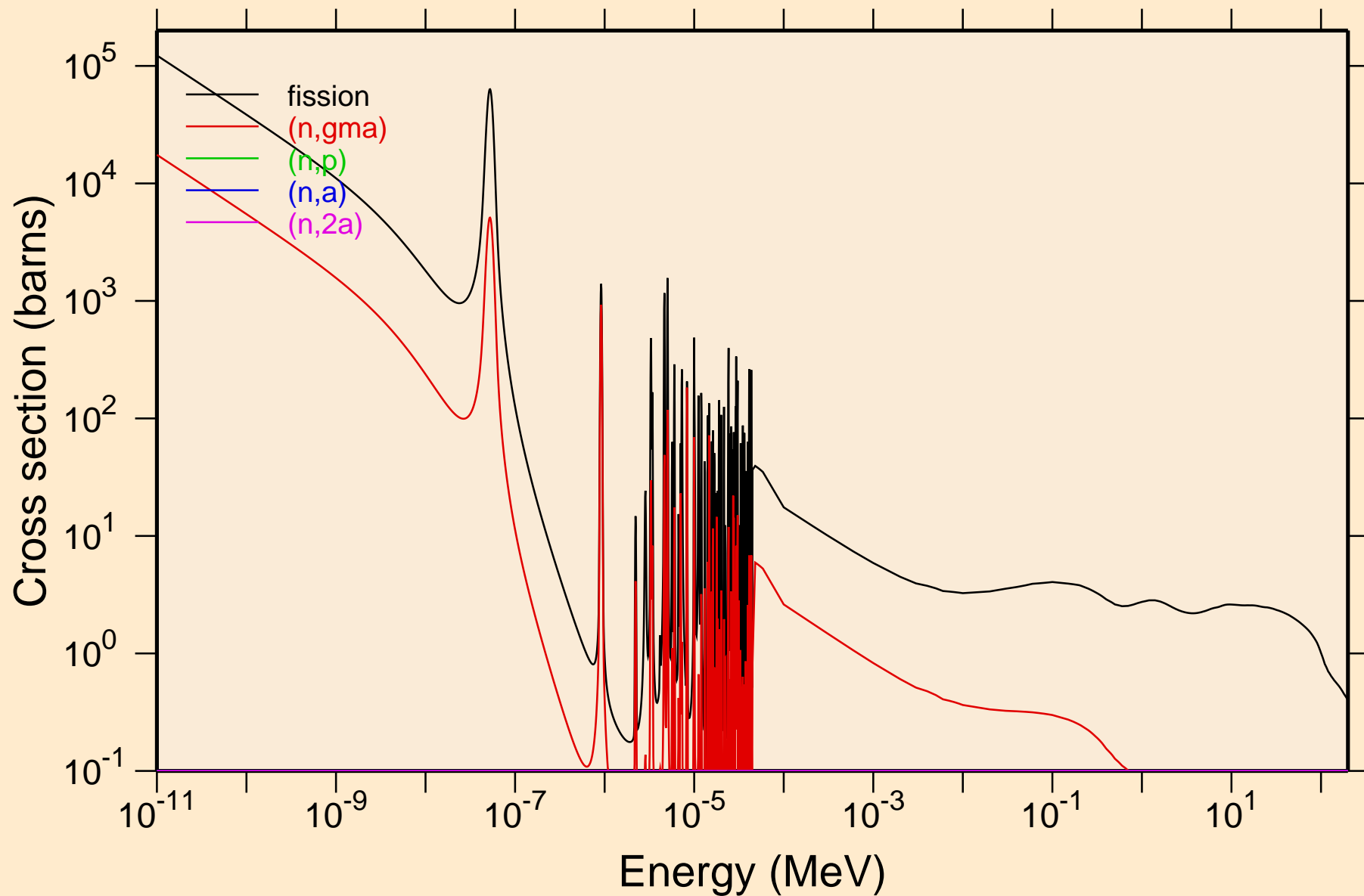

RF261 NEUTRON ACER TENDL-2019 LIBRARY; T=293.16K
Non-threshold reactions

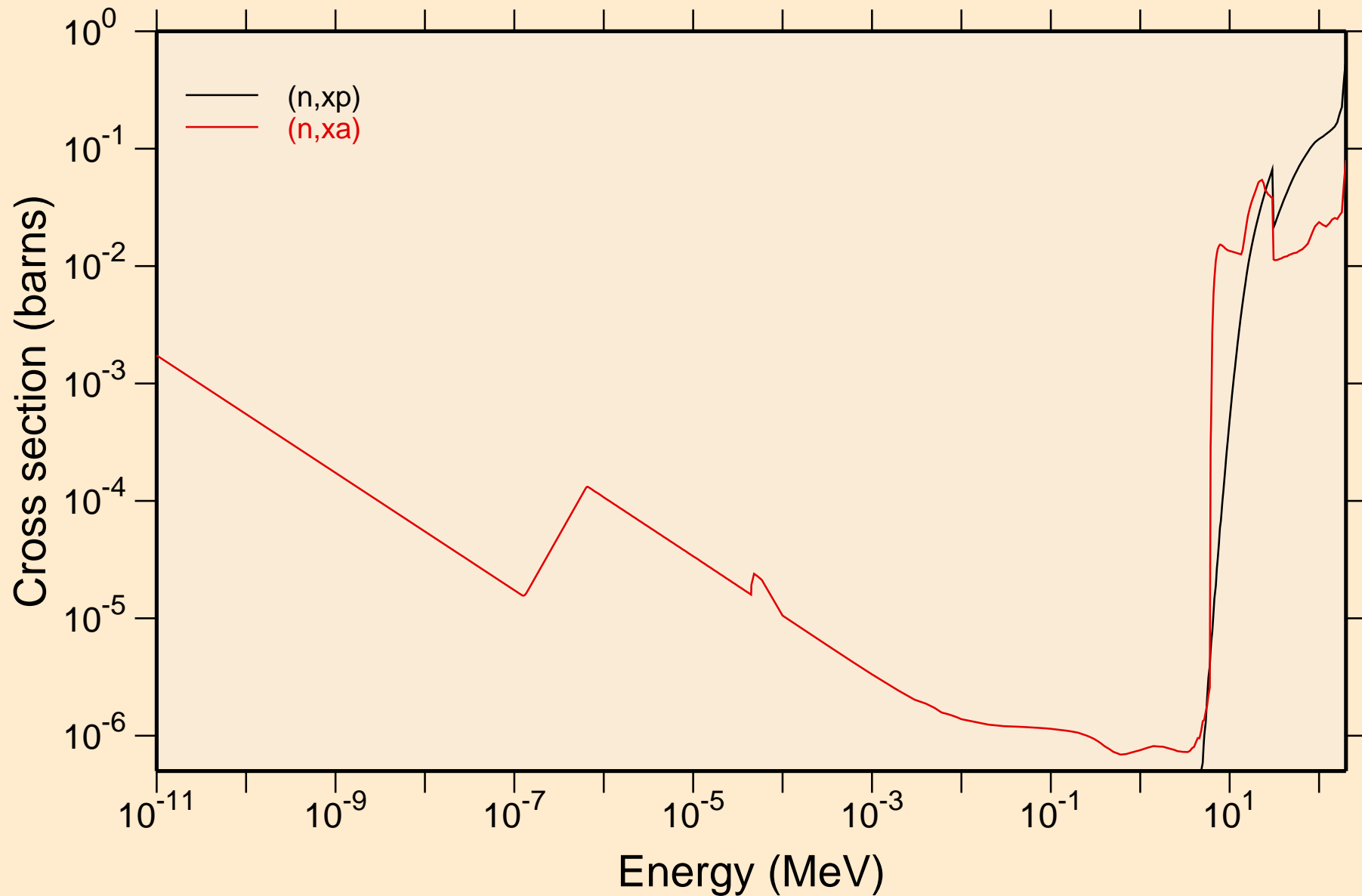

RF261 NEUTRON ACER TENDL-2019 LIBRARY; T=293.16K

Principal cross sections

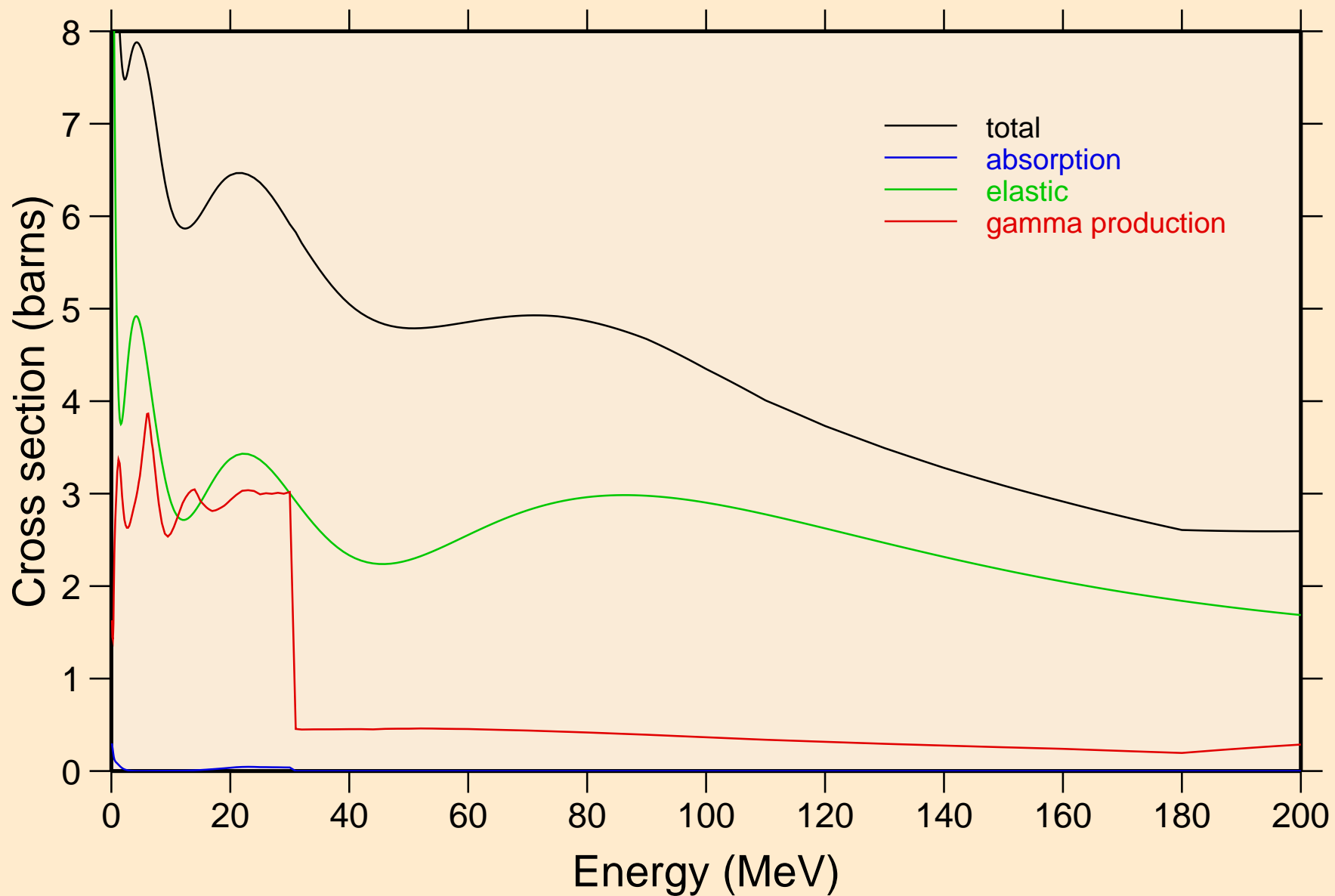

RF261 NEUTRON ACER TENDL-2019 LIBRARY; T=293.16K
Heating

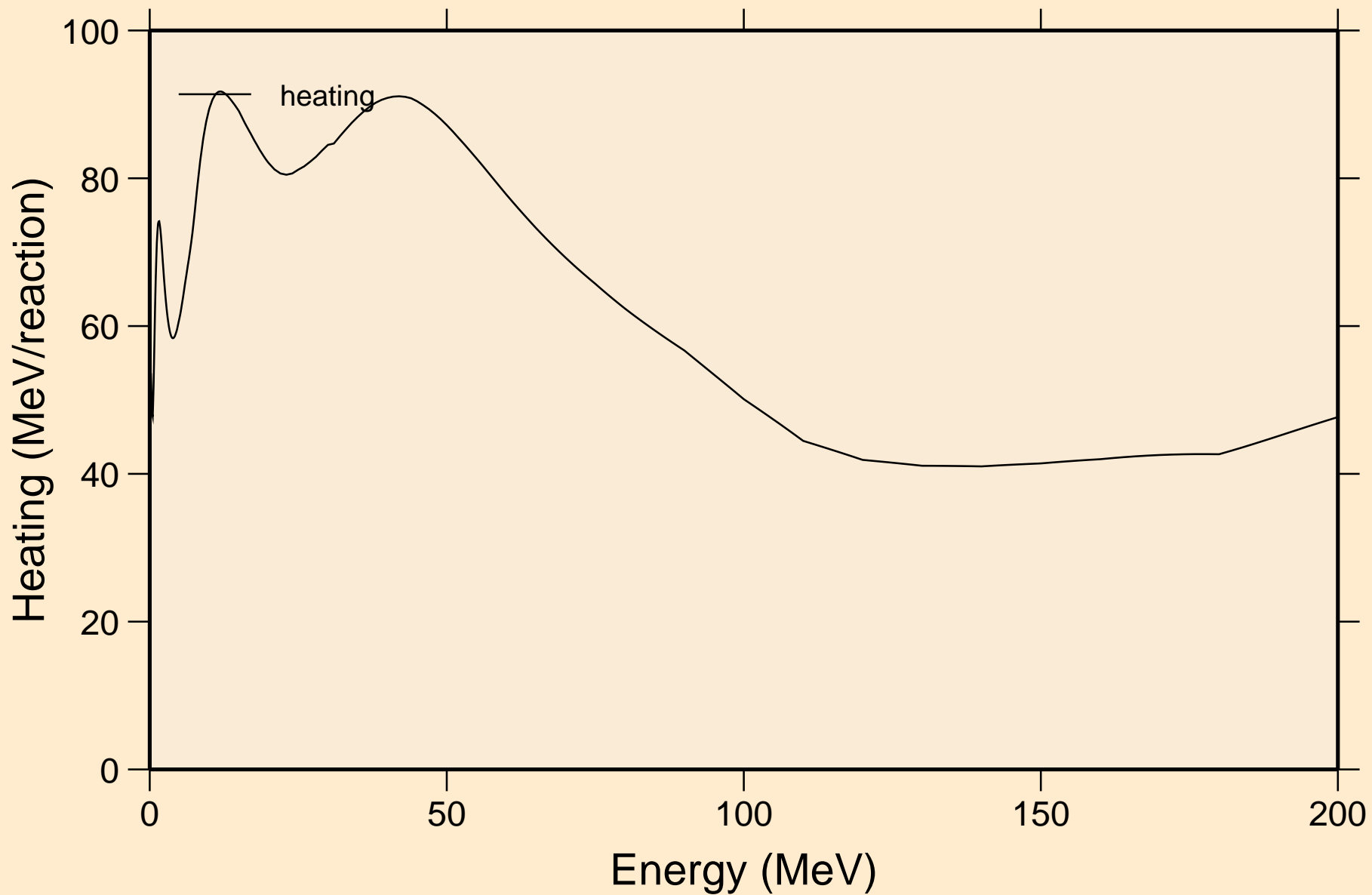

RF261 NEUTRON ACER TENDL-2019 LIBRARY; T=293.16K
Damage

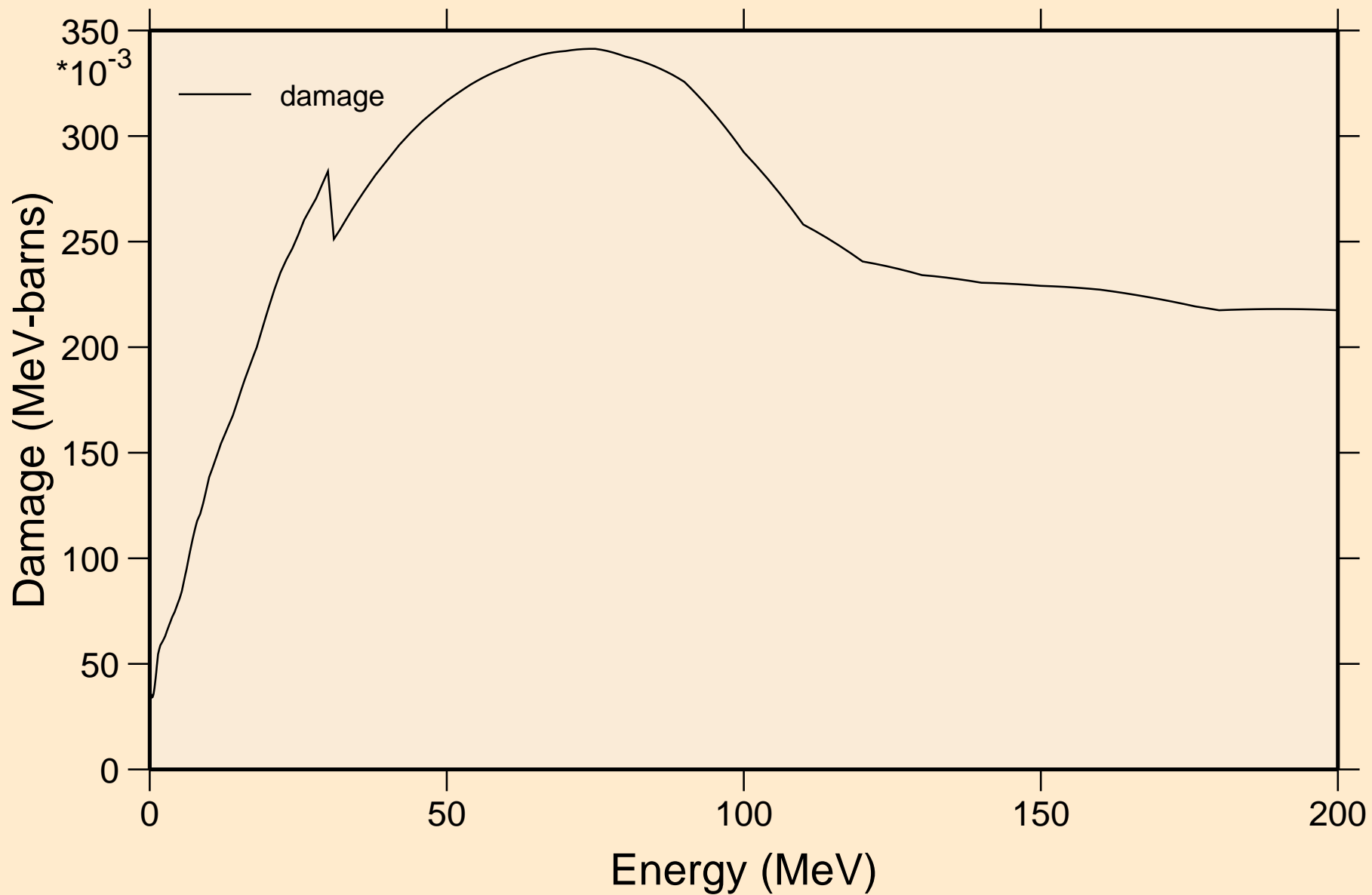

RF261 NEUTRON ACER TENDL-2019 LIBRARY; T=293.16K
Non-threshold reactions

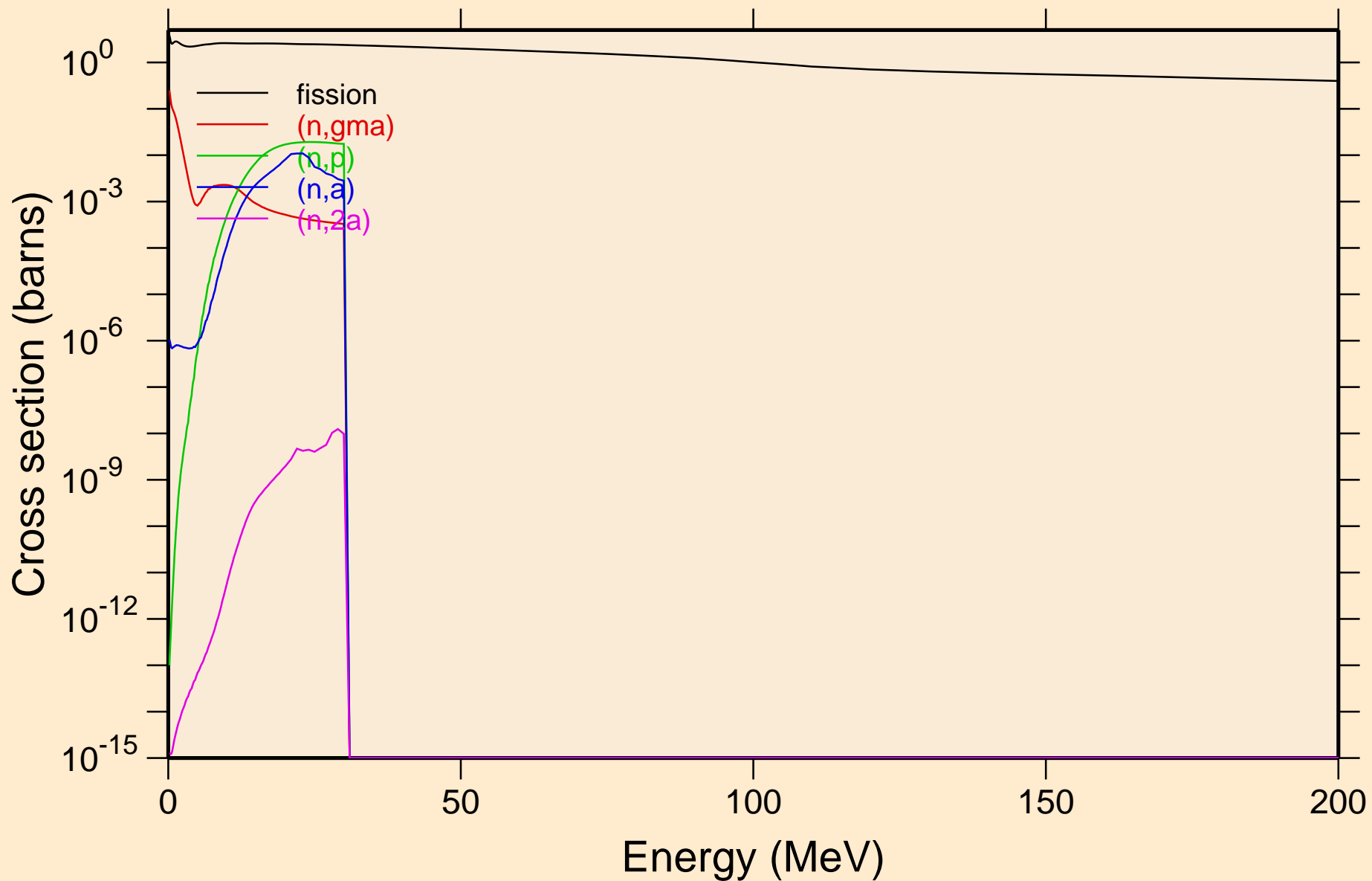

RF261 NEUTRON ACER TENDL-2019 LIBRARY; T=293.16K
Non-threshold reactions

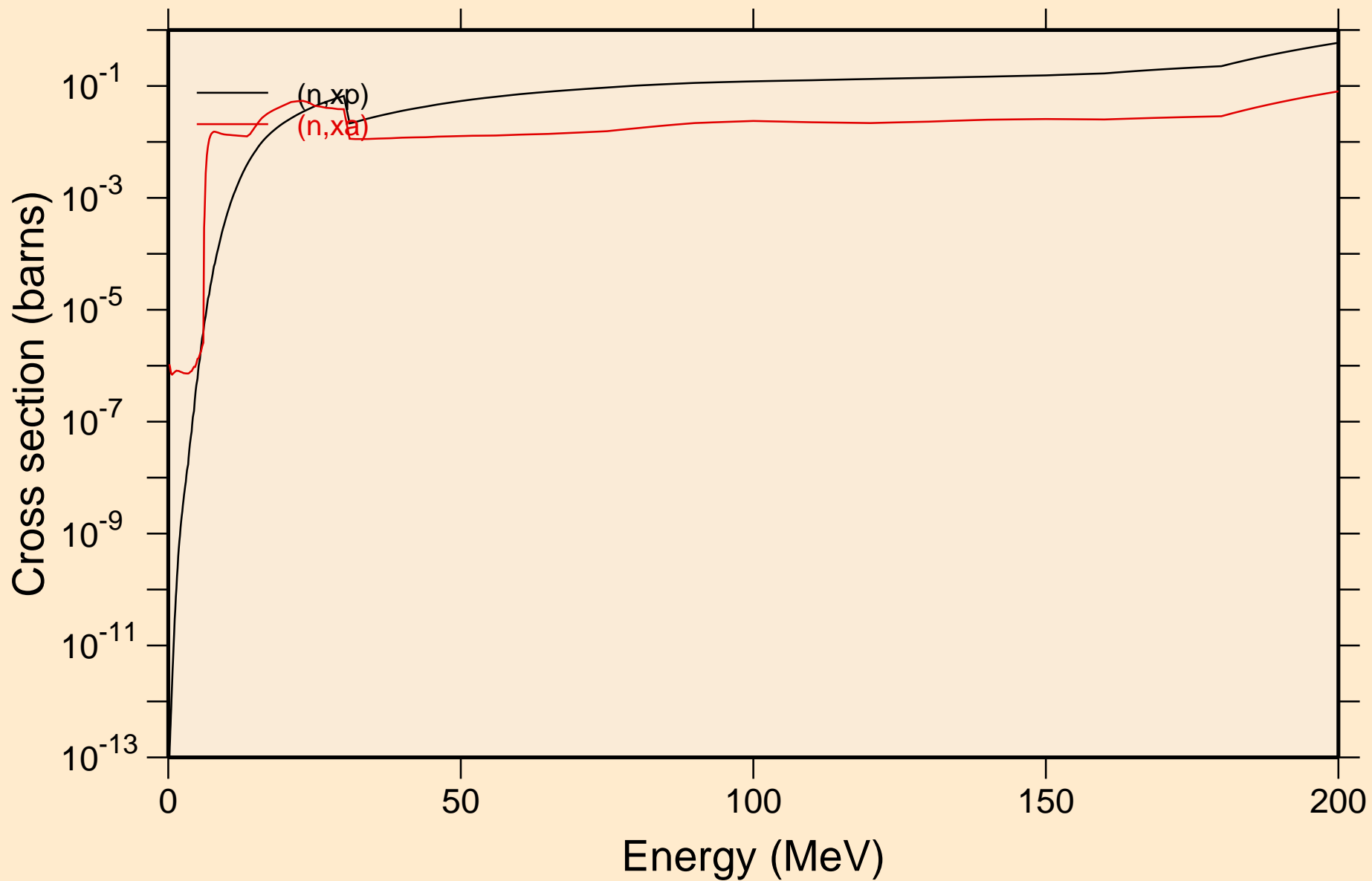

RF261 NEUTRON ACER TENDL-2019 LIBRARY; T=293.16K
Inelastic levels

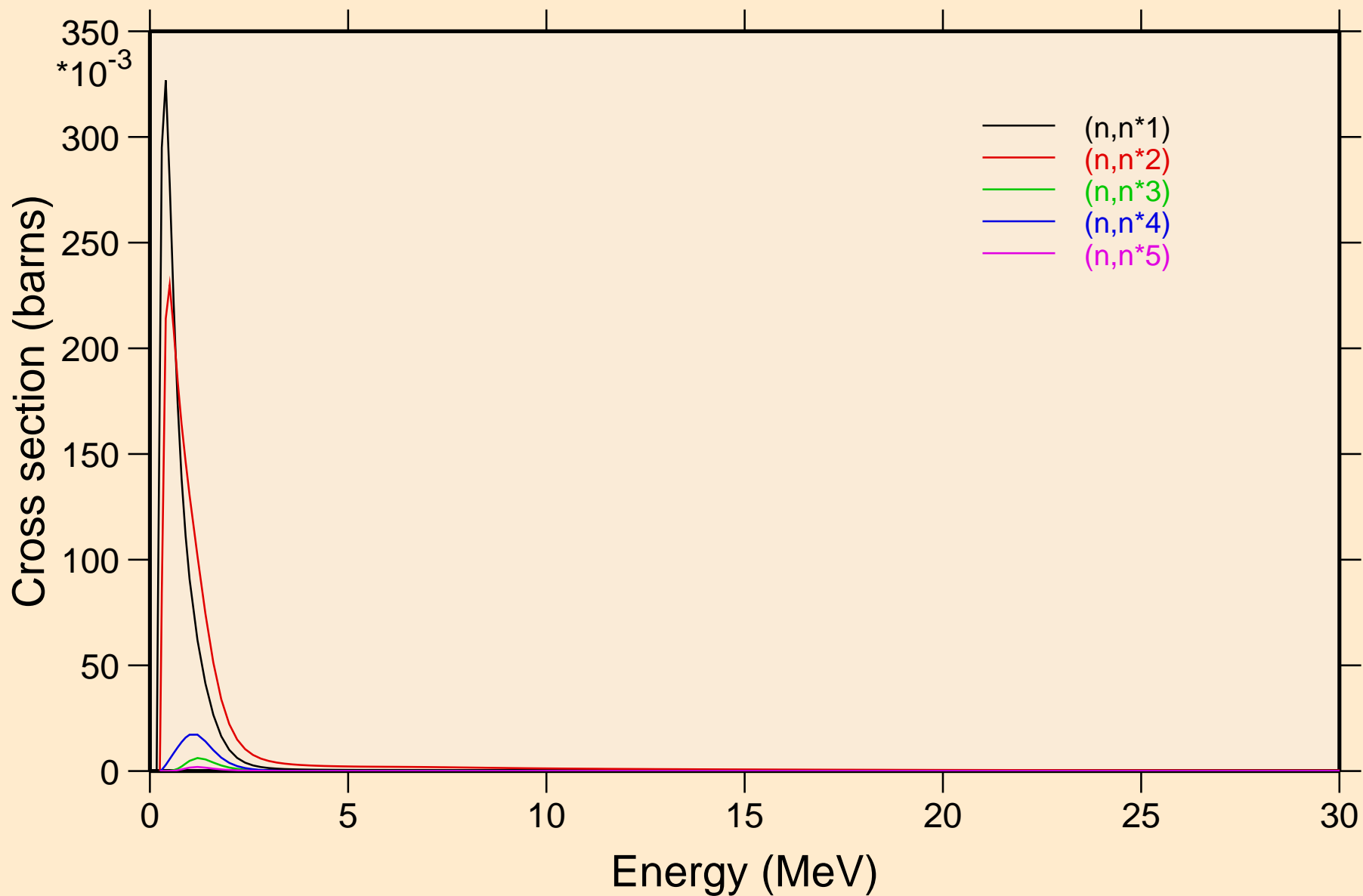

RF261 NEUTRON ACER TENDL-2019 LIBRARY; T=293.16K
Inelastic levels

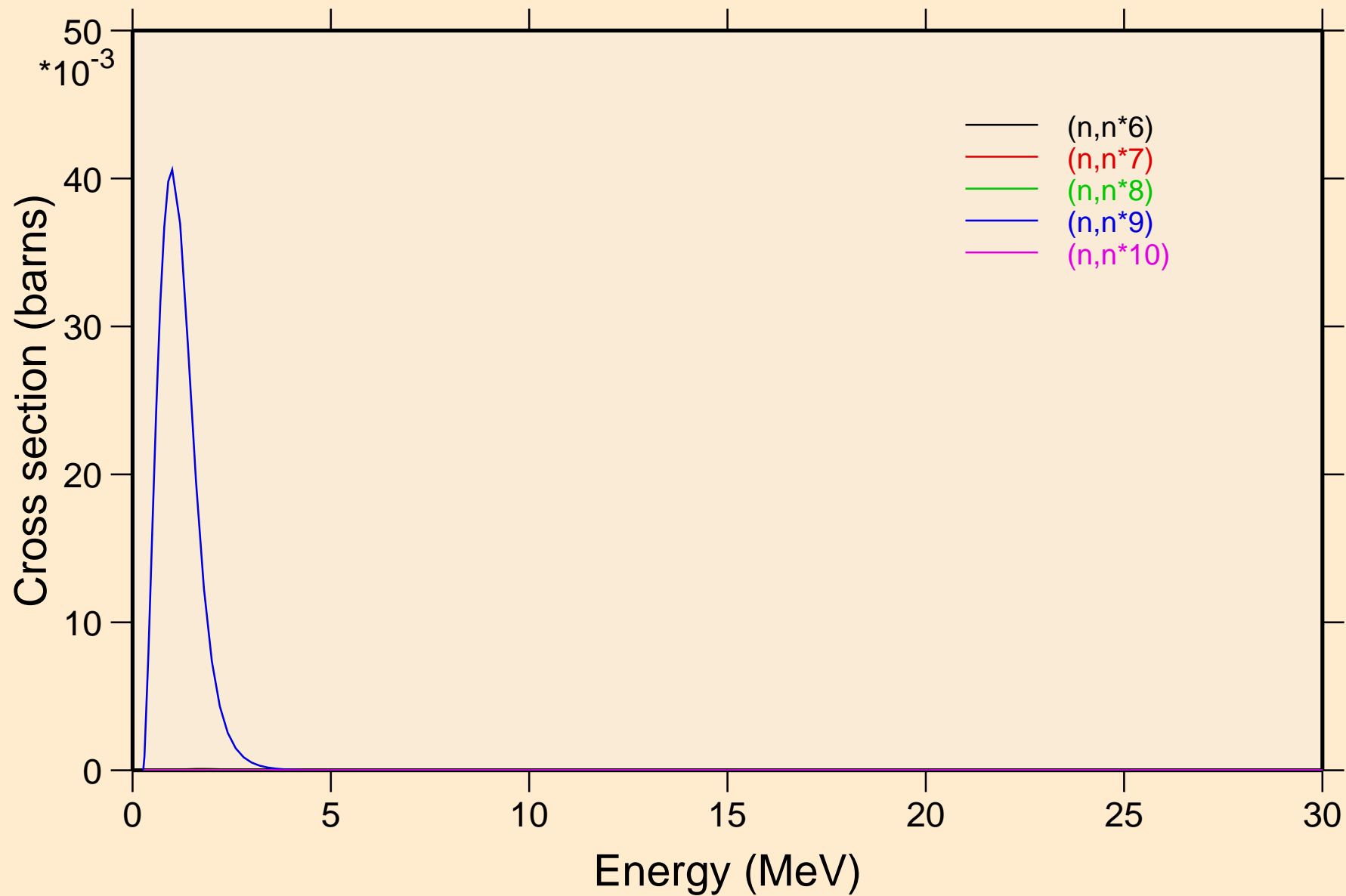

RF261 NEUTRON ACER TENDL-2019 LIBRARY; T=293.16K
Inelastic levels

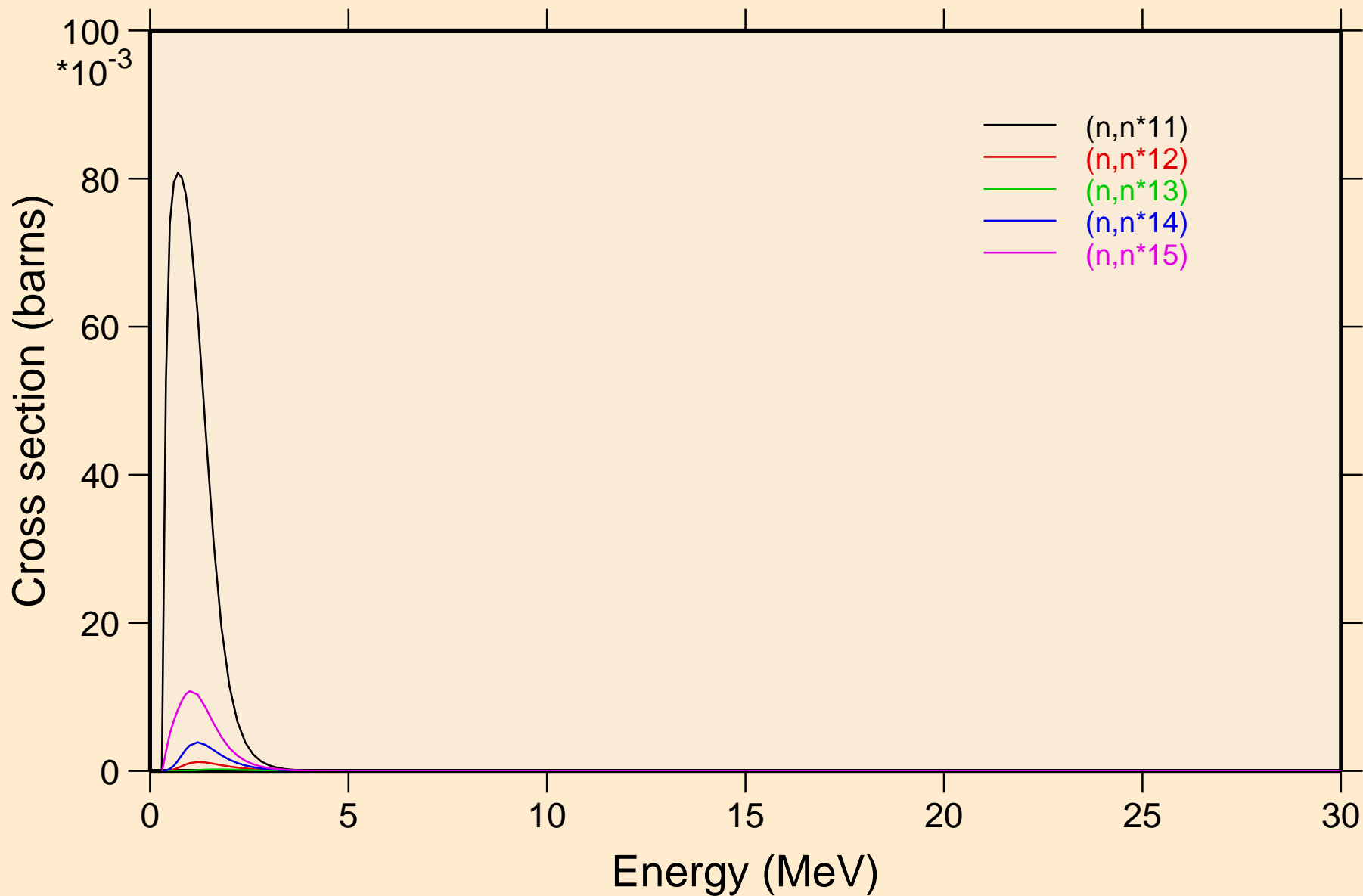

RF261 NEUTRON ACER TENDL-2019 LIBRARY; T=293.16K
Inelastic levels

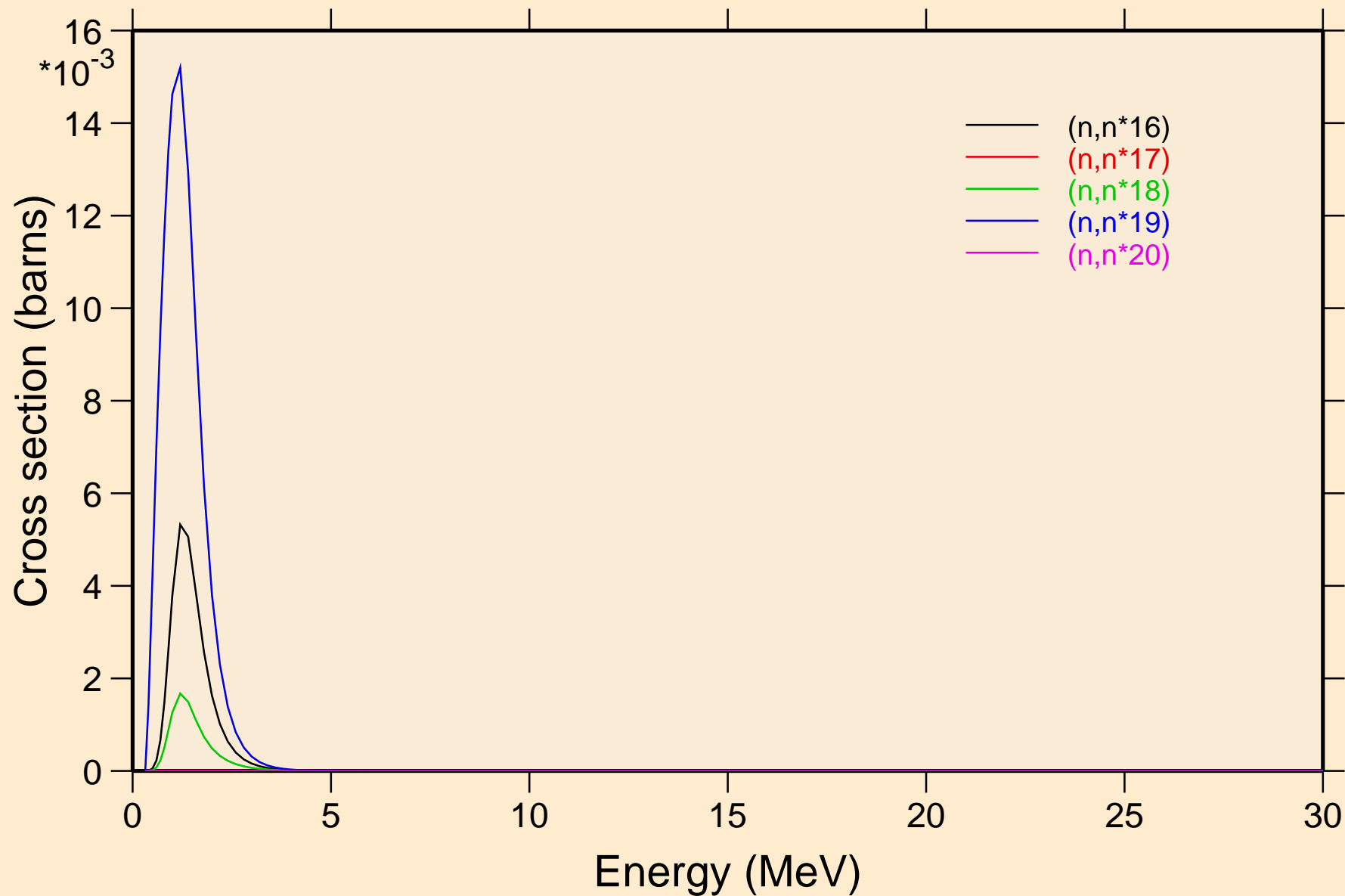

RF261 NEUTRON ACER TENDL-2019 LIBRARY; T=293.16K
Inelastic levels

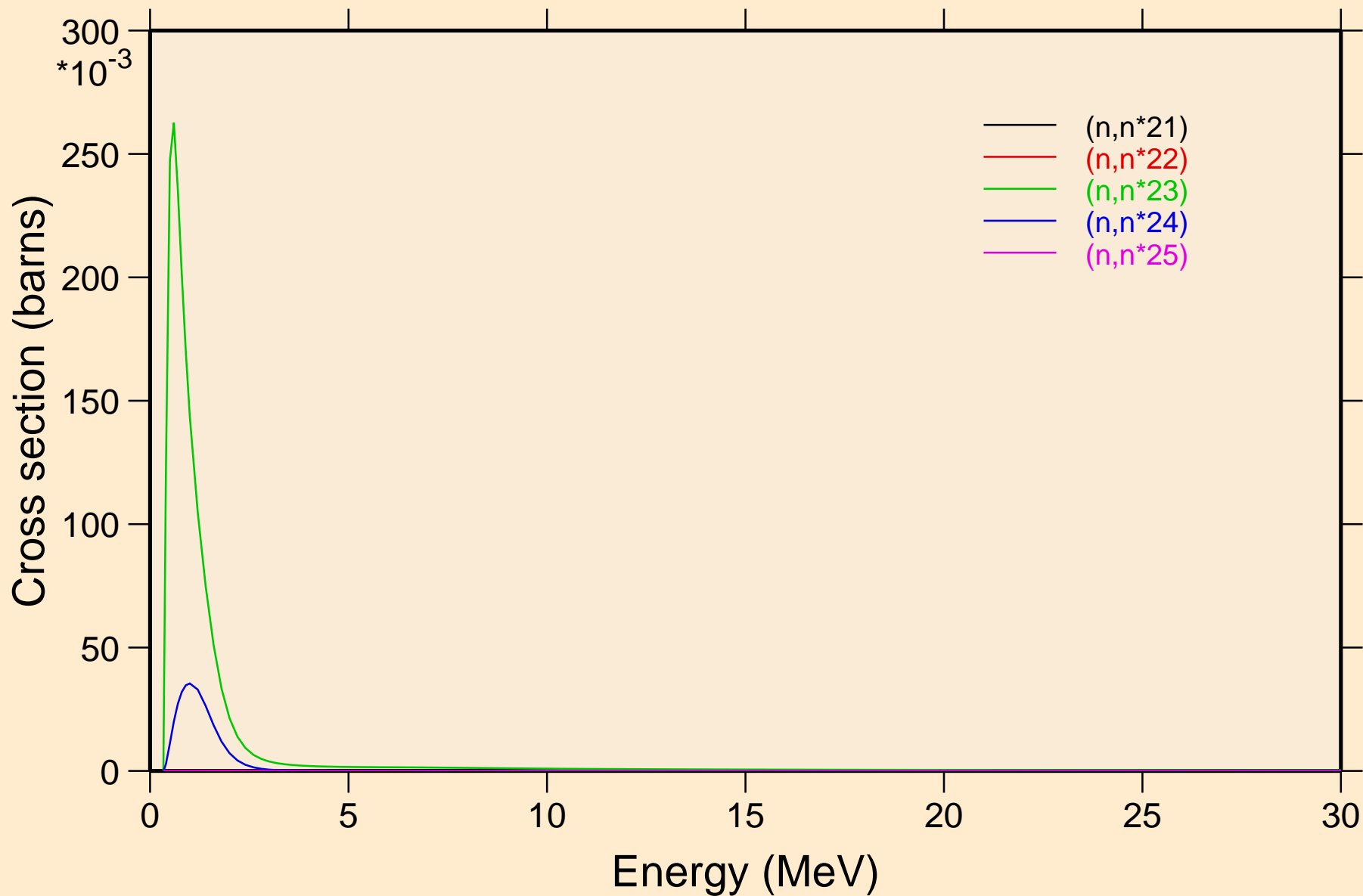

RF261 NEUTRON ACER TENDL-2019 LIBRARY; T=293.16K
Inelastic levels

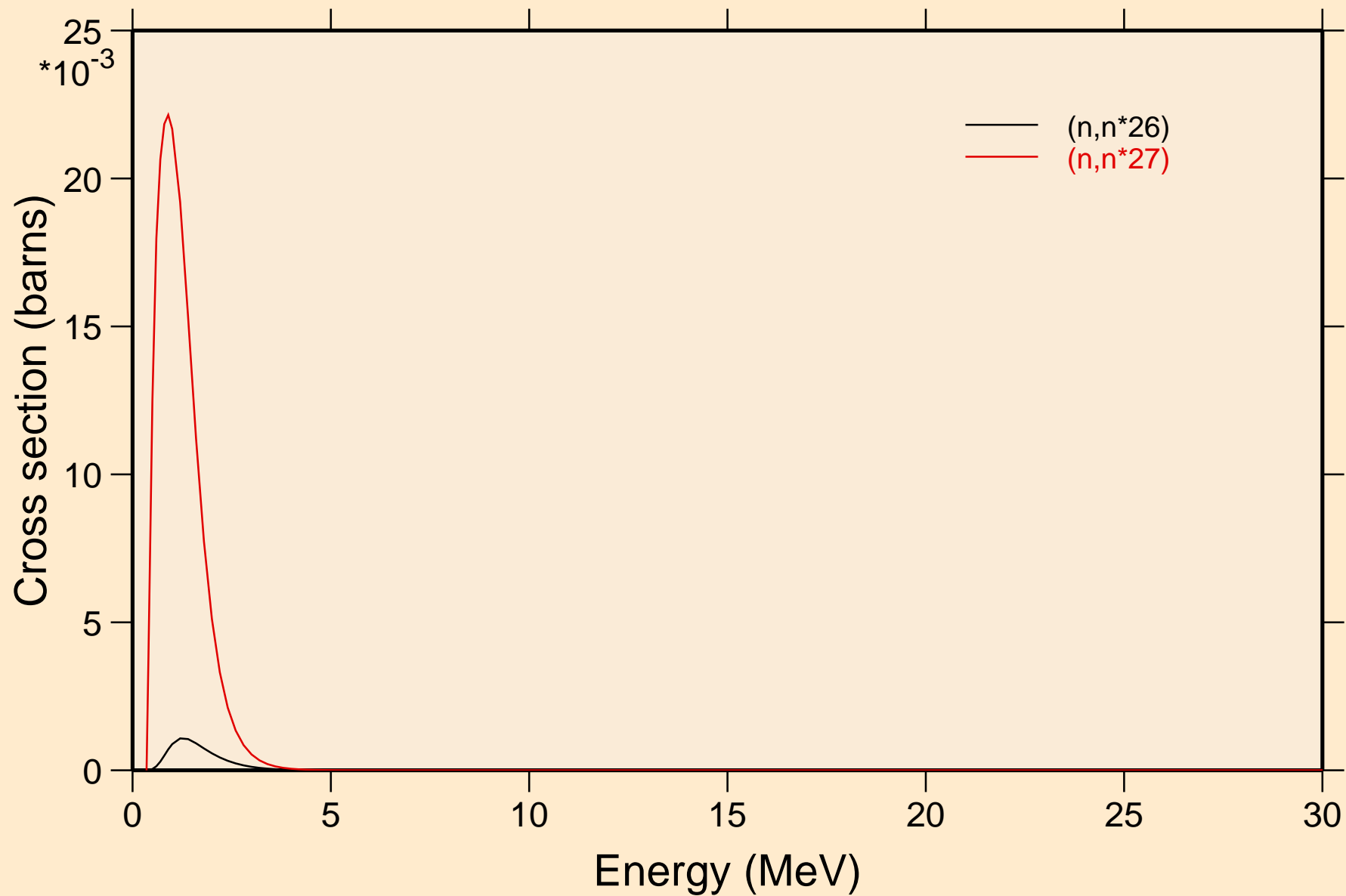

RF261 NEUTRON ACER TENDL-2019 LIBRARY; T=293.16K
Threshold reactions

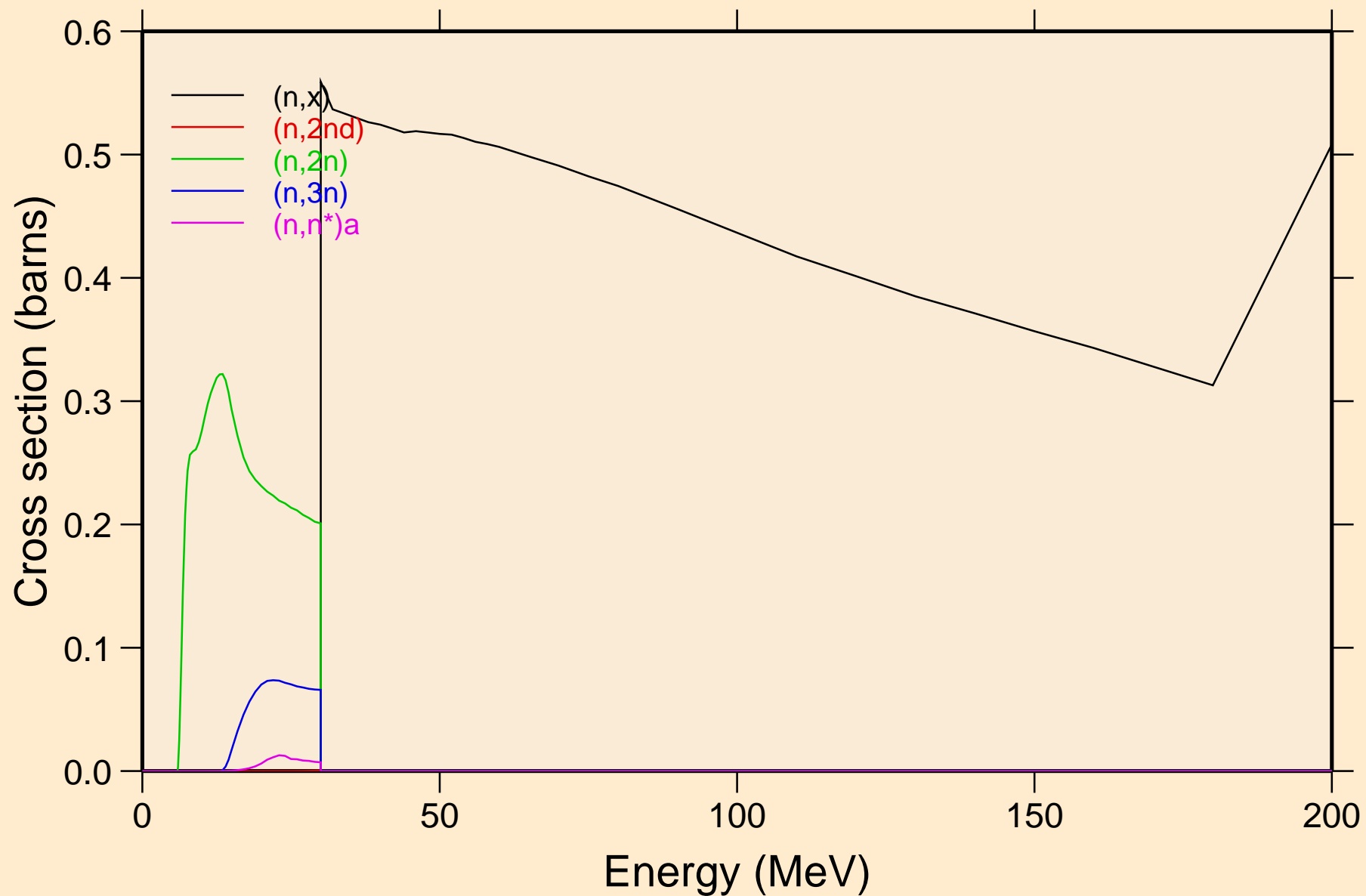

RF261 NEUTRON ACER TENDL-2019 LIBRARY; T=293.16K
Threshold reactions

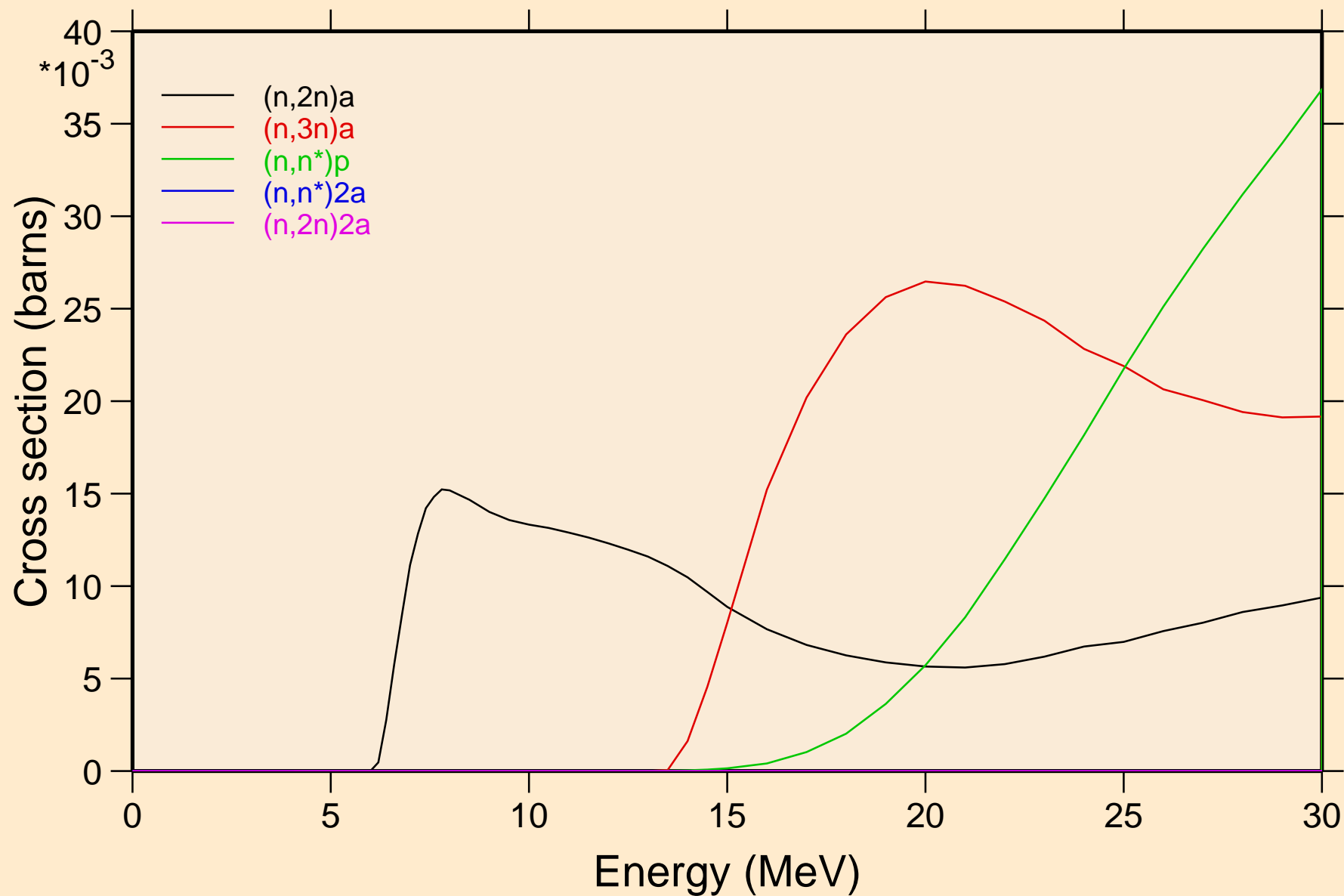

RF261 NEUTRON ACER TENDL-2019 LIBRARY; T=293.16K
Threshold reactions

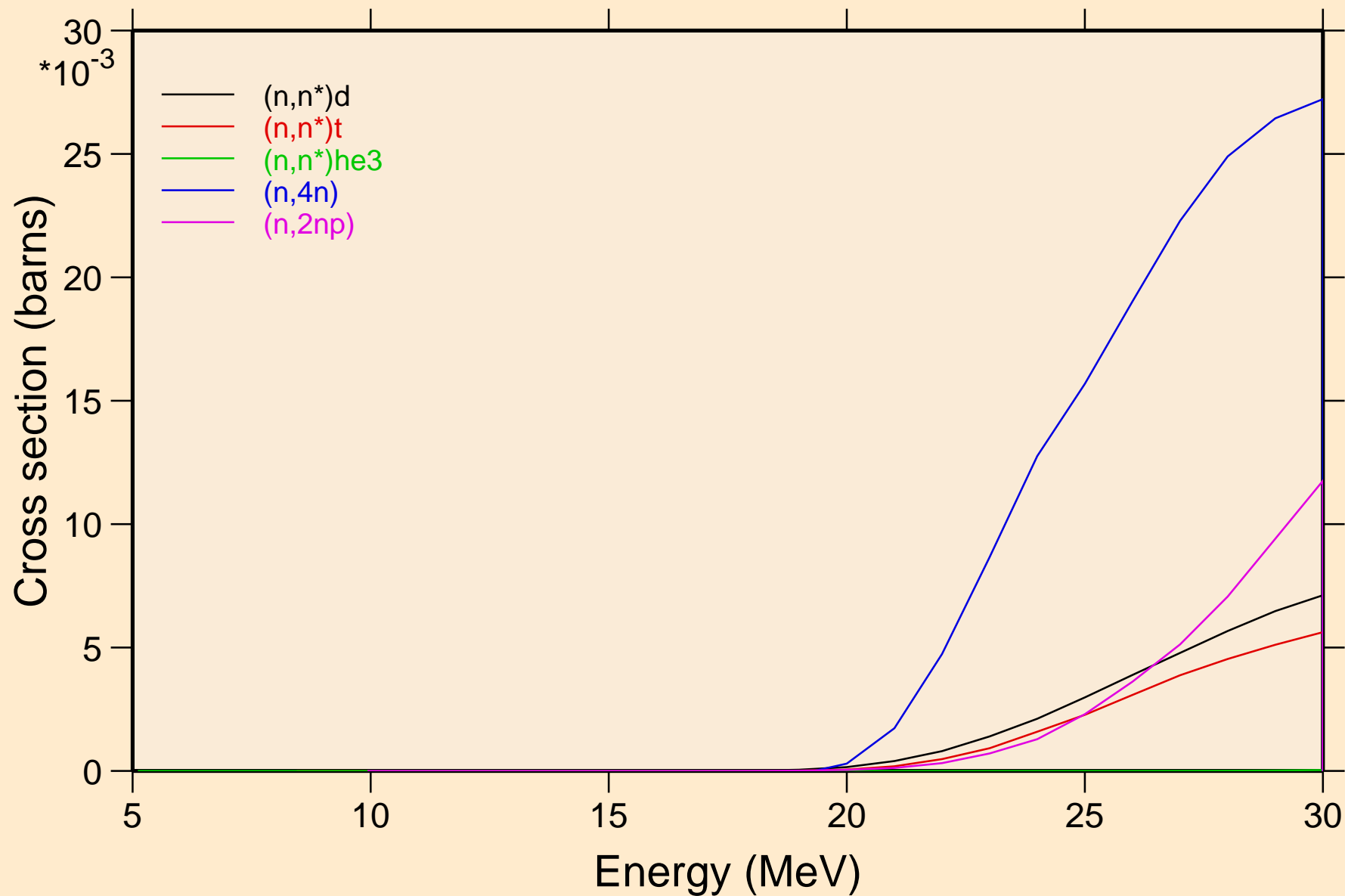

RF261 NEUTRON ACER TENDL-2019 LIBRARY; T=293.16K
Threshold reactions

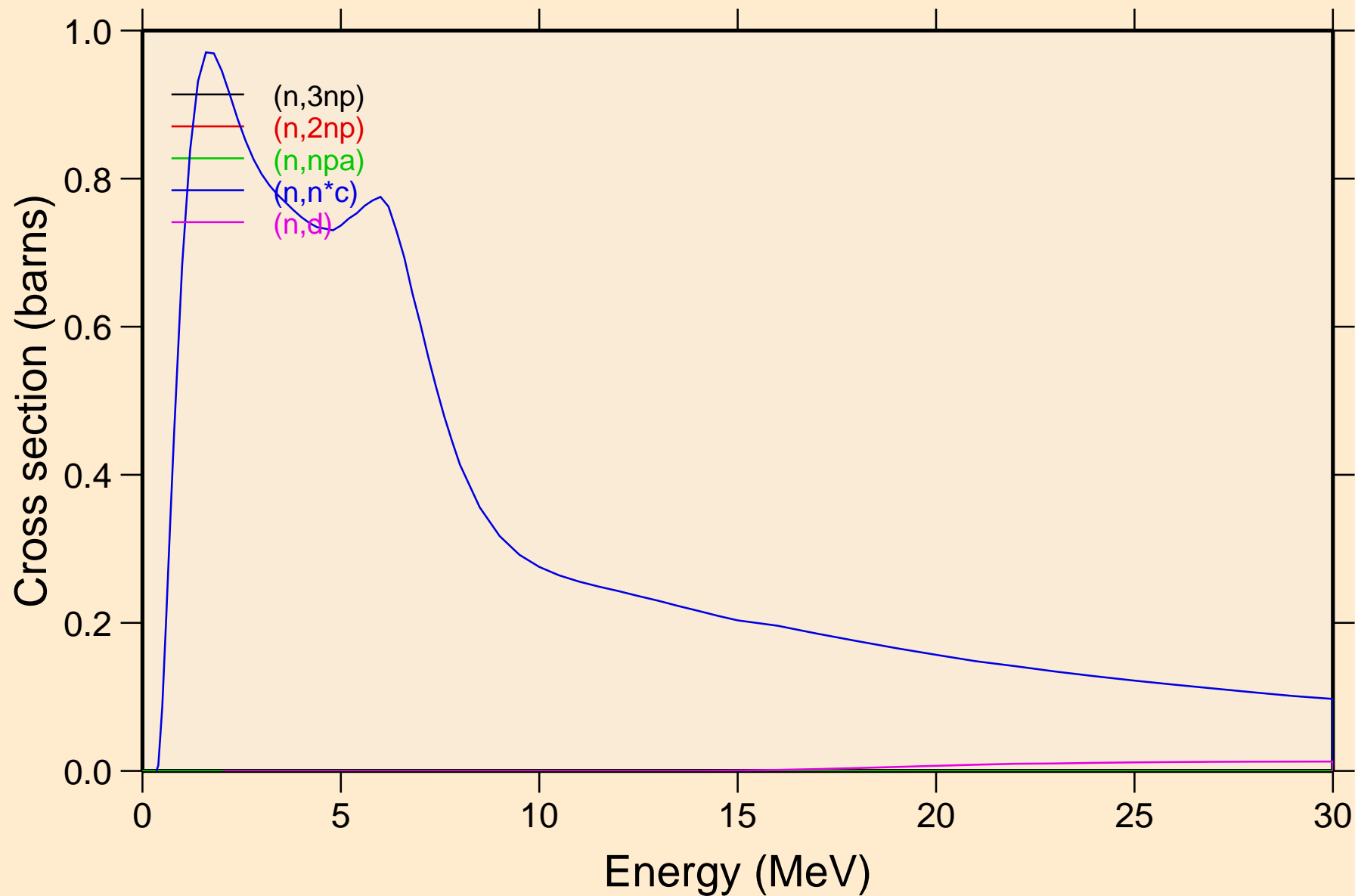

RF261 NEUTRON ACER TENDL-2019 LIBRARY; T=293.16K
Threshold reactions

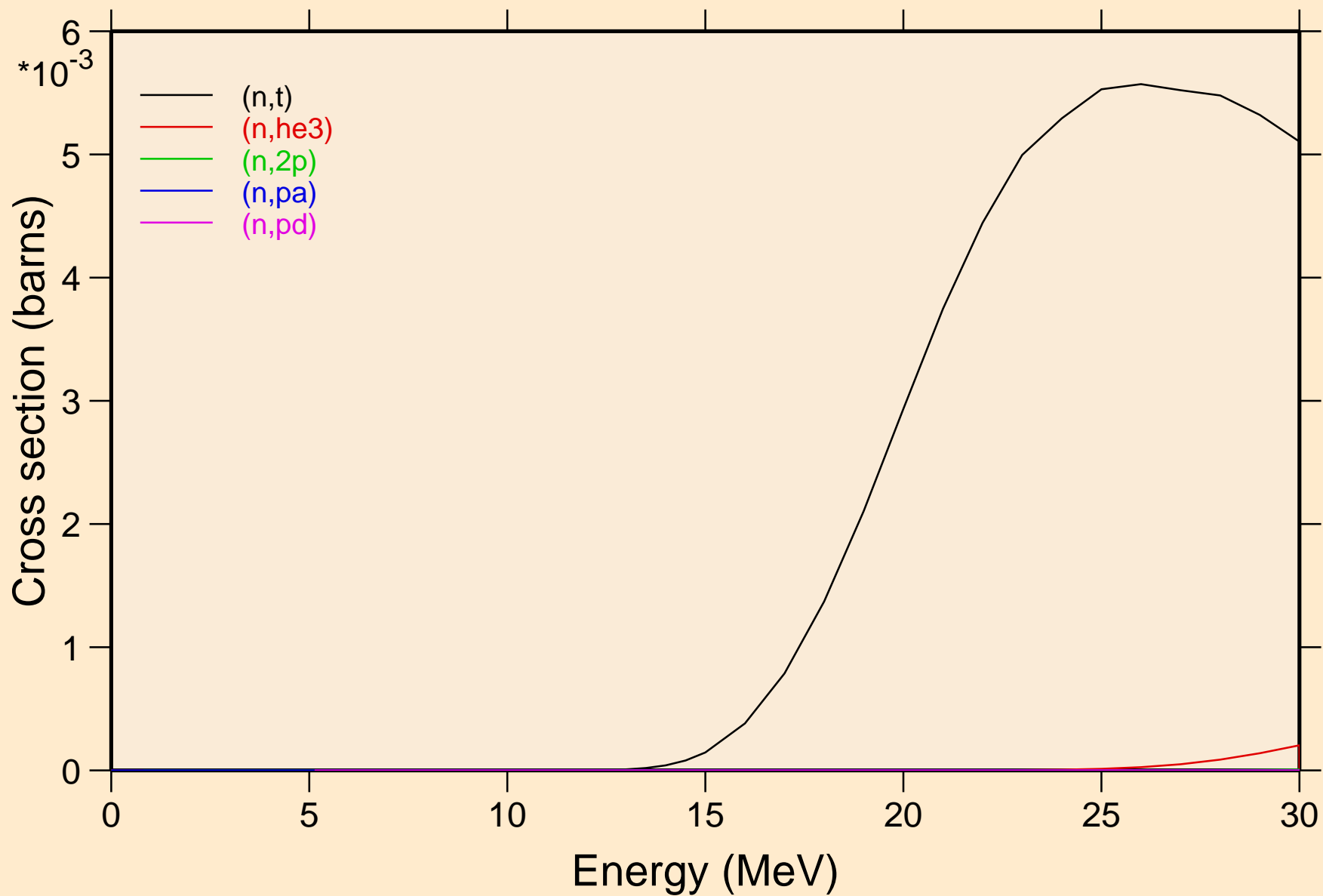

RF261 NEUTRON ACER TENDL-2019 LIBRARY; T=293.16K
Threshold reactions

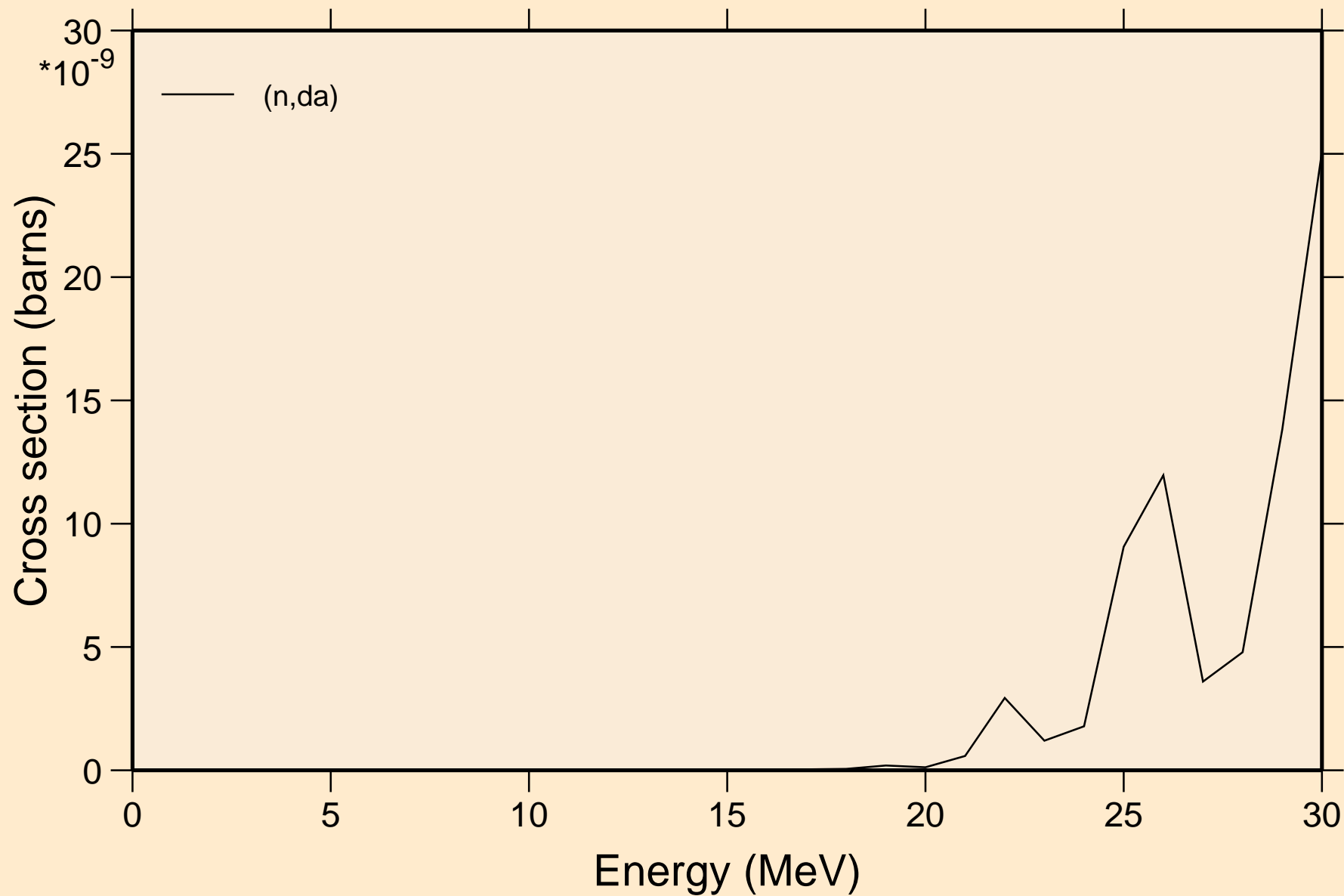

RF261 NEUTRON ACER TENDL-2019 LIBRARY; T=293.16K
Threshold reactions

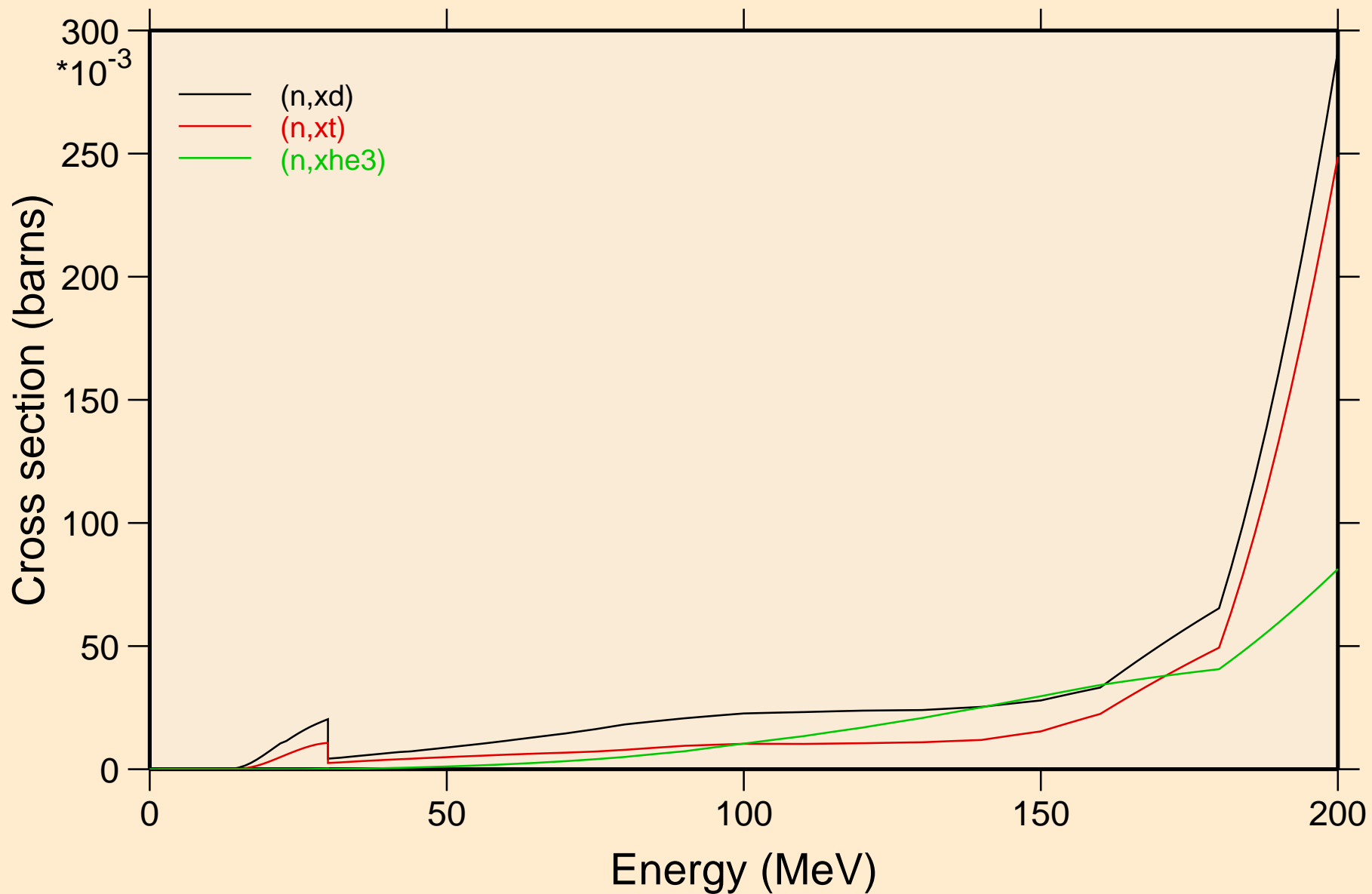

RF261 NEUTRON ACER TENDL-2019 LIBRARY; T=293.16K
angular distribution for elastic

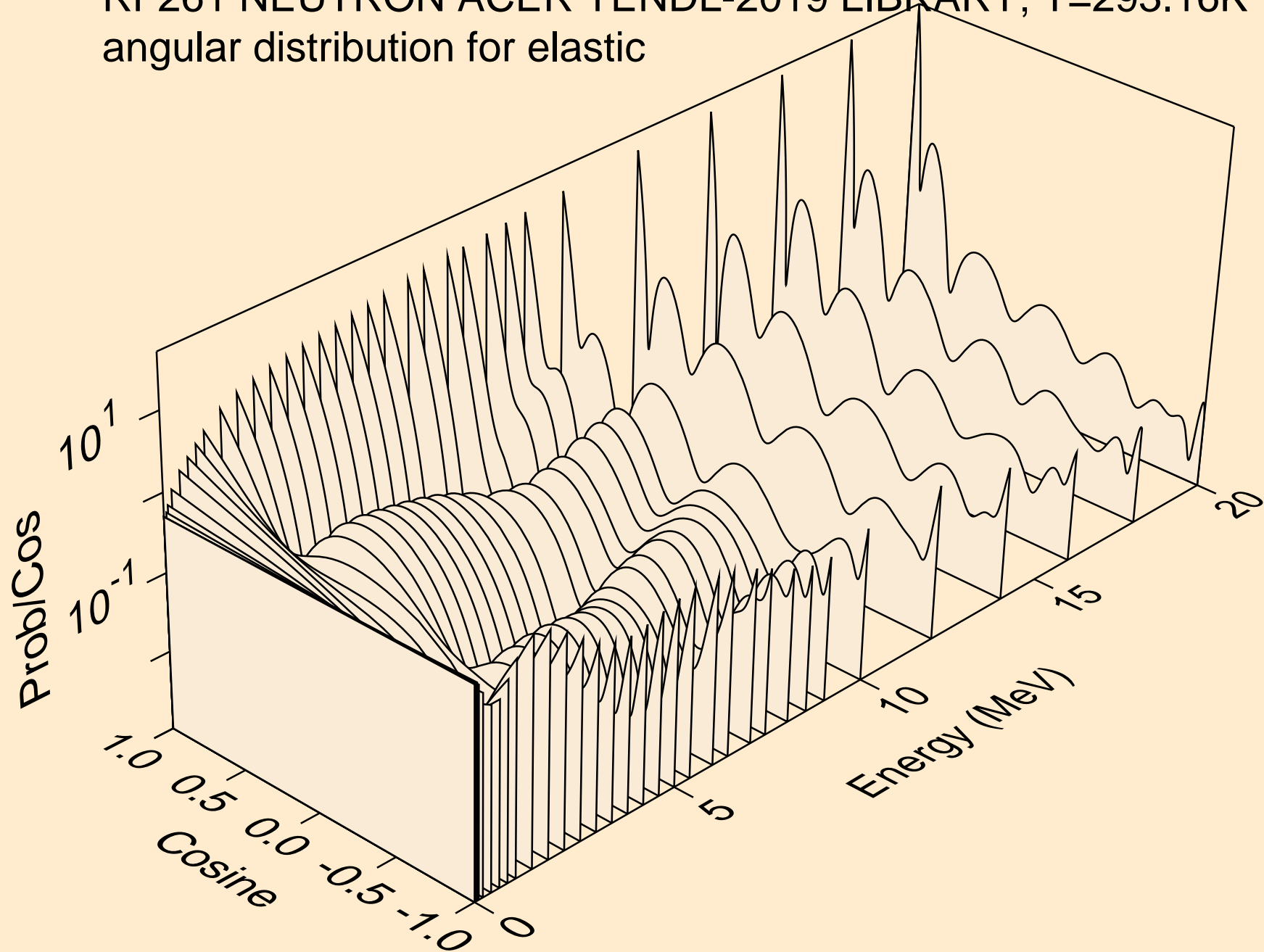

RF261 NEUTRON ACER TENDL-2019 LIBRARY; T=293.16K
angular distribution for elastic

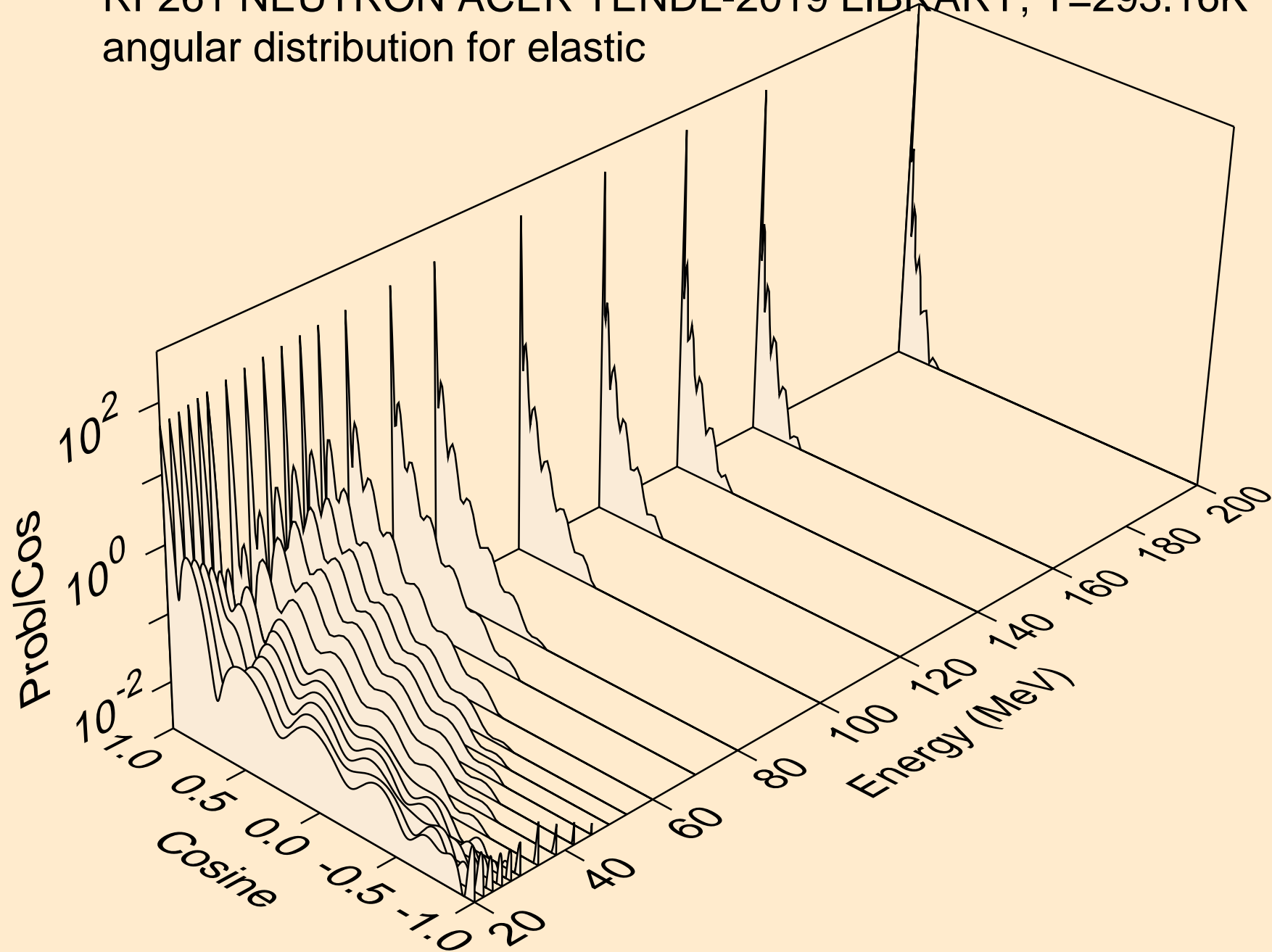

RF261 NEUTRON ACER TENDL-2019 LIBRARY; T=293.16K
angular distribution for (n,n*1)

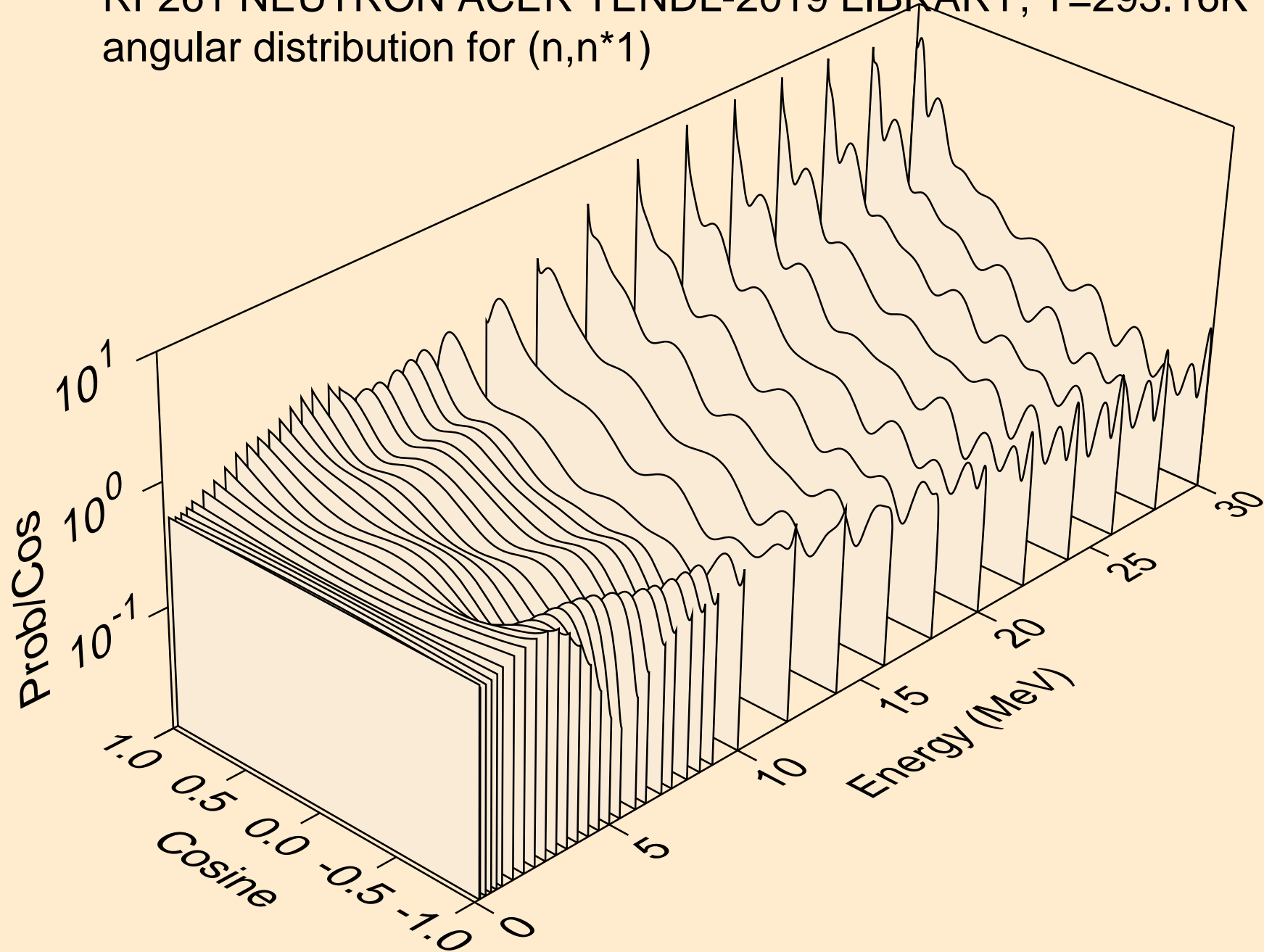

RF261 NEUTRON ACER TENDL-2019 LIBRARY; T=293.16K
angular distribution for (n,n*2)

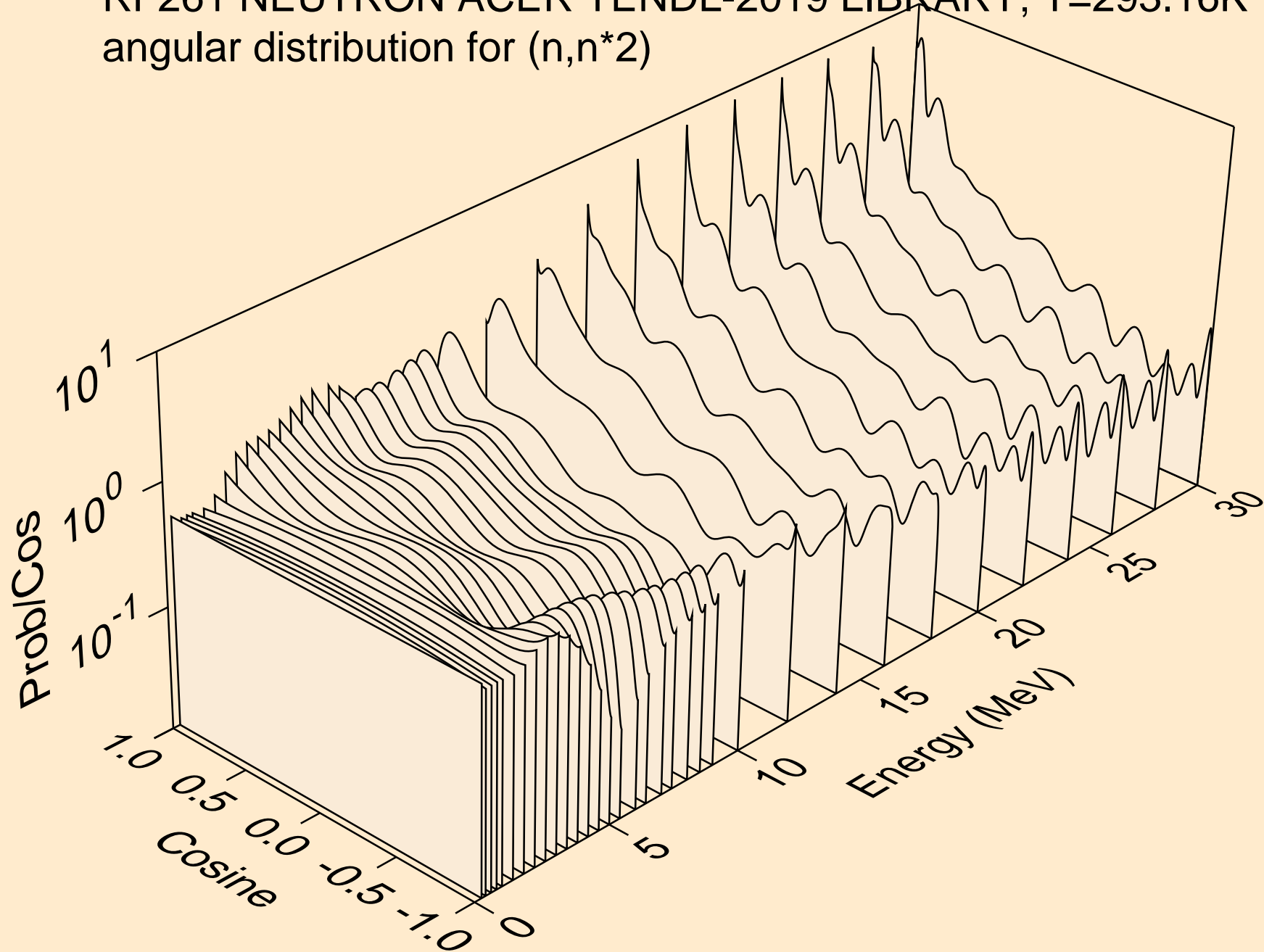

RF261 NEUTRON ACER TENDL-2019 LIBRARY; T=293.16K
angular distribution for (n,n*3)

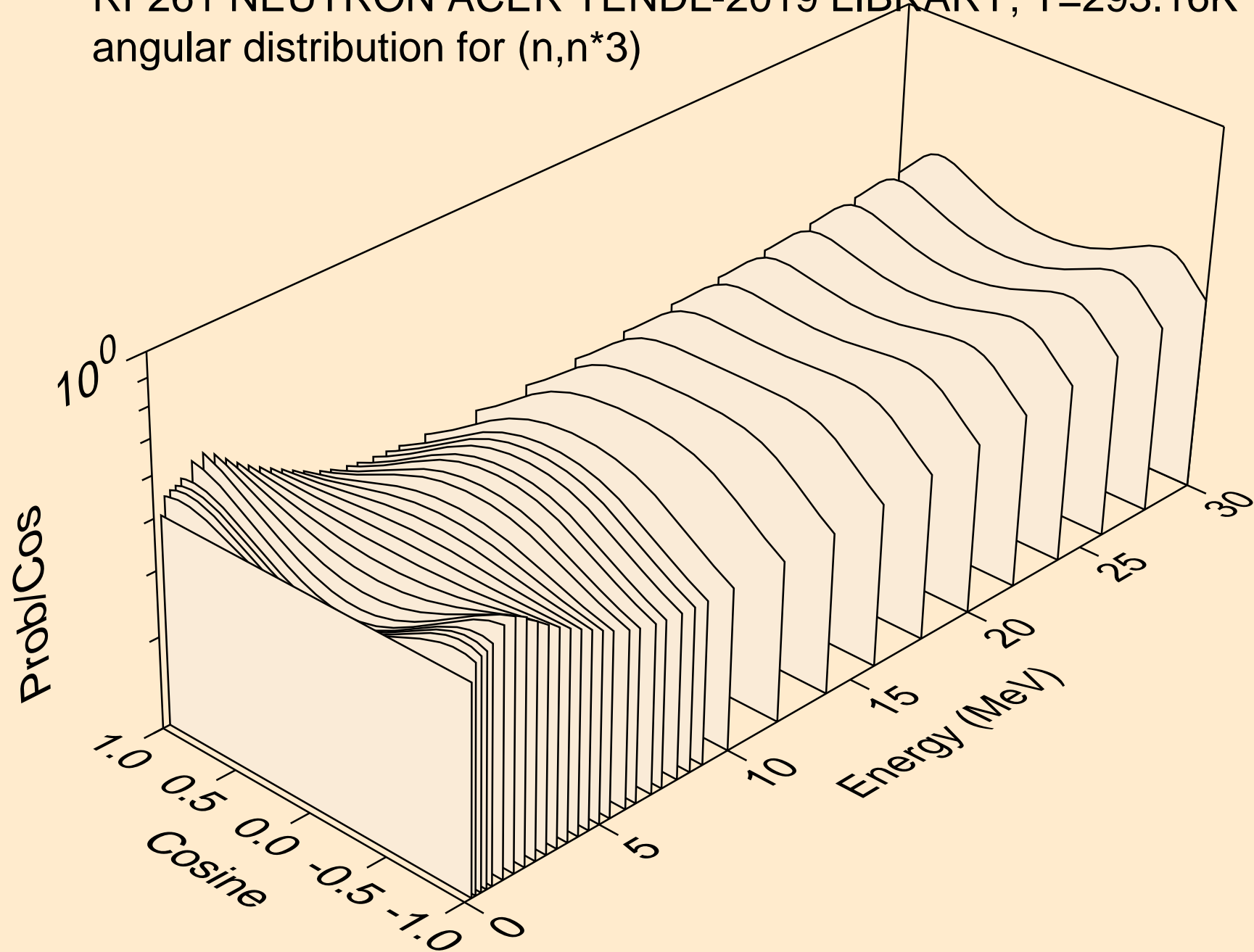

RF261 NEUTRON ACER TENDL-2019 LIBRARY; T=293.16K
angular distribution for (n,n*4)

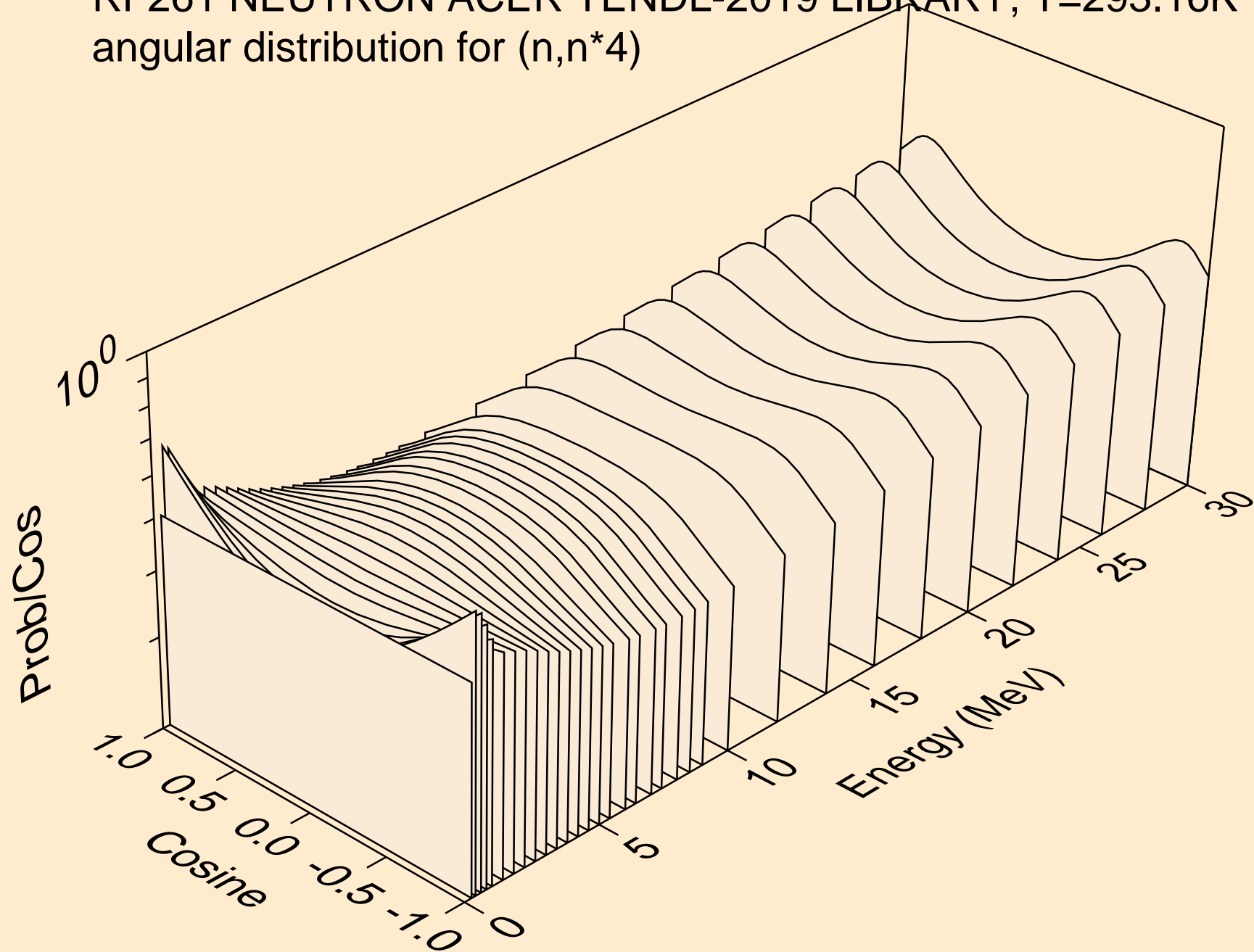

RF261 NEUTRON ACER TENDL-2019 LIBRARY; T=293.16K
angular distribution for (n,n*5)

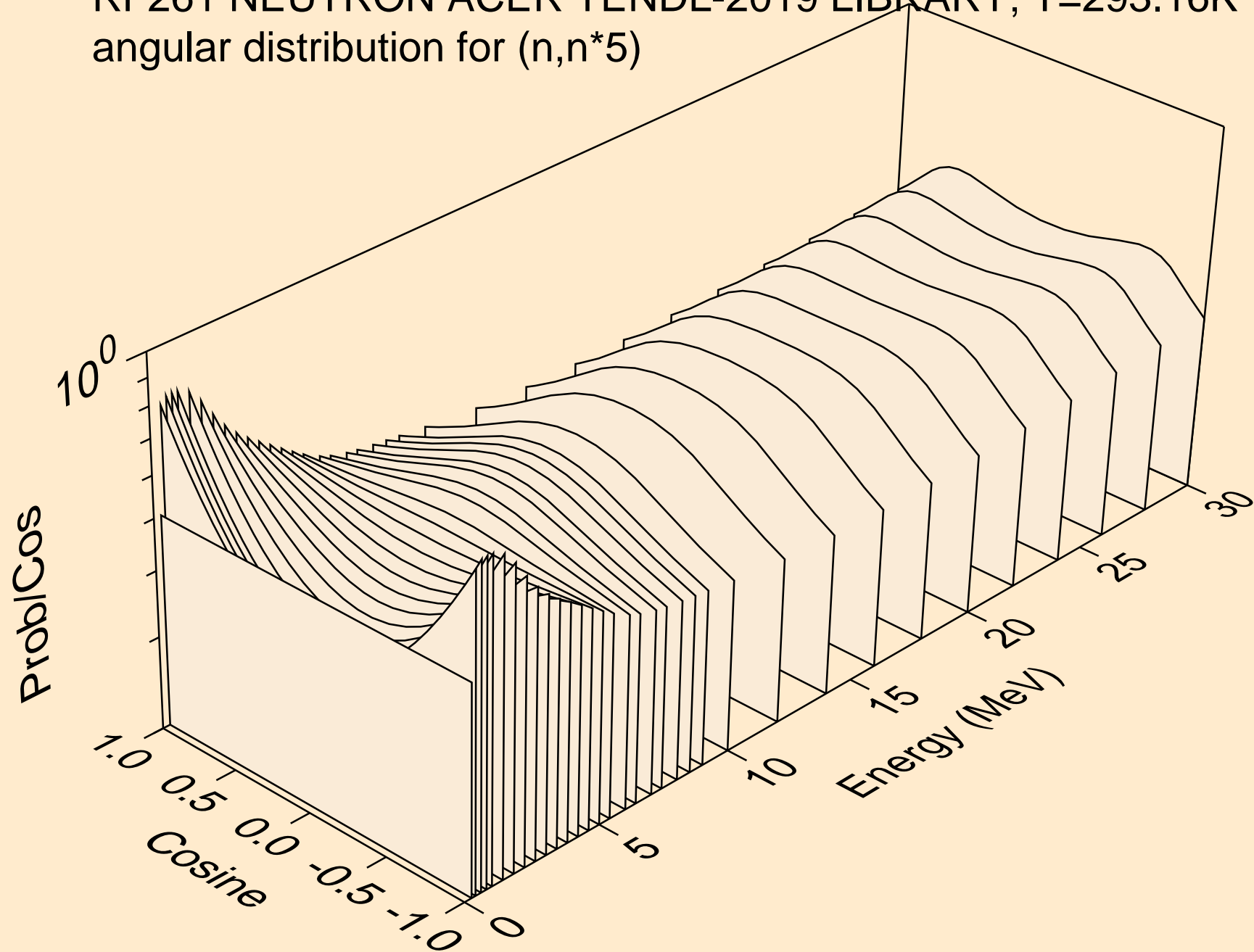

RF261 NEUTRON ACER TENDL-2019 LIBRARY; T=293.16K
angular distribution for (n,n*6)

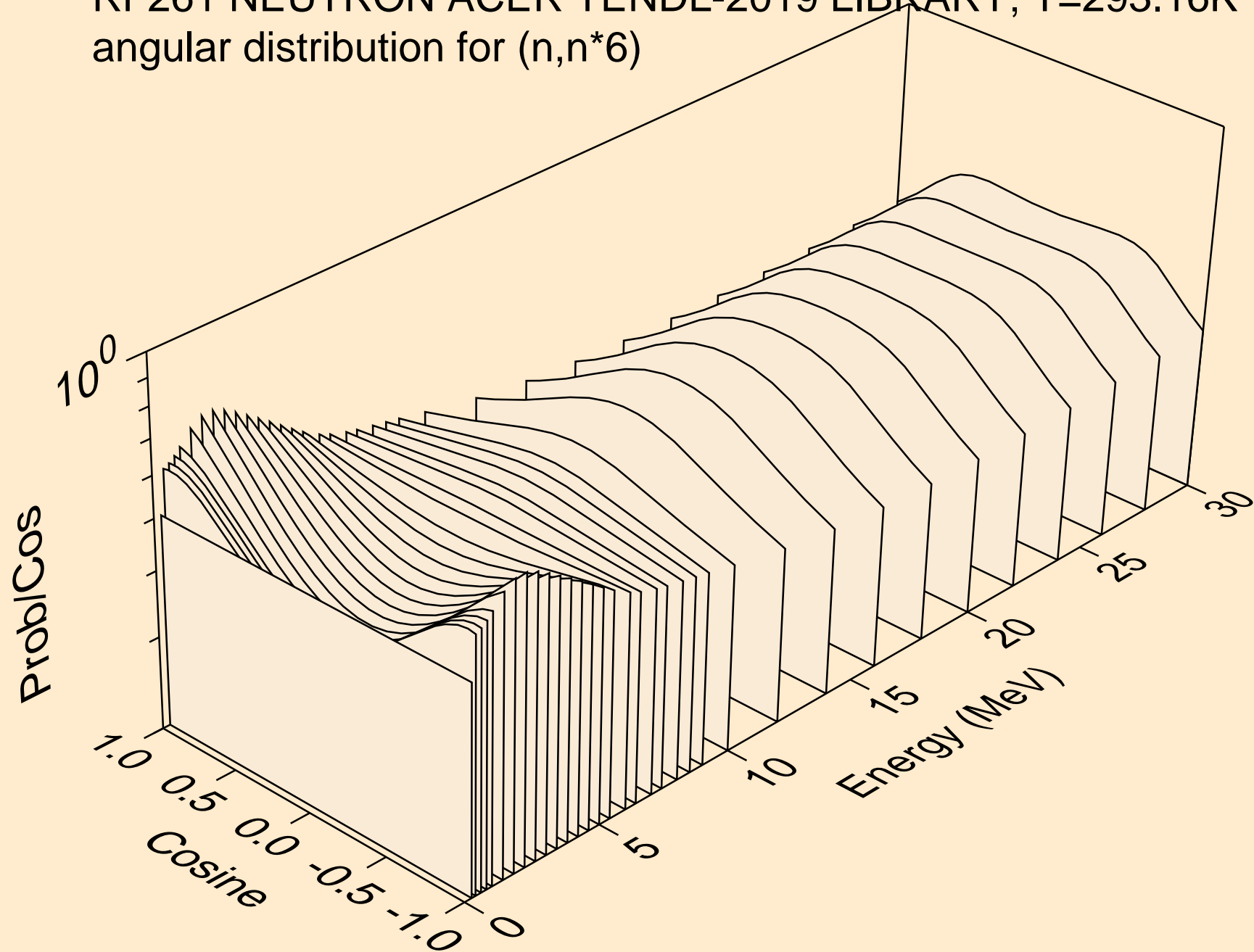

RF261 NEUTRON ACER TENDL-2019 LIBRARY; T=293.16K
angular distribution for (n,n*7)

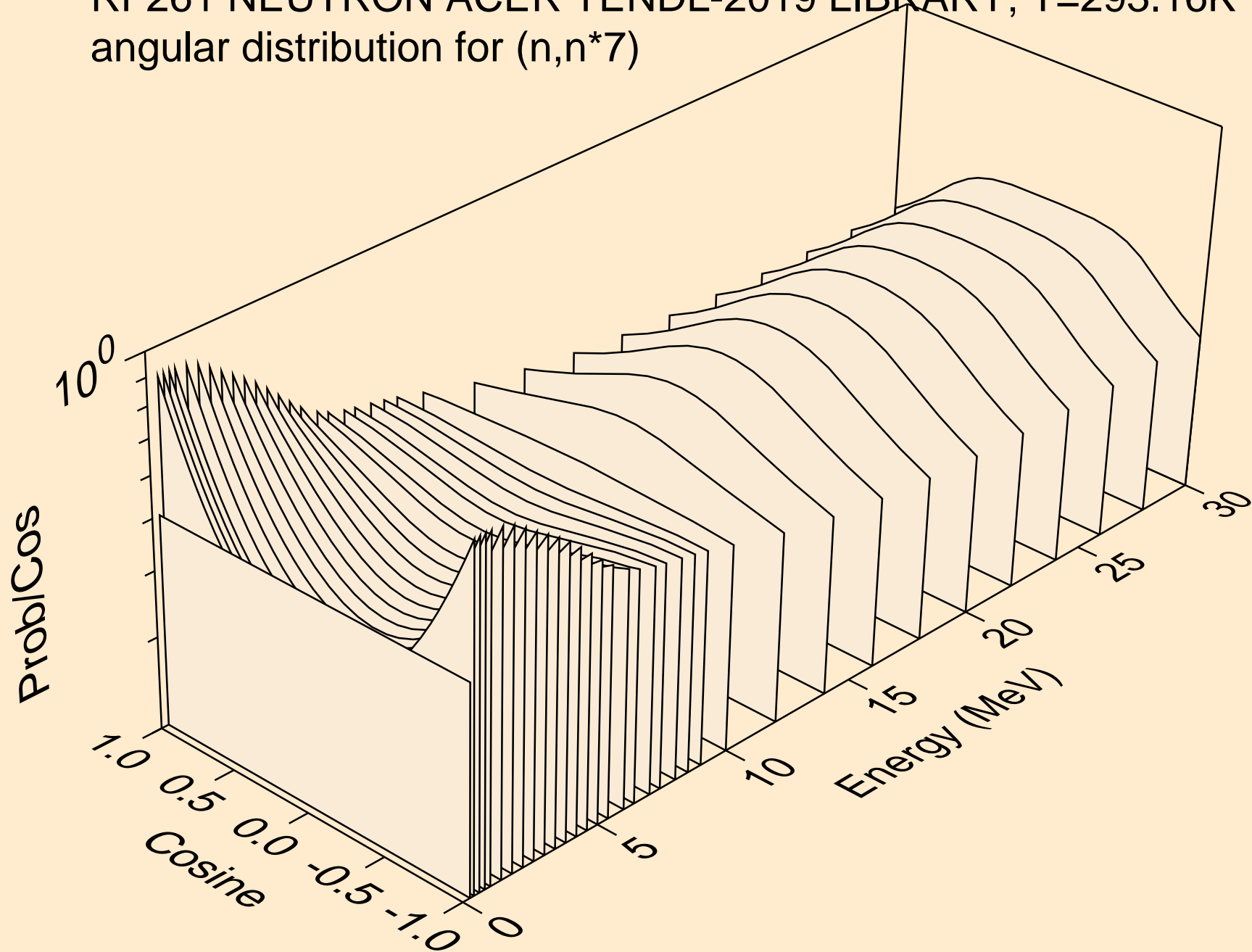

RF261 NEUTRON ACER TENDL-2019 LIBRARY; T=293.16K
angular distribution for (n,n*8)

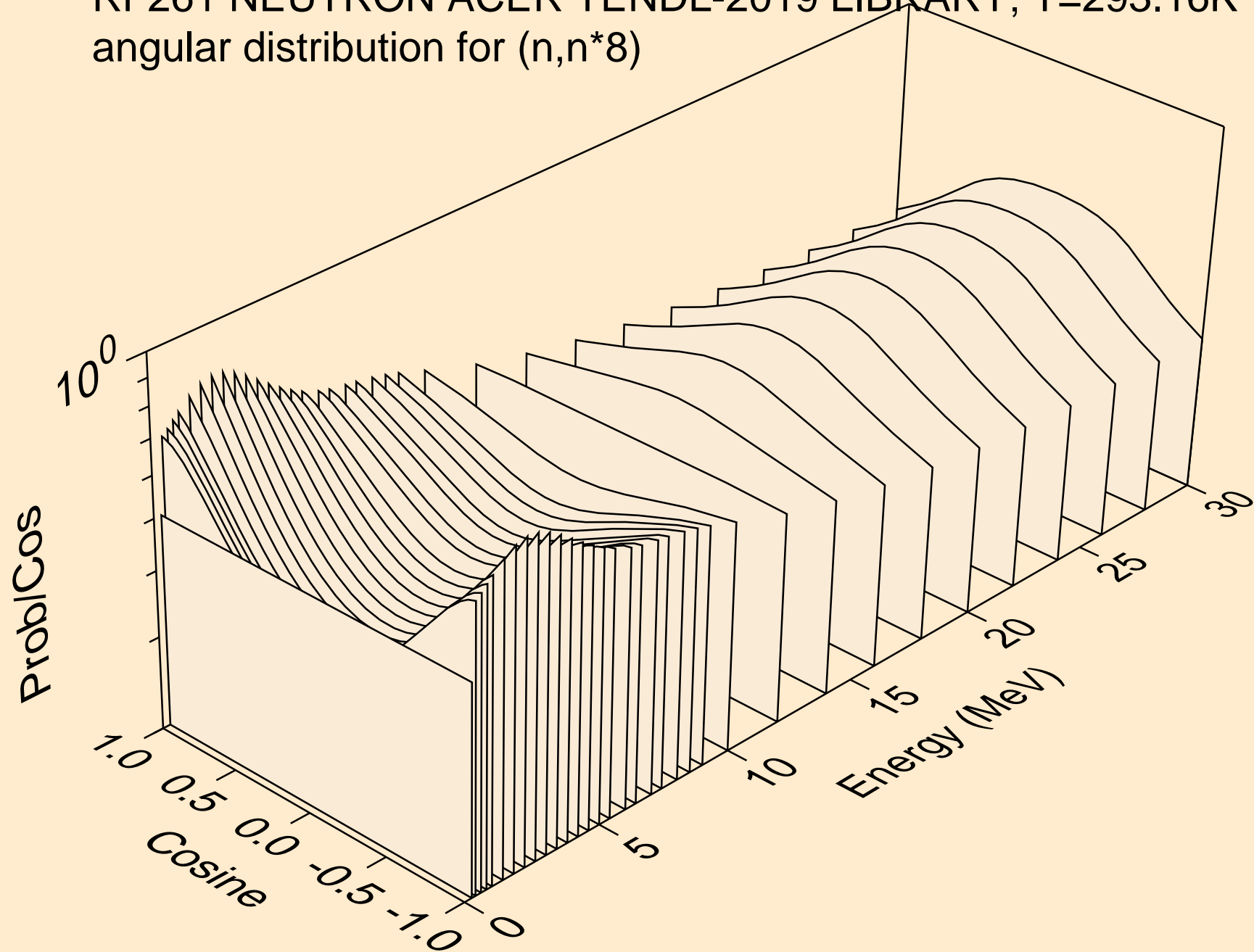

RF261 NEUTRON ACER TENDL-2019 LIBRARY; T=293.16K
angular distribution for (n,n*9)

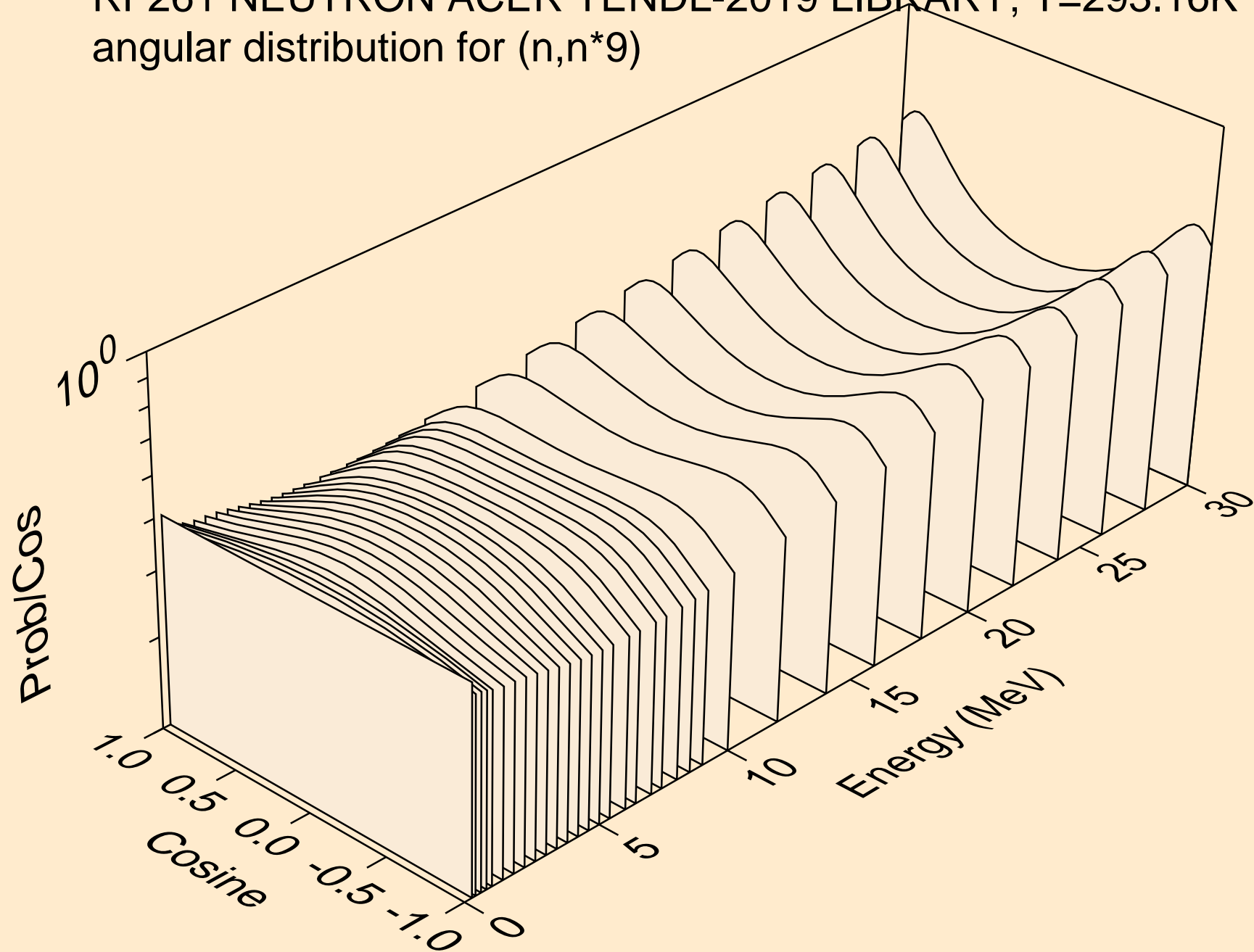

RF261 NEUTRON ACER TENDL-2019 LIBRARY; T=293.16K
angular distribution for (n,n*10)

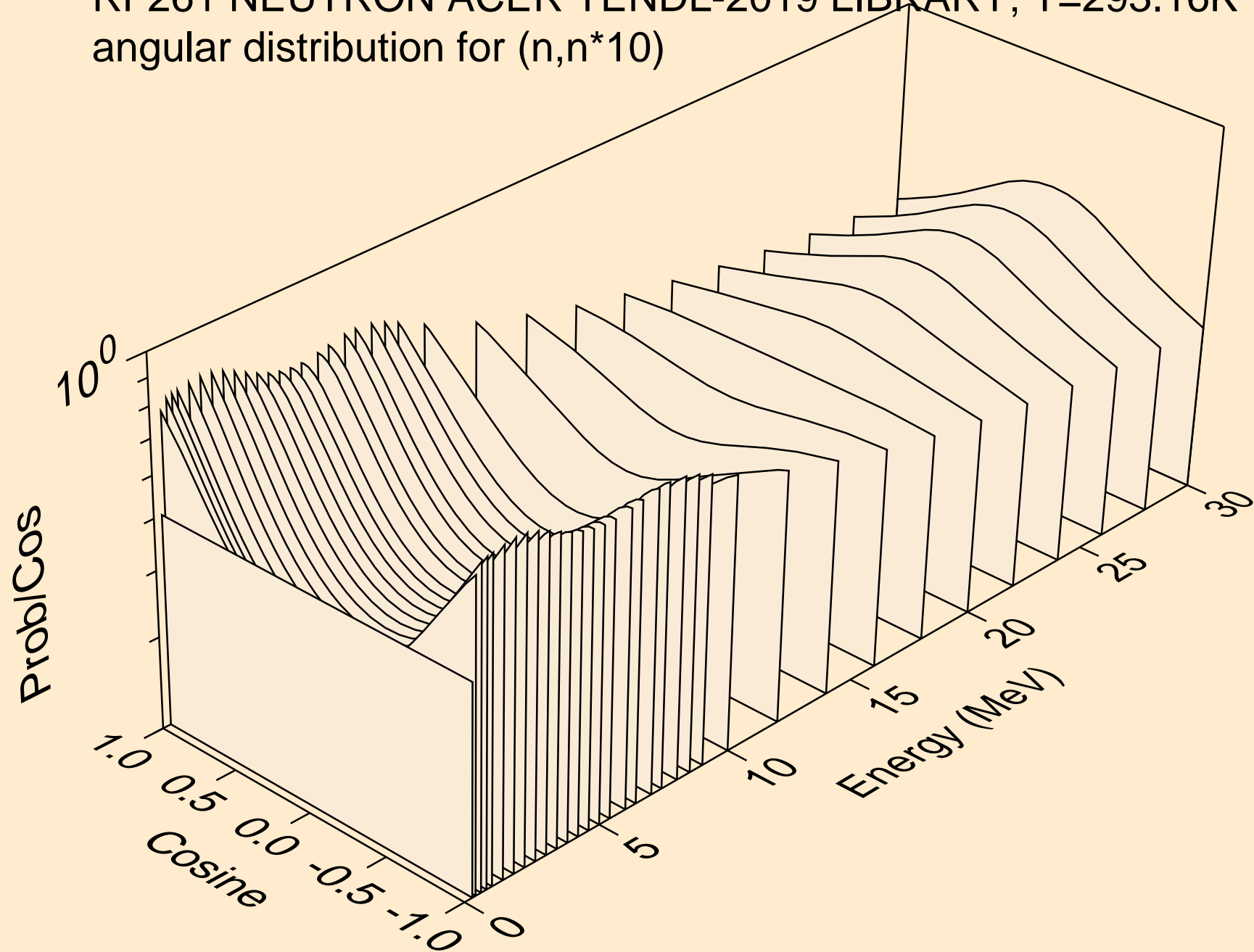

RF261 NEUTRON ACER TENDL-2019 LIBRARY; T=293.16K
angular distribution for (n,n*11)

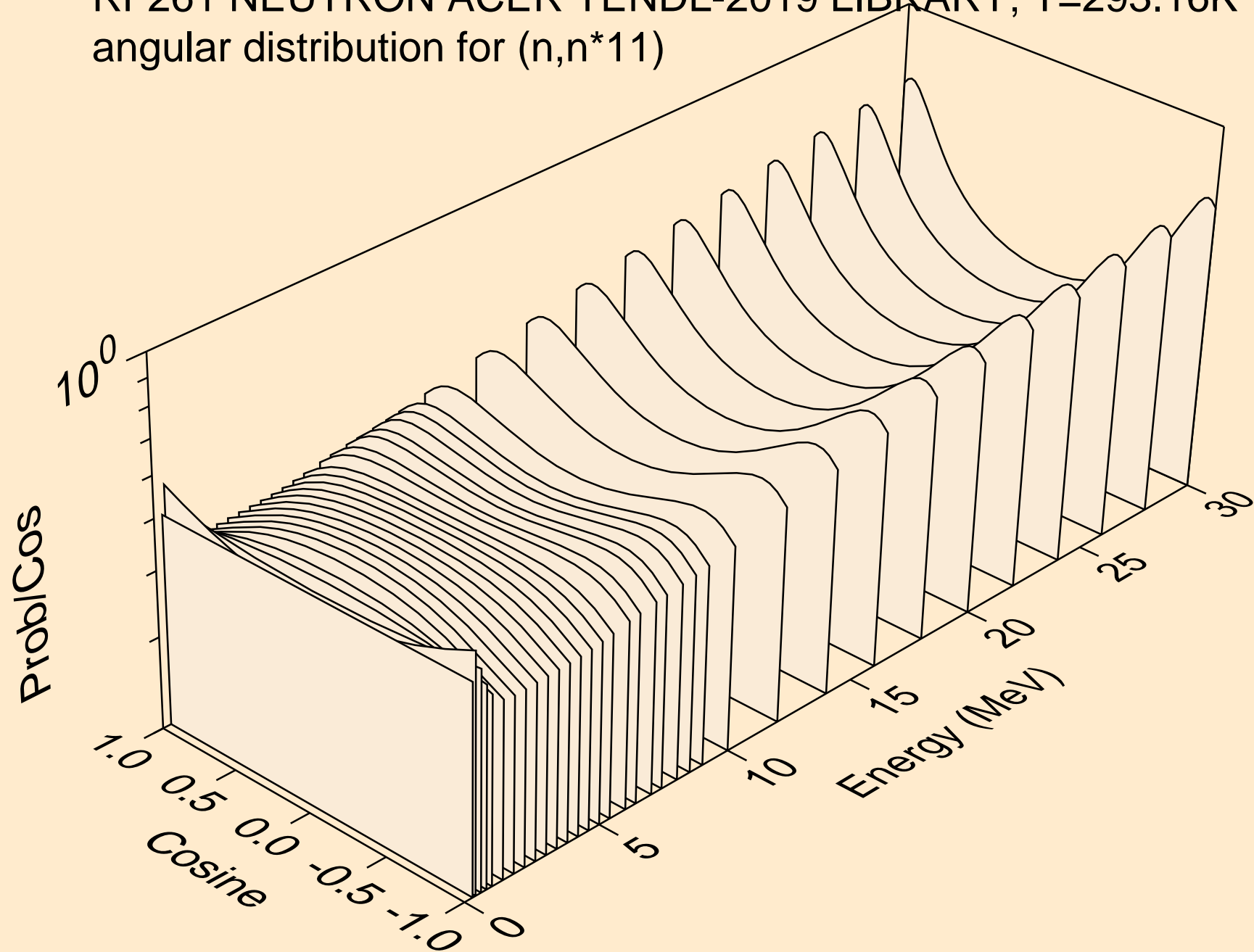

RF261 NEUTRON ACER TENDL-2019 LIBRARY; T=293.16K
angular distribution for (n,n*12)

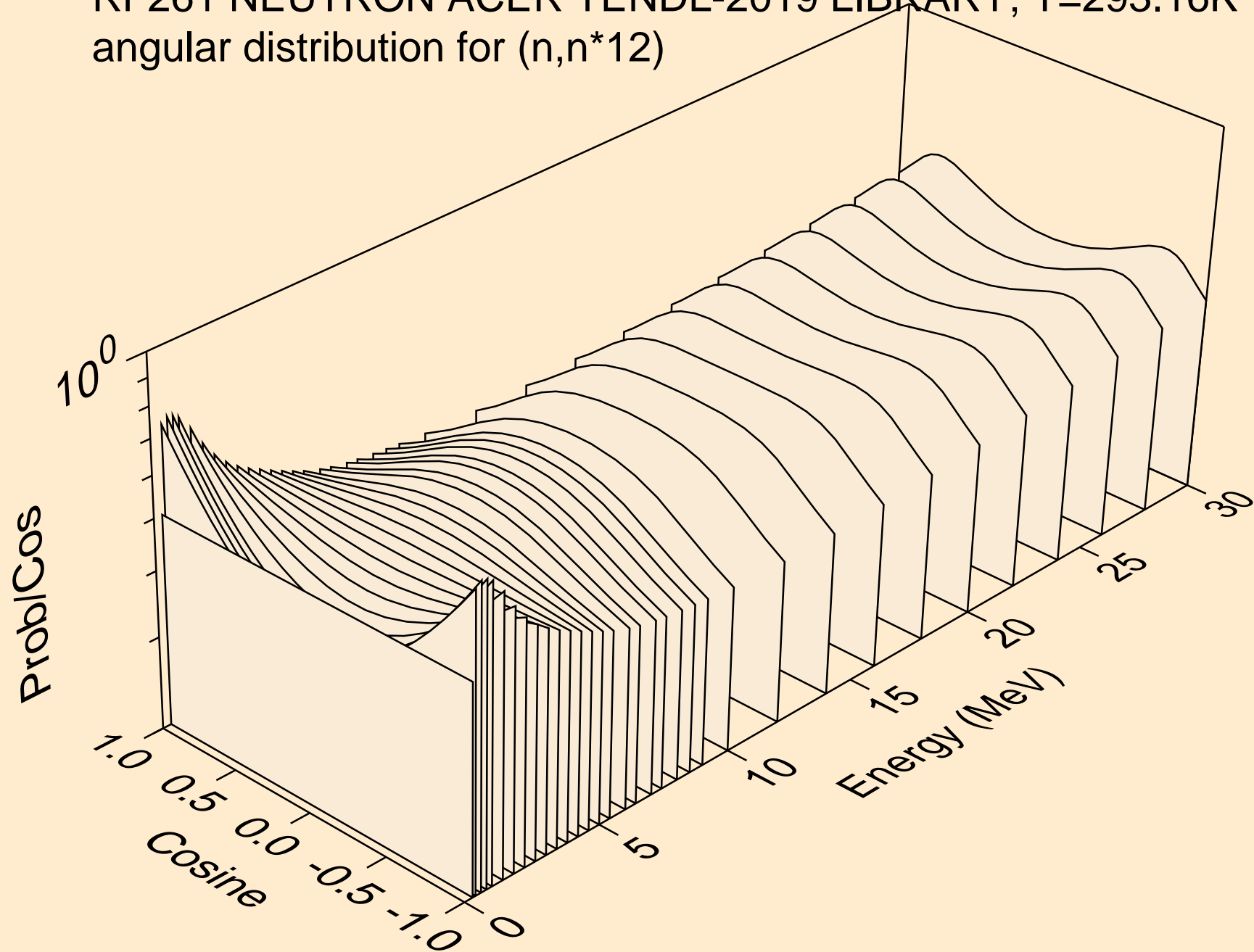

RF261 NEUTRON ACER TENDL-2019 LIBRARY; T=293.16K
angular distribution for (n,n*13)

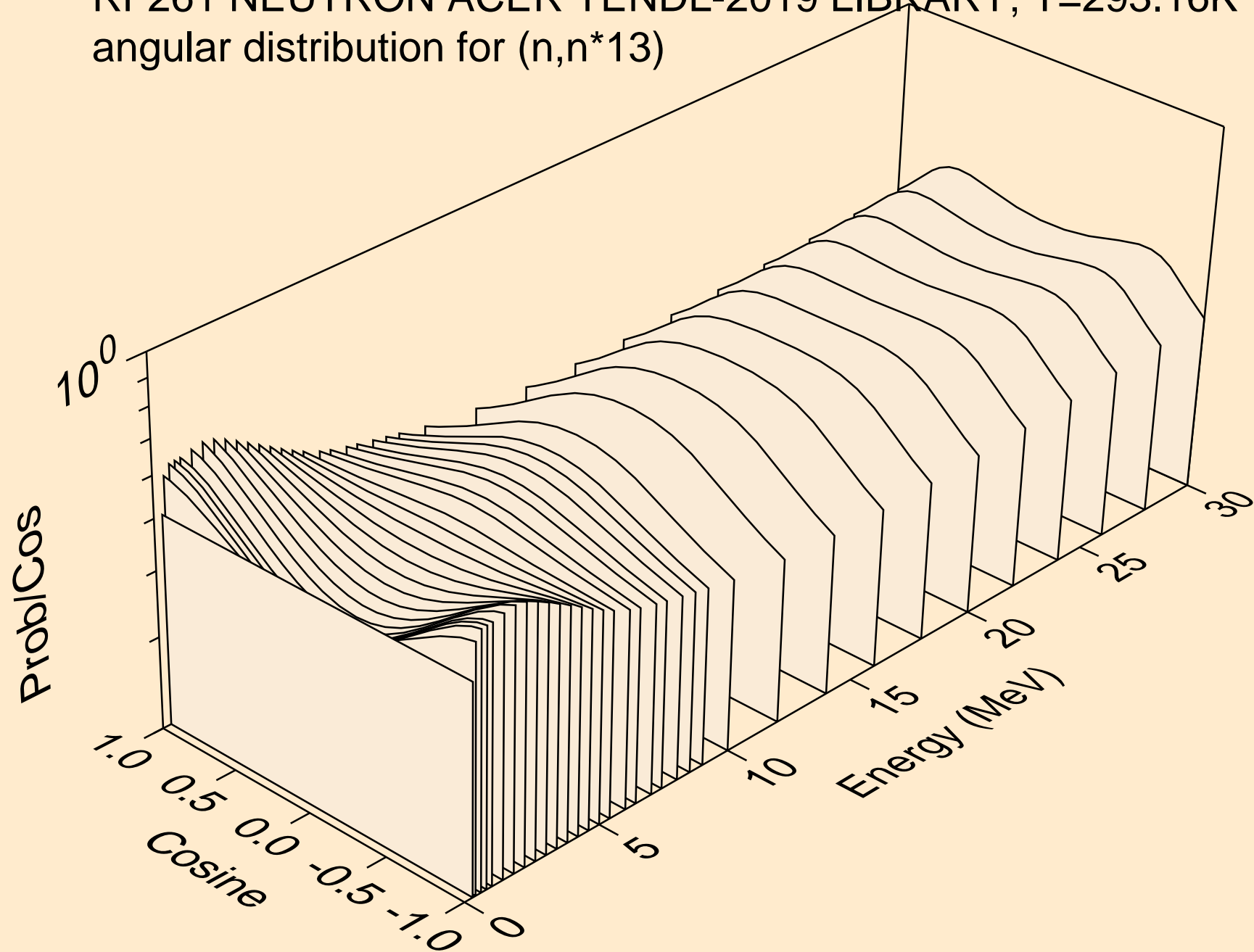

RF261 NEUTRON ACER TENDL-2019 LIBRARY; T=293.16K
angular distribution for (n,n*14)

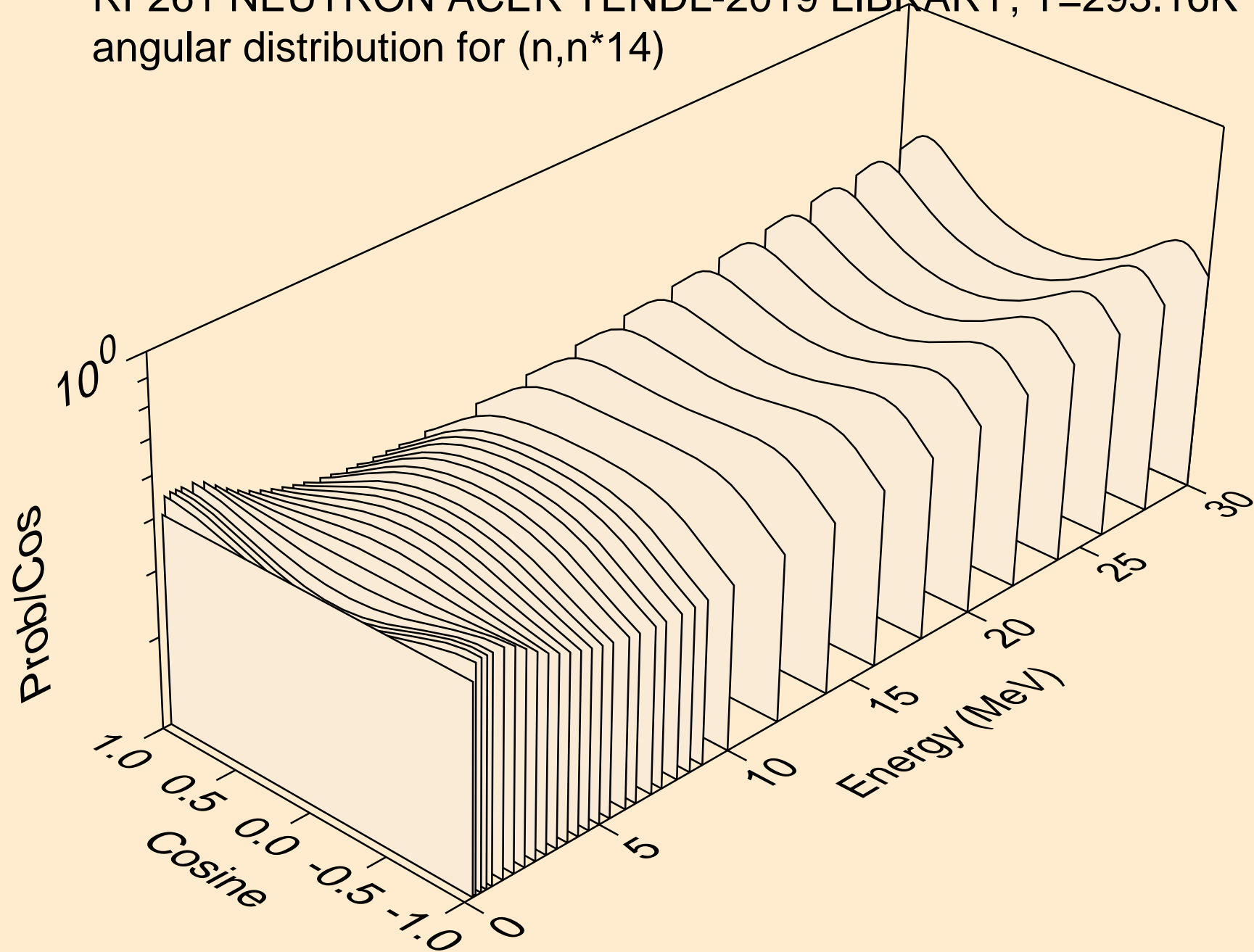

RF261 NEUTRON ACER TENDL-2019 LIBRARY; T=293.16K
angular distribution for (n,n*15)

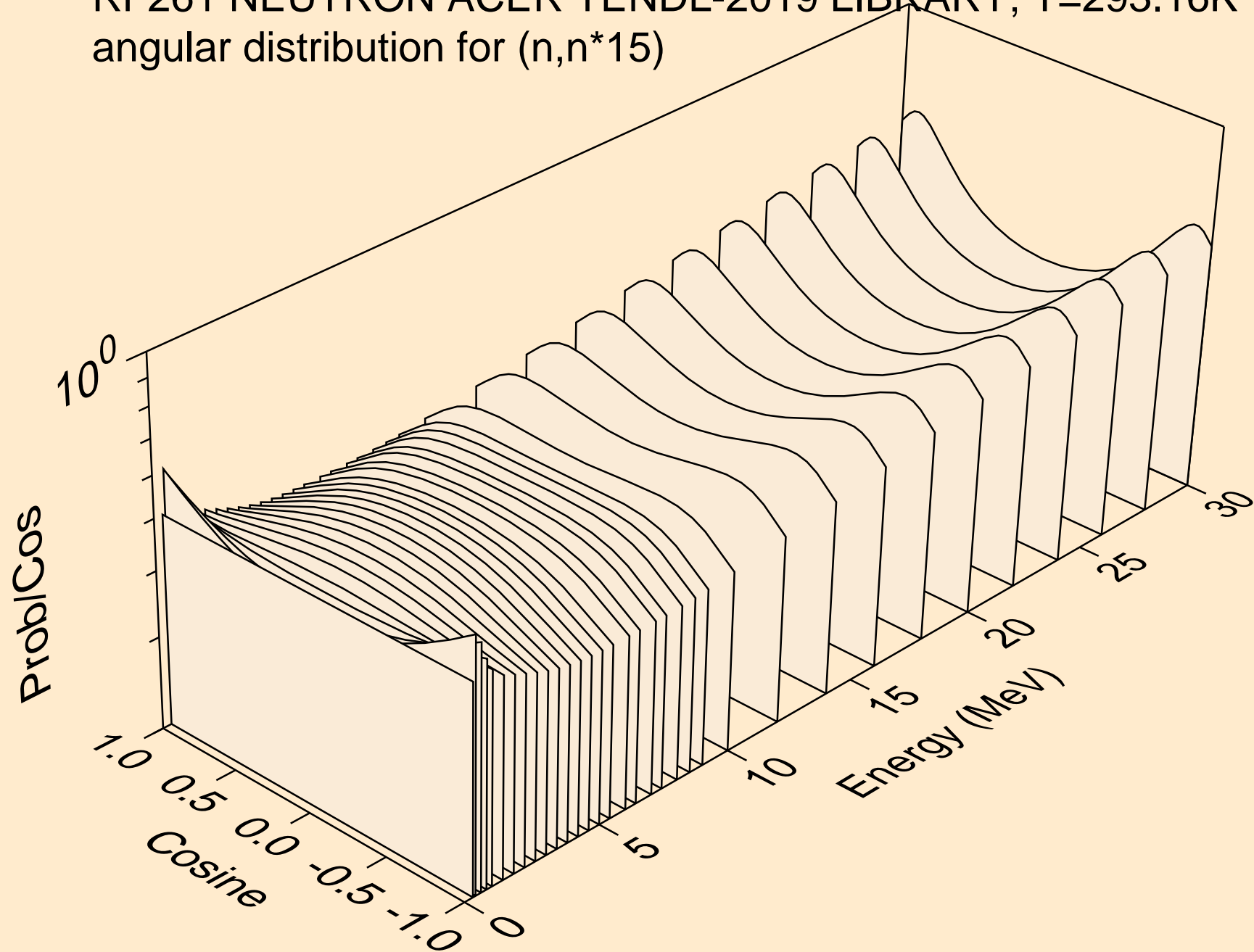

RF261 NEUTRON ACER TENDL-2019 LIBRARY; T=293.16K
angular distribution for (n,n*16)

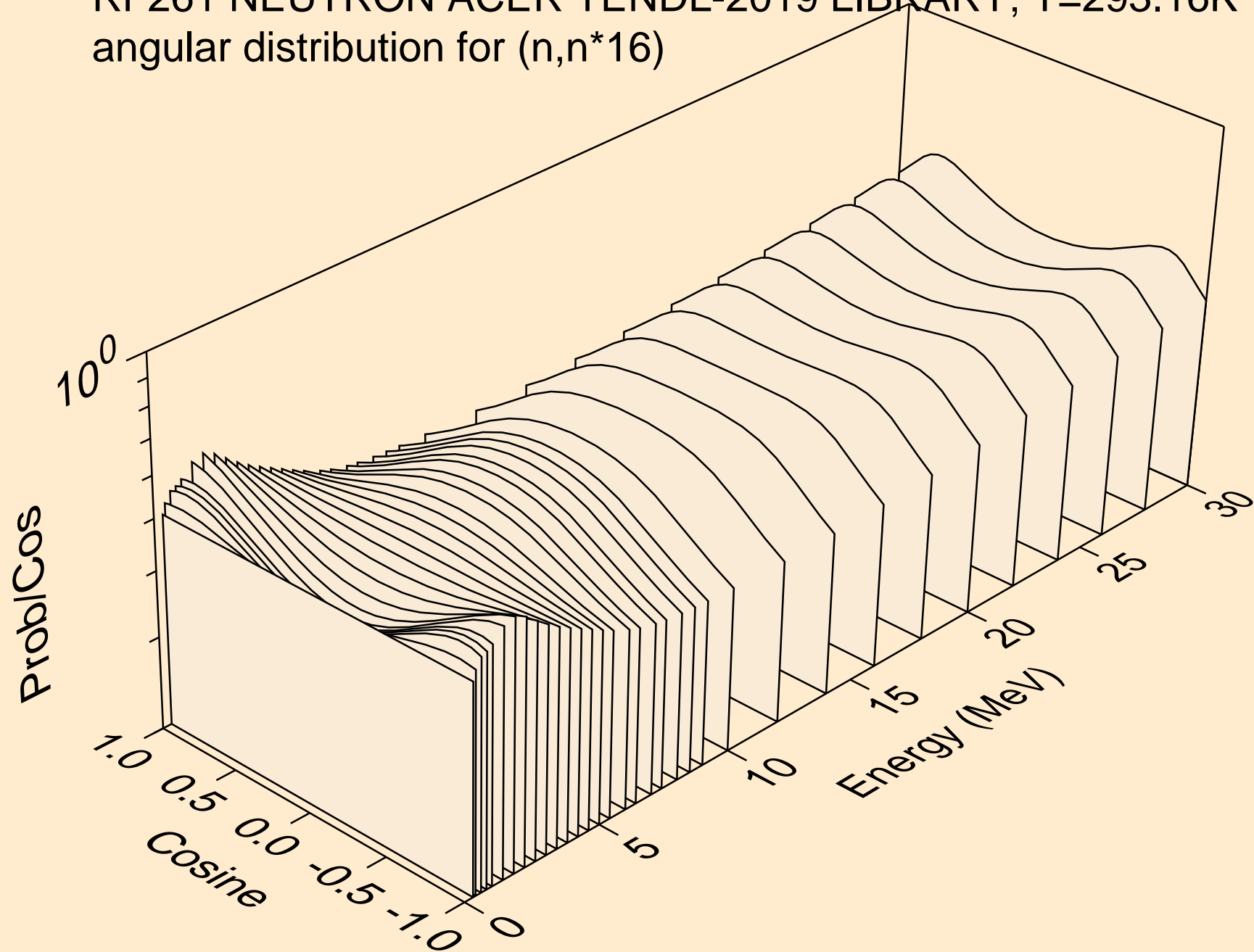

RF261 NEUTRON ACER TENDL-2019 LIBRARY; T=293.16K
angular distribution for (n,n*17)

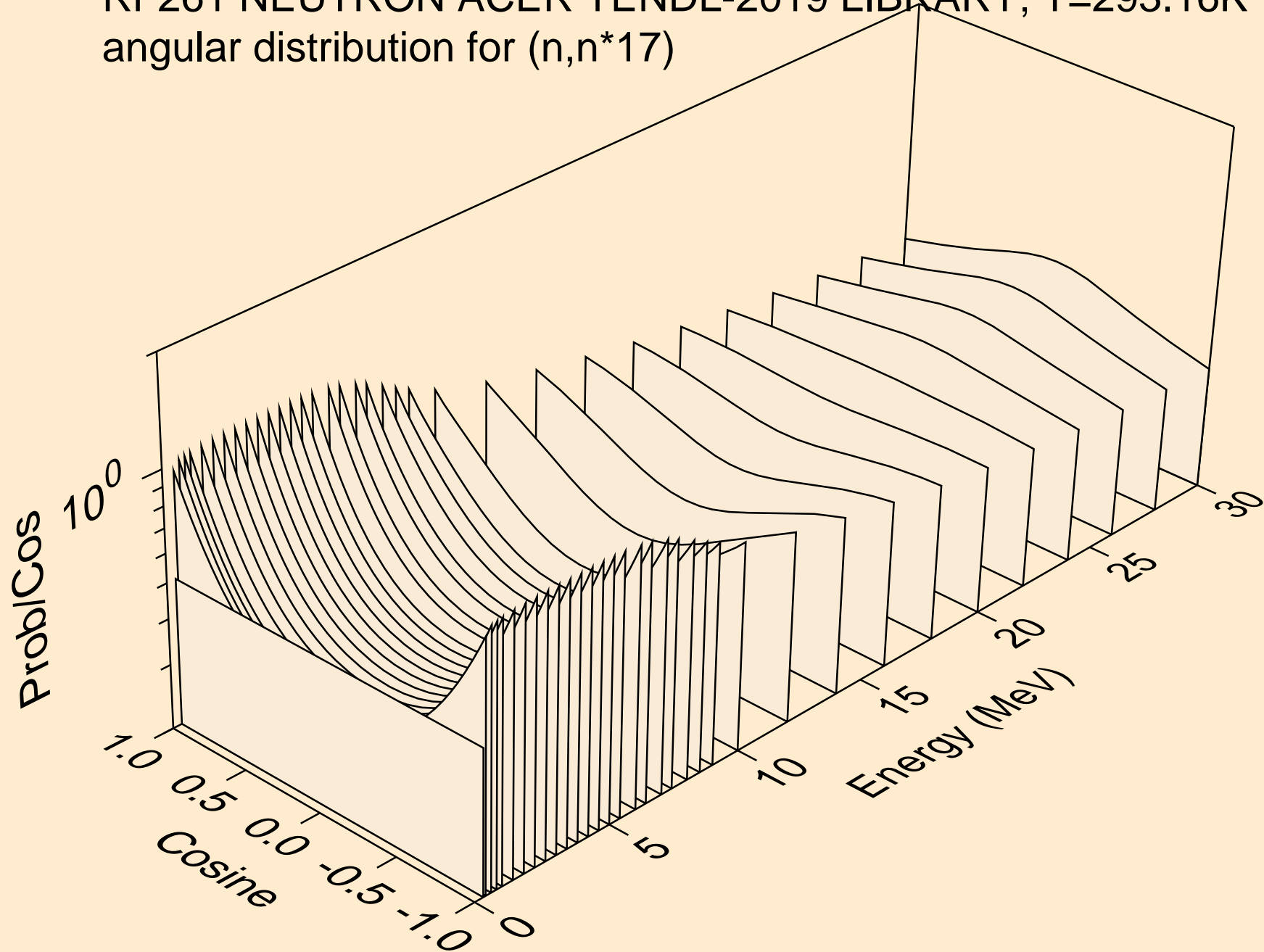

RF261 NEUTRON ACER TENDL-2019 LIBRARY; T=293.16K
angular distribution for (n,n*18)

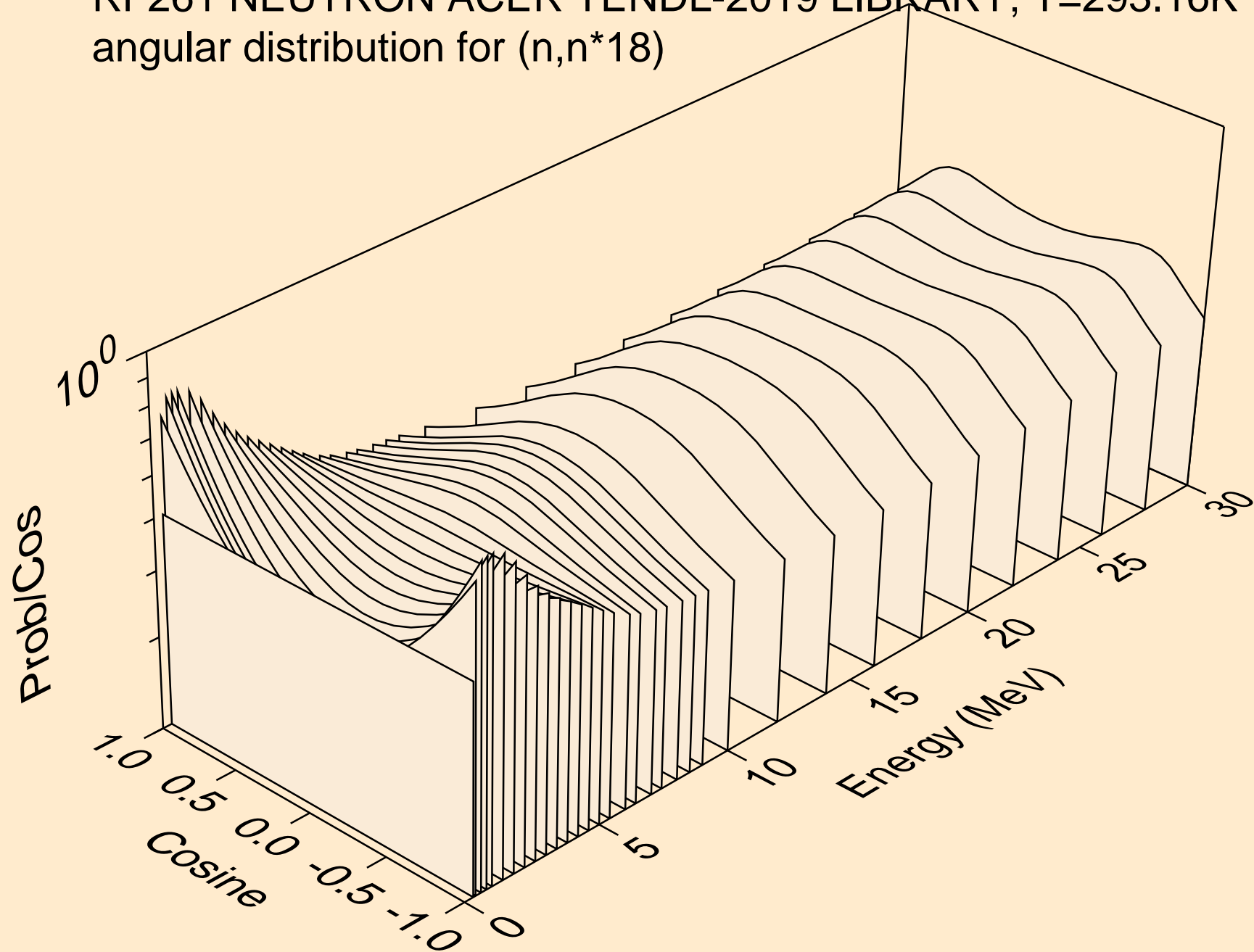

RF261 NEUTRON ACER TENDL-2019 LIBRARY; T=293.16K
angular distribution for (n,n*19)

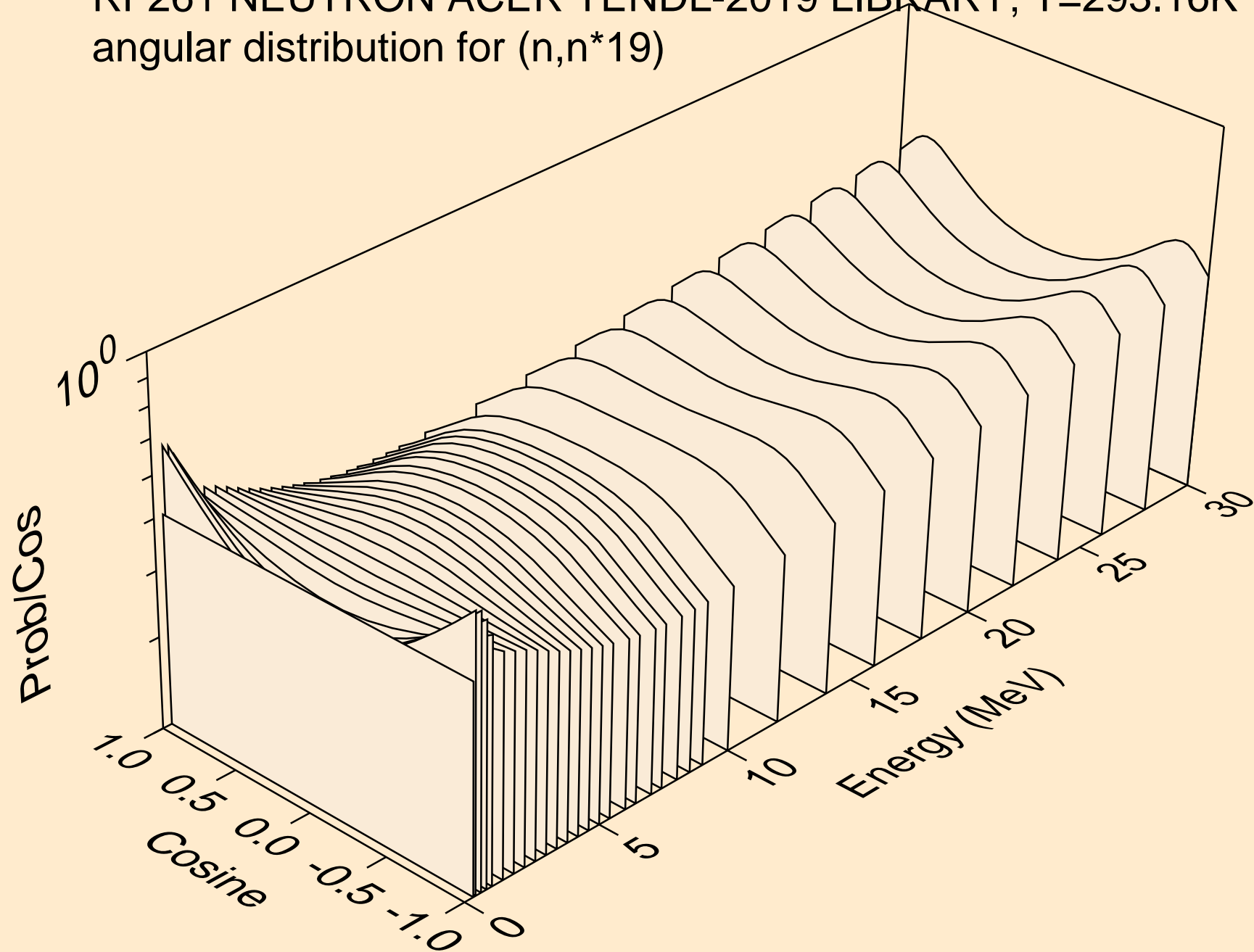

RF261 NEUTRON ACER TENDL-2019 LIBRARY; T=293.16K
angular distribution for (n,n*20)

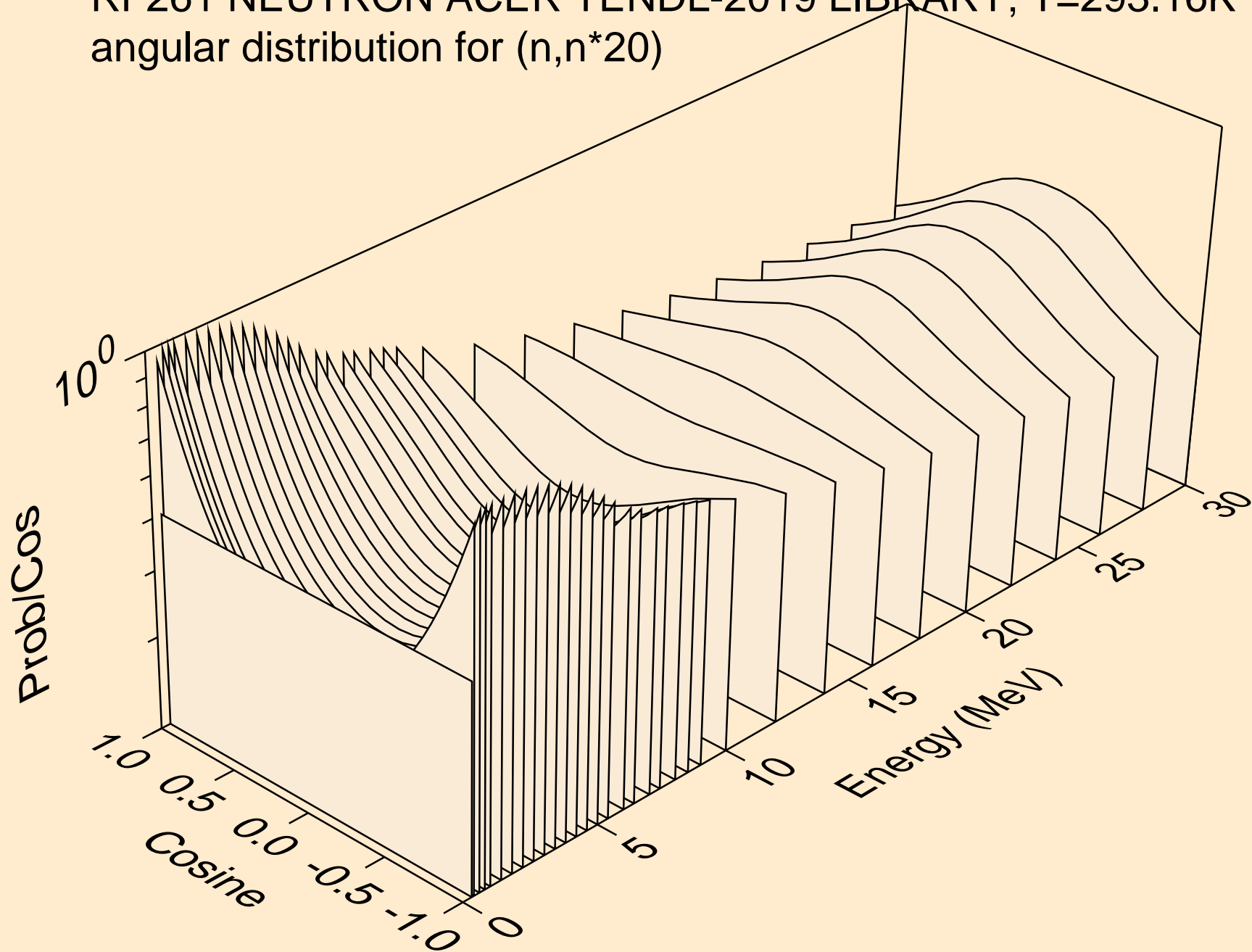

RF261 NEUTRON ACER TENDL-2019 LIBRARY; T=293.16K
angular distribution for (n,n*21)

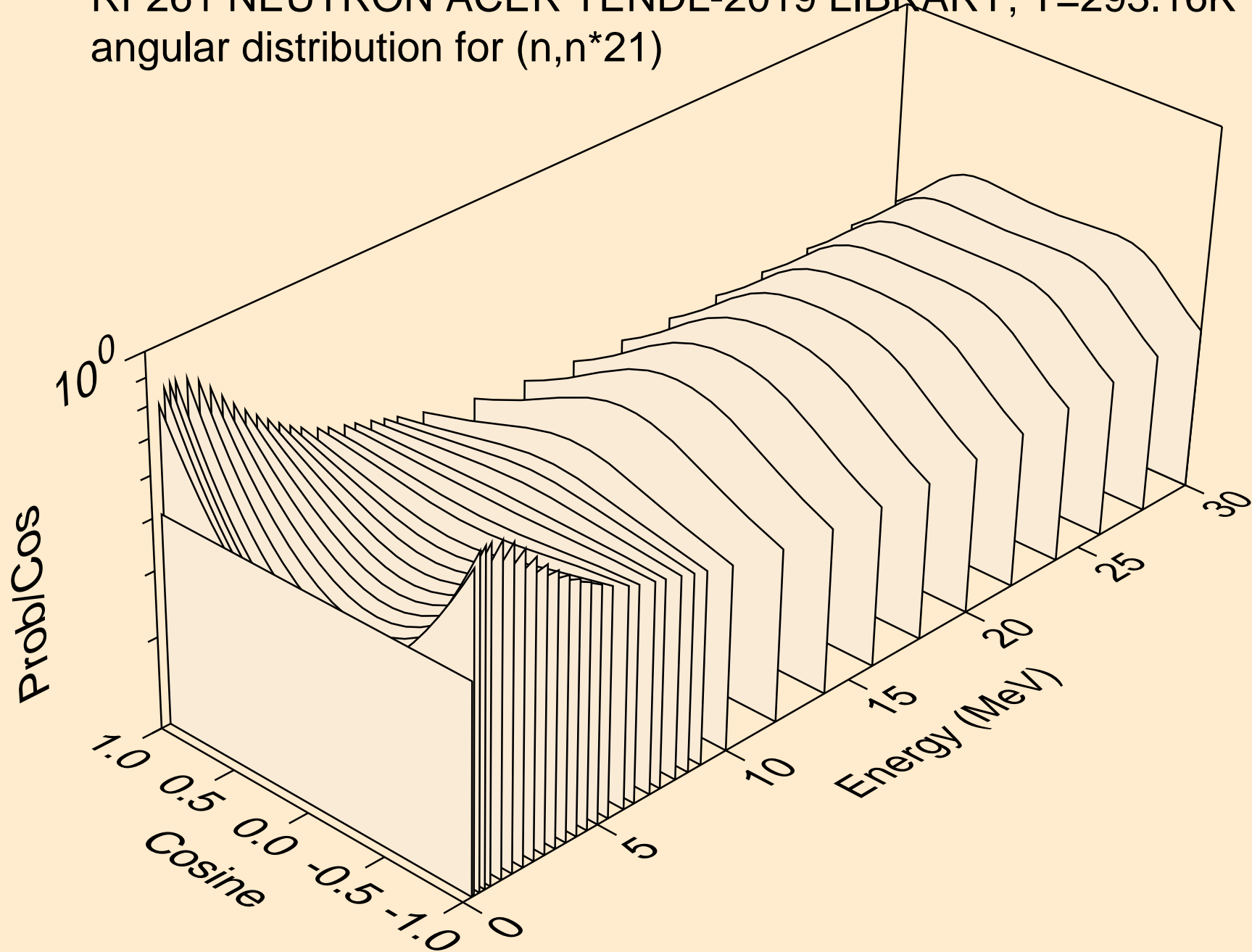

RF261 NEUTRON ACER TENDL-2019 LIBRARY; T=293.16K
angular distribution for (n,n*22)

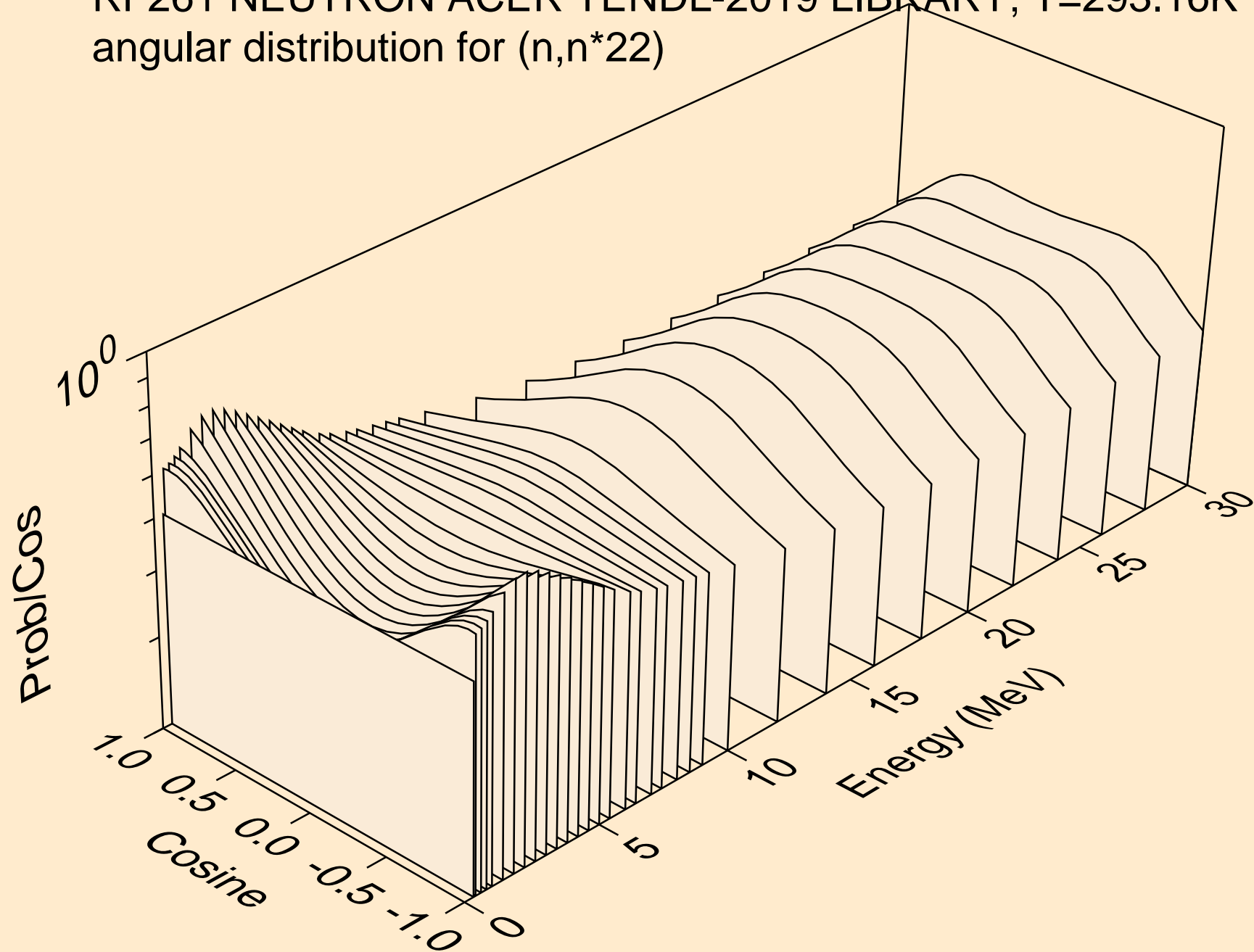

RF261 NEUTRON ACER TENDL-2019 LIBRARY; T=293.16K
angular distribution for (n,n*23)

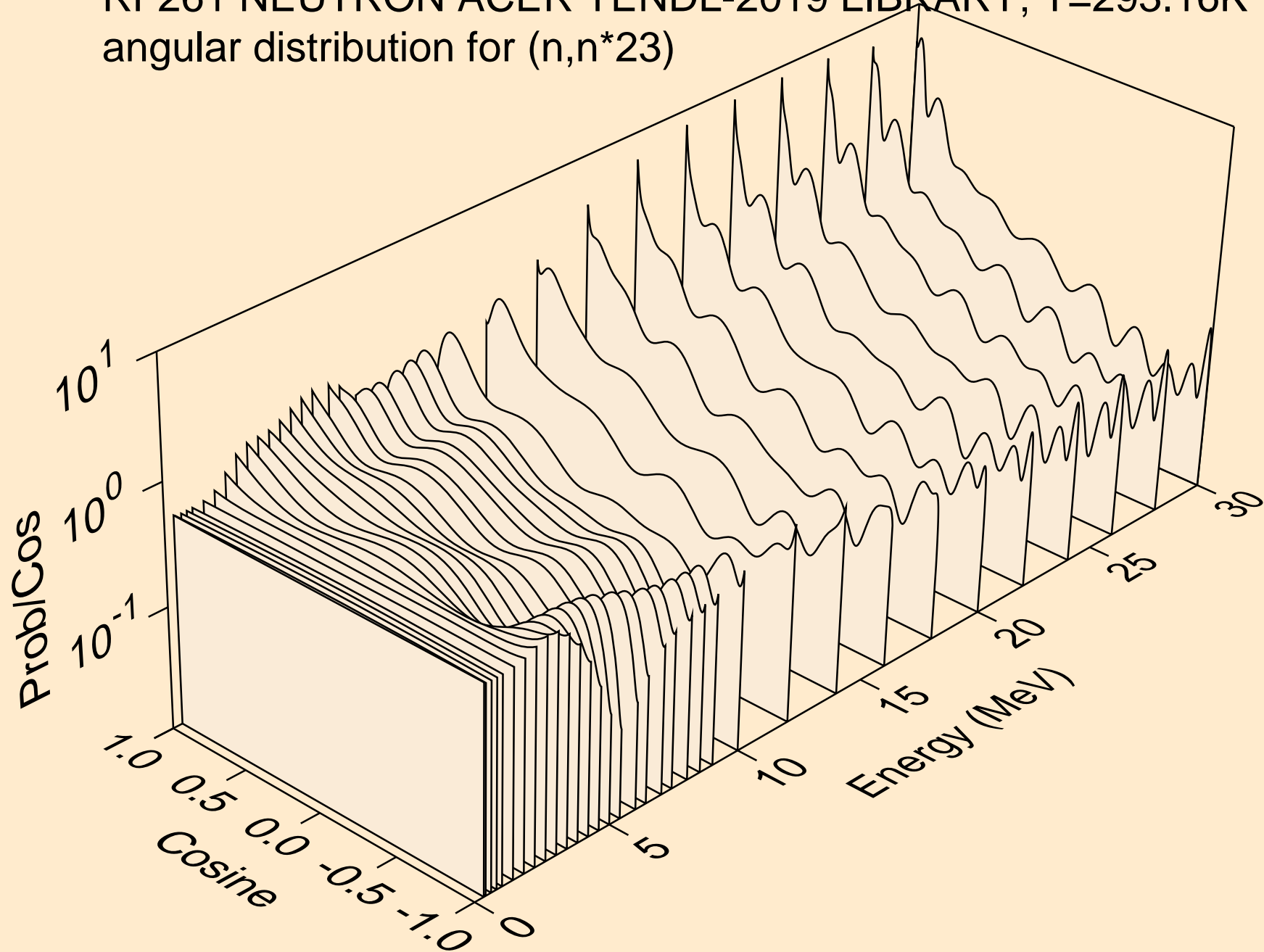

RF261 NEUTRON ACER TENDL-2019 LIBRARY; T=293.16K
angular distribution for (n,n*24)

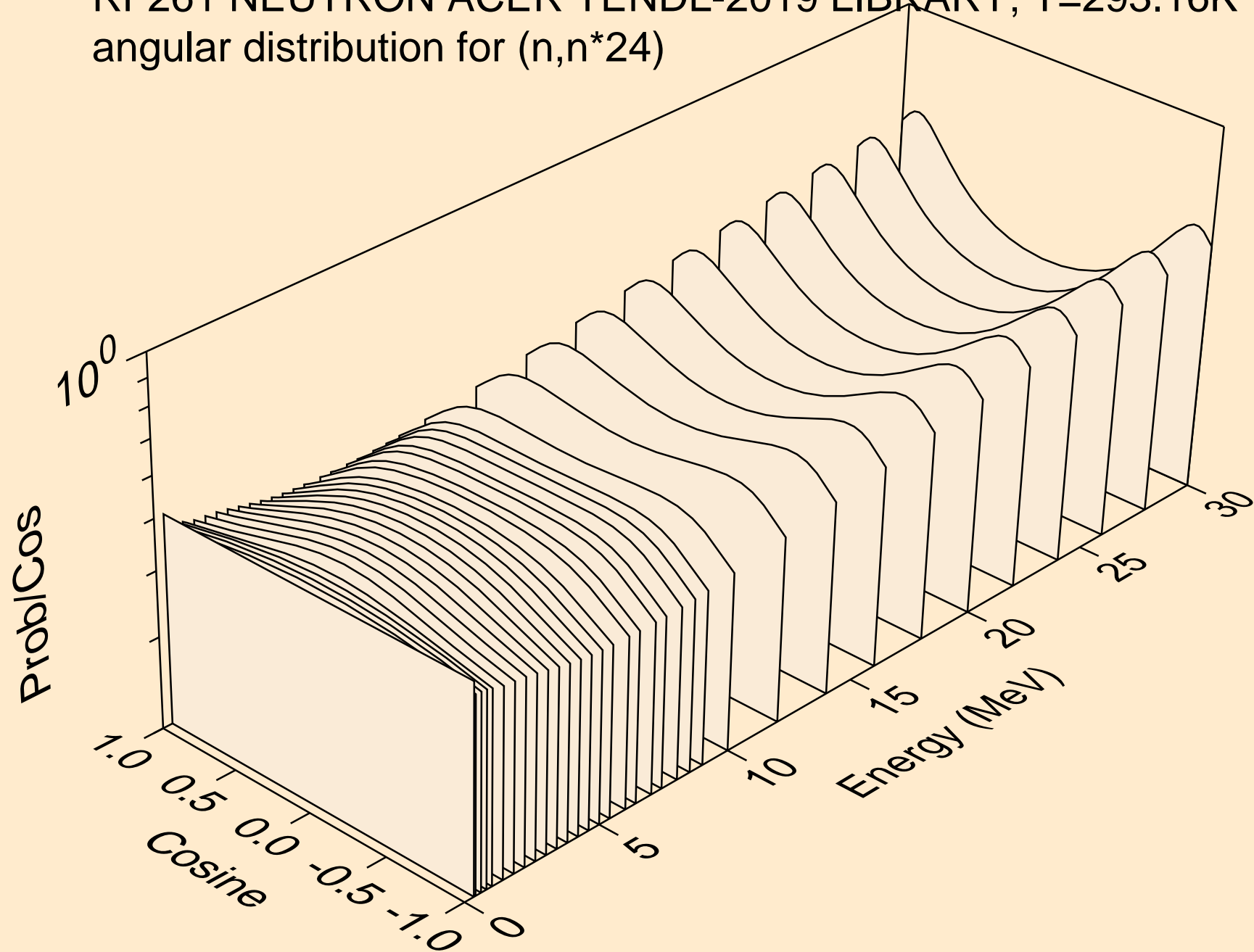

RF261 NEUTRON ACER TENDL-2019 LIBRARY; T=293.16K
angular distribution for (n,n*25)

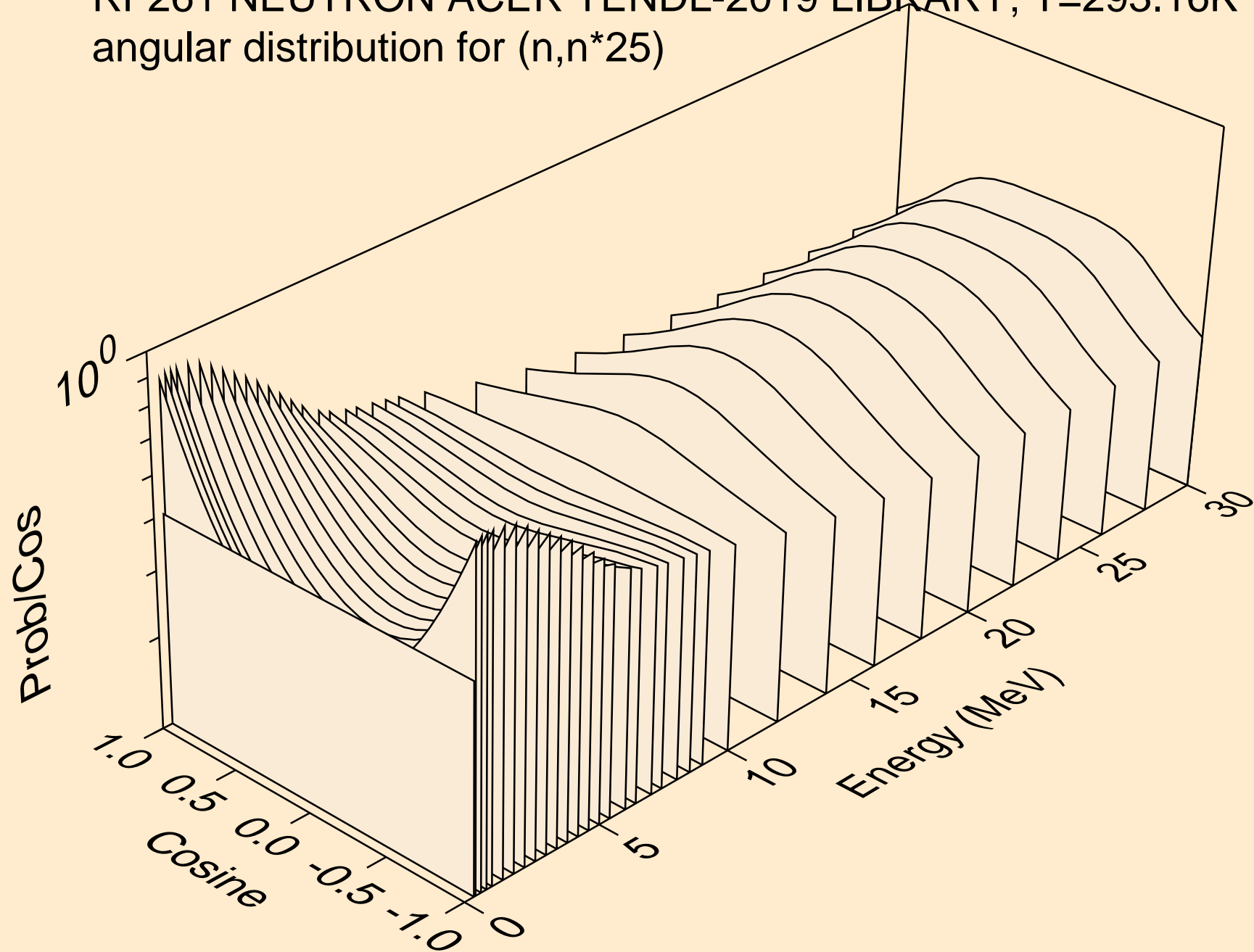

RF261 NEUTRON ACER TENDL-2019 LIBRARY; T=293.16K
angular distribution for (n,n*26)

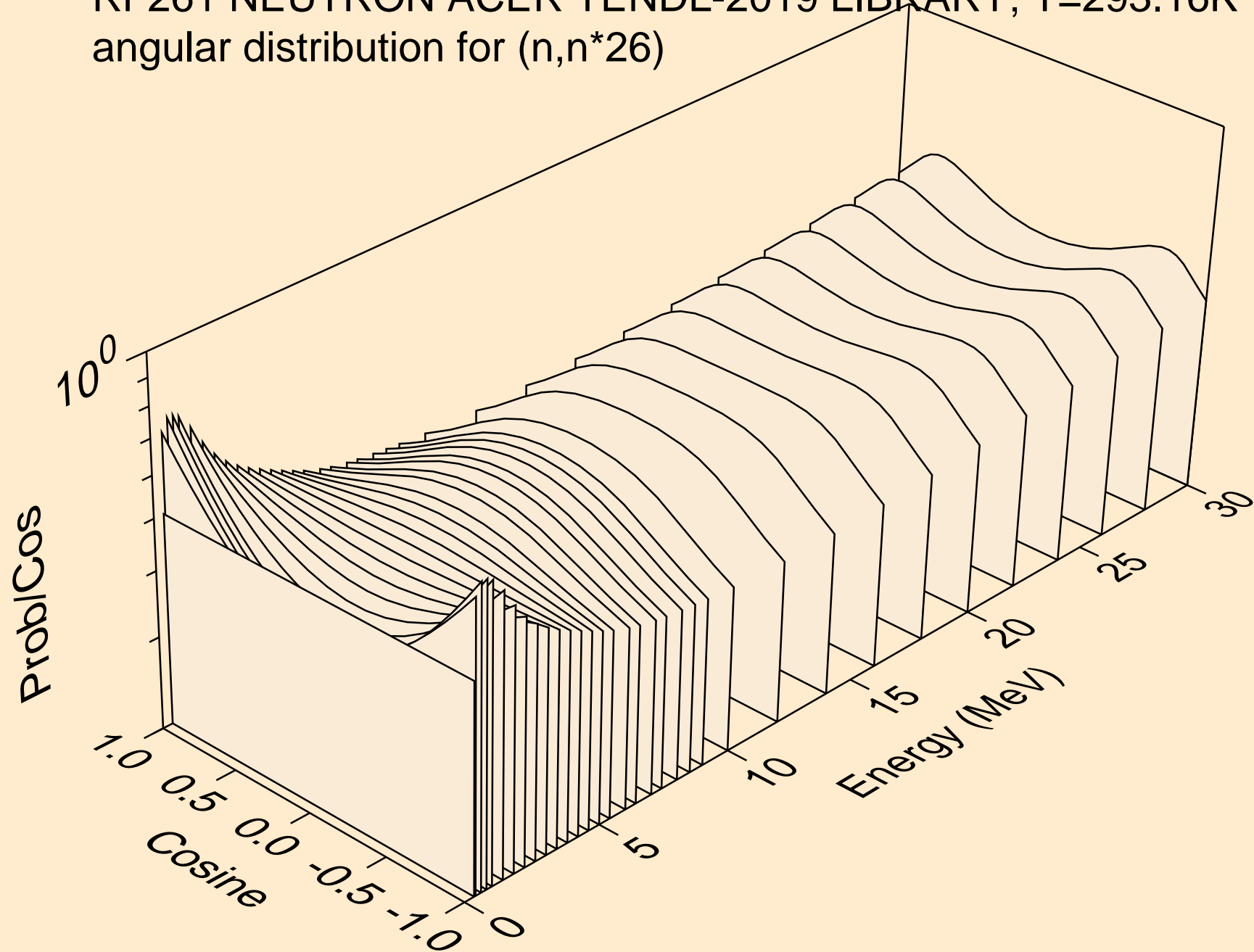

RF261 NEUTRON ACER TENDL-2019 LIBRARY; T=293.16K
angular distribution for (n,n*27)

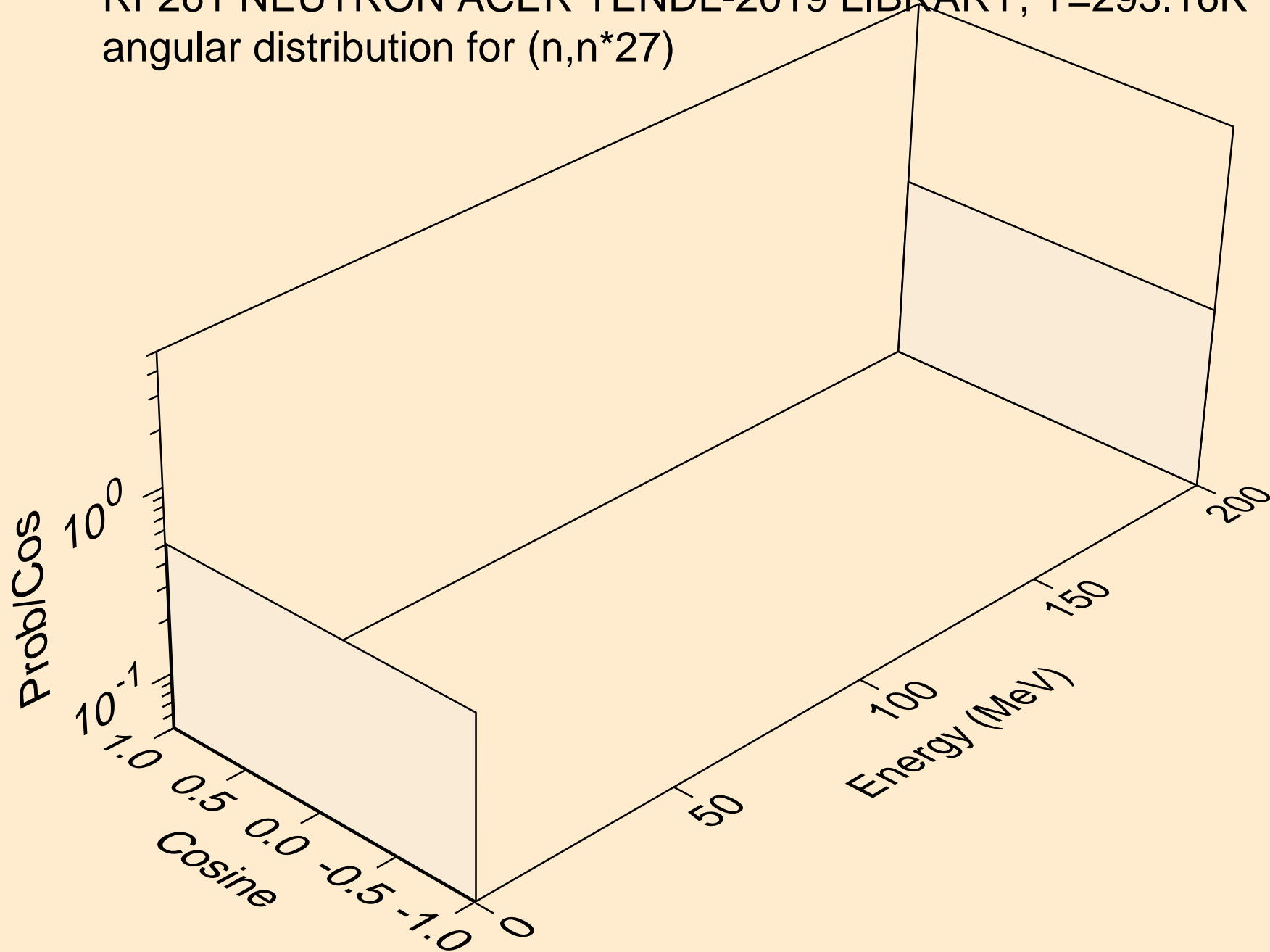

RF261 NEUTRON ACER TENDL-2019 LIBRARY; T=293.16K
Total fission nubar

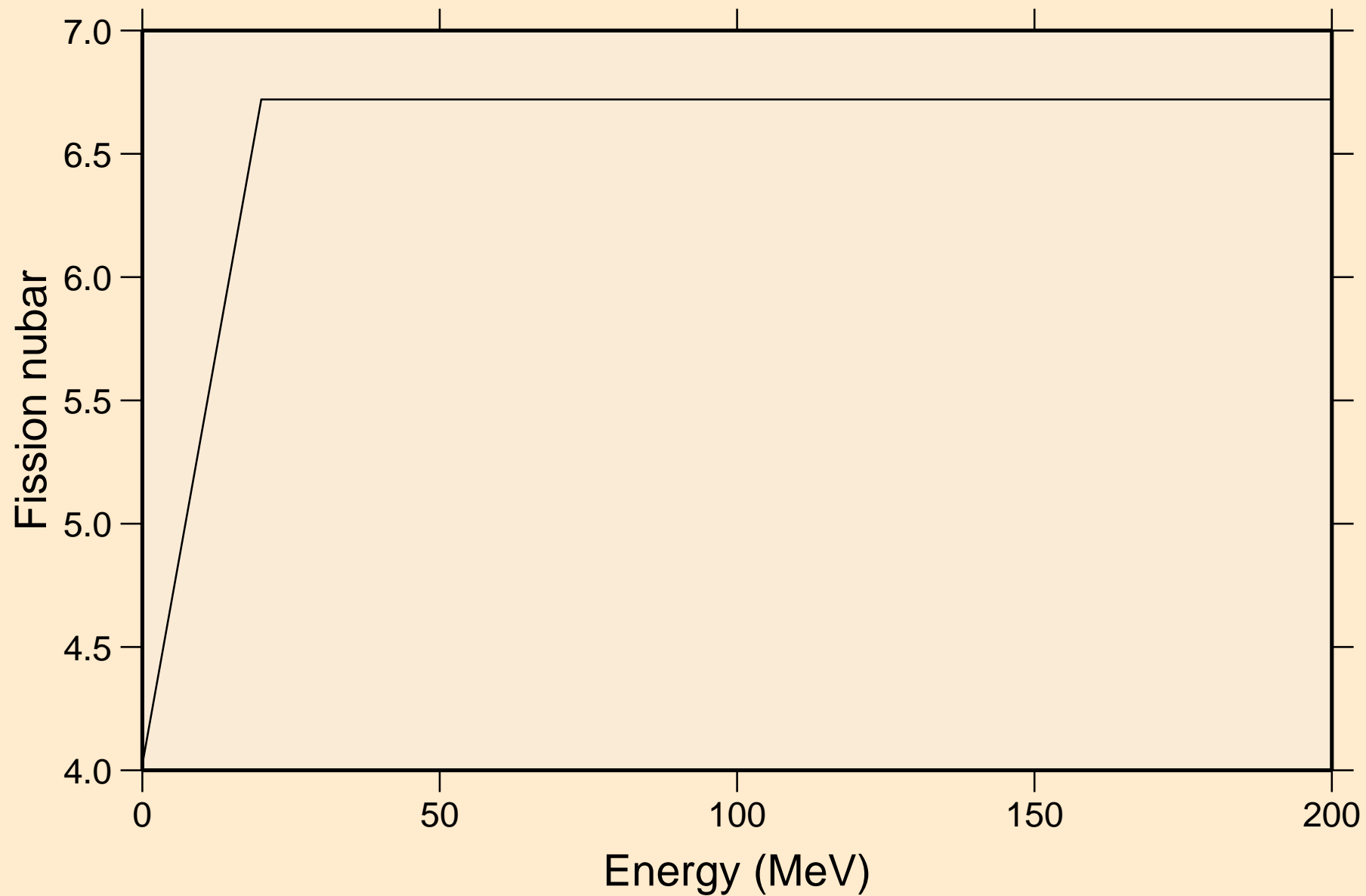

RF261 NEUTRON ACER TENDL-2019 LIBRARY; T=293.16K
Neutron emission for (n,x)

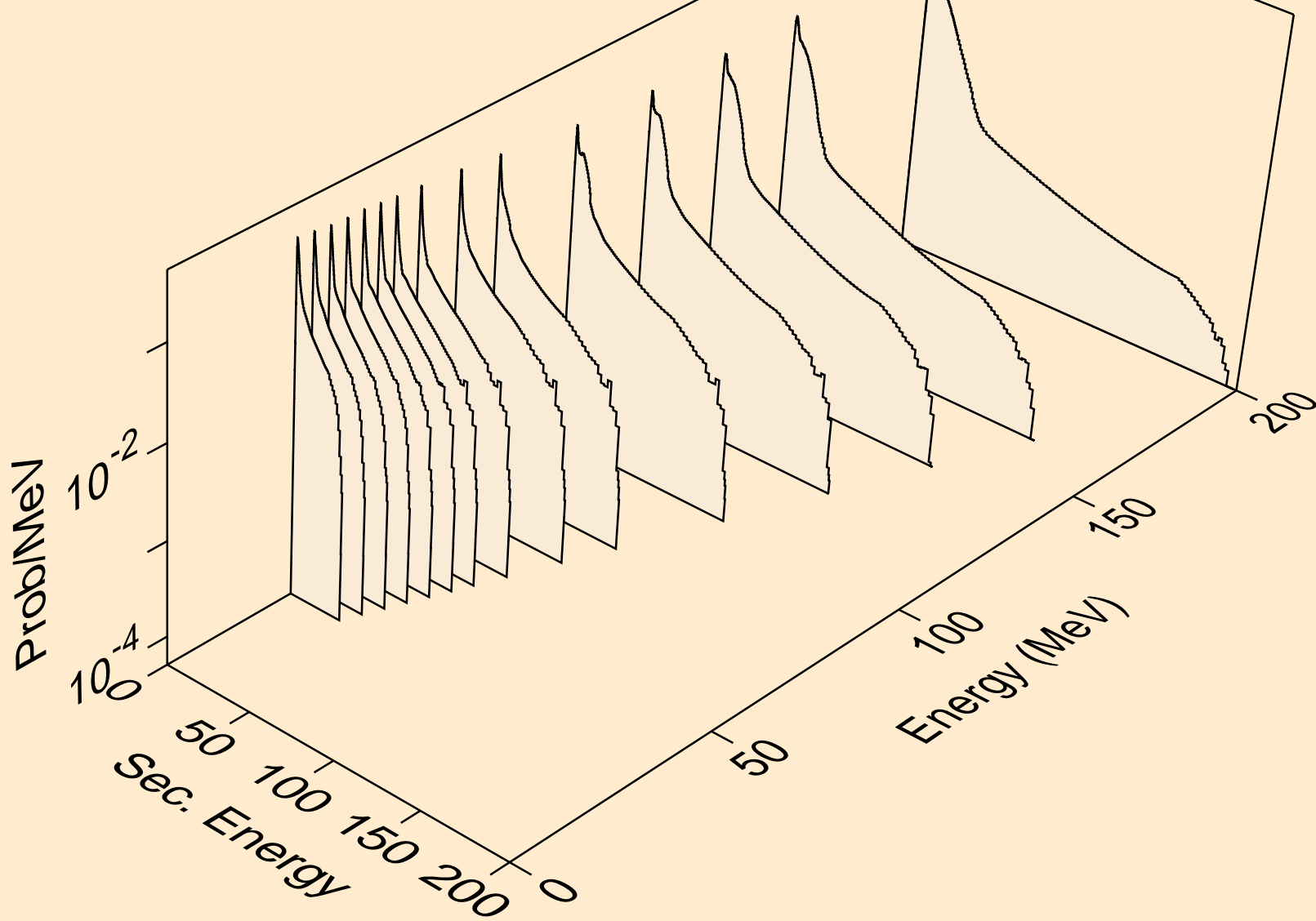

RF261 NEUTRON ACER TENDL-2019 LIBRARY; T=293.16K
Neutron emission for (n,2nd)

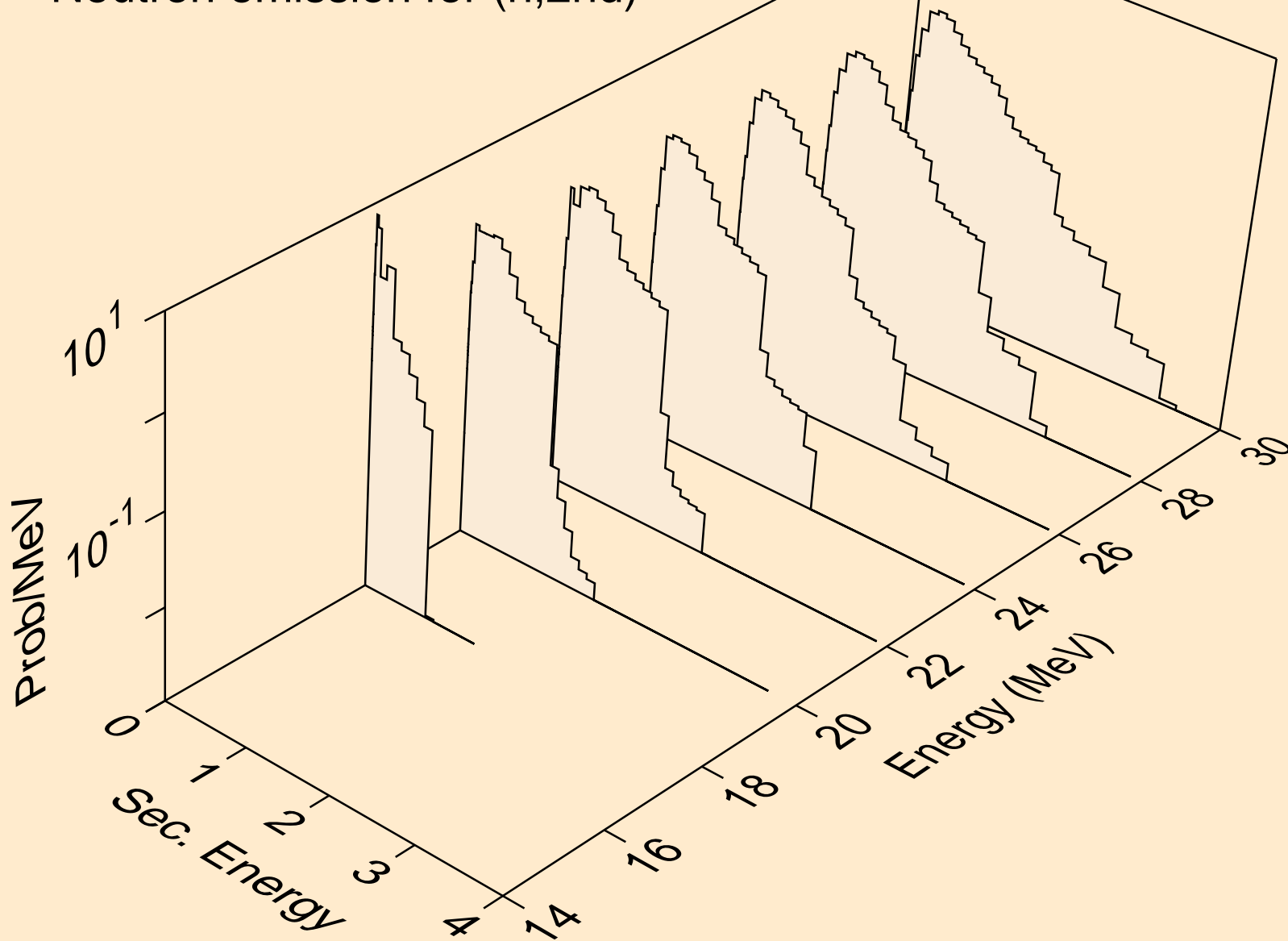

RF261 NEUTRON ACER TENDL-2019 LIBRARY; T=293.16K
Neutron emission for (n,2n)

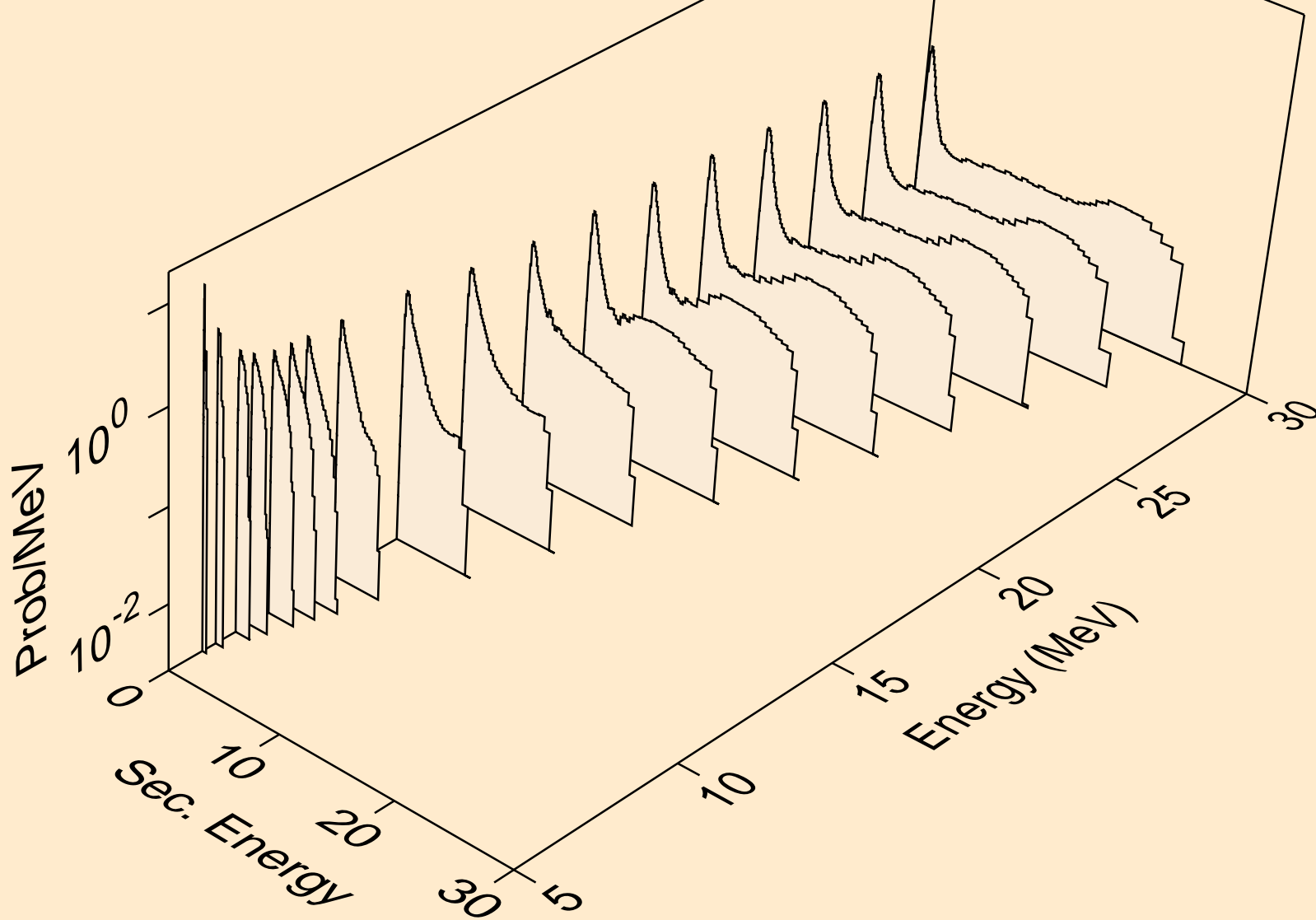

RF261 NEUTRON ACER TENDL-2019 LIBRARY; T=293.16K
Neutron emission for (n,3n)

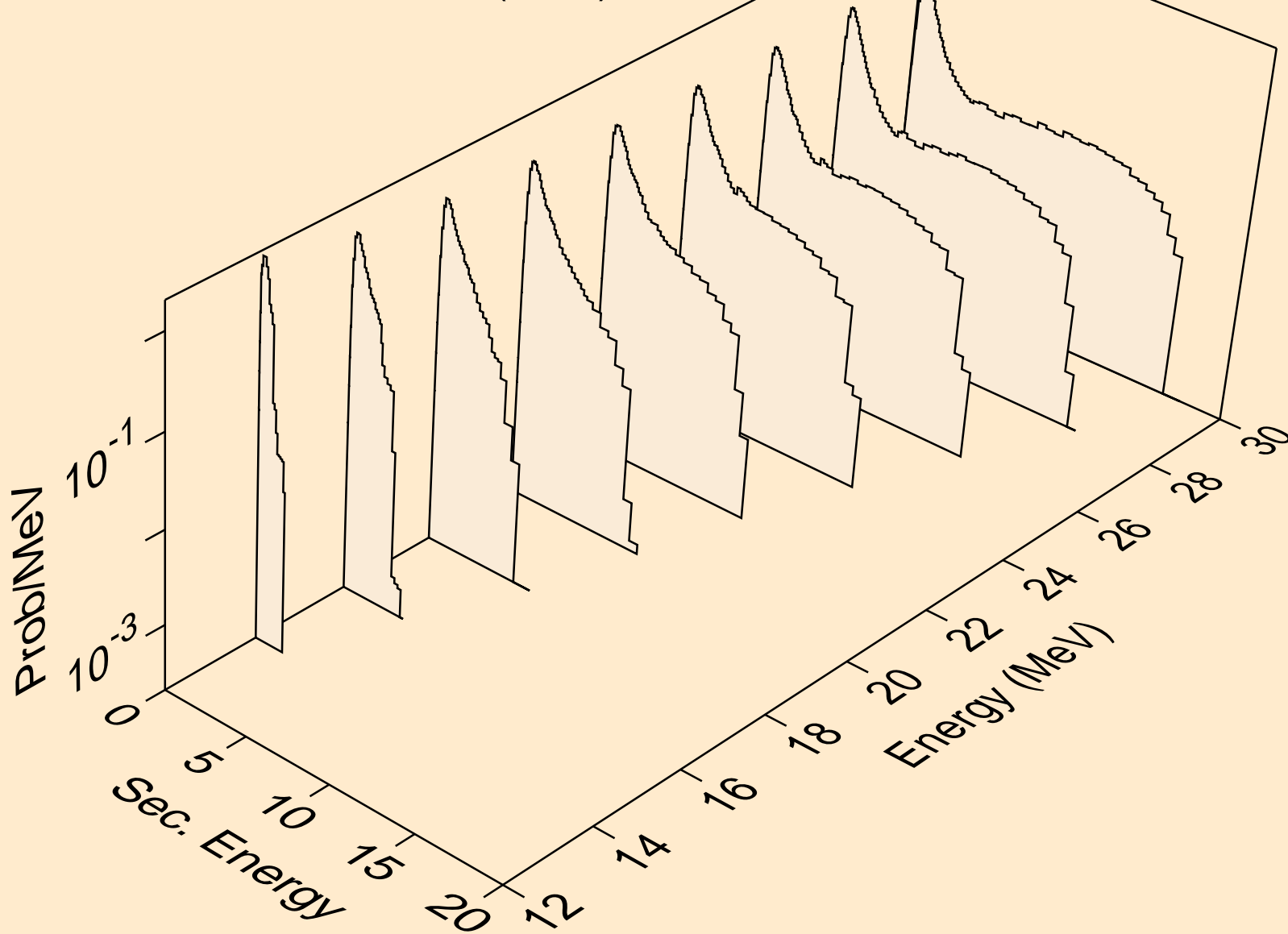

RF261 NEUTRON ACER TENDL-2019 LIBRARY; T=293.16K
Neutron emission for fission

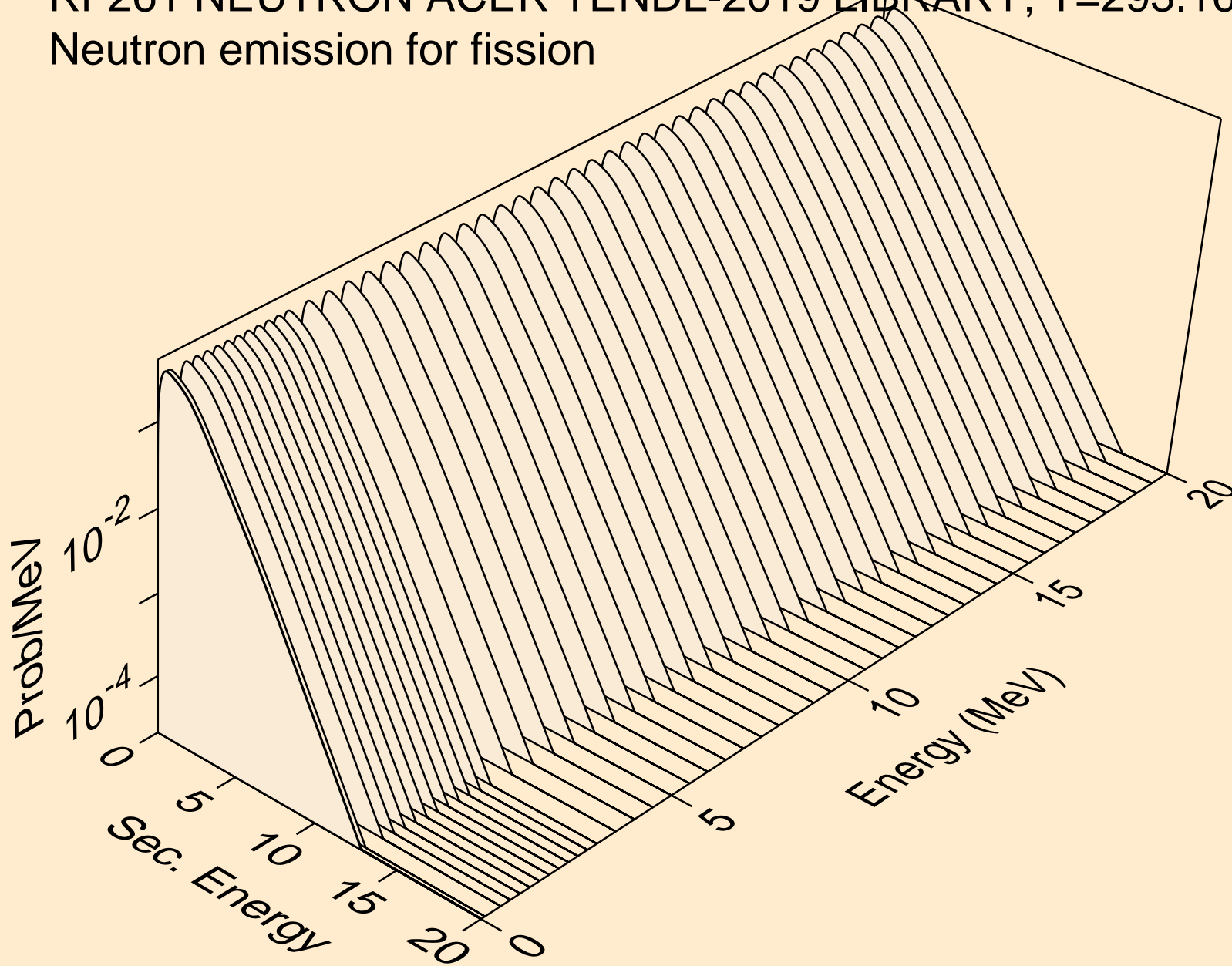

RF261 NEUTRON ACER TENDL-2019 LIBRARY; T=293.16K
Neutron emission for (n,n*)a

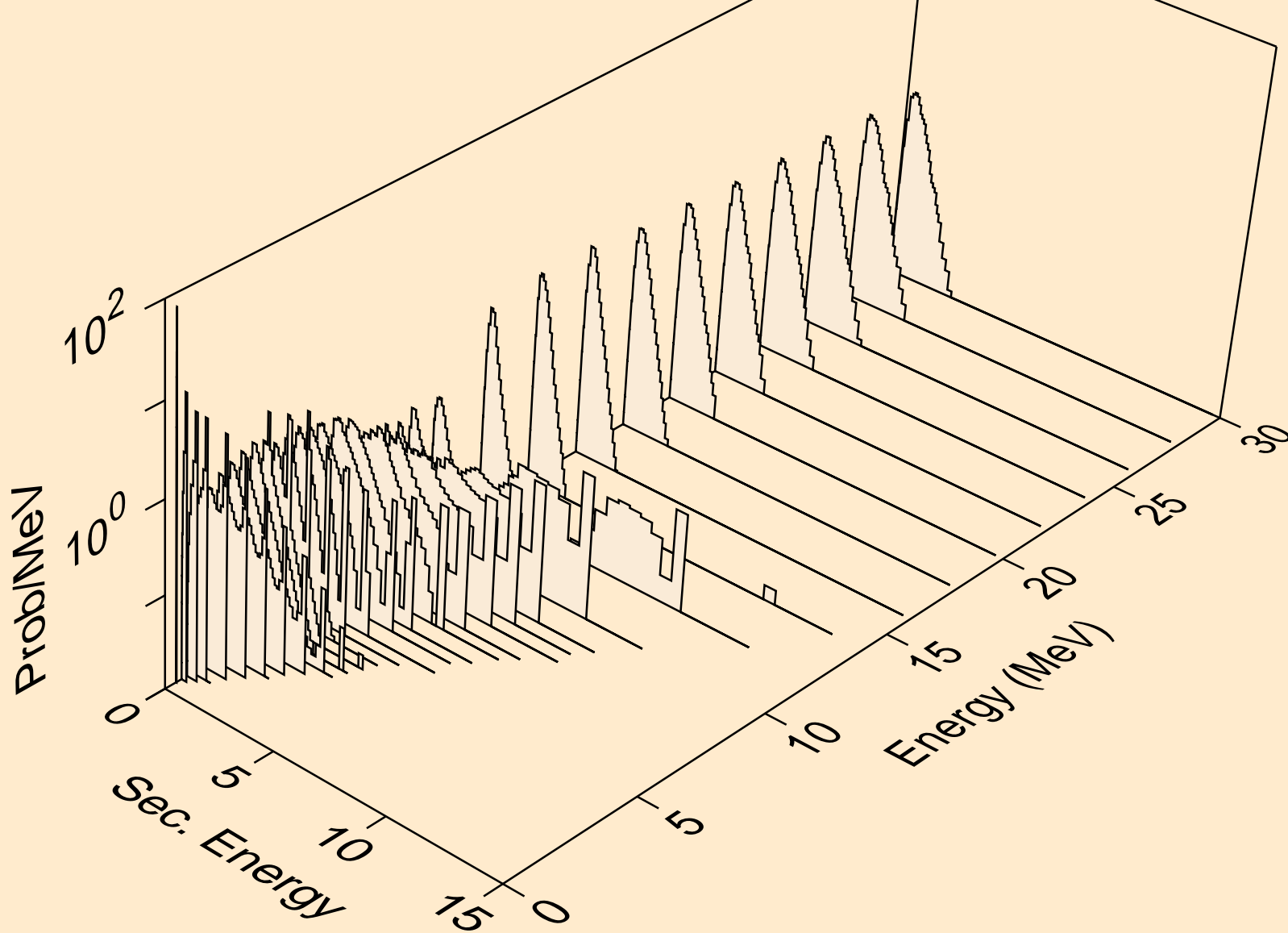

RF261 NEUTRON ACER TENDL-2019 LIBRARY; T=293.16K
Neutron emission for (n,2n)a

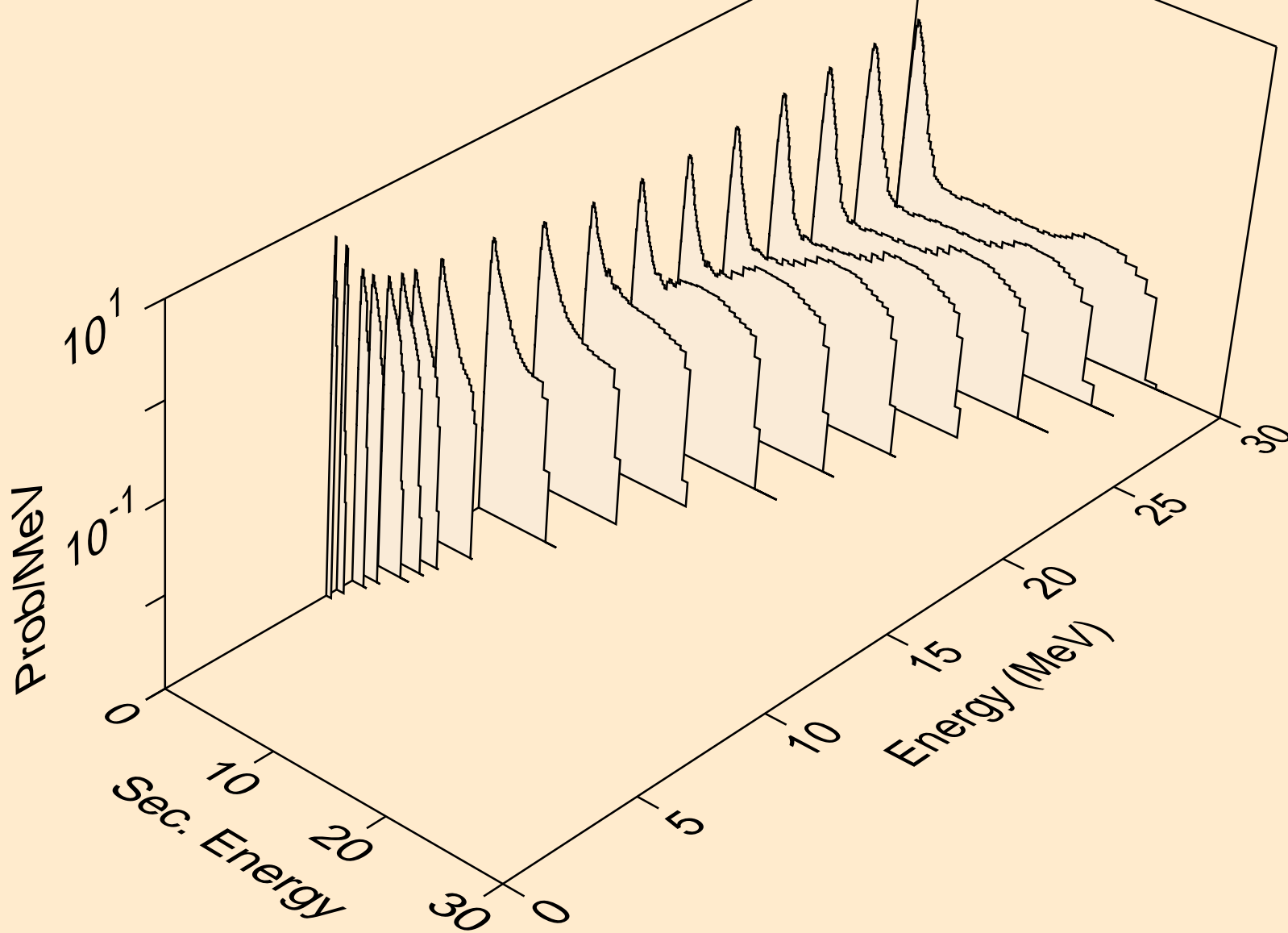

RF261 NEUTRON ACER TENDL-2019 LIBRARY; T=293.16K
Neutron emission for (n,3n)a

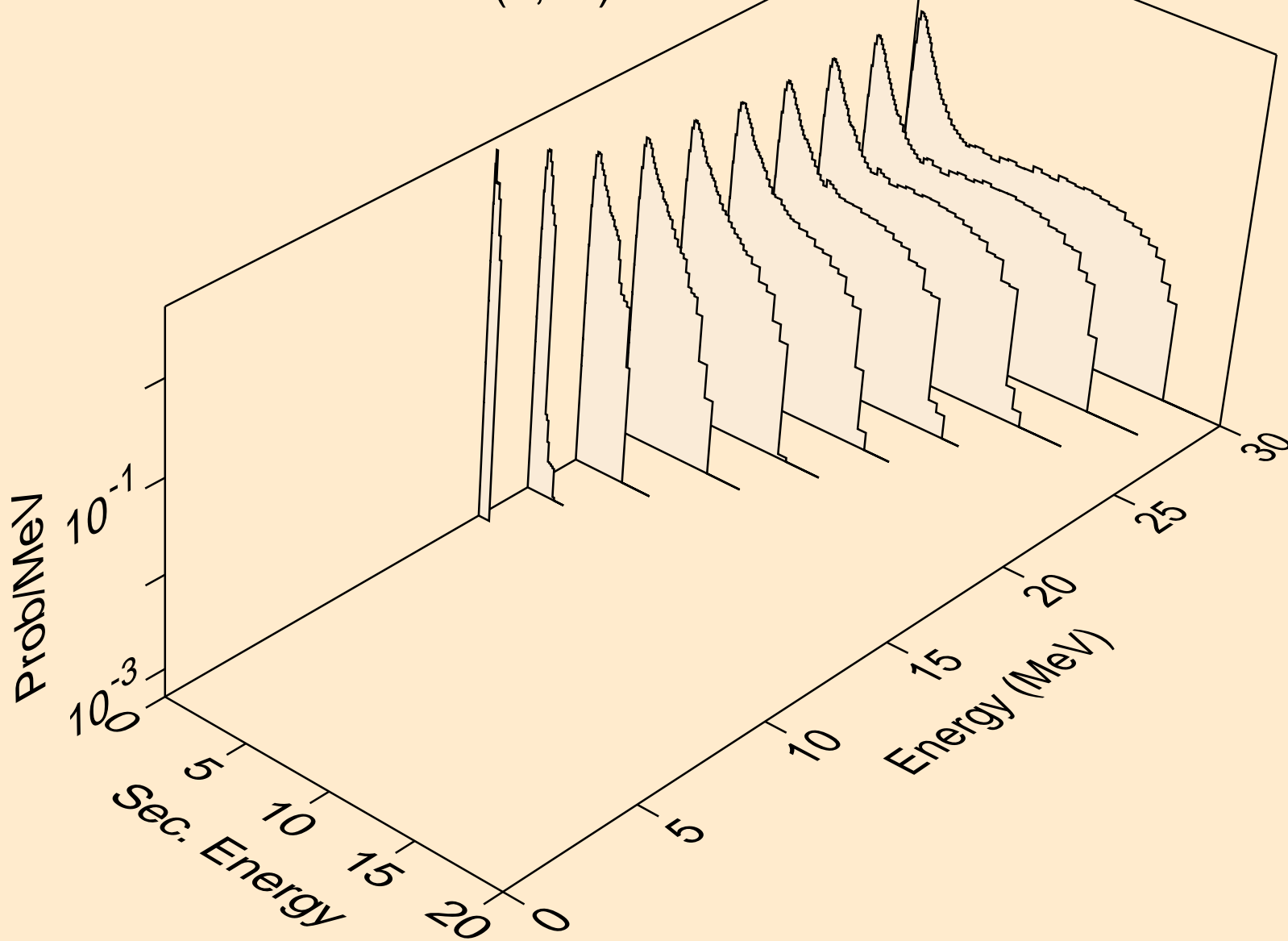

RF261 NEUTRON ACER TENDL-2019 LIBRARY; T=293.16K
Neutron emission for (n,n*)p

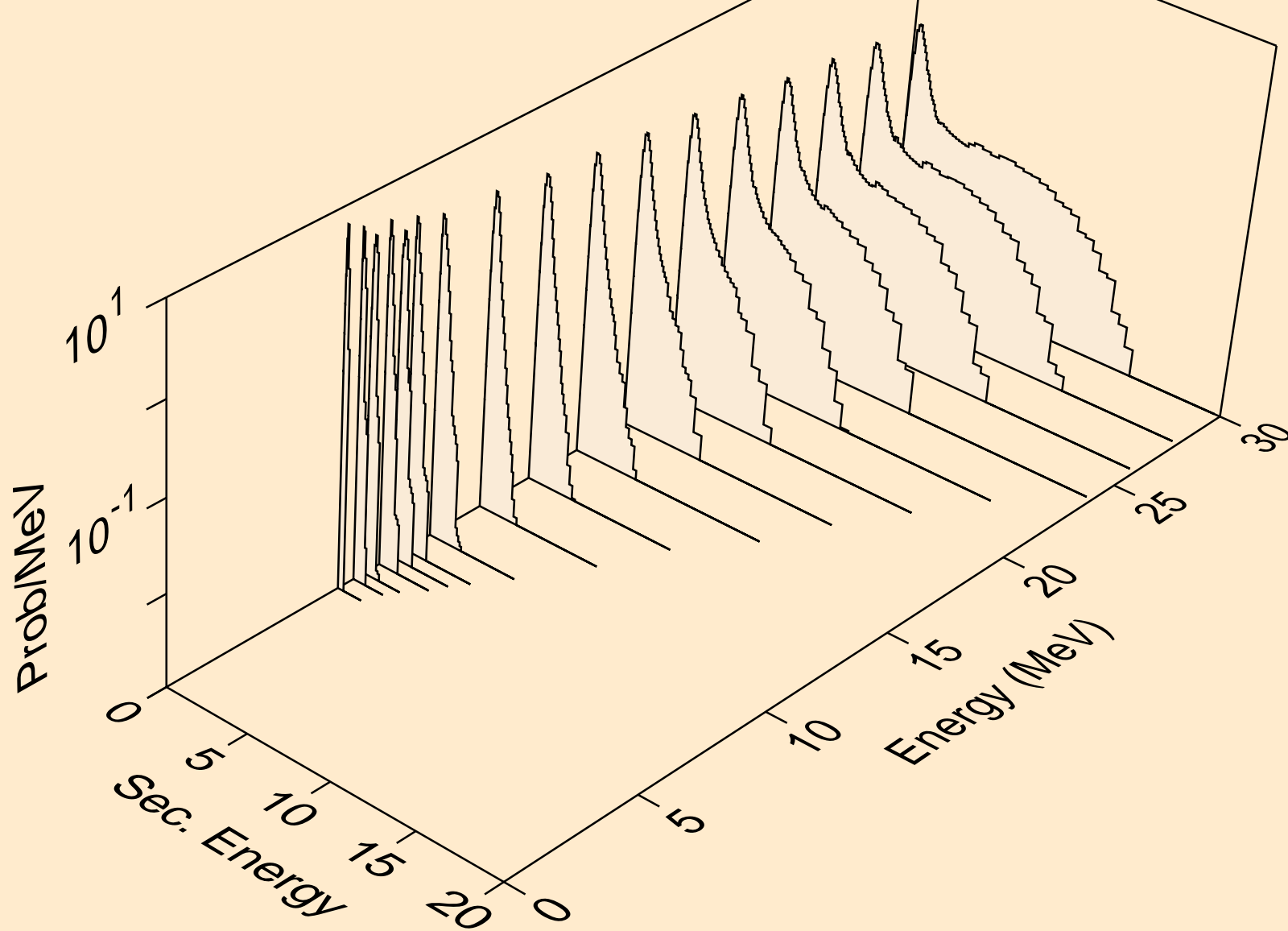

RF261 NEUTRON ACER TENDL-2019 LIBRARY; T=293.16K
Neutron emission for (n,n*)2a

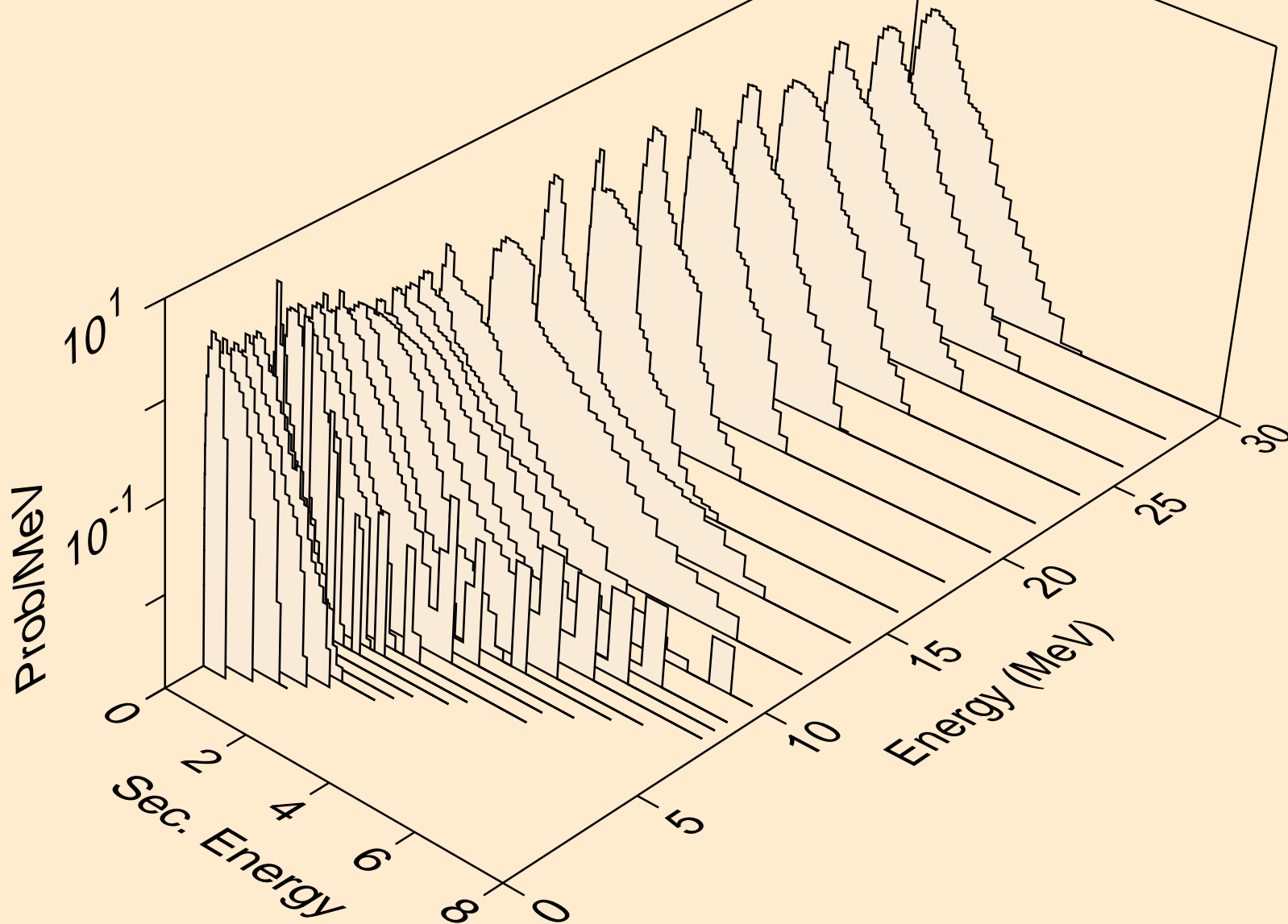

RF261 NEUTRON ACER TENDL-2019 LIBRARY; T=293.16K
Neutron emission for (n,2n)2a

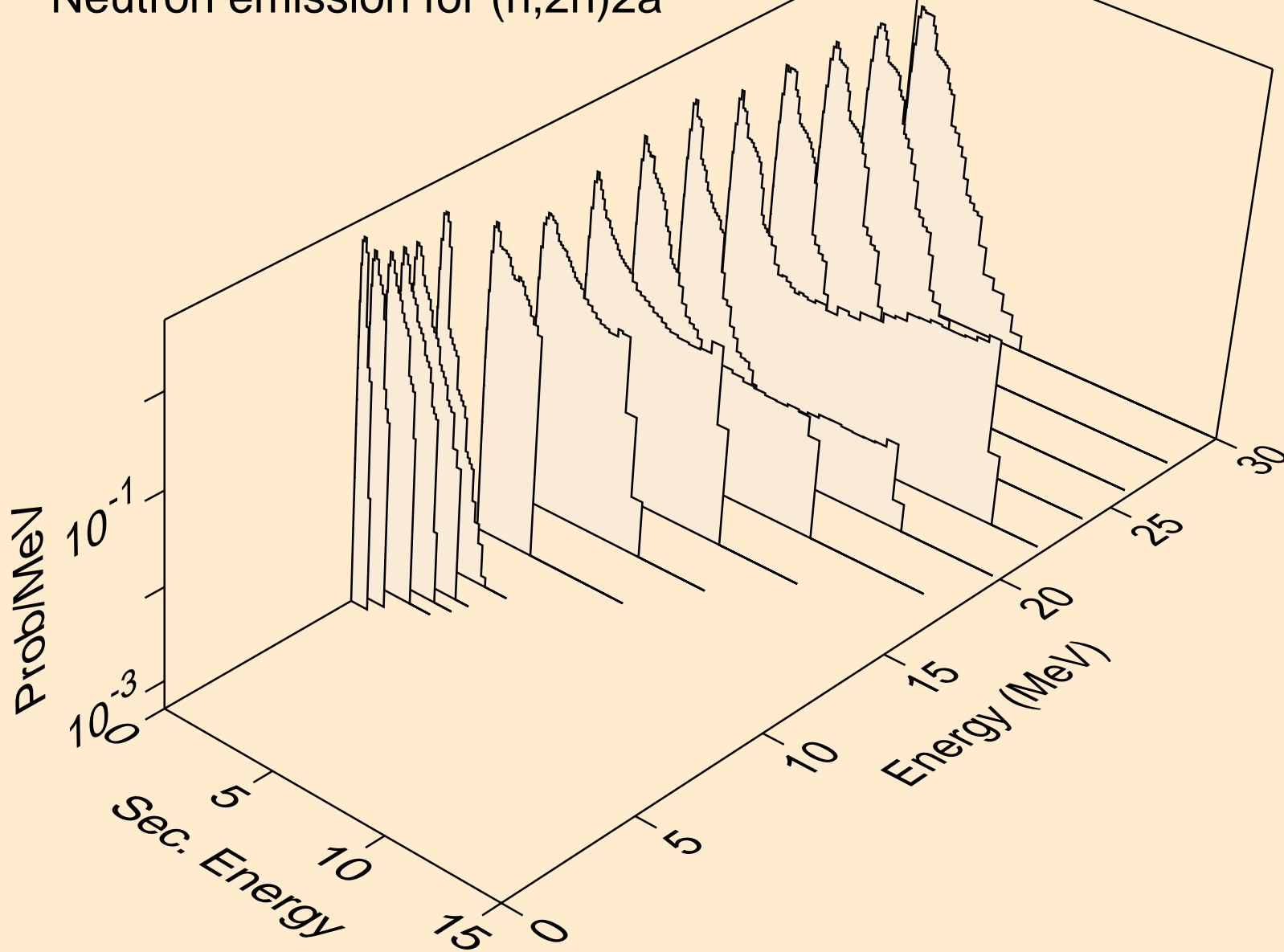

RF261 NEUTRON ACER TENDL-2019 LIBRARY; T=293.16K
Neutron emission for (n,n*)d

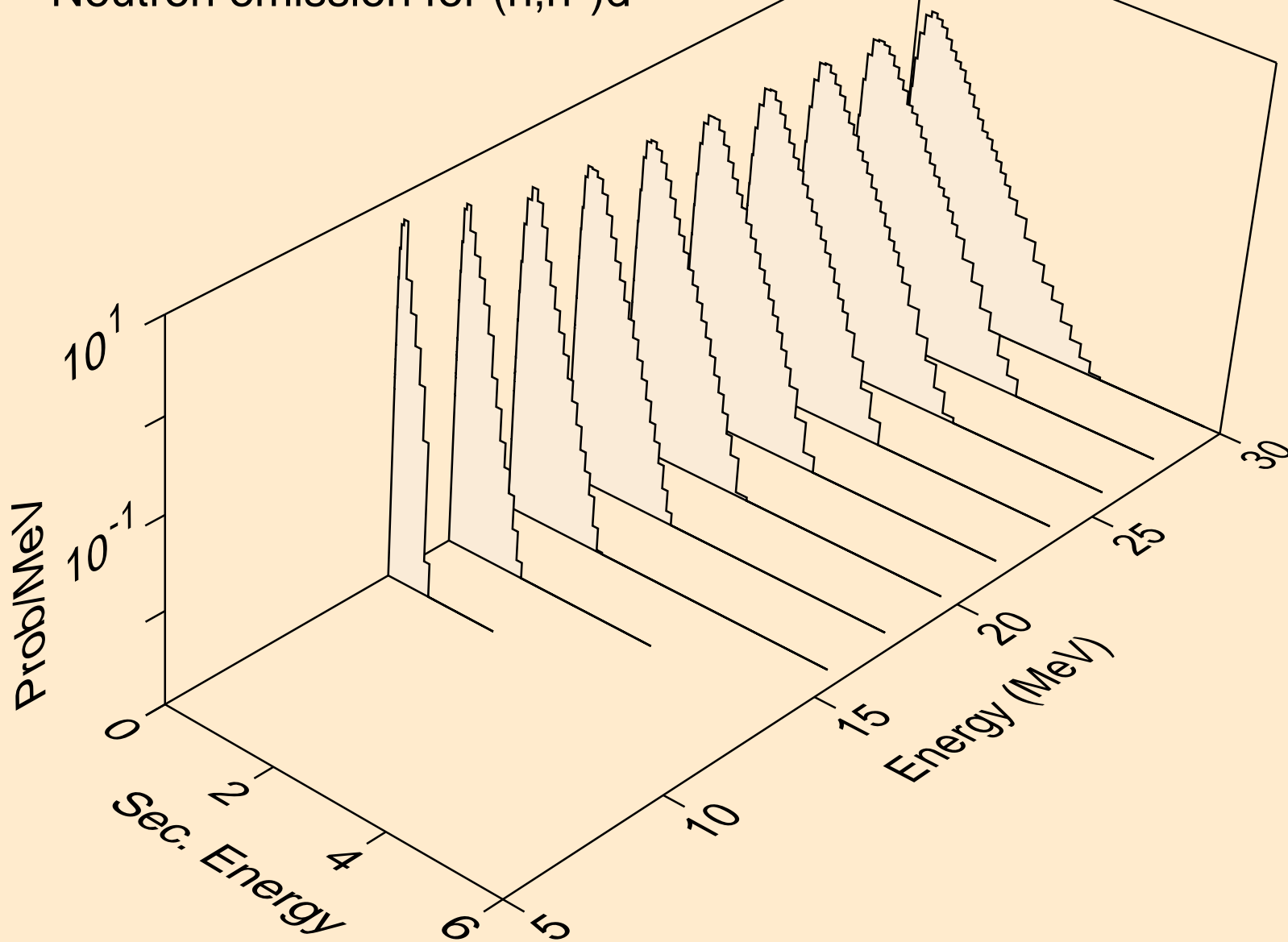

RF261 NEUTRON ACER TENDL-2019 LIBRARY; T=293.16K
Neutron emission for (n,n*)t

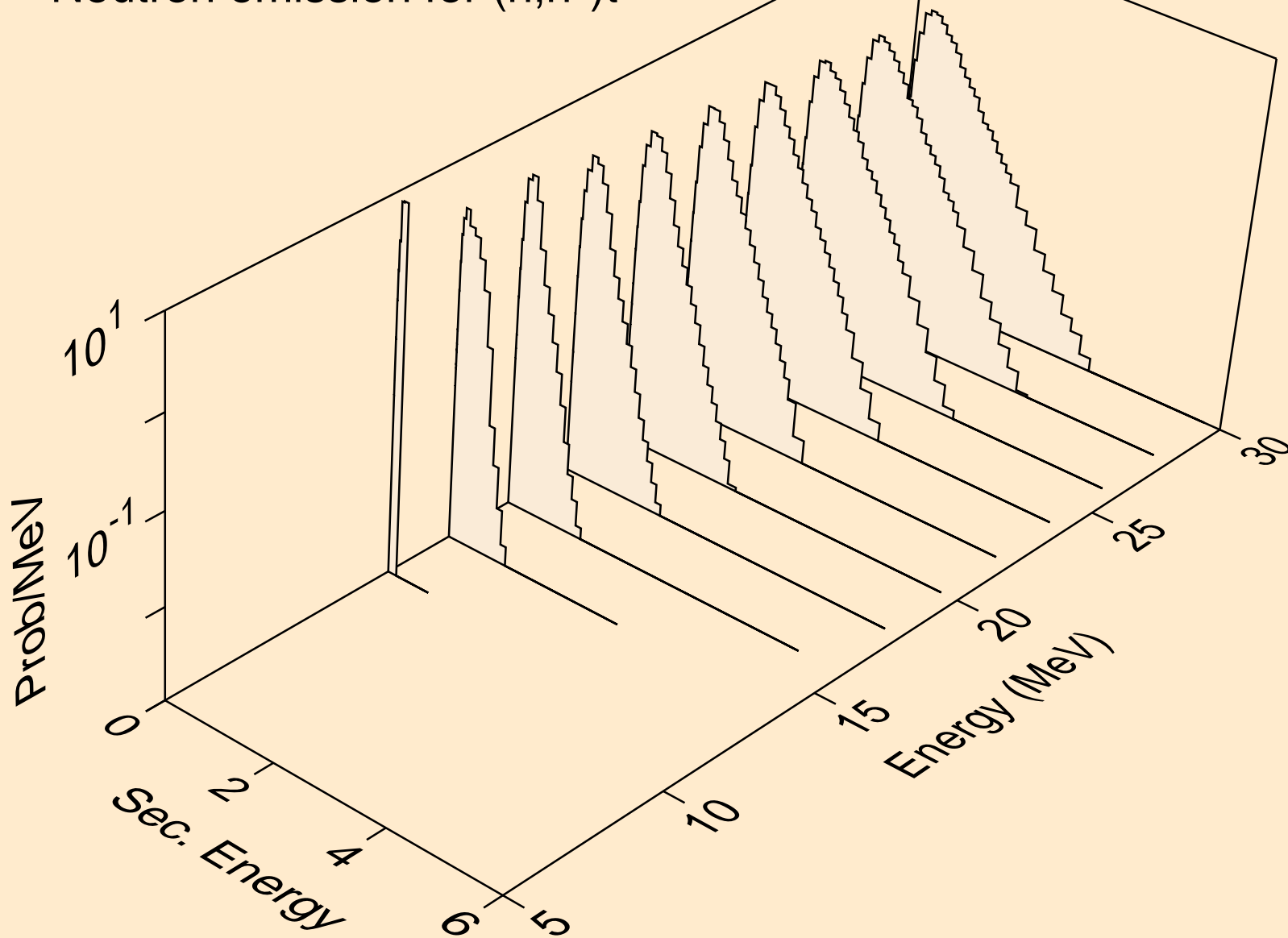

RF261 NEUTRON ACER TENDL-2019 LIBRARY; T=293.16K
Neutron emission for (n,n*)he3

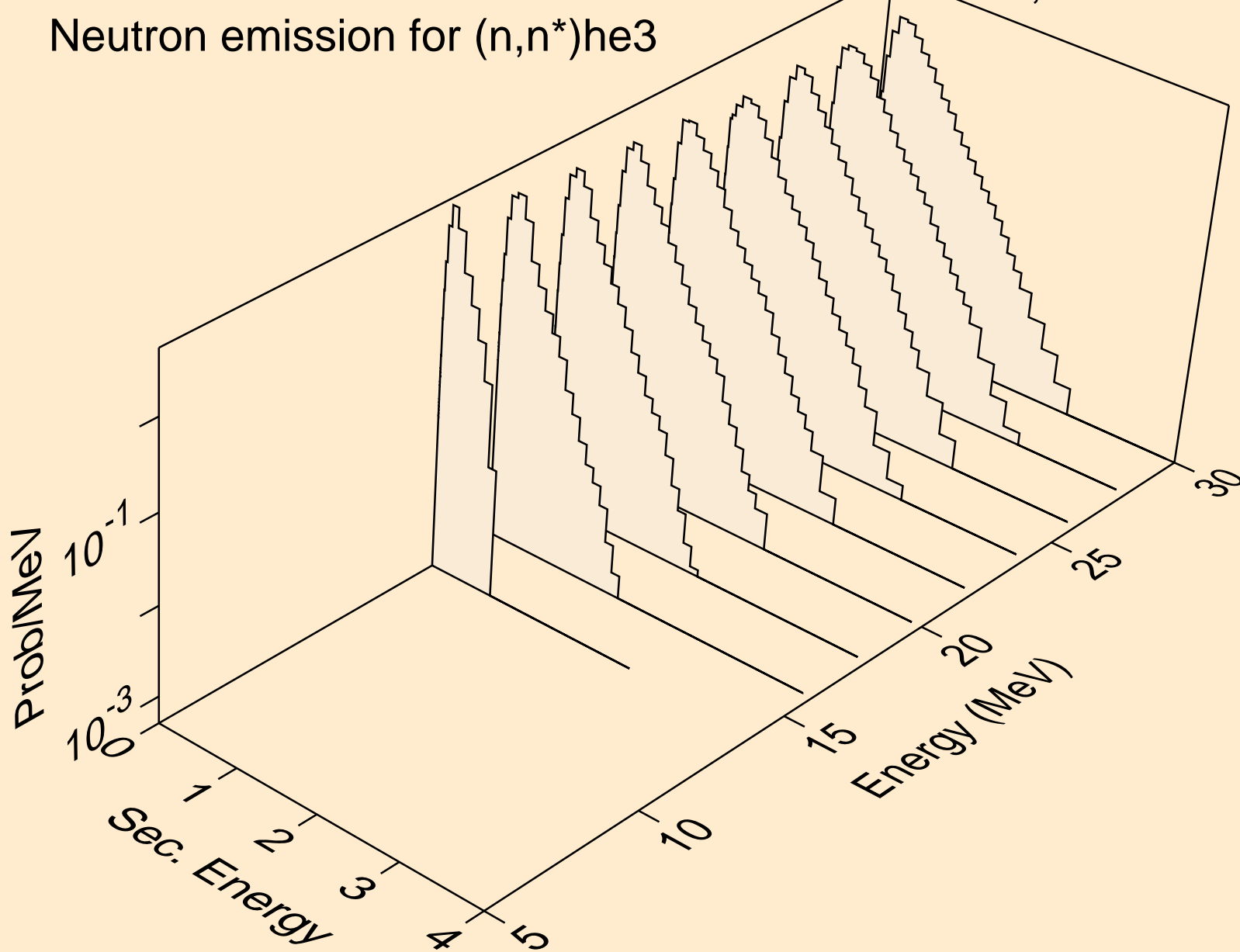

RF261 NEUTRON ACER TENDL-2019 LIBRARY; T=293.16K
Neutron emission for (n,4n)

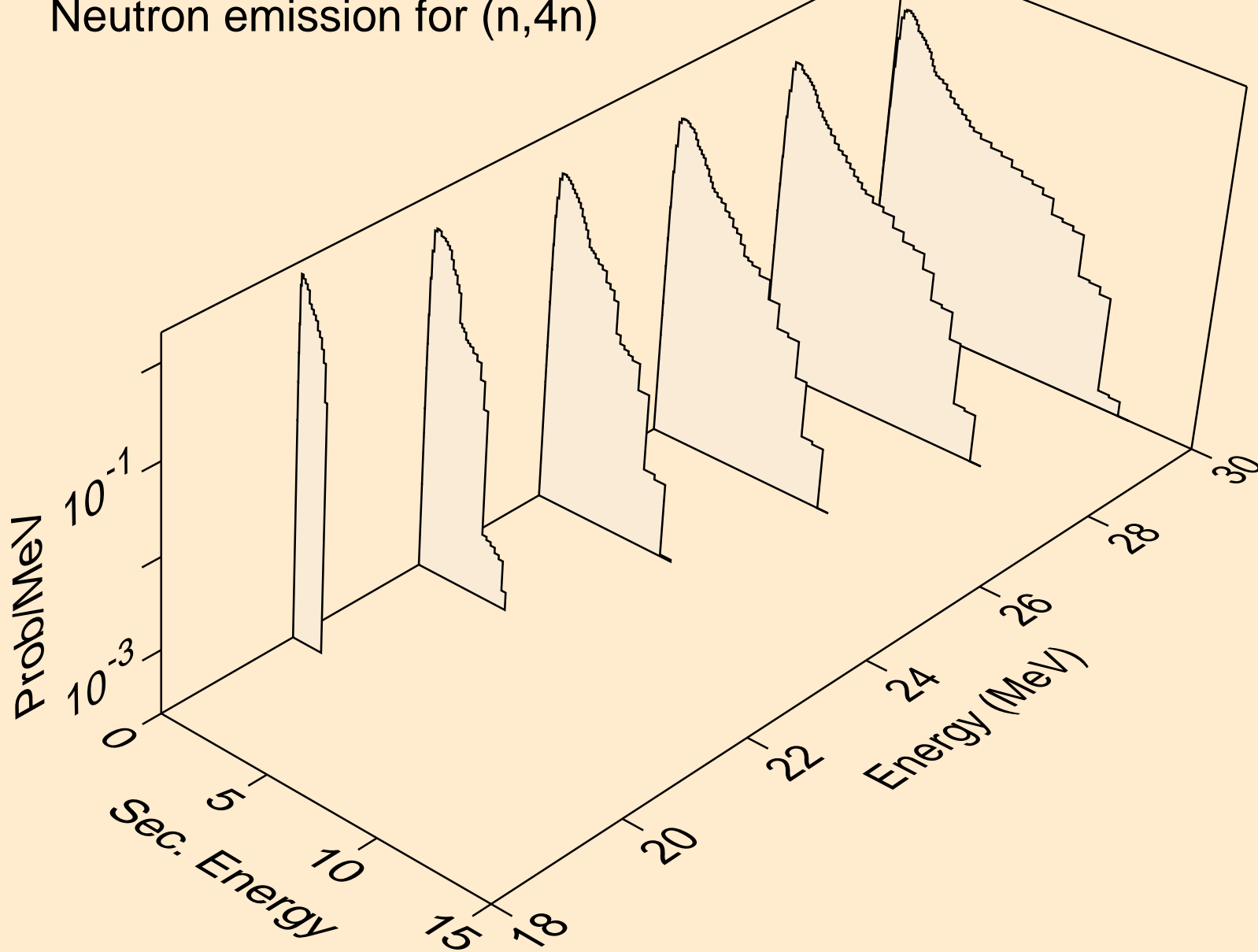

RF261 NEUTRON ACER TENDL-2019 LIBRARY; T=293.16K
Neutron emission for (n,2np)

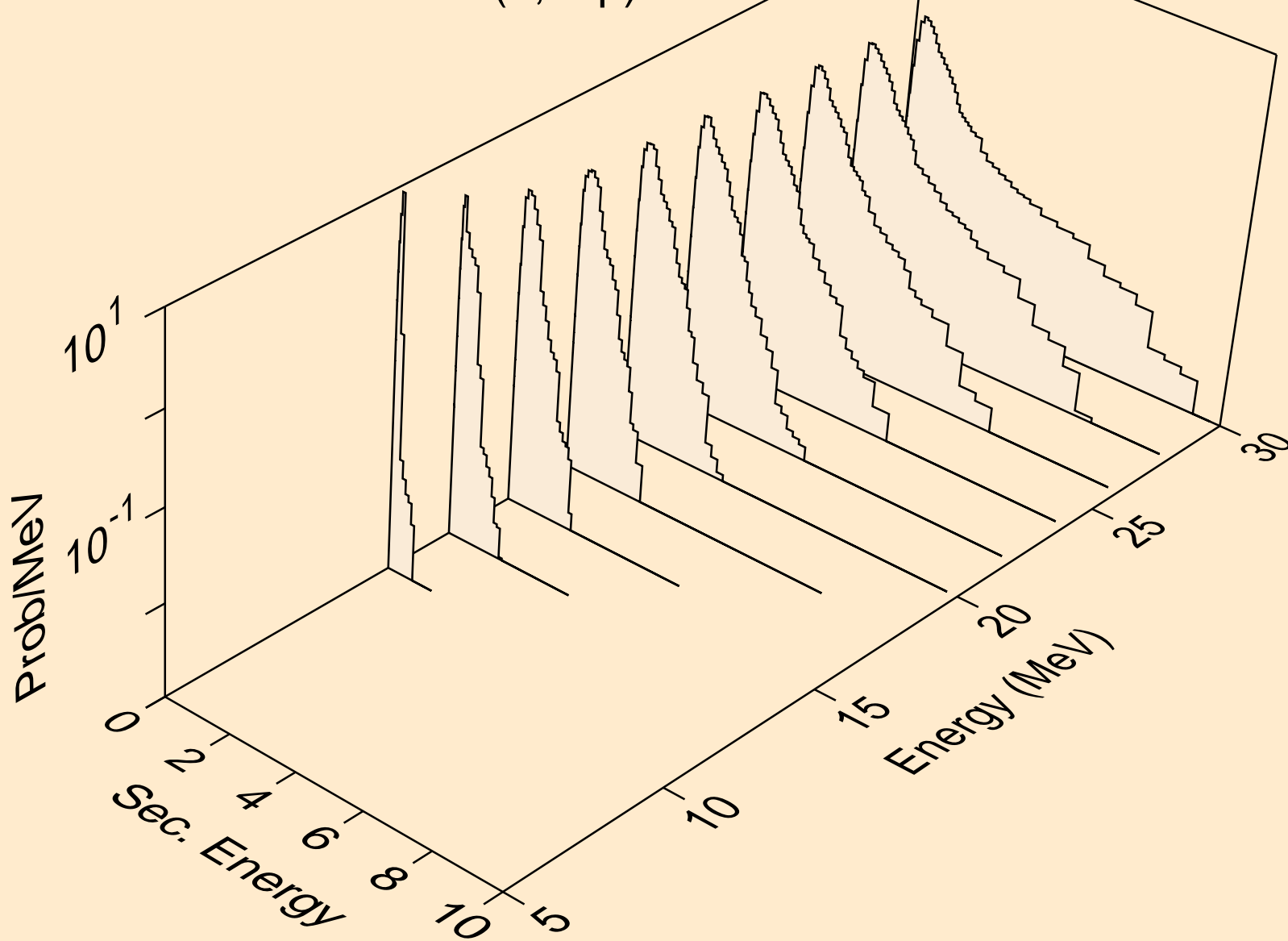

RF261 NEUTRON ACER TENDL-2019 LIBRARY; T=293.16K
Neutron emission for (n,3np)

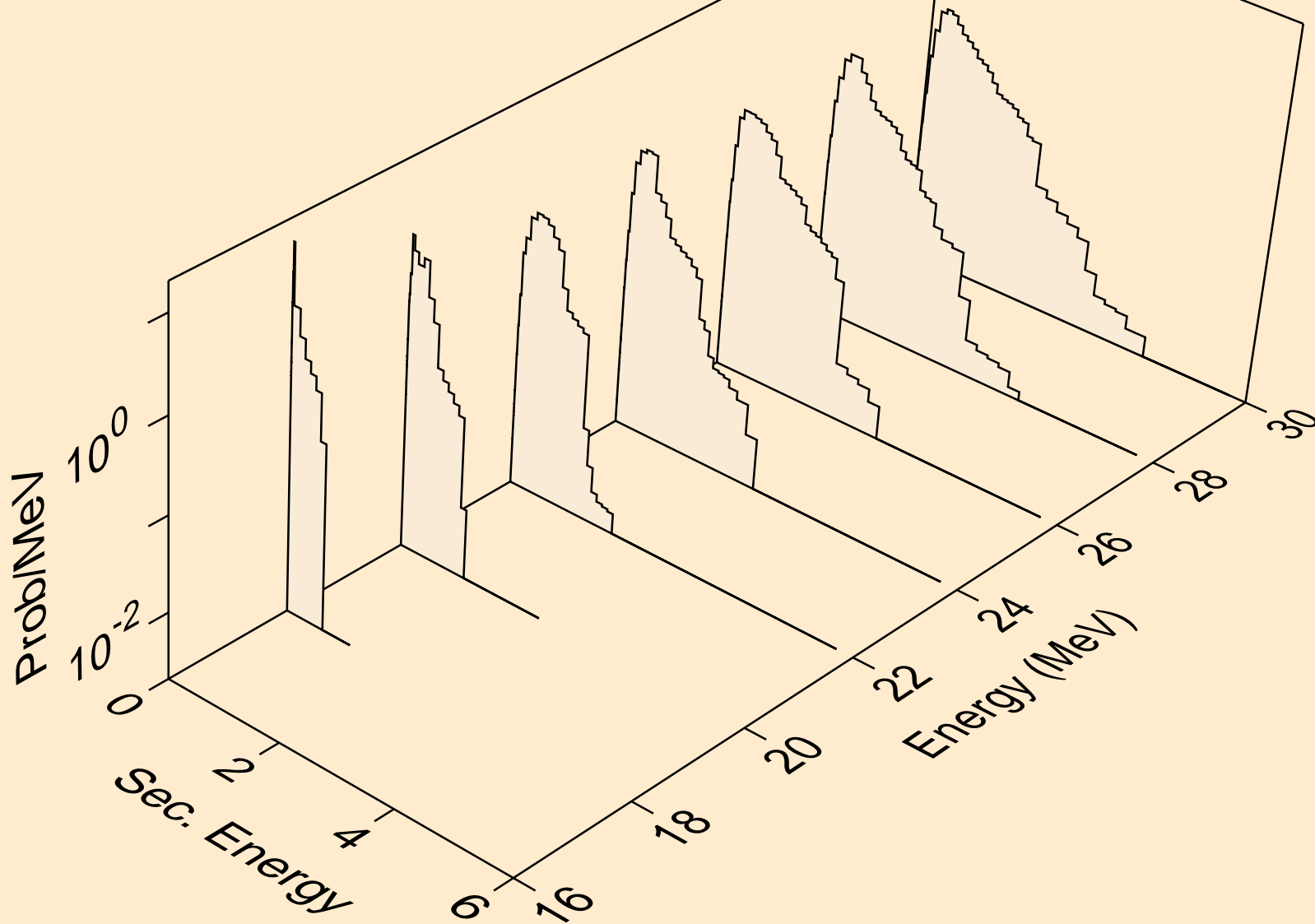

RF261 NEUTRON ACER TENDL-2019 LIBRARY; T=293.16K
Neutron emission for (n,2np)

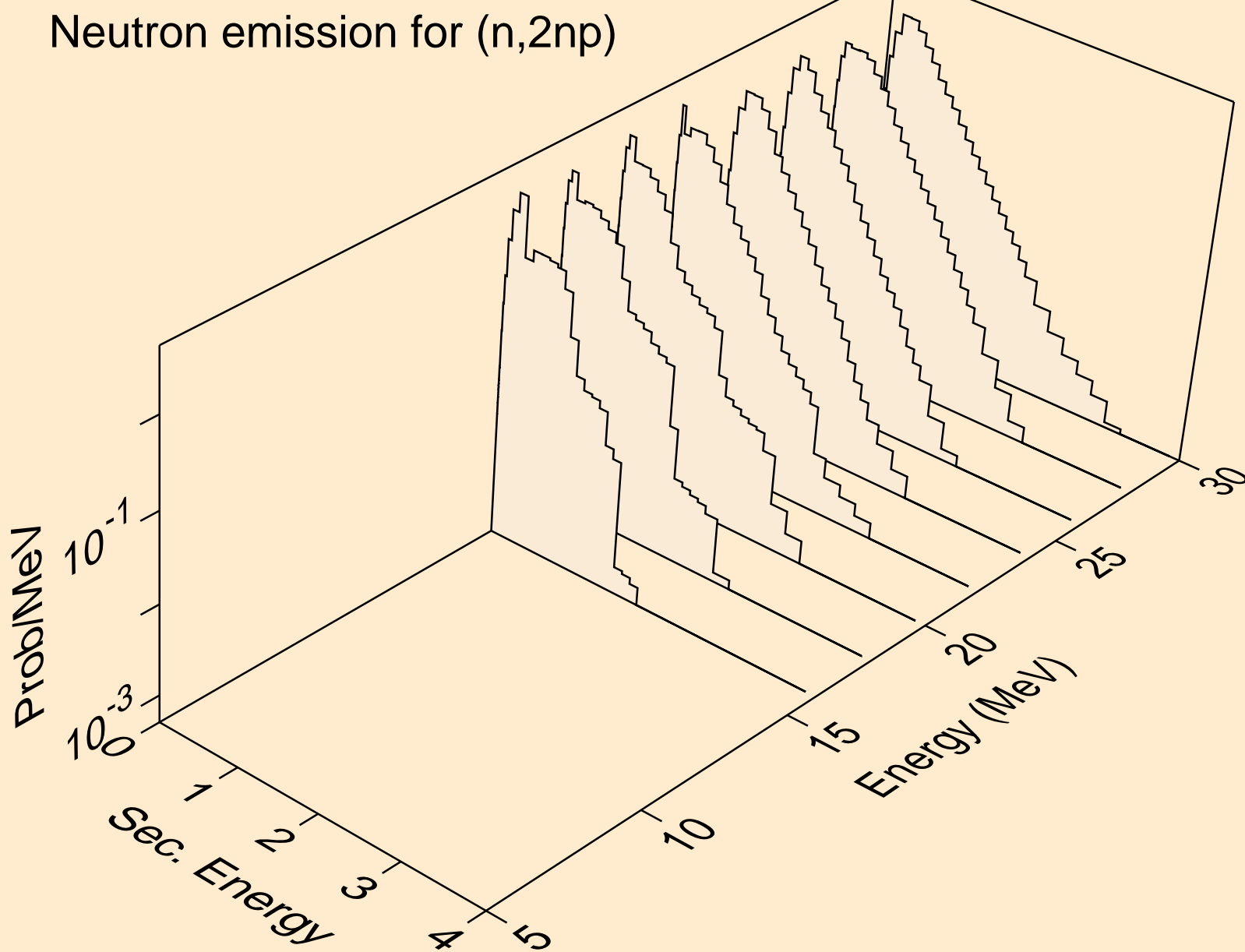

RF261 NEUTRON ACER TENDL-2019 LIBRARY; T=293.16K
Neutron emission for (n,npa)

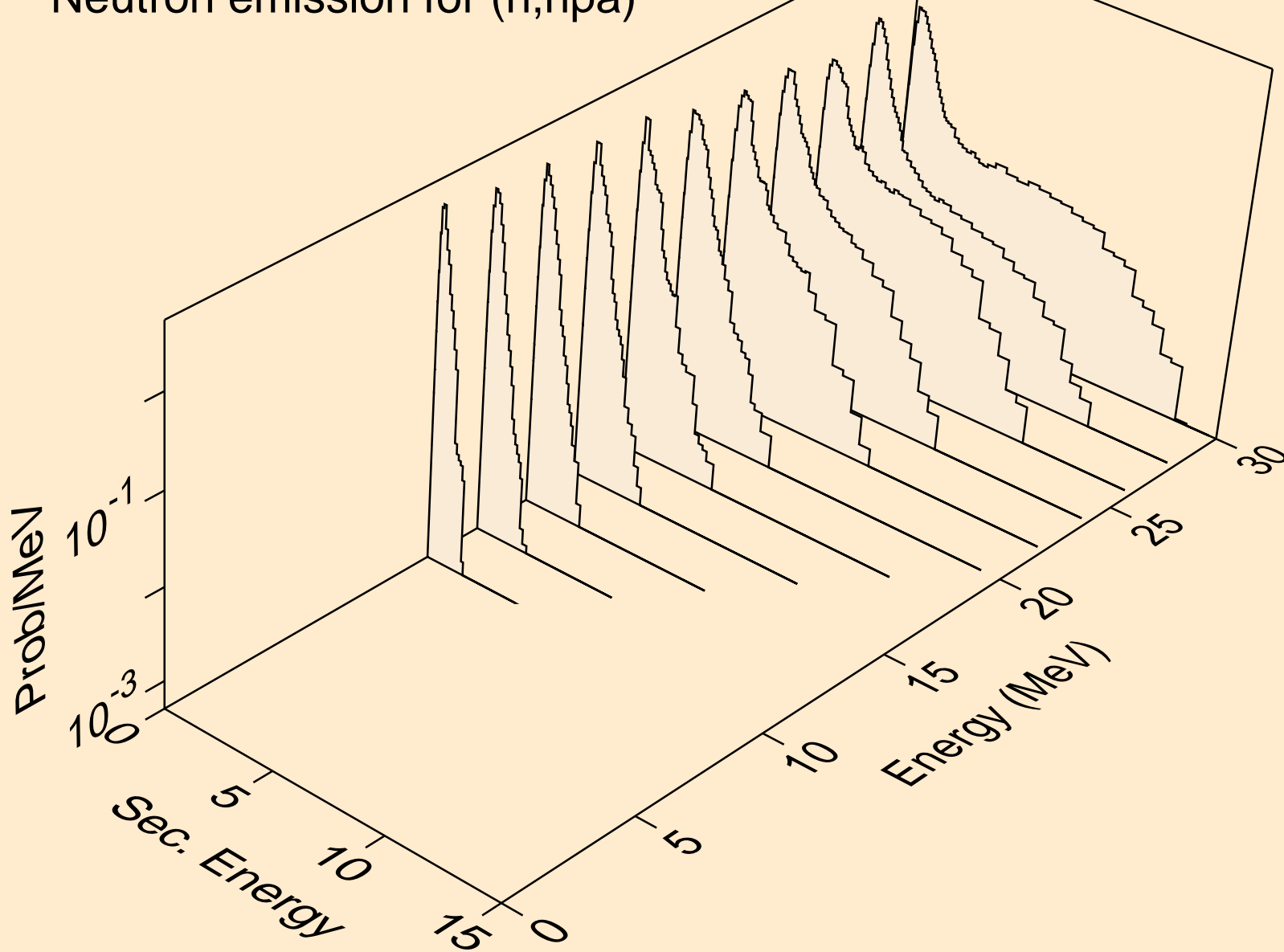

RF261 NEUTRON ACER TENDL-2019 LIBRARY; T=293.16K
Neutron emission for (n,n*c)

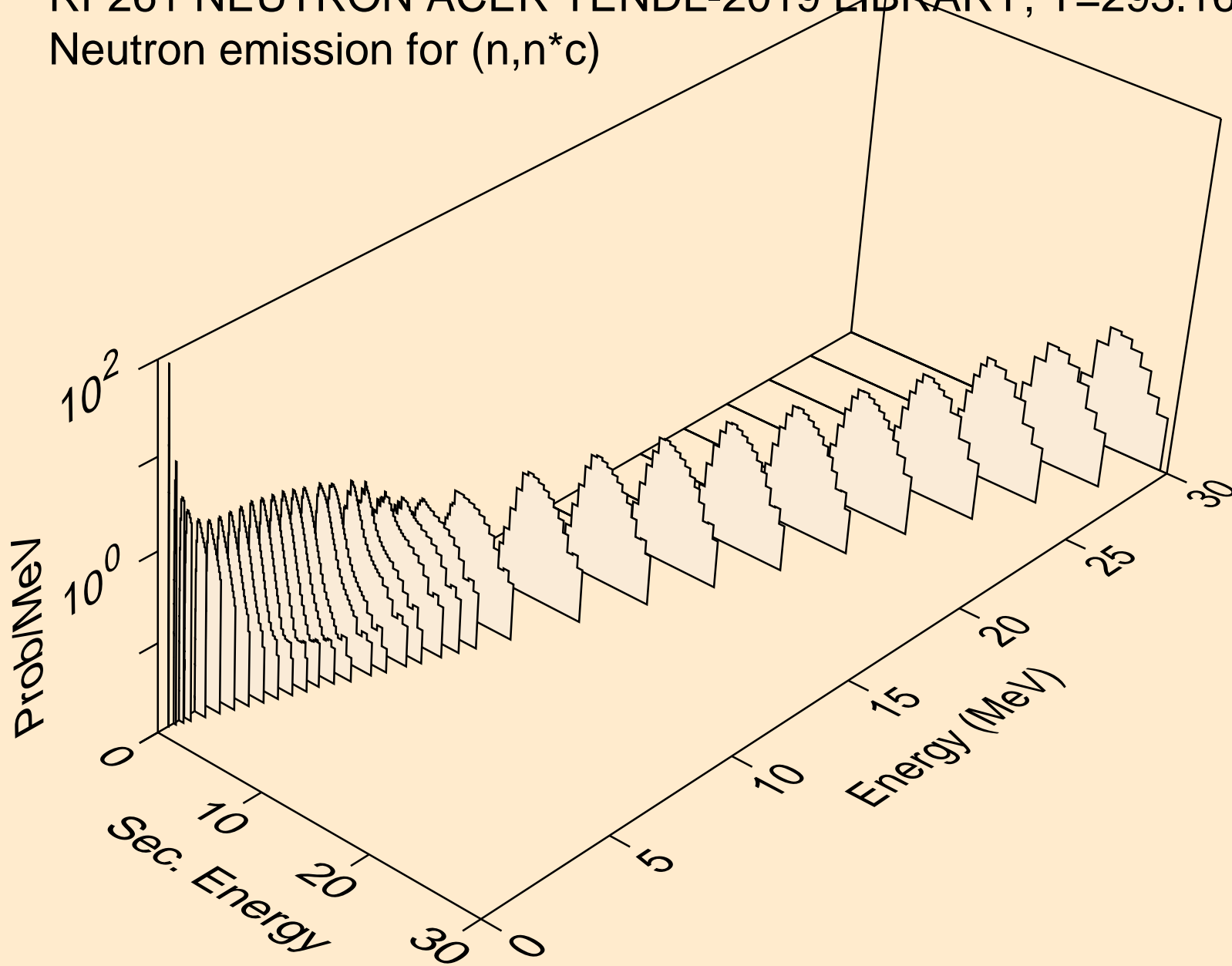

RF261 NEUTRON ACER TENDL-2019 LIBRARY; T=293.16K
Delayed nubar

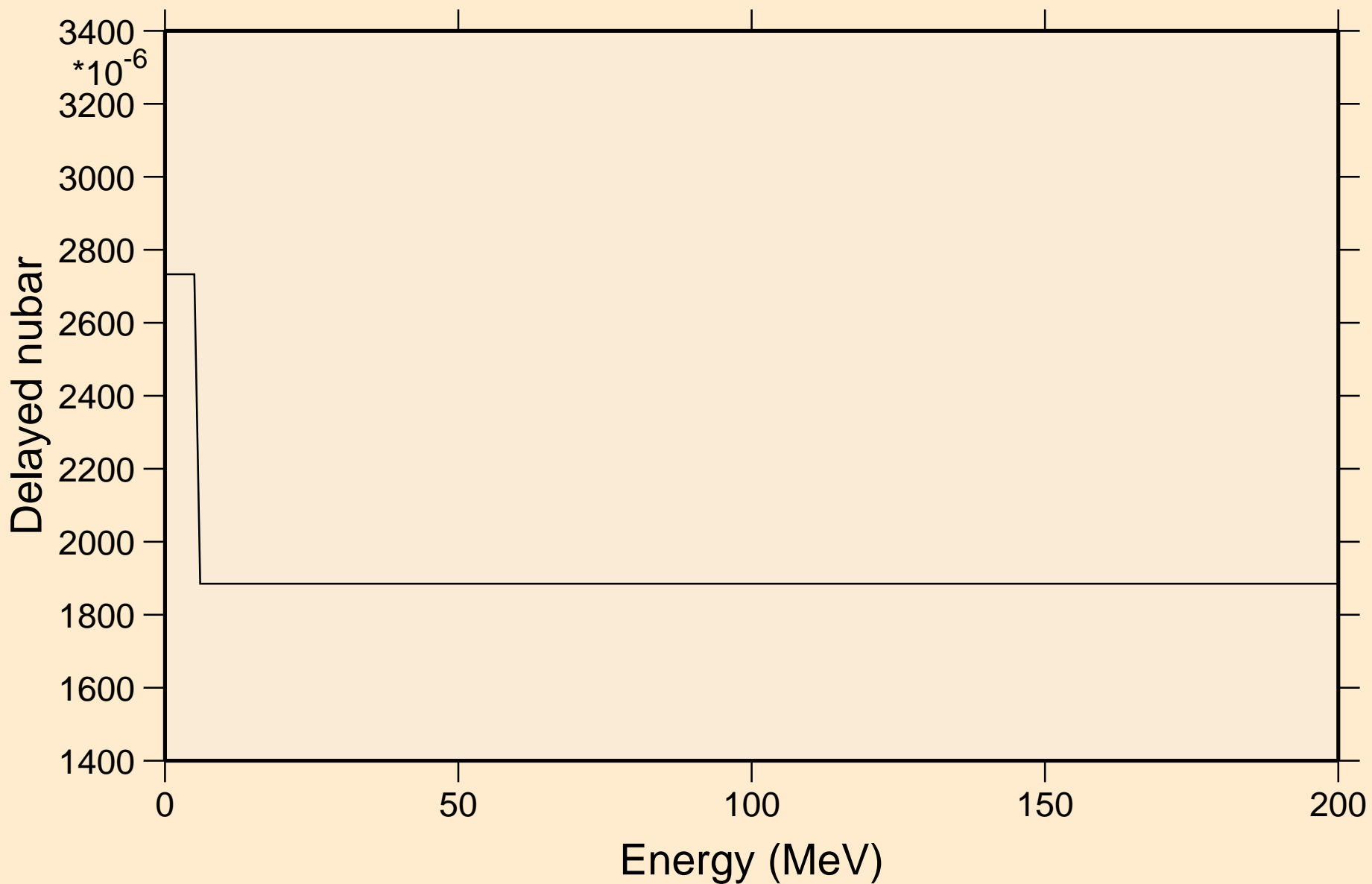

RF261 NEUTRON ACER TENDL-2019 LIBRARY; T=293.16K

Delayed neutron spectra

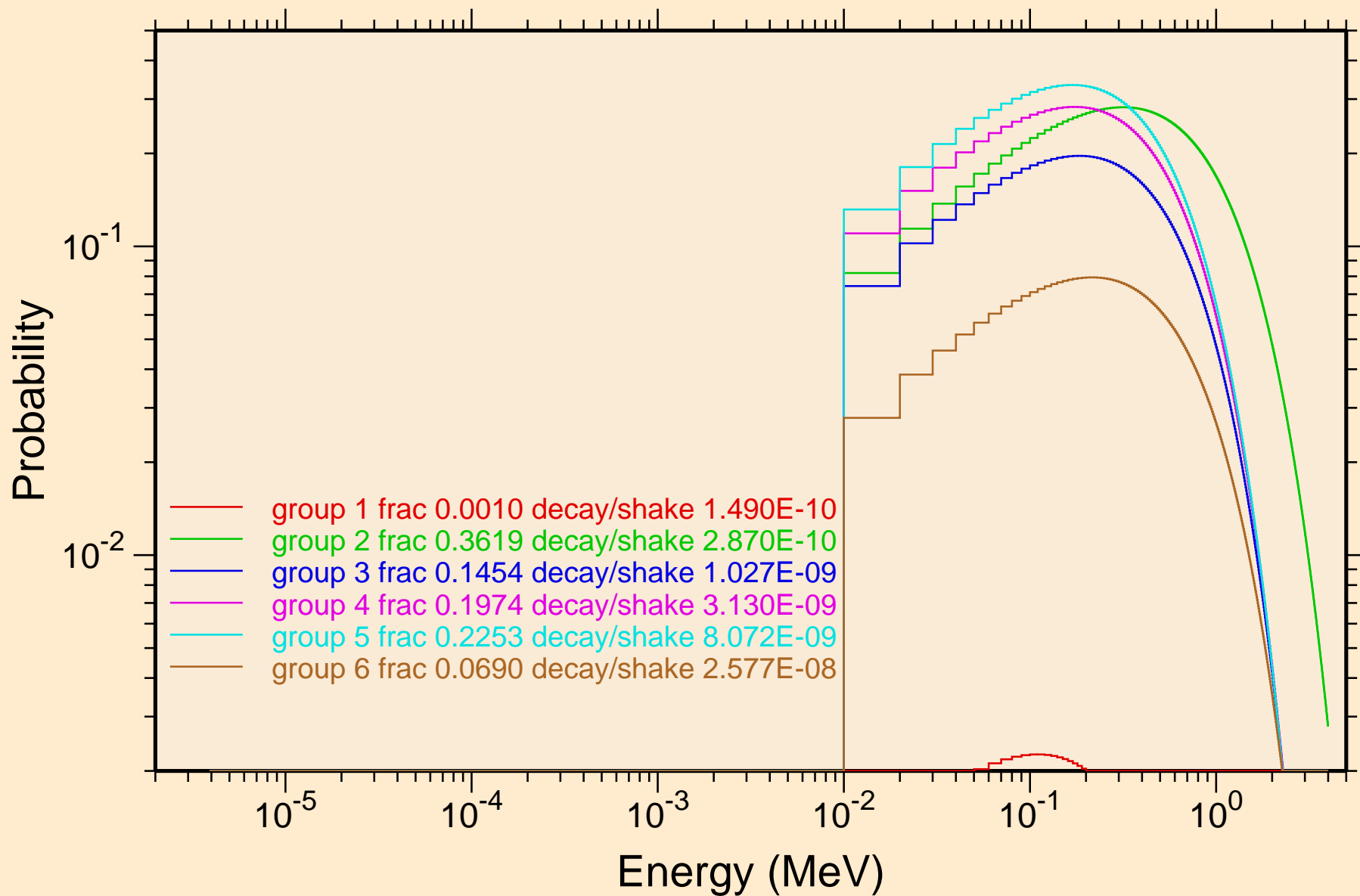

RF261 NEUTRON ACER TENDL-2019 LIBRARY; T=293.16K
Photon emission for (n,x)

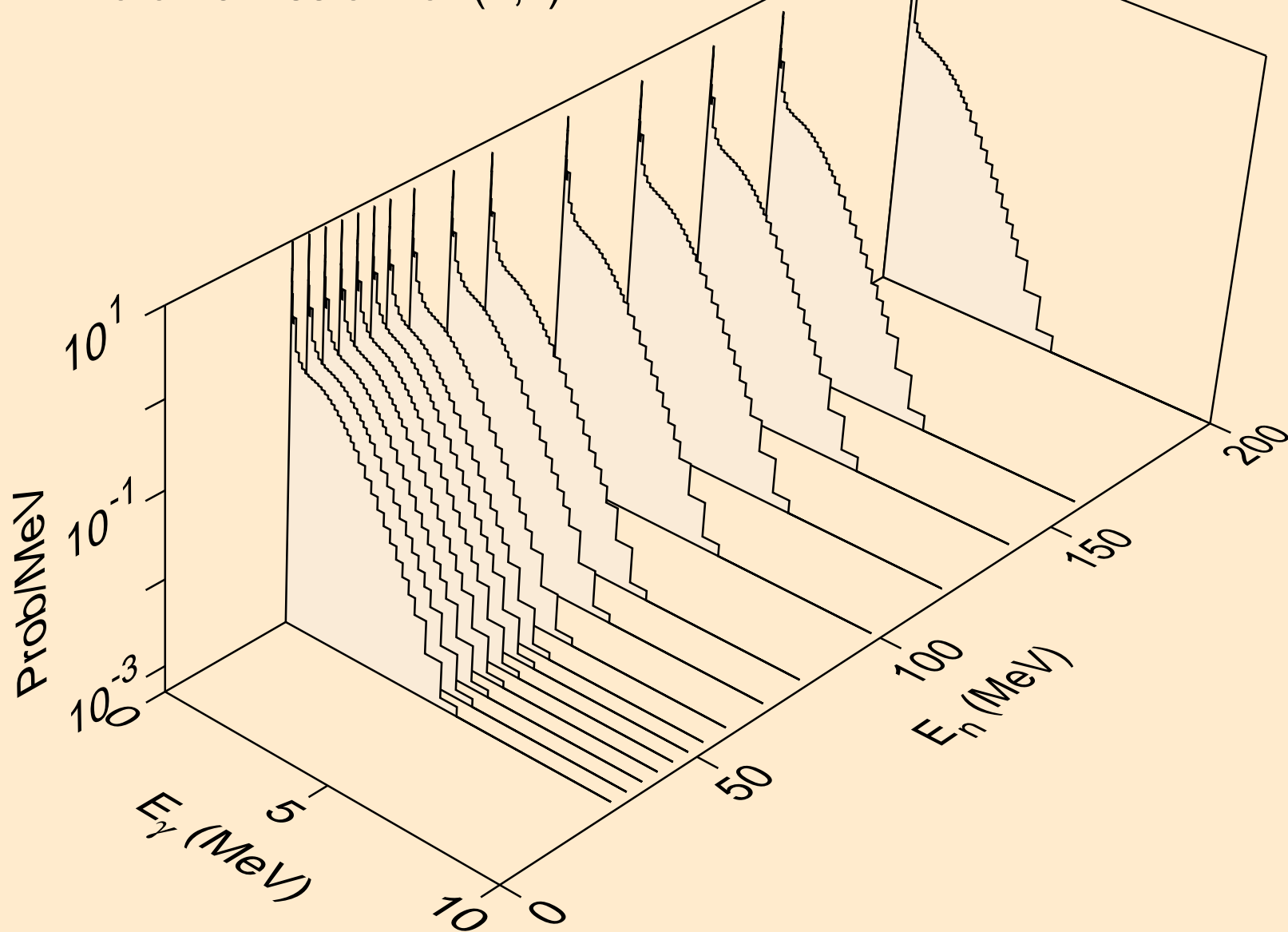

RF261 NEUTRON ACER TENDL-2019 LIBRARY; T=293.16K
Photon emission for (n,2nd)

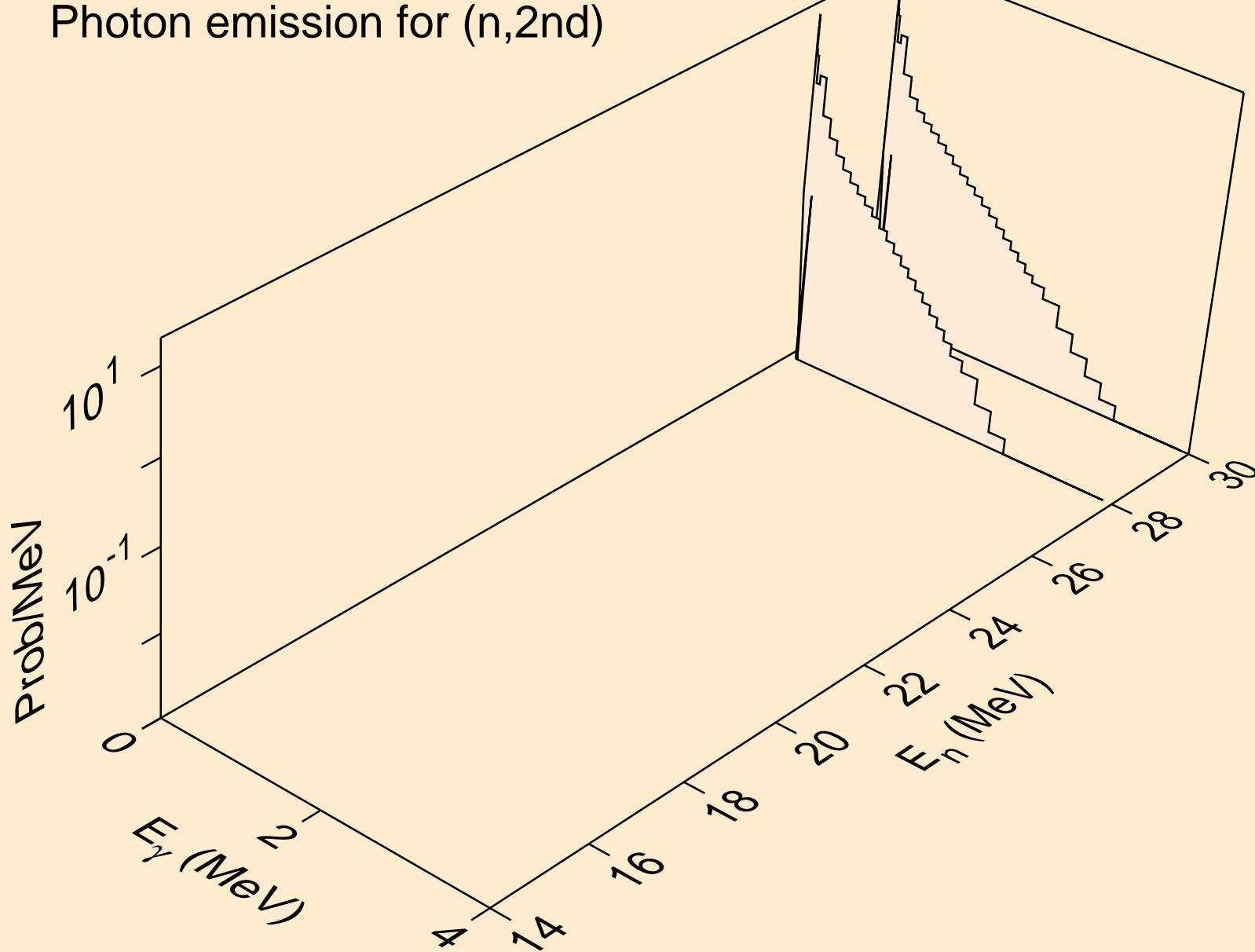

RF261 NEUTRON ACER TENDL-2019 LIBRARY; T=293.16K
Photon emission for (n,2n)

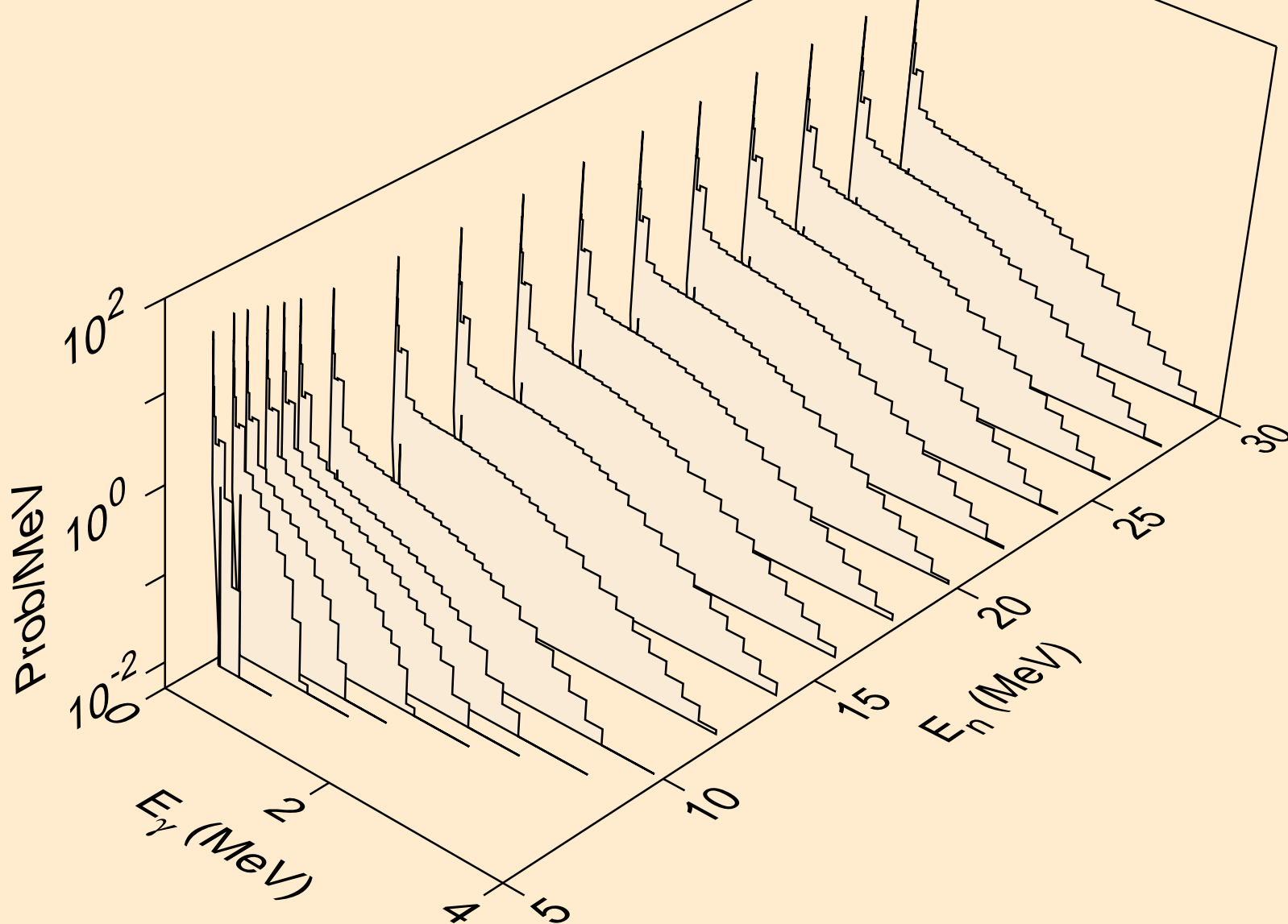

RF261 NEUTRON ACER TENDL-2019 LIBRARY; T=293.16K
Photon emission for (n,3n)

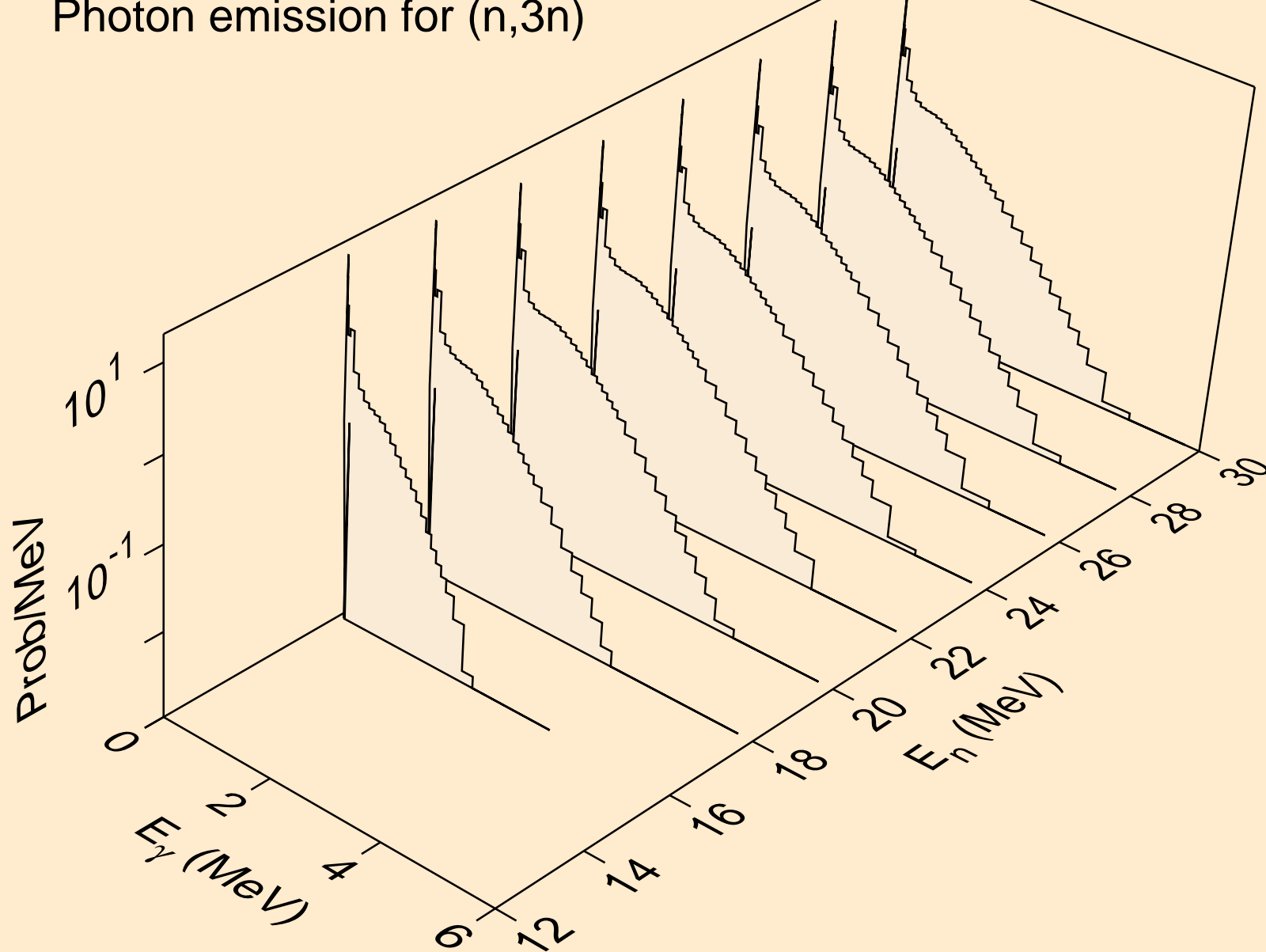

RF261 NEUTRON ACER TENDL-2019 LIBRARY; T=293.16K
Photon emission for (n,n*)a

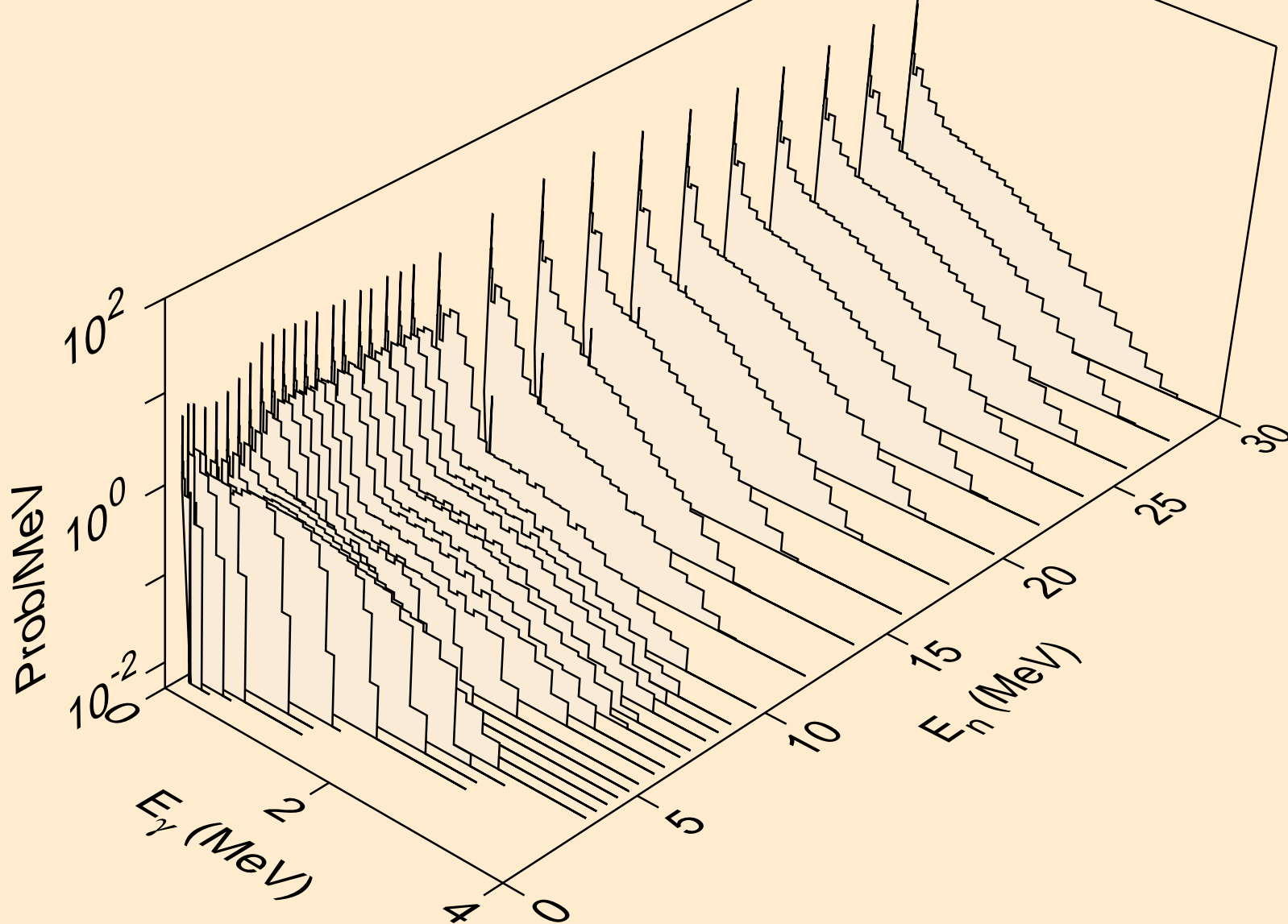

RF261 NEUTRON ACER TENDL-2019 LIBRARY; T=293.16K
Photon emission for (n,2n)a

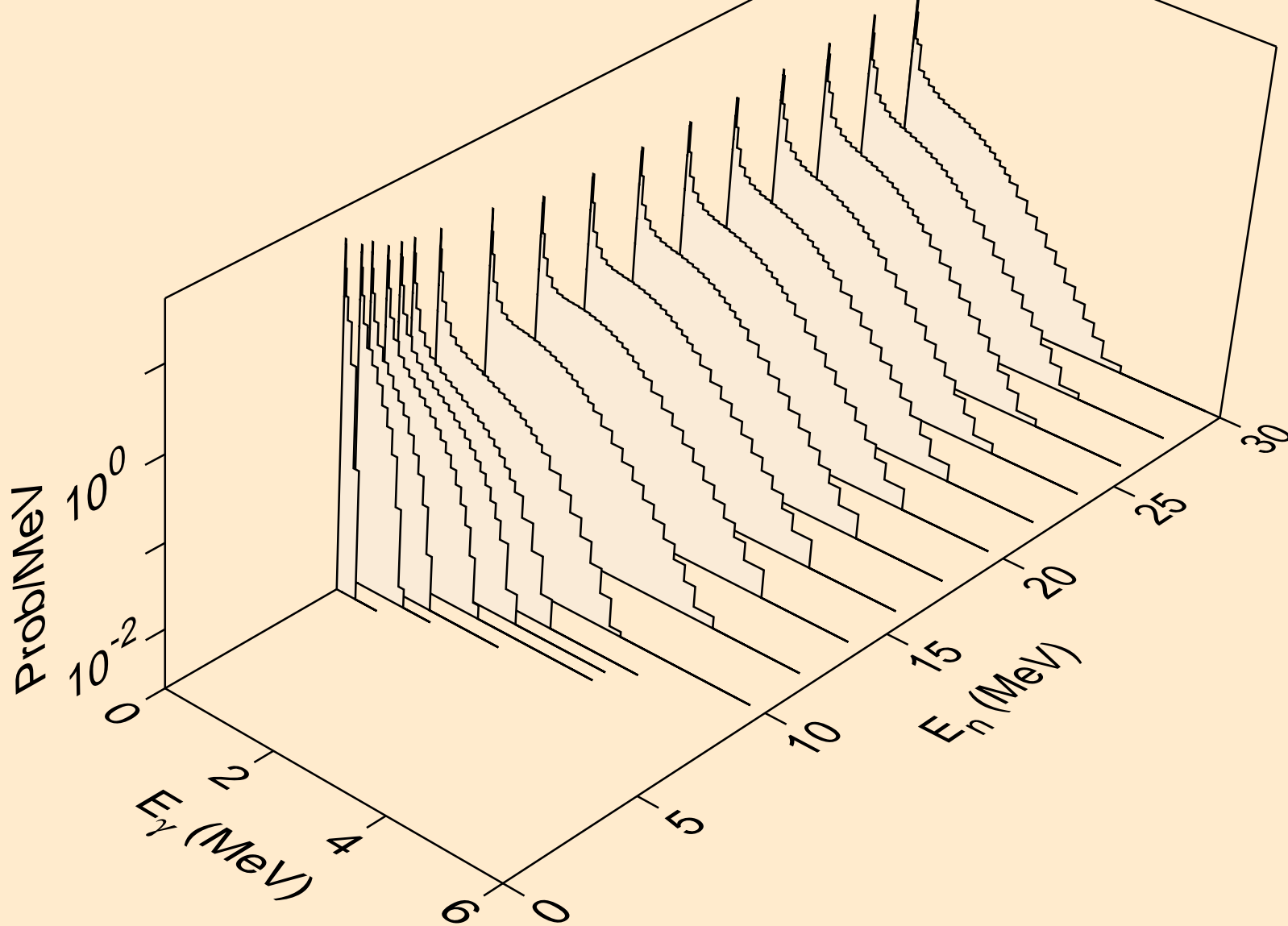

RF261 NEUTRON ACER TENDL-2019 LIBRARY; T=293.16K
Photon emission for (n,3n)a

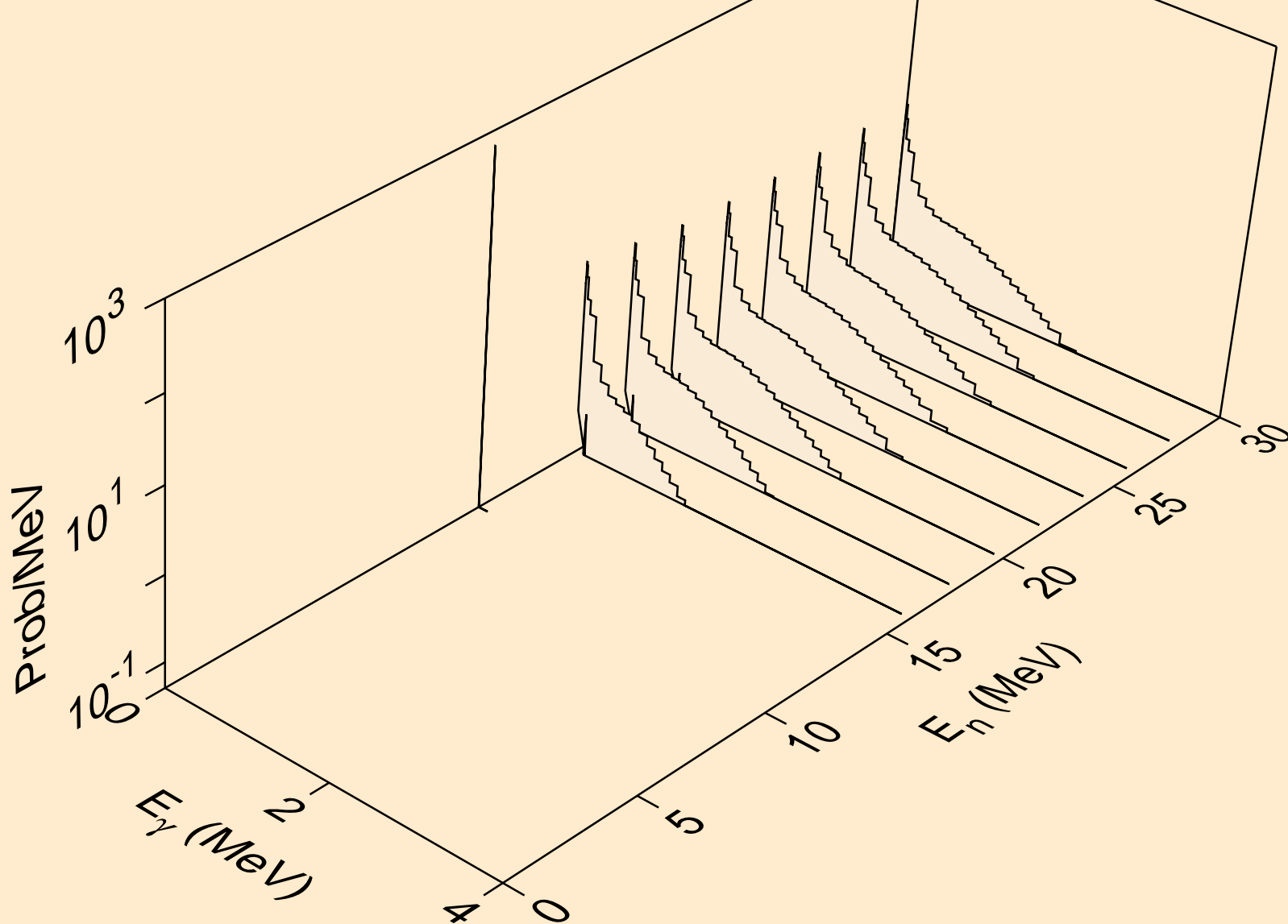

RF261 NEUTRON ACER TENDL-2019 LIBRARY; T=293.16K
Photon emission for (n,n*)p

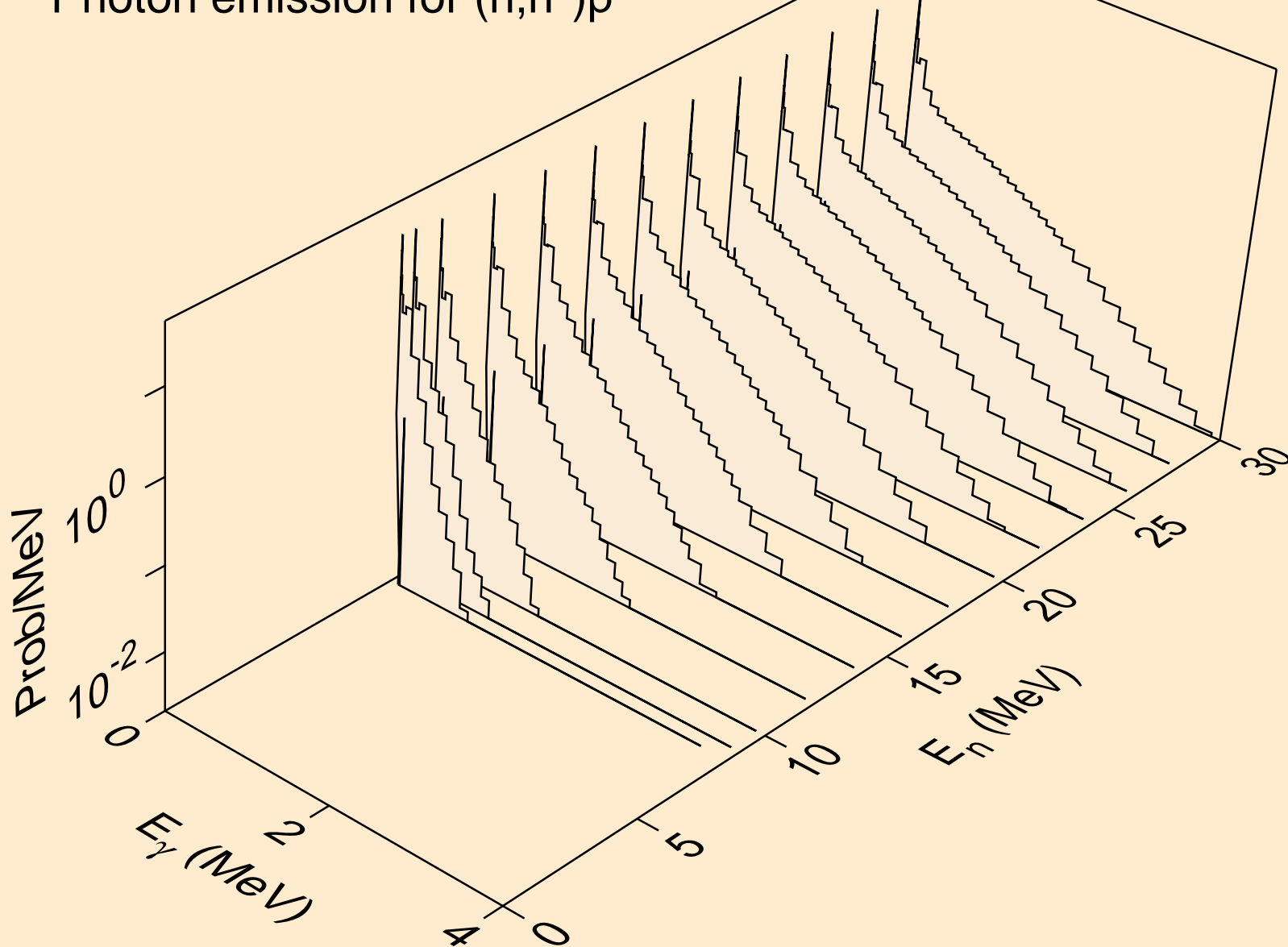

RF261 NEUTRON ACER TENDL-2019 LIBRARY; T=293.16K
Photon emission for (n,n*)2a

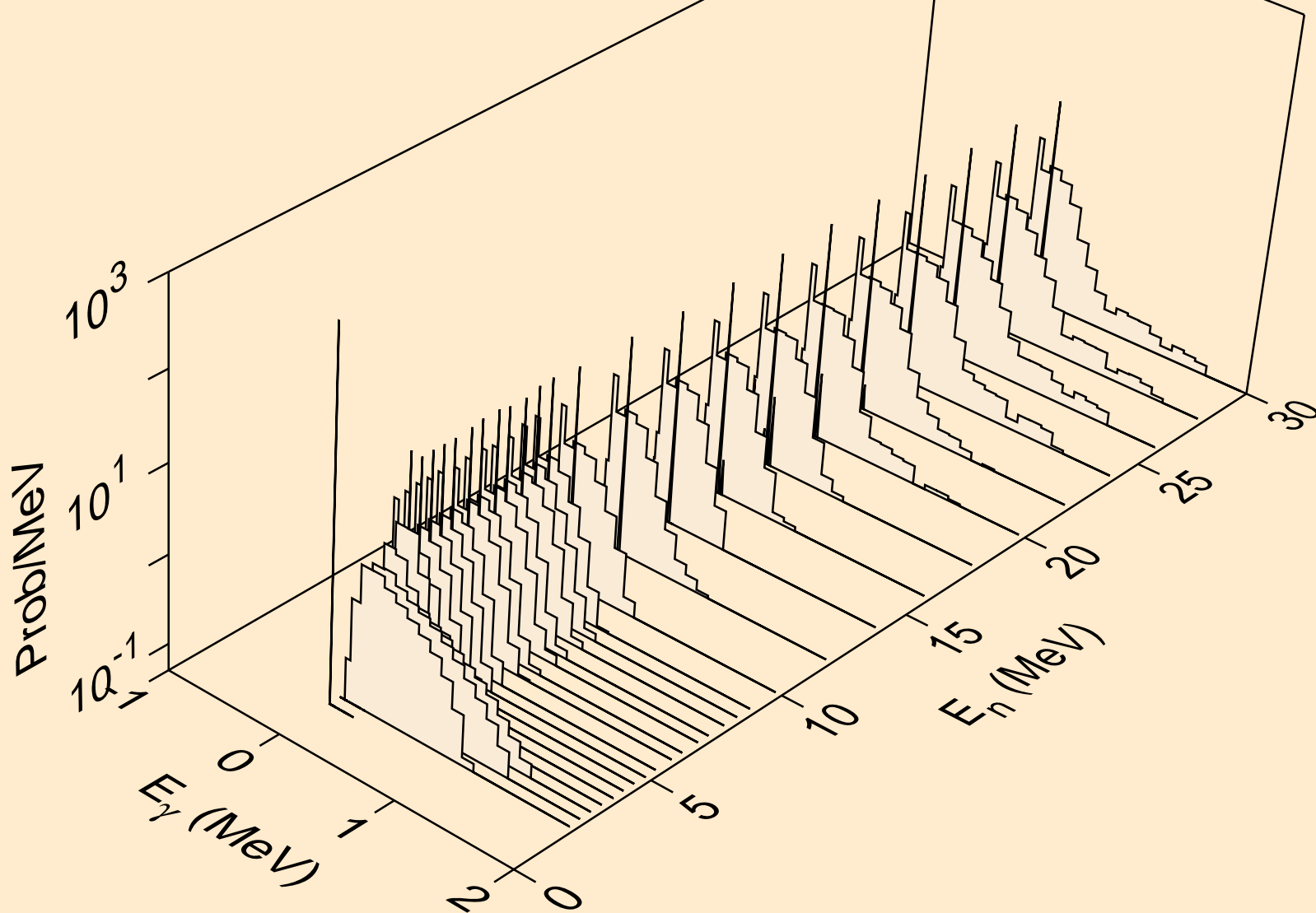

RF261 NEUTRON ACER TENDL-2019 LIBRARY; T=293.16K
Photon emission for (n,2n)2a

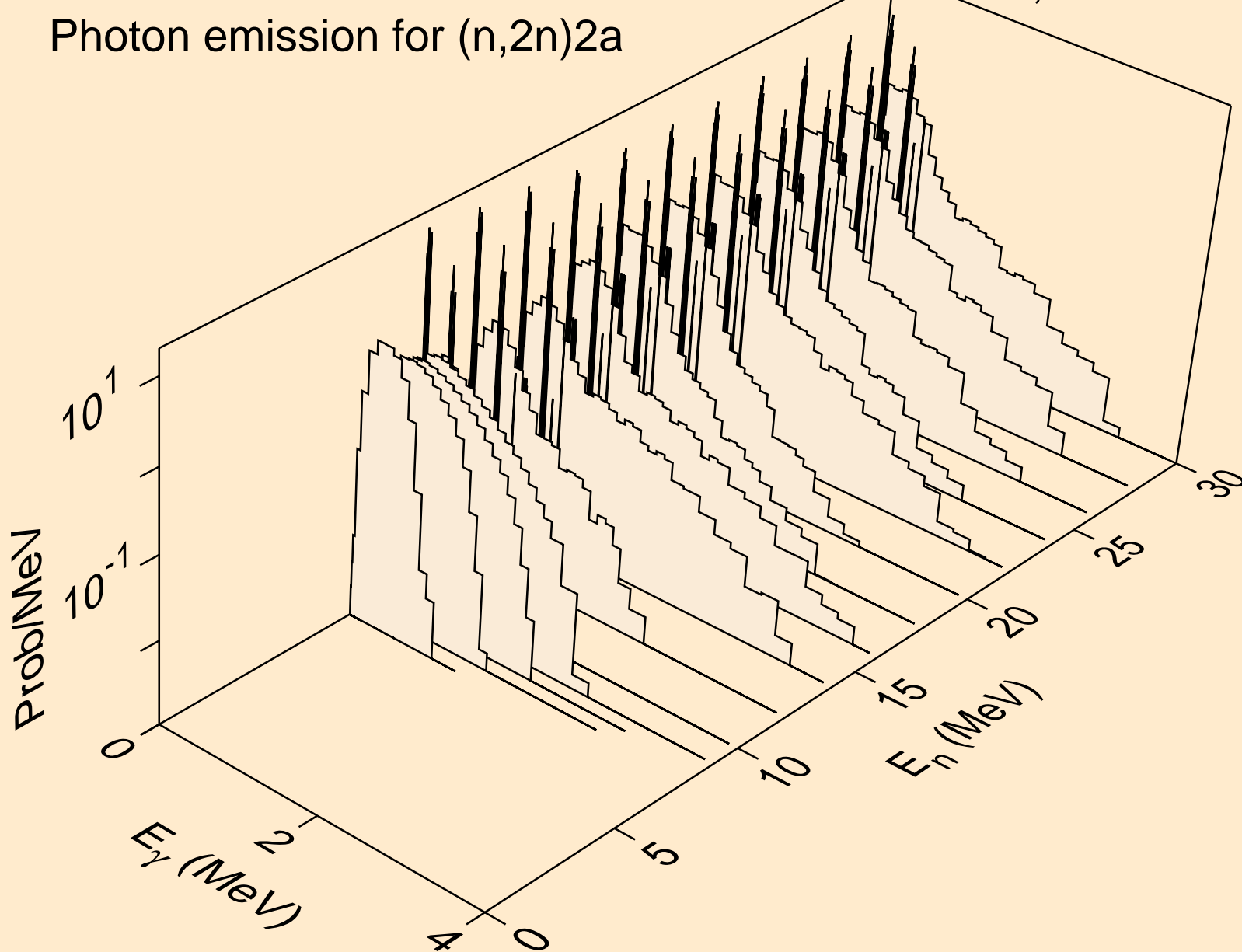

RF261 NEUTRON ACER TENDL-2019 LIBRARY; T=293.16K
Photon emission for (n,n*)d

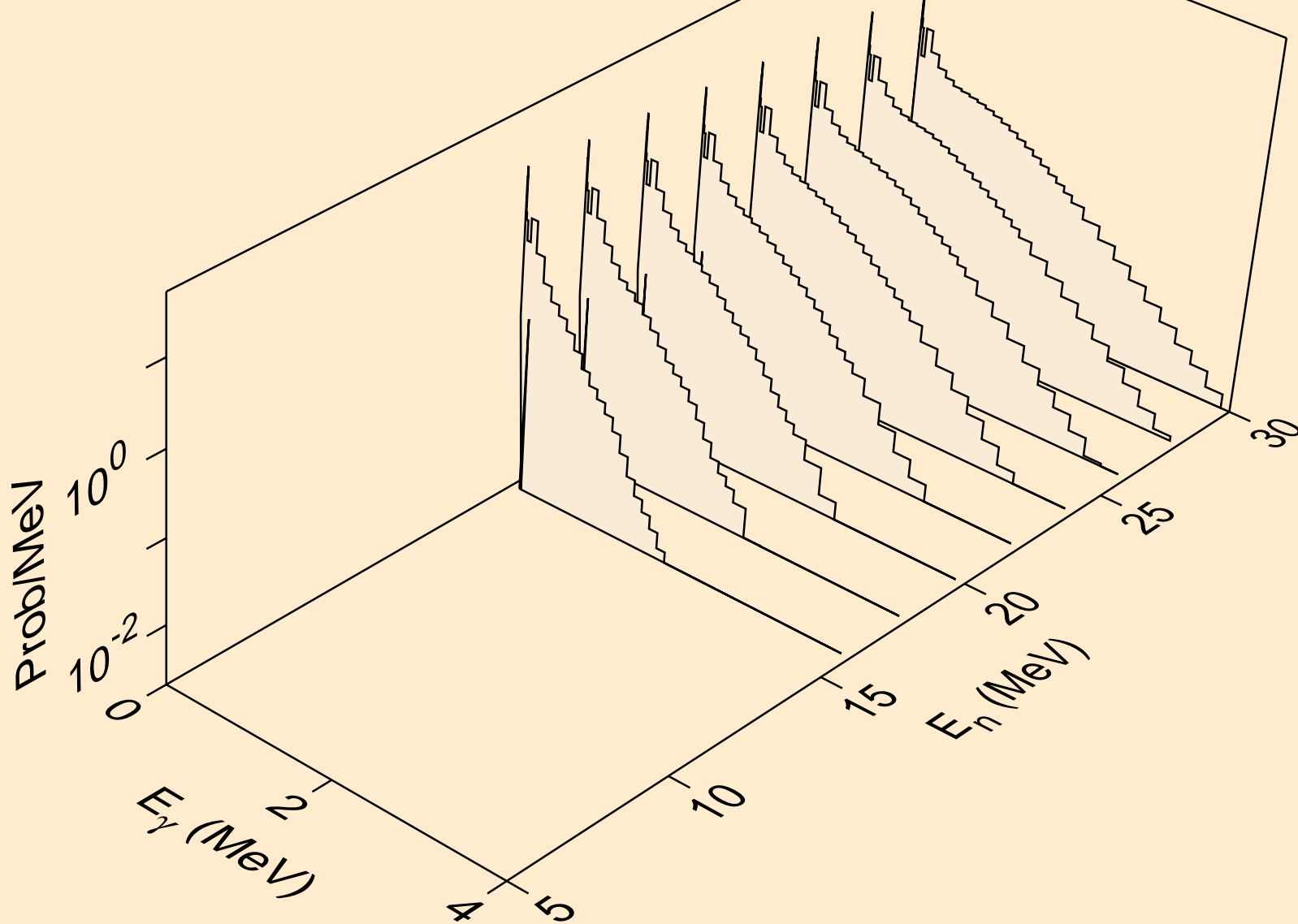

RF261 NEUTRON ACER TENDL-2019 LIBRARY; T=293.16K
Photon emission for (n,n*)t

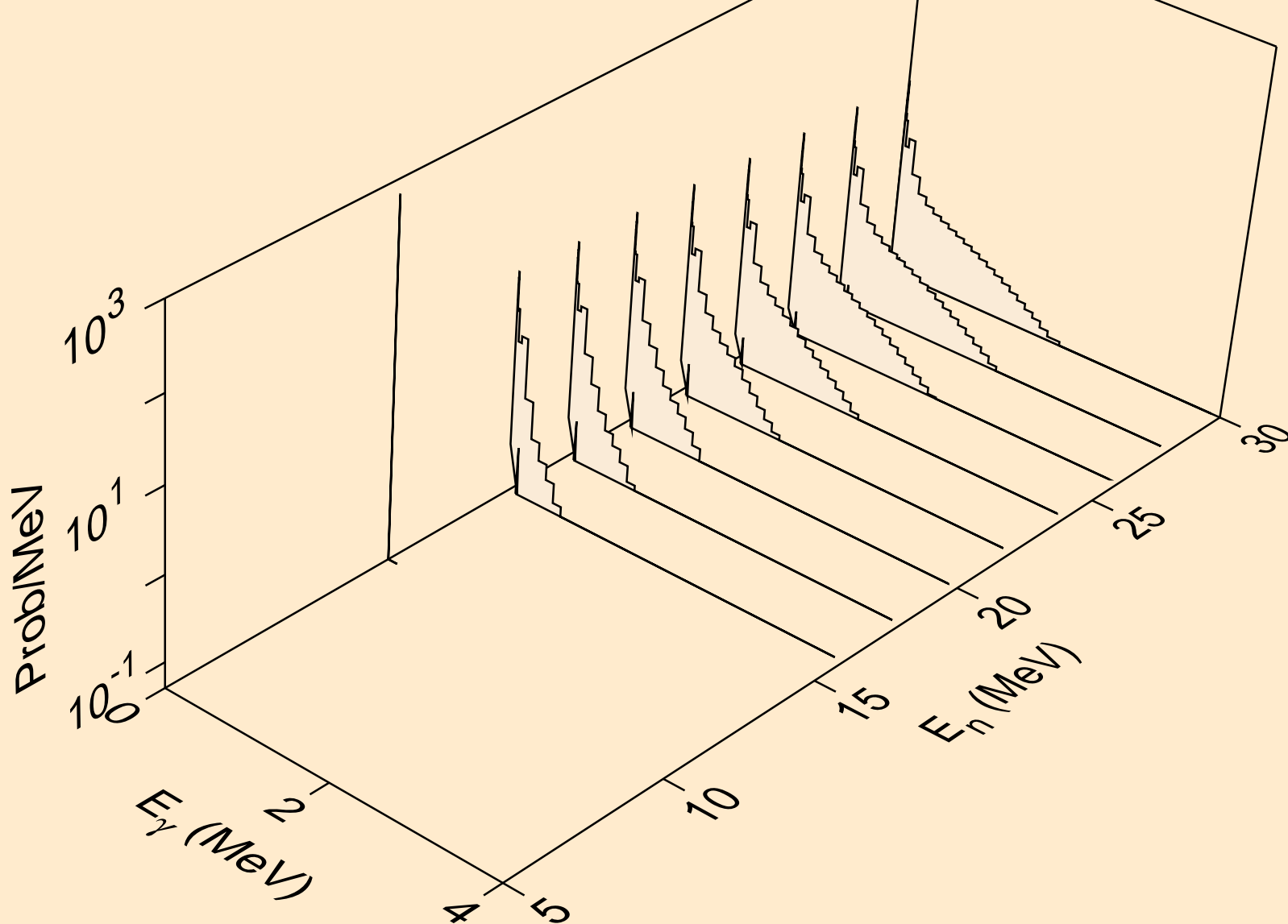

RF261 NEUTRON ACER TENDL-2019 LIBRARY; T=293.16K
Photon emission for (n,n*)he3

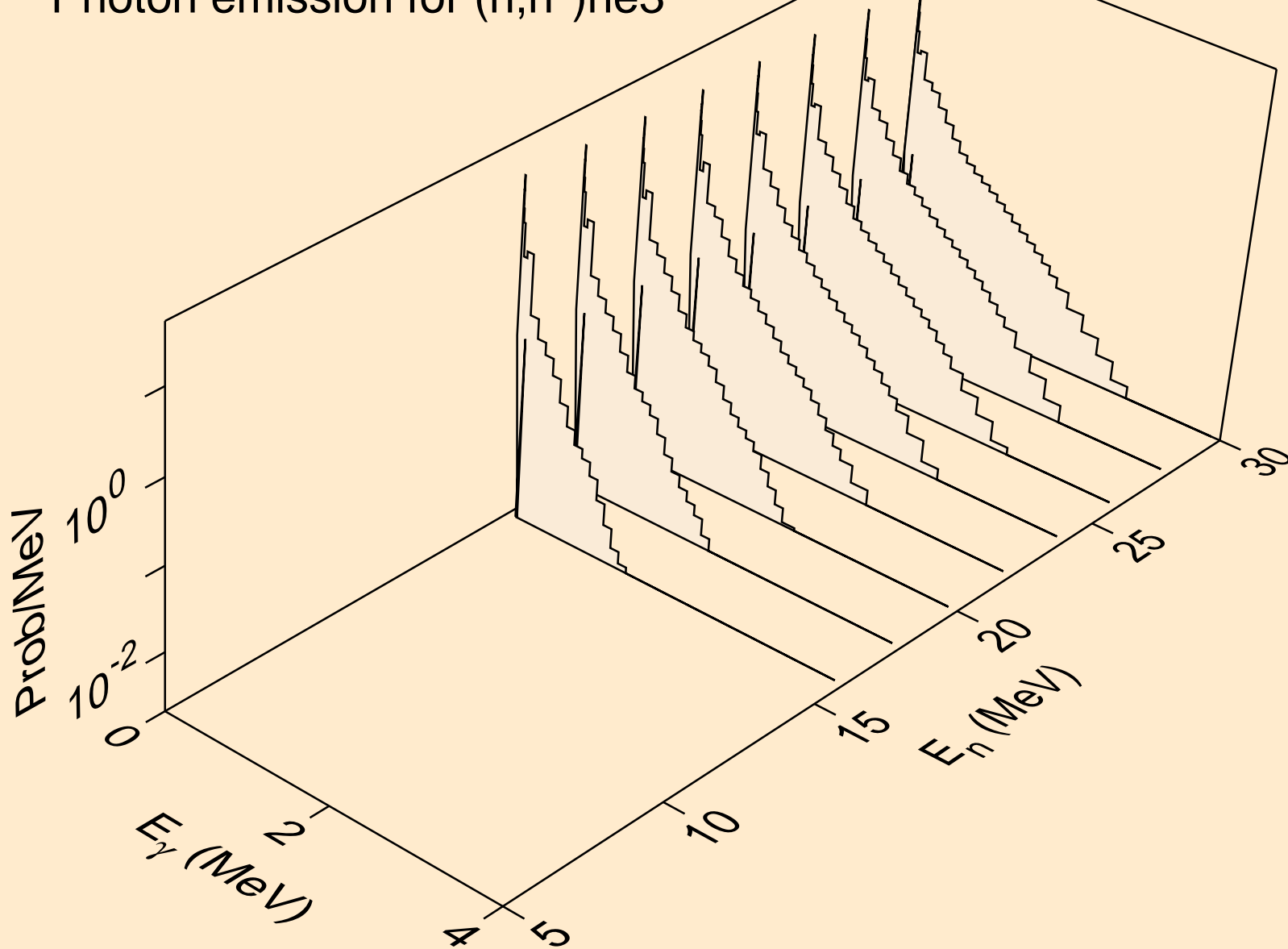

RF261 NEUTRON ACER TENDL-2019 LIBRARY; T=293.16K
Photon emission for (n,4n)

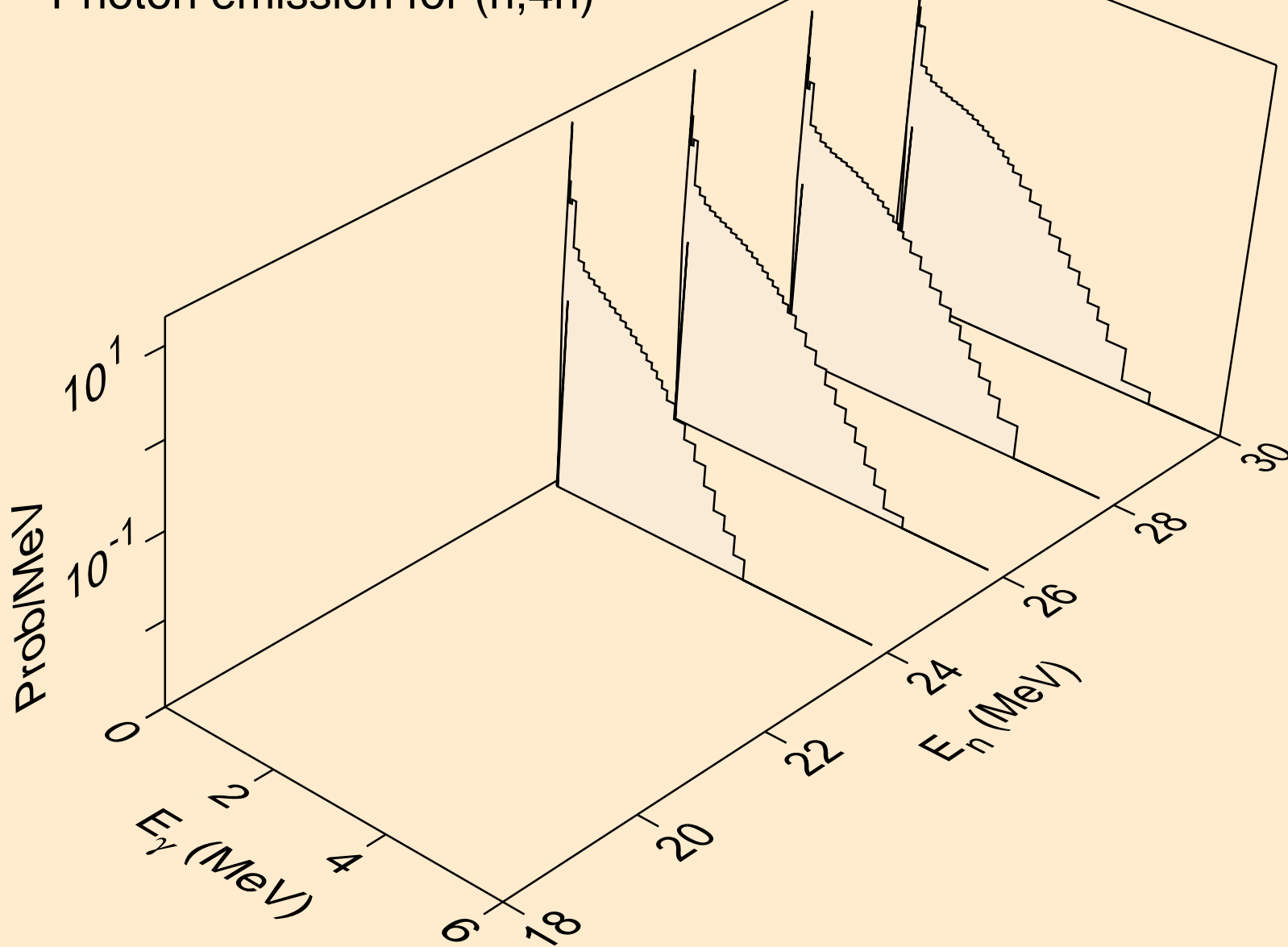

RF261 NEUTRON ACER TENDL-2019 LIBRARY; T=293.16K
Photon emission for (n,2np)

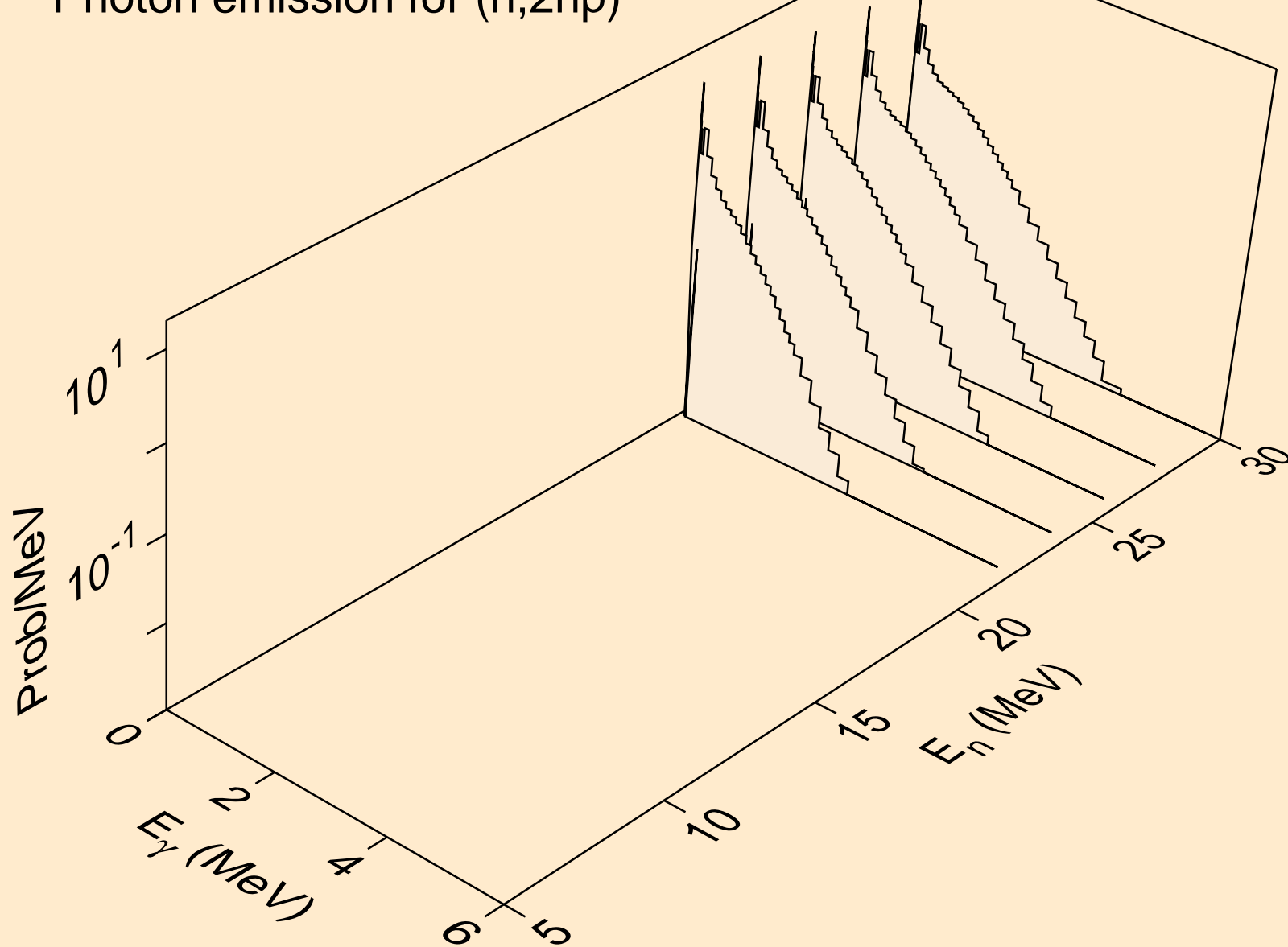

RF261 NEUTRON ACER TENDL-2019 LIBRARY; T=293.16K
Photon emission for (n,3np)

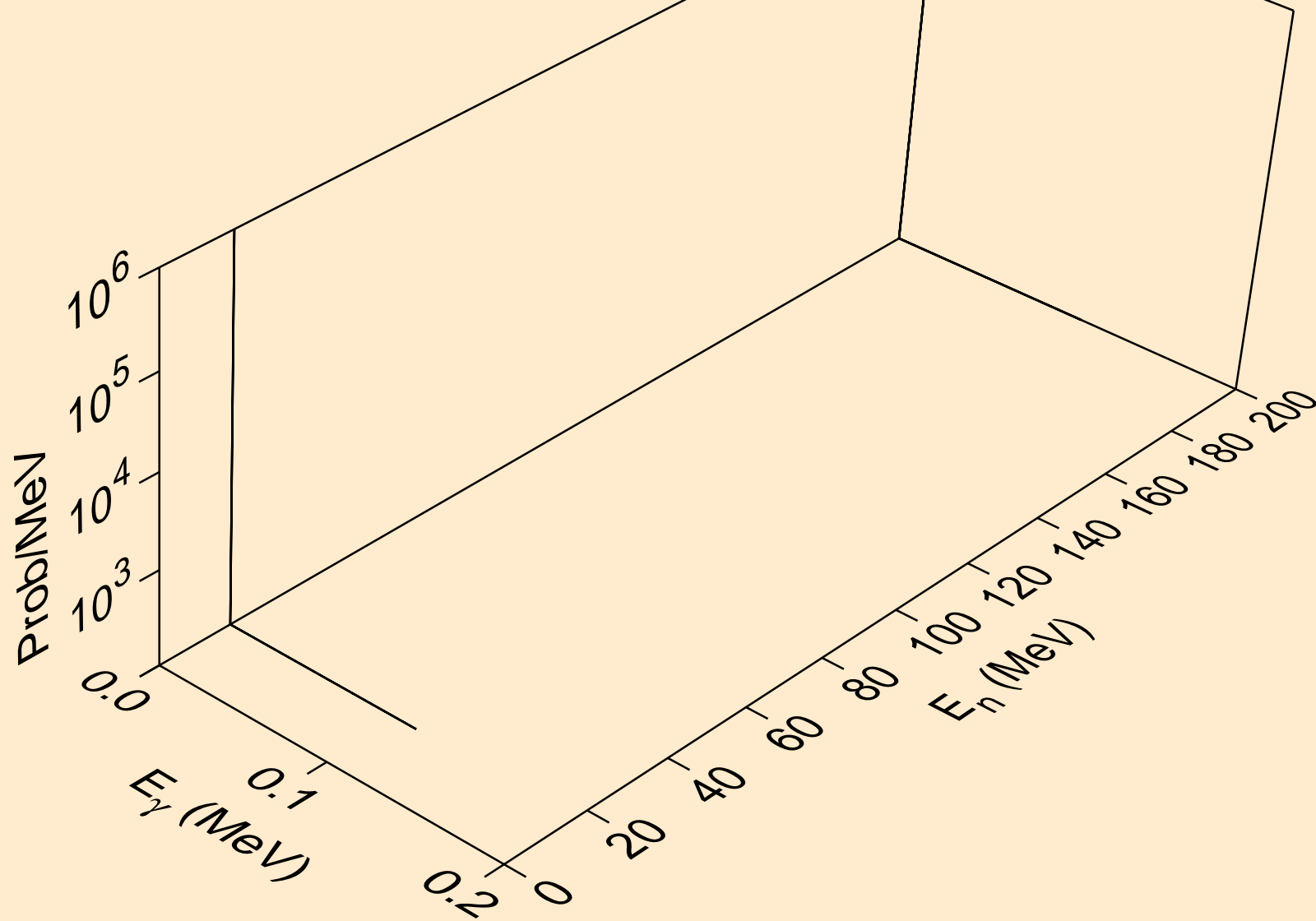

RF261 NEUTRON ACER TENDL-2019 LIBRARY; T=293.16K
Photon emission for (n,2np)

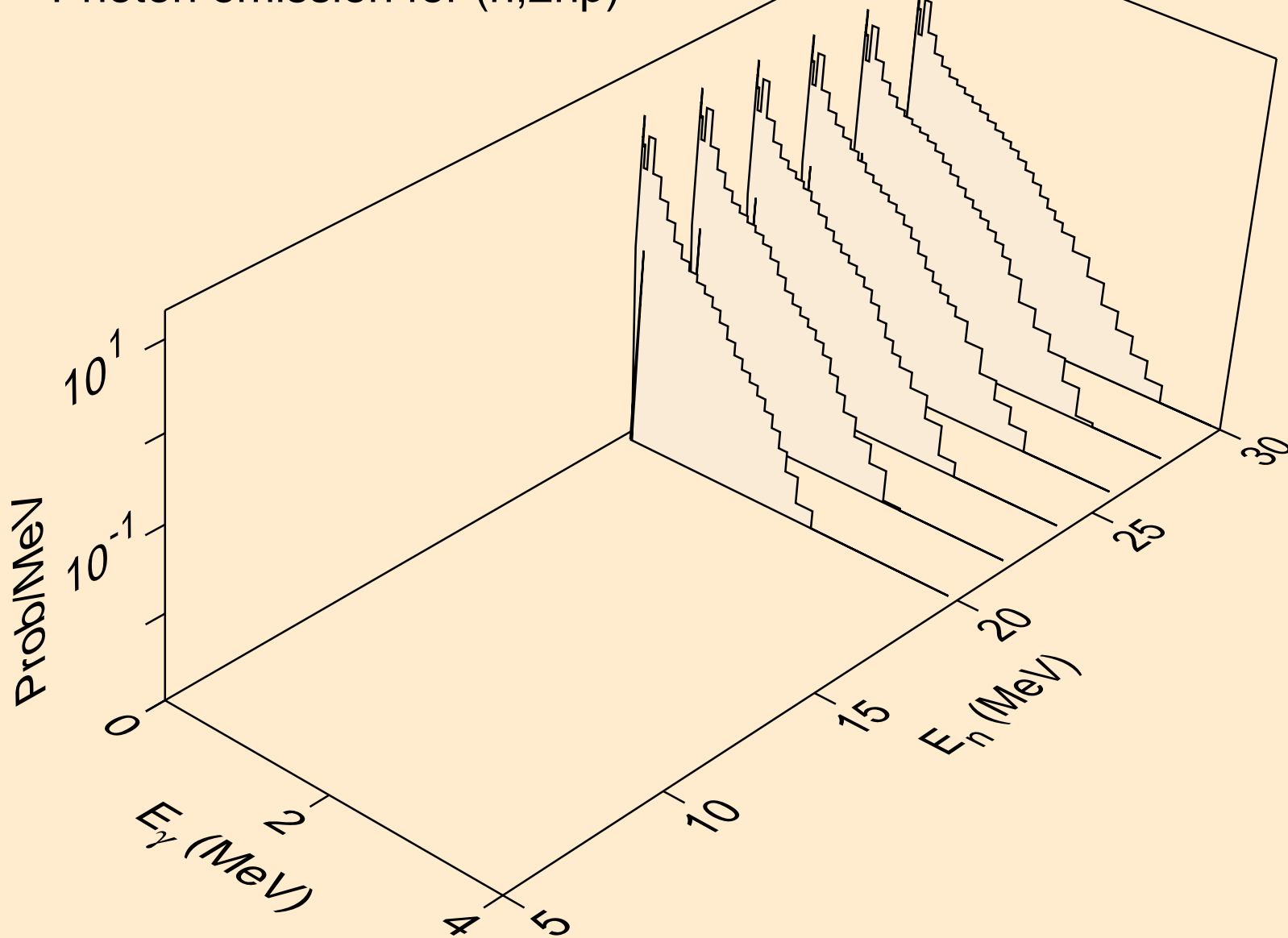

RF261 NEUTRON ACER TENDL-2019 LIBRARY; T=293.16K
Photon emission for (n,npa)

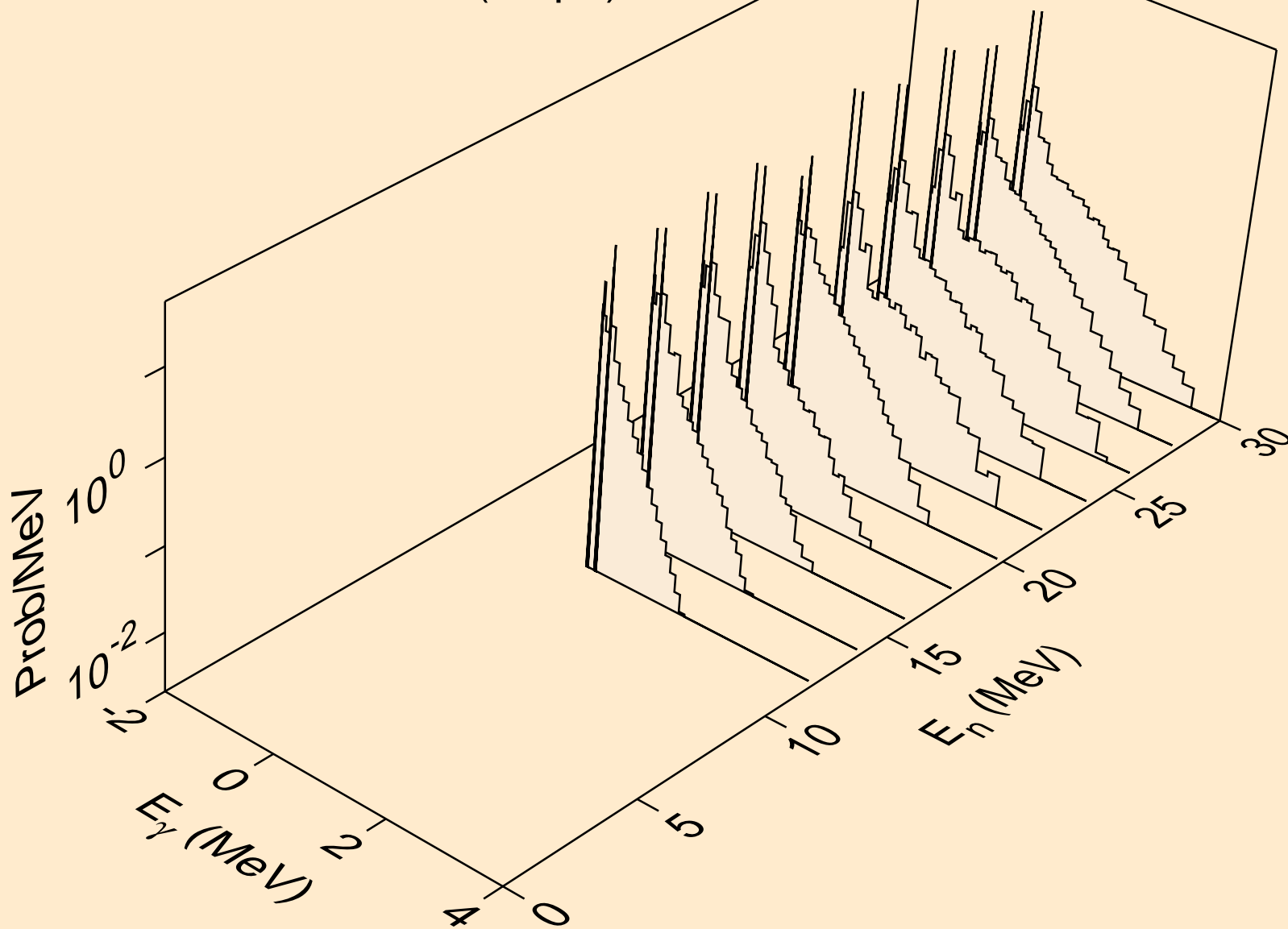

RF261 NEUTRON ACER TENDL-2019 LIBRARY; T=293.16K
Photon emission for (n,n*c)

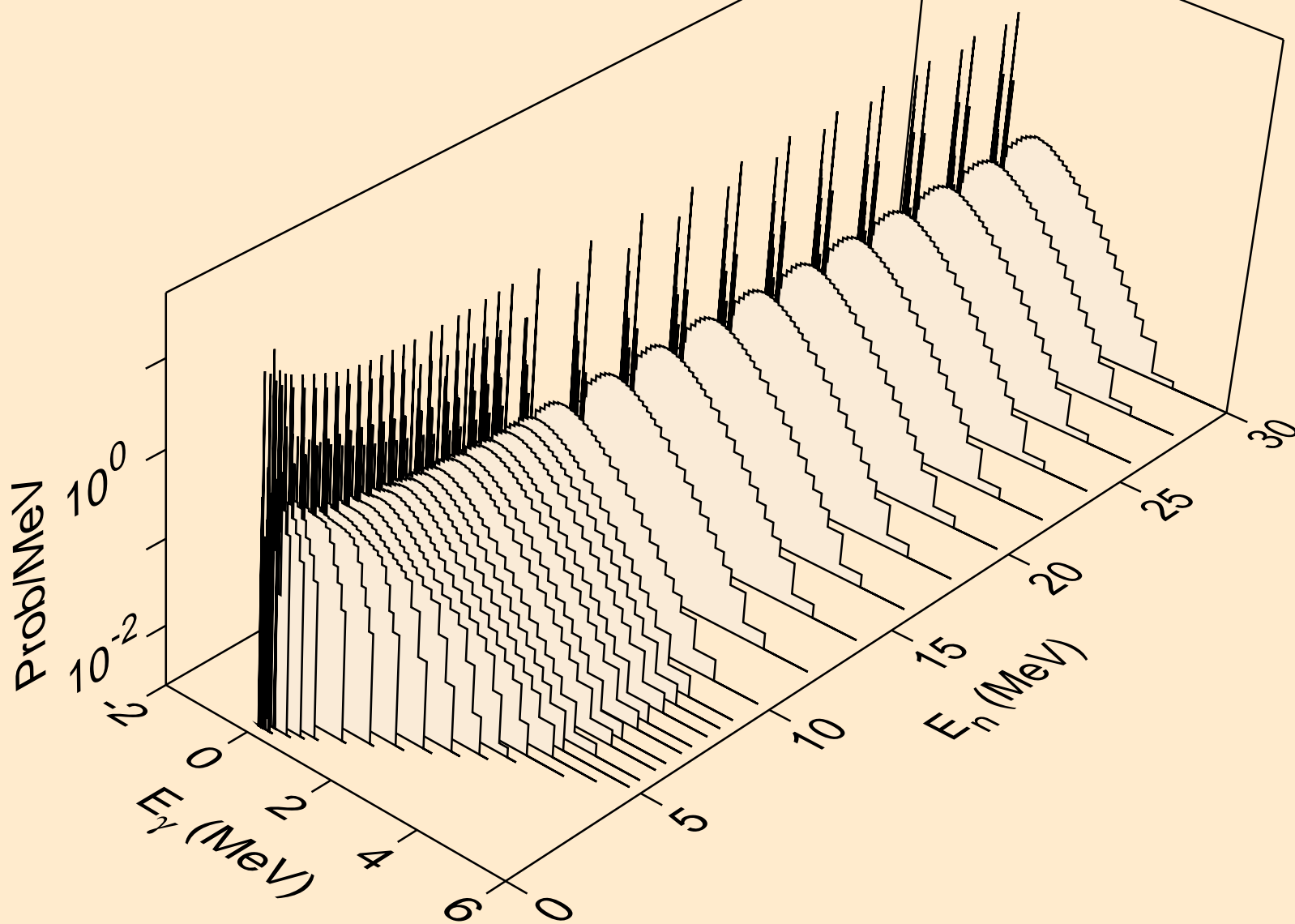

RF261 NEUTRON ACER TENDL-2019 LIBRARY; T=293.16K
Photon emission for (n,gma)

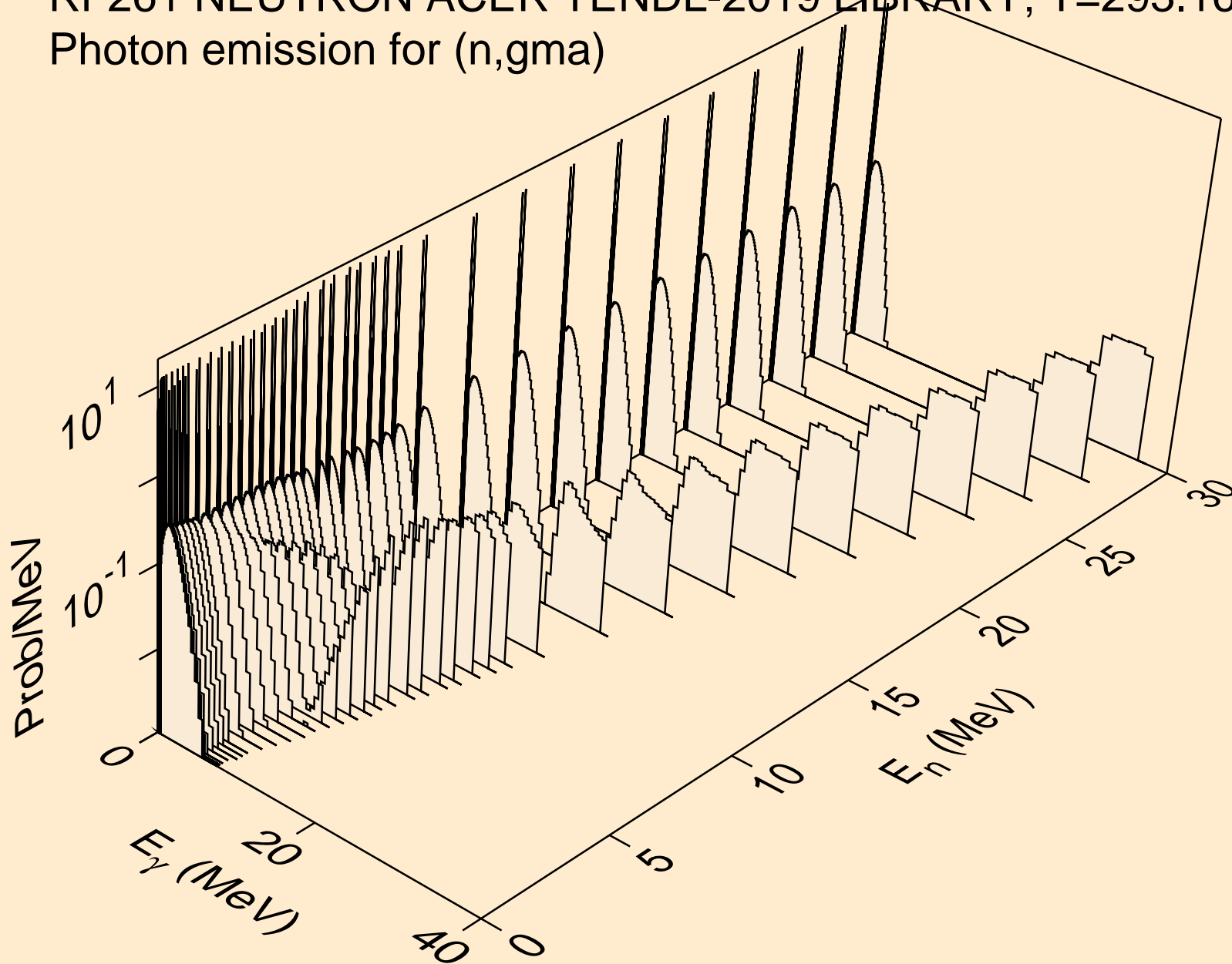

RF261 NEUTRON ACER TENDL-2019 LIBRARY; T=293.16K
Photon emission for (n,p)

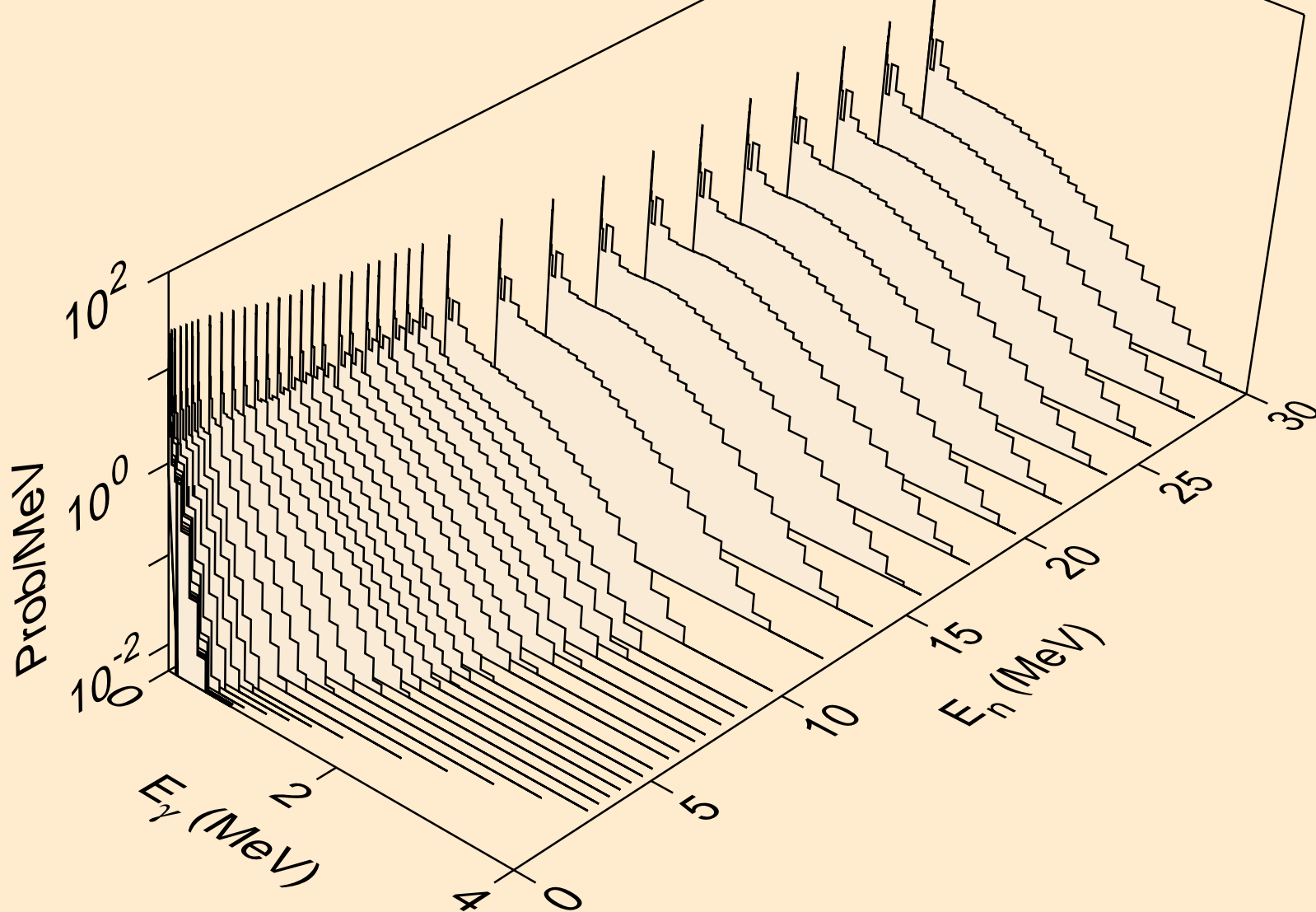

RF261 NEUTRON ACER TENDL-2019 LIBRARY; T=293.16K
Photon emission for (n,d)

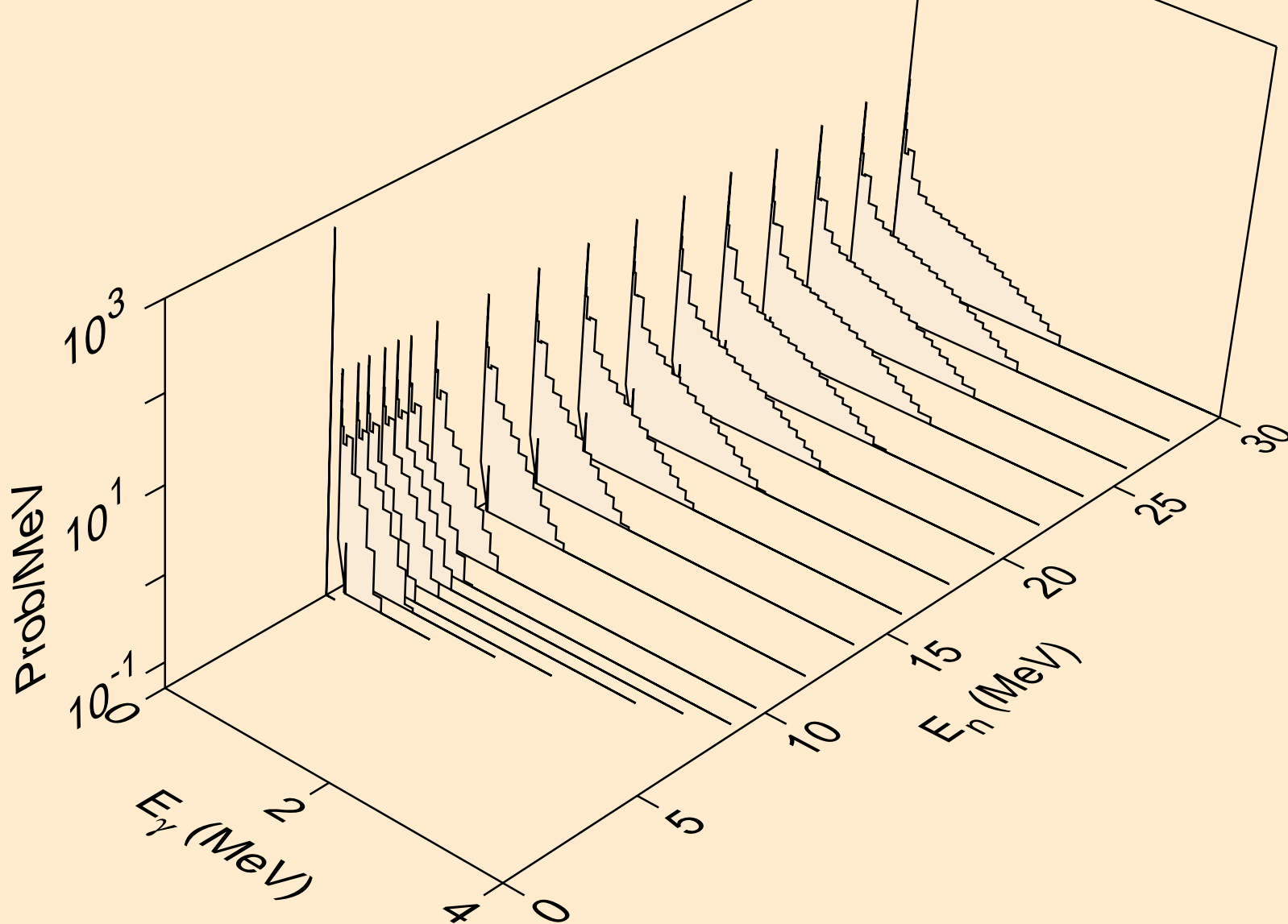

RF261 NEUTRON ACER TENDL-2019 LIBRARY; T=293.16K
Photon emission for (n,t)

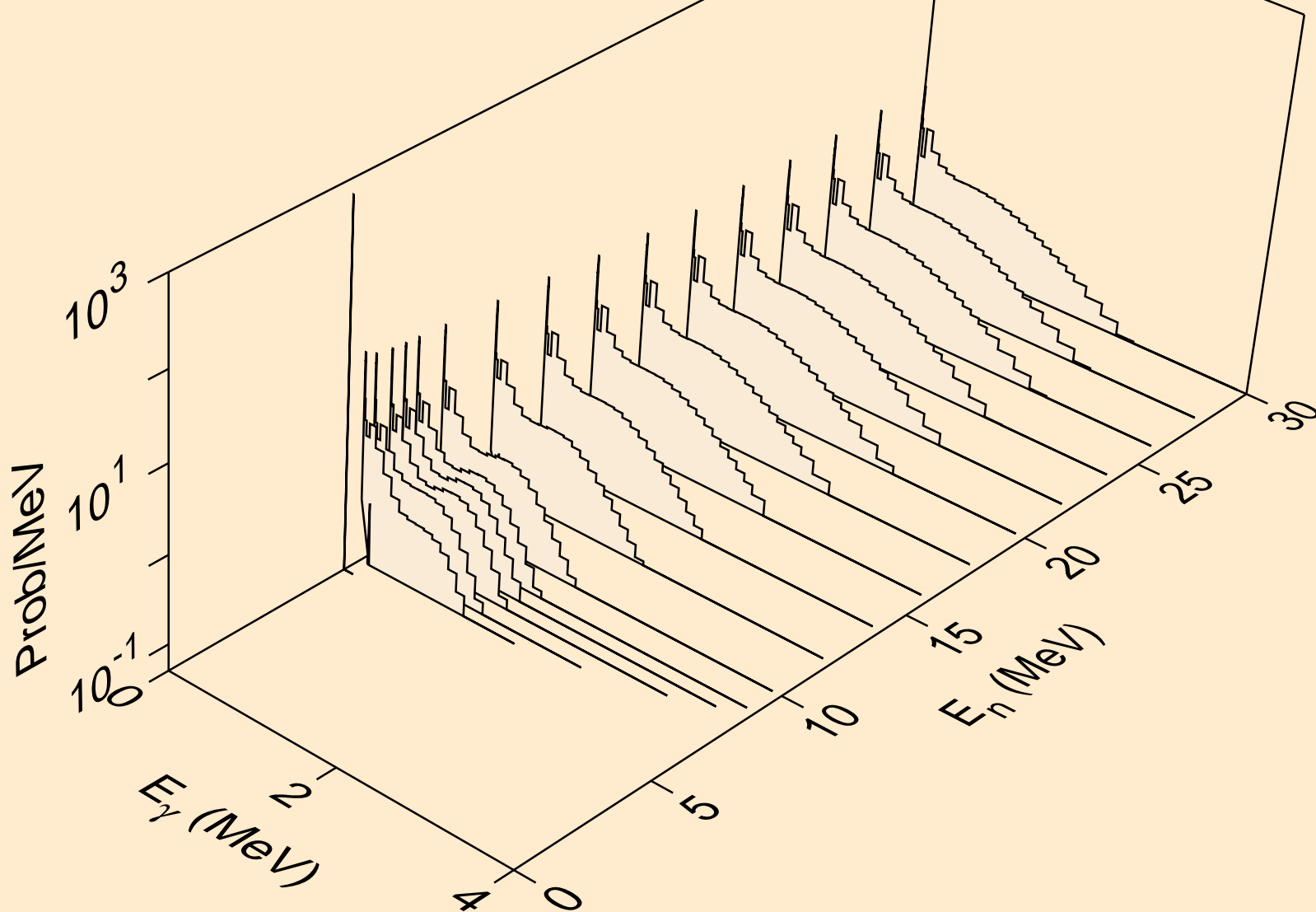

RF261 NEUTRON ACER TENDL-2019 LIBRARY; T=293.16K
Photon emission for (n,he3)

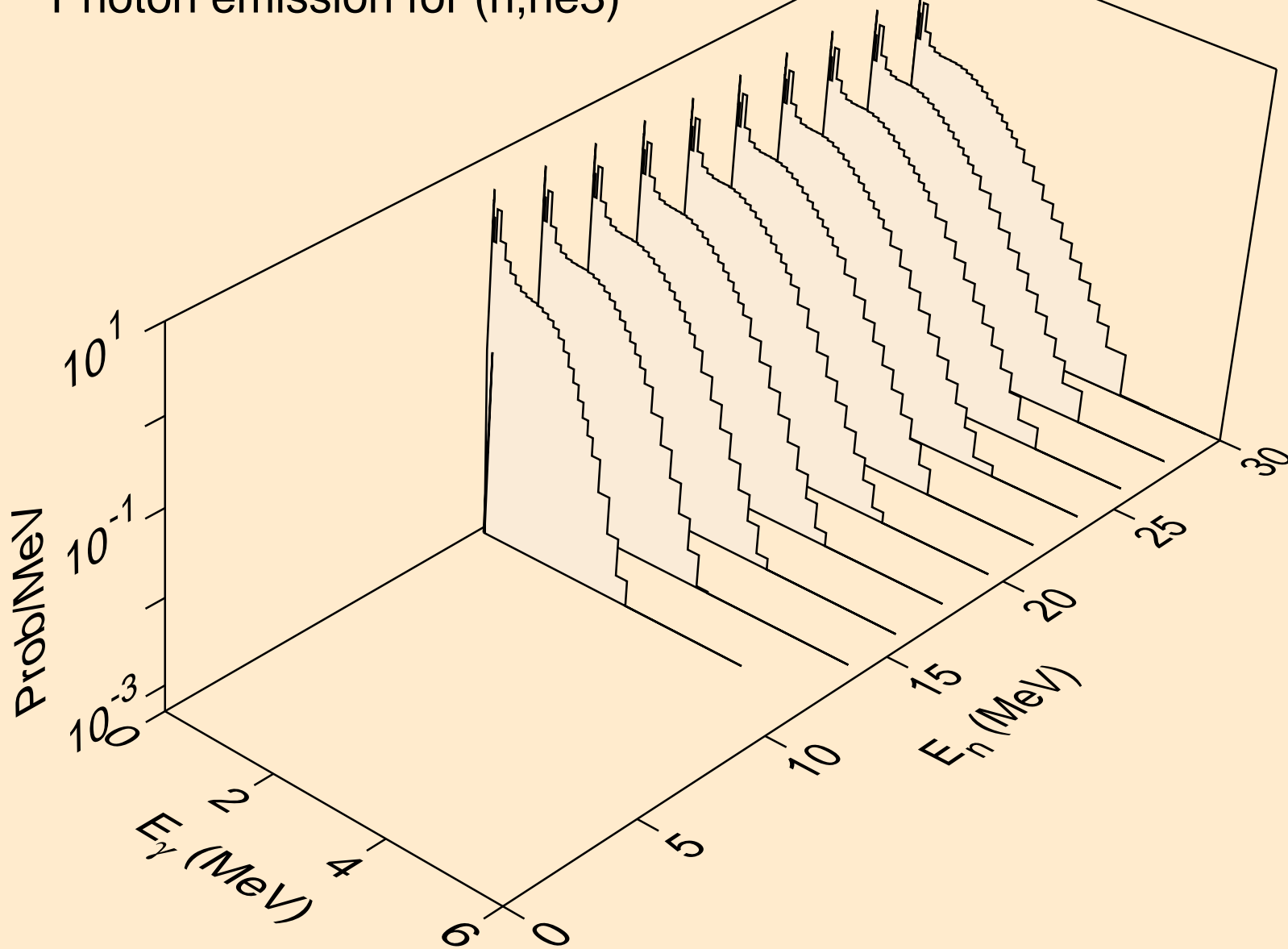

RF261 NEUTRON ACER TENDL-2019 LIBRARY; T=293.16K
Photon emission for (n,a)

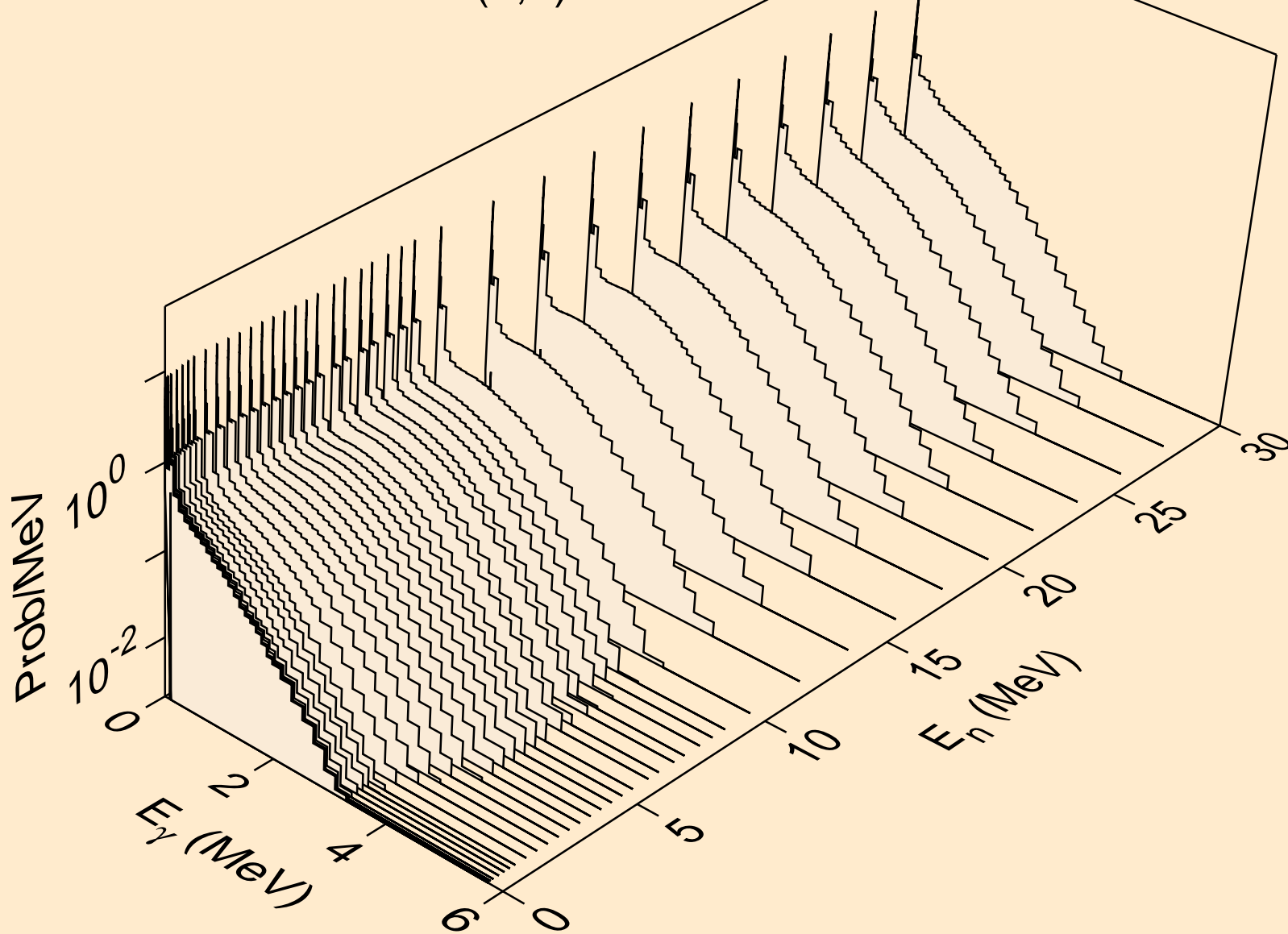

RF261 NEUTRON ACER TENDL-2019 LIBRARY; T=293.16K
Photon emission for (n,2a)

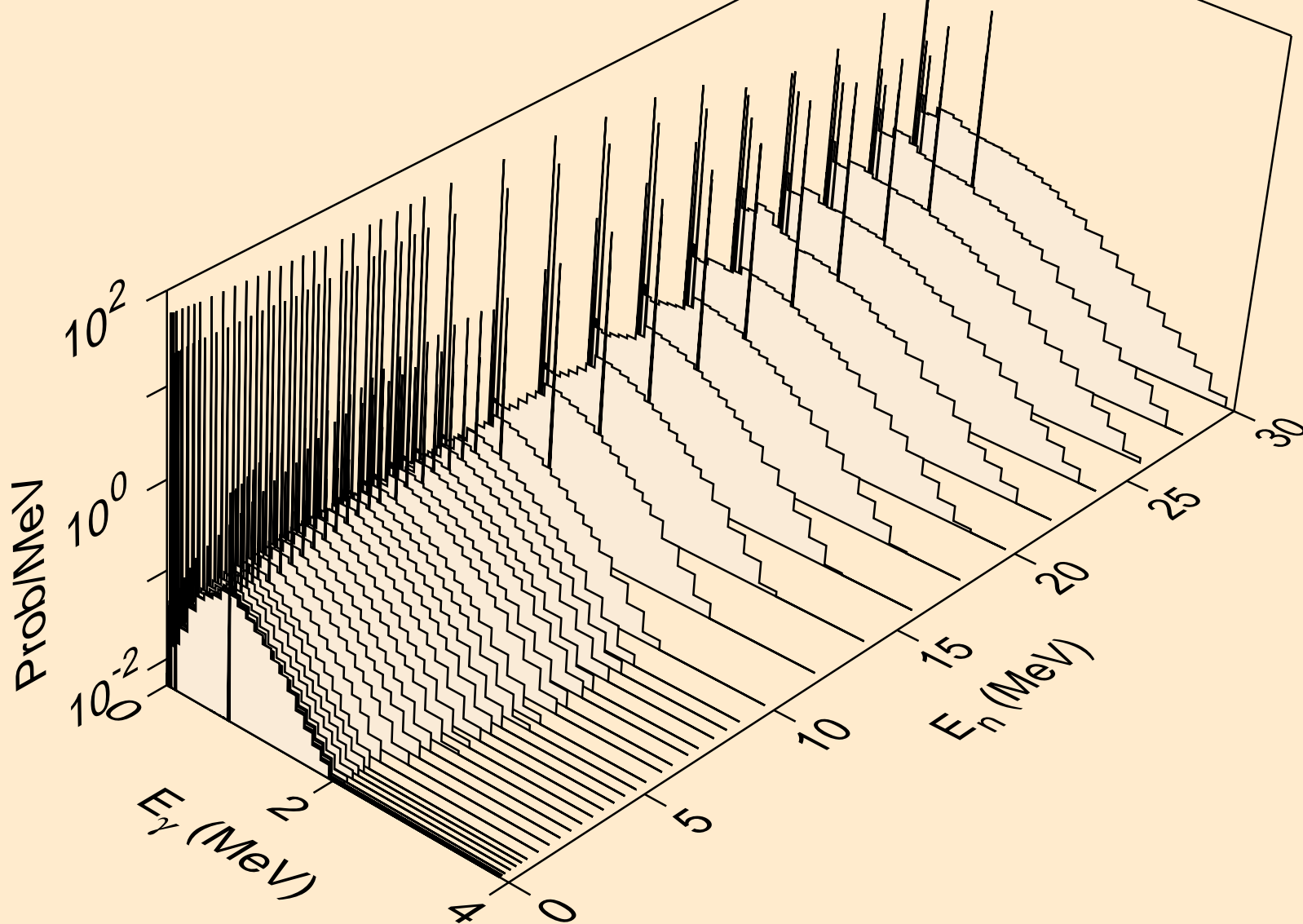

RF261 NEUTRON ACER TENDL-2019 LIBRARY; T=293.16K
Photon emission for (n,2p)

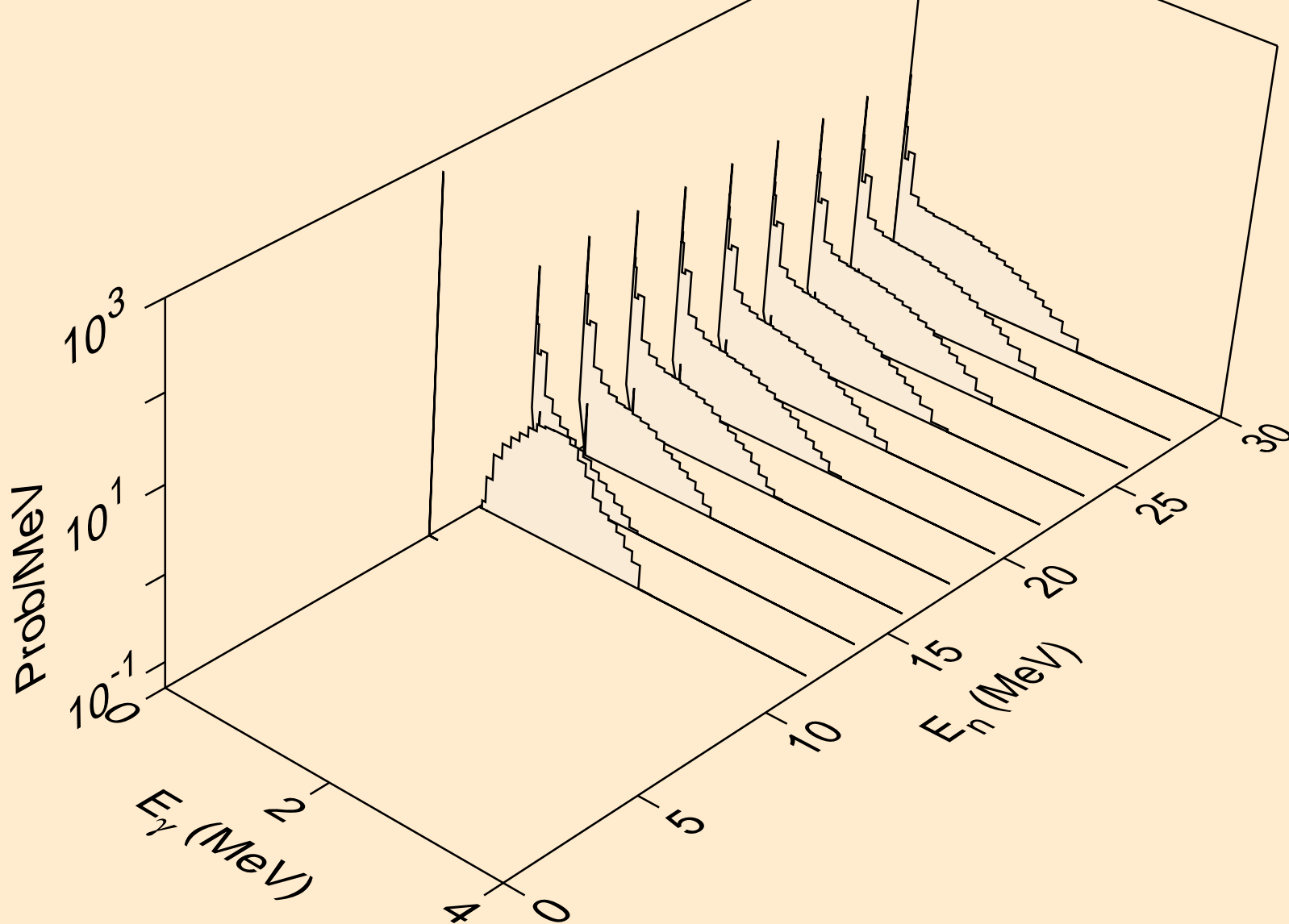

RF261 NEUTRON ACER TENDL-2019 LIBRARY; T=293.16K
Photon emission for (n,p)

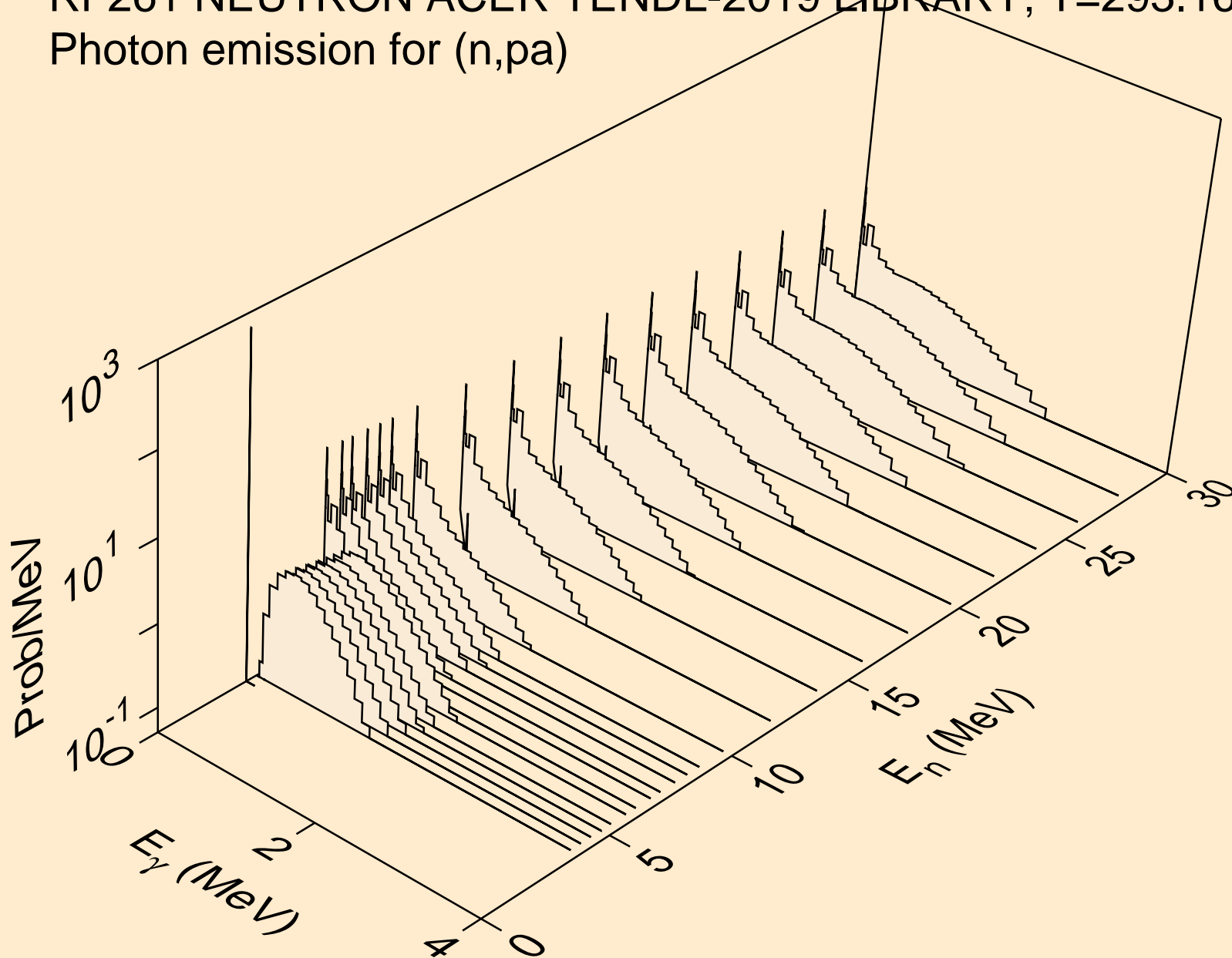

RF261 NEUTRON ACER TENDL-2019 LIBRARY; T=293.16K
Photon emission for (n,pd)

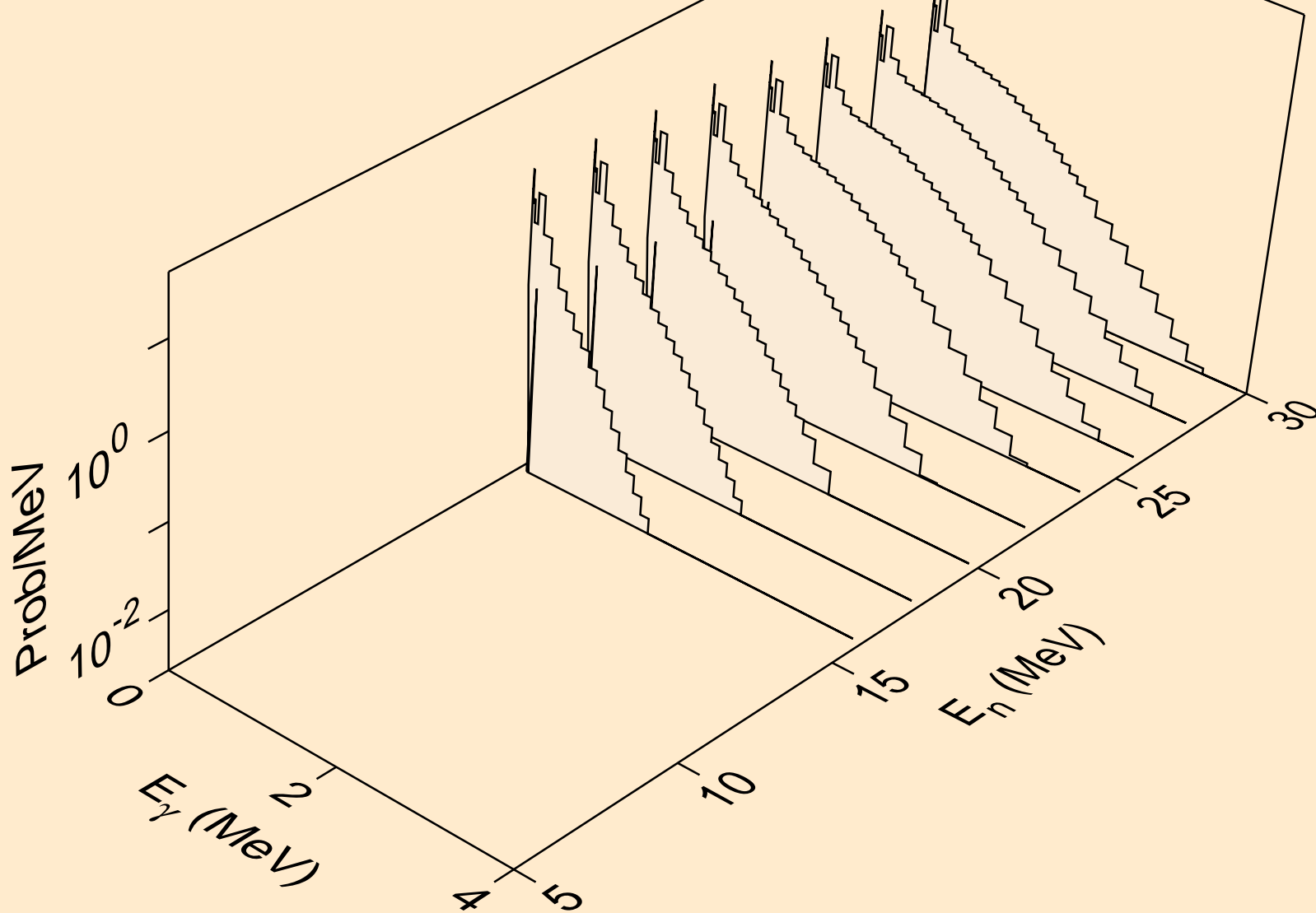

RF261 NEUTRON ACER TENDL-2019 LIBRARY; T=293.16K
Photon emission for (n,da)

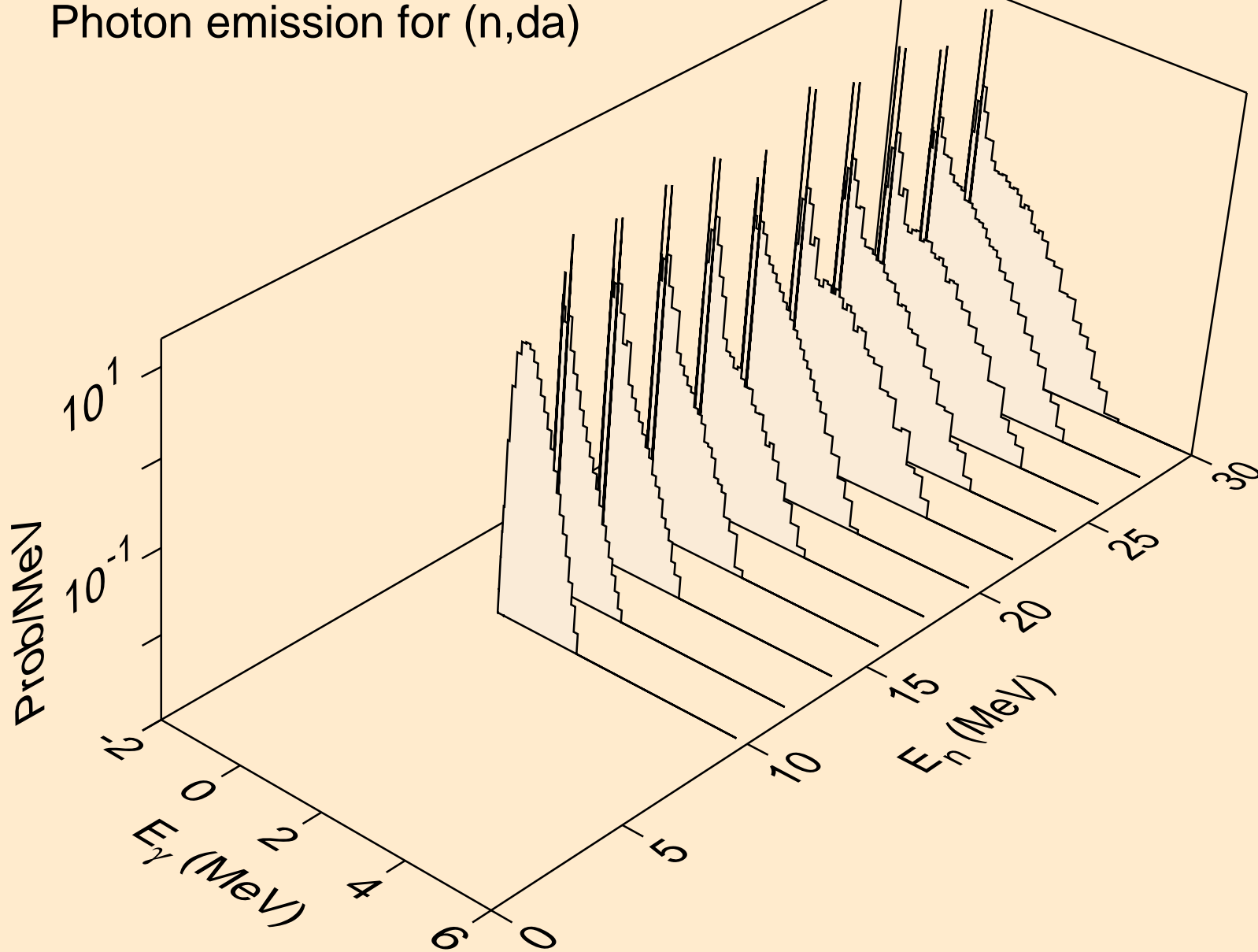

RF261 NEUTRON ACER TENDL-2019 LIBRARY; T=293.16K
thermal capture photon spectrum

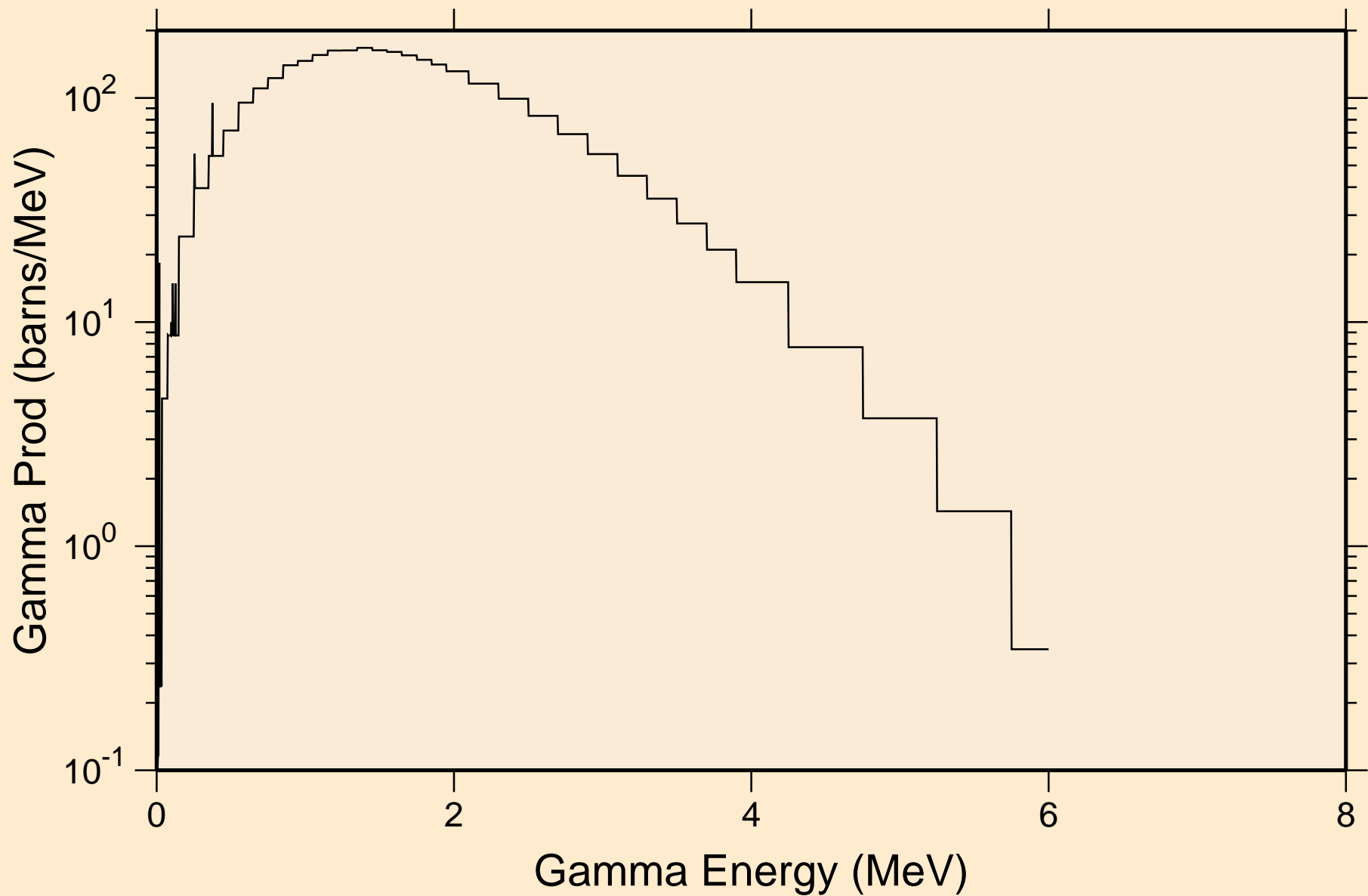

RF261 NEUTRON ACER TENDL-2019 LIBRARY; T=293.16K
14 MeV photon spectrum

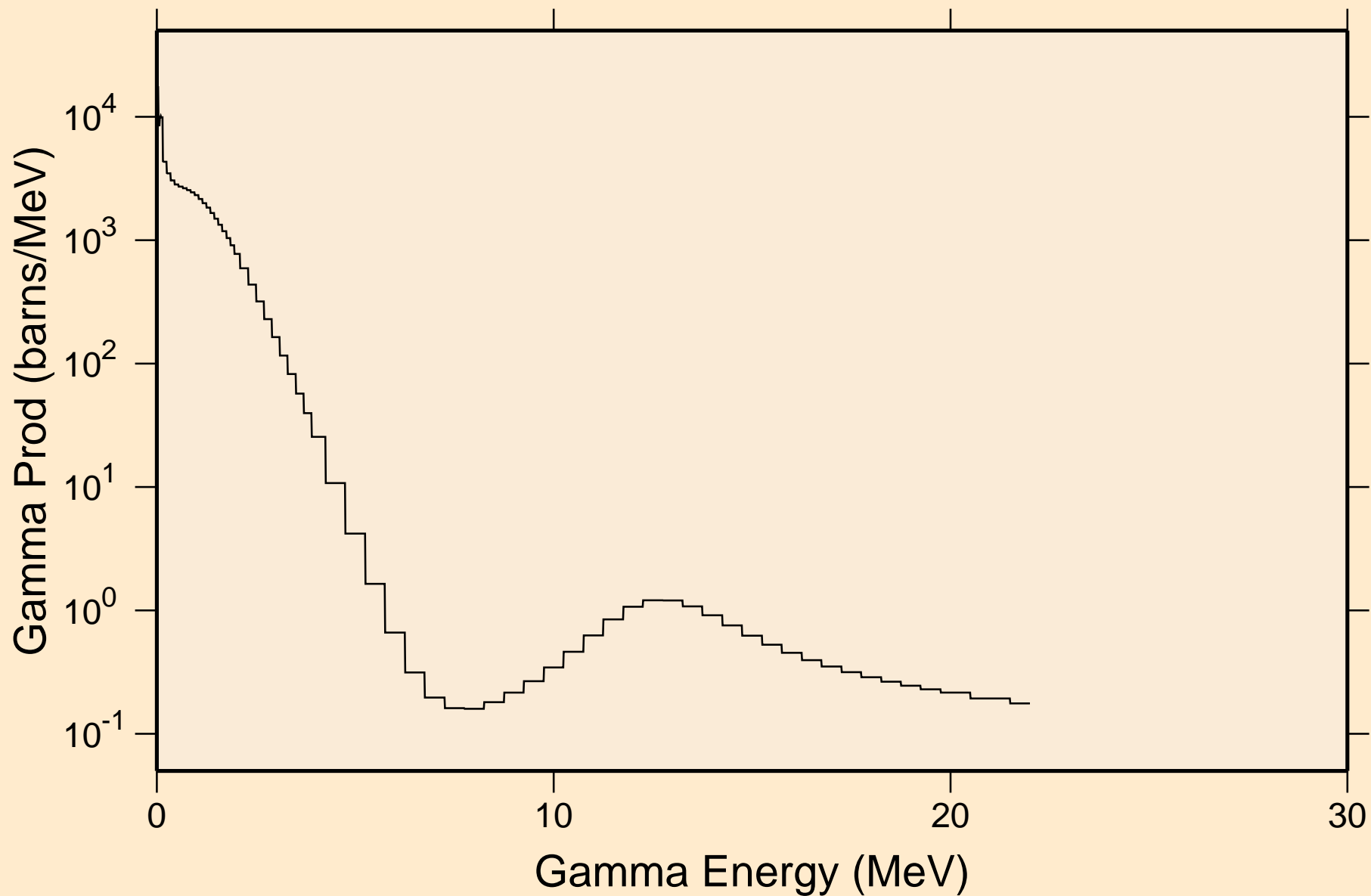

RF261 NEUTRON ACER TENDL-2019 LIBRARY; T=293.16K
Particle heating contributions

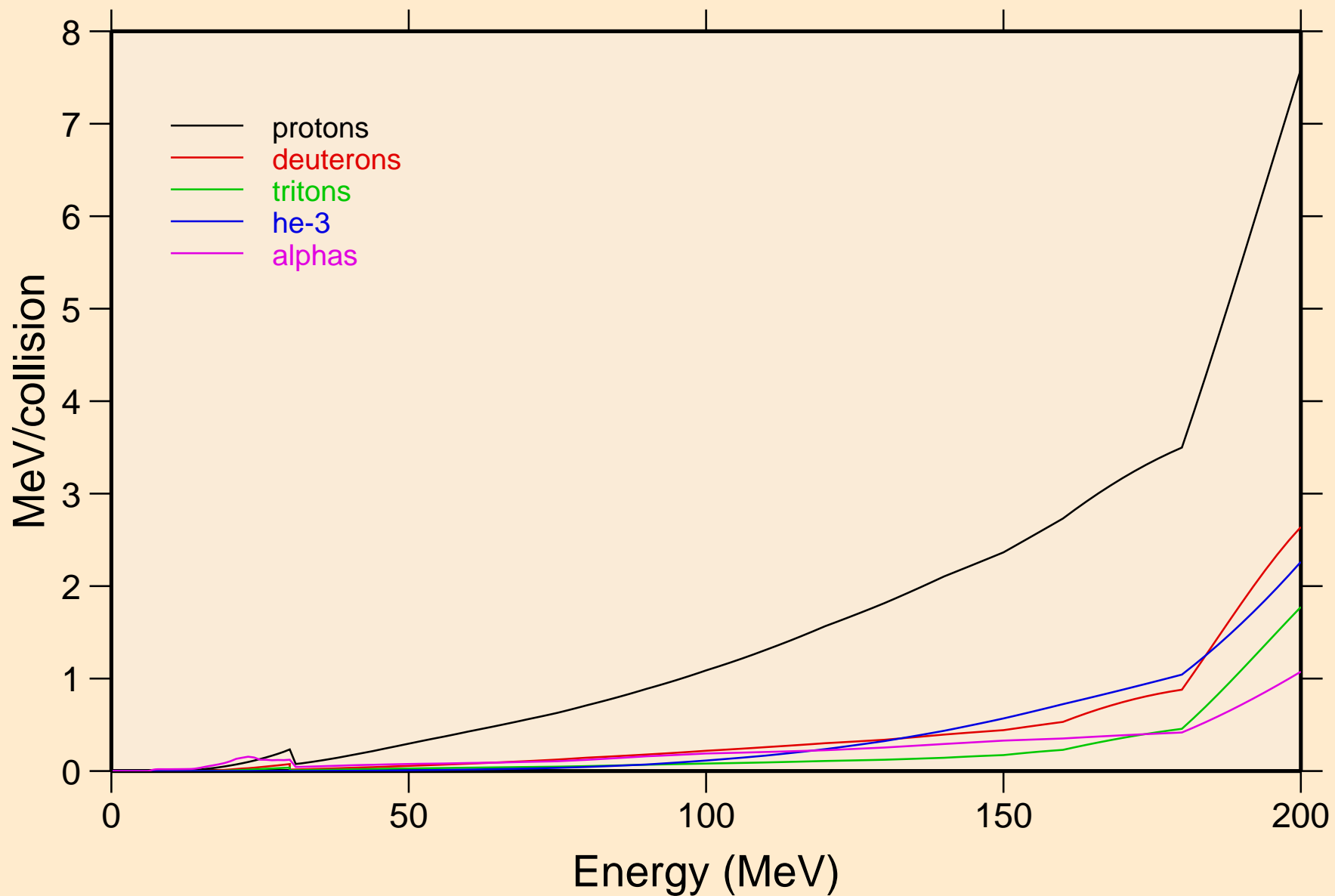

RF261 NEUTRON ACER TENDL-2019 LIBRARY; T=293.16K
Recoil Heating

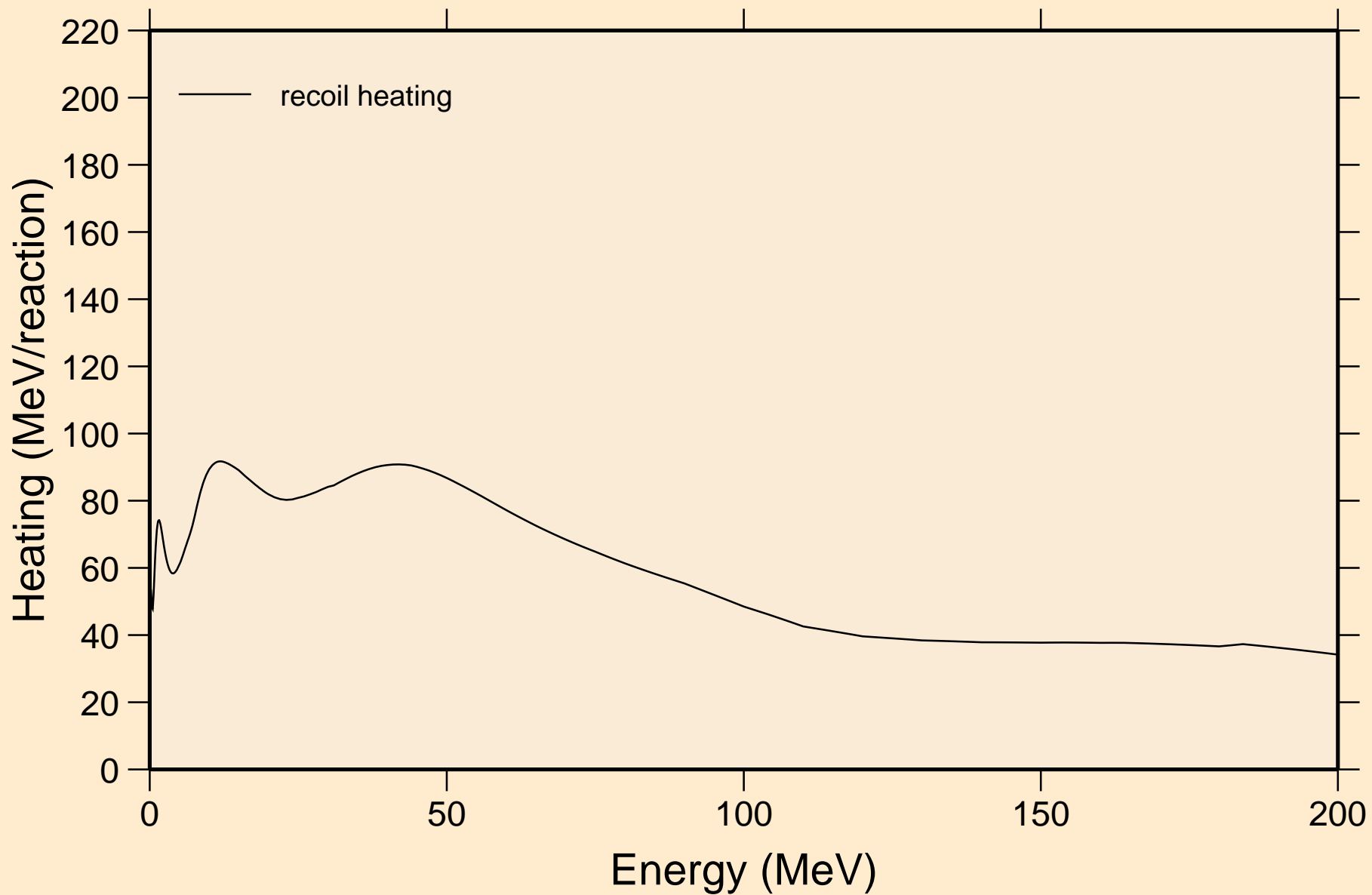

RF261 NEUTRON ACER TENDL-2019 LIBRARY; T=293.16K
Particle production cross sections

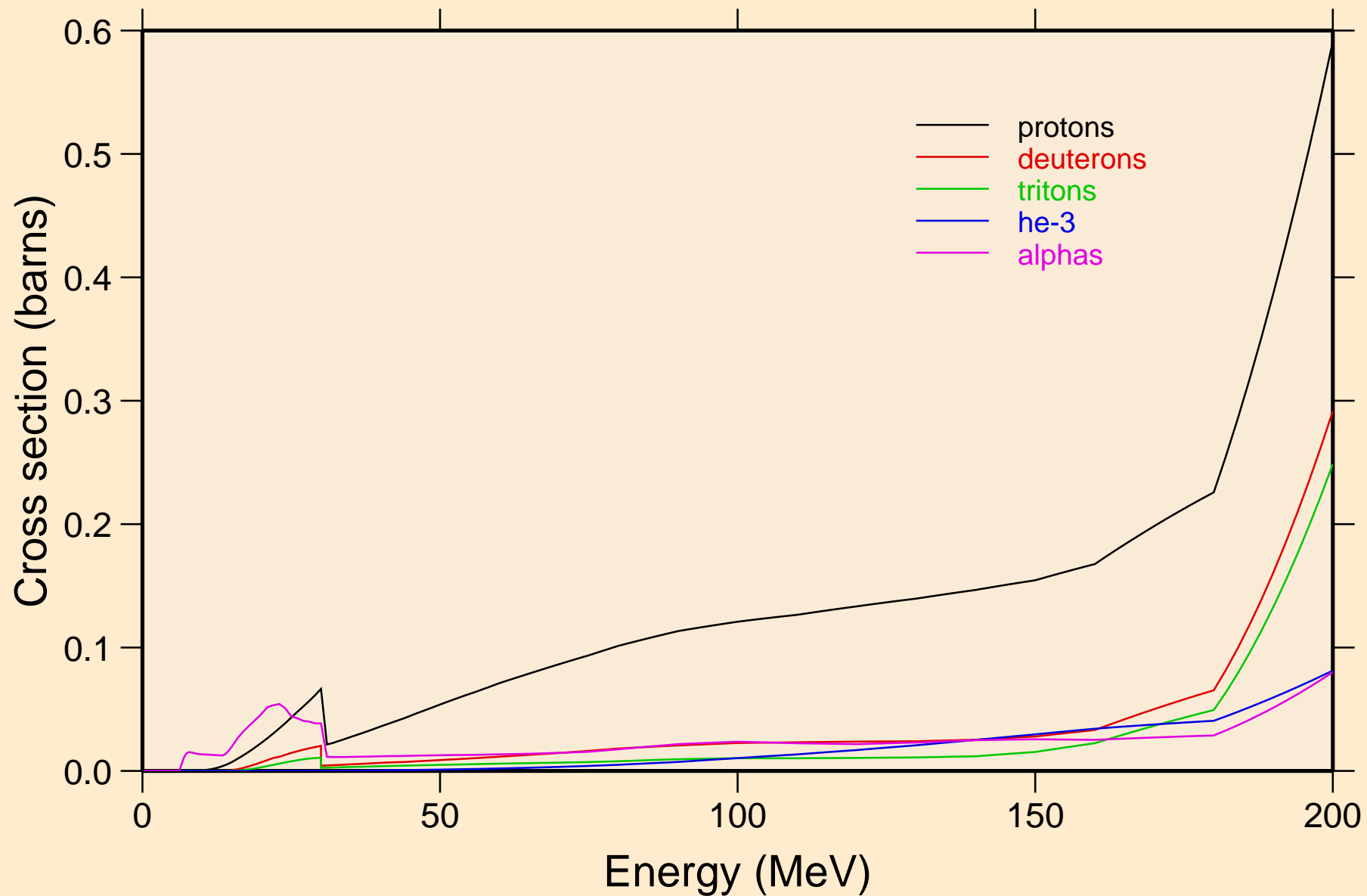

RF261 NEUTRON ACER TENDL-2019 LIBRARY; T=293.16K
protons from (n,x)

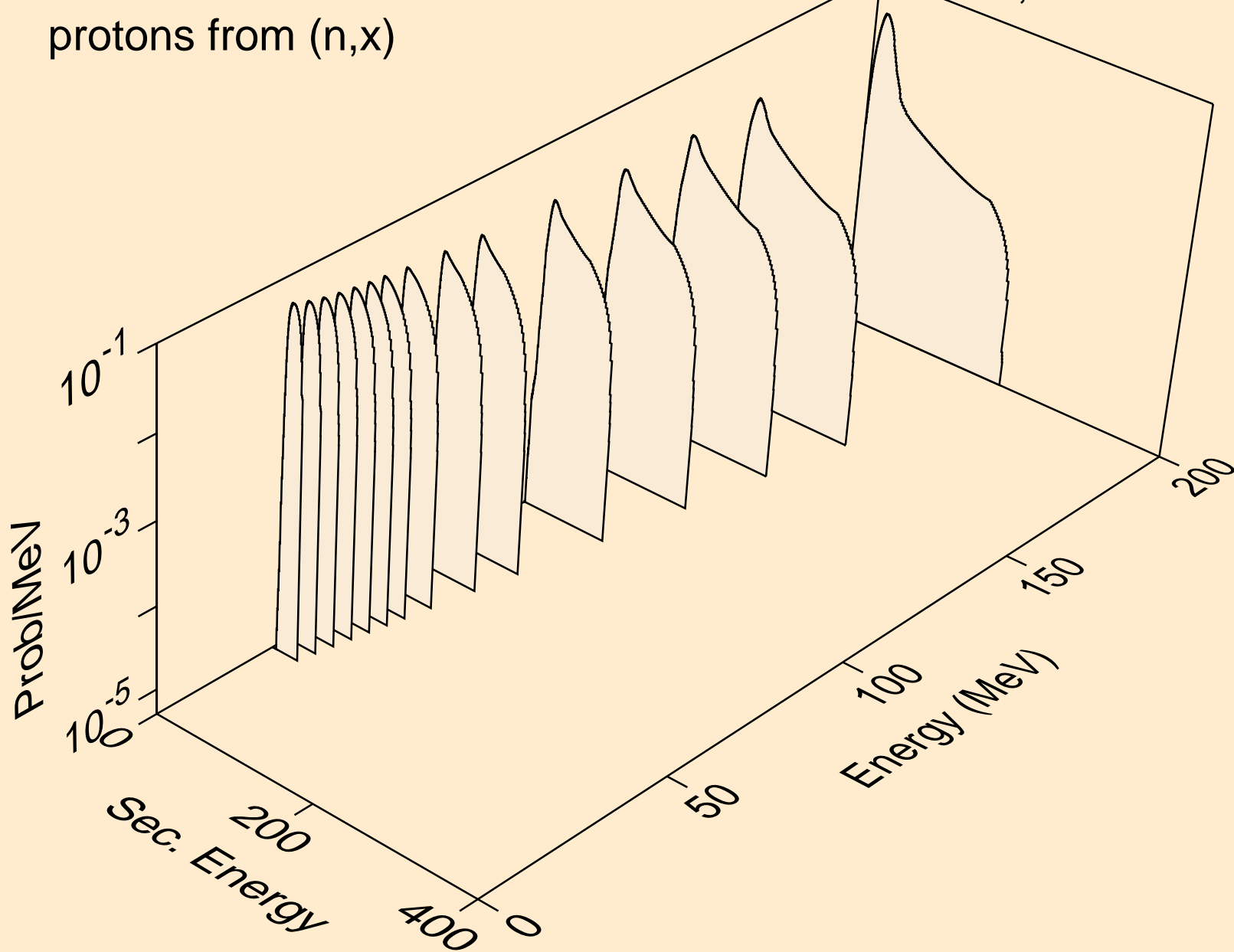

RF261 NEUTRON ACER TENDL-2019 LIBRARY; T=293.16K
protons from (n,n*)p

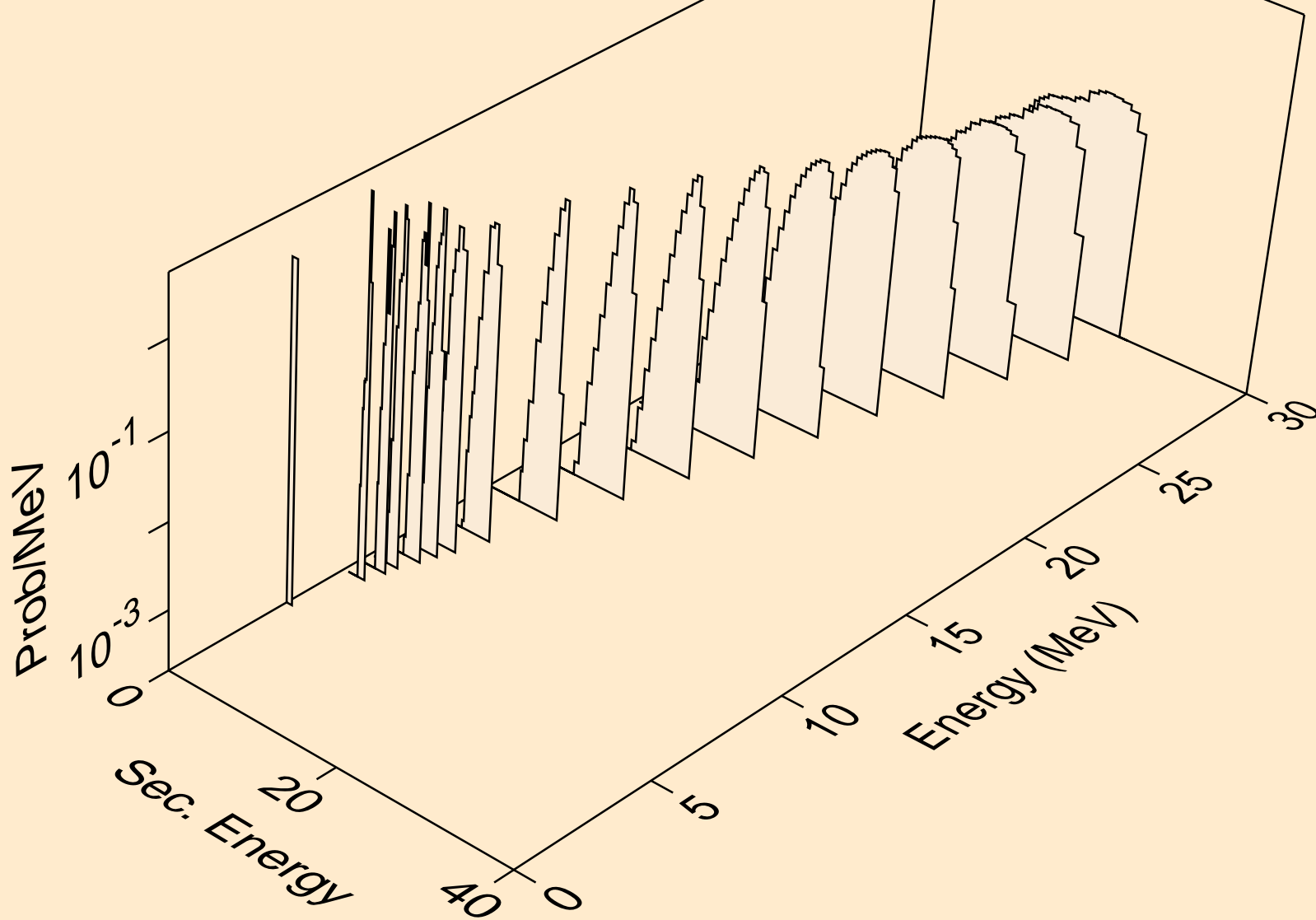

RF261 NEUTRON ACER TENDL-2019 LIBRARY; T=293.16K
protons from (n,2np)

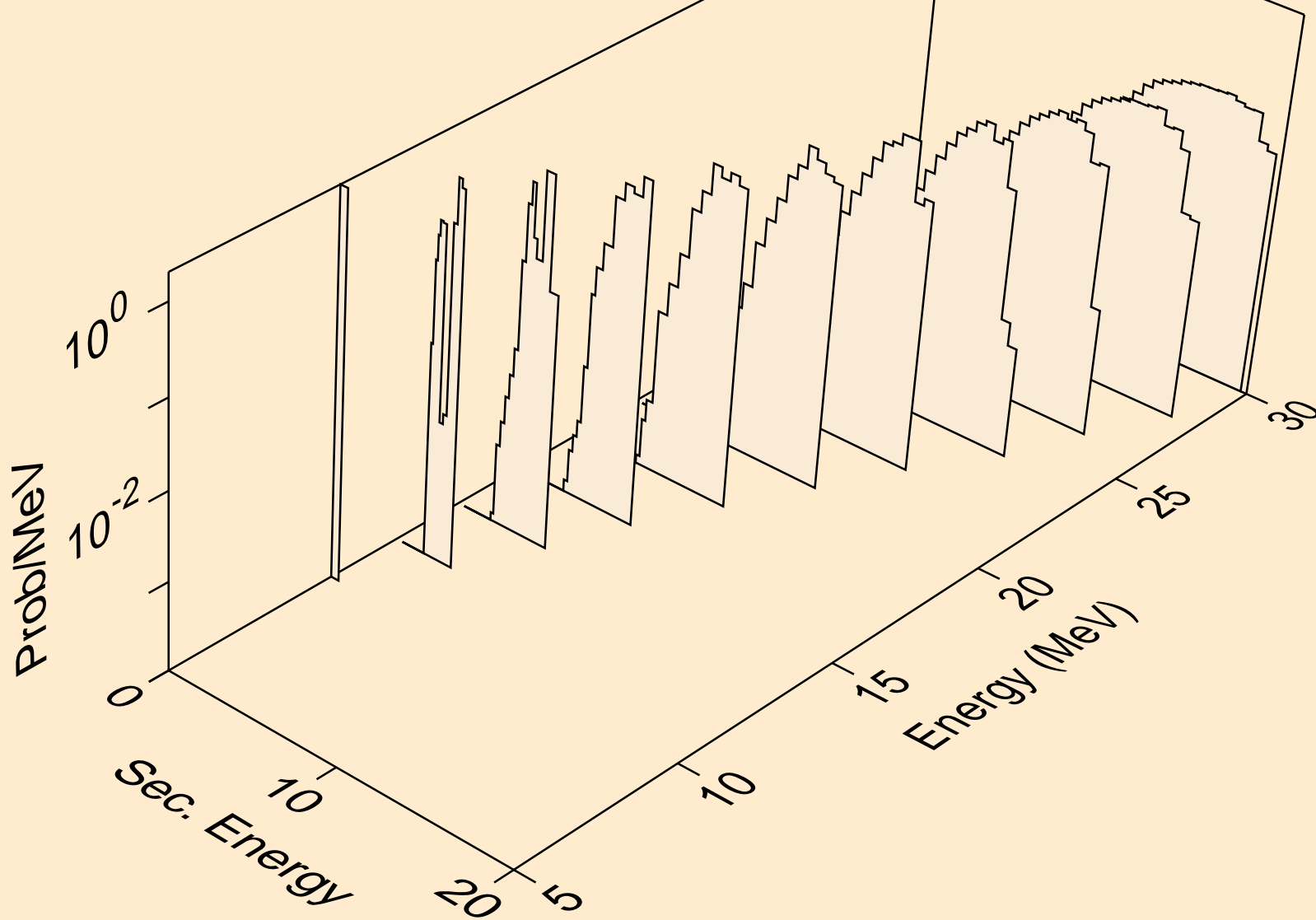

RF261 NEUTRON ACER TENDL-2019 LIBRARY; T=293.16K
protons from (n,3np)

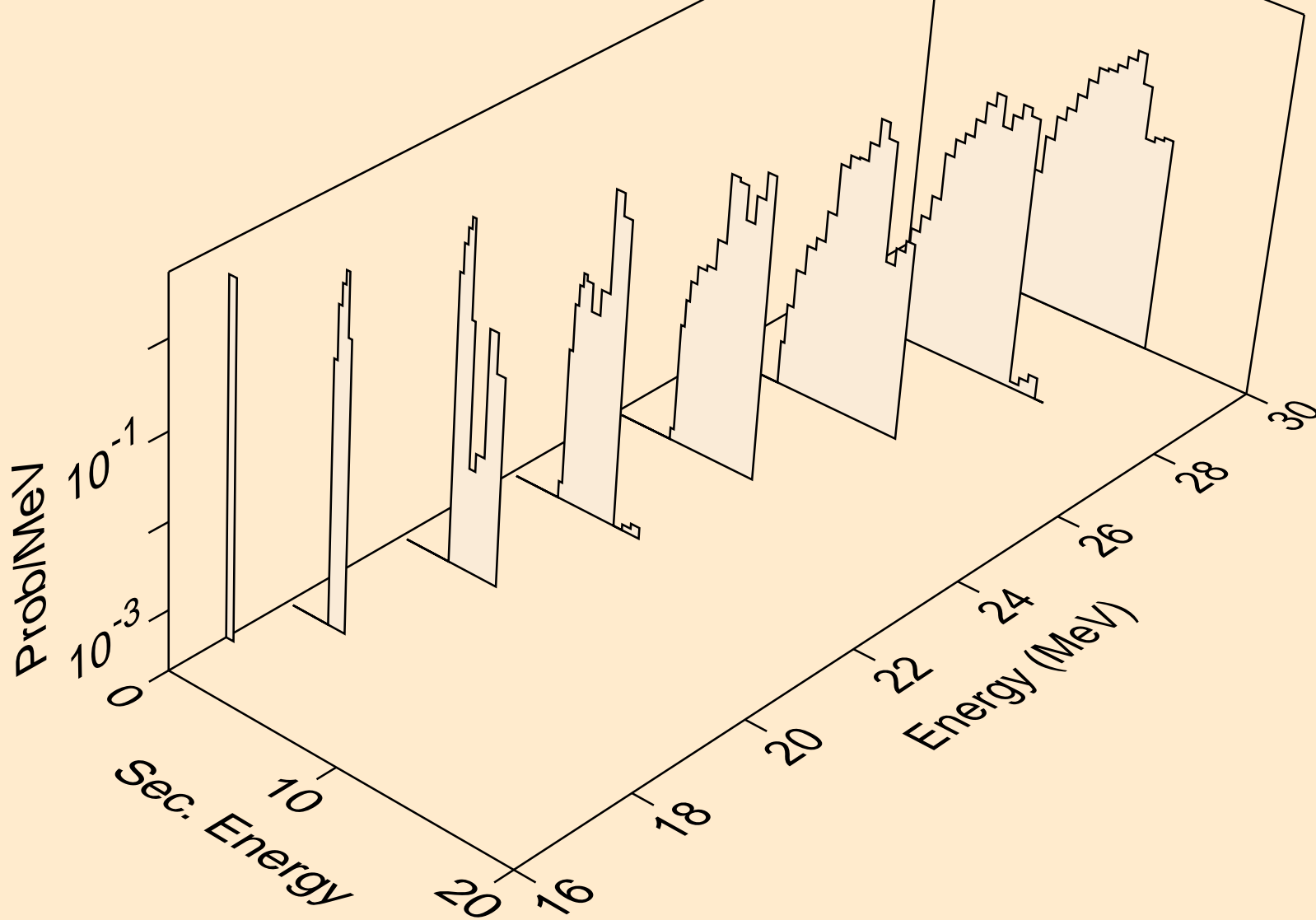

RF261 NEUTRON ACER TENDL-2019 LIBRARY; T=293.16K
protons from (n,2np)

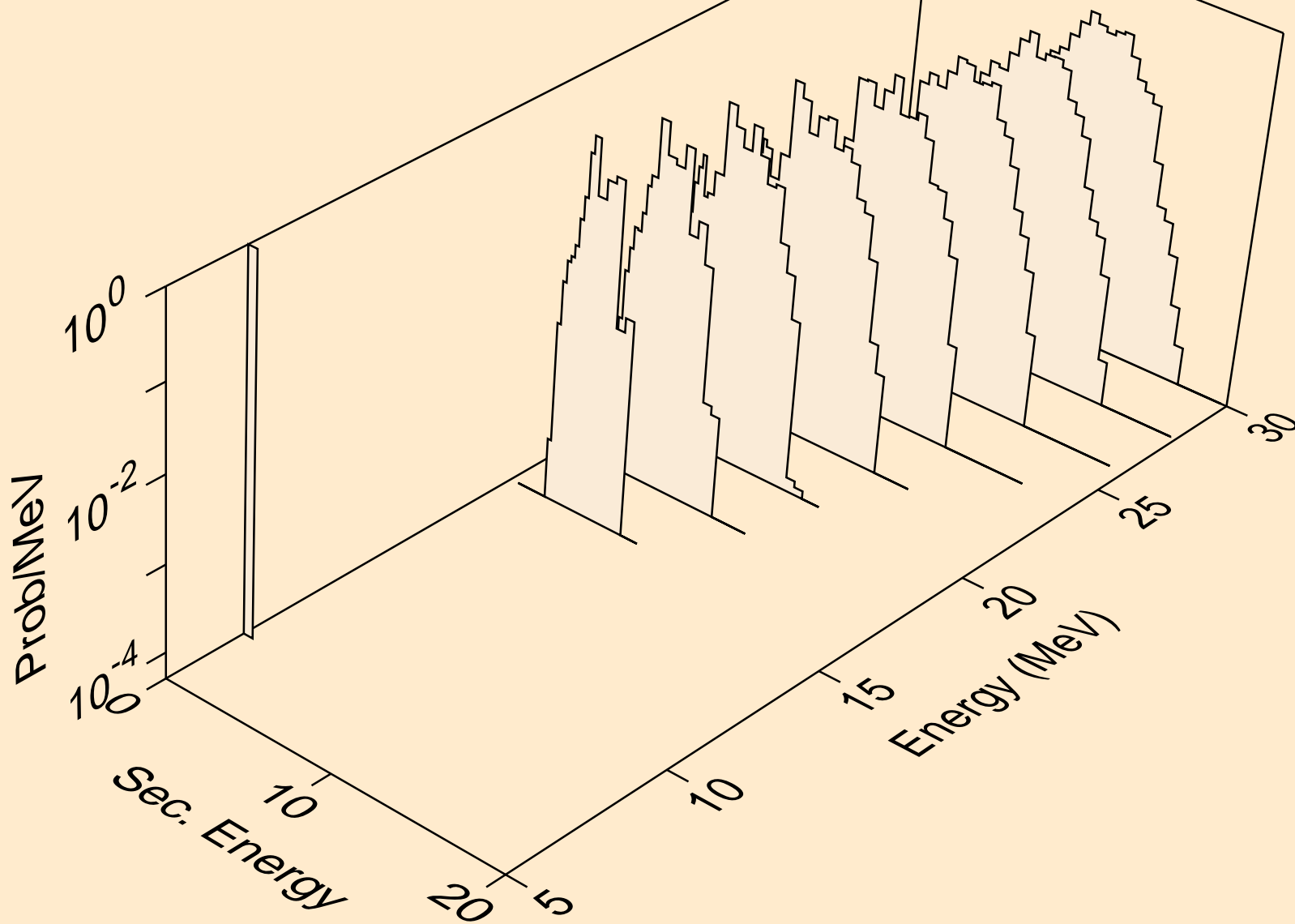

RF261 NEUTRON ACER TENDL-2019 LIBRARY; T=293.16K
protons from (n,npa)

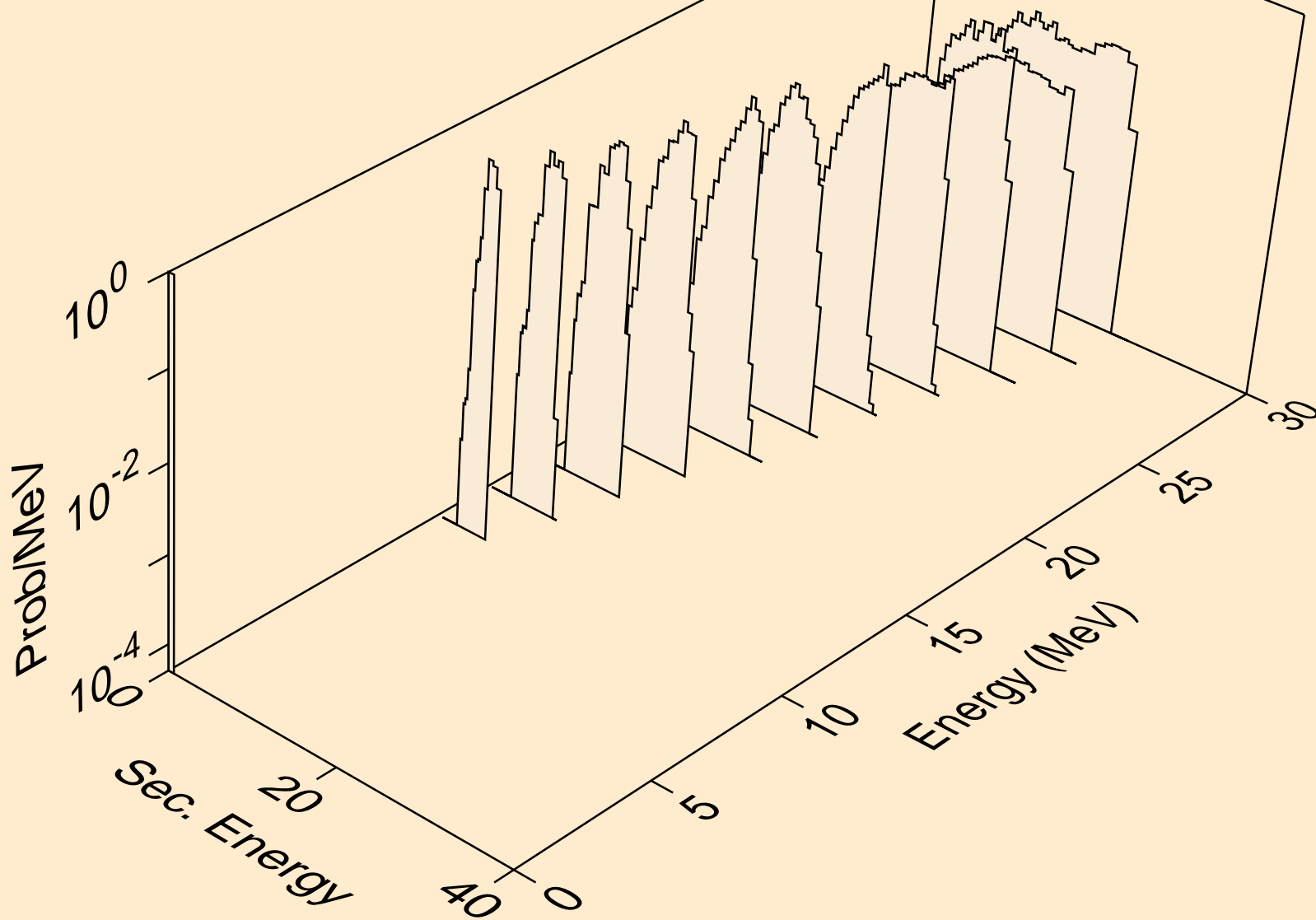

RF261 NEUTRON ACER TENDL-2019 LIBRARY; T=293.16K
protons from (n,p)

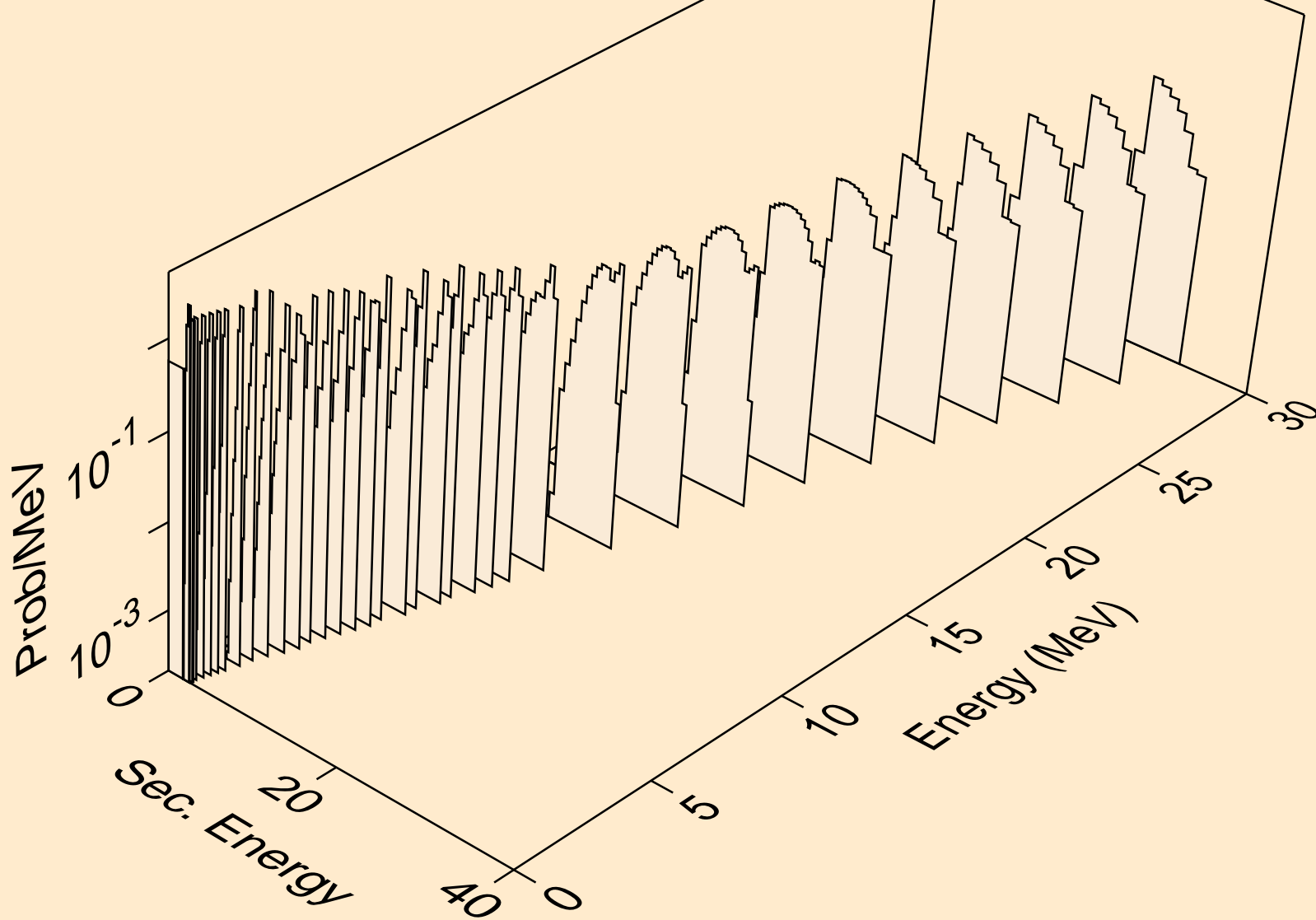

RF261 NEUTRON ACER TENDL-2019 LIBRARY; T=293.16K
protons from (n,2p)

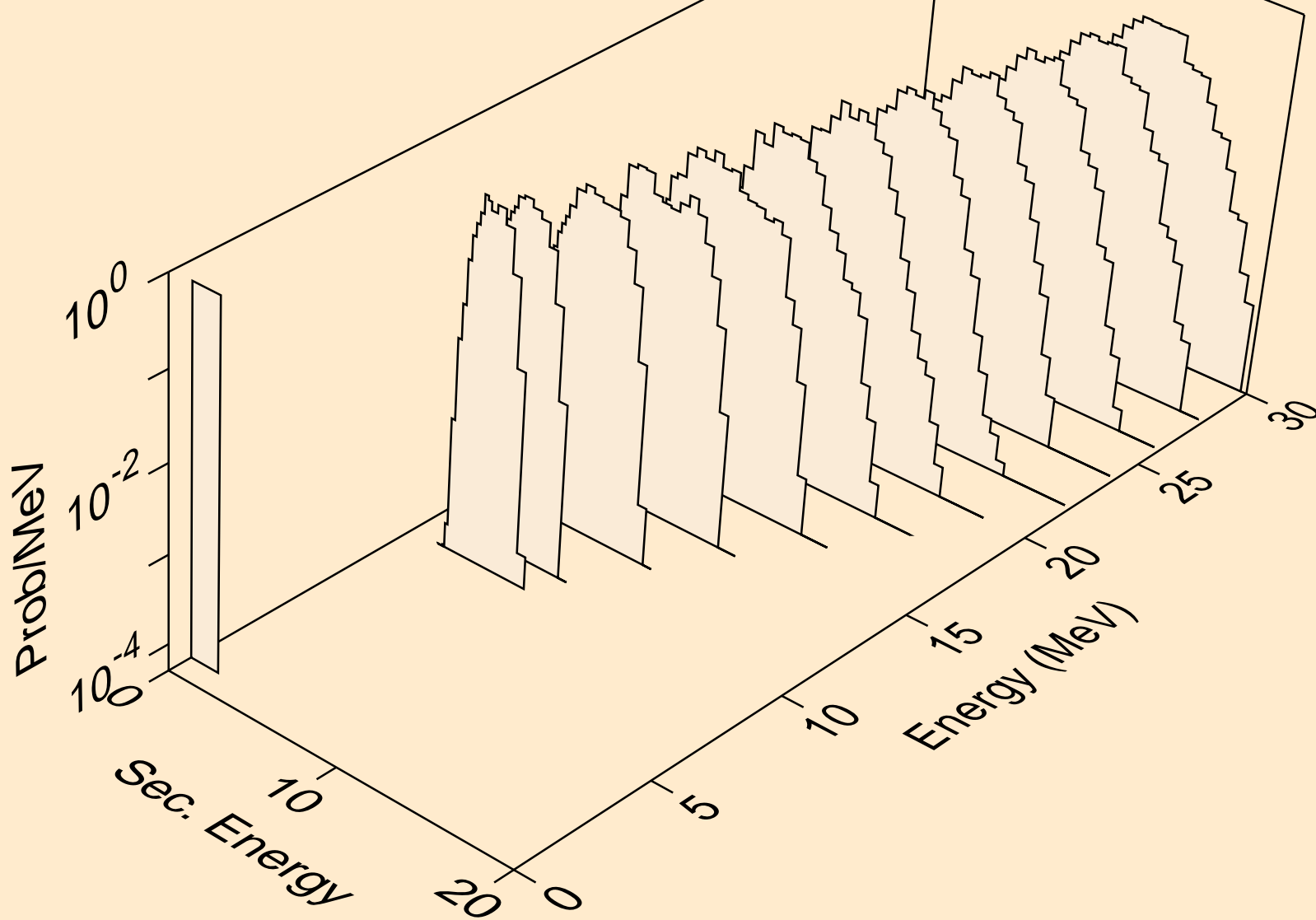

RF261 NEUTRON ACER TENDL-2019 LIBRARY; T=293.16K
protons from (n,p)

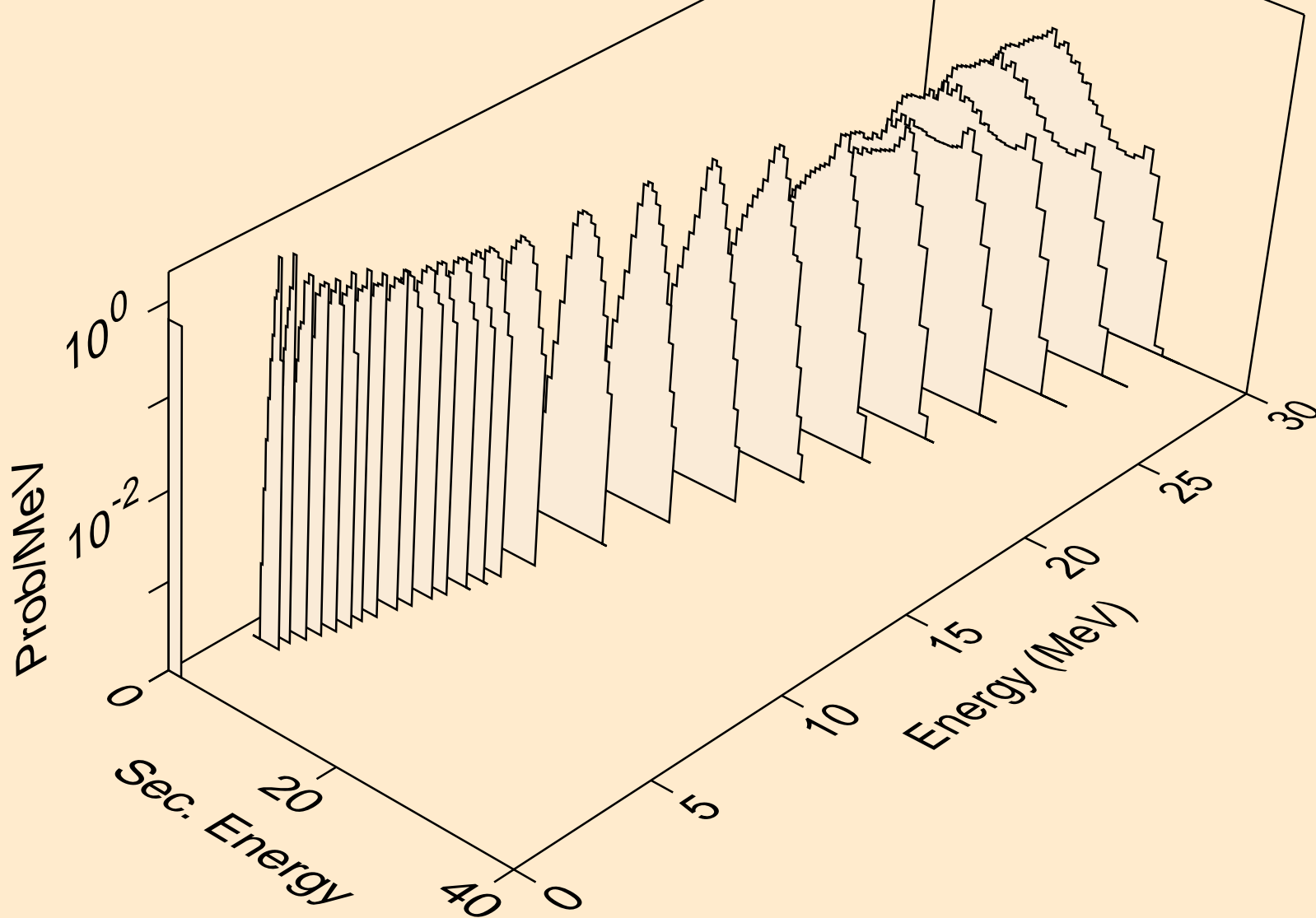

RF261 NEUTRON ACER TENDL-2019 LIBRARY; T=293.16K
protons from (n,pd)

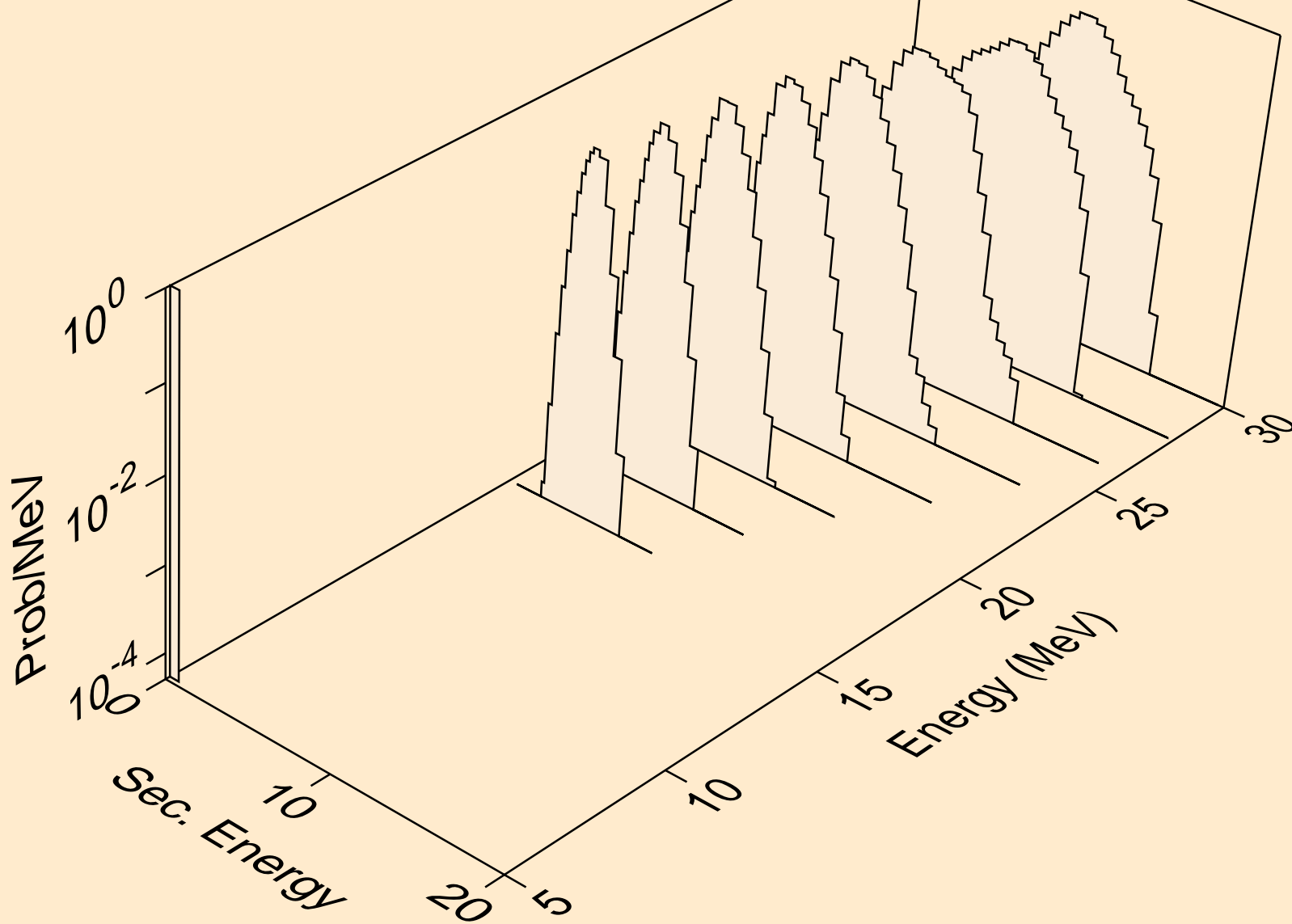

RF261 NEUTRON ACER TENDL-2019 LIBRARY; T=293.16K
deuterons from (n,x)

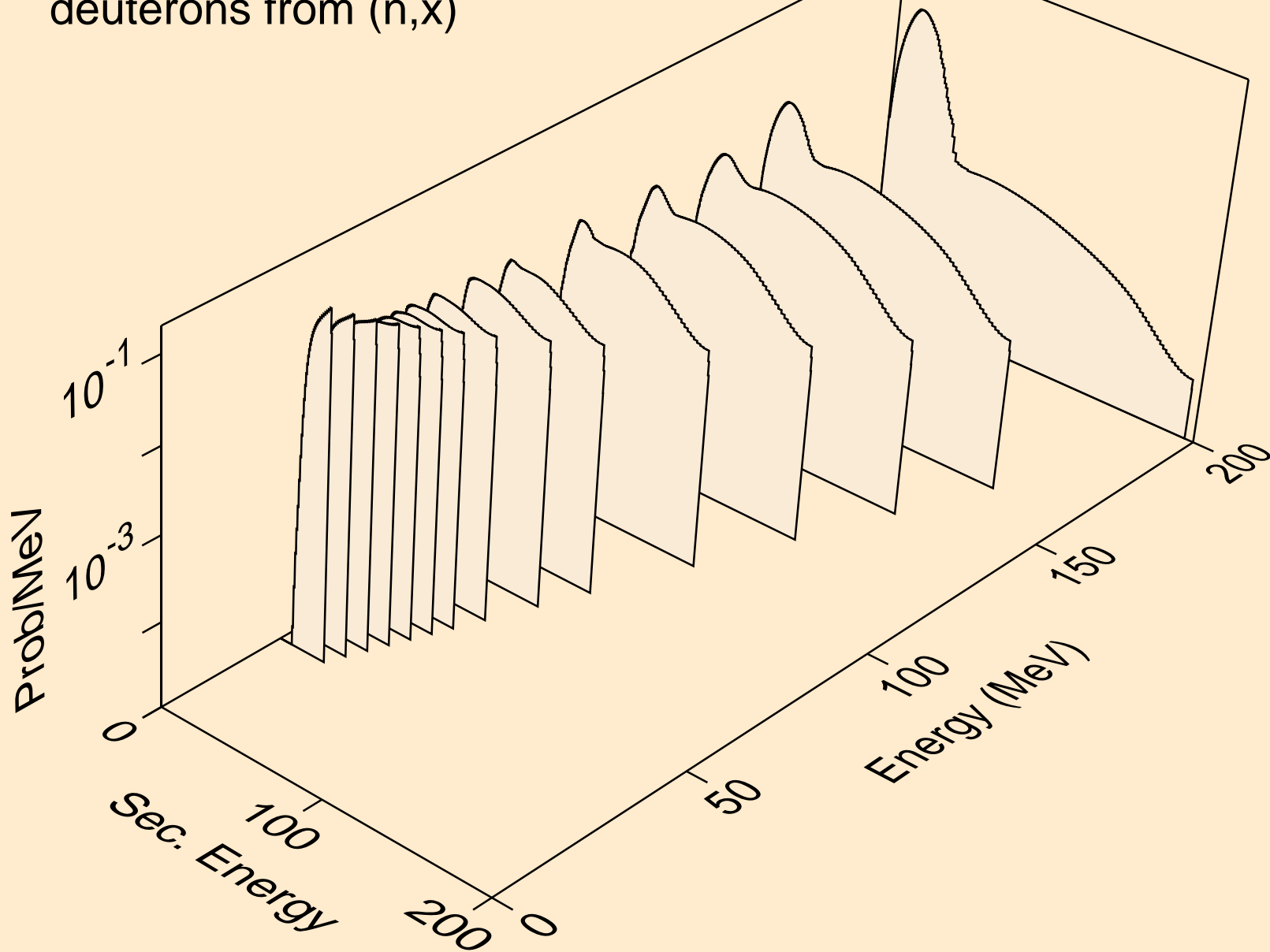

RF261 NEUTRON ACER TENDL-2019 LIBRARY; T=293.16K
deuterons from (n,2nd)

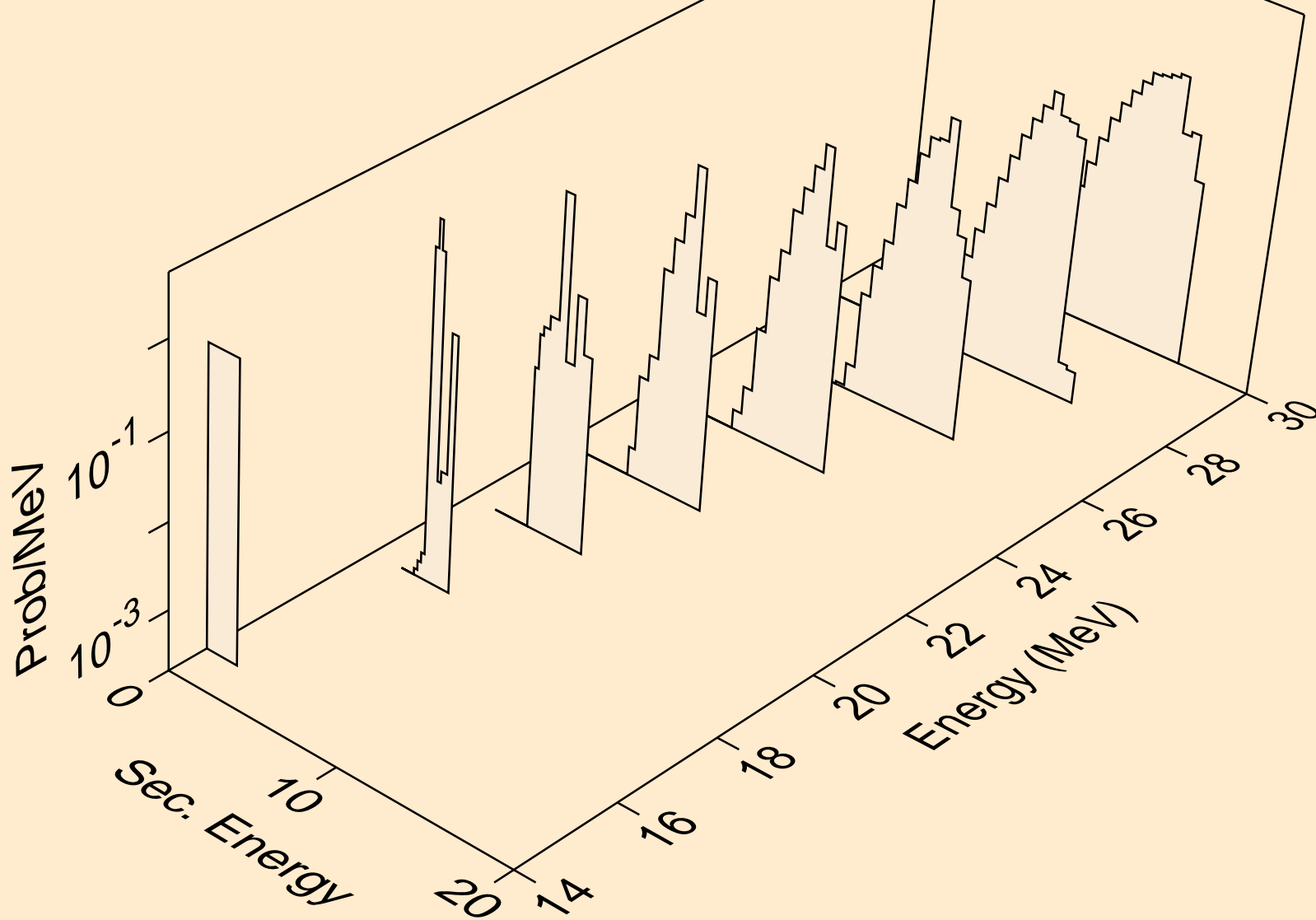

RF261 NEUTRON ACER TENDL-2019 LIBRARY; T=293.16K
deuterons from (n,n*)d

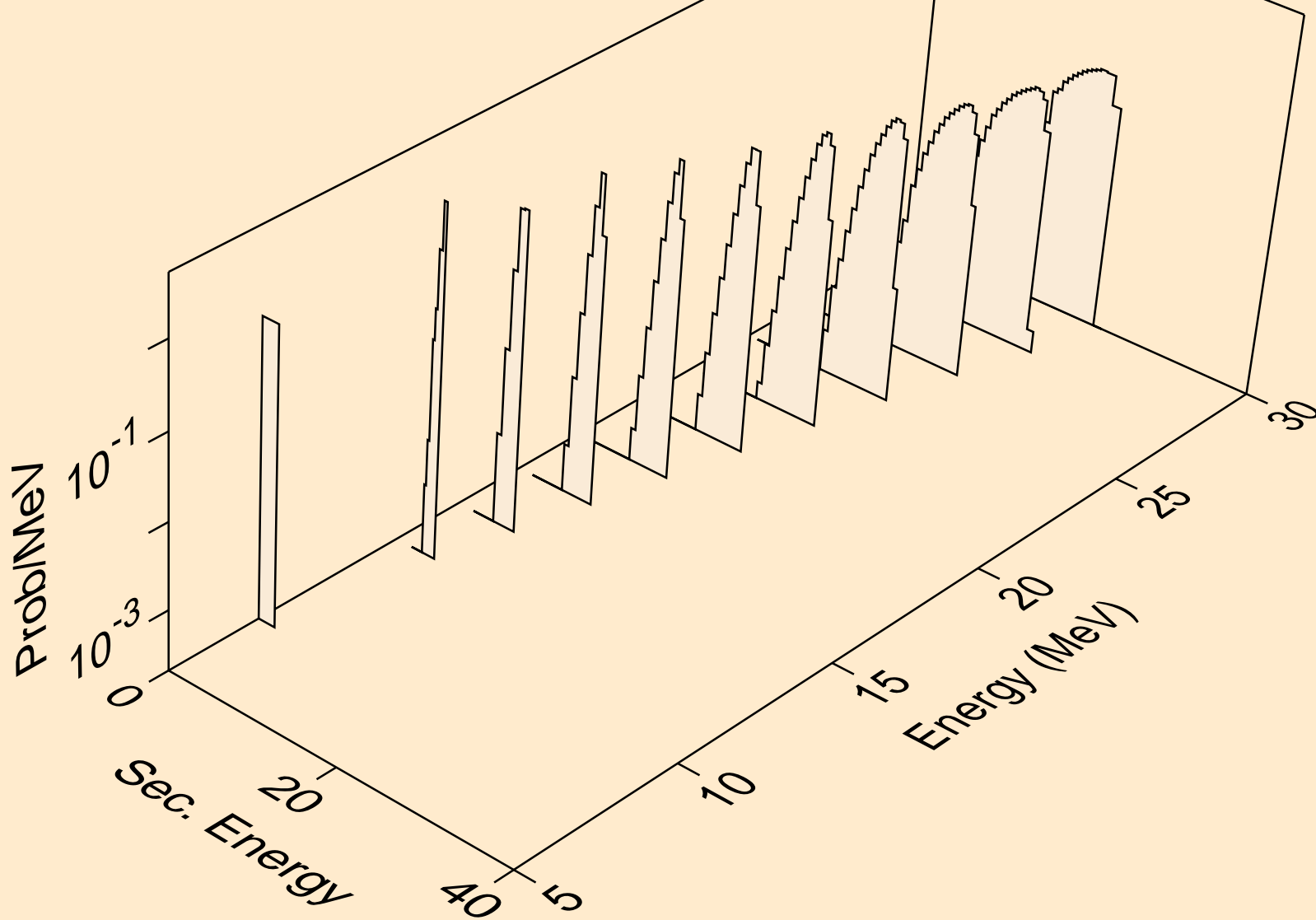

RF261 NEUTRON ACER TENDL-2019 LIBRARY; T=293.16K
deuterons from (n,d)

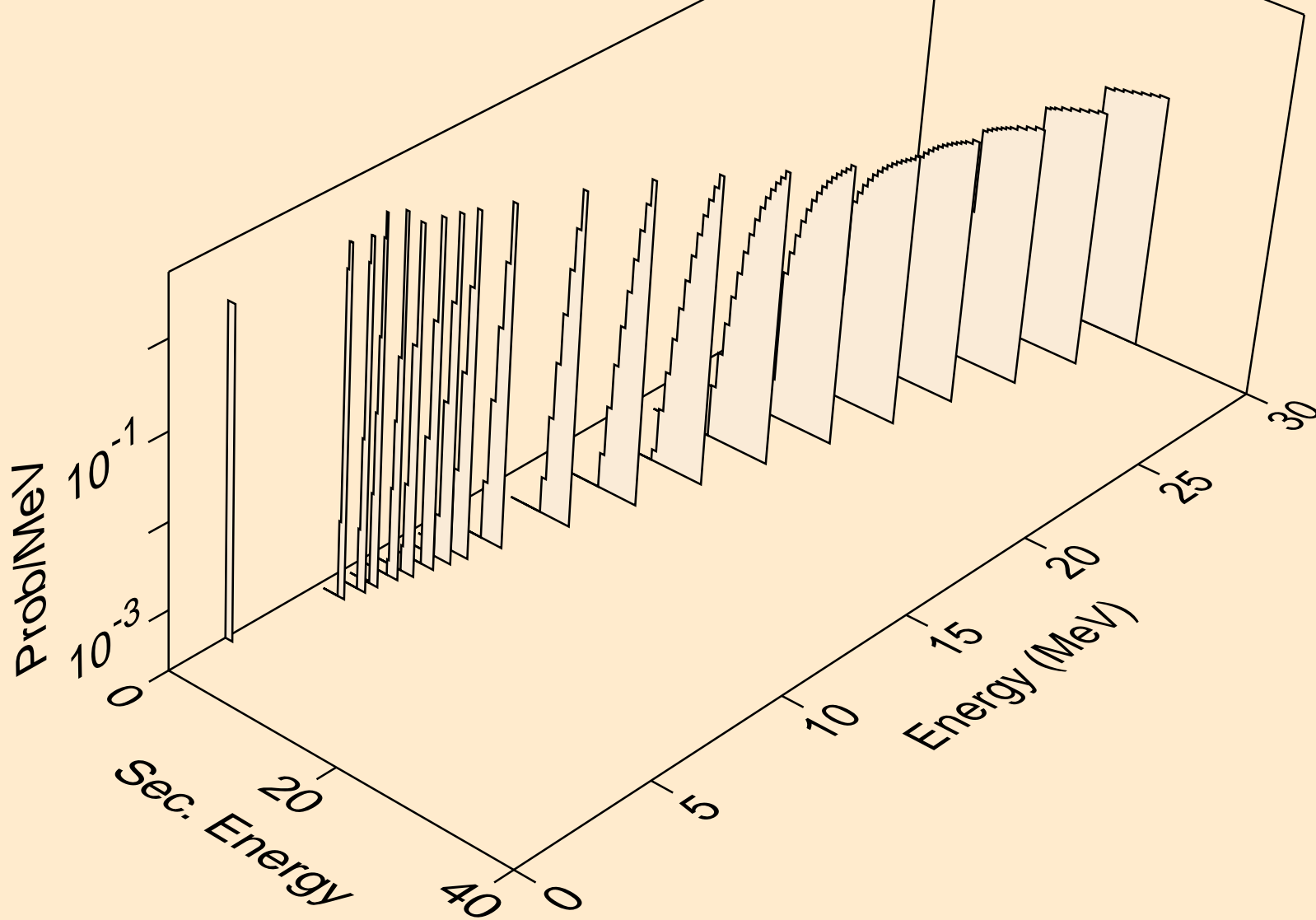

RF261 NEUTRON ACER TENDL-2019 LIBRARY; T=293.16K
deuterons from (n,pd)

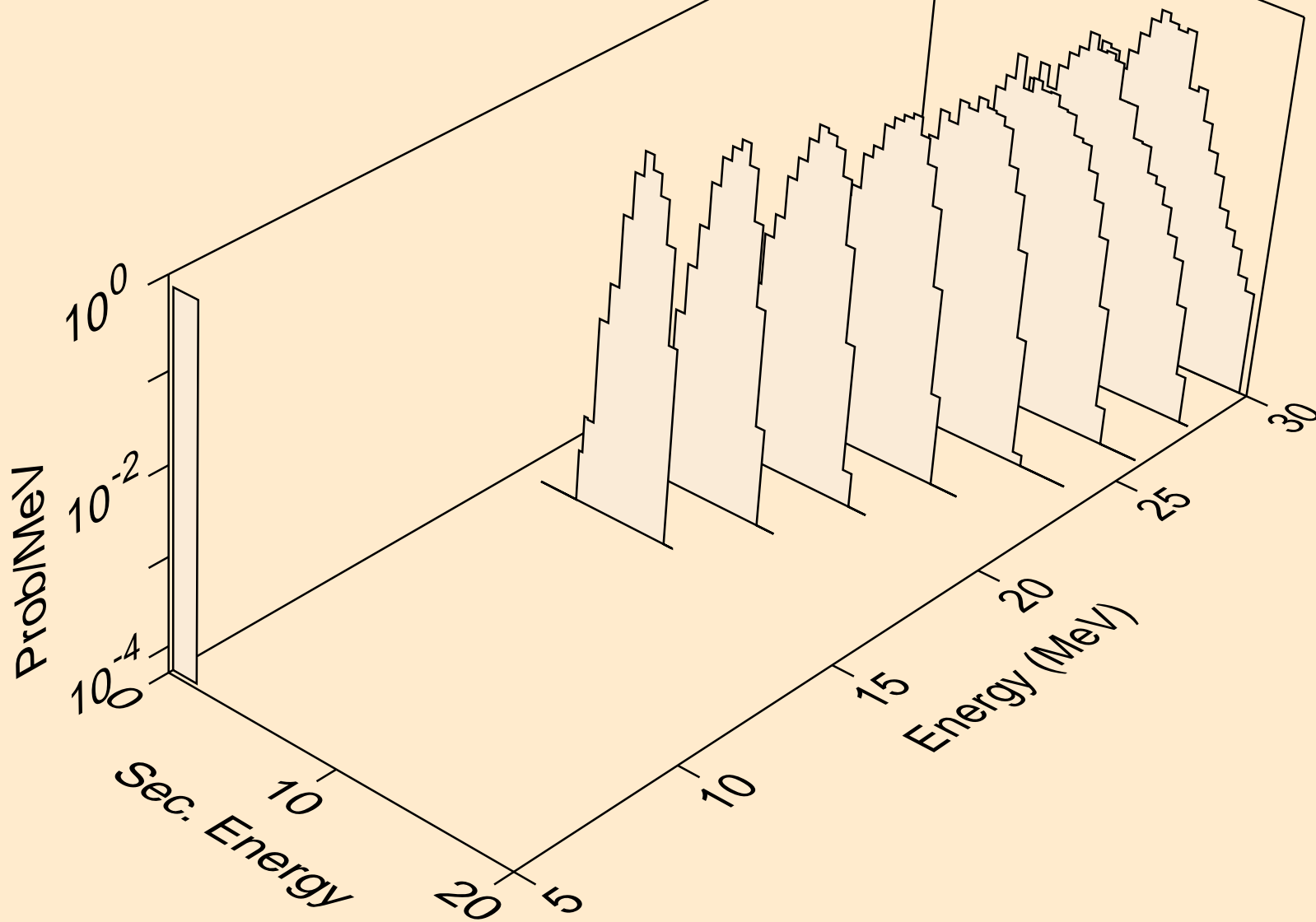

RF261 NEUTRON ACER TENDL-2019 LIBRARY; T=293.16K
deuterons from (n,da)

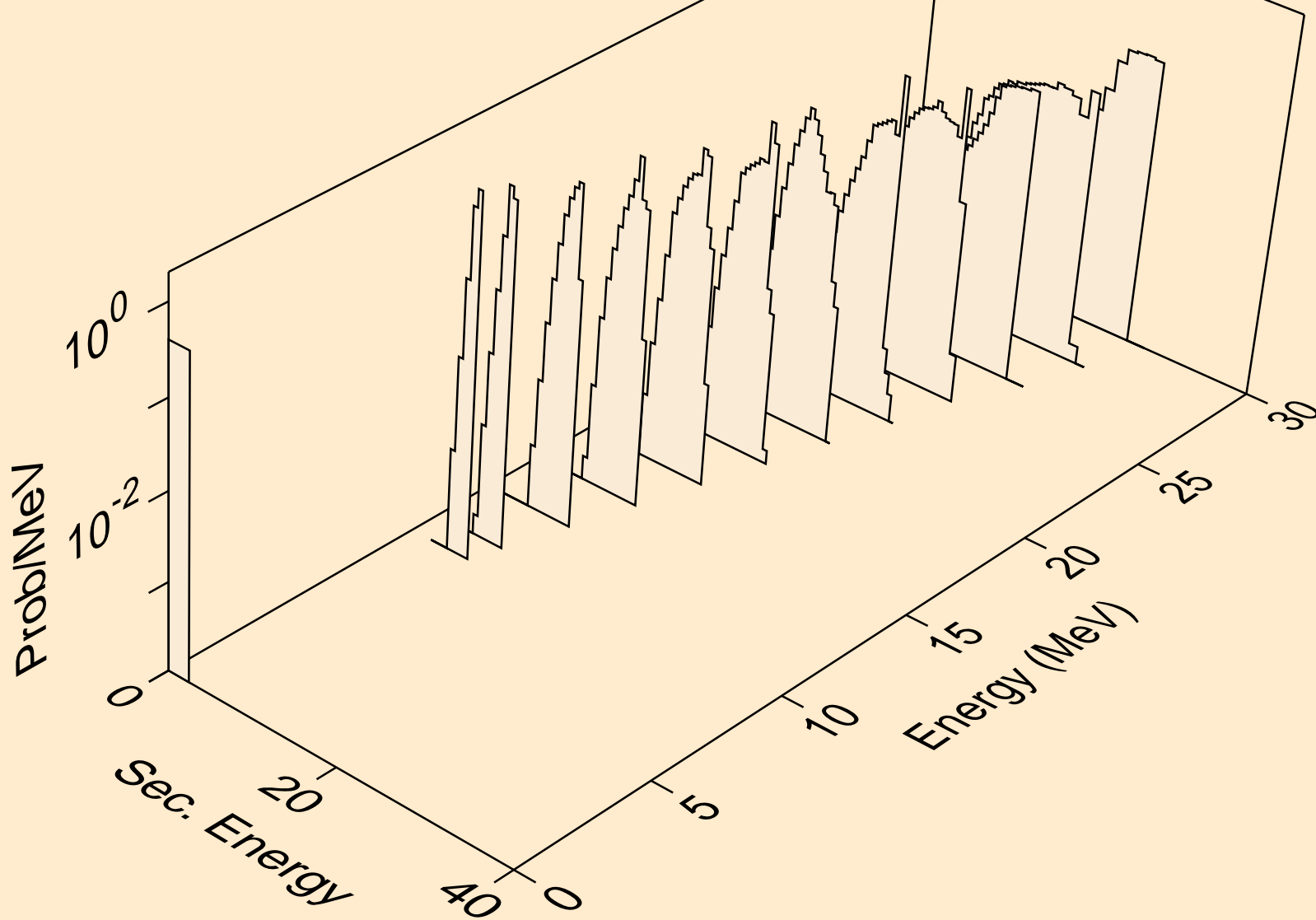

RF261 NEUTRON ACER TENDL-2019 LIBRARY; T=293.16K
tritons from (n,x)

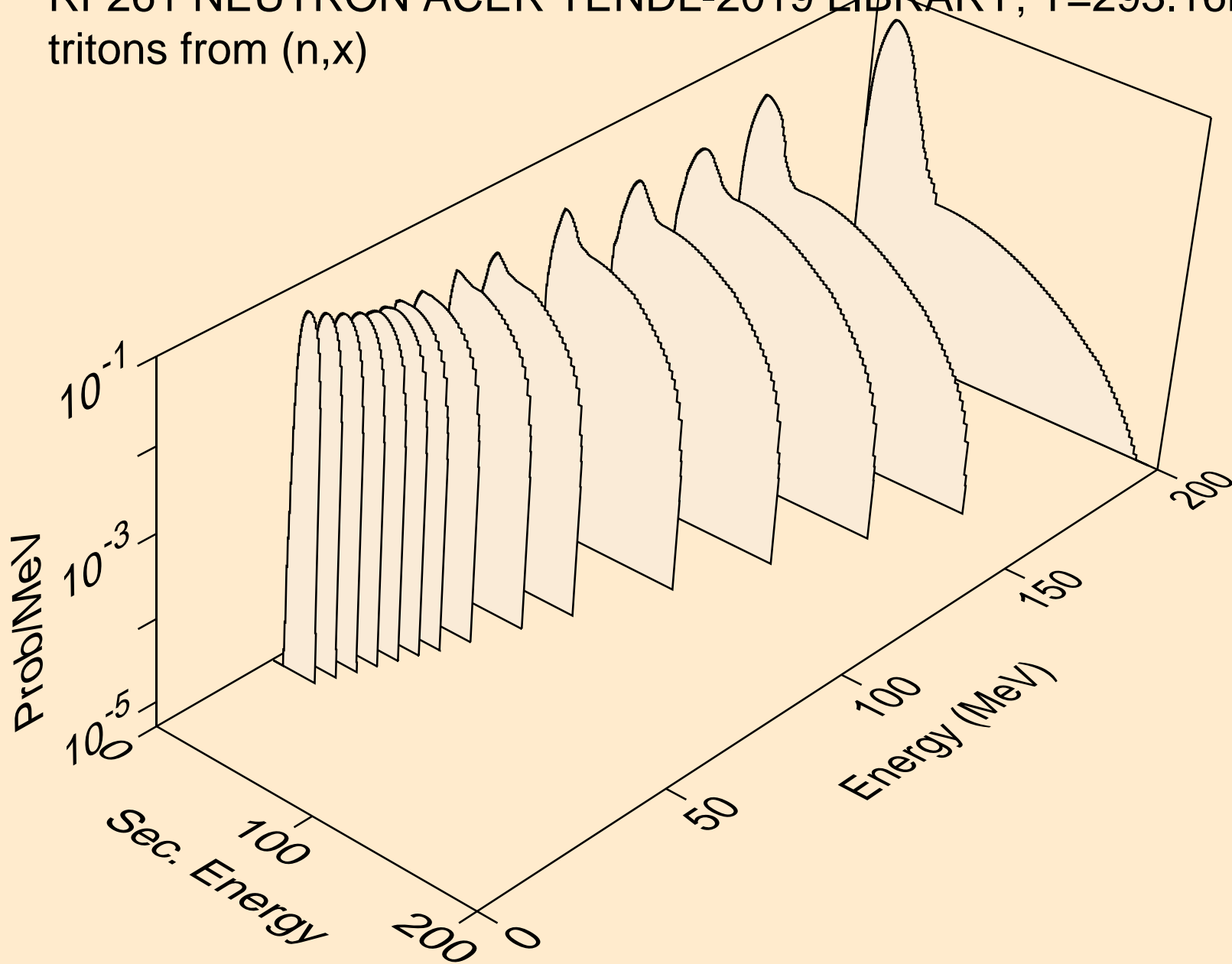

RF261 NEUTRON ACER TENDL-2019 LIBRARY; T=293.16K
tritons from (n,n*)t

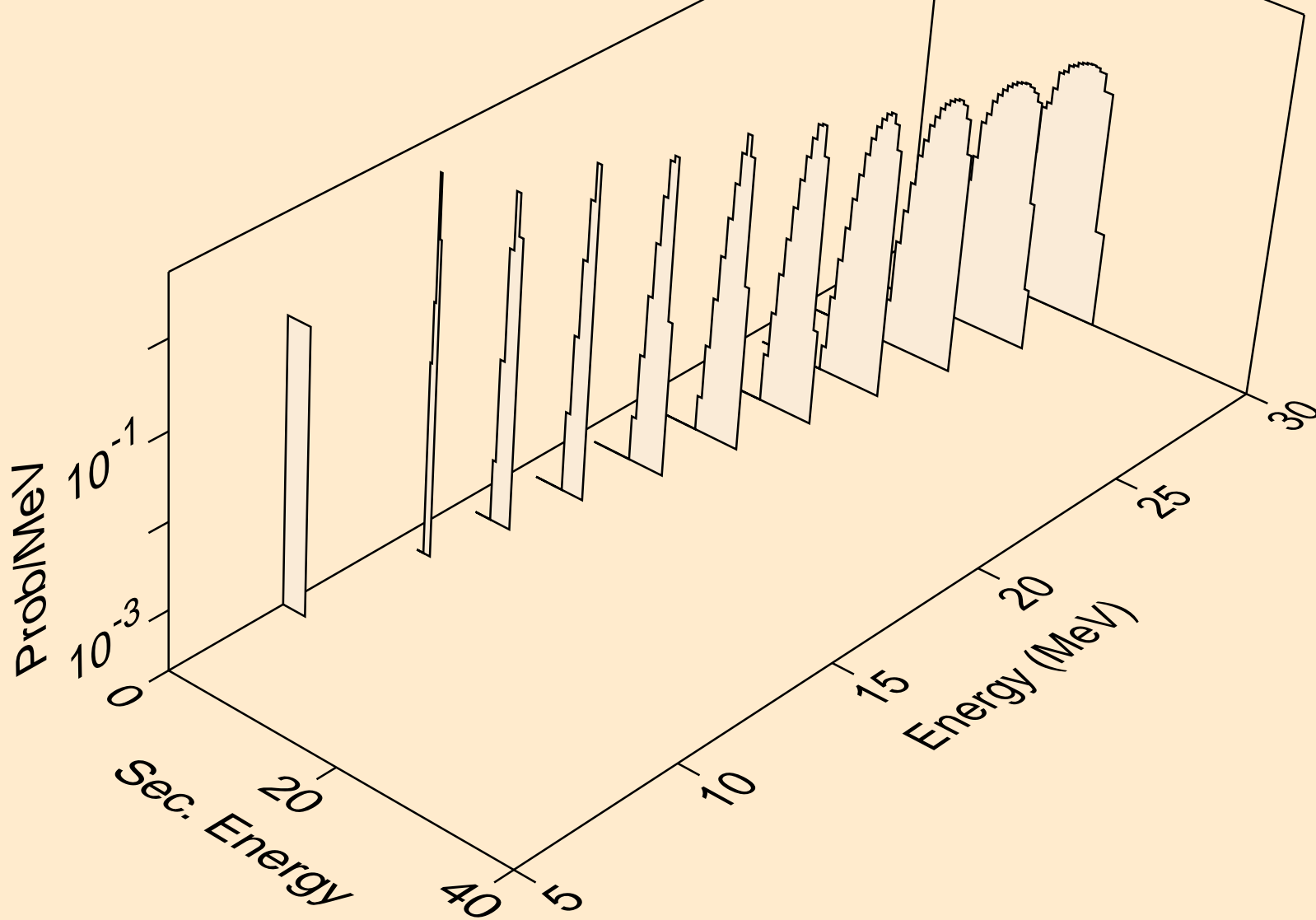

RF261 NEUTRON ACER TENDL-2019 LIBRARY; T=293.16K
tritons from (n,t)

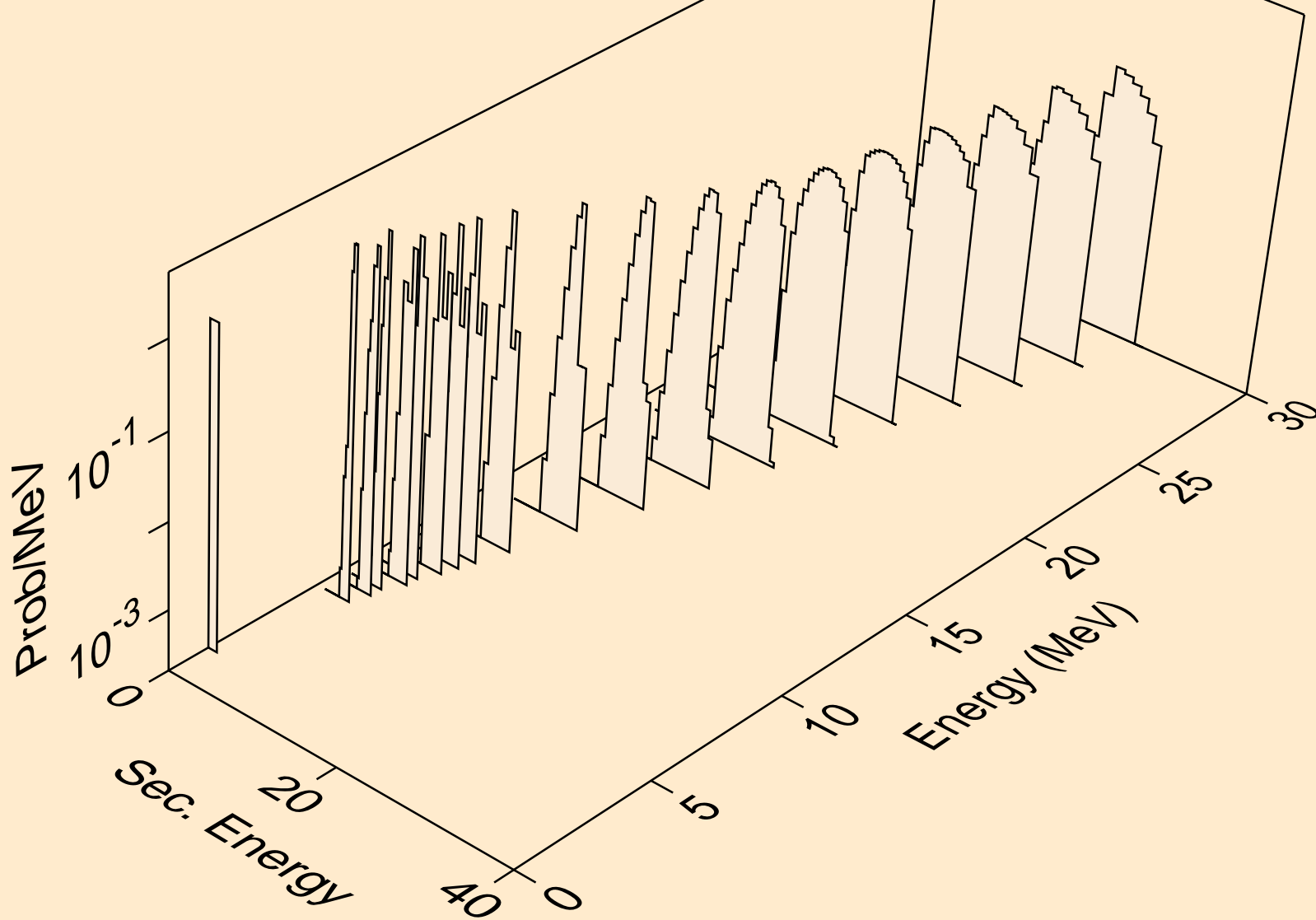

RF261 NEUTRON ACER TENDL-2019 LIBRARY; T=293.16K
he3s from (n,x)

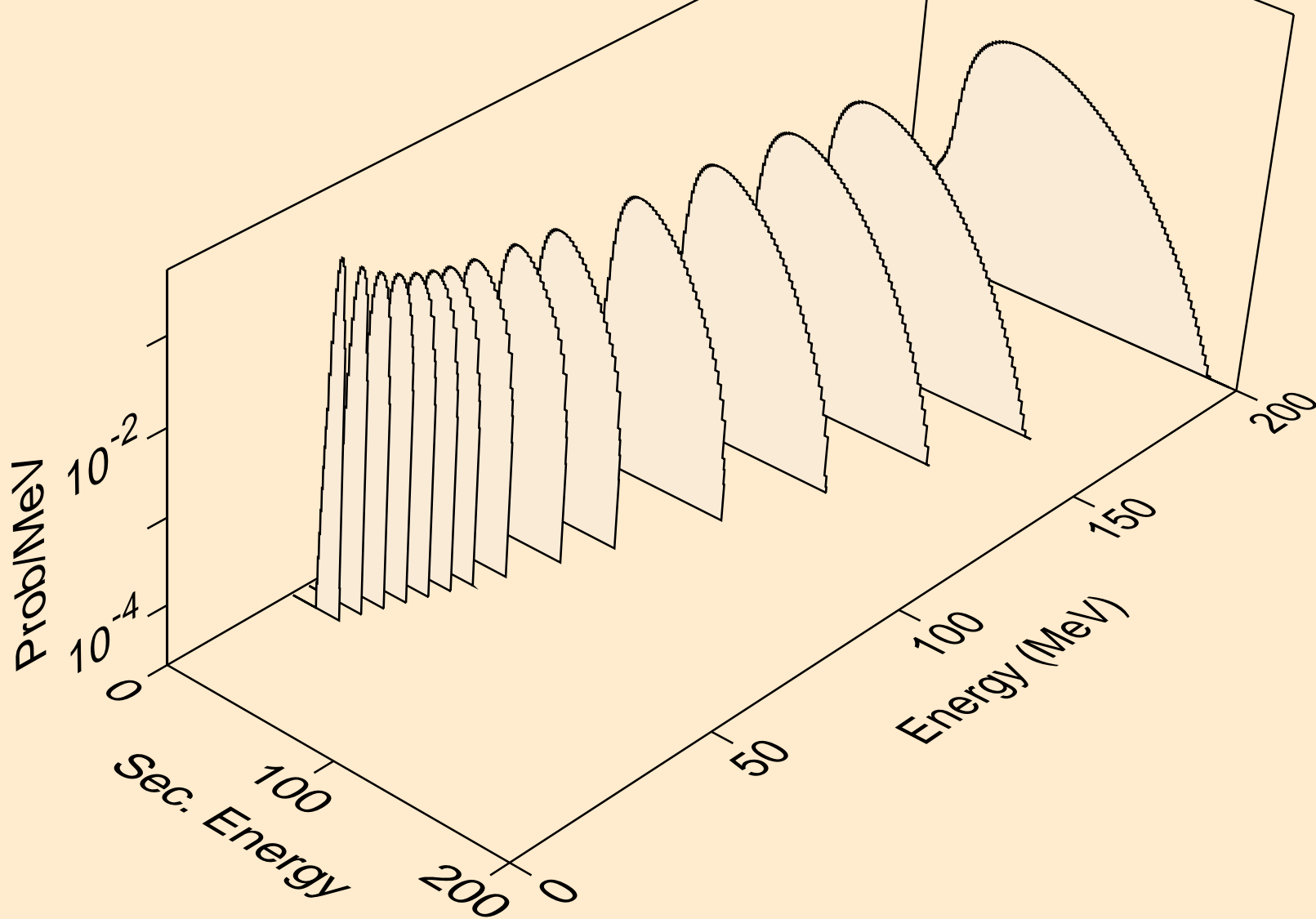

RF261 NEUTRON ACER TENDL-2019 LIBRARY; T=293.16K
he3s from (n,n*)he3

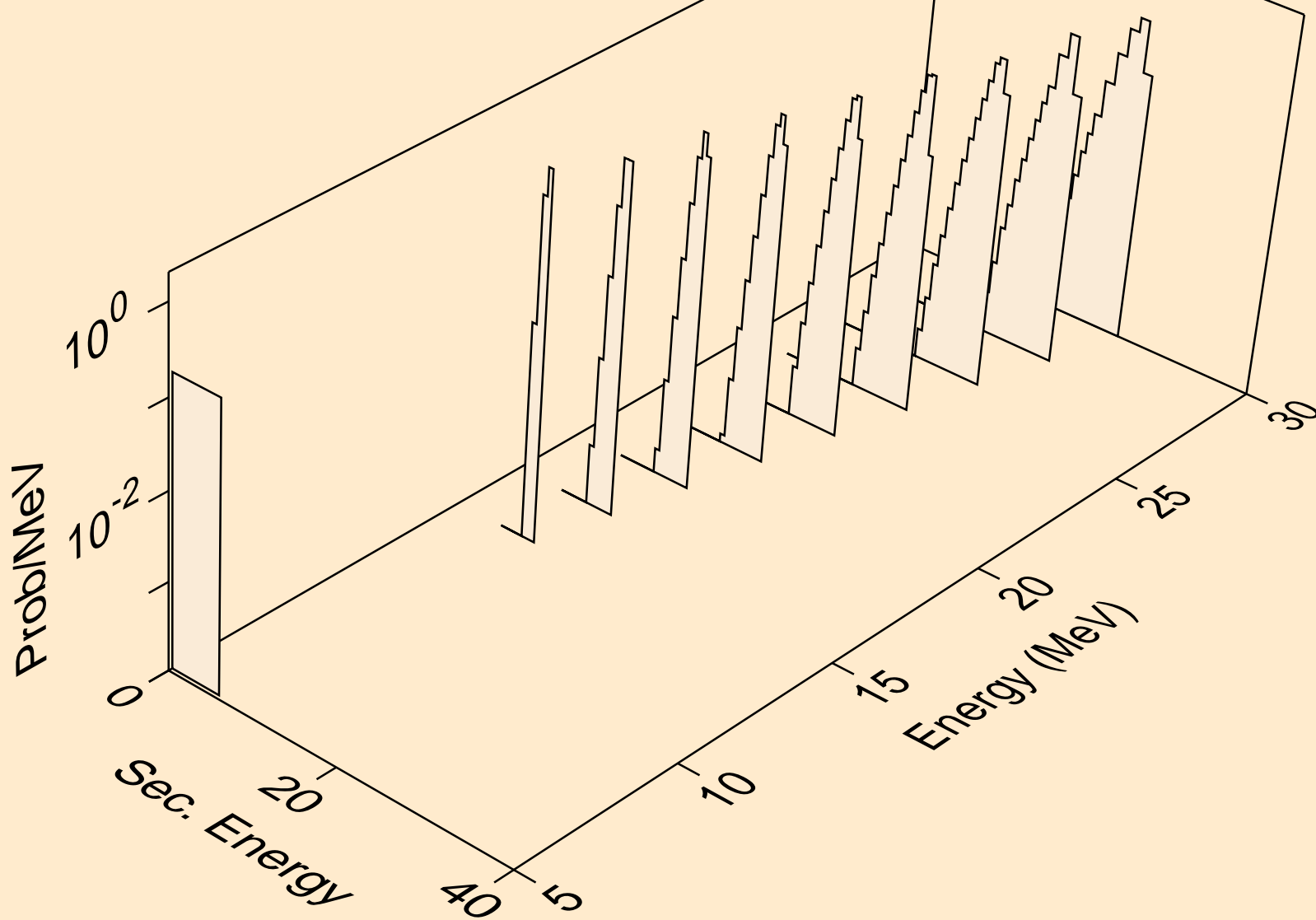

RF261 NEUTRON ACER TENDL-2019 LIBRARY; T=293.16K
he3s from (n,he3)

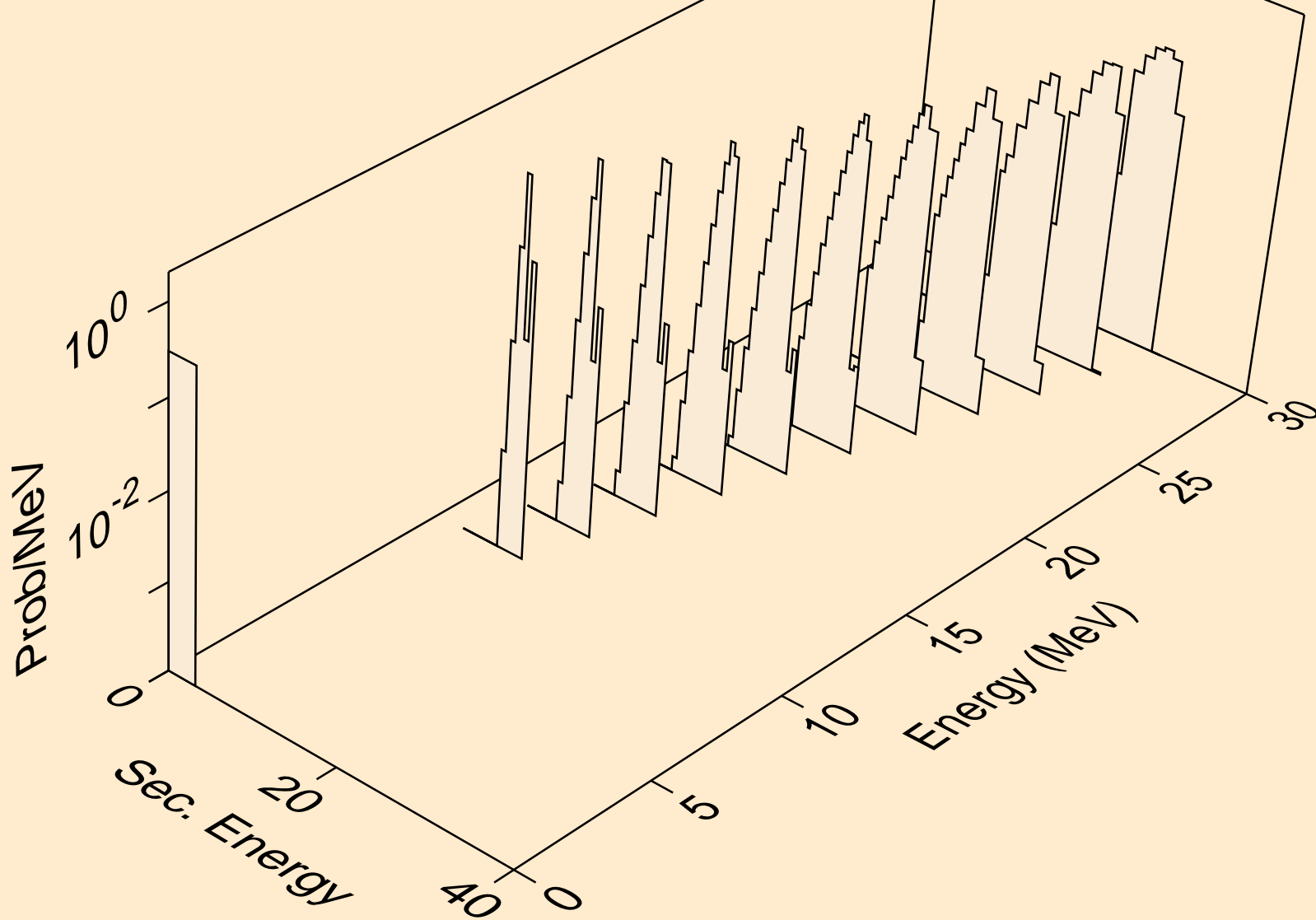

RF261 NEUTRON ACER TENDL-2019 LIBRARY; T=293.16K
alphas from (n,x)

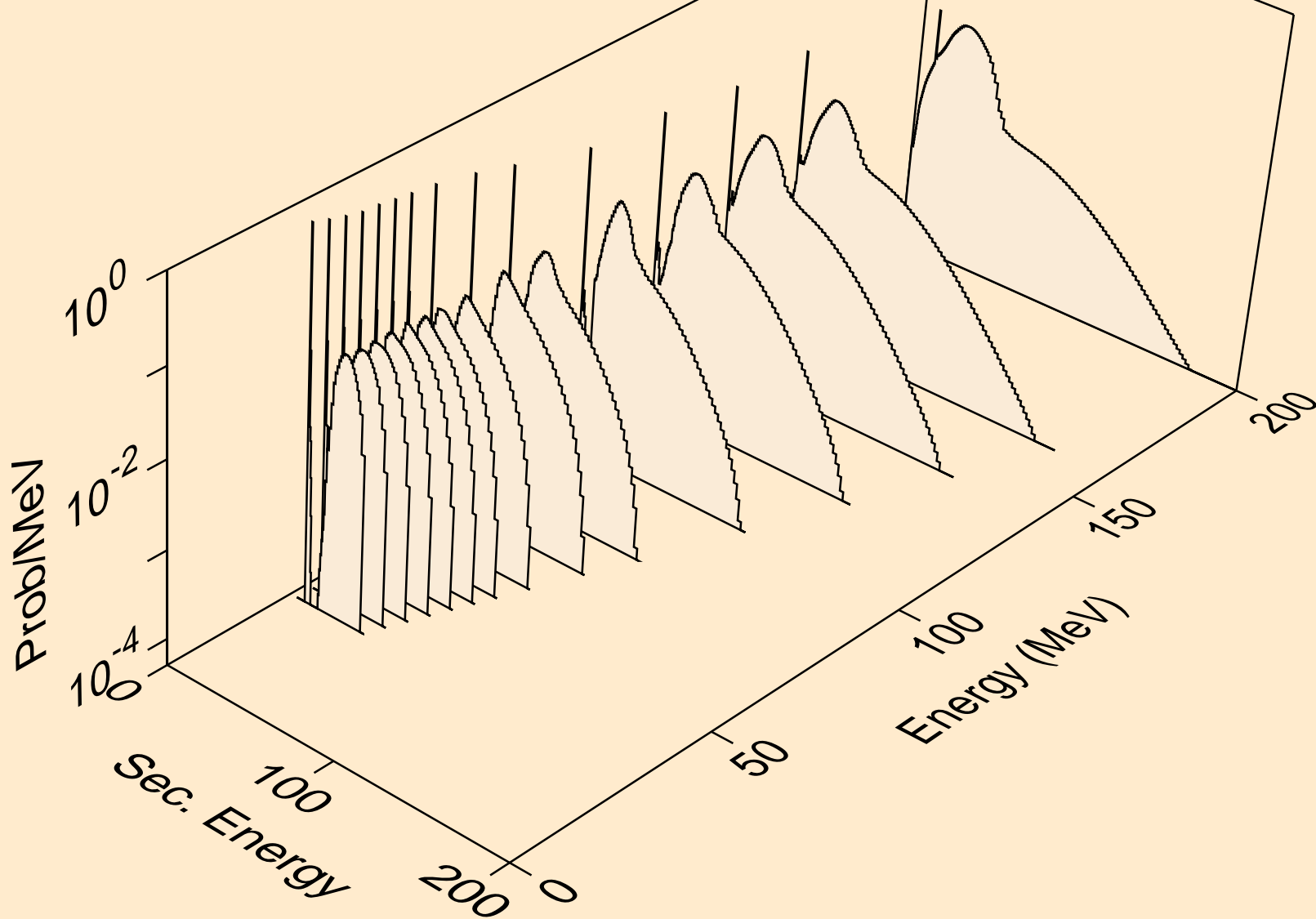

RF261 NEUTRON ACER TENDL-2019 LIBRARY; T=293.16K
alphas from (n,n*)a

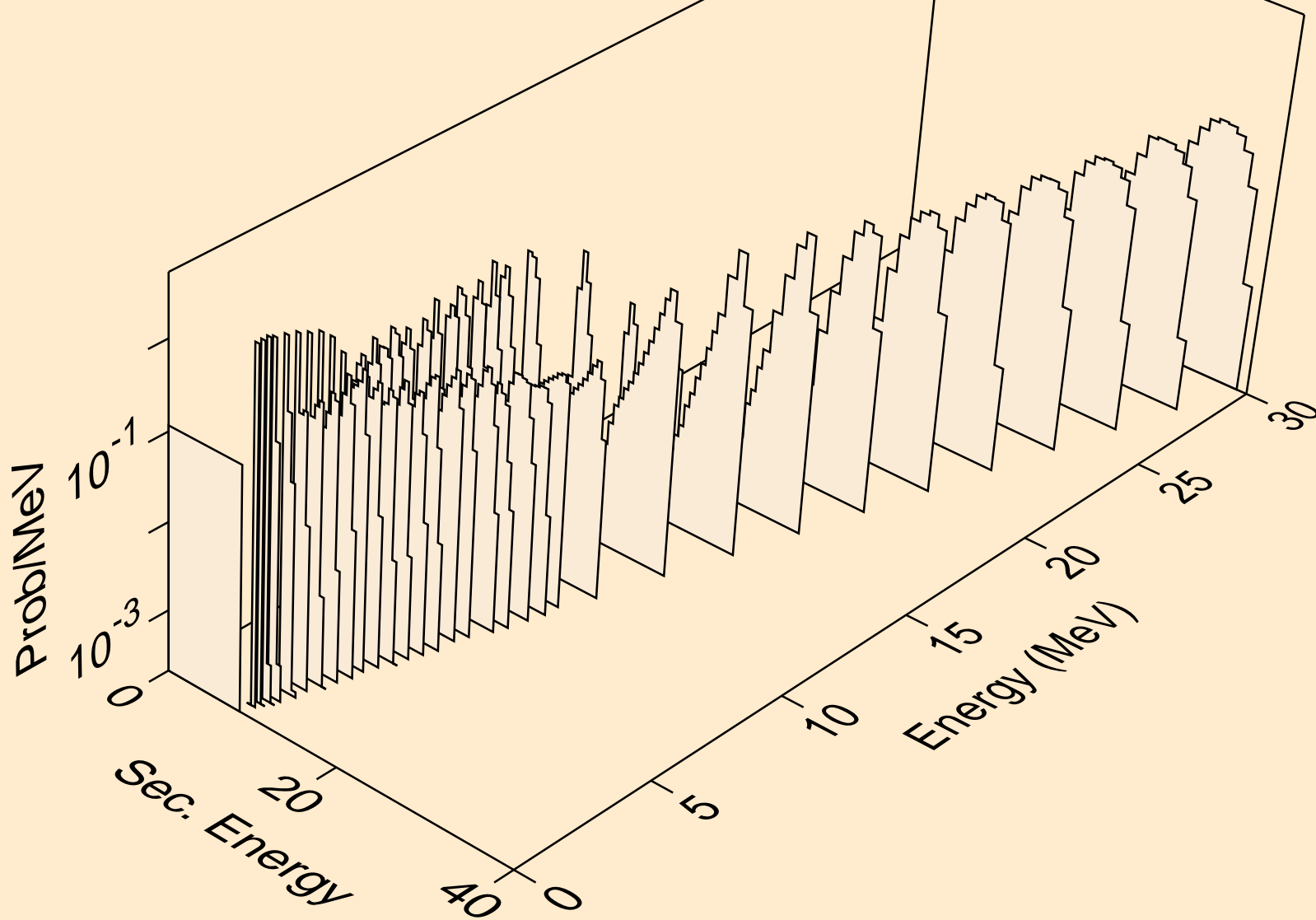

RF261 NEUTRON ACER TENDL-2019 LIBRARY; T=293.16K
alphas from (n,2n)a

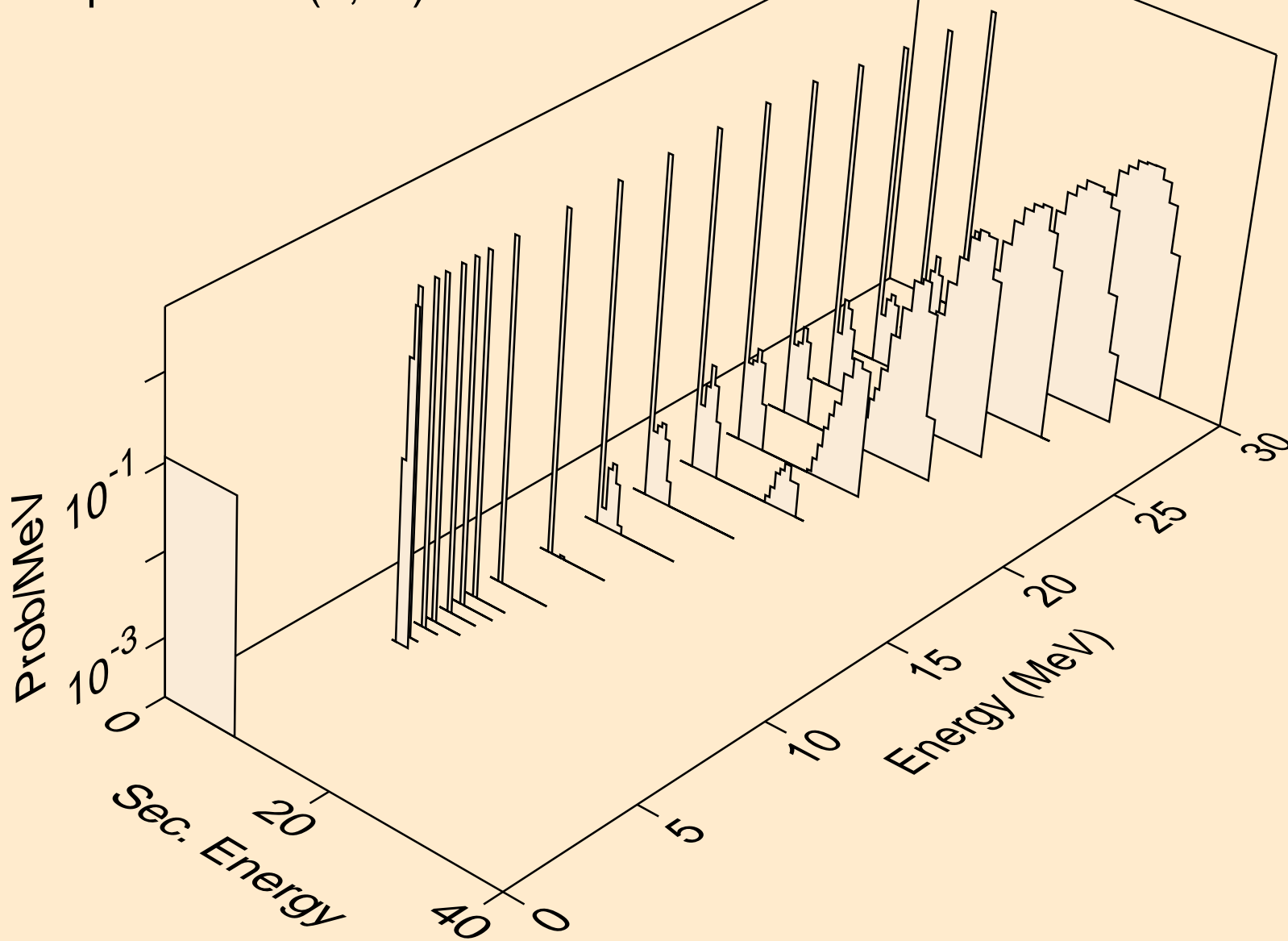

RF261 NEUTRON ACER TENDL-2019 LIBRARY; T=293.16K
alphas from (n,3n)a

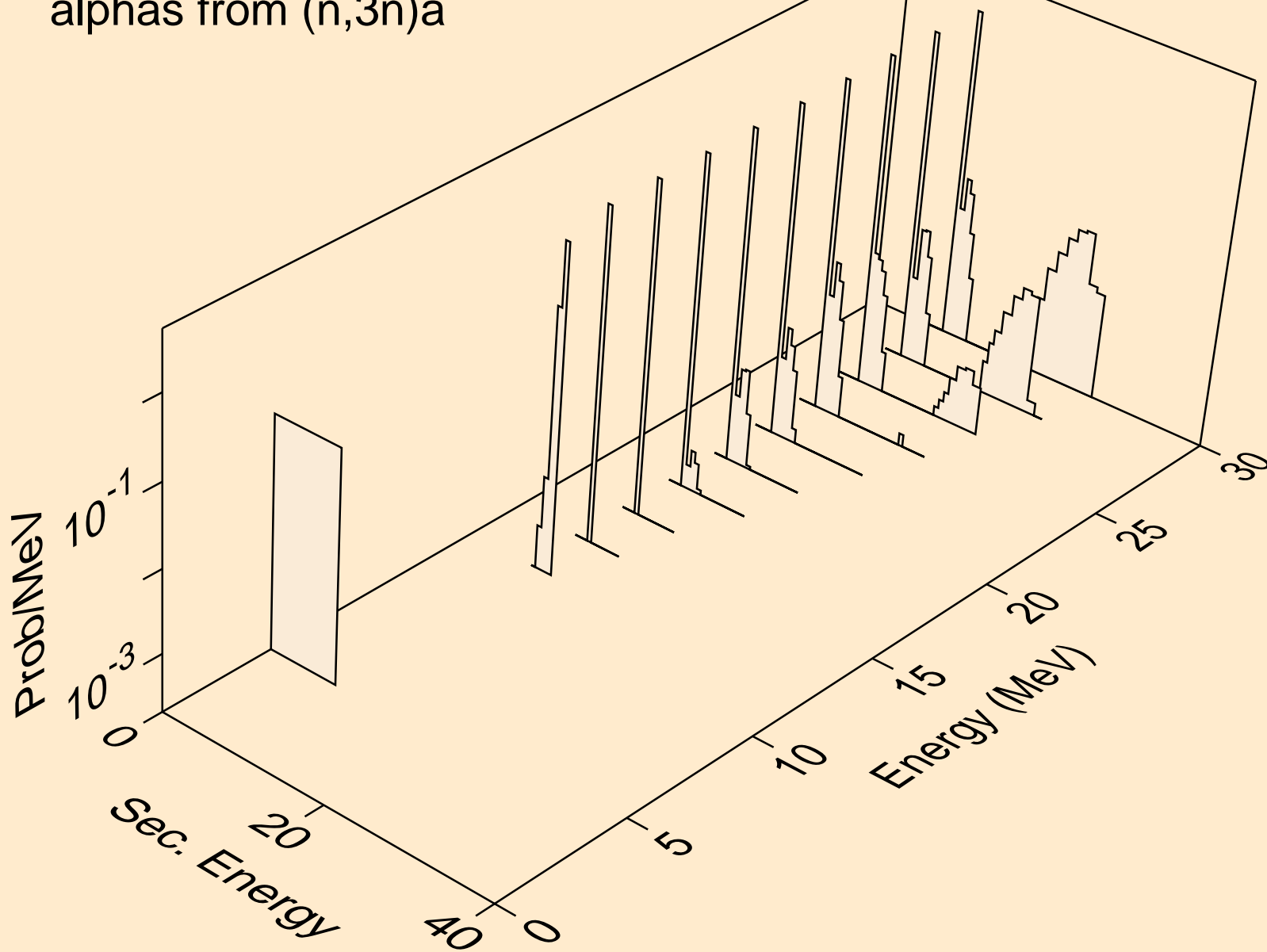

RF261 NEUTRON ACER TENDL-2019 LIBRARY; T=293.16K
alphas from (n,n*)2a

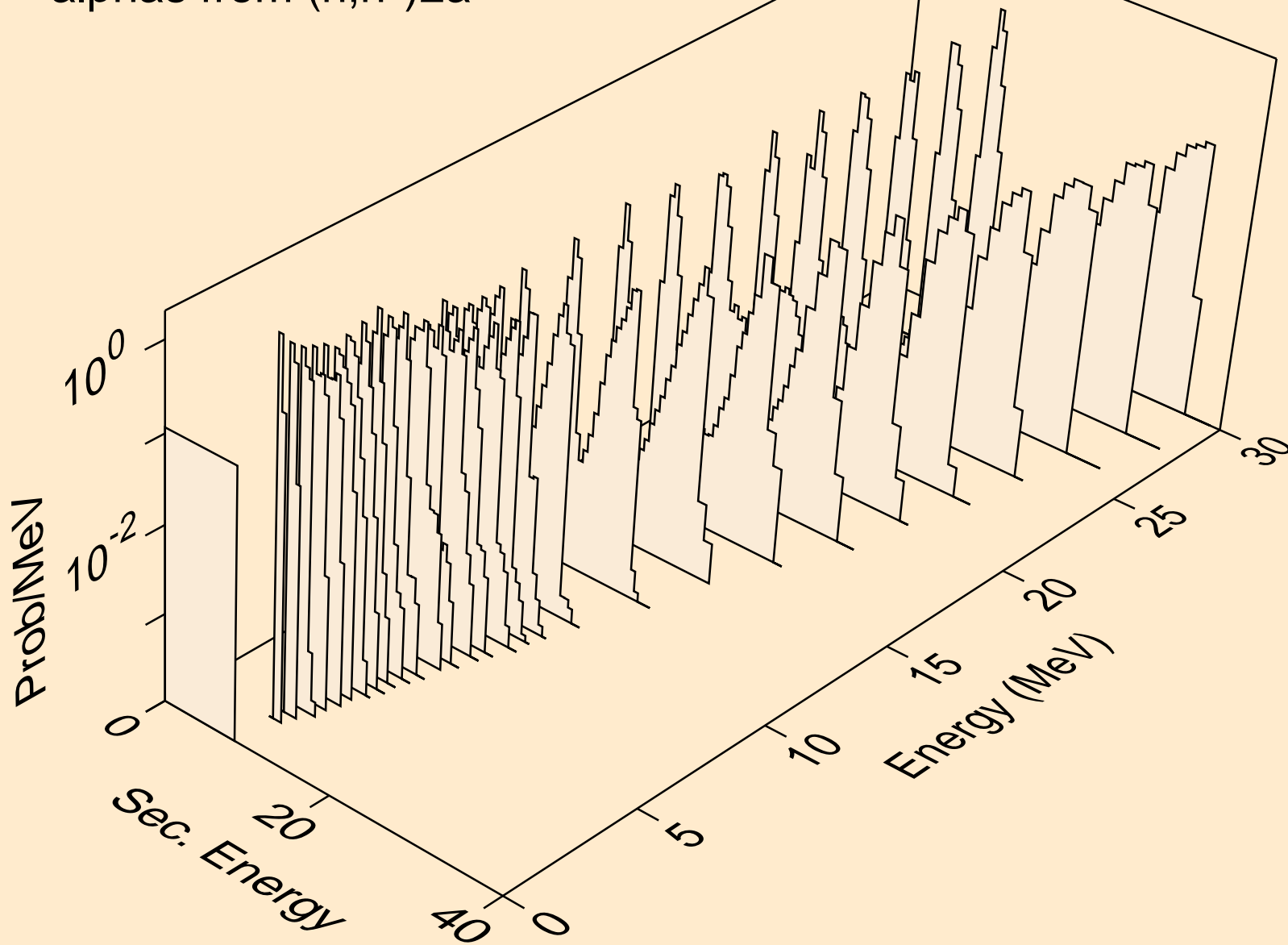

RF261 NEUTRON ACER TENDL-2019 LIBRARY; T=293.16K
alphas from (n,2n)2a

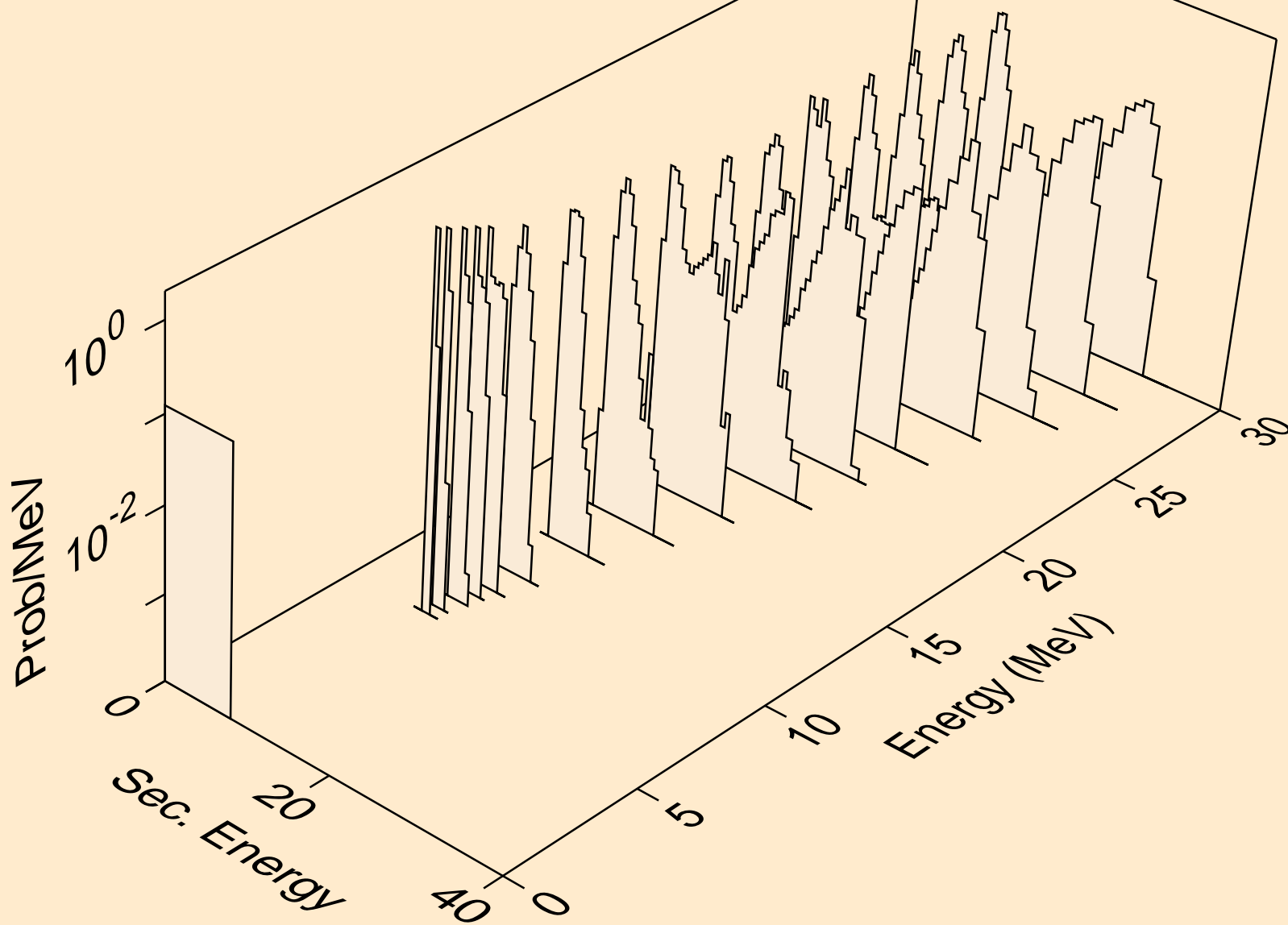

RF261 NEUTRON ACER TENDL-2019 LIBRARY; T=293.16K
alphas from (n,npa)

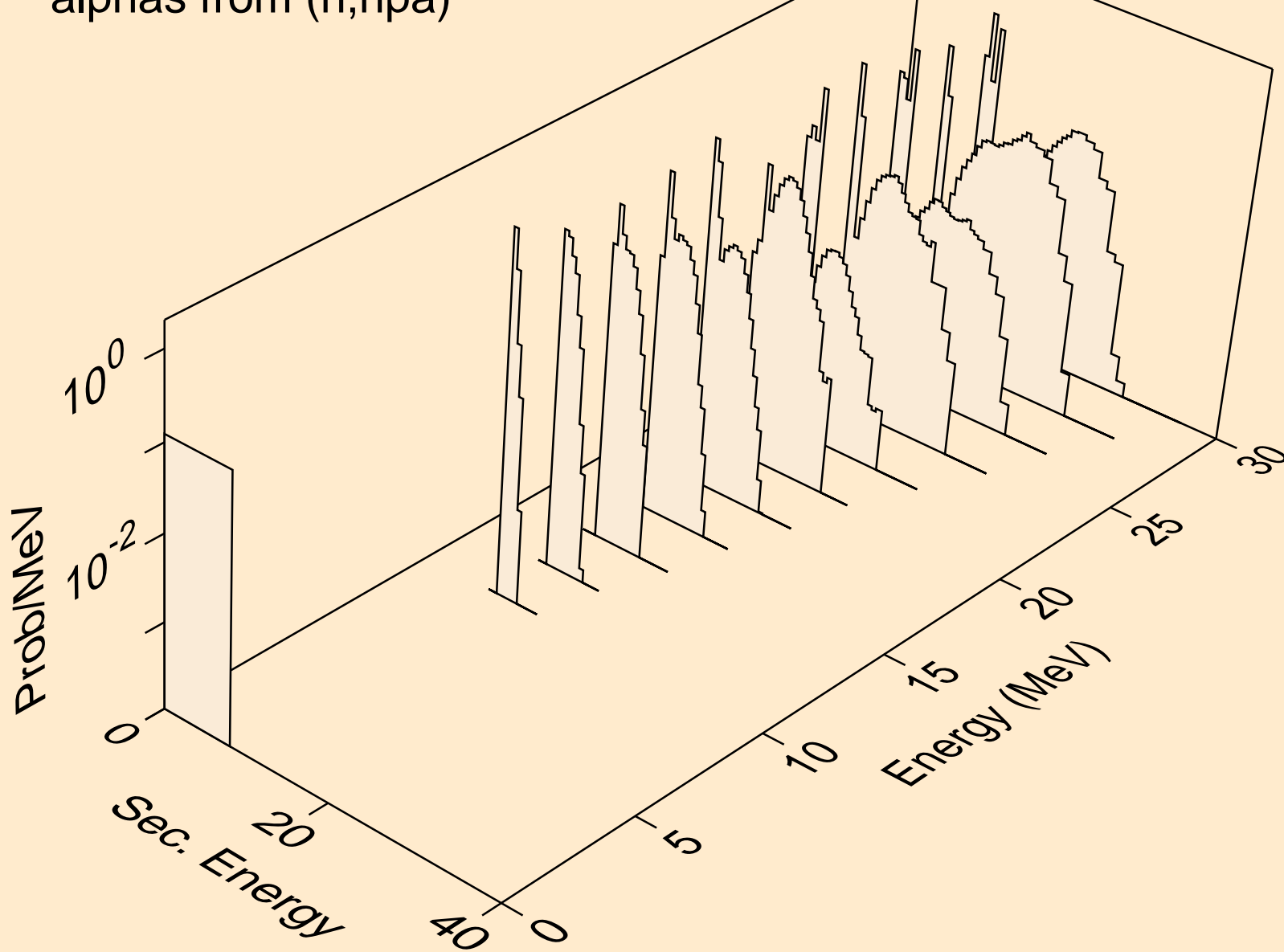

RF261 NEUTRON ACER TENDL-2019 LIBRARY; T=293.16K
alphas from (n,a)

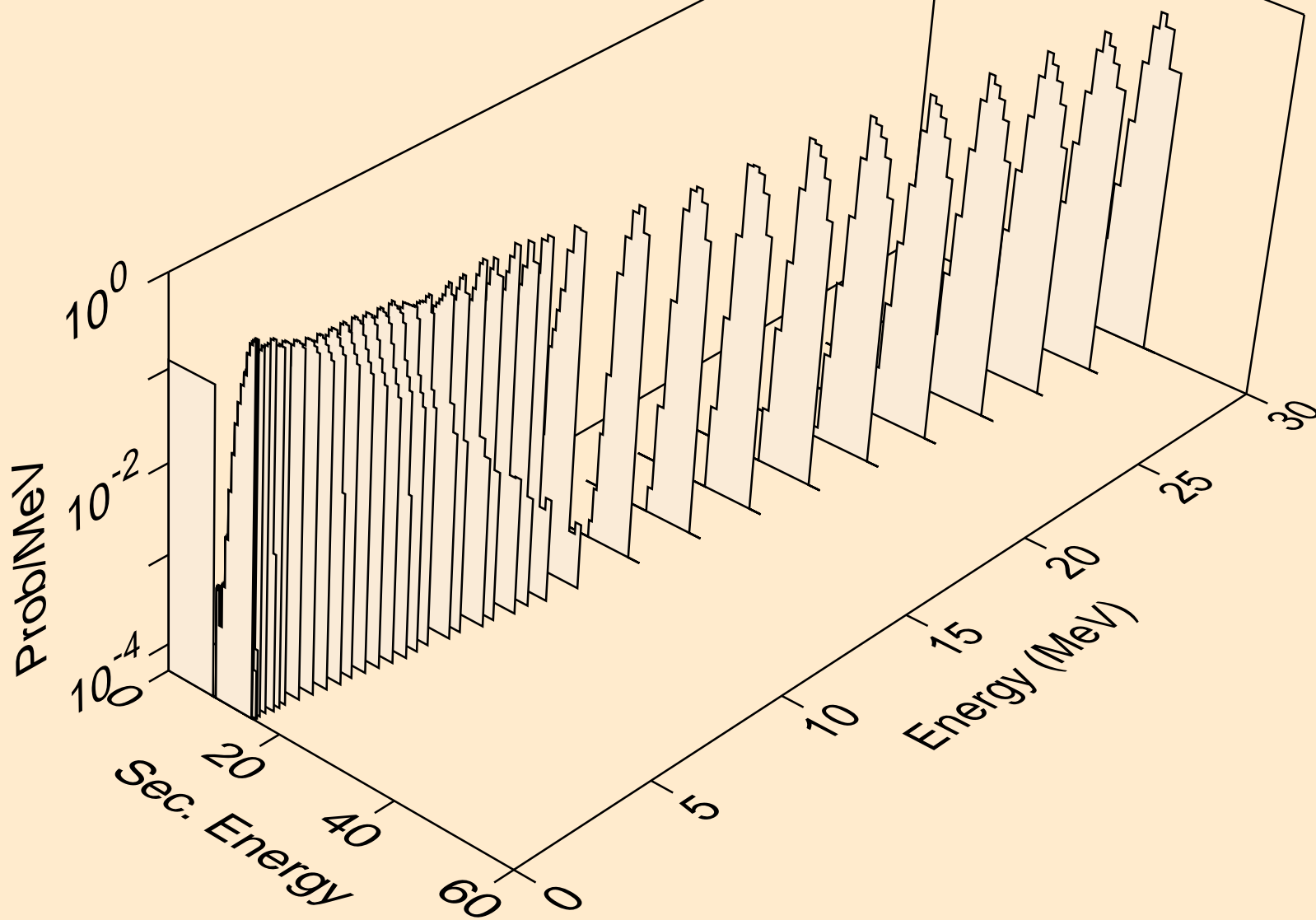

RF261 NEUTRON ACER TENDL-2019 LIBRARY; T=293.16K
alphas from (n,2a)

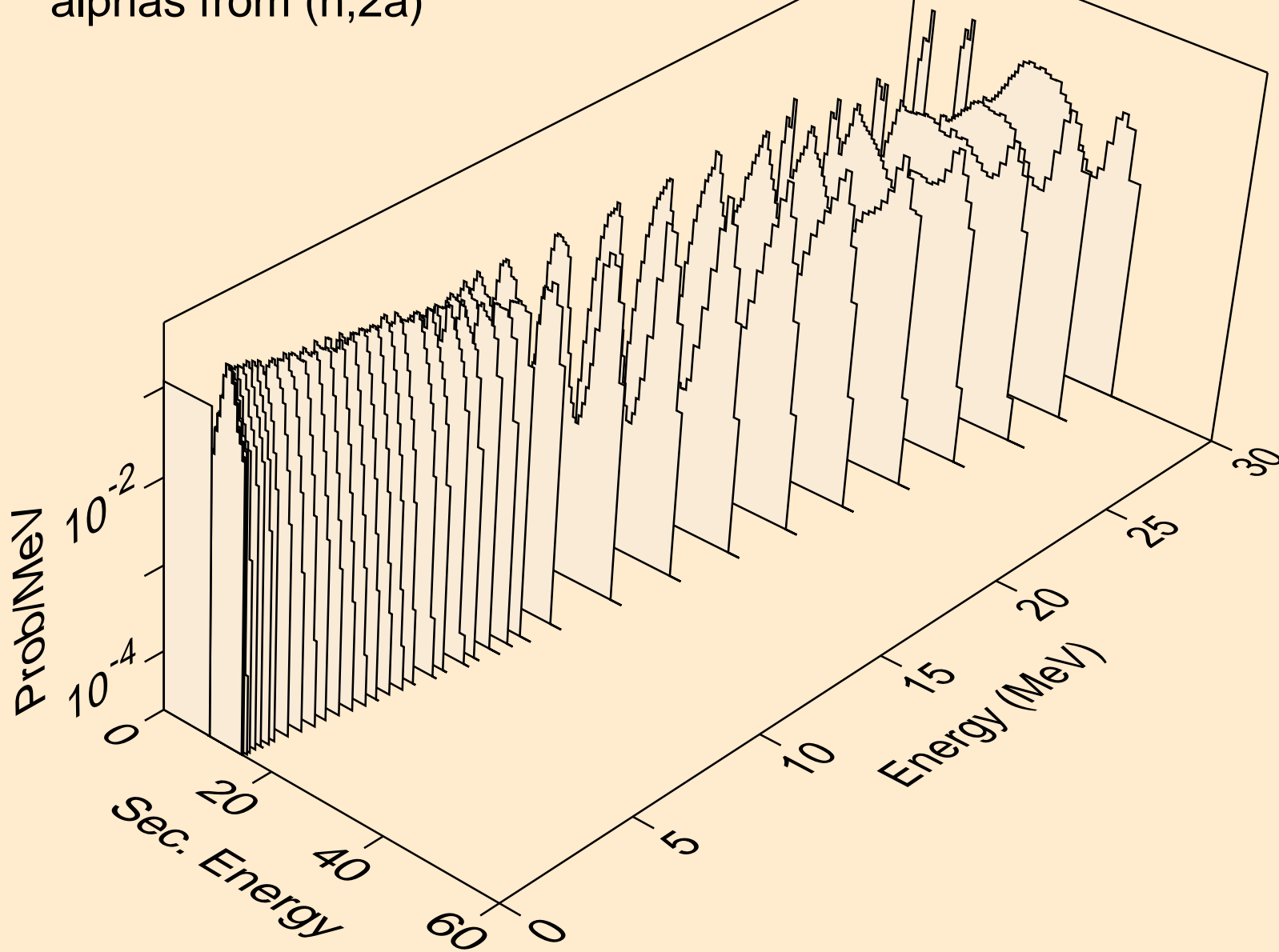

RF261 NEUTRON ACER TENDL-2019 LIBRARY; T=293.16K
alphas from (n,pa)

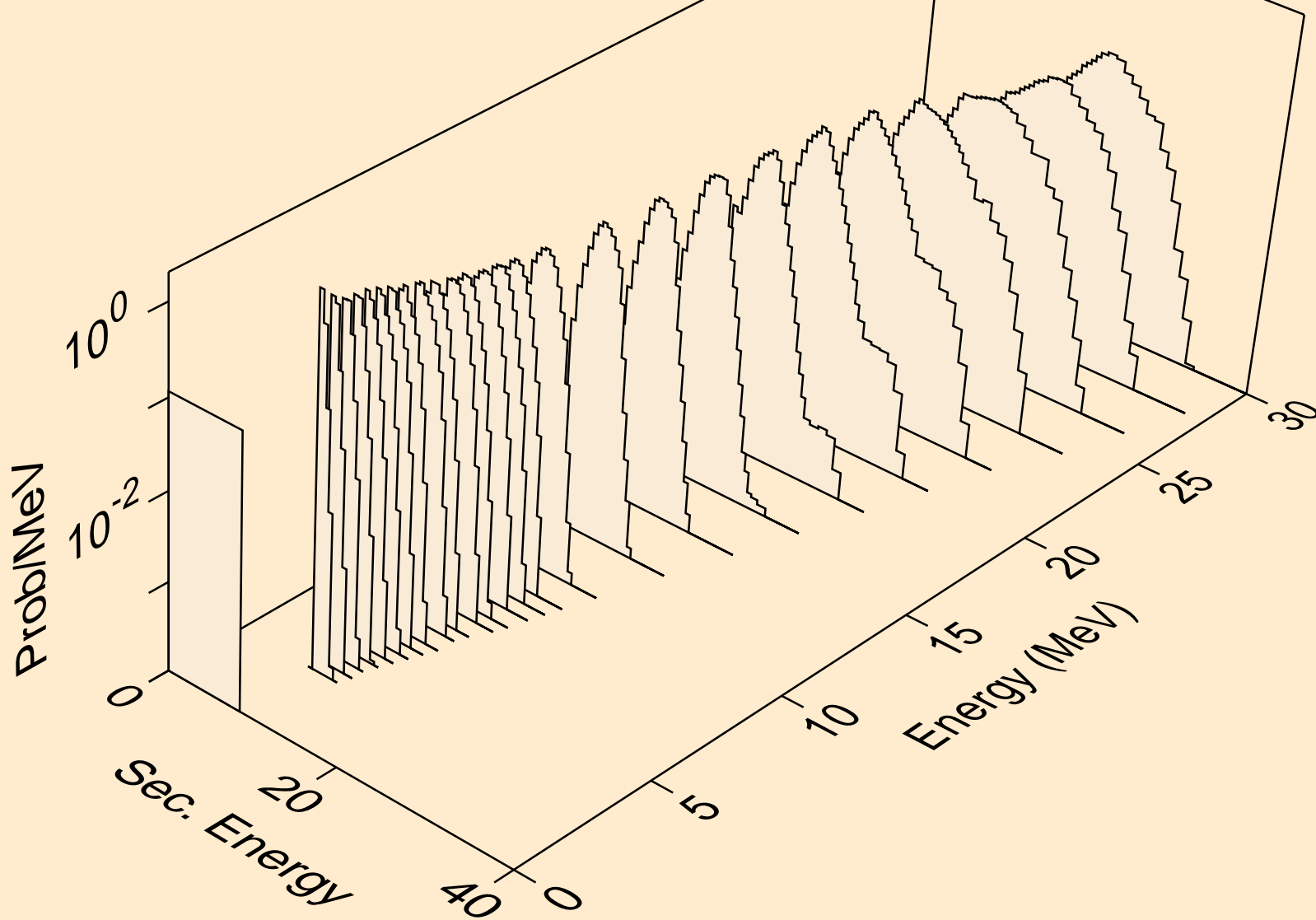

RF261 NEUTRON ACER TENDL-2019 LIBRARY; T=293.16K
alphas from (n,da)

