

RG282 NEUTRON ACER TENDL-2019 LIBRARY; T=293.16K
Principal cross sections

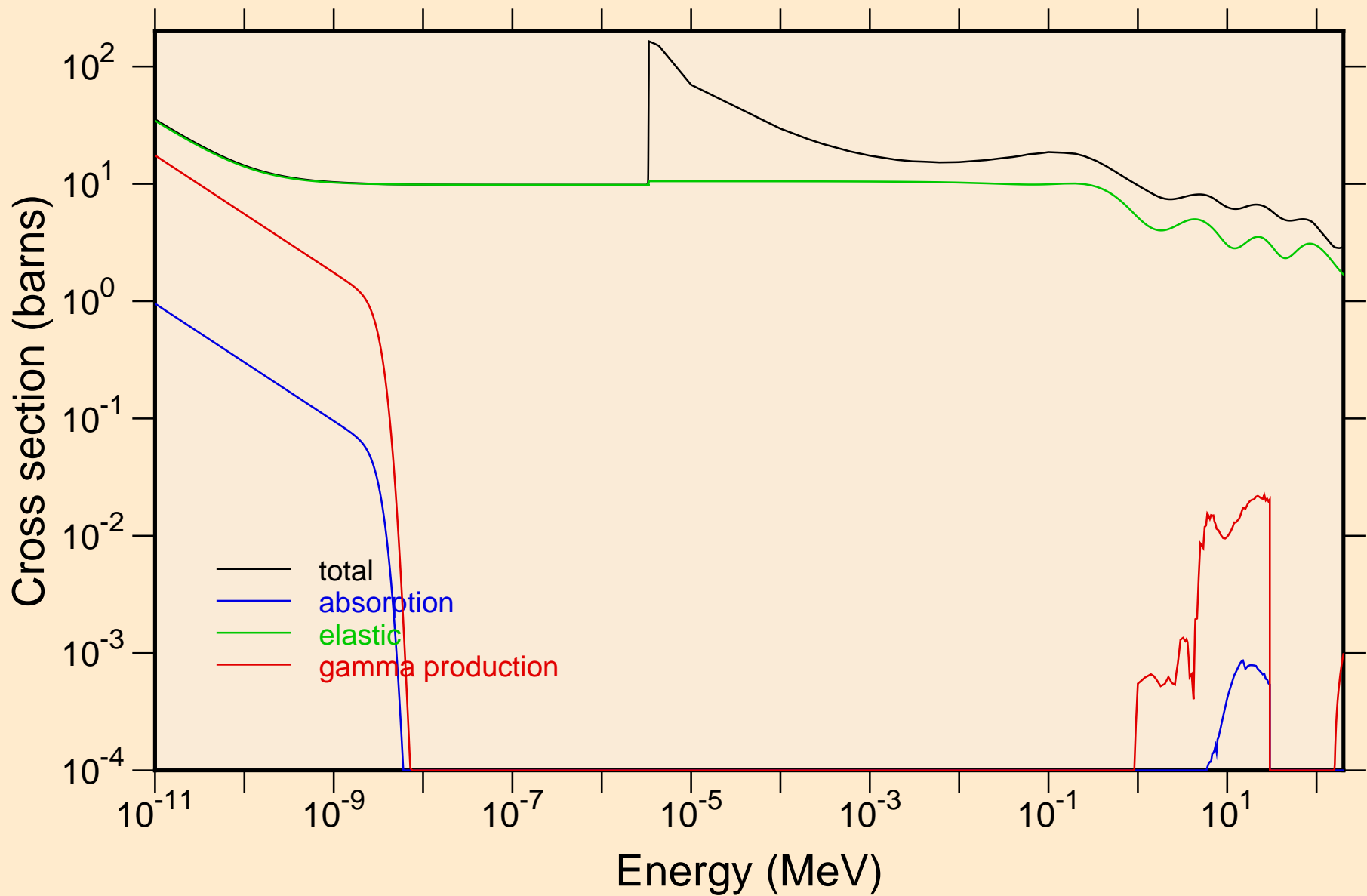

RG282 NEUTRON ACER TENDL-2019 LIBRARY; T=293.16K
Heating

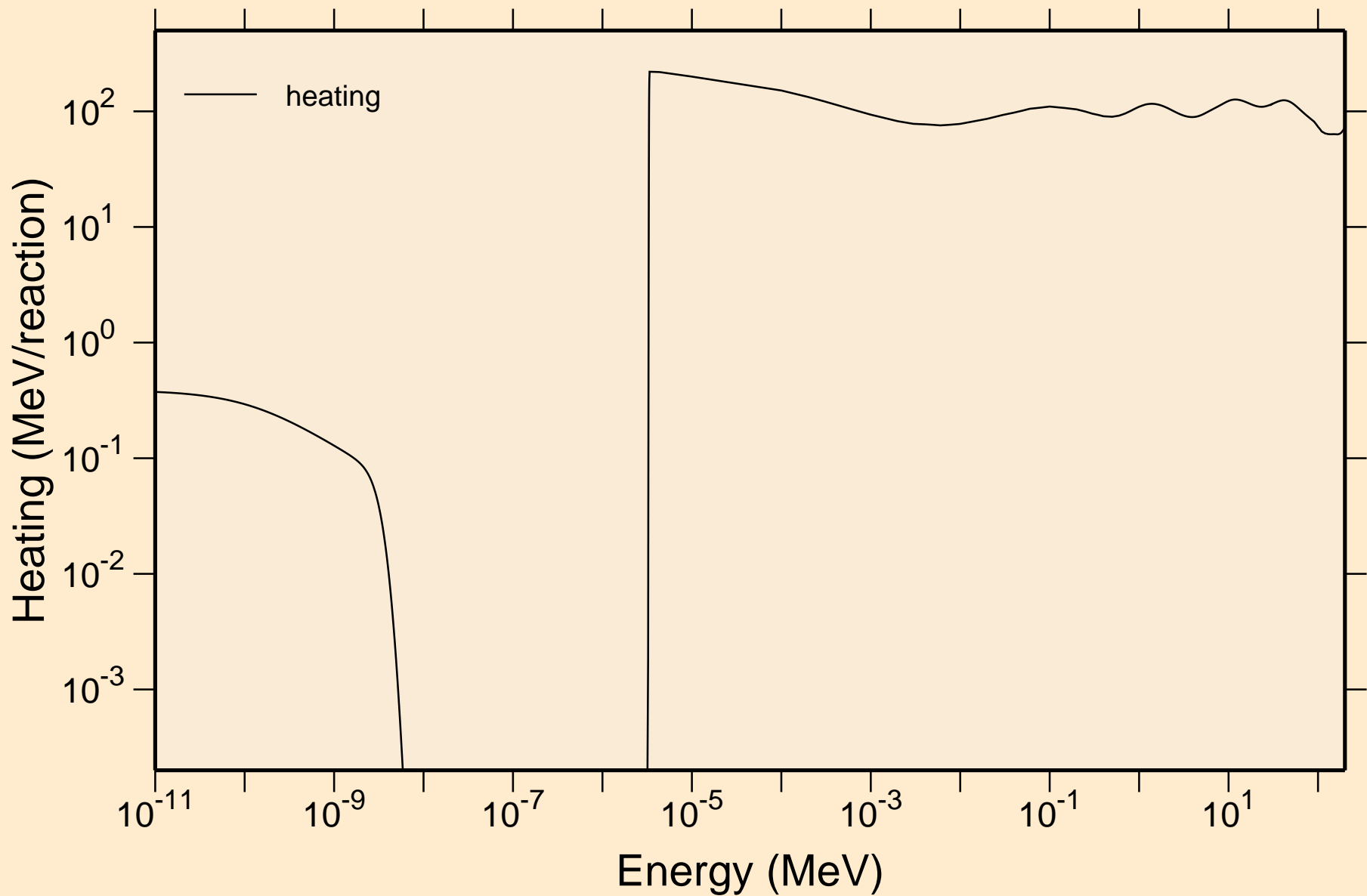

RG282 NEUTRON ACER TENDL-2019 LIBRARY; T=293.16K
Damage

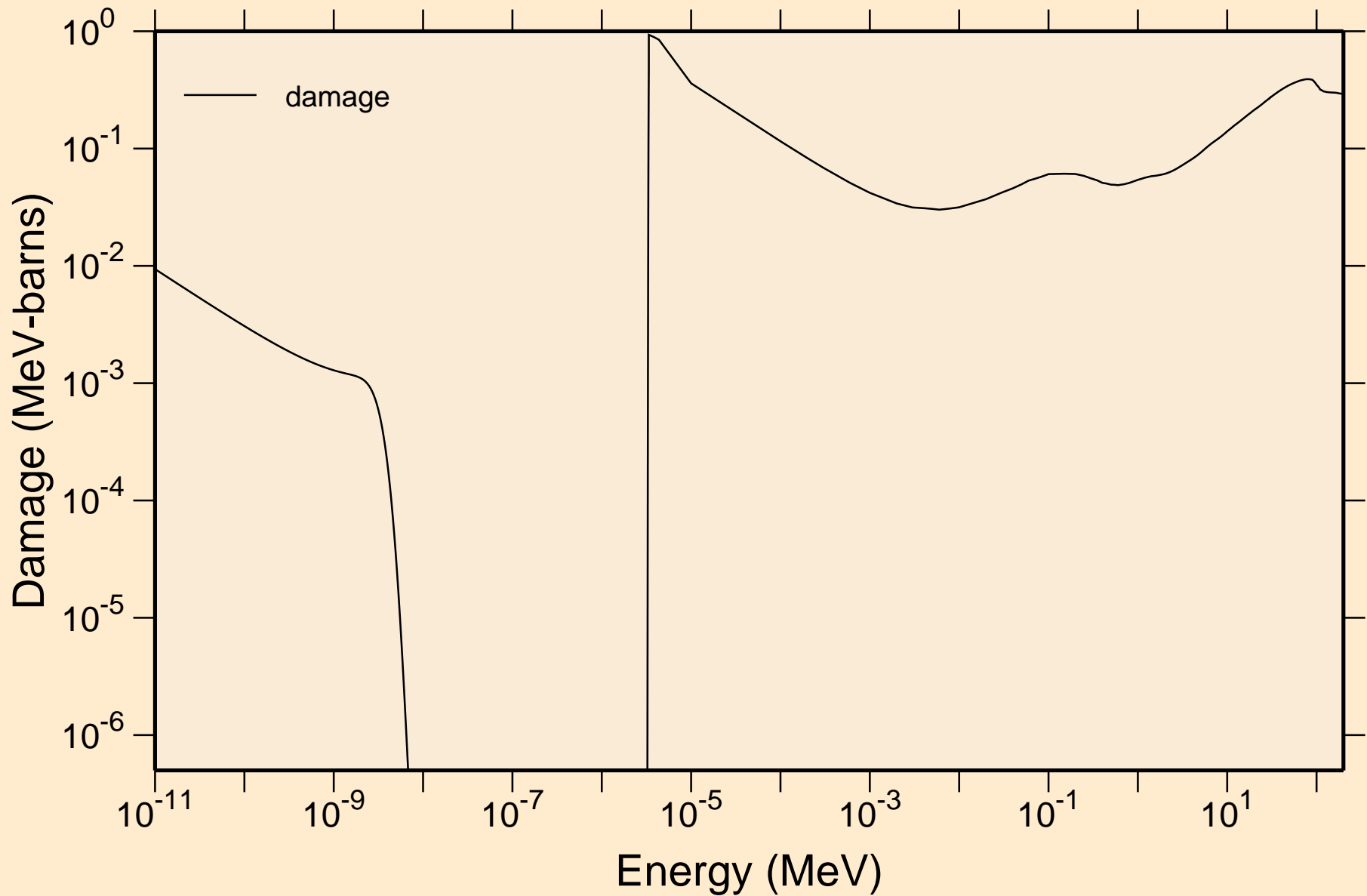

RG282 NEUTRON ACER TENDL-2019 LIBRARY; T=293.16K
Non-threshold reactions

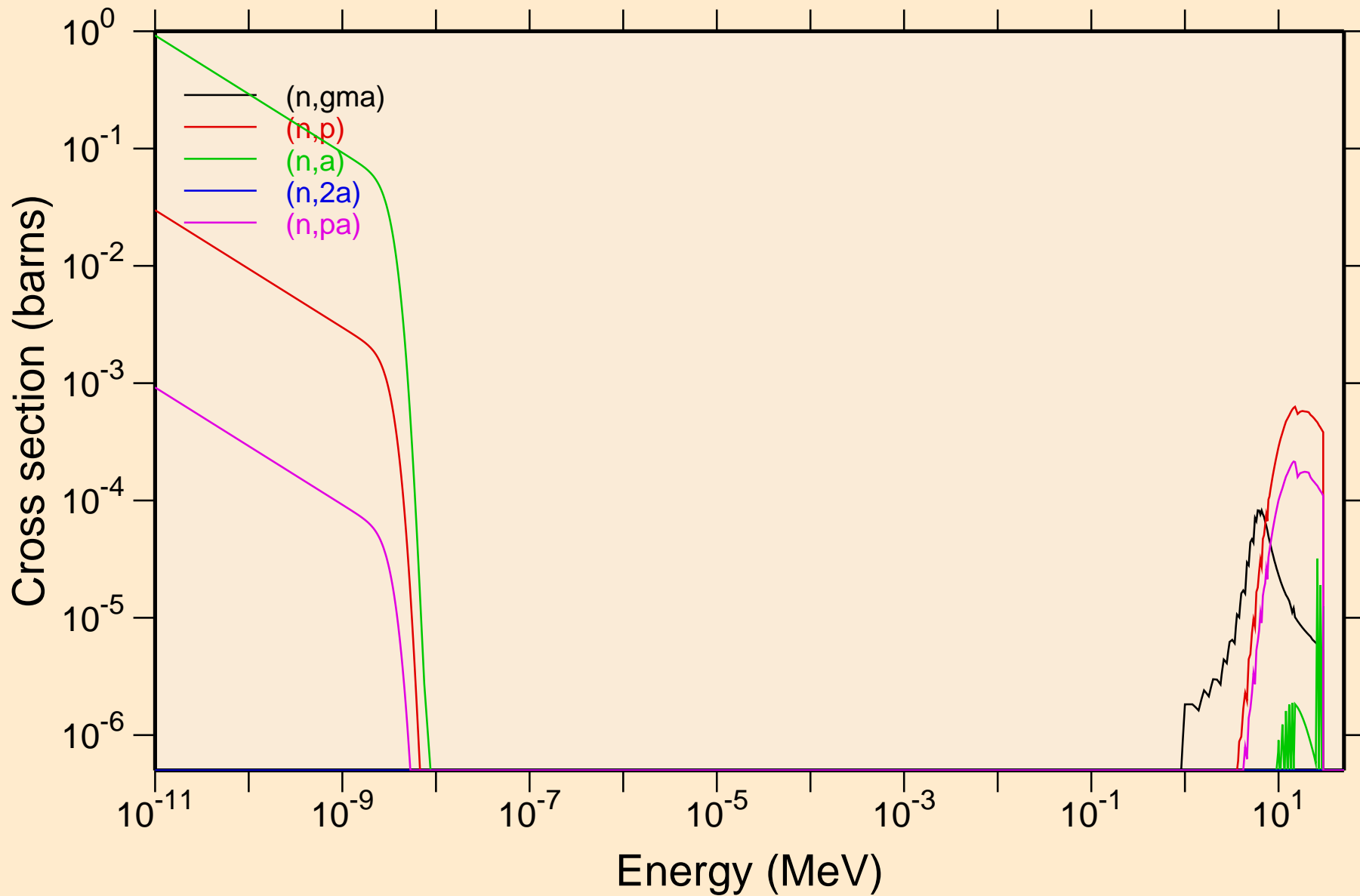

RG282 NEUTRON ACER TENDL-2019 LIBRARY; T=293.16K
Non-threshold reactions

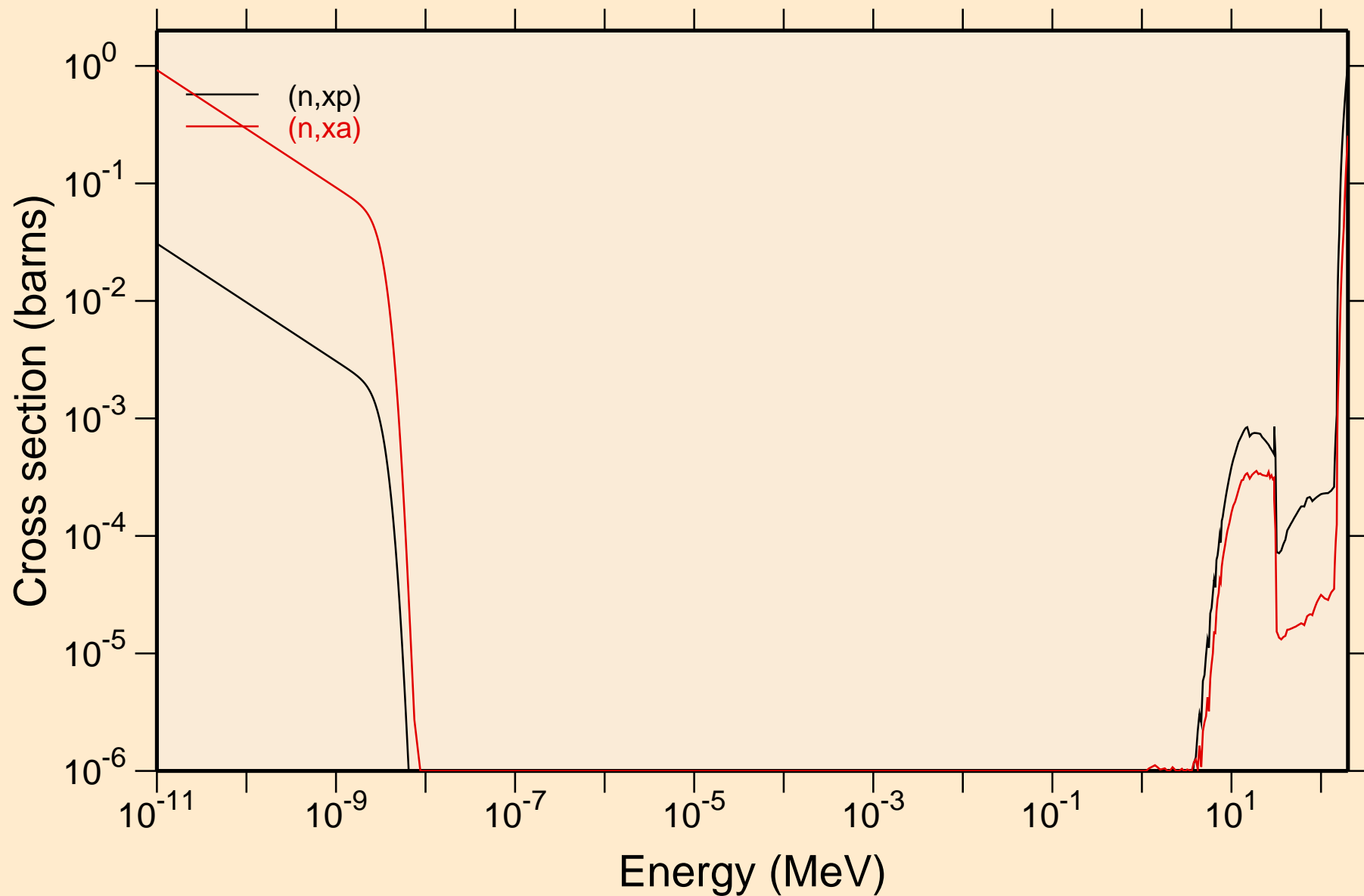

RG282 NEUTRON ACER TENDL-2019 LIBRARY; T=293.16K
Principal cross sections

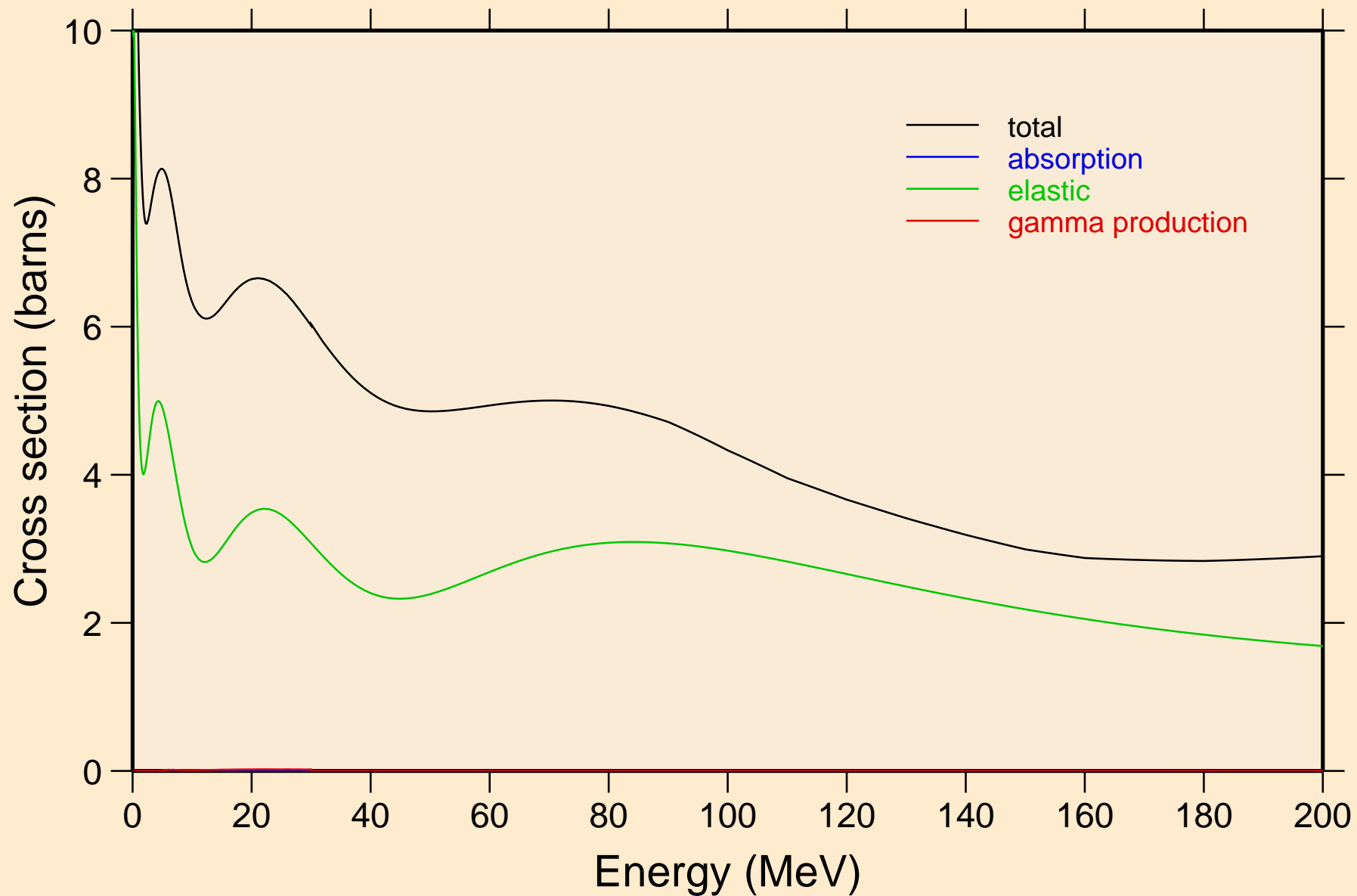

RG282 NEUTRON ACER TENDL-2019 LIBRARY; T=293.16K
Heating

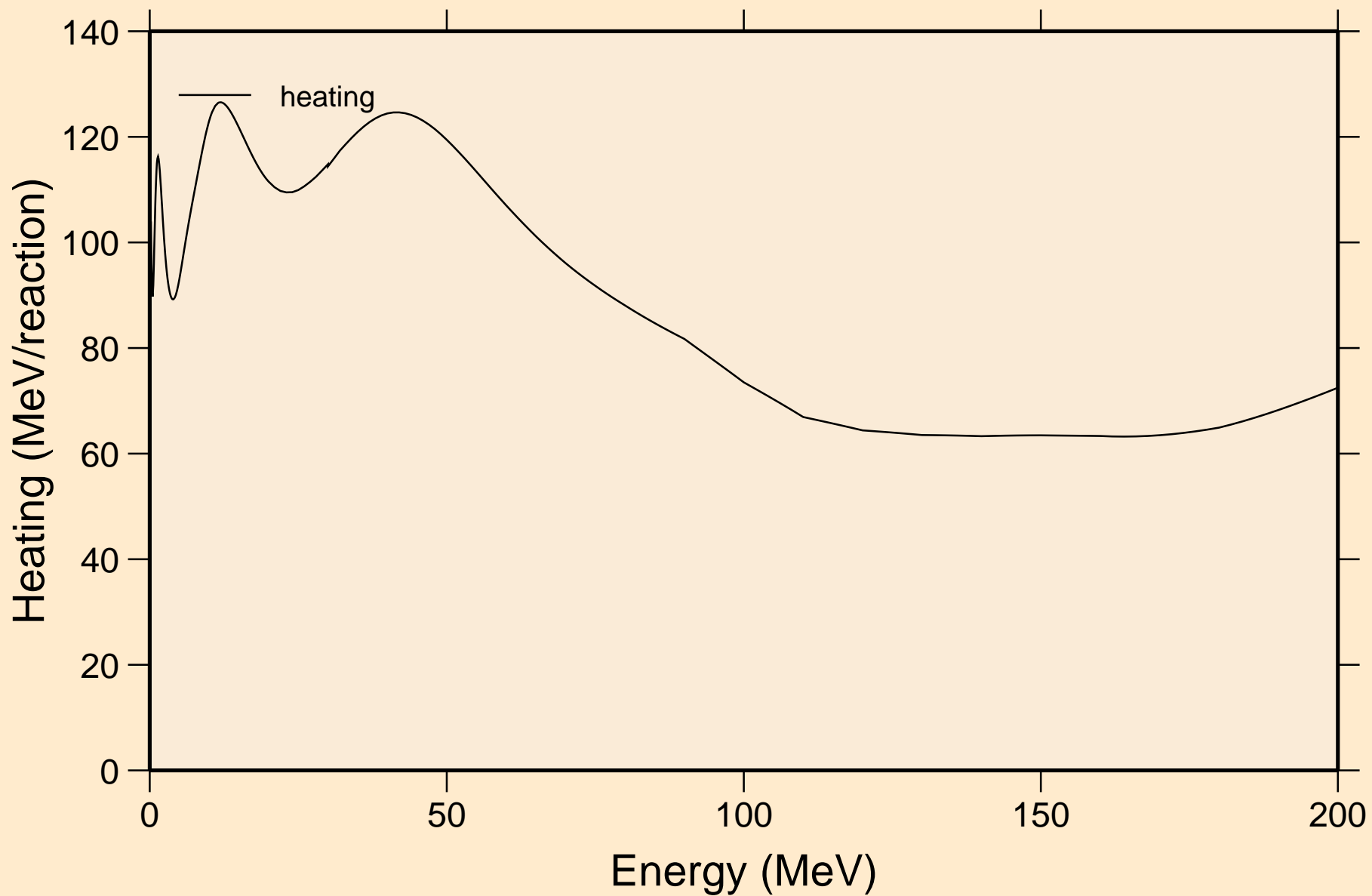

RG282 NEUTRON ACER TENDL-2019 LIBRARY; T=293.16K
Damage

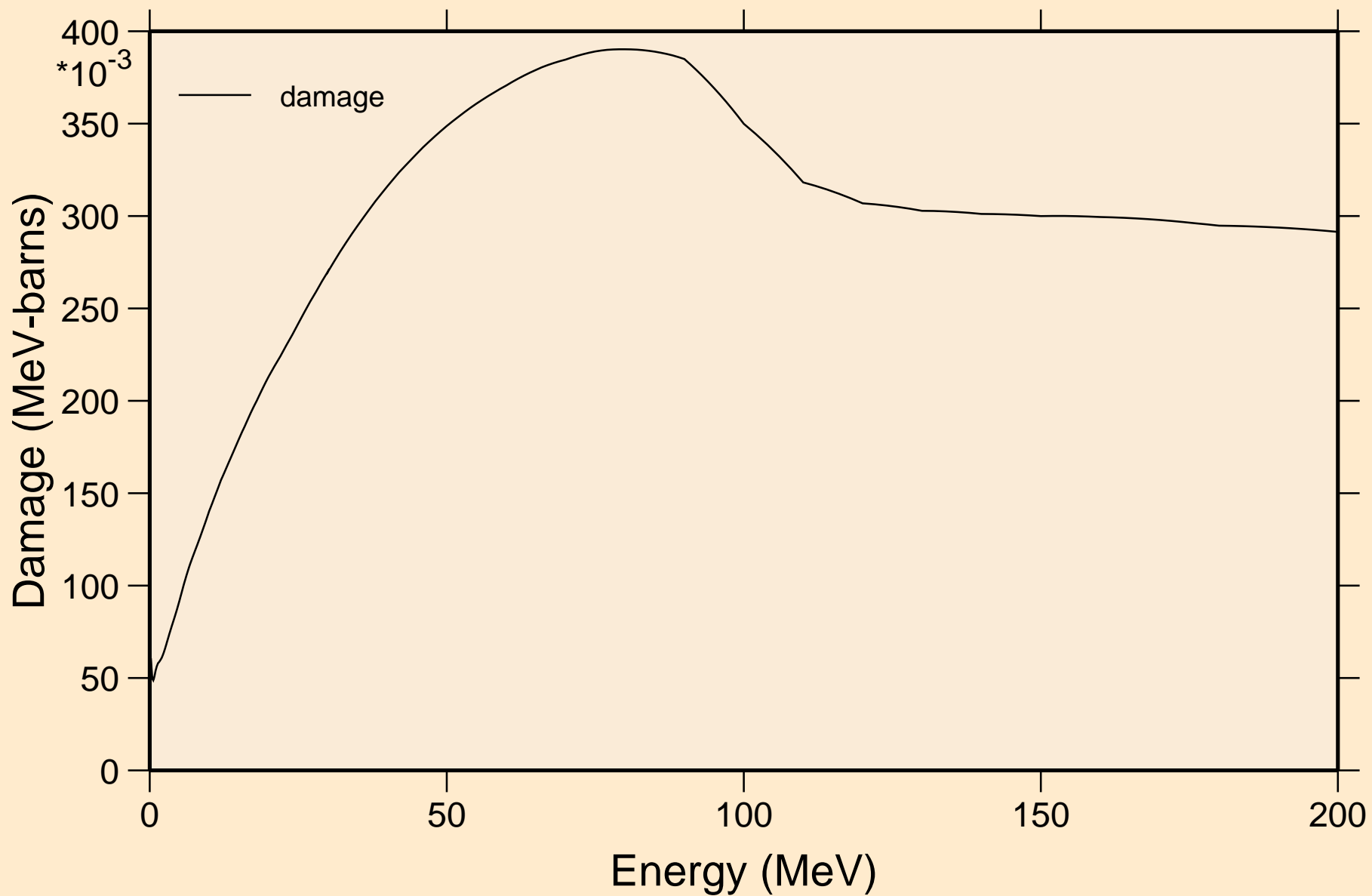

RG282 NEUTRON ACER TENDL-2019 LIBRARY; T=293.16K
Non-threshold reactions

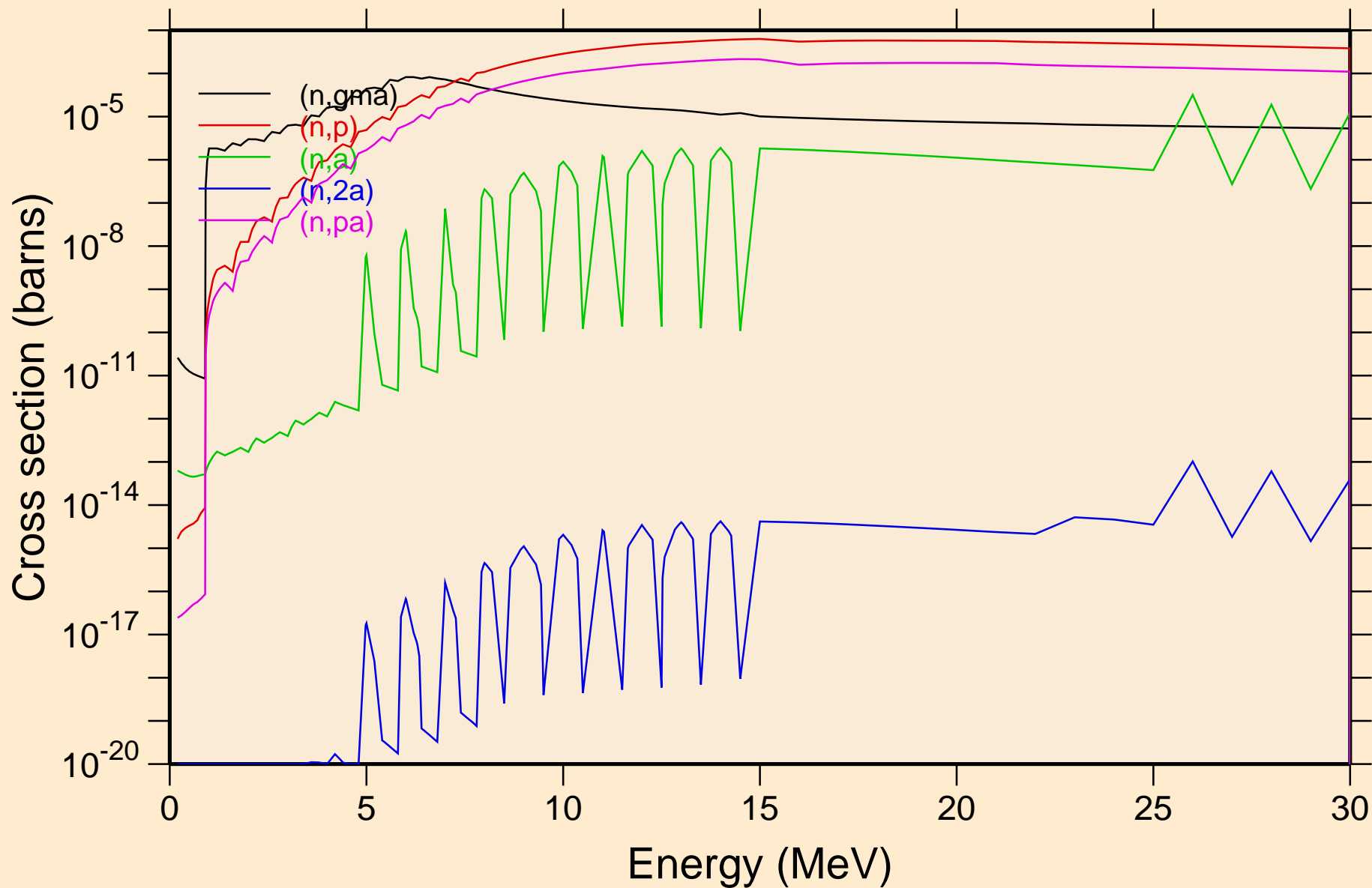

RG282 NEUTRON ACER TENDL-2019 LIBRARY; T=293.16K
Non-threshold reactions

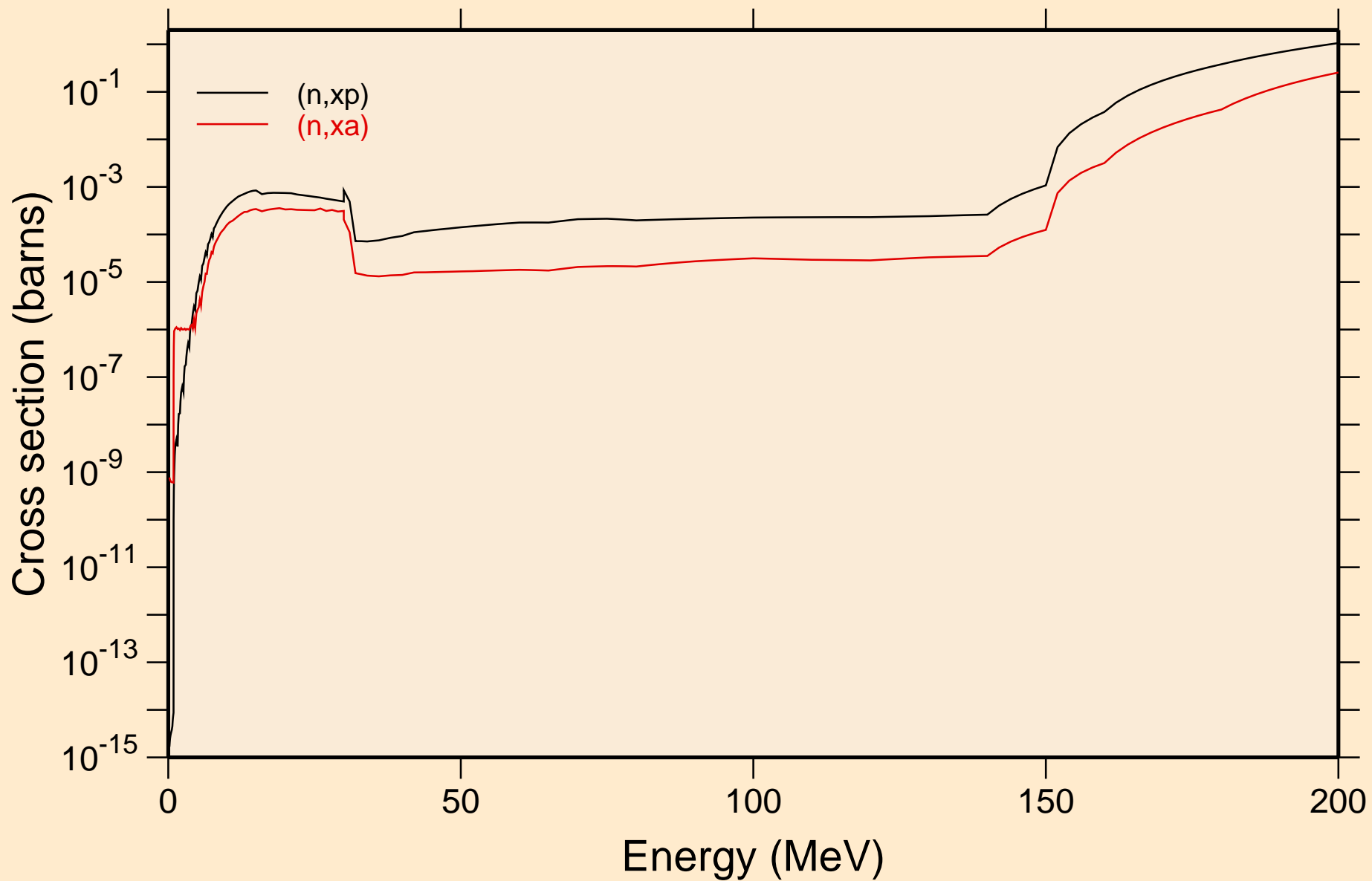

RG282 NEUTRON ACER TENDL-2019 LIBRARY; T=293.16K
Inelastic levels

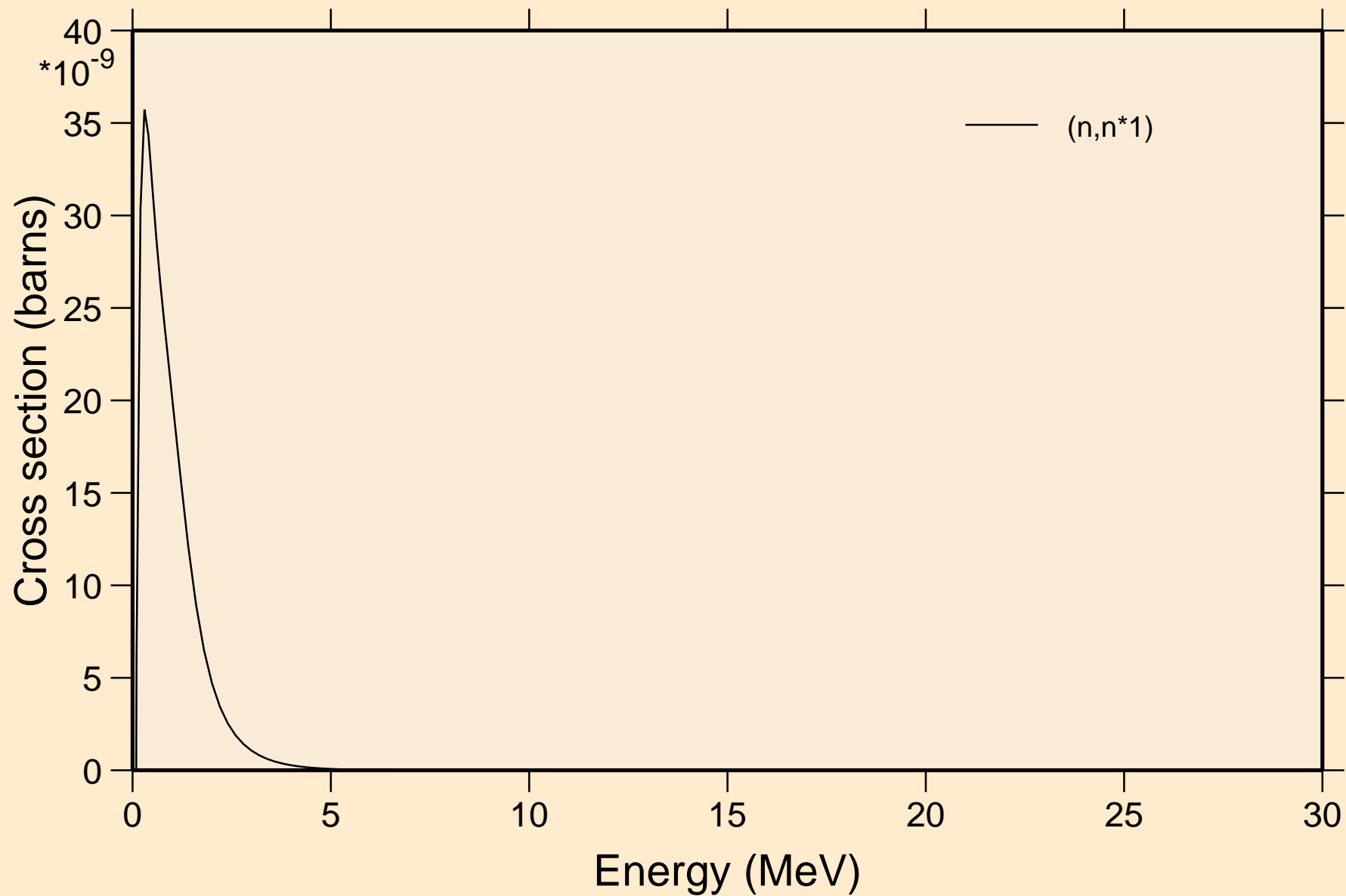

RG282 NEUTRON ACER TENDL-2019 LIBRARY; T=293.16K
Threshold reactions

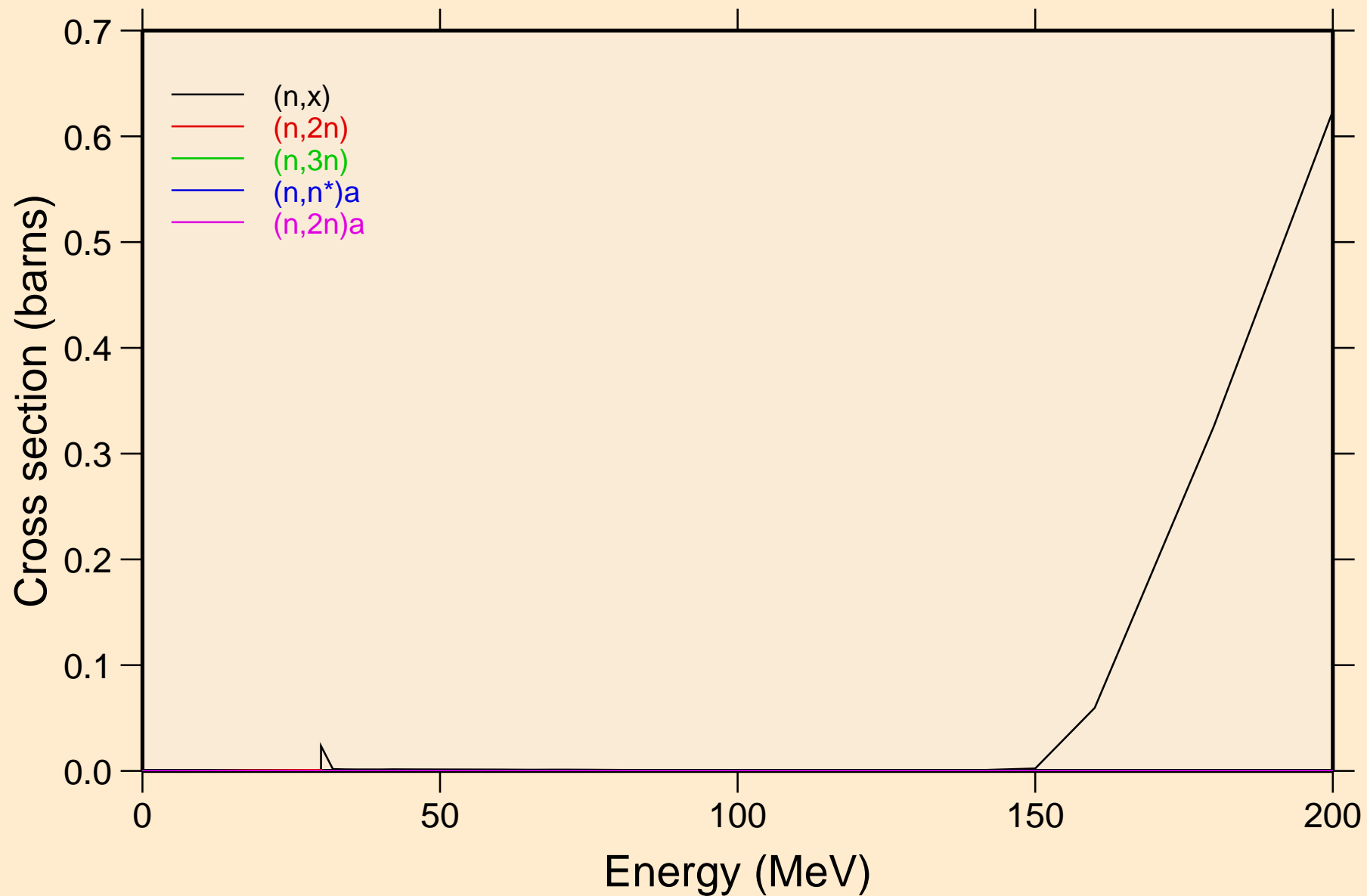

RG282 NEUTRON ACER TENDL-2019 LIBRARY; T=293.16K

Threshold reactions

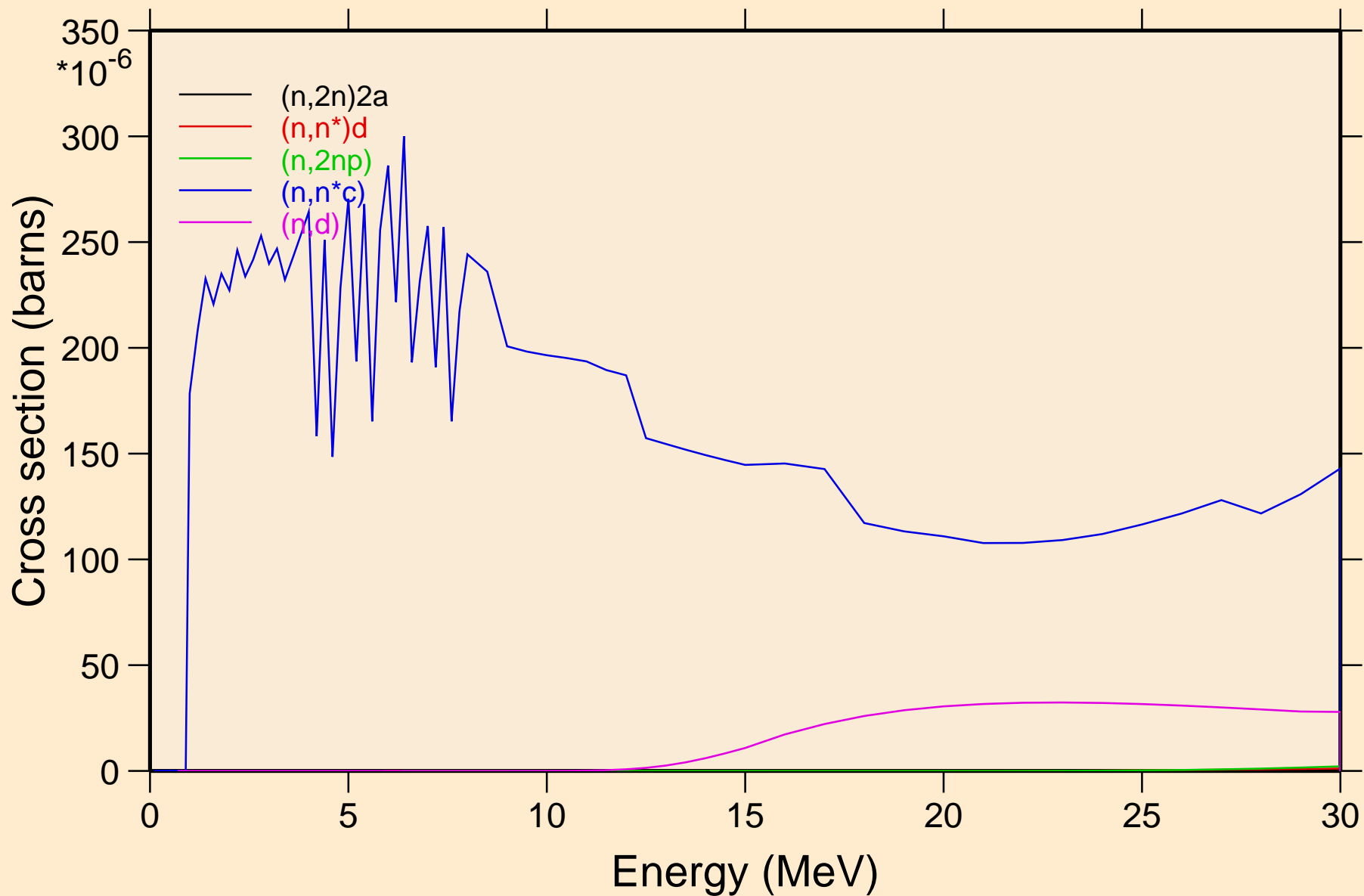

RG282 NEUTRON ACER TENDL-2019 LIBRARY; T=293.16K
Threshold reactions

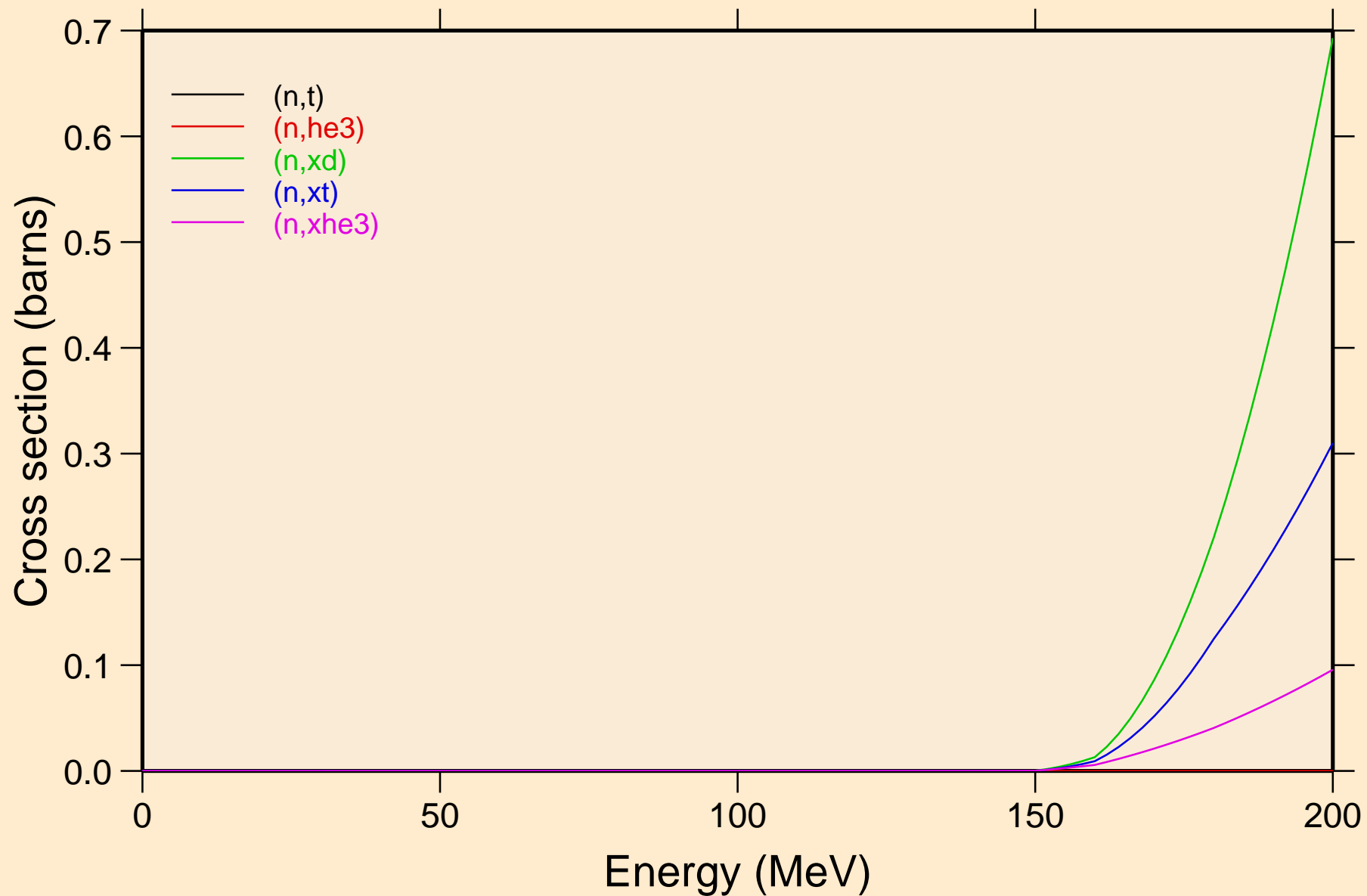

RG282 NEUTRON ACER TENDL-2019 LIBRARY; T=293.16K
angular distribution for elastic

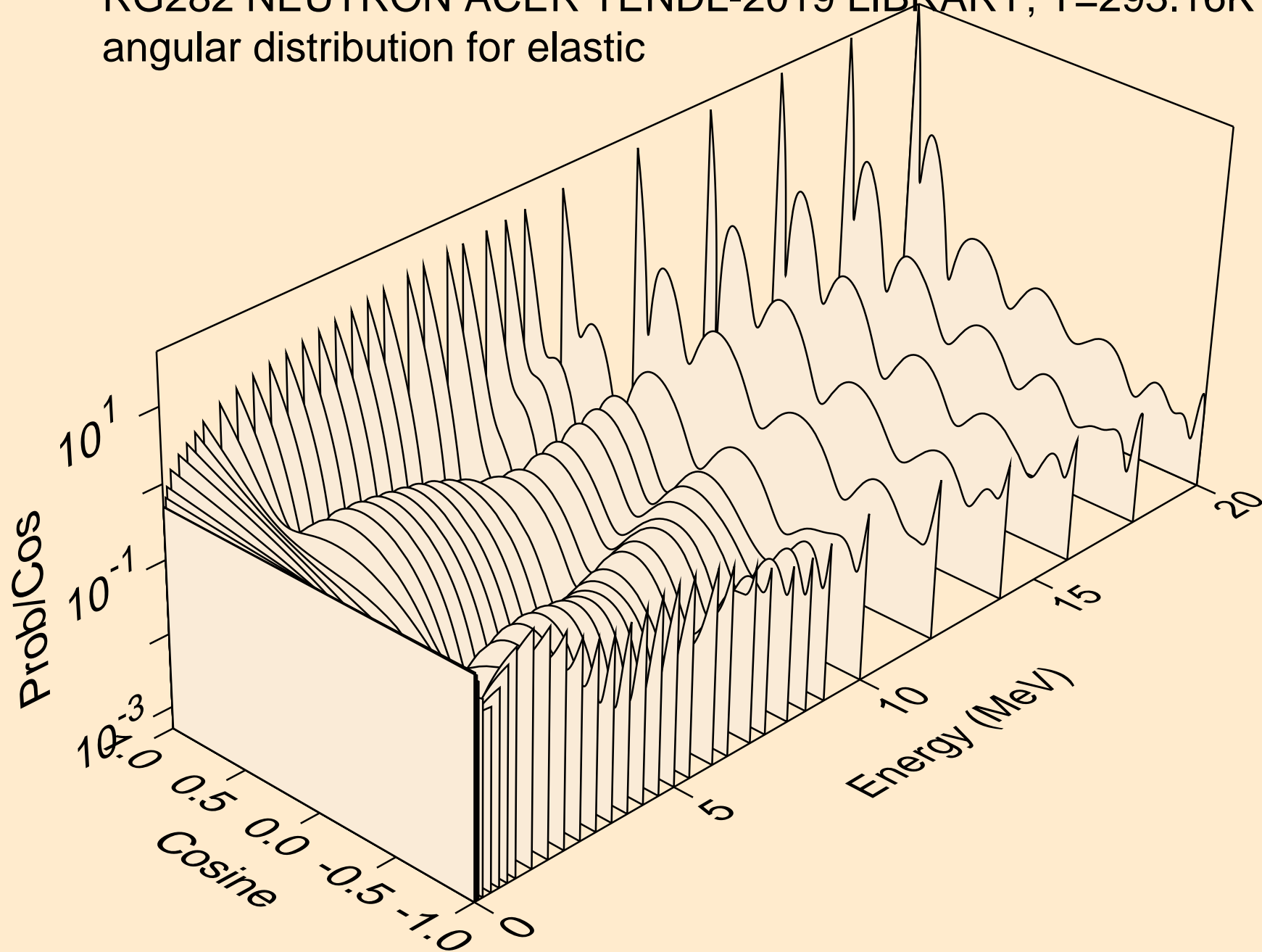

RG282 NEUTRON ACER TENDL-2019 LIBRARY; T=293.16K
angular distribution for elastic

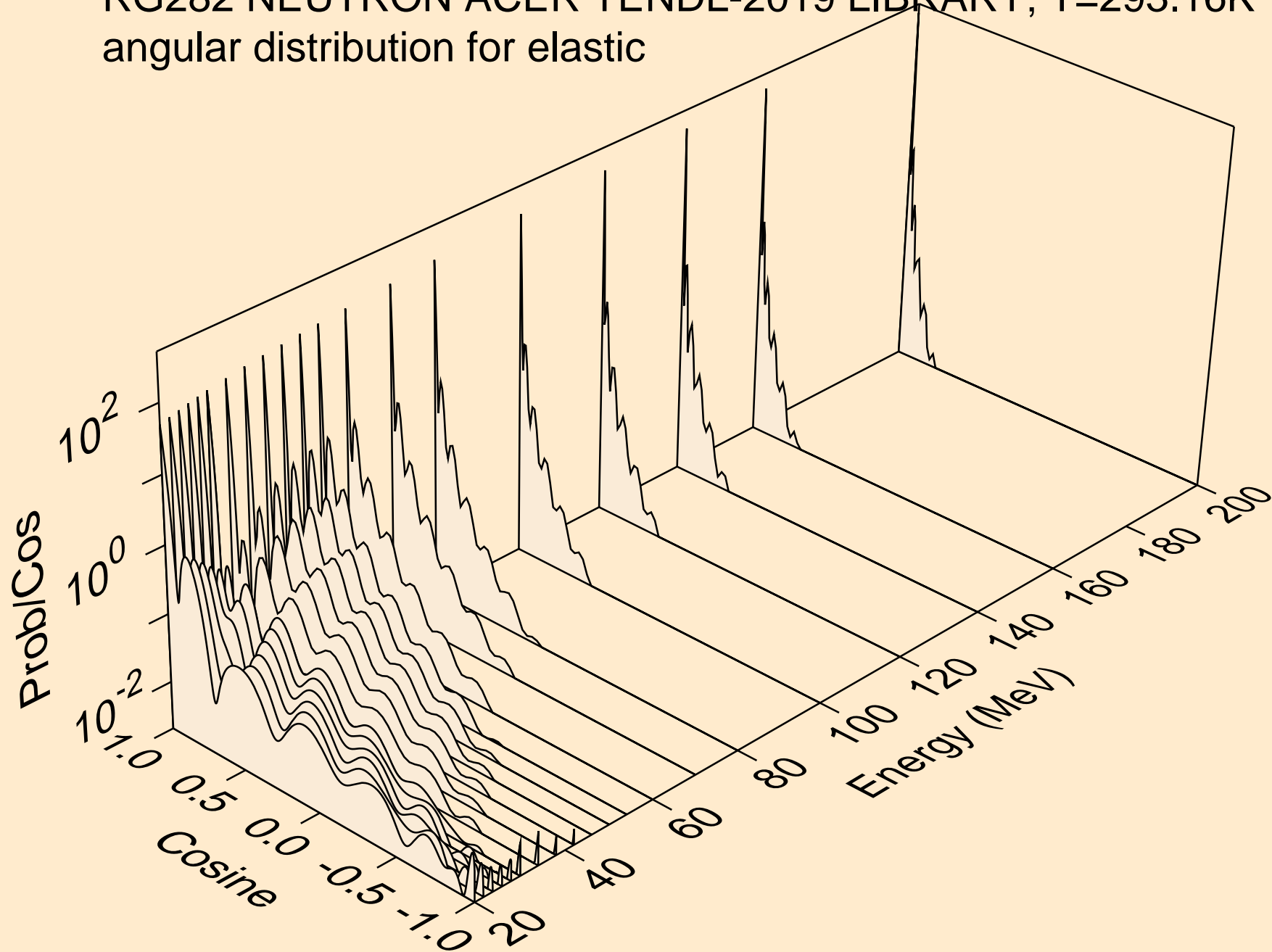

RG282 NEUTRON ACER TENDL-2019 LIBRARY; T=293.16K
angular distribution for (n,n*1)

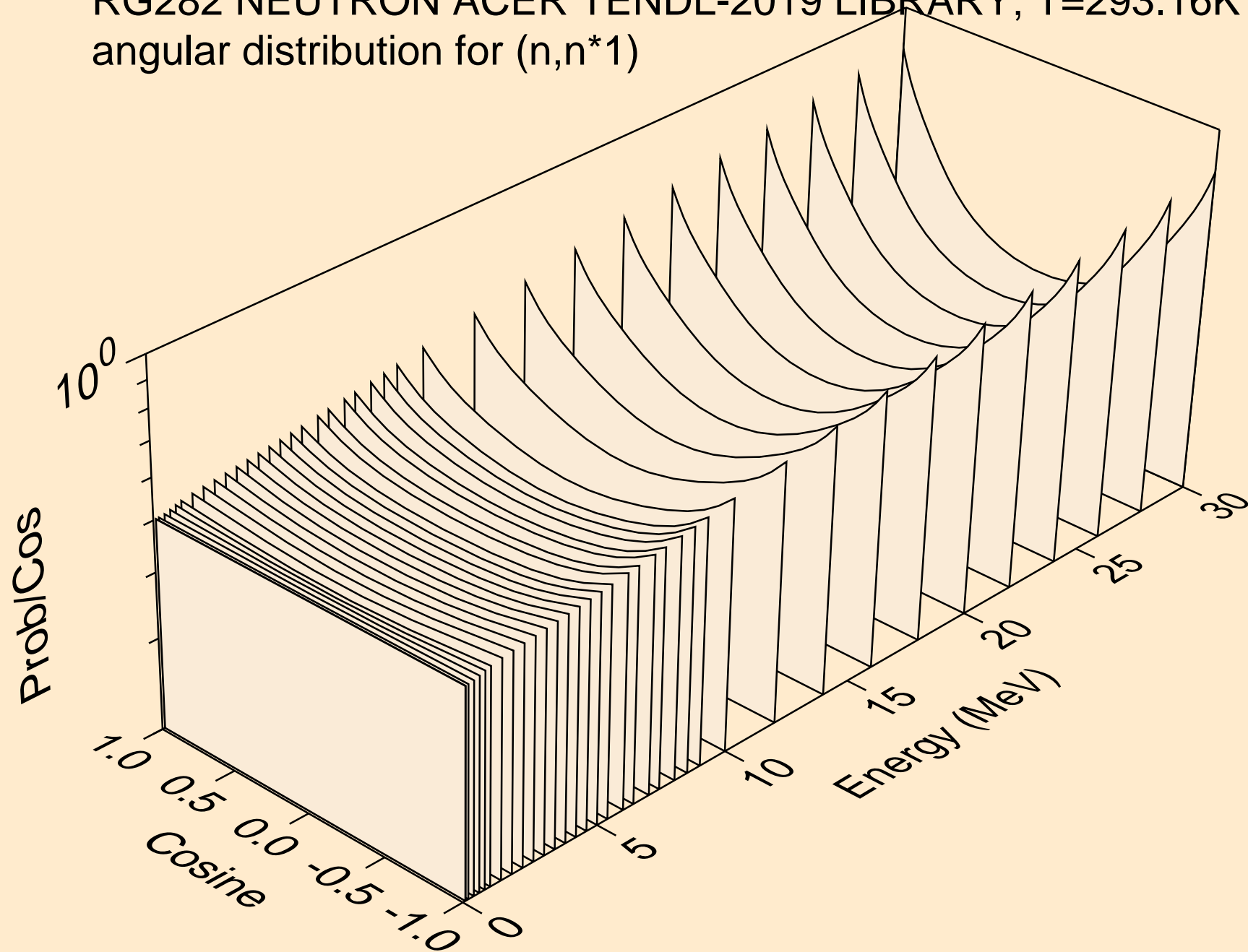

RG282 NEUTRON ACER TENDL-2019 LIBRARY; T=293.16K
Total fission nuubar

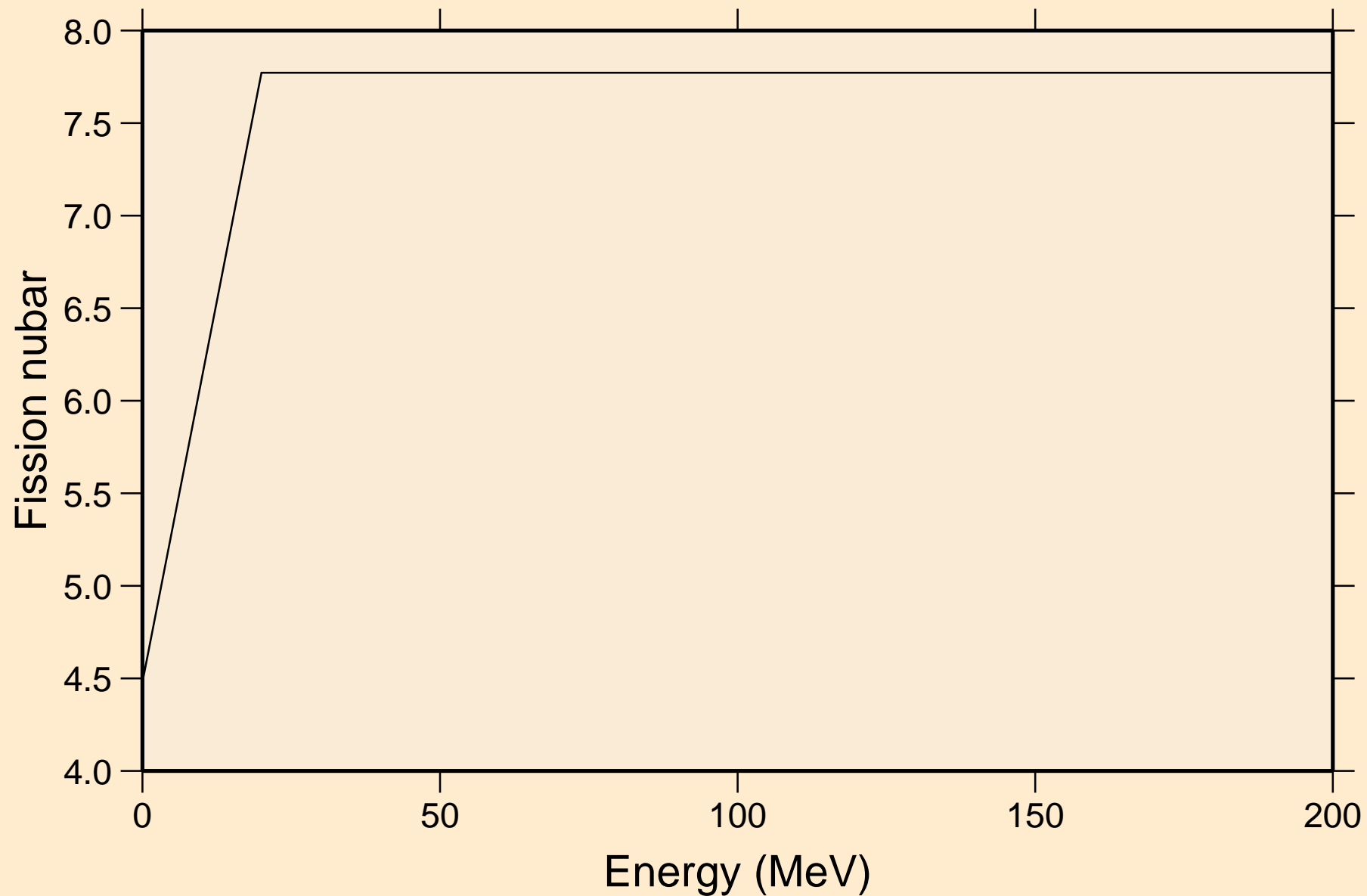

RG282 NEUTRON ACER TENDL-2019 LIBRARY; T=293.16K
Neutron emission for (n,x)

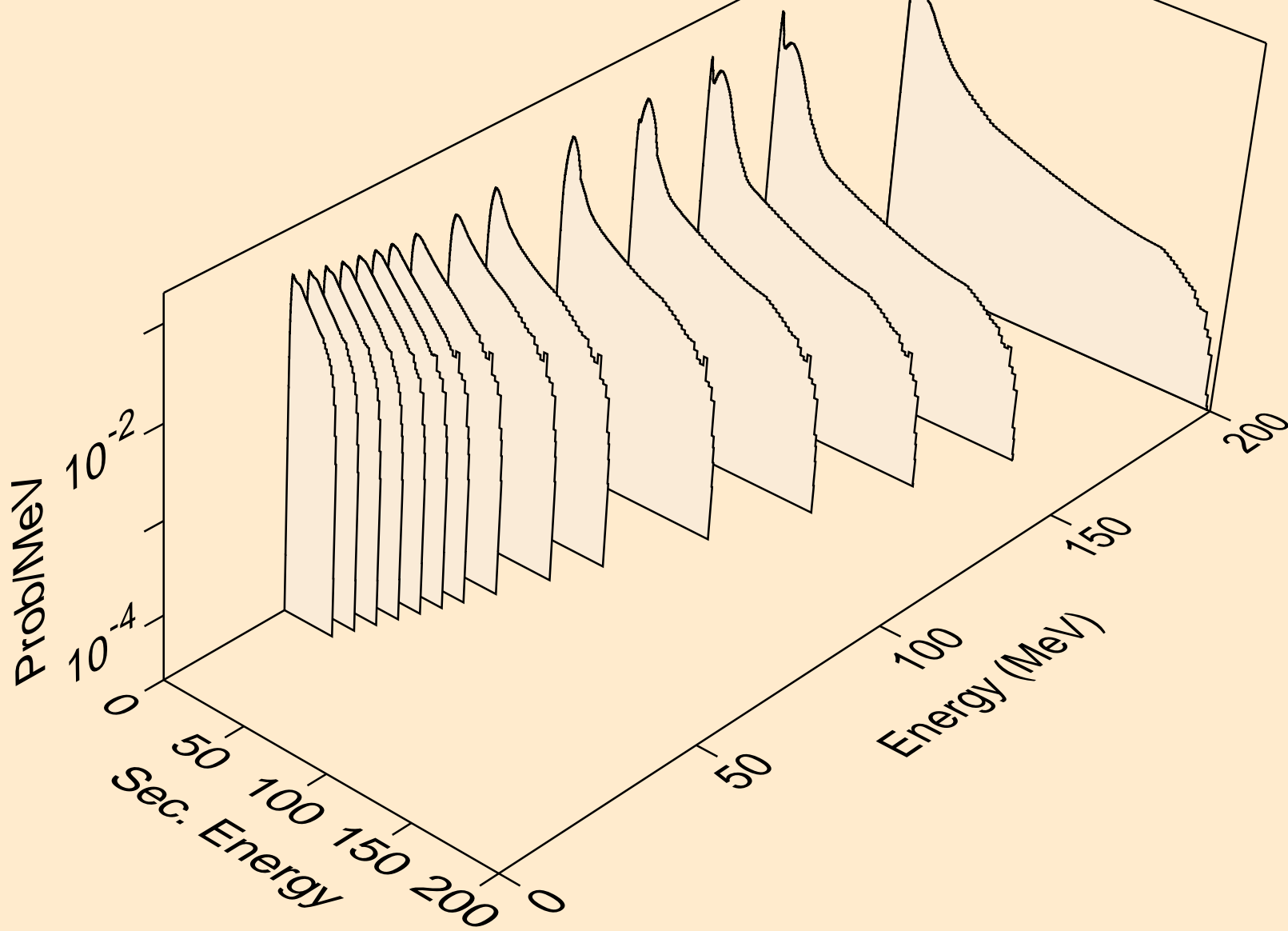

RG282 NEUTRON ACER TENDL-2019 LIBRARY; T=293.16K
Neutron emission for (n,2n)

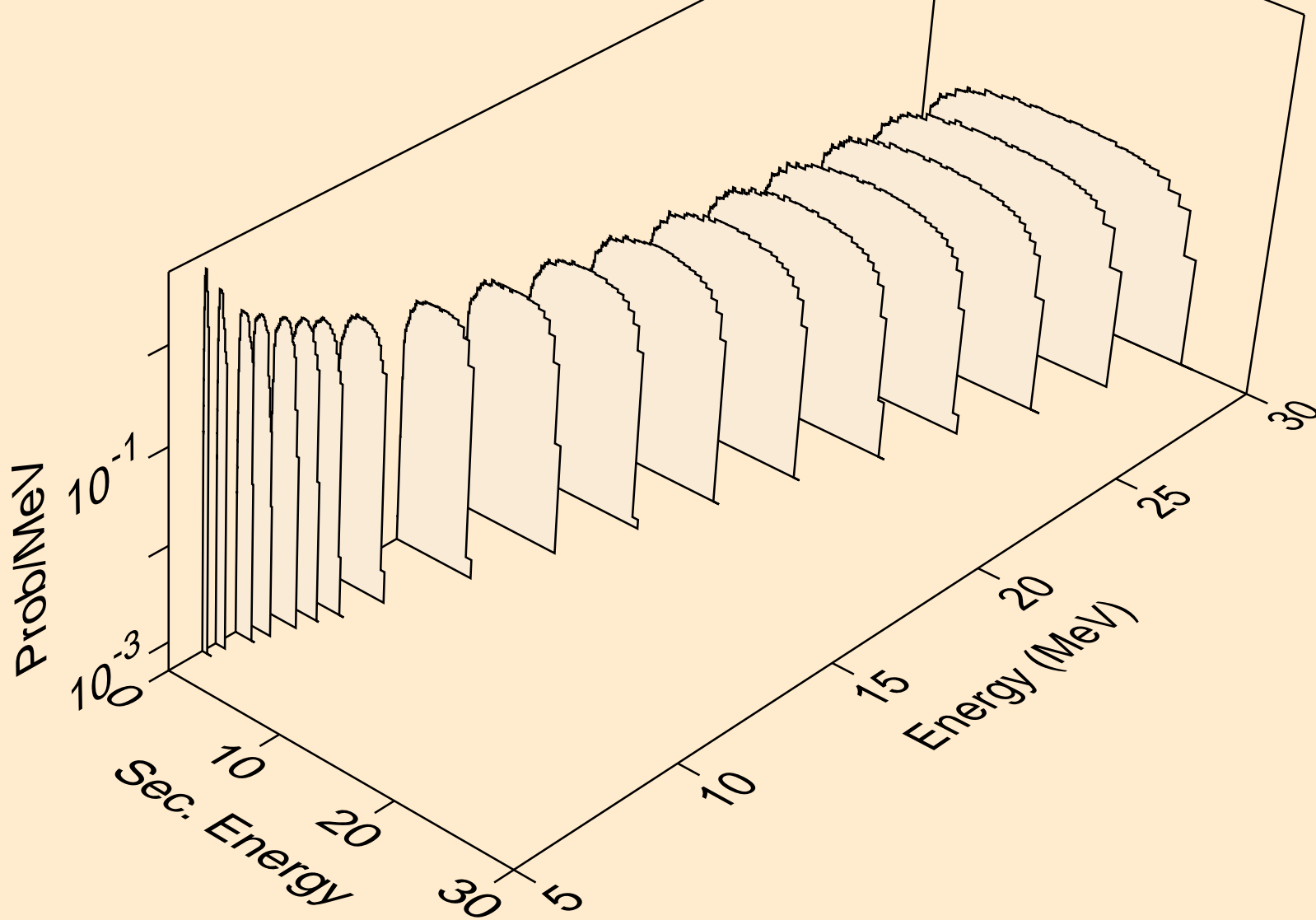

RG282 NEUTRON ACER TENDL-2019 LIBRARY; T=293.16K
Neutron emission for (n,3n)

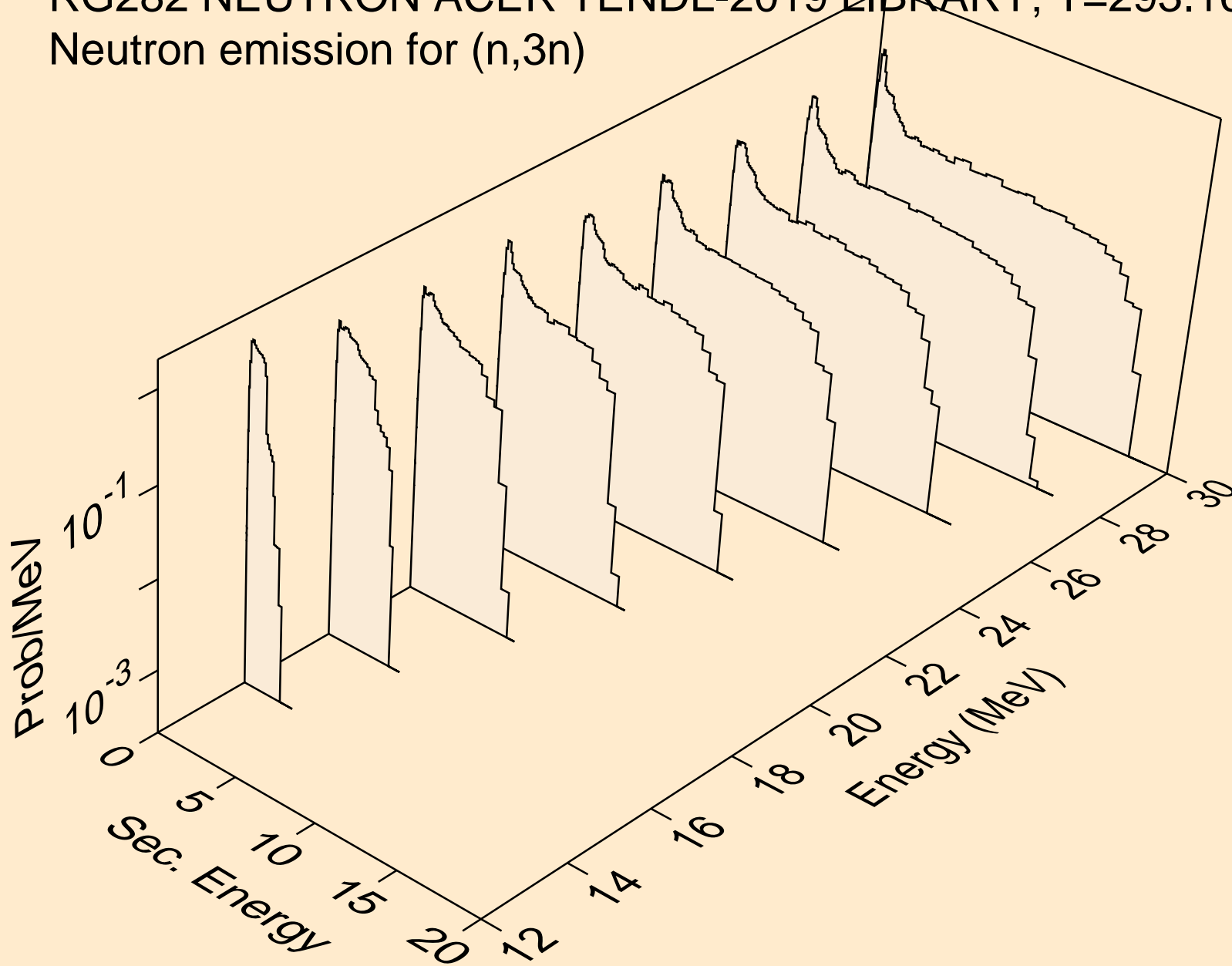

RG282 NEUTRON ACER TENDL-2019 LIBRARY; T=293.16K
Neutron emission for fission

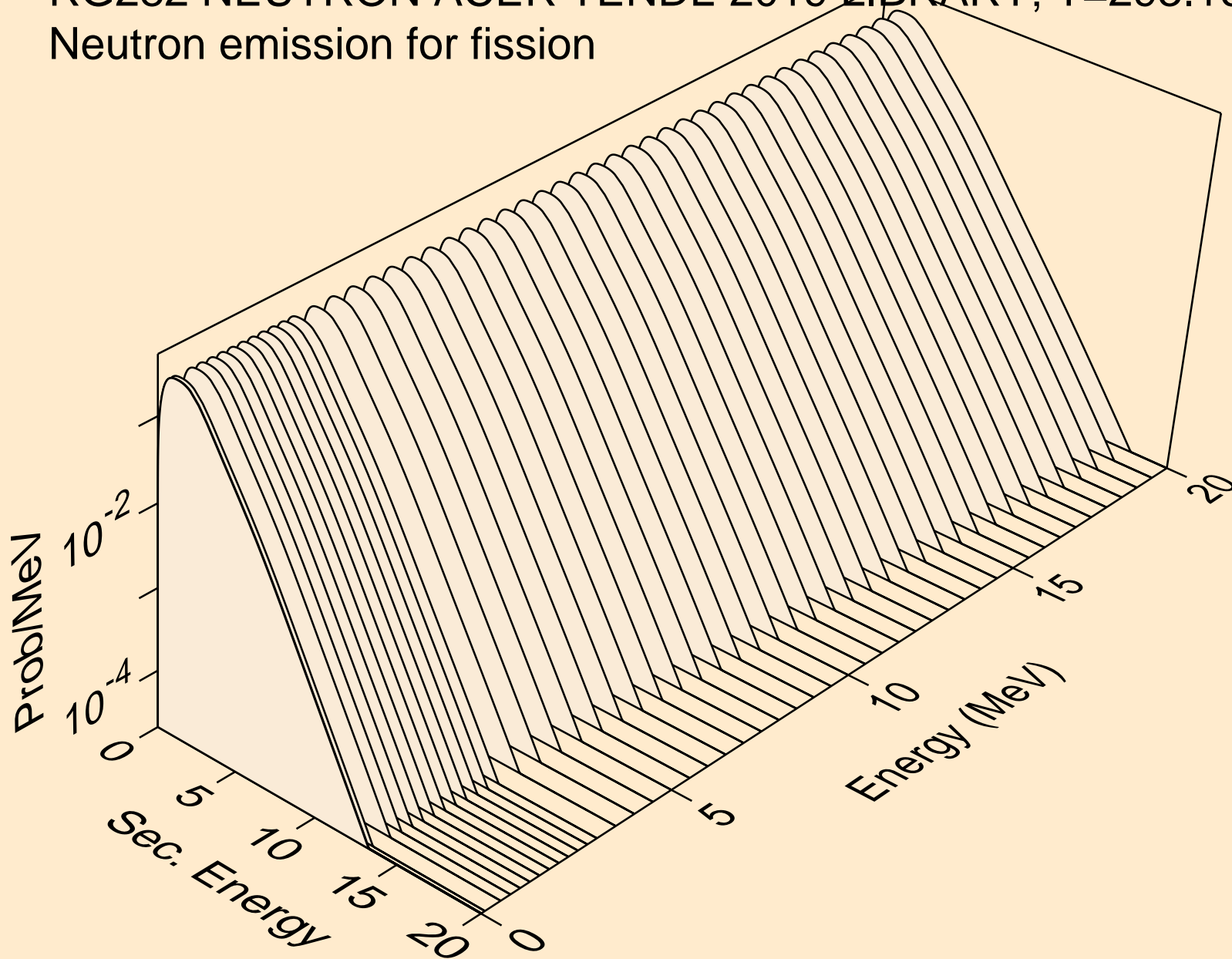

RG282 NEUTRON ACER TENDL-2019 LIBRARY; T=293.16K
Neutron emission for (n,n*)a

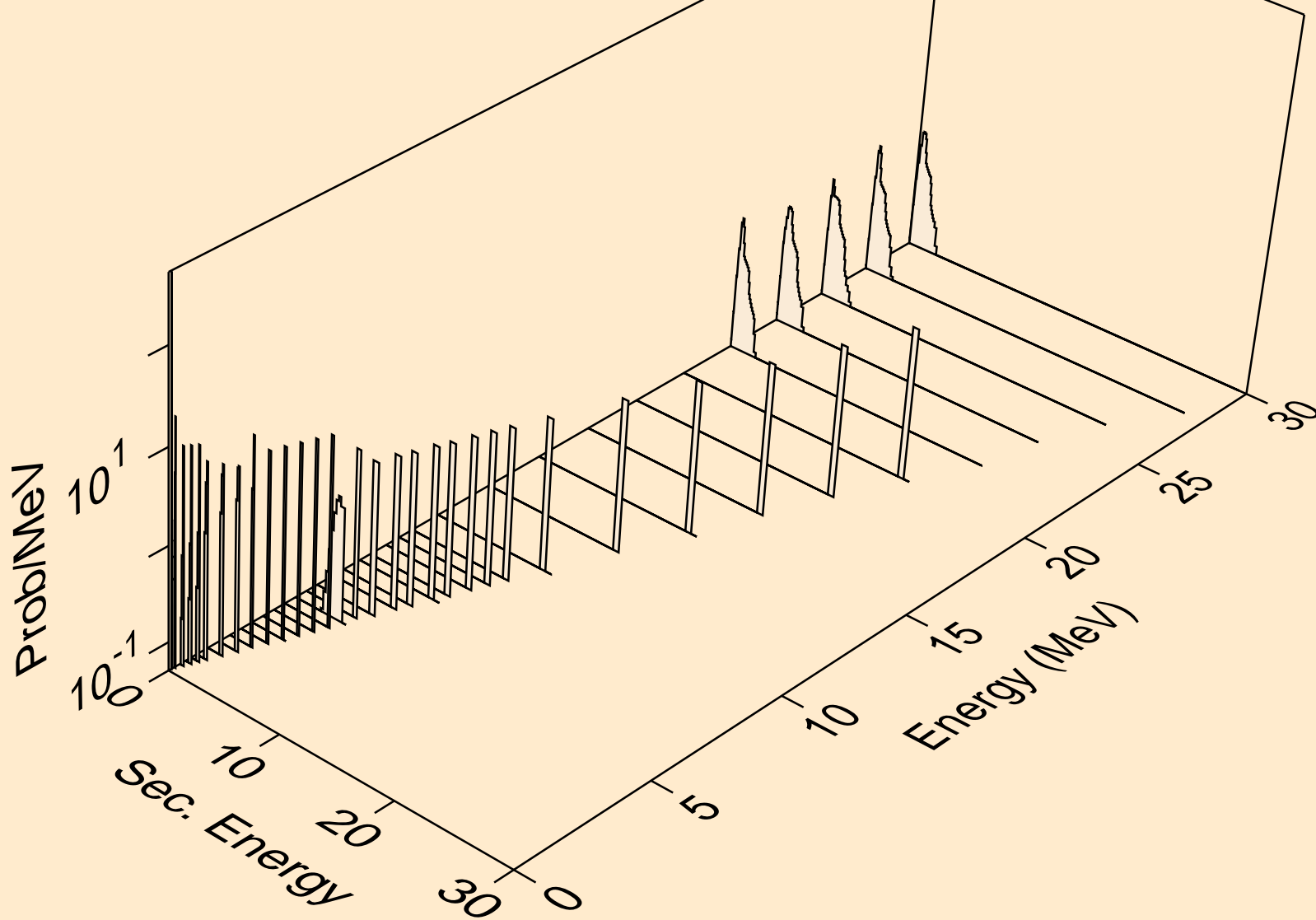

RG282 NEUTRON ACER TENDL-2019 LIBRARY; T=293.16K
Neutron emission for (n,2n)a

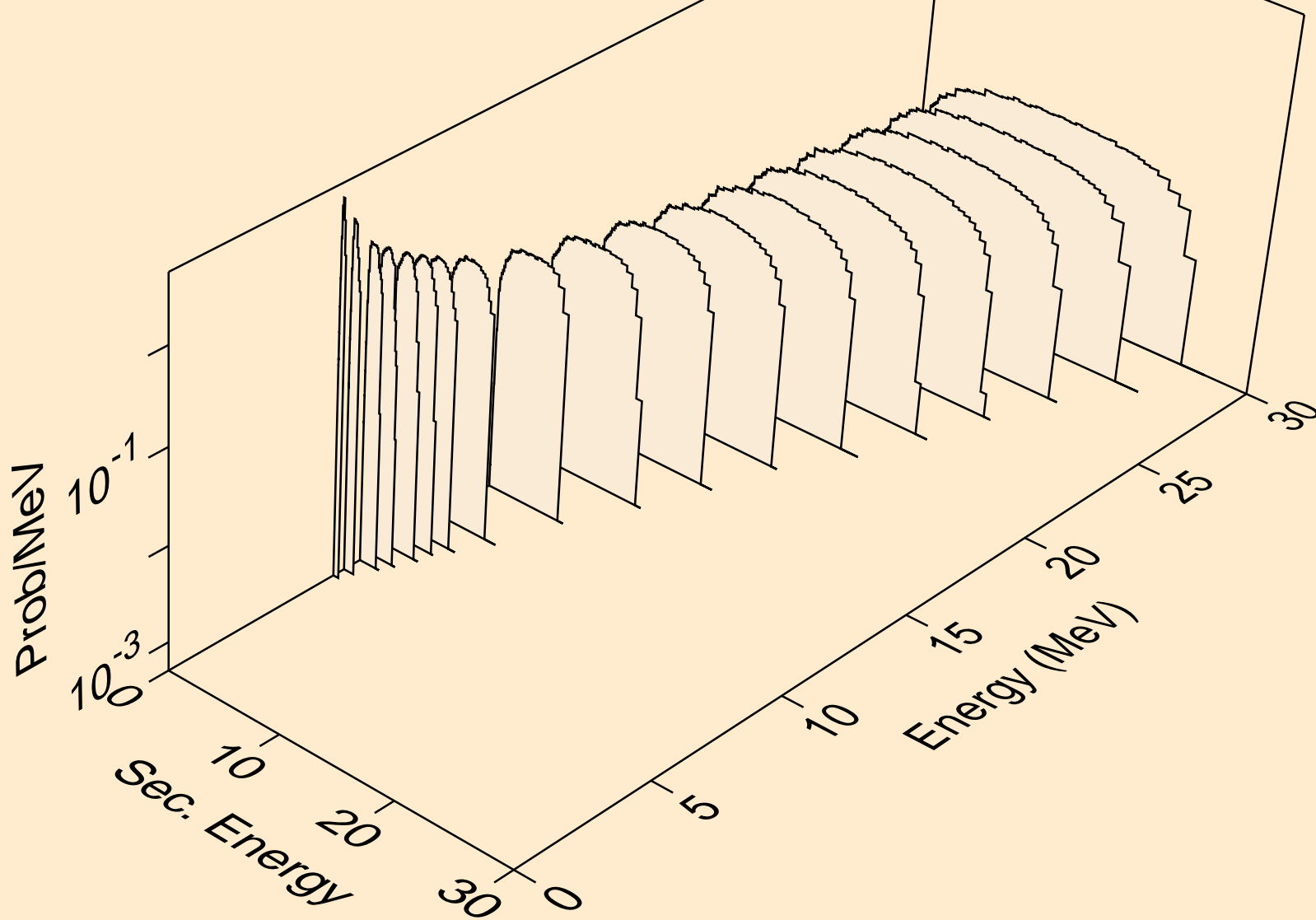

RG282 NEUTRON ACER TENDL-2019 LIBRARY; T=293.16K
Neutron emission for (n,2n)2a

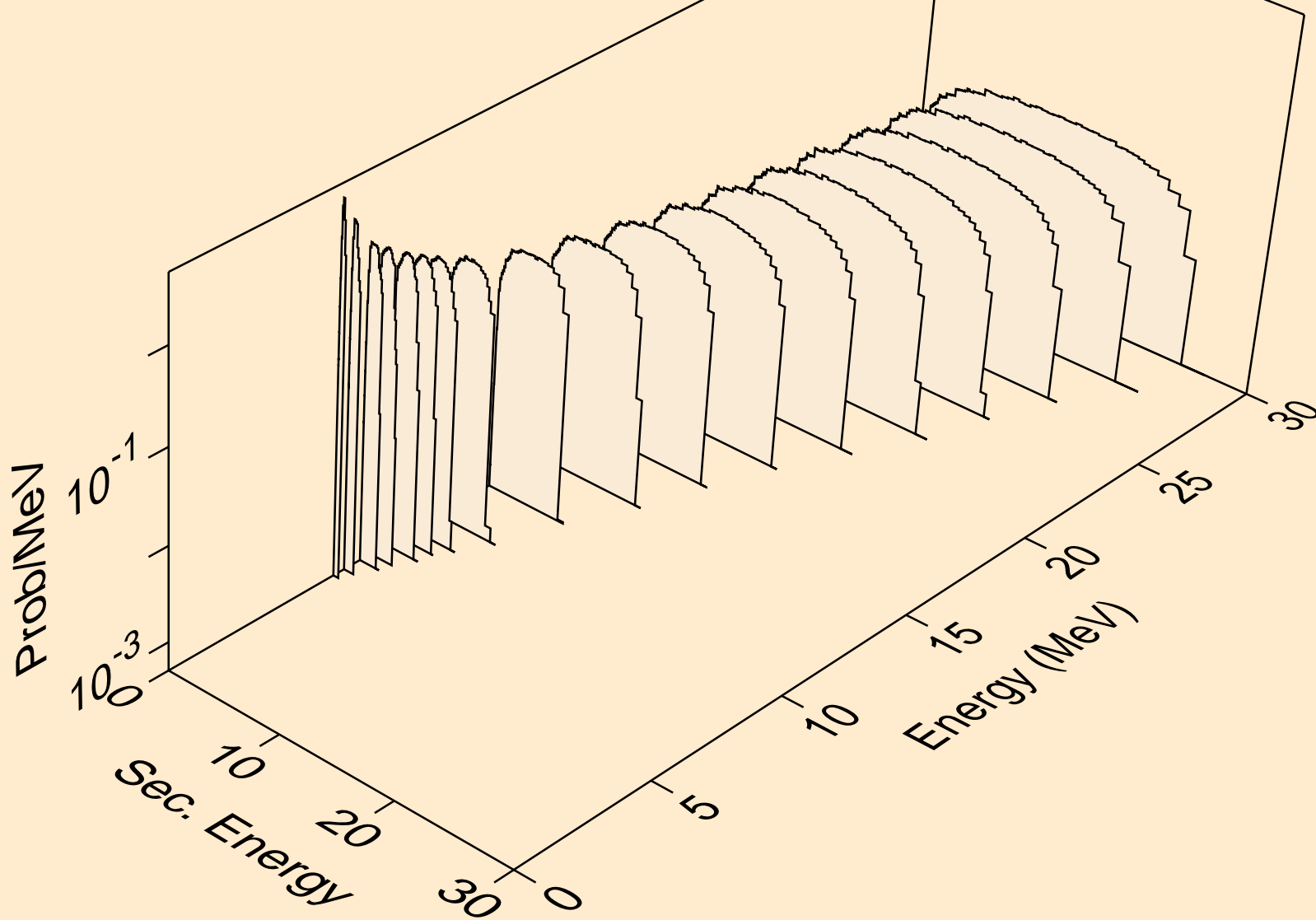

RG282 NEUTRON ACER TENDL-2019 LIBRARY; T=293.16K
Neutron emission for (n,n*)d

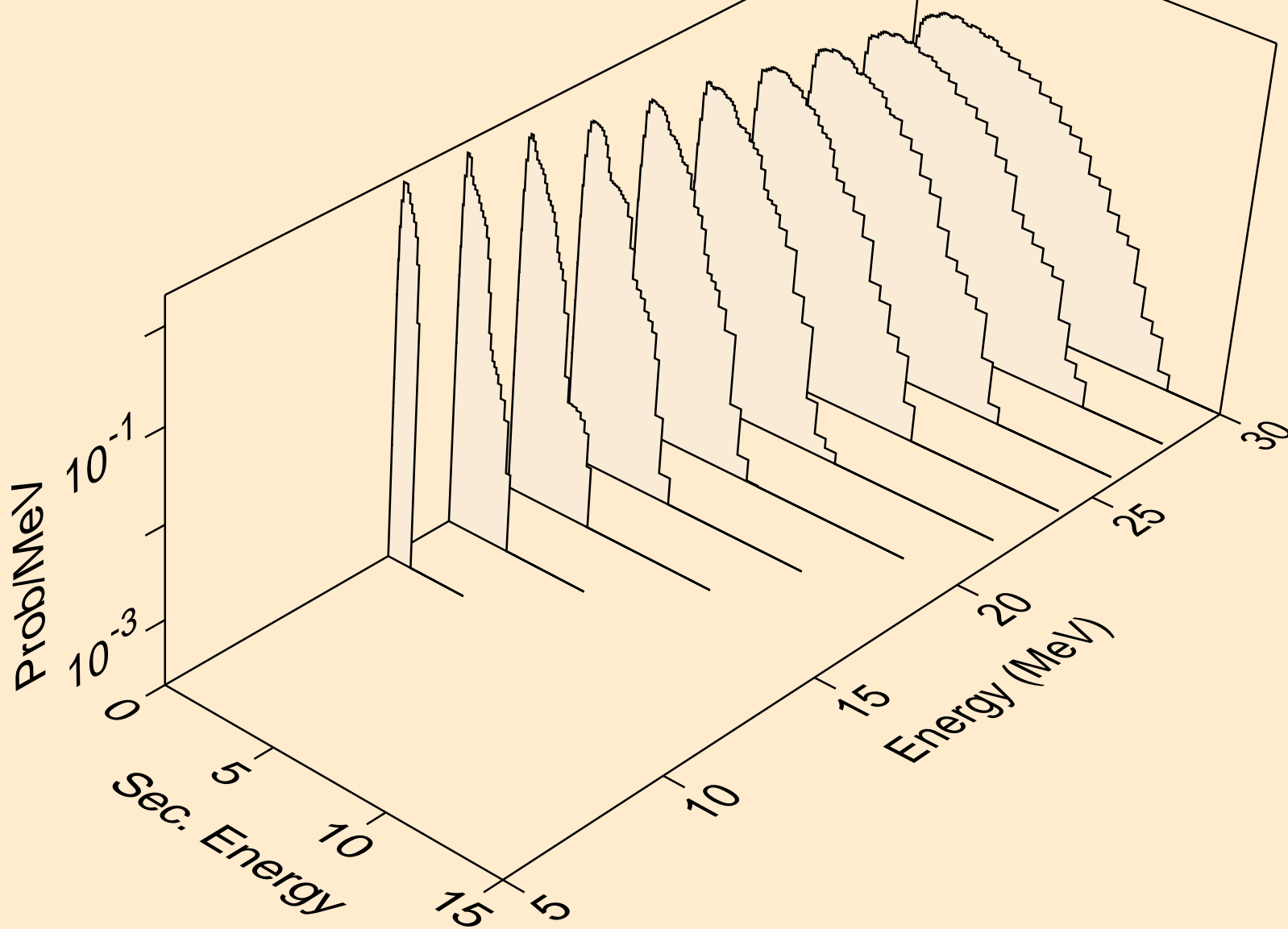

RG282 NEUTRON ACER TENDL-2019 LIBRARY; T=293.16K
Neutron emission for (n,2np)

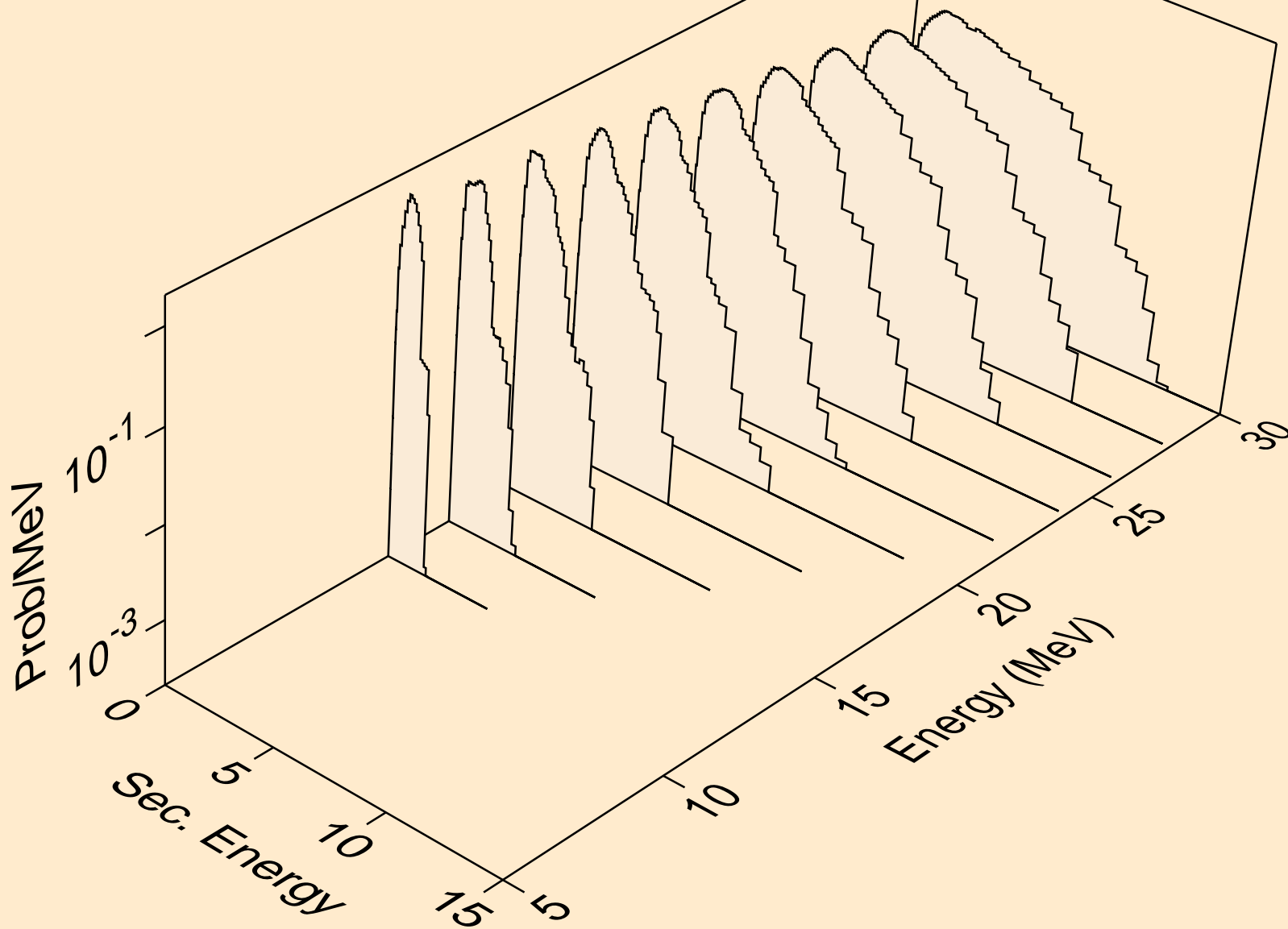

RG282 NEUTRON ACER TENDL-2019 LIBRARY; T=293.16K
Neutron emission for (n,n*c)

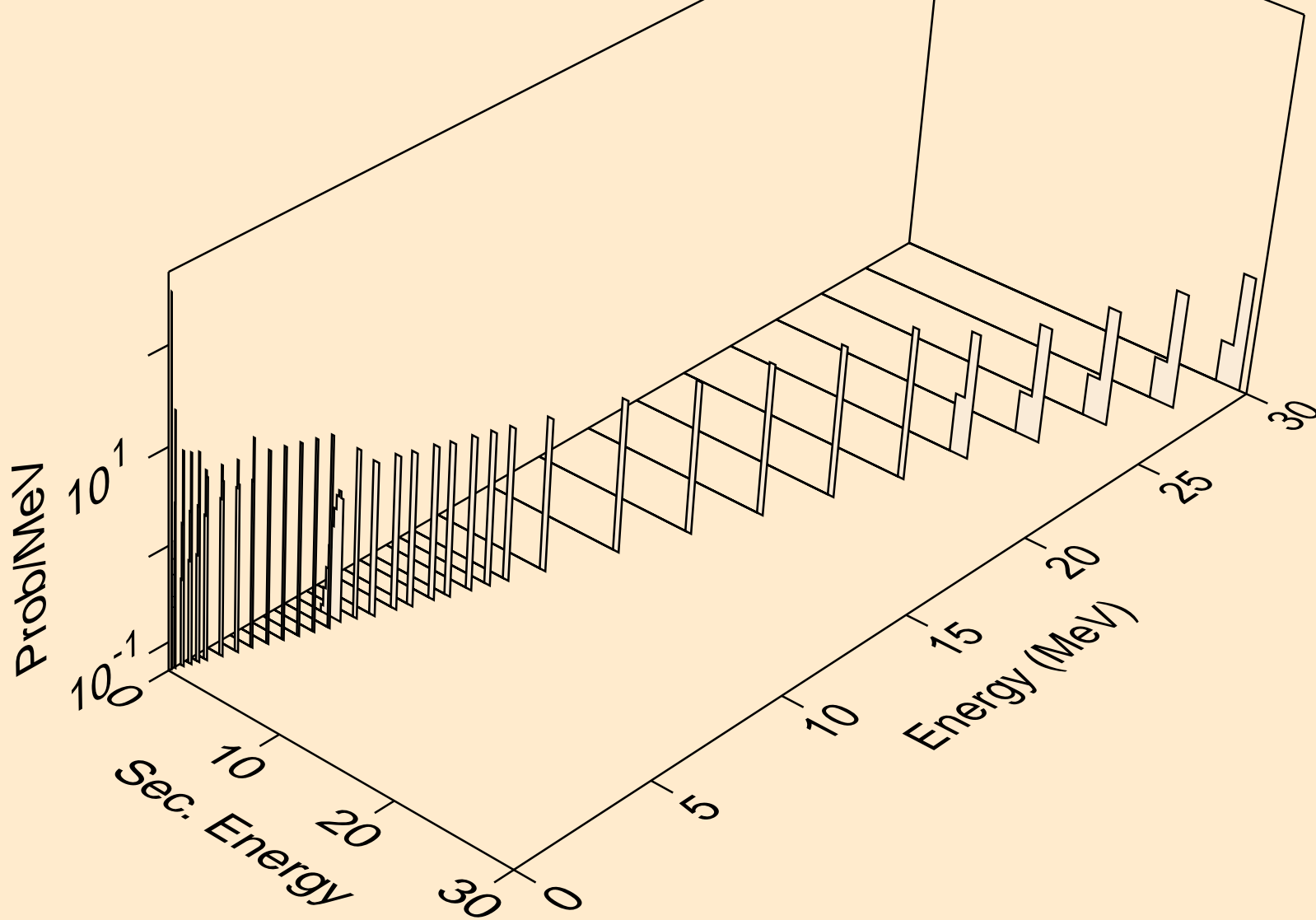

RG282 NEUTRON ACER TENDL-2019 LIBRARY; T=293.16K

Delayed nubar

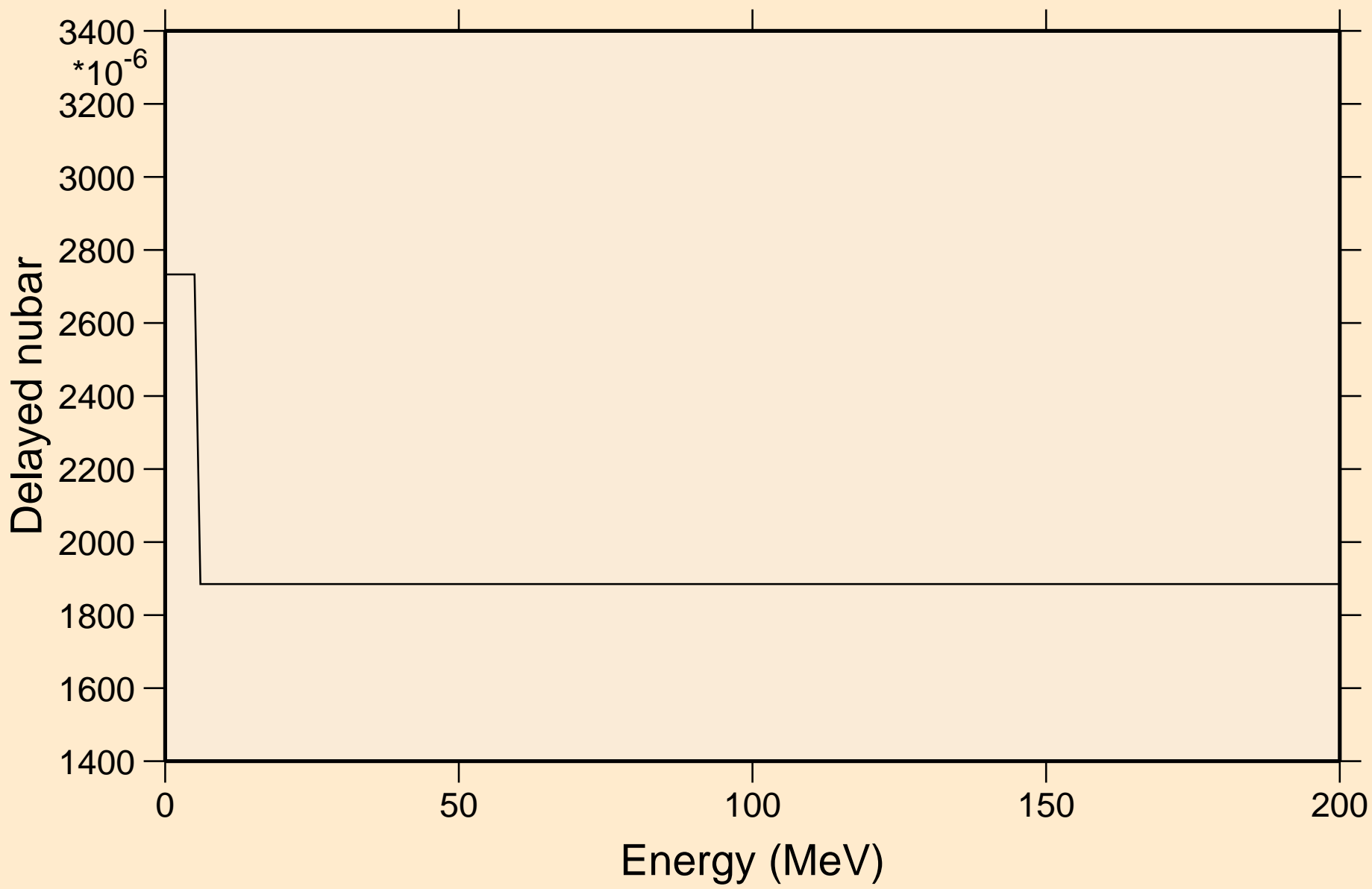

RG282 NEUTRON ACER TENDL-2019 LIBRARY; T=293.16K

Delayed neutron spectra

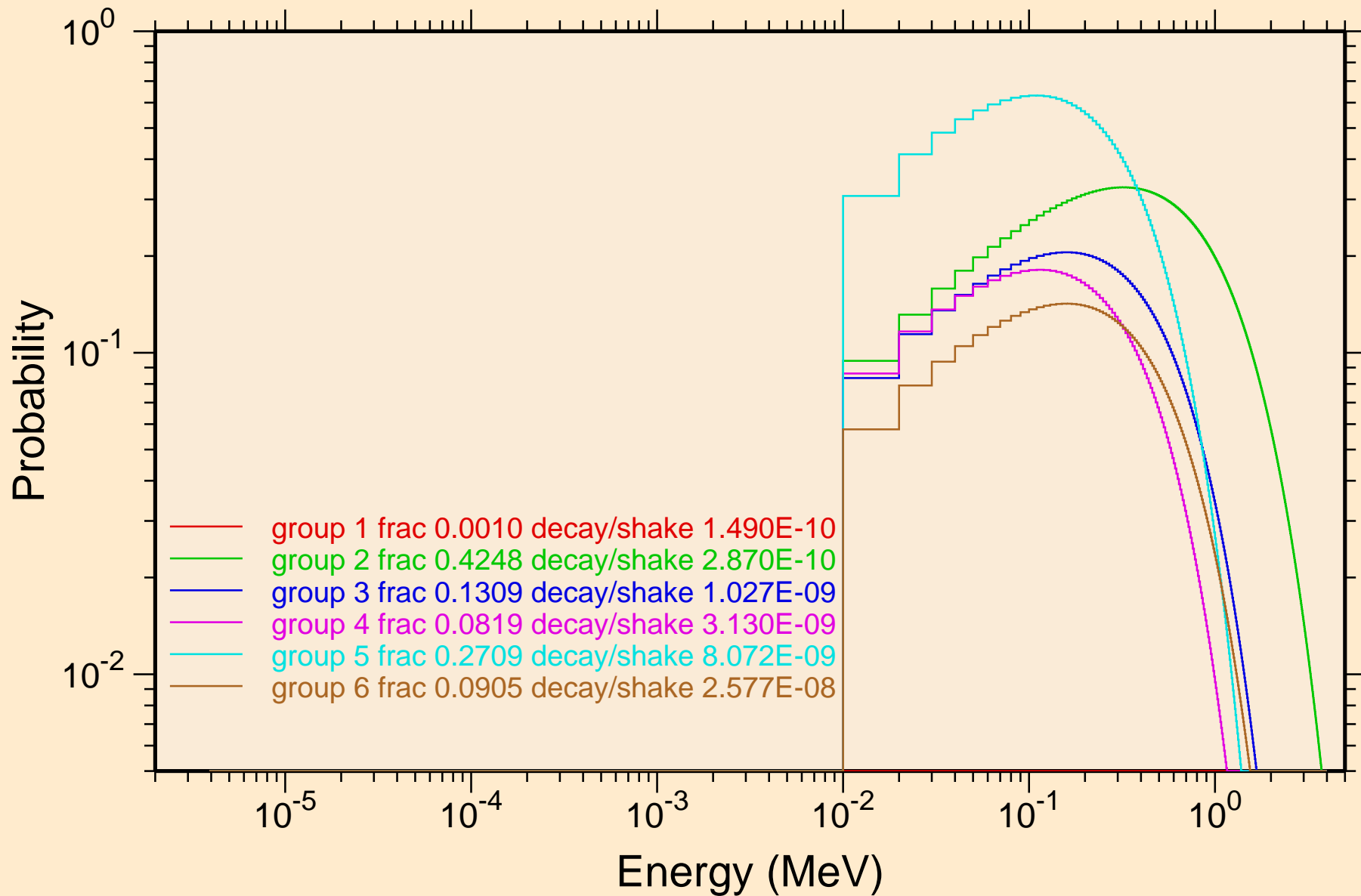

RG282 NEUTRON ACER TENDL-2019 LIBRARY; T=293.16K
Photon emission for (n,x)

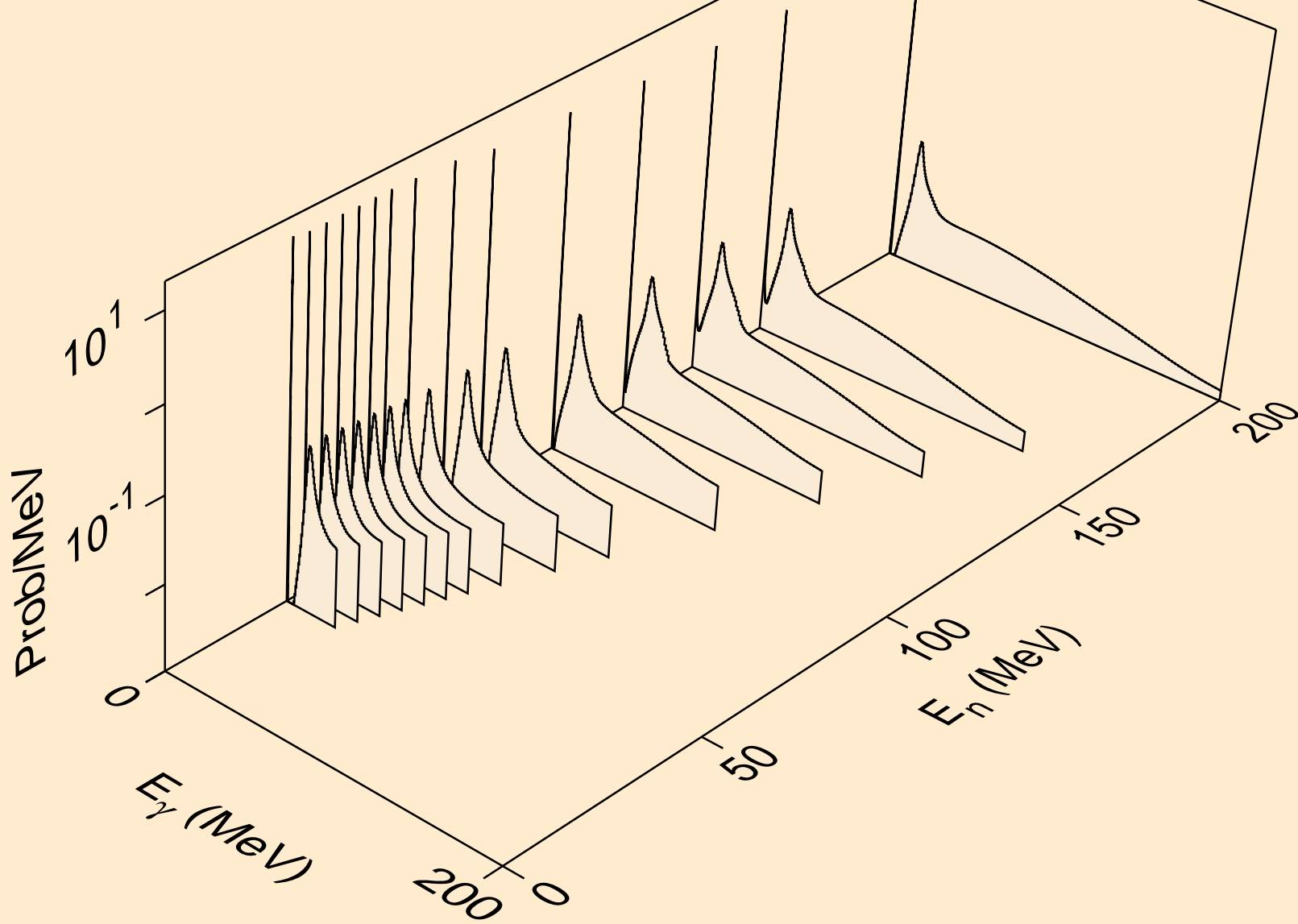

RG282 NEUTRON ACER TENDL-2019 LIBRARY; T=293.16K
Photon emission for (n,2n)

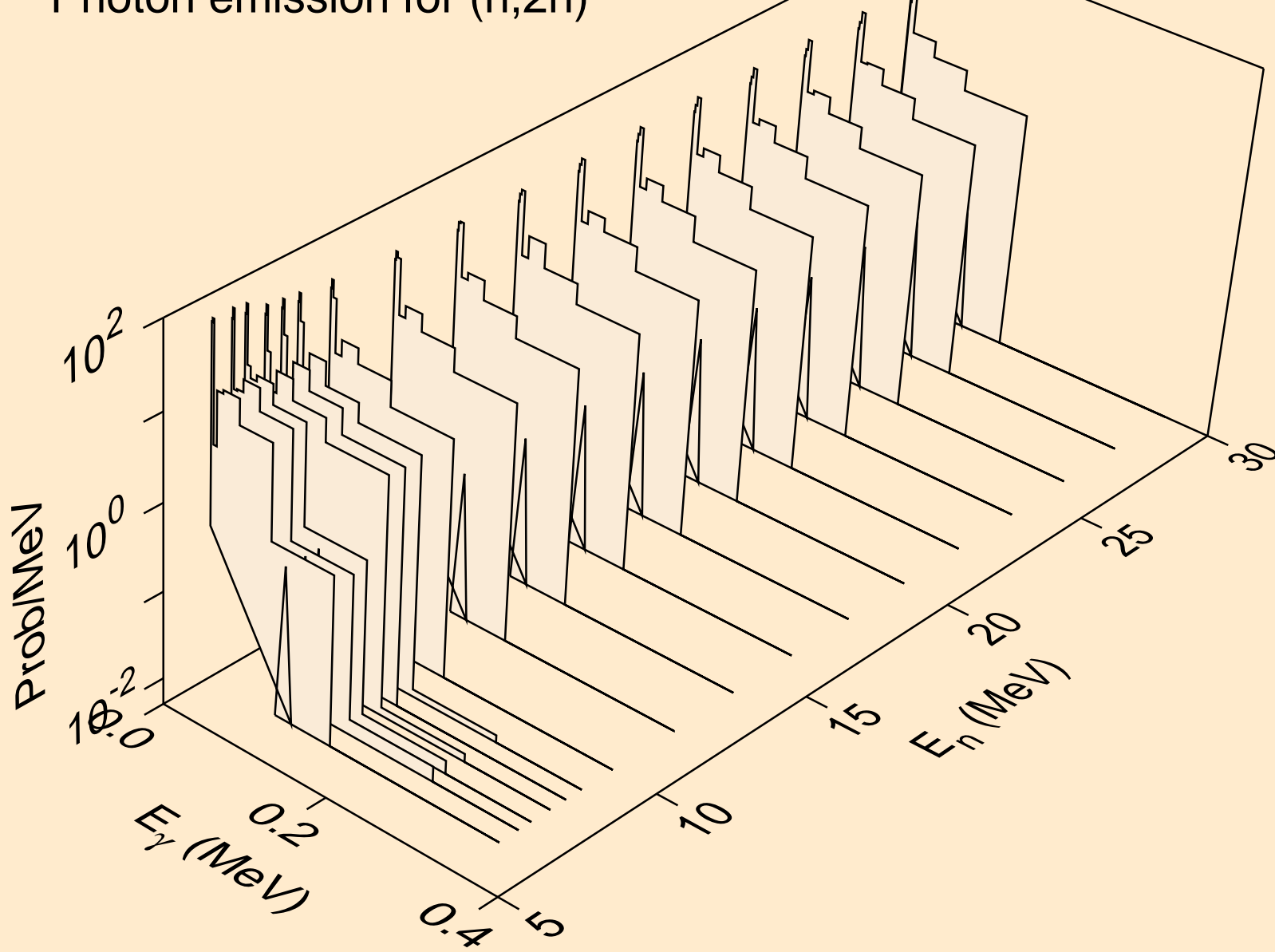

RG282 NEUTRON ACER TENDL-2019 LIBRARY; T=293.16K
Photon emission for (n,3n)

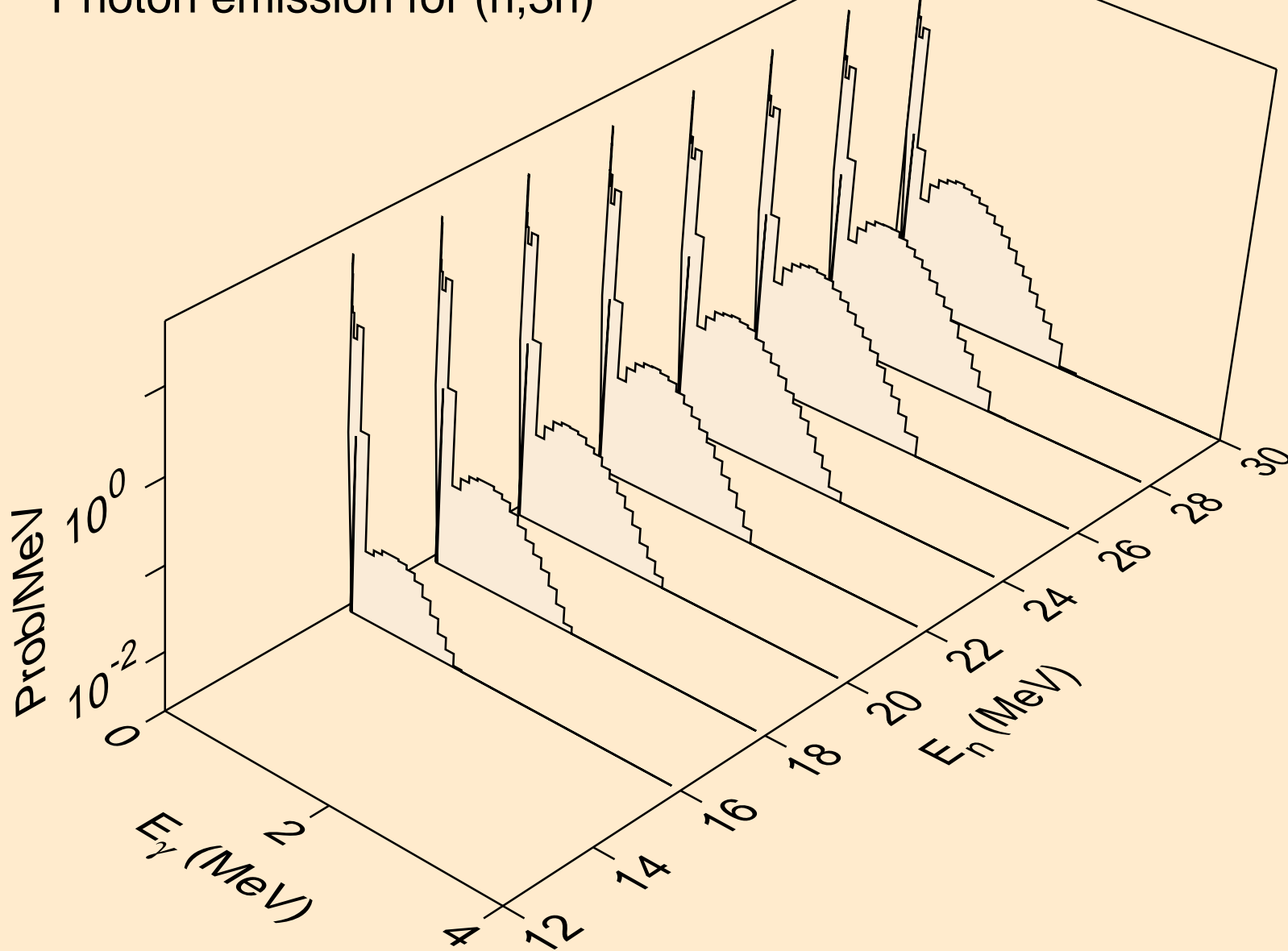

RG282 NEUTRON ACER TENDL-2019 LIBRARY; T=293.16K
Photon emission for (n,n*)a

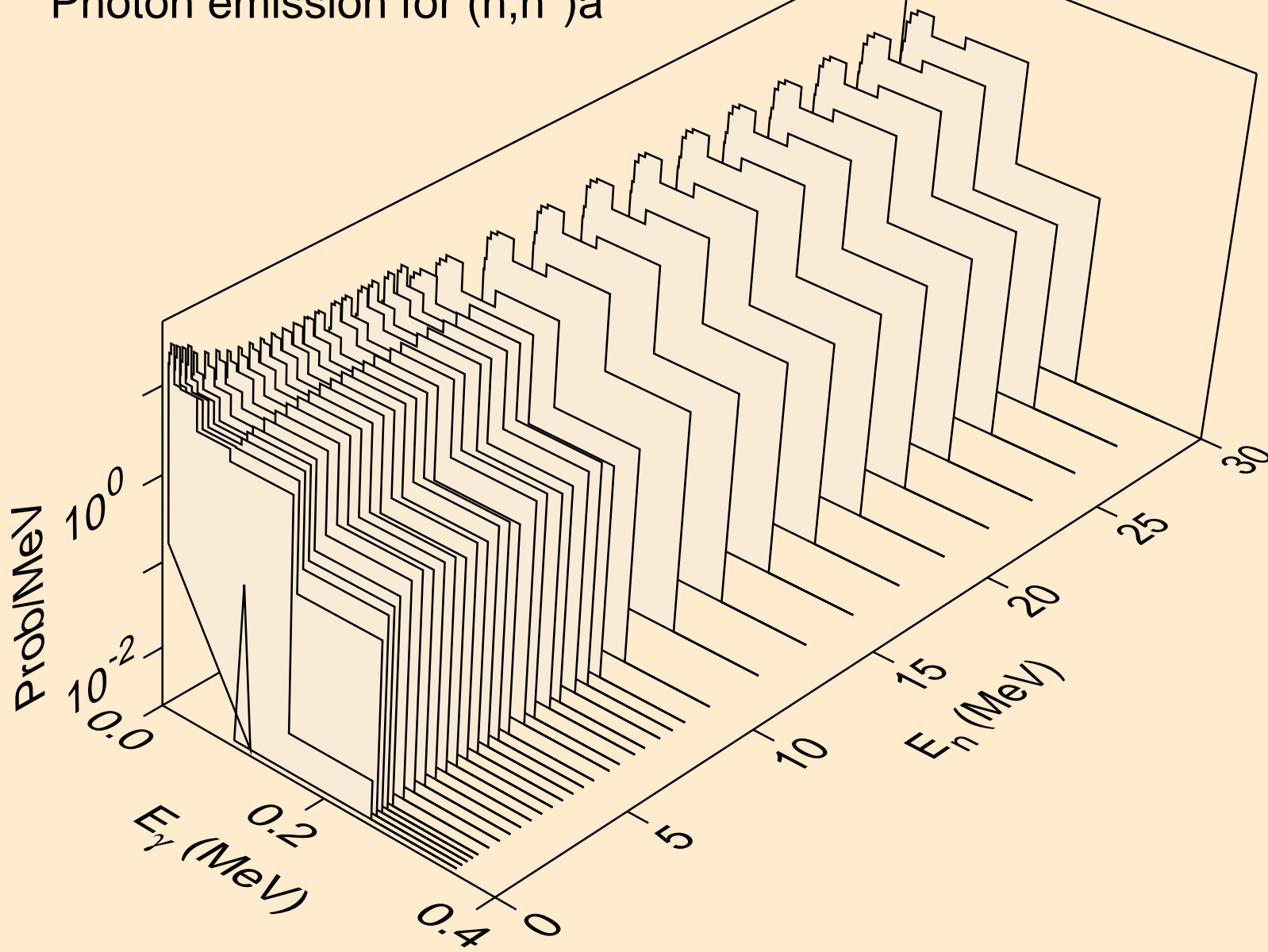

RG282 NEUTRON ACER TENDL-2019 LIBRARY; T=293.16K
Photon emission for (n,2n)a

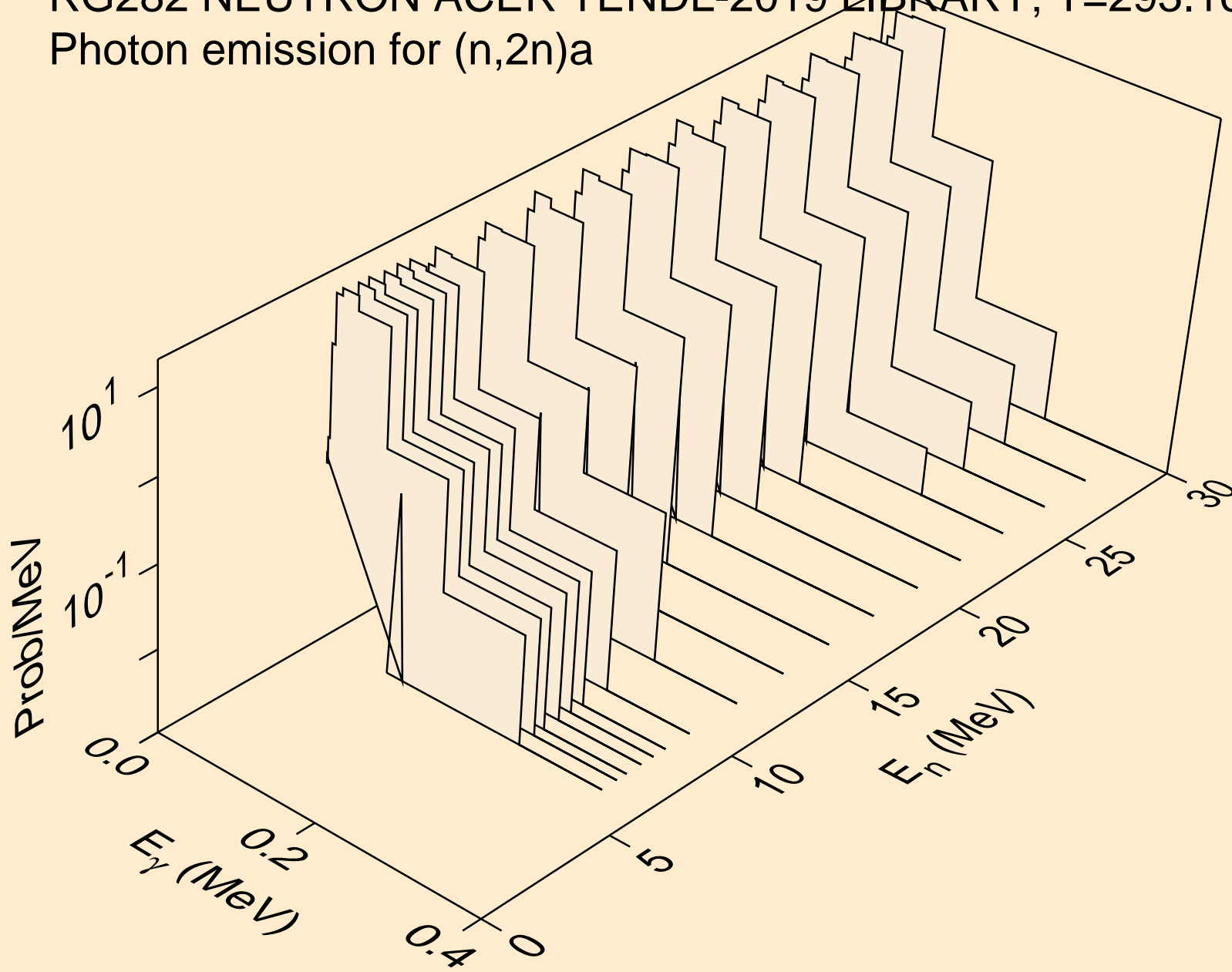

RG282 NEUTRON ACER TENDL-2019 LIBRARY; T=293.16K
Photon emission for (n,2n)2a

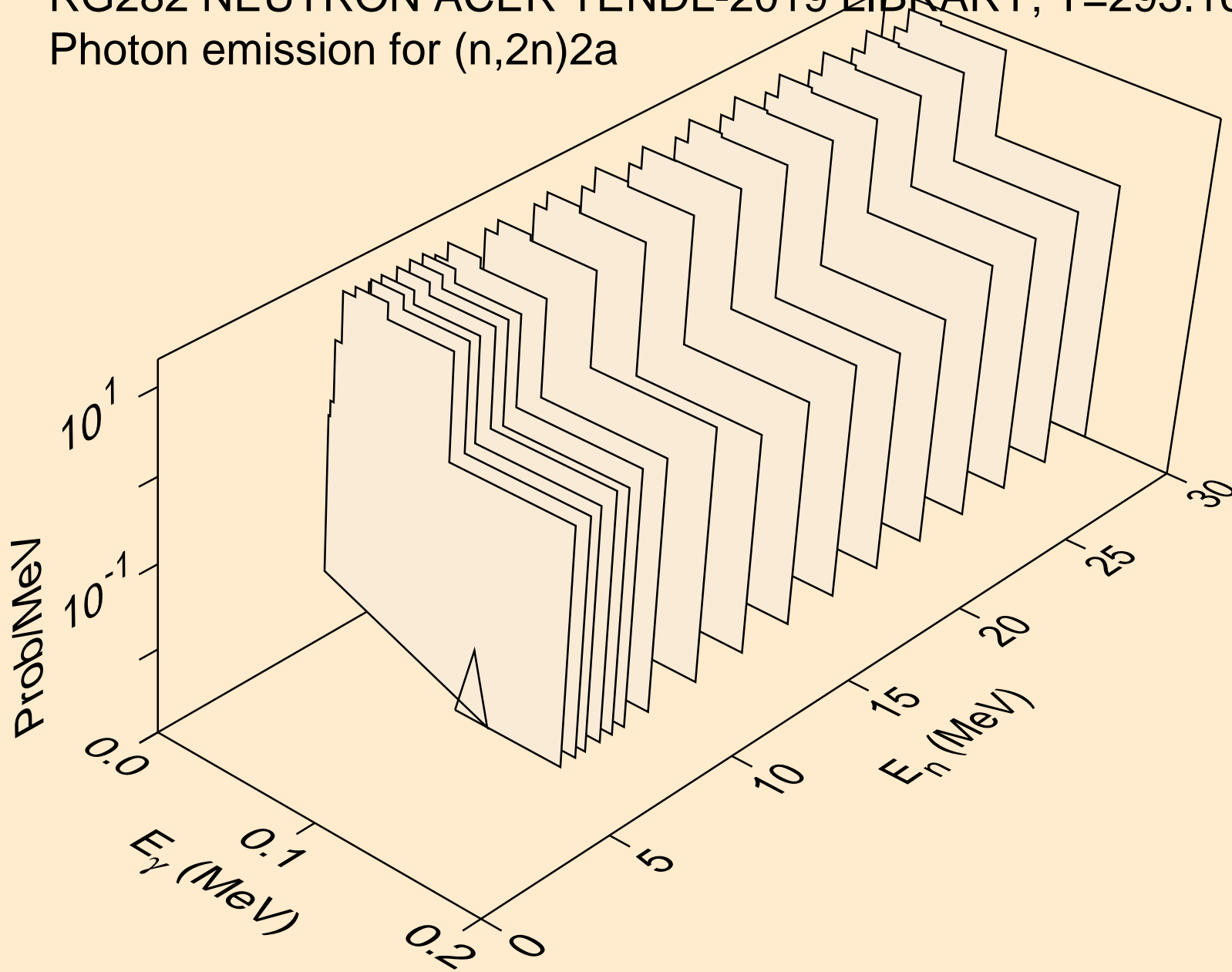

RG282 NEUTRON ACER TENDL-2019 LIBRARY; T=293.16K
Photon emission for (n,n*)d

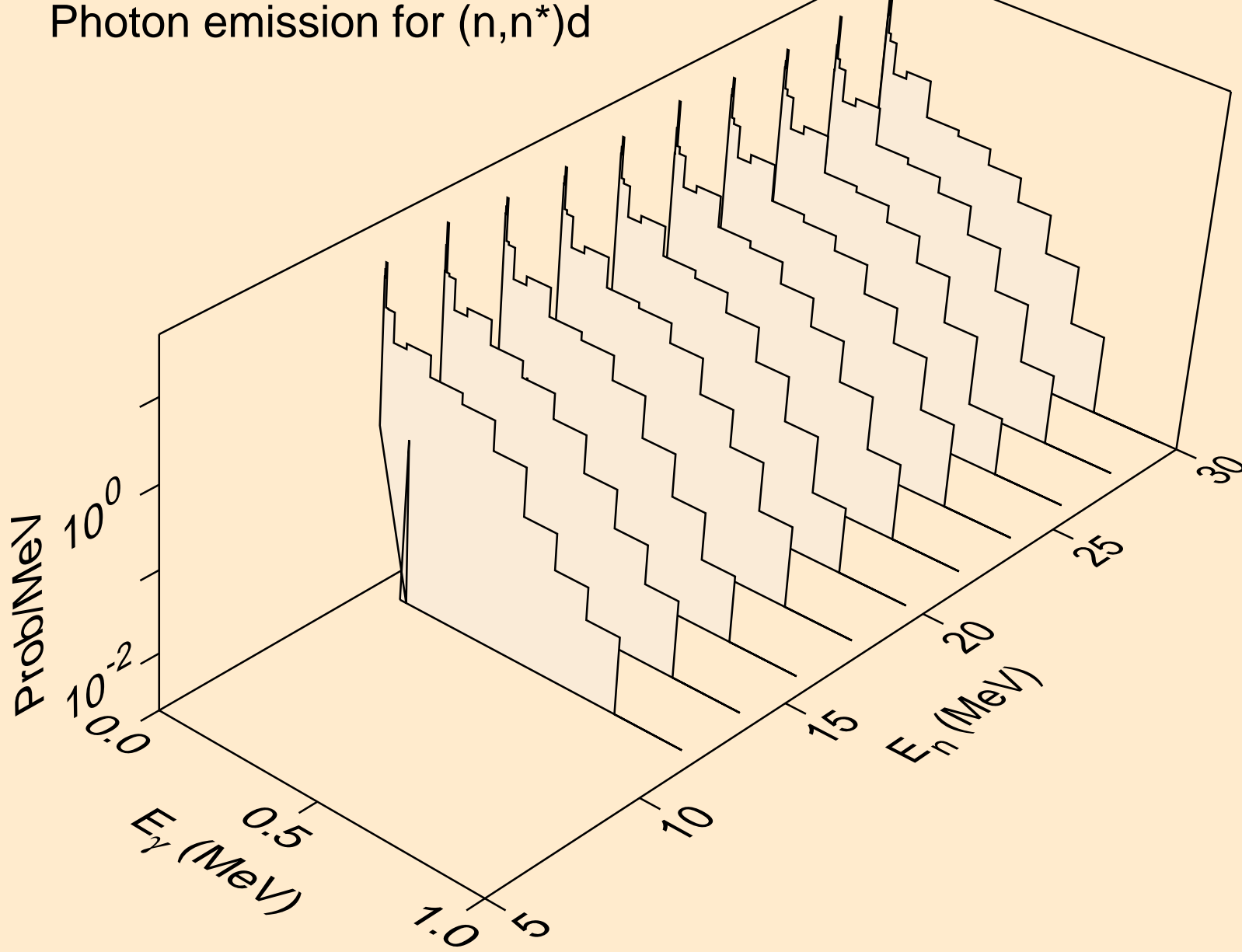

RG282 NEUTRON ACER TENDL-2019 LIBRARY; T=293.16K
Photon emission for (n,2np)

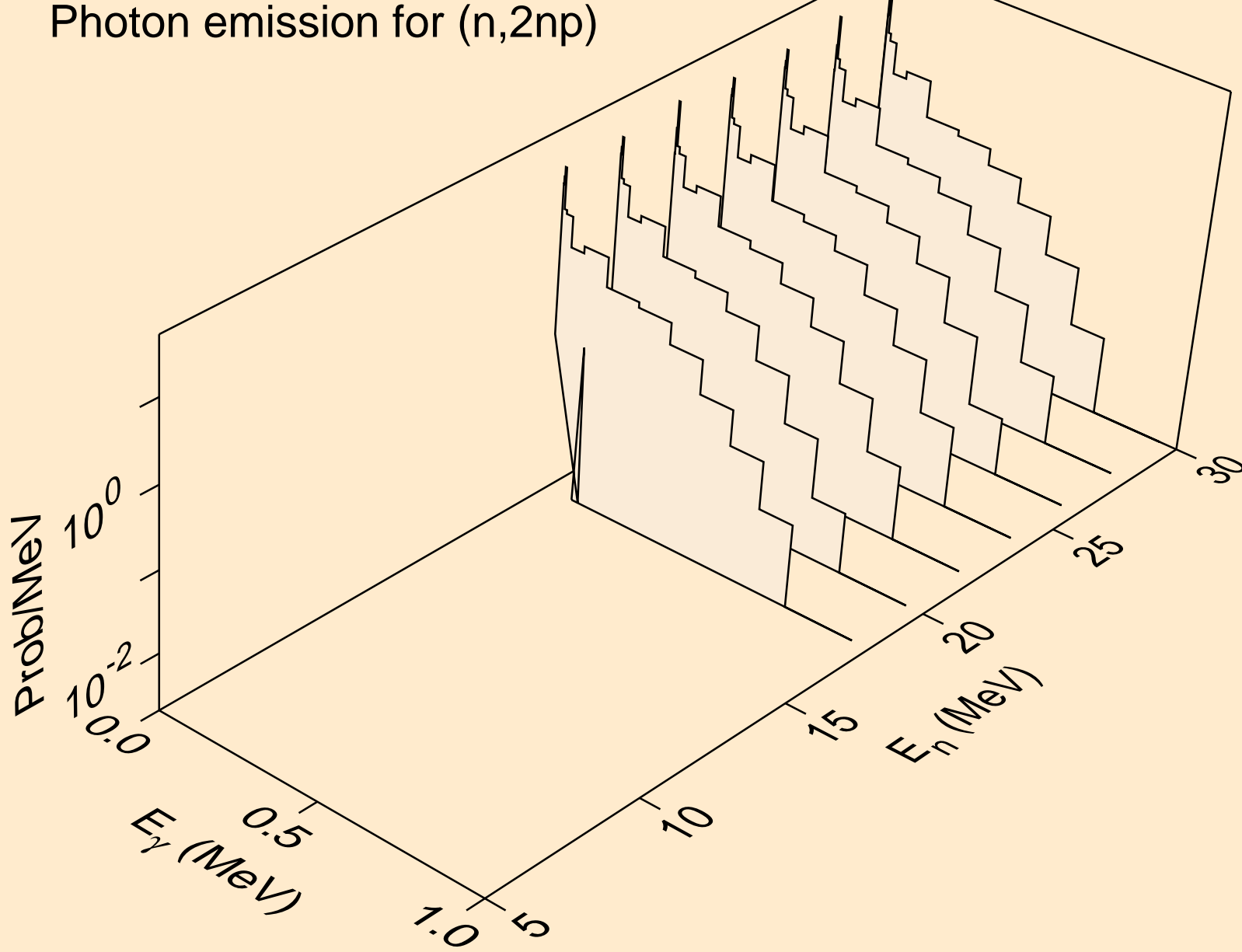

RG282 NEUTRON ACER TENDL-2019 LIBRARY; T=293.16K
Photon emission for (n,n*c)

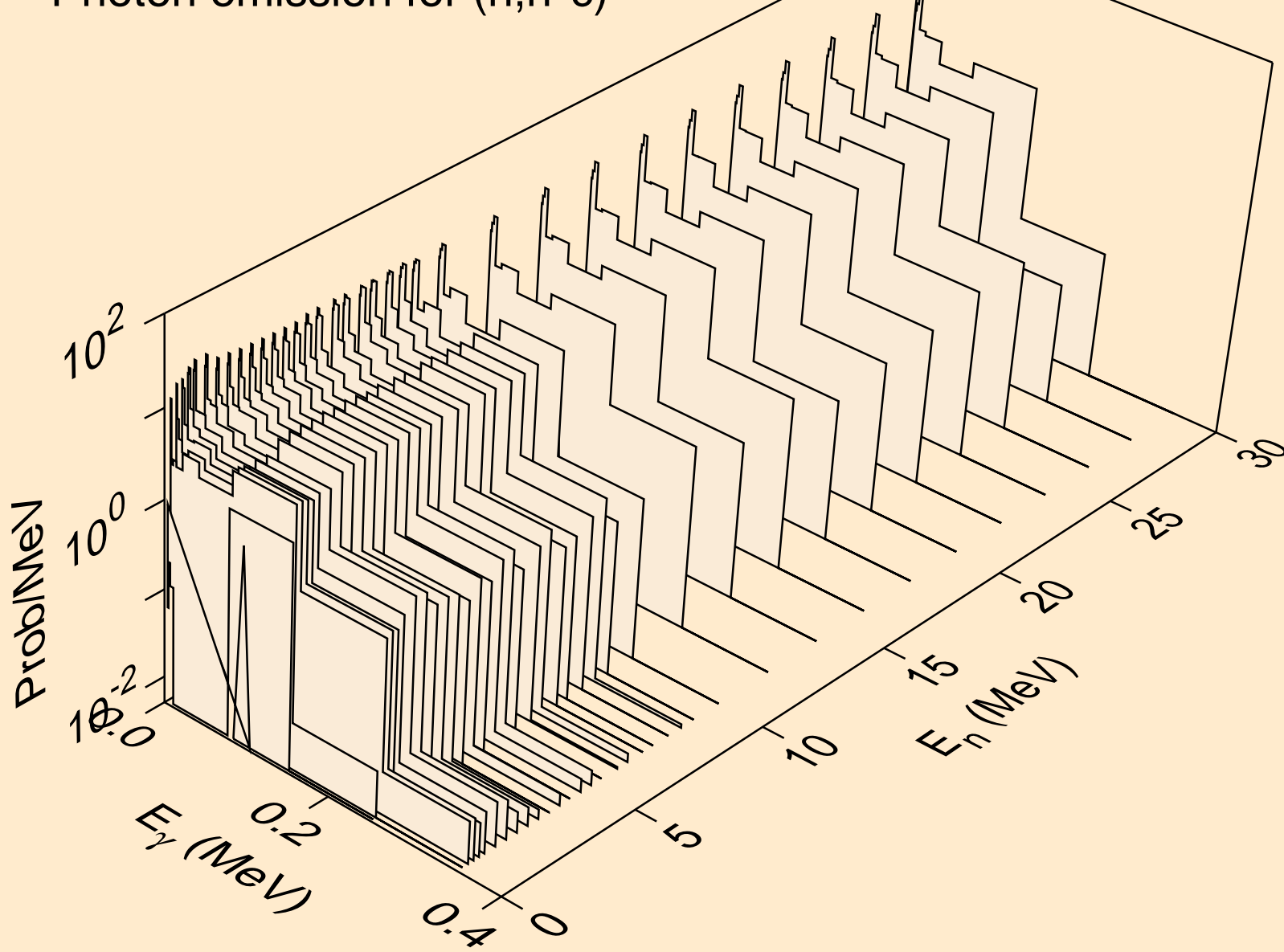

RG282 NEUTRON ACER TENDL-2019 LIBRARY; T=293.16K
Photon emission for (n,gma)

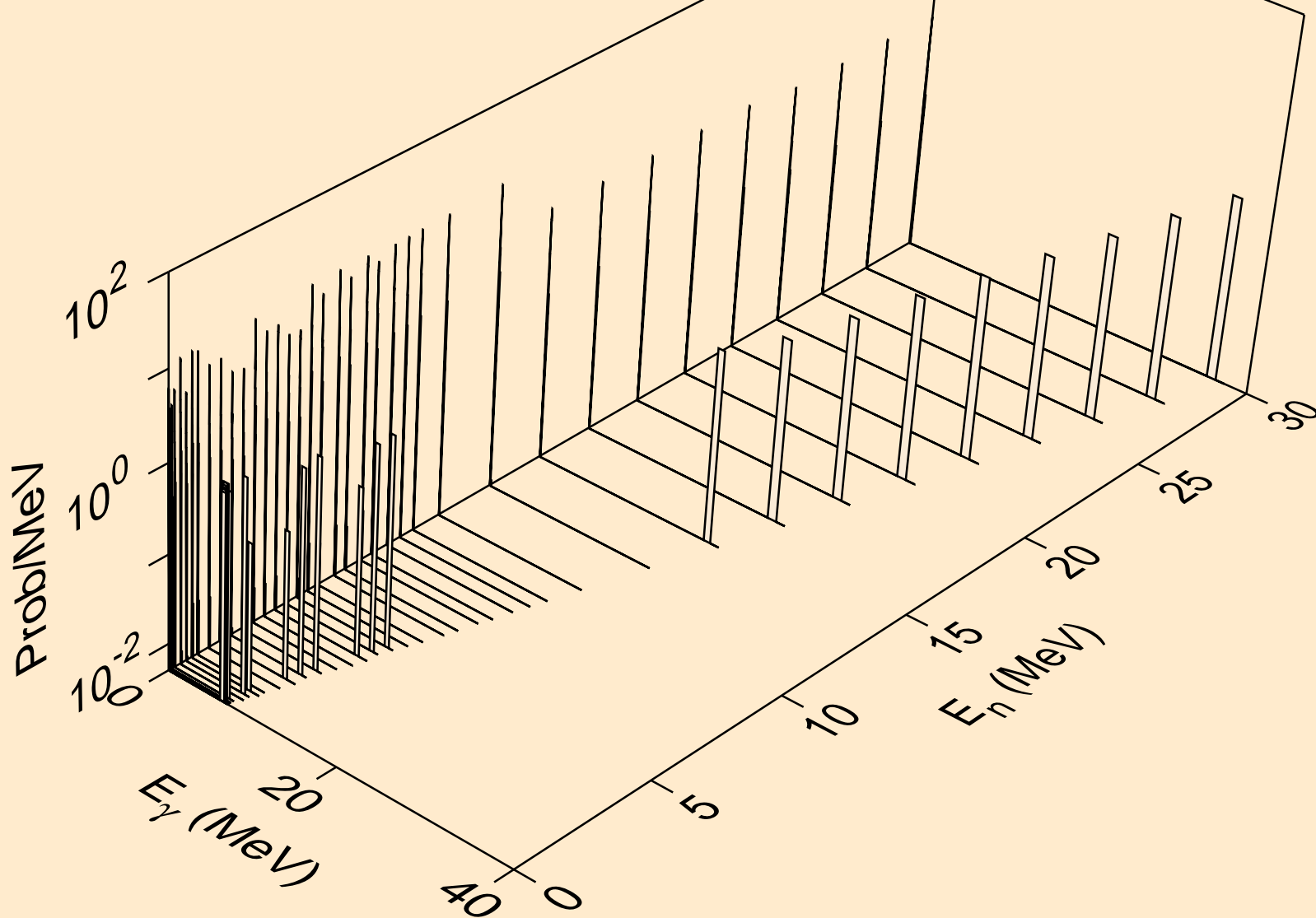

RG282 NEUTRON ACER TENDL-2019 LIBRARY; T=293.16K
Photon emission for (n,p)

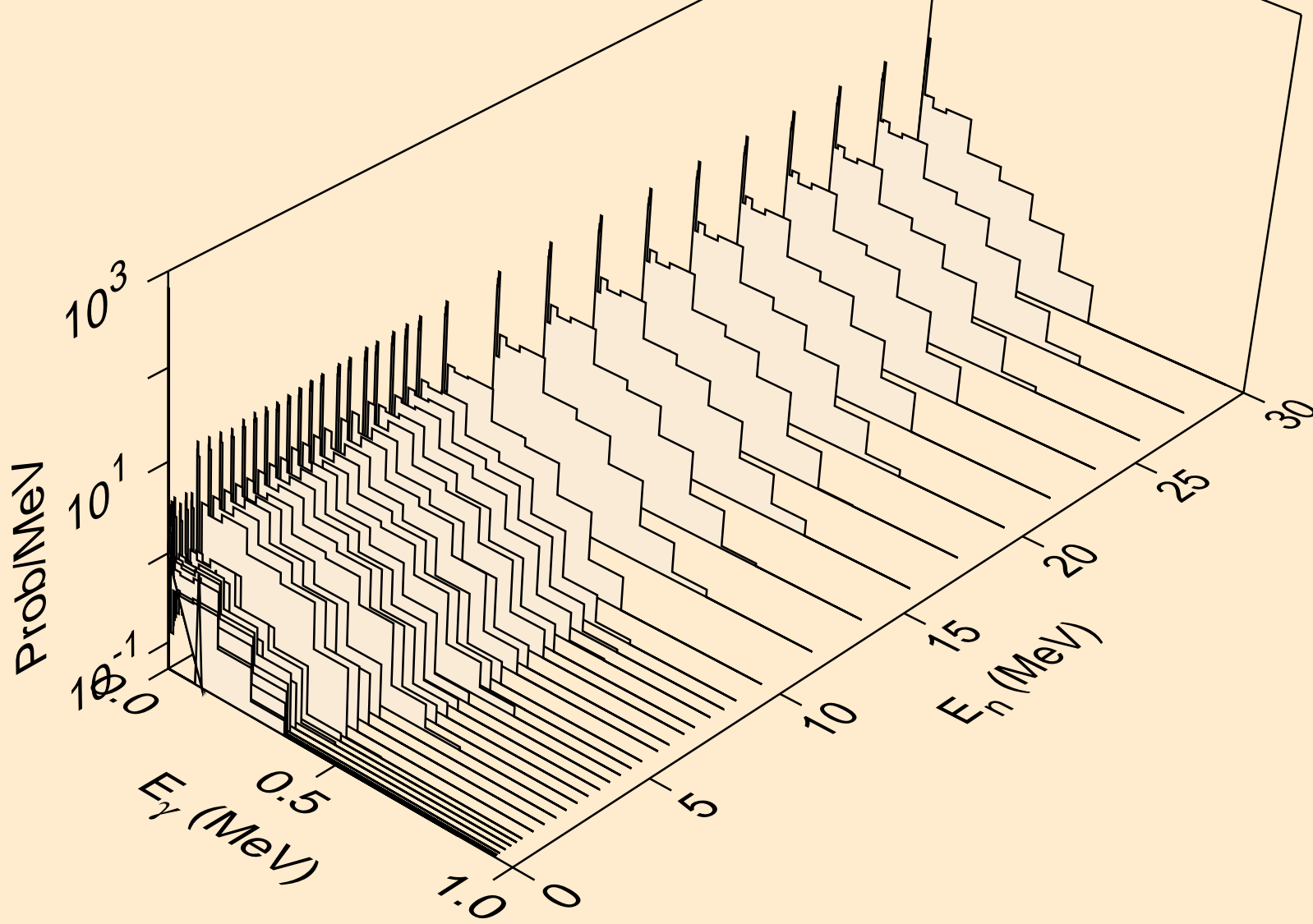

RG282 NEUTRON ACER TENDL-2019 LIBRARY; T=293.16K
Photon emission for (n,d)

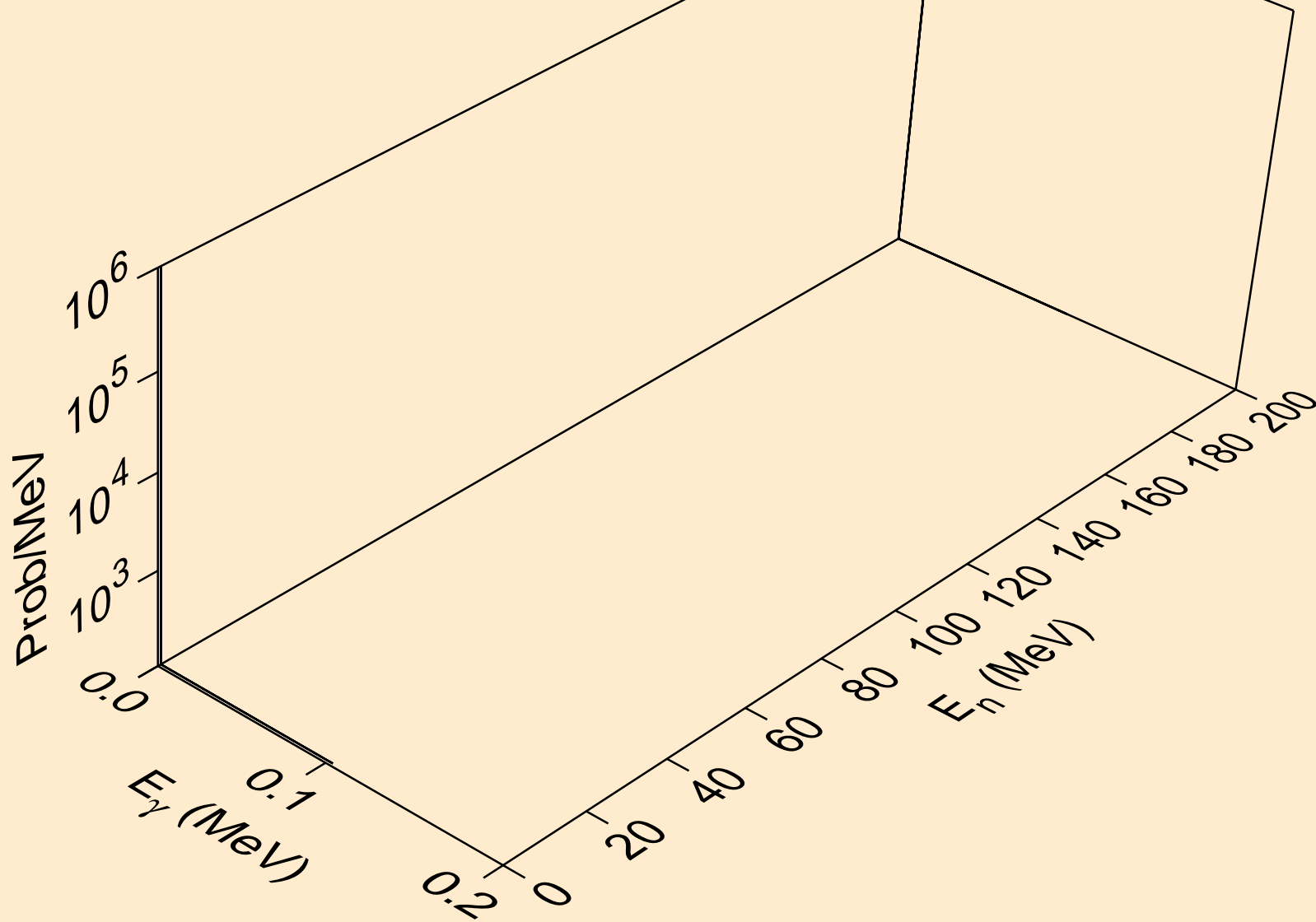

RG282 NEUTRON ACER TENDL-2019 LIBRARY; T=293.16K
Photon emission for (n,t)

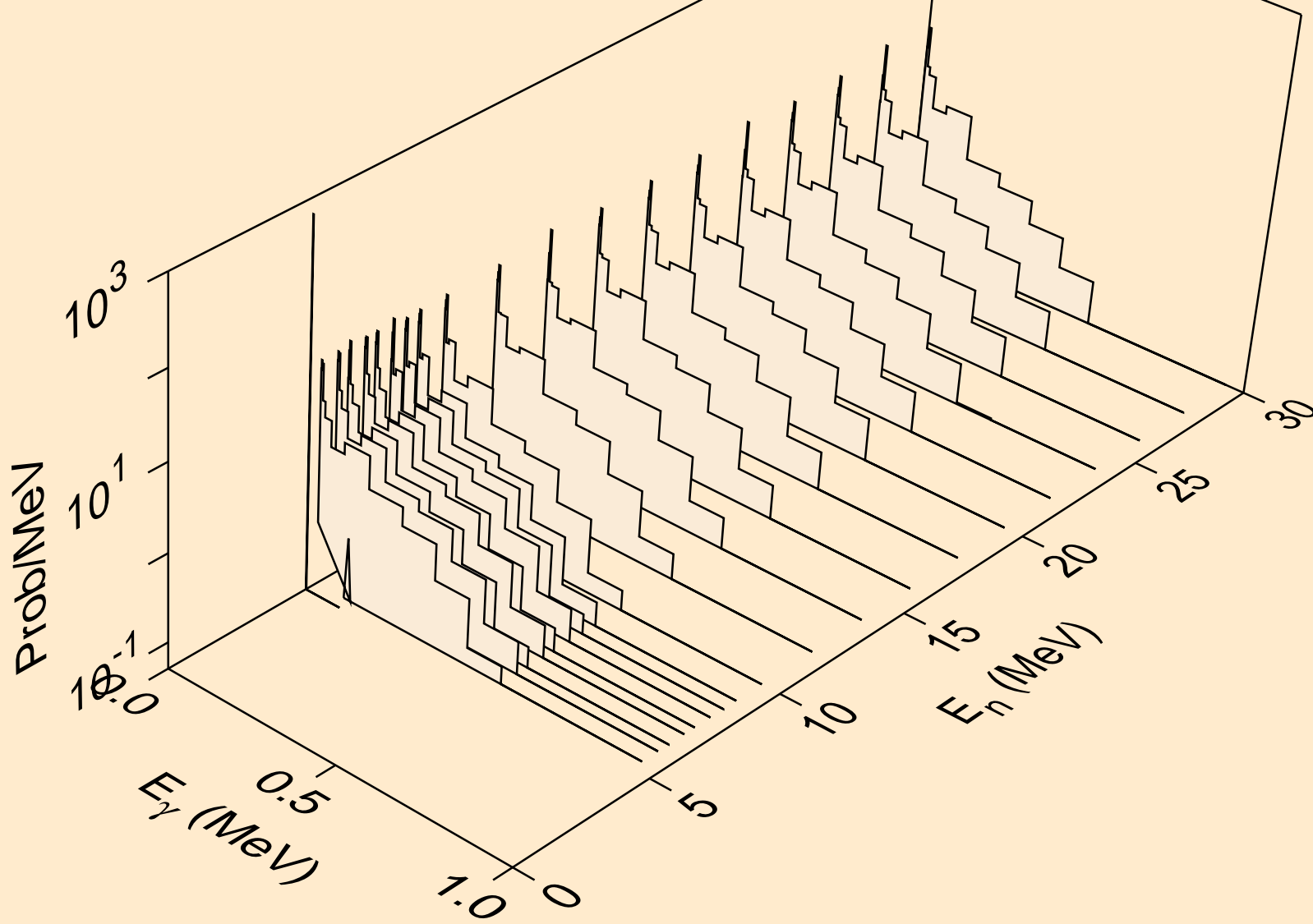

RG282 NEUTRON ACER TENDL-2019 LIBRARY; T=293.16K
Photon emission for (n,he3)

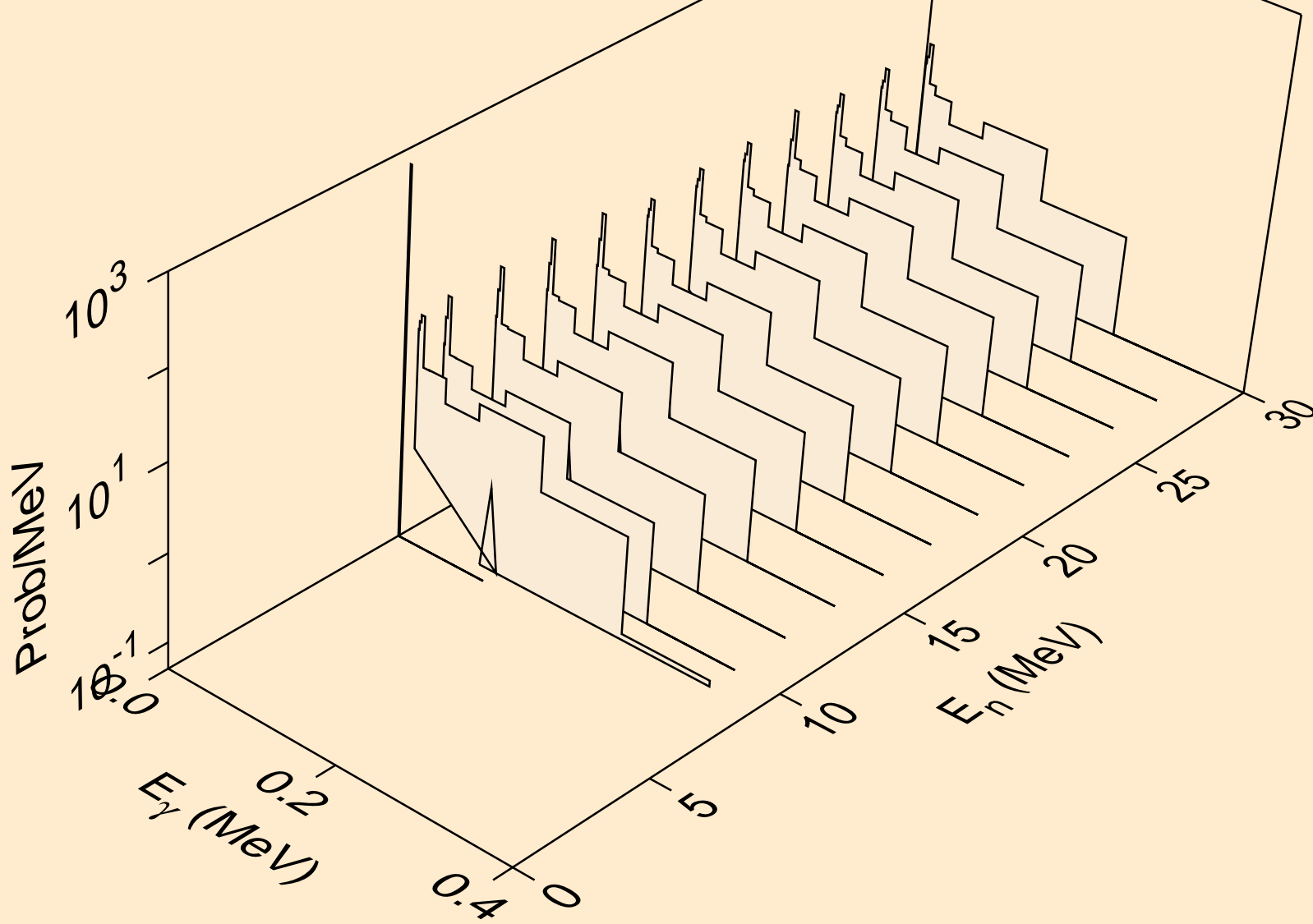

RG282 NEUTRON ACER TENDL-2019 LIBRARY; T=293.16K
Photon emission for (n,a)

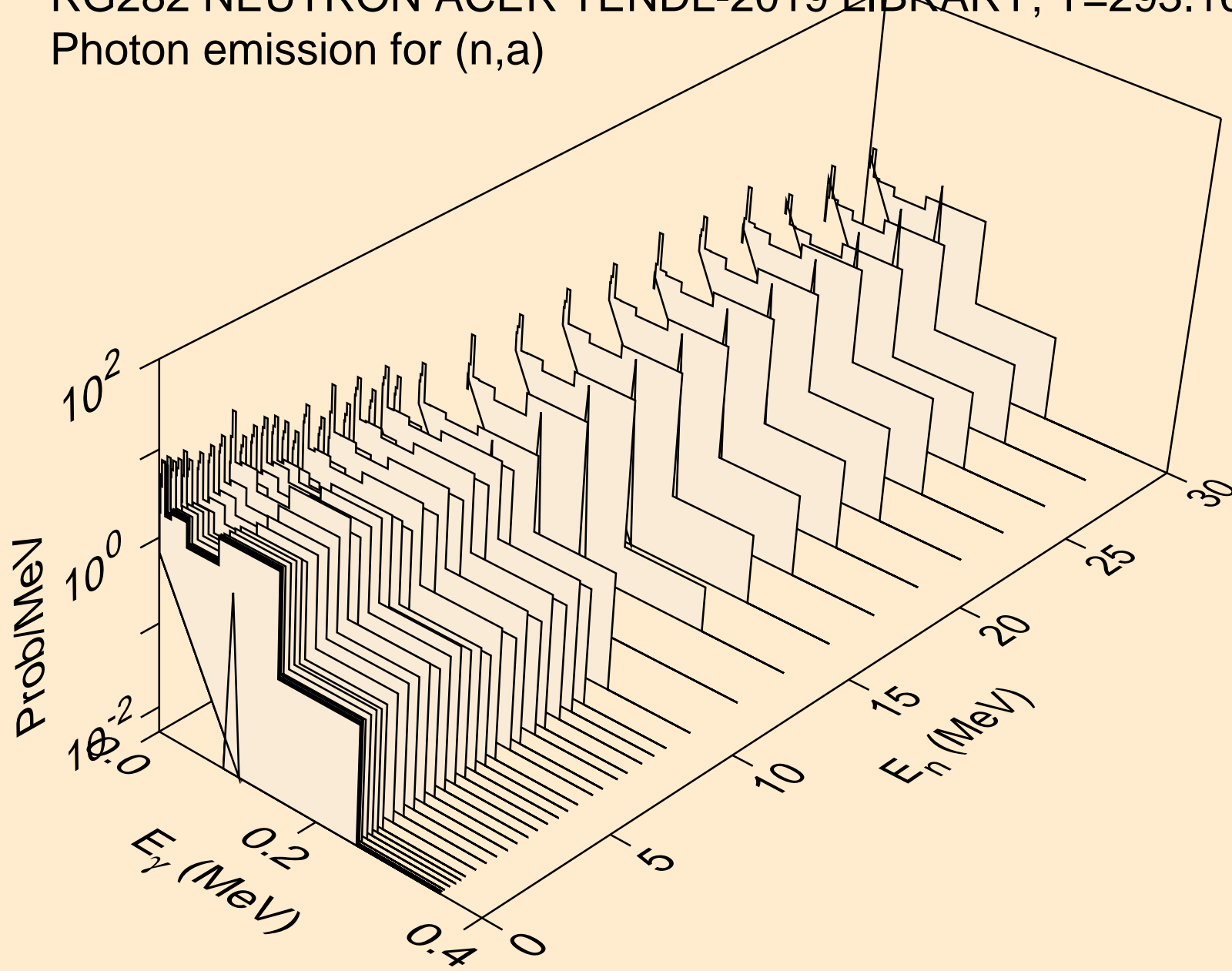

RG282 NEUTRON ACER TENDL-2019 LIBRARY; T=293.16K
Photon emission for (n,2a)

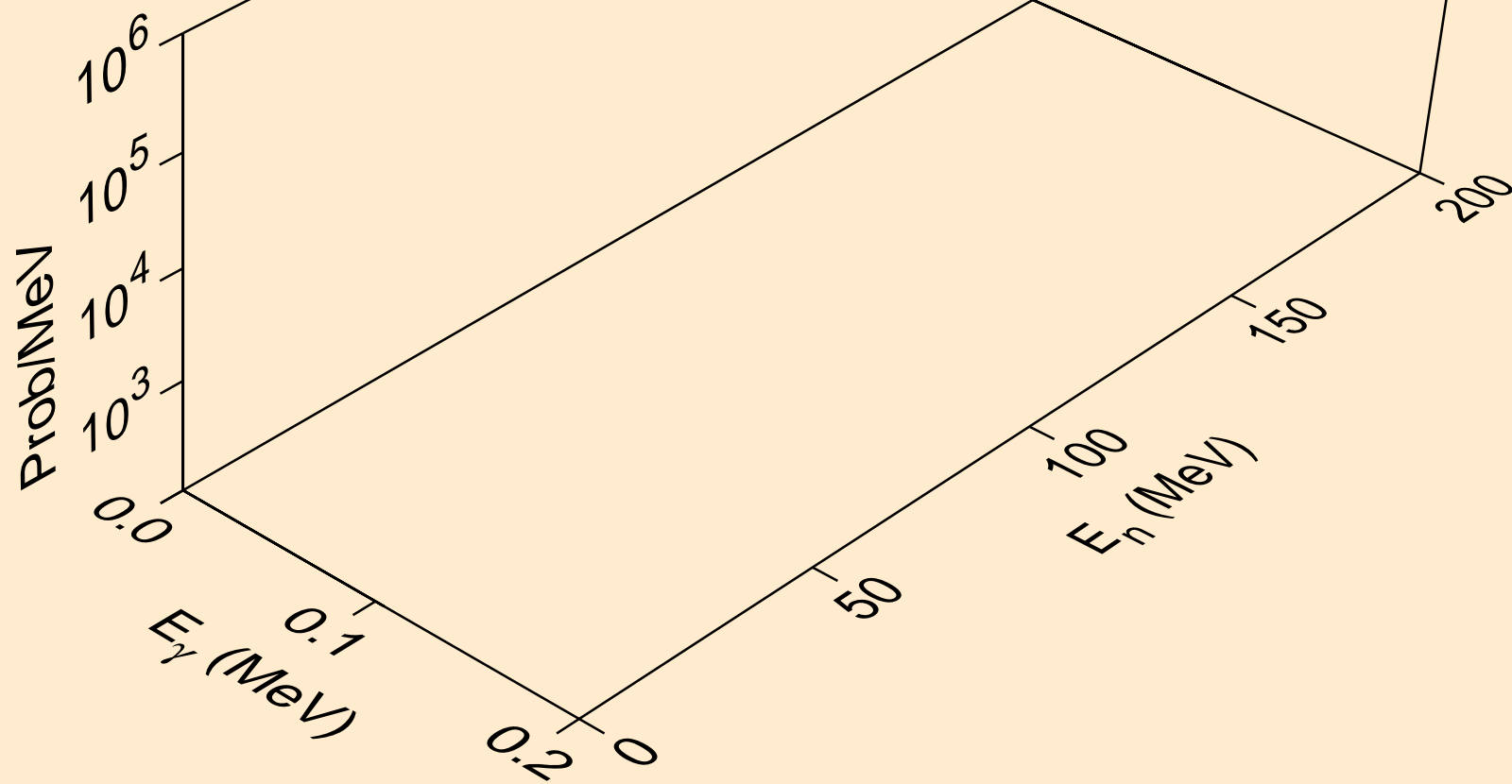

RG282 NEUTRON ACER TENDL-2019 LIBRARY; T=293.16K
Photon emission for (n,p)

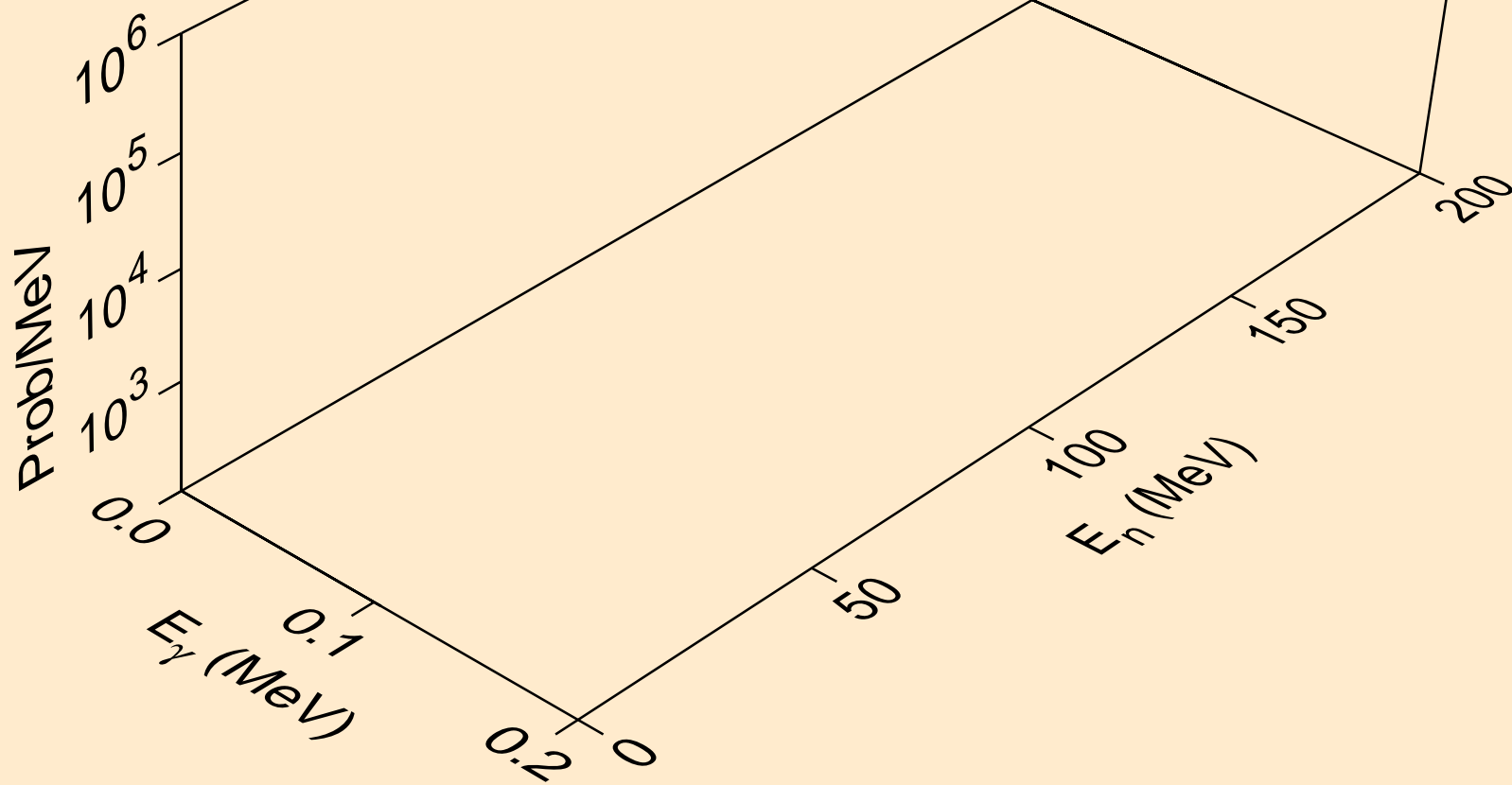

RG282 NEUTRON ACER TENDL-2019 LIBRARY; T=293.16K
thermal capture photon spectrum

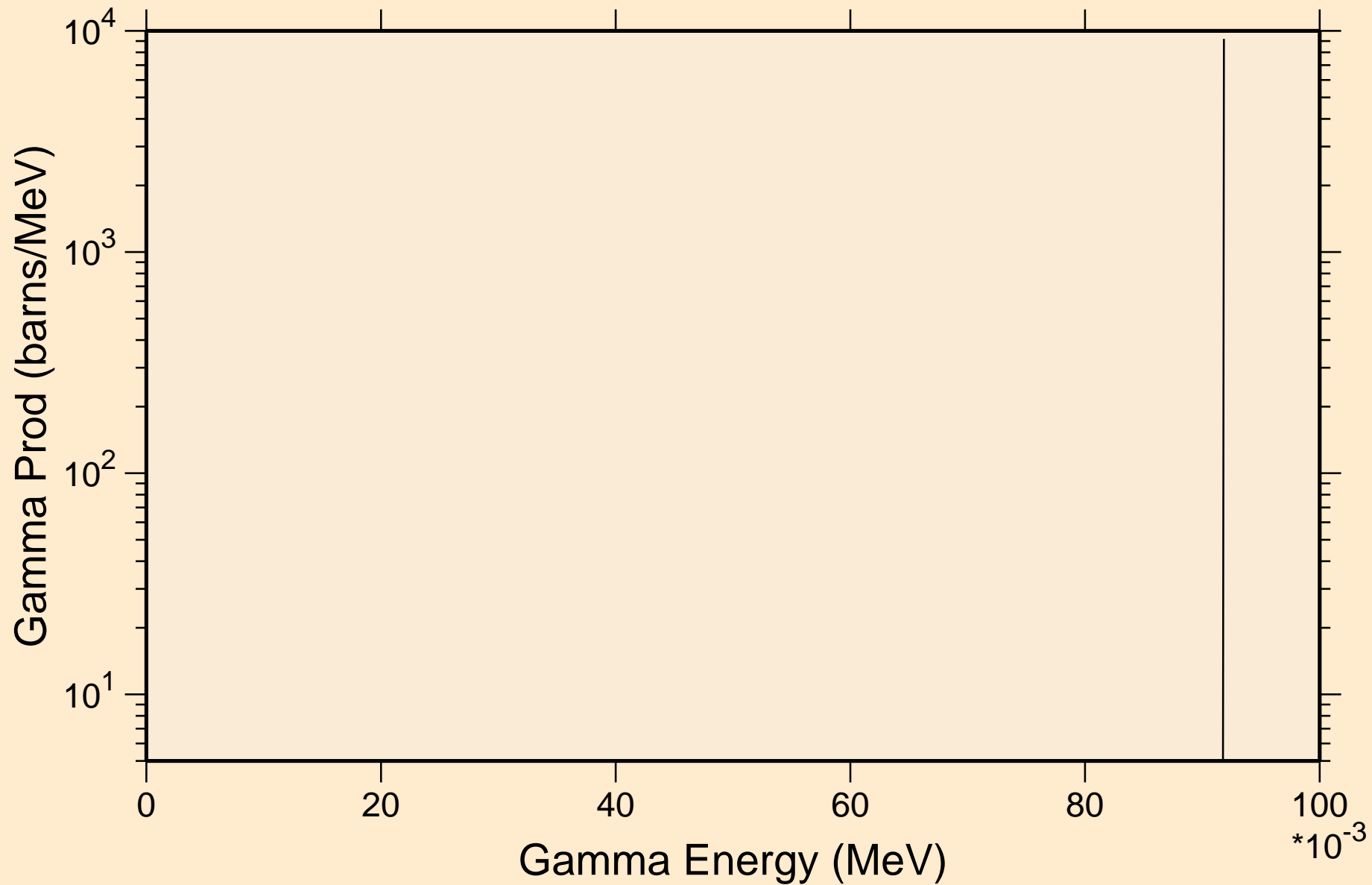

RG282 NEUTRON ACER TENDL-2019 LIBRARY; T=293.16K
14 MeV photon spectrum

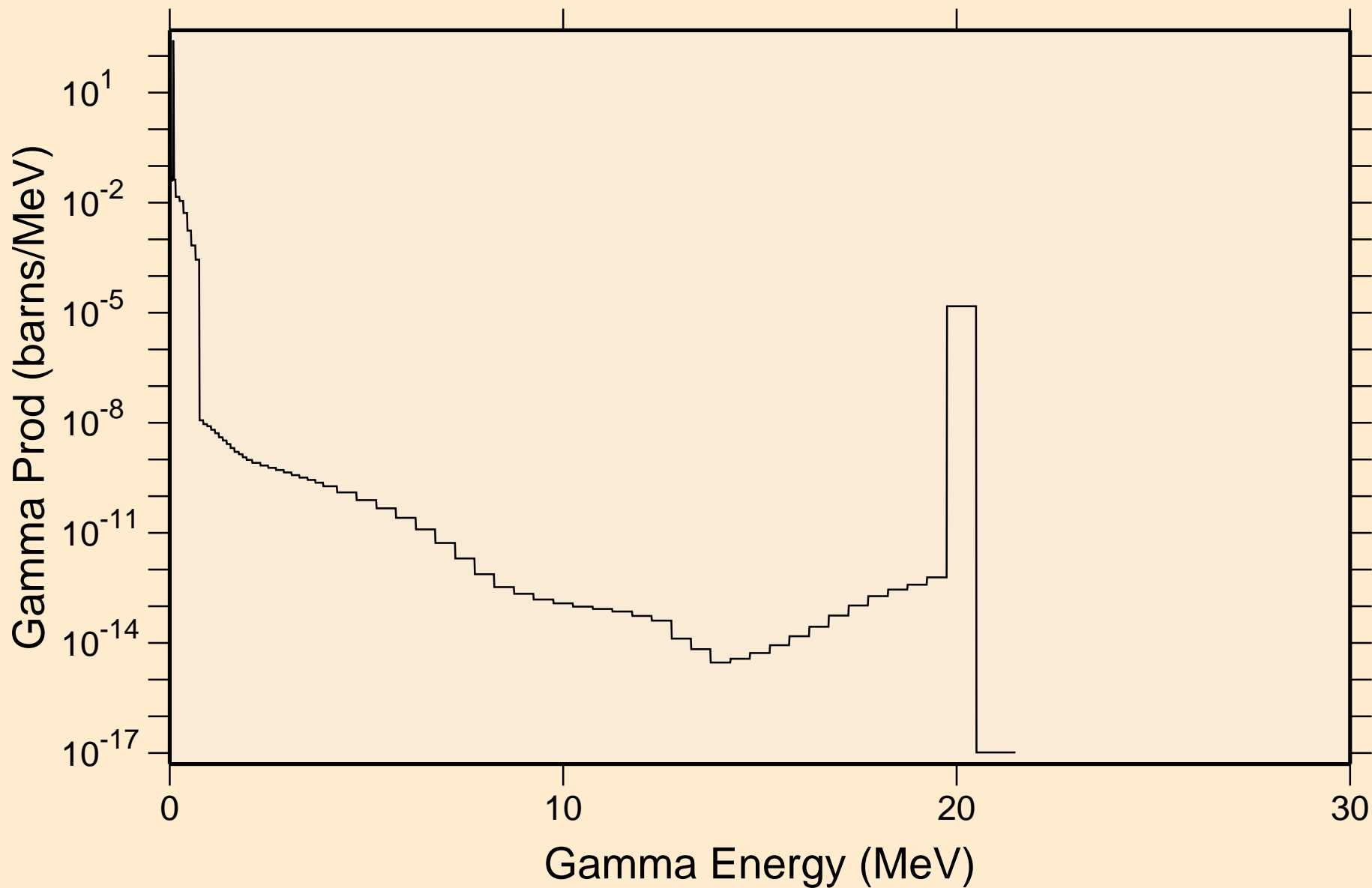

RG282 NEUTRON ACER TENDL-2019 LIBRARY; T=293.16K
Particle heating contributions

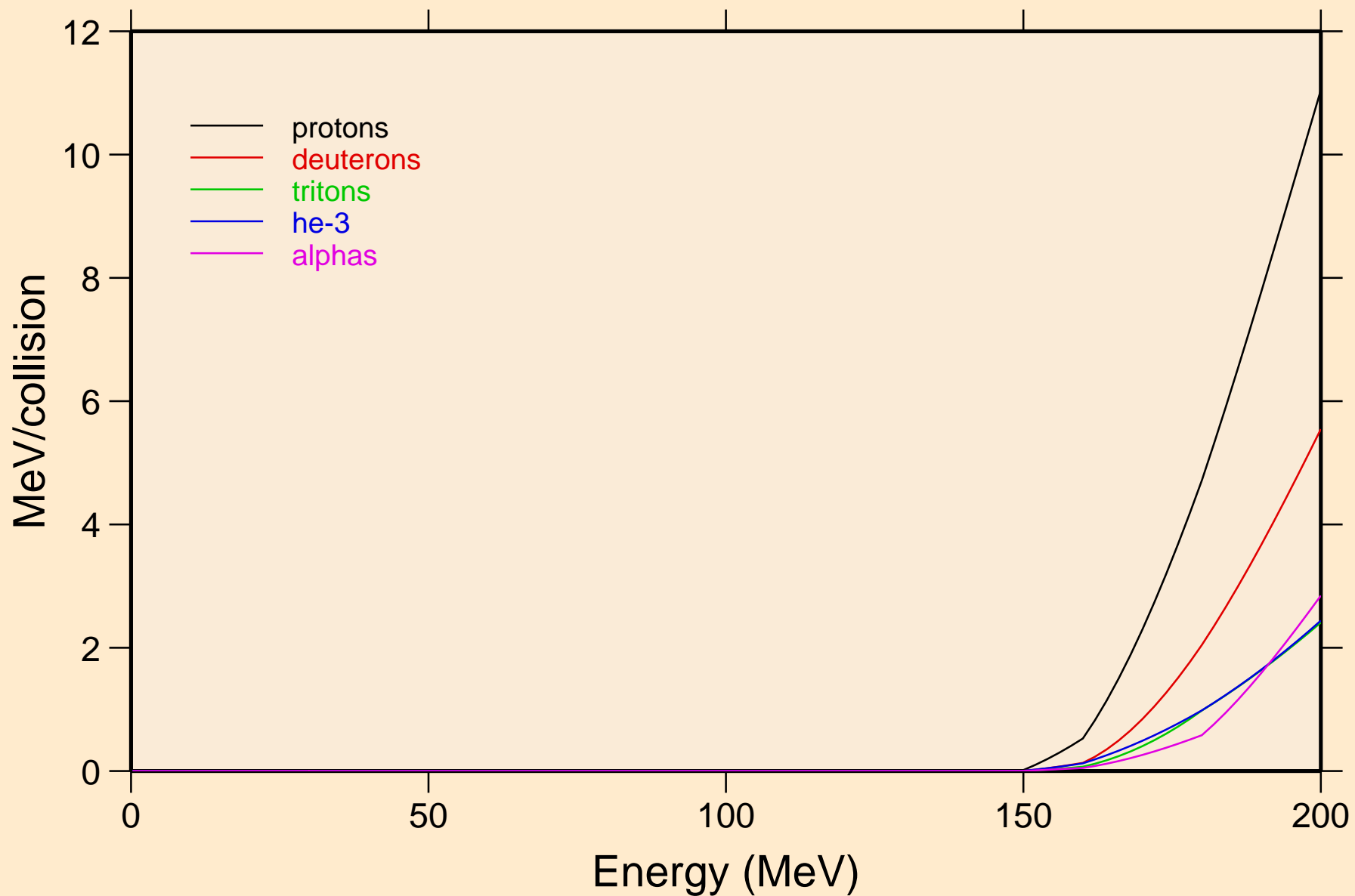

RG282 NEUTRON ACER TENDL-2019 LIBRARY; T=293.16K
Recoil Heating

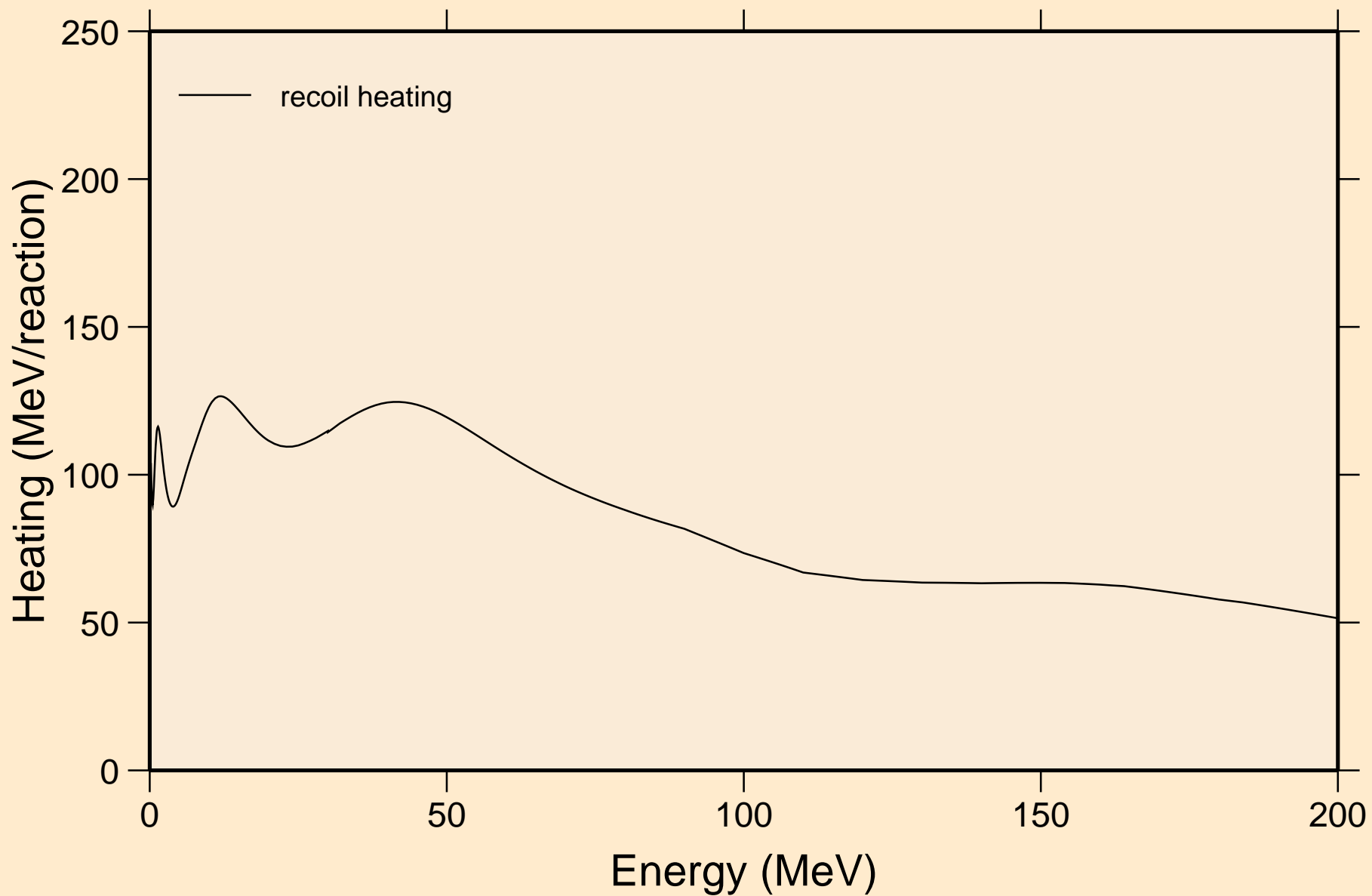

RG282 NEUTRON ACER TENDL-2019 LIBRARY; T=293.16K
Particle production cross sections

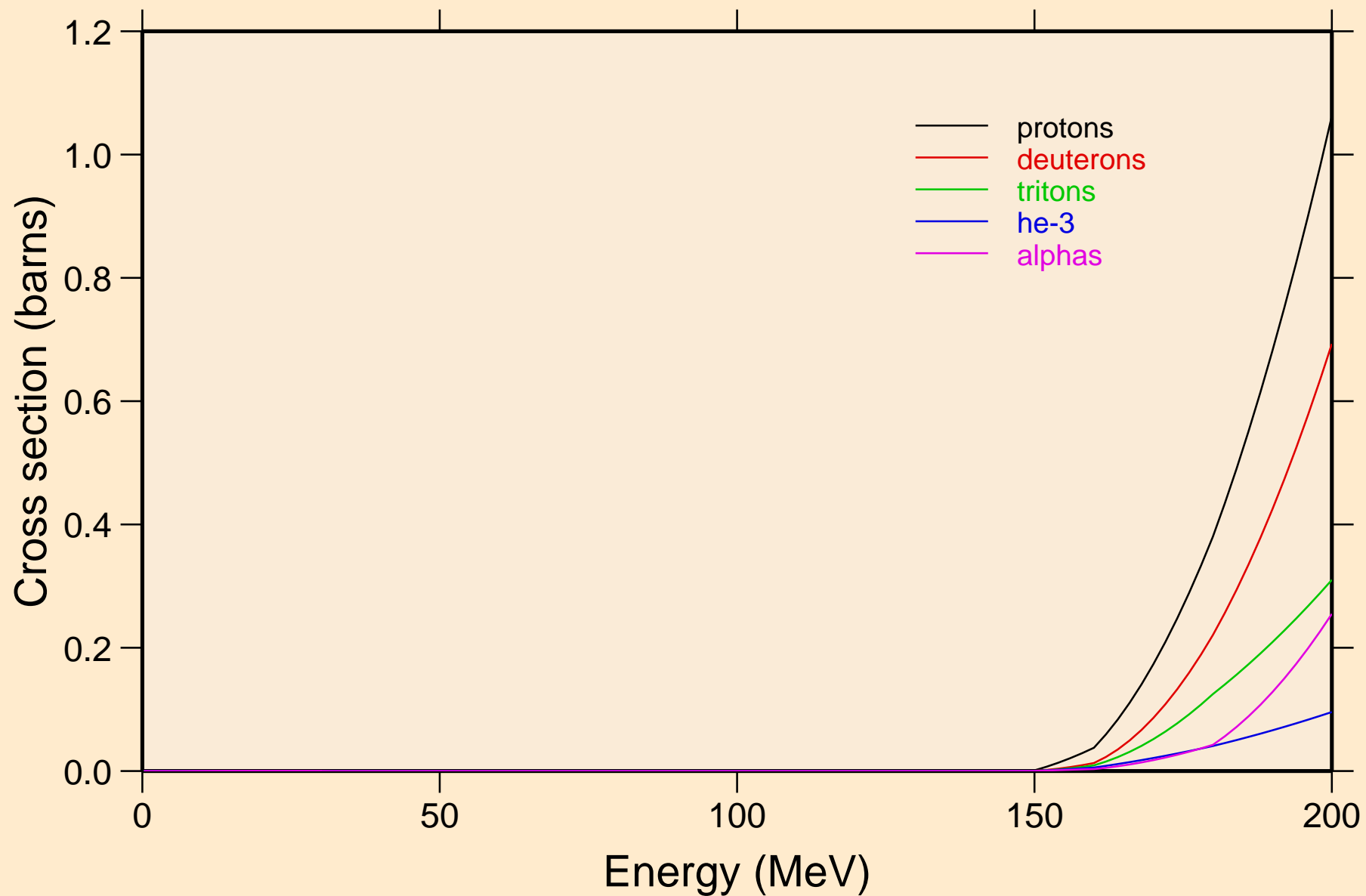

RG282 NEUTRON ACER TENDL-2019 LIBRARY; T=293.16K
protons from (n,x)

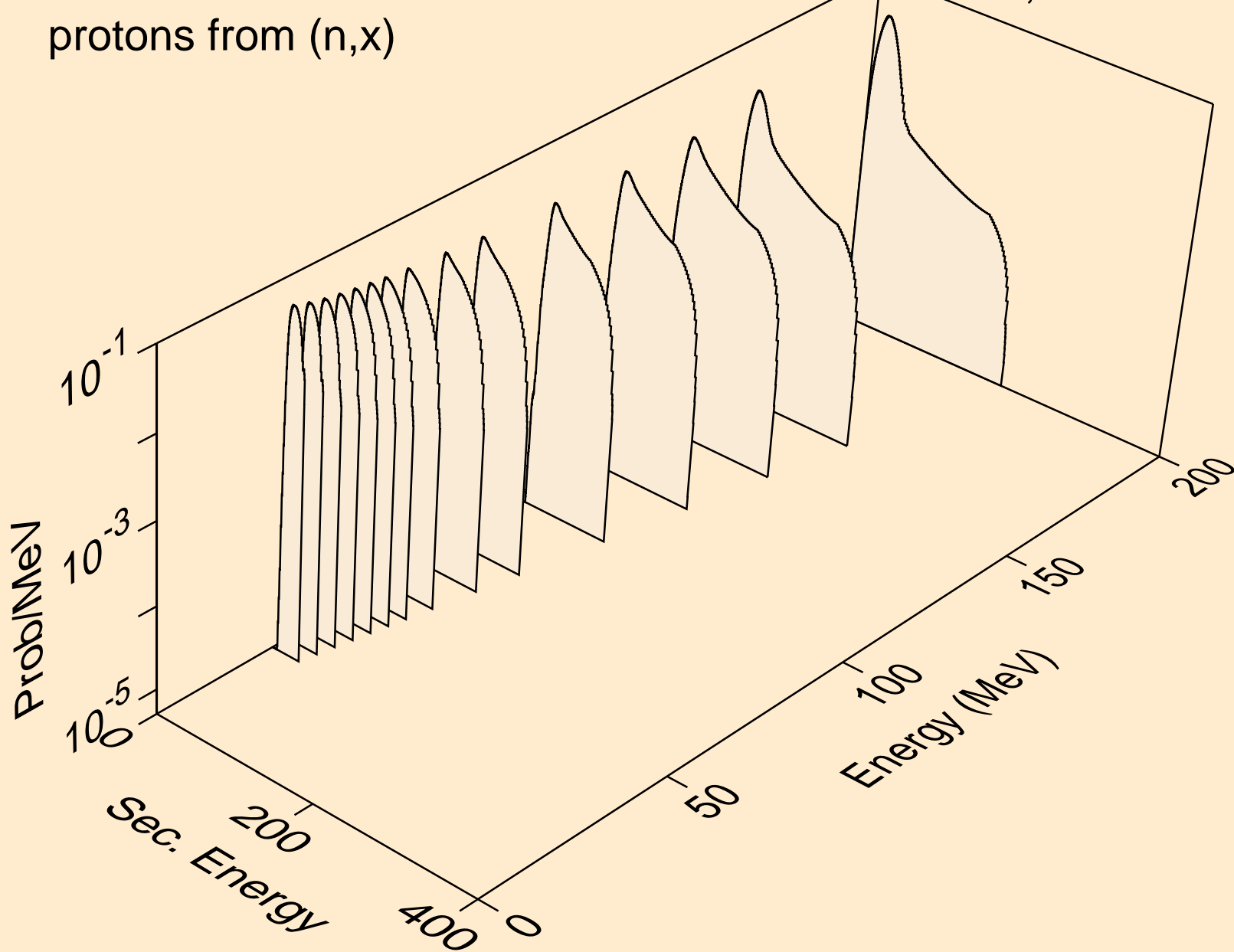

RG282 NEUTRON ACER TENDL-2019 LIBRARY; T=293.16K
protons from (n,2np)

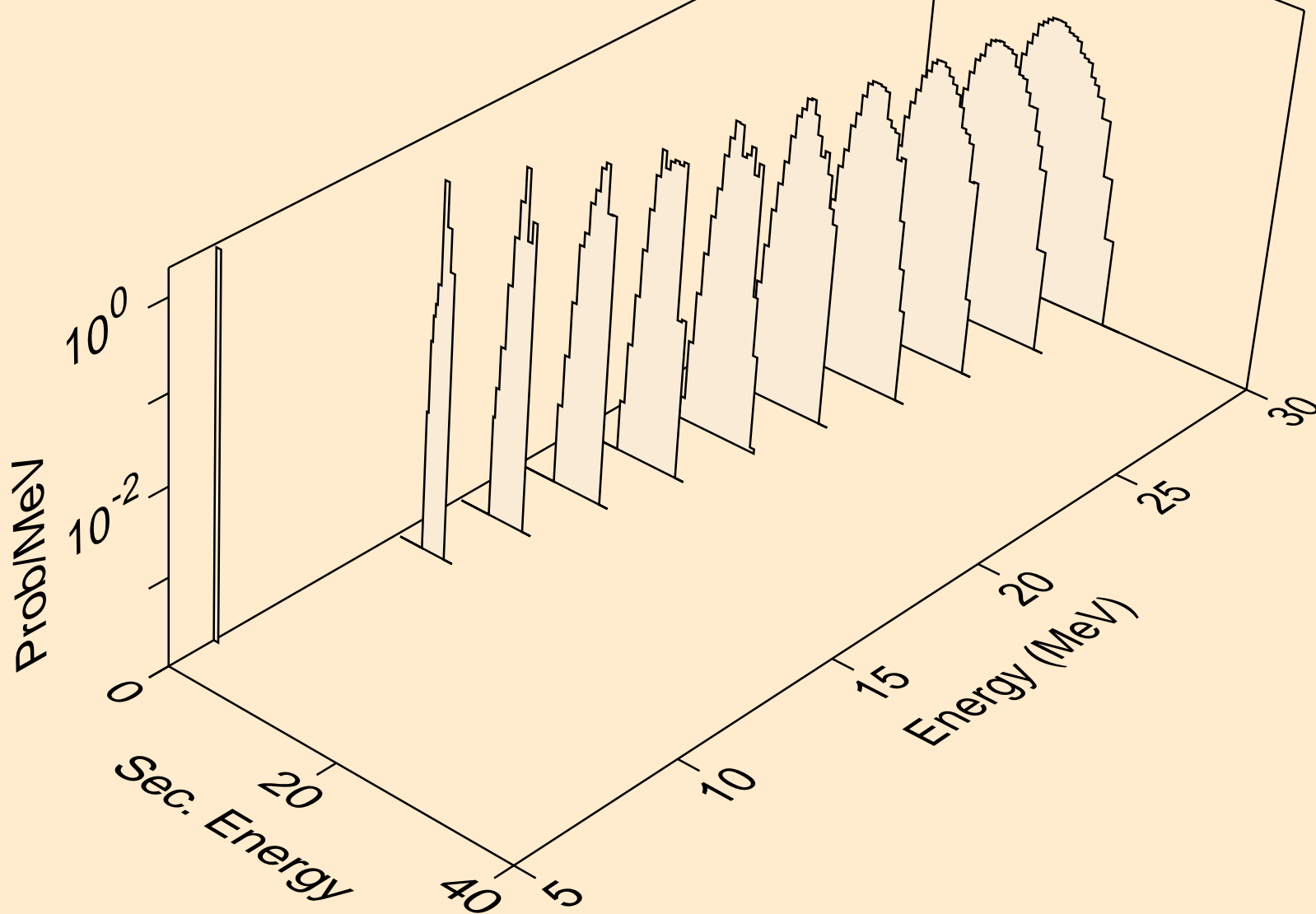

RG282 NEUTRON ACER TENDL-2019 LIBRARY; T=293.16K
protons from (n,p)

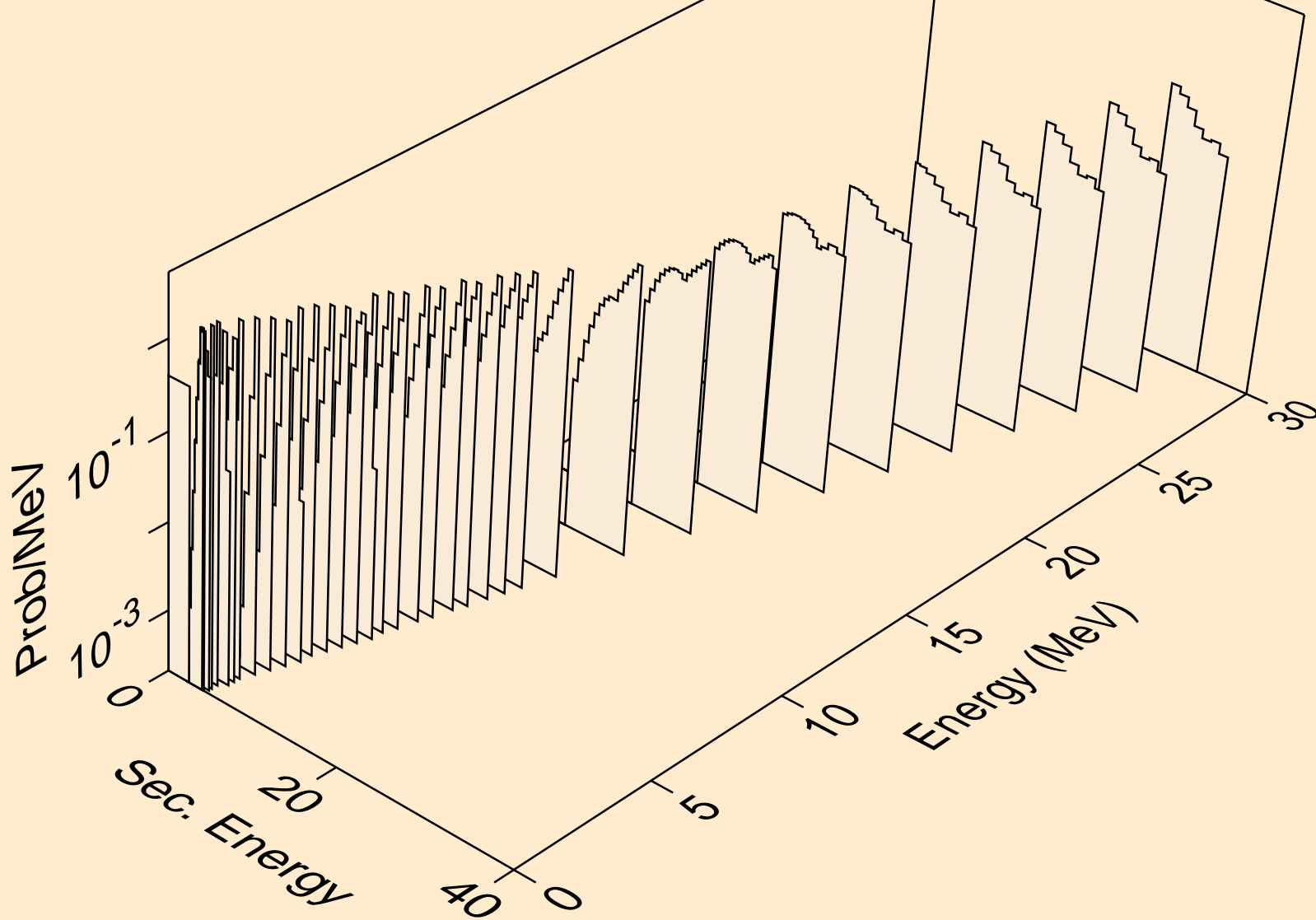

RG282 NEUTRON ACER TENDL-2019 LIBRARY; T=293.16K
protons from (n,p)

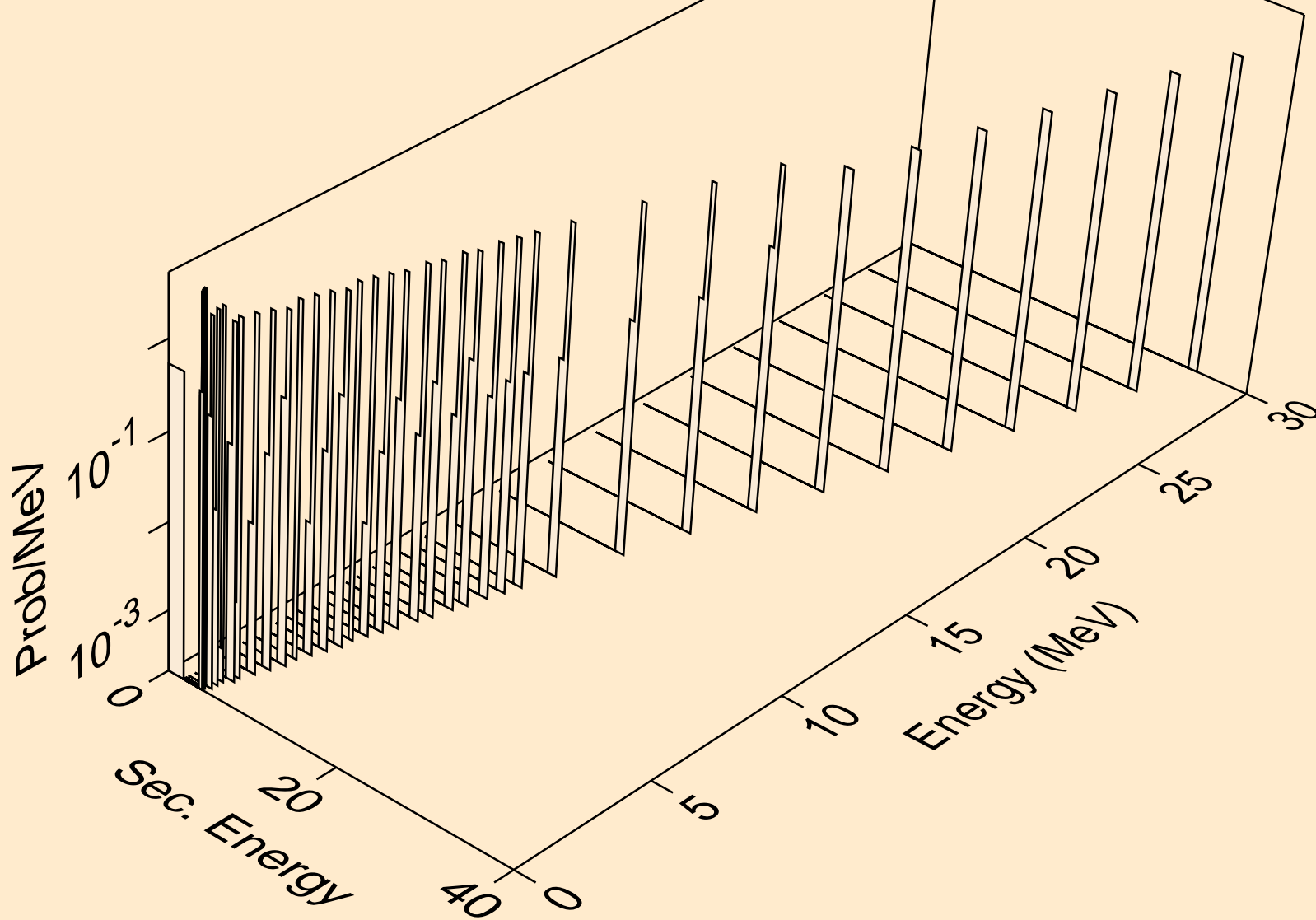

RG282 NEUTRON ACER TENDL-2019 LIBRARY; T=293.16K
deuterons from (n,x)

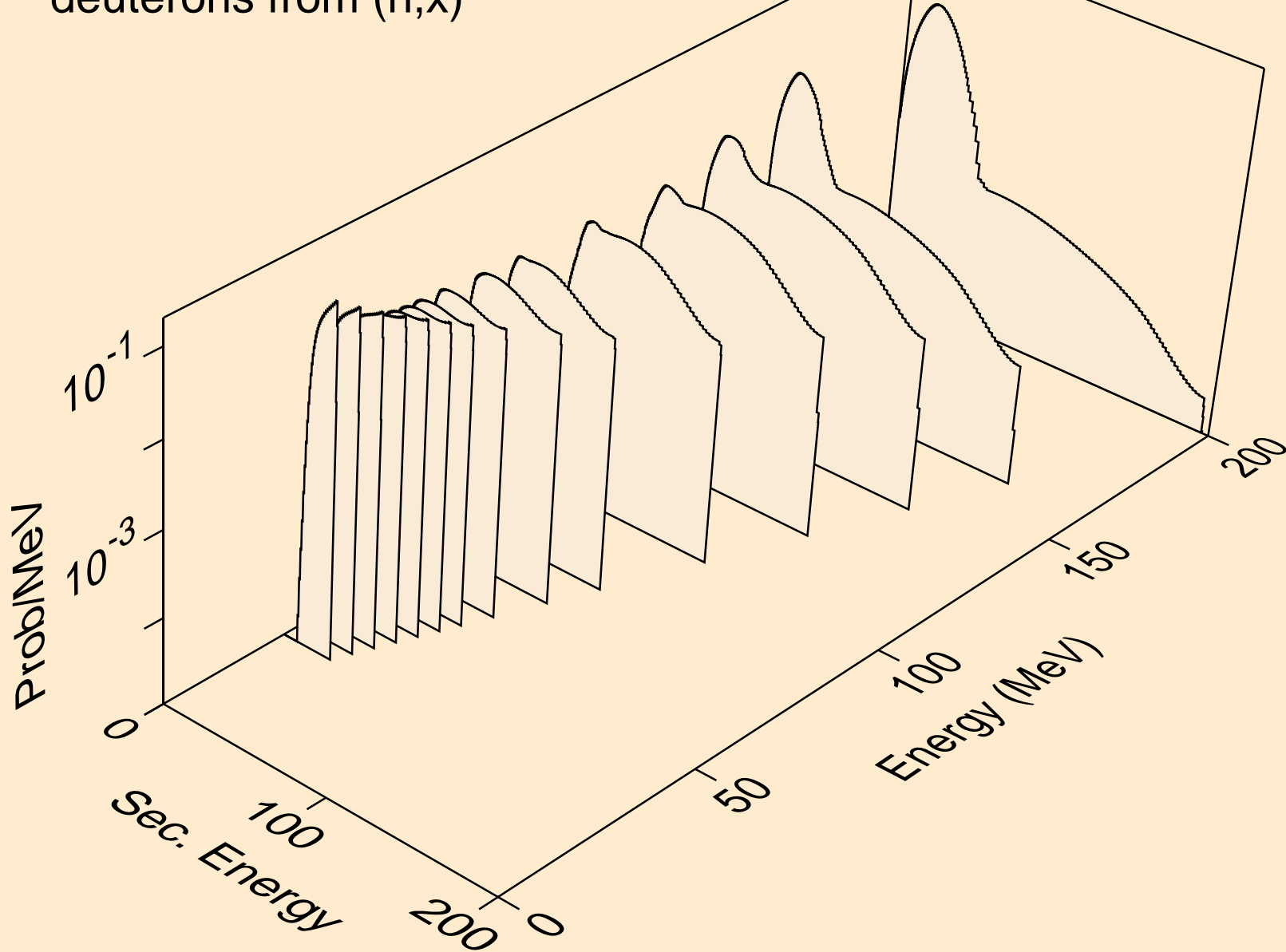

RG282 NEUTRON ACER TENDL-2019 LIBRARY; T=293.16K
deuterons from (n,n*)d

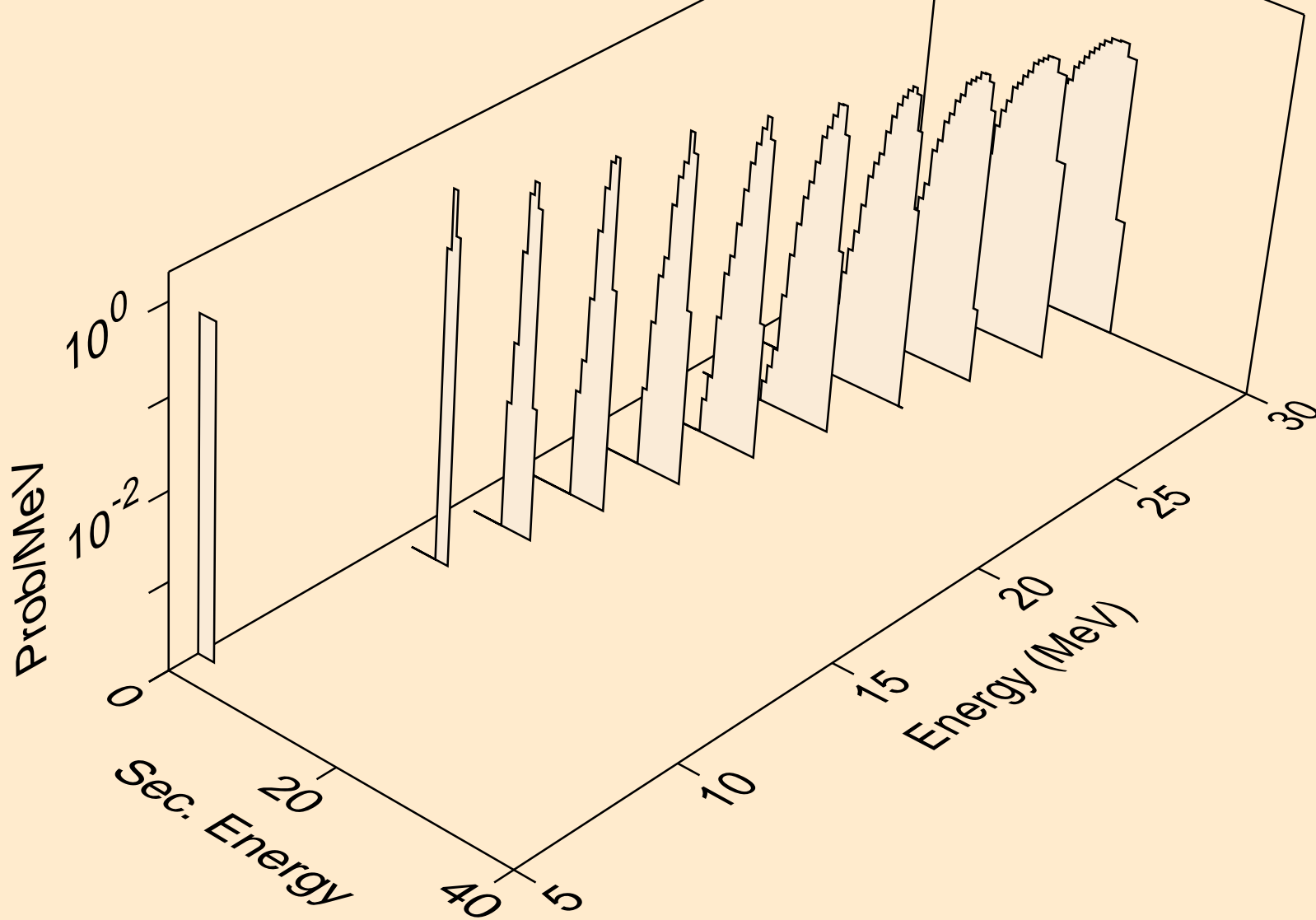

RG282 NEUTRON ACER TENDL-2019 LIBRARY; T=293.16K
deuterons from (n,d)

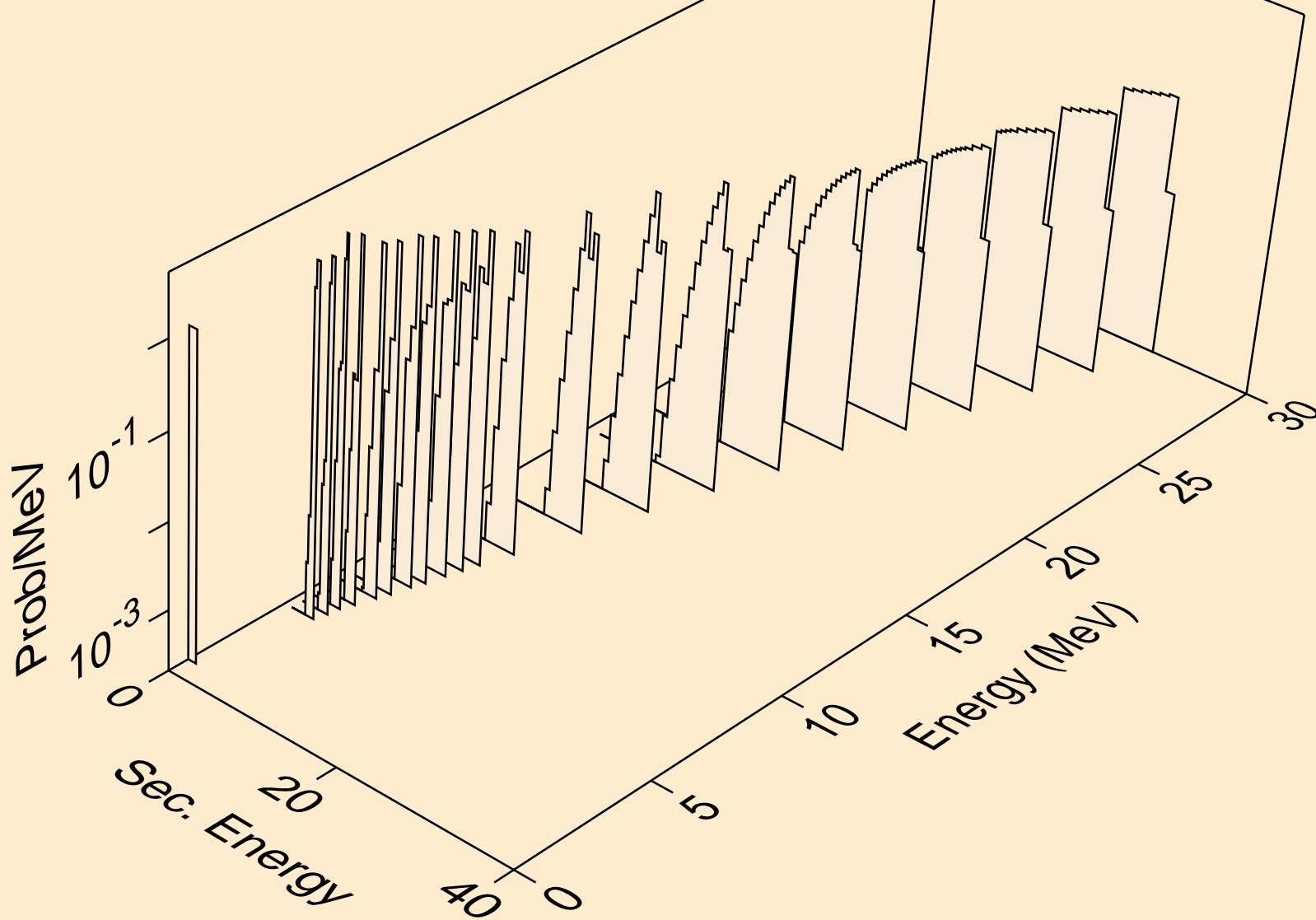

RG282 NEUTRON ACER TENDL-2019 LIBRARY; T=293.16K
tritons from (n,x)

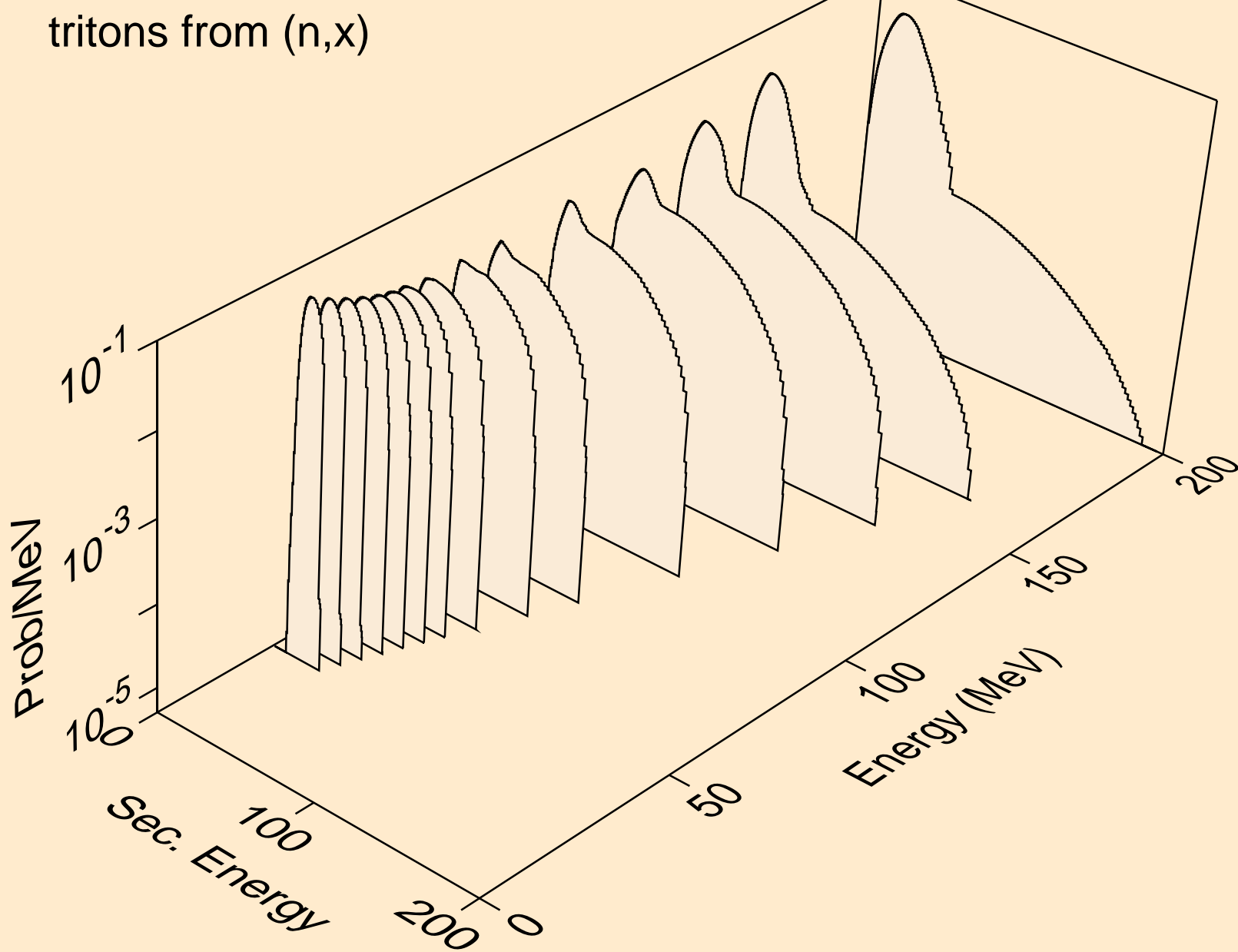

RG282 NEUTRON ACER TENDL-2019 LIBRARY; T=293.16K
tritons from (n,t)

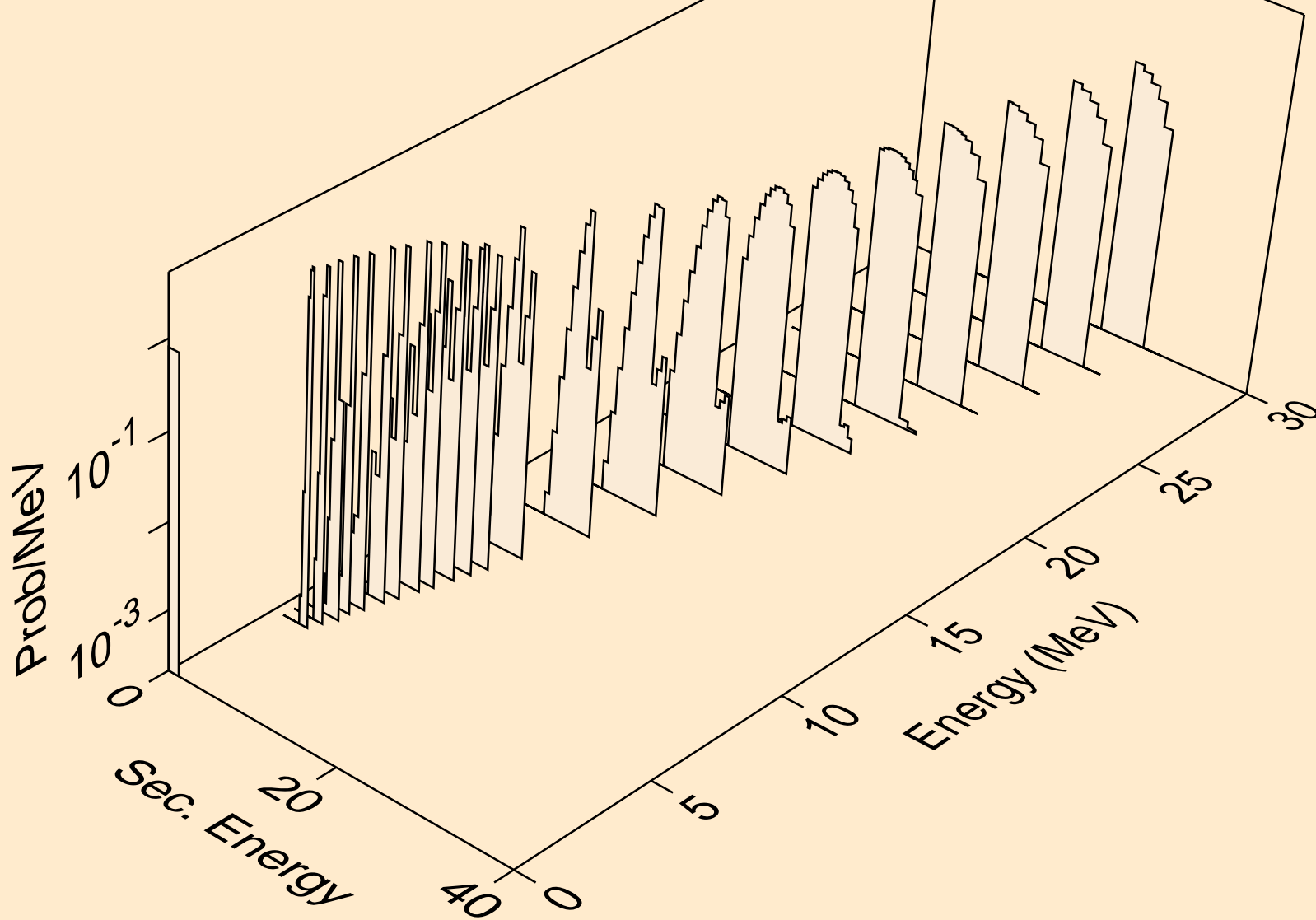

RG282 NEUTRON ACER TENDL-2019 LIBRARY; T=293.16K
he3s from (n,x)

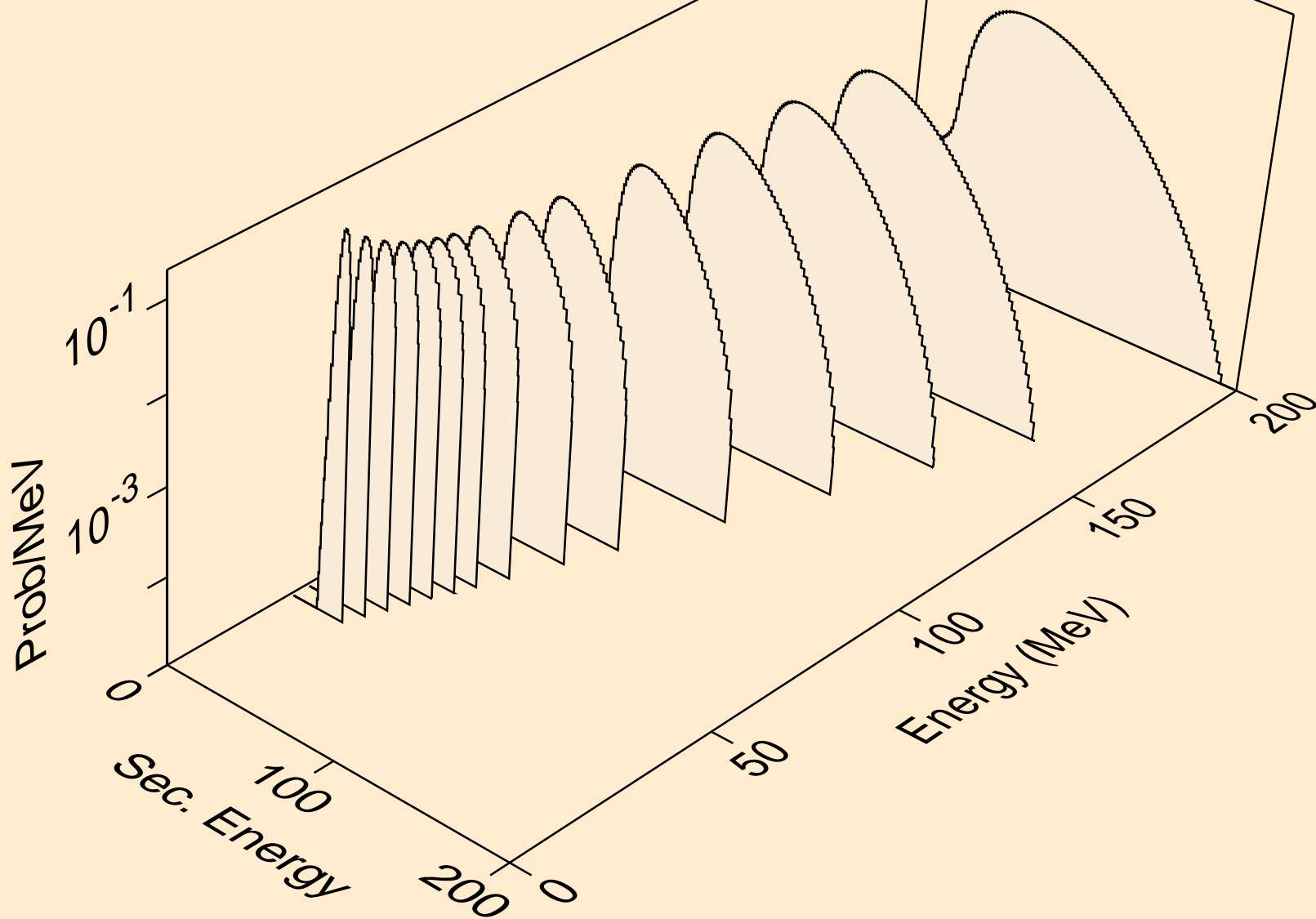

RG282 NEUTRON ACER TENDL-2019 LIBRARY; T=293.16K
he3s from (n,he3)

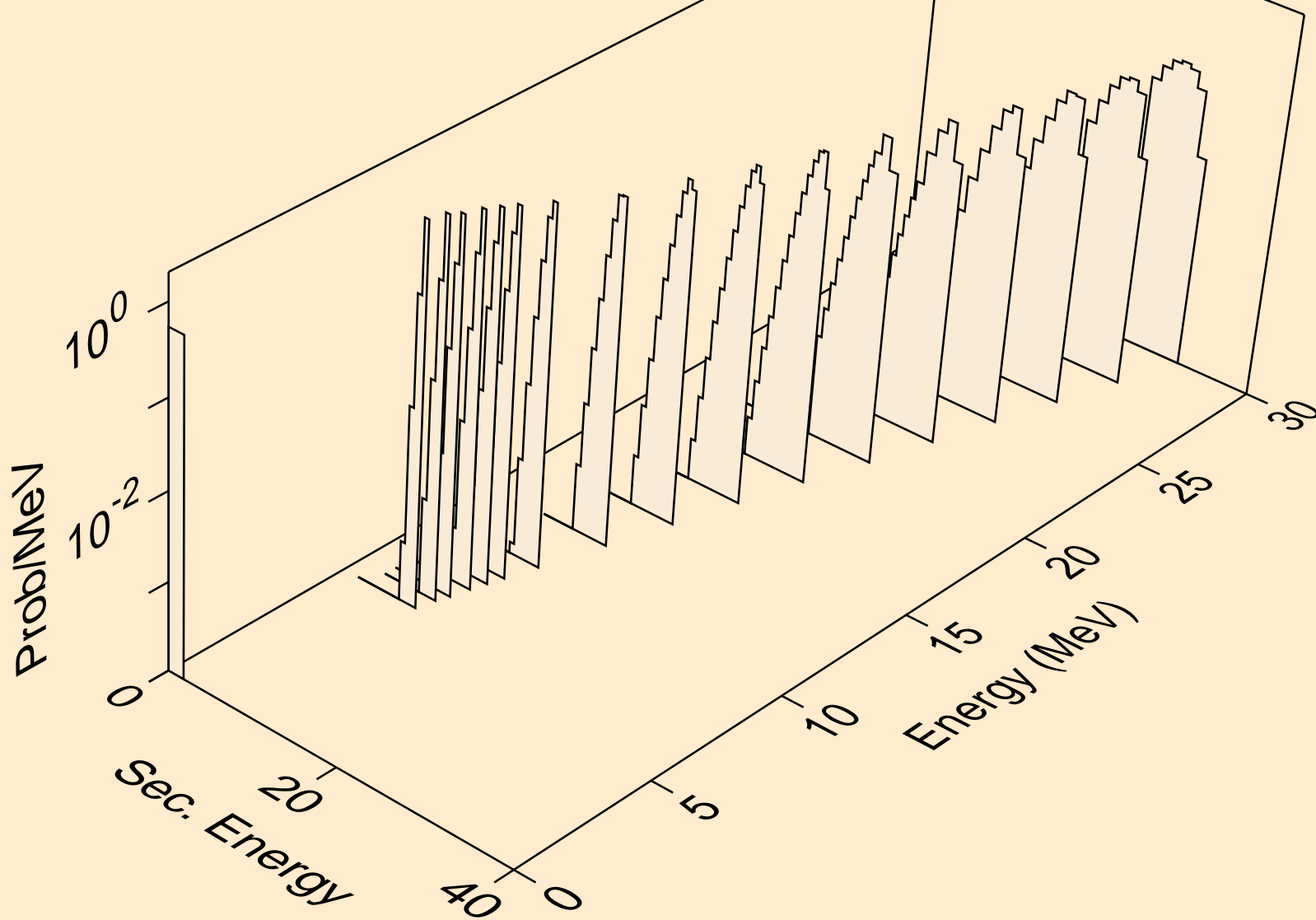

RG282 NEUTRON ACER TENDL-2019 LIBRARY; T=293.16K
alphas from (n,x)

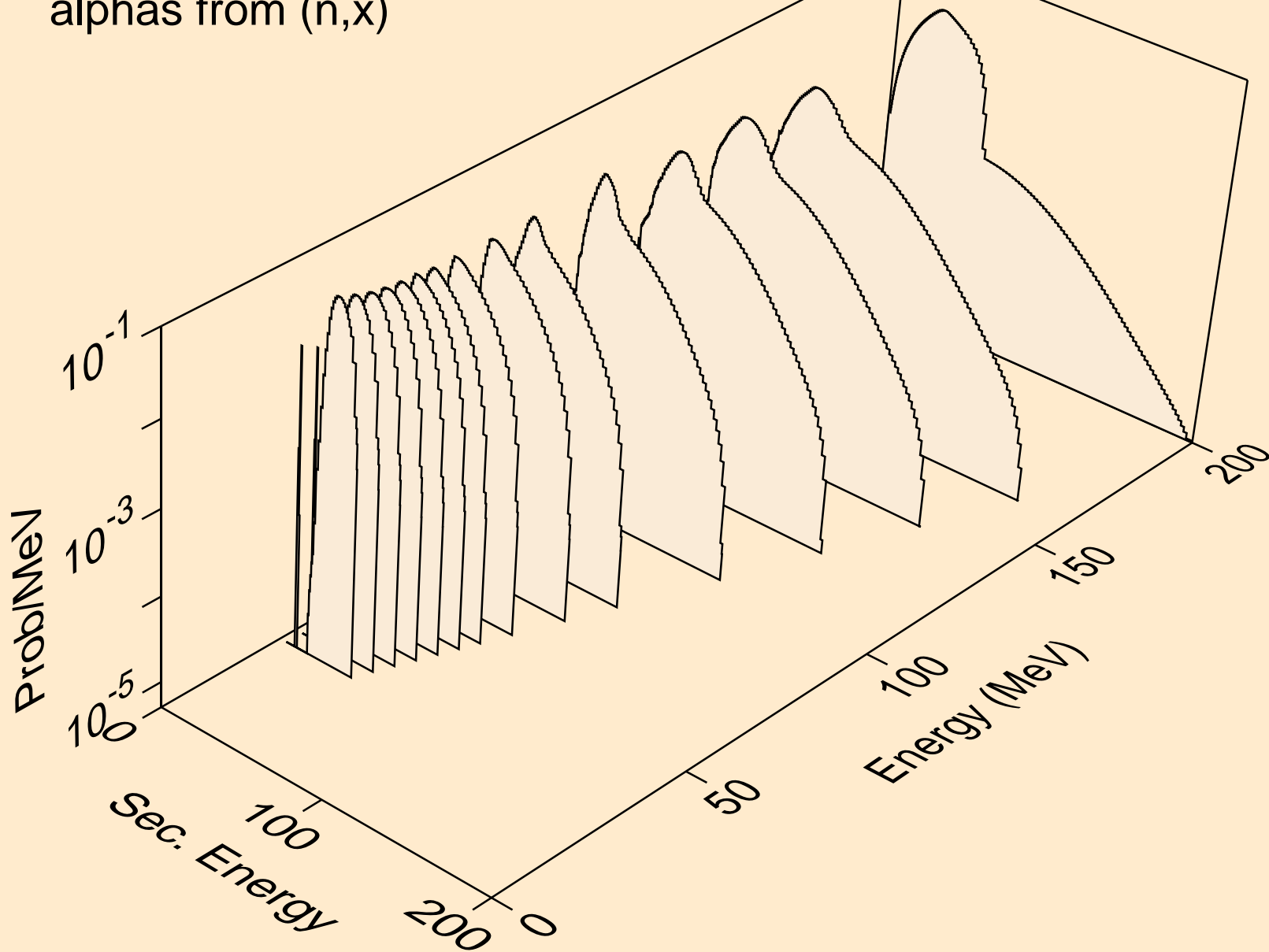

RG282 NEUTRON ACER TENDL-2019 LIBRARY; T=293.16K
alphas from (n,n*)a

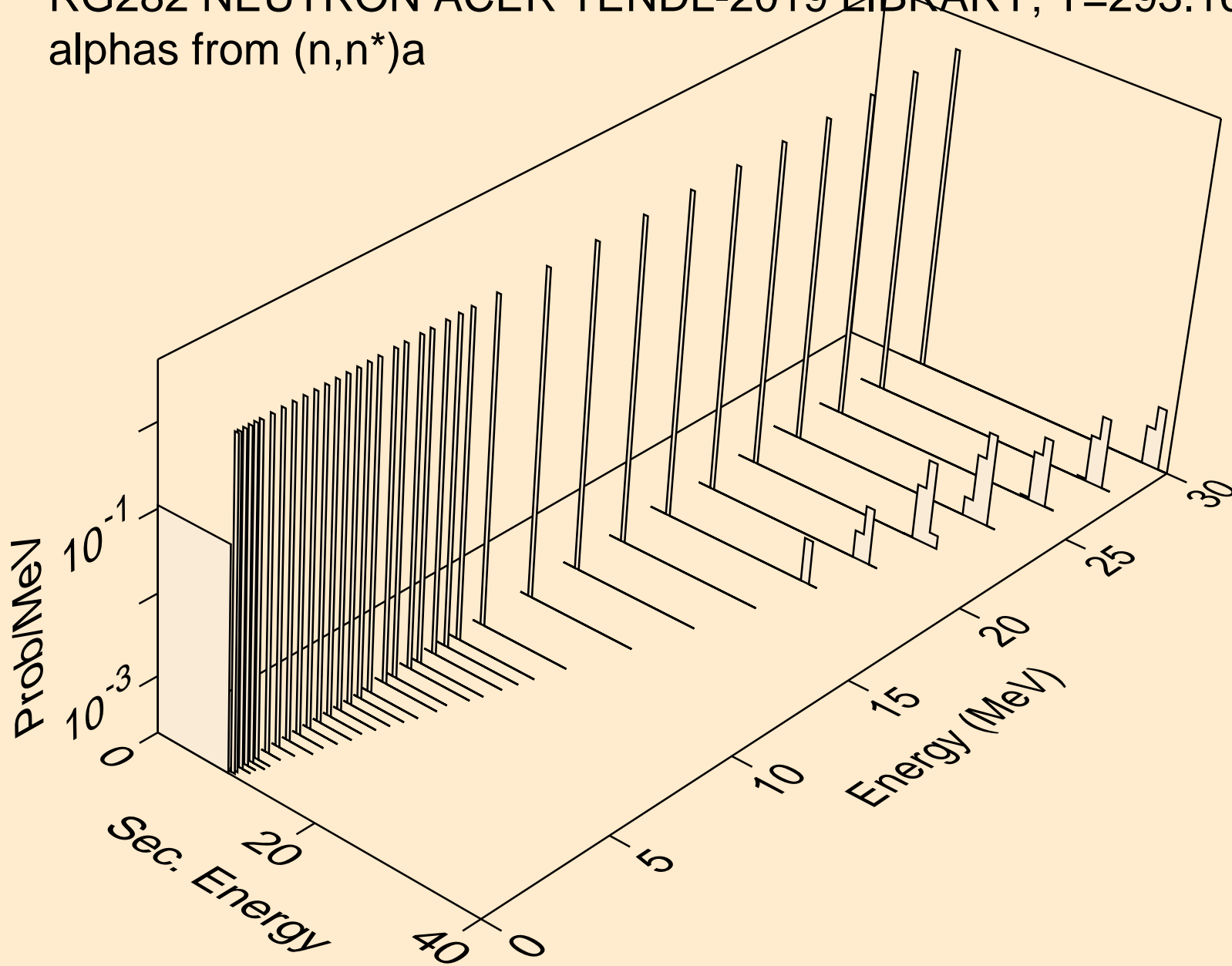

RG282 NEUTRON ACER TENDL-2019 LIBRARY; T=293.16K
alphas from (n,2n)a

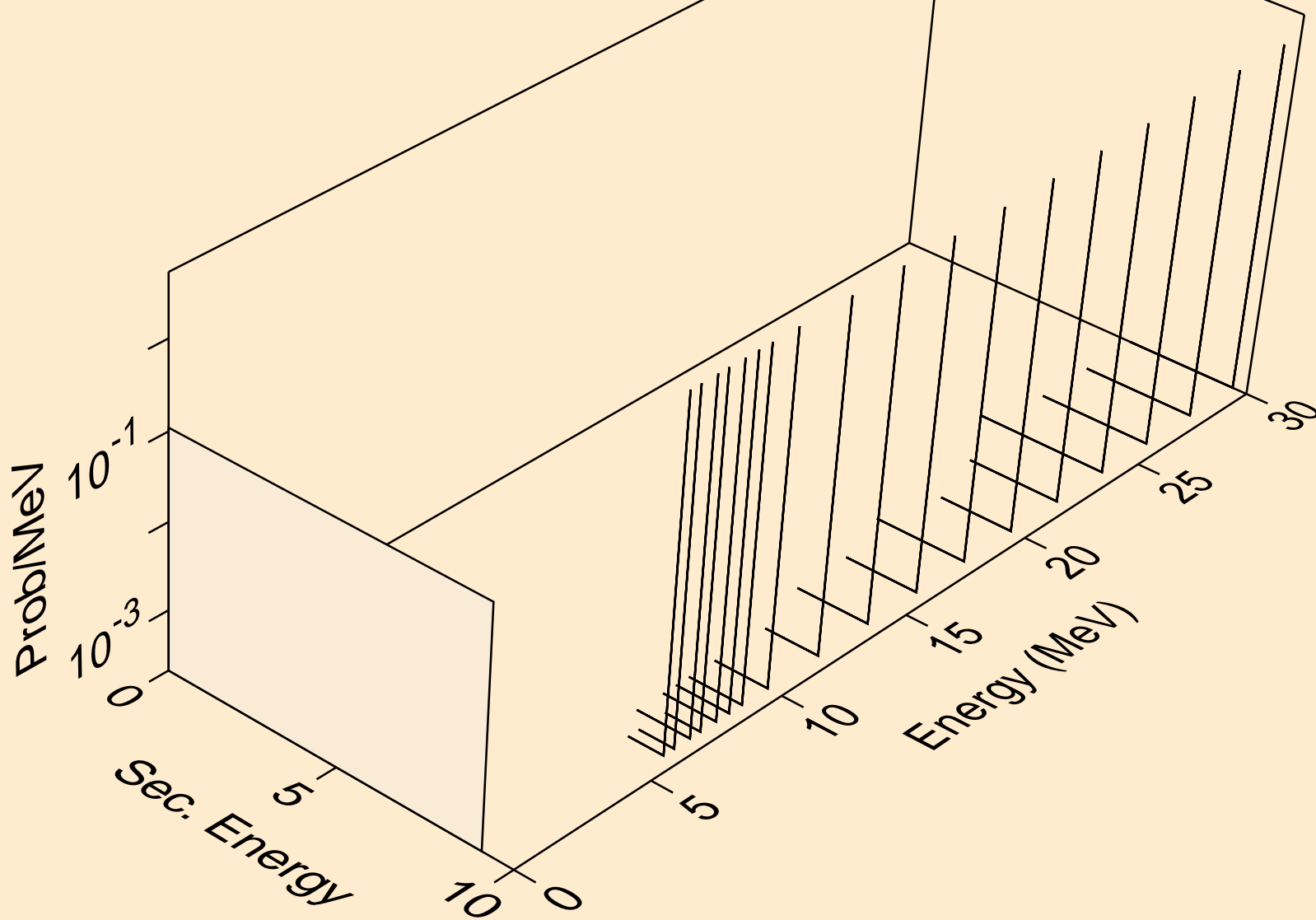

RG282 NEUTRON ACER TENDL-2019 LIBRARY; T=293.16K
alphas from (n,2n)2a

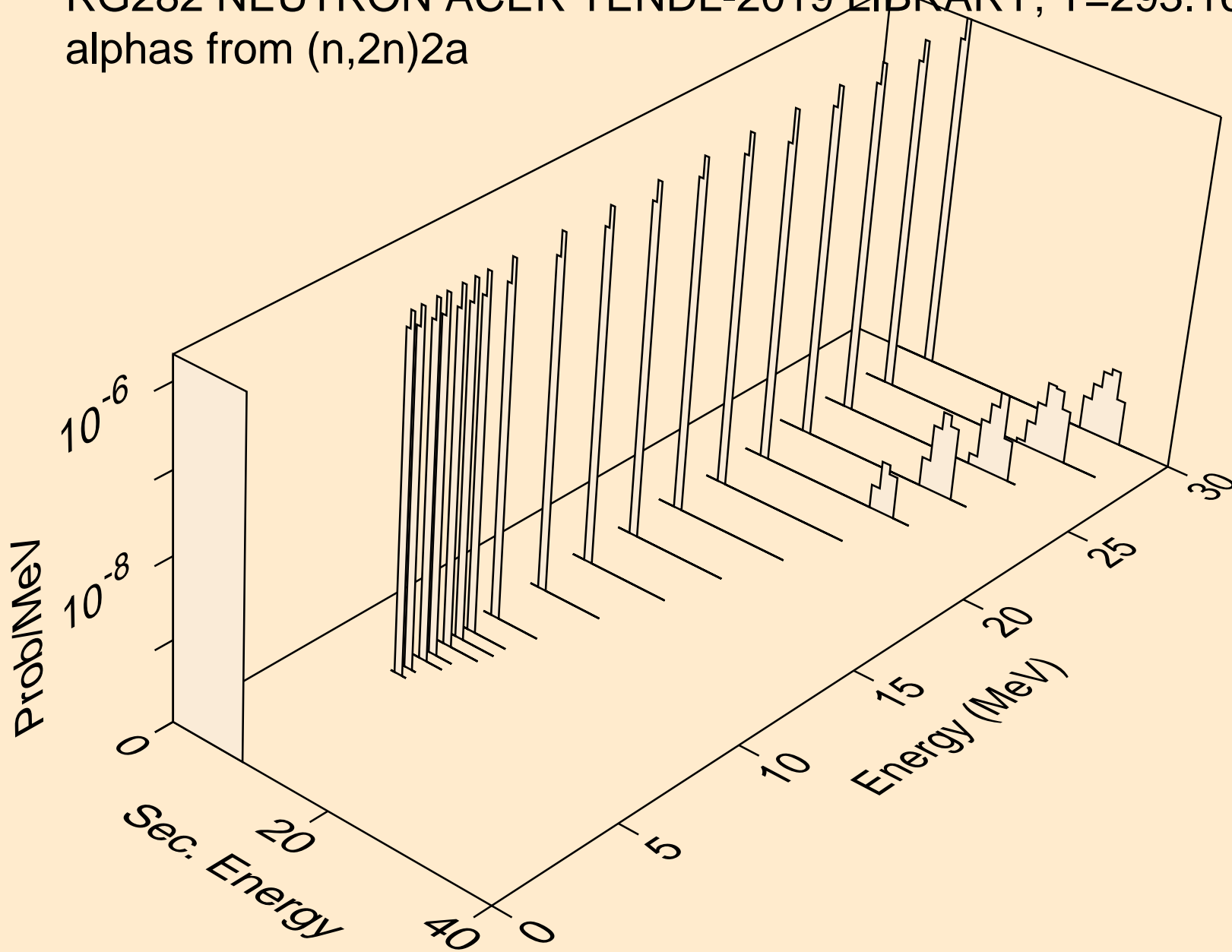

RG282 NEUTRON ACER TENDL-2019 LIBRARY; T=293.16K
alphas from (n,a)

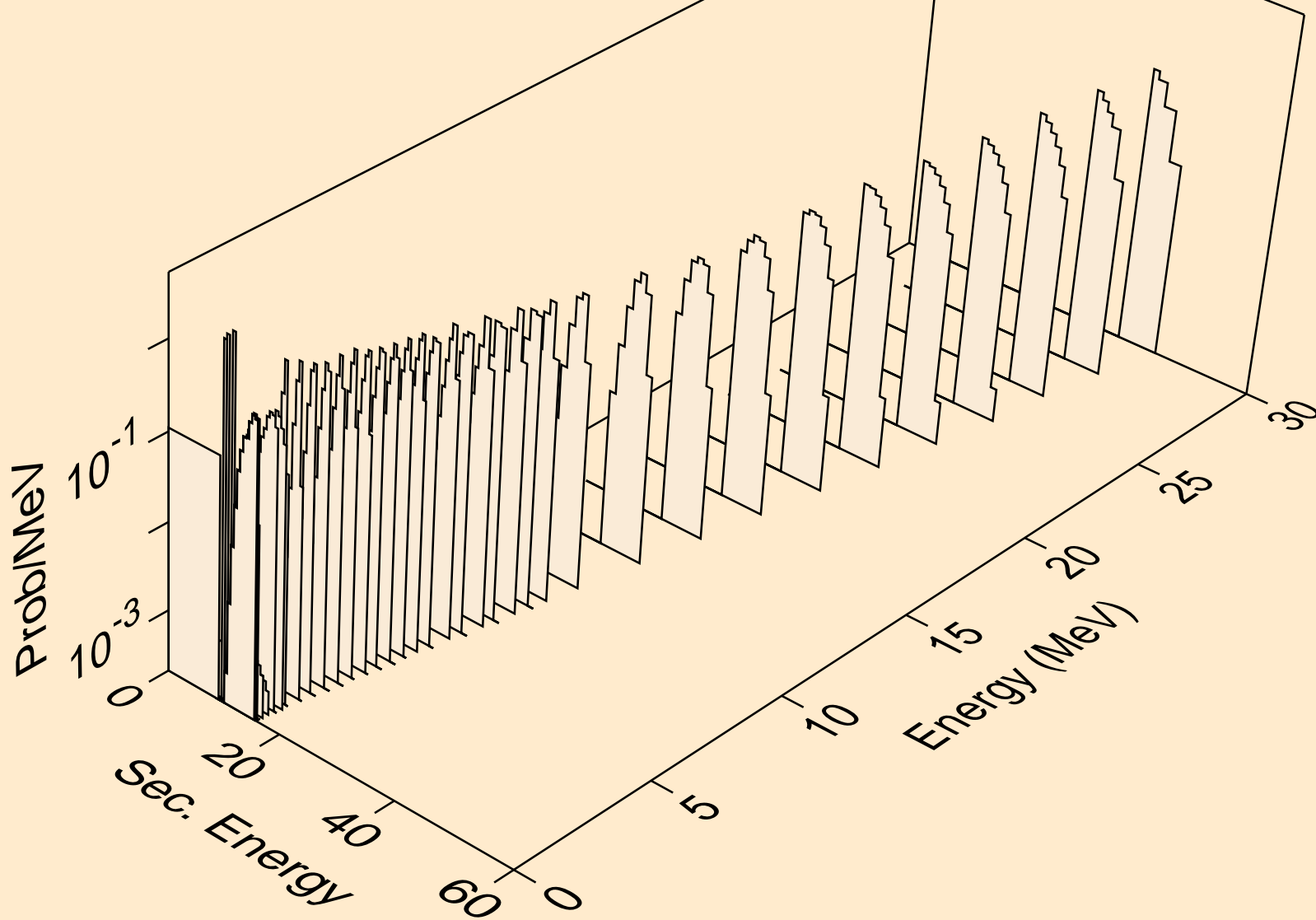

RG282 NEUTRON ACER TENDL-2019 LIBRARY; T=293.16K
alphas from (n,2a)

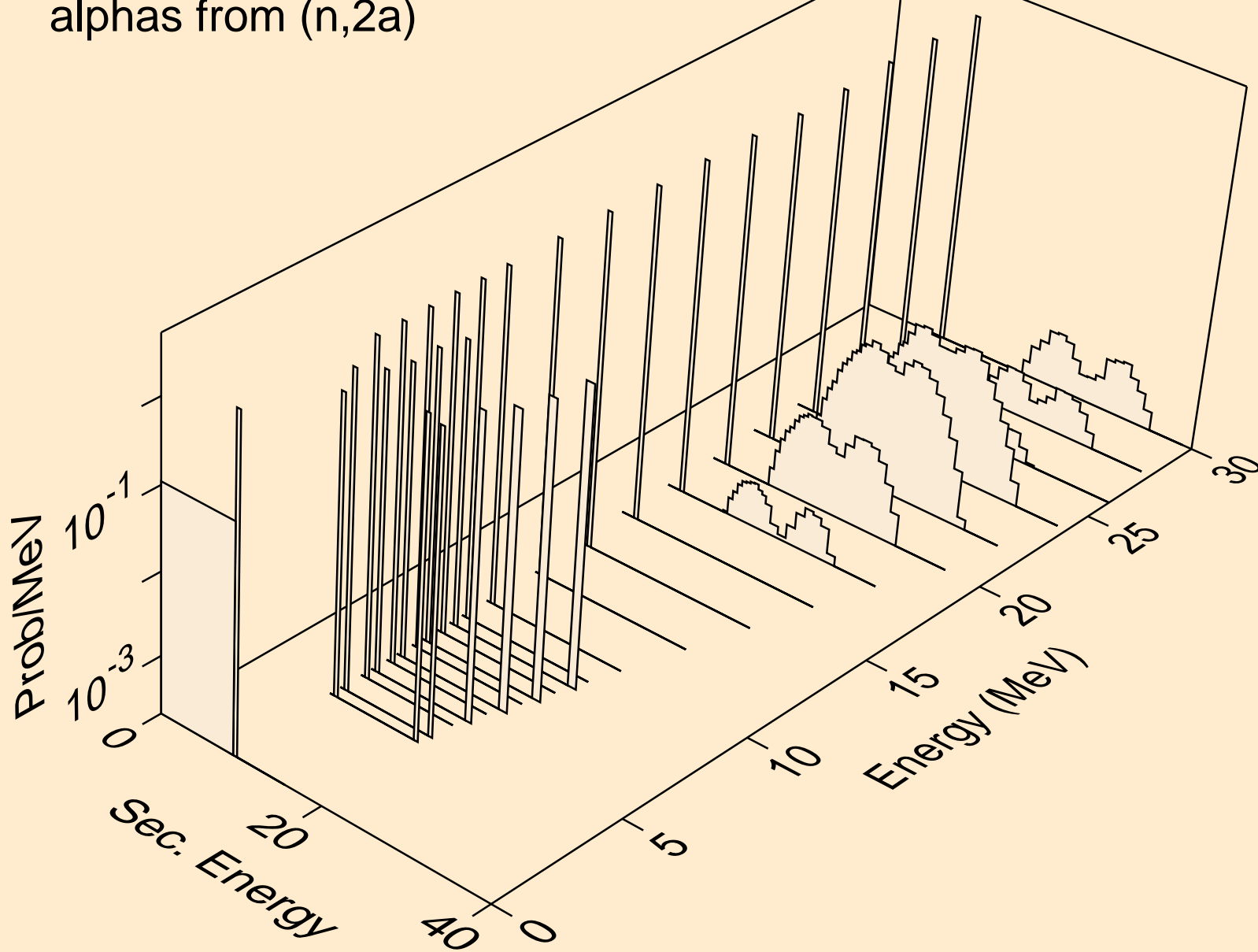

RG282 NEUTRON ACER TENDL-2019 LIBRARY; T=293.16K
alphas from (n,pa)

