

RH091 NEUTRON ACER TENDL-2019 LIBRARY; T=293.16K
Principal cross sections

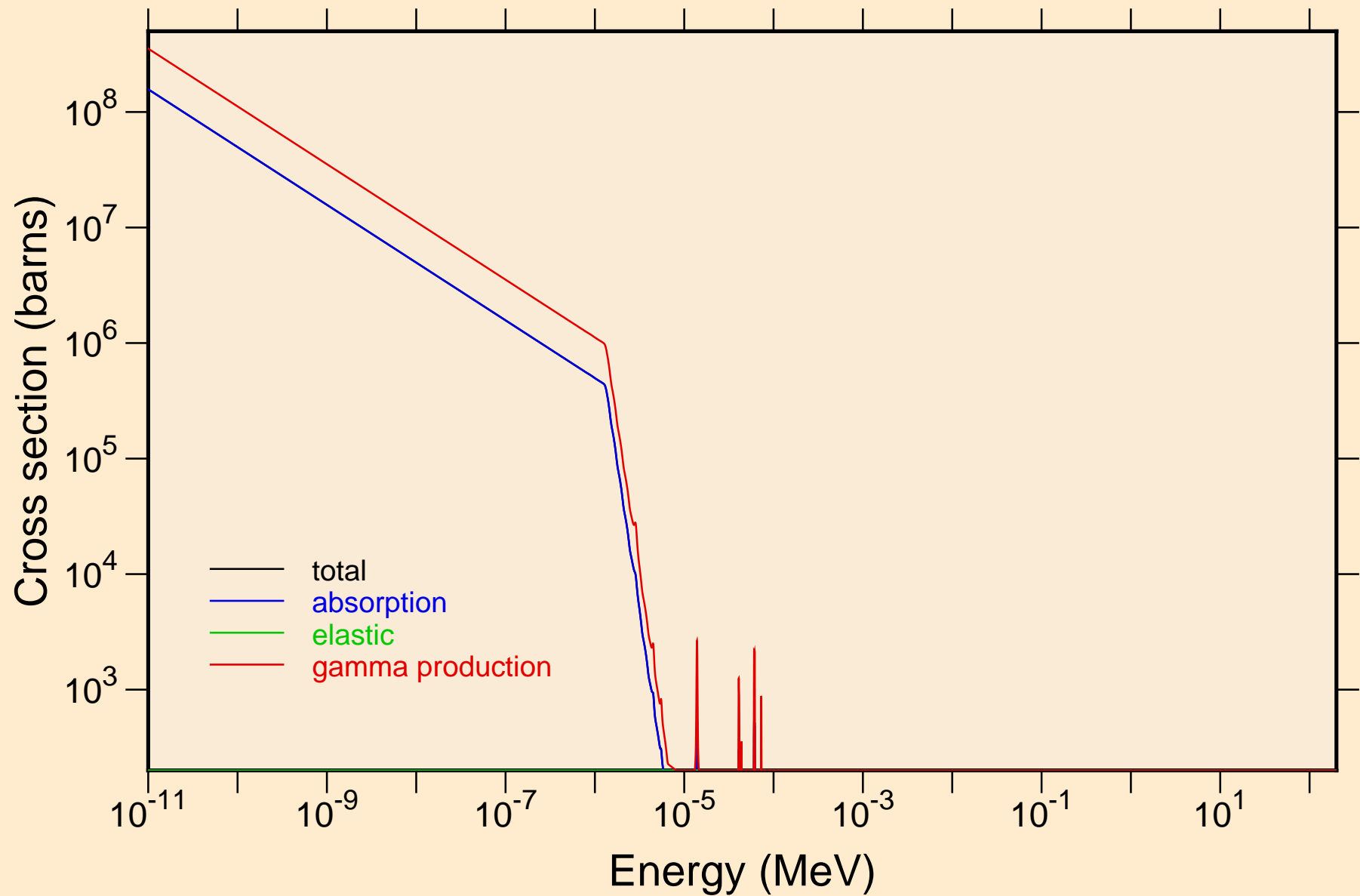

RH091 NEUTRON ACER TENDL-2019 LIBRARY; T=293.16K
resonance total cross section

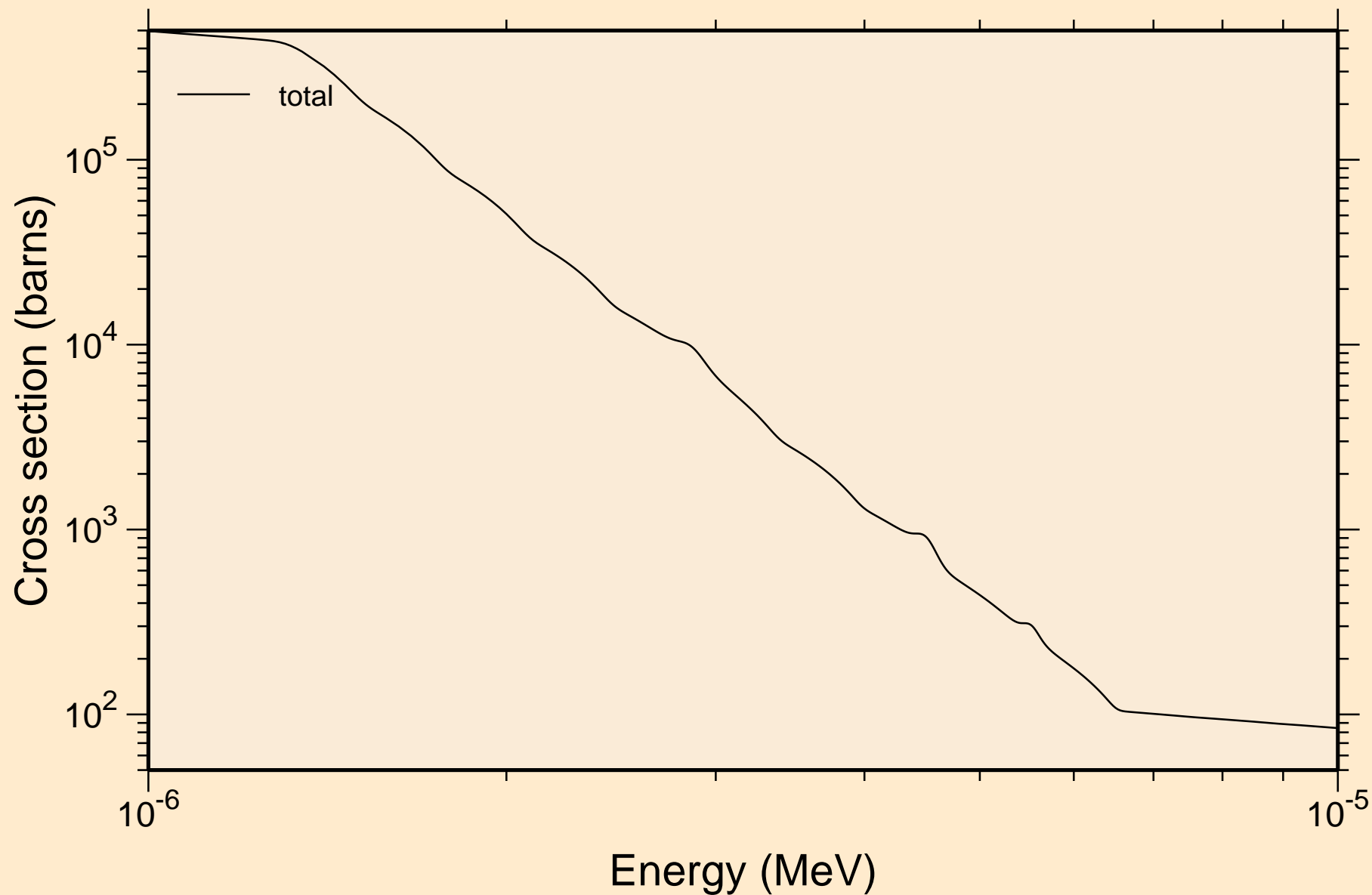

RH091 NEUTRON ACER TENDL-2019 LIBRARY; T=293.16K
resonance total cross section

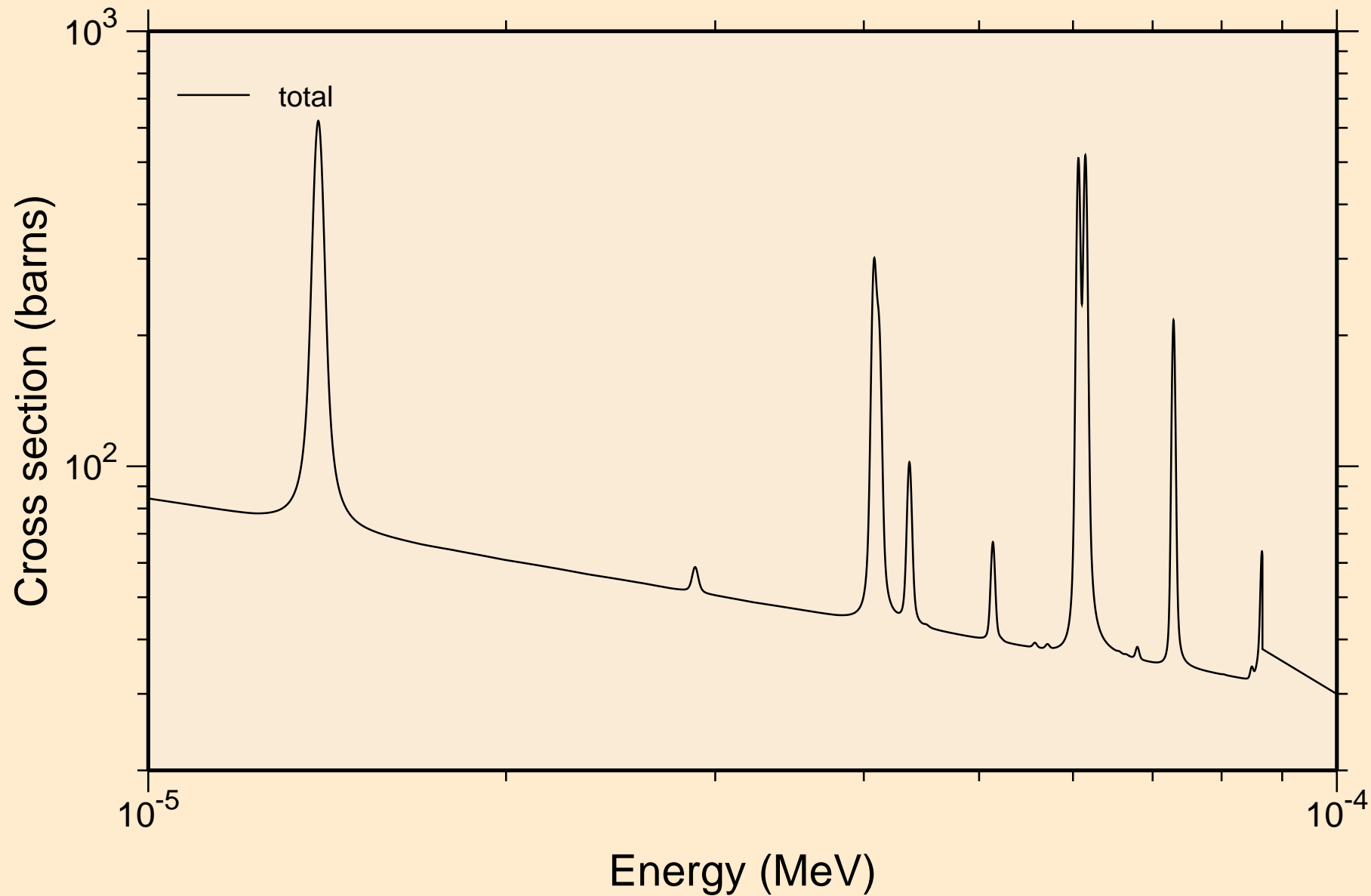

RH091 NEUTRON ACER TENDL-2019 LIBRARY; T=293.16K
resonance total cross section

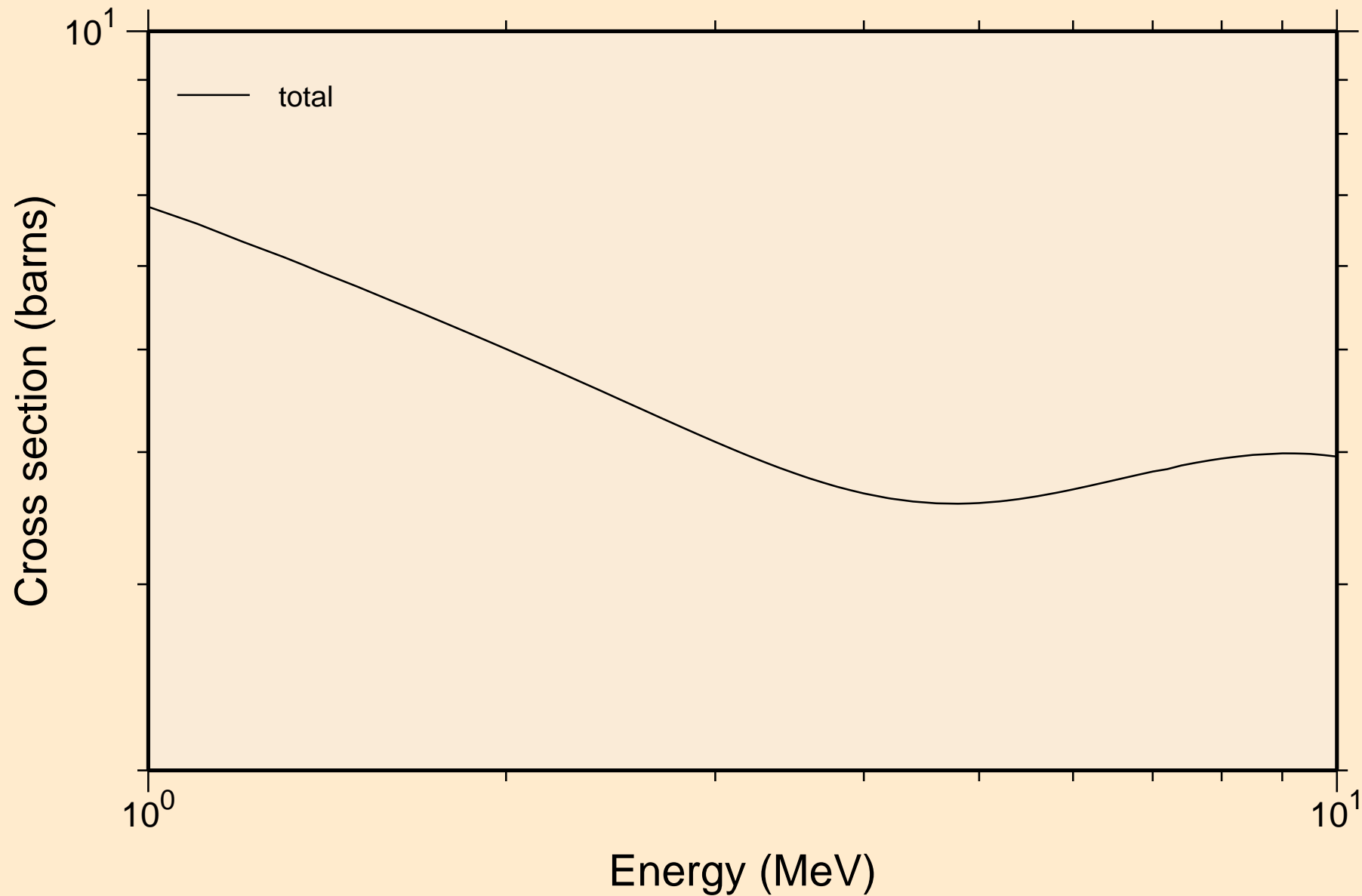

RH091 NEUTRON ACER TENDL-2019 LIBRARY; T=293.16K
resonance absorption cross sections

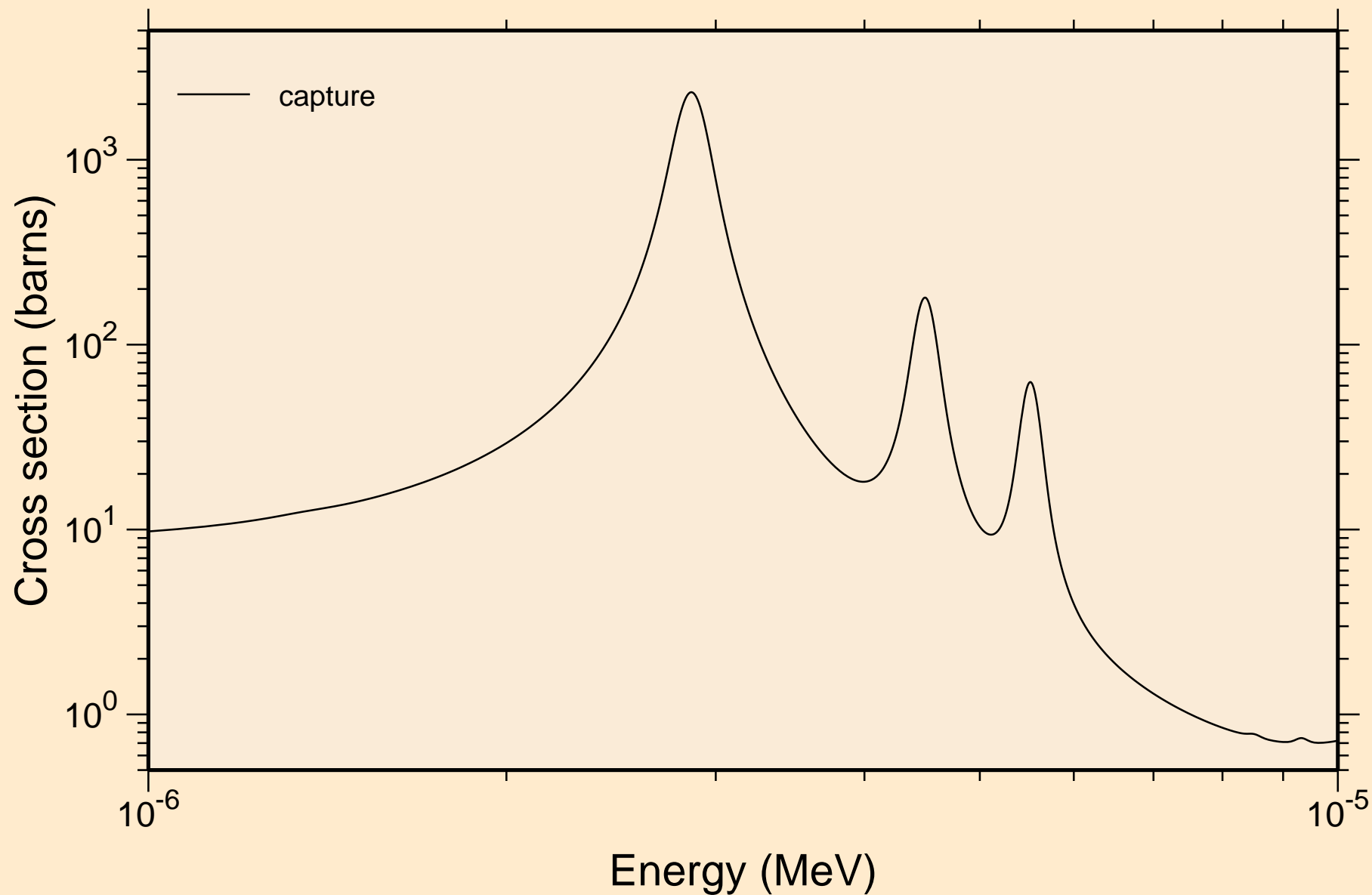

RH091 NEUTRON ACER TENDL-2019 LIBRARY; T=293.16K
resonance absorption cross sections

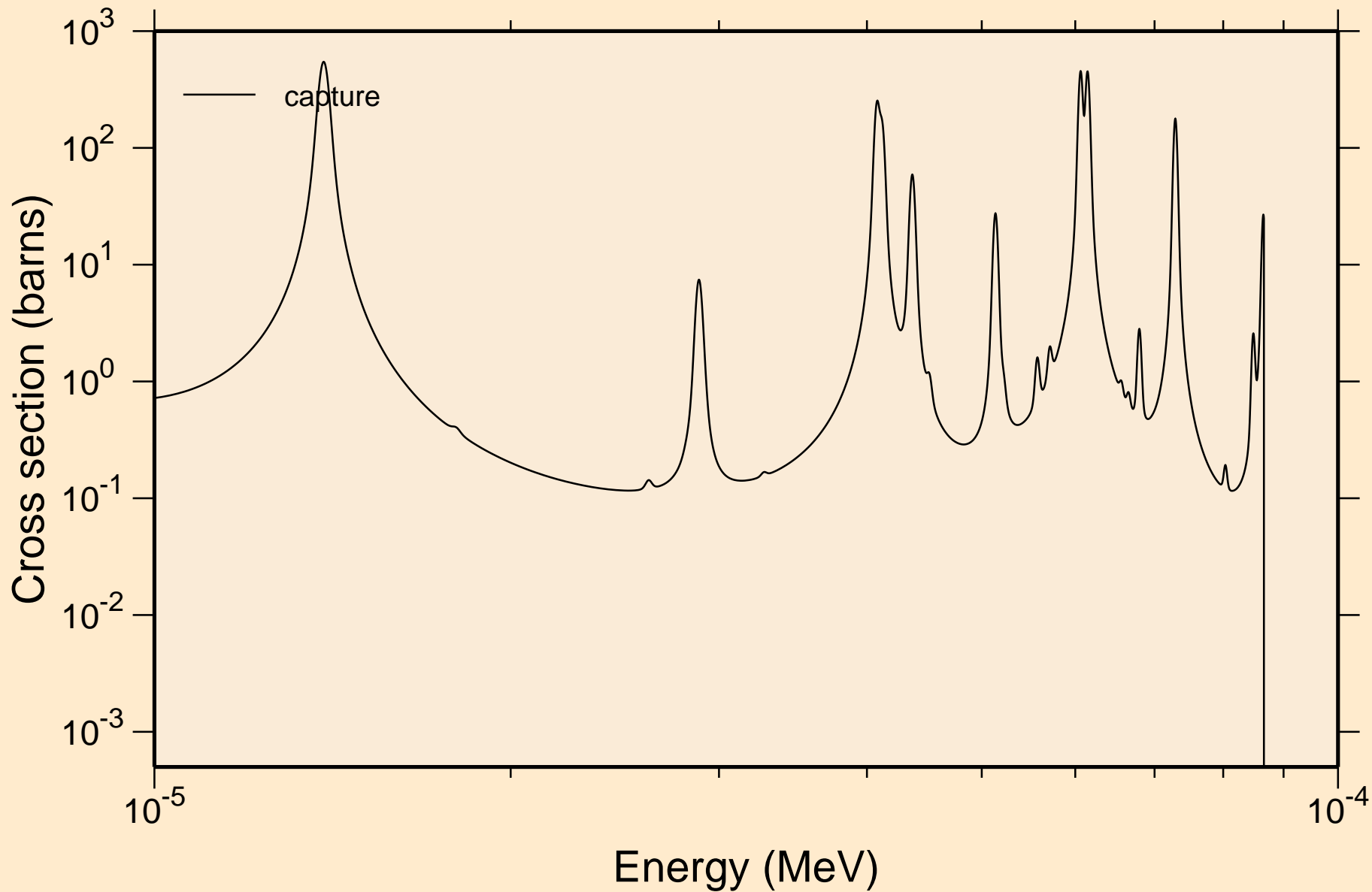

RH091 NEUTRON ACER TENDL-2019 LIBRARY; T=293.16K
resonance absorption cross sections

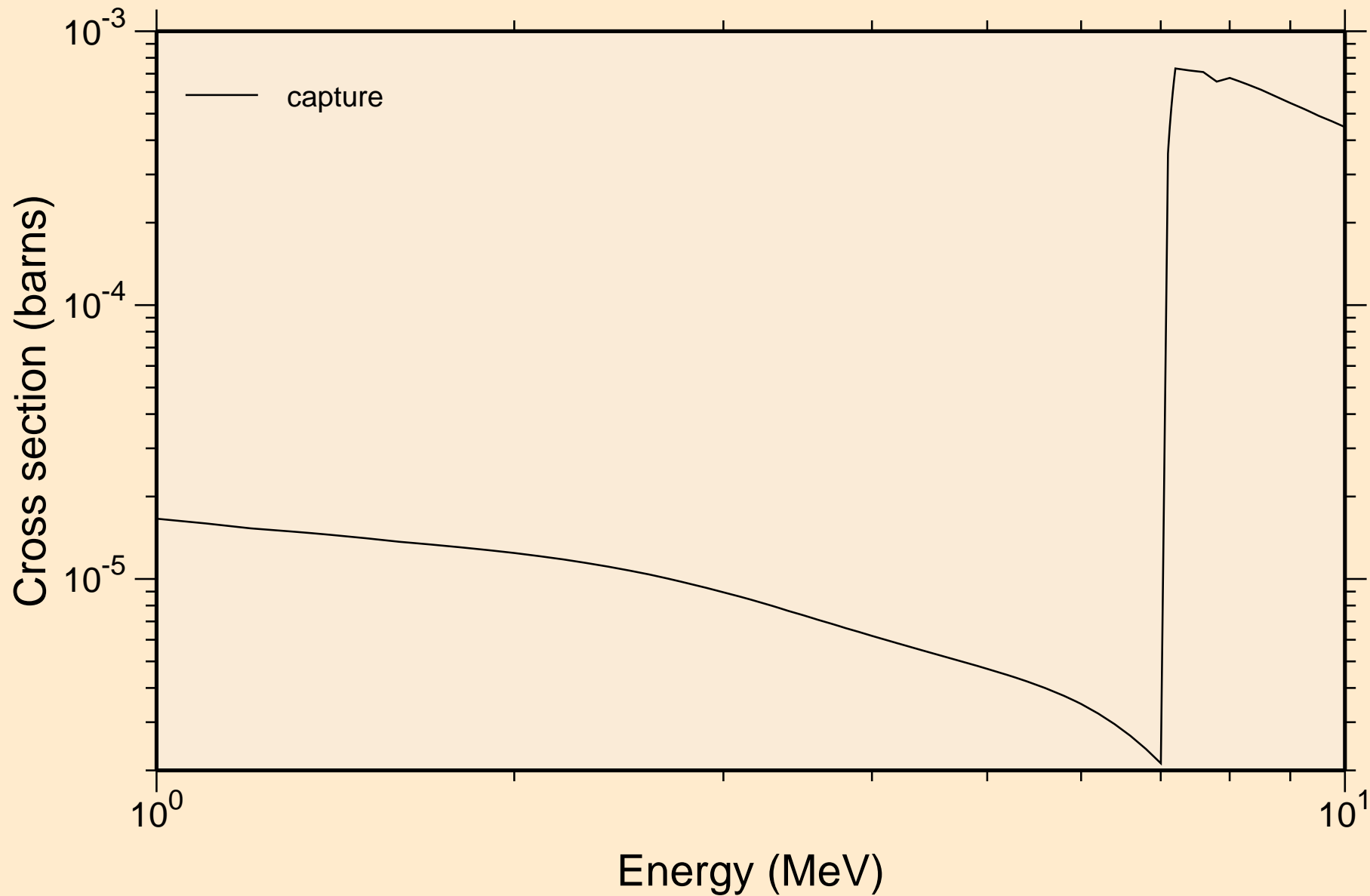

RH091 NEUTRON ACER TENDL-2019 LIBRARY; T=293.16K
Heating

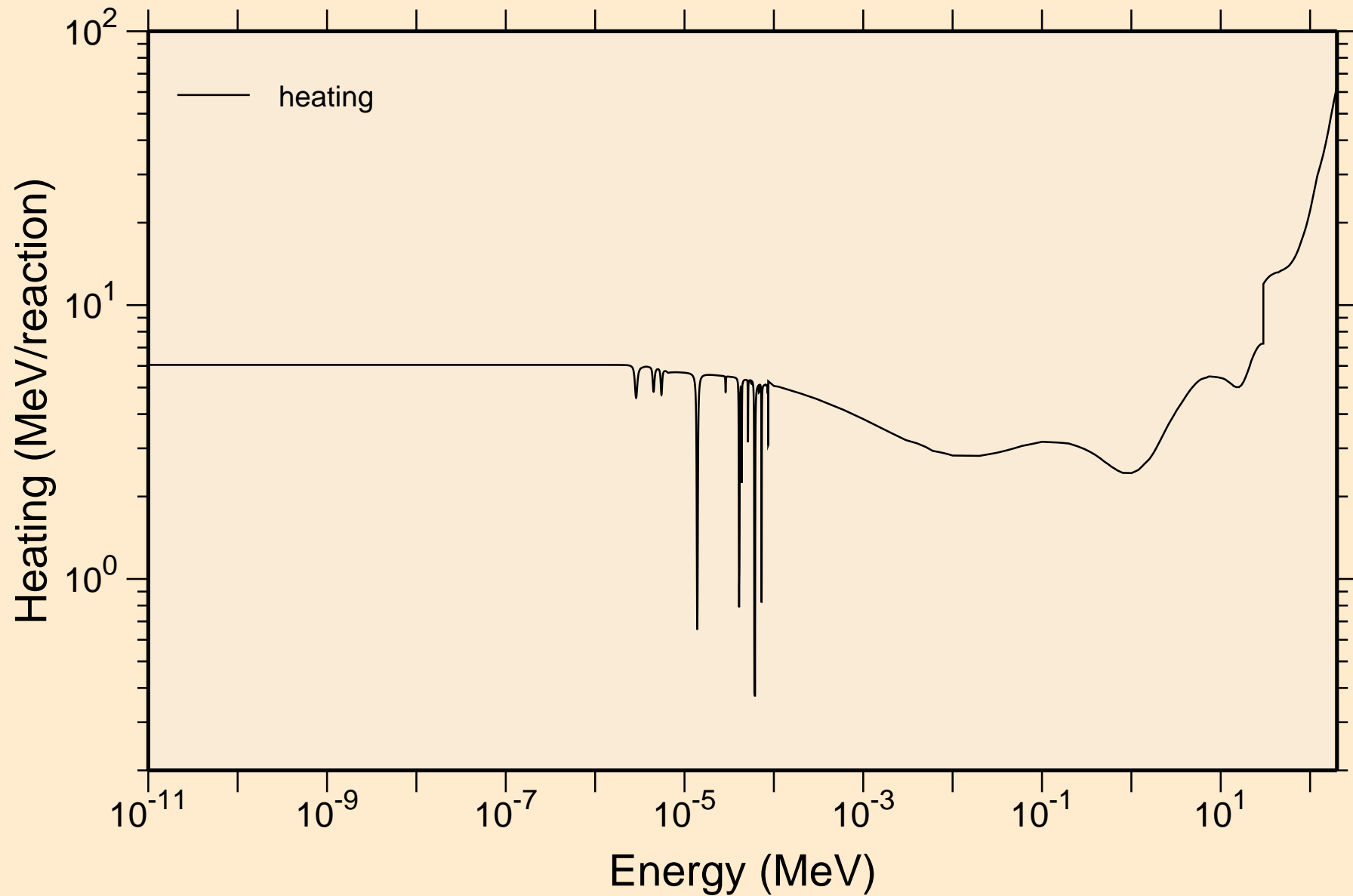

RH091 NEUTRON ACER TENDL-2019 LIBRARY; T=293.16K
Damage

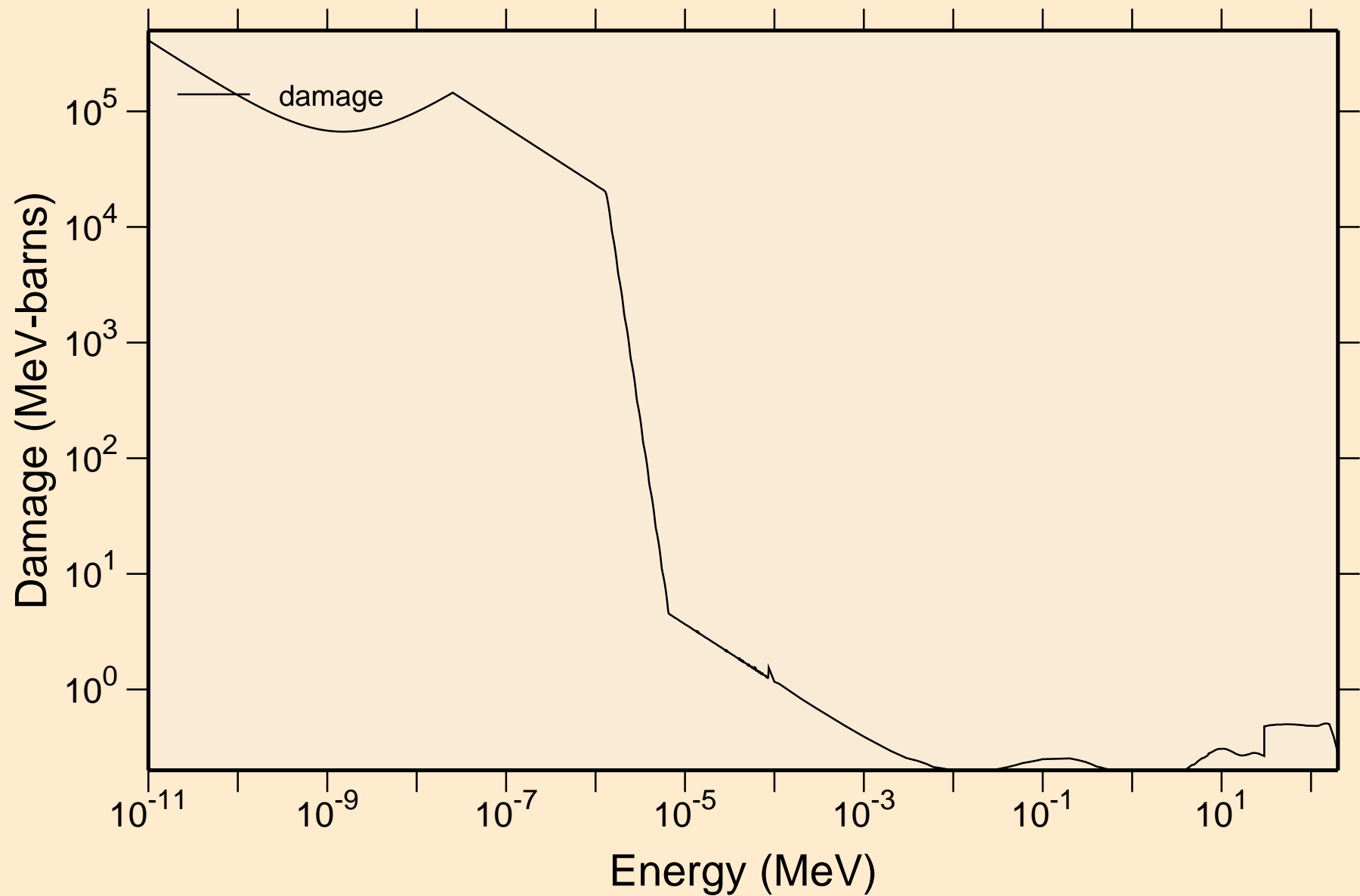

RH091 NEUTRON ACER TENDL-2019 LIBRARY; T=293.16K
Non-threshold reactions

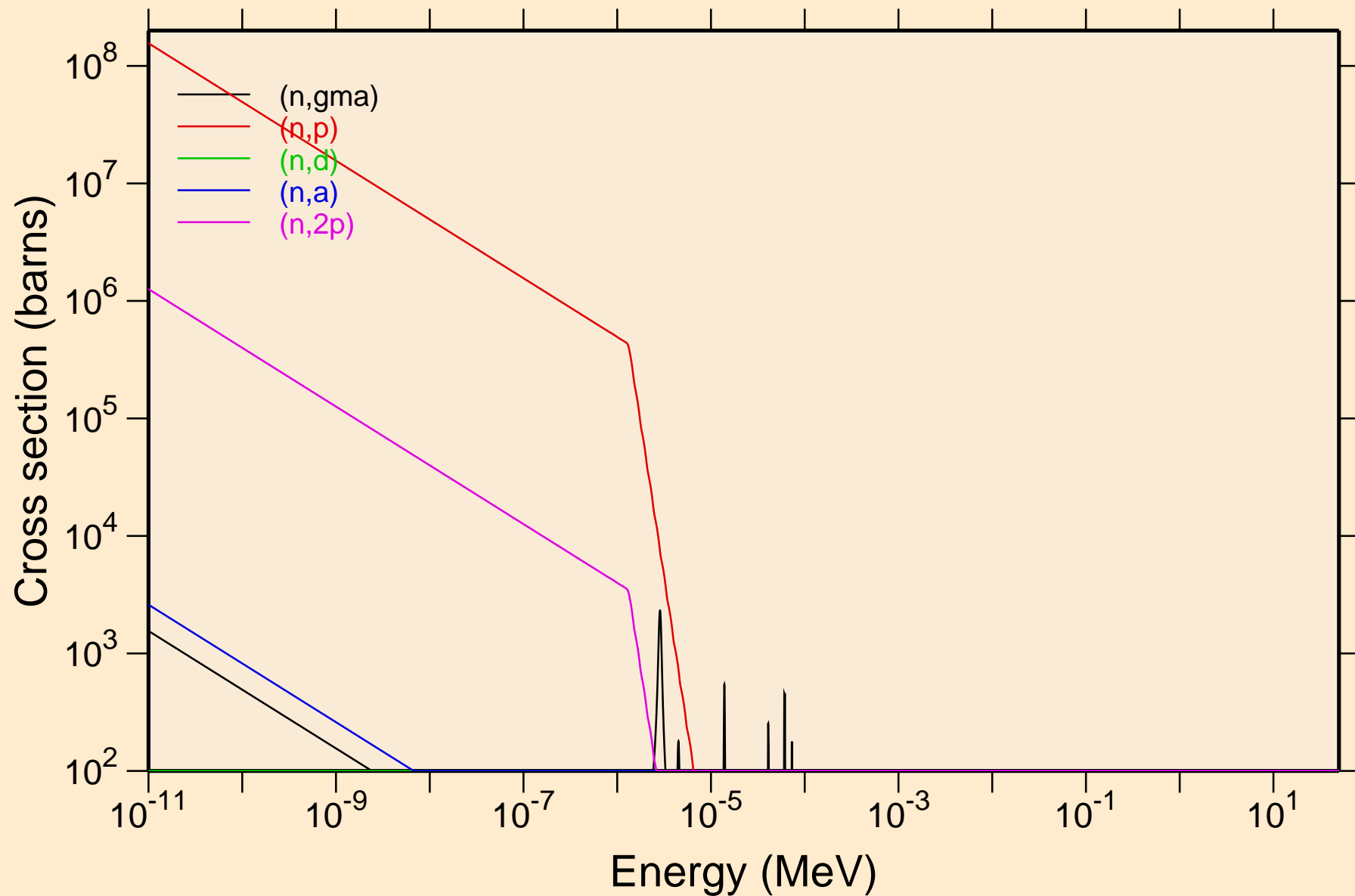

RH091 NEUTRON ACER TENDL-2019 LIBRARY; T=293.16K
Non-threshold reactions

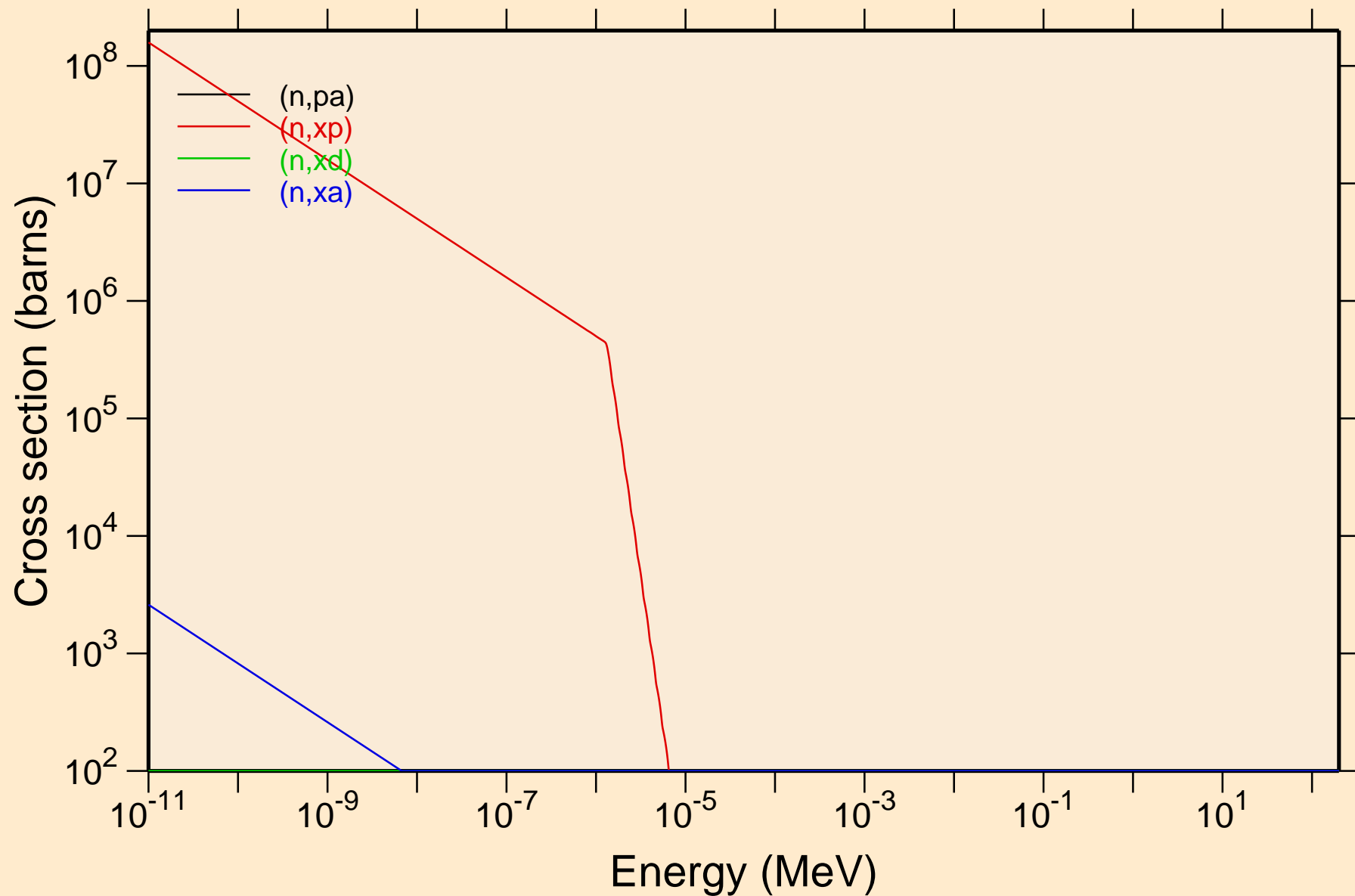

RH091 NEUTRON ACER TENDL-2019 LIBRARY; T=293.16K
Principal cross sections

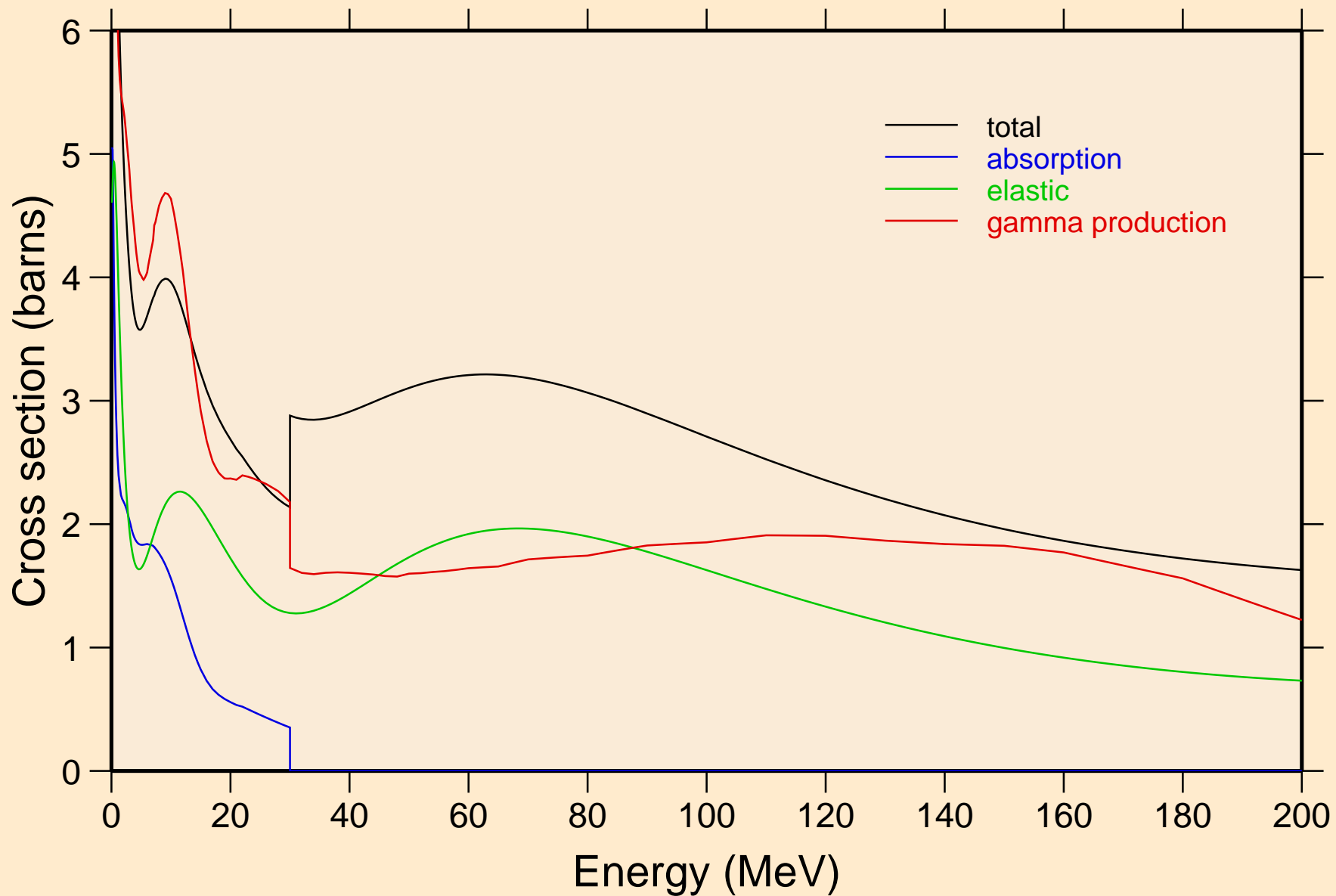

RH091 NEUTRON ACER TENDL-2019 LIBRARY; T=293.16K
Heating

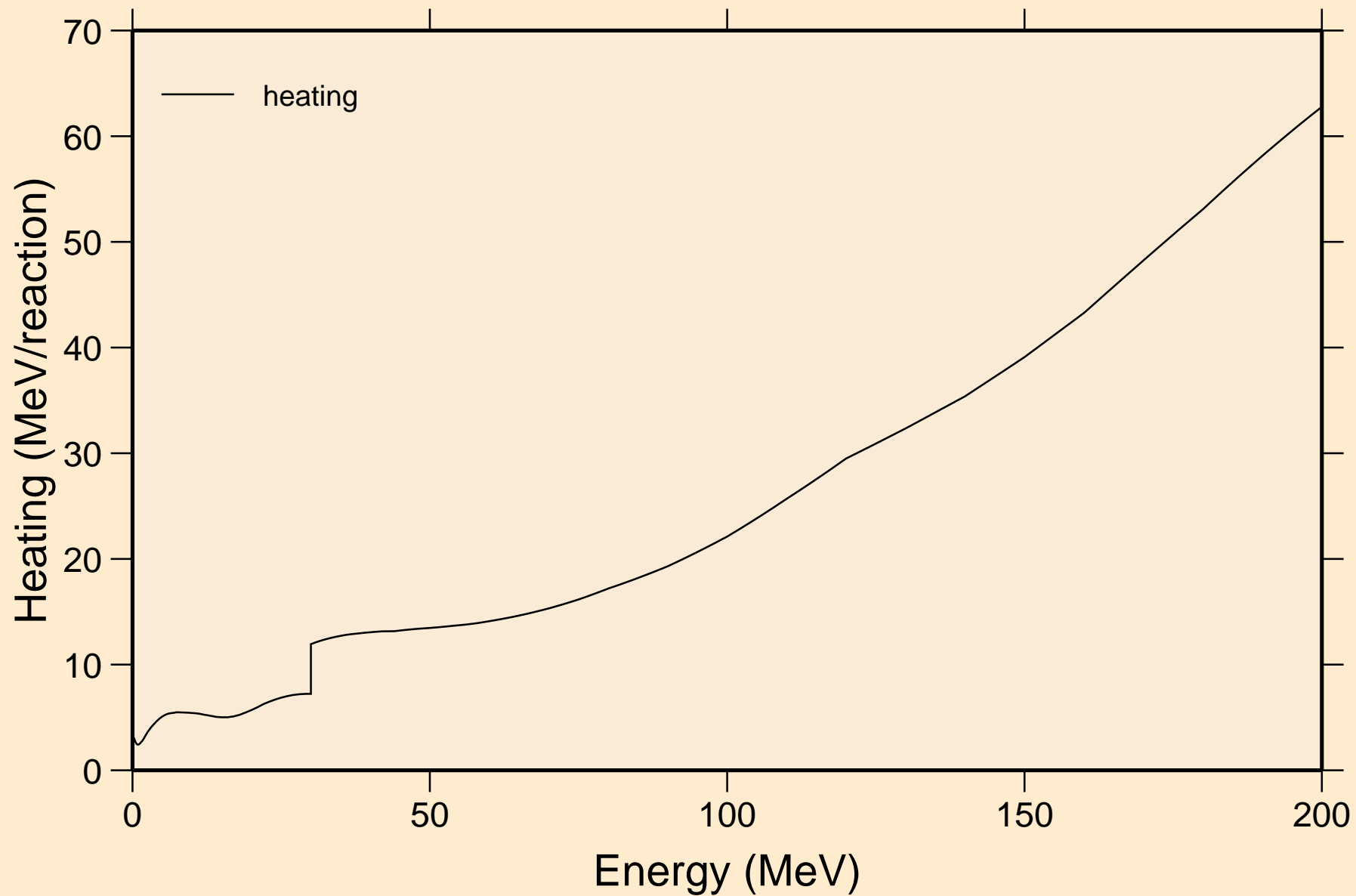

RH091 NEUTRON ACER TENDL-2019 LIBRARY; T=293.16K
Damage

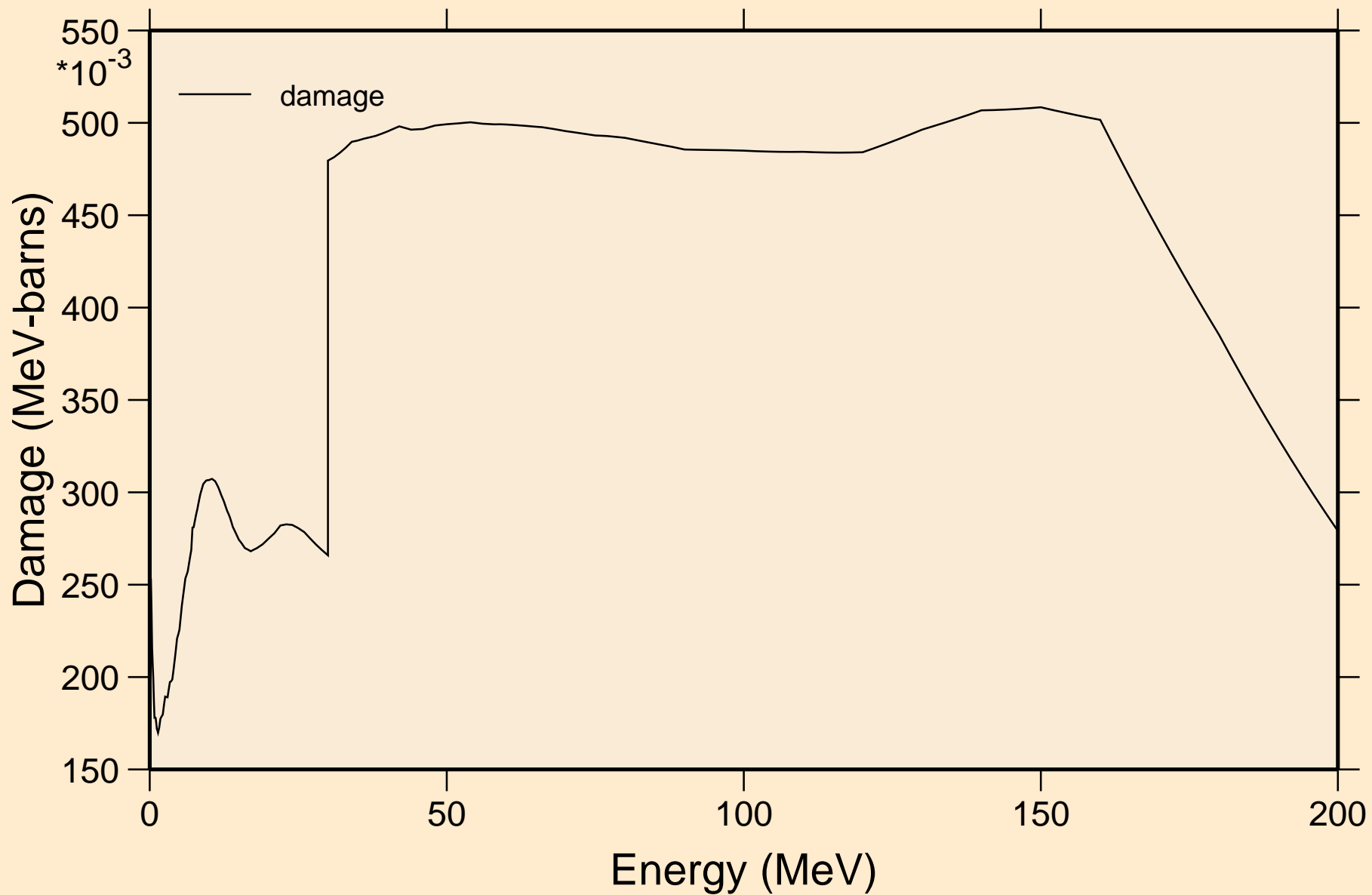

RH091 NEUTRON ACER TENDL-2019 LIBRARY; T=293.16K
Non-threshold reactions

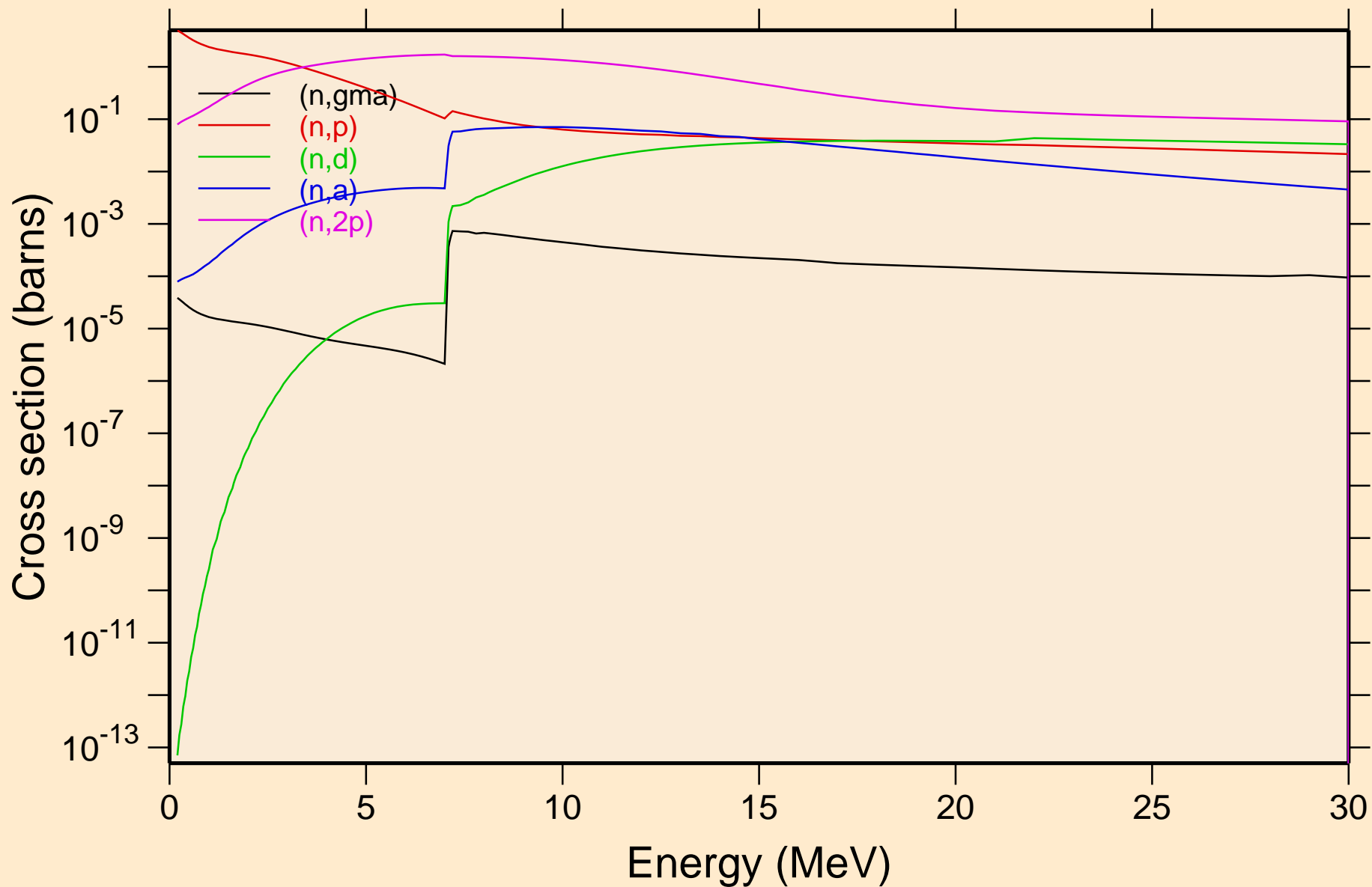

RH091 NEUTRON ACER TENDL-2019 LIBRARY; T=293.16K
Non-threshold reactions

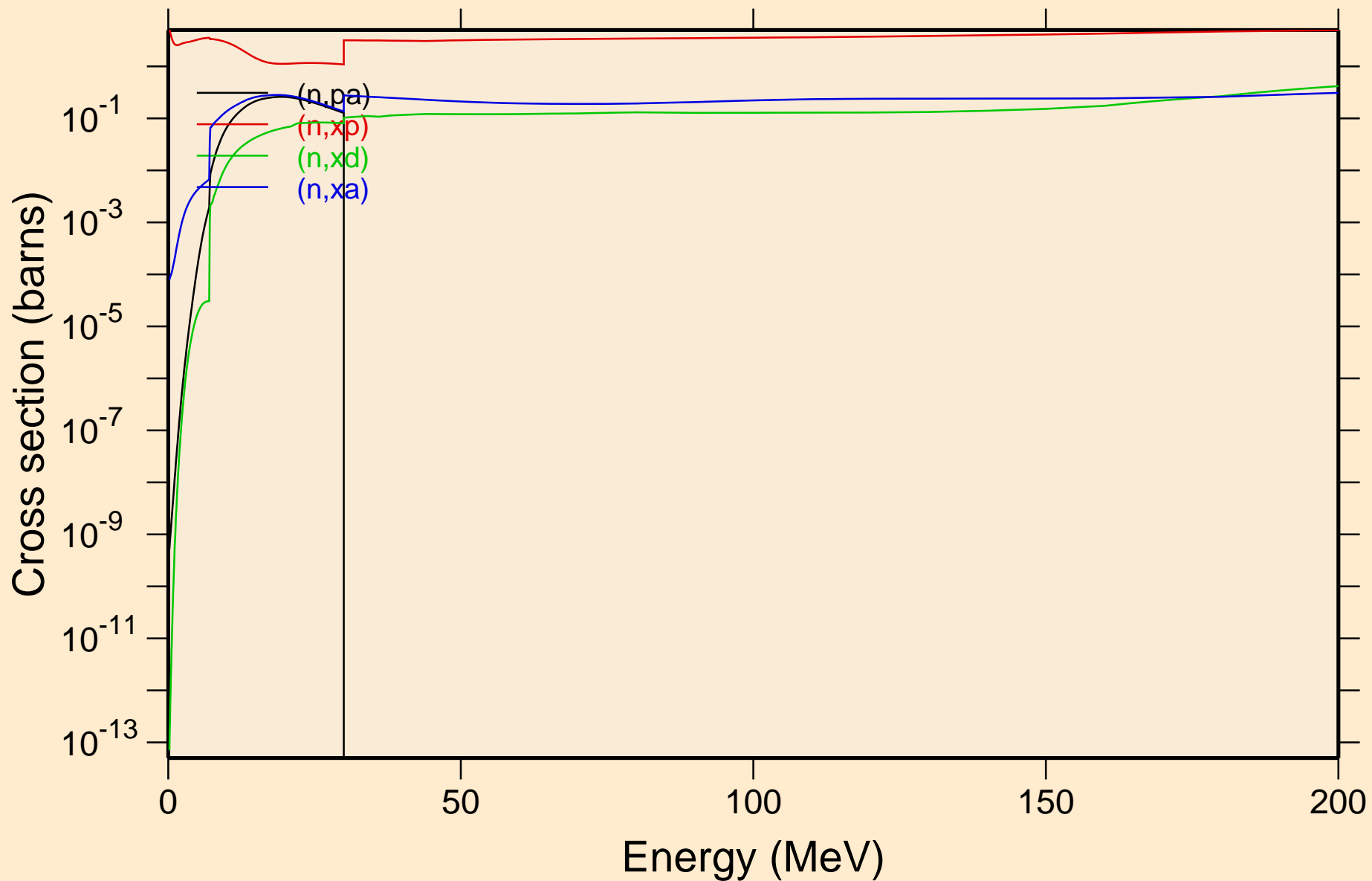

RH091 NEUTRON ACER TENDL-2019 LIBRARY; T=293.16K
Inelastic levels

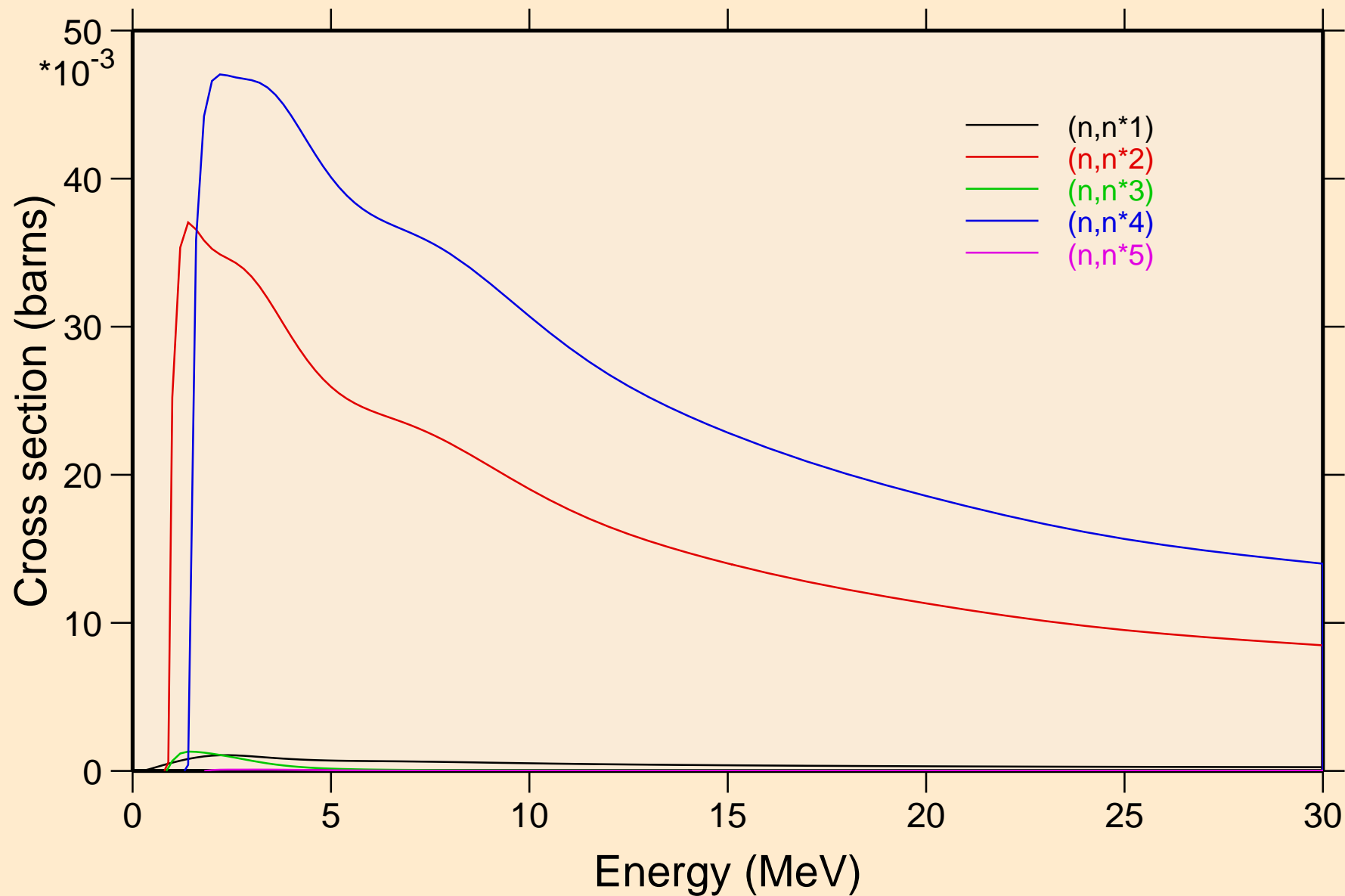

RH091 NEUTRON ACER TENDL-2019 LIBRARY; T=293.16K
Inelastic levels

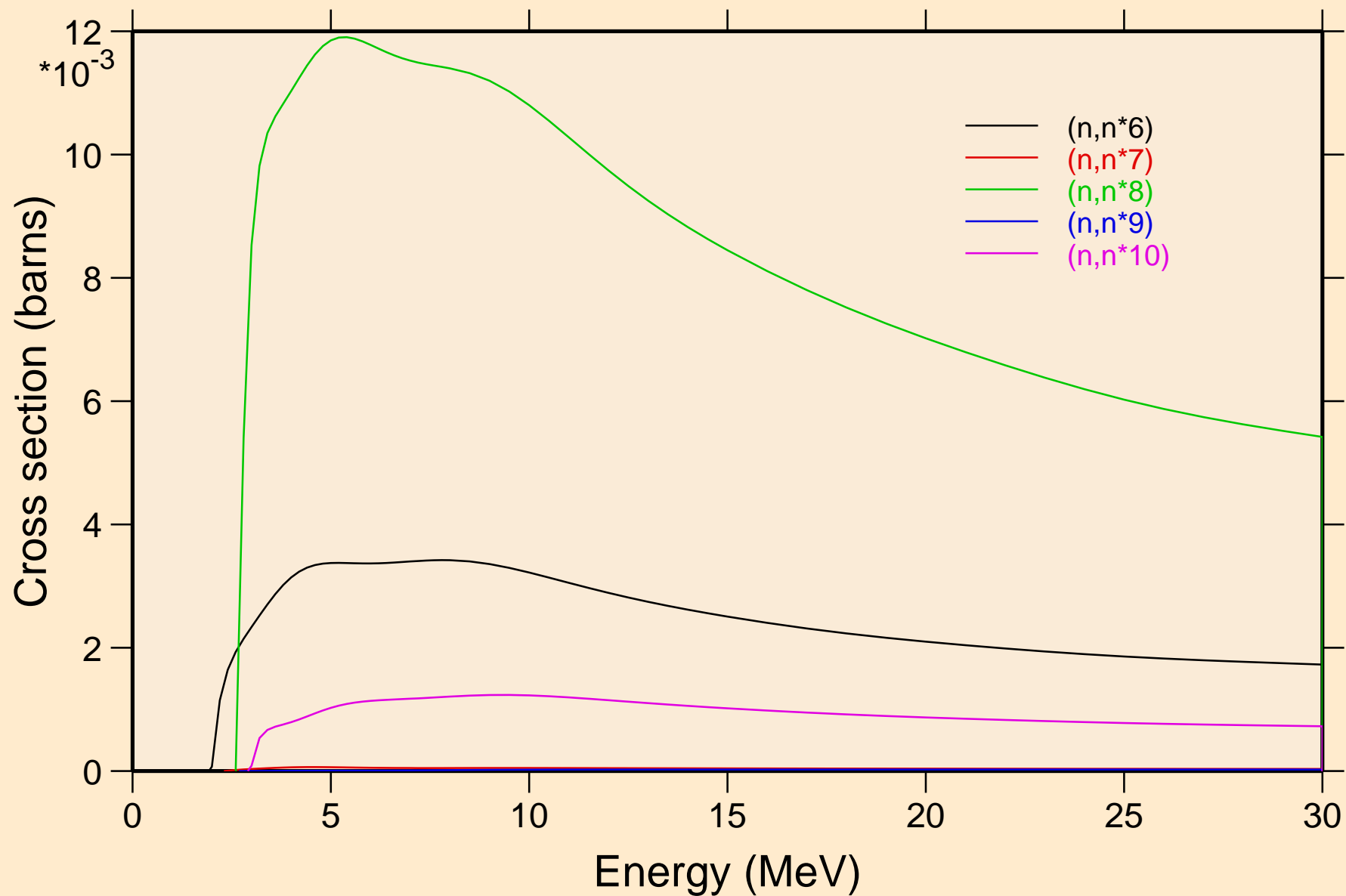

RH091 NEUTRON ACER TENDL-2019 LIBRARY; T=293.16K
Inelastic levels

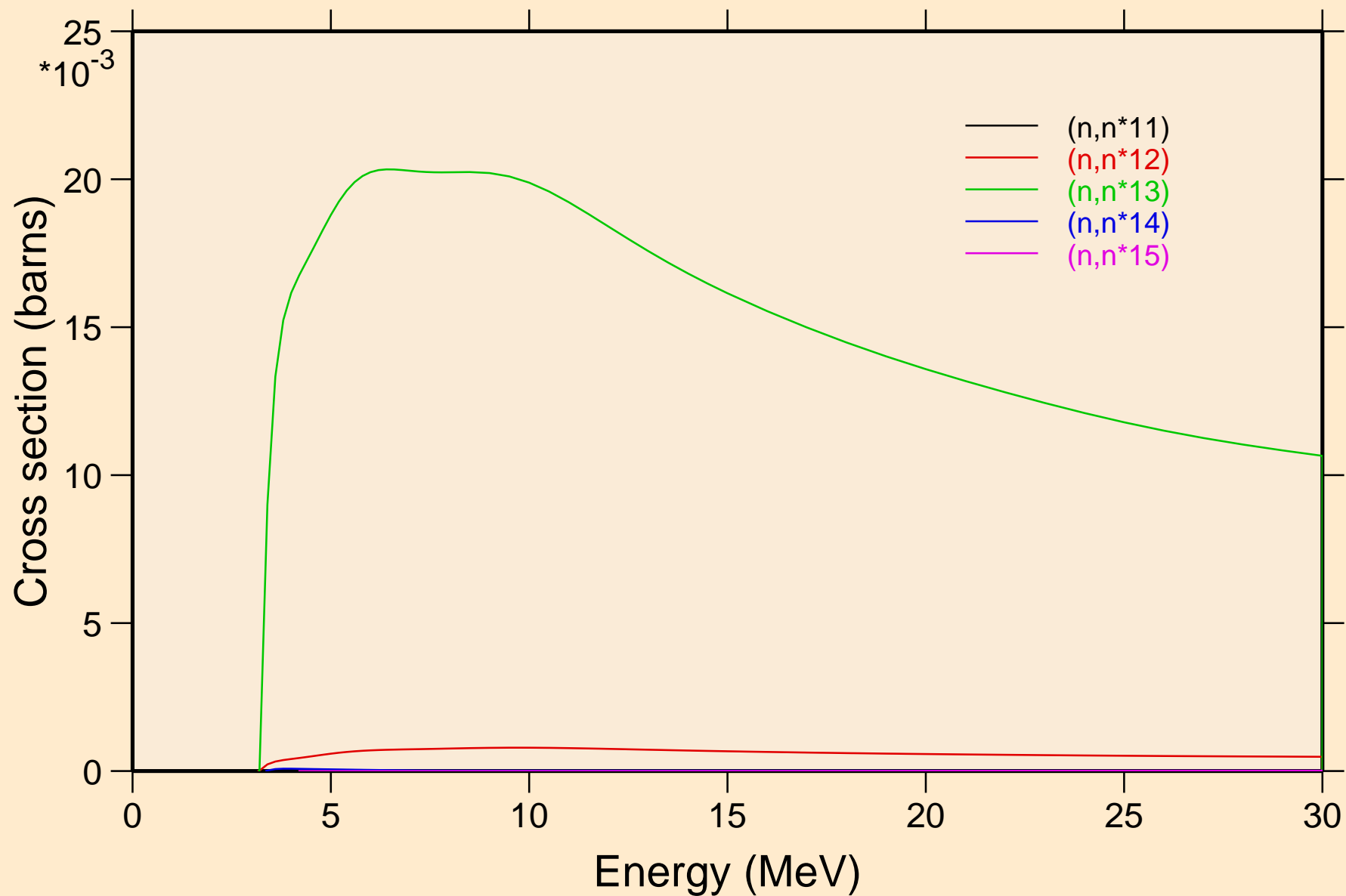

RH091 NEUTRON ACER TENDL-2019 LIBRARY; T=293.16K
Inelastic levels

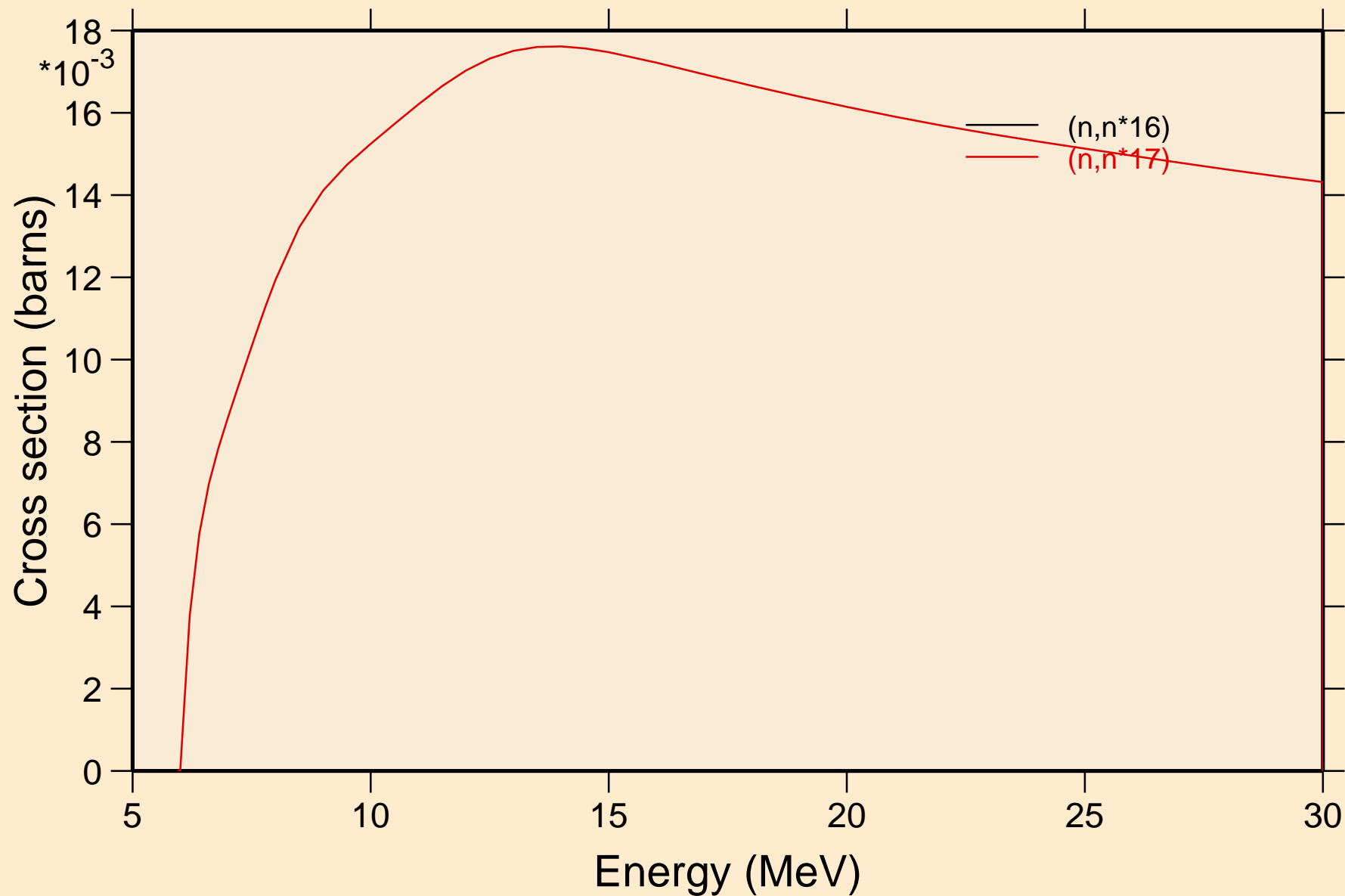

RH091 NEUTRON ACER TENDL-2019 LIBRARY; T=293.16K
Threshold reactions

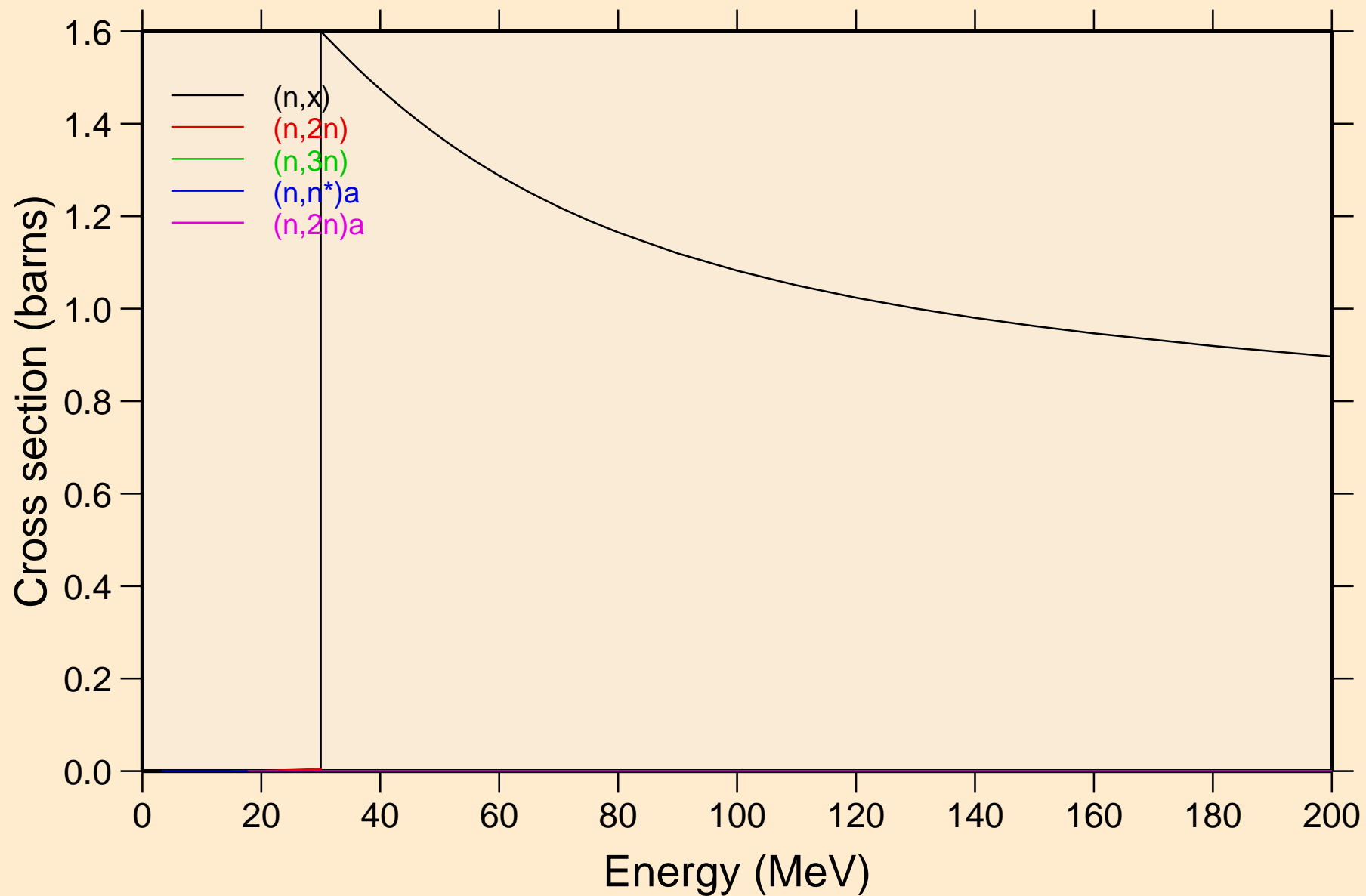

RH091 NEUTRON ACER TENDL-2019 LIBRARY; T=293.16K
Threshold reactions

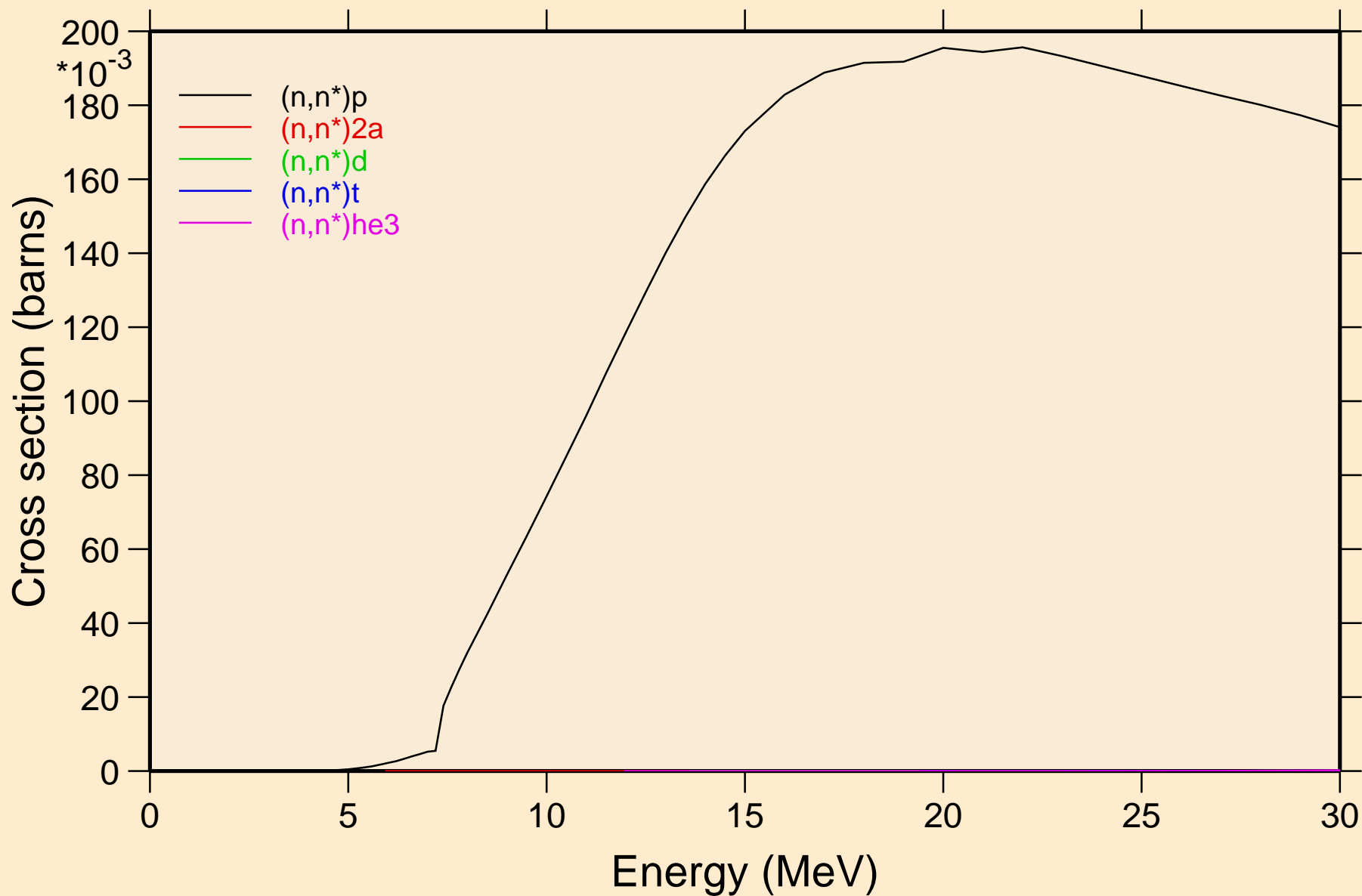

RH091 NEUTRON ACER TENDL-2019 LIBRARY; T=293.16K
Threshold reactions

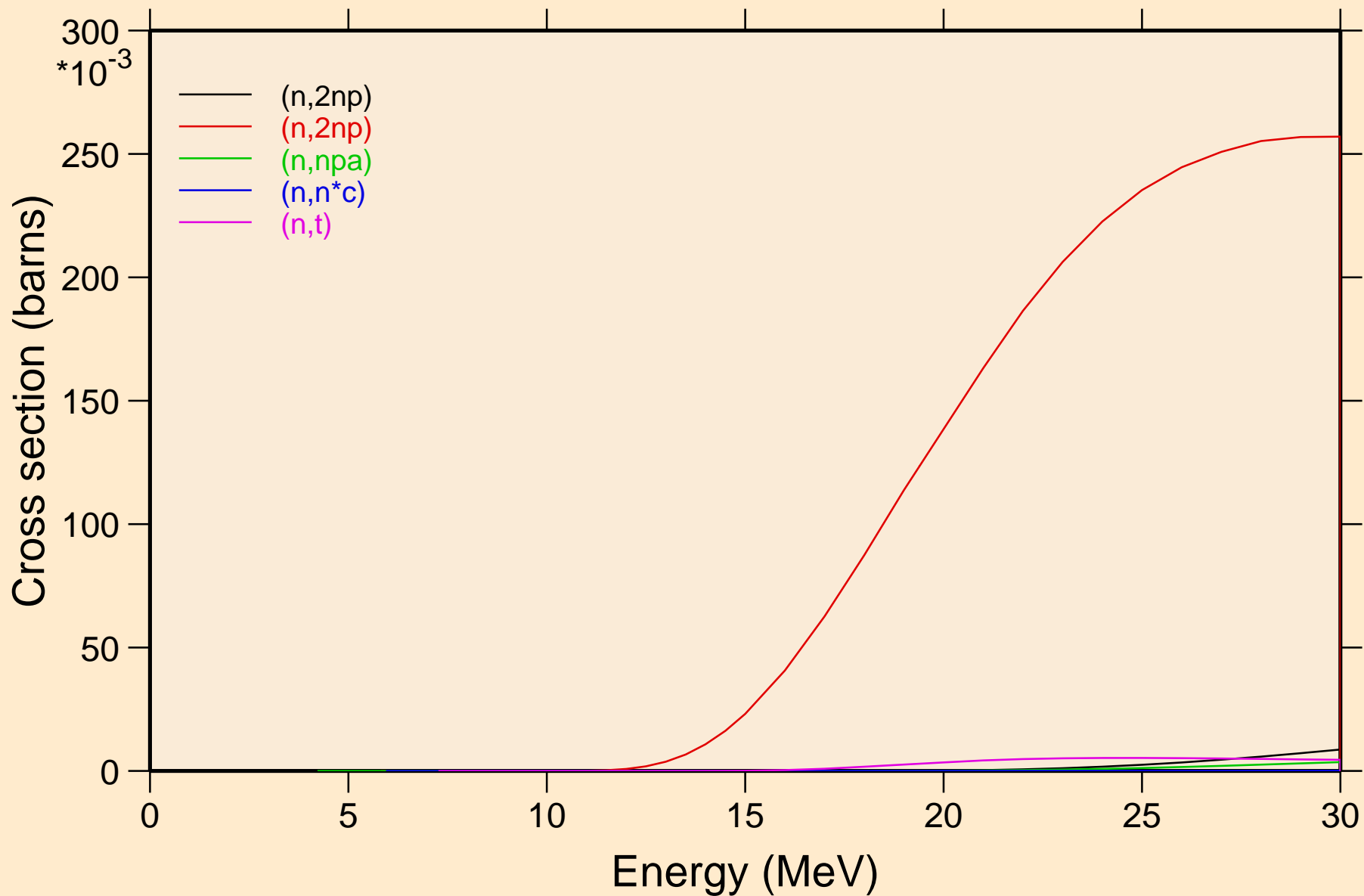

RH091 NEUTRON ACER TENDL-2019 LIBRARY; T=293.16K
Threshold reactions

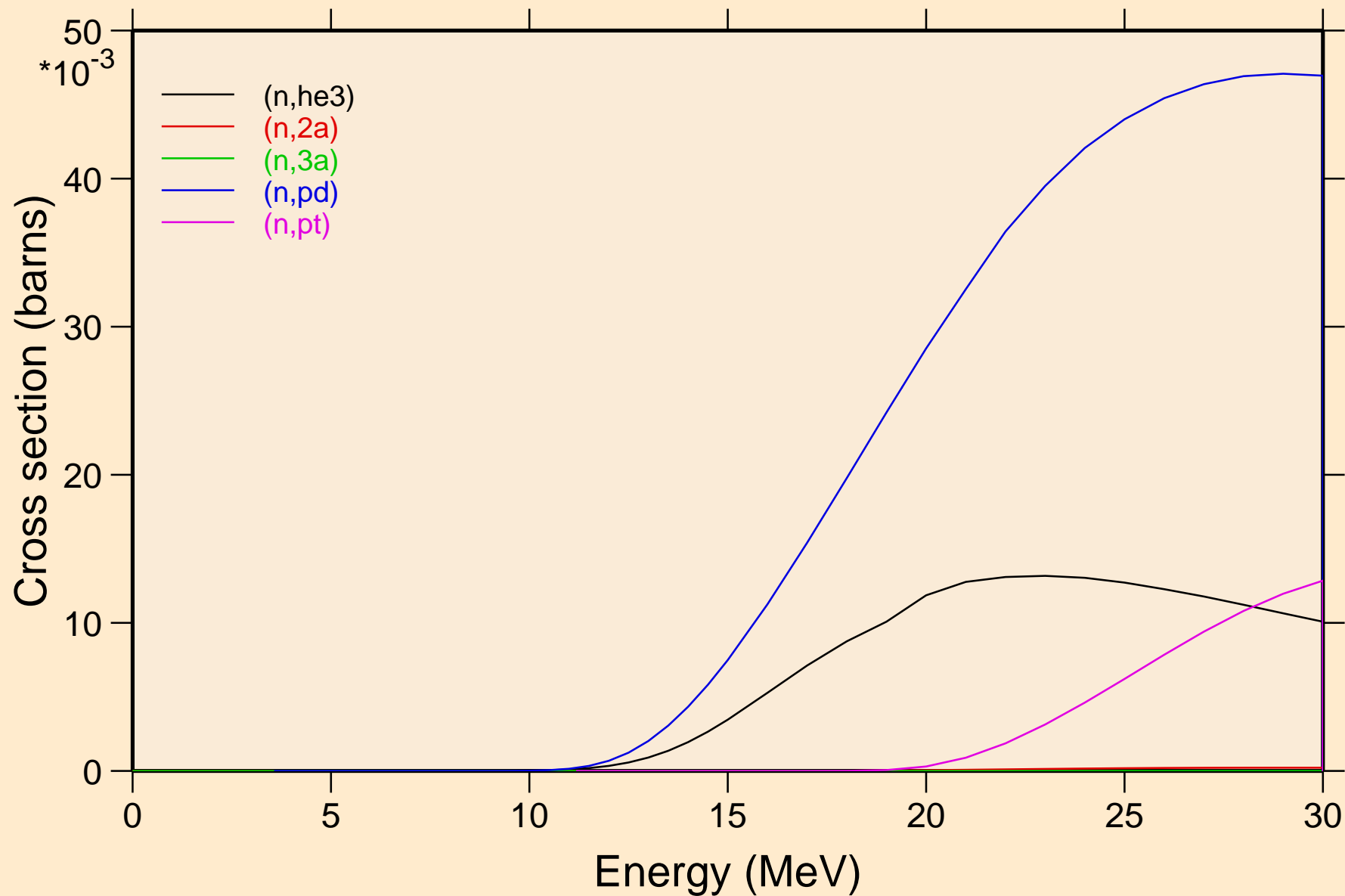

RH091 NEUTRON ACER TENDL-2019 LIBRARY; T=293.16K
Threshold reactions

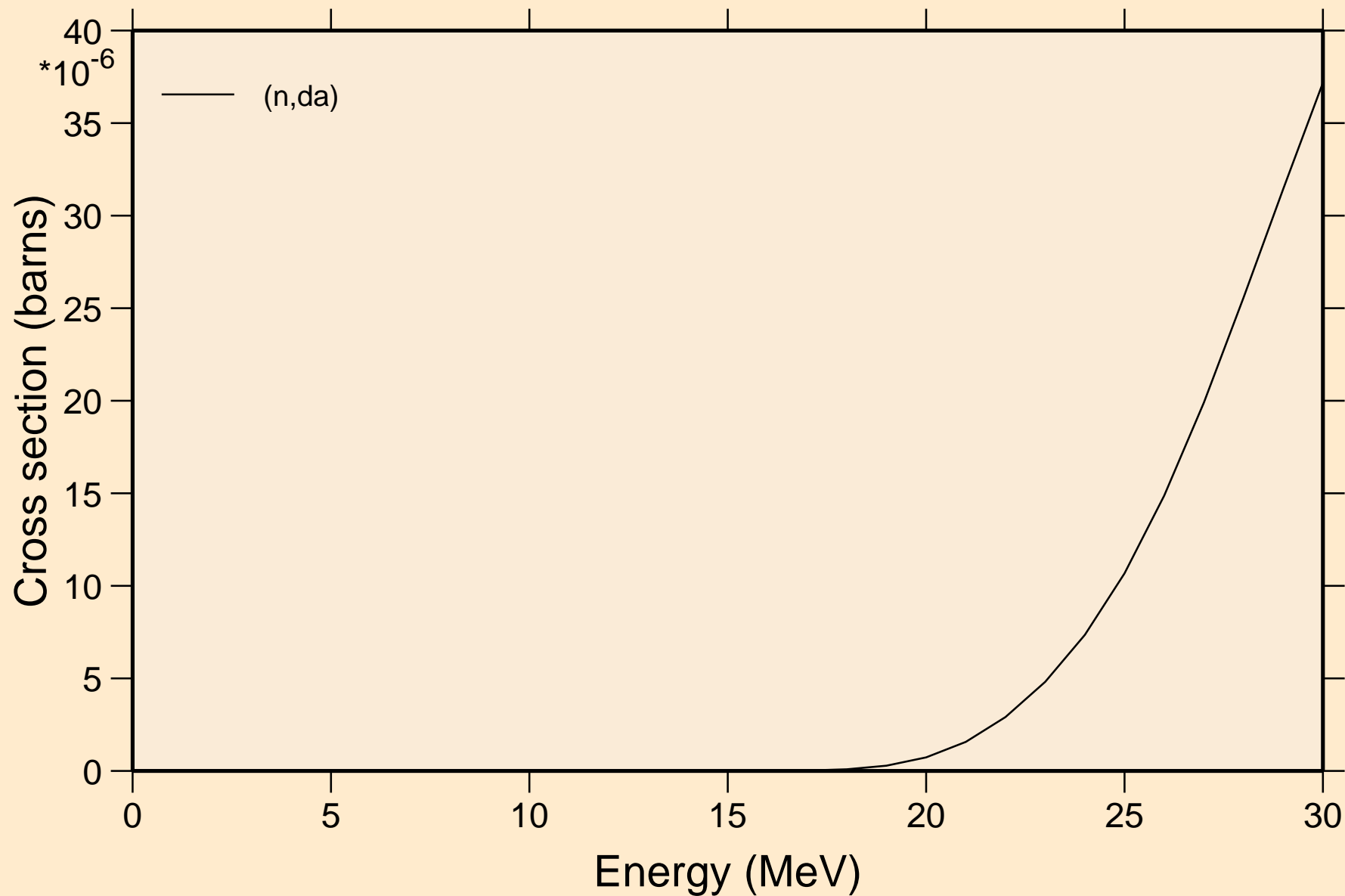

RH091 NEUTRON ACER TENDL-2019 LIBRARY; T=293.16K
Threshold reactions

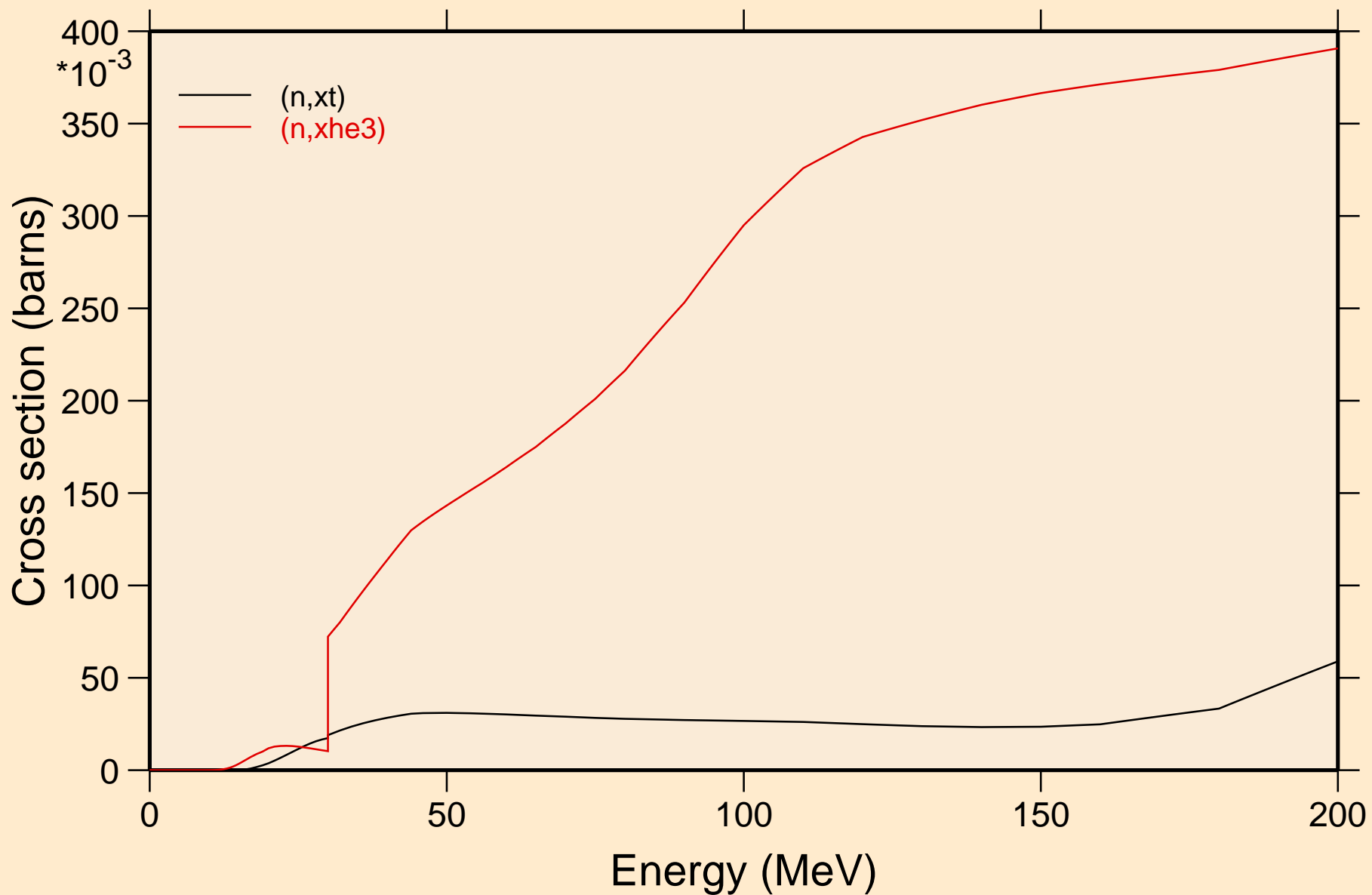

RH091 NEUTRON ACER TENDL-2019 LIBRARY; T=293.16K
angular distribution for elastic

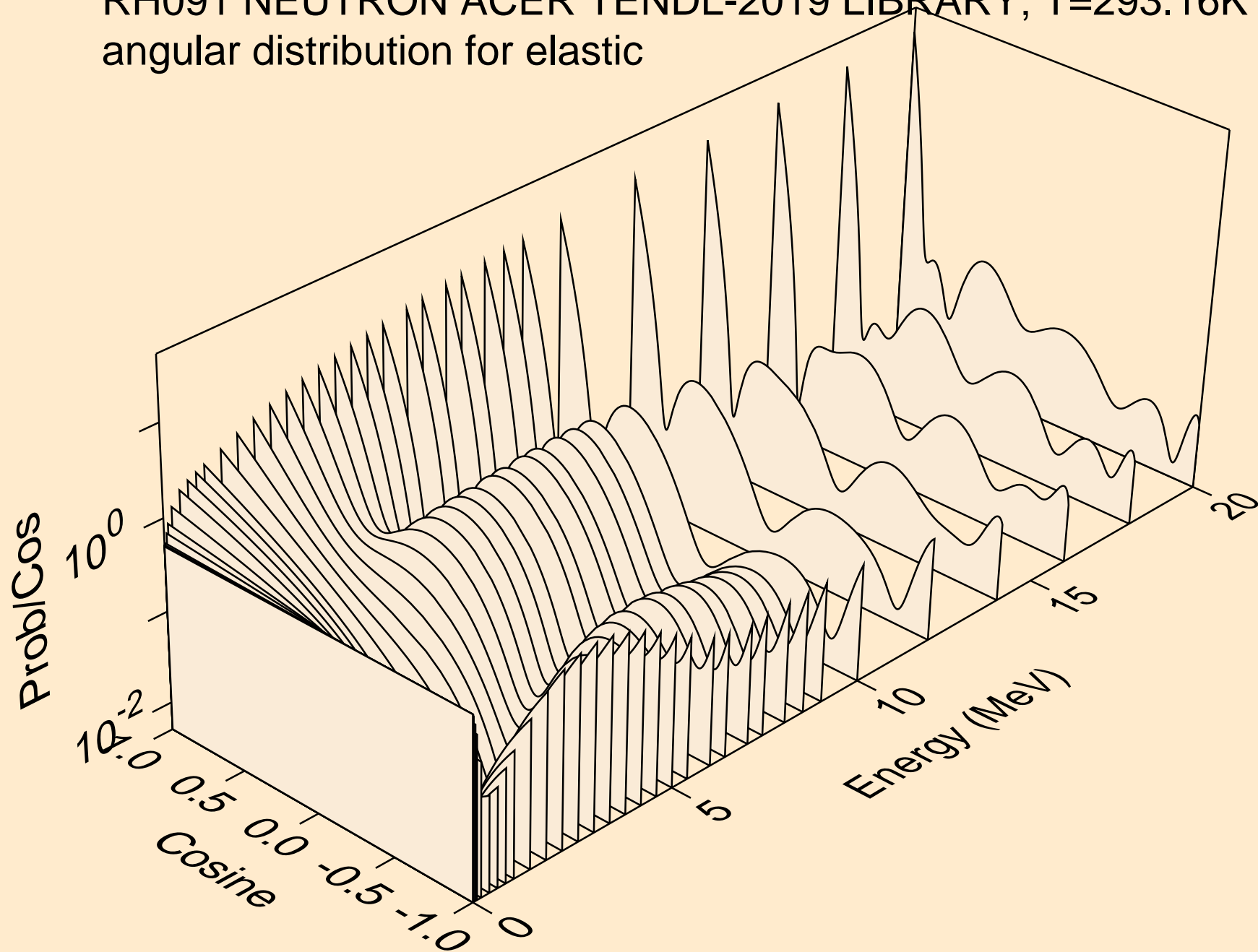

RH091 NEUTRON ACER TENDL-2019 LIBRARY; T=293.16K
angular distribution for elastic

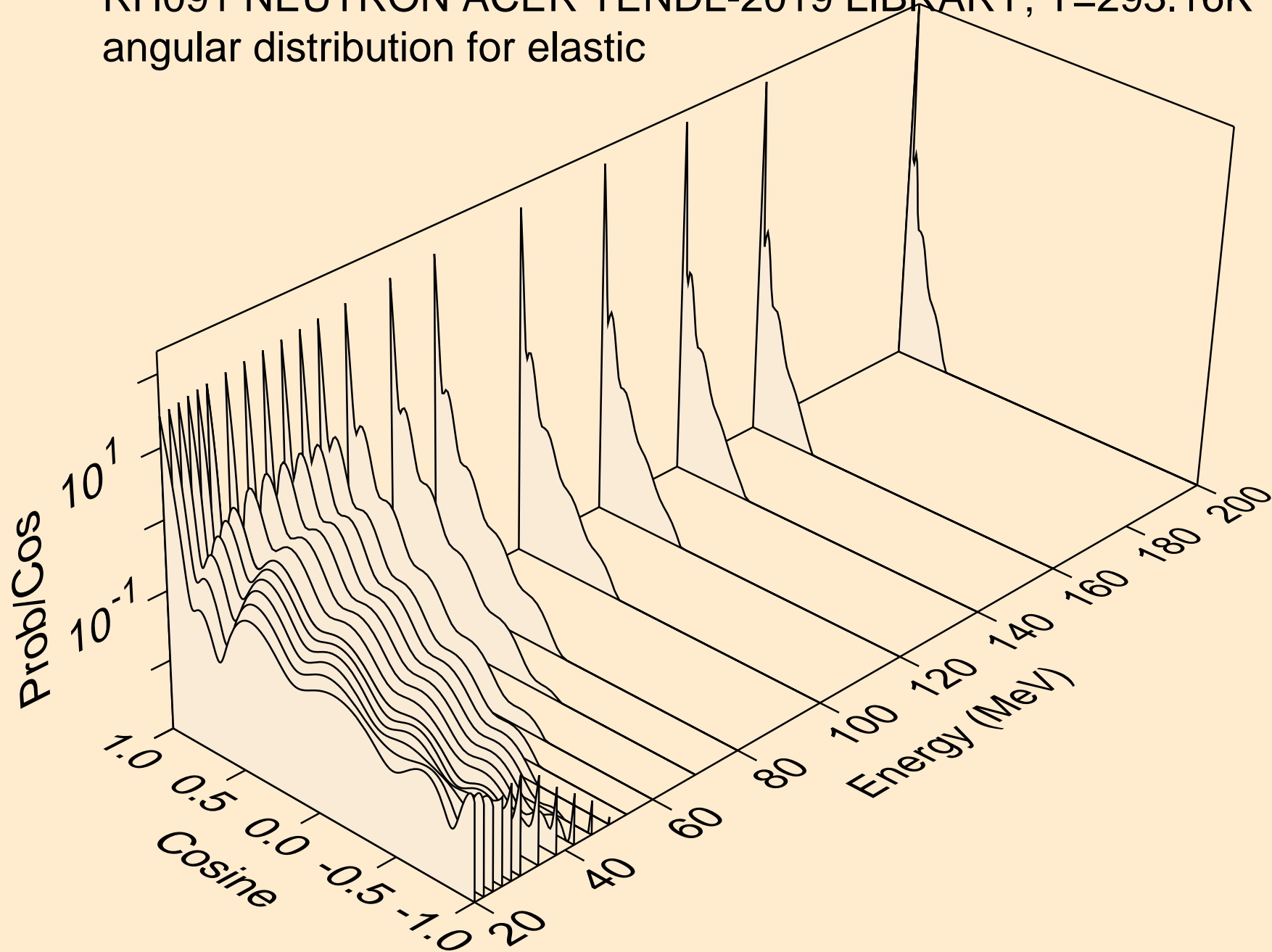

RH091 NEUTRON ACER TENDL-2019 LIBRARY; T=293.16K
angular distribution for (n,n*1)

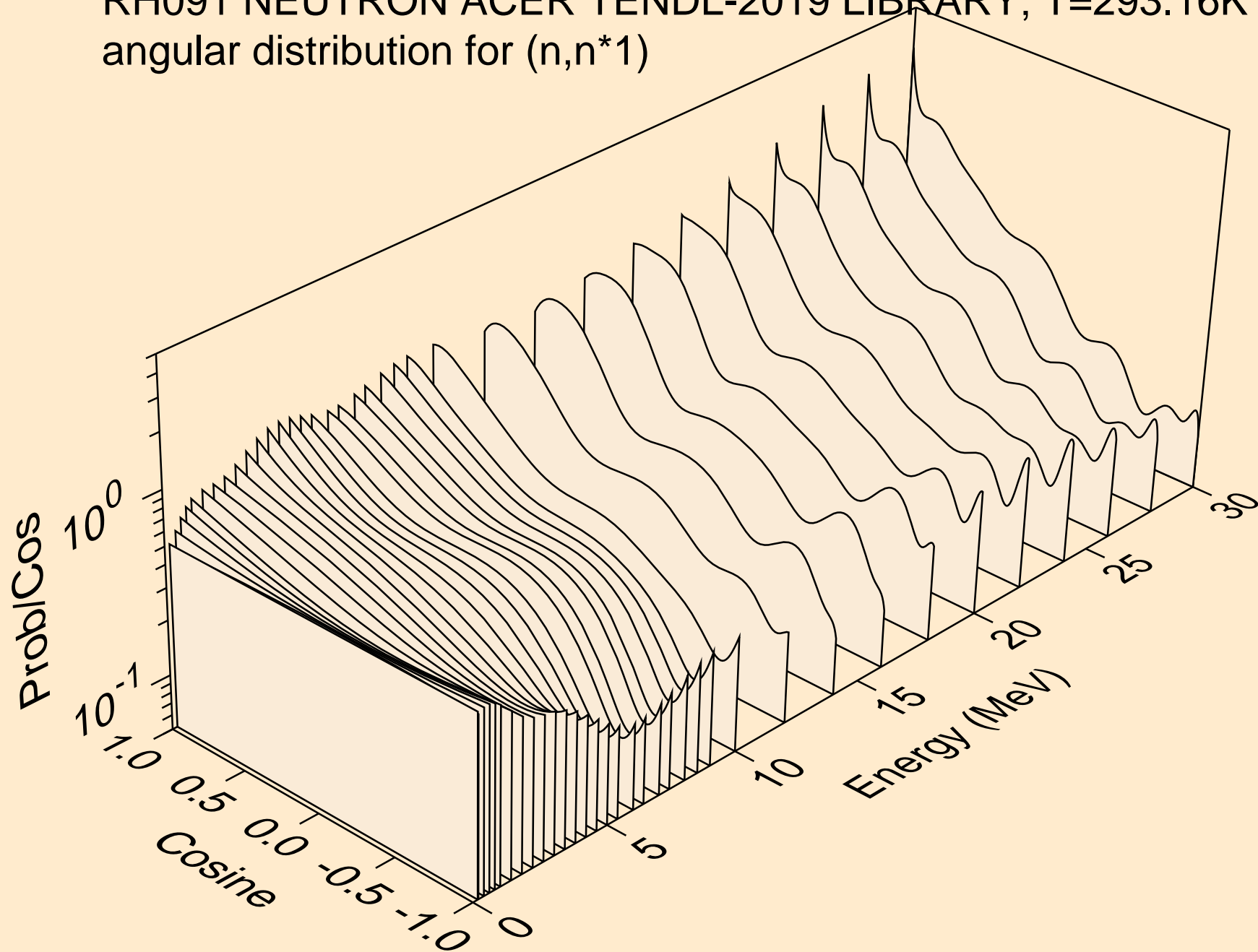

RH091 NEUTRON ACER TENDL-2019 LIBRARY; T=293.16K
angular distribution for (n,n*2)

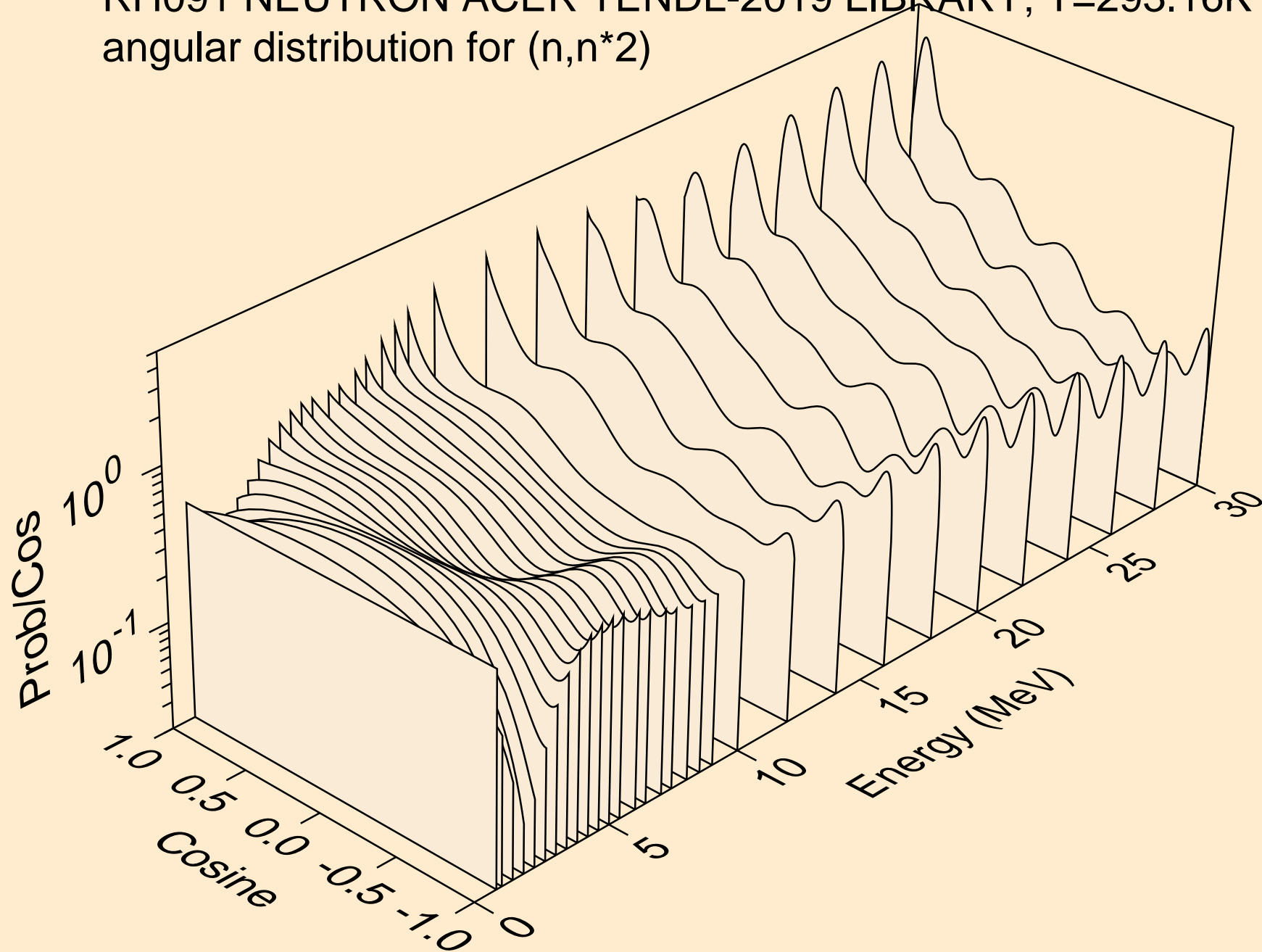

RH091 NEUTRON ACER TENDL-2019 LIBRARY; T=293.16K
angular distribution for (n,n*3)

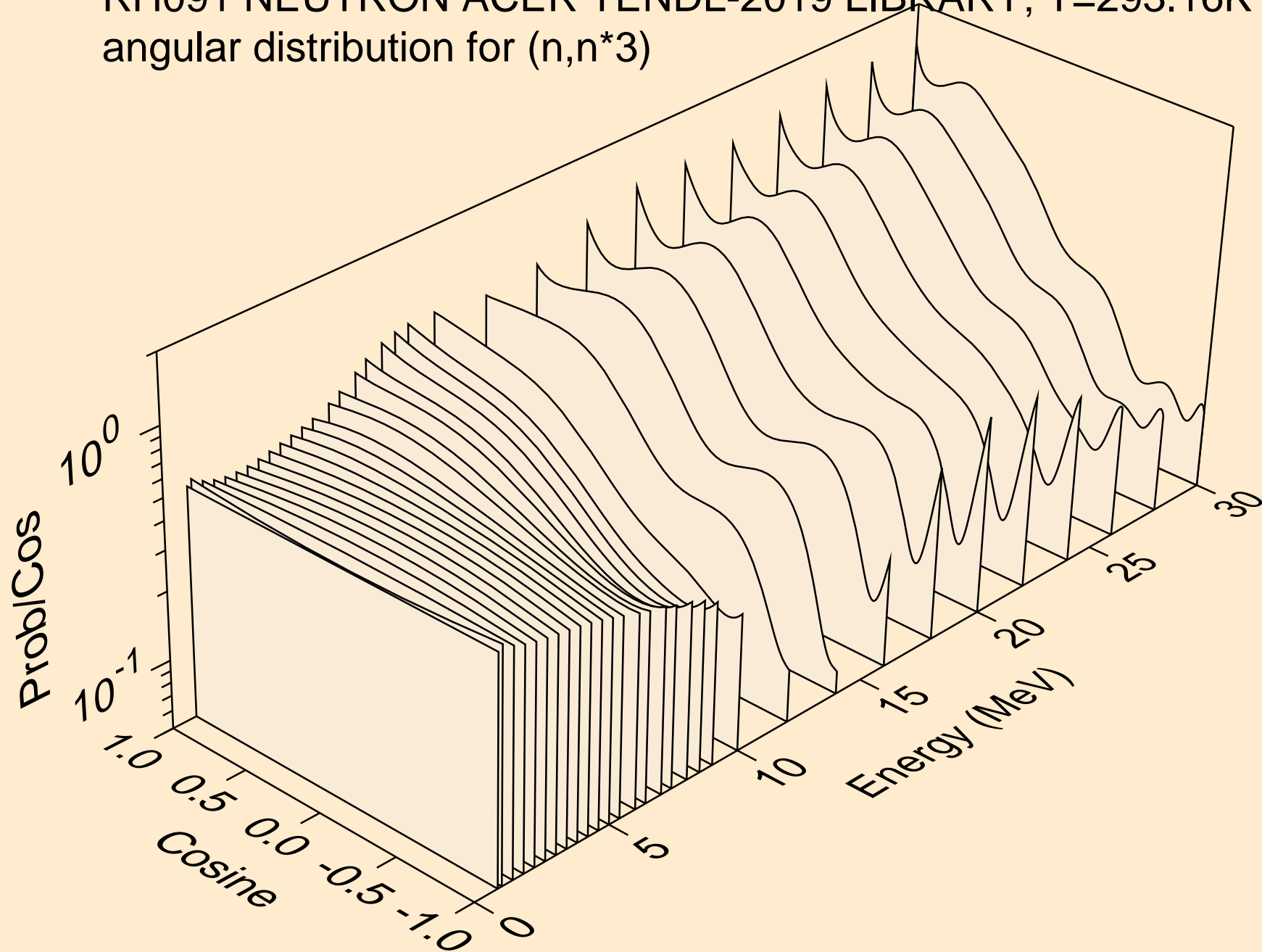

RH091 NEUTRON ACER TENDL-2019 LIBRARY; T=293.16K
angular distribution for (n,n*4)

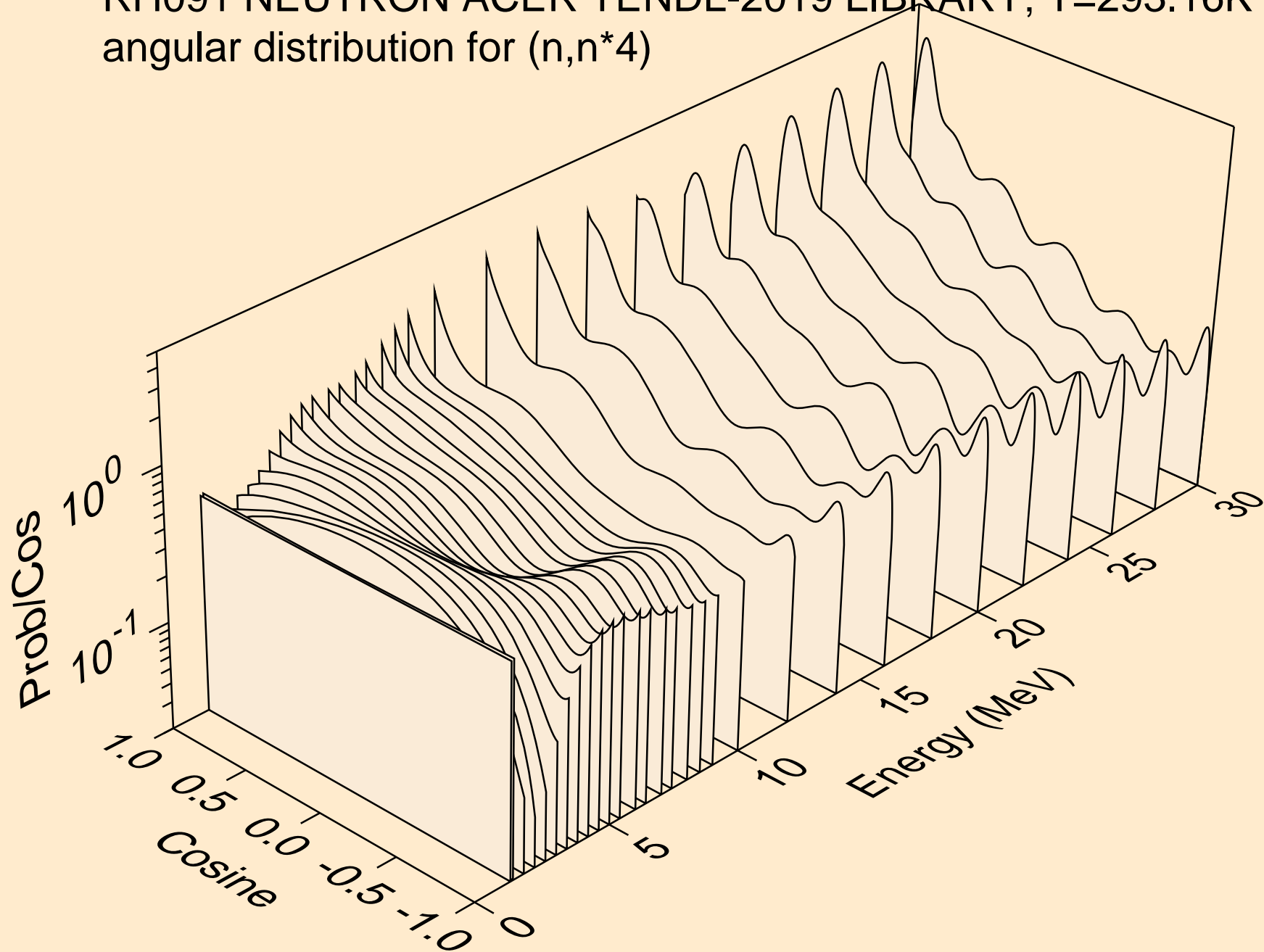

RH091 NEUTRON ACER TENDL-2019 LIBRARY; T=293.16K
angular distribution for (n,n*5)

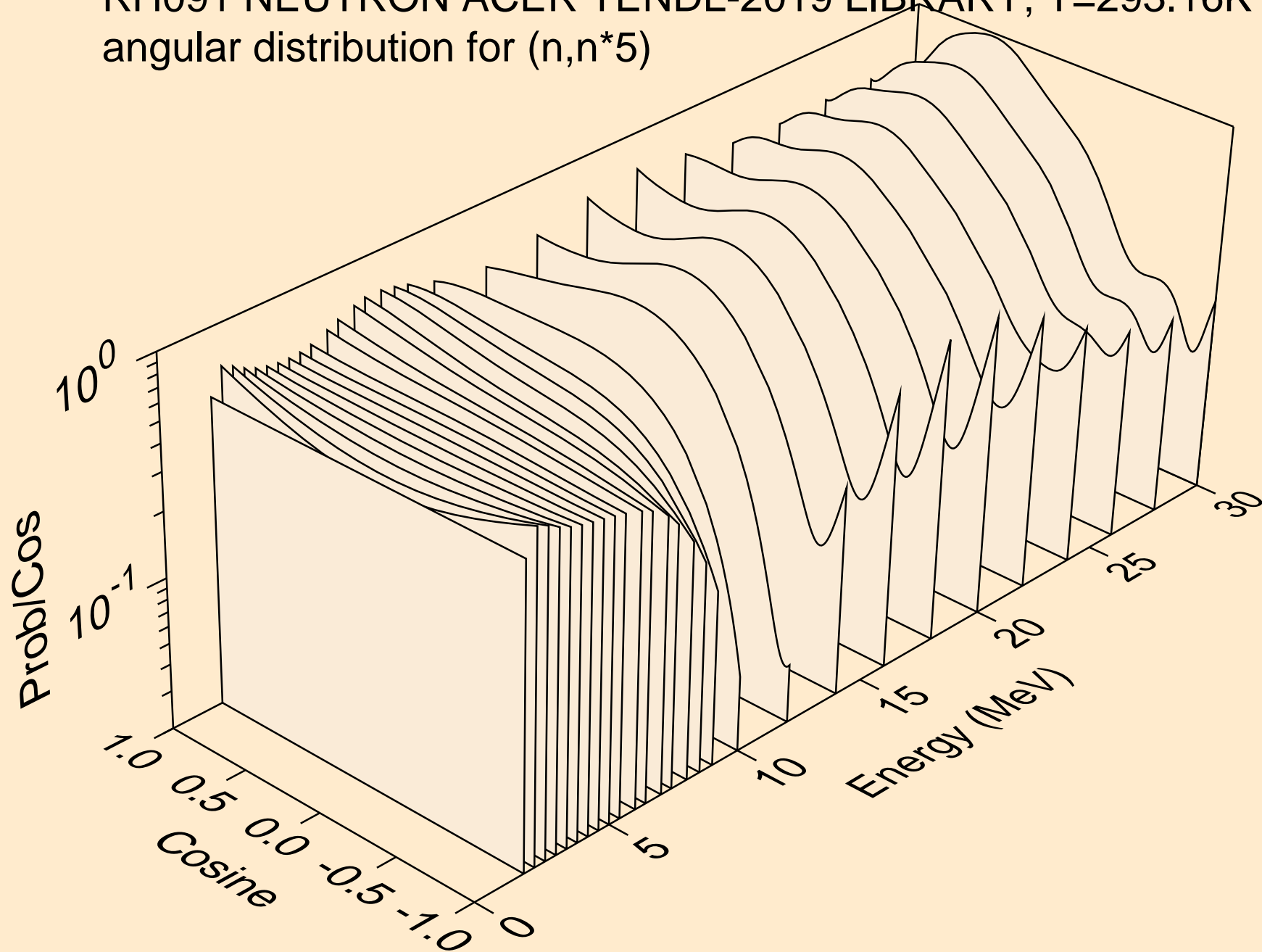

RH091 NEUTRON ACER TENDL-2019 LIBRARY; T=293.16K
angular distribution for (n,n*6)

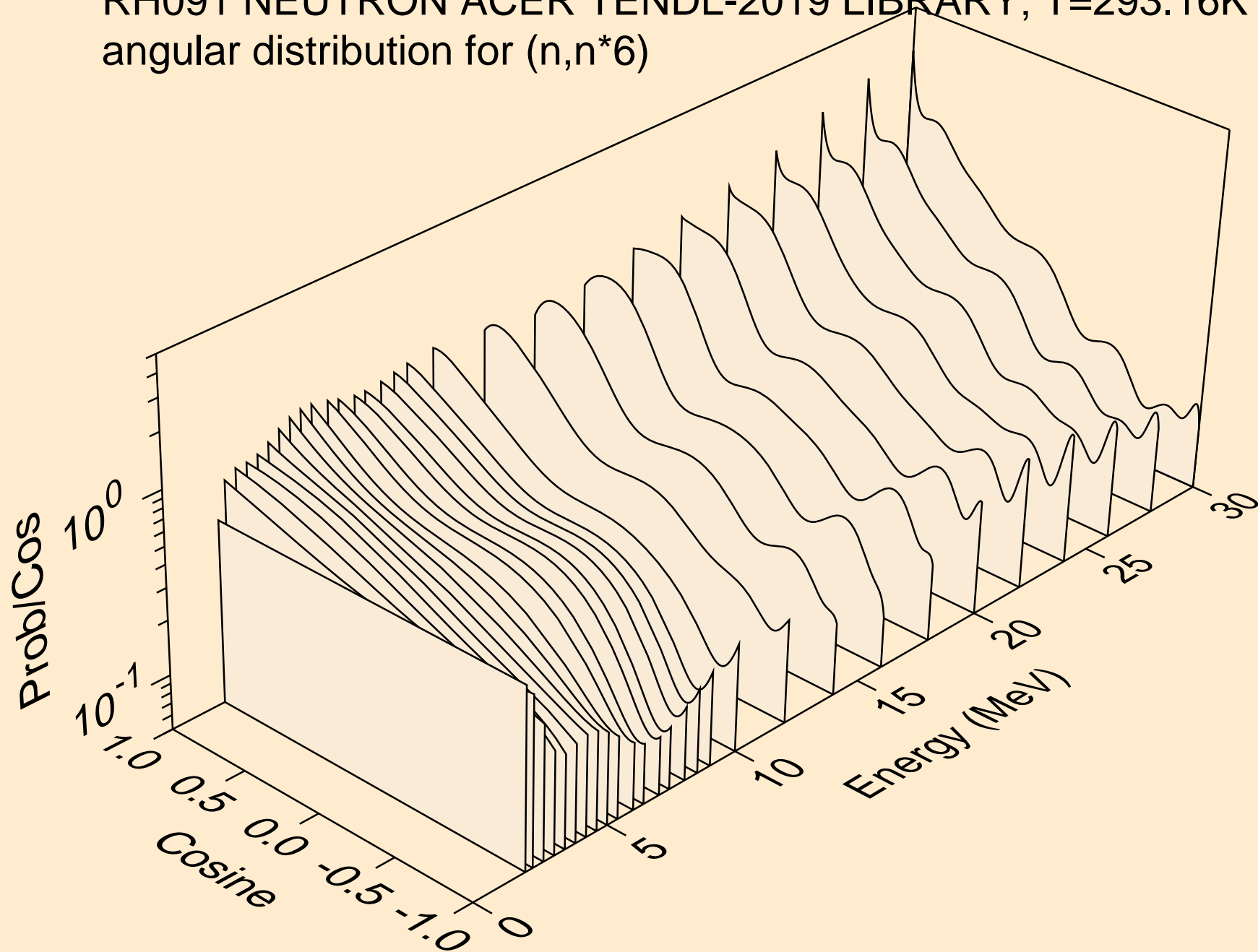

RH091 NEUTRON ACER TENDL-2019 LIBRARY; T=293.16K
angular distribution for (n,n*7)

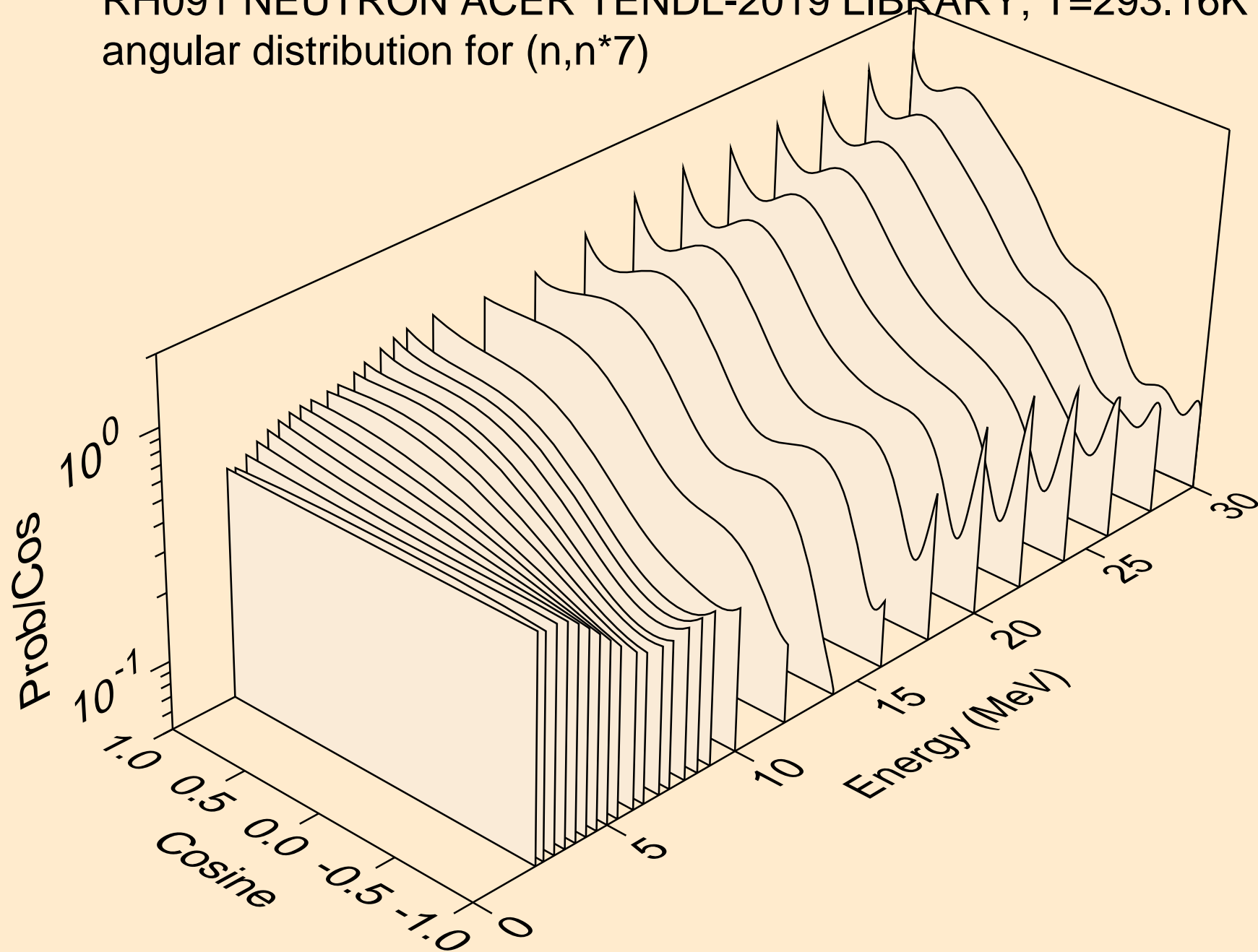

RH091 NEUTRON ACER TENDL-2019 LIBRARY; T=293.16K
angular distribution for (n,n*8)

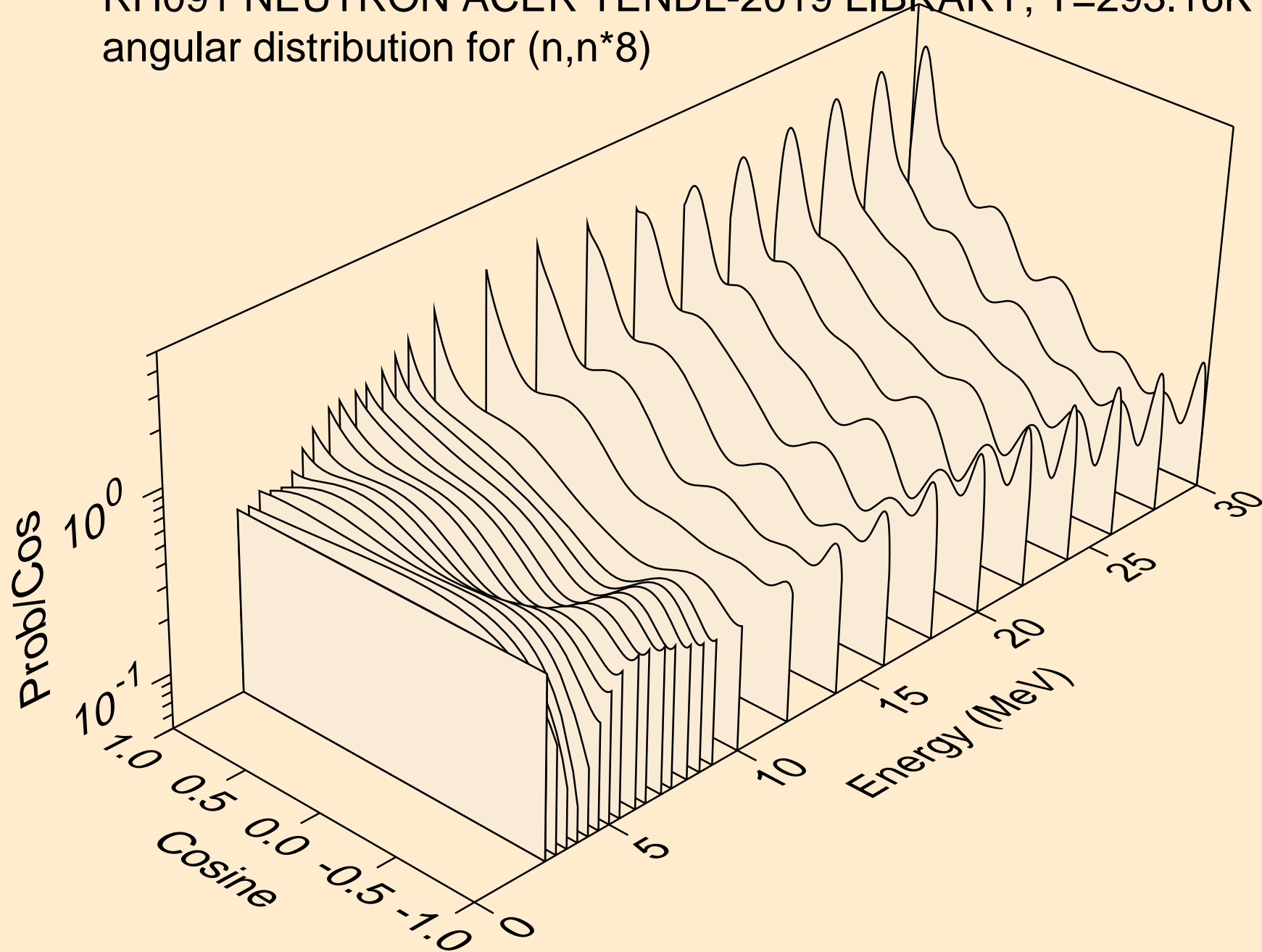

RH091 NEUTRON ACER TENDL-2019 LIBRARY; T=293.16K
angular distribution for (n,n*9)

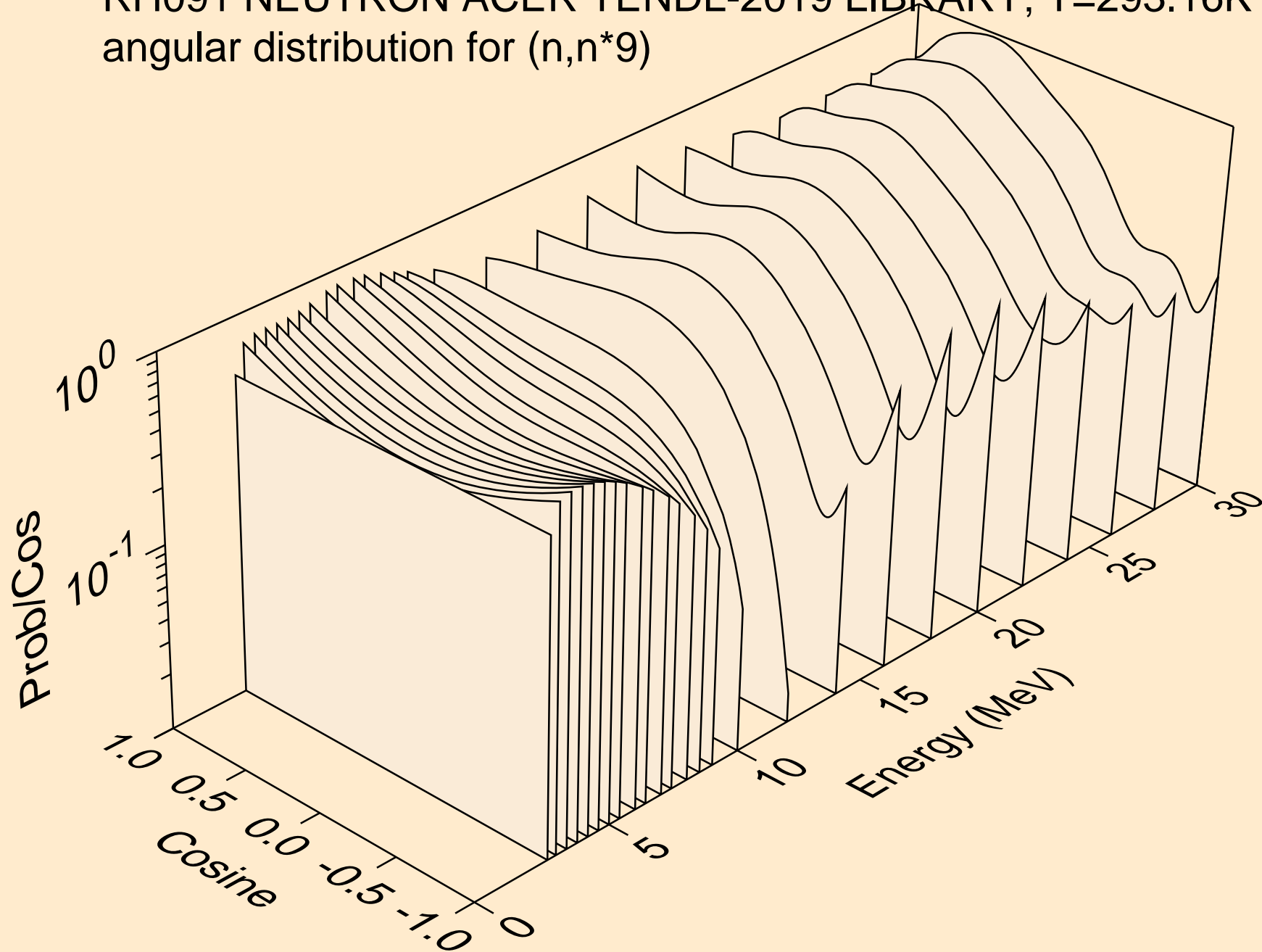

RH091 NEUTRON ACER TENDL-2019 LIBRARY; T=293.16K
angular distribution for (n,n*10)

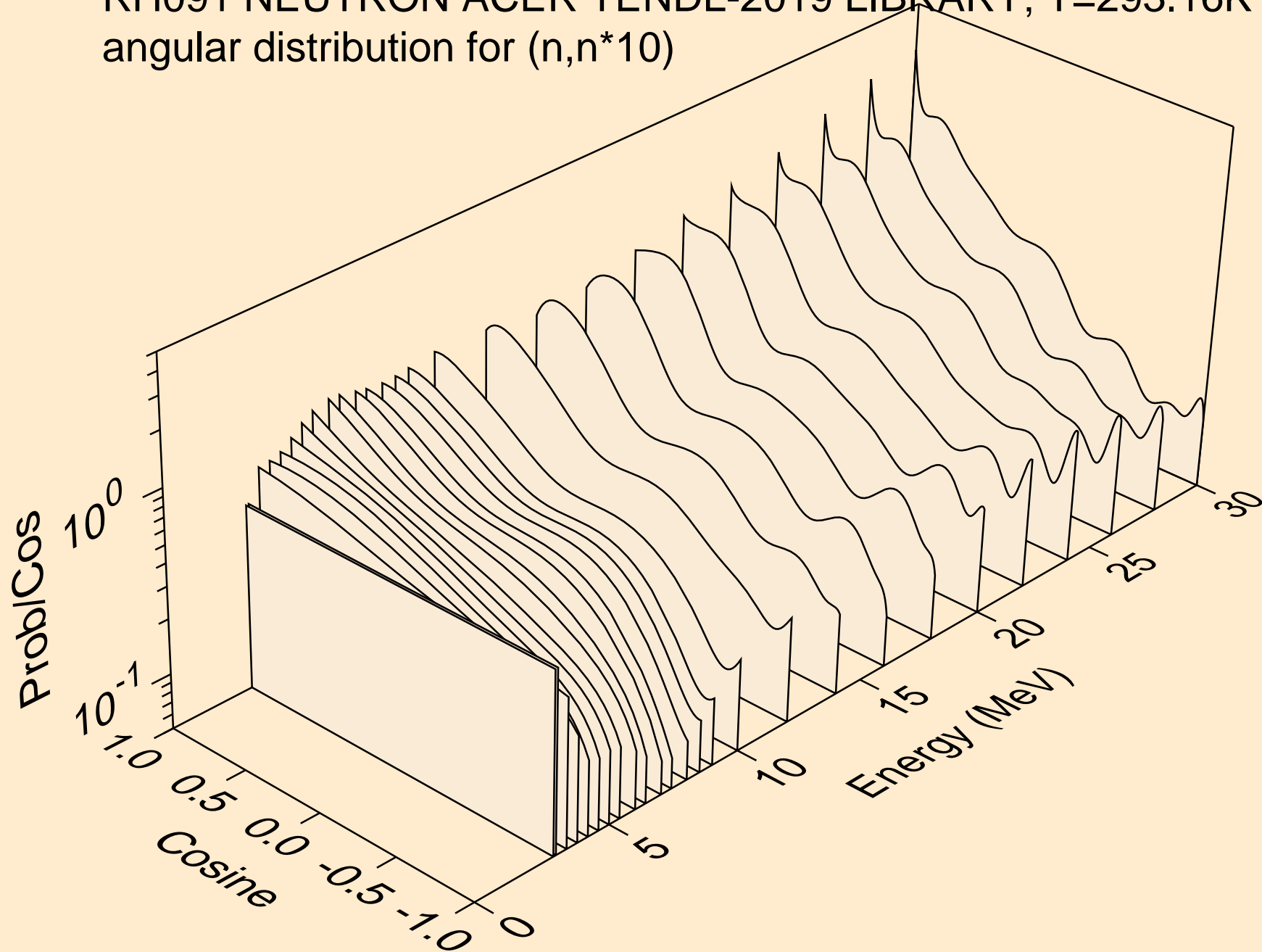

RH091 NEUTRON ACER TENDL-2019 LIBRARY; T=293.16K
angular distribution for (n,n*11)

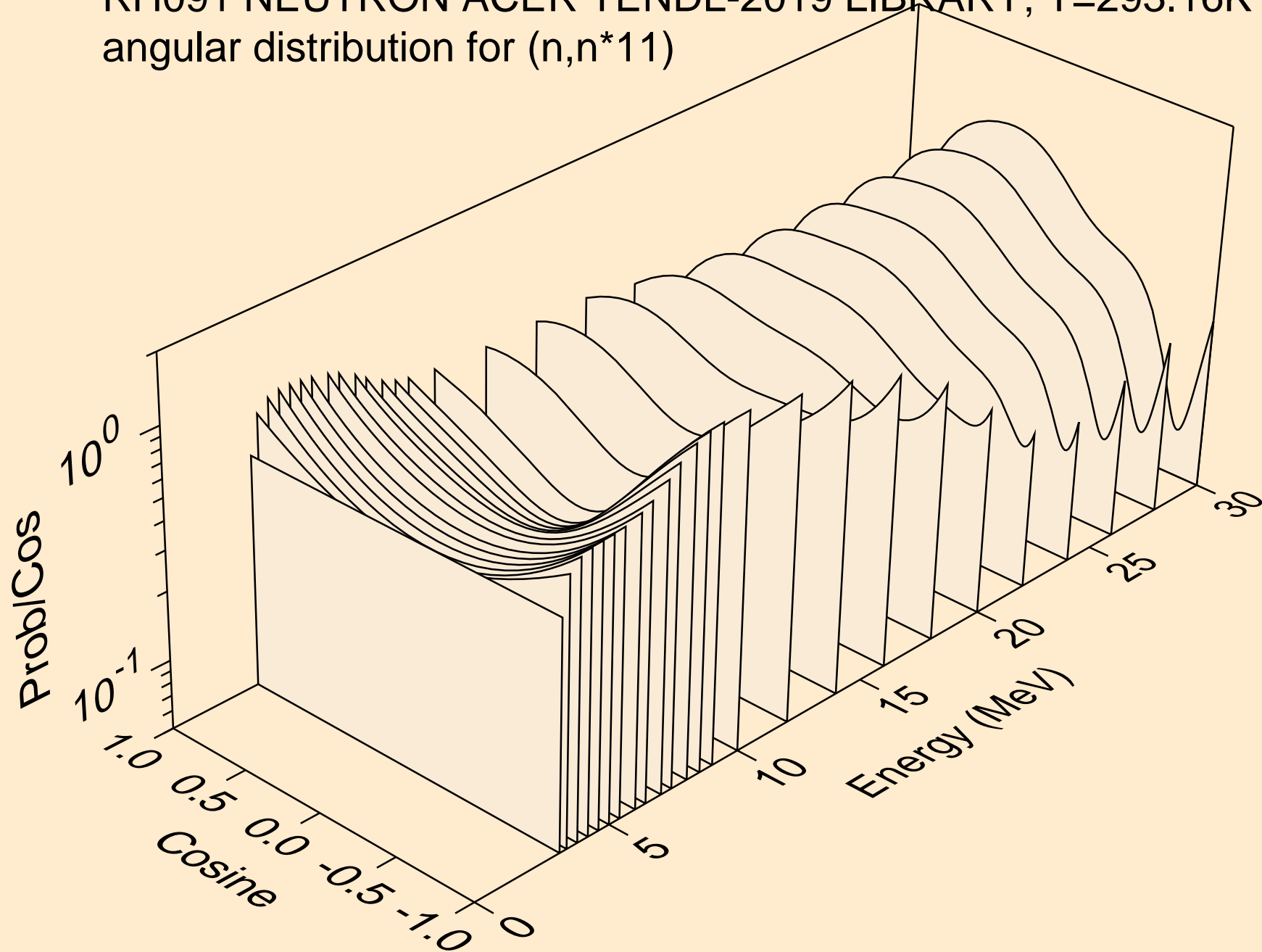

RH091 NEUTRON ACER TENDL-2019 LIBRARY; T=293.16K
angular distribution for (n,n*12)

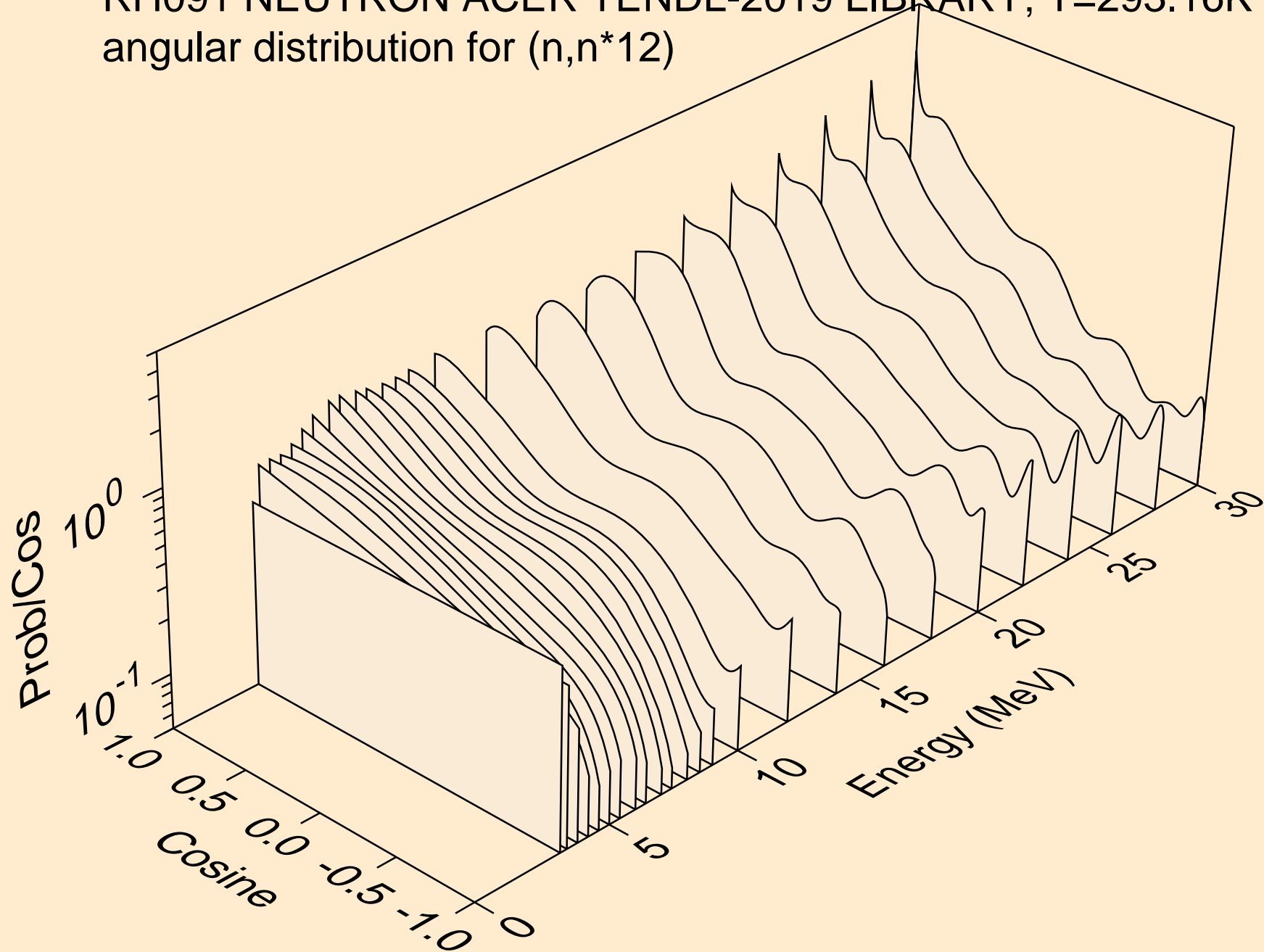

RH091 NEUTRON ACER TENDL-2019 LIBRARY; T=293.16K
angular distribution for (n,n*13)

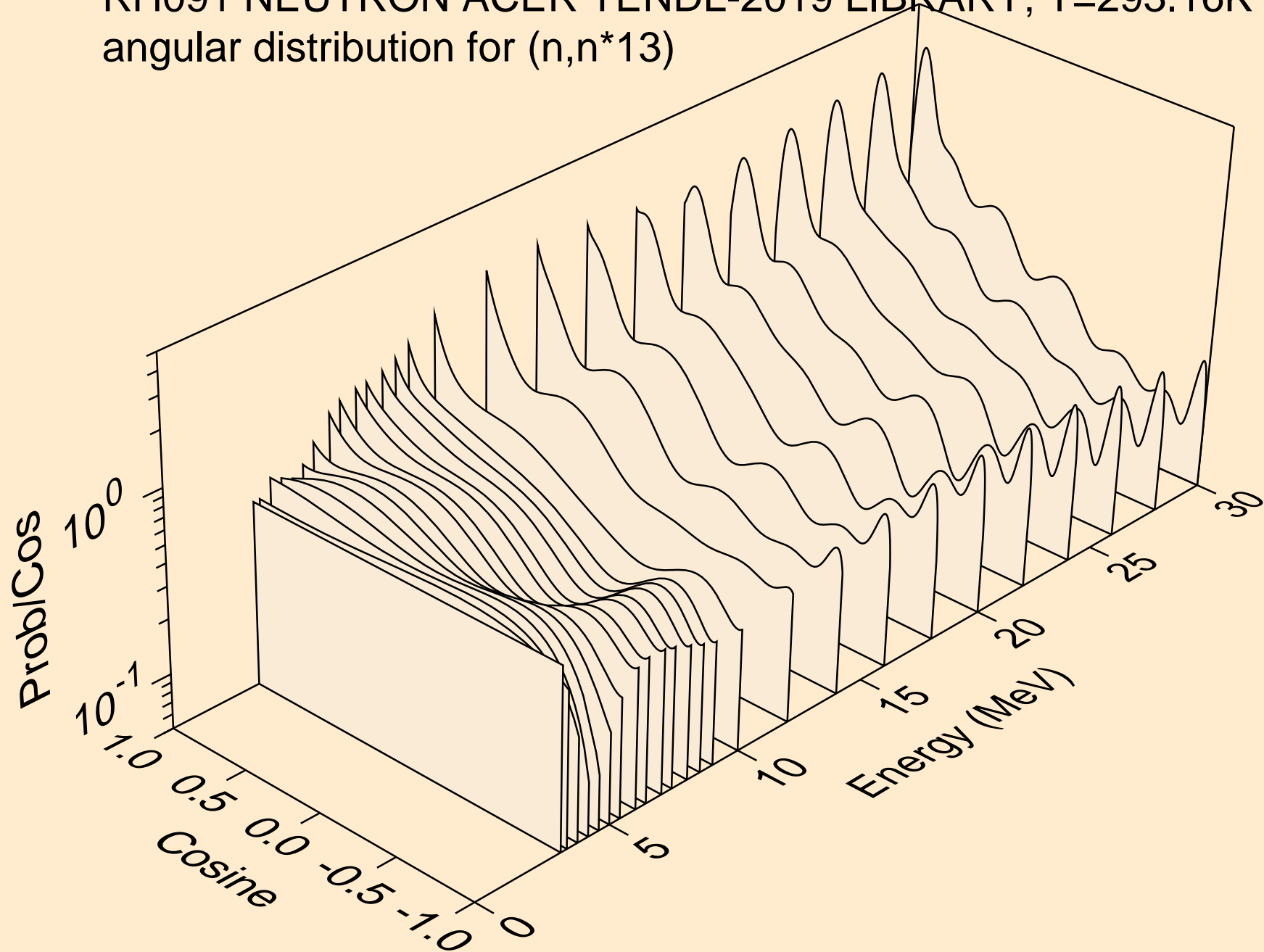

RH091 NEUTRON ACER TENDL-2019 LIBRARY; T=293.16K
angular distribution for (n,n*14)

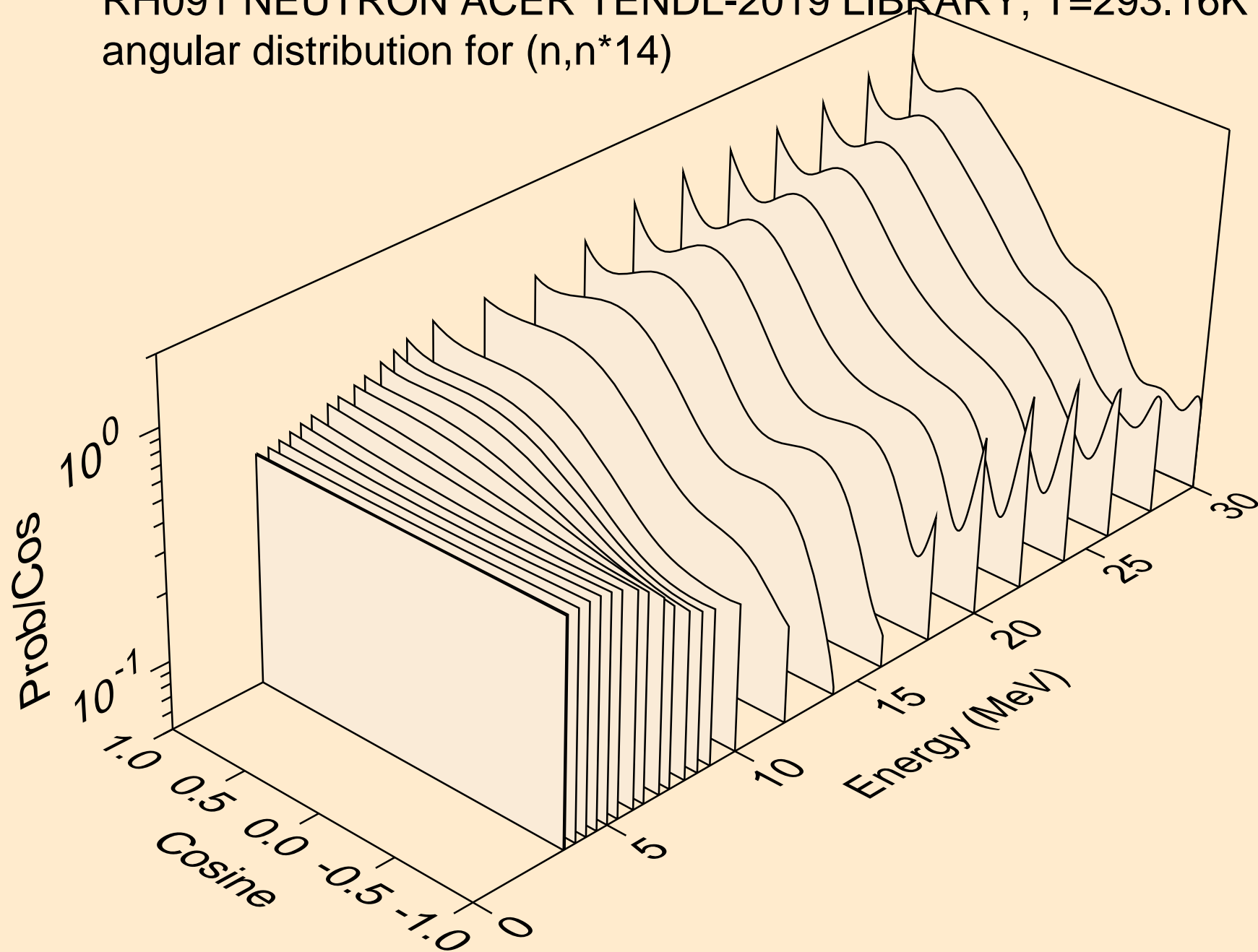

RH091 NEUTRON ACER TENDL-2019 LIBRARY; T=293.16K
angular distribution for (n,n*15)

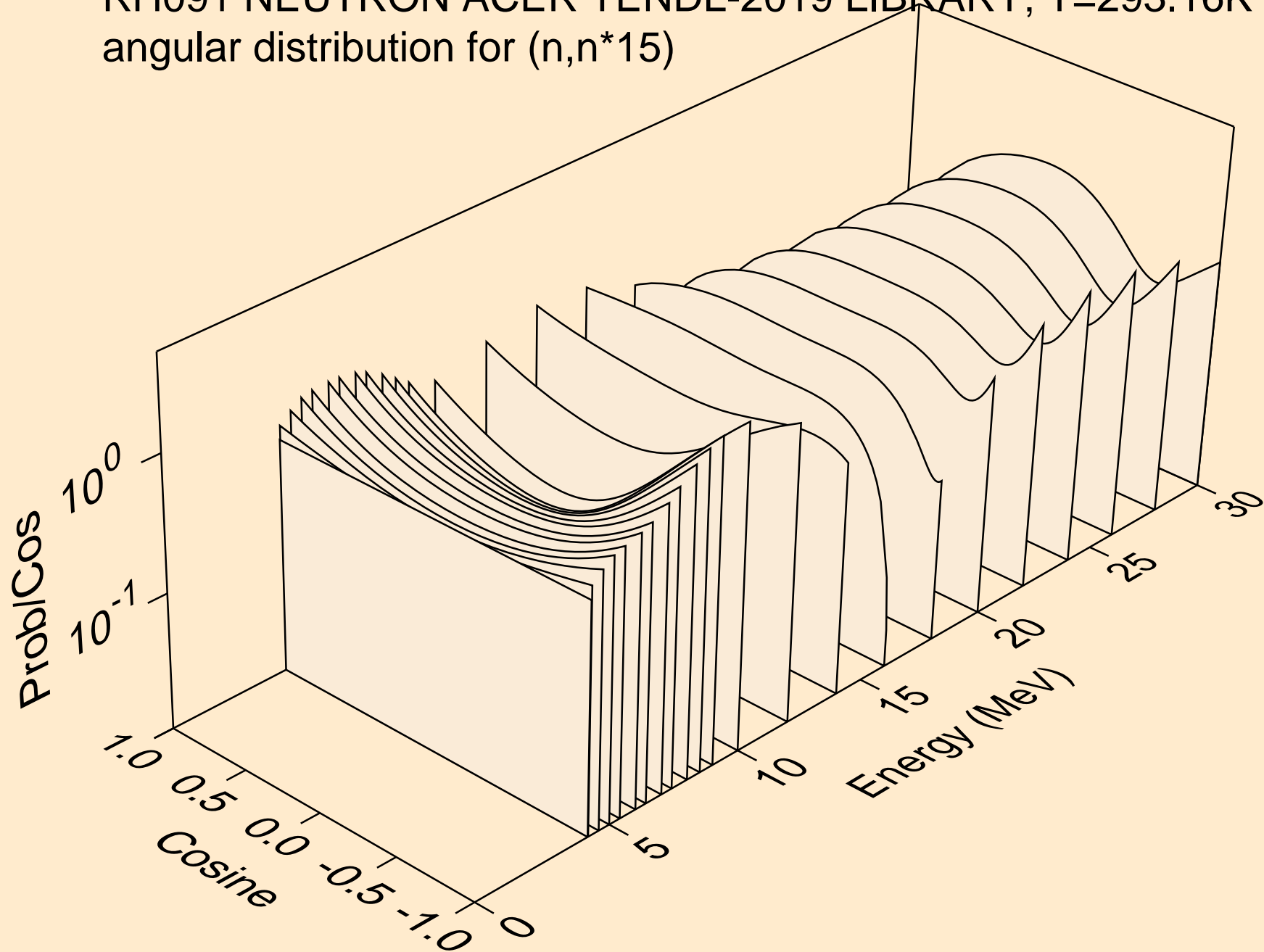

RH091 NEUTRON ACER TENDL-2019 LIBRARY; T=293.16K
angular distribution for (n,n*16)

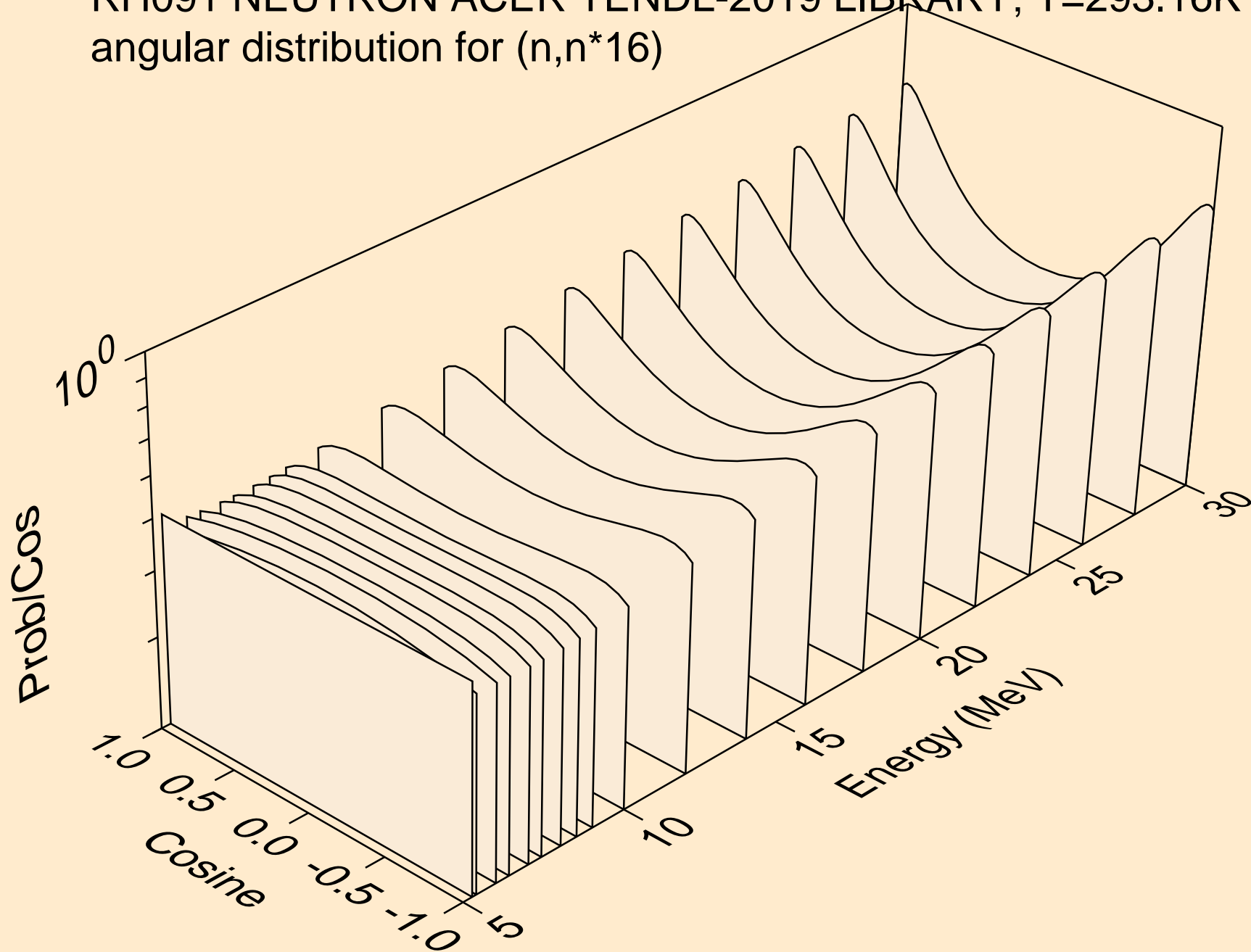

RH091 NEUTRON ACER TENDL-2019 LIBRARY; T=293.16K
angular distribution for (n,n*17)

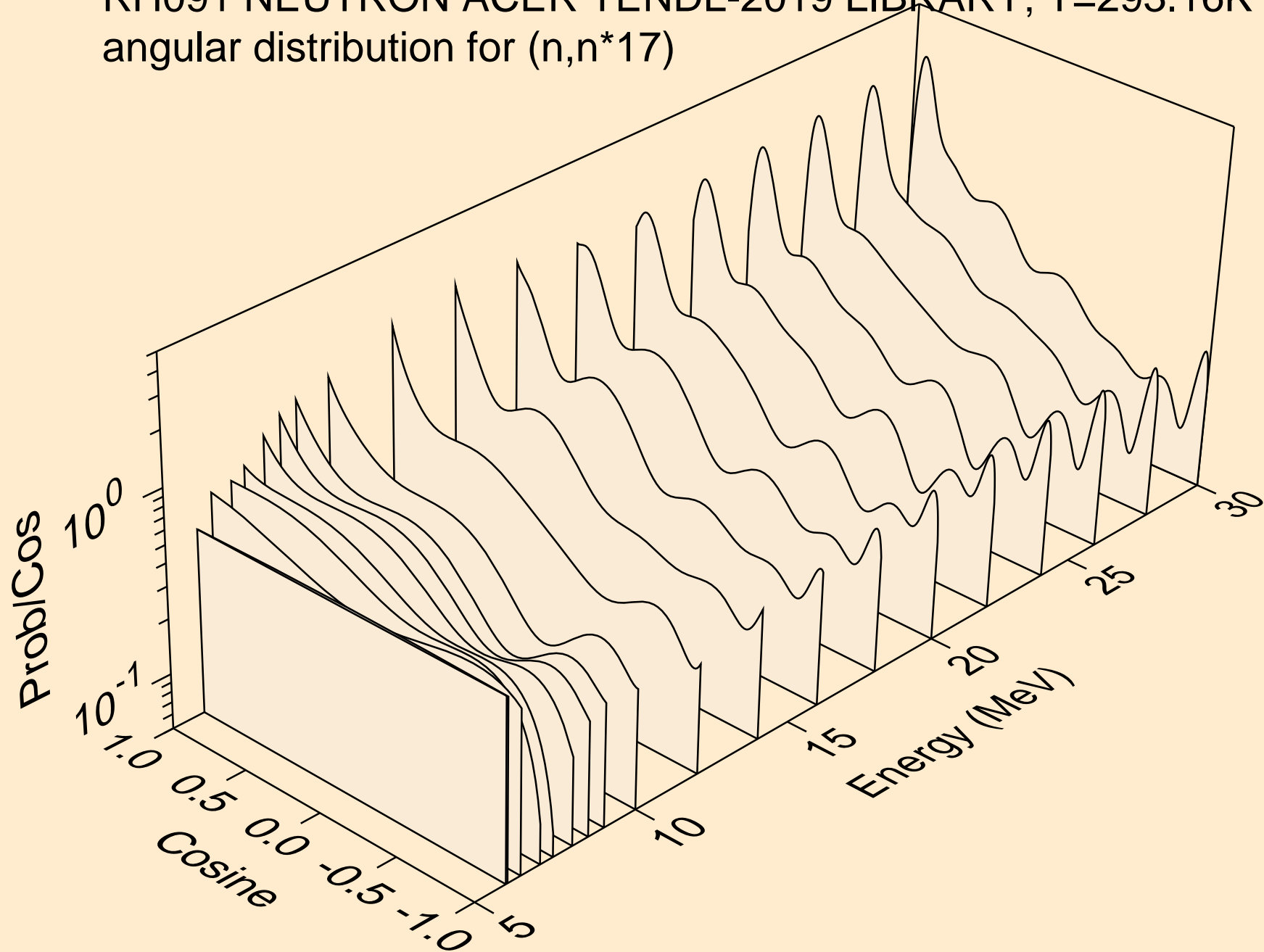

RH091 NEUTRON ACER TENDL-2019 LIBRARY; T=293.16K
Neutron emission for (n,x)

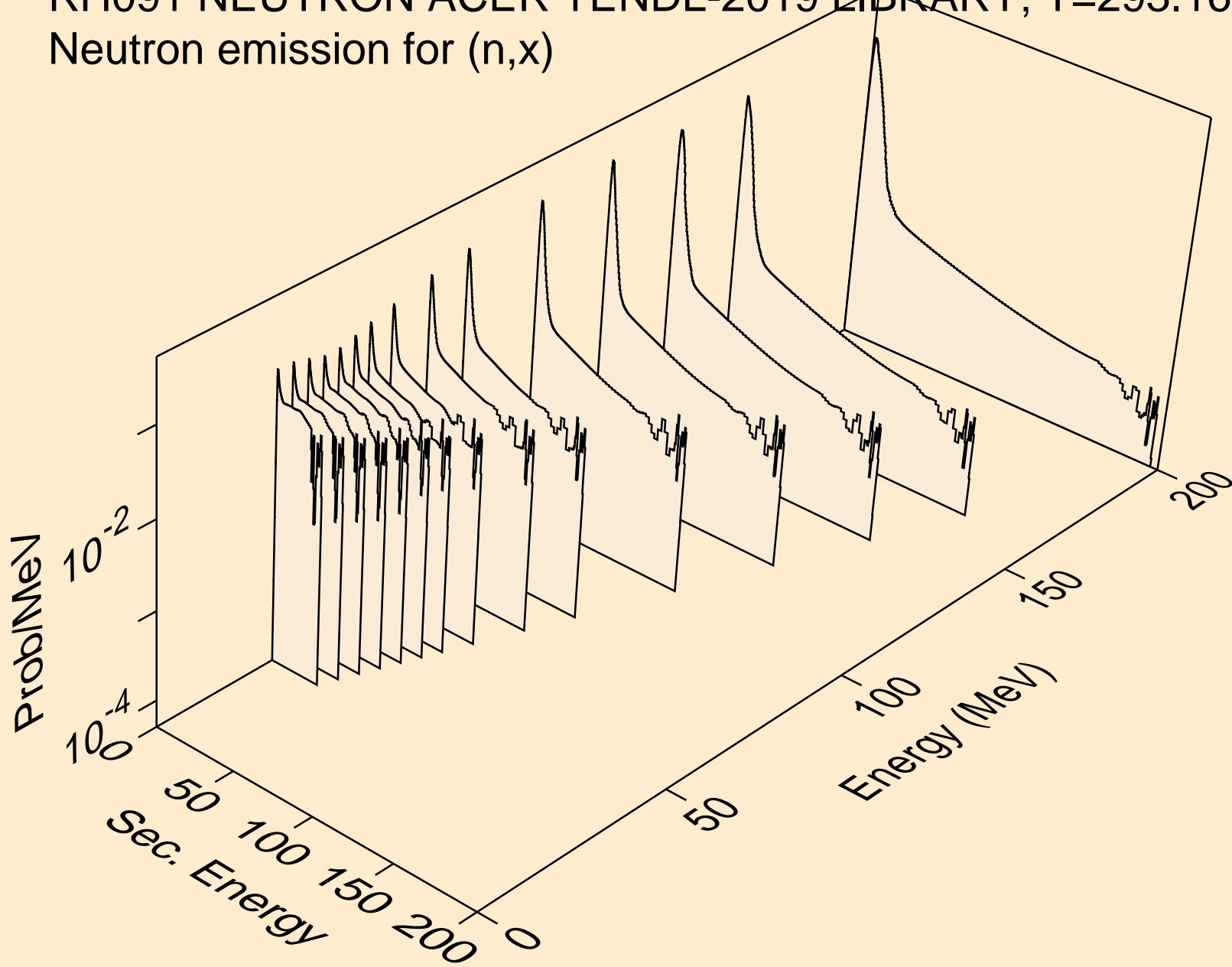

RH091 NEUTRON ACER TENDL-2019 LIBRARY; T=293.16K
Neutron emission for (n,2n)

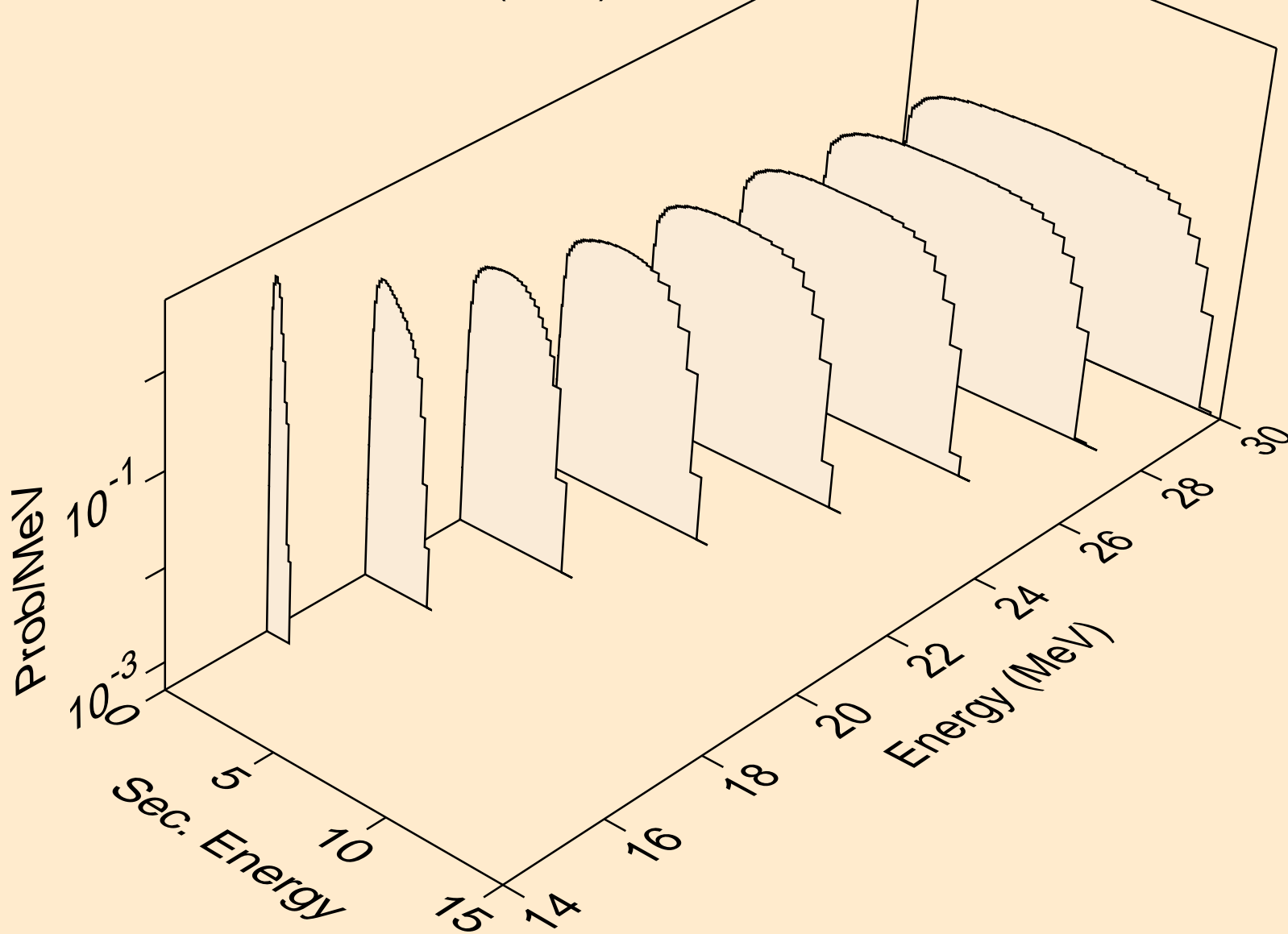

RH091 NEUTRON ACER TENDL-2019 LIBRARY; T=293.16K
Neutron emission for (n,3n)

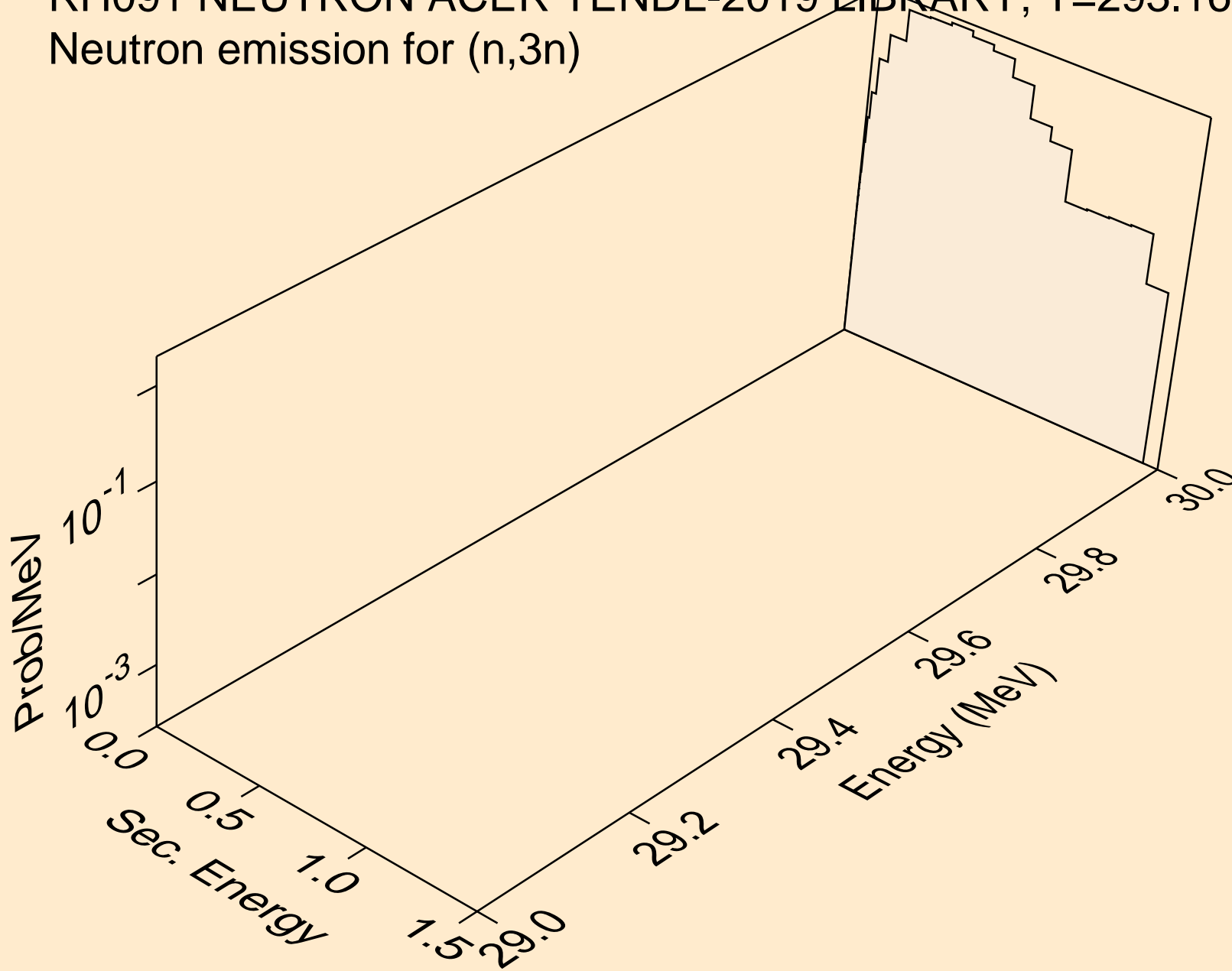

RH091 NEUTRON ACER TENDL-2019 LIBRARY; T=293.16K
Neutron emission for (n,n*)a

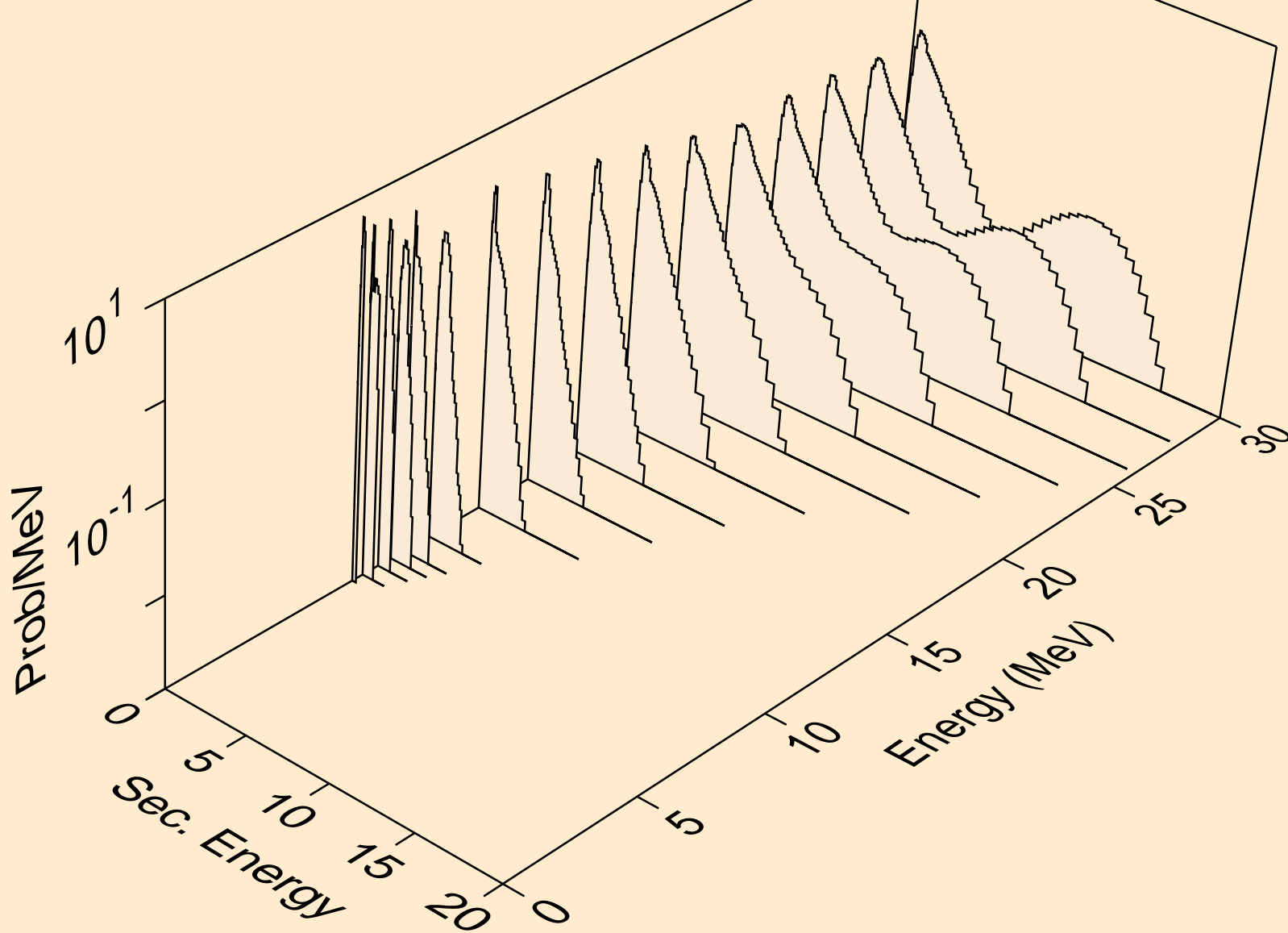

RH091 NEUTRON ACER TENDL-2019 LIBRARY; T=293.16K
Neutron emission for (n,2n)a

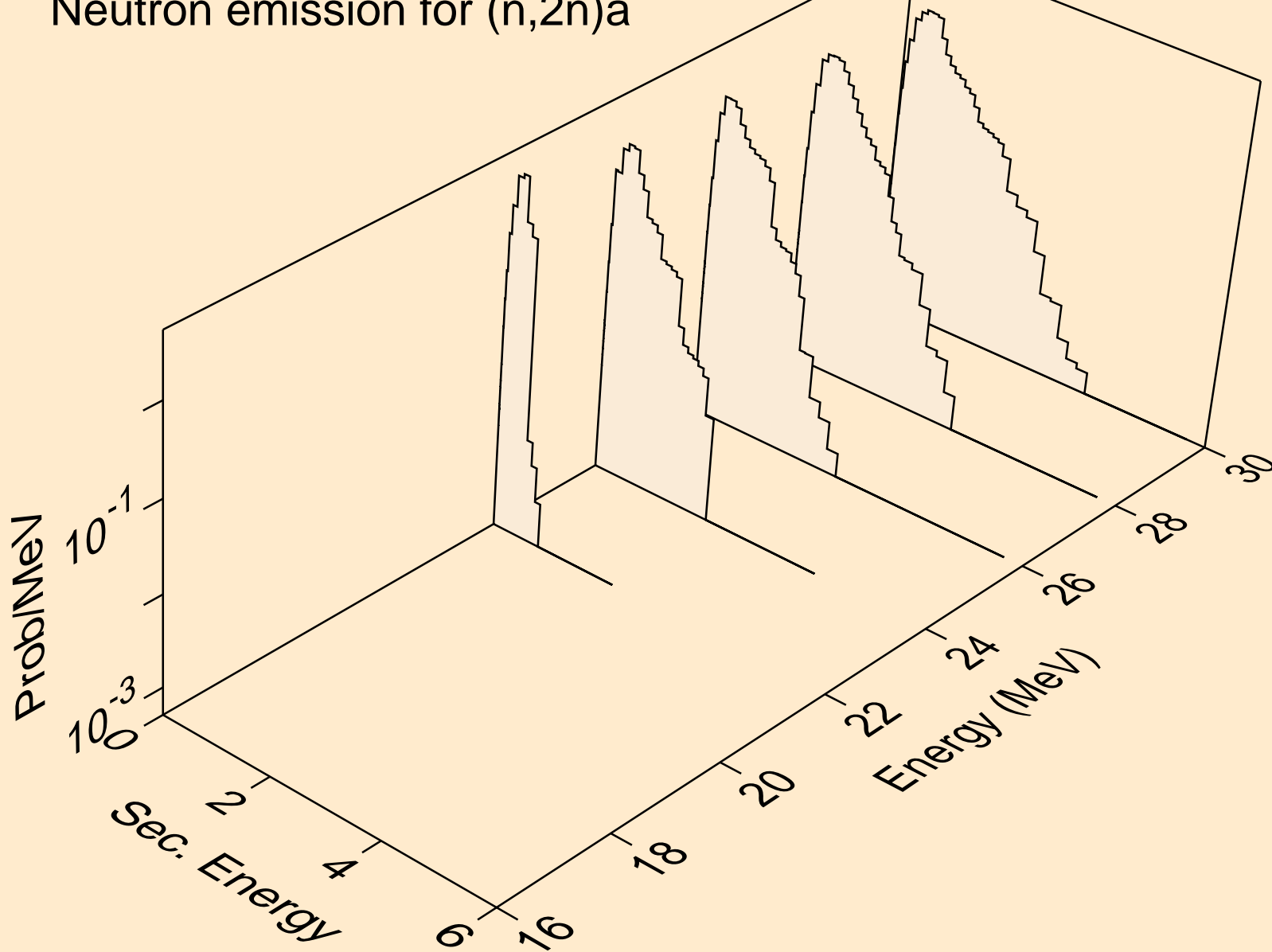

RH091 NEUTRON ACER TENDL-2019 LIBRARY; T=293.16K
Neutron emission for (n,n*)p

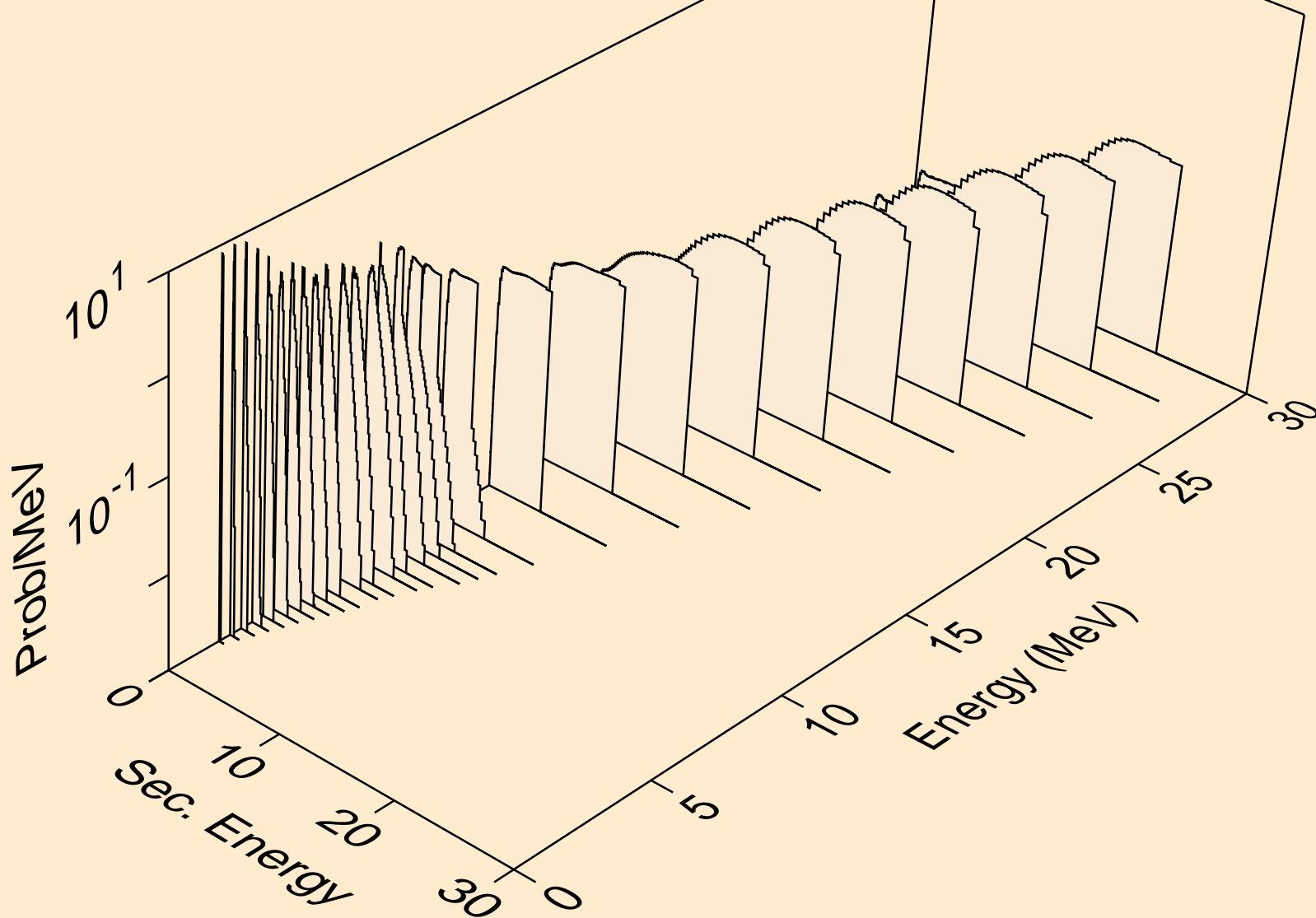

RH091 NEUTRON ACER TENDL-2019 LIBRARY; T=293.16K
Neutron emission for (n,n*)2a

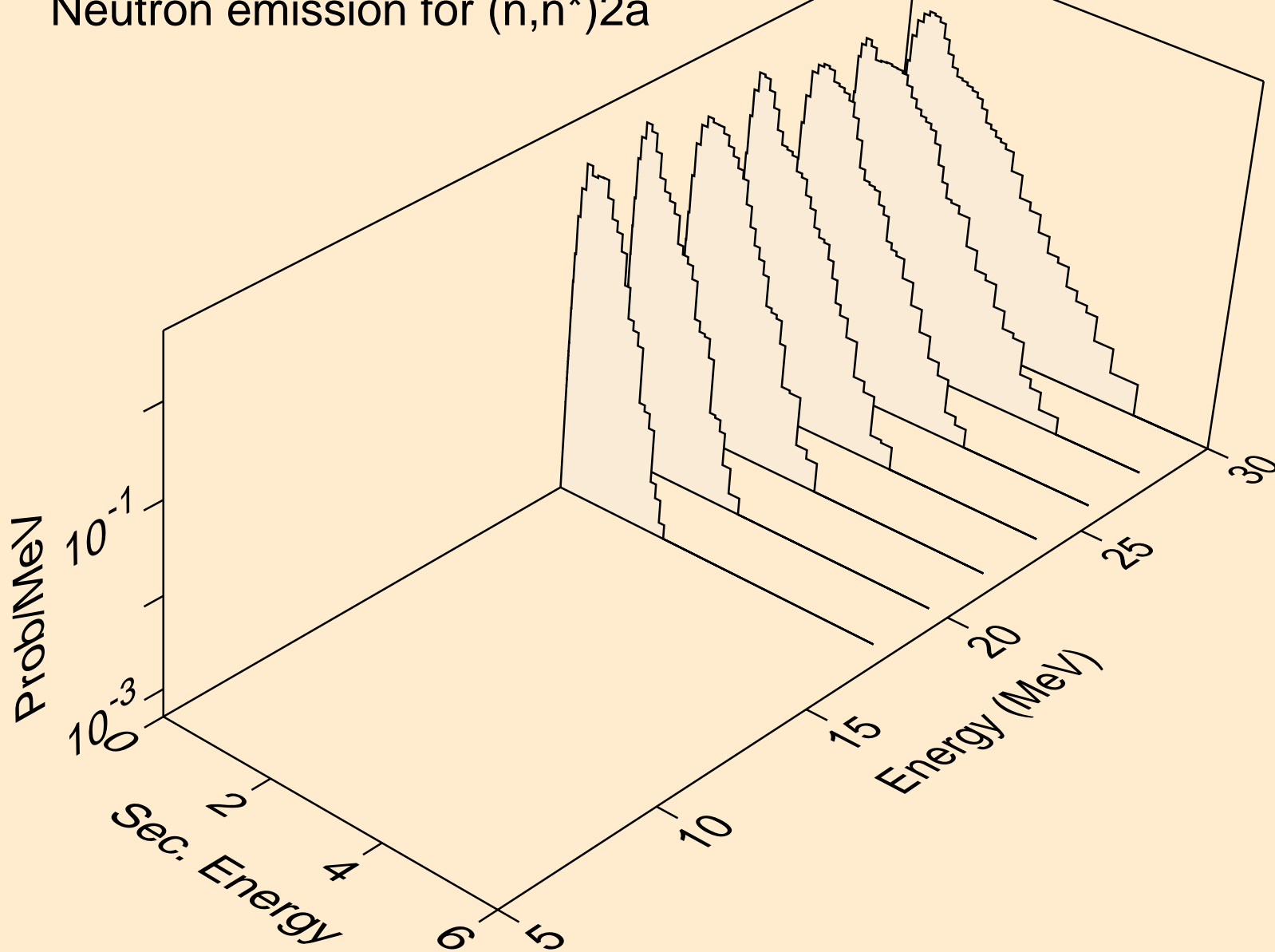

RH091 NEUTRON ACER TENDL-2019 LIBRARY; T=293.16K
Neutron emission for (n,n*)d

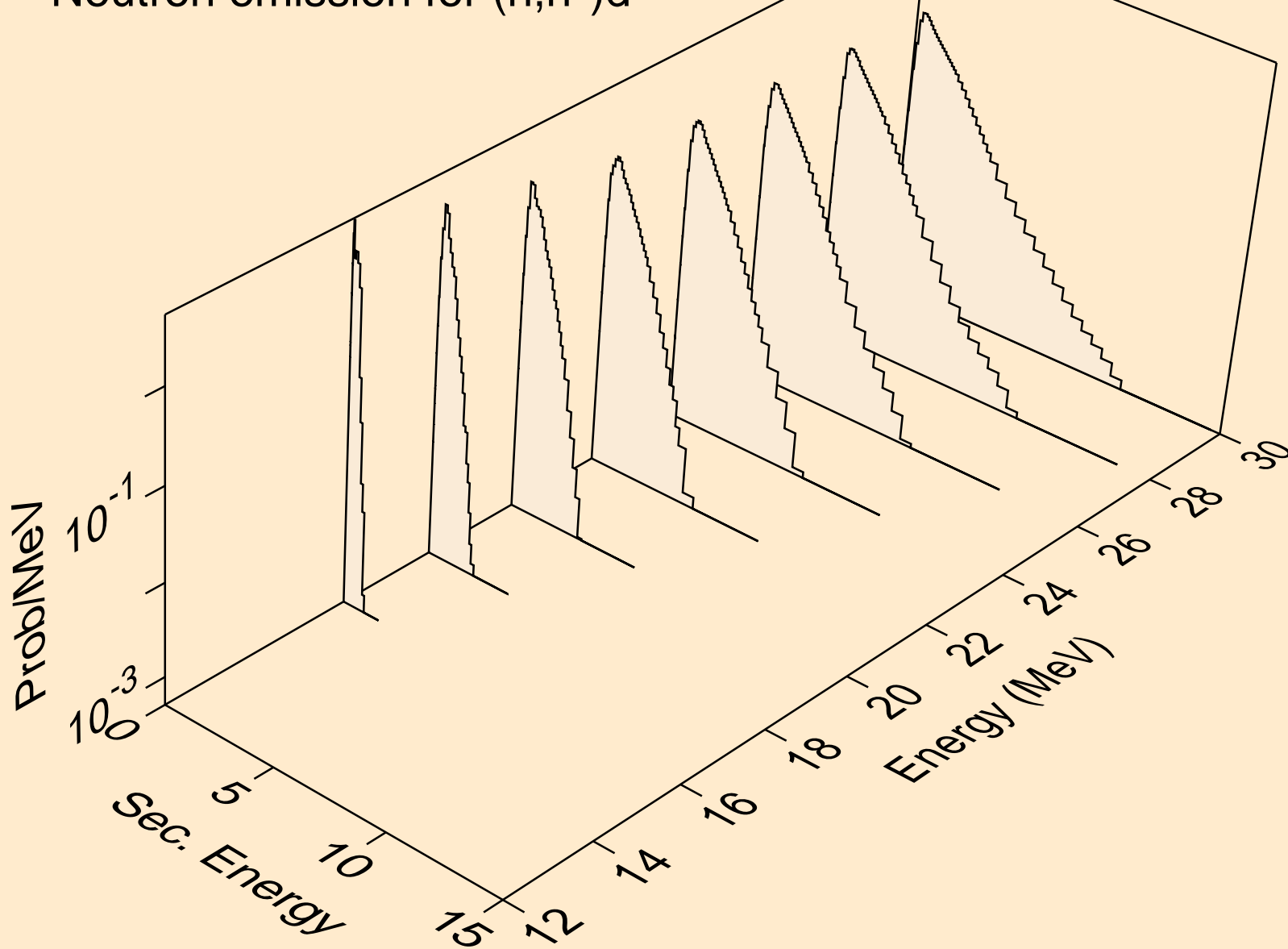

RH091 NEUTRON ACER TENDL-2019 LIBRARY; T=293.16K
Neutron emission for (n,n*)t

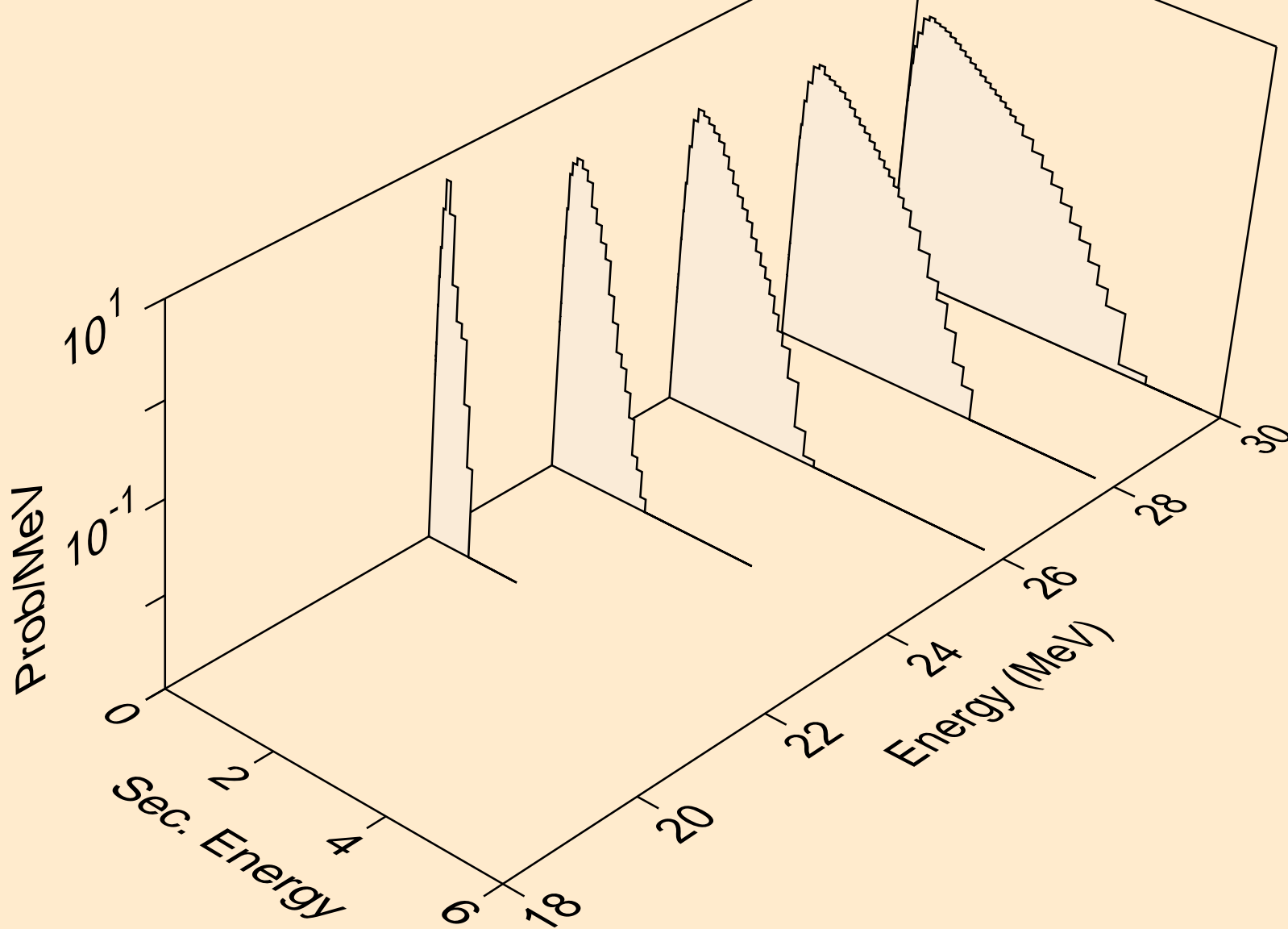

RH091 NEUTRON ACER TENDL-2019 LIBRARY; T=293.16K
Neutron emission for (n,n*)he3

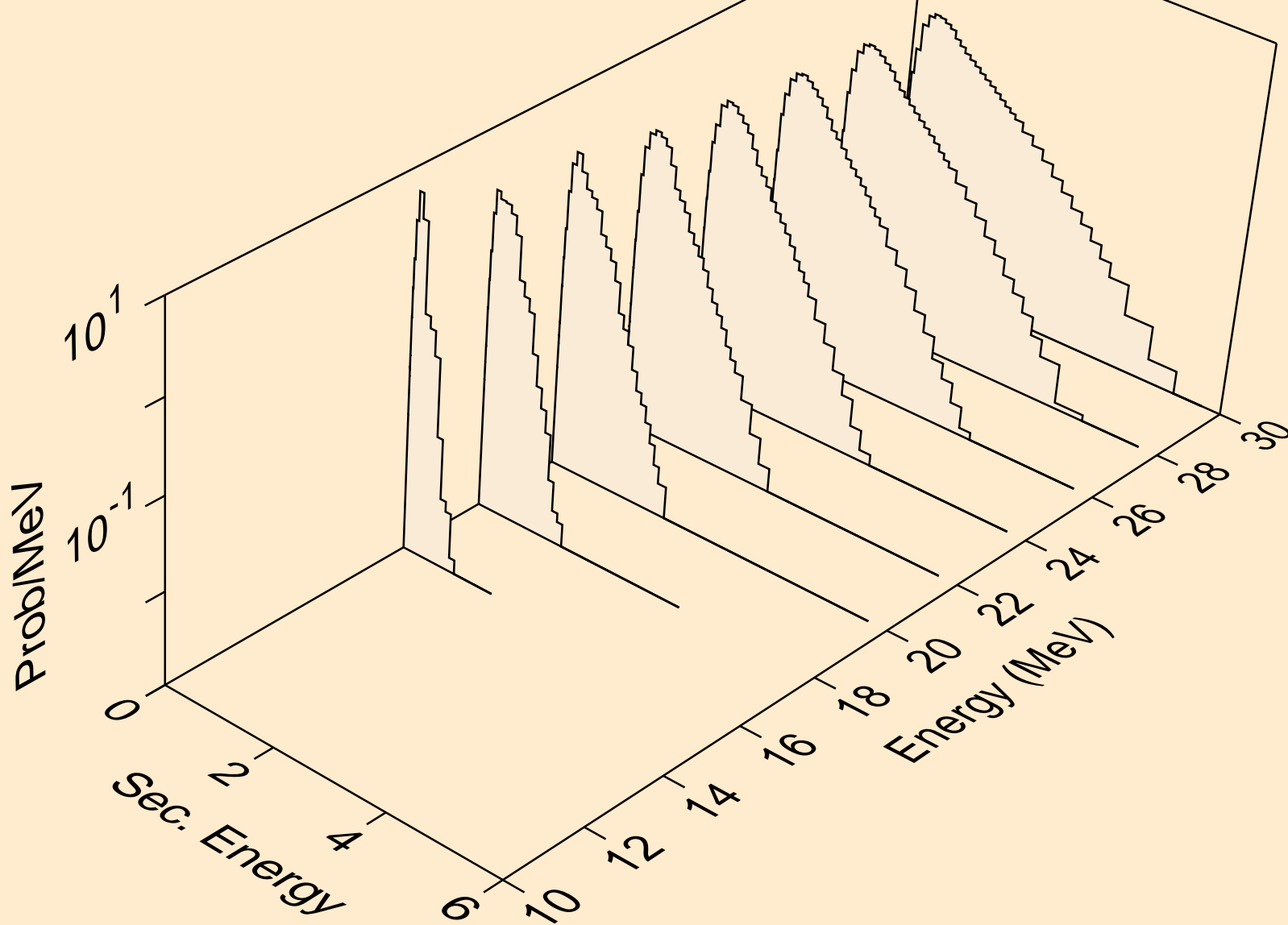

RH091 NEUTRON ACER TENDL-2019 LIBRARY; T=293.16K
Neutron emission for (n,2np)

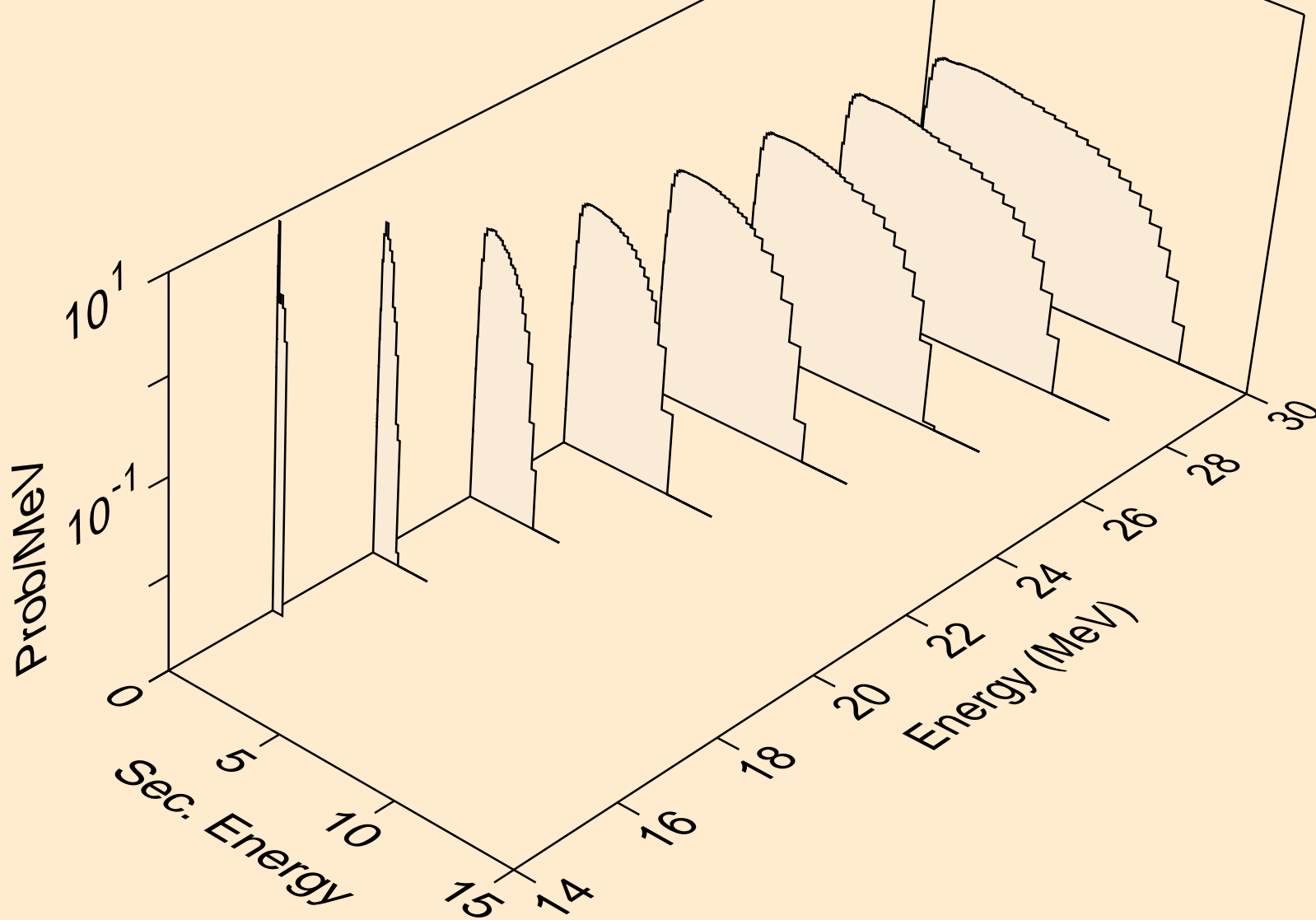

RH091 NEUTRON ACER TENDL-2019 LIBRARY; T=293.16K
Neutron emission for (n,2np)

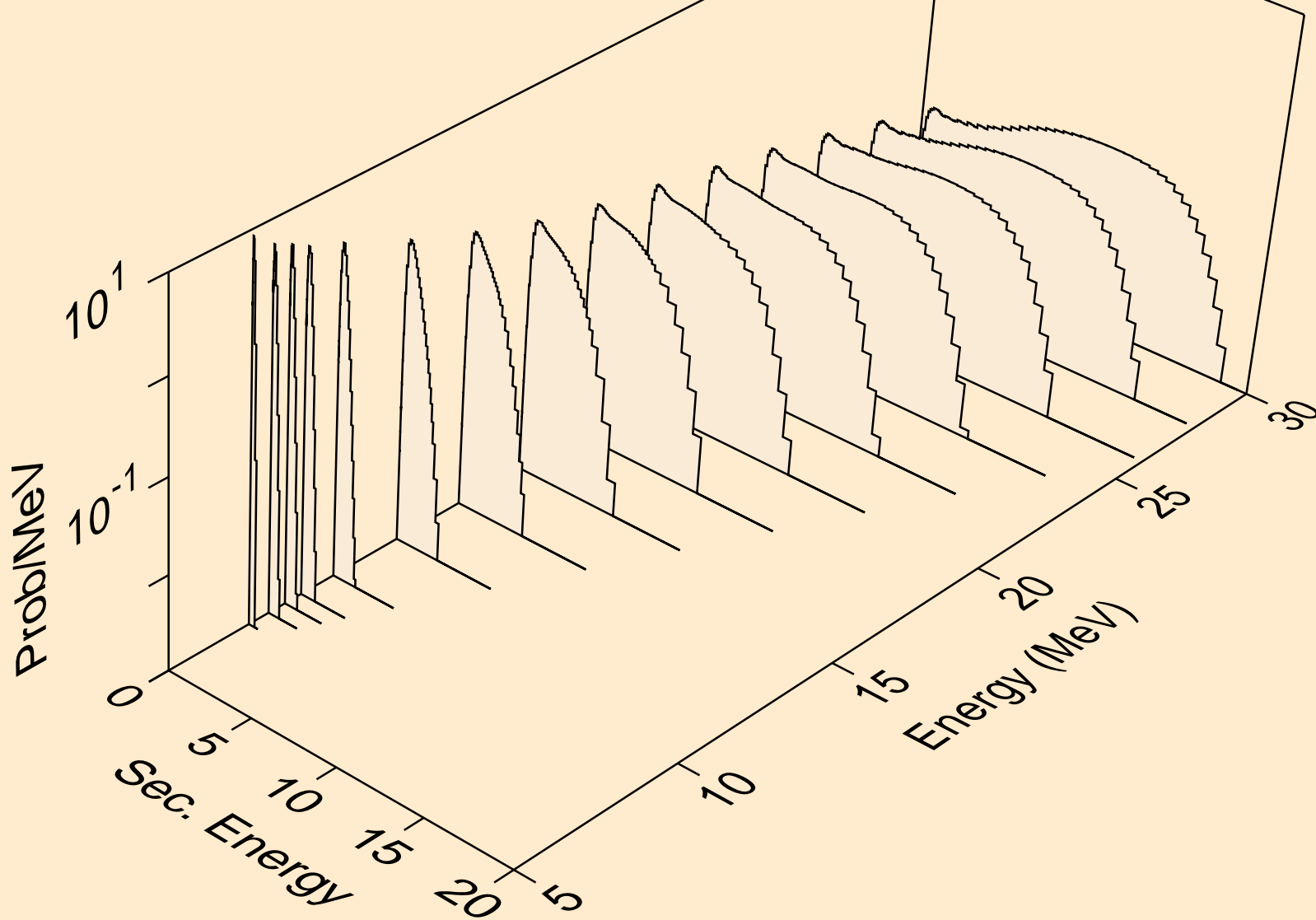

RH091 NEUTRON ACER TENDL-2019 LIBRARY; T=293.16K
Neutron emission for (n,npa)

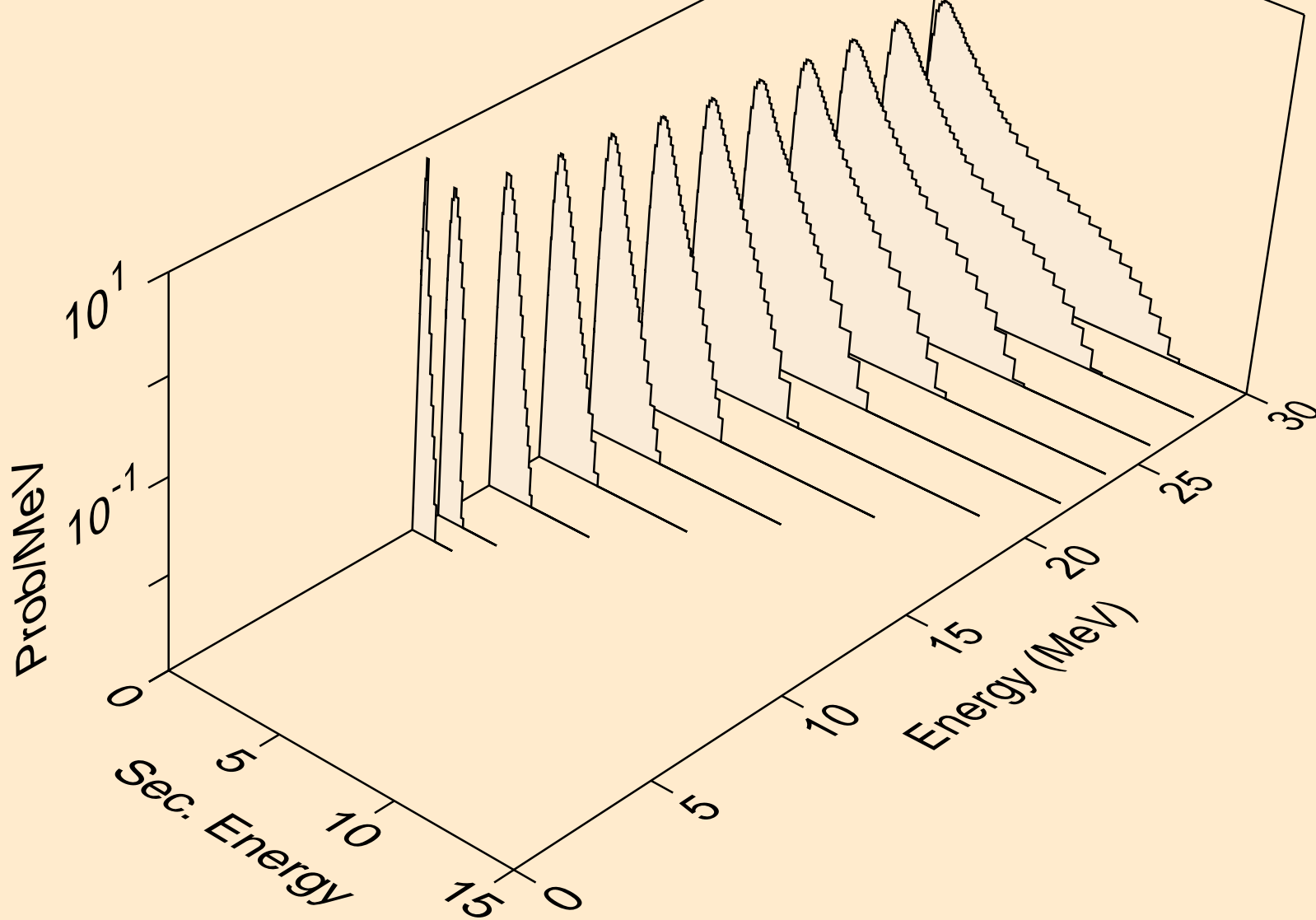

RH091 NEUTRON ACER TENDL-2019 LIBRARY; T=293.16K
Neutron emission for (n,n*c)

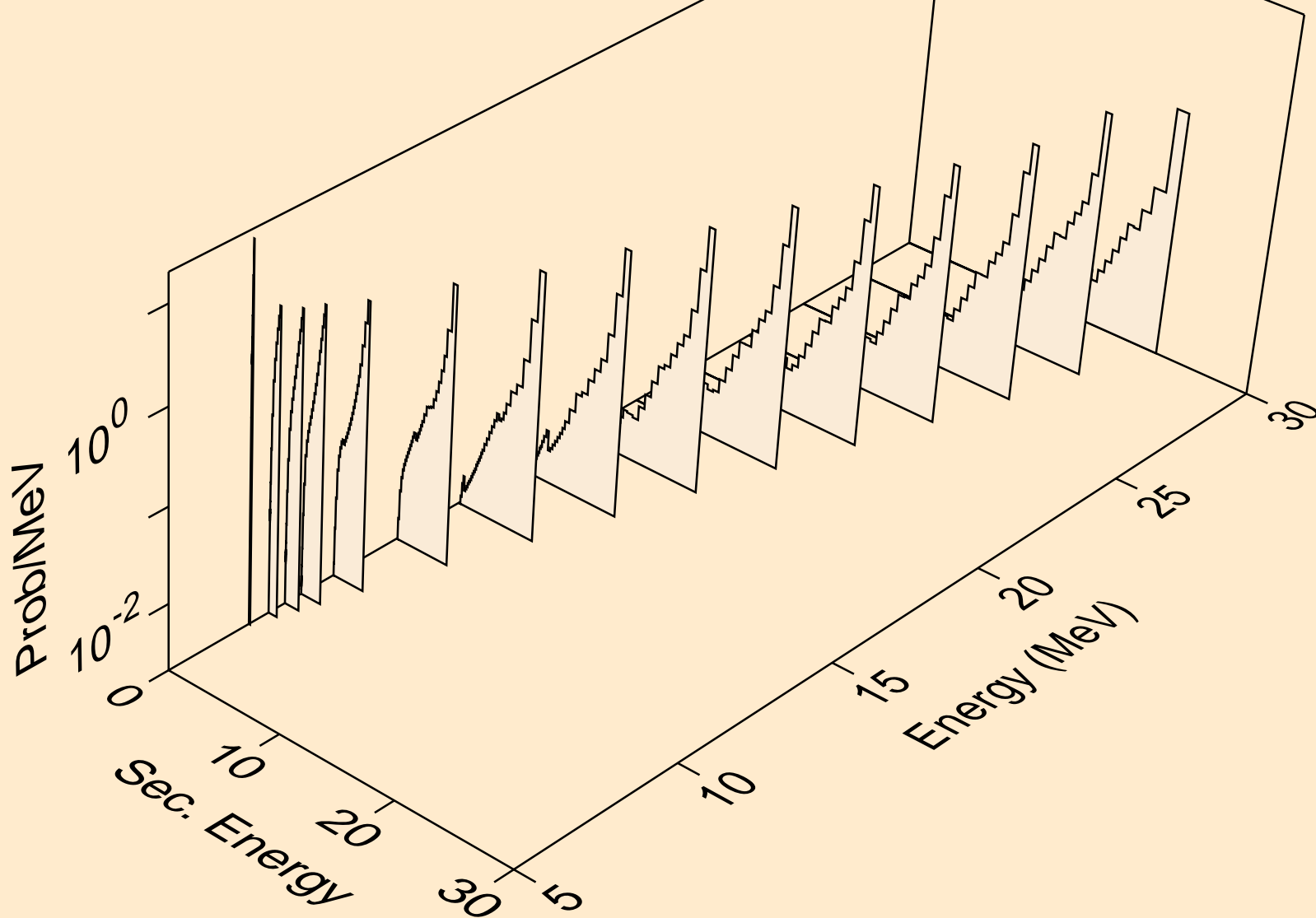

RH091 NEUTRON ACER TENDL-2019 LIBRARY; T=293.16K
Photon emission for (n,x)

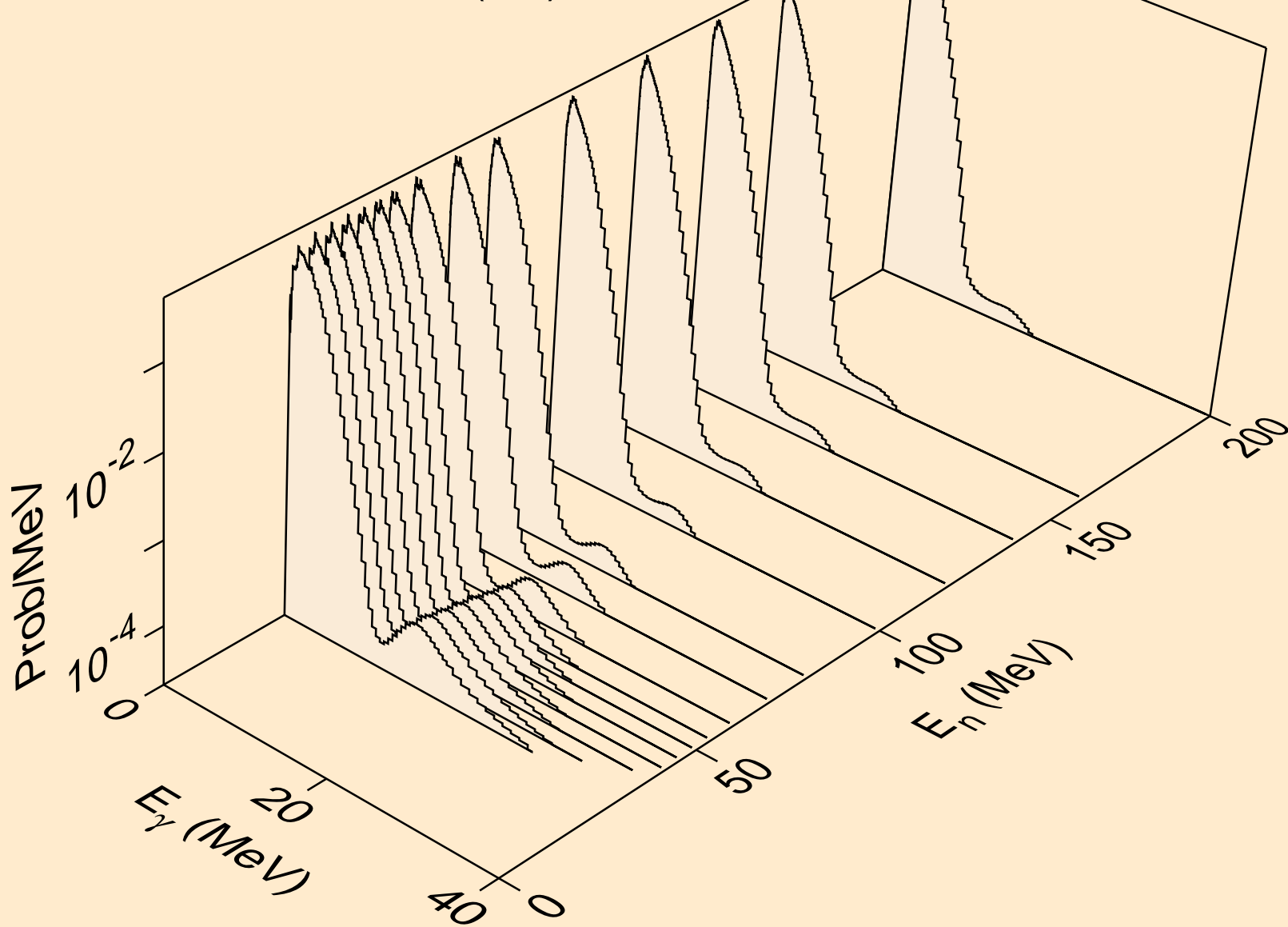

RH091 NEUTRON ACER TENDL-2019 LIBRARY; T=293.16K
Photon emission for (n,2n)

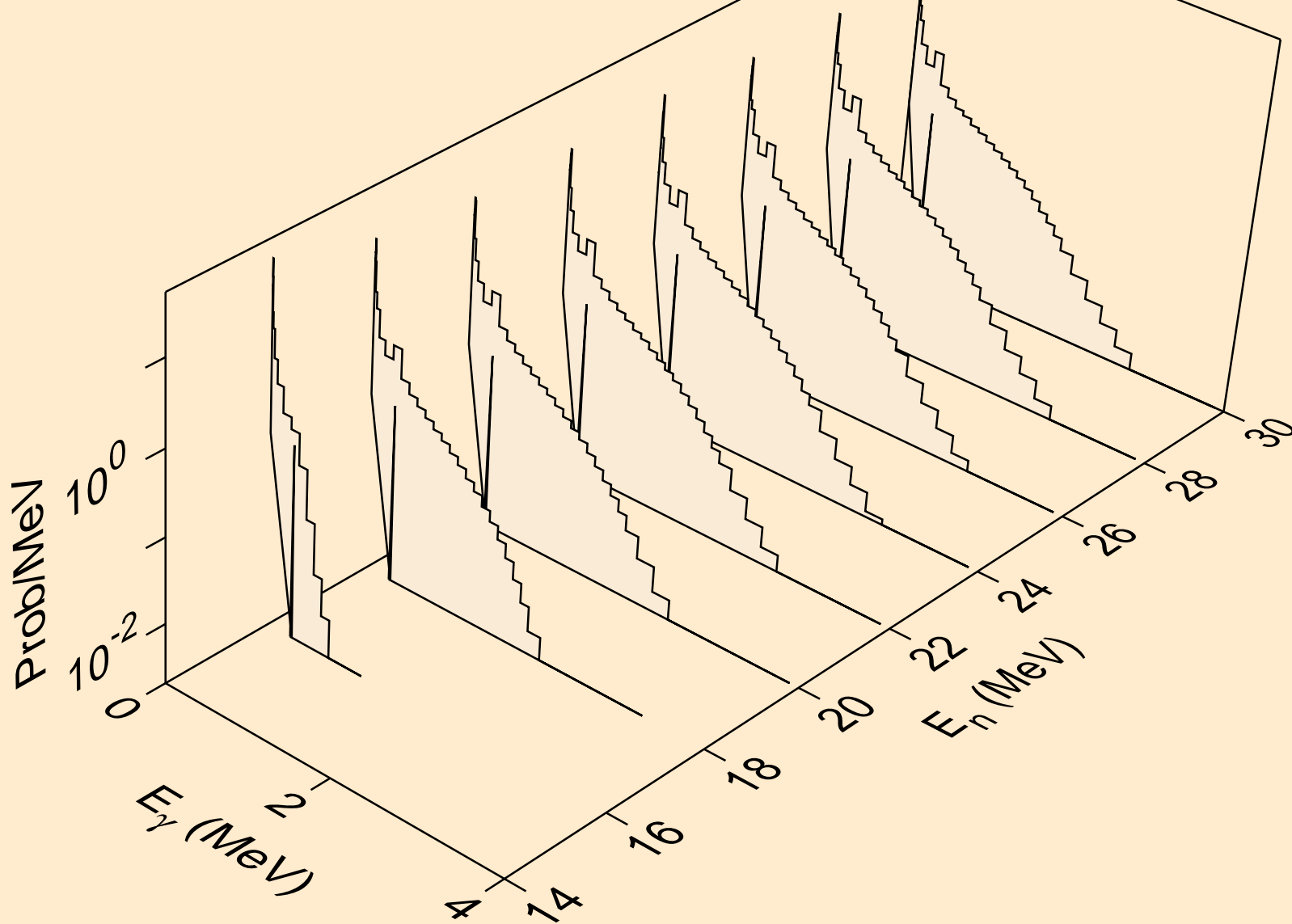

RH091 NEUTRON ACER TENDL-2019 LIBRARY; T=293.16K
Photon emission for (n,3n)

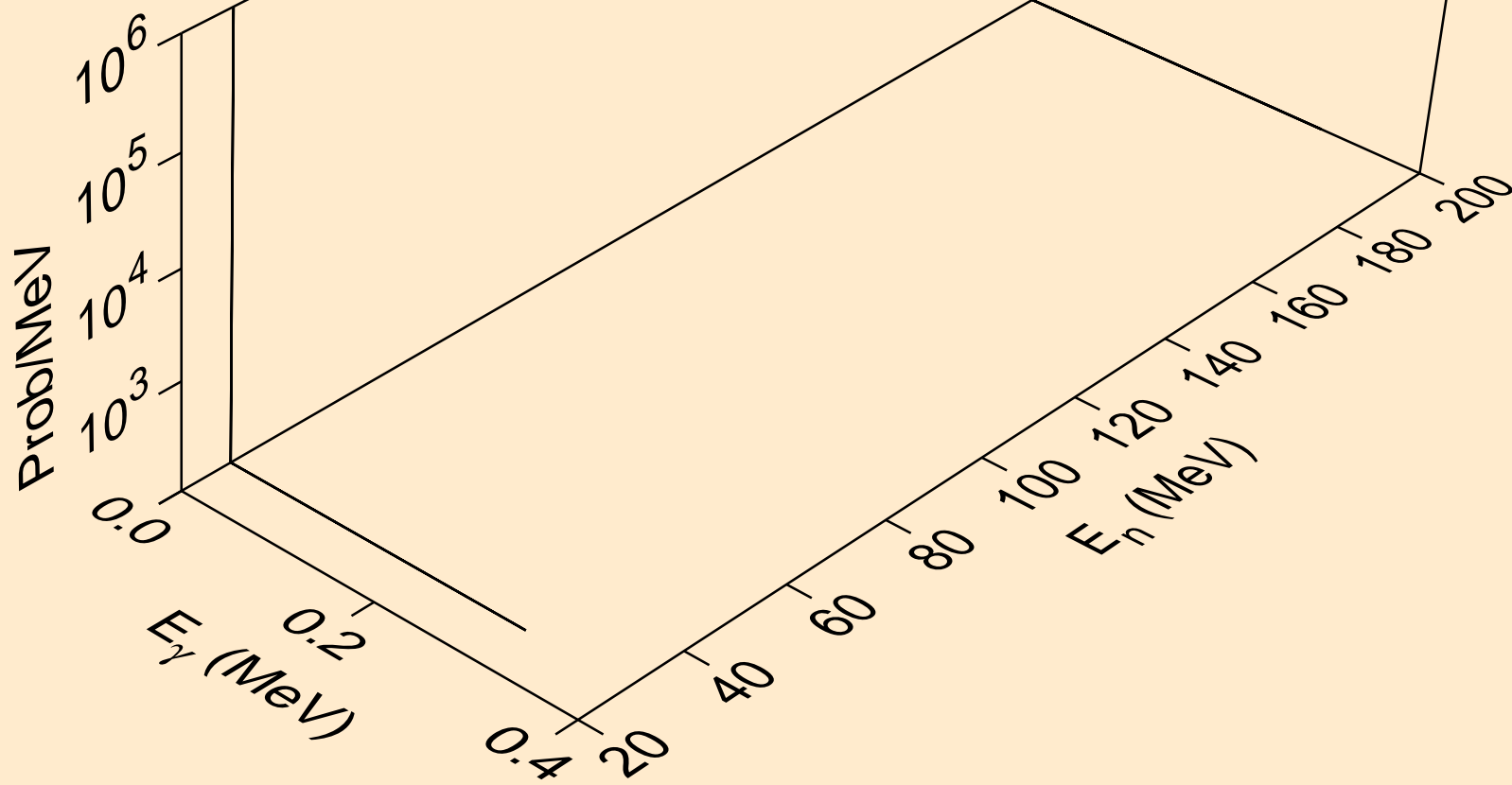

RH091 NEUTRON ACER TENDL-2019 LIBRARY; T=293.16K
Photon emission for (n,n*)a

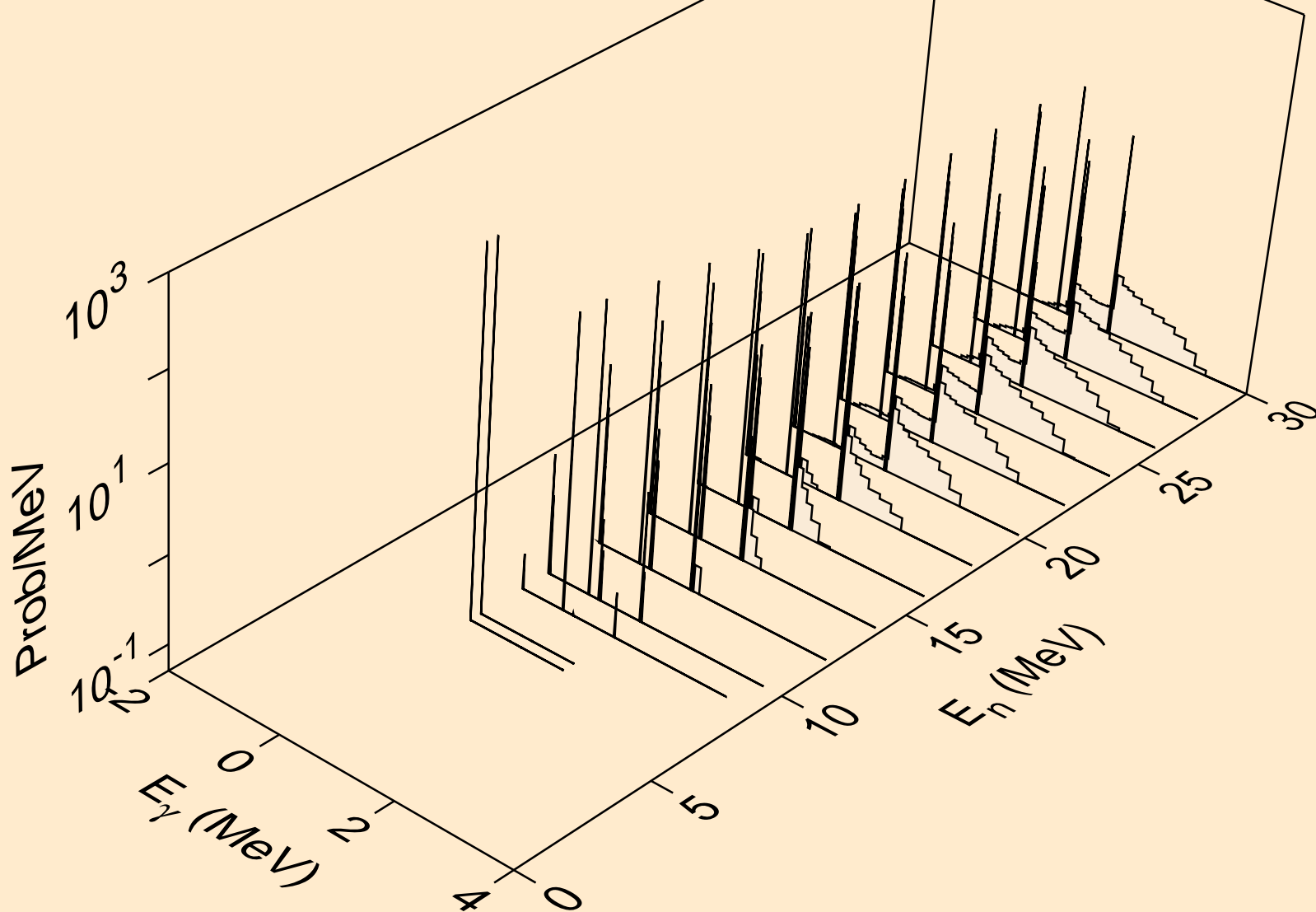

RH091 NEUTRON ACER TENDL-2019 LIBRARY; T=293.16K
Photon emission for (n,2n)a

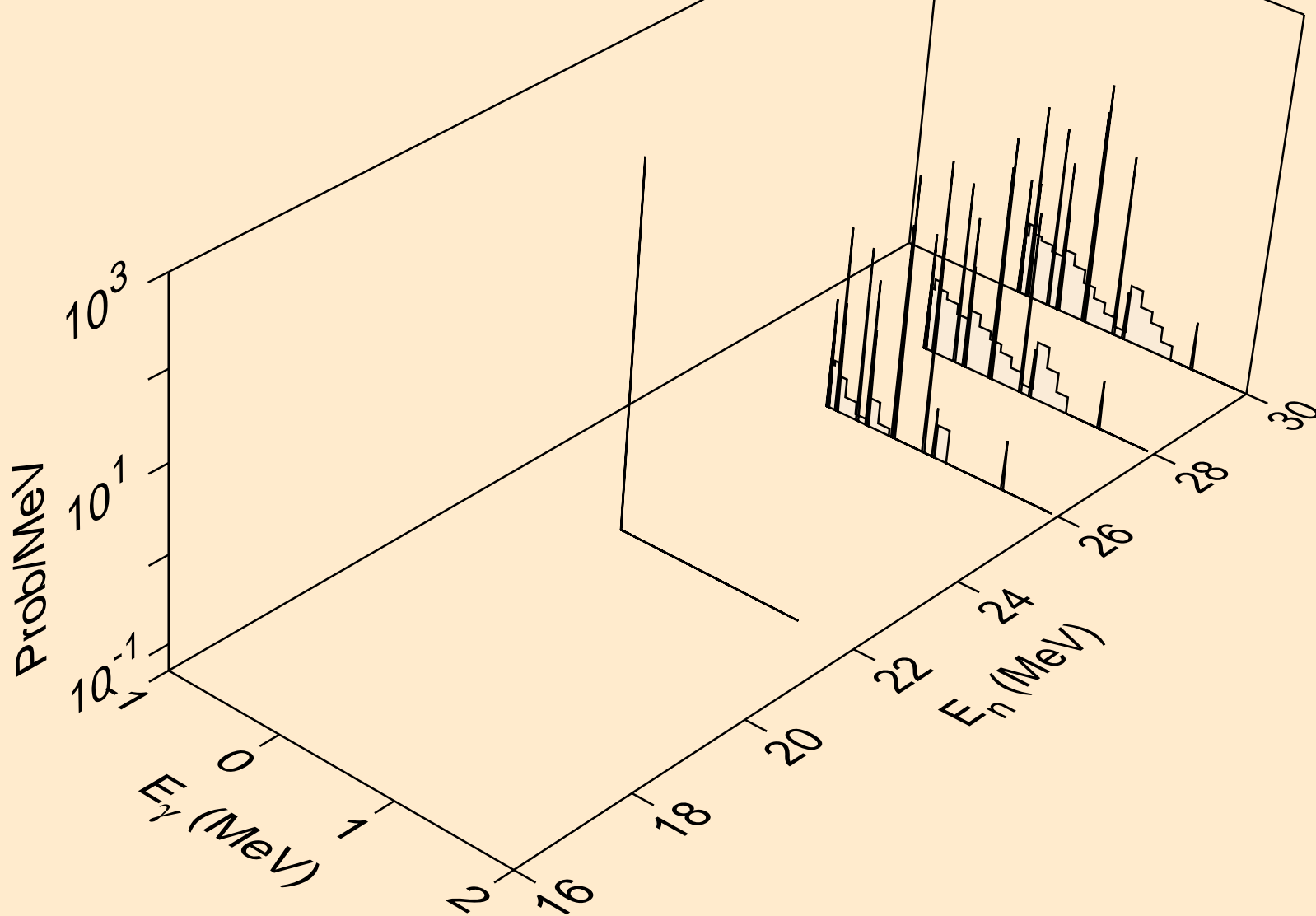

RH091 NEUTRON ACER TENDL-2019 LIBRARY; T=293.16K
Photon emission for (n,n*)p

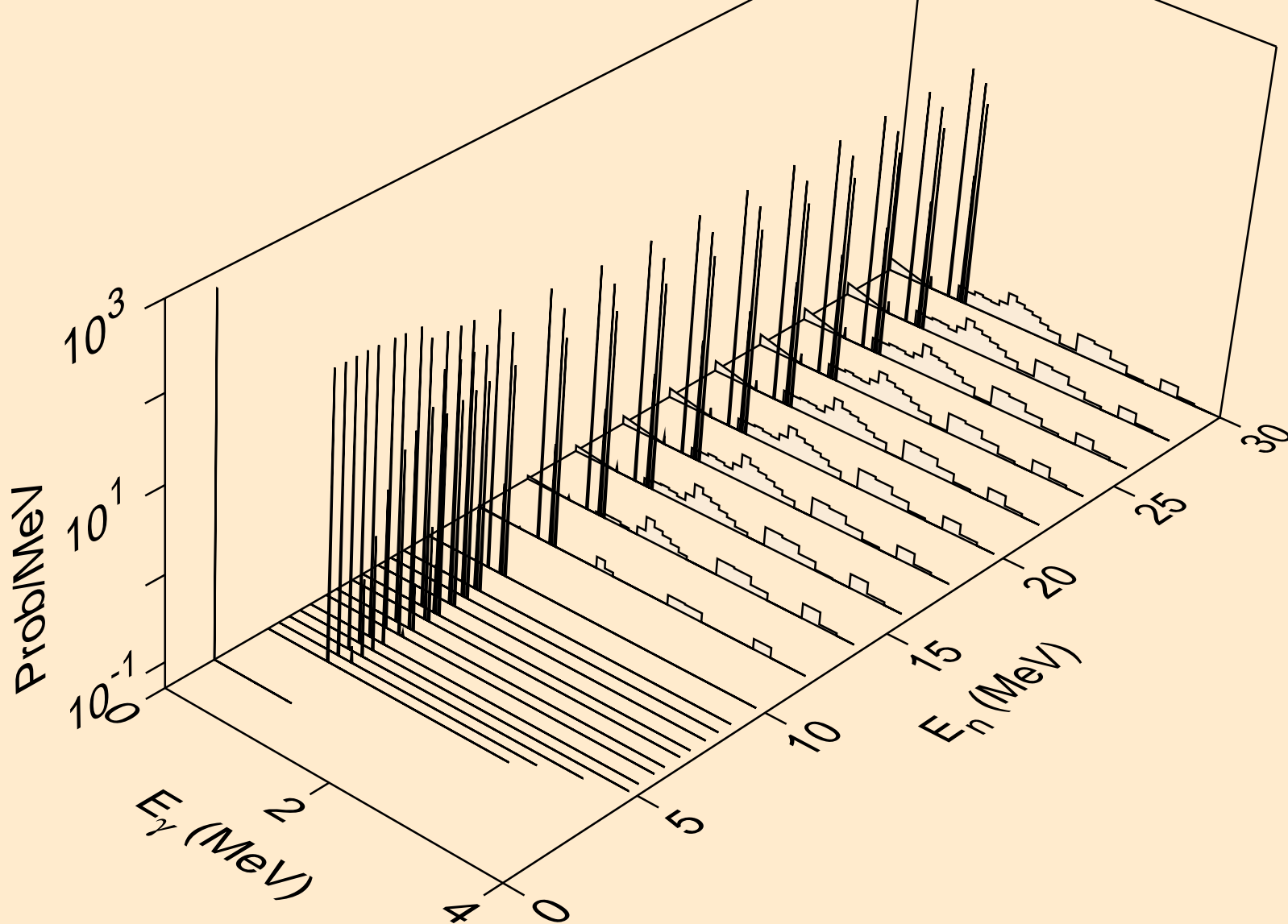

RH091 NEUTRON ACER TENDL-2019 LIBRARY; T=293.16K
Photon emission for (n,n*)2a

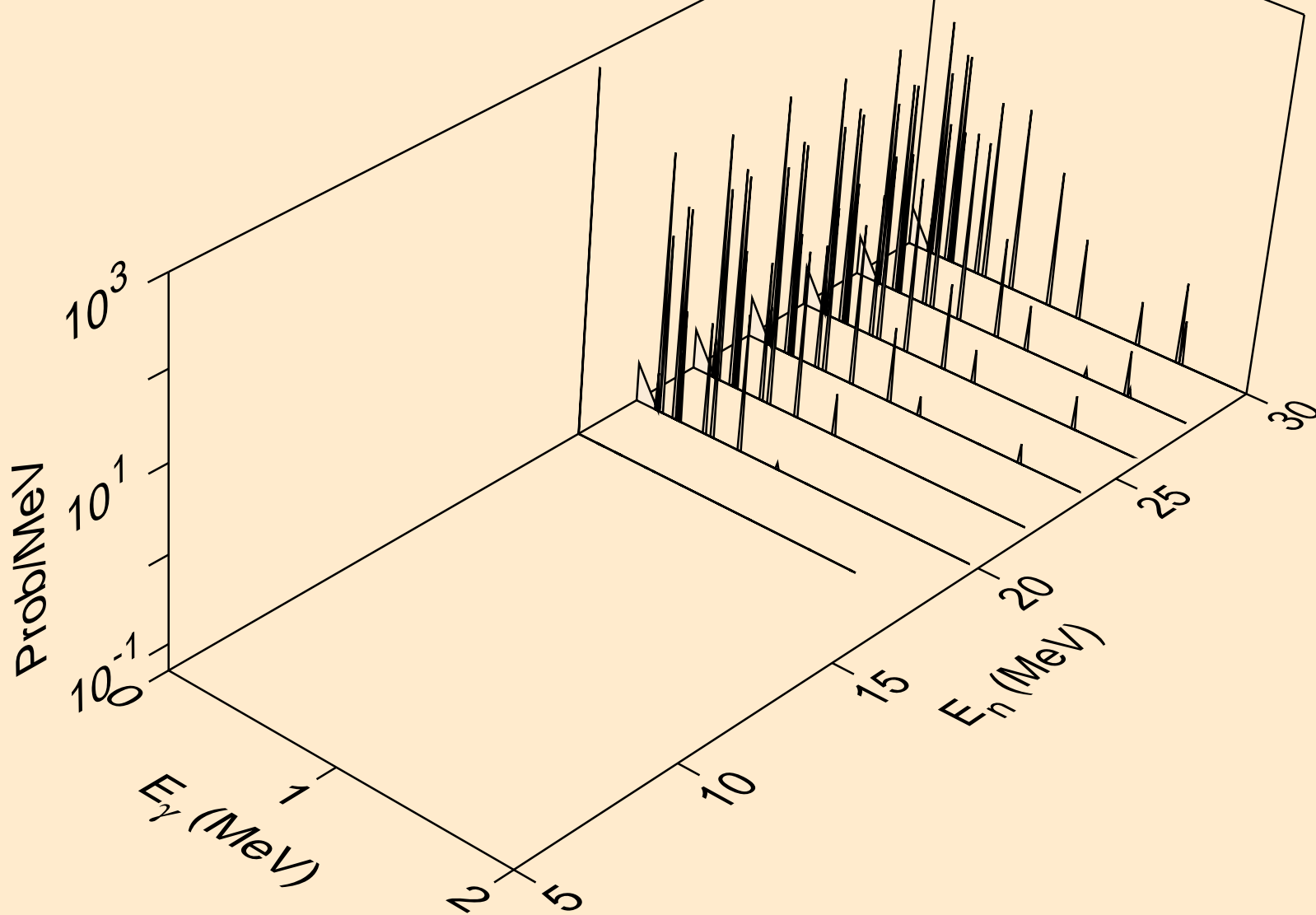

RH091 NEUTRON ACER TENDL-2019 LIBRARY; T=293.16K
Photon emission for (n,n*)d

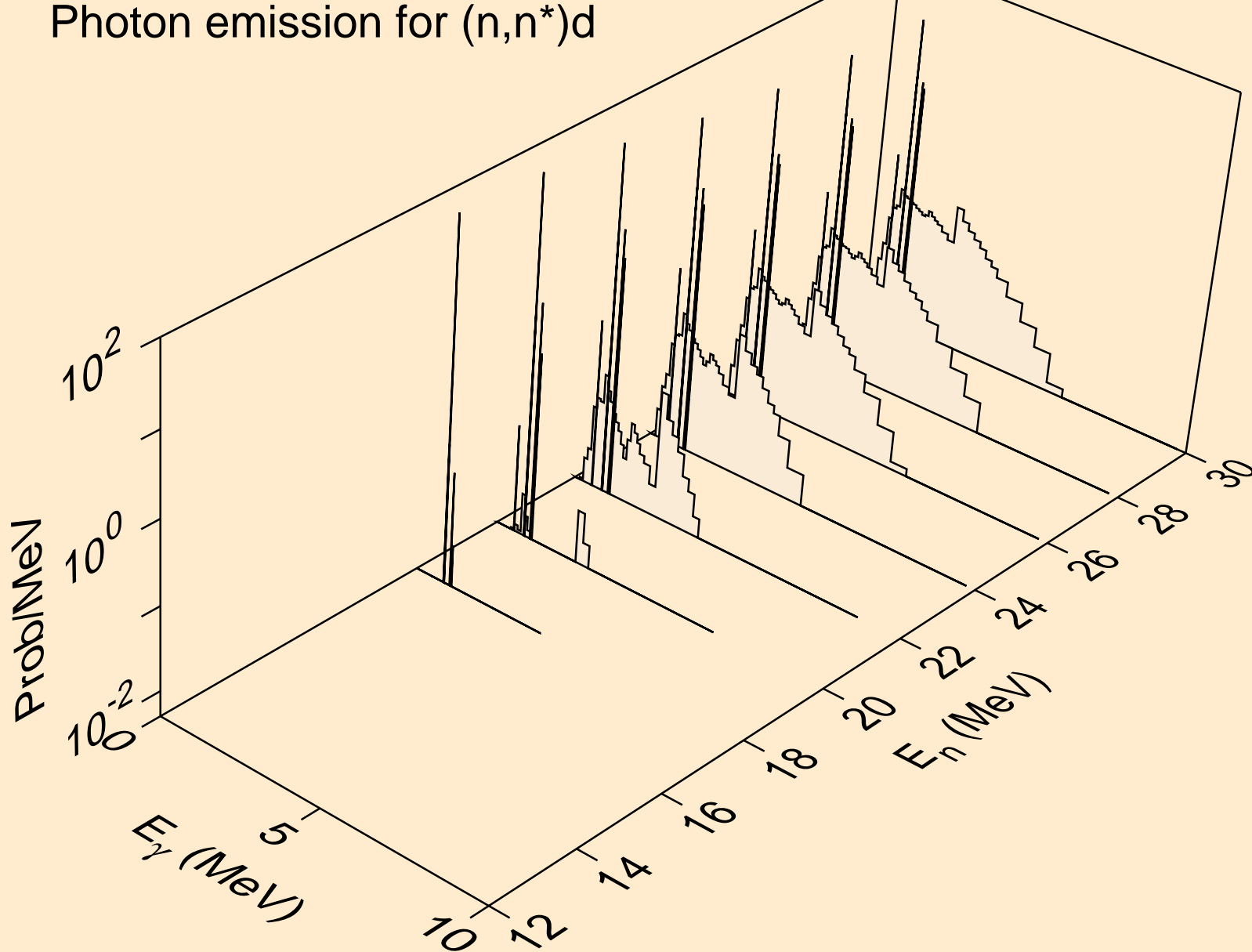

RH091 NEUTRON ACER TENDL-2019 LIBRARY; T=293.16K
Photon emission for (n,n*)t

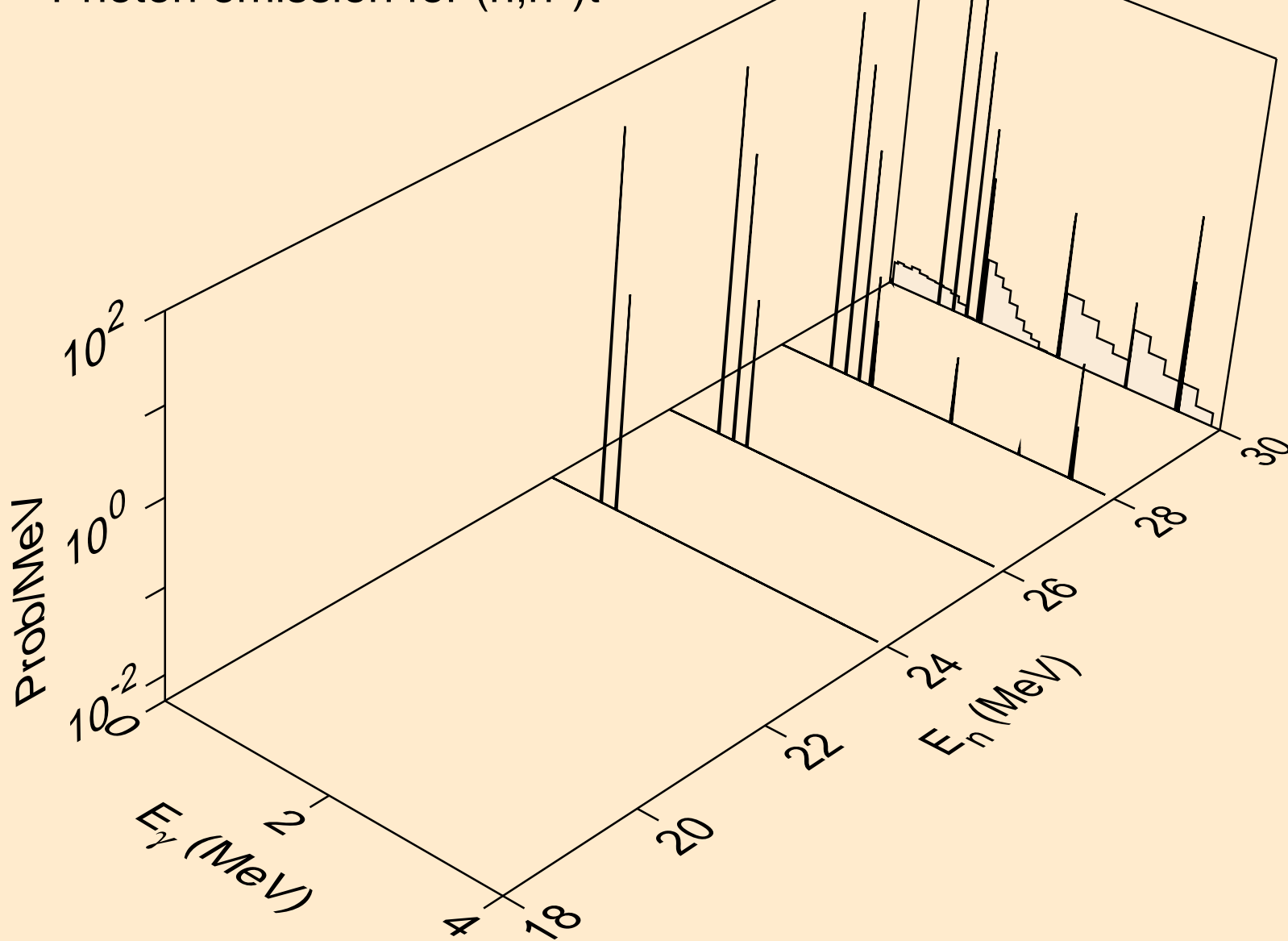

RH091 NEUTRON ACER TENDL-2019 LIBRARY; T=293.16K
Photon emission for (n,n*)he3

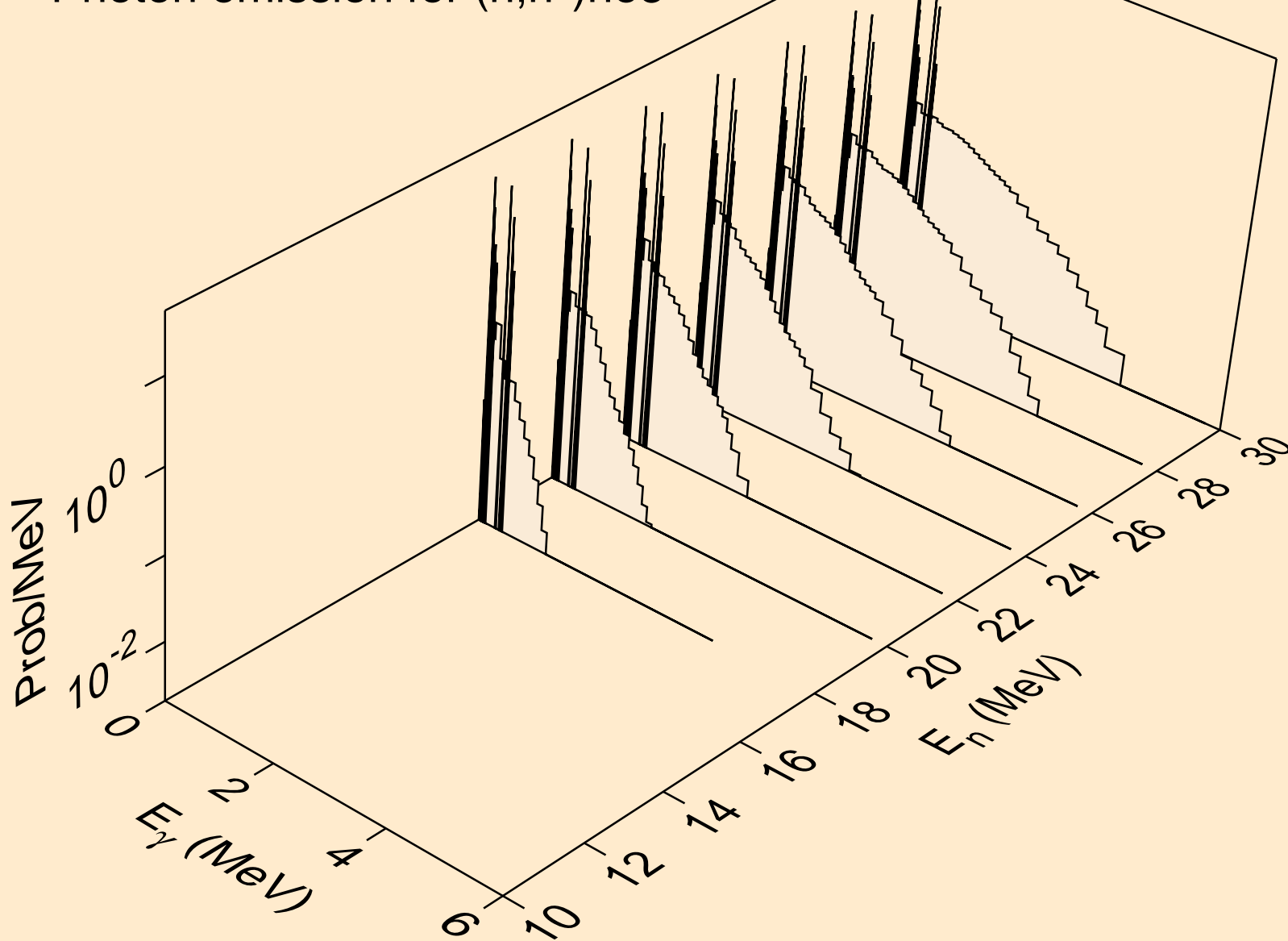

RH091 NEUTRON ACER TENDL-2019 LIBRARY; T=293.16K
Photon emission for (n,2np)

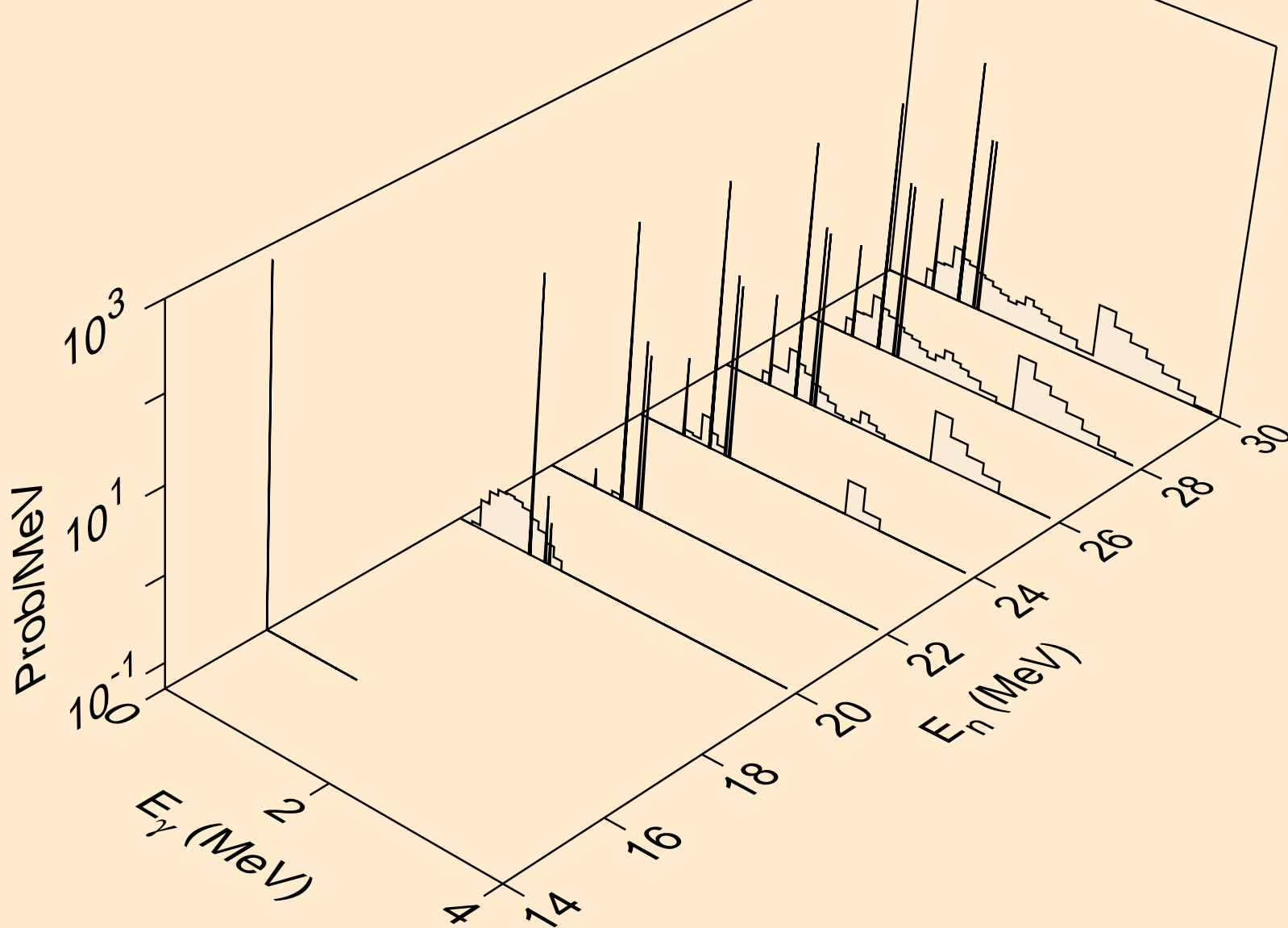

RH091 NEUTRON ACER TENDL-2019 LIBRARY; T=293.16K
Photon emission for (n,2np)

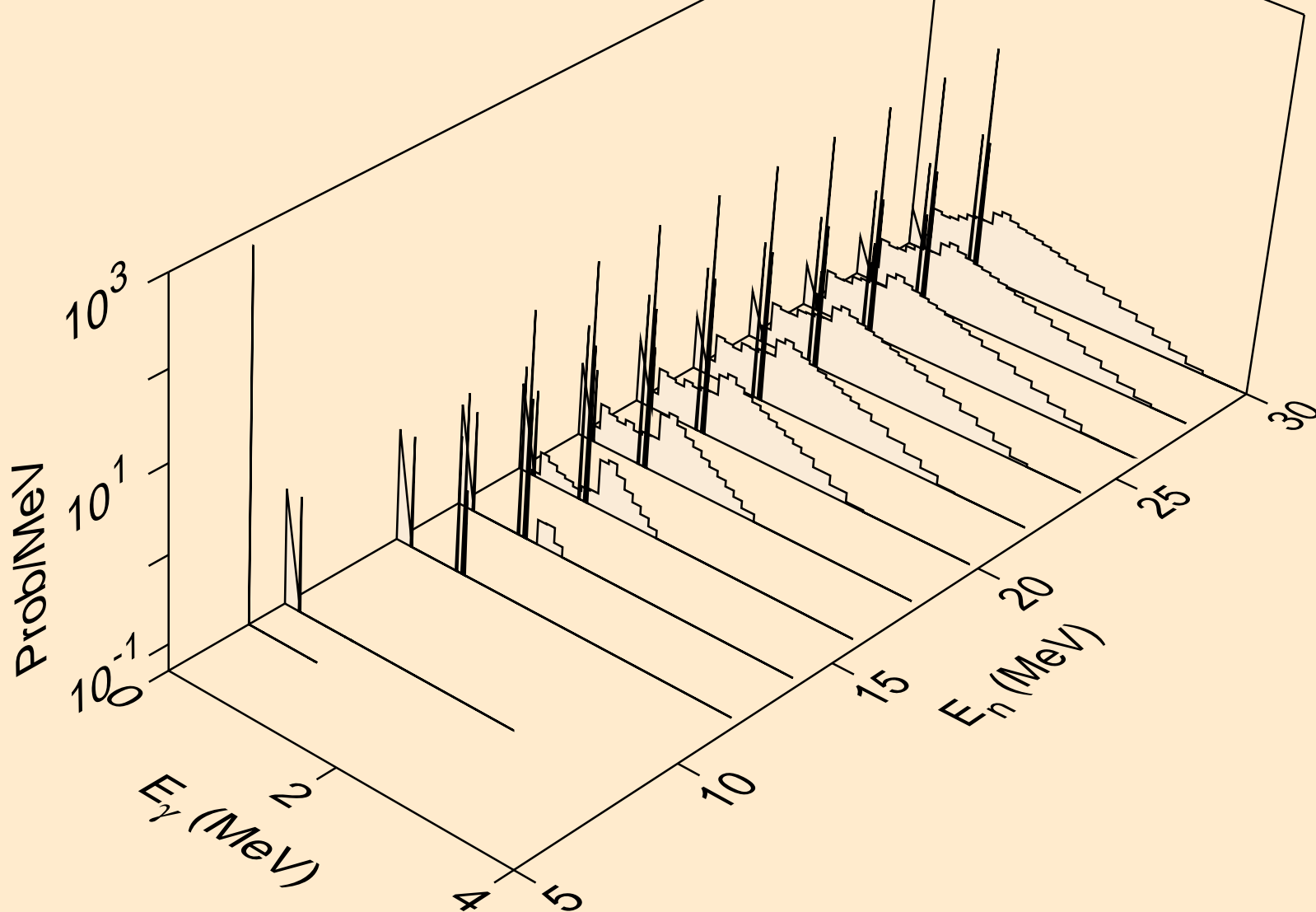

RH091 NEUTRON ACER TENDL-2019 LIBRARY; T=293.16K
Photon emission for (n,npa)

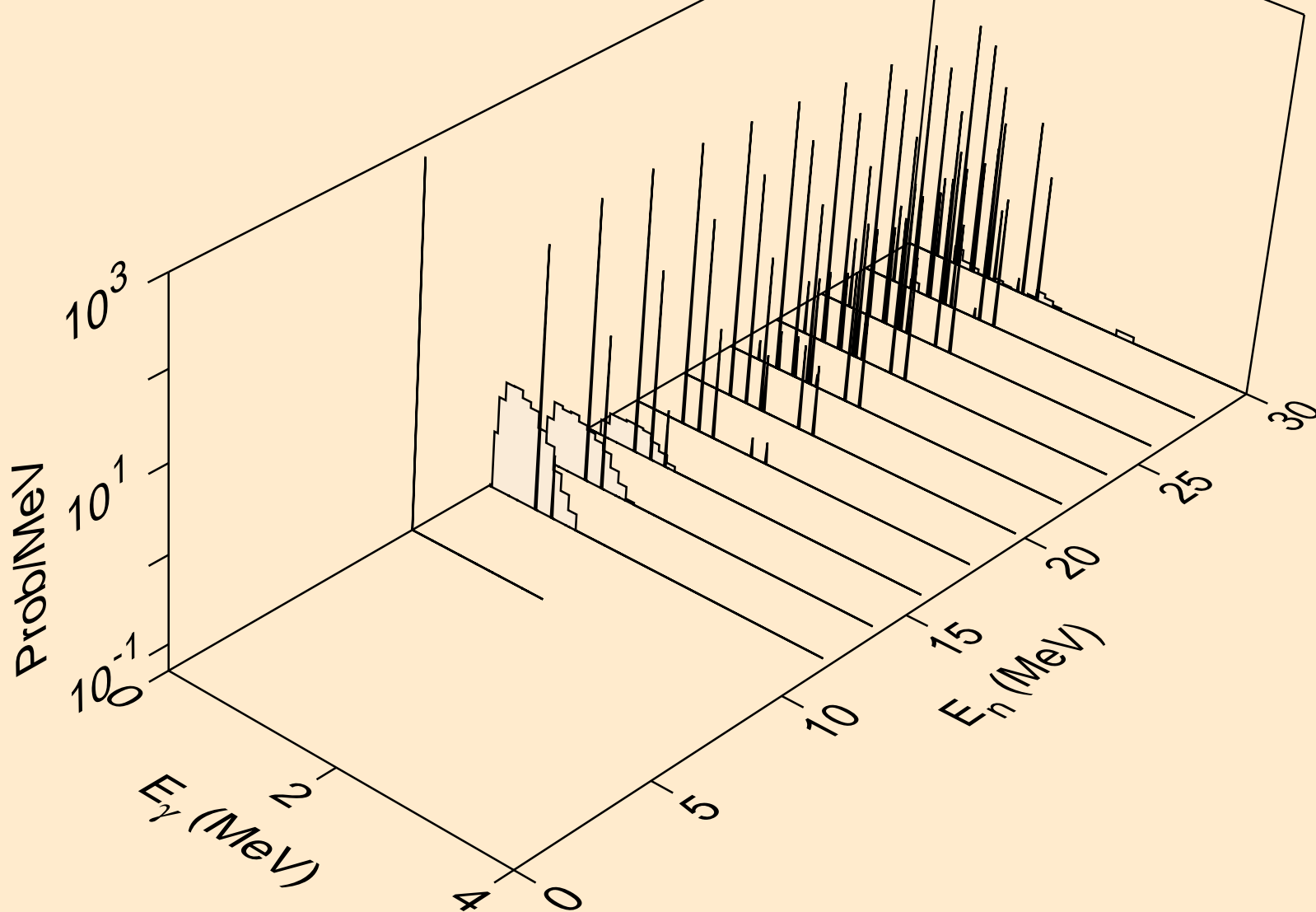

RH091 NEUTRON ACER TENDL-2019 LIBRARY; T=293.16K
Photon emission for (n,n*c)

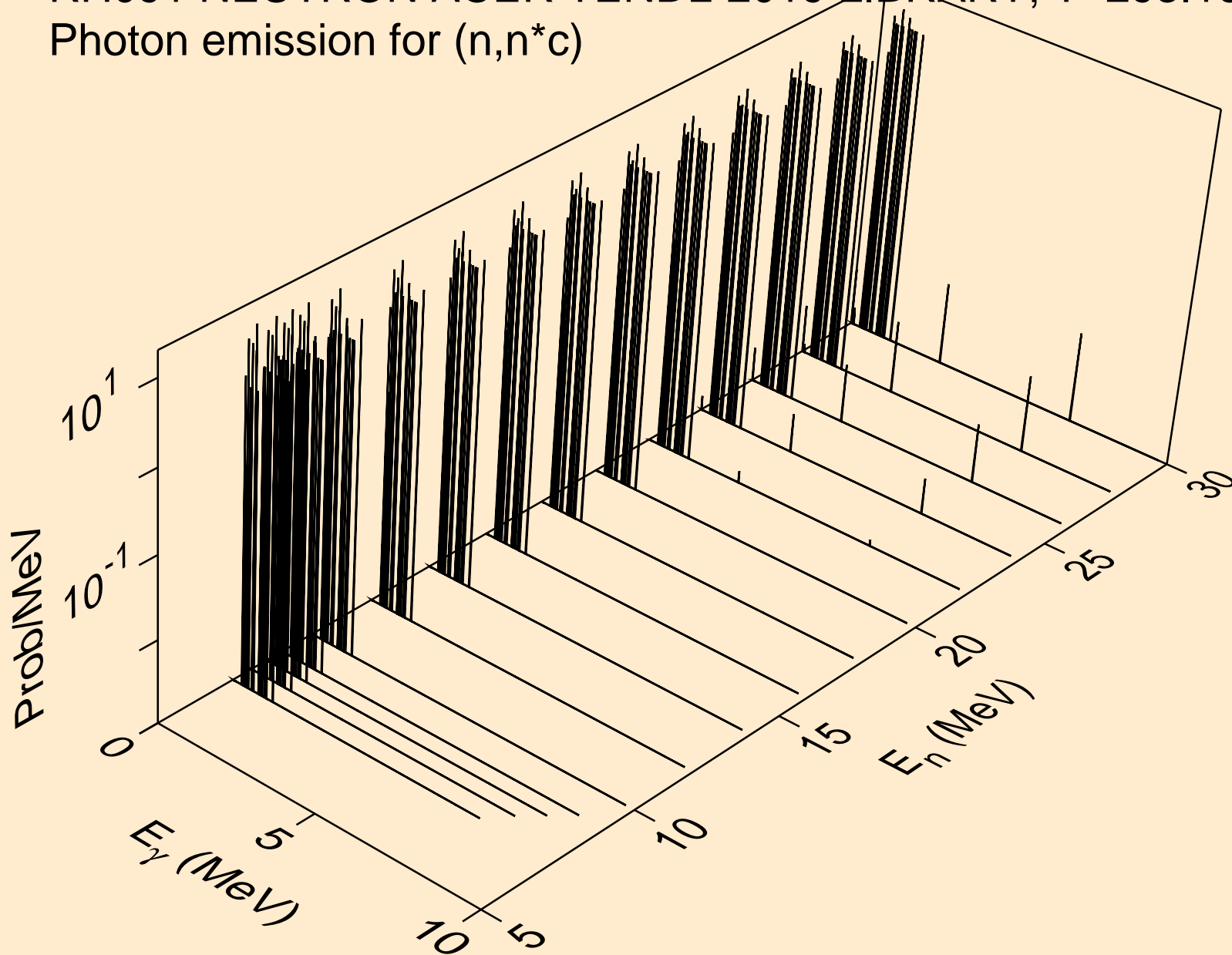

RH091 NEUTRON ACER TENDL-2019 LIBRARY; T=293.16K
Photon emission for (n,gma)

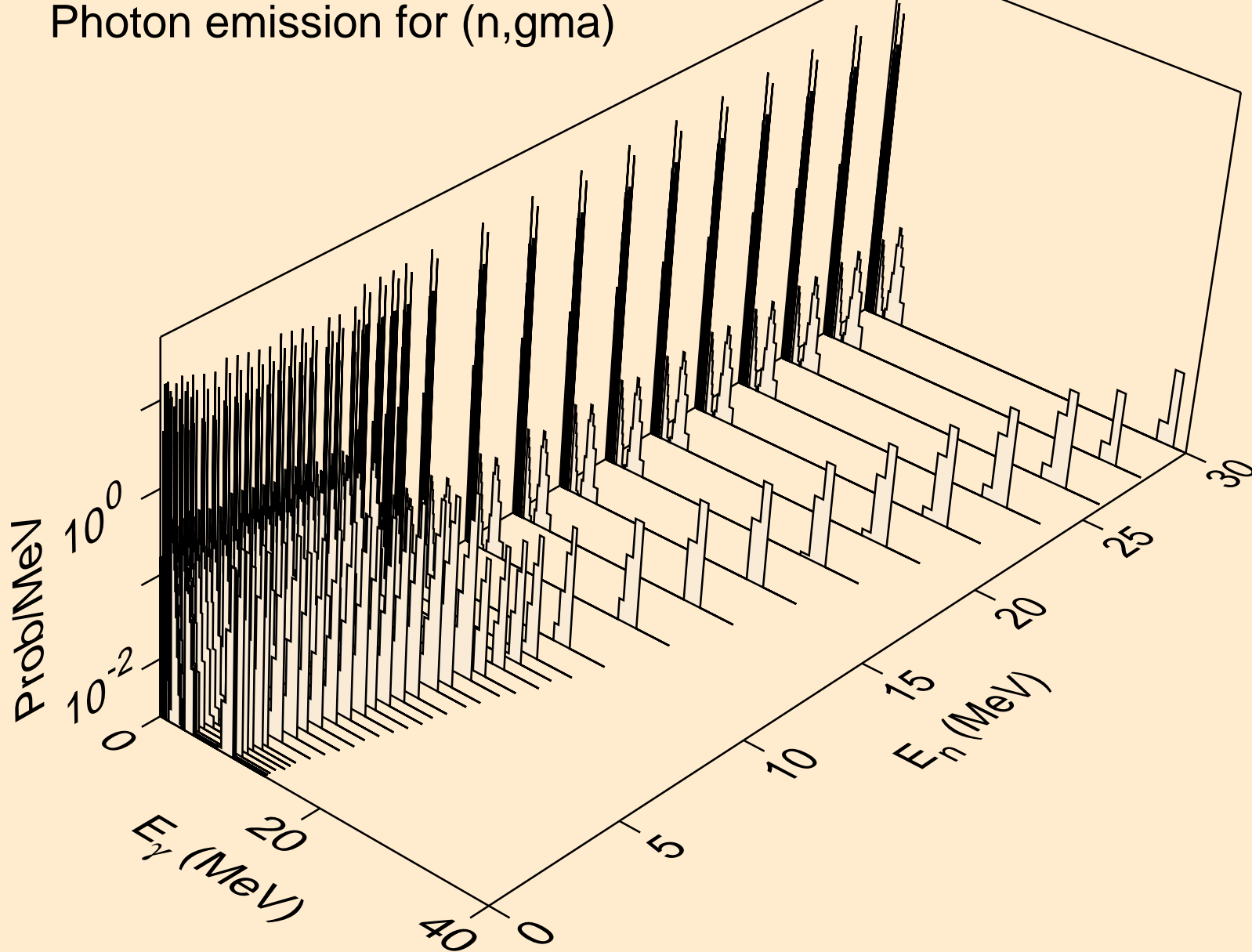

RH091 NEUTRON ACER TENDL-2019 LIBRARY; T=293.16K
Photon emission for (n,p)

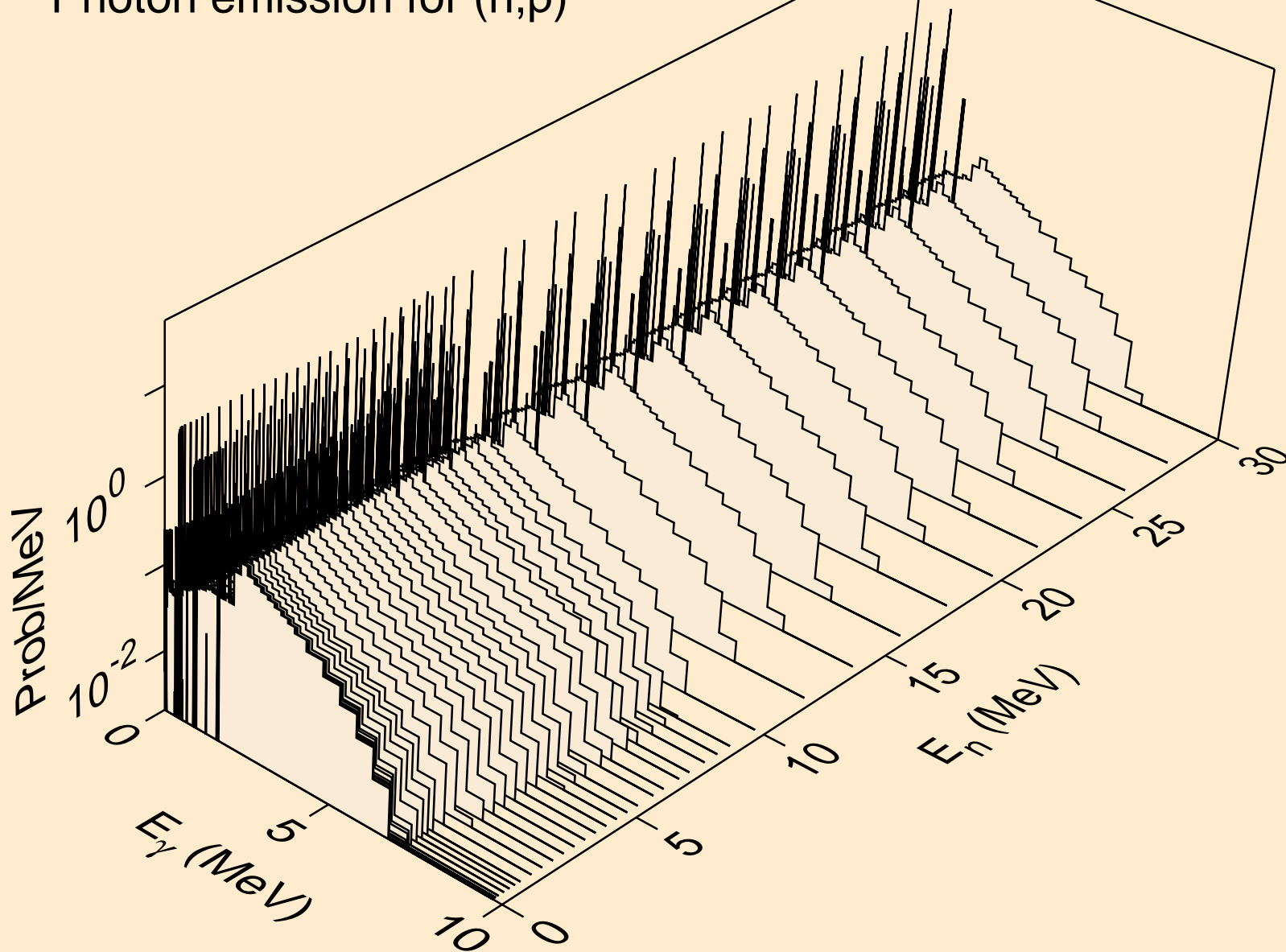

RH091 NEUTRON ACER TENDL-2019 LIBRARY; T=293.16K
Photon emission for (n,d)

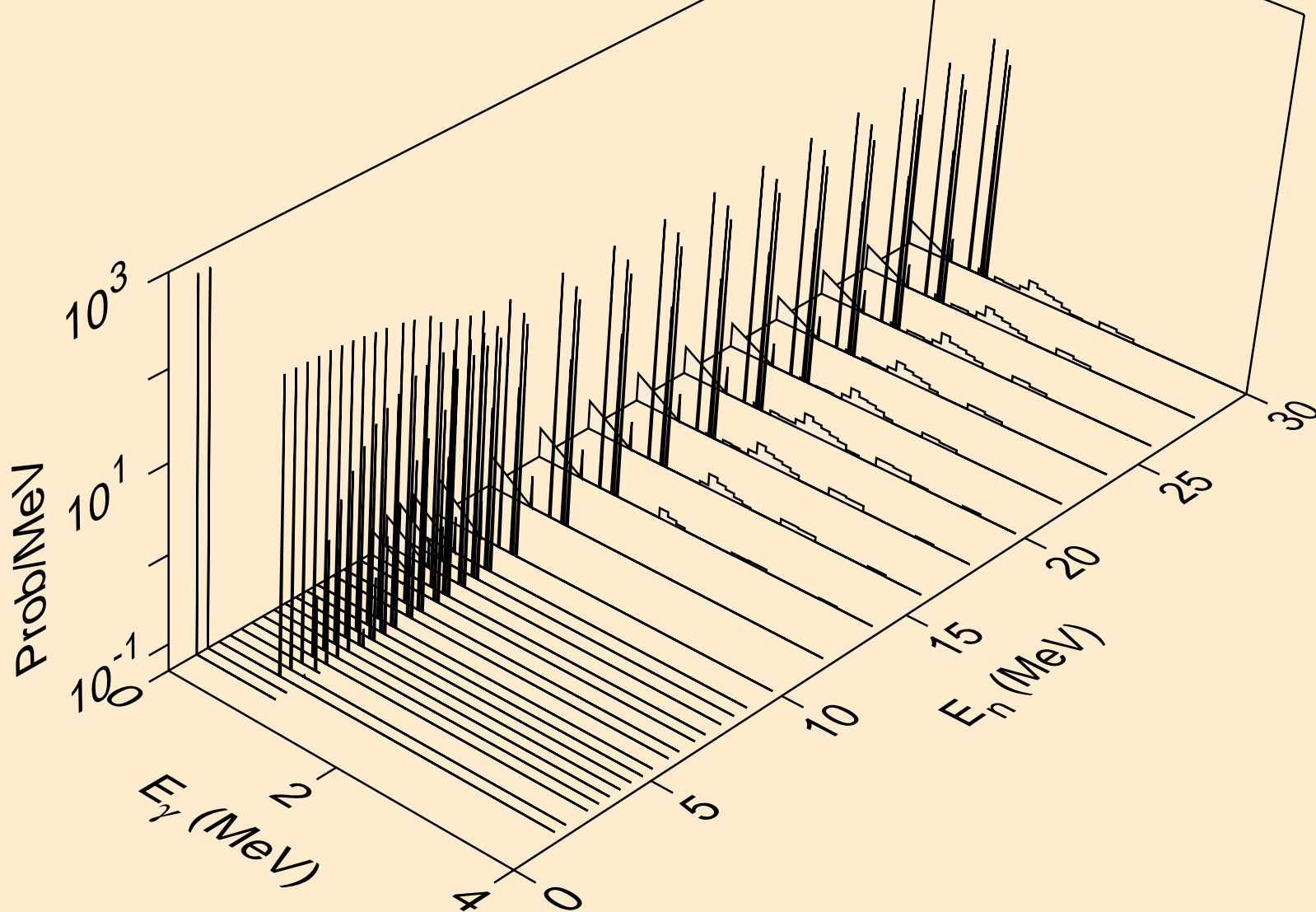

RH091 NEUTRON ACER TENDL-2019 LIBRARY; T=293.16K
Photon emission for (n,t)

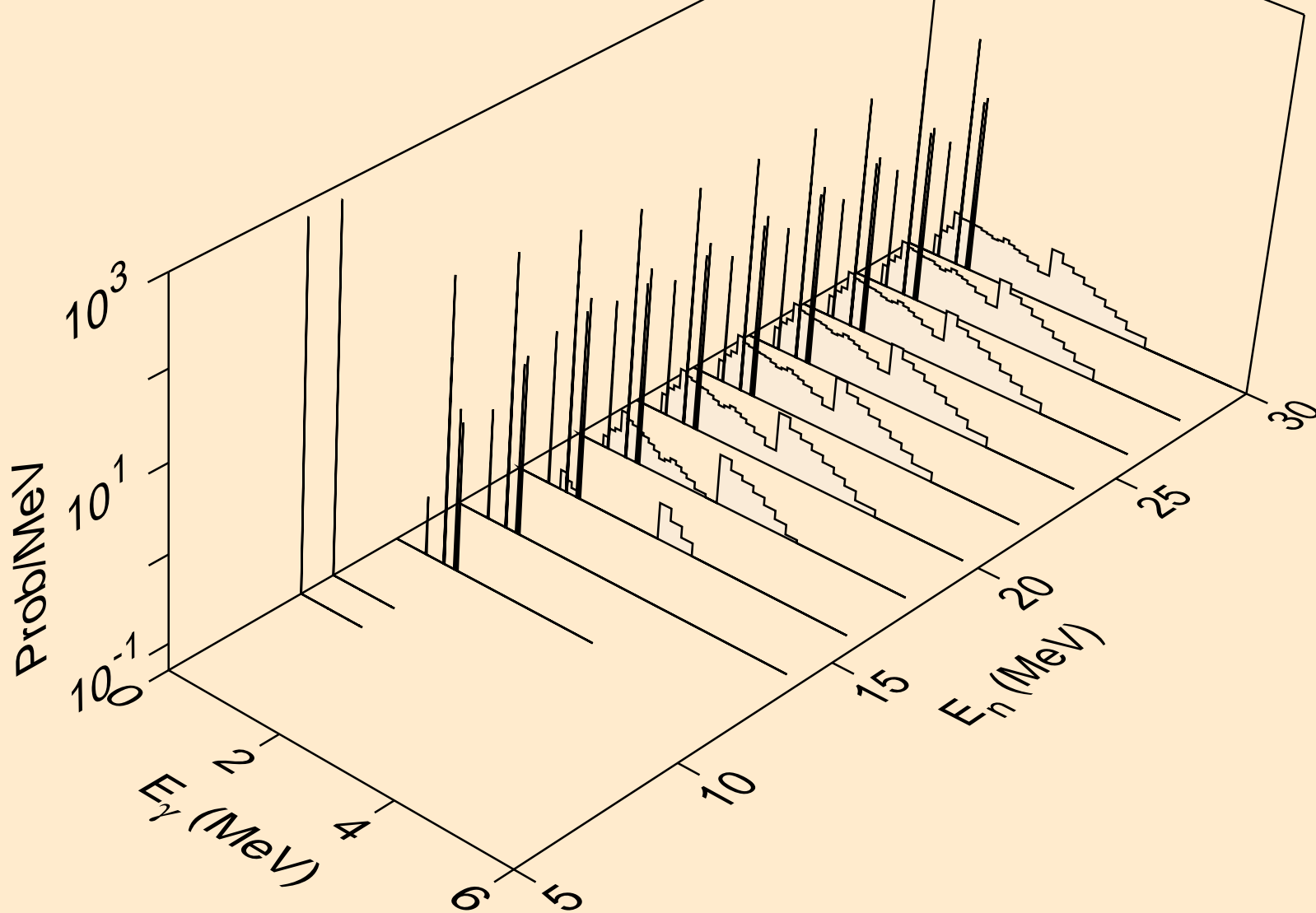

RH091 NEUTRON ACER TENDL-2019 LIBRARY; T=293.16K
Photon emission for (n,he3)

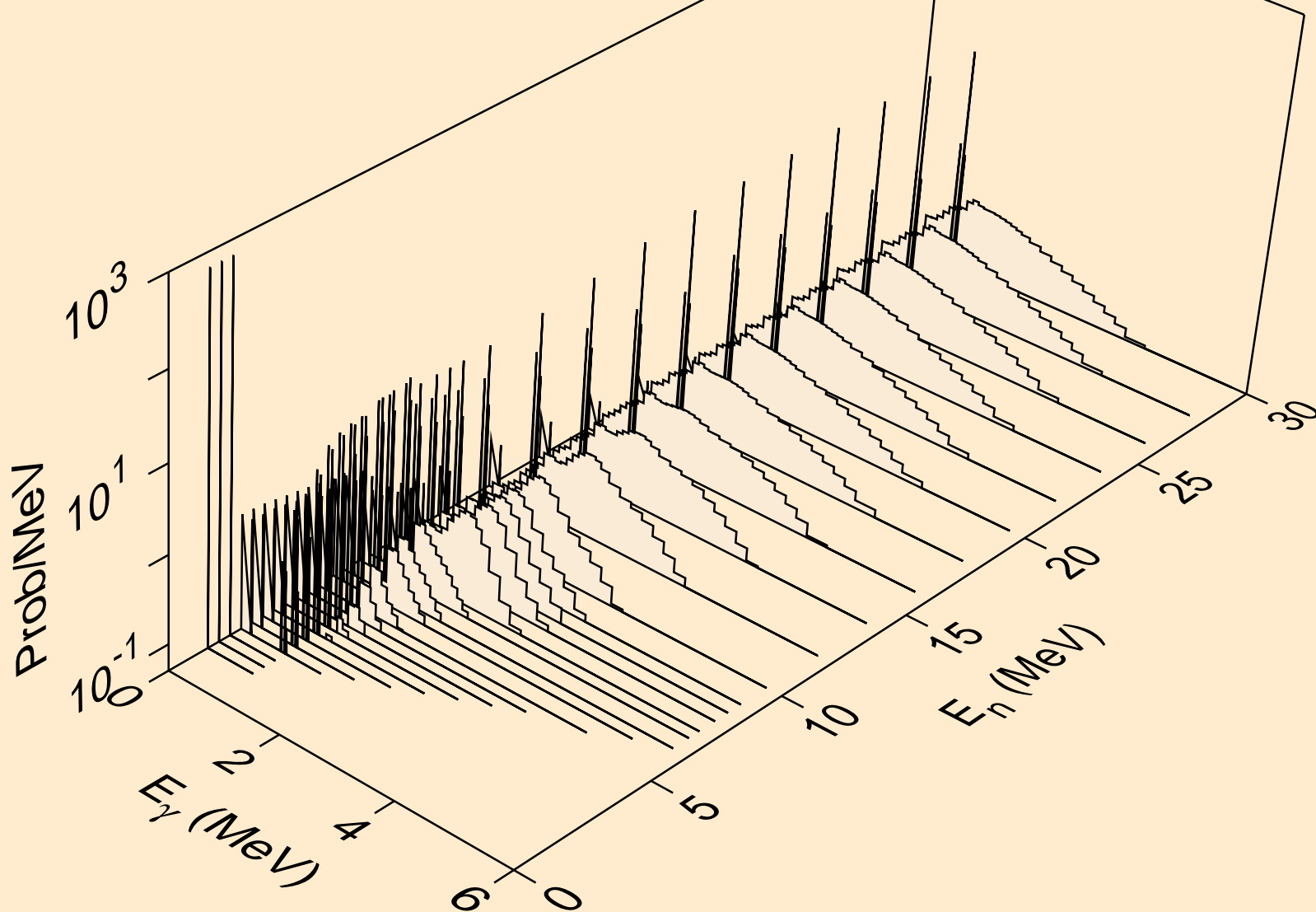

RH091 NEUTRON ACER TENDL-2019 LIBRARY; T=293.16K
Photon emission for (n,a)

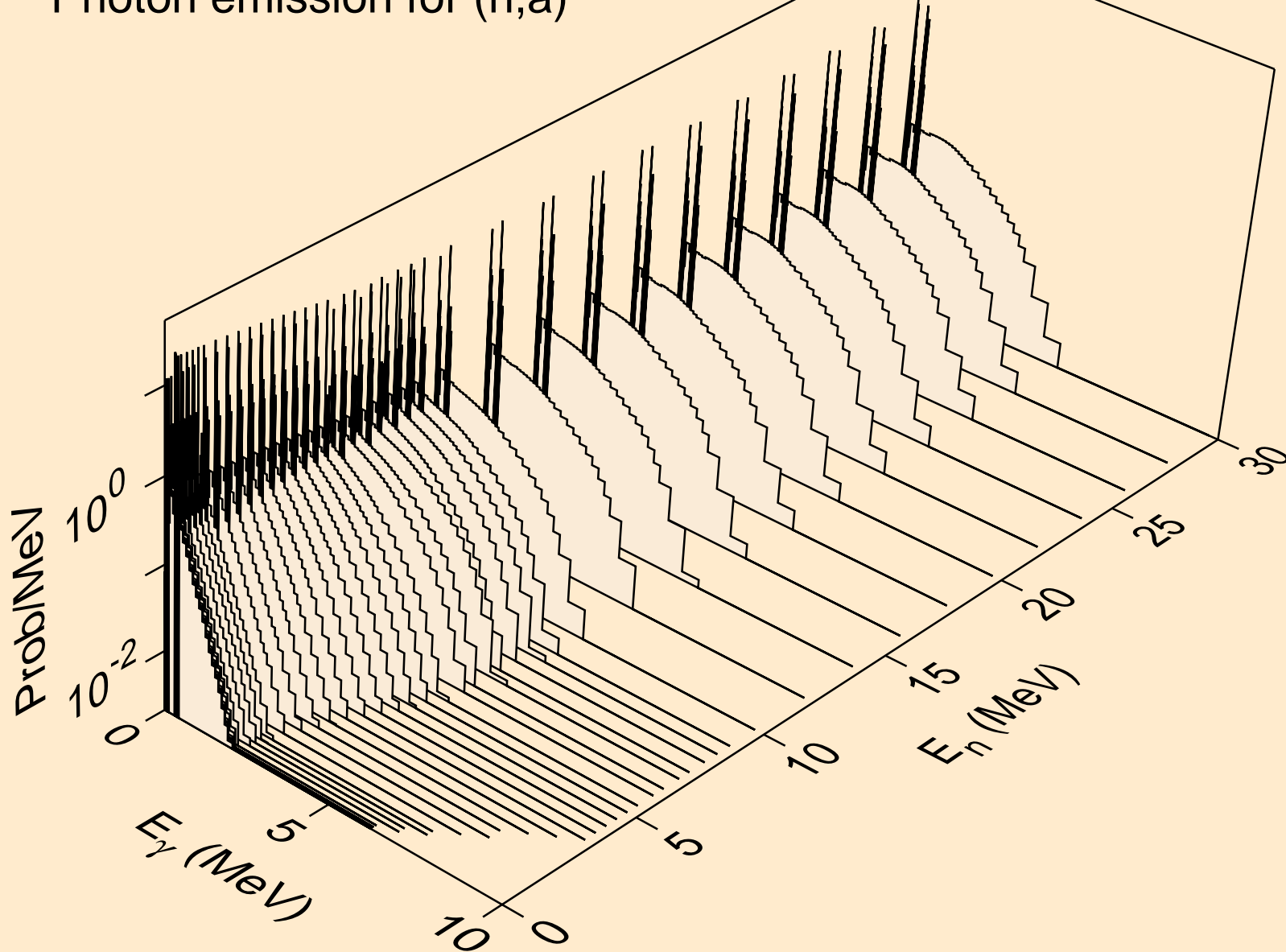

RH091 NEUTRON ACER TENDL-2019 LIBRARY; T=293.16K
Photon emission for (n,2a)

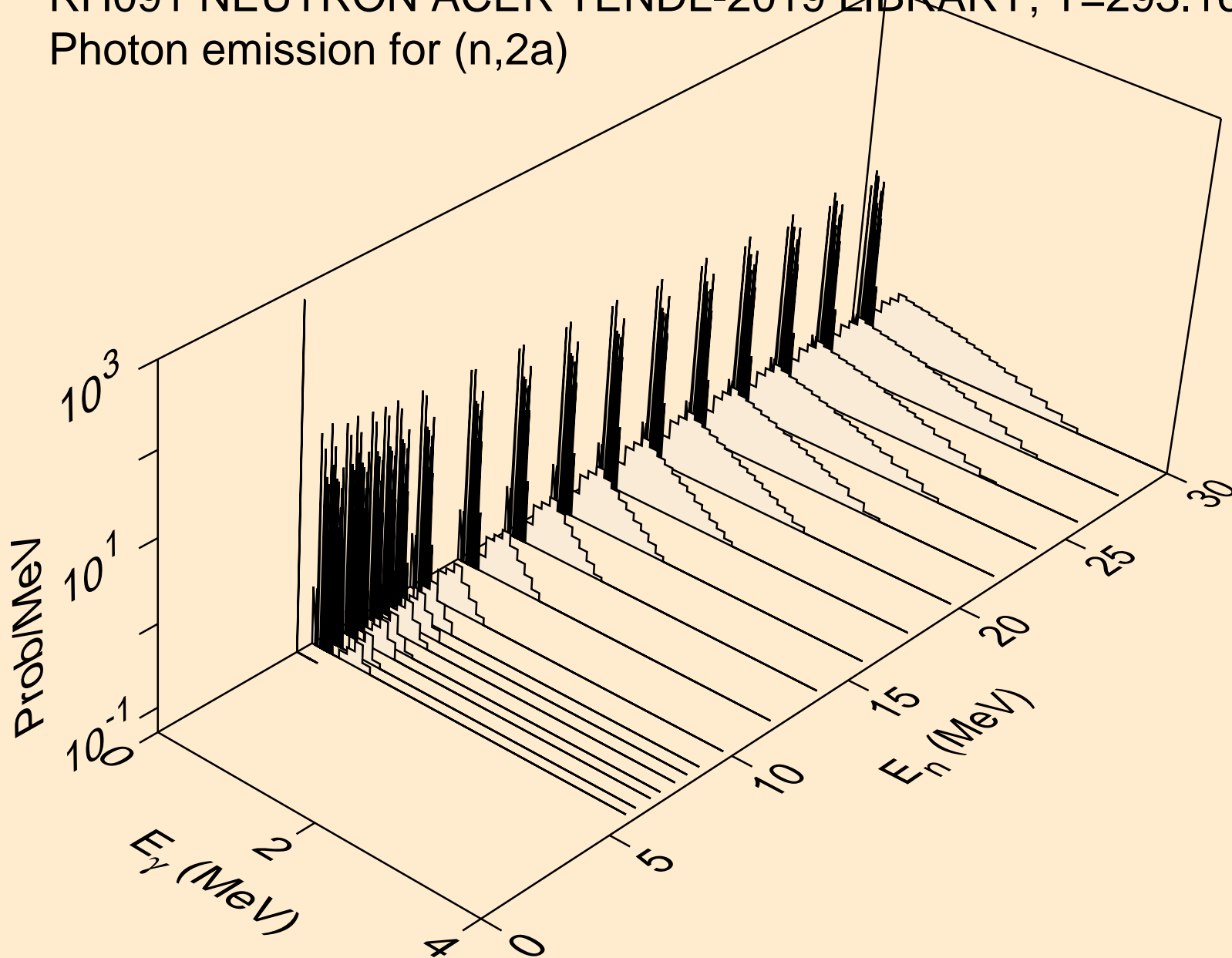

RH091 NEUTRON ACER TENDL-2019 LIBRARY; T=293.16K
Photon emission for (n,3a)

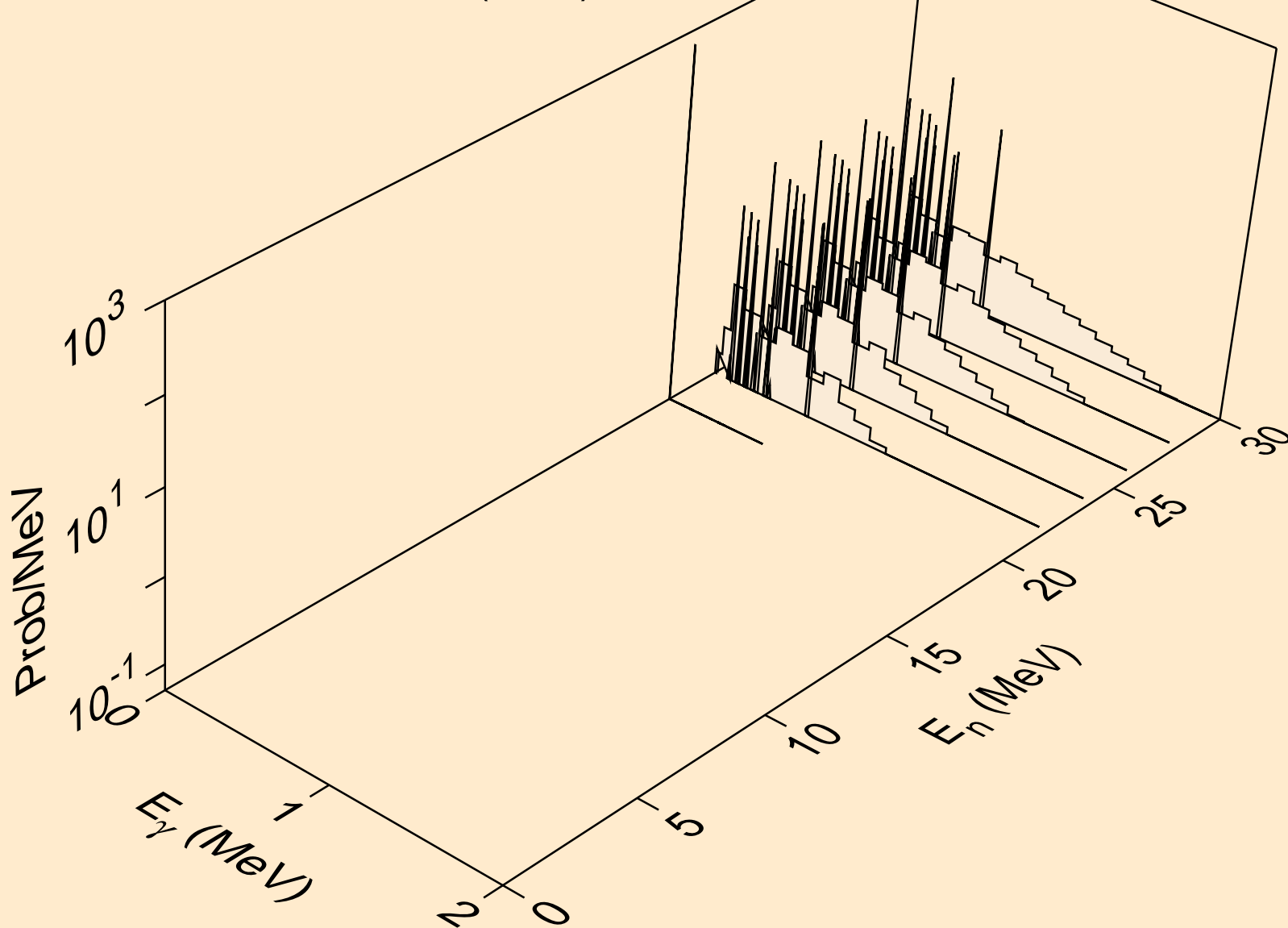

RH091 NEUTRON ACER TENDL-2019 LIBRARY; T=293.16K
Photon emission for (n,2p)

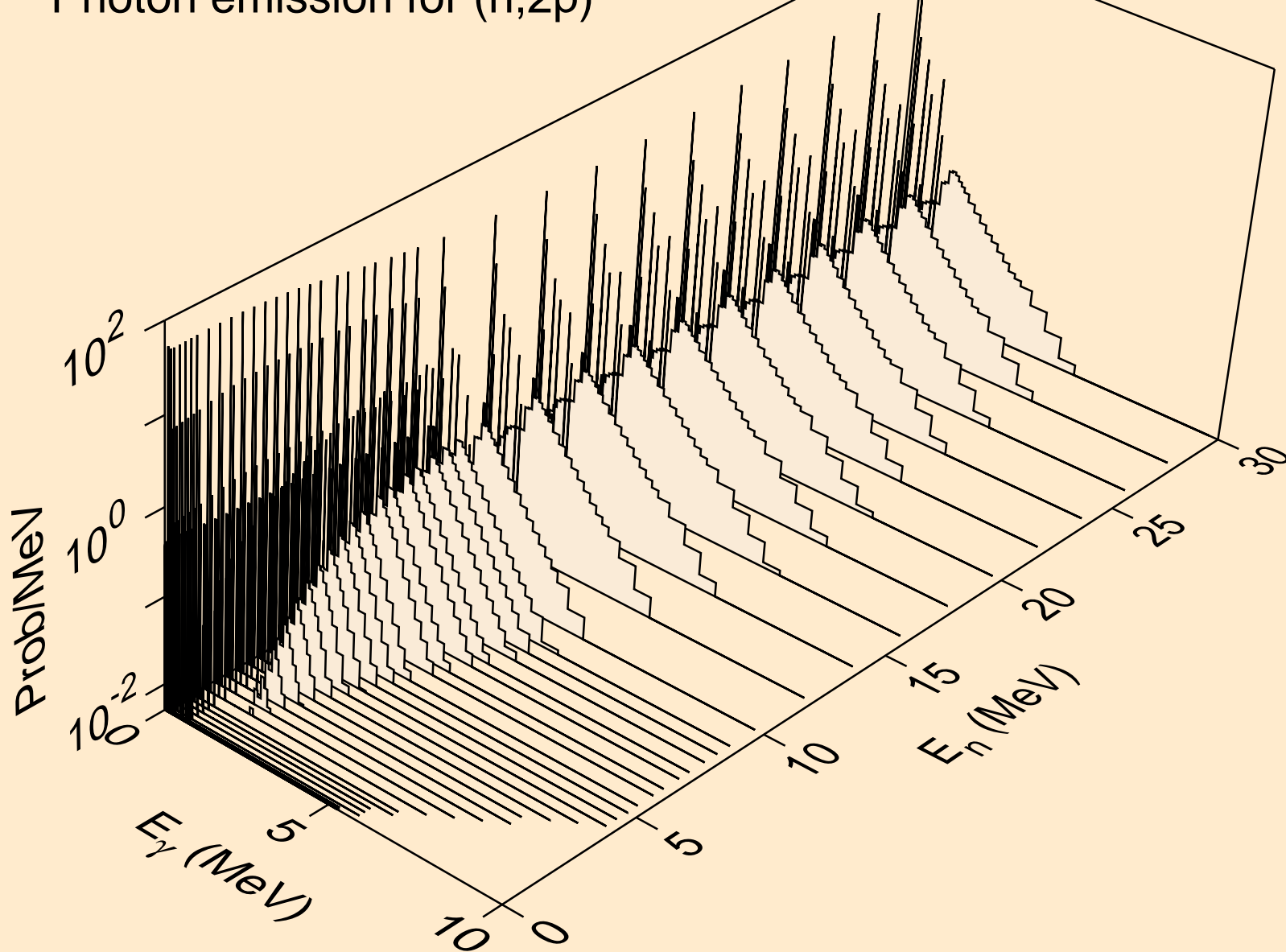

RH091 NEUTRON ACER TENDL-2019 LIBRARY; T=293.16K
Photon emission for (n,p α)

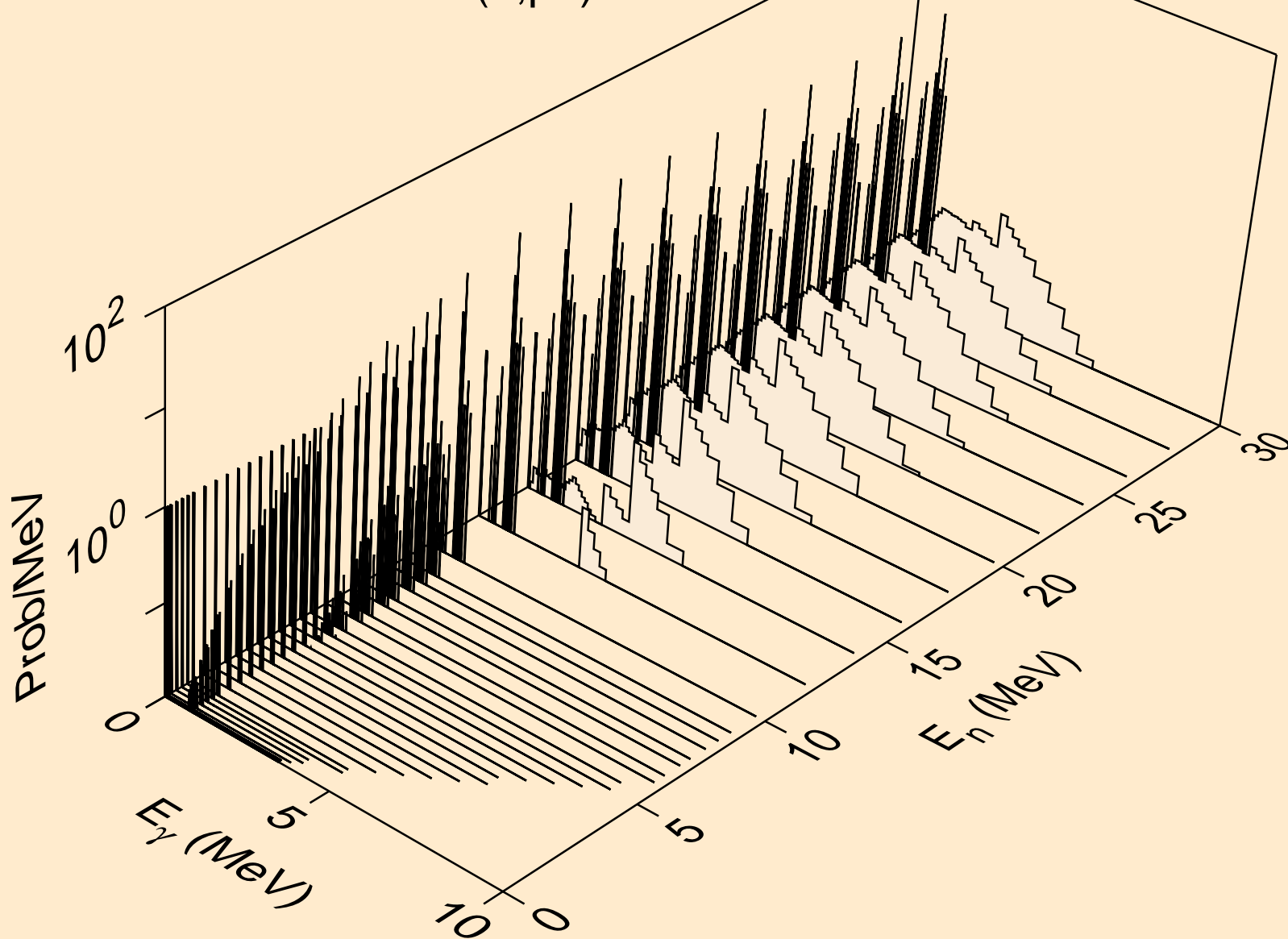

RH091 NEUTRON ACER TENDL-2019 LIBRARY; T=293.16K
Photon emission for (n,pd)

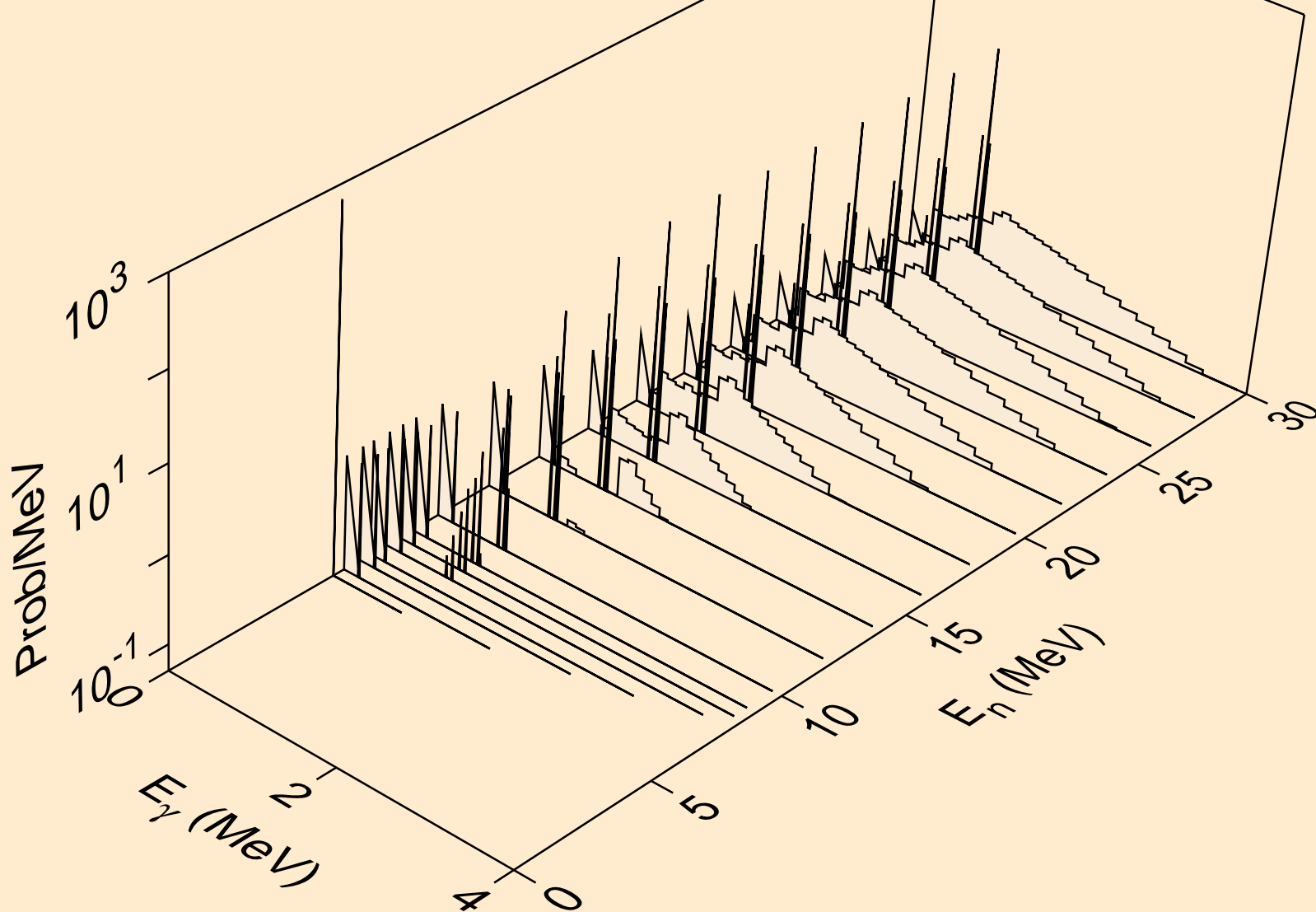

RH091 NEUTRON ACER TENDL-2019 LIBRARY; T=293.16K
Photon emission for (n,pt)

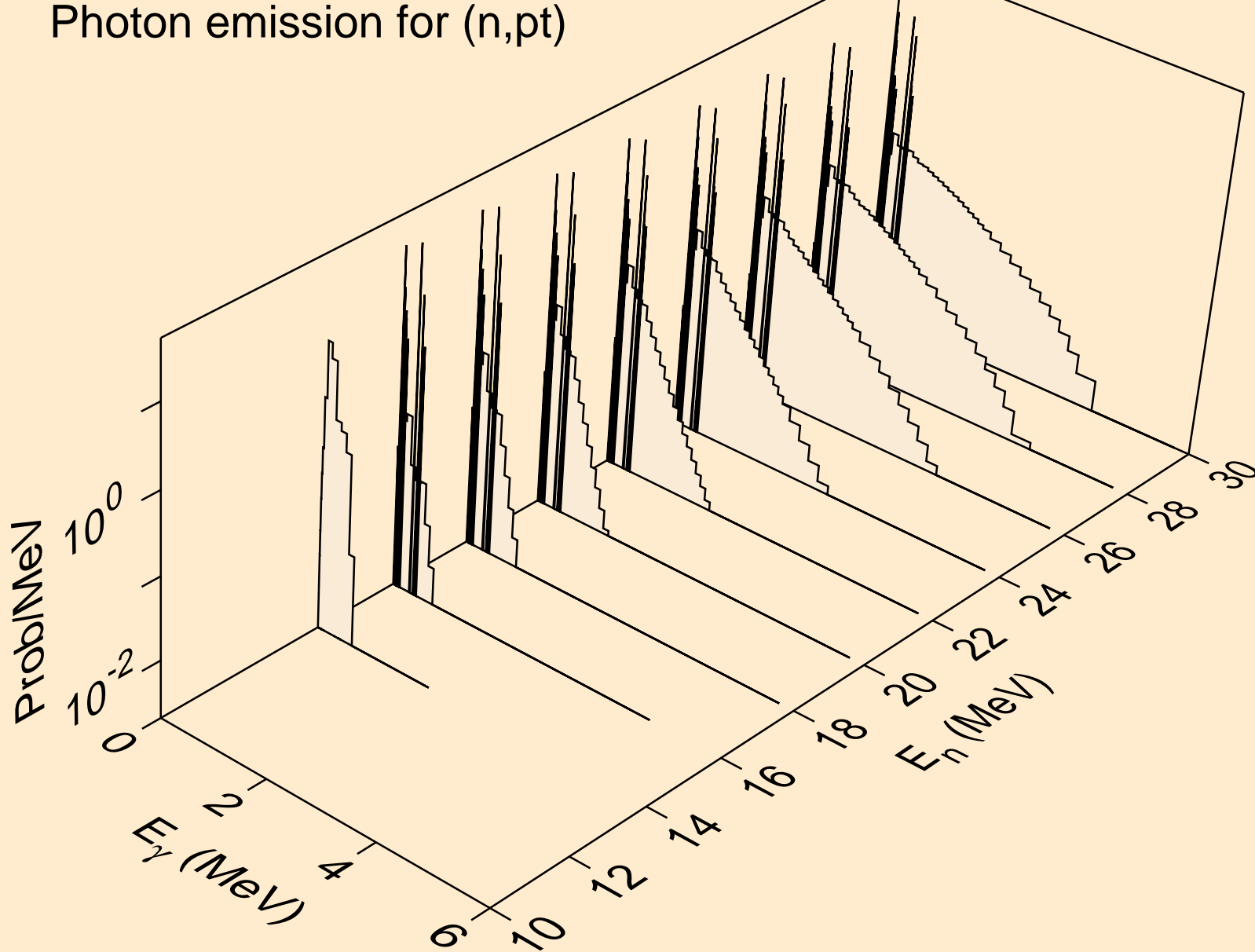

RH091 NEUTRON ACER TENDL-2019 LIBRARY; T=293.16K
Photon emission for (n,da)

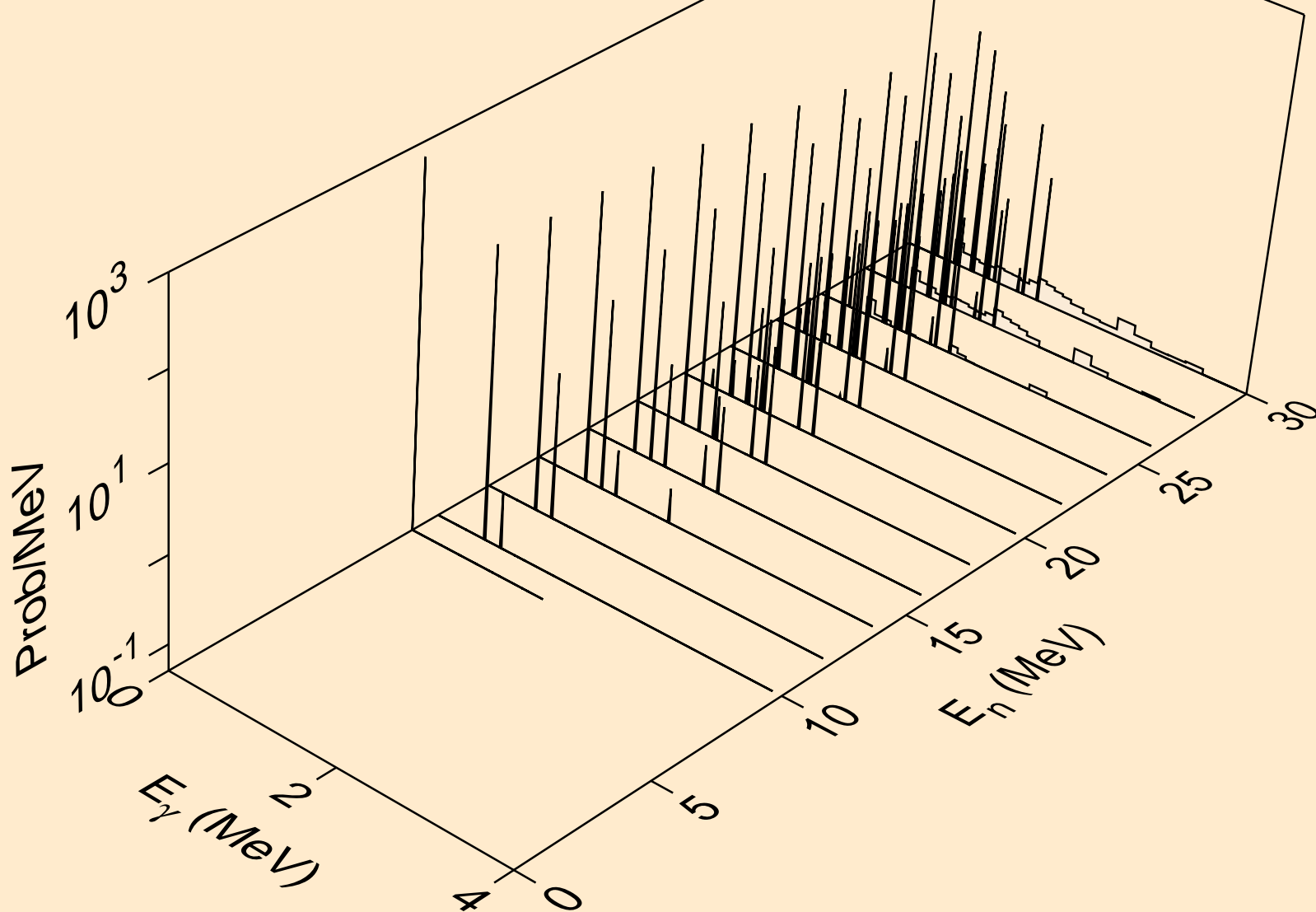

RH091 NEUTRON ACER TENDL-2019 LIBRARY; T=293.16K
thermal capture photon spectrum

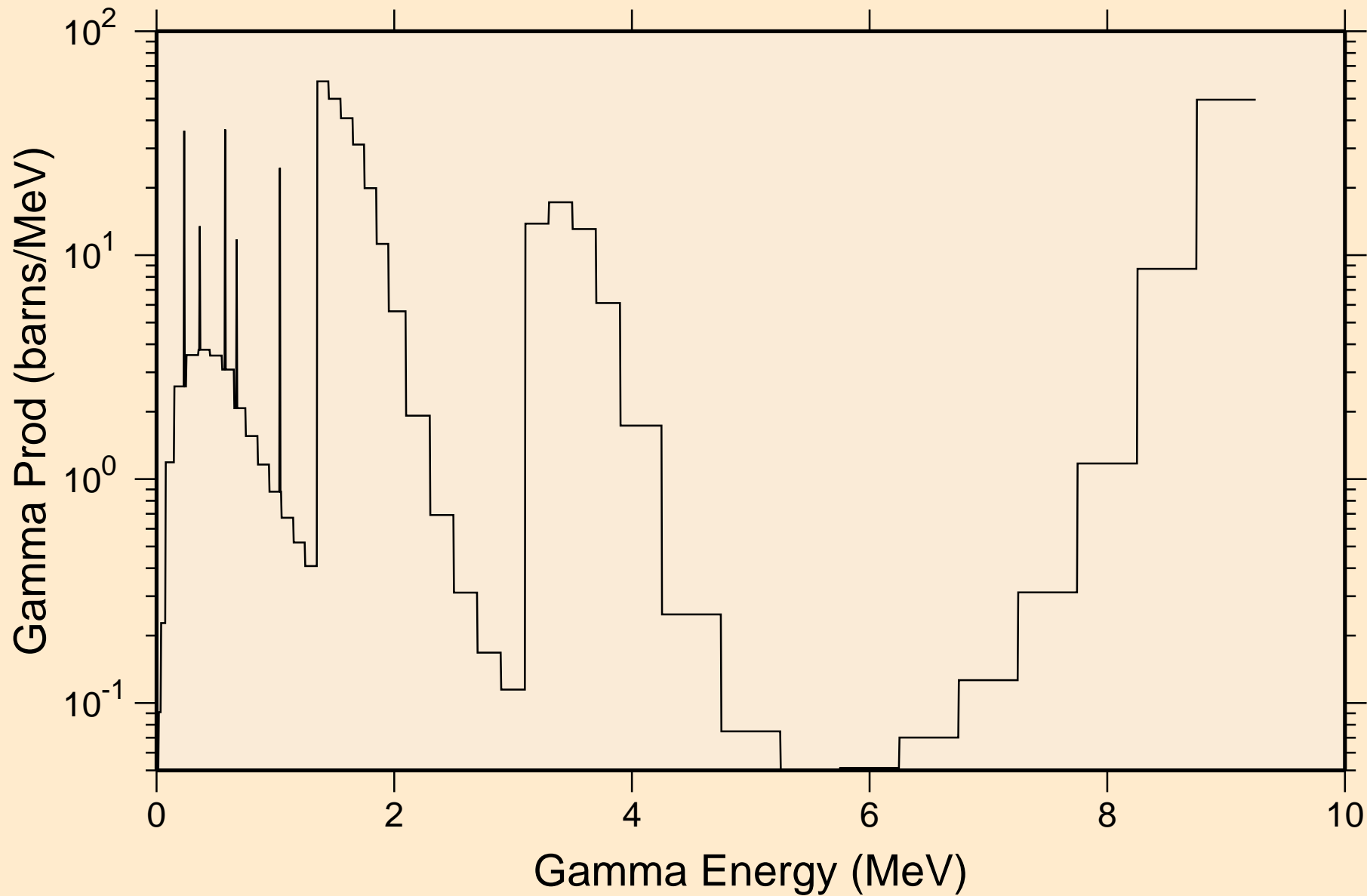

RH091 NEUTRON ACER TENDL-2019 LIBRARY; T=293.16K
14 MeV photon spectrum

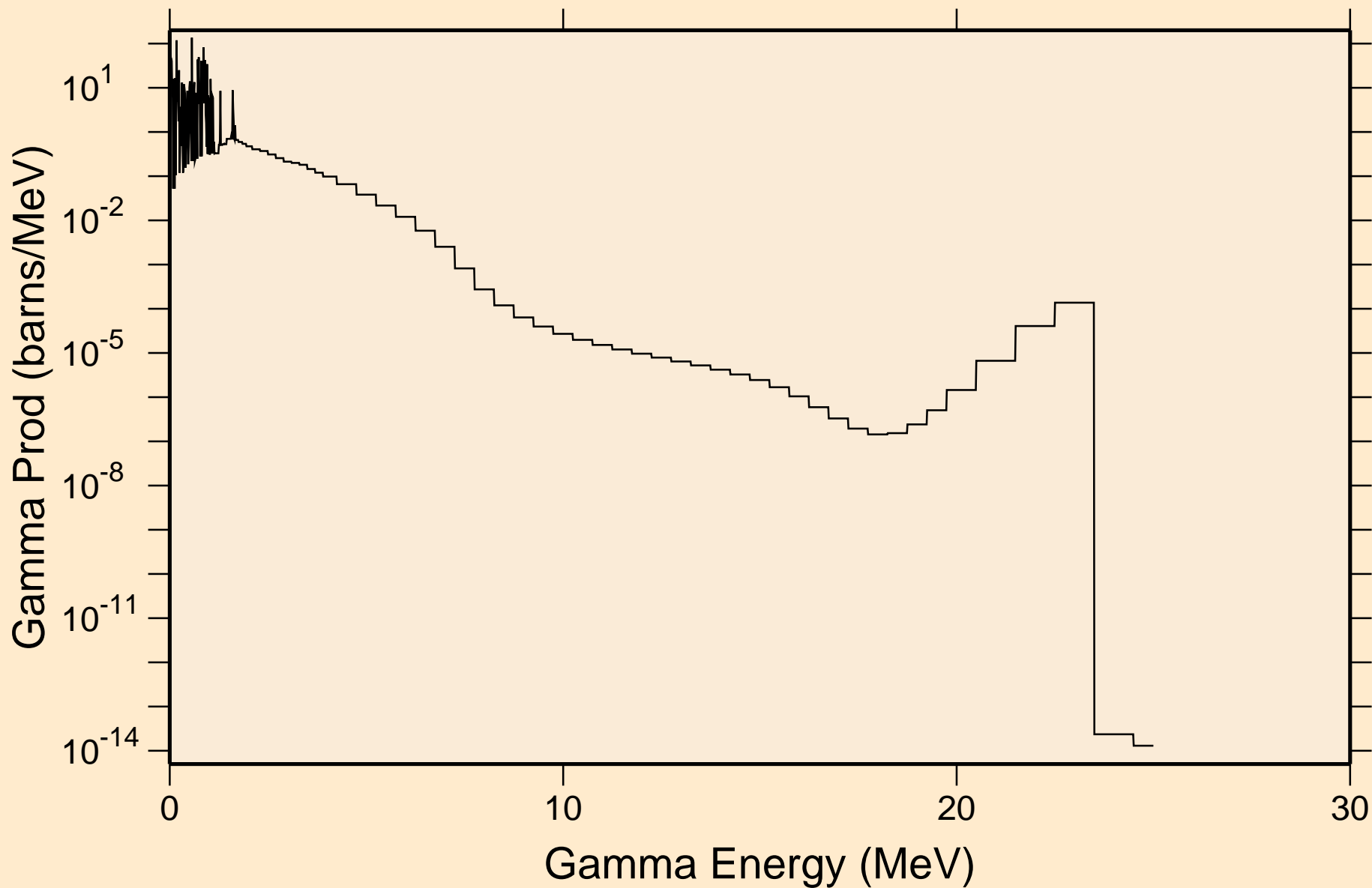

RH091 NEUTRON ACER TENDL-2019 LIBRARY; T=293.16K
Particle heating contributions

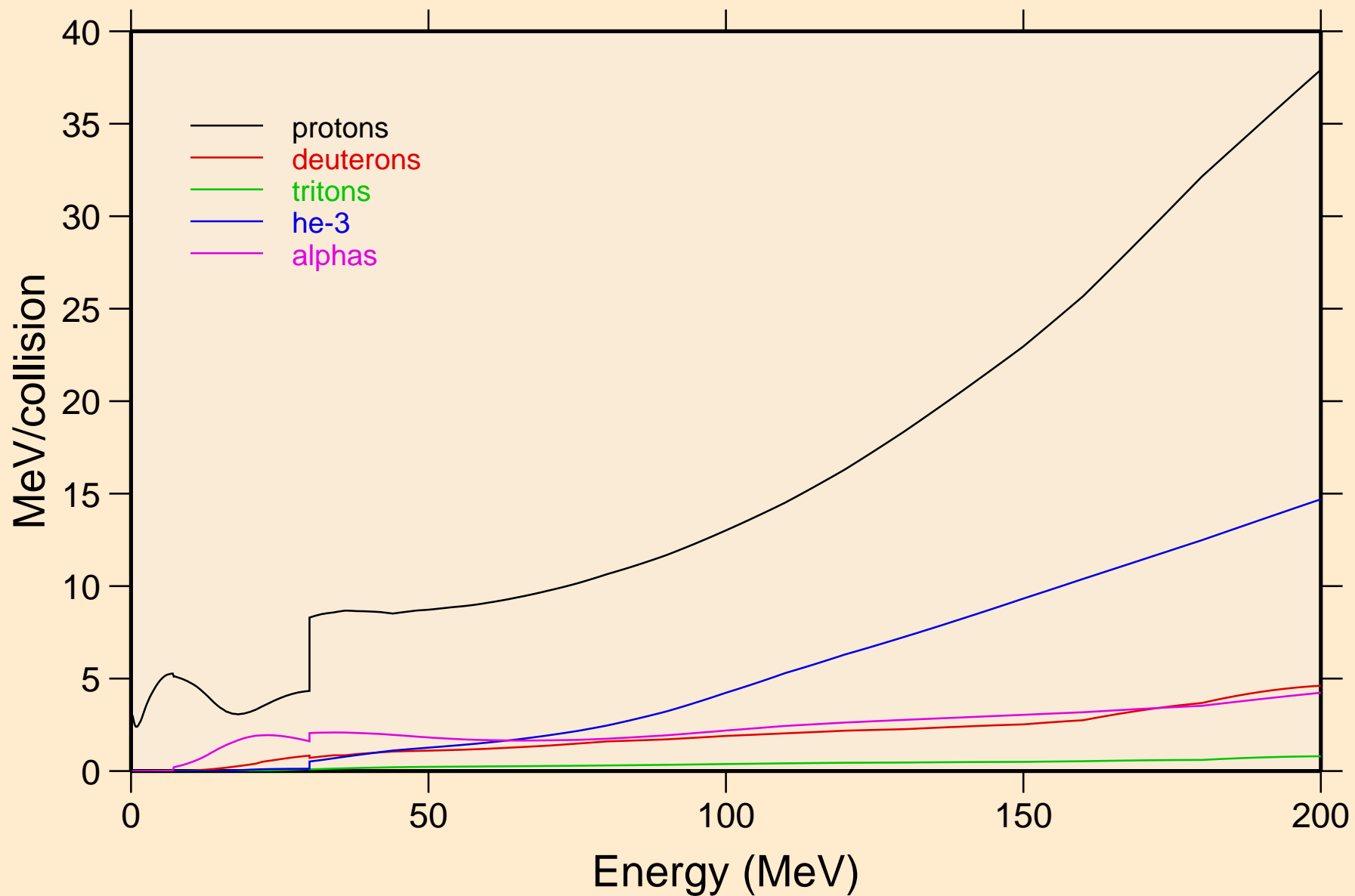

RH091 NEUTRON ACER TENDL-2019 LIBRARY; T=293.16K
Recoil Heating

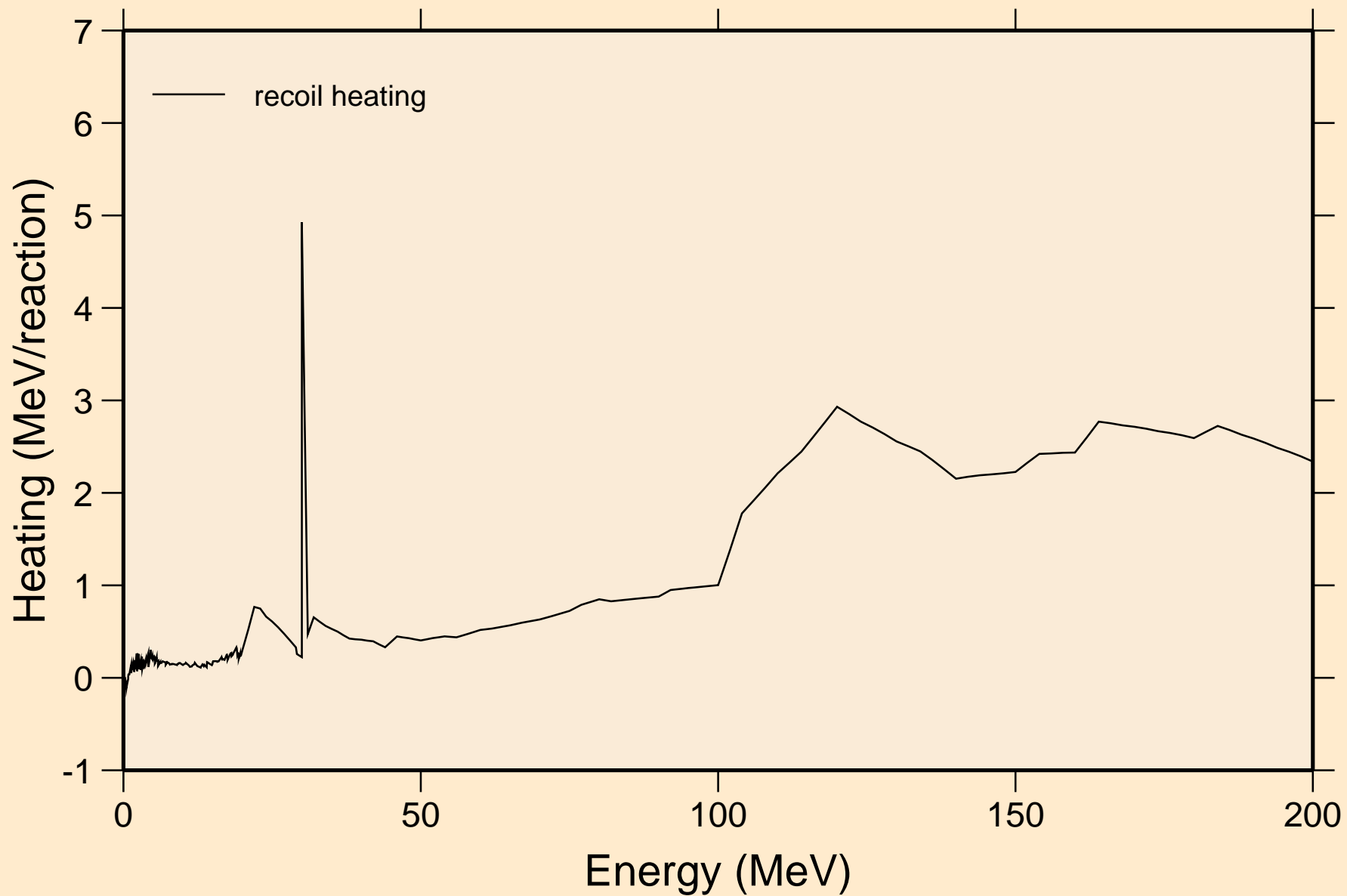

RH091 NEUTRON ACER TENDL-2019 LIBRARY; T=293.16K
Particle production cross sections

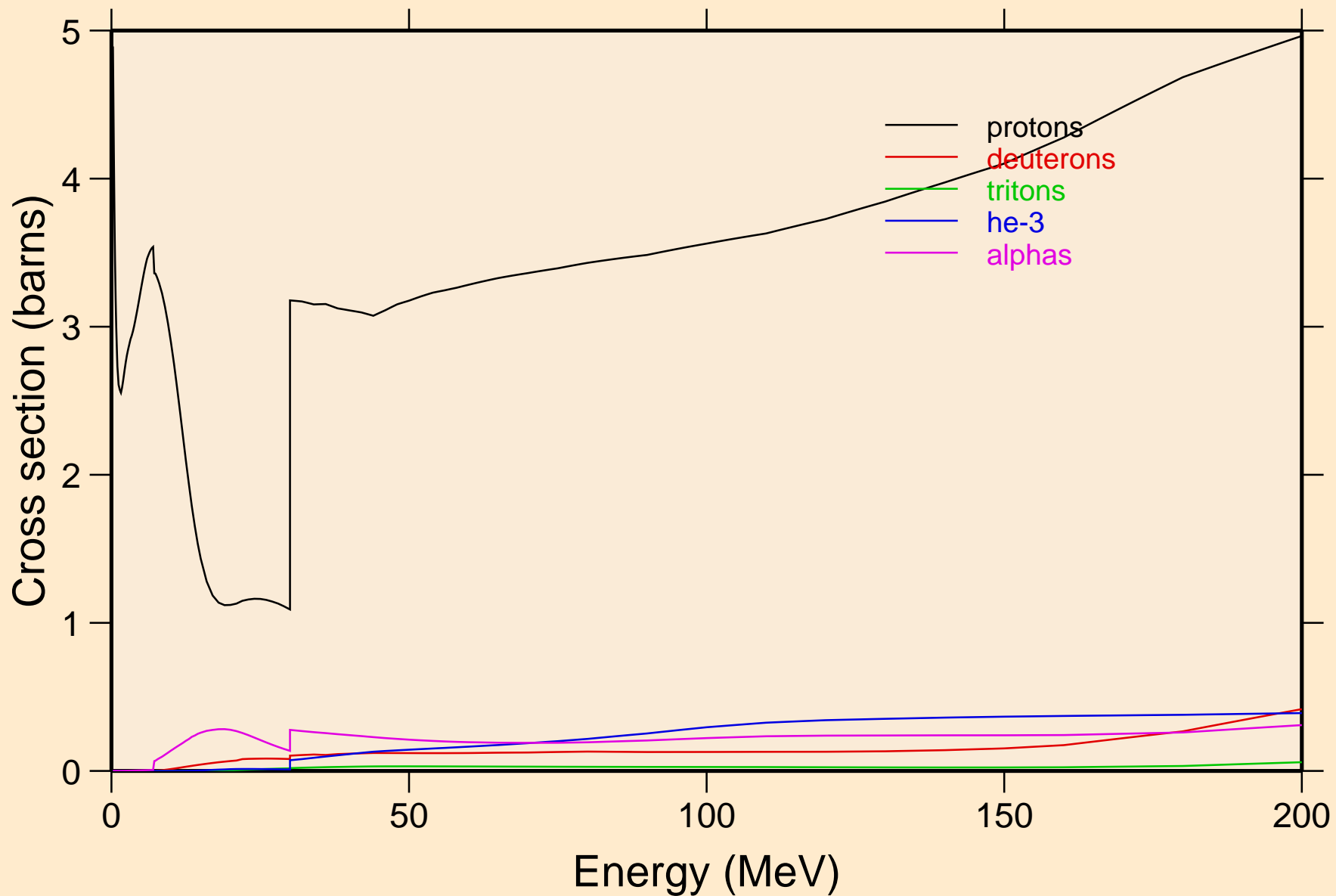

RH091 NEUTRON ACER TENDL-2019 LIBRARY; T=293.16K
protons from (n,x)

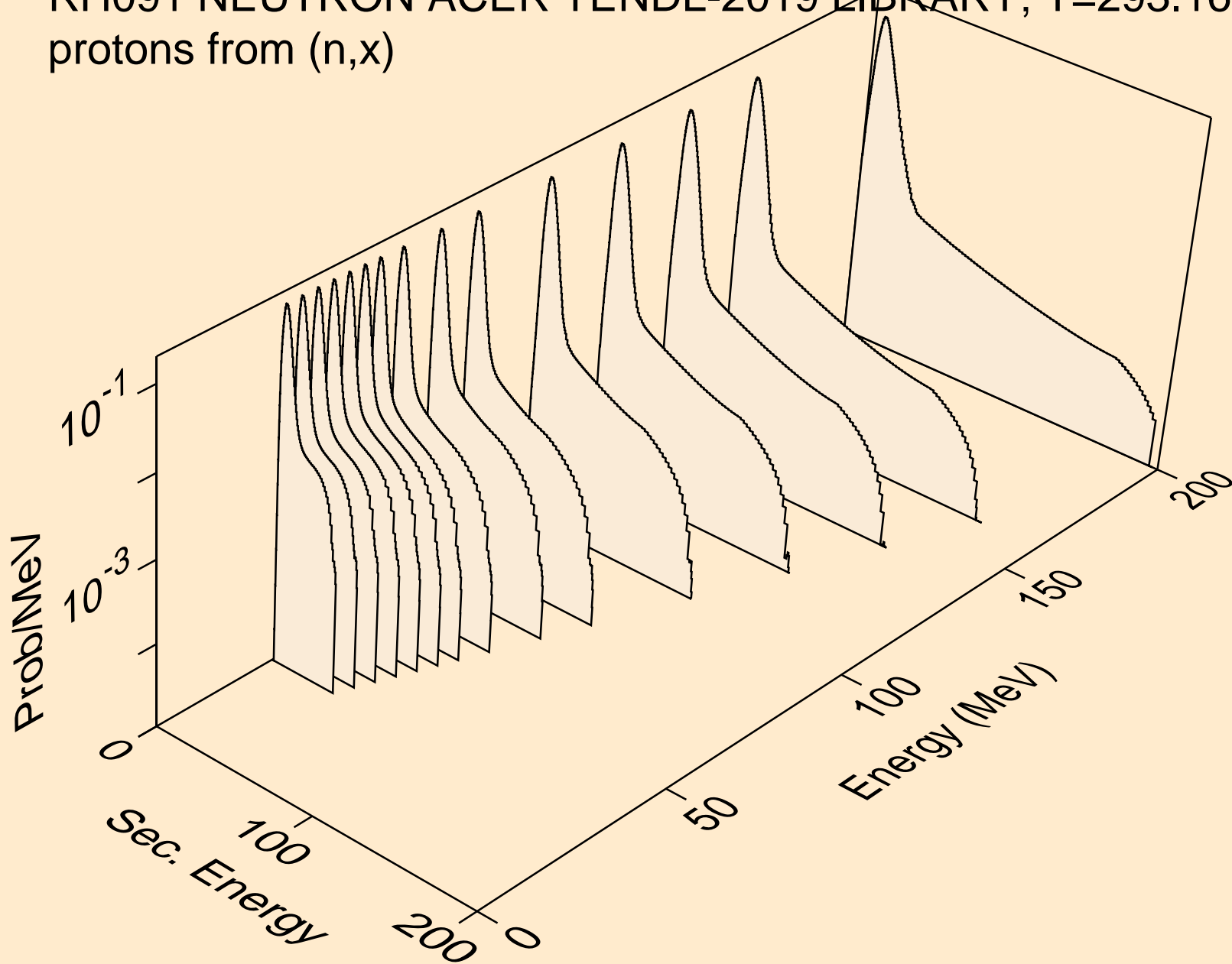

RH091 NEUTRON ACER TENDL-2019 LIBRARY; T=293.16K
protons from (n,n*)p

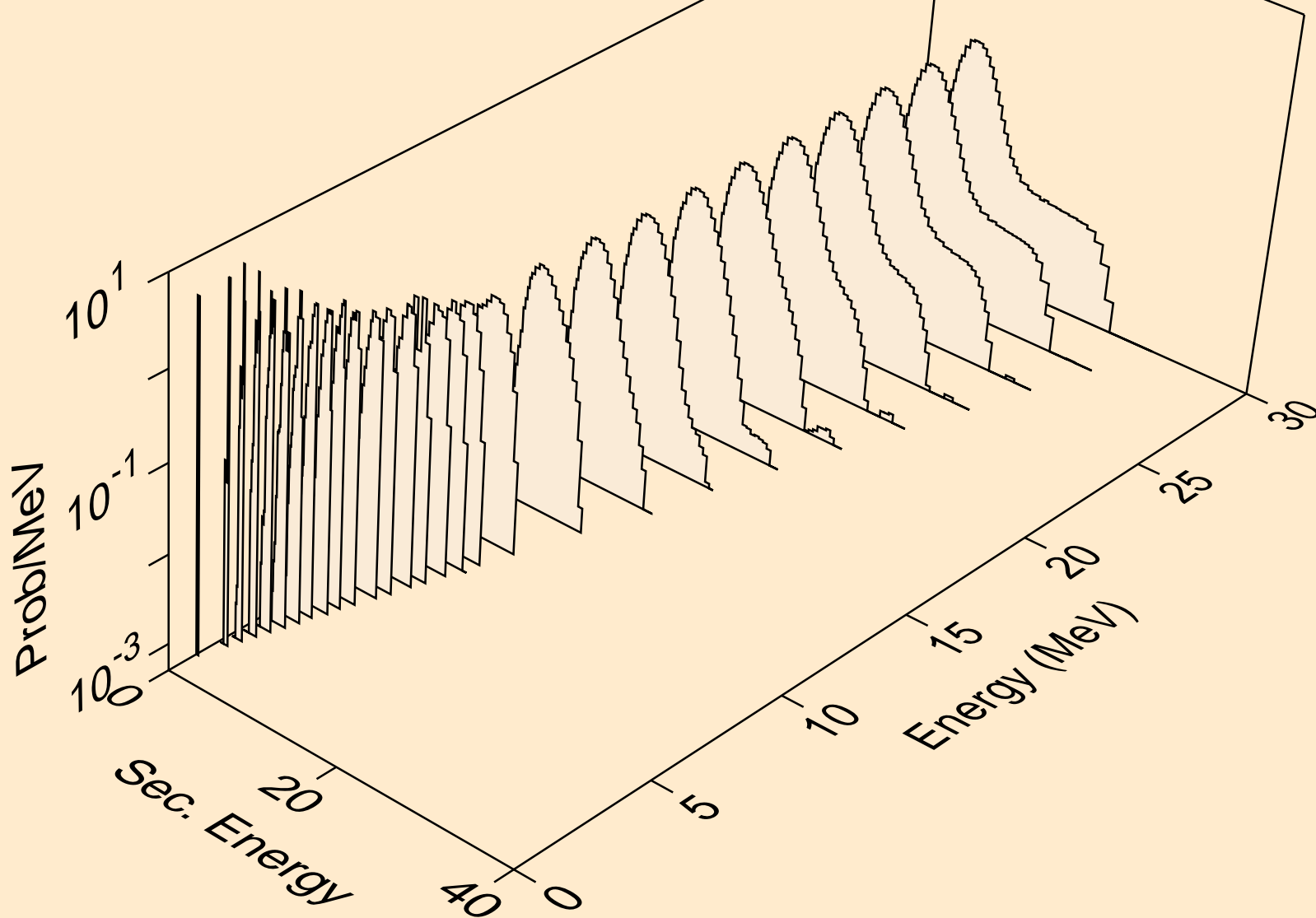

RH091 NEUTRON ACER TENDL-2019 LIBRARY; T=293.16K
protons from (n,2np)

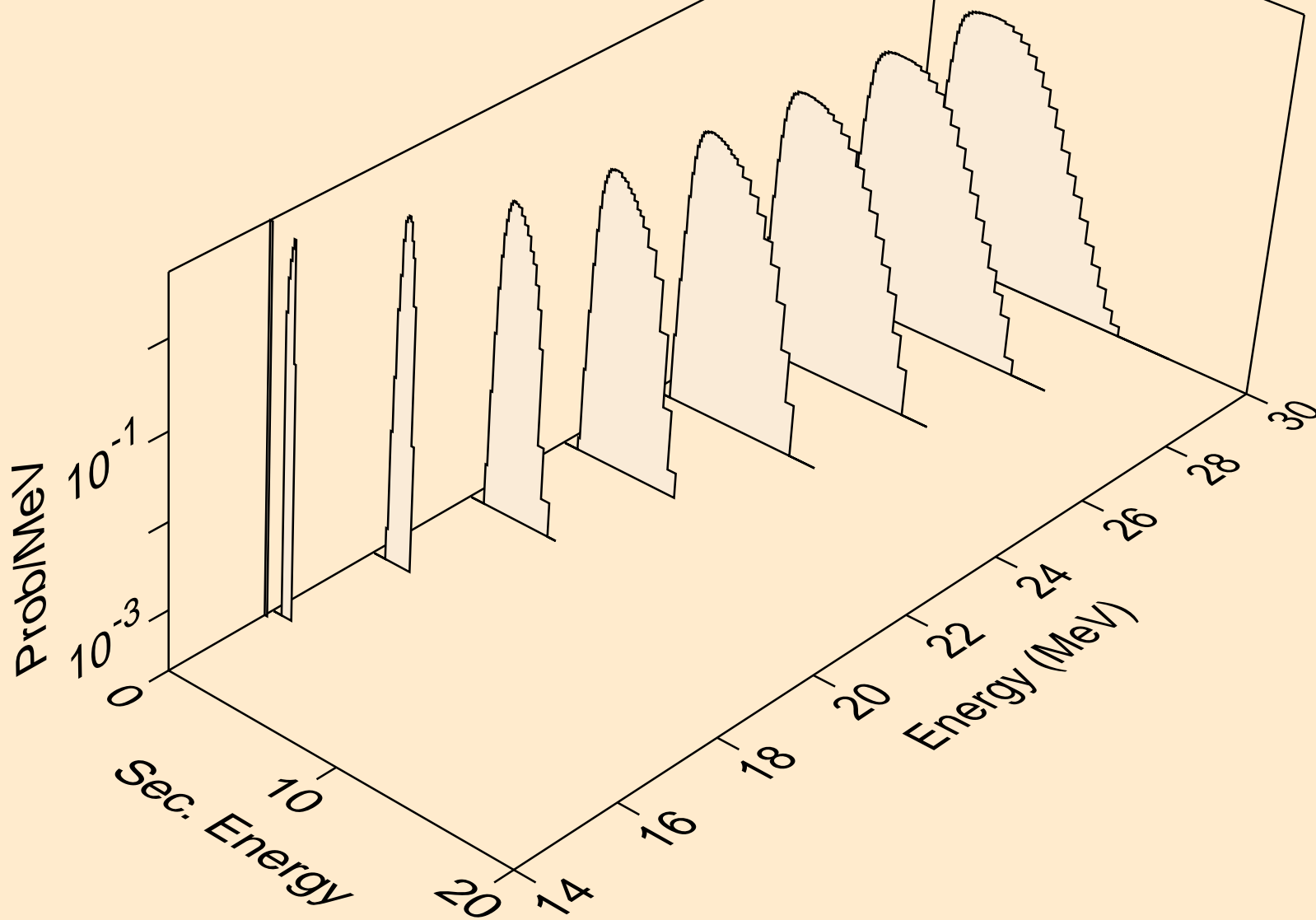

RH091 NEUTRON ACER TENDL-2019 LIBRARY; T=293.16K
protons from (n,2np)

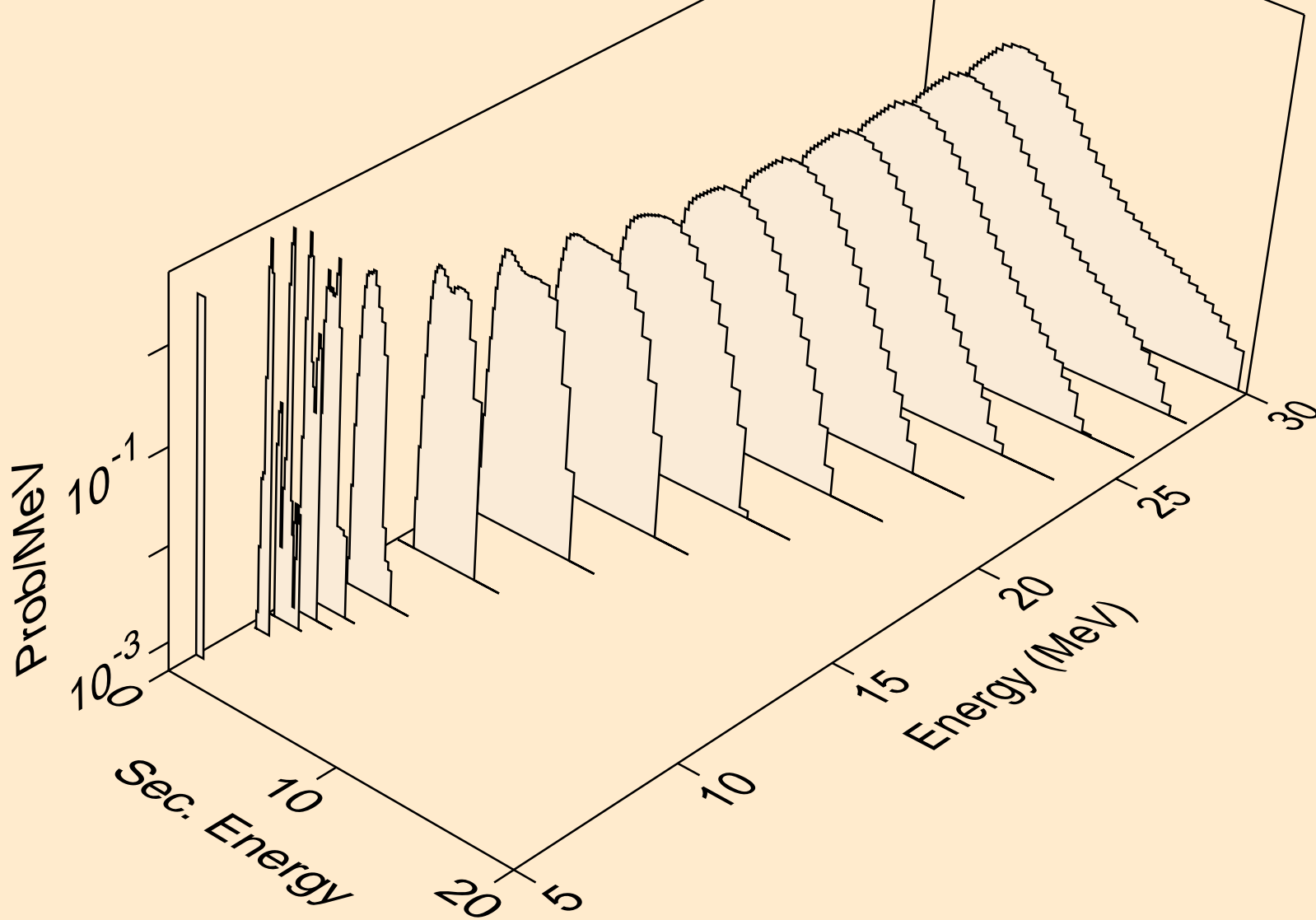

RH091 NEUTRON ACER TENDL-2019 LIBRARY; T=293.16K
protons from (n,npa)

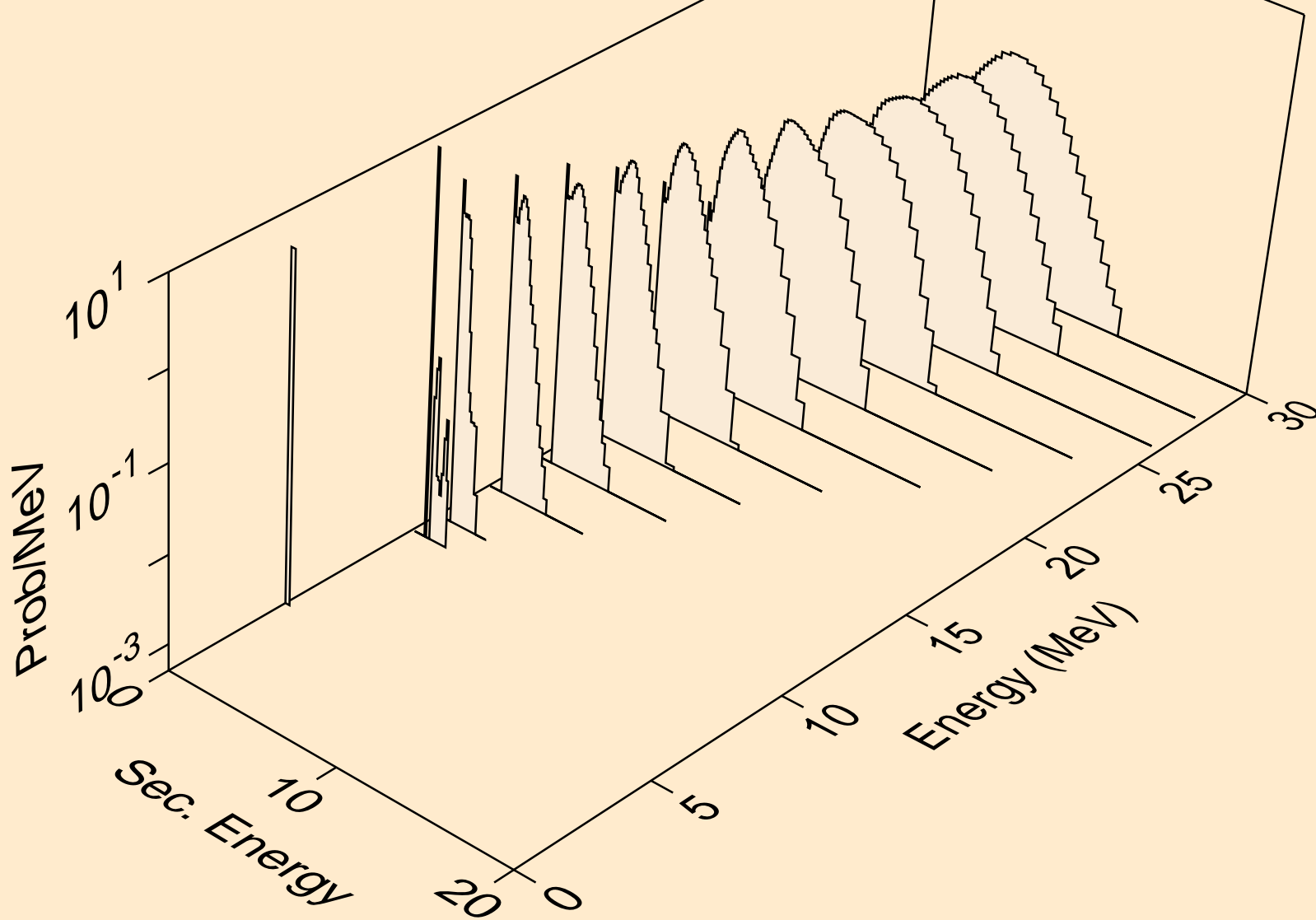

RH091 NEUTRON ACER TENDL-2019 LIBRARY; T=293.16K
protons from (n,p)

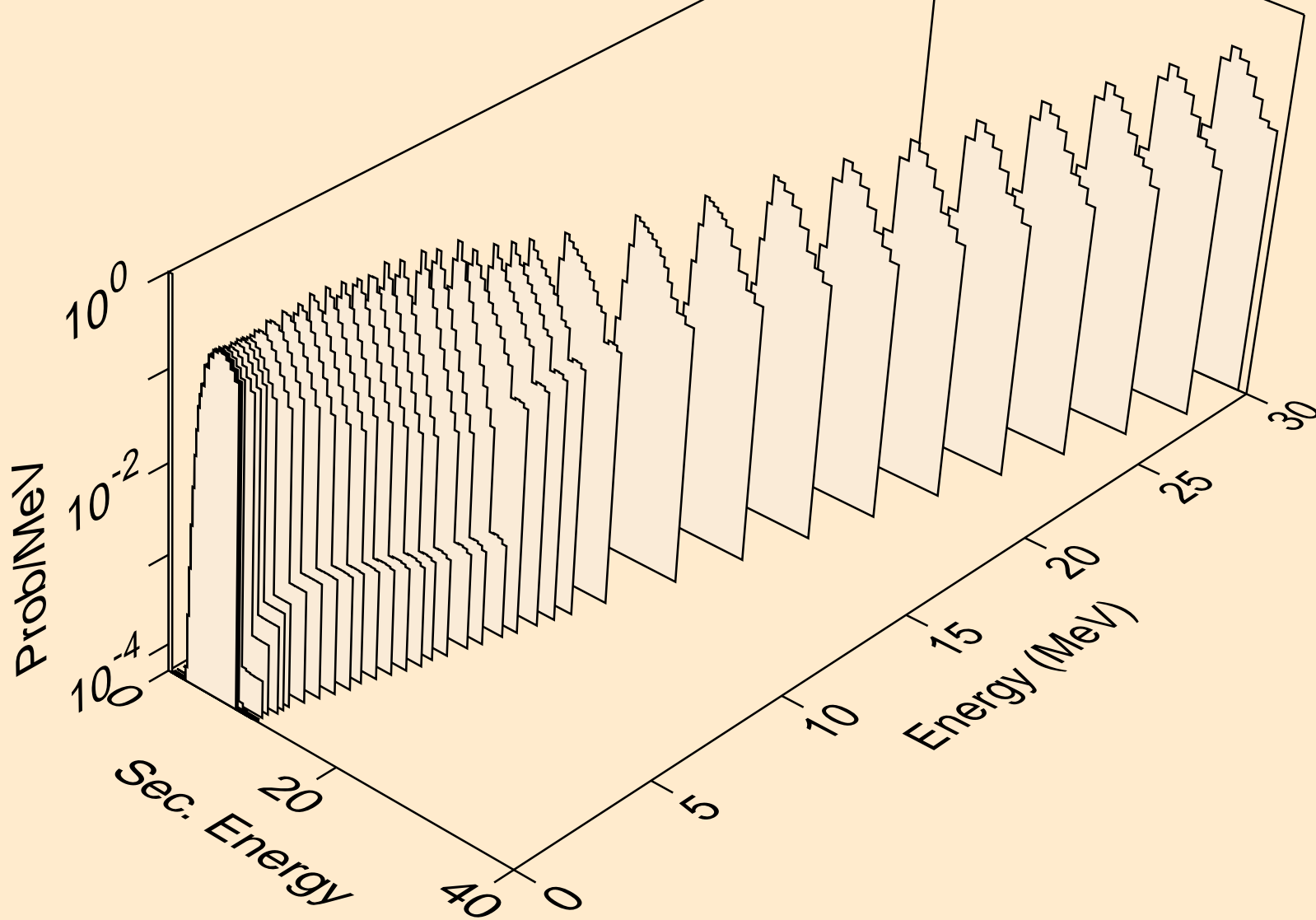

RH091 NEUTRON ACER TENDL-2019 LIBRARY; T=293.16K
protons from (n,2p)

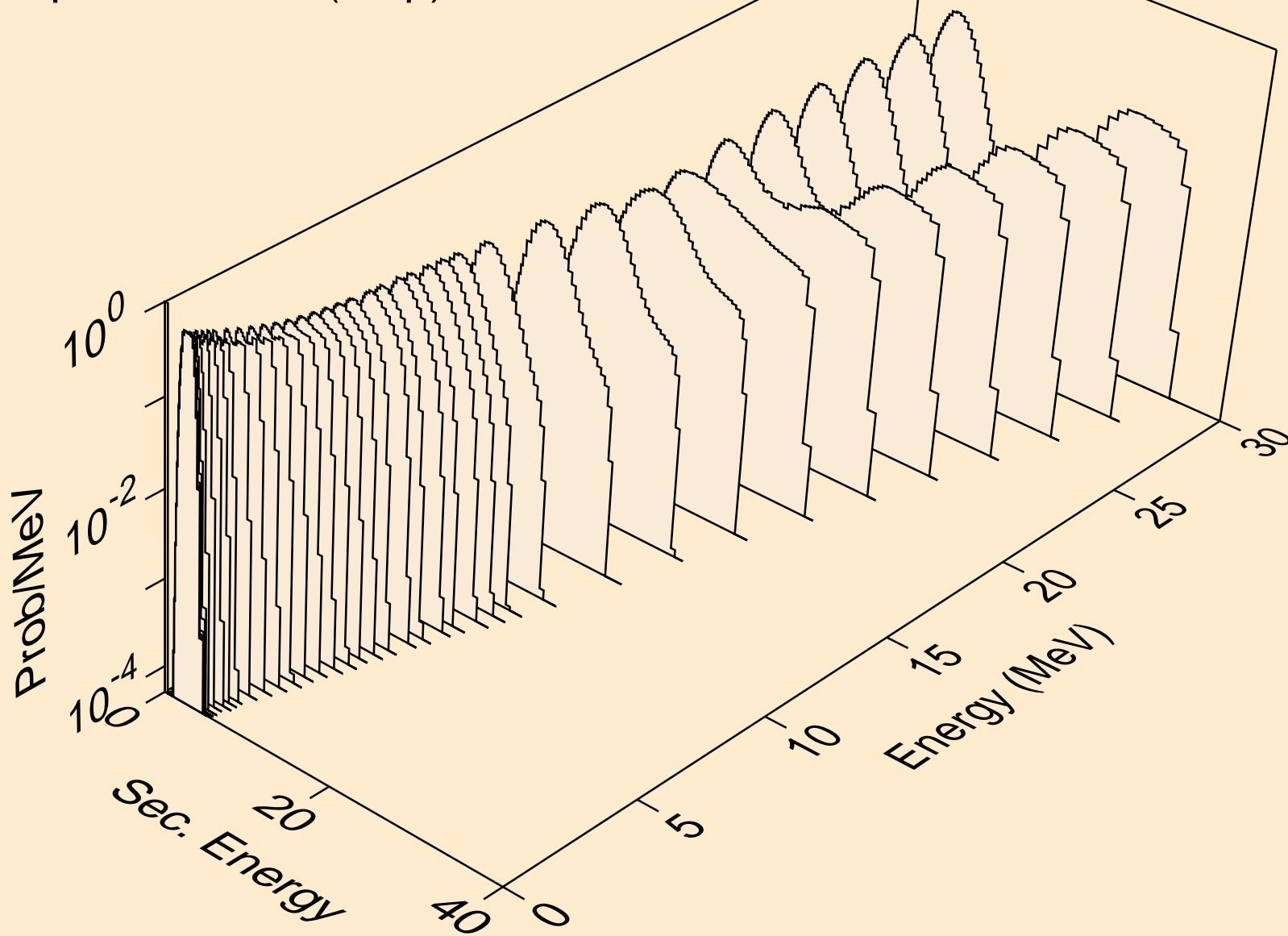

RH091 NEUTRON ACER TENDL-2019 LIBRARY; T=293.16K
protons from (n,p)

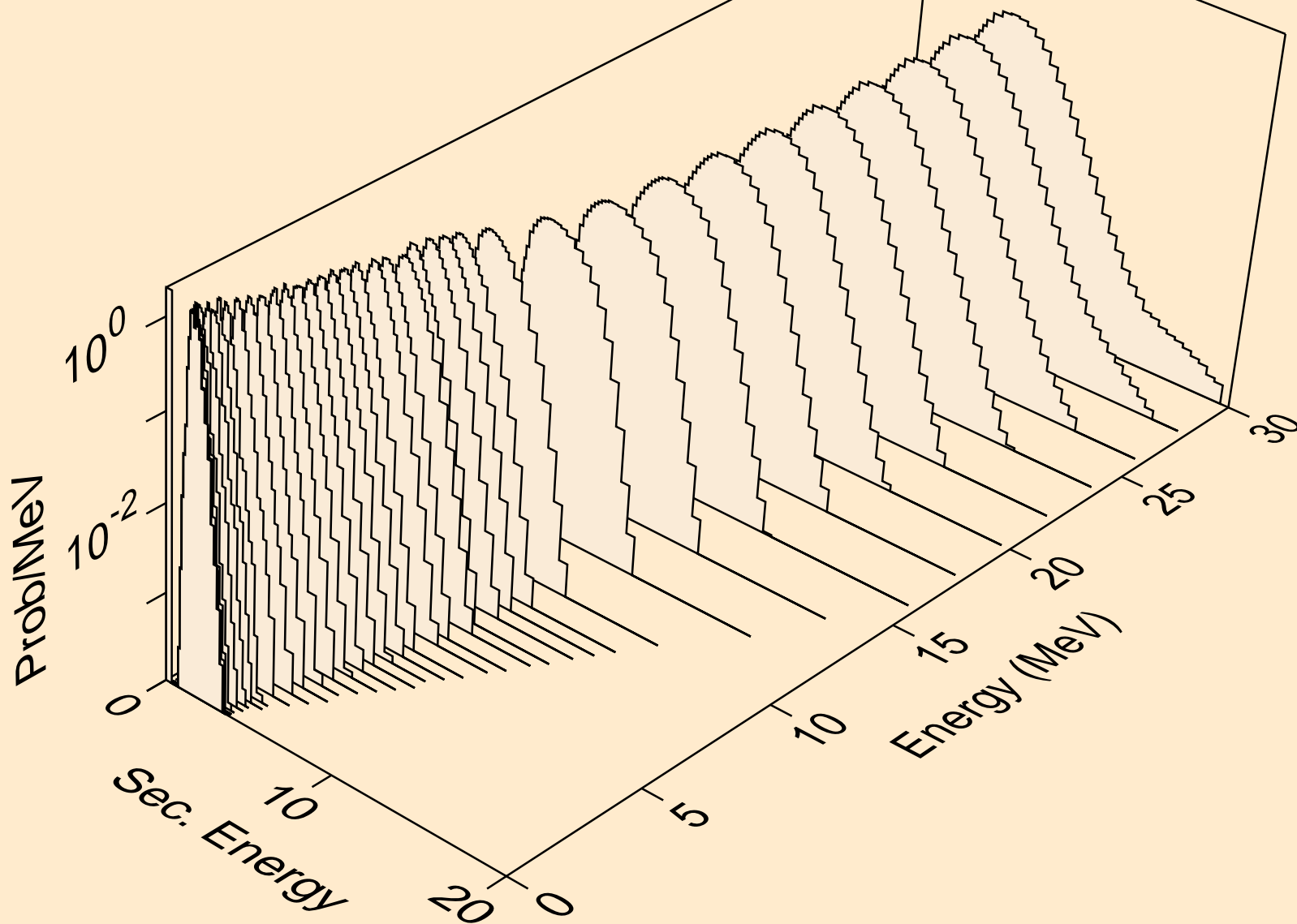

RH091 NEUTRON ACER TENDL-2019 LIBRARY; T=293.16K
protons from (n,pd)

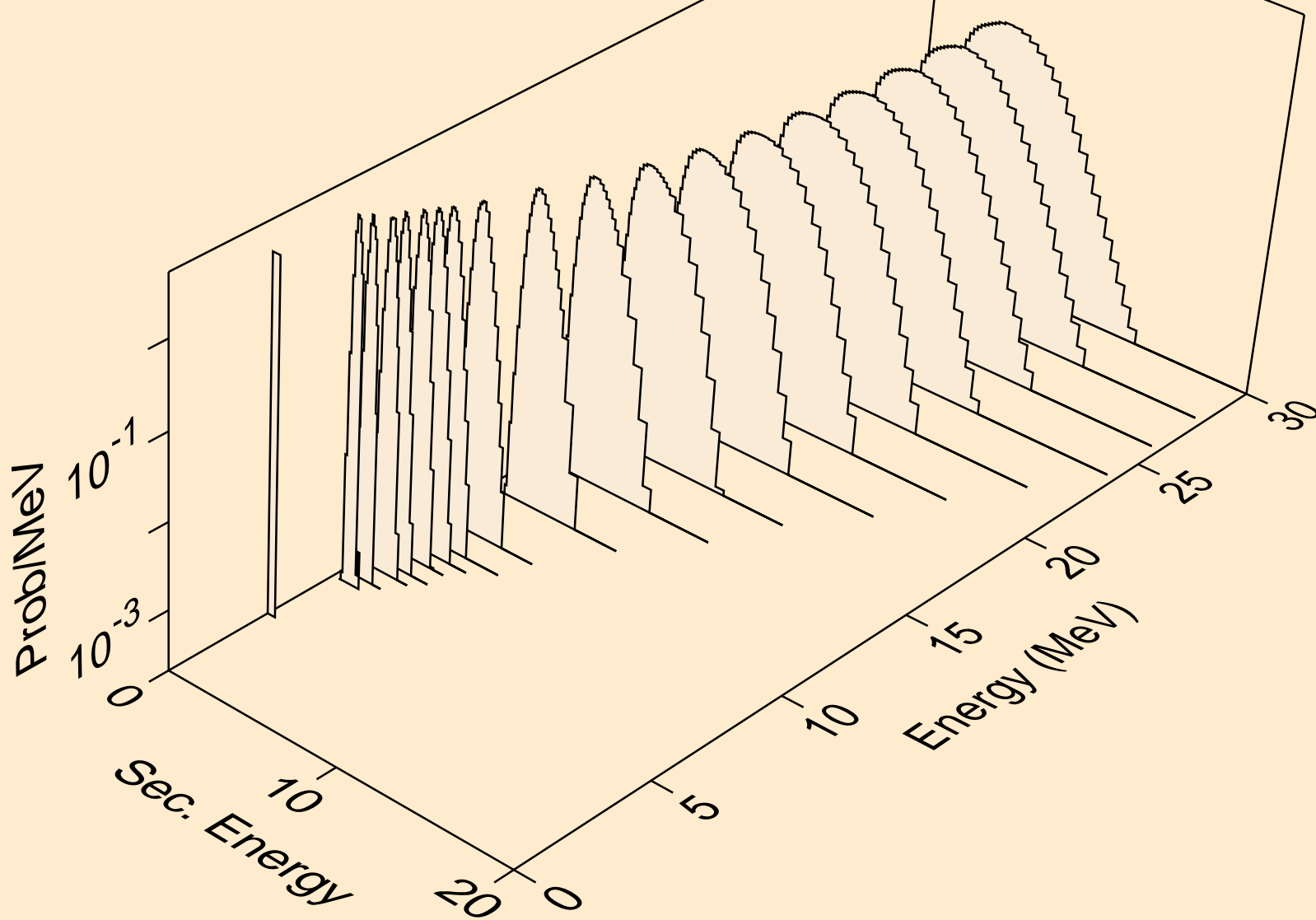

RH091 NEUTRON ACER TENDL-2019 LIBRARY; T=293.16K
protons from (n,pt)

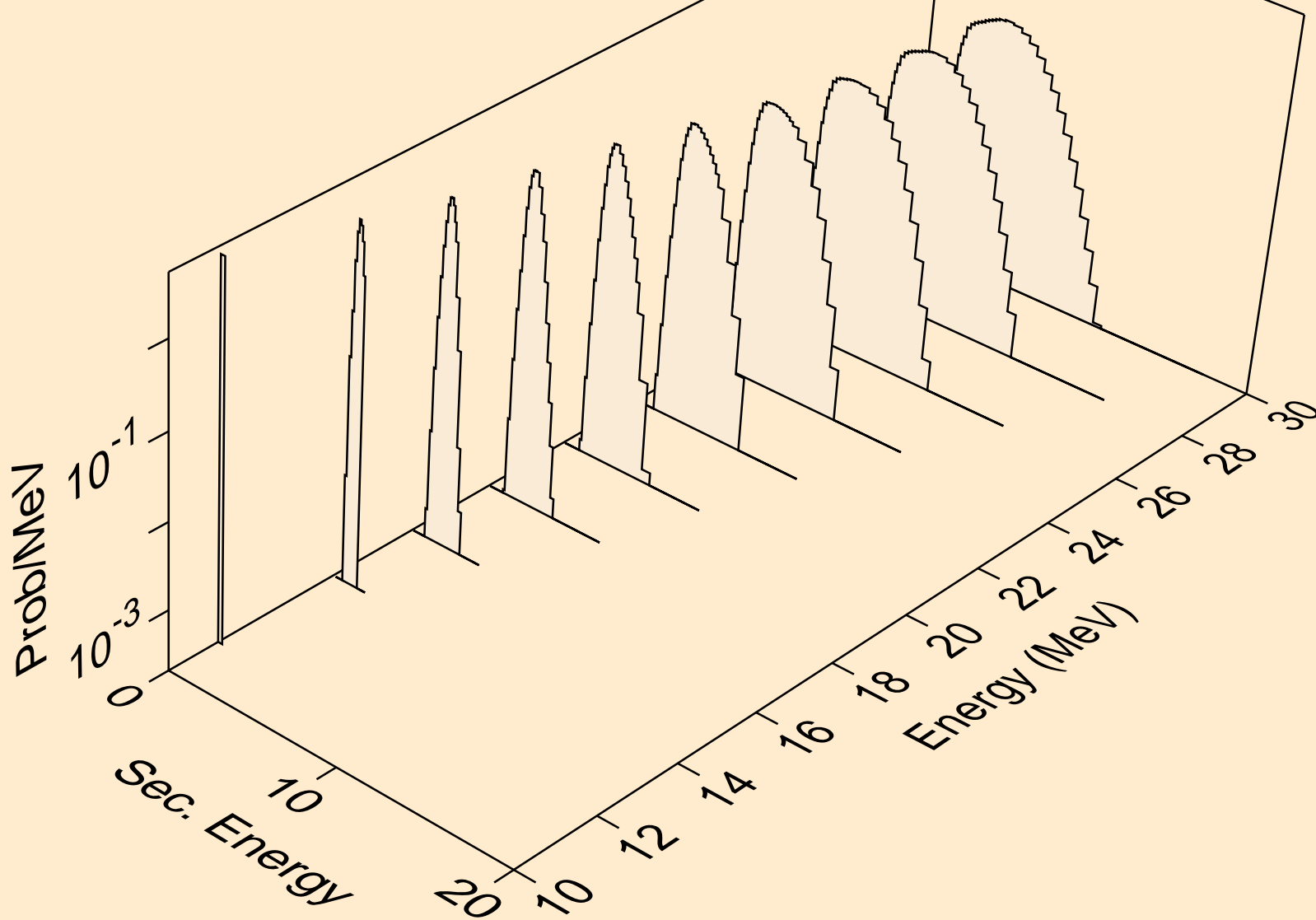

RH091 NEUTRON ACER TENDL-2019 LIBRARY; T=293.16K
deuterons from (n,x)

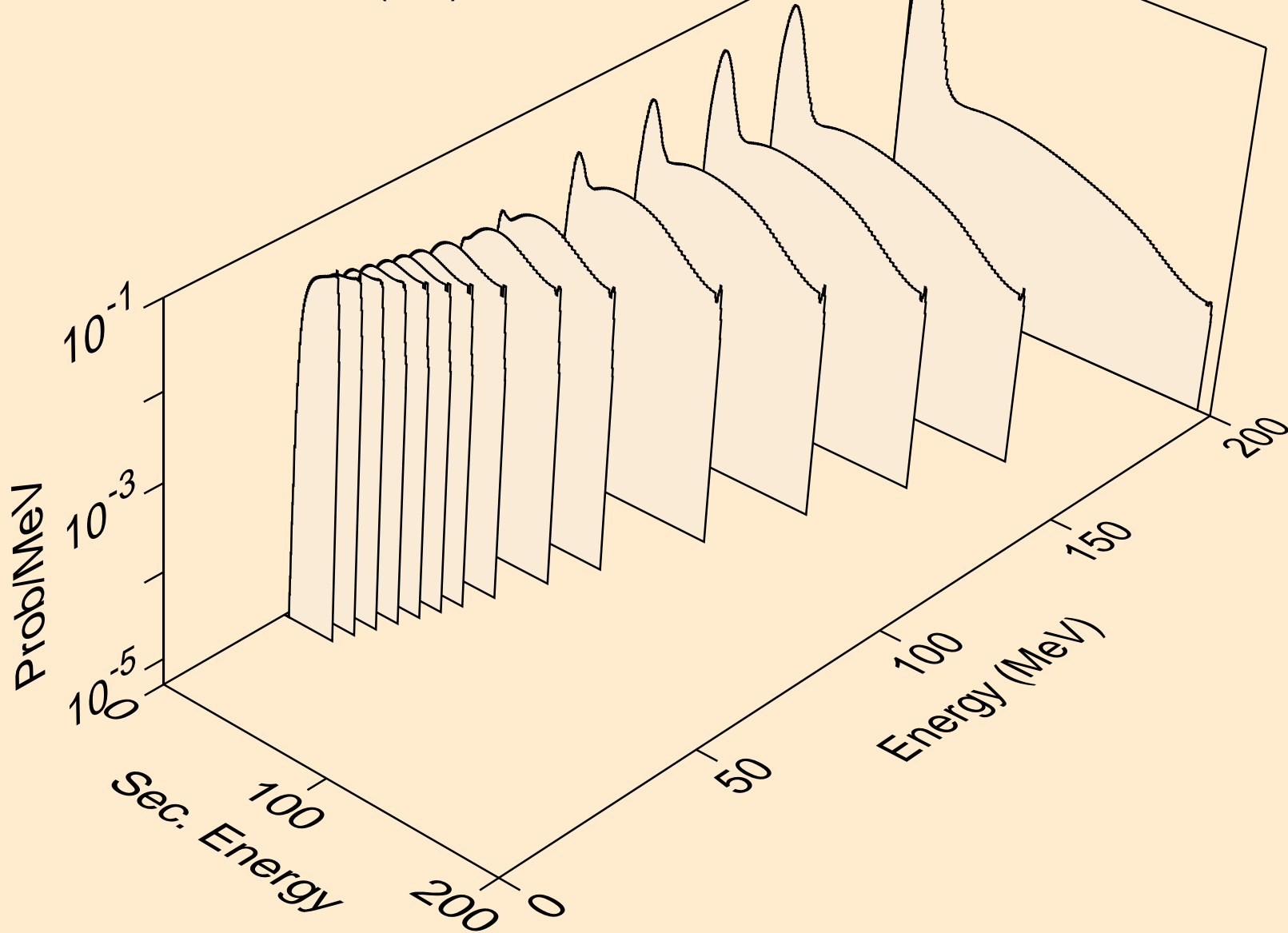

RH091 NEUTRON ACER TENDL-2019 LIBRARY; T=293.16K
deuterons from (n,n*)d

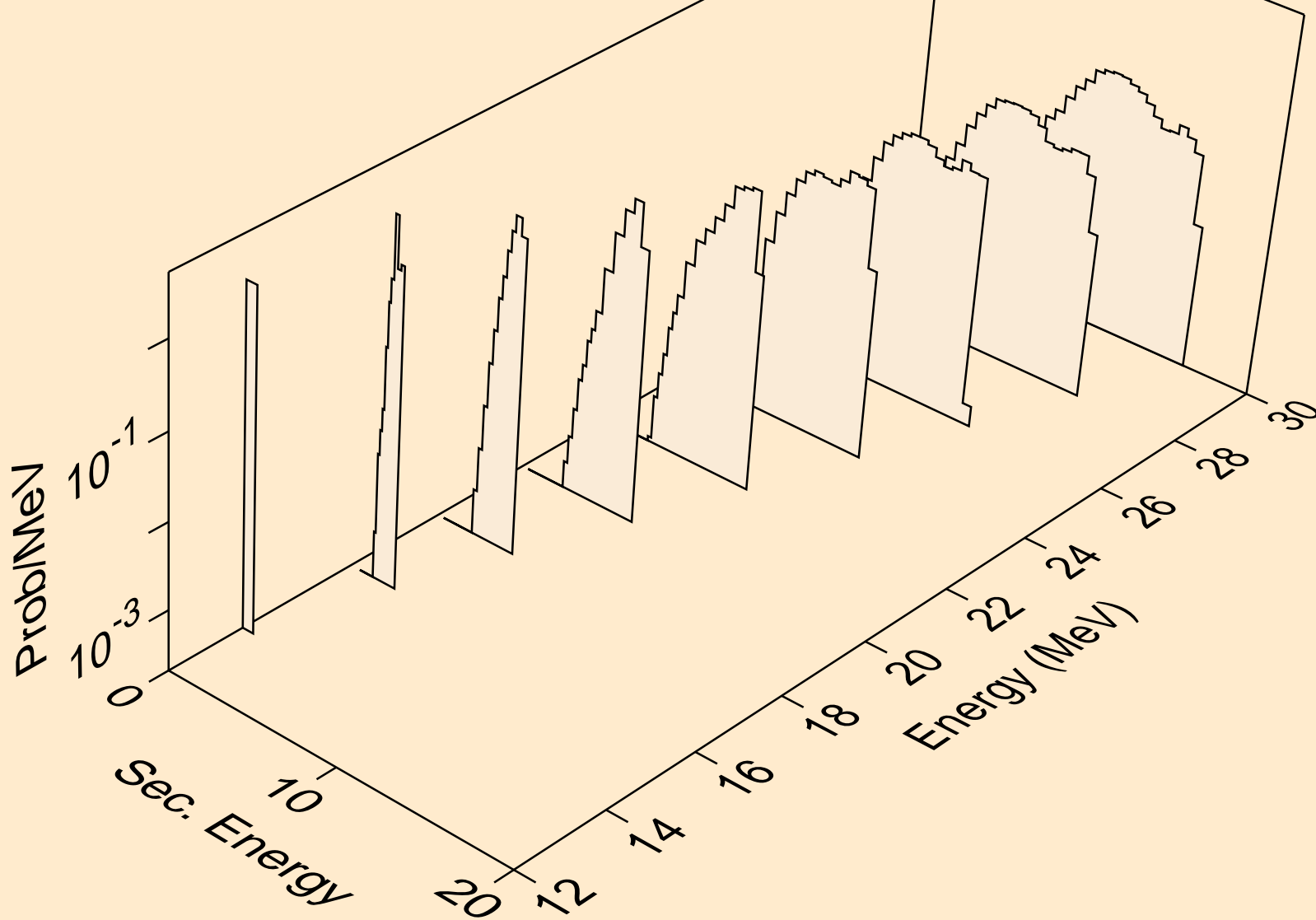

RH091 NEUTRON ACER TENDL-2019 LIBRARY; T=293.16K
deuterons from (n,d)

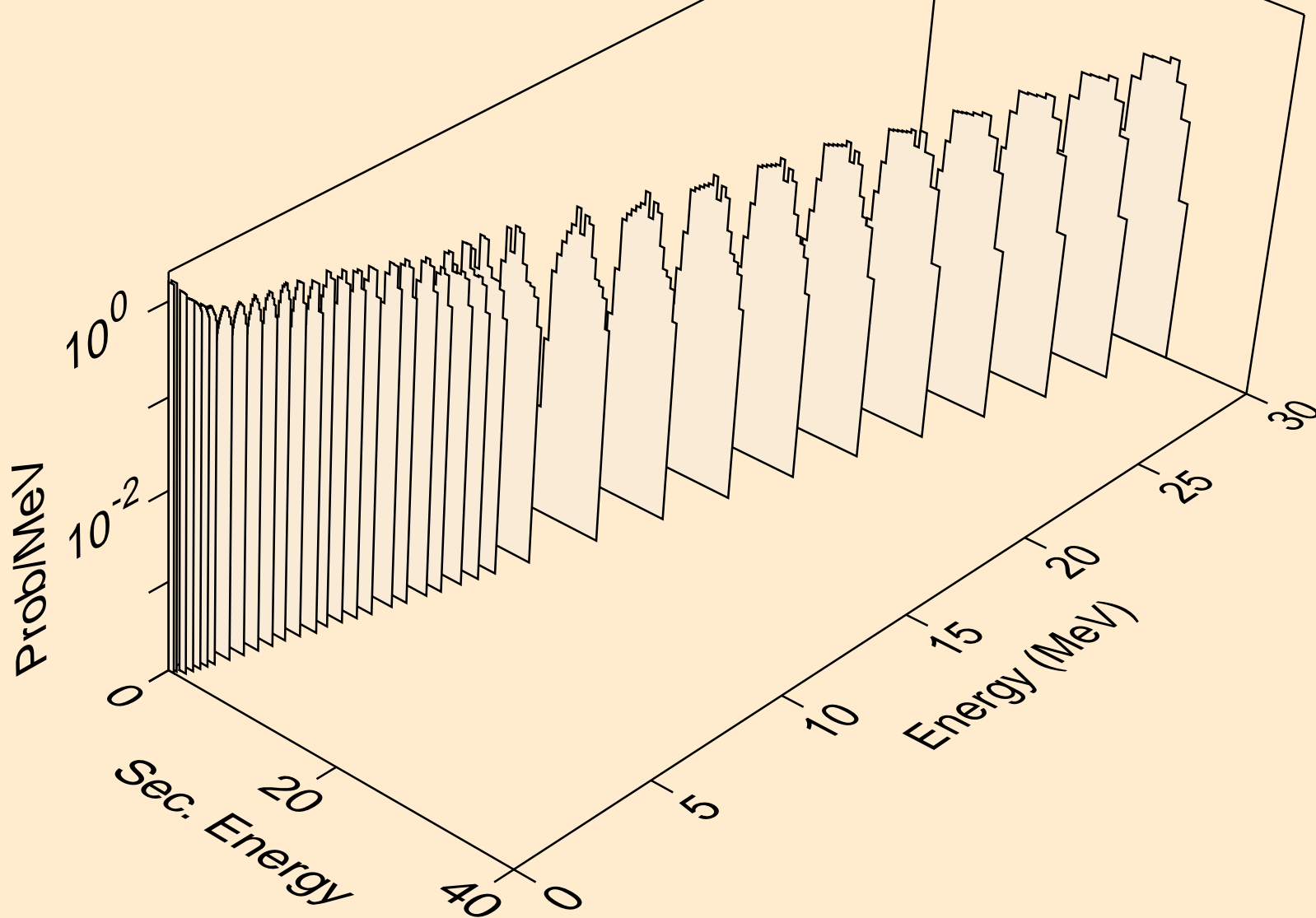

RH091 NEUTRON ACER TENDL-2019 LIBRARY; T=293.16K
deuterons from (n,pd)

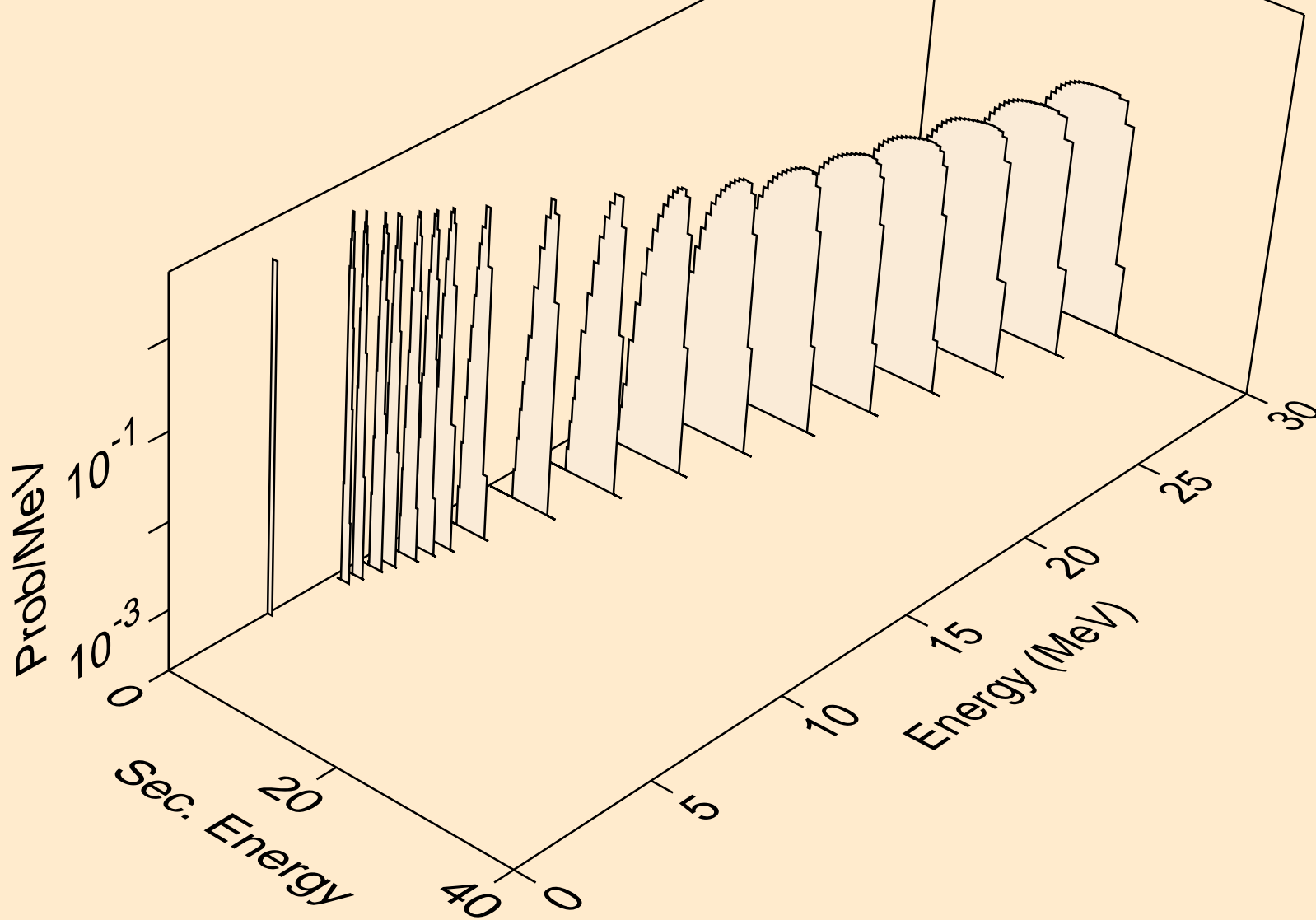

RH091 NEUTRON ACER TENDL-2019 LIBRARY; T=293.16K
deuterons from (n,da)

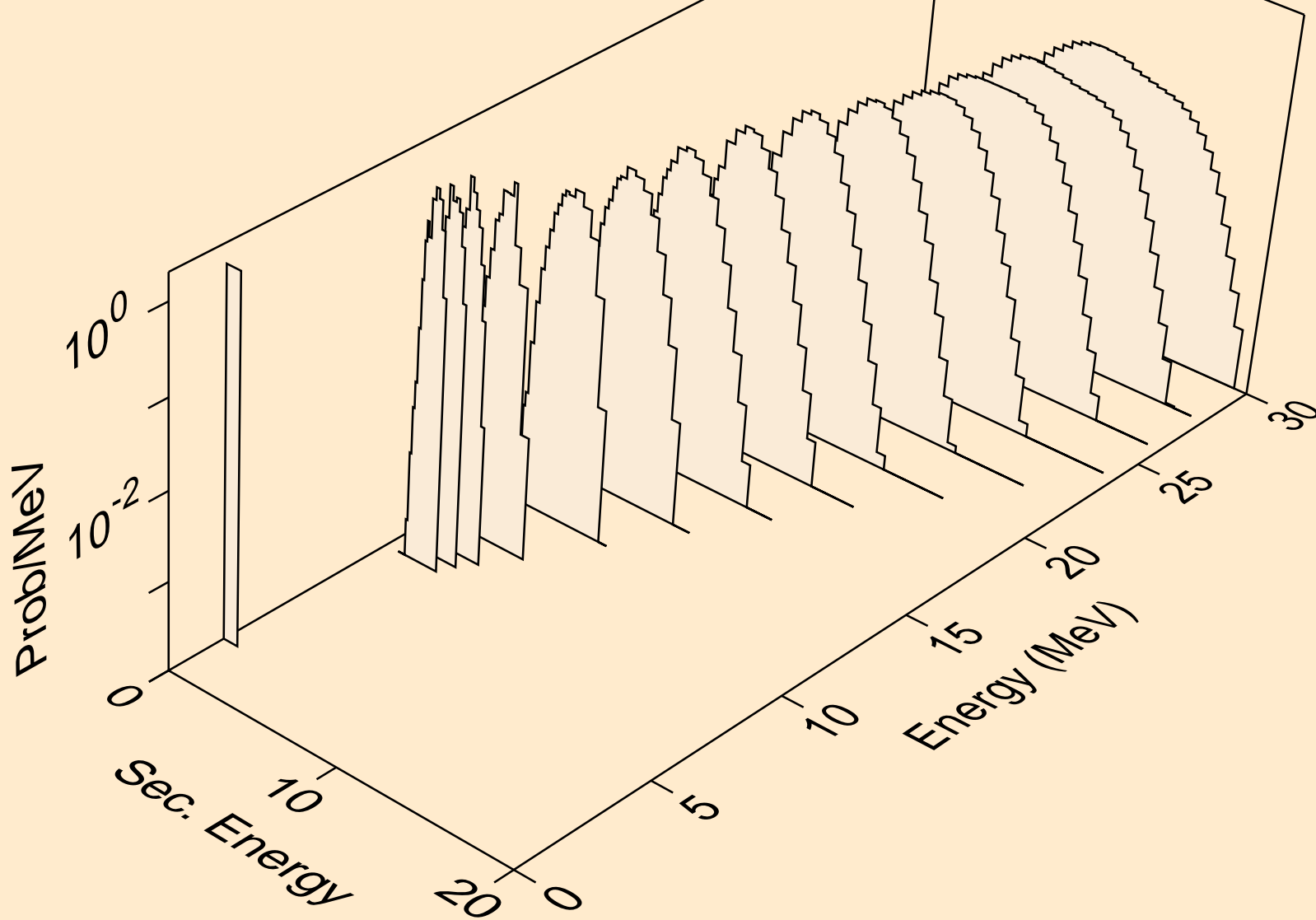

RH091 NEUTRON ACER TENDL-2019 LIBRARY; T=293.16K
tritons from (n,x)

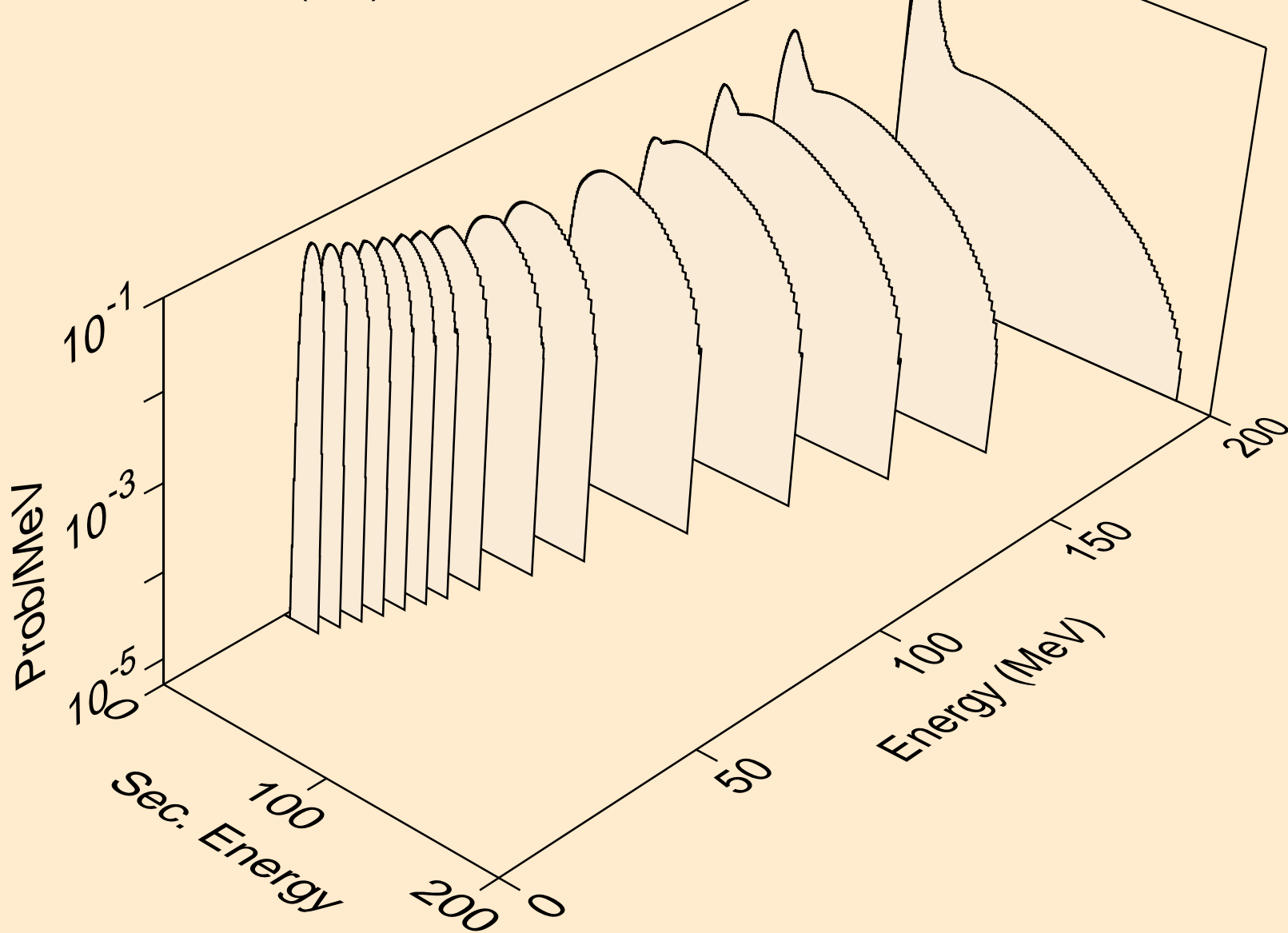

RH091 NEUTRON ACER TENDL-2019 LIBRARY; T=293.16K
tritons from (n,n*)t

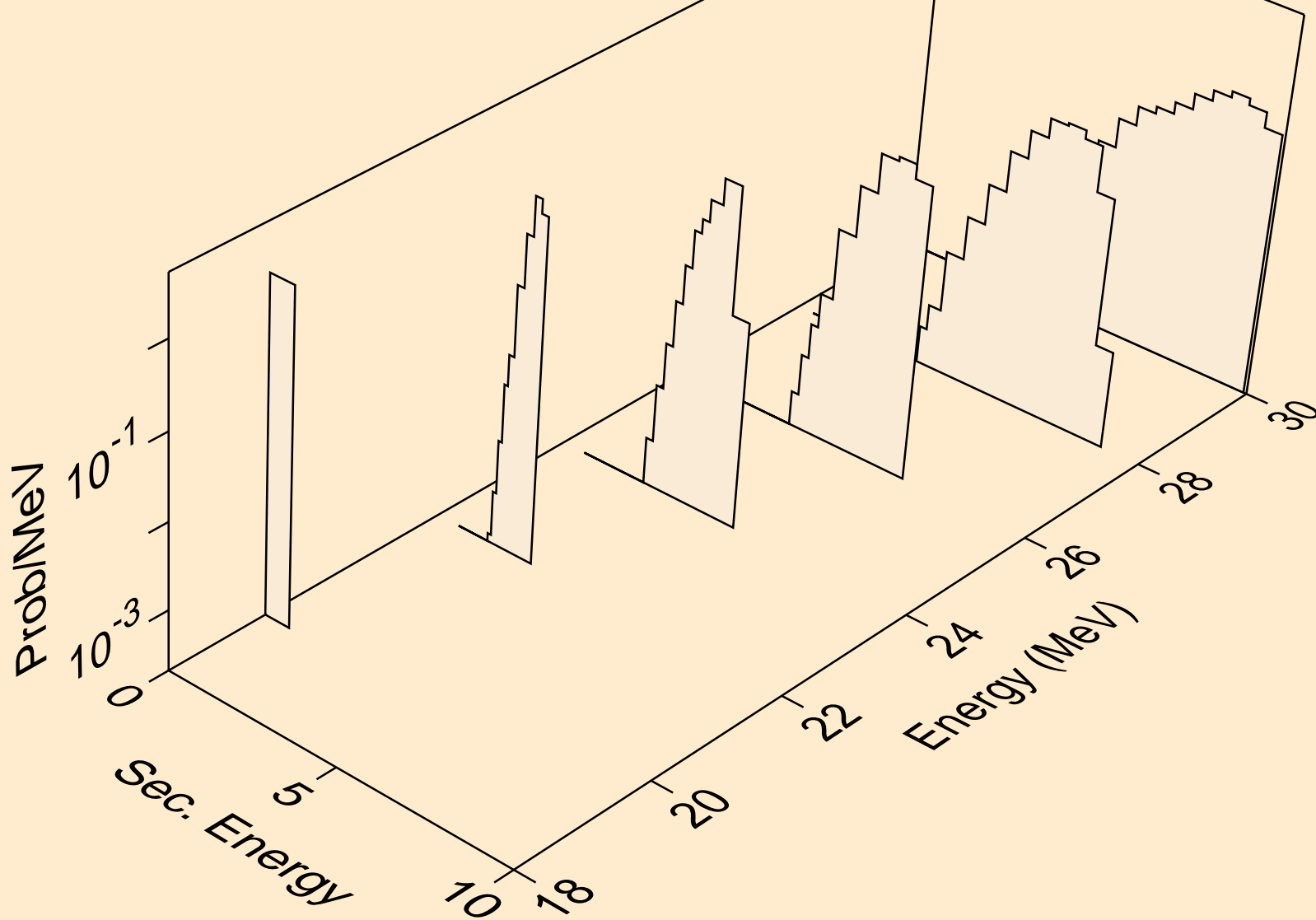

RH091 NEUTRON ACER TENDL-2019 LIBRARY; T=293.16K
tritons from (n,t)

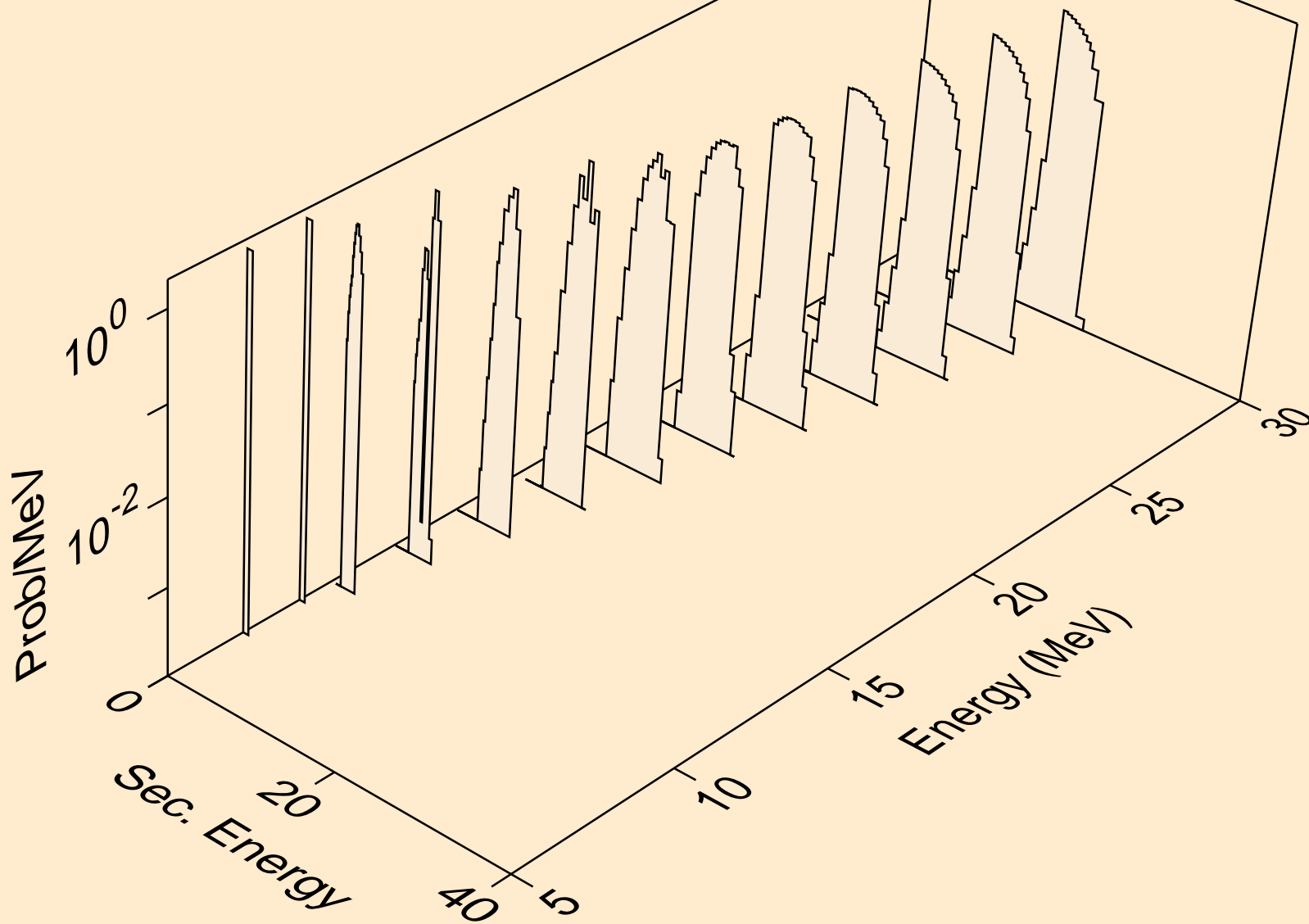

RH091 NEUTRON ACER TENDL-2019 LIBRARY; T=293.16K
tritons from (n,pt)

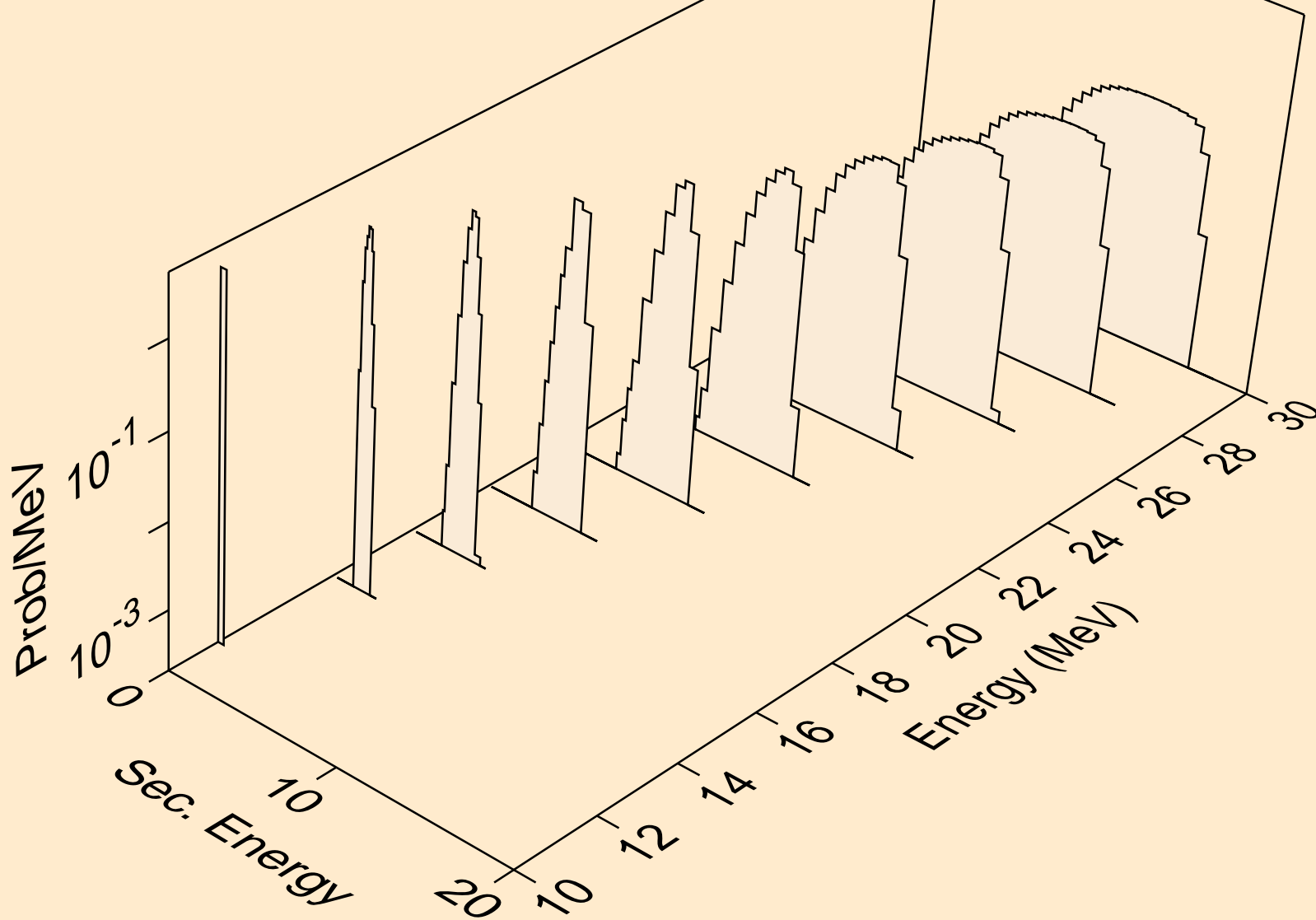

RH091 NEUTRON ACER TENDL-2019 LIBRARY; T=293.16K
he3s from (n,x)

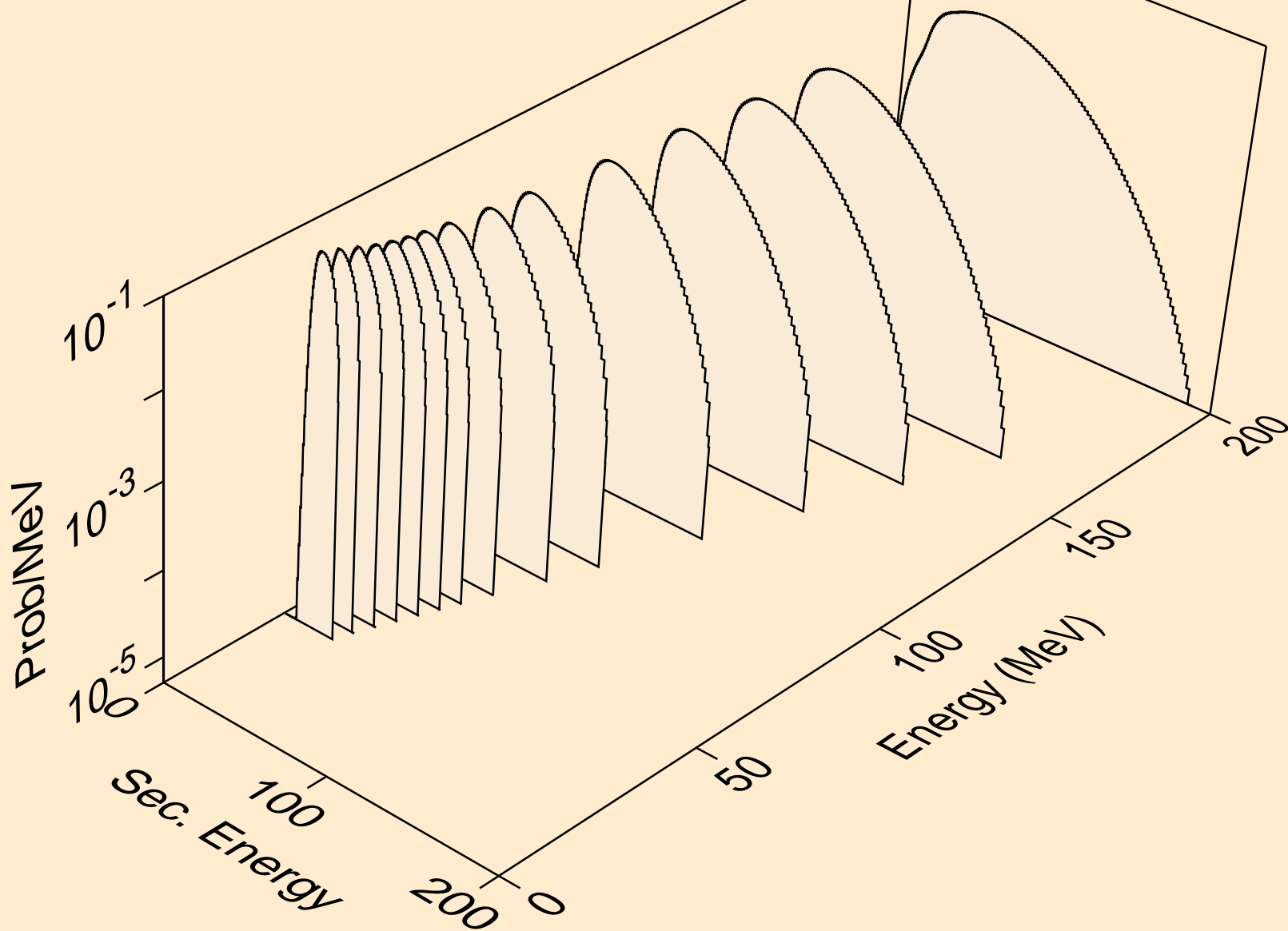

RH091 NEUTRON ACER TENDL-2019 LIBRARY; T=293.16K
he3s from (n,n*)he3

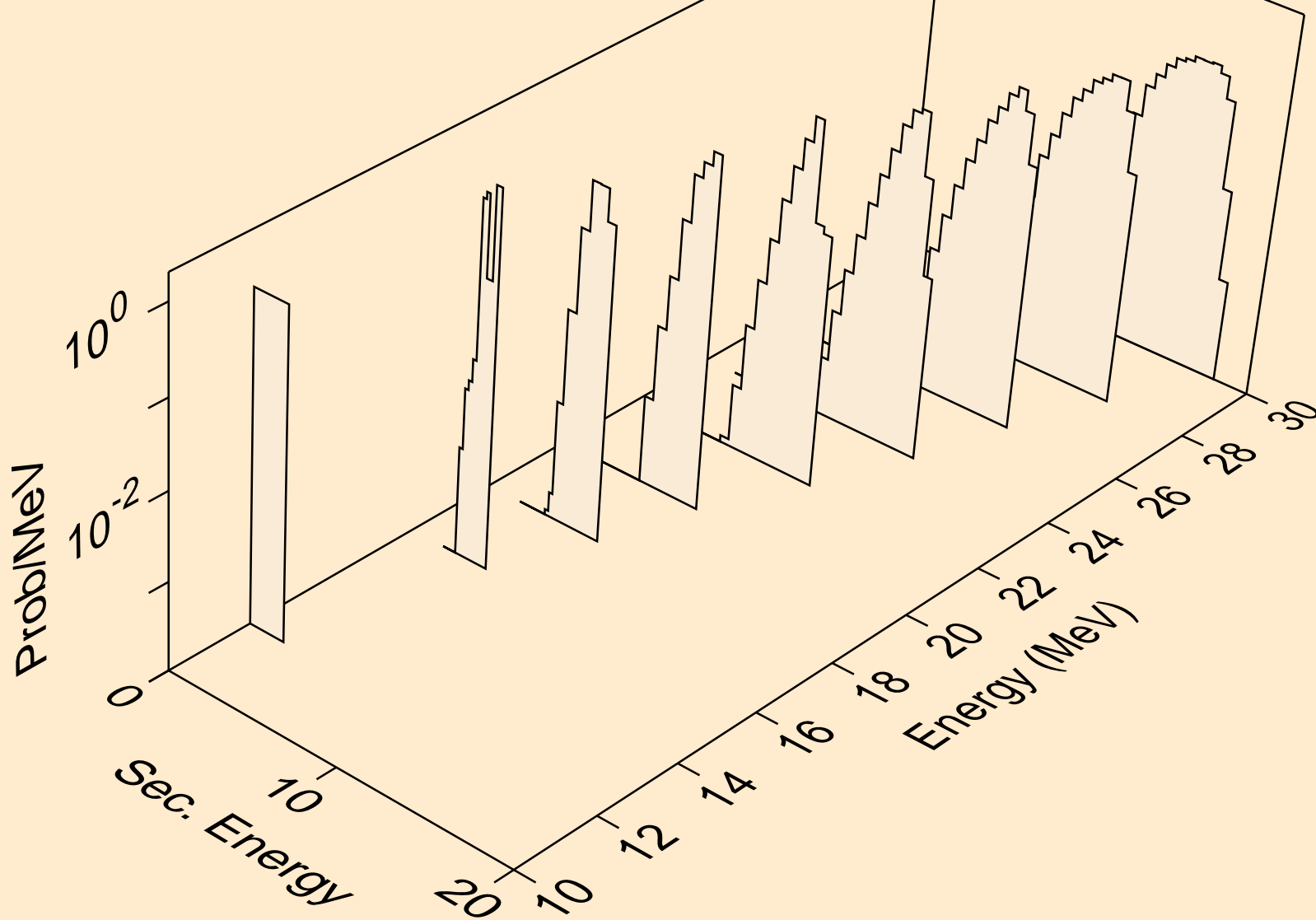

RH091 NEUTRON ACER TENDL-2019 LIBRARY; T=293.16K
he3s from (n,he3)

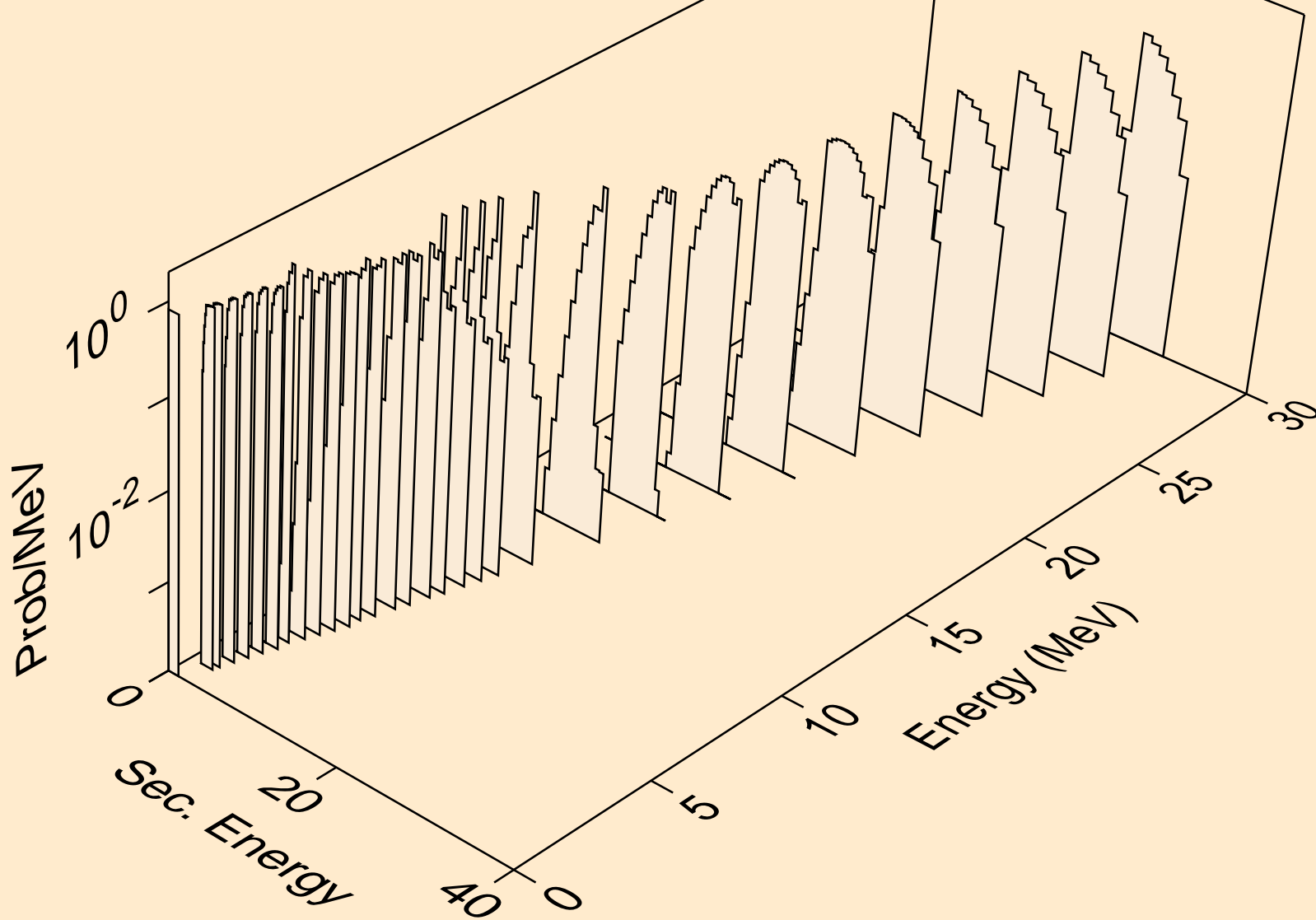

RH091 NEUTRON ACER TENDL-2019 LIBRARY; T=293.16K
alphas from (n,x)

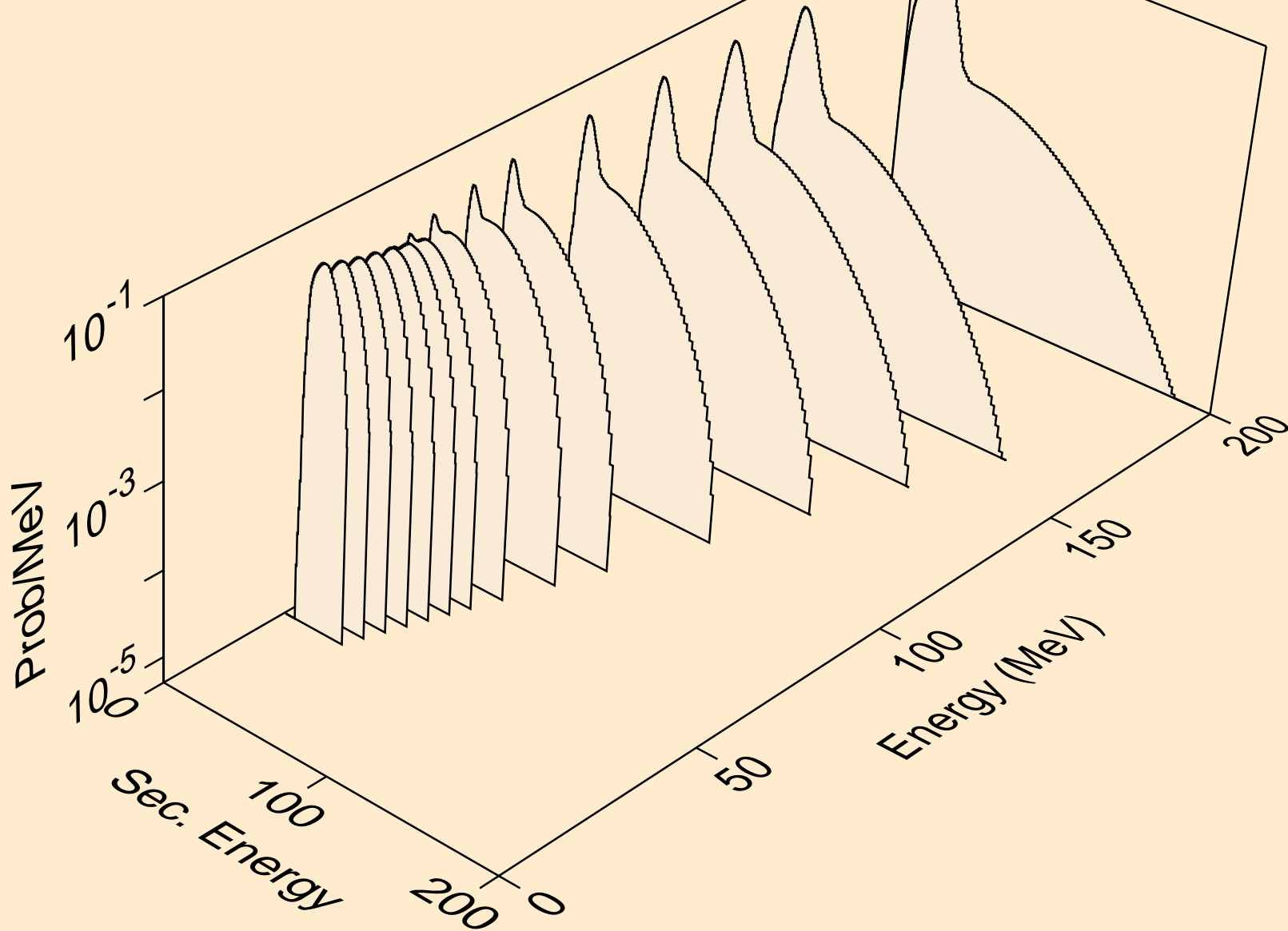

RH091 NEUTRON ACER TENDL-2019 LIBRARY; T=293.16K
alphas from (n,n*)a

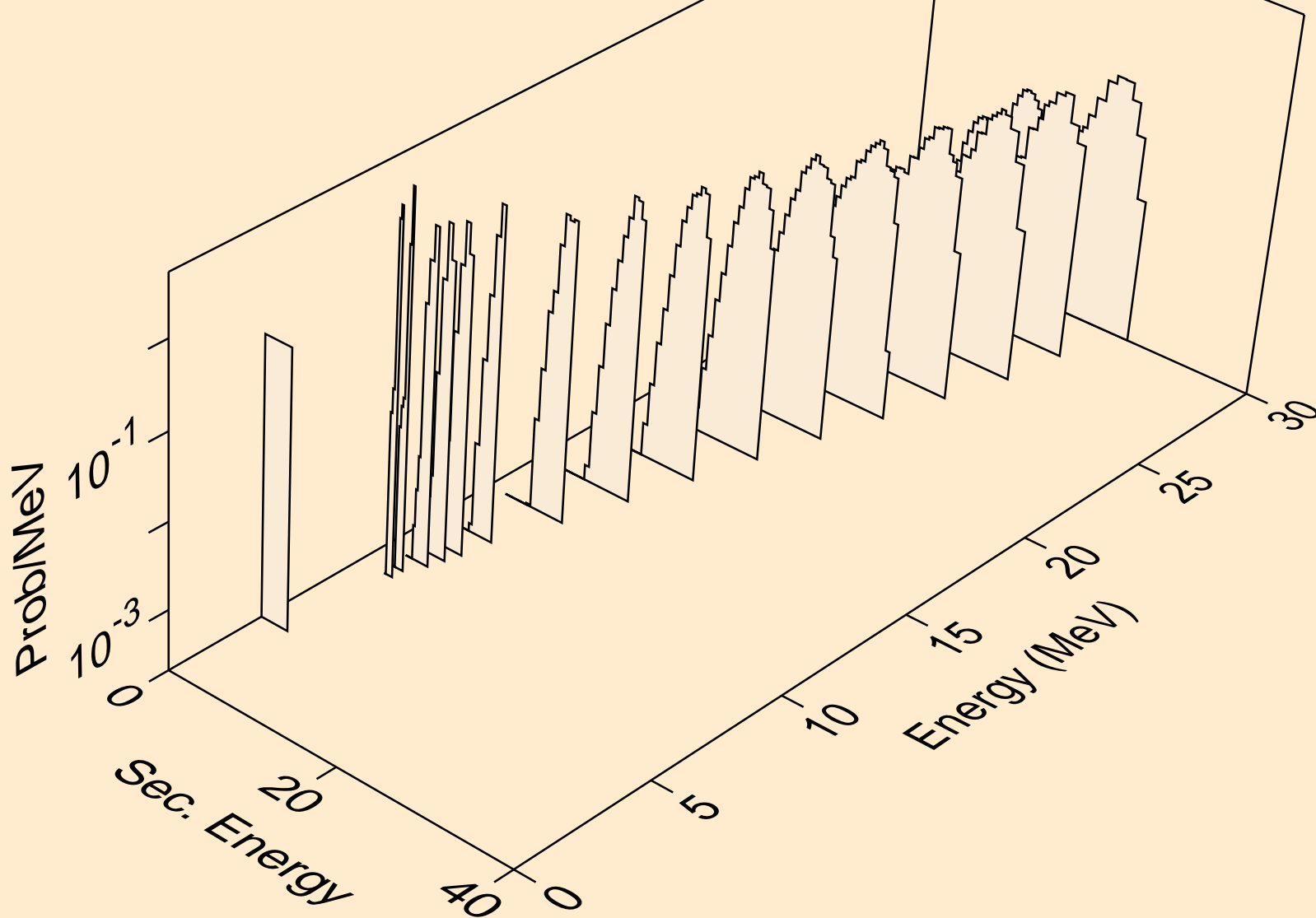

RH091 NEUTRON ACER TENDL-2019 LIBRARY; T=293.16K
alphas from (n,2n)a

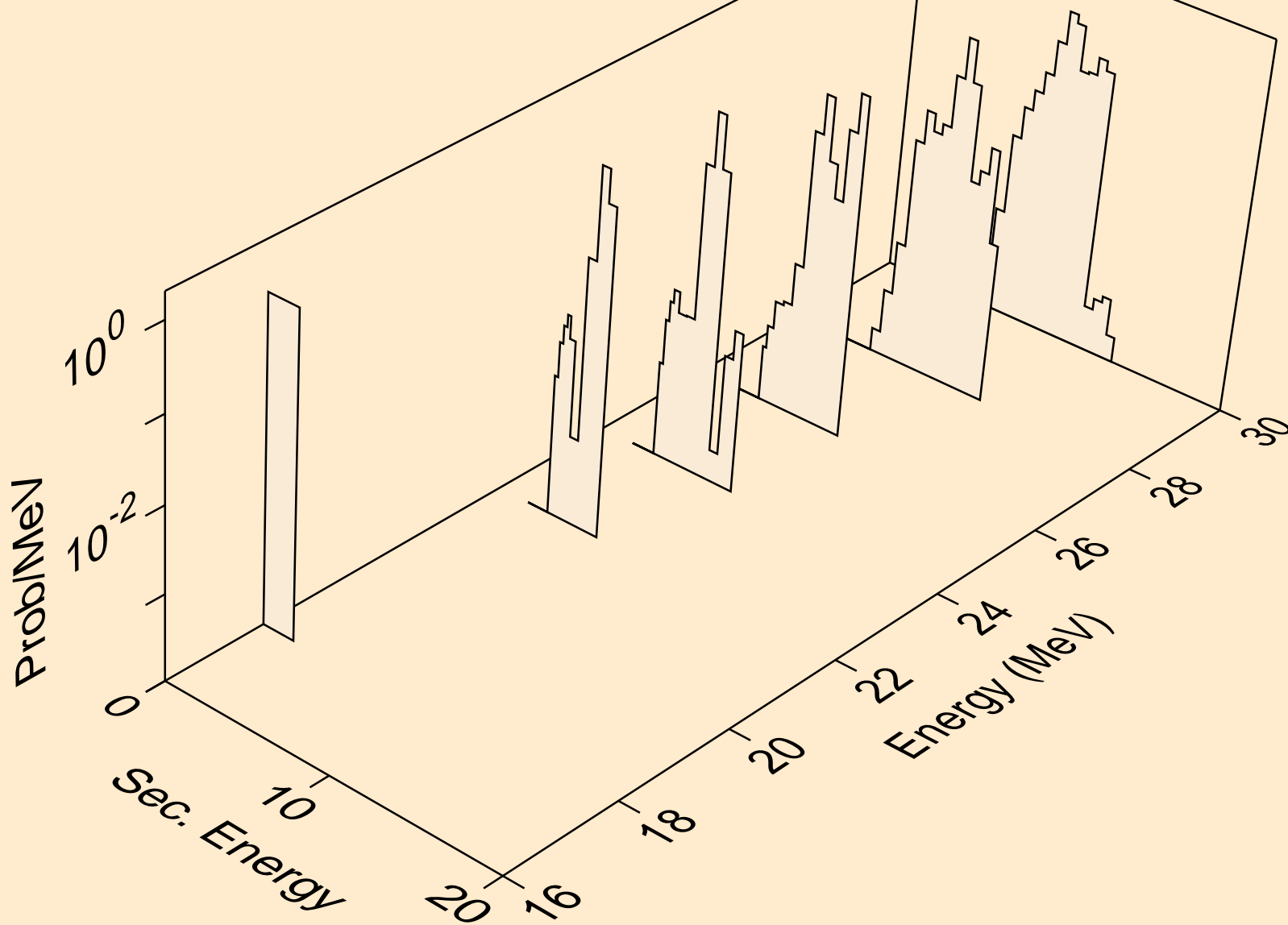

RH091 NEUTRON ACER TENDL-2019 LIBRARY; T=293.16K
alphas from (n,n*)2a

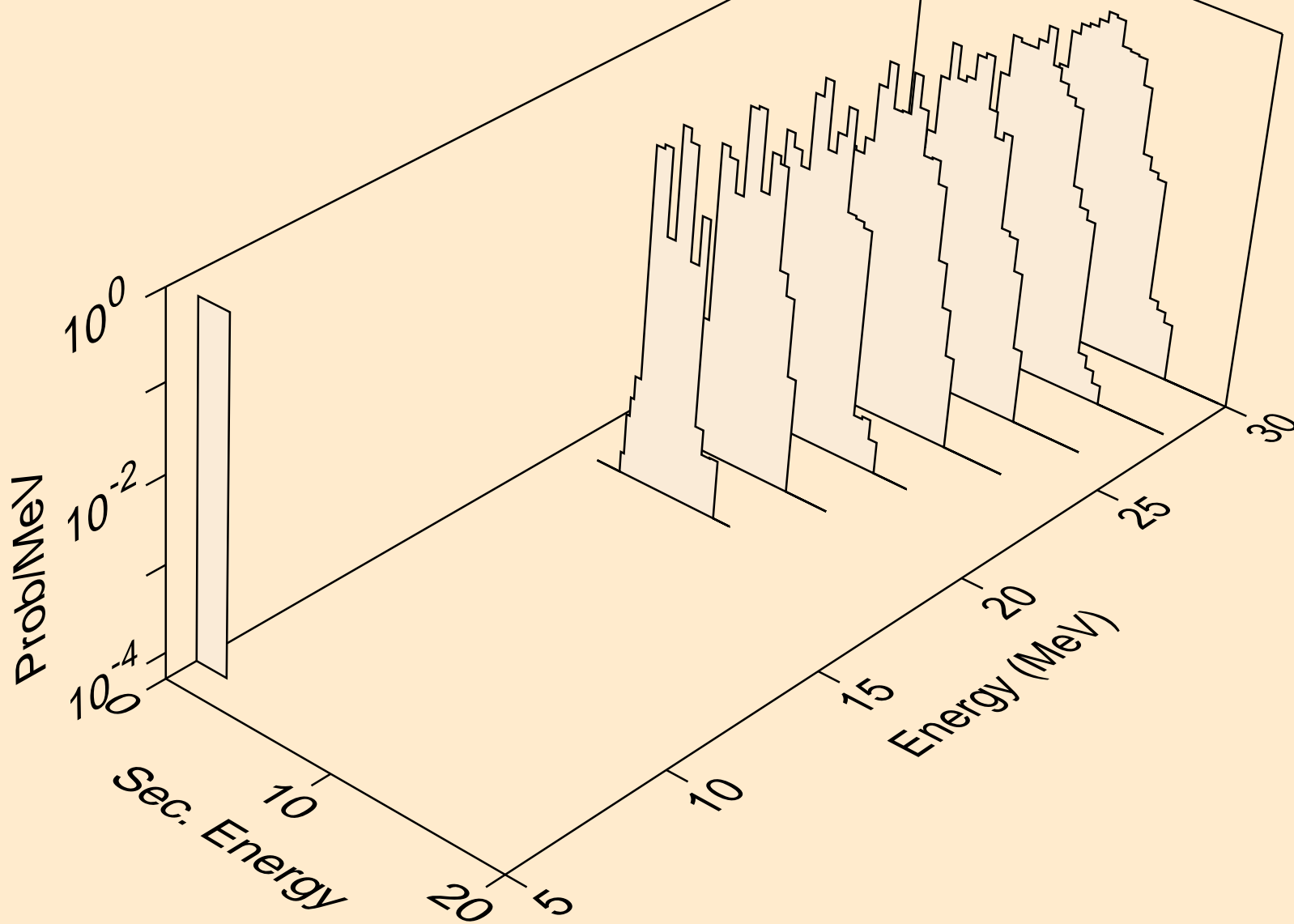

RH091 NEUTRON ACER TENDL-2019 LIBRARY; T=293.16K
alphas from (n,npa)

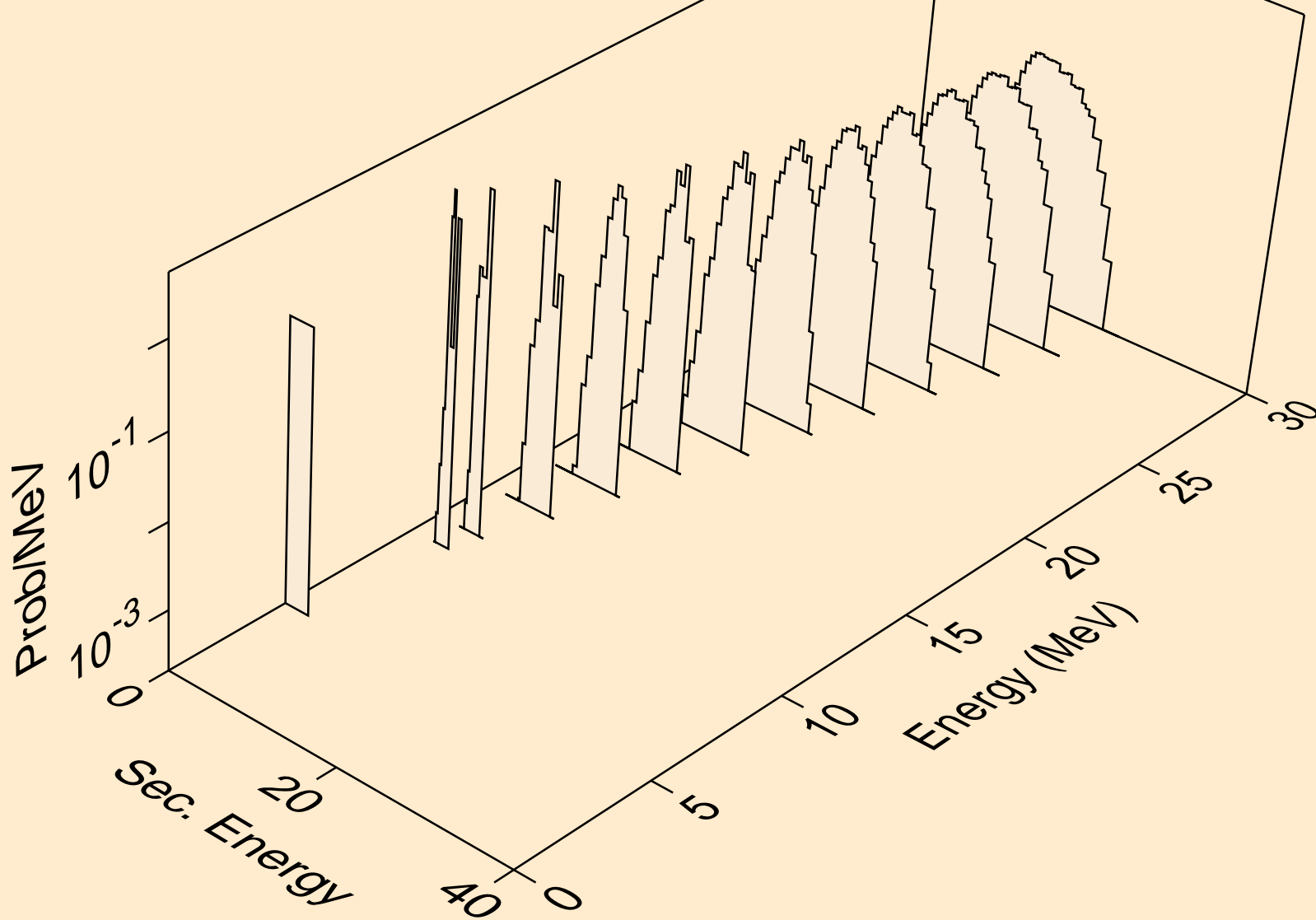

RH091 NEUTRON ACER TENDL-2019 LIBRARY; T=293.16K
alphas from (n,a)

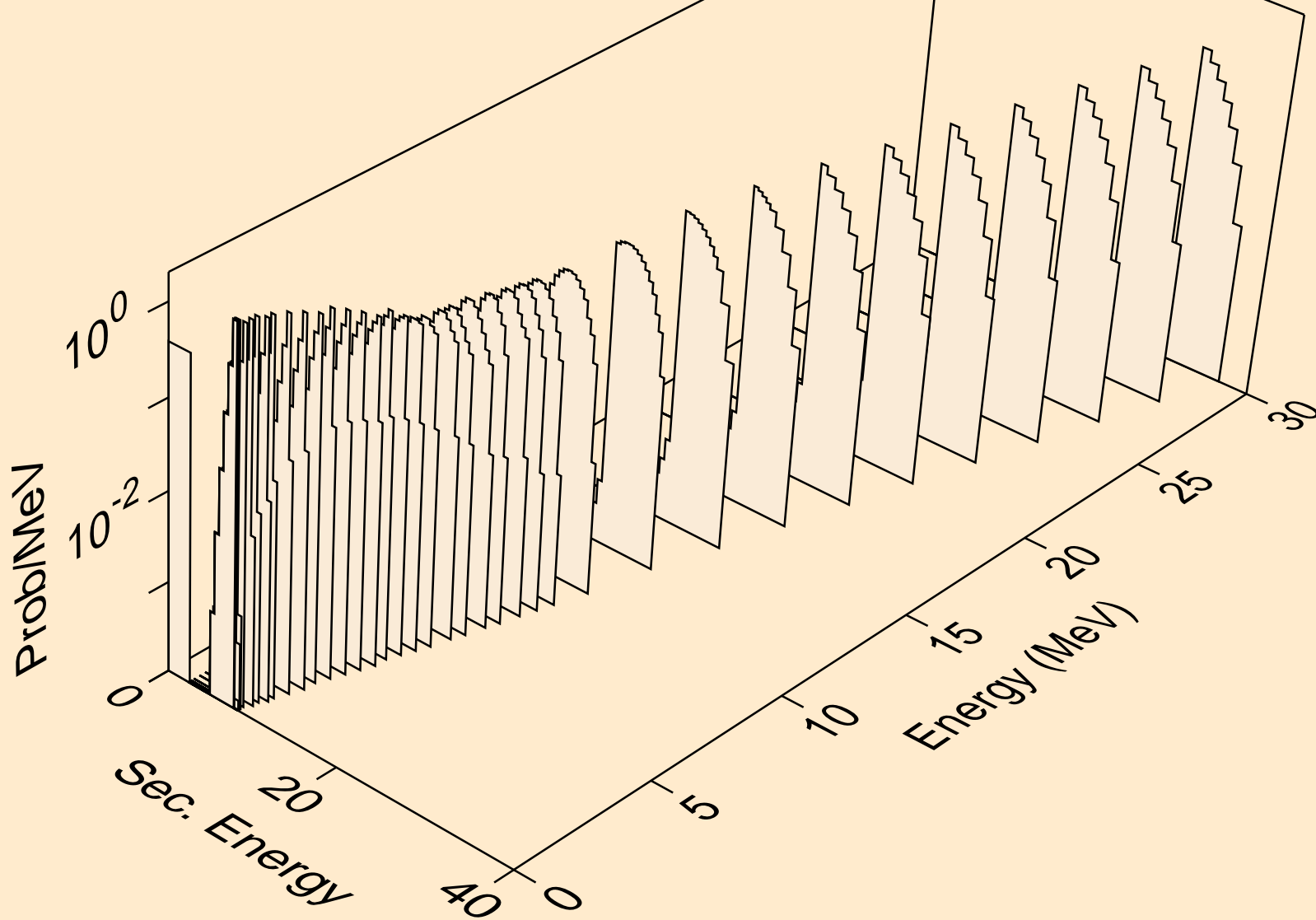

RH091 NEUTRON ACER TENDL-2019 LIBRARY; T=293.16K
alphas from (n,2a)

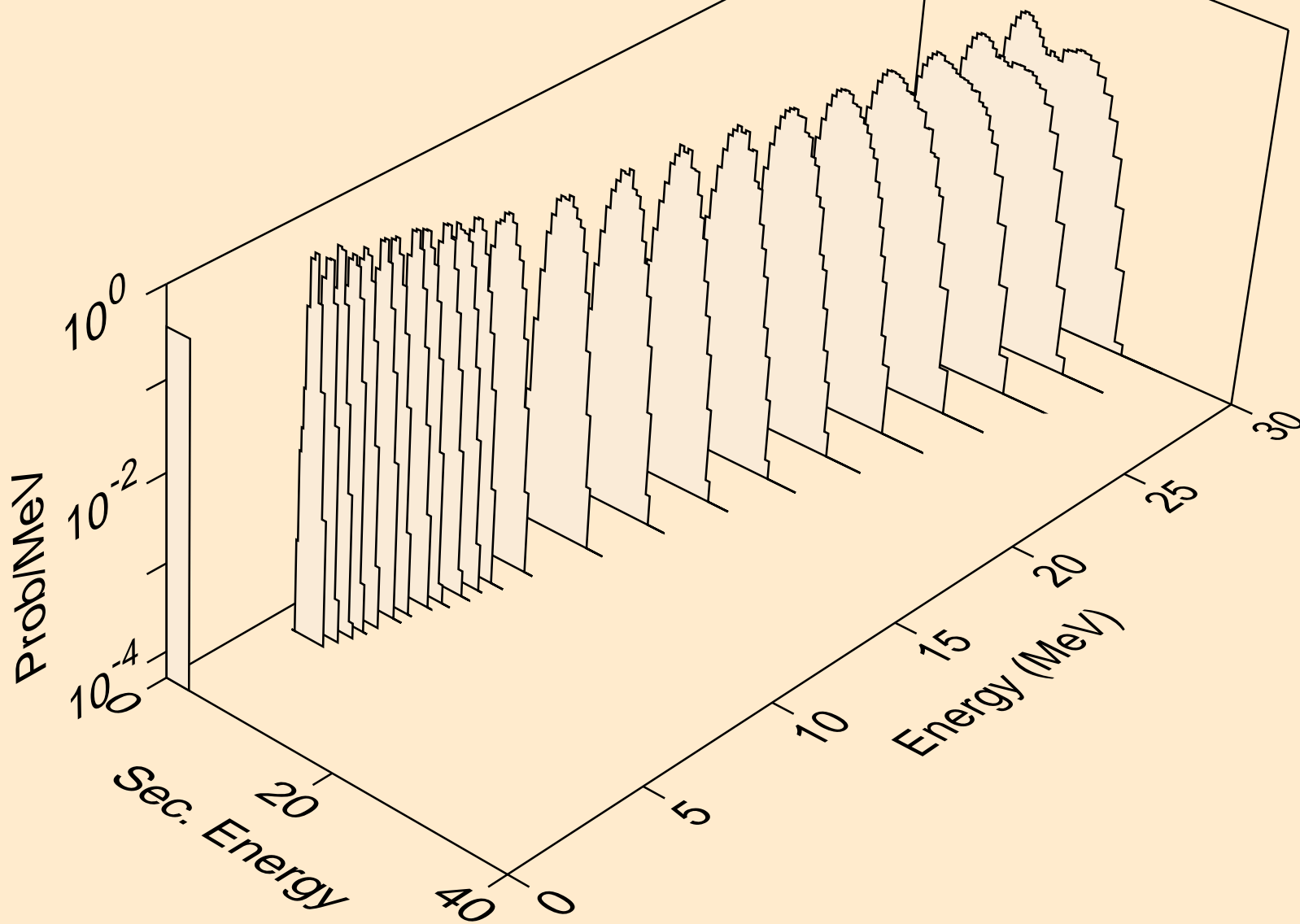

RH091 NEUTRON ACER TENDL-2019 LIBRARY; T=293.16K
alphas from (n,3a)

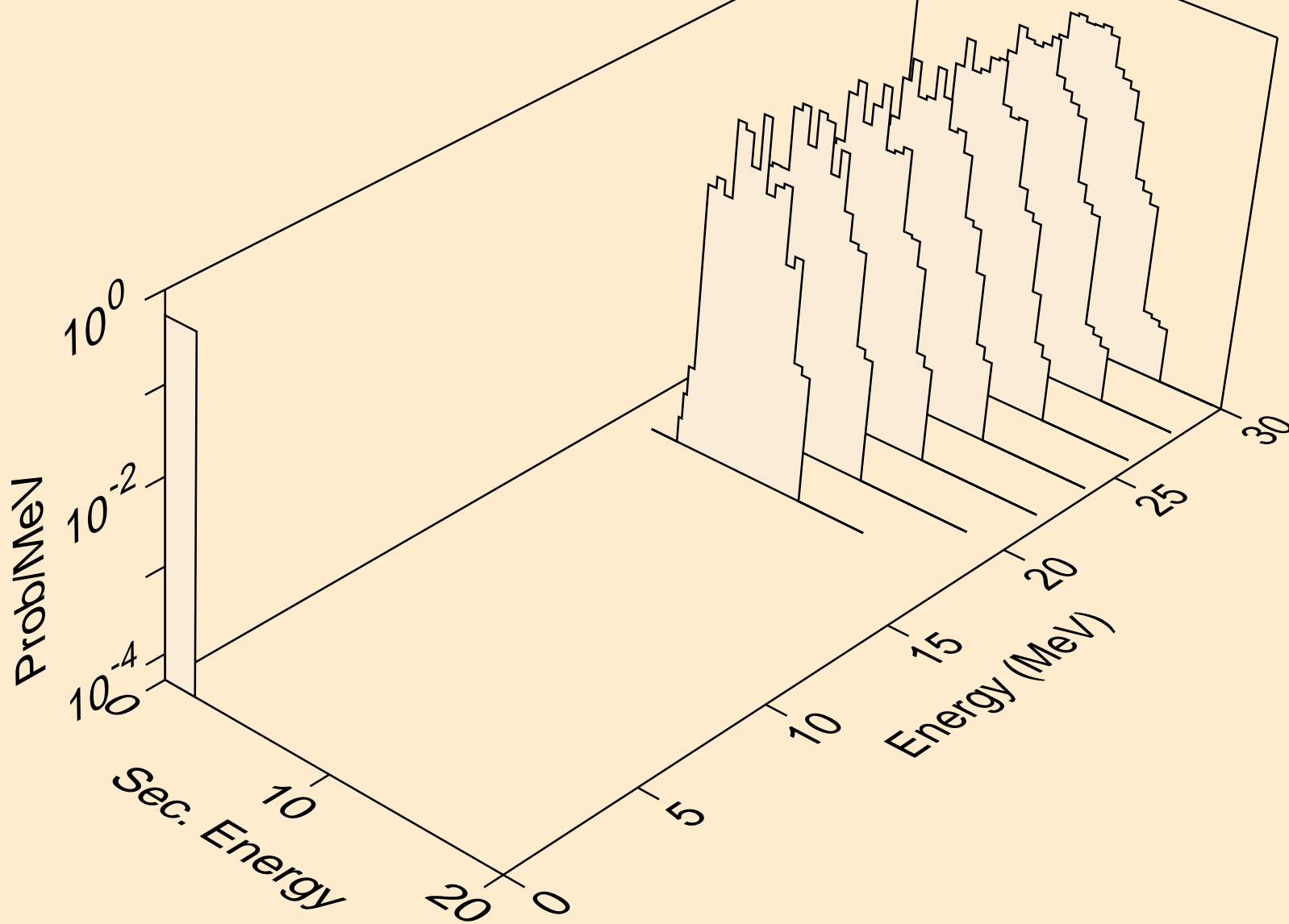

RH091 NEUTRON ACER TENDL-2019 LIBRARY; T=293.16K
alphas from (n,pa)

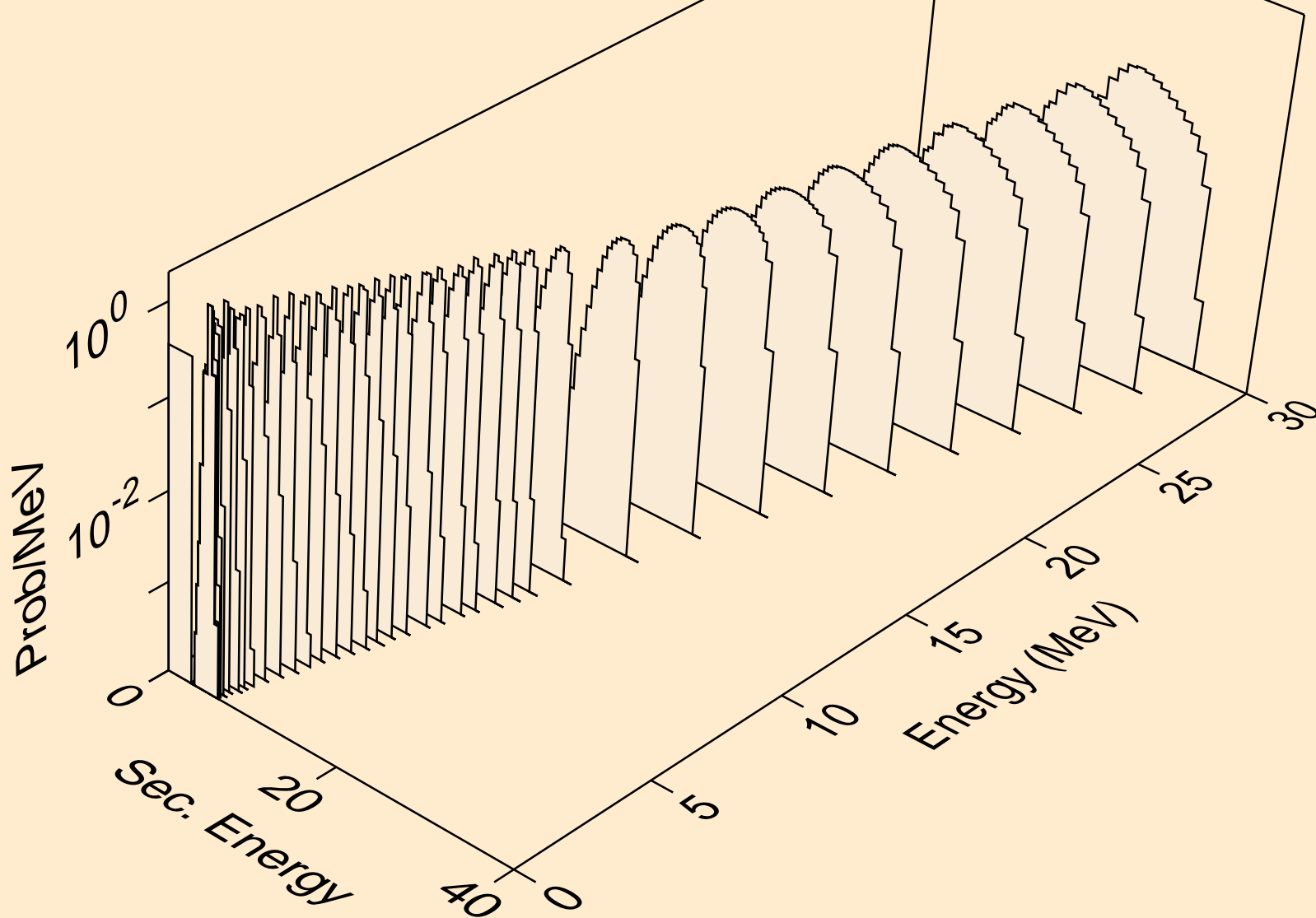

RH091 NEUTRON ACER TENDL-2019 LIBRARY; T=293.16K
alphas from (n,da)

