

RH109 NEUTRON ACER TENDL-2019 LIBRARY; T=293.16K  
Principal cross sections

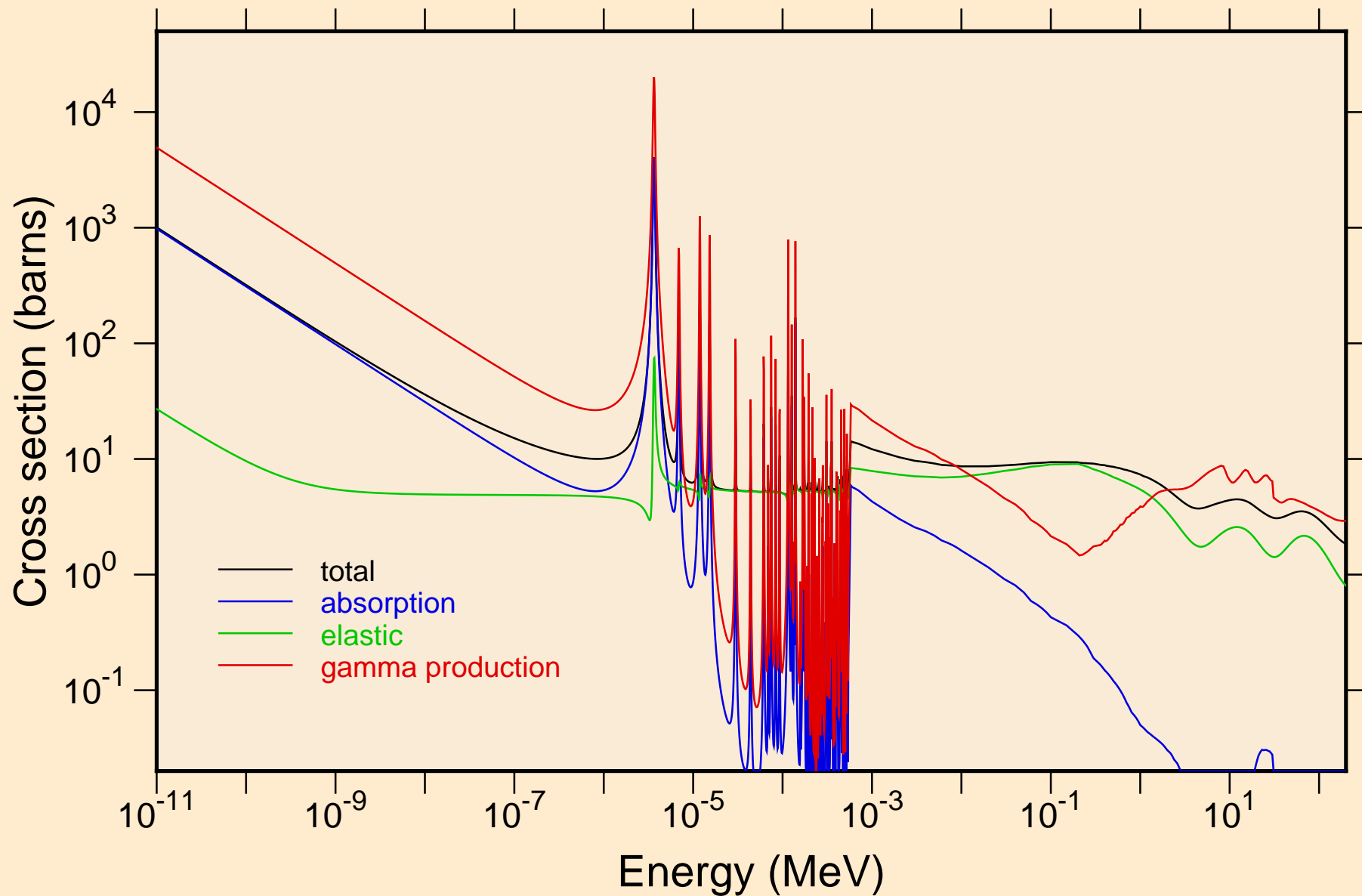

RH109 NEUTRON ACER TENDL-2019 LIBRARY; T=293.16K  
resonance total cross section

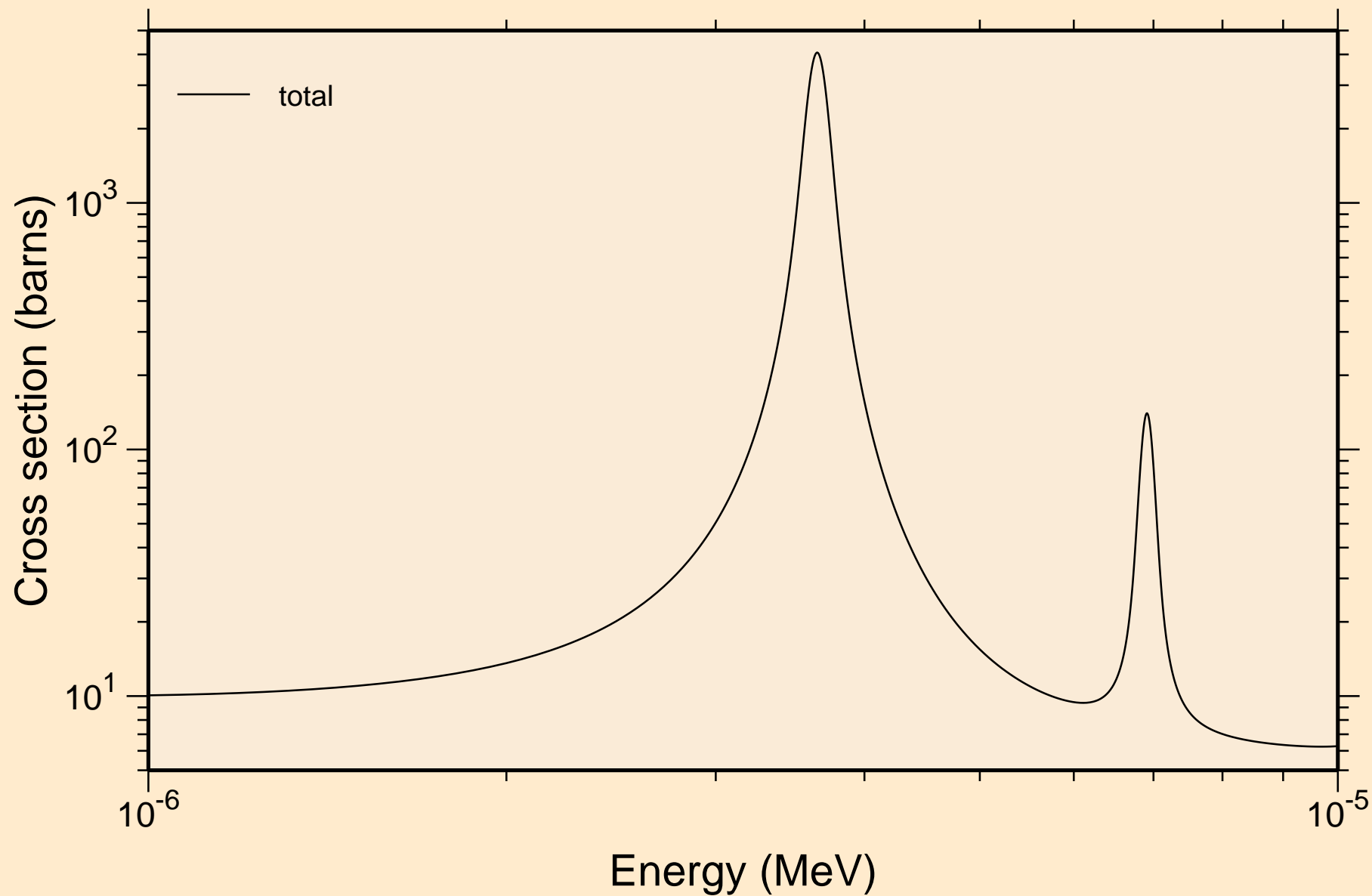

RH109 NEUTRON ACER TENDL-2019 LIBRARY; T=293.16K  
resonance total cross section

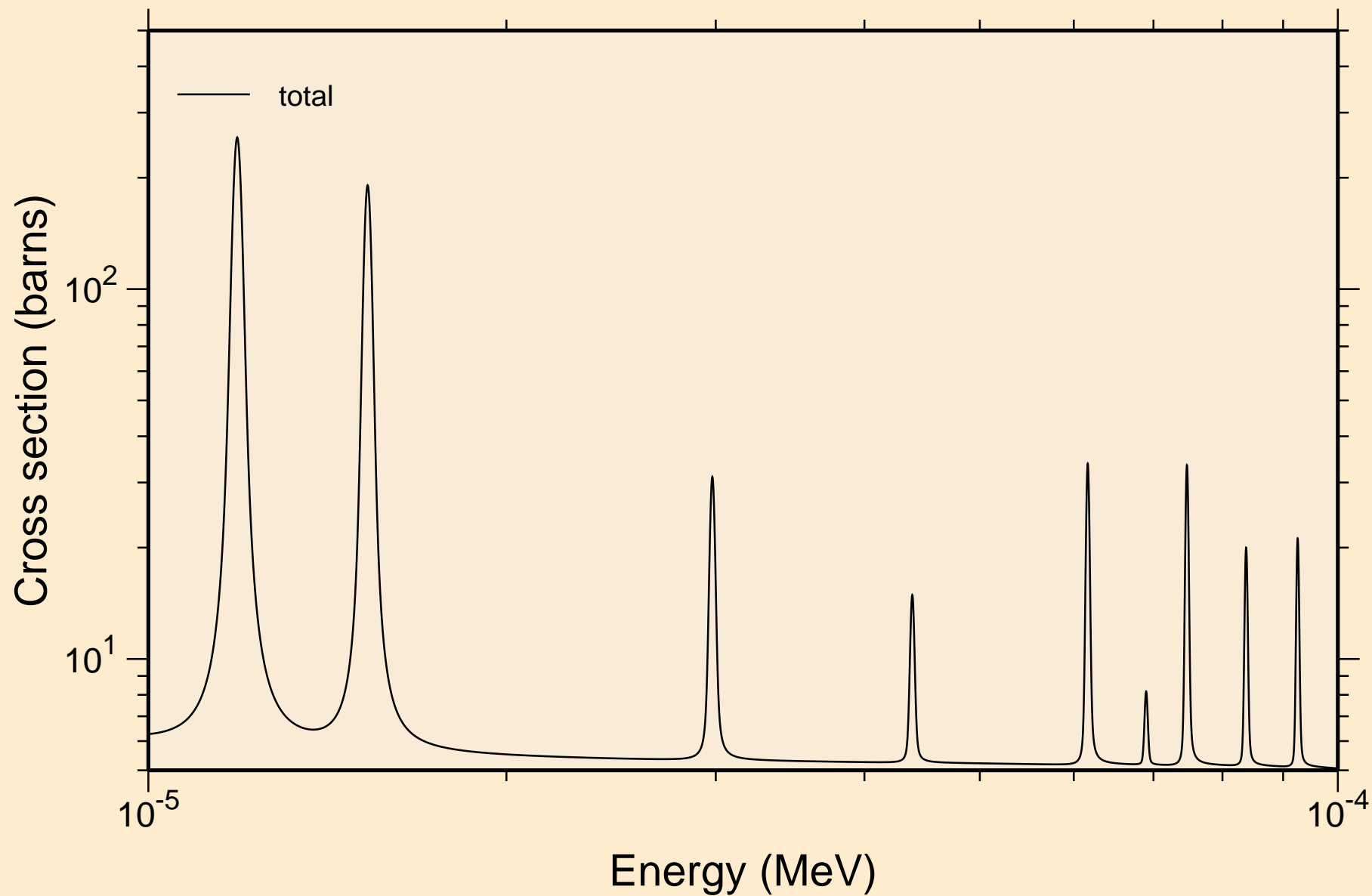

RH109 NEUTRON ACER TENDL-2019 LIBRARY; T=293.16K  
resonance total cross section

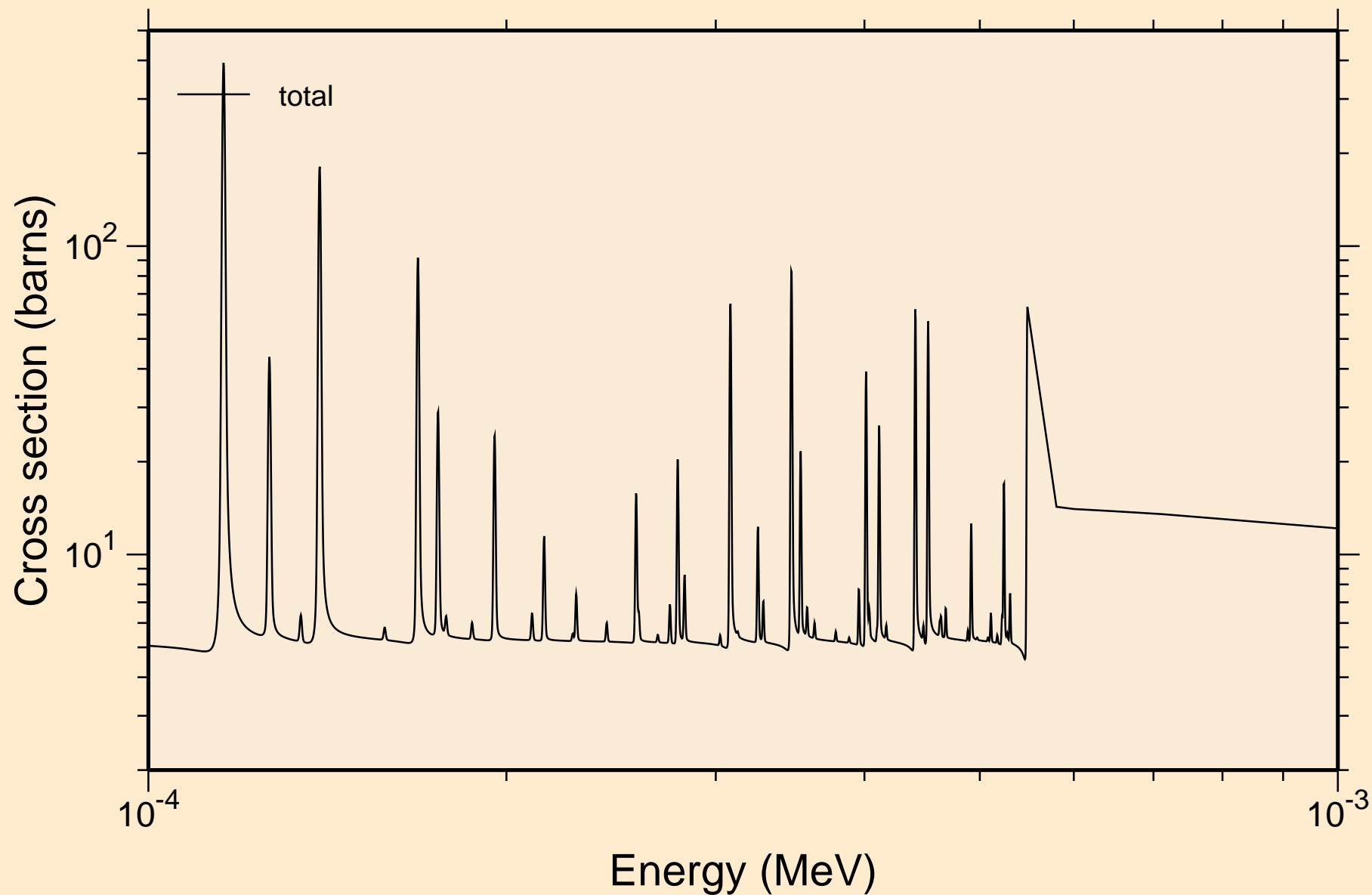

RH109 NEUTRON ACER TENDL-2019 LIBRARY; T=293.16K  
resonance total cross section

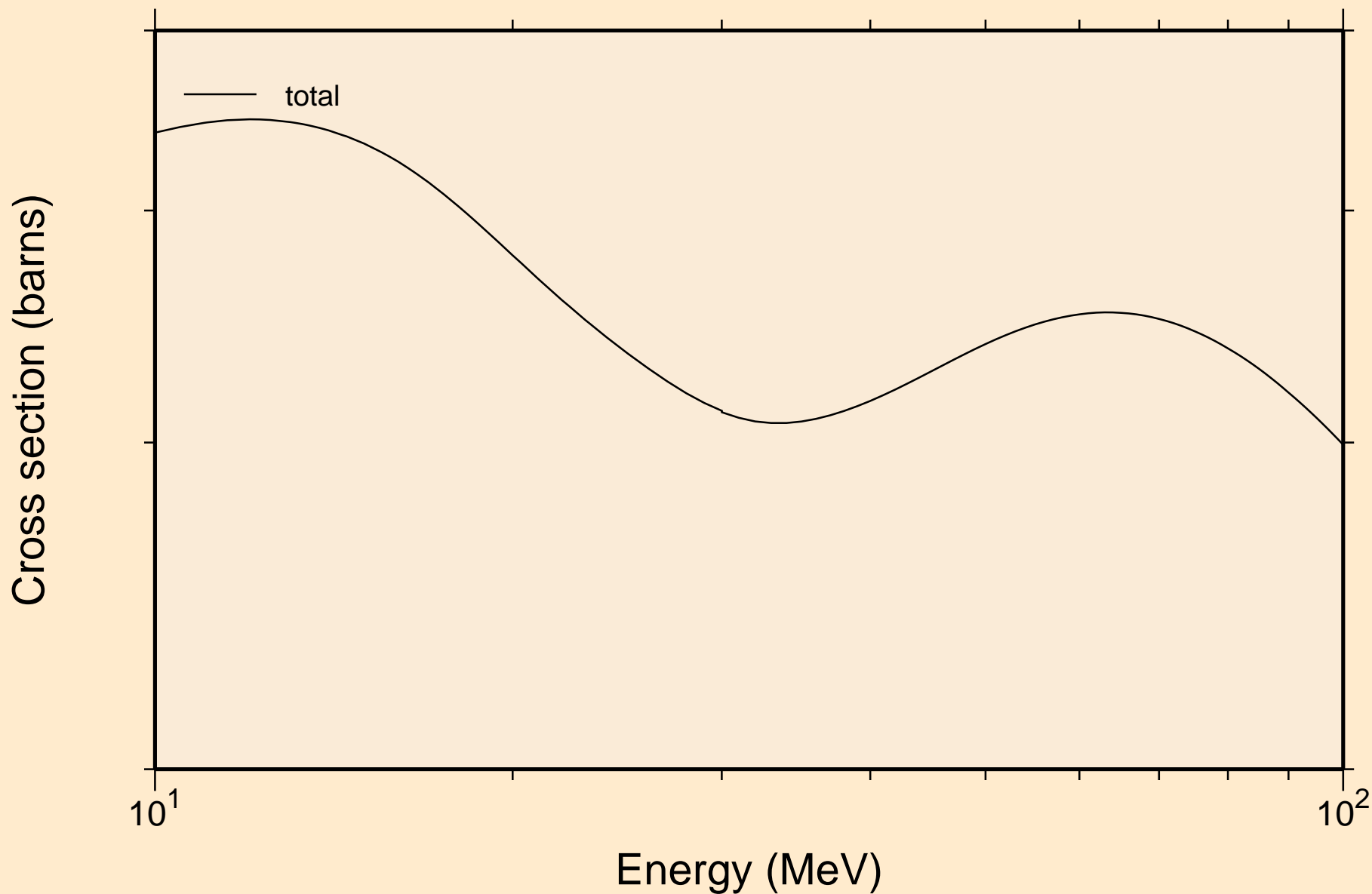

RH109 NEUTRON ACER TENDL-2019 LIBRARY; T=293.16K  
resonance absorption cross sections

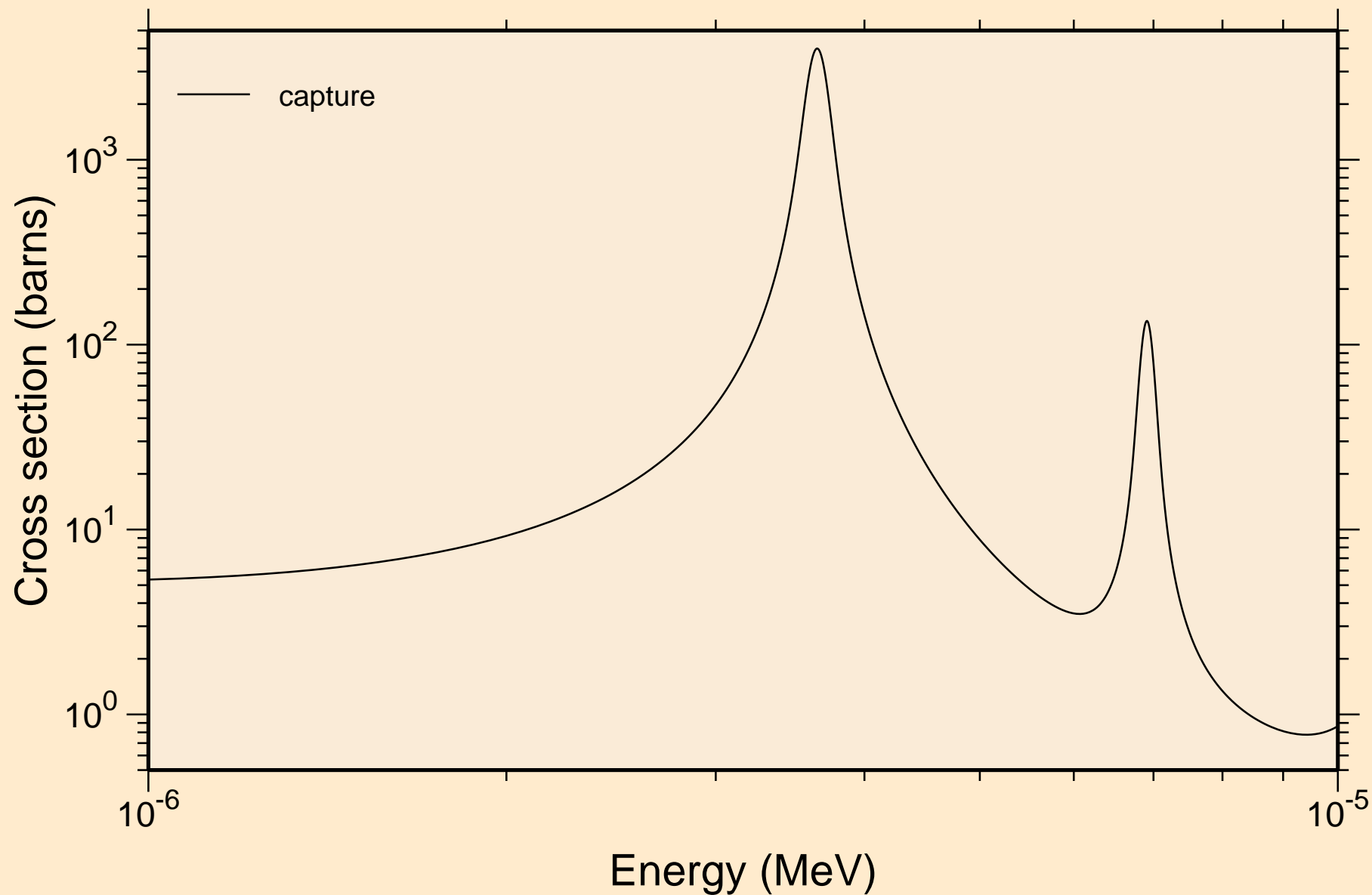

RH109 NEUTRON ACER TENDL-2019 LIBRARY; T=293.16K  
resonance absorption cross sections

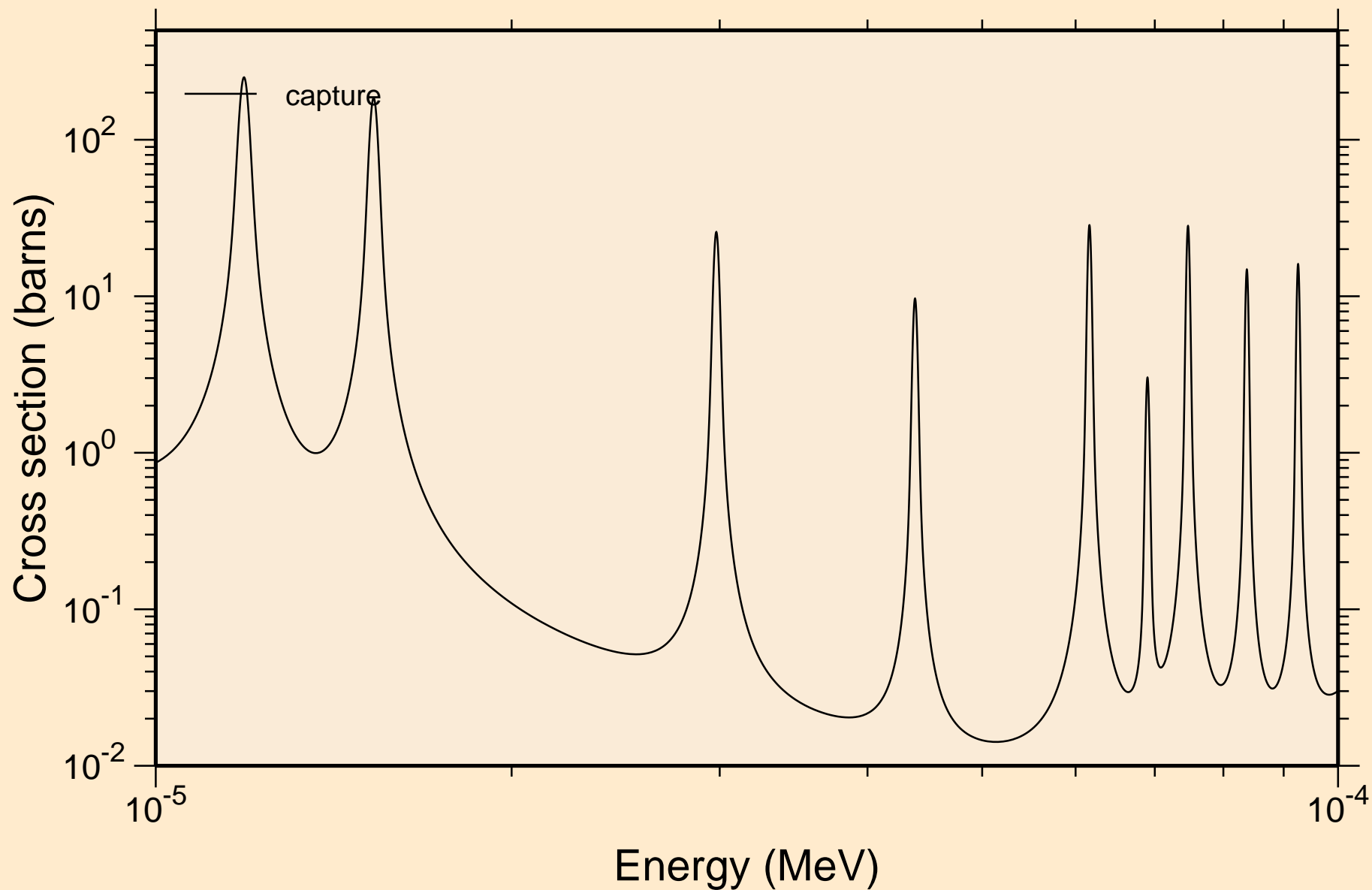

RH109 NEUTRON ACER TENDL-2019 LIBRARY; T=293.16K  
resonance absorption cross sections

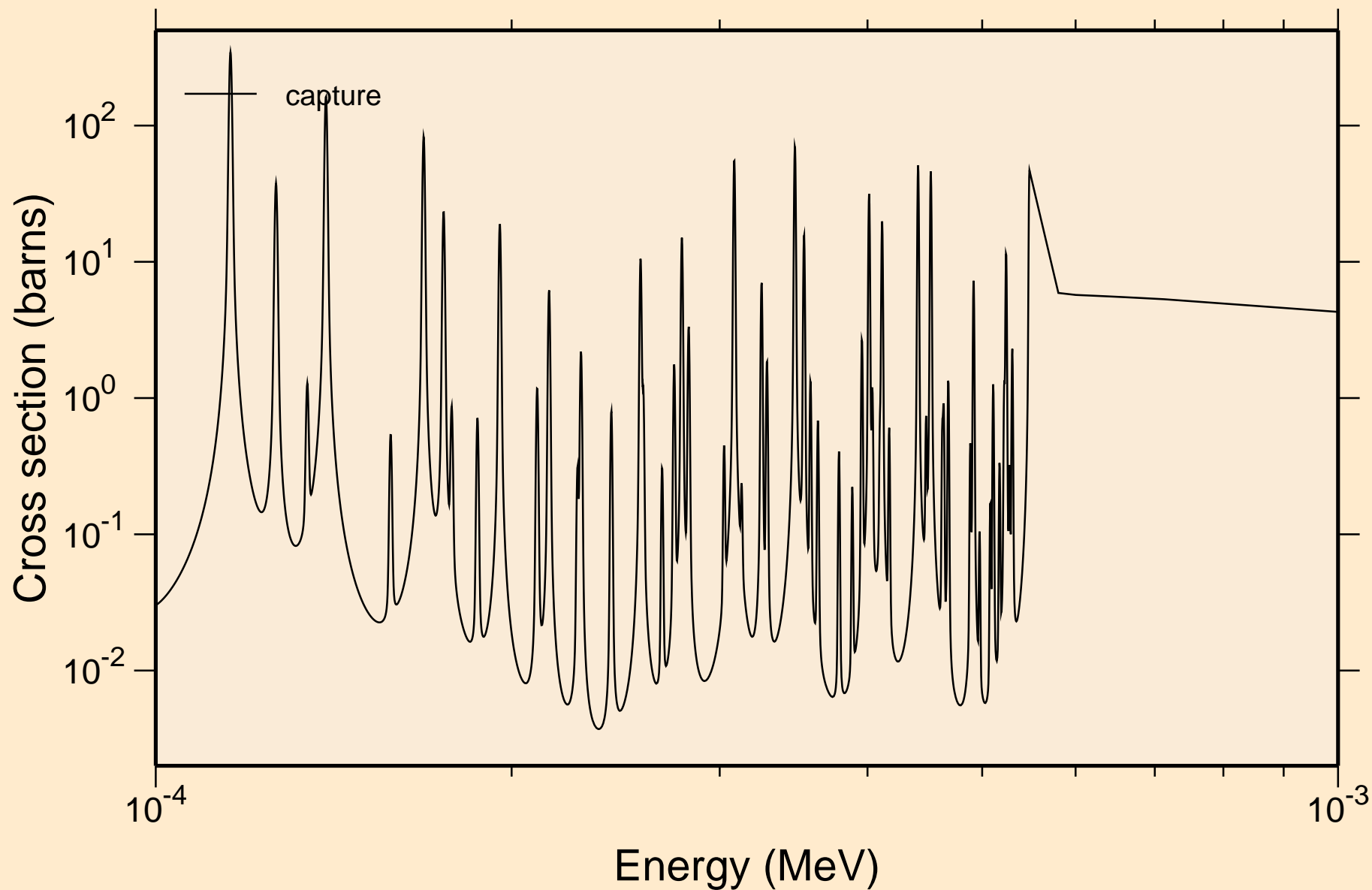



RH109 NEUTRON ACER TENDL-2019 LIBRARY; T=293.16K  
resonance absorption cross sections

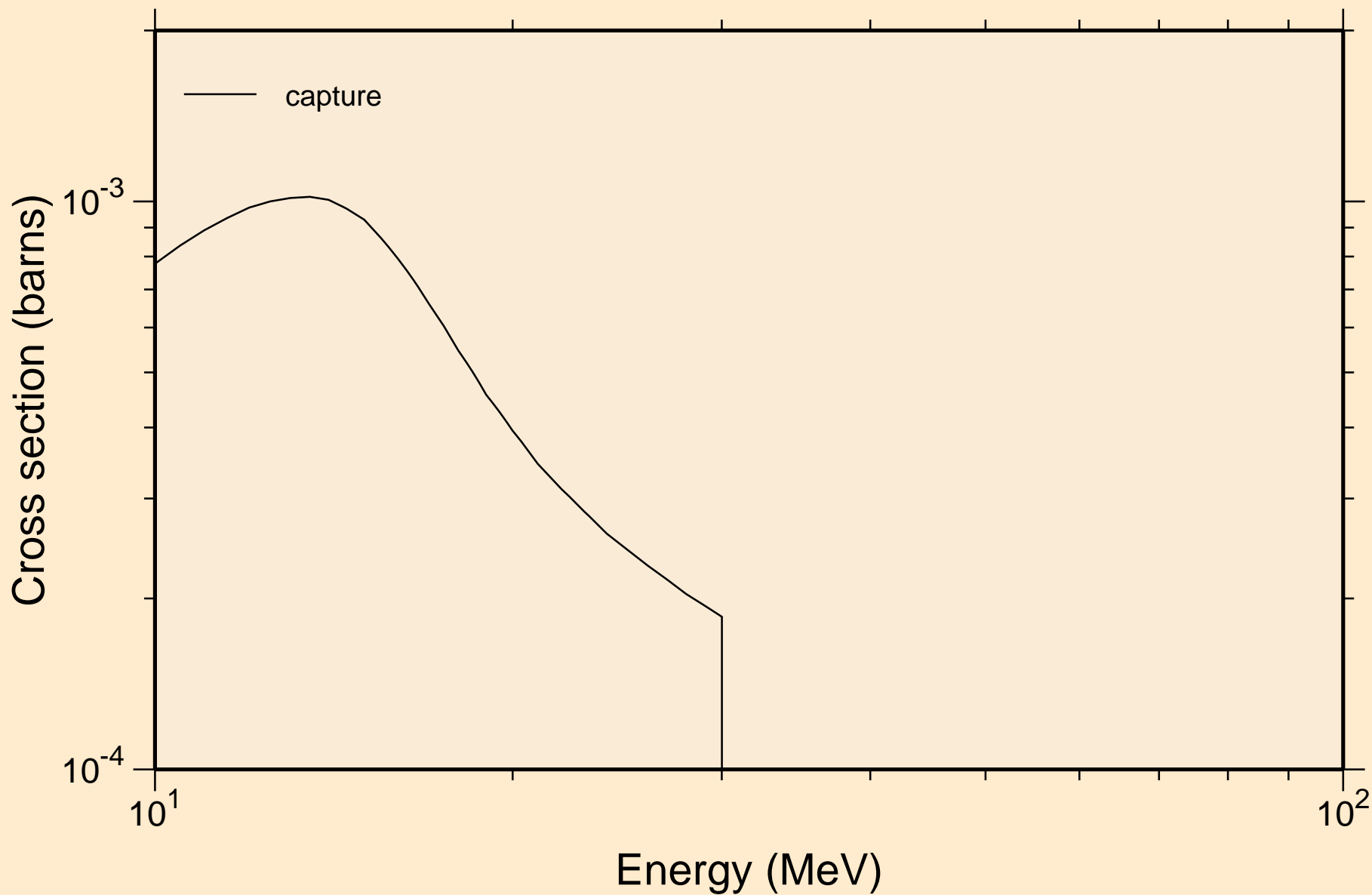

RH109 NEUTRON ACER TENDL-2019 LIBRARY; T=293.16K  
Heating

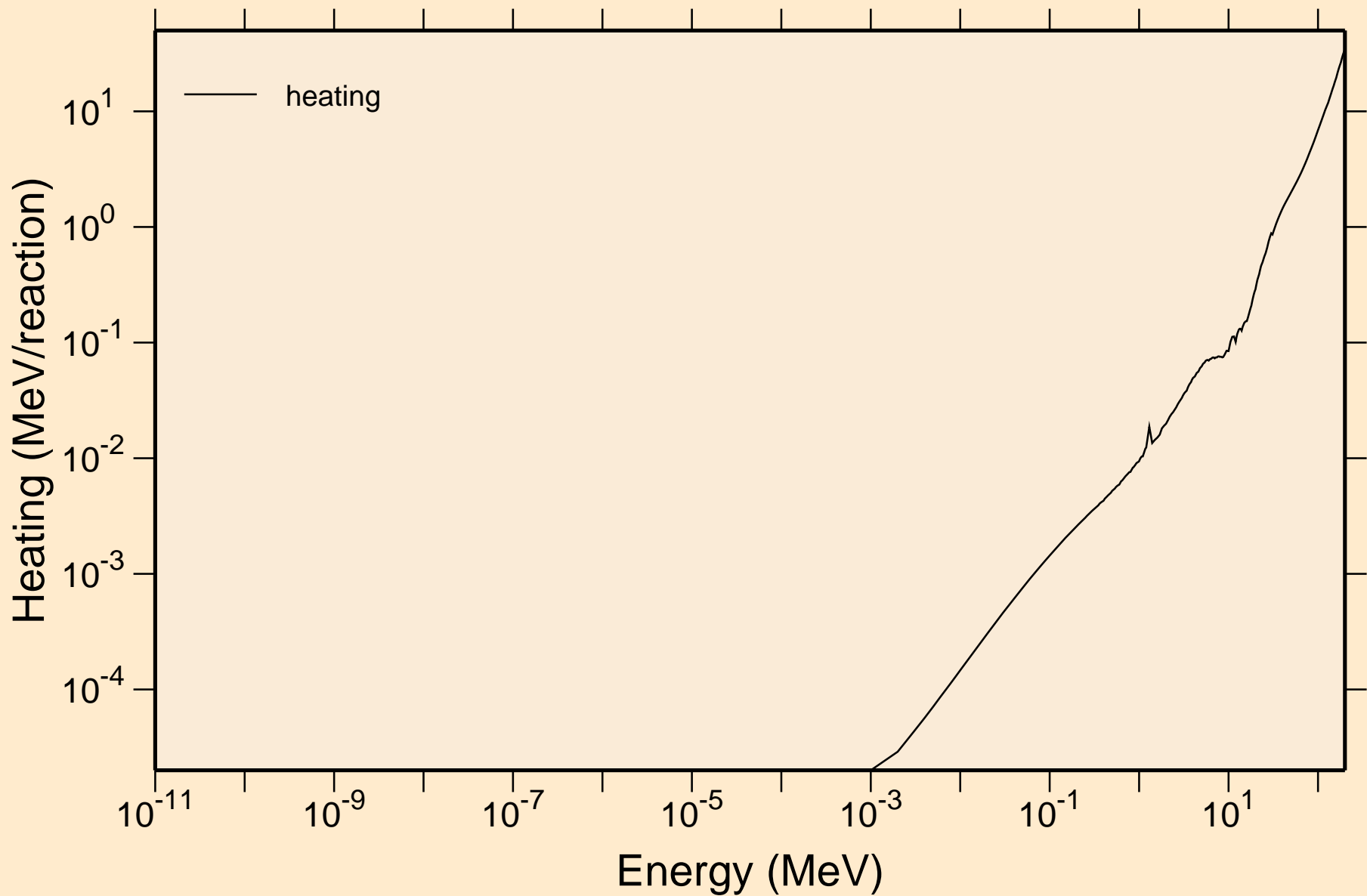

RH109 NEUTRON ACER TENDL-2019 LIBRARY; T=293.16K  
Damage

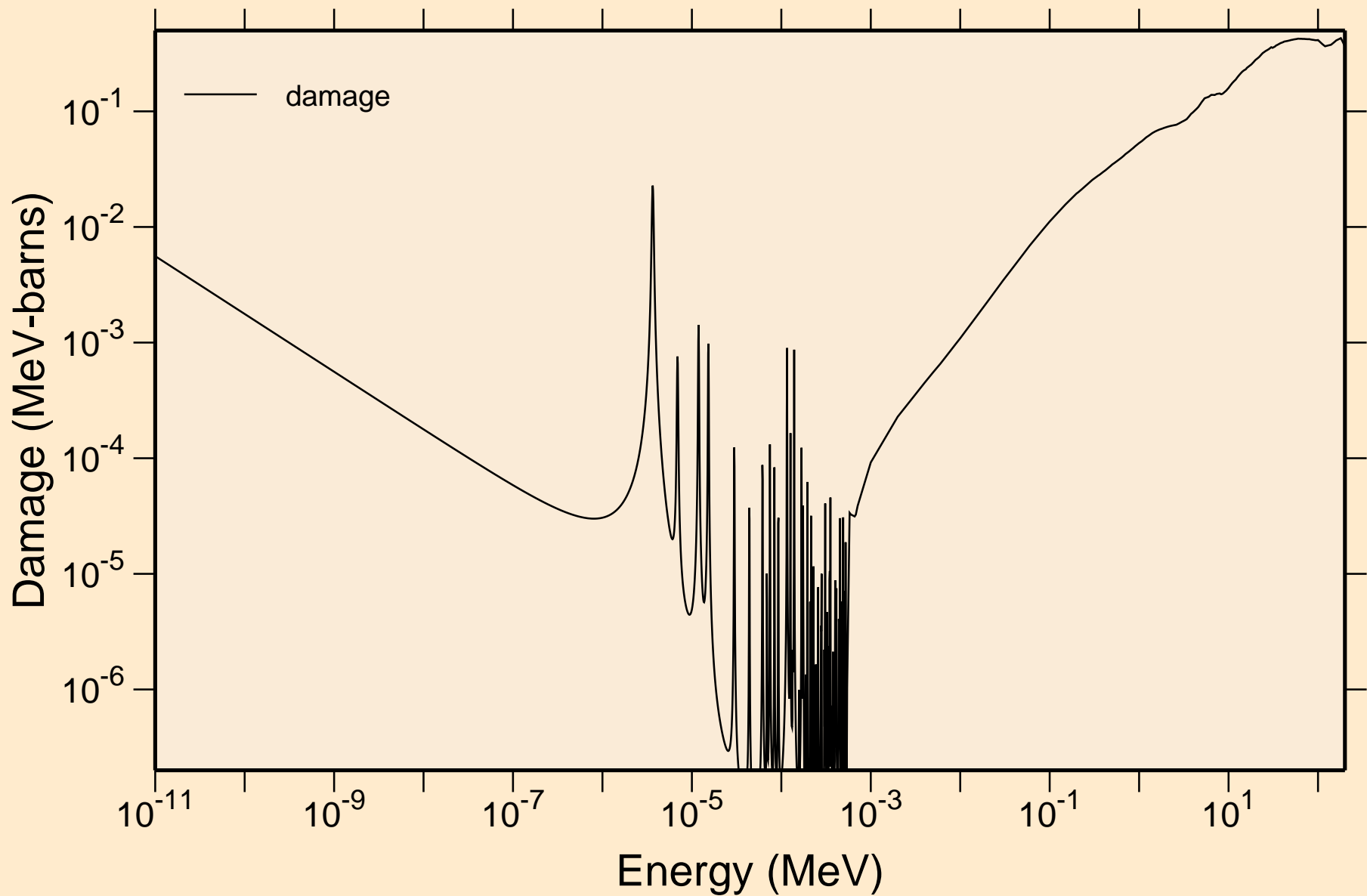

RH109 NEUTRON ACER TENDL-2019 LIBRARY; T=293.16K  
Non-threshold reactions

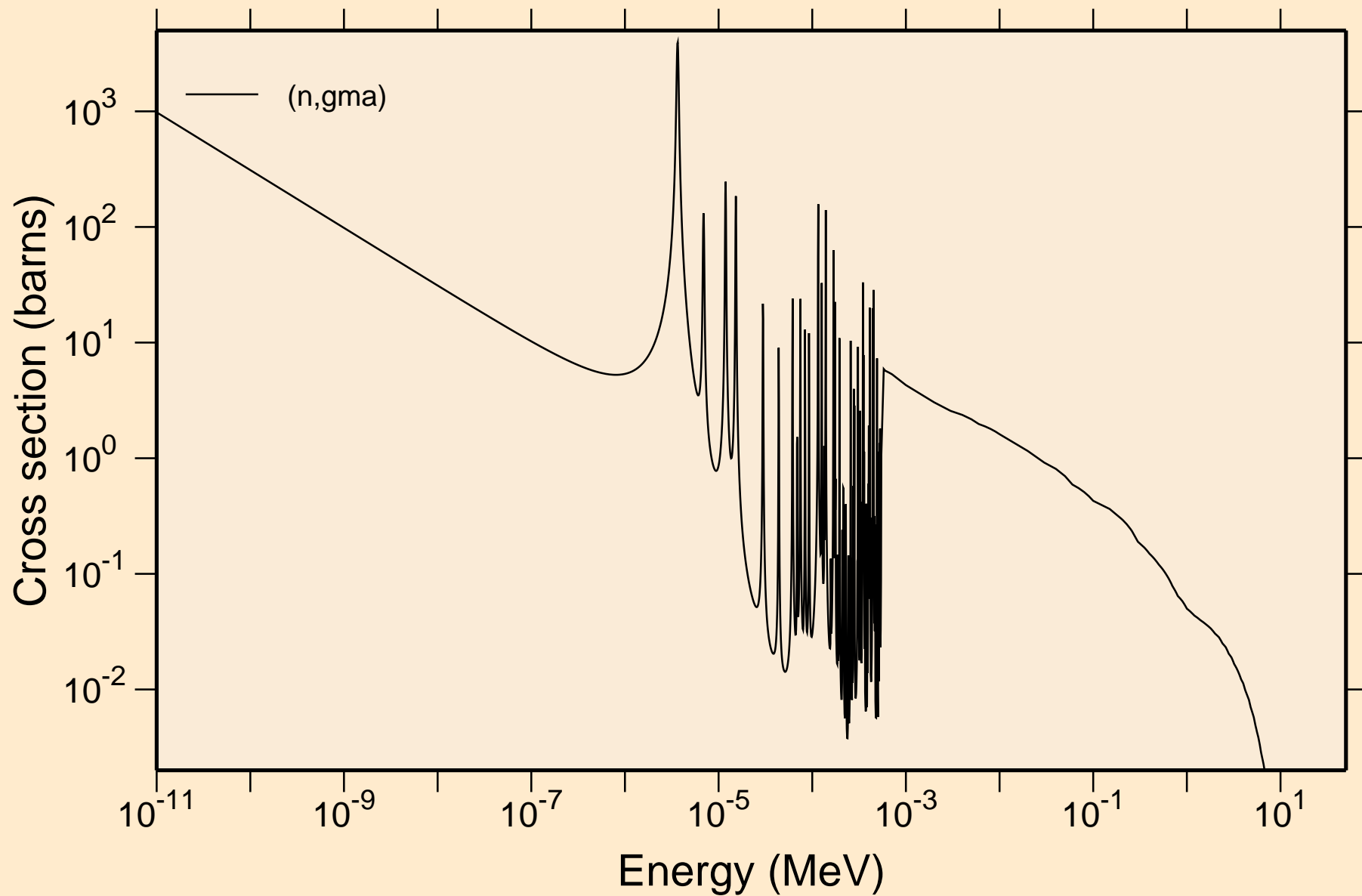

RH109 NEUTRON ACER TENDL-2019 LIBRARY; T=293.16K  
Principal cross sections

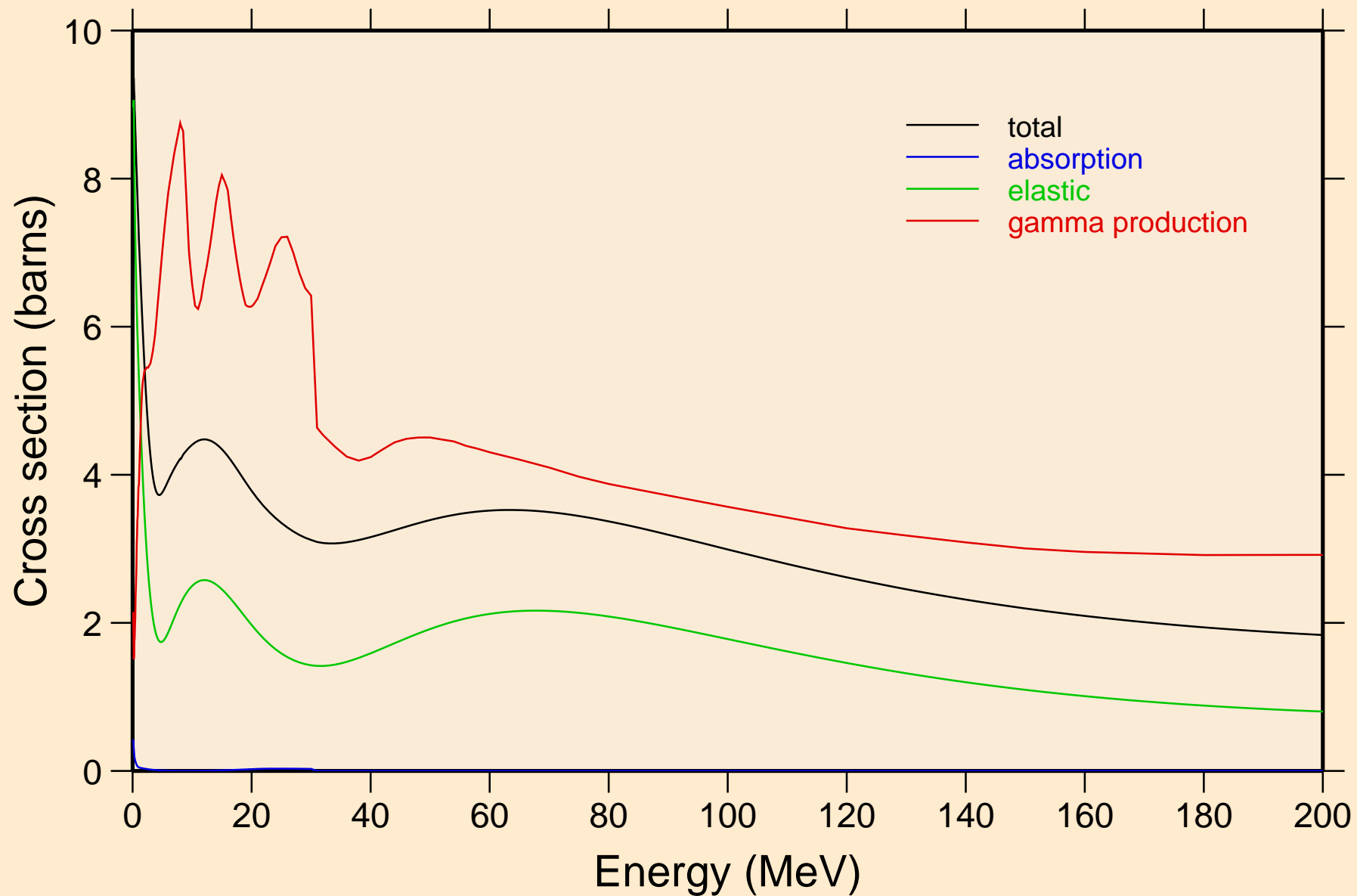

RH109 NEUTRON ACER TENDL-2019 LIBRARY; T=293.16K  
Heating

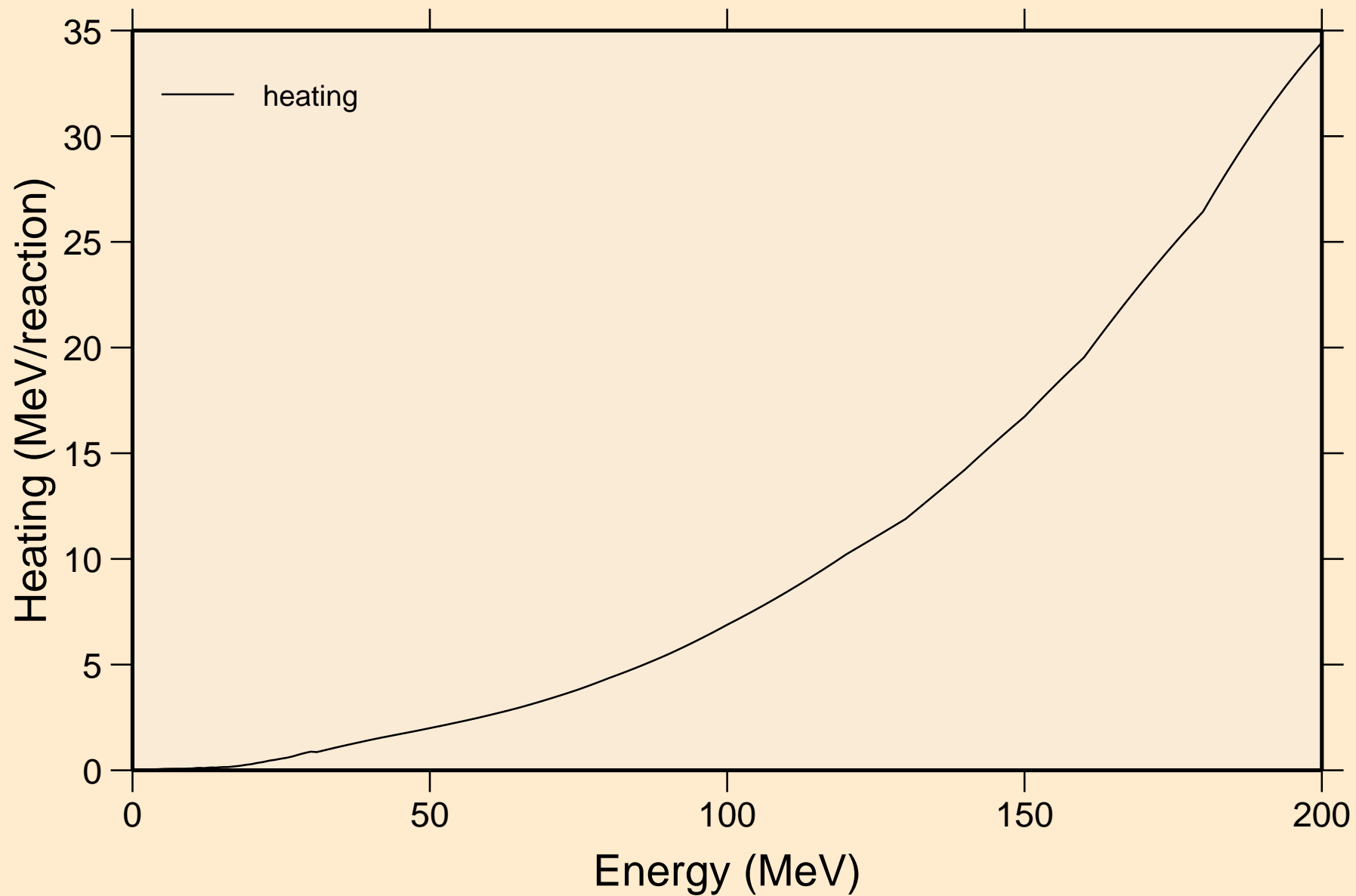

RH109 NEUTRON ACER TENDL-2019 LIBRARY; T=293.16K  
Damage

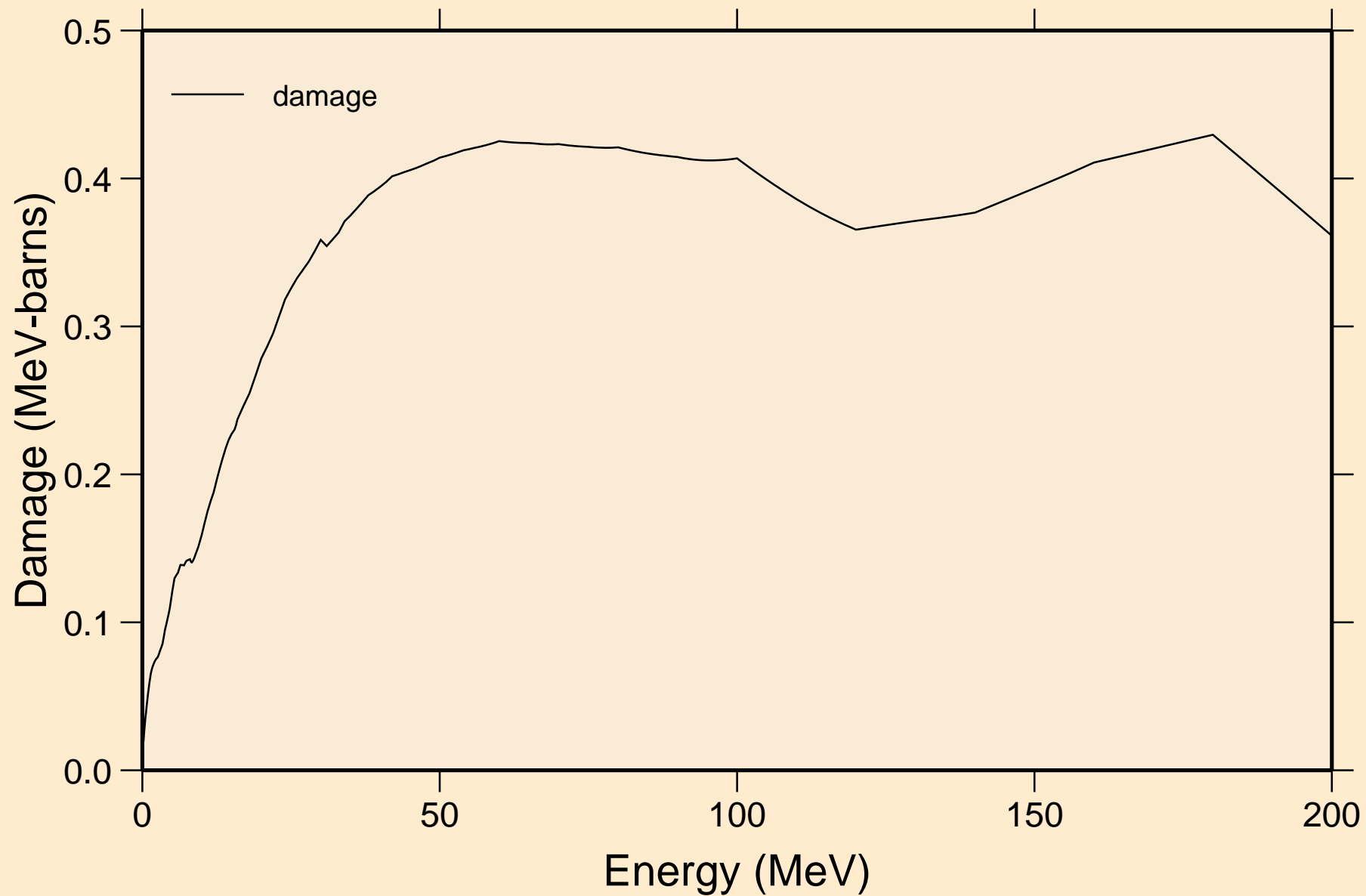

RH109 NEUTRON ACER TENDL-2019 LIBRARY; T=293.16K  
Non-threshold reactions

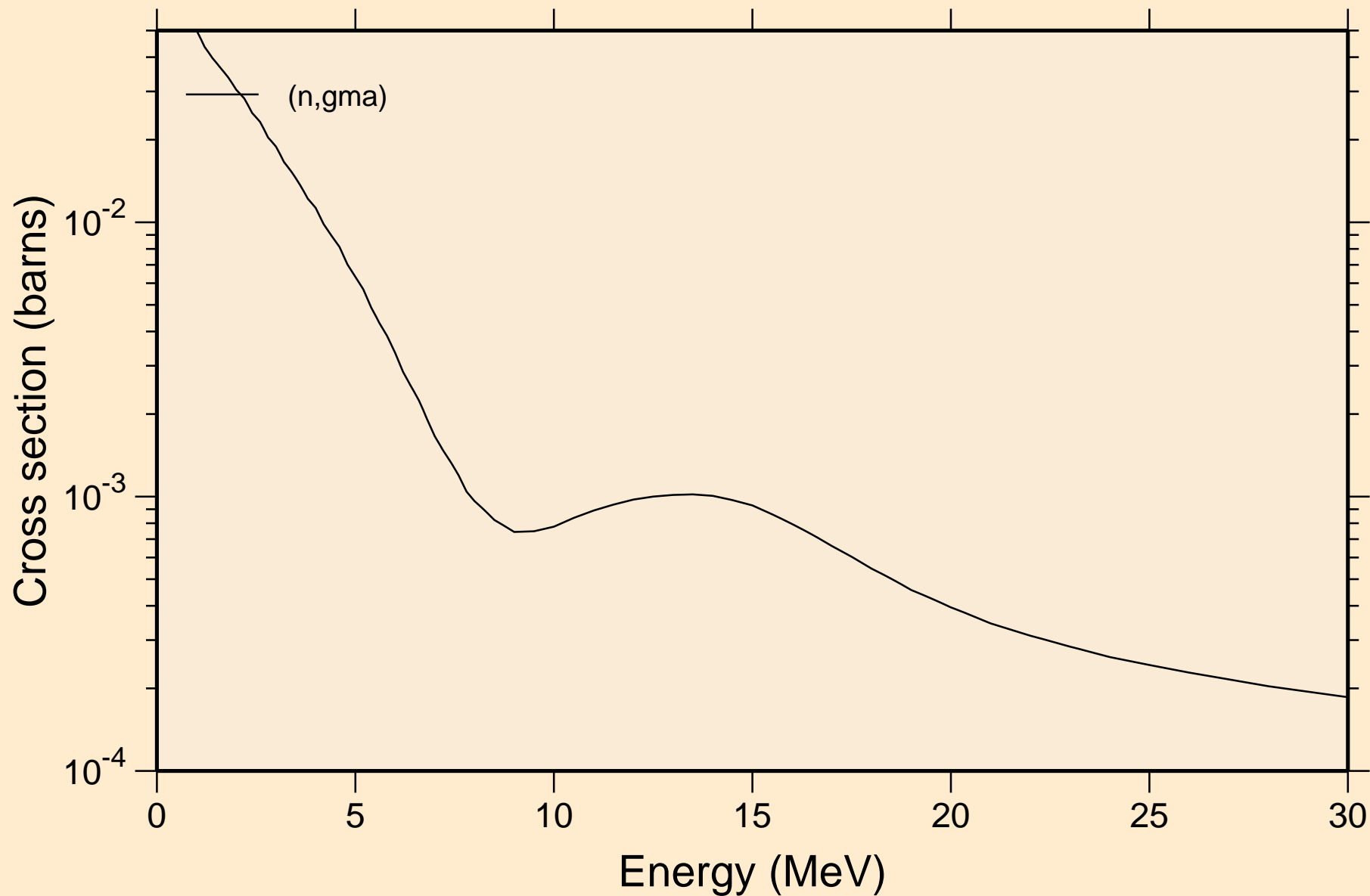



RH109 NEUTRON ACER TENDL-2019 LIBRARY; T=293.16K  
Inelastic levels

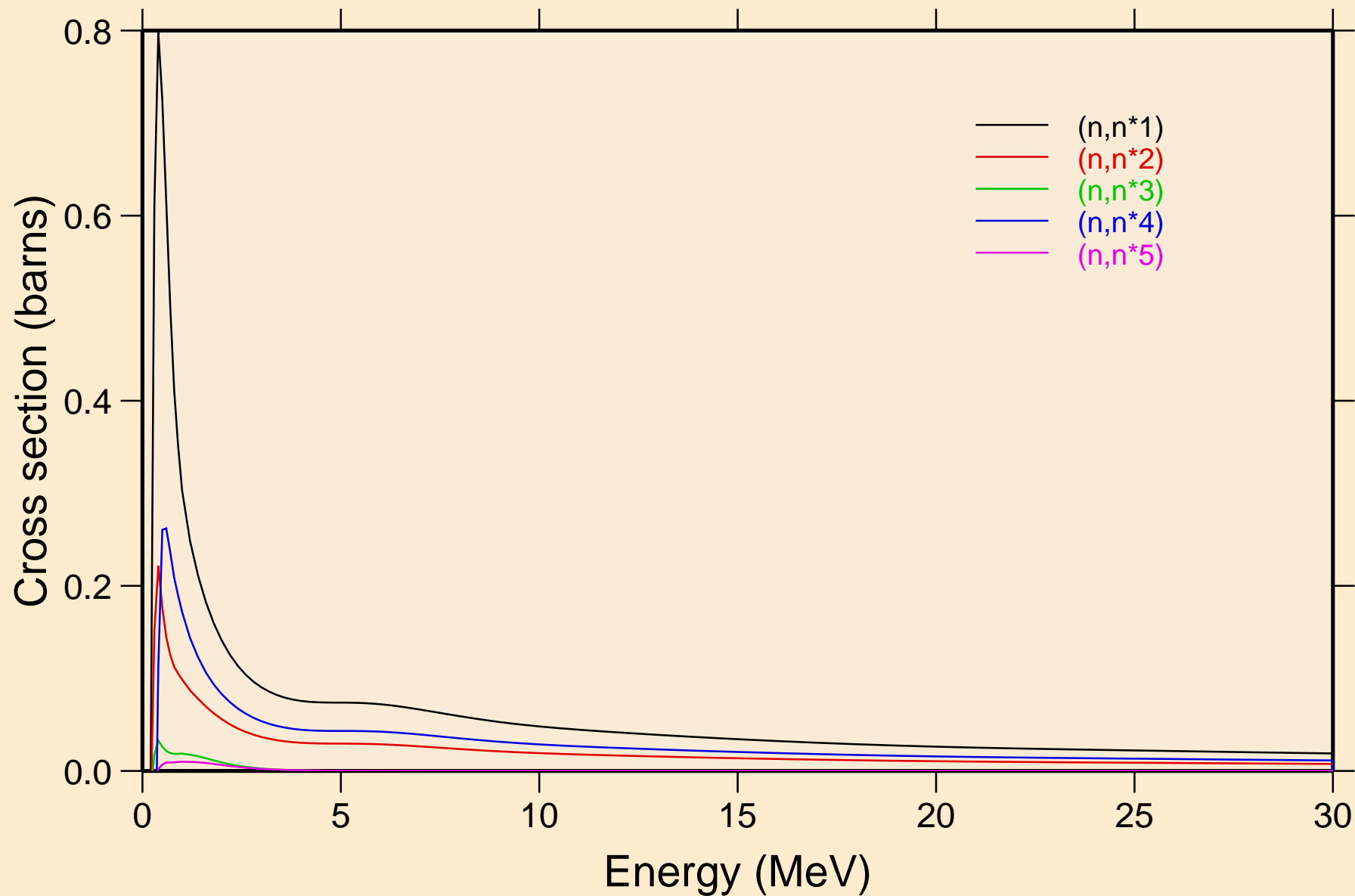

RH109 NEUTRON ACER TENDL-2019 LIBRARY; T=293.16K  
Inelastic levels

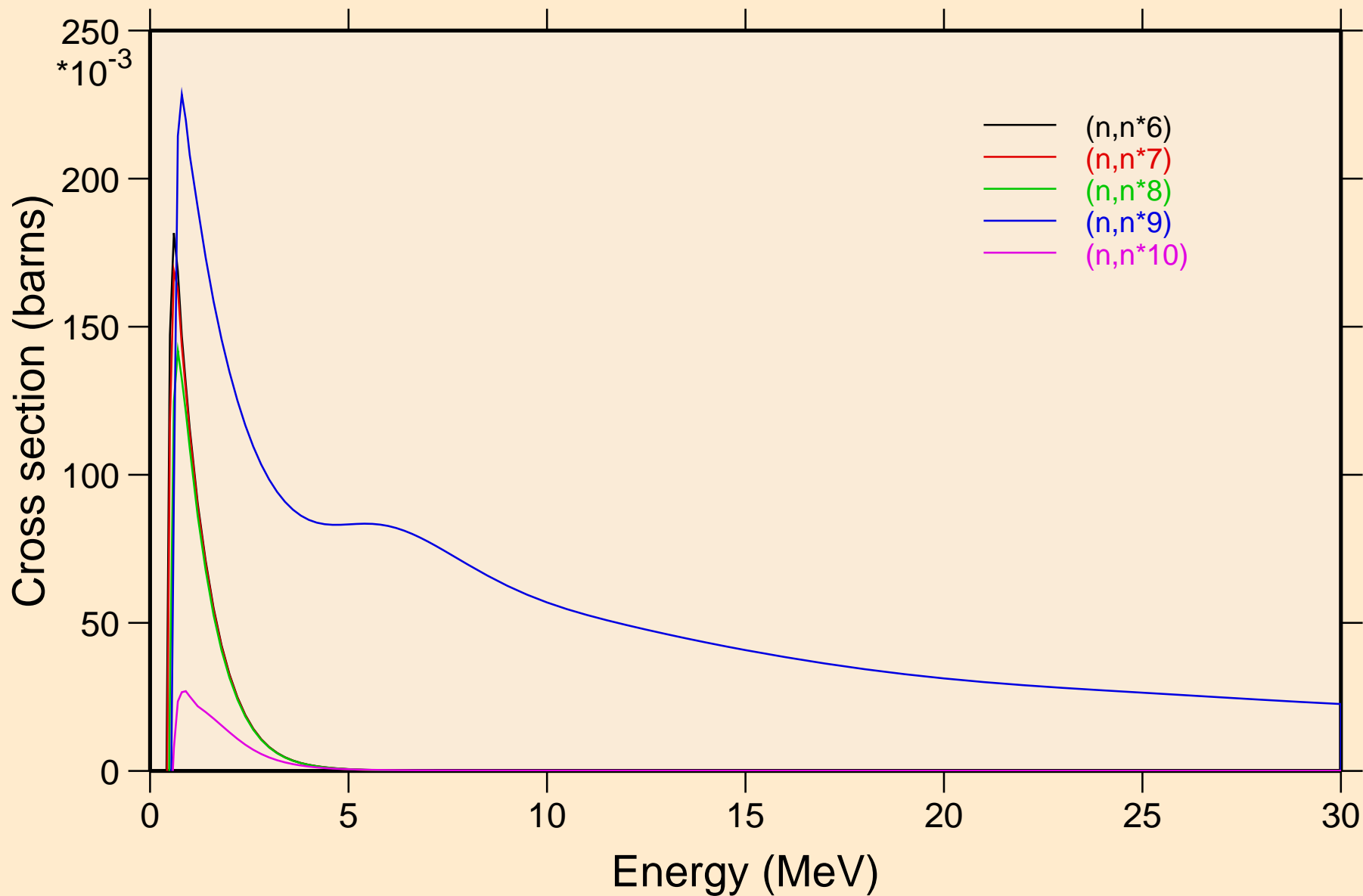

RH109 NEUTRON ACER TENDL-2019 LIBRARY; T=293.16K  
Inelastic levels

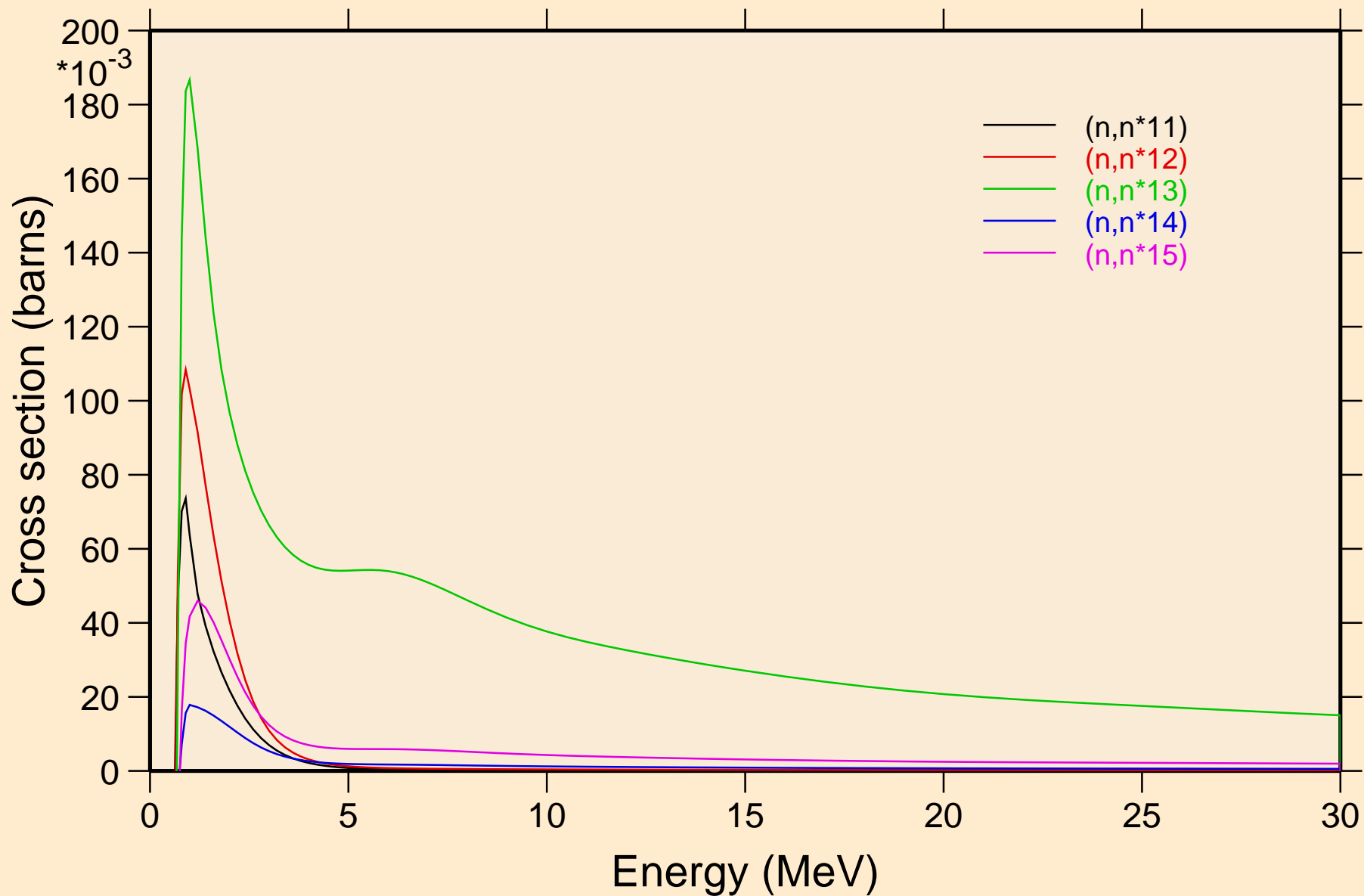

RH109 NEUTRON ACER TENDL-2019 LIBRARY; T=293.16K  
Inelastic levels

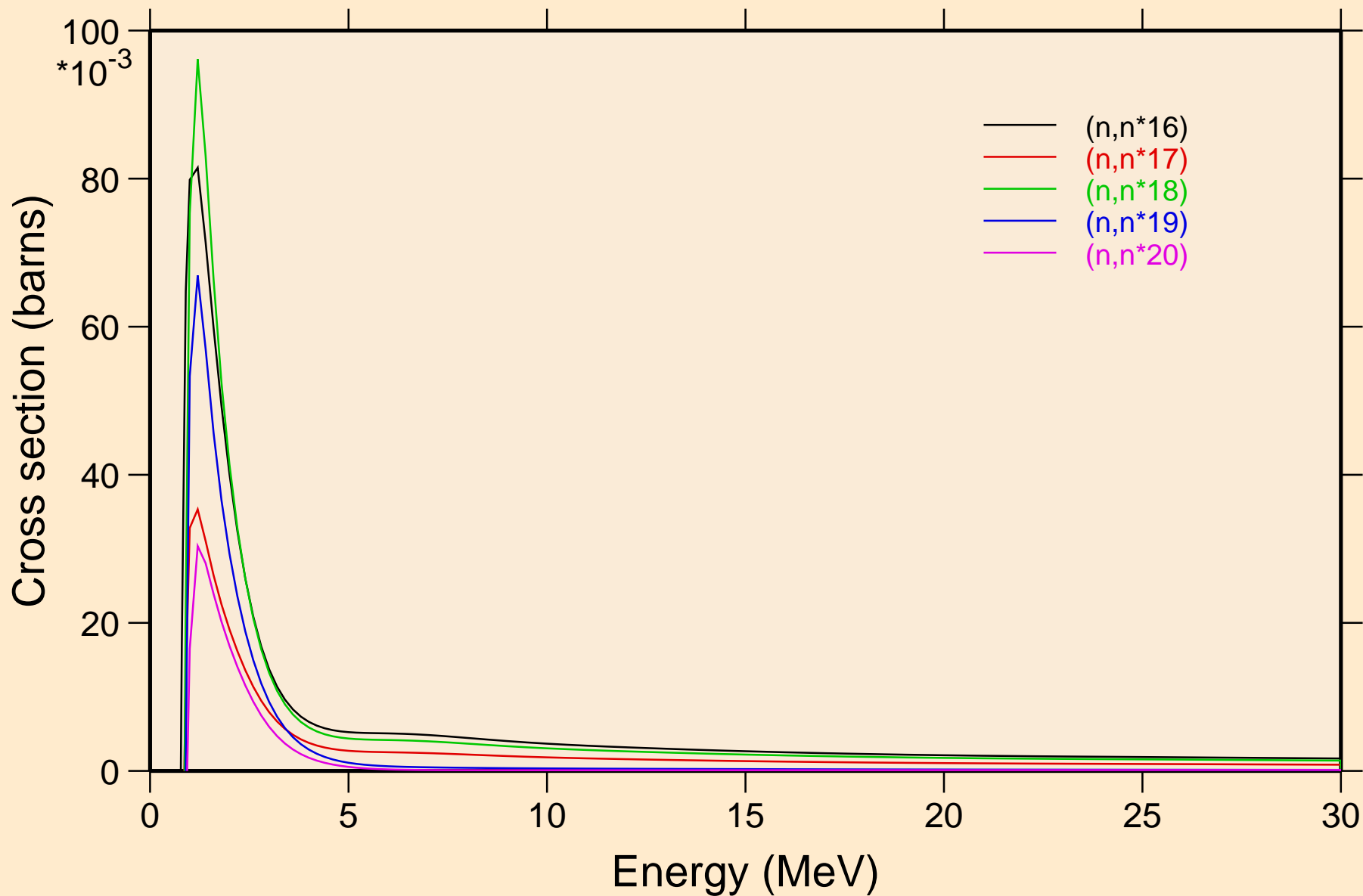

RH109 NEUTRON ACER TENDL-2019 LIBRARY; T=293.16K  
Inelastic levels

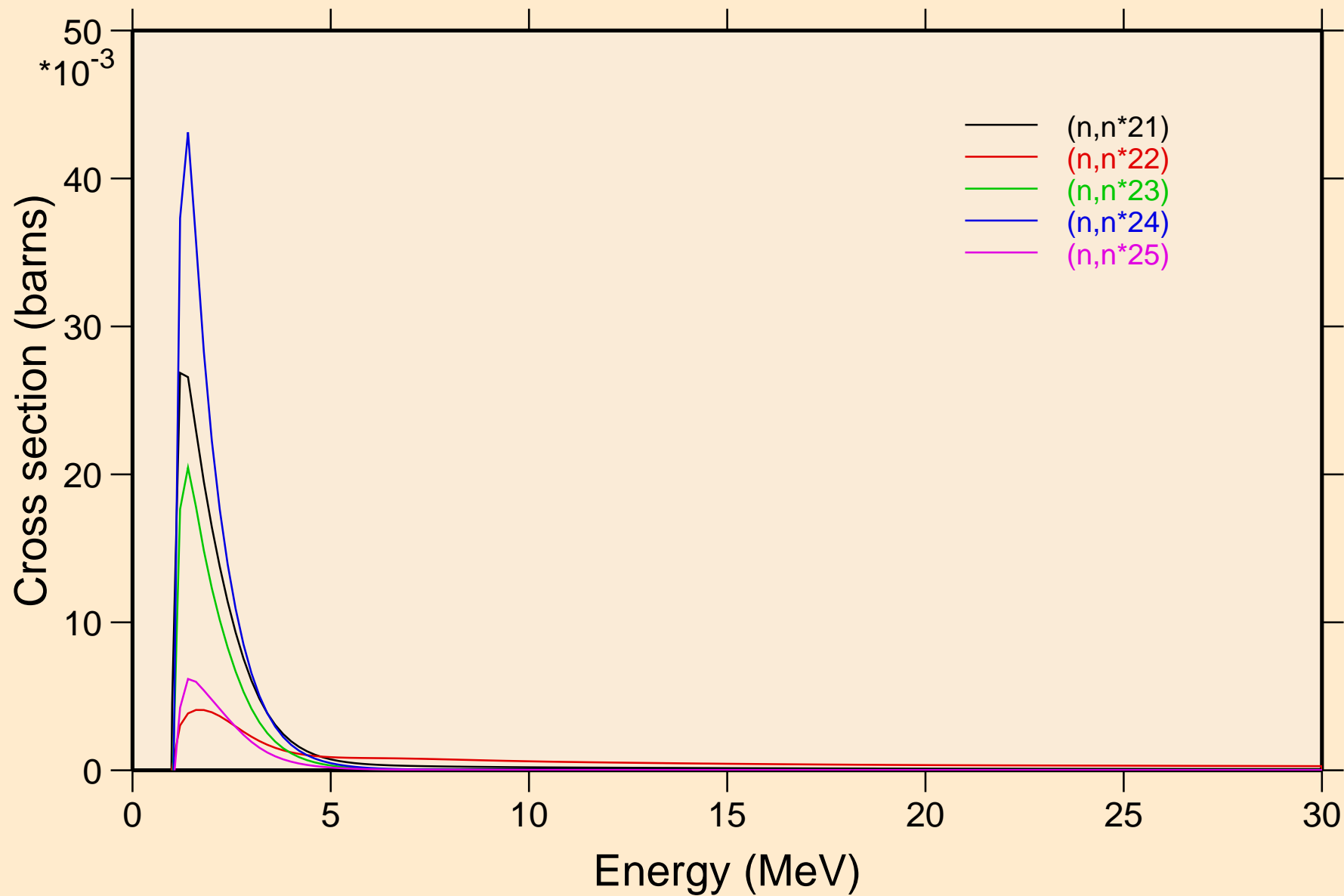

RH109 NEUTRON ACER TENDL-2019 LIBRARY; T=293.16K  
Inelastic levels

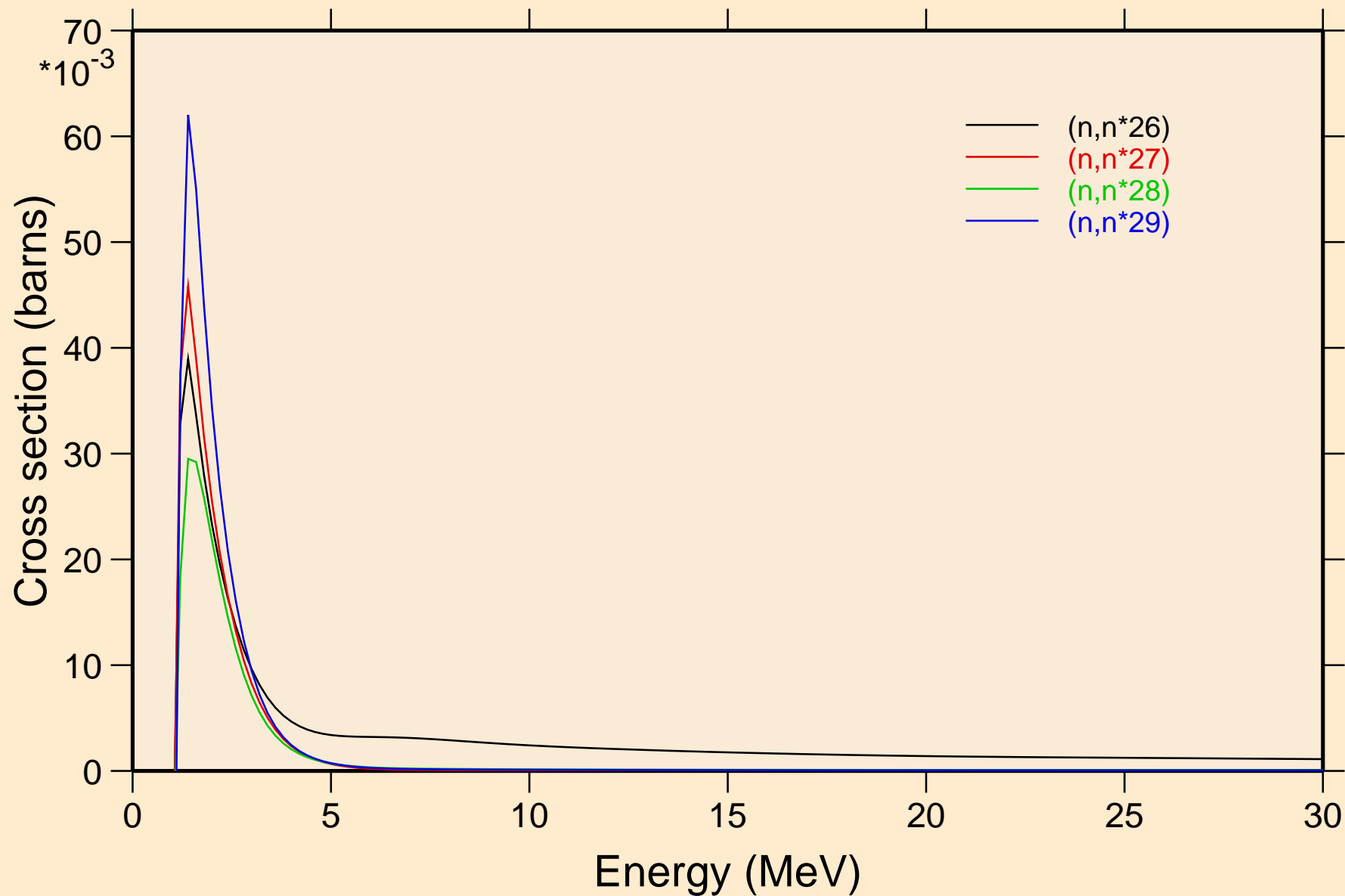

RH109 NEUTRON ACER TENDL-2019 LIBRARY; T=293.16K  
Threshold reactions

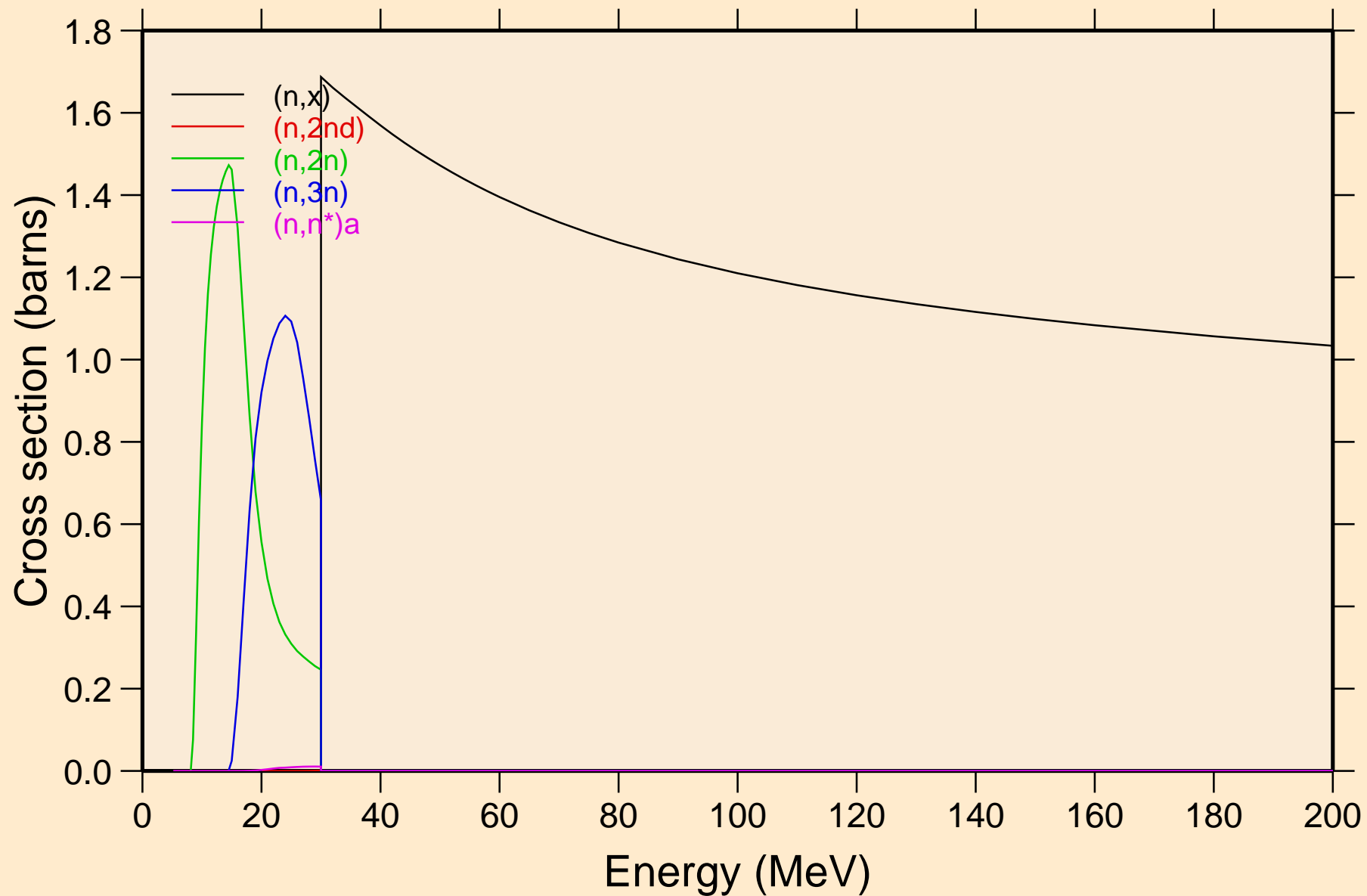

RH109 NEUTRON ACER TENDL-2019 LIBRARY; T=293.16K  
Threshold reactions

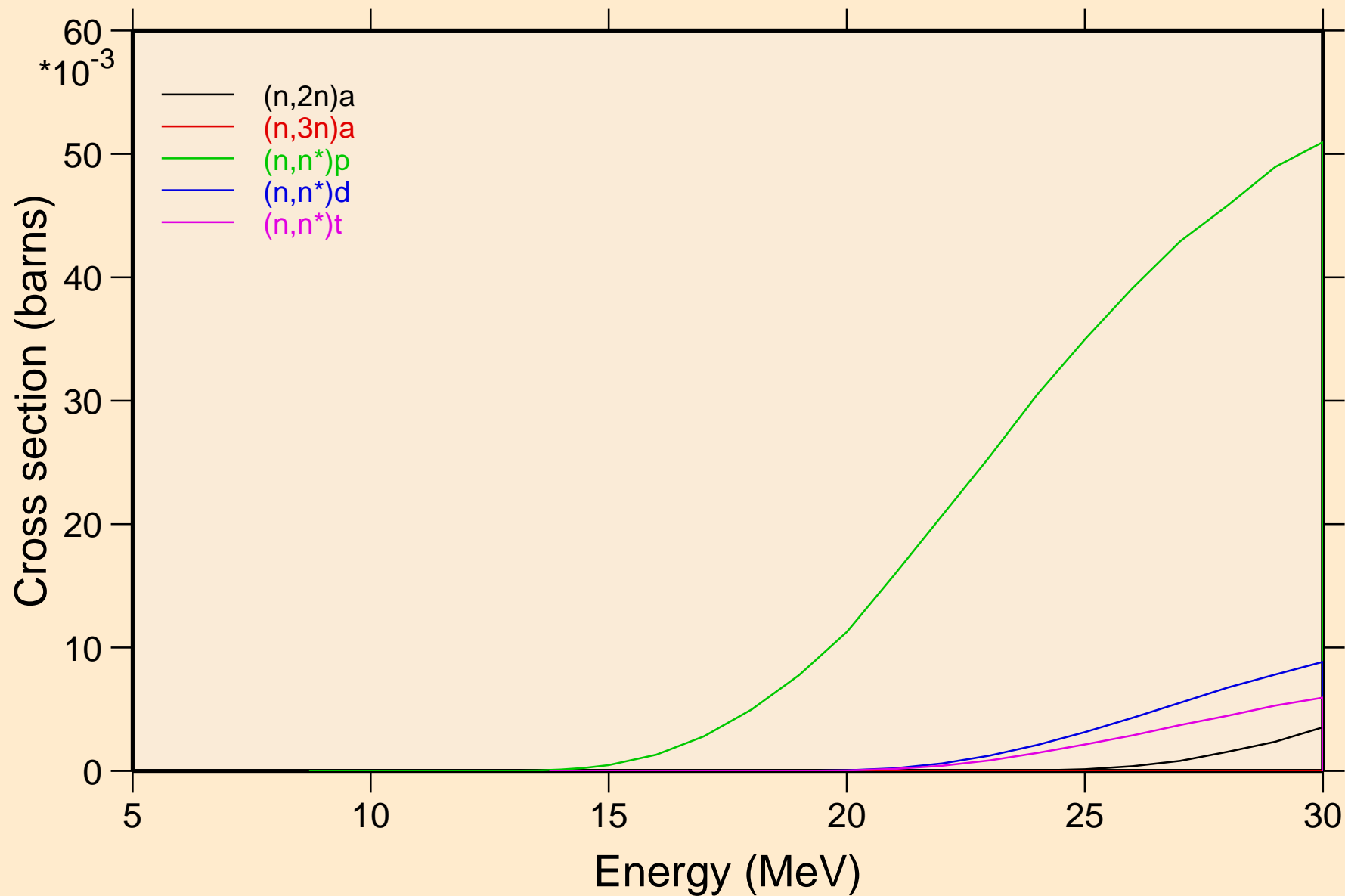



RH109 NEUTRON ACER TENDL-2019 LIBRARY; T=293.16K  
Threshold reactions

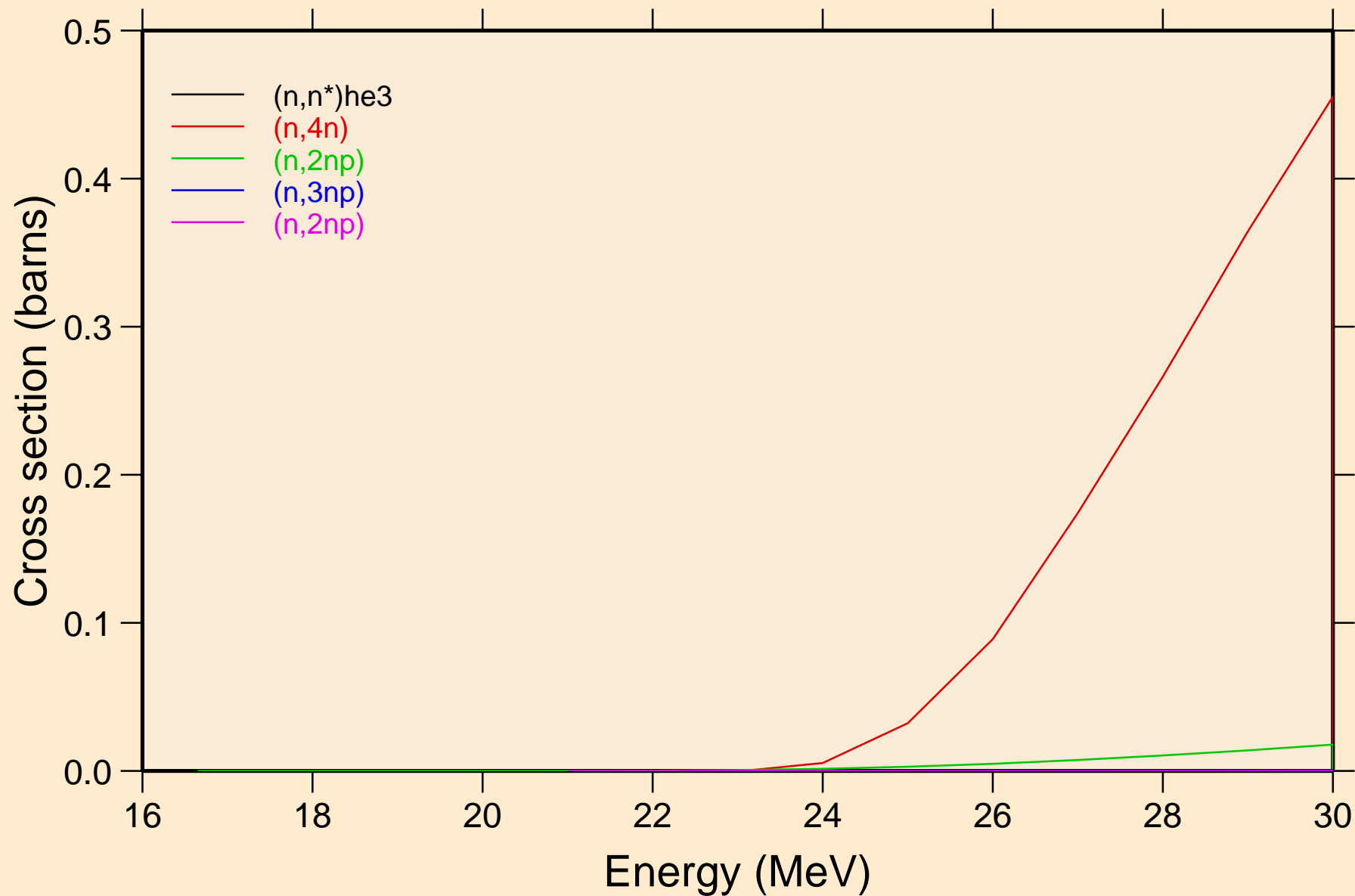

RH109 NEUTRON ACER TENDL-2019 LIBRARY; T=293.16K  
Threshold reactions

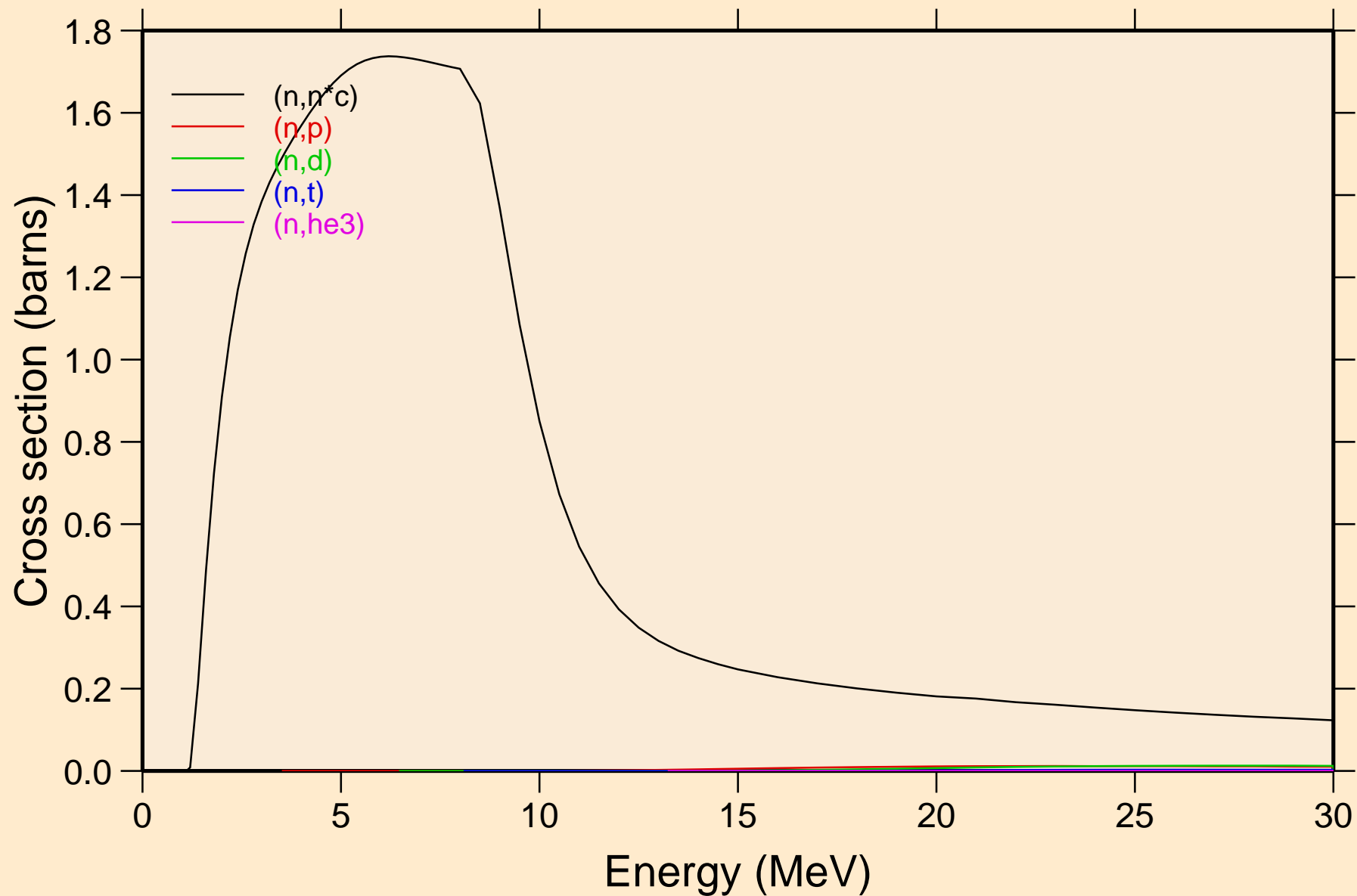

RH109 NEUTRON ACER TENDL-2019 LIBRARY; T=293.16K  
Threshold reactions

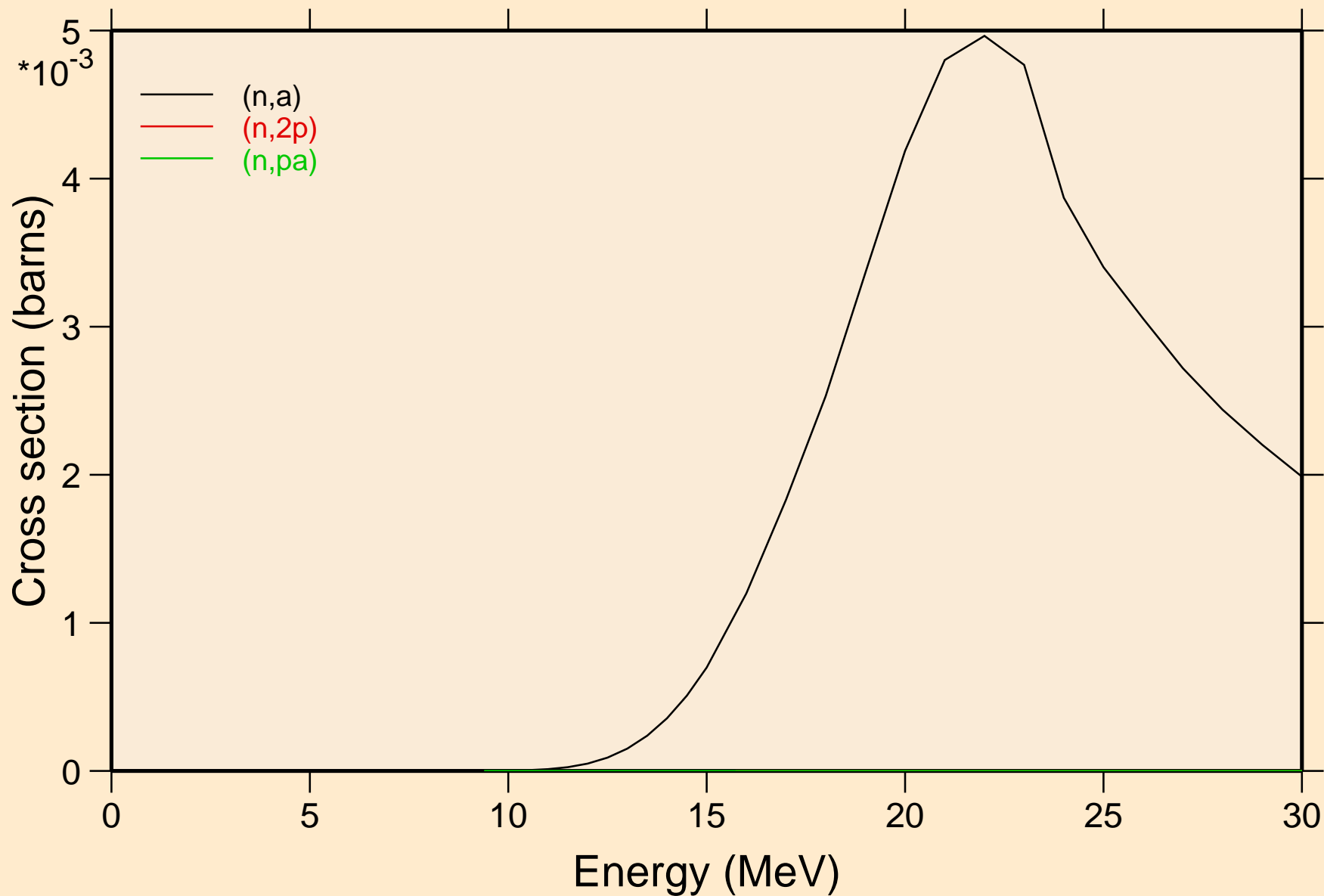

RH109 NEUTRON ACER TENDL-2019 LIBRARY; T=293.16K  
Threshold reactions

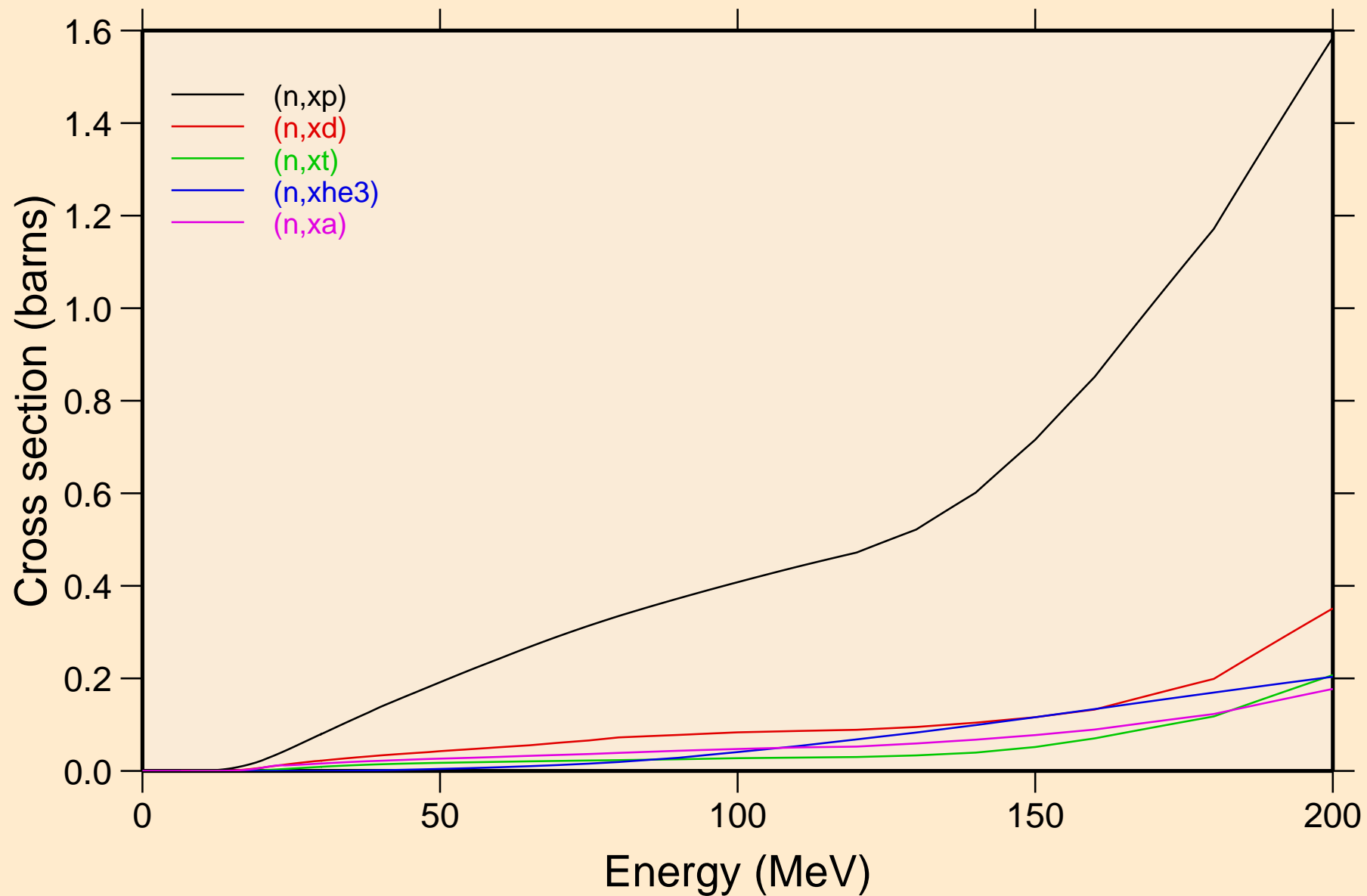

RH109 NEUTRON ACER TENDL-2019 LIBRARY; T=293.16K  
angular distribution for elastic

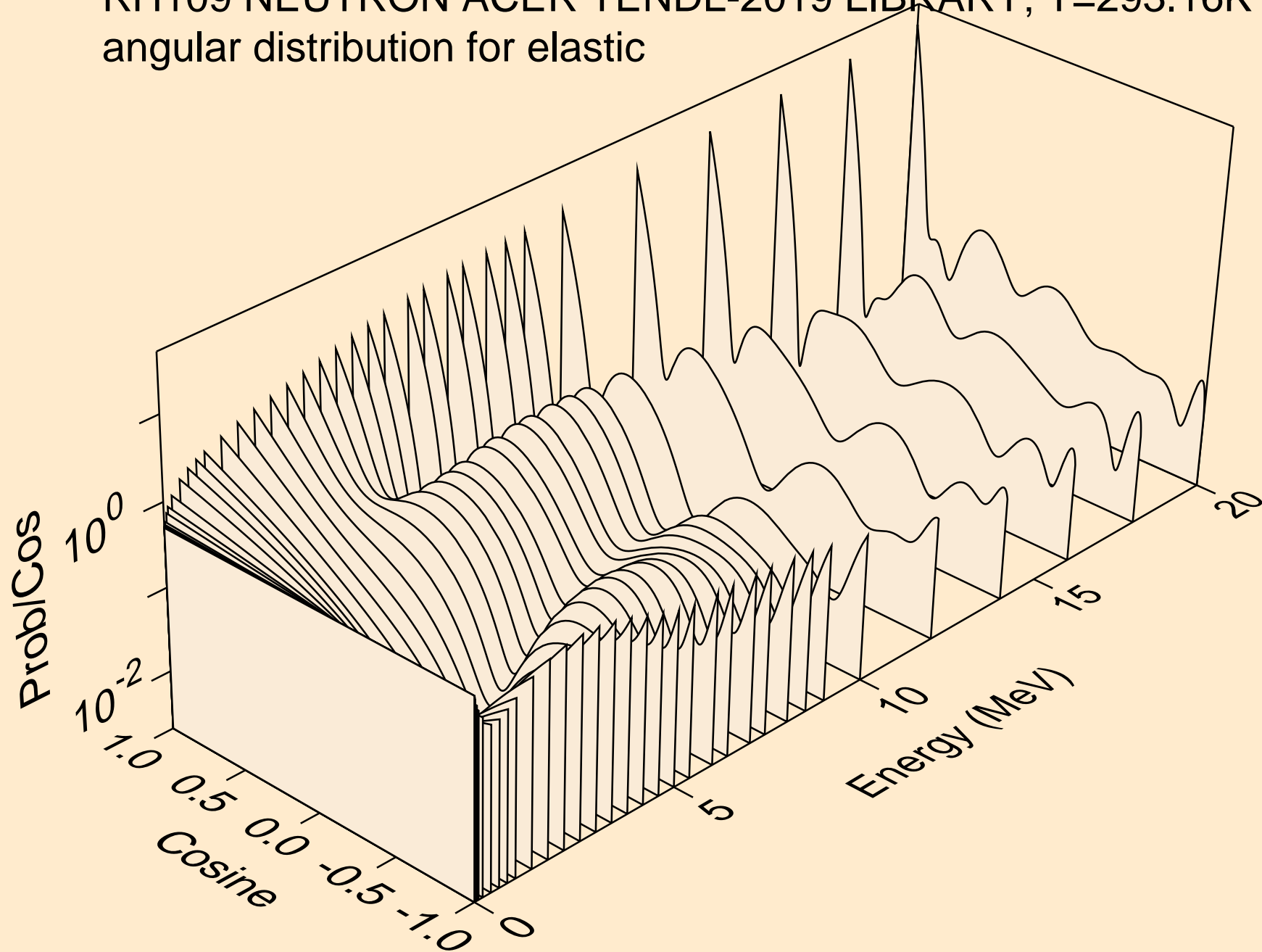

RH109 NEUTRON ACER TENDL-2019 LIBRARY; T=293.16K  
angular distribution for elastic

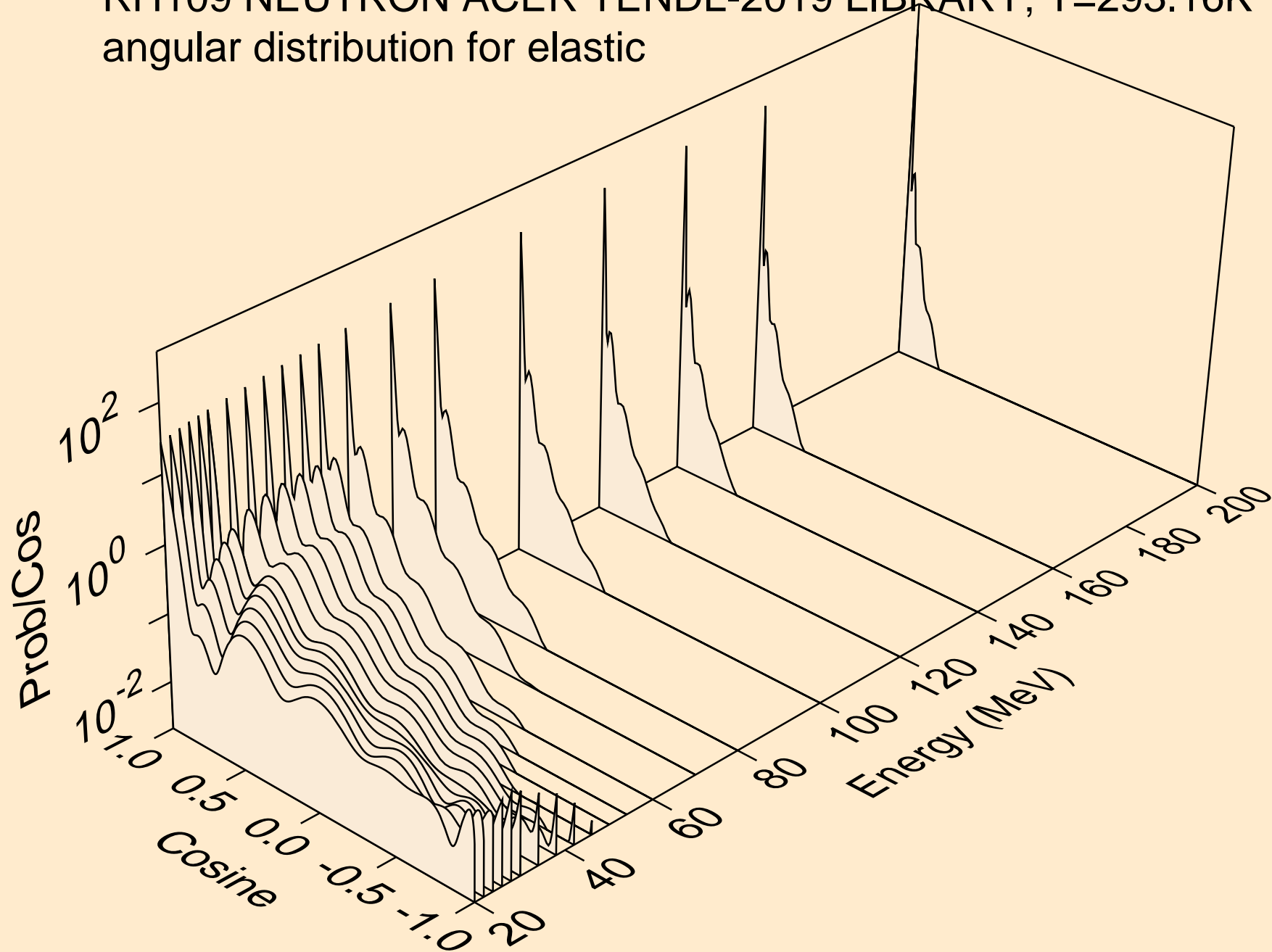

RH109 NEUTRON ACER TENDL-2019 LIBRARY; T=293.16K  
angular distribution for (n,n\*1)

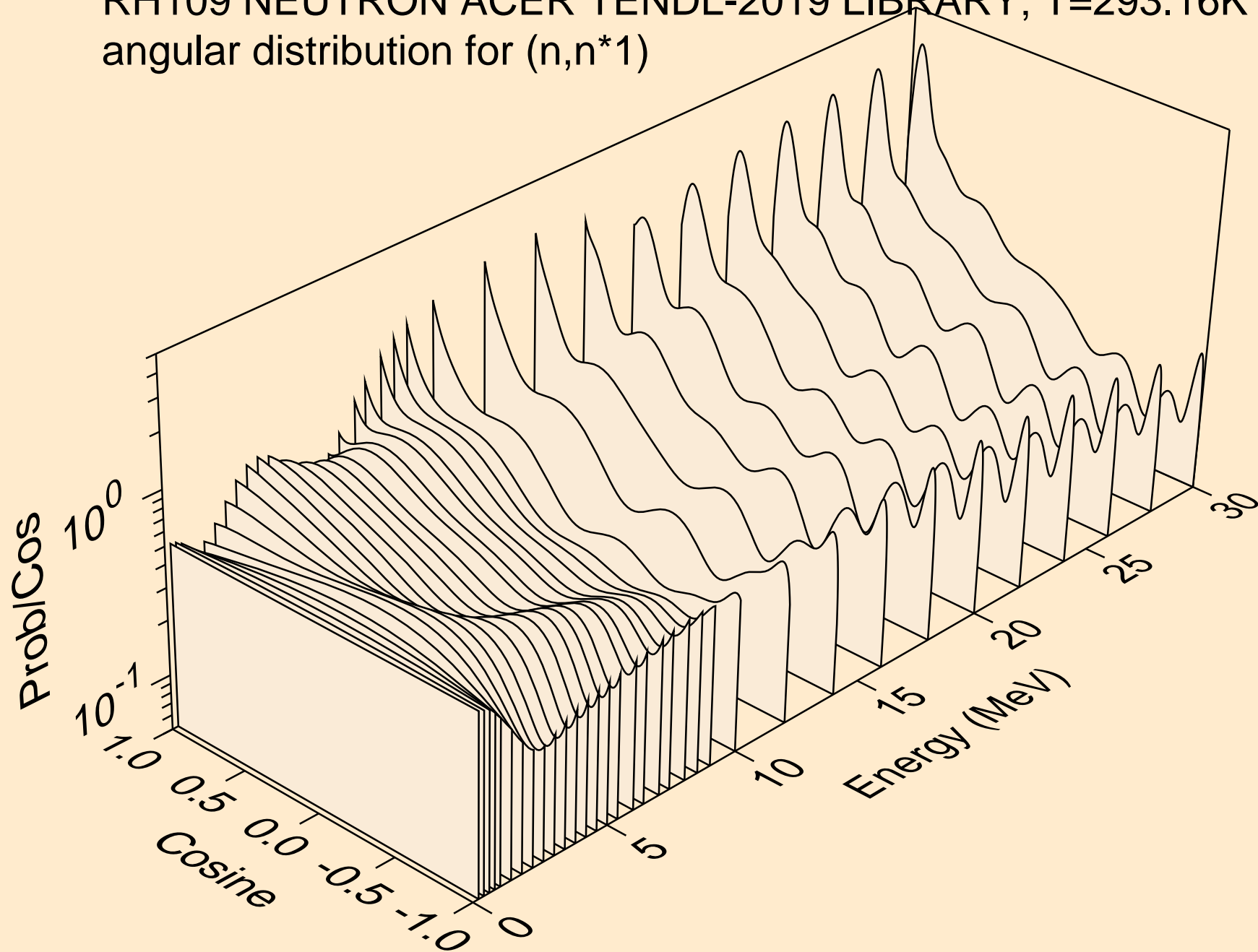

RH109 NEUTRON ACER TENDL-2019 LIBRARY; T=293.16K  
angular distribution for (n,n\*2)

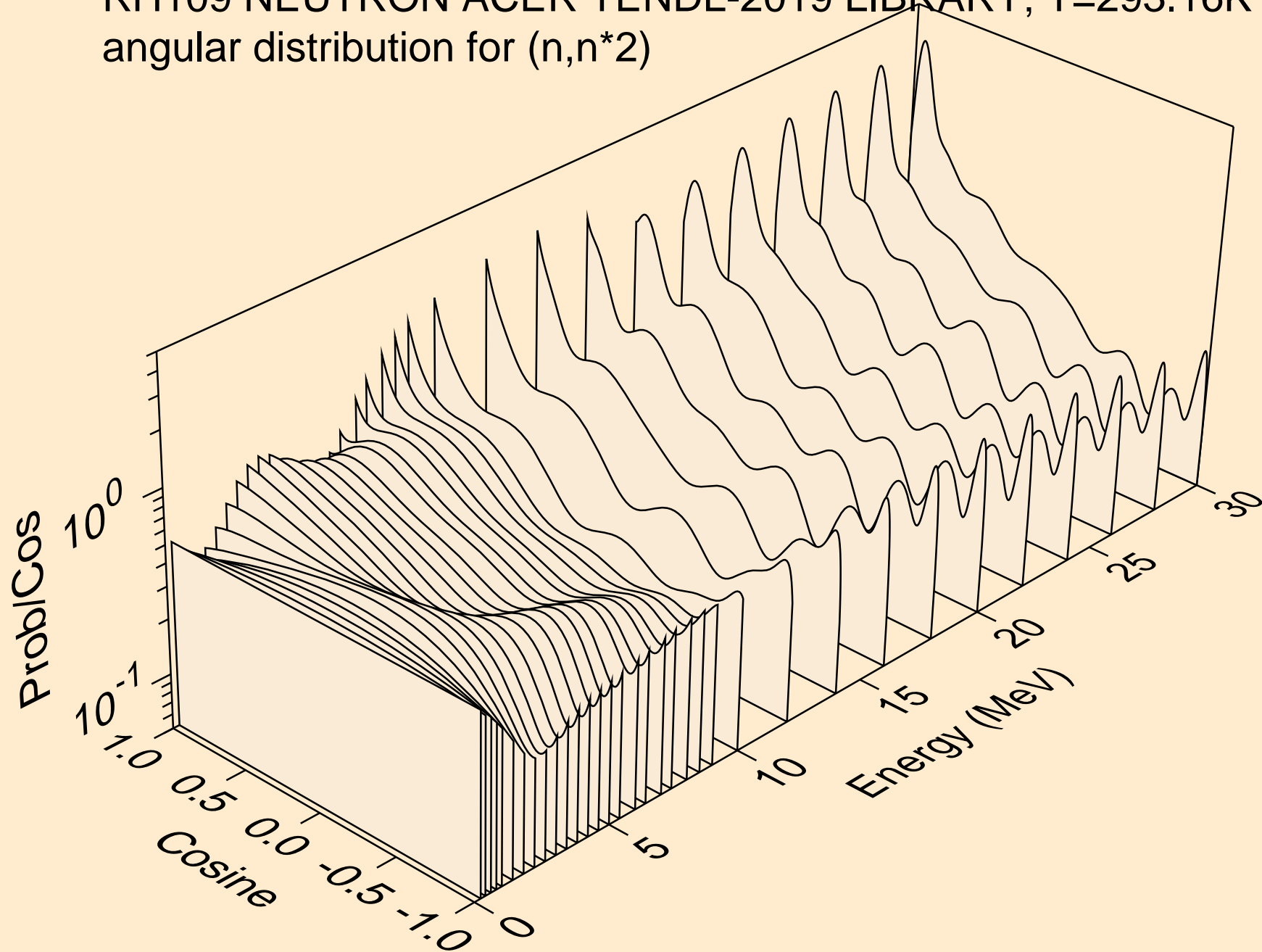



RH109 NEUTRON ACER TENDL-2019 LIBRARY; T=293.16K  
angular distribution for (n,n\*3)

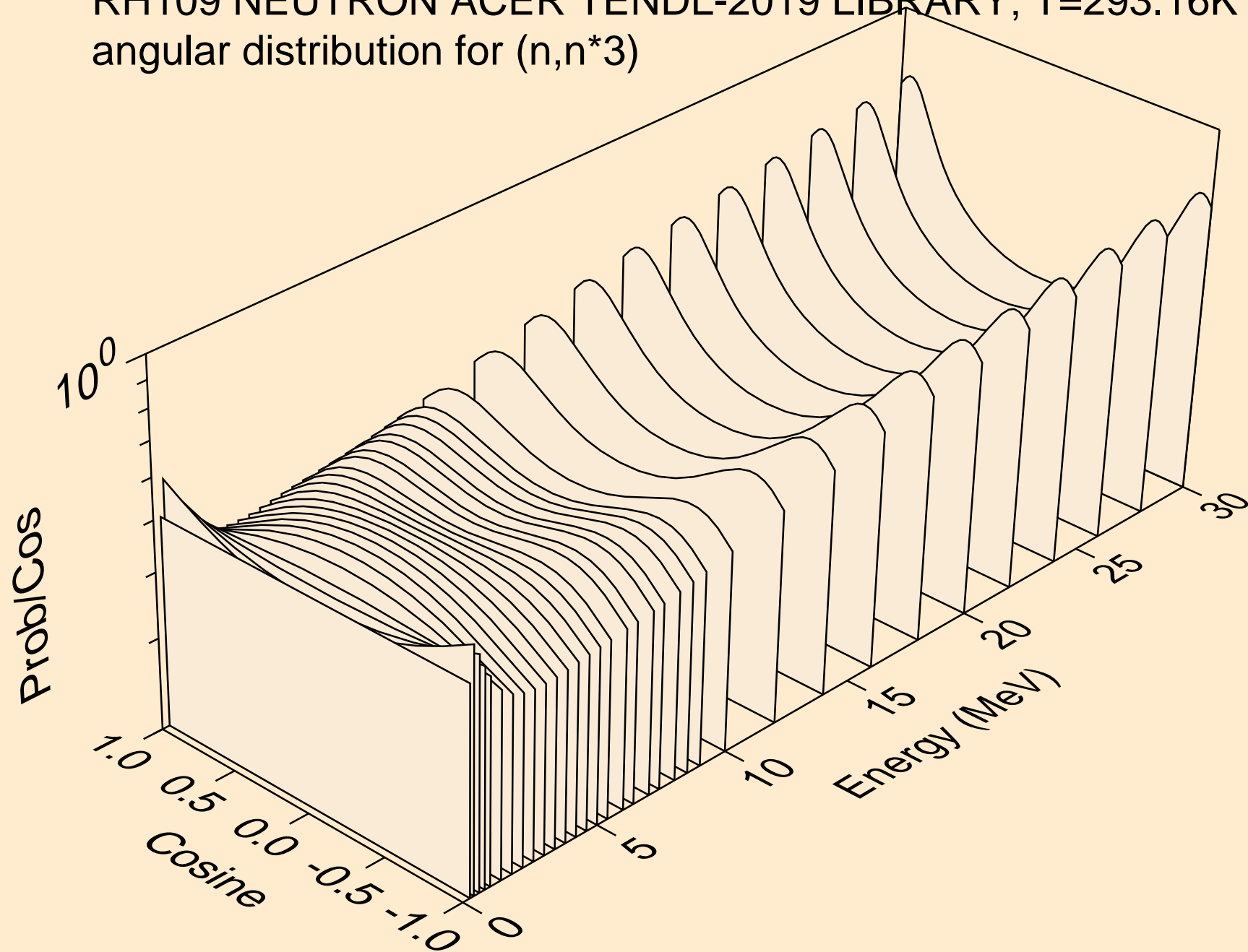

RH109 NEUTRON ACER TENDL-2019 LIBRARY; T=293.16K  
angular distribution for (n,n\*4)

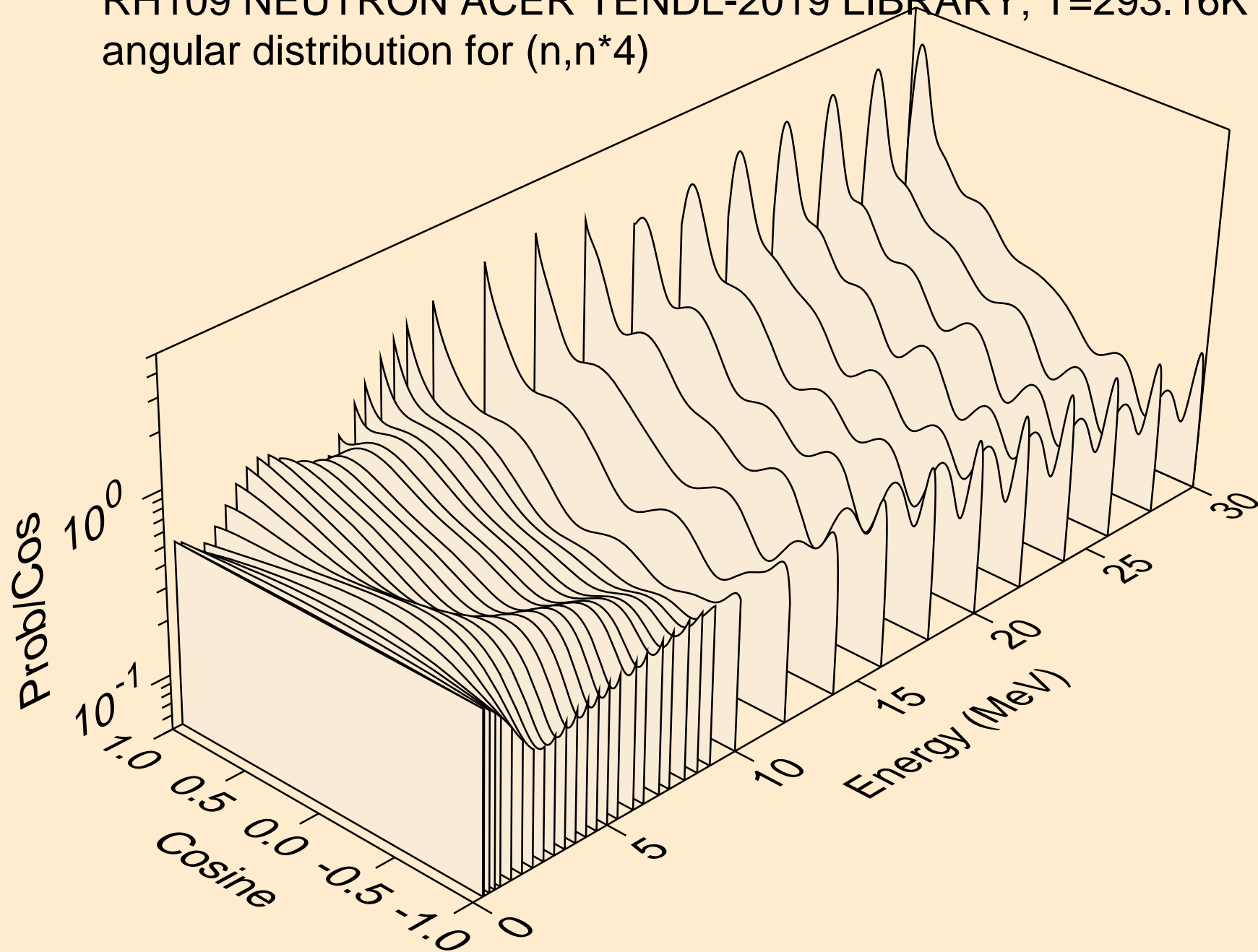

RH109 NEUTRON ACER TENDL-2019 LIBRARY; T=293.16K  
angular distribution for (n,n\*5)

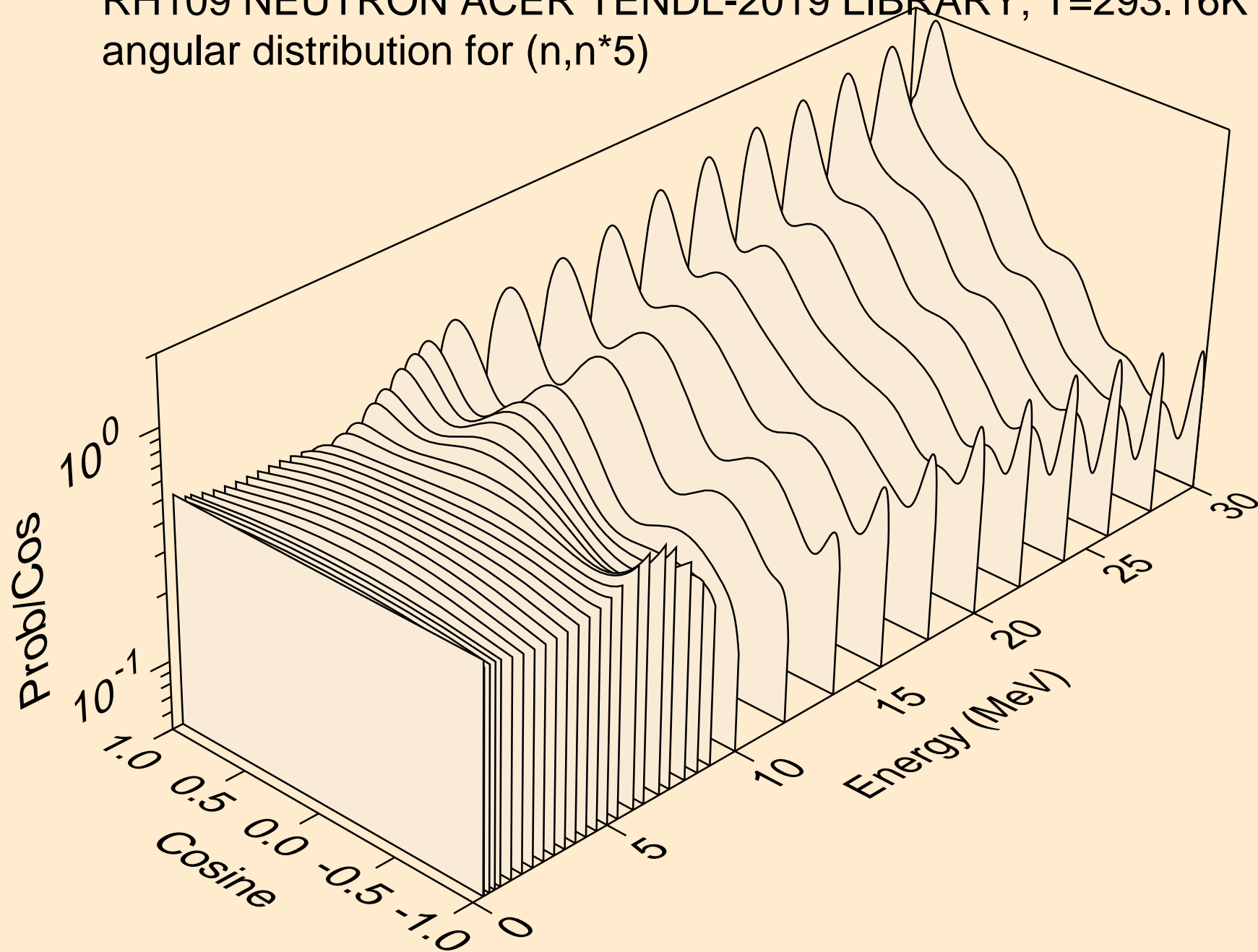

RH109 NEUTRON ACER TENDL-2019 LIBRARY; T=293.16K  
angular distribution for (n,n\*6)

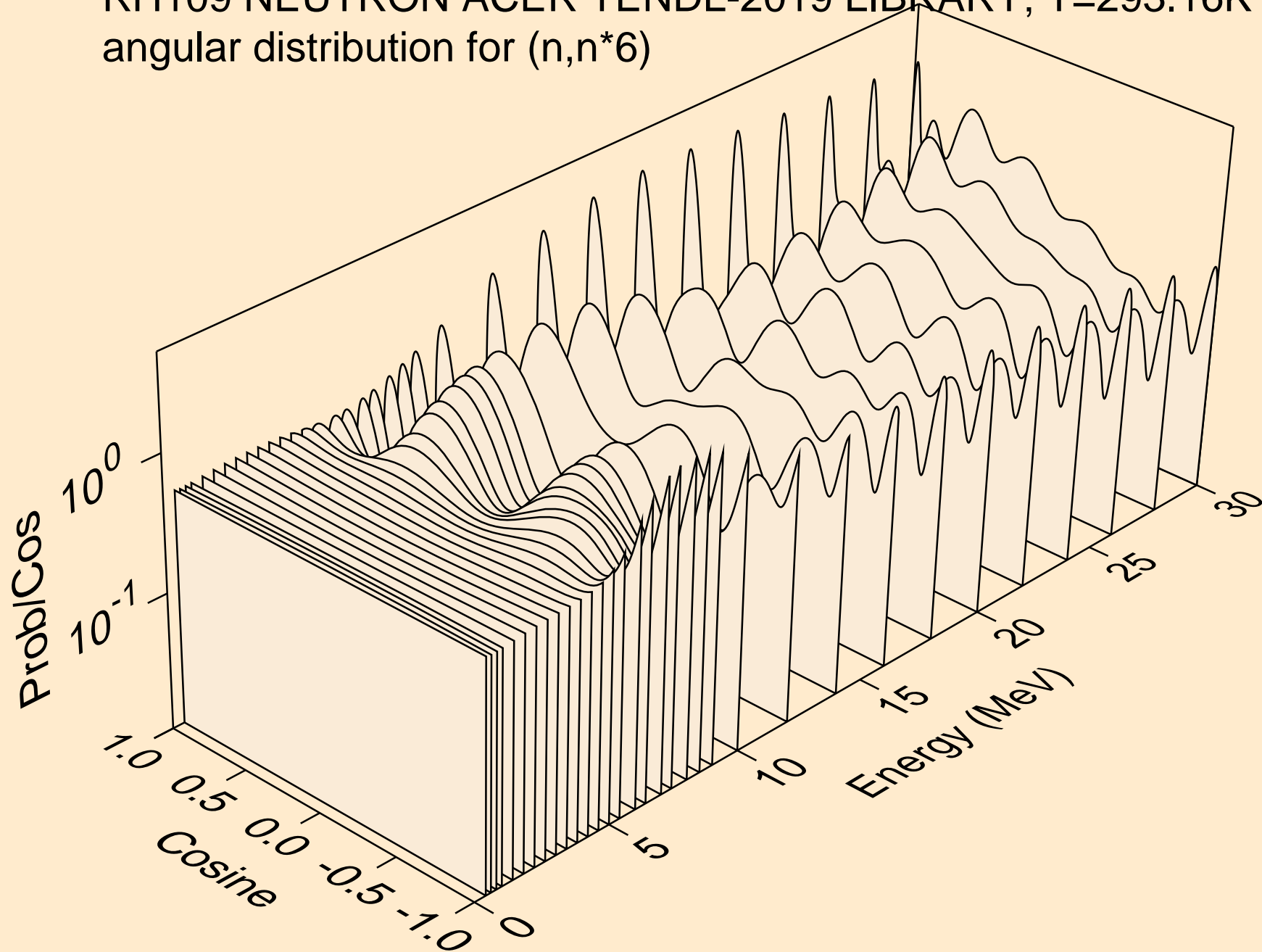

RH109 NEUTRON ACER TENDL-2019 LIBRARY; T=293.16K  
angular distribution for (n,n\*7)

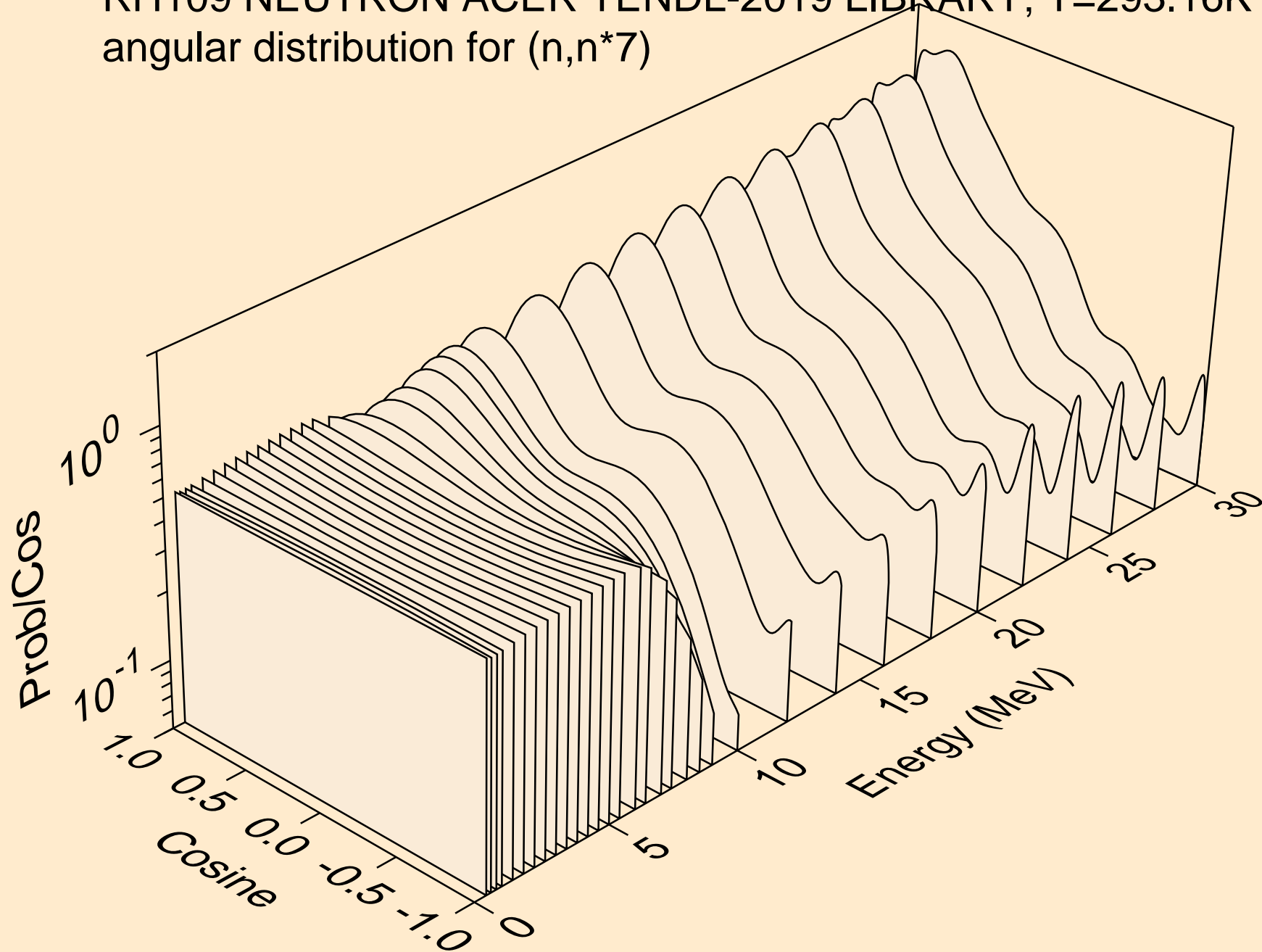

RH109 NEUTRON ACER TENDL-2019 LIBRARY; T=293.16K  
angular distribution for (n,n\*8)

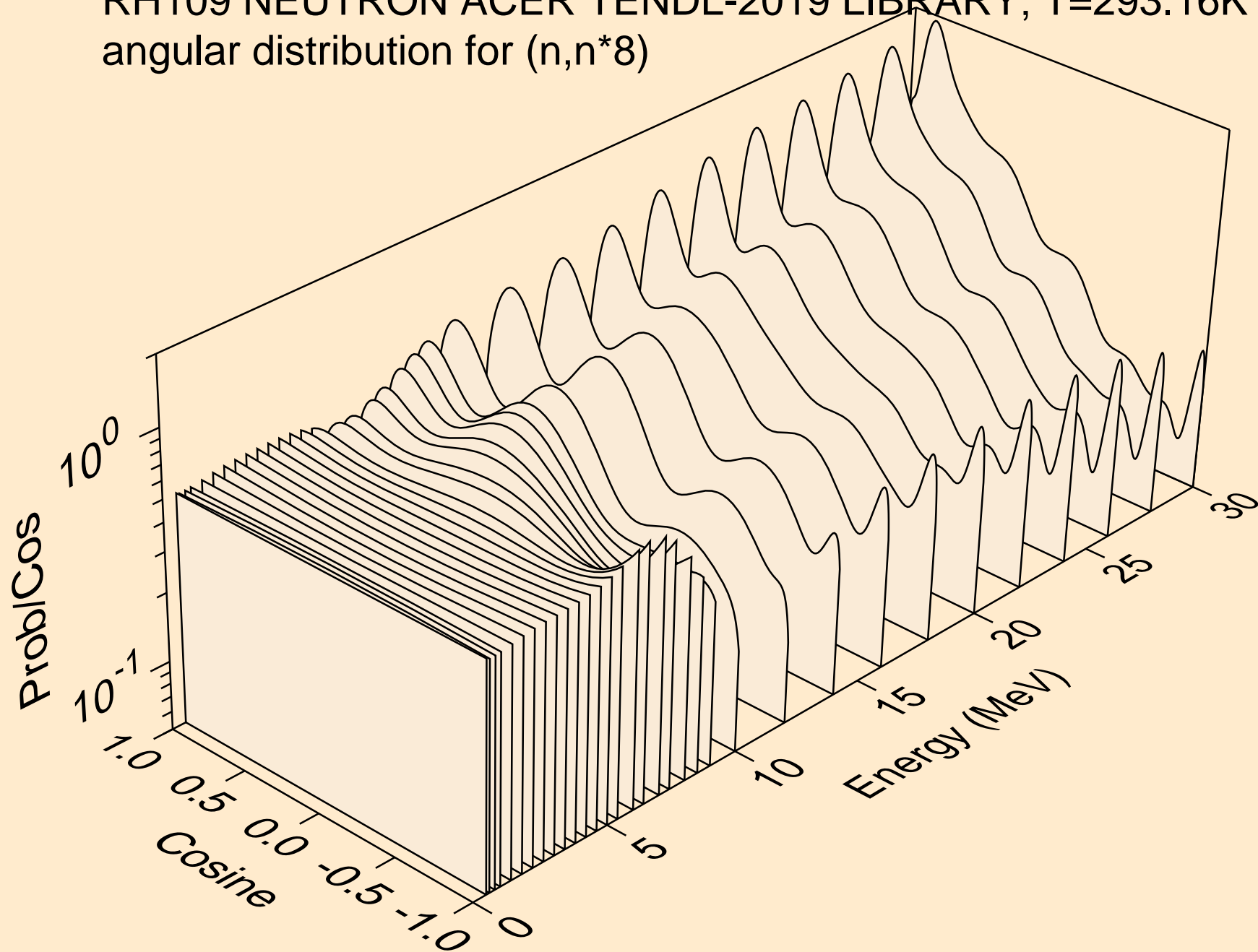

RH109 NEUTRON ACER TENDL-2019 LIBRARY; T=293.16K  
angular distribution for (n,n\*9)

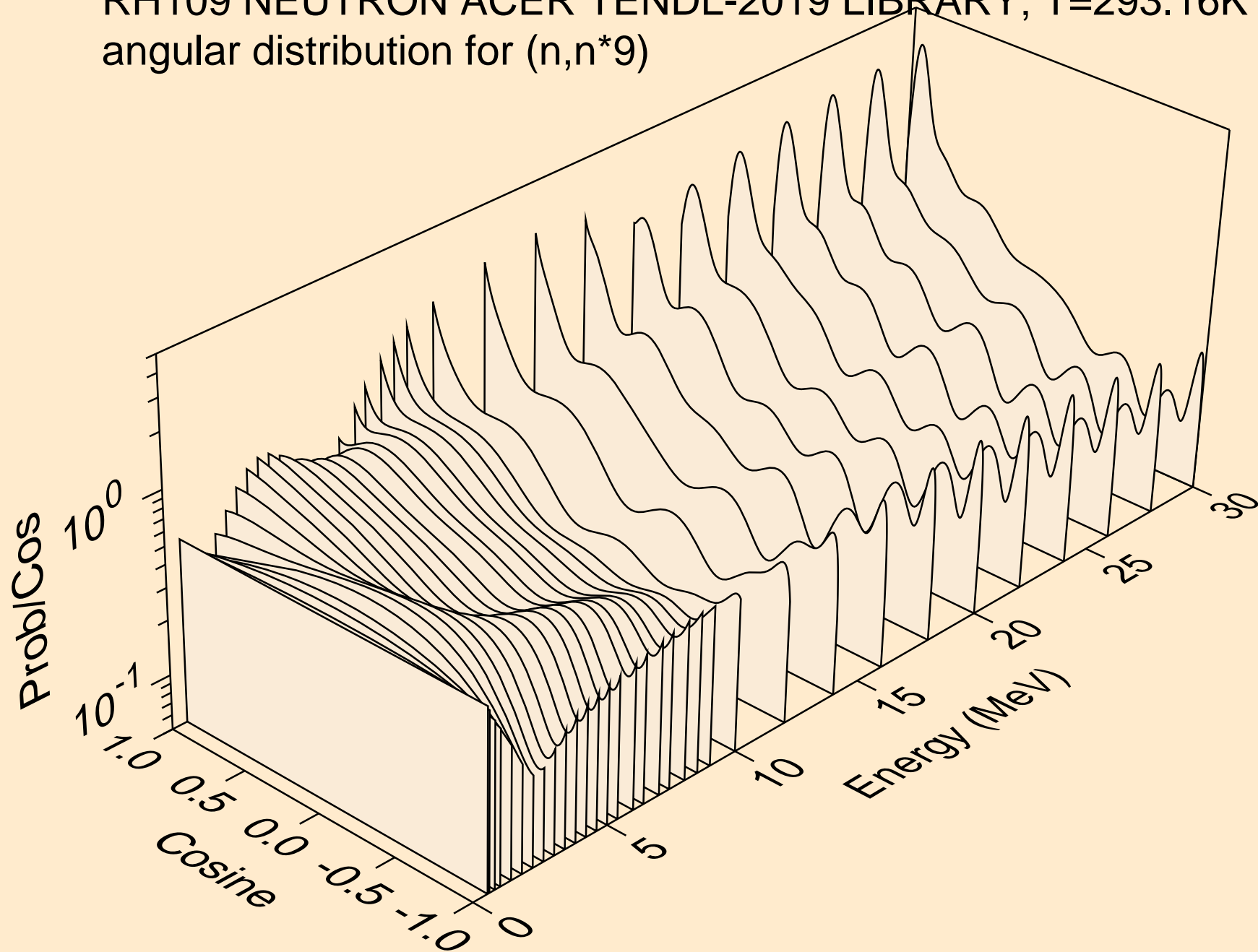

RH109 NEUTRON ACER TENDL-2019 LIBRARY; T=293.16K  
angular distribution for (n,n\*10)

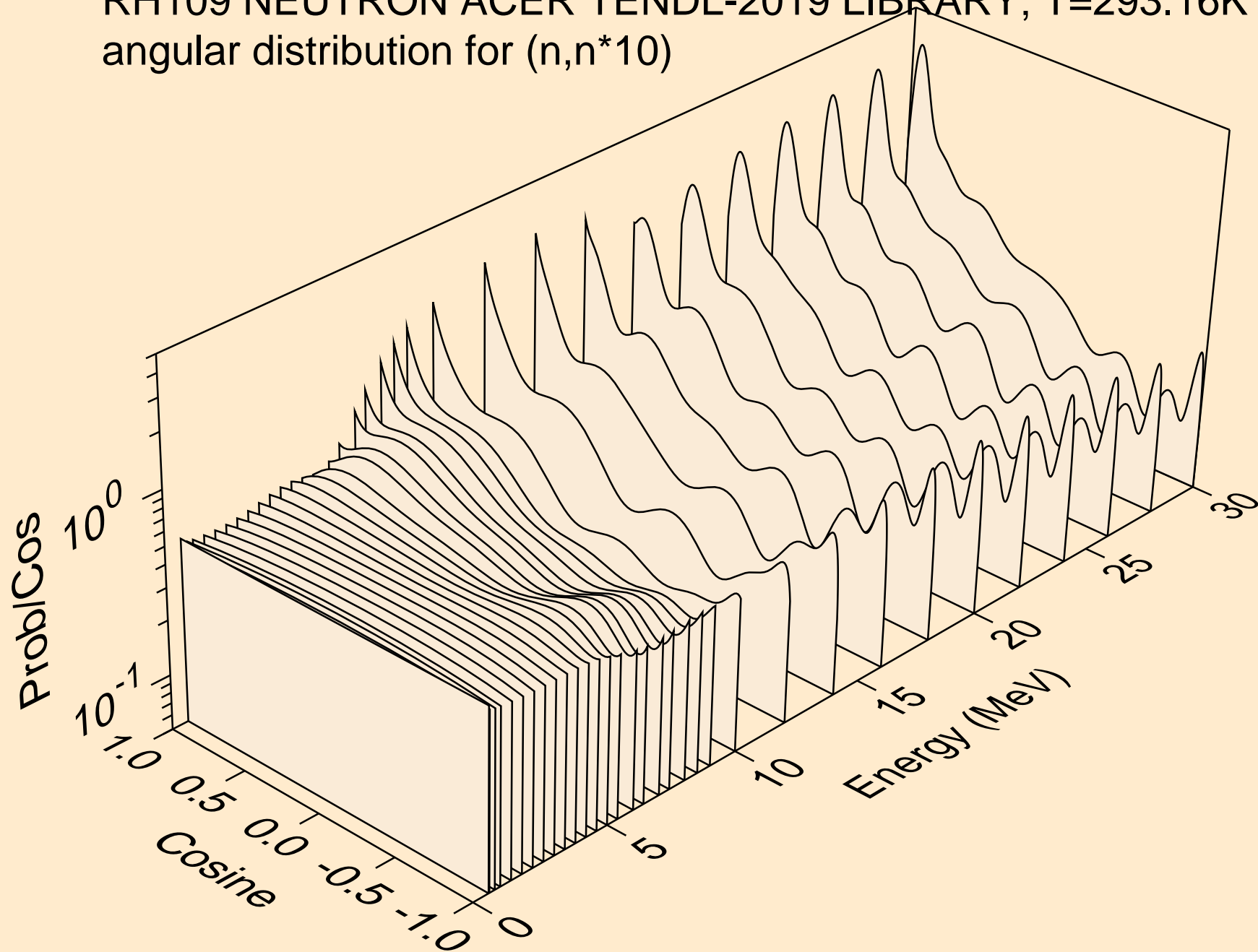



RH109 NEUTRON ACER TENDL-2019 LIBRARY; T=293.16K  
angular distribution for (n,n\*11)

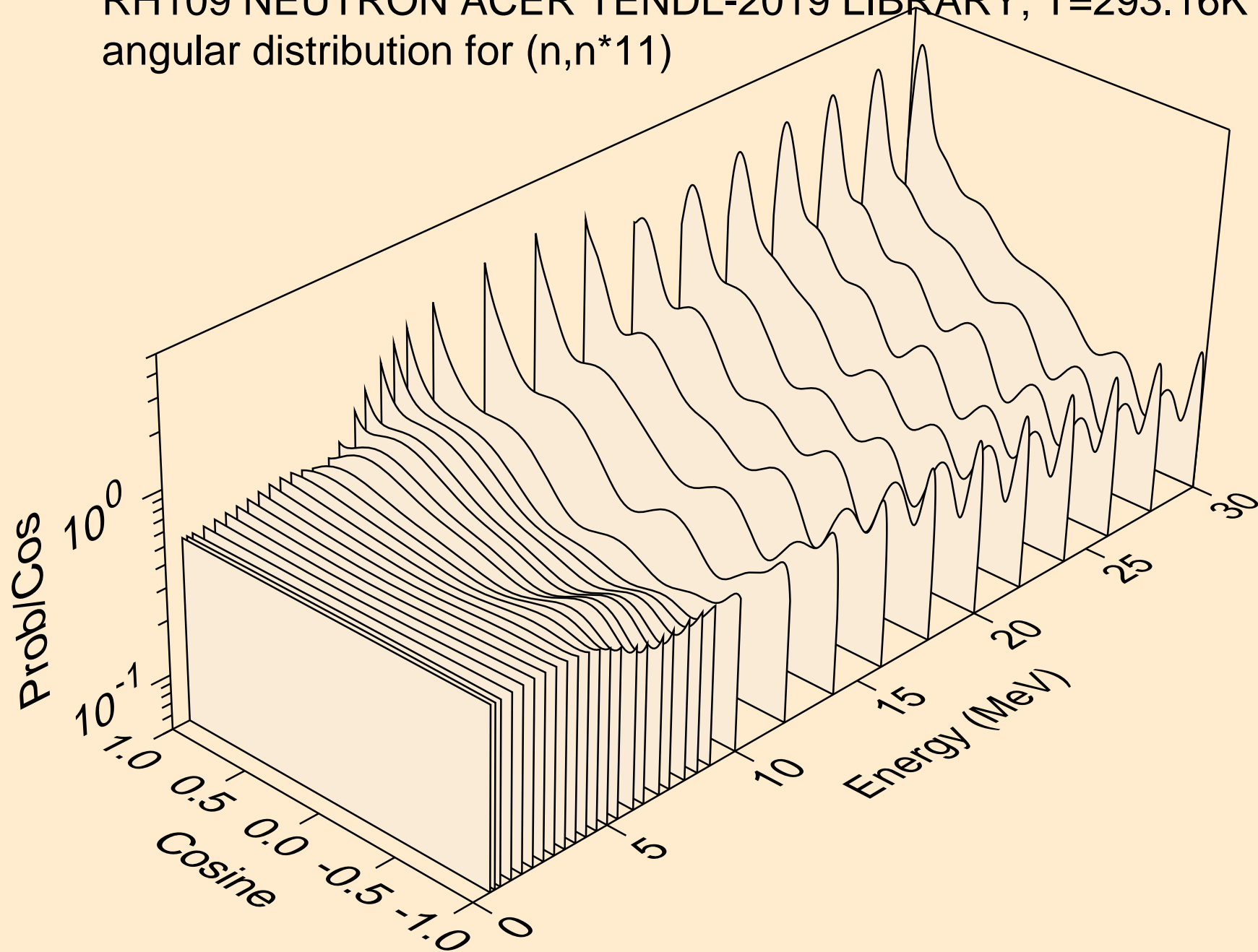

RH109 NEUTRON ACER TENDL-2019 LIBRARY; T=293.16K  
angular distribution for (n,n\*12)

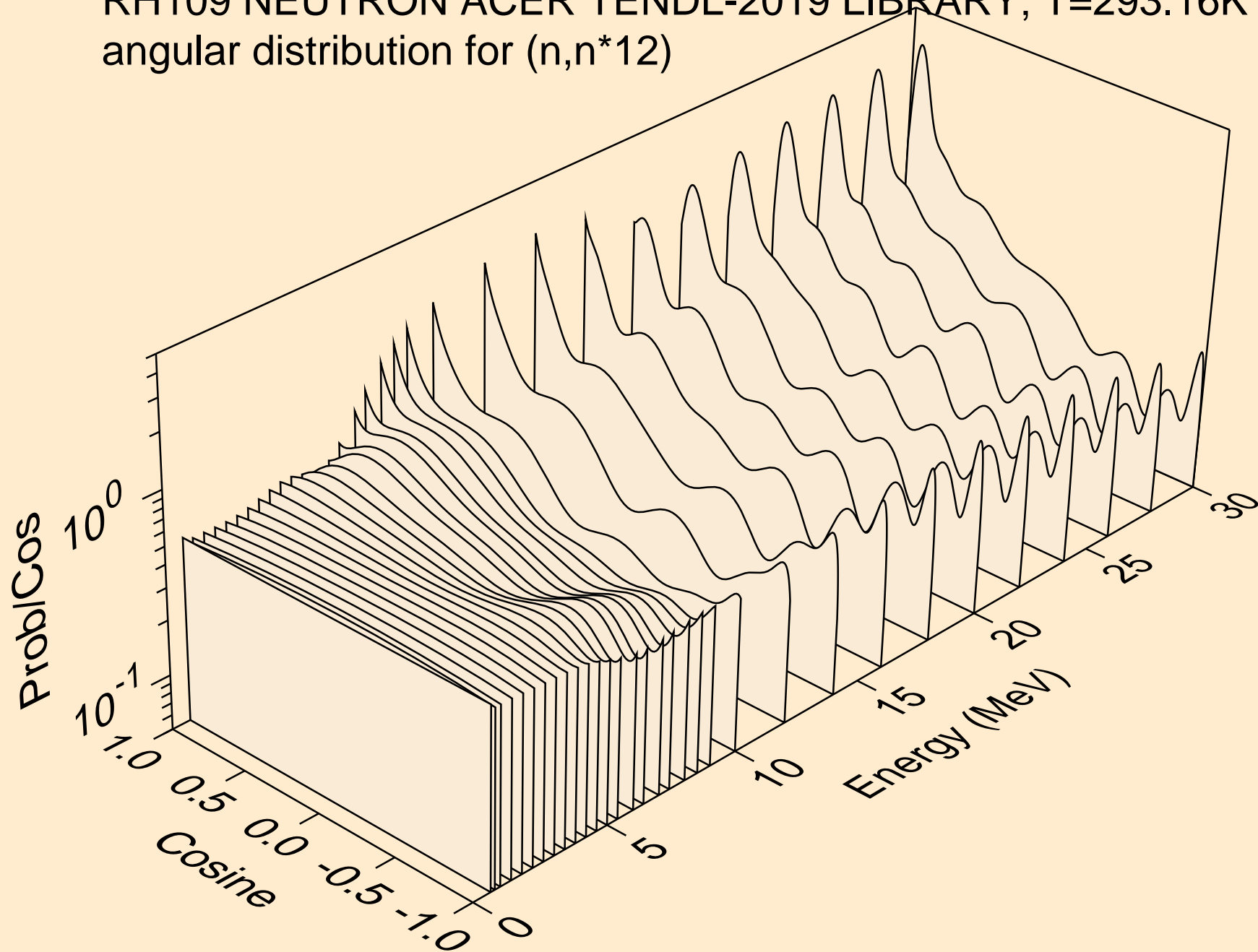

RH109 NEUTRON ACER TENDL-2019 LIBRARY; T=293.16K  
angular distribution for (n,n\*13)

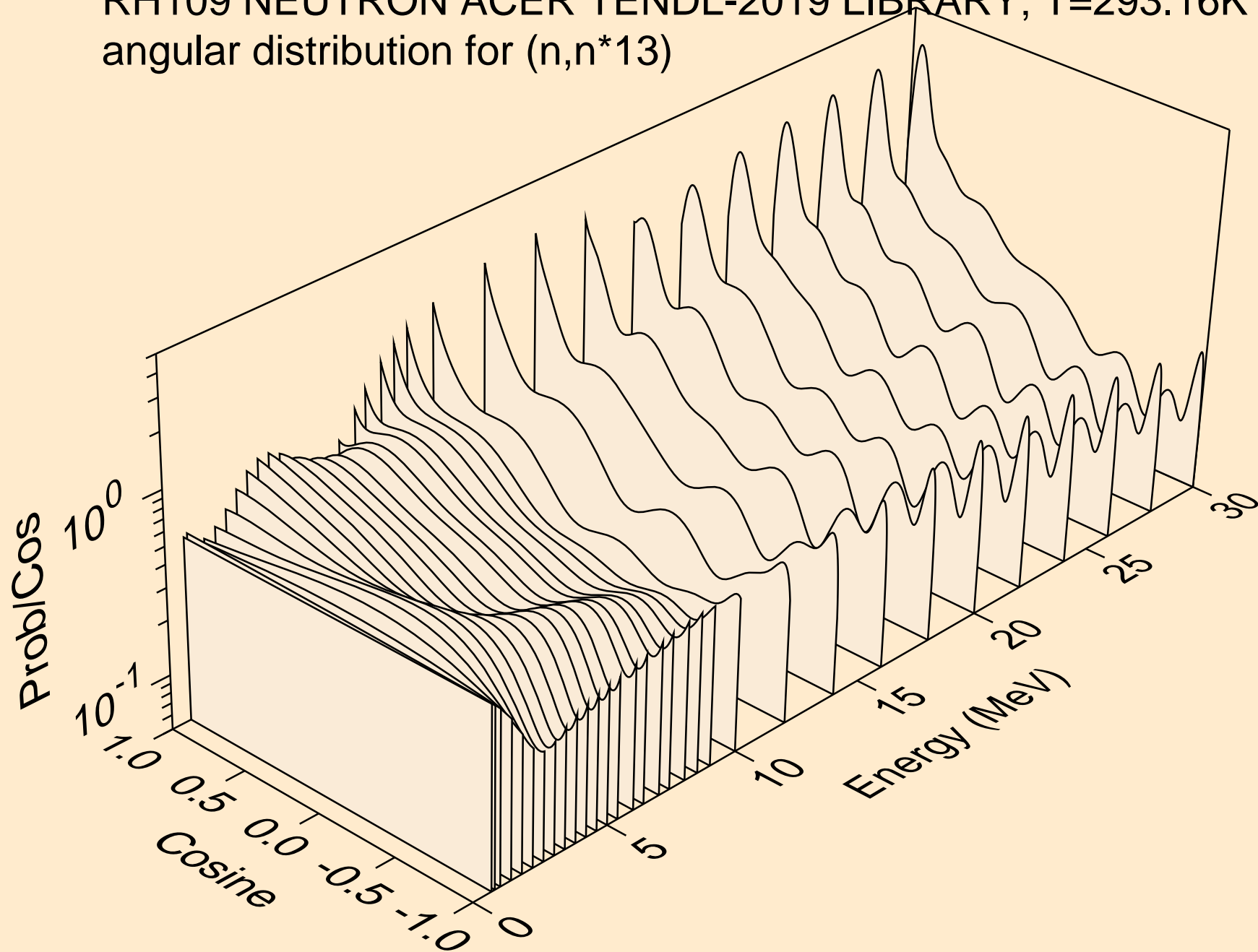

RH109 NEUTRON ACER TENDL-2019 LIBRARY; T=293.16K  
angular distribution for (n,n\*14)

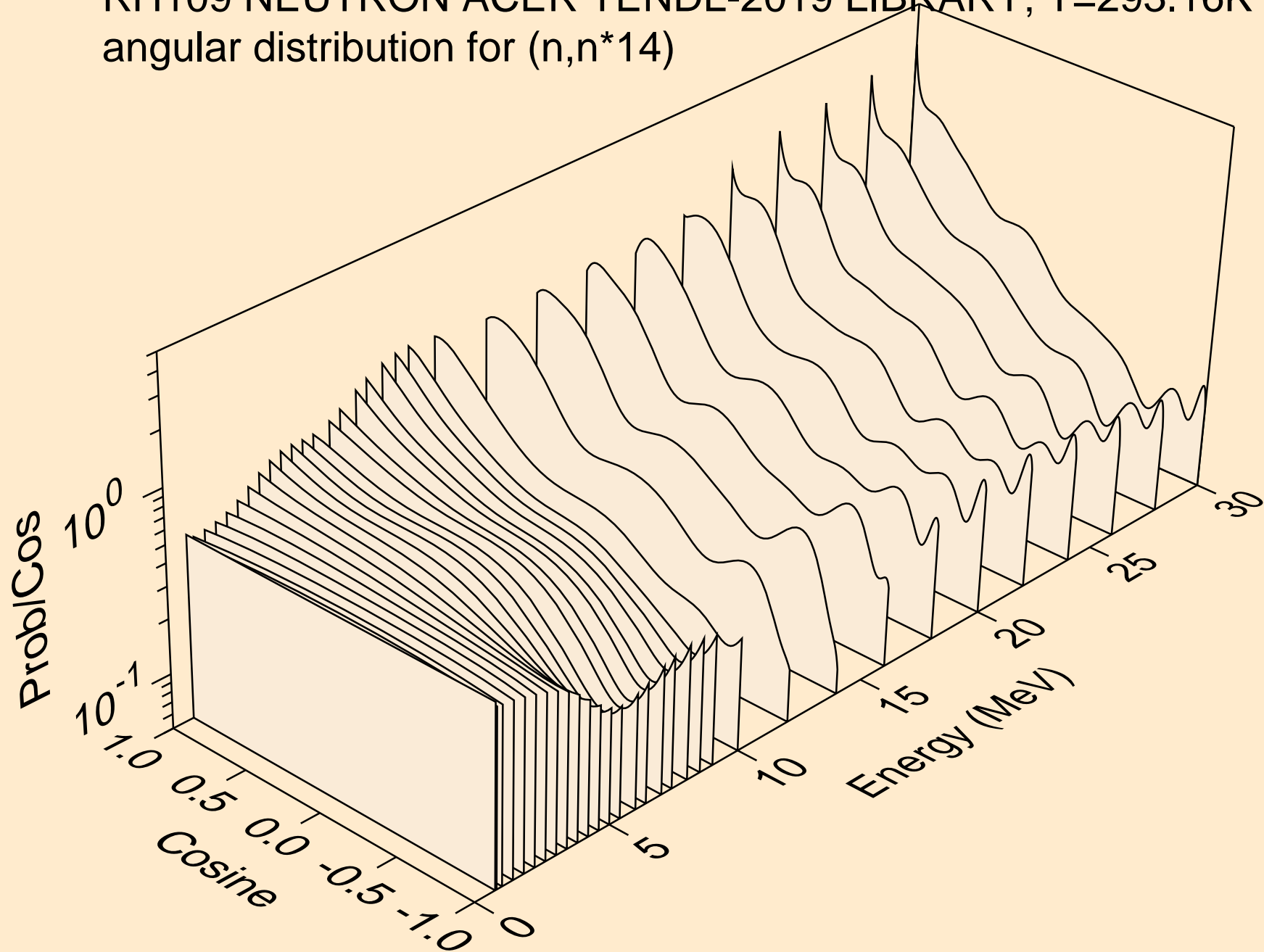

RH109 NEUTRON ACER TENDL-2019 LIBRARY; T=293.16K  
angular distribution for (n,n\*15)

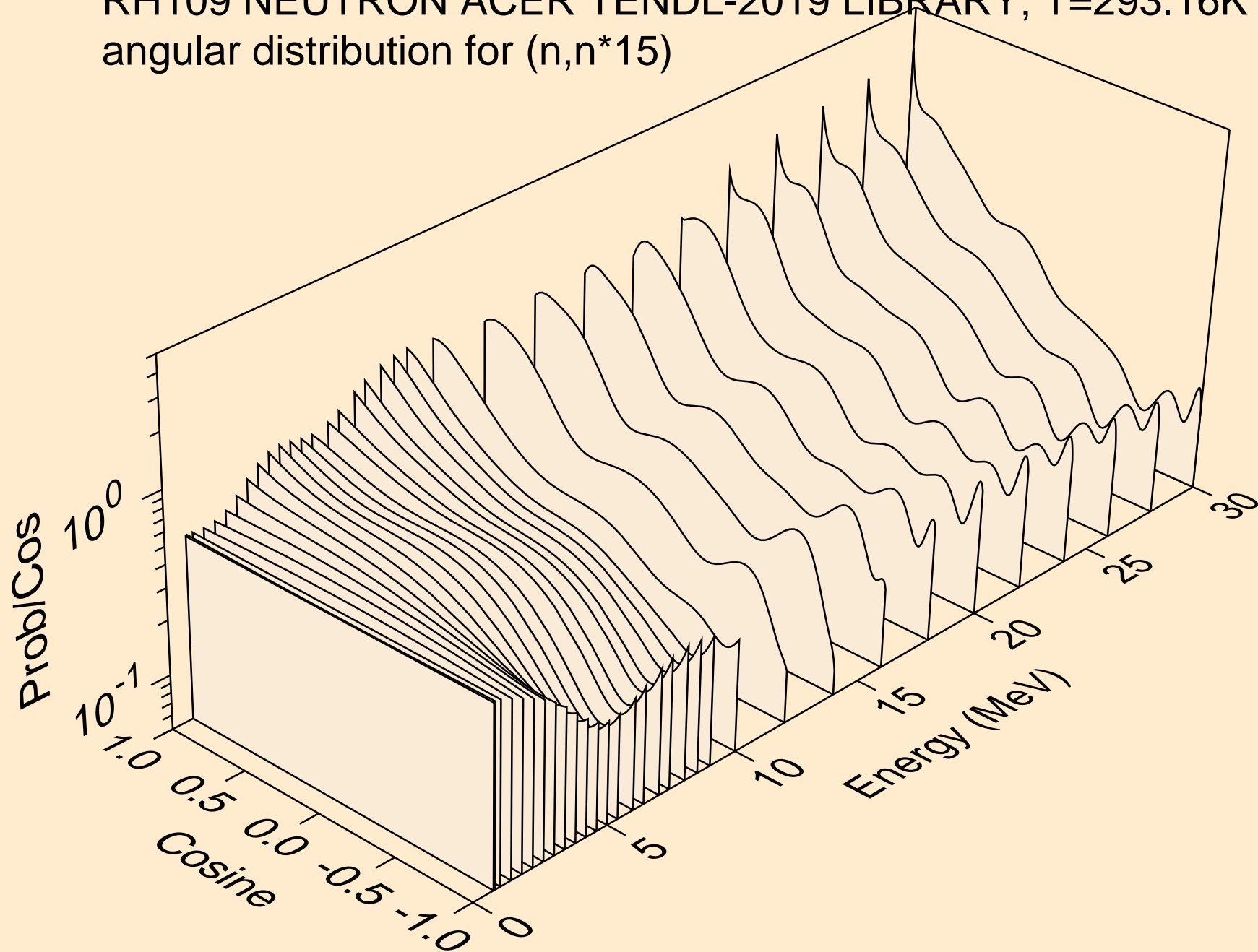

RH109 NEUTRON ACER TENDL-2019 LIBRARY; T=293.16K  
angular distribution for (n,n\*16)

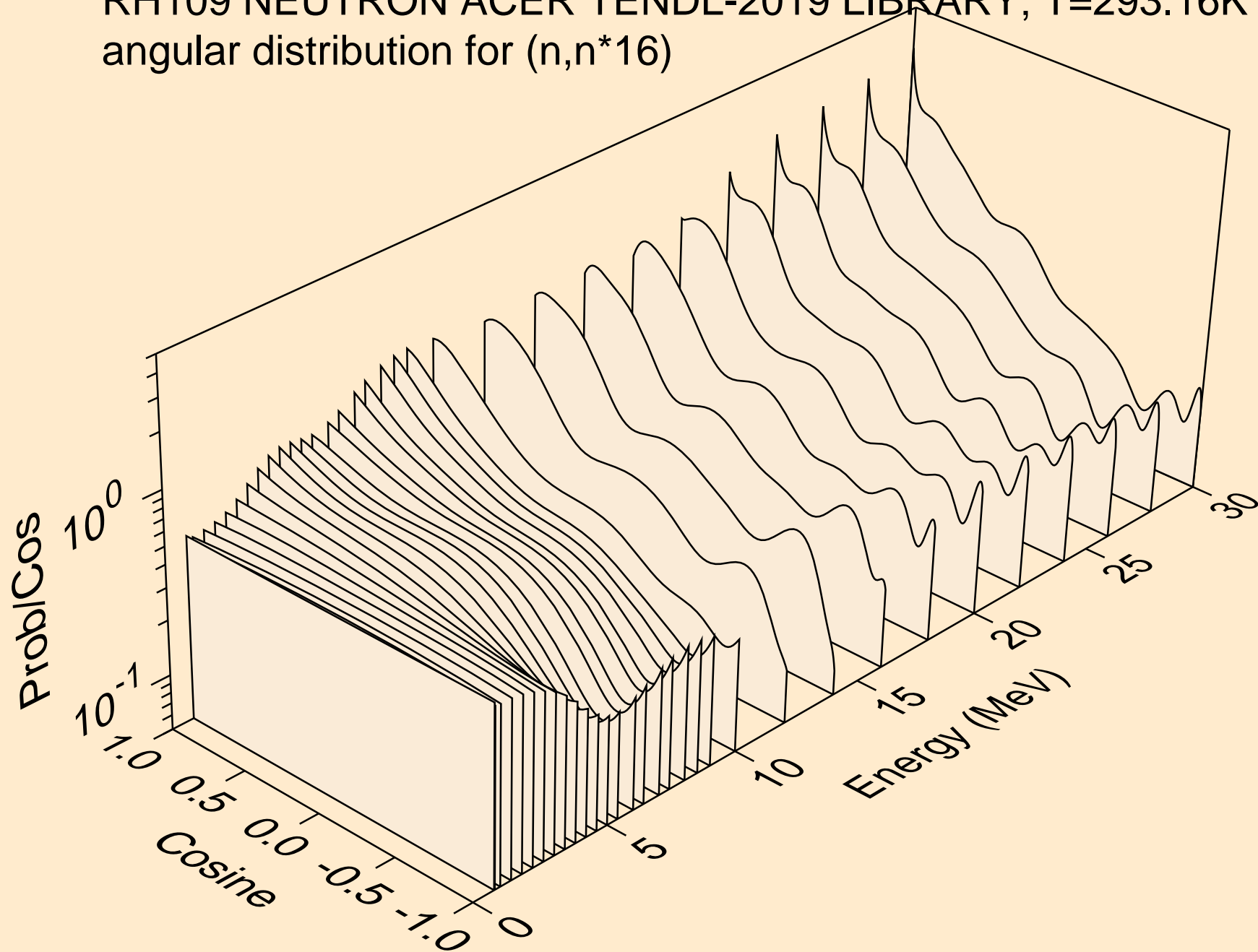

RH109 NEUTRON ACER TENDL-2019 LIBRARY; T=293.16K  
angular distribution for (n,n\*17)

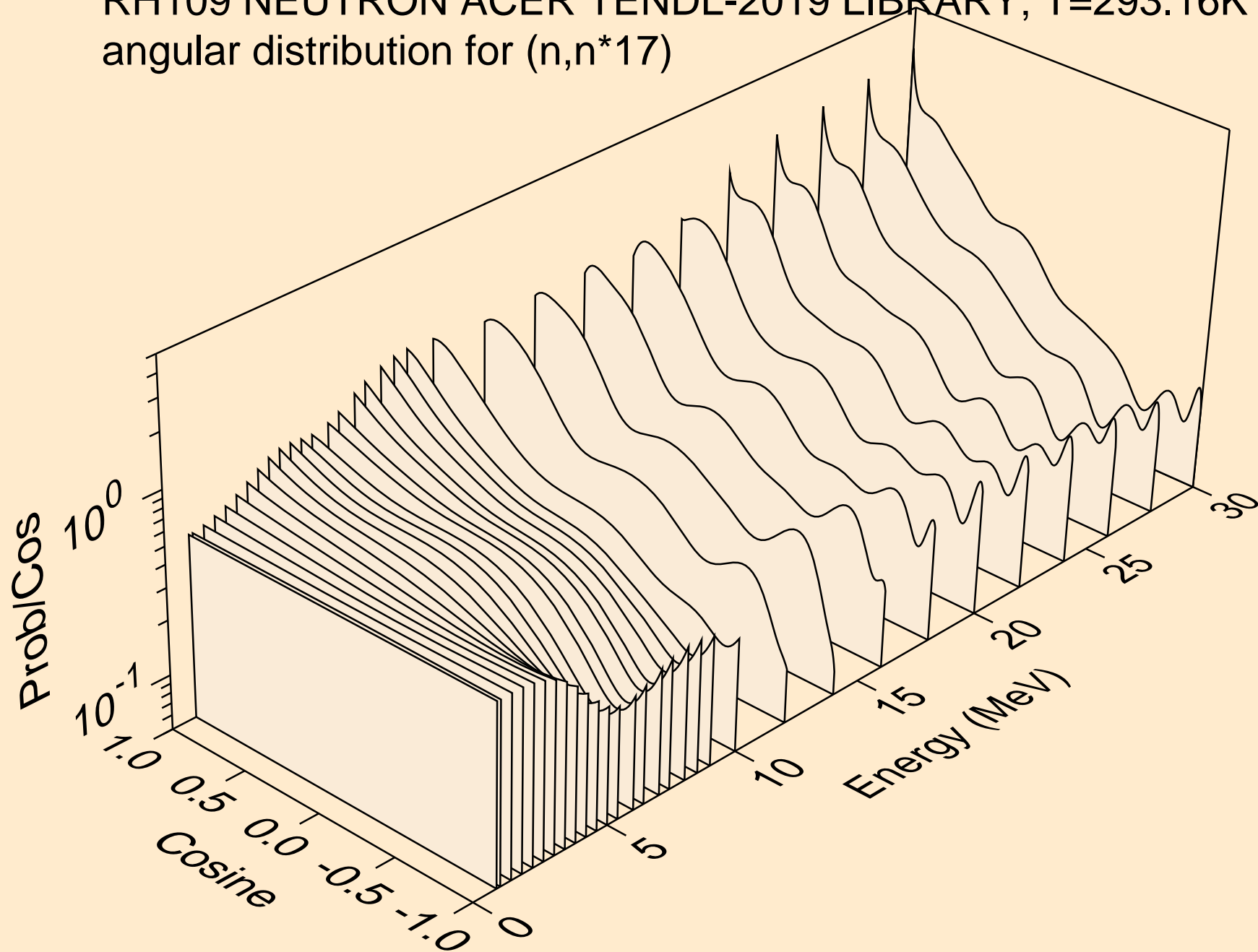

RH109 NEUTRON ACER TENDL-2019 LIBRARY; T=293.16K  
angular distribution for (n,n\*18)

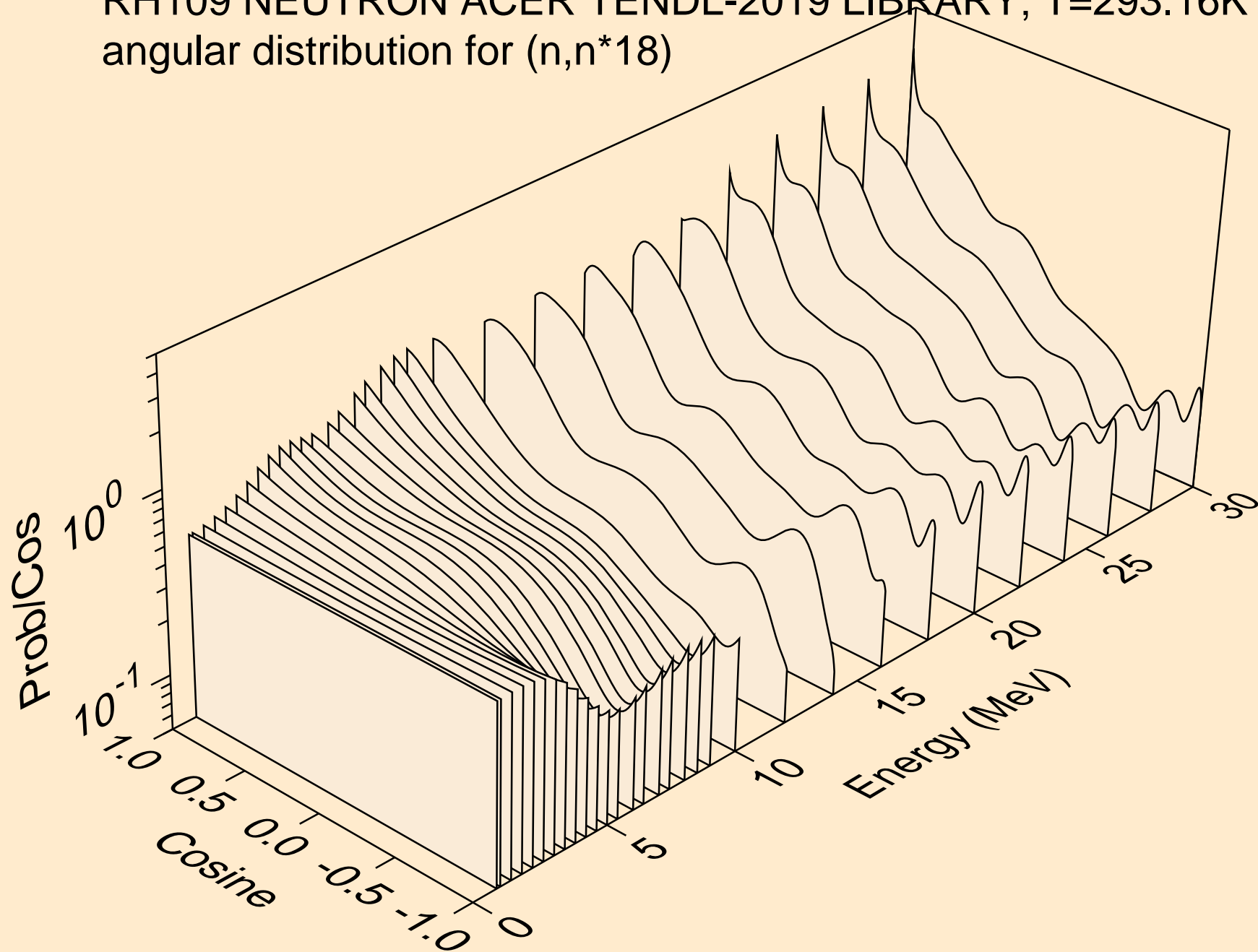



RH109 NEUTRON ACER TENDL-2019 LIBRARY; T=293.16K  
angular distribution for (n,n\*19)

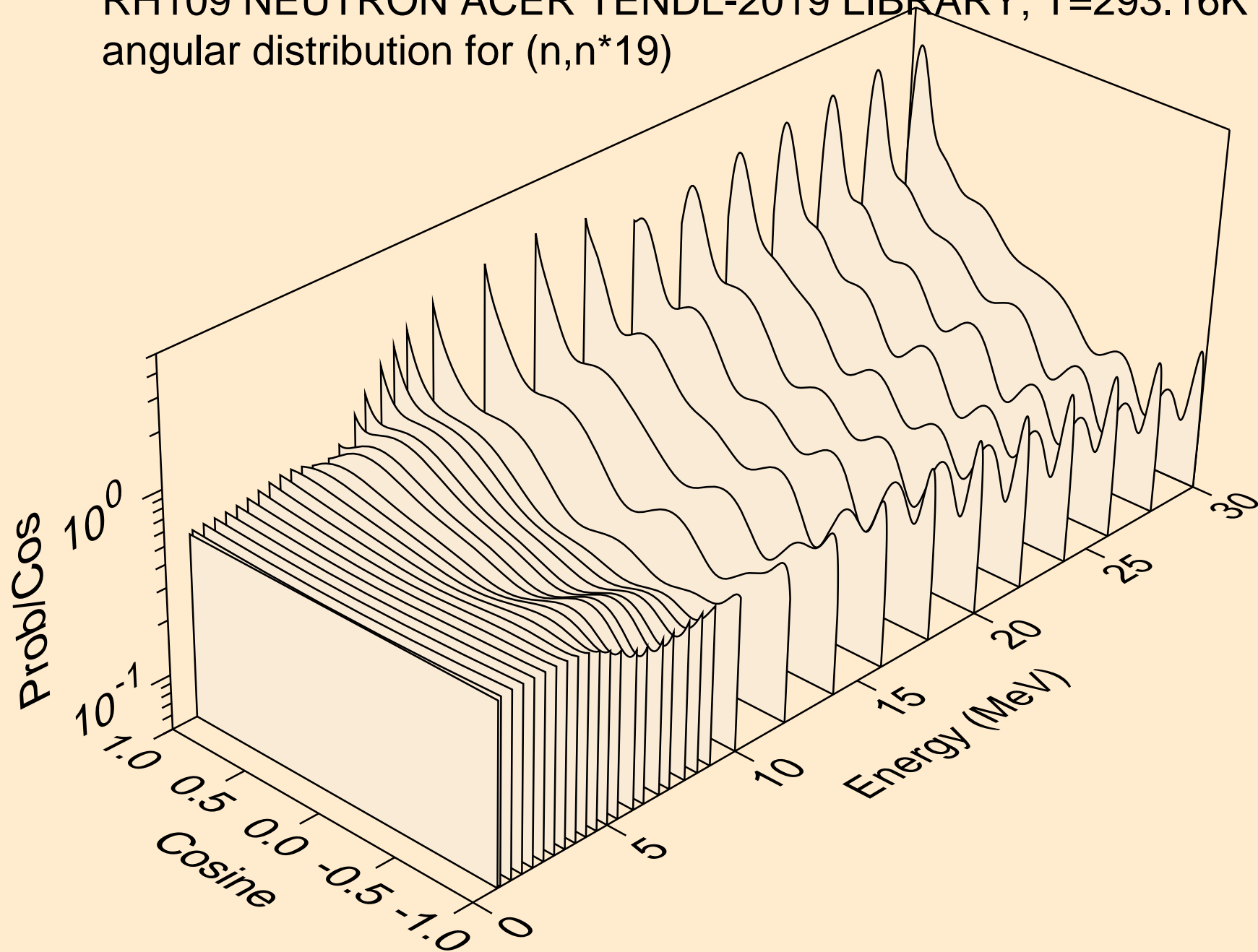

RH109 NEUTRON ACER TENDL-2019 LIBRARY; T=293.16K  
angular distribution for (n,n\*20)

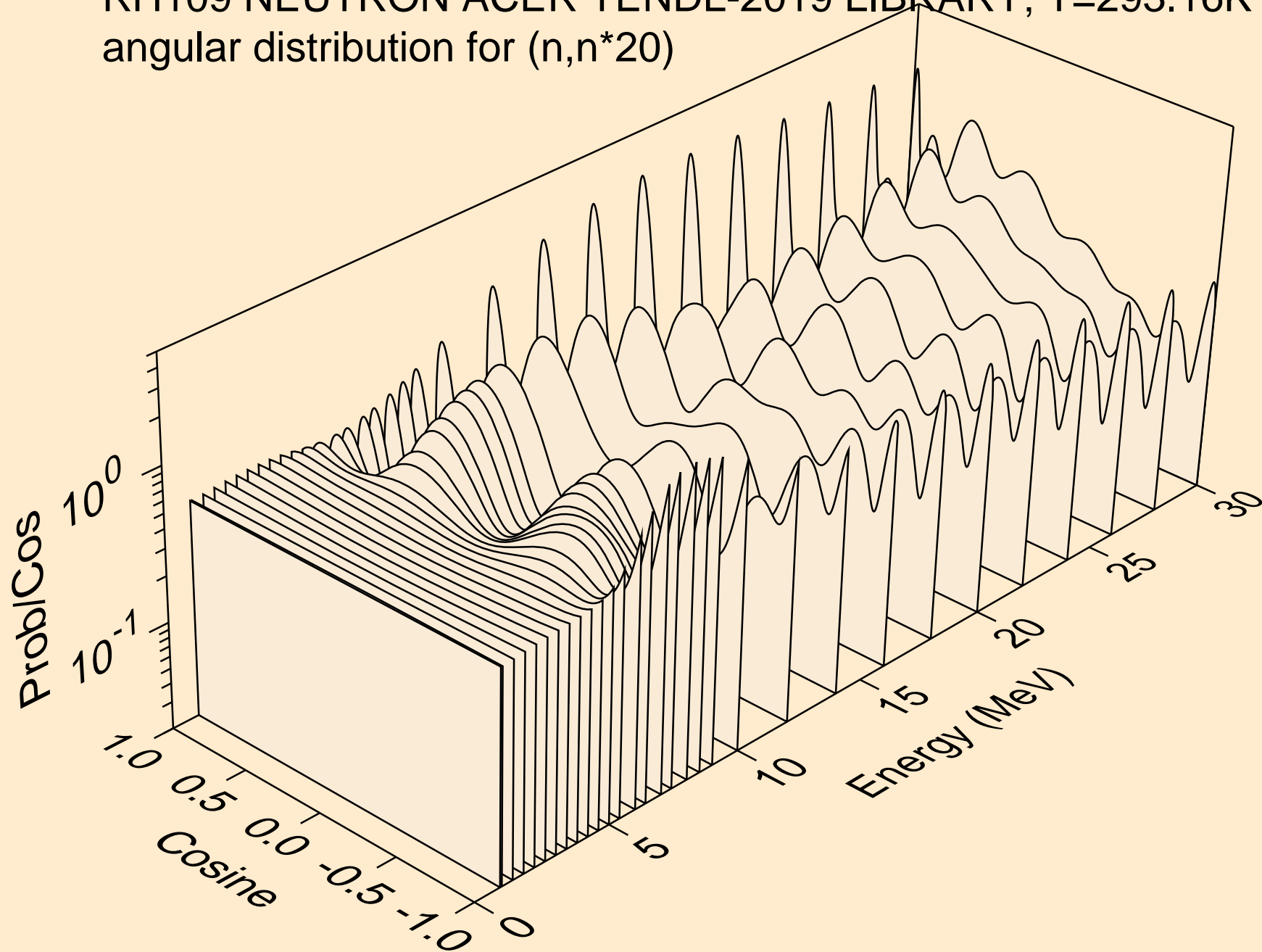

RH109 NEUTRON ACER TENDL-2019 LIBRARY; T=293.16K  
angular distribution for (n,n\*21)

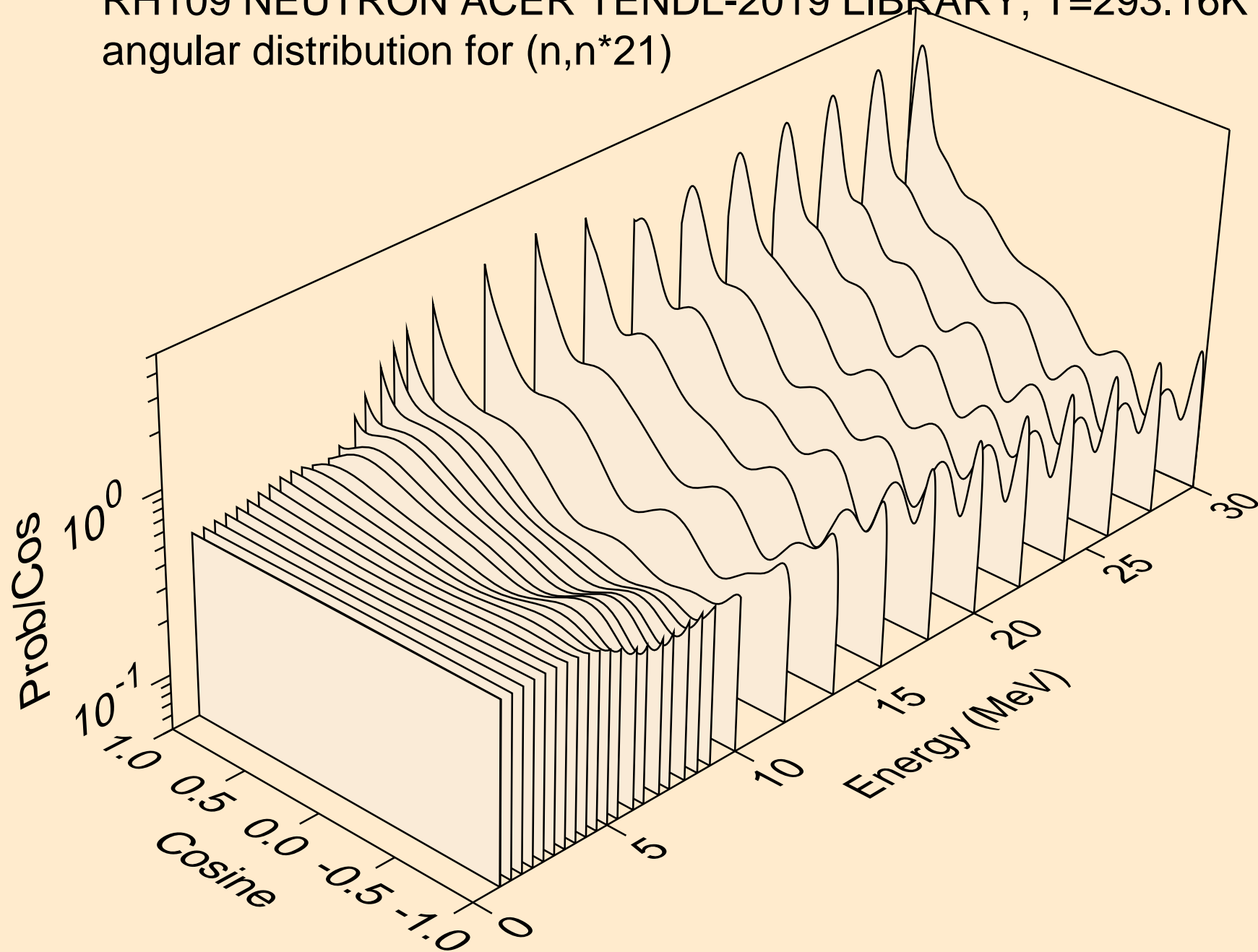

RH109 NEUTRON ACER TENDL-2019 LIBRARY; T=293.16K  
angular distribution for (n,n\*22)

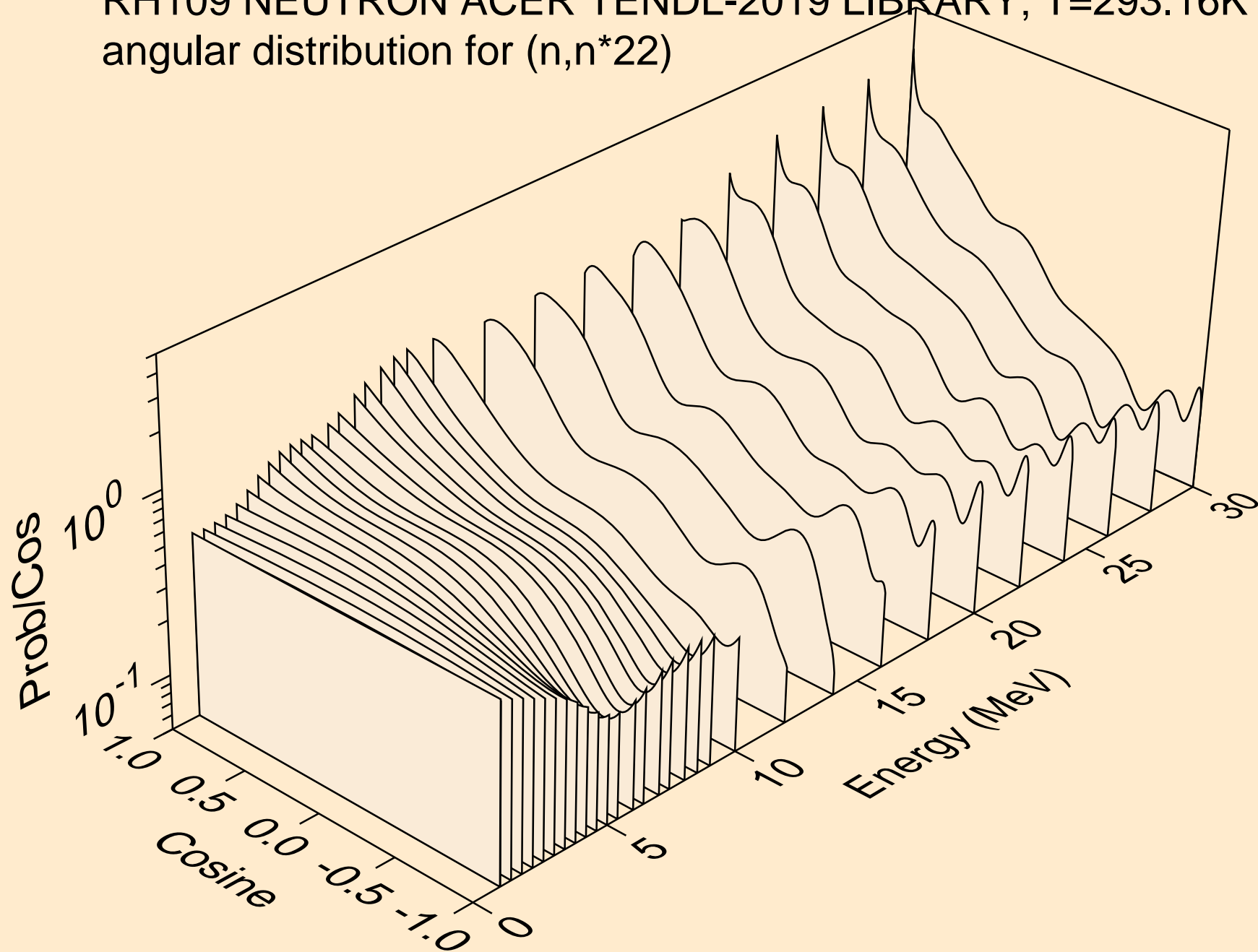

RH109 NEUTRON ACER TENDL-2019 LIBRARY; T=293.16K  
angular distribution for (n,n\*23)

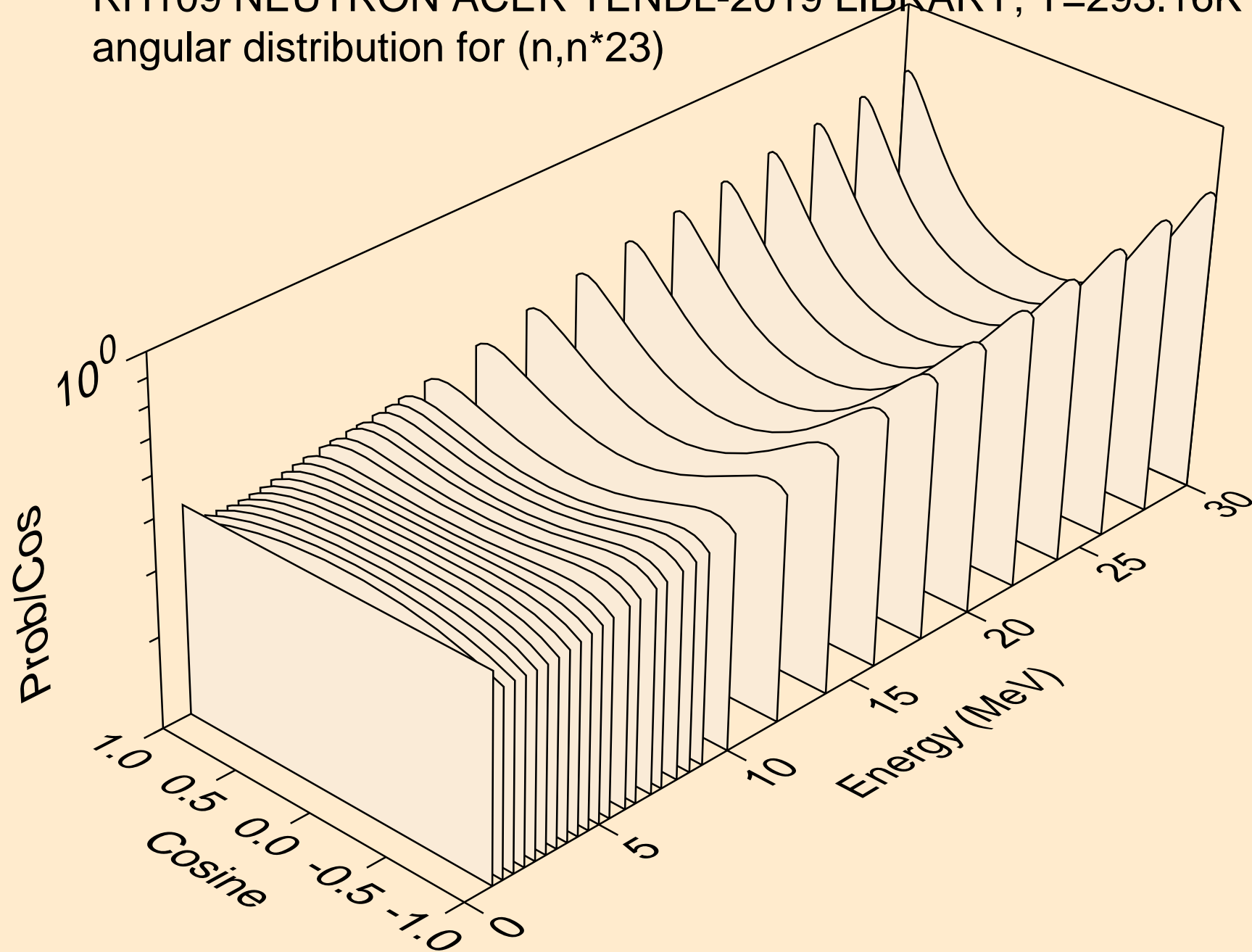

RH109 NEUTRON ACER TENDL-2019 LIBRARY; T=293.16K  
angular distribution for (n,n\*24)

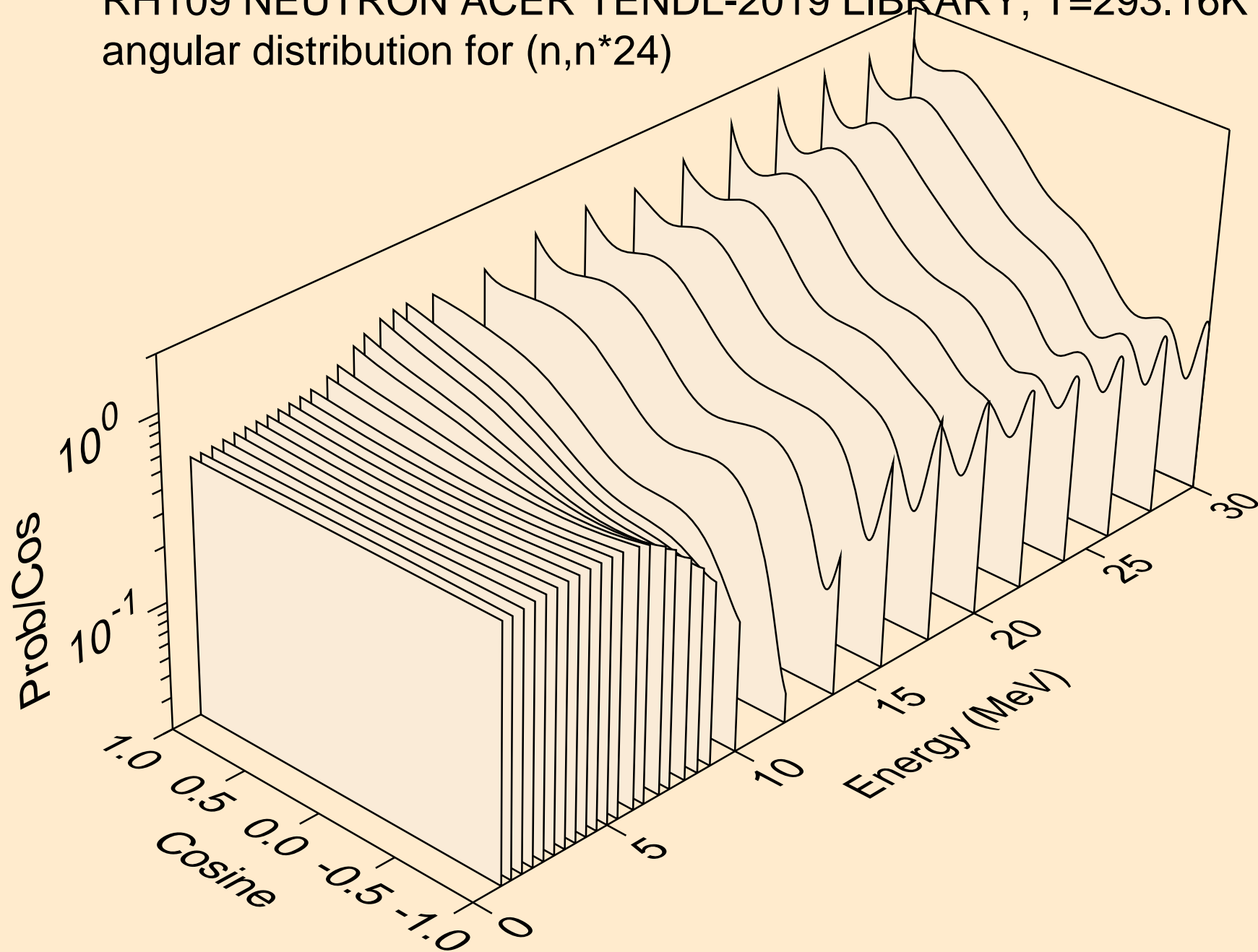

RH109 NEUTRON ACER TENDL-2019 LIBRARY; T=293.16K  
angular distribution for (n,n\*25)

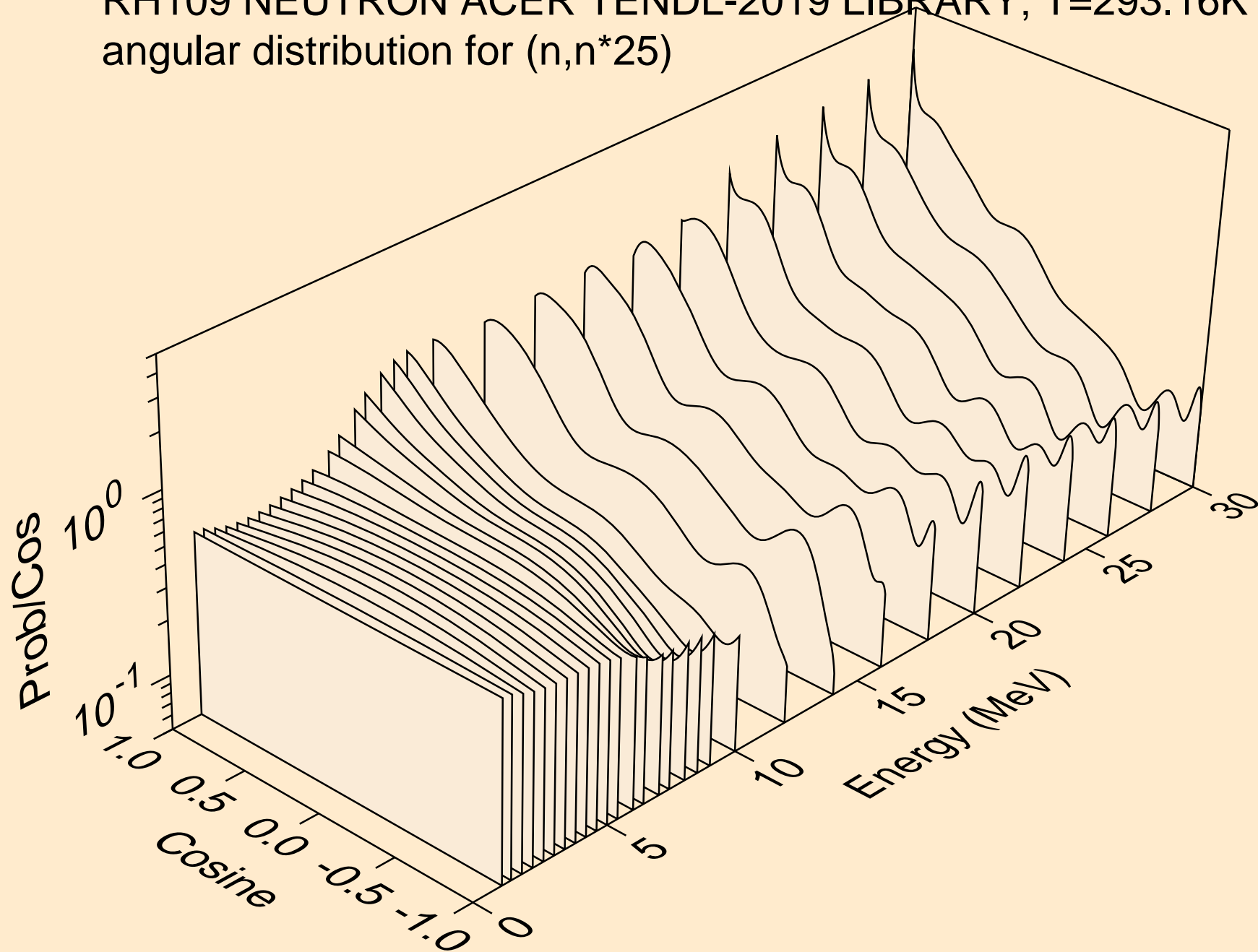

RH109 NEUTRON ACER TENDL-2019 LIBRARY; T=293.16K  
angular distribution for (n,n\*26)

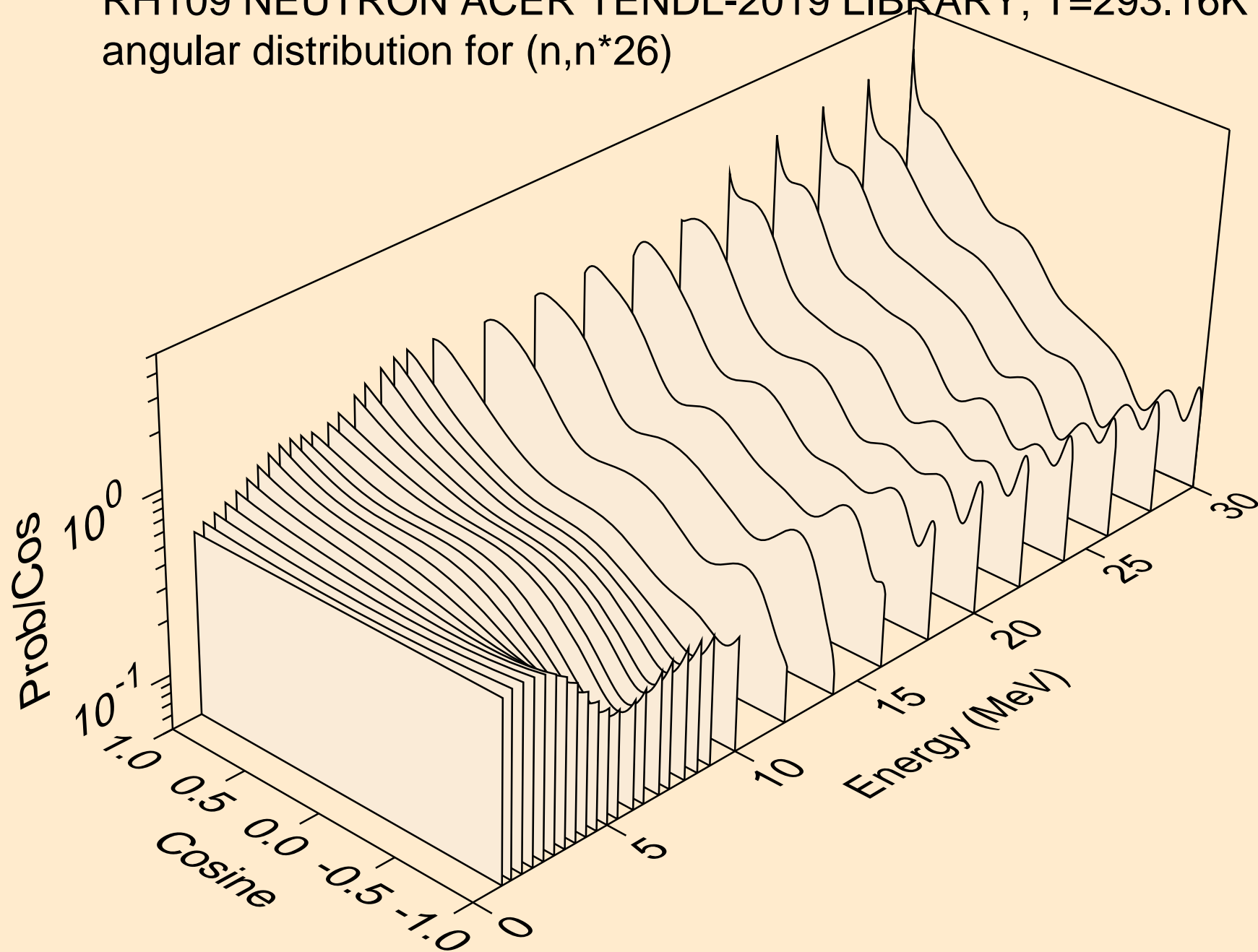



RH109 NEUTRON ACER TENDL-2019 LIBRARY; T=293.16K  
angular distribution for (n,n\*27)

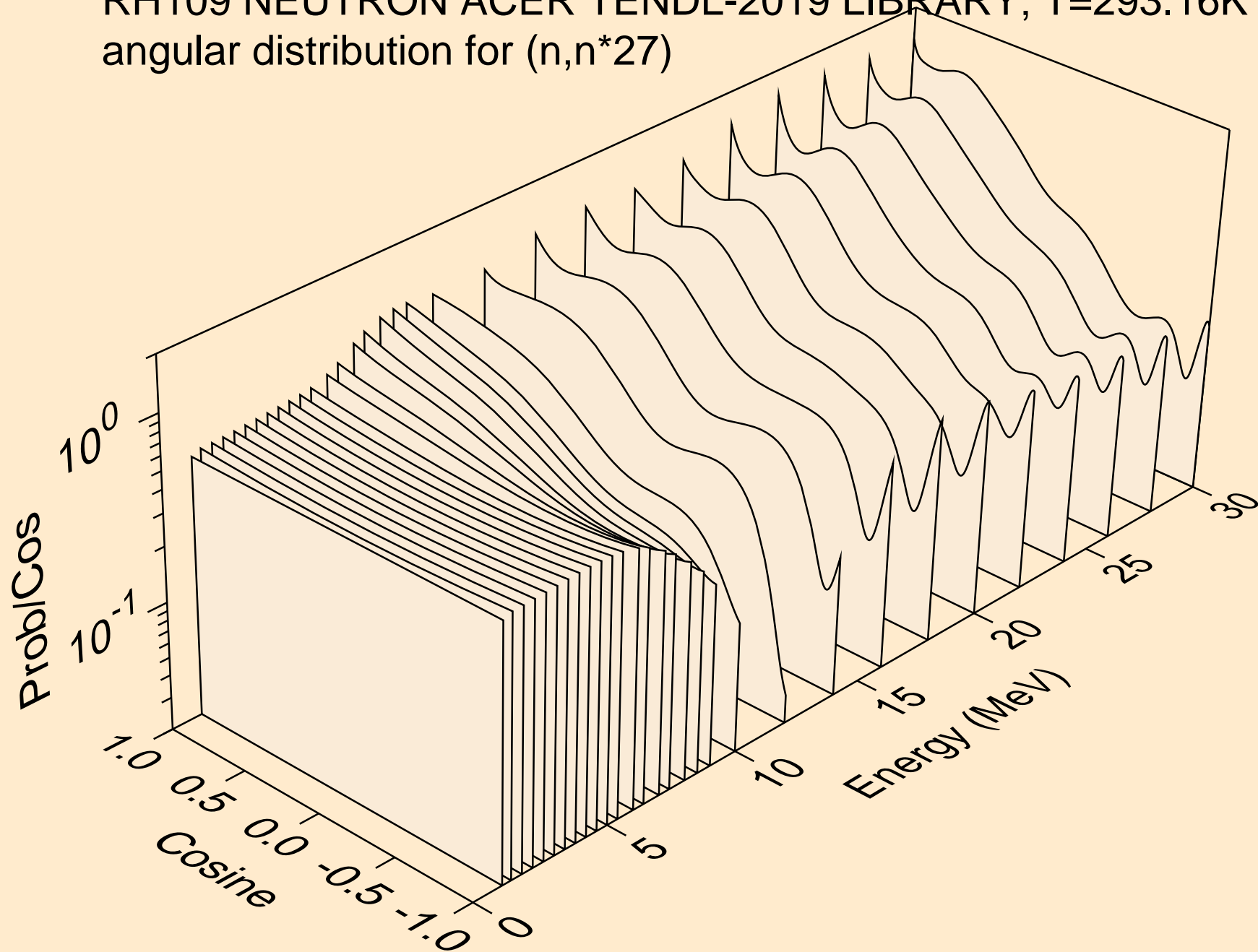

RH109 NEUTRON ACER TENDL-2019 LIBRARY; T=293.16K  
angular distribution for (n,n\*28)

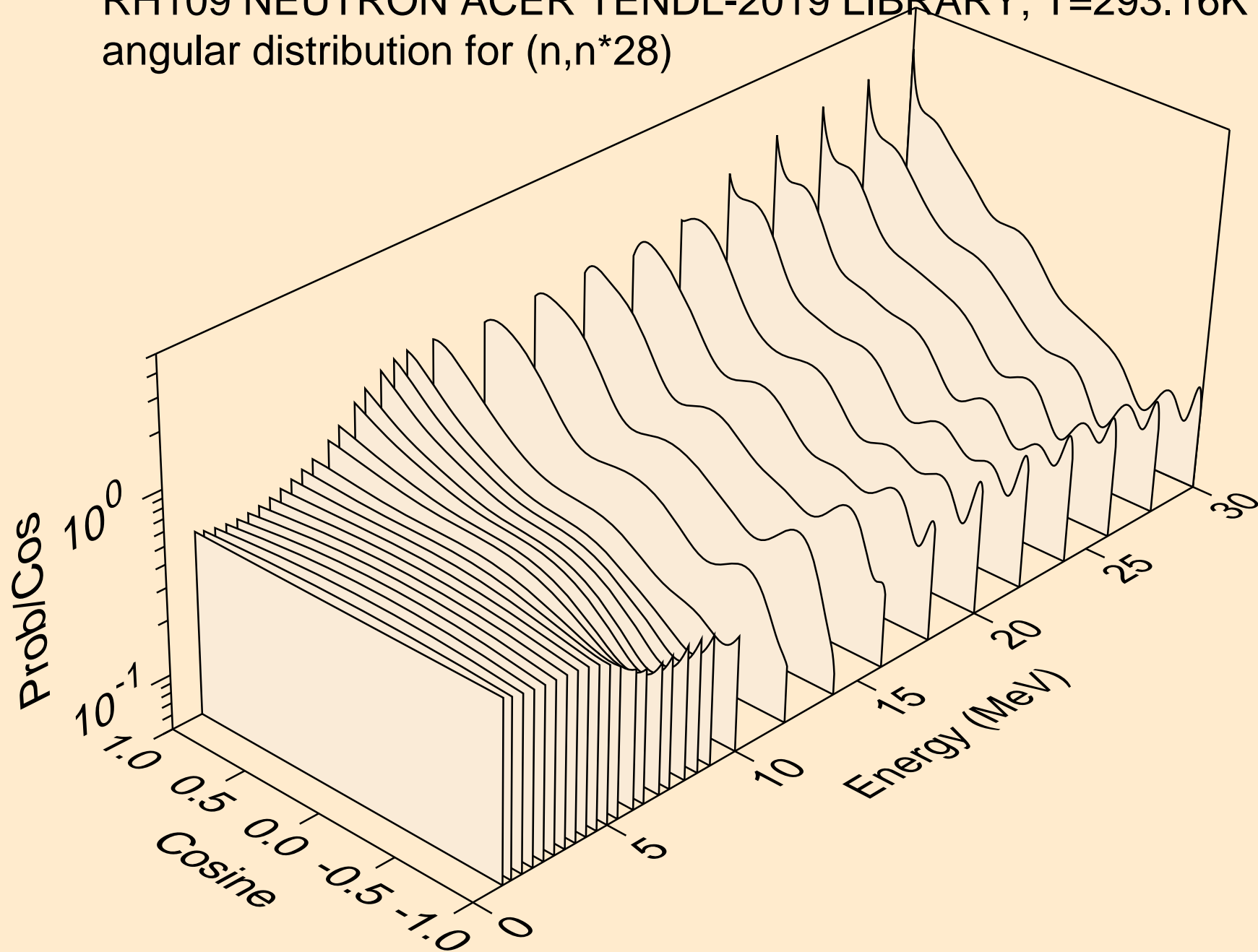

RH109 NEUTRON ACER TENDL-2019 LIBRARY; T=293.16K  
angular distribution for (n,n\*29)

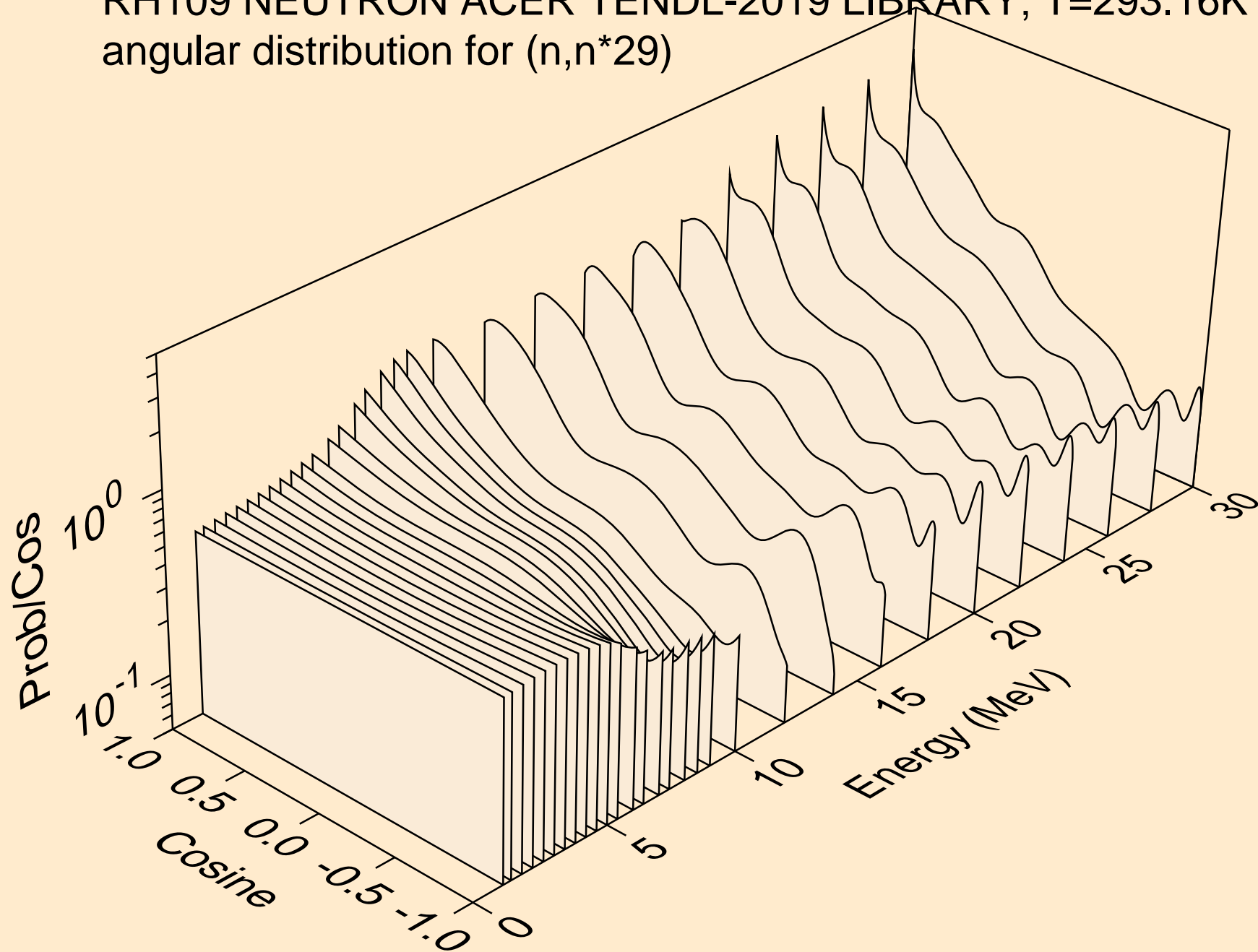

RH109 NEUTRON ACER TENDL-2019 LIBRARY; T=293.16K  
Neutron emission for (n,x)

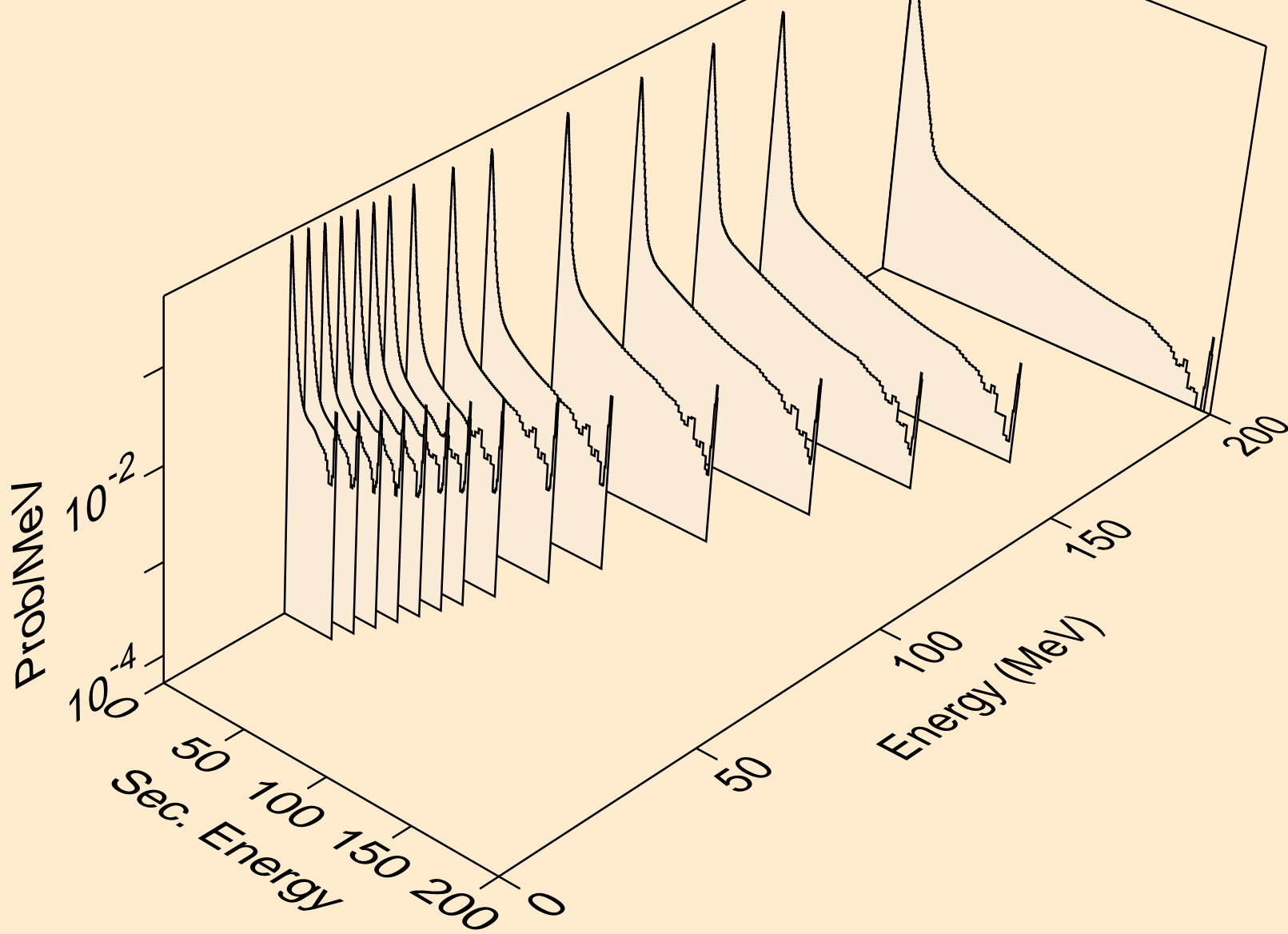

RH109 NEUTRON ACER TENDL-2019 LIBRARY; T=293.16K  
Neutron emission for (n,2nd)

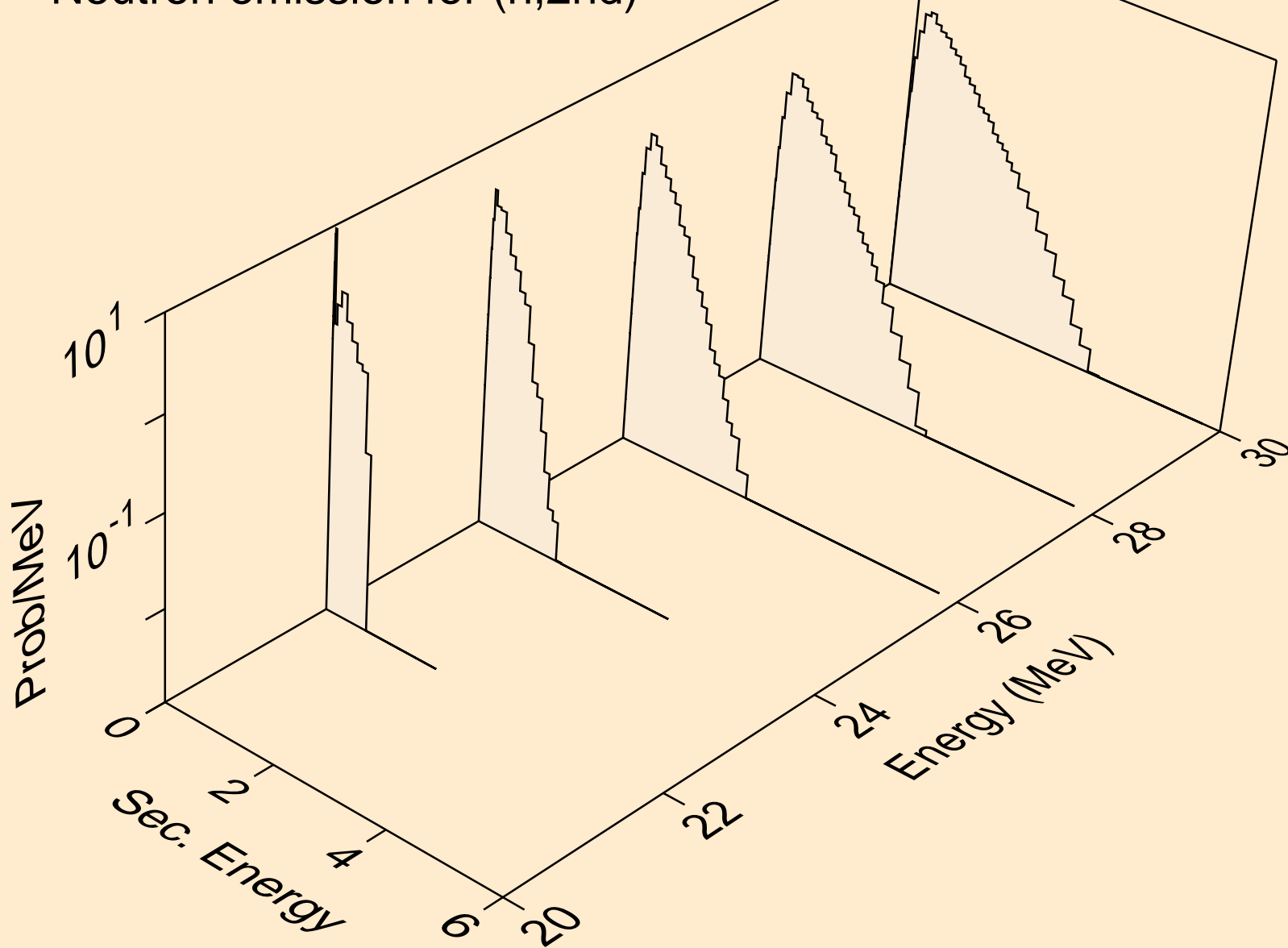

RH109 NEUTRON ACER TENDL-2019 LIBRARY; T=293.16K  
Neutron emission for (n,2n)

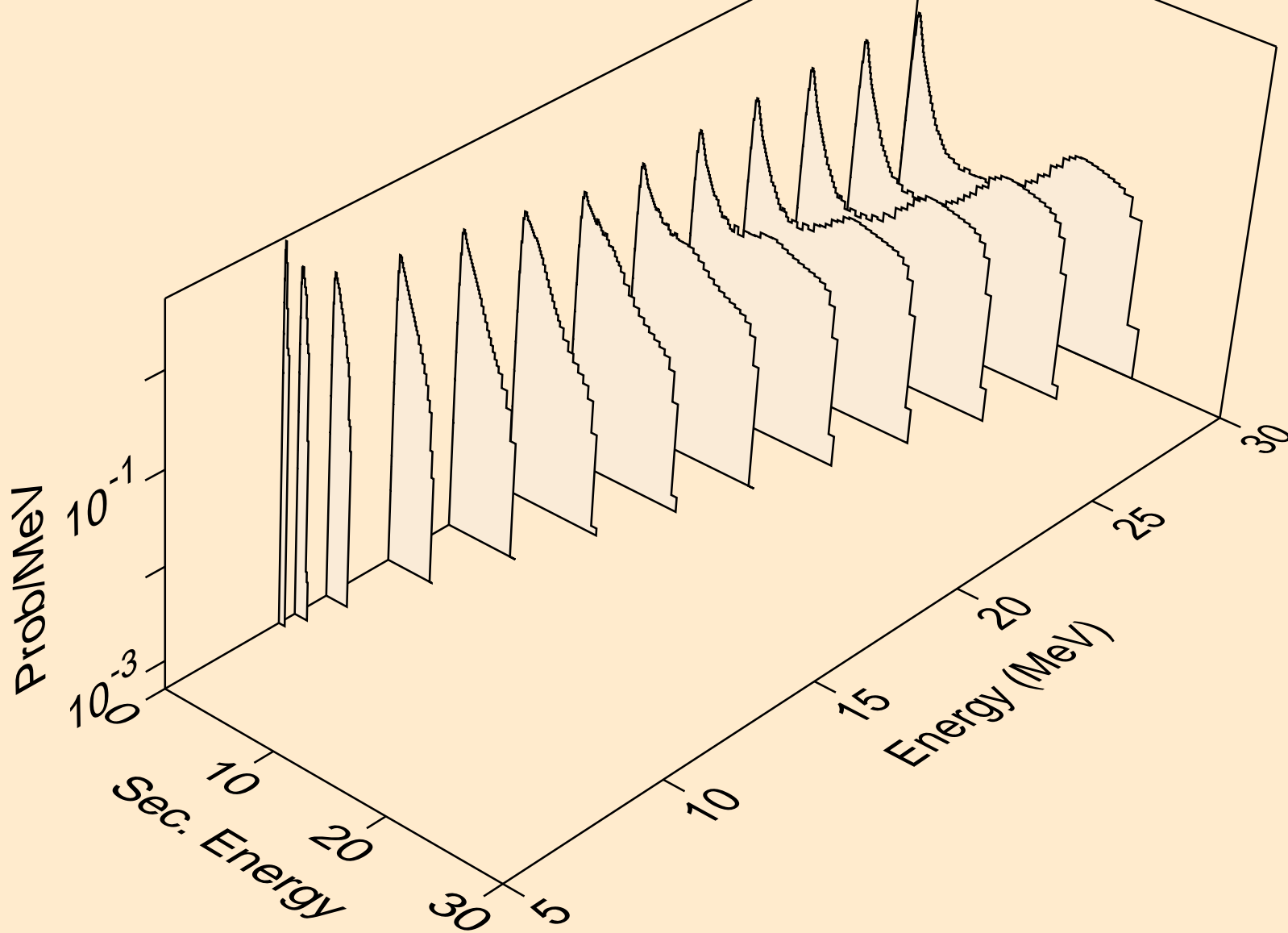

RH109 NEUTRON ACER TENDL-2019 LIBRARY; T=293.16K  
Neutron emission for (n,3n)

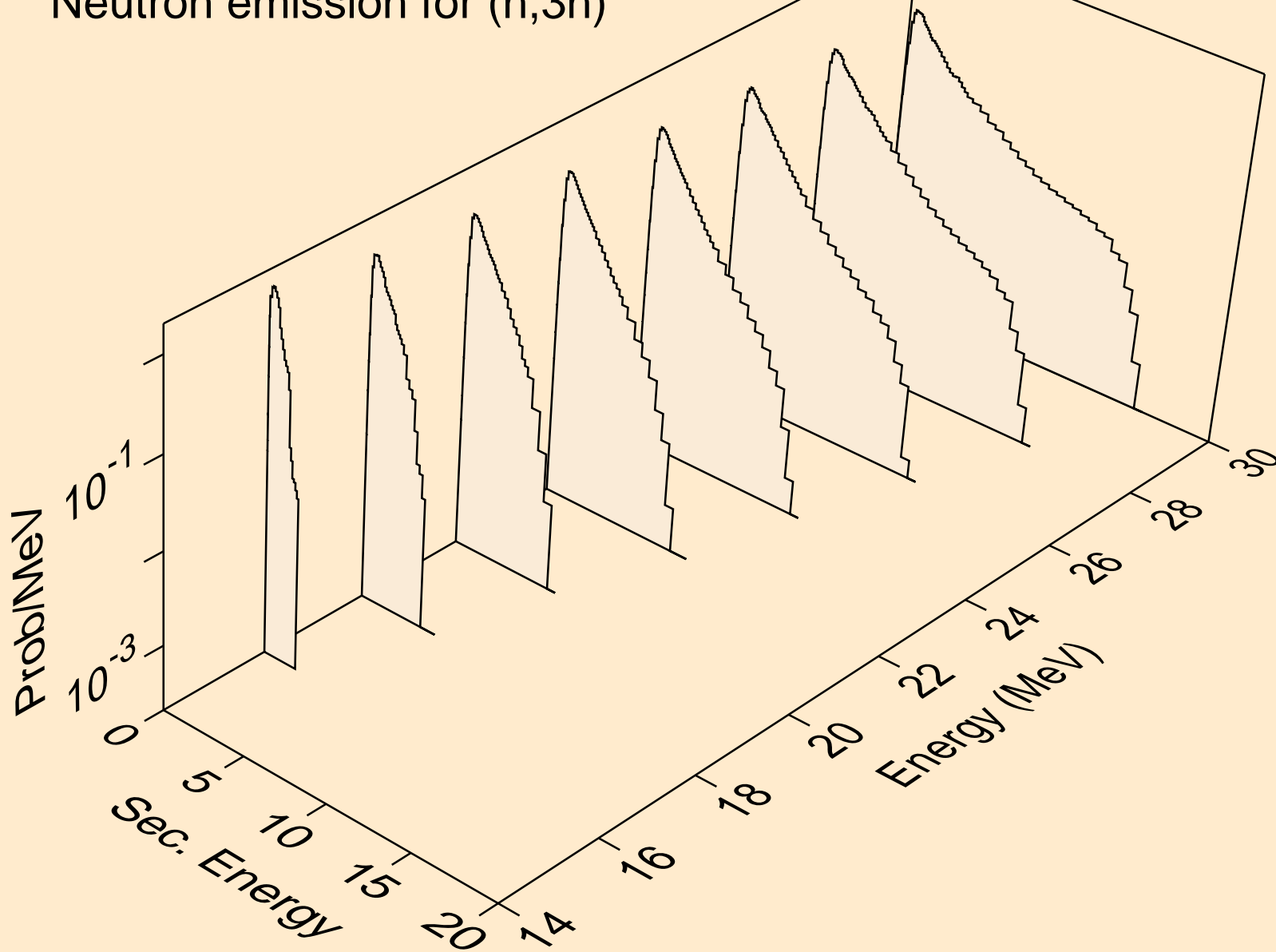

RH109 NEUTRON ACER TENDL-2019 LIBRARY; T=293.16K  
Neutron emission for (n,n\*)a

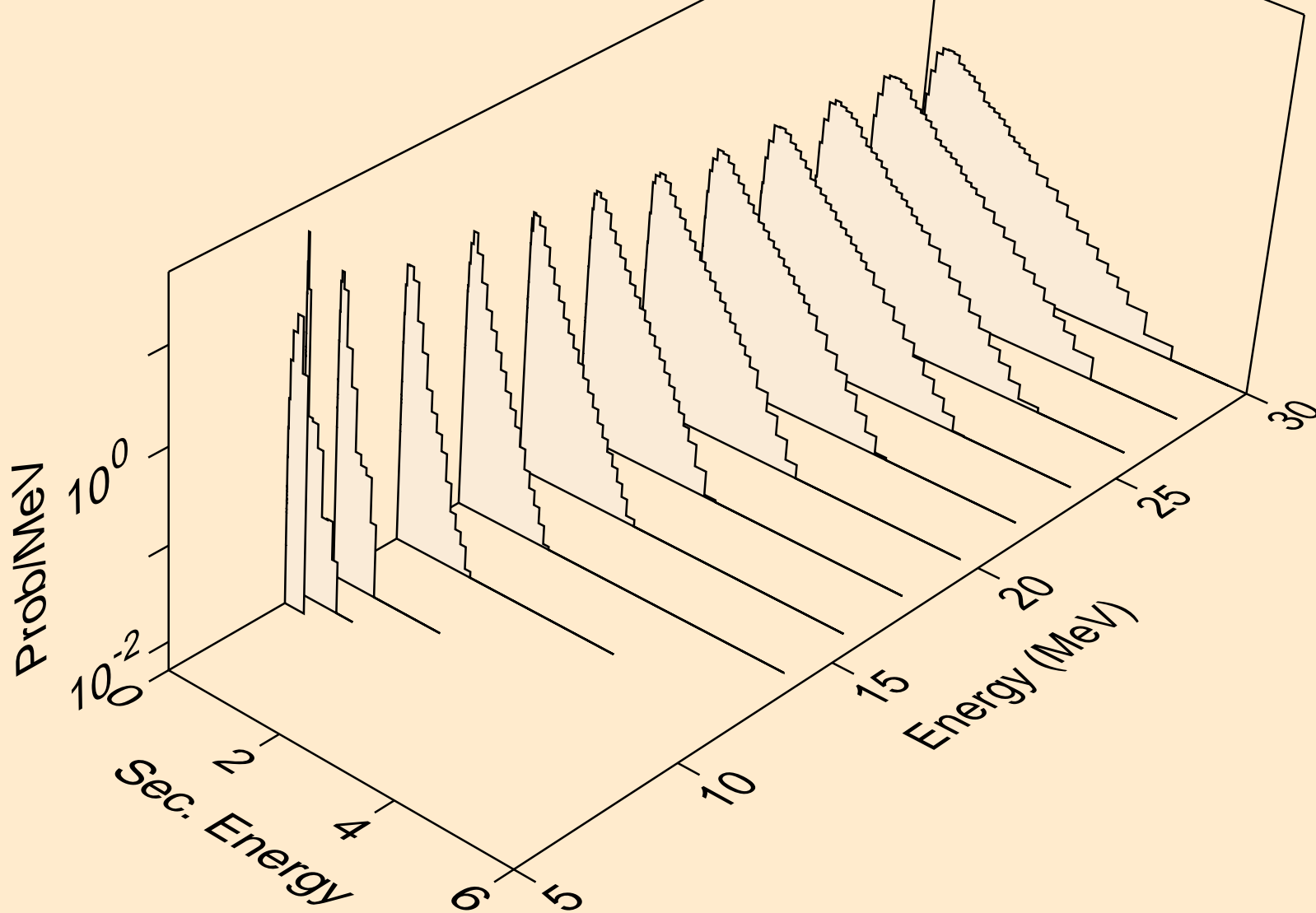



RH109 NEUTRON ACER TENDL-2019 LIBRARY; T=293.16K  
Neutron emission for (n,2n)a

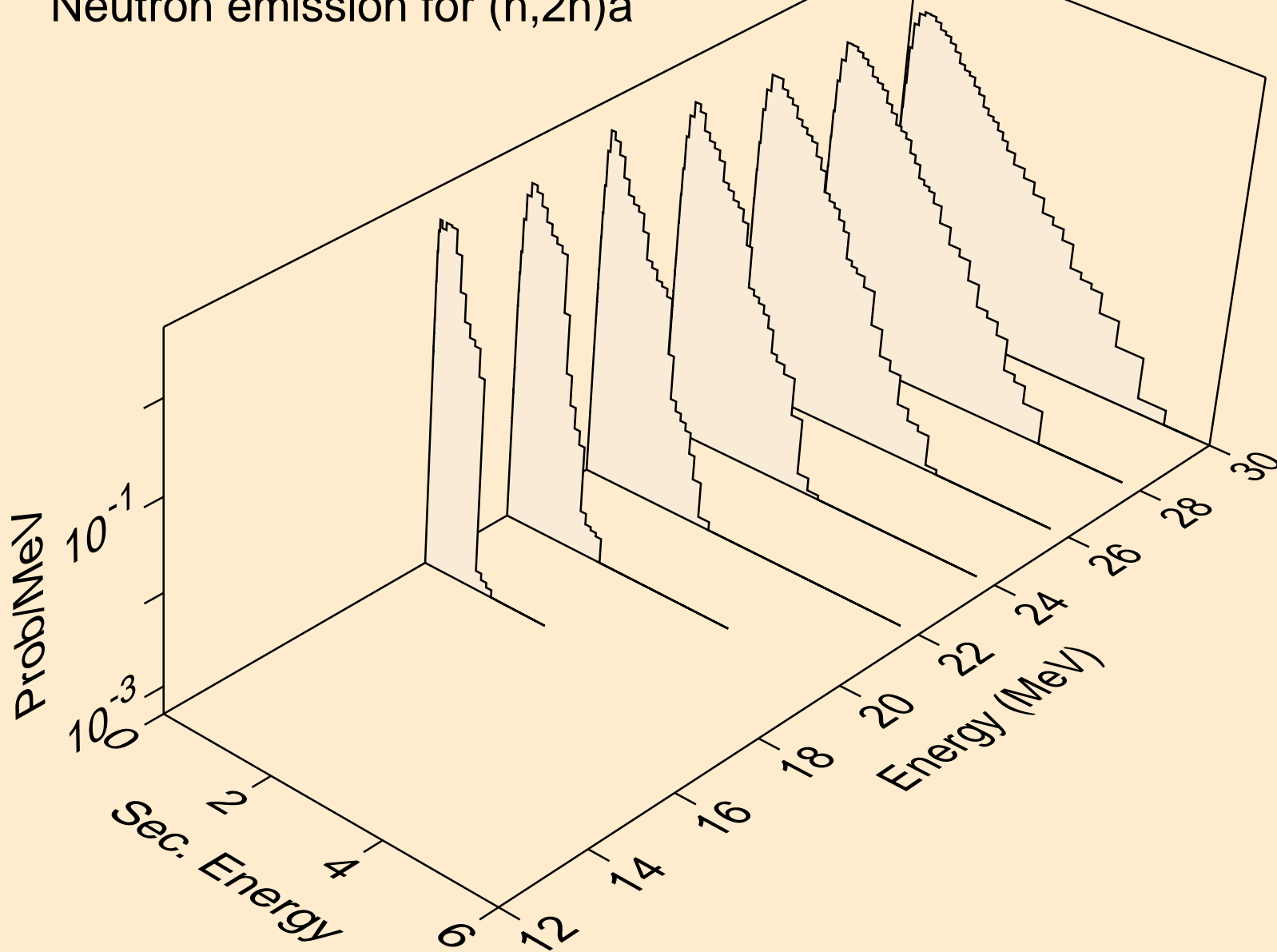

RH109 NEUTRON ACER TENDL-2019 LIBRARY; T=293.16K  
Neutron emission for (n,3n)a

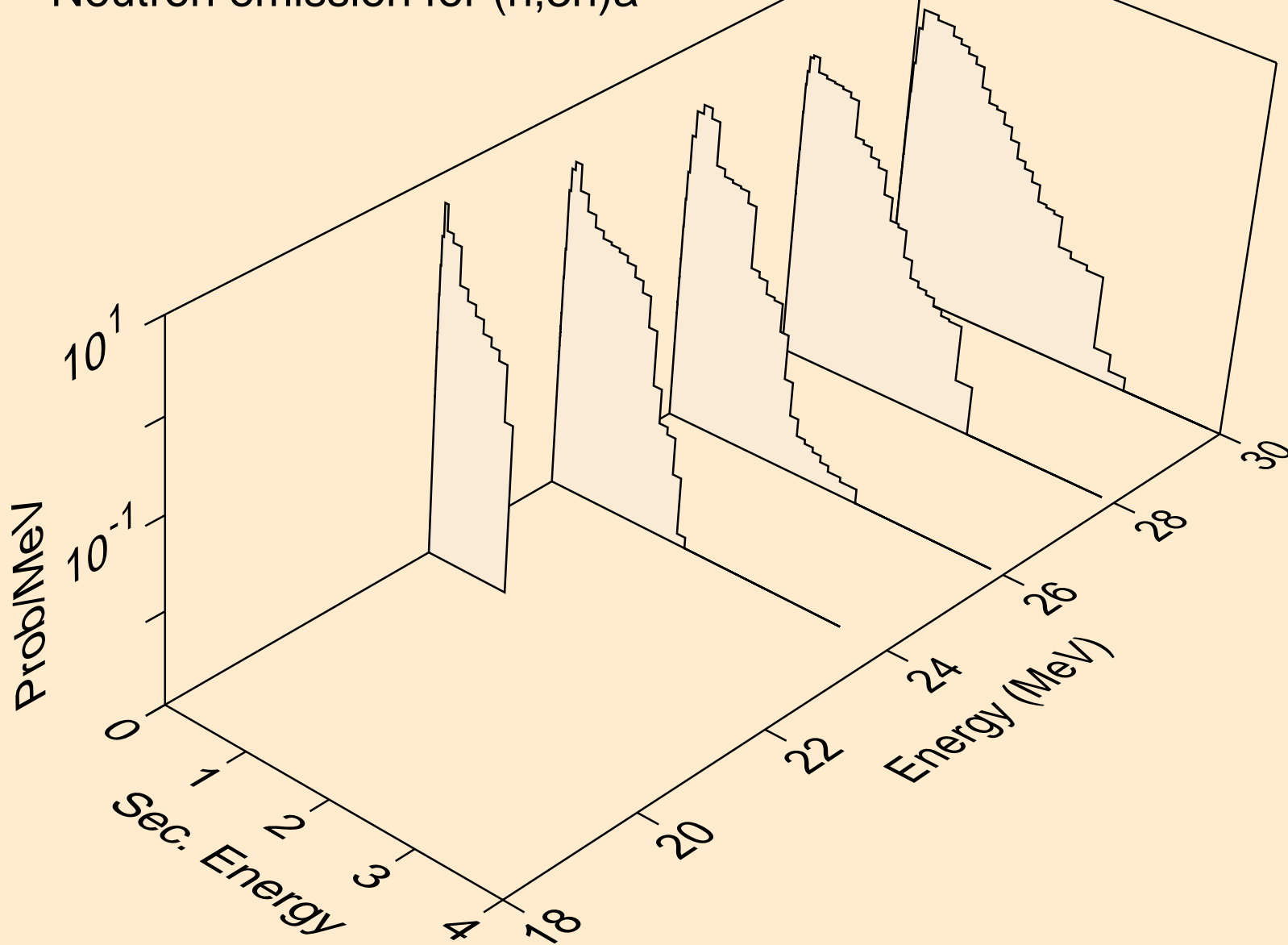

RH109 NEUTRON ACER TENDL-2019 LIBRARY; T=293.16K  
Neutron emission for (n,n\*)p

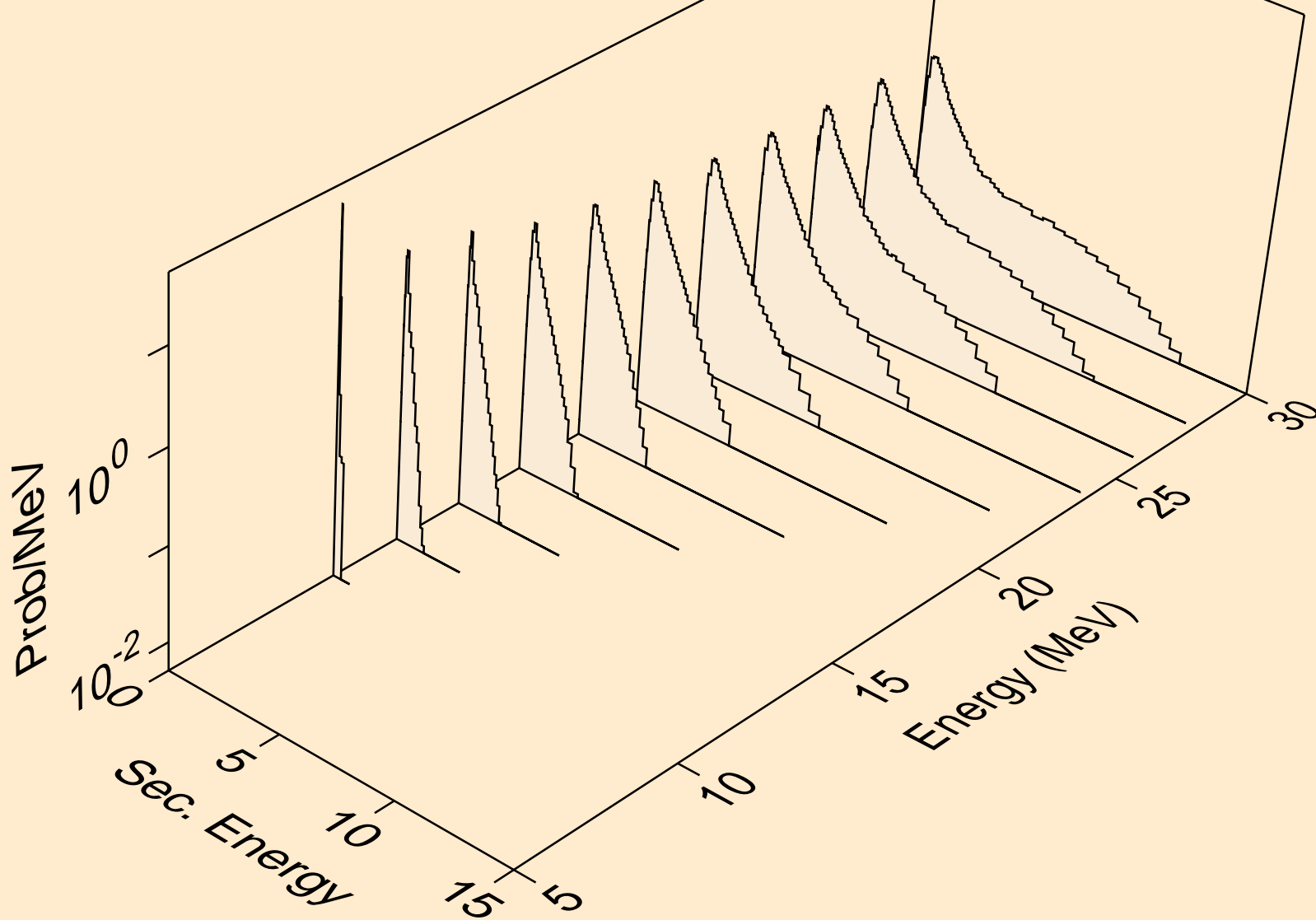

RH109 NEUTRON ACER TENDL-2019 LIBRARY; T=293.16K  
Neutron emission for (n,n\*)d

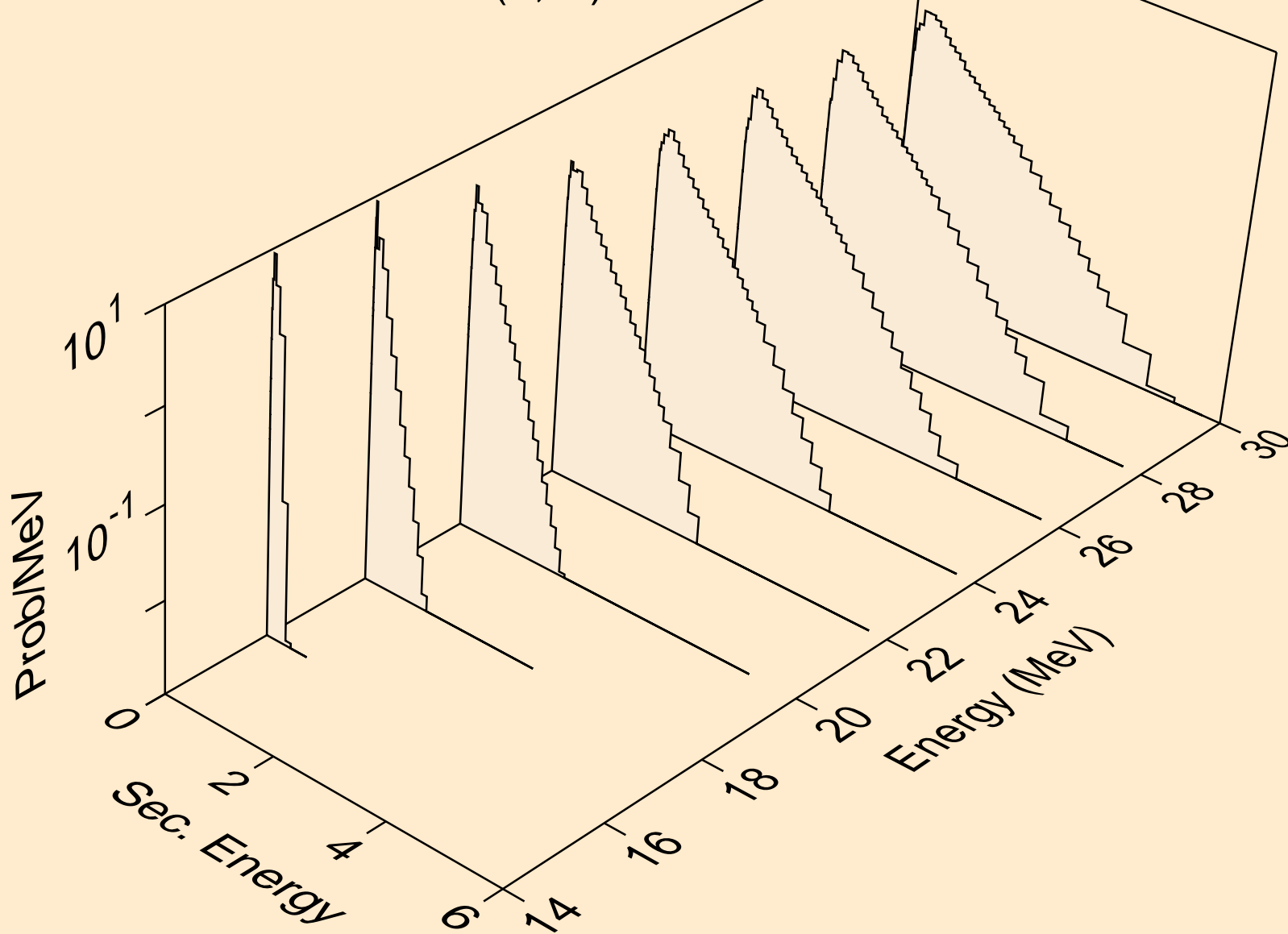

RH109 NEUTRON ACER TENDL-2019 LIBRARY; T=293.16K  
Neutron emission for (n,n\*)t

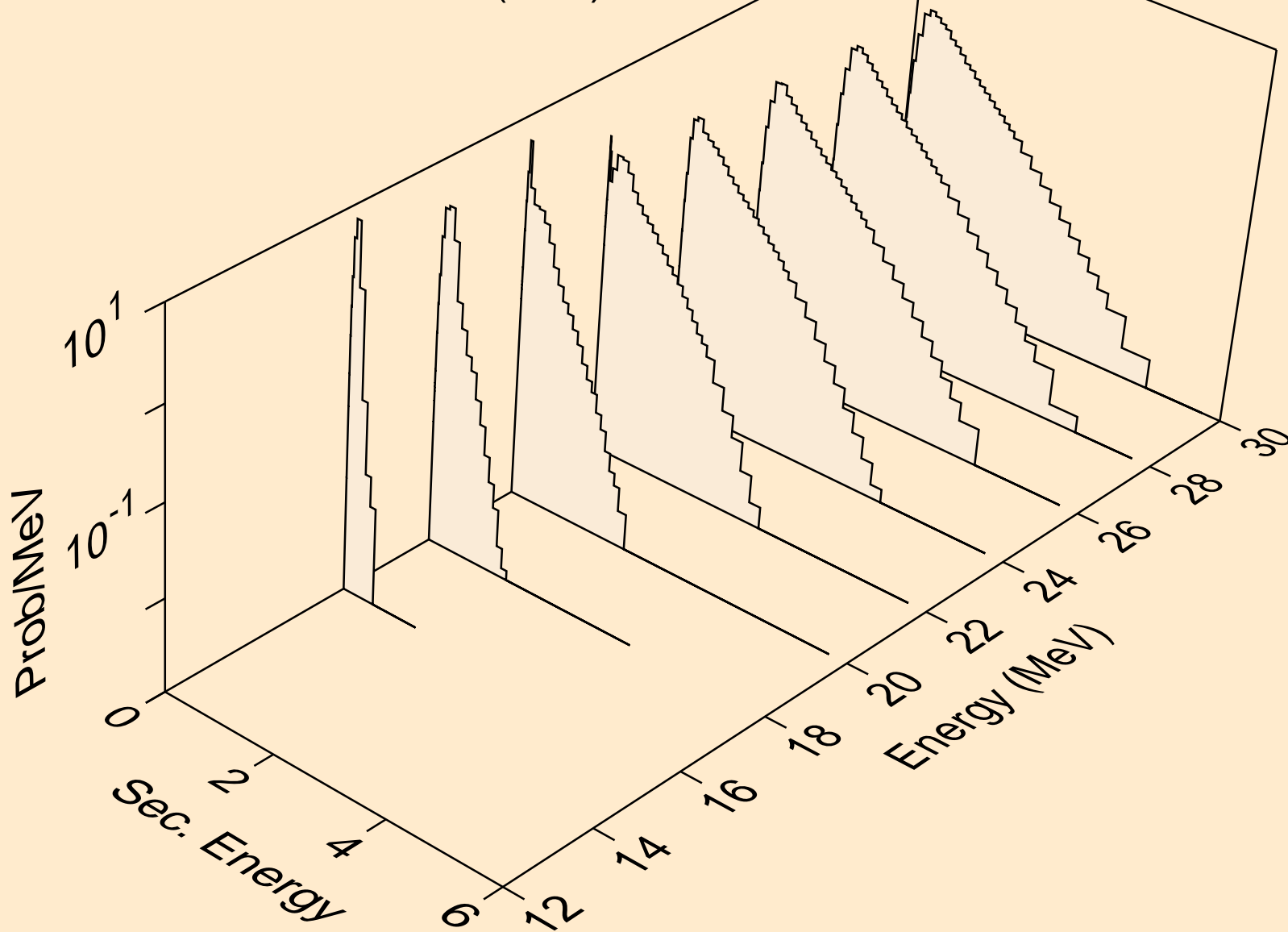

RH109 NEUTRON ACER TENDL-2019 LIBRARY; T=293.16K  
Neutron emission for (n,n\*)he3

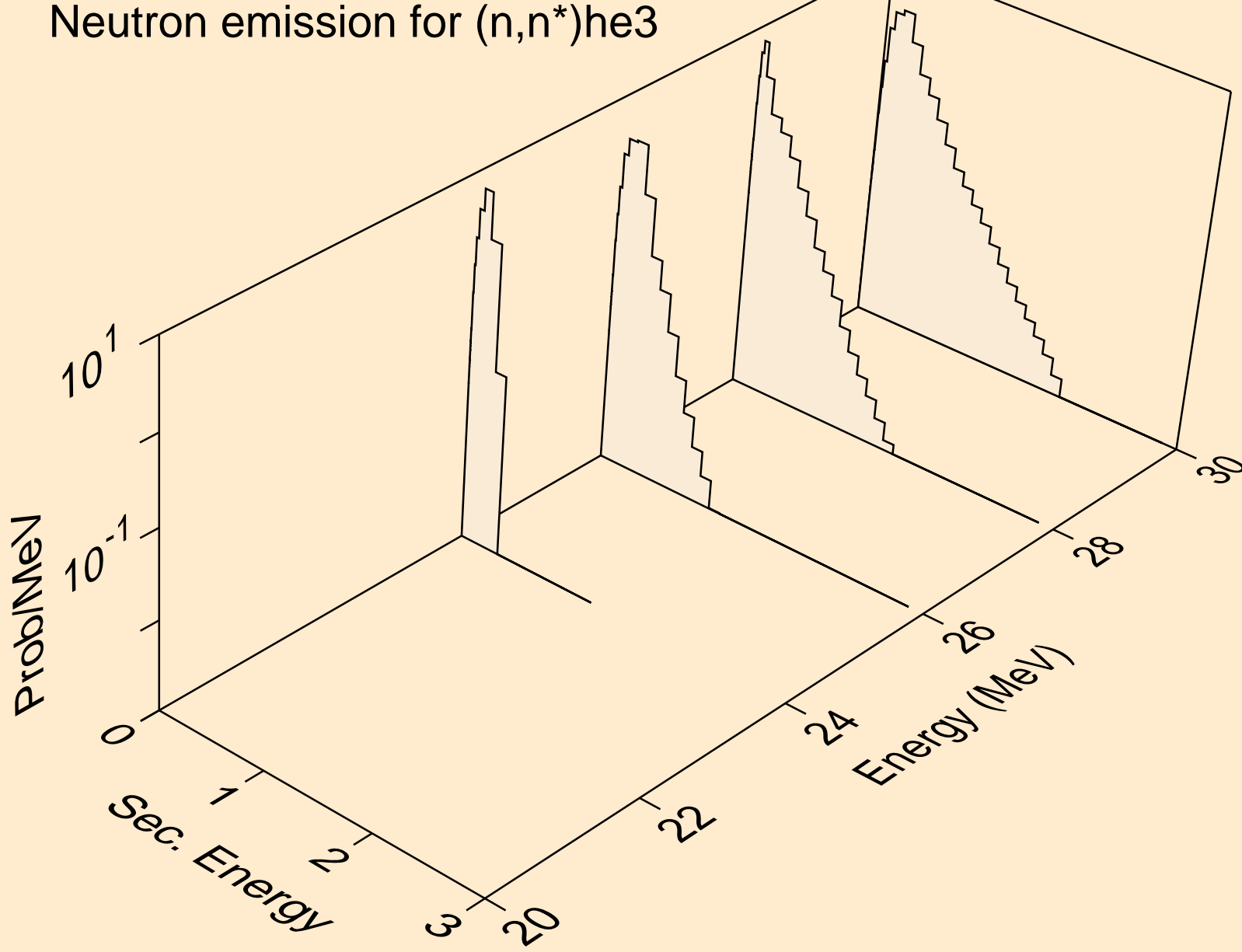

RH109 NEUTRON ACER TENDL-2019 LIBRARY; T=293.16K  
Neutron emission for (n,4n)

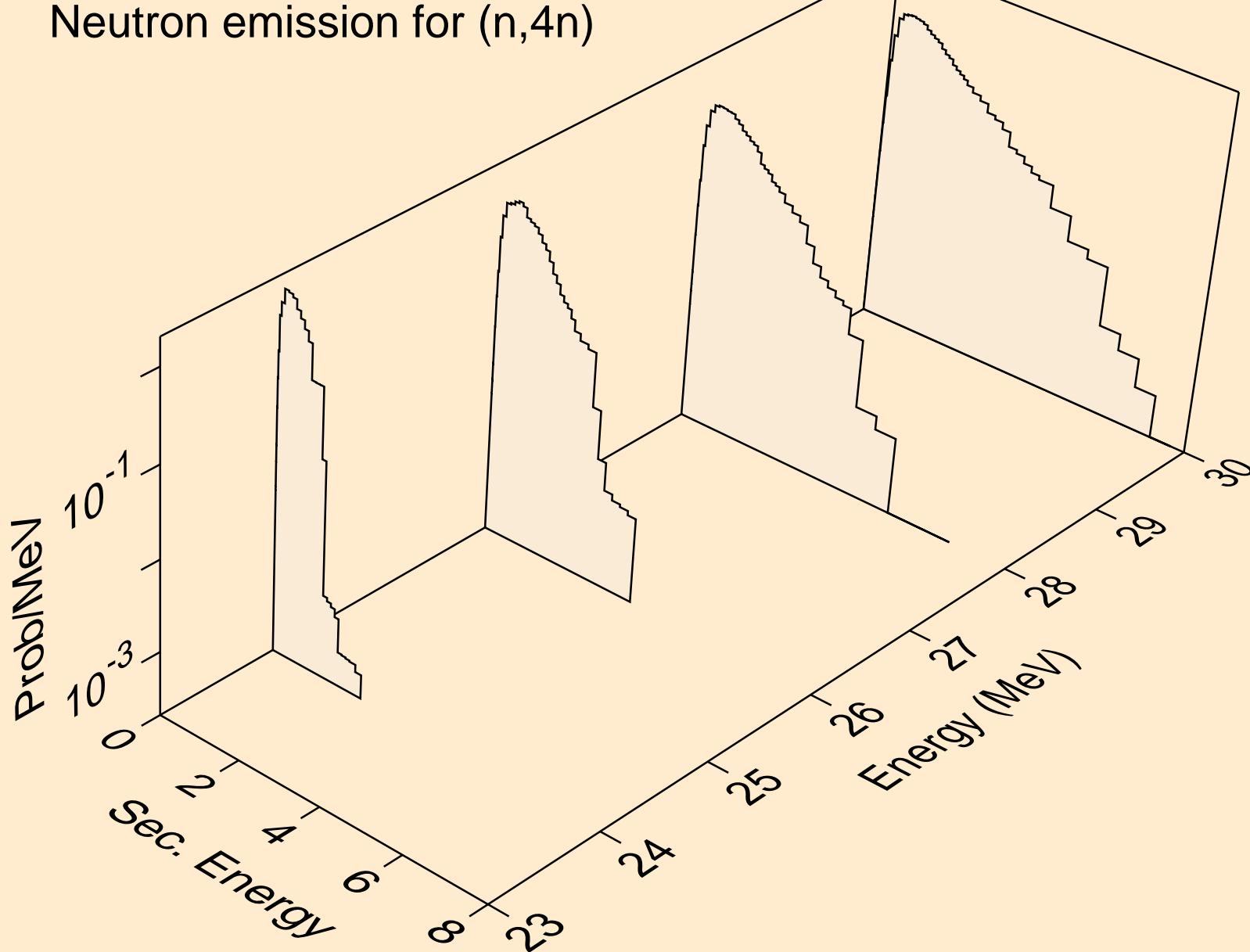

RH109 NEUTRON ACER TENDL-2019 LIBRARY; T=293.16K  
Neutron emission for (n,2np)

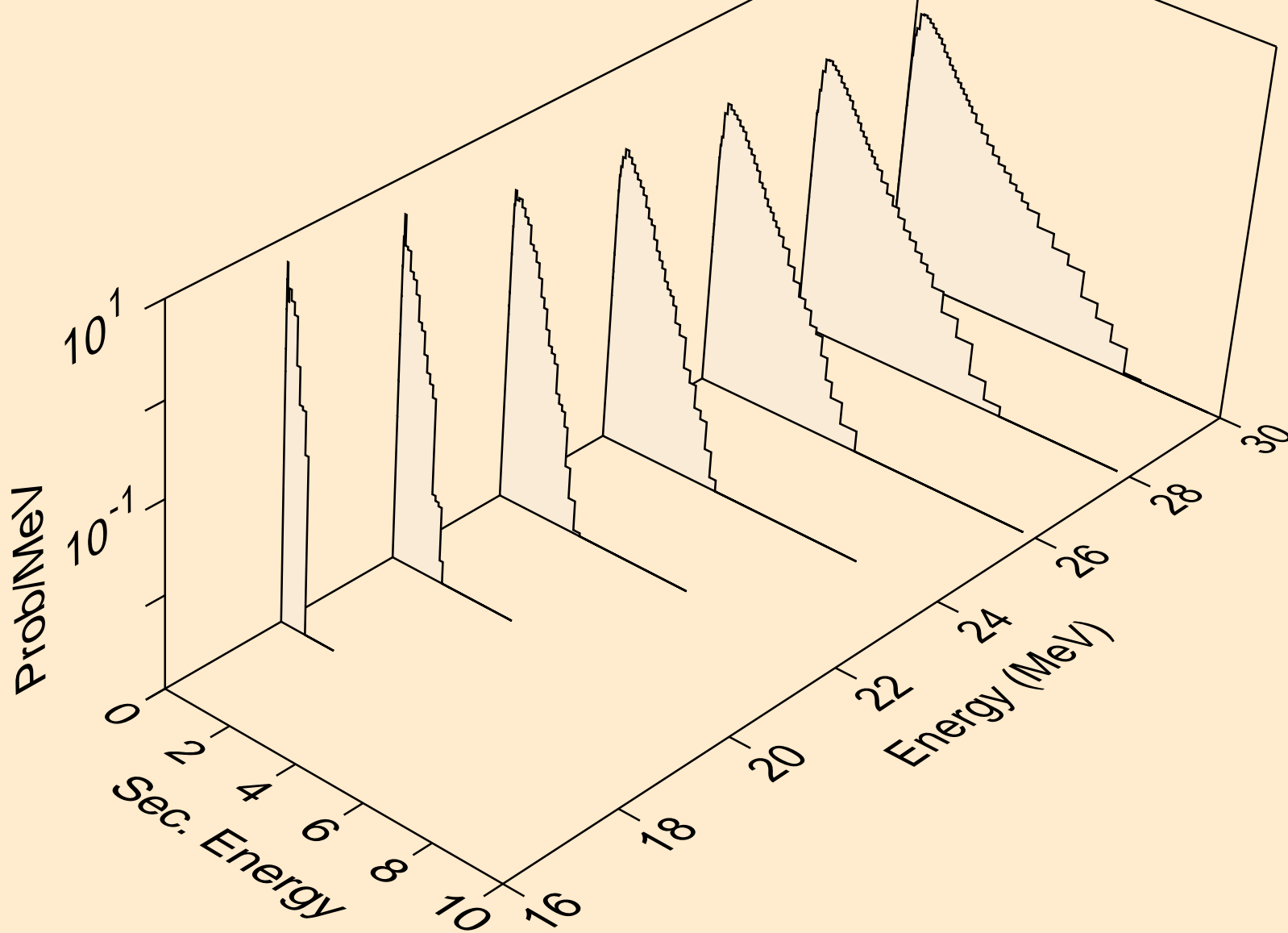



RH109 NEUTRON ACER TENDL-2019 LIBRARY; T=293.16K  
Neutron emission for (n,3np)

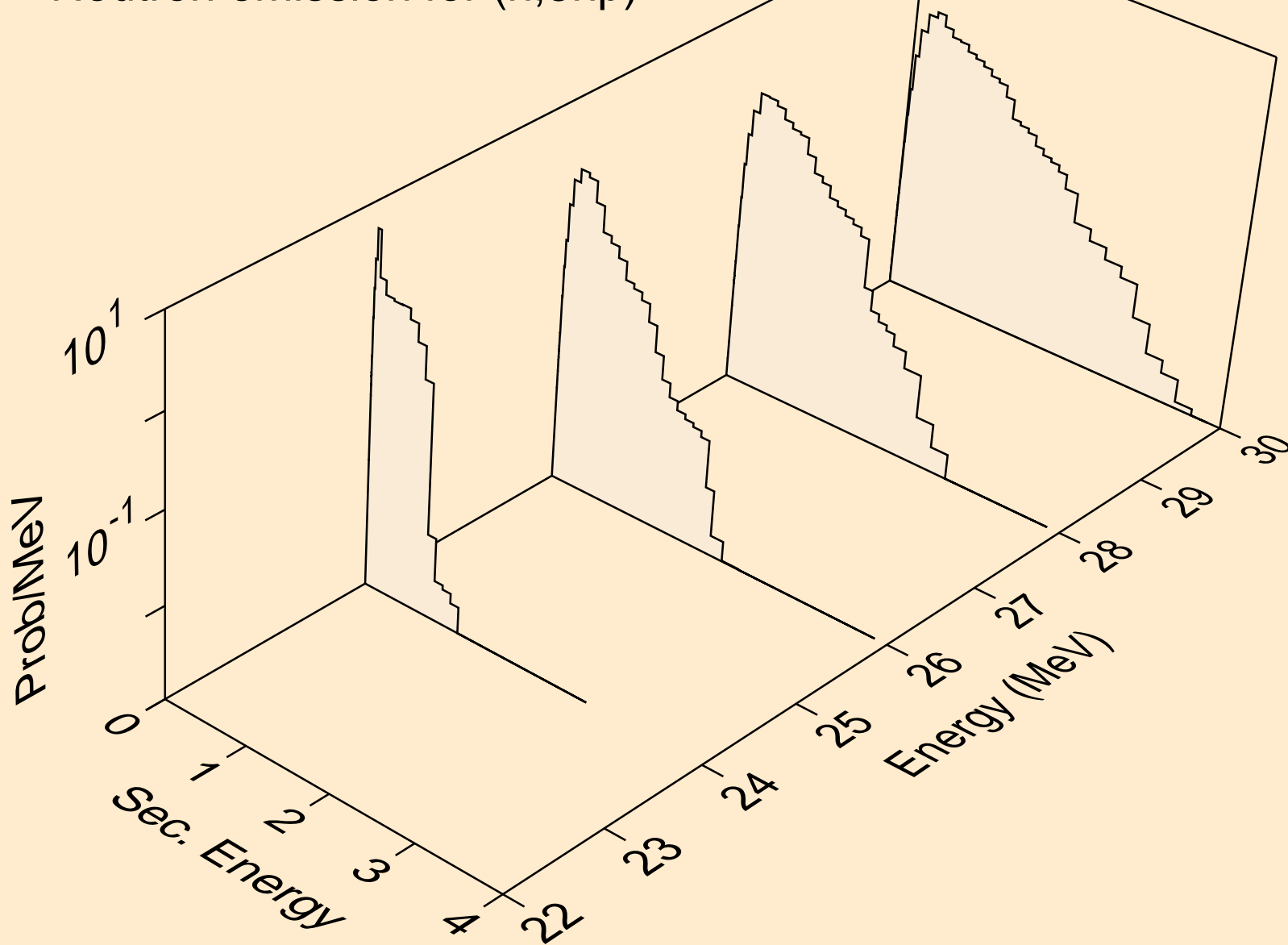

RH109 NEUTRON ACER TENDL-2019 LIBRARY; T=293.16K  
Neutron emission for (n,2np)

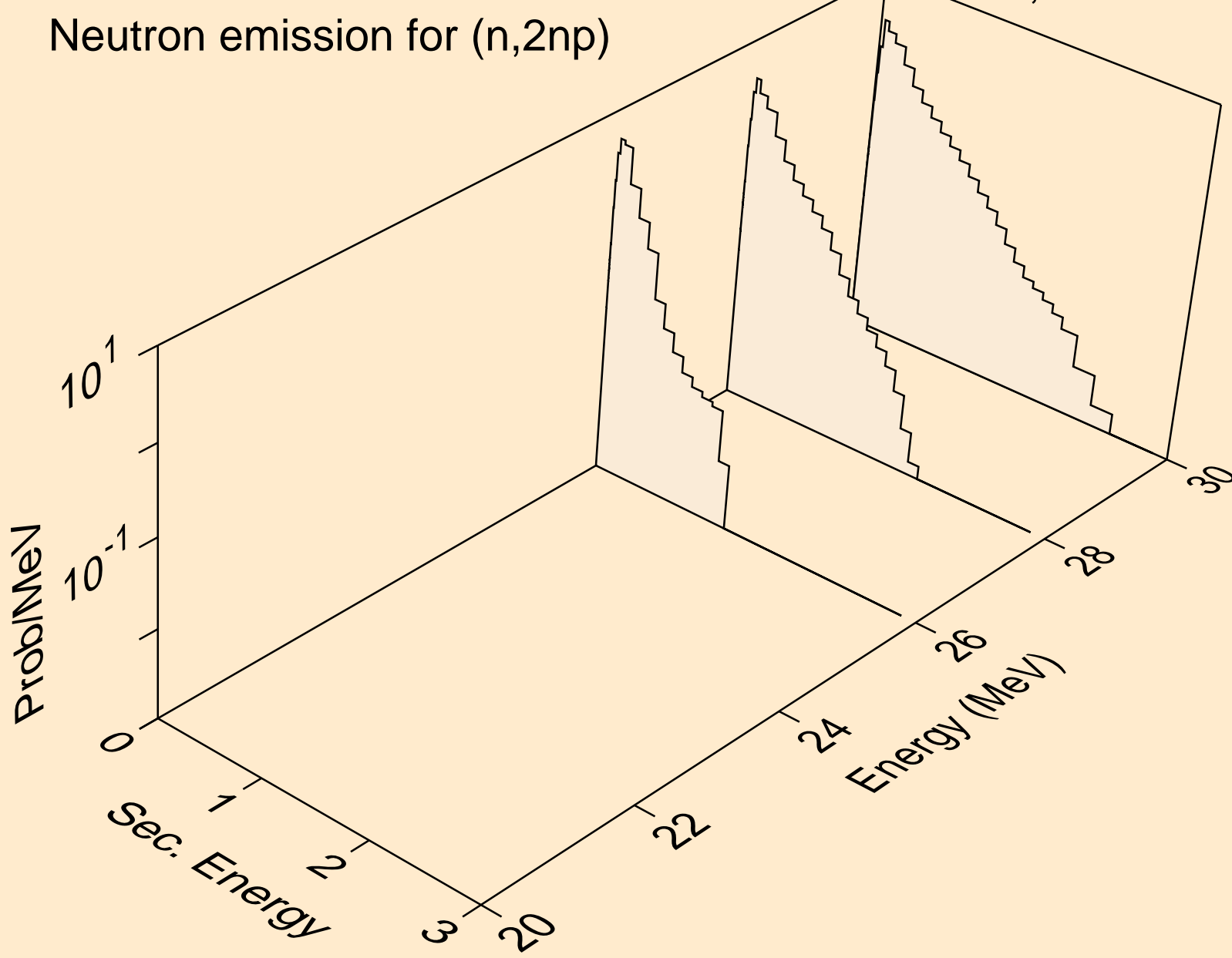

RH109 NEUTRON ACER TENDL-2019 LIBRARY; T=293.16K  
Neutron emission for (n,n\*c)

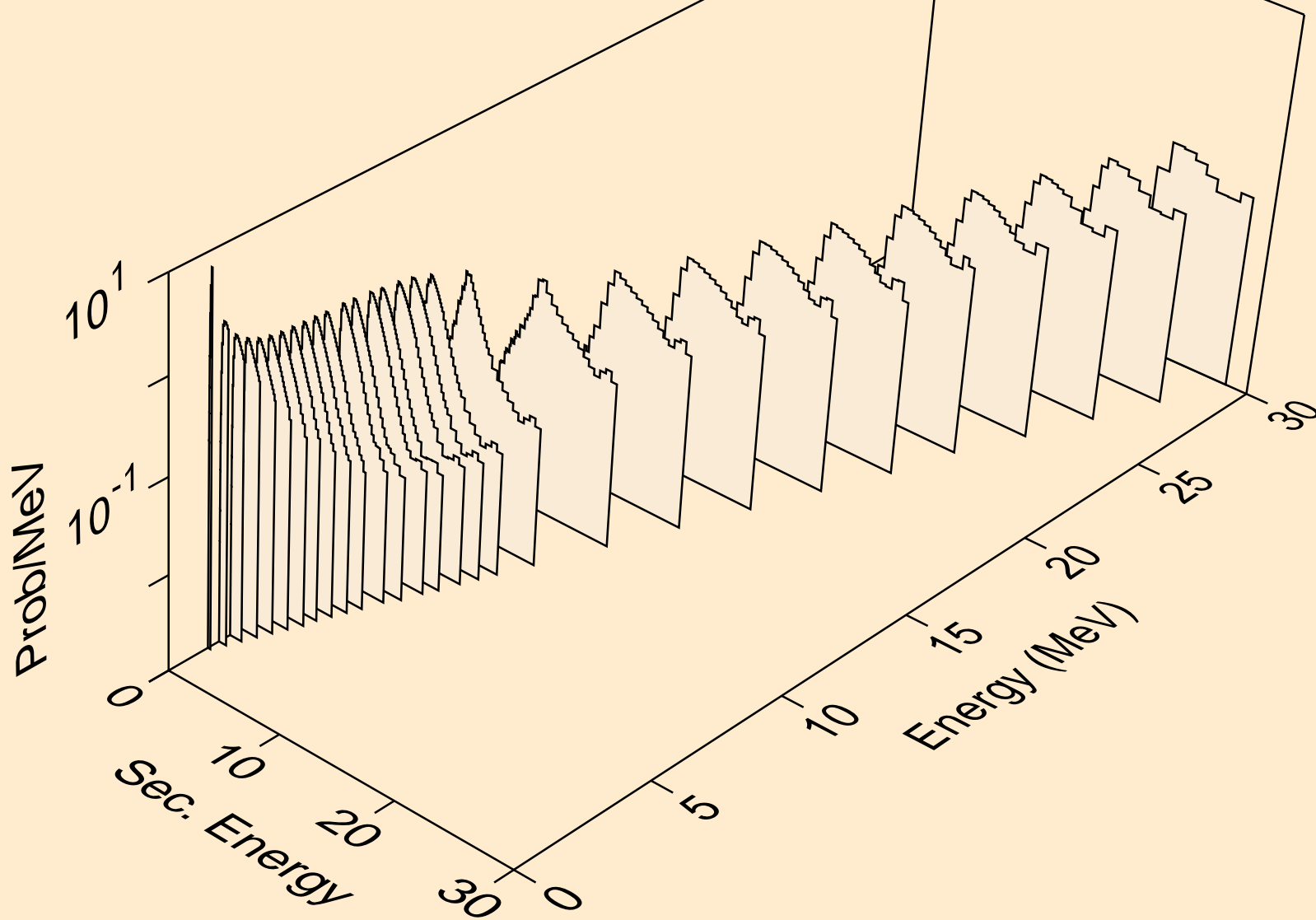

RH109 NEUTRON ACER TENDL-2019 LIBRARY; T=293.16K  
Photon emission for (n,x)

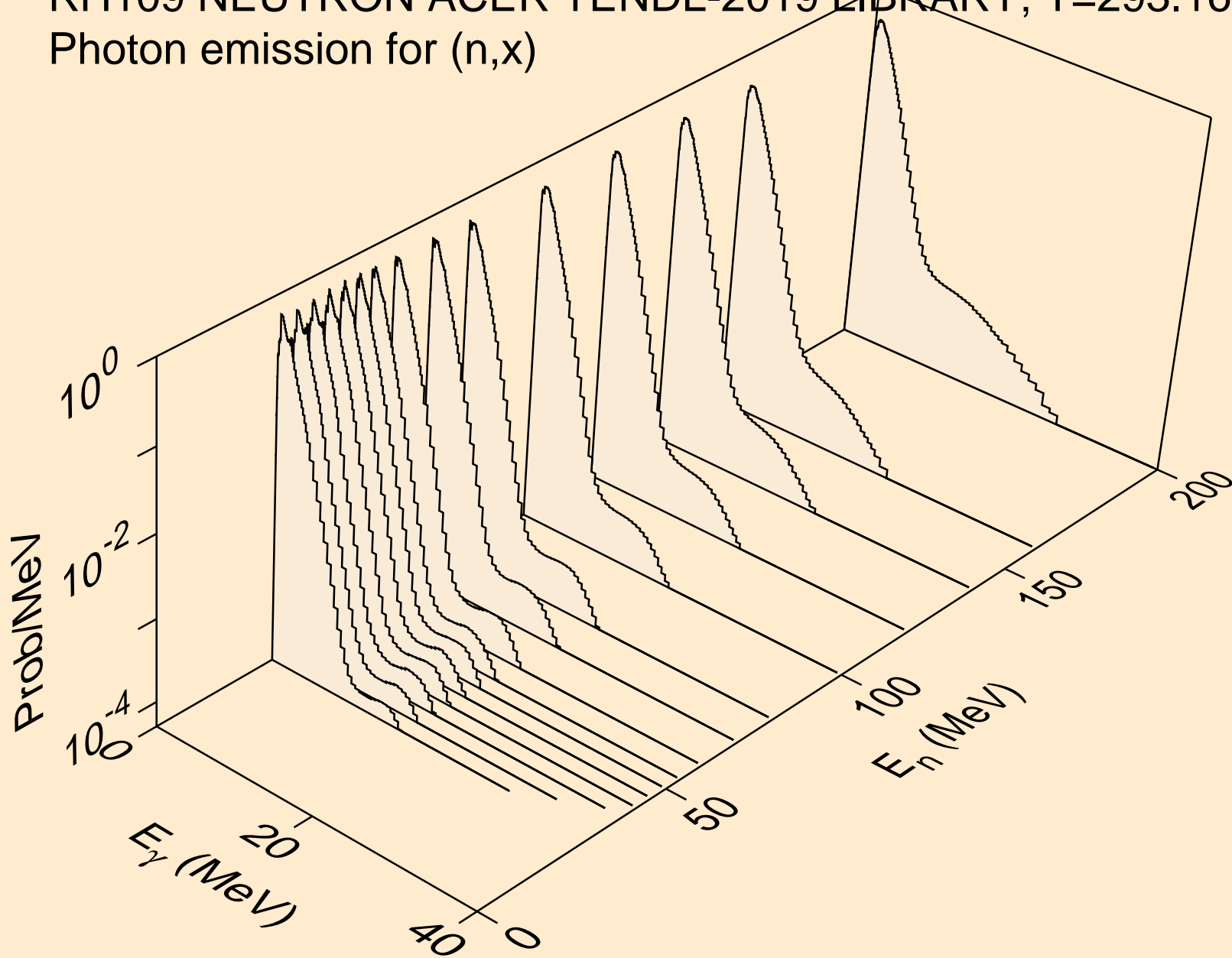

RH109 NEUTRON ACER TENDL-2019 LIBRARY; T=293.16K  
Photon emission for (n,2nd)

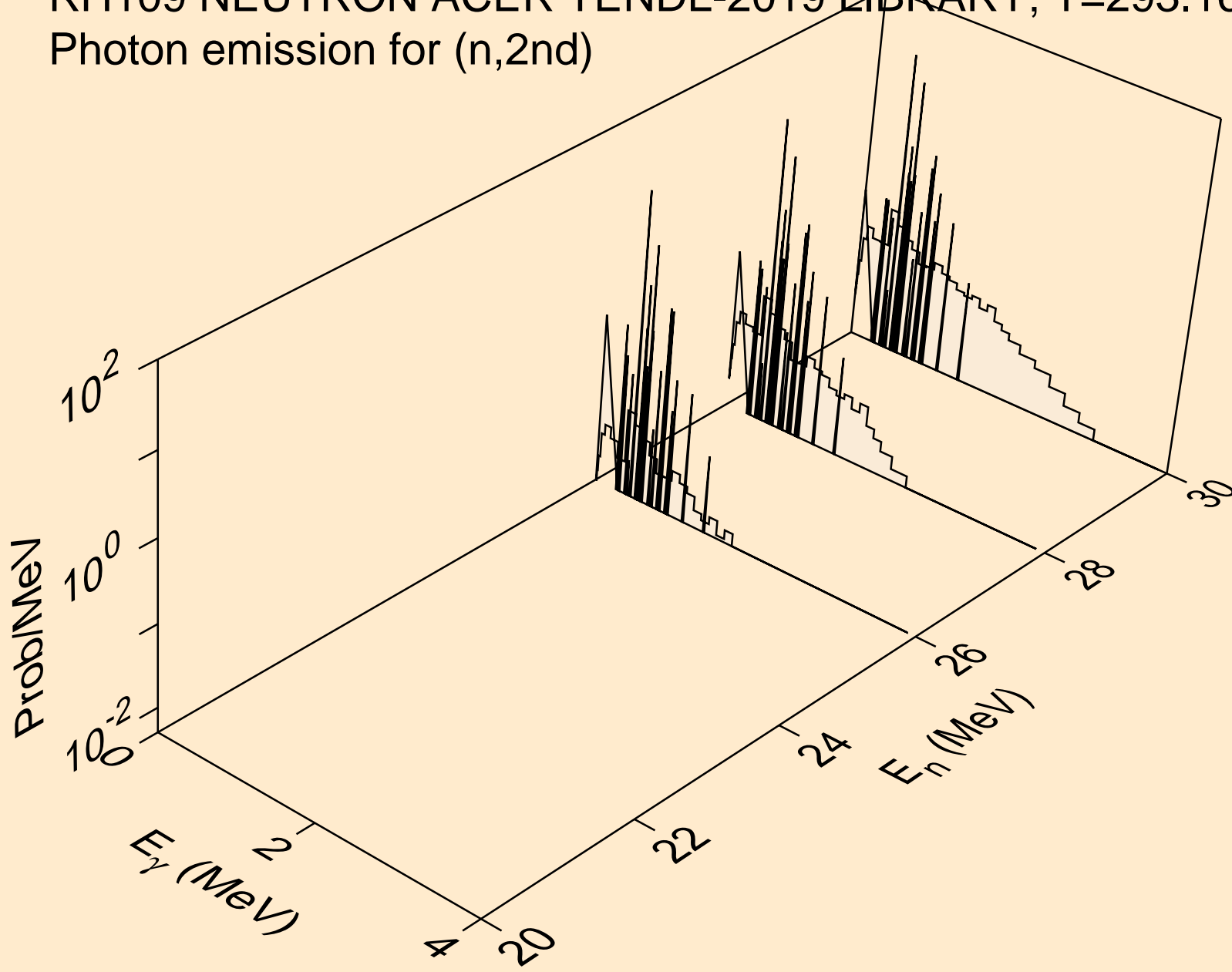

RH109 NEUTRON ACER TENDL-2019 LIBRARY; T=293.16K  
Photon emission for (n,2n)

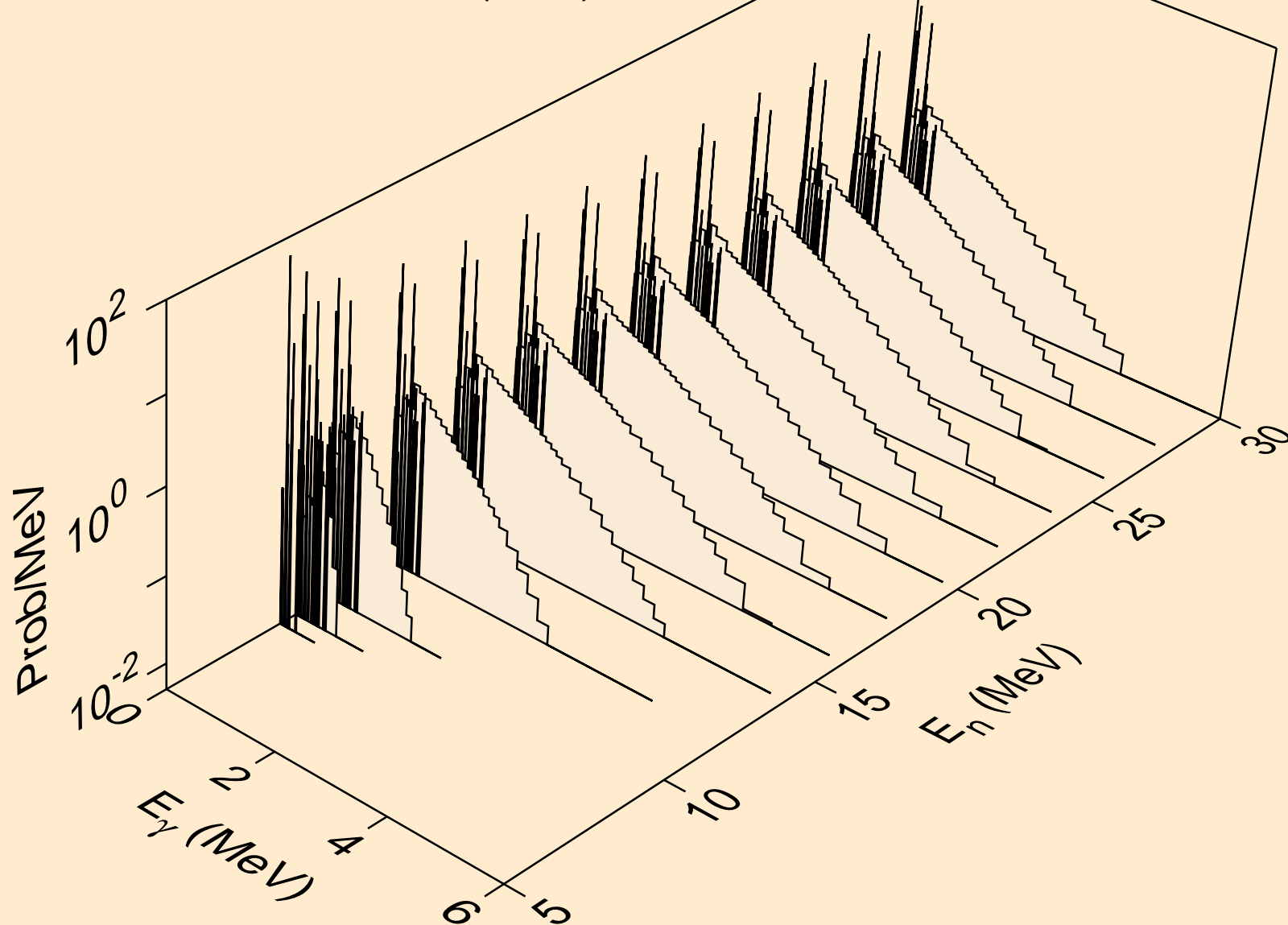

RH109 NEUTRON ACER TENDL-2019 LIBRARY; T=293.16K  
Photon emission for (n,3n)

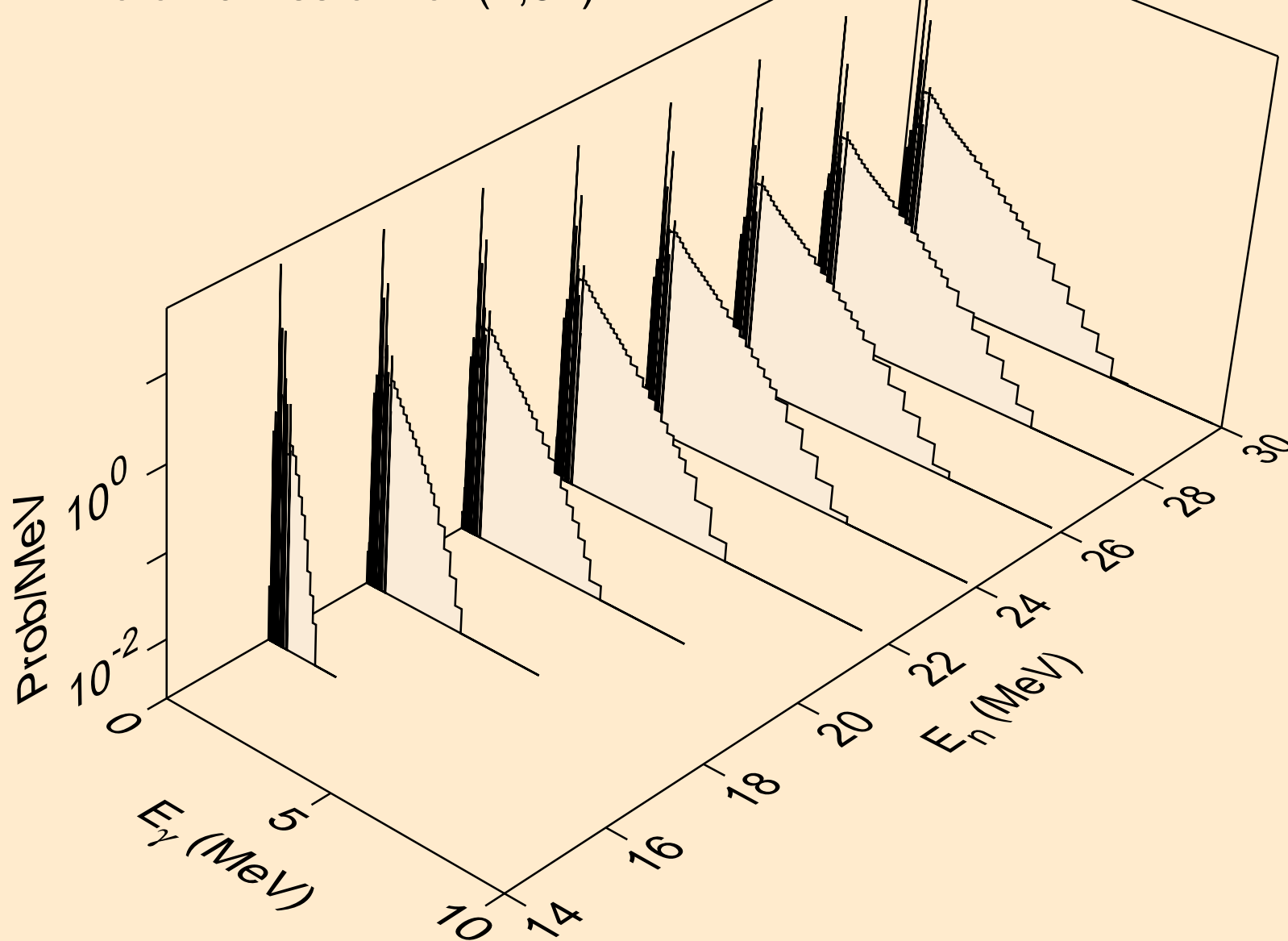

RH109 NEUTRON ACER TENDL-2019 LIBRARY; T=293.16K  
Photon emission for (n,n\*)a

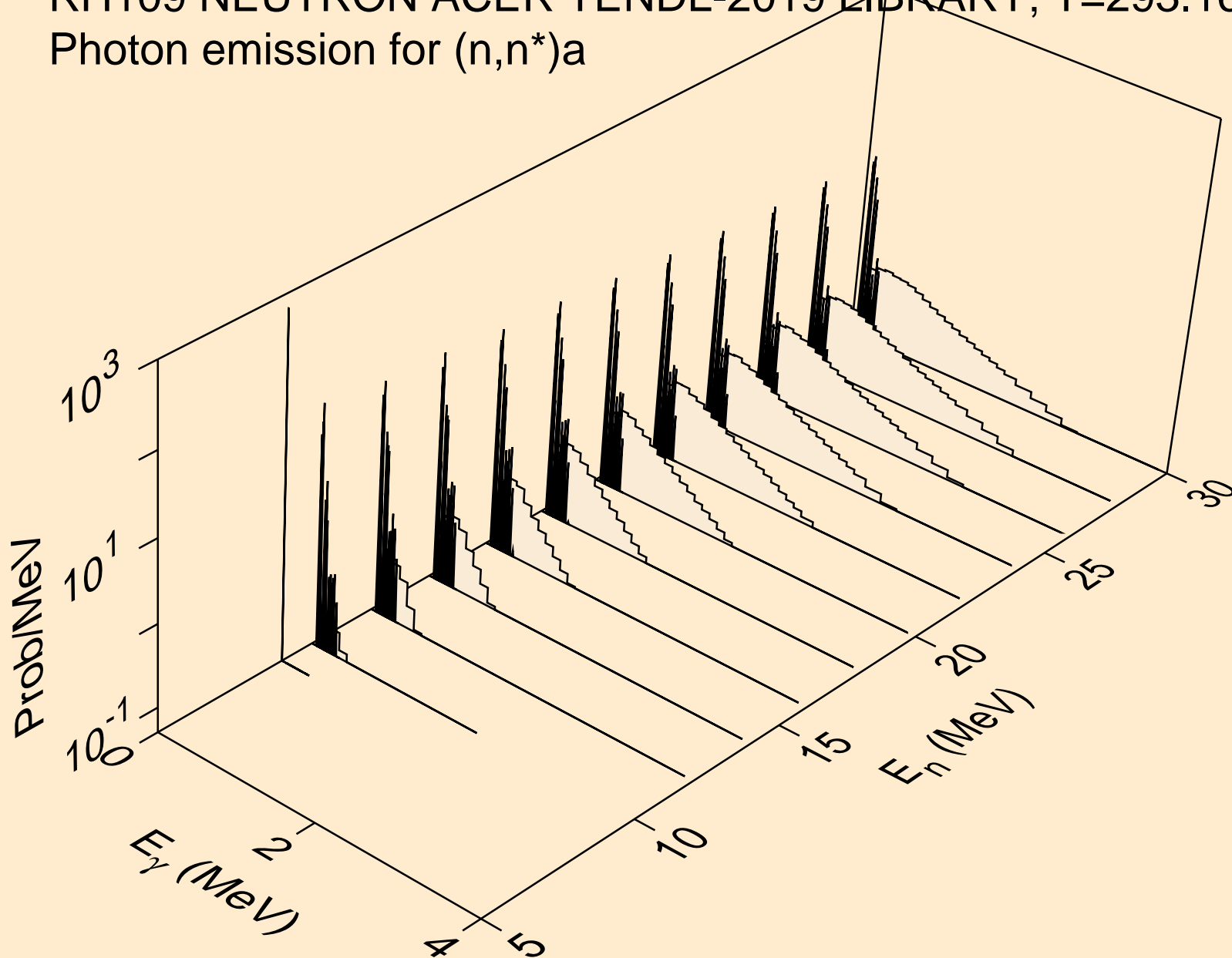



RH109 NEUTRON ACER TENDL-2019 LIBRARY; T=293.16K  
Photon emission for (n,2n)a

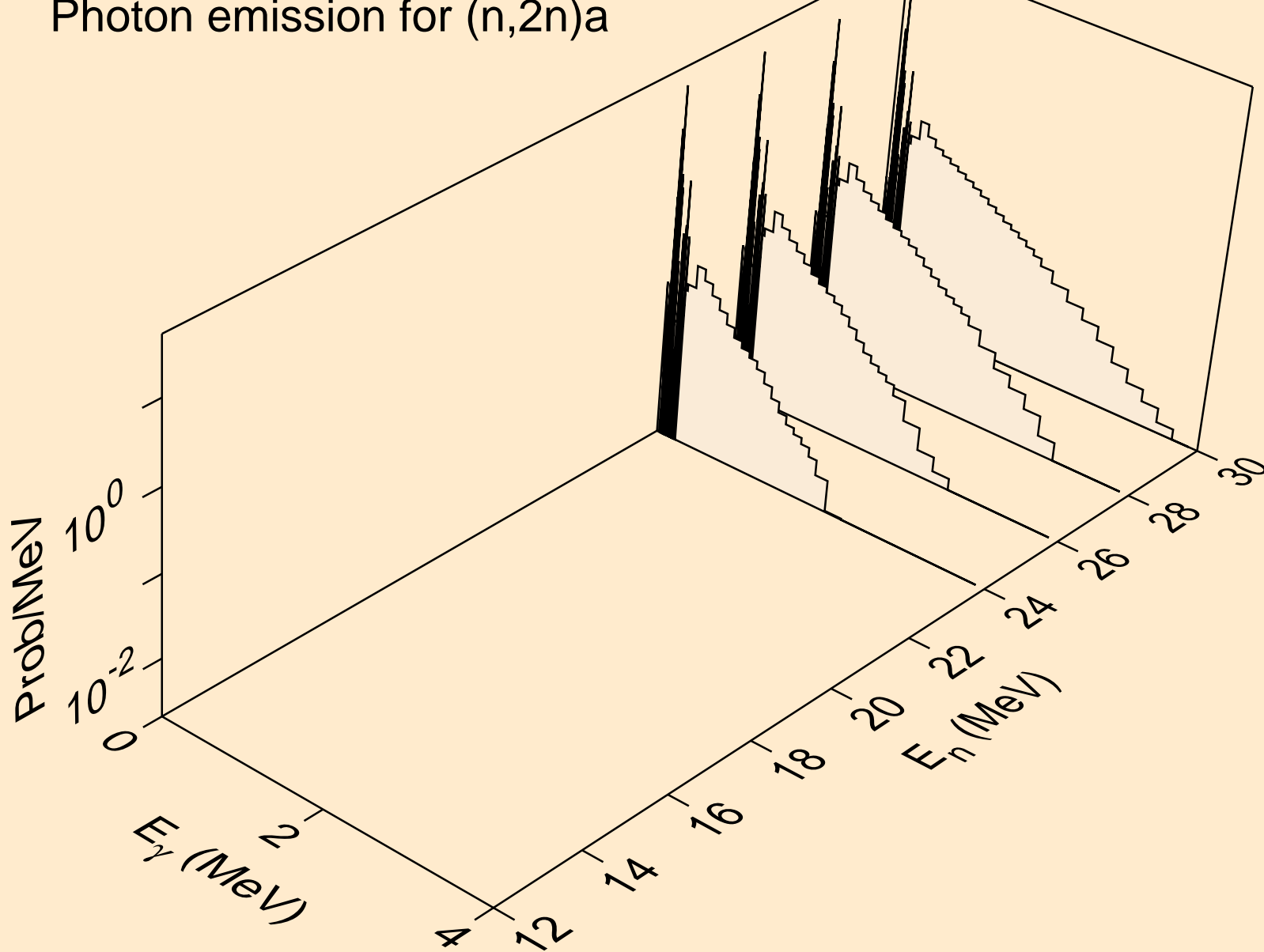

RH109 NEUTRON ACER TENDL-2019 LIBRARY; T=293.16K  
Photon emission for (n,3n)a

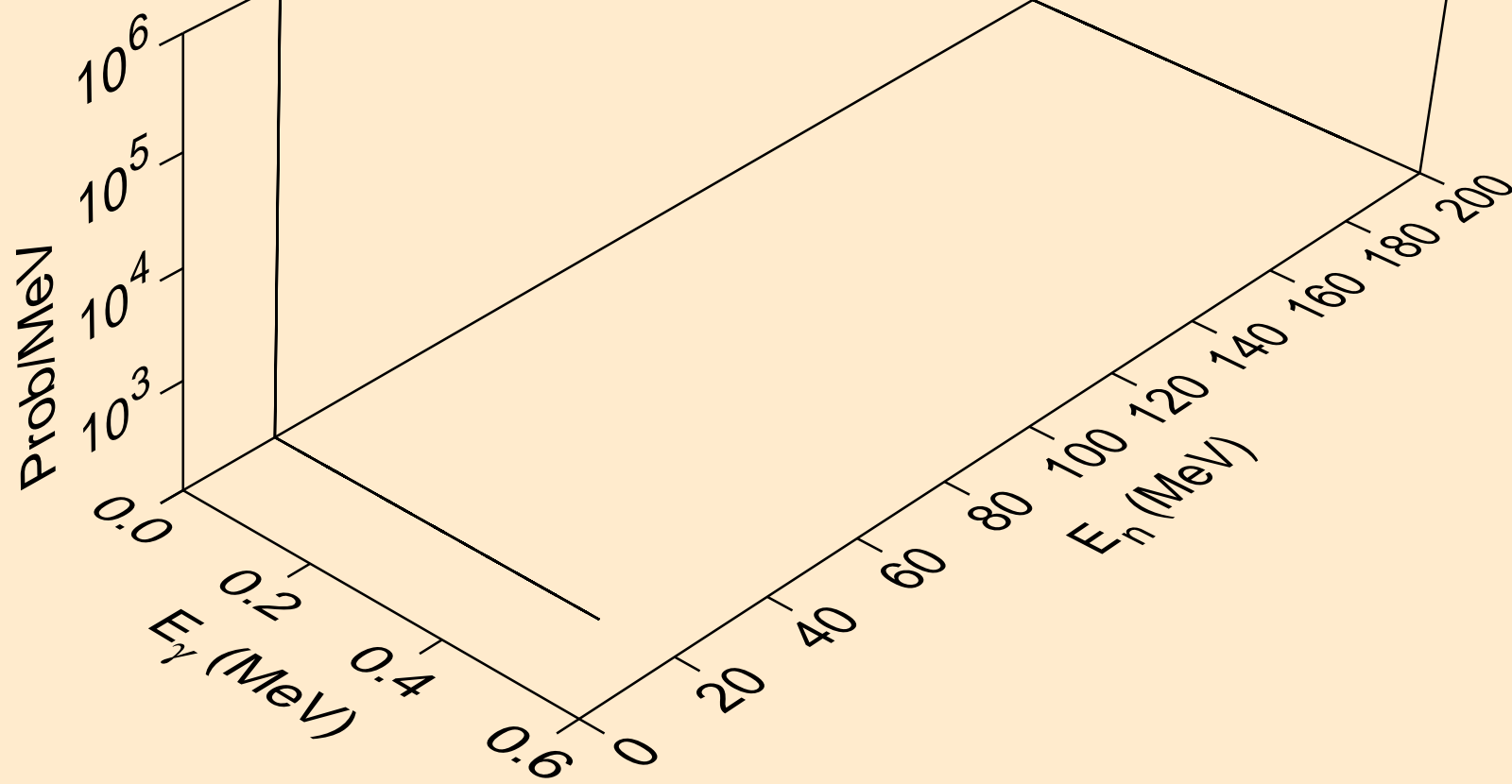

RH109 NEUTRON ACER TENDL-2019 LIBRARY; T=293.16K  
Photon emission for (n,n\*)p

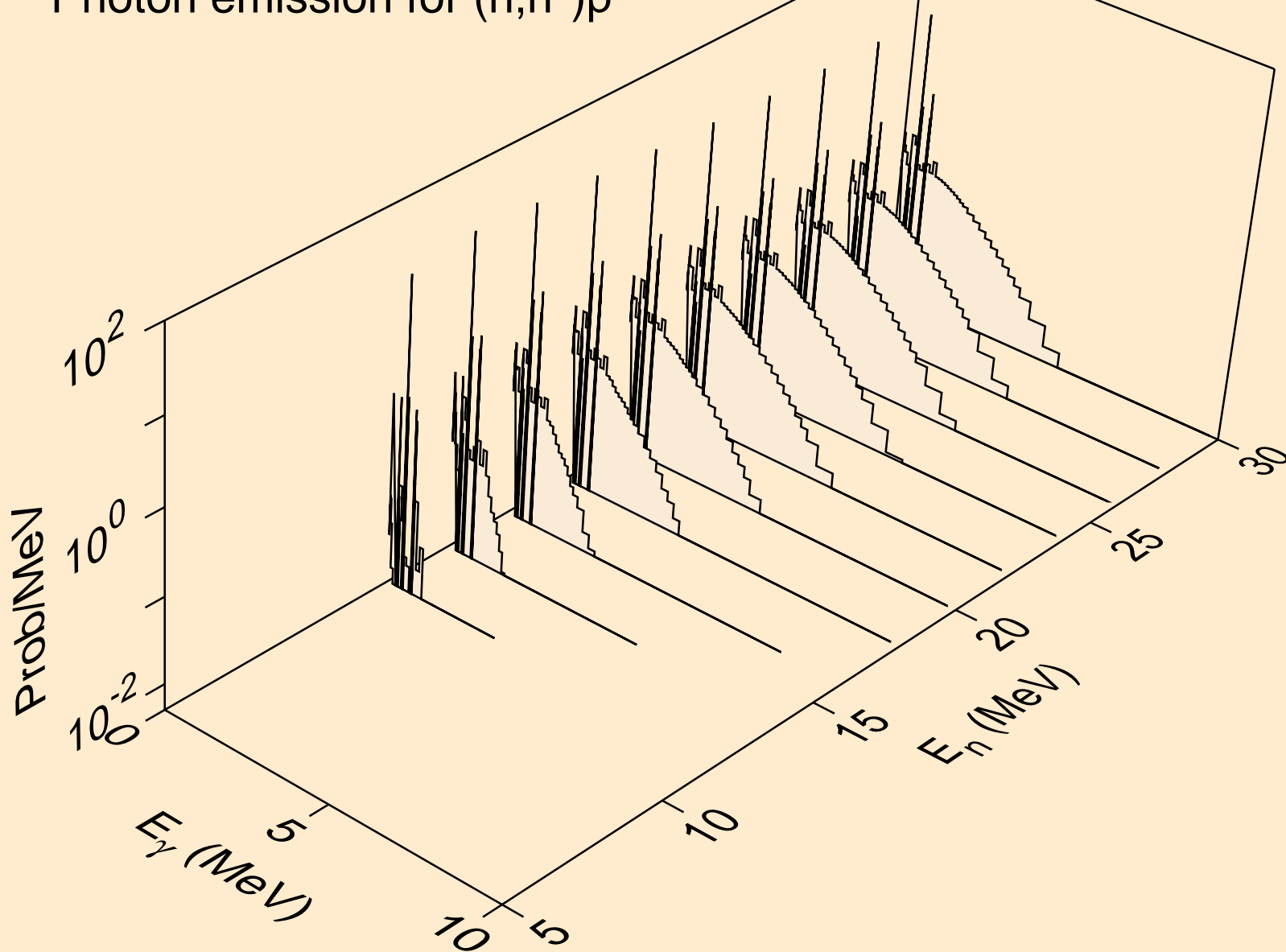

RH109 NEUTRON ACER TENDL-2019 LIBRARY; T=293.16K  
Photon emission for (n,n\*)d

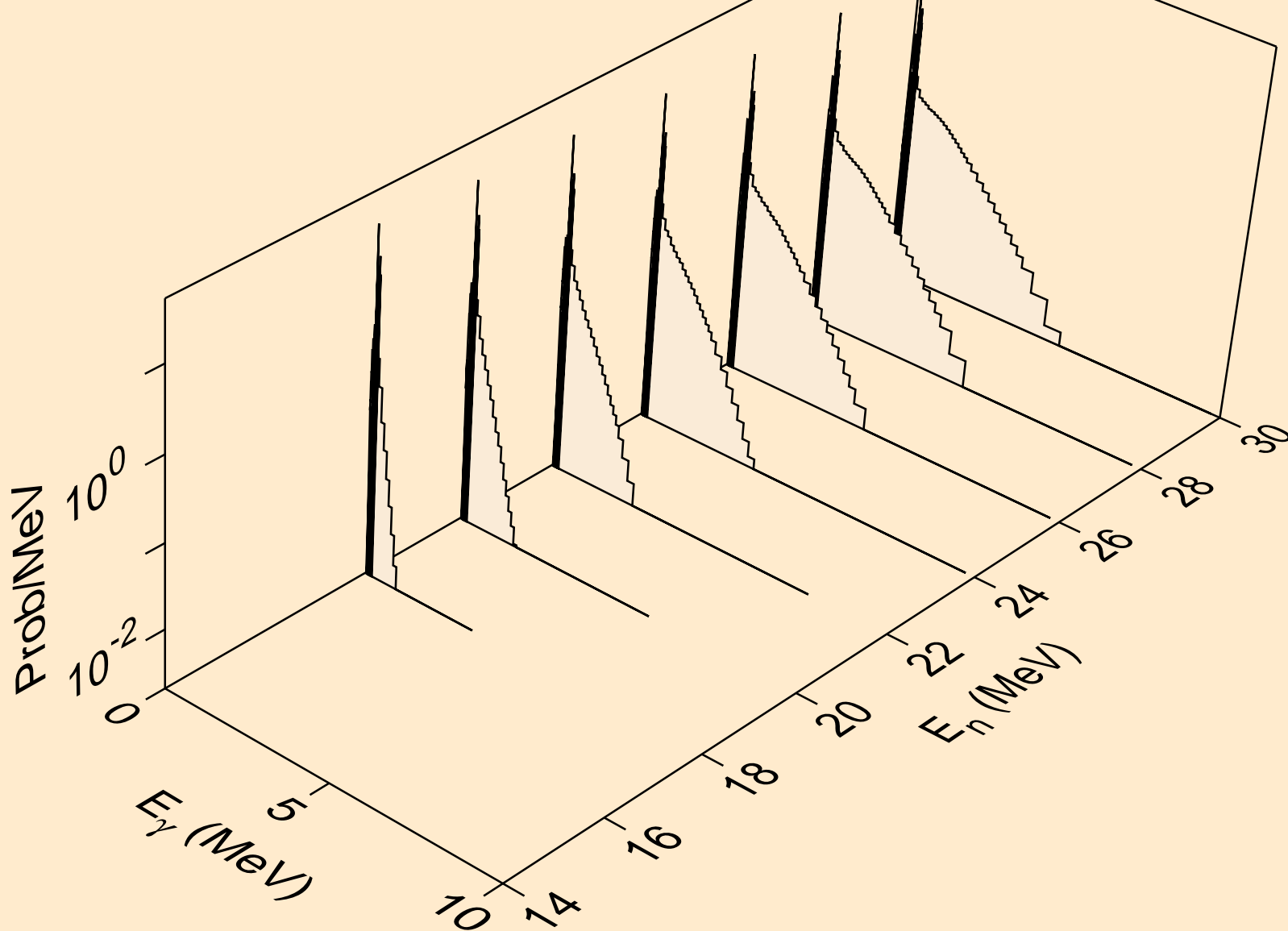

RH109 NEUTRON ACER TENDL-2019 LIBRARY; T=293.16K  
Photon emission for (n,n\*)t

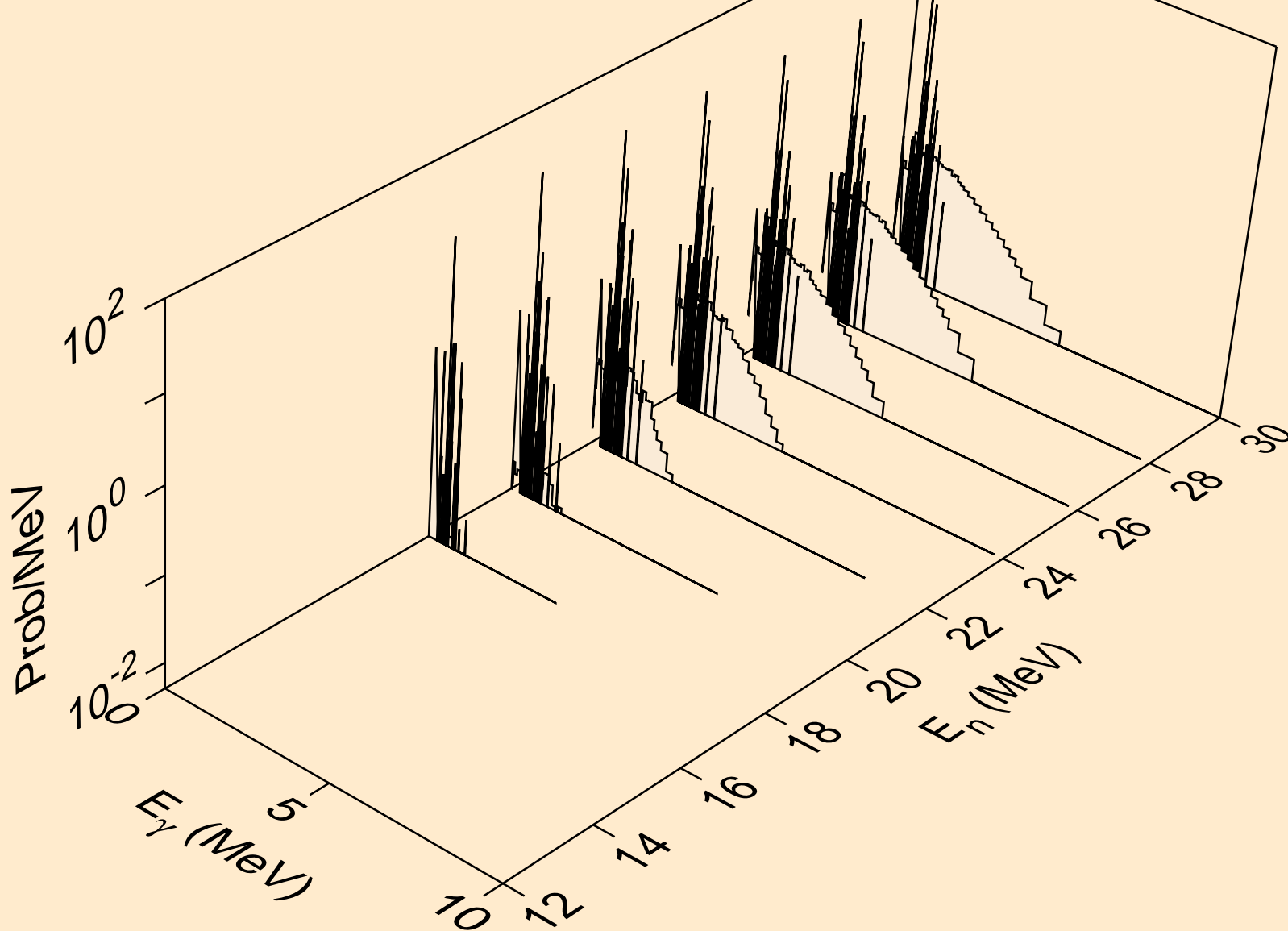

RH109 NEUTRON ACER TENDL-2019 LIBRARY; T=293.16K  
Photon emission for (n,n\*)he3

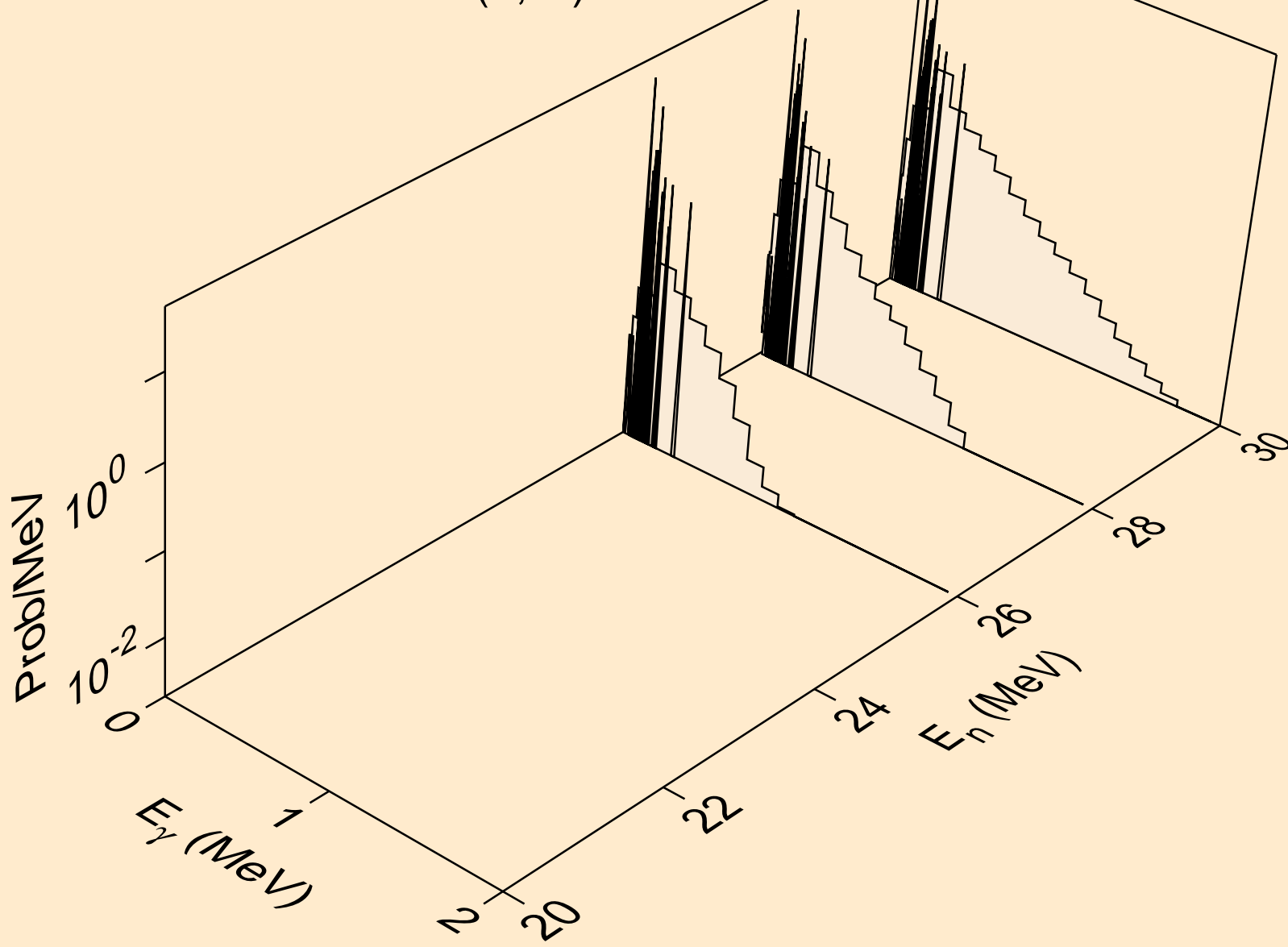

RH109 NEUTRON ACER TENDL-2019 LIBRARY; T=293.16K  
Photon emission for (n,4n)

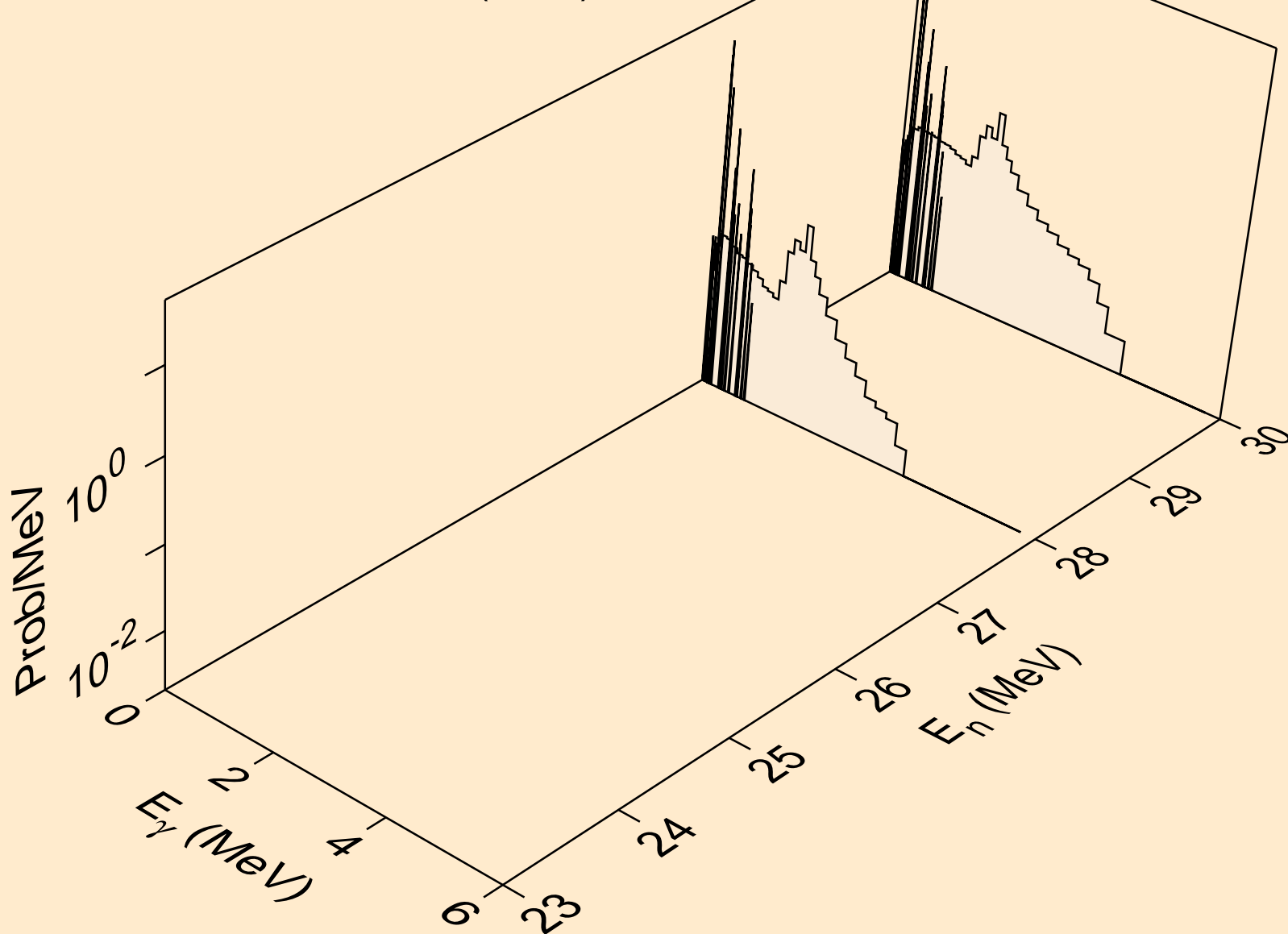

RH109 NEUTRON ACER TENDL-2019 LIBRARY; T=293.16K  
Photon emission for (n,2np)

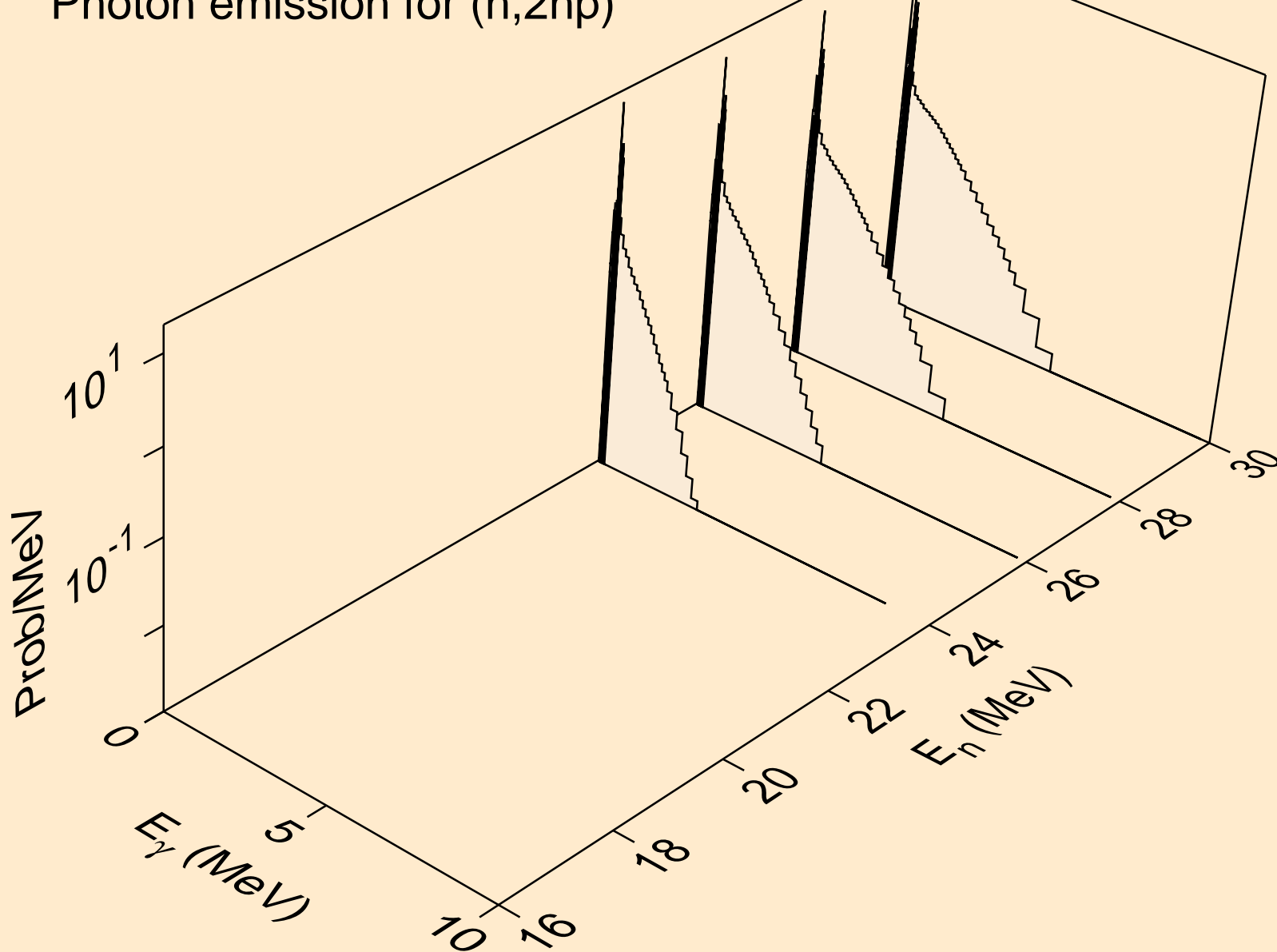



RH109 NEUTRON ACER TENDL-2019 LIBRARY; T=293.16K  
Photon emission for (n,3np)

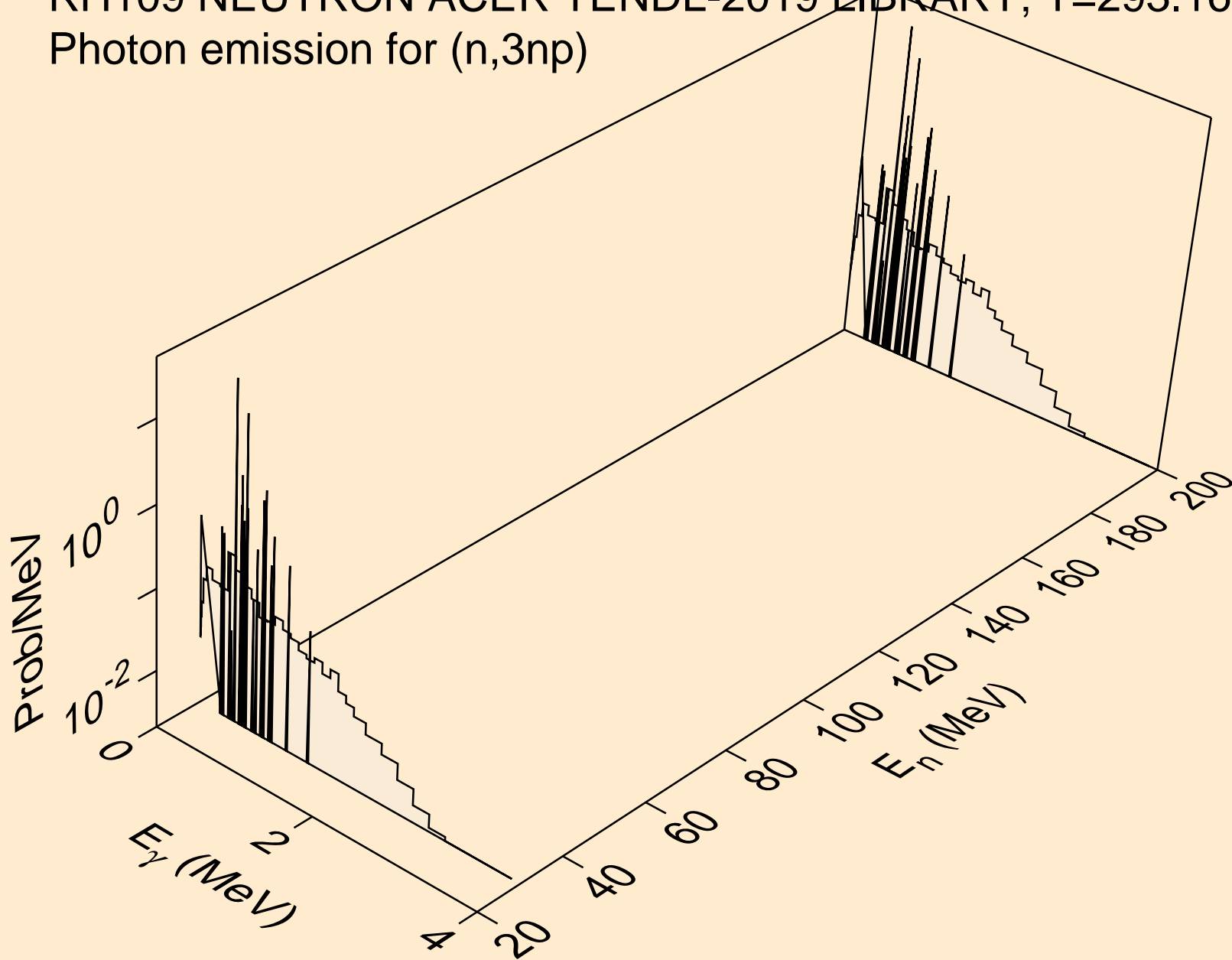

RH109 NEUTRON ACER TENDL-2019 LIBRARY; T=293.16K  
Photon emission for (n,2np)

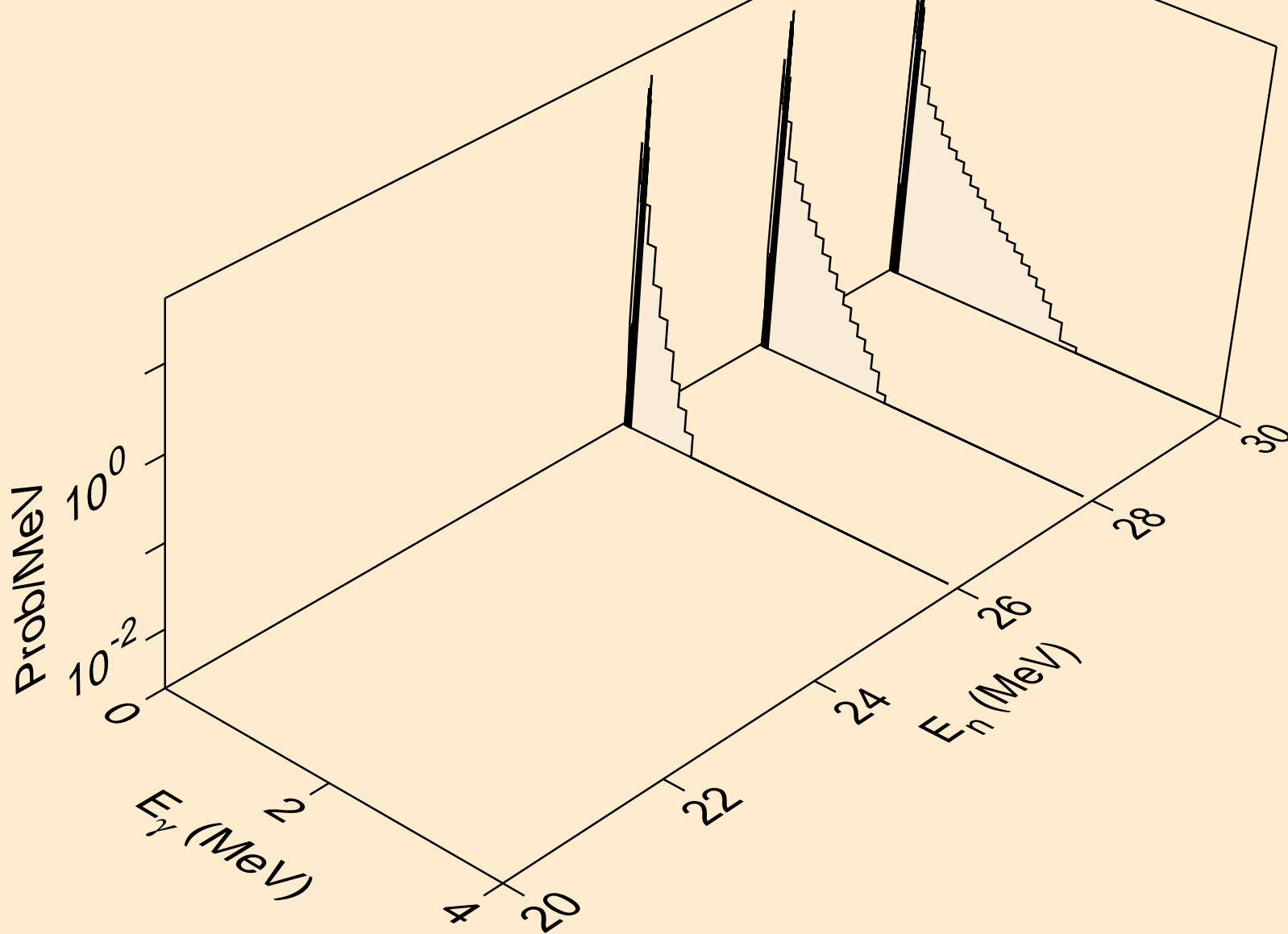

RH109 NEUTRON ACER TENDL-2019 LIBRARY; T=293.16K  
Photon emission for (n,n\*c)

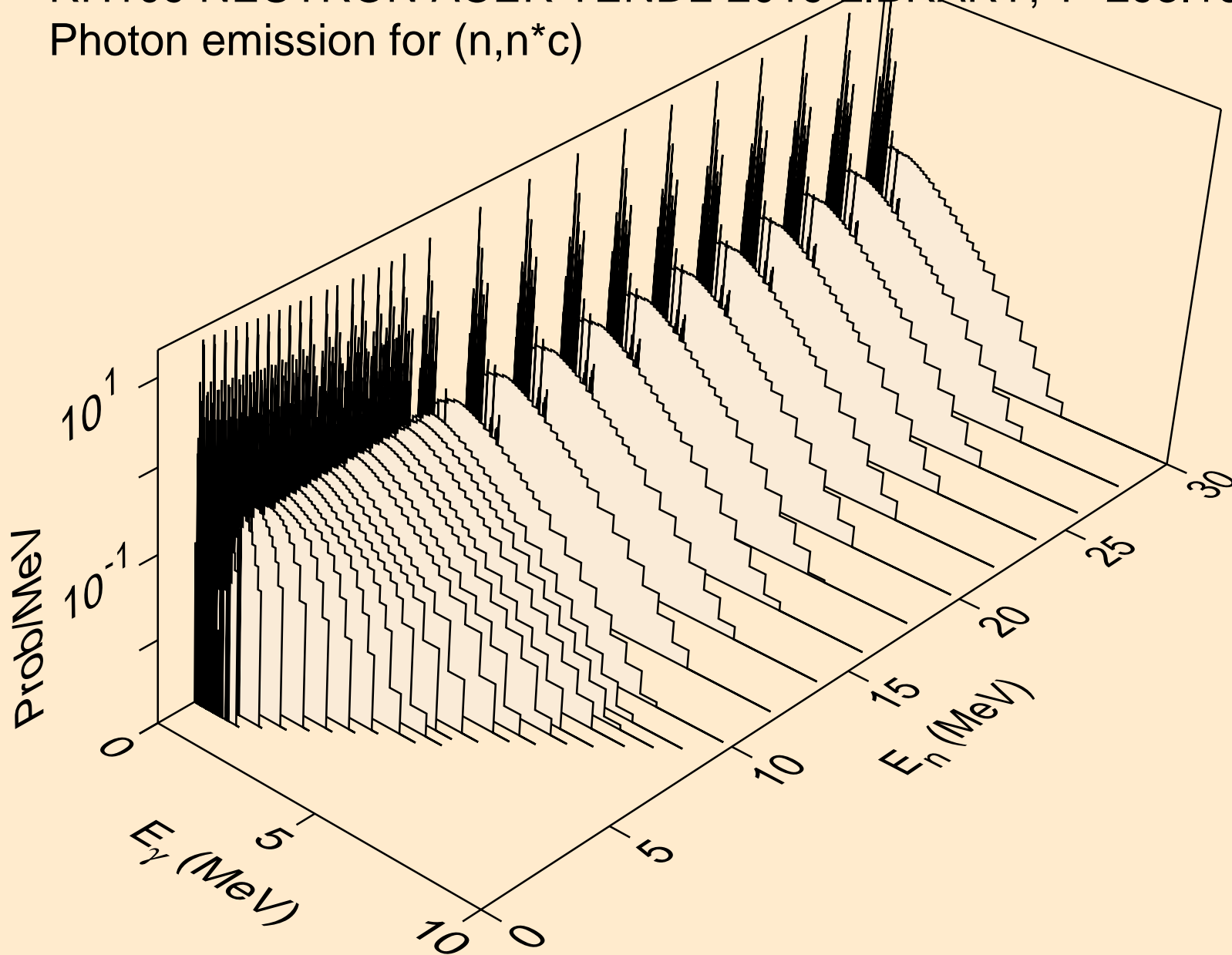

RH109 NEUTRON ACER TENDL-2019 LIBRARY; T=293.16K  
Photon emission for (n,gma)

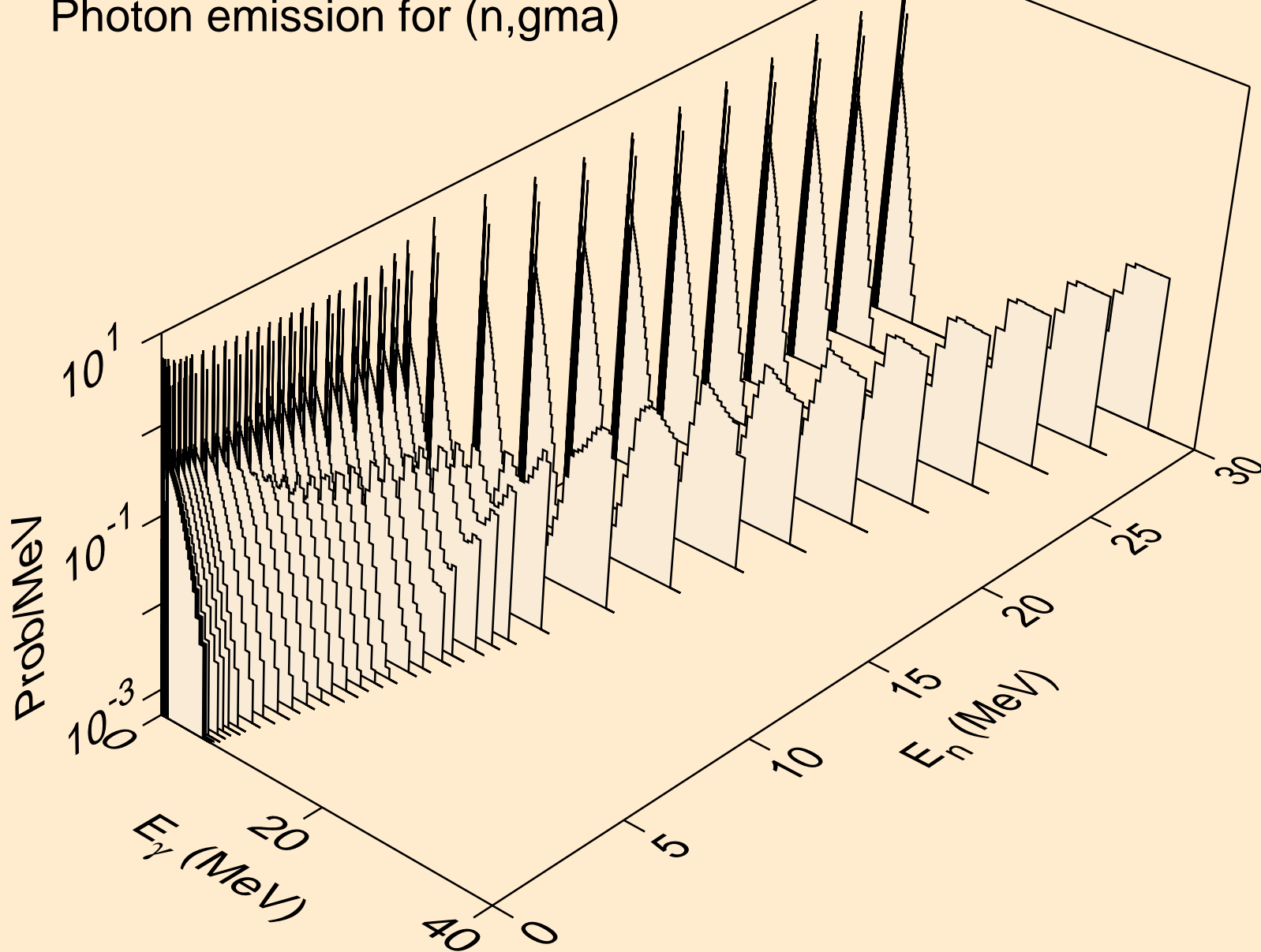

RH109 NEUTRON ACER TENDL-2019 LIBRARY; T=293.16K  
Photon emission for (n,p)

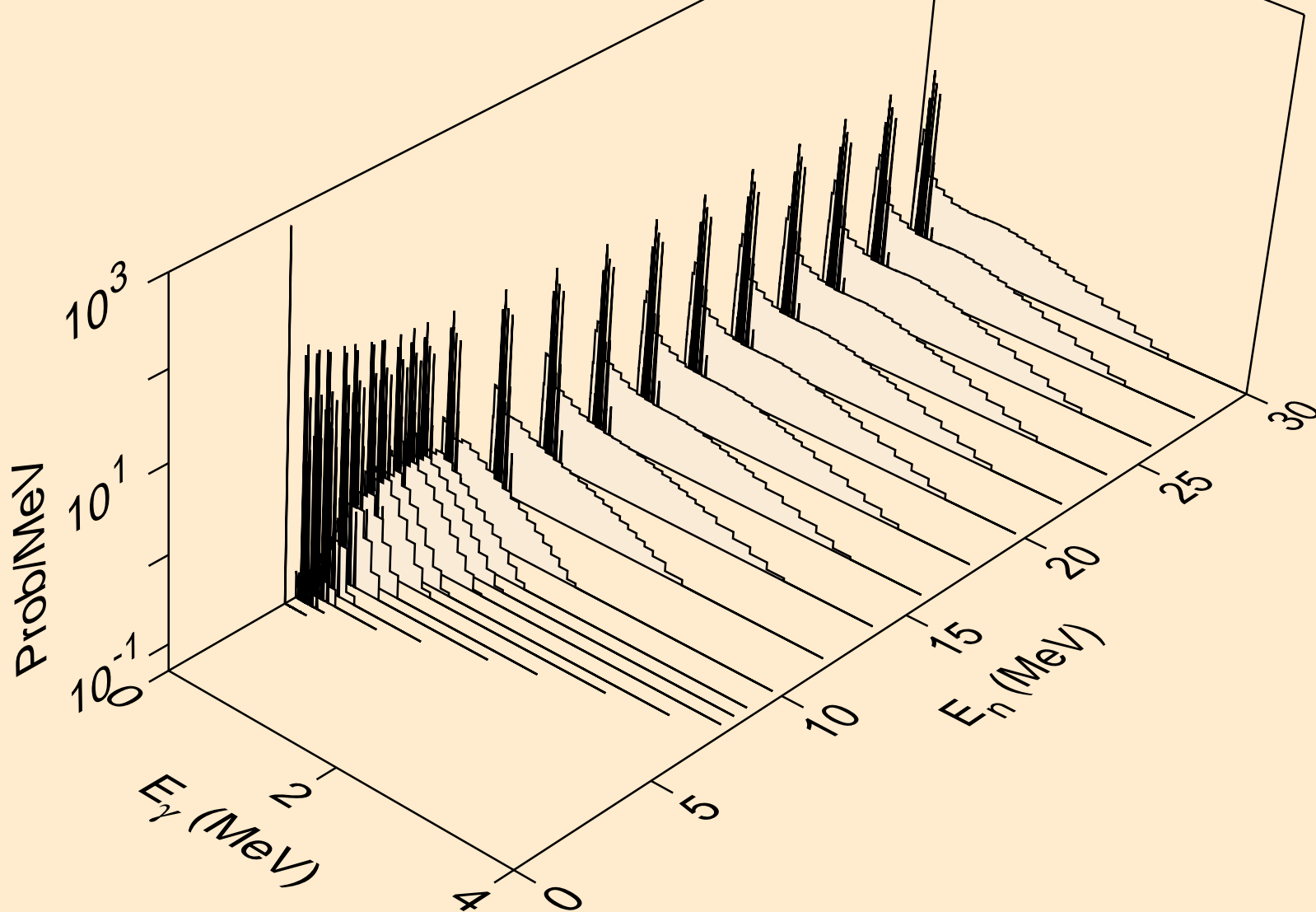

RH109 NEUTRON ACER TENDL-2019 LIBRARY; T=293.16K  
Photon emission for (n,d)

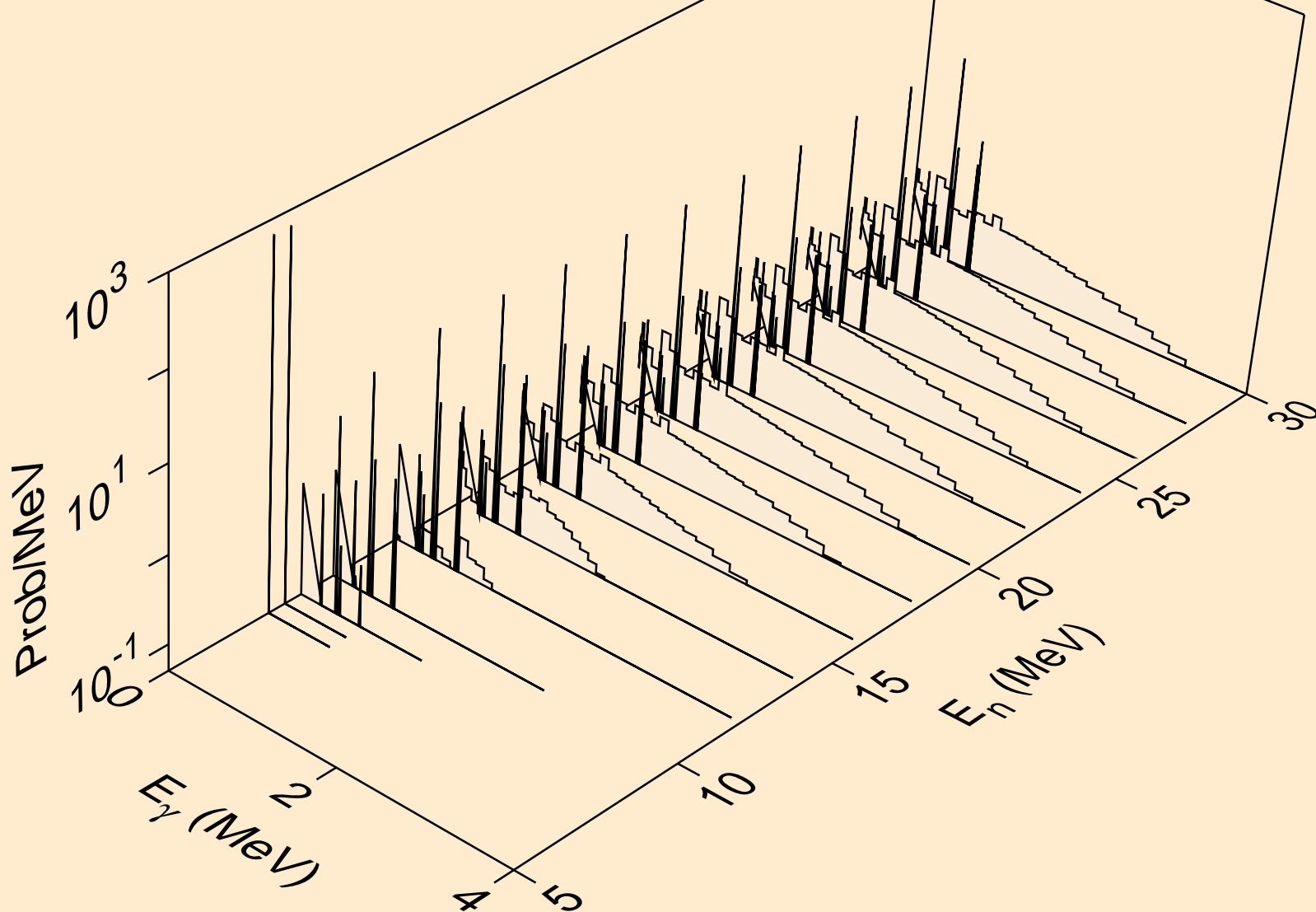

RH109 NEUTRON ACER TENDL-2019 LIBRARY; T=293.16K  
Photon emission for (n,t)

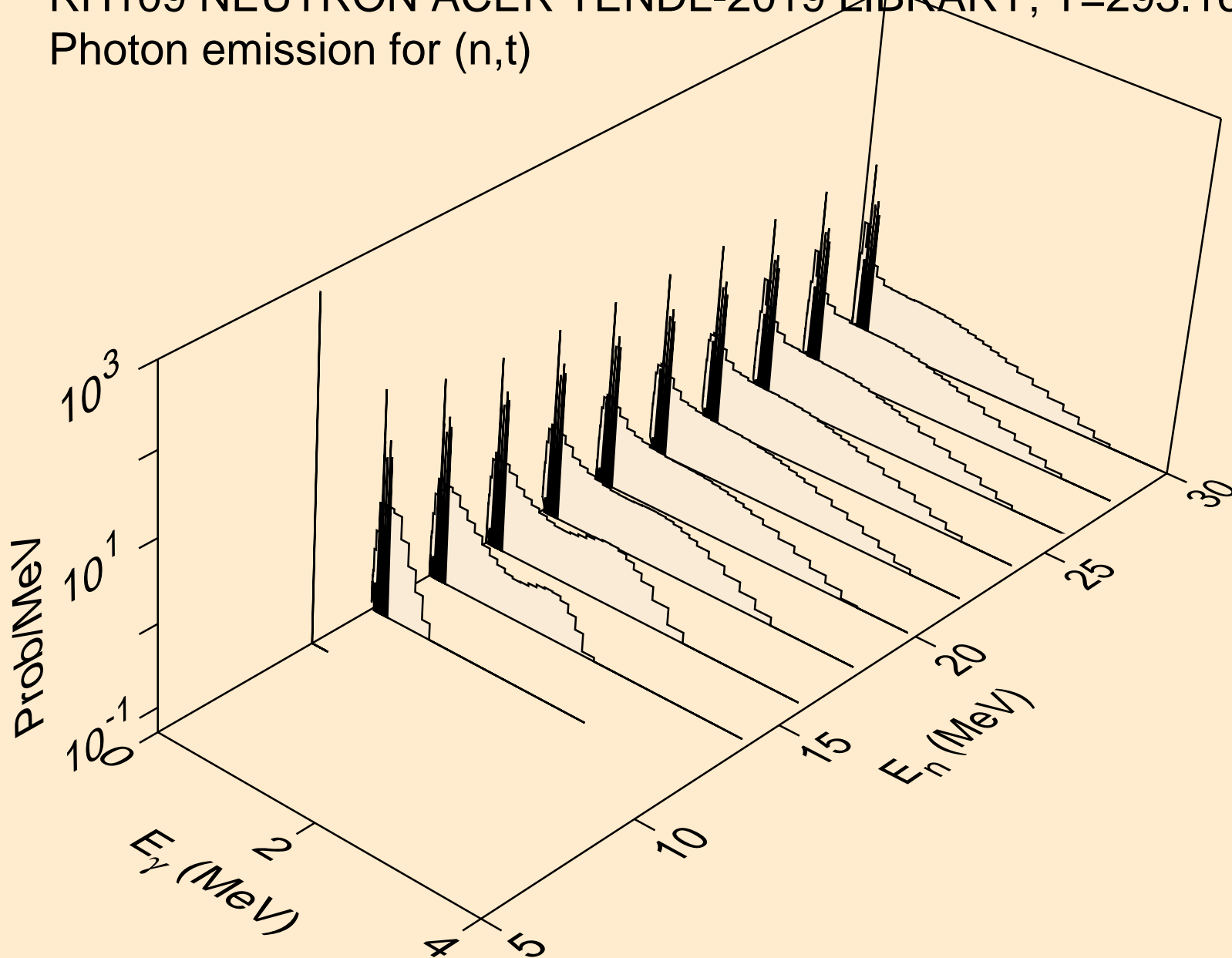

RH109 NEUTRON ACER TENDL-2019 LIBRARY; T=293.16K  
Photon emission for (n,he3)

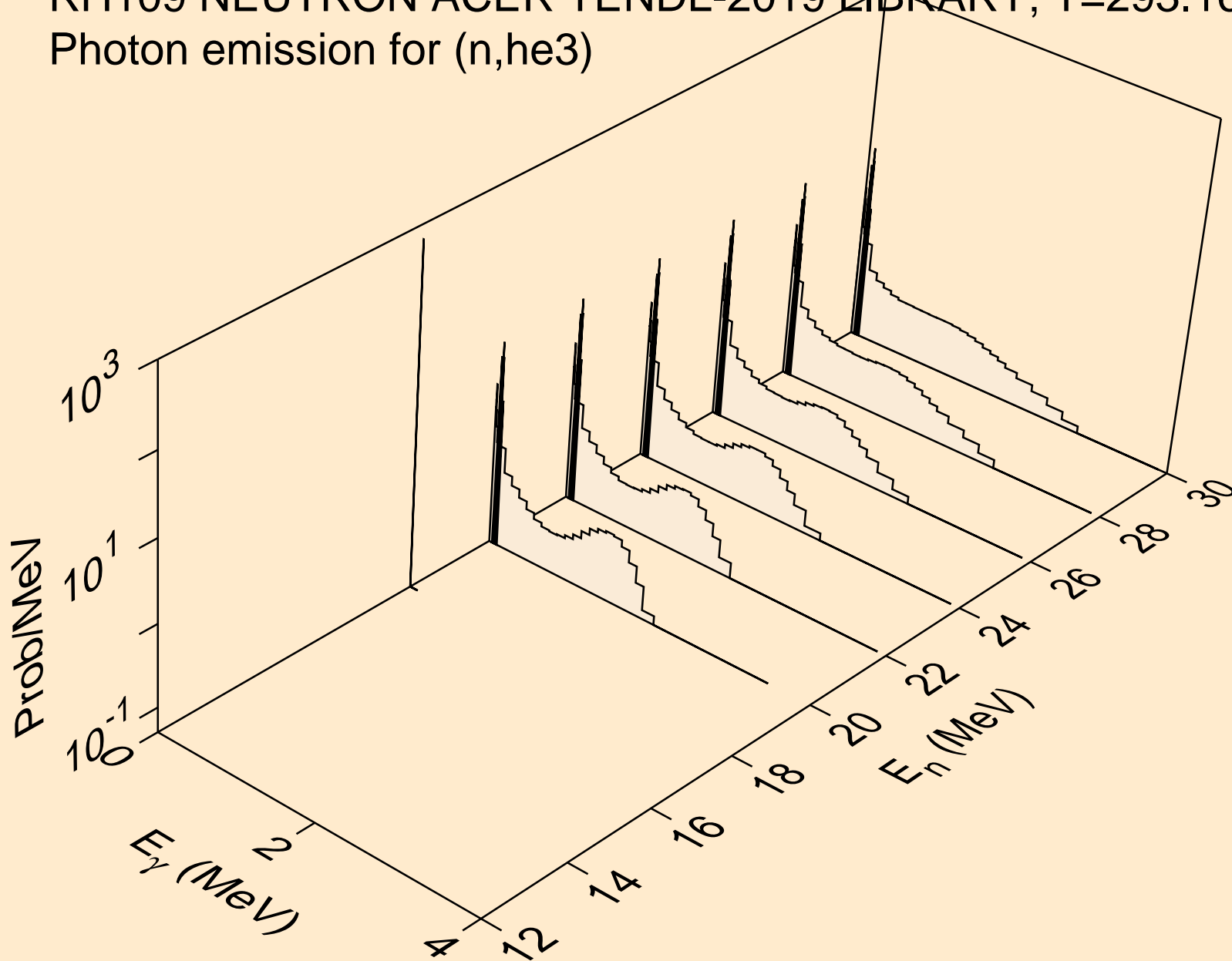



RH109 NEUTRON ACER TENDL-2019 LIBRARY; T=293.16K  
Photon emission for (n,a)

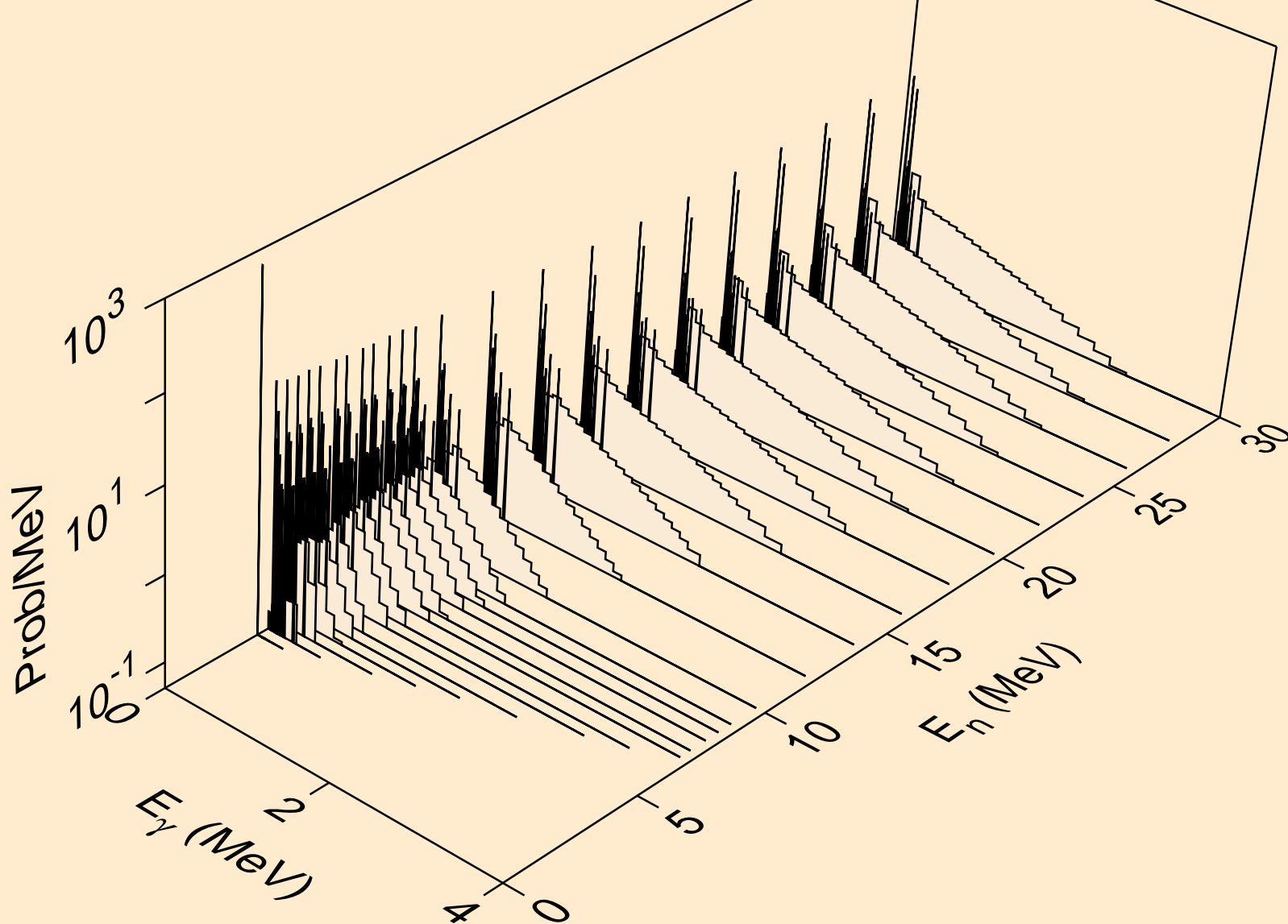

RH109 NEUTRON ACER TENDL-2019 LIBRARY; T=293.16K  
Photon emission for (n,2p)

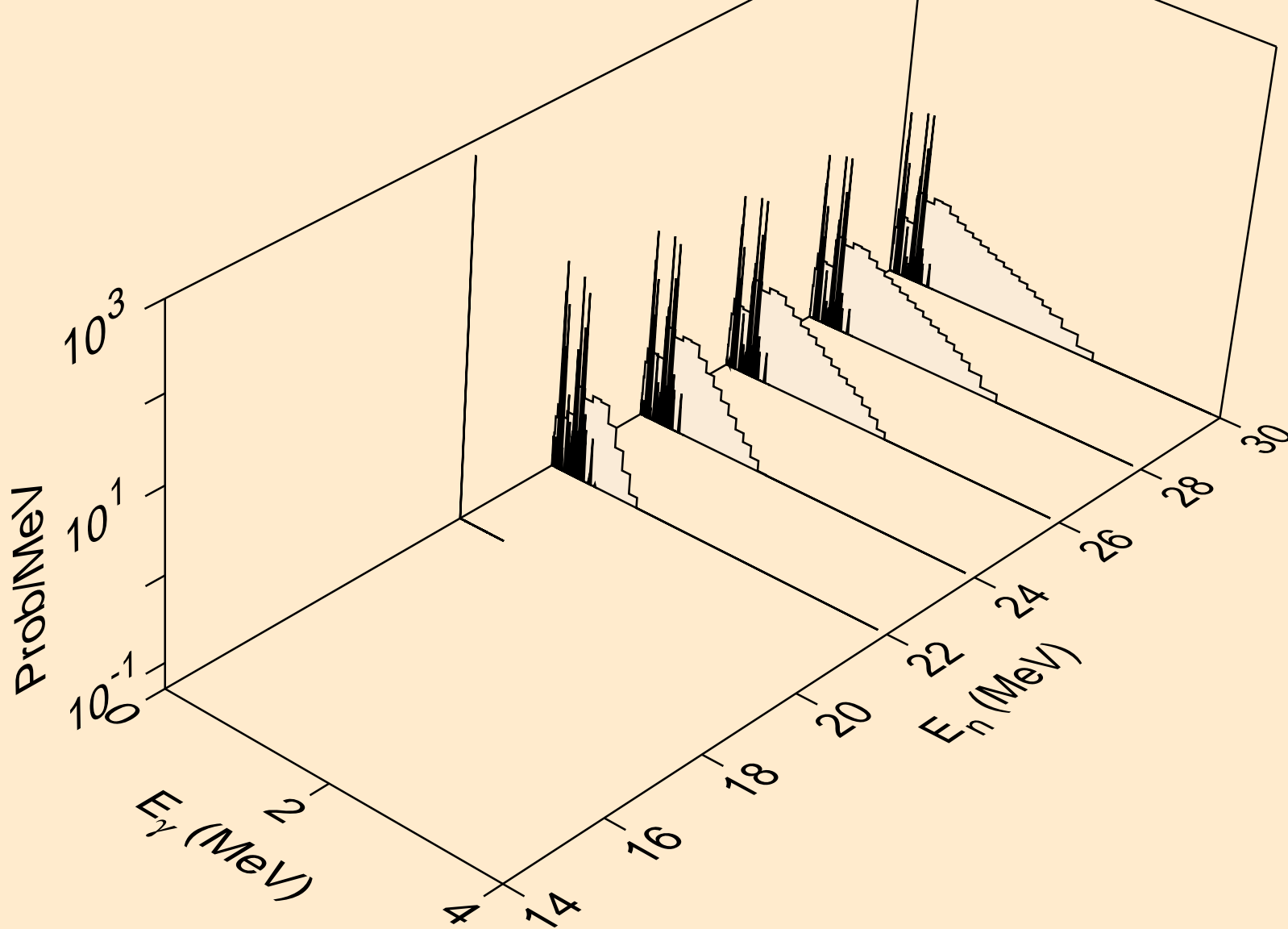

RH109 NEUTRON ACER TENDL-2019 LIBRARY; T=293.16K  
Photon emission for (n,p $\alpha$ )

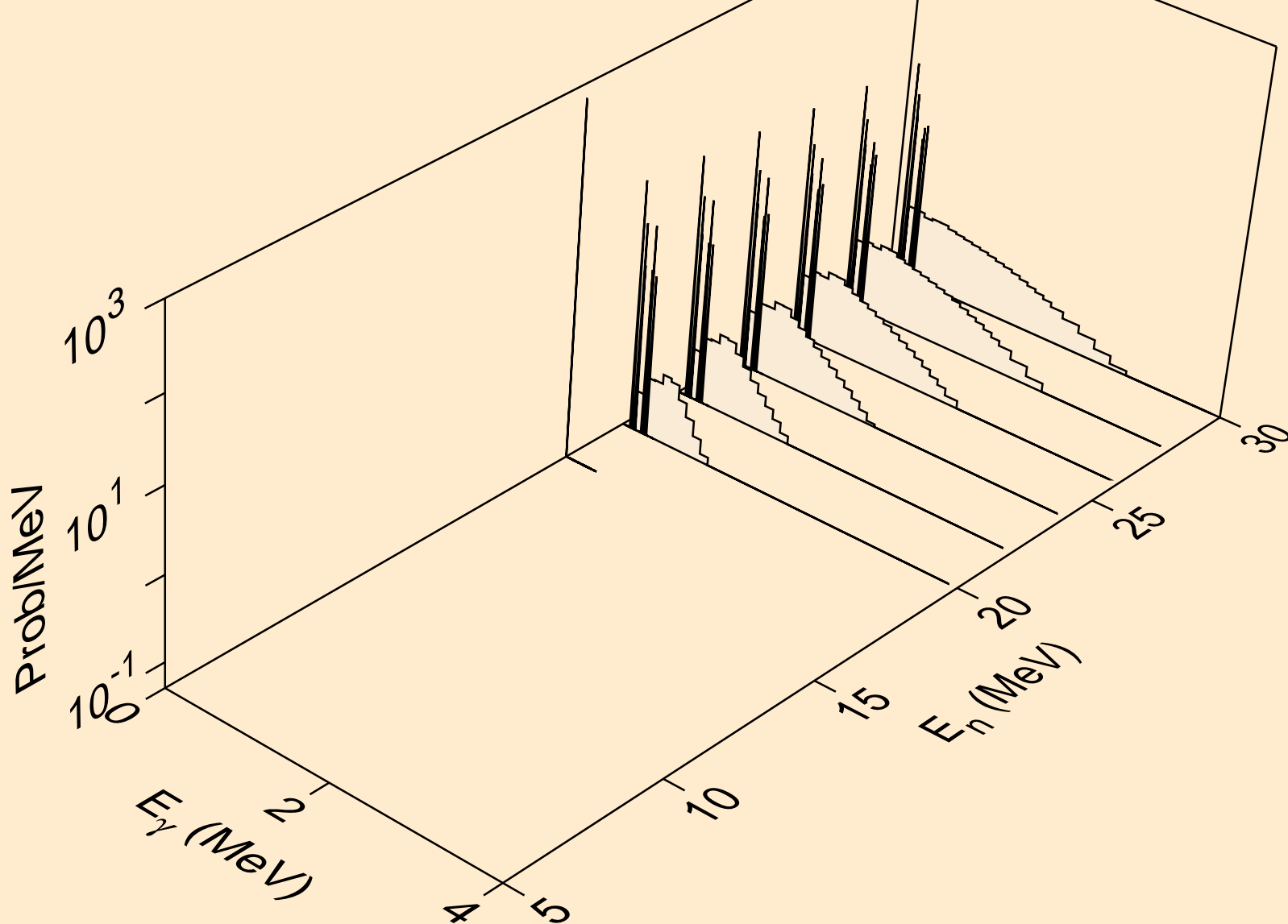

RH109 NEUTRON ACER TENDL-2019 LIBRARY; T=293.16K  
thermal capture photon spectrum

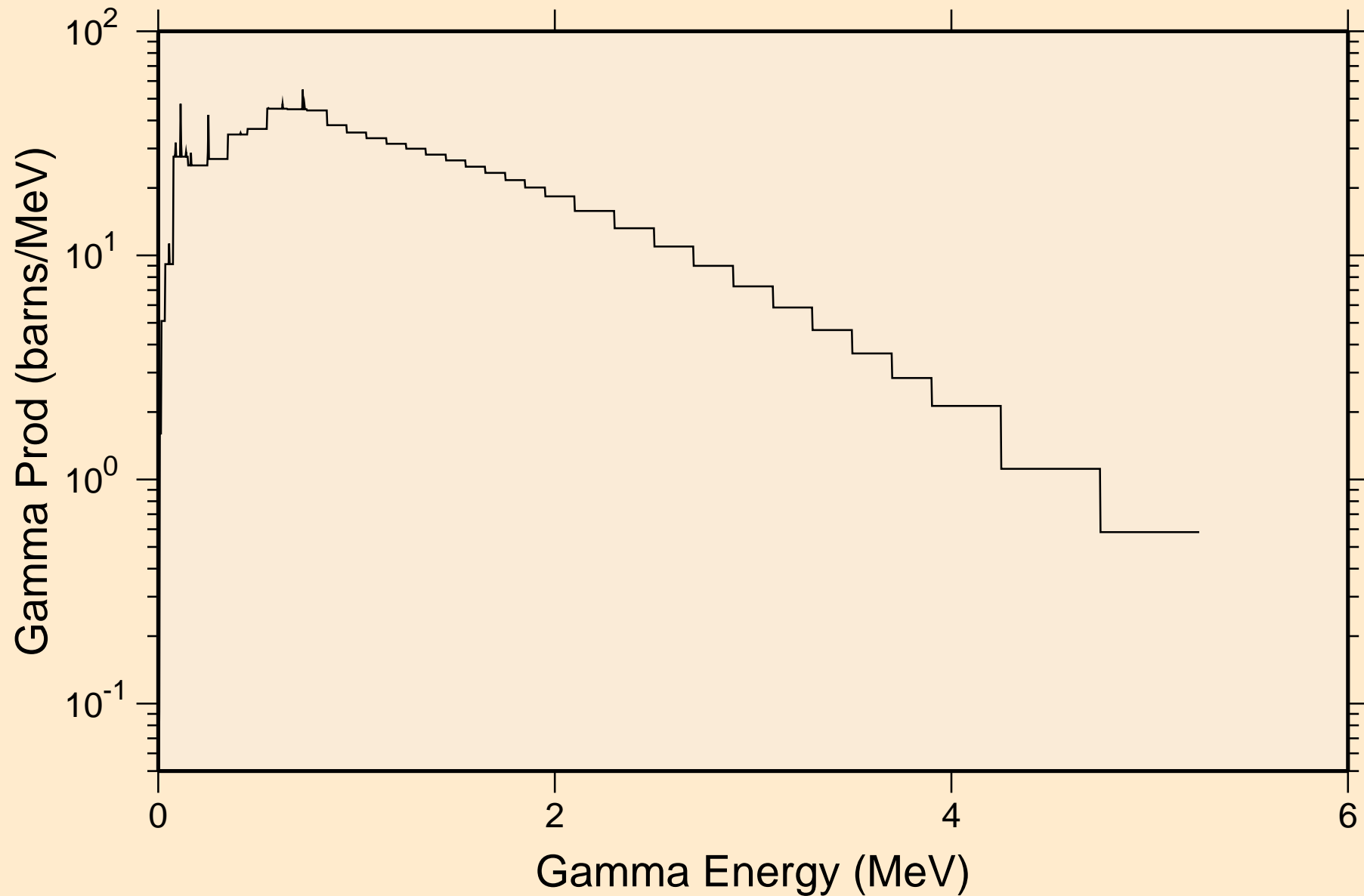

RH109 NEUTRON ACER TENDL-2019 LIBRARY; T=293.16K  
14 MeV photon spectrum

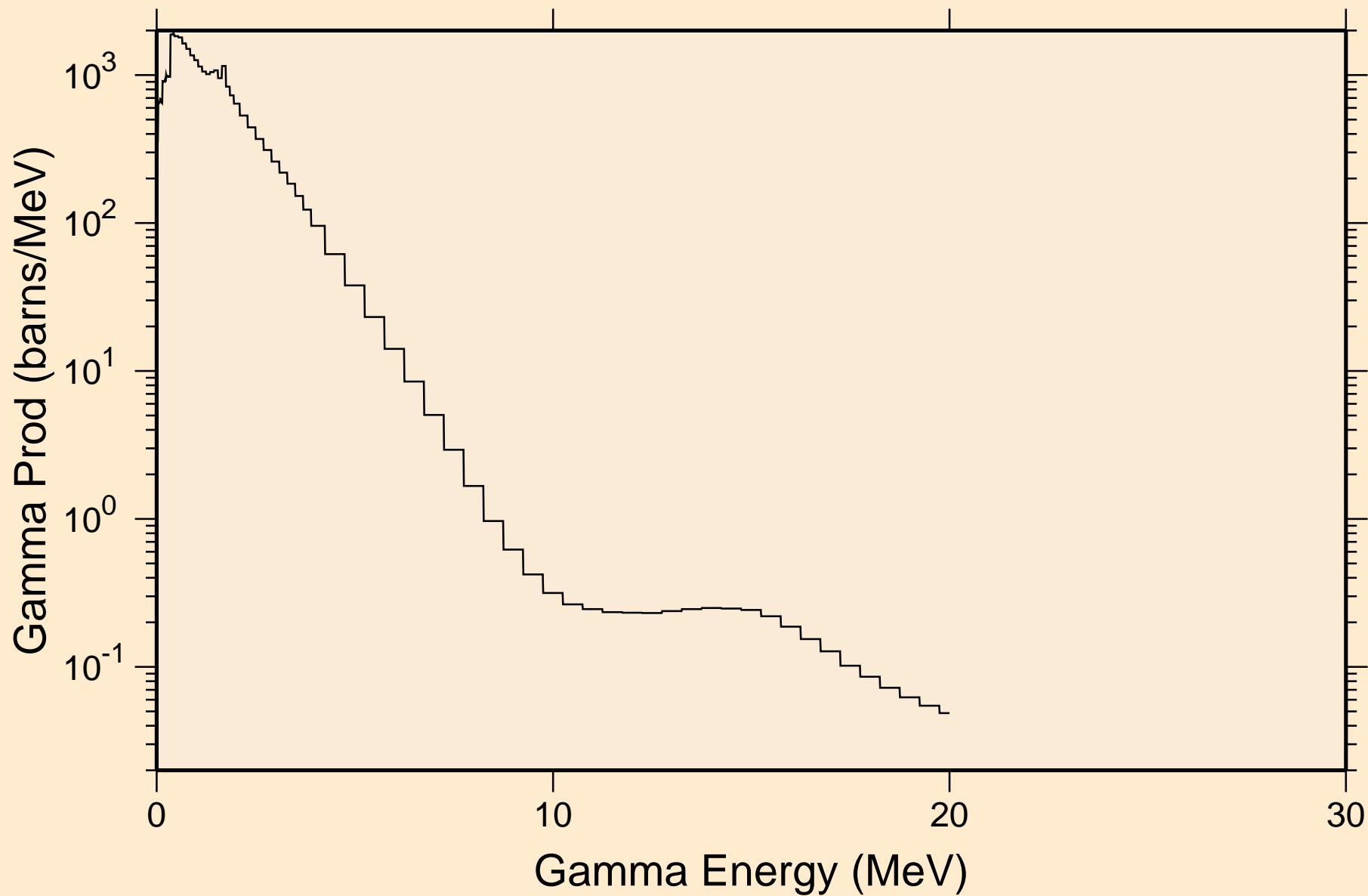

RH109 NEUTRON ACER TENDL-2019 LIBRARY; T=293.16K  
Particle heating contributions

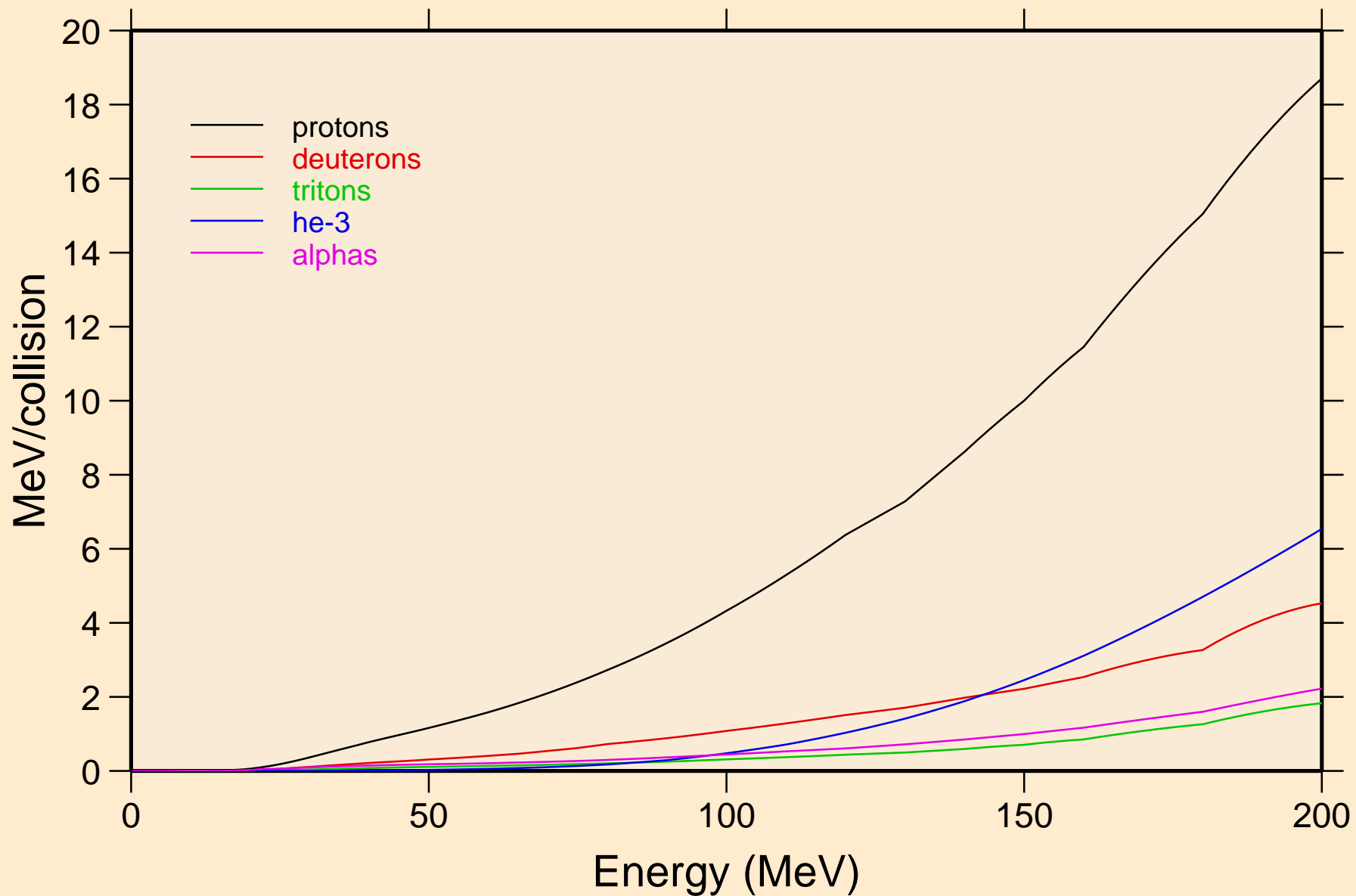

RH109 NEUTRON ACER TENDL-2019 LIBRARY; T=293.16K  
Recoil Heating

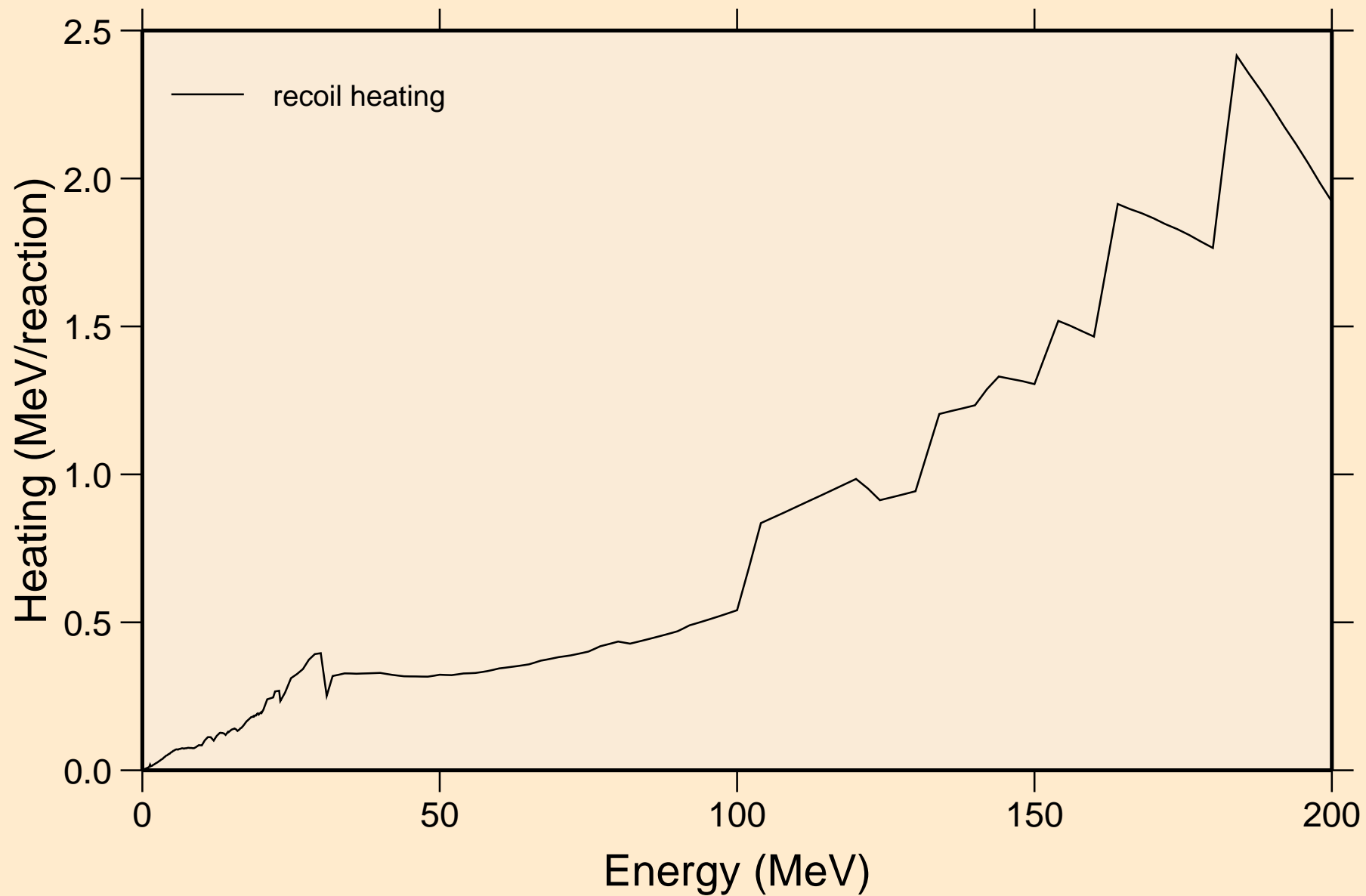

RH109 NEUTRON ACER TENDL-2019 LIBRARY; T=293.16K  
Particle production cross sections

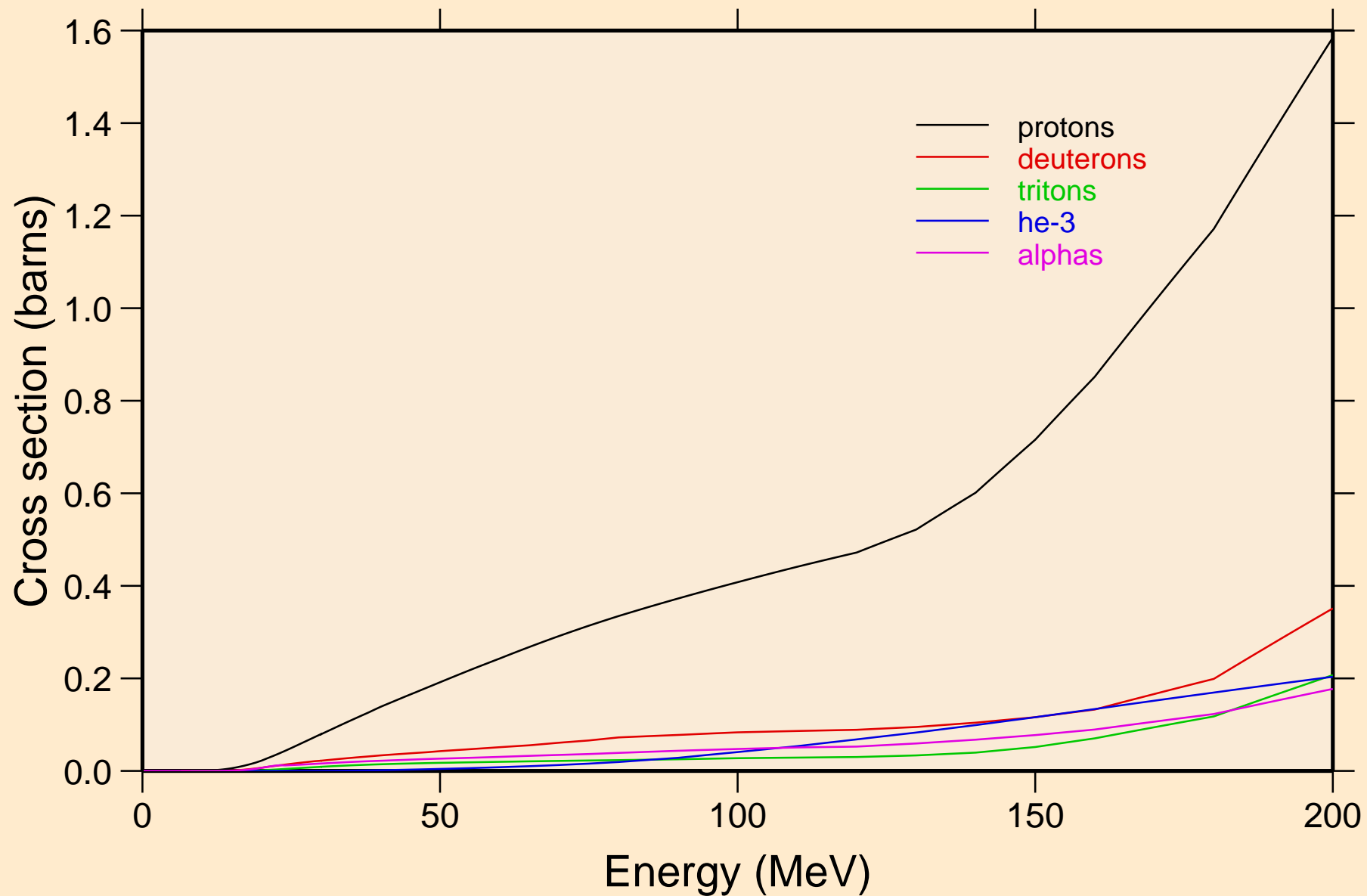



RH109 NEUTRON ACER TENDL-2019 LIBRARY; T=293.16K  
protons from (n,x)

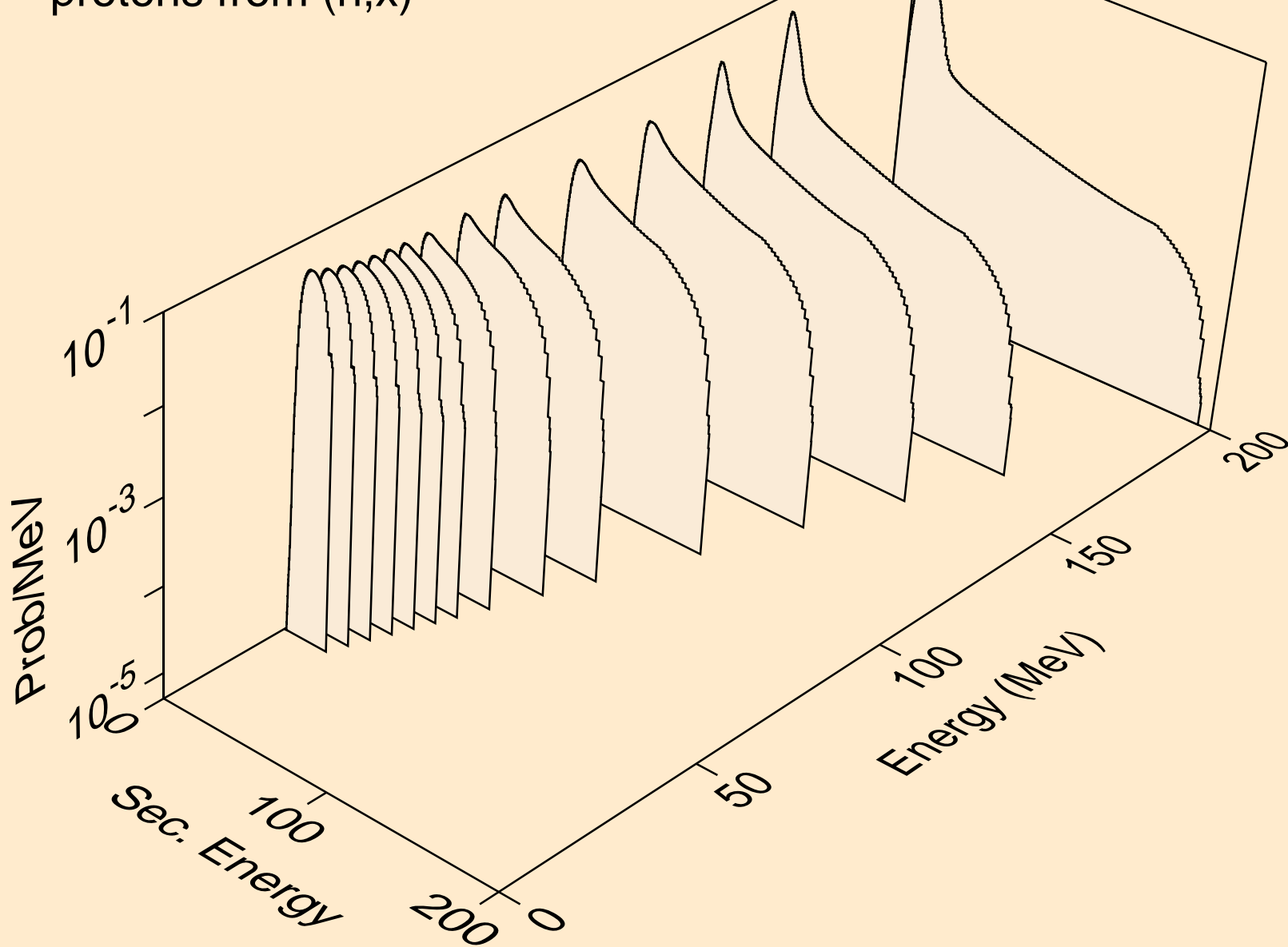

RH109 NEUTRON ACER TENDL-2019 LIBRARY; T=293.16K  
protons from (n,n\*)p

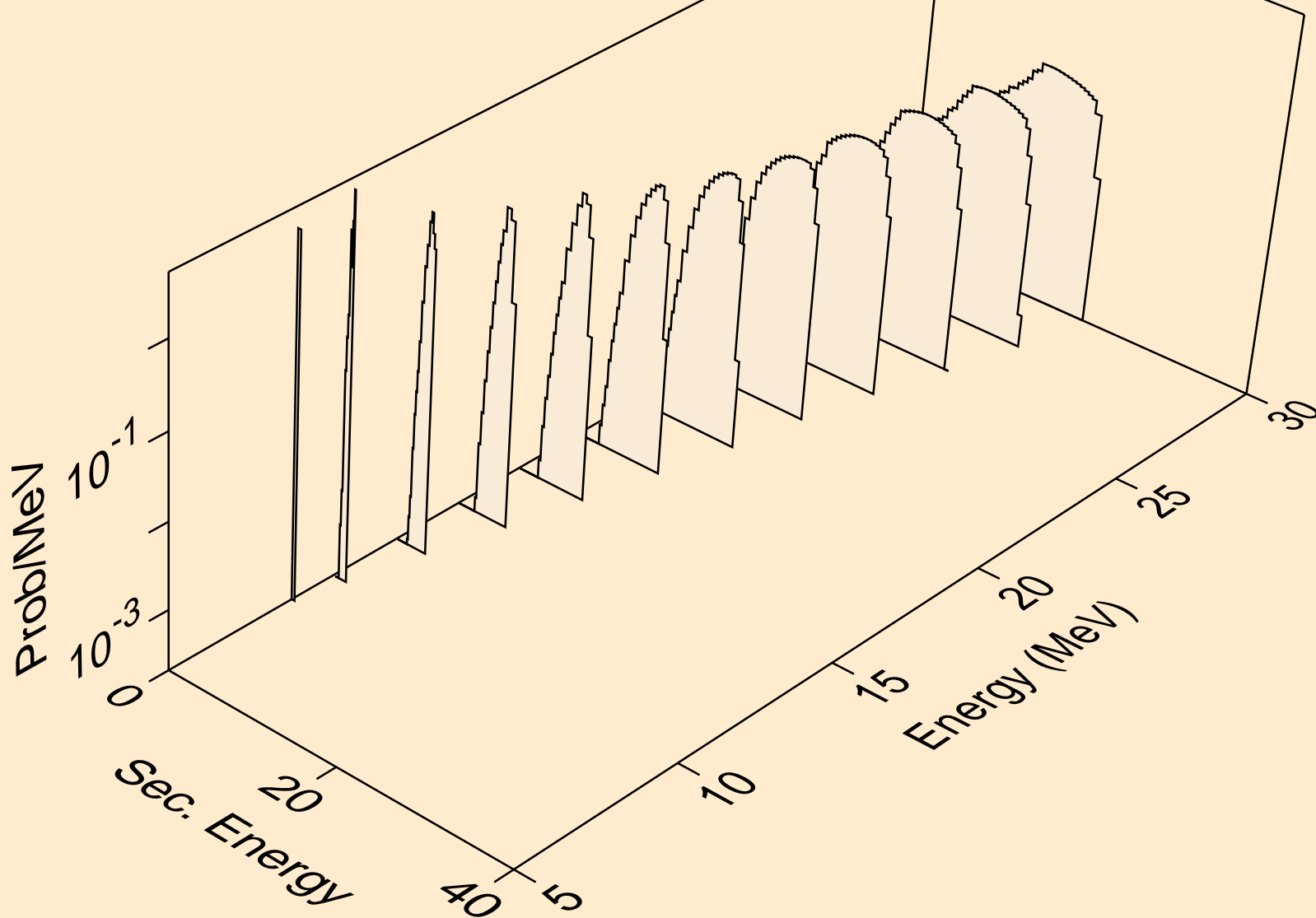

RH109 NEUTRON ACER TENDL-2019 LIBRARY; T=293.16K  
protons from (n,2np)

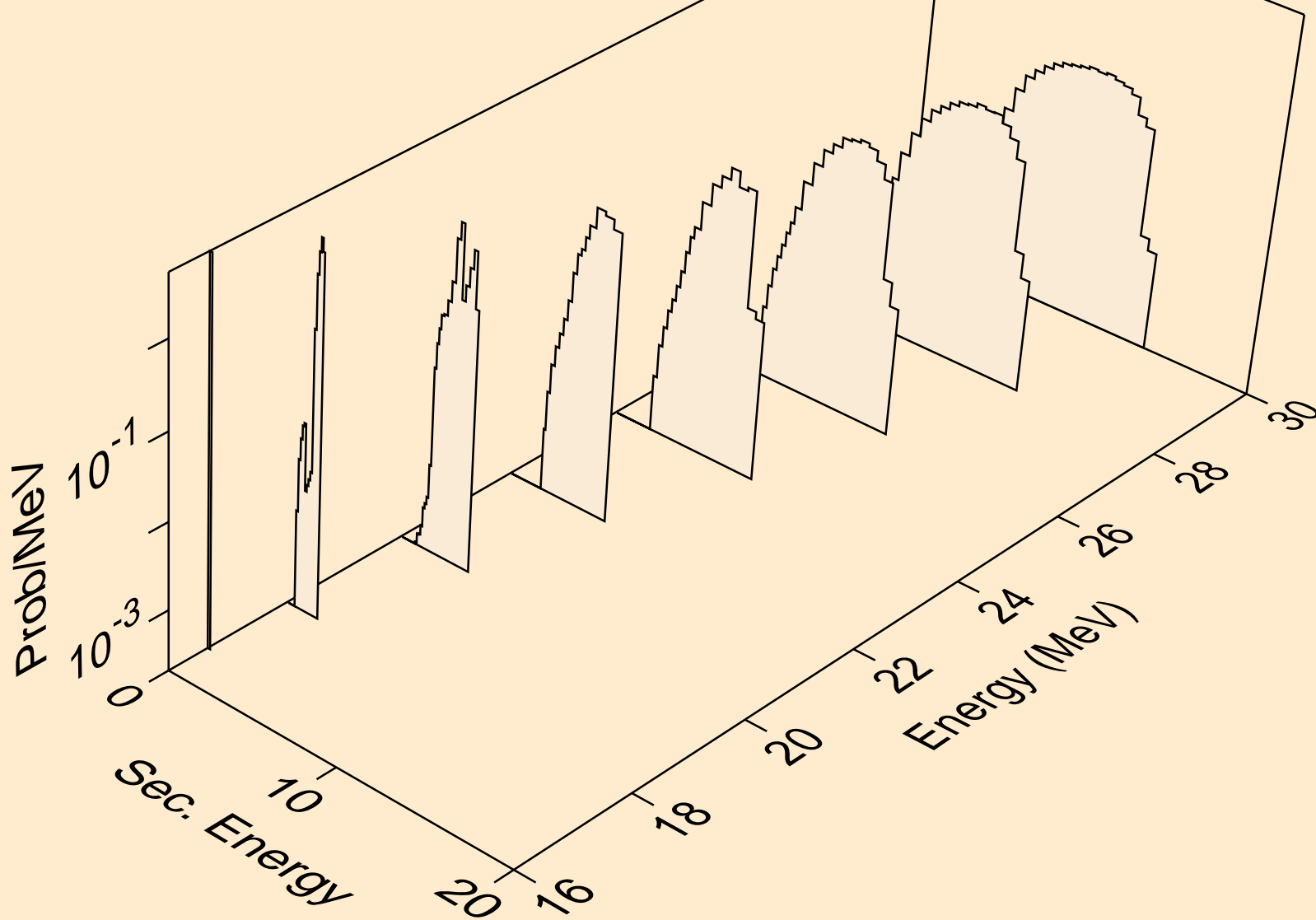

RH109 NEUTRON ACER TENDL-2019 LIBRARY; T=293.16K  
protons from (n,3np)

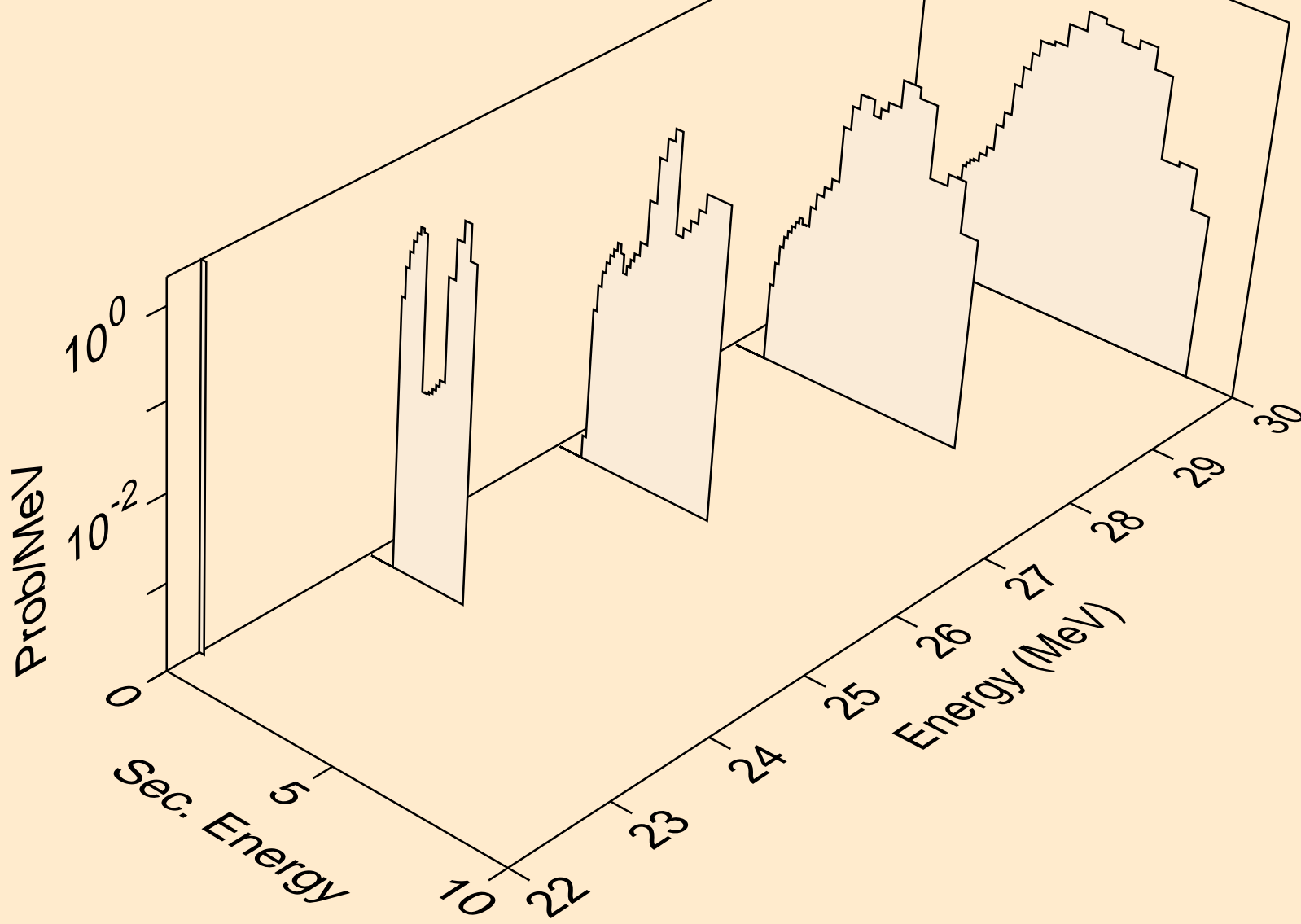

RH109 NEUTRON ACER TENDL-2019 LIBRARY; T=293.16K  
protons from (n,2np)

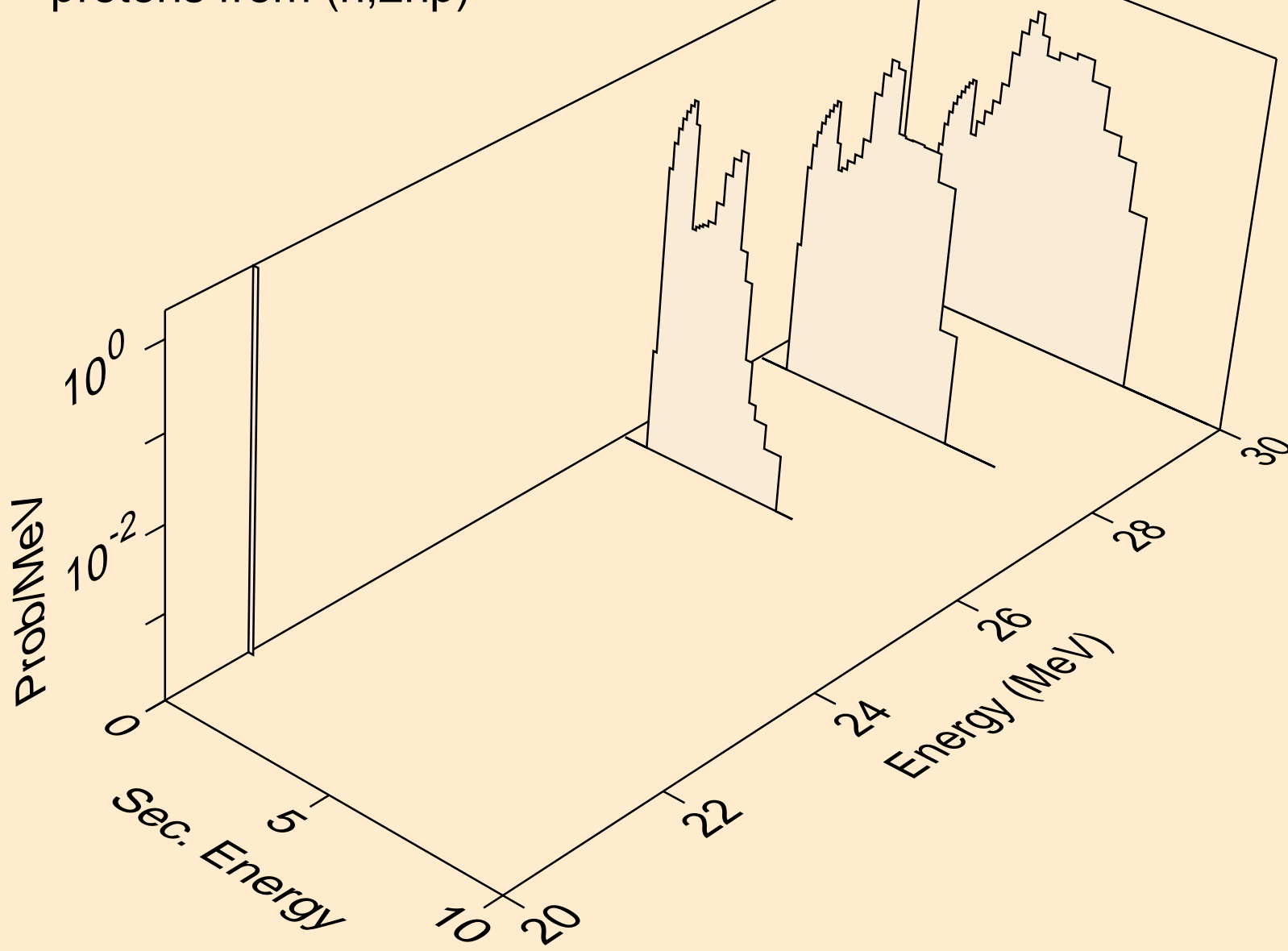

RH109 NEUTRON ACER TENDL-2019 LIBRARY; T=293.16K  
protons from (n,p)

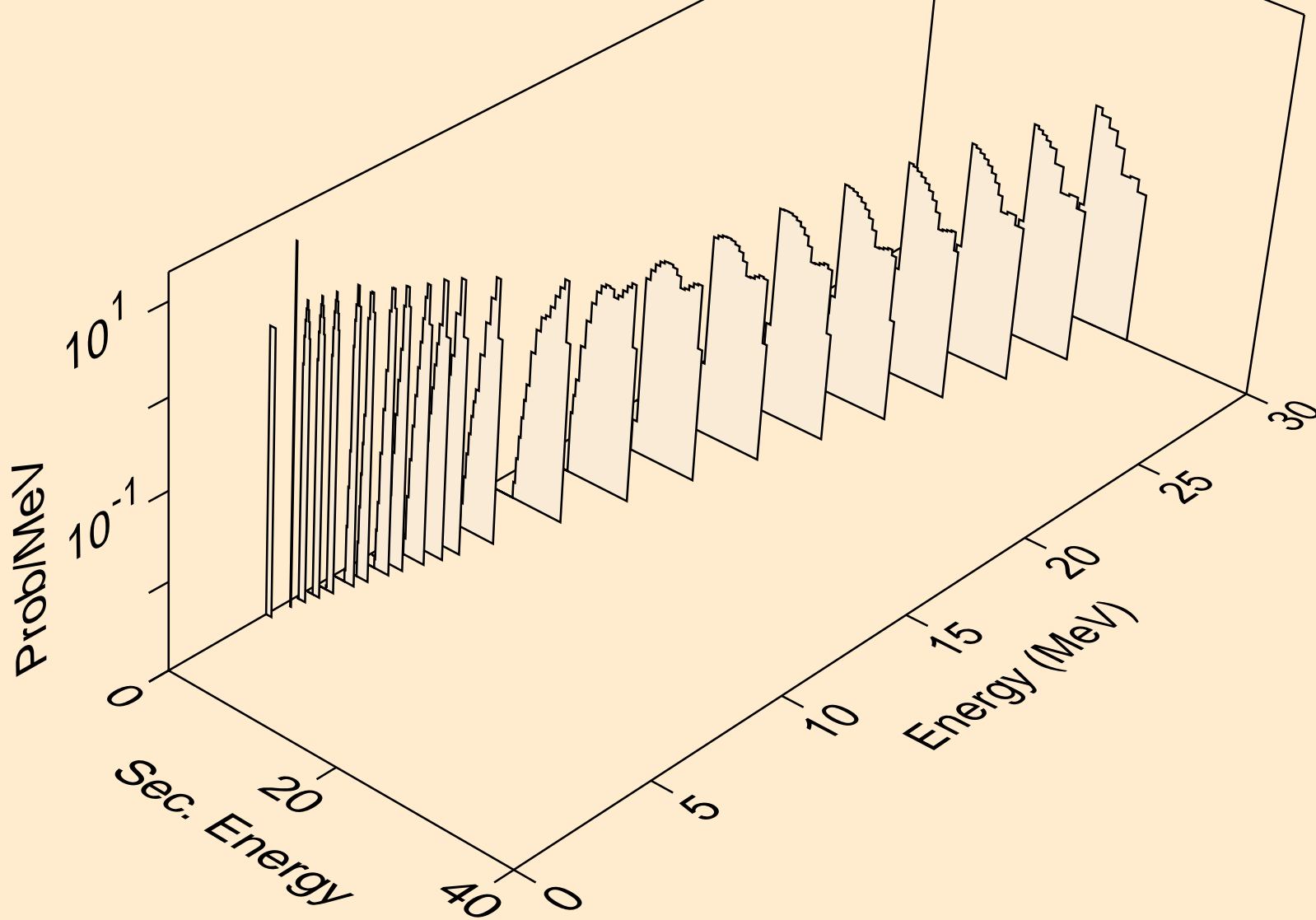

RH109 NEUTRON ACER TENDL-2019 LIBRARY; T=293.16K  
protons from (n,2p)

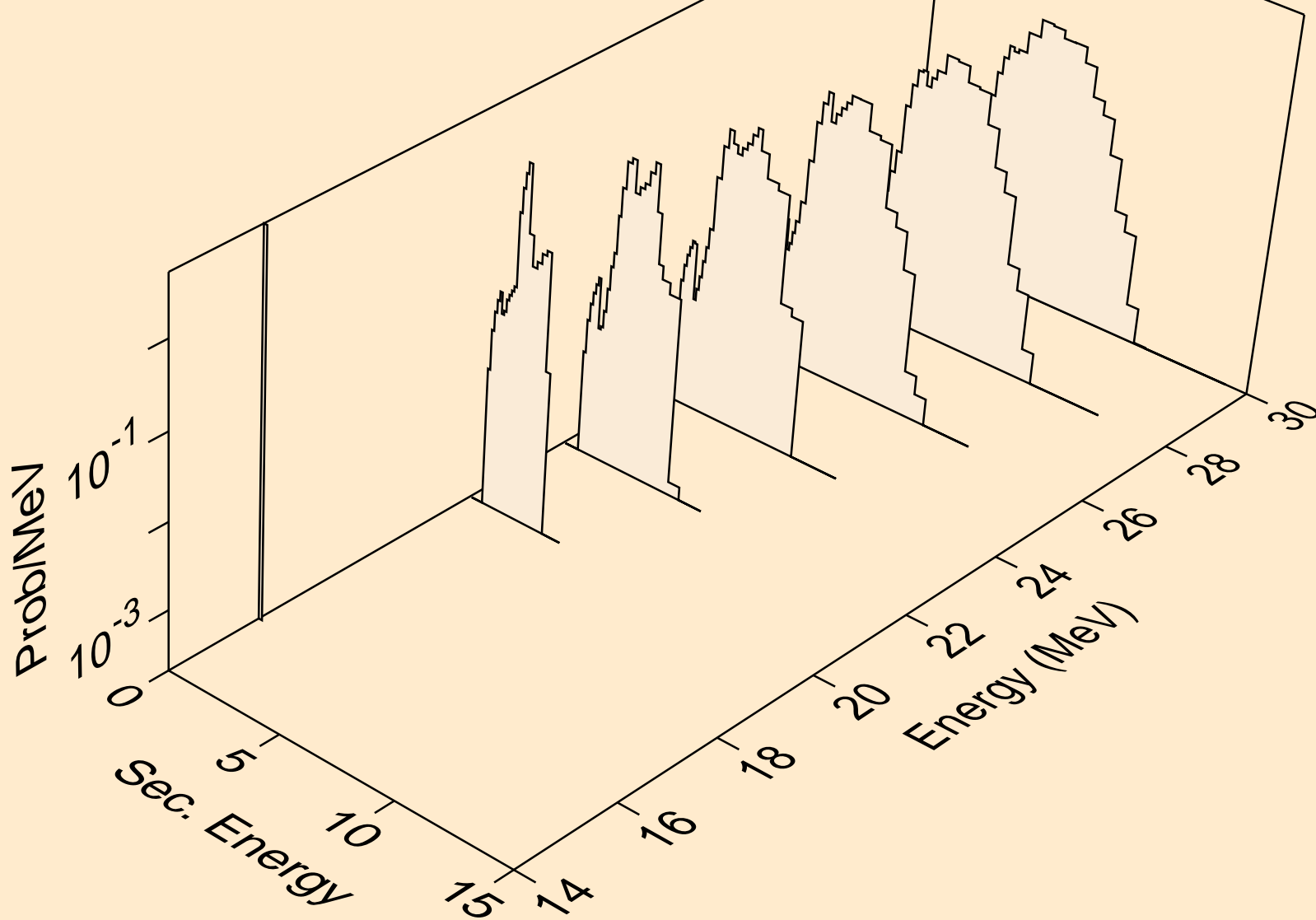

RH109 NEUTRON ACER TENDL-2019 LIBRARY; T=293.16K  
protons from (n,p)

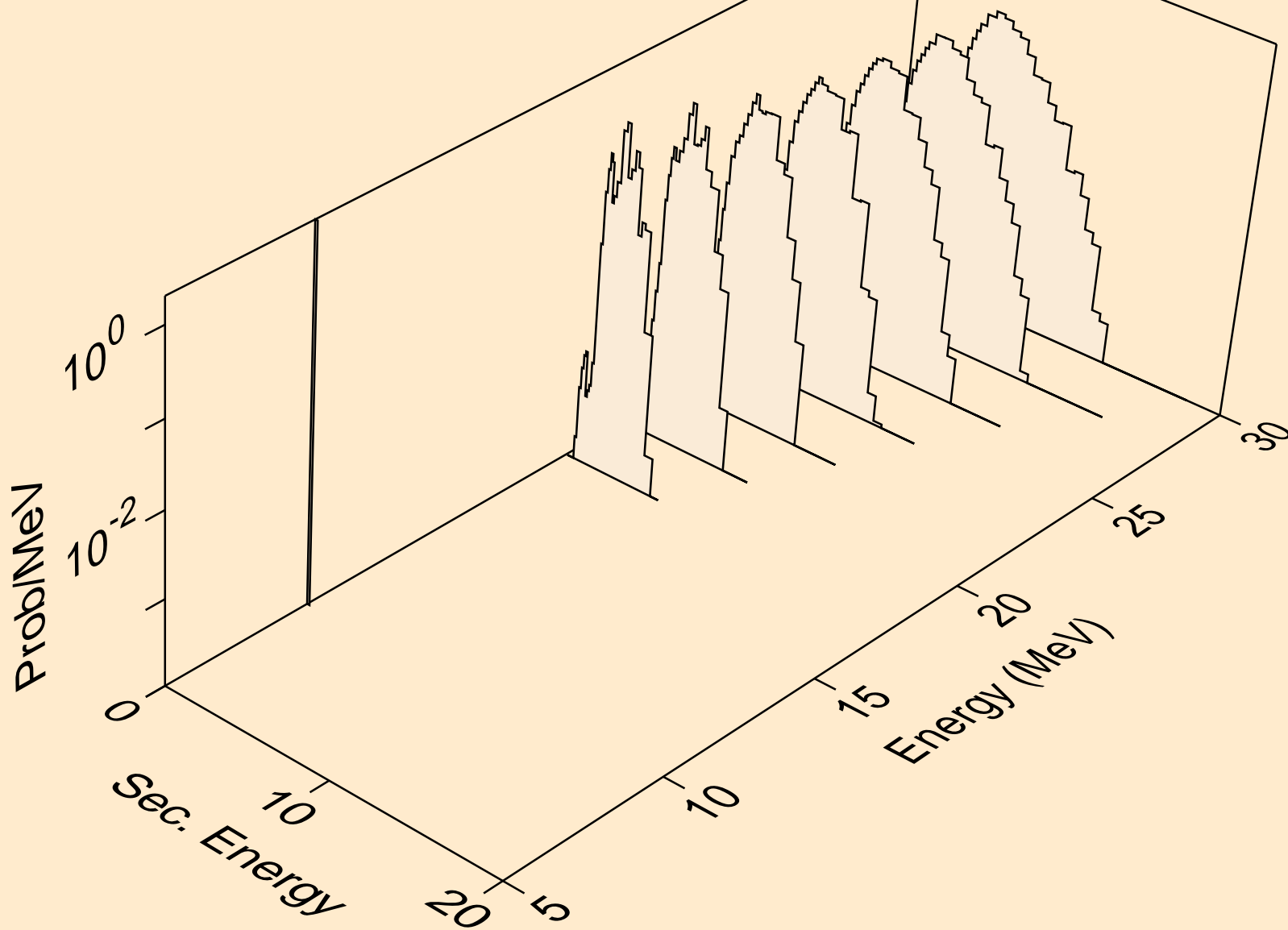



RH109 NEUTRON ACER TENDL-2019 LIBRARY; T=293.16K  
deuterons from (n,x)

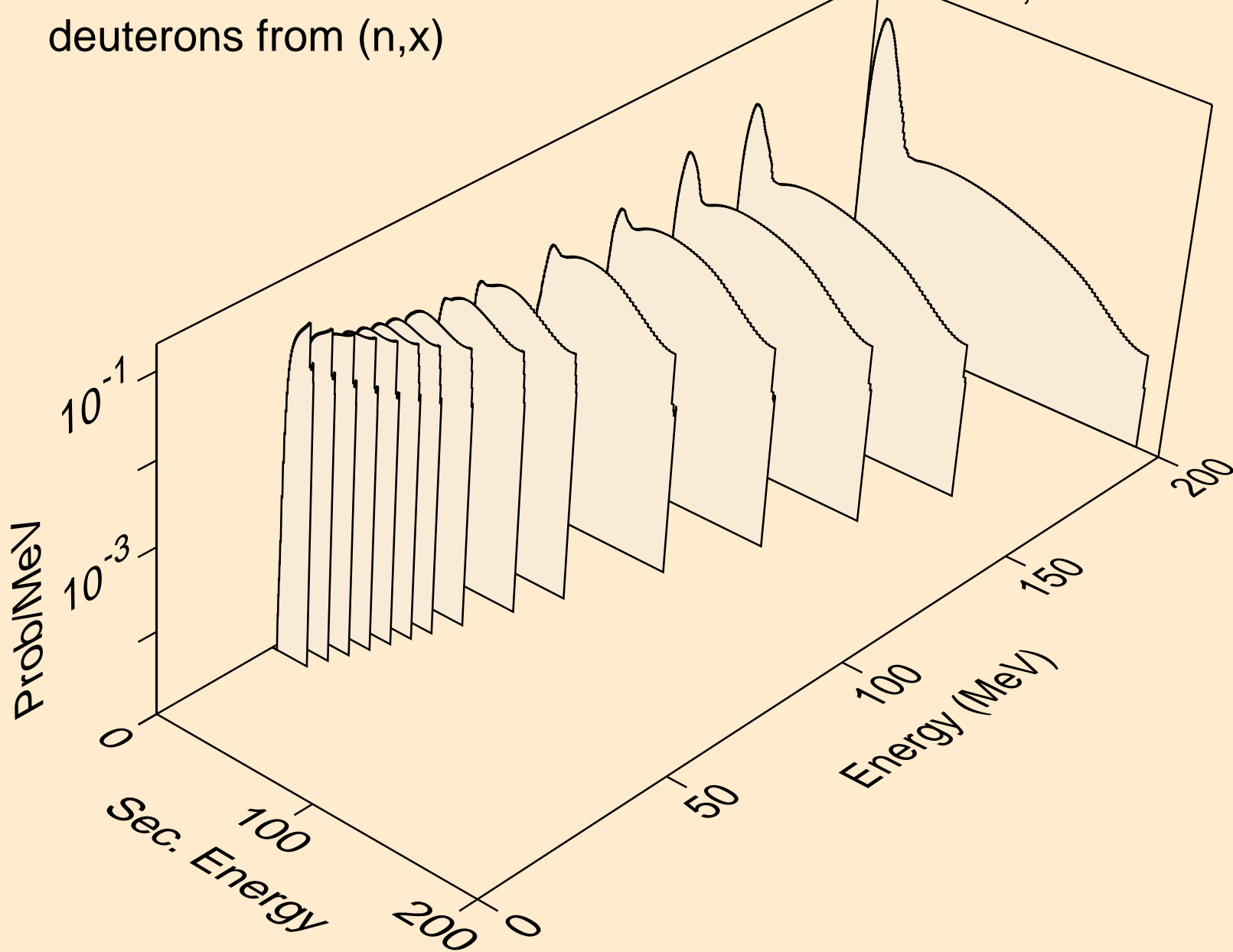

RH109 NEUTRON ACER TENDL-2019 LIBRARY; T=293.16K  
deuterons from (n,2nd)

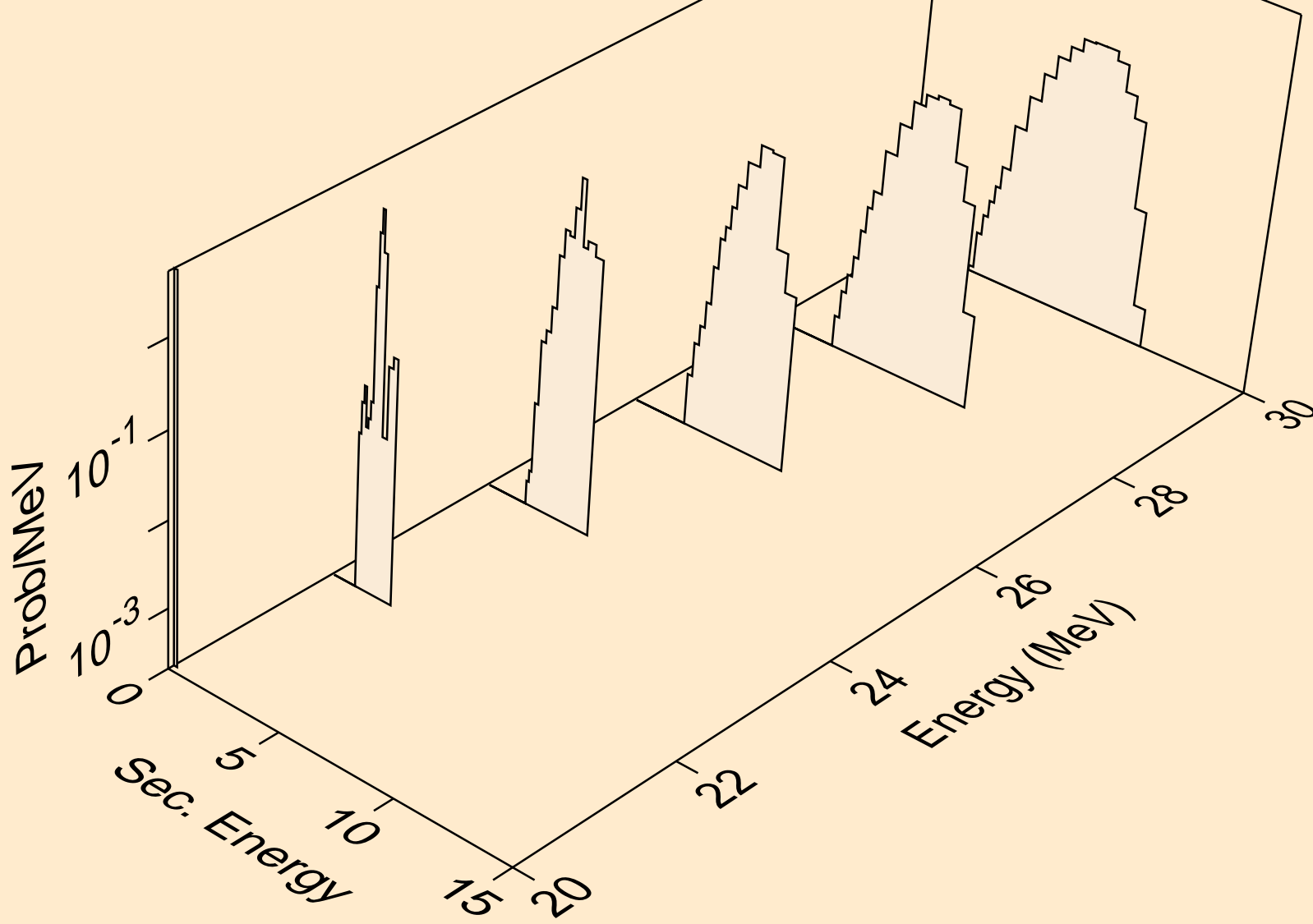

RH109 NEUTRON ACER TENDL-2019 LIBRARY; T=293.16K  
deuterons from (n,n\*)d

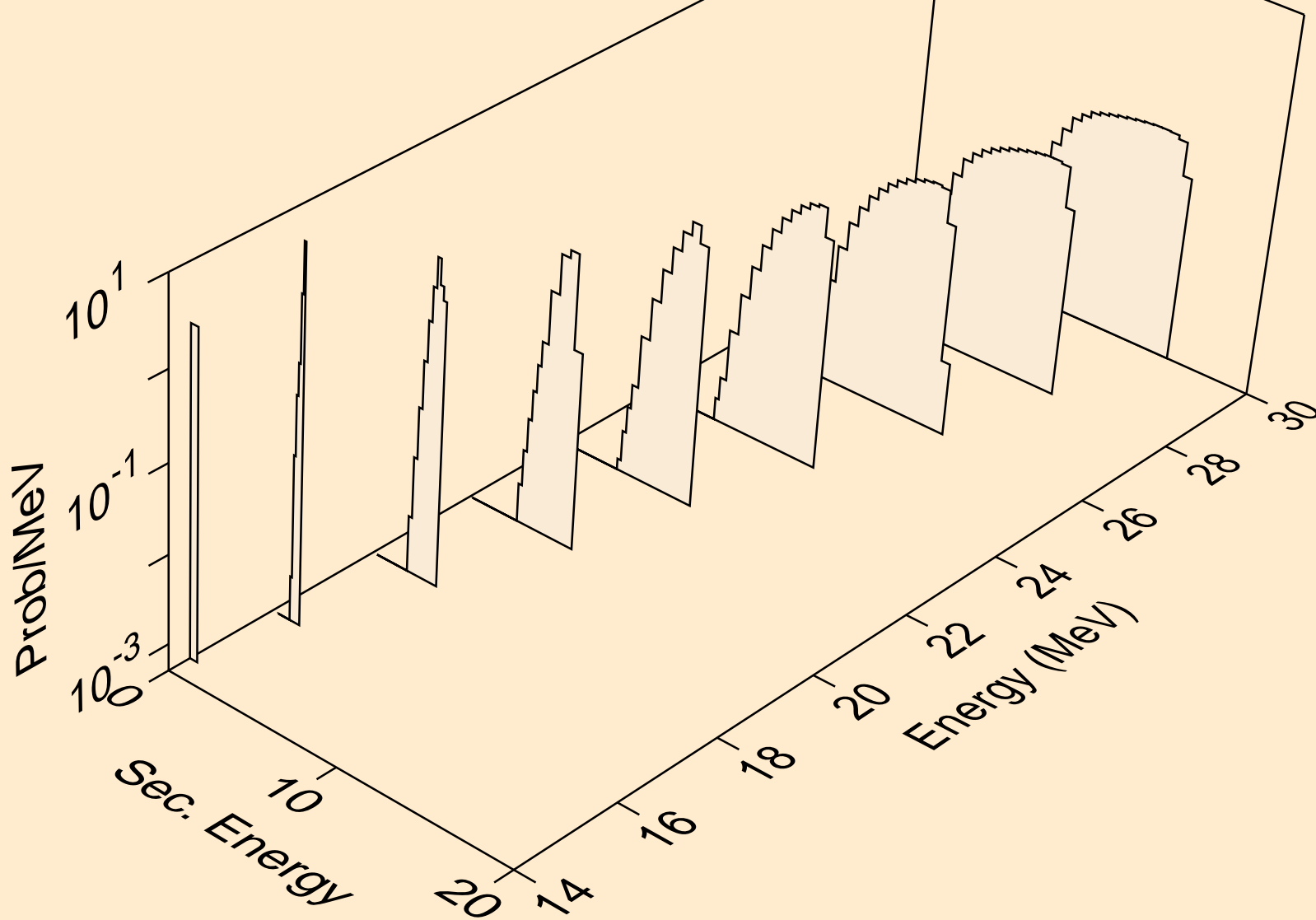

RH109 NEUTRON ACER TENDL-2019 LIBRARY; T=293.16K  
deuterons from (n,d)

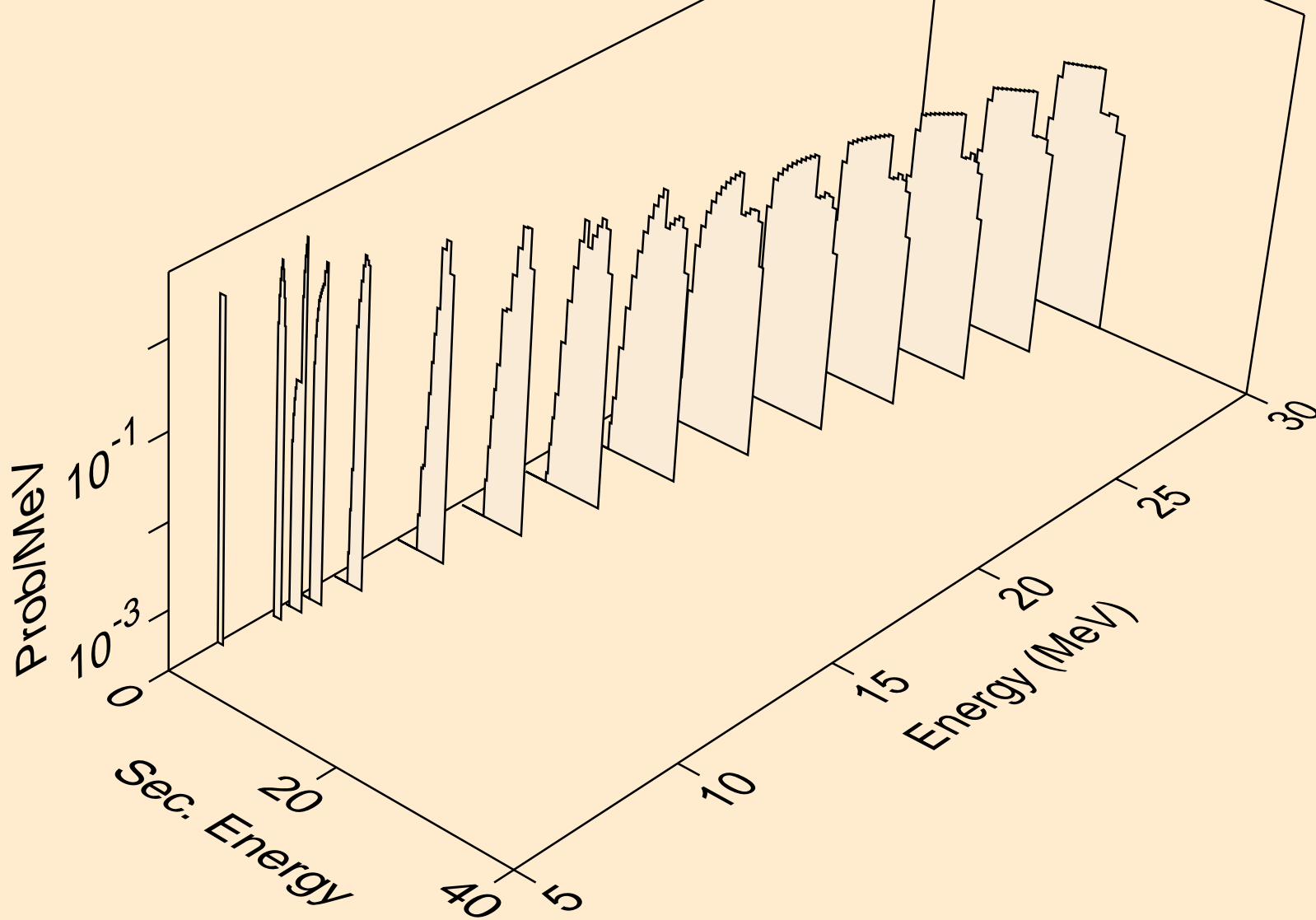

RH109 NEUTRON ACER TENDL-2019 LIBRARY; T=293.16K  
tritons from (n,x)

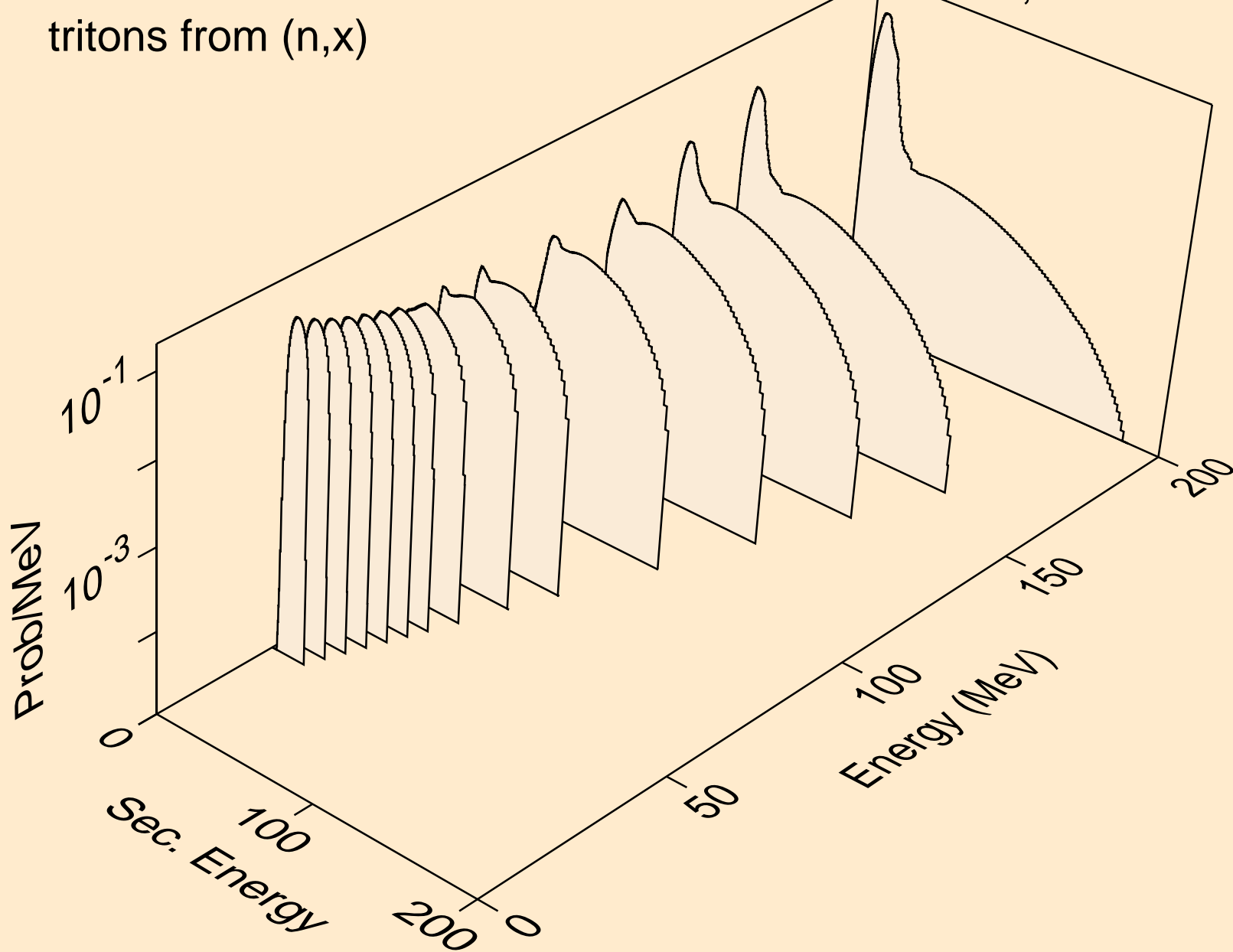

RH109 NEUTRON ACER TENDL-2019 LIBRARY; T=293.16K  
tritons from (n,n\*)t

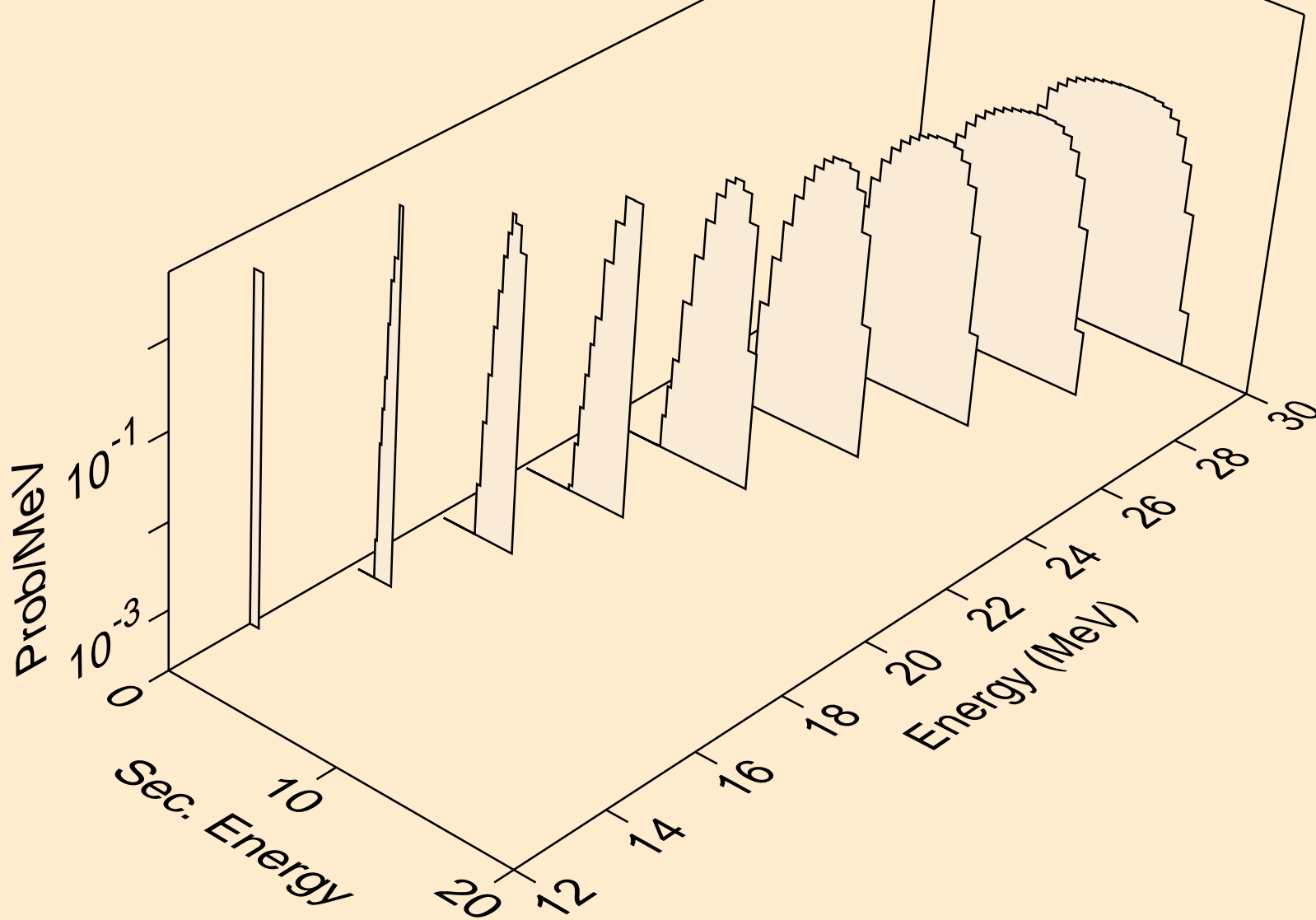

RH109 NEUTRON ACER TENDL-2019 LIBRARY; T=293.16K  
tritons from (n,t)

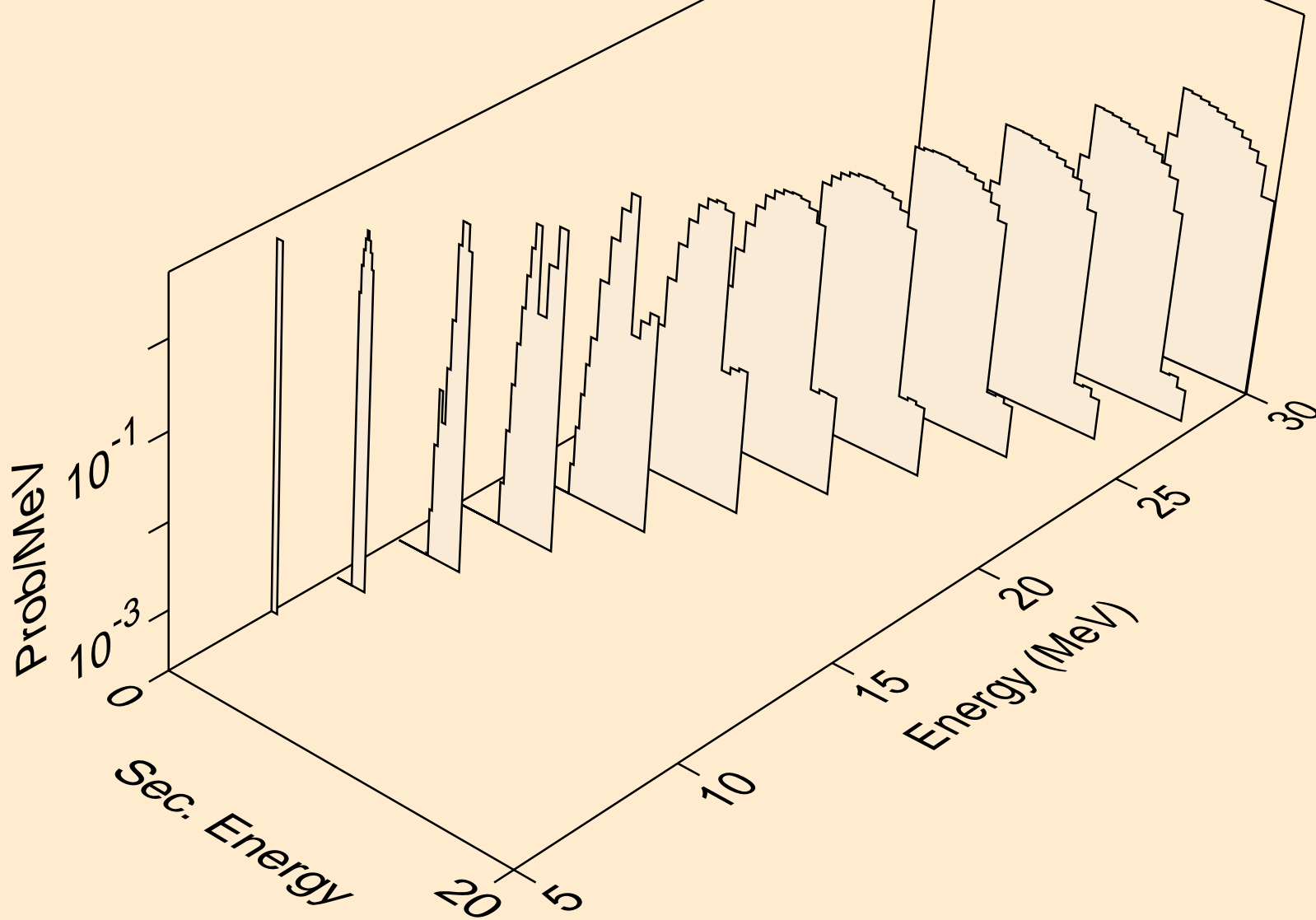

RH109 NEUTRON ACER TENDL-2019 LIBRARY; T=293.16K  
he3s from (n,x)

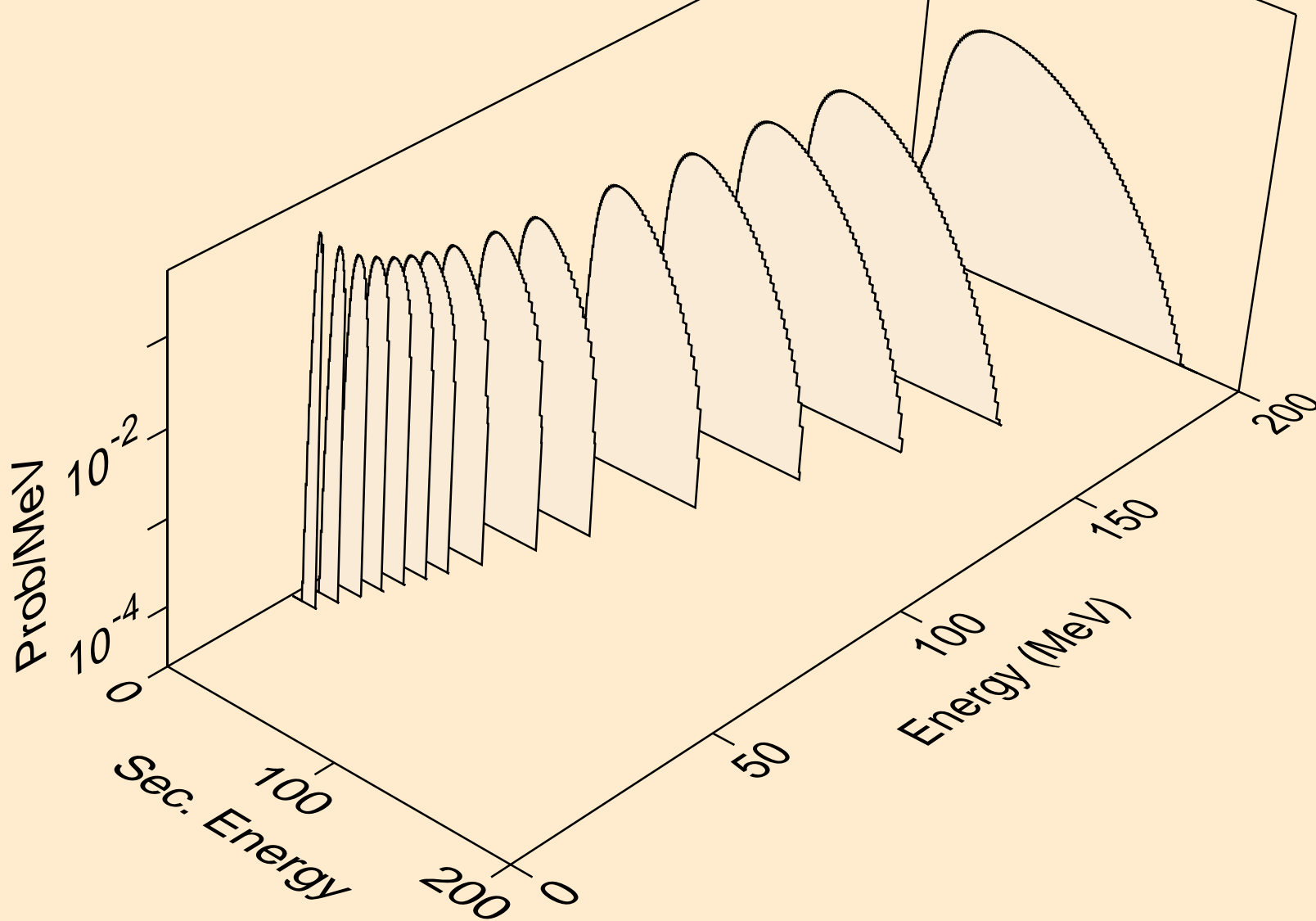



RH109 NEUTRON ACER TENDL-2019 LIBRARY; T=293.16K  
he3s from (n,n\*)he3

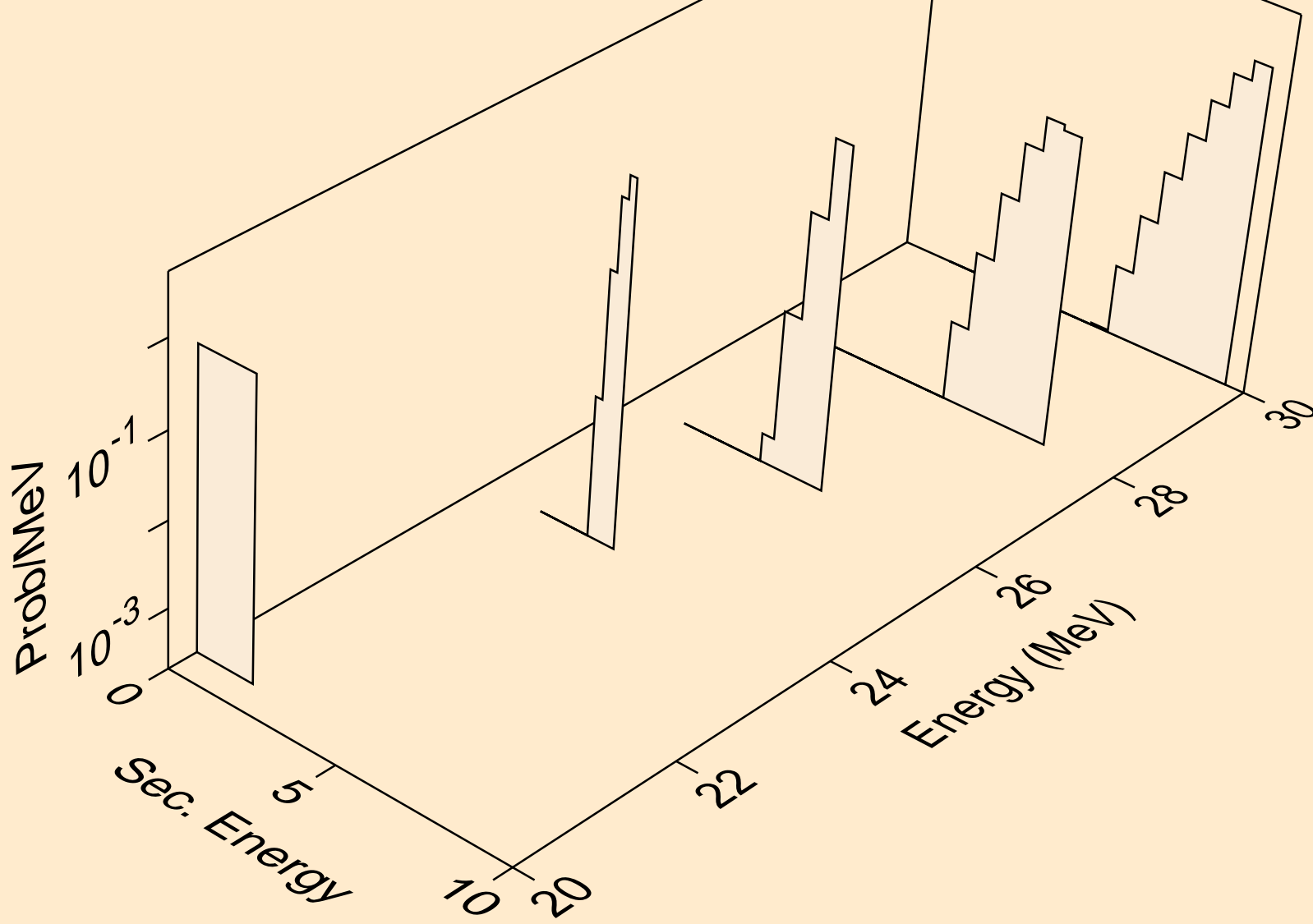

RH109 NEUTRON ACER TENDL-2019 LIBRARY; T=293.16K  
he3s from (n,he3)

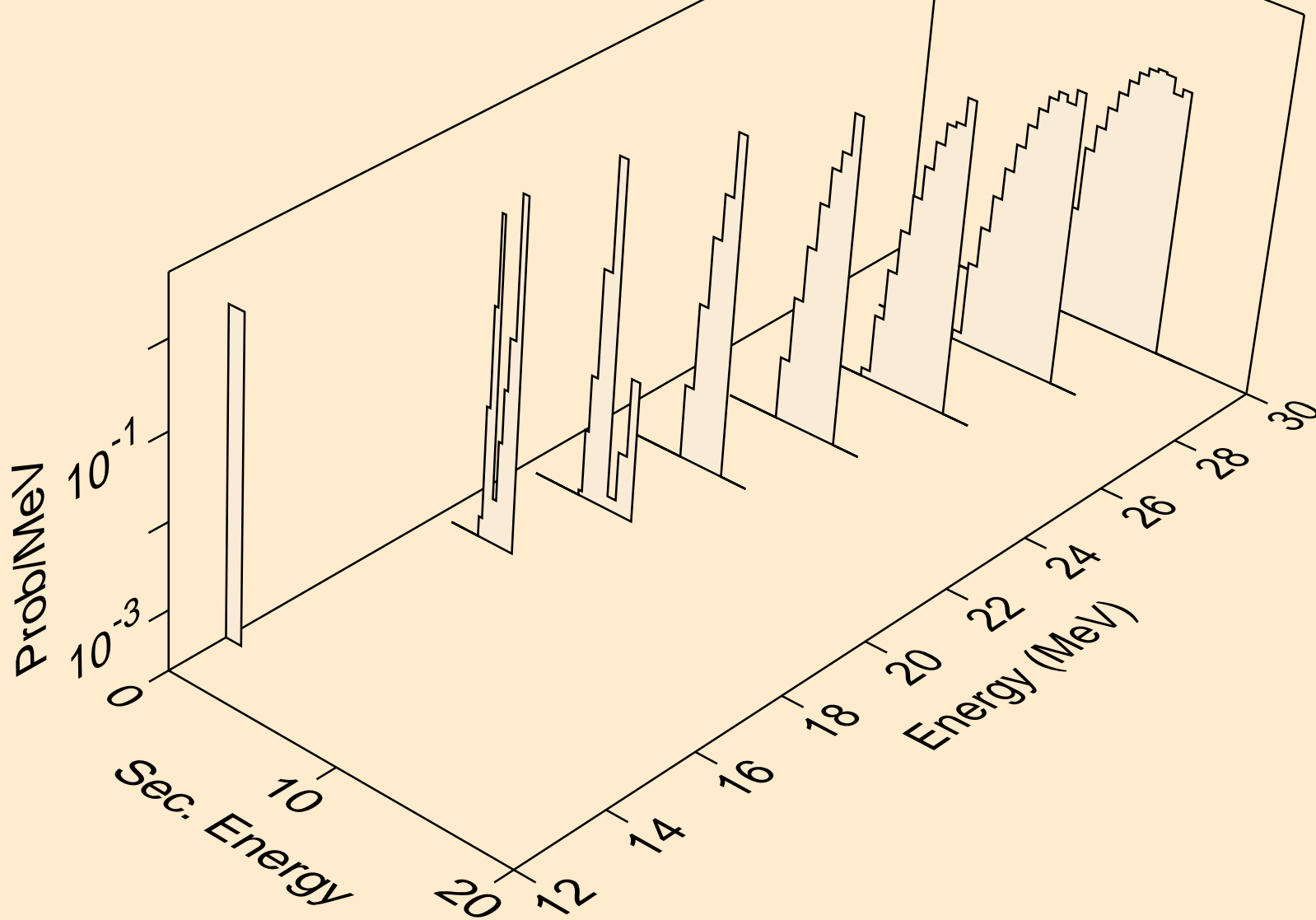

RH109 NEUTRON ACER TENDL-2019 LIBRARY; T=293.16K  
alphas from (n,x)

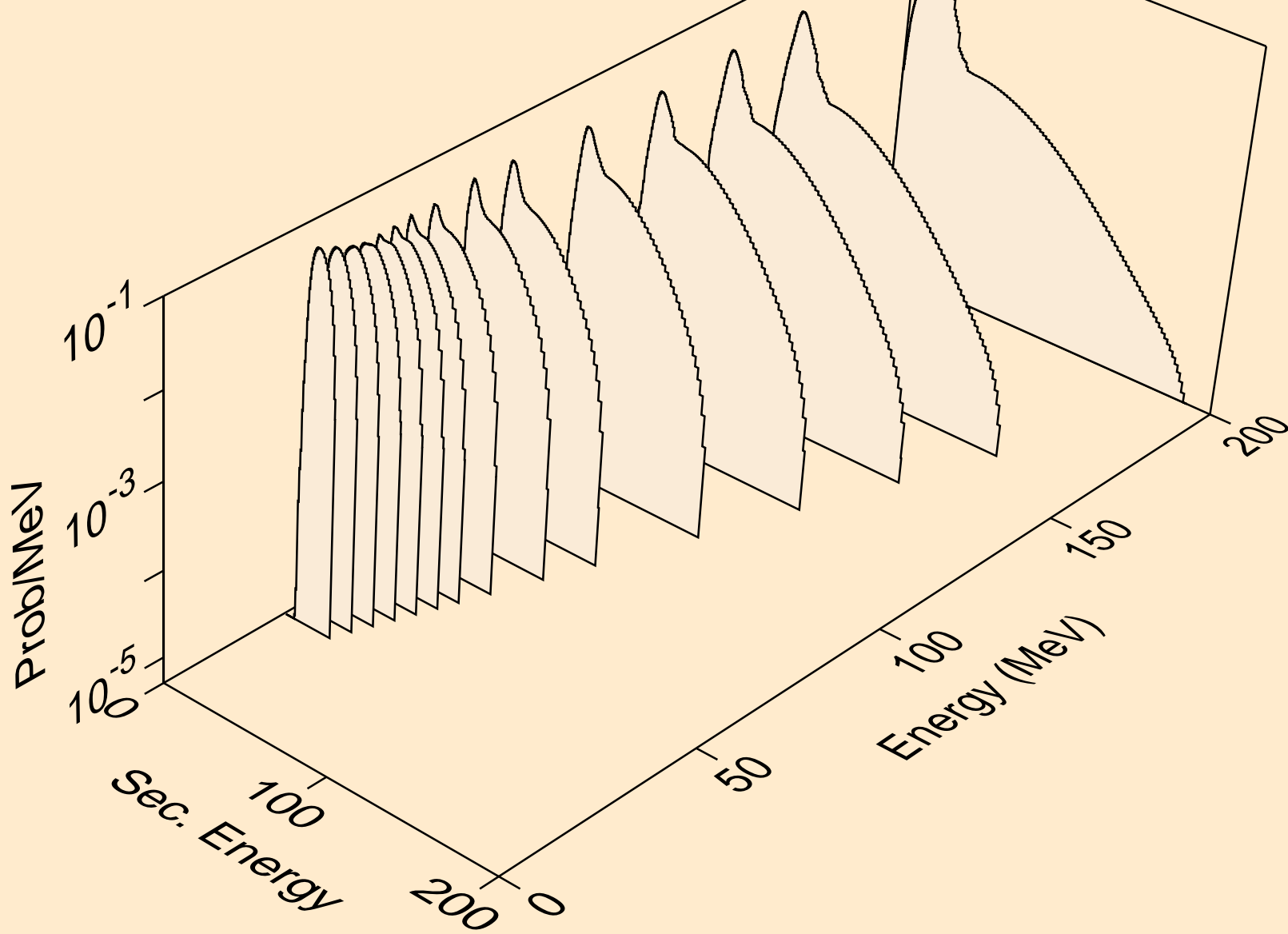

RH109 NEUTRON ACER TENDL-2019 LIBRARY; T=293.16K  
alphas from (n,n\*)a

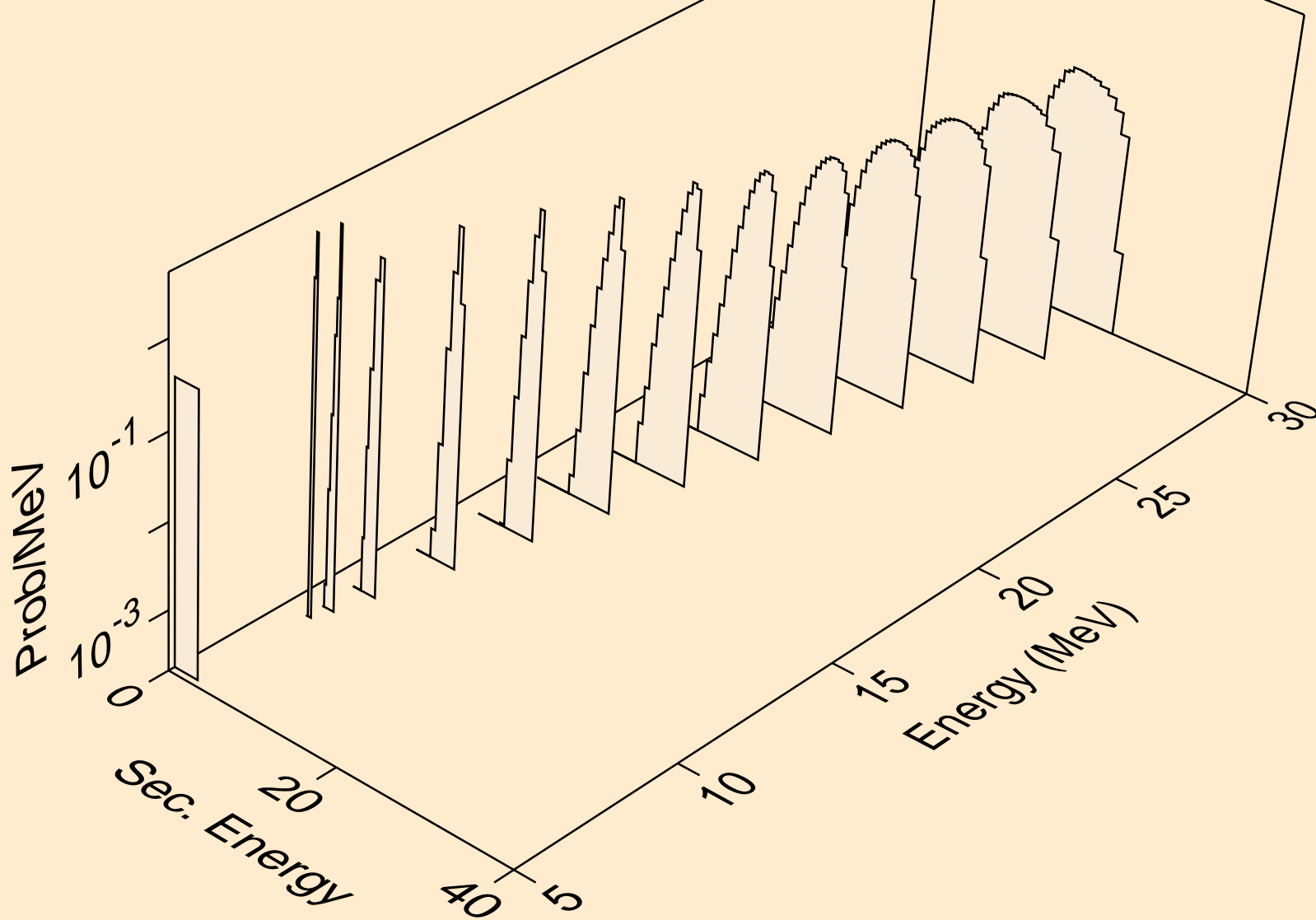

RH109 NEUTRON ACER TENDL-2019 LIBRARY; T=293.16K  
alphas from (n,2n)a

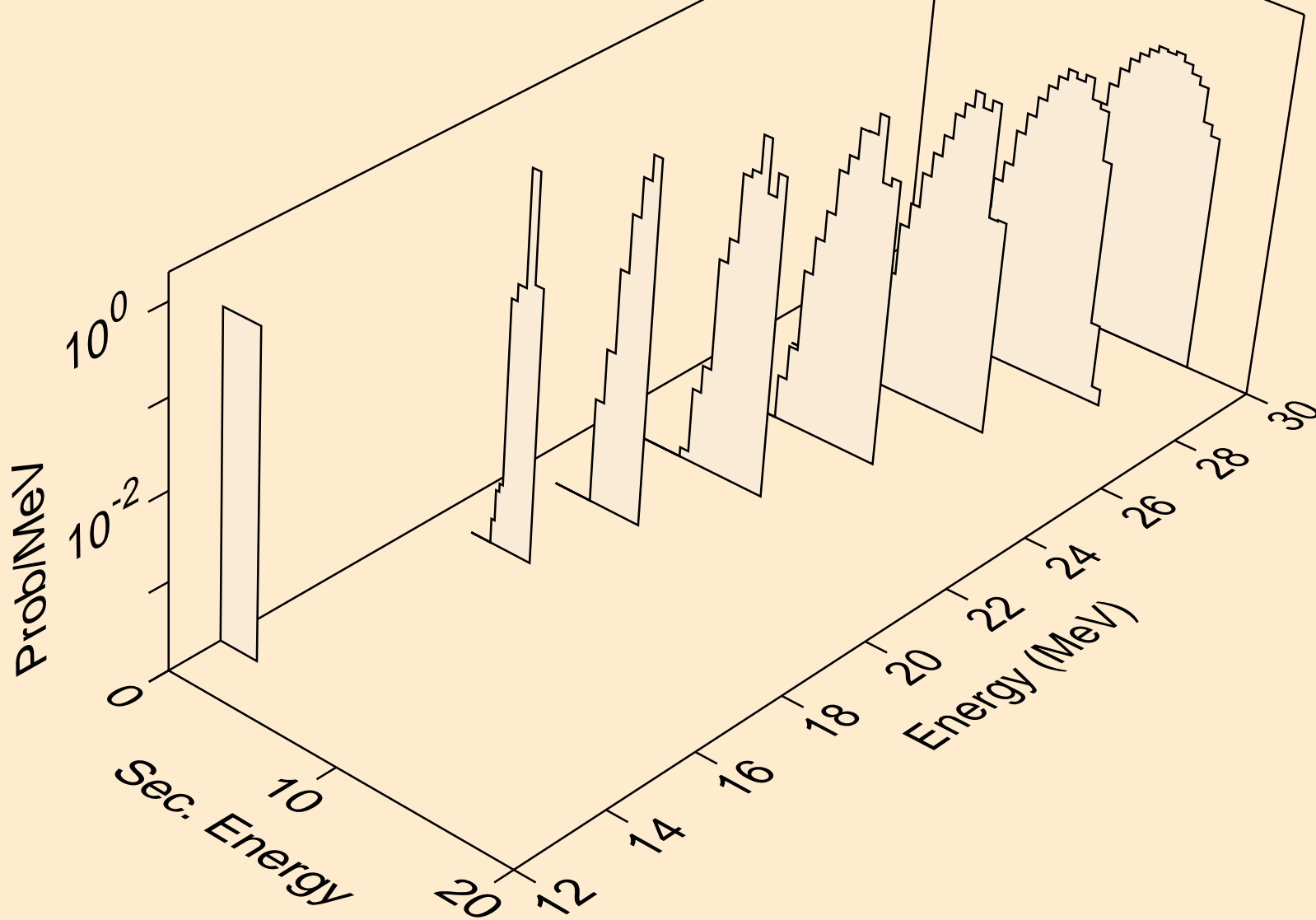

RH109 NEUTRON ACER TENDL-2019 LIBRARY; T=293.16K  
alphas from (n,3n)a

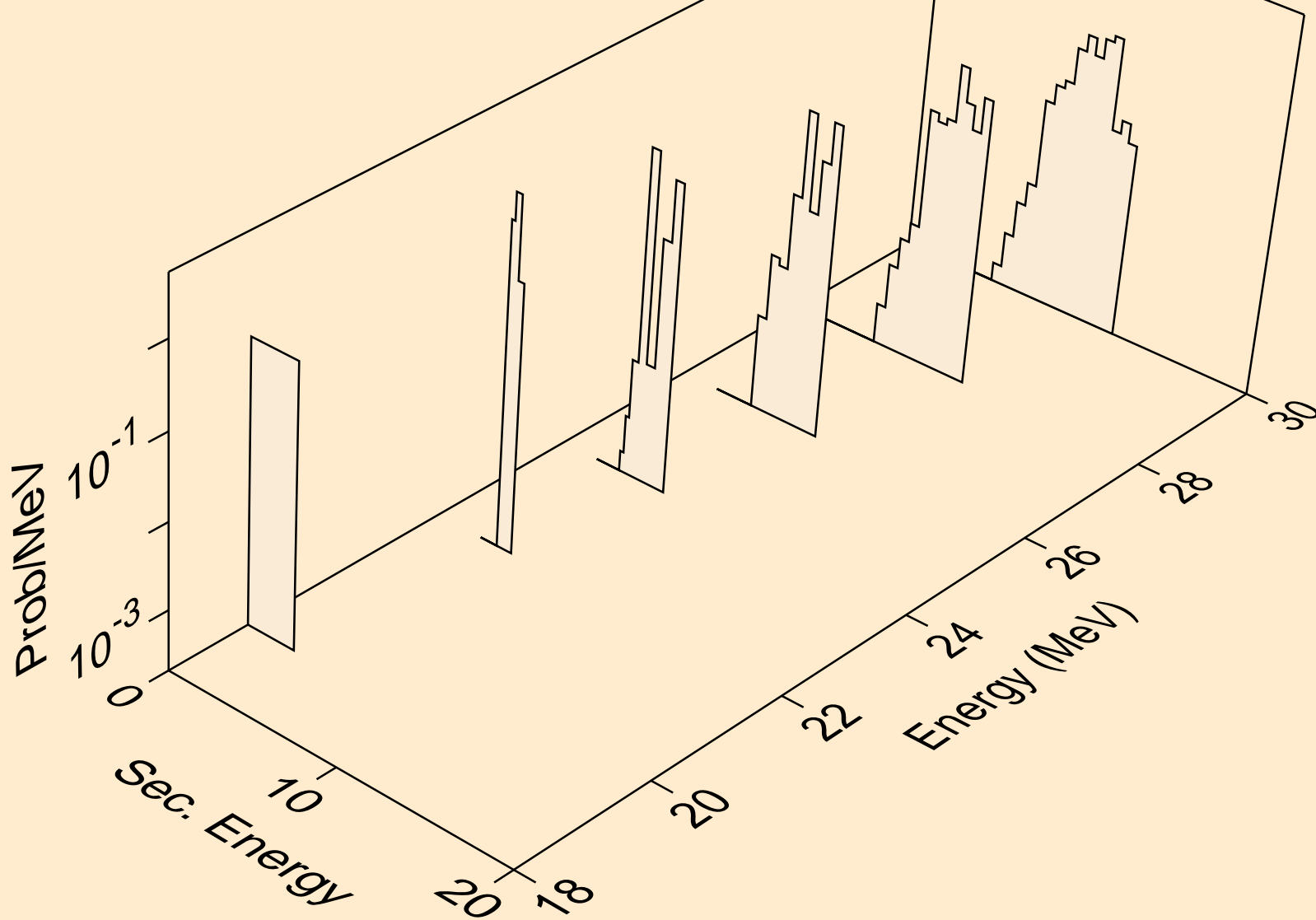

RH109 NEUTRON ACER TENDL-2019 LIBRARY; T=293.16K  
alphas from (n,a)

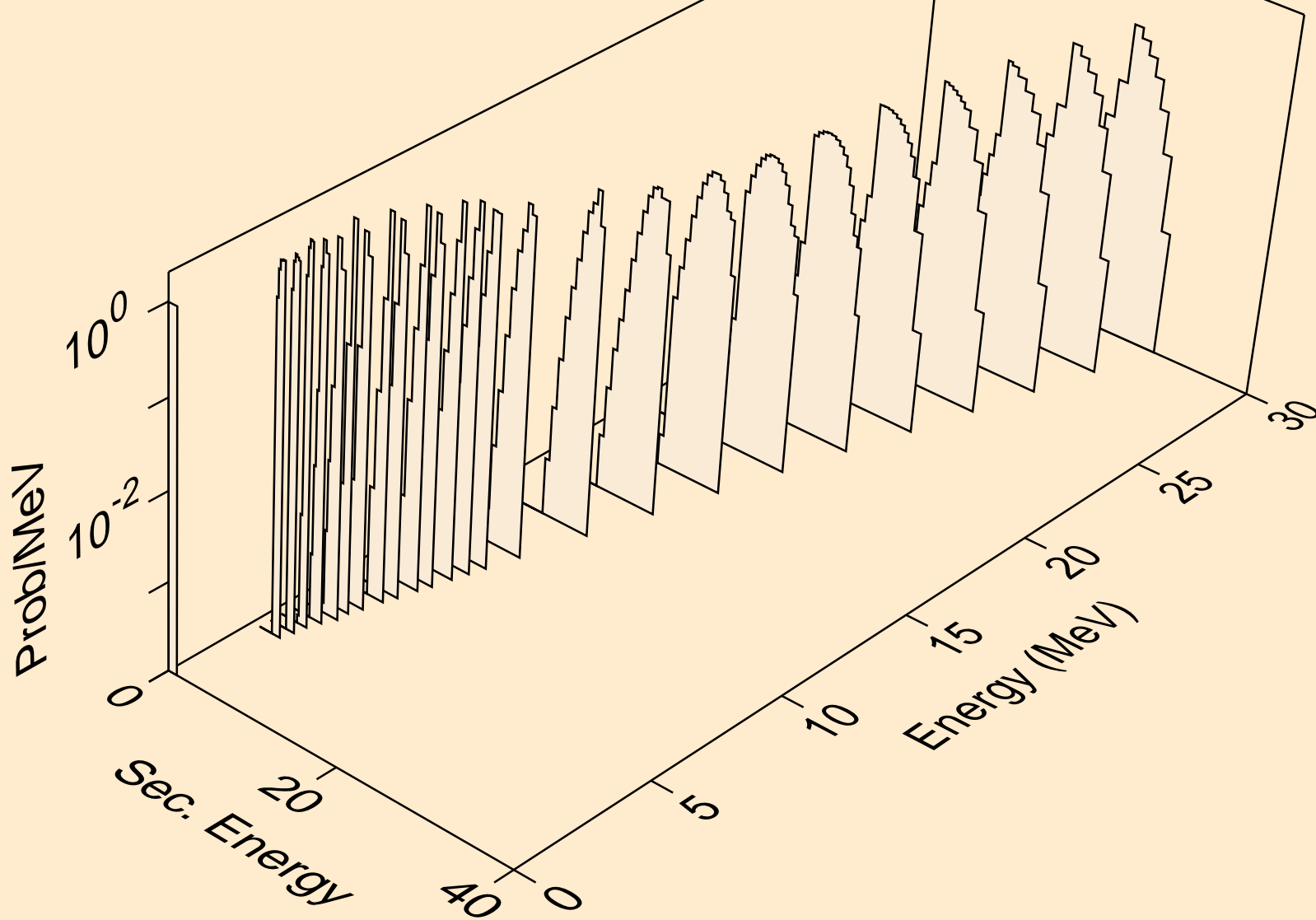

RH109 NEUTRON ACER TENDL-2019 LIBRARY; T=293.16K  
alphas from (n,pa)

