

RN208 NEUTRON ACER TENDL-2019 LIBRARY; T=293.16K
Principal cross sections

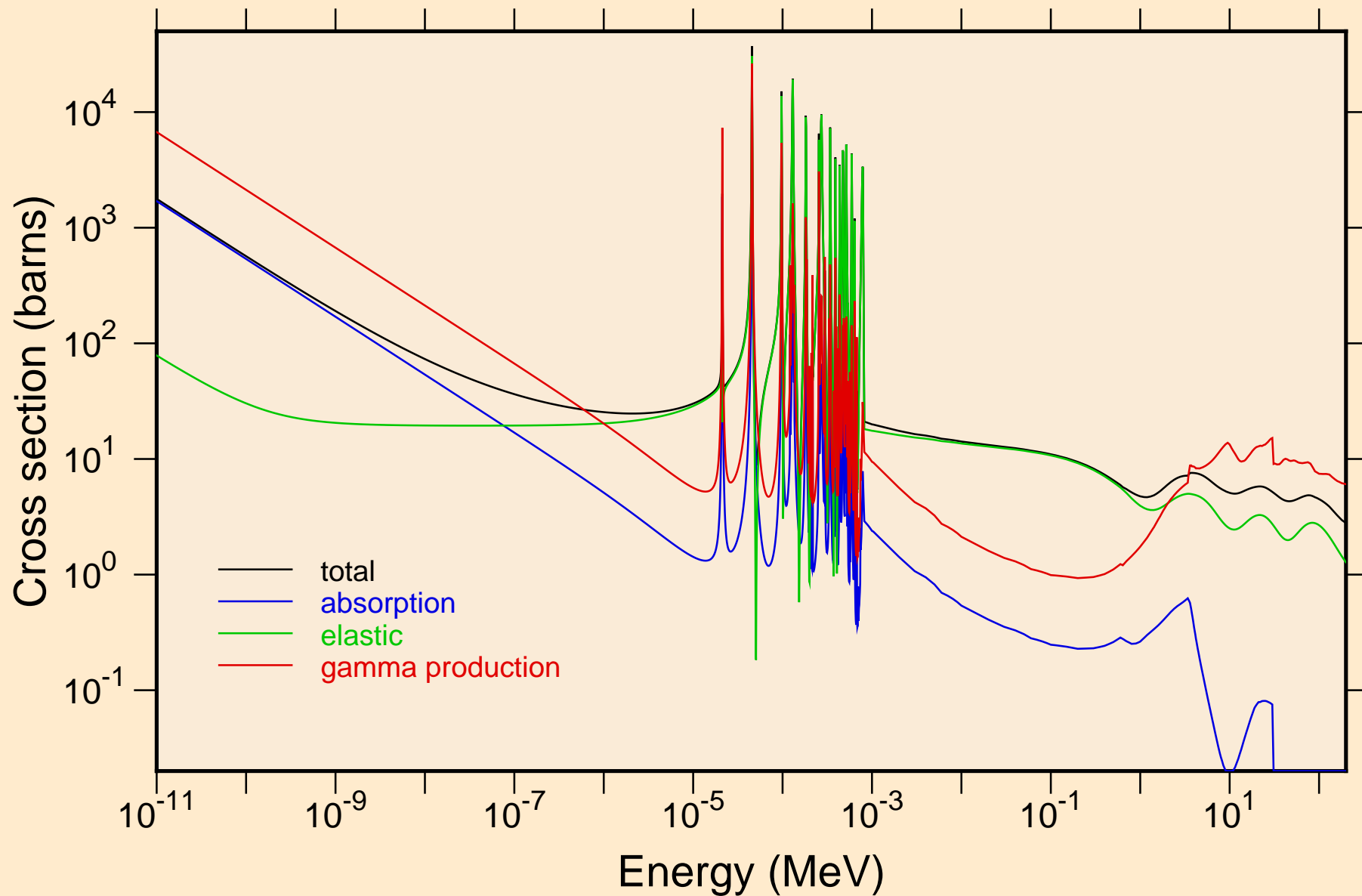

RN208 NEUTRON ACER TENDL-2019 LIBRARY; T=293.16K
resonance total cross section

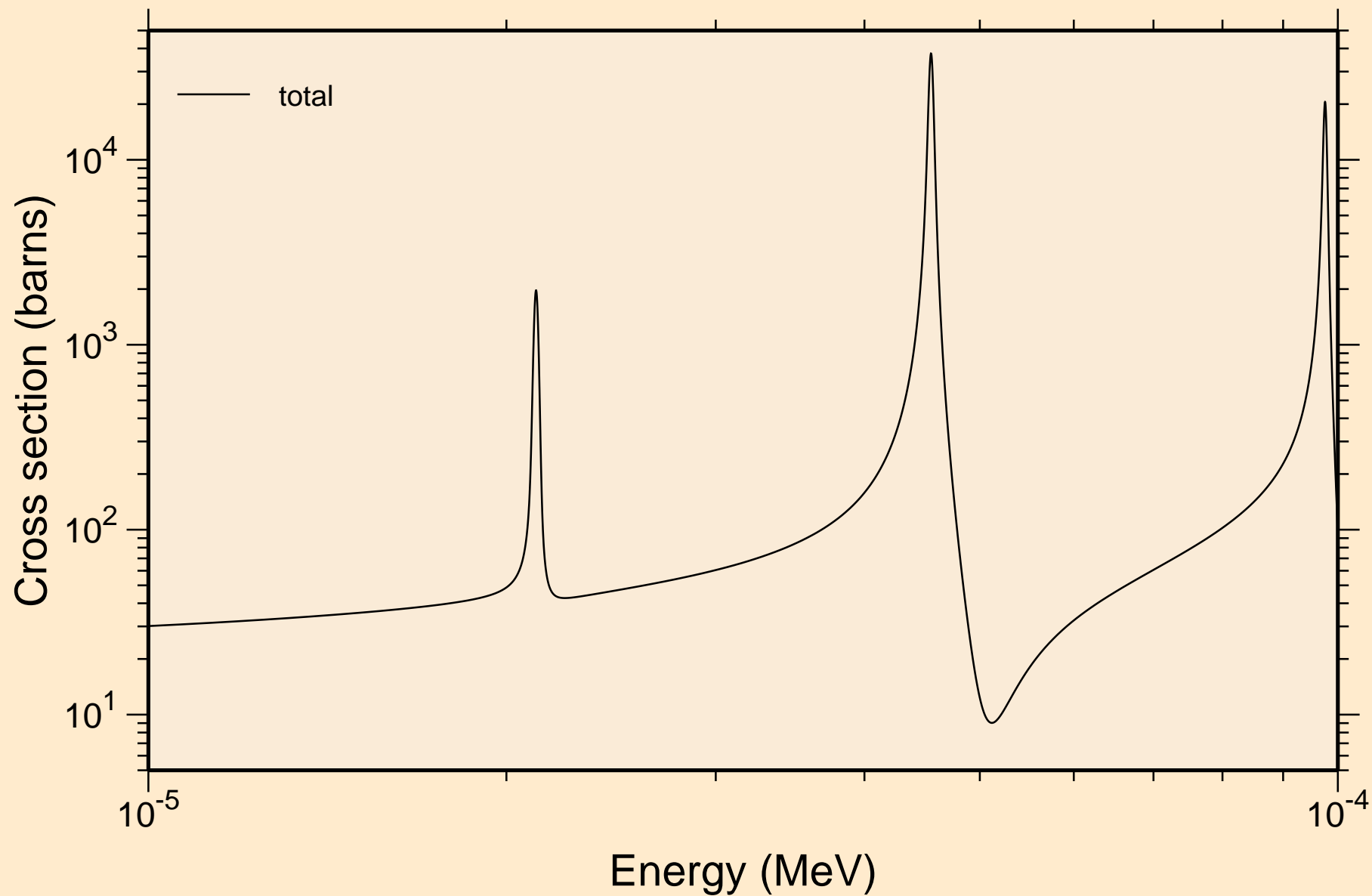

RN208 NEUTRON ACER TENDL-2019 LIBRARY; T=293.16K
resonance total cross section

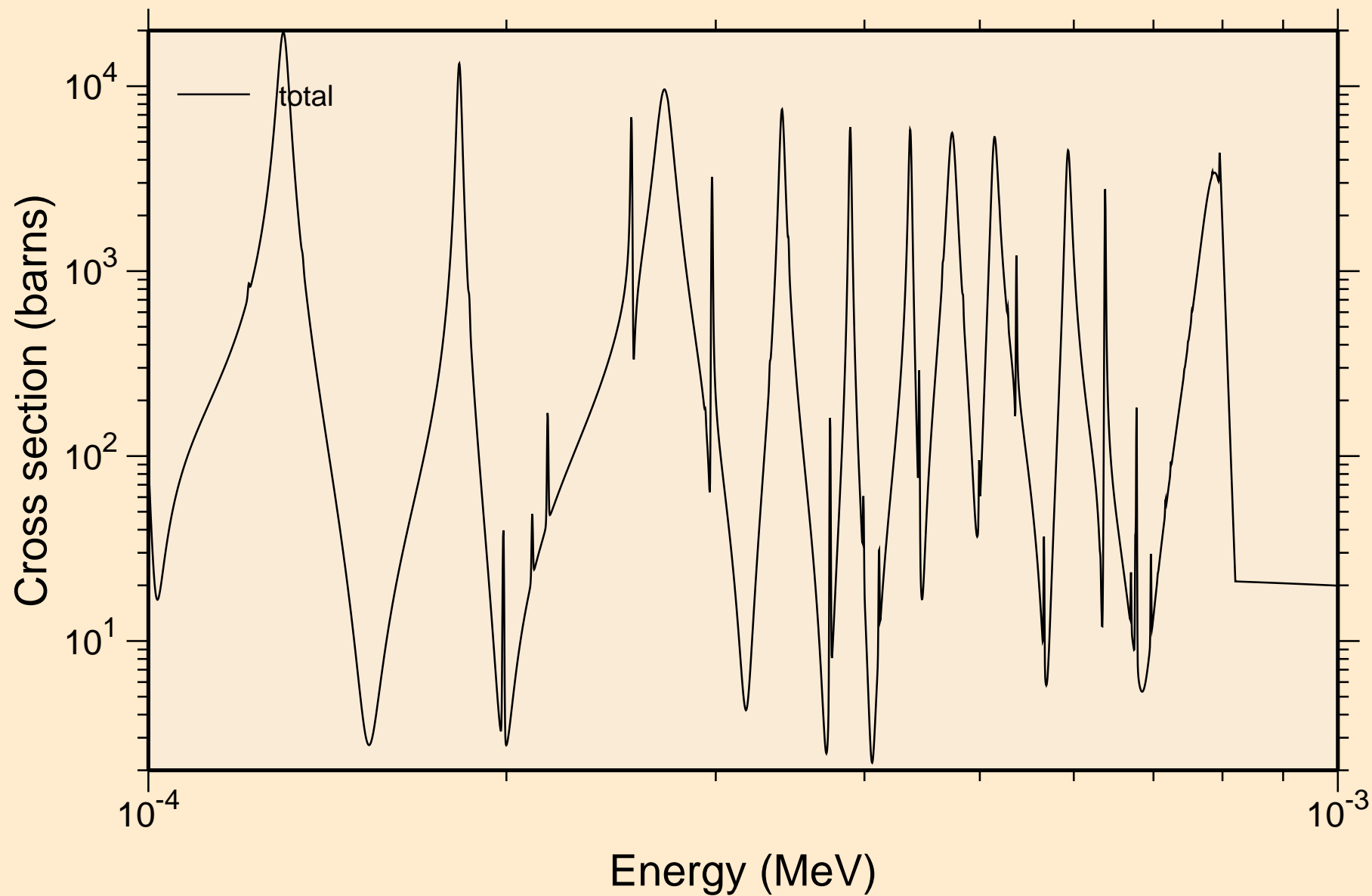

RN208 NEUTRON ACER TENDL-2019 LIBRARY; T=293.16K
resonance total cross section

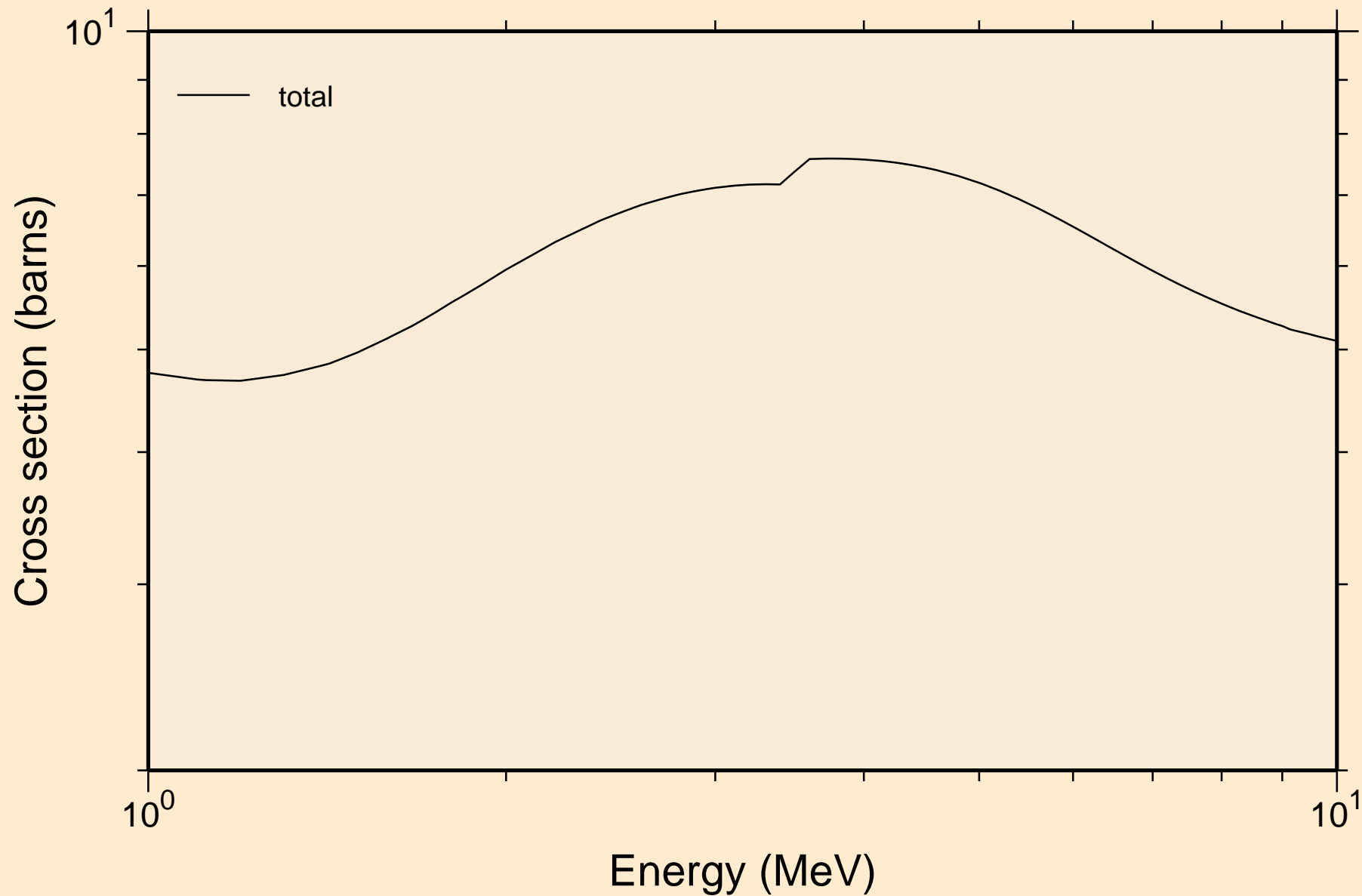

RN208 NEUTRON ACER TENDL-2019 LIBRARY; T=293.16K
resonance absorption cross sections

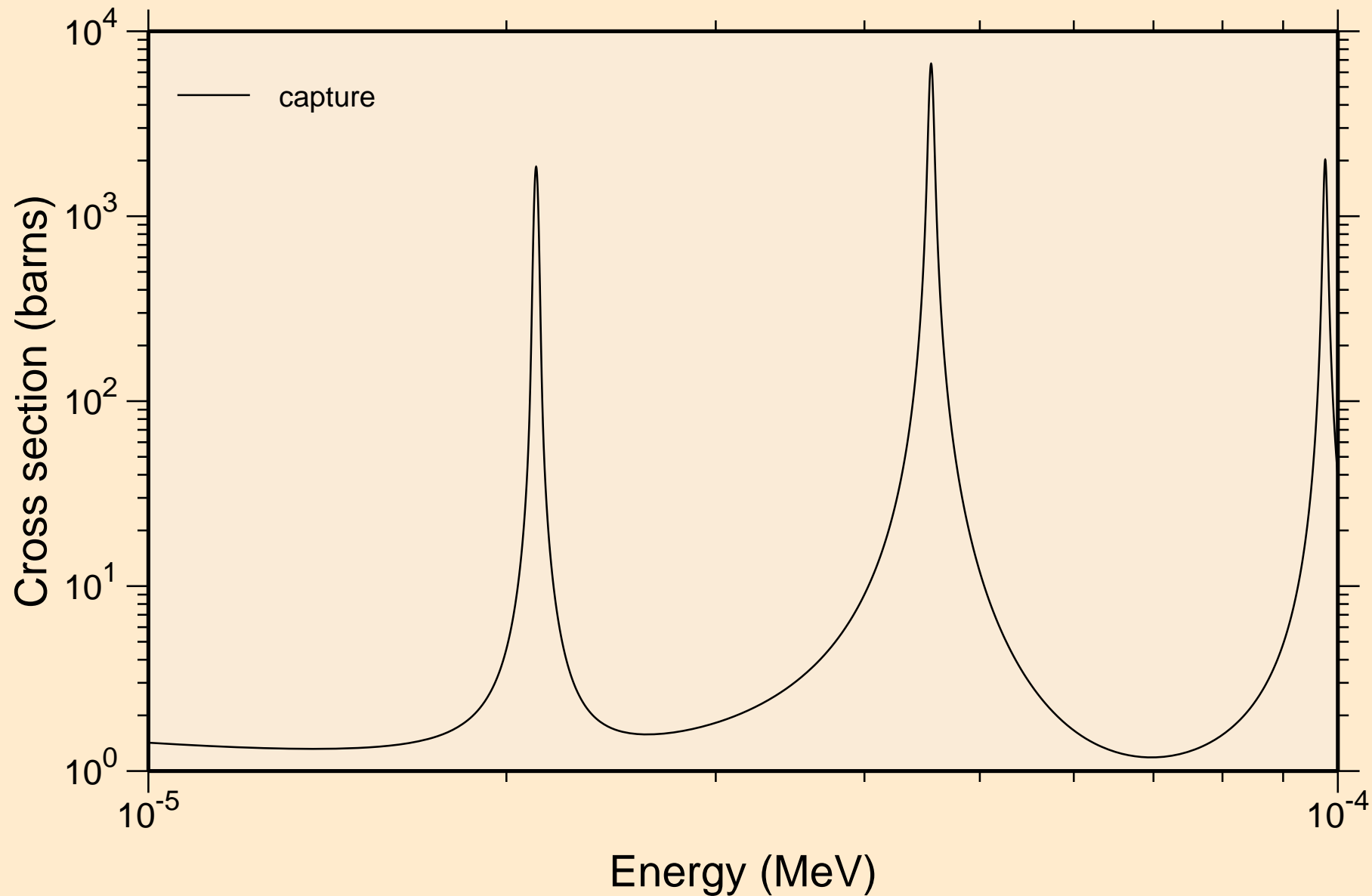

RN208 NEUTRON ACER TENDL-2019 LIBRARY; T=293.16K
resonance absorption cross sections

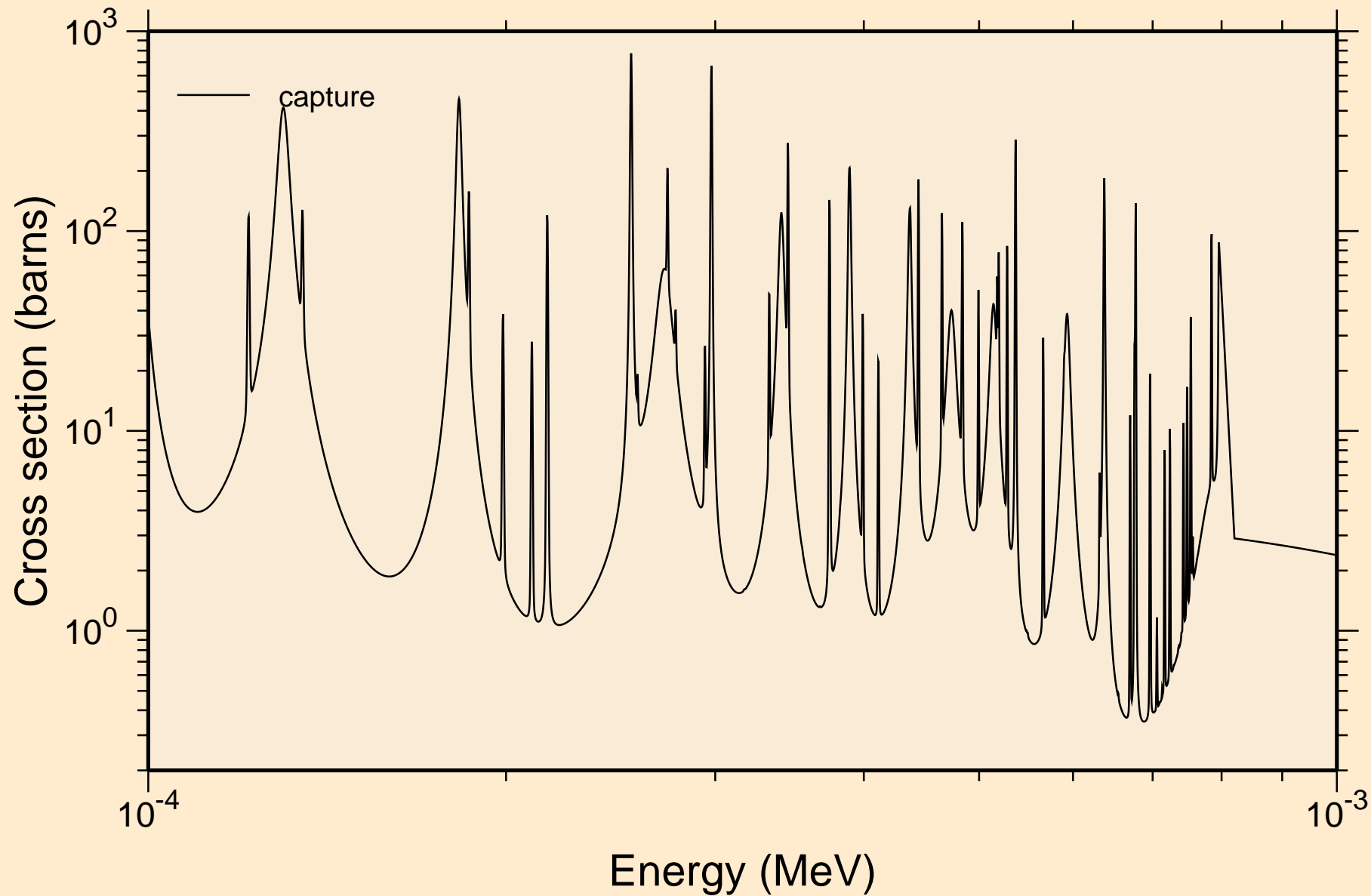

RN208 NEUTRON ACER TENDL-2019 LIBRARY; T=293.16K
resonance absorption cross sections

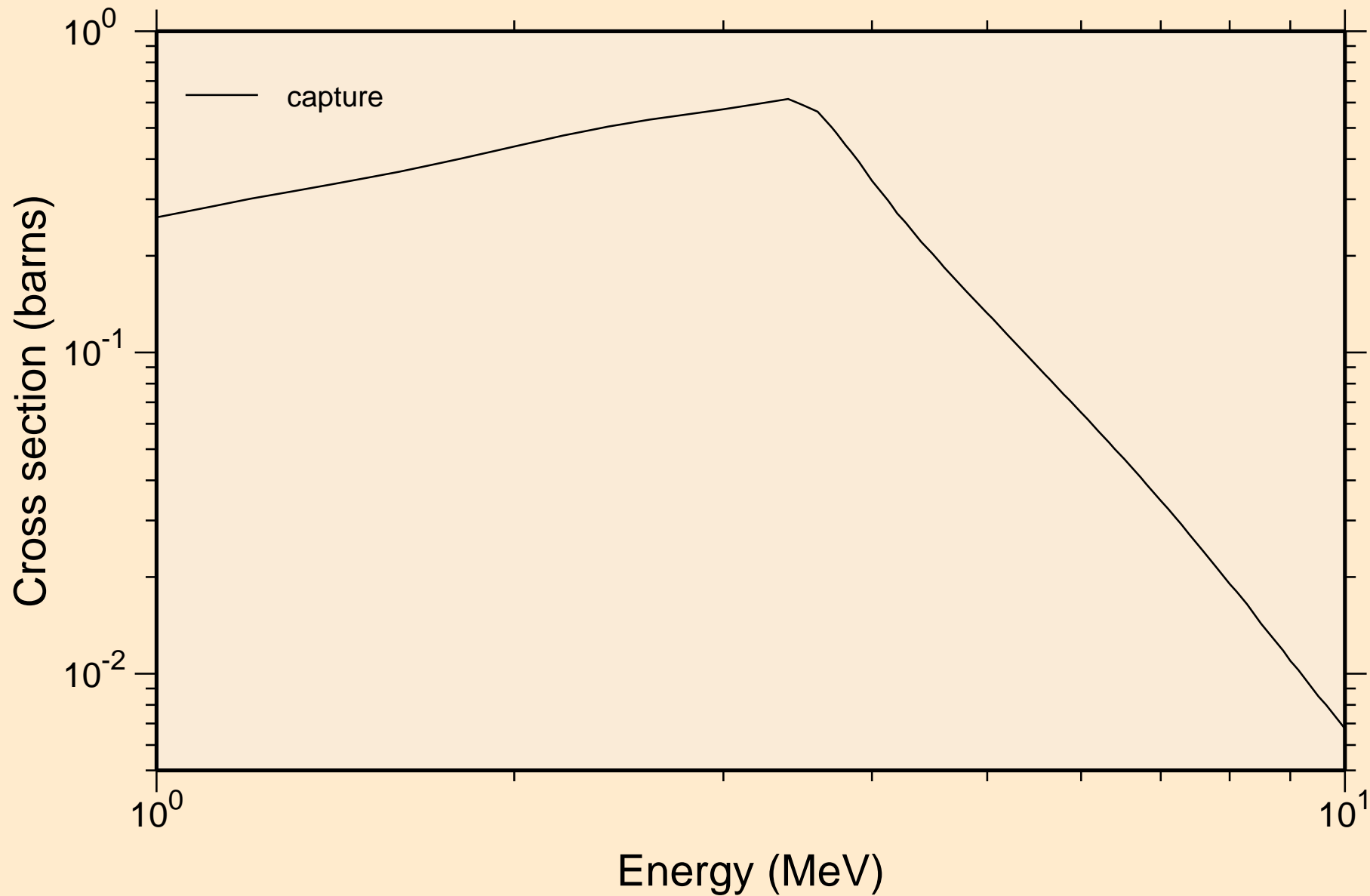

RN208 NEUTRON ACER TENDL-2019 LIBRARY; T=293.16K
Heating

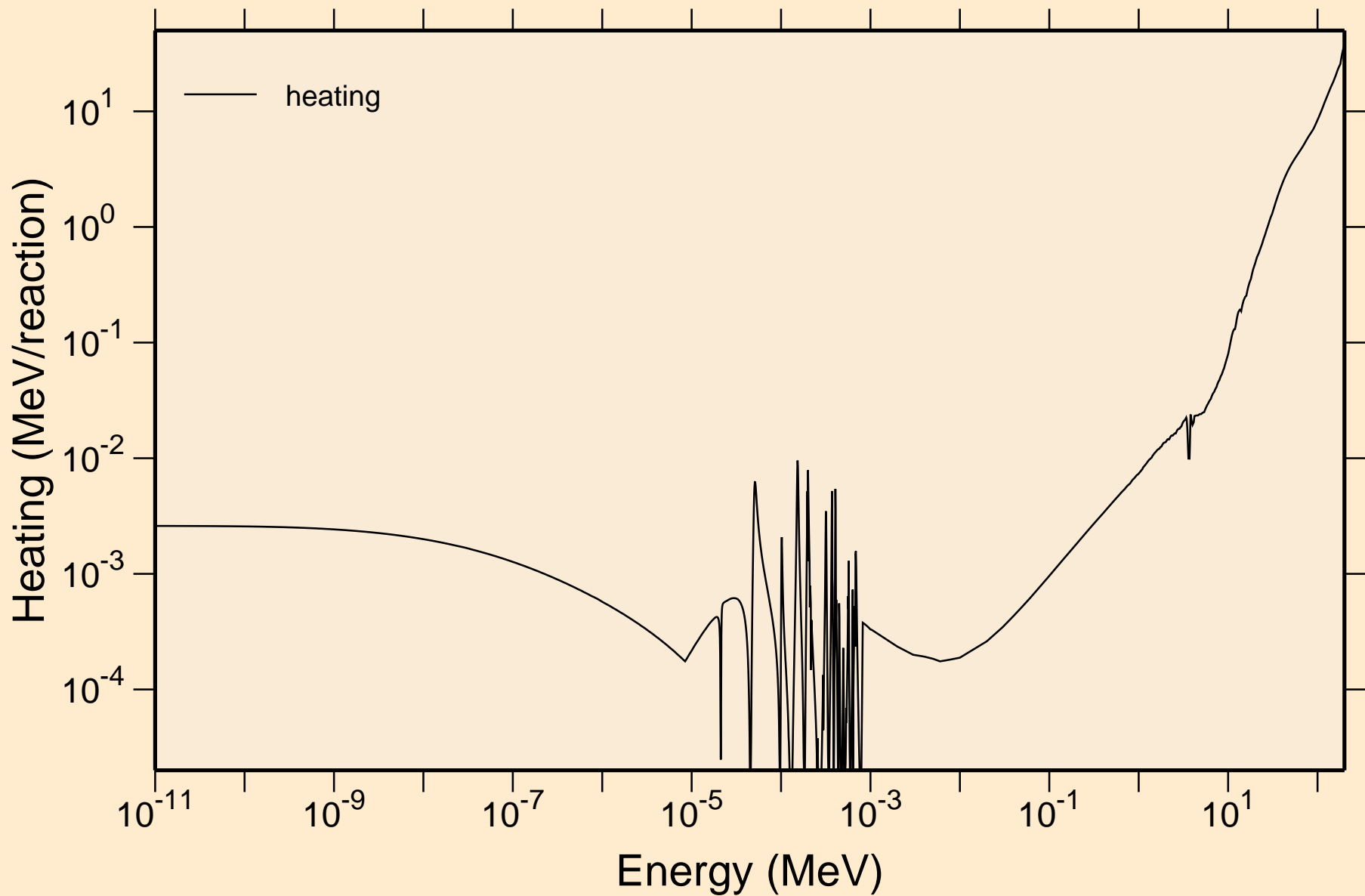

RN208 NEUTRON ACER TENDL-2019 LIBRARY; T=293.16K
Damage

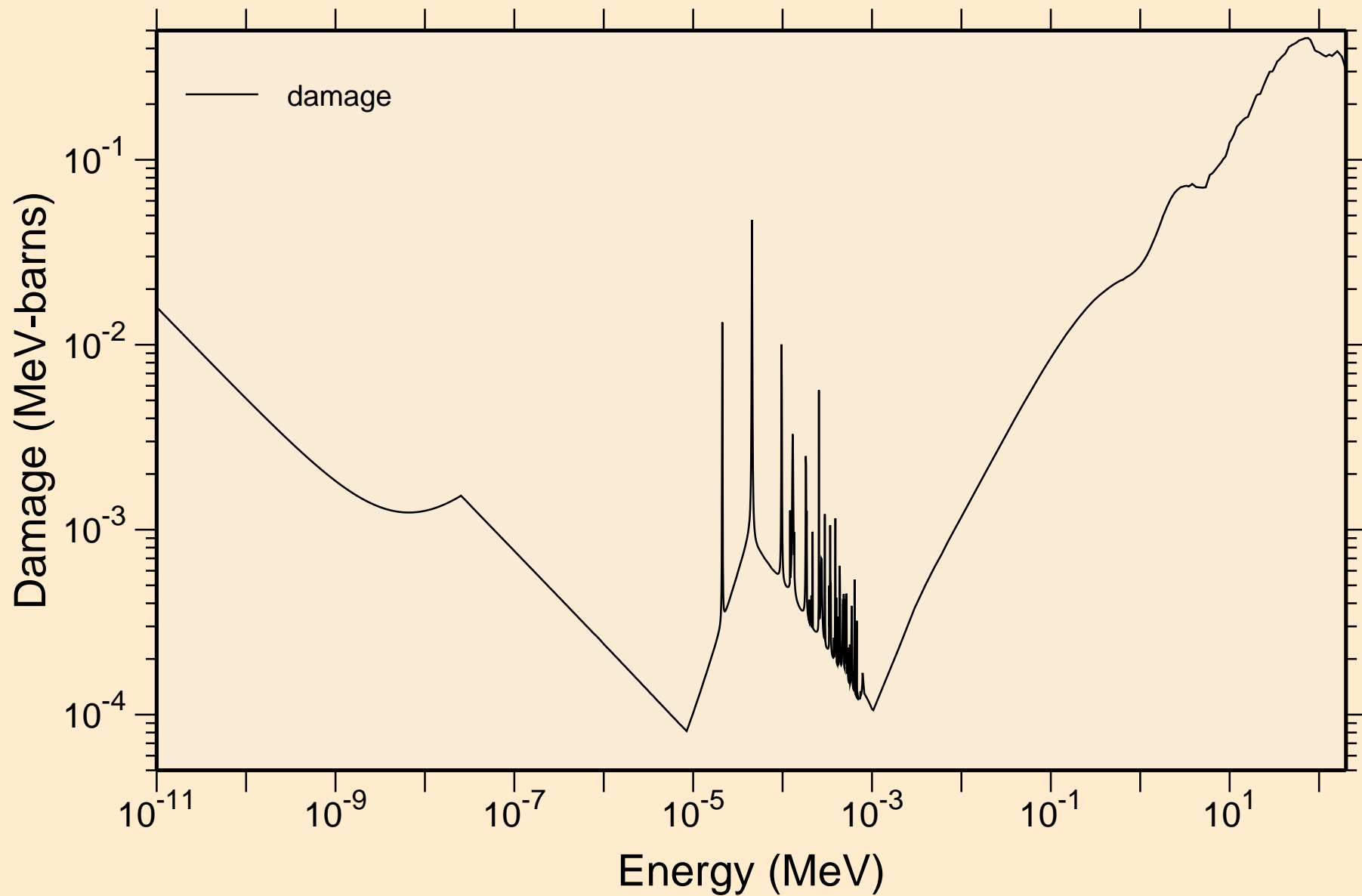

RN208 NEUTRON ACER TENDL-2019 LIBRARY; T=293.16K
Non-threshold reactions

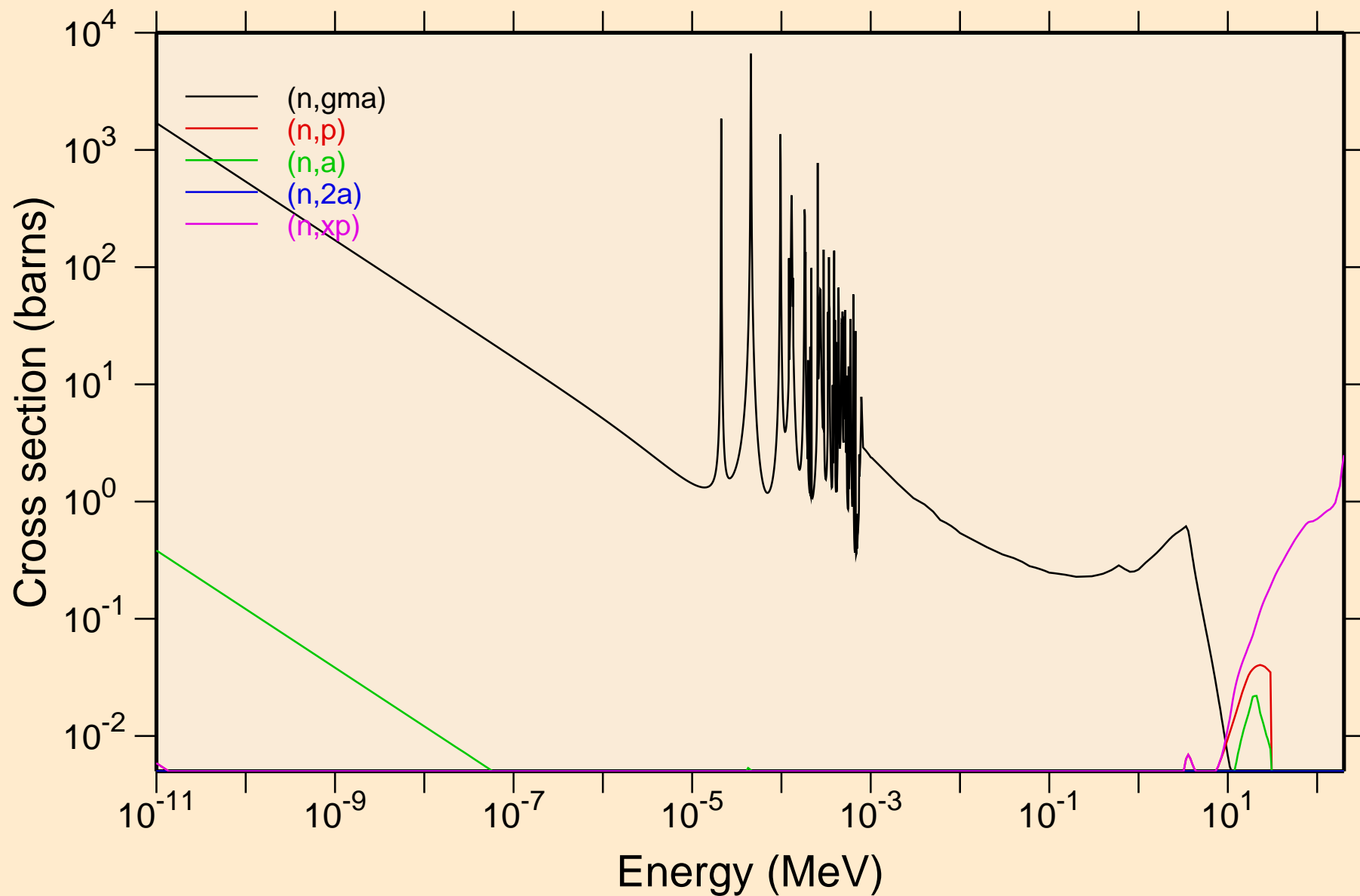

RN208 NEUTRON ACER TENDL-2019 LIBRARY; T=293.16K
Non-threshold reactions

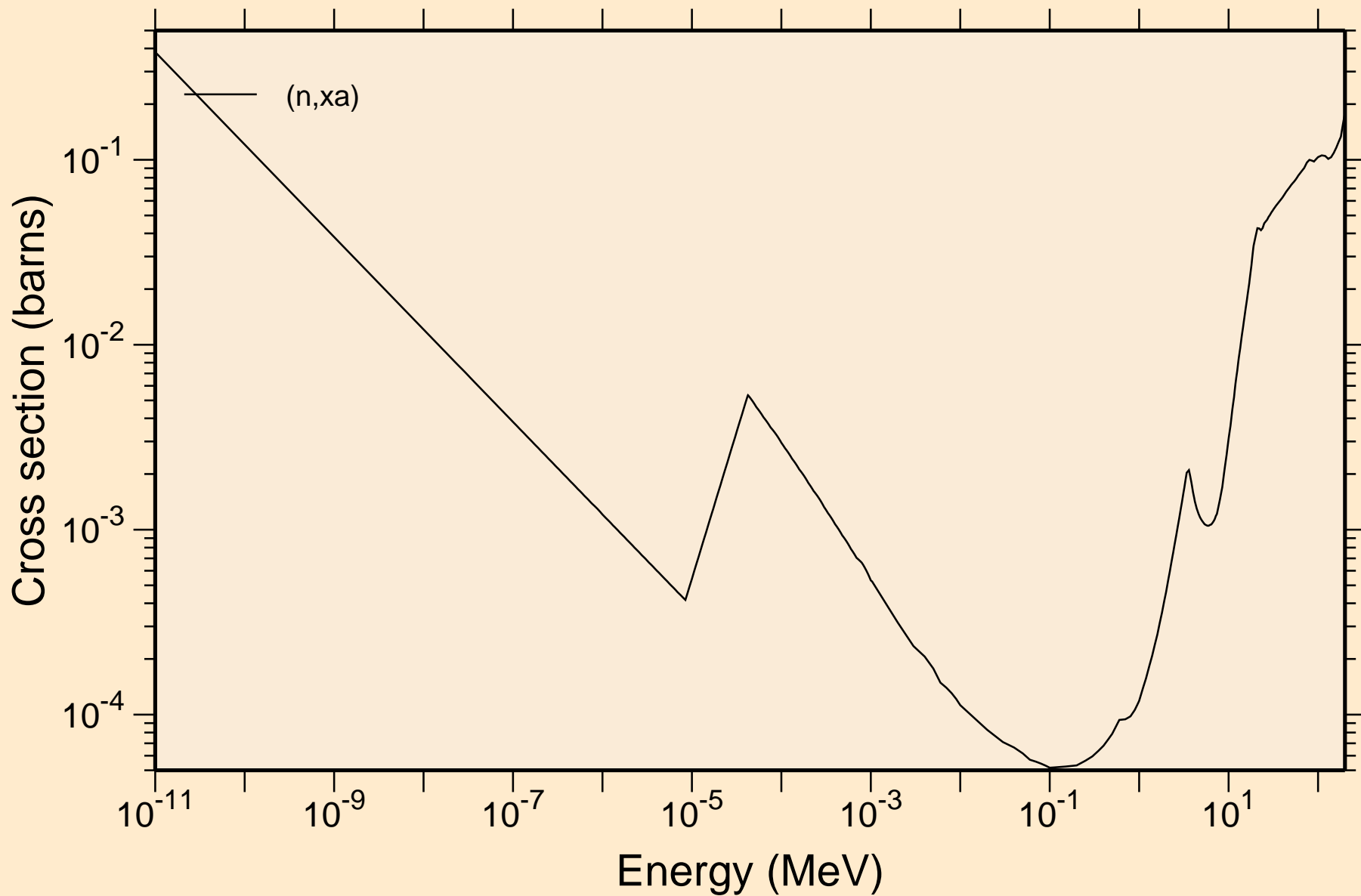

RN208 NEUTRON ACER TENDL-2019 LIBRARY; T=293.16K
Principal cross sections

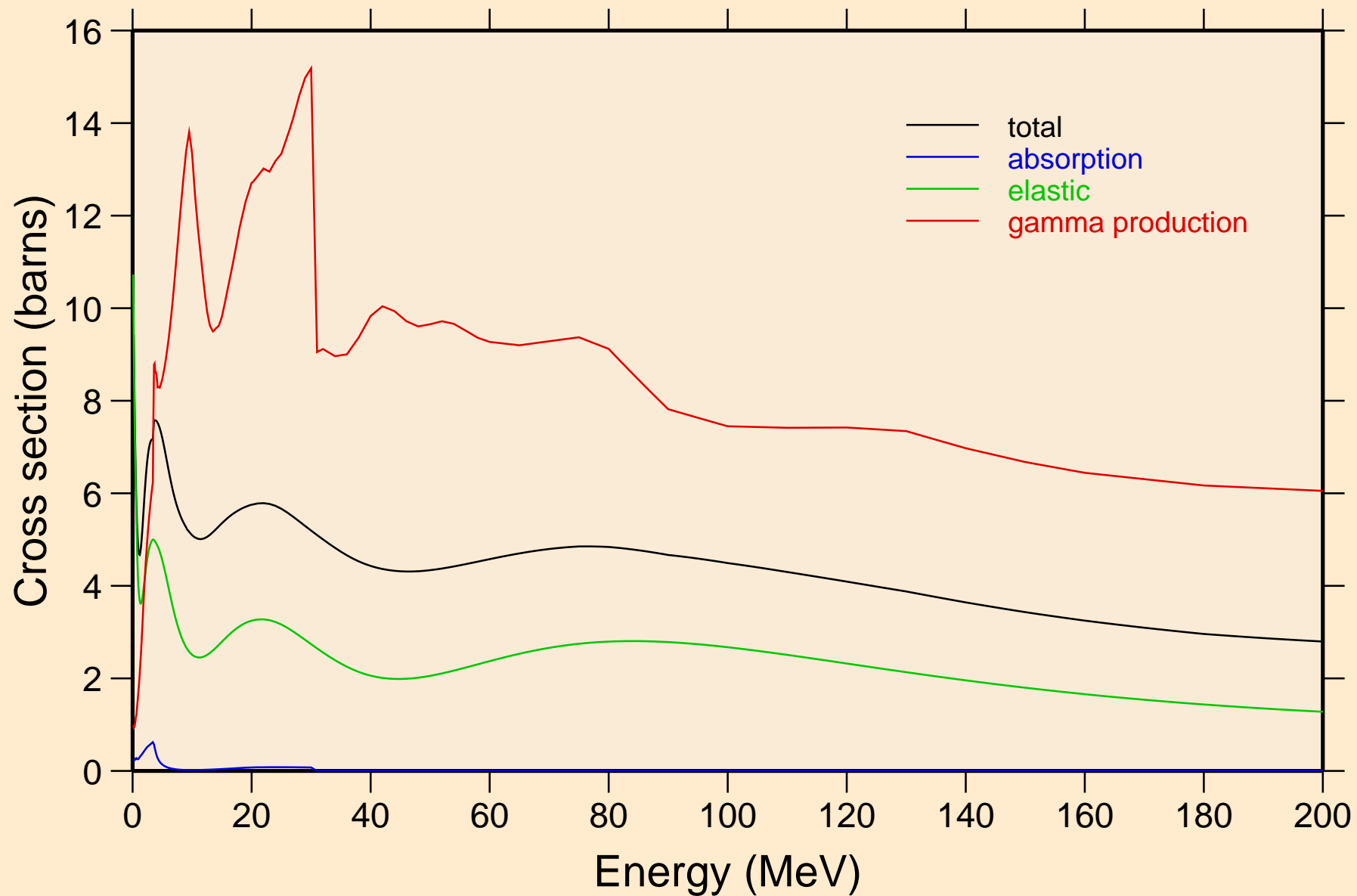

RN208 NEUTRON ACER TENDL-2019 LIBRARY; T=293.16K
Heating

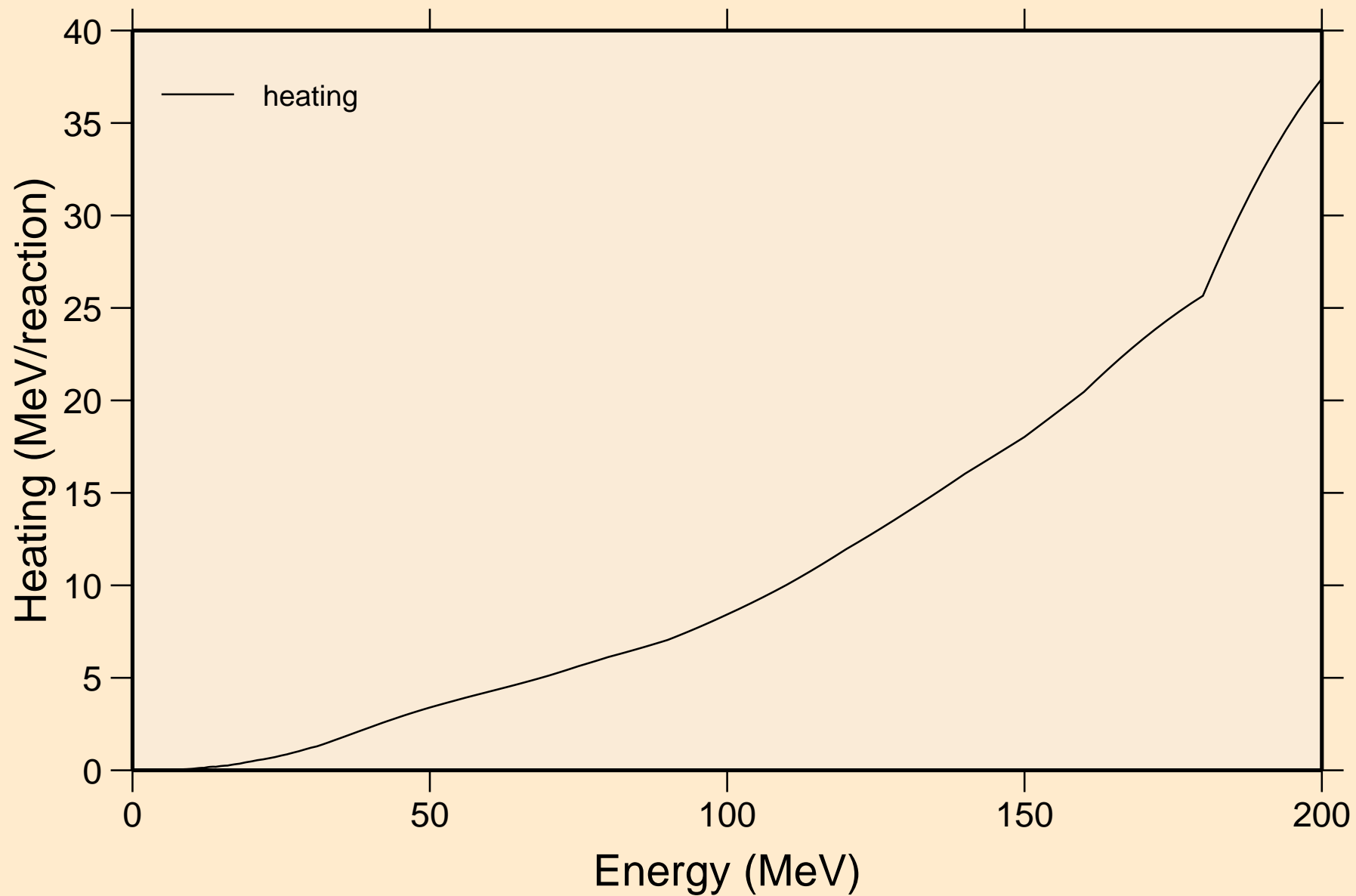

RN208 NEUTRON ACER TENDL-2019 LIBRARY; T=293.16K
Damage

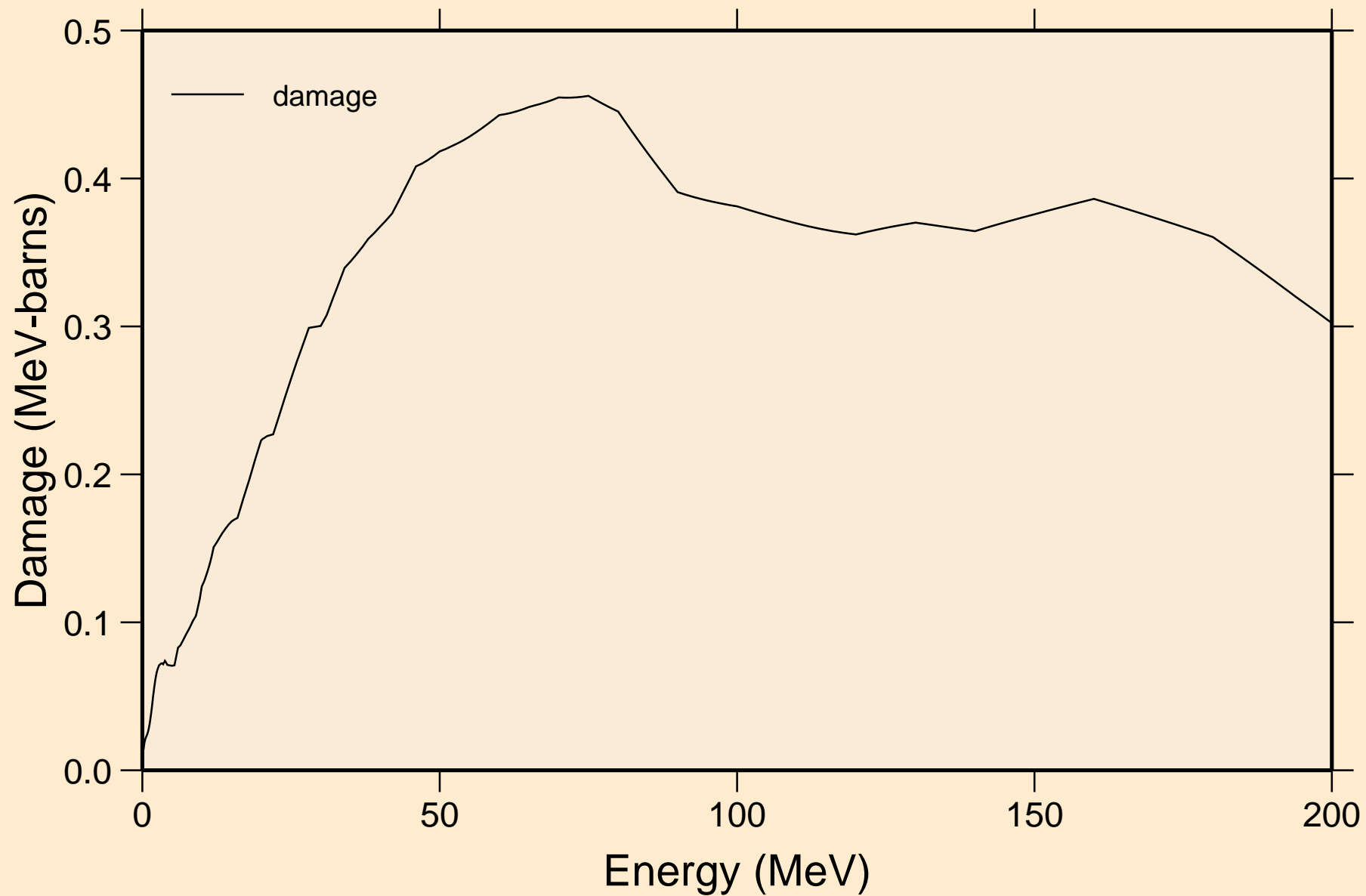

RN208 NEUTRON ACER TENDL-2019 LIBRARY; T=293.16K
Non-threshold reactions

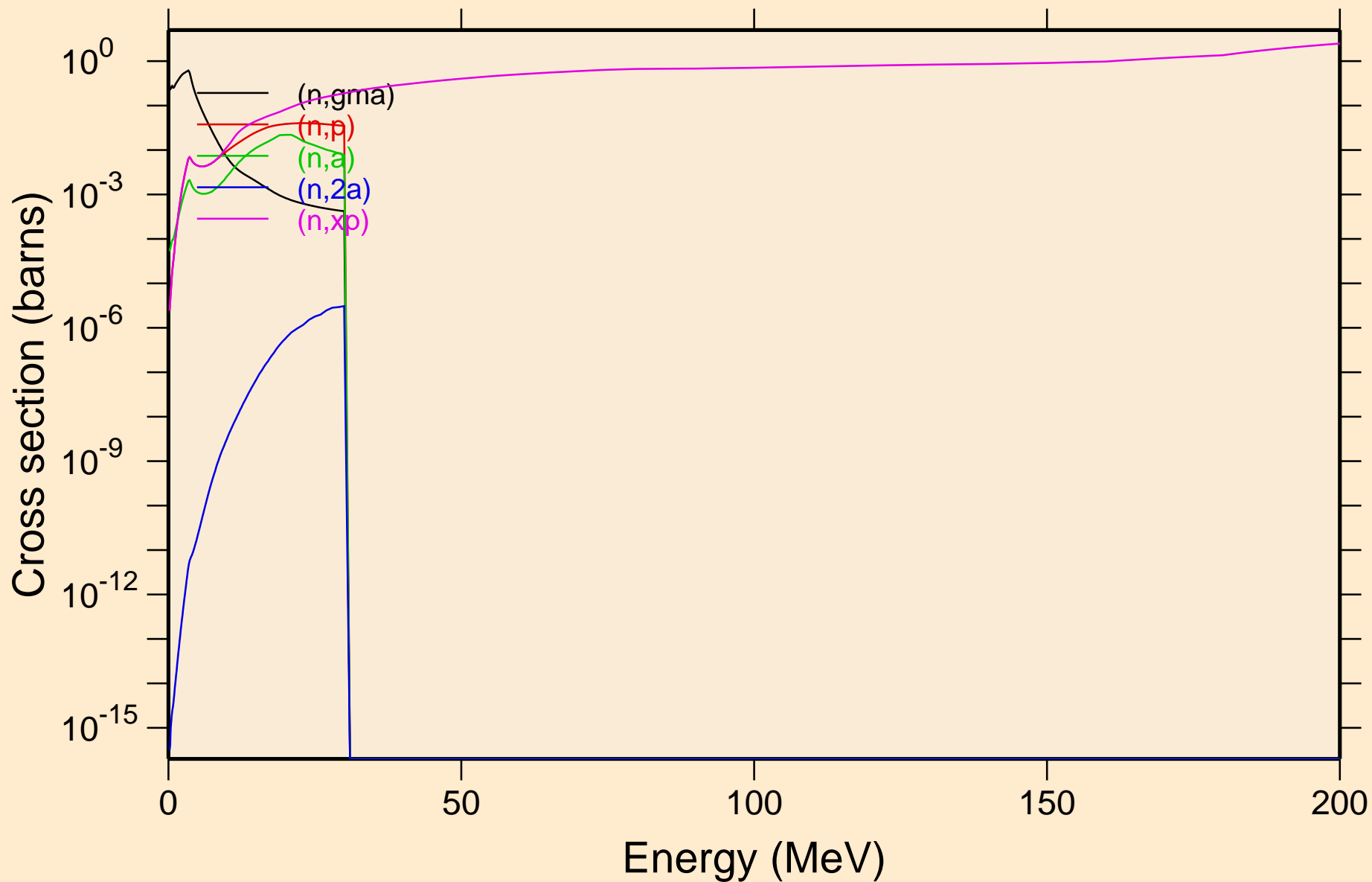

RN208 NEUTRON ACER TENDL-2019 LIBRARY; T=293.16K
Non-threshold reactions

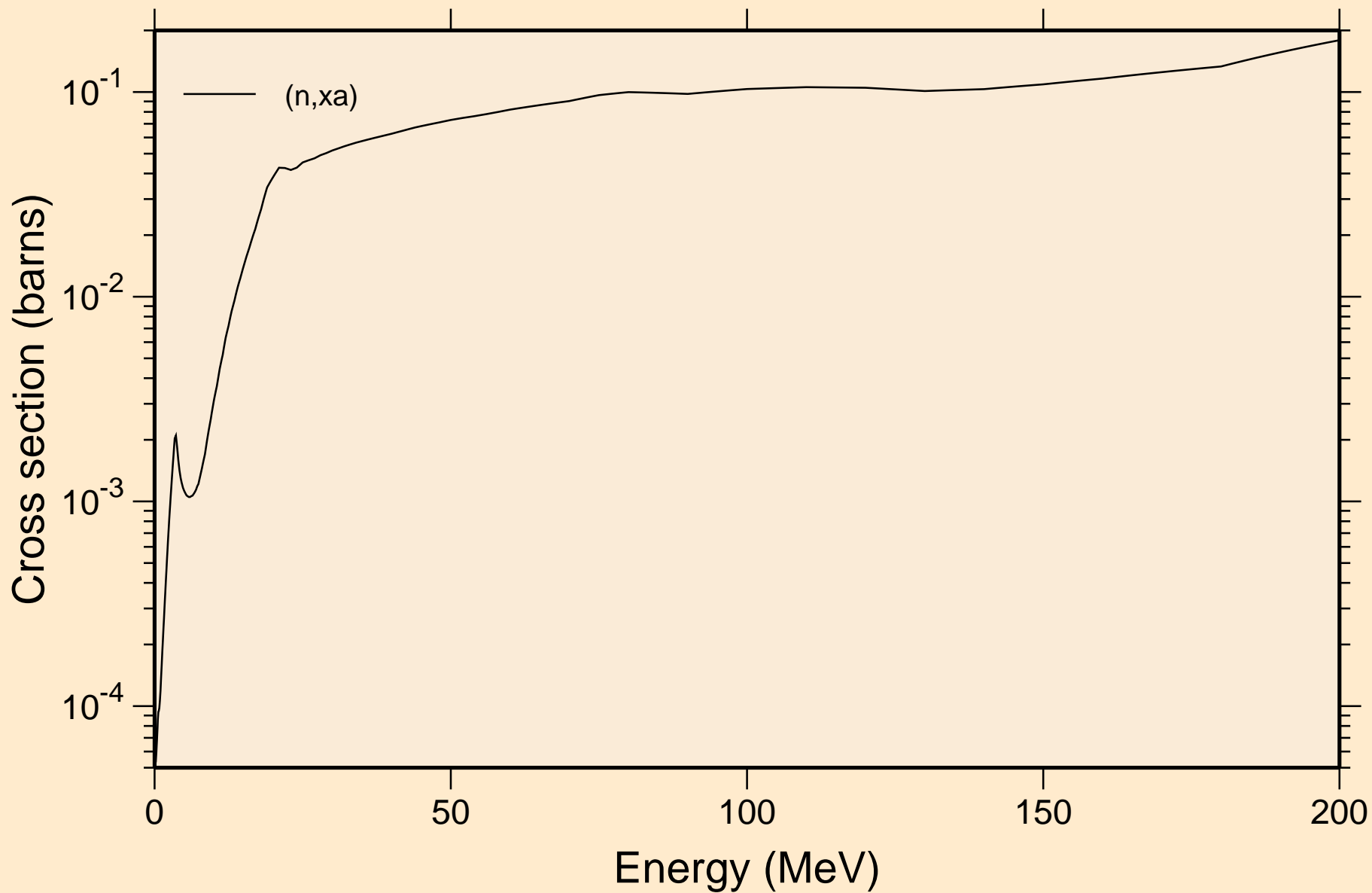

RN208 NEUTRON ACER TENDL-2019 LIBRARY; T=293.16K
Inelastic levels

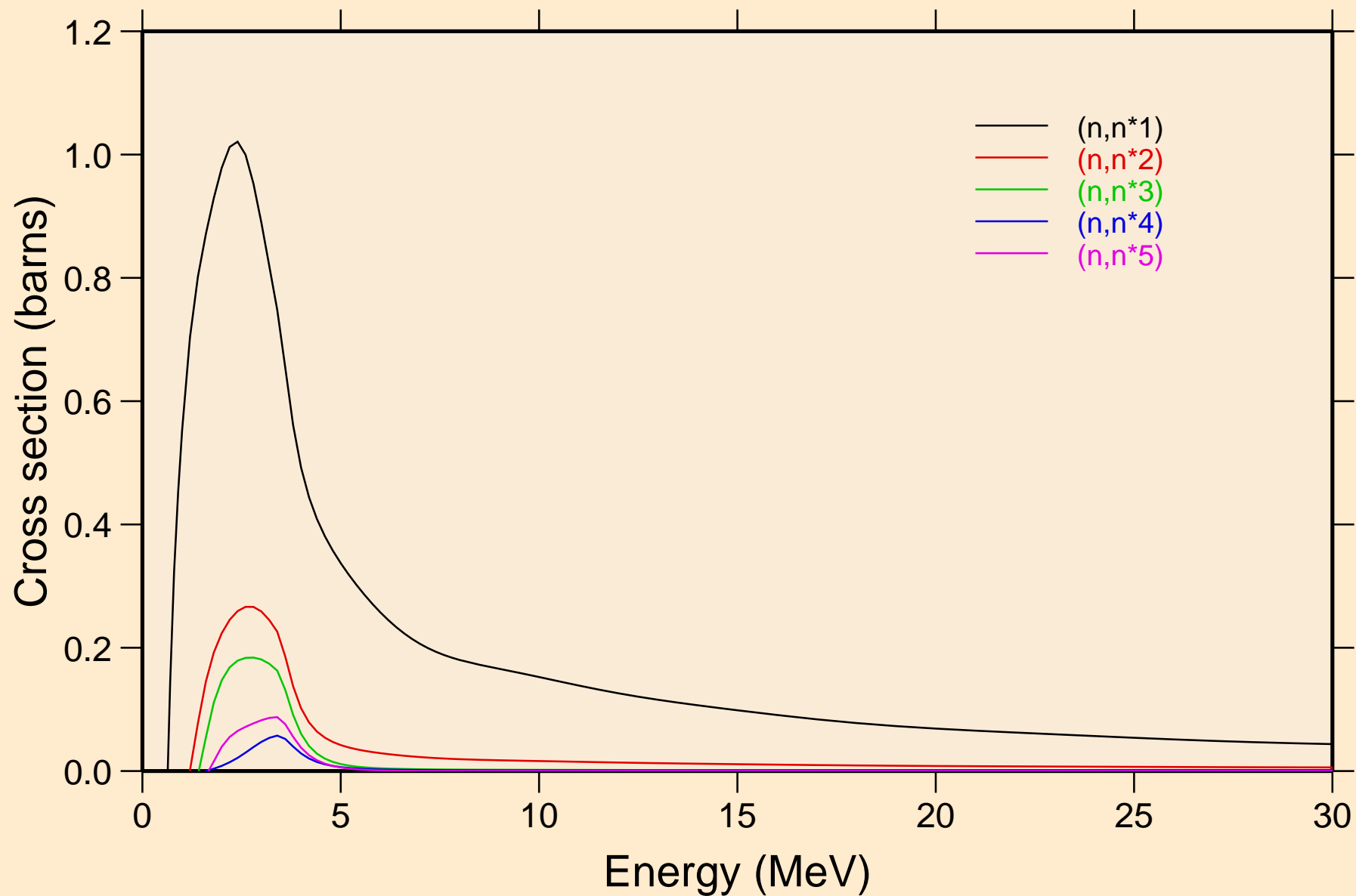

RN208 NEUTRON ACER TENDL-2019 LIBRARY; T=293.16K
Inelastic levels

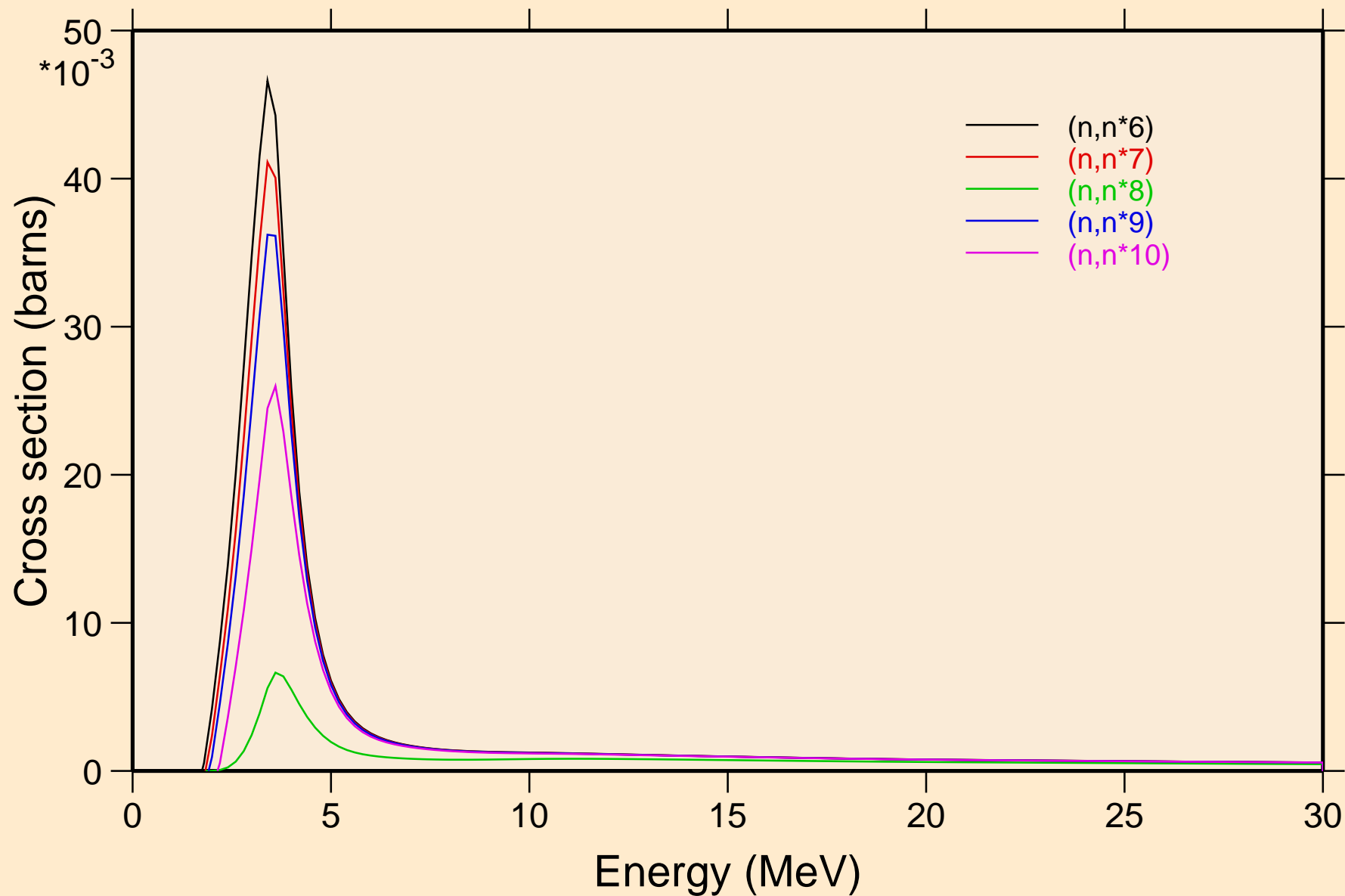

RN208 NEUTRON ACER TENDL-2019 LIBRARY; T=293.16K
Inelastic levels

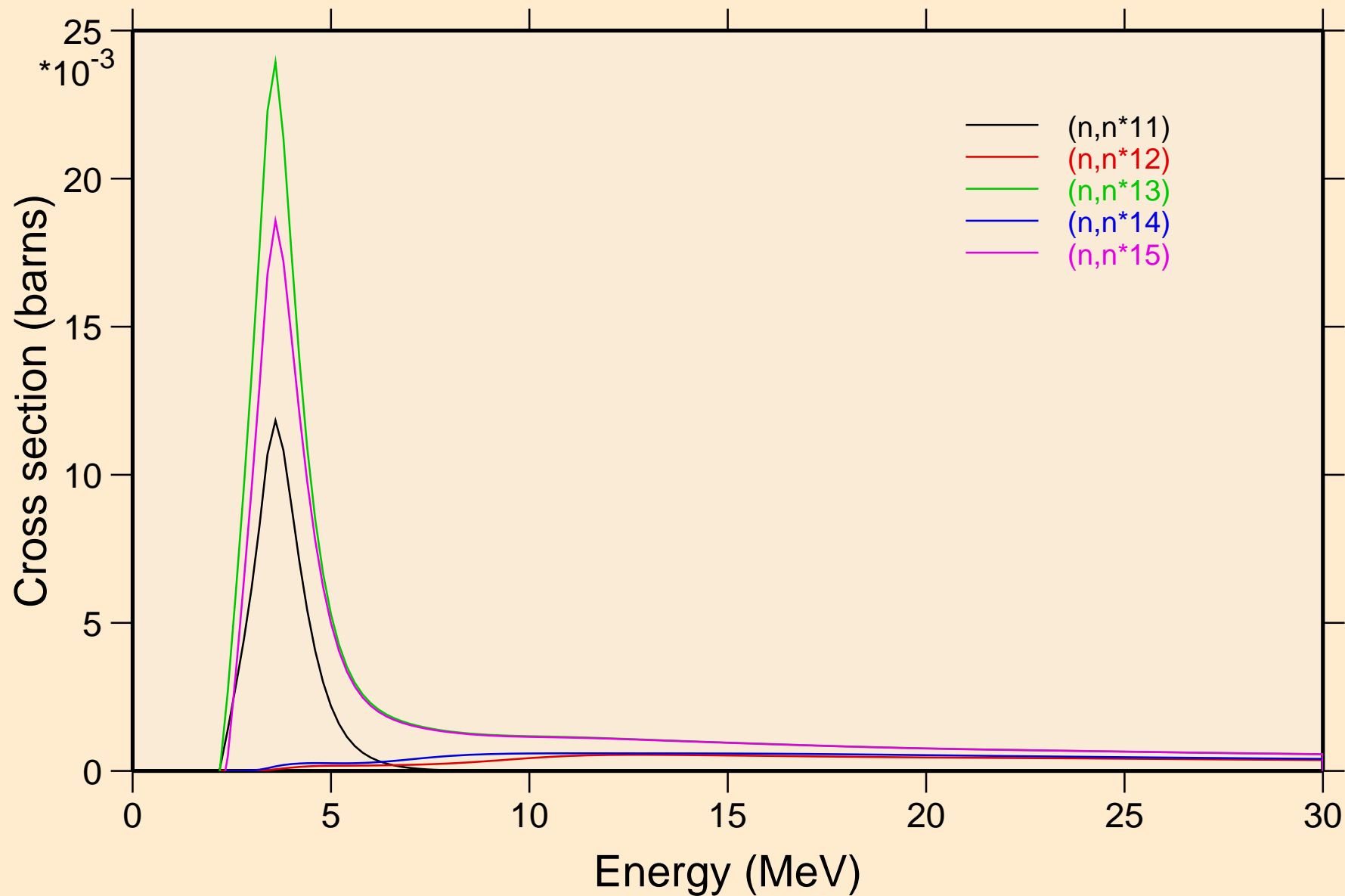

RN208 NEUTRON ACER TENDL-2019 LIBRARY; T=293.16K
Inelastic levels

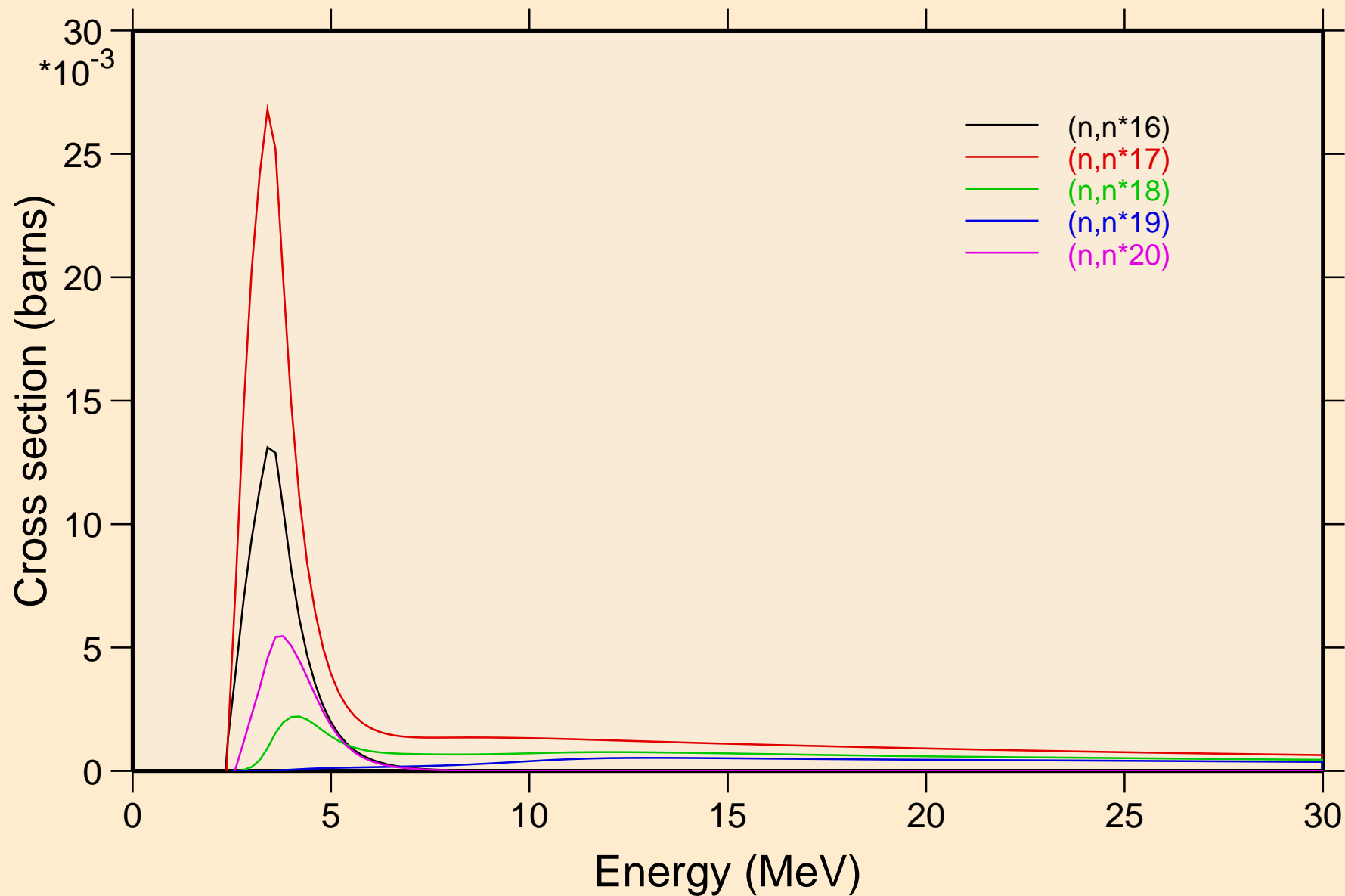

RN208 NEUTRON ACER TENDL-2019 LIBRARY; T=293.16K
Inelastic levels

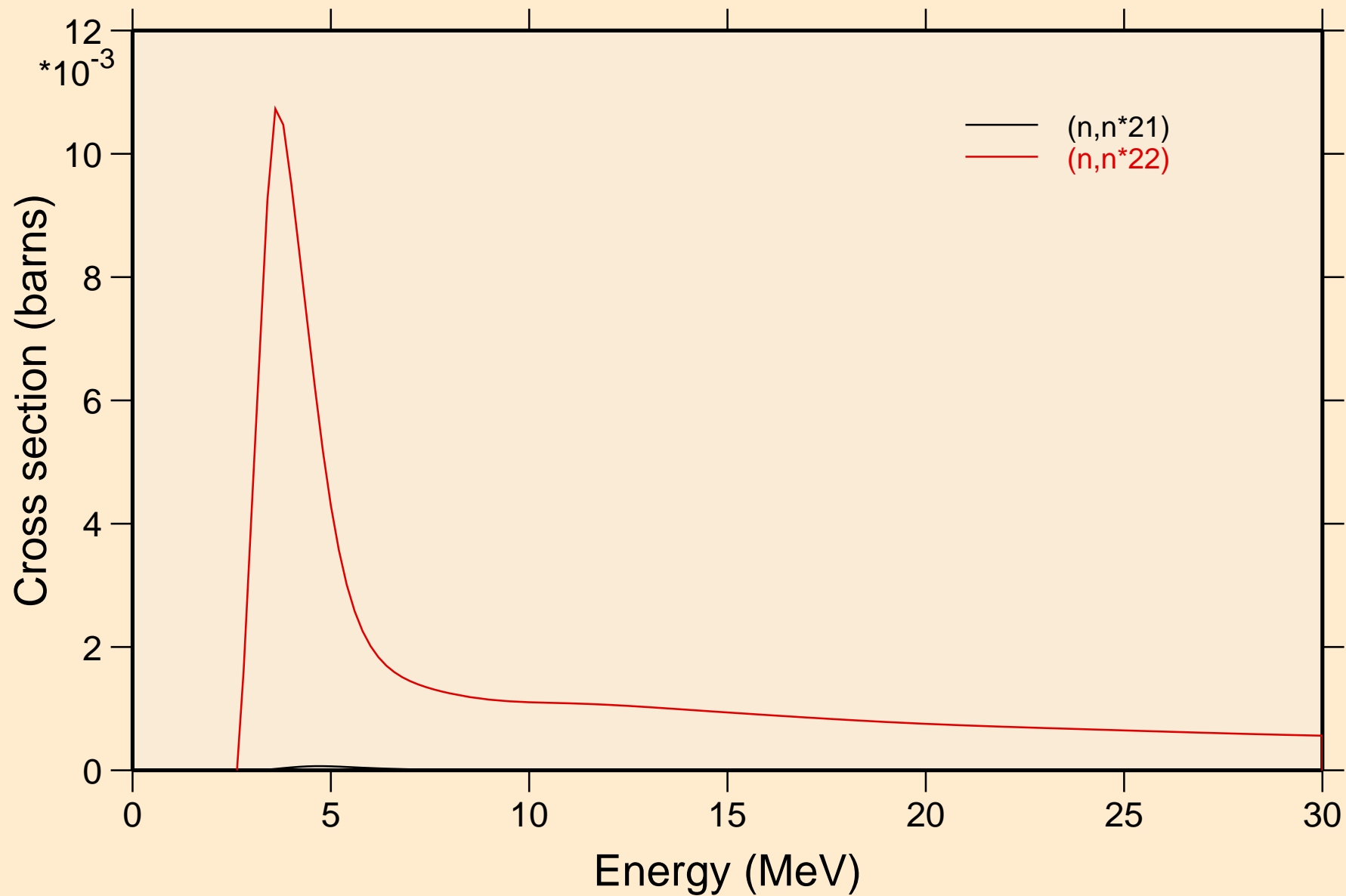

RN208 NEUTRON ACER TENDL-2019 LIBRARY; T=293.16K
Threshold reactions

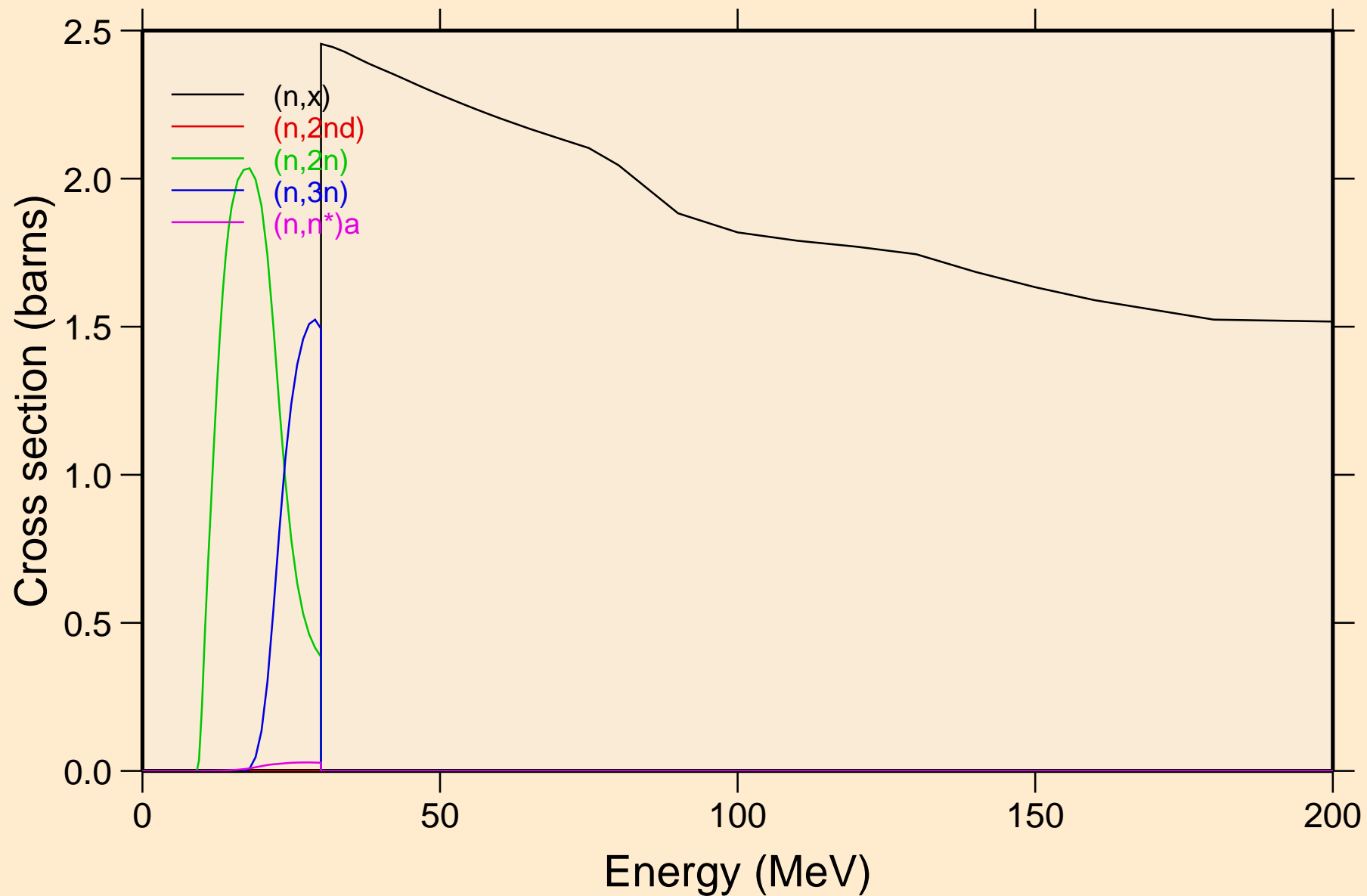

RN208 NEUTRON ACER TENDL-2019 LIBRARY; T=293.16K
Threshold reactions

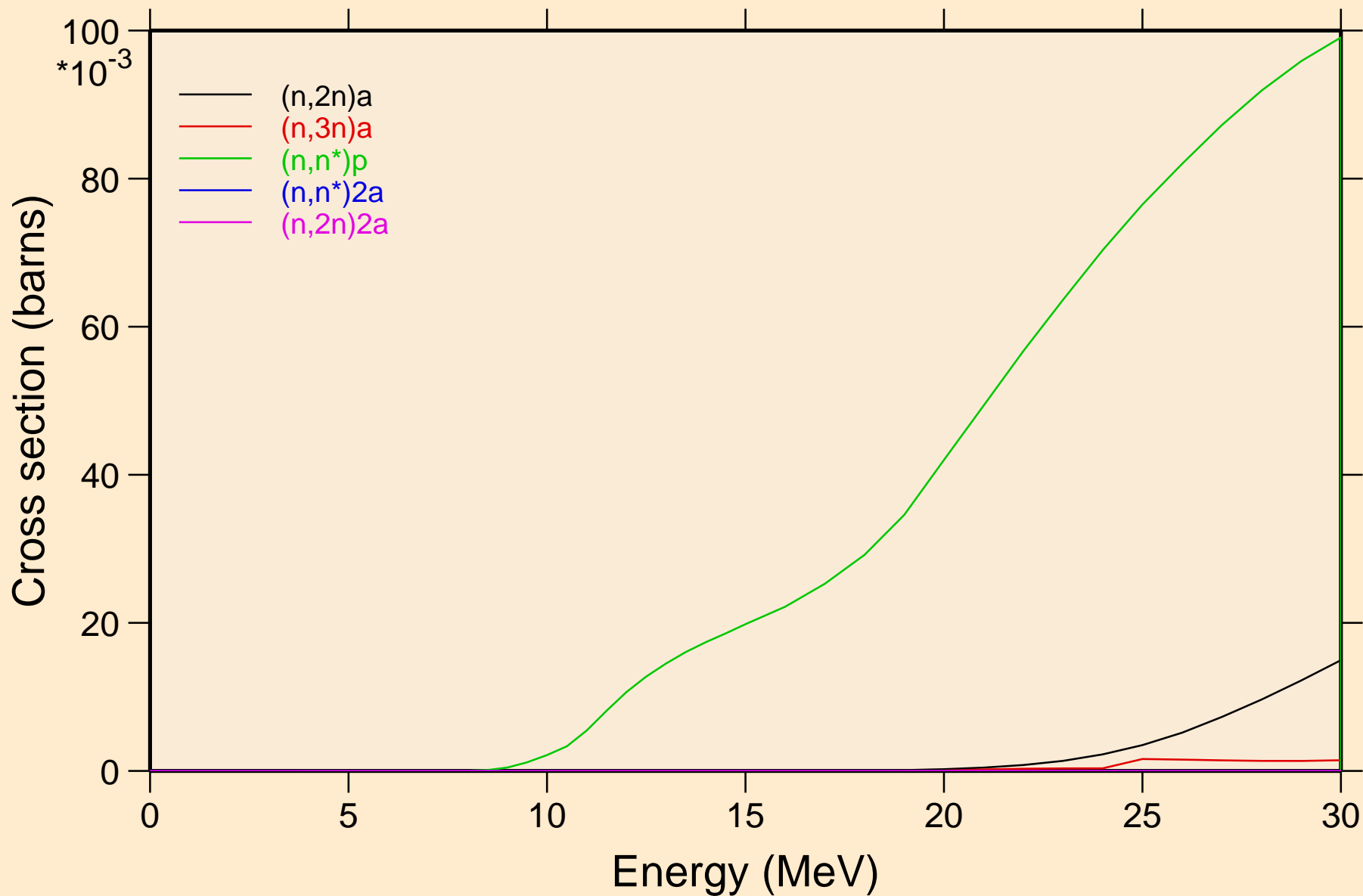

RN208 NEUTRON ACER TENDL-2019 LIBRARY; T=293.16K
Threshold reactions

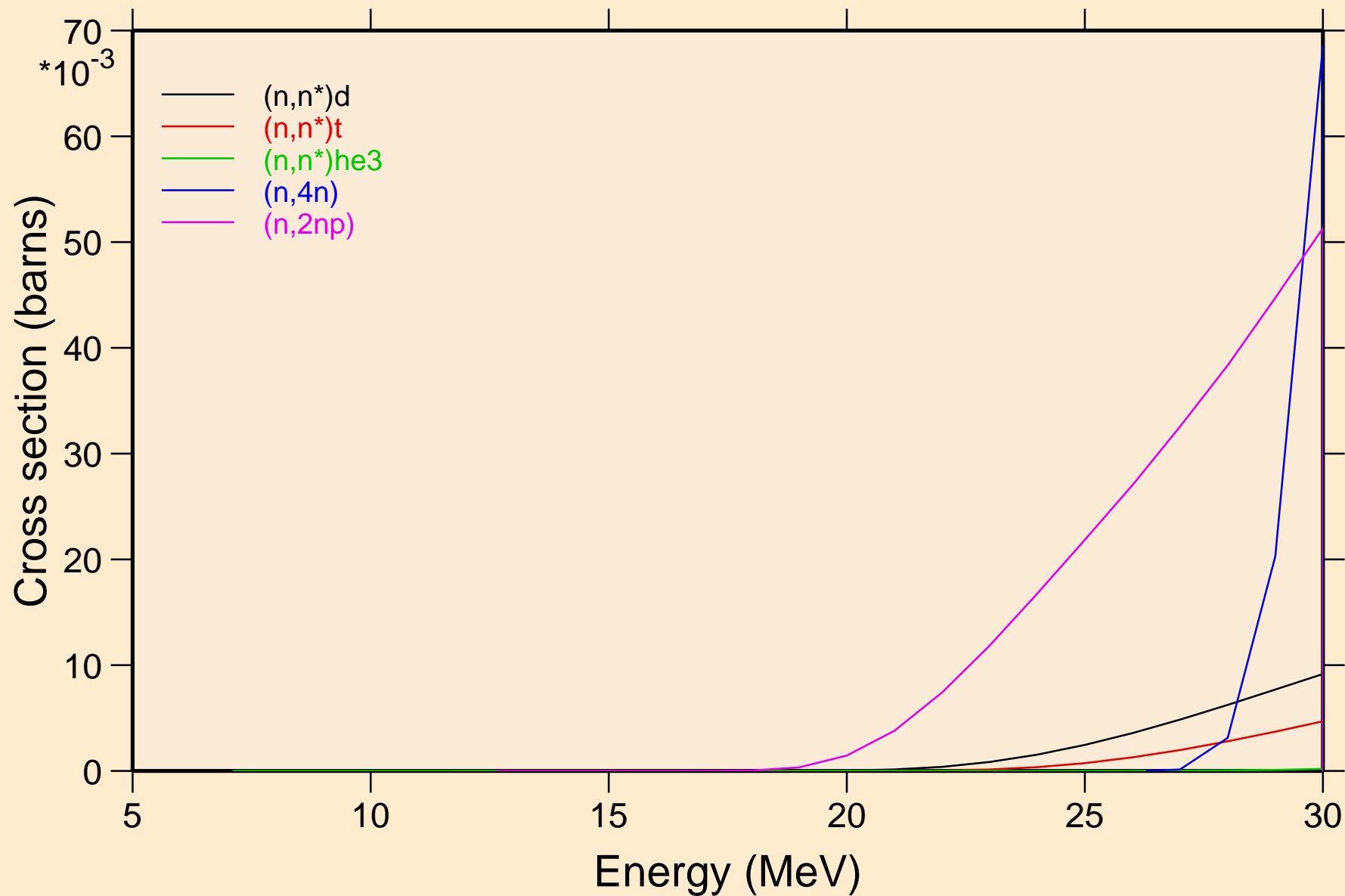

RN208 NEUTRON ACER TENDL-2019 LIBRARY; T=293.16K
Threshold reactions

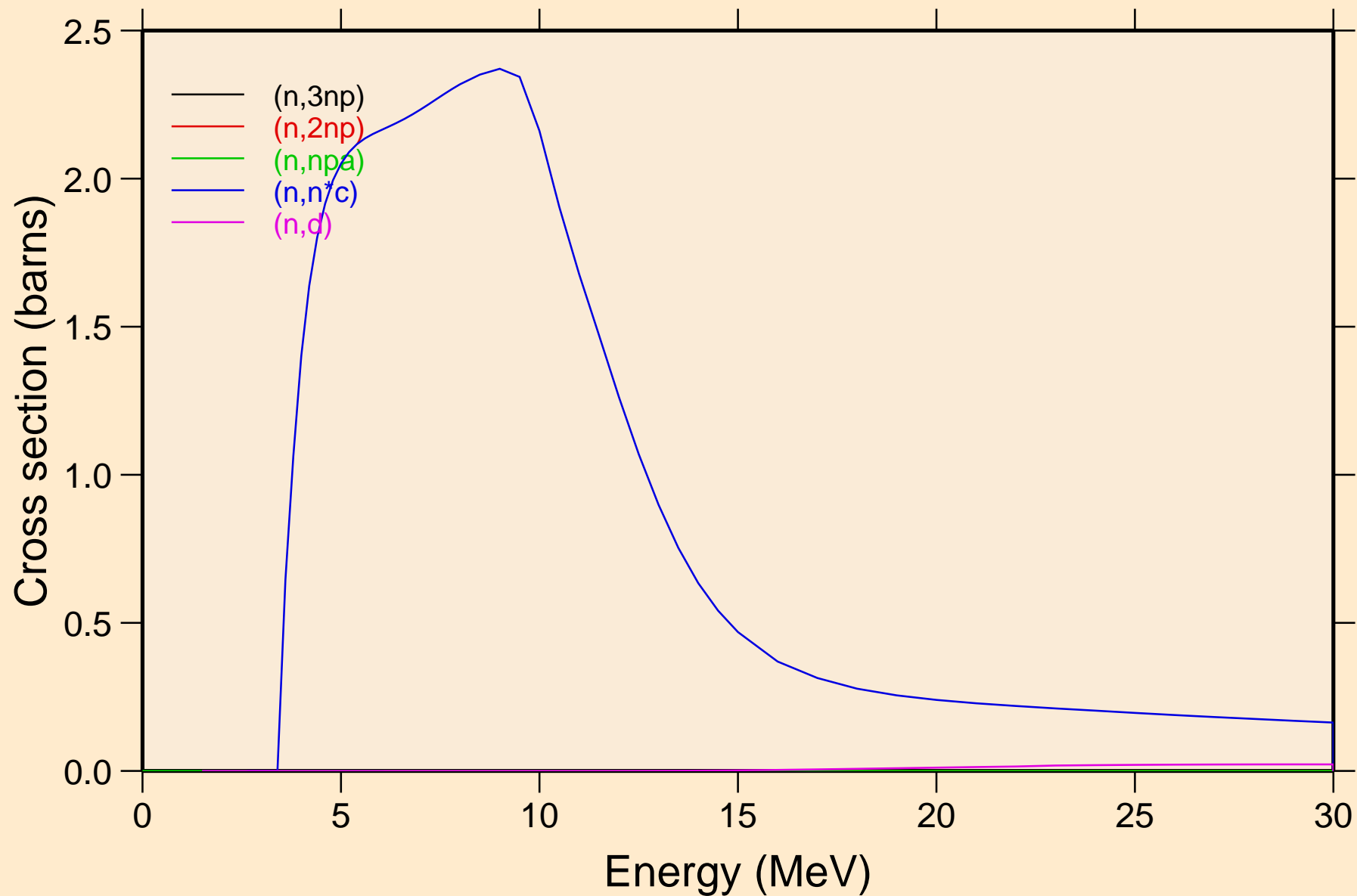

RN208 NEUTRON ACER TENDL-2019 LIBRARY; T=293.16K
Threshold reactions

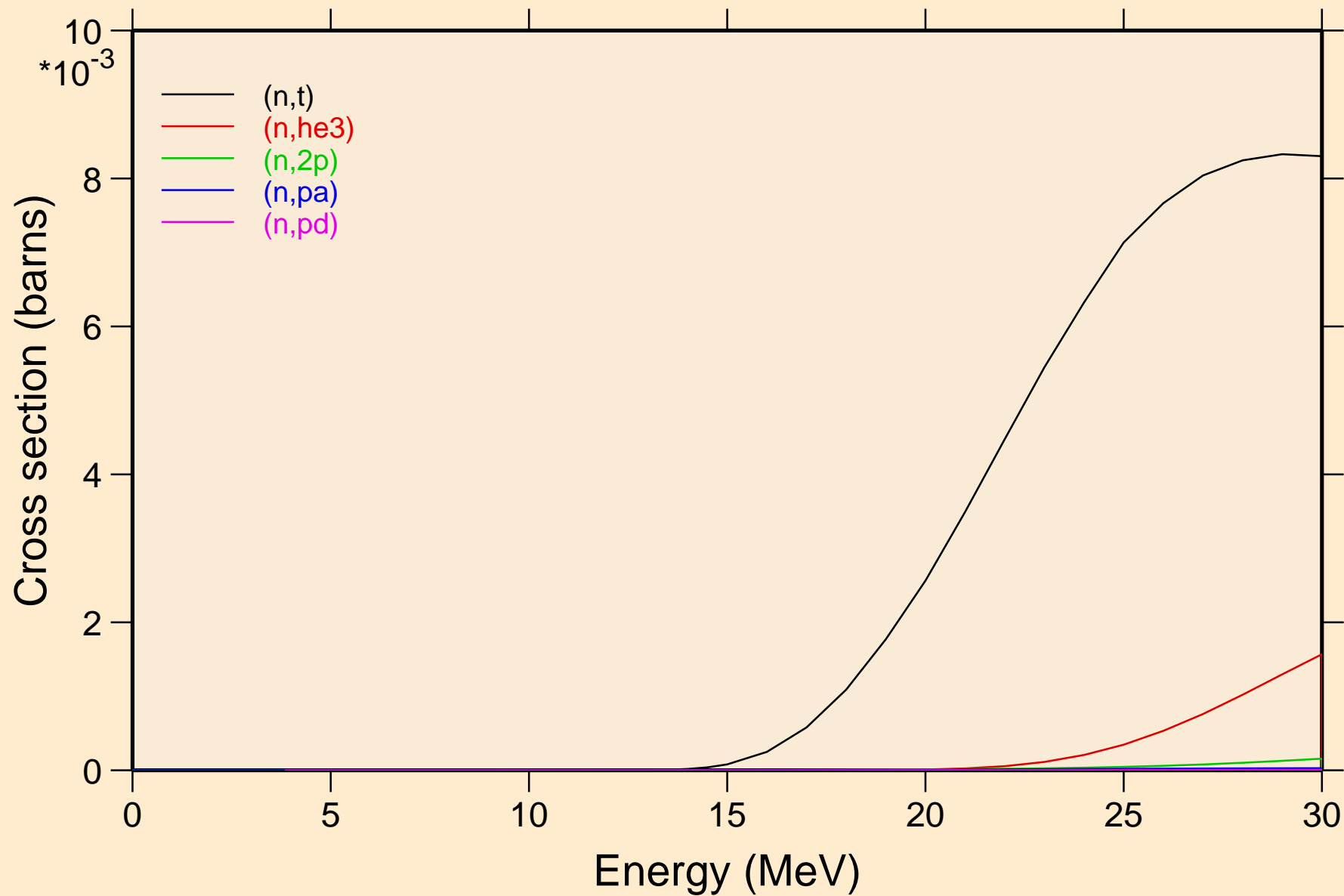

RN208 NEUTRON ACER TENDL-2019 LIBRARY; T=293.16K
Threshold reactions

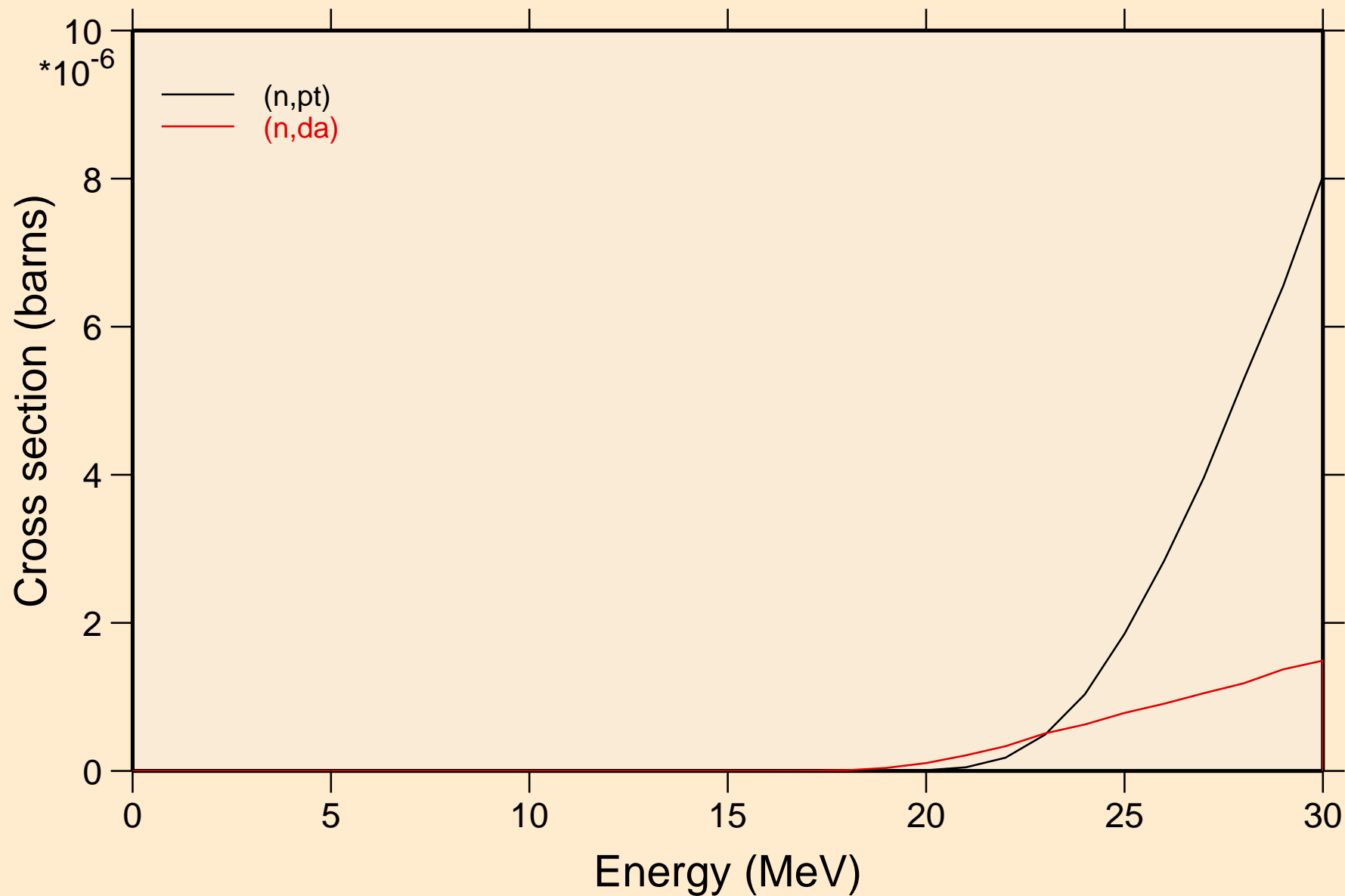

RN208 NEUTRON ACER TENDL-2019 LIBRARY; T=293.16K
Threshold reactions

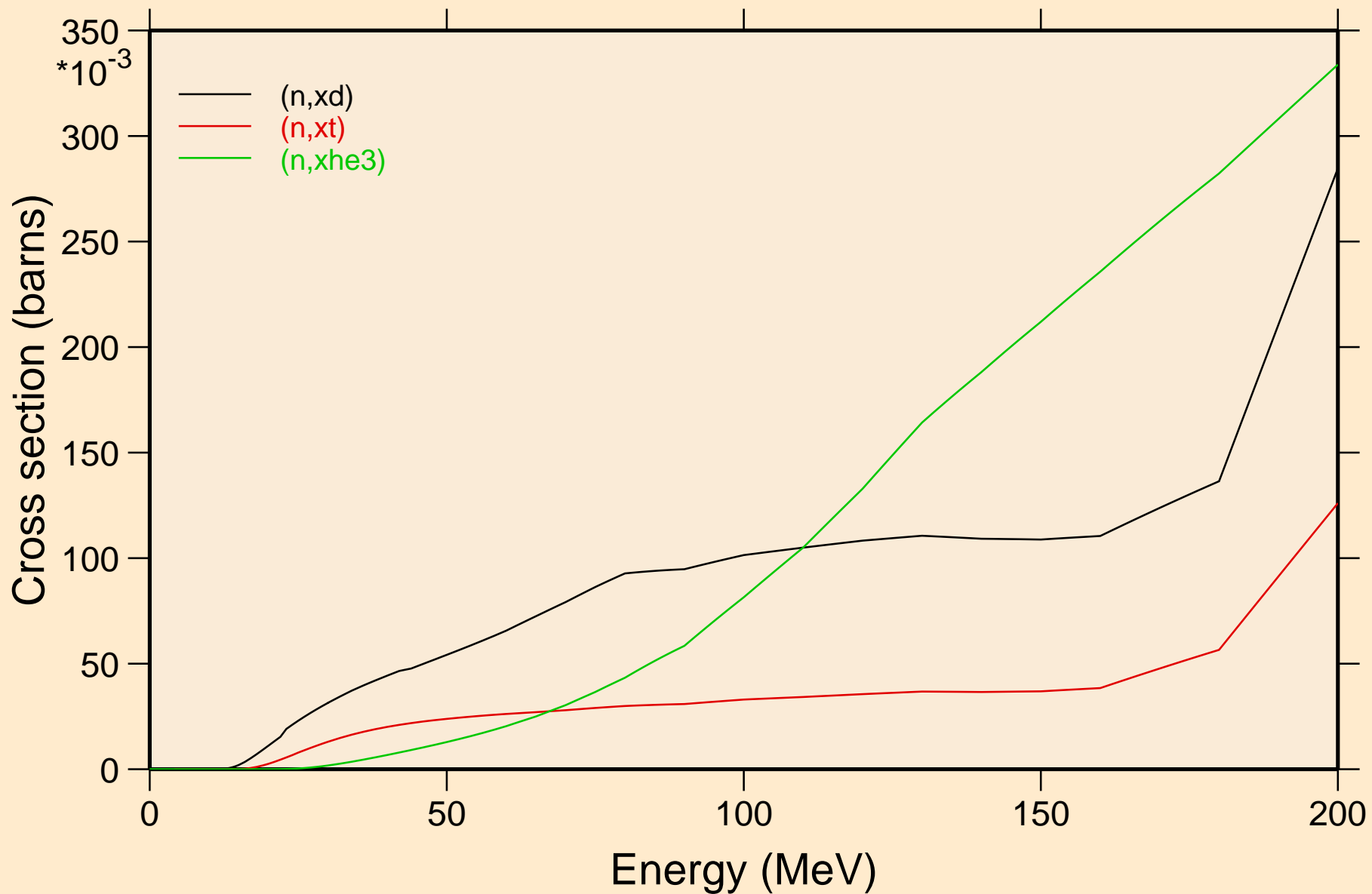

RN208 NEUTRON ACER TENDL-2019 LIBRARY; T=293.16K
angular distribution for elastic

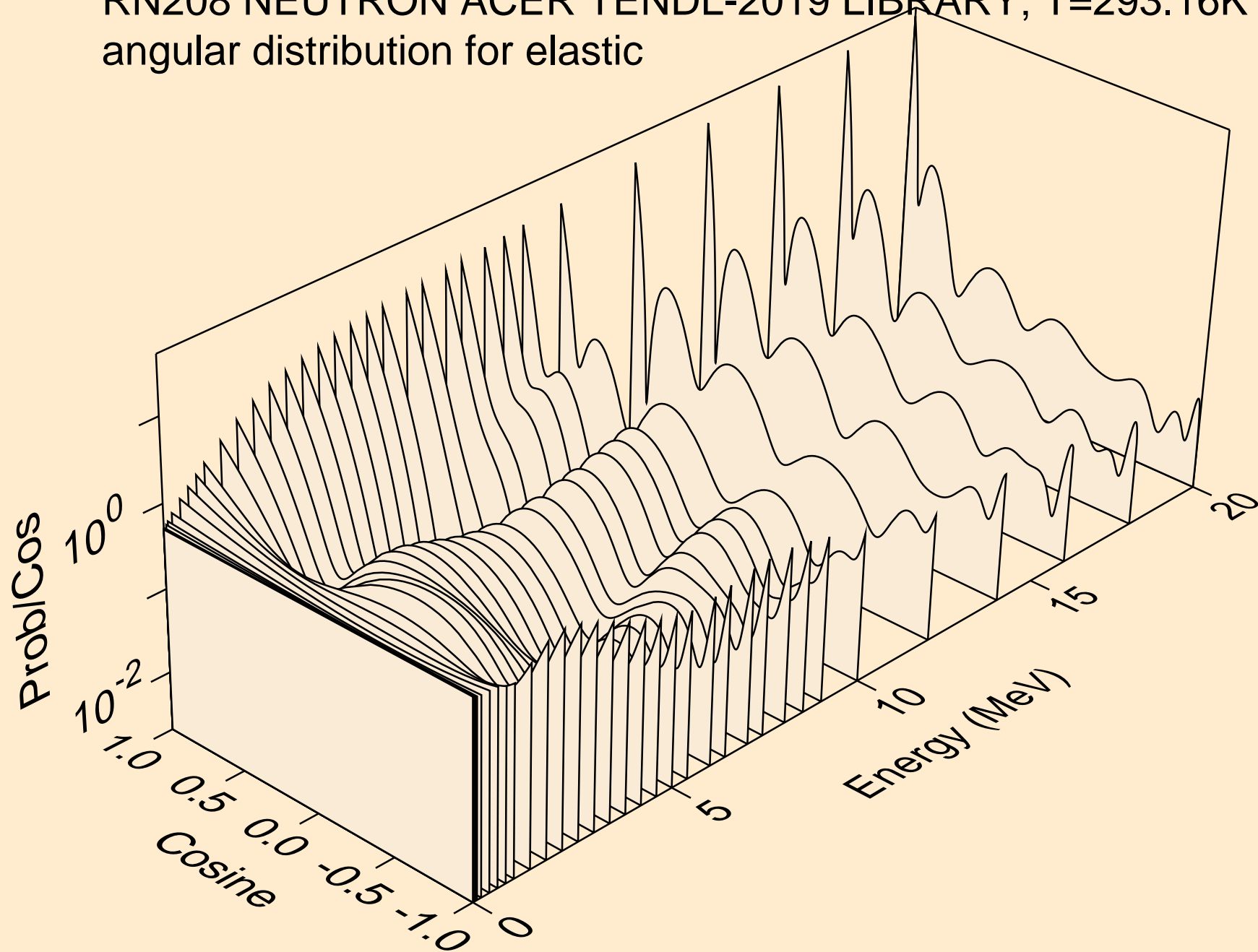

RN208 NEUTRON ACER TENDL-2019 LIBRARY; T=293.16K
angular distribution for elastic

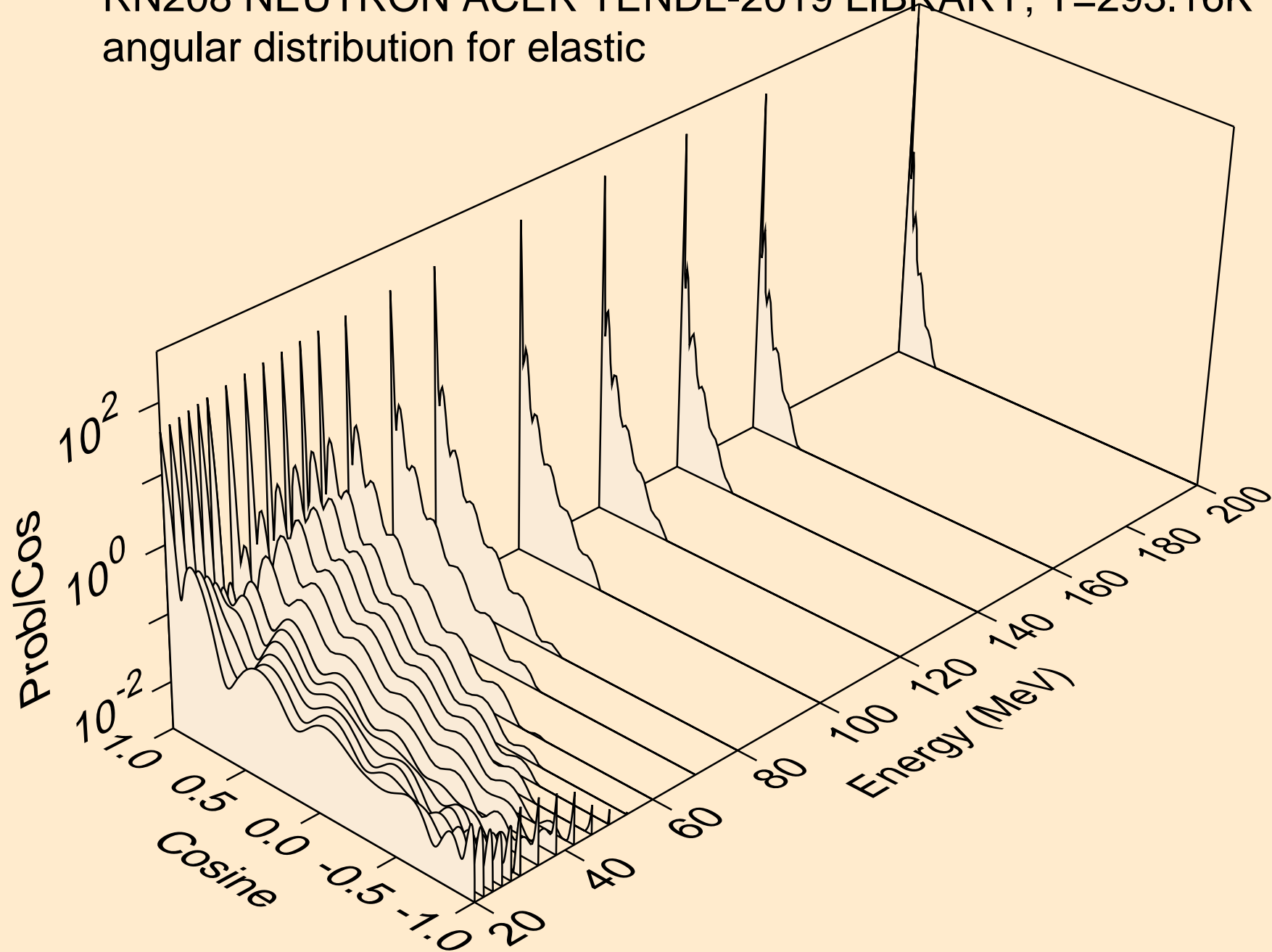

RN208 NEUTRON ACER TENDL-2019 LIBRARY; T=293.16K
angular distribution for (n,n*1)

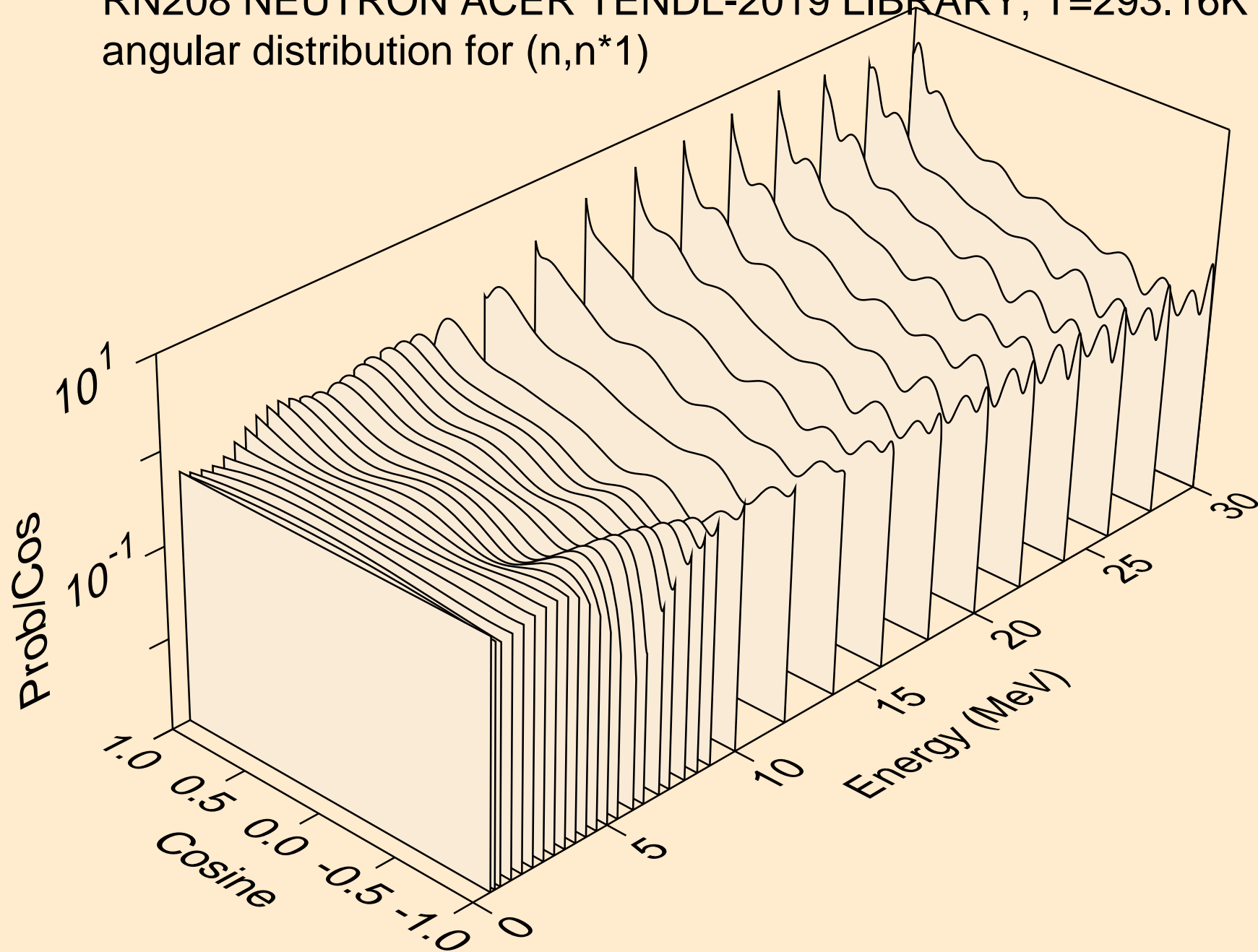

RN208 NEUTRON ACER TENDL-2019 LIBRARY; T=293.16K
angular distribution for (n,n*2)

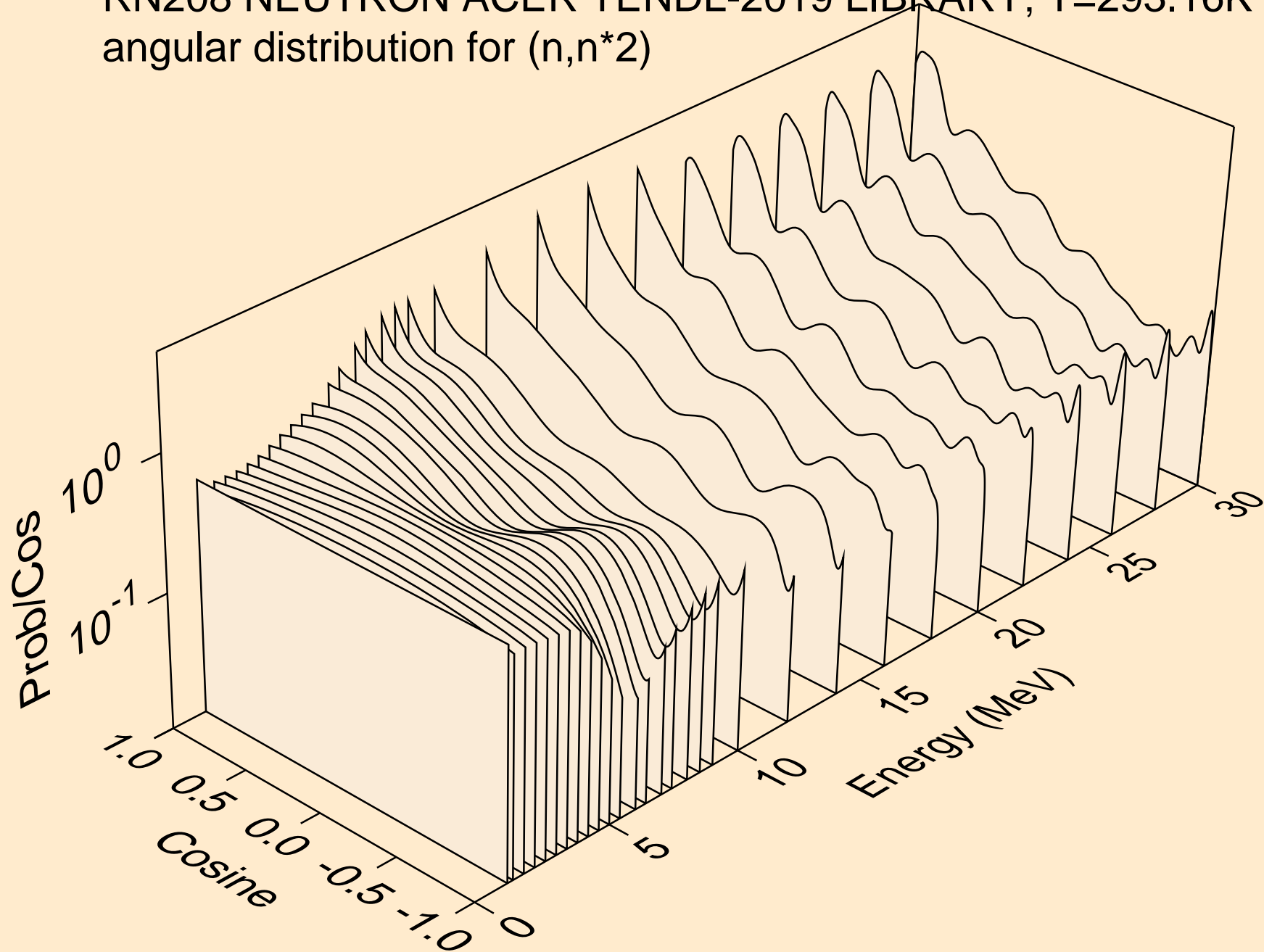

RN208 NEUTRON ACER TENDL-2019 LIBRARY; T=293.16K
angular distribution for (n,n*3)

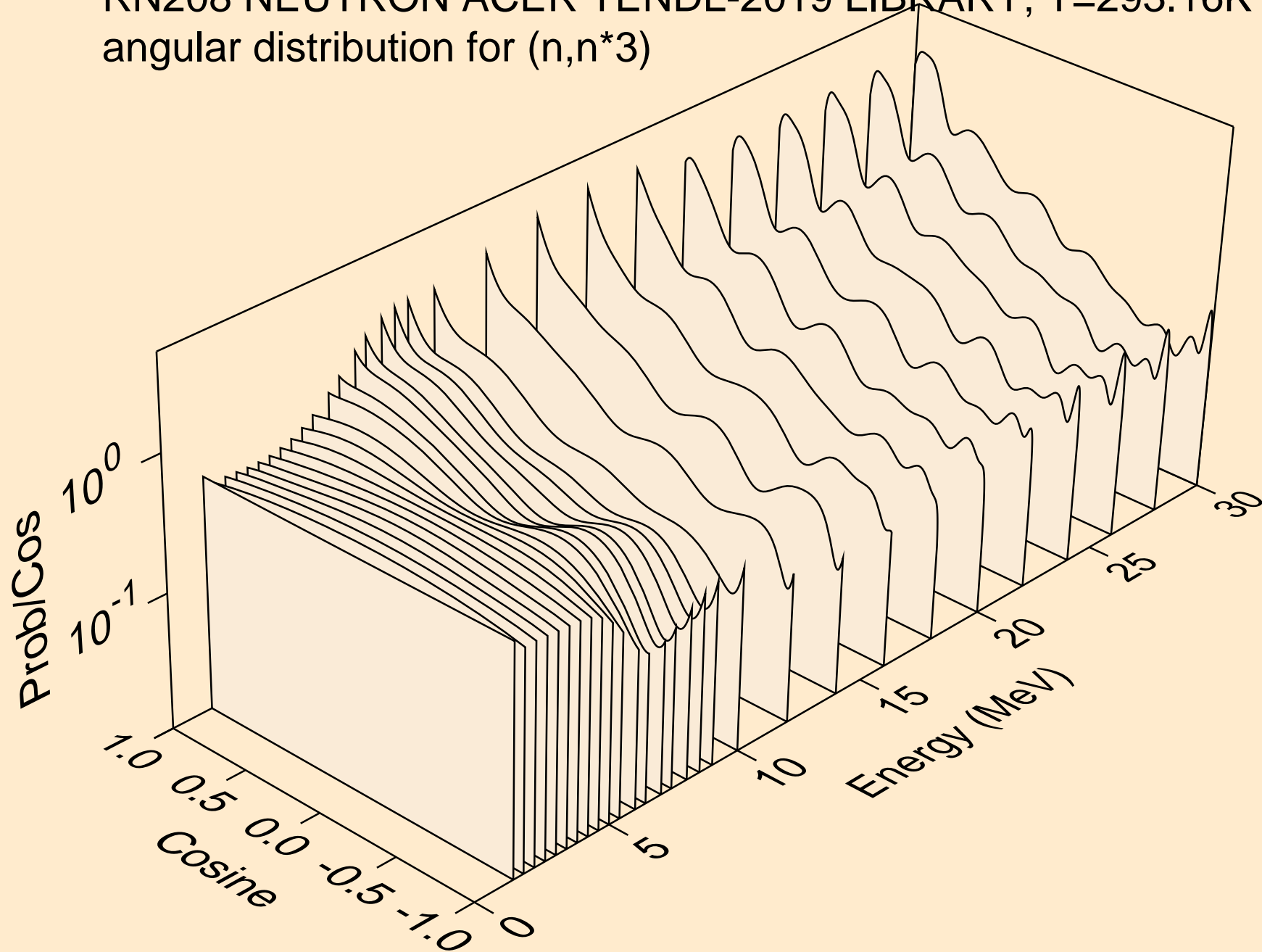

RN208 NEUTRON ACER TENDL-2019 LIBRARY; T=293.16K
angular distribution for (n,n*4)

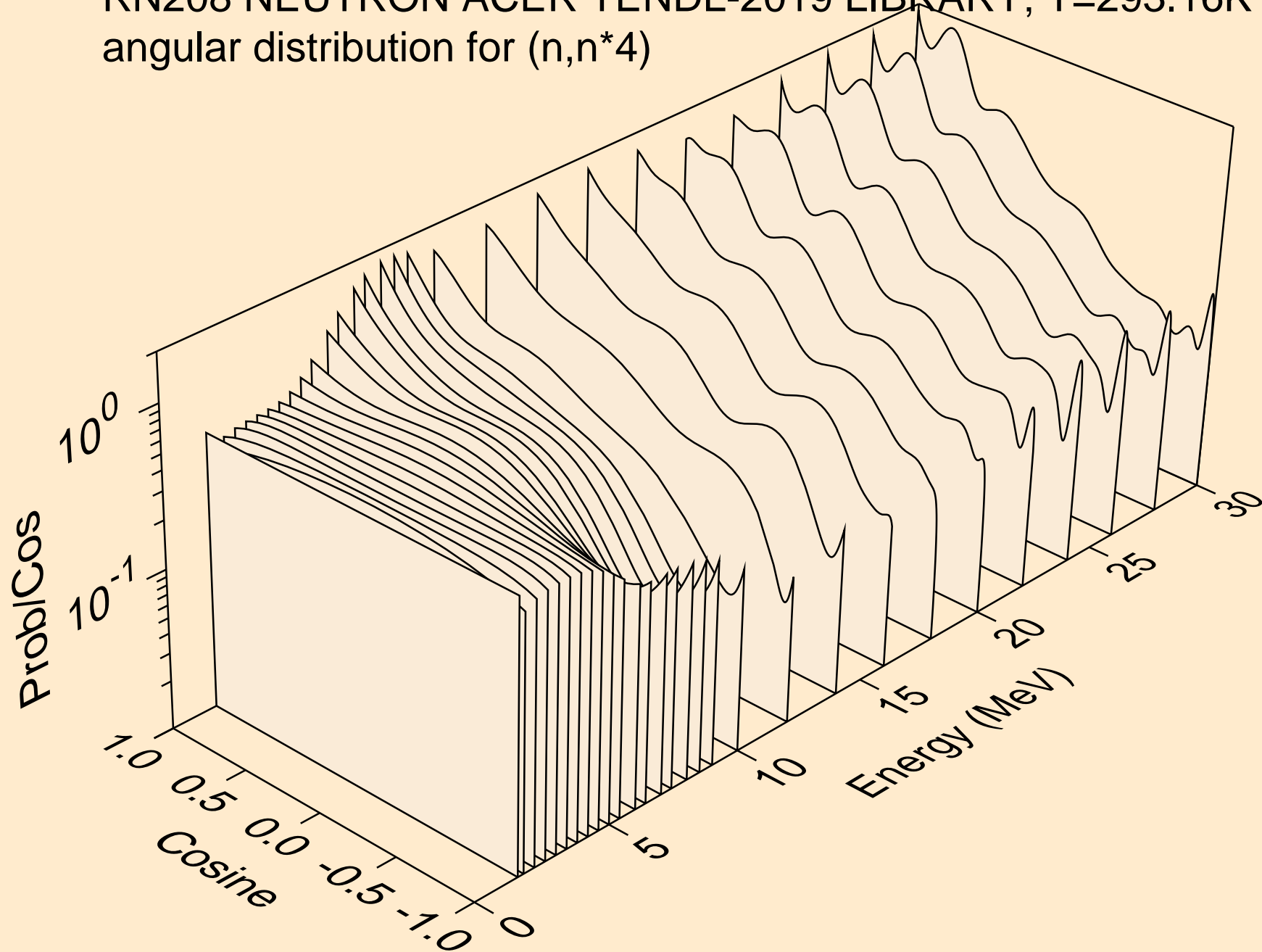

RN208 NEUTRON ACER TENDL-2019 LIBRARY; T=293.16K
angular distribution for (n,n*5)

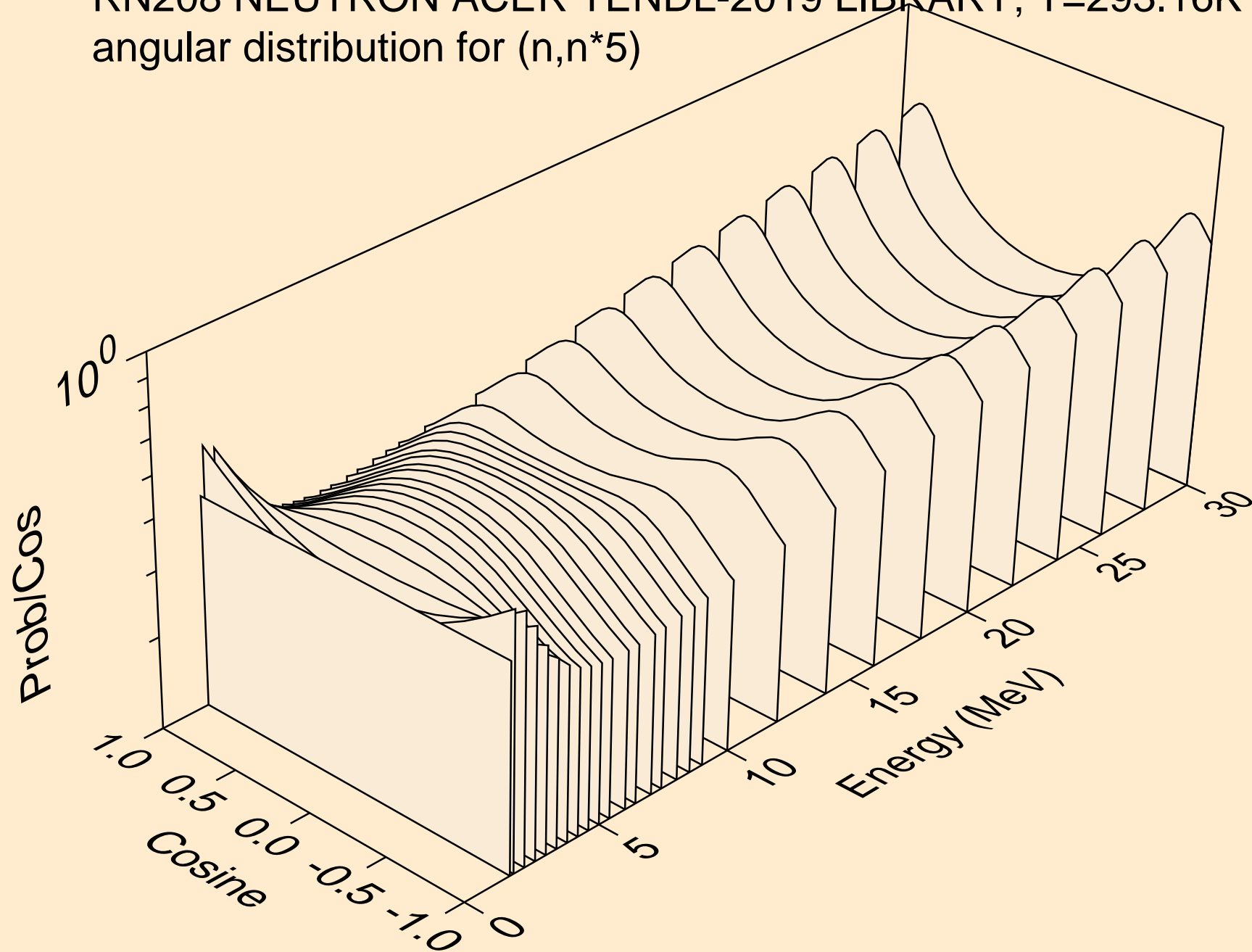

RN208 NEUTRON ACER TENDL-2019 LIBRARY; T=293.16K
angular distribution for (n,n*6)

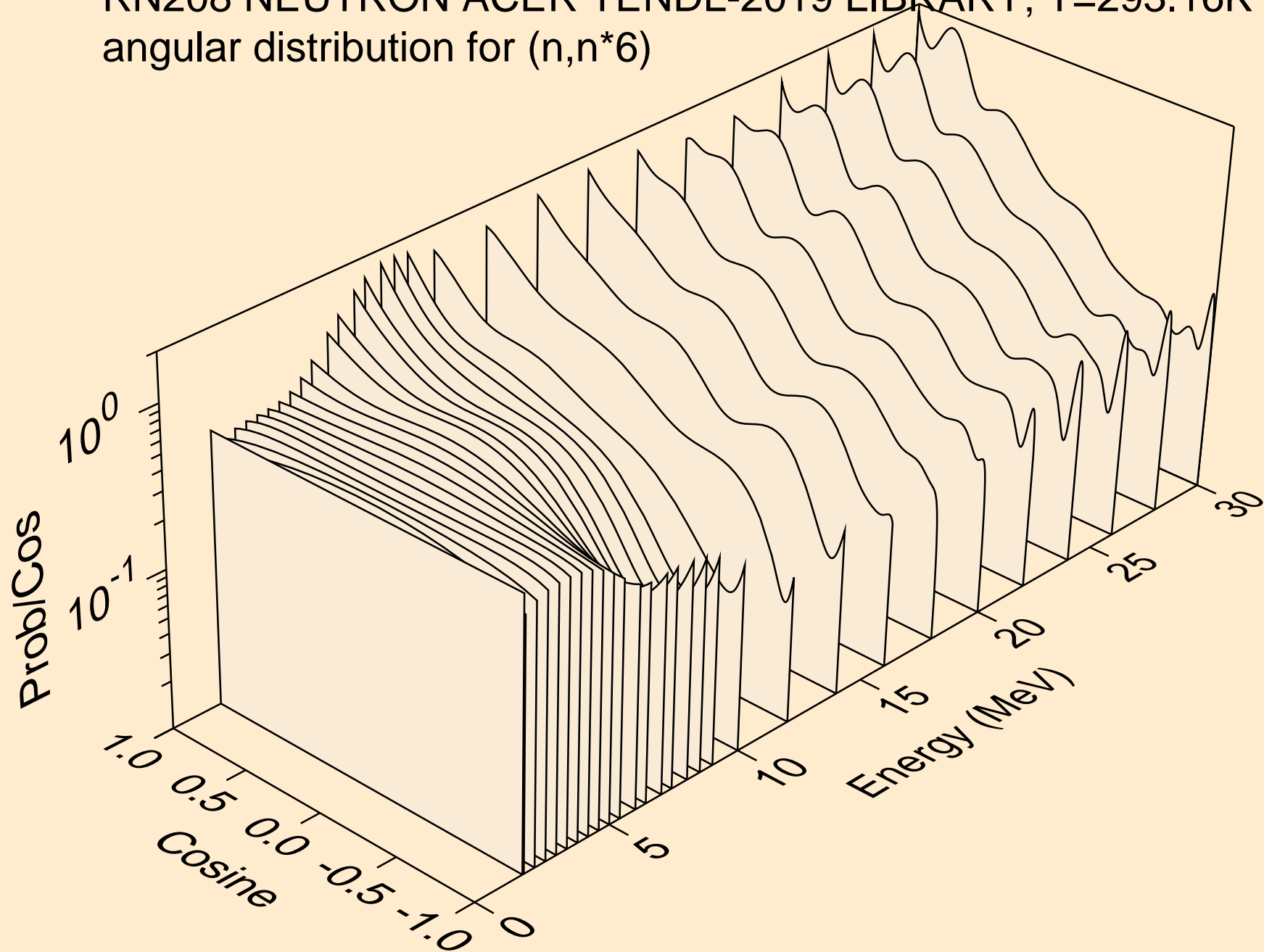

RN208 NEUTRON ACER TENDL-2019 LIBRARY; T=293.16K
angular distribution for (n,n*7)

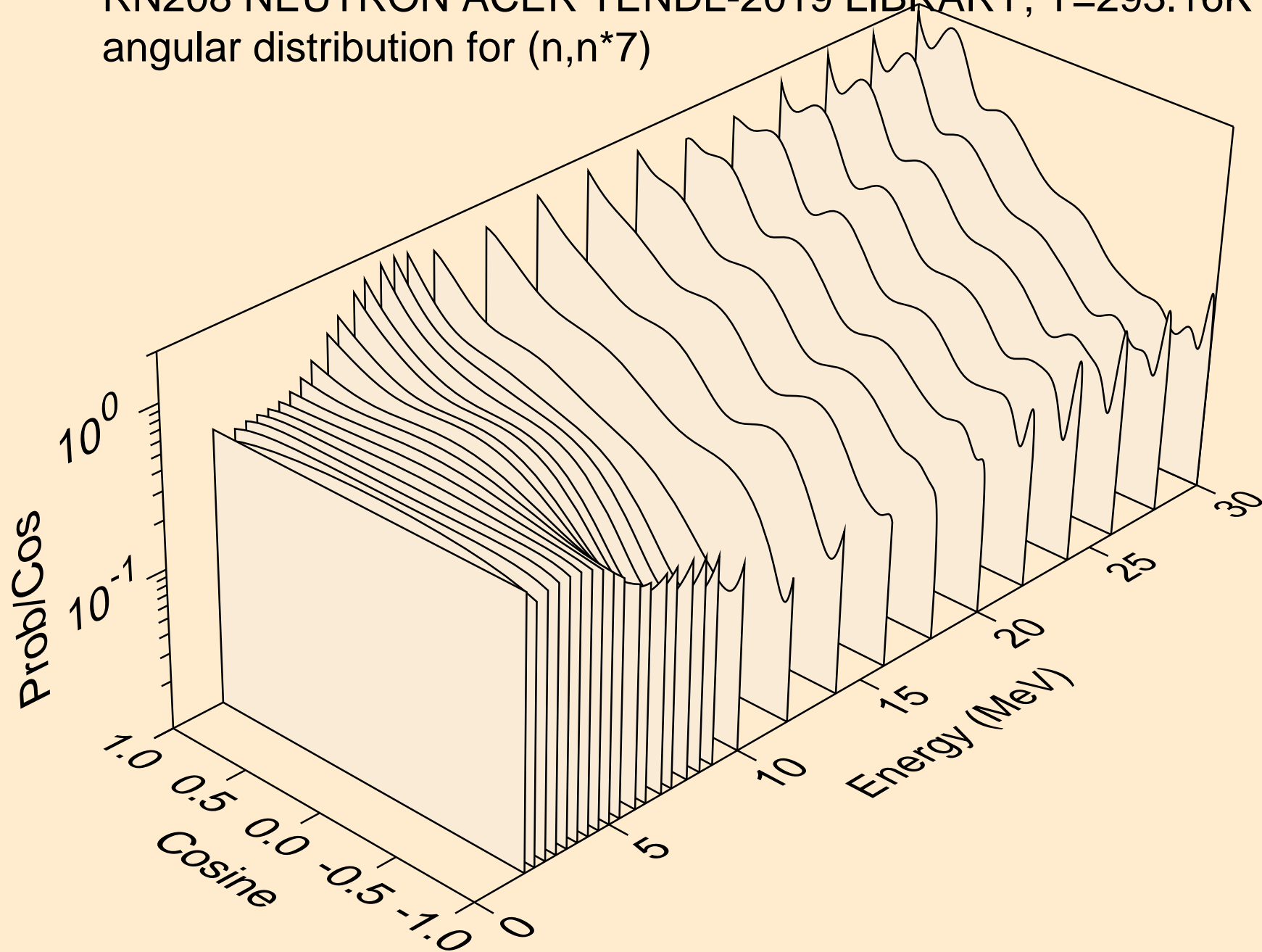

RN208 NEUTRON ACER TENDL-2019 LIBRARY; T=293.16K
angular distribution for (n,n*8)

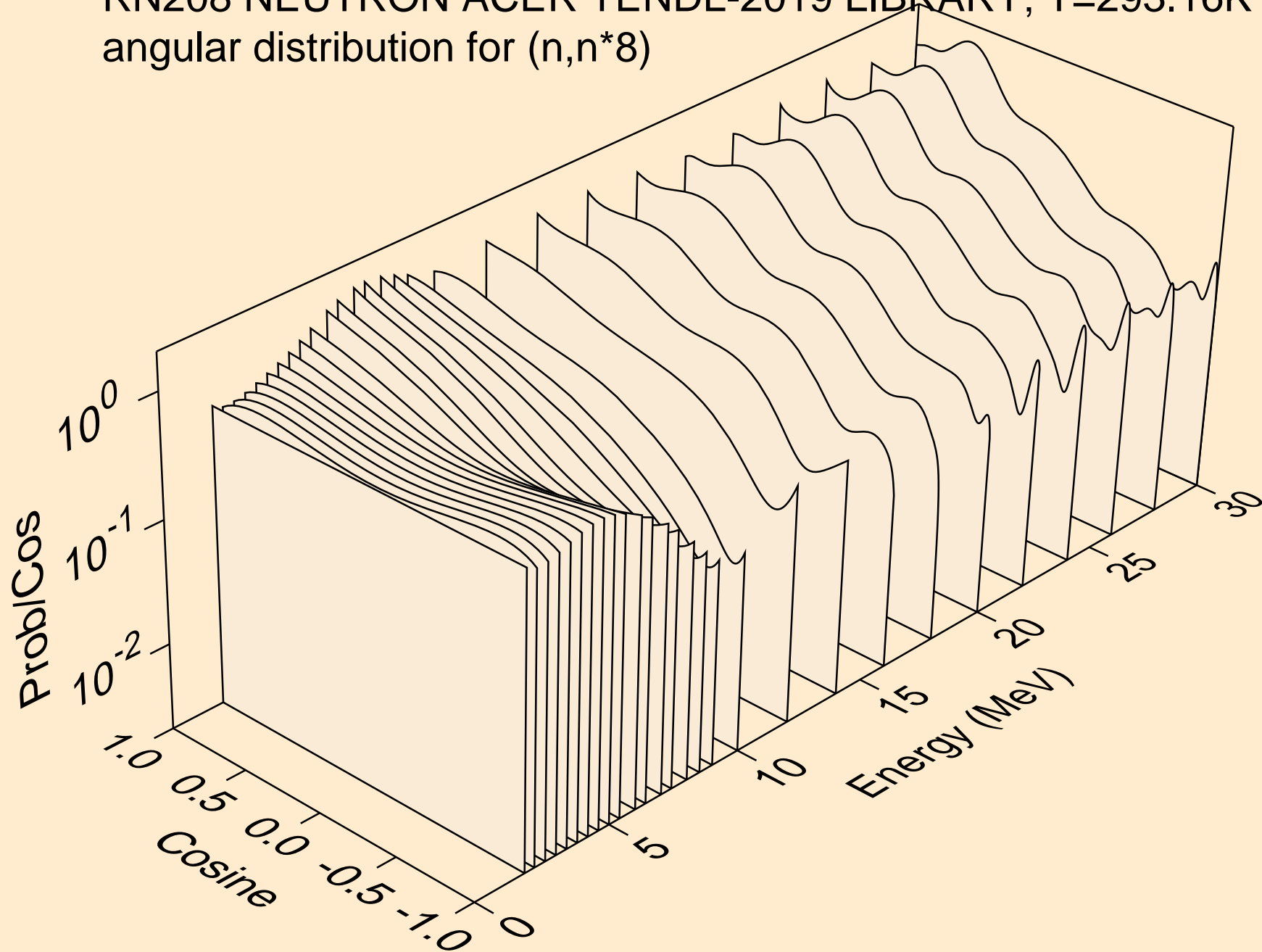

RN208 NEUTRON ACER TENDL-2019 LIBRARY; T=293.16K
angular distribution for (n,n*9)

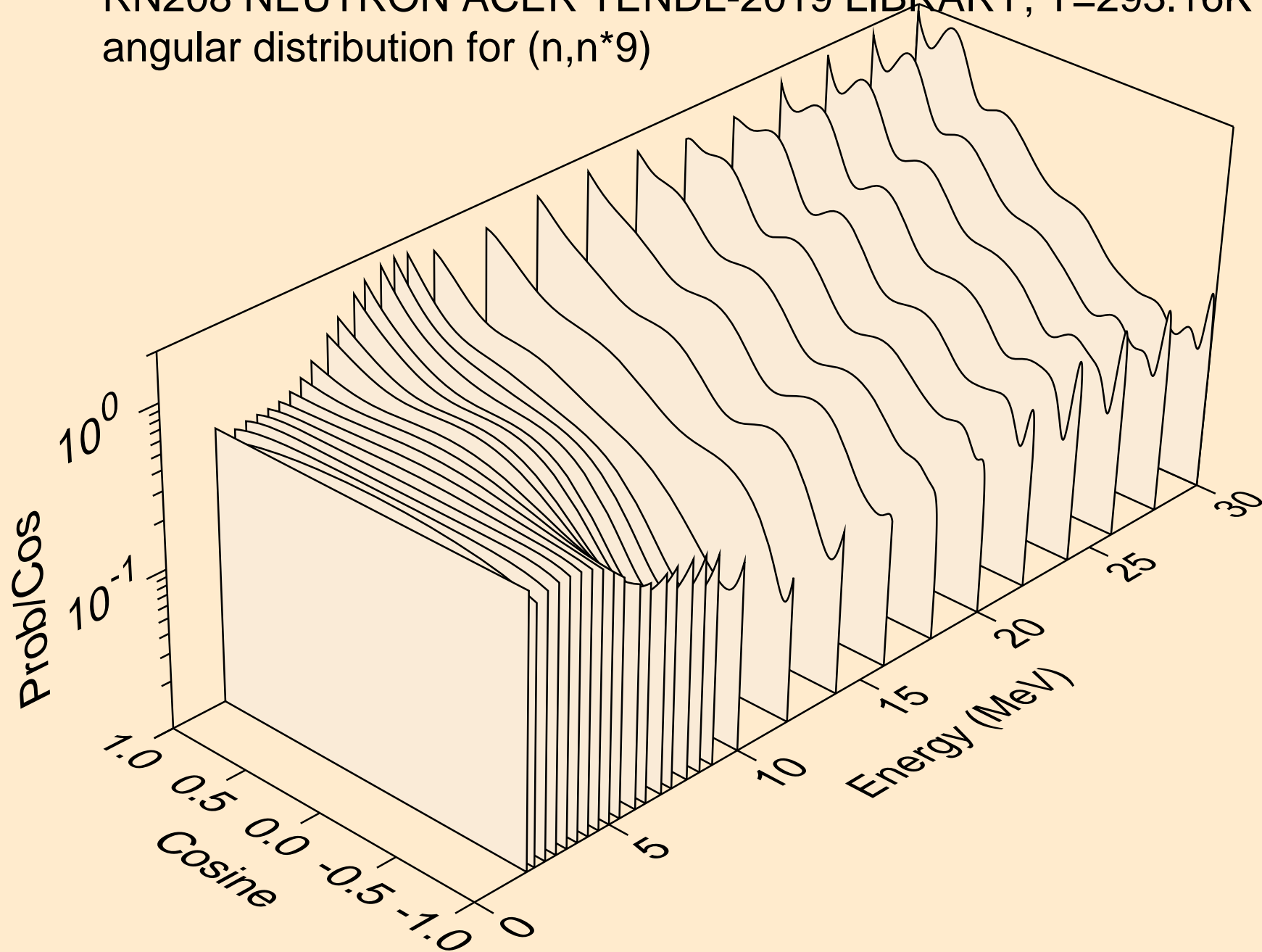

RN208 NEUTRON ACER TENDL-2019 LIBRARY; T=293.16K
angular distribution for (n,n*10)

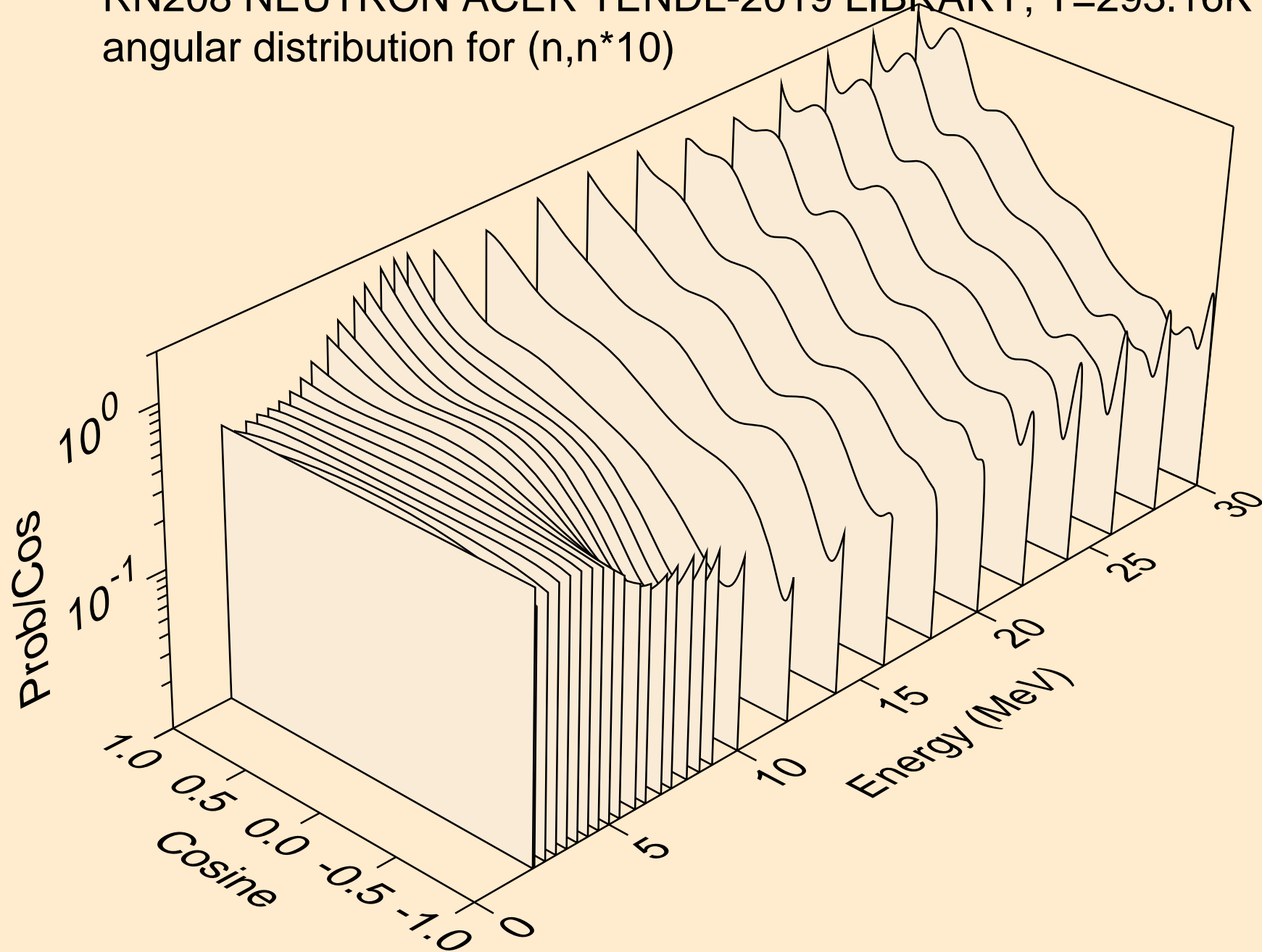

RN208 NEUTRON ACER TENDL-2019 LIBRARY; T=293.16K
angular distribution for (n,n*11)

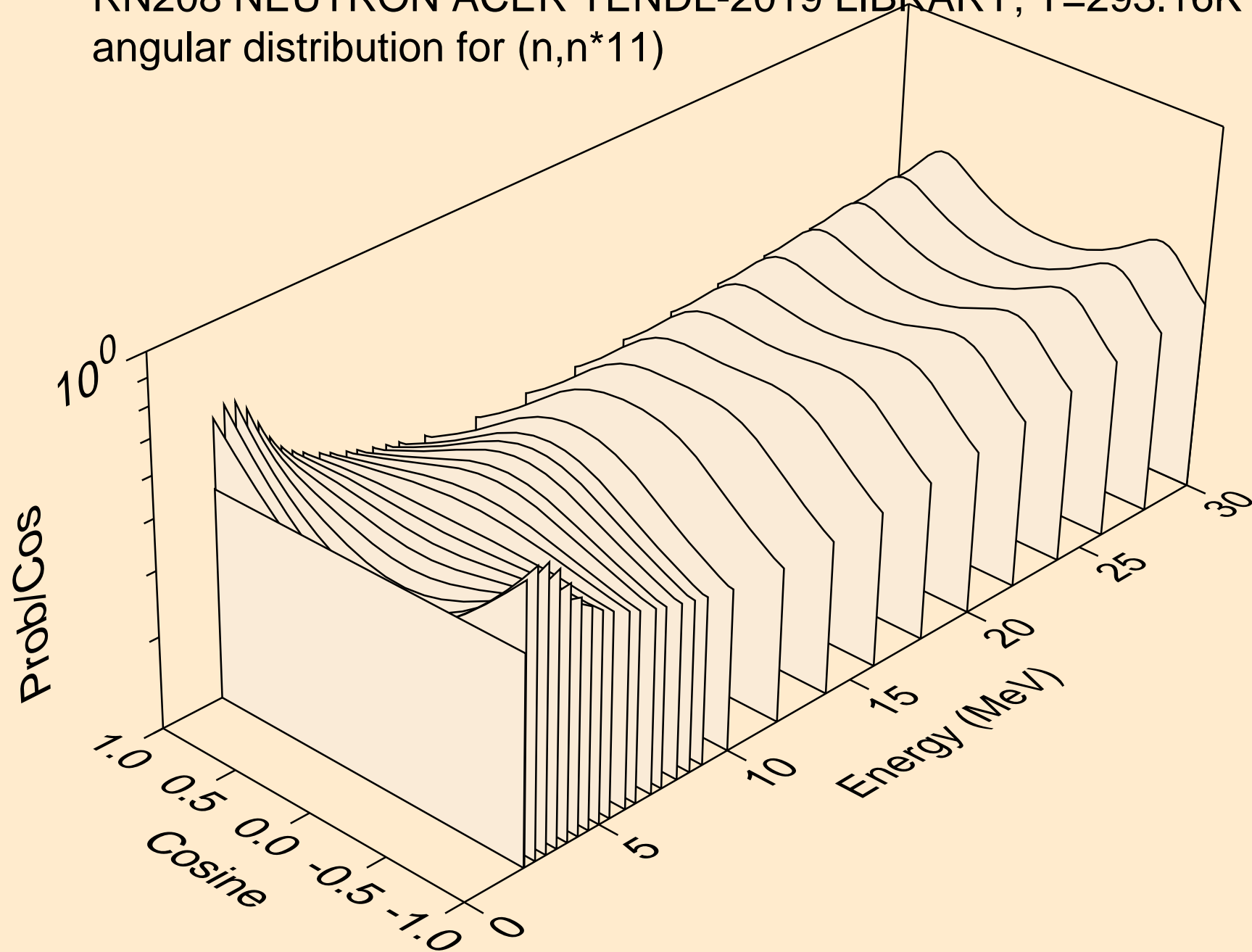

RN208 NEUTRON ACER TENDL-2019 LIBRARY; T=293.16K
angular distribution for (n,n*12)

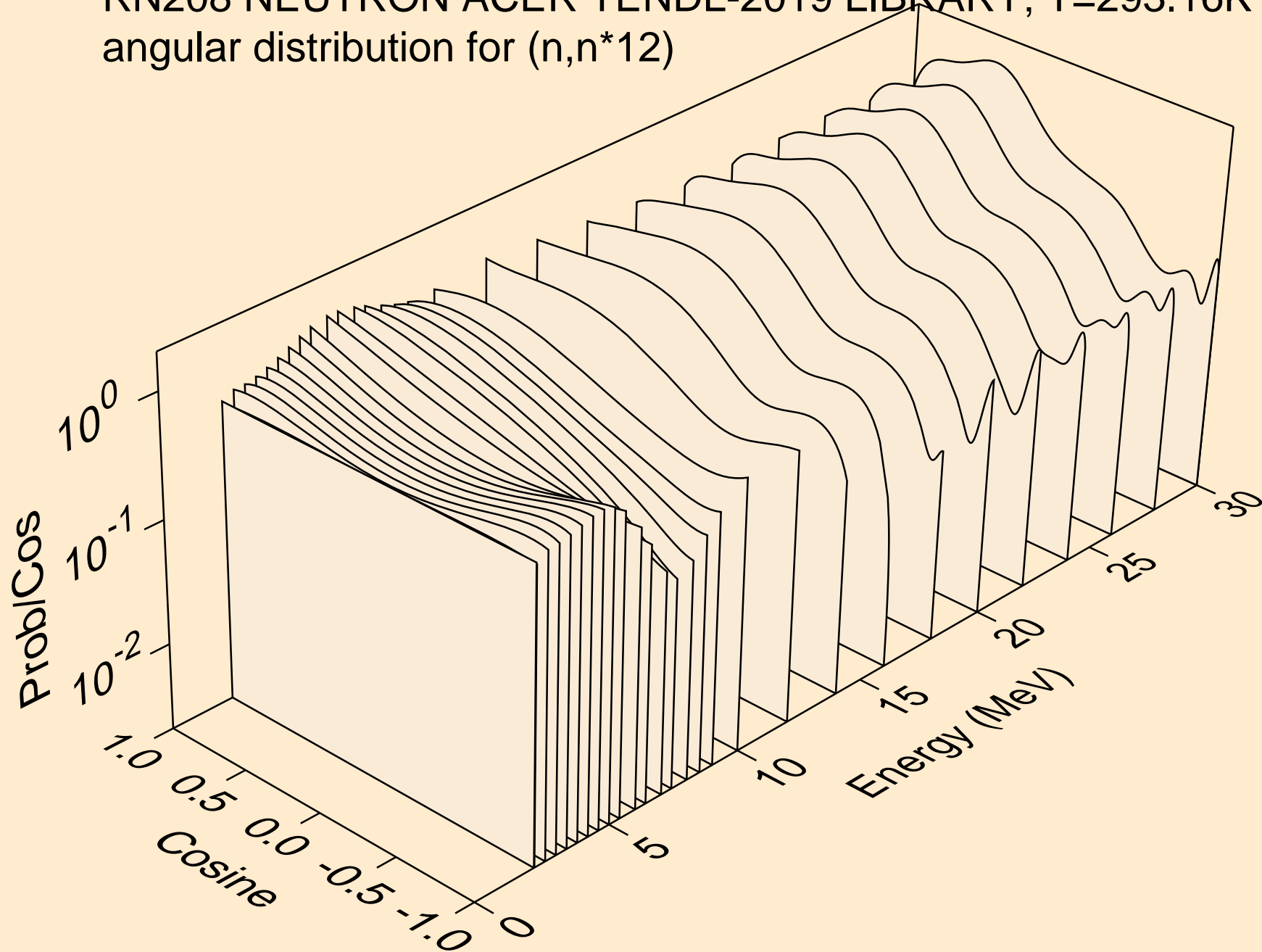

RN208 NEUTRON ACER TENDL-2019 LIBRARY; T=293.16K
angular distribution for (n,n*13)

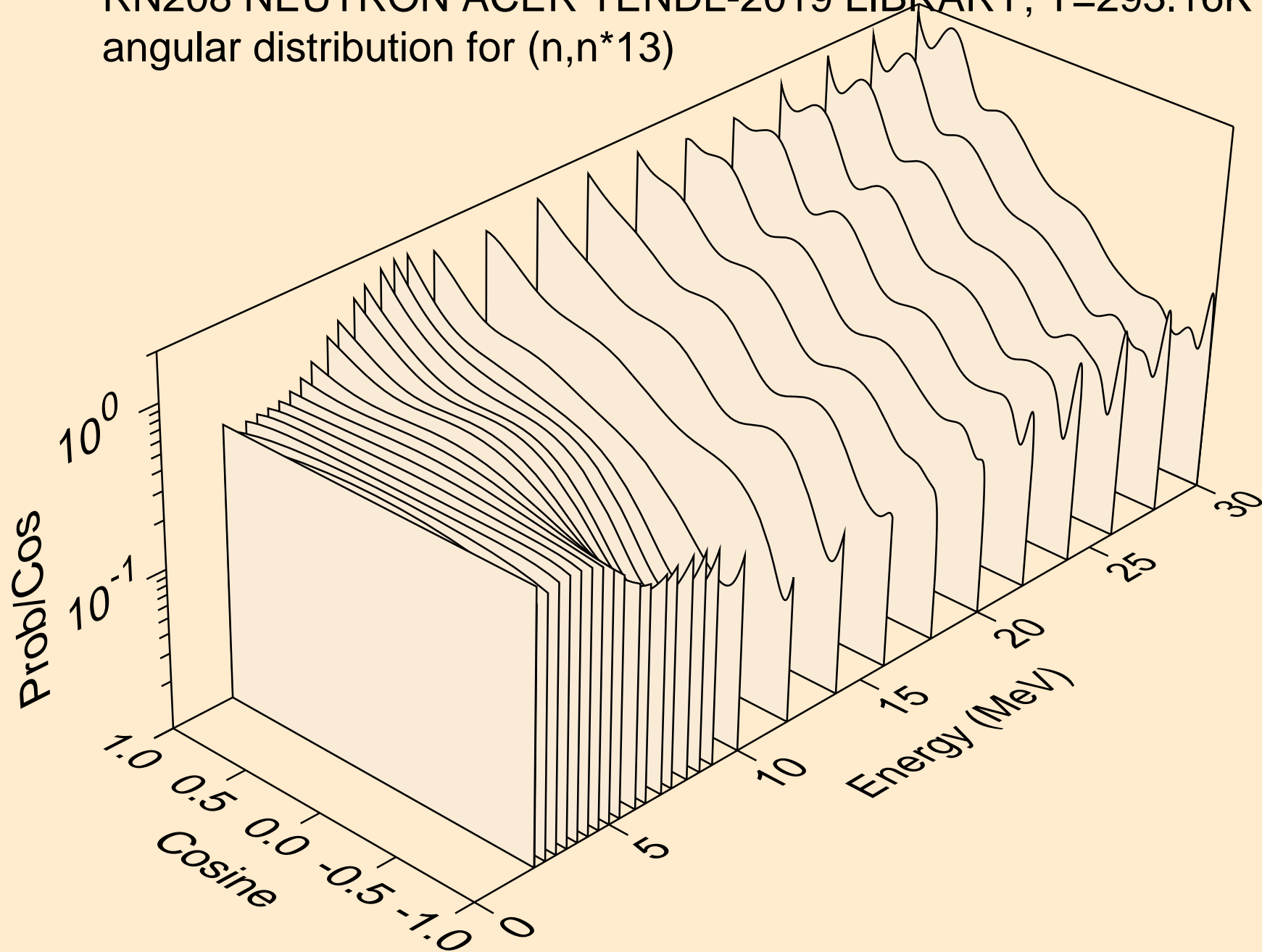

RN208 NEUTRON ACER TENDL-2019 LIBRARY; T=293.16K
angular distribution for (n,n*14)

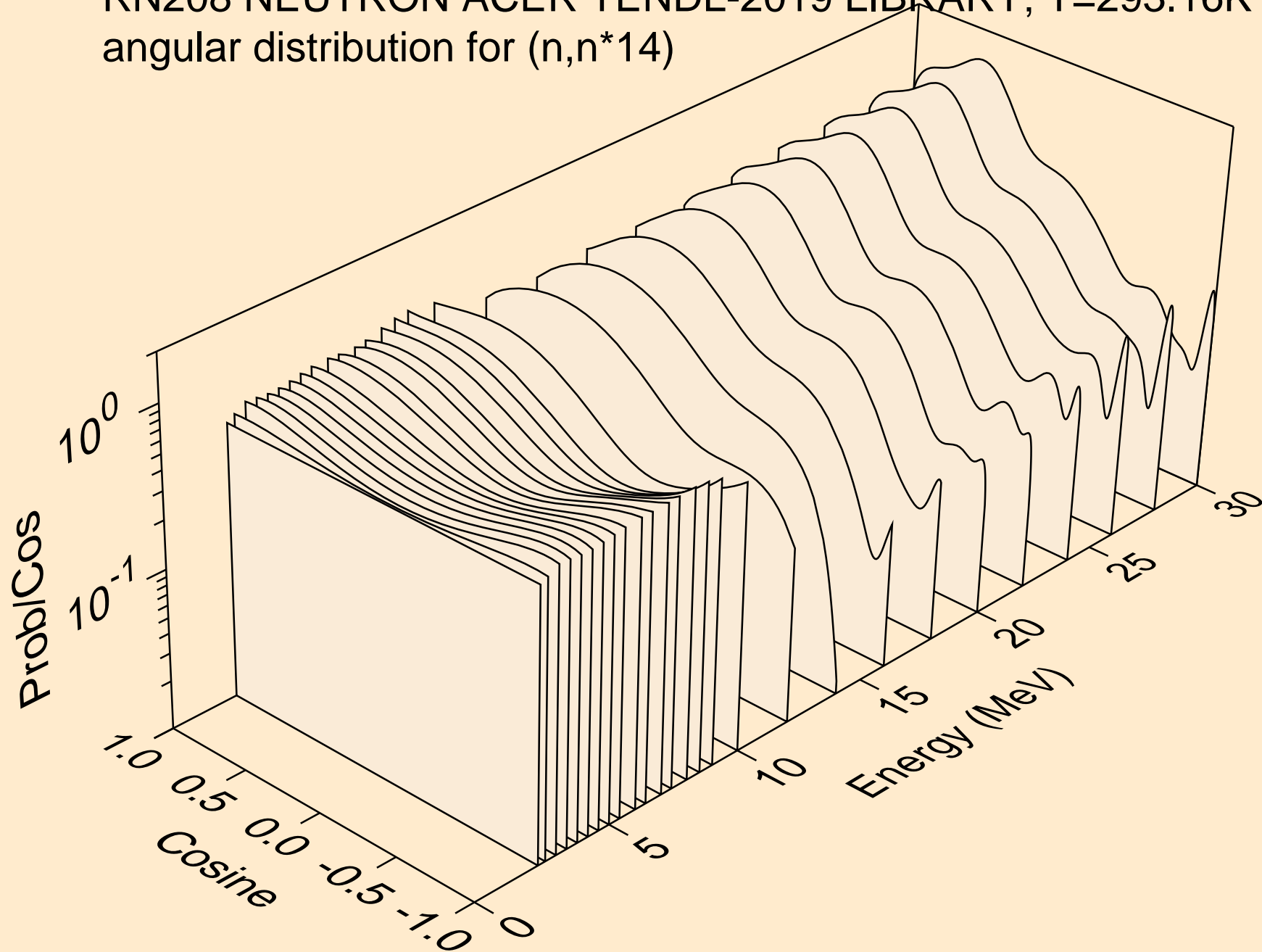

RN208 NEUTRON ACER TENDL-2019 LIBRARY; T=293.16K
angular distribution for (n,n*15)

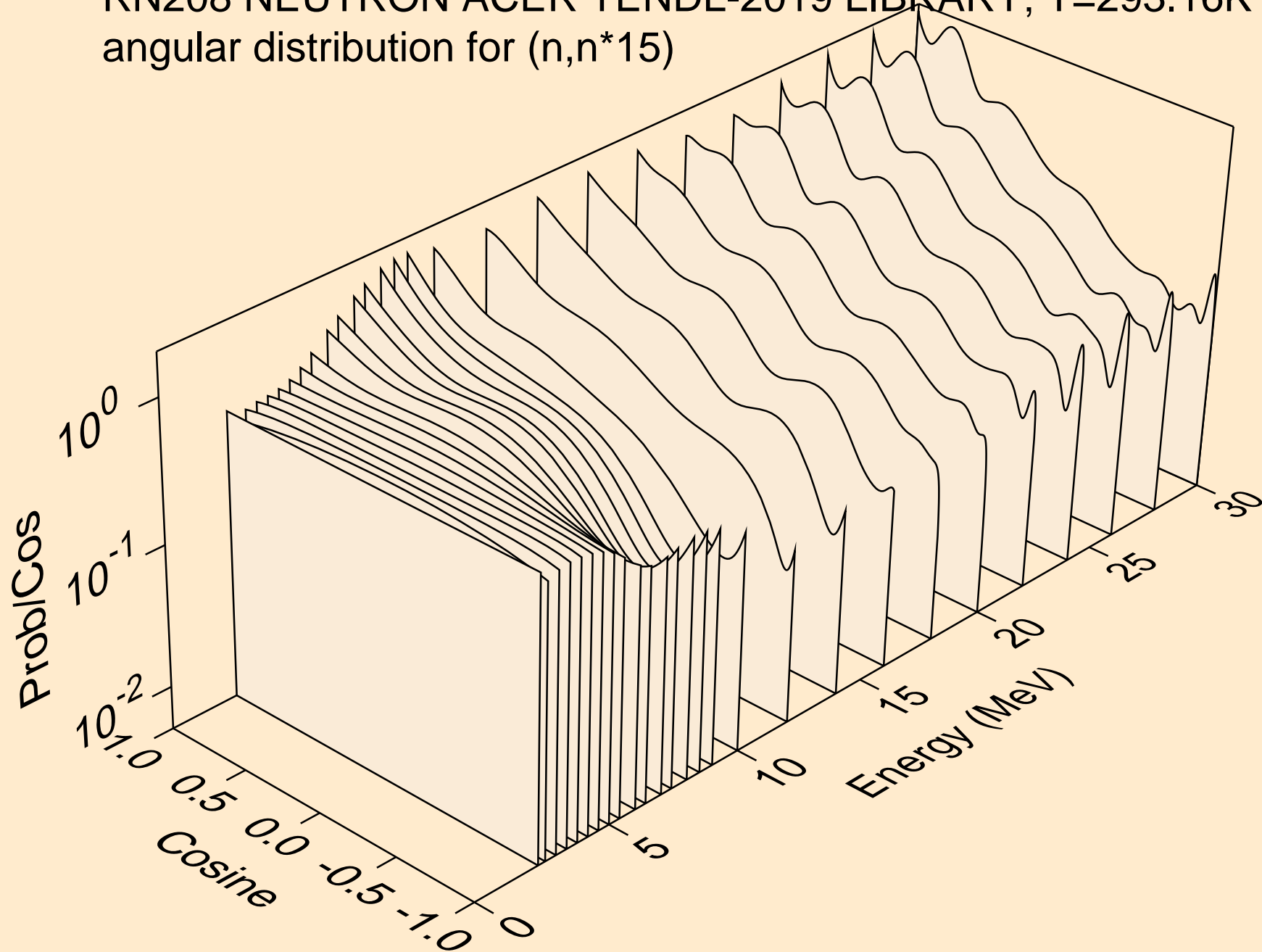

RN208 NEUTRON ACER TENDL-2019 LIBRARY; T=293.16K
angular distribution for (n,n*16)

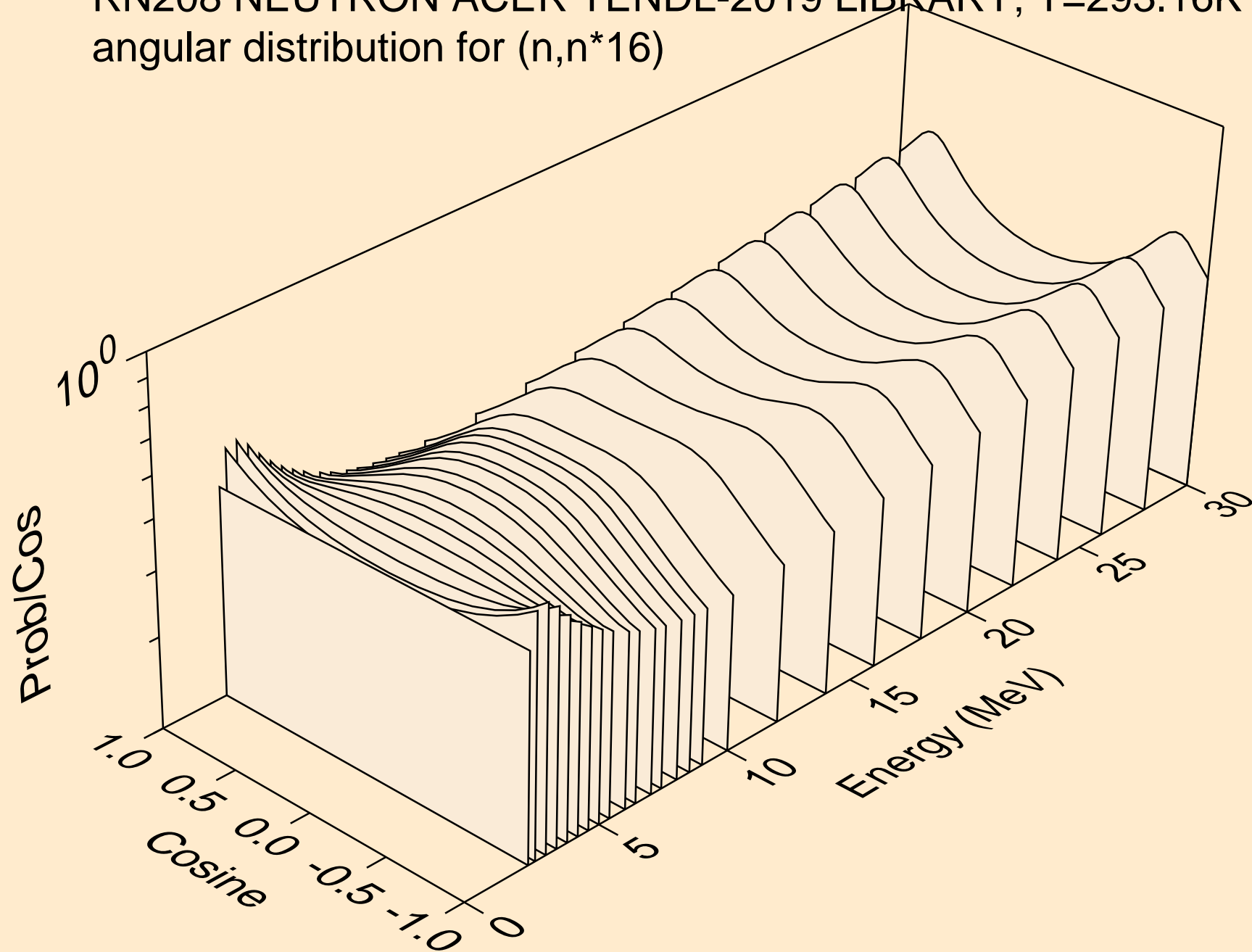

RN208 NEUTRON ACER TENDL-2019 LIBRARY; T=293.16K
angular distribution for (n,n*17)

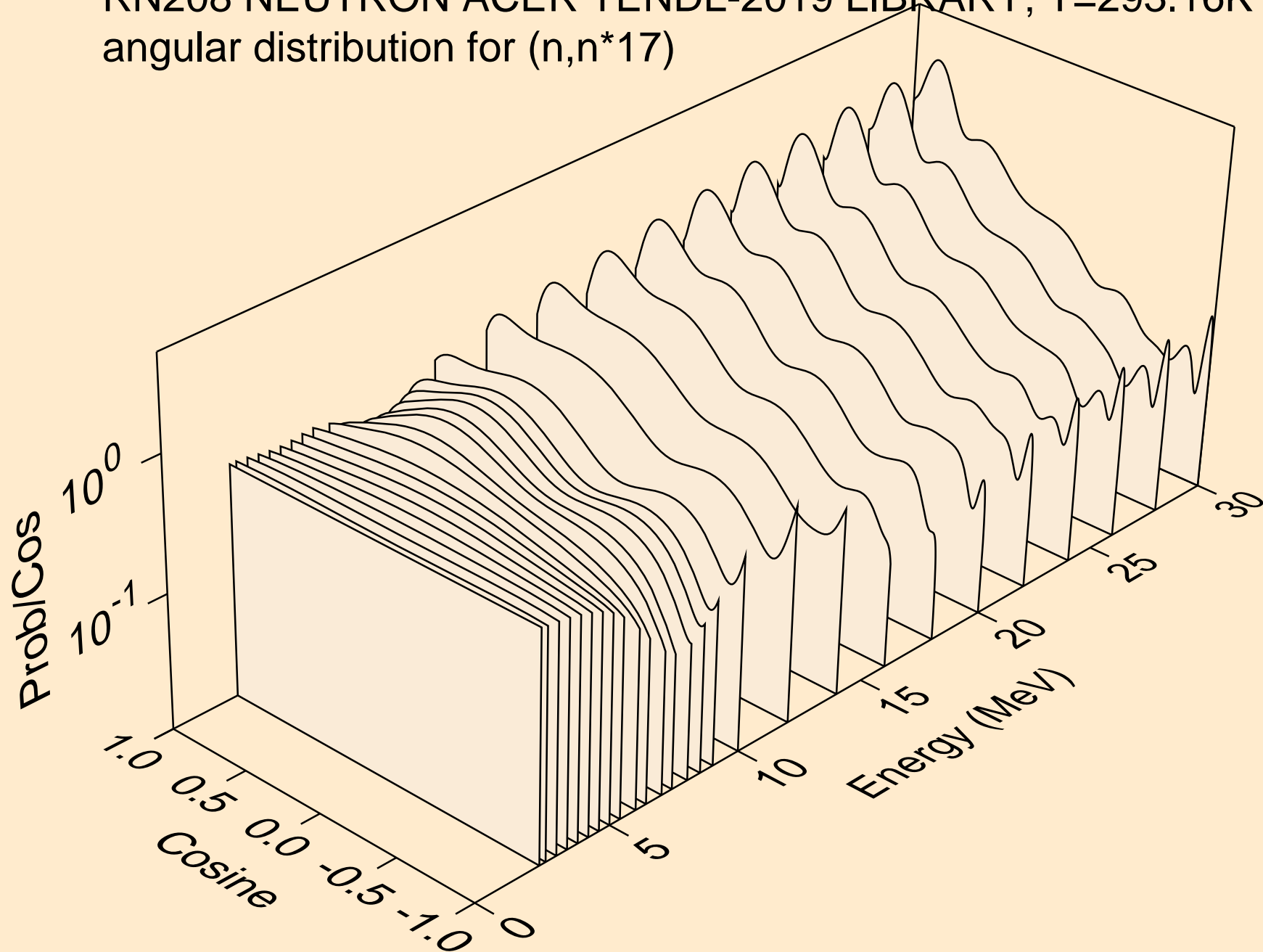

RN208 NEUTRON ACER TENDL-2019 LIBRARY; T=293.16K
angular distribution for (n,n*18)

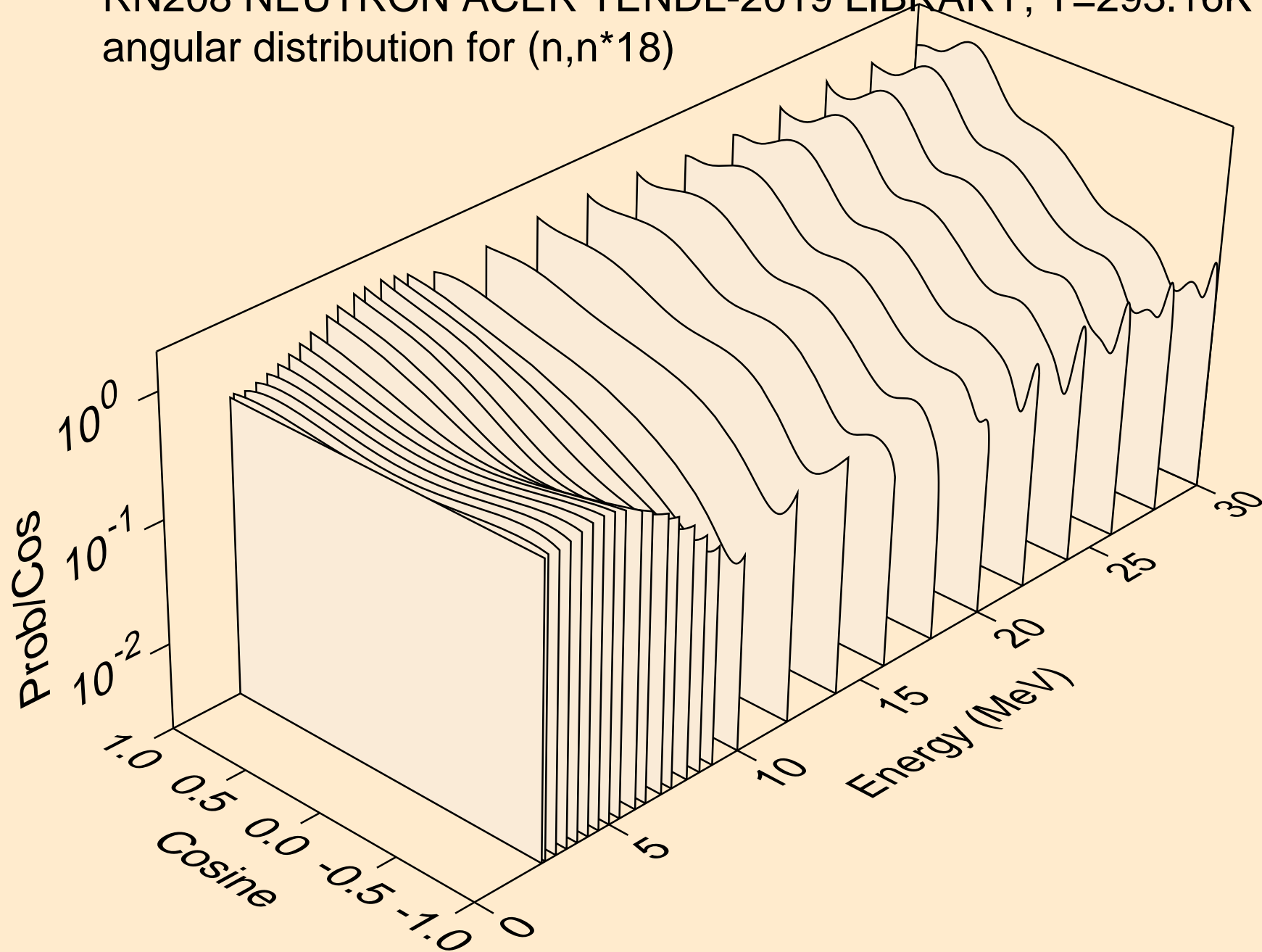

RN208 NEUTRON ACER TENDL-2019 LIBRARY; T=293.16K
angular distribution for (n,n*19)

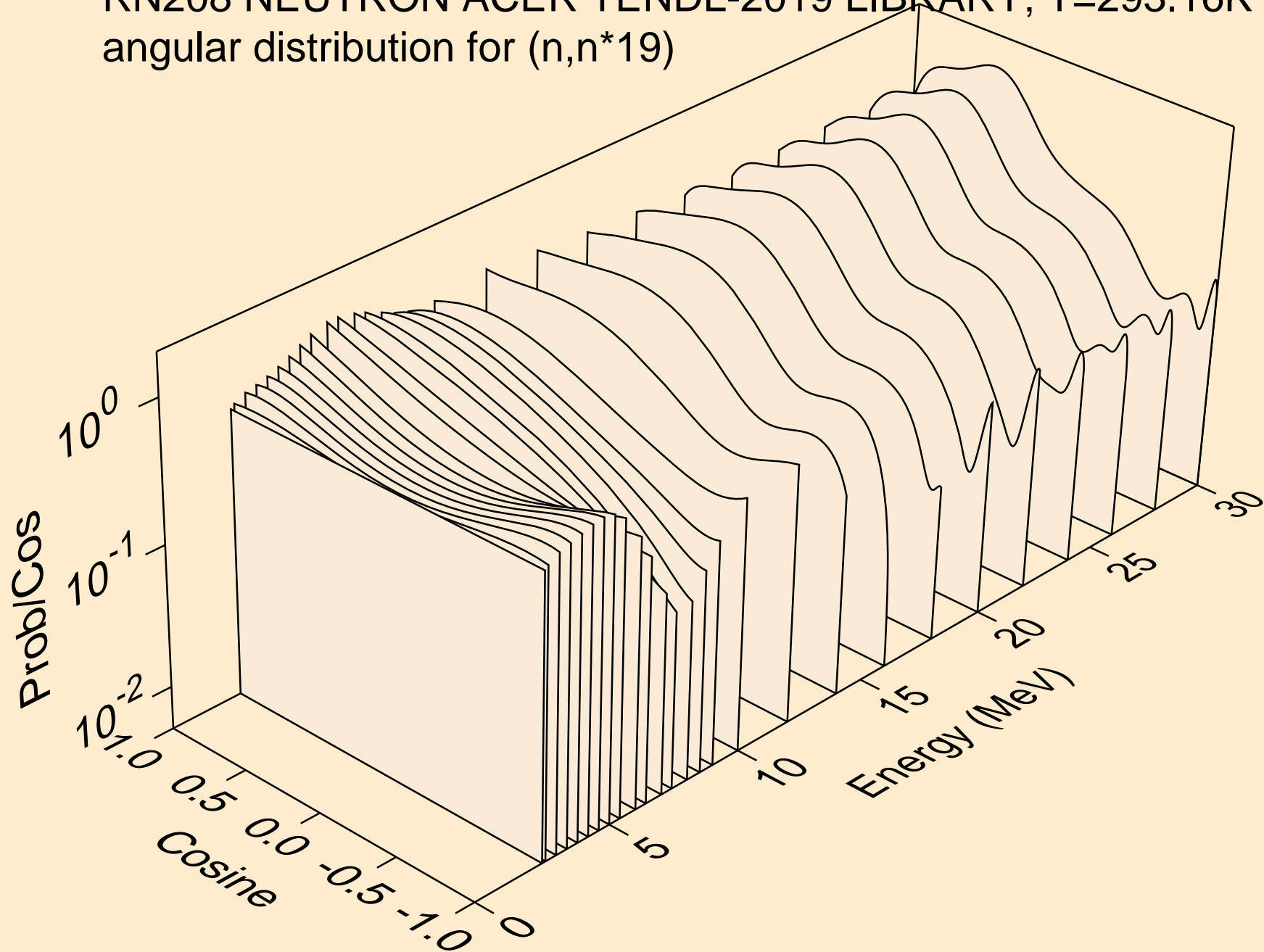

RN208 NEUTRON ACER TENDL-2019 LIBRARY; T=293.16K
angular distribution for (n,n*20)

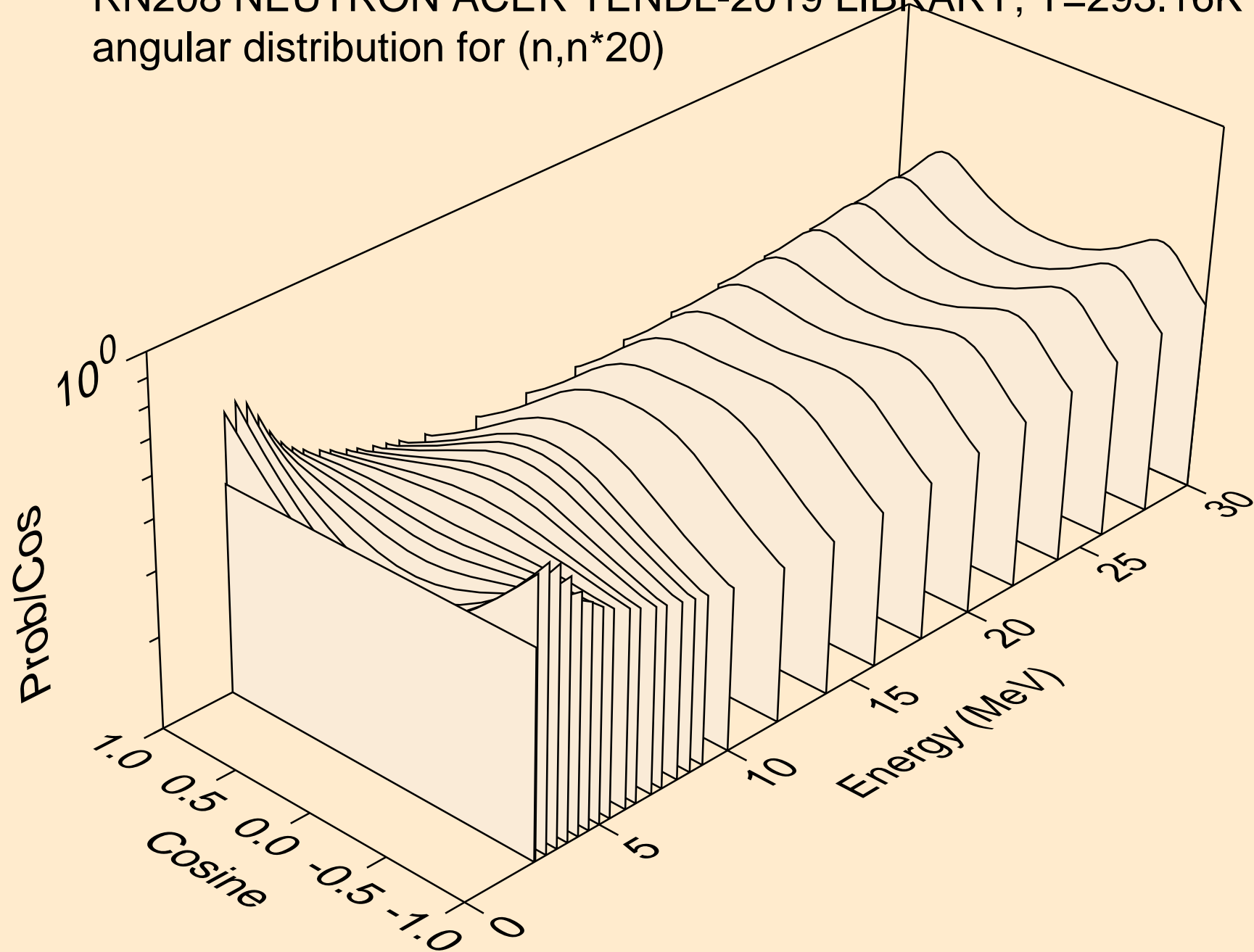

RN208 NEUTRON ACER TENDL-2019 LIBRARY; T=293.16K
angular distribution for (n,n*21)

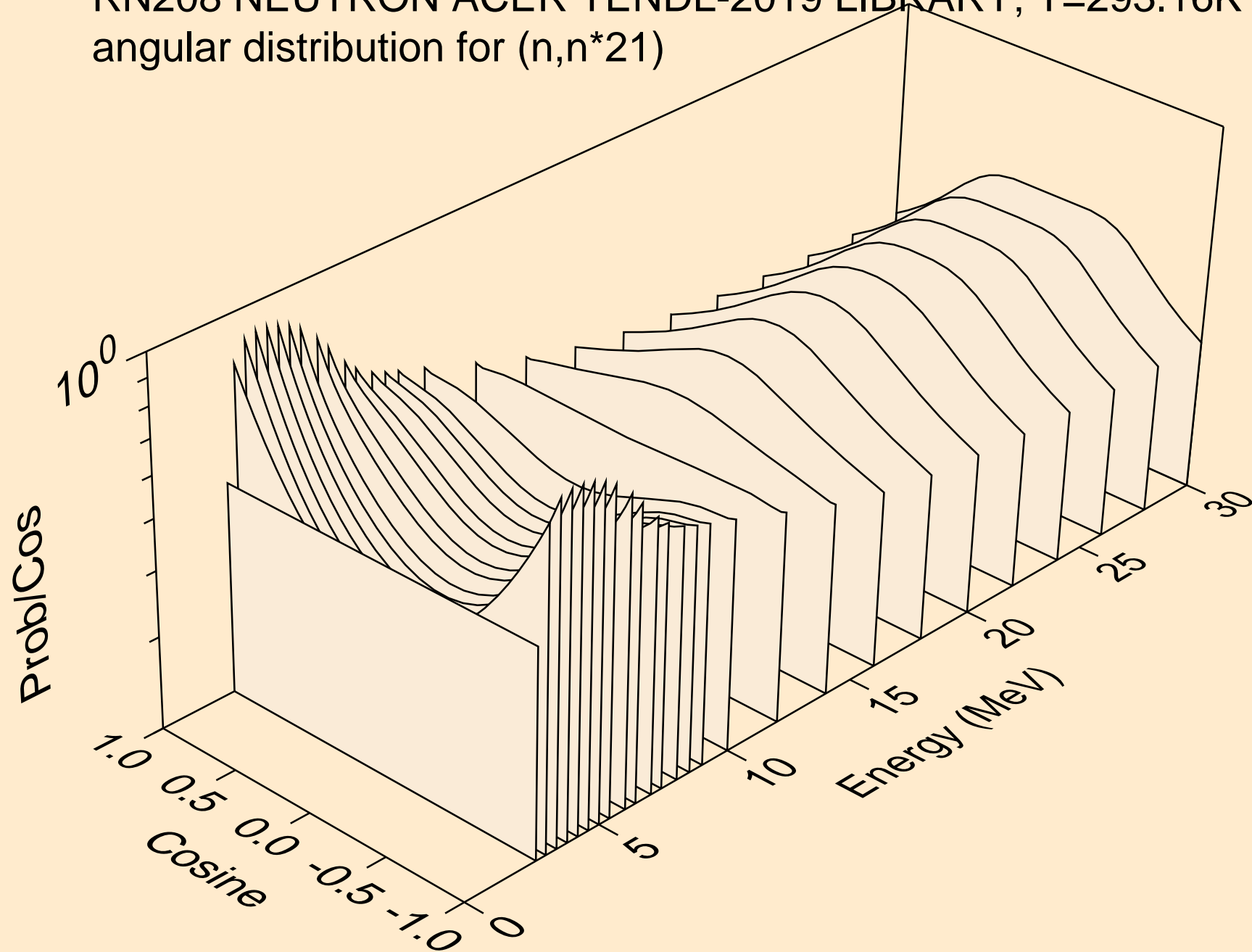

RN208 NEUTRON ACER TENDL-2019 LIBRARY; T=293.16K
angular distribution for (n,n*22)

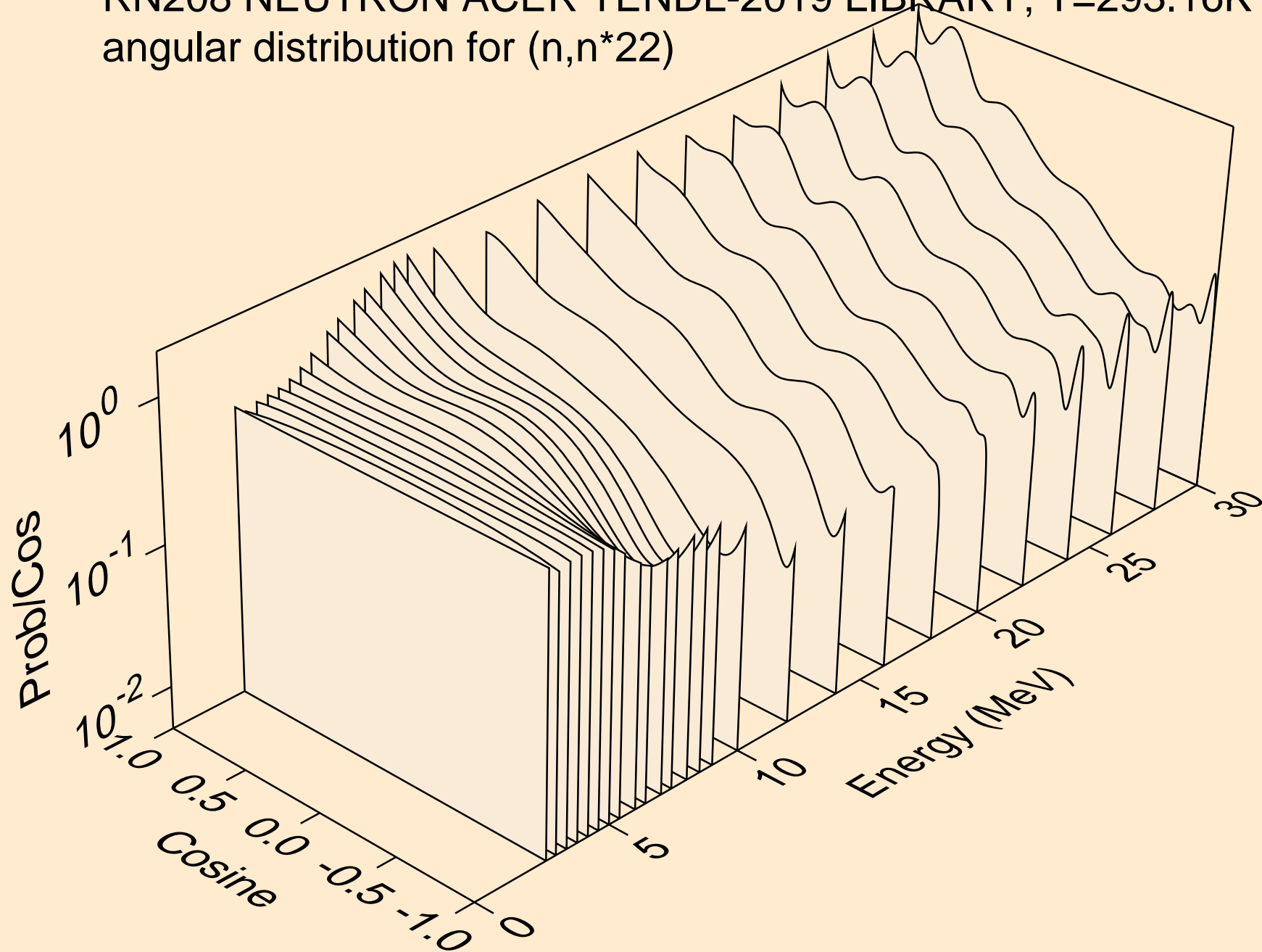

RN208 NEUTRON ACER TENDL-2019 LIBRARY; T=293.16K
Neutron emission for (n,x)

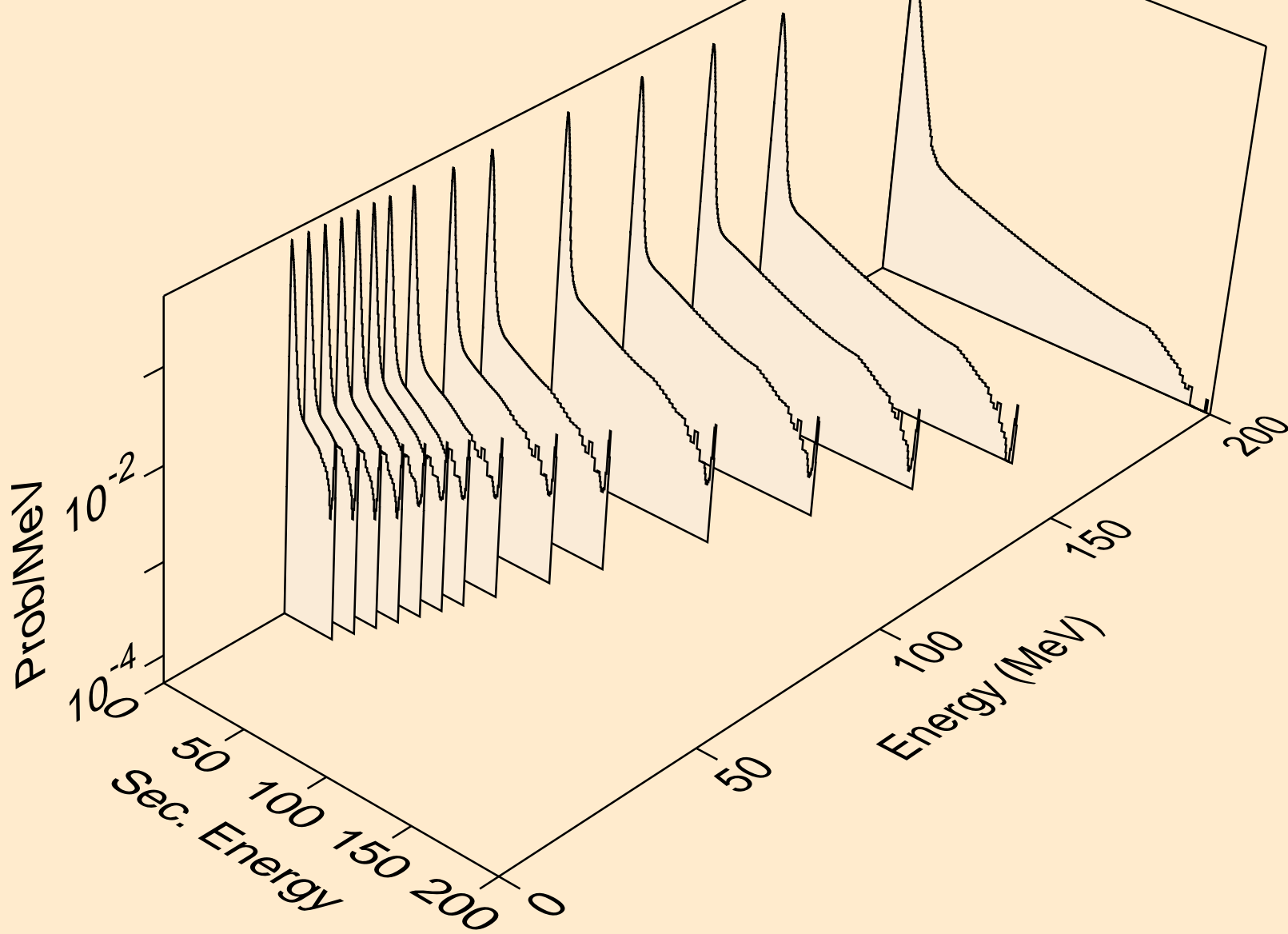

RN208 NEUTRON ACER TENDL-2019 LIBRARY; T=293.16K
Neutron emission for (n,2nd)

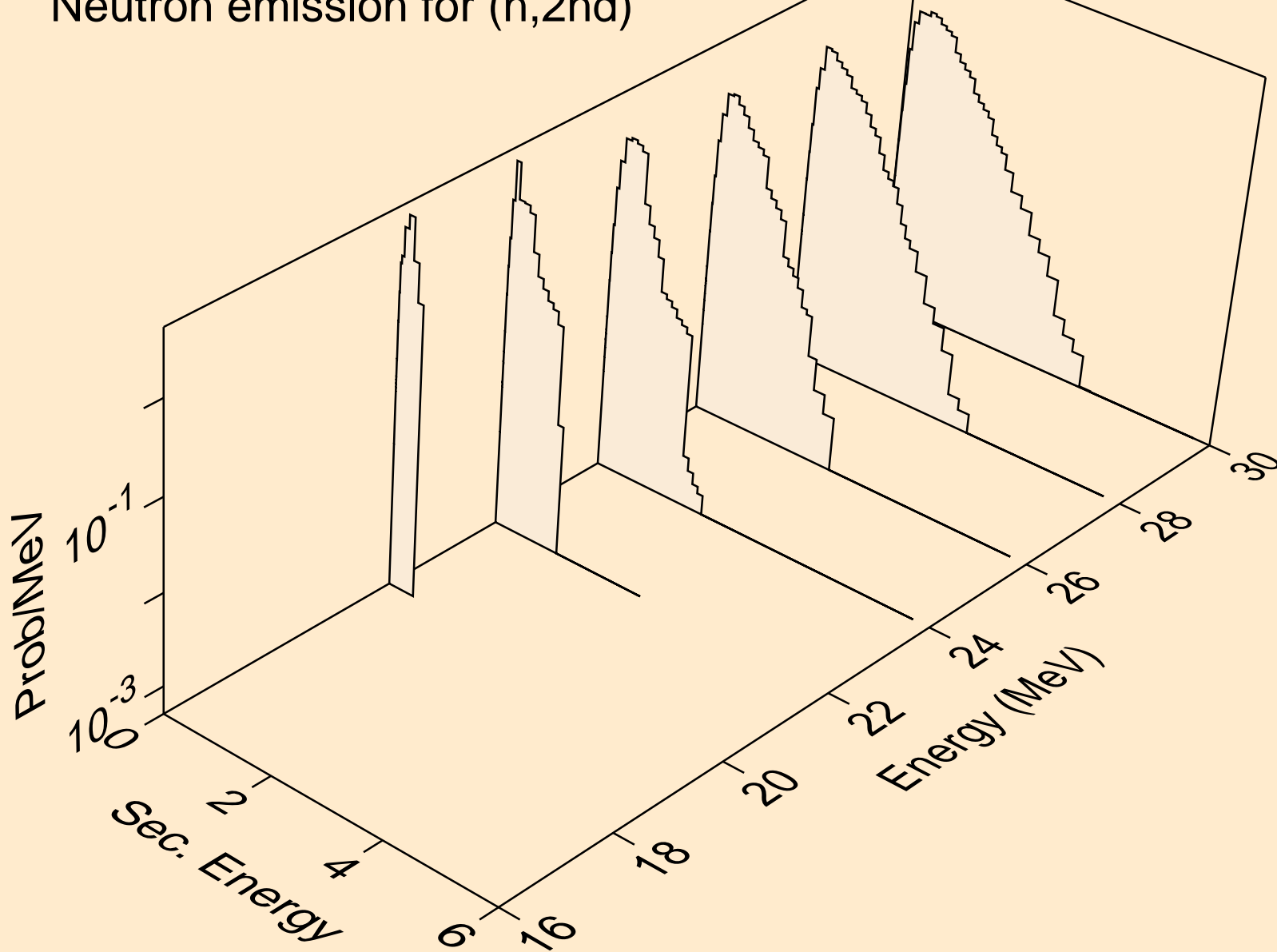

RN208 NEUTRON ACER TENDL-2019 LIBRARY; T=293.16K
Neutron emission for (n,2n)

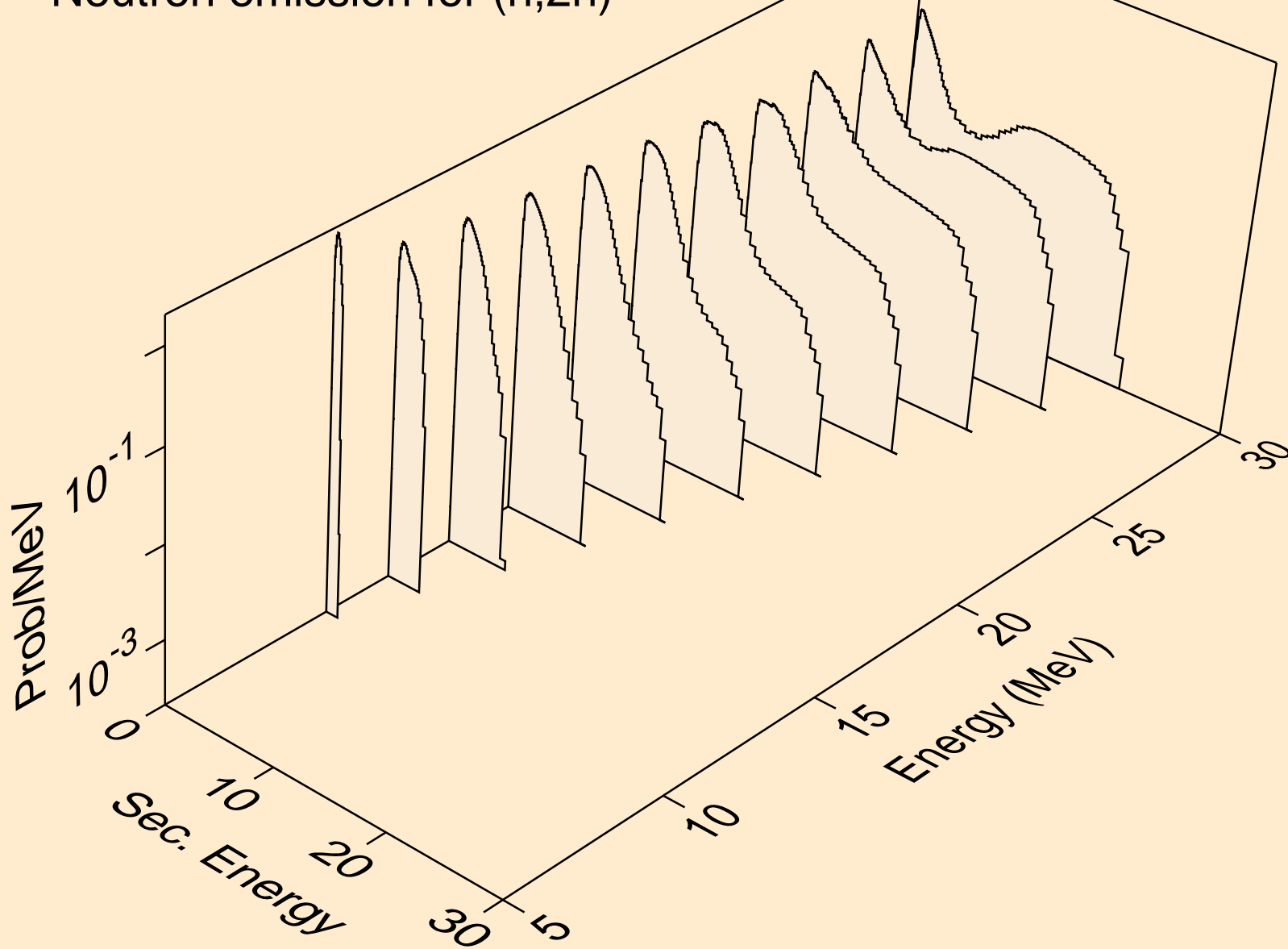

RN208 NEUTRON ACER TENDL-2019 LIBRARY; T=293.16K
Neutron emission for (n,3n)

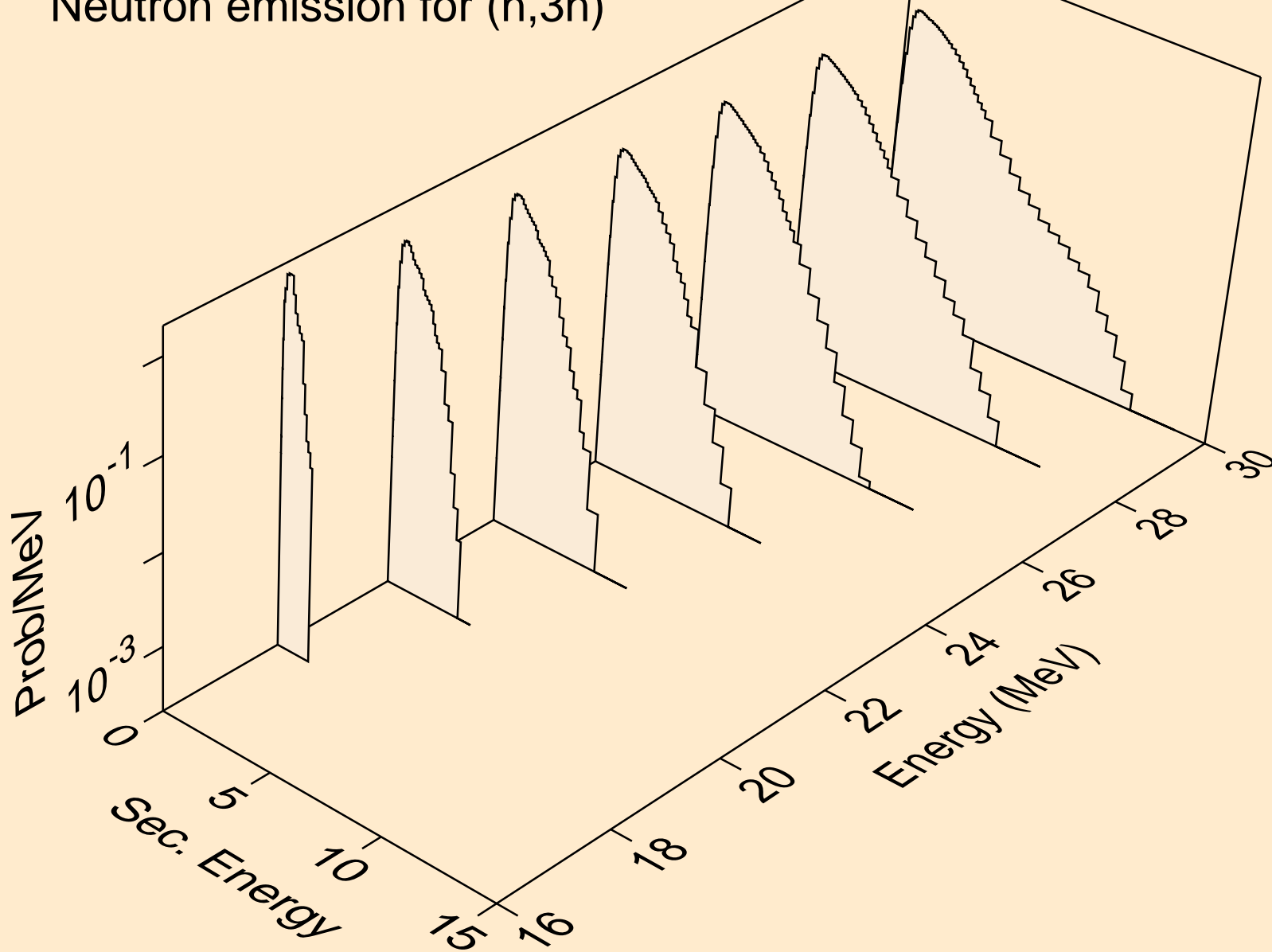

RN208 NEUTRON ACER TENDL-2019 LIBRARY; T=293.16K
Neutron emission for (n,n*)a

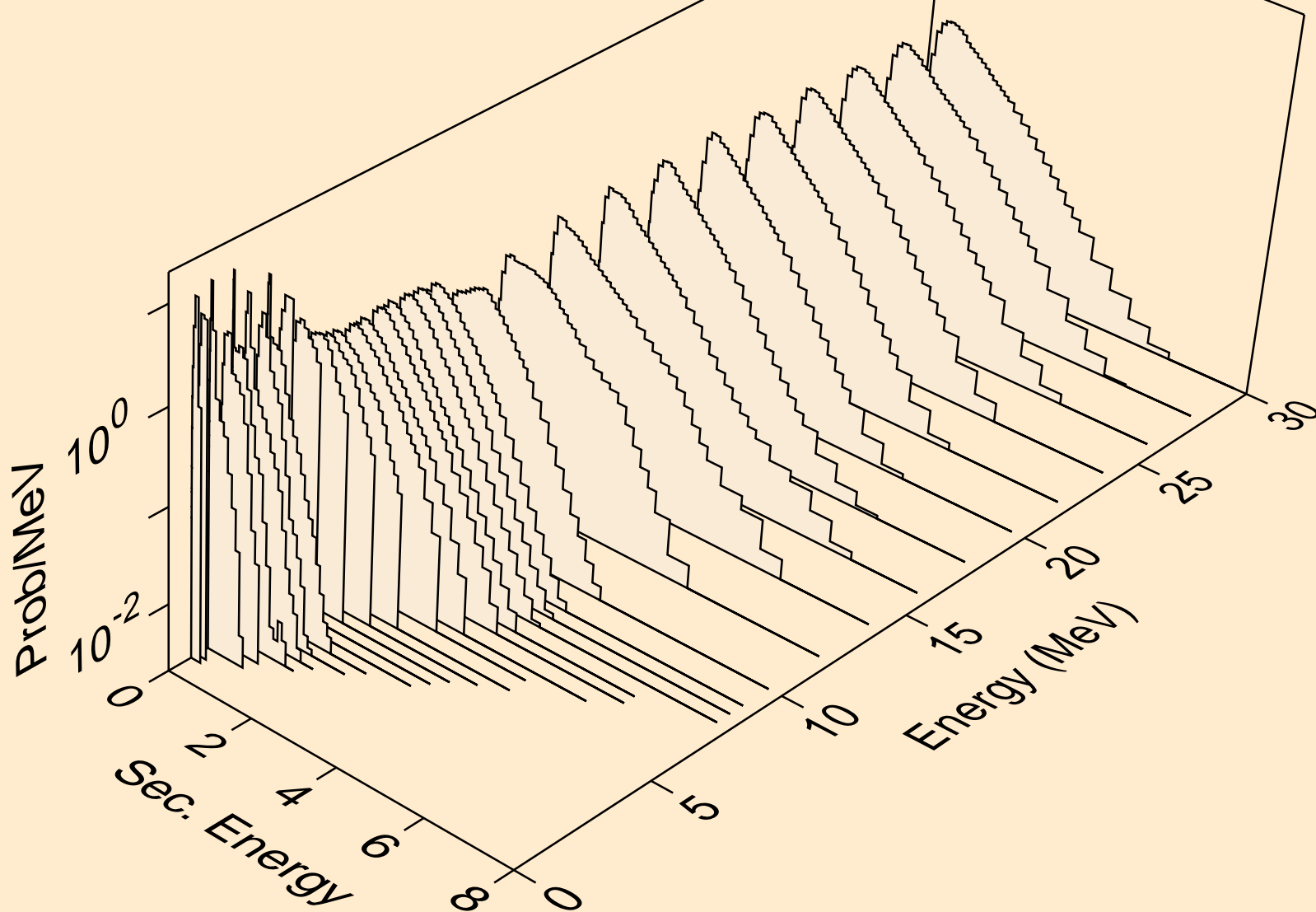

RN208 NEUTRON ACER TENDL-2019 LIBRARY; T=293.16K
Neutron emission for (n,2n)a

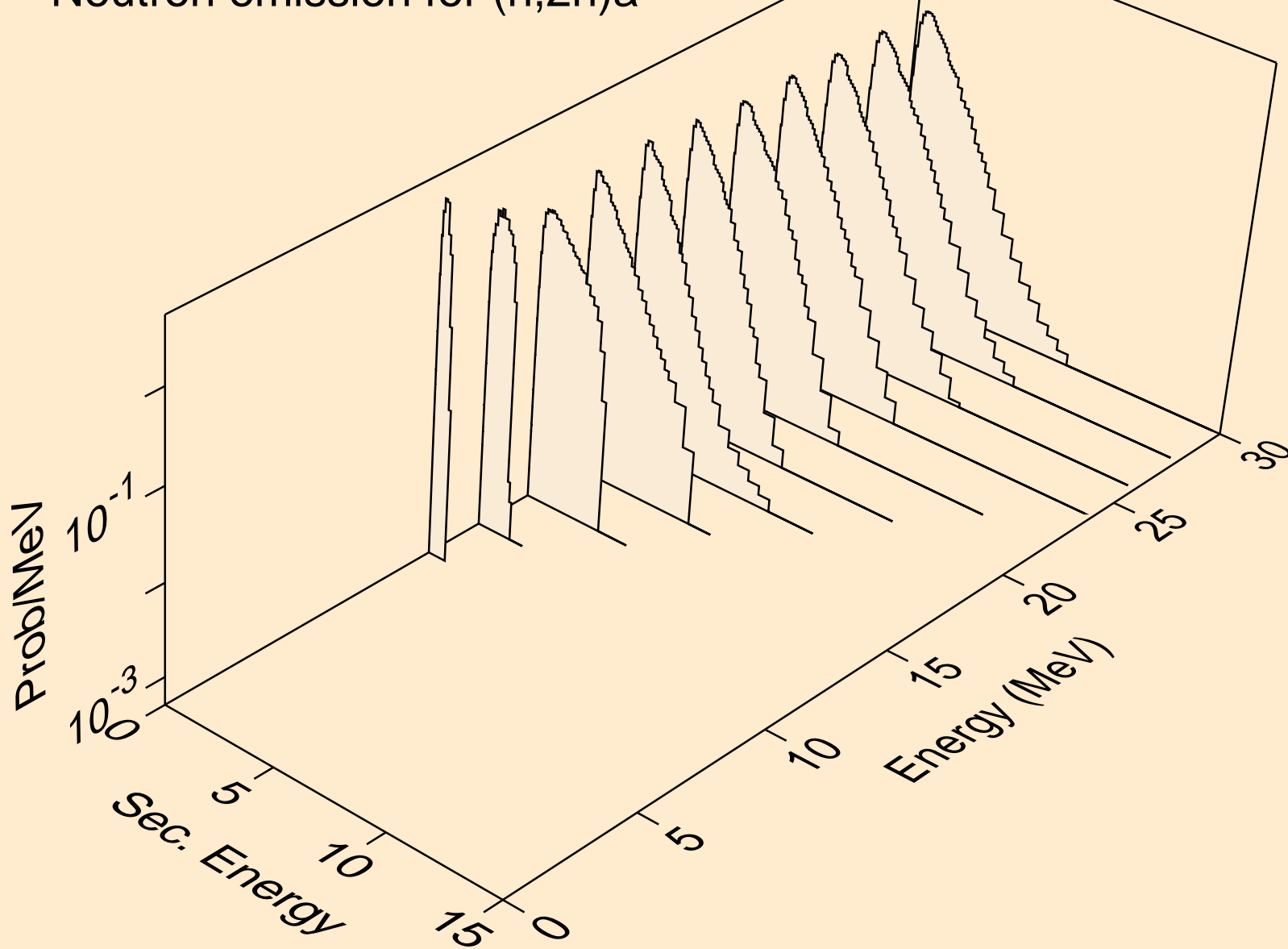

RN208 NEUTRON ACER TENDL-2019 LIBRARY; T=293.16K
Neutron emission for (n,3n)a

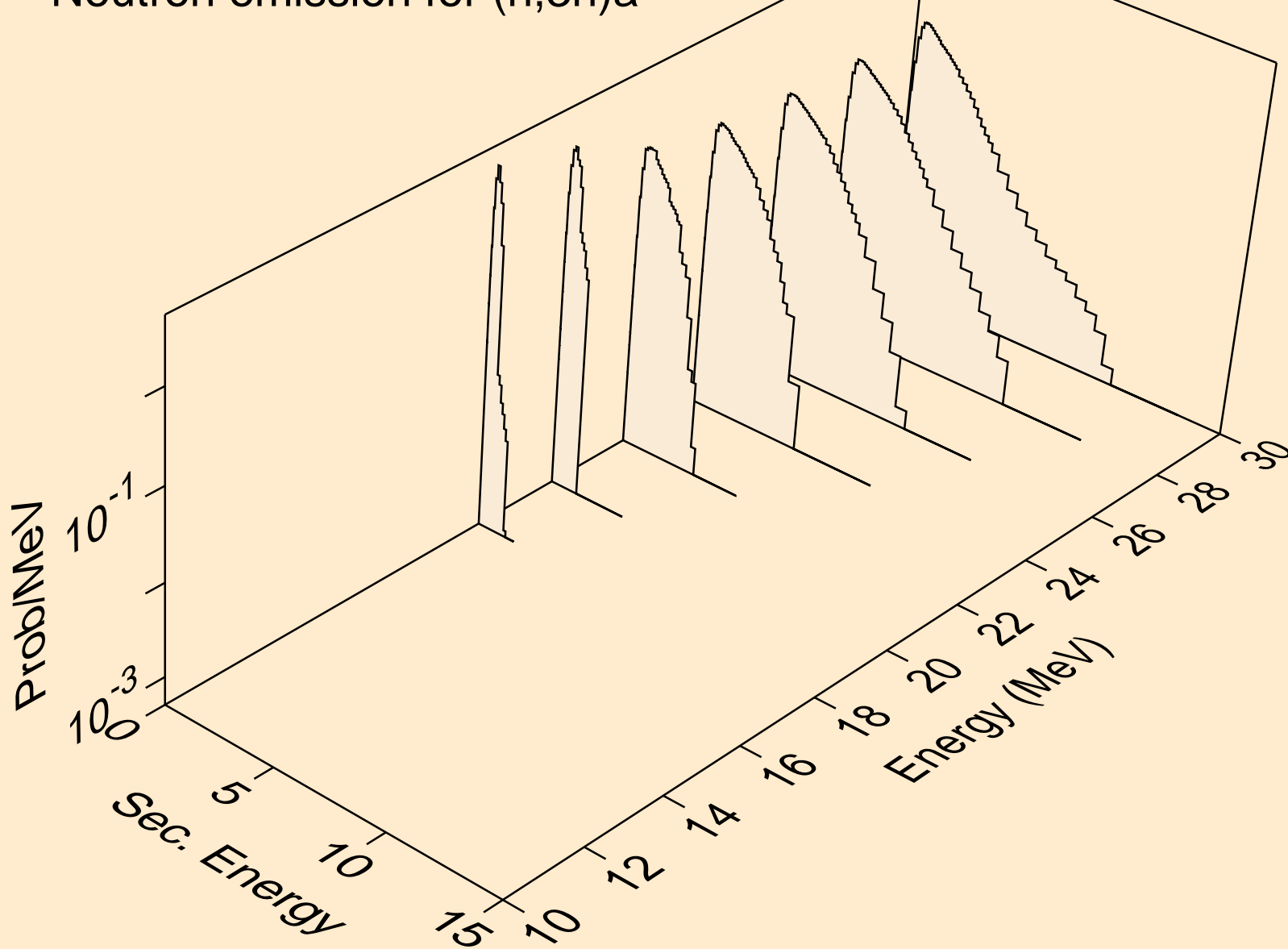

RN208 NEUTRON ACER TENDL-2019 LIBRARY; T=293.16K
Neutron emission for (n,n*)p

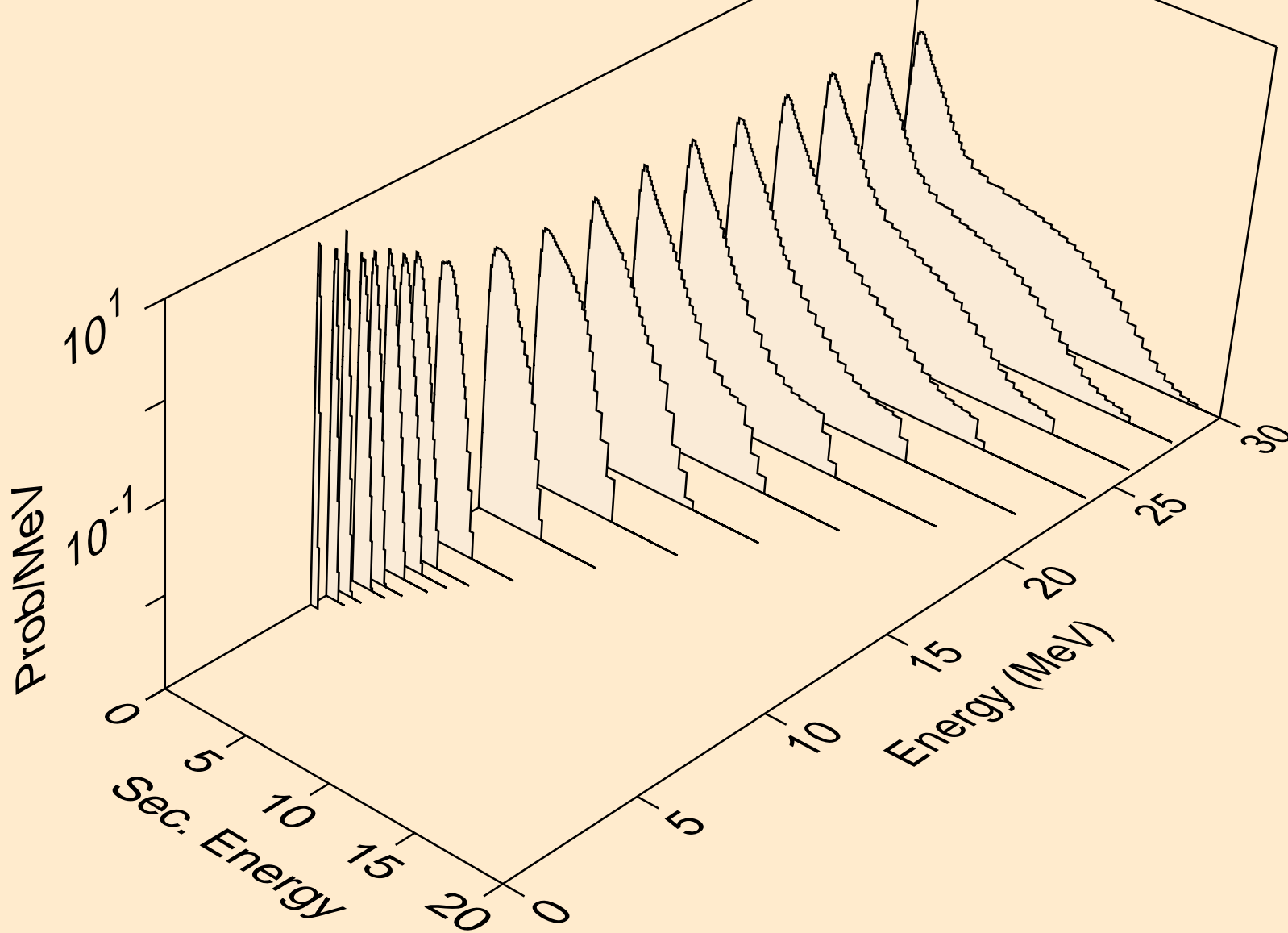

RN208 NEUTRON ACER TENDL-2019 LIBRARY; T=293.16K
Neutron emission for (n,n*)2a

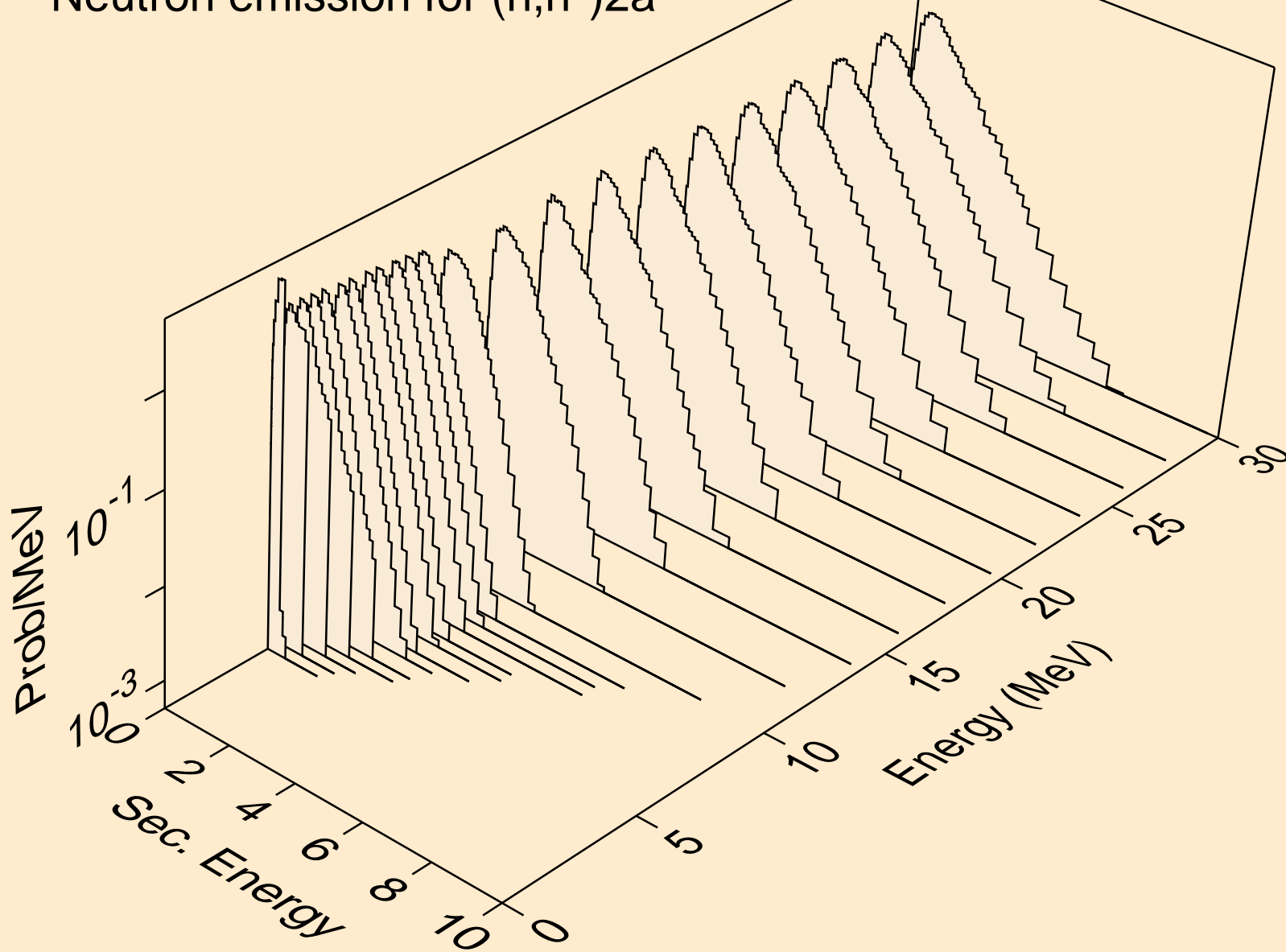

RN208 NEUTRON ACER TENDL-2019 LIBRARY; T=293.16K
Neutron emission for (n,2n)2a

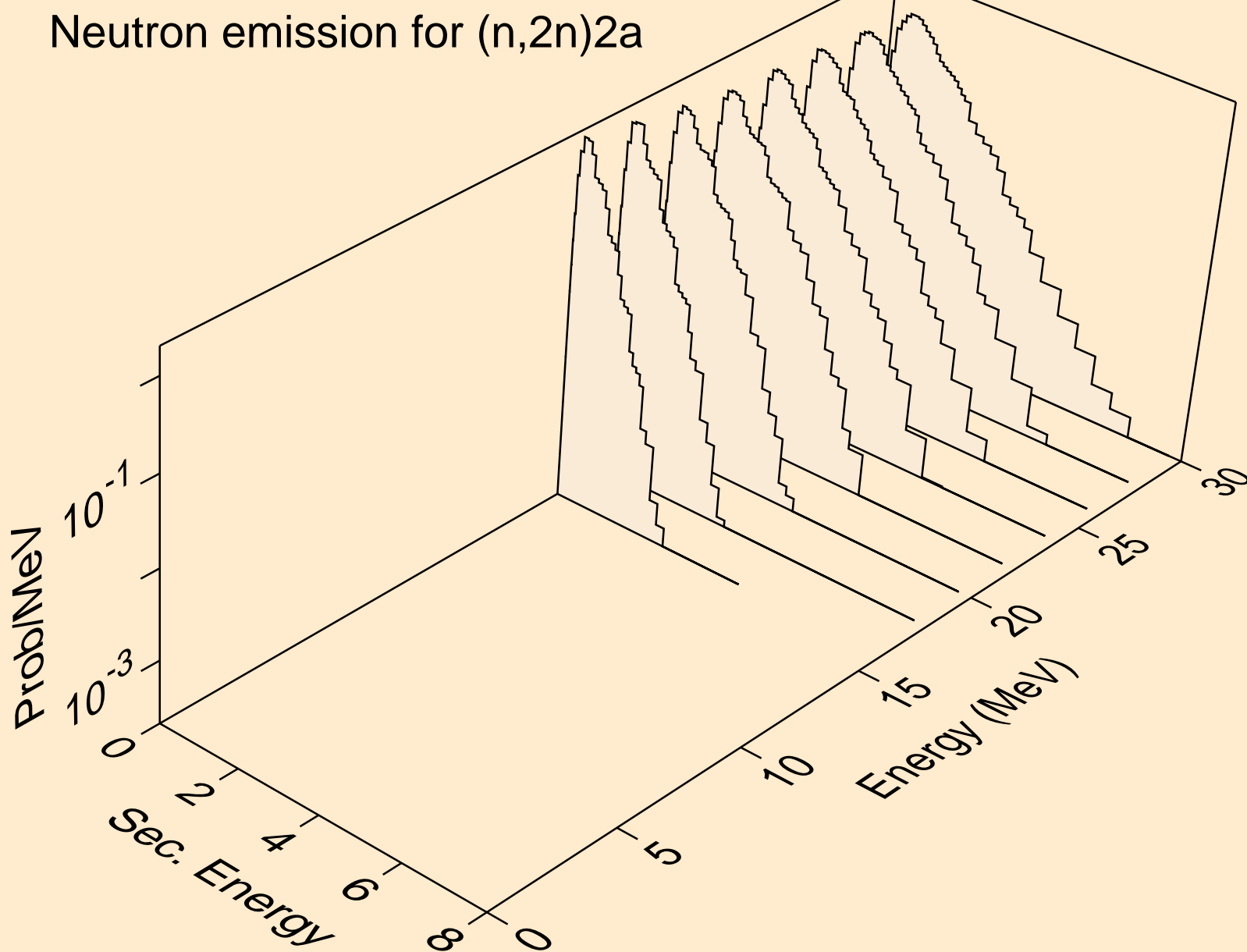

RN208 NEUTRON ACER TENDL-2019 LIBRARY; T=293.16K
Neutron emission for (n,n*)d

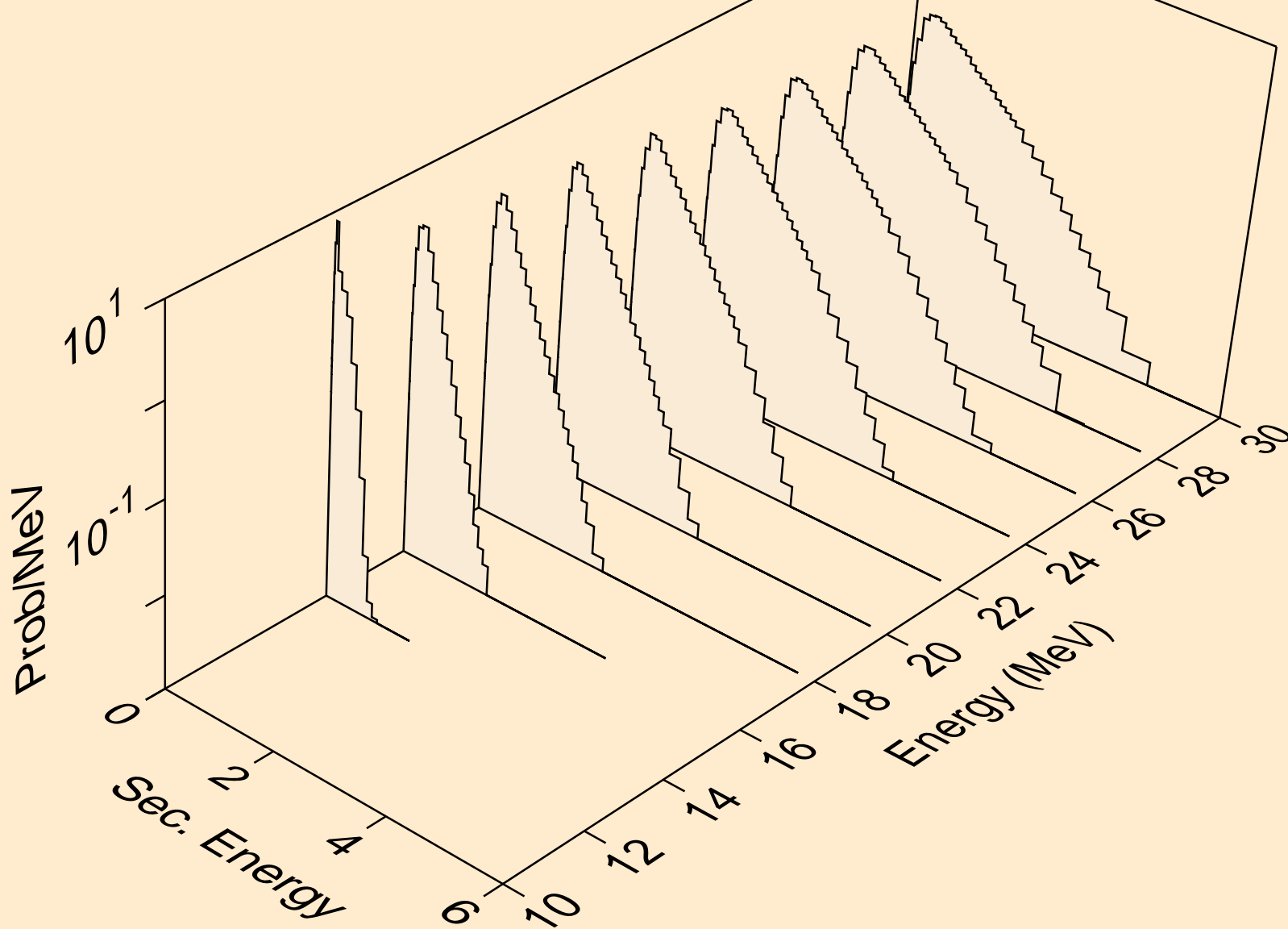

RN208 NEUTRON ACER TENDL-2019 LIBRARY; T=293.16K
Neutron emission for (n,n*)t

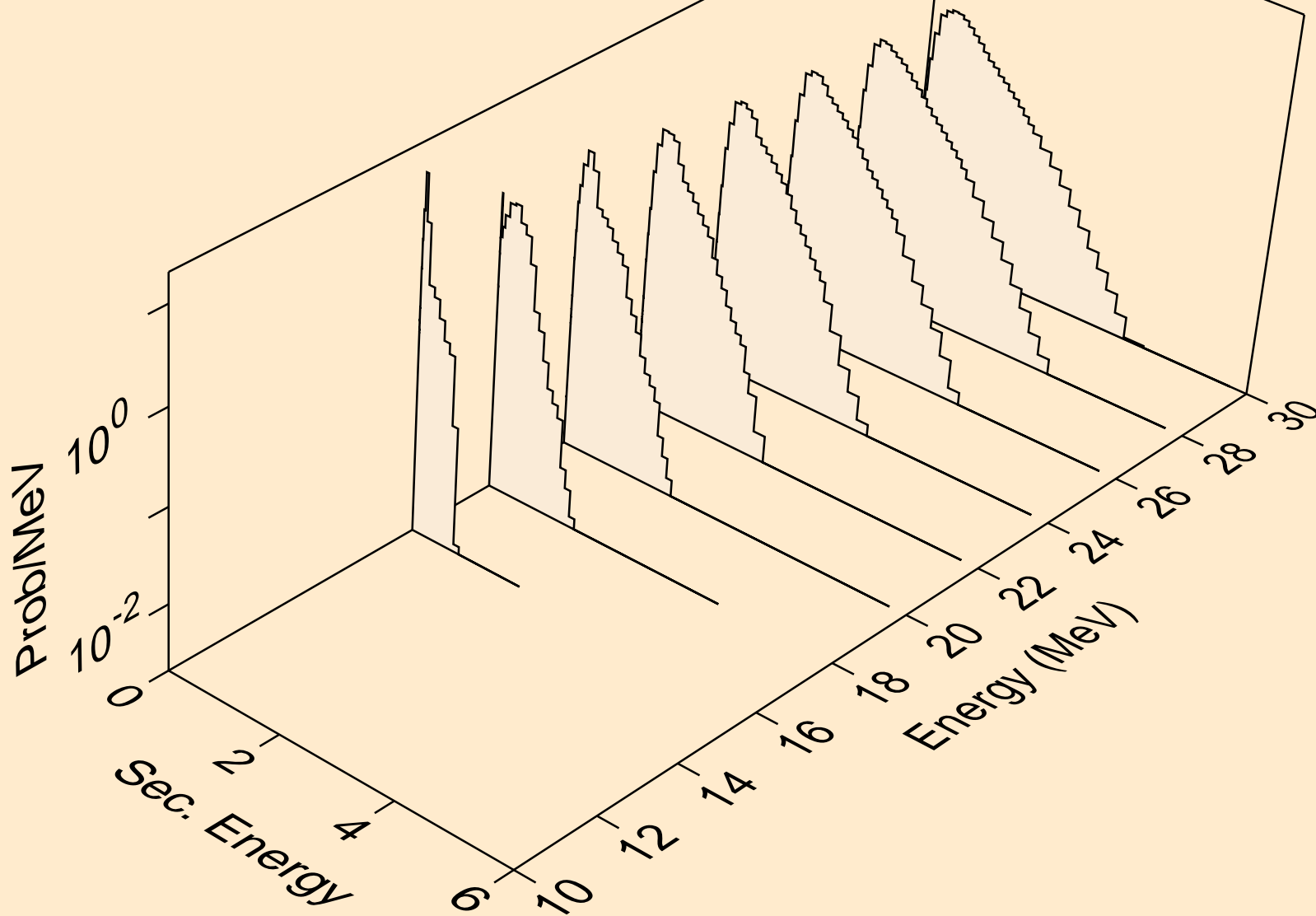

RN208 NEUTRON ACER TENDL-2019 LIBRARY; T=293.16K
Neutron emission for (n,n*)he3

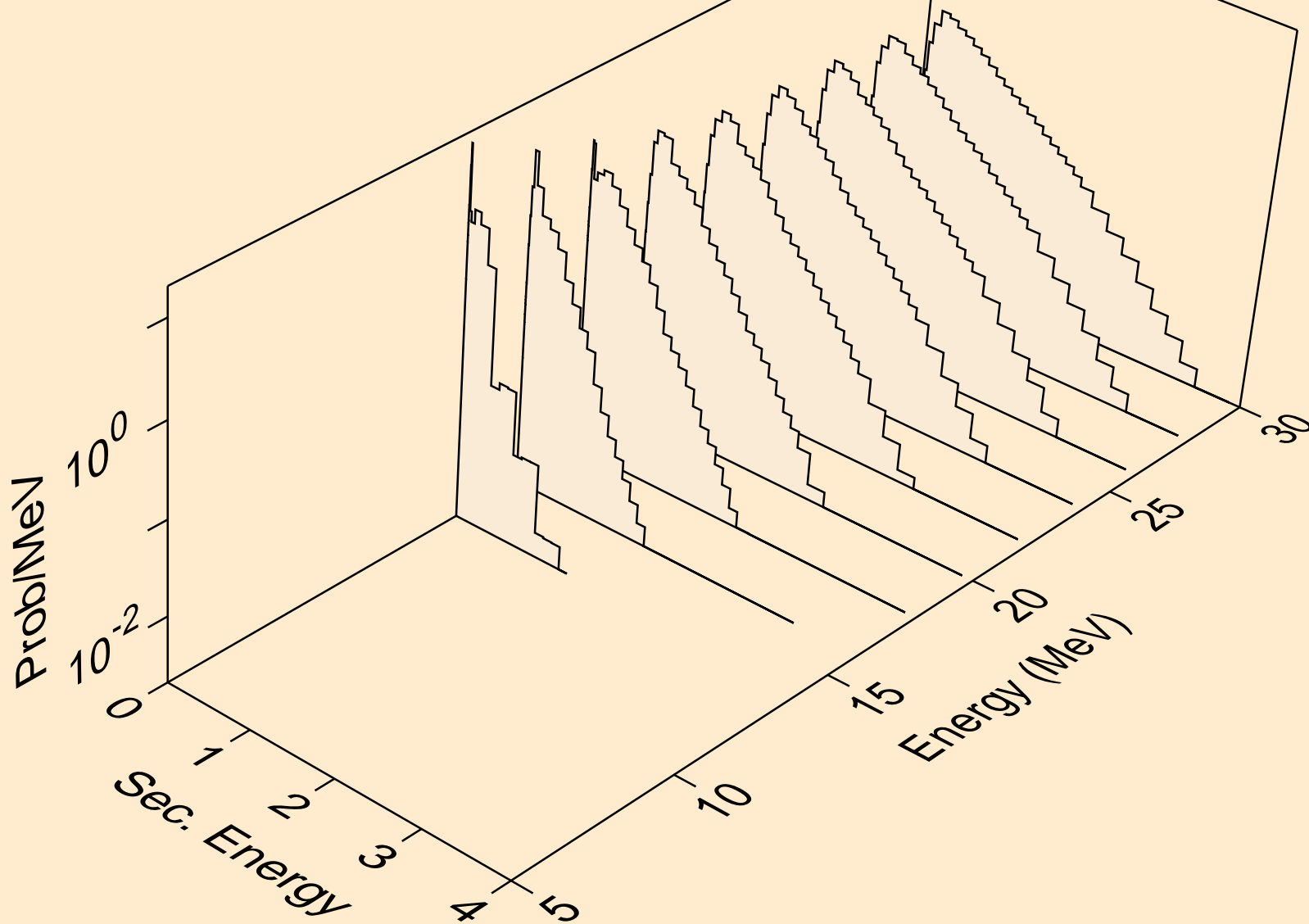

RN208 NEUTRON ACER TENDL-2019 LIBRARY; T=293.16K
Neutron emission for (n,4n)

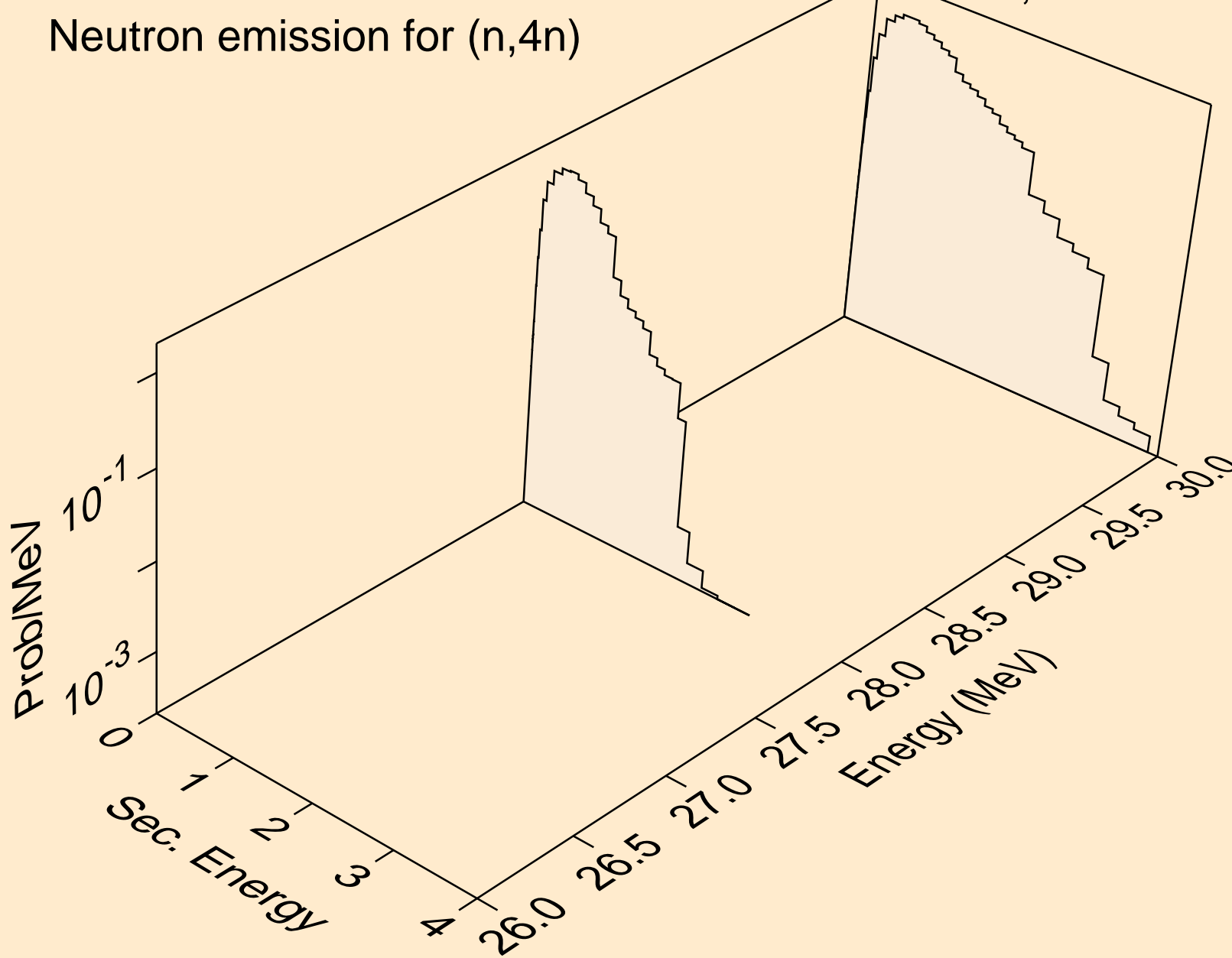

RN208 NEUTRON ACER TENDL-2019 LIBRARY; T=293.16K
Neutron emission for (n,2np)

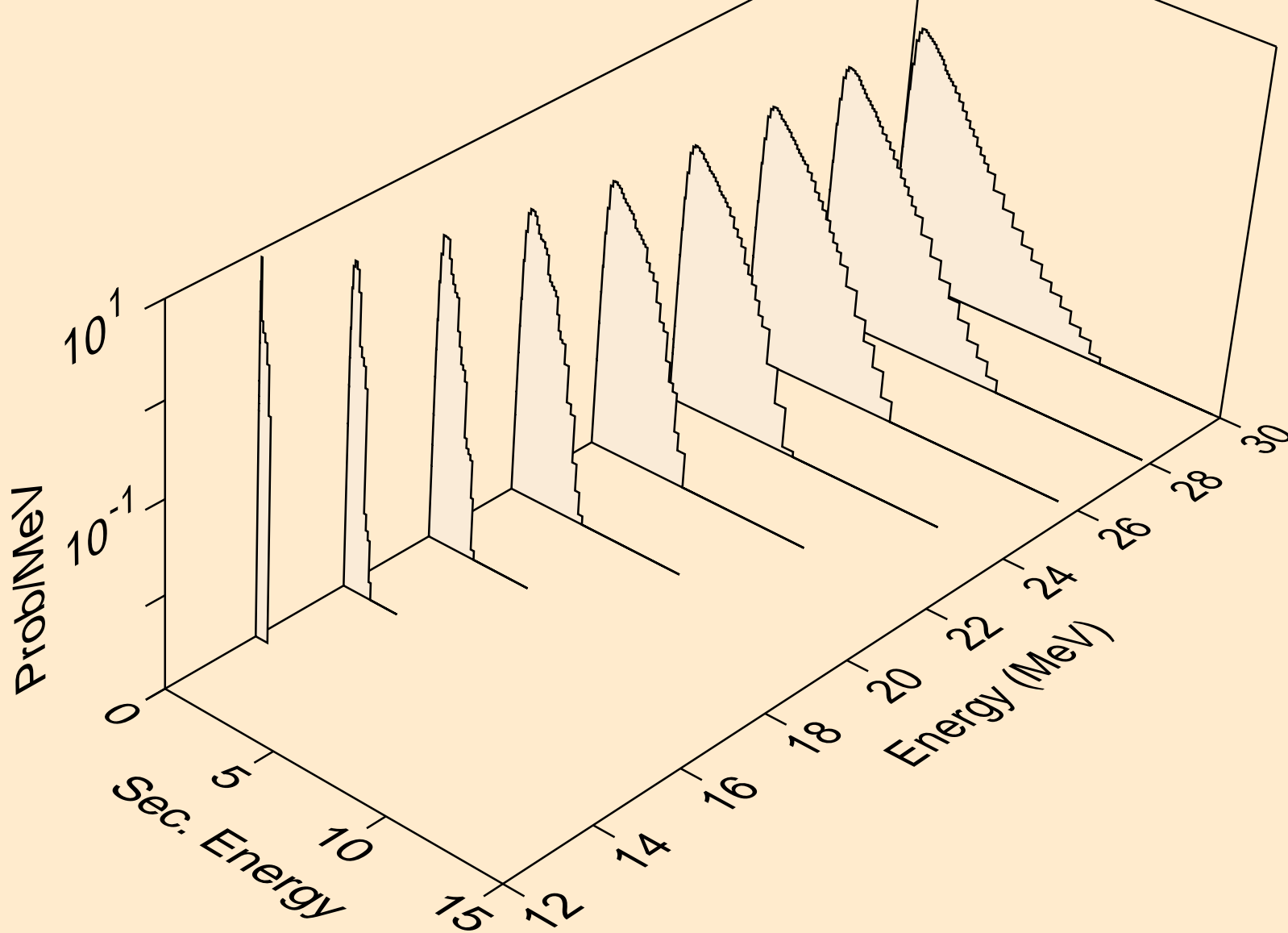

RN208 NEUTRON ACER TENDL-2019 LIBRARY; T=293.16K
Neutron emission for (n,3np)

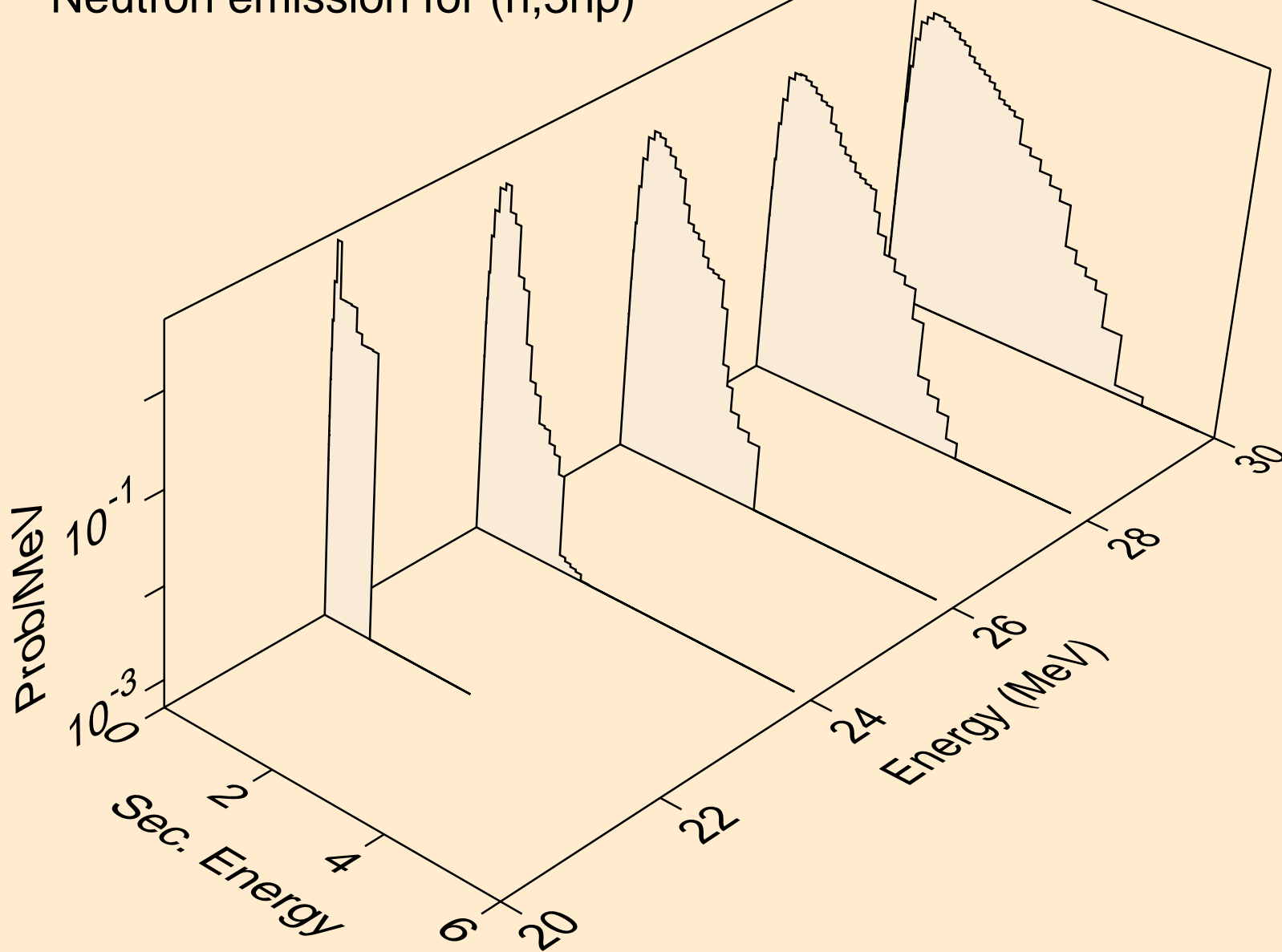

RN208 NEUTRON ACER TENDL-2019 LIBRARY; T=293.16K
Neutron emission for (n,2np)

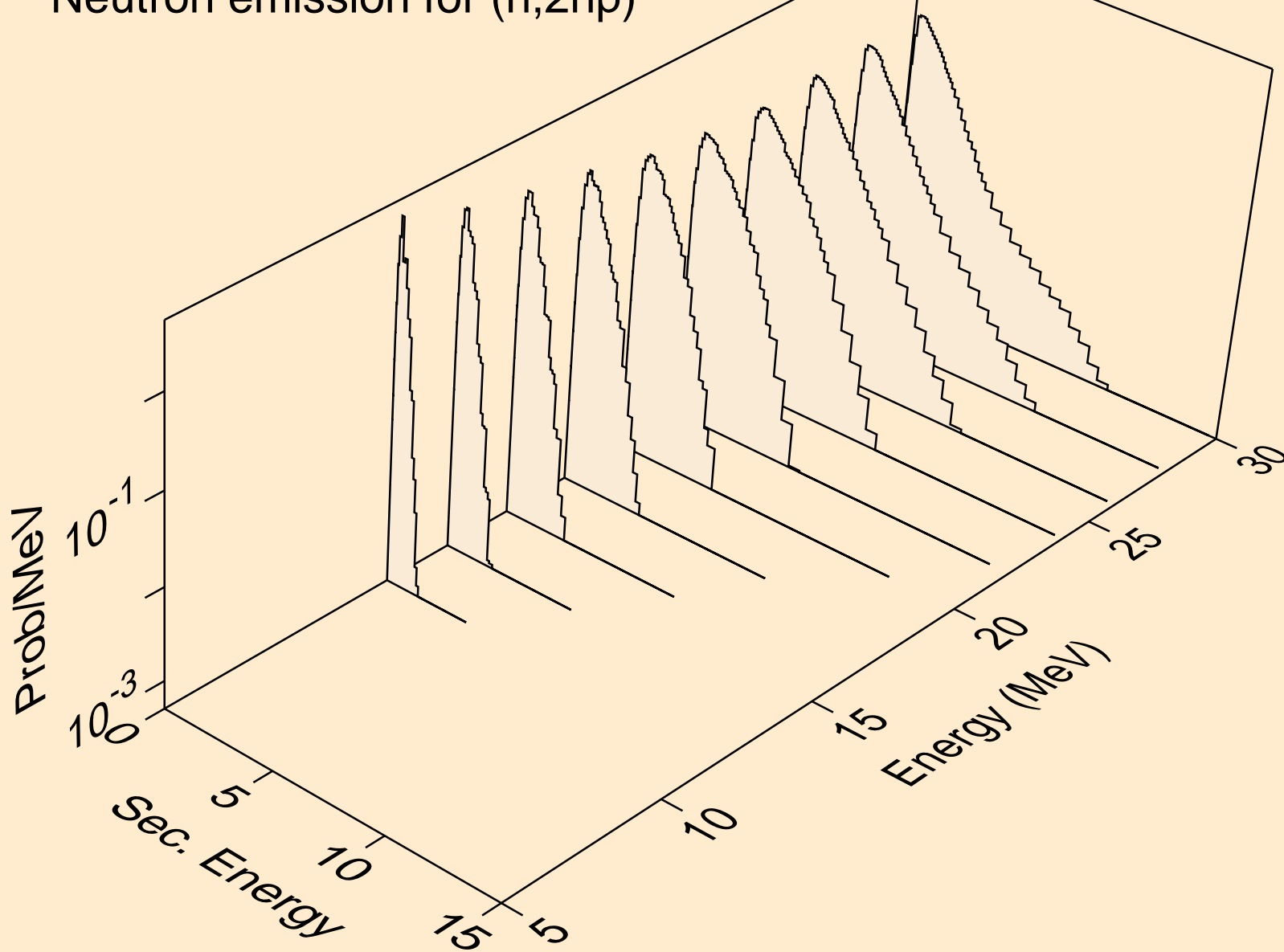

RN208 NEUTRON ACER TENDL-2019 LIBRARY; T=293.16K
Neutron emission for (n,npa)

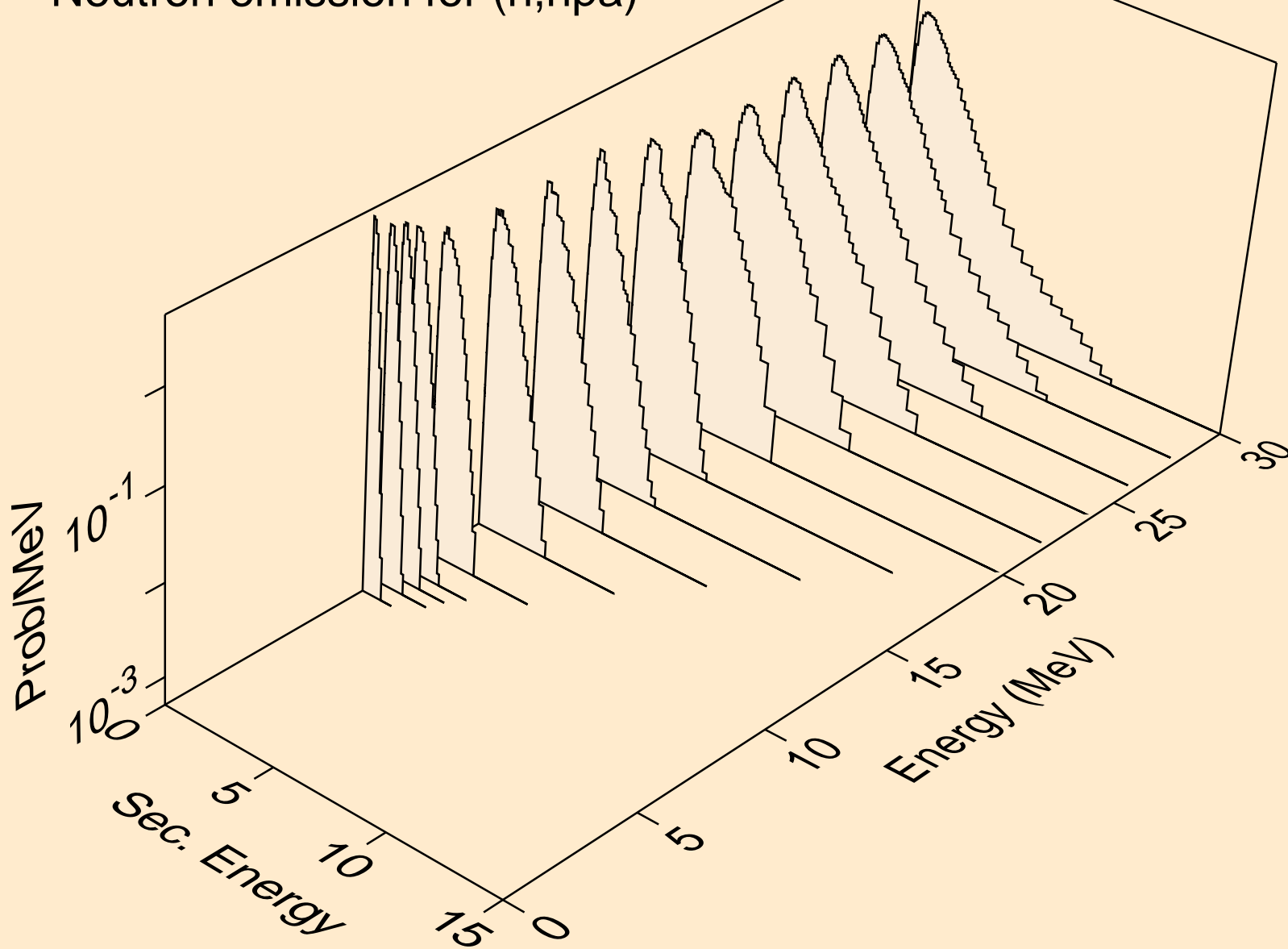

RN208 NEUTRON ACER TENDL-2019 LIBRARY; T=293.16K
Neutron emission for (n,n*c)

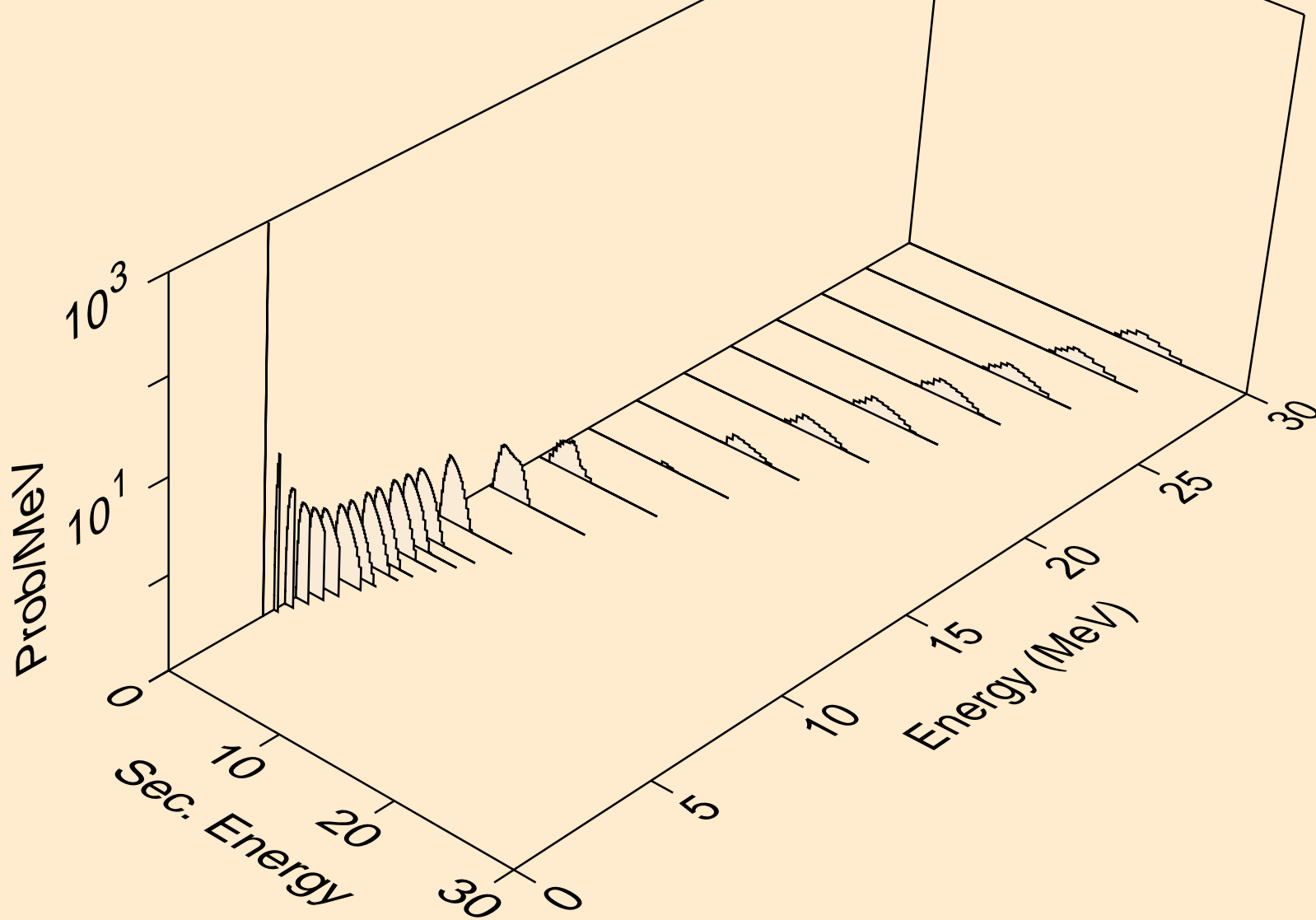

RN208 NEUTRON ACER TENDL-2019 LIBRARY; T=293.16K
Photon emission for (n,x)

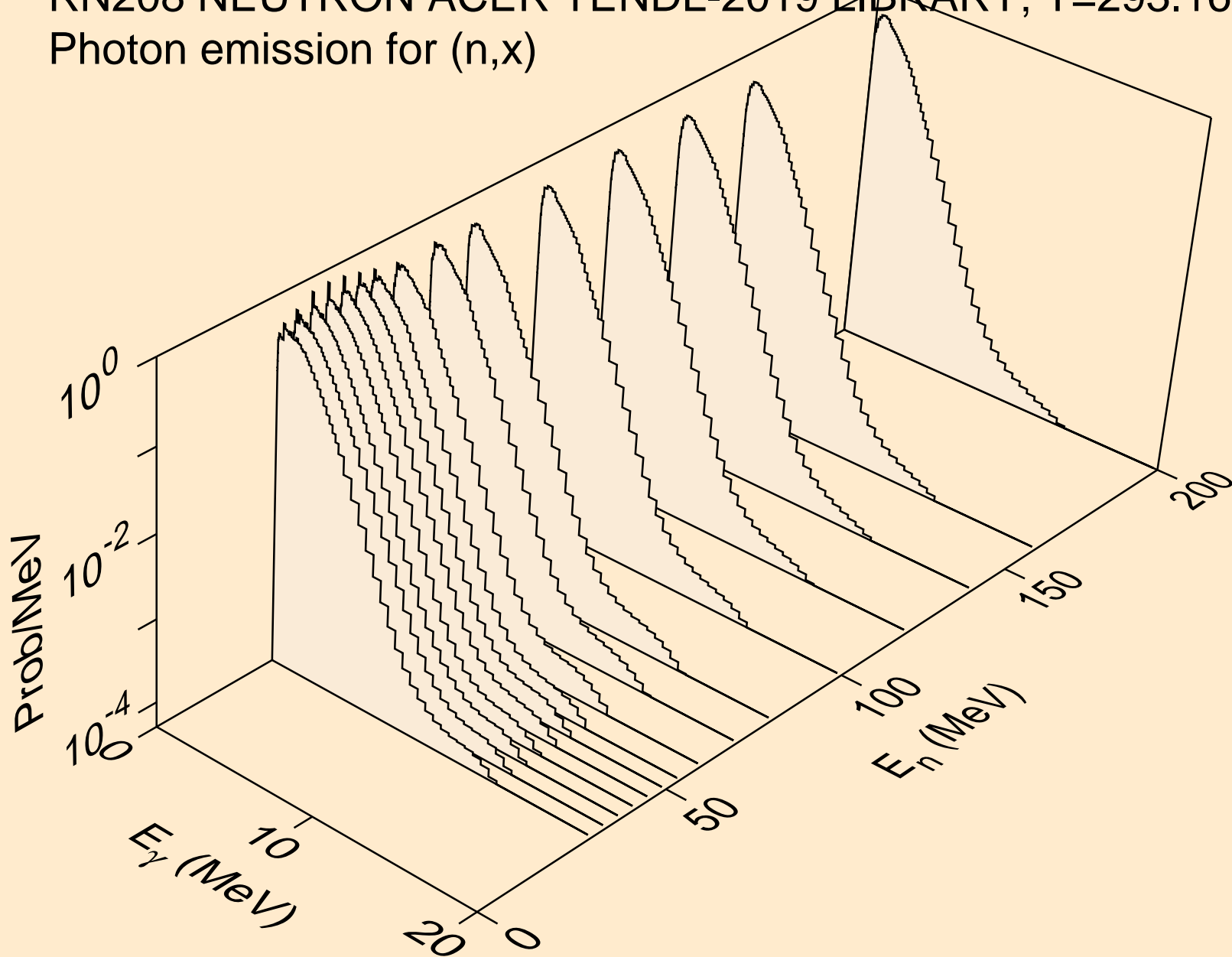

RN208 NEUTRON ACER TENDL-2019 LIBRARY; T=293.16K
Photon emission for (n,2nd)

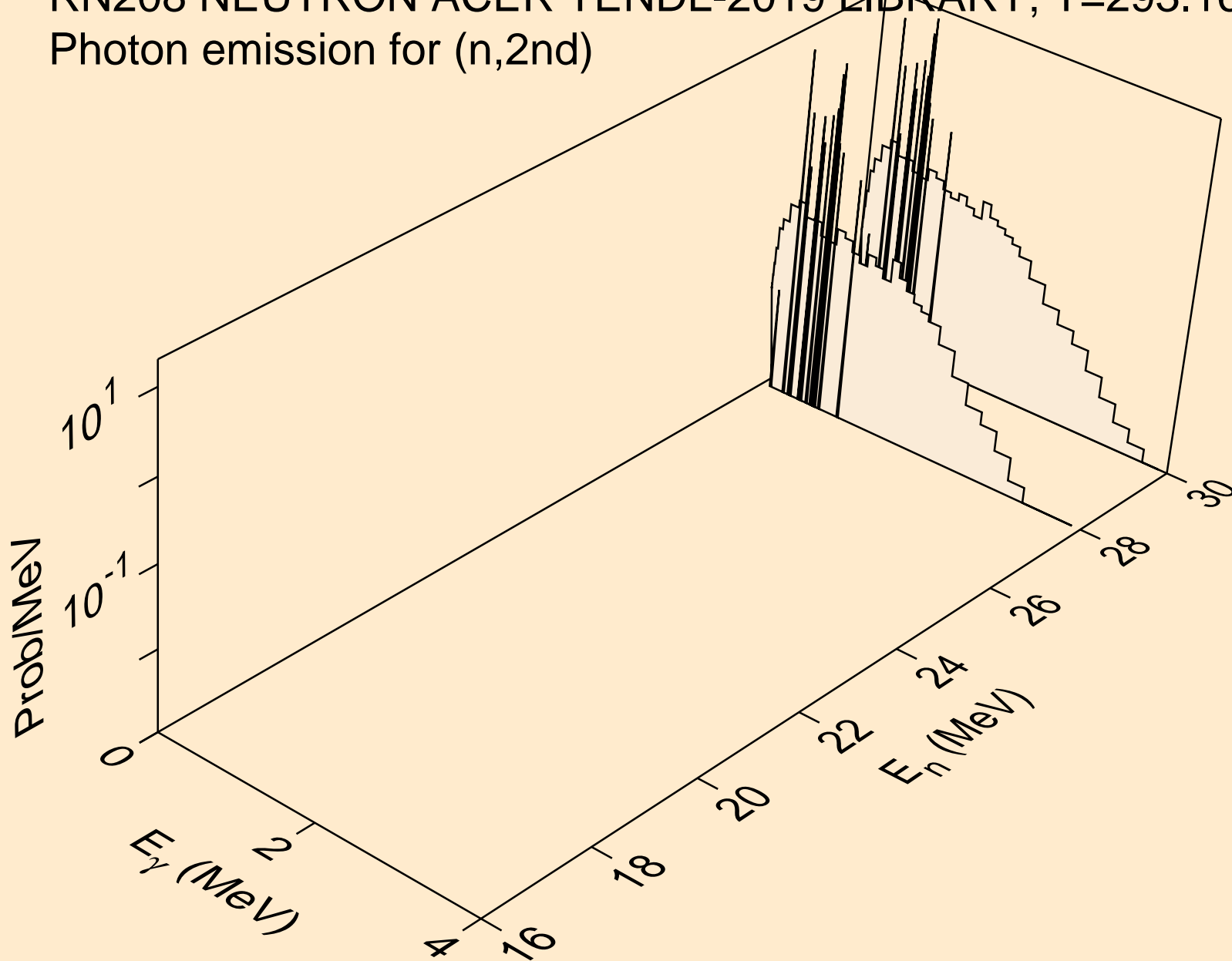

RN208 NEUTRON ACER TENDL-2019 LIBRARY; T=293.16K
Photon emission for (n,2n)

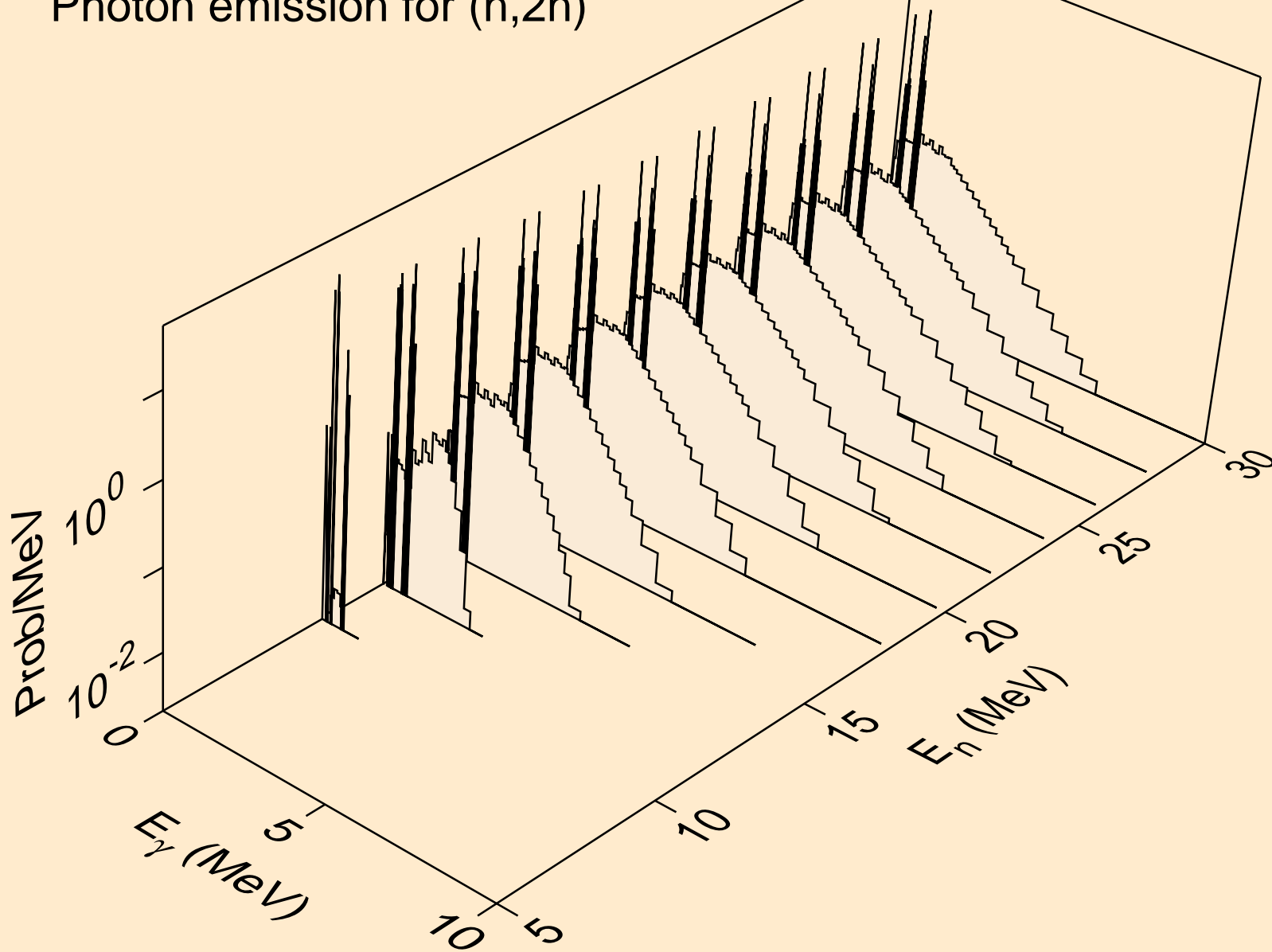

RN208 NEUTRON ACER TENDL-2019 LIBRARY; T=293.16K
Photon emission for (n,3n)

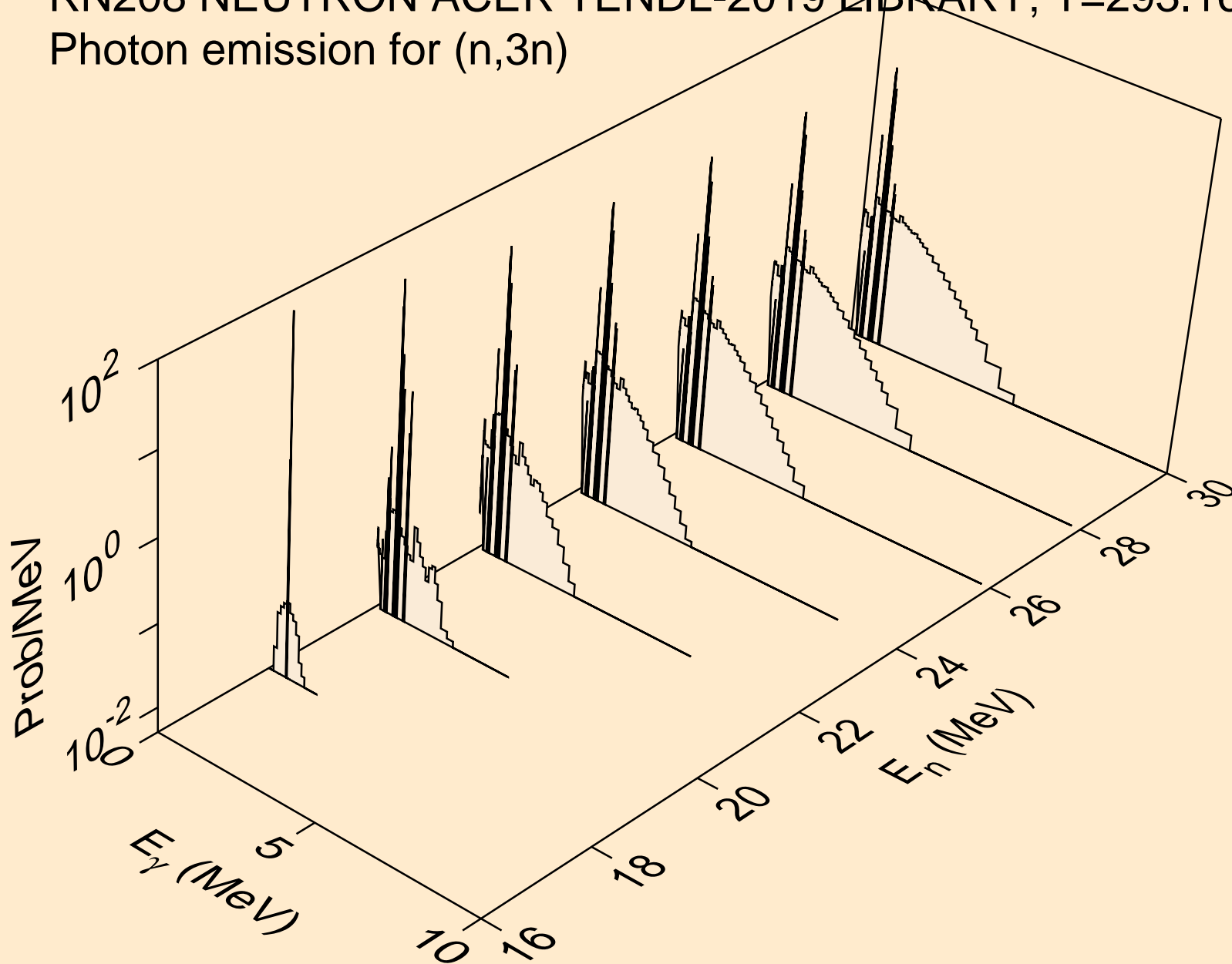

RN208 NEUTRON ACER TENDL-2019 LIBRARY; T=293.16K
Photon emission for (n,n*)a

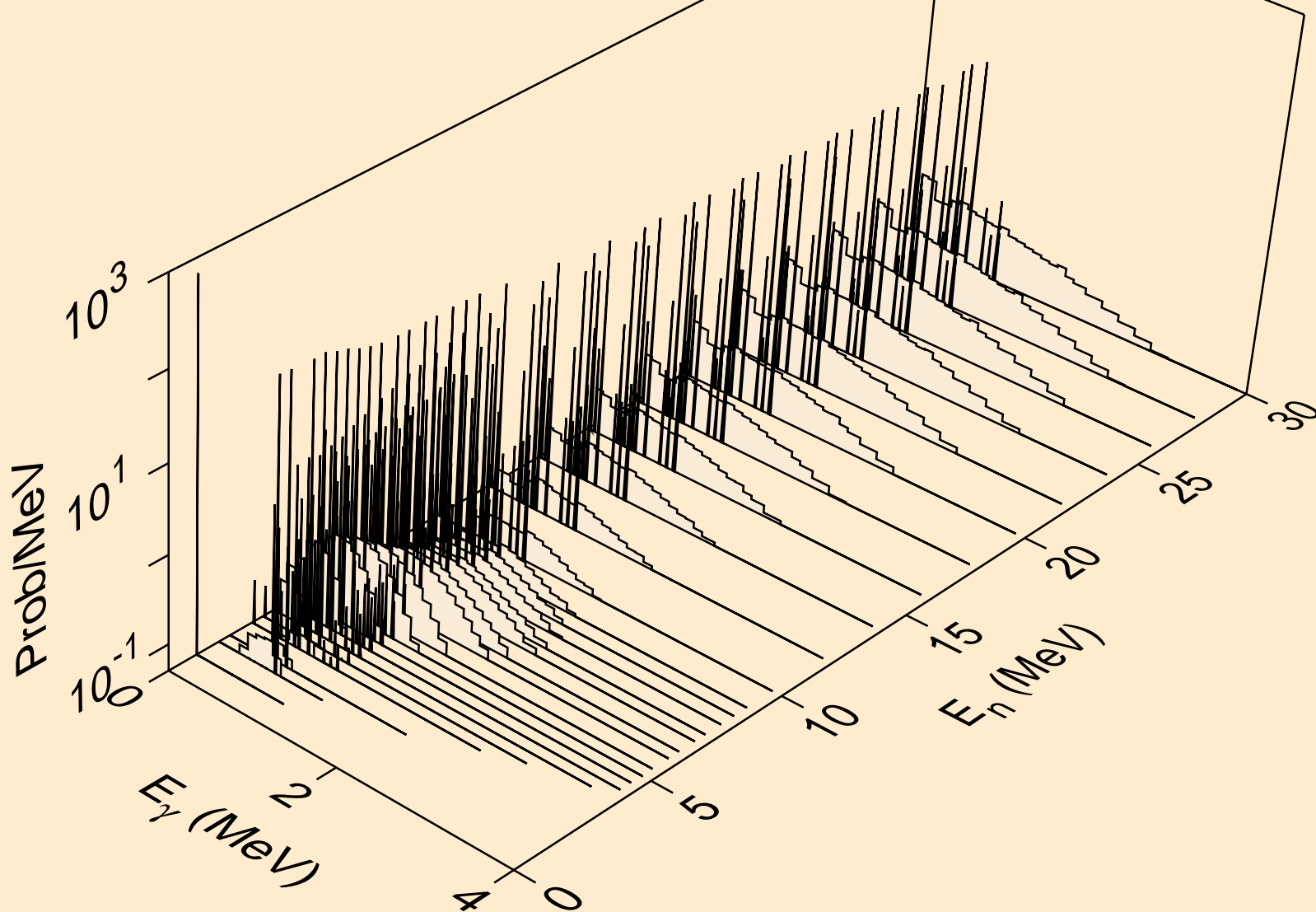

RN208 NEUTRON ACER TENDL-2019 LIBRARY; T=293.16K
Photon emission for (n,2n)a

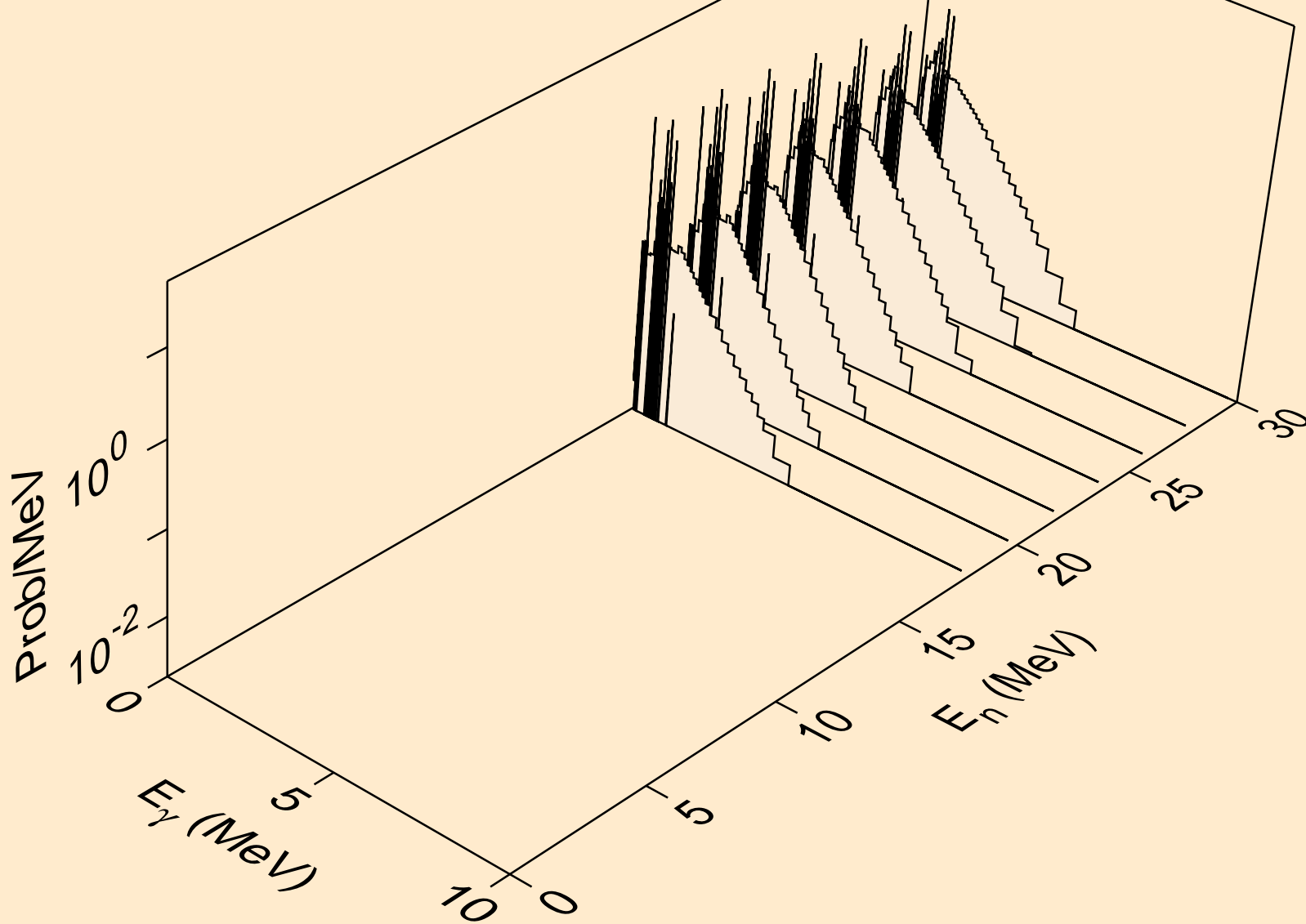

RN208 NEUTRON ACER TENDL-2019 LIBRARY; T=293.16K
Photon emission for (n,3n)a

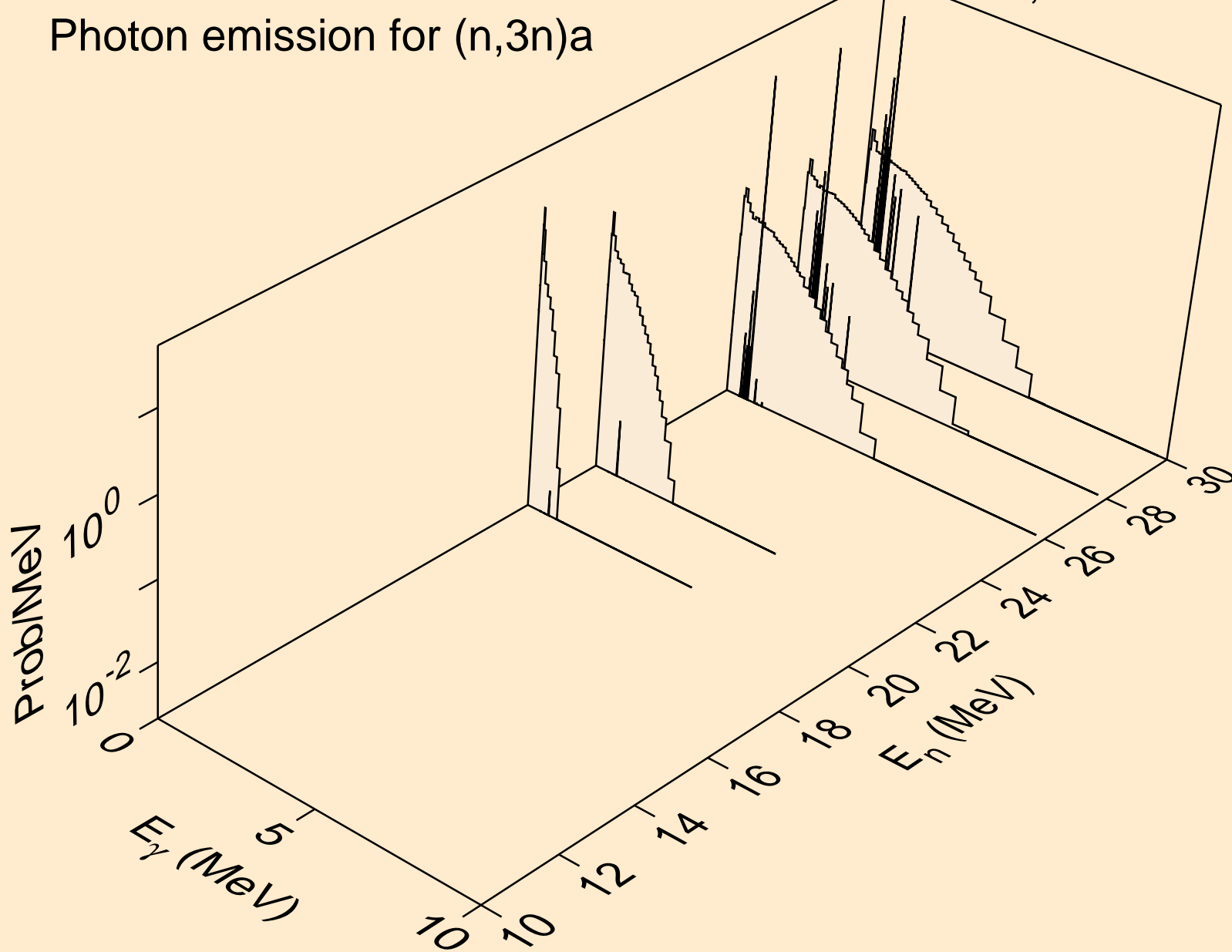

RN208 NEUTRON ACER TENDL-2019 LIBRARY; T=293.16K
Photon emission for (n,n*)p

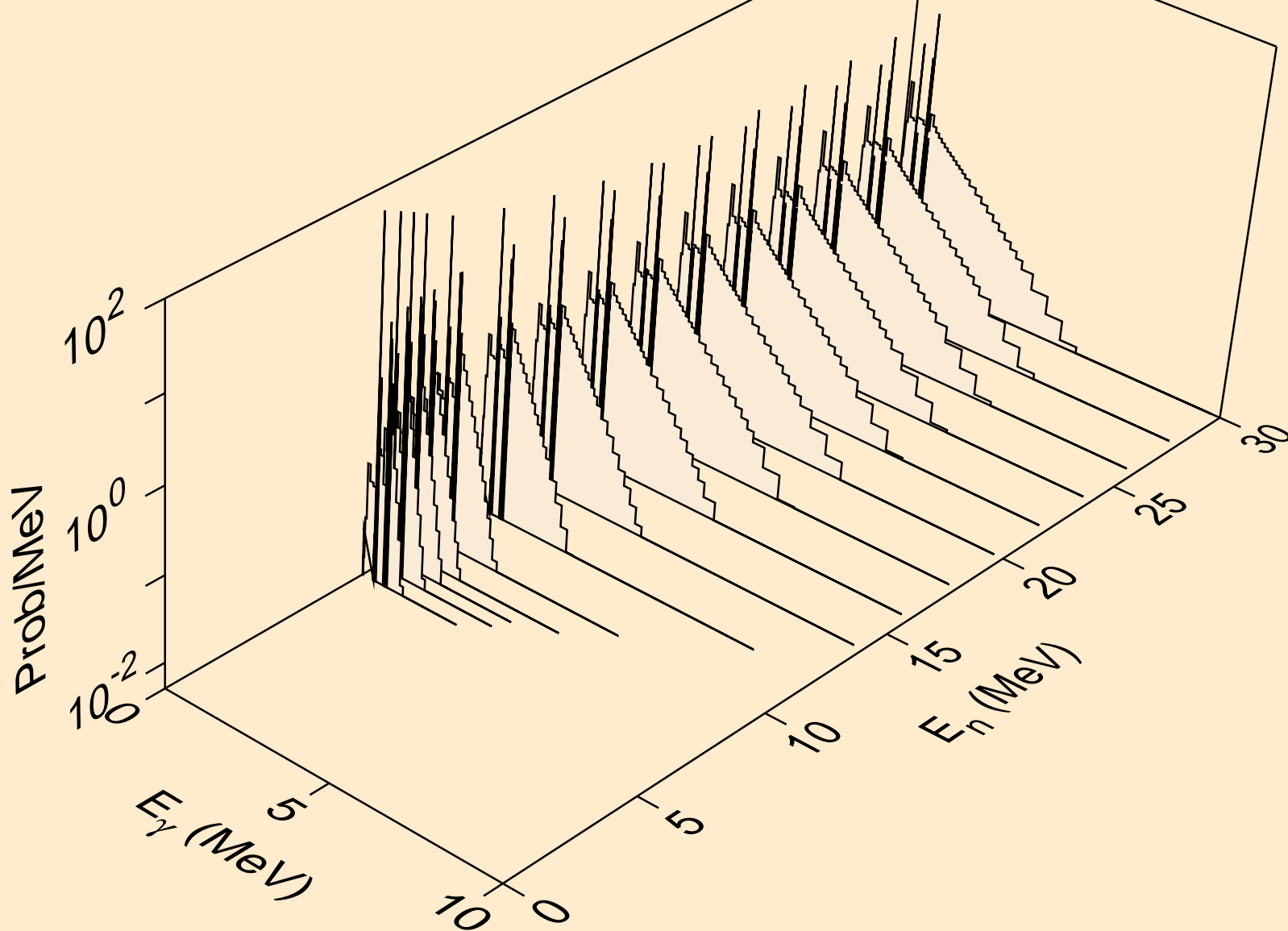

RN208 NEUTRON ACER TENDL-2019 LIBRARY; T=293.16K
Photon emission for (n,n*)2a

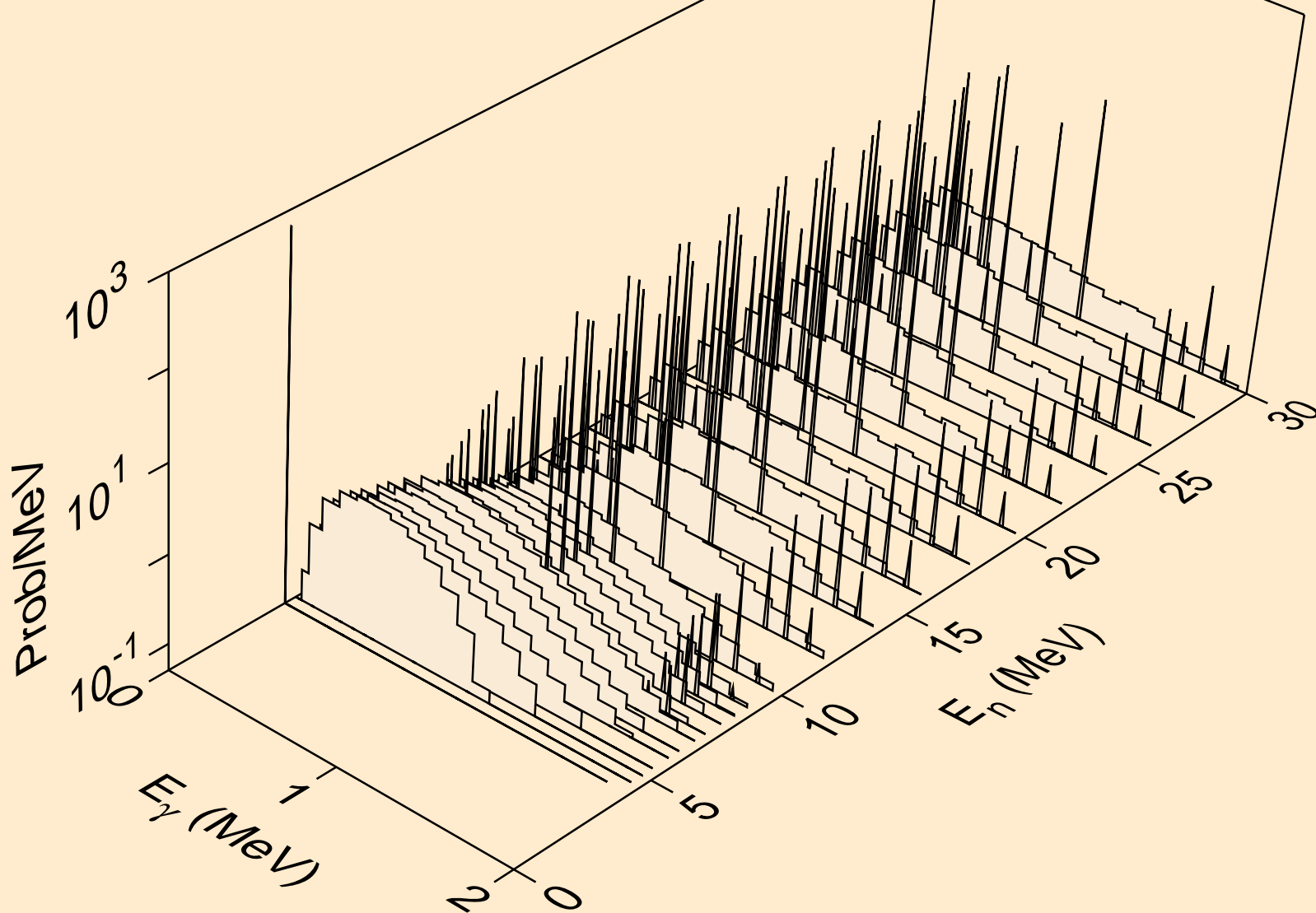

RN208 NEUTRON ACER TENDL-2019 LIBRARY; T=293.16K
Photon emission for (n,2n)2a

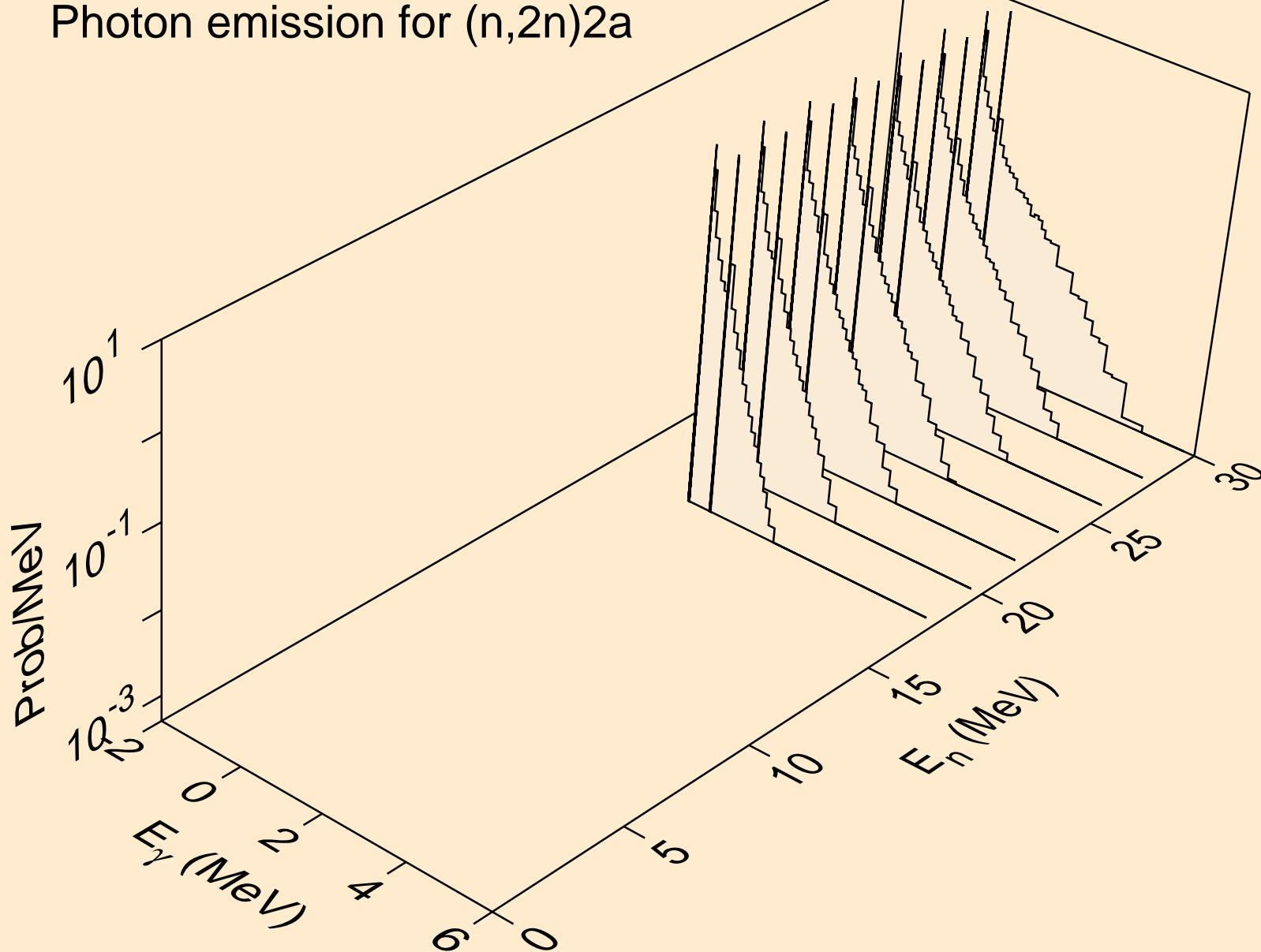

RN208 NEUTRON ACER TENDL-2019 LIBRARY; T=293.16K
Photon emission for (n,n*)d

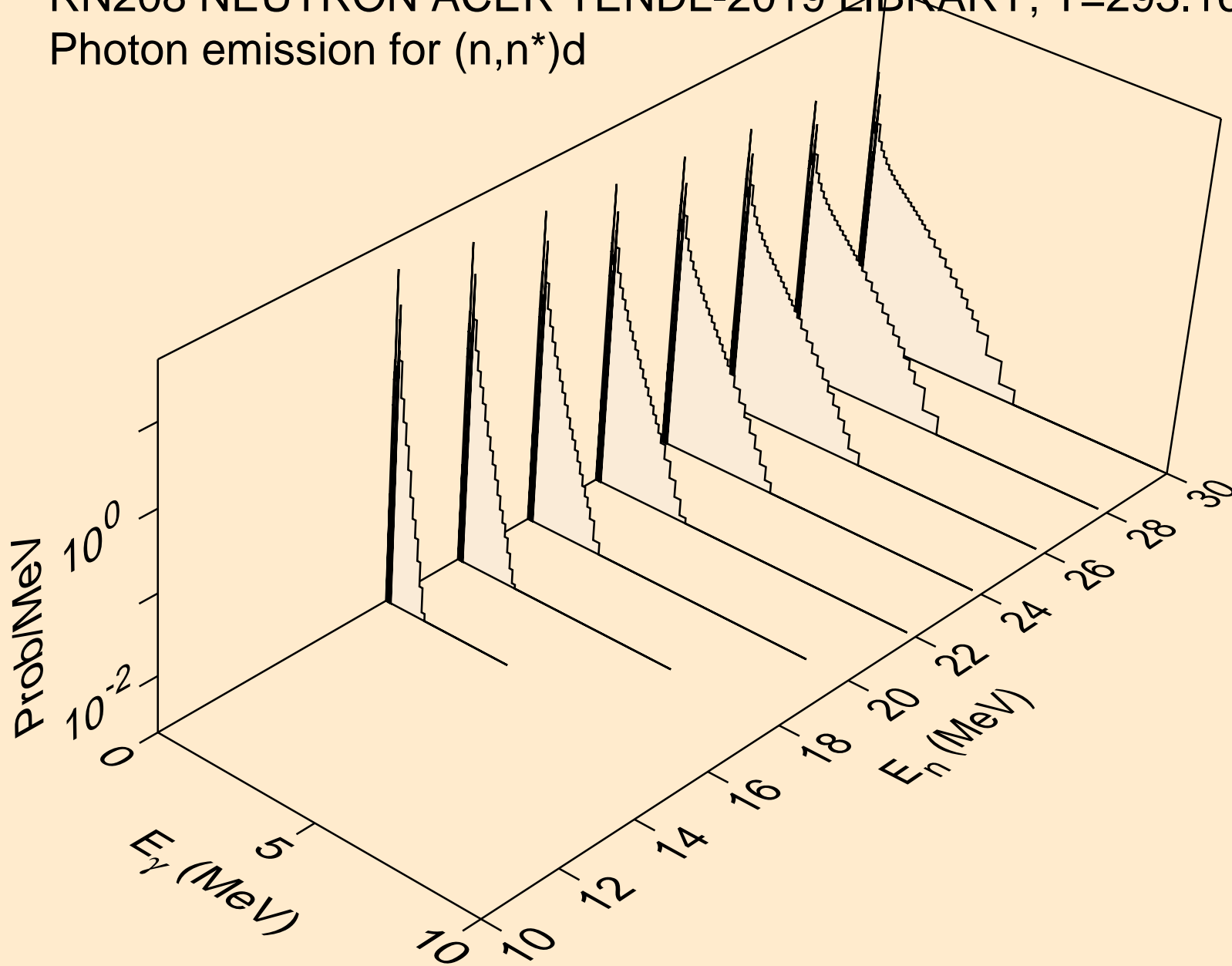

RN208 NEUTRON ACER TENDL-2019 LIBRARY; T=293.16K
Photon emission for (n,n*)t

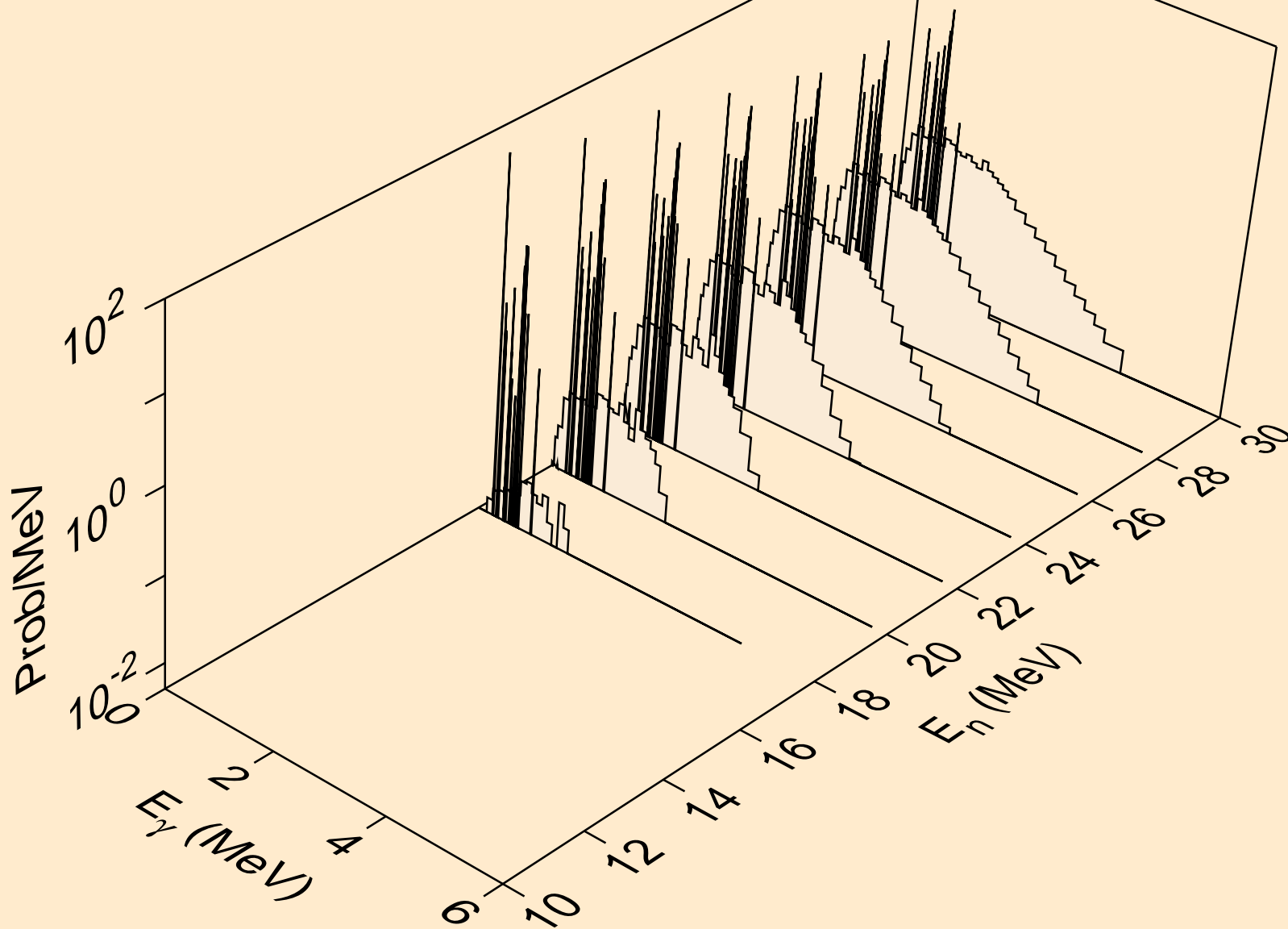

RN208 NEUTRON ACER TENDL-2019 LIBRARY; T=293.16K
Photon emission for (n,n*)he3

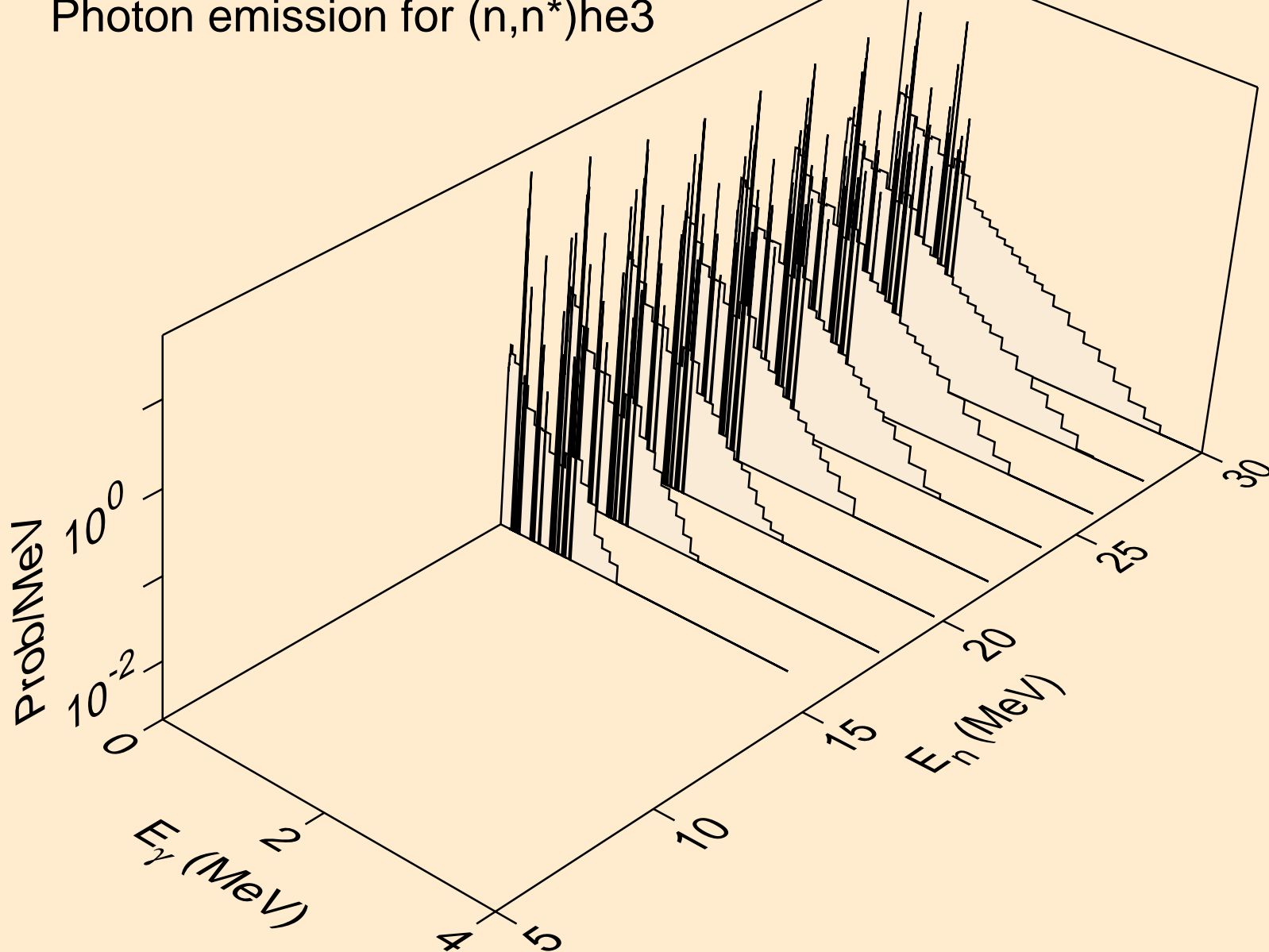

RN208 NEUTRON ACER TENDL-2019 LIBRARY; T=293.16K
Photon emission for (n,4n)

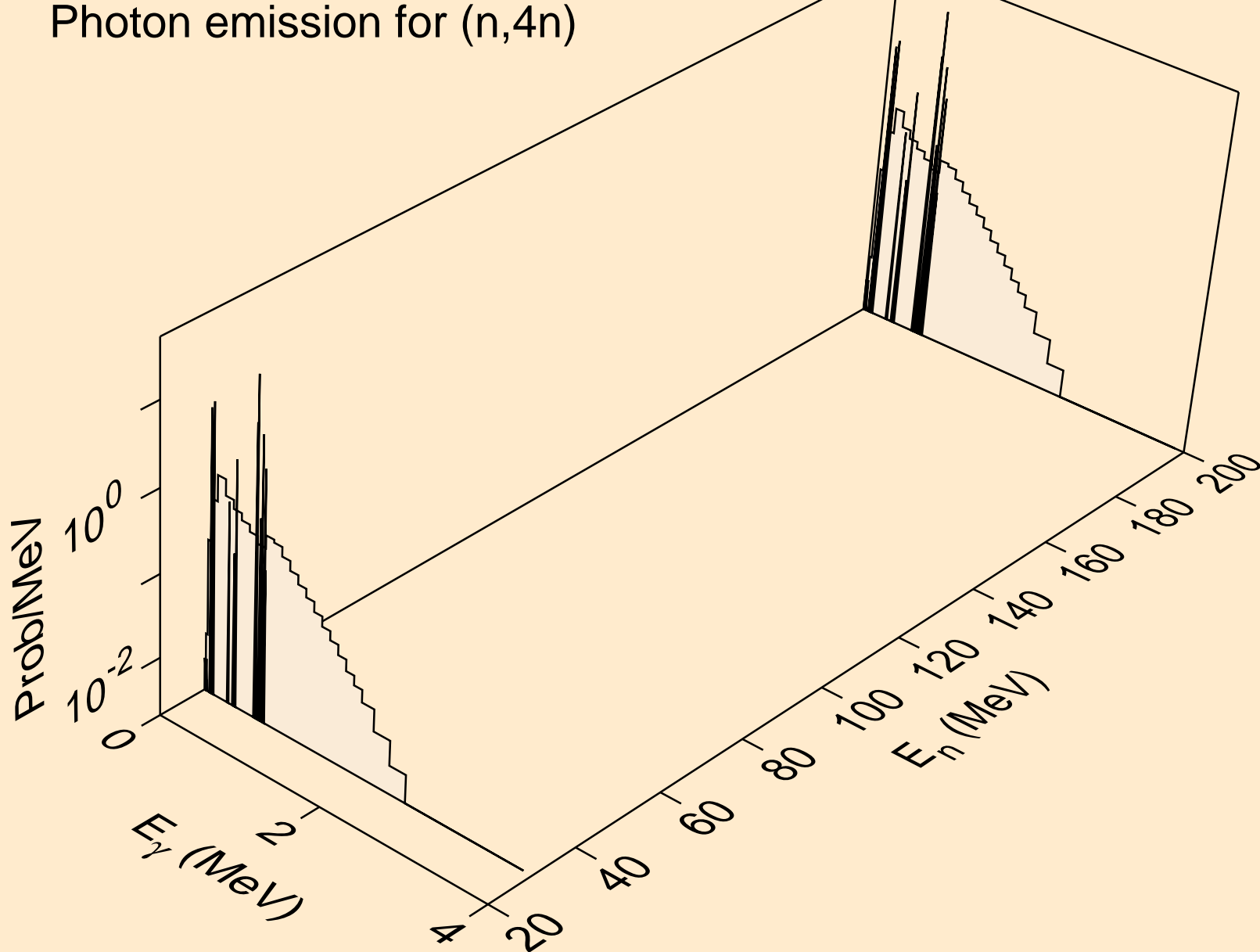

RN208 NEUTRON ACER TENDL-2019 LIBRARY; T=293.16K
Photon emission for (n,2np)

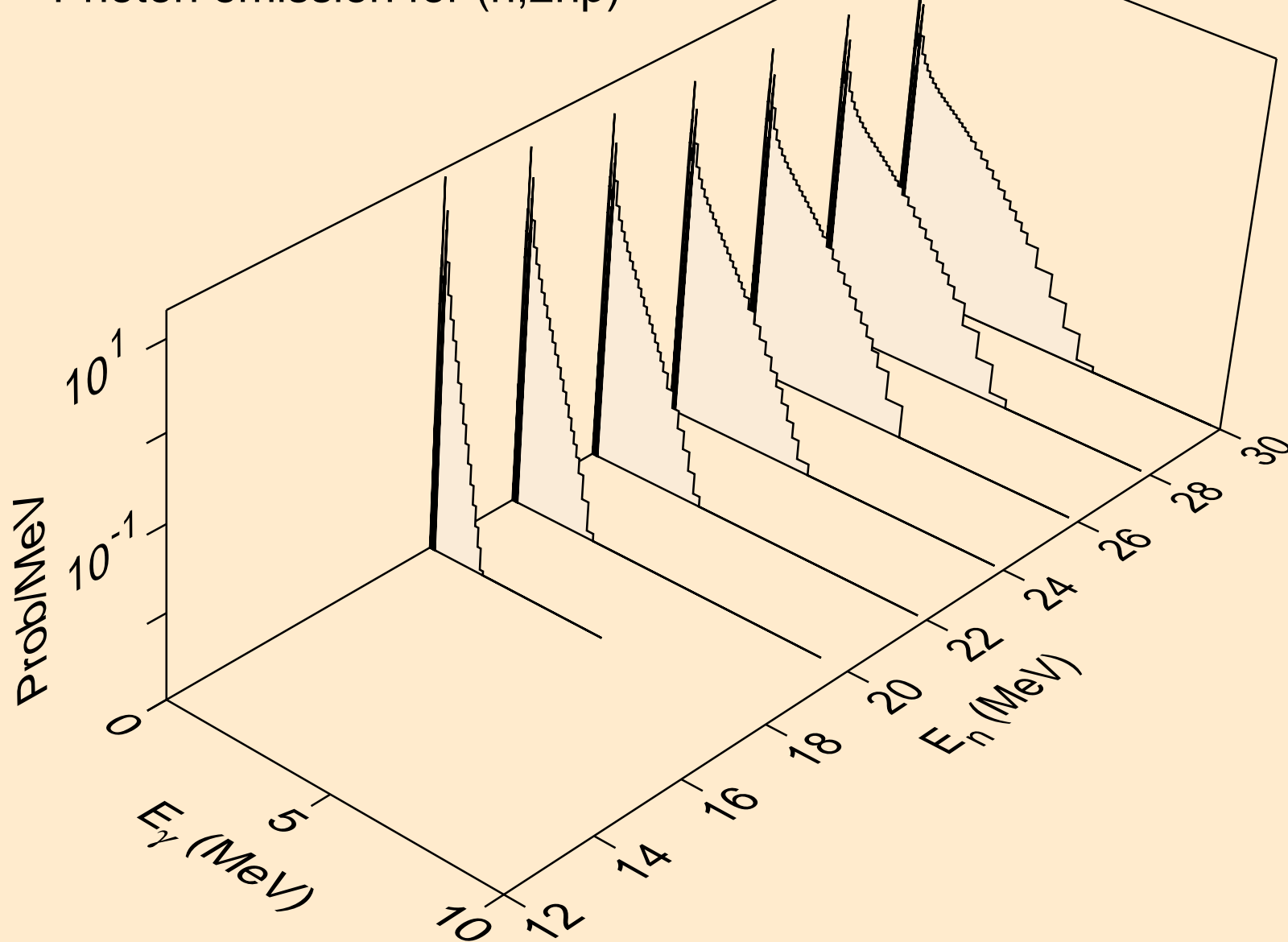

RN208 NEUTRON ACER TENDL-2019 LIBRARY; T=293.16K
Photon emission for (n,3np)

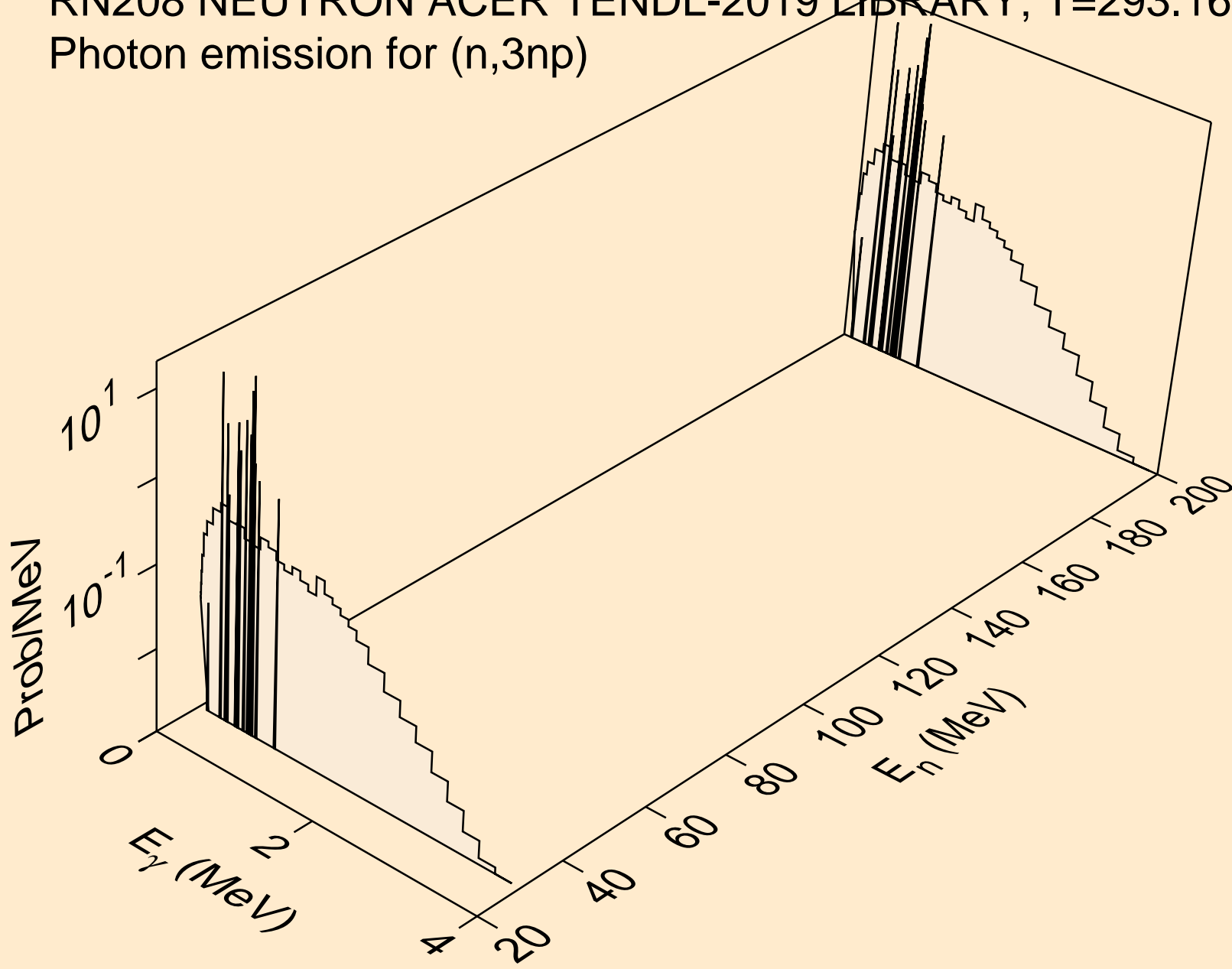

RN208 NEUTRON ACER TENDL-2019 LIBRARY; T=293.16K
Photon emission for (n,2np)

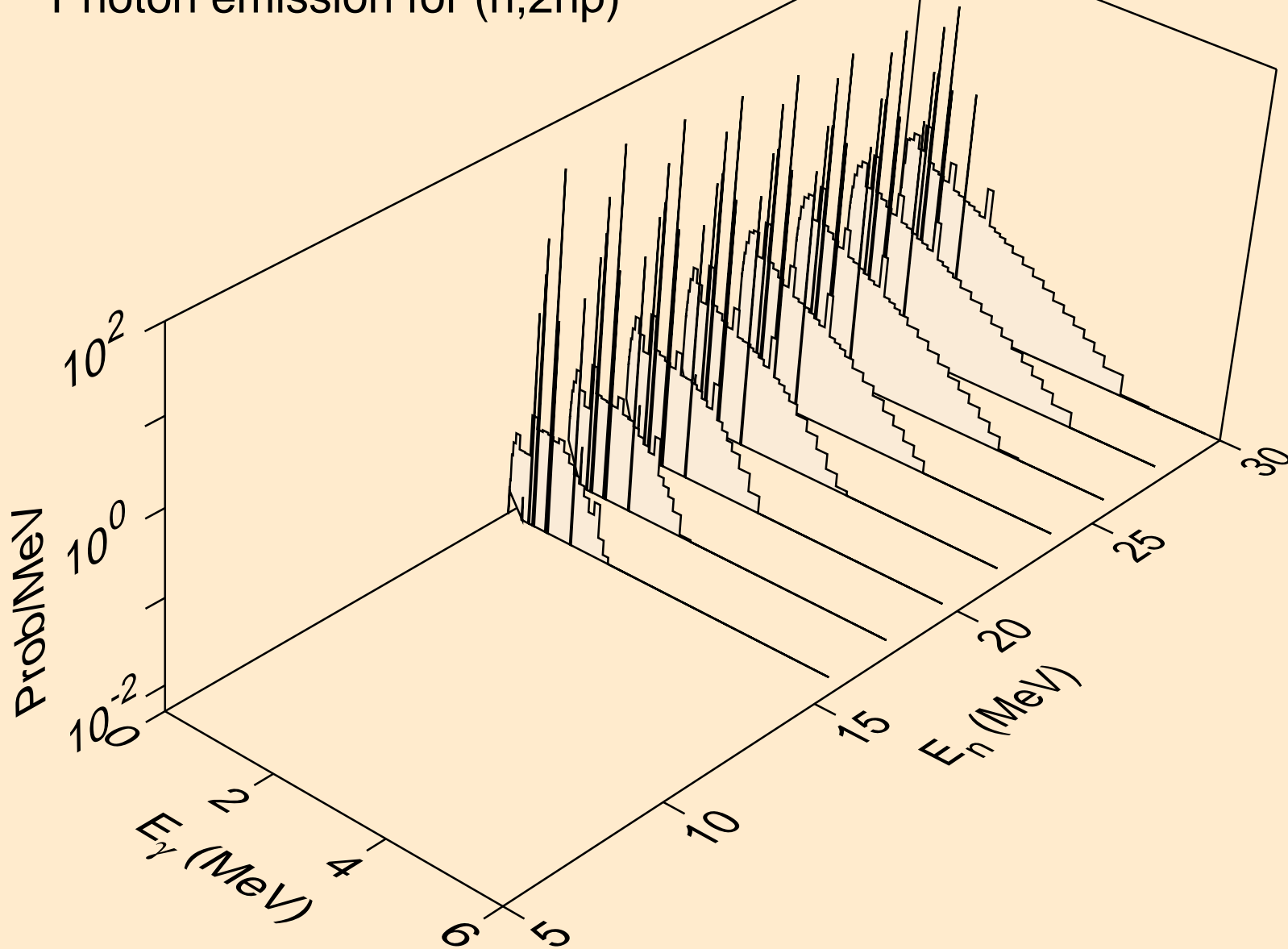

RN208 NEUTRON ACER TENDL-2019 LIBRARY; T=293.16K
Photon emission for (n,npa)

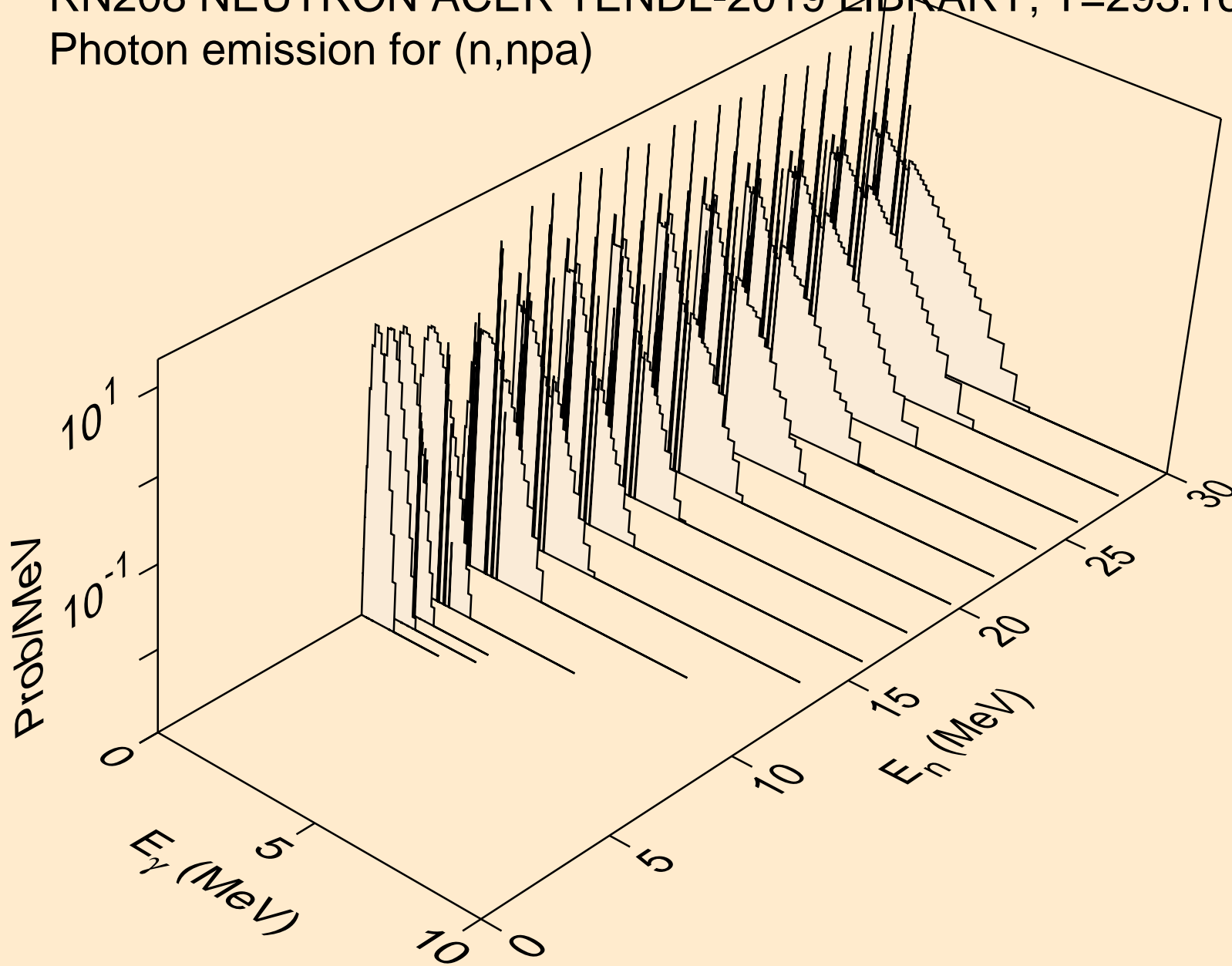

RN208 NEUTRON ACER TENDL-2019 LIBRARY; T=293.16K
Photon emission for (n,n*c)

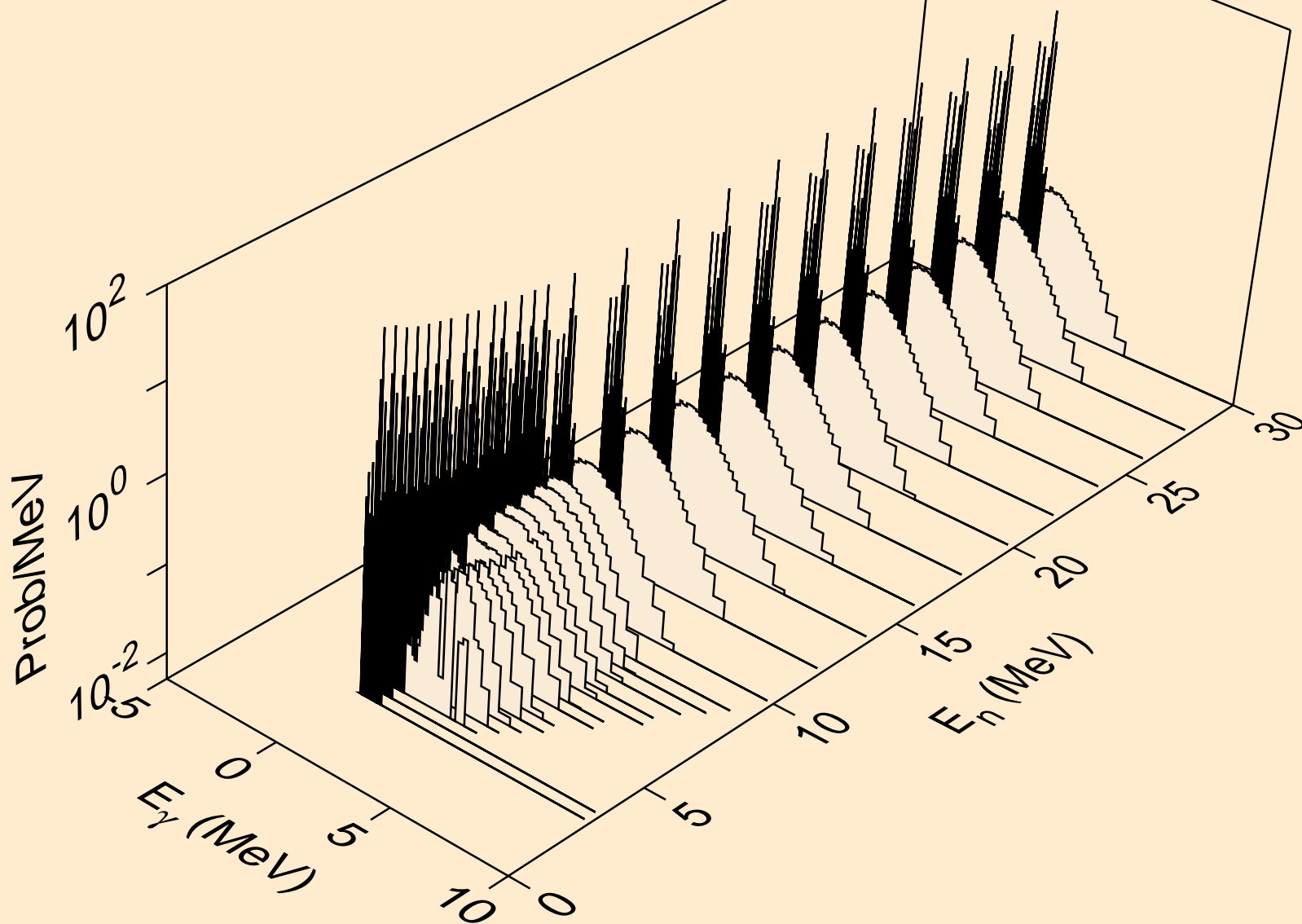

RN208 NEUTRON ACER TENDL-2019 LIBRARY; T=293.16K
Photon emission for (n,gma)

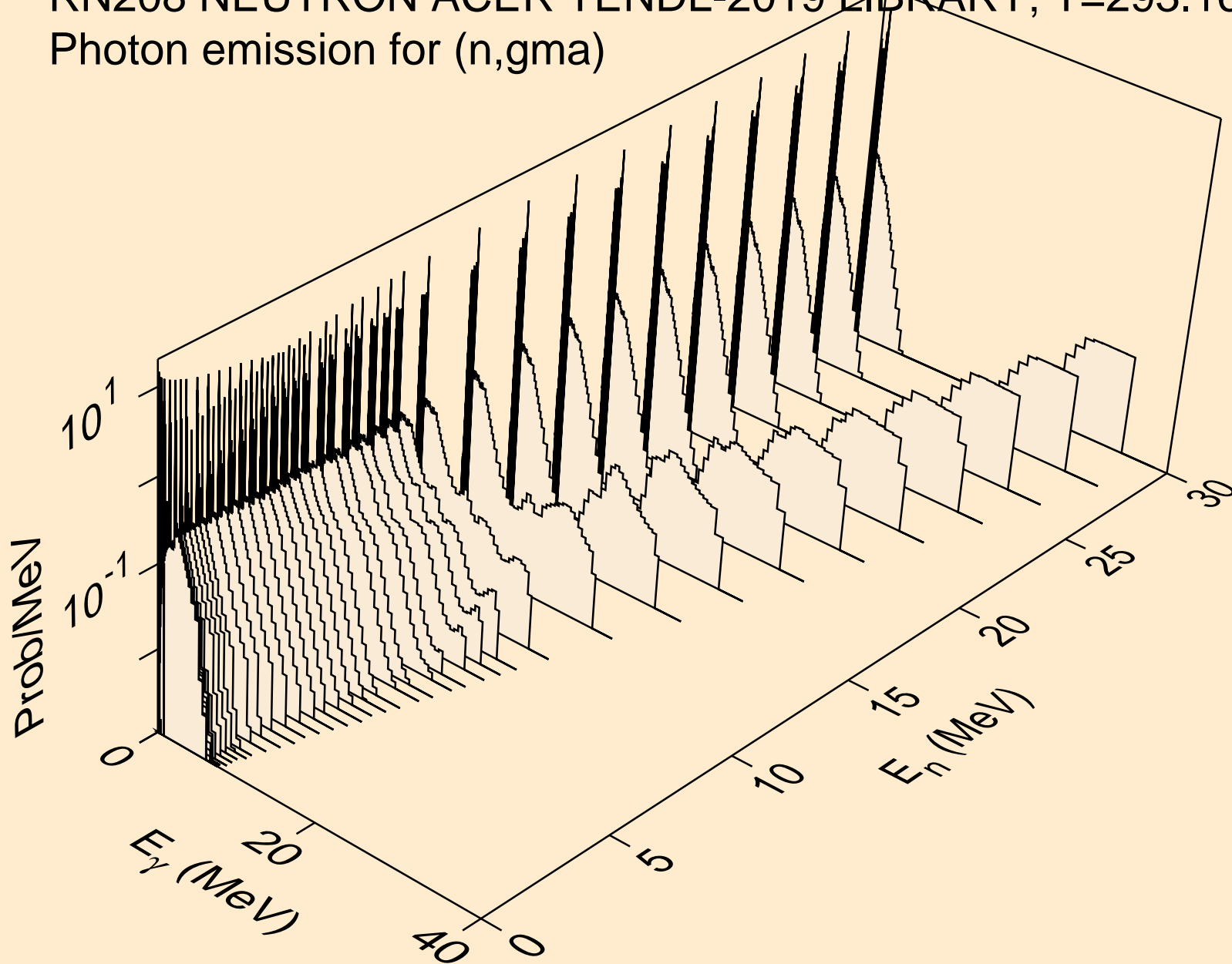

RN208 NEUTRON ACER TENDL-2019 LIBRARY; T=293.16K
Photon emission for (n,p)

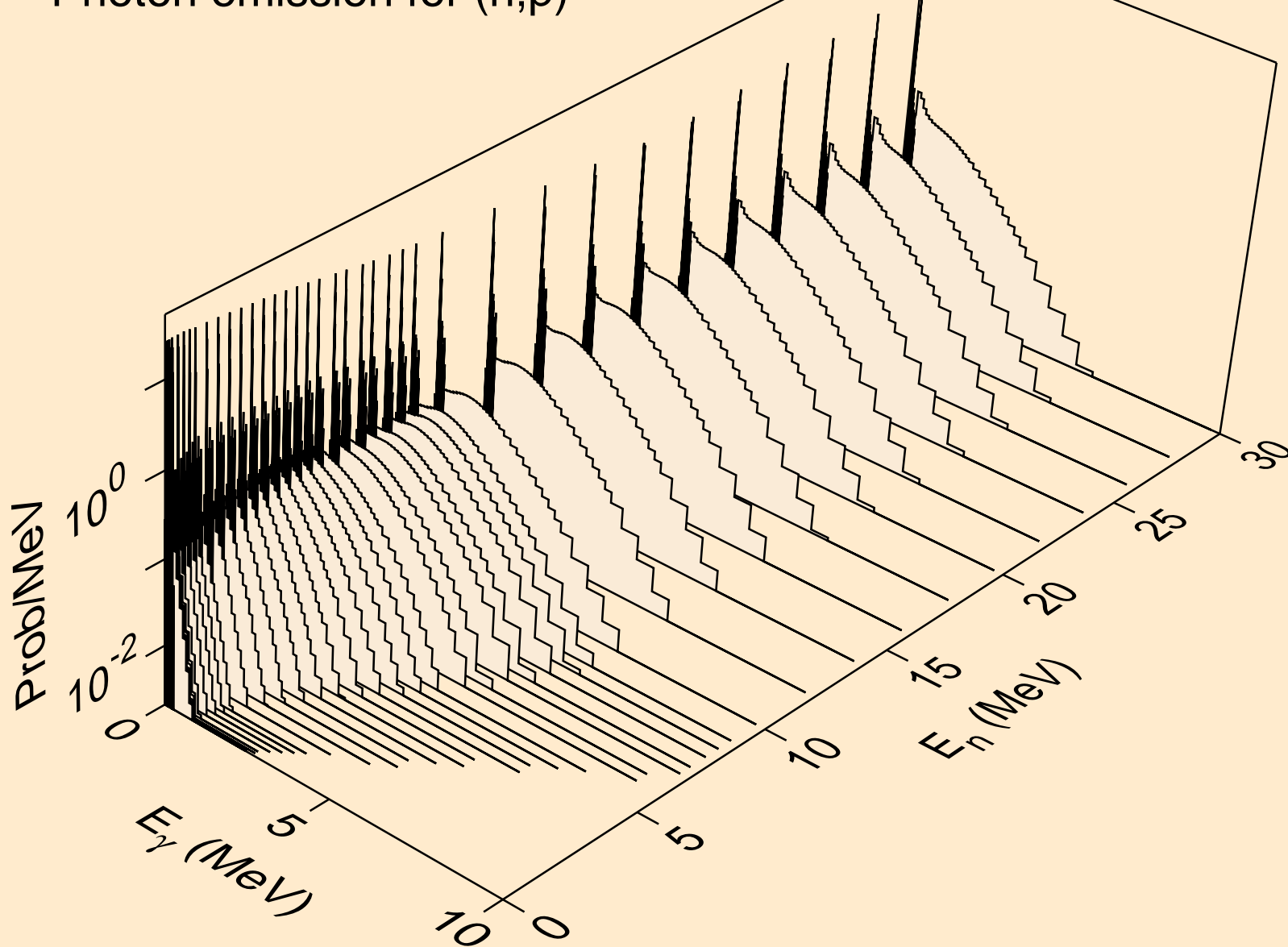

RN208 NEUTRON ACER TENDL-2019 LIBRARY; T=293.16K
Photon emission for (n,d)

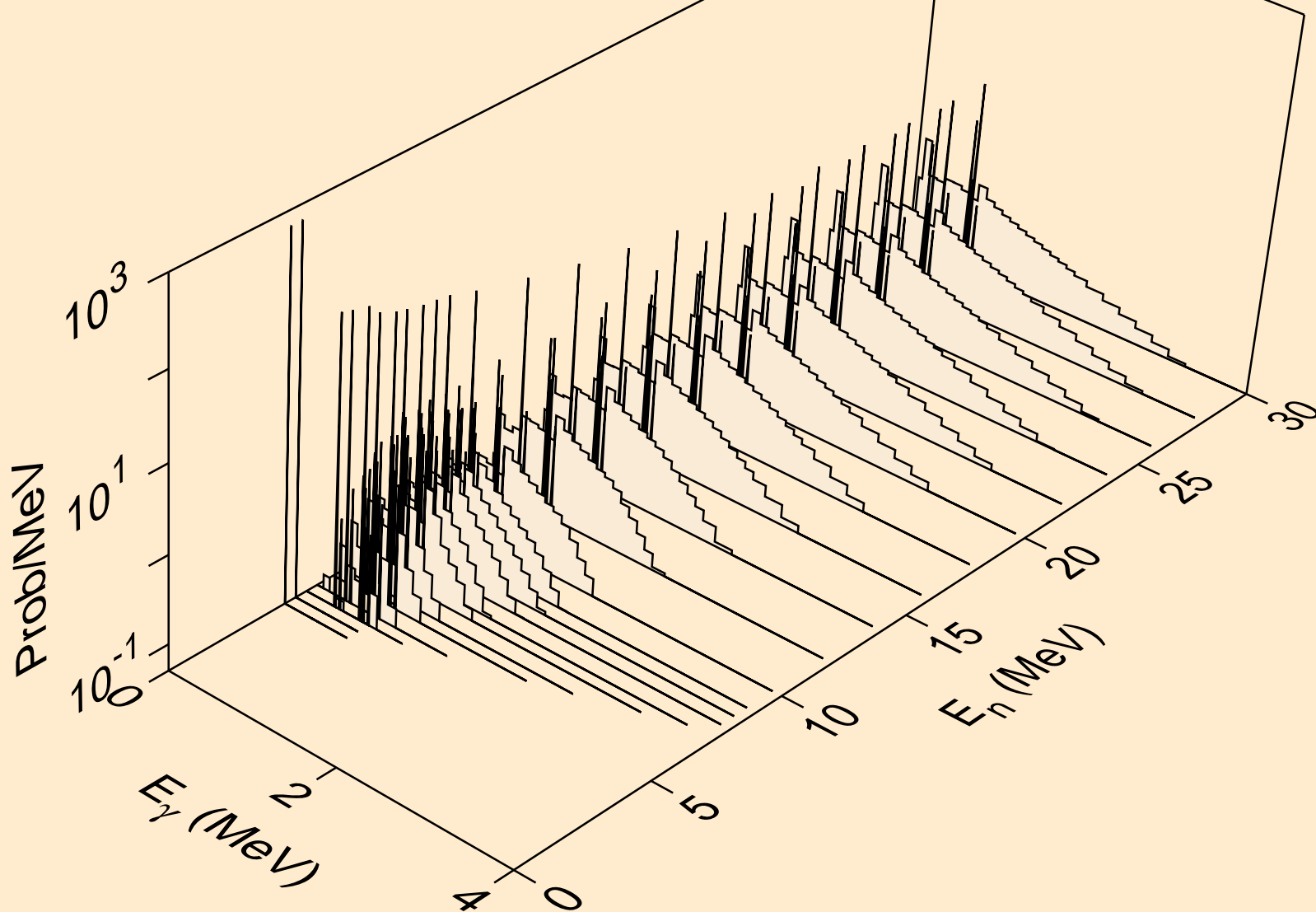

RN208 NEUTRON ACER TENDL-2019 LIBRARY; T=293.16K
Photon emission for (n,t)

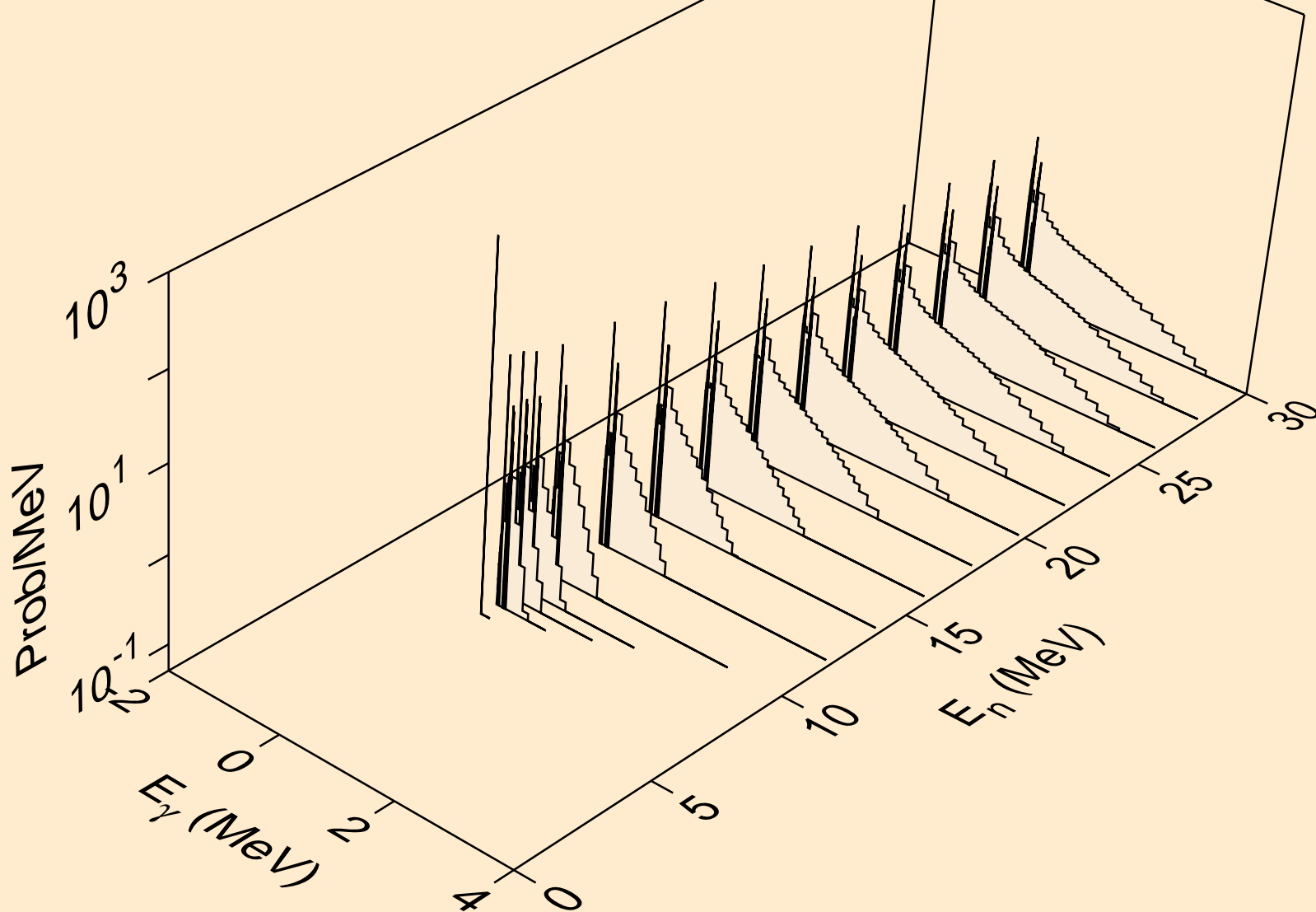

RN208 NEUTRON ACER TENDL-2019 LIBRARY; T=293.16K
Photon emission for (n,he3)

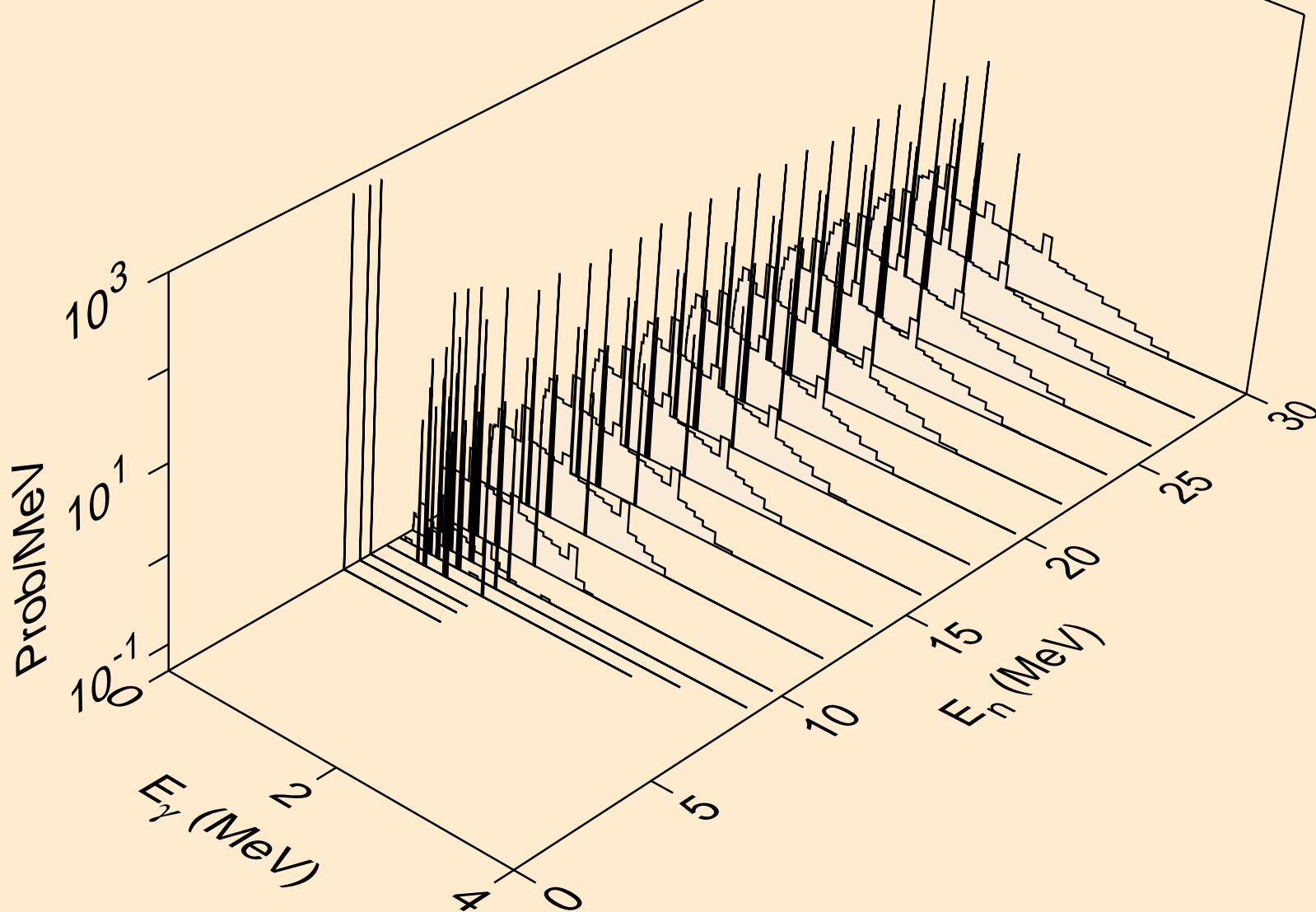

RN208 NEUTRON ACER TENDL-2019 LIBRARY; T=293.16K
Photon emission for (n,a)

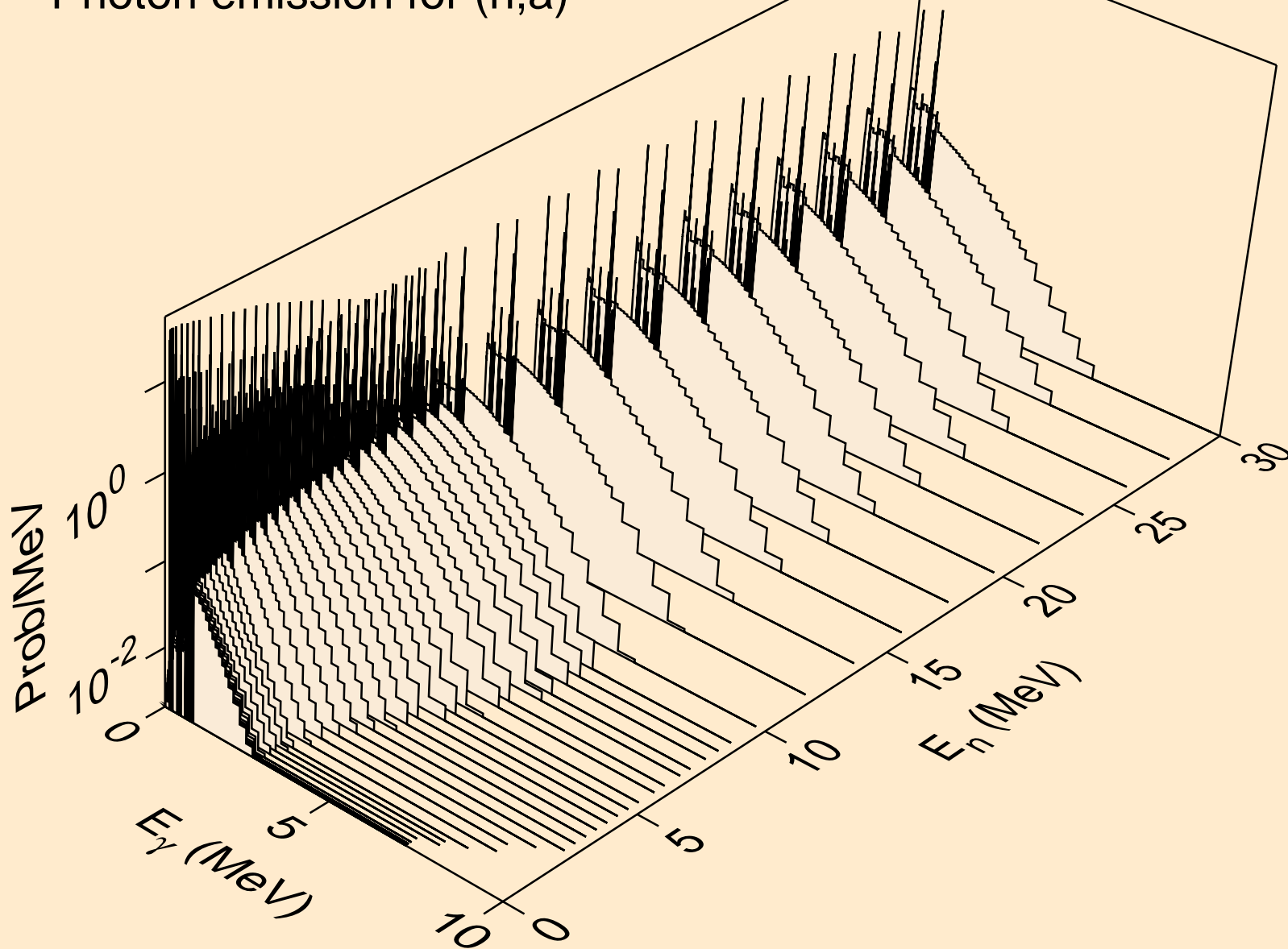

RN208 NEUTRON ACER TENDL-2019 LIBRARY; T=293.16K
Photon emission for (n,2a)

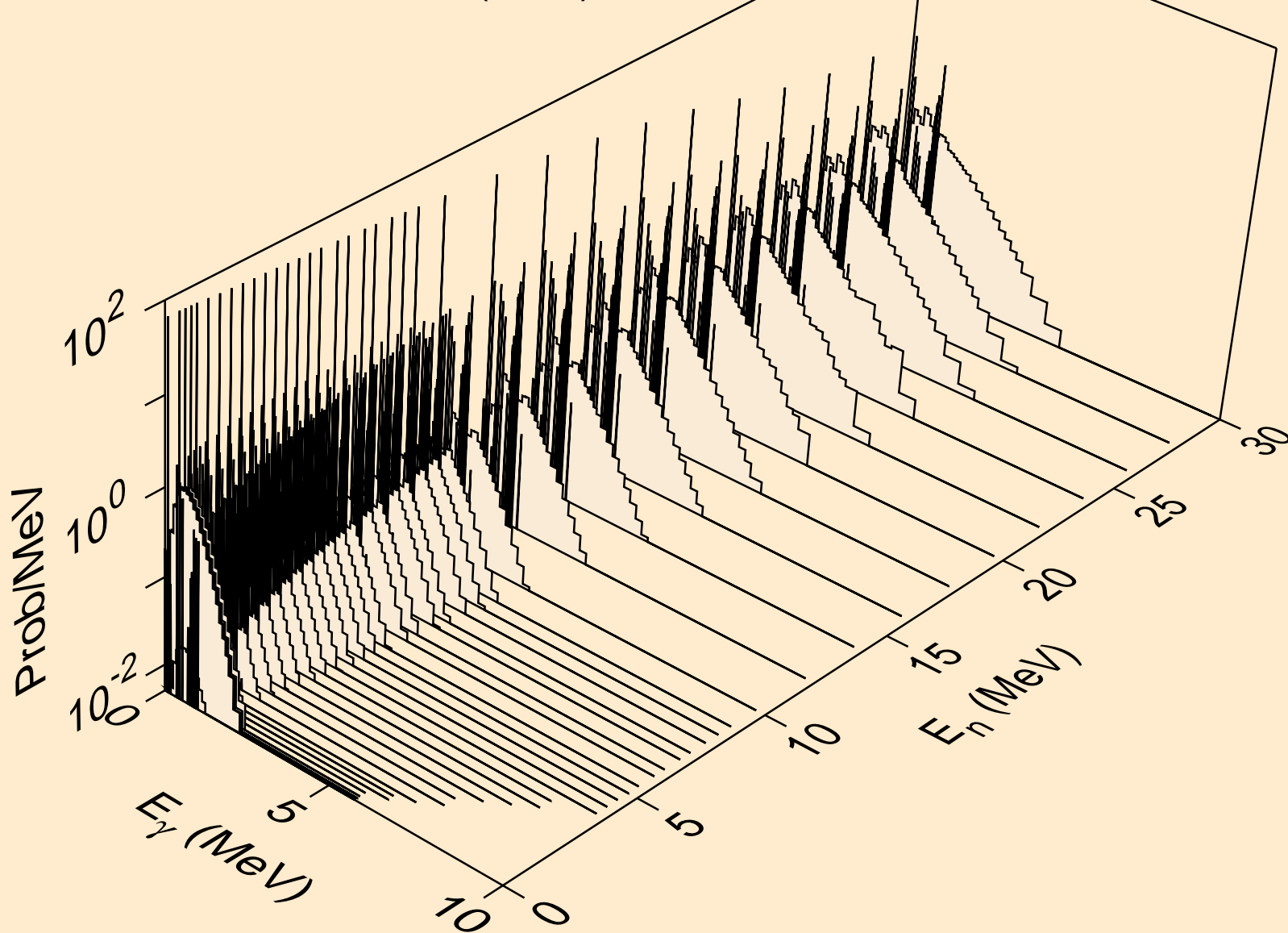

RN208 NEUTRON ACER TENDL-2019 LIBRARY; T=293.16K
Photon emission for (n,2p)

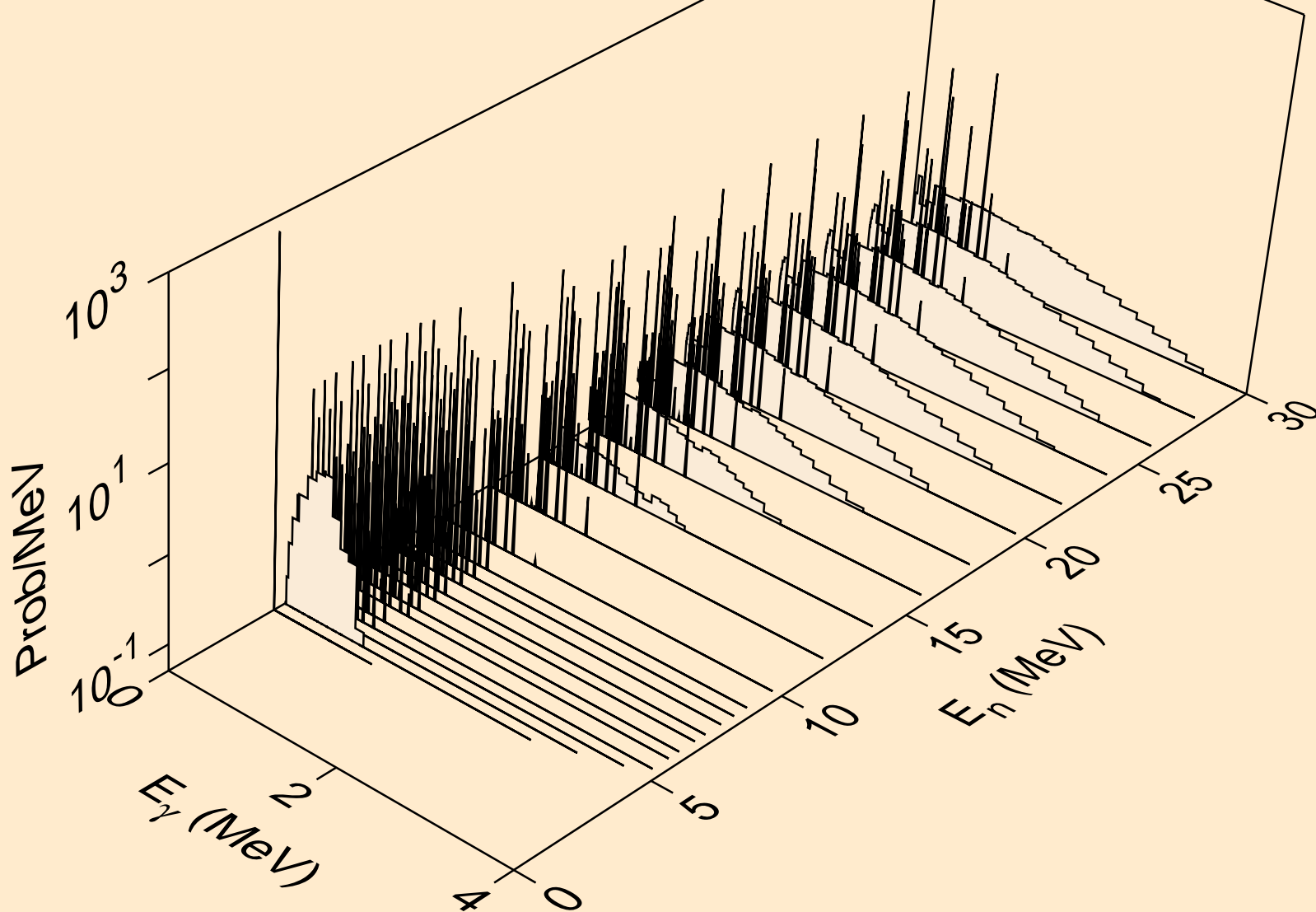

RN208 NEUTRON ACER TENDL-2019 LIBRARY; T=293.16K
Photon emission for (n,p α)

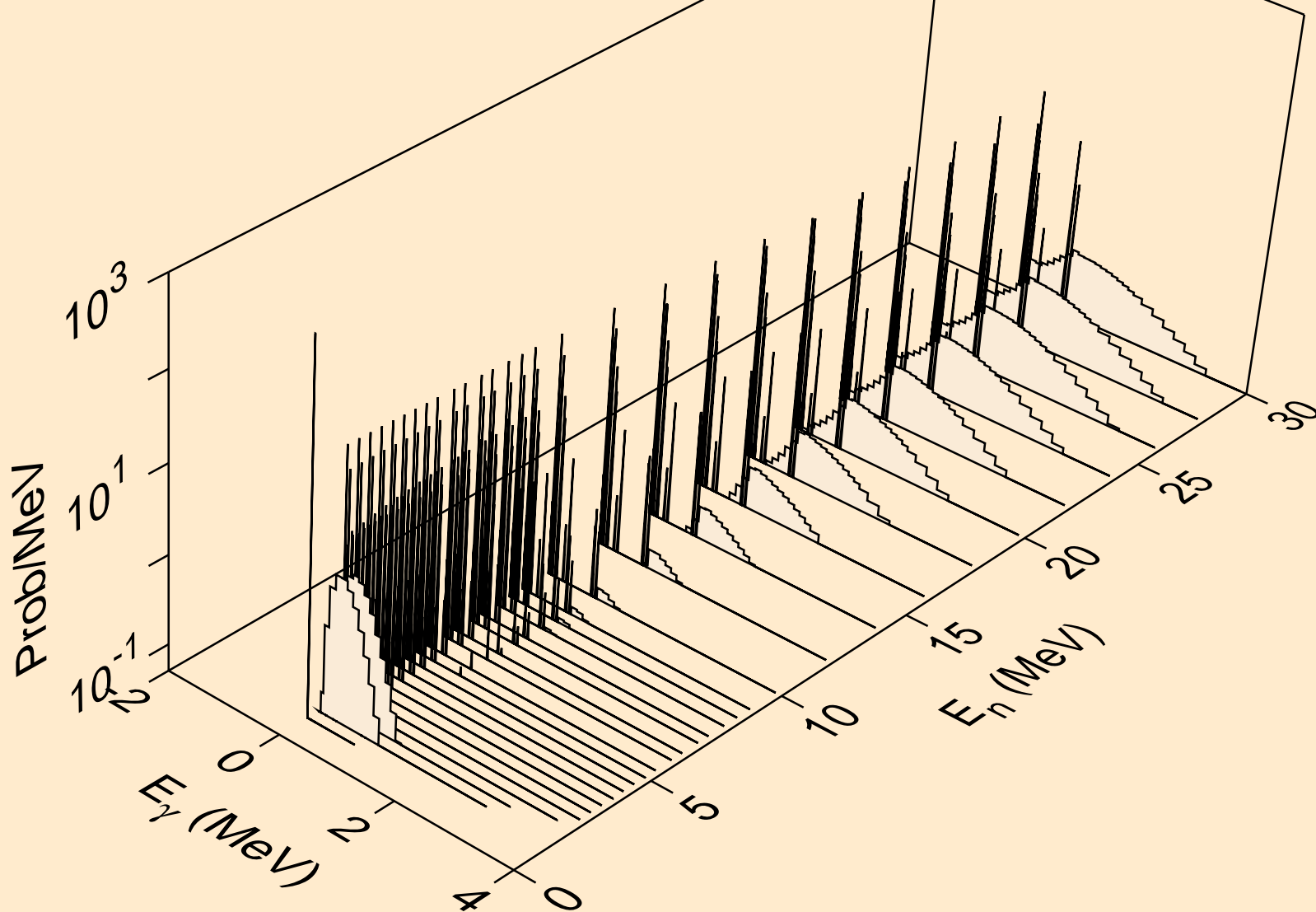

RN208 NEUTRON ACER TENDL-2019 LIBRARY; T=293.16K
Photon emission for (n,pd)

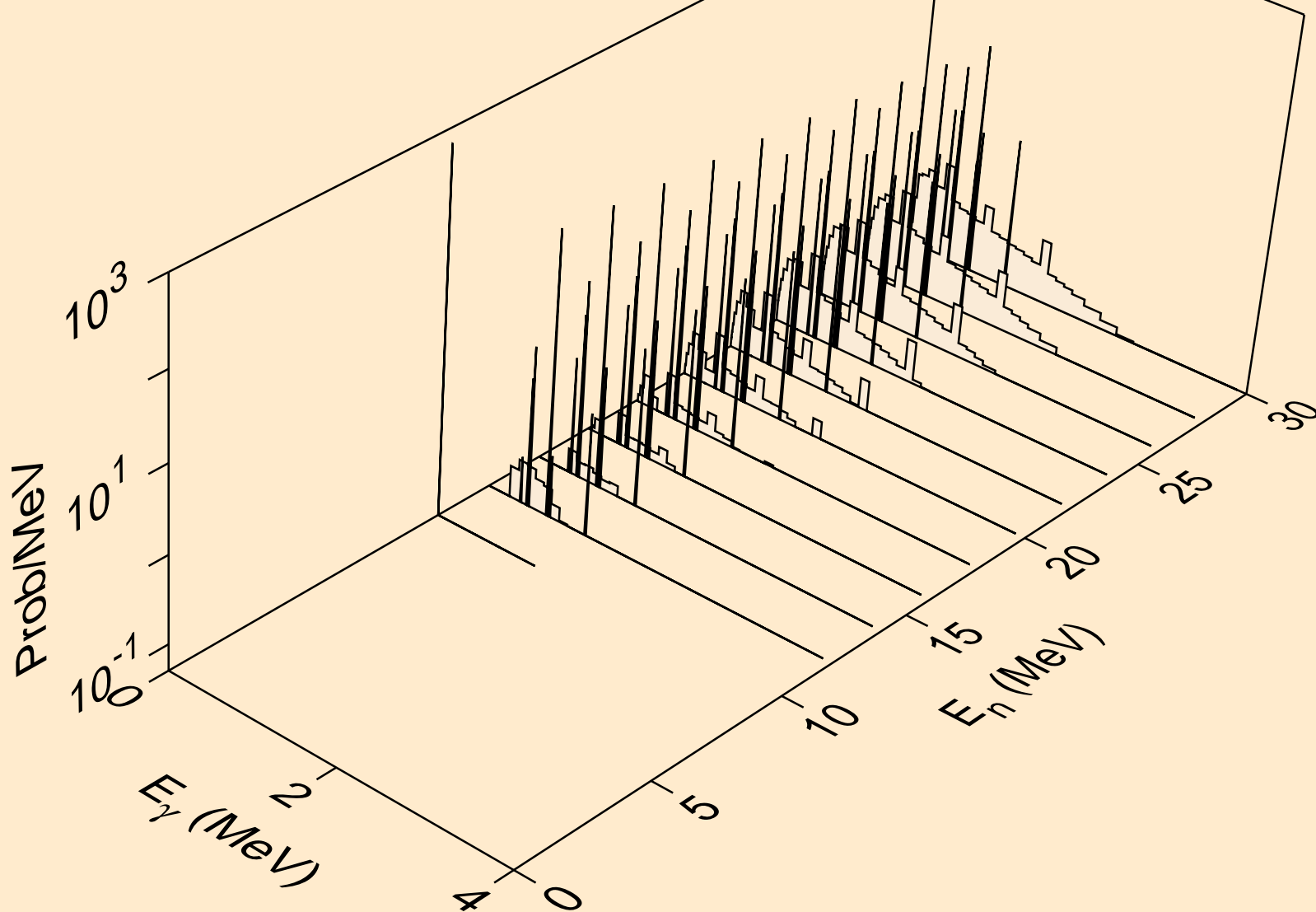

RN208 NEUTRON ACER TENDL-2019 LIBRARY; T=293.16K
Photon emission for (n,pt)

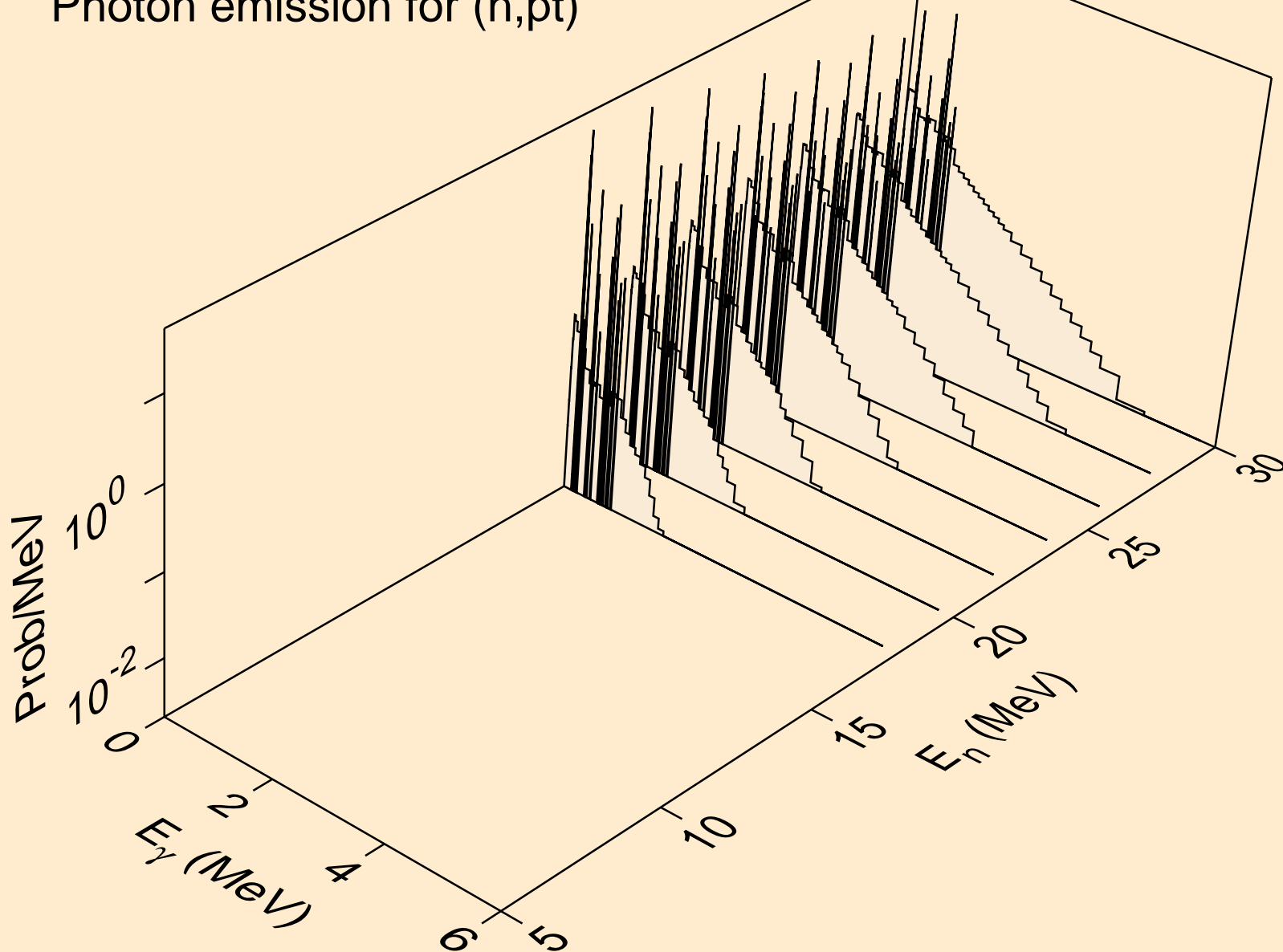

RN208 NEUTRON ACER TENDL-2019 LIBRARY; T=293.16K
Photon emission for (n,da)

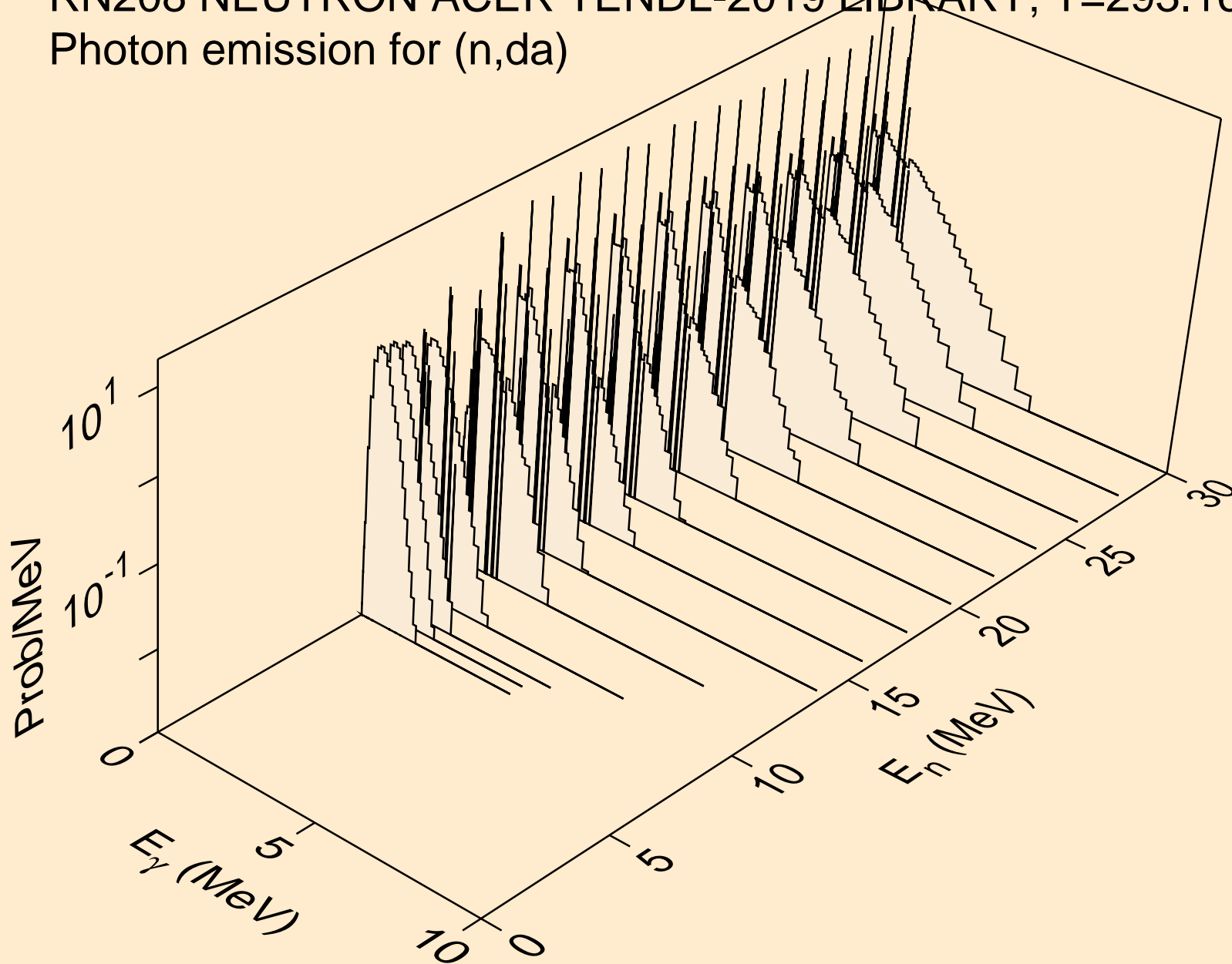

RN208 NEUTRON ACER TENDL-2019 LIBRARY; T=293.16K
thermal capture photon spectrum

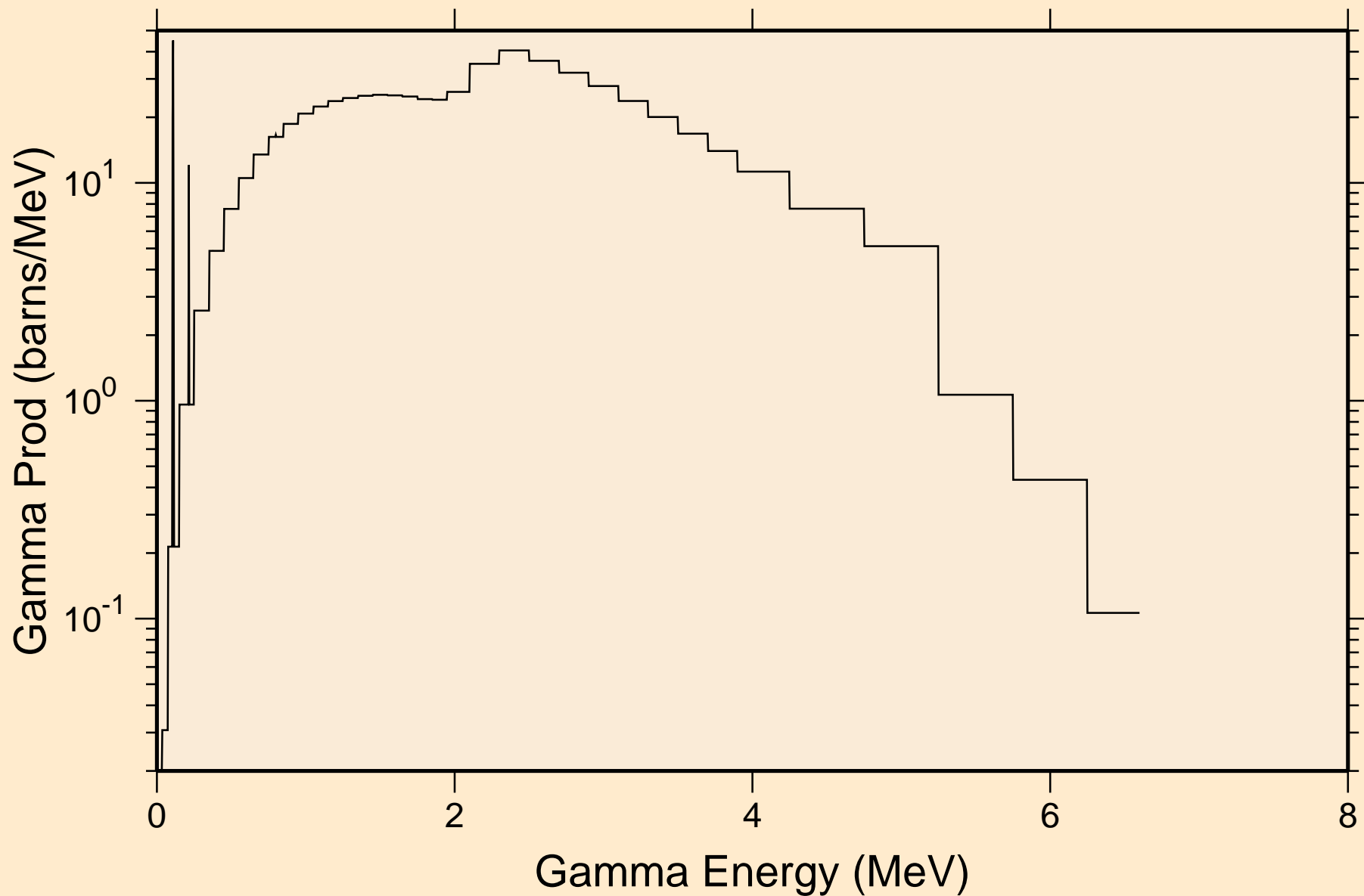

RN208 NEUTRON ACER TENDL-2019 LIBRARY; T=293.16K
14 MeV photon spectrum

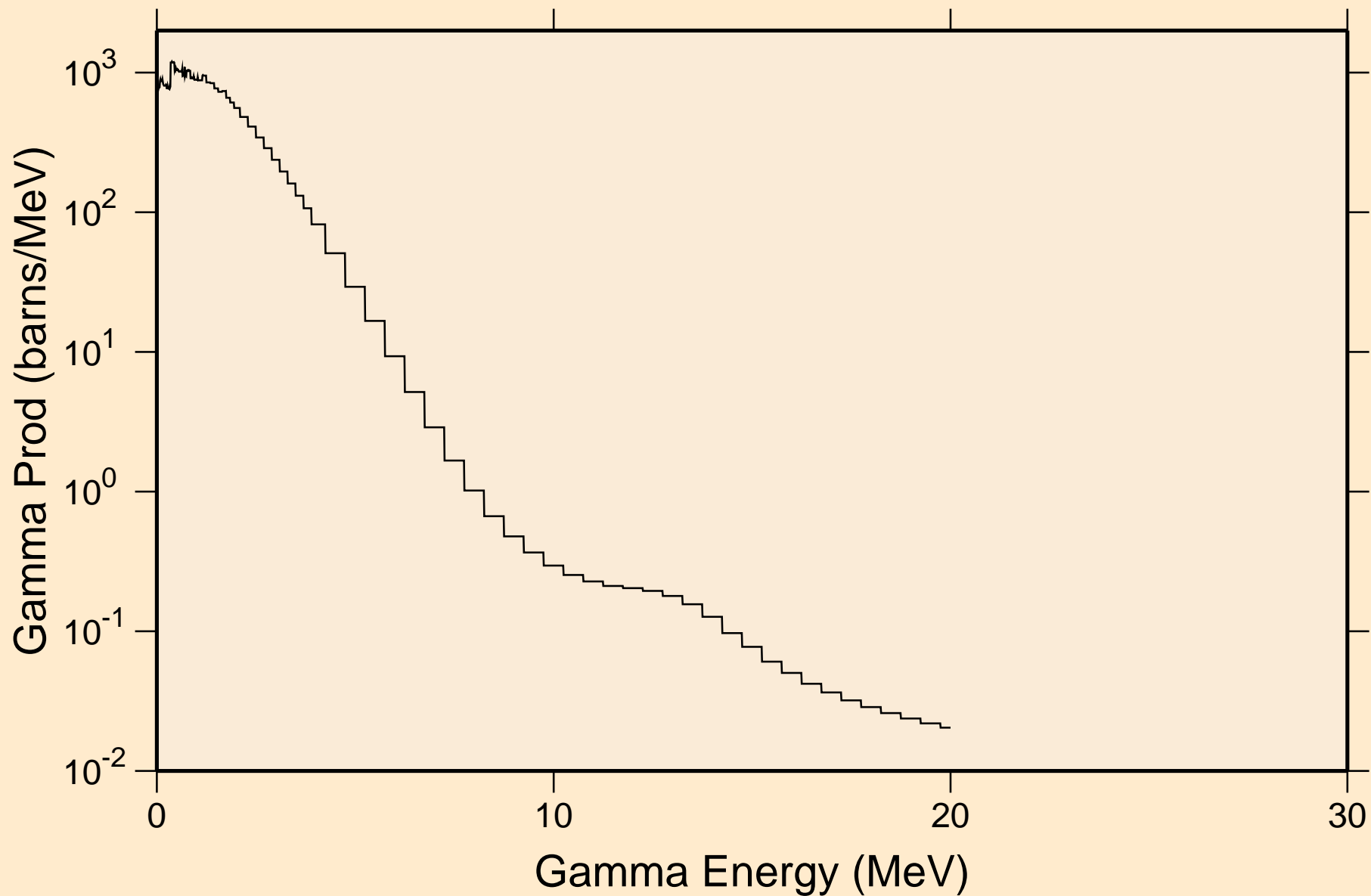

RN208 NEUTRON ACER TENDL-2019 LIBRARY; T=293.16K
Particle heating contributions

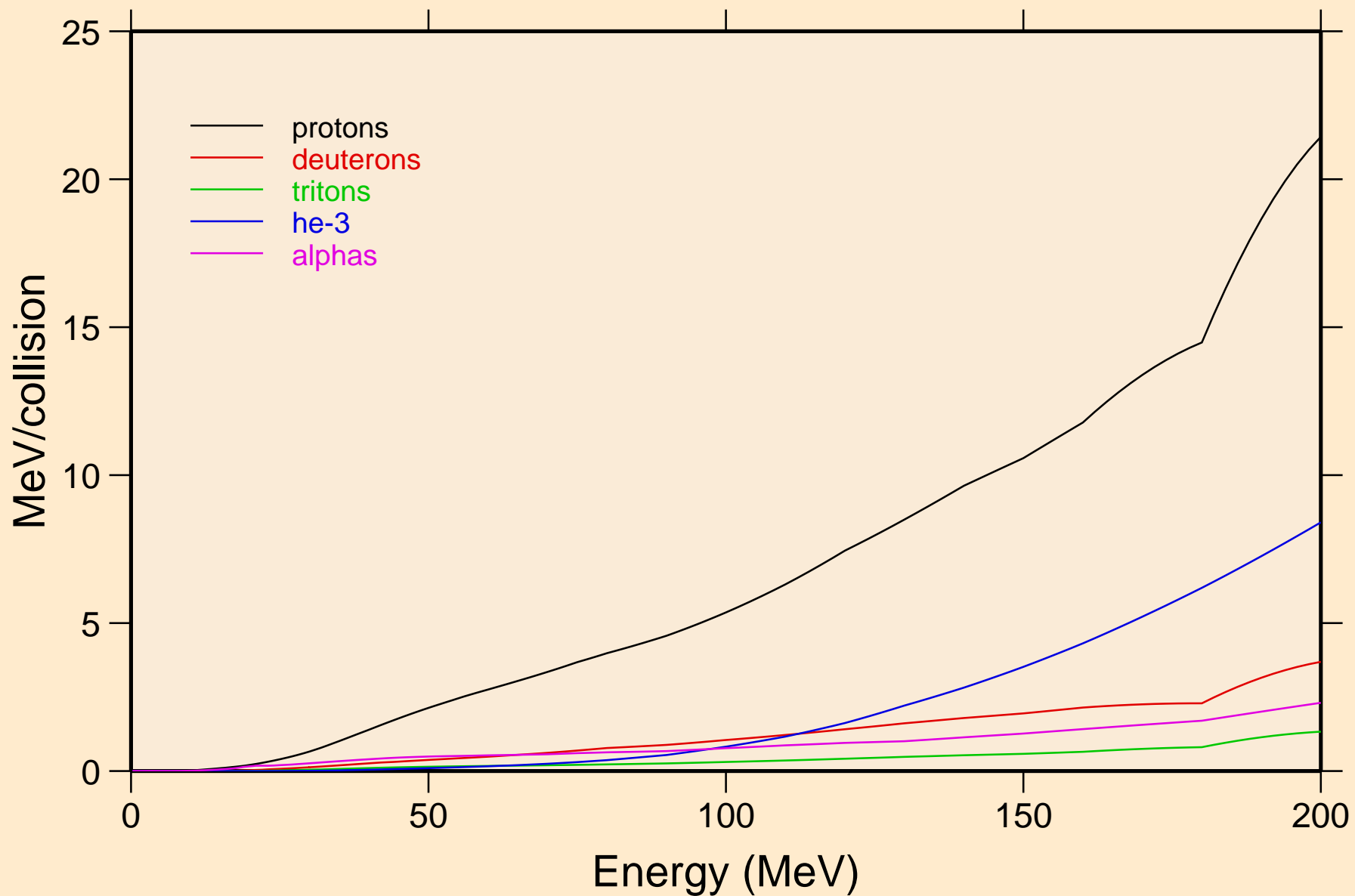

RN208 NEUTRON ACER TENDL-2019 LIBRARY; T=293.16K
Recoil Heating

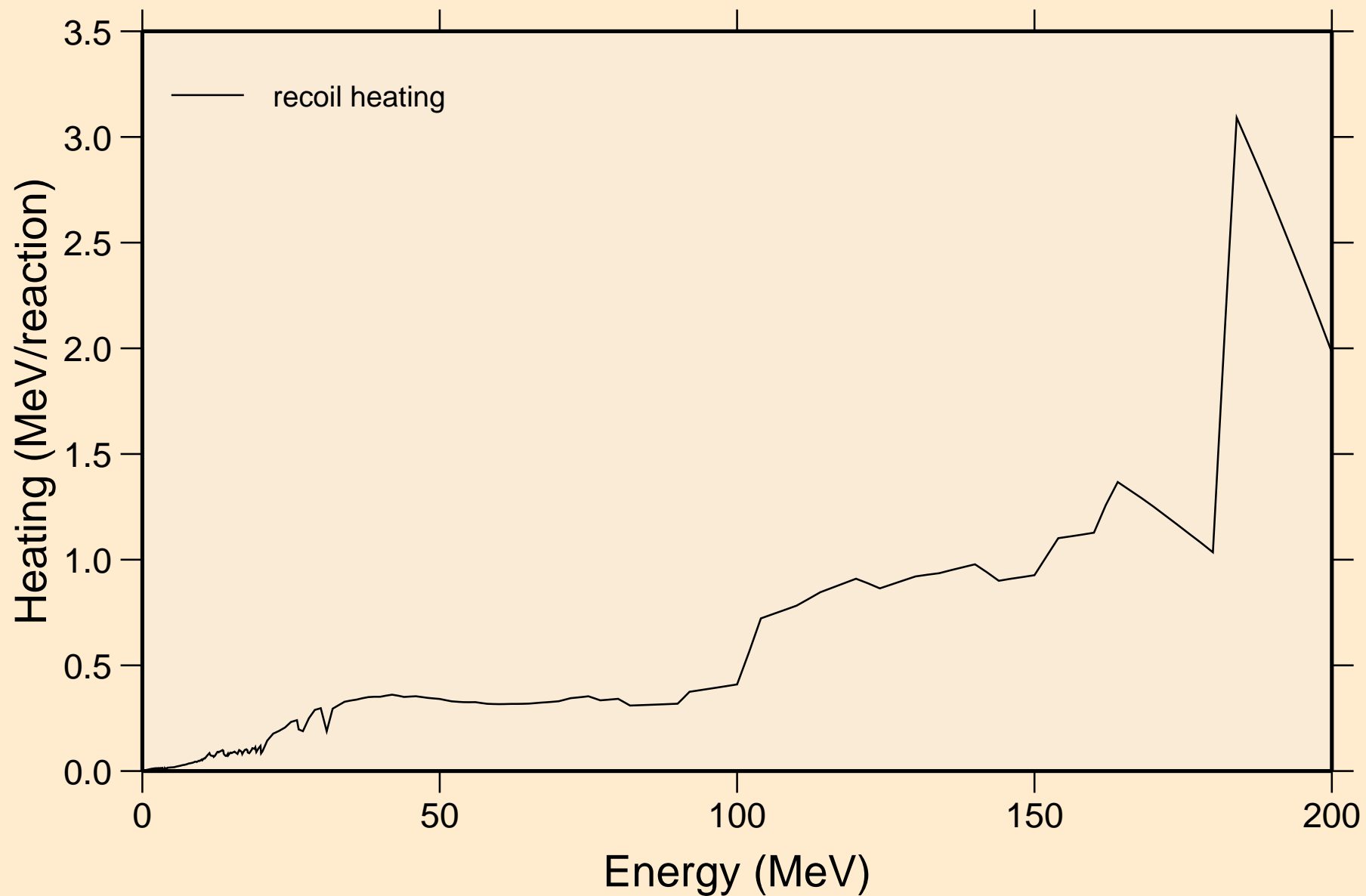

RN208 NEUTRON ACER TENDL-2019 LIBRARY; T=293.16K
Particle production cross sections

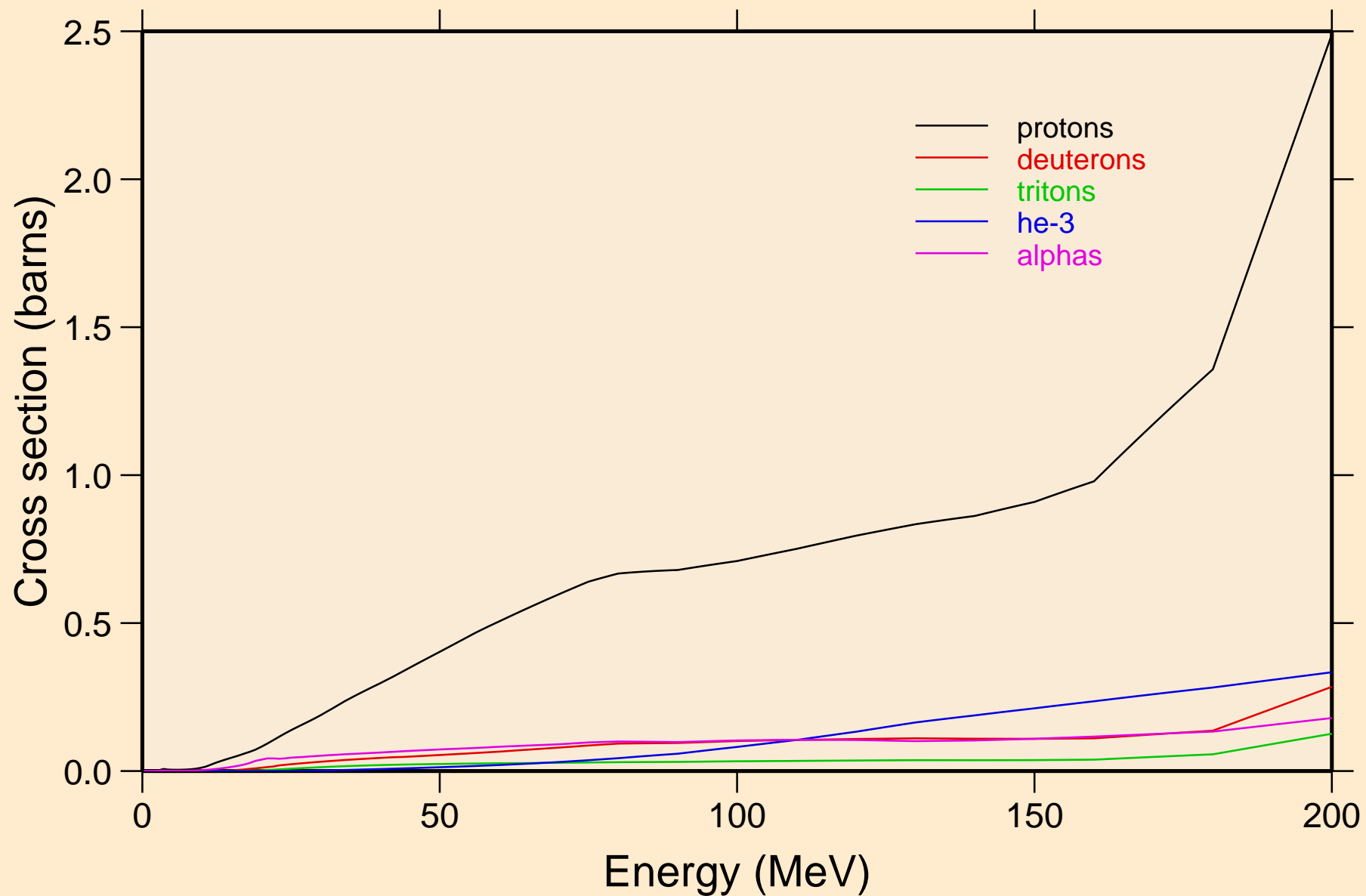

RN208 NEUTRON ACER TENDL-2019 LIBRARY; T=293.16K
protons from (n,x)

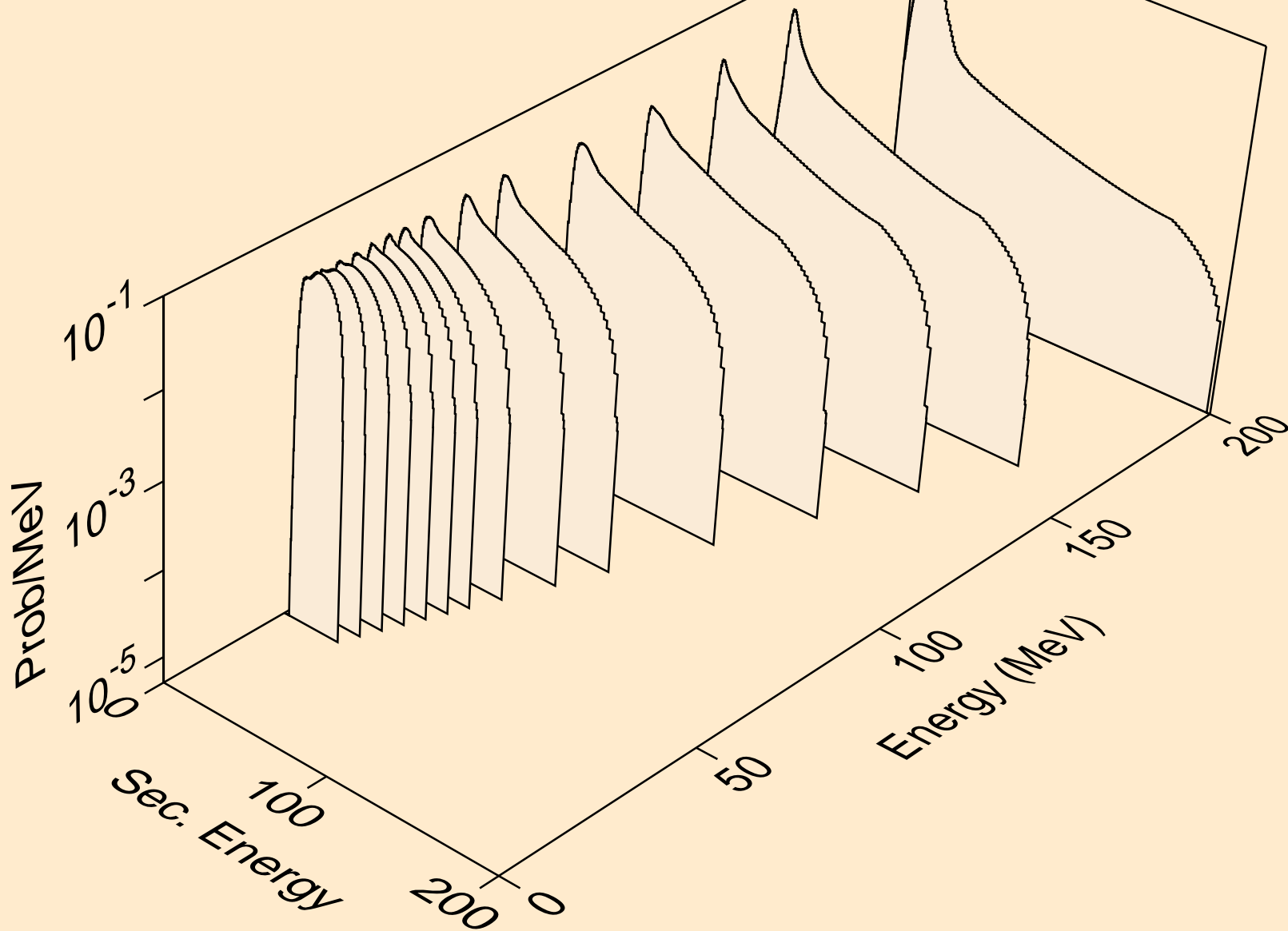

RN208 NEUTRON ACER TENDL-2019 LIBRARY; T=293.16K
protons from (n,n*)p

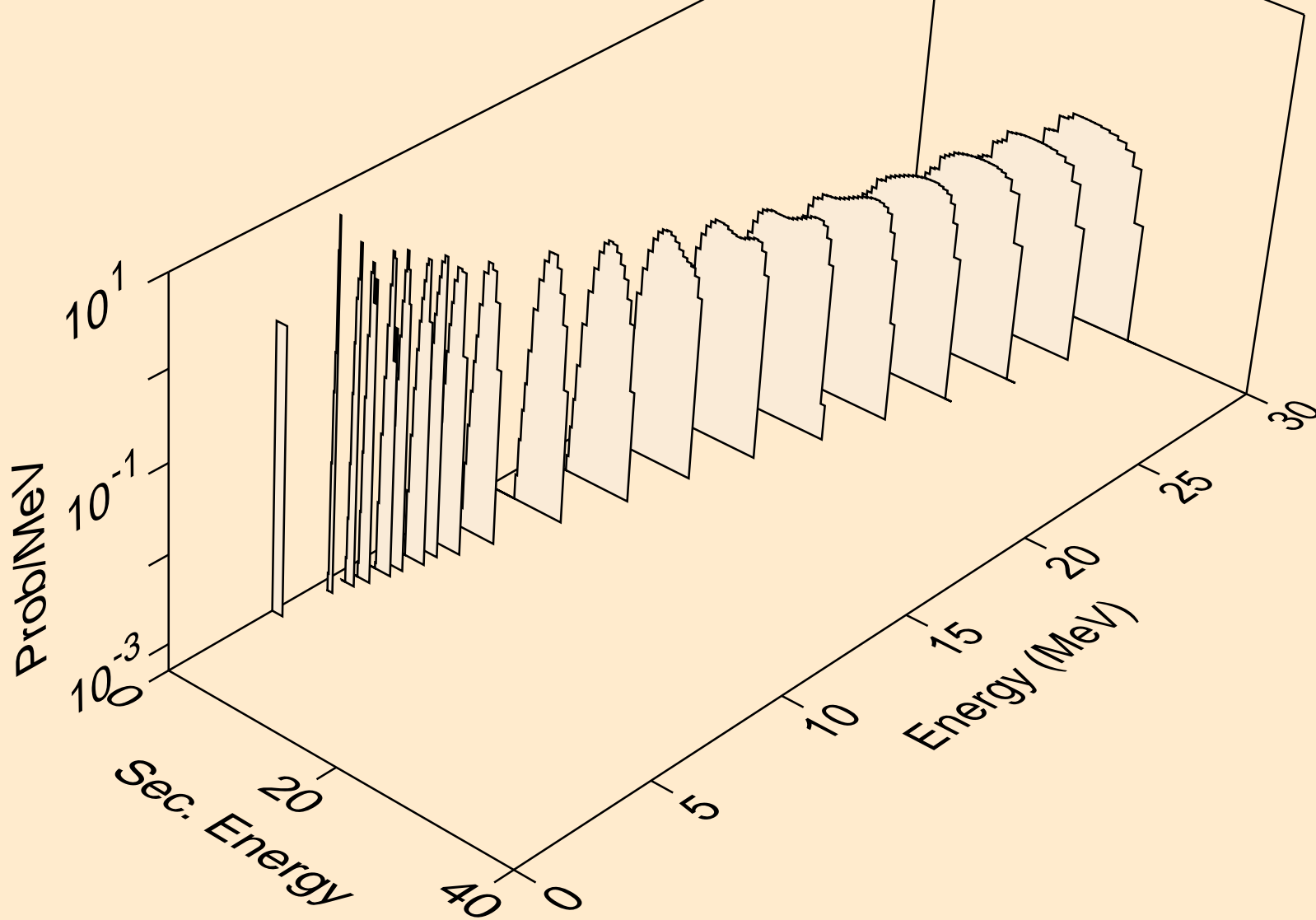

RN208 NEUTRON ACER TENDL-2019 LIBRARY; T=293.16K
protons from (n,2np)

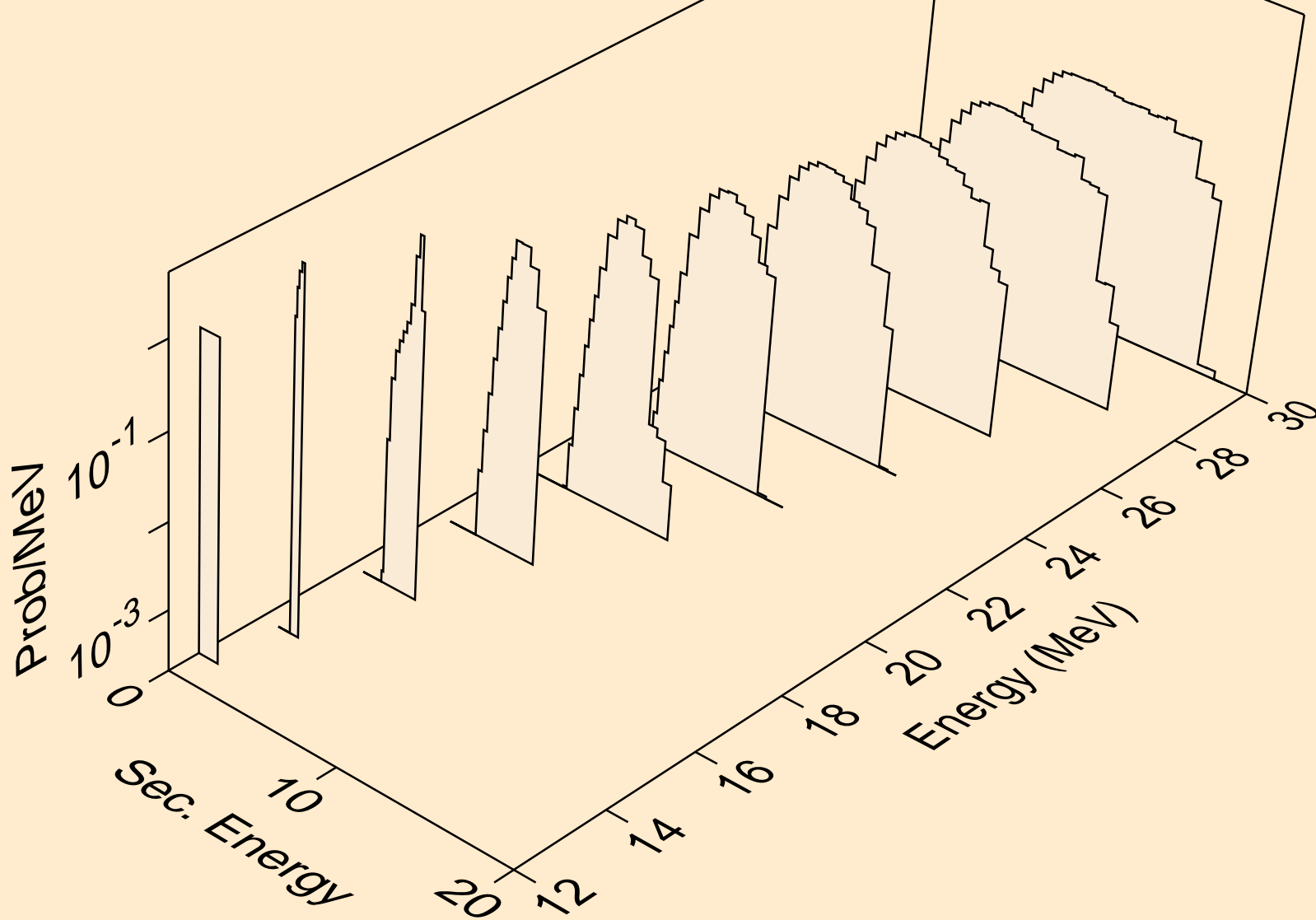

RN208 NEUTRON ACER TENDL-2019 LIBRARY; T=293.16K
protons from (n,3np)

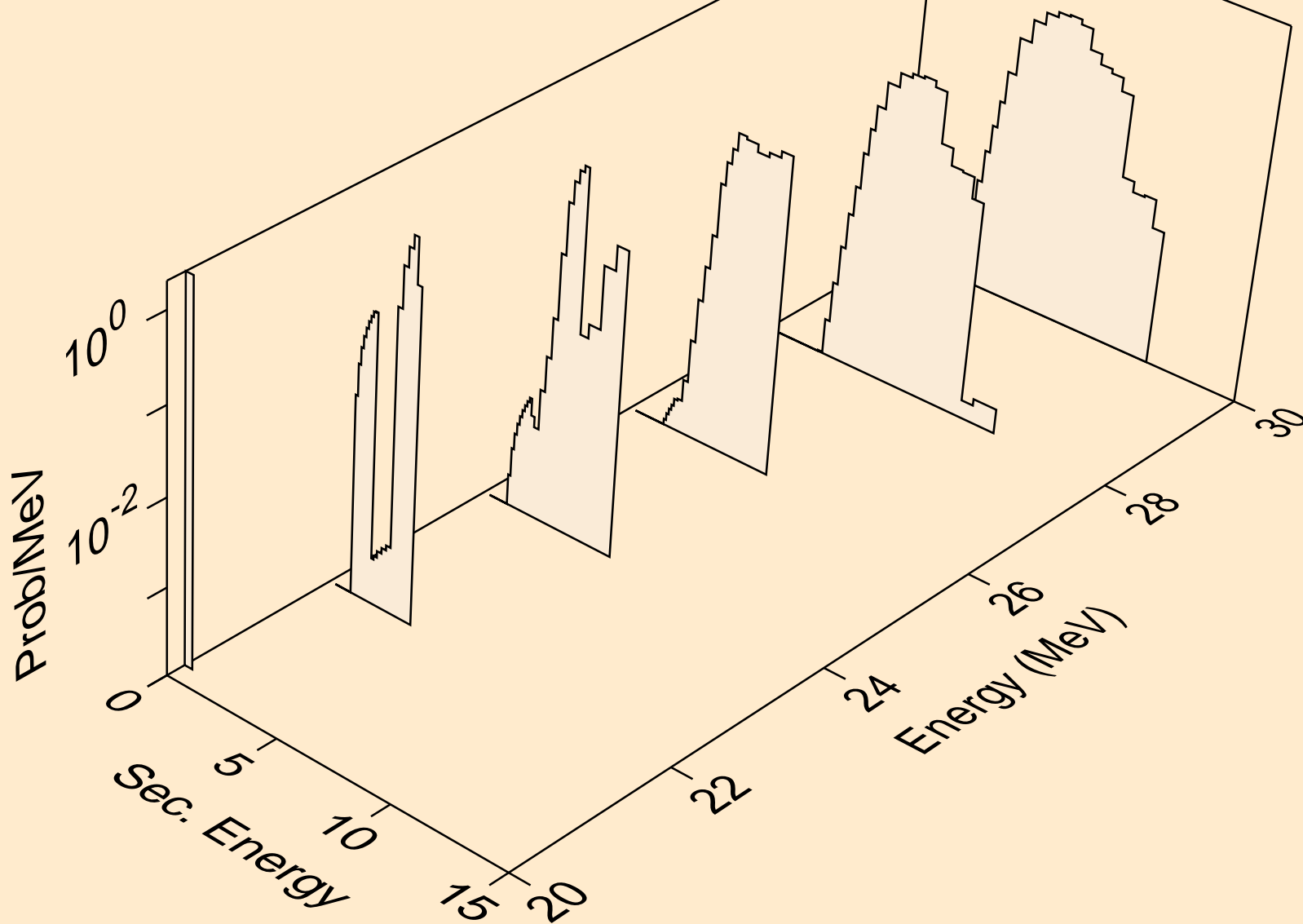

RN208 NEUTRON ACER TENDL-2019 LIBRARY; T=293.16K
protons from (n,2np)

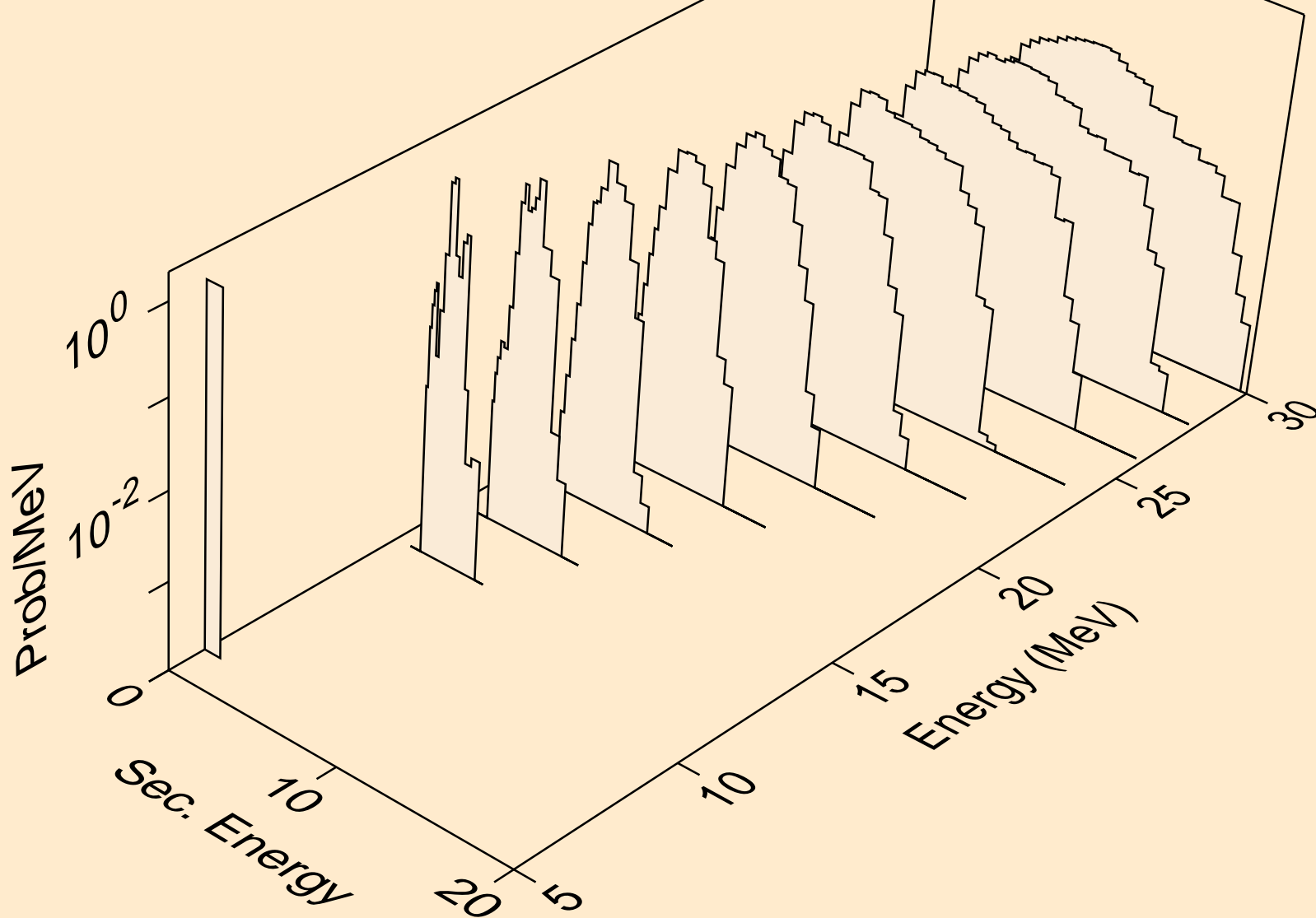

RN208 NEUTRON ACER TENDL-2019 LIBRARY; T=293.16K
protons from (n,npa)

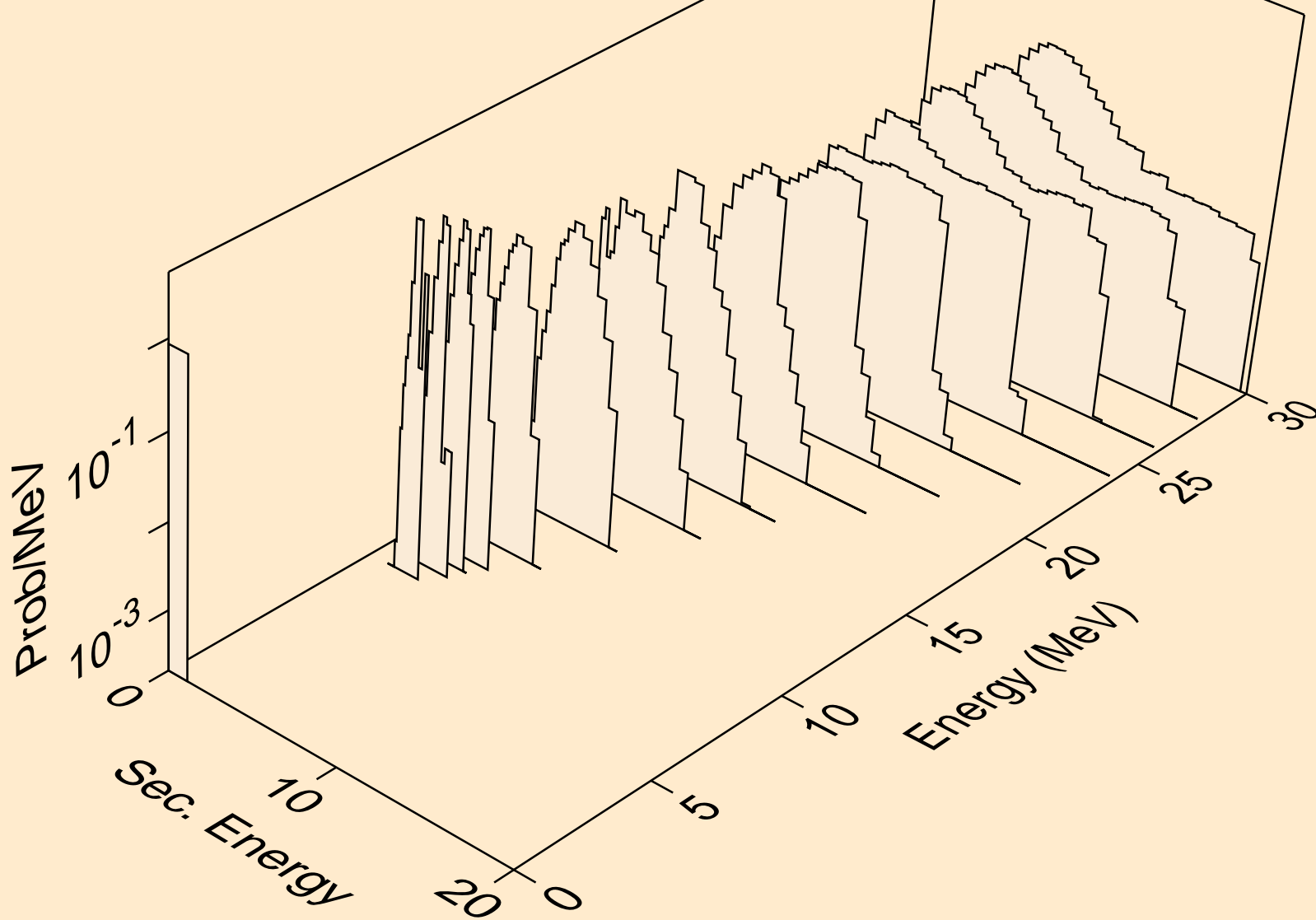

RN208 NEUTRON ACER TENDL-2019 LIBRARY; T=293.16K
protons from (n,p)

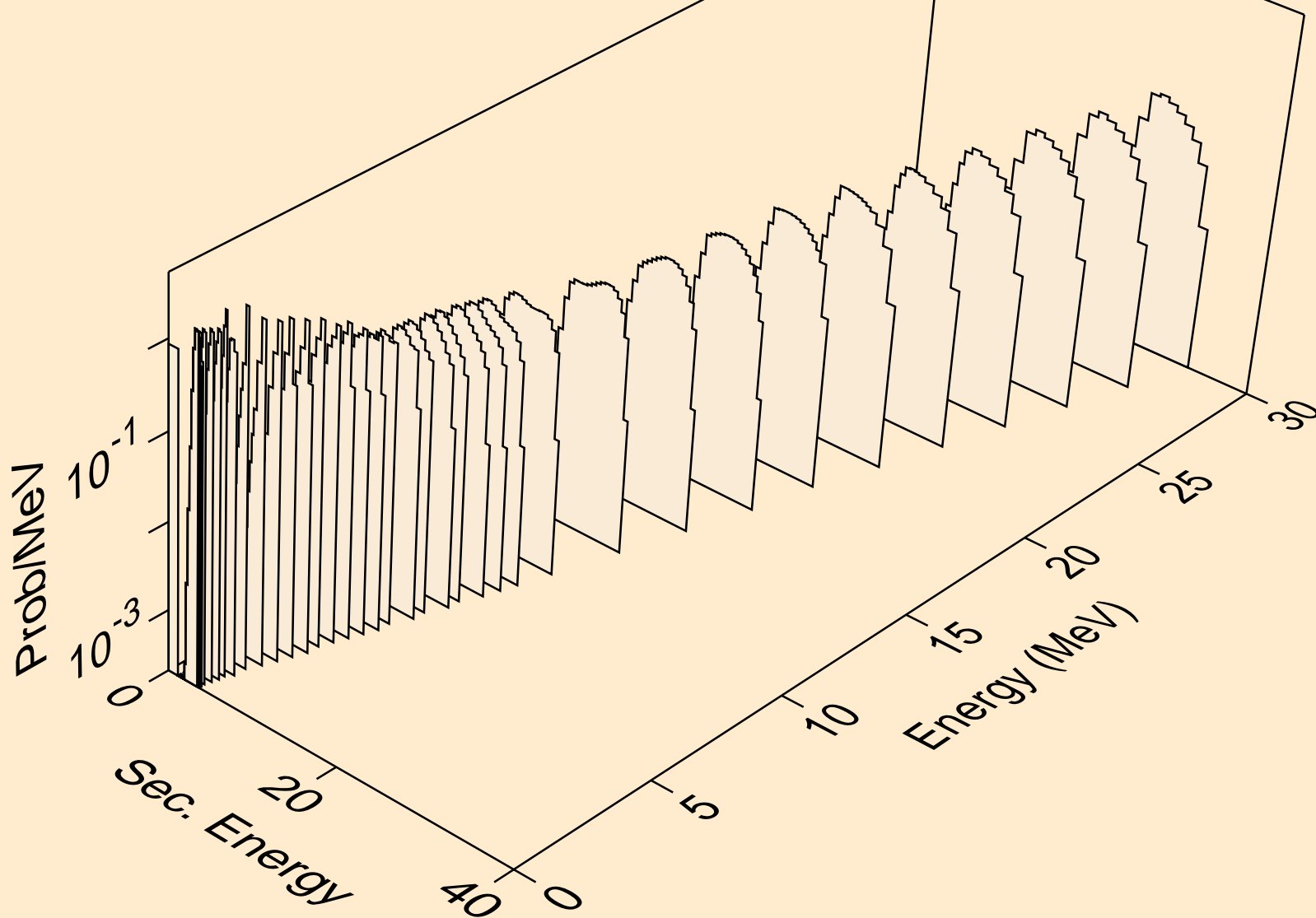

RN208 NEUTRON ACER TENDL-2019 LIBRARY; T=293.16K
protons from (n,2p)

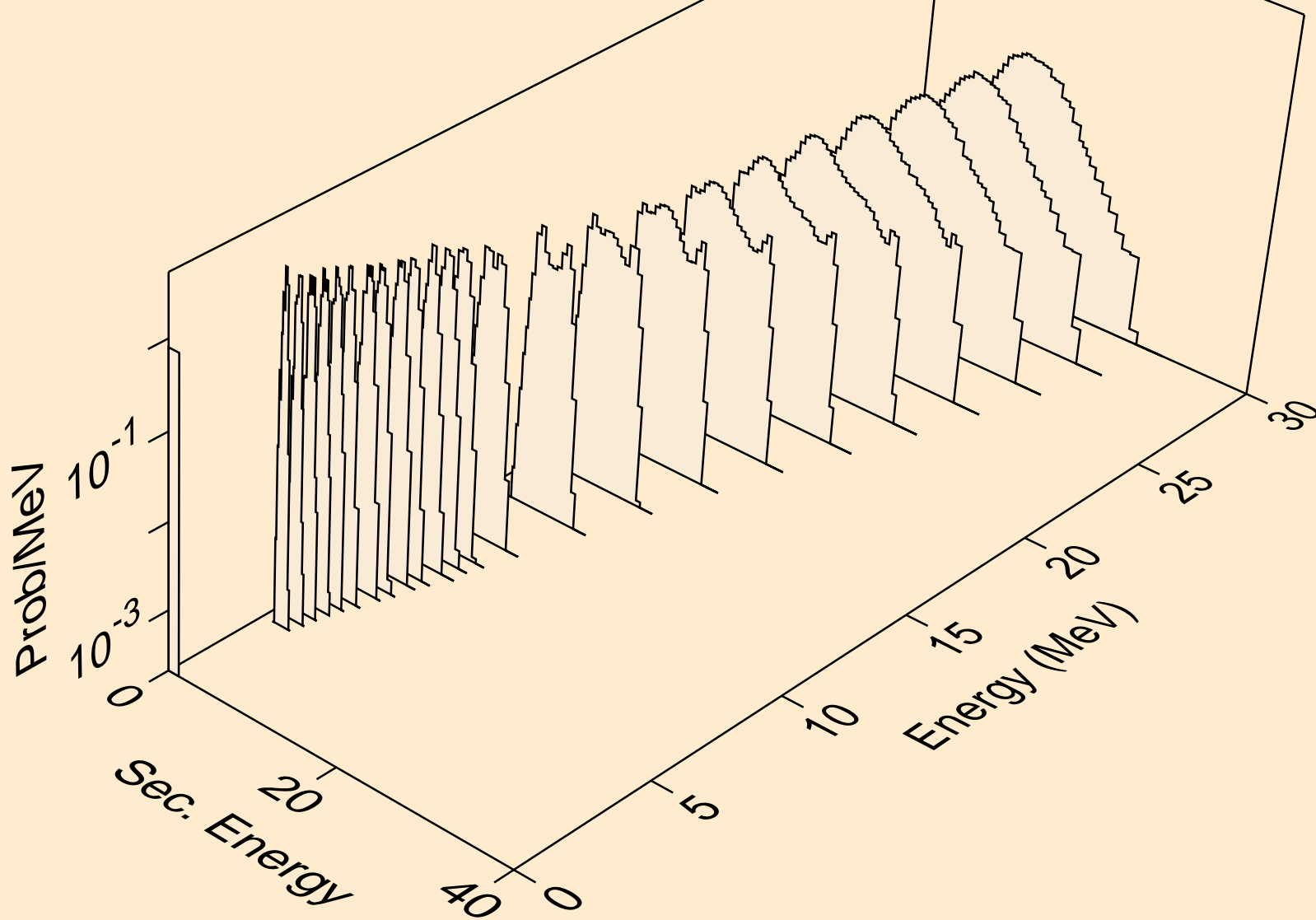

RN208 NEUTRON ACER TENDL-2019 LIBRARY; T=293.16K
protons from (n,p)

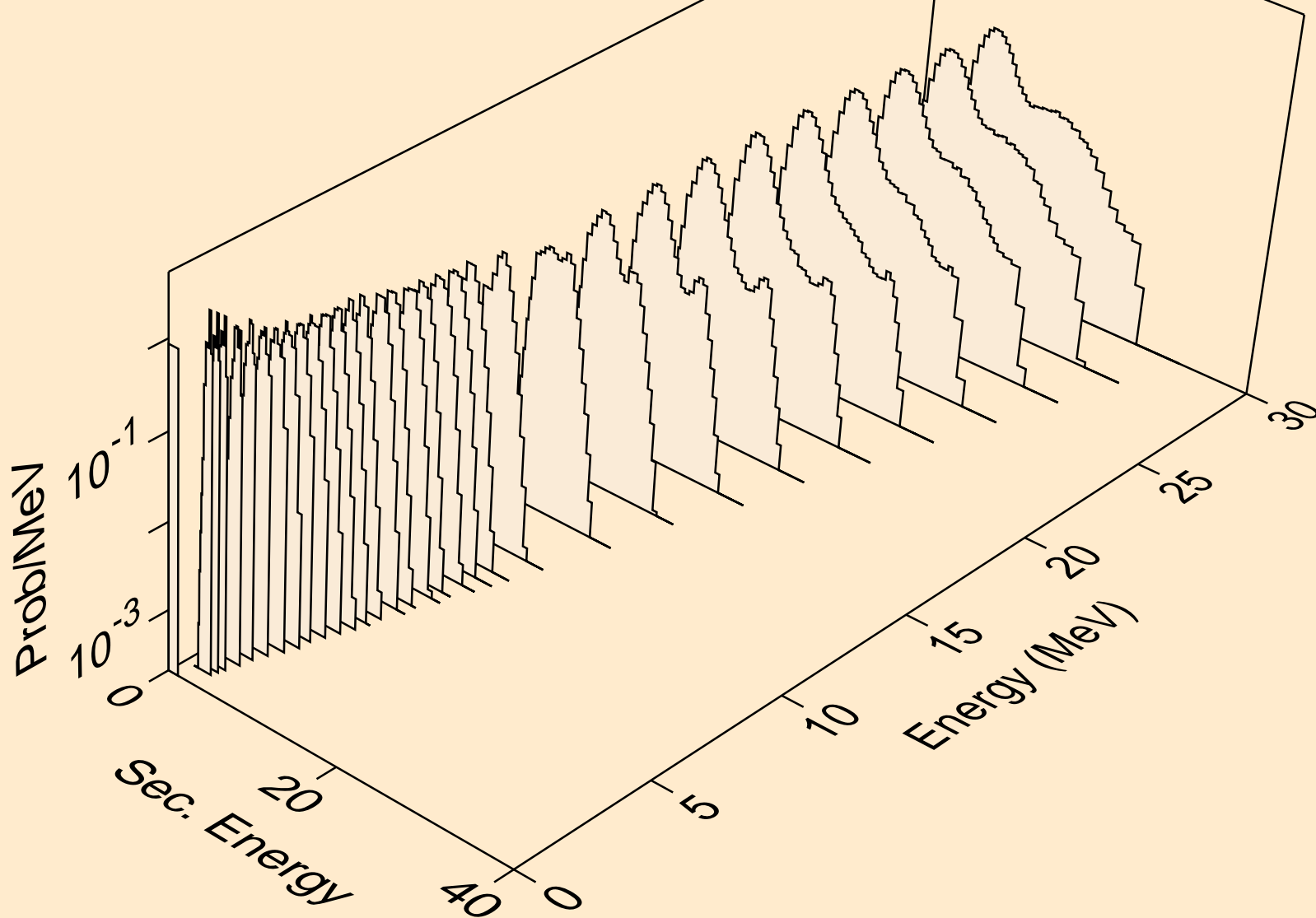

RN208 NEUTRON ACER TENDL-2019 LIBRARY; T=293.16K
protons from (n,pd)

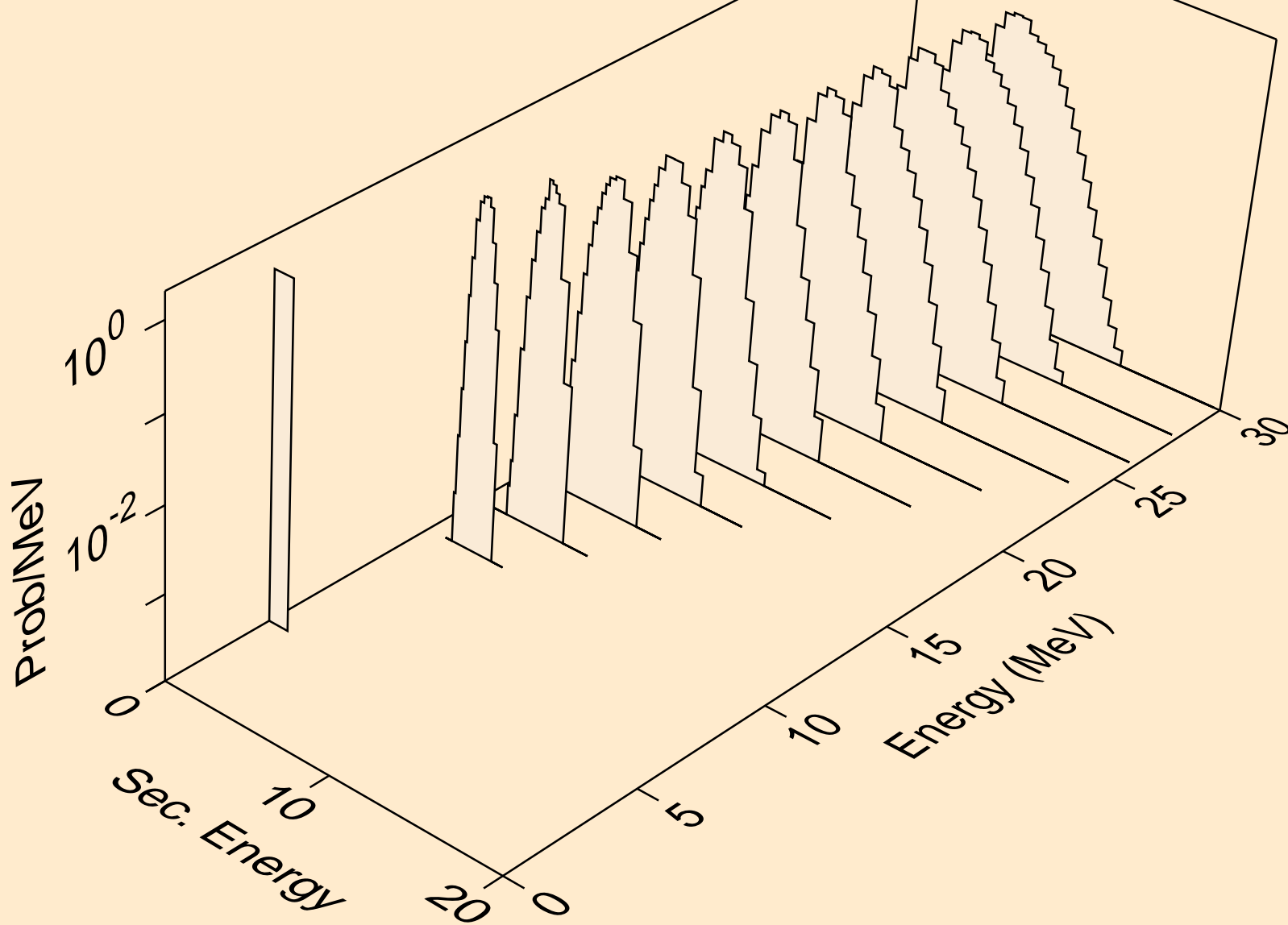

RN208 NEUTRON ACER TENDL-2019 LIBRARY; T=293.16K
protons from (n,pt)

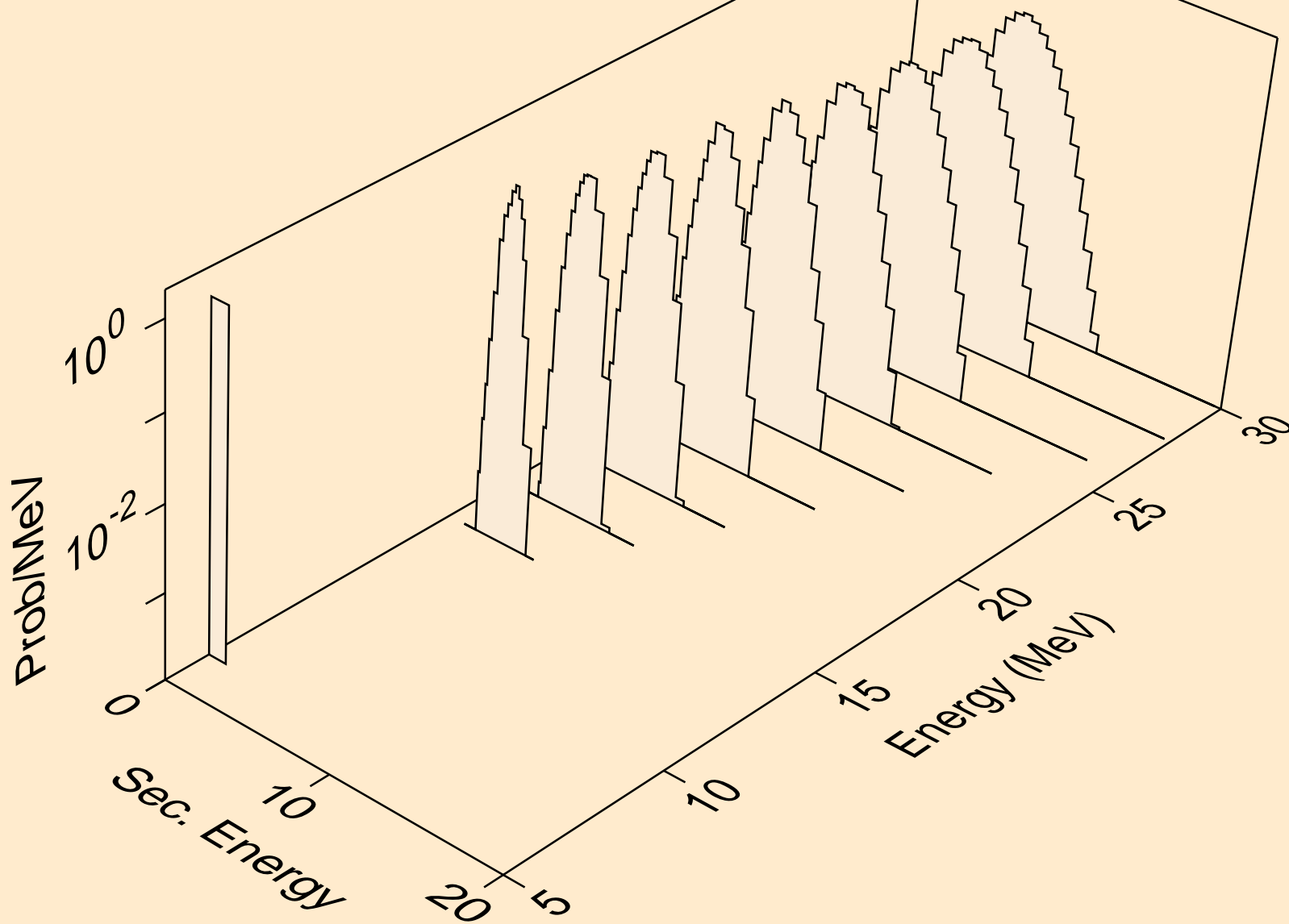

RN208 NEUTRON ACER TENDL-2019 LIBRARY; T=293.16K
deuterons from (n,x)

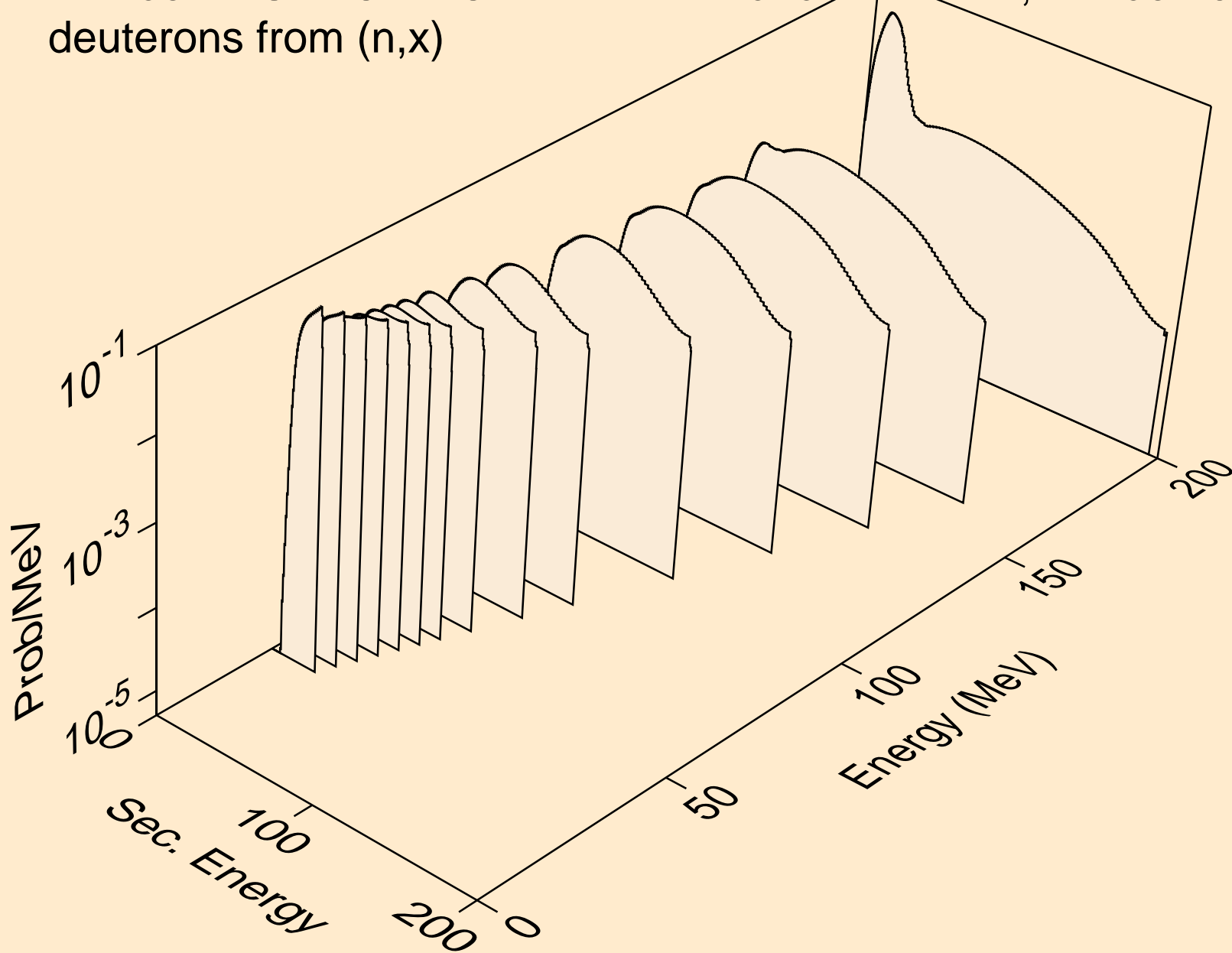

RN208 NEUTRON ACER TENDL-2019 LIBRARY; T=293.16K
deuterons from (n,2nd)

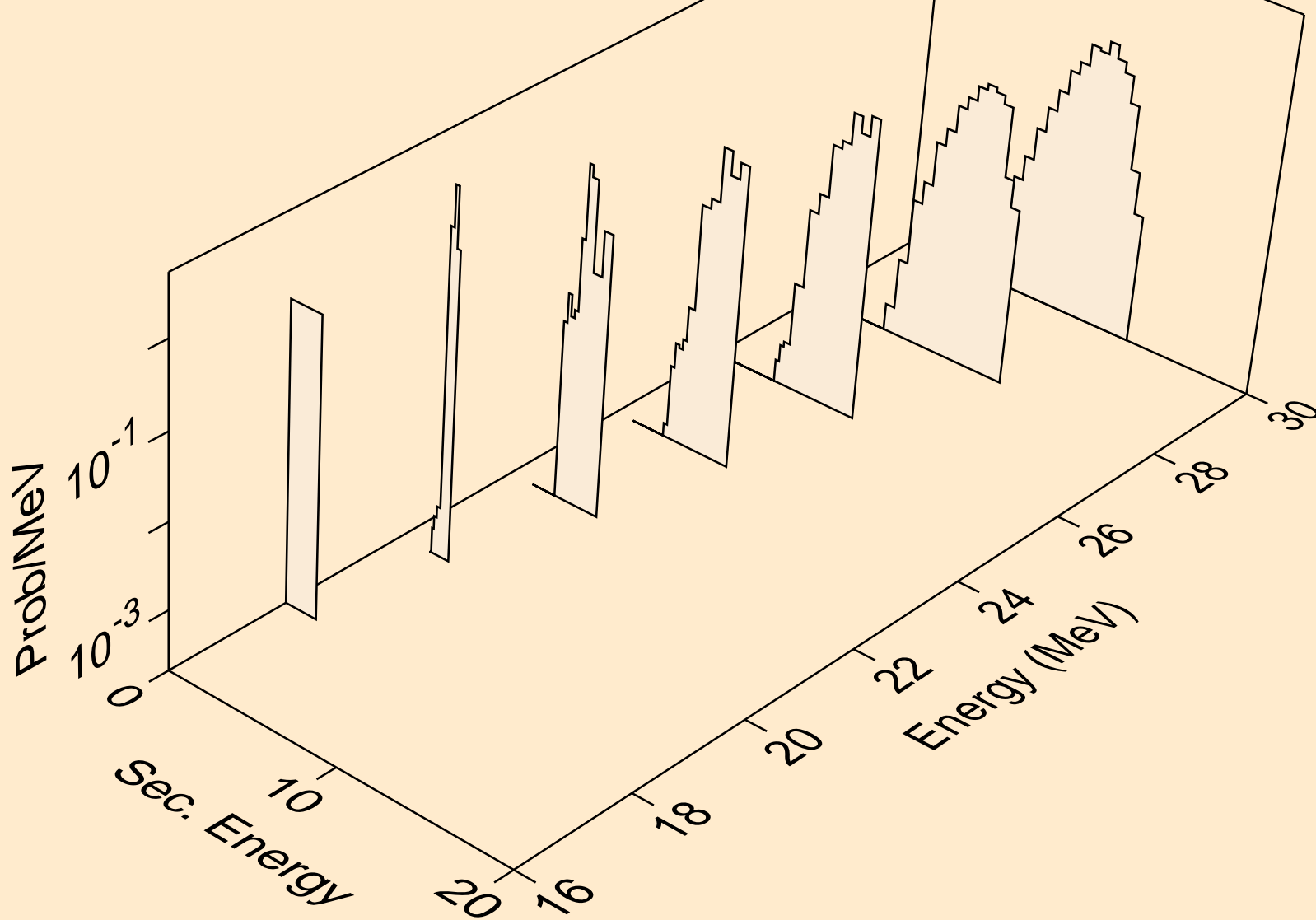

RN208 NEUTRON ACER TENDL-2019 LIBRARY; T=293.16K
deuterons from (n,n*)d

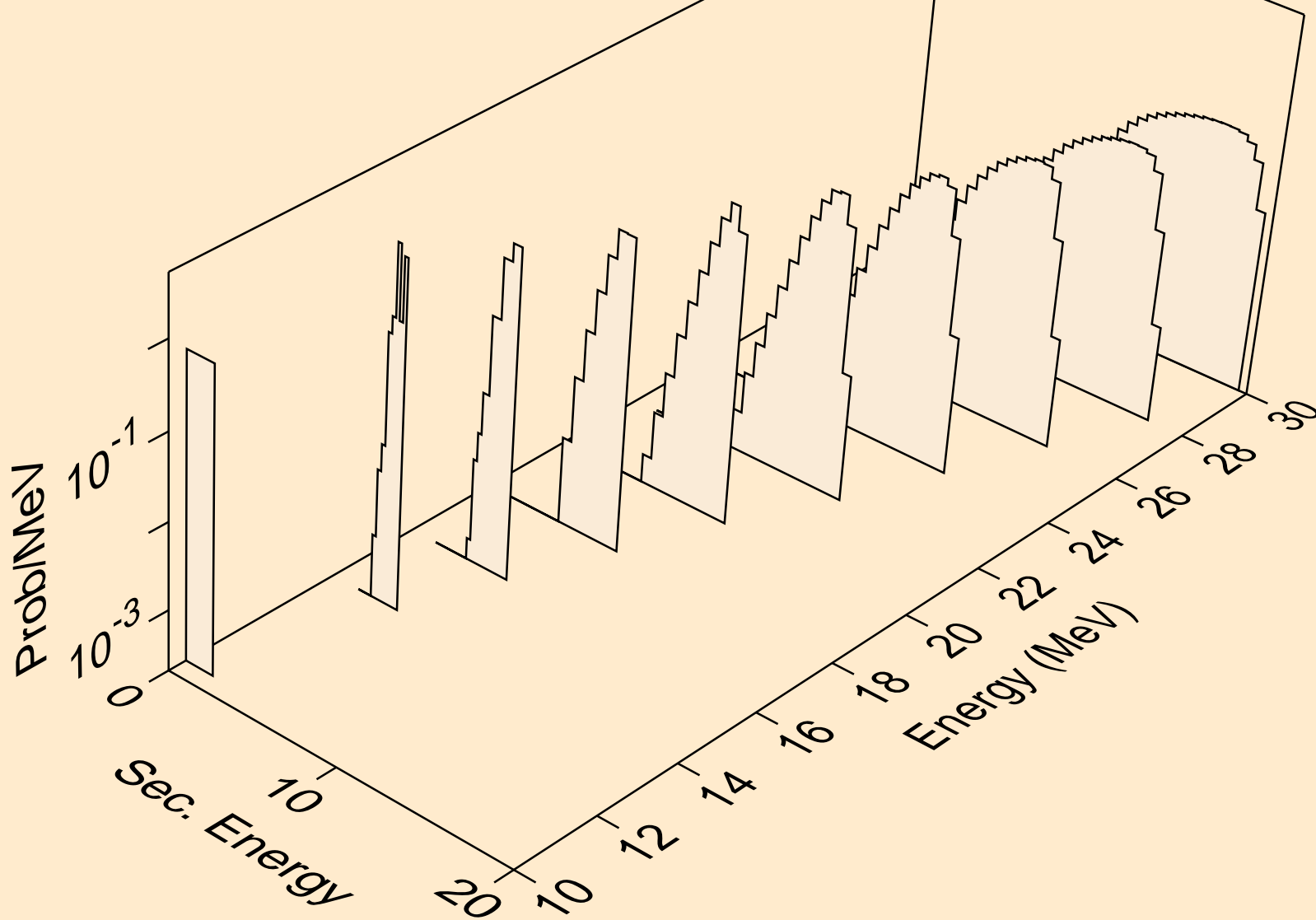

RN208 NEUTRON ACER TENDL-2019 LIBRARY; T=293.16K
deuterons from (n,d)

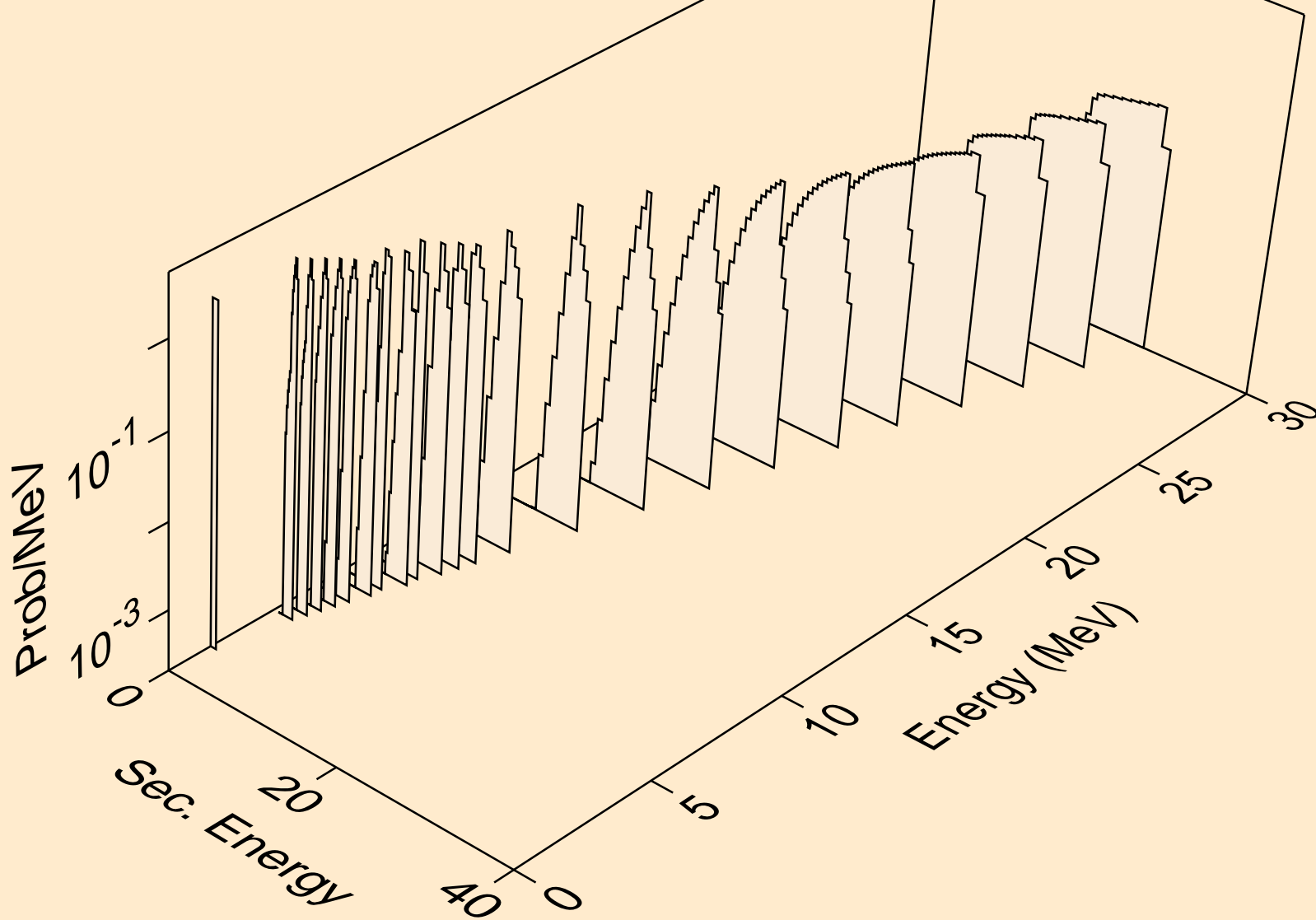

RN208 NEUTRON ACER TENDL-2019 LIBRARY; T=293.16K
deuterons from (n,pd)

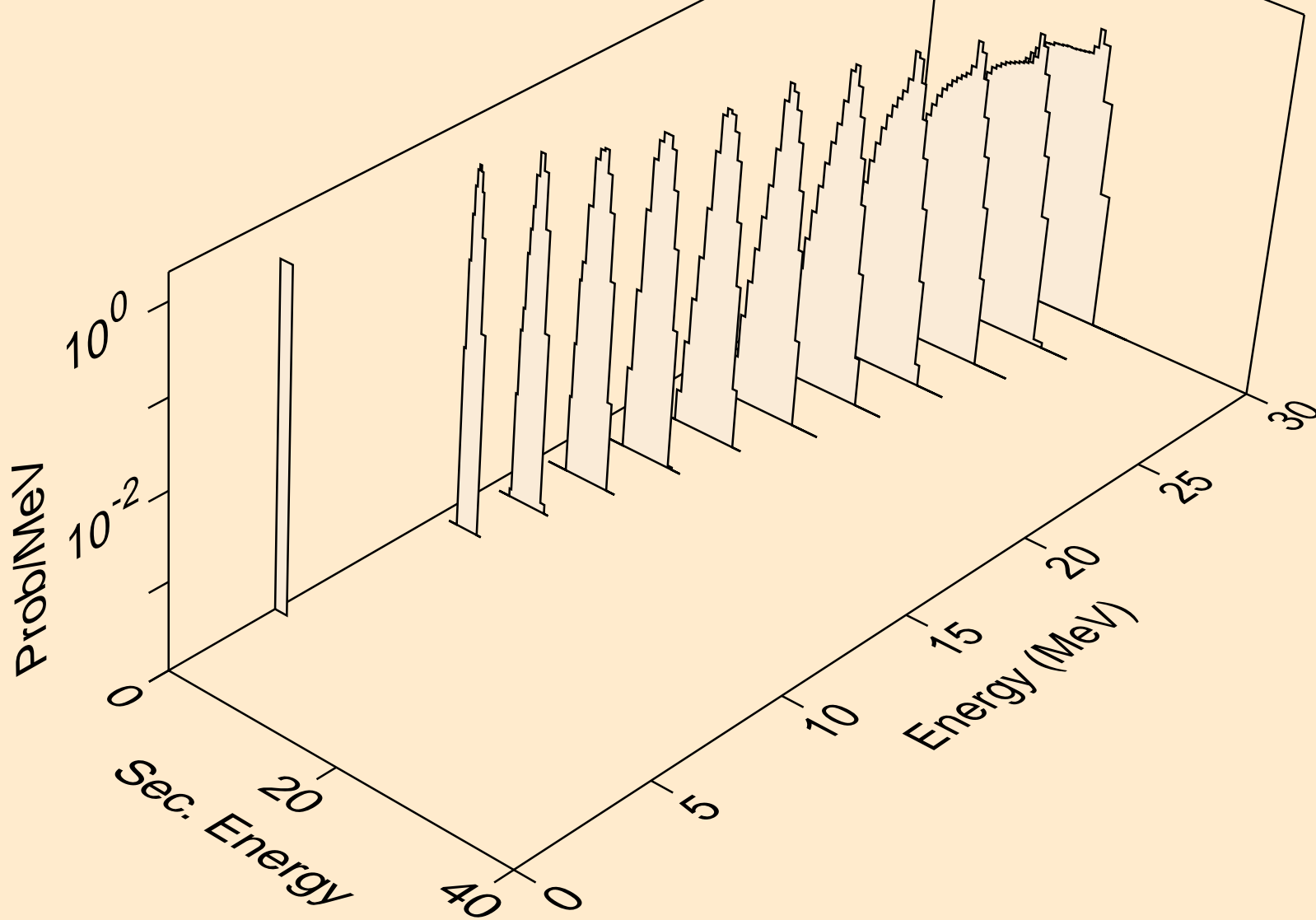

RN208 NEUTRON ACER TENDL-2019 LIBRARY; T=293.16K
deuterons from (n,da)

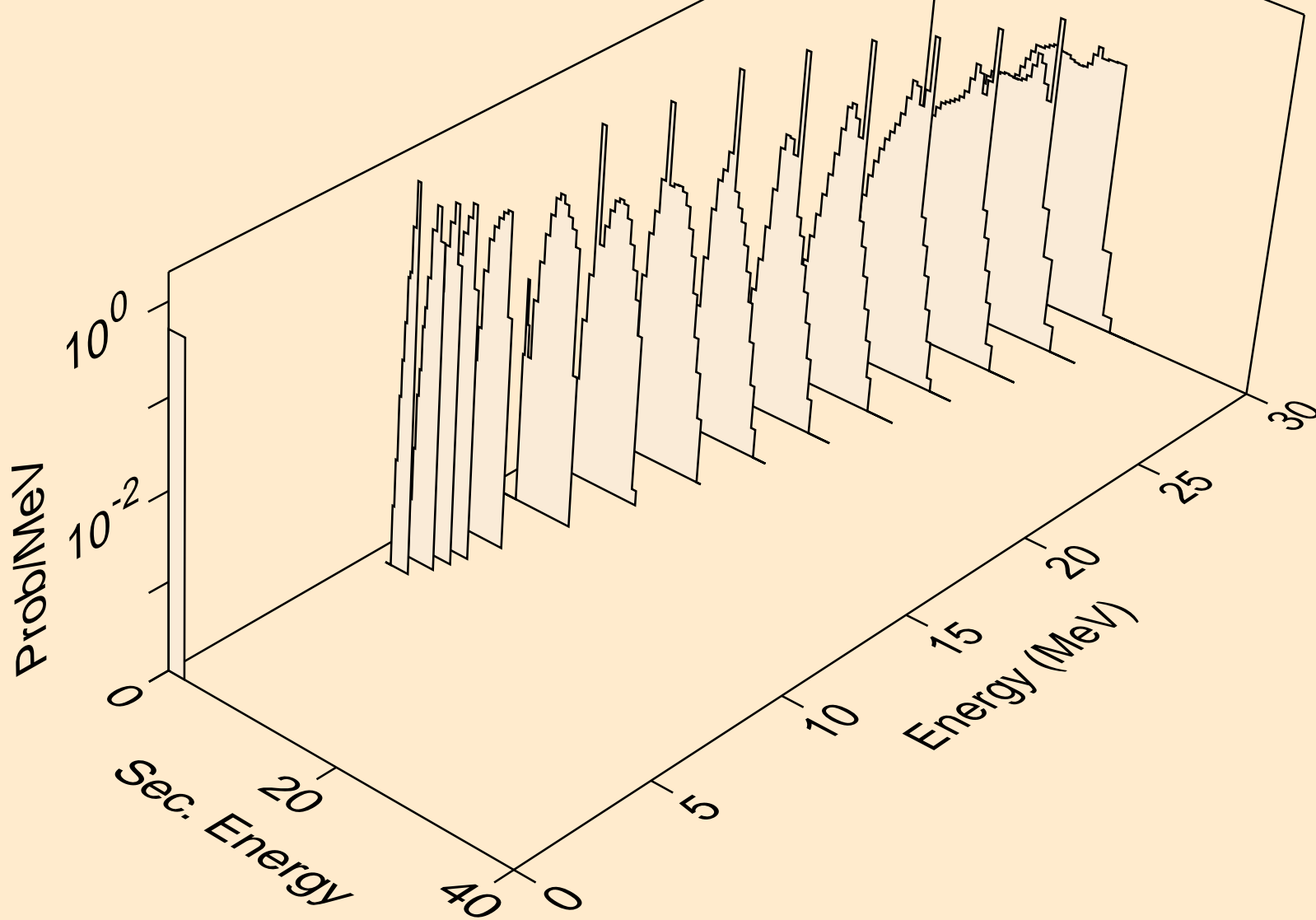

RN208 NEUTRON ACER TENDL-2019 LIBRARY; T=293.16K
tritons from (n,x)

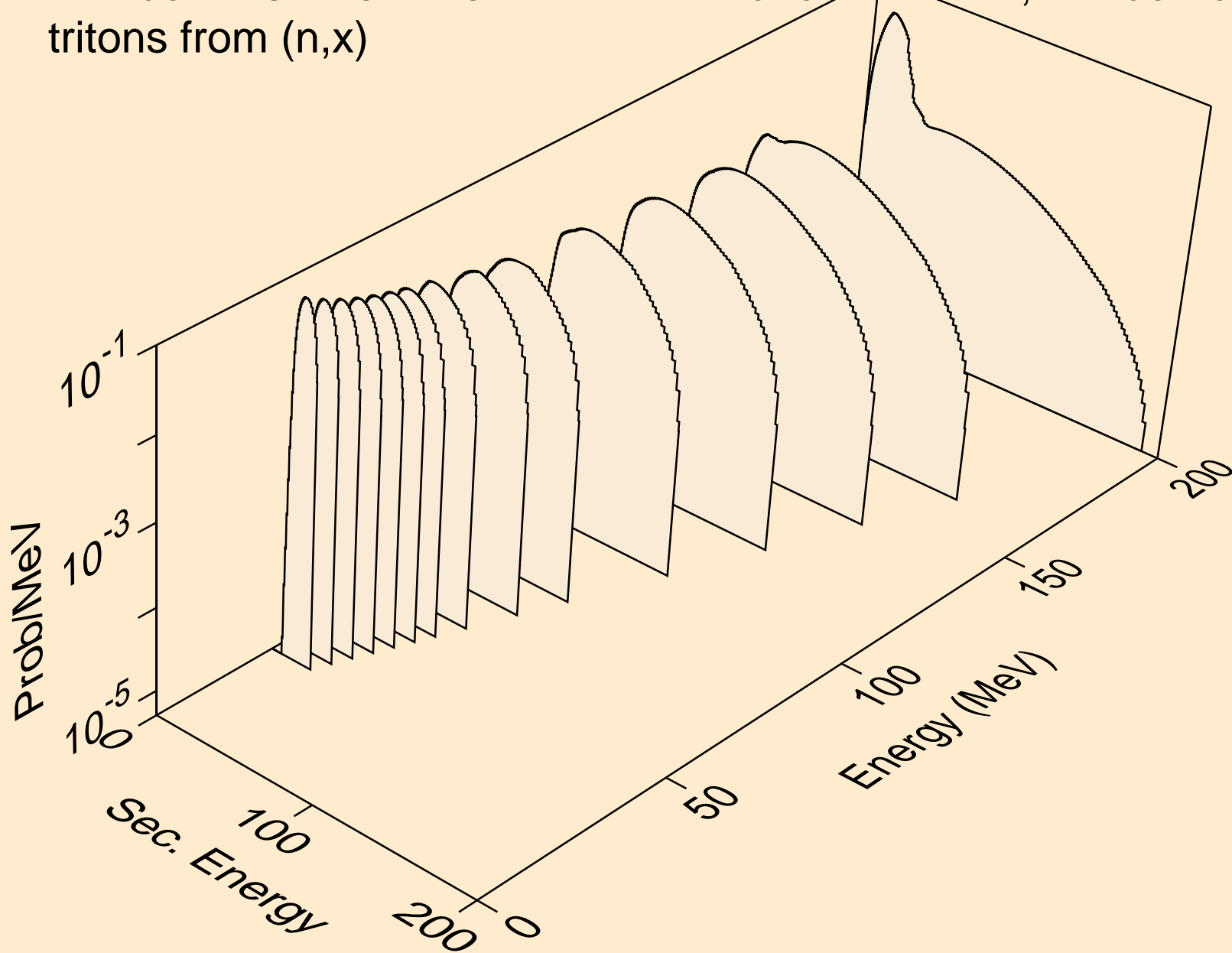

RN208 NEUTRON ACER TENDL-2019 LIBRARY; T=293.16K
tritons from (n,n*)t

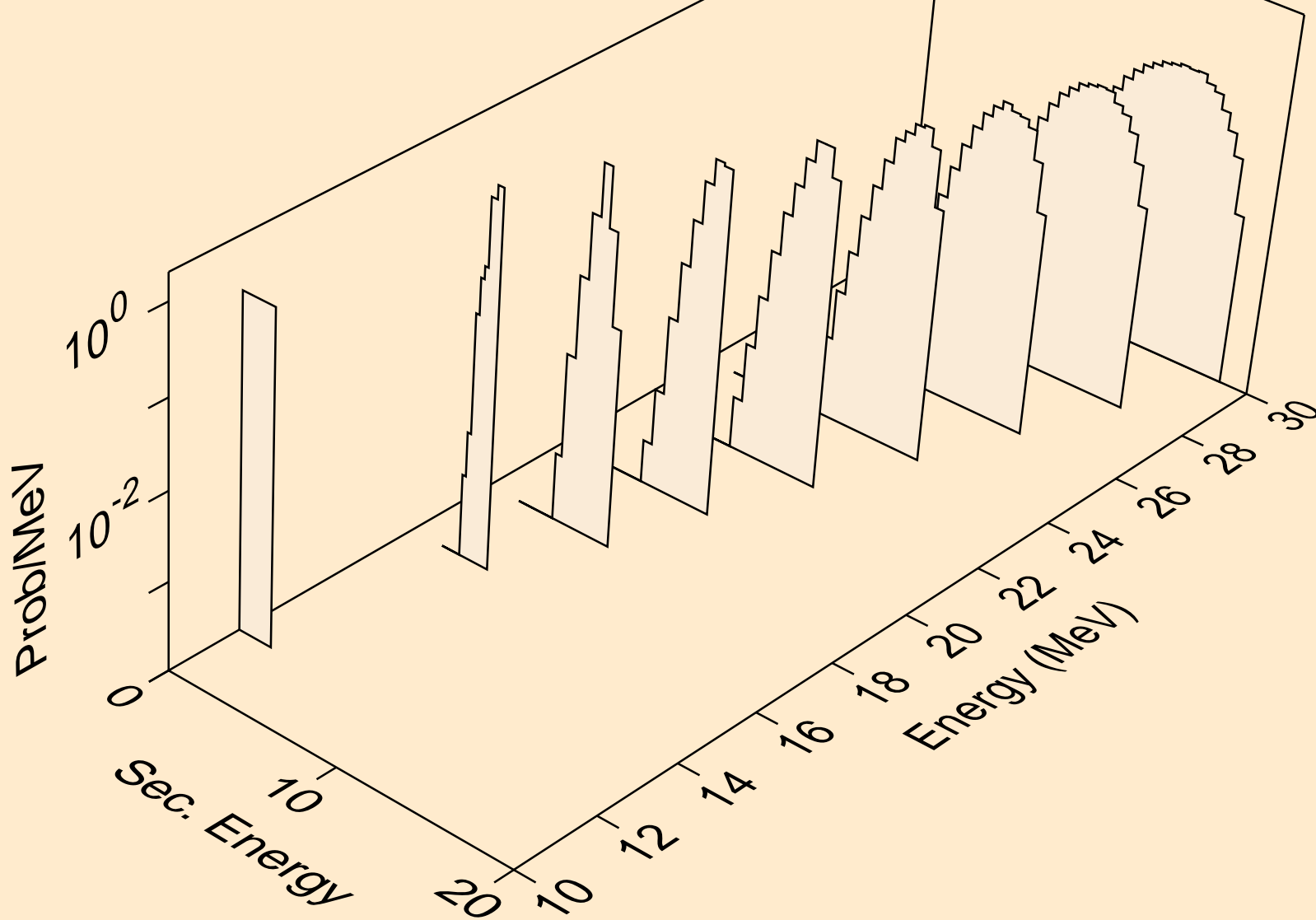

RN208 NEUTRON ACER TENDL-2019 LIBRARY; T=293.16K
tritons from (n,t)

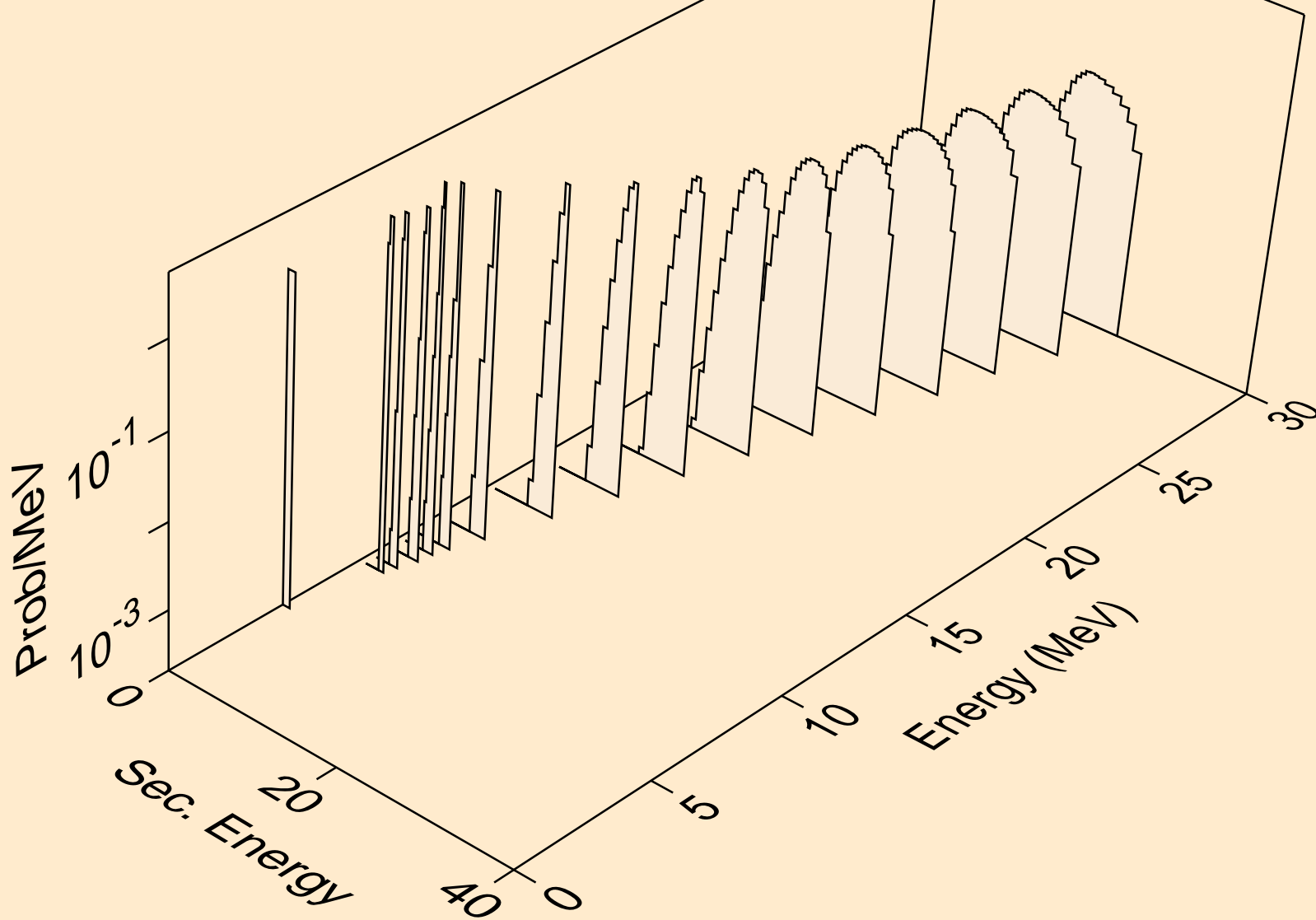

RN208 NEUTRON ACER TENDL-2019 LIBRARY; T=293.16K
tritons from (n,pt)

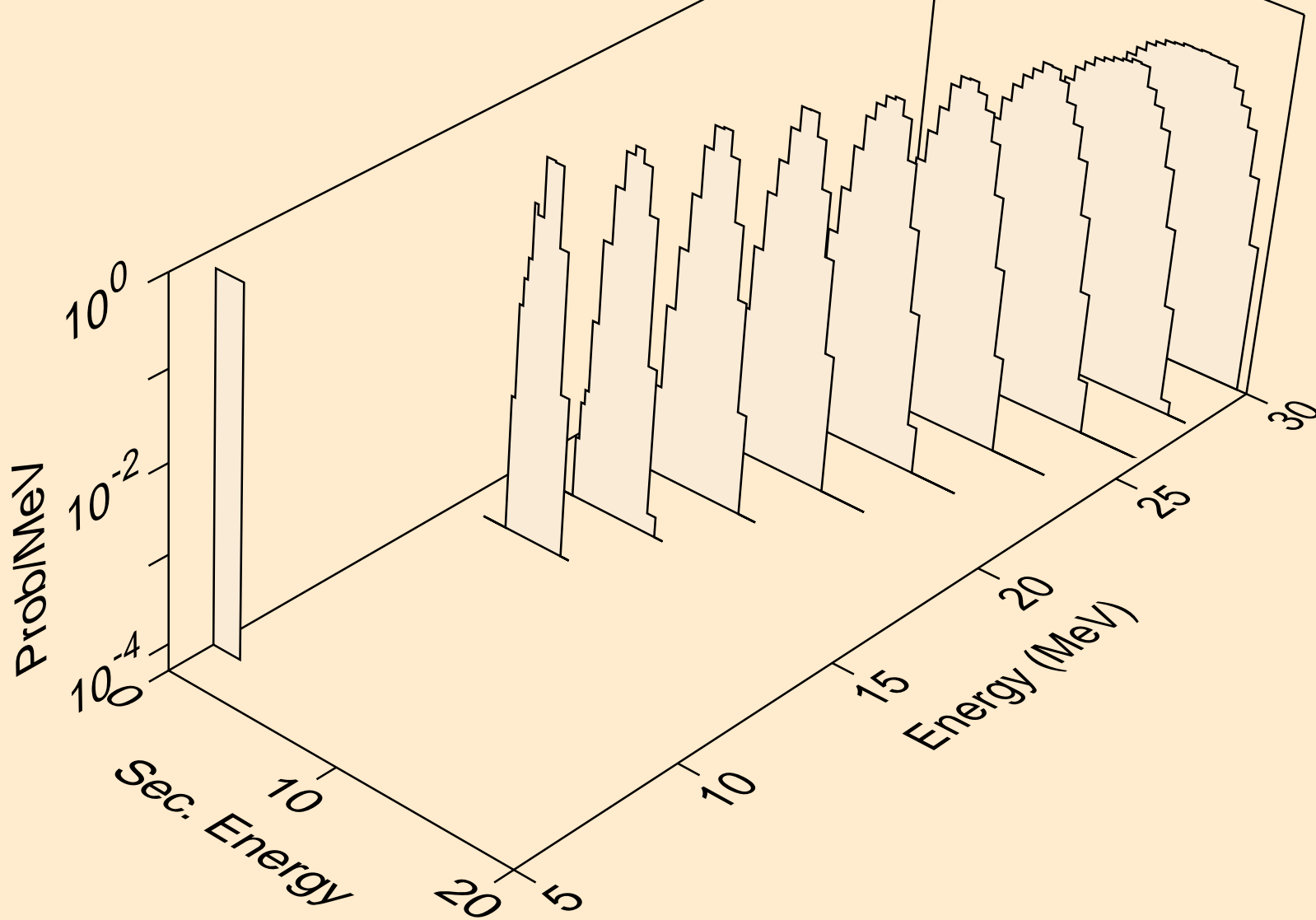

RN208 NEUTRON ACER TENDL-2019 LIBRARY; T=293.16K
he3s from (n,x)

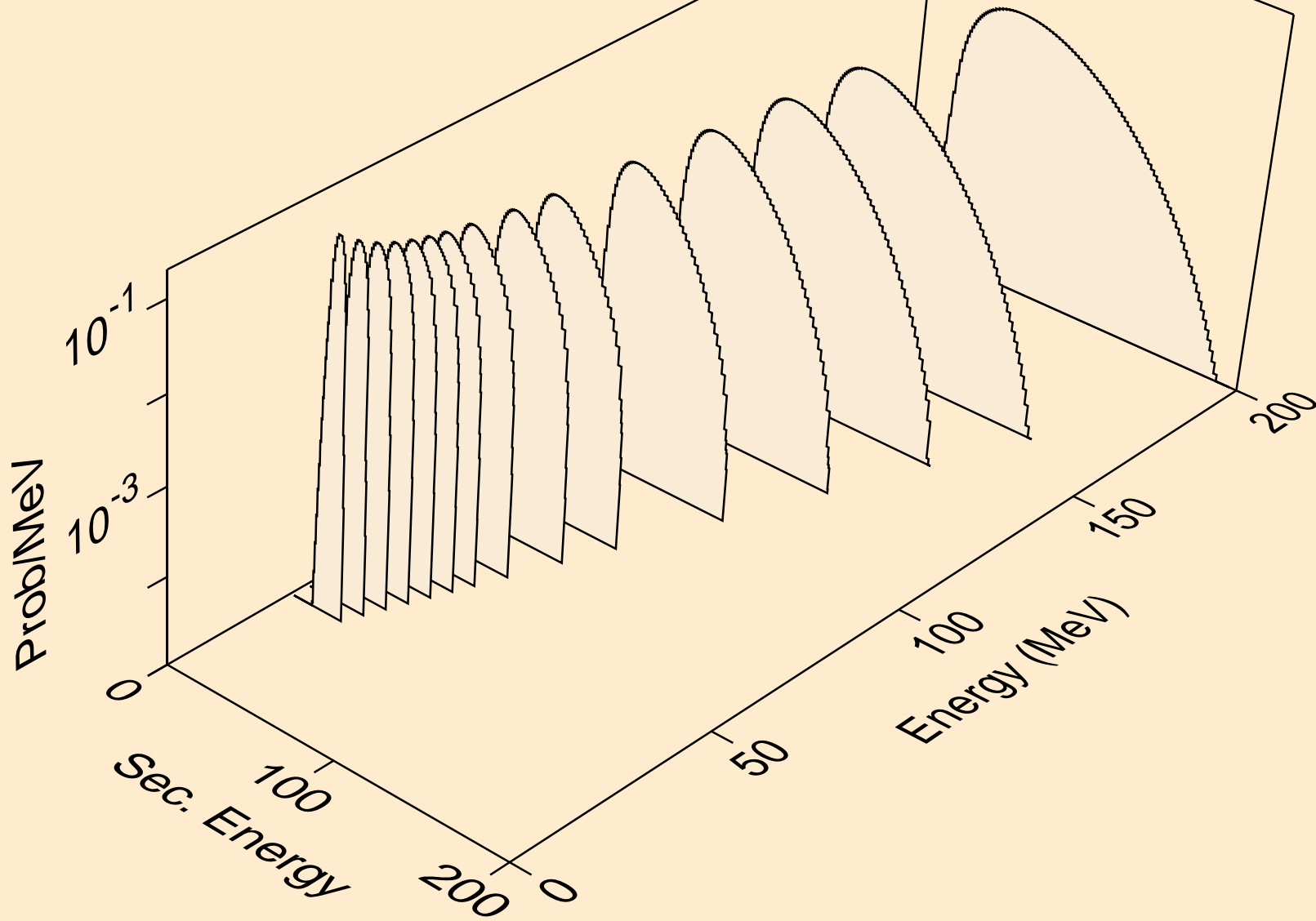

RN208 NEUTRON ACER TENDL-2019 LIBRARY; T=293.16K
he3s from (n,n*)he3

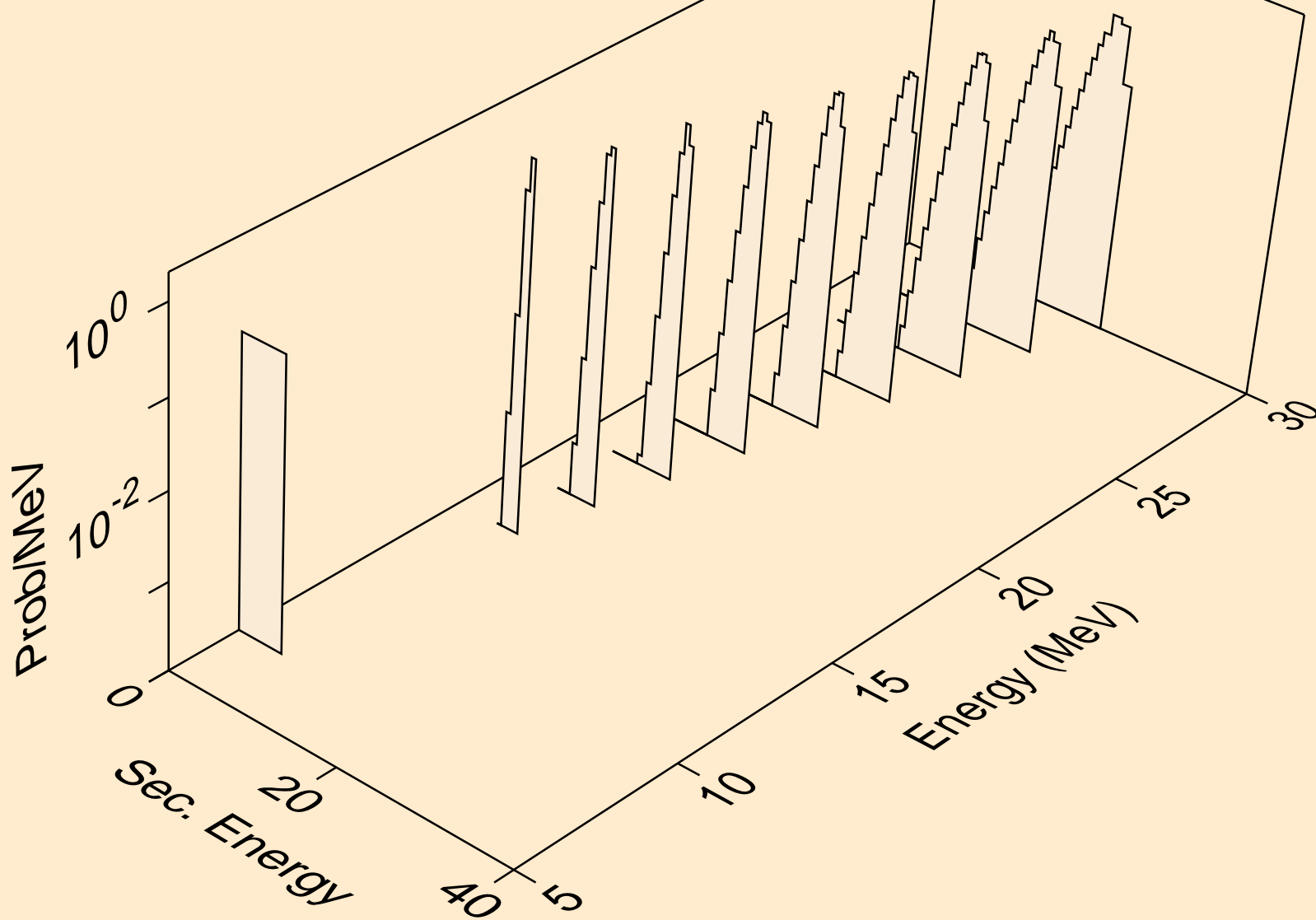

RN208 NEUTRON ACER TENDL-2019 LIBRARY; T=293.16K
he3s from (n,he3)

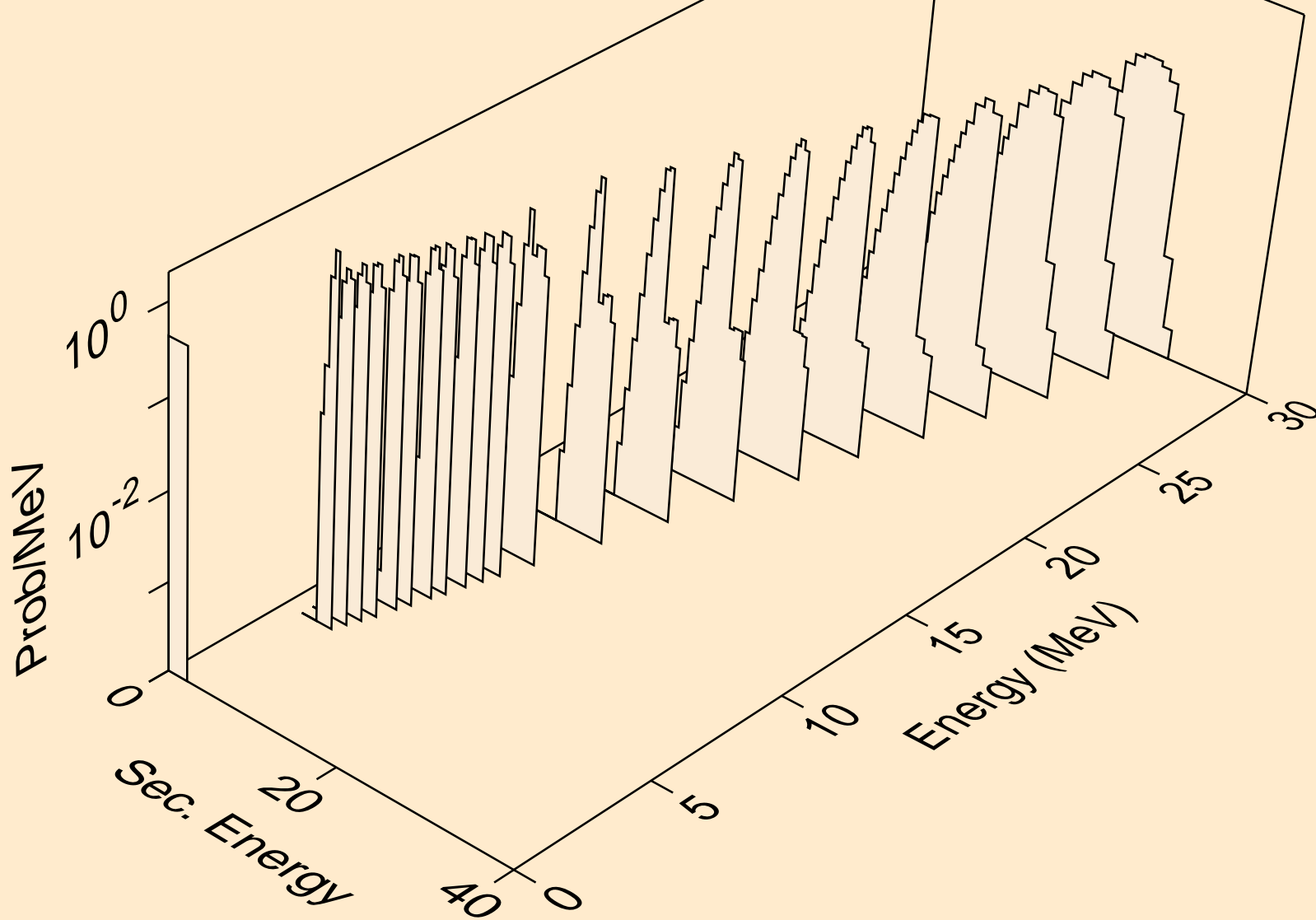

RN208 NEUTRON ACER TENDL-2019 LIBRARY; T=293.16K
alphas from (n,x)

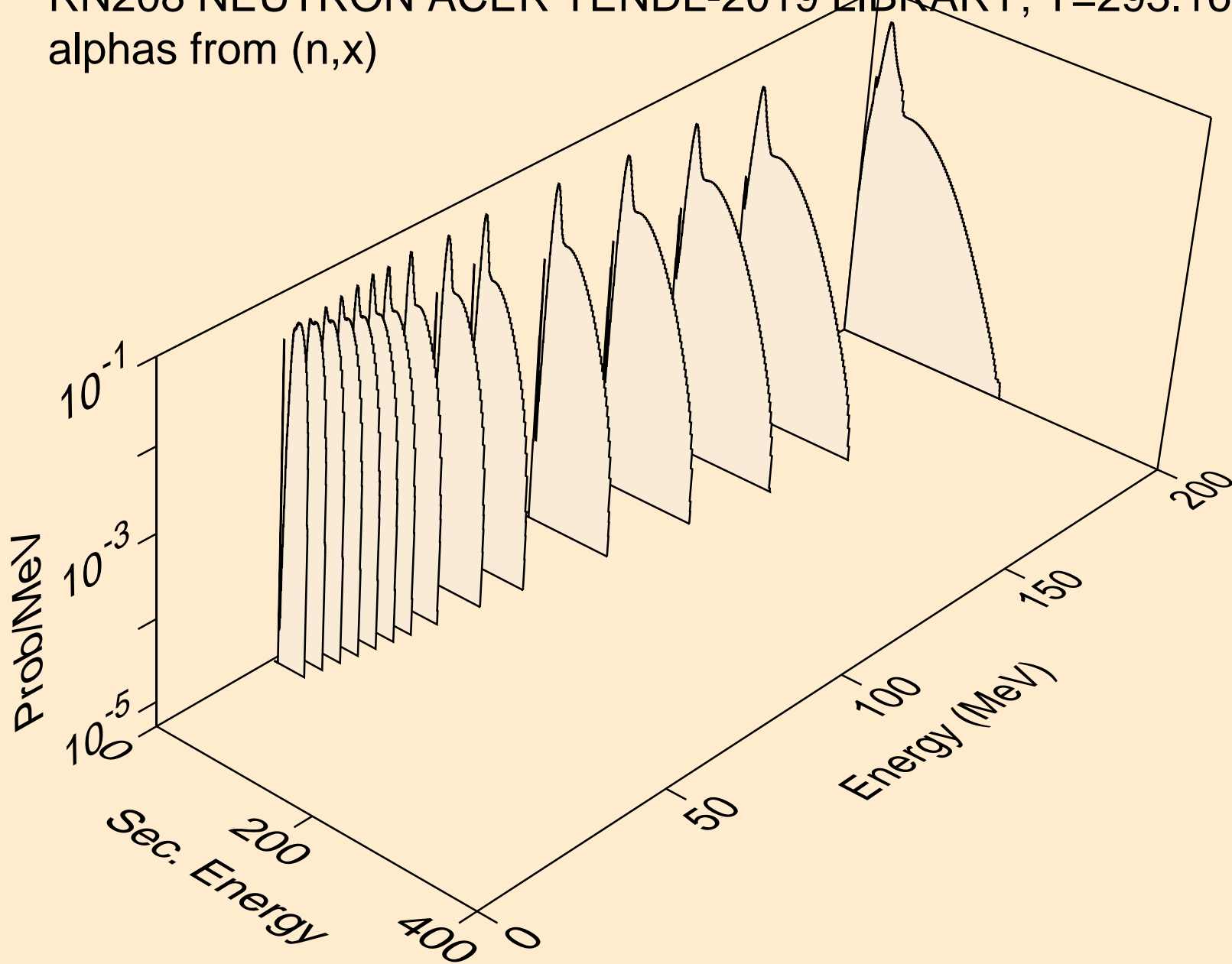

RN208 NEUTRON ACER TENDL-2019 LIBRARY; T=293.16K
alphas from (n,n*)a

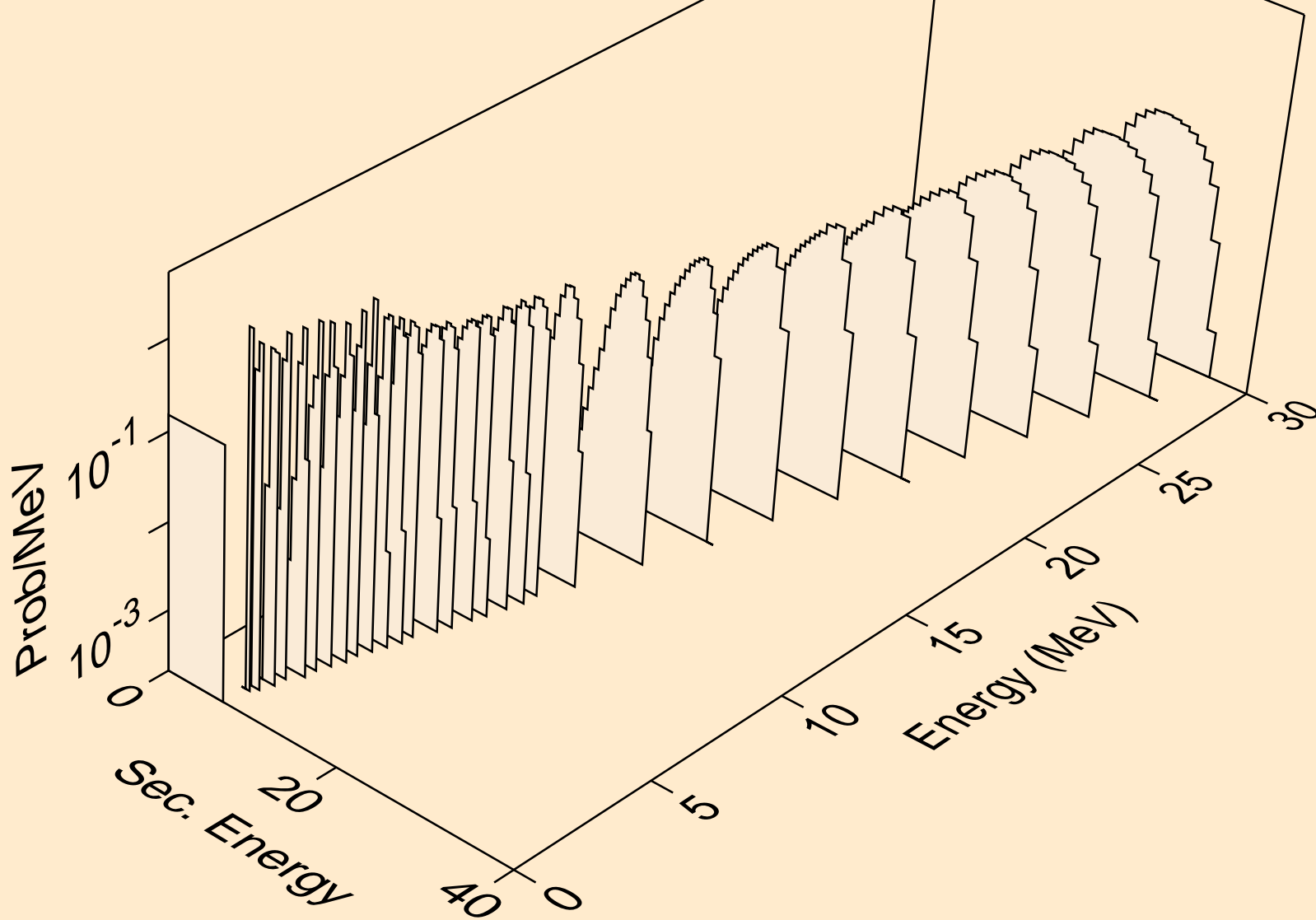

RN208 NEUTRON ACER TENDL-2019 LIBRARY; T=293.16K
alphas from (n,2n)a

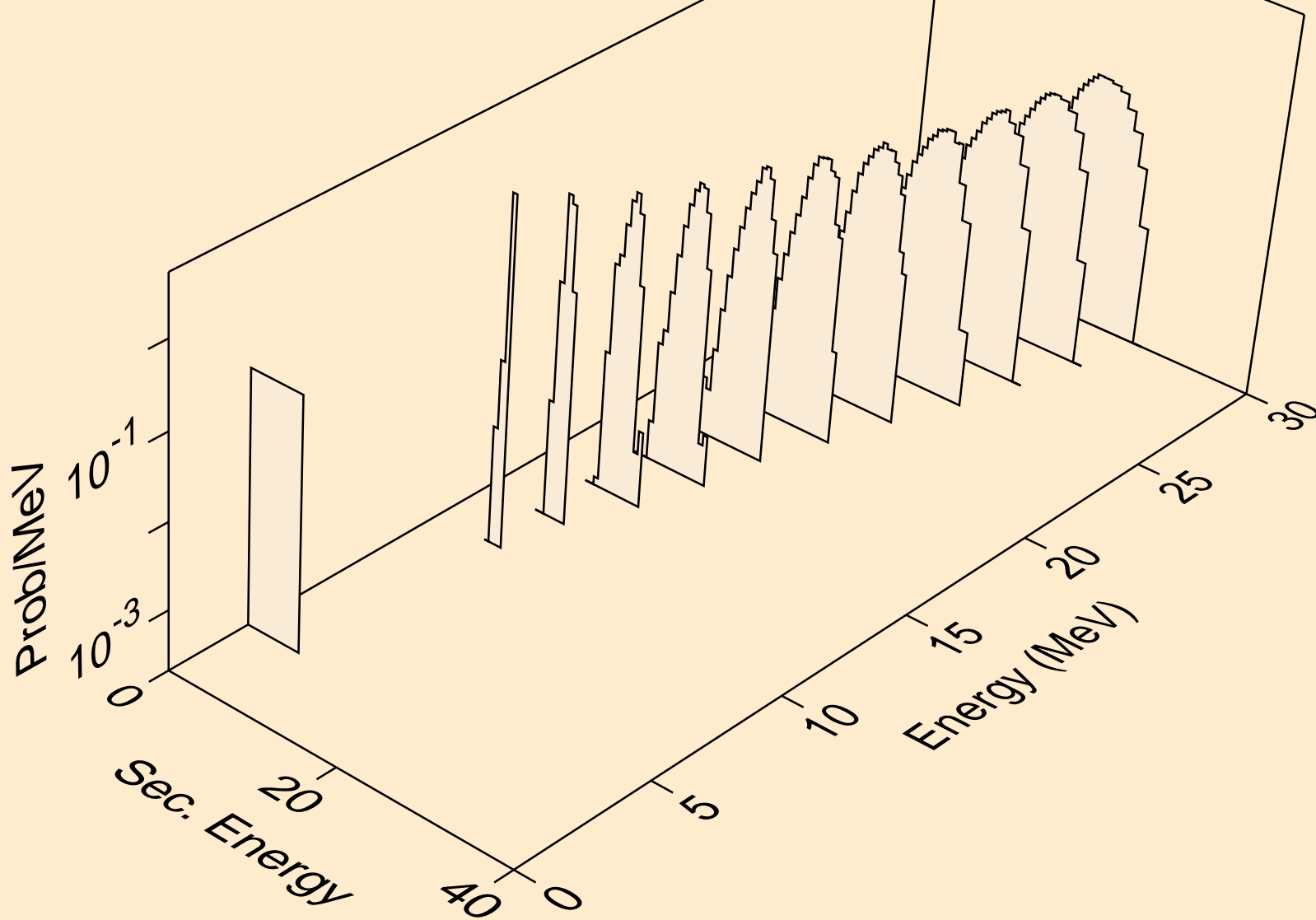

RN208 NEUTRON ACER TENDL-2019 LIBRARY; T=293.16K
alphas from (n,3n)a

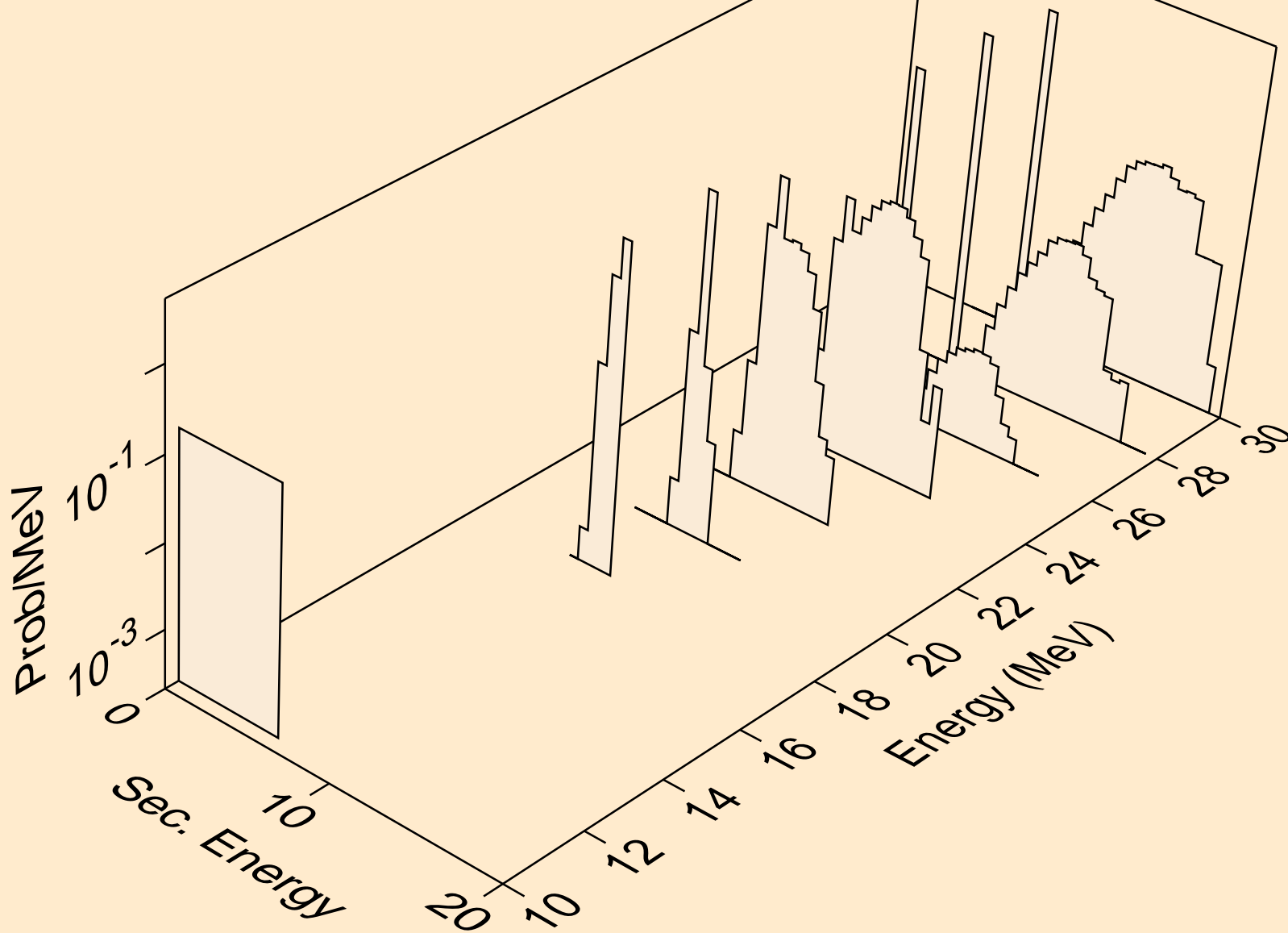

RN208 NEUTRON ACER TENDL-2019 LIBRARY; T=293.16K
alphas from (n,n*)2a

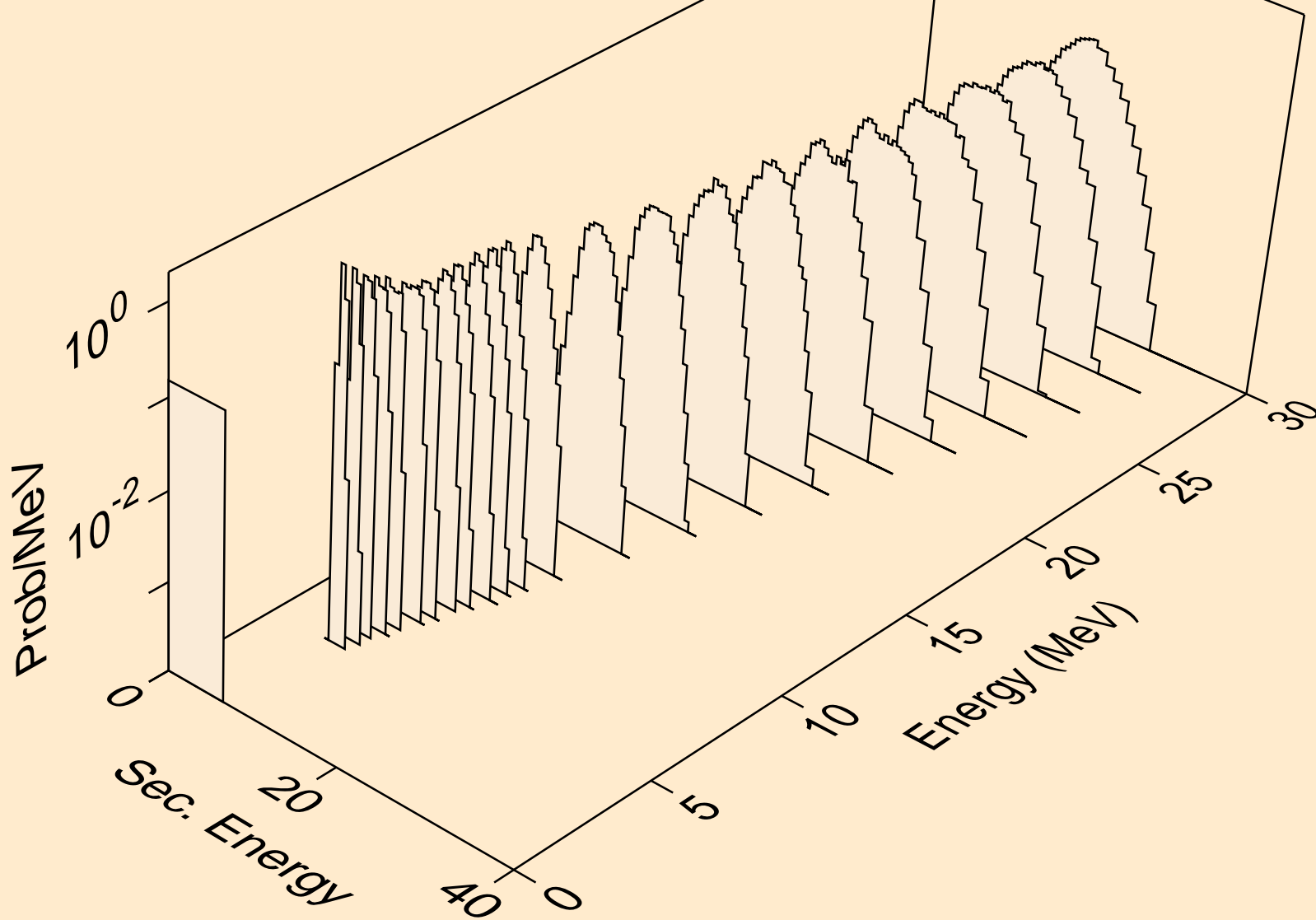

RN208 NEUTRON ACER TENDL-2019 LIBRARY; T=293.16K
alphas from (n,2n)2a

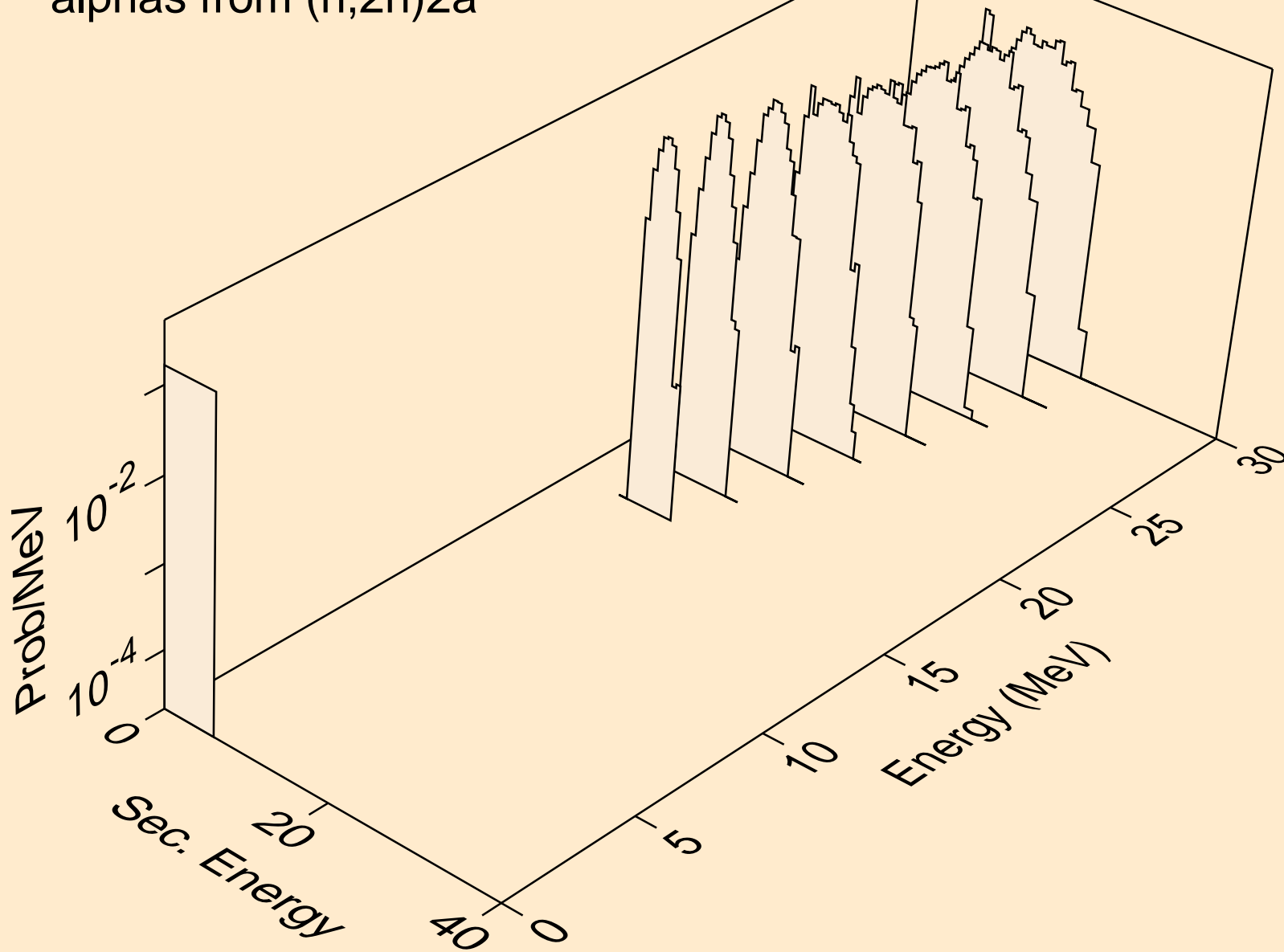

RN208 NEUTRON ACER TENDL-2019 LIBRARY; T=293.16K
alphas from (n,npa)

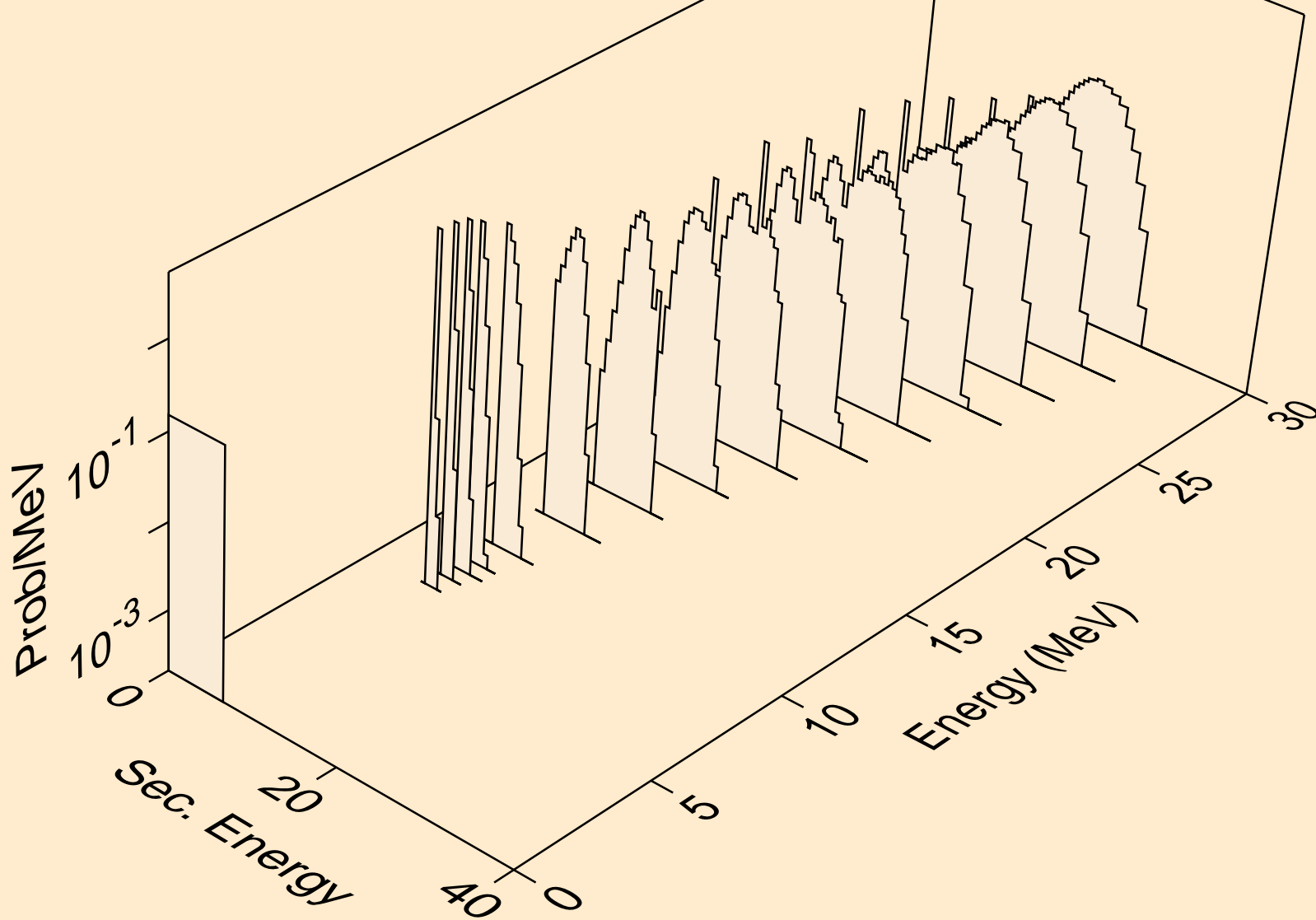

RN208 NEUTRON ACER TENDL-2019 LIBRARY; T=293.16K
alphas from (n,a)

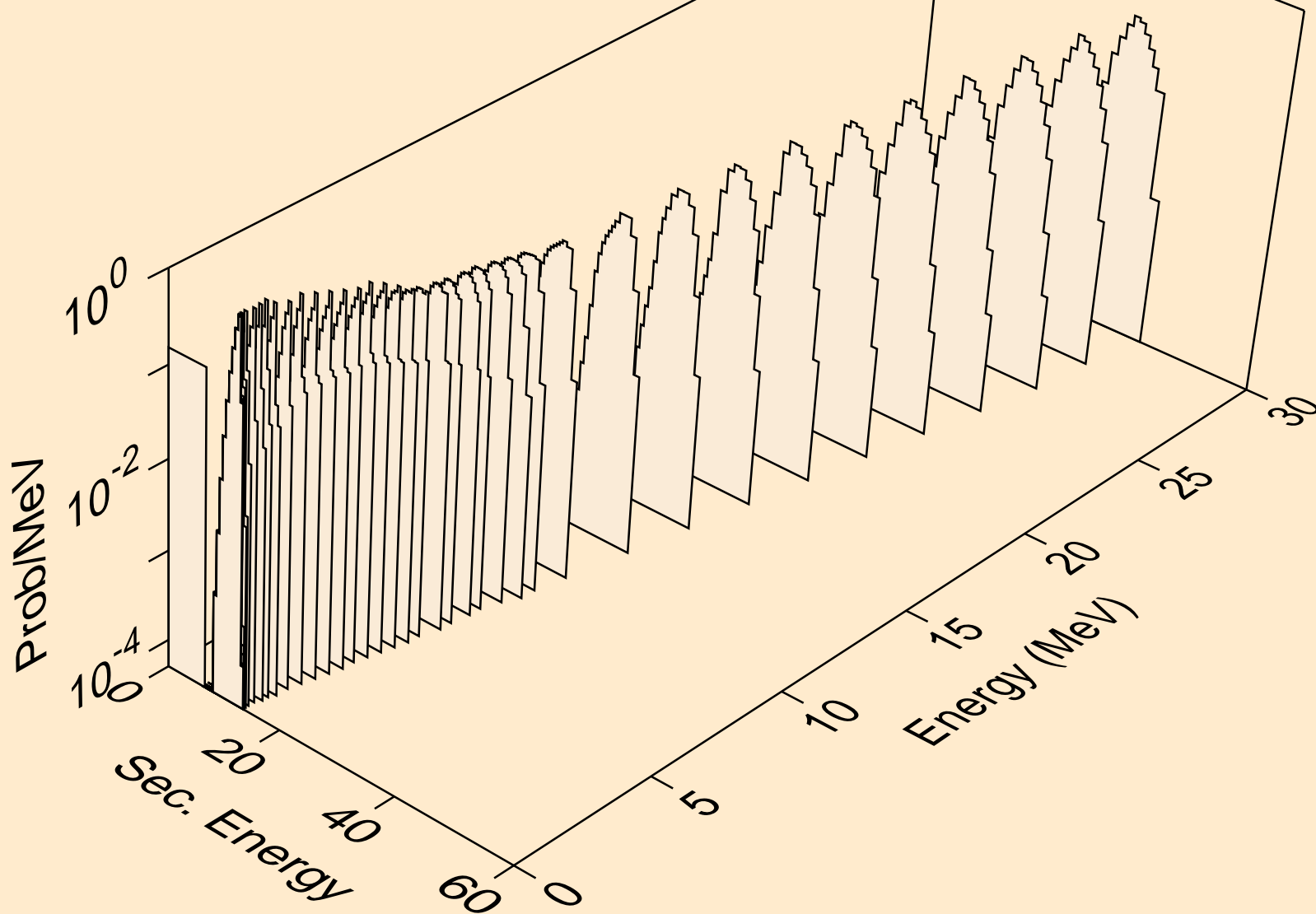

RN208 NEUTRON ACER TENDL-2019 LIBRARY; T=293.16K
alphas from (n,2a)

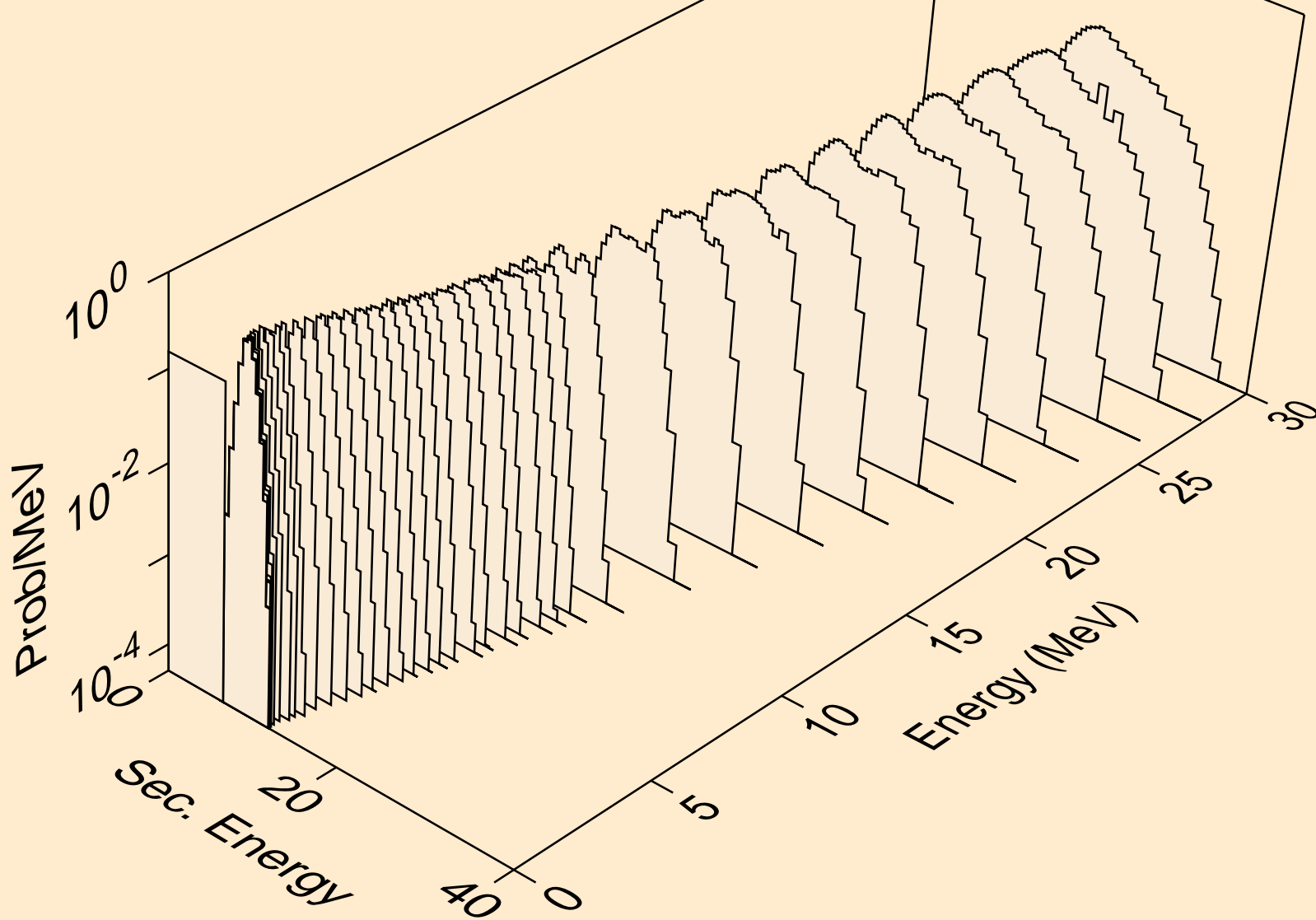

RN208 NEUTRON ACER TENDL-2019 LIBRARY; T=293.16K
alphas from (n,pa)

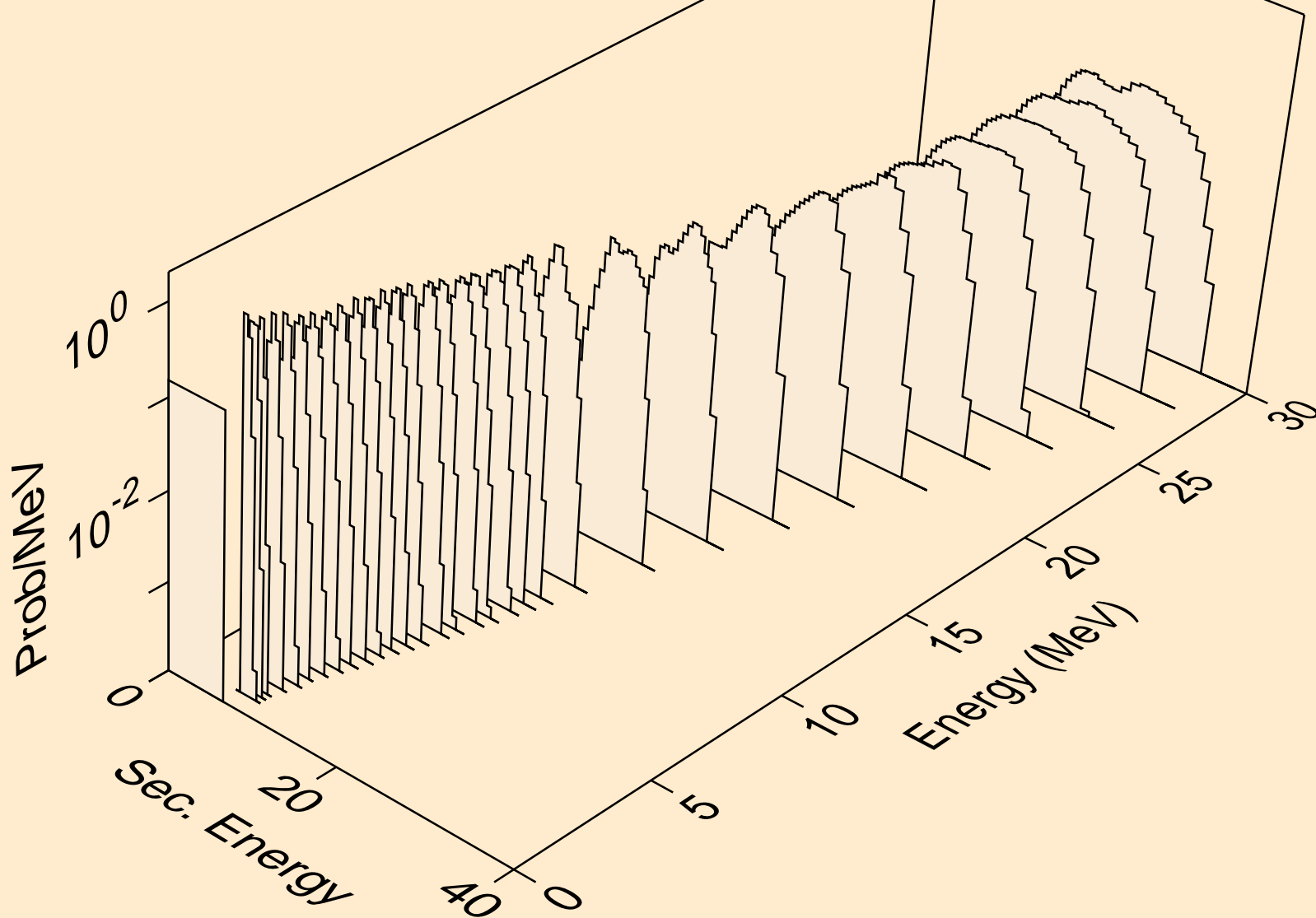

RN208 NEUTRON ACER TENDL-2019 LIBRARY; T=293.16K
alphas from (n,da)

