

RU090 NEUTRON ACER TENDL-2019 LIBRARY; T=293.16K
Principal cross sections

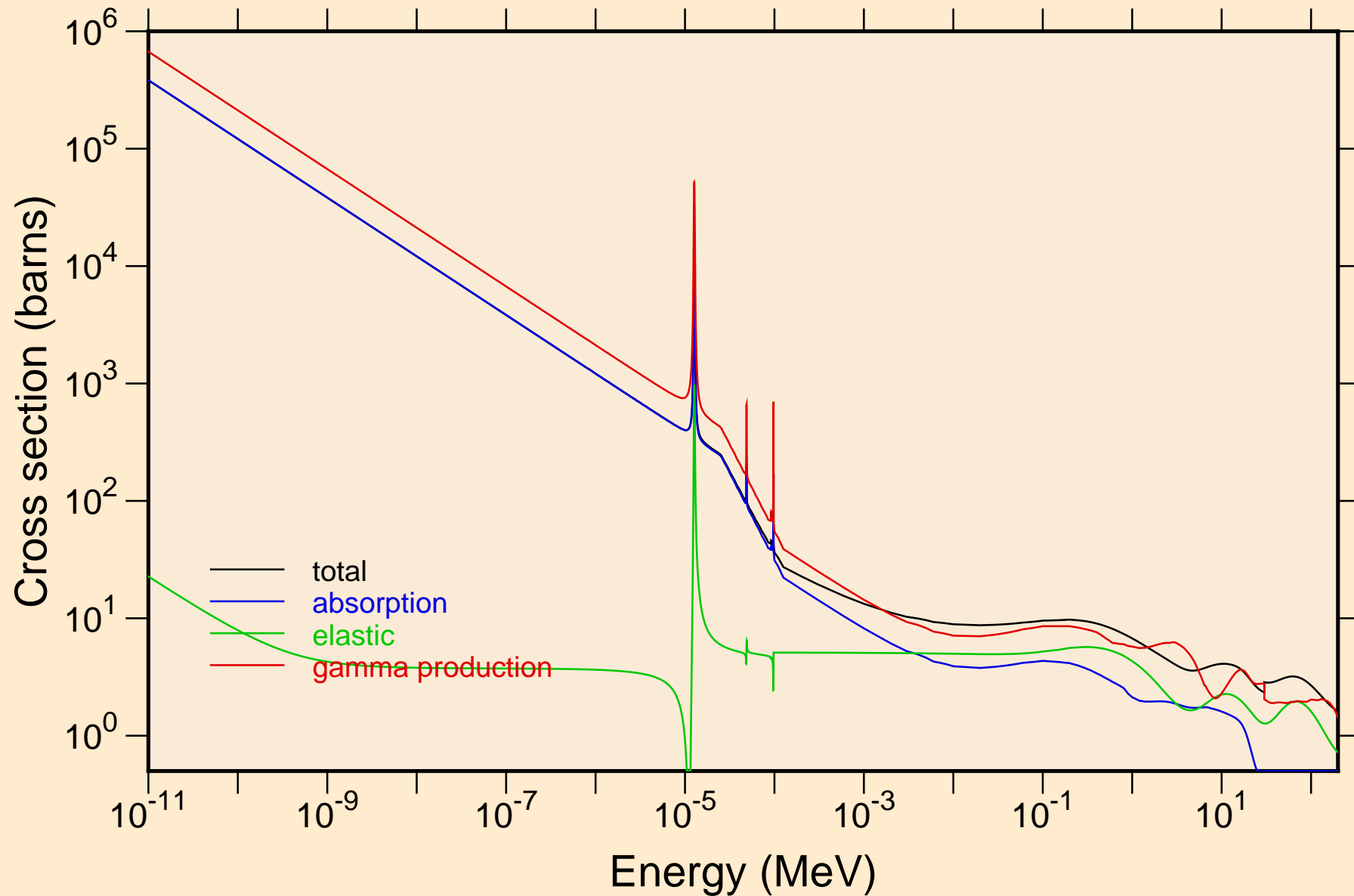

RU090 NEUTRON ACER TENDL-2019 LIBRARY; T=293.16K
resonance total cross section

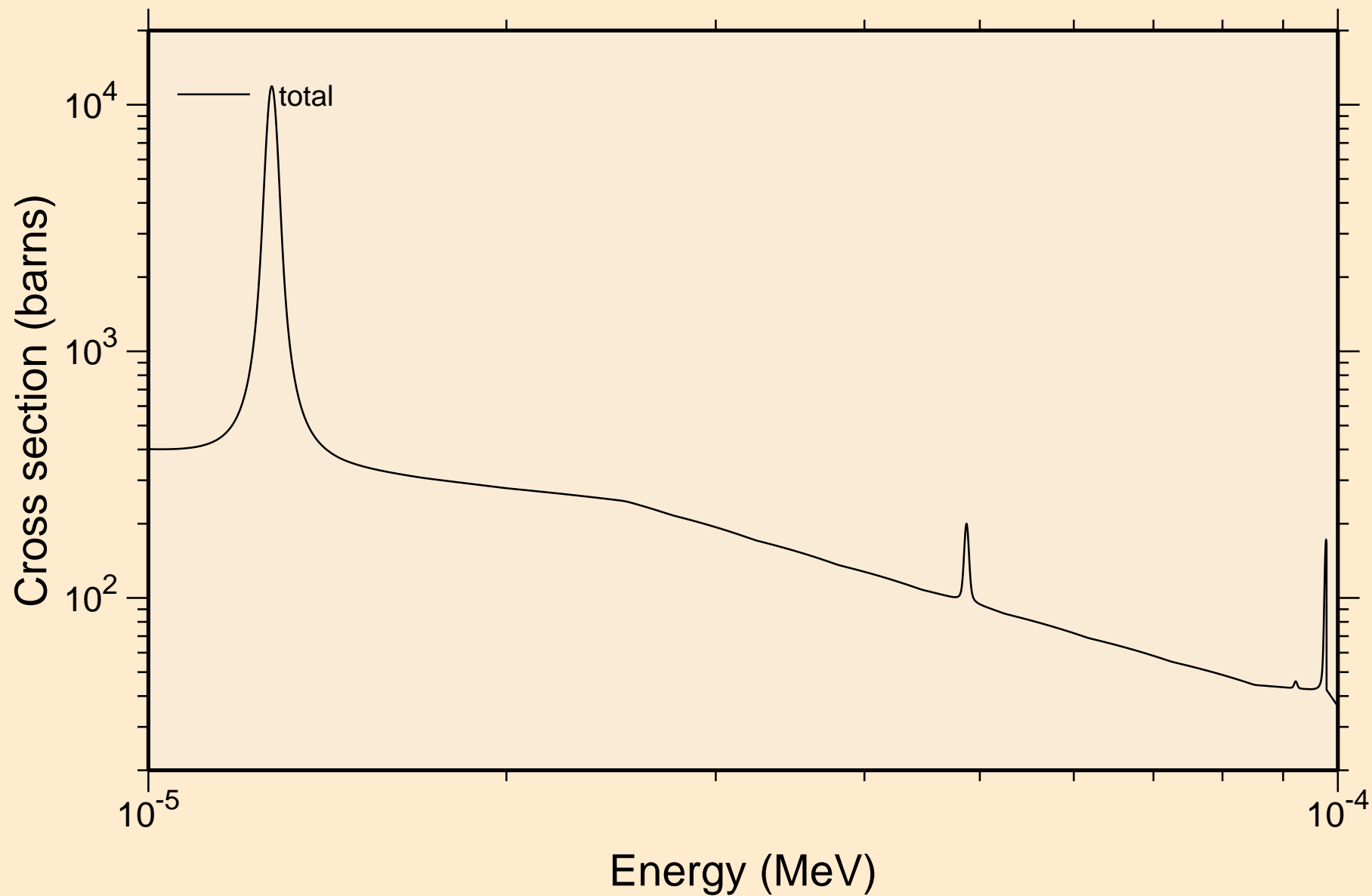

RÜ090 NEUTRON ACER TENDL-2019 LIBRARY; T=293.16K
resonance total cross section

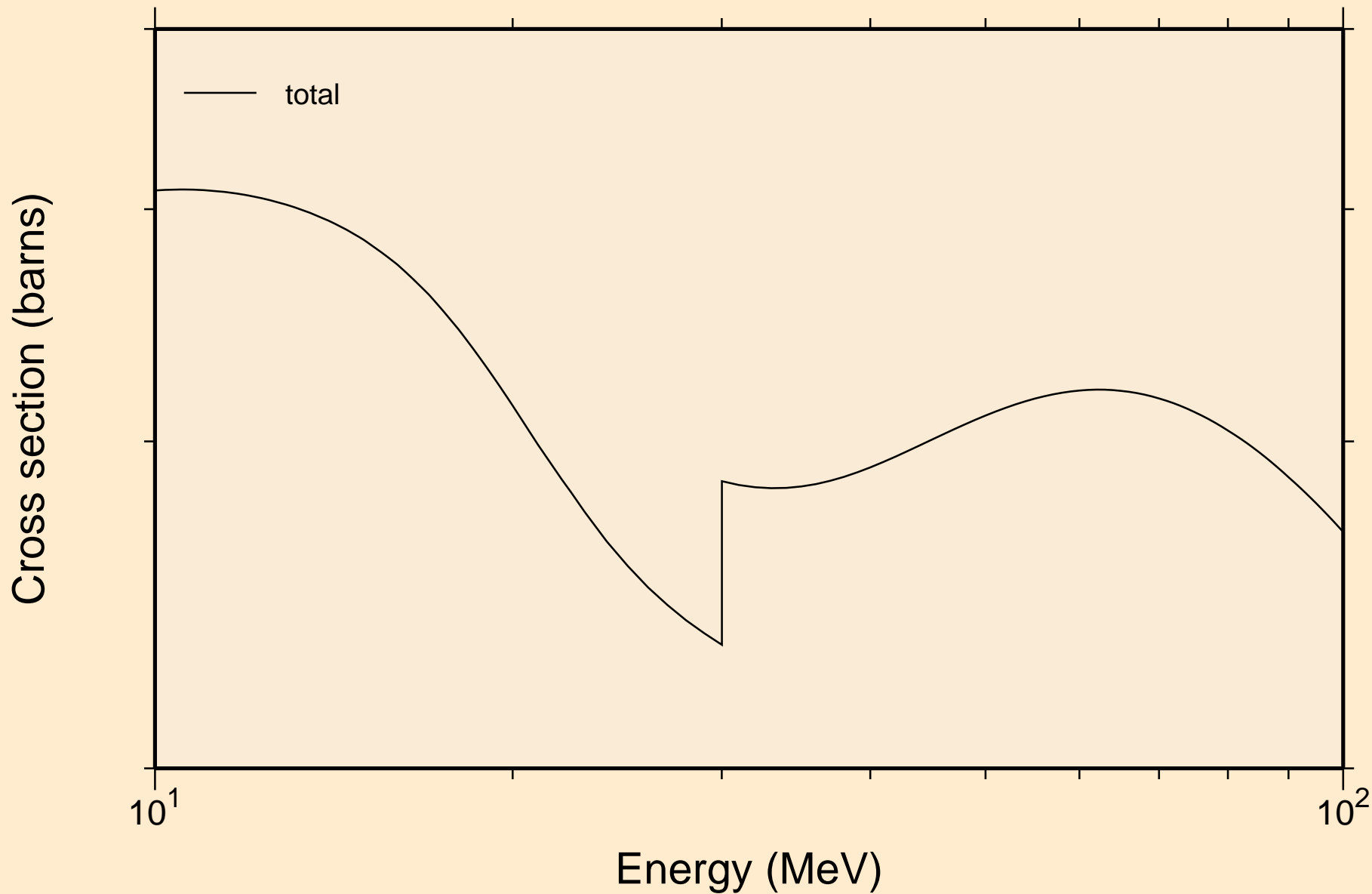

RU090 NEUTRON ACER TENDL-2019 LIBRARY; T=293.16K
resonance absorption cross sections

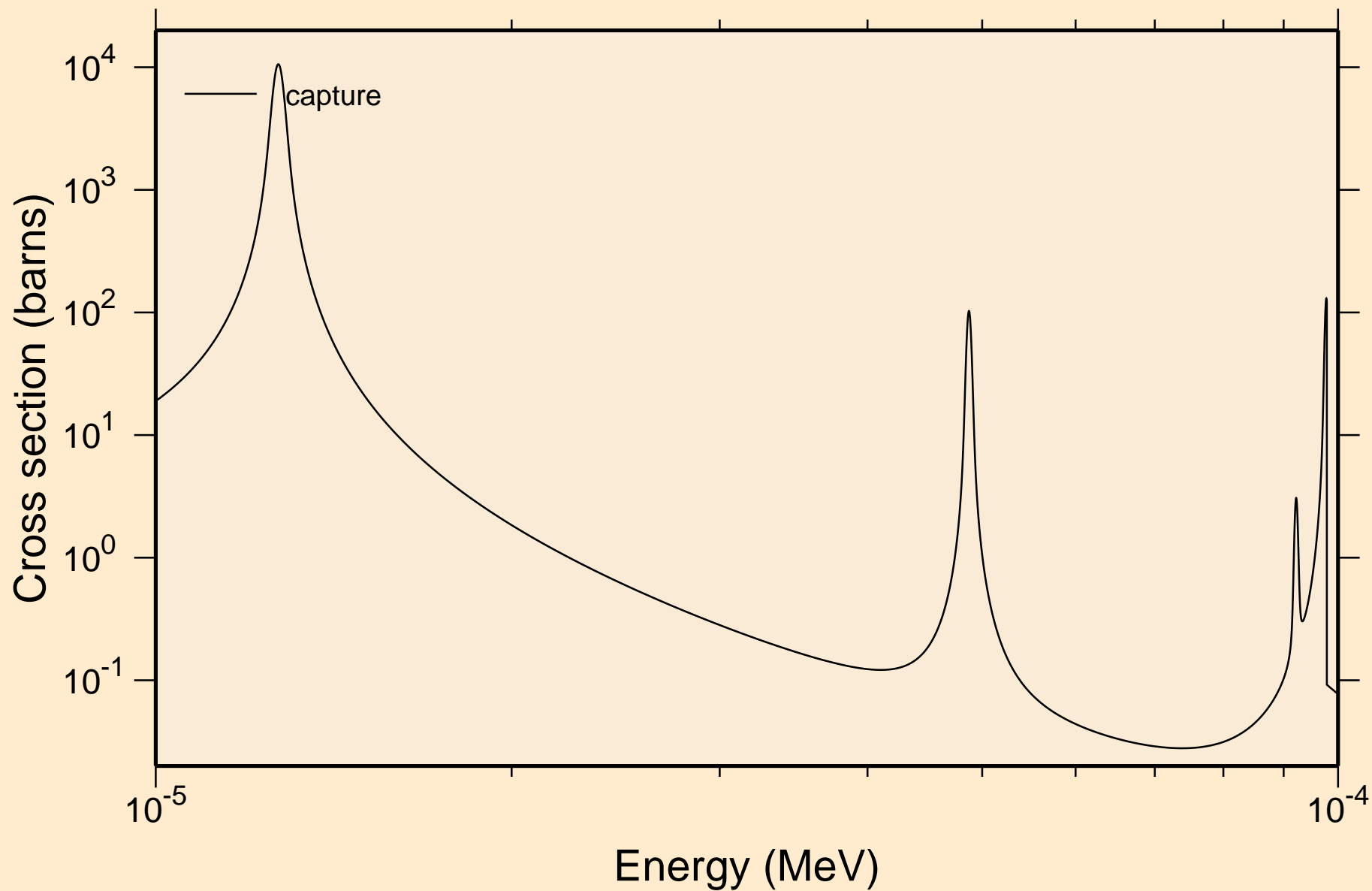

RU090 NEUTRON ACER TENDL-2019 LIBRARY; T=293.16K
resonance absorption cross sections

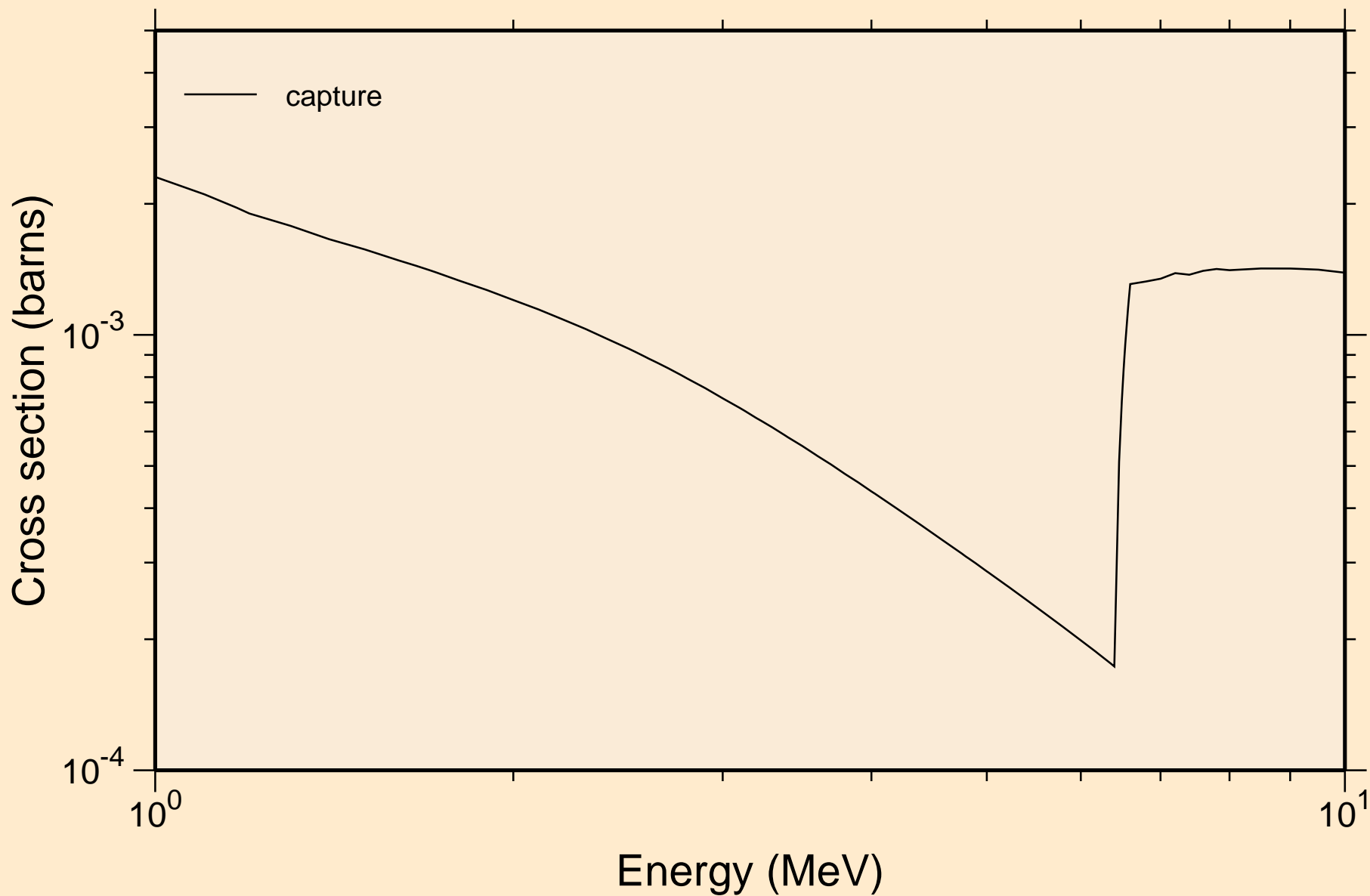

RU090 NEUTRON ACER TENDL-2019 LIBRARY; T=293.16K
Heating

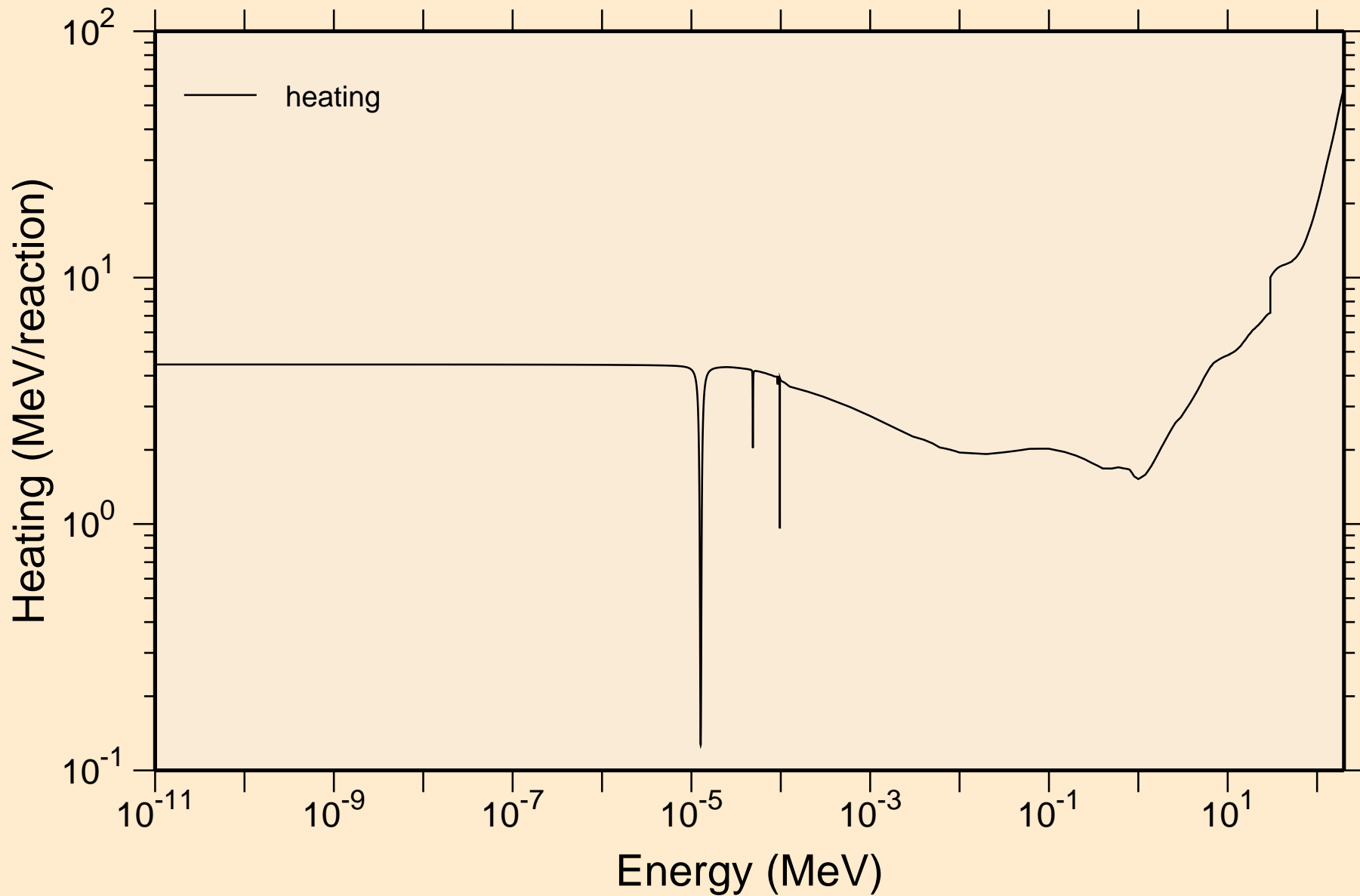

RU090 NEUTRON ACER TENDL-2019 LIBRARY; T=293.16K
Damage

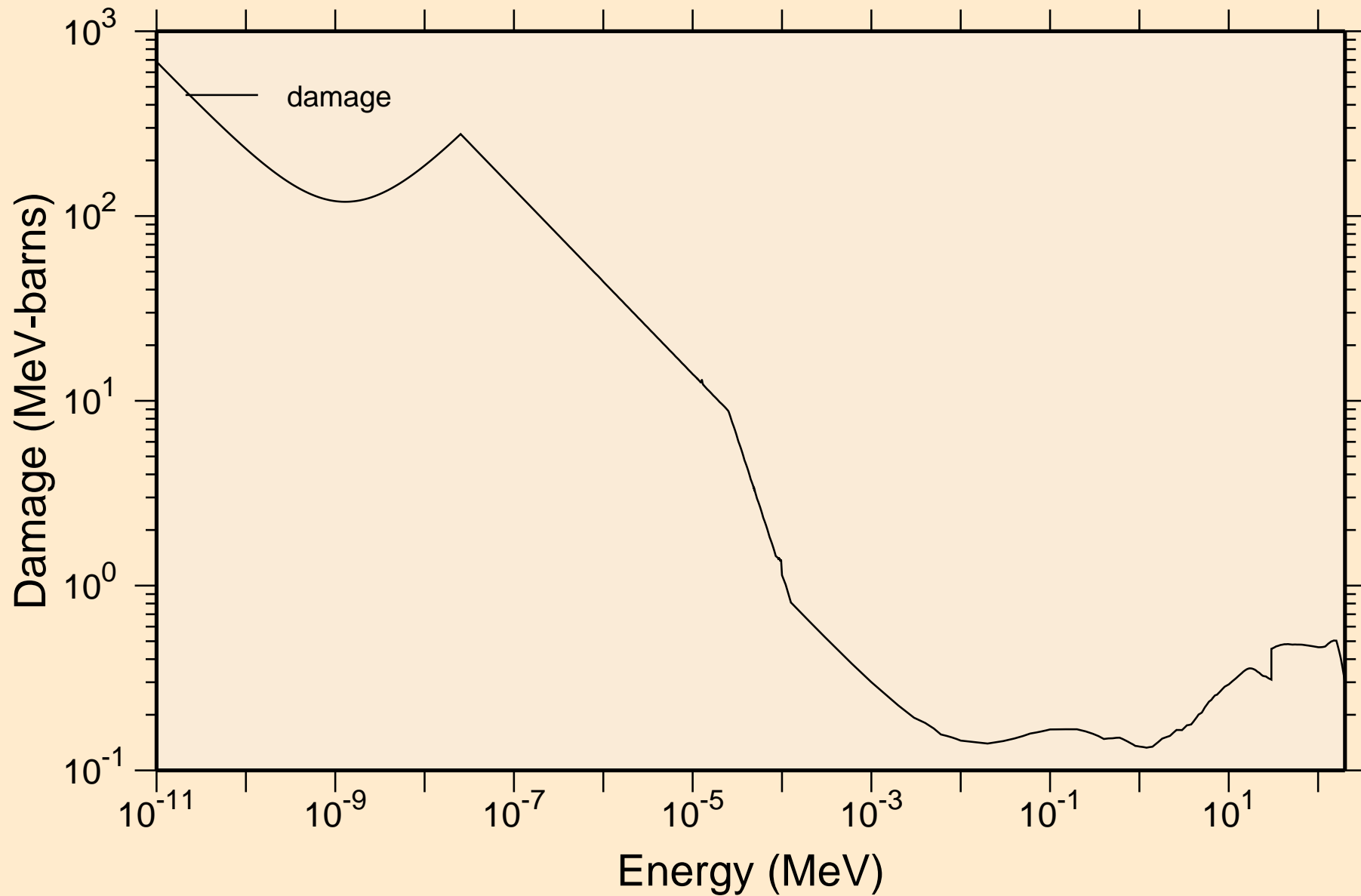

RU090 NEUTRON ACER TENDL-2019 LIBRARY; T=293.16K
Non-threshold reactions

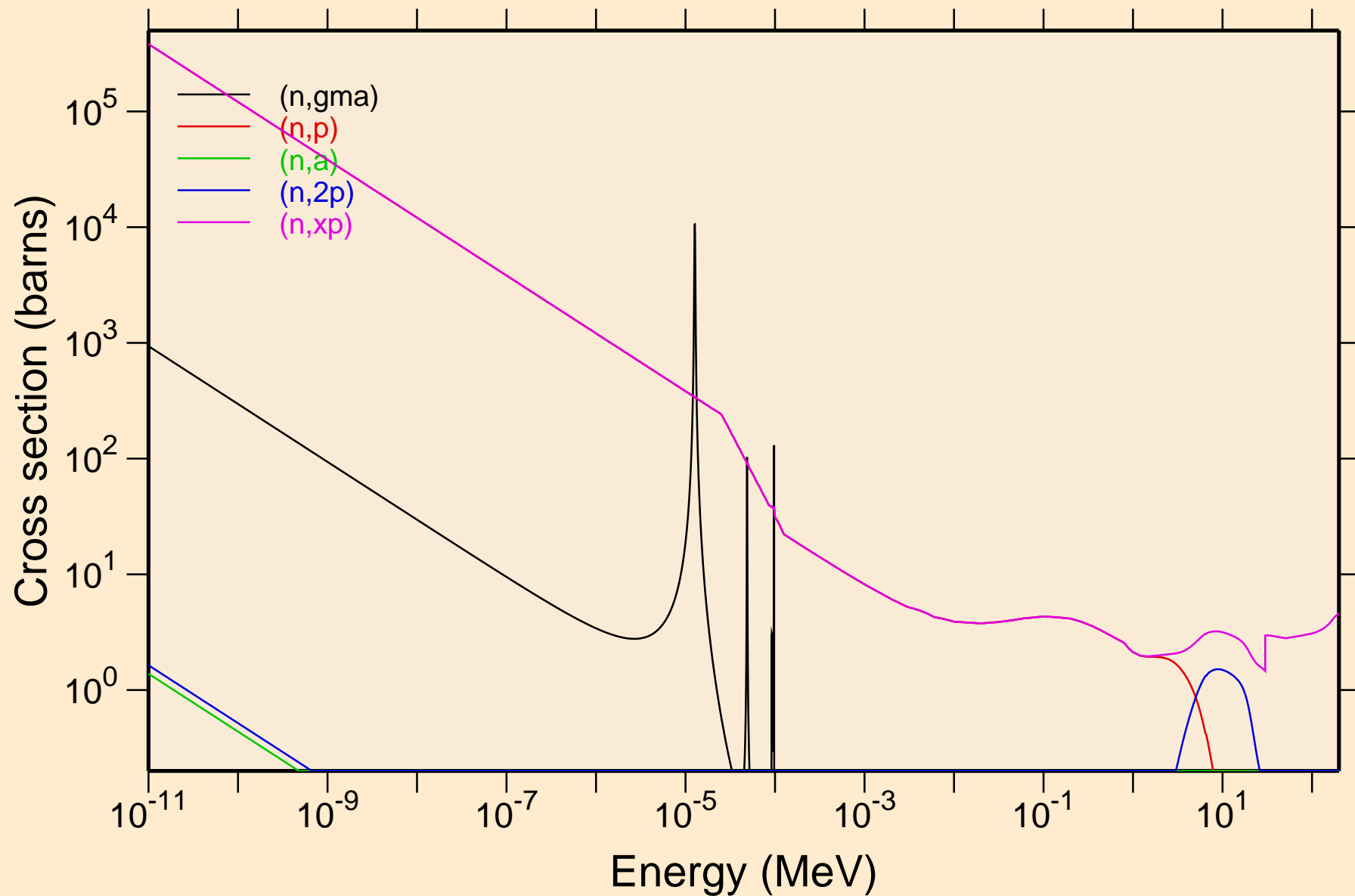

RU090 NEUTRON ACER TENDL-2019 LIBRARY; T=293.16K
Non-threshold reactions

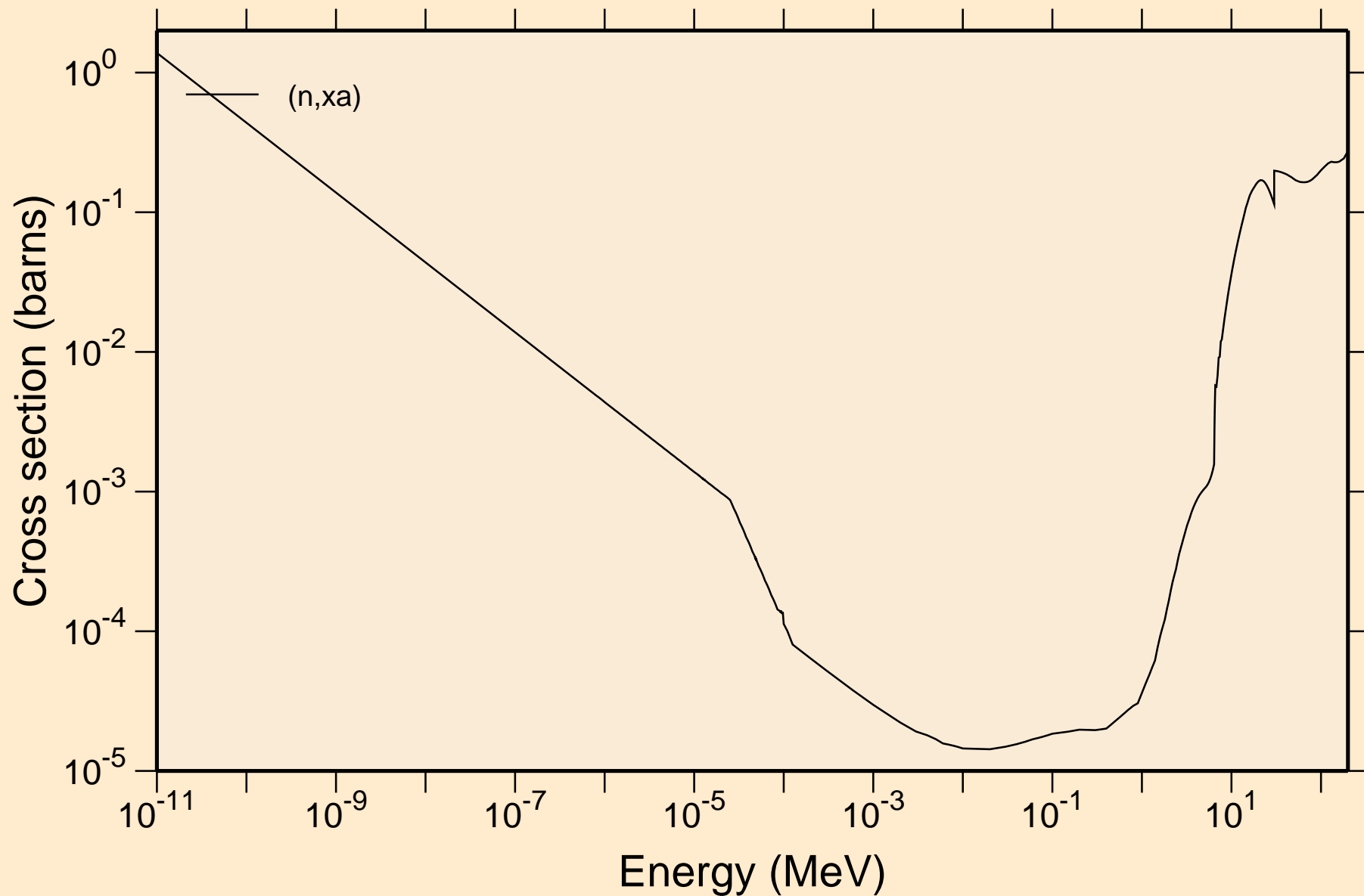

RU090 NEUTRON ACER TENDL-2019 LIBRARY; T=293.16K
Principal cross sections

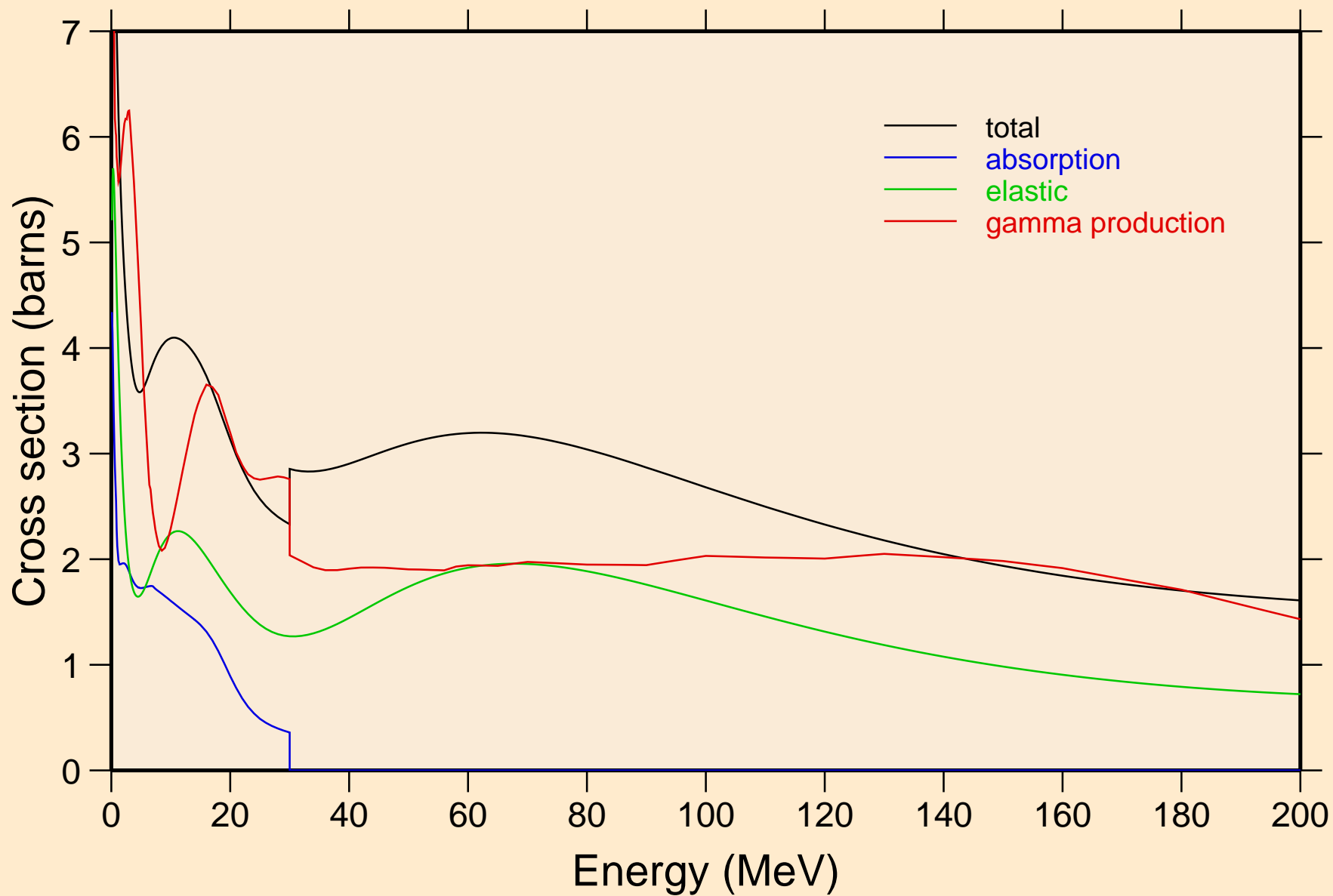

RU090 NEUTRON ACER TENDL-2019 LIBRARY; T=293.16K
Heating

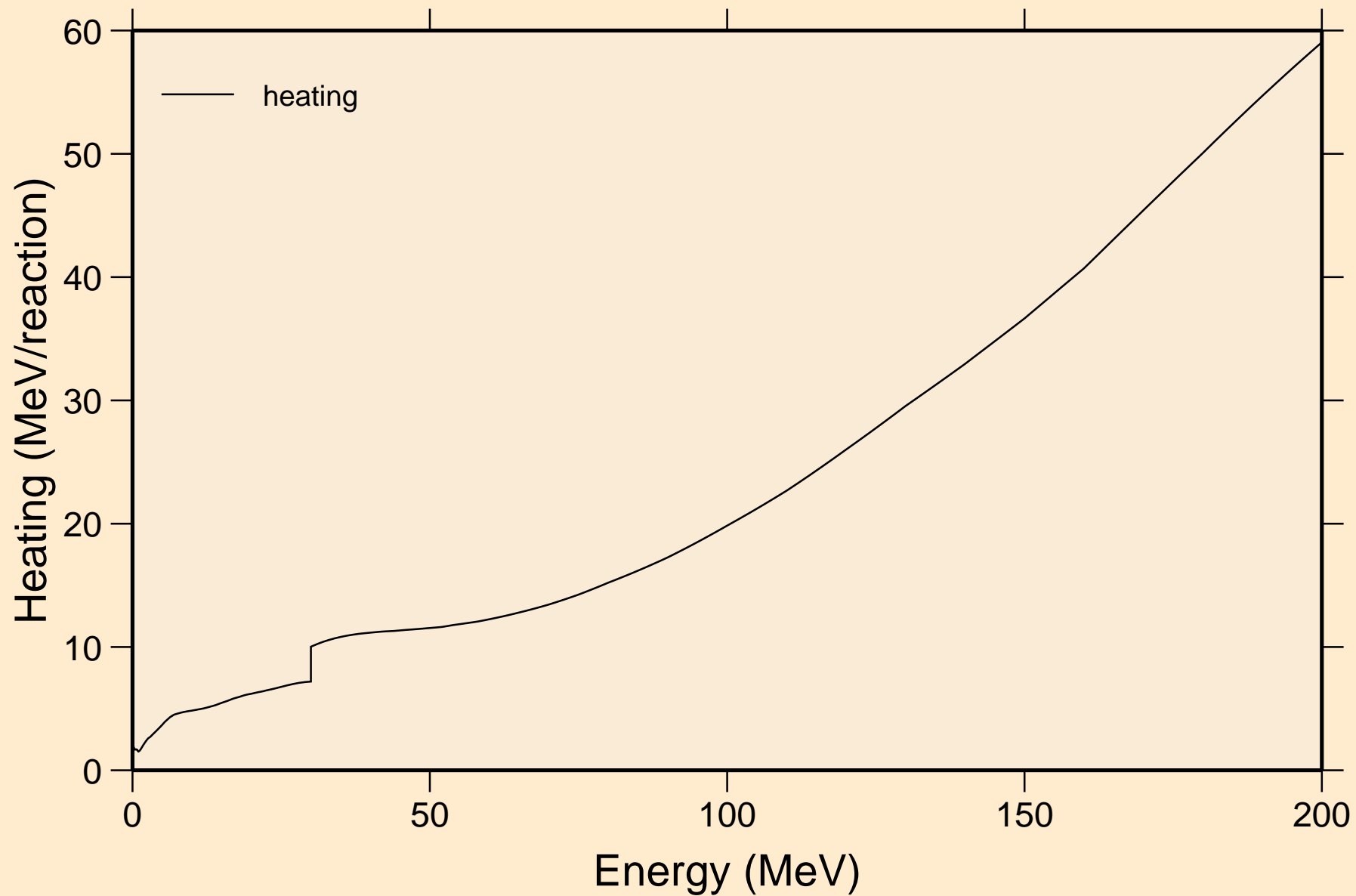

RU090 NEUTRON ACER TENDL-2019 LIBRARY; T=293.16K
Damage

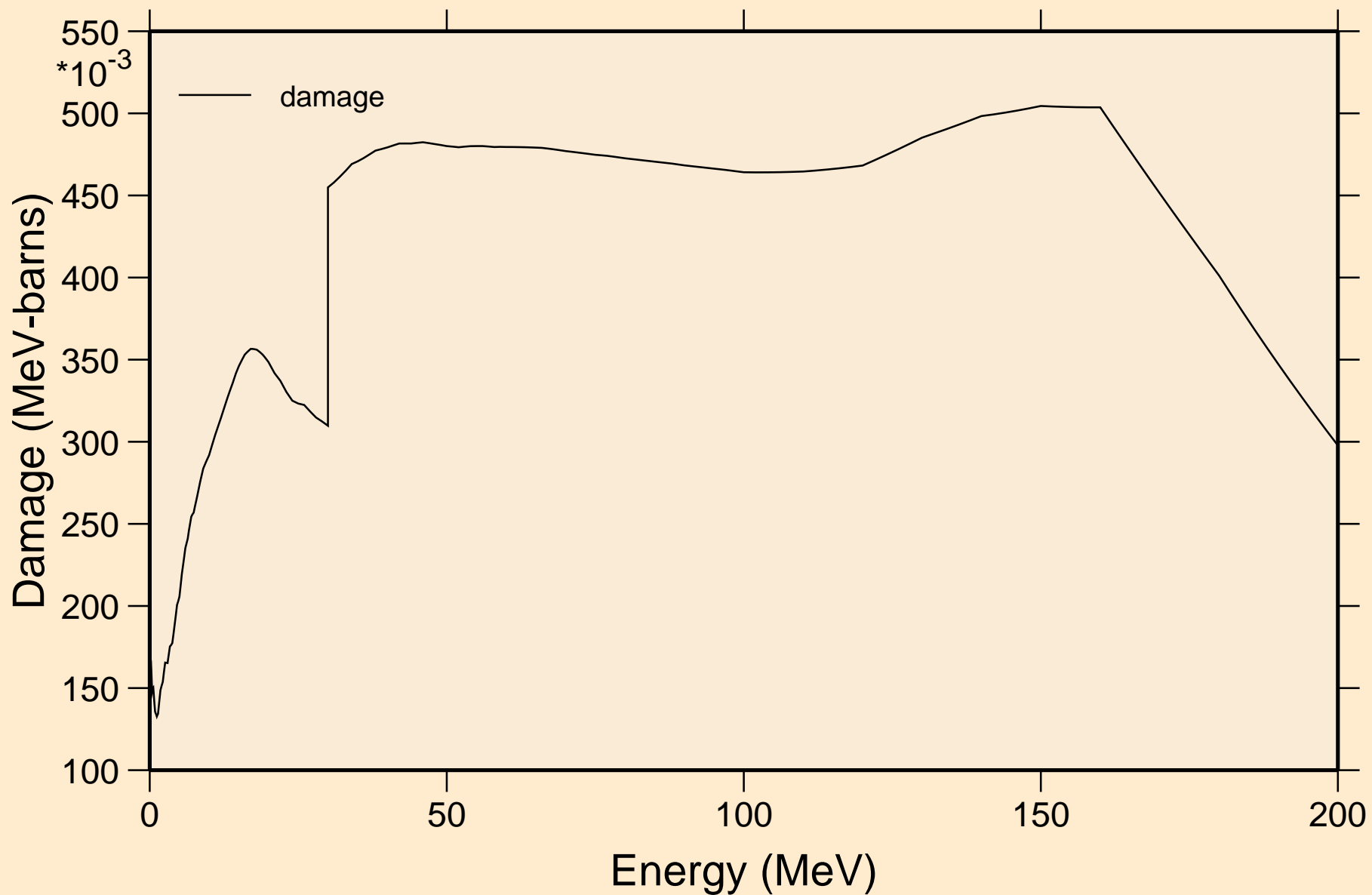

RU090 NEUTRON ACER TENDL-2019 LIBRARY; T=293.16K
Non-threshold reactions

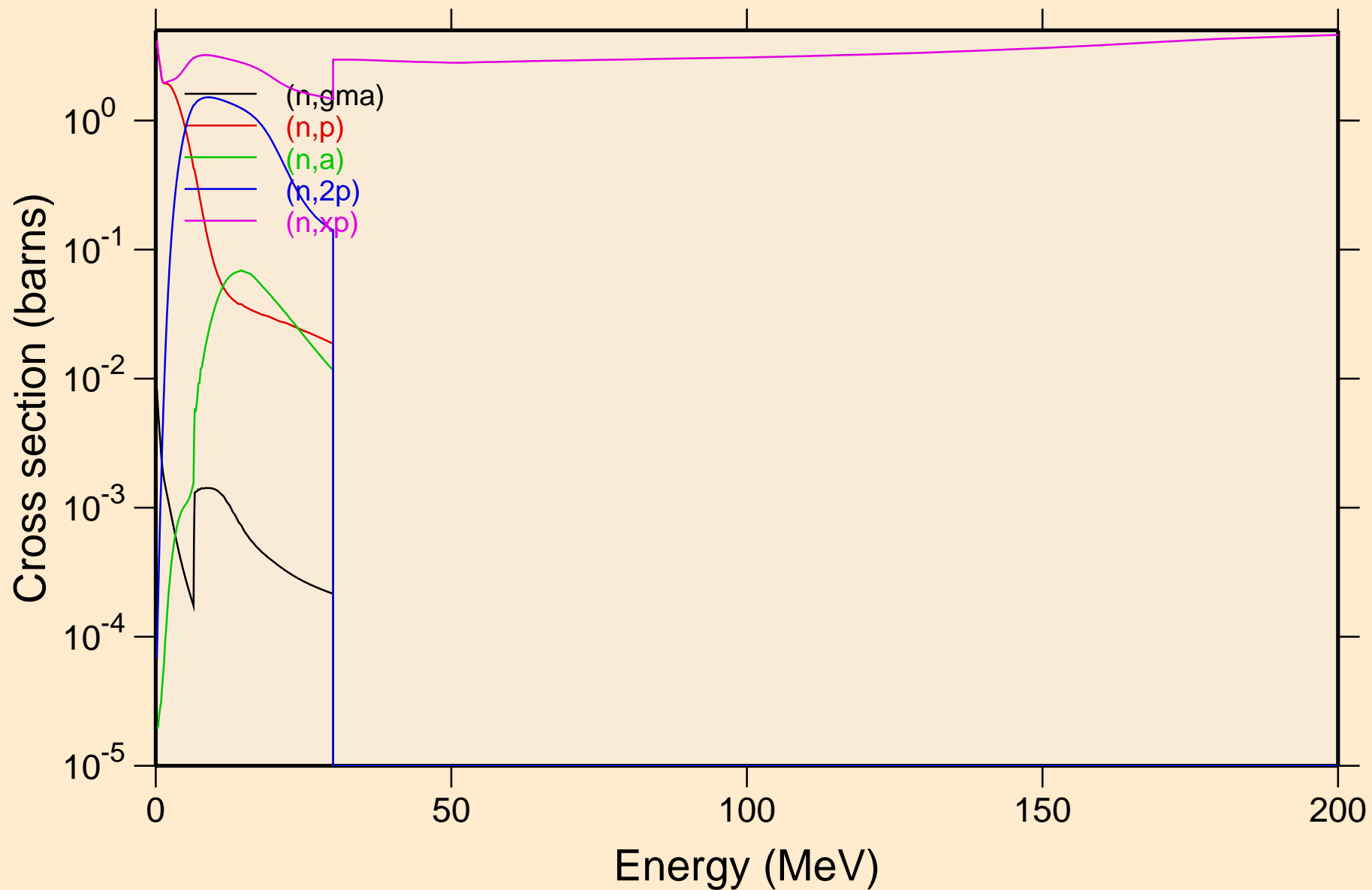

RU090 NEUTRON ACER TENDL-2019 LIBRARY; T=293.16K
Non-threshold reactions

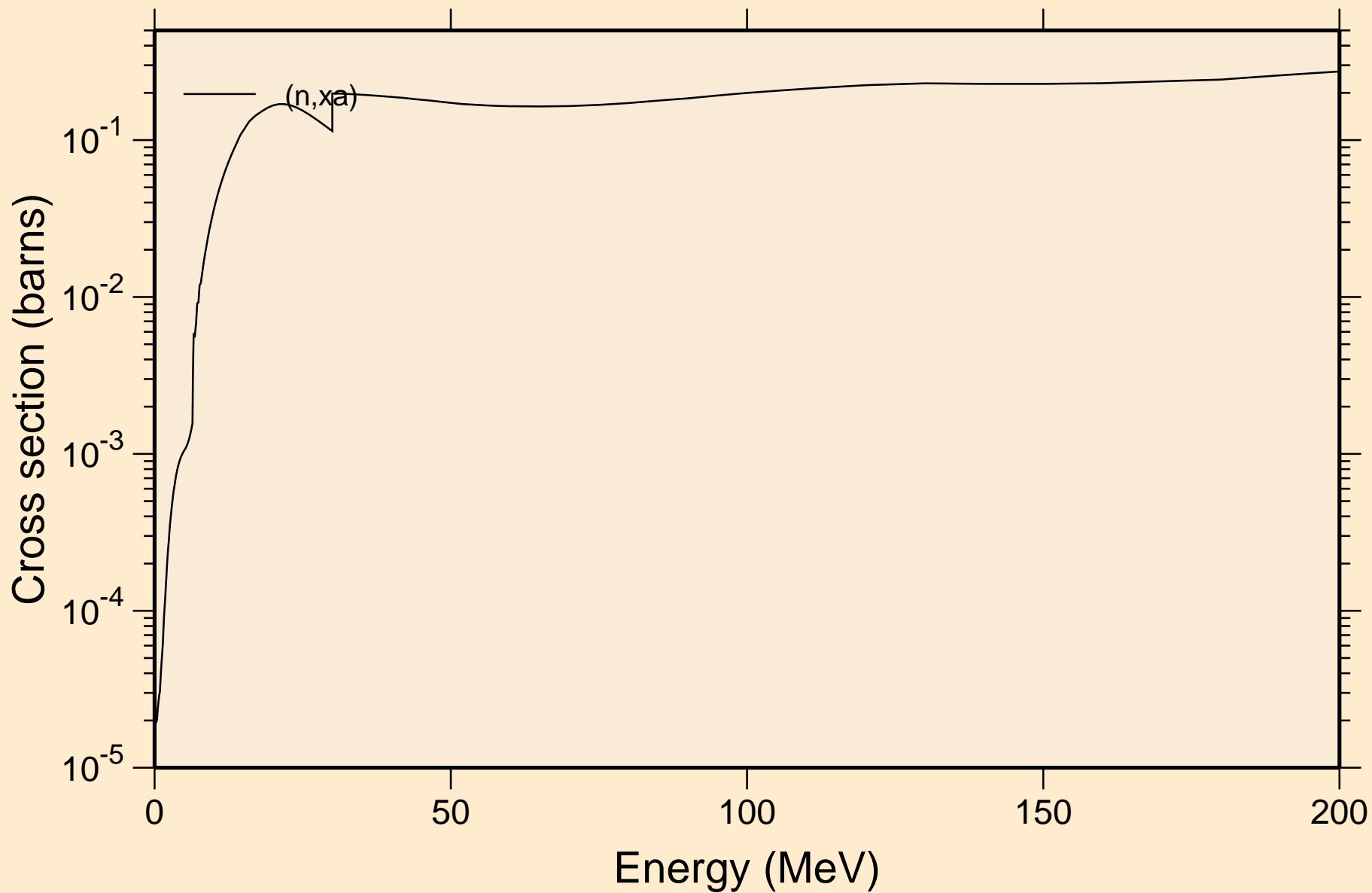

RU090 NEUTRON ACER TENDL-2019 LIBRARY; T=293.16K
Inelastic levels

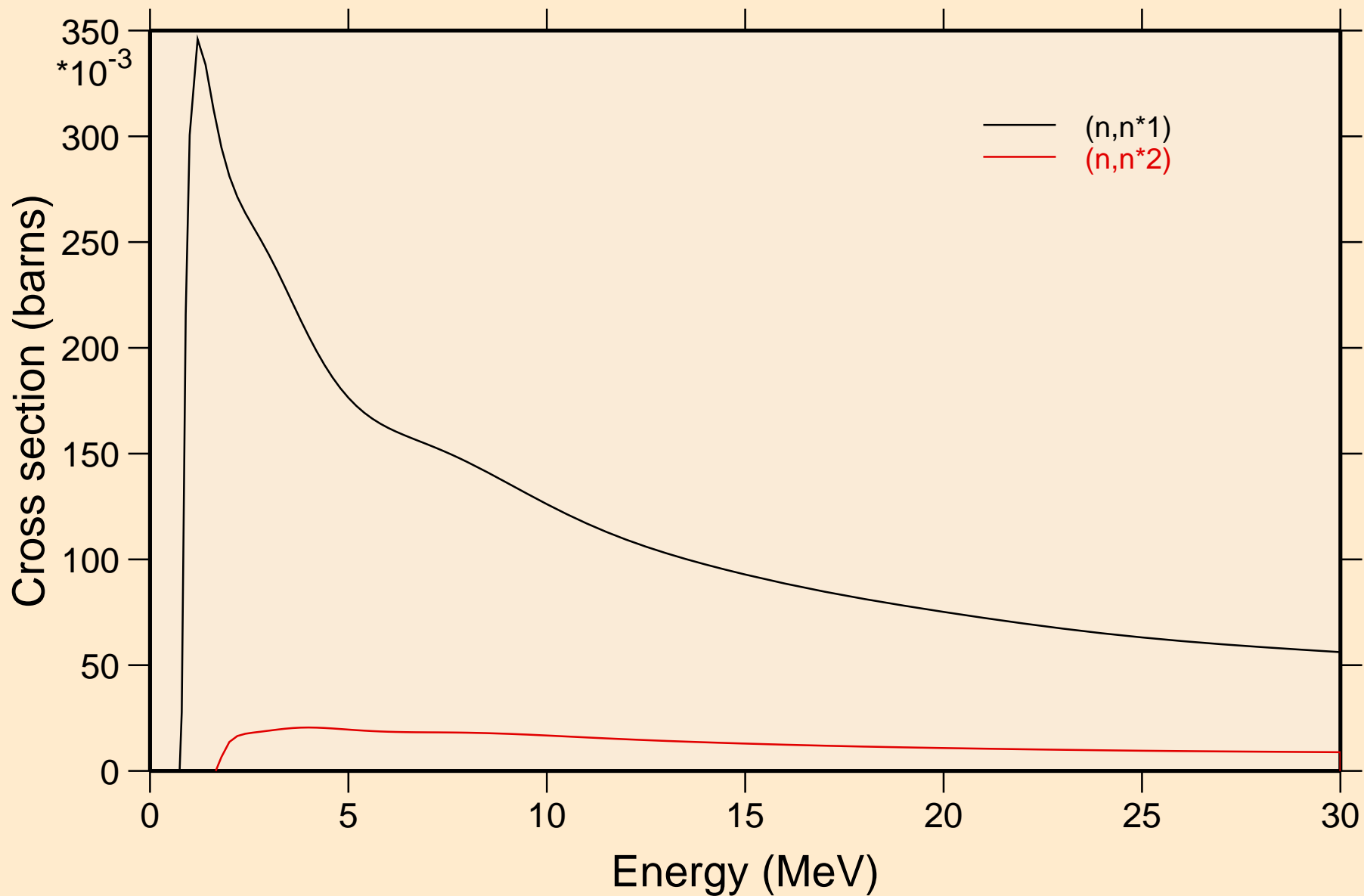

RU090 NEUTRON ACER TENDL-2019 LIBRARY; T=293.16K
Threshold reactions

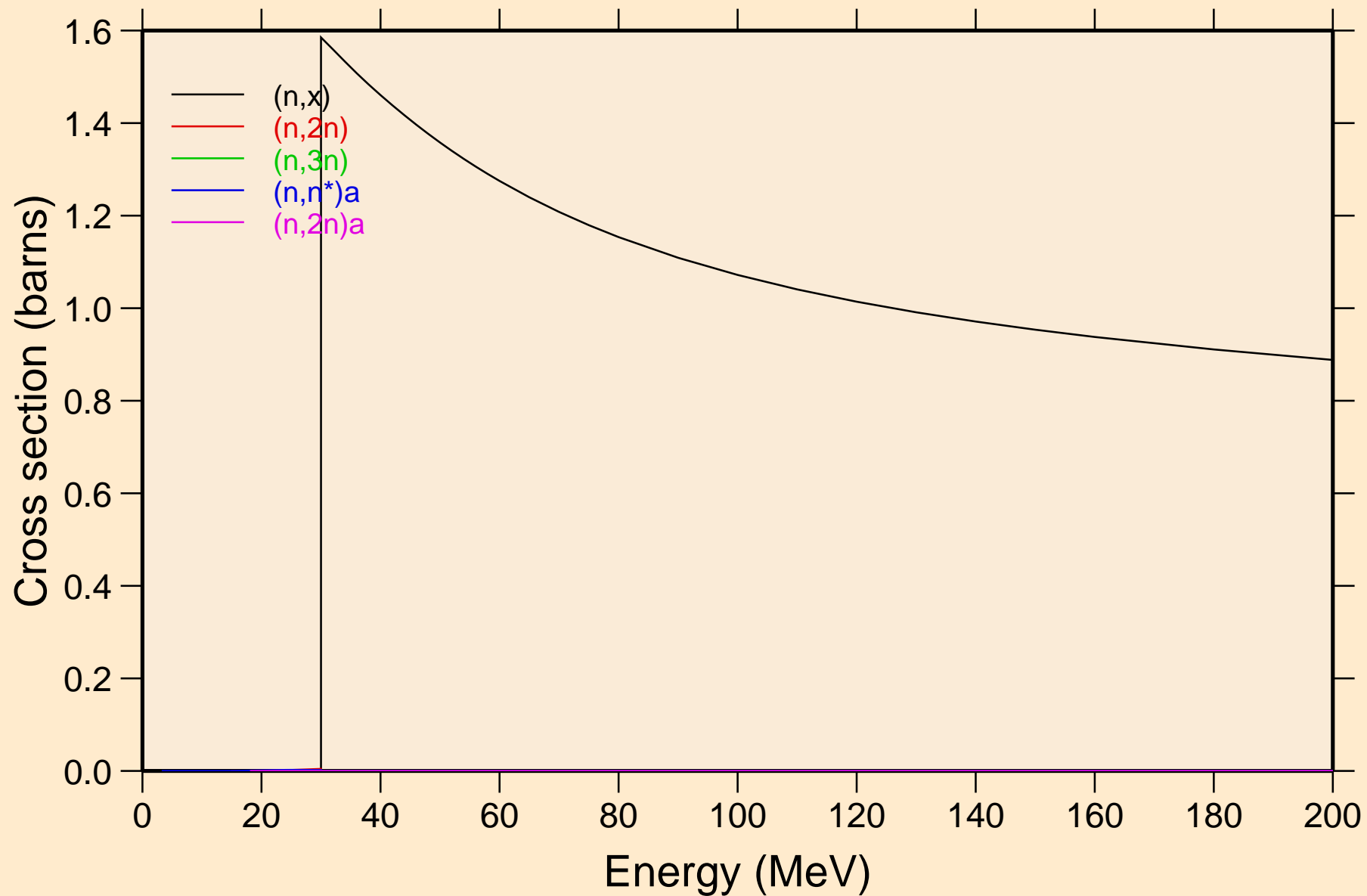

RU090 NEUTRON ACER TENDL-2019 LIBRARY; T=293.16K
Threshold reactions

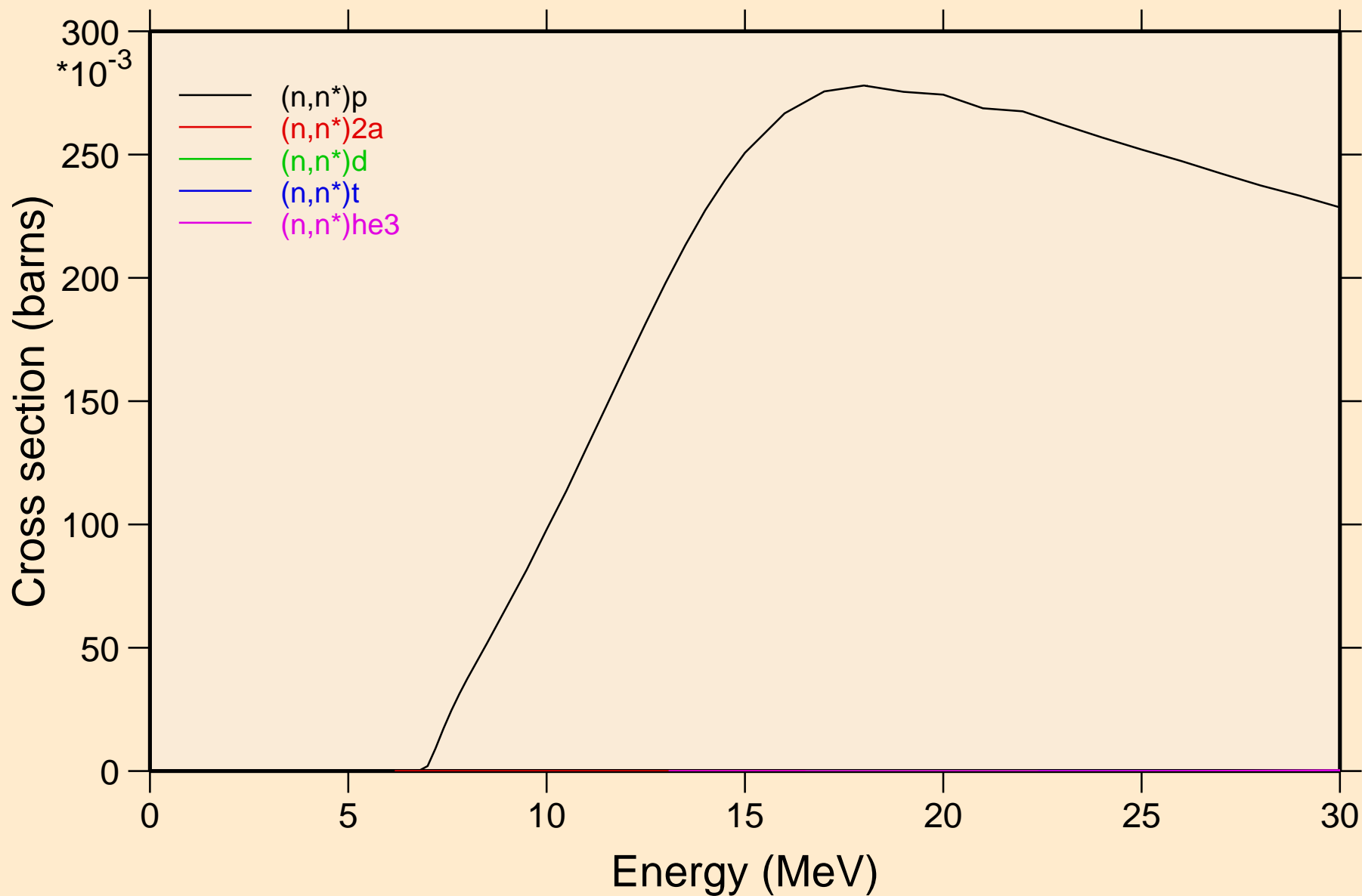

RU090 NEUTRON ACER TENDL-2019 LIBRARY; T=293.16K
Threshold reactions

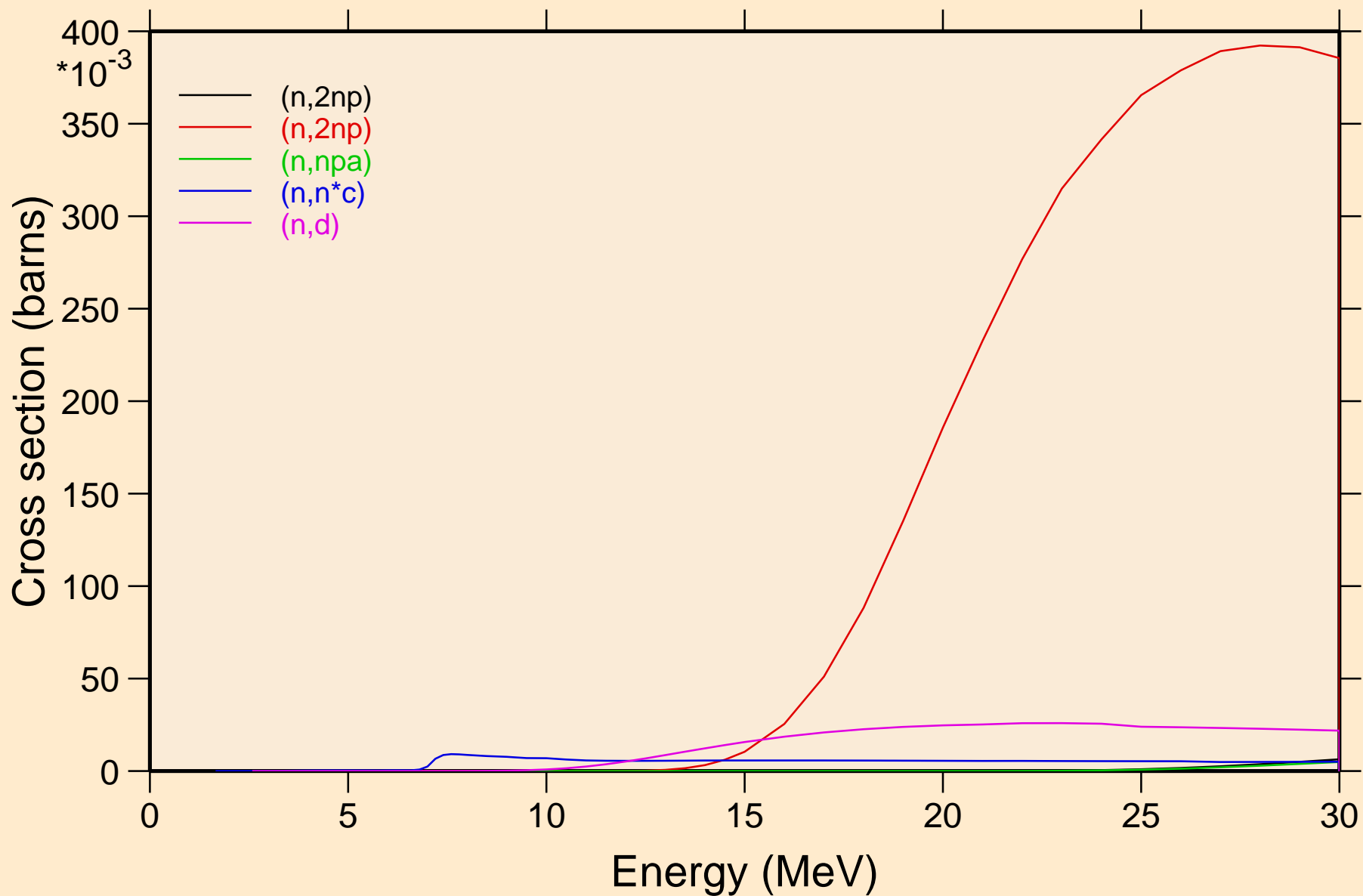

RU090 NEUTRON ACER TENDL-2019 LIBRARY; T=293.16K
Threshold reactions

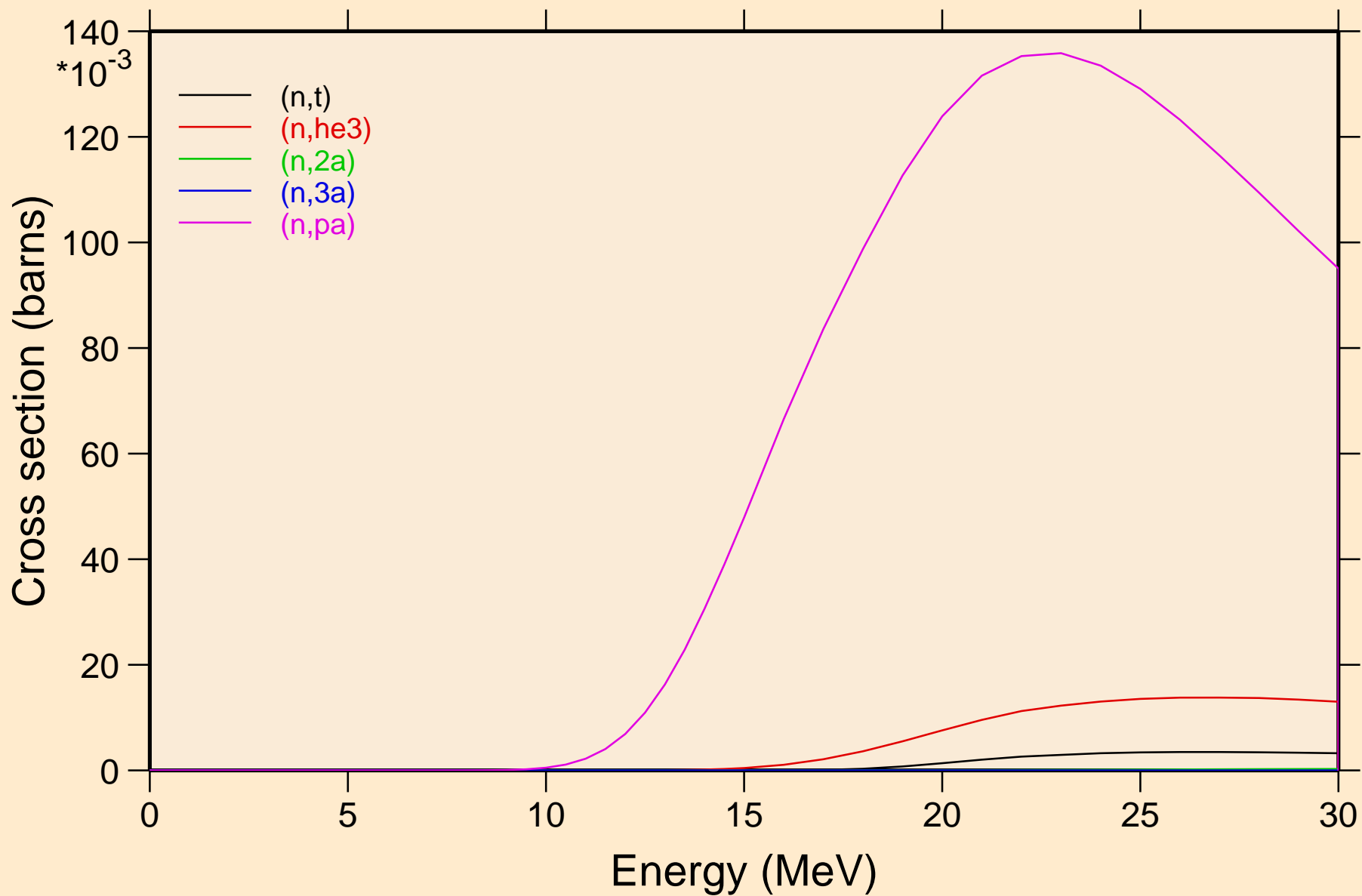

RU090 NEUTRON ACER TENDL-2019 LIBRARY; T=293.16K
Threshold reactions

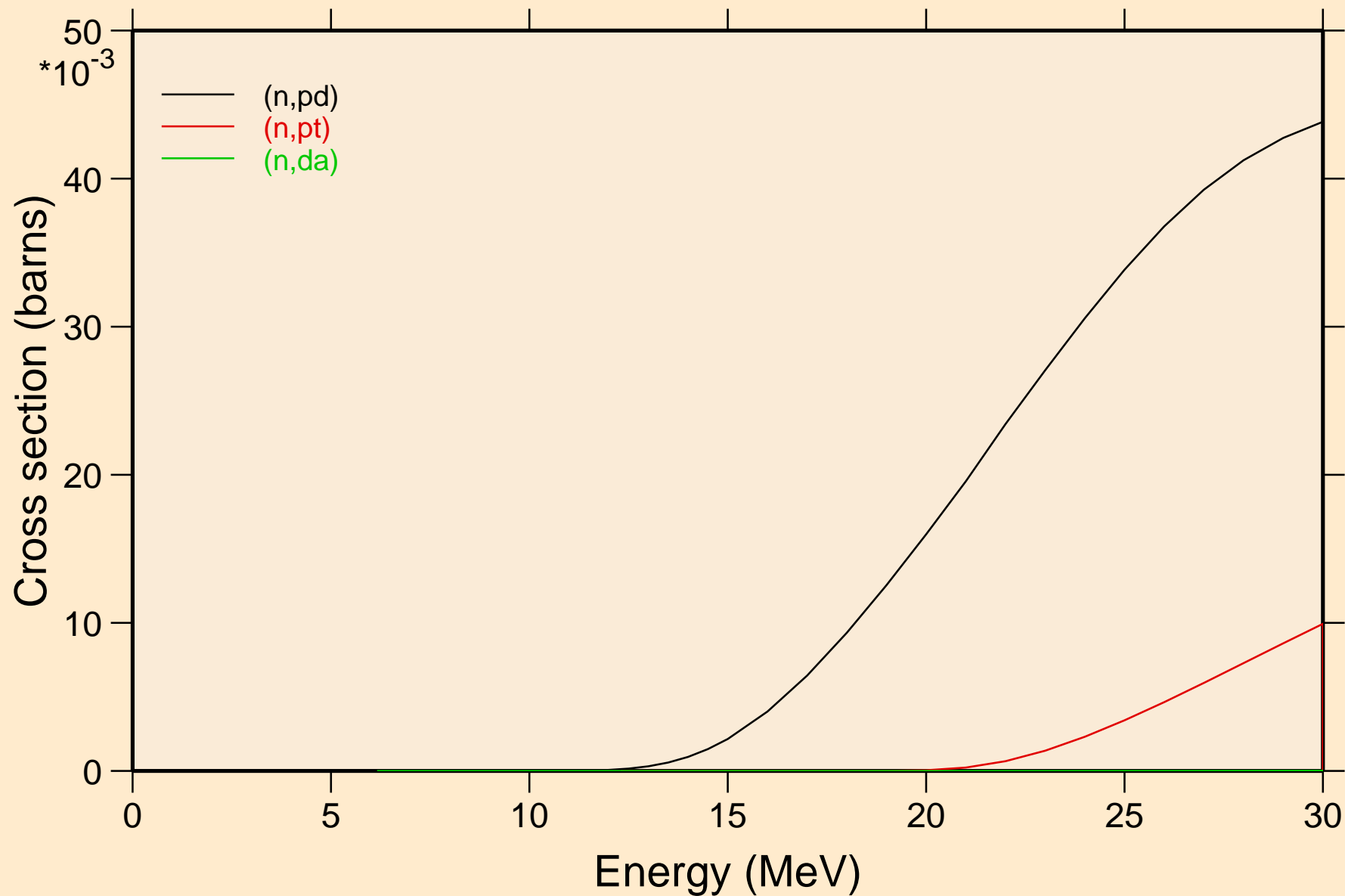

RU090 NEUTRON ACER TENDL-2019 LIBRARY; T=293.16K
Threshold reactions

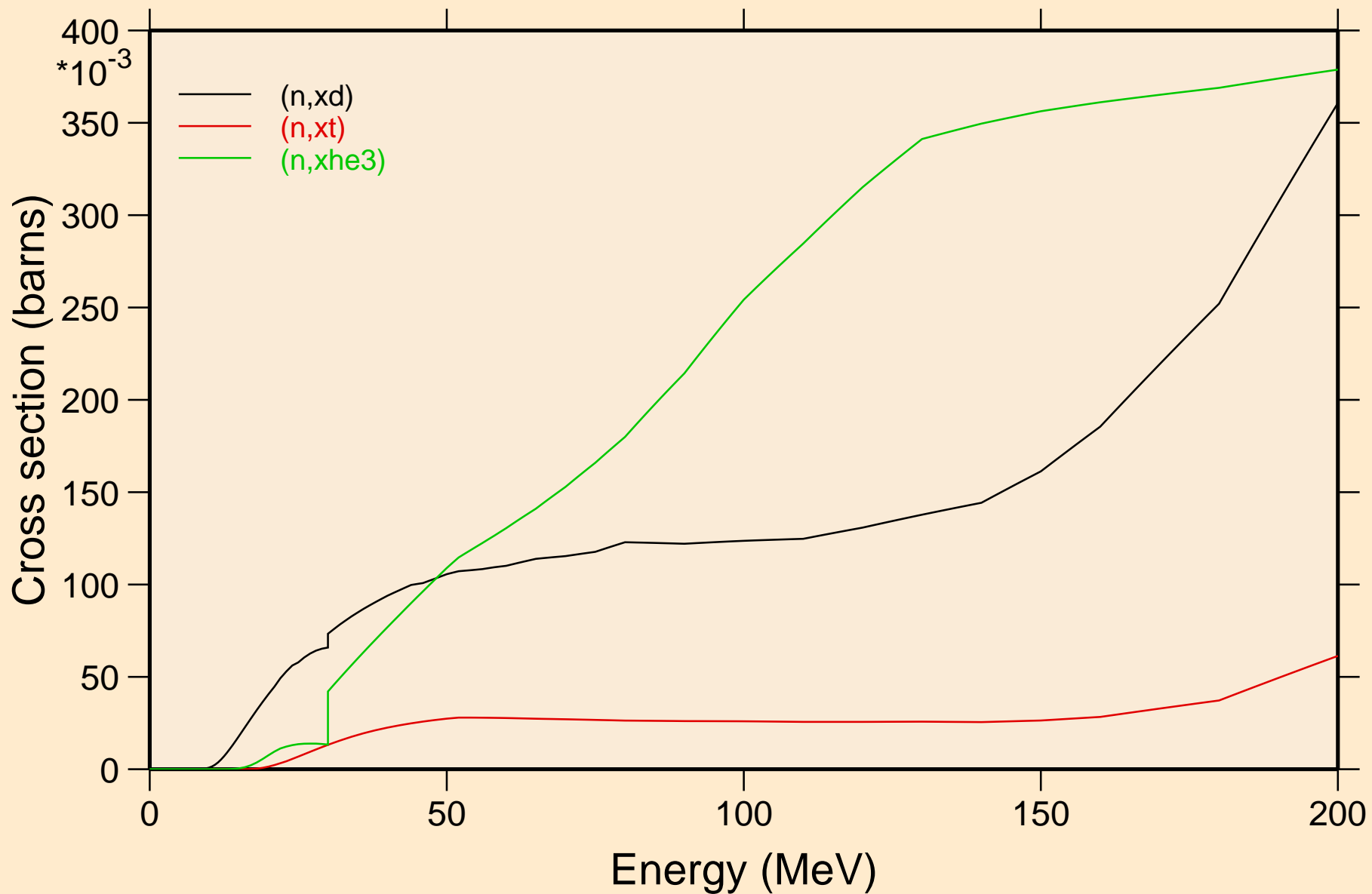

RU090 NEUTRON ACER TENDL-2019 LIBRARY; T=293.16K
angular distribution for elastic

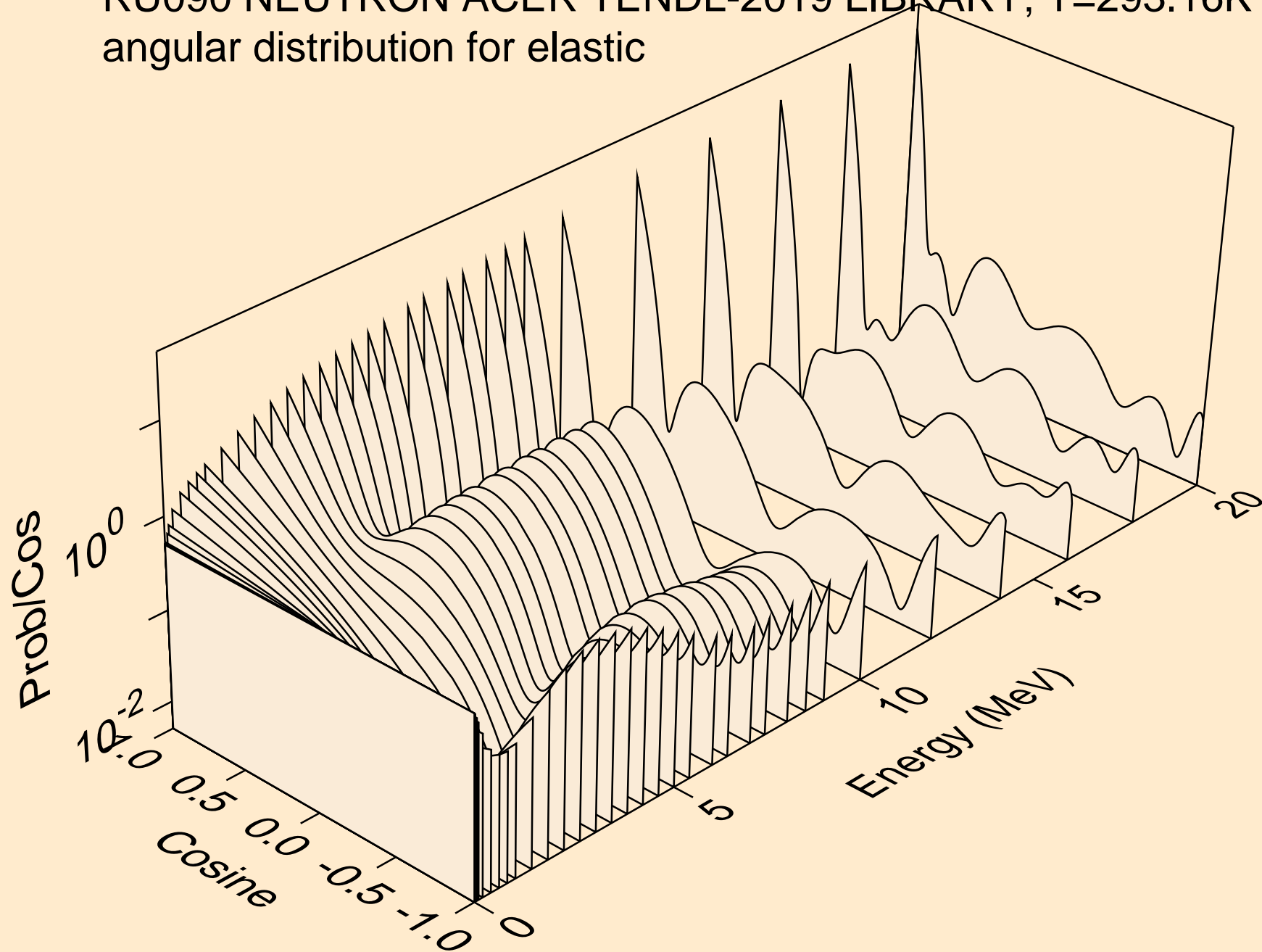

RU090 NEUTRON ACER TENDL-2019 LIBRARY; T=293.16K
angular distribution for elastic

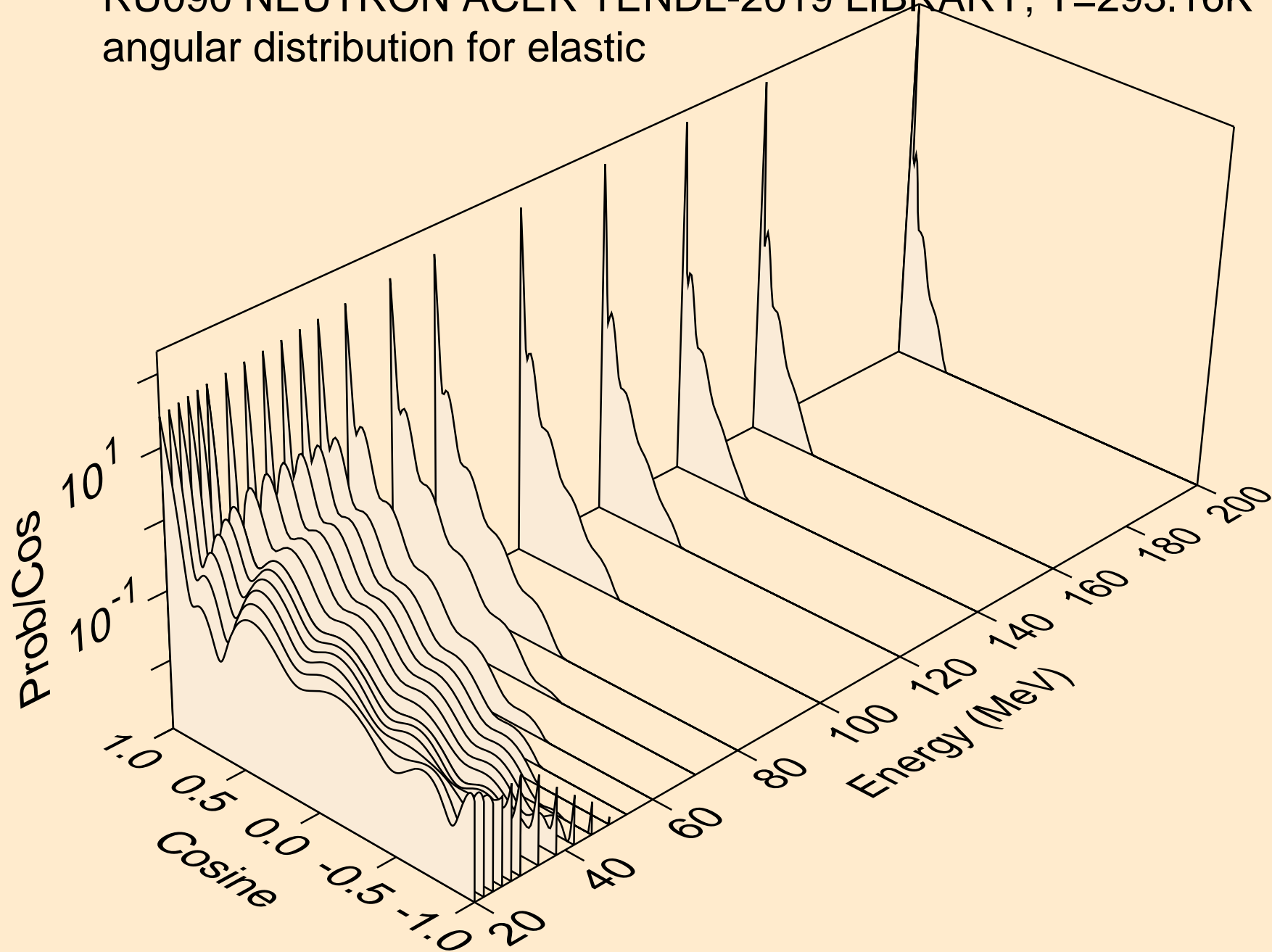

RU090 NEUTRON ACER TENDL-2019 LIBRARY; T=293.16K
angular distribution for (n,n*1)

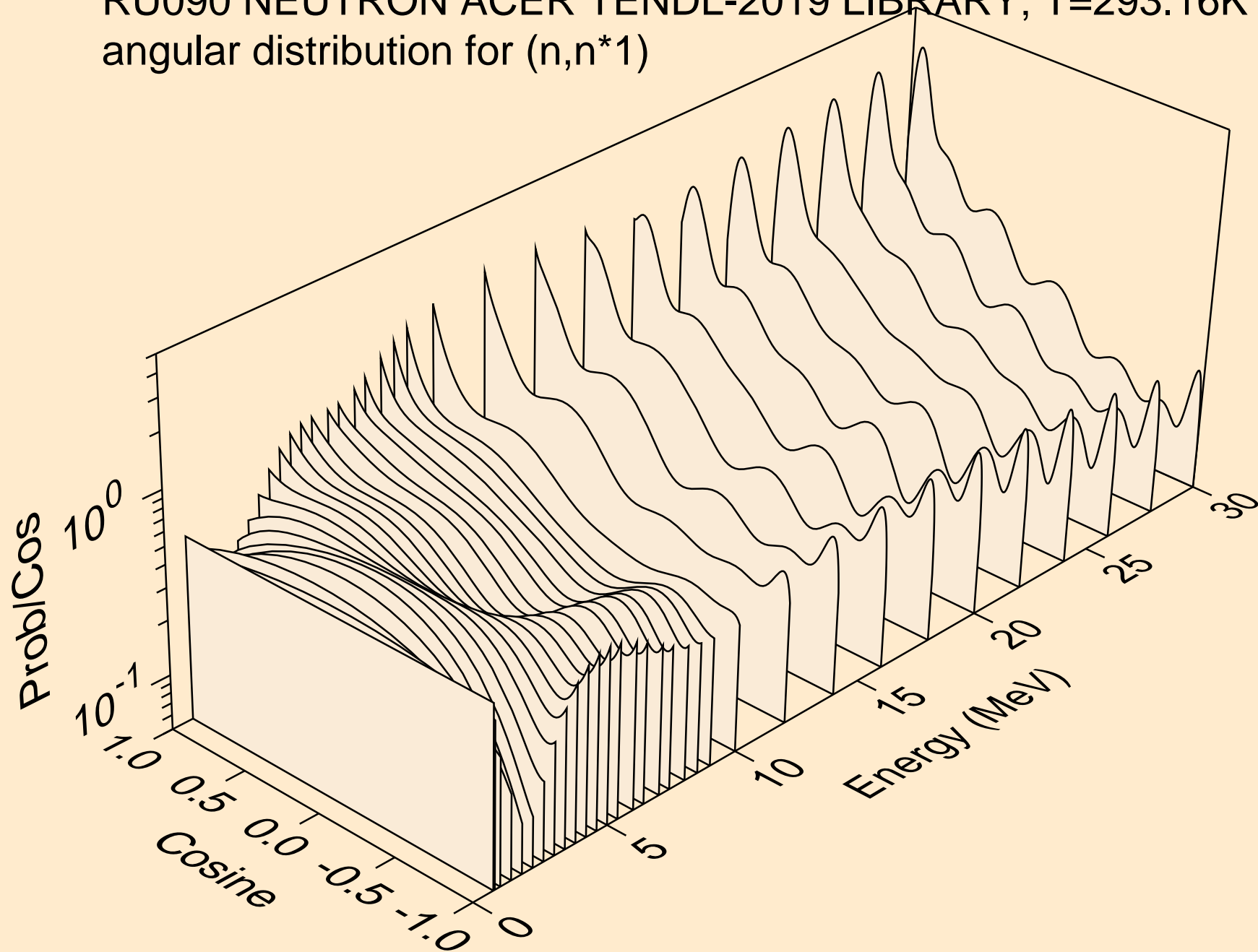

RU090 NEUTRON ACER TENDL-2019 LIBRARY; T=293.16K
angular distribution for (n,n*2)

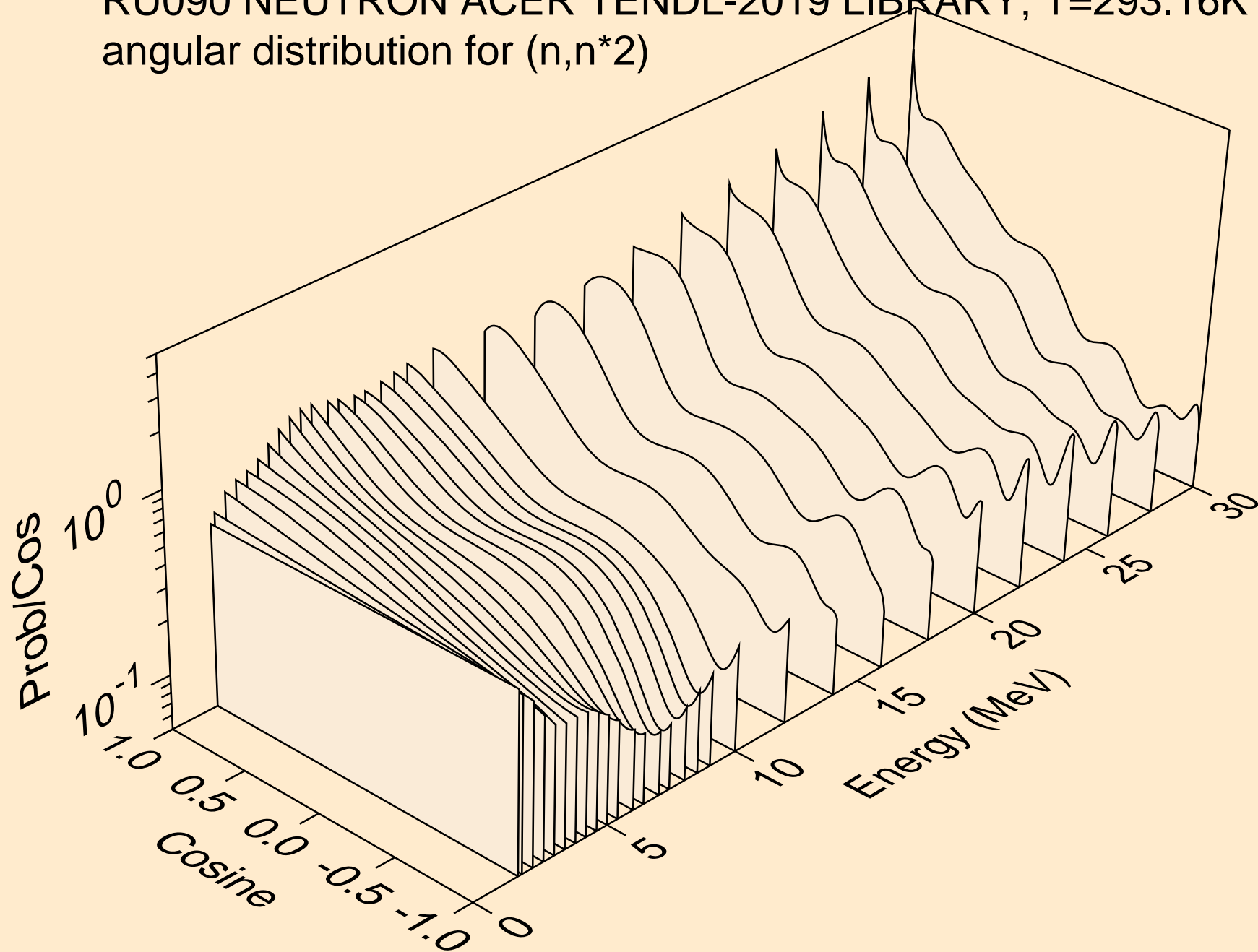

RU090 NEUTRON ACER TENDL-2019 LIBRARY; T=293.16K
Neutron emission for (n,x)

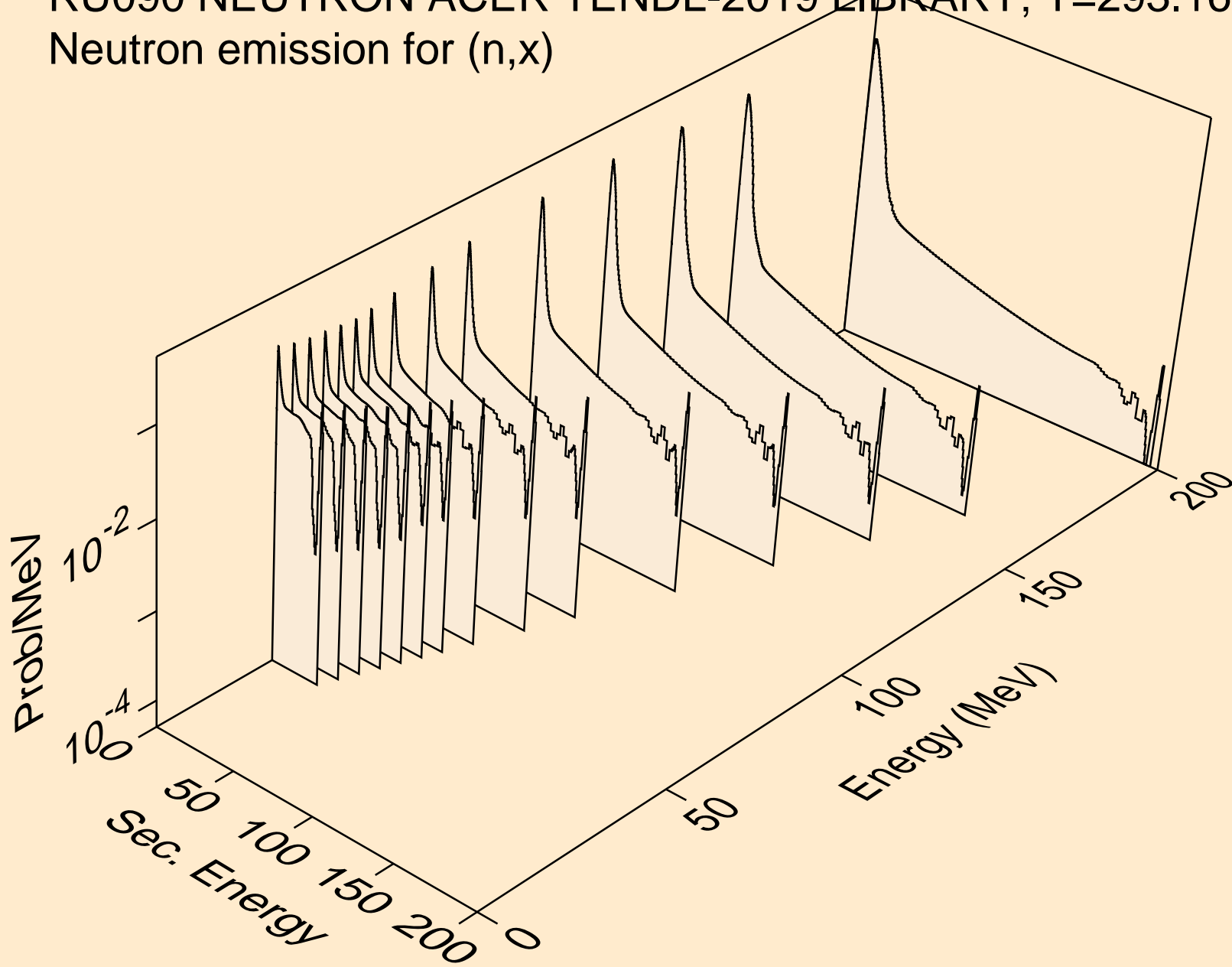

RU090 NEUTRON ACER TENDL-2019 LIBRARY; T=293.16K
Neutron emission for (n,2n)

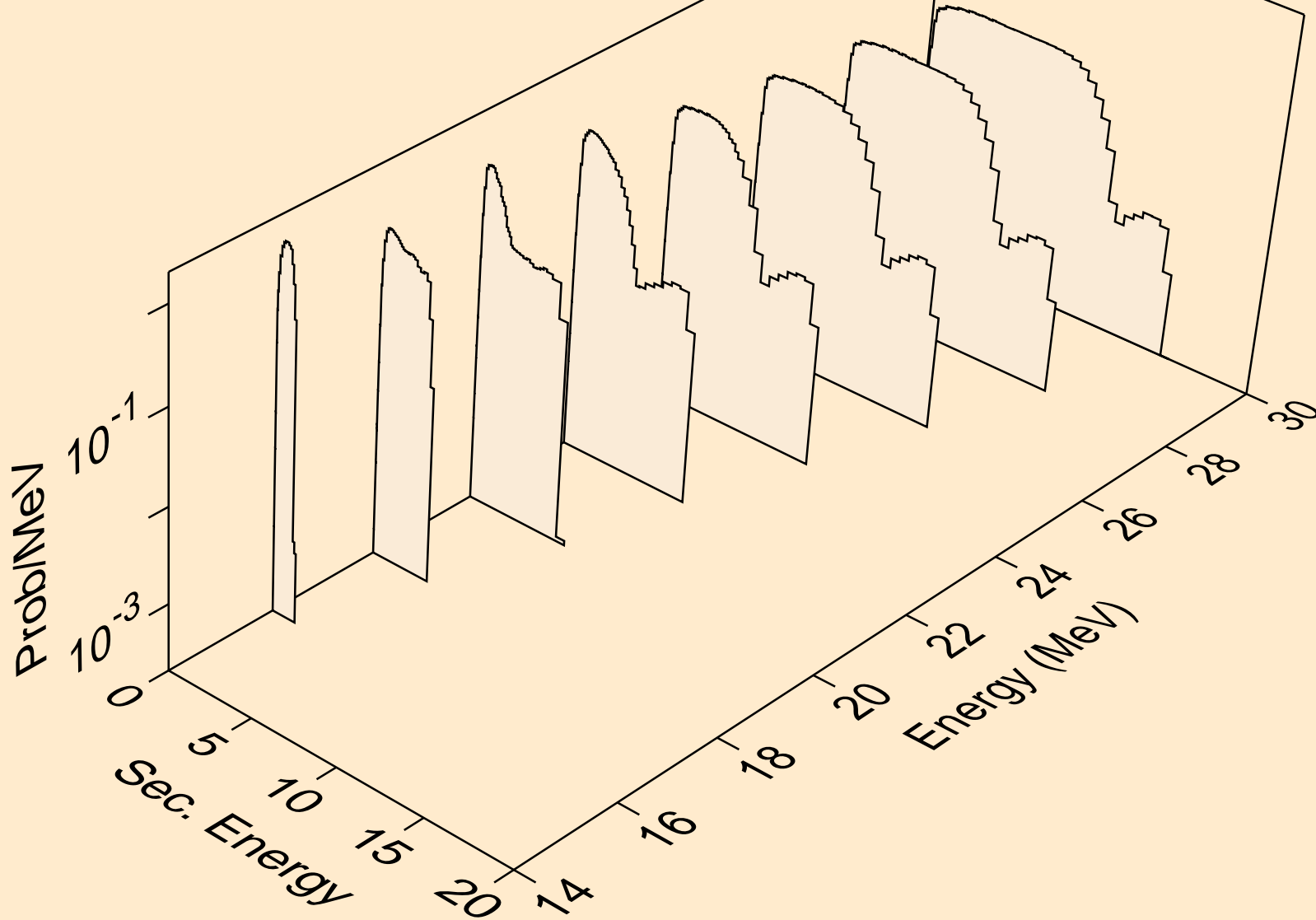

RU090 NEUTRON ACER TENDL-2019 LIBRARY; T=293.16K
Neutron emission for (n,3n)

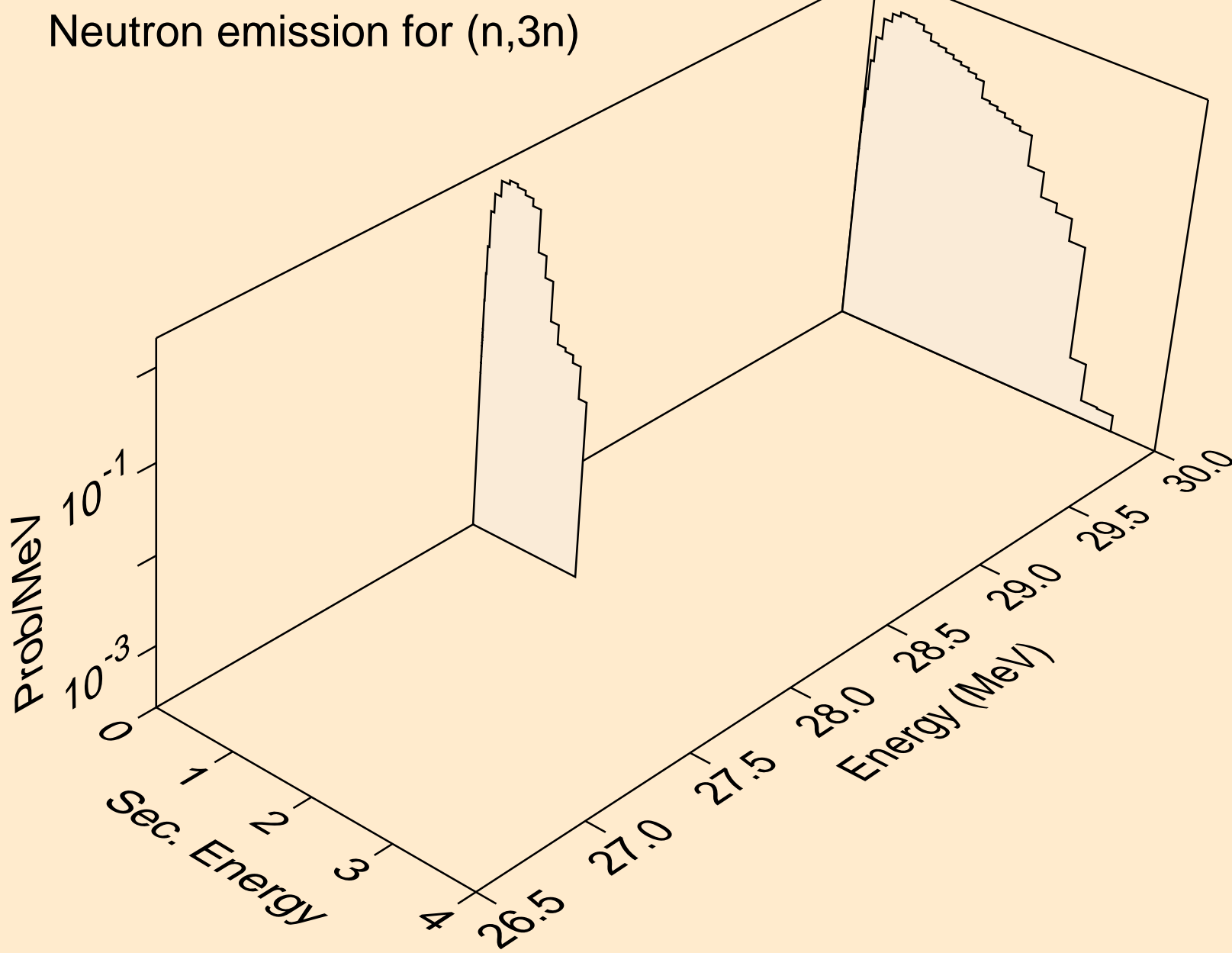

RU090 NEUTRON ACER TENDL-2019 LIBRARY; T=293.16K
Neutron emission for (n,n*)a

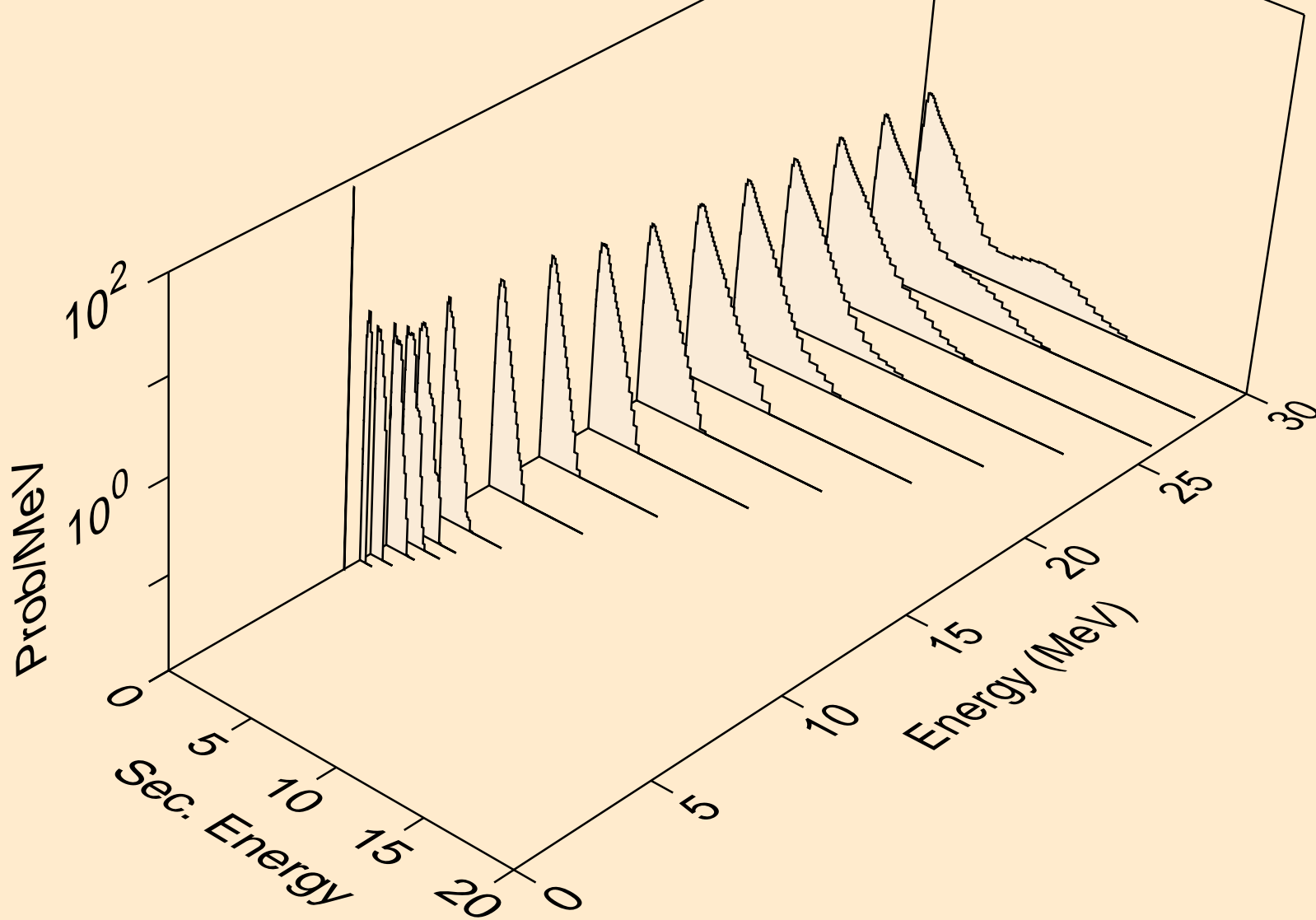

RU090 NEUTRON ACER TENDL-2019 LIBRARY; T=293.16K
Neutron emission for (n,2n)a

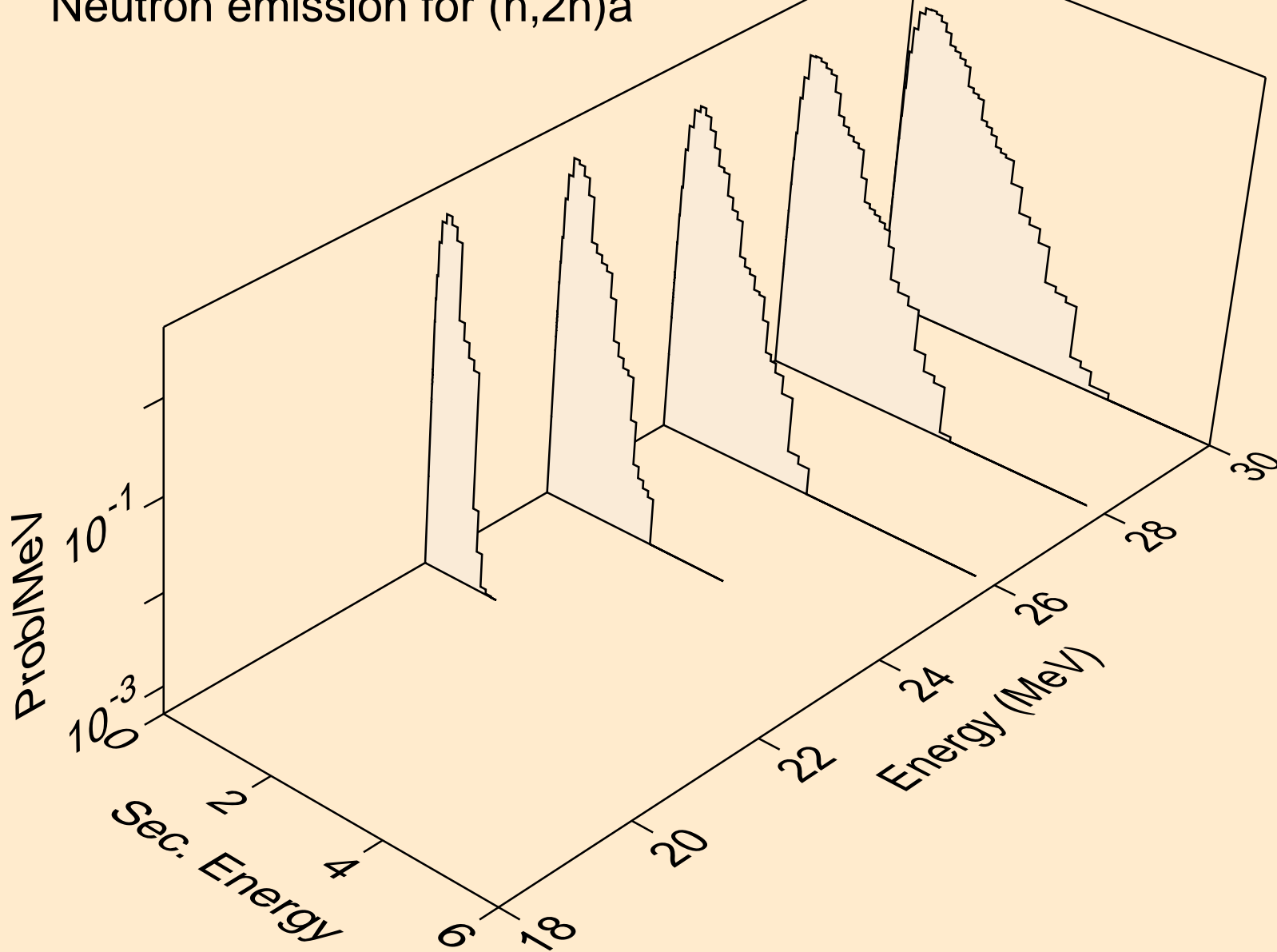

RU090 NEUTRON ACER TENDL-2019 LIBRARY; T=293.16K
Neutron emission for (n,n*)p

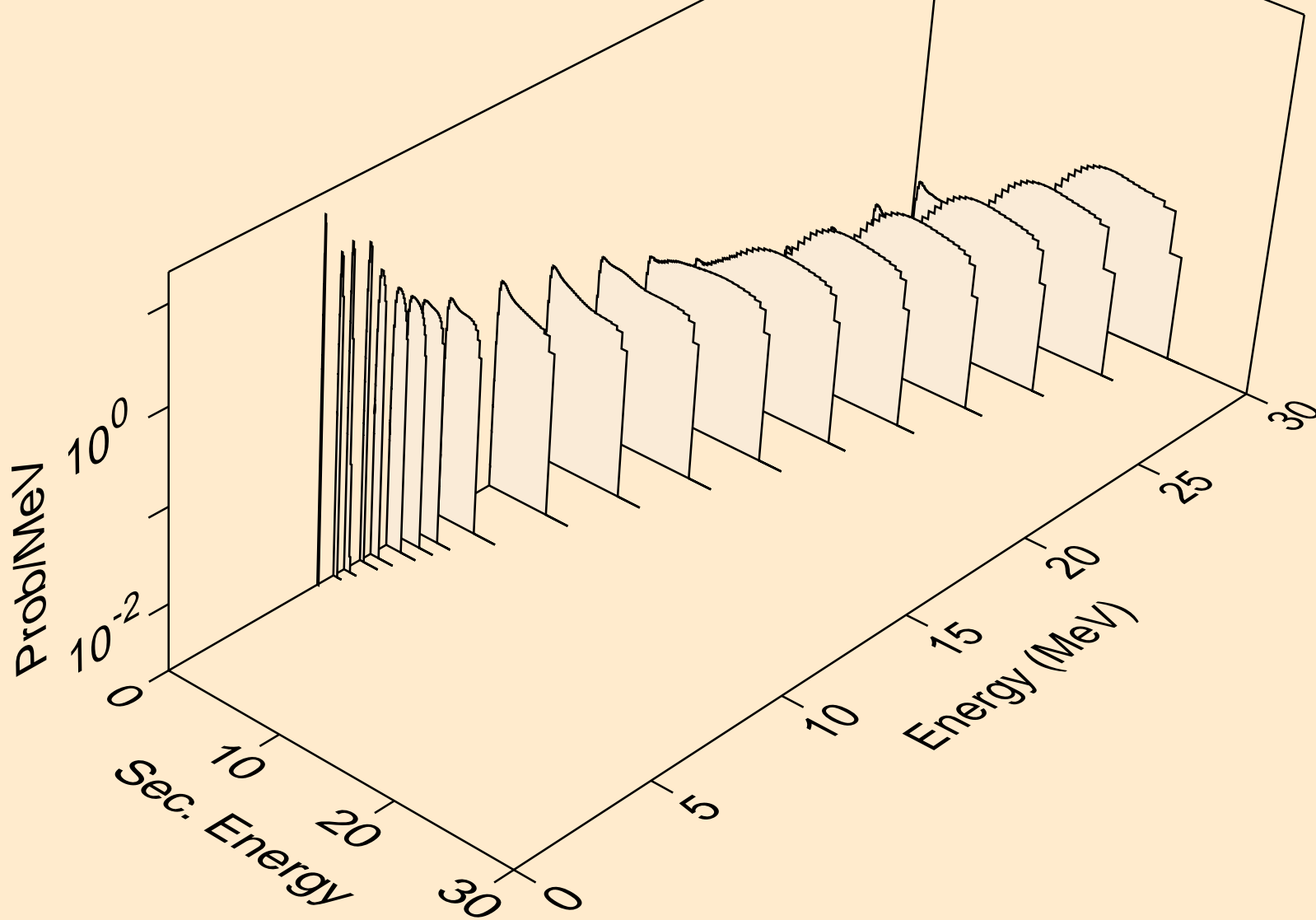

RU090 NEUTRON ACER TENDL-2019 LIBRARY; T=293.16K
Neutron emission for (n,n*)2a

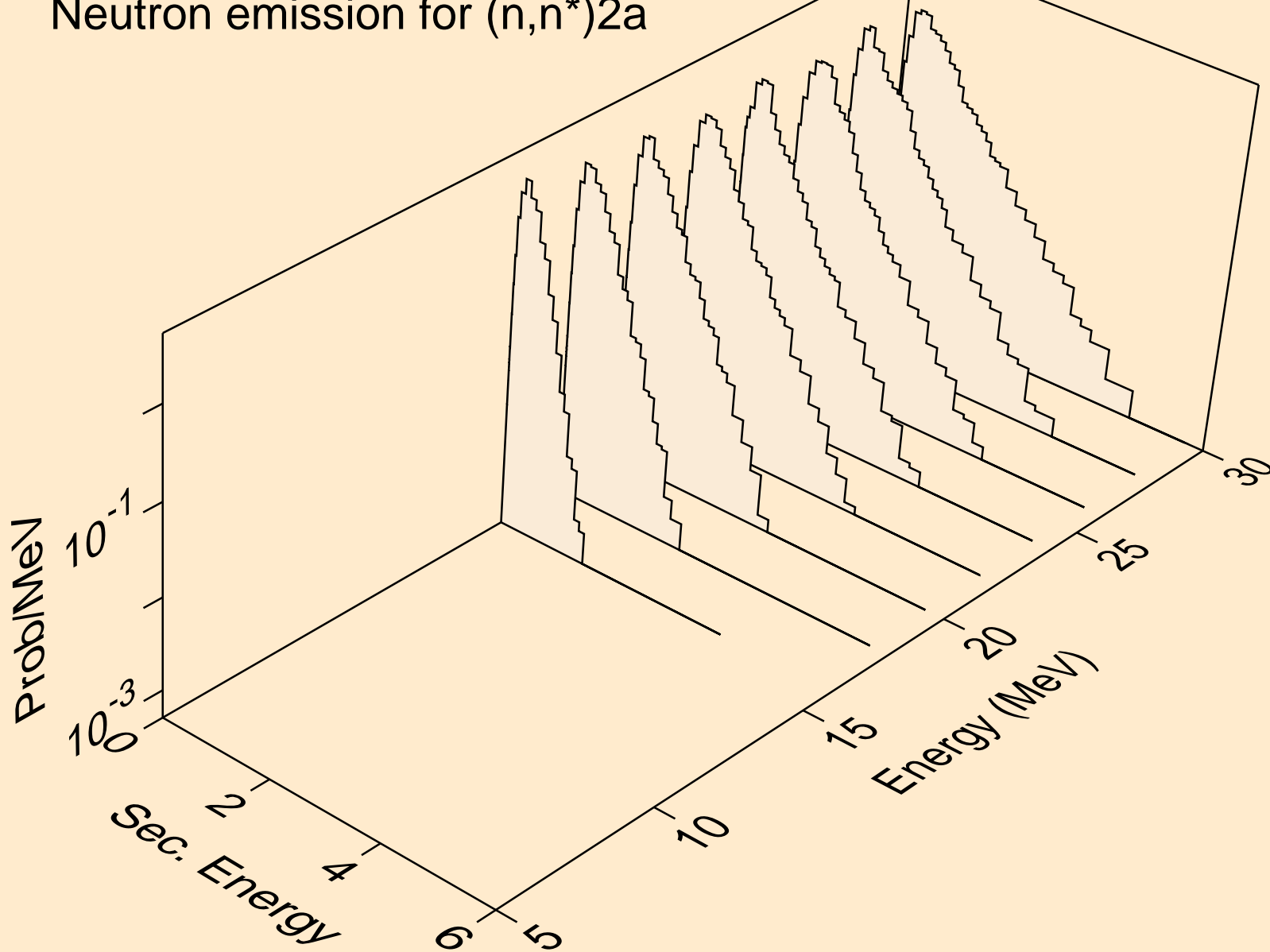

RU090 NEUTRON ACER TENDL-2019 LIBRARY; T=293.16K
Neutron emission for (n,n*)d

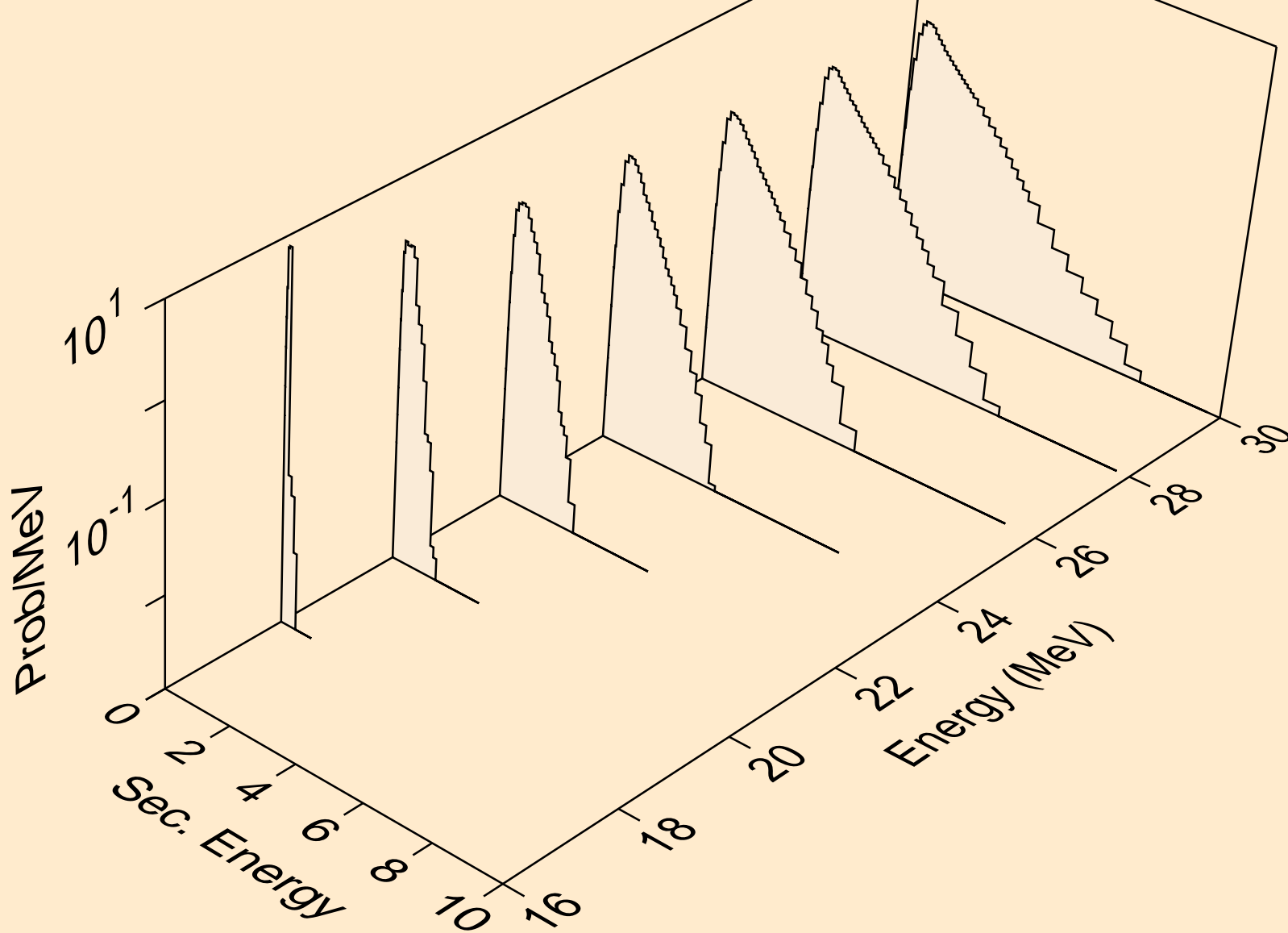

RU090 NEUTRON ACER TENDL-2019 LIBRARY; T=293.16K
Neutron emission for (n,n*)t

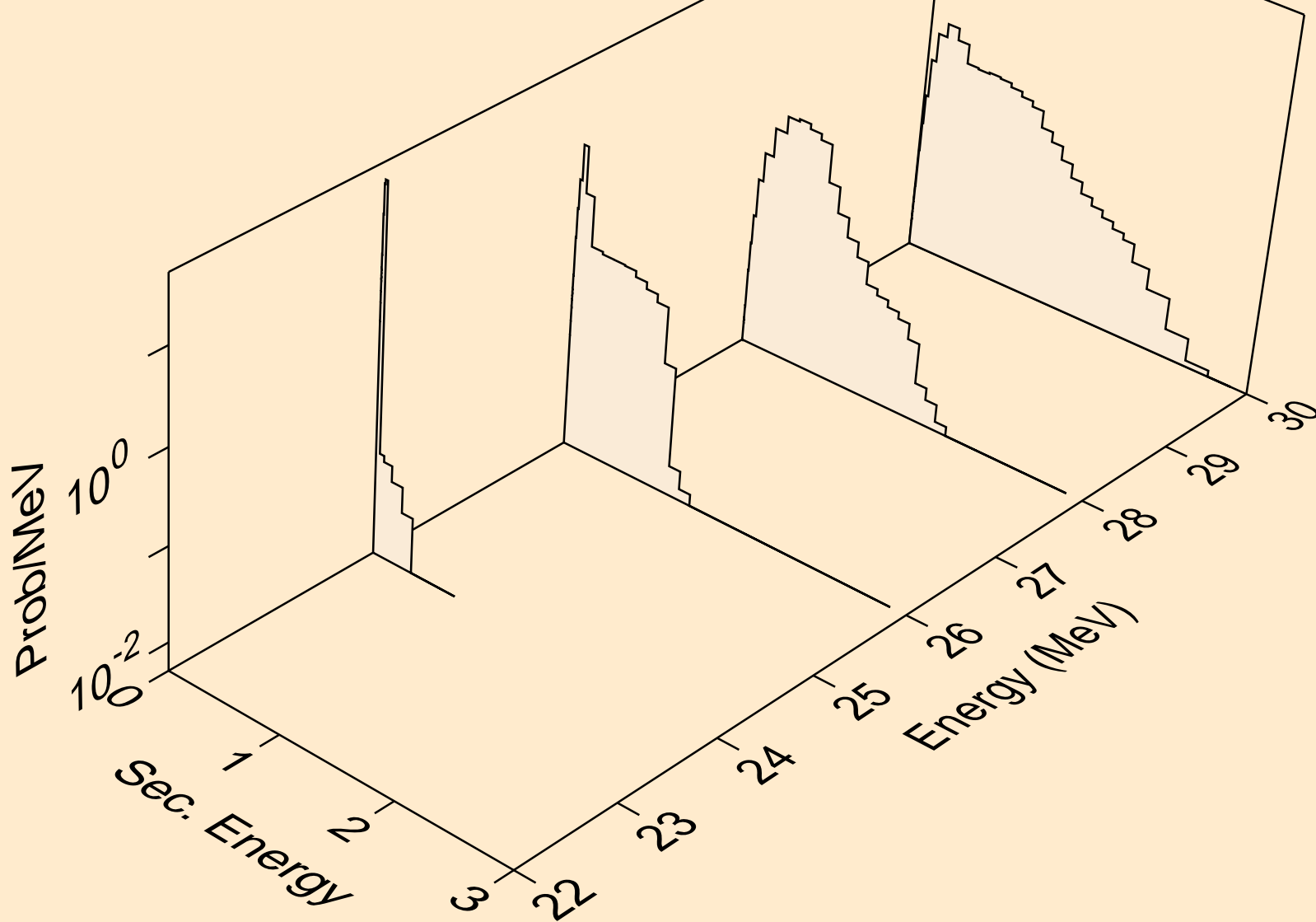

RU090 NEUTRON ACER TENDL-2019 LIBRARY; T=293.16K
Neutron emission for (n,n*)he3

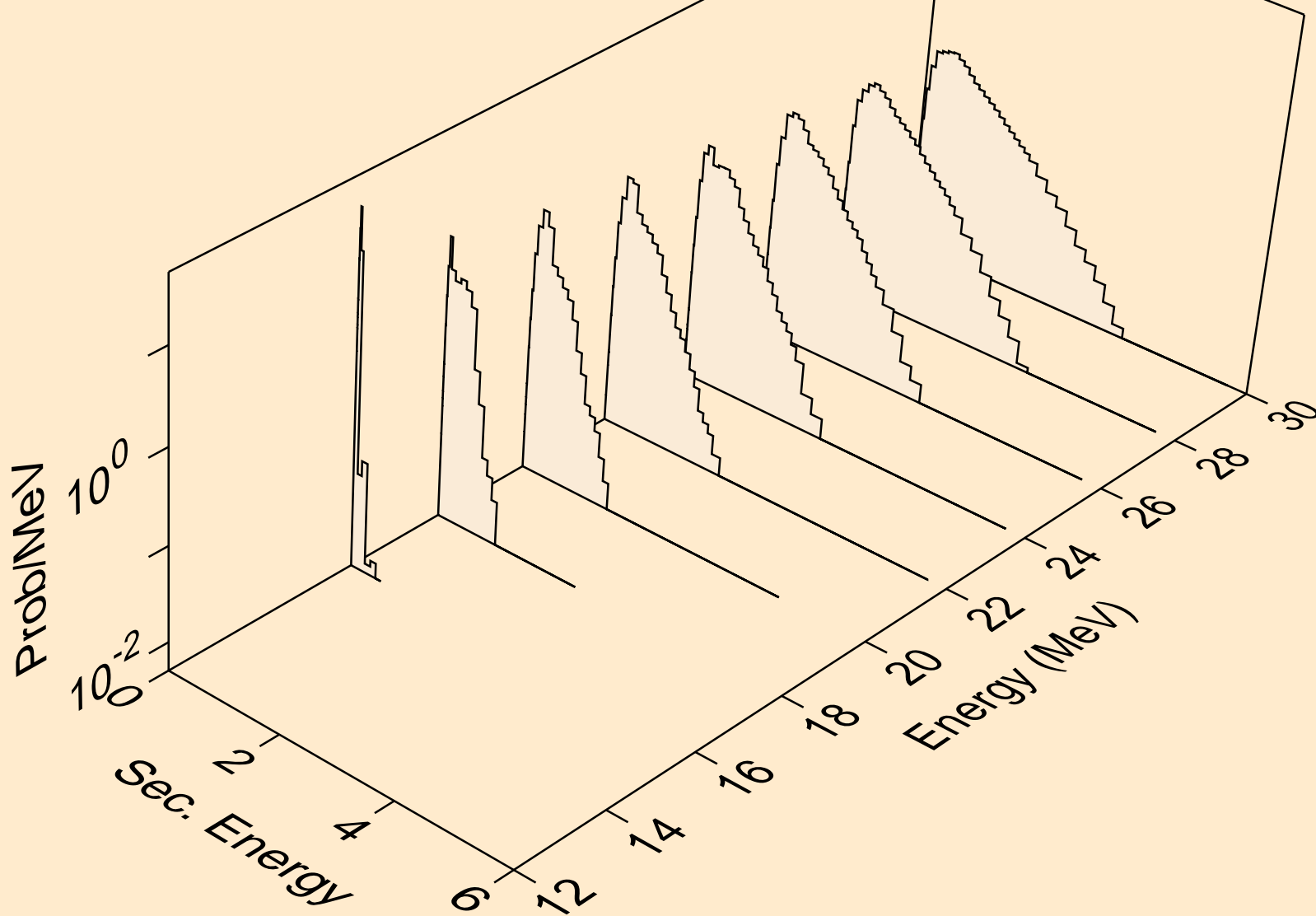

RU090 NEUTRON ACER TENDL-2019 LIBRARY; T=293.16K
Neutron emission for (n,2np)

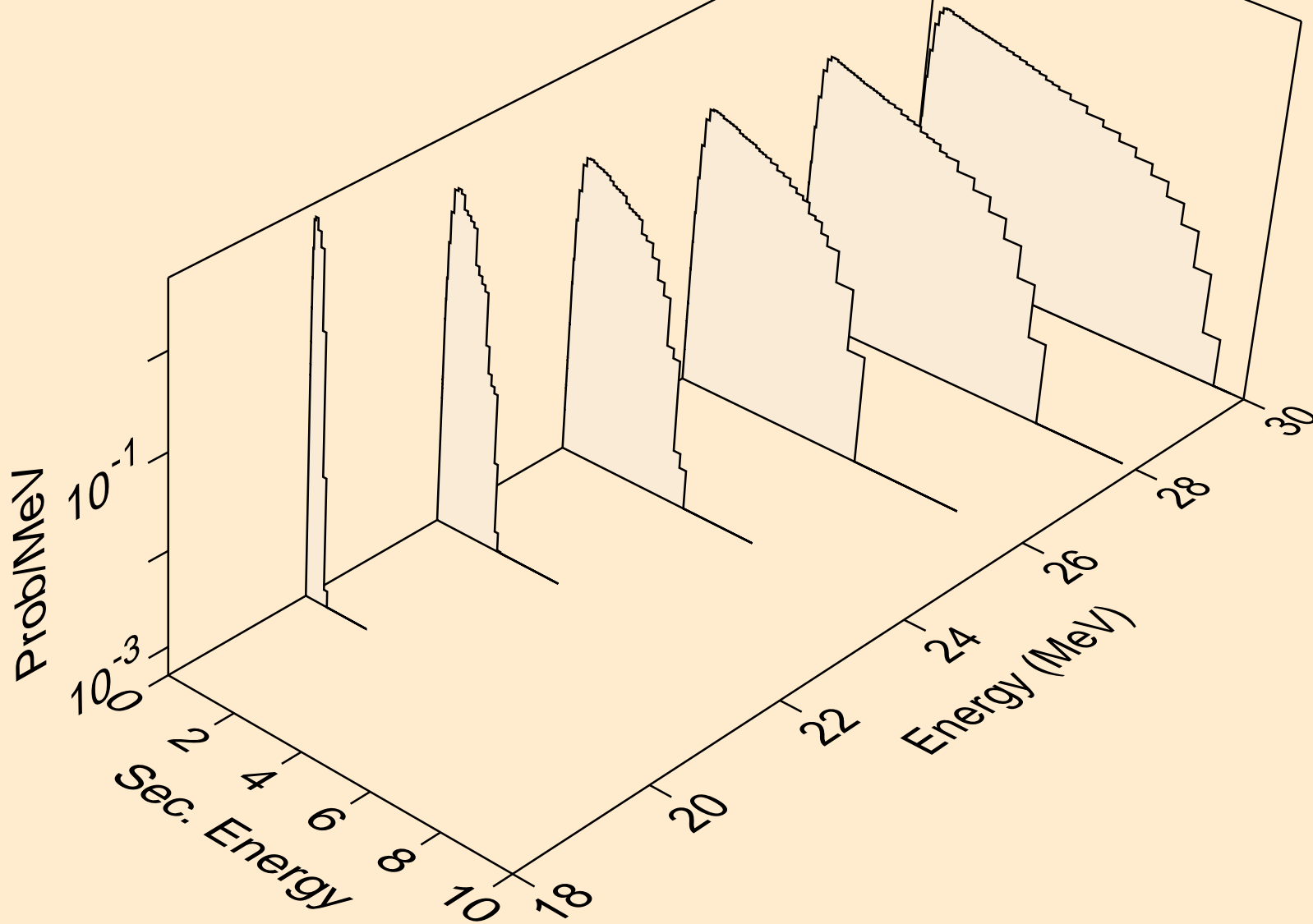

RU090 NEUTRON ACER TENDL-2019 LIBRARY; T=293.16K
Neutron emission for (n,2np)

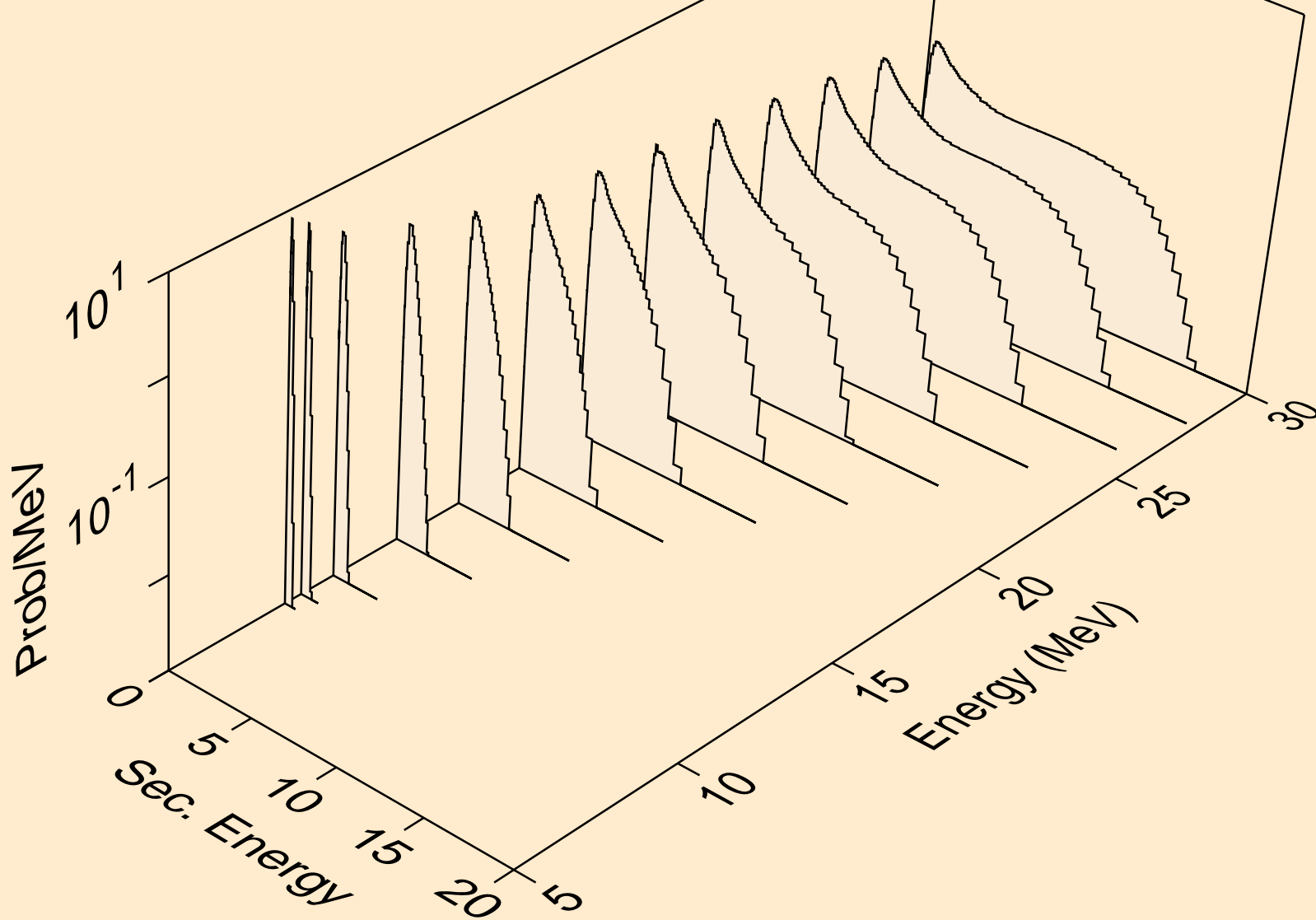

RU090 NEUTRON ACER TENDL-2019 LIBRARY; T=293.16K
Neutron emission for (n,npa)

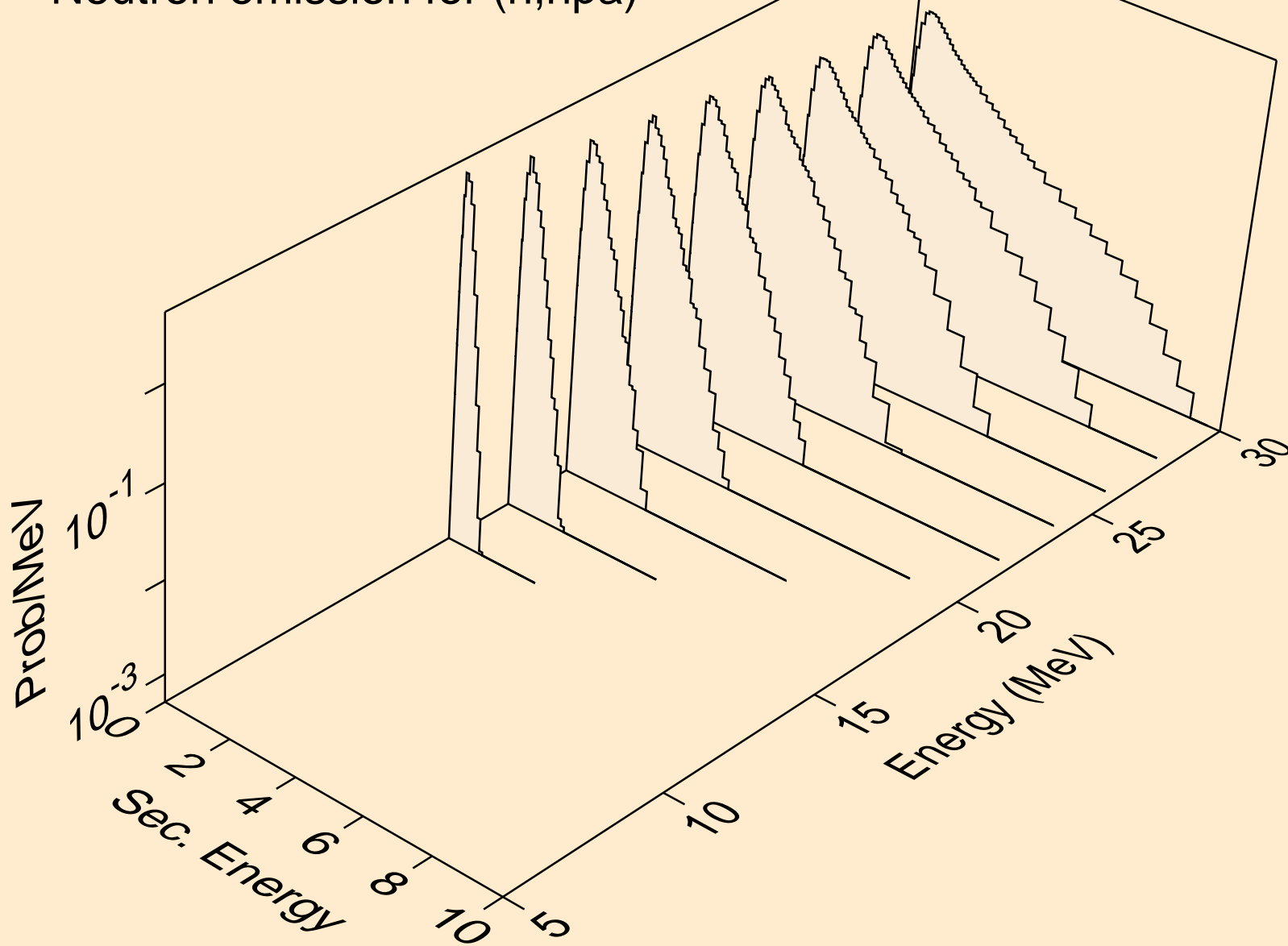

RU090 NEUTRON ACER TENDL-2019 LIBRARY; T=293.16K
Neutron emission for (n,n*c)

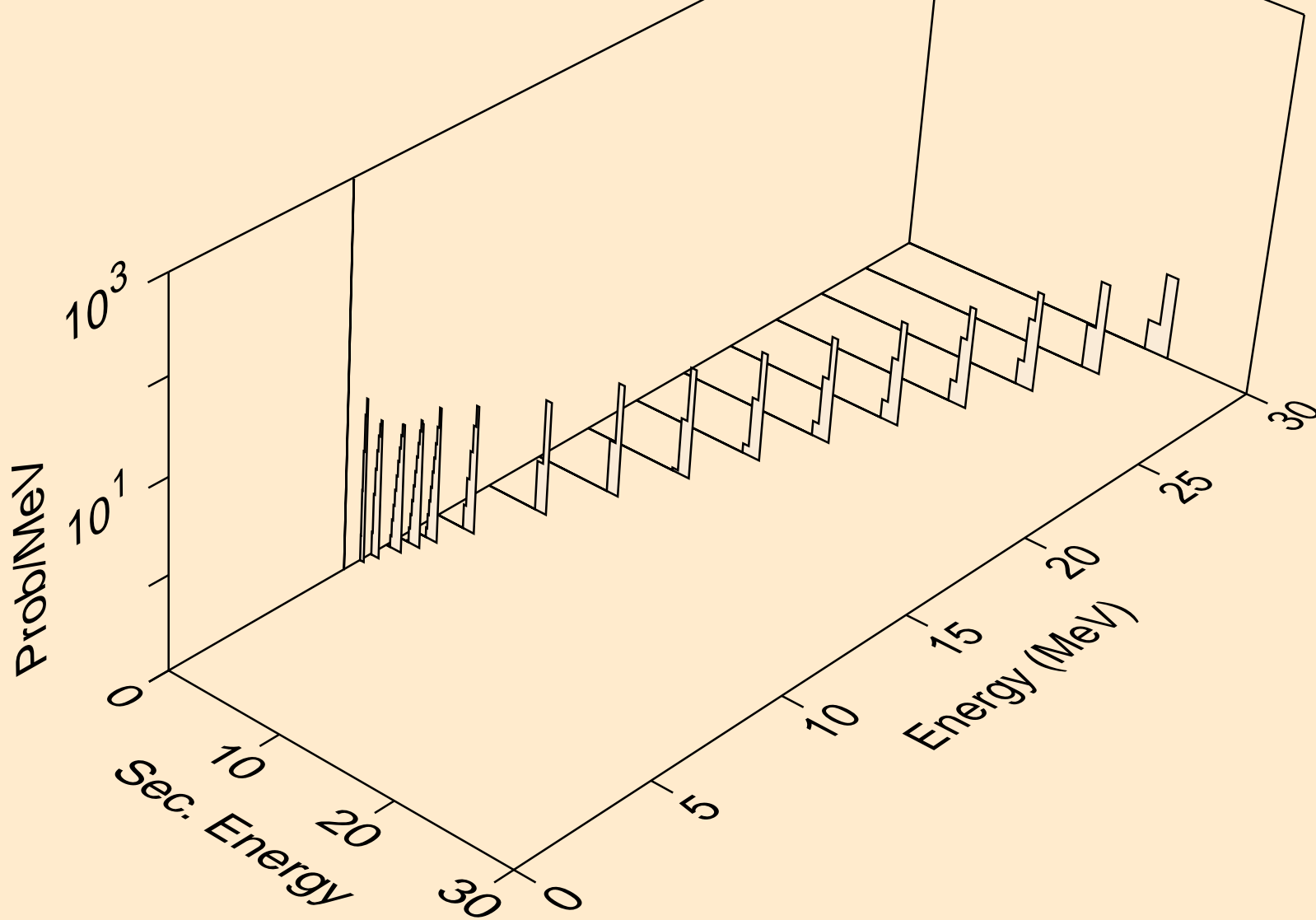

RU090 NEUTRON ACER TENDL-2019 LIBRARY; T=293.16K
Photon emission for (n,x)

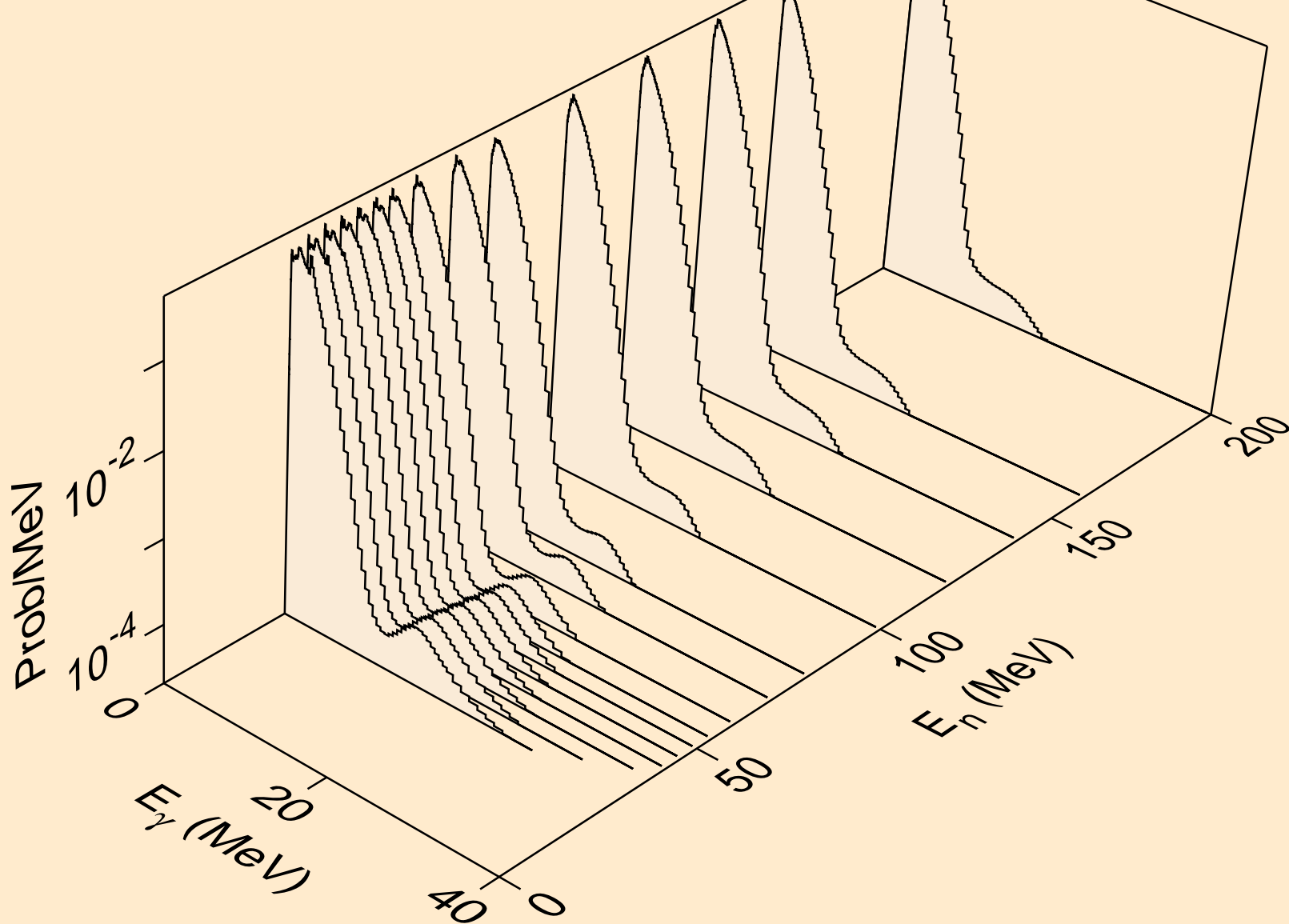

RU090 NEUTRON ACER TENDL-2019 LIBRARY; T=293.16K
Photon emission for (n,2n)

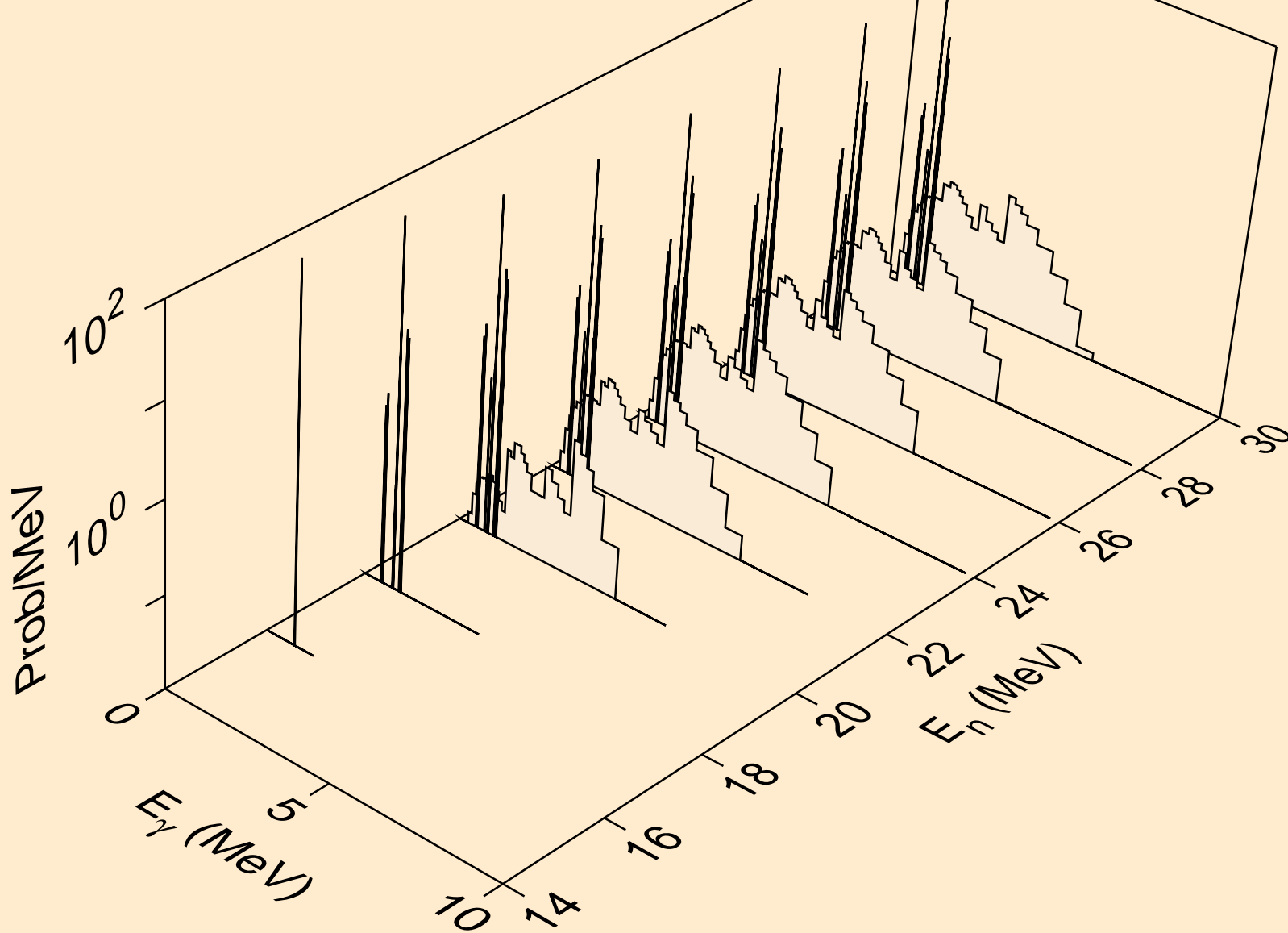

RU090 NEUTRON ACER TENDL-2019 LIBRARY; T=293.16K
Photon emission for (n,3n)

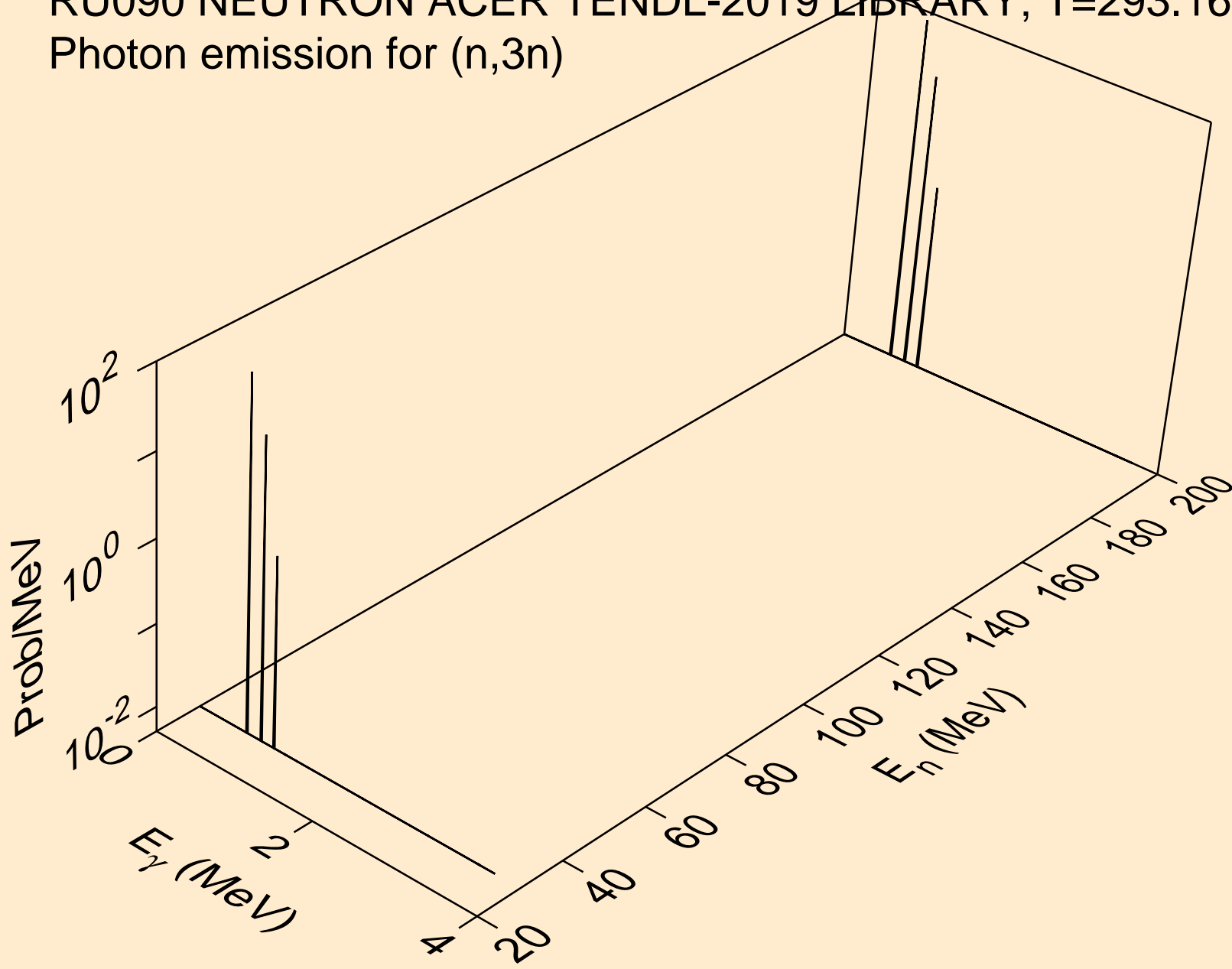

RU090 NEUTRON ACER TENDL-2019 LIBRARY; T=293.16K
Photon emission for (n,n*)a

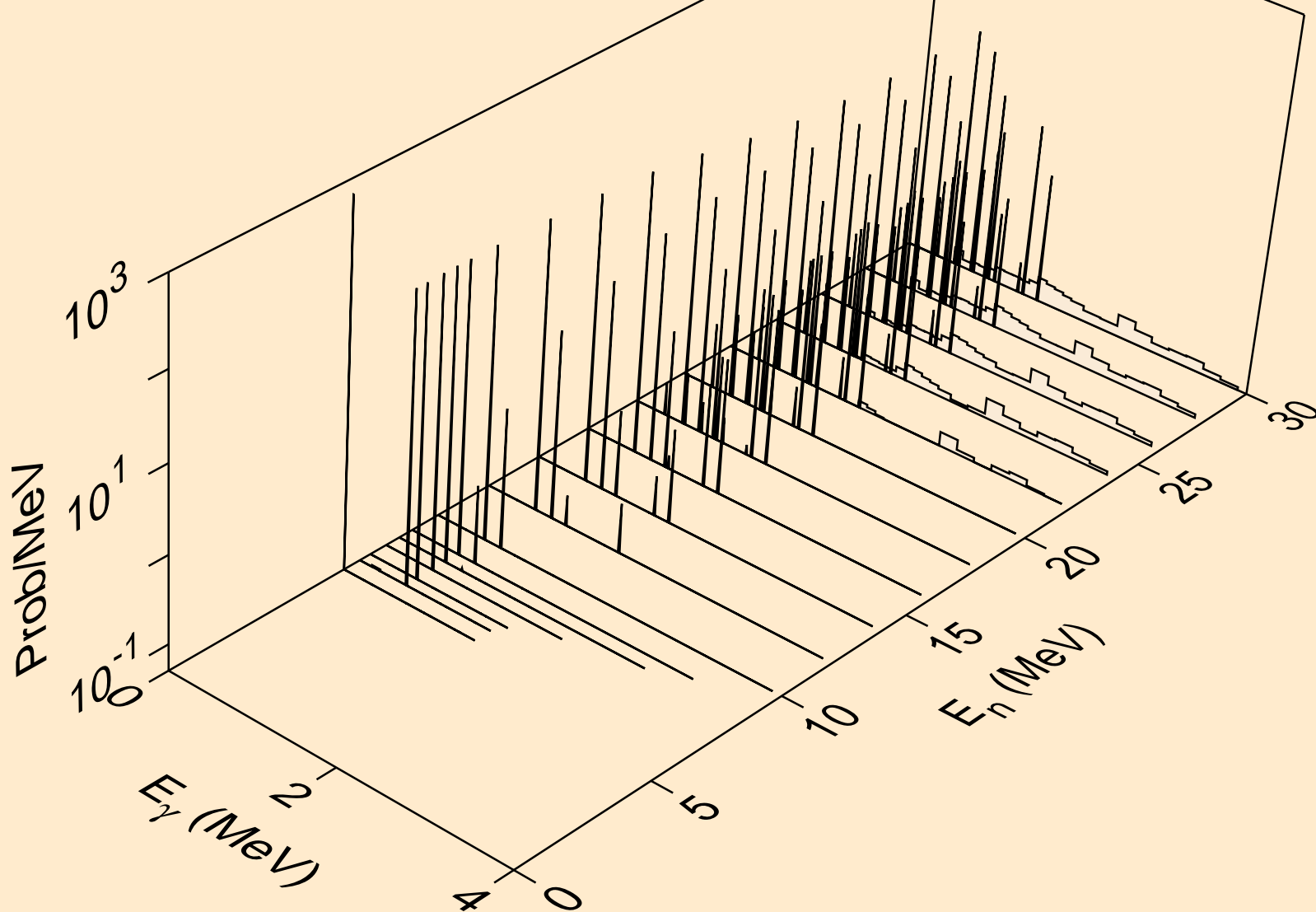

RU090 NEUTRON ACER TENDL-2019 LIBRARY; T=293.16K
Photon emission for (n,2n)a

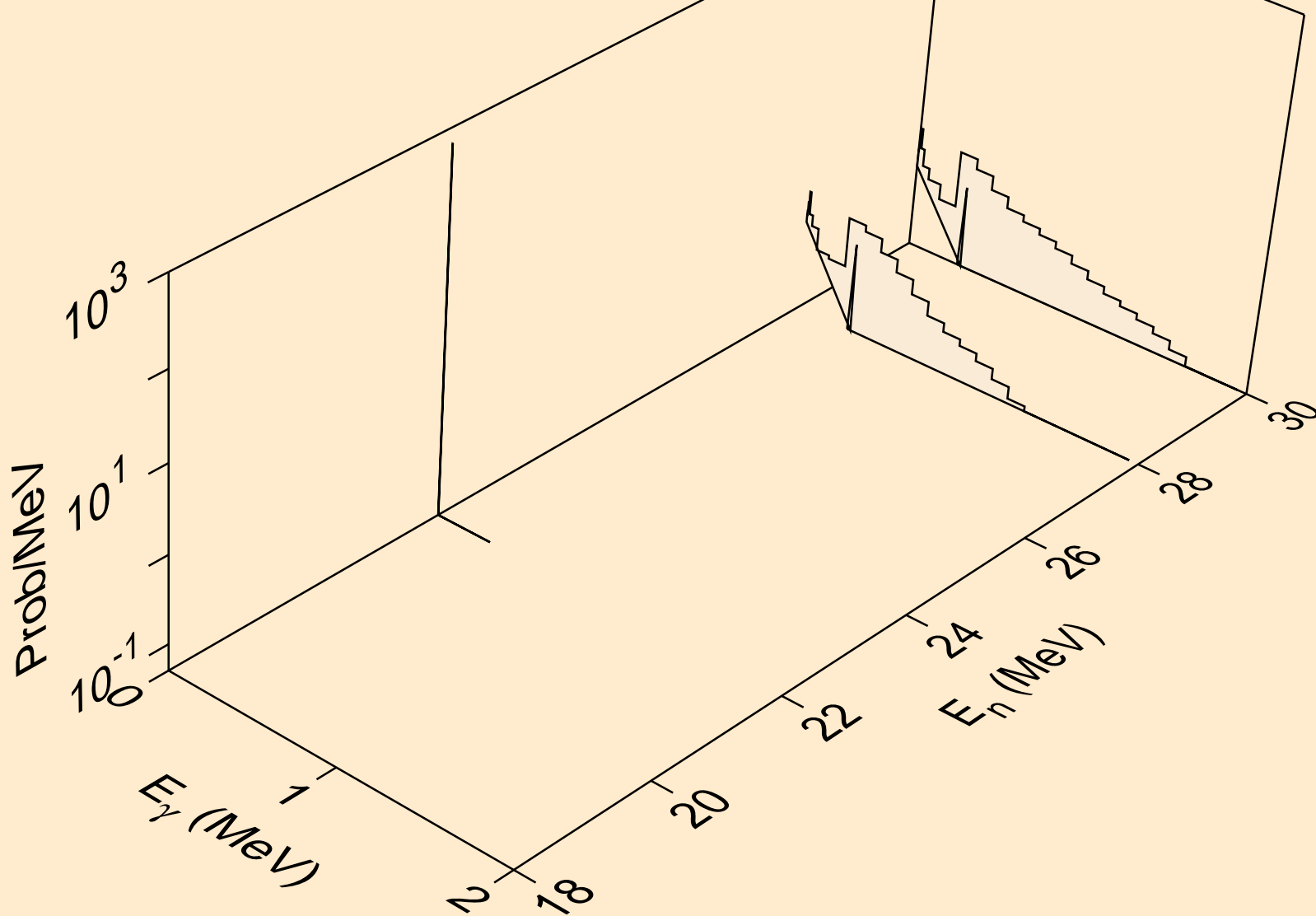

RU090 NEUTRON ACER TENDL-2019 LIBRARY; T=293.16K
Photon emission for (n,n*)p

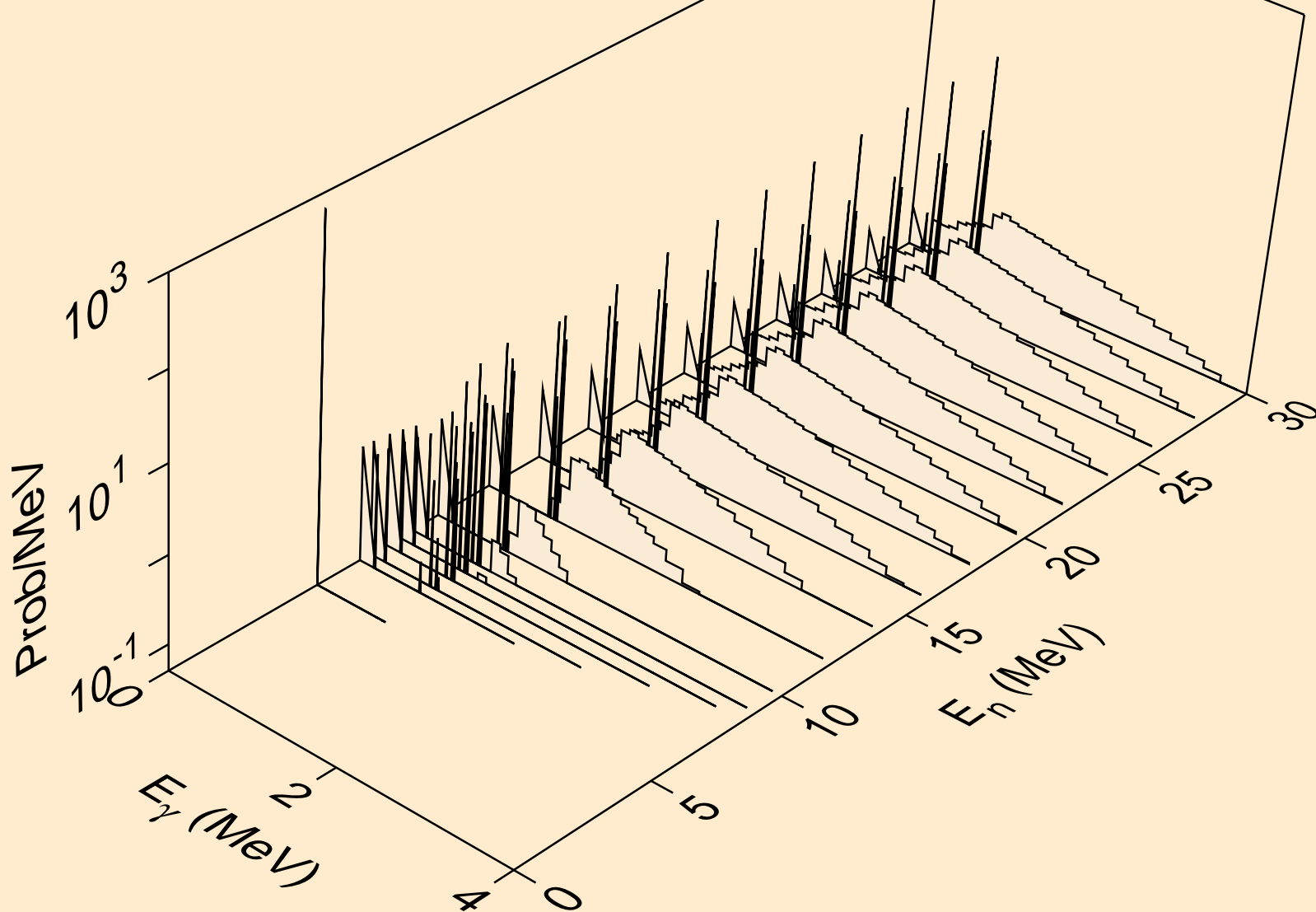

RU090 NEUTRON ACER TENDL-2019 LIBRARY; T=293.16K
Photon emission for (n,n*)2a

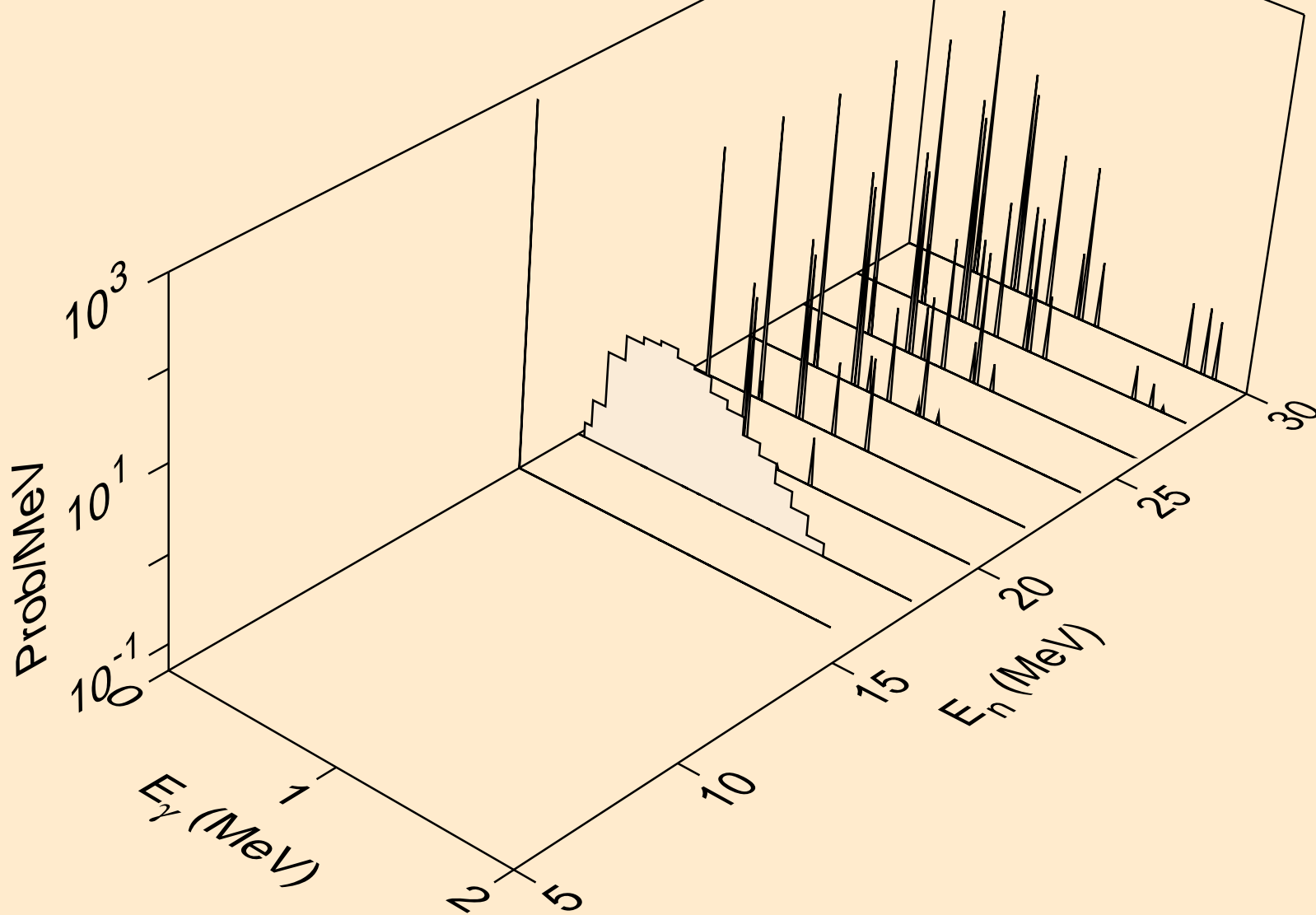

RU090 NEUTRON ACER TENDL-2019 LIBRARY; T=293.16K
Photon emission for (n,n*)d

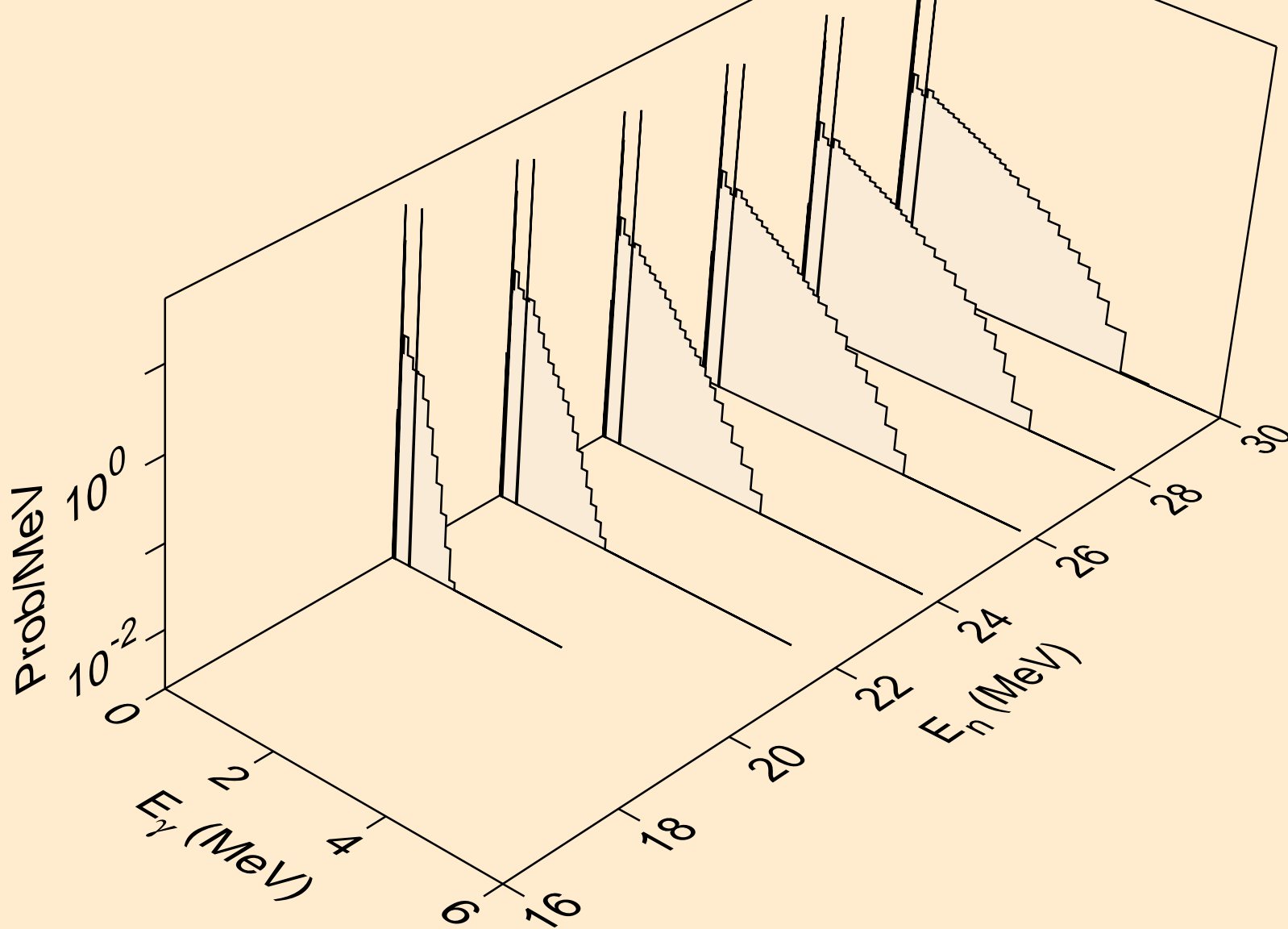

RU090 NEUTRON ACER TENDL-2019 LIBRARY; T=293.16K
Photon emission for (n,n*)t

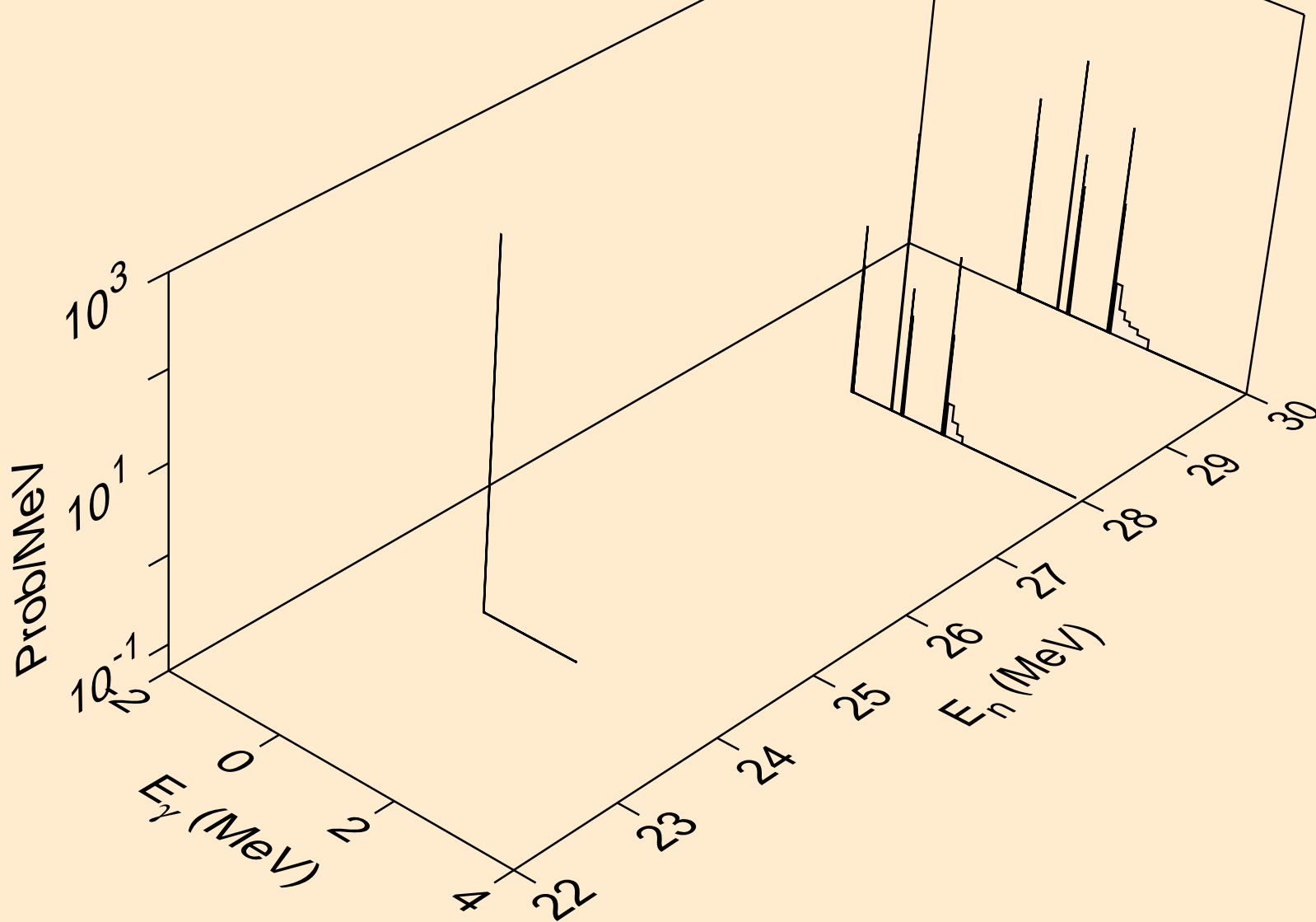

RU090 NEUTRON ACER TENDL-2019 LIBRARY; T=293.16K
Photon emission for (n,n*)he3

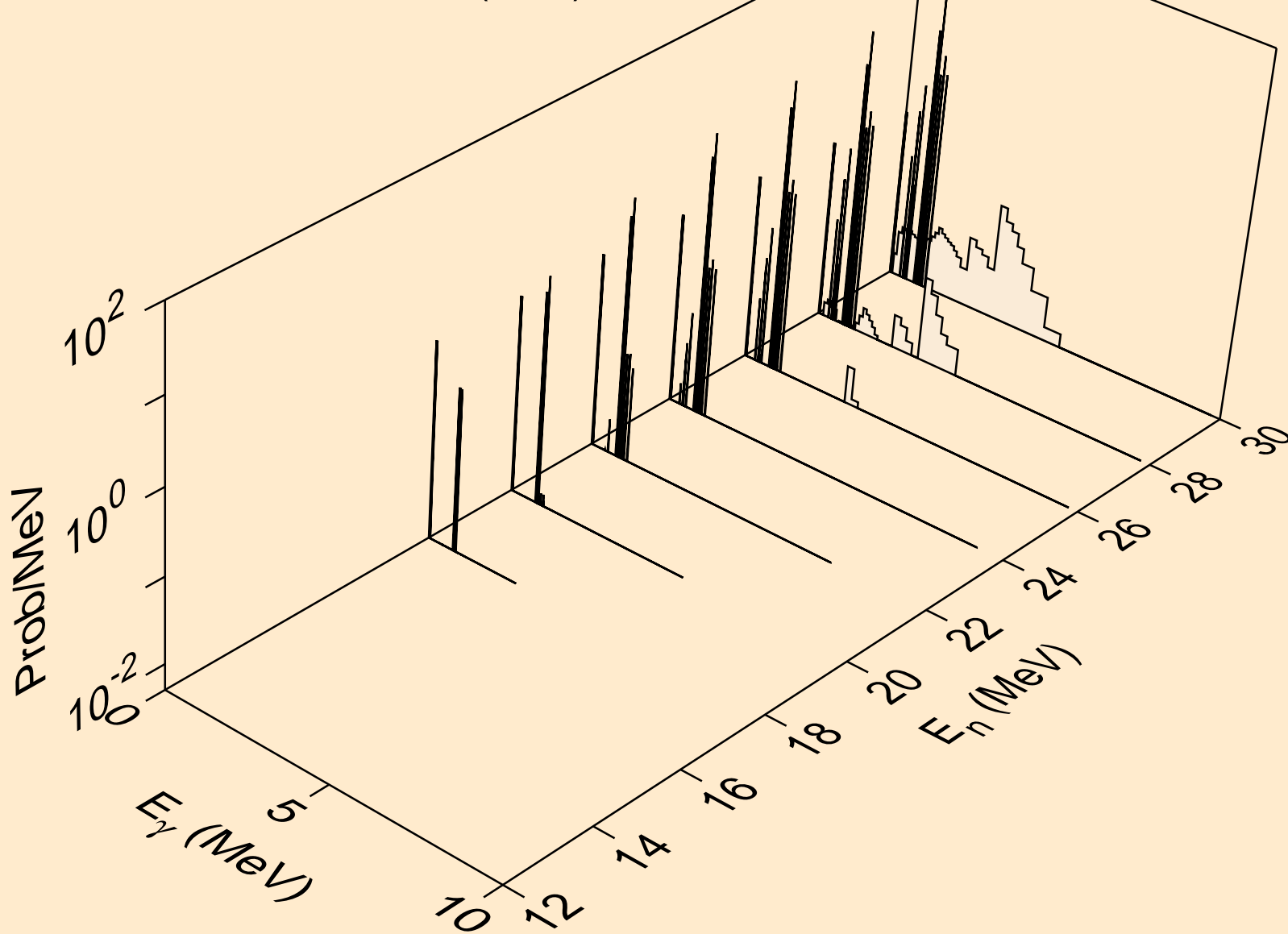

RU090 NEUTRON ACER TENDL-2019 LIBRARY; T=293.16K
Photon emission for (n,2np)

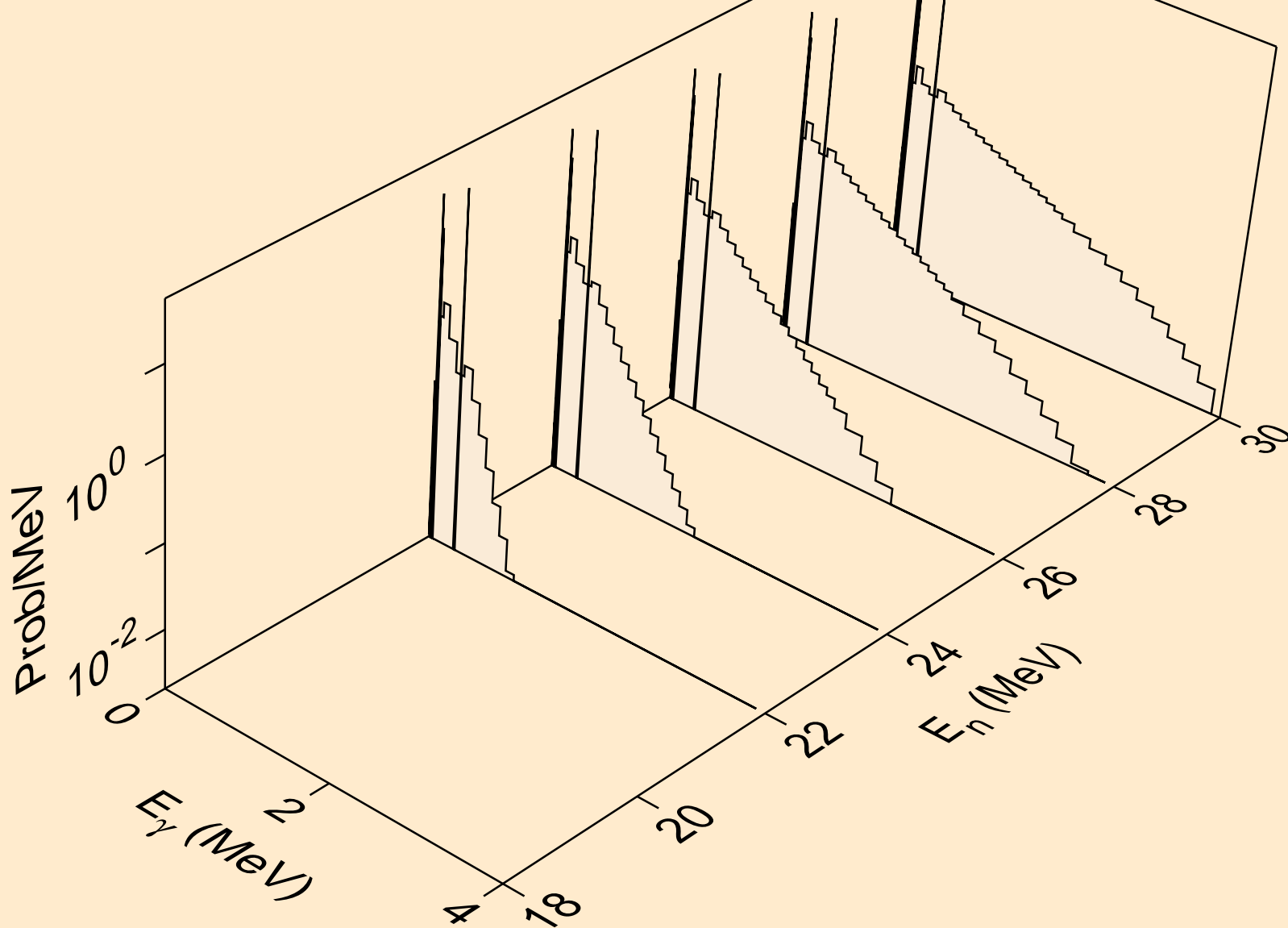

RU090 NEUTRON ACER TENDL-2019 LIBRARY; T=293.16K
Photon emission for (n,2np)

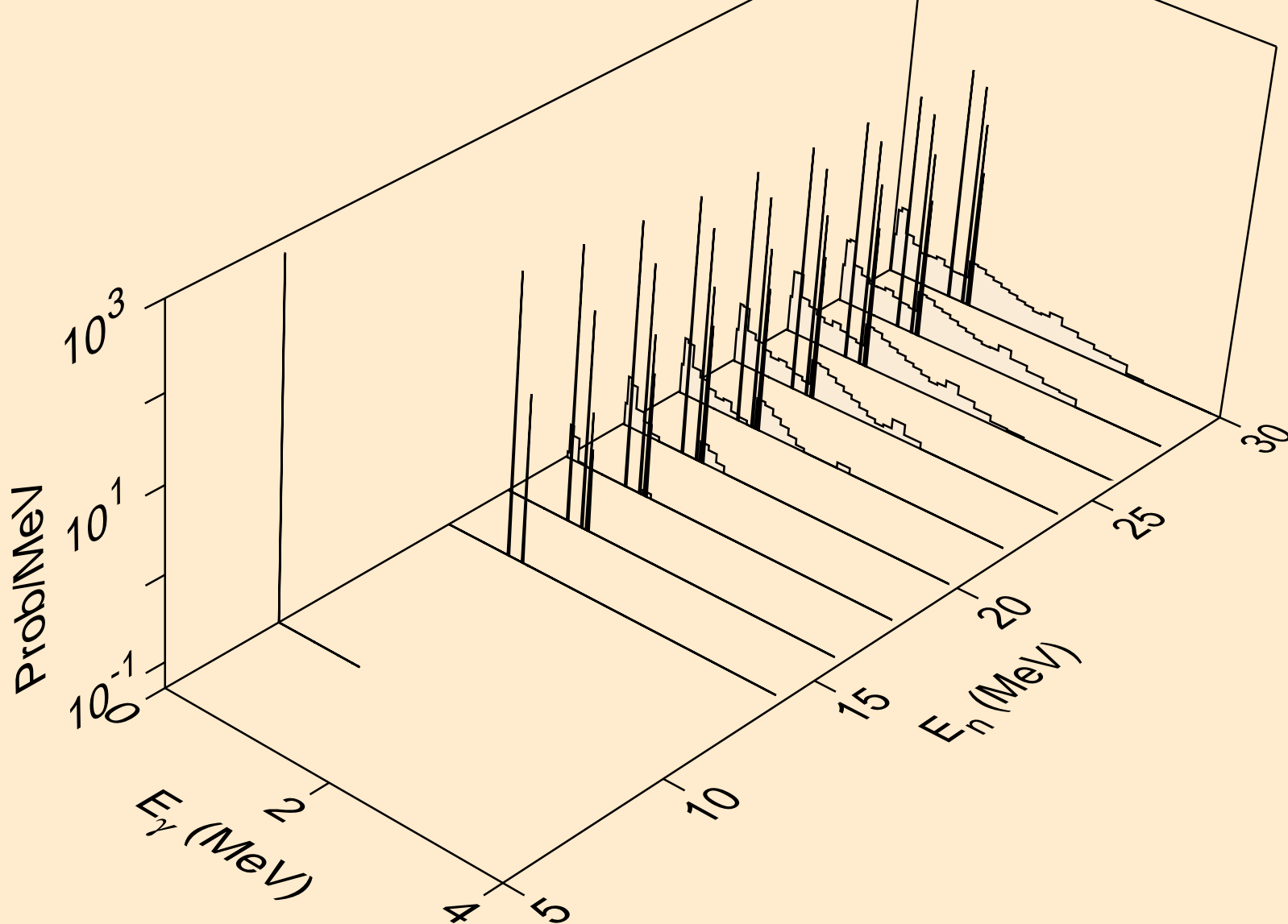

RU090 NEUTRON ACER TENDL-2019 LIBRARY; T=293.16K
Photon emission for (n,npa)

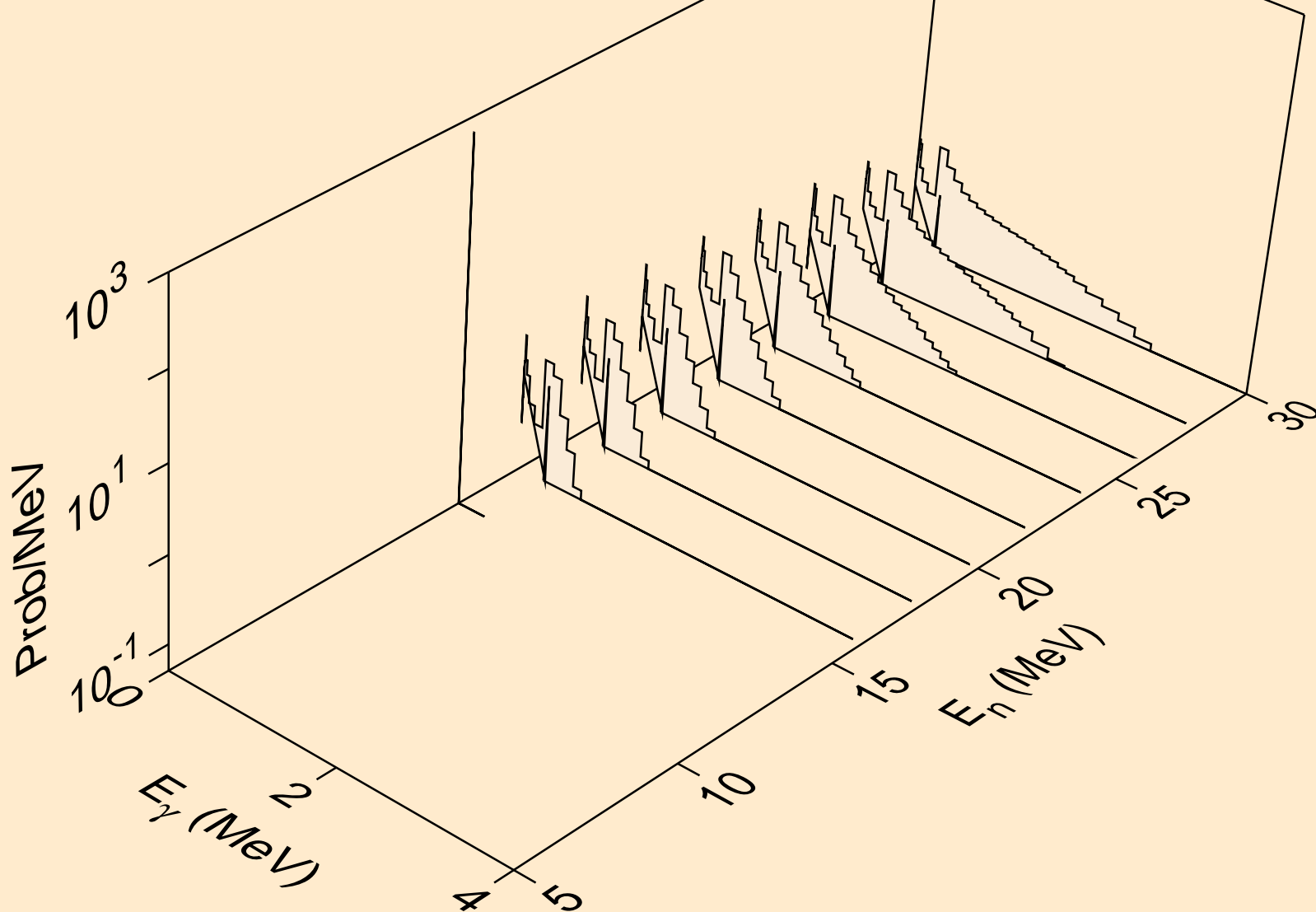

RU090 NEUTRON ACER TENDL-2019 LIBRARY; T=293.16K
Photon emission for (n,n*c)

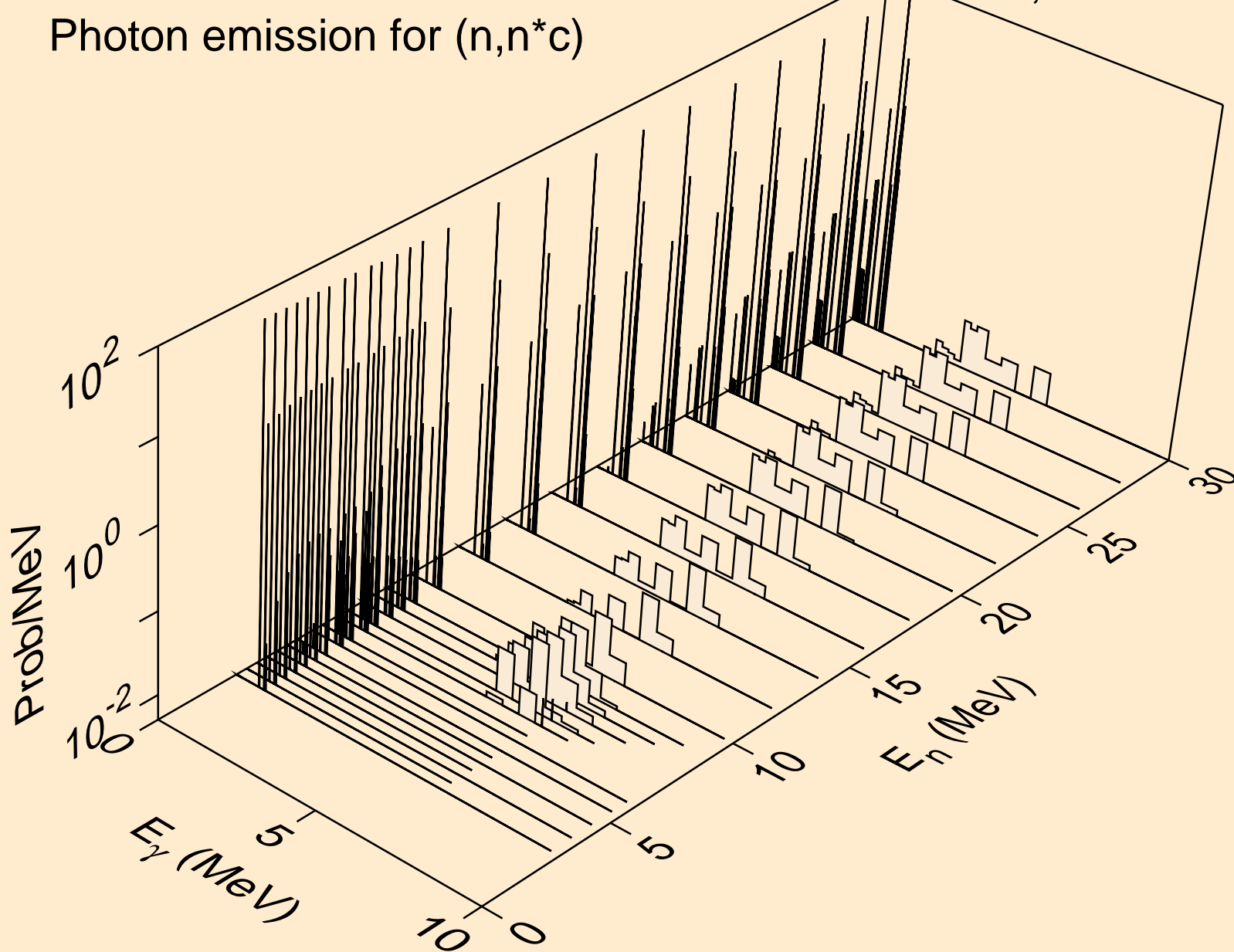

RU090 NEUTRON ACER TENDL-2019 LIBRARY; T=293.16K
Photon emission for (n,gma)

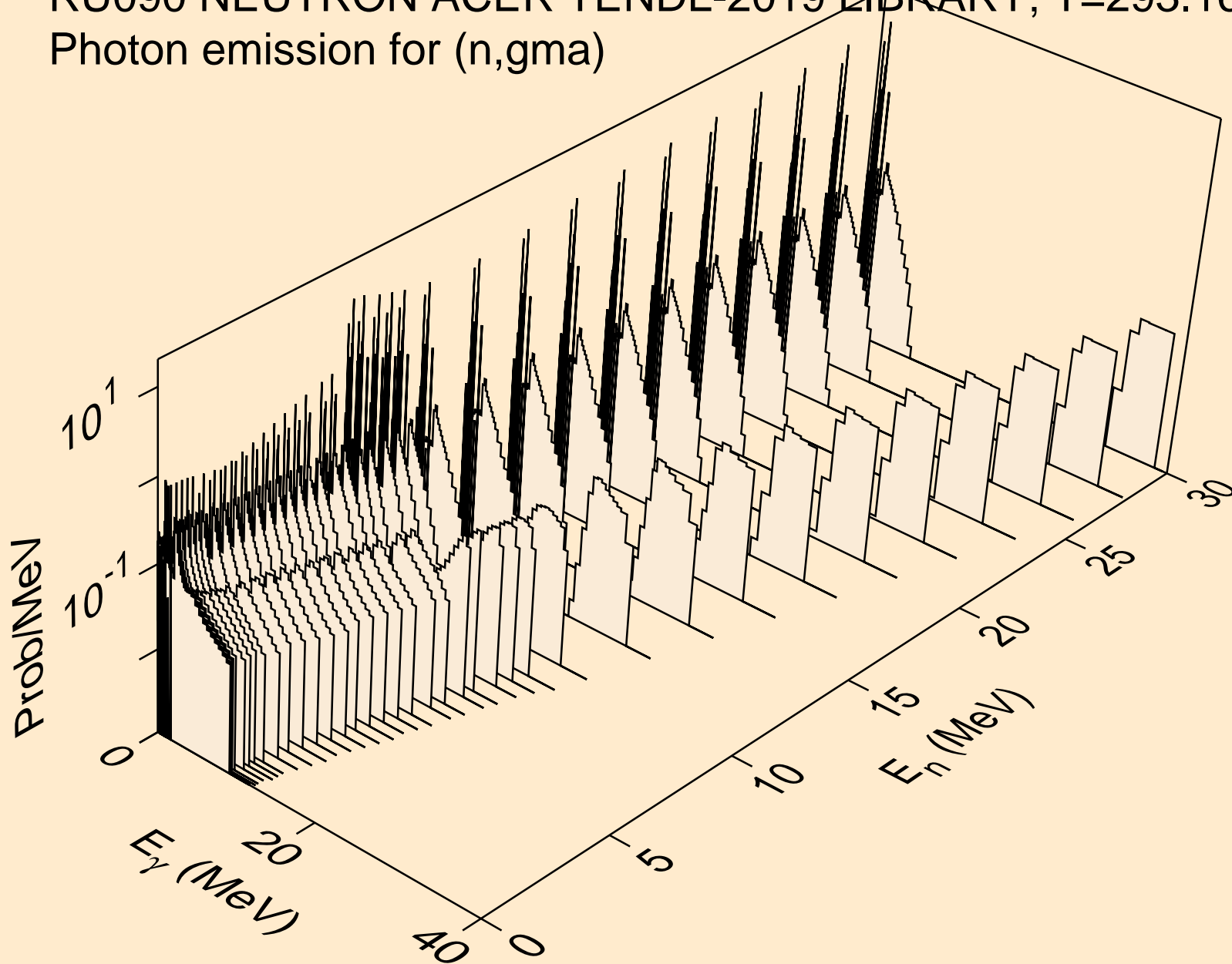

RU090 NEUTRON ACER TENDL-2019 LIBRARY; T=293.16K
Photon emission for (n,p)

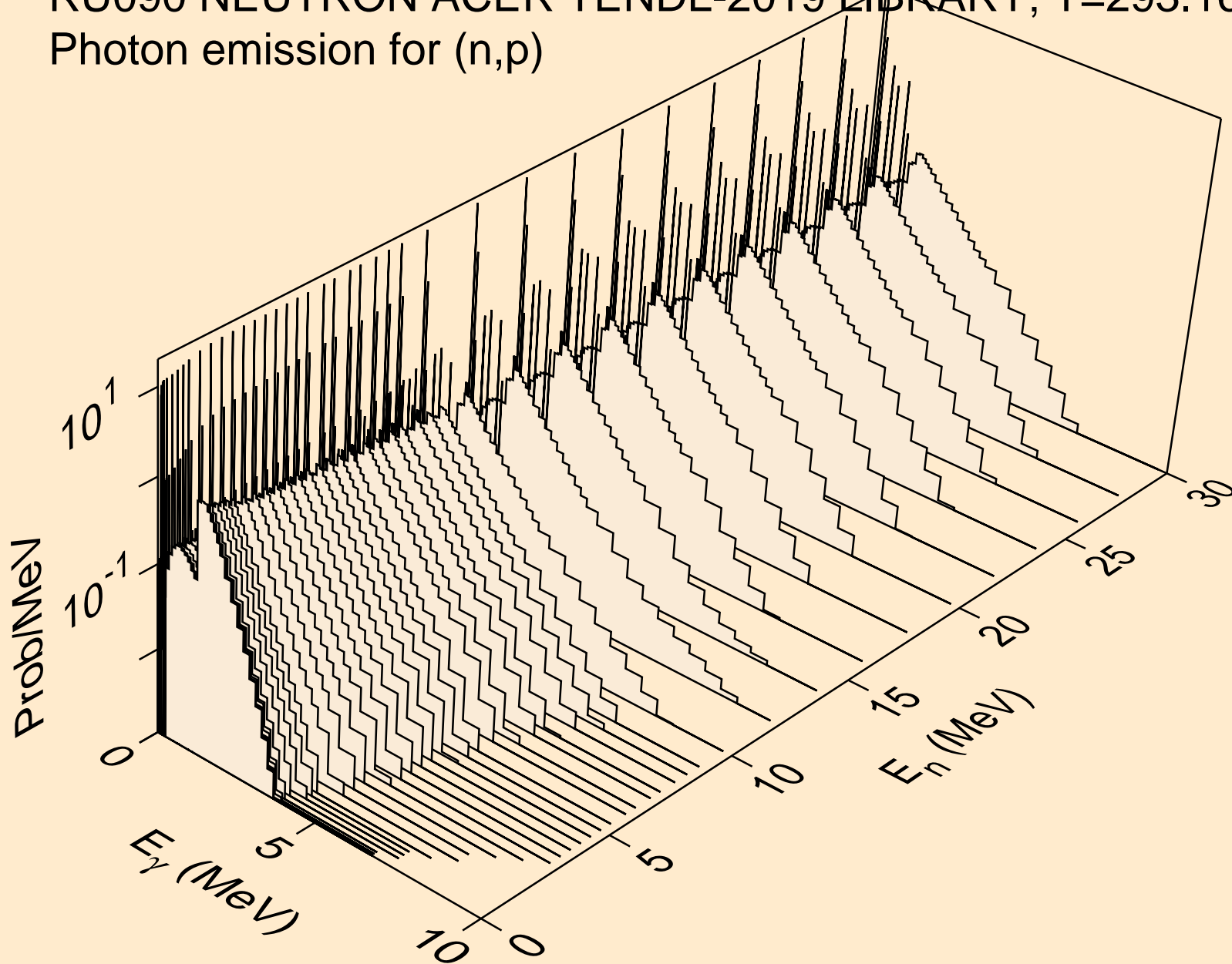

RU090 NEUTRON ACER TENDL-2019 LIBRARY; T=293.16K
Photon emission for (n,d)

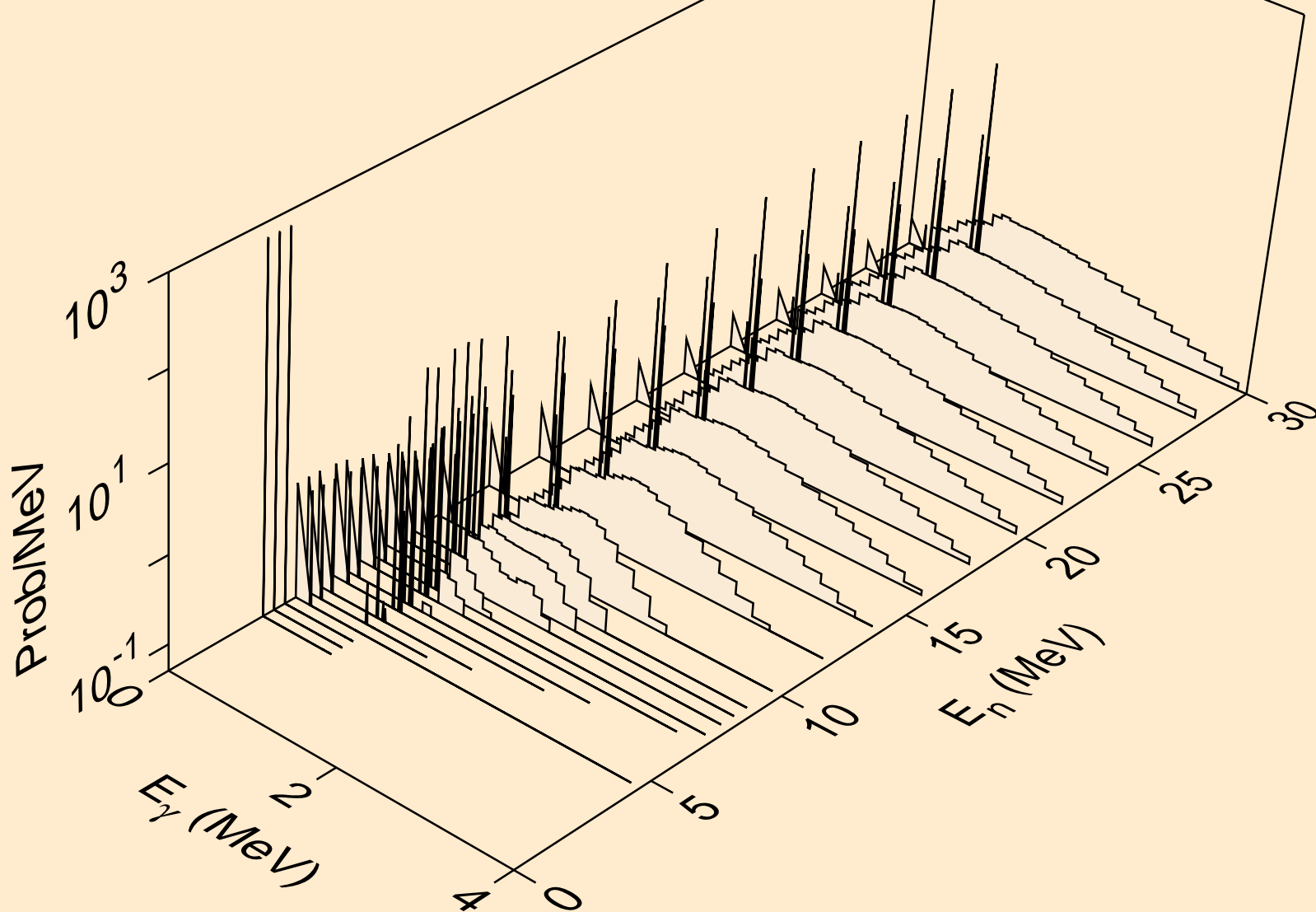

RU090 NEUTRON ACER TENDL-2019 LIBRARY; T=293.16K
Photon emission for (n,t)

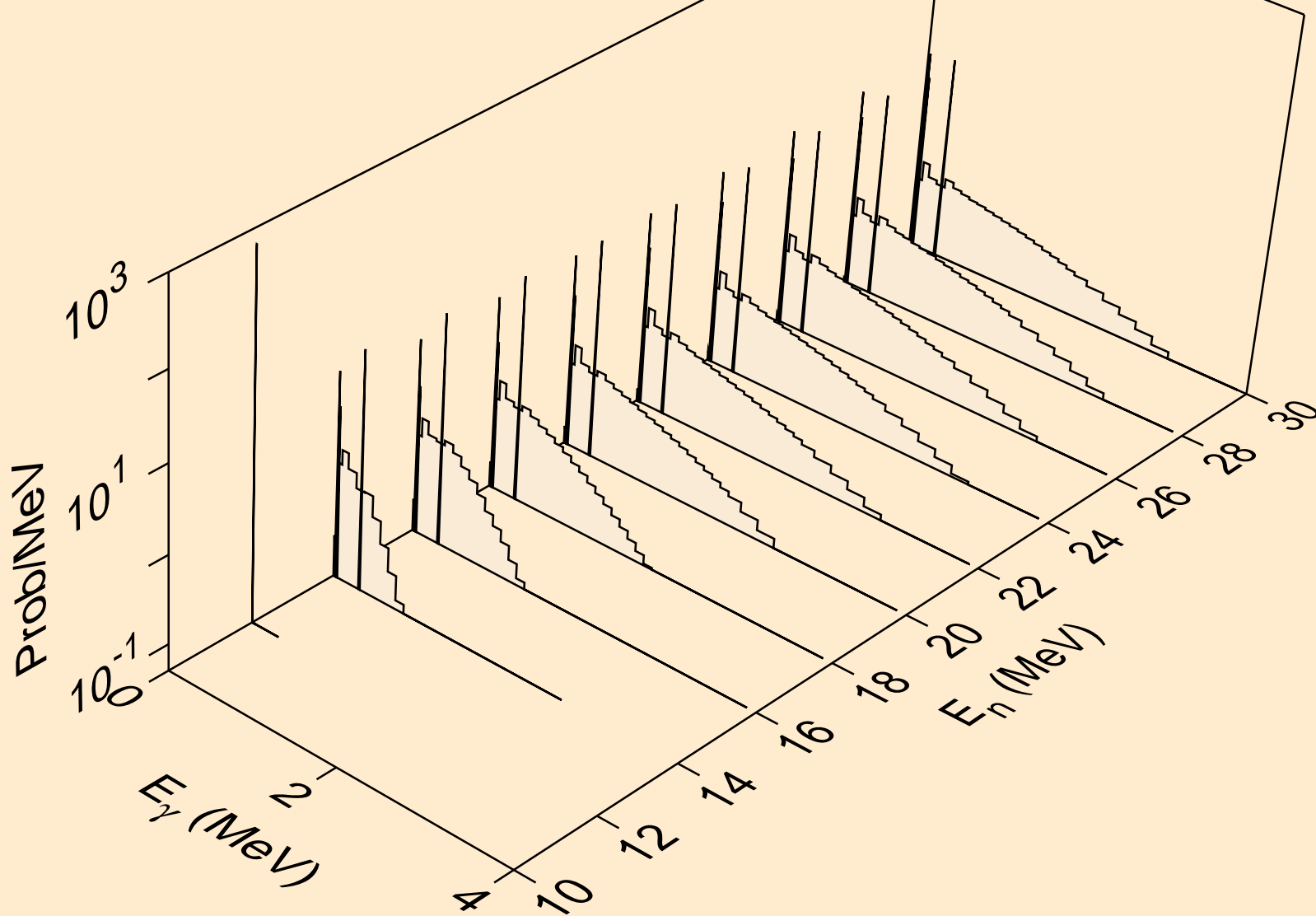

RU090 NEUTRON ACER TENDL-2019 LIBRARY; T=293.16K
Photon emission for (n,he3)

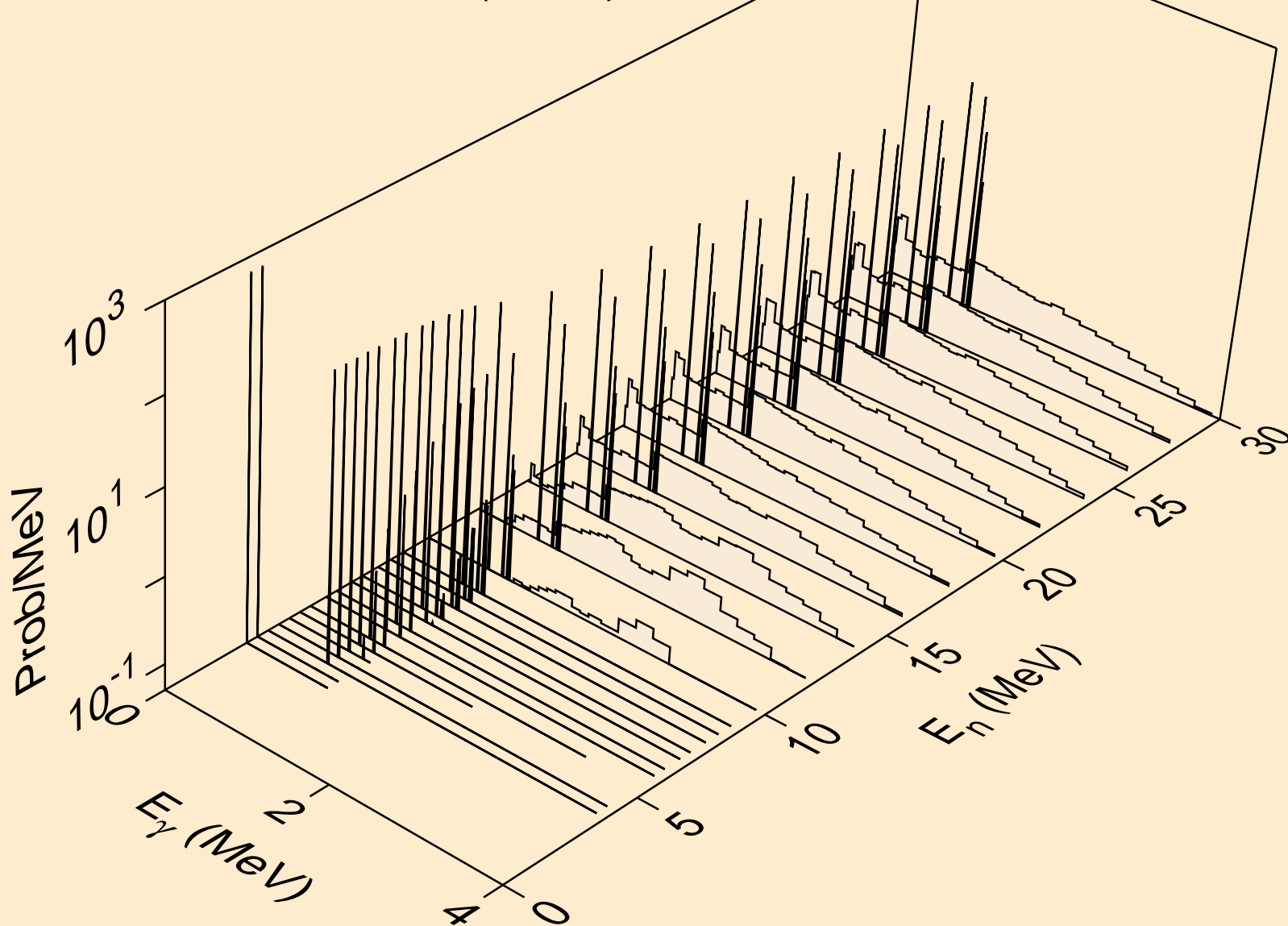

RU090 NEUTRON ACER TENDL-2019 LIBRARY; T=293.16K
Photon emission for (n,a)

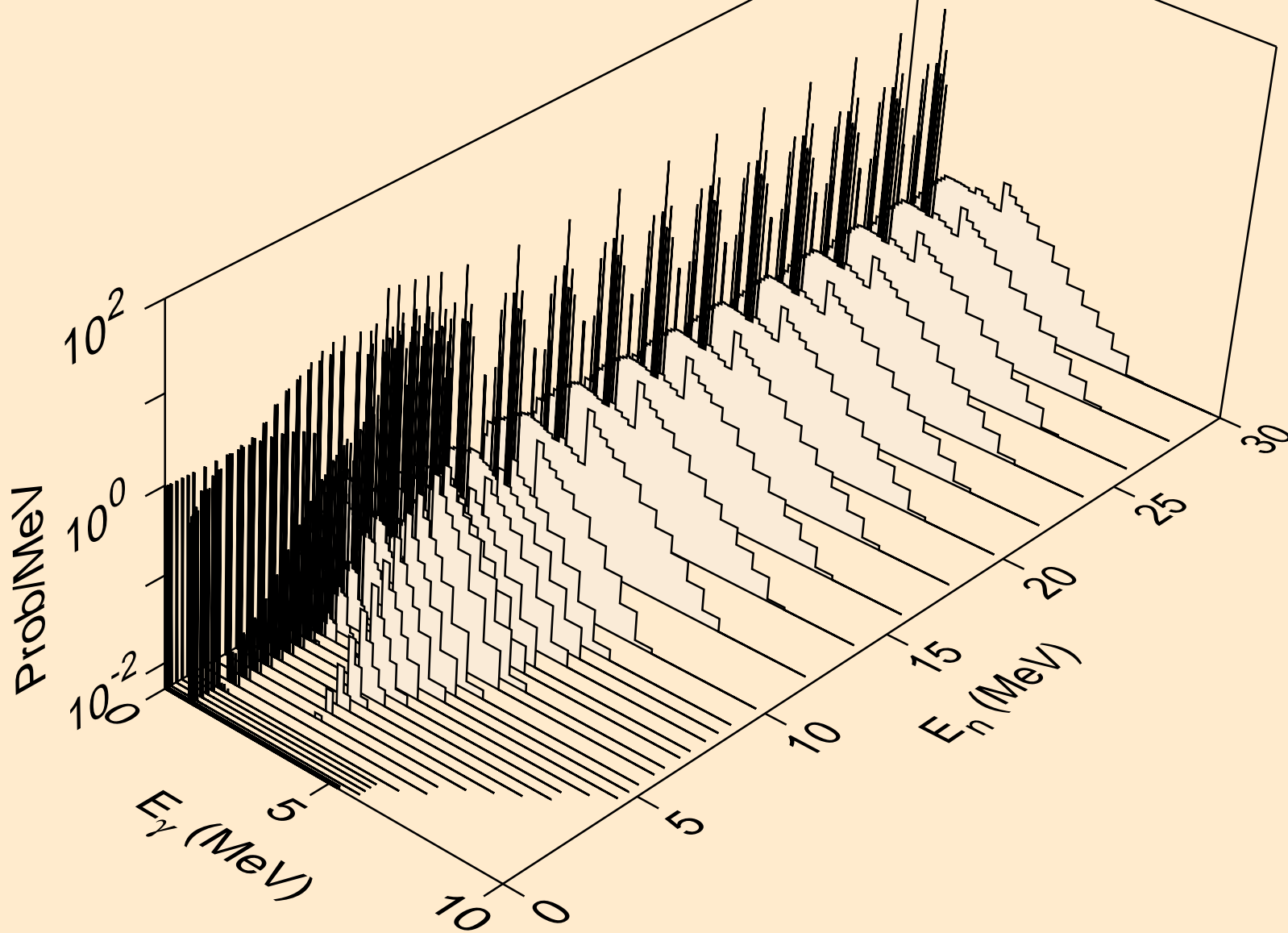

RU090 NEUTRON ACER TENDL-2019 LIBRARY; T=293.16K
Photon emission for (n,2a)

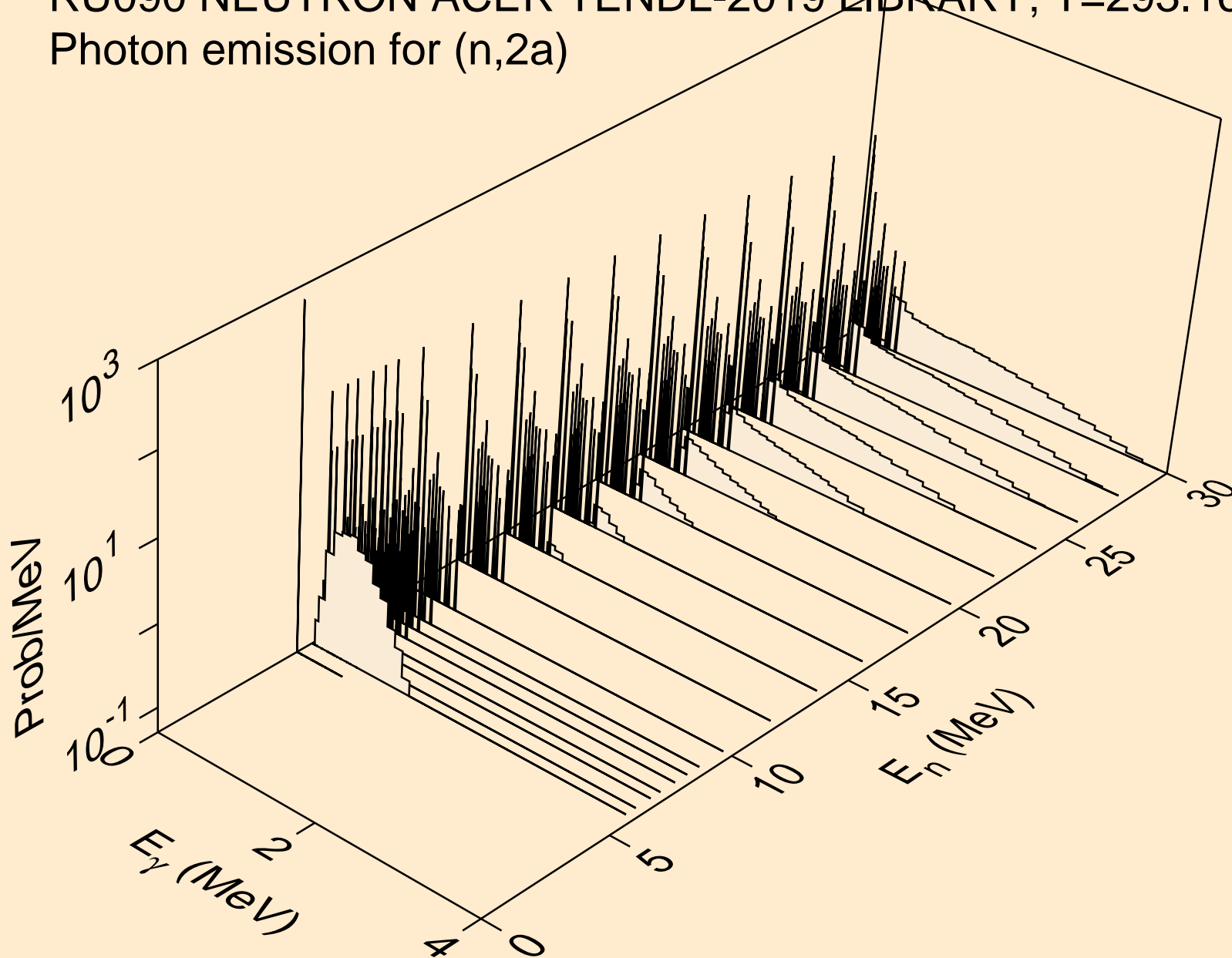

RU090 NEUTRON ACER TENDL-2019 LIBRARY; T=293.16K
Photon emission for (n,3a)

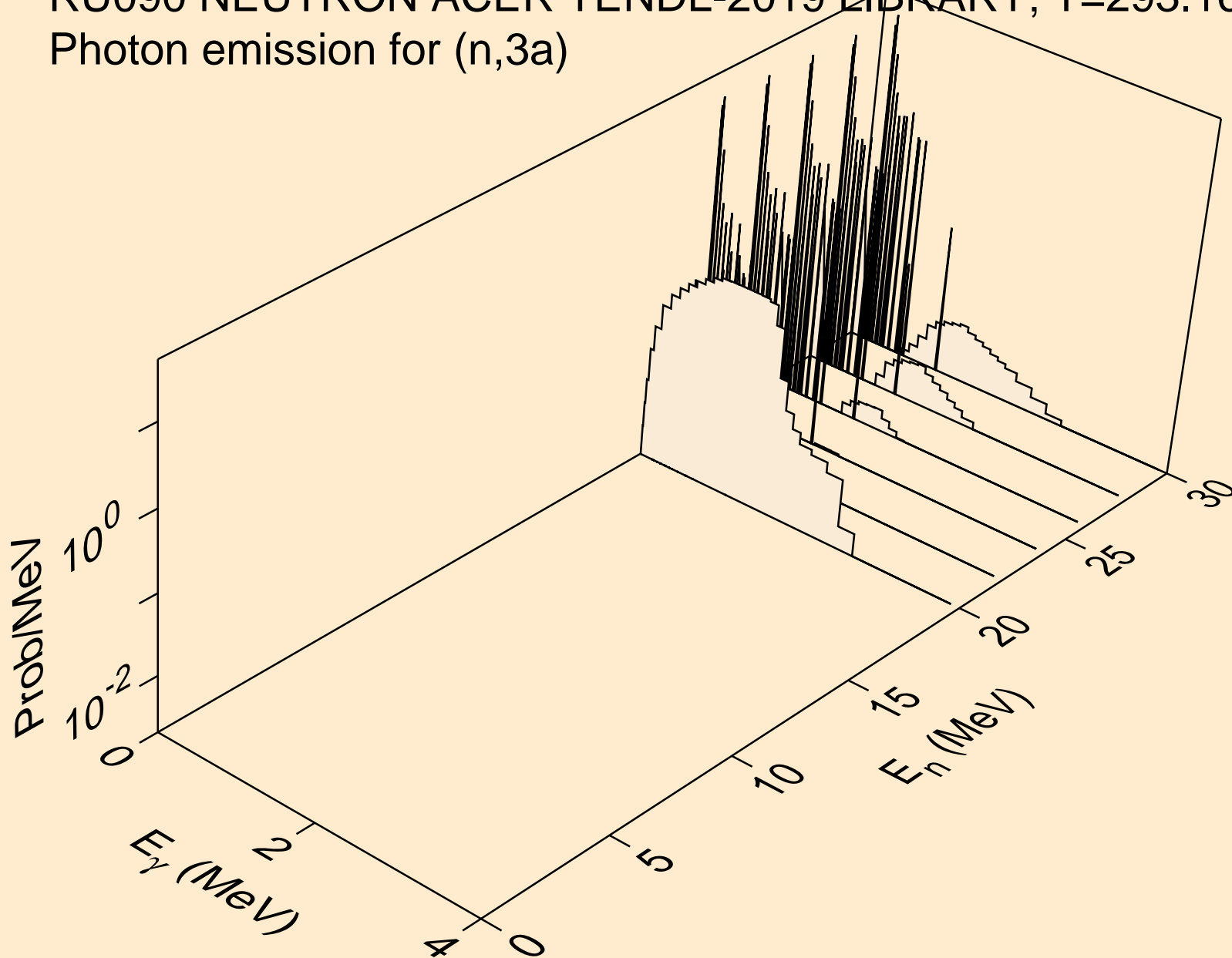

RU090 NEUTRON ACER TENDL-2019 LIBRARY; T=293.16K
Photon emission for (n,2p)

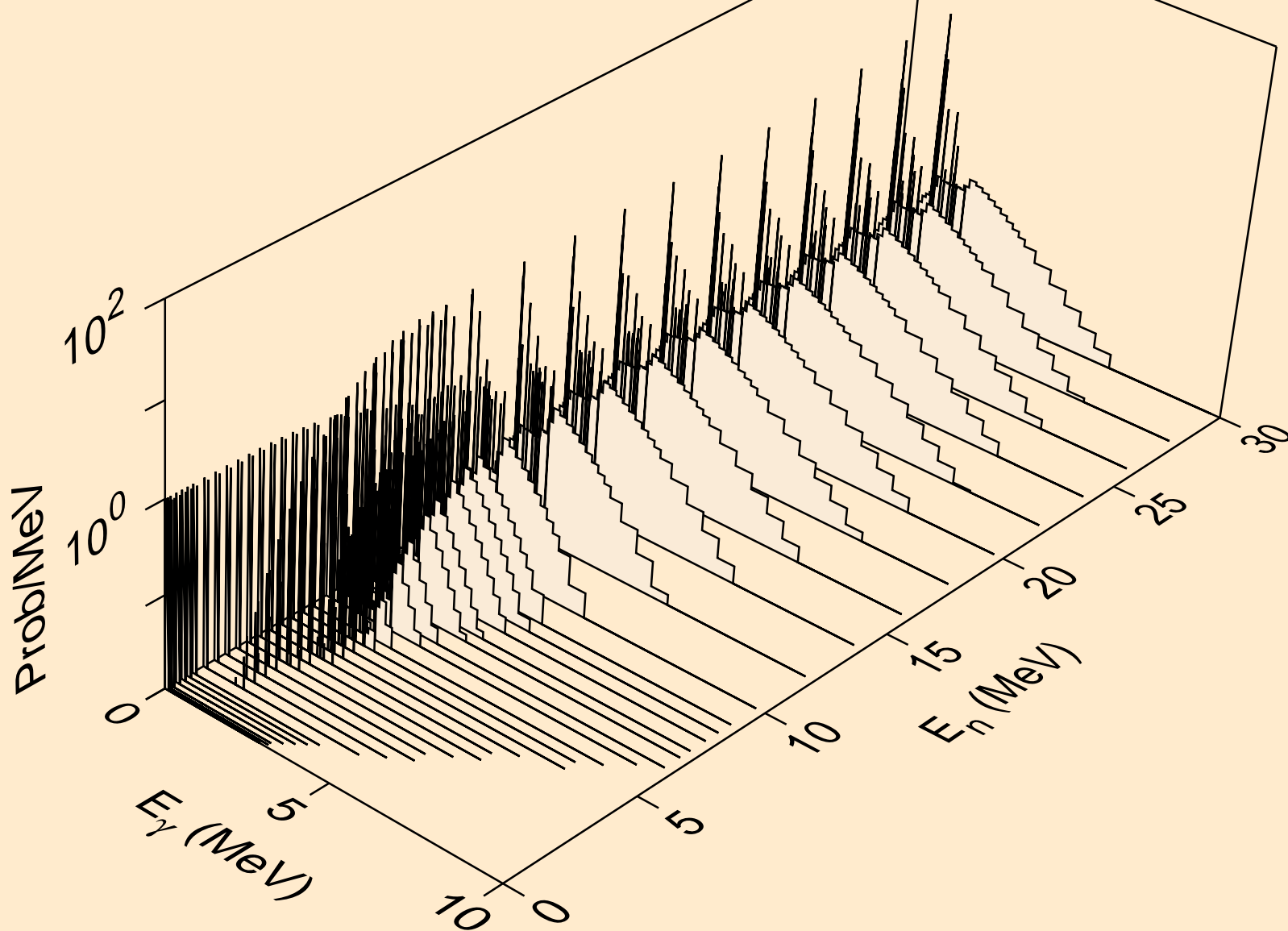

RU090 NEUTRON ACER TENDL-2019 LIBRARY; T=293.16K
Photon emission for (n,p α)

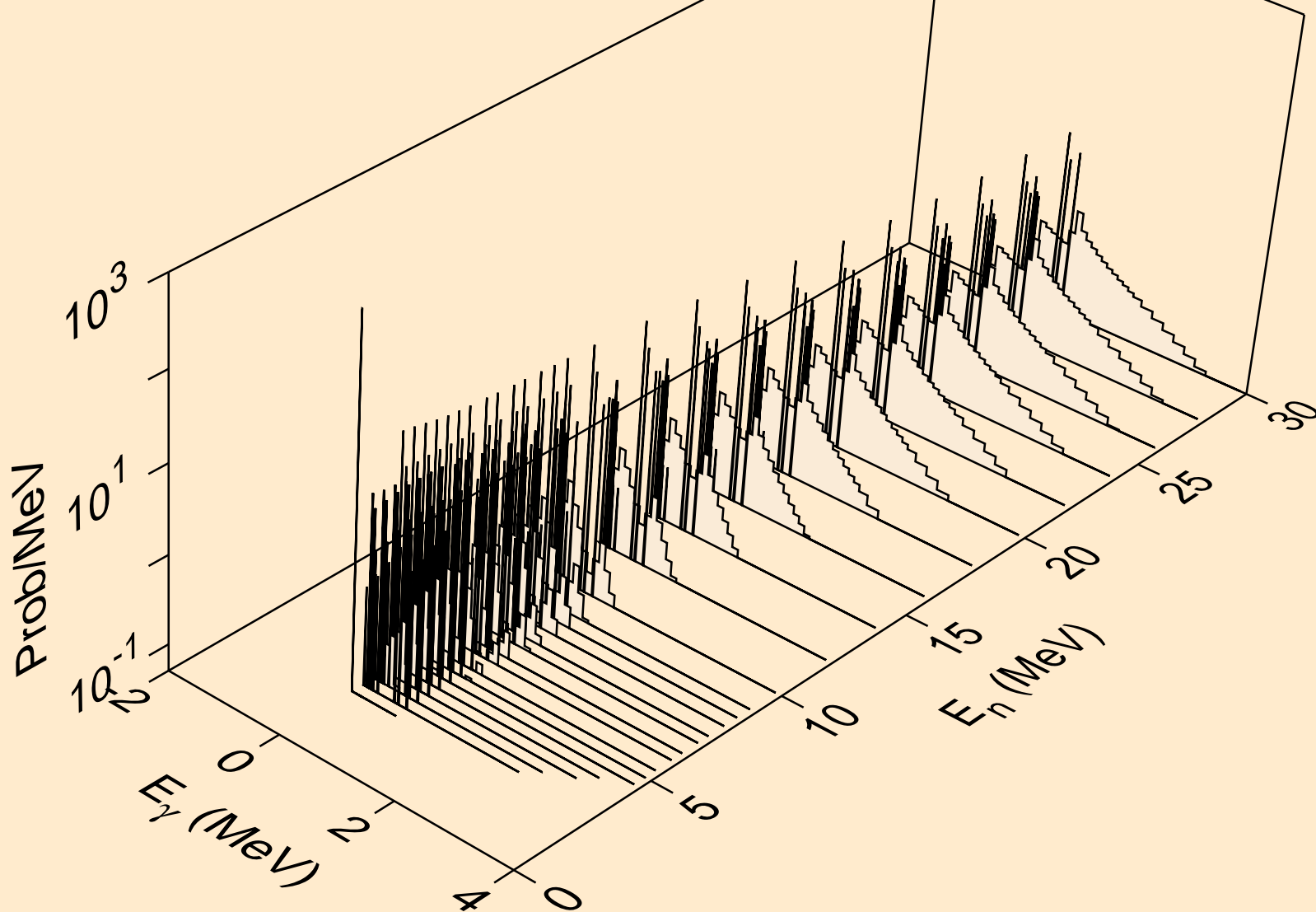

RU090 NEUTRON ACER TENDL-2019 LIBRARY; T=293.16K
Photon emission for (n,pd)

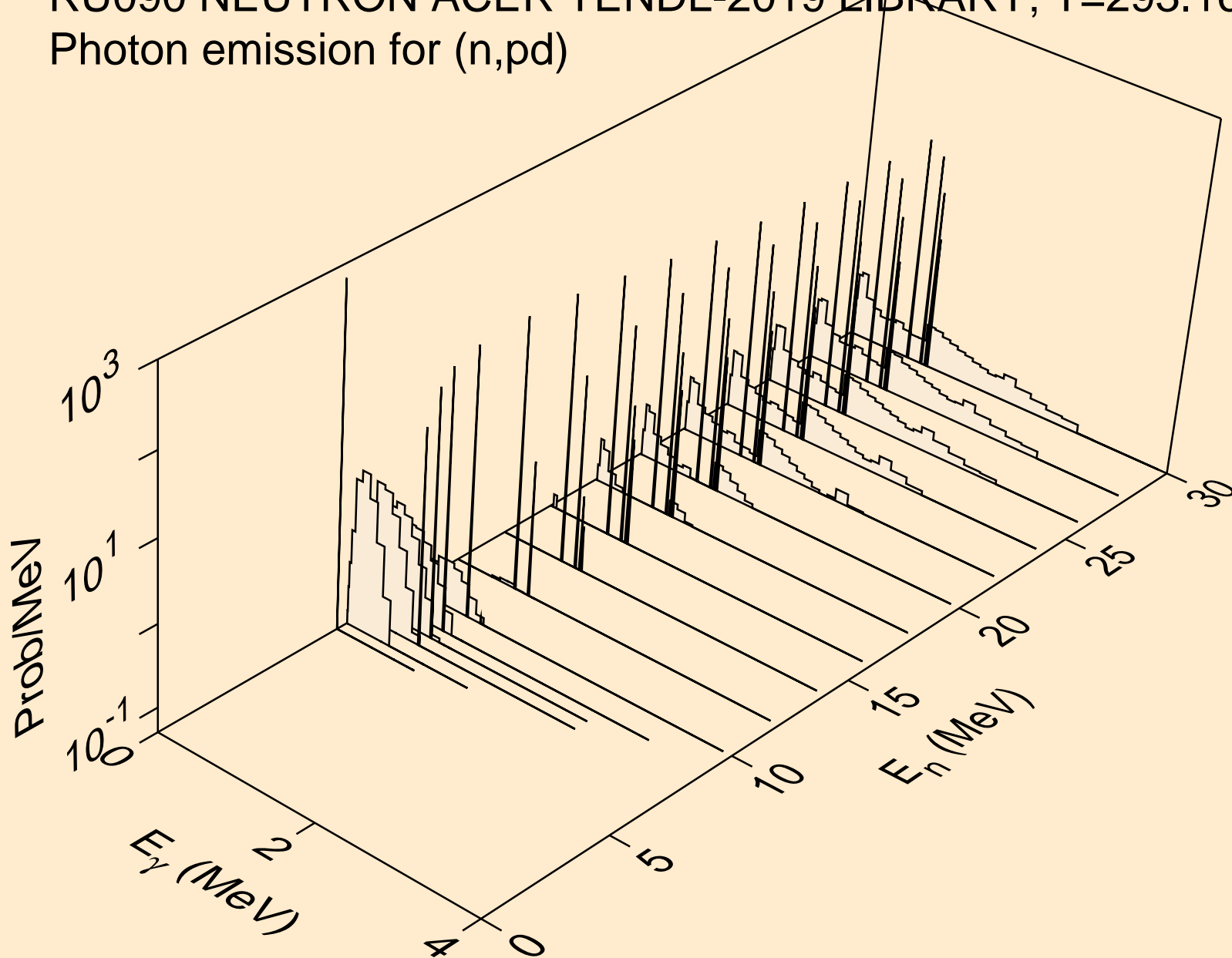

RU090 NEUTRON ACER TENDL-2019 LIBRARY; T=293.16K
Photon emission for (n,pt)

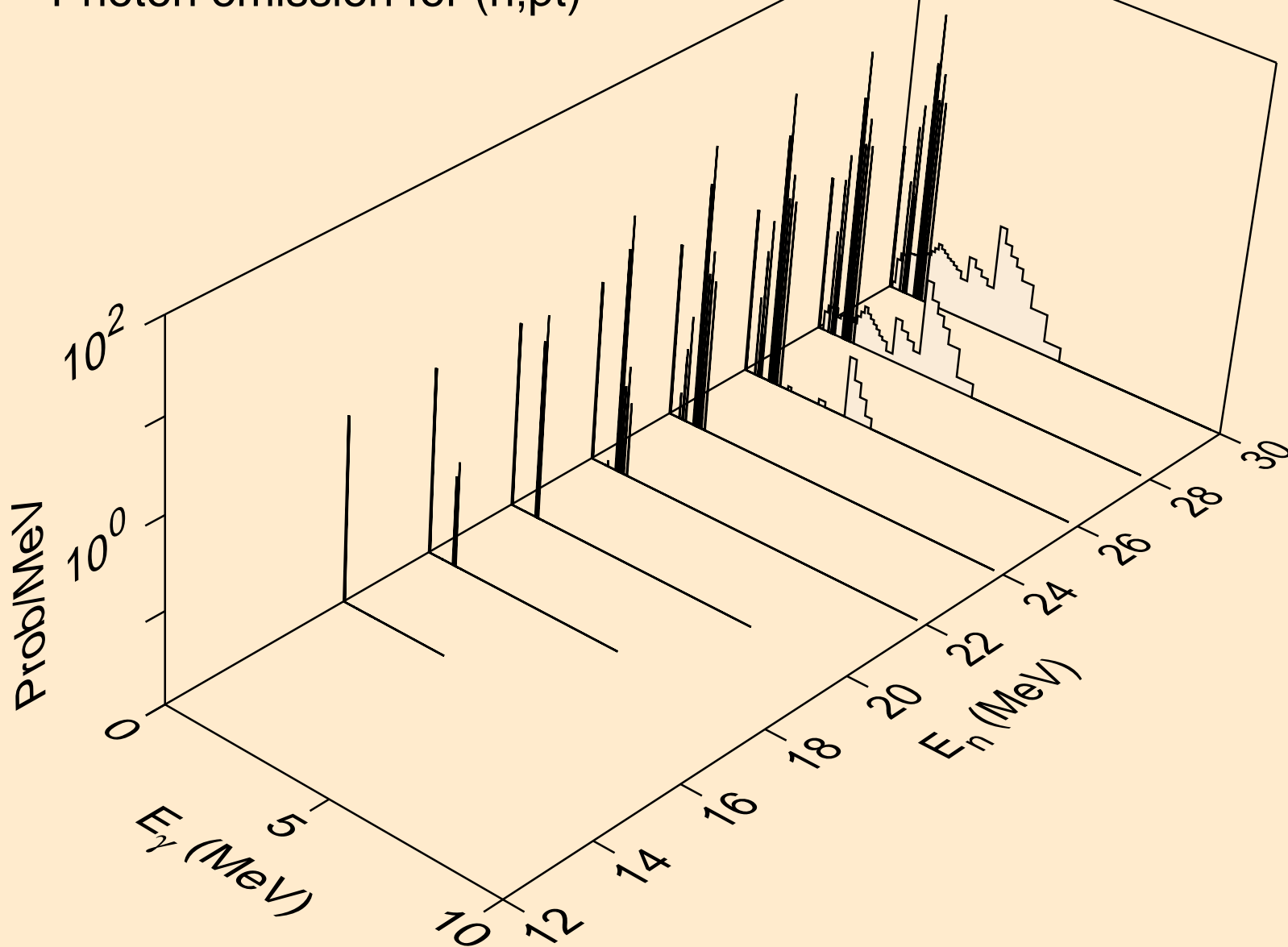

RU090 NEUTRON ACER TENDL-2019 LIBRARY; T=293.16K
Photon emission for (n,da)

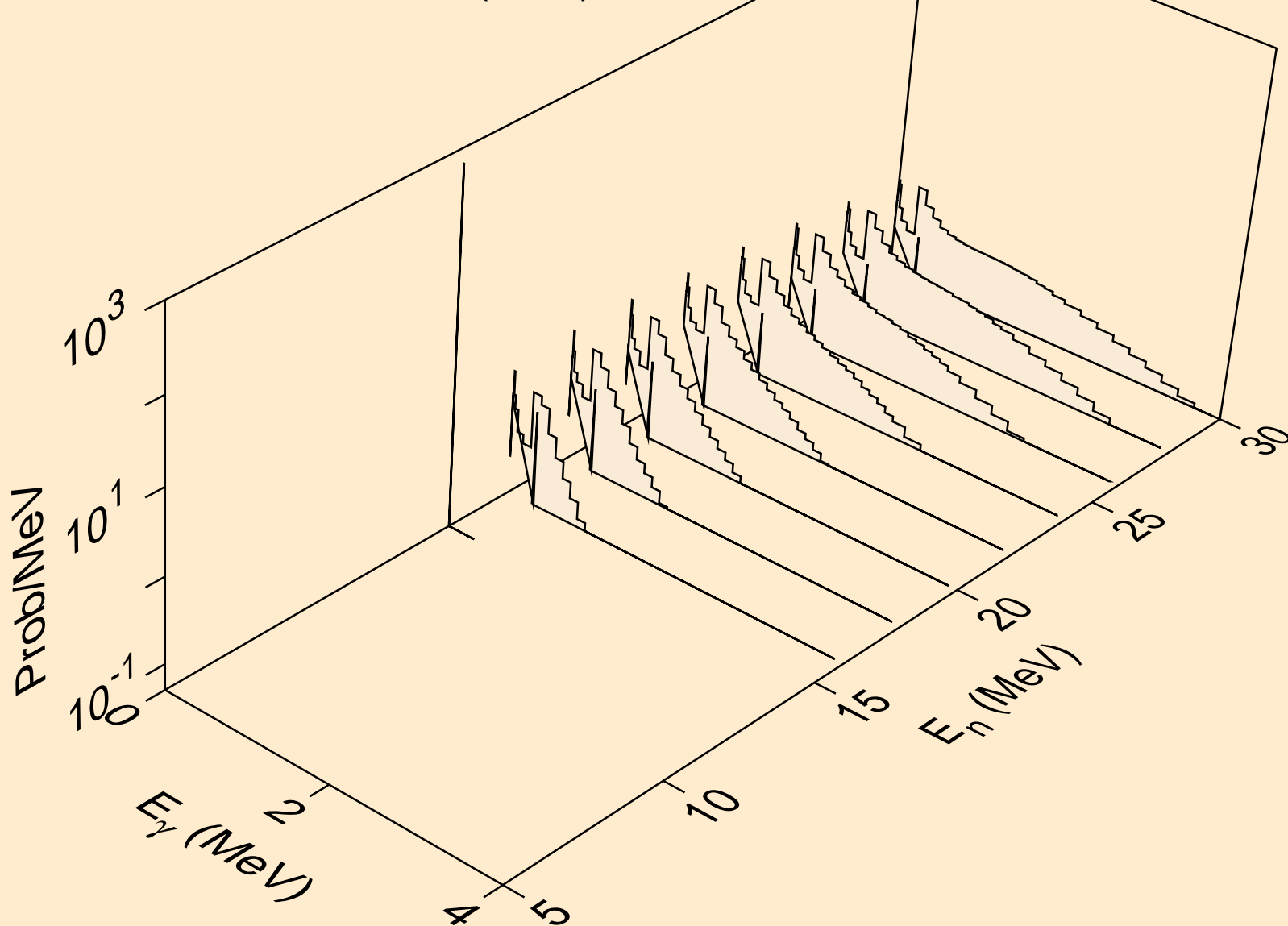

RU090 NEUTRON ACER TENDL-2019 LIBRARY; T=293.16K
thermal capture photon spectrum

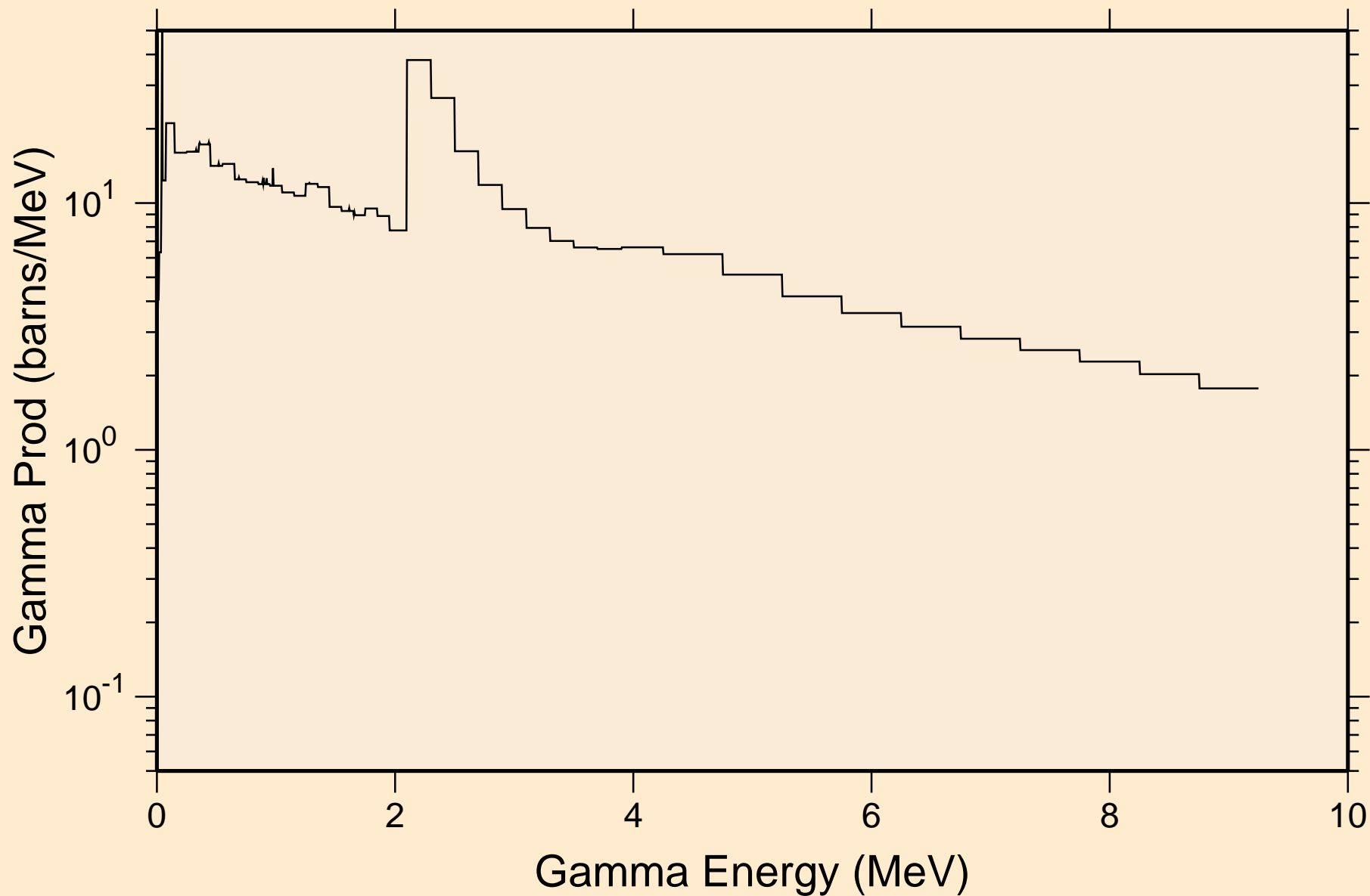

RU090 NEUTRON ACER TENDL-2019 LIBRARY; T=293.16K
14 MeV photon spectrum

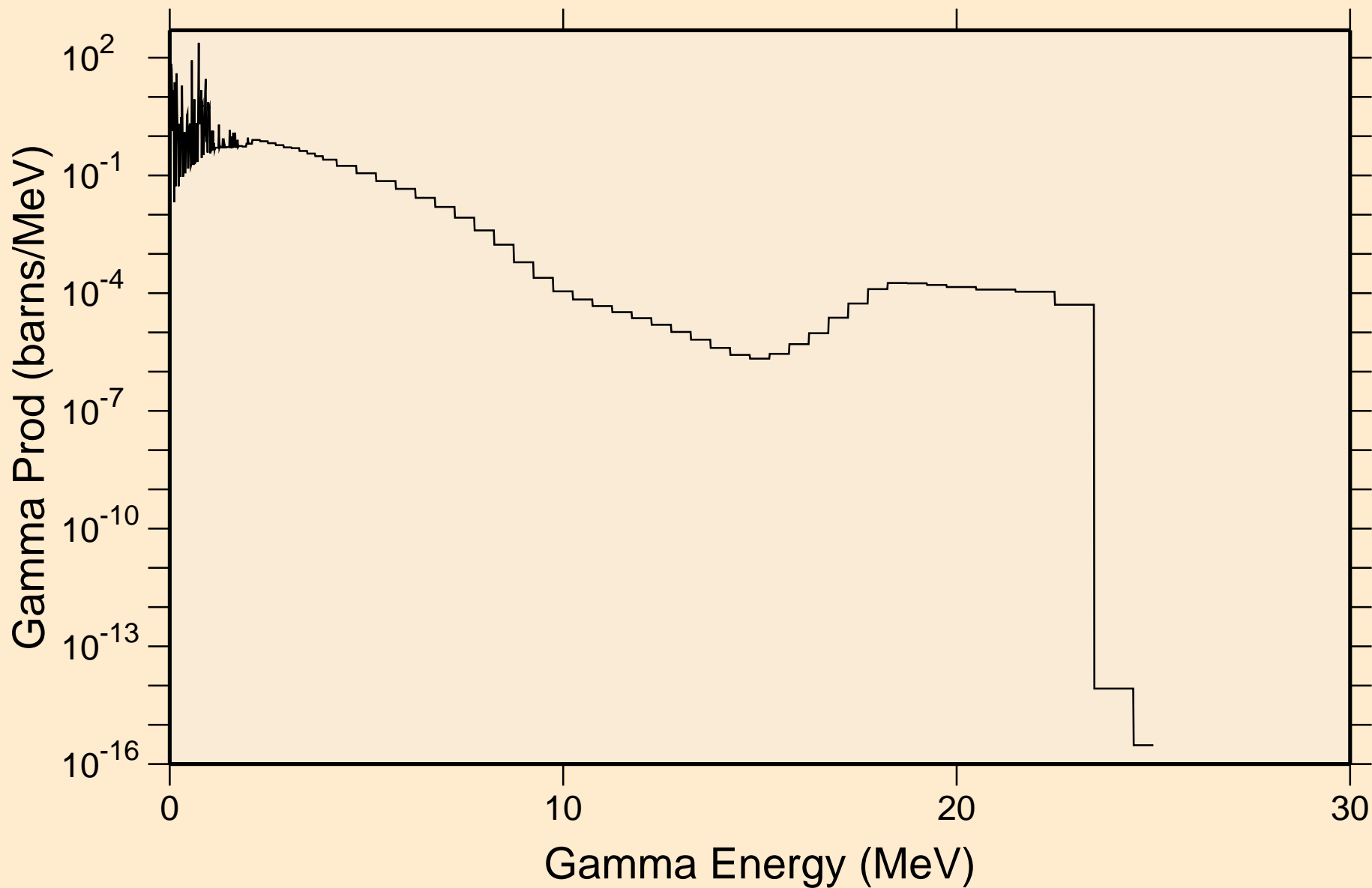

RU090 NEUTRON ACER TENDL-2019 LIBRARY; T=293.16K
Particle heating contributions

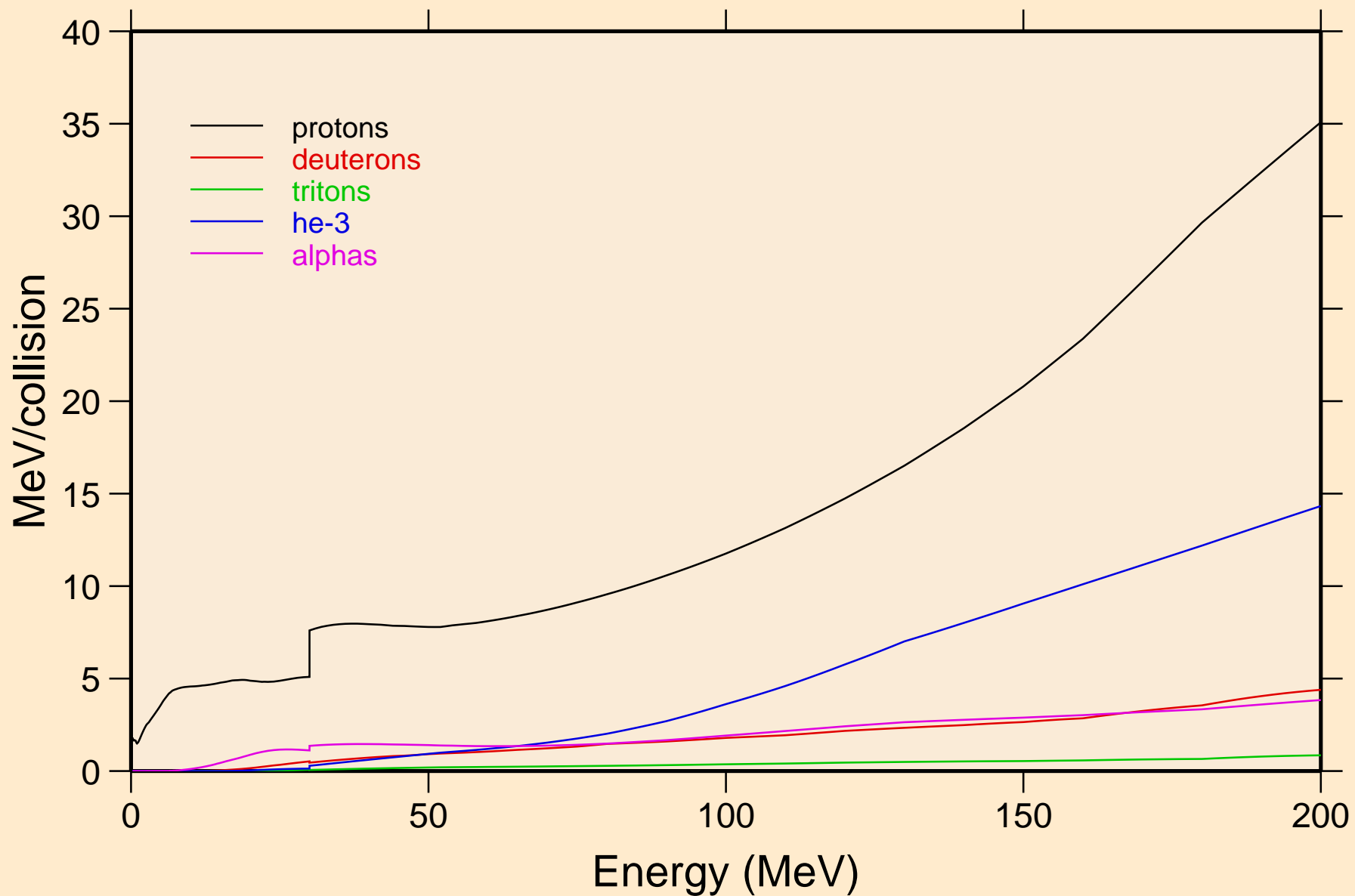

RU090 NEUTRON ACER TENDL-2019 LIBRARY; T=293.16K
Recoil Heating

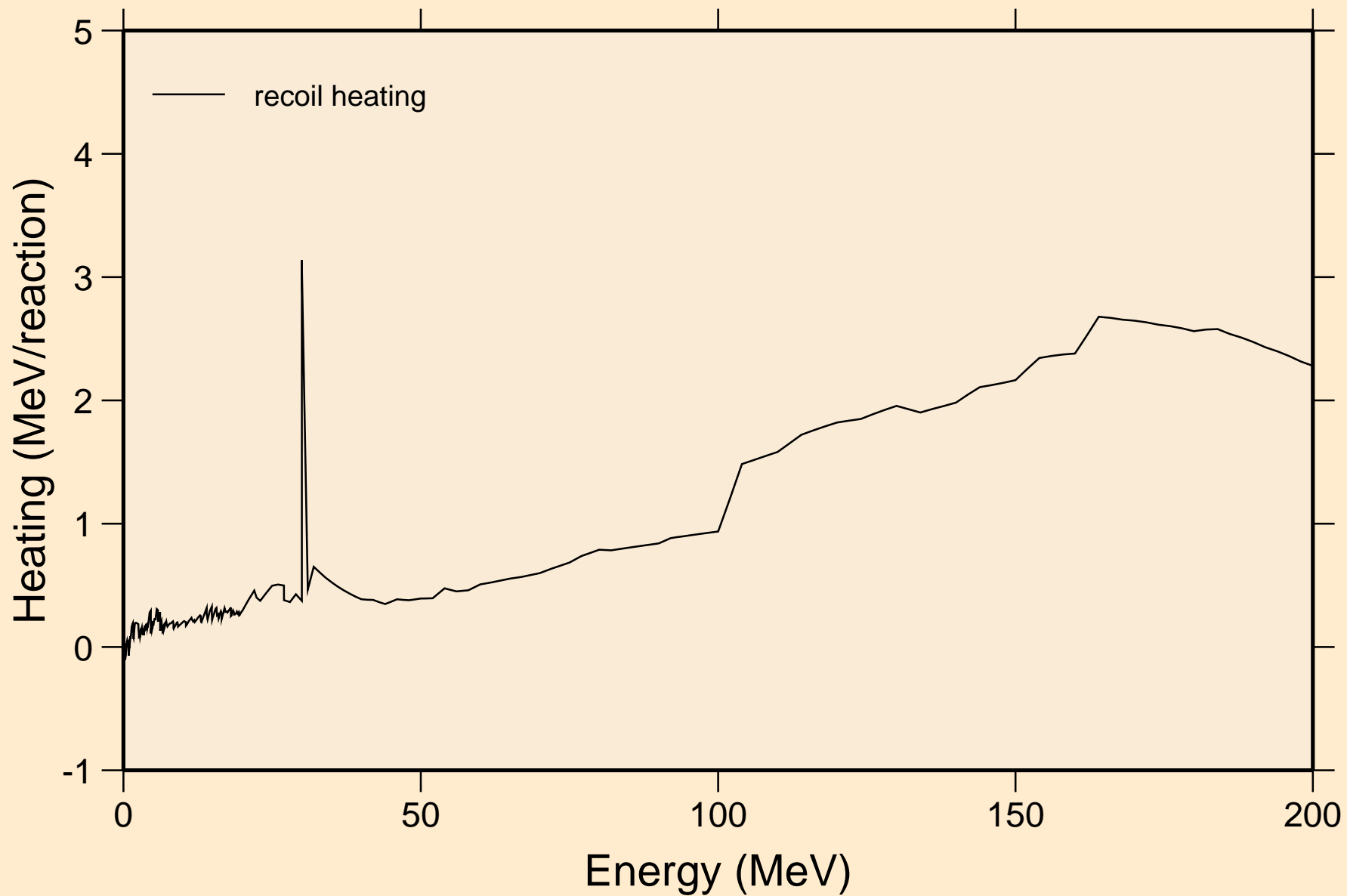

RU090 NEUTRON ACER TENDL-2019 LIBRARY; T=293.16K
Particle production cross sections

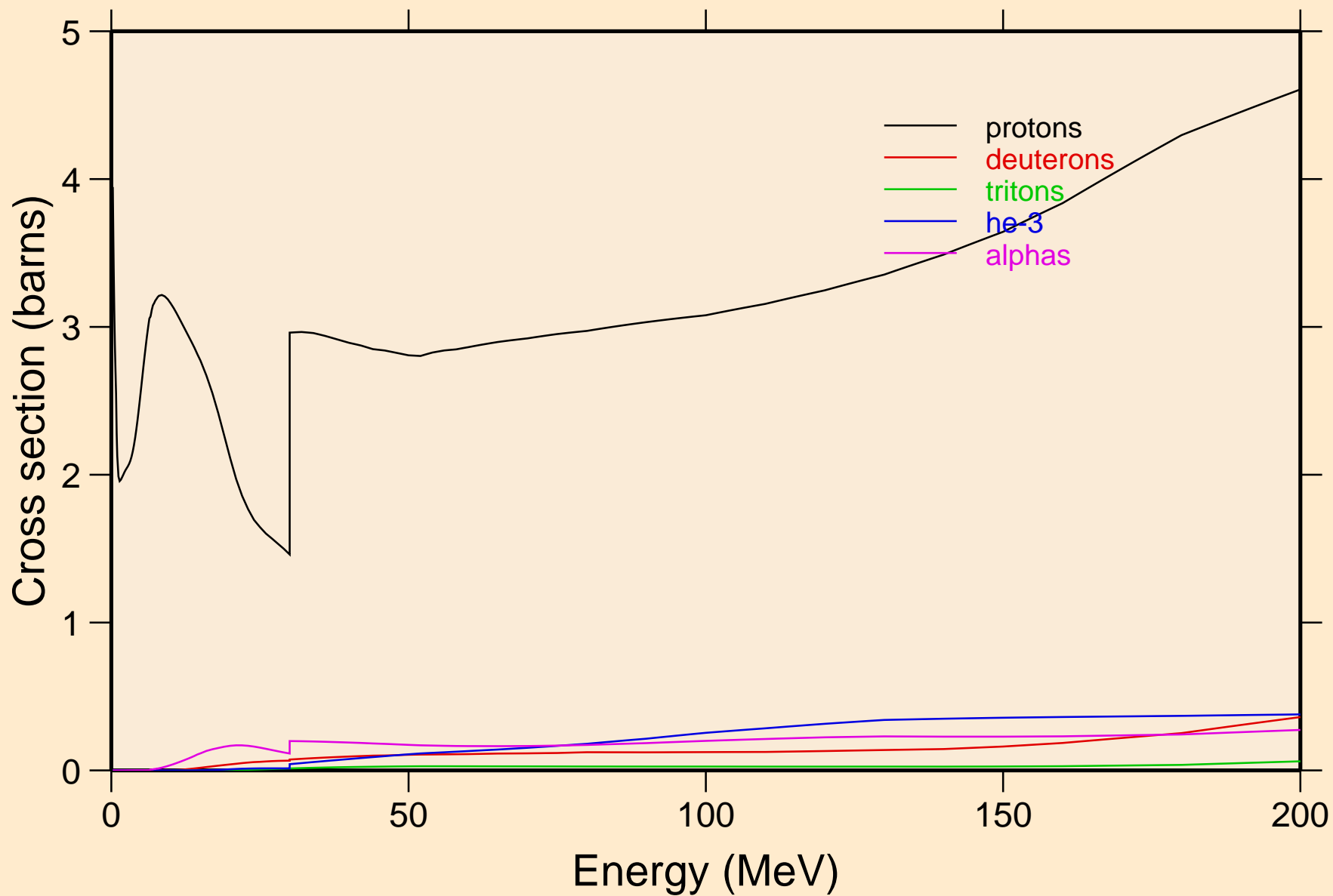

RU090 NEUTRON ACER TENDL-2019 LIBRARY; T=293.16K
protons from (n,x)

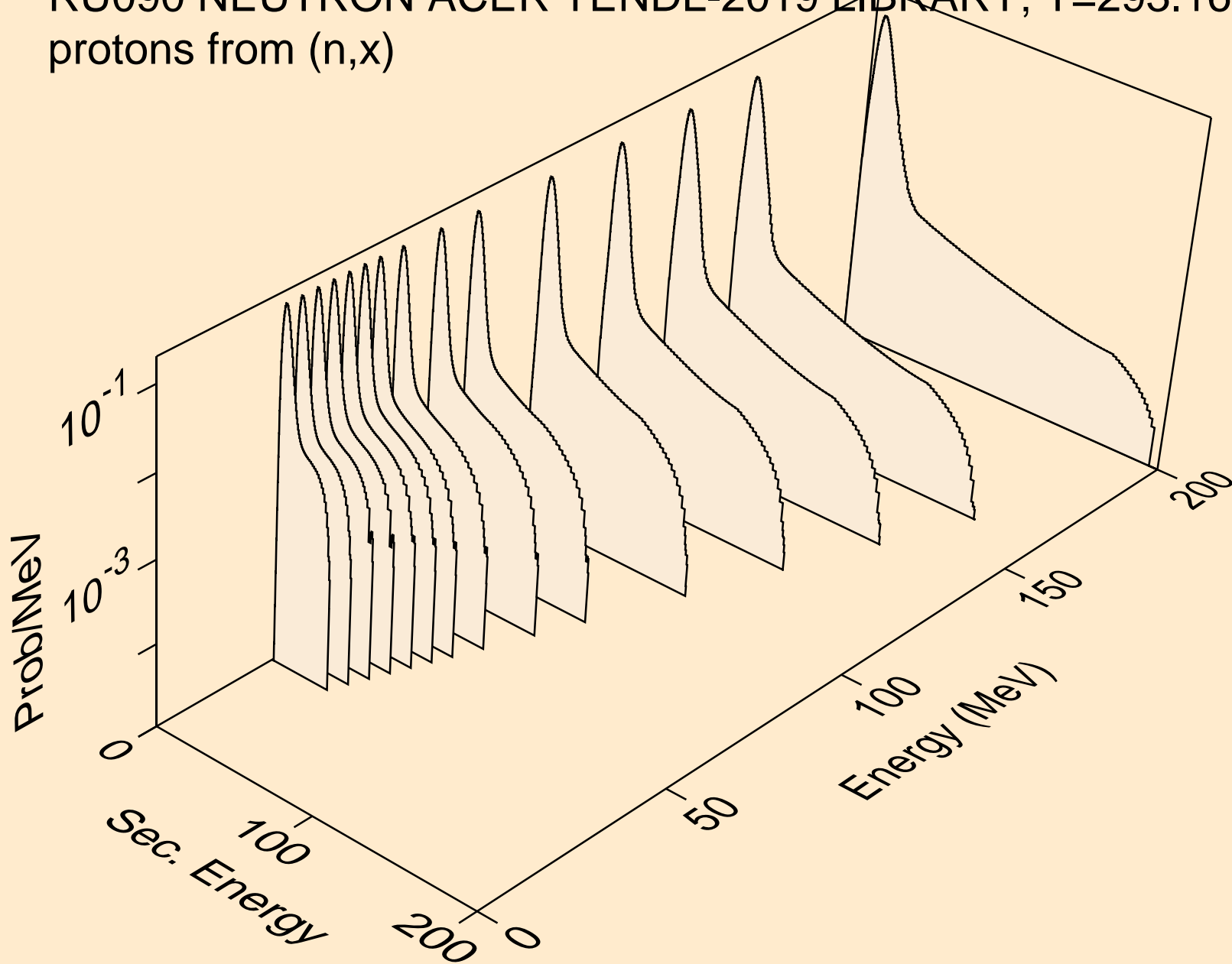

RU090 NEUTRON ACER TENDL-2019 LIBRARY; T=293.16K
protons from (n,n*)p

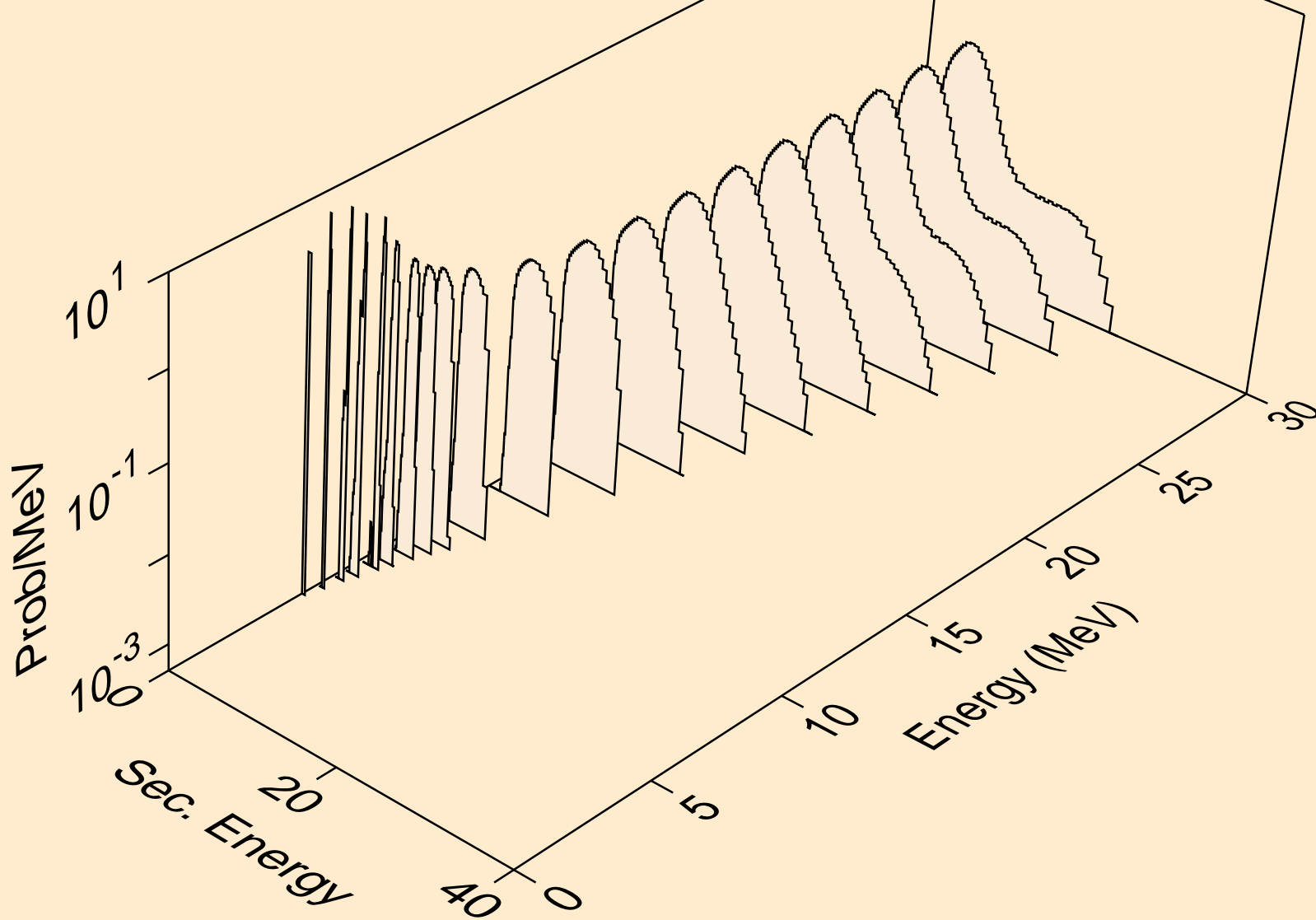

RU090 NEUTRON ACER TENDL-2019 LIBRARY; T=293.16K
protons from (n,2np)

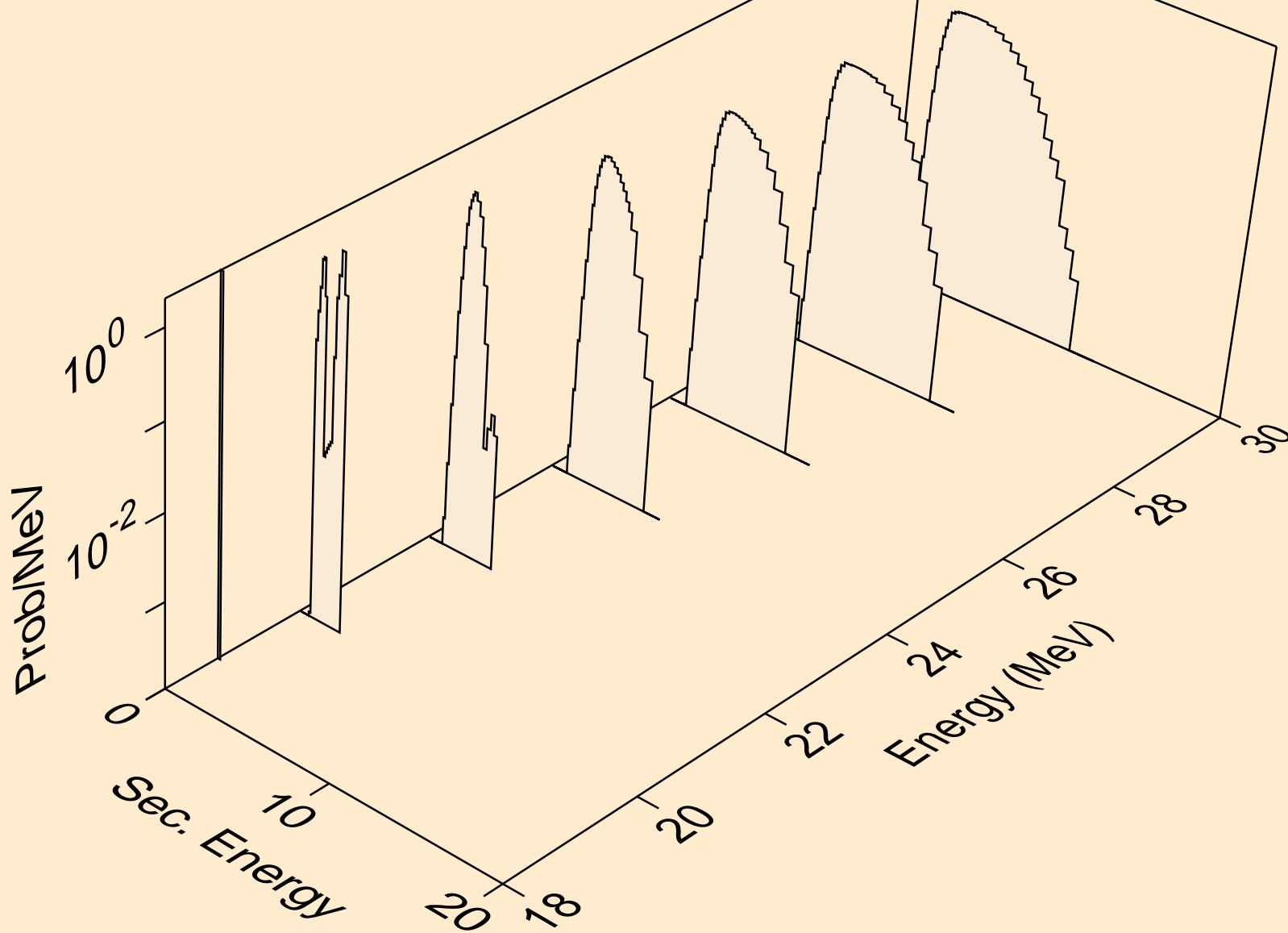

RU090 NEUTRON ACER TENDL-2019 LIBRARY; T=293.16K
protons from (n,2np)

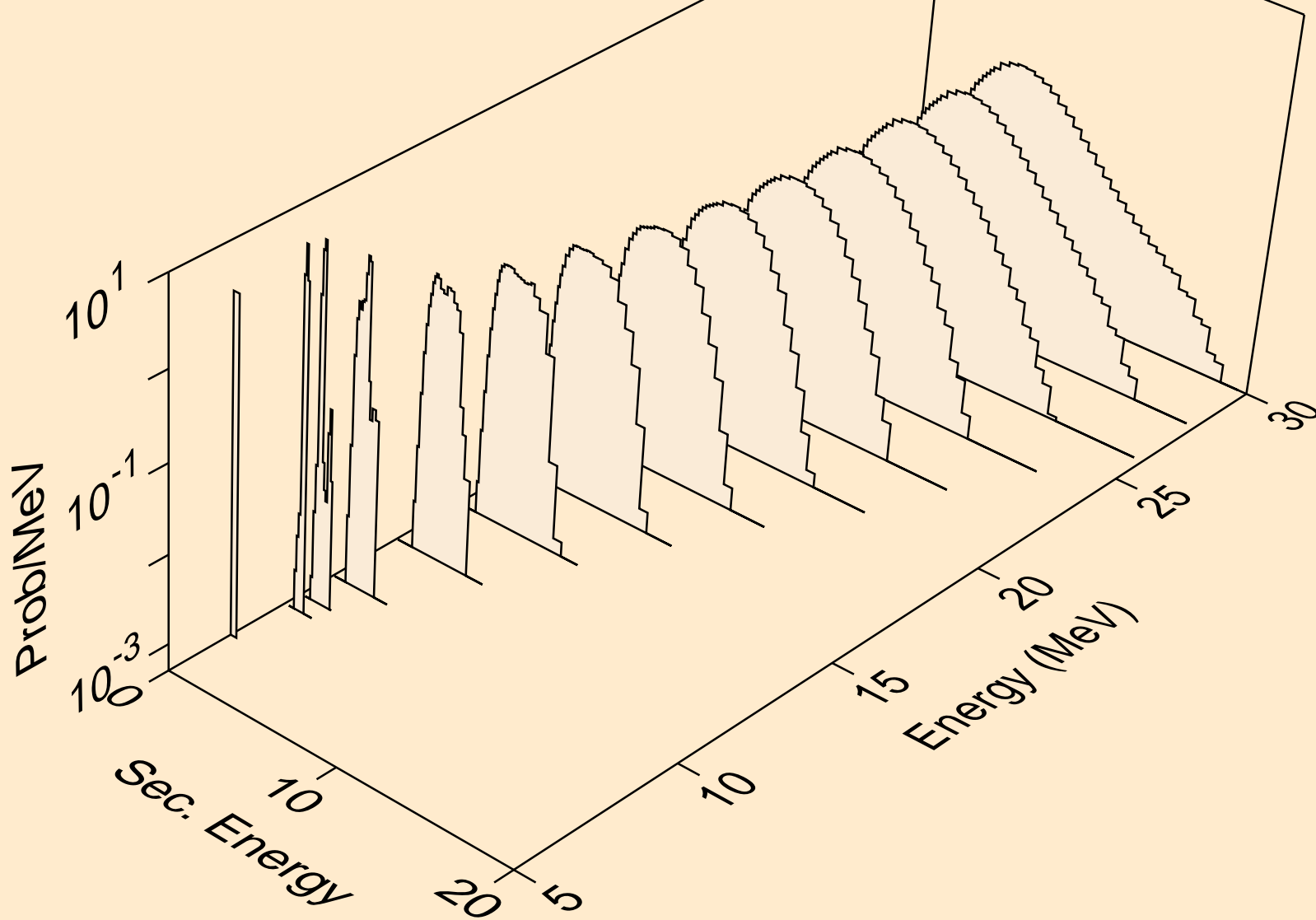

RU090 NEUTRON ACER TENDL-2019 LIBRARY; T=293.16K
protons from (n,npa)

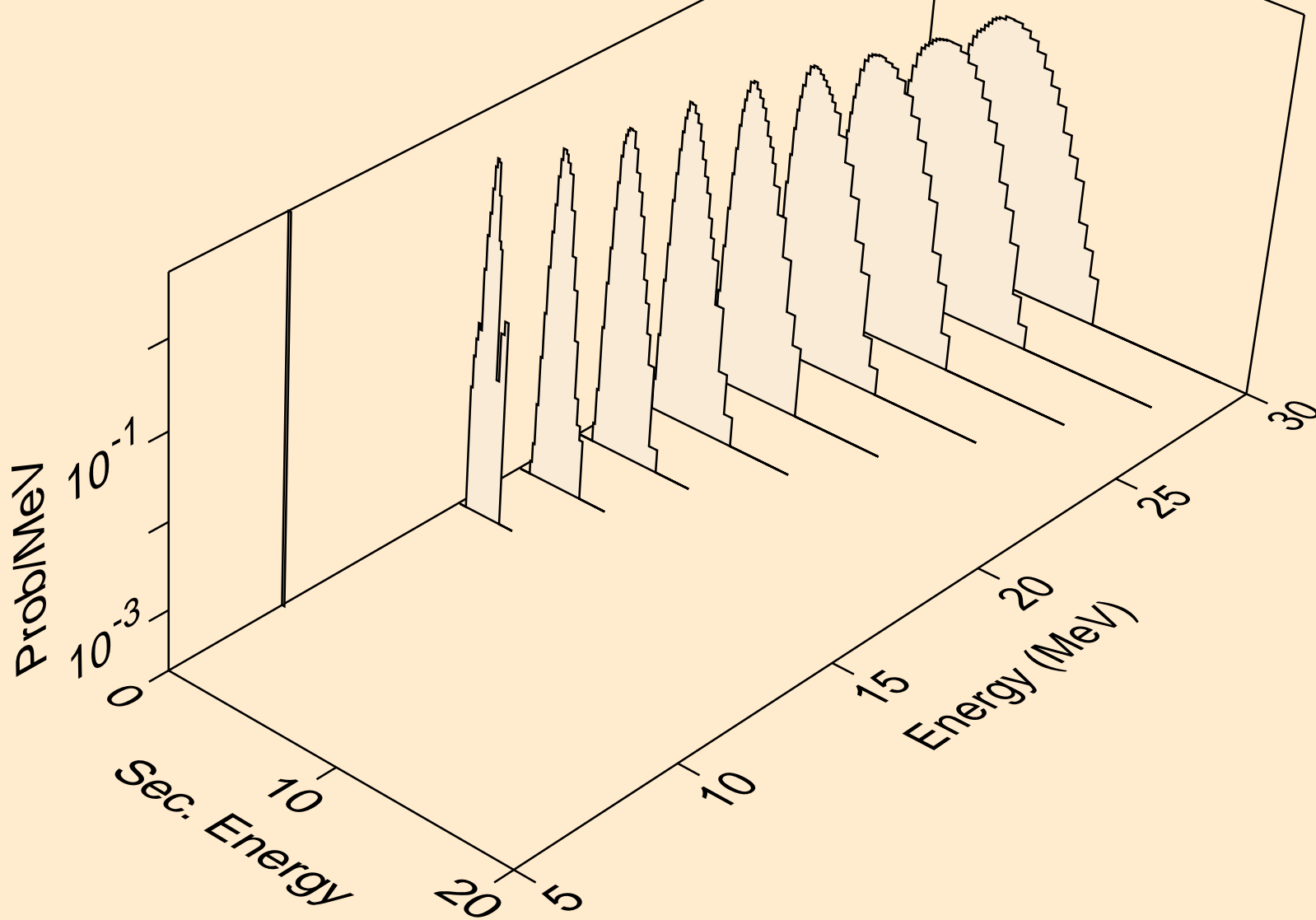

RU090 NEUTRON ACER TENDL-2019 LIBRARY; T=293.16K
protons from (n,p)

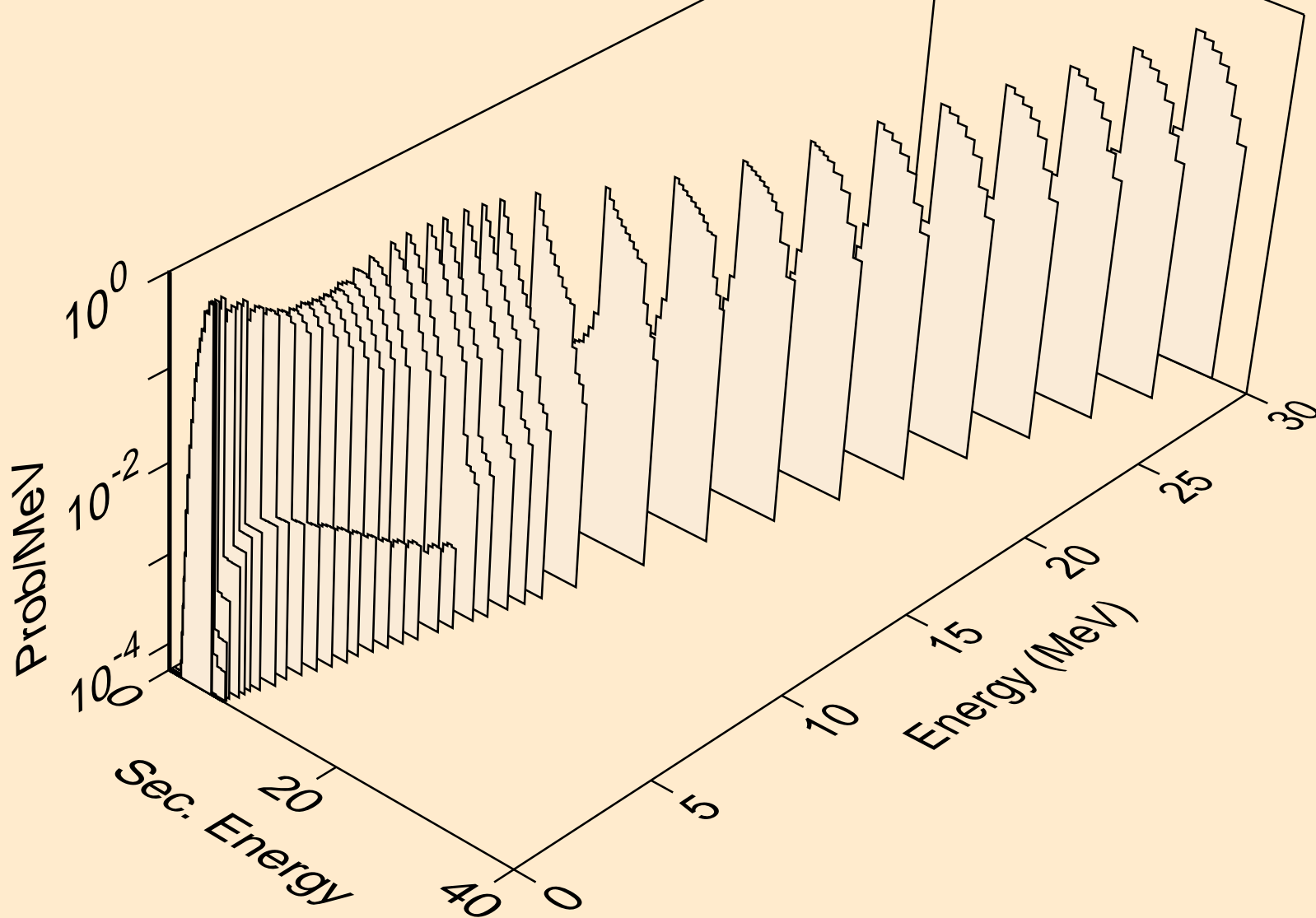

RU090 NEUTRON ACER TENDL-2019 LIBRARY; T=293.16K
protons from (n,2p)

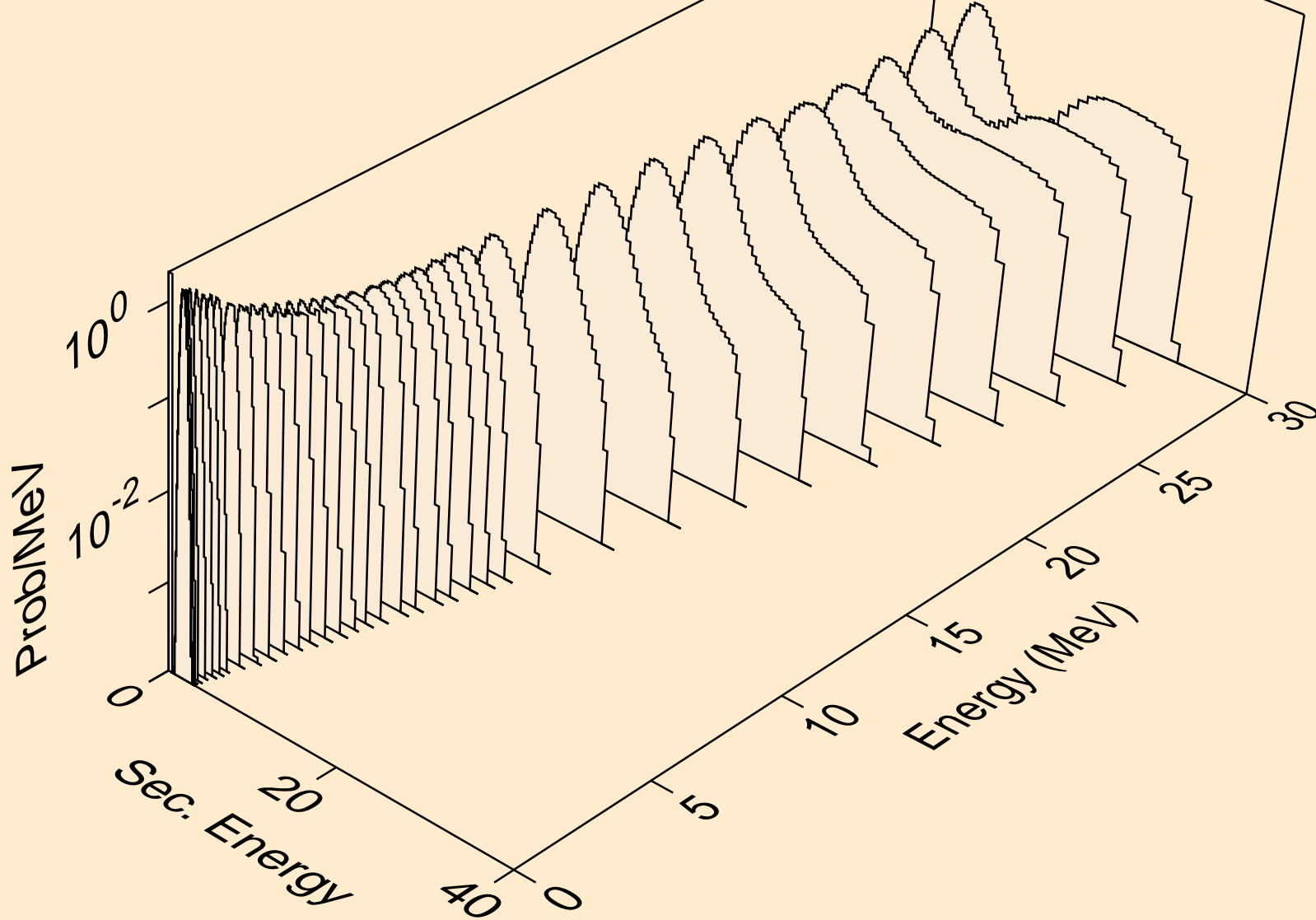

RU090 NEUTRON ACER TENDL-2019 LIBRARY; T=293.16K
protons from (n,p)

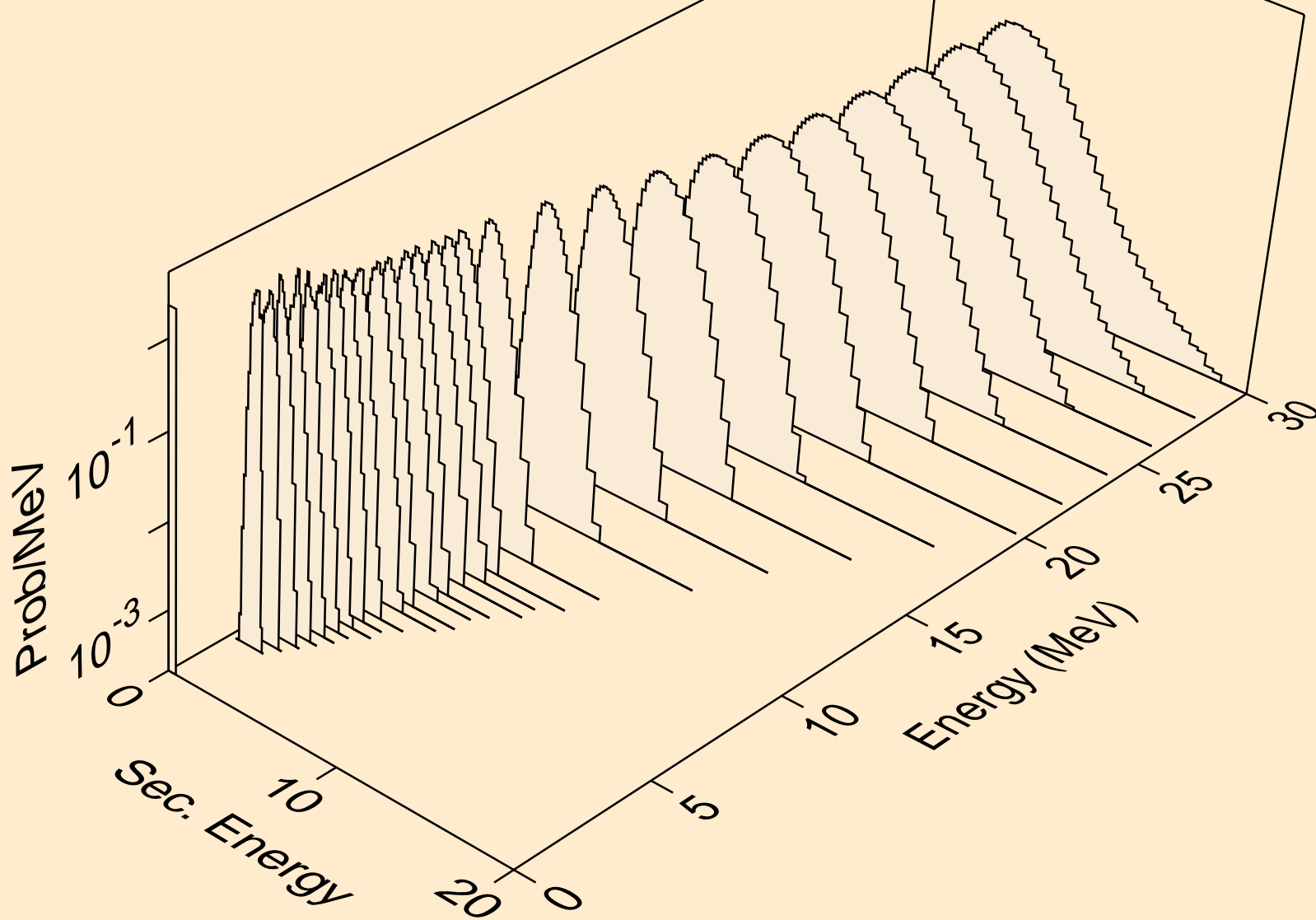

RU090 NEUTRON ACER TENDL-2019 LIBRARY; T=293.16K
protons from (n,pd)

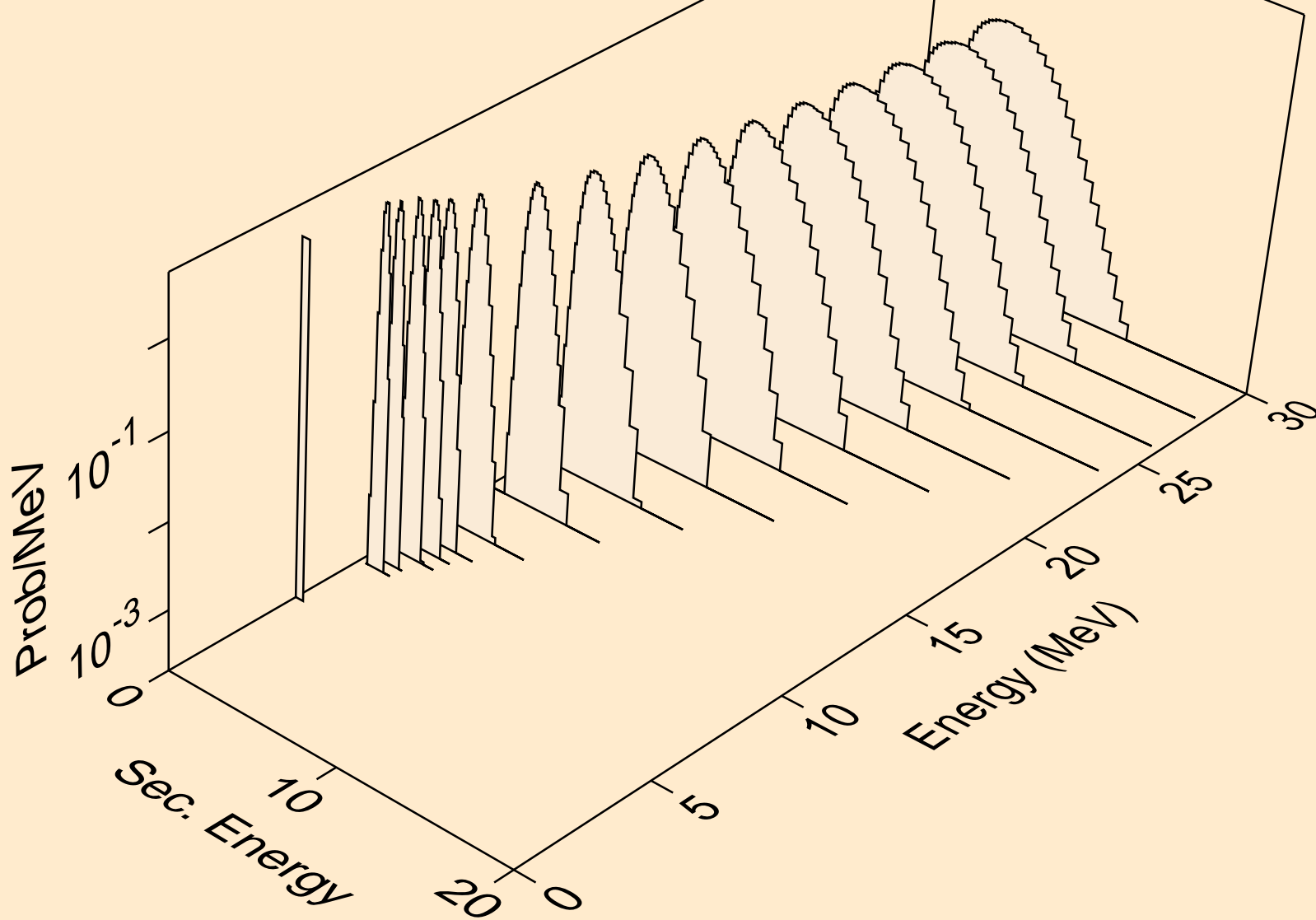

RU090 NEUTRON ACER TENDL-2019 LIBRARY; T=293.16K
protons from (n,pt)

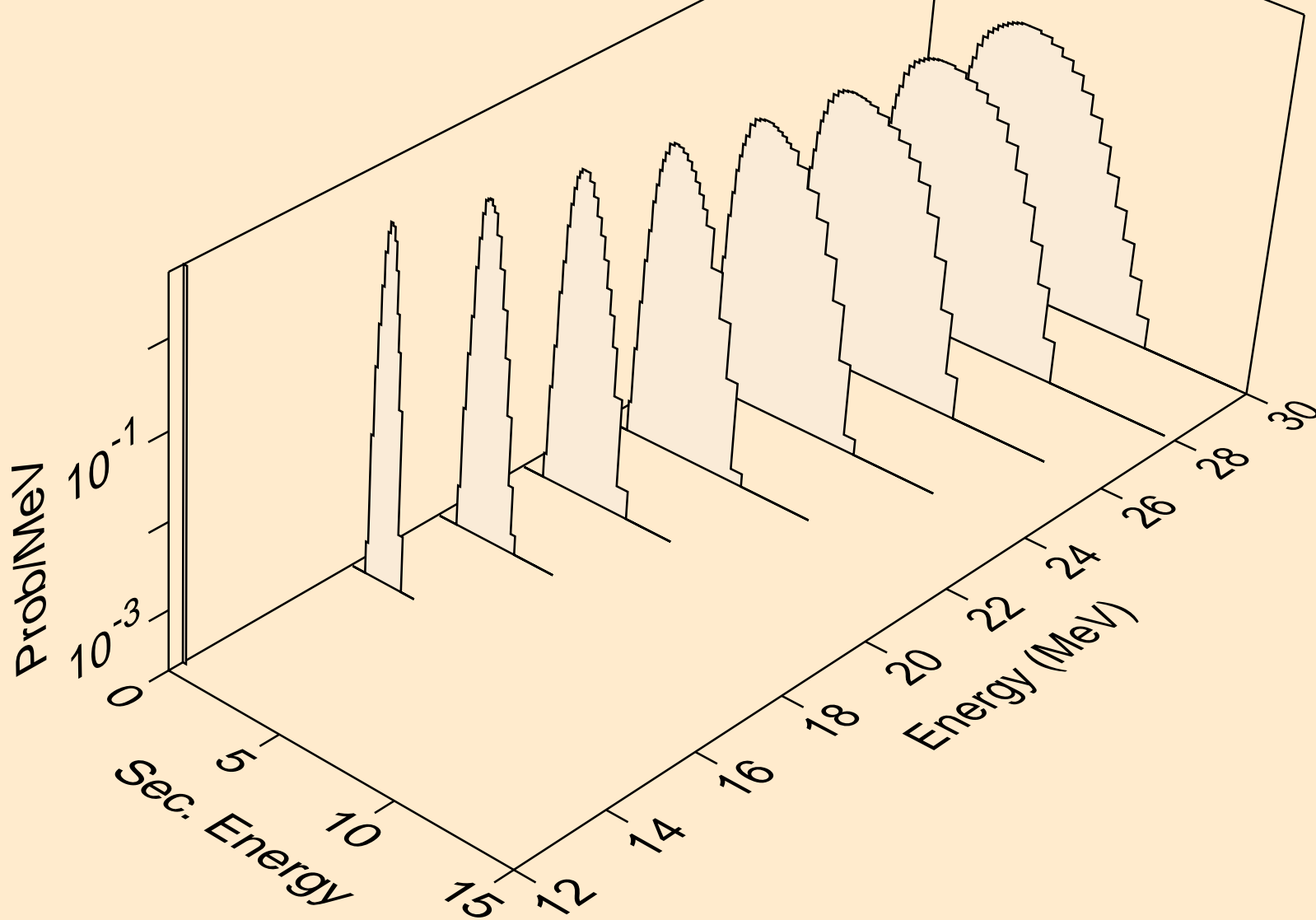

RU090 NEUTRON ACER TENDL-2019 LIBRARY; T=293.16K
deuterons from (n,x)

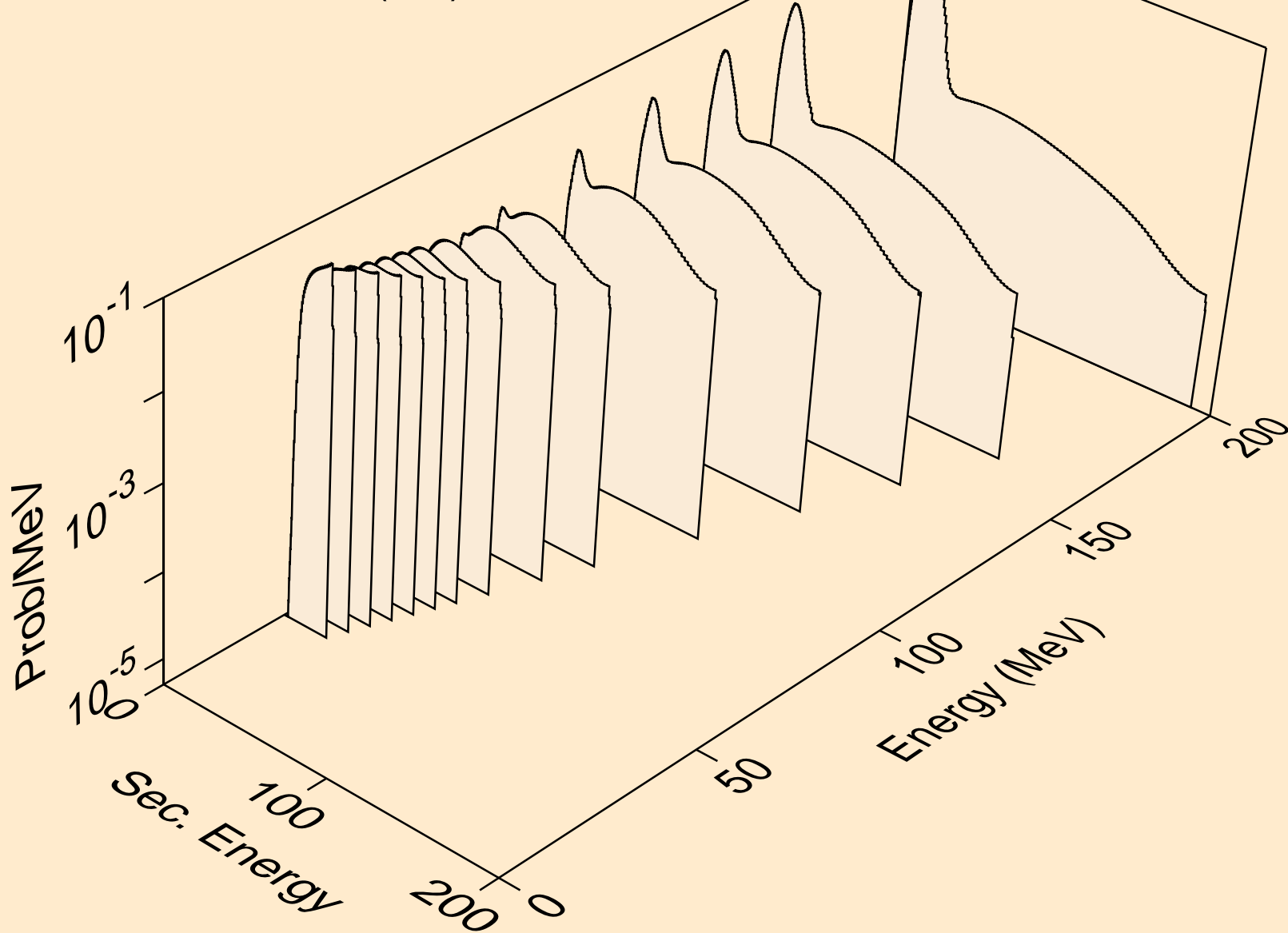

RU090 NEUTRON ACER TENDL-2019 LIBRARY; T=293.16K
deuterons from (n,n*)d

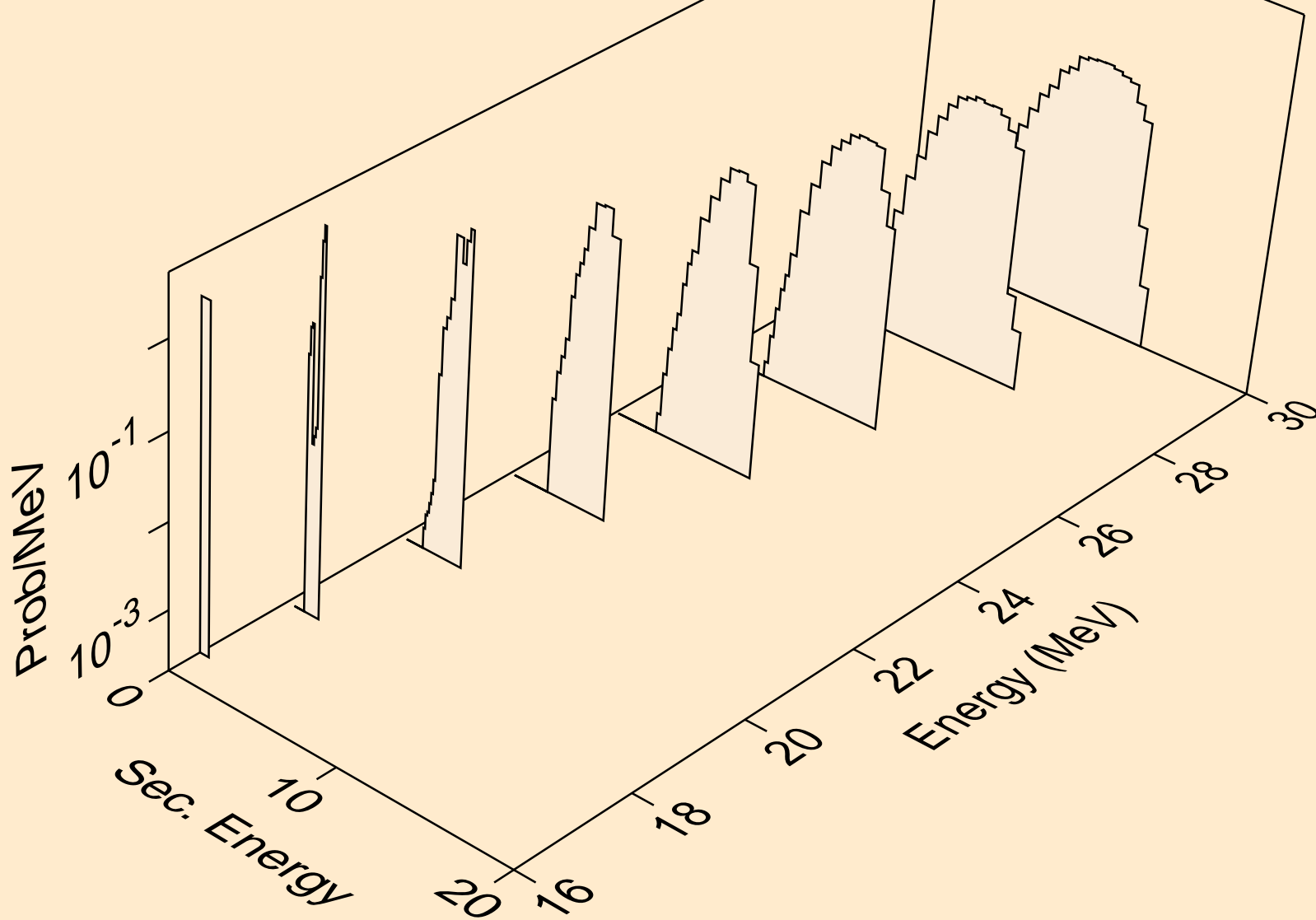

RU090 NEUTRON ACER TENDL-2019 LIBRARY; T=293.16K
deuterons from (n,d)

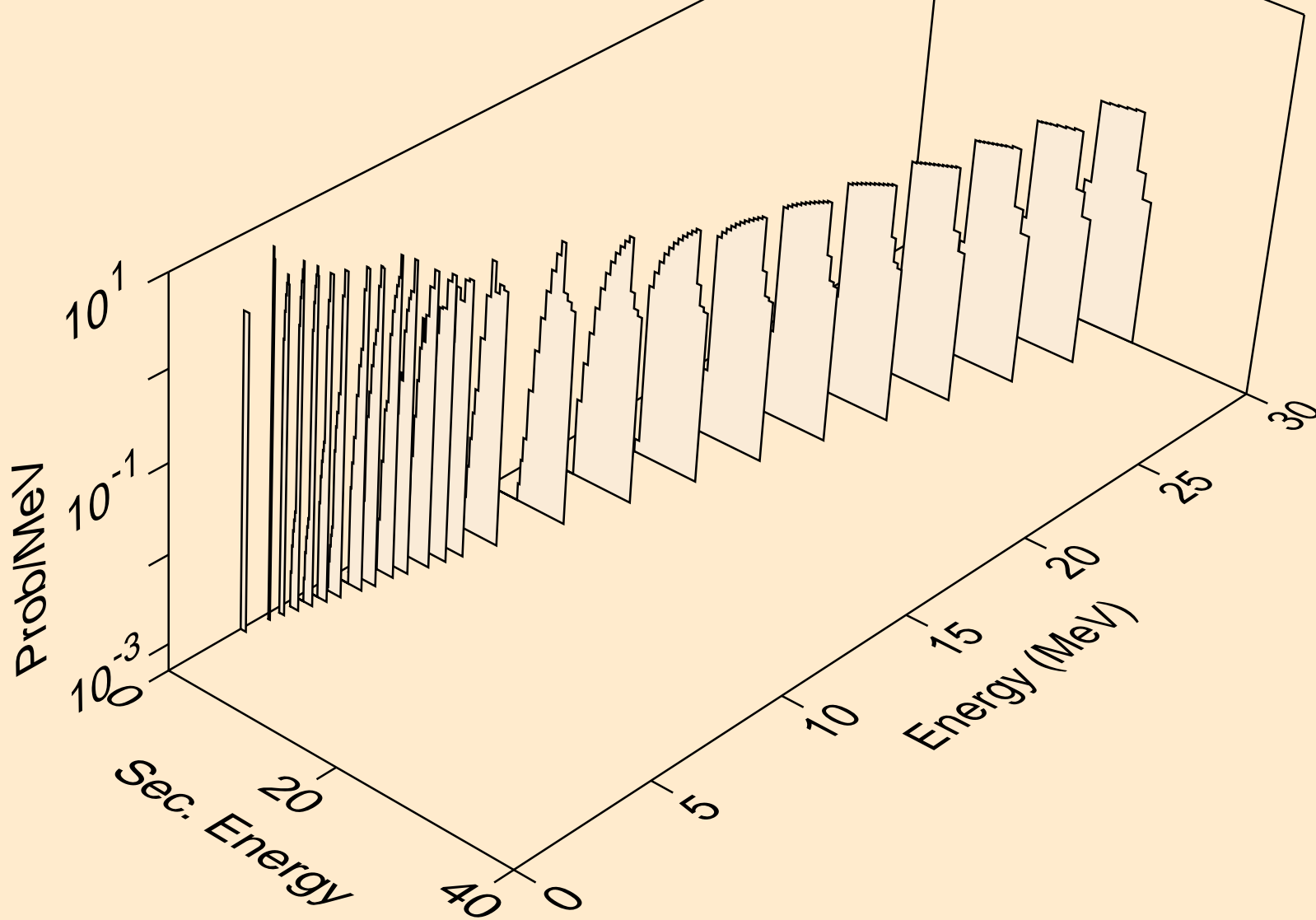

RU090 NEUTRON ACER TENDL-2019 LIBRARY; T=293.16K
deuterons from (n,pd)

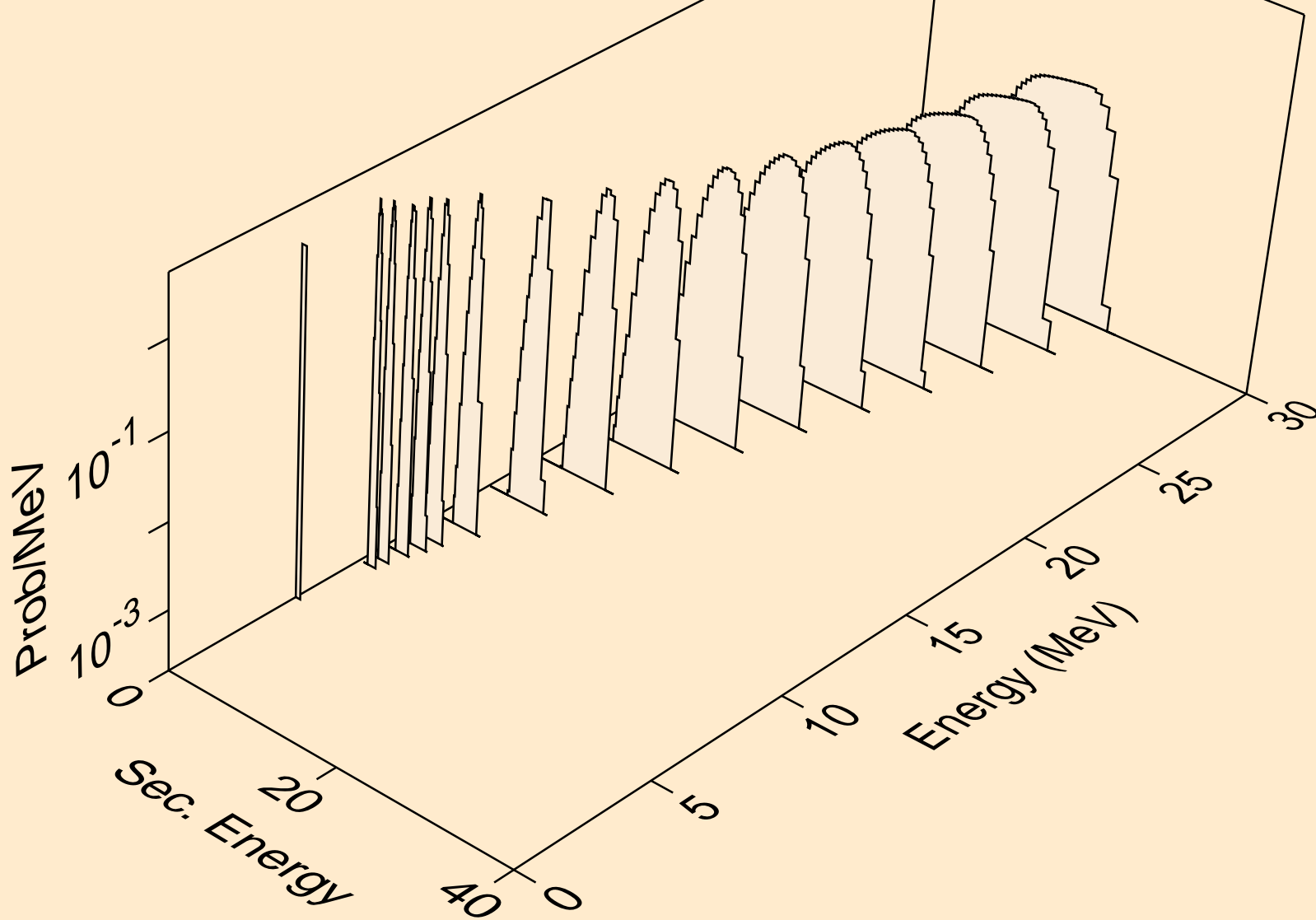

RU090 NEUTRON ACER TENDL-2019 LIBRARY; T=293.16K
deuterons from (n,da)

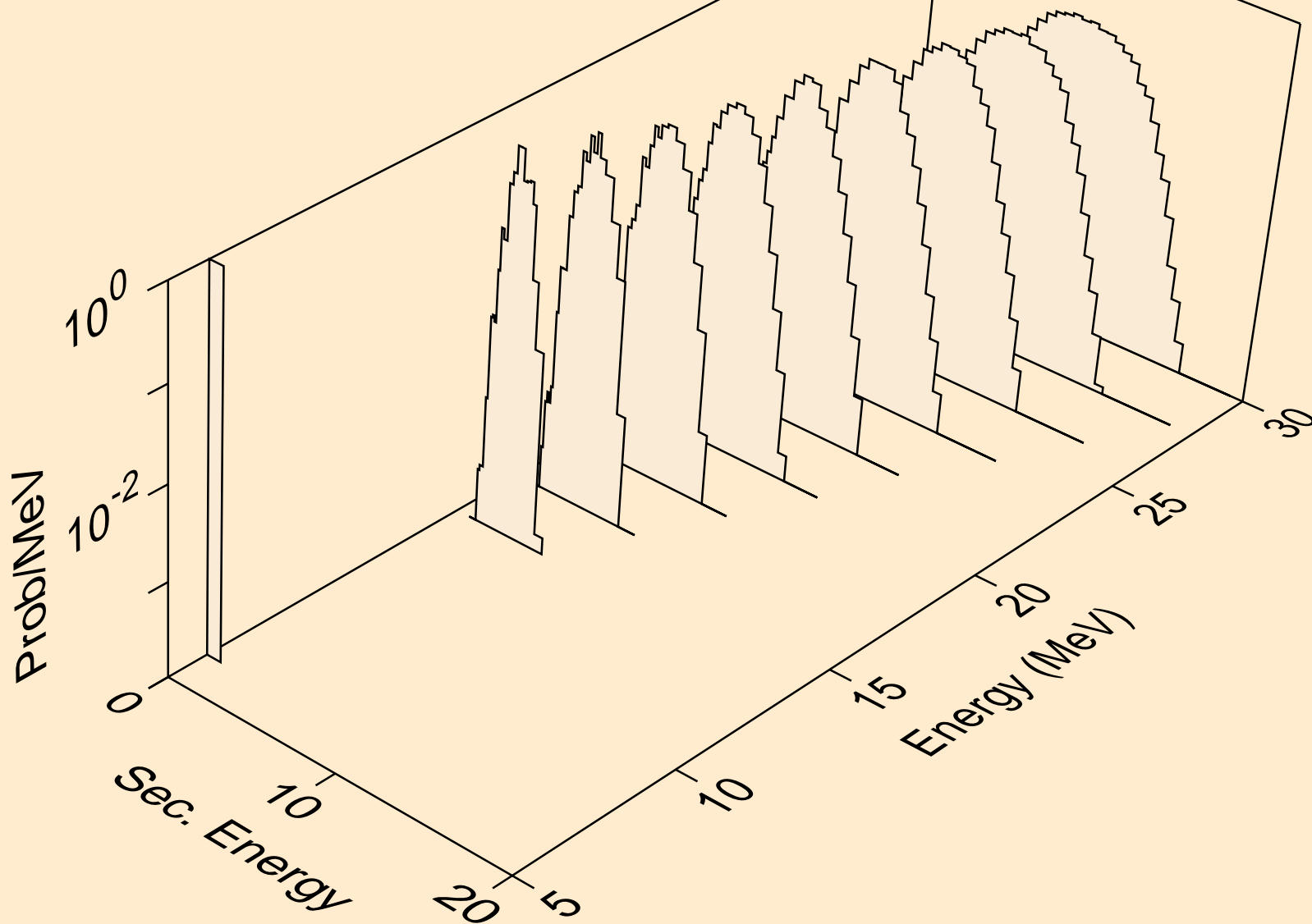

RU090 NEUTRON ACER TENDL-2019 LIBRARY; T=293.16K
tritons from (n,x)

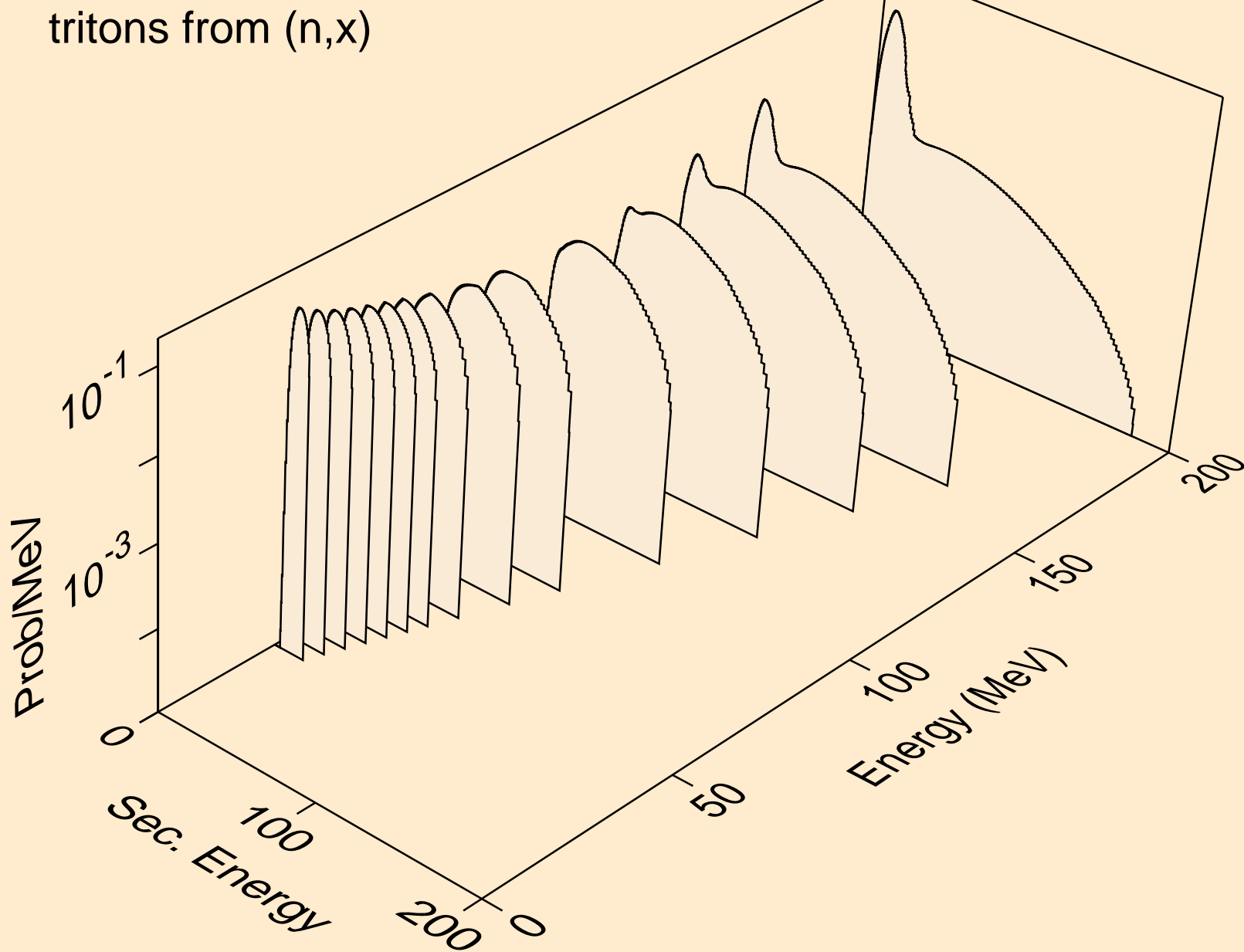

RU090 NEUTRON ACER TENDL-2019 LIBRARY; T=293.16K
tritons from (n,n*)t

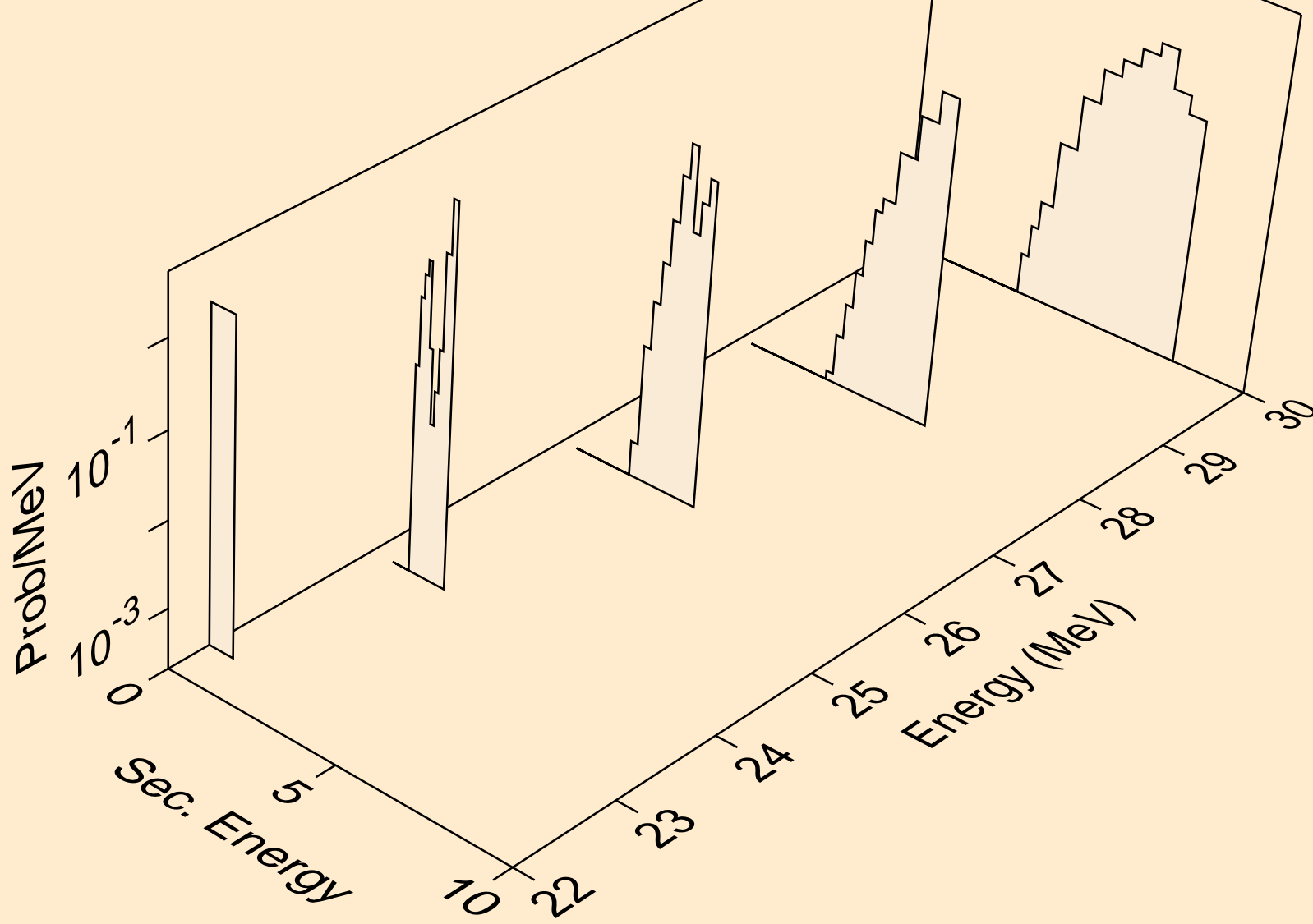

RU090 NEUTRON ACER TENDL-2019 LIBRARY; T=293.16K
tritons from (n,t)

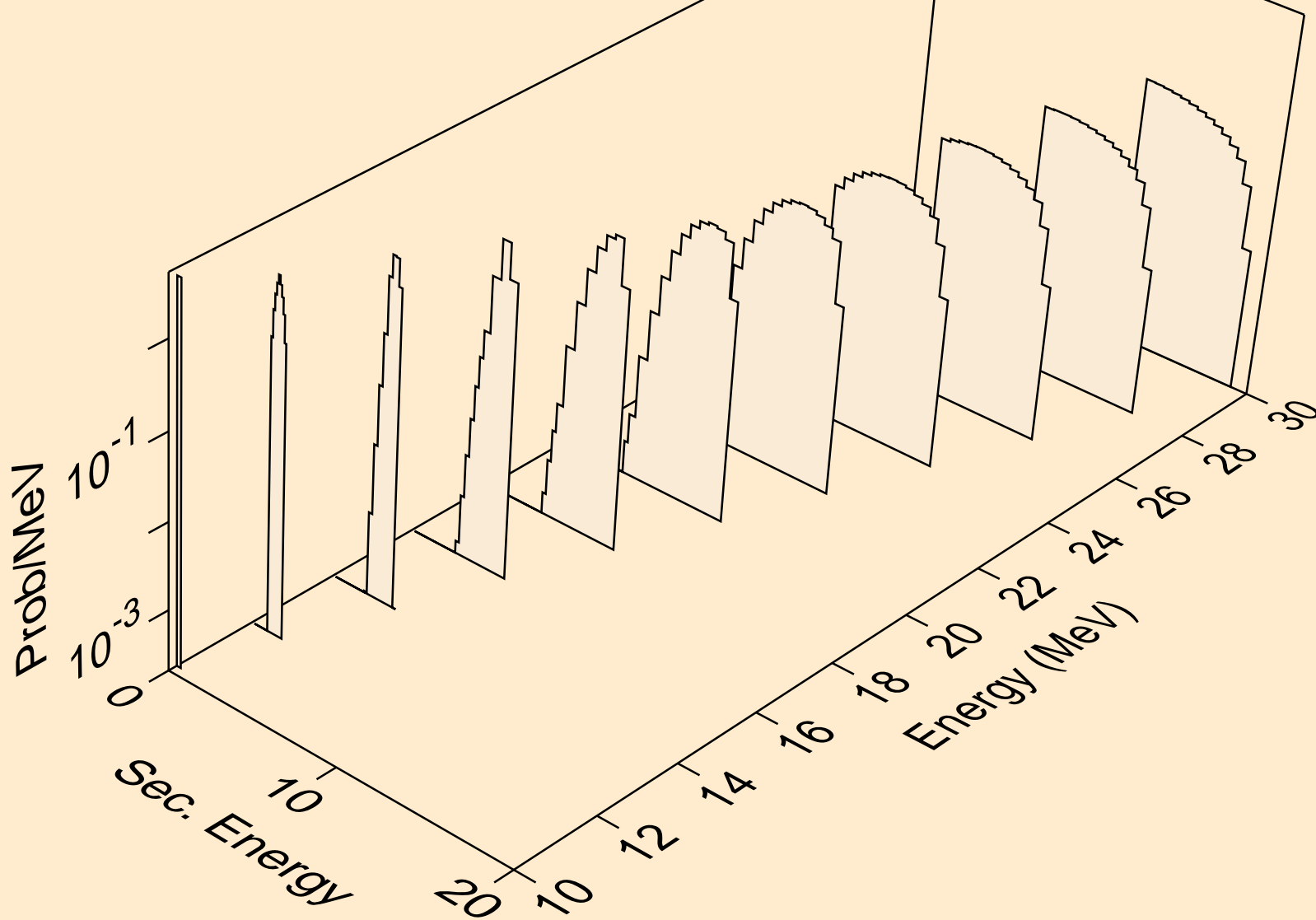

RU090 NEUTRON ACER TENDL-2019 LIBRARY; T=293.16K
tritons from (n,pt)

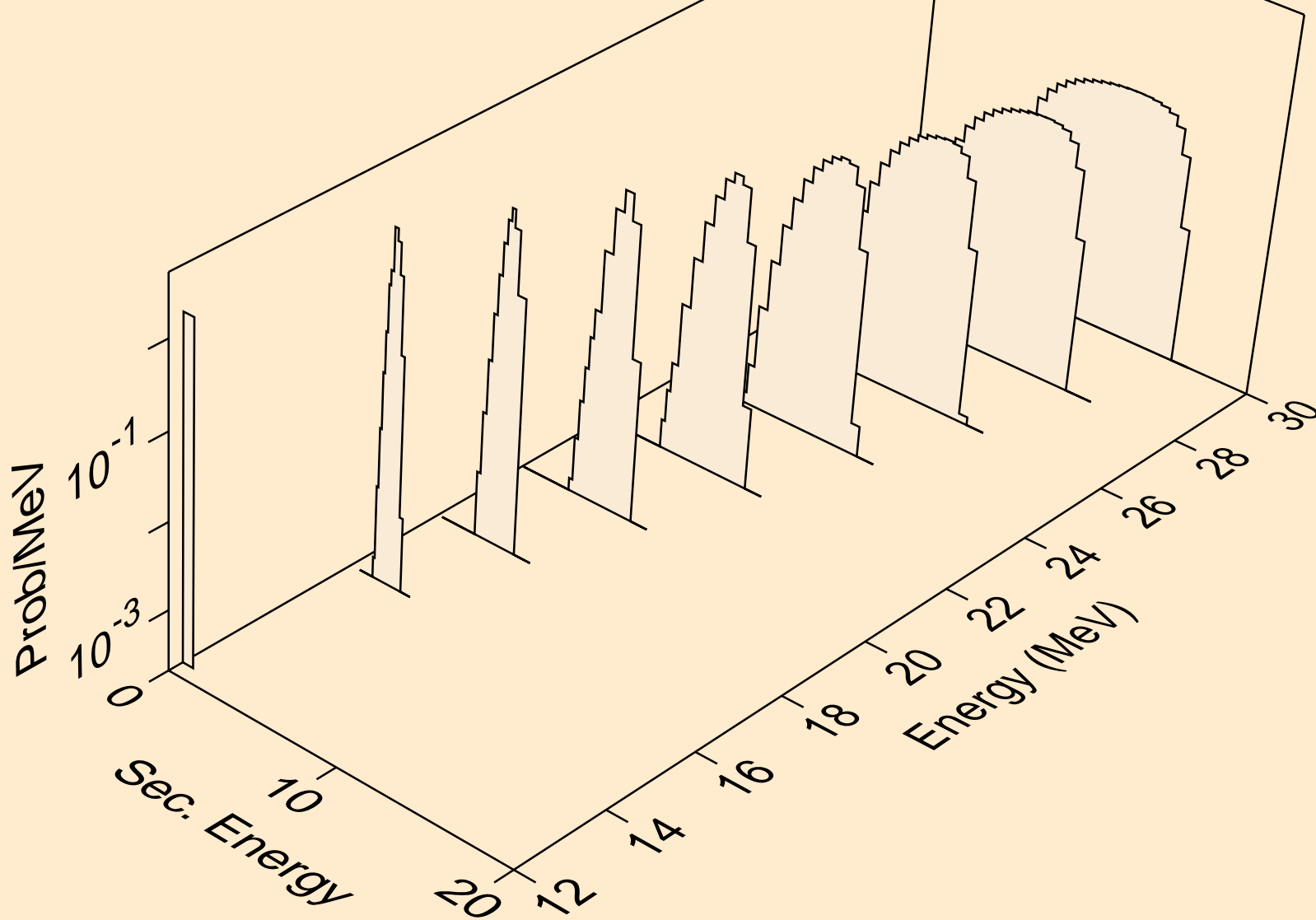

RU090 NEUTRON ACER TENDL-2019 LIBRARY; T=293.16K
he3s from (n,x)

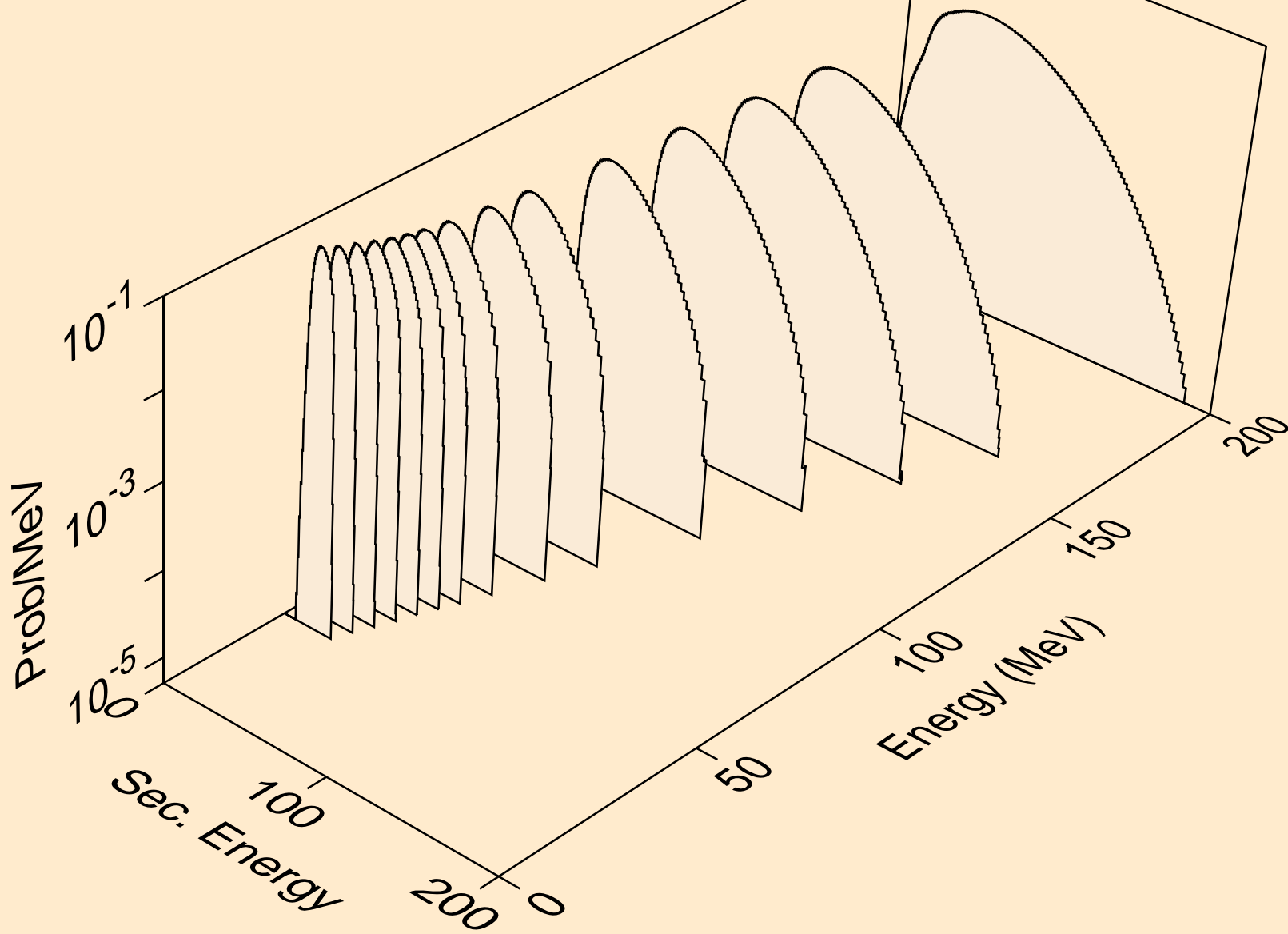

RU090 NEUTRON ACER TENDL-2019 LIBRARY; T=293.16K
he3s from (n,n*)he3

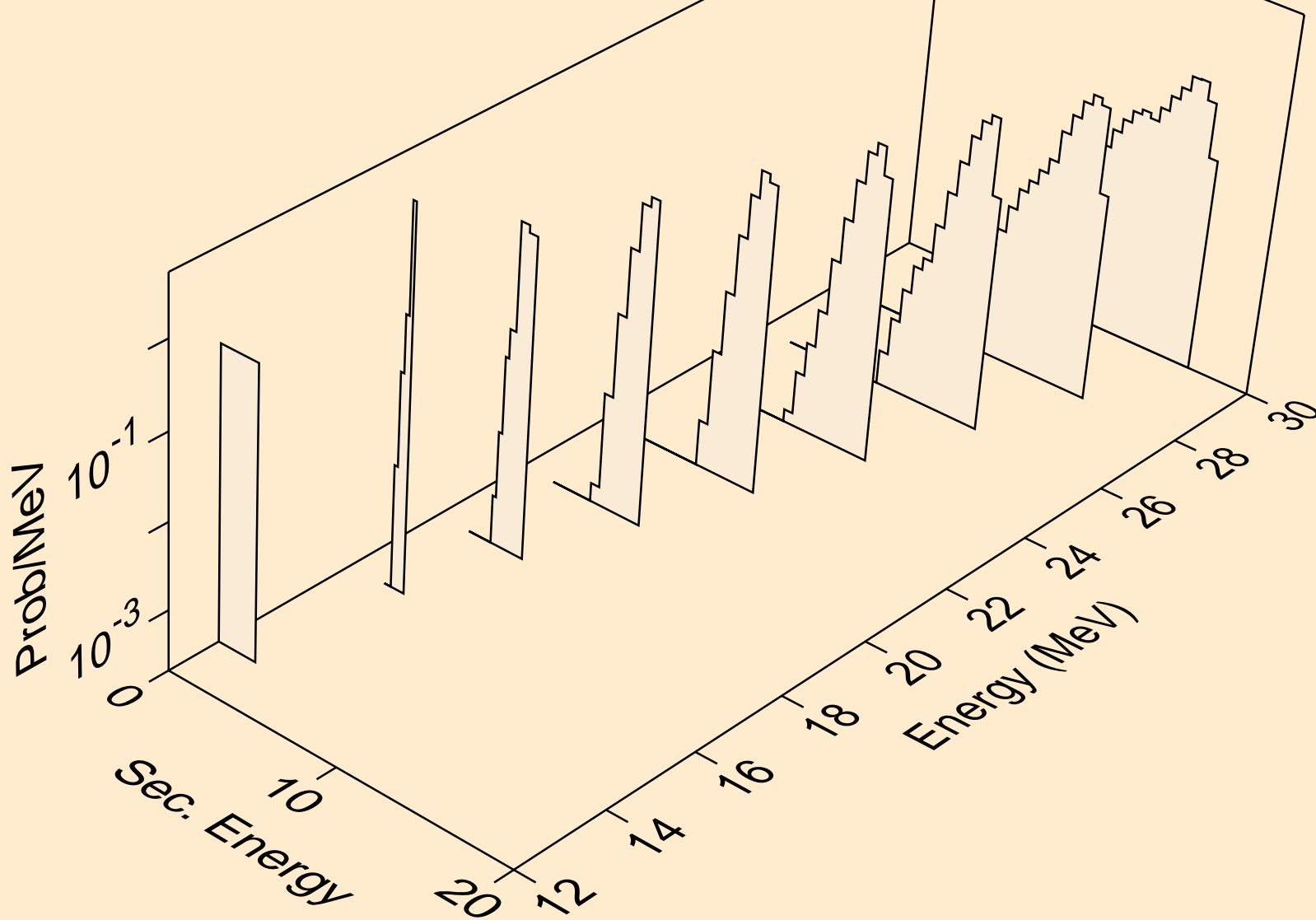

RU090 NEUTRON ACER TENDL-2019 LIBRARY; T=293.16K
he3s from (n,he3)

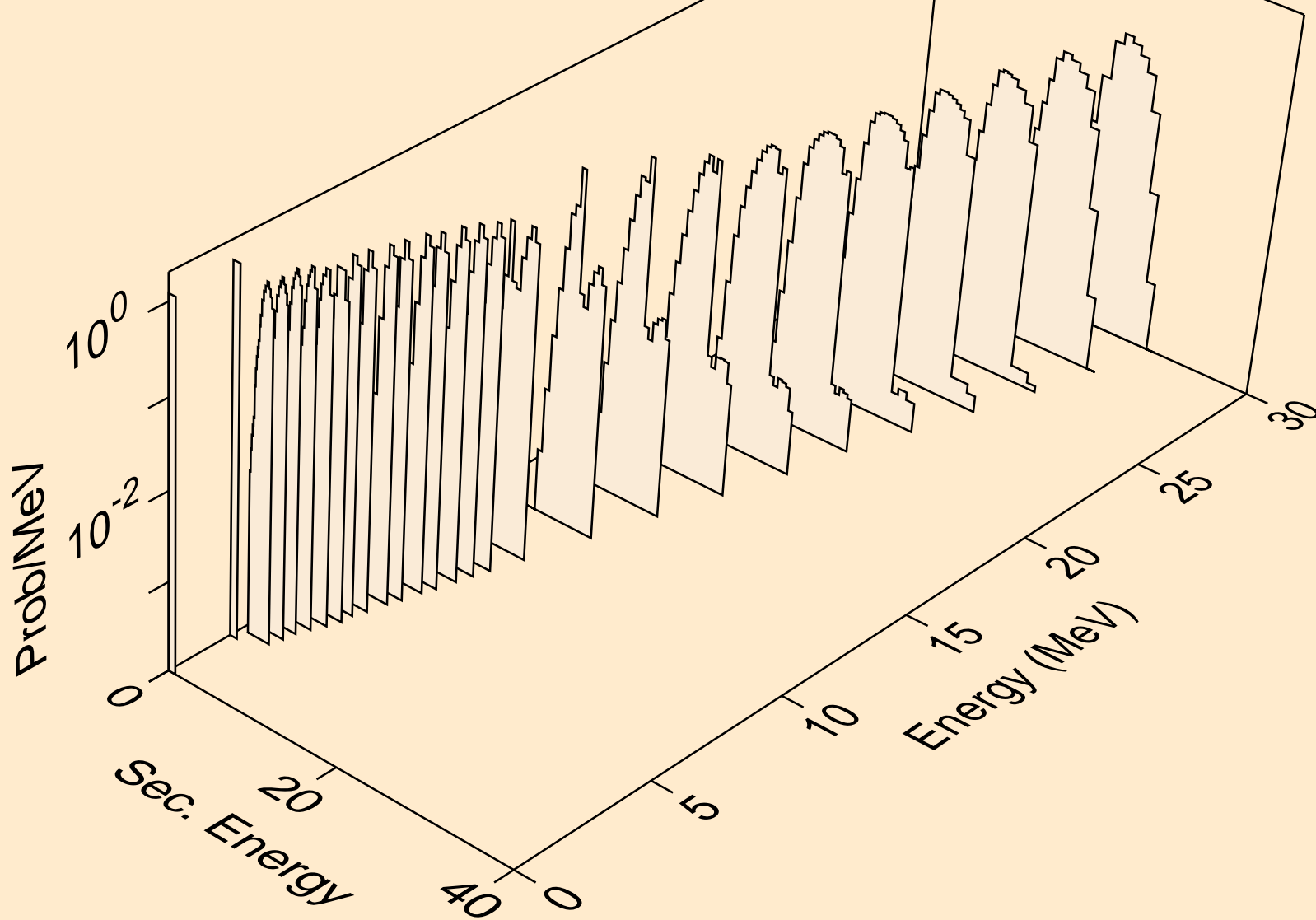

RU090 NEUTRON ACER TENDL-2019 LIBRARY; T=293.16K
alphas from (n,x)

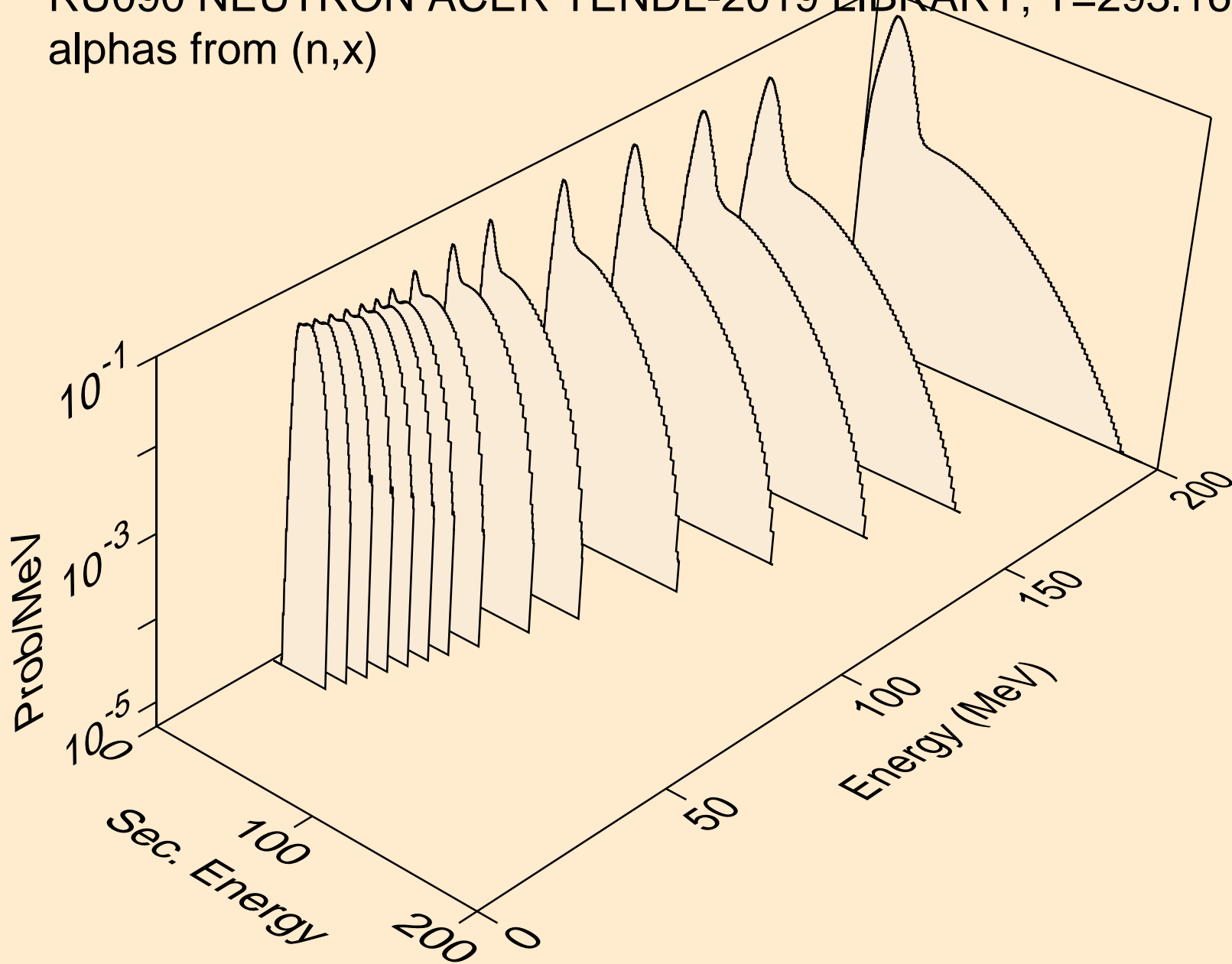

RU090 NEUTRON ACER TENDL-2019 LIBRARY; T=293.16K
alphas from (n,n*)a

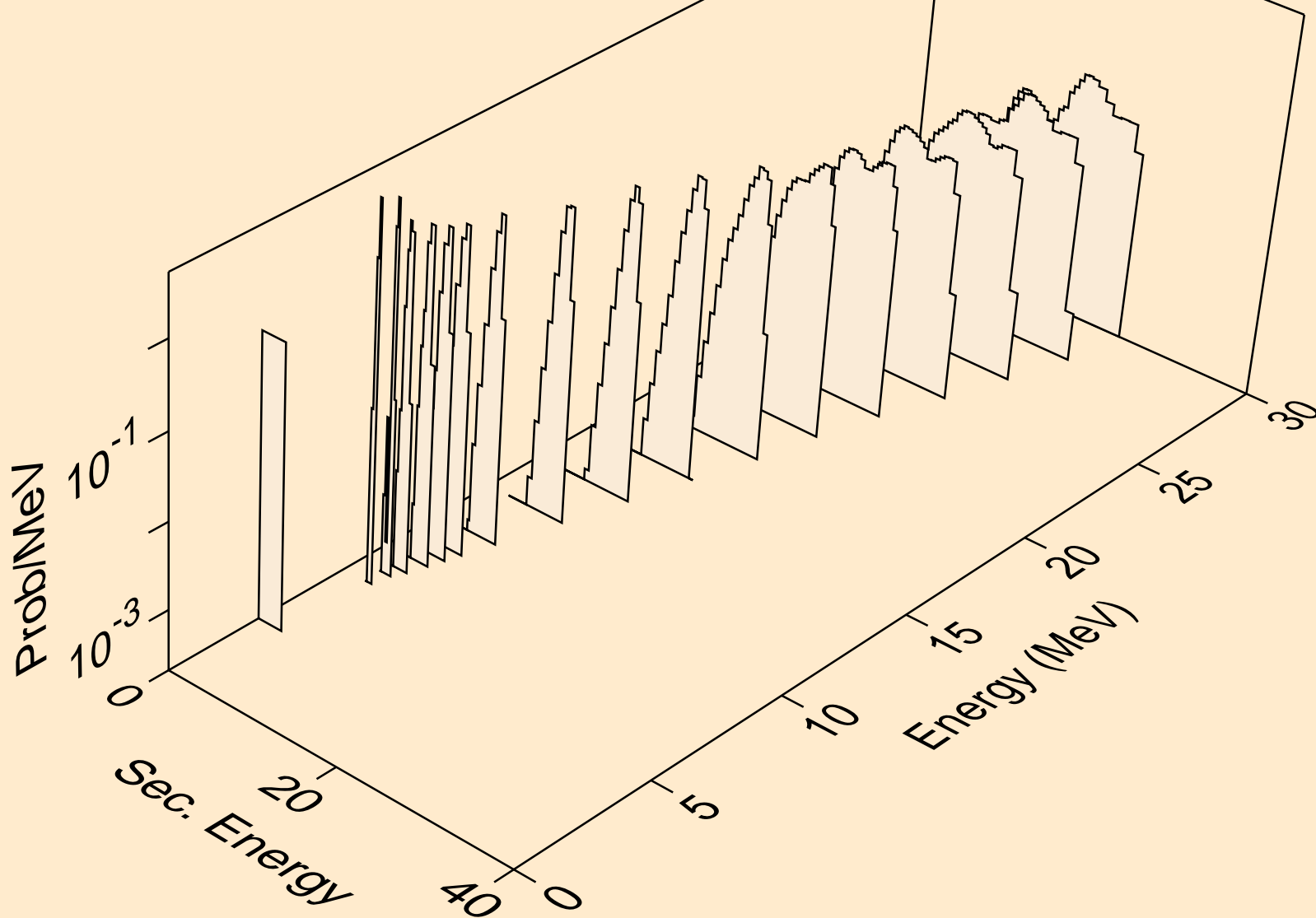

RU090 NEUTRON ACER TENDL-2019 LIBRARY; T=293.16K
alphas from (n,2n)a

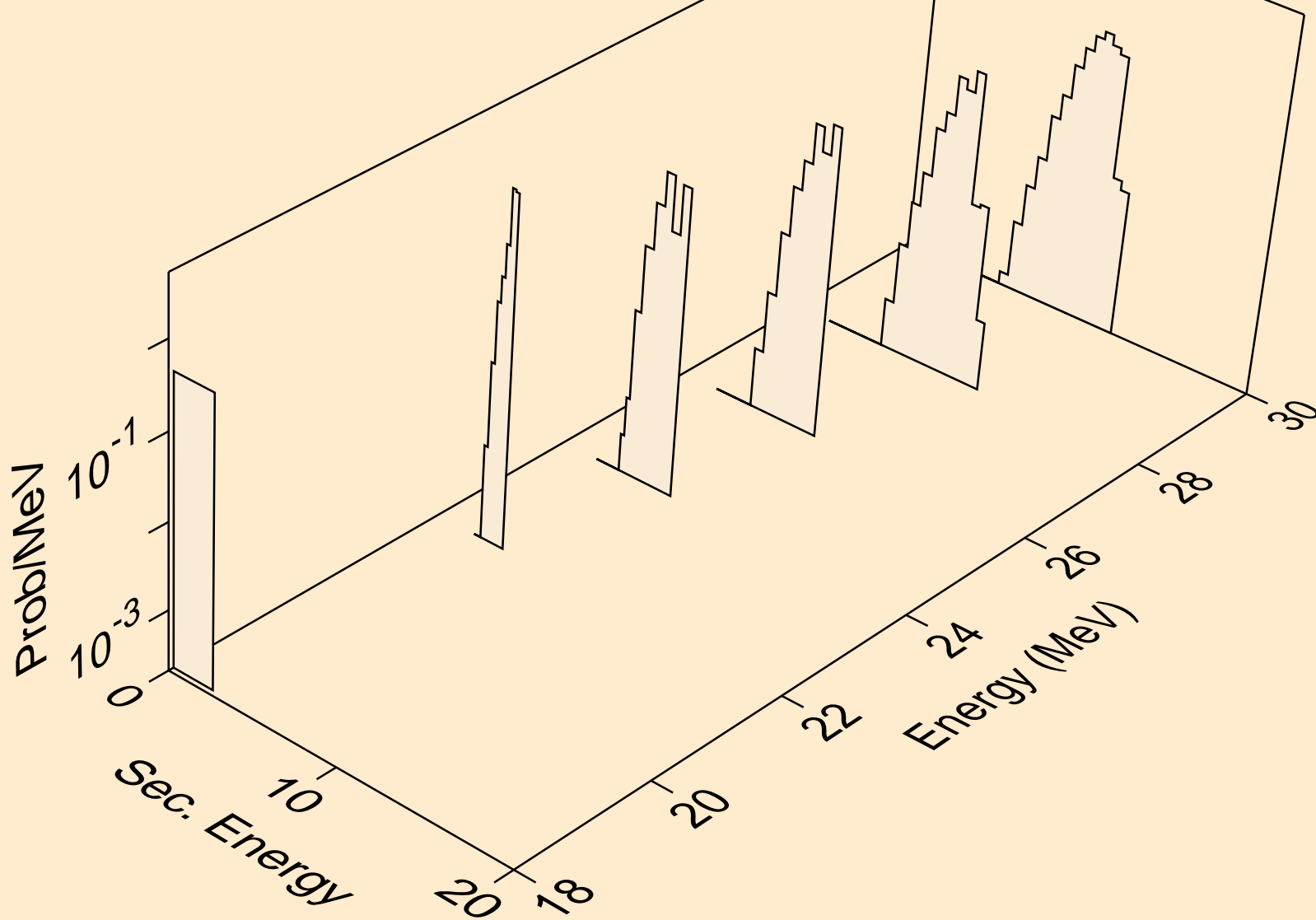

RU090 NEUTRON ACER TENDL-2019 LIBRARY; T=293.16K
alphas from (n,n*)2a

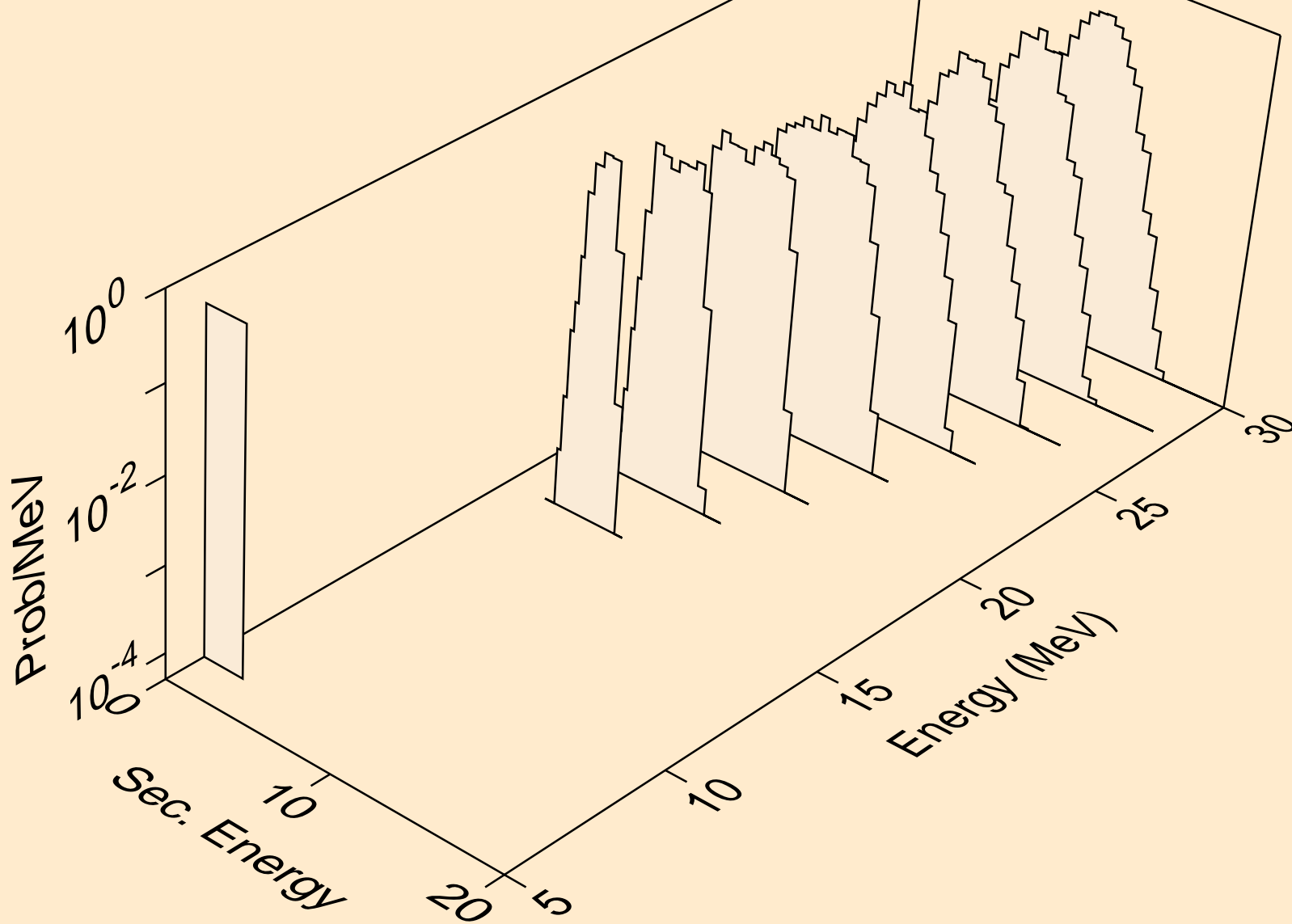

RU090 NEUTRON ACER TENDL-2019 LIBRARY; T=293.16K
alphas from (n,npa)

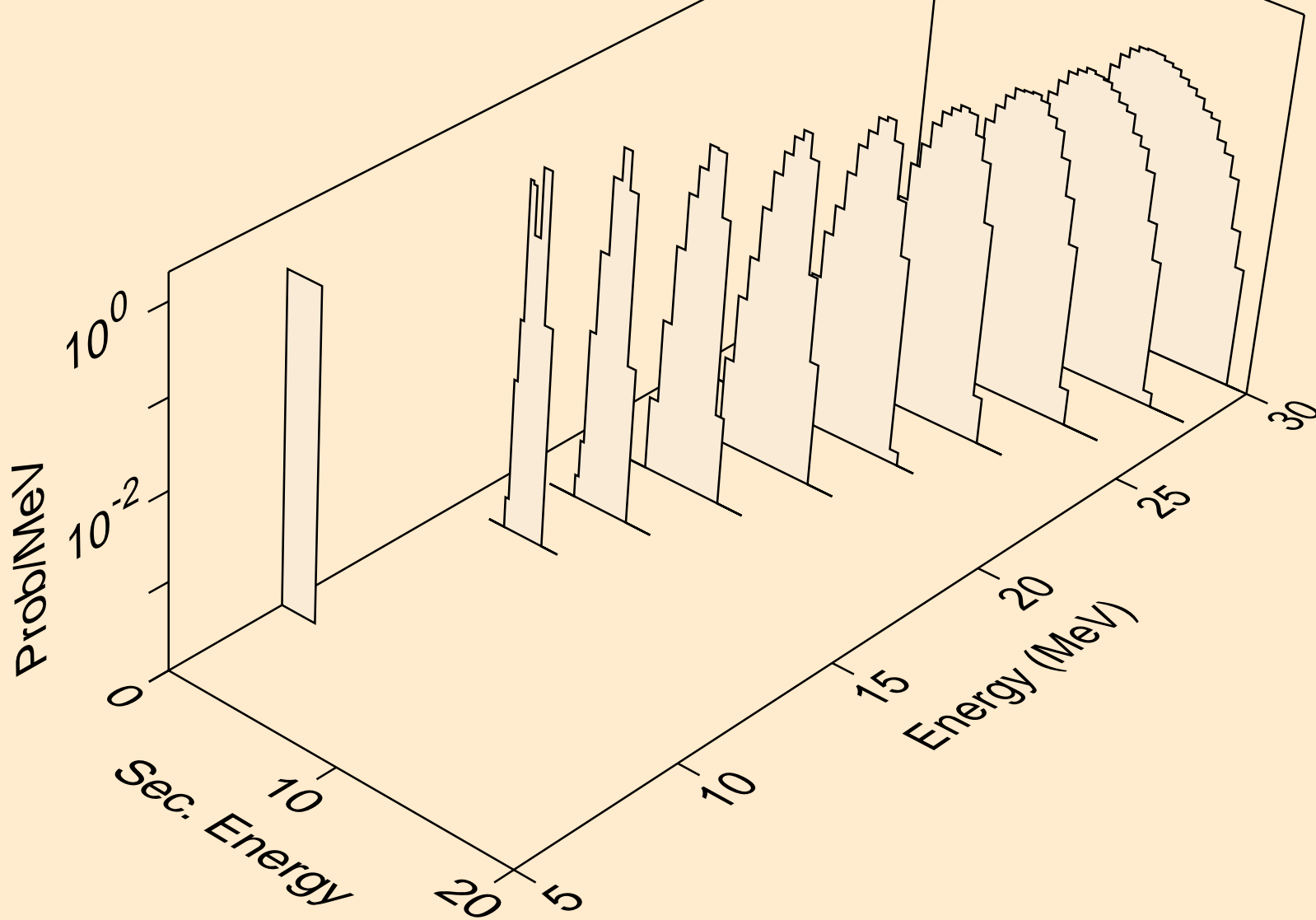

RU090 NEUTRON ACER TENDL-2019 LIBRARY; T=293.16K
alphas from (n,a)

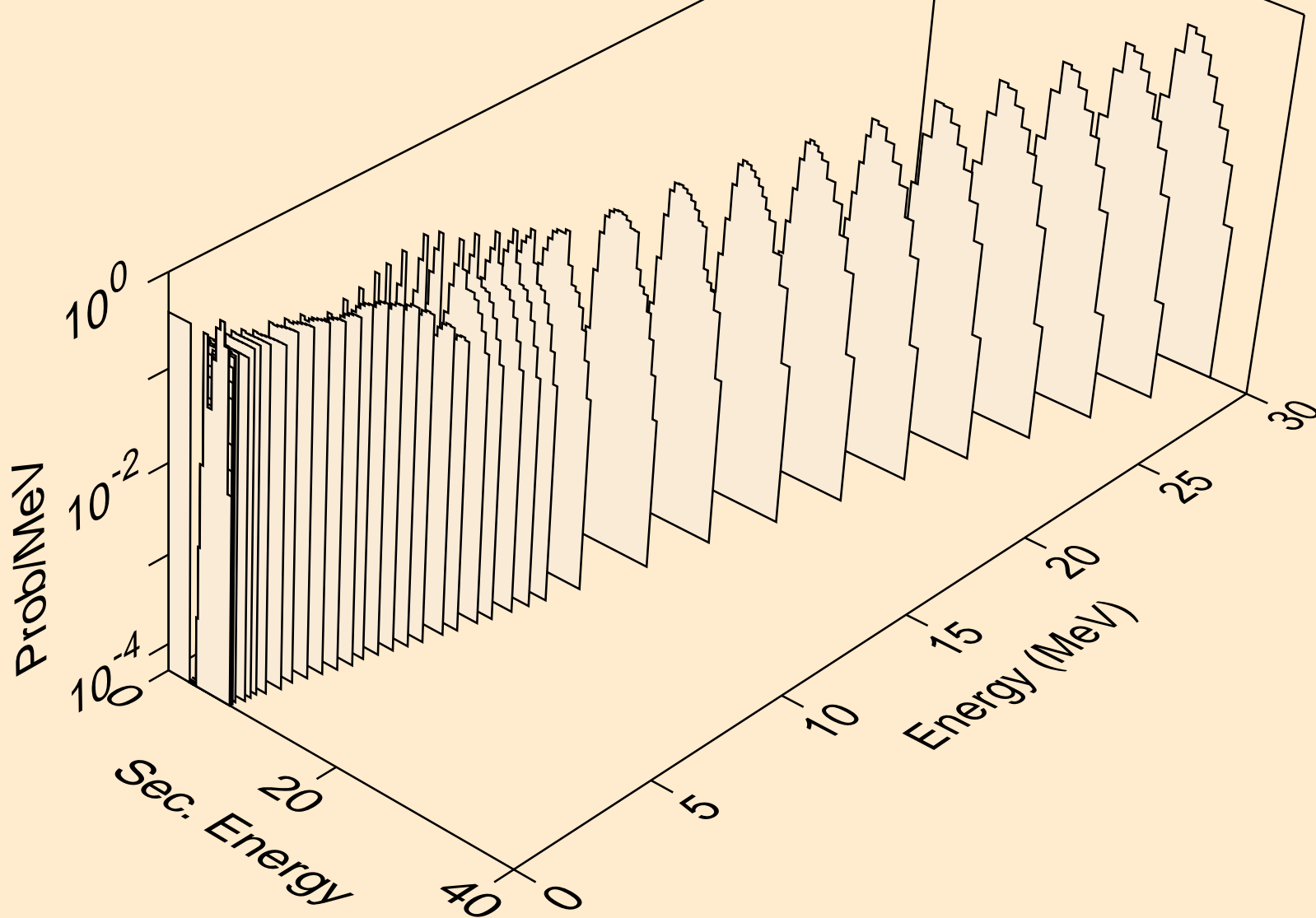

RU090 NEUTRON ACER TENDL-2019 LIBRARY; T=293.16K
alphas from (n,2a)

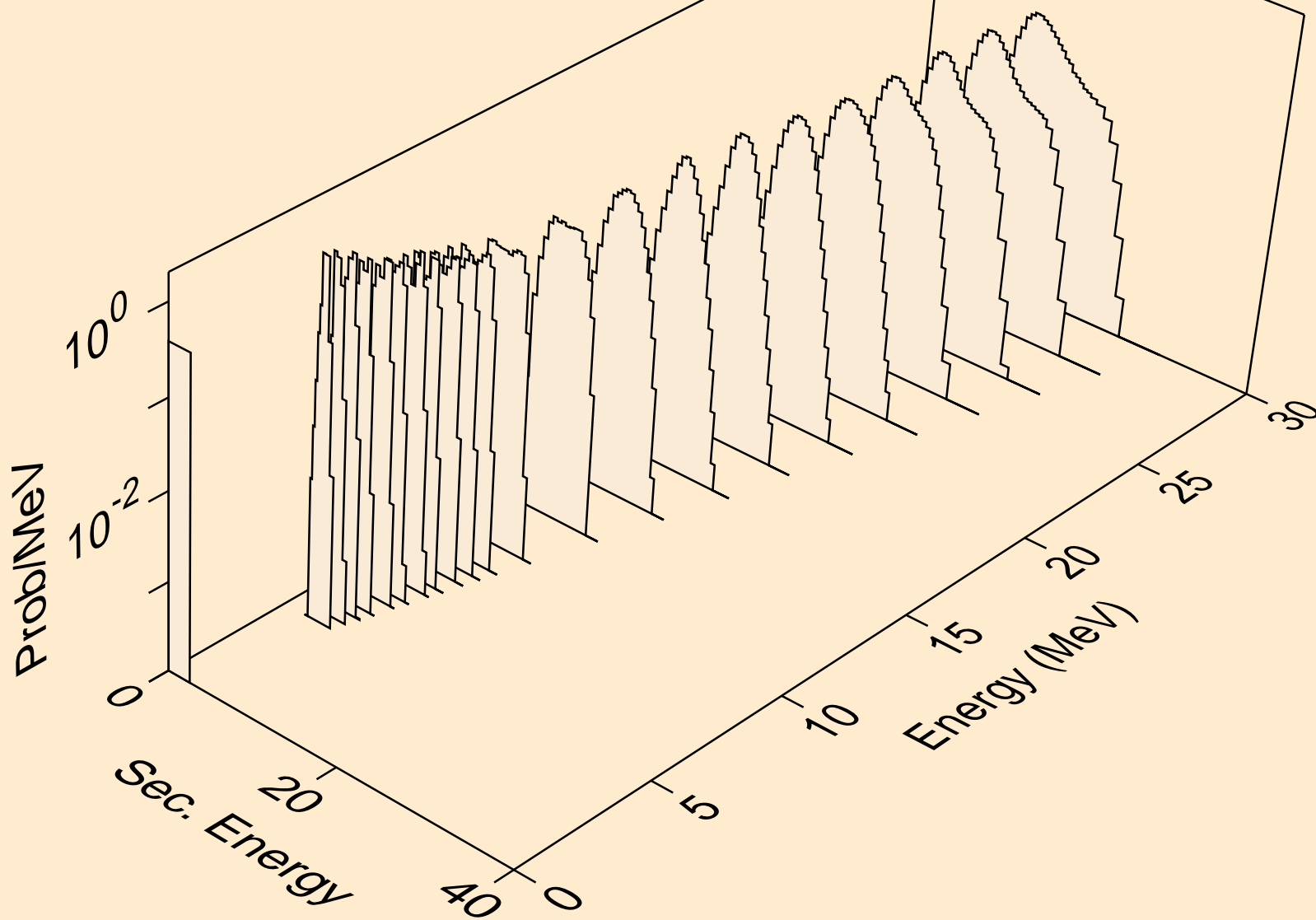

RU090 NEUTRON ACER TENDL-2019 LIBRARY; T=293.16K
alphas from (n,3a)

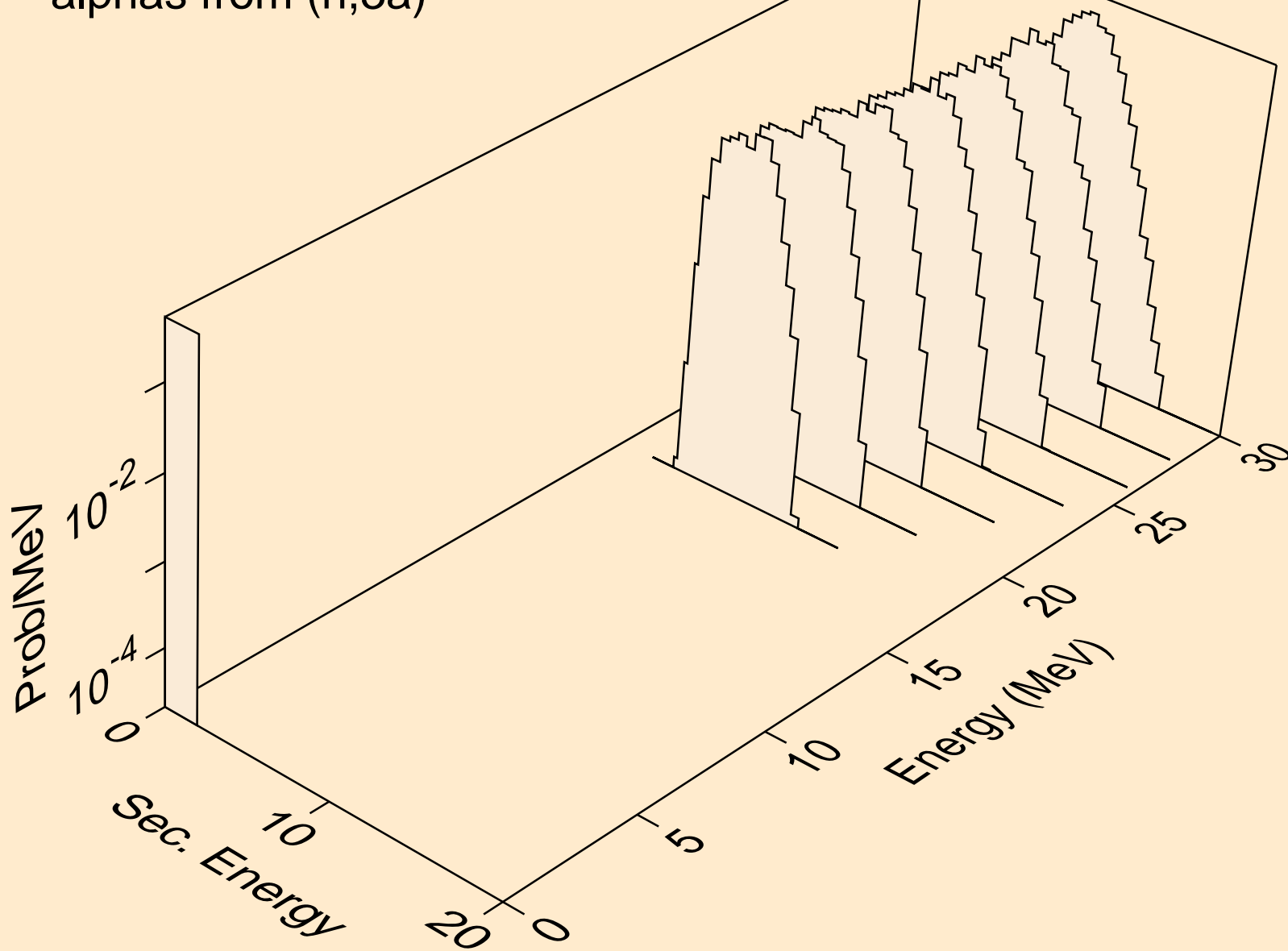

RU090 NEUTRON ACER TENDL-2019 LIBRARY; T=293.16K
alphas from (n,pa)

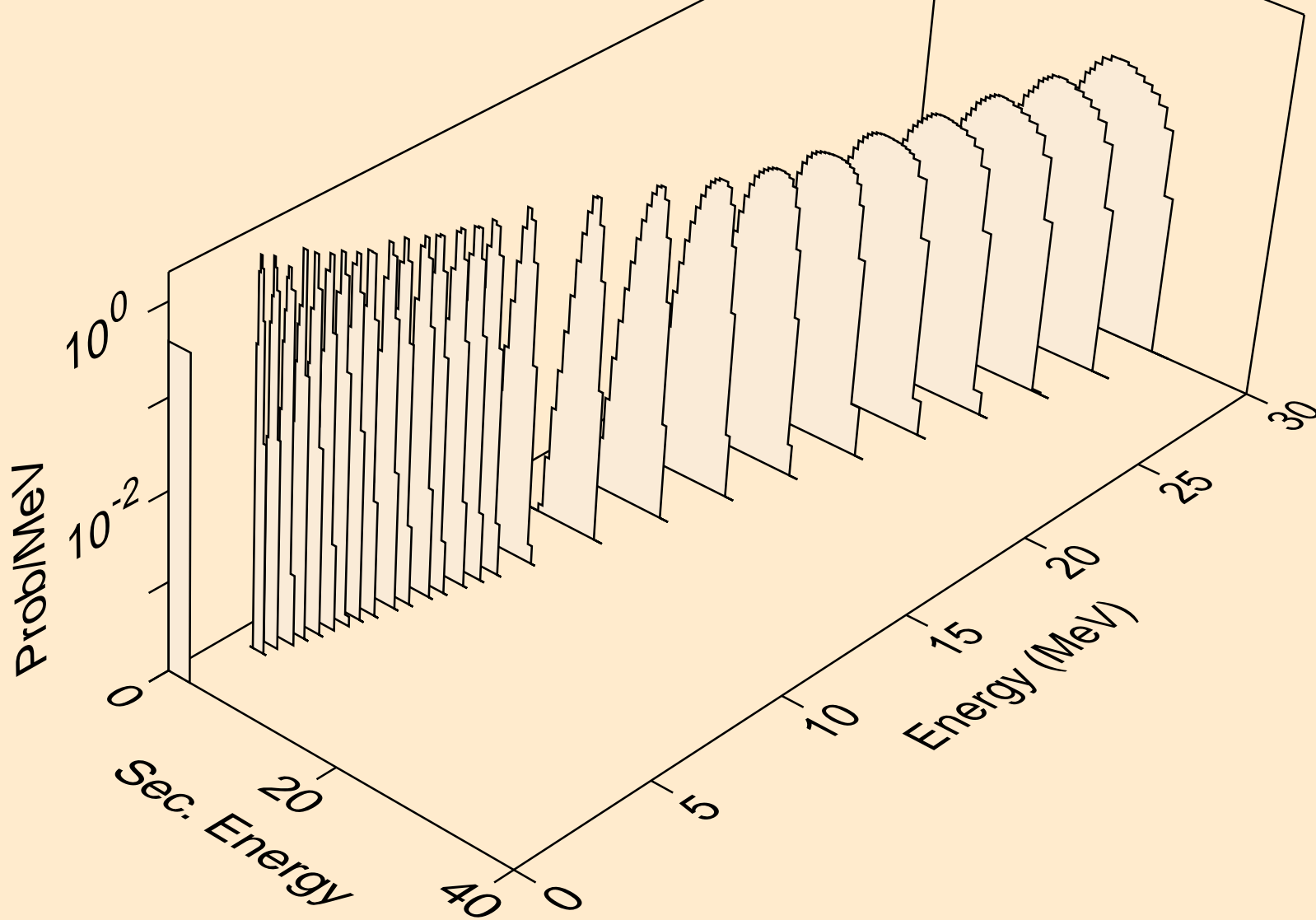

RU090 NEUTRON ACER TENDL-2019 LIBRARY; T=293.16K
alphas from (n,da)

