

RU109 NEUTRON ACER TENDL-2019 LIBRARY; T=293.16K  
Principal cross sections

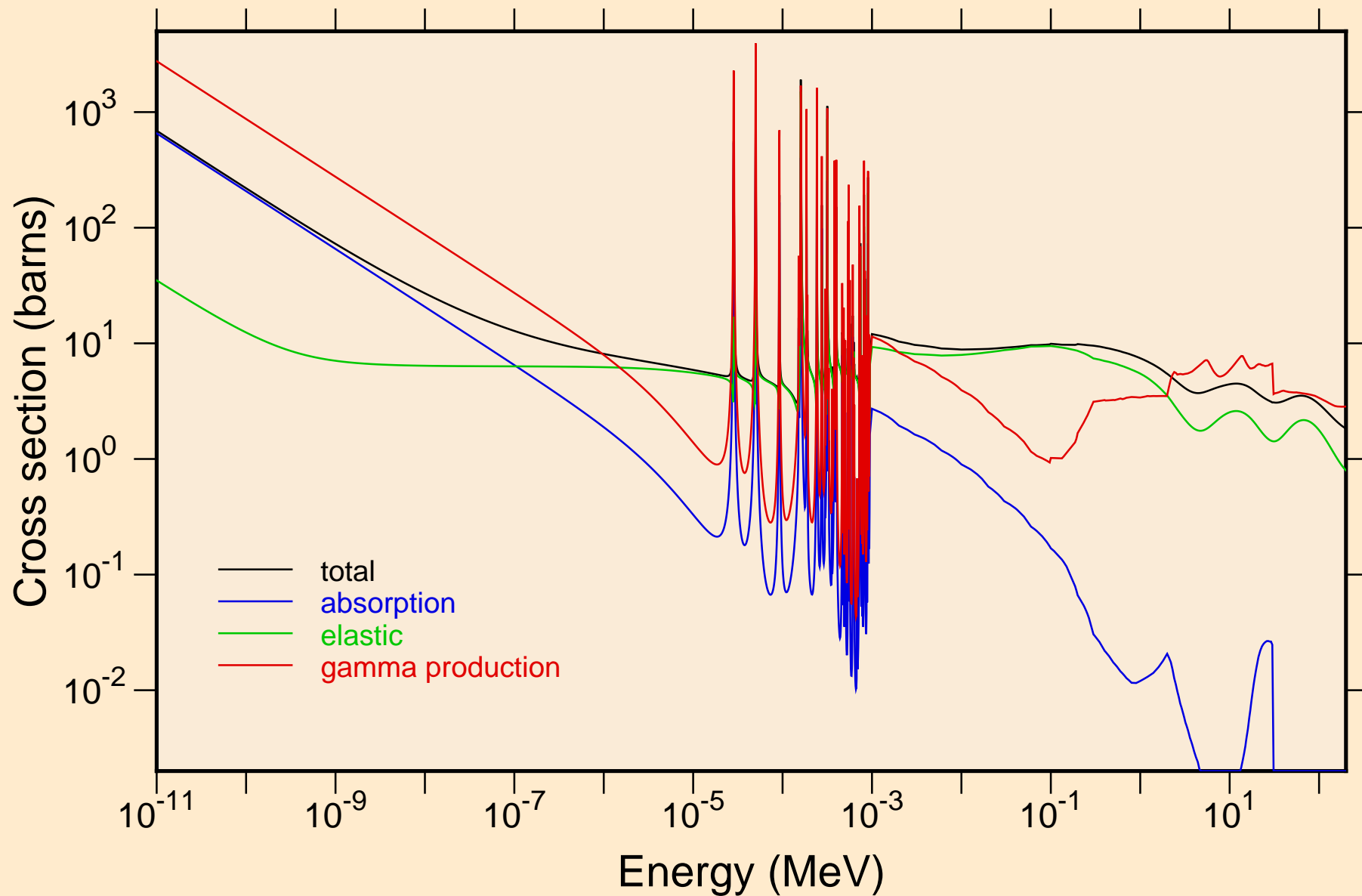

RU109 NEUTRON ACER TENDL-2019 LIBRARY; T=293.16K  
resonance total cross section

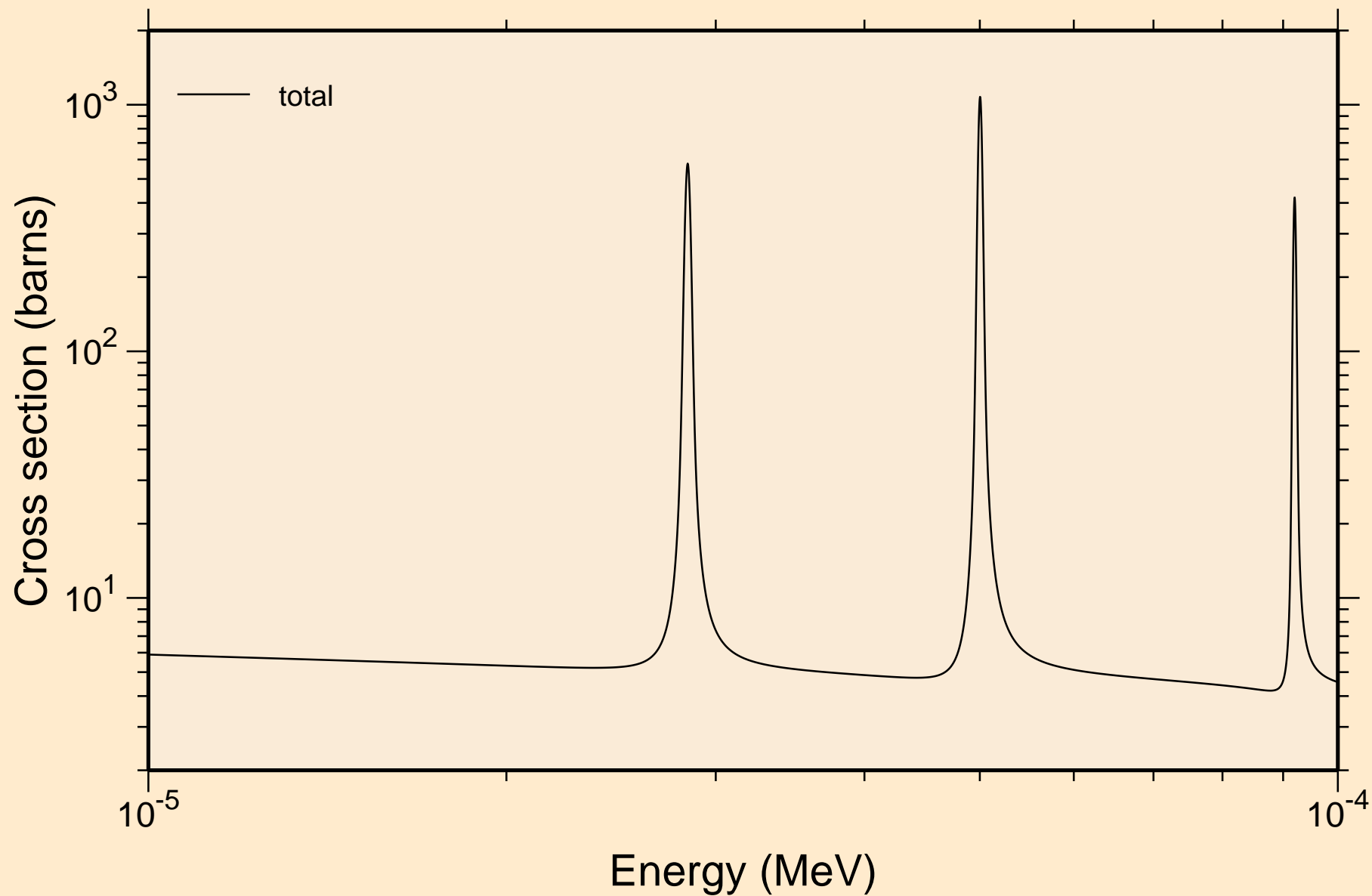

RU109 NEUTRON ACER TENDL-2019 LIBRARY; T=293.16K  
resonance total cross section

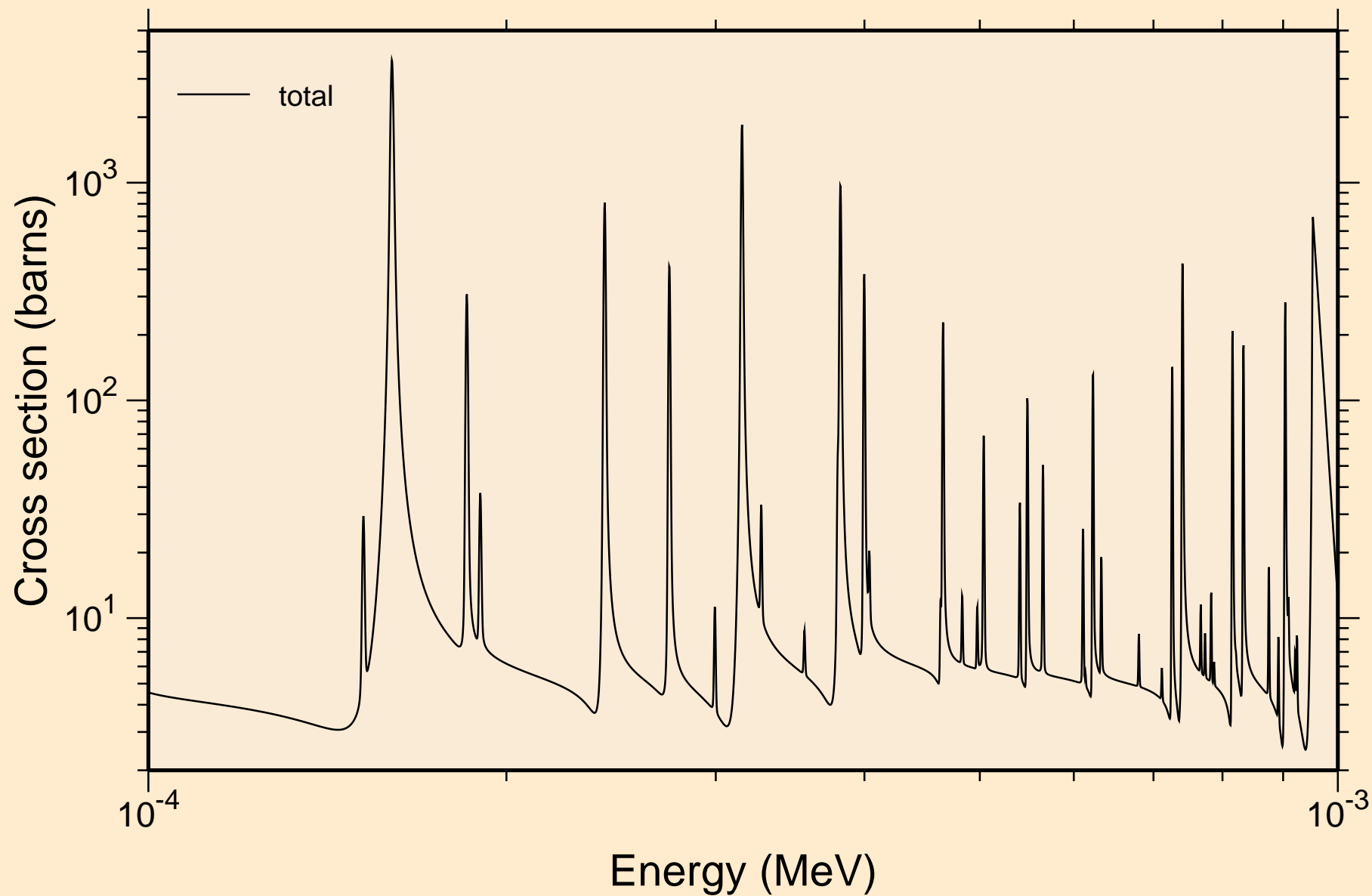

RŪ109 NEUTRON ACER TENDL-2019 LIBRARY; T=293.16K  
resonance total cross section

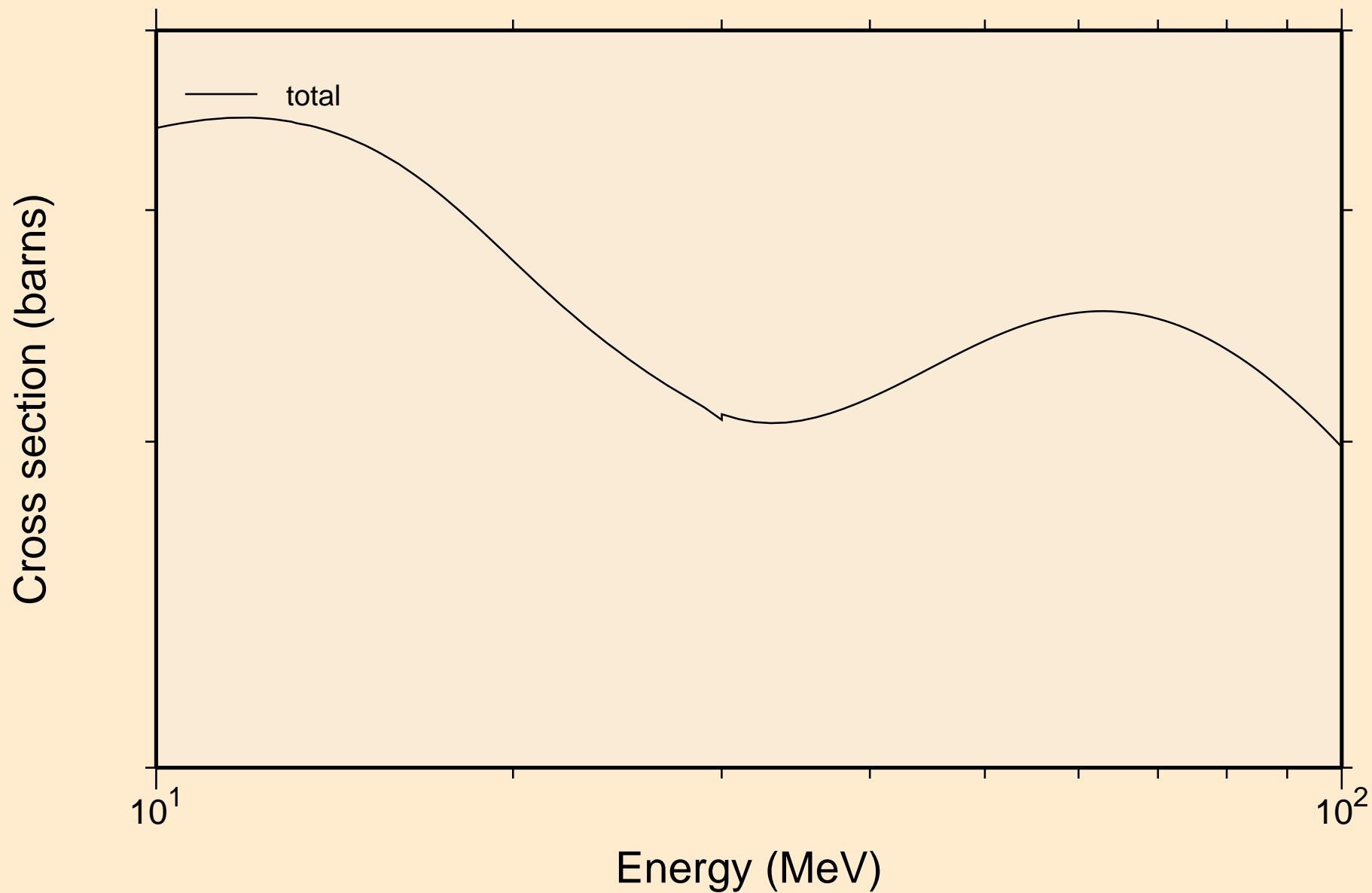

RU109 NEUTRON ACER TENDL-2019 LIBRARY; T=293.16K  
resonance absorption cross sections

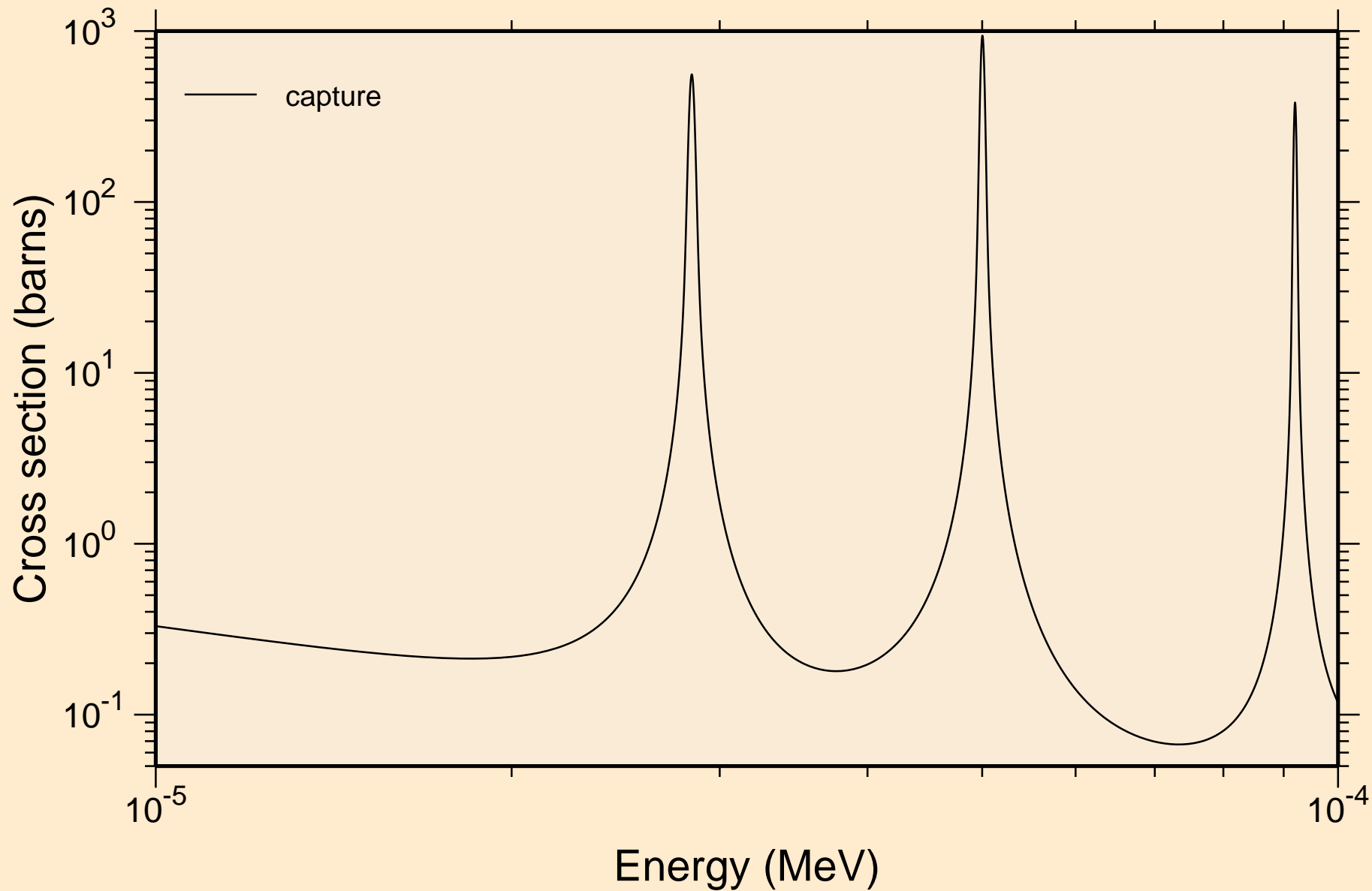

RU109 NEUTRON ACER TENDL-2019 LIBRARY; T=293.16K  
resonance absorption cross sections

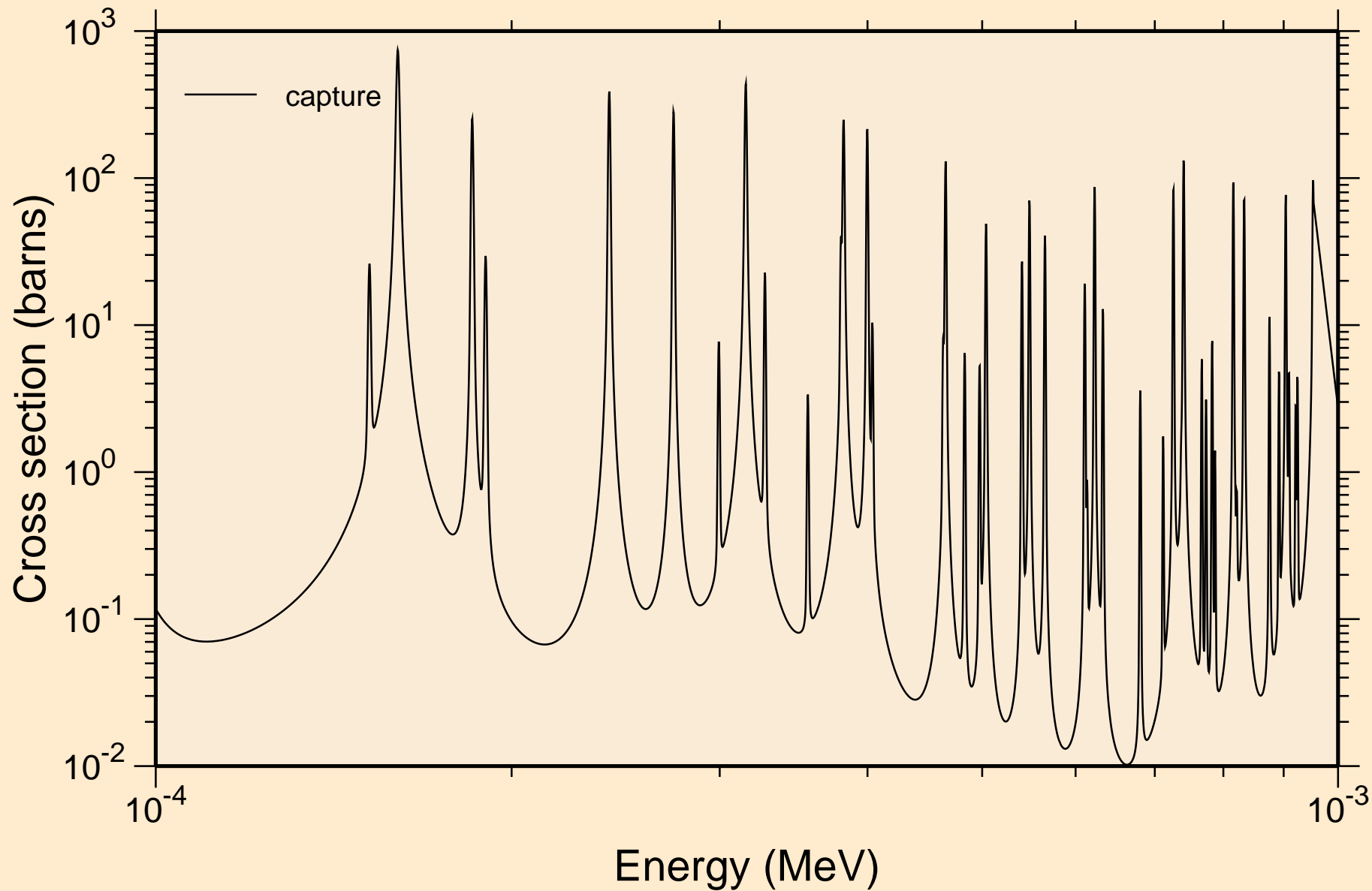

RU109 NEUTRON ACER TENDL-2019 LIBRARY; T=293.16K  
resonance absorption cross sections

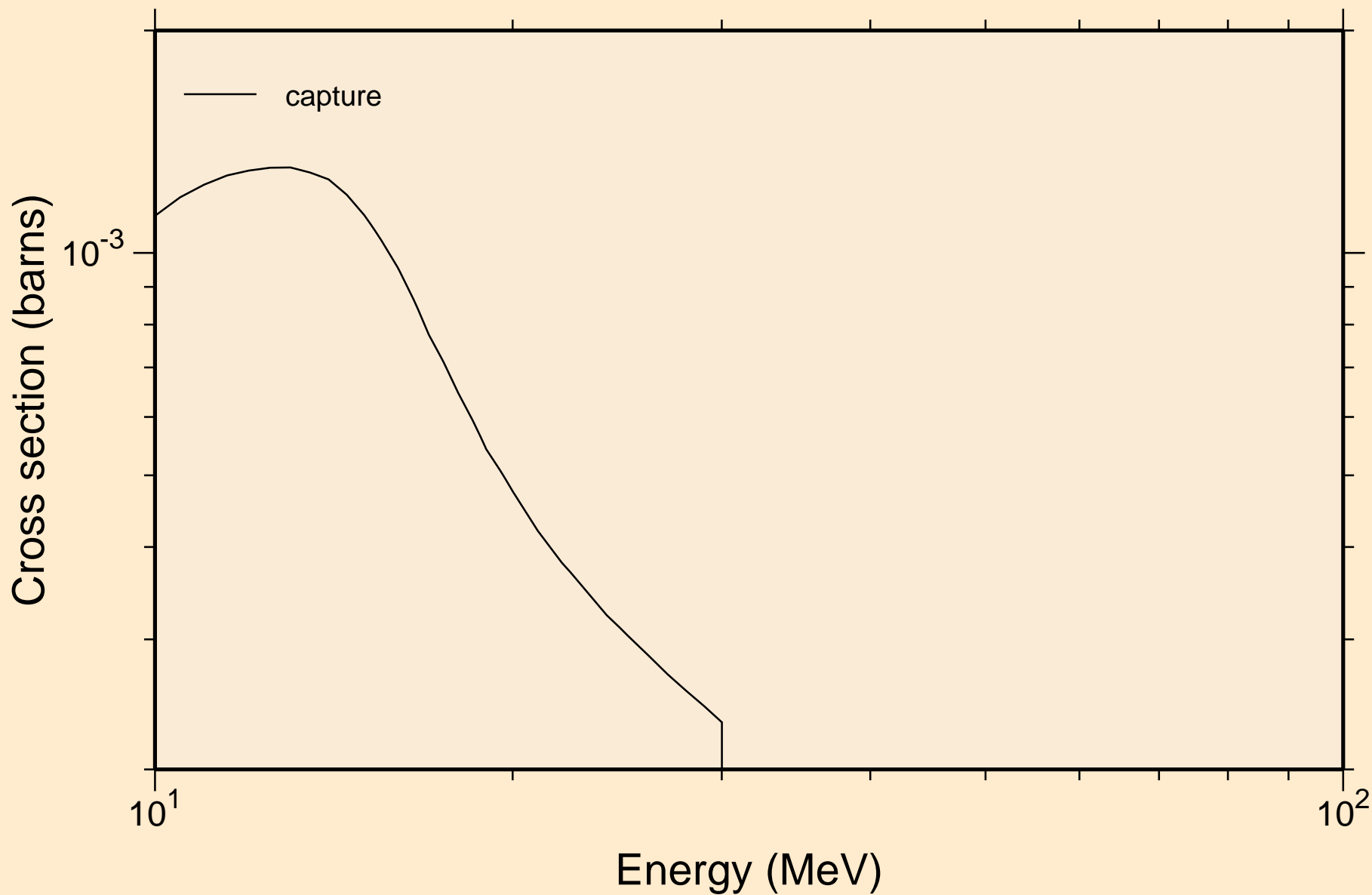

RU109 NEUTRON ACER TENDL-2019 LIBRARY; T=293.16K  
Heating

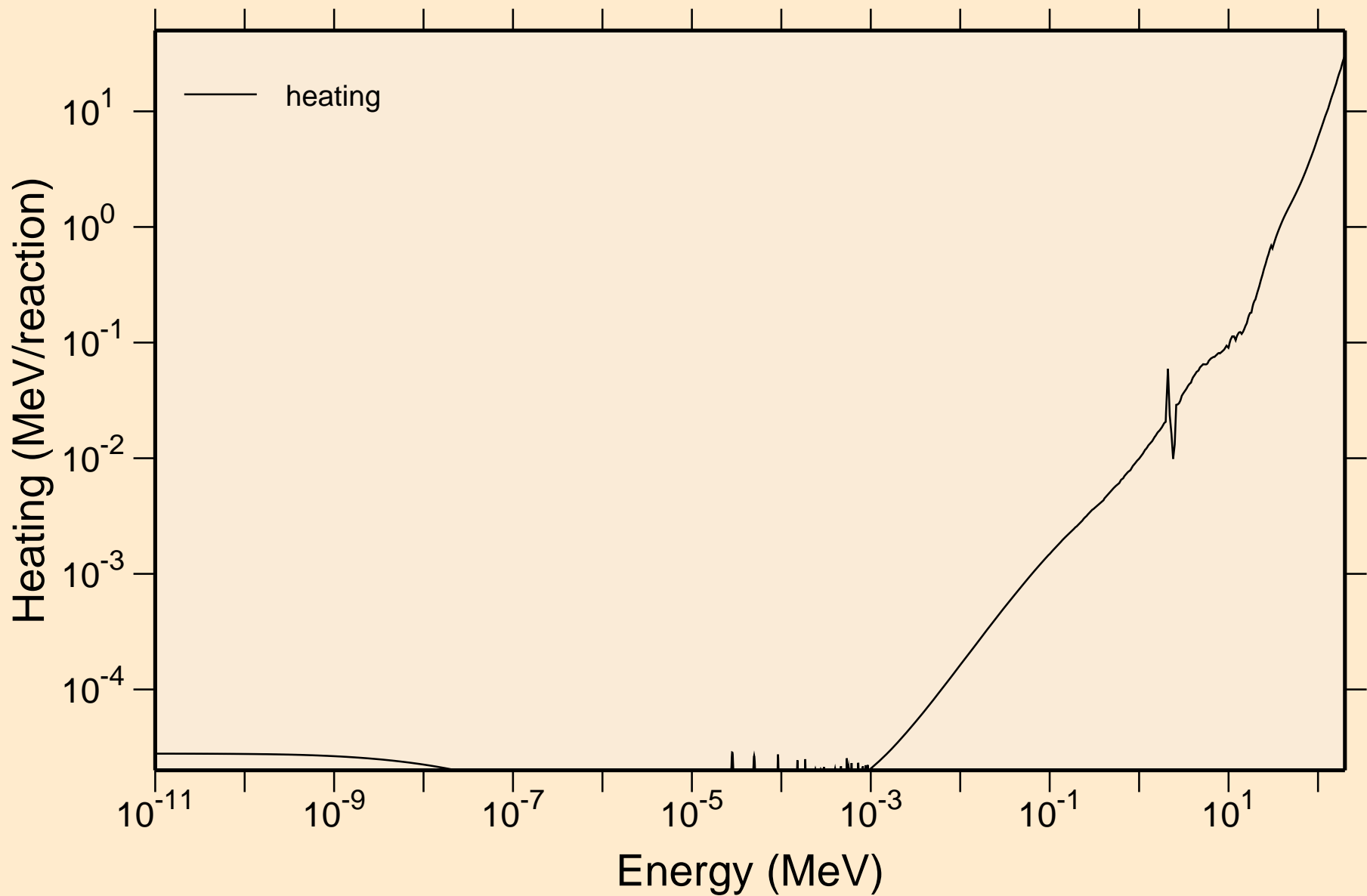



RU109 NEUTRON ACER TENDL-2019 LIBRARY; T=293.16K  
Damage

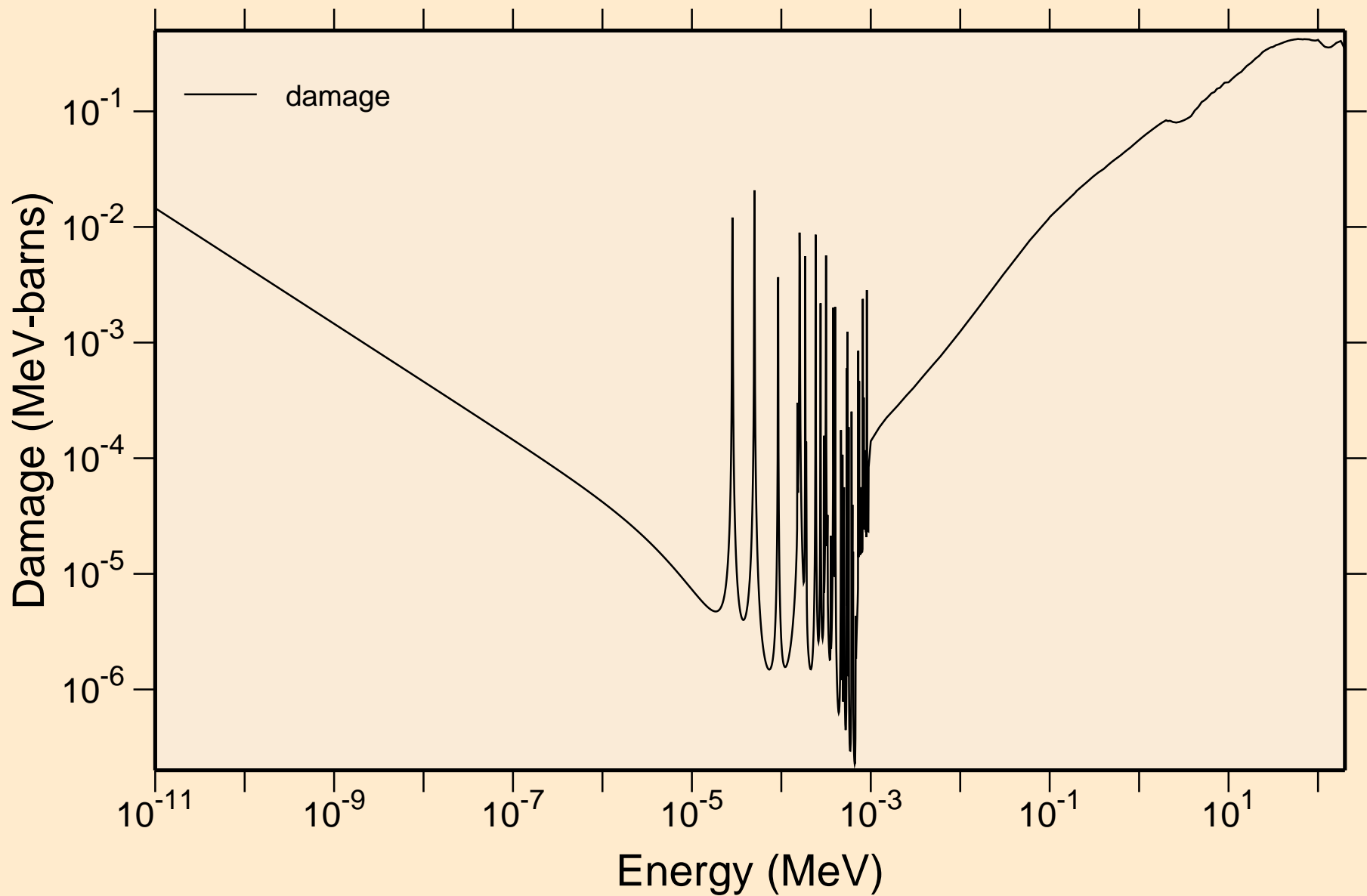

RU109 NEUTRON ACER TENDL-2019 LIBRARY; T=293.16K  
Non-threshold reactions

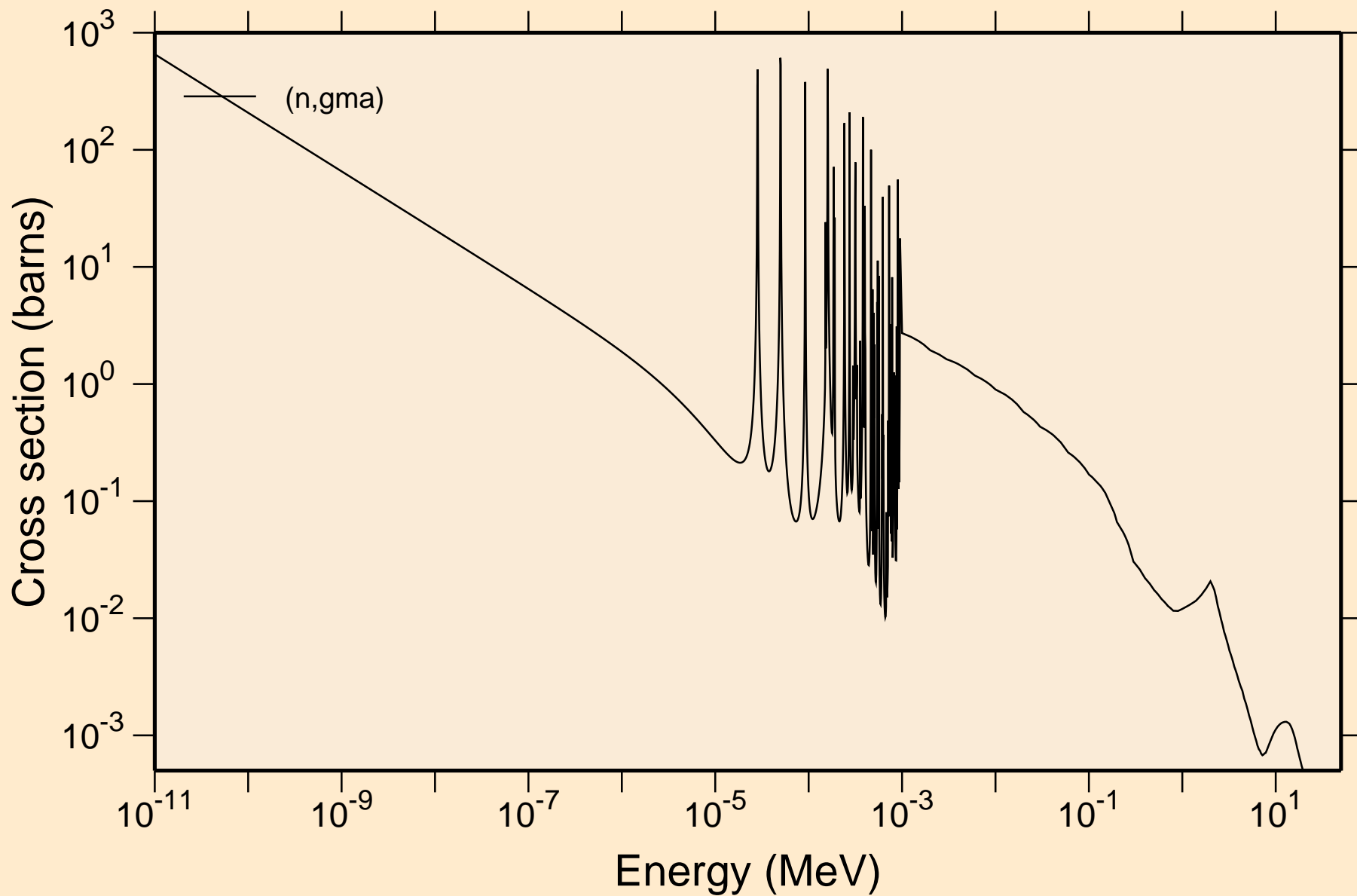

RU109 NEUTRON ACER TENDL-2019 LIBRARY; T=293.16K  
Principal cross sections

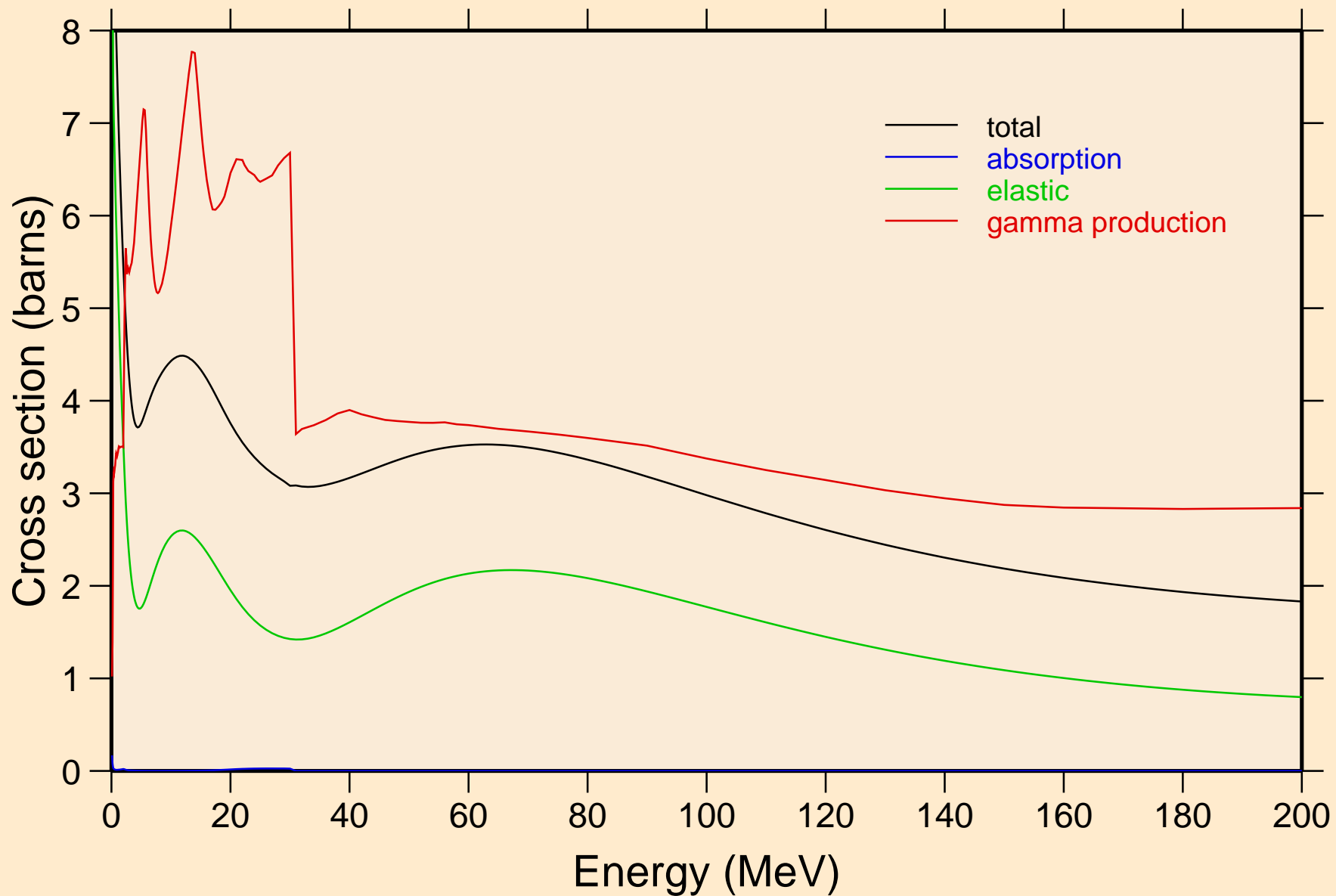

RU109 NEUTRON ACER TENDL-2019 LIBRARY; T=293.16K  
Heating

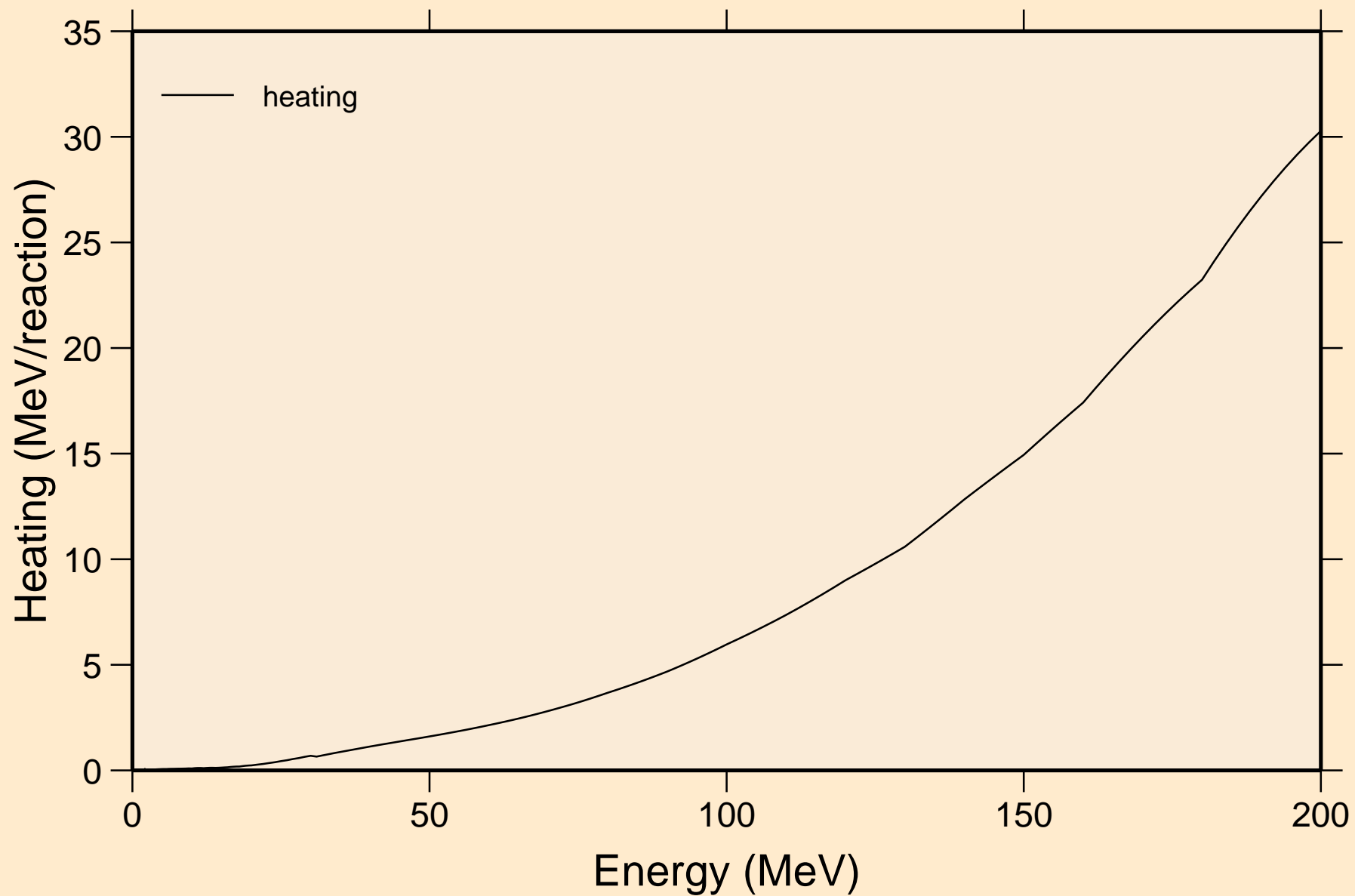

RU109 NEUTRON ACER TENDL-2019 LIBRARY; T=293.16K  
Damage

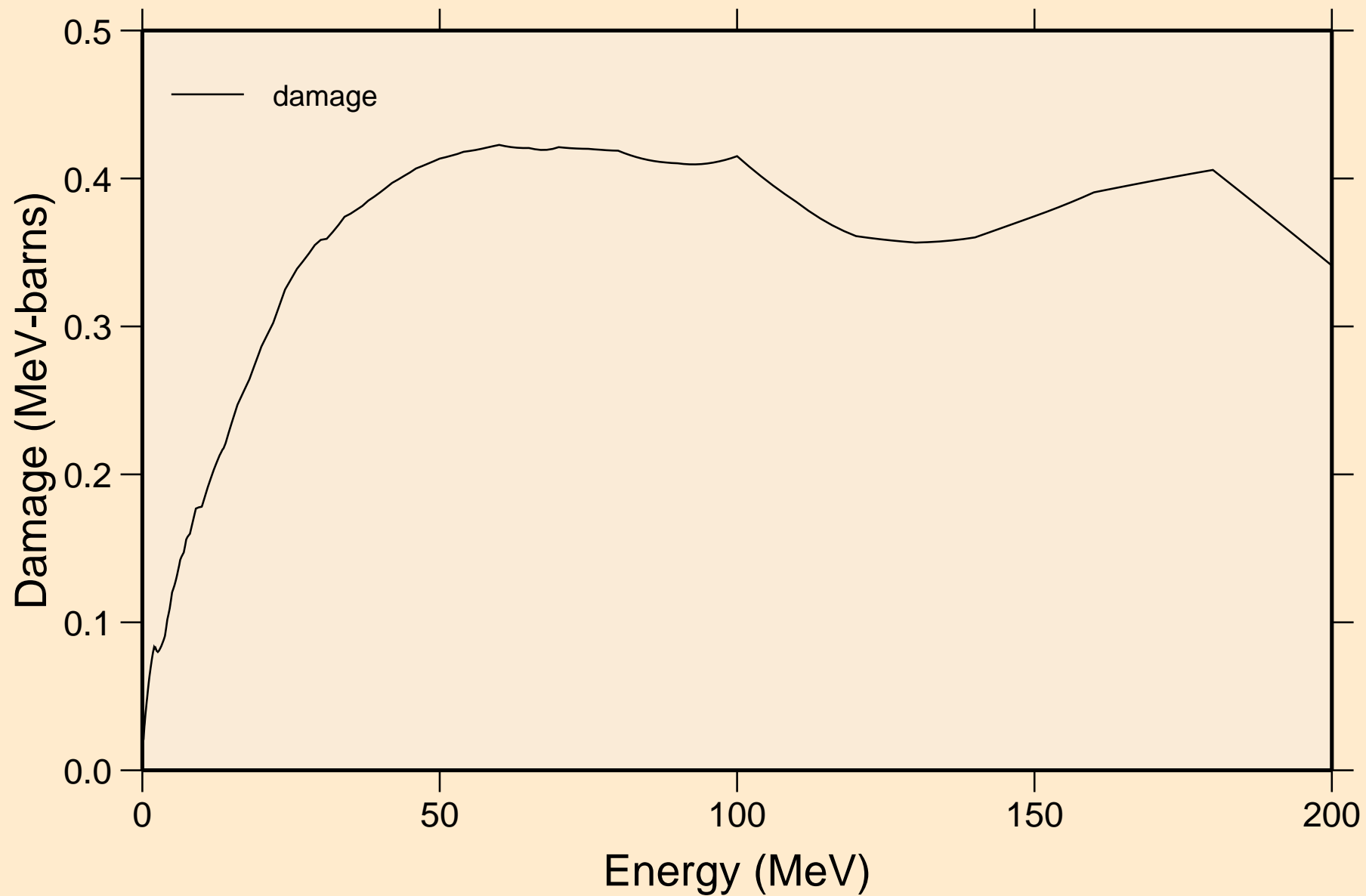

RU109 NEUTRON ACER TENDL-2019 LIBRARY; T=293.16K  
Non-threshold reactions

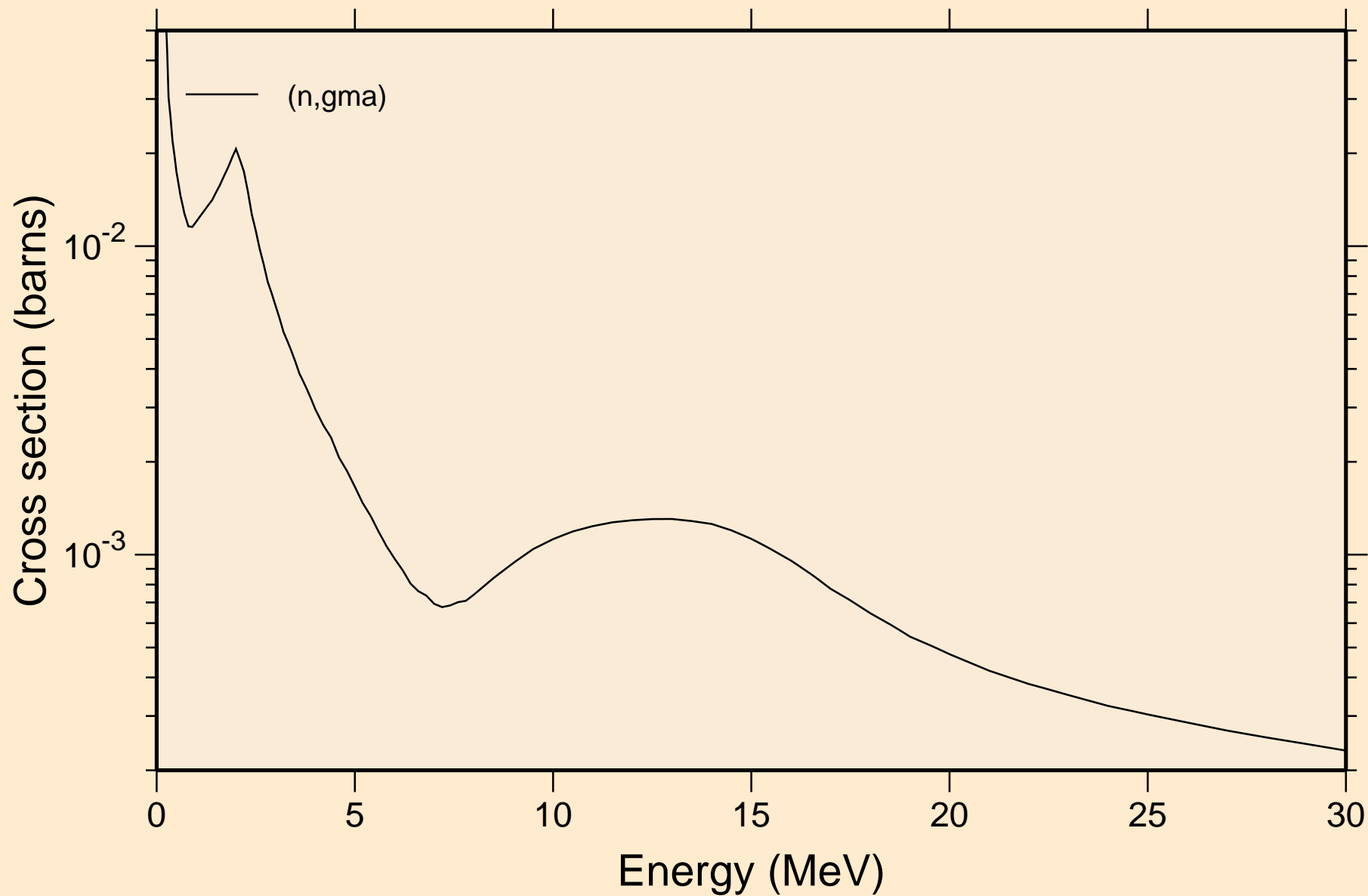

RU109 NEUTRON ACER TENDL-2019 LIBRARY; T=293.16K  
Inelastic levels

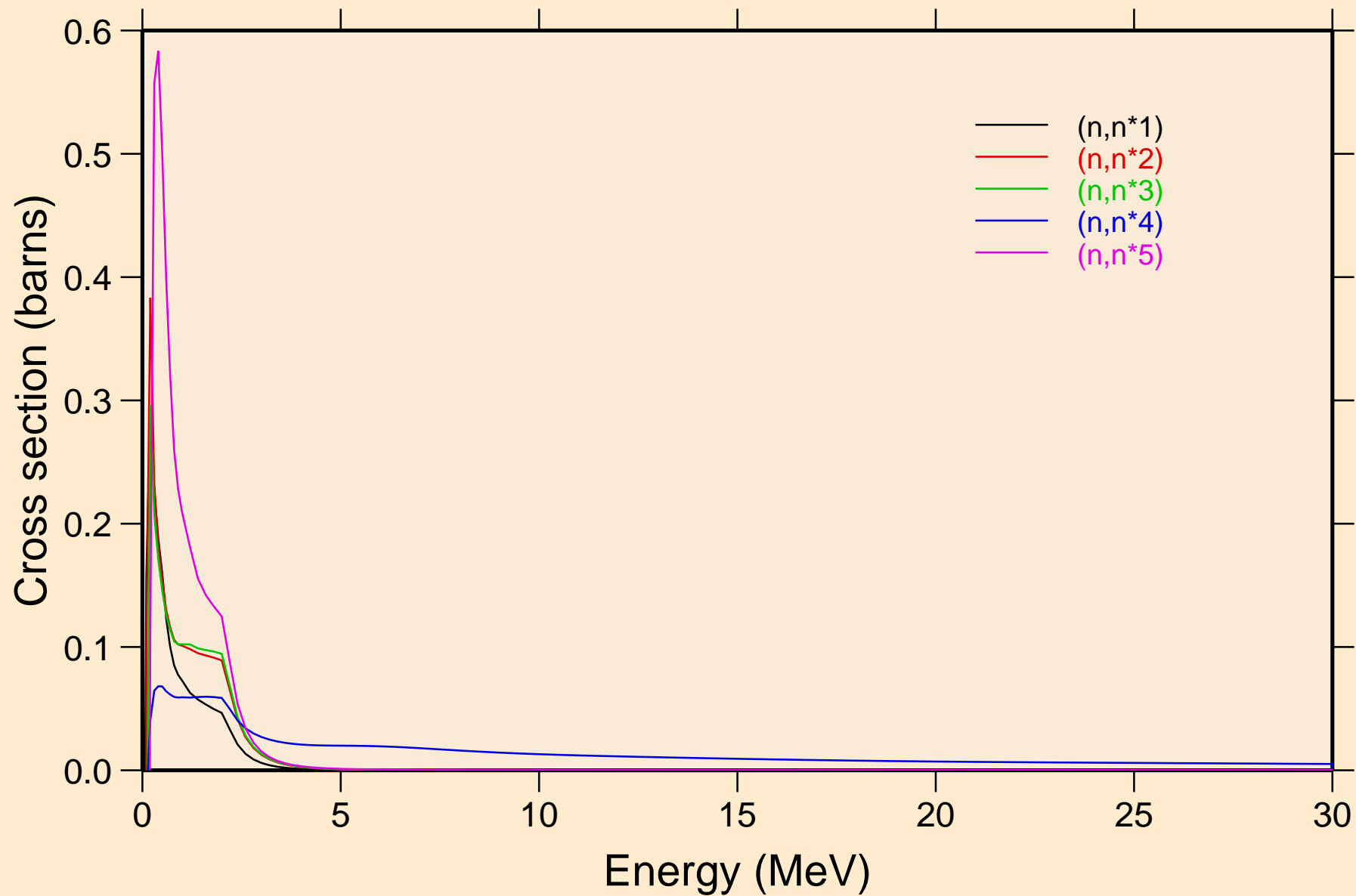

RU109 NEUTRON ACER TENDL-2019 LIBRARY; T=293.16K  
Inelastic levels

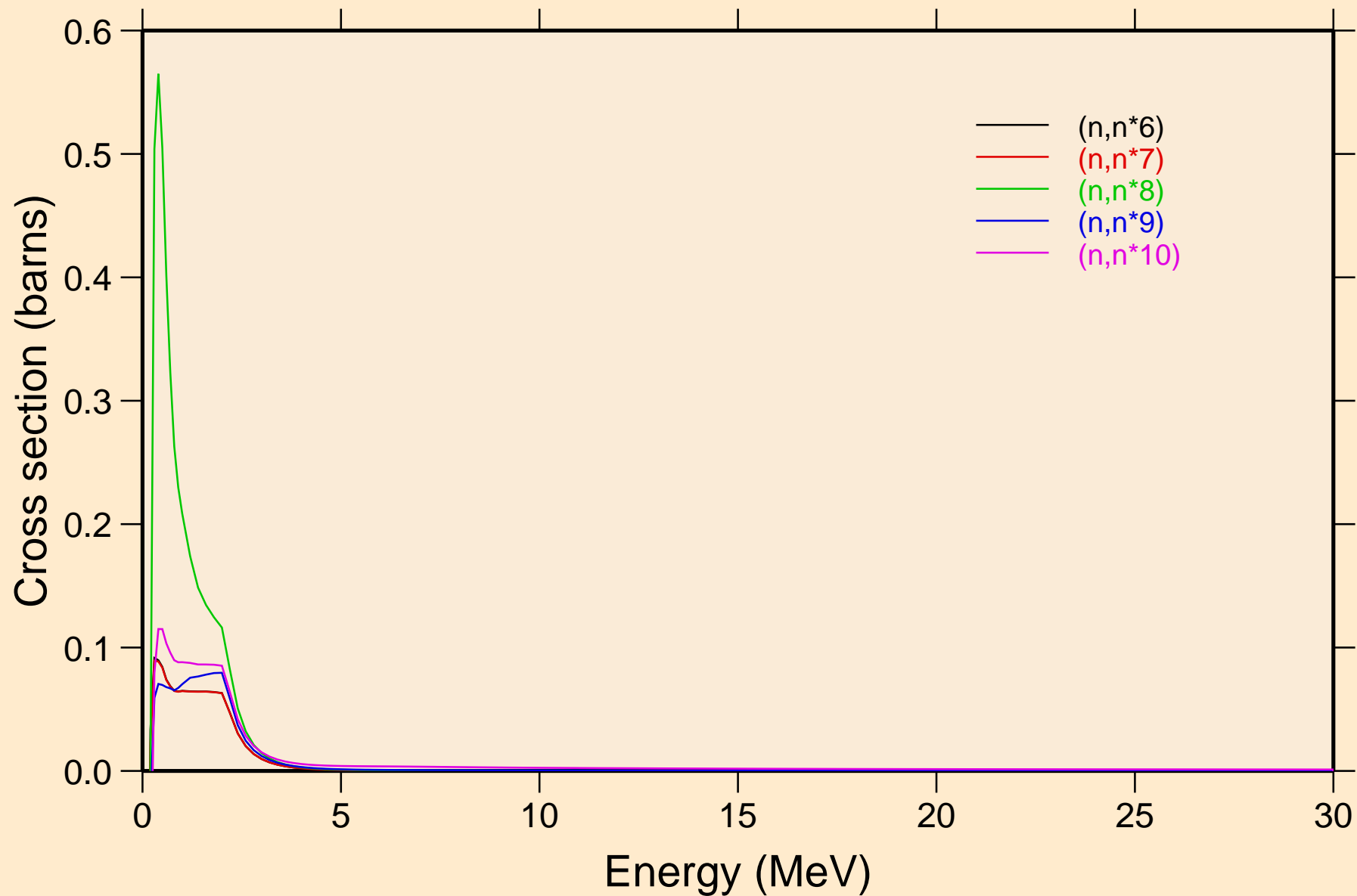



RU109 NEUTRON ACER TENDL-2019 LIBRARY; T=293.16K  
Inelastic levels

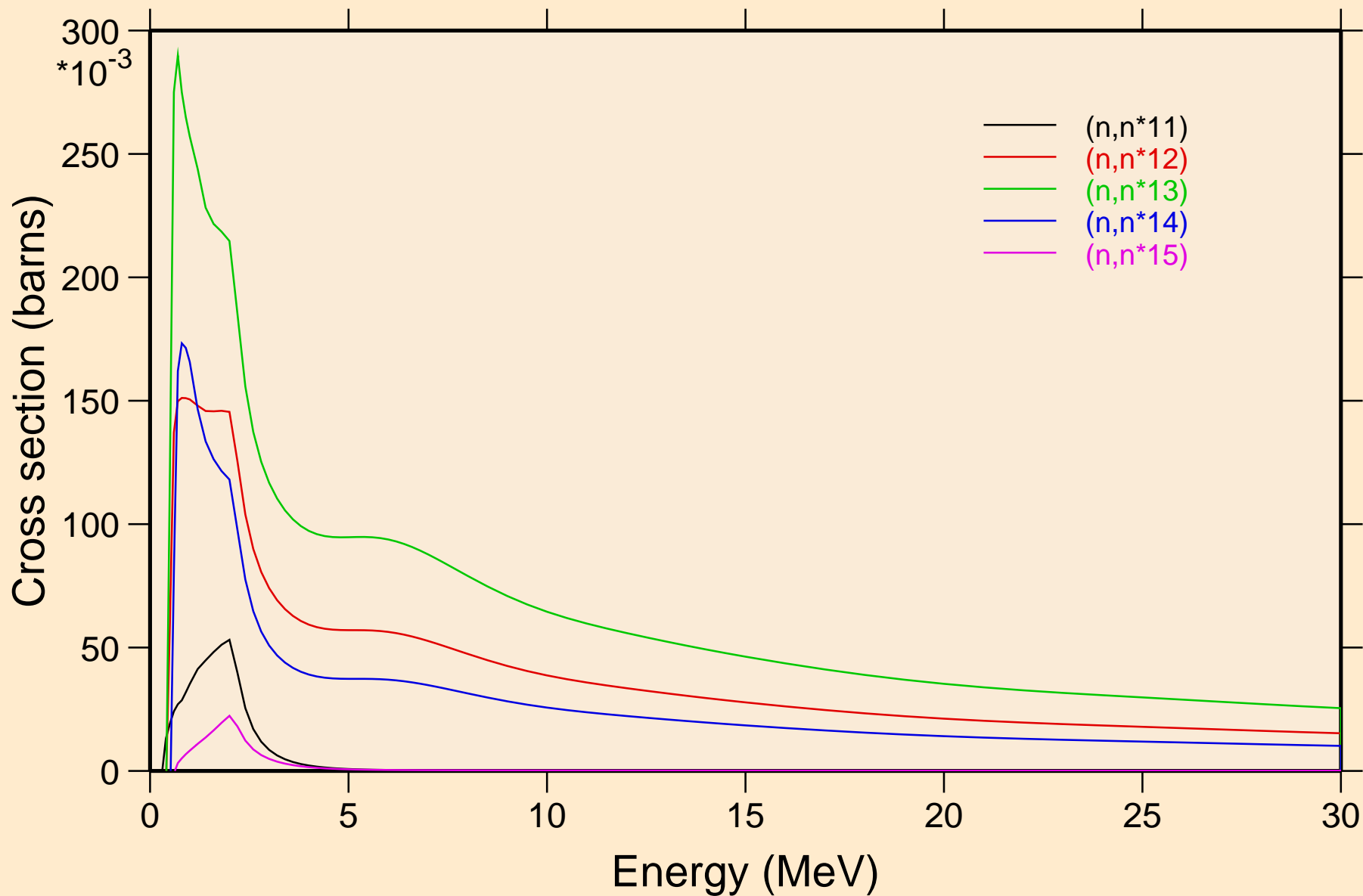

RU109 NEUTRON ACER TENDL-2019 LIBRARY; T=293.16K  
Inelastic levels

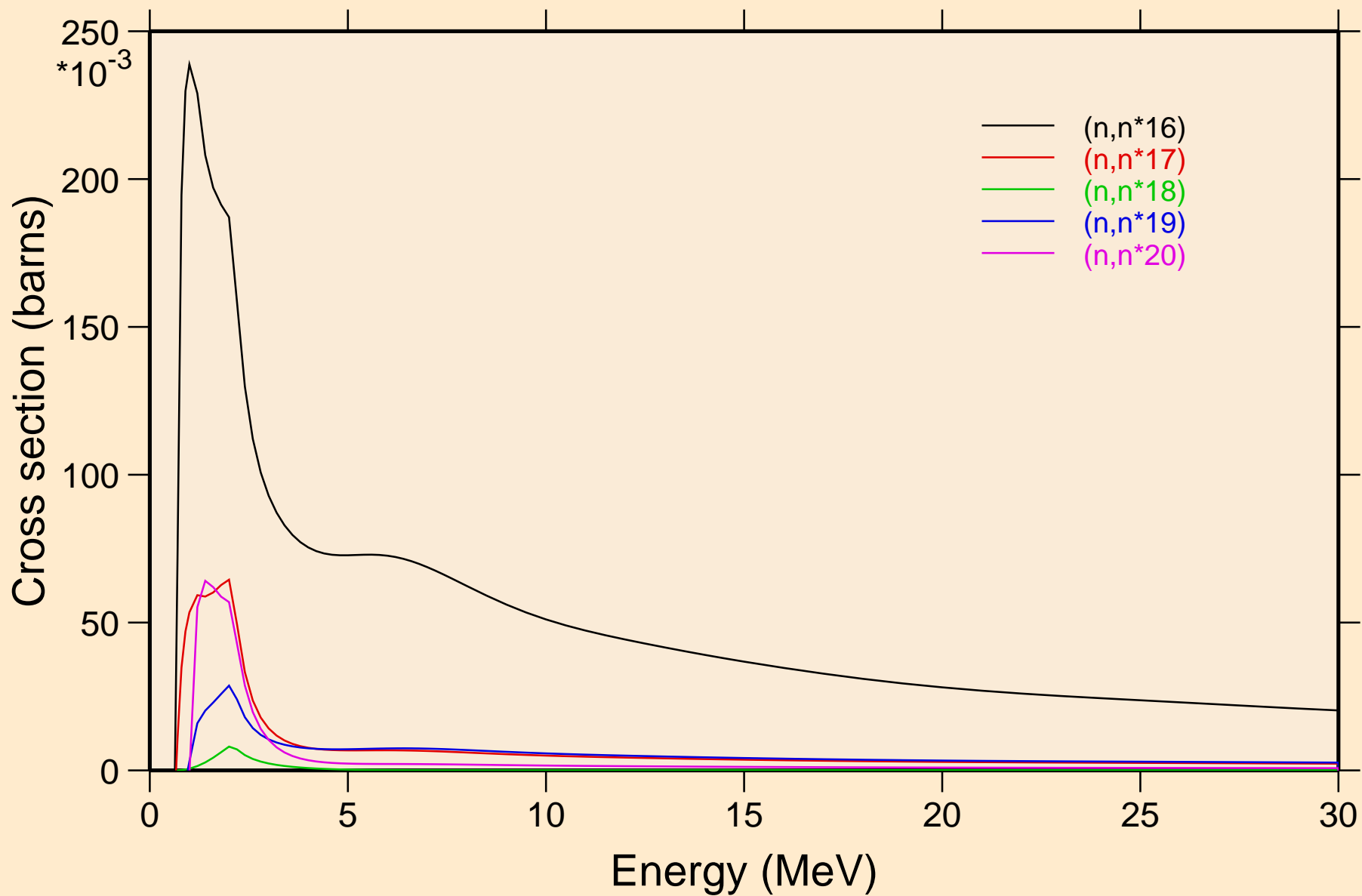

RU109 NEUTRON ACER TENDL-2019 LIBRARY; T=293.16K  
Inelastic levels

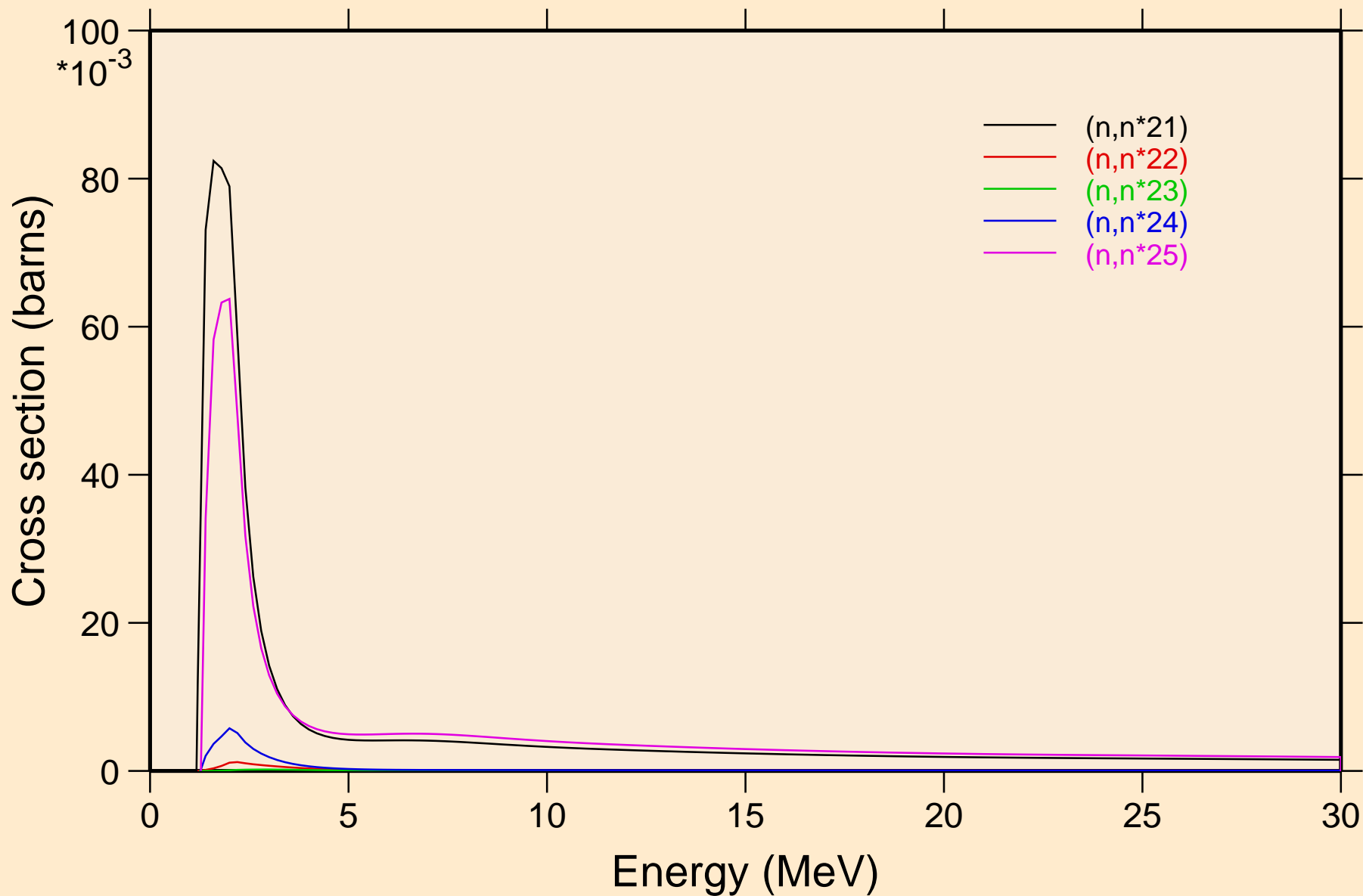

RU109 NEUTRON ACER TENDL-2019 LIBRARY; T=293.16K  
Inelastic levels

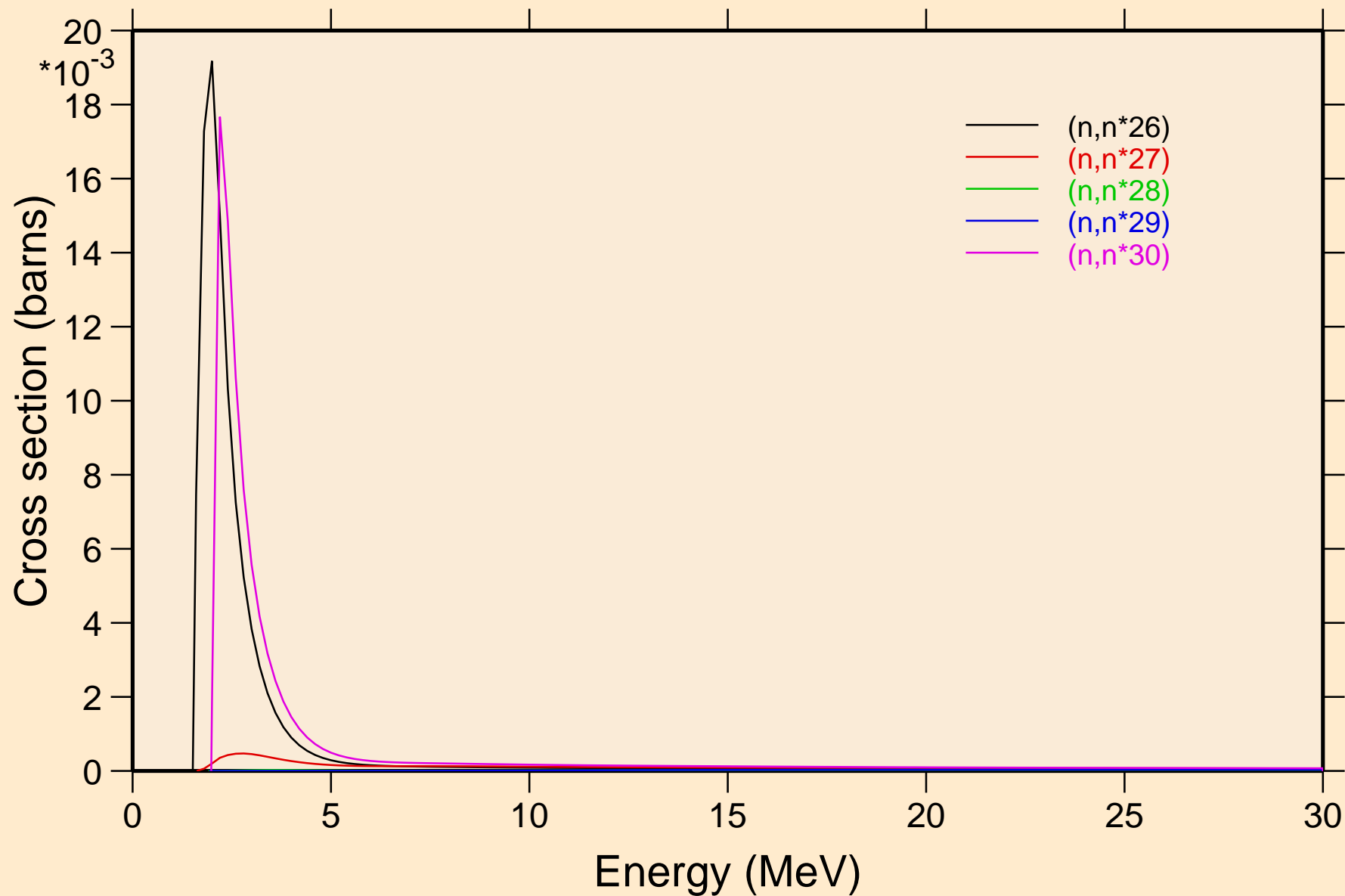

RU109 NEUTRON ACER TENDL-2019 LIBRARY; T=293.16K  
Threshold reactions

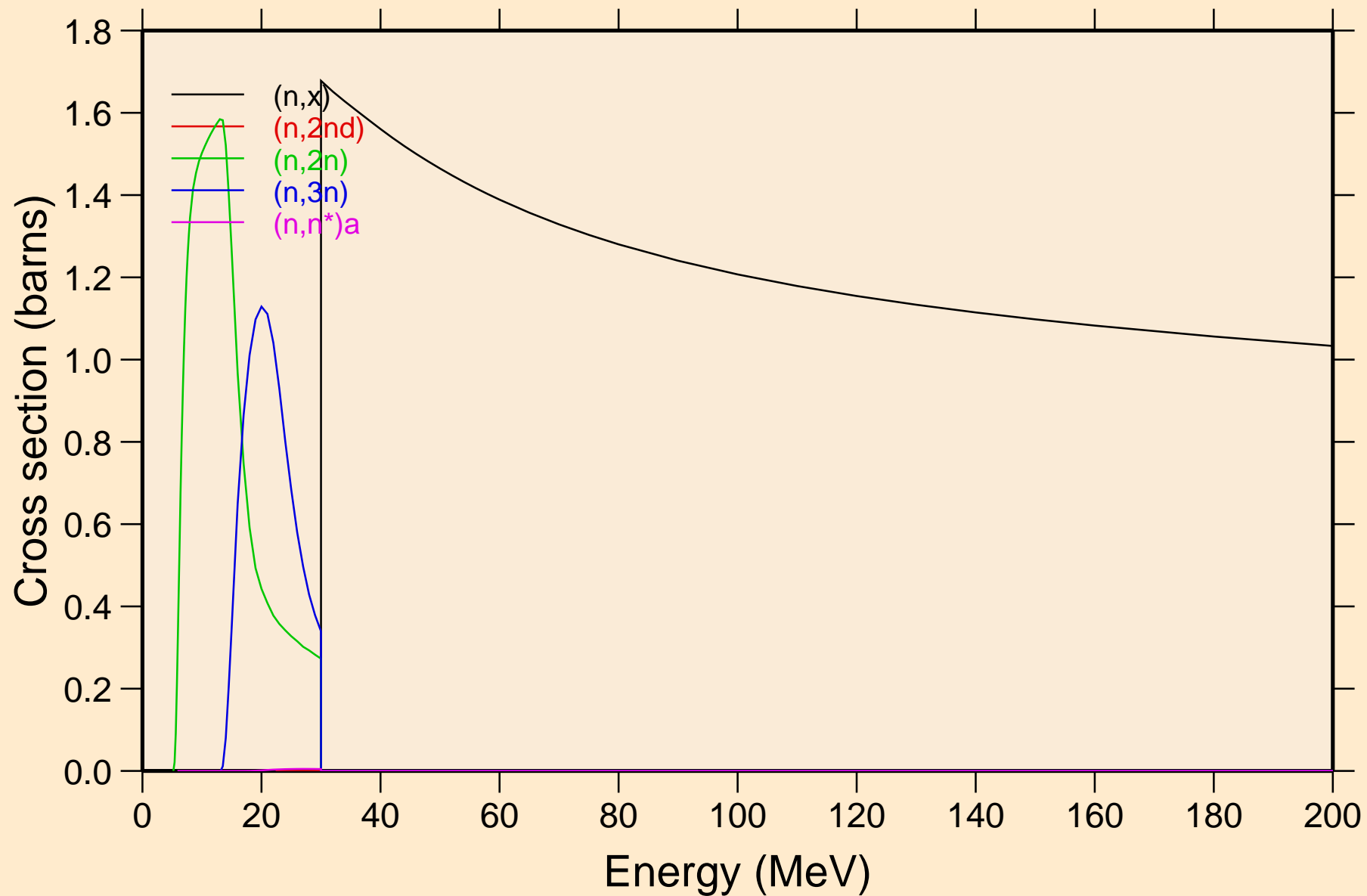

RU109 NEUTRON ACER TENDL-2019 LIBRARY; T=293.16K  
Threshold reactions

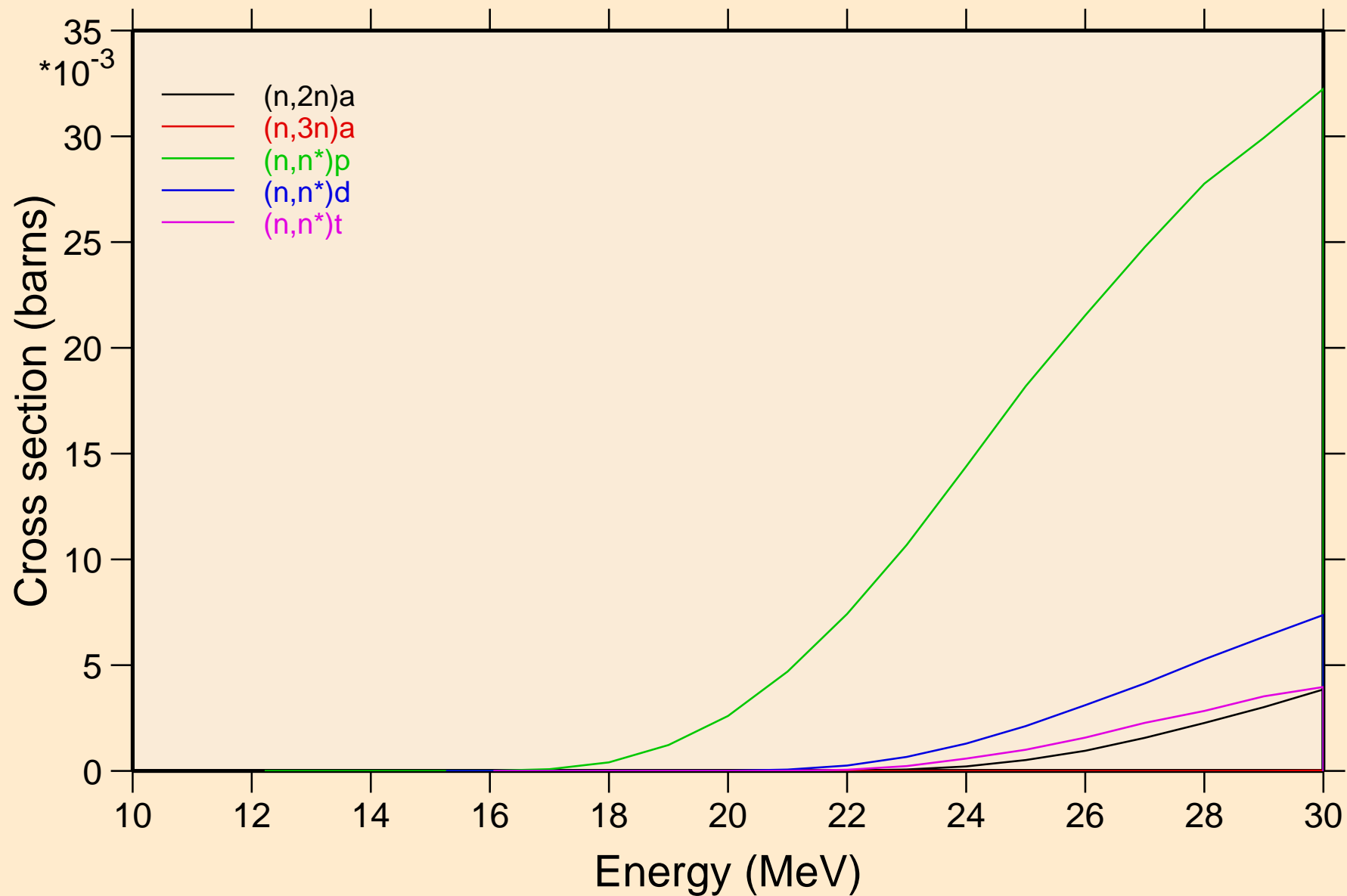

RU109 NEUTRON ACER TENDL-2019 LIBRARY; T=293.16K  
Threshold reactions

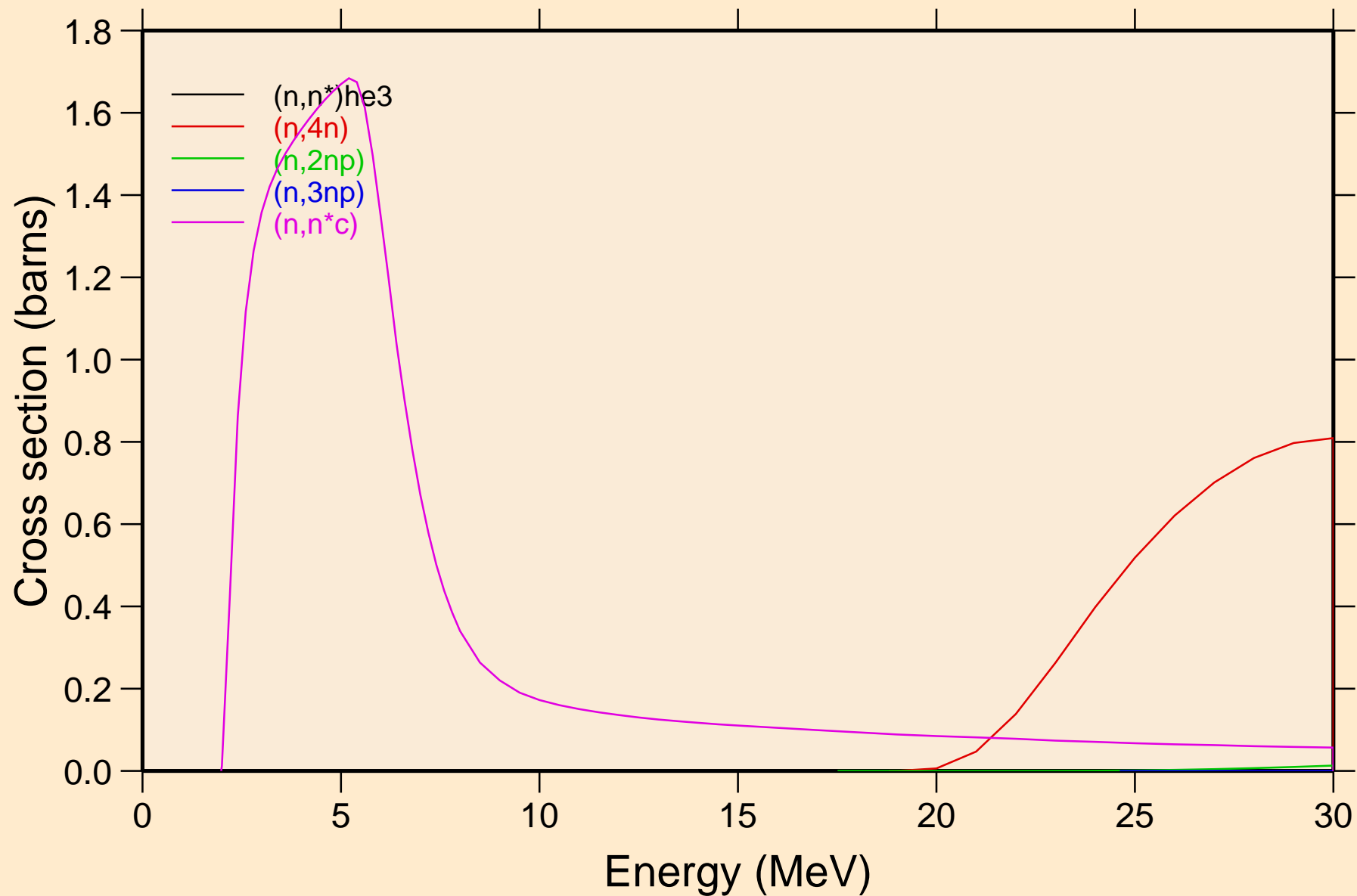

RU109 NEUTRON ACER TENDL-2019 LIBRARY; T=293.16K  
Threshold reactions

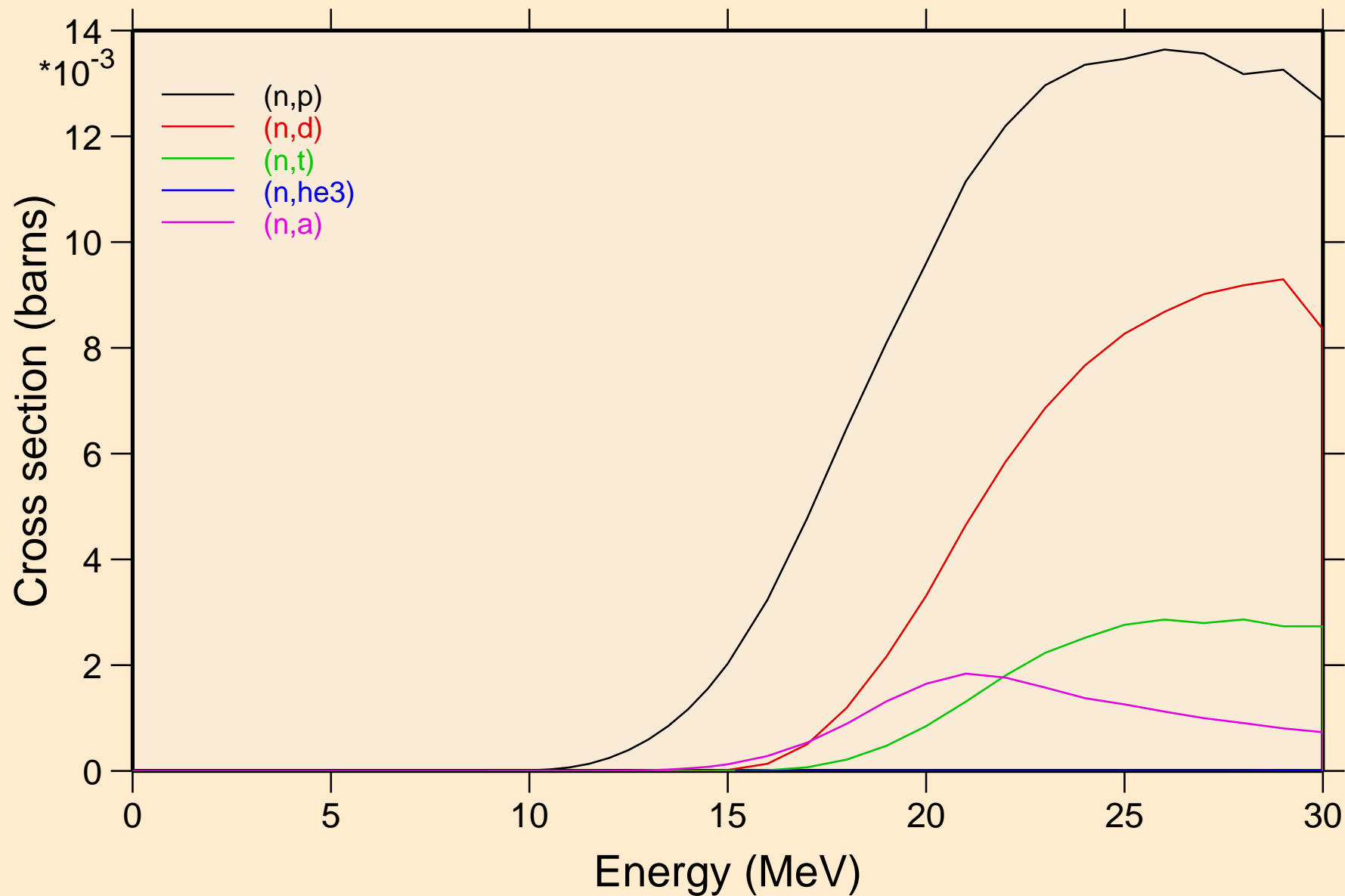



RU109 NEUTRON ACER TENDL-2019 LIBRARY; T=293.16K  
Threshold reactions

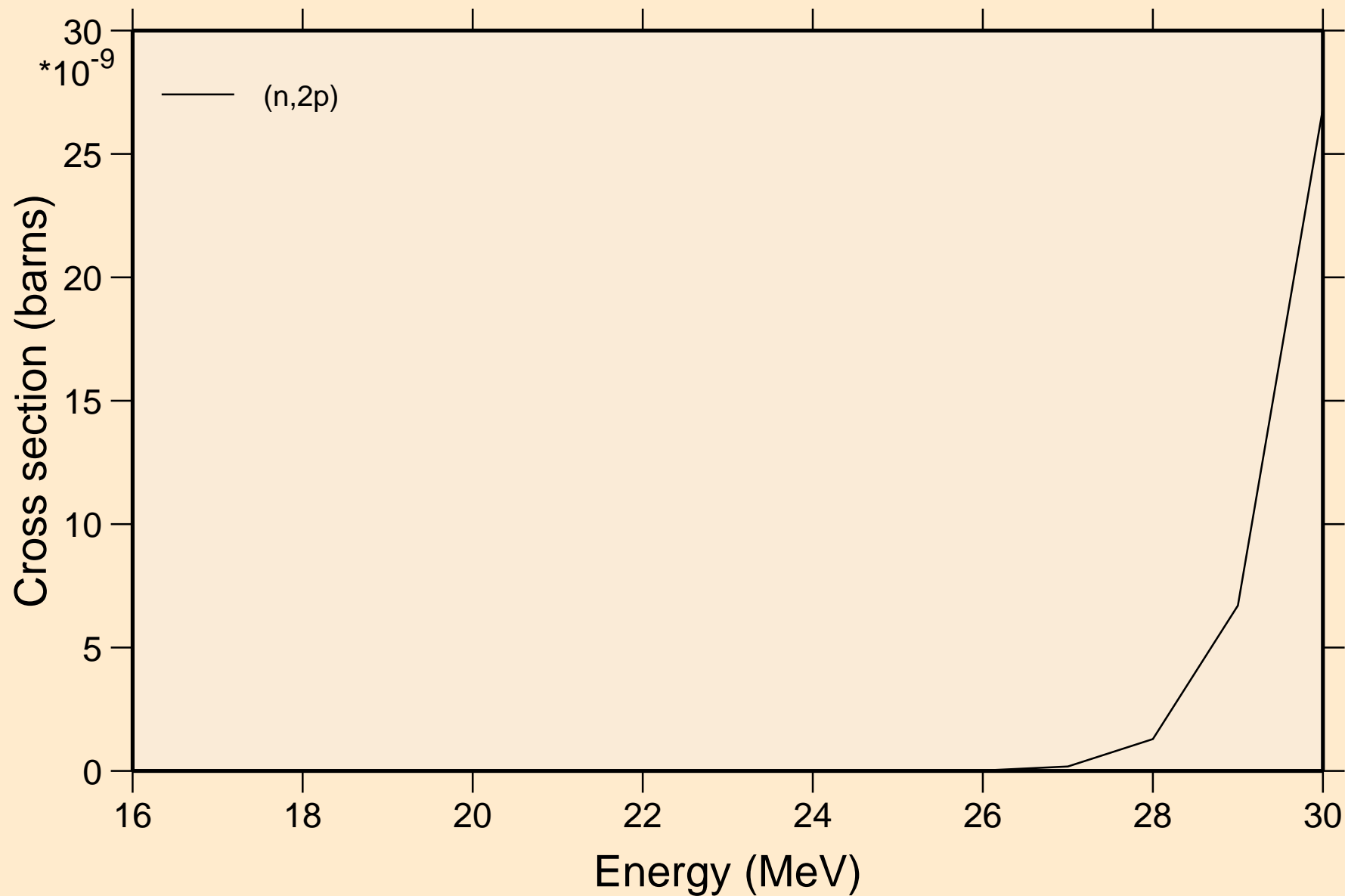

RU109 NEUTRON ACER TENDL-2019 LIBRARY; T=293.16K  
Threshold reactions

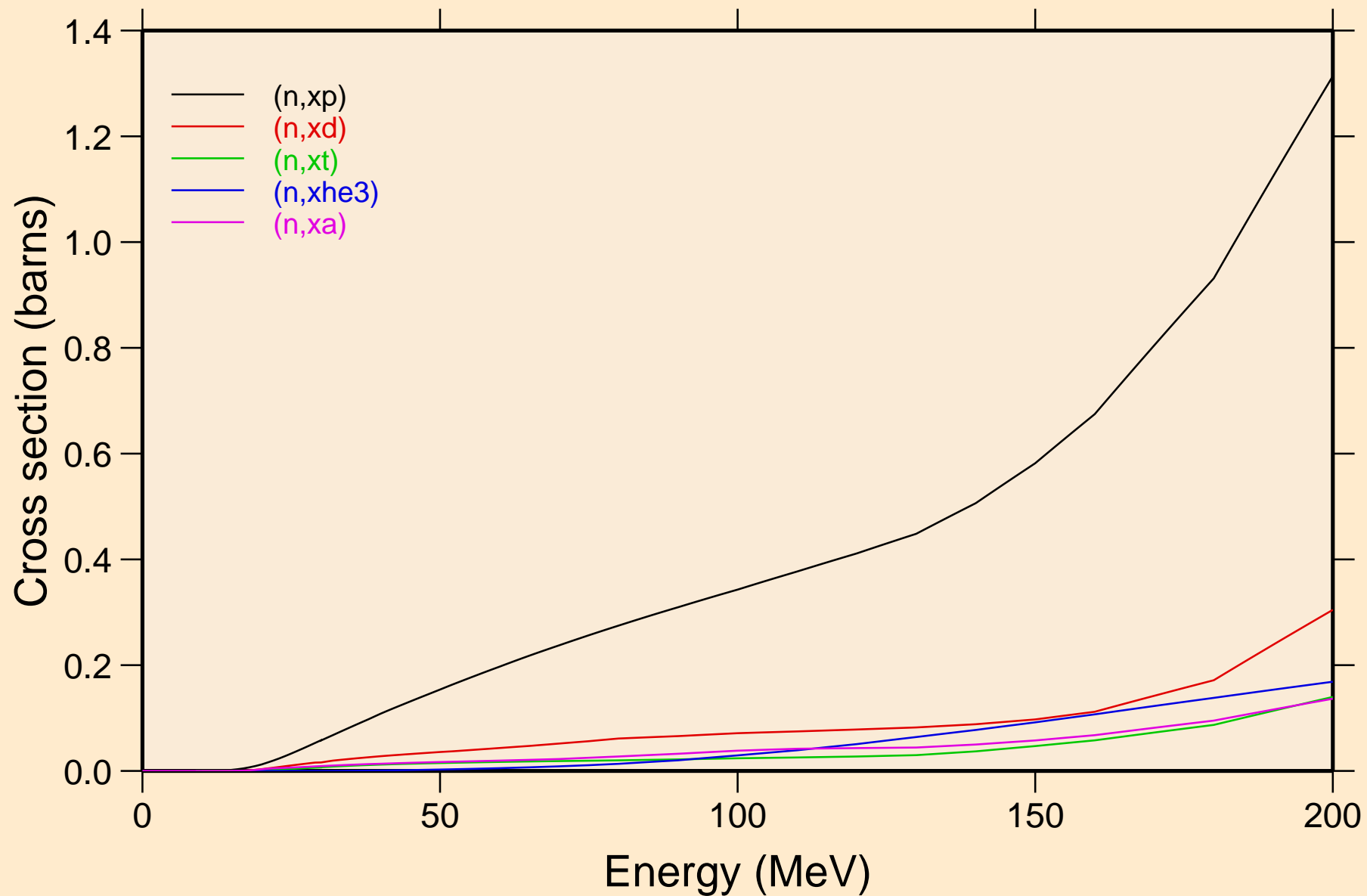

RU109 NEUTRON ACER TENDL-2019 LIBRARY; T=293.16K  
angular distribution for elastic

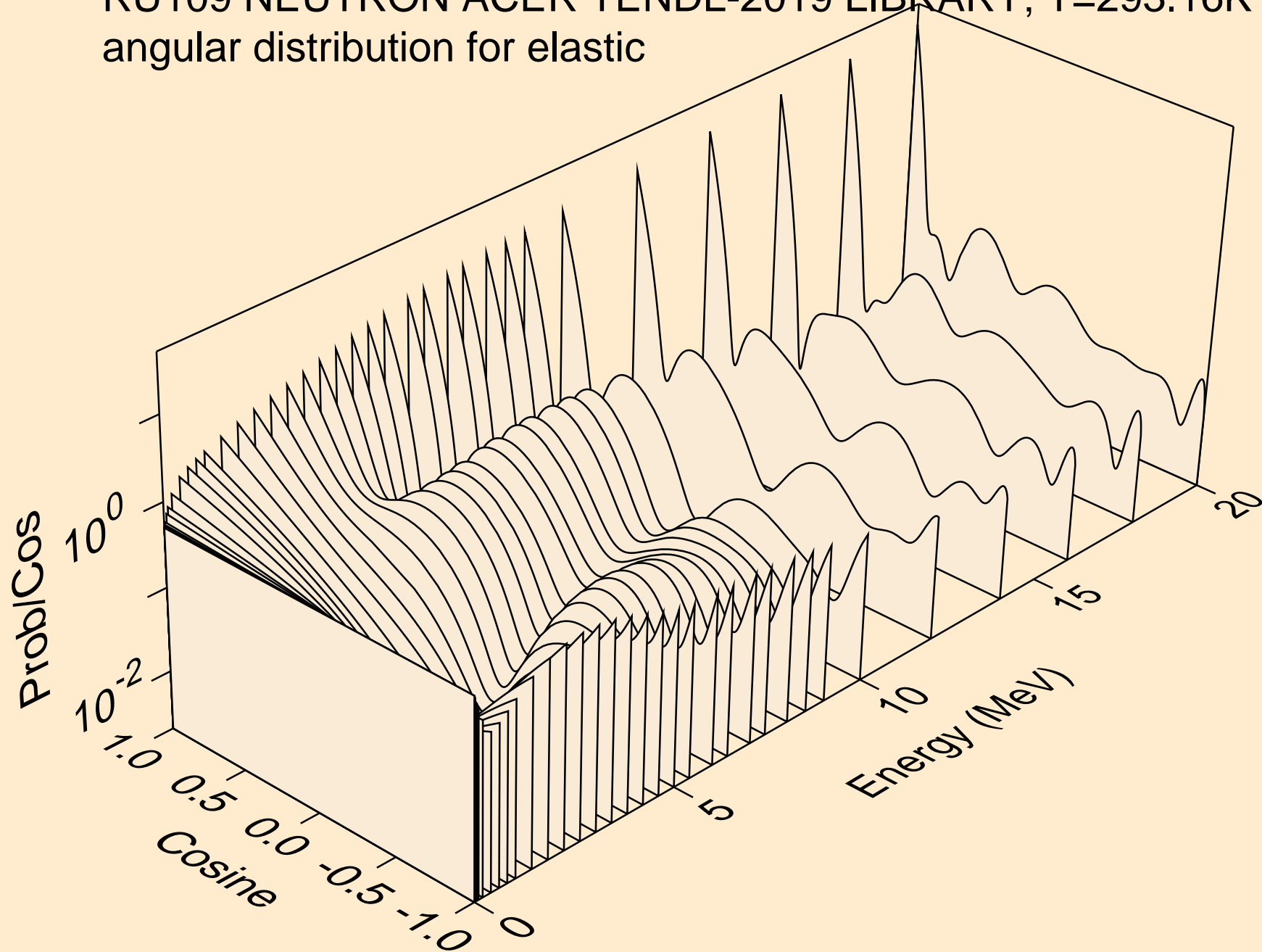

RU109 NEUTRON ACER TENDL-2019 LIBRARY; T=293.16K  
angular distribution for elastic

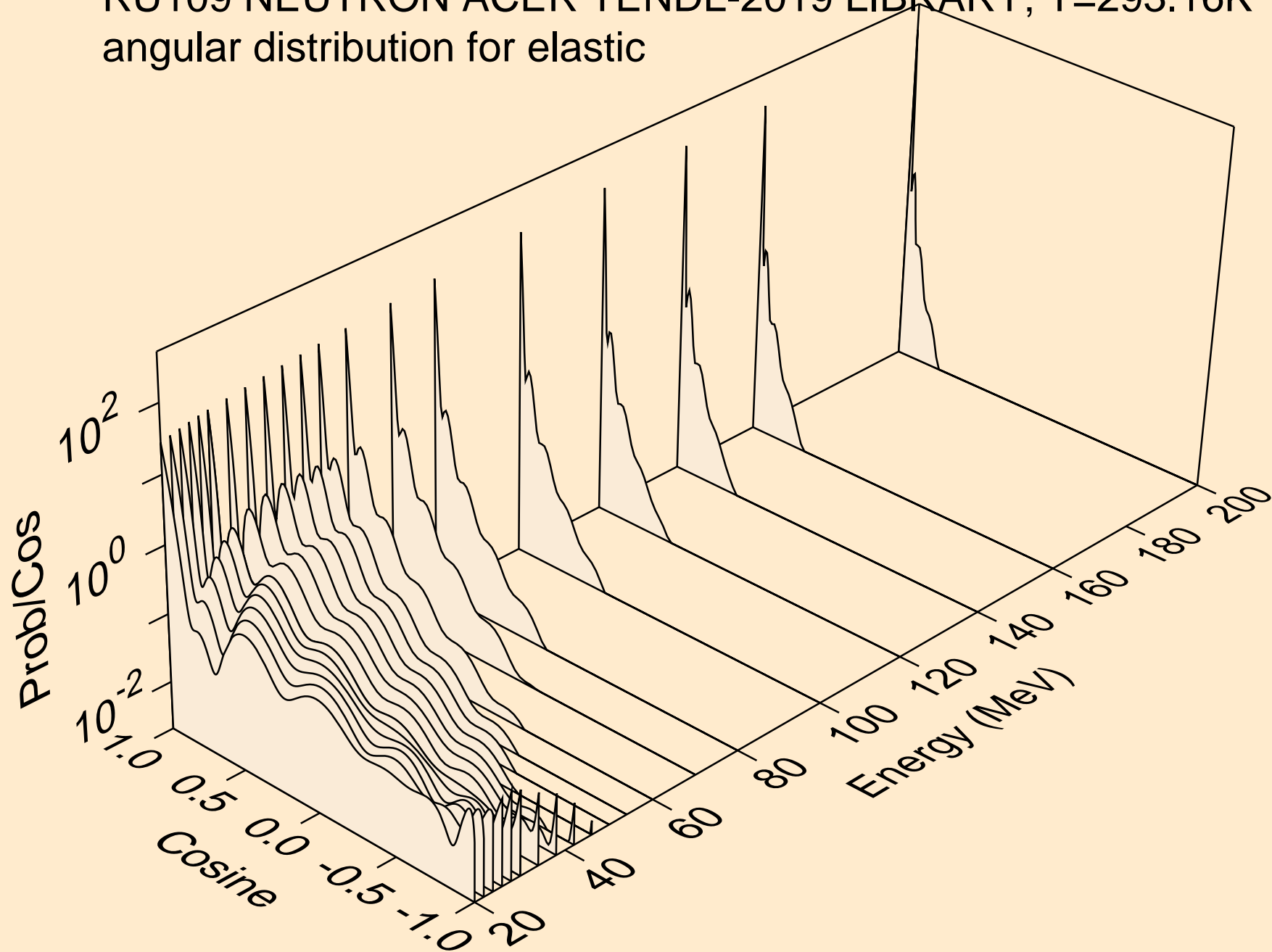

RU109 NEUTRON ACER TENDL-2019 LIBRARY; T=293.16K  
angular distribution for (n,n\*1)

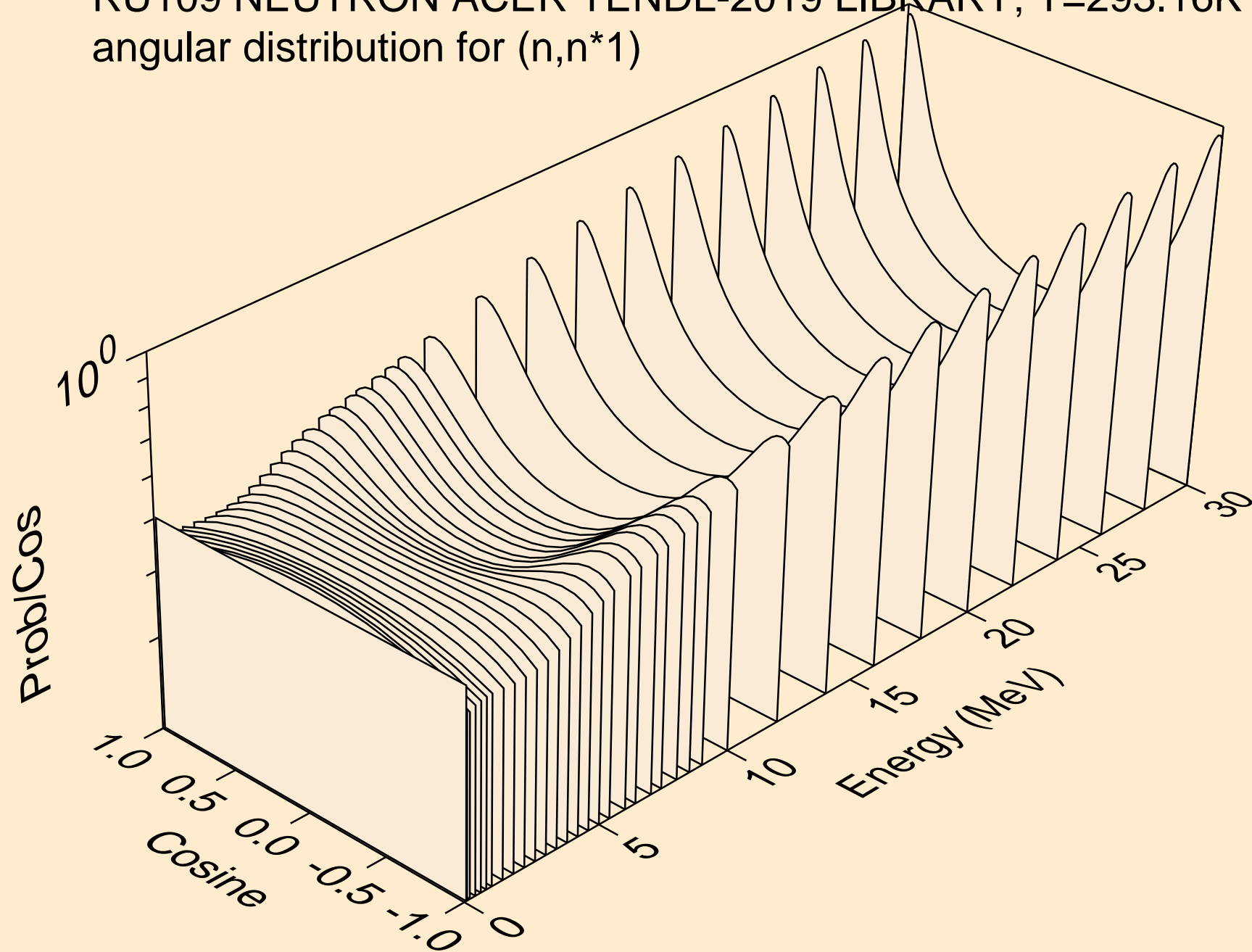

RU109 NEUTRON ACER TENDL-2019 LIBRARY; T=293.16K  
angular distribution for (n,n\*2)

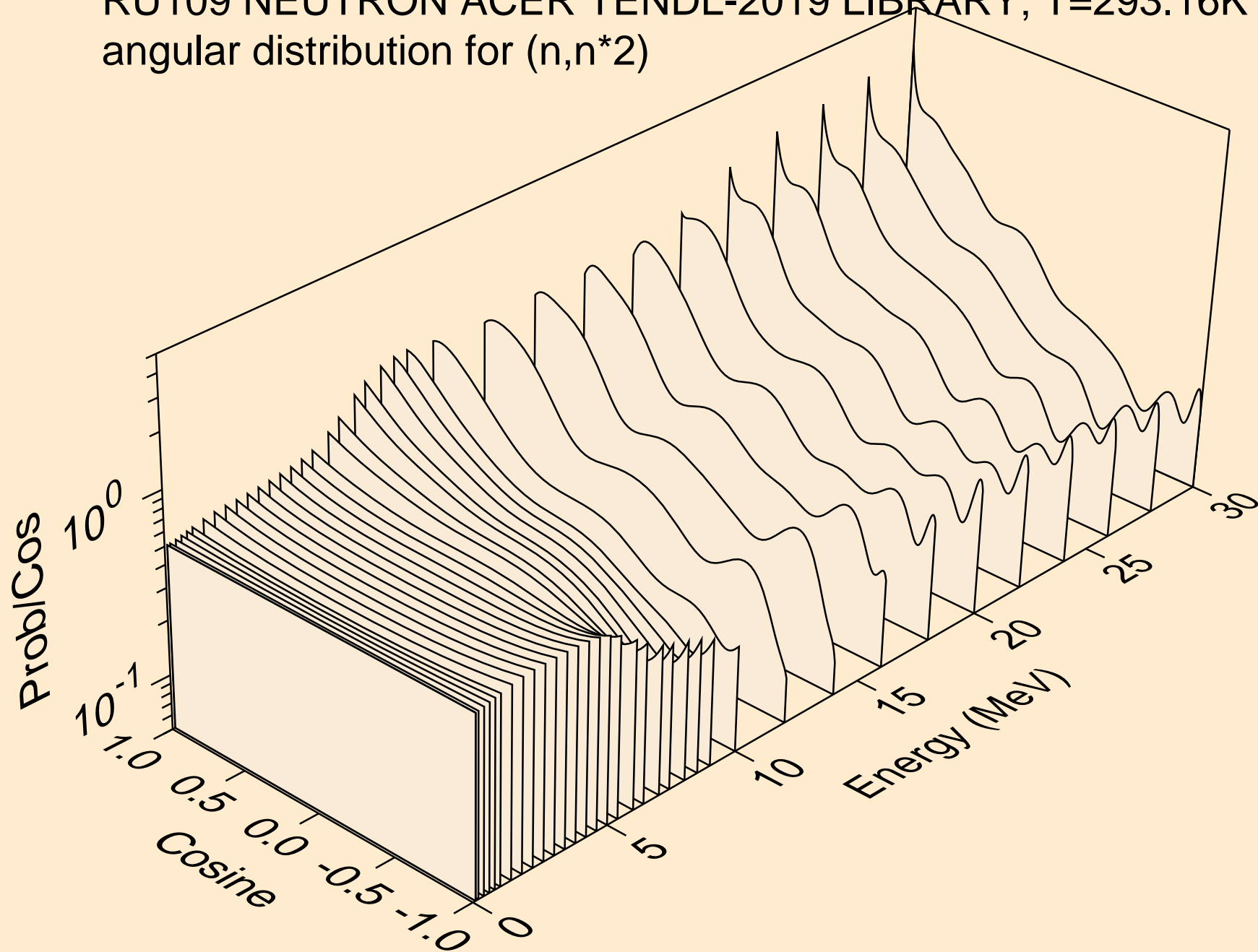

RU109 NEUTRON ACER TENDL-2019 LIBRARY; T=293.16K  
angular distribution for (n,n\*3)

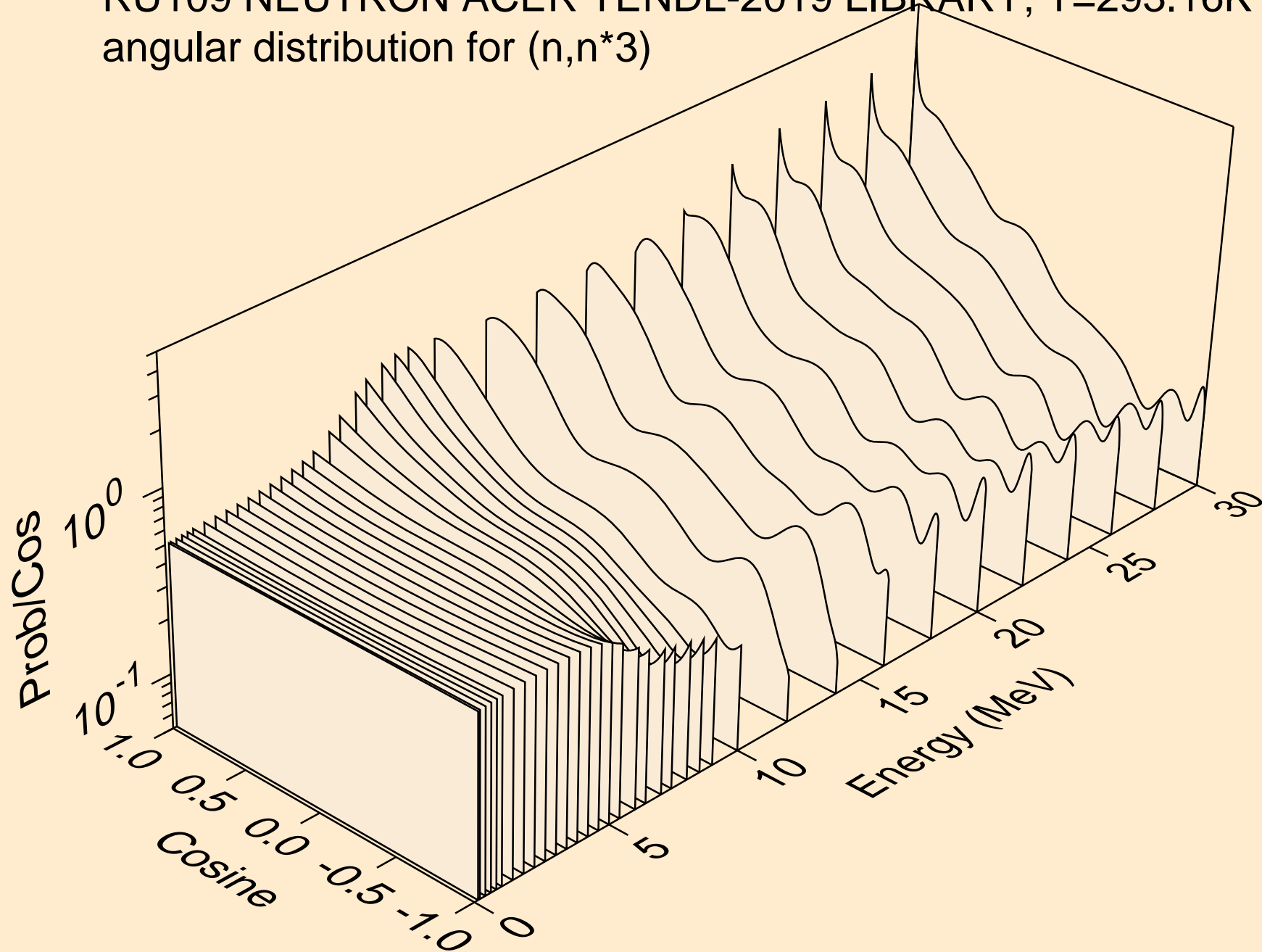

RU109 NEUTRON ACER TENDL-2019 LIBRARY; T=293.16K  
angular distribution for (n,n\*4)

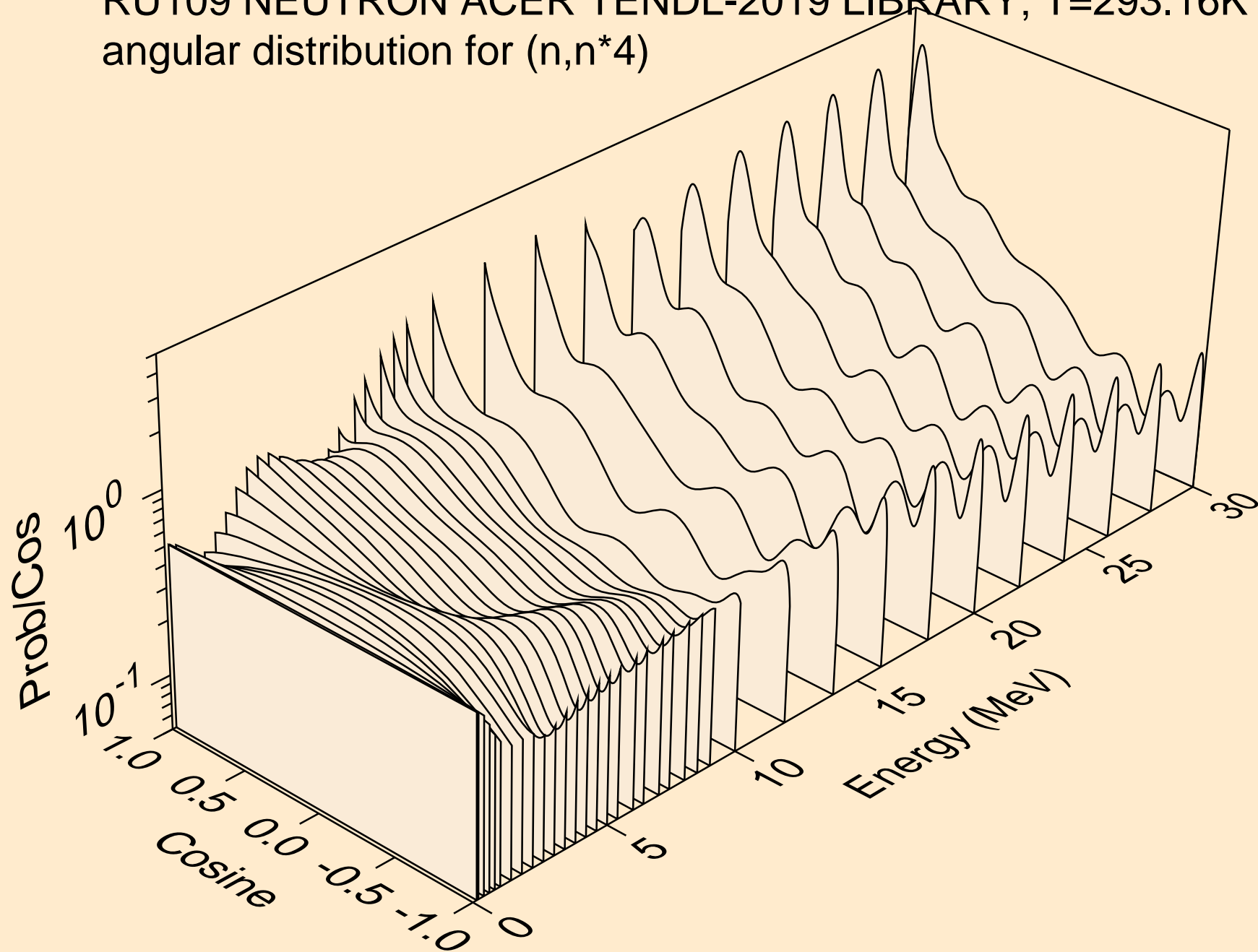



RU109 NEUTRON ACER TENDL-2019 LIBRARY; T=293.16K  
angular distribution for (n,n\*5)

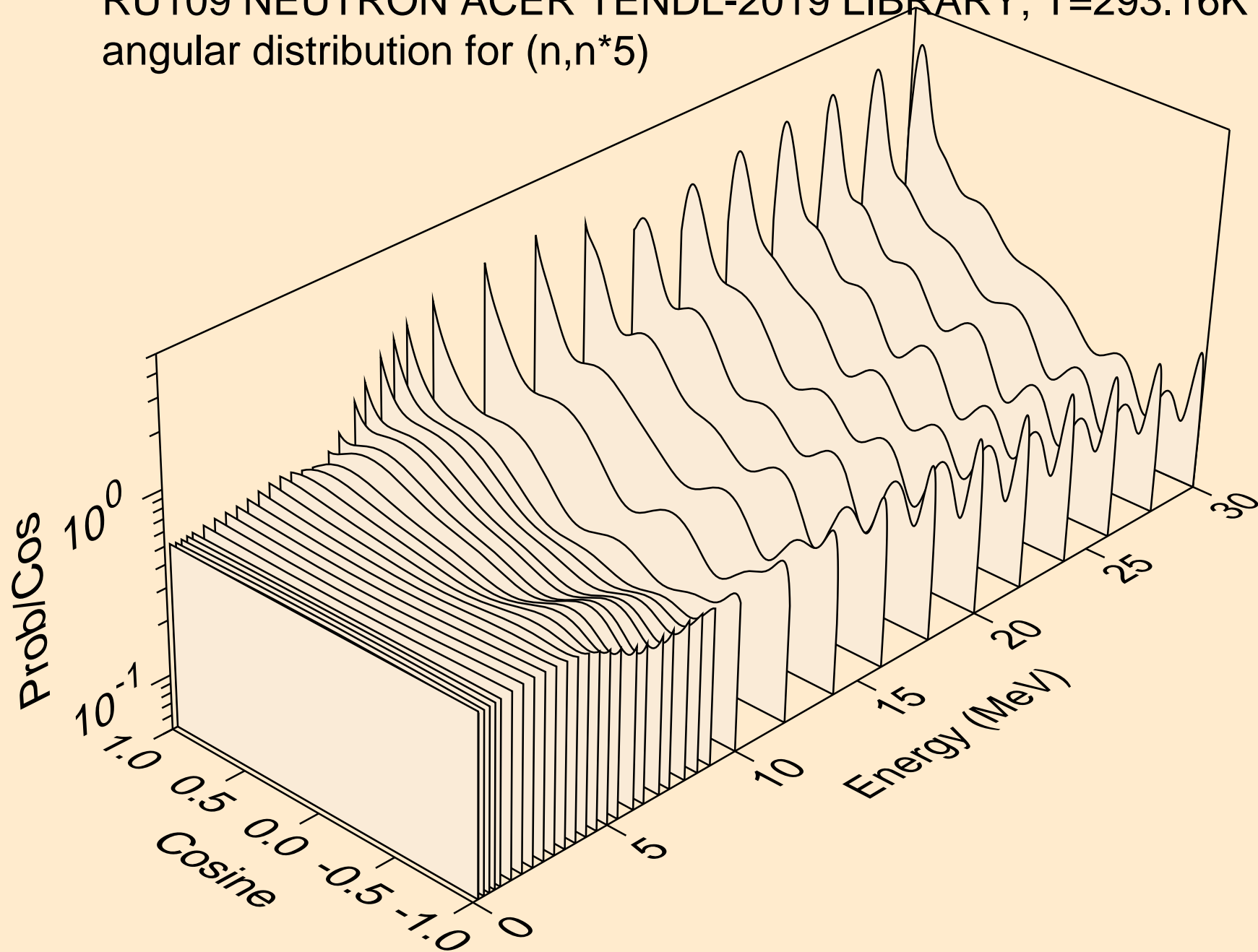

RU109 NEUTRON ACER TENDL-2019 LIBRARY; T=293.16K  
angular distribution for (n,n\*6)

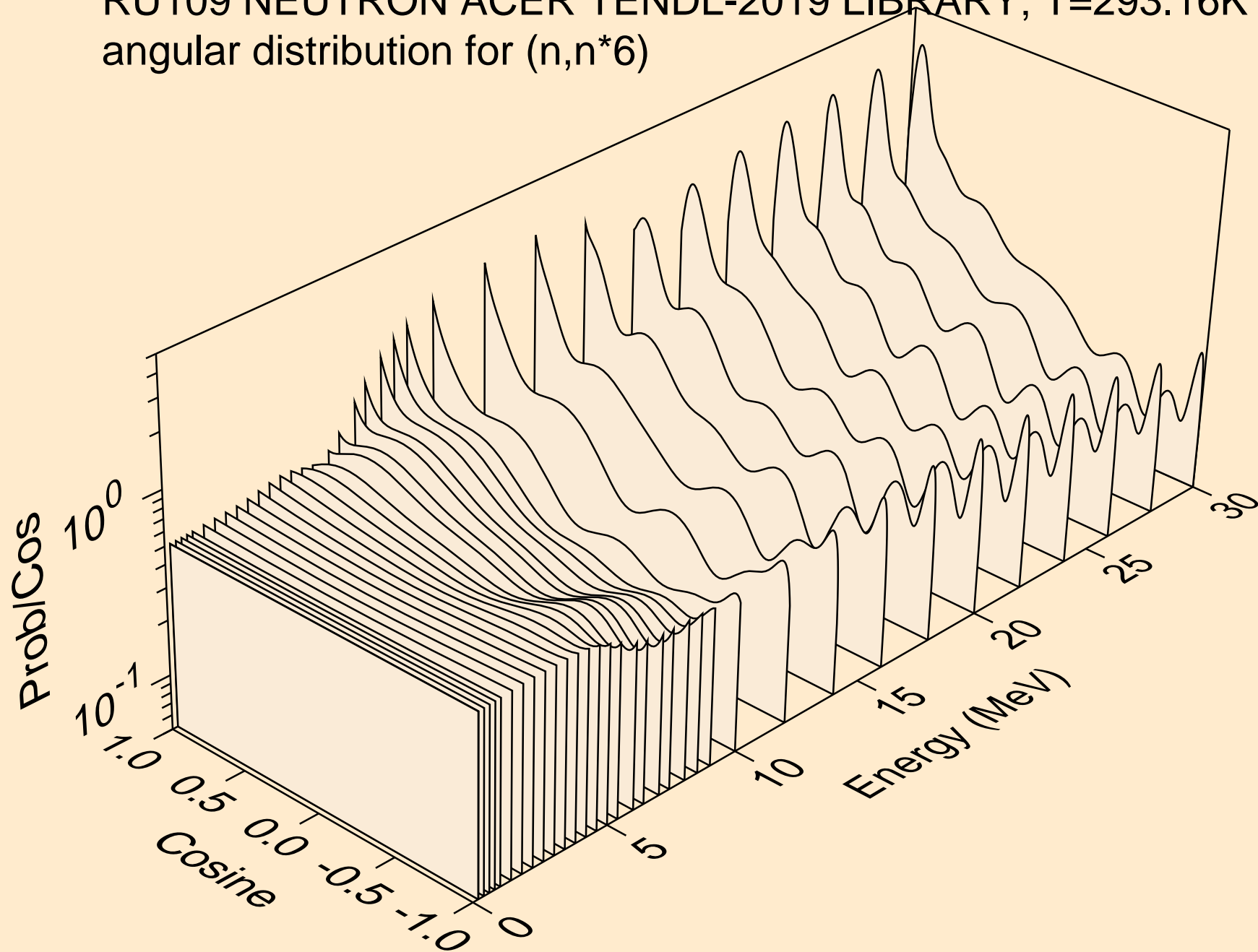

RU109 NEUTRON ACER TENDL-2019 LIBRARY; T=293.16K  
angular distribution for (n,n\*7)

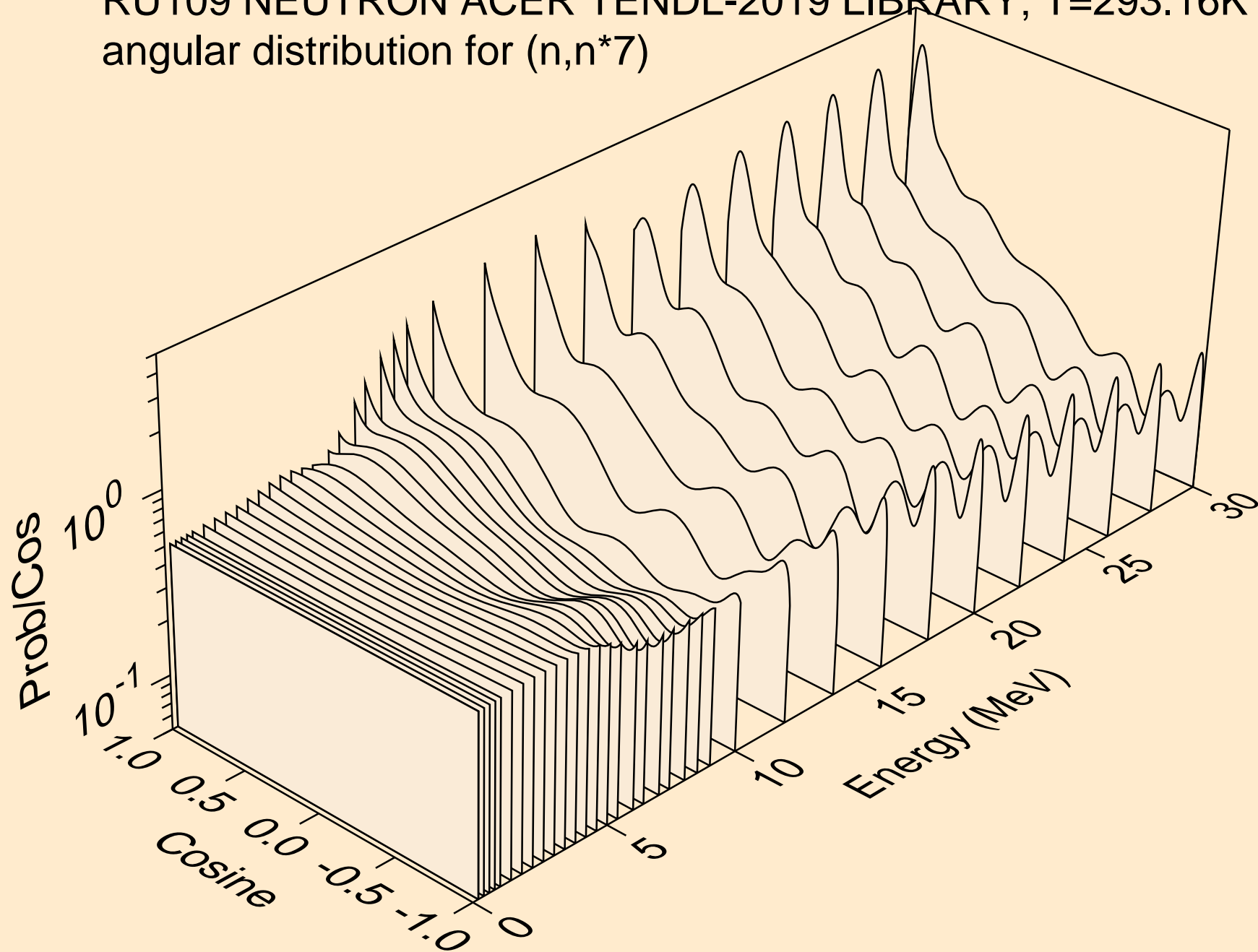

RU109 NEUTRON ACER TENDL-2019 LIBRARY; T=293.16K  
angular distribution for (n,n\*8)

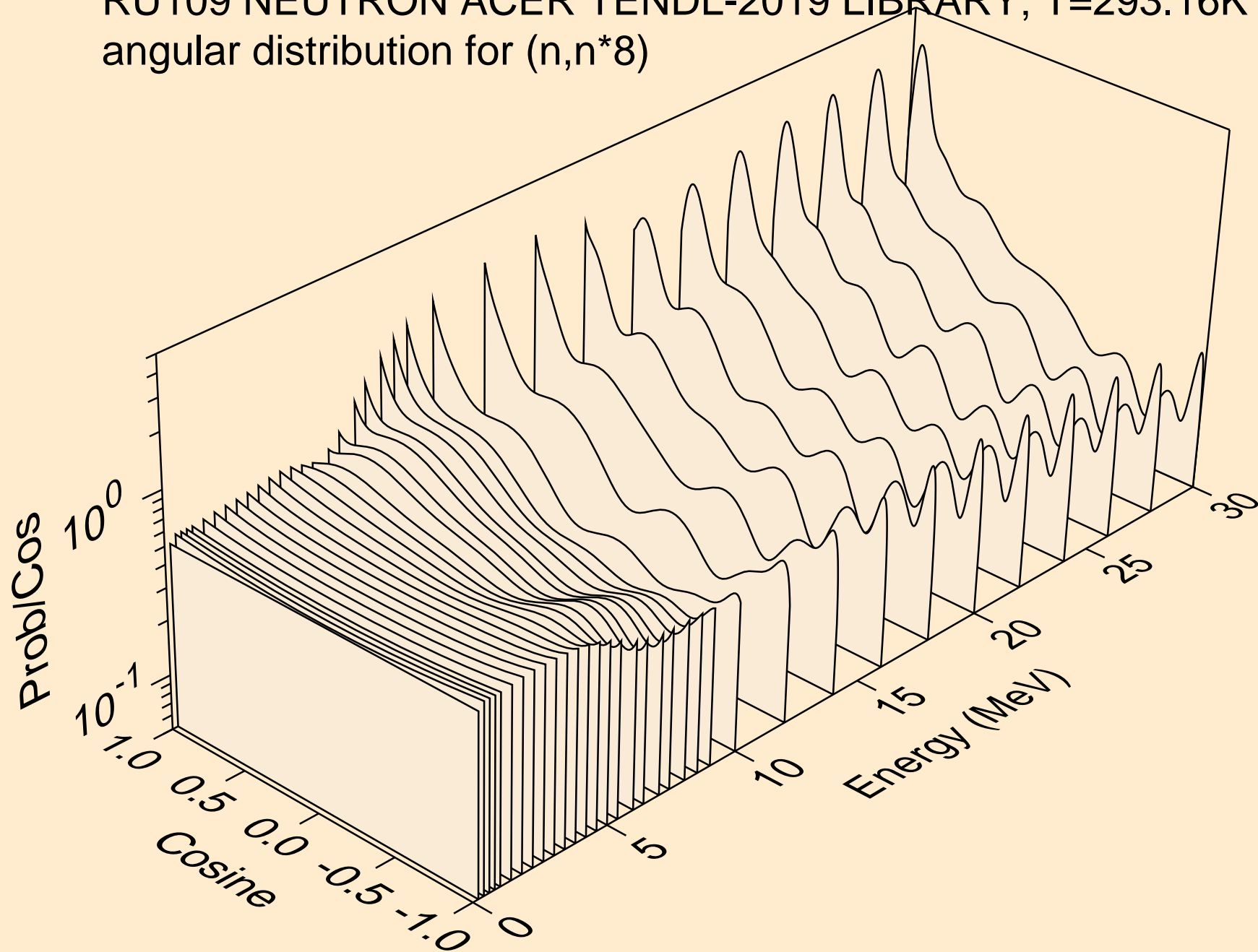

RU109 NEUTRON ACER TENDL-2019 LIBRARY; T=293.16K  
angular distribution for (n,n\*9)

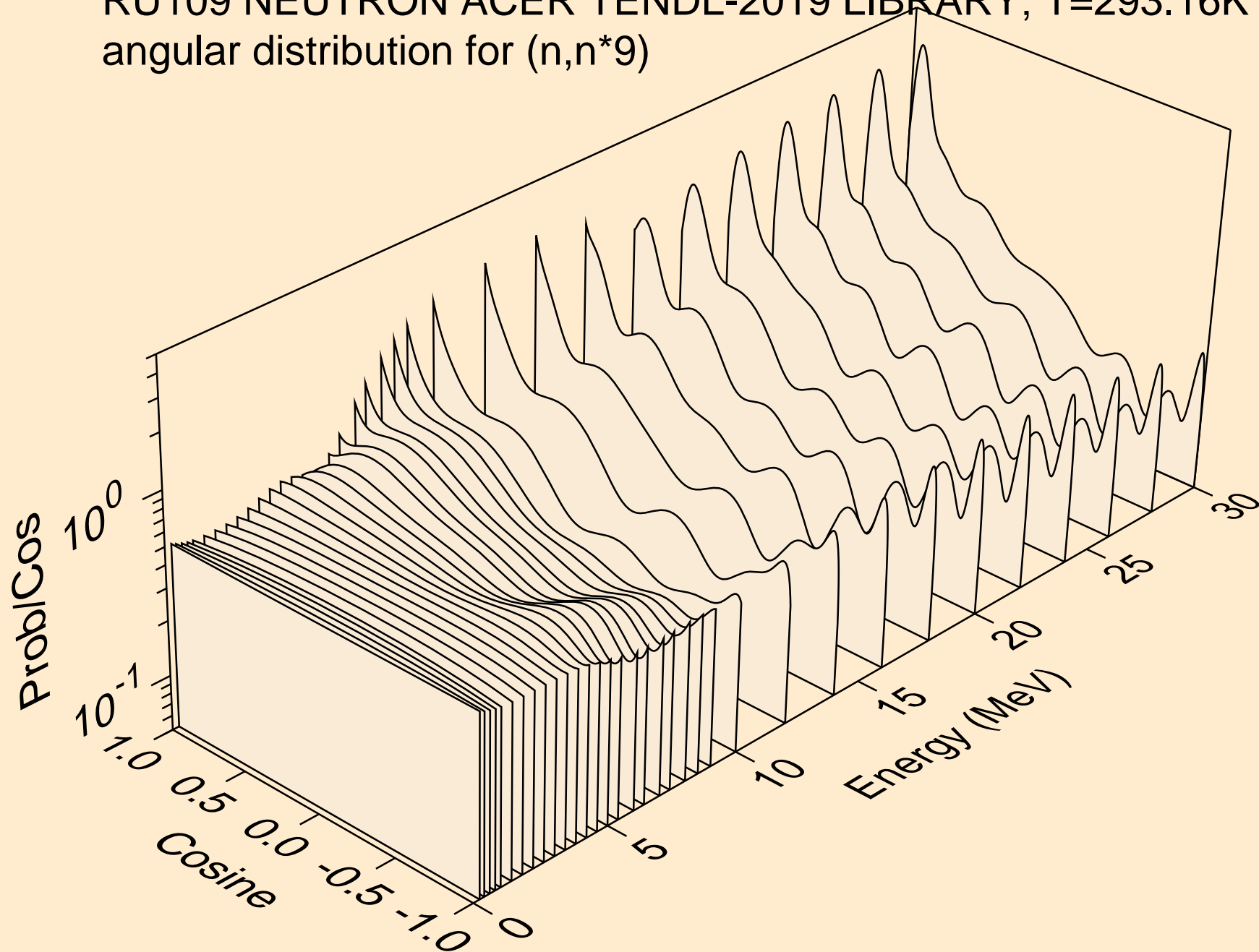

RU109 NEUTRON ACER TENDL-2019 LIBRARY; T=293.16K  
angular distribution for (n,n\*10)

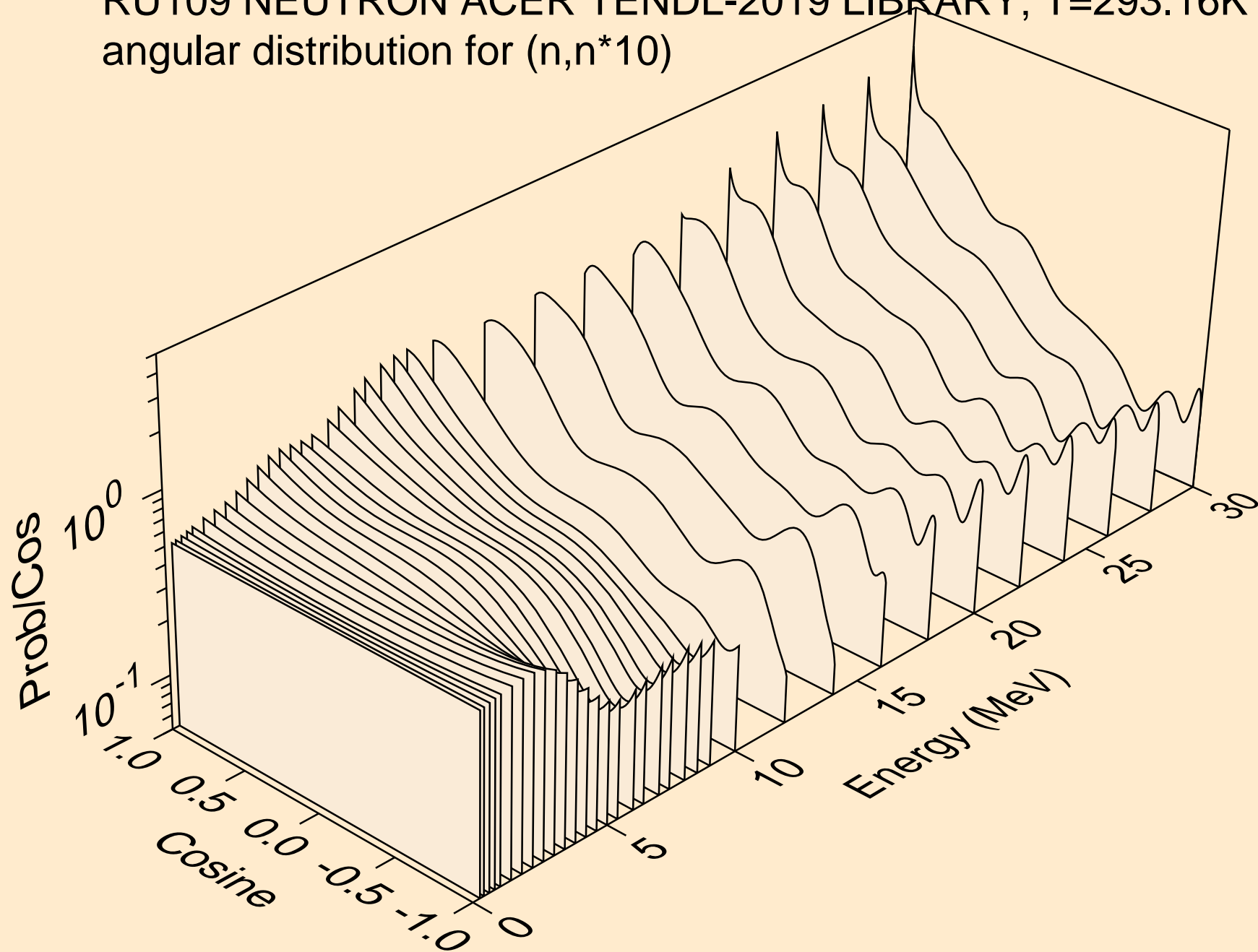

RU109 NEUTRON ACER TENDL-2019 LIBRARY; T=293.16K  
angular distribution for (n,n\*11)

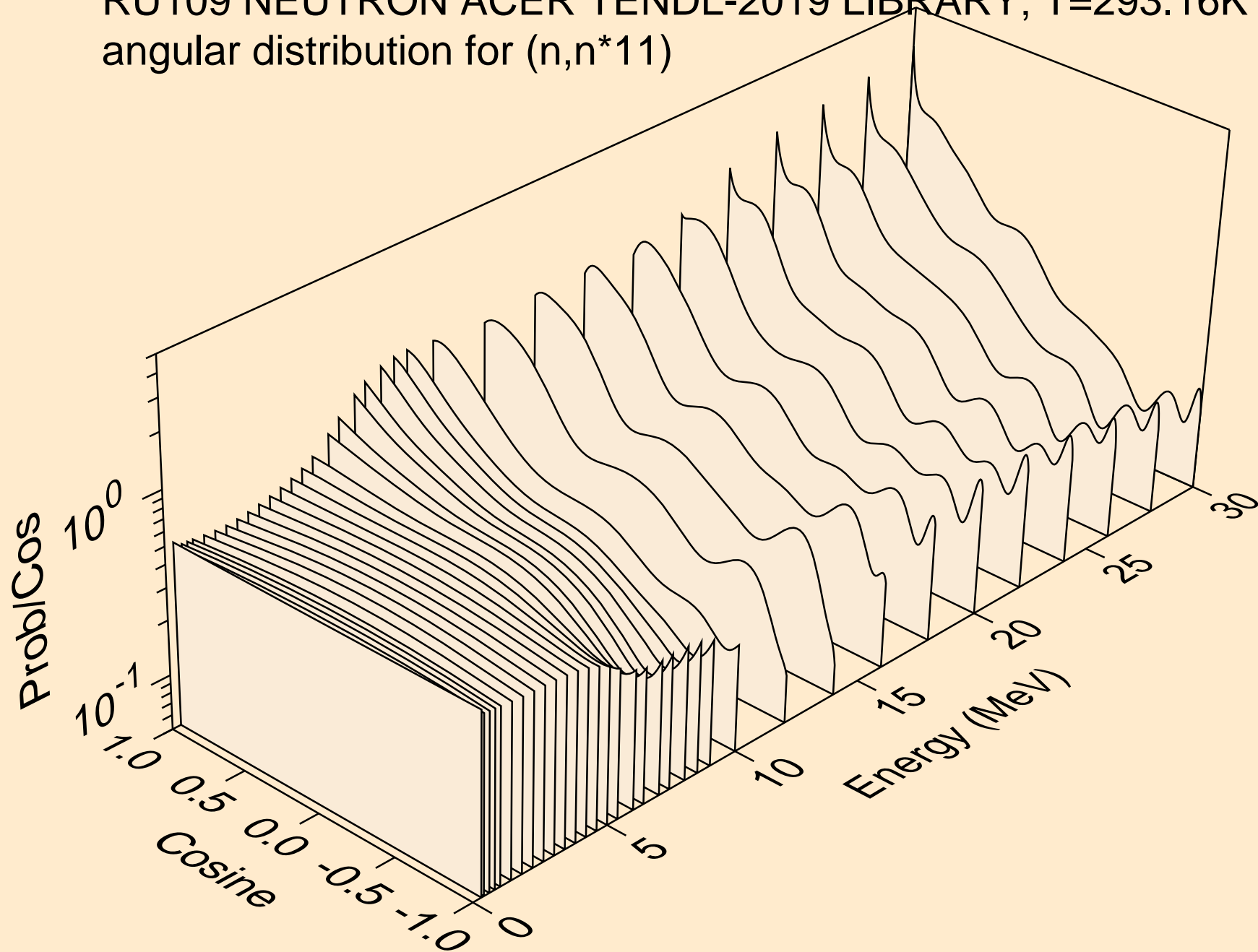

RU109 NEUTRON ACER TENDL-2019 LIBRARY; T=293.16K  
angular distribution for (n,n\*12)

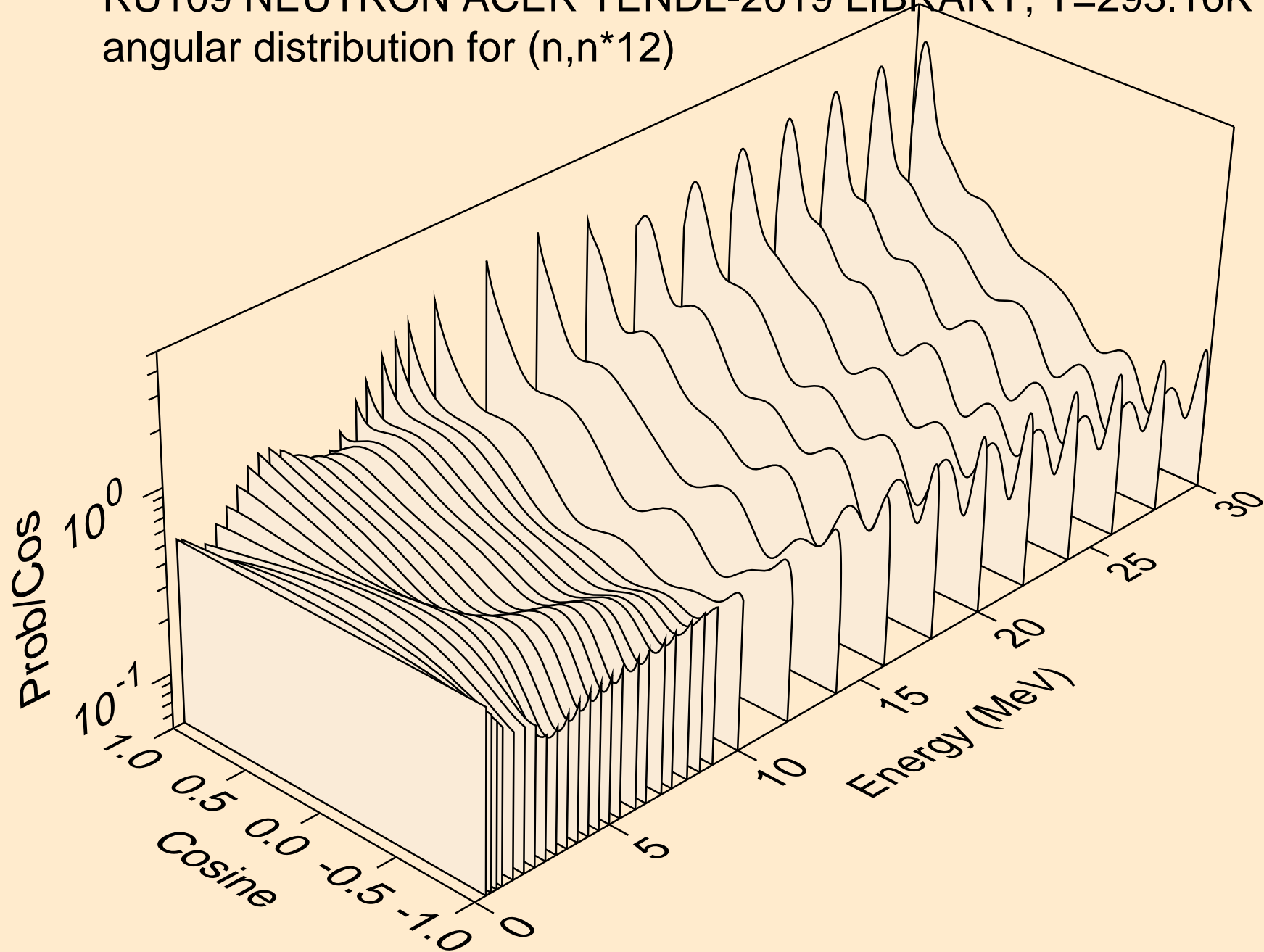



RU109 NEUTRON ACER TENDL-2019 LIBRARY; T=293.16K  
angular distribution for (n,n\*13)

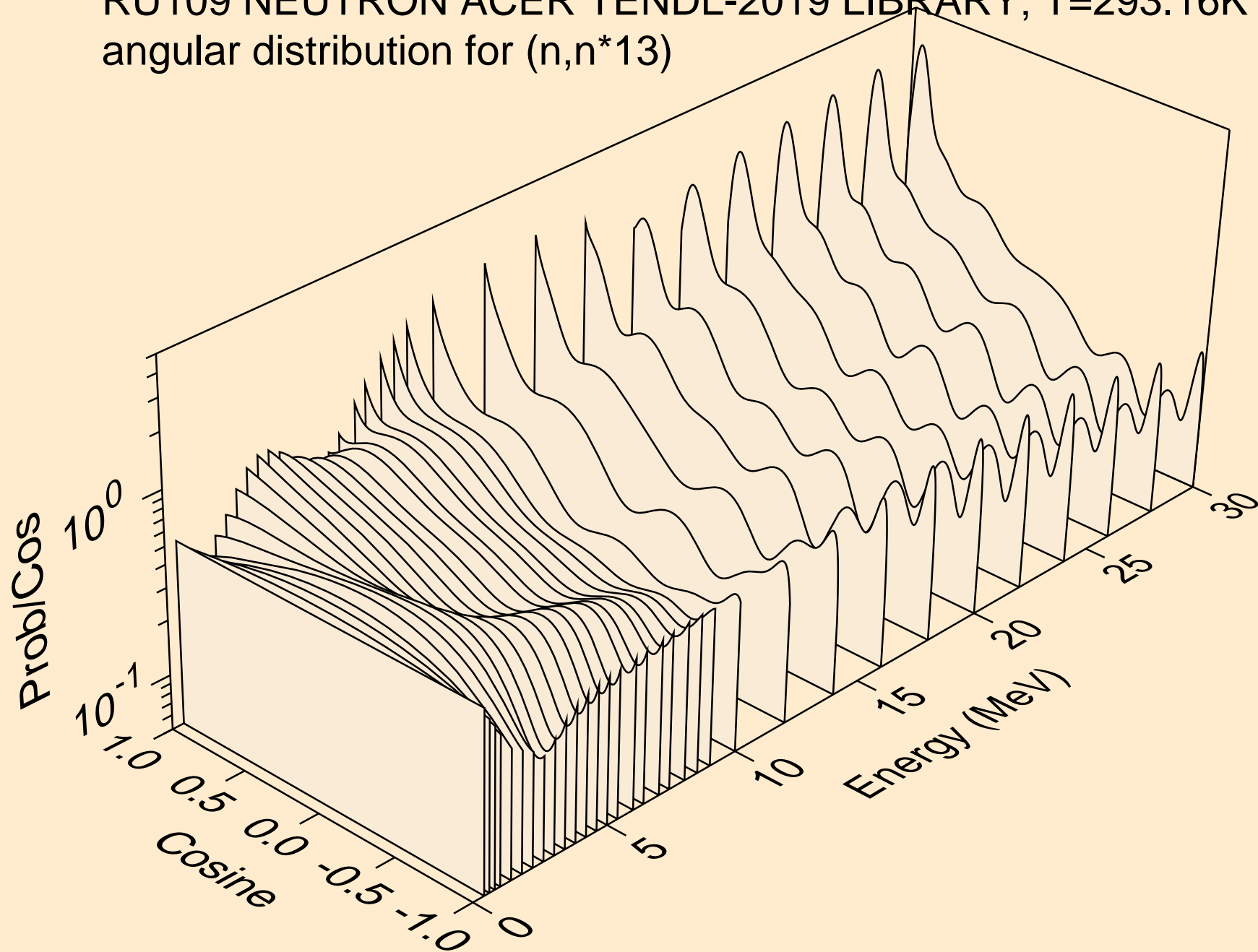

RU109 NEUTRON ACER TENDL-2019 LIBRARY; T=293.16K  
angular distribution for (n,n\*14)

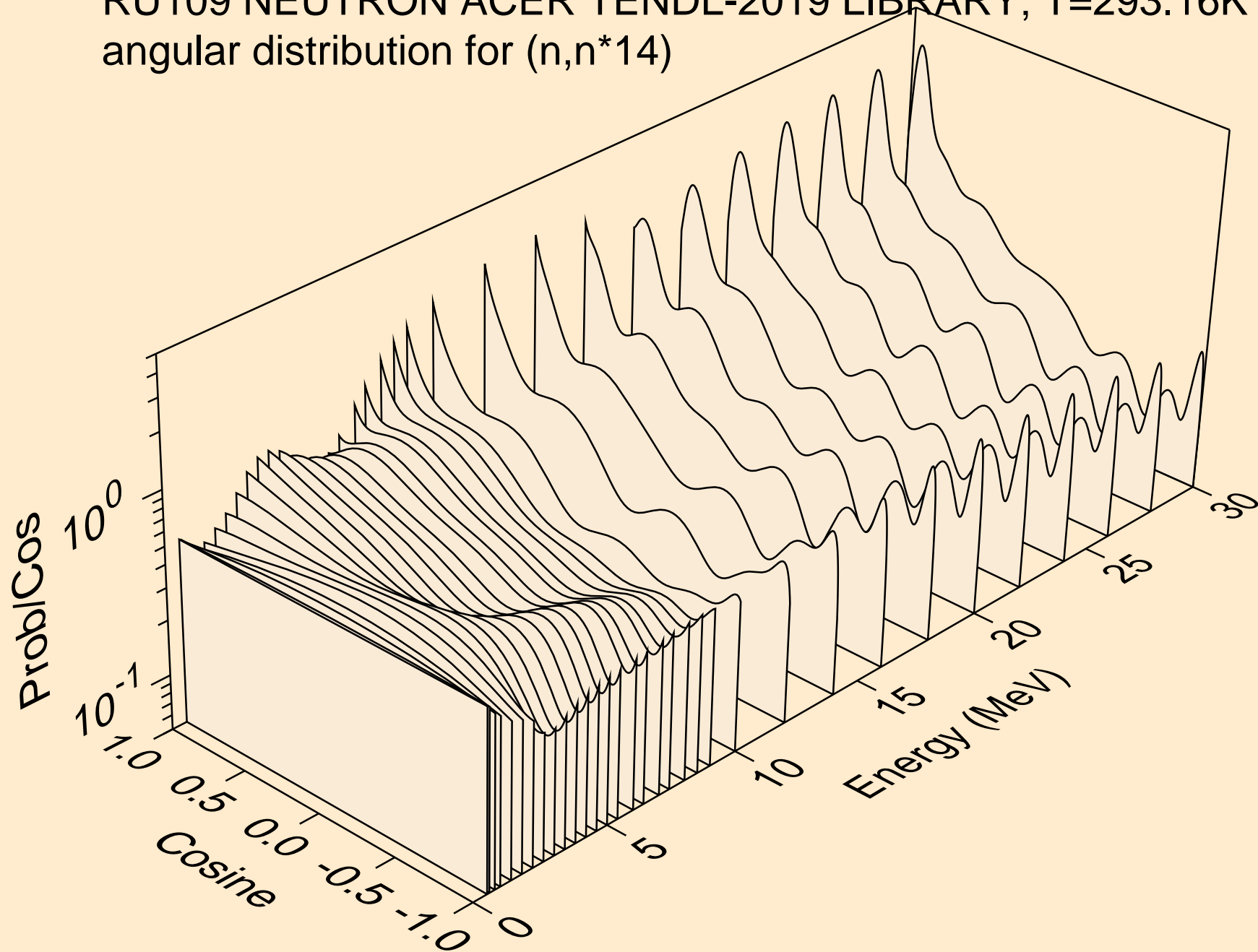

RU109 NEUTRON ACER TENDL-2019 LIBRARY; T=293.16K  
angular distribution for (n,n\*15)

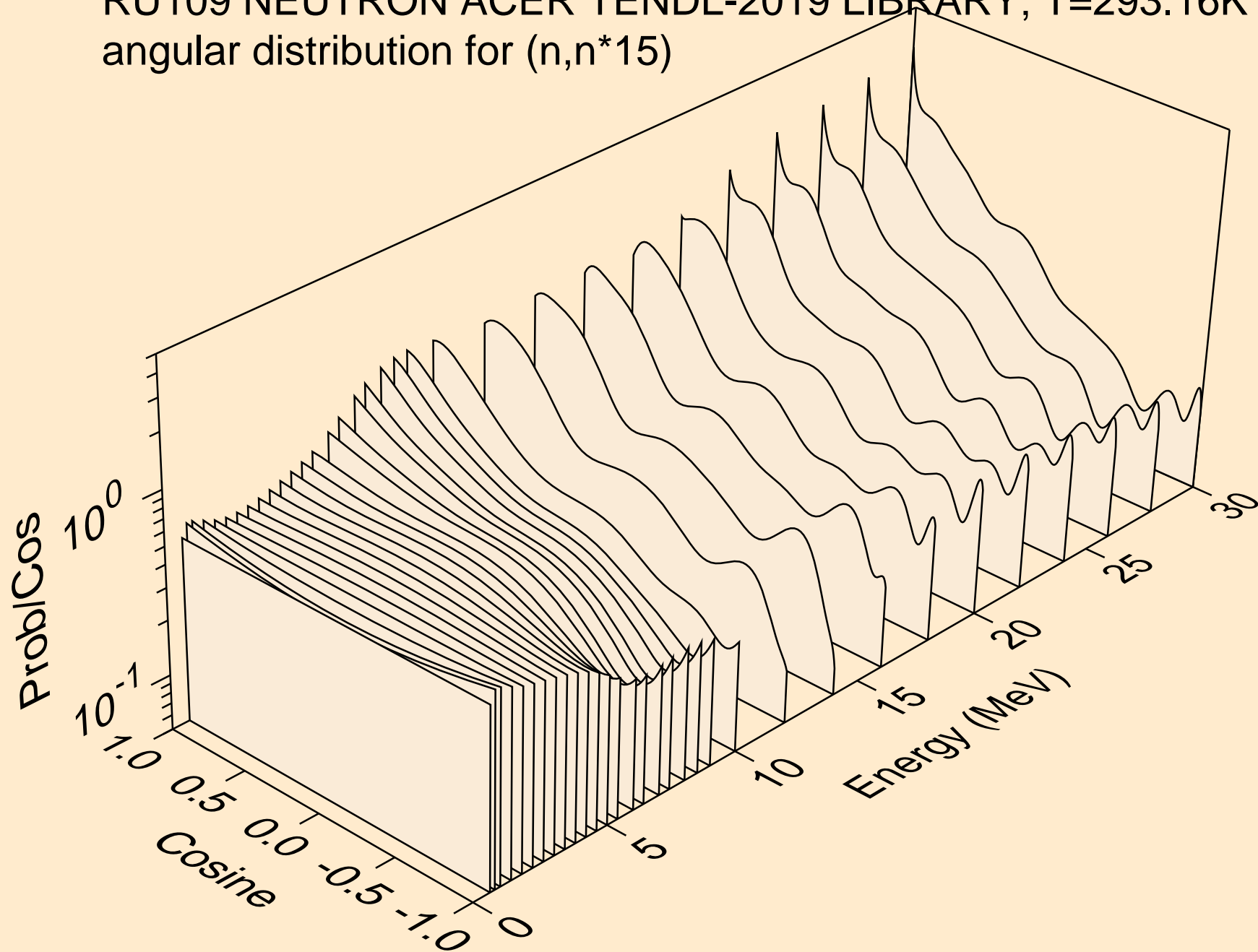

RU109 NEUTRON ACER TENDL-2019 LIBRARY; T=293.16K  
angular distribution for (n,n\*16)

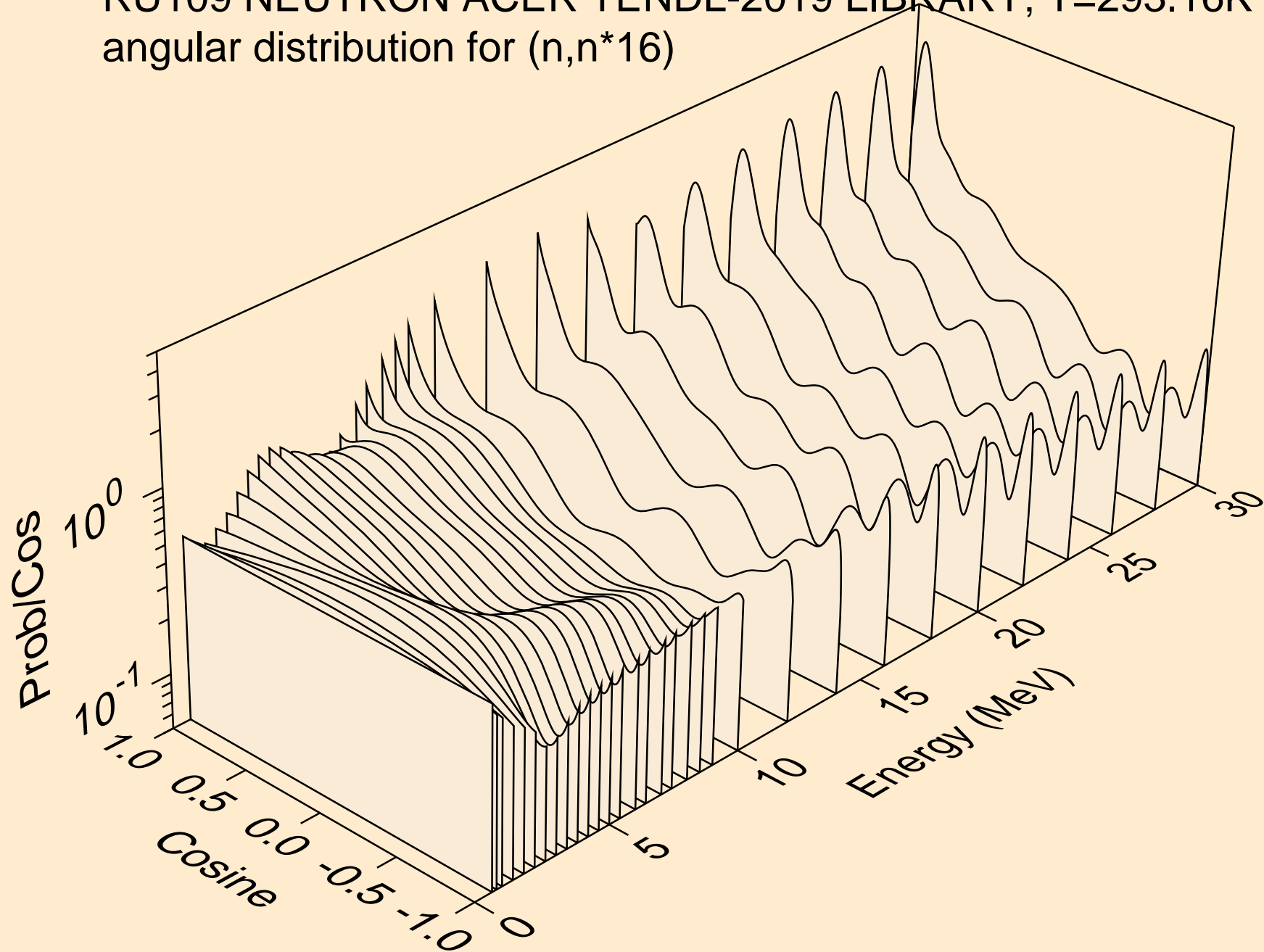

RU109 NEUTRON ACER TENDL-2019 LIBRARY; T=293.16K  
angular distribution for (n,n\*17)

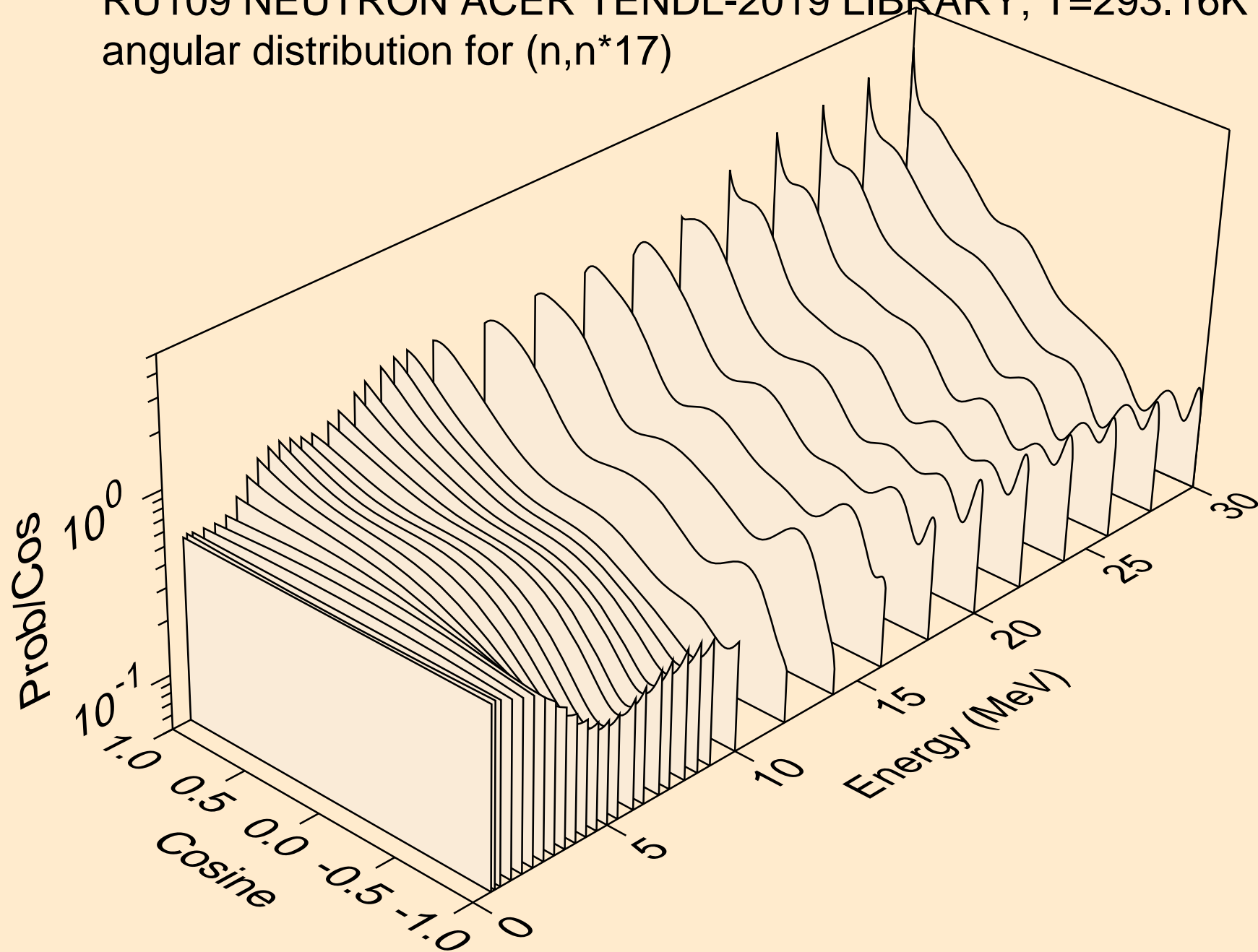

RU109 NEUTRON ACER TENDL-2019 LIBRARY; T=293.16K  
angular distribution for (n,n\*18)

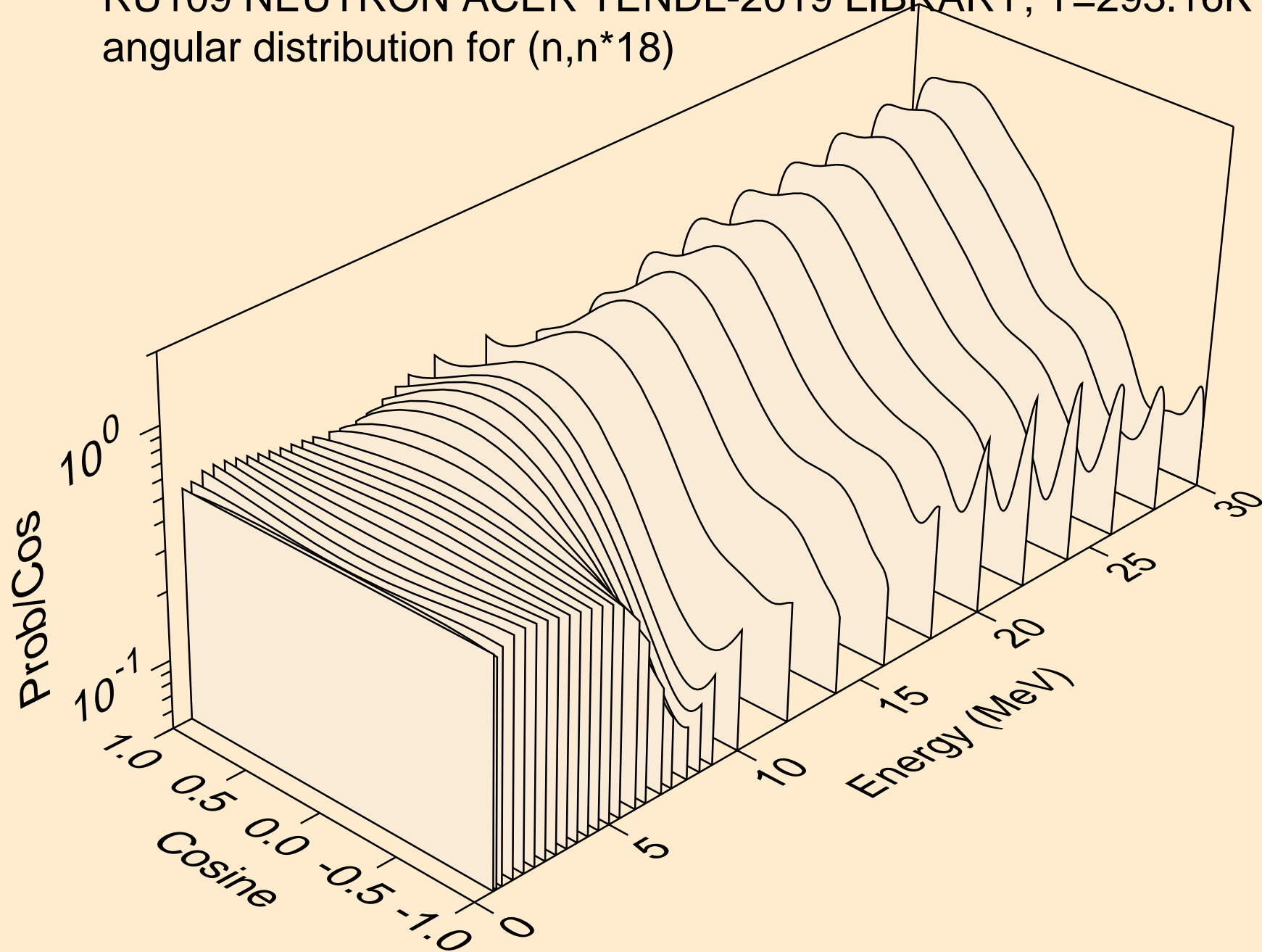

RU109 NEUTRON ACER TENDL-2019 LIBRARY; T=293.16K  
angular distribution for (n,n\*19)

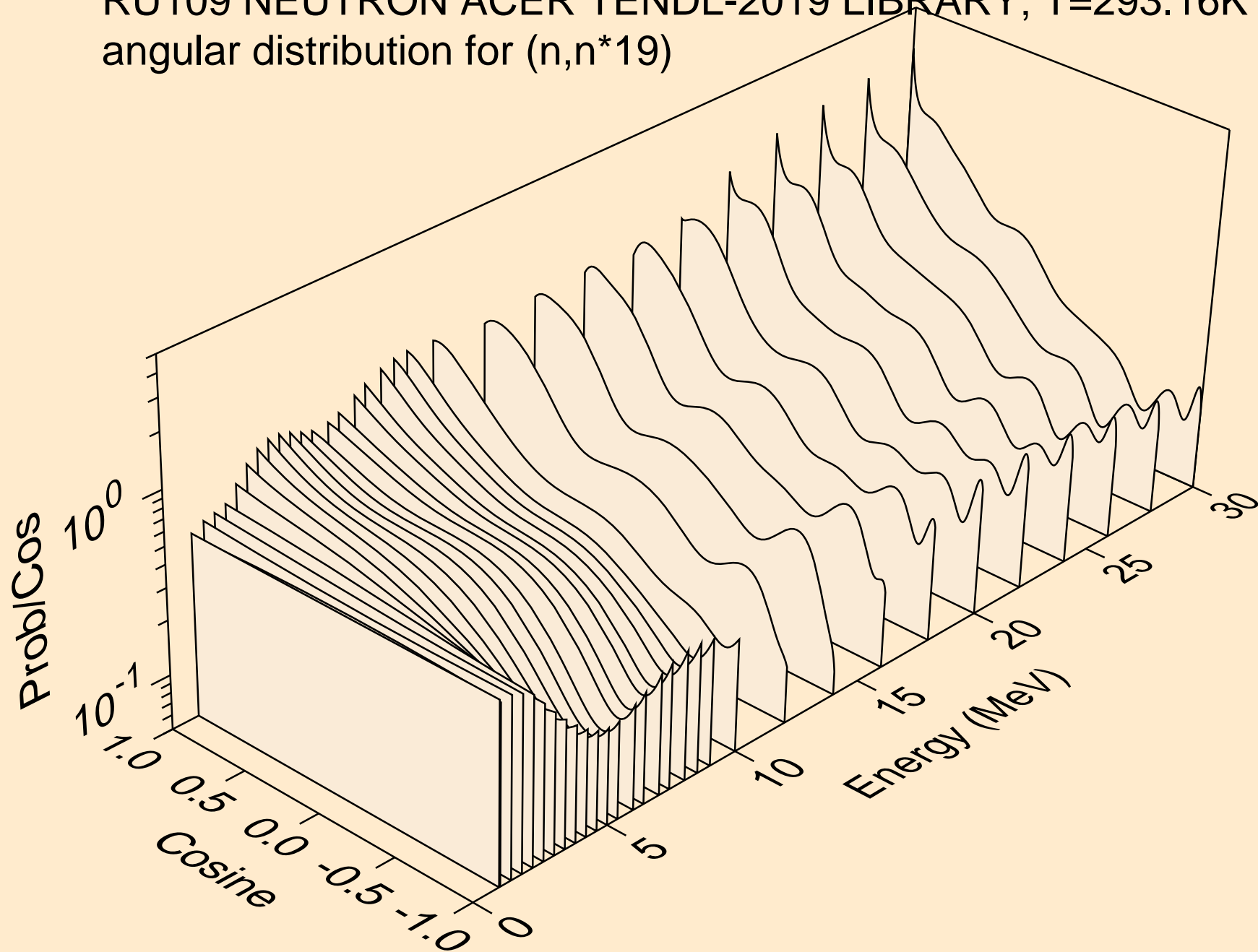

RU109 NEUTRON ACER TENDL-2019 LIBRARY; T=293.16K  
angular distribution for (n,n\*20)

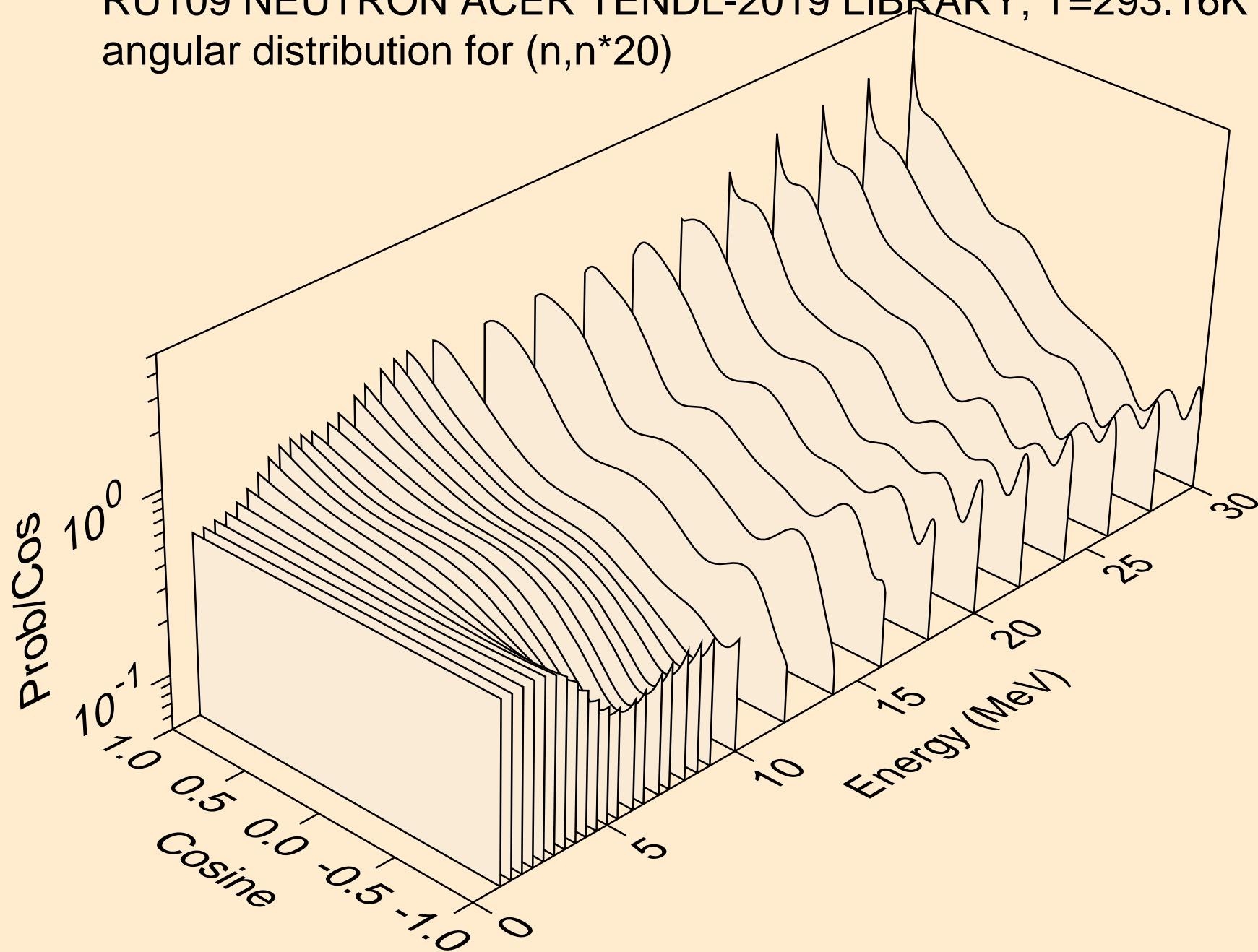



RU109 NEUTRON ACER TENDL-2019 LIBRARY; T=293.16K  
angular distribution for (n,n\*21)

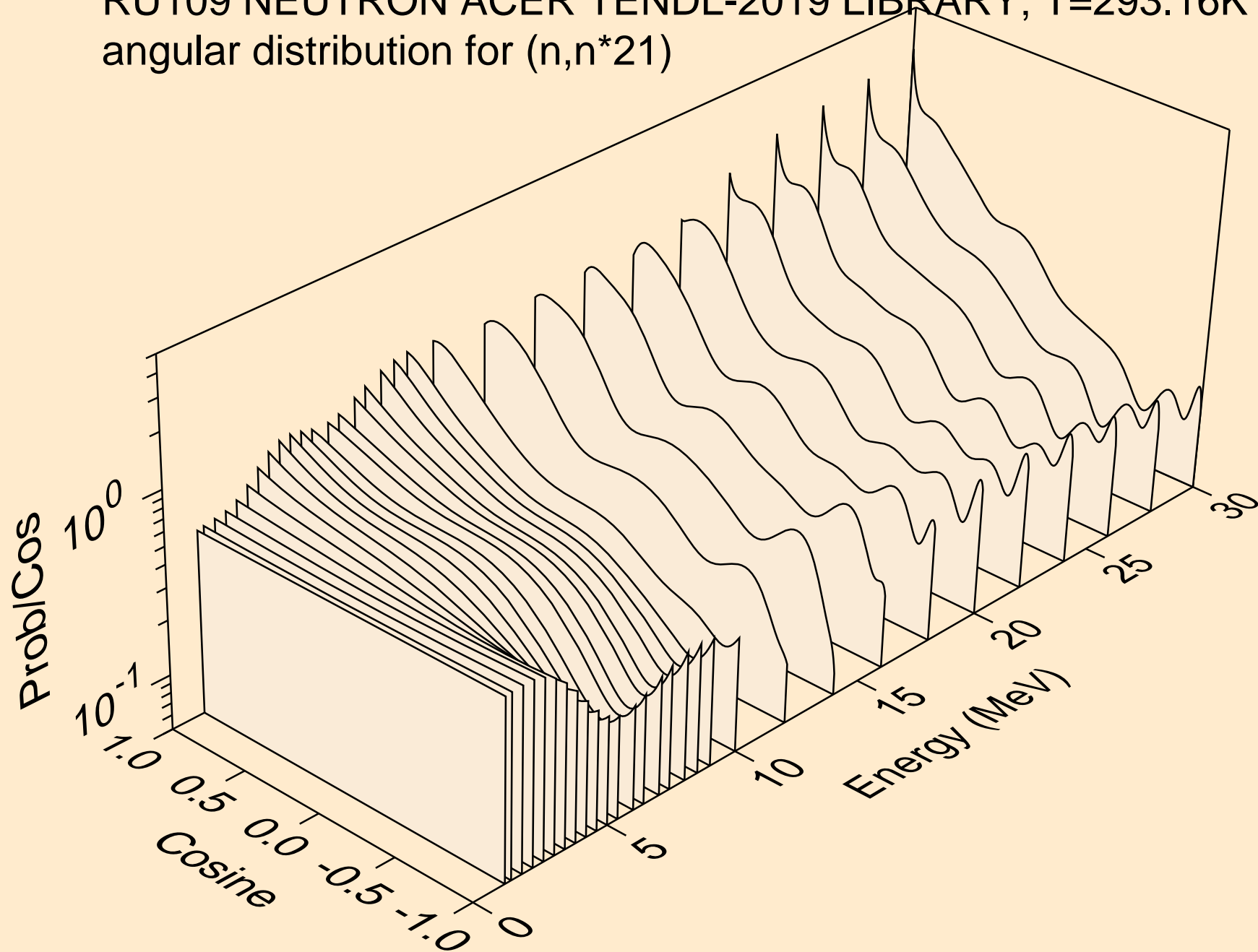

RU109 NEUTRON ACER TENDL-2019 LIBRARY; T=293.16K  
angular distribution for (n,n\*22)

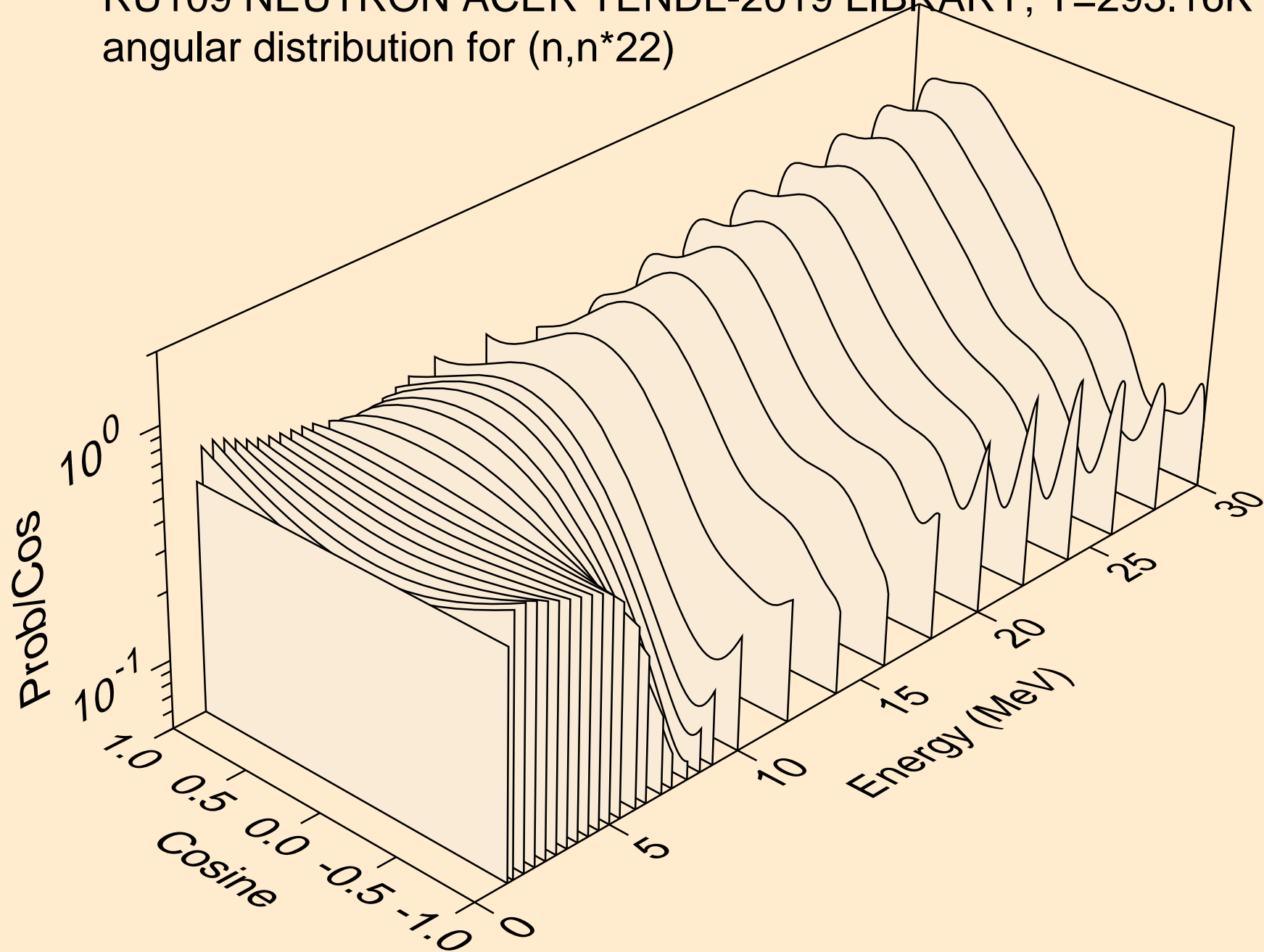

RU109 NEUTRON ACER TENDL-2019 LIBRARY; T=293.16K  
angular distribution for (n,n\*23)

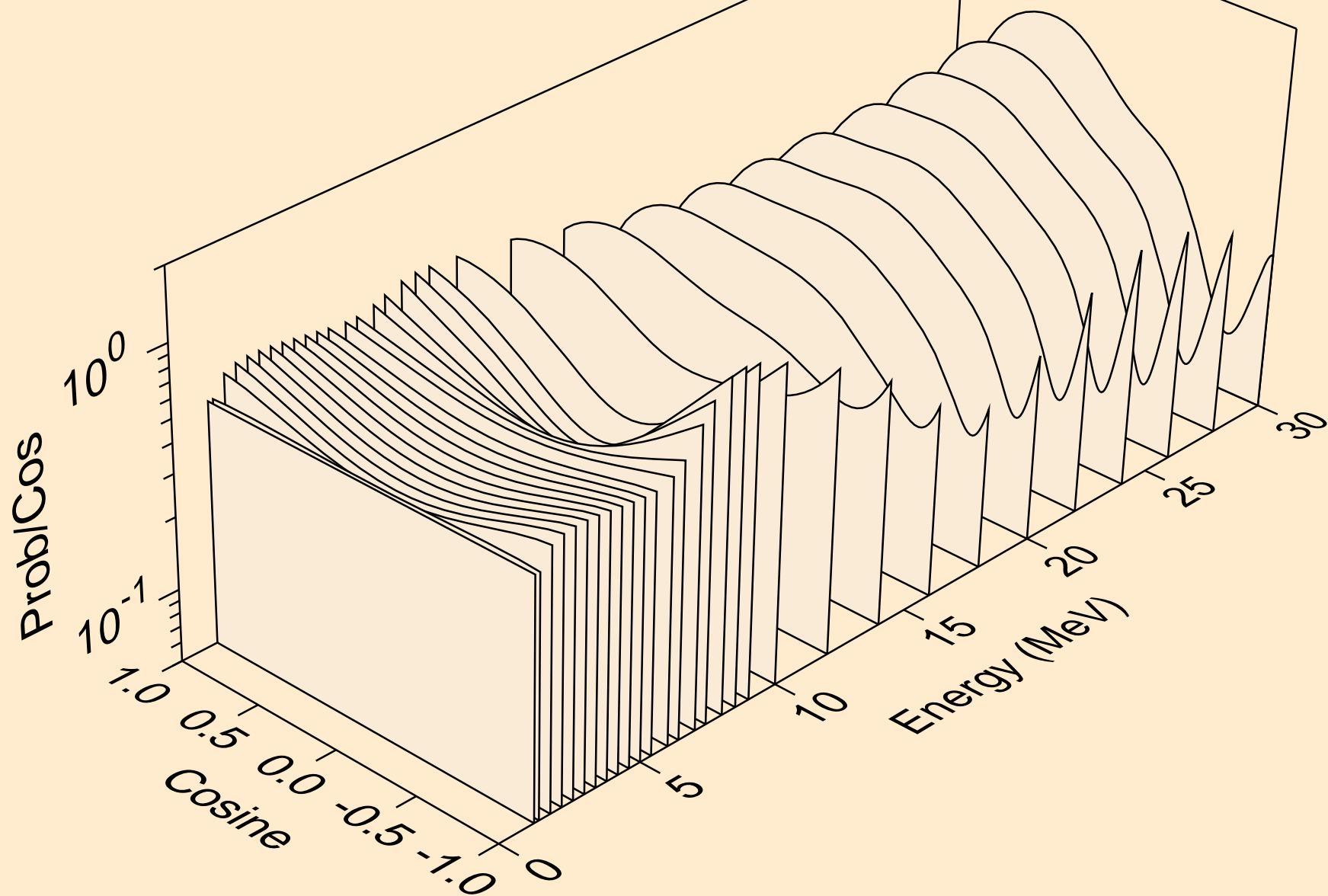

RU109 NEUTRON ACER TENDL-2019 LIBRARY; T=293.16K  
angular distribution for (n,n\*24)

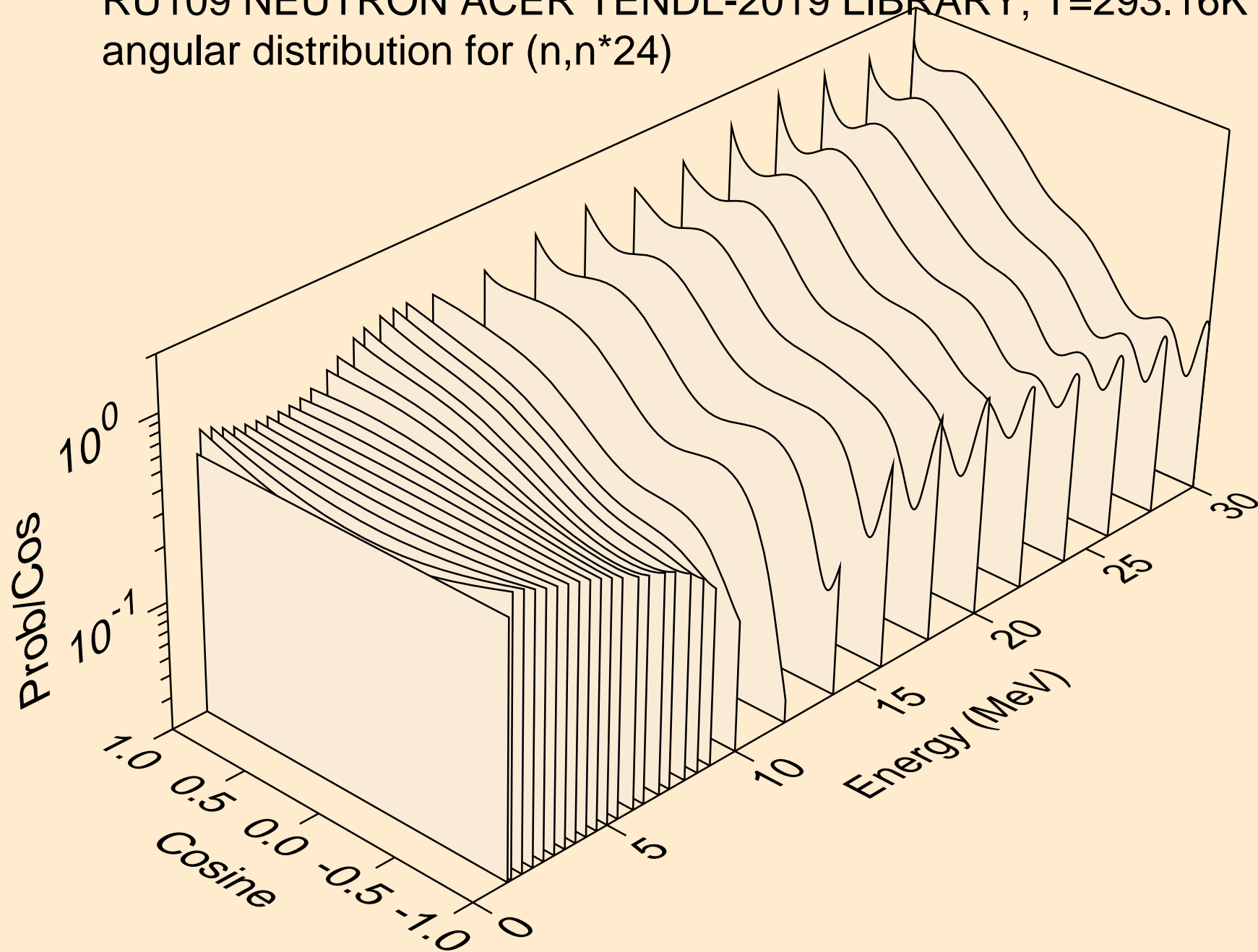

RU109 NEUTRON ACER TENDL-2019 LIBRARY; T=293.16K  
angular distribution for (n,n\*25)

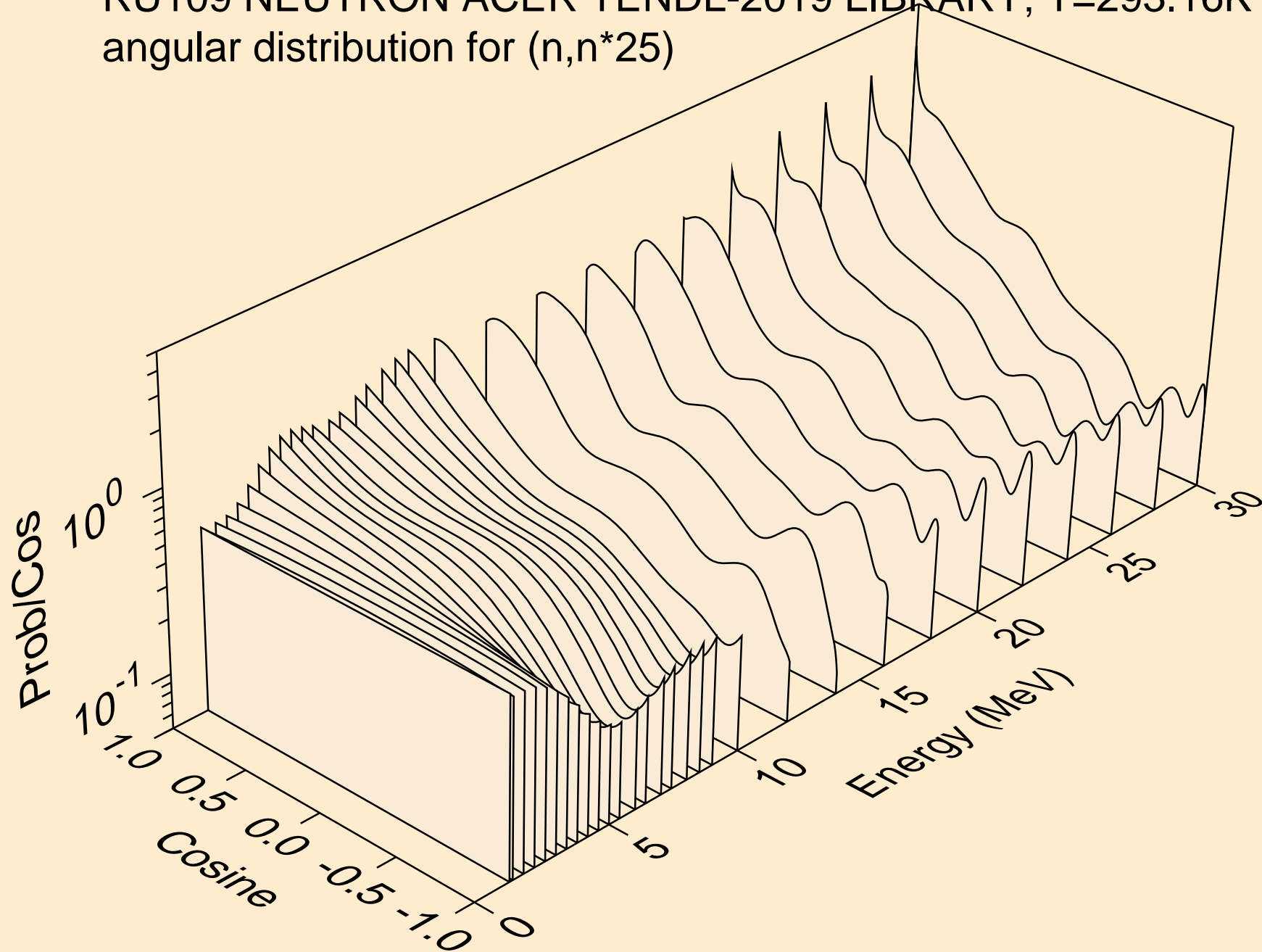

RU109 NEUTRON ACER TENDL-2019 LIBRARY; T=293.16K  
angular distribution for (n,n\*26)

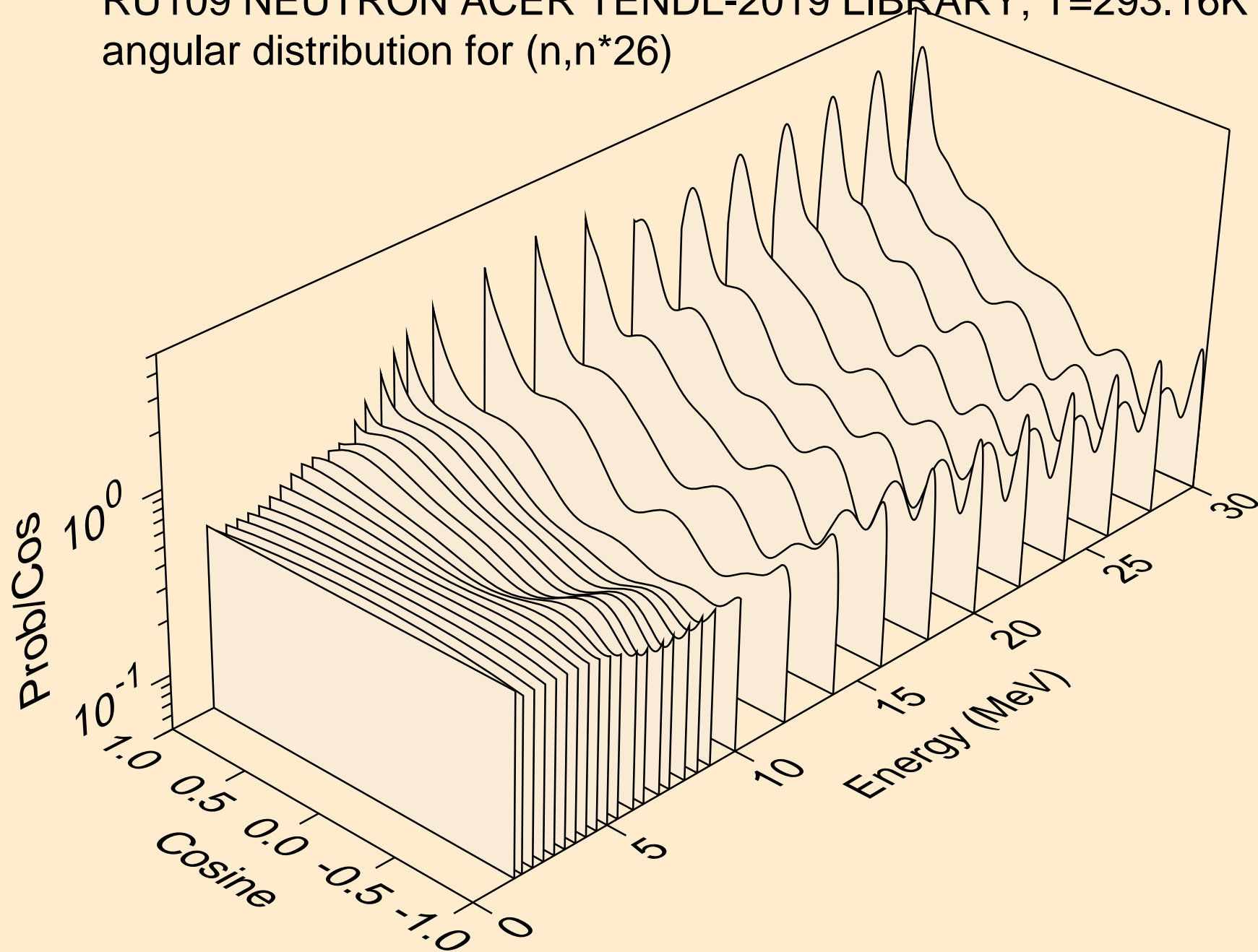

RU109 NEUTRON ACER TENDL-2019 LIBRARY; T=293.16K  
angular distribution for (n,n\*27)

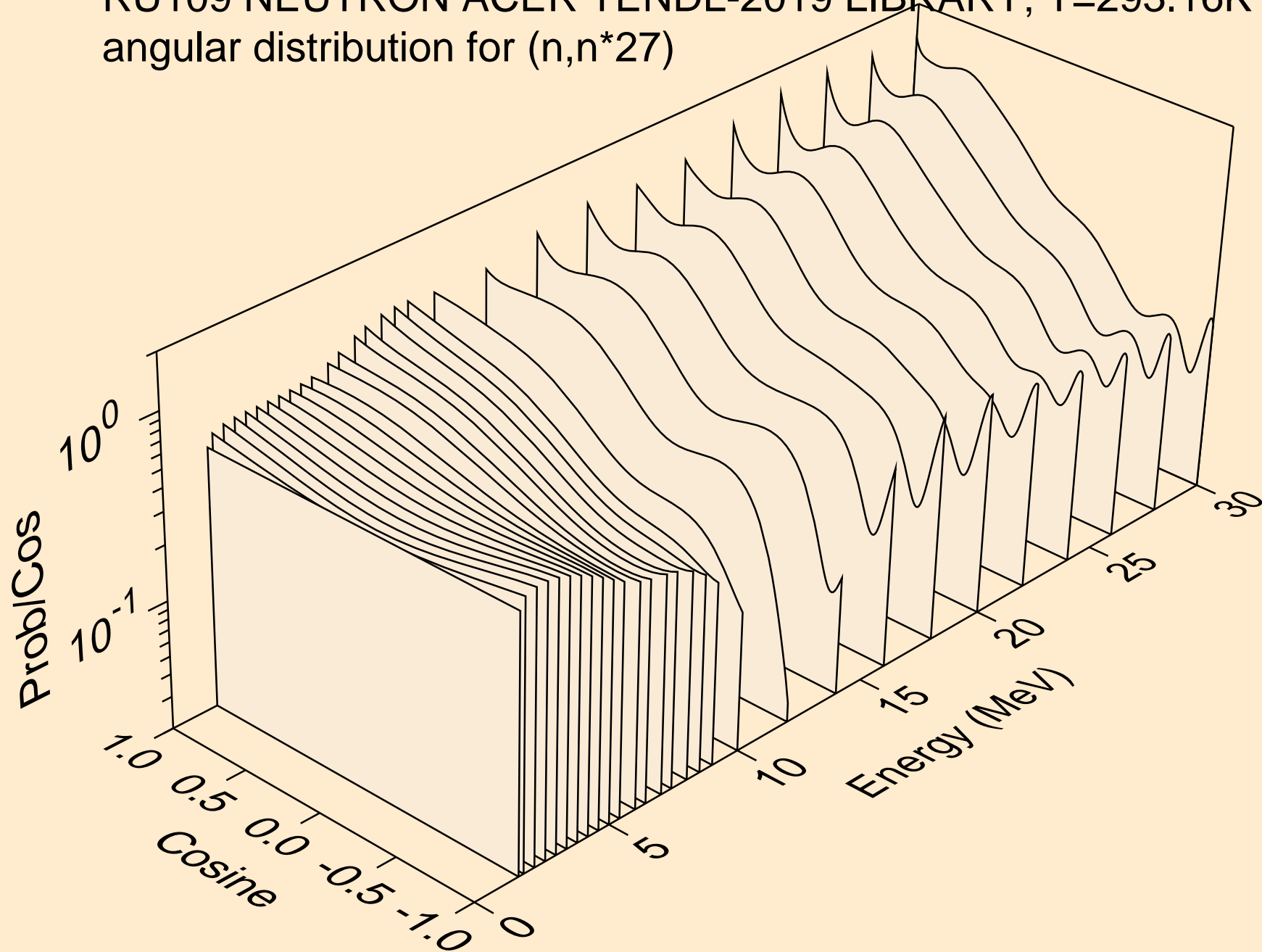

RU109 NEUTRON ACER TENDL-2019 LIBRARY; T=293.16K  
angular distribution for (n,n\*28)

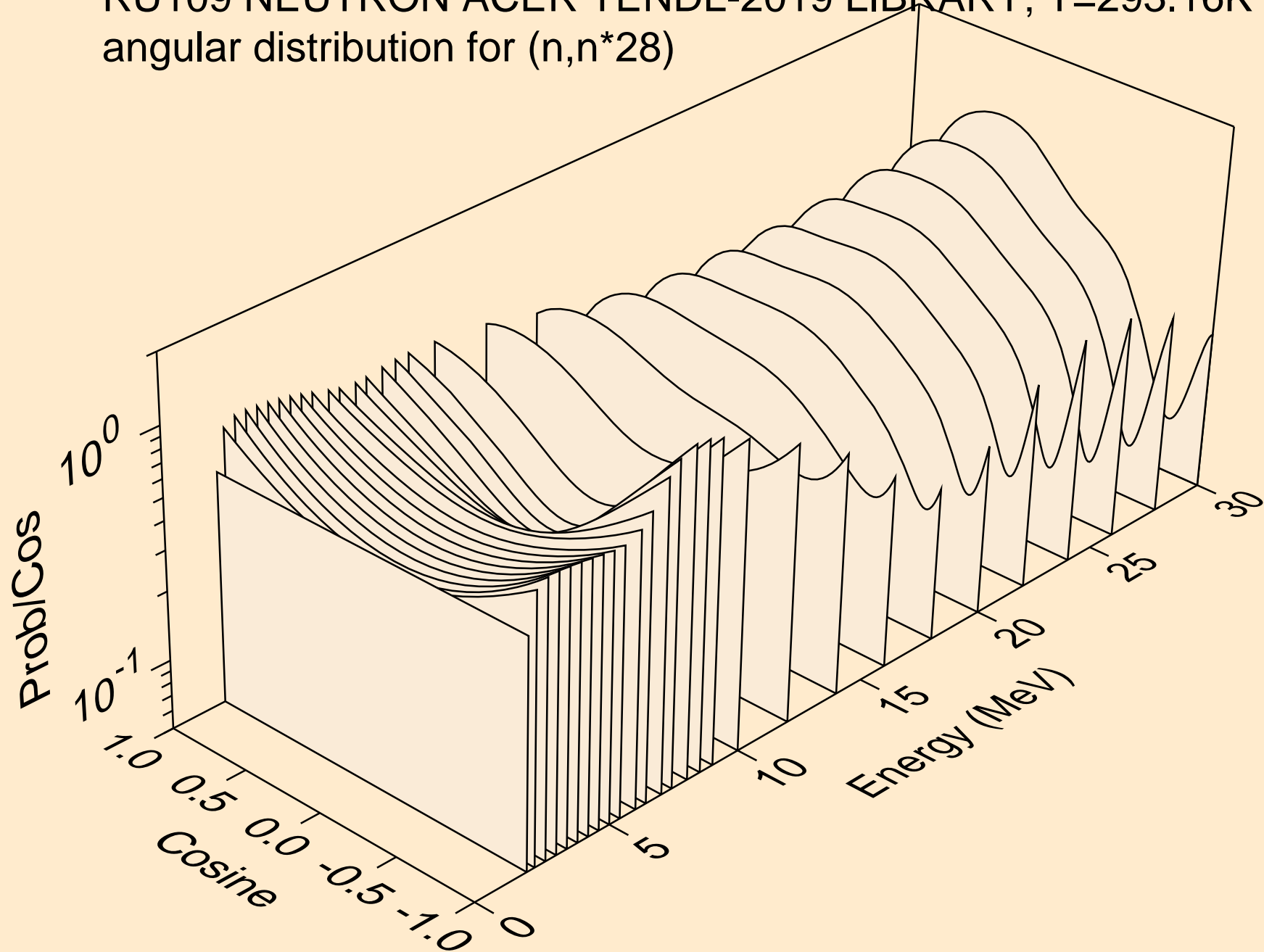



RU109 NEUTRON ACER TENDL-2019 LIBRARY; T=293.16K  
angular distribution for (n,n\*29)

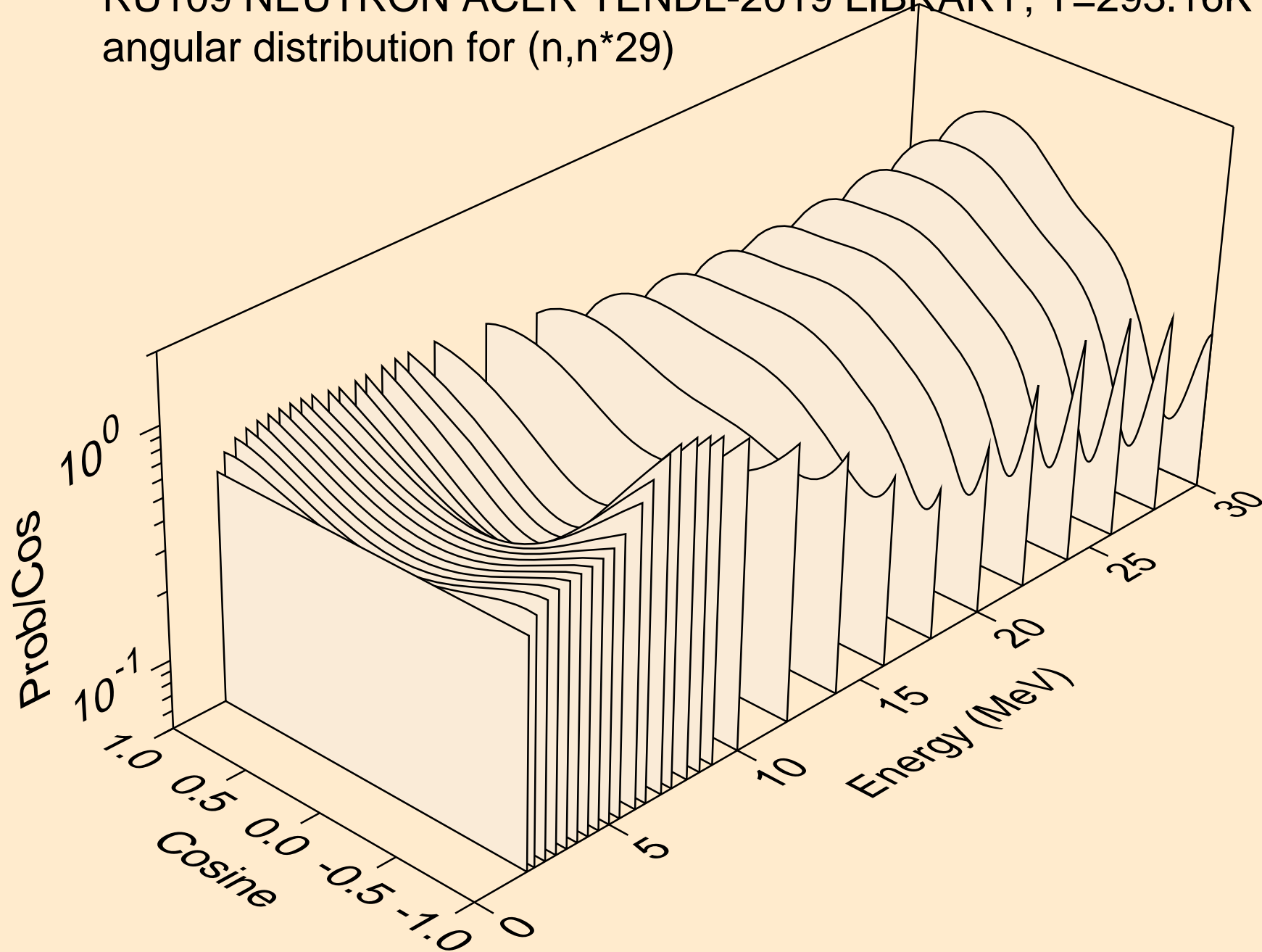

RU109 NEUTRON ACER TENDL-2019 LIBRARY; T=293.16K  
angular distribution for (n,n\*30)

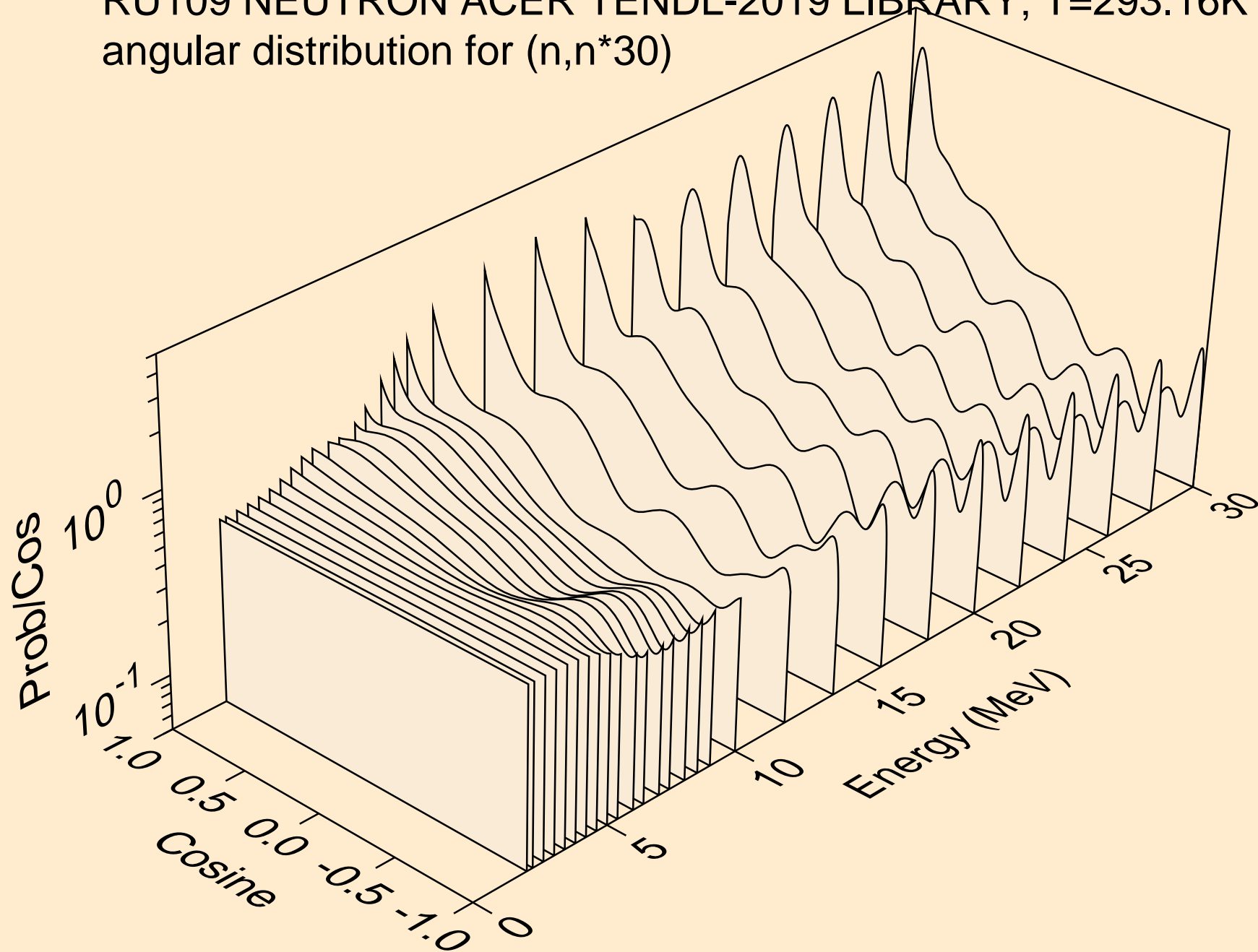

RU109 NEUTRON ACER TENDL-2019 LIBRARY; T=293.16K  
Neutron emission for (n,x)

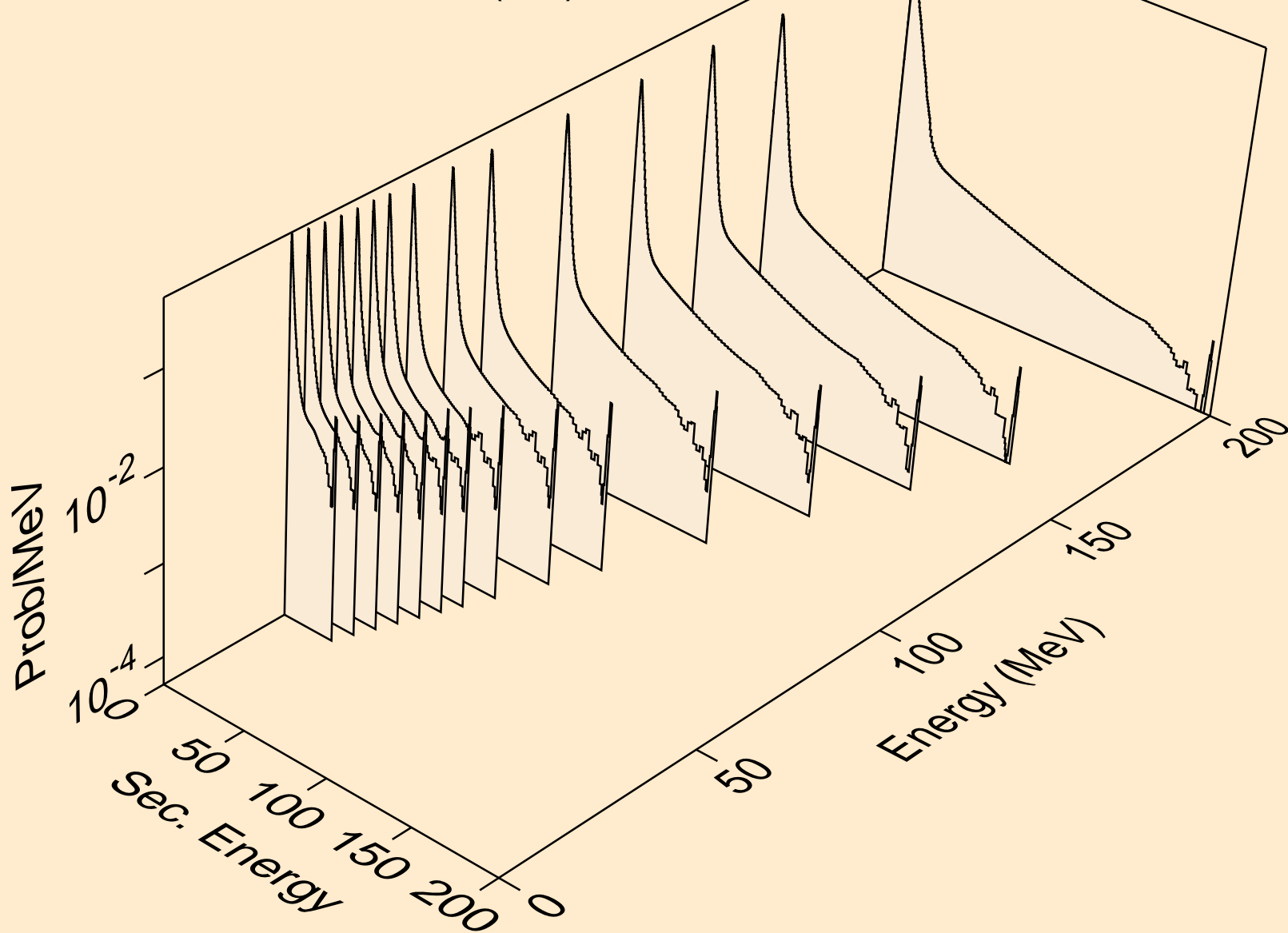

RU109 NEUTRON ACER TENDL-2019 LIBRARY; T=293.16K  
Neutron emission for (n,2nd)

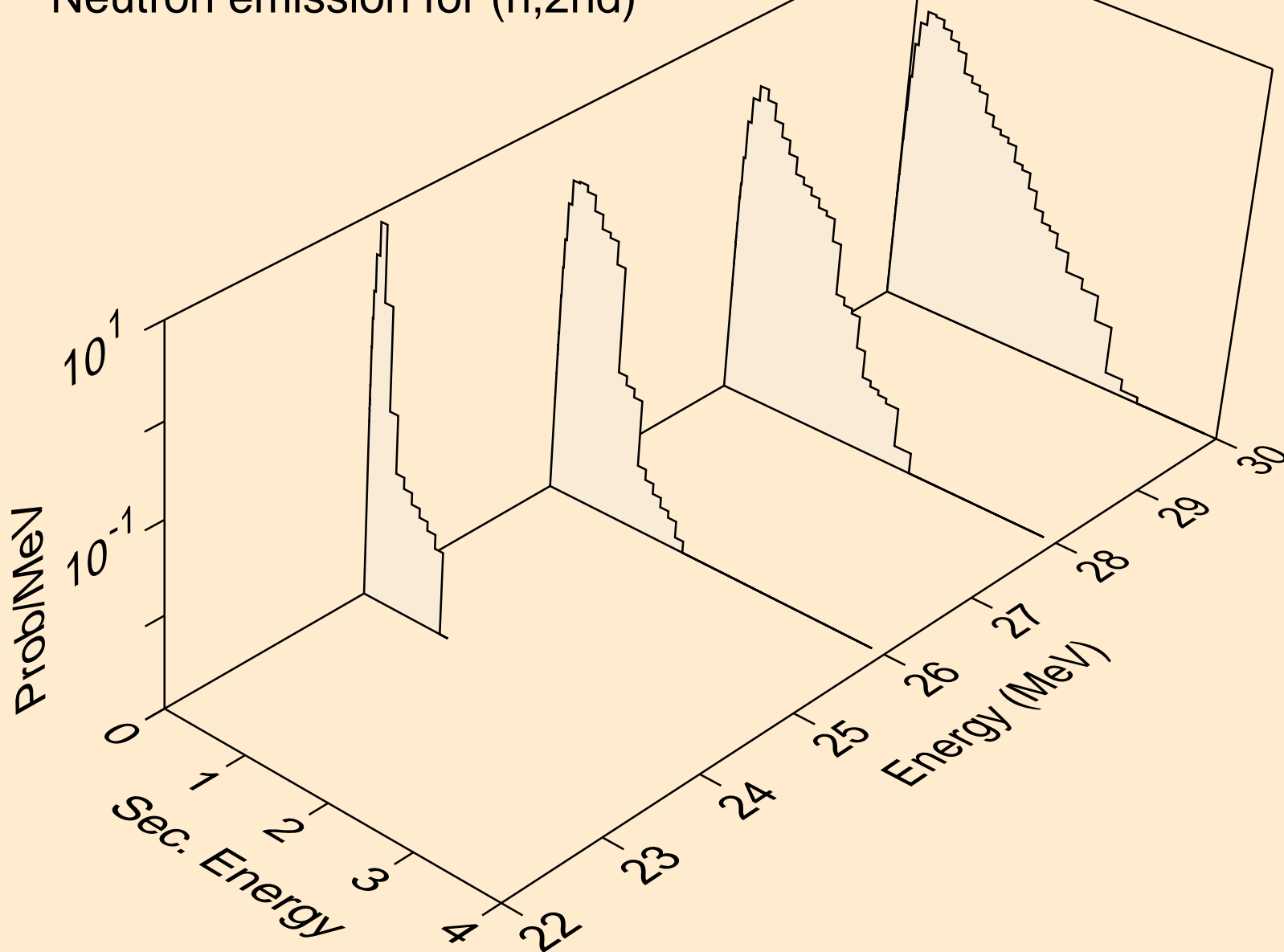

RU109 NEUTRON ACER TENDL-2019 LIBRARY; T=293.16K  
Neutron emission for (n,2n)

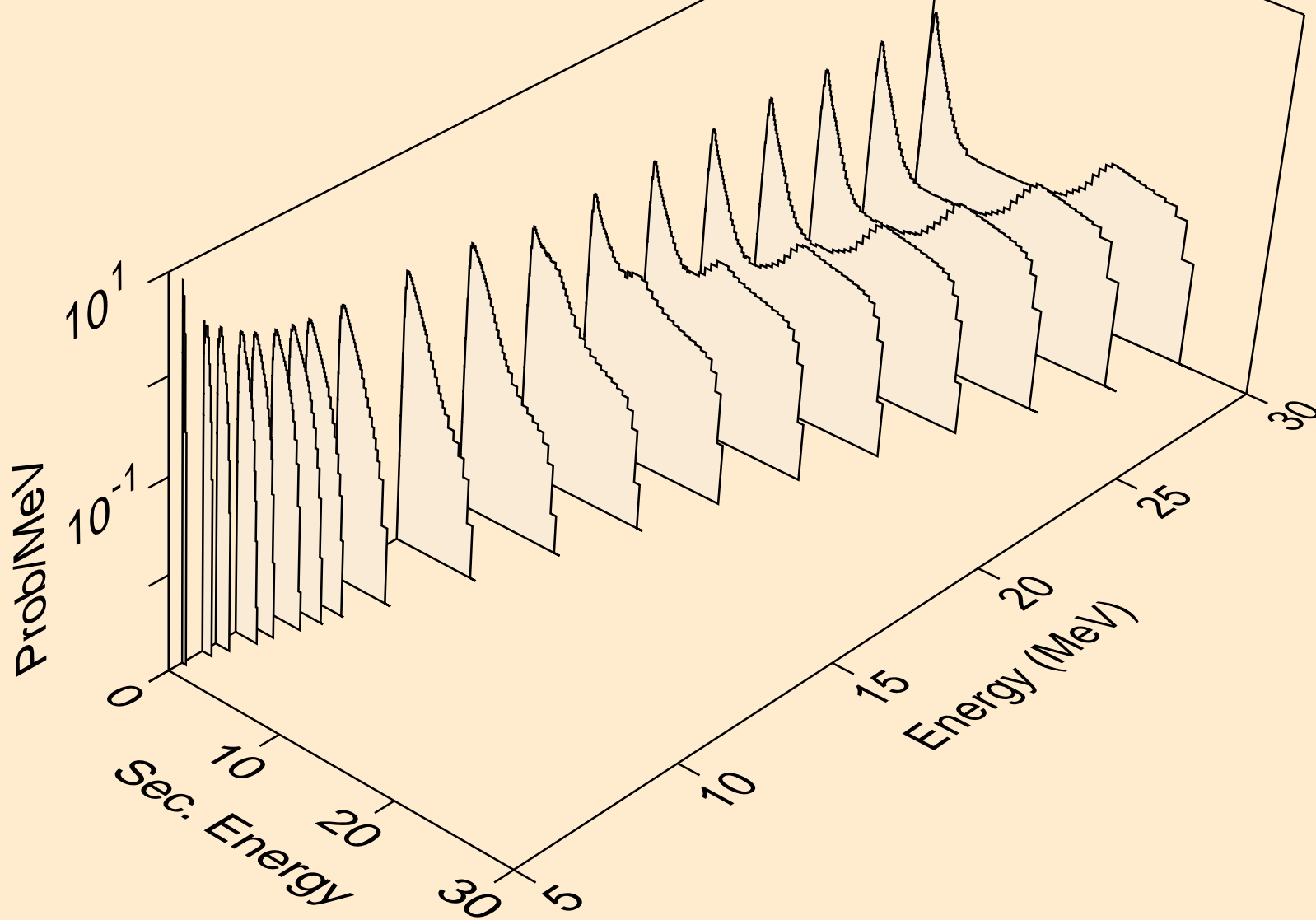

RU109 NEUTRON ACER TENDL-2019 LIBRARY; T=293.16K  
Neutron emission for (n,3n)

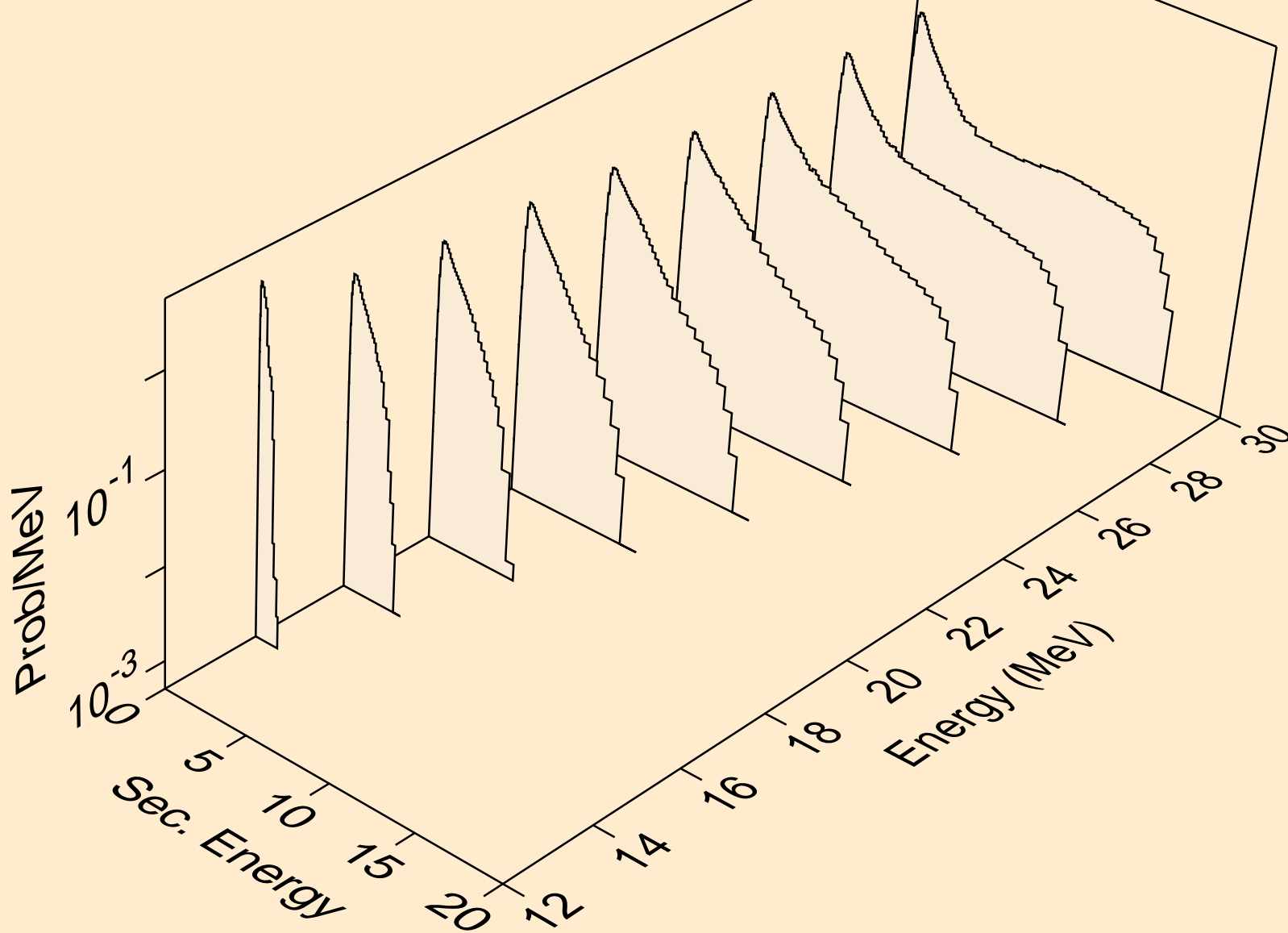

RU109 NEUTRON ACER TENDL-2019 LIBRARY; T=293.16K  
Neutron emission for (n,n\*)a

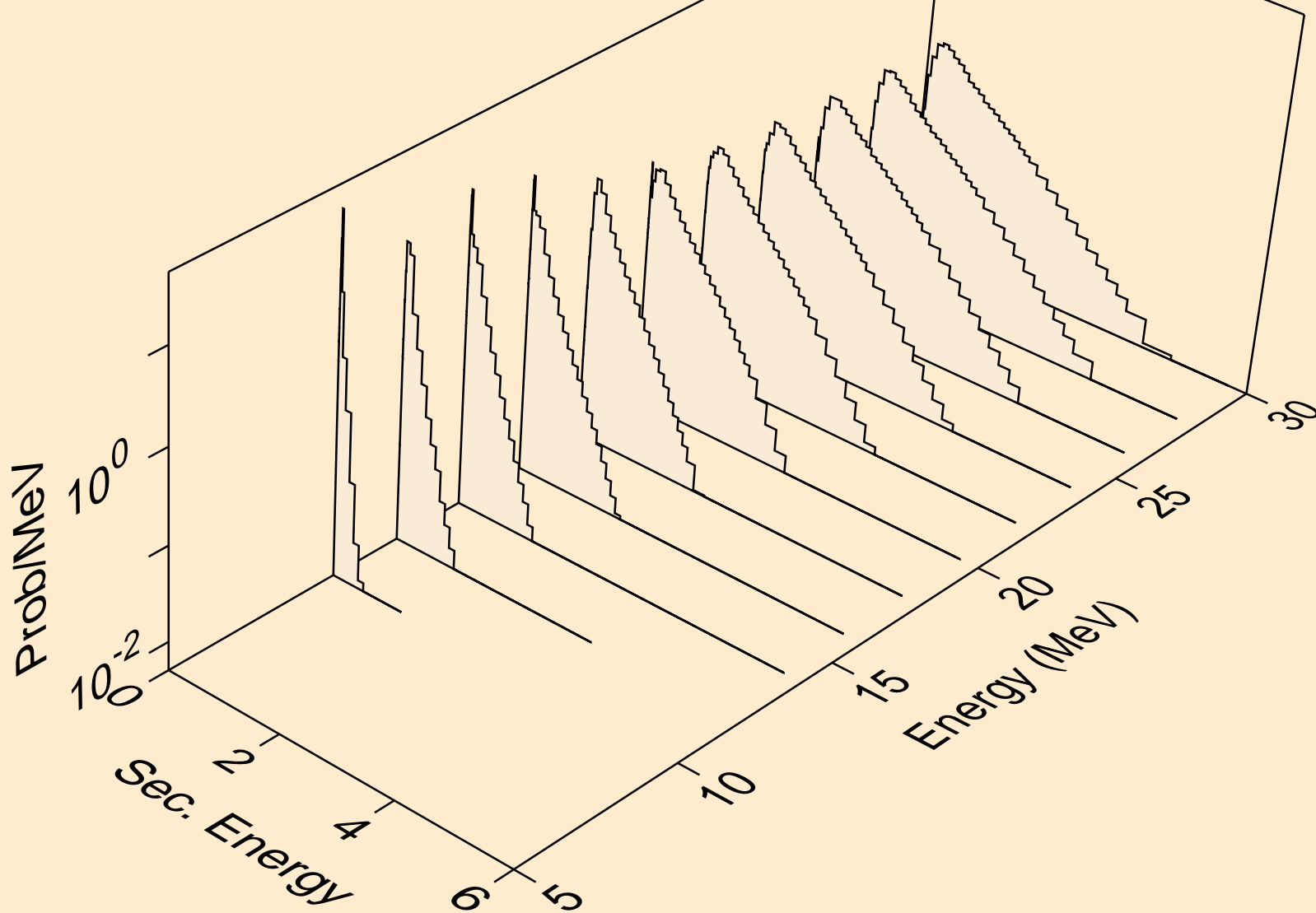

RU109 NEUTRON ACER TENDL-2019 LIBRARY; T=293.16K  
Neutron emission for (n,2n)a

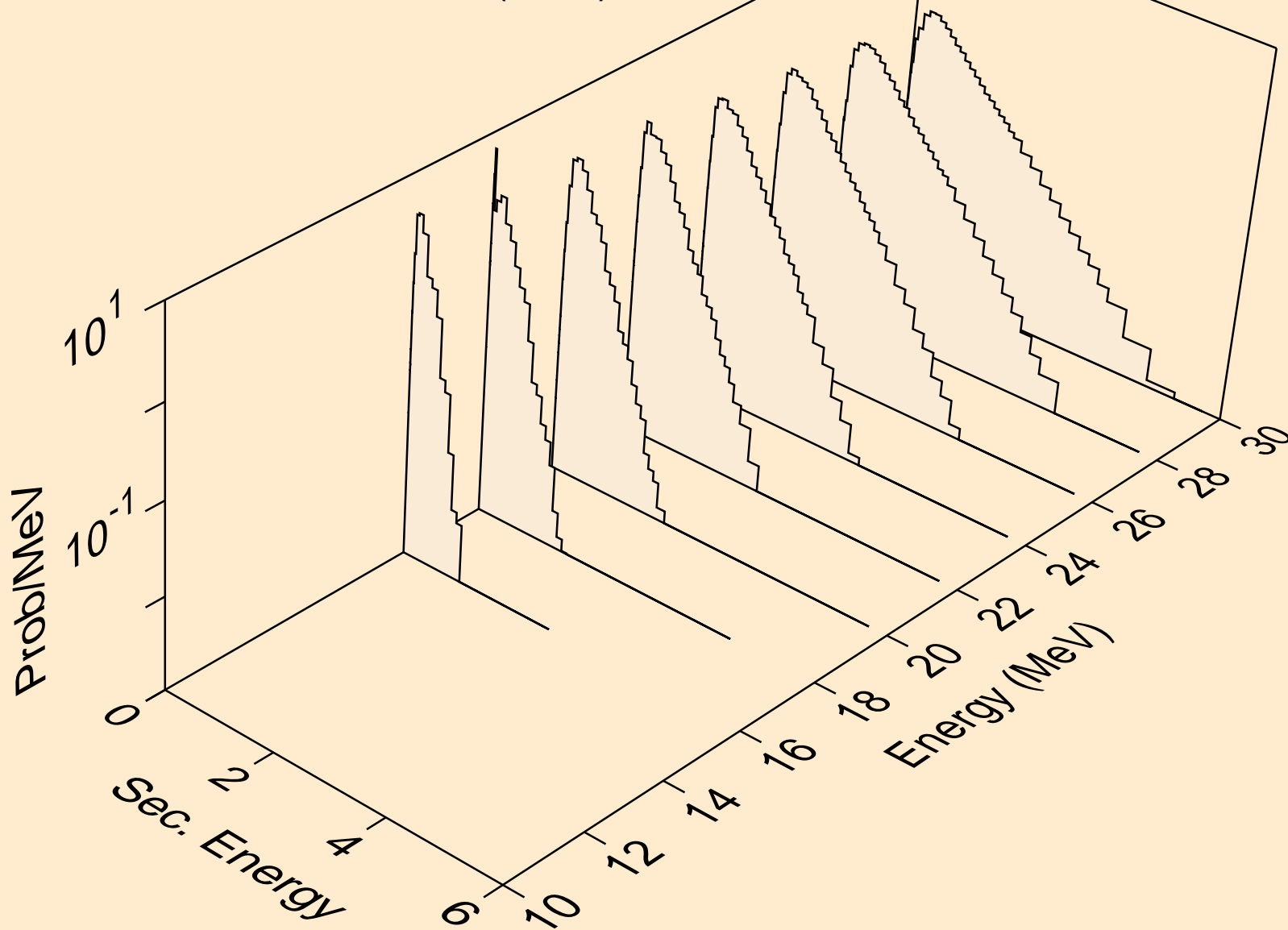



RU109 NEUTRON ACER TENDL-2019 LIBRARY; T=293.16K  
Neutron emission for (n,3n)a

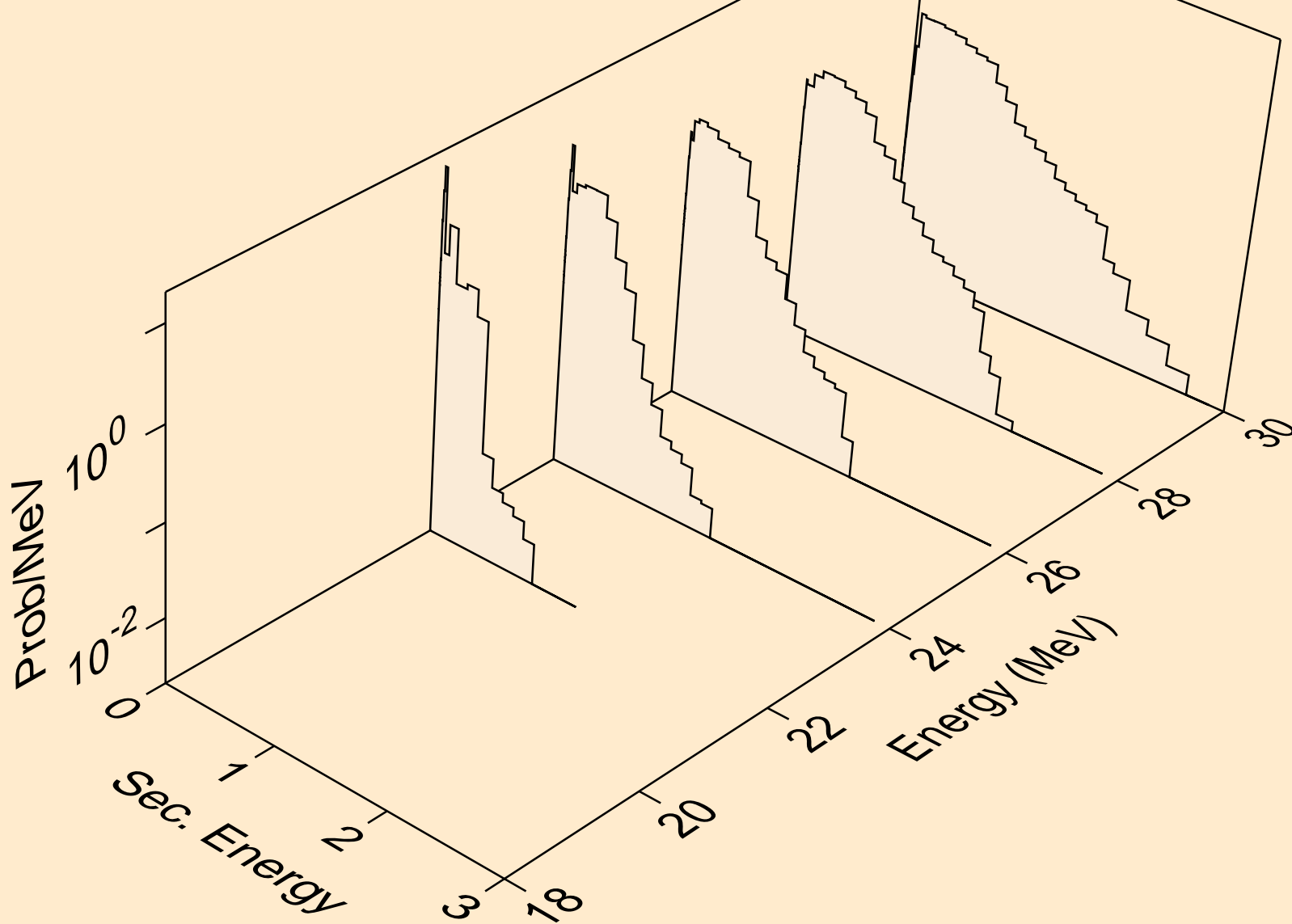

RU109 NEUTRON ACER TENDL-2019 LIBRARY; T=293.16K  
Neutron emission for (n,n\*)p

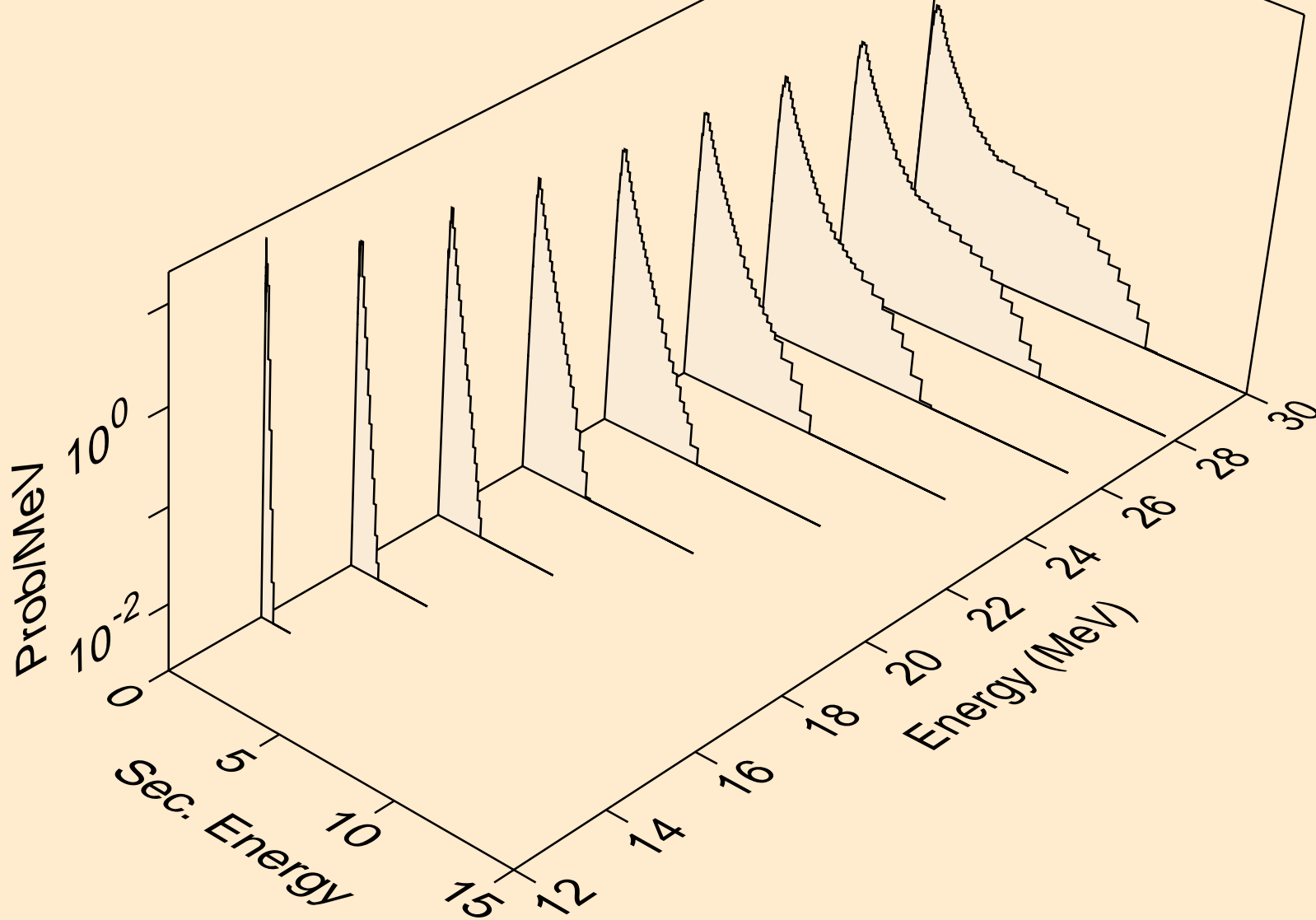

RU109 NEUTRON ACER TENDL-2019 LIBRARY; T=293.16K  
Neutron emission for (n,n\*)d

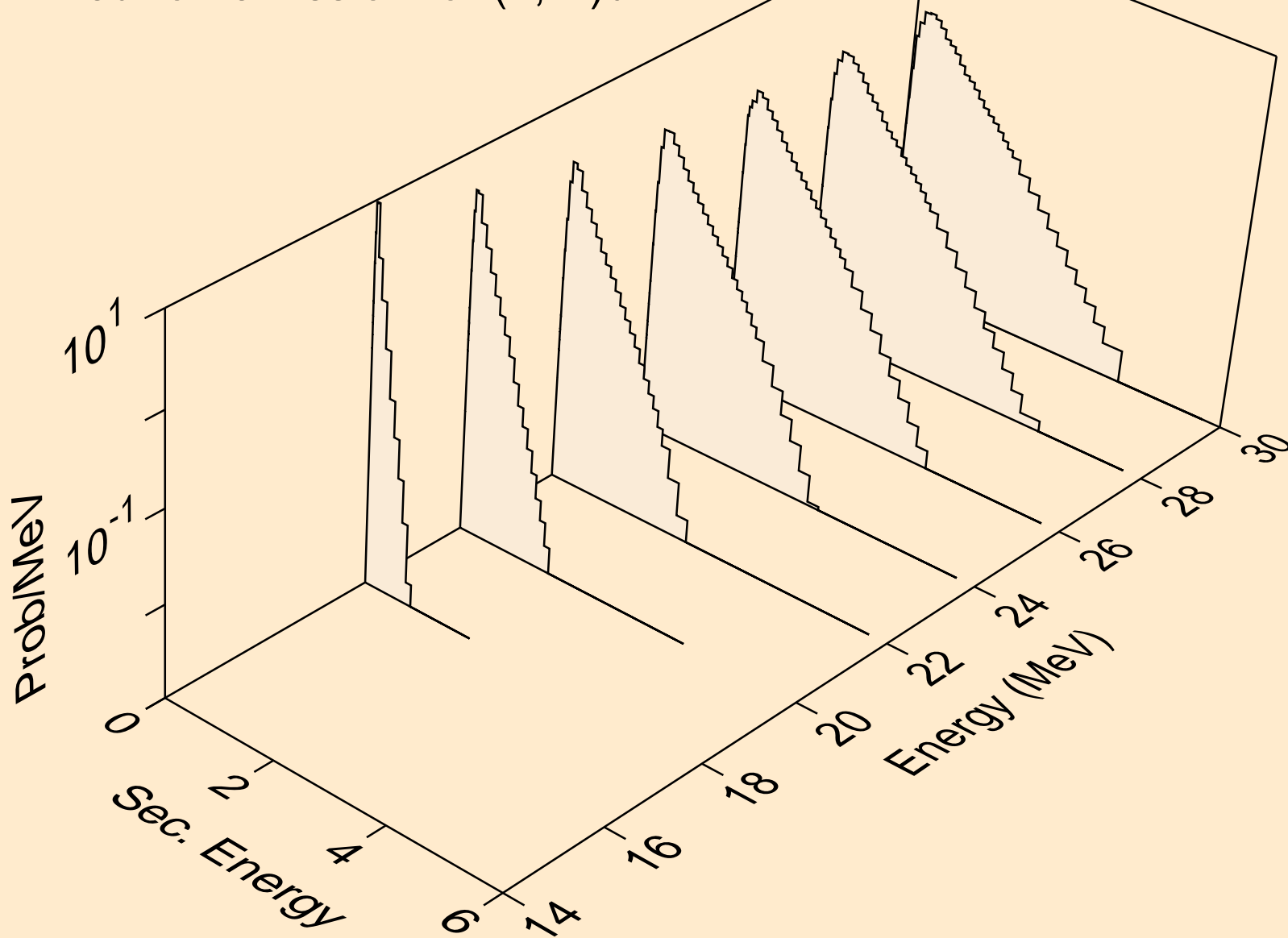

RU109 NEUTRON ACER TENDL-2019 LIBRARY; T=293.16K  
Neutron emission for (n,n\*)t

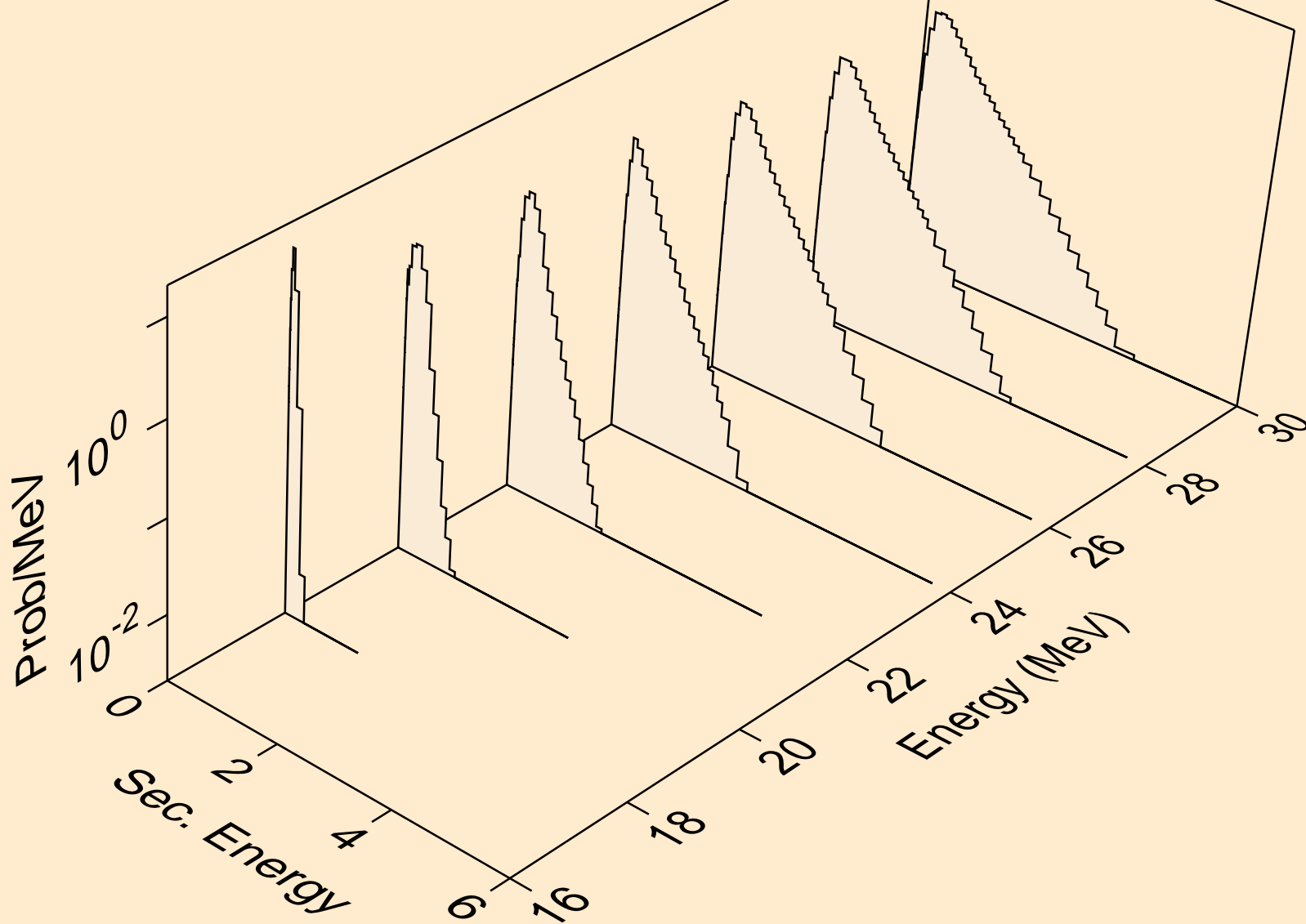

RU109 NEUTRON ACER TENDL-2019 LIBRARY; T=293.16K  
Neutron emission for (n,n\*)he3

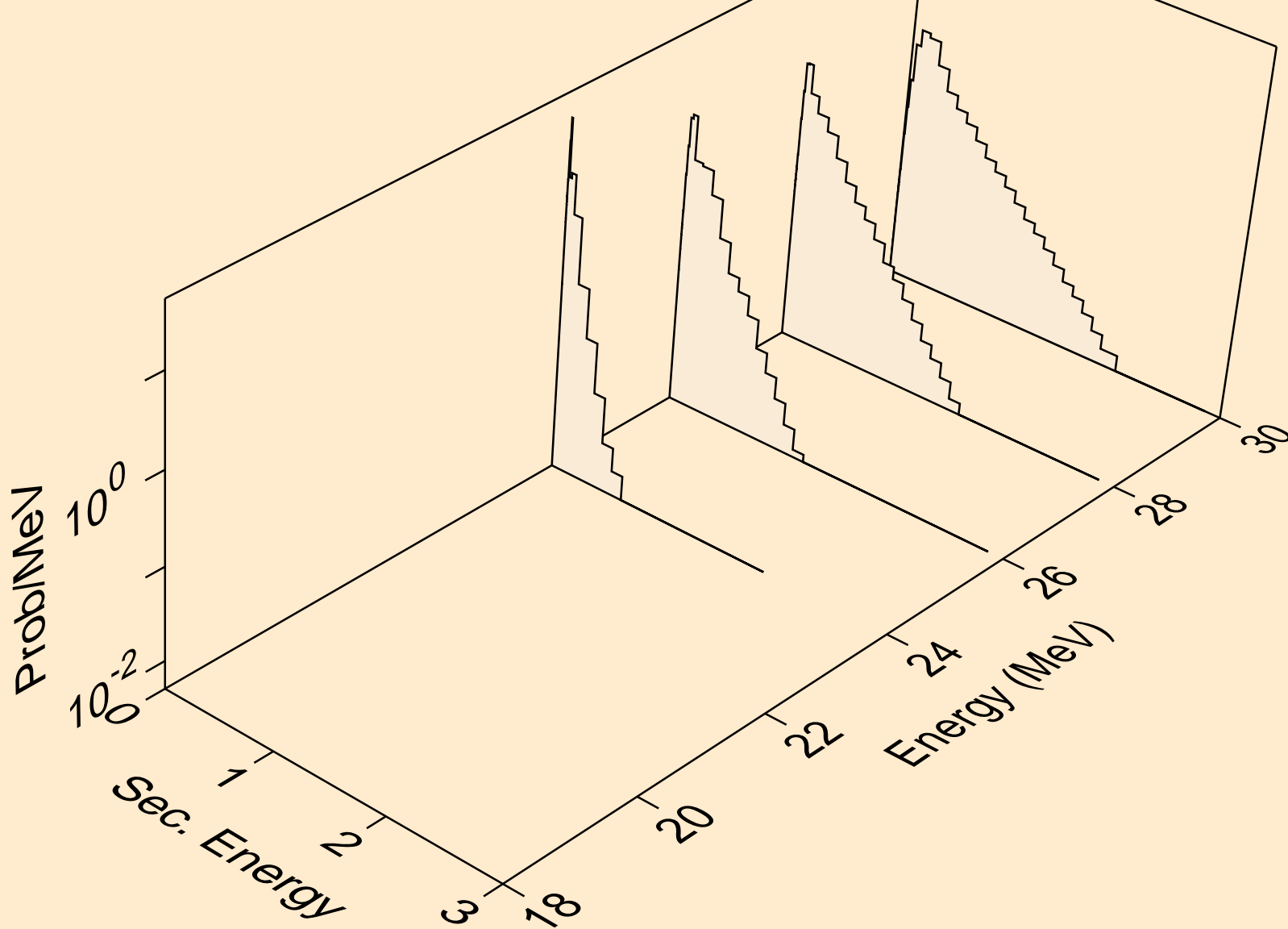

RU109 NEUTRON ACER TENDL-2019 LIBRARY; T=293.16K  
Neutron emission for (n,4n)

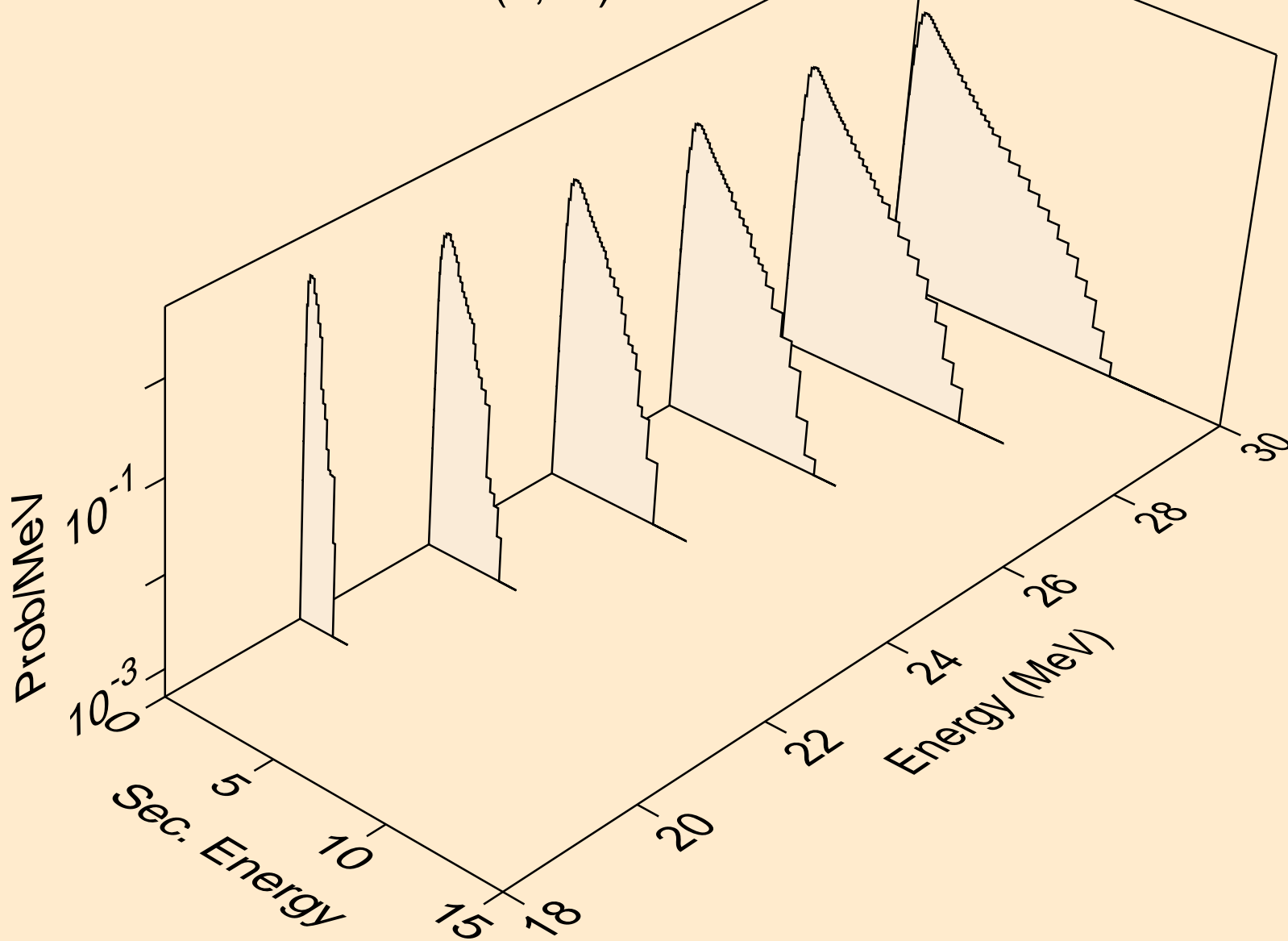

RU109 NEUTRON ACER TENDL-2019 LIBRARY; T=293.16K  
Neutron emission for (n,2np)

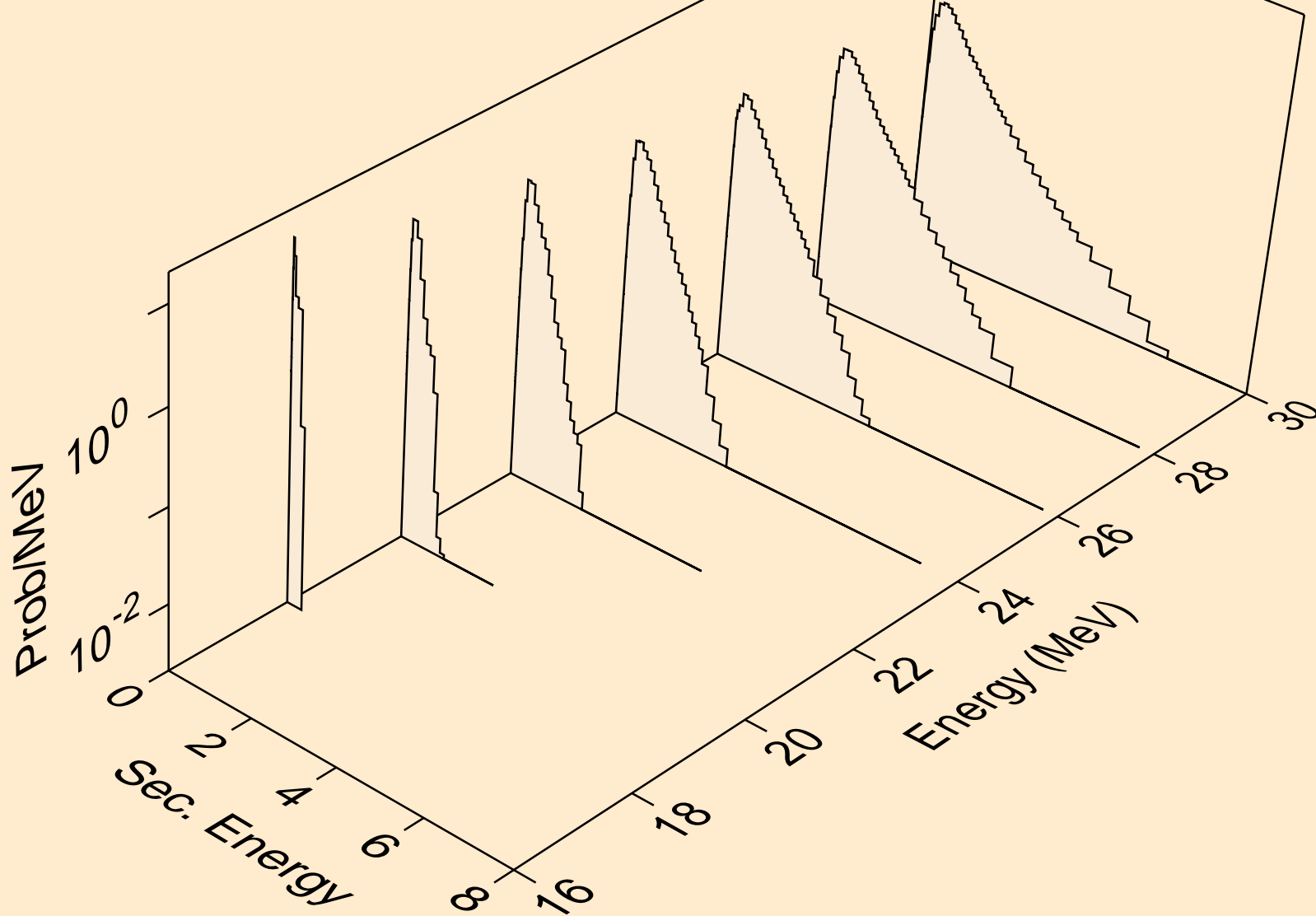

RU109 NEUTRON ACER TENDL-2019 LIBRARY; T=293.16K  
Neutron emission for (n,3np)

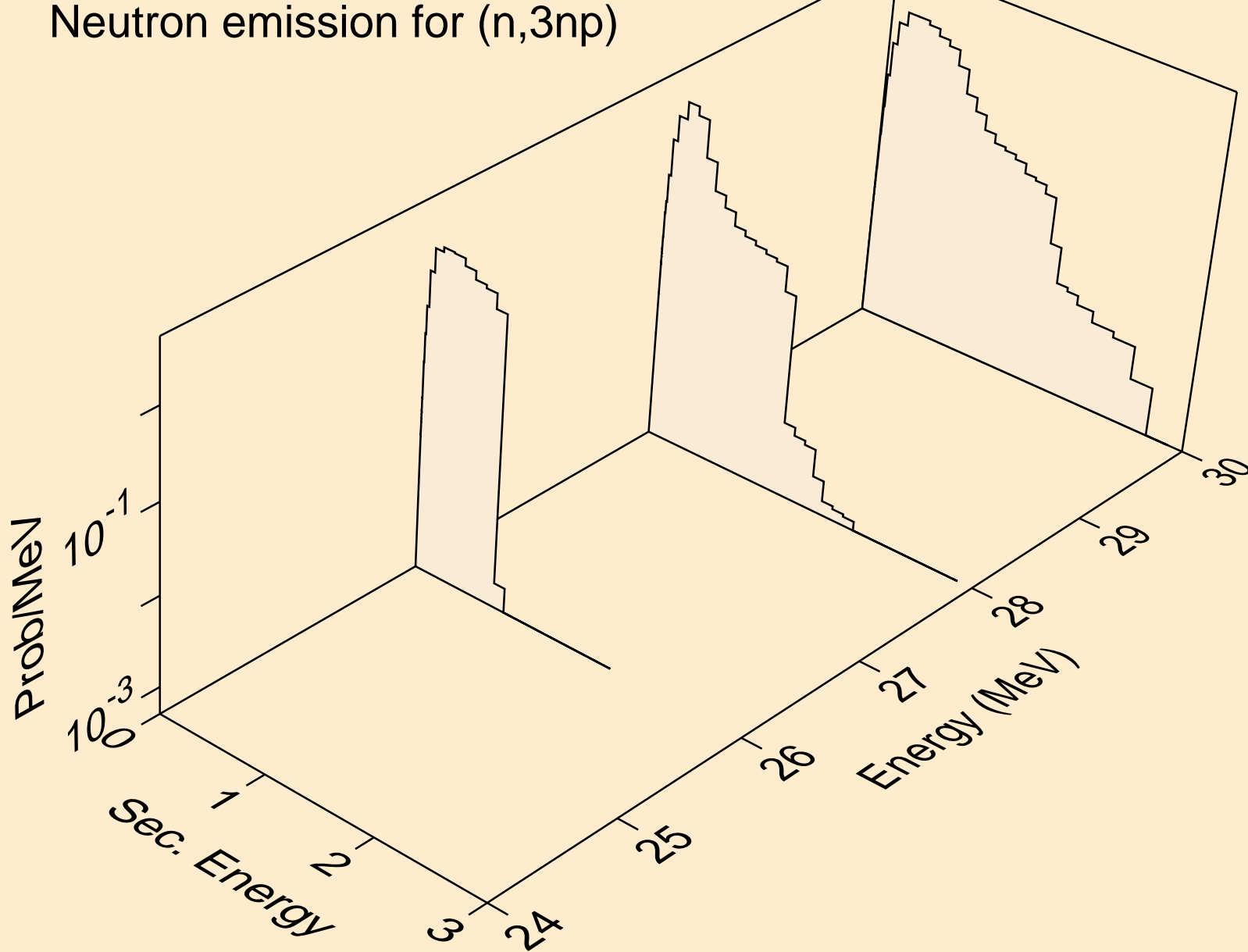



RU109 NEUTRON ACER TENDL-2019 LIBRARY; T=293.16K  
Neutron emission for (n,n\*c)

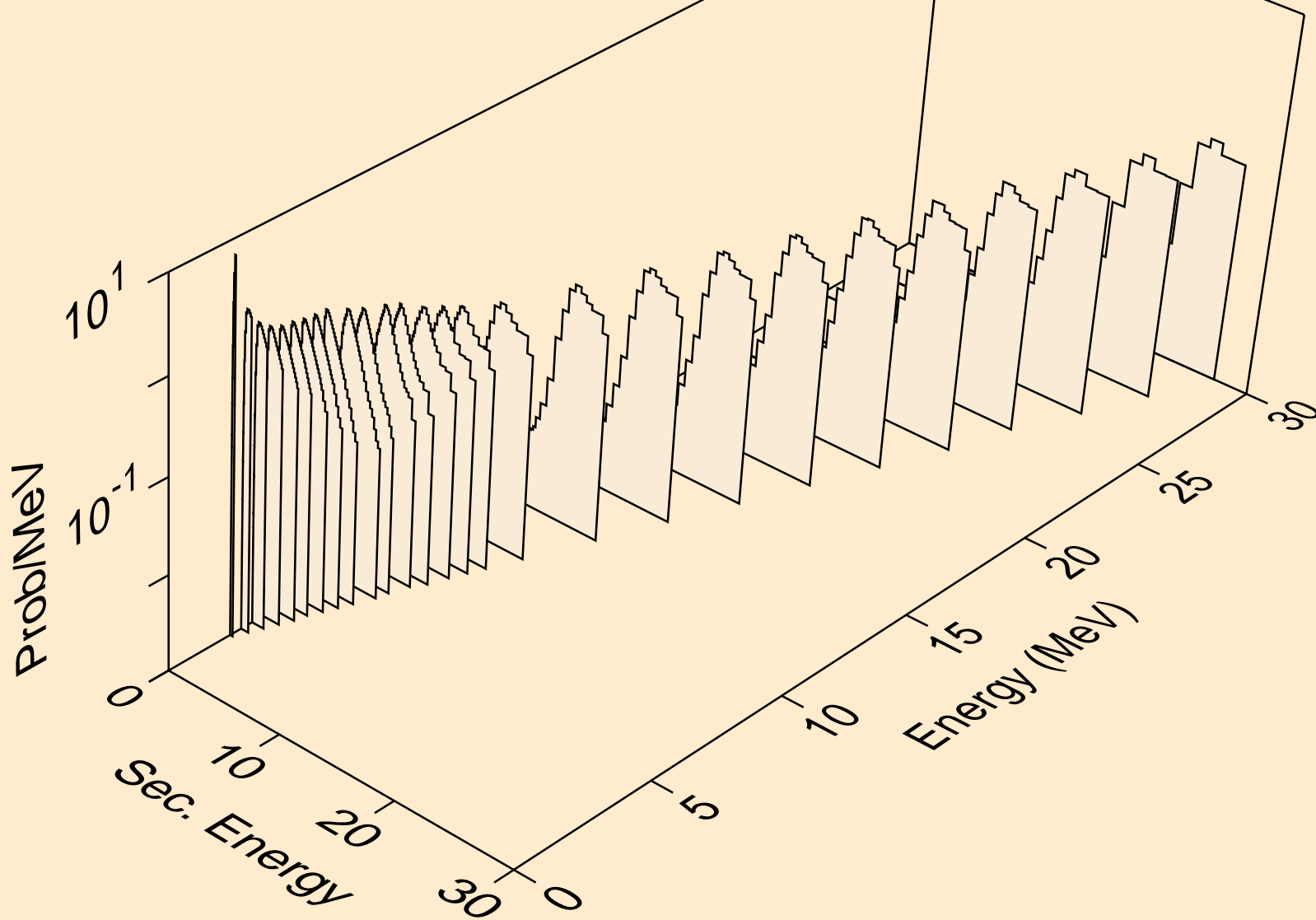

RU109 NEUTRON ACER TENDL-2019 LIBRARY; T=293.16K  
Photon emission for (n,x)

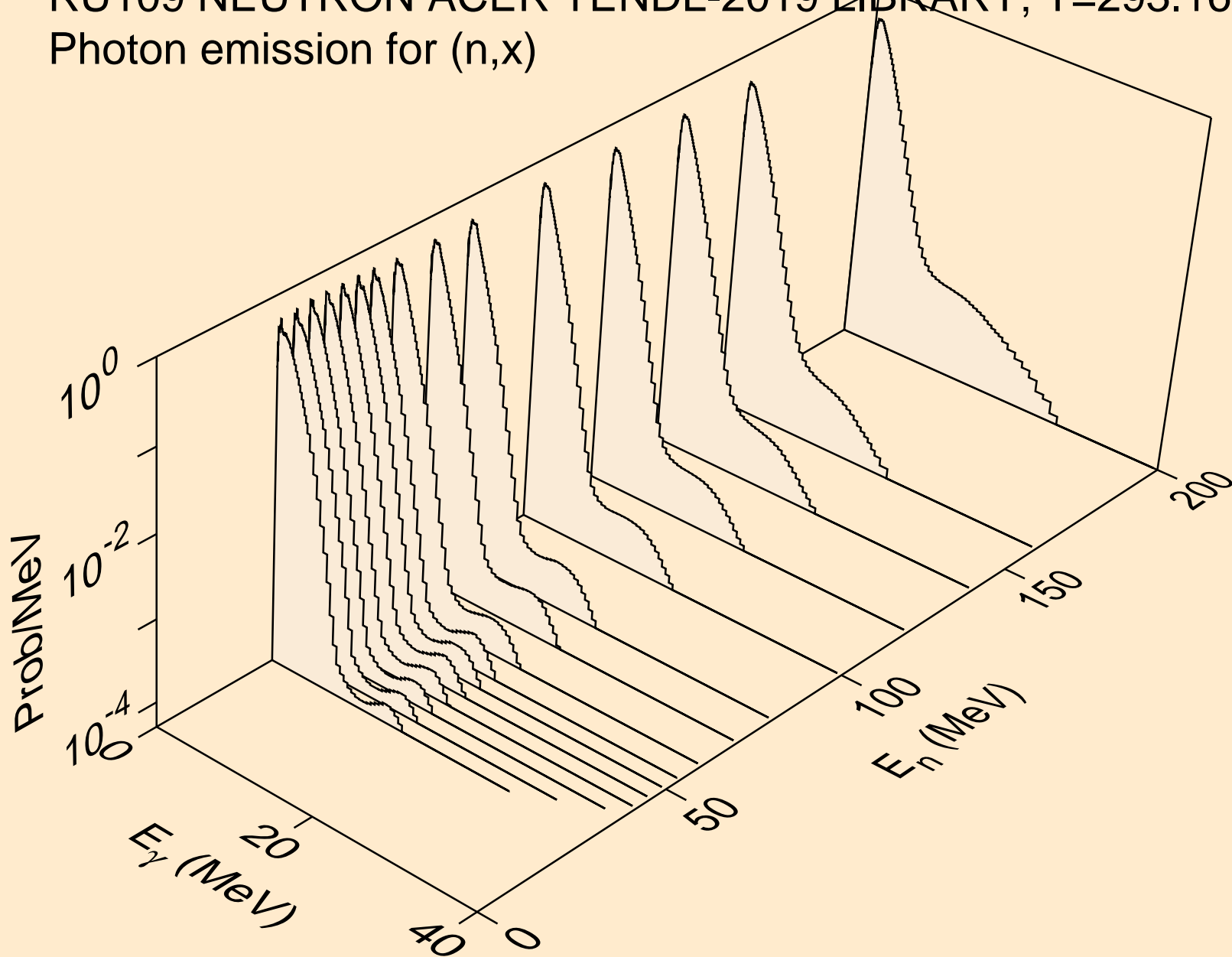

RU109 NEUTRON ACER TENDL-2019 LIBRARY; T=293.16K  
Photon emission for (n,2nd)

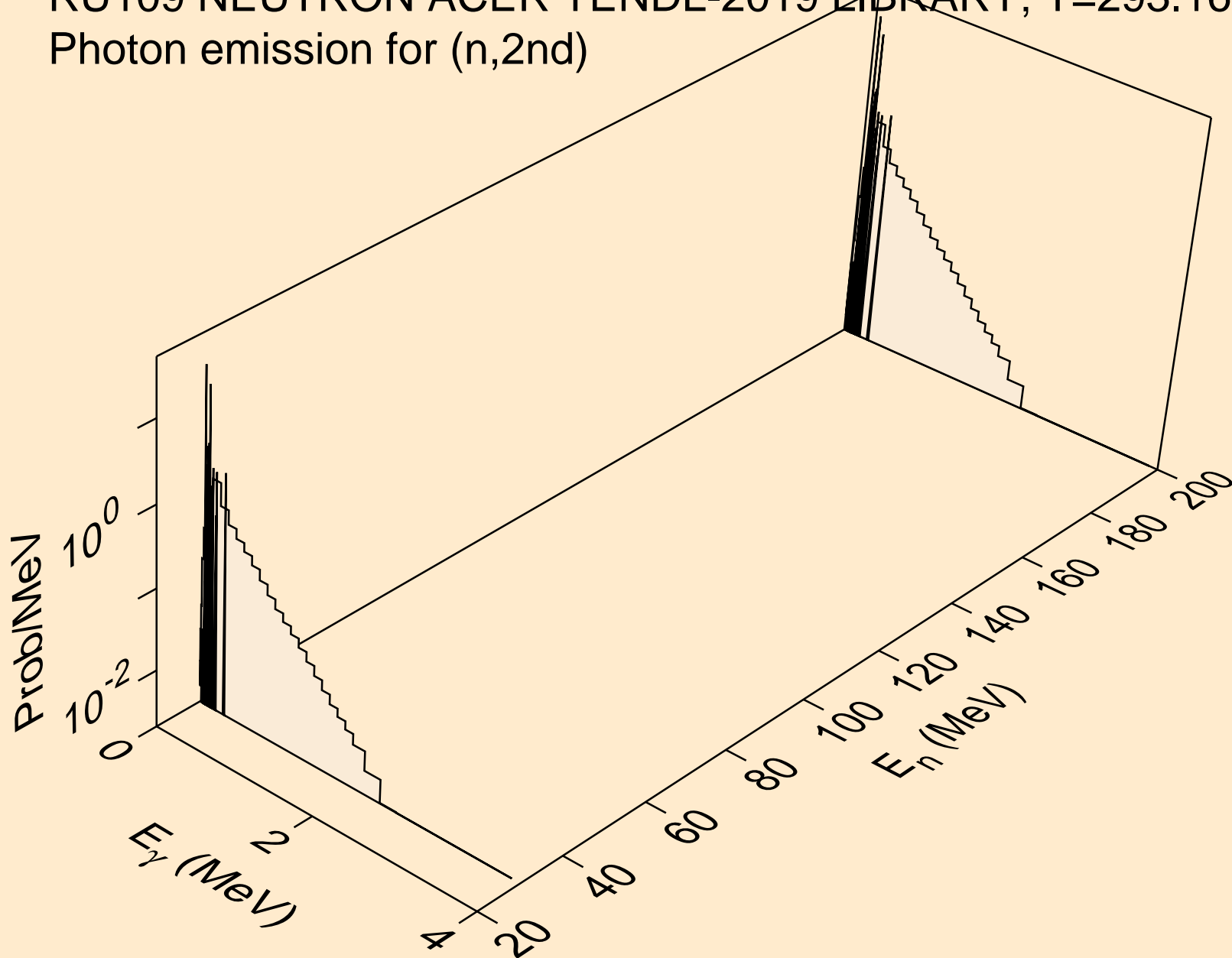

RU109 NEUTRON ACER TENDL-2019 LIBRARY; T=293.16K  
Photon emission for (n,2n)

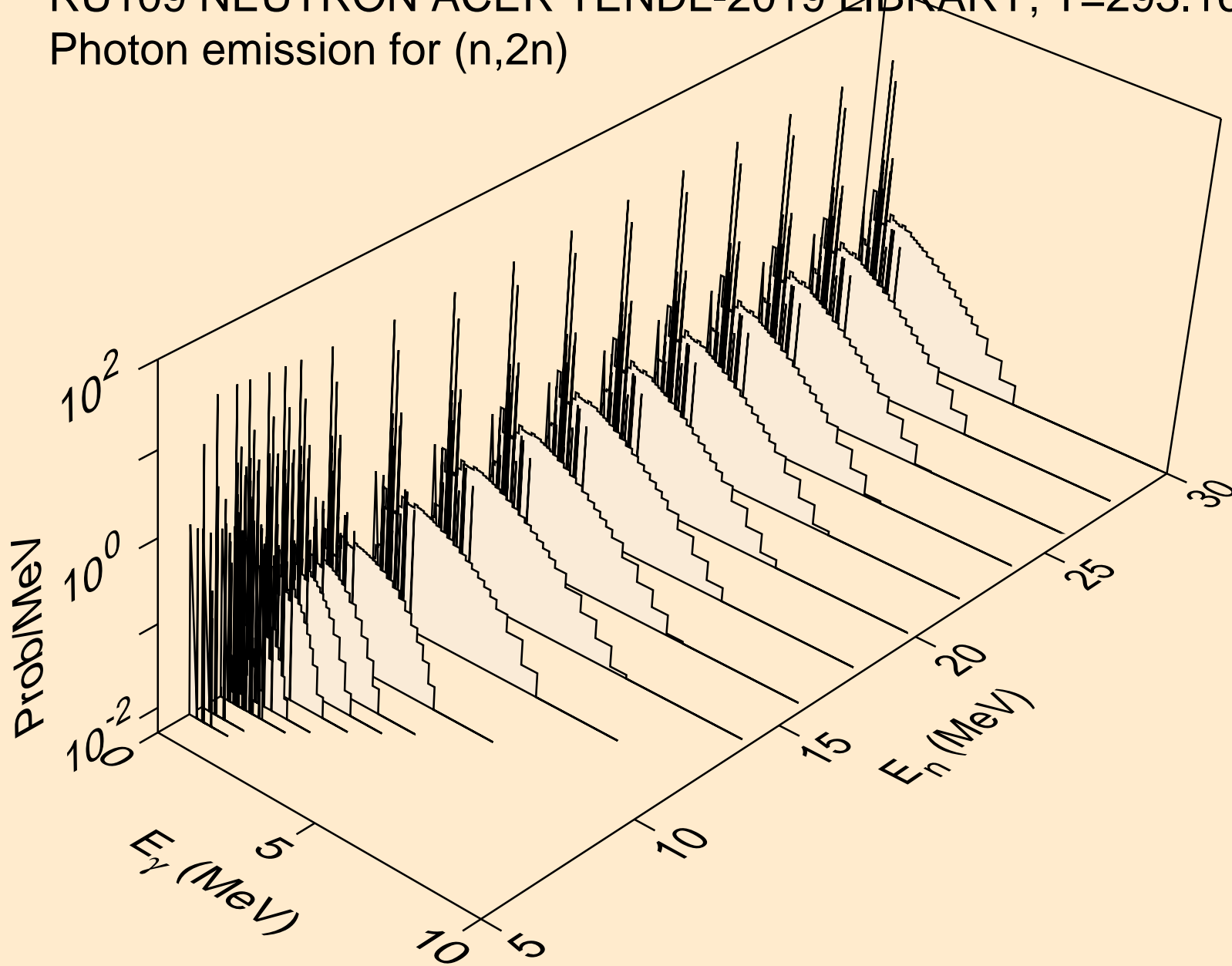

RU109 NEUTRON ACER TENDL-2019 LIBRARY; T=293.16K  
Photon emission for (n,3n)

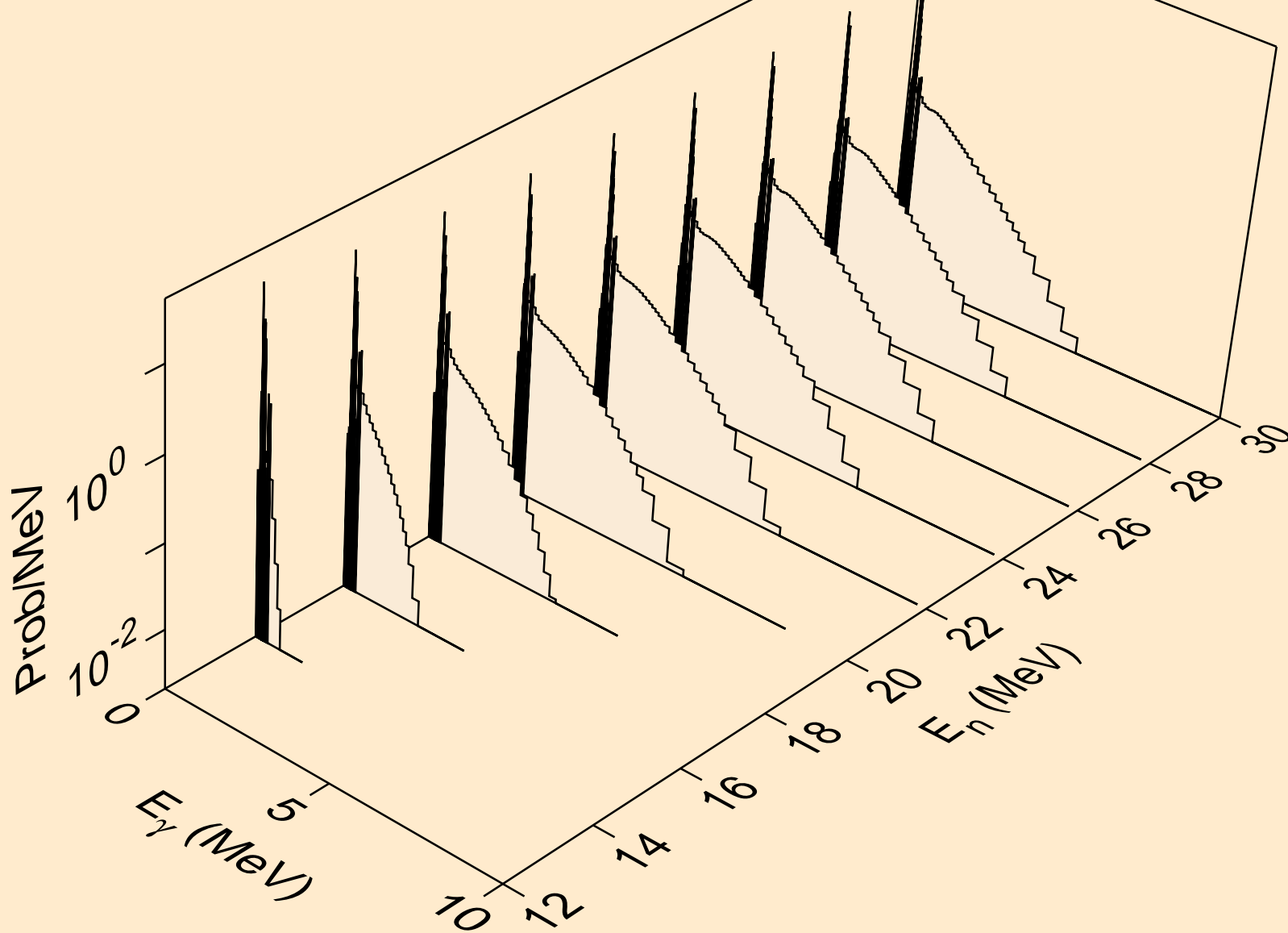

RU109 NEUTRON ACER TENDL-2019 LIBRARY; T=293.16K  
Photon emission for (n,n\*)a

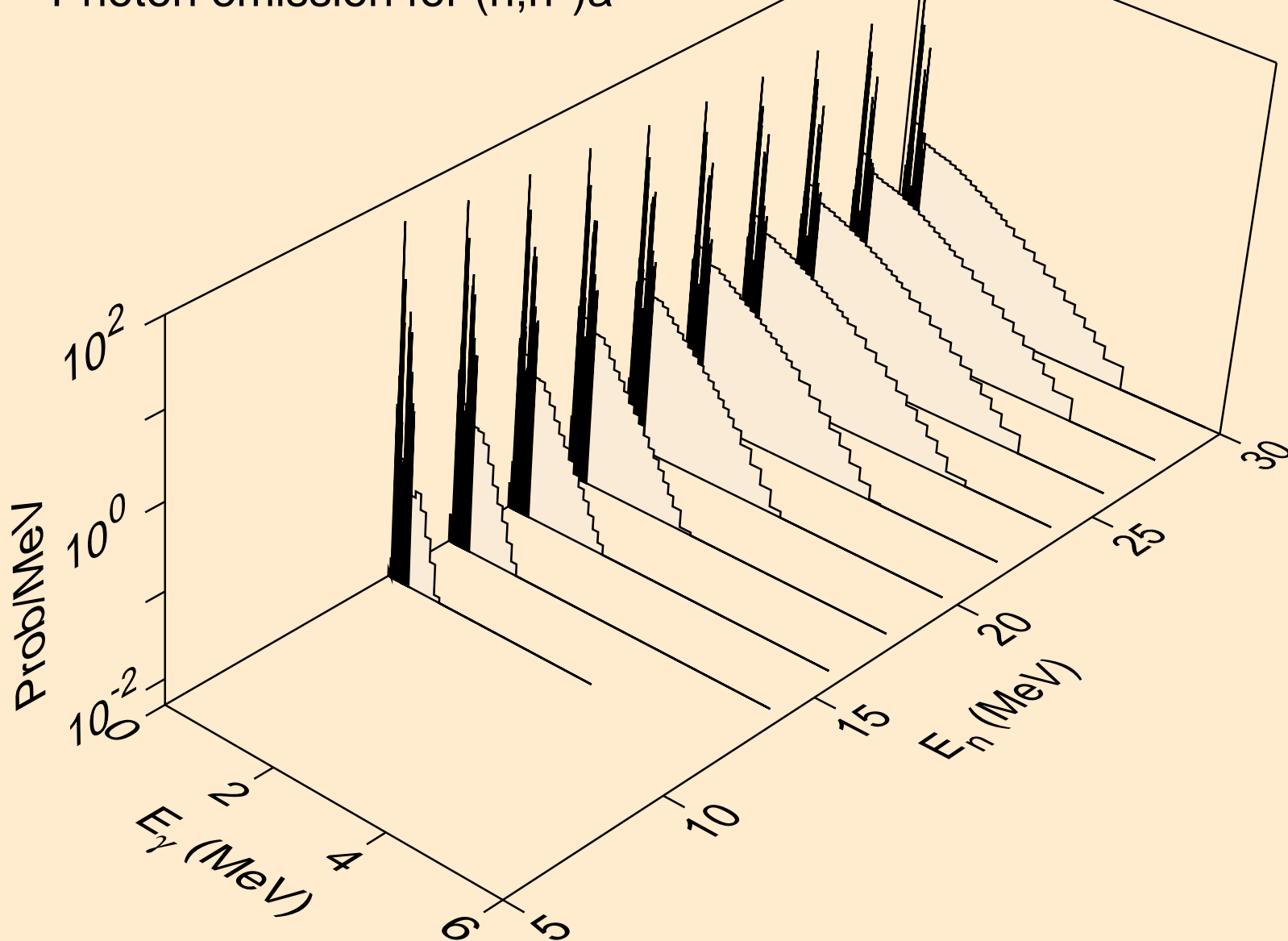

RU109 NEUTRON ACER TENDL-2019 LIBRARY; T=293.16K  
Photon emission for (n,2n)a

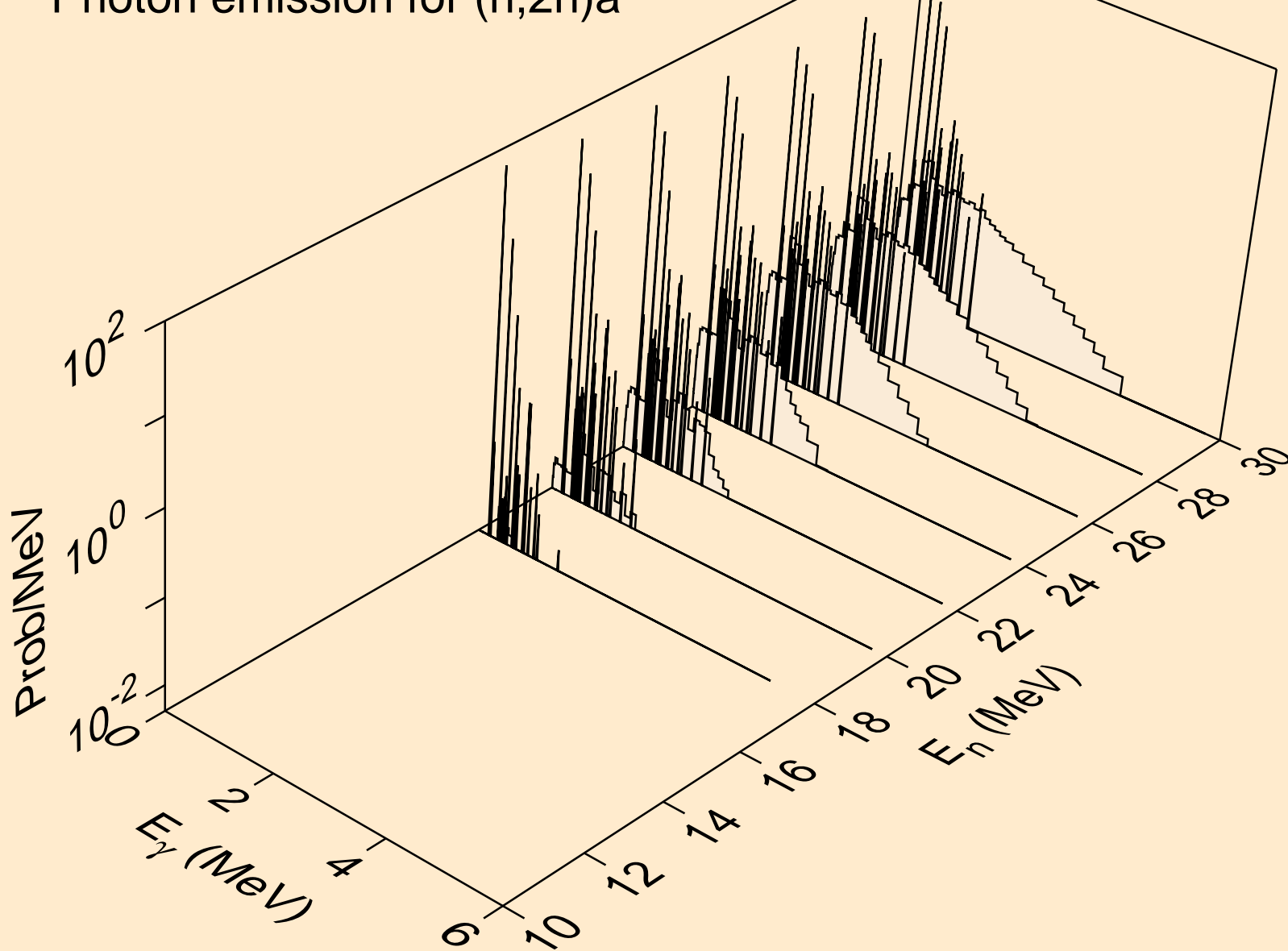

RU109 NEUTRON ACER TENDL-2019 LIBRARY; T=293.16K  
Photon emission for (n,3n)a

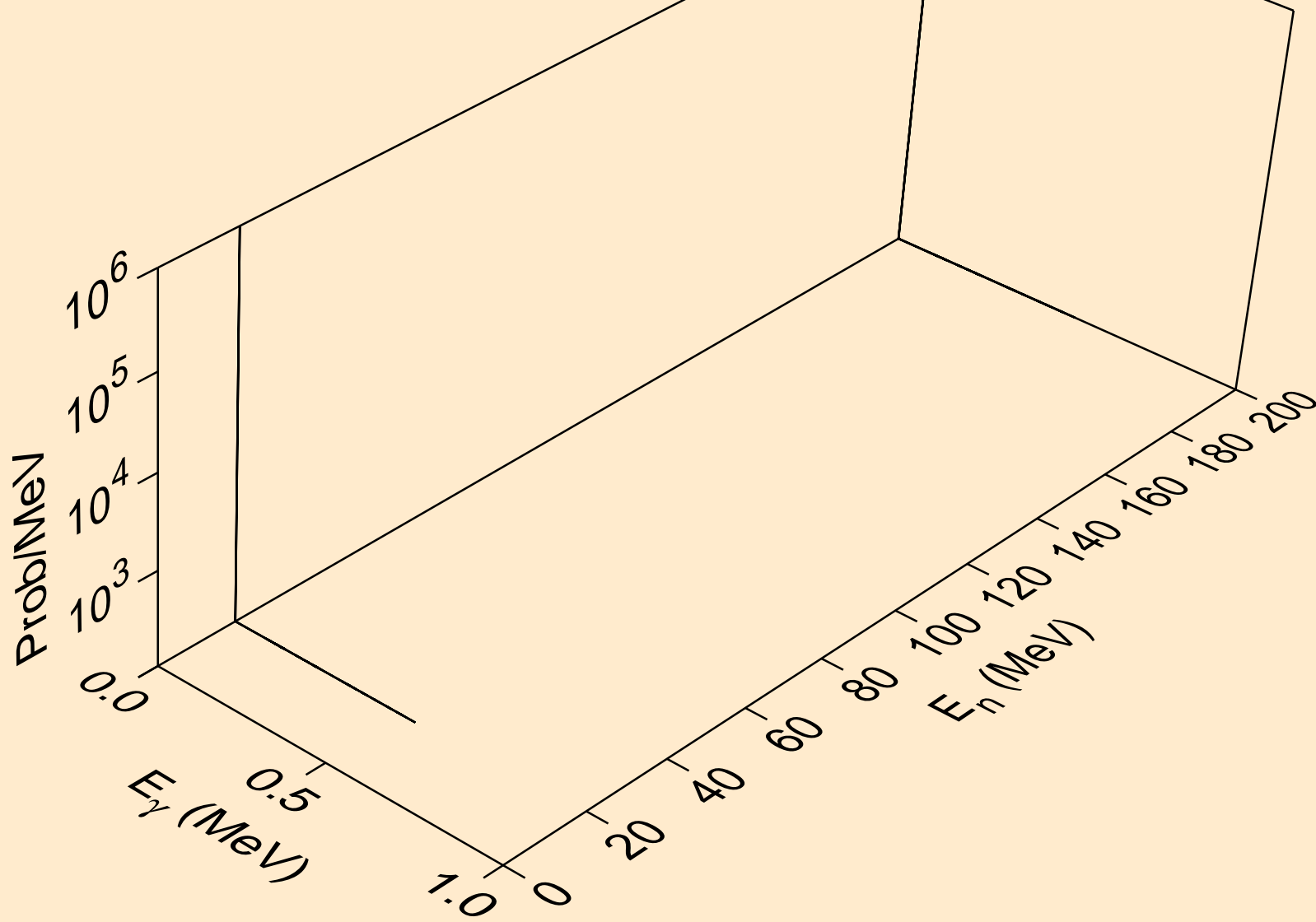



RU109 NEUTRON ACER TENDL-2019 LIBRARY; T=293.16K  
Photon emission for (n,n\*)p

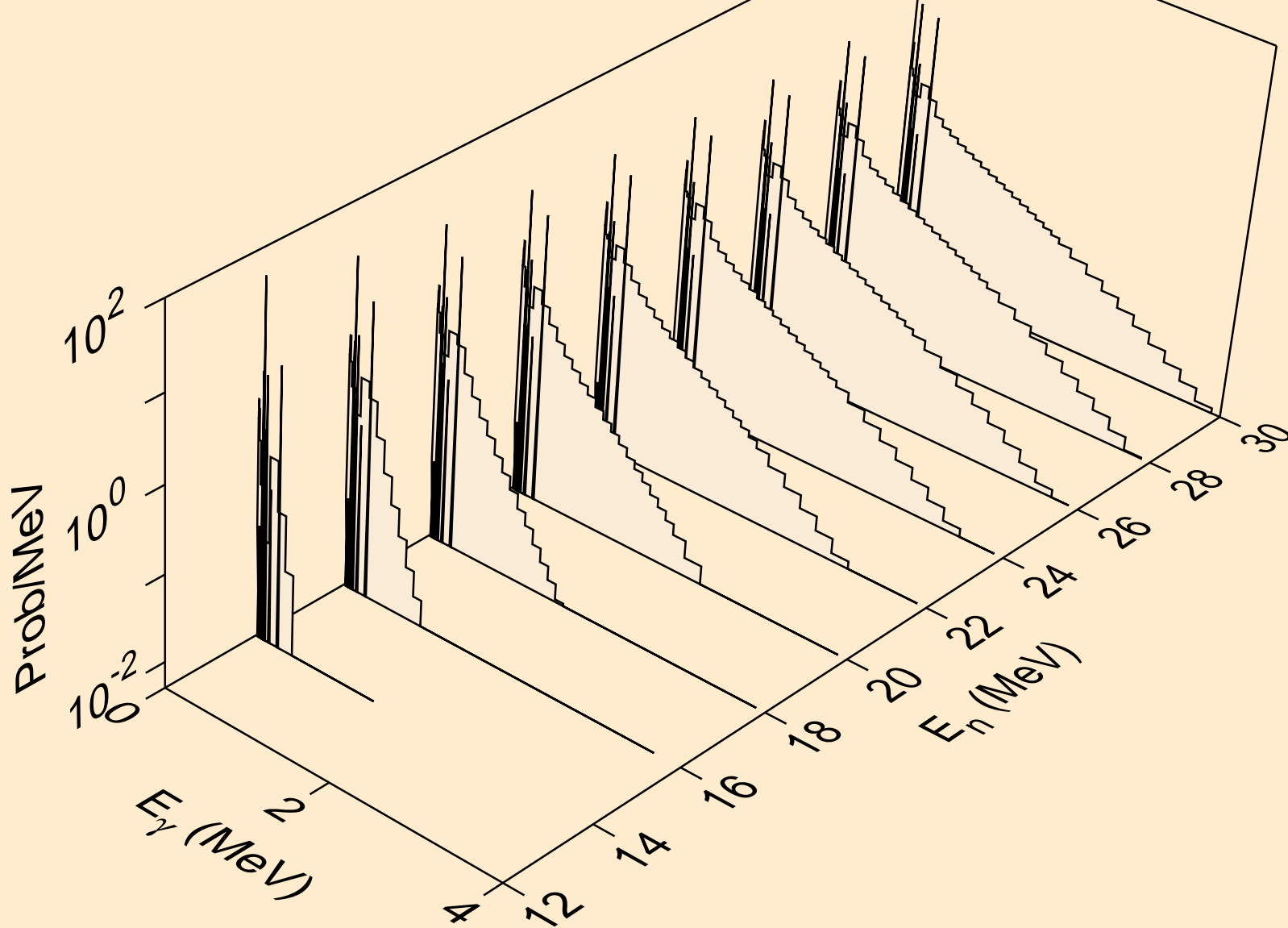

RU109 NEUTRON ACER TENDL-2019 LIBRARY; T=293.16K  
Photon emission for (n,n\*)d

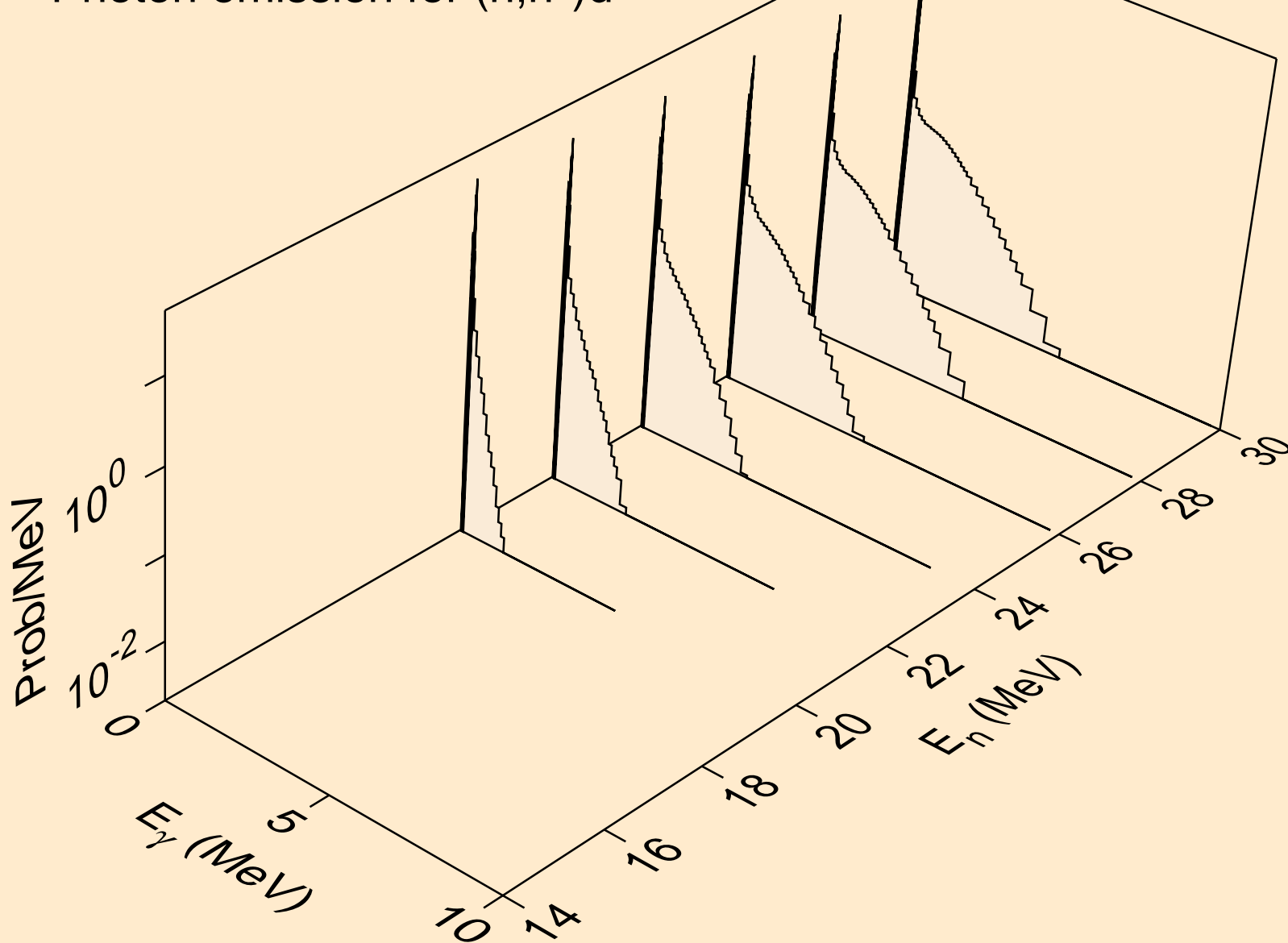

RU109 NEUTRON ACER TENDL-2019 LIBRARY; T=293.16K  
Photon emission for (n,n\*)t

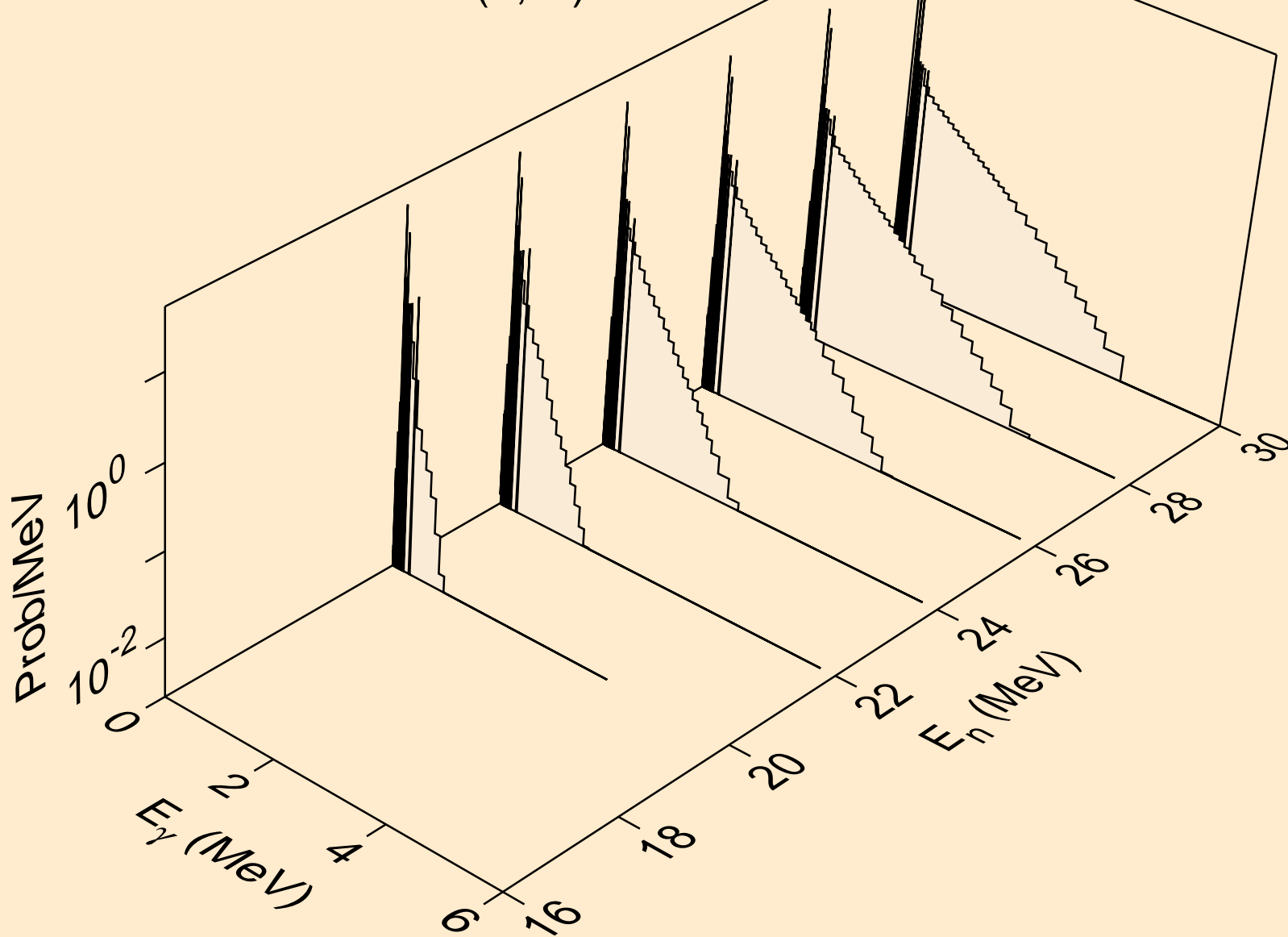

RU109 NEUTRON ACER TENDL-2019 LIBRARY; T=293.16K  
Photon emission for (n,n\*)he3

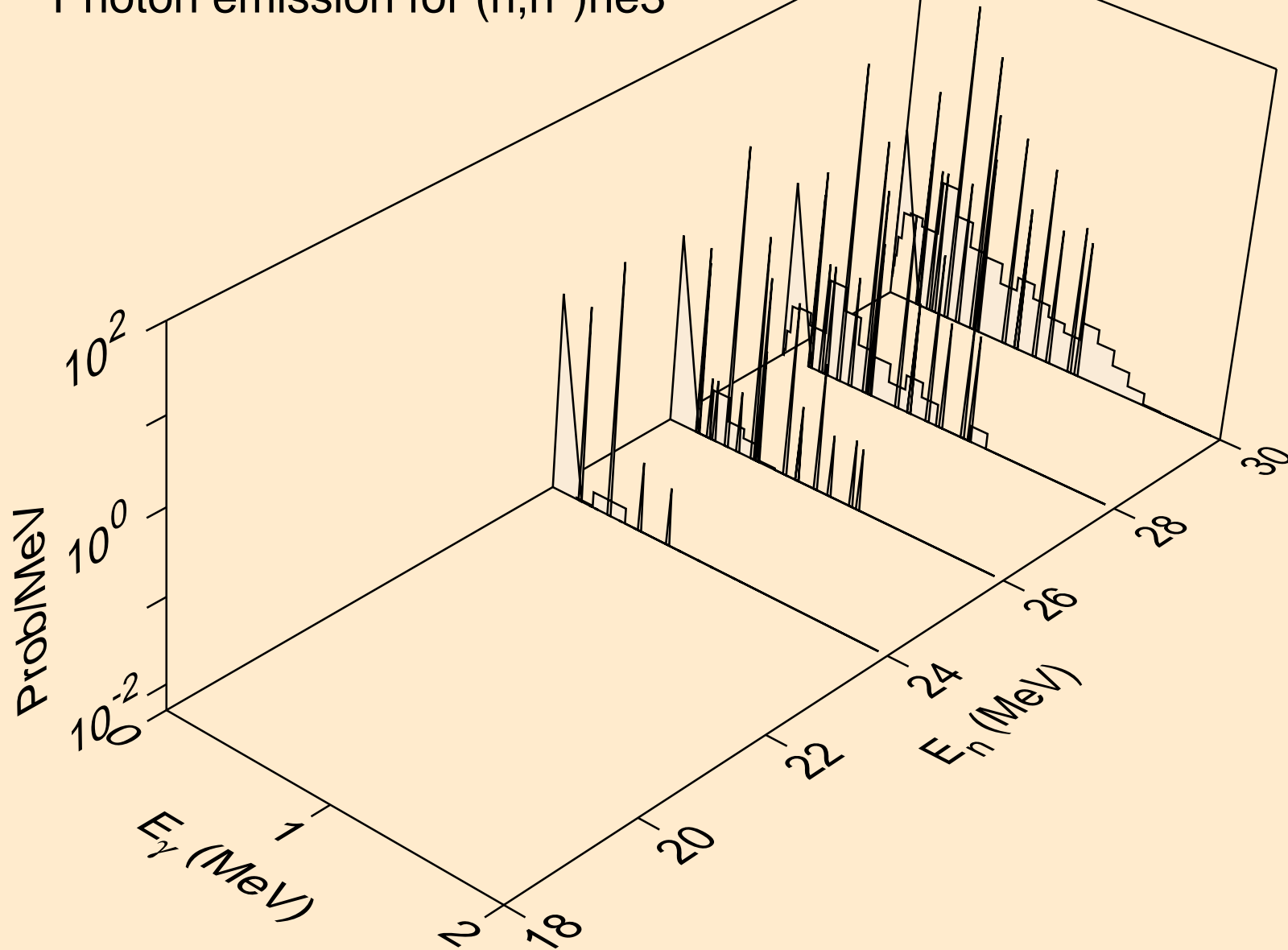

RU109 NEUTRON ACER TENDL-2019 LIBRARY; T=293.16K  
Photon emission for (n,4n)

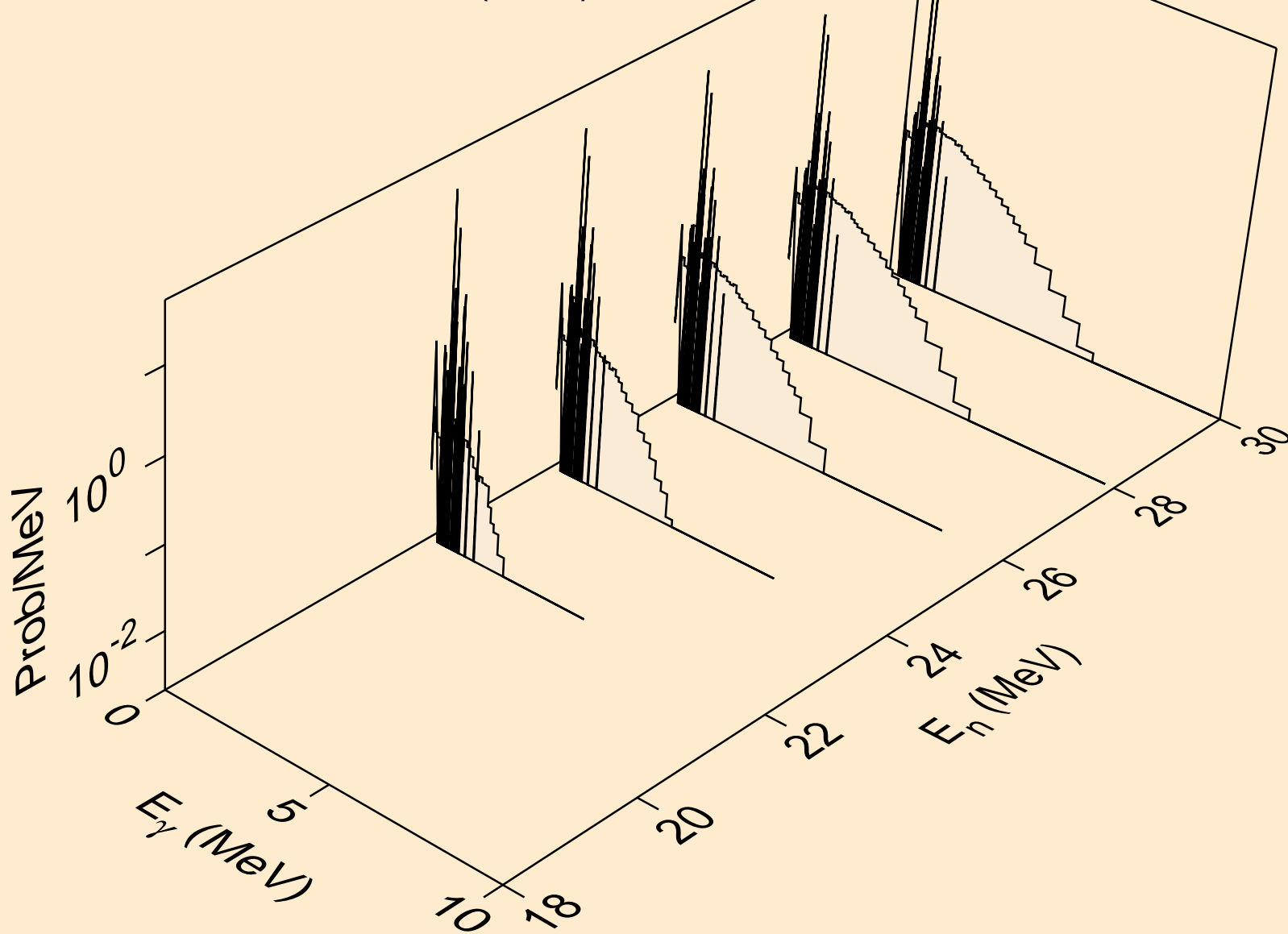

RU109 NEUTRON ACER TENDL-2019 LIBRARY; T=293.16K  
Photon emission for (n,2np)

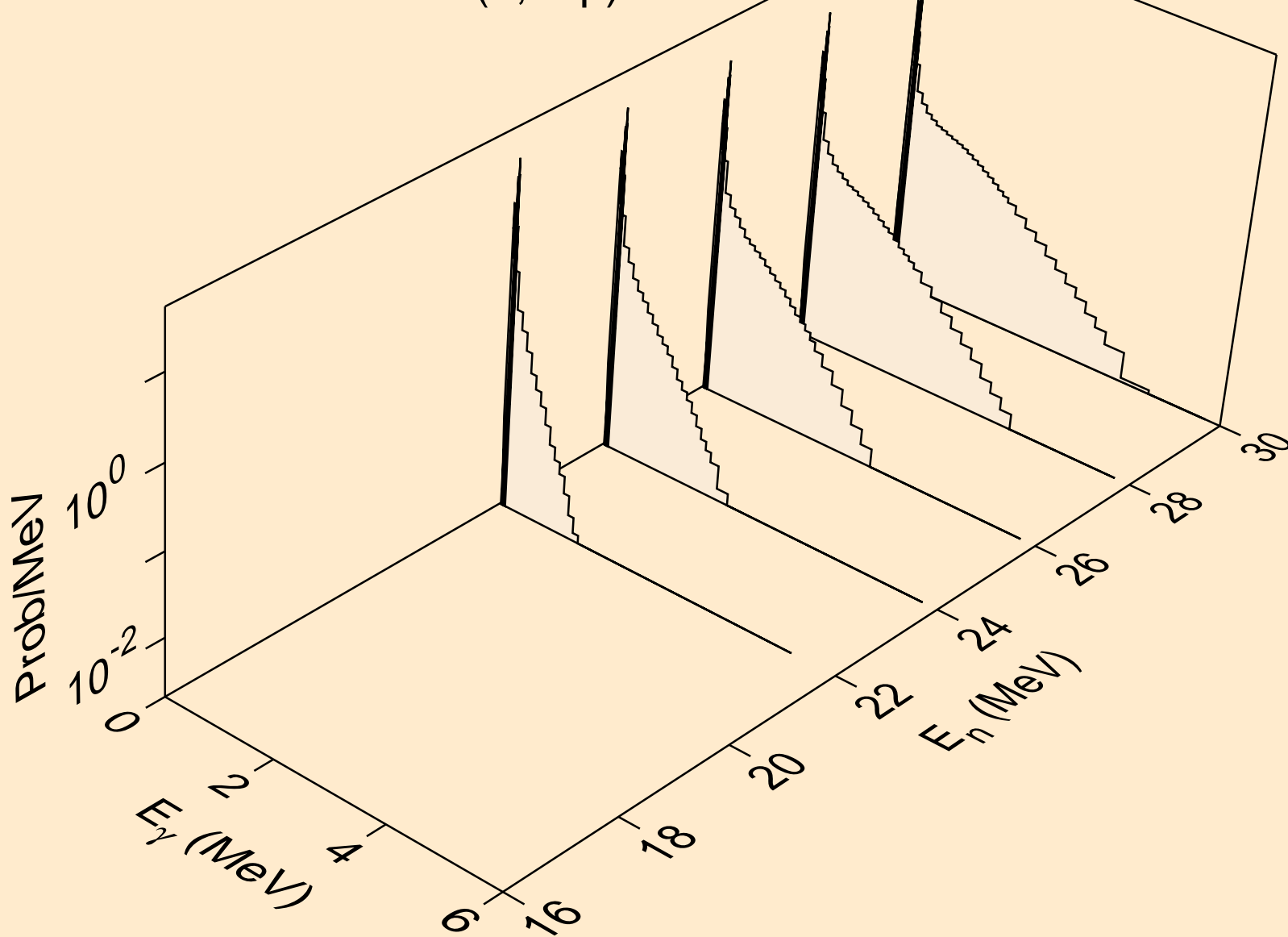

RU109 NEUTRON ACER TENDL-2019 LIBRARY; T=293.16K  
Photon emission for (n,3np)

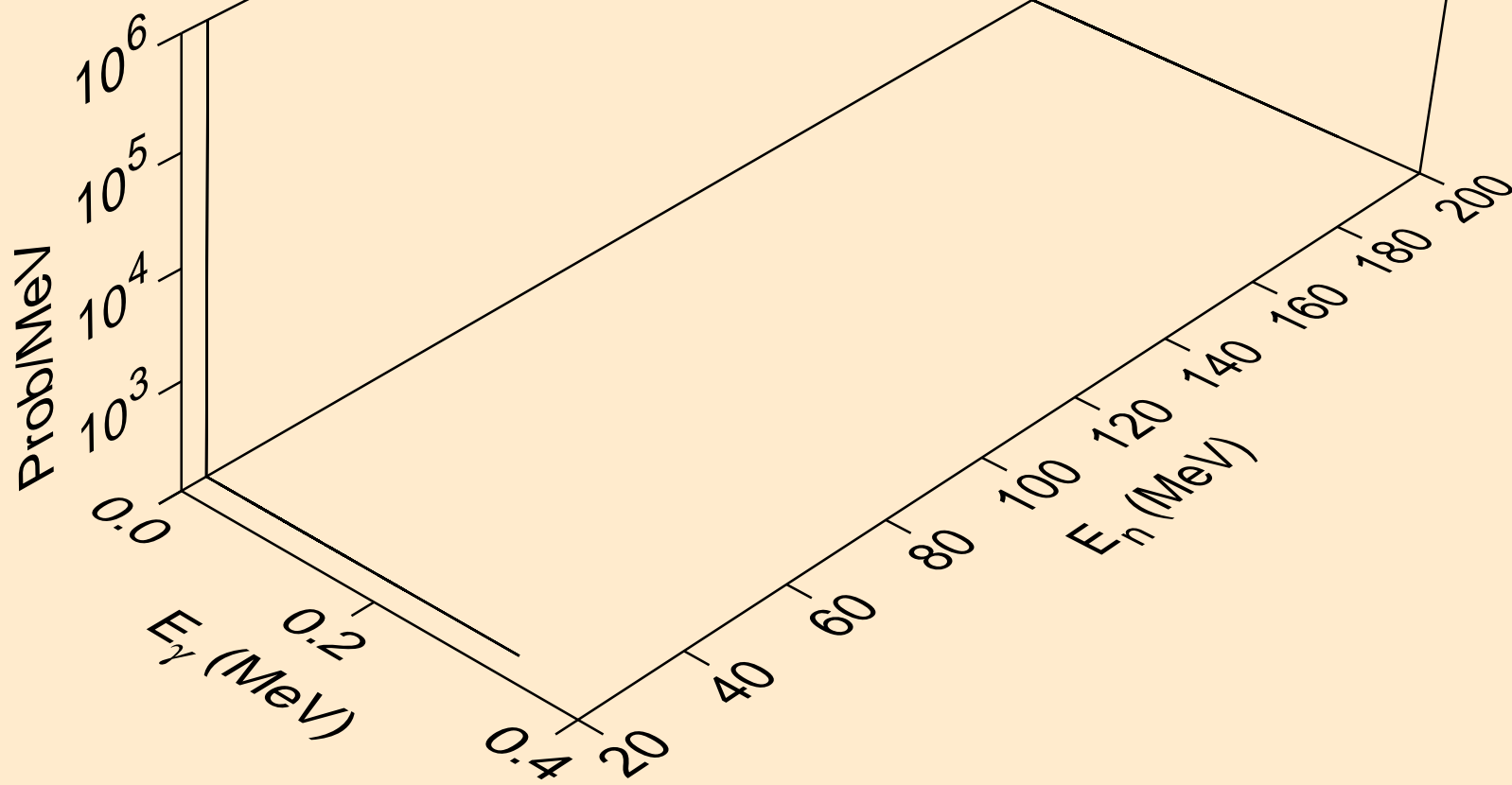

RU109 NEUTRON ACER TENDL-2019 LIBRARY; T=293.16K  
Photon emission for (n,n\*c)

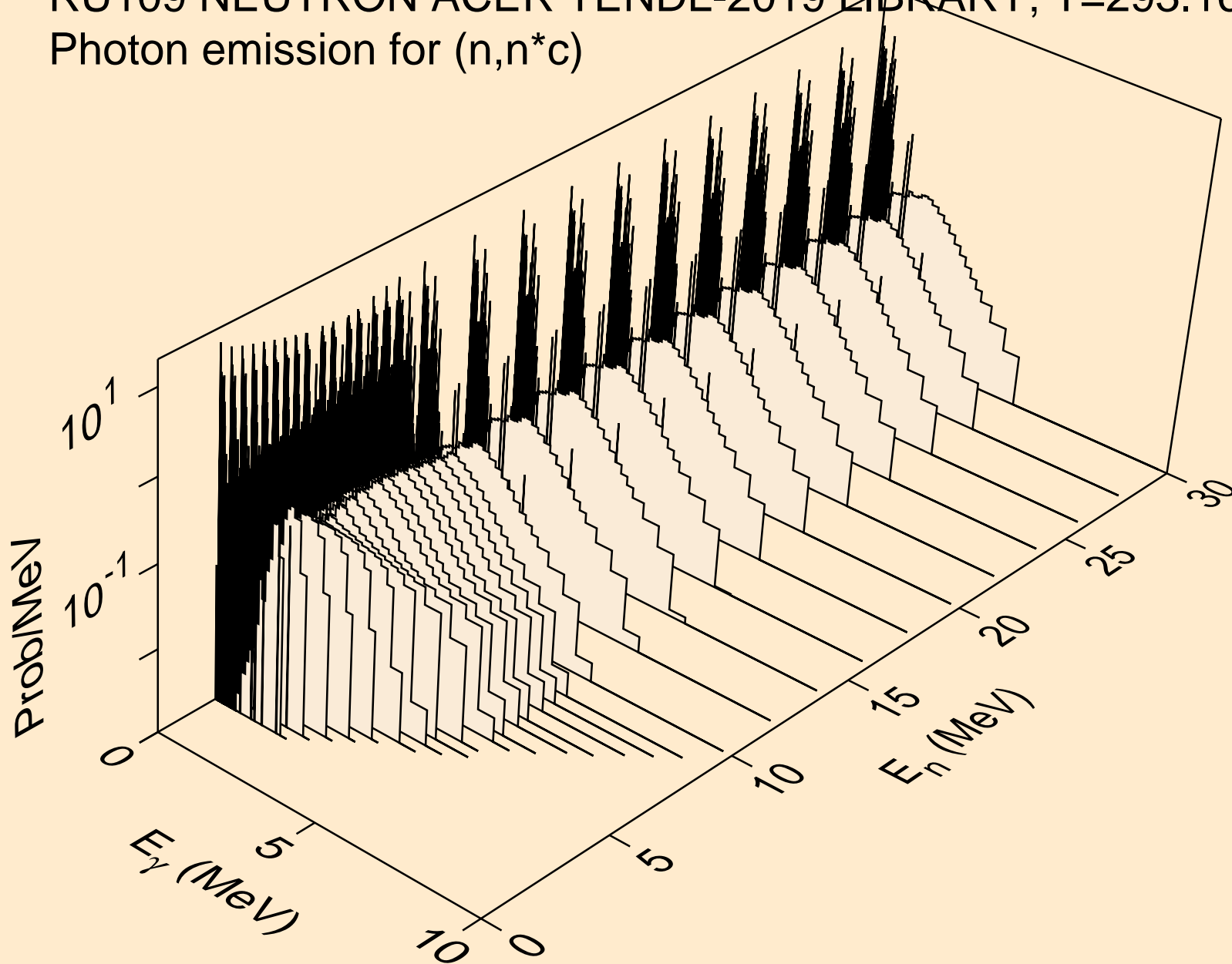



RU109 NEUTRON ACER TENDL-2019 LIBRARY; T=293.16K  
Photon emission for (n,gma)

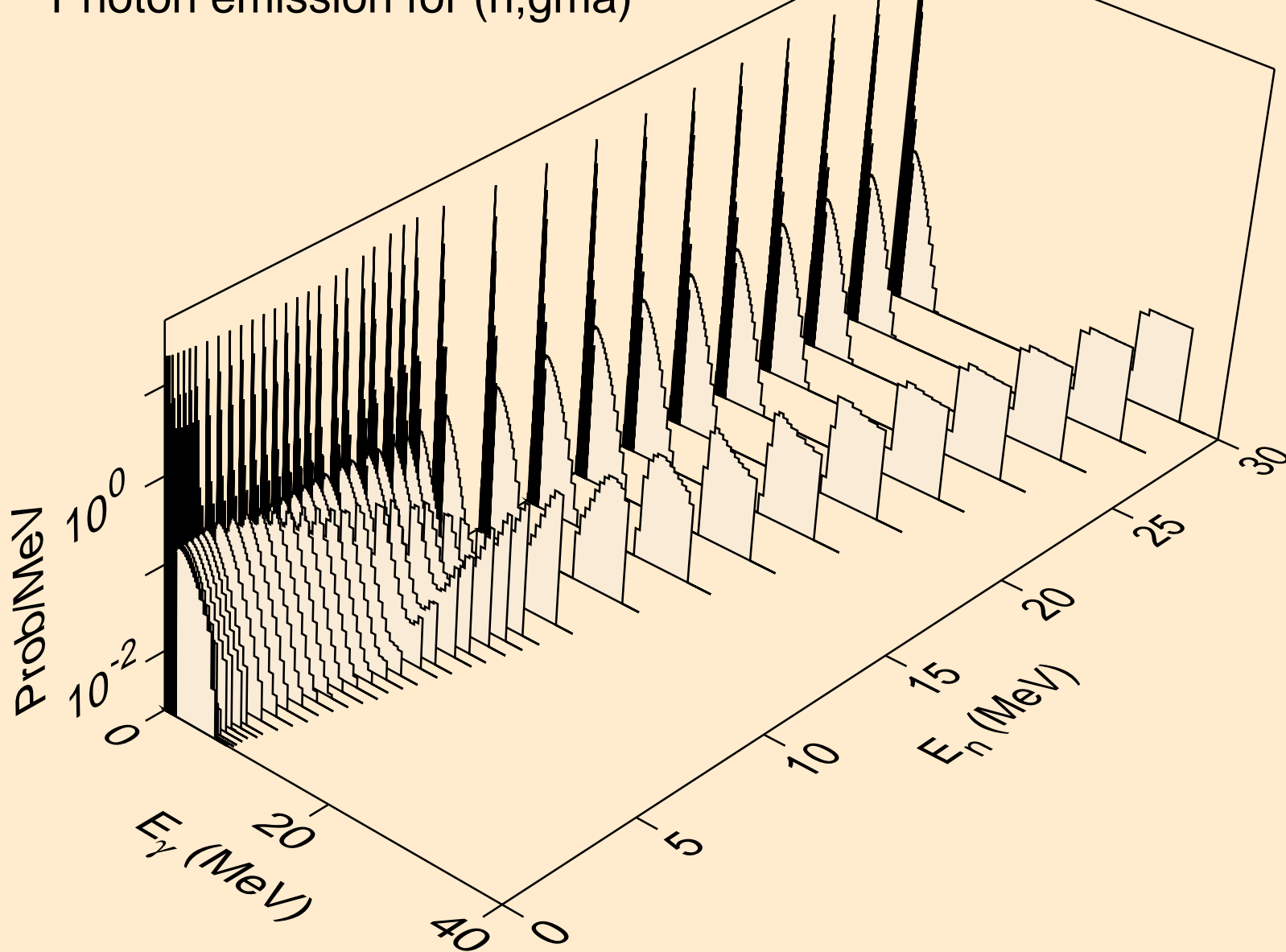

RU109 NEUTRON ACER TENDL-2019 LIBRARY; T=293.16K  
Photon emission for (n,p)

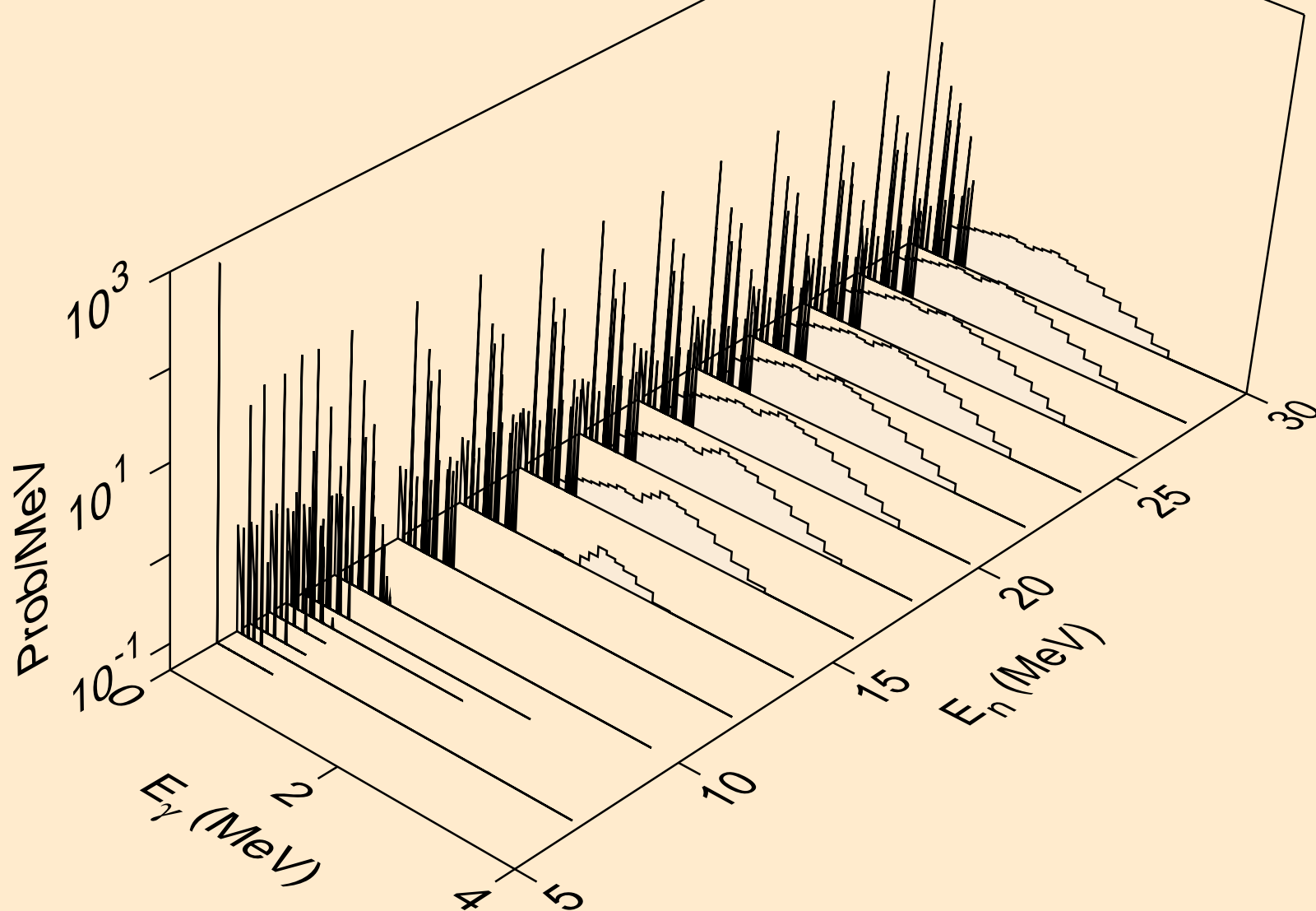

RU109 NEUTRON ACER TENDL-2019 LIBRARY; T=293.16K  
Photon emission for (n,d)

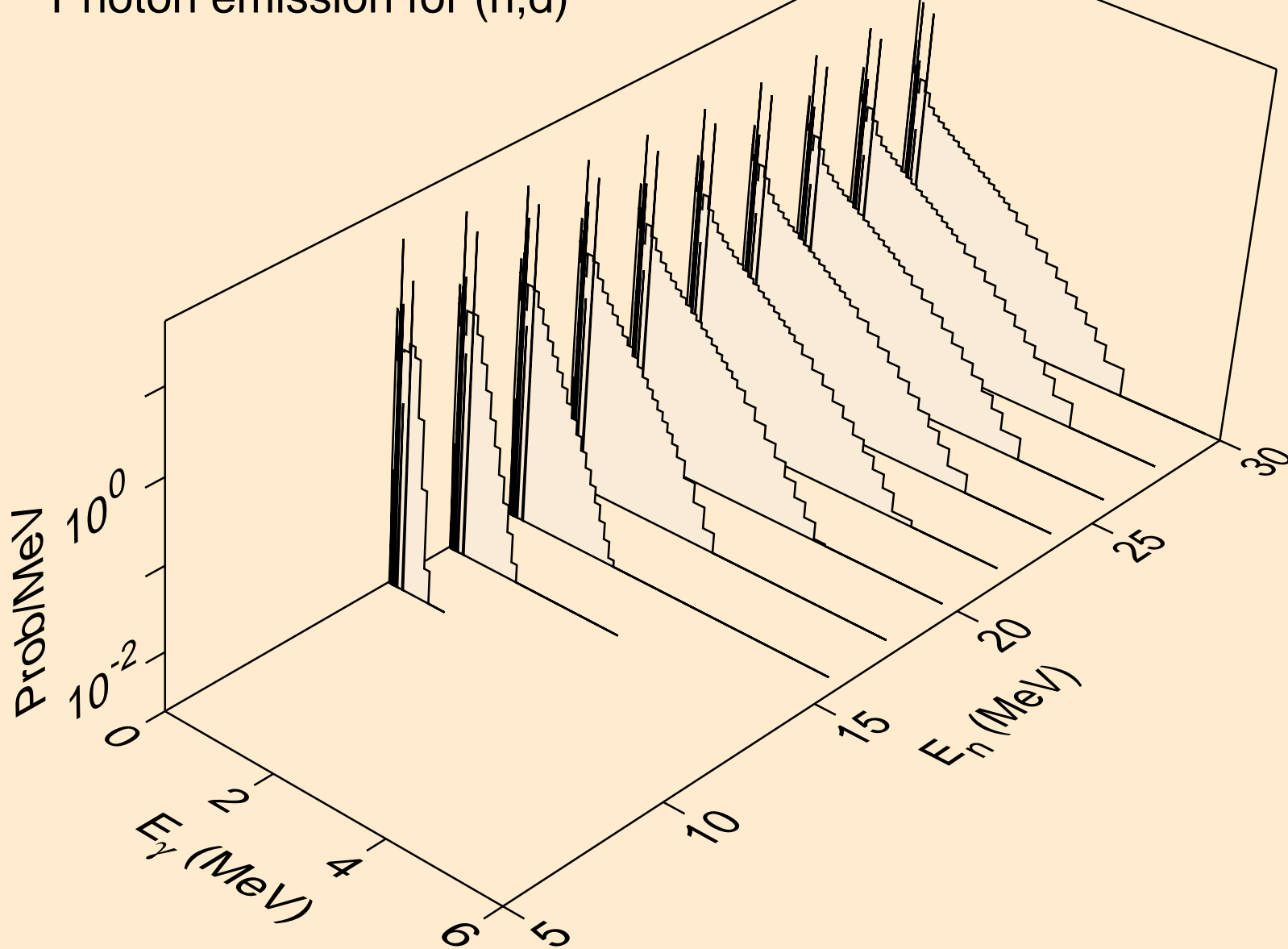

RU109 NEUTRON ACER TENDL-2019 LIBRARY; T=293.16K  
Photon emission for (n,t)

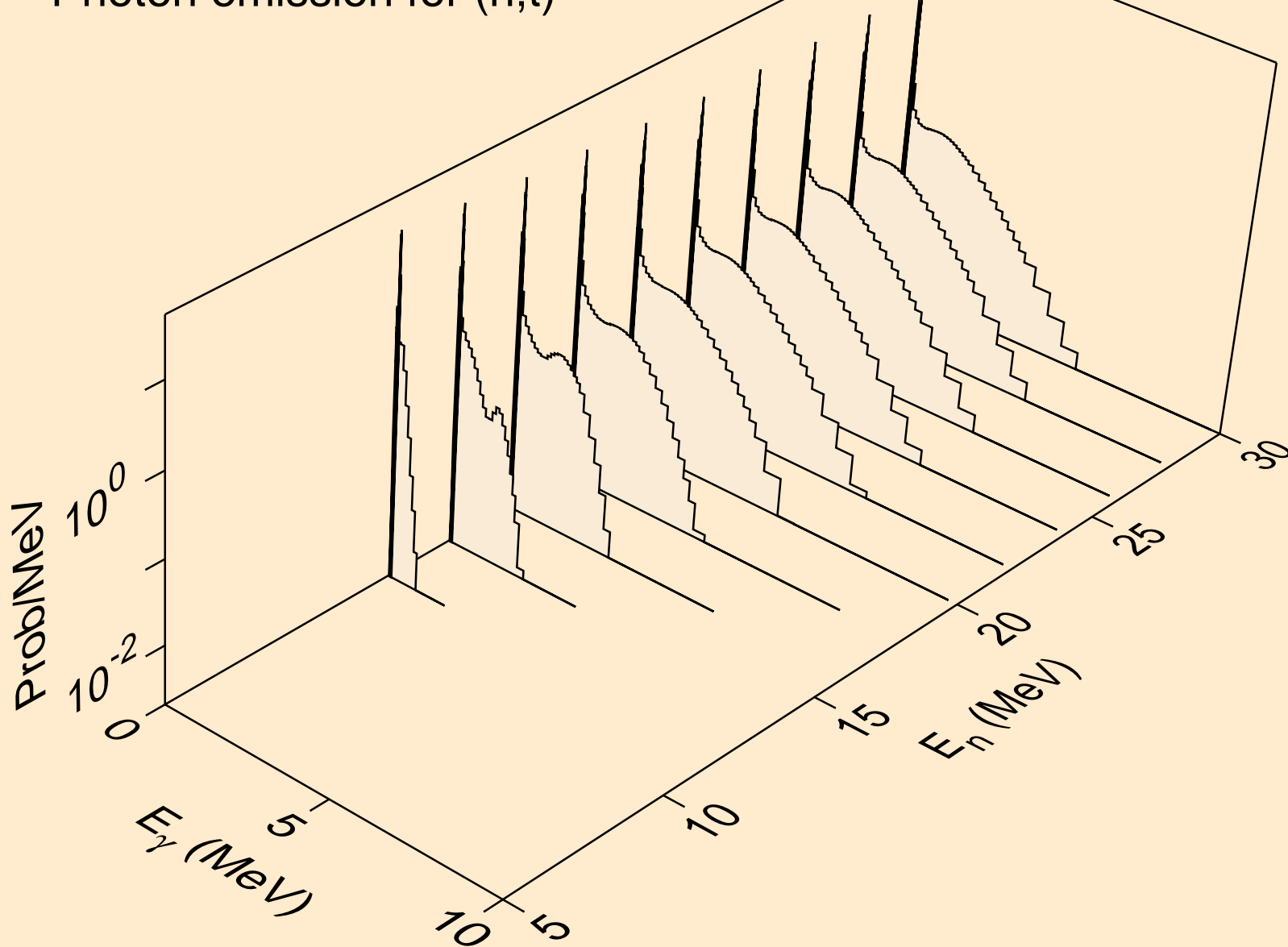

RU109 NEUTRON ACER TENDL-2019 LIBRARY; T=293.16K  
Photon emission for (n,he3)

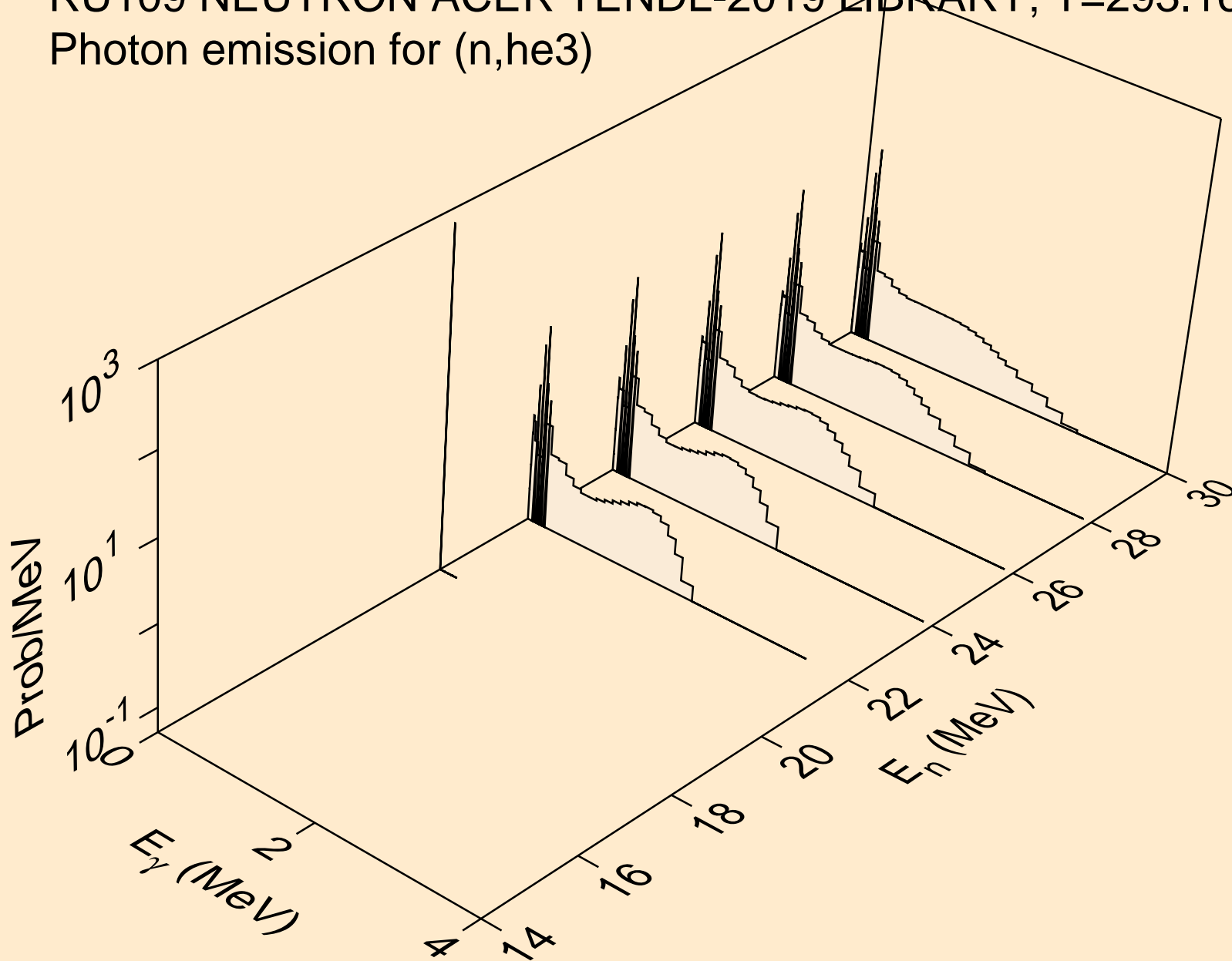

RU109 NEUTRON ACER TENDL-2019 LIBRARY; T=293.16K  
Photon emission for (n,a)

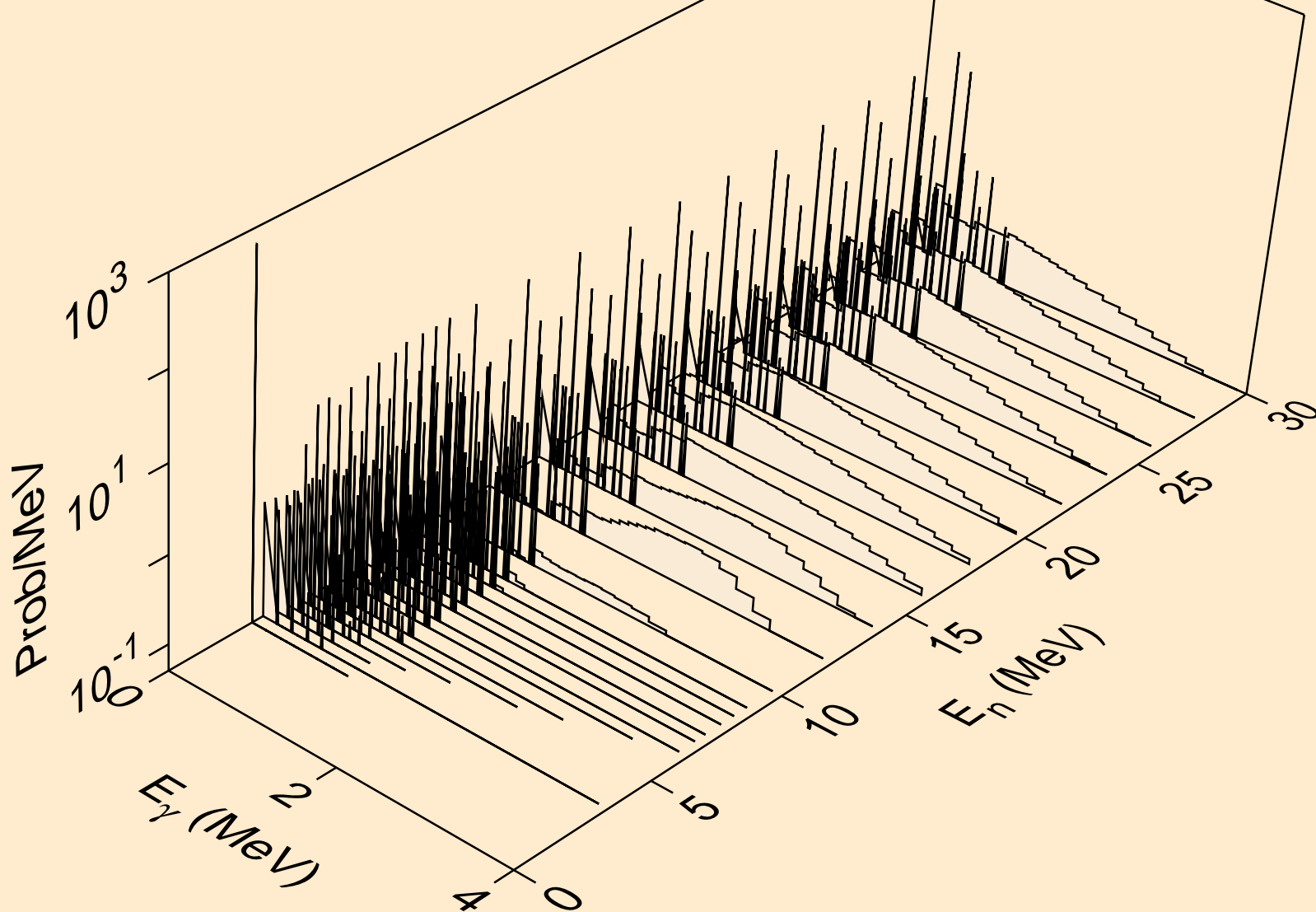

RU109 NEUTRON ACER TENDL-2019 LIBRARY; T=293.16K  
Photon emission for (n,2p)

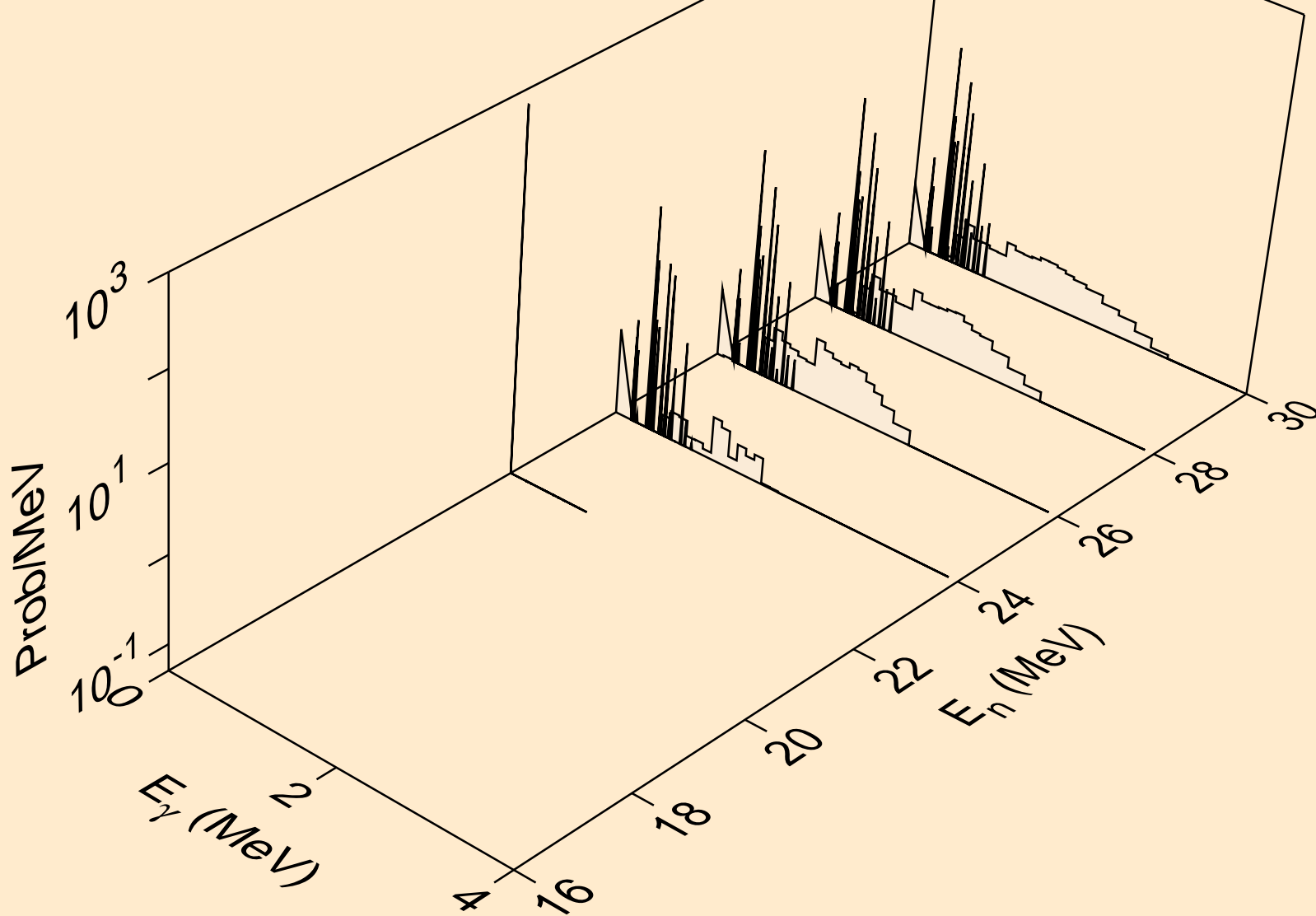

RU109 NEUTRON ACER TENDL-2019 LIBRARY; T=293.16K  
thermal capture photon spectrum

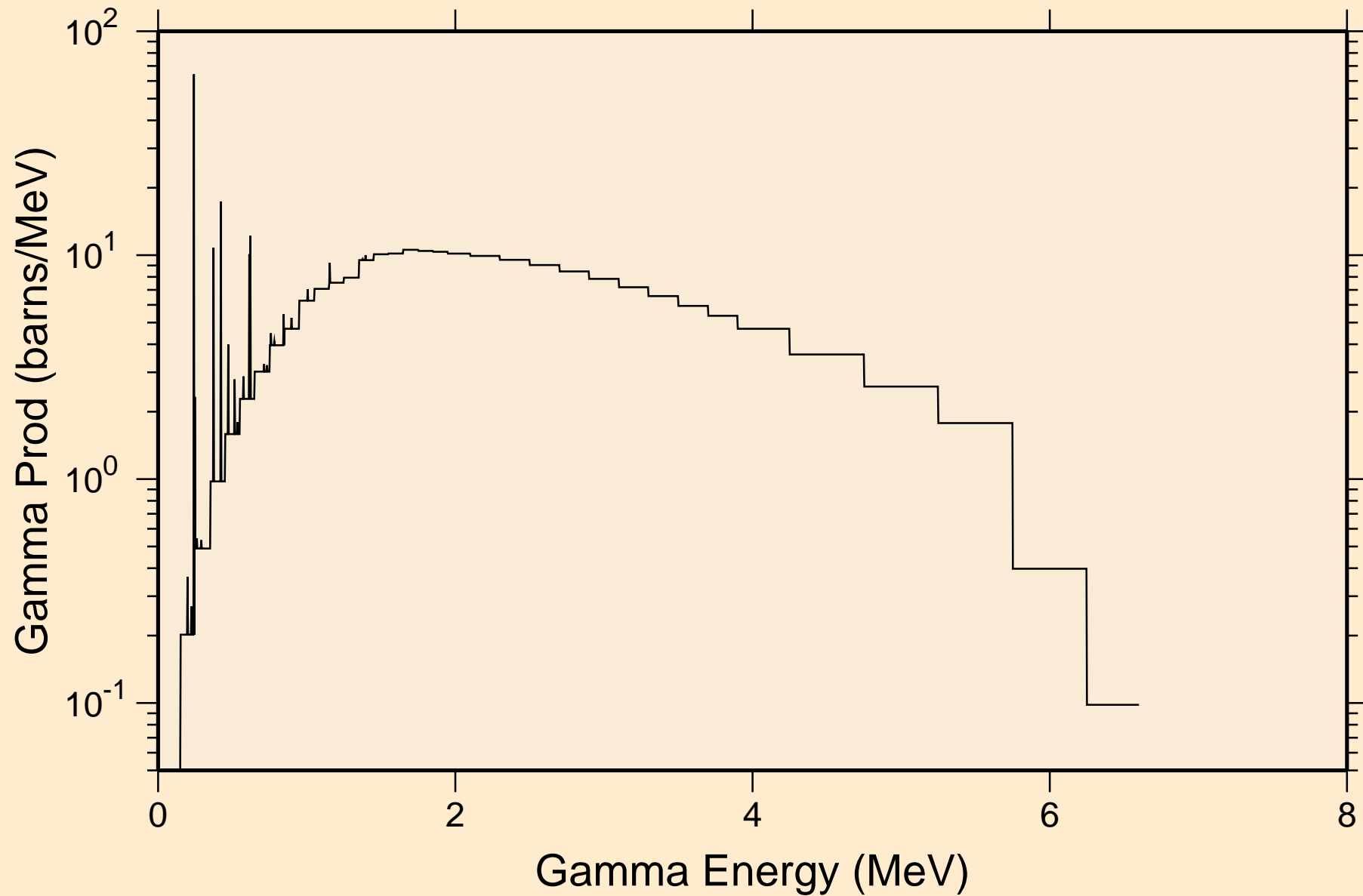



RU109 NEUTRON ACER TENDL-2019 LIBRARY; T=293.16K  
14 MeV photon spectrum

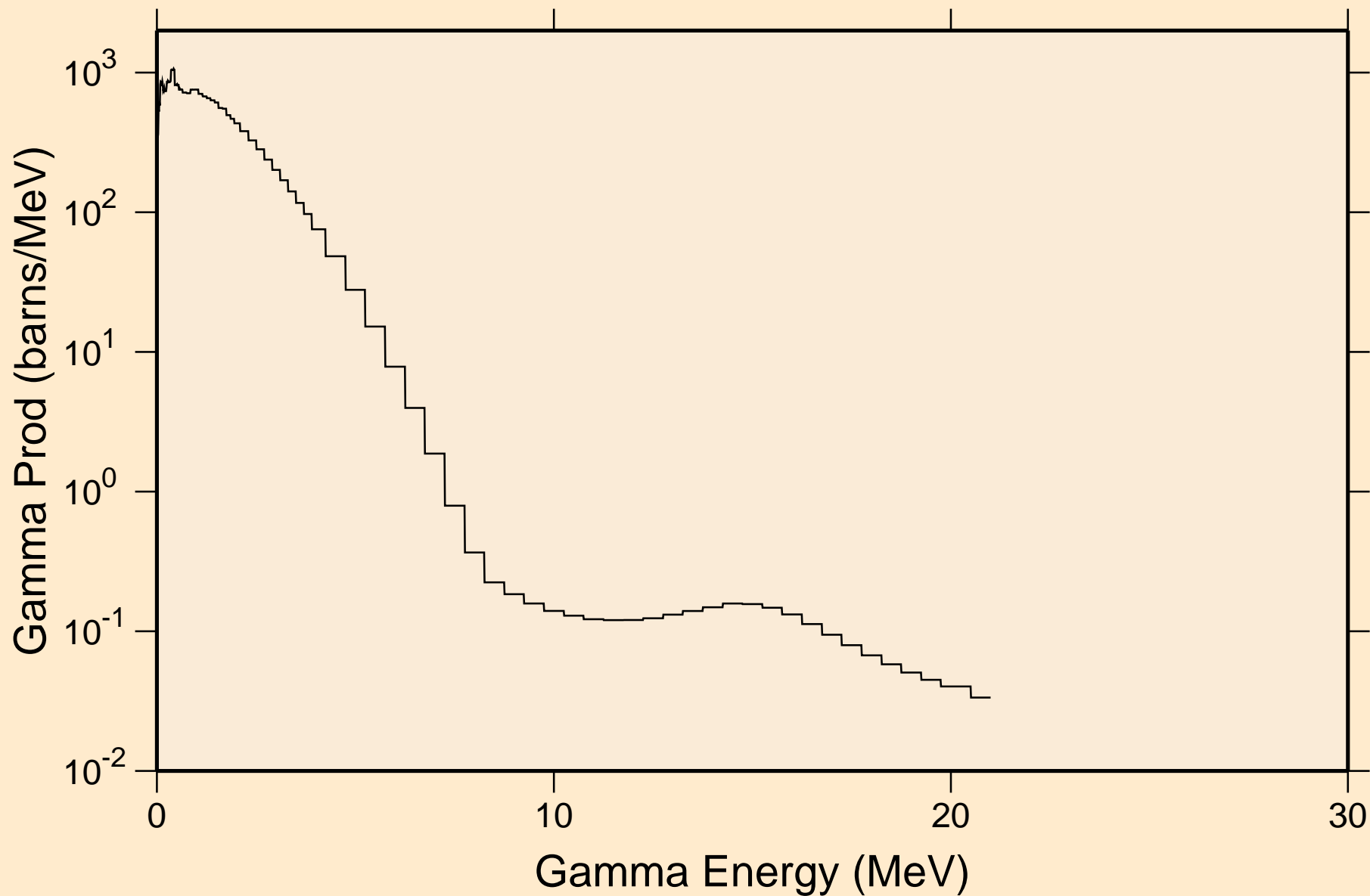

RU109 NEUTRON ACER TENDL-2019 LIBRARY; T=293.16K  
Particle heating contributions

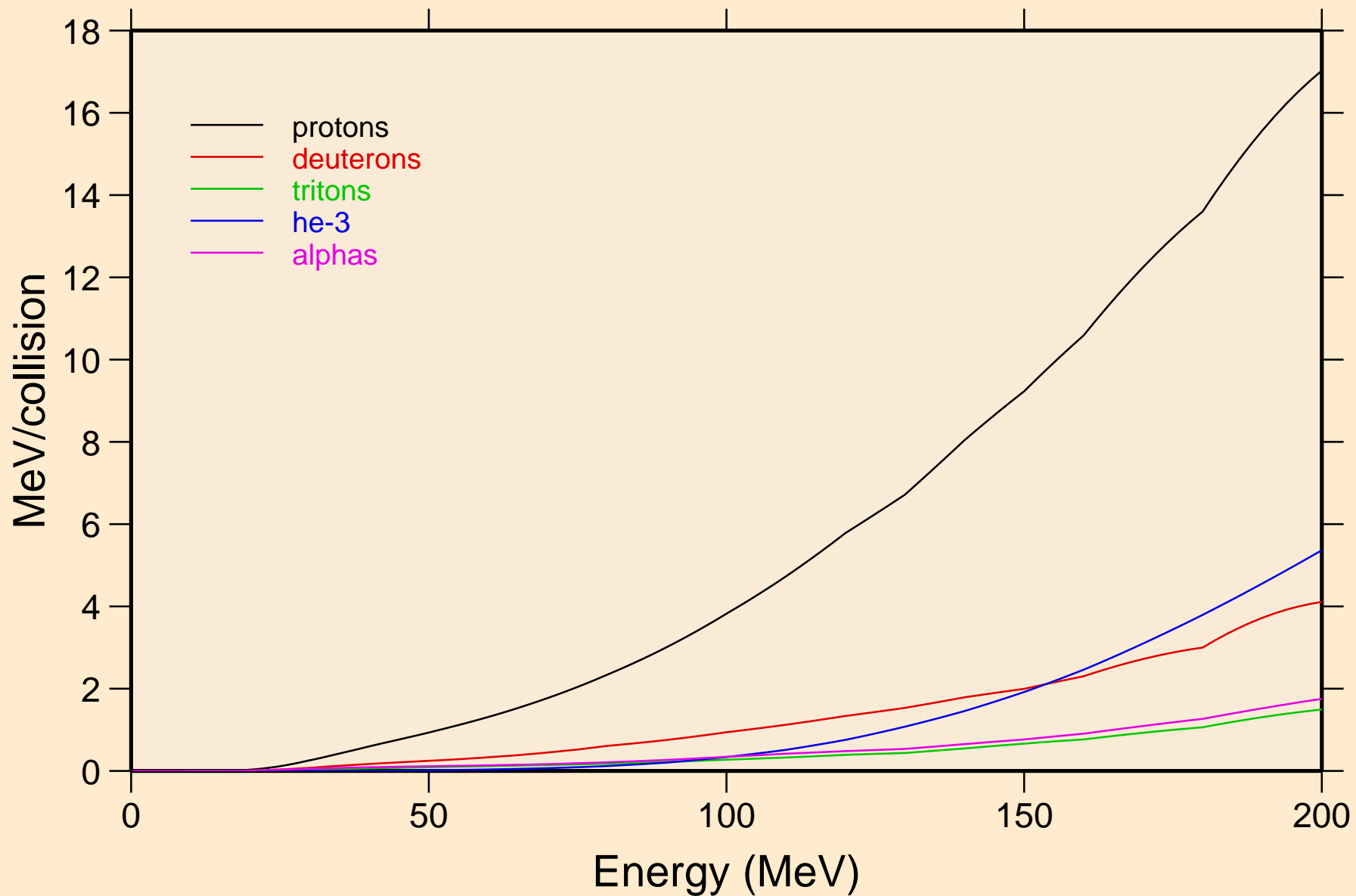

RU109 NEUTRON ACER TENDL-2019 LIBRARY; T=293.16K  
Recoil Heating

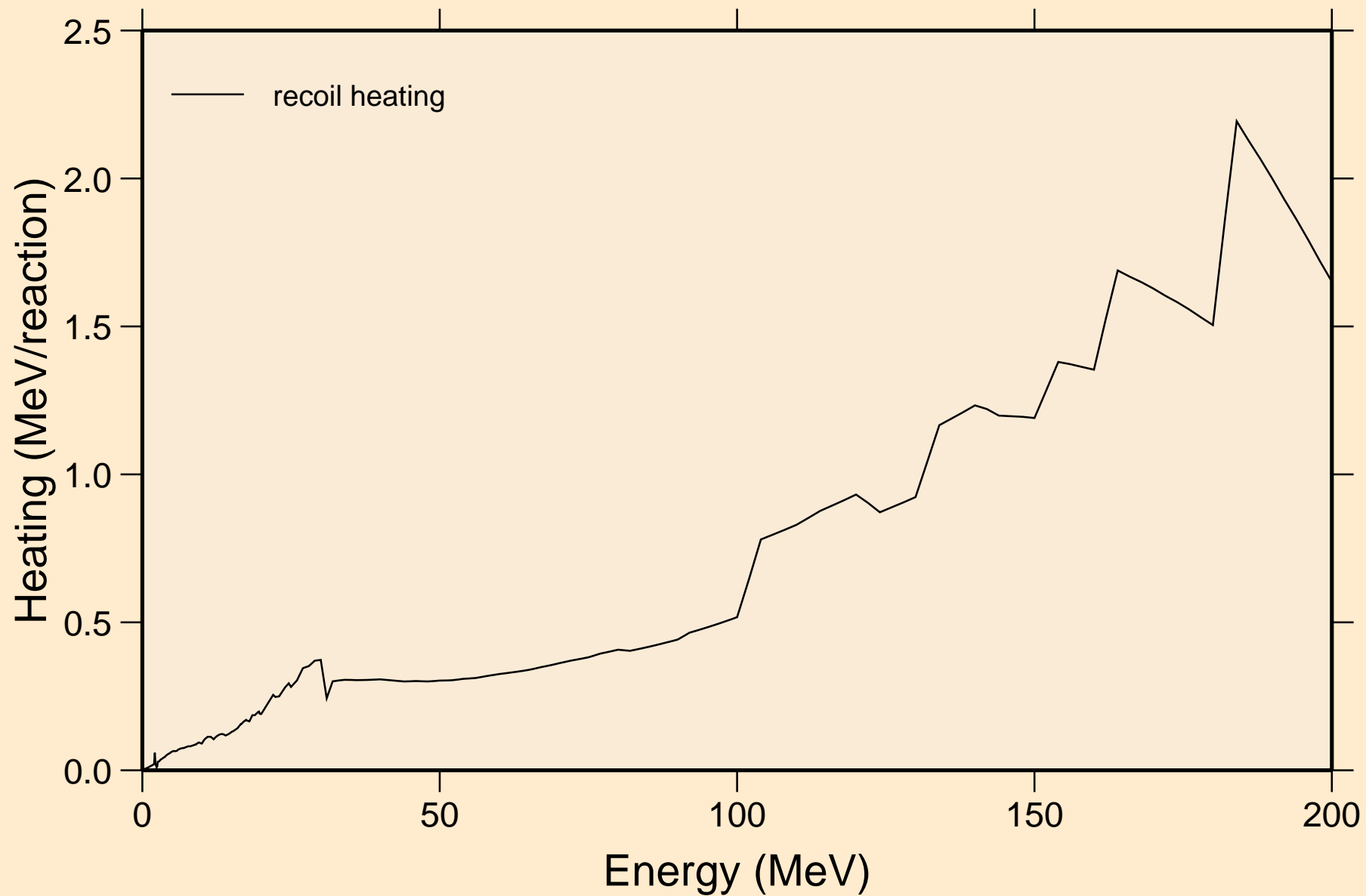

RU109 NEUTRON ACER TENDL-2019 LIBRARY; T=293.16K  
Particle production cross sections

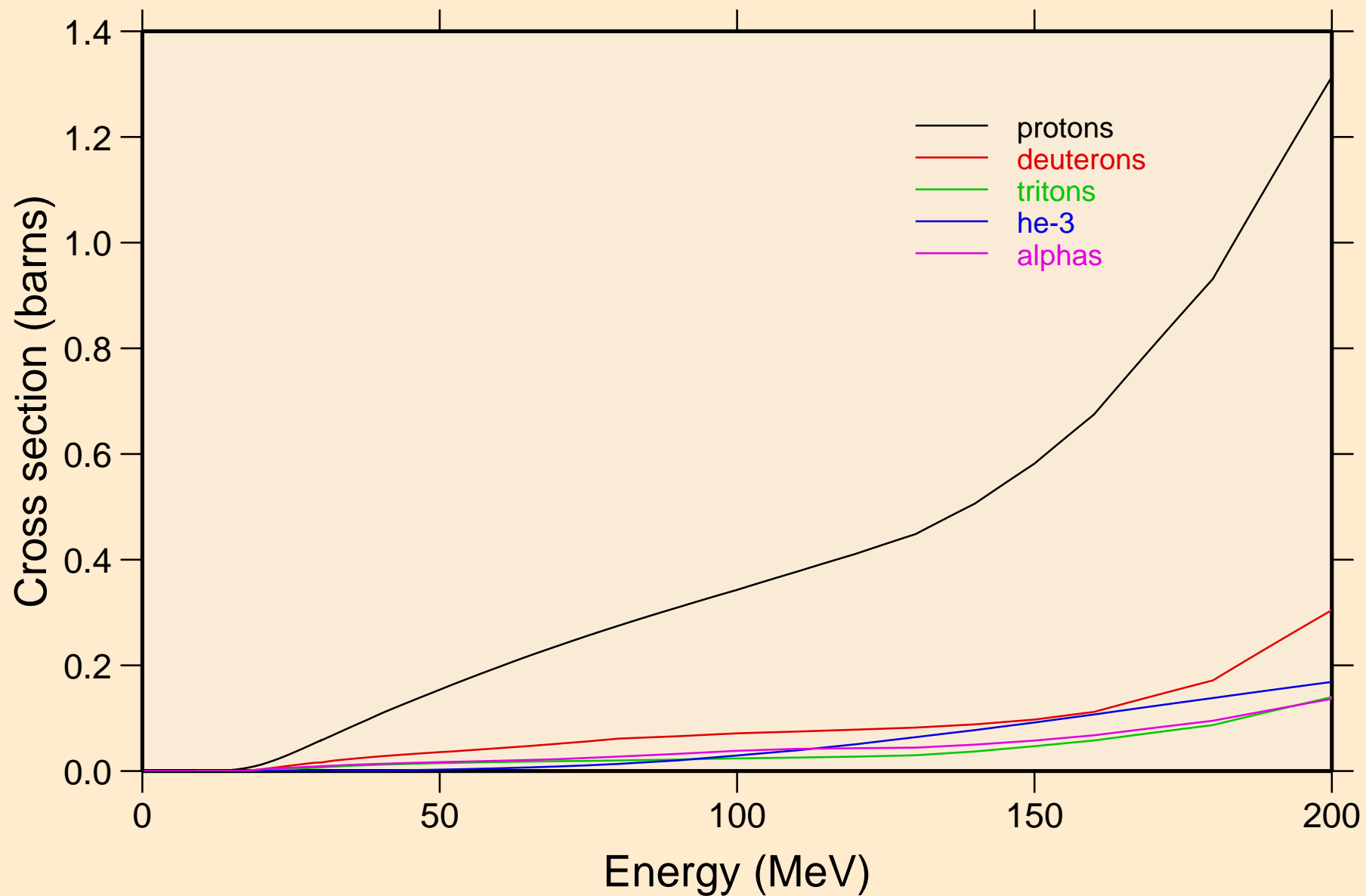

RU109 NEUTRON ACER TENDL-2019 LIBRARY; T=293.16K  
protons from (n,x)

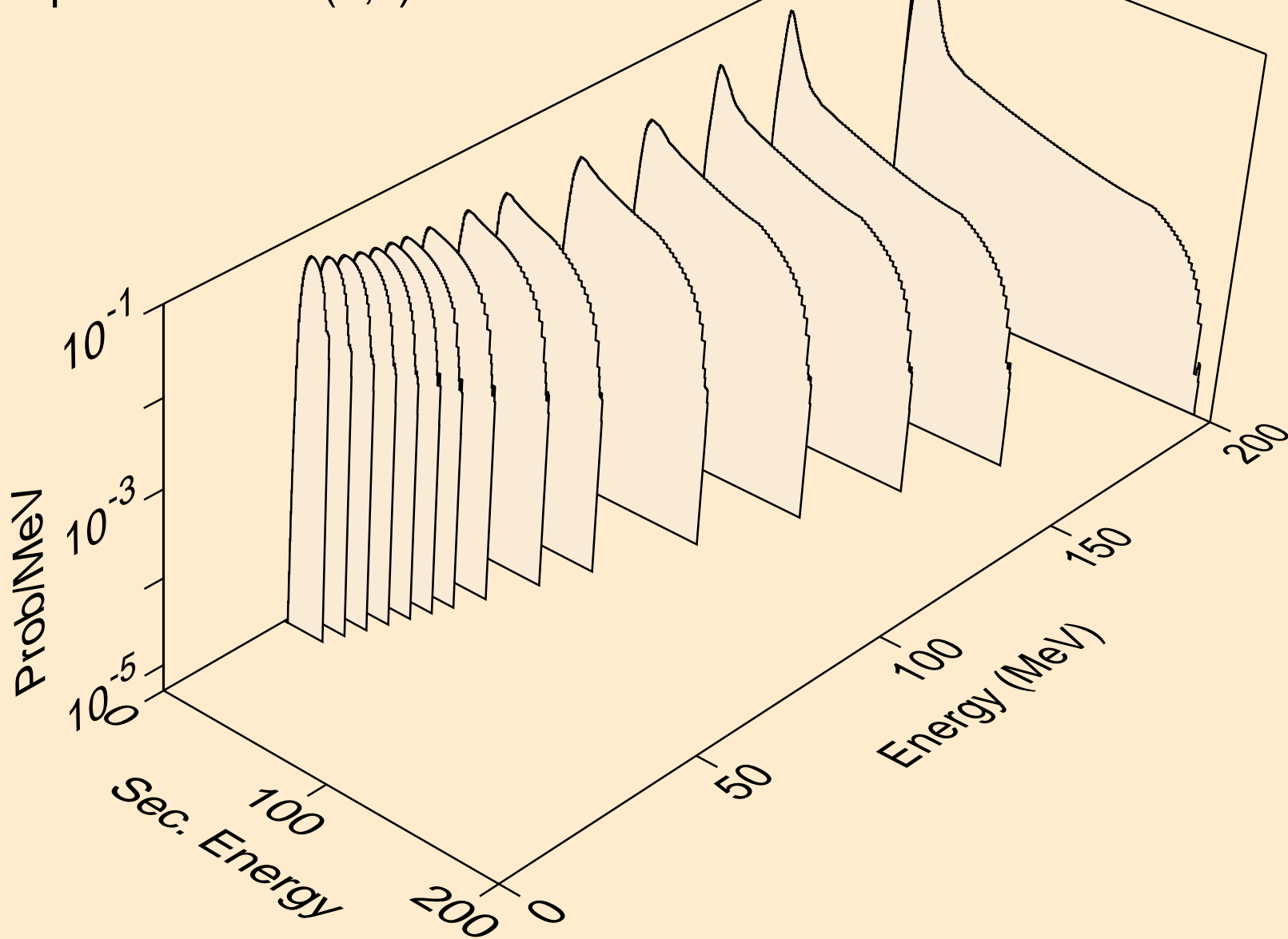

RU109 NEUTRON ACER TENDL-2019 LIBRARY; T=293.16K  
protons from (n,n\*)p

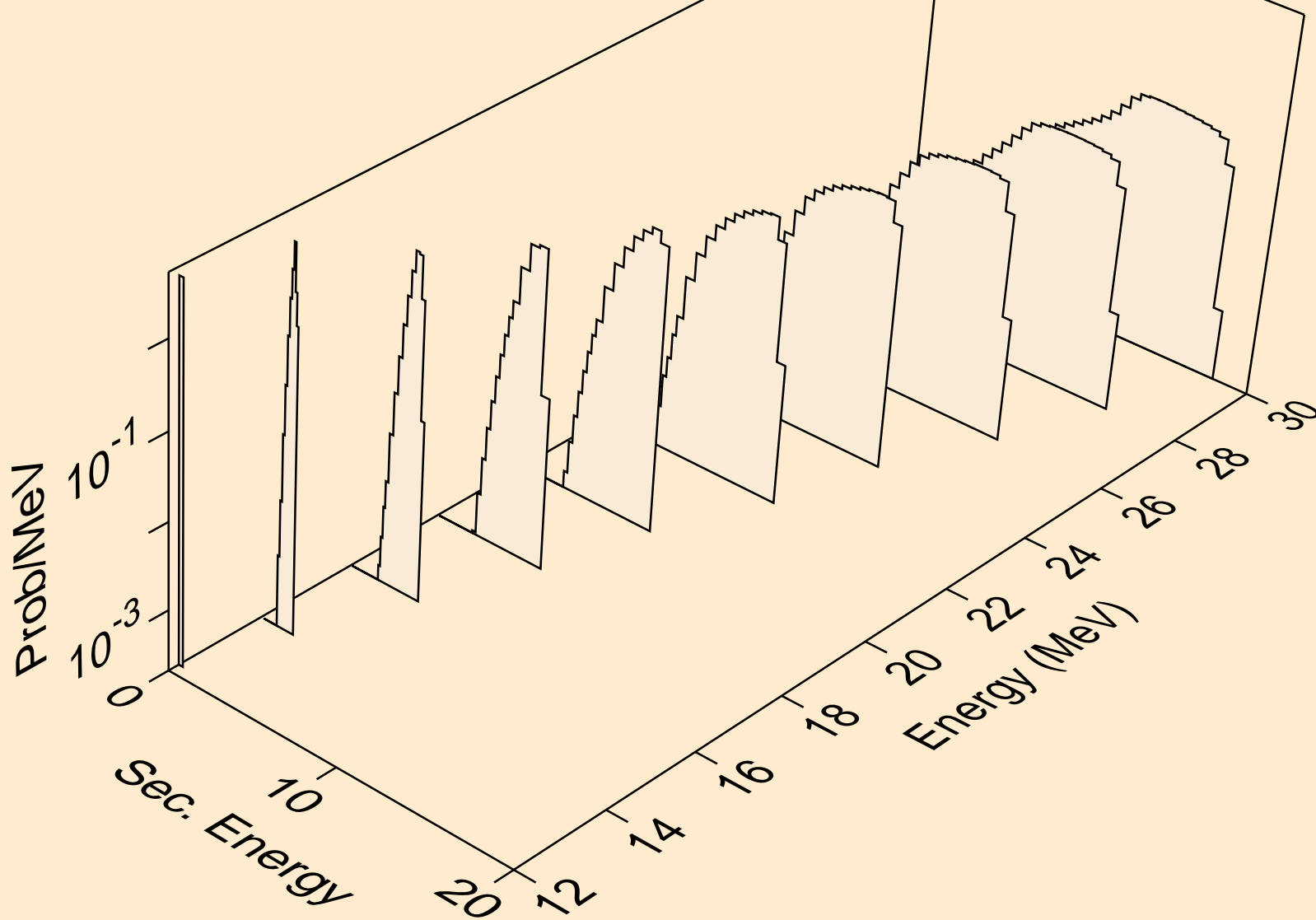

RU109 NEUTRON ACER TENDL-2019 LIBRARY; T=293.16K  
protons from (n,2np)

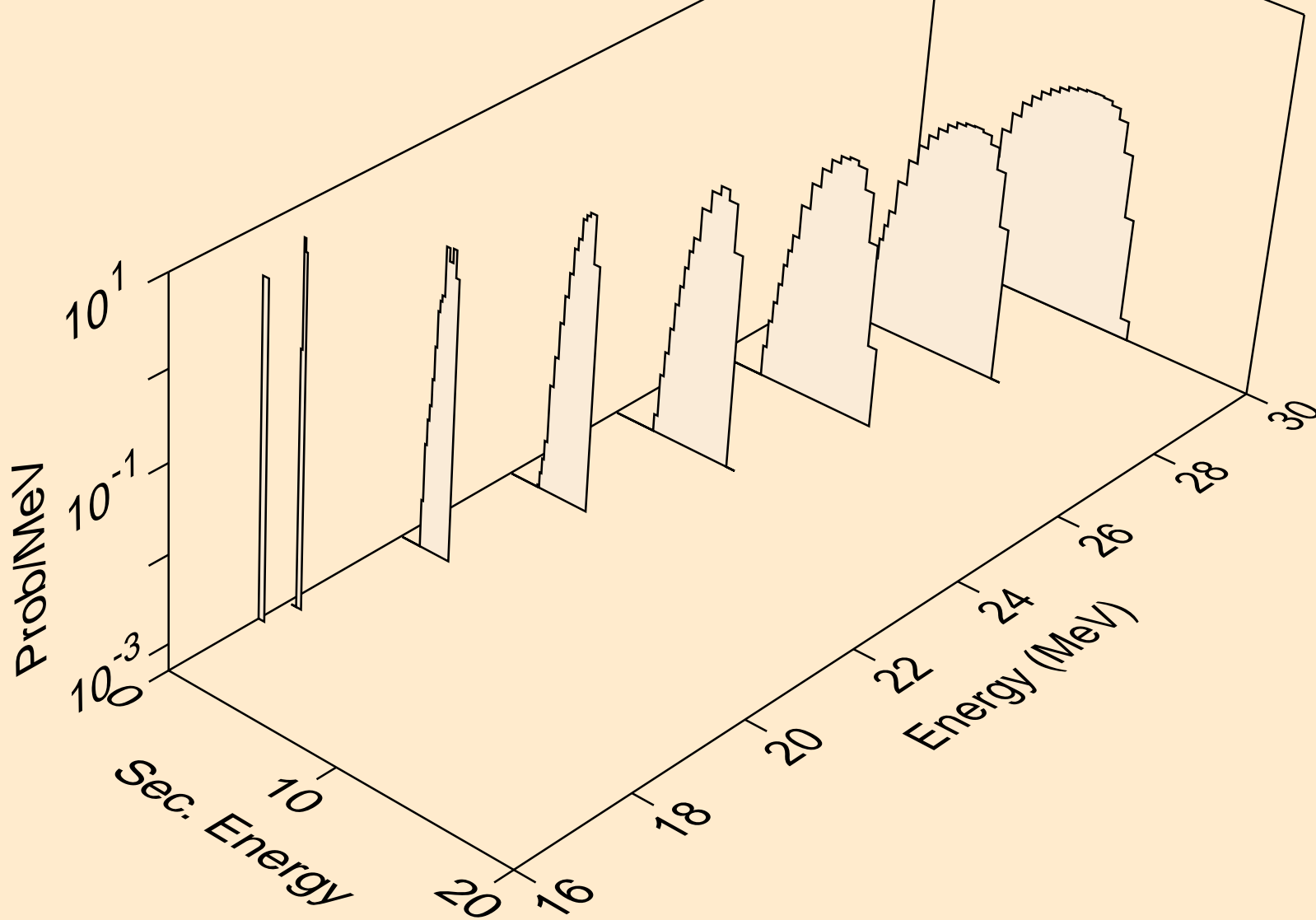

RU109 NEUTRON ACER TENDL-2019 LIBRARY; T=293.16K  
protons from (n,3np)

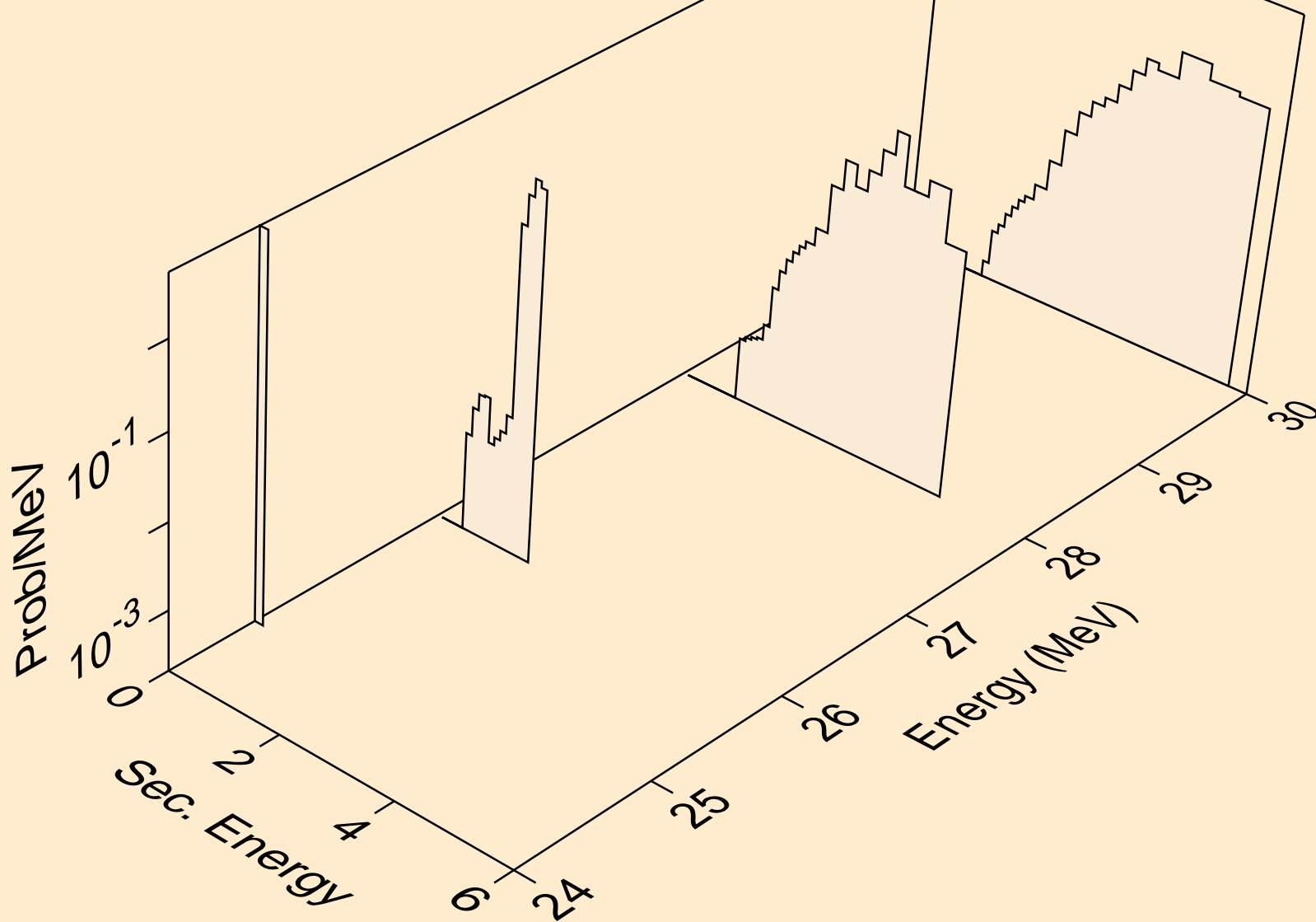



RU109 NEUTRON ACER TENDL-2019 LIBRARY; T=293.16K  
protons from (n,p)

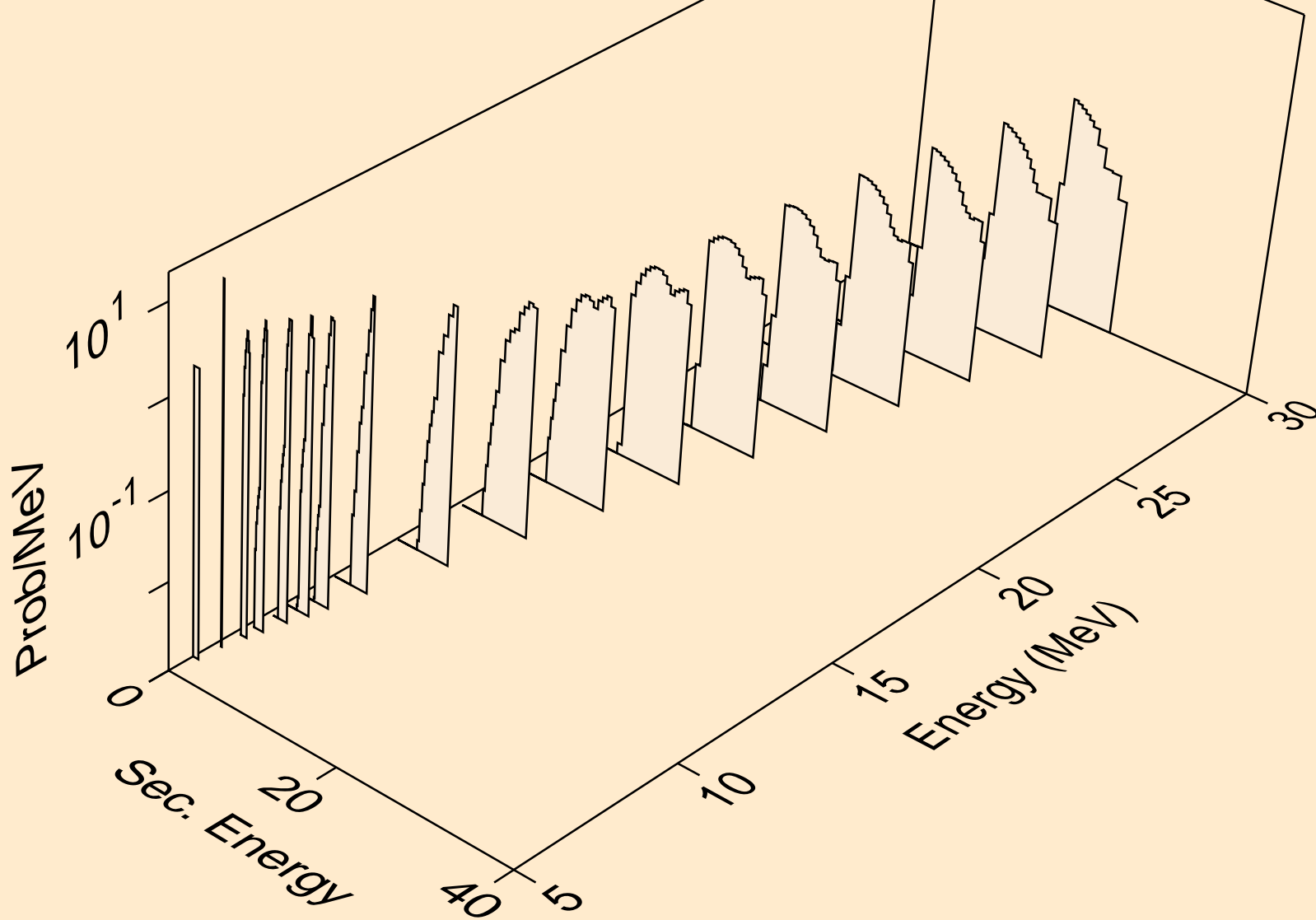

RU109 NEUTRON ACER TENDL-2019 LIBRARY; T=293.16K  
protons from (n,2p)

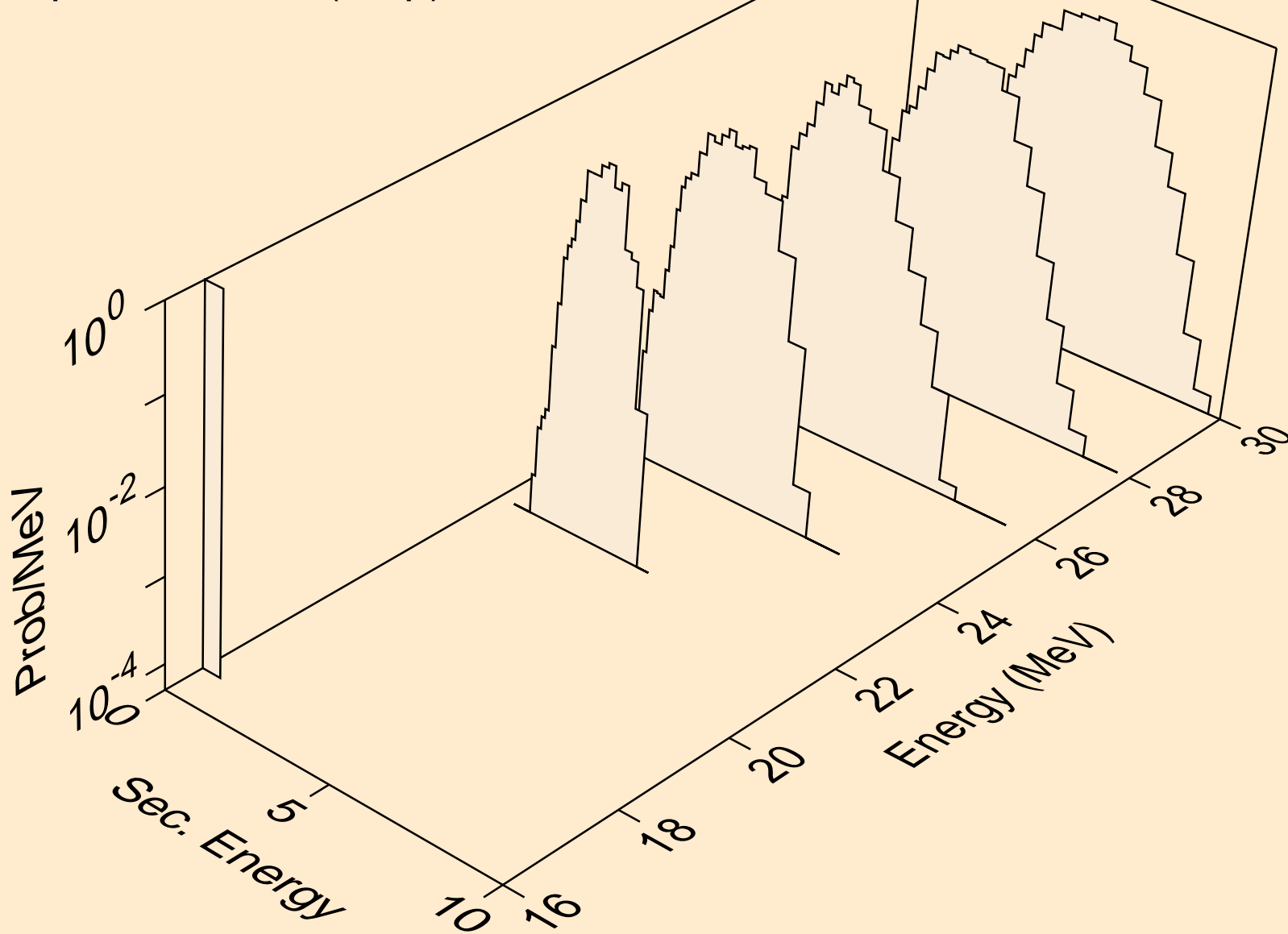

RU109 NEUTRON ACER TENDL-2019 LIBRARY; T=293.16K  
deuterons from (n,x)

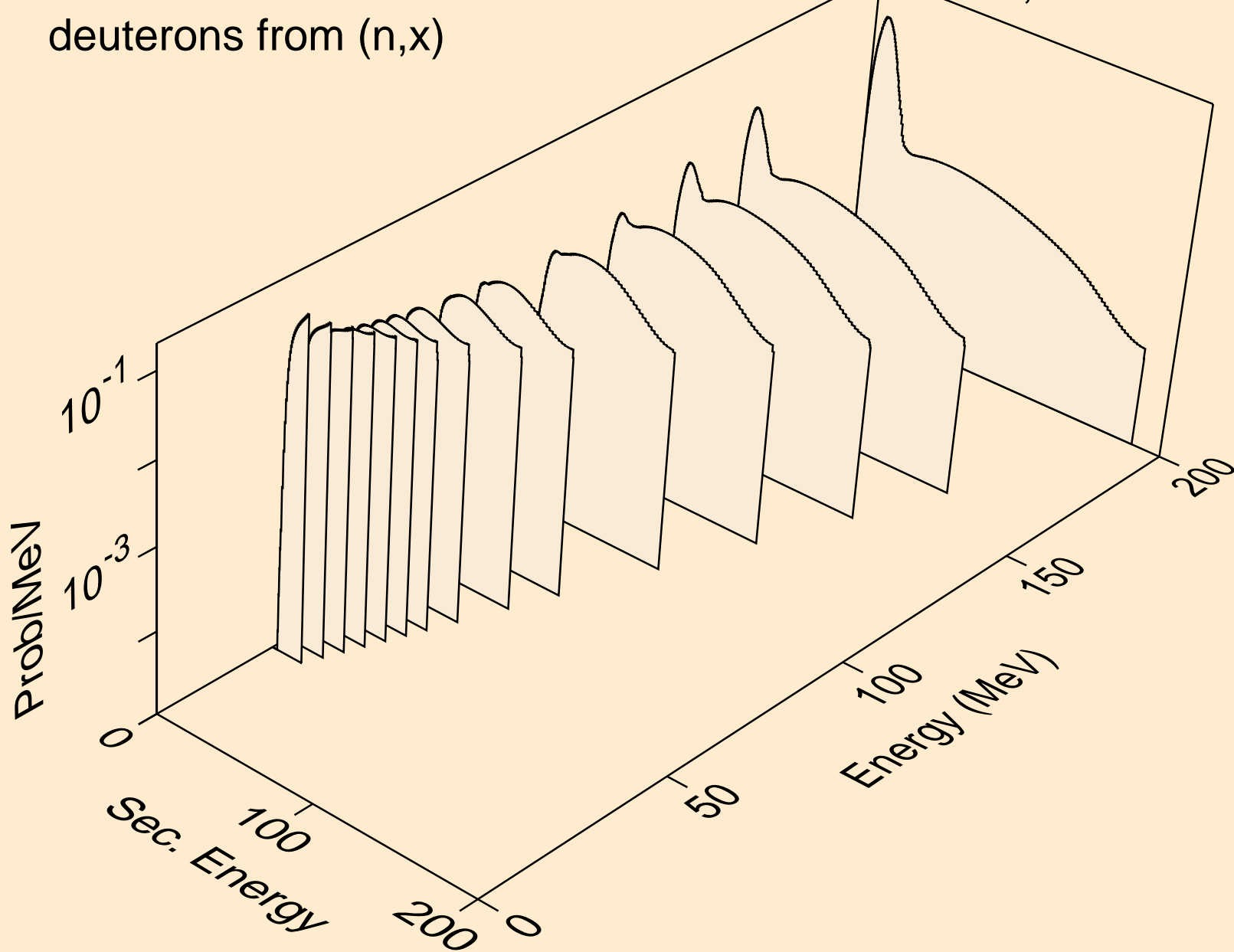

RU109 NEUTRON ACER TENDL-2019 LIBRARY; T=293.16K  
deuterons from (n,2nd)

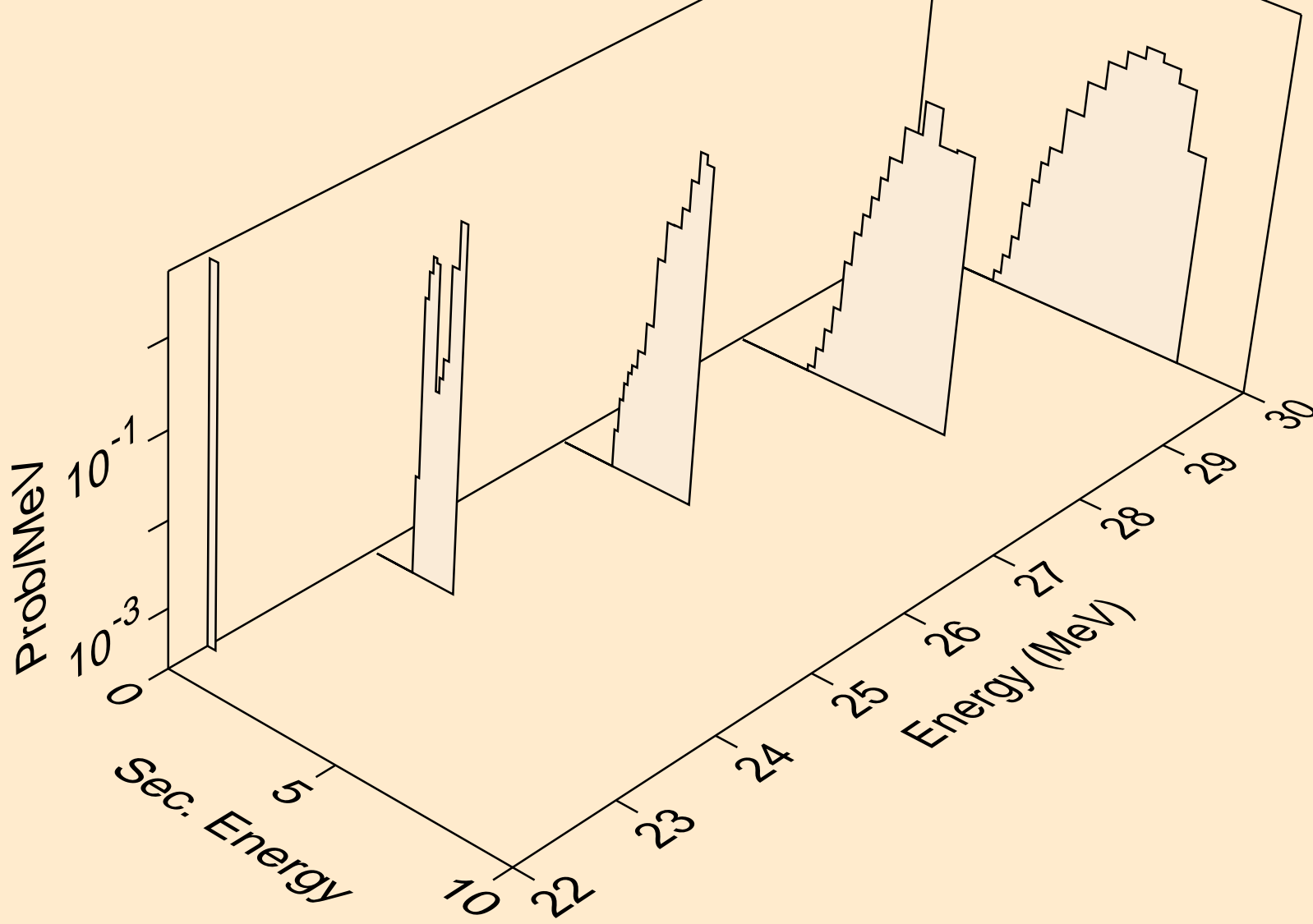

RU109 NEUTRON ACER TENDL-2019 LIBRARY; T=293.16K  
deuterons from (n,n\*)d

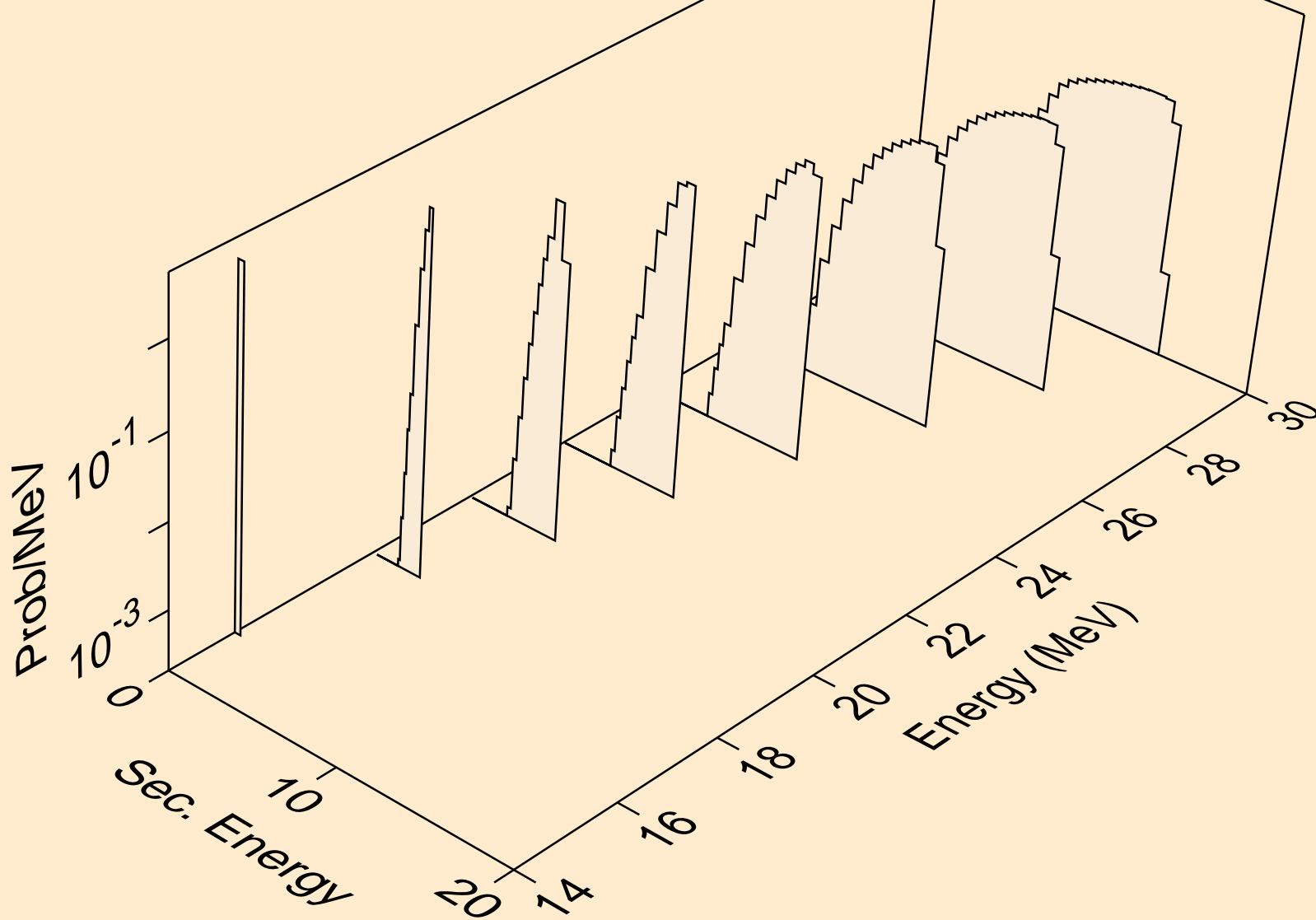

RU109 NEUTRON ACER TENDL-2019 LIBRARY; T=293.16K  
deuterons from (n,d)

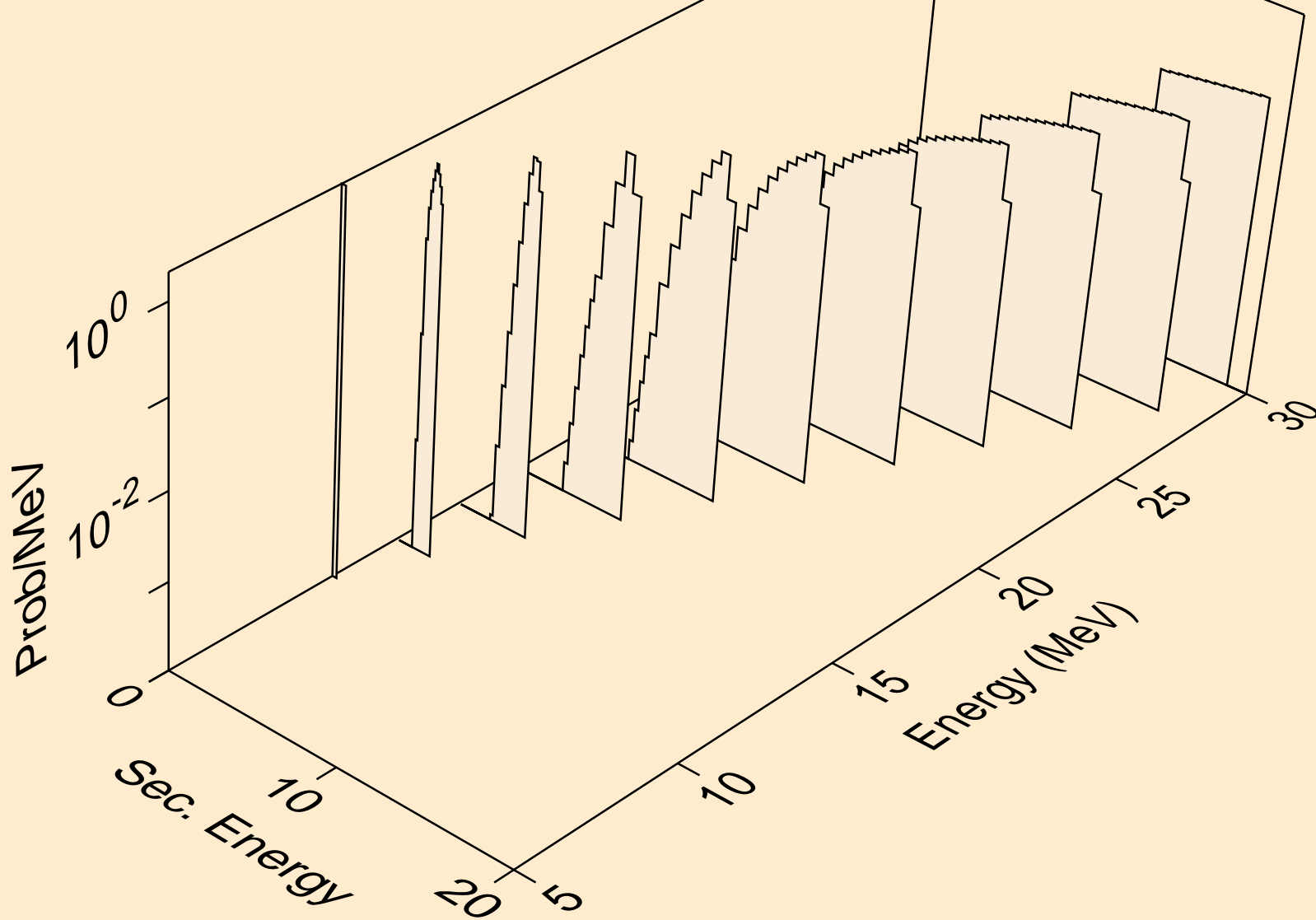

RU109 NEUTRON ACER TENDL-2019 LIBRARY; T=293.16K  
tritons from (n,x)

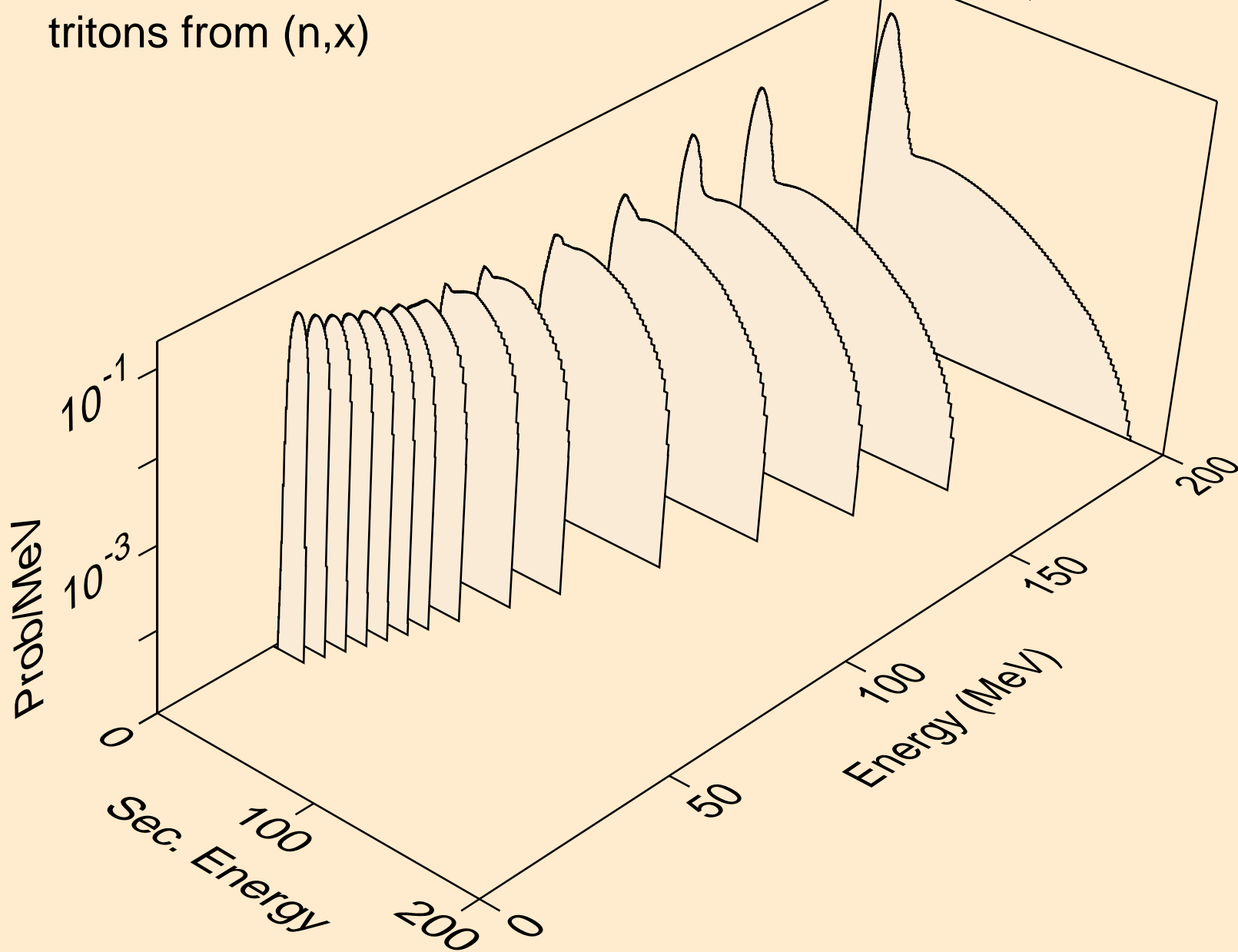

RU109 NEUTRON ACER TENDL-2019 LIBRARY; T=293.16K  
tritons from (n,n\*)t

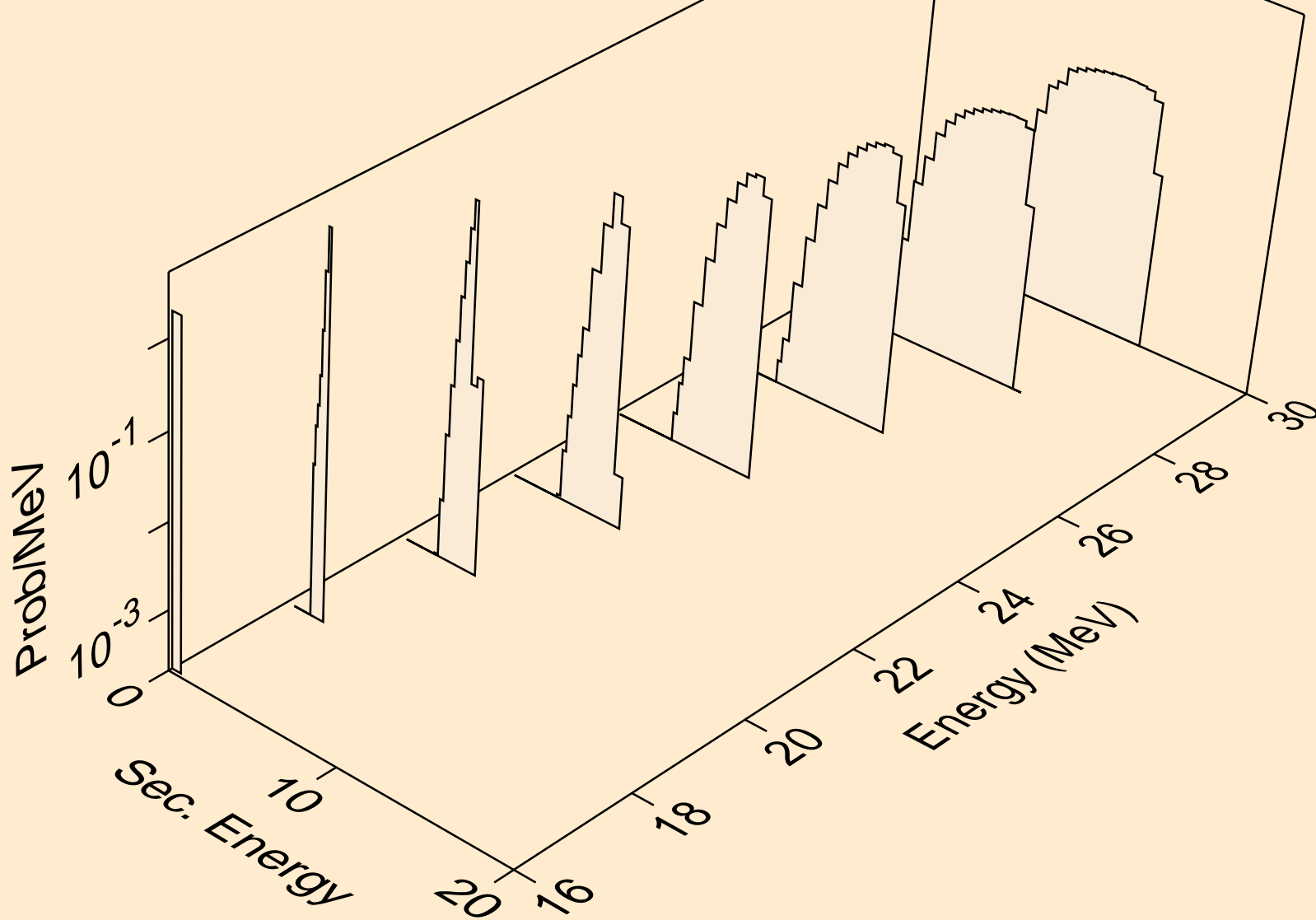



RU109 NEUTRON ACER TENDL-2019 LIBRARY; T=293.16K  
tritons from (n,t)

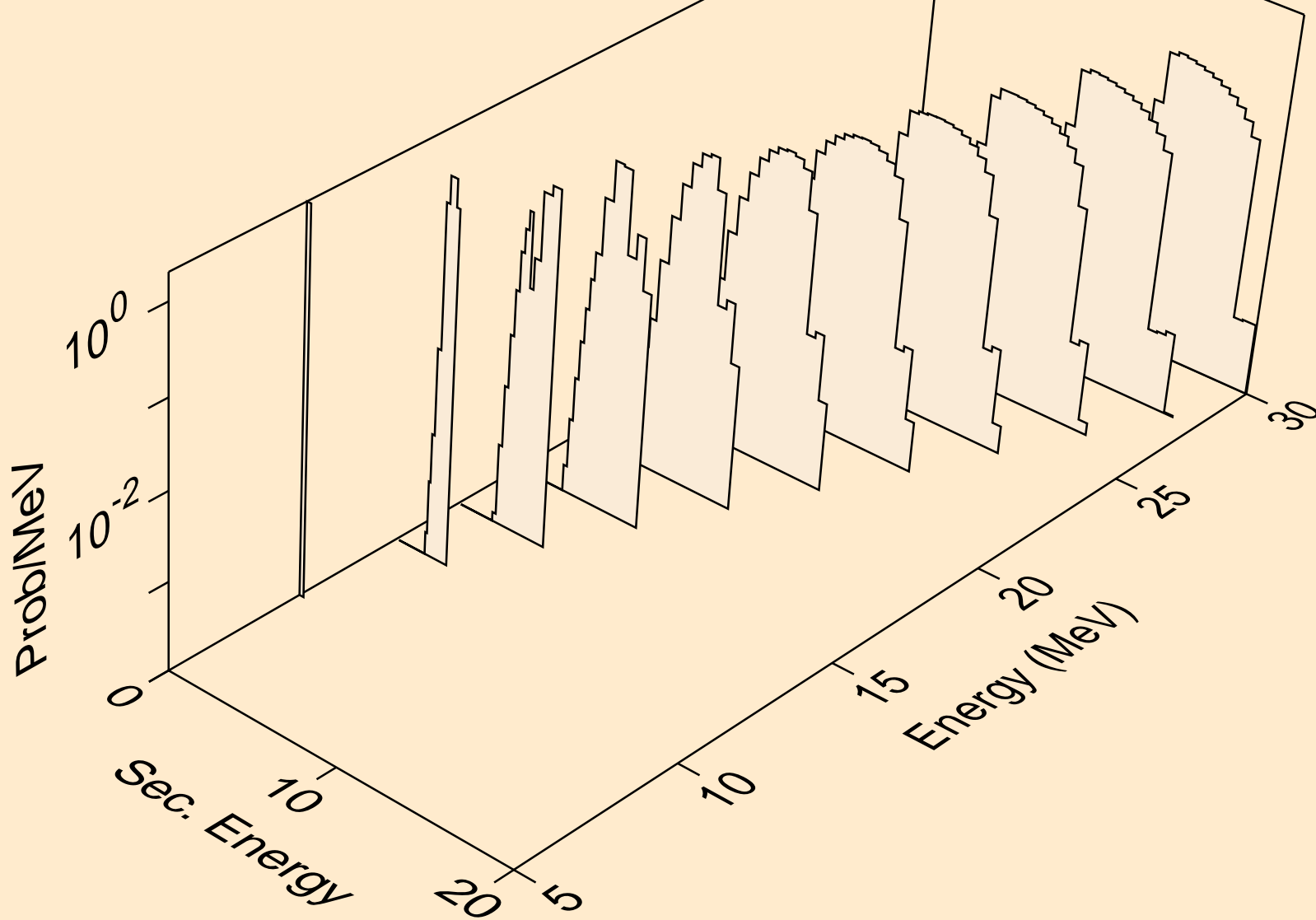

RU109 NEUTRON ACER TENDL-2019 LIBRARY; T=293.16K  
he3s from (n,x)

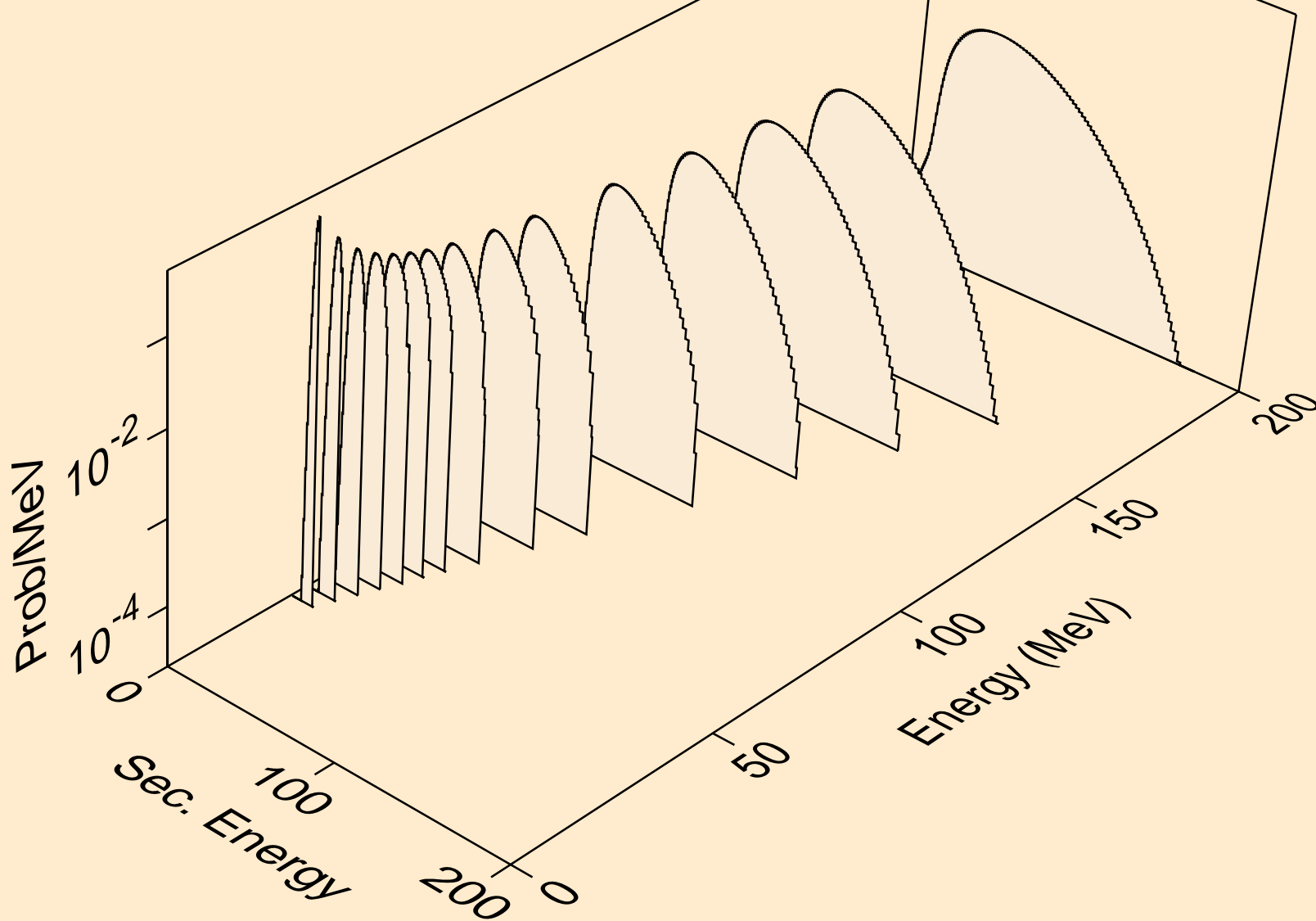

RU109 NEUTRON ACER TENDL-2019 LIBRARY; T=293.16K  
he3s from (n,n\*)he3

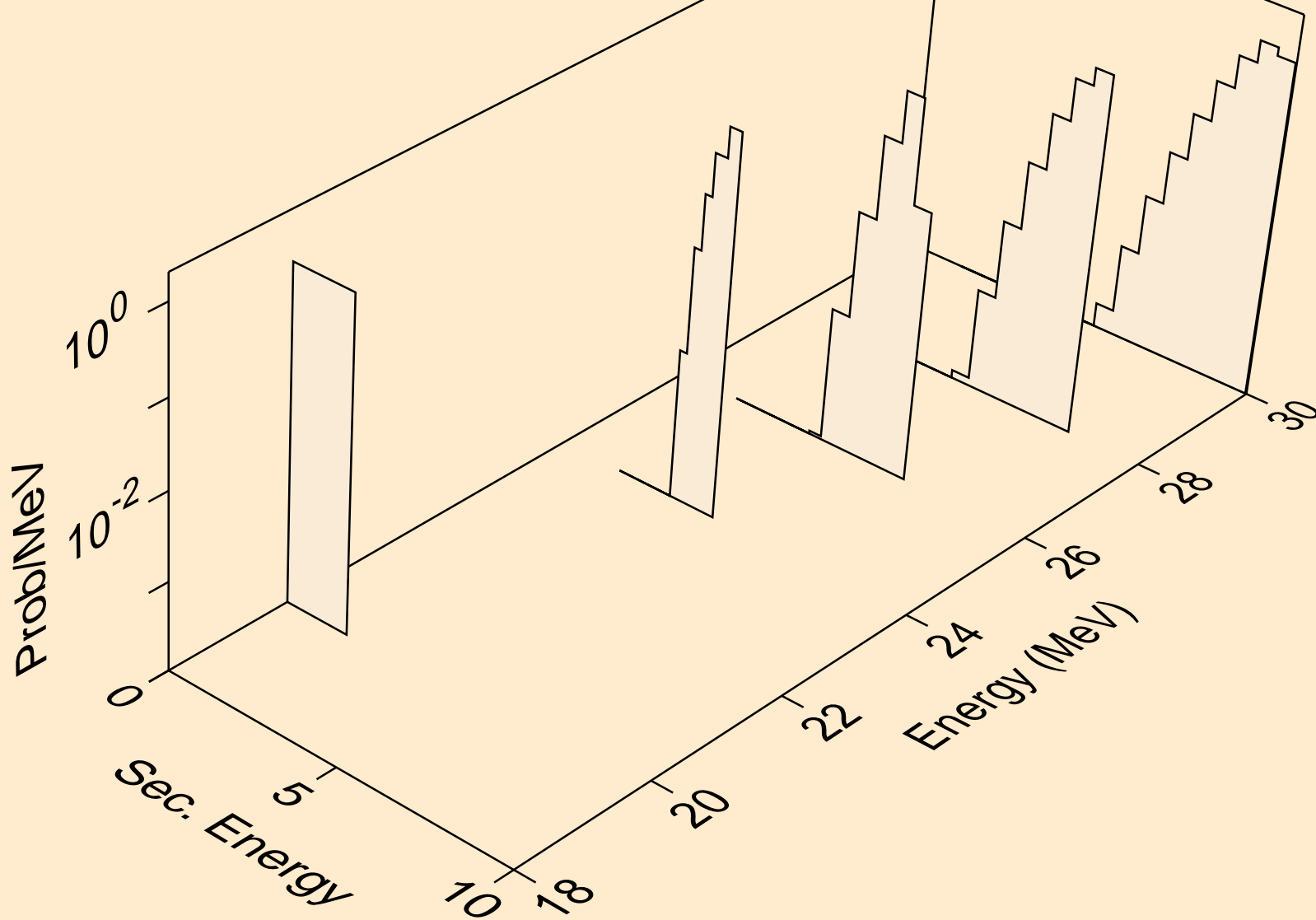

RU109 NEUTRON ACER TENDL-2019 LIBRARY; T=293.16K  
he3s from (n,he3)

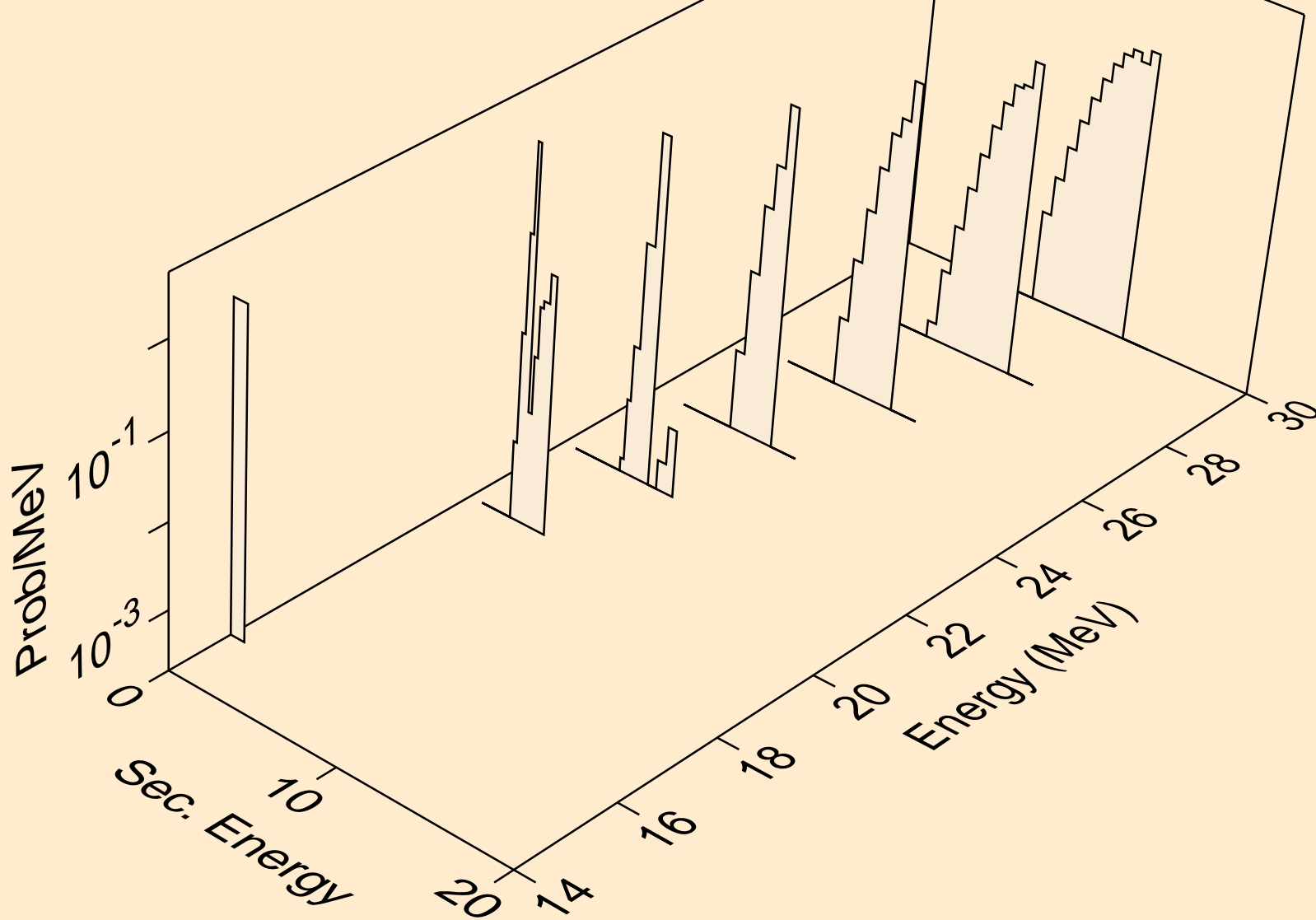

RU109 NEUTRON ACER TENDL-2019 LIBRARY; T=293.16K  
alphas from (n,x)

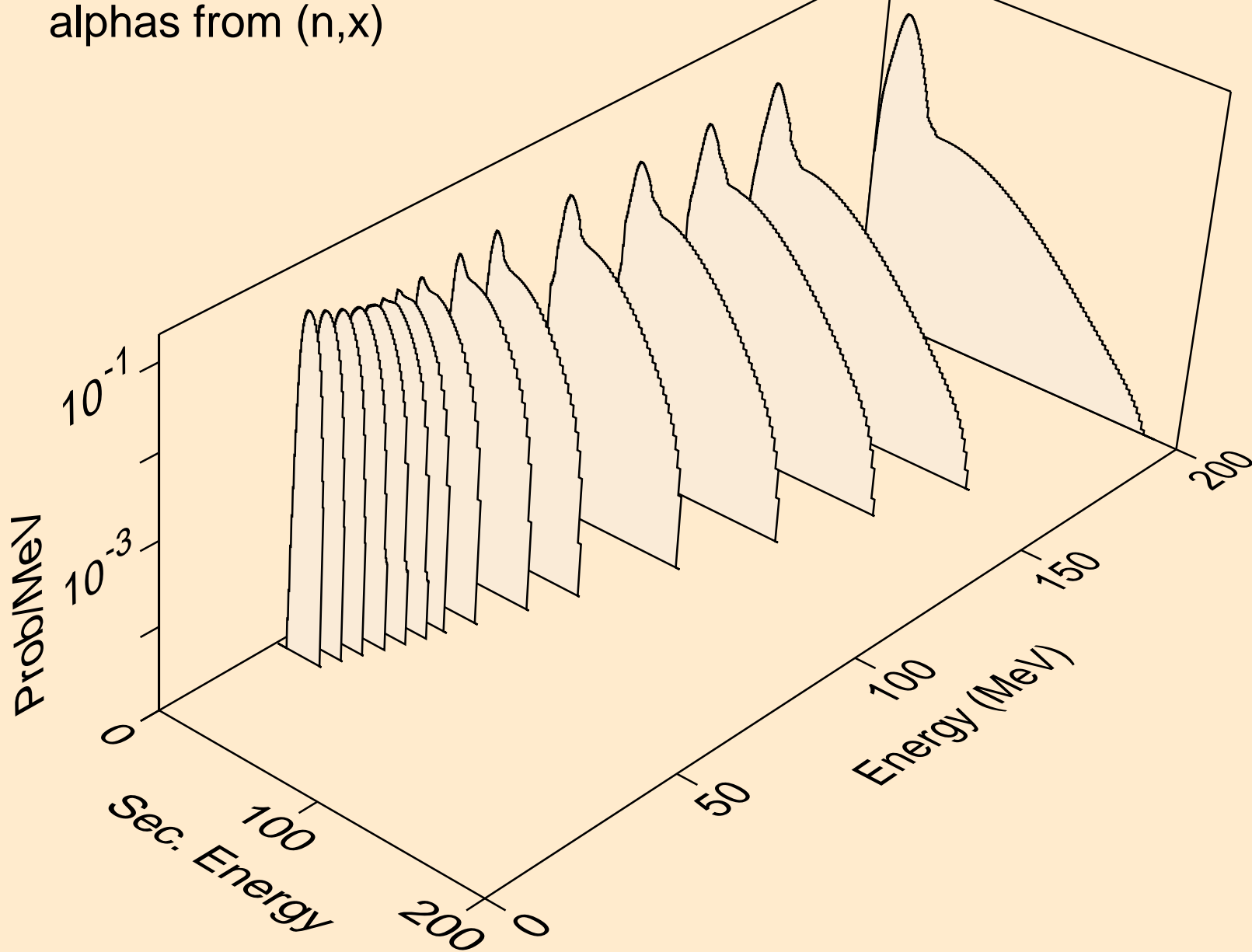

RU109 NEUTRON ACER TENDL-2019 LIBRARY; T=293.16K  
alphas from (n,n\*)a

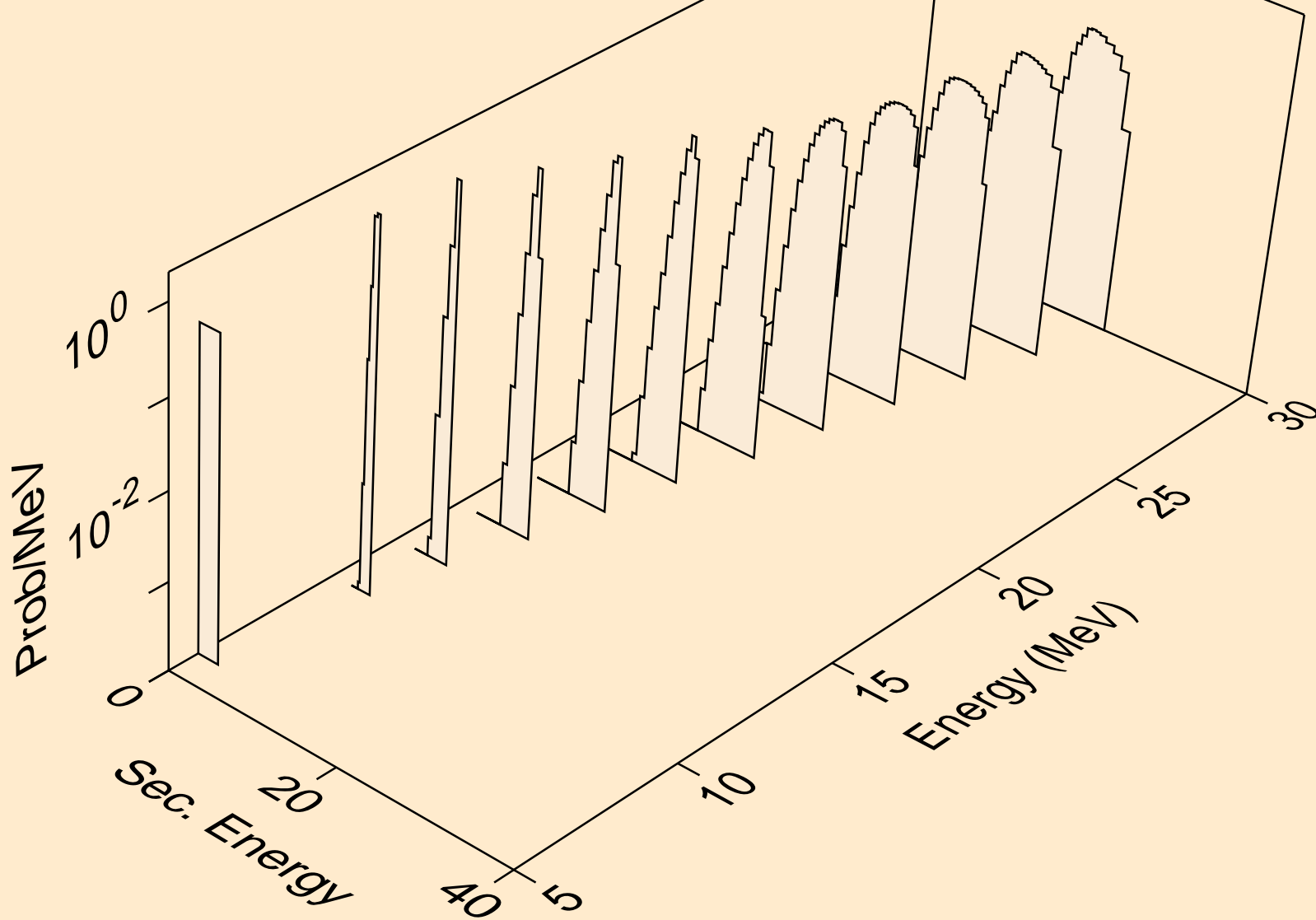

RU109 NEUTRON ACER TENDL-2019 LIBRARY; T=293.16K  
alphas from (n,2n)a

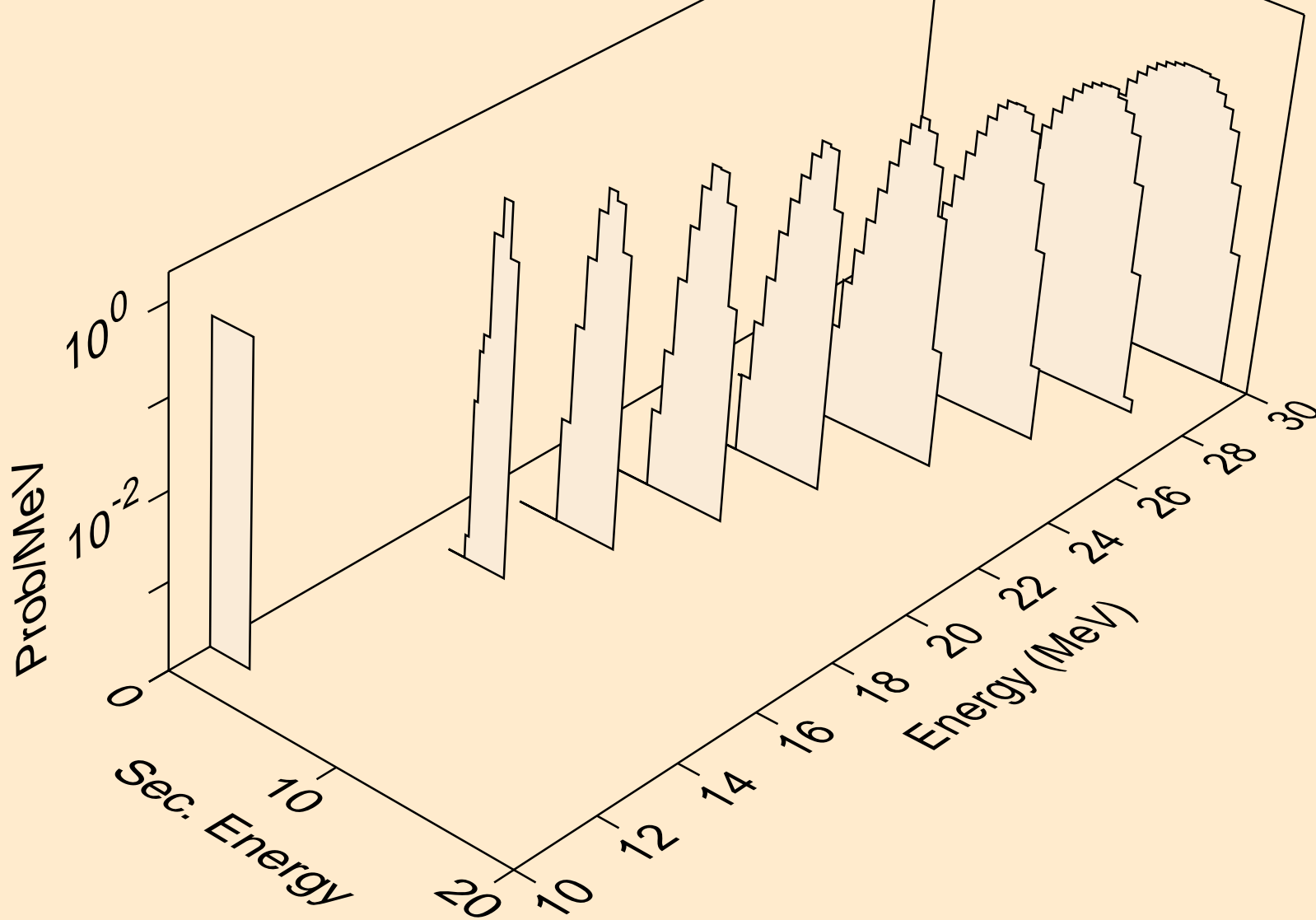

RU109 NEUTRON ACER TENDL-2019 LIBRARY; T=293.16K  
alphas from (n,3n)a

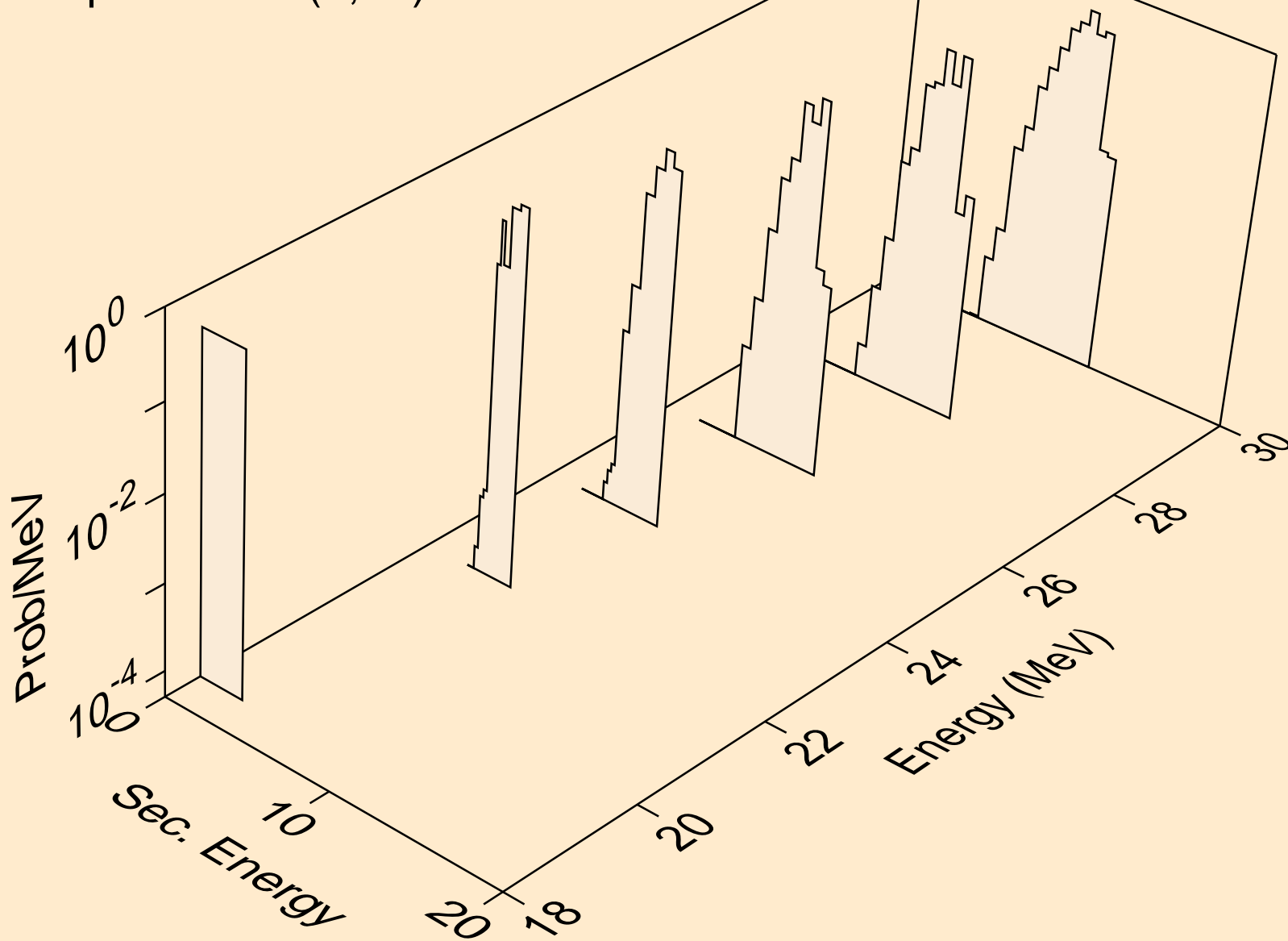



RU109 NEUTRON ACER TENDL-2019 LIBRARY; T=293.16K  
alphas from (n,a)

