

S032 NEUTRON ACER TENDL-2019 LIBRARY; T=293.16K  
Principal cross sections

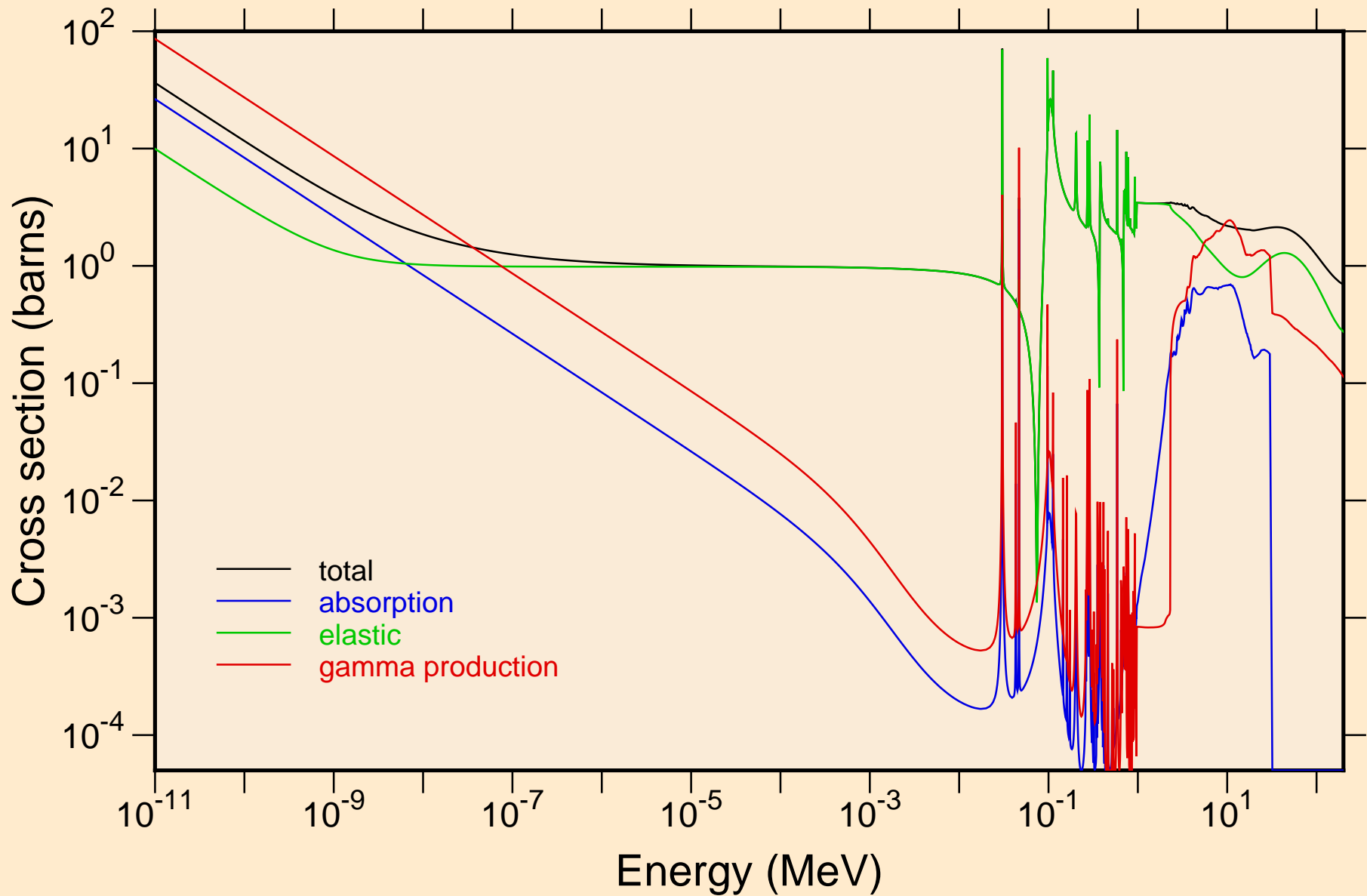

S032 NEUTRON ACER TENDL-2019 LIBRARY; T=293.16K  
resonance total cross section

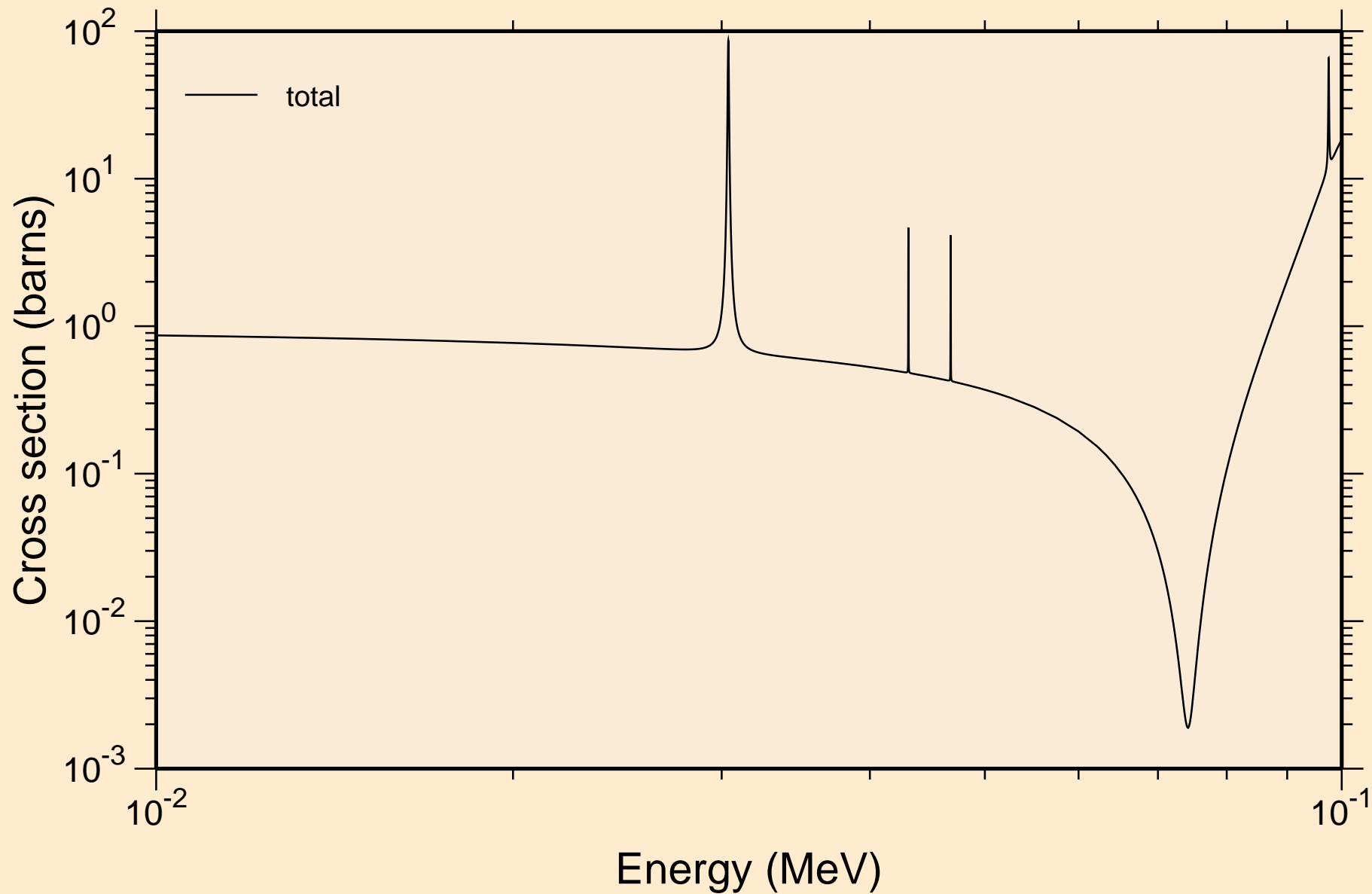

S032 NEUTRON ACER TENDL-2019 LIBRARY; T=293.16K  
resonance total cross section

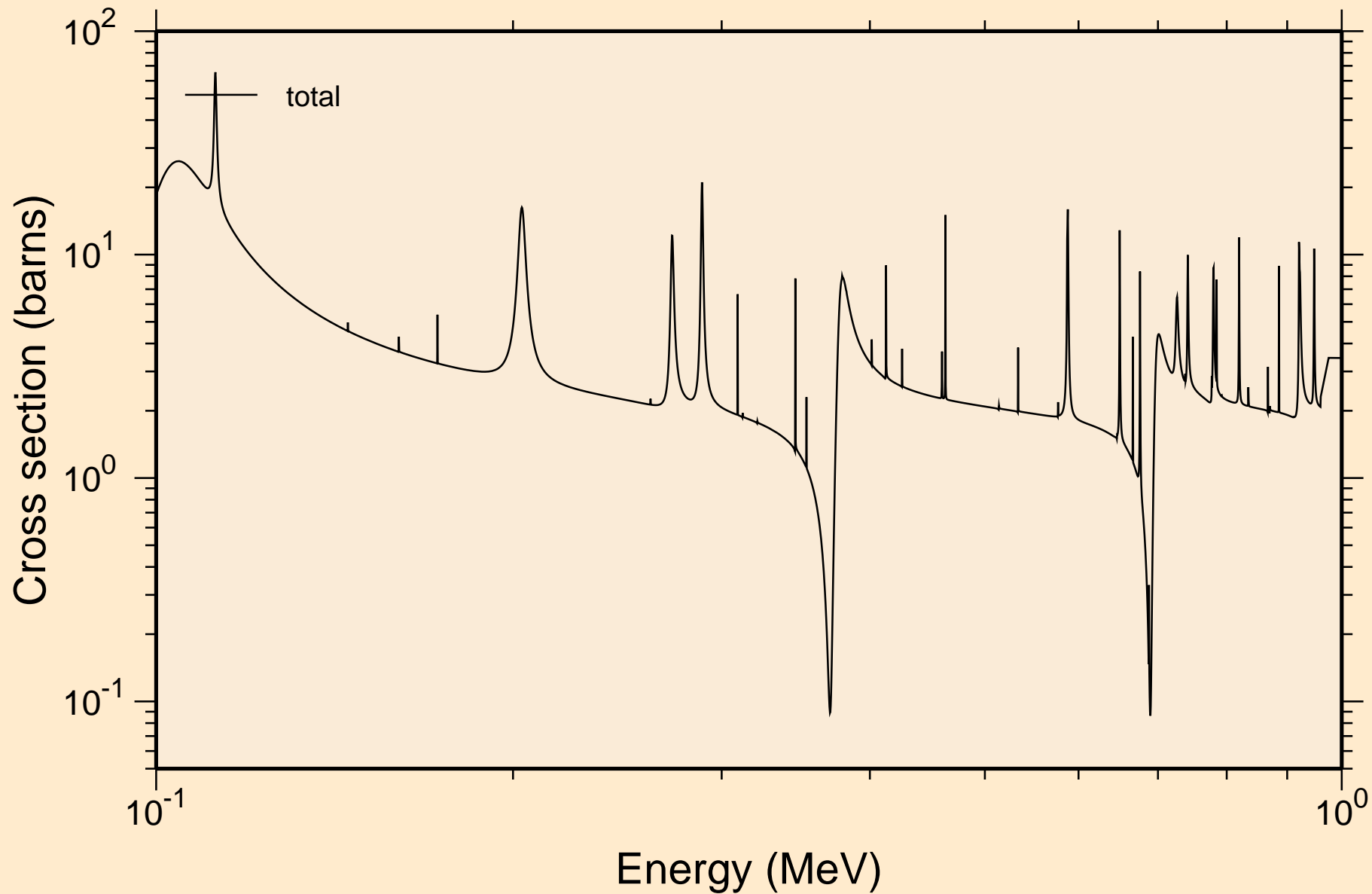

S032 NEUTRON ACER TENDL-2019 LIBRARY; T=293.16K  
resonance total cross section

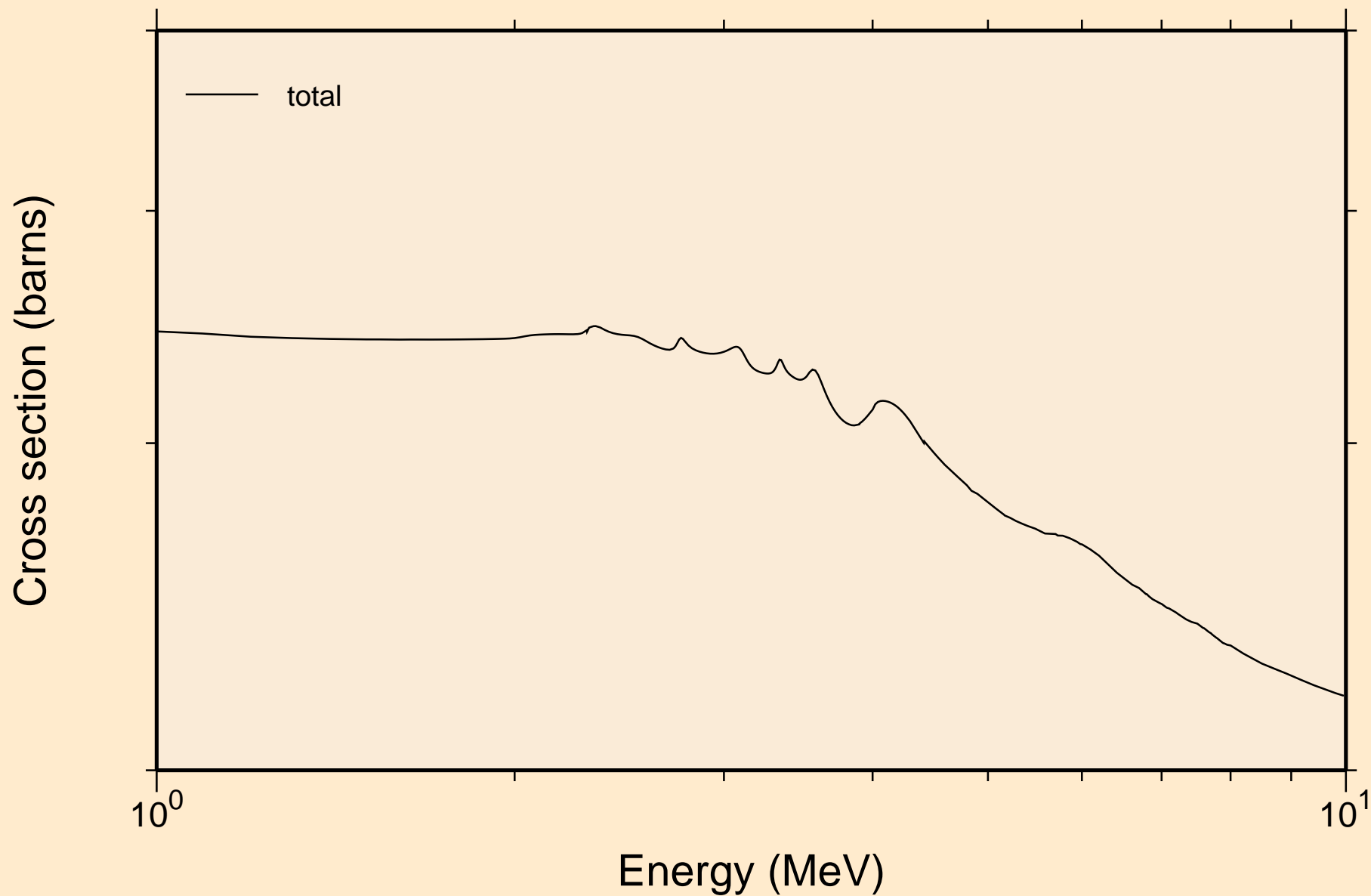

S032 NEUTRON ACER TENDL-2019 LIBRARY; T=293.16K  
resonance absorption cross sections

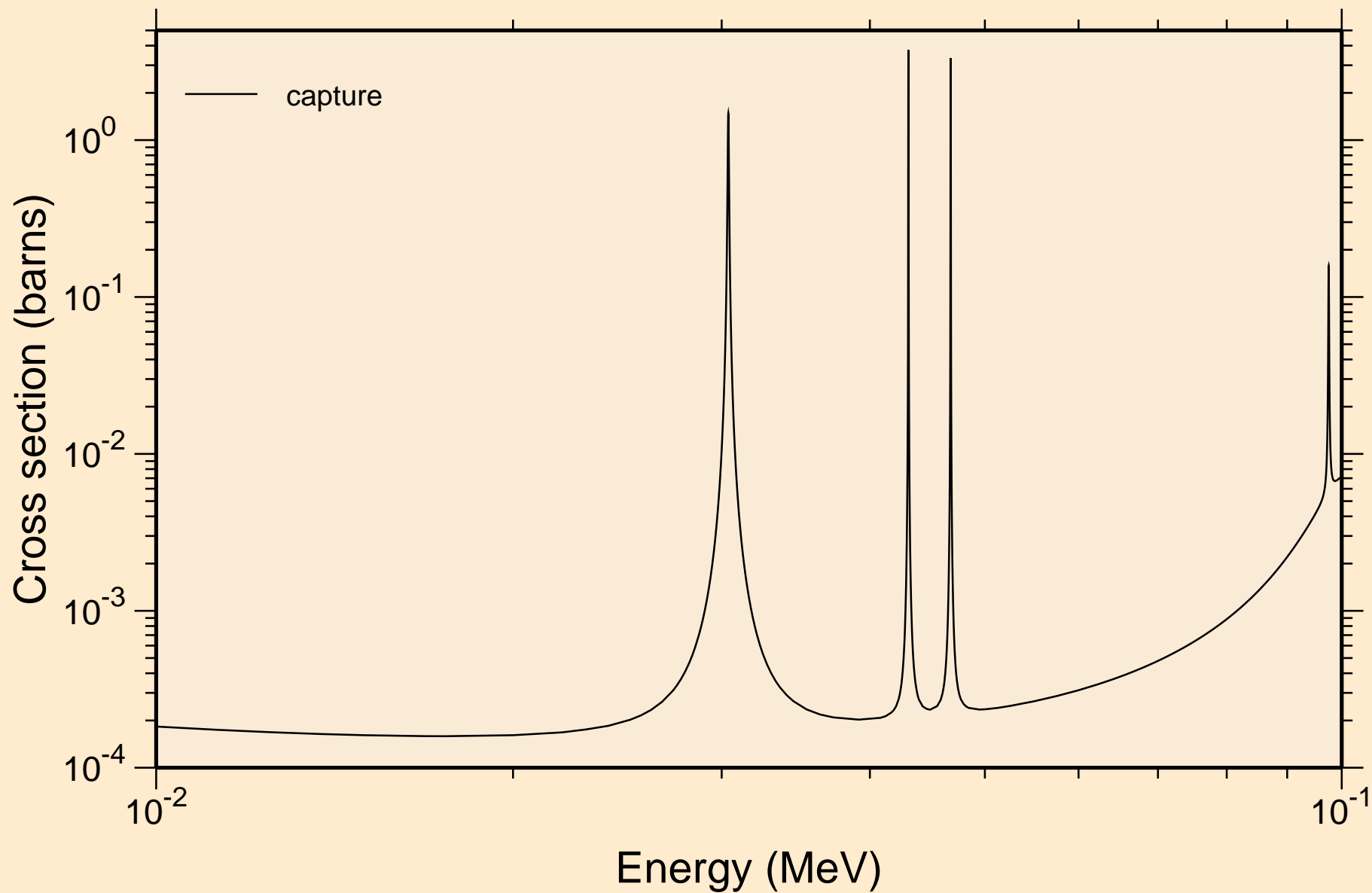

S032 NEUTRON ACER TENDL-2019 LIBRARY; T=293.16K  
resonance absorption cross sections

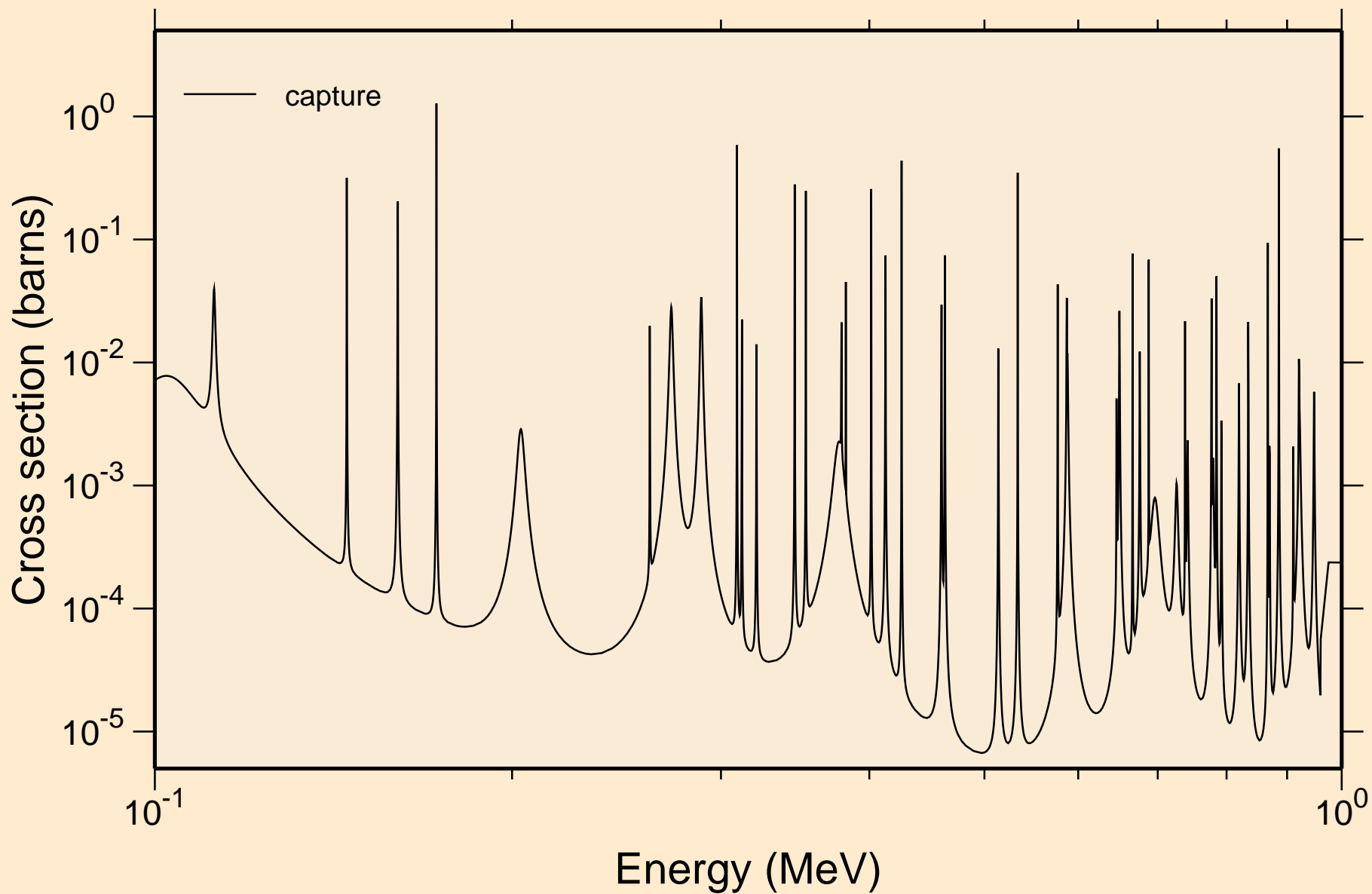

S032 NEUTRON ACER TENDL-2019 LIBRARY; T=293.16K  
resonance absorption cross sections

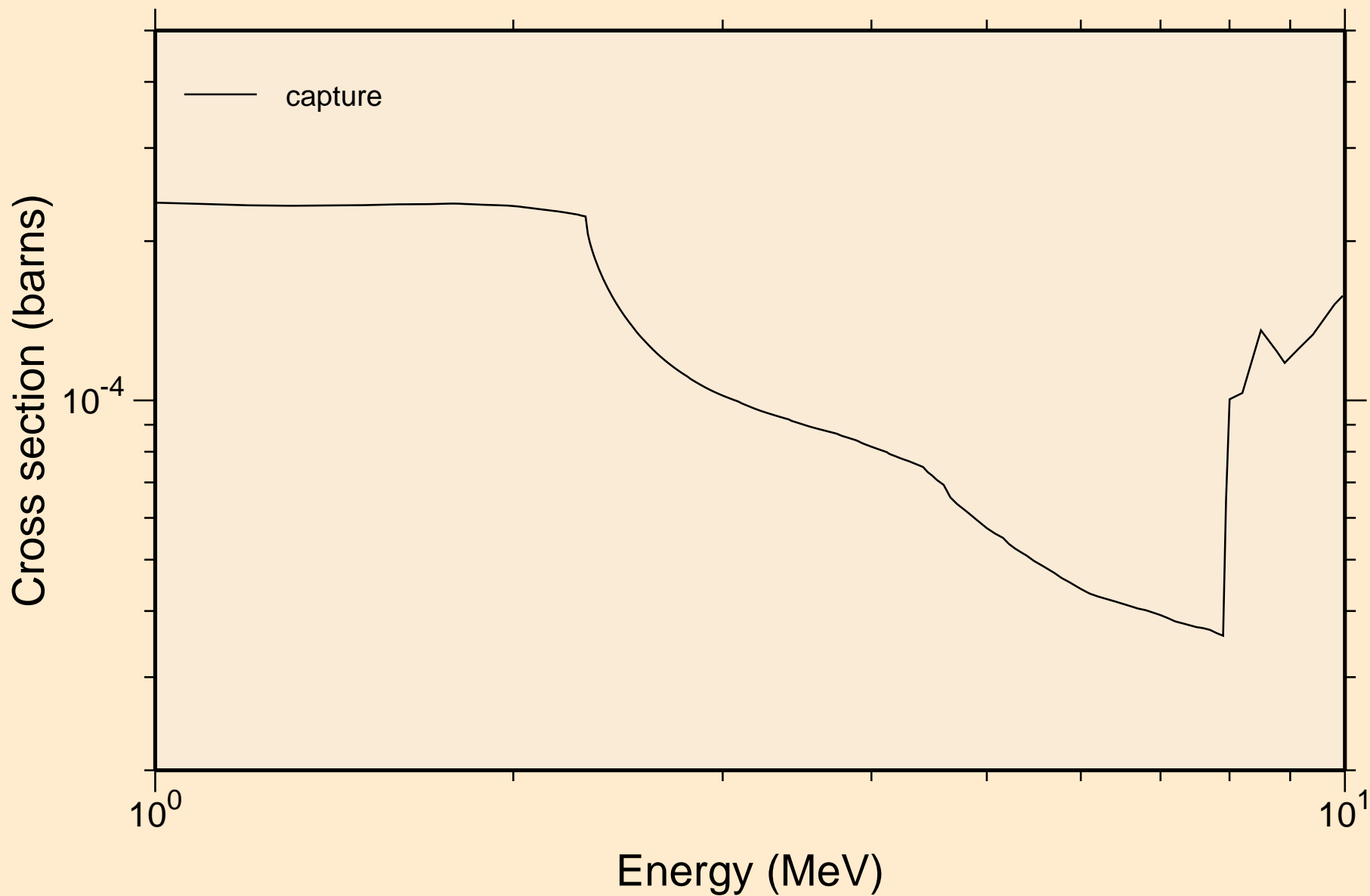

S032 NEUTRON ACER TENDL-2019 LIBRARY; T=293.16K  
Heating

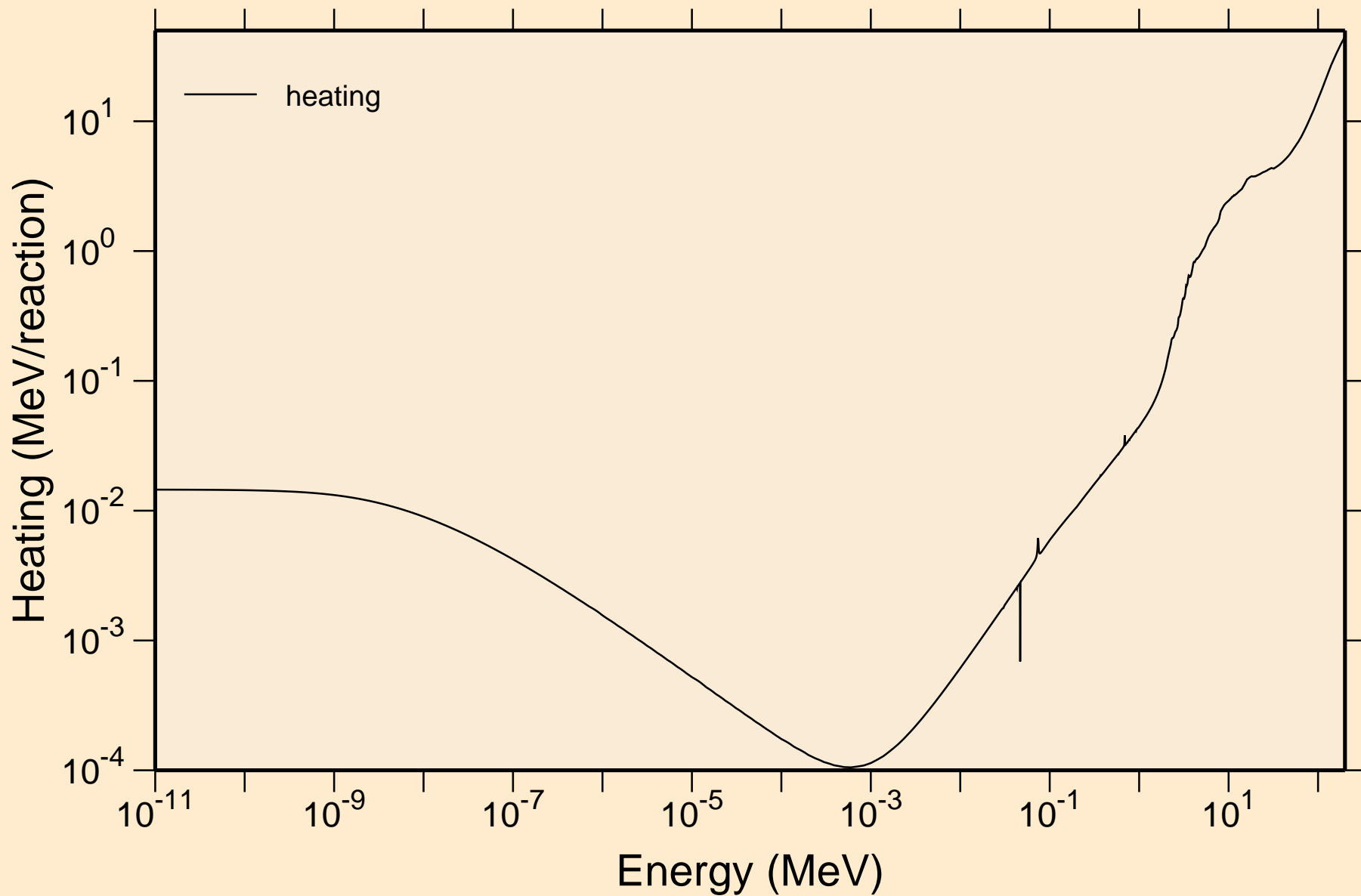



S032 NEUTRON ACER TENDL-2019 LIBRARY; T=293.16K  
Damage

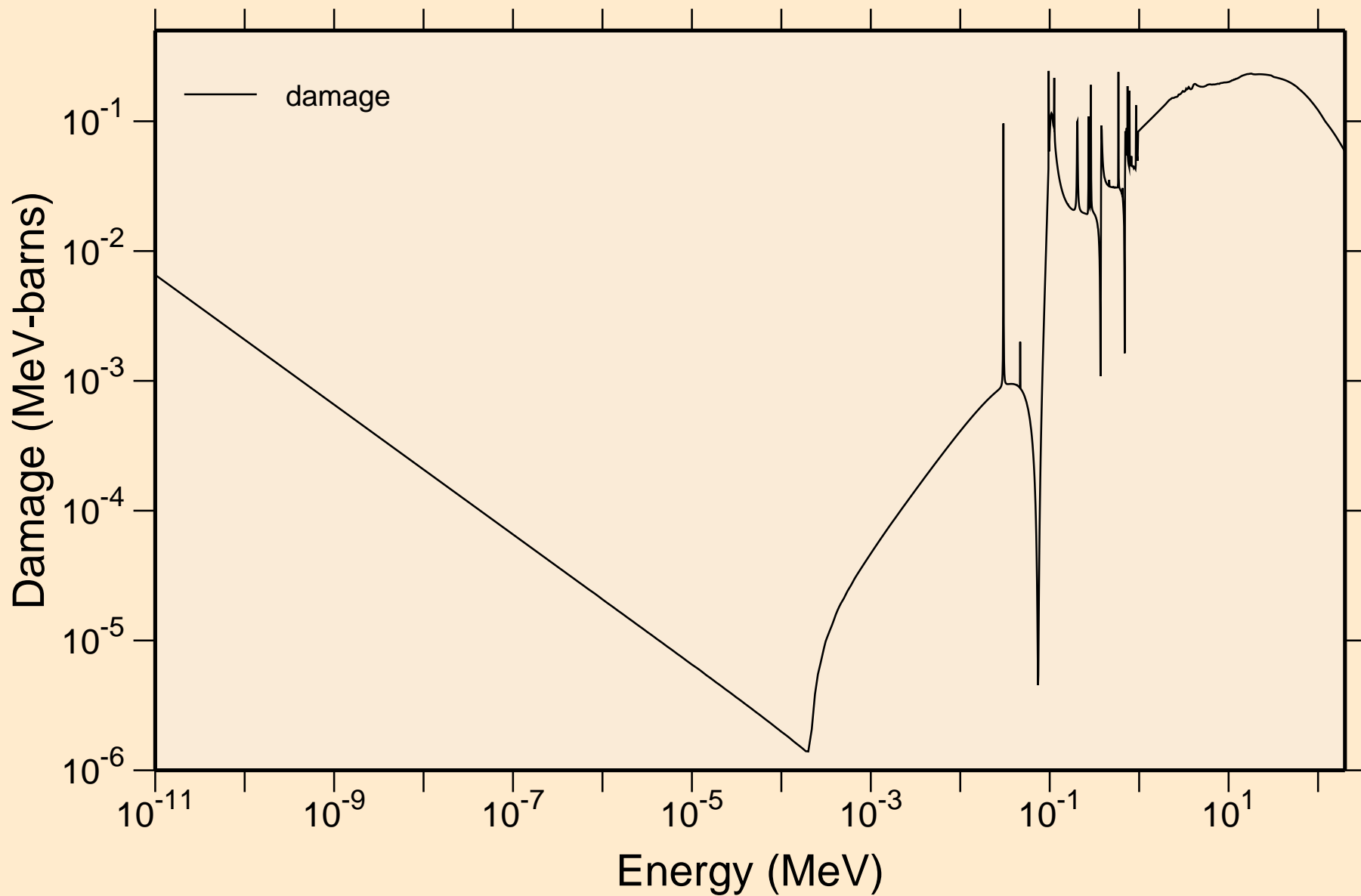

S032 NEUTRON ACER TENDL-2019 LIBRARY; T=293.16K  
Non-threshold reactions

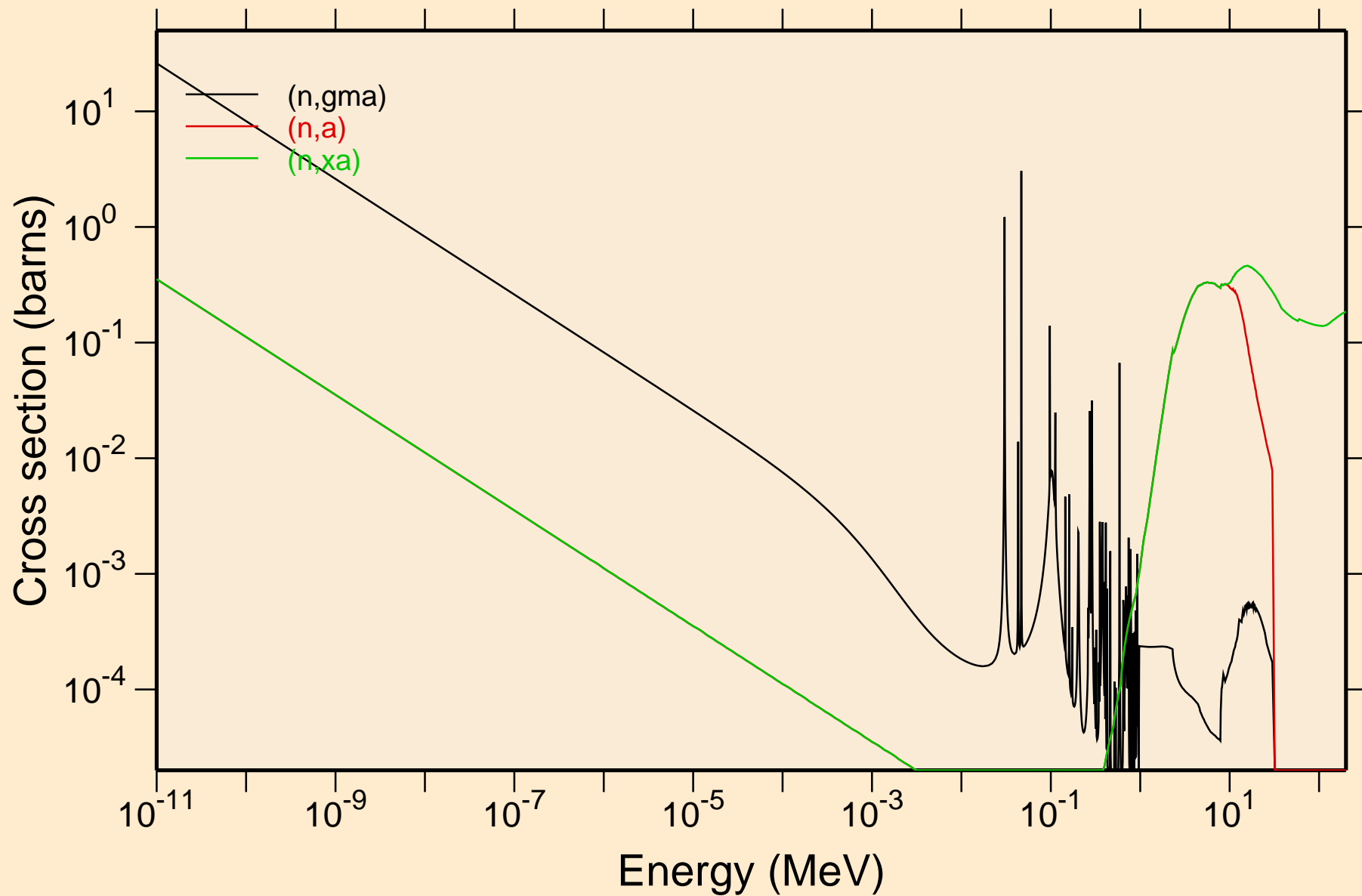

S032 NEUTRON ACER TENDL-2019 LIBRARY; T=293.16K  
Principal cross sections

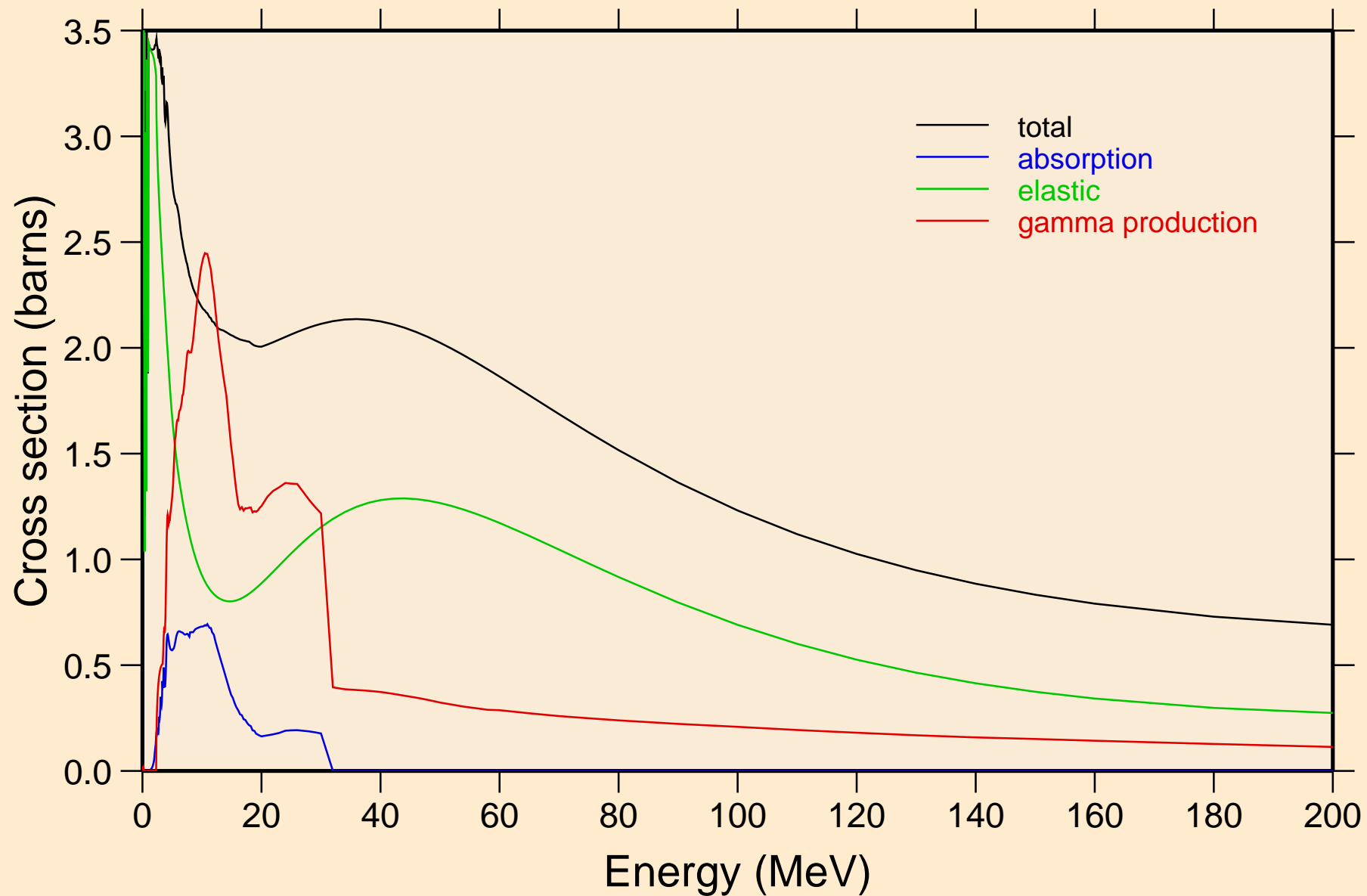

S032 NEUTRON ACER TENDL-2019 LIBRARY; T=293.16K  
Heating

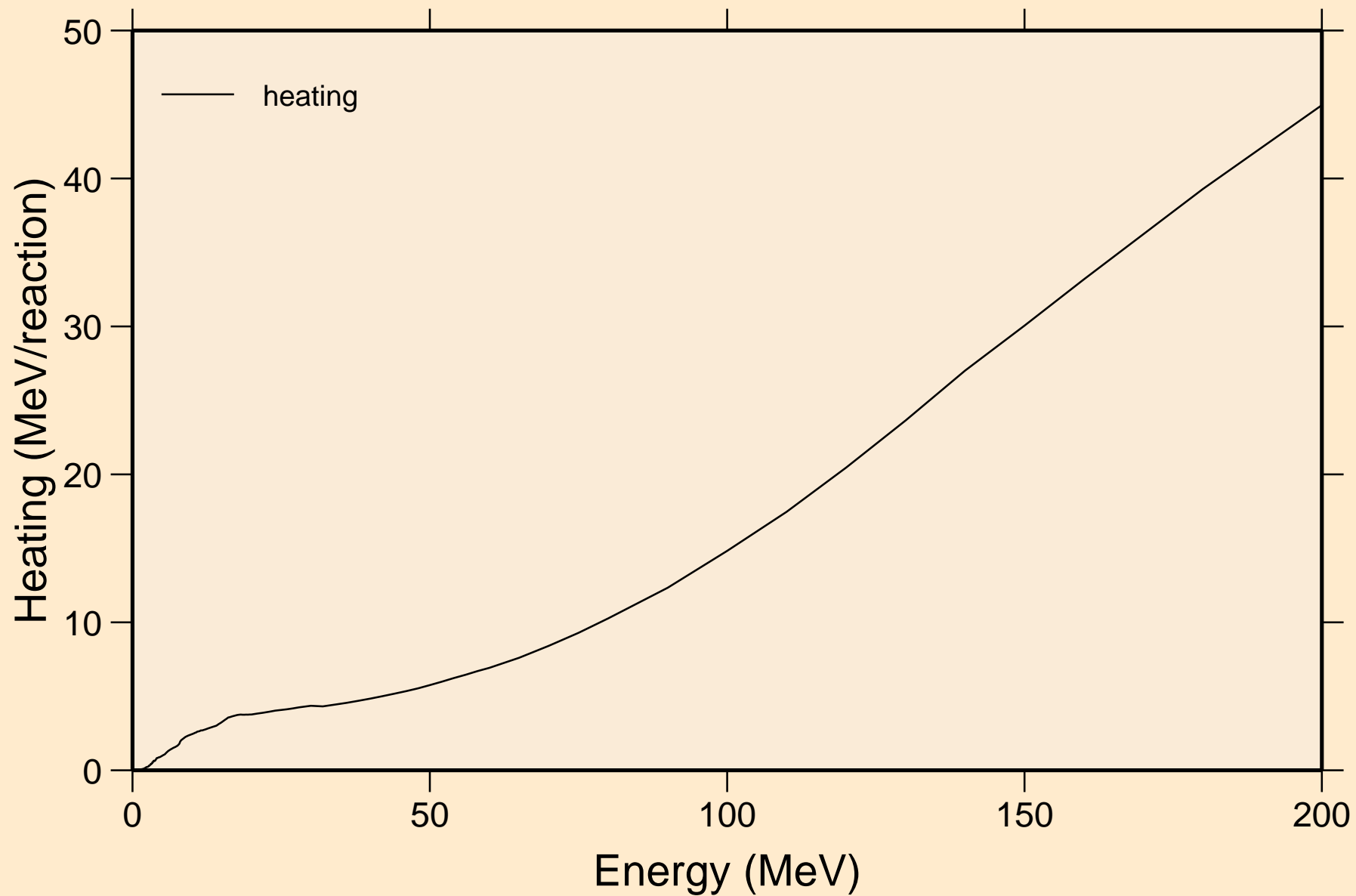

S032 NEUTRON ACER TENDL-2019 LIBRARY; T=293.16K  
Damage

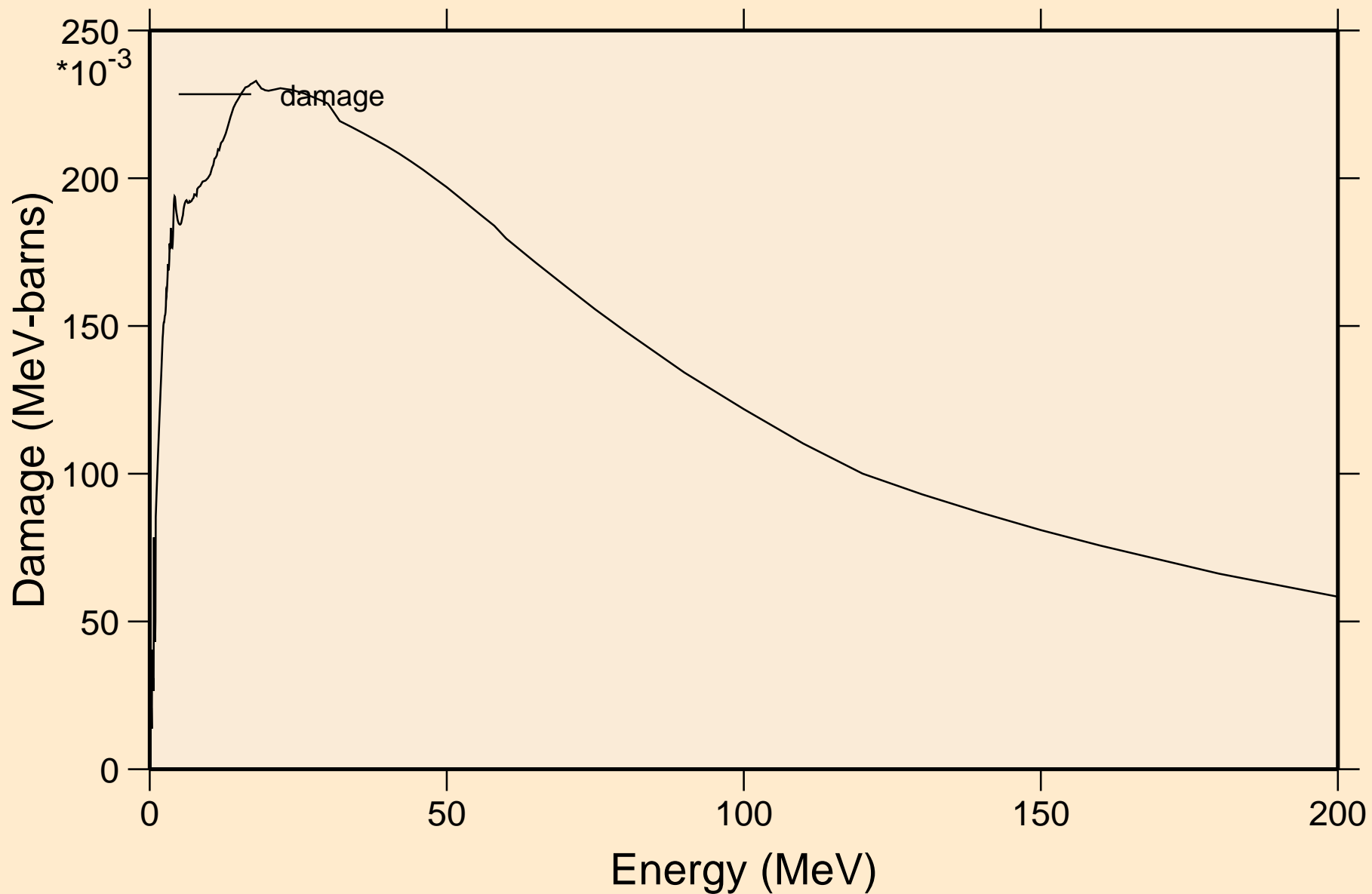

S032 NEUTRON ACER TENDL-2019 LIBRARY; T=293.16K  
Non-threshold reactions

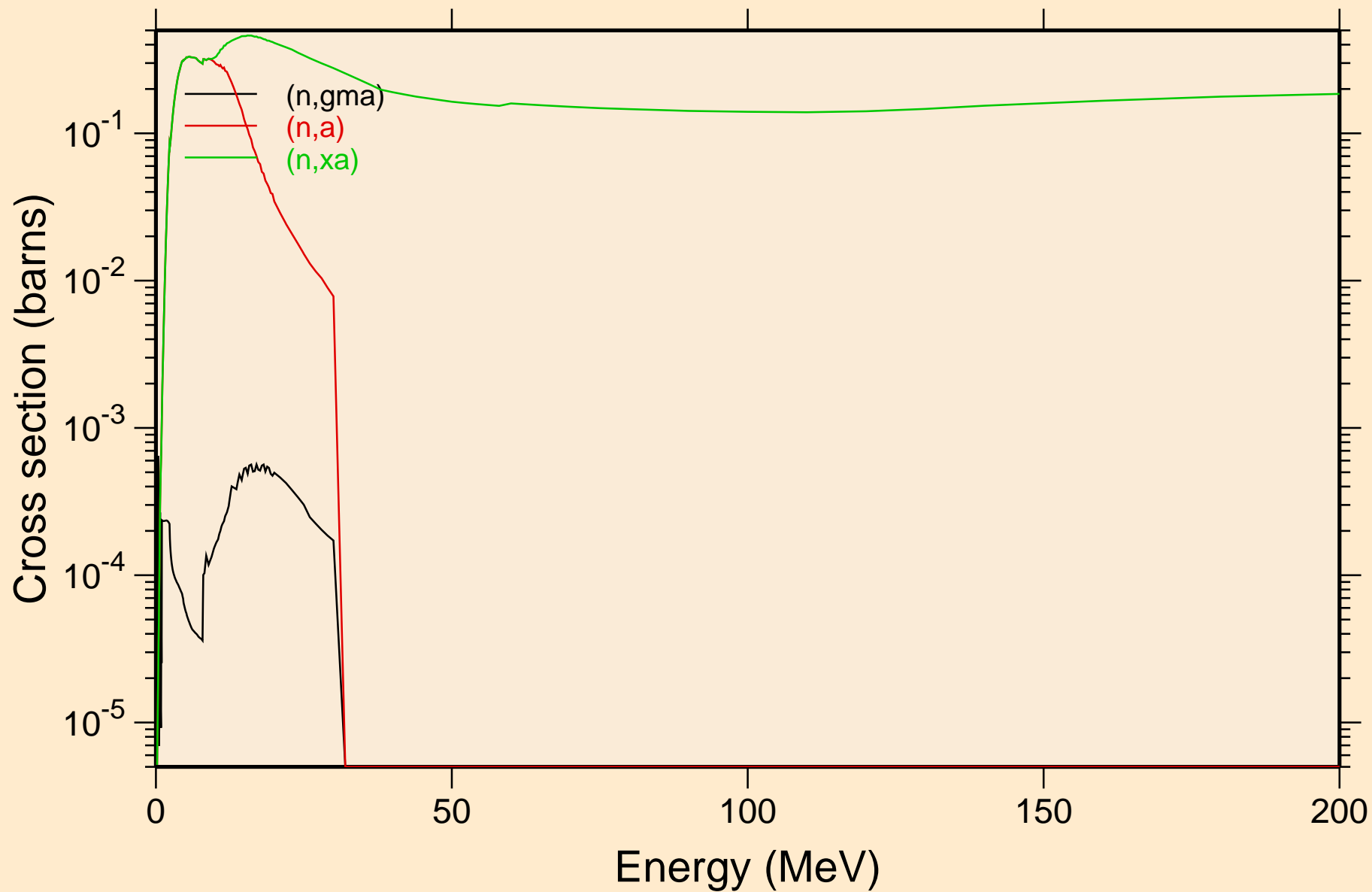

S032 NEUTRON ACER TENDL-2019 LIBRARY; T=293.16K  
Inelastic levels

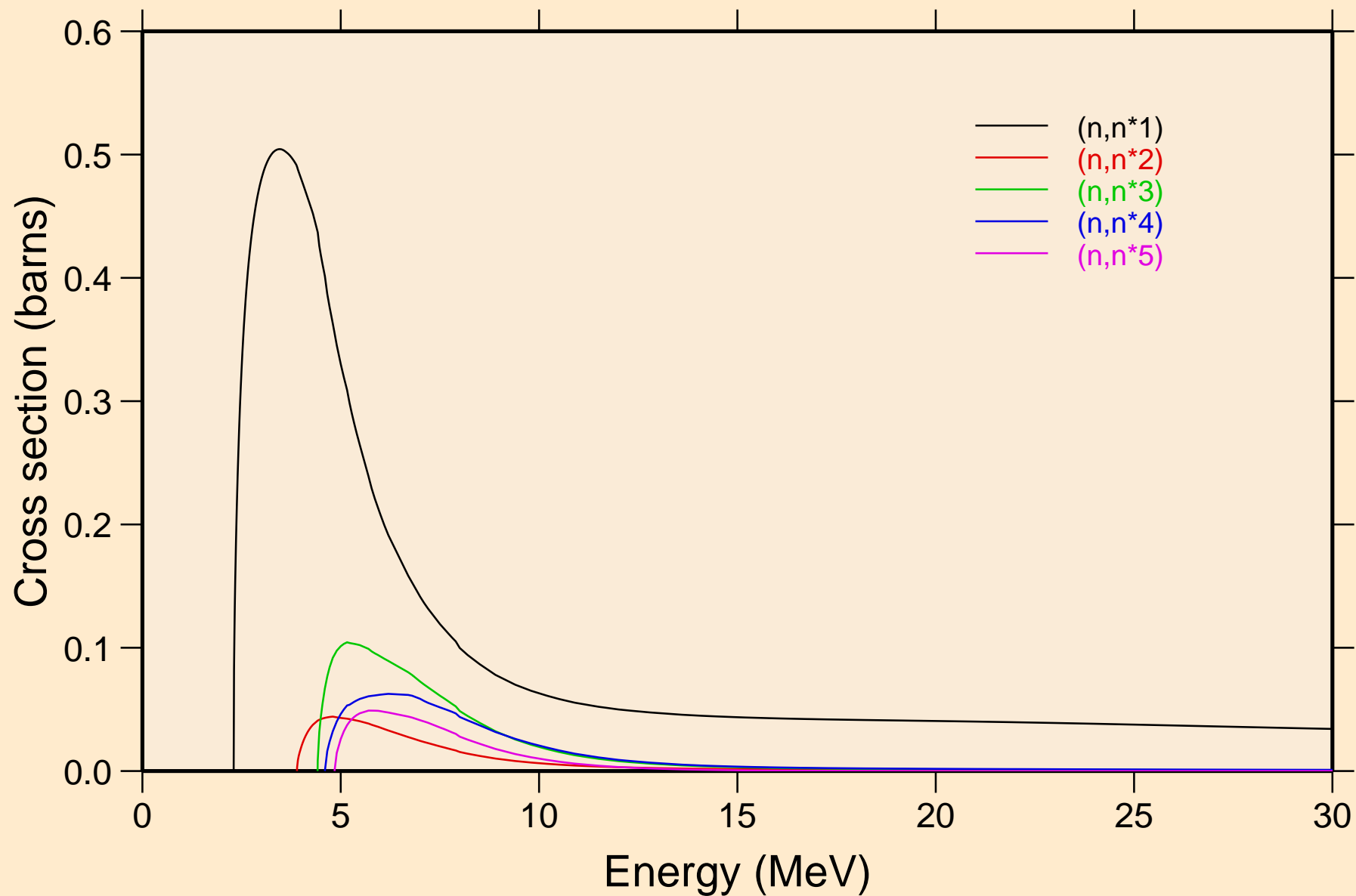

S032 NEUTRON ACER TENDL-2019 LIBRARY; T=293.16K  
Inelastic levels

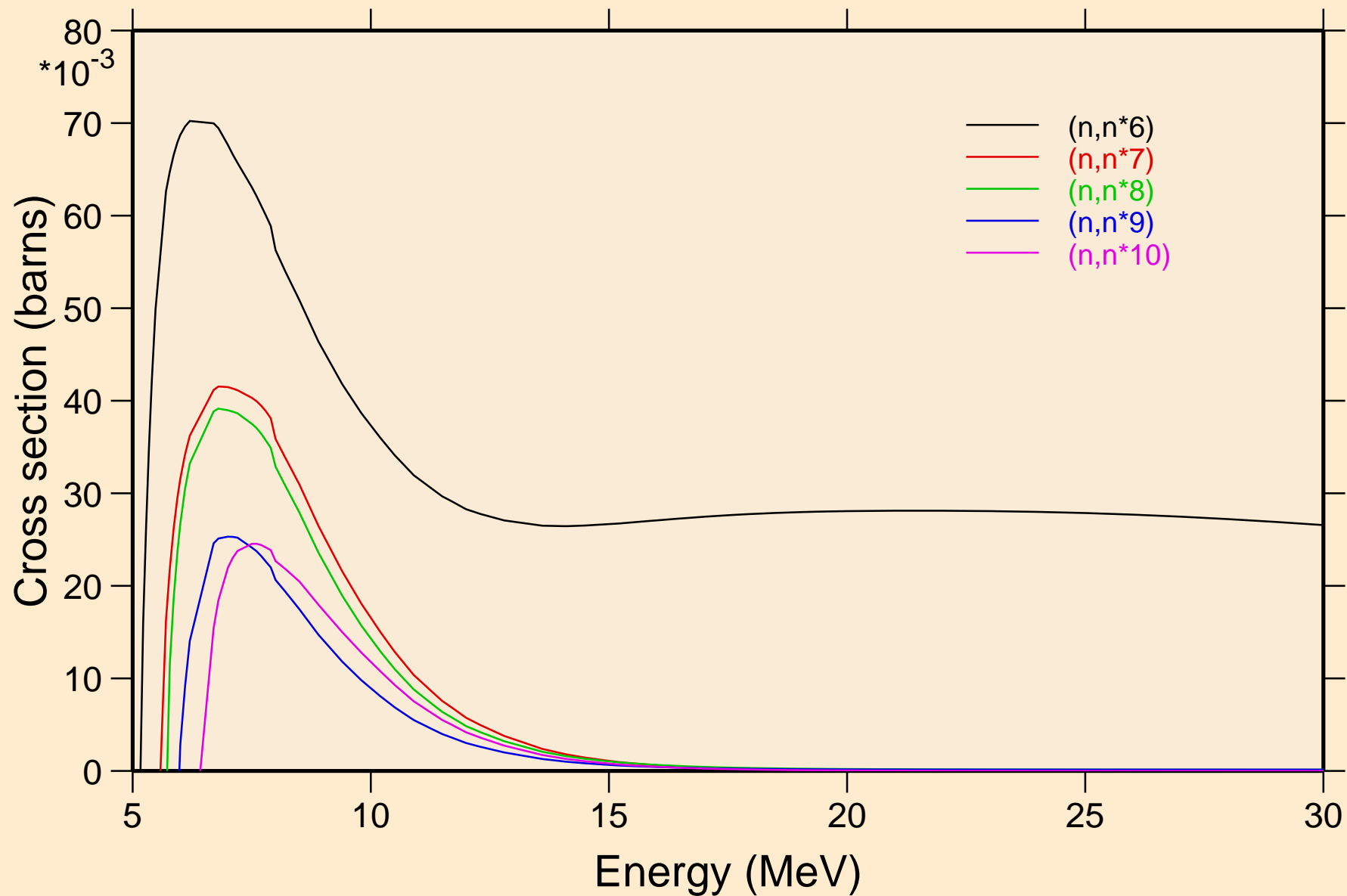



S032 NEUTRON ACER TENDL-2019 LIBRARY; T=293.16K  
Inelastic levels

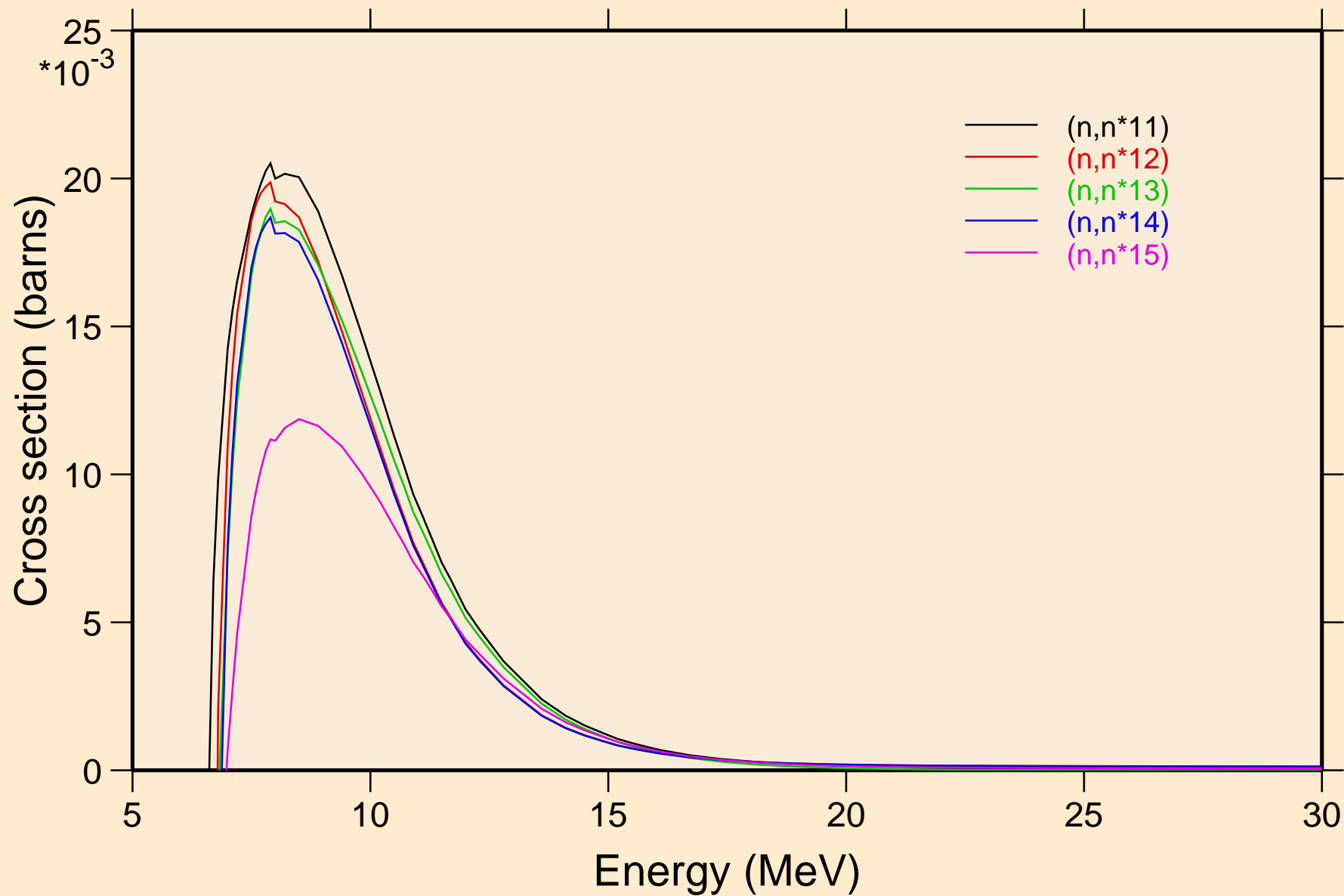

S032 NEUTRON ACER TENDL-2019 LIBRARY; T=293.16K  
Inelastic levels

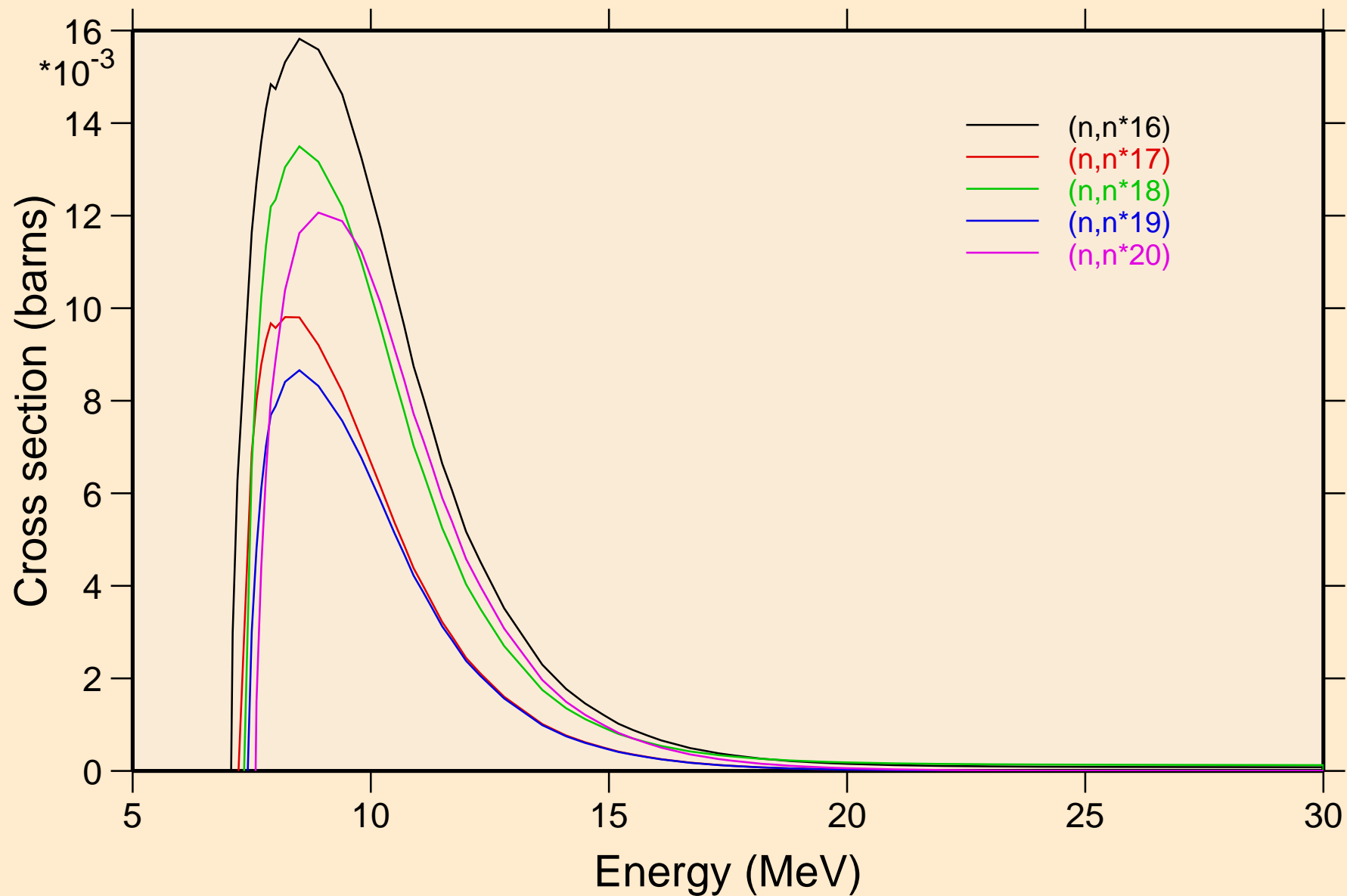

S032 NEUTRON ACER TENDL-2019 LIBRARY; T=293.16K  
Inelastic levels

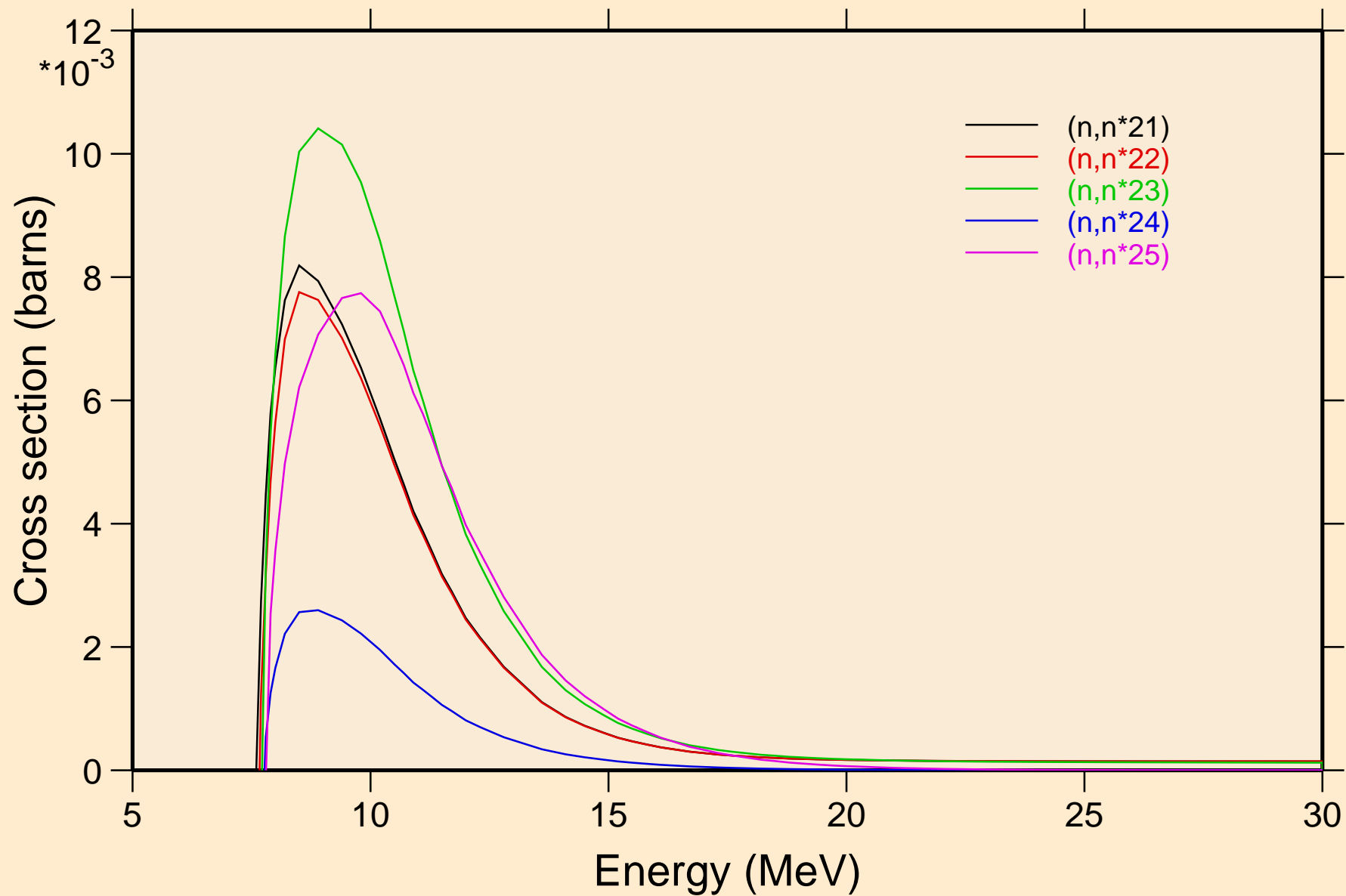

S032 NEUTRON ACER TENDL-2019 LIBRARY; T=293.16K  
Inelastic levels

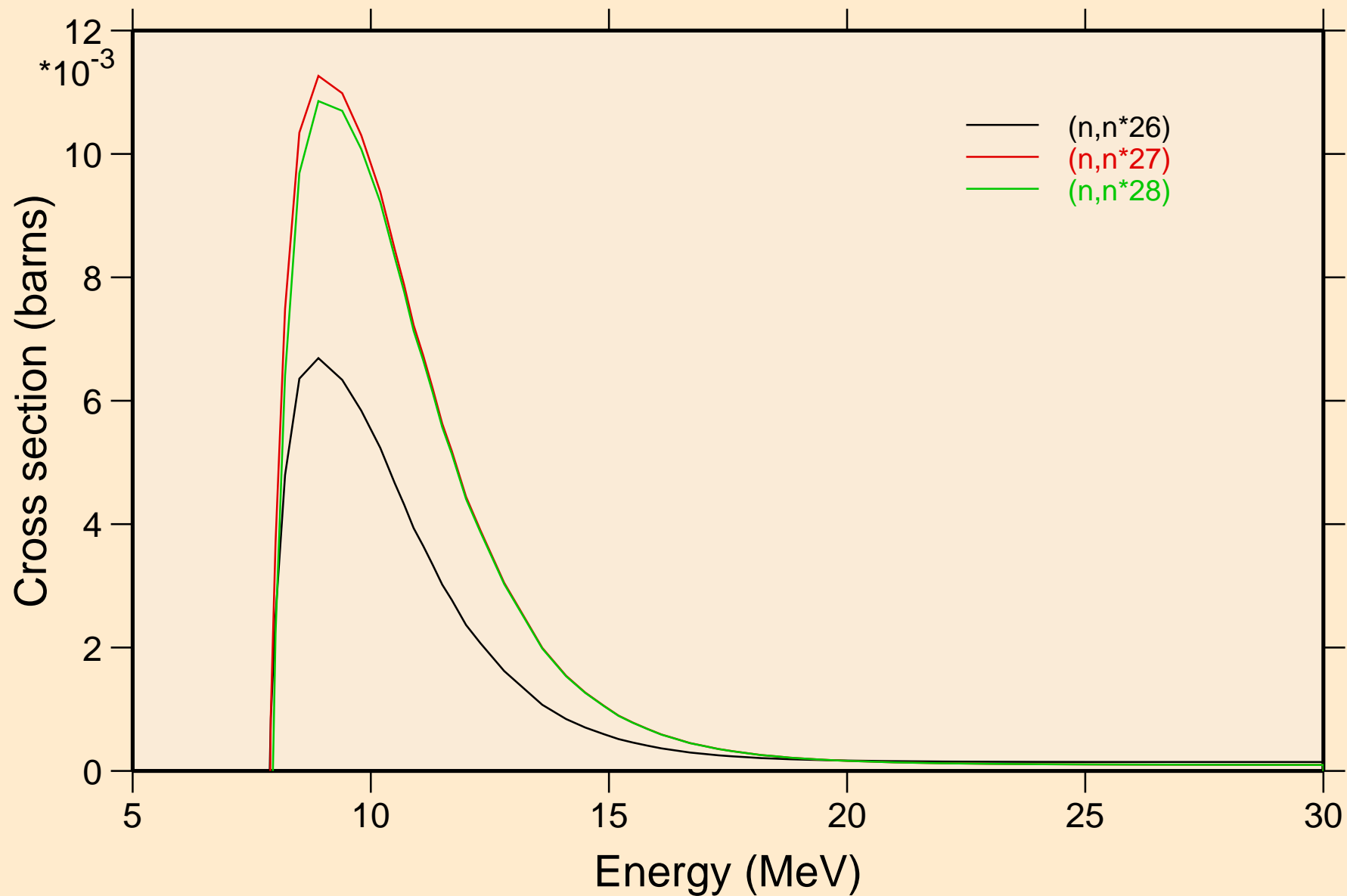

S032 NEUTRON ACER TENDL-2019 LIBRARY; T=293.16K  
Threshold reactions

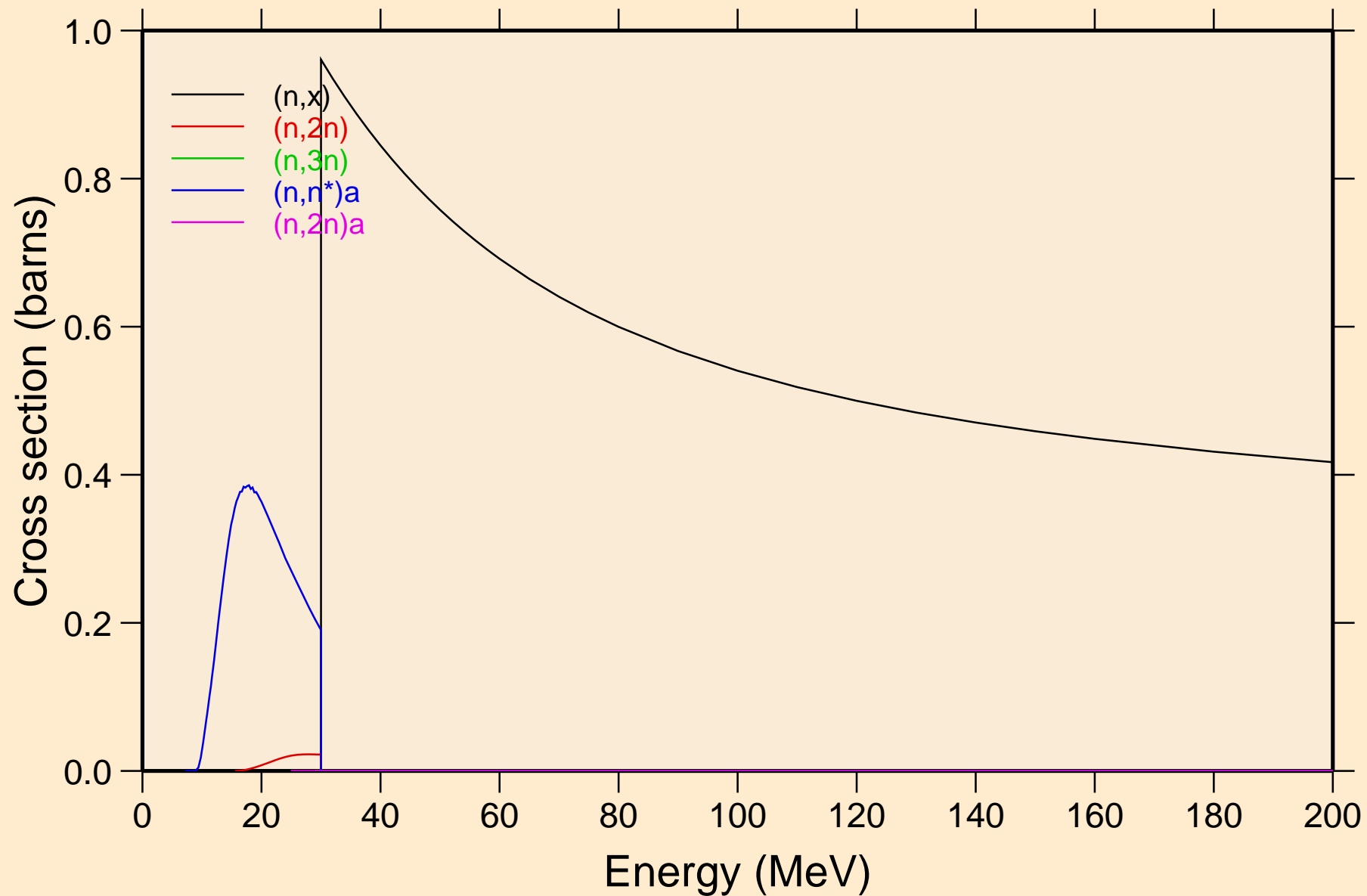

S032 NEUTRON ACER TENDL-2019 LIBRARY; T=293.16K  
Threshold reactions

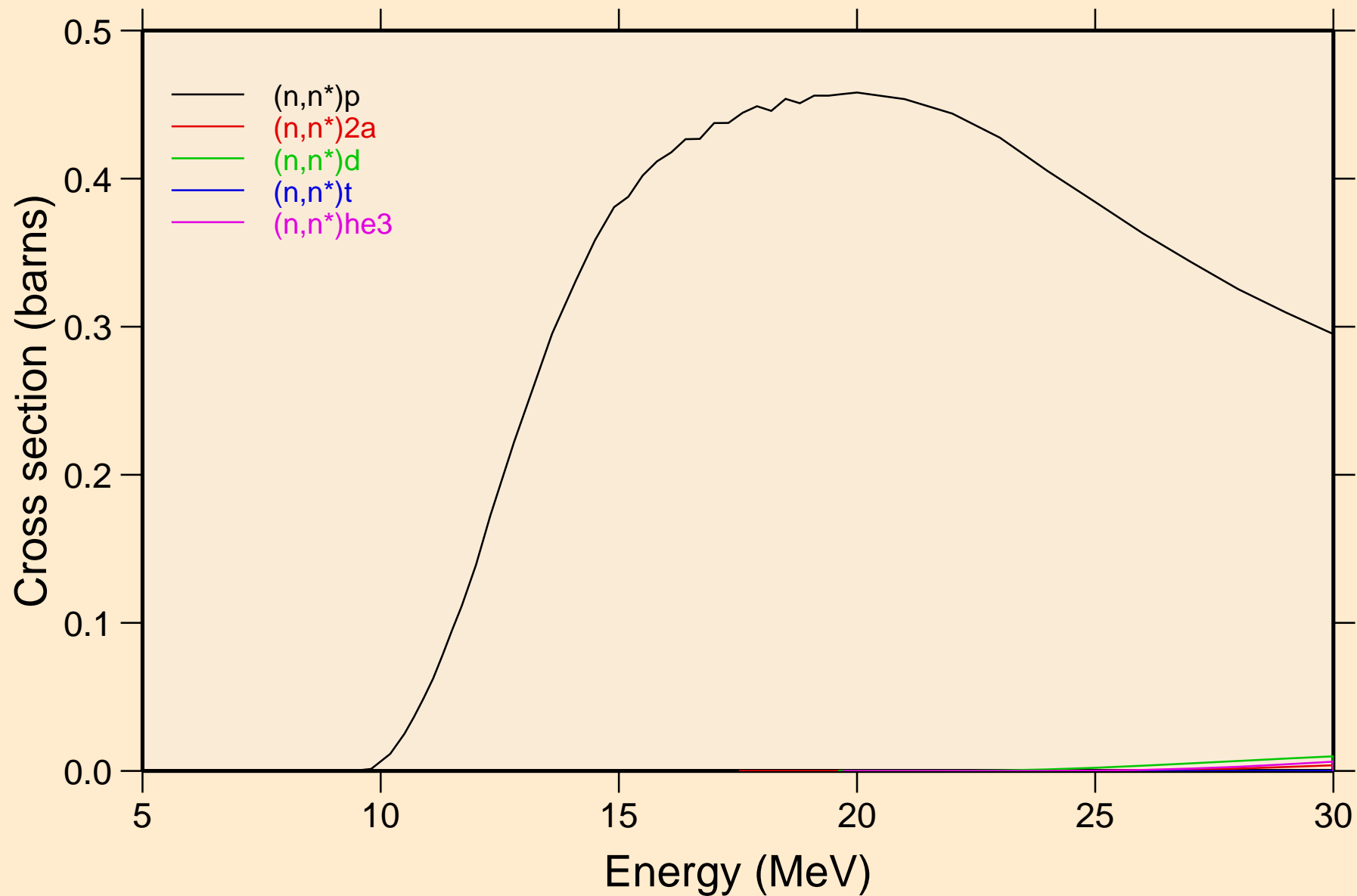

# S032 NEUTRON ACER TENDL-2019 LIBRARY; T=293.16K

## Threshold reactions

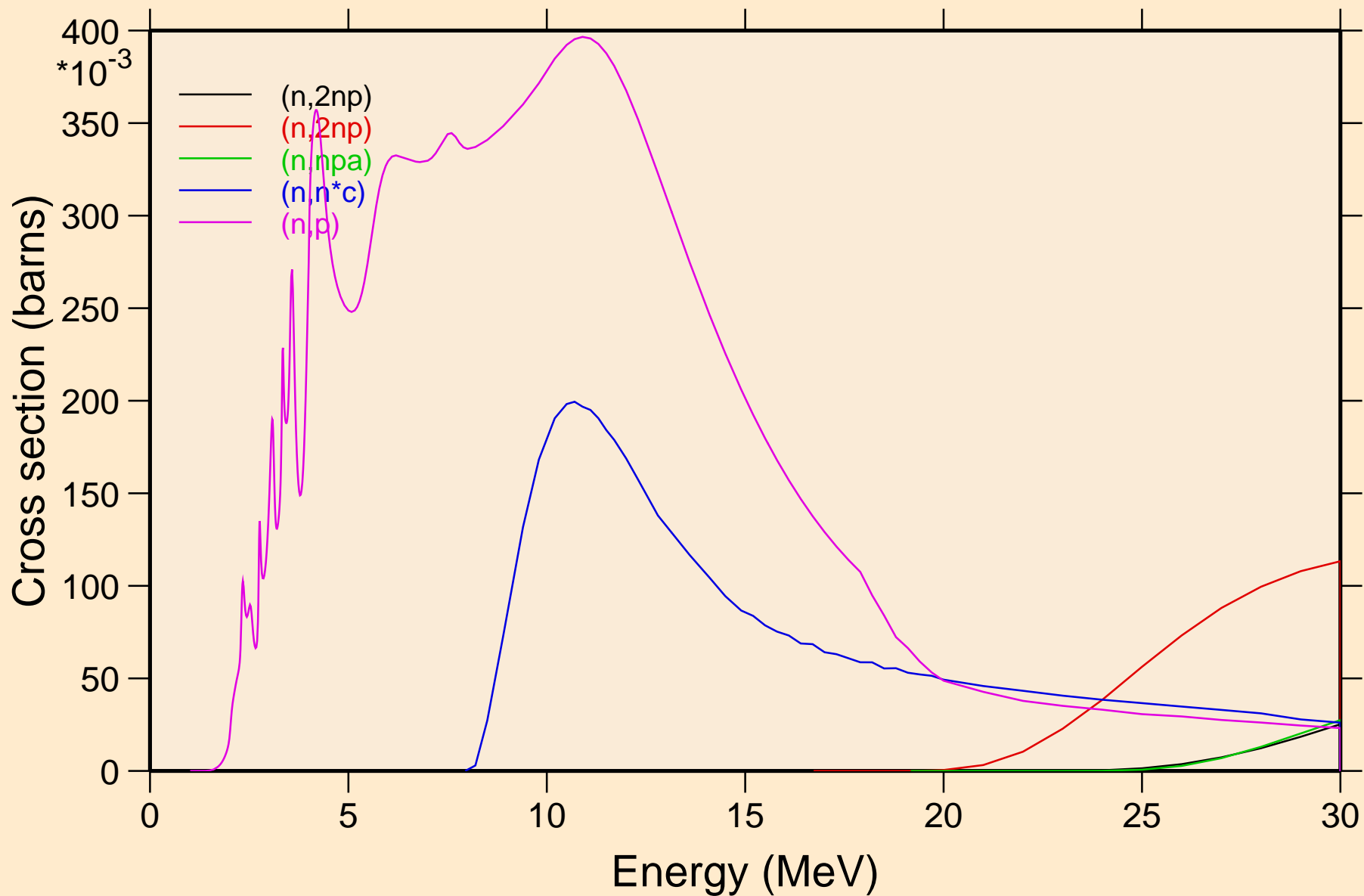

S032 NEUTRON ACER TENDL-2019 LIBRARY; T=293.16K  
Threshold reactions

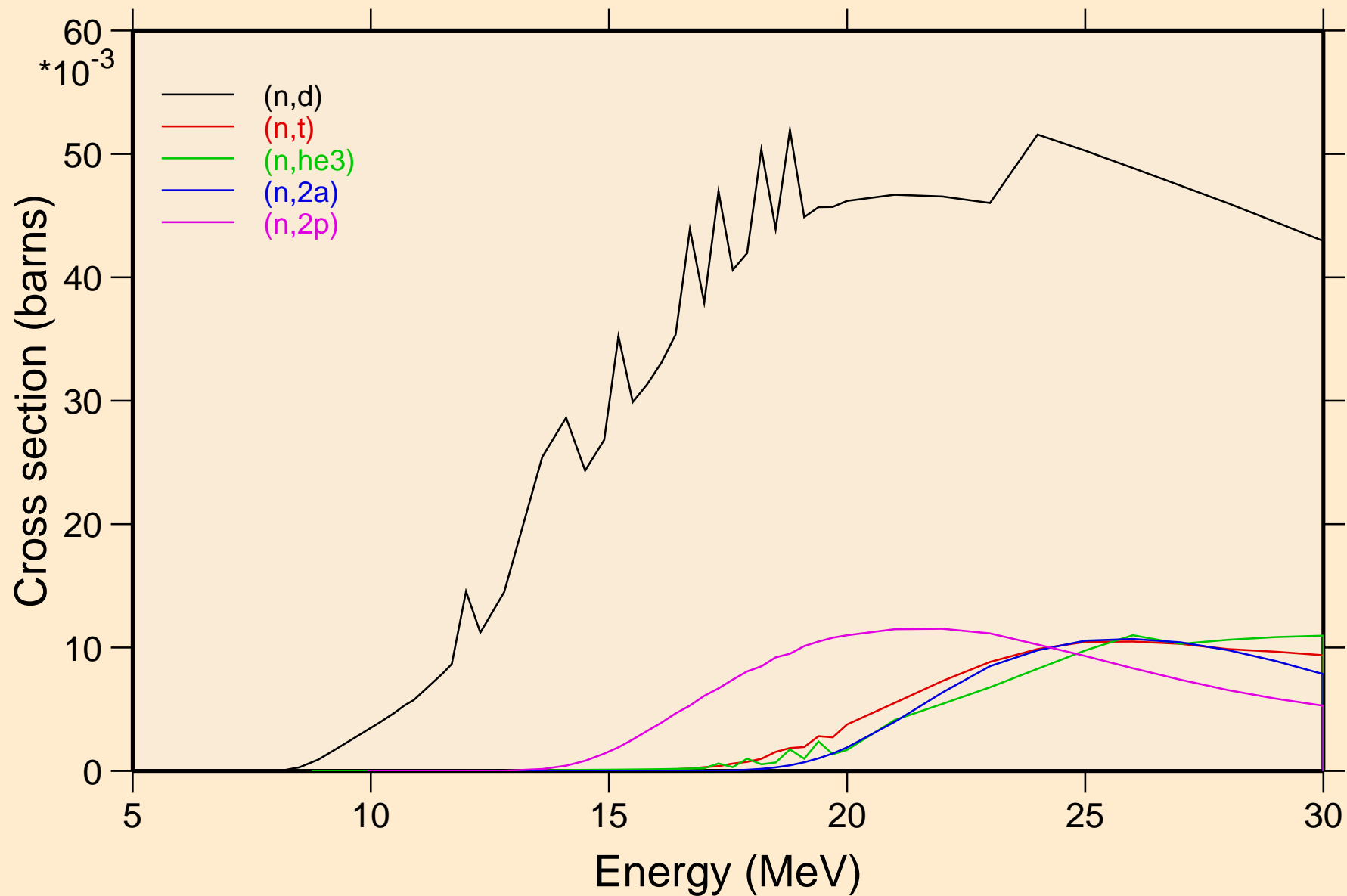



S032 NEUTRON ACER TENDL-2019 LIBRARY; T=293.16K  
Threshold reactions

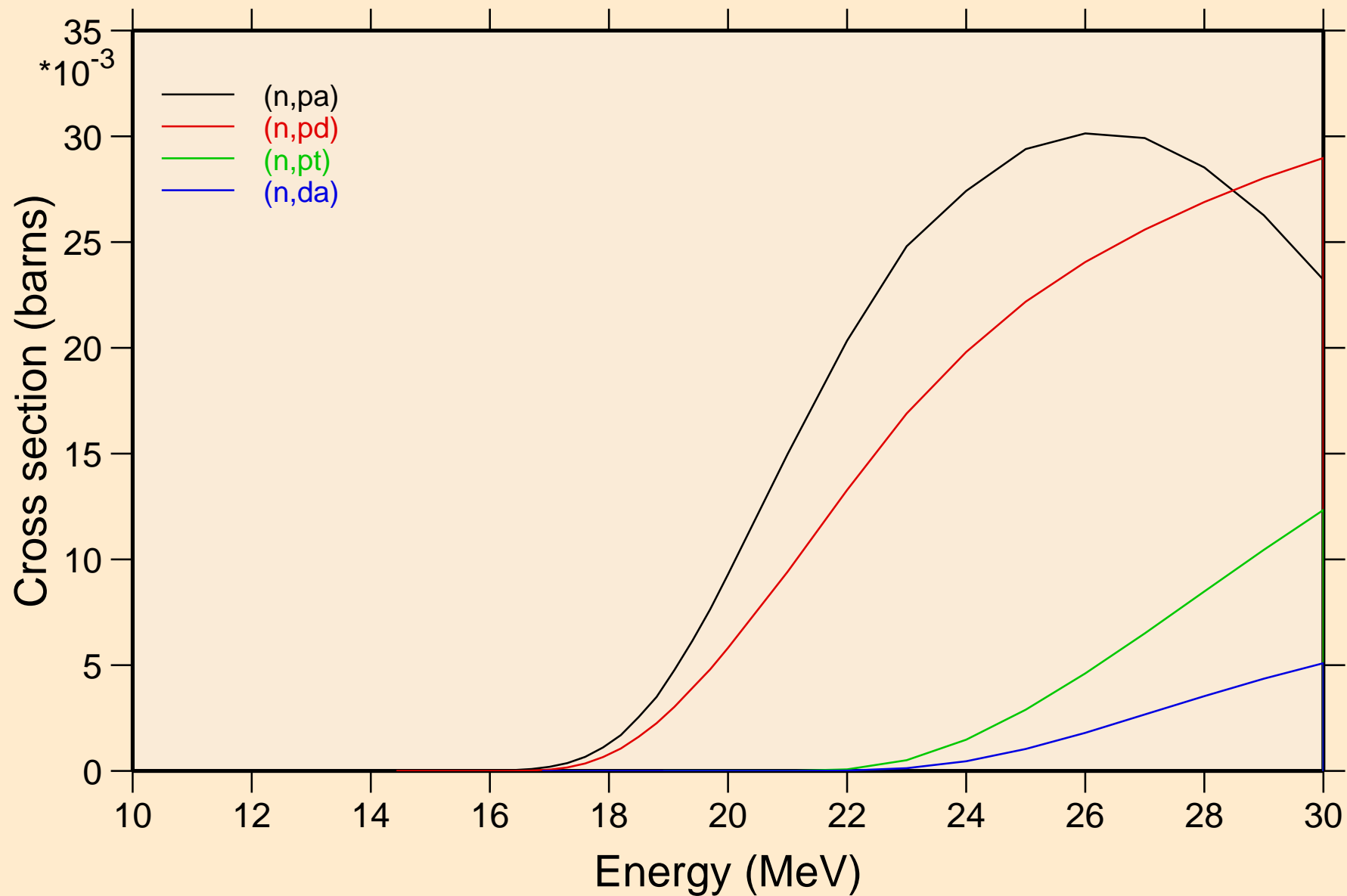

S032 NEUTRON ACER TENDL-2019 LIBRARY; T=293.16K  
Threshold reactions

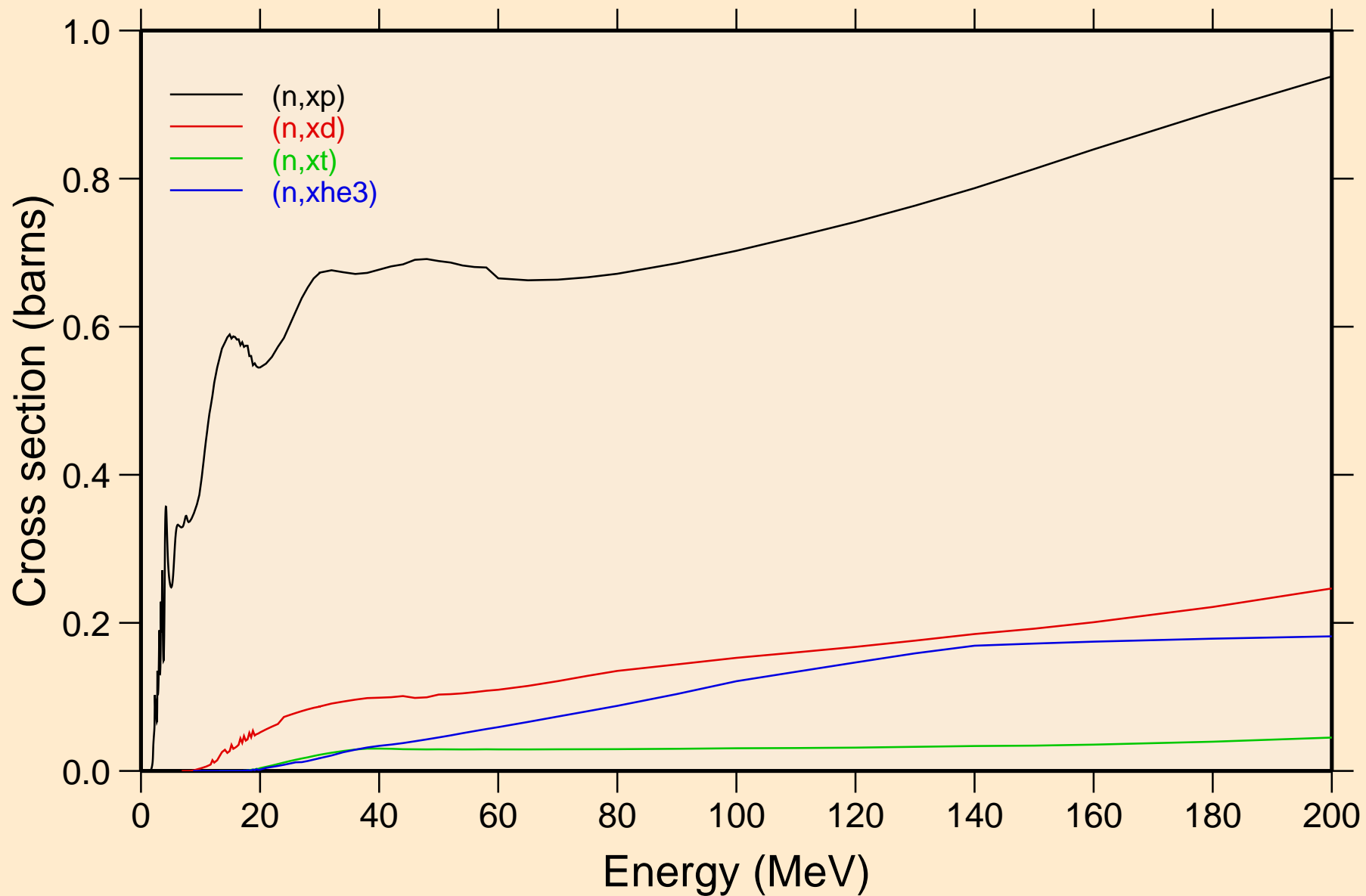

S032 NEUTRON ACER TENDL-2019 LIBRARY; T=293.16K  
angular distribution for elastic

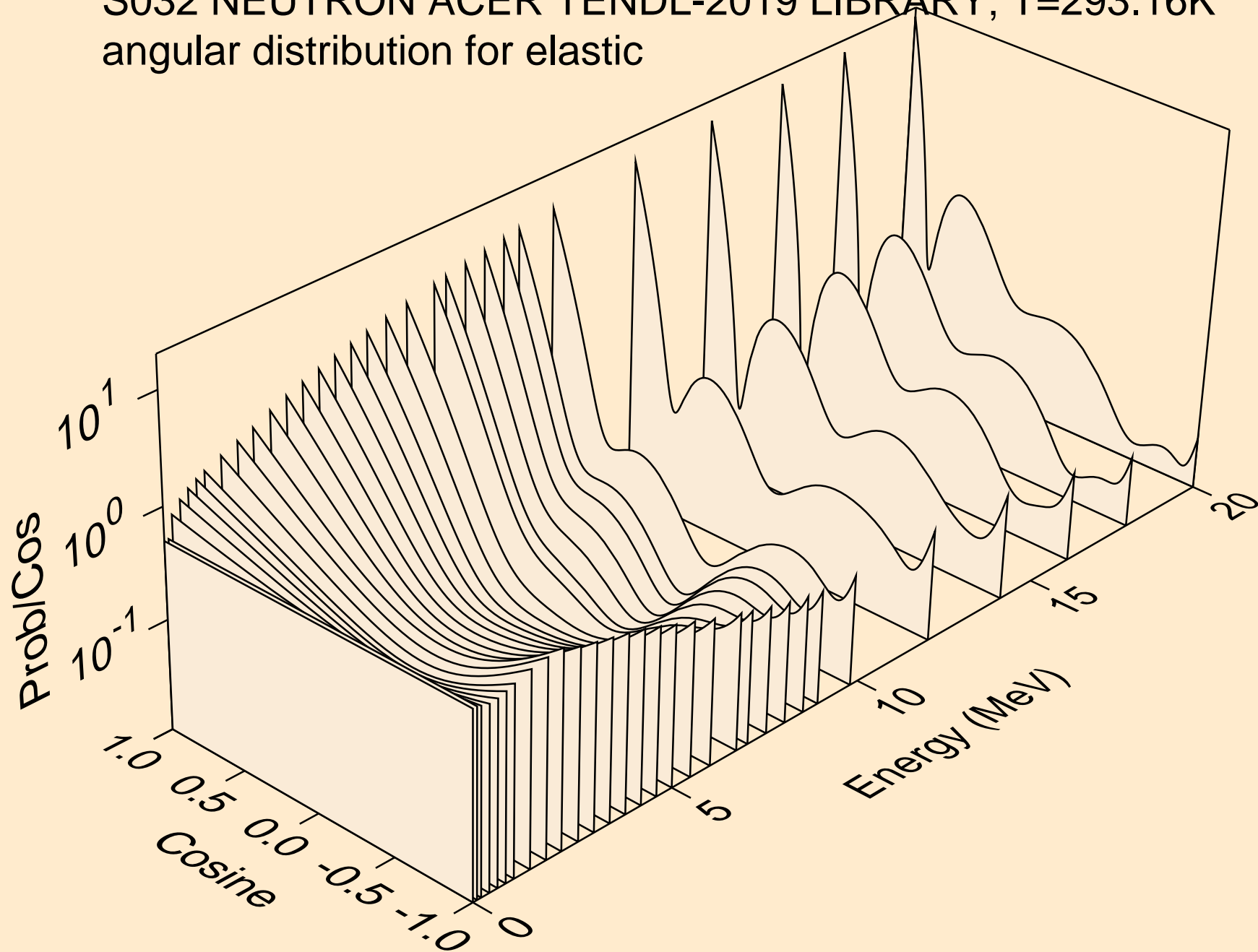

S032 NEUTRON ACER TENDL-2019 LIBRARY; T=293.16K  
angular distribution for elastic

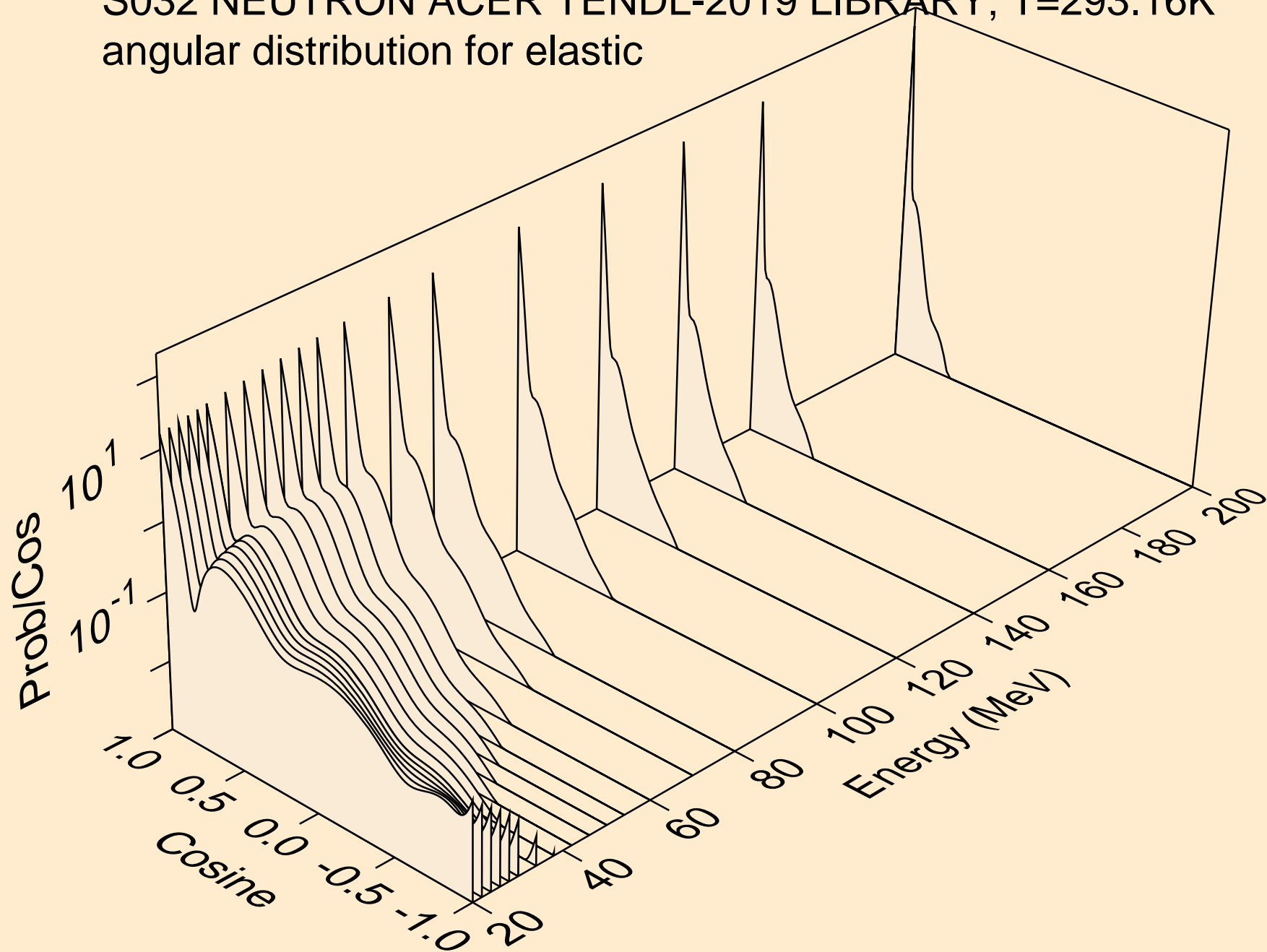

S032 NEUTRON ACER TENDL-2019 LIBRARY; T=293.16K  
angular distribution for (n,n\*1)

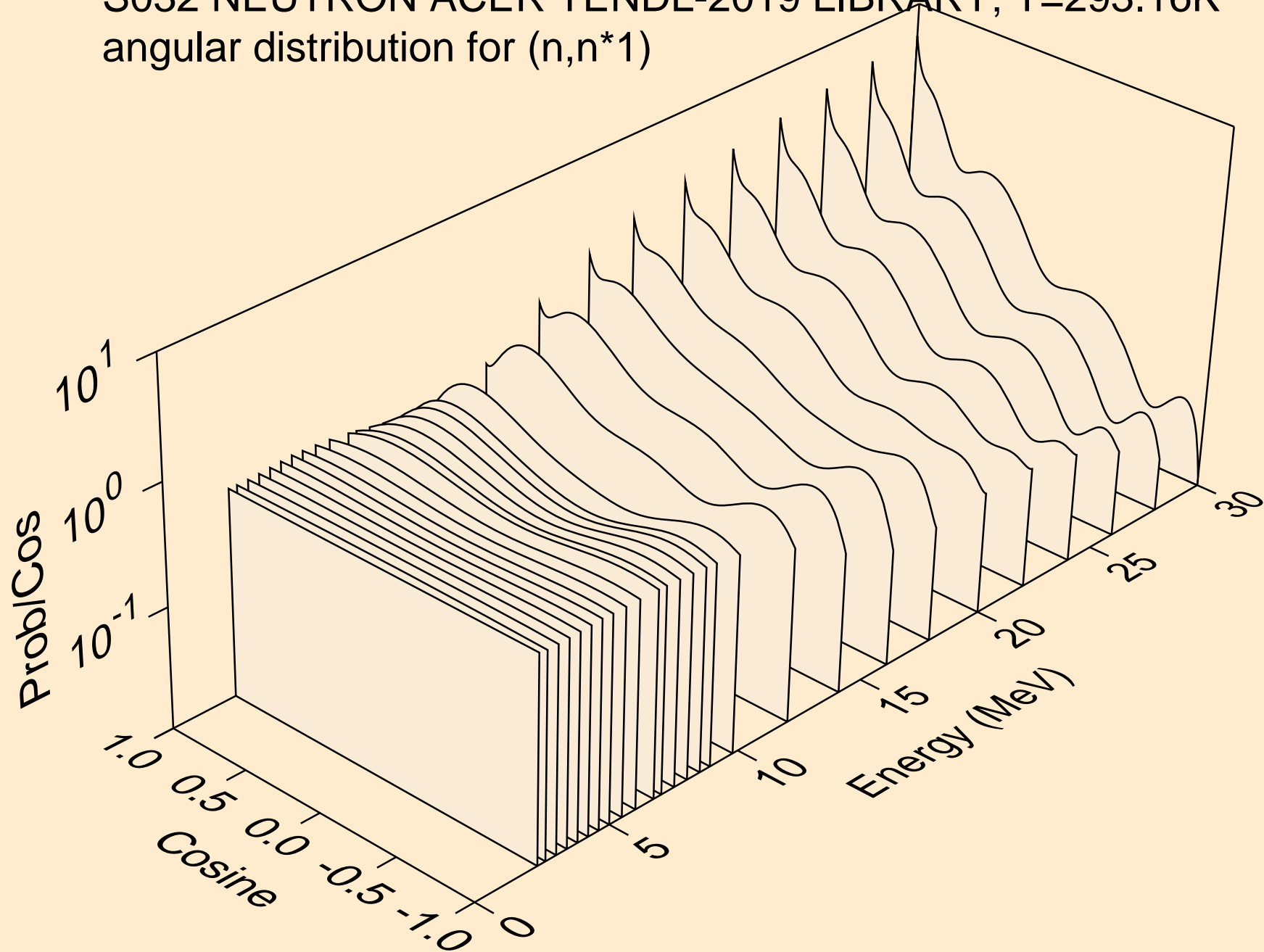

S032 NEUTRON ACER TENDL-2019 LIBRARY; T=293.16K  
angular distribution for (n,n\*2)

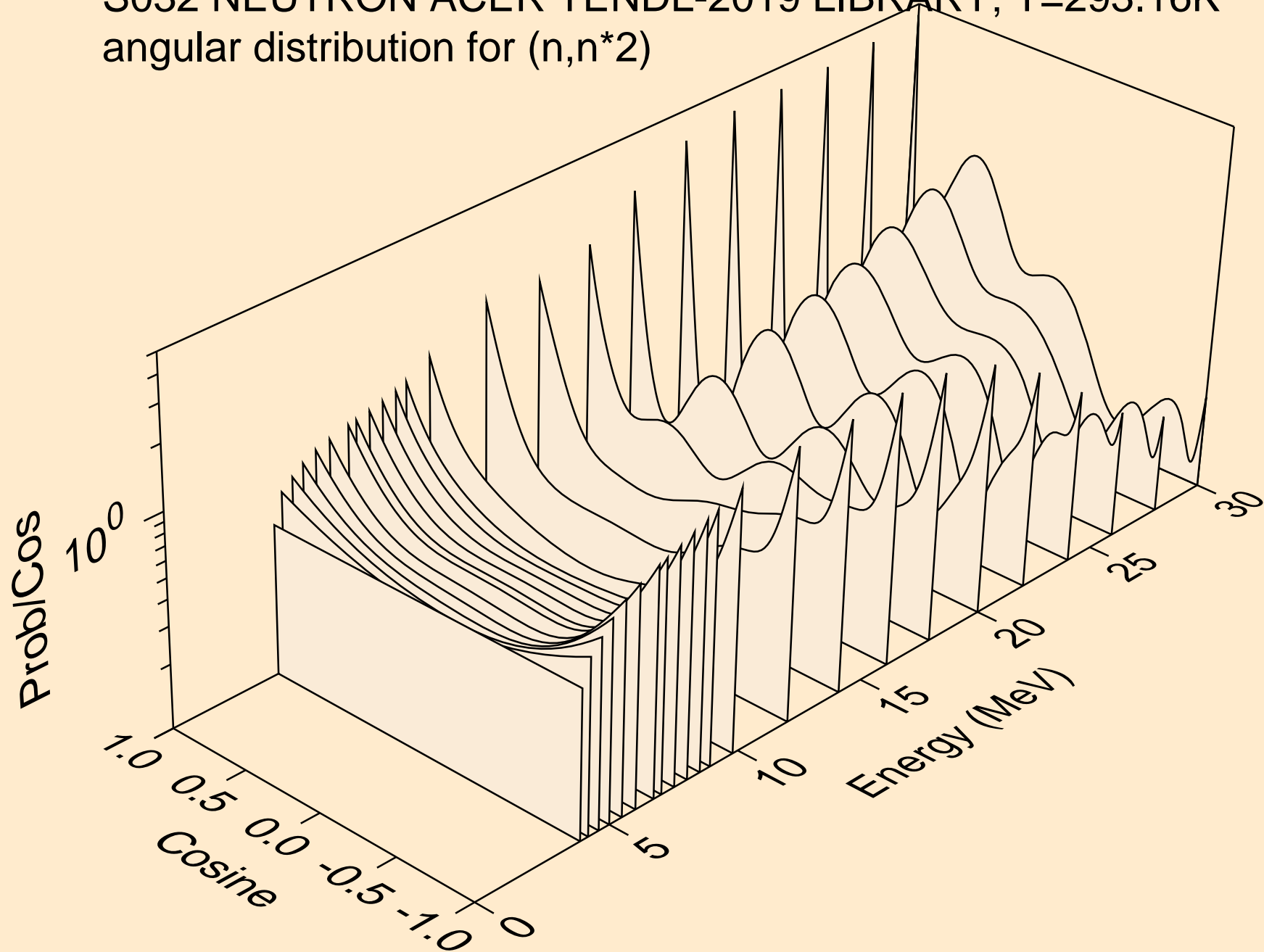

S032 NEUTRON ACER TENDL-2019 LIBRARY; T=293.16K  
angular distribution for (n,n\*3)

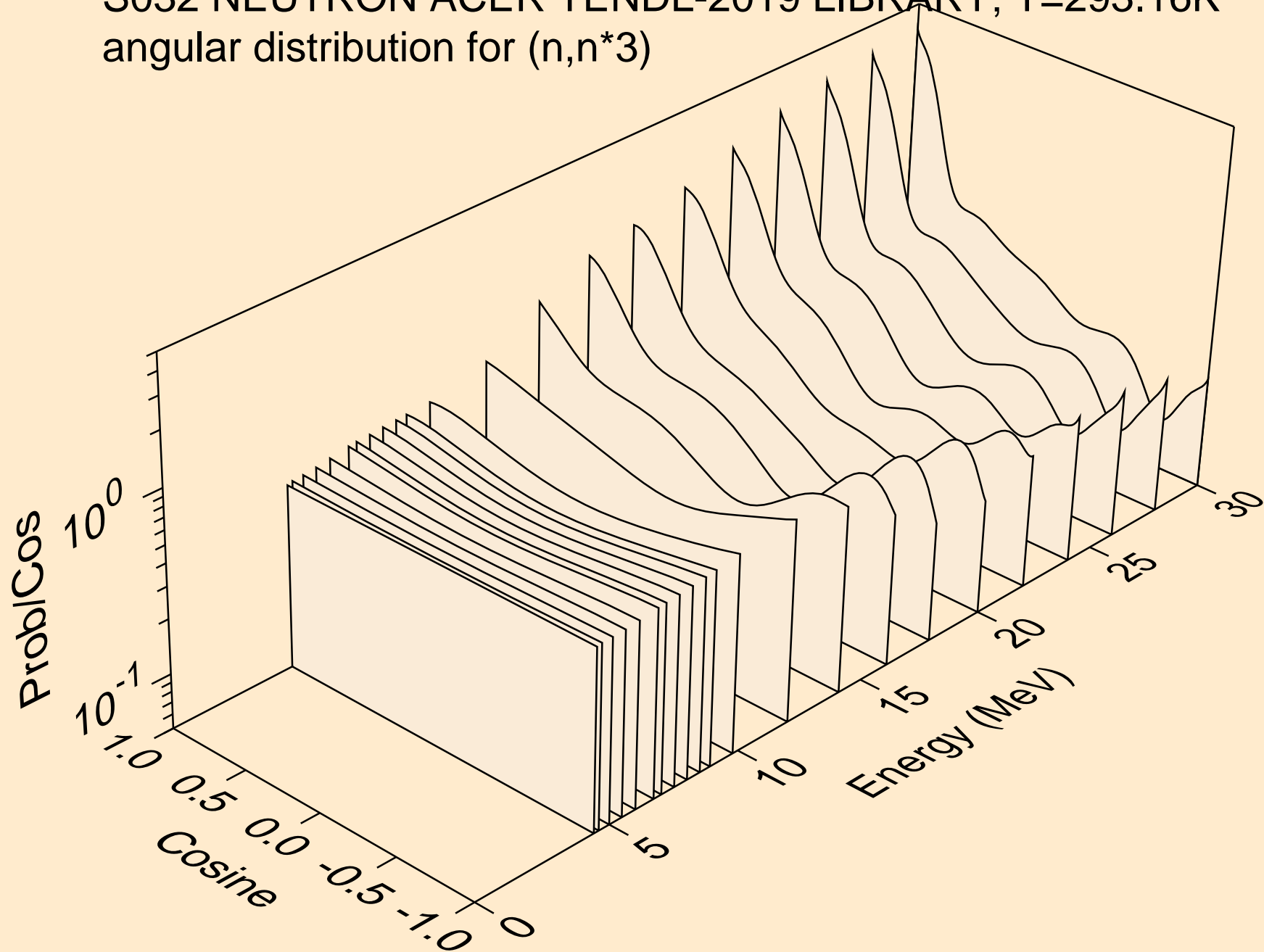

S032 NEUTRON ACER TENDL-2019 LIBRARY; T=293.16K  
angular distribution for (n,n\*4)

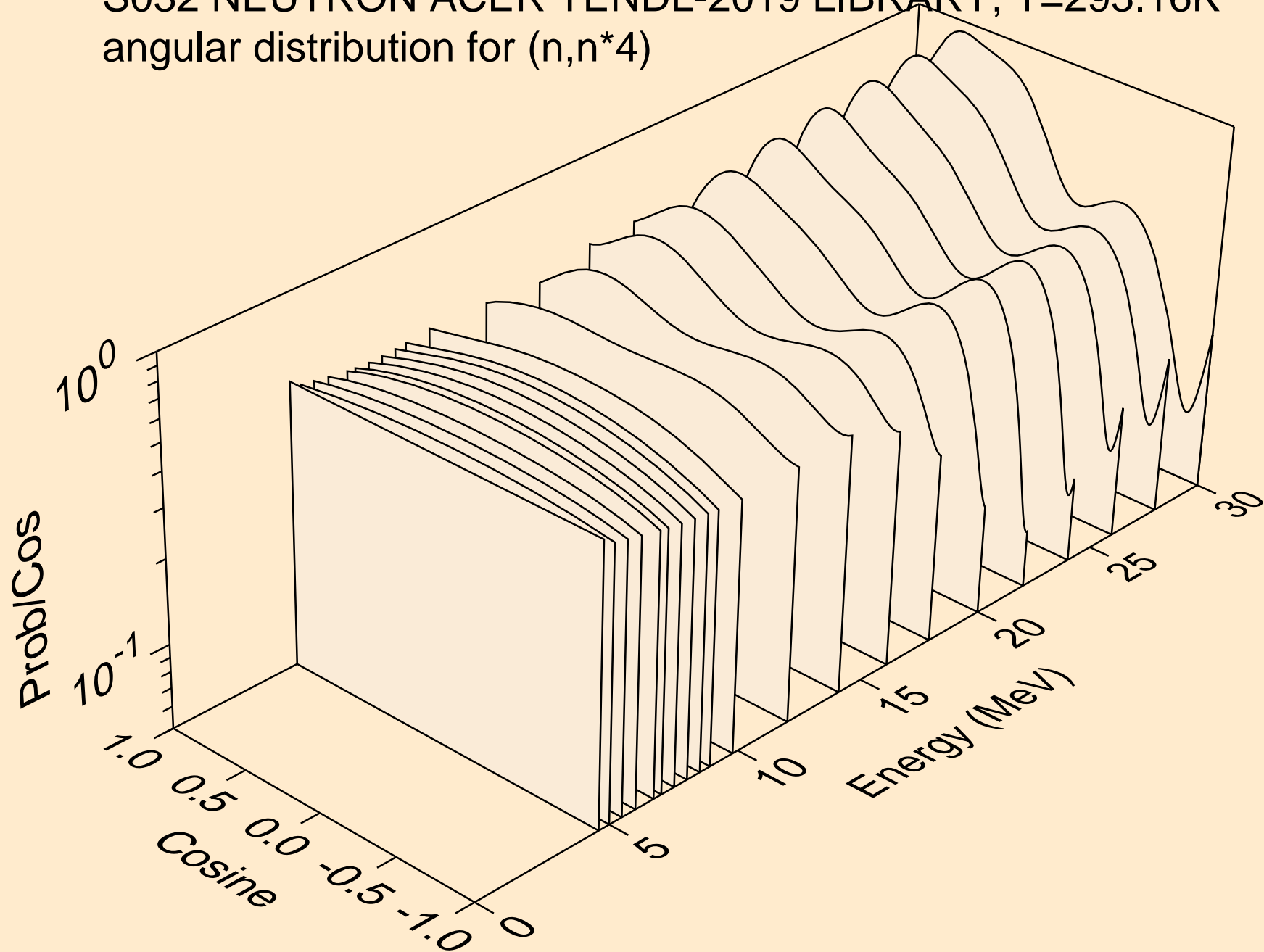



S032 NEUTRON ACER TENDL-2019 LIBRARY; T=293.16K  
angular distribution for (n,n\*5)

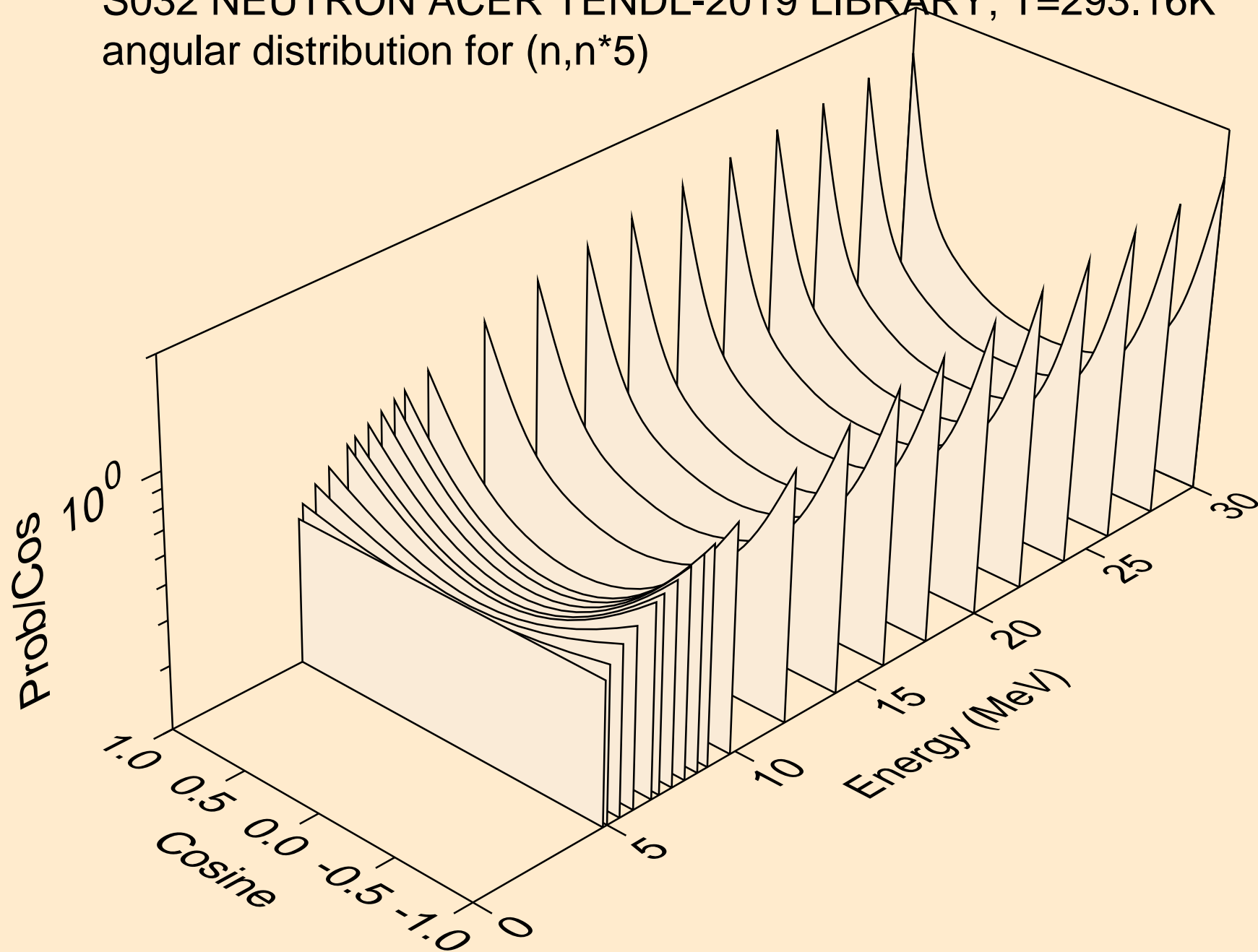

S032 NEUTRON ACER TENDL-2019 LIBRARY; T=293.16K  
angular distribution for (n,n\*6)

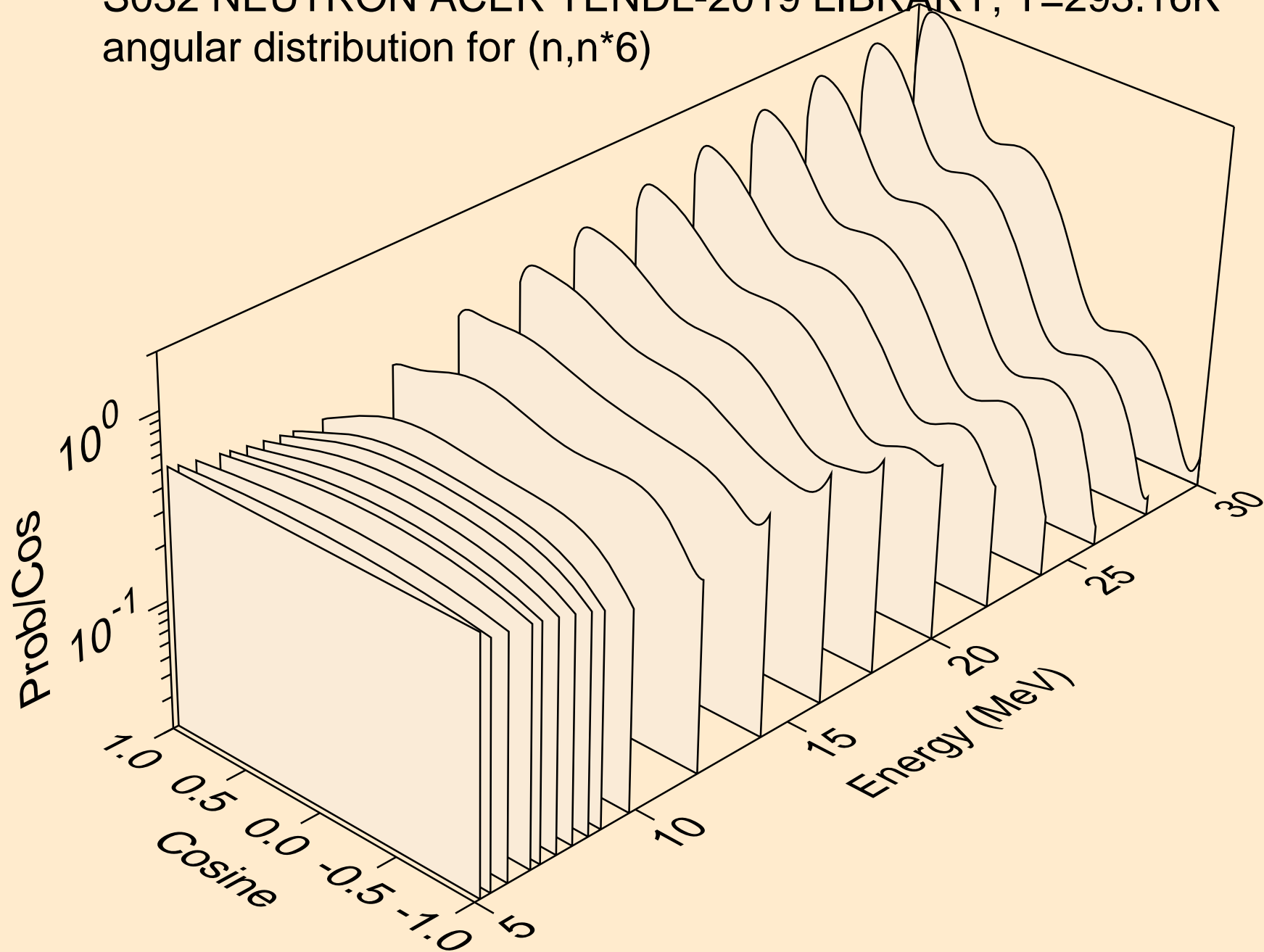

S032 NEUTRON ACER TENDL-2019 LIBRARY; T=293.16K  
angular distribution for (n,n\*7)

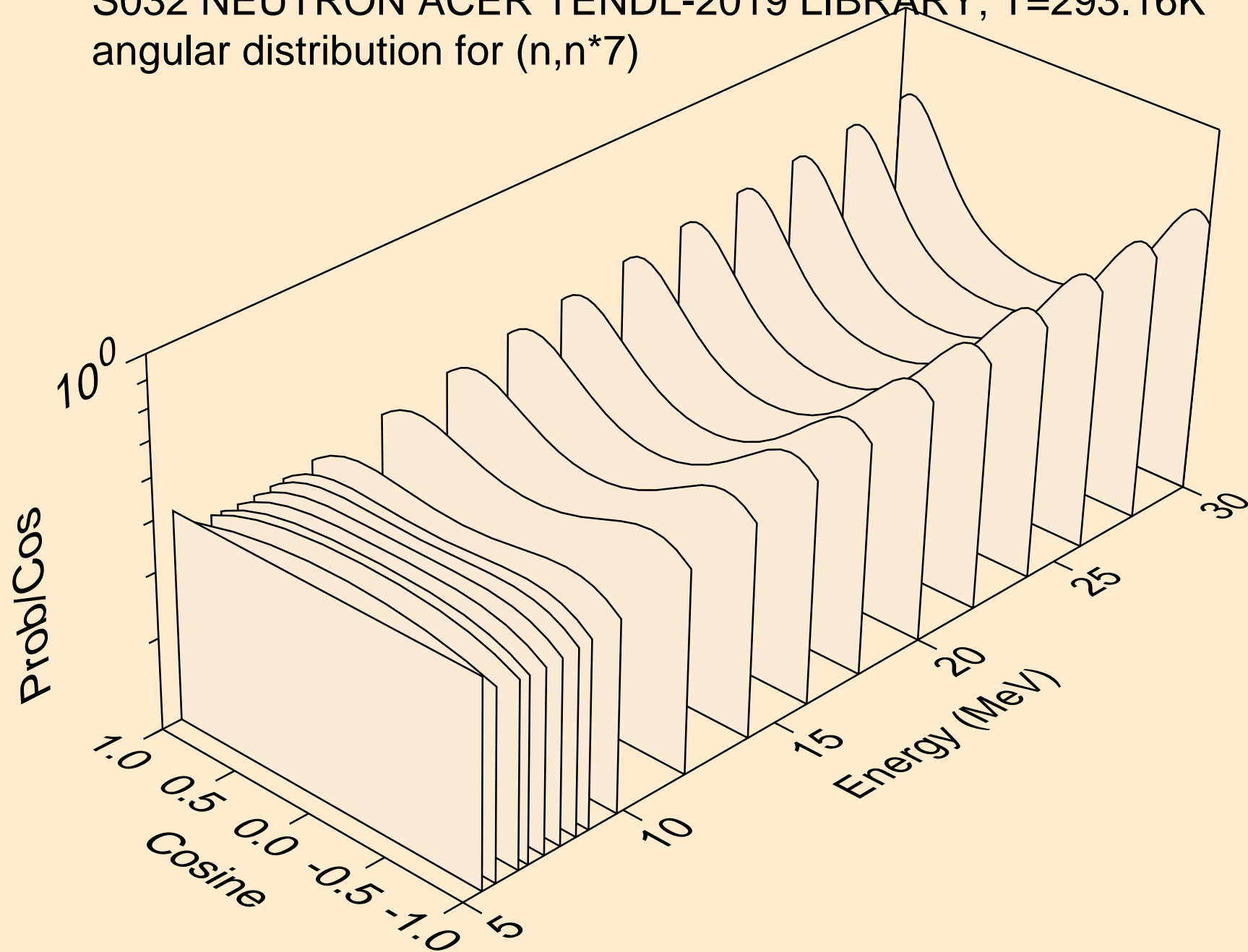

S032 NEUTRON ACER TENDL-2019 LIBRARY; T=293.16K  
angular distribution for (n,n\*8)

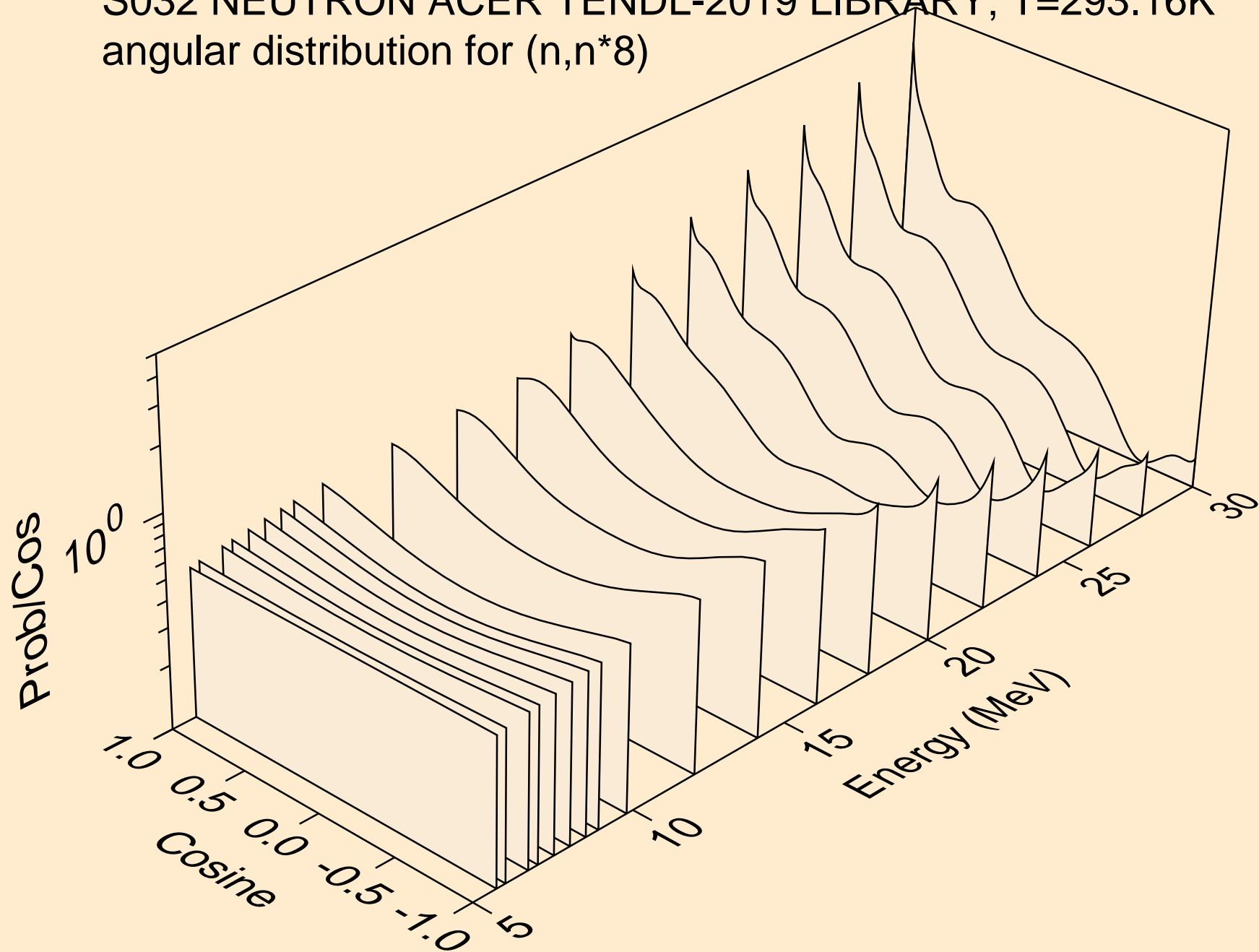

S032 NEUTRON ACER TENDL-2019 LIBRARY; T=293.16K  
angular distribution for (n,n\*9)

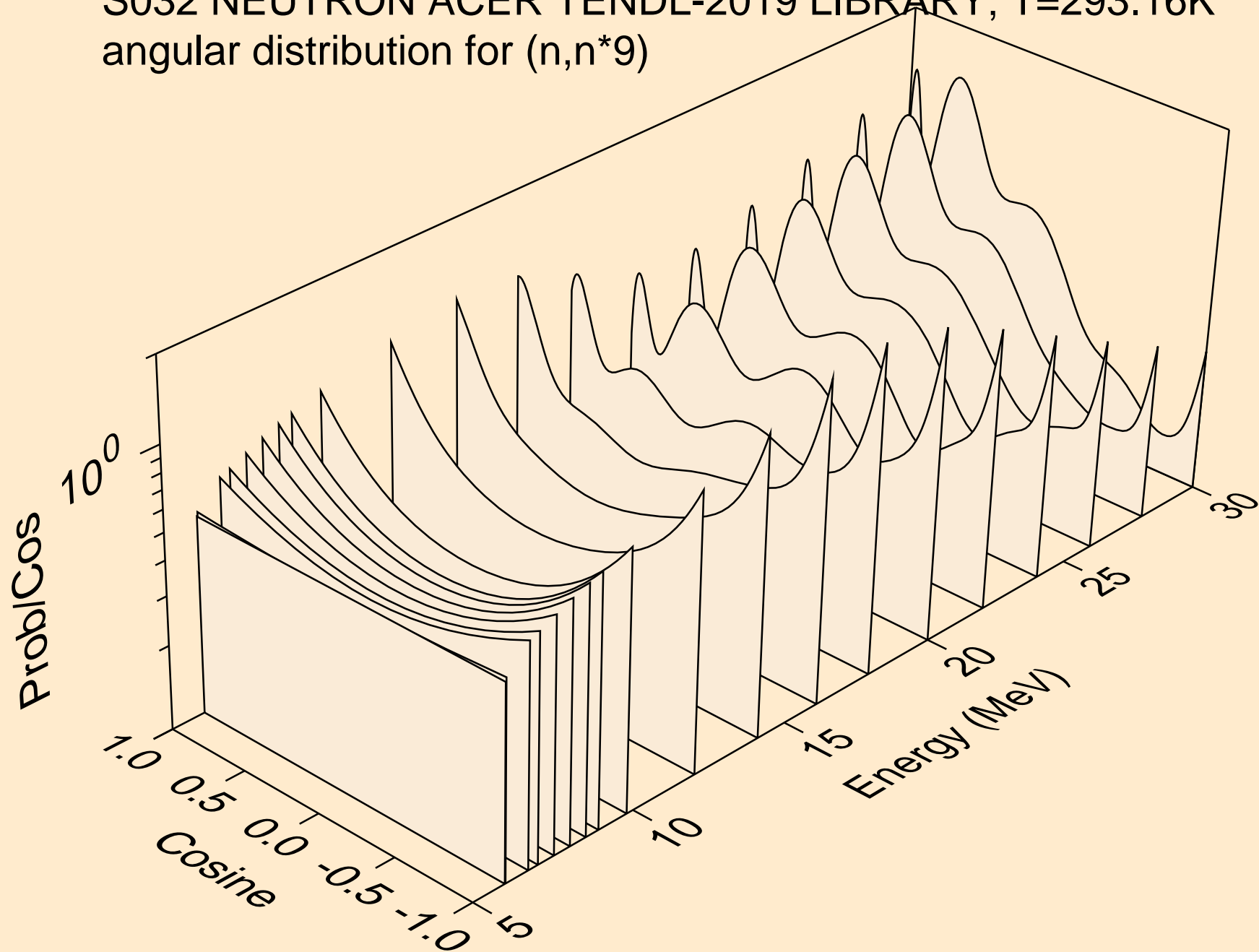

S032 NEUTRON ACER TENDL-2019 LIBRARY; T=293.16K  
angular distribution for (n,n\*10)

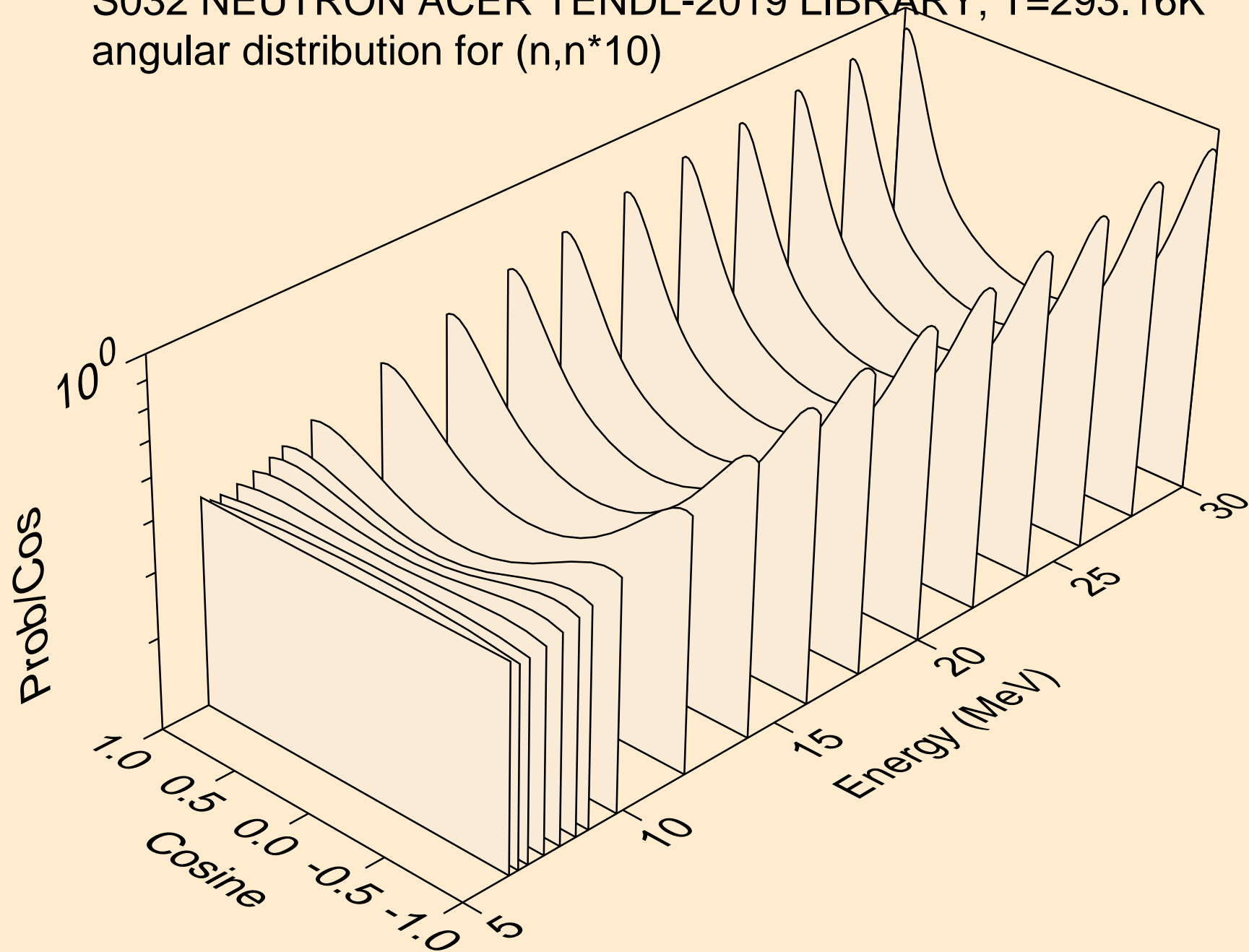

S032 NEUTRON ACER TENDL-2019 LIBRARY; T=293.16K  
angular distribution for (n,n\*11)

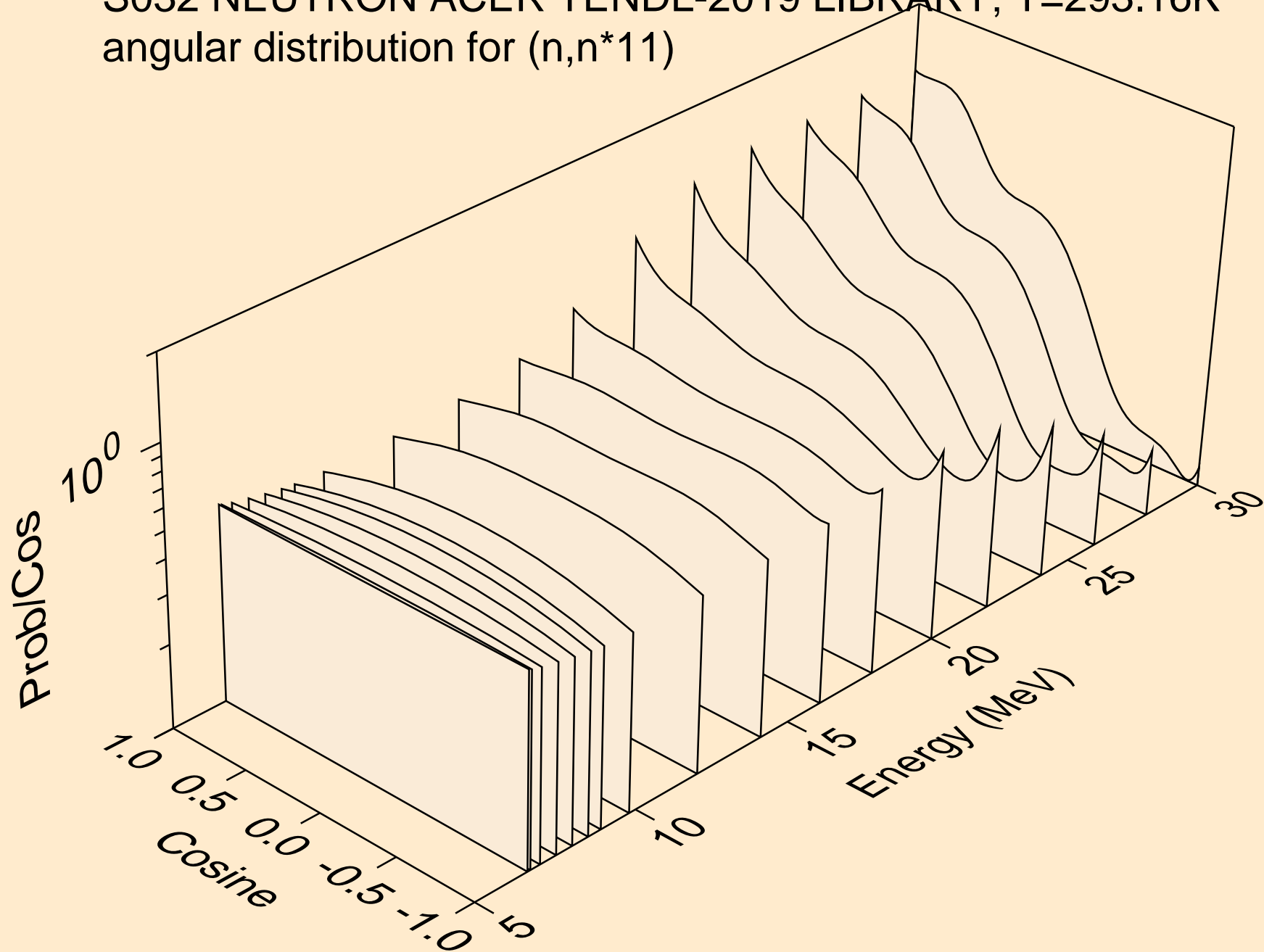

S032 NEUTRON ACER TENDL-2019 LIBRARY; T=293.16K  
angular distribution for (n,n\*12)

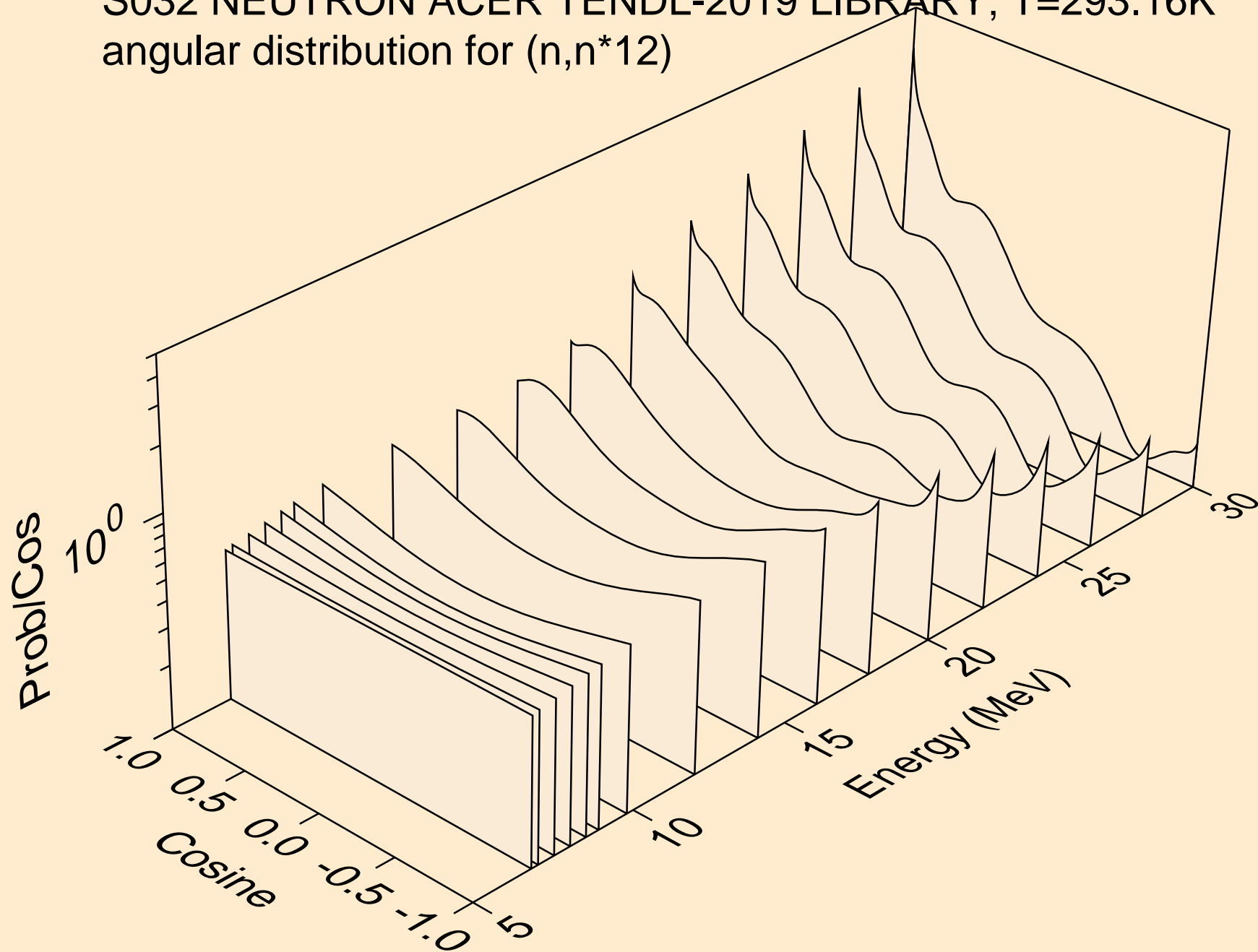



S032 NEUTRON ACER TENDL-2019 LIBRARY; T=293.16K  
angular distribution for (n,n\*13)

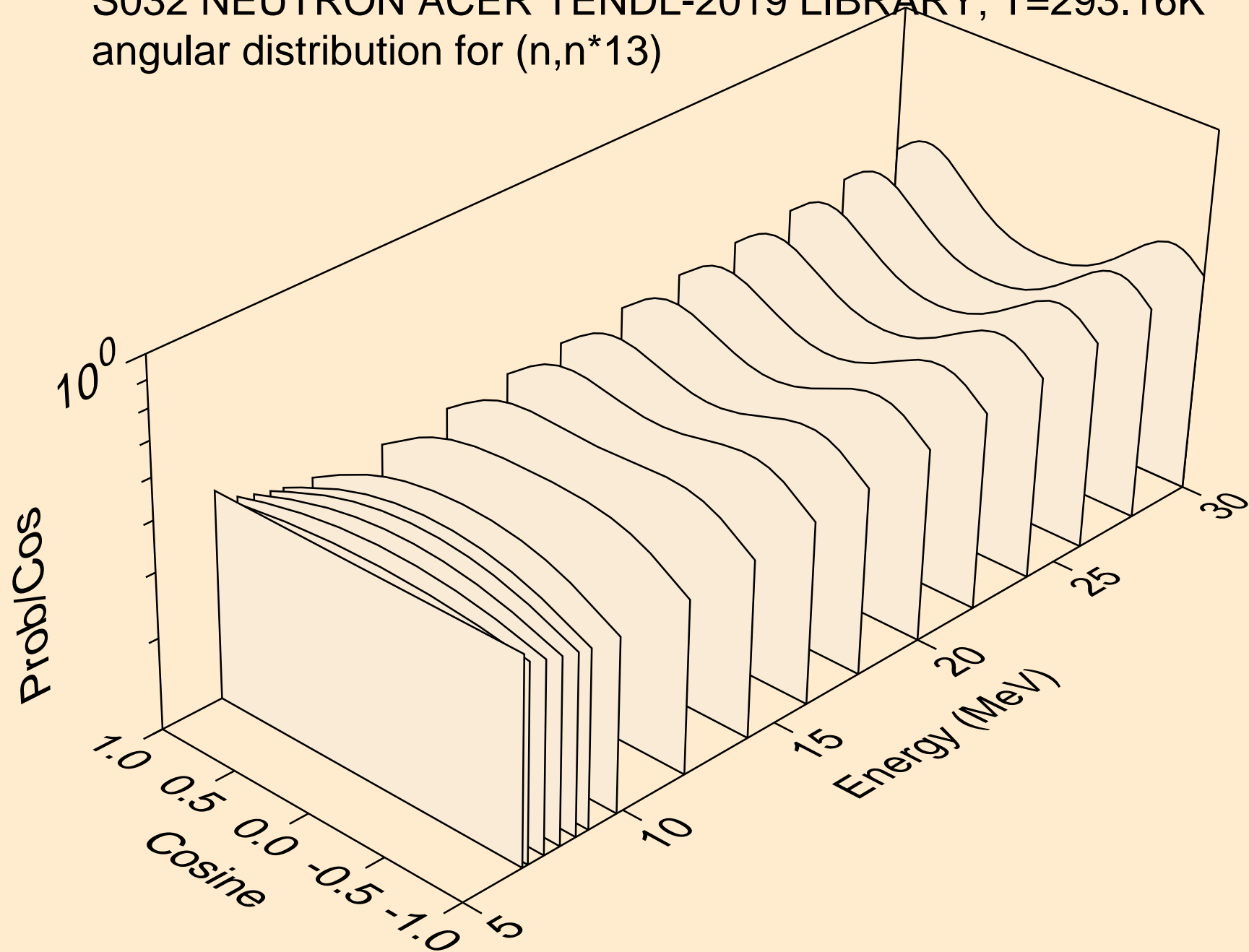

S032 NEUTRON ACER TENDL-2019 LIBRARY; T=293.16K  
angular distribution for (n,n\*14)

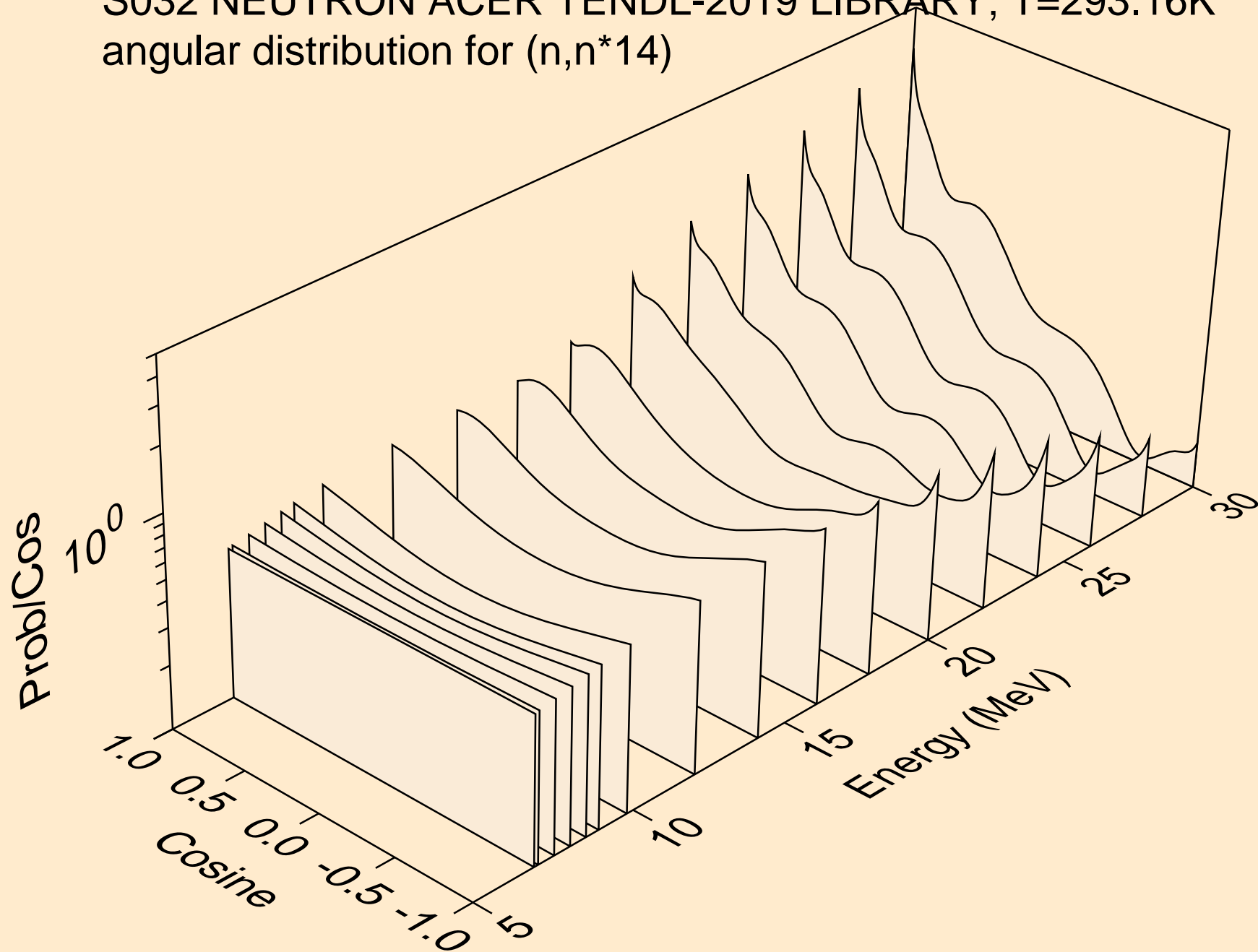

S032 NEUTRON ACER TENDL-2019 LIBRARY; T=293.16K  
angular distribution for (n,n\*15)

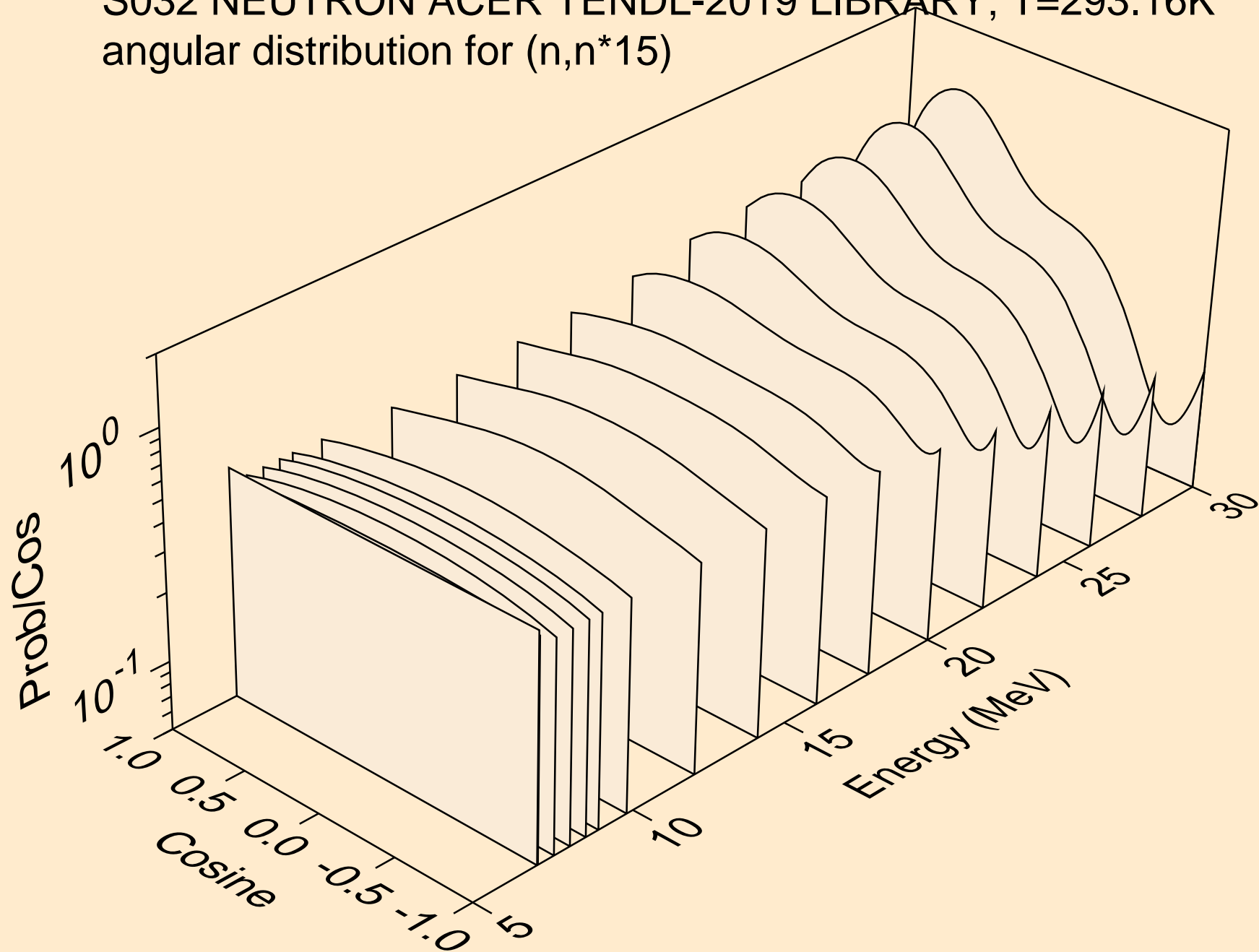

S032 NEUTRON ACER TENDL-2019 LIBRARY; T=293.16K  
angular distribution for (n,n\*16)

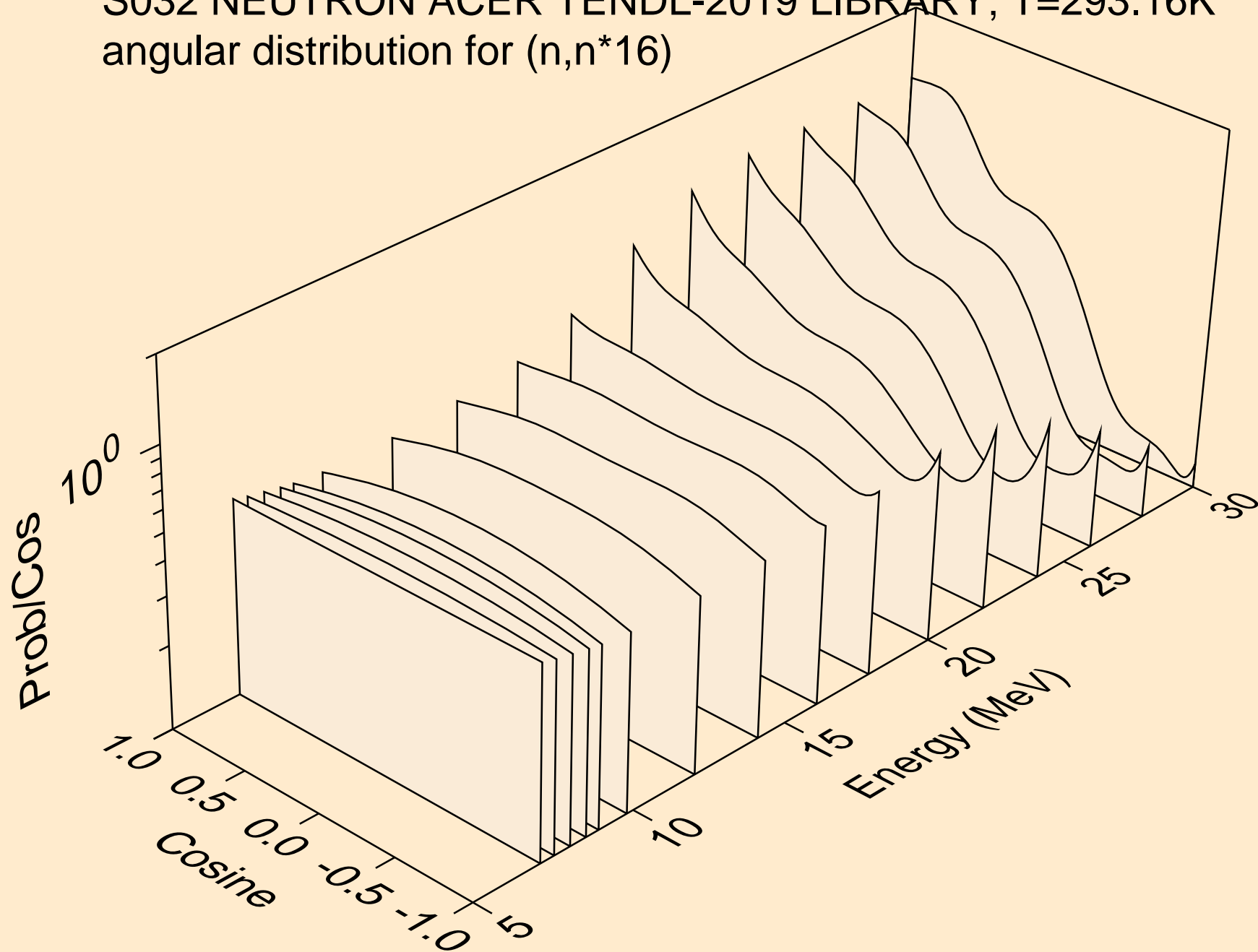

S032 NEUTRON ACER TENDL-2019 LIBRARY; T=293.16K  
angular distribution for (n,n\*17)

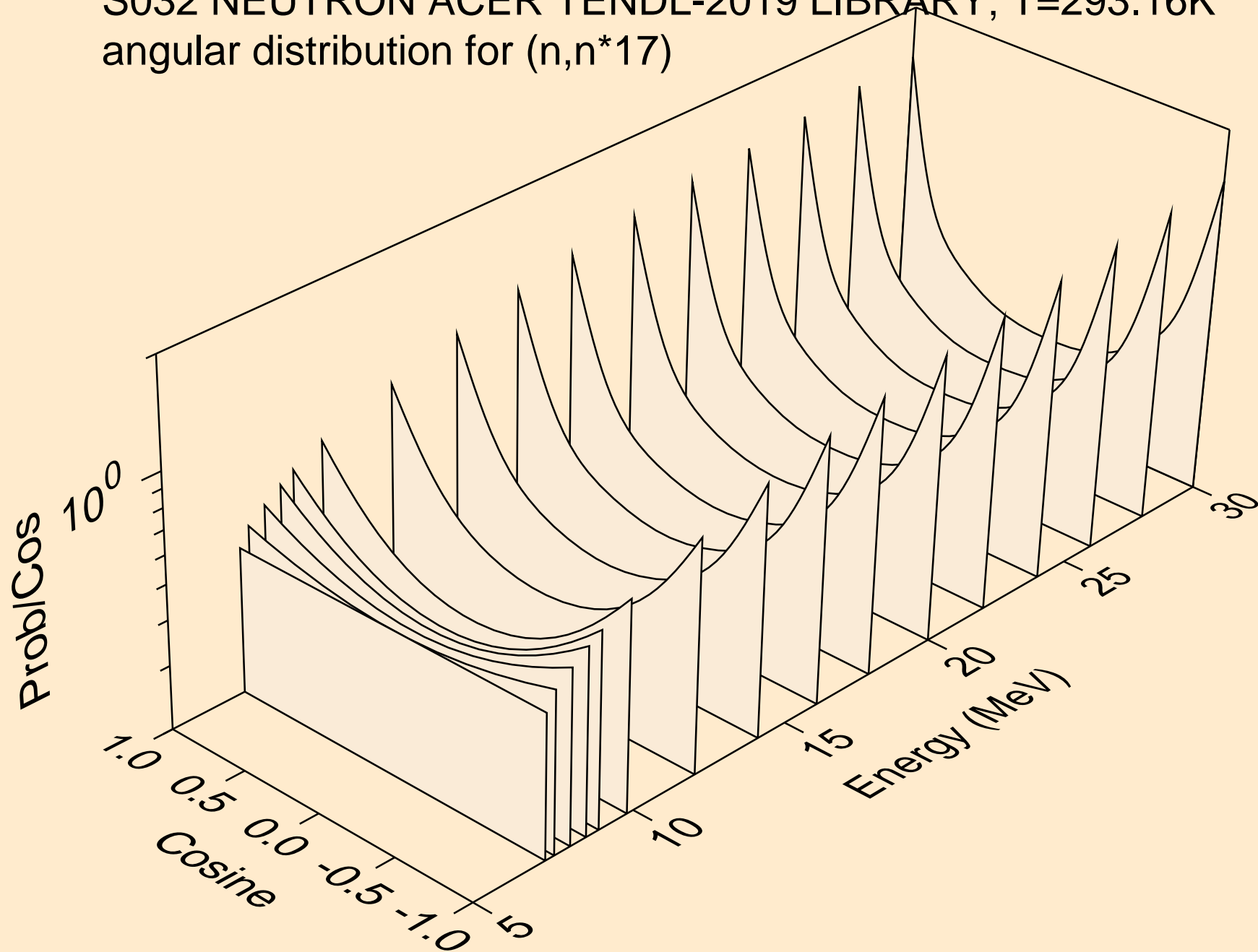

S032 NEUTRON ACER TENDL-2019 LIBRARY; T=293.16K  
angular distribution for (n,n\*18)

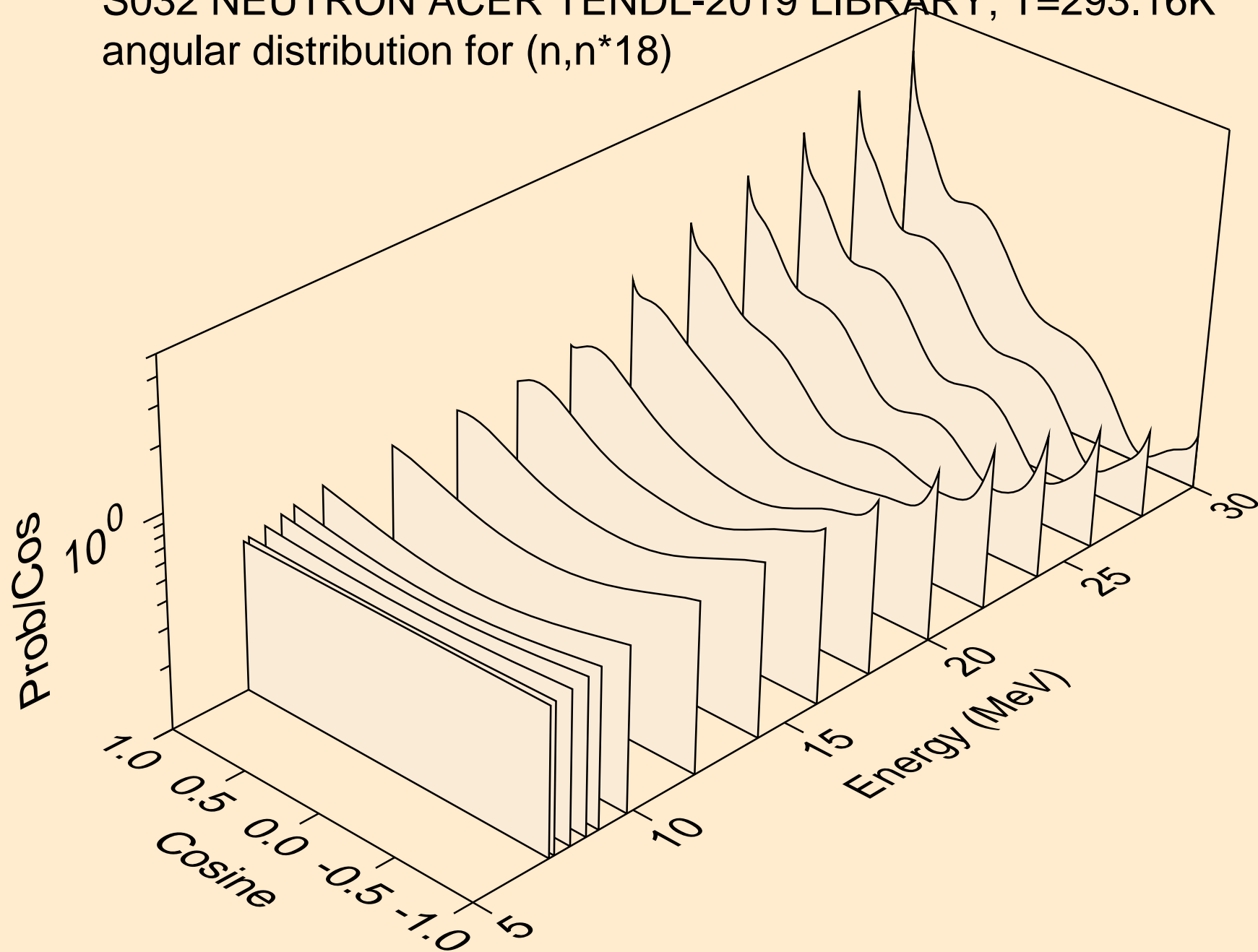

S032 NEUTRON ACER TENDL-2019 LIBRARY; T=293.16K  
angular distribution for (n,n\*19)

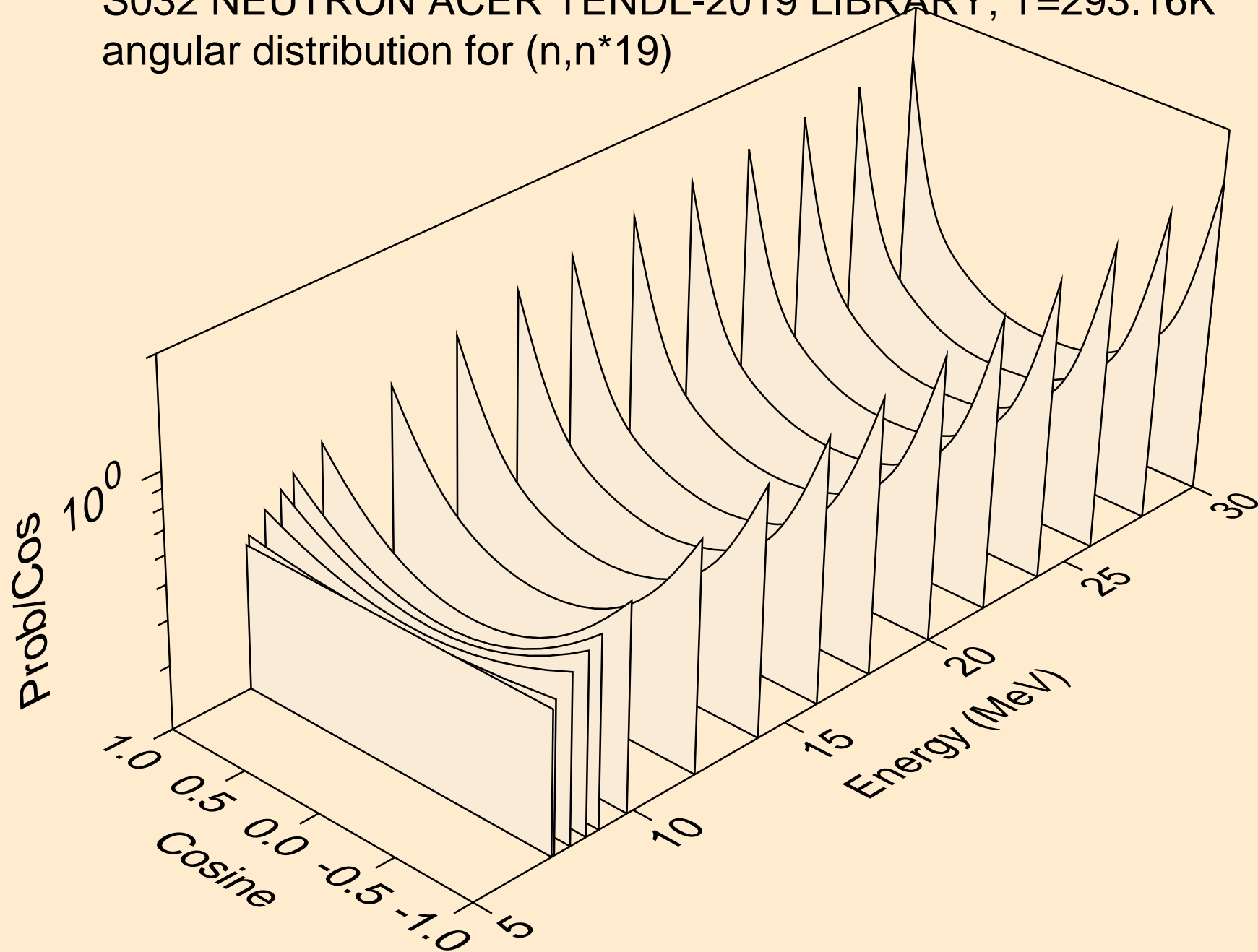

S032 NEUTRON ACER TENDL-2019 LIBRARY; T=293.16K  
angular distribution for (n,n\*20)

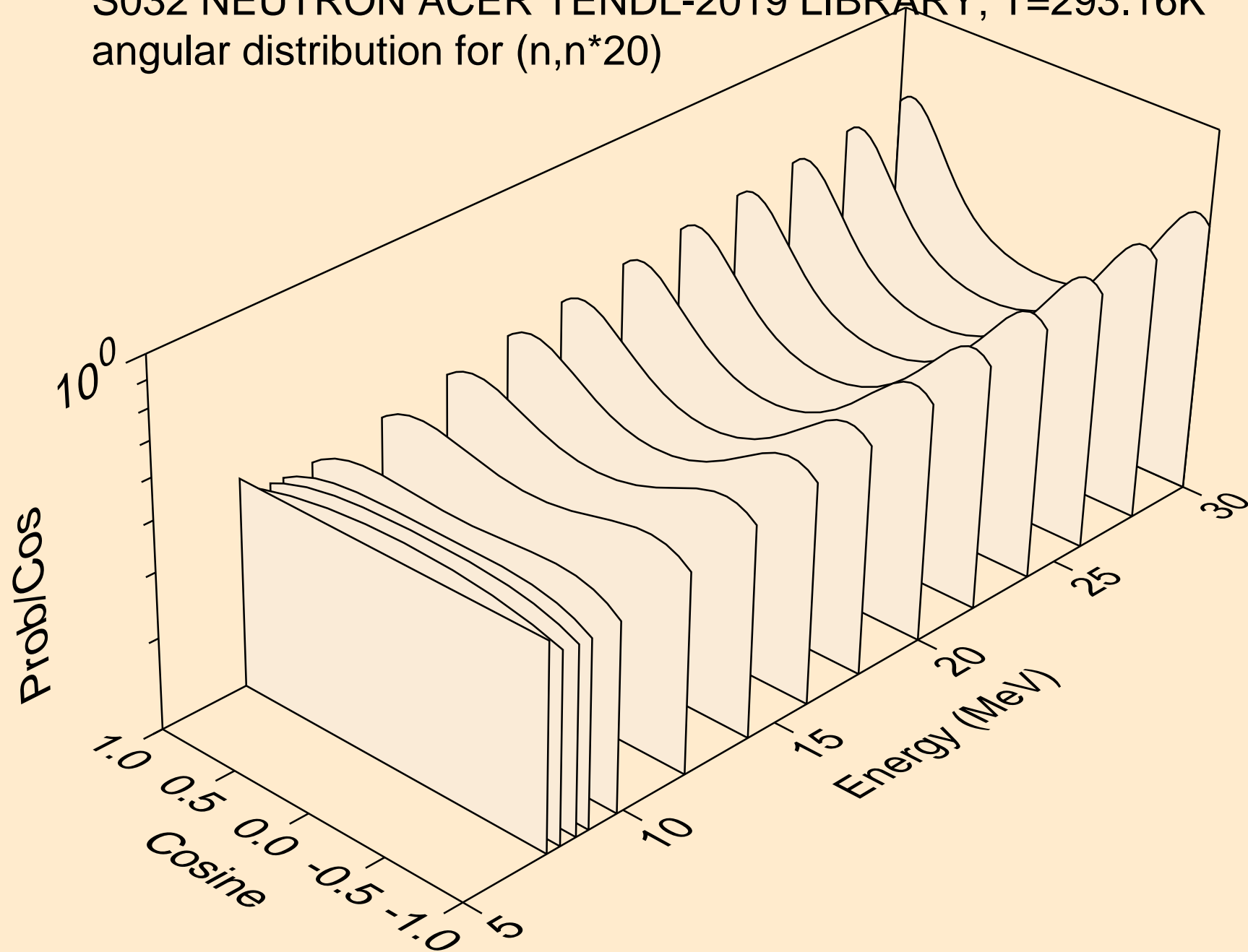



S032 NEUTRON ACER TENDL-2019 LIBRARY; T=293.16K  
angular distribution for (n,n\*21)

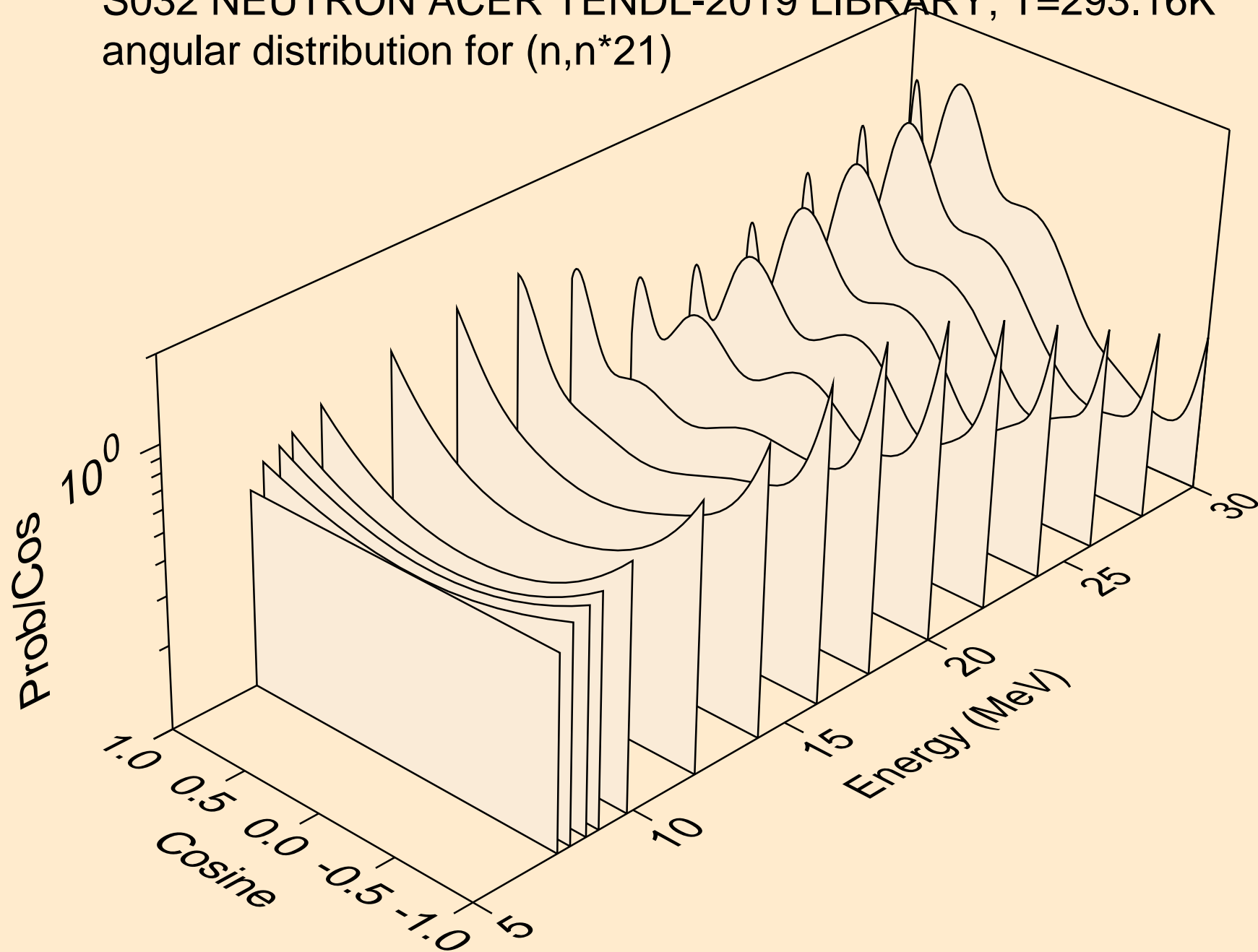

S032 NEUTRON ACER TENDL-2019 LIBRARY; T=293.16K  
angular distribution for (n,n\*22)

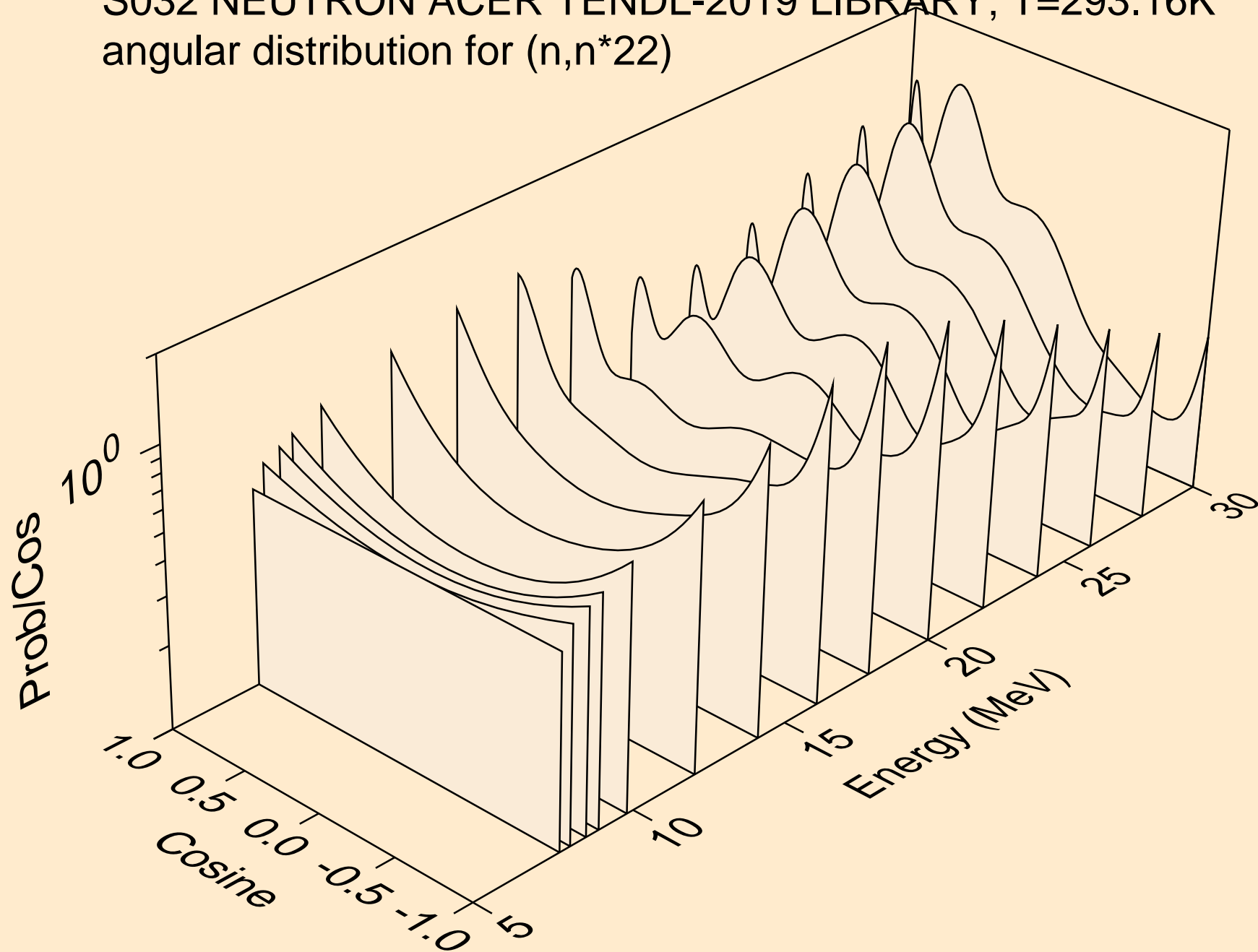

S032 NEUTRON ACER TENDL-2019 LIBRARY; T=293.16K  
angular distribution for (n,n\*23)

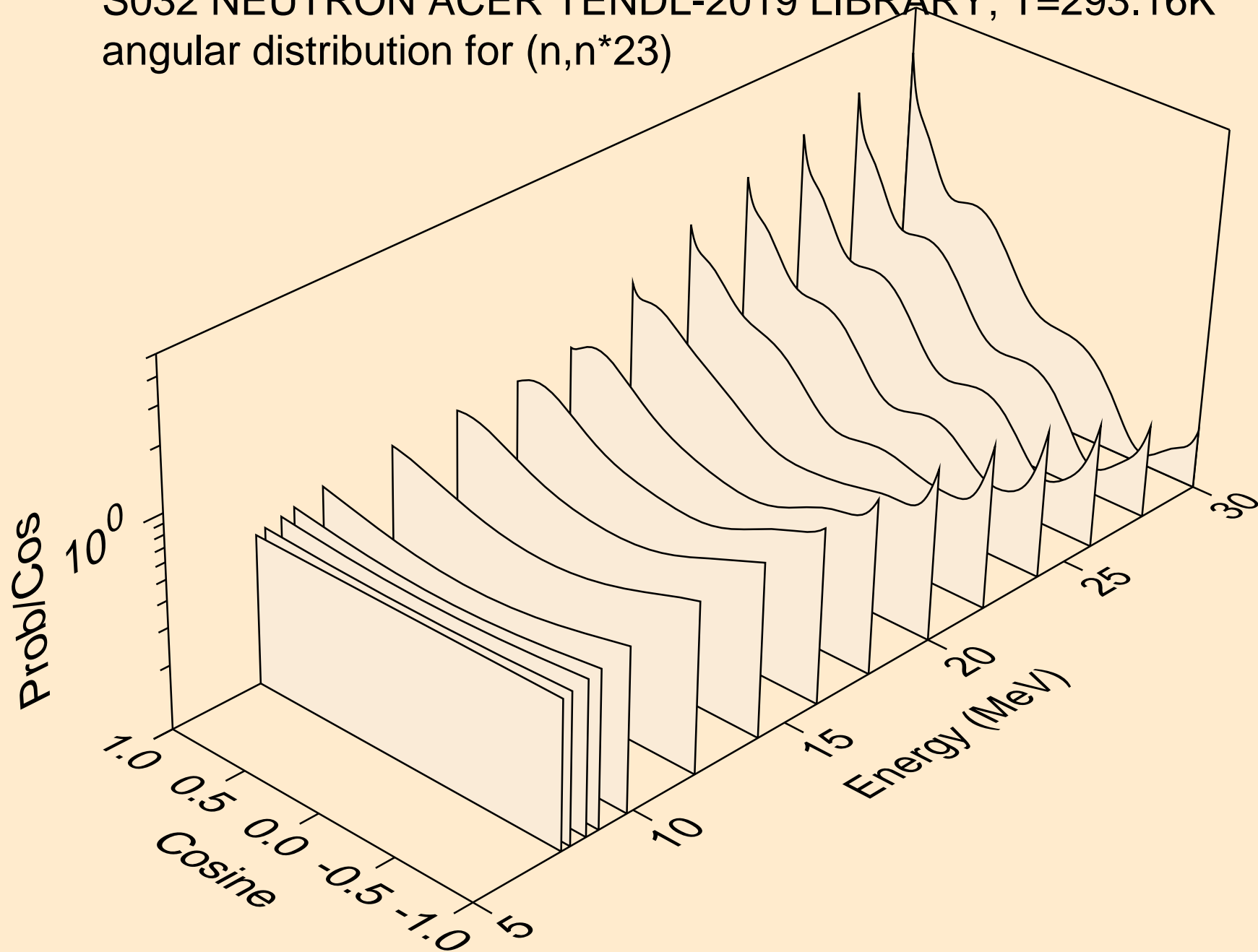

S032 NEUTRON ACER TENDL-2019 LIBRARY; T=293.16K  
angular distribution for (n,n\*24)

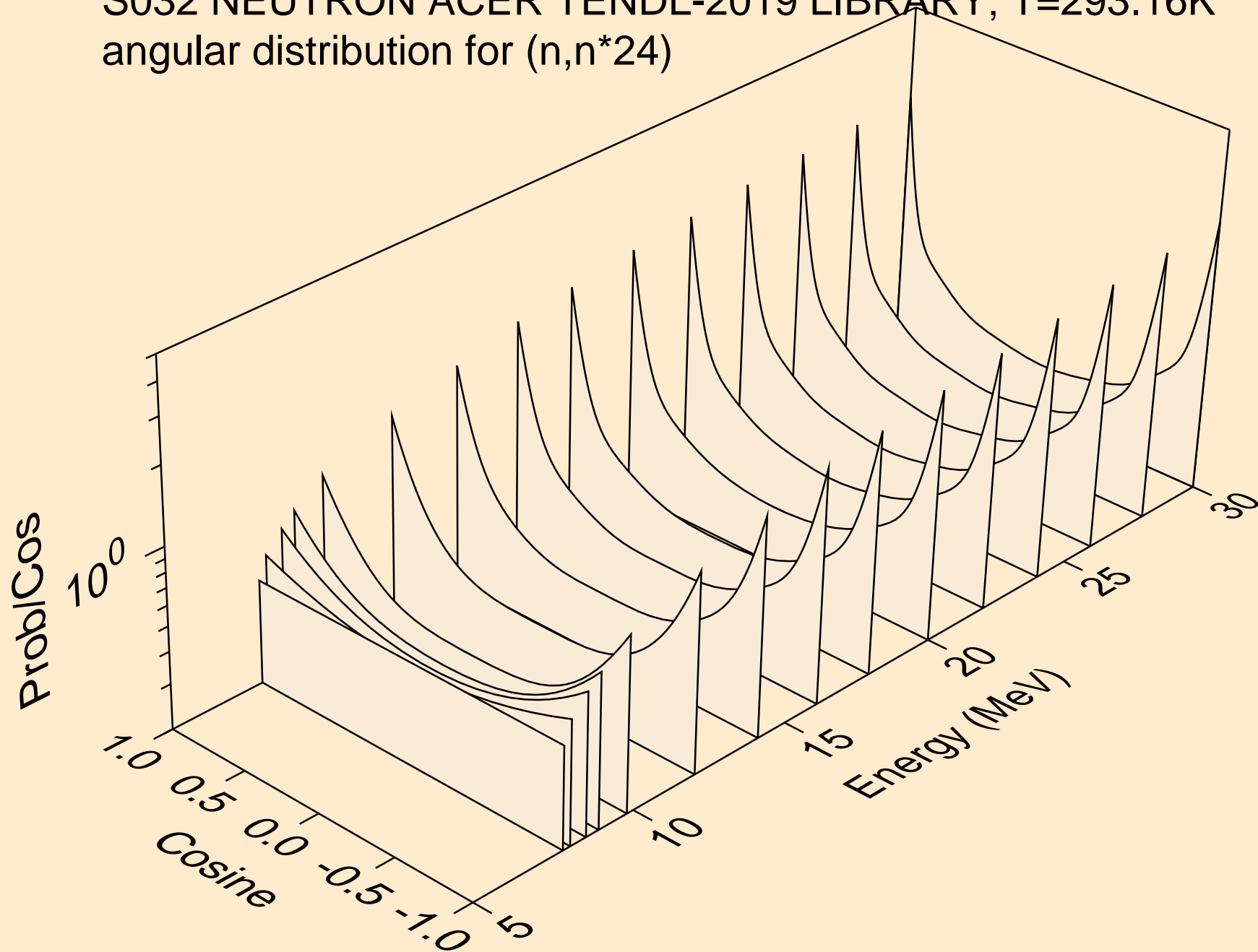

S032 NEUTRON ACER TENDL-2019 LIBRARY; T=293.16K  
angular distribution for (n,n\*25)

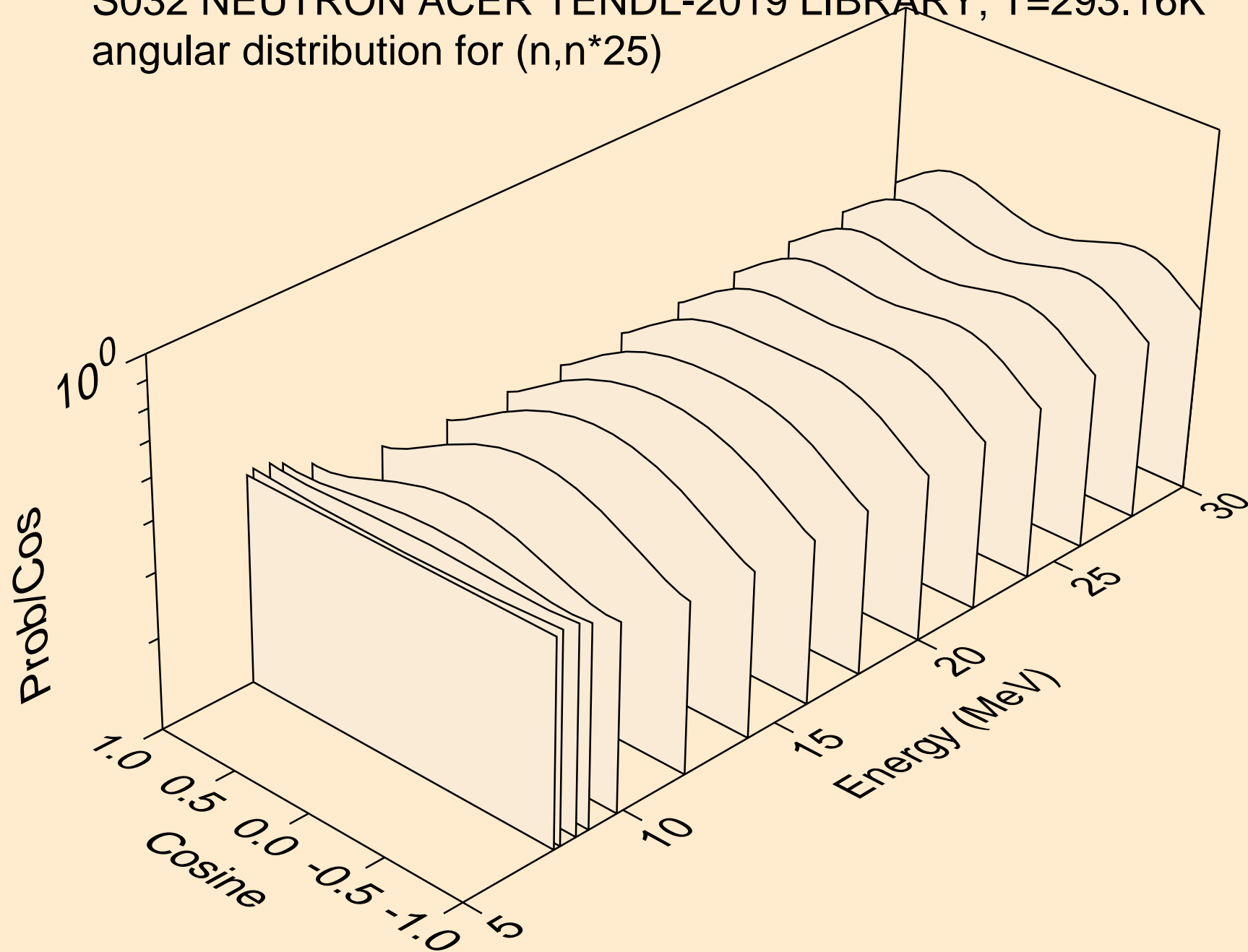

S032 NEUTRON ACER TENDL-2019 LIBRARY; T=293.16K  
angular distribution for (n,n\*26)

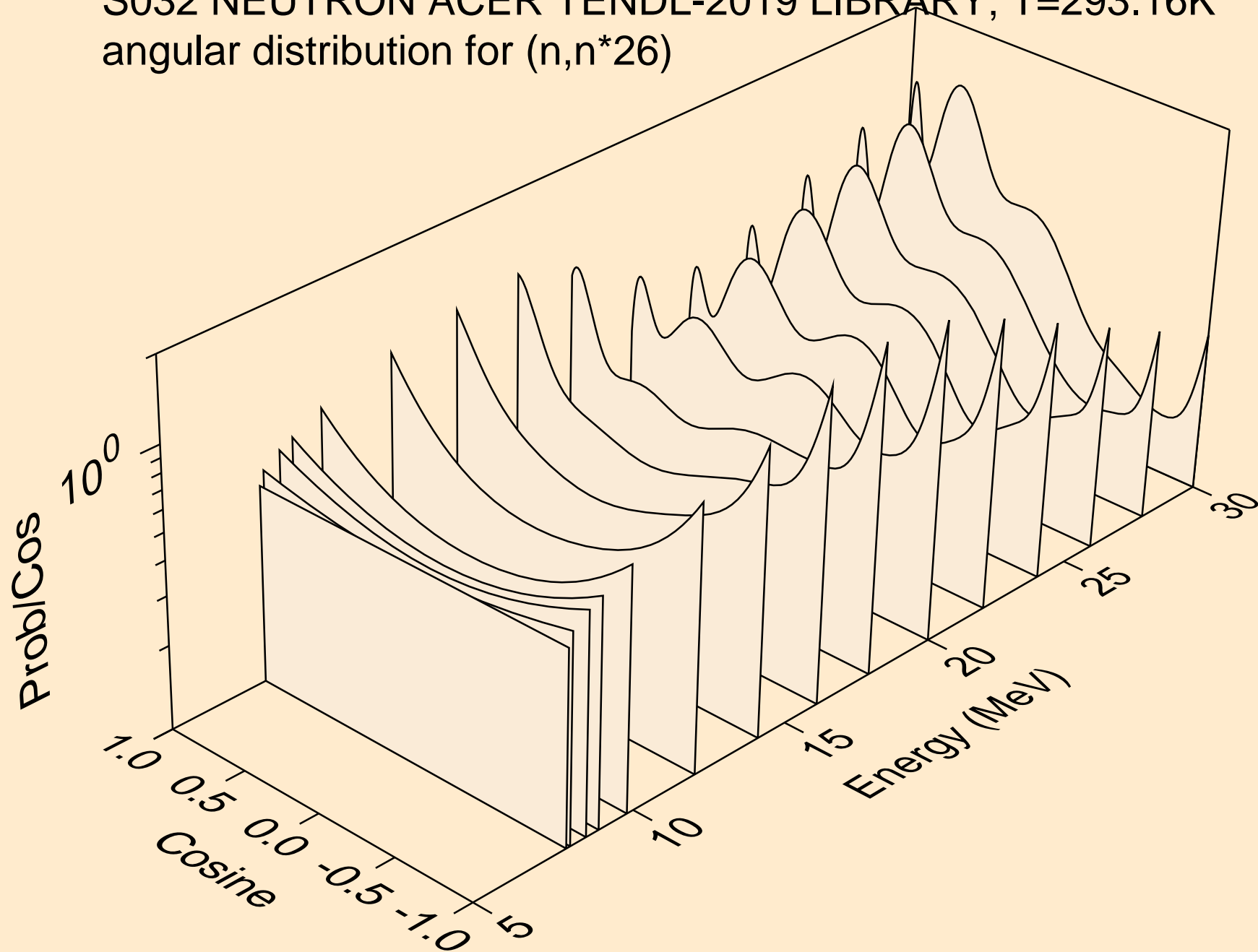

S032 NEUTRON ACER TENDL-2019 LIBRARY; T=293.16K  
angular distribution for (n,n\*27)

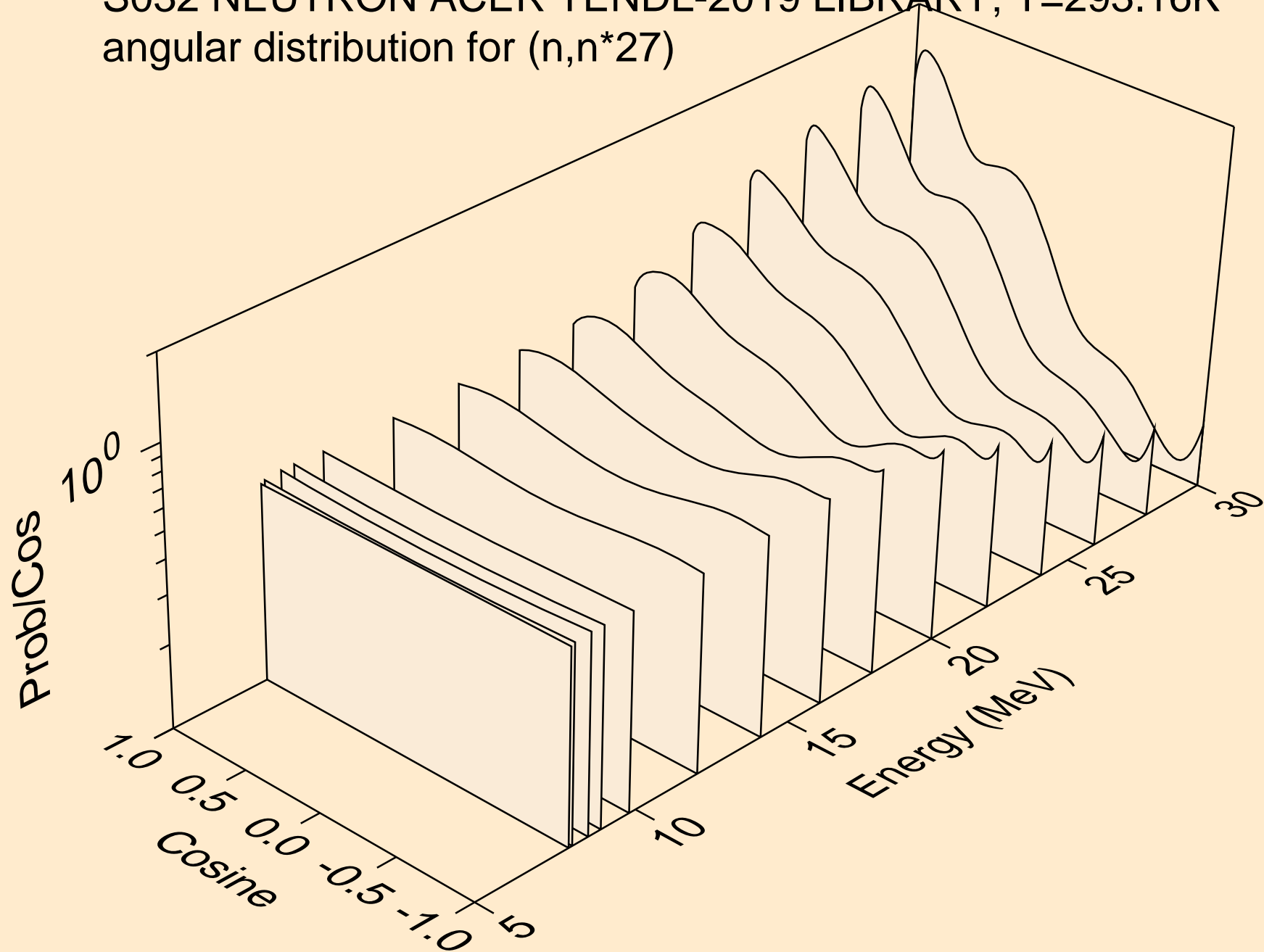

S032 NEUTRON ACER TENDL-2019 LIBRARY; T=293.16K  
angular distribution for (n,n\*28)

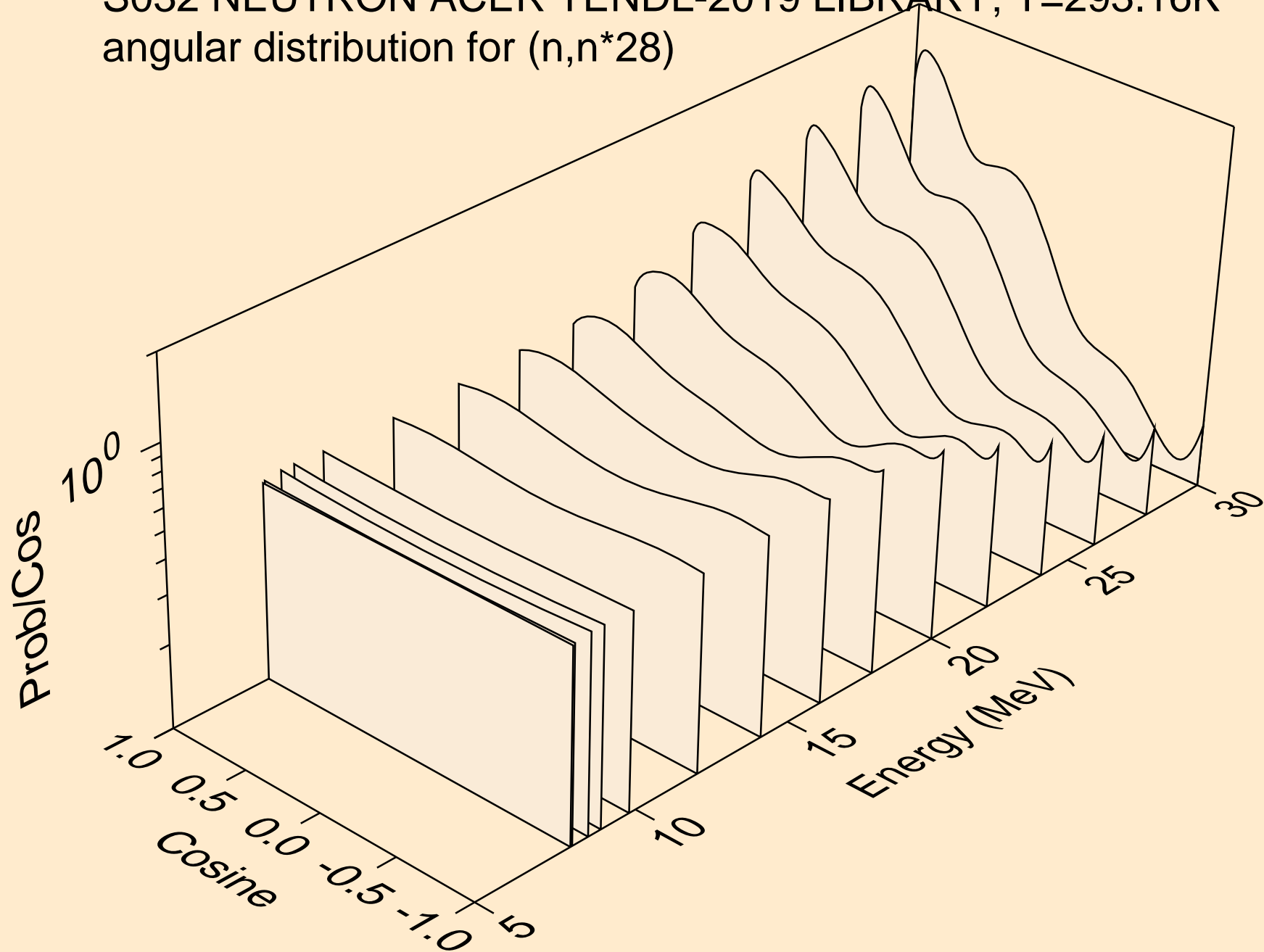



S032 NEUTRON ACER TENDL-2019 LIBRARY; T=293.16K  
Neutron emission for (n,x)

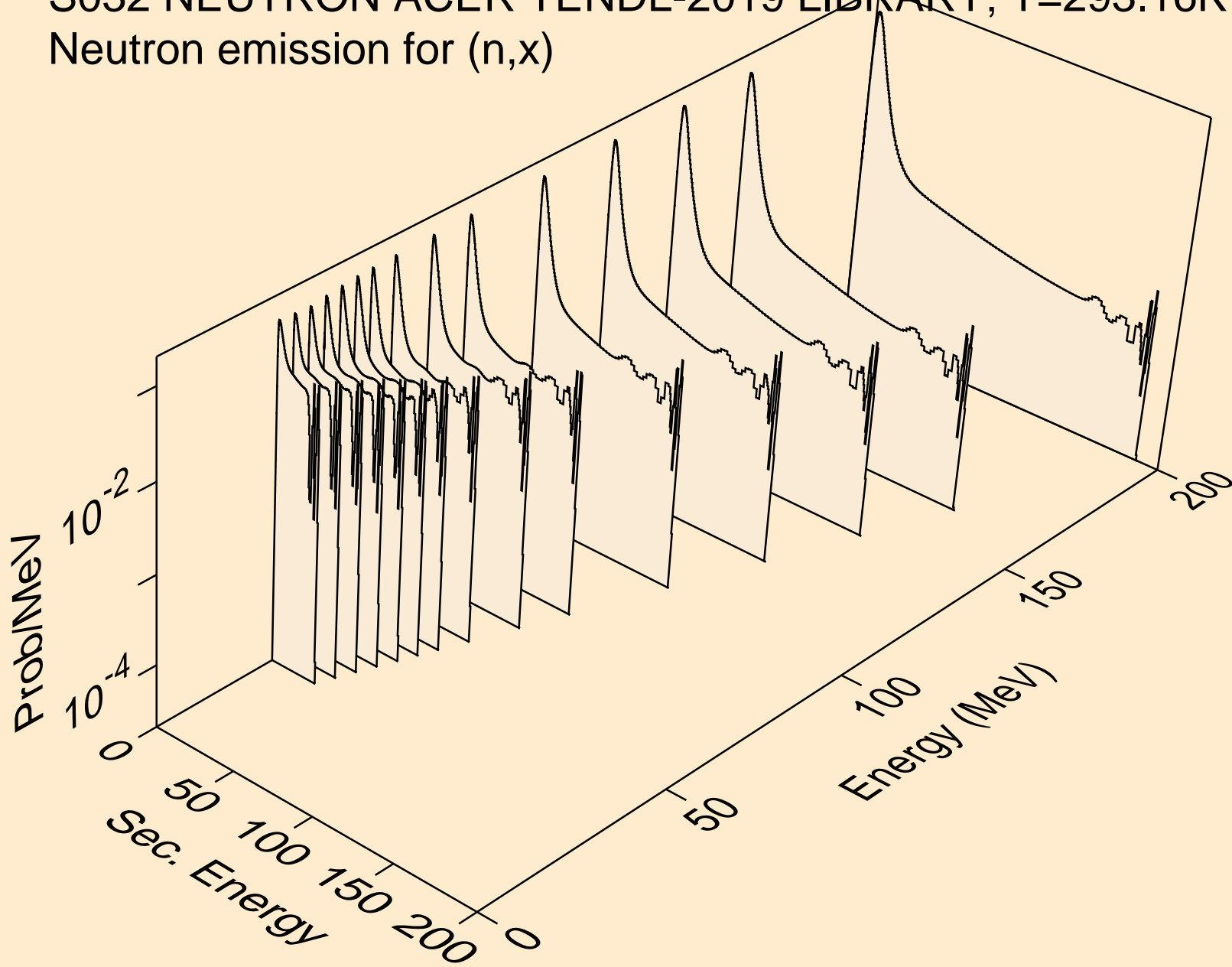

S032 NEUTRON ACER TENDL-2019 LIBRARY; T=293.16K  
Neutron emission for (n,2n)

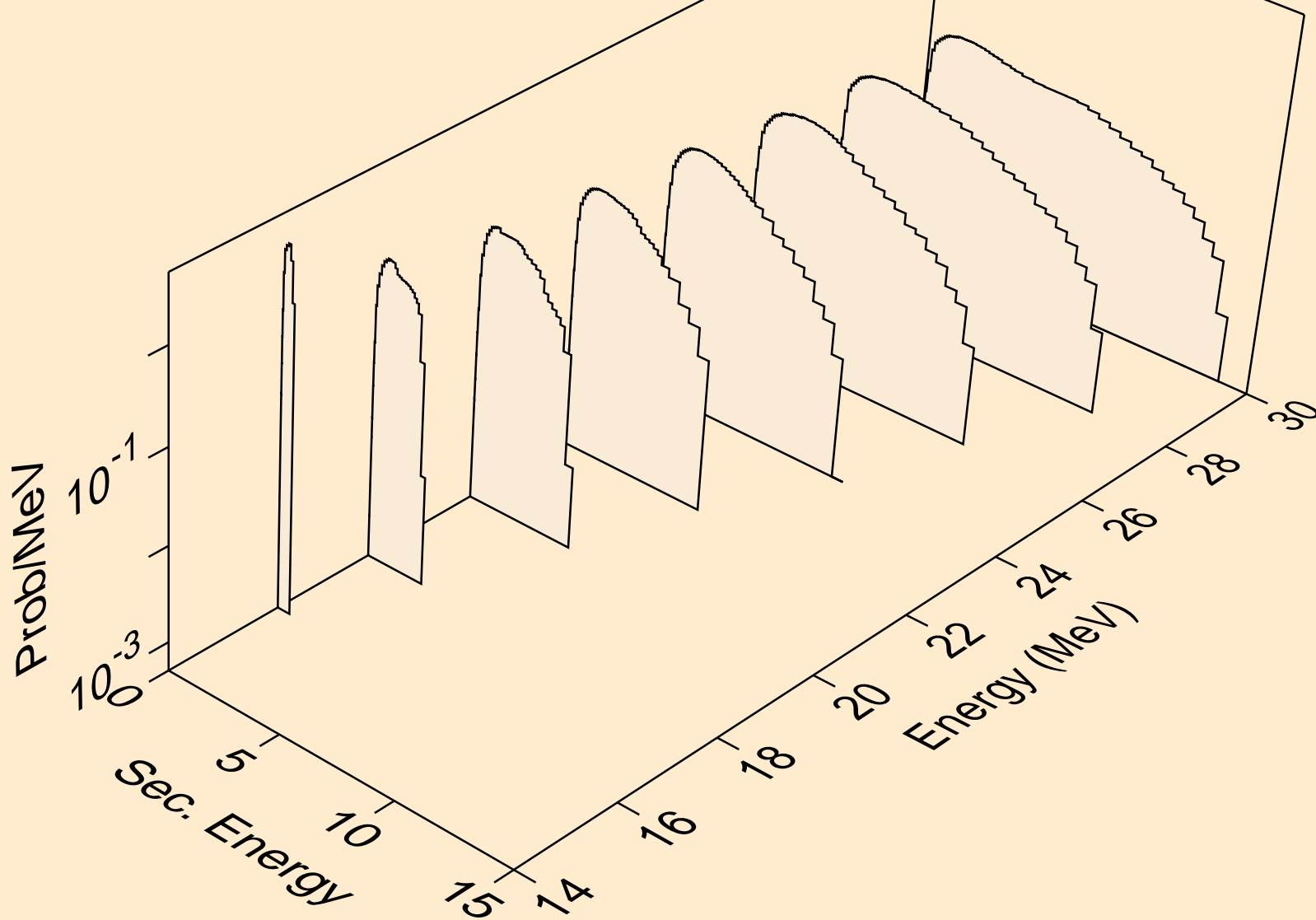

S032 NEUTRON ACER TENDL-2019 LIBRARY; T=293.16K  
Neutron emission for (n,3n)

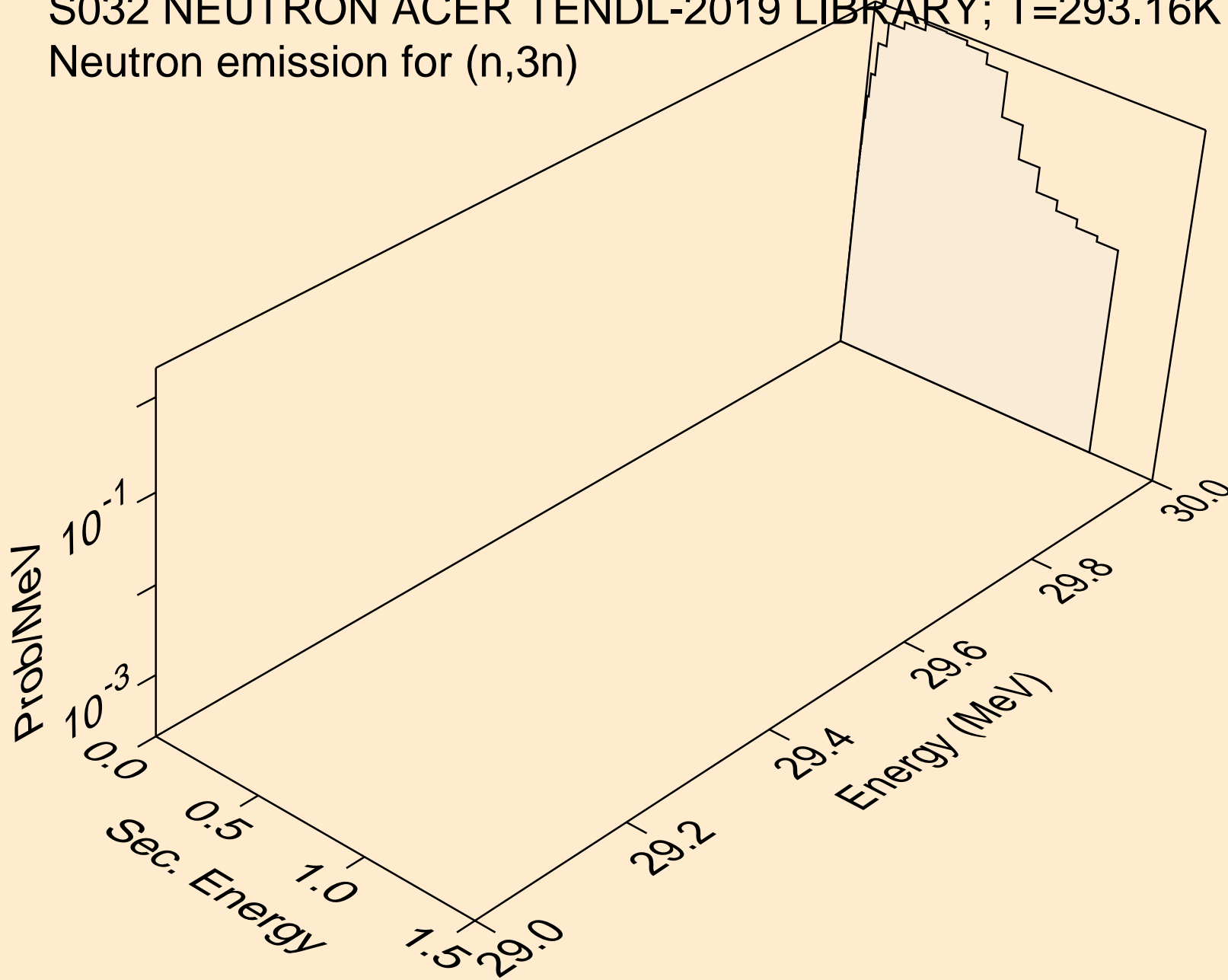

S032 NEUTRON ACER TENDL-2019 LIBRARY; T=293.16K  
Neutron emission for (n,n\*)a

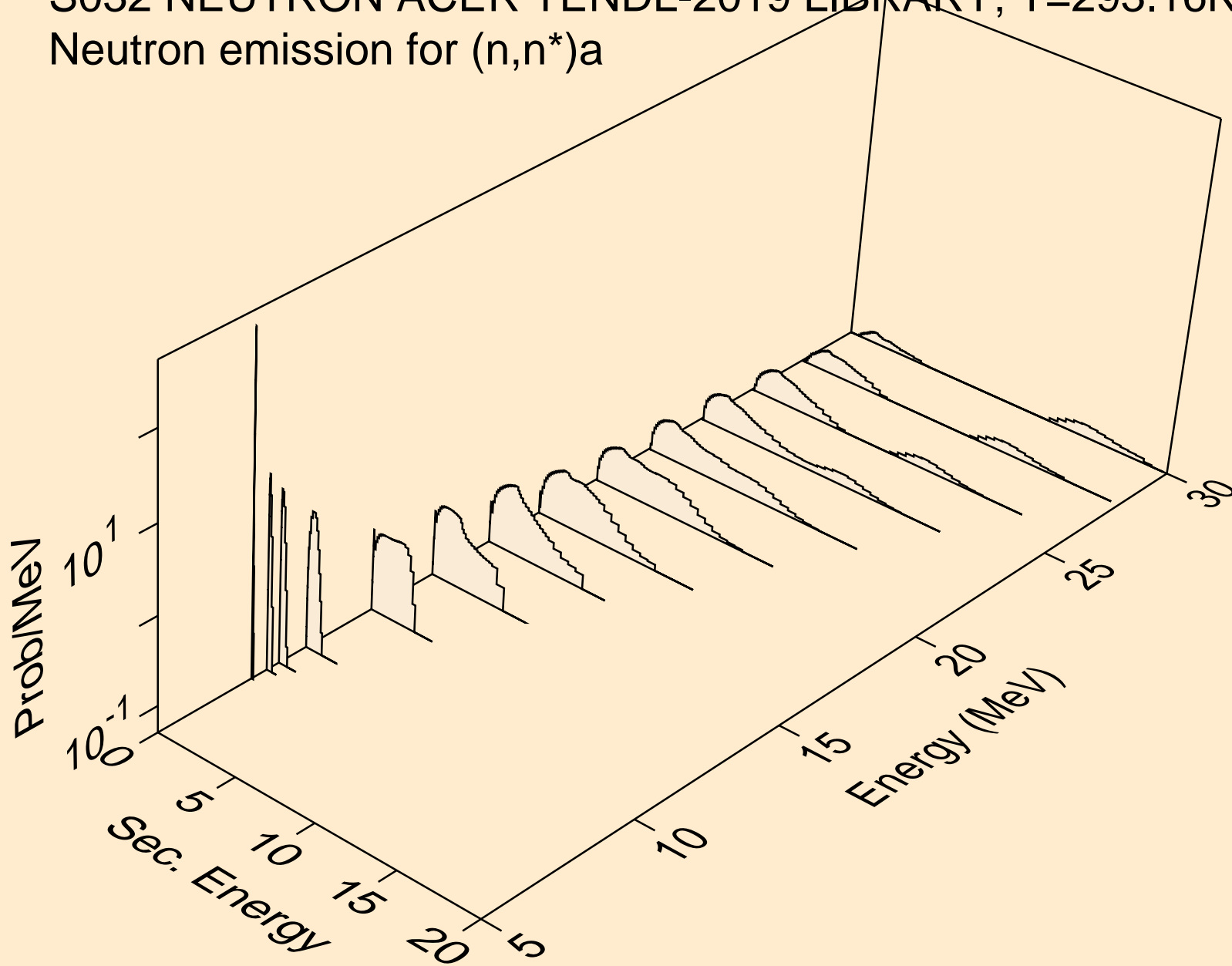

S032 NEUTRON ACER TENDL-2019 LIBRARY; T=293.16K  
Neutron emission for (n,2n)a

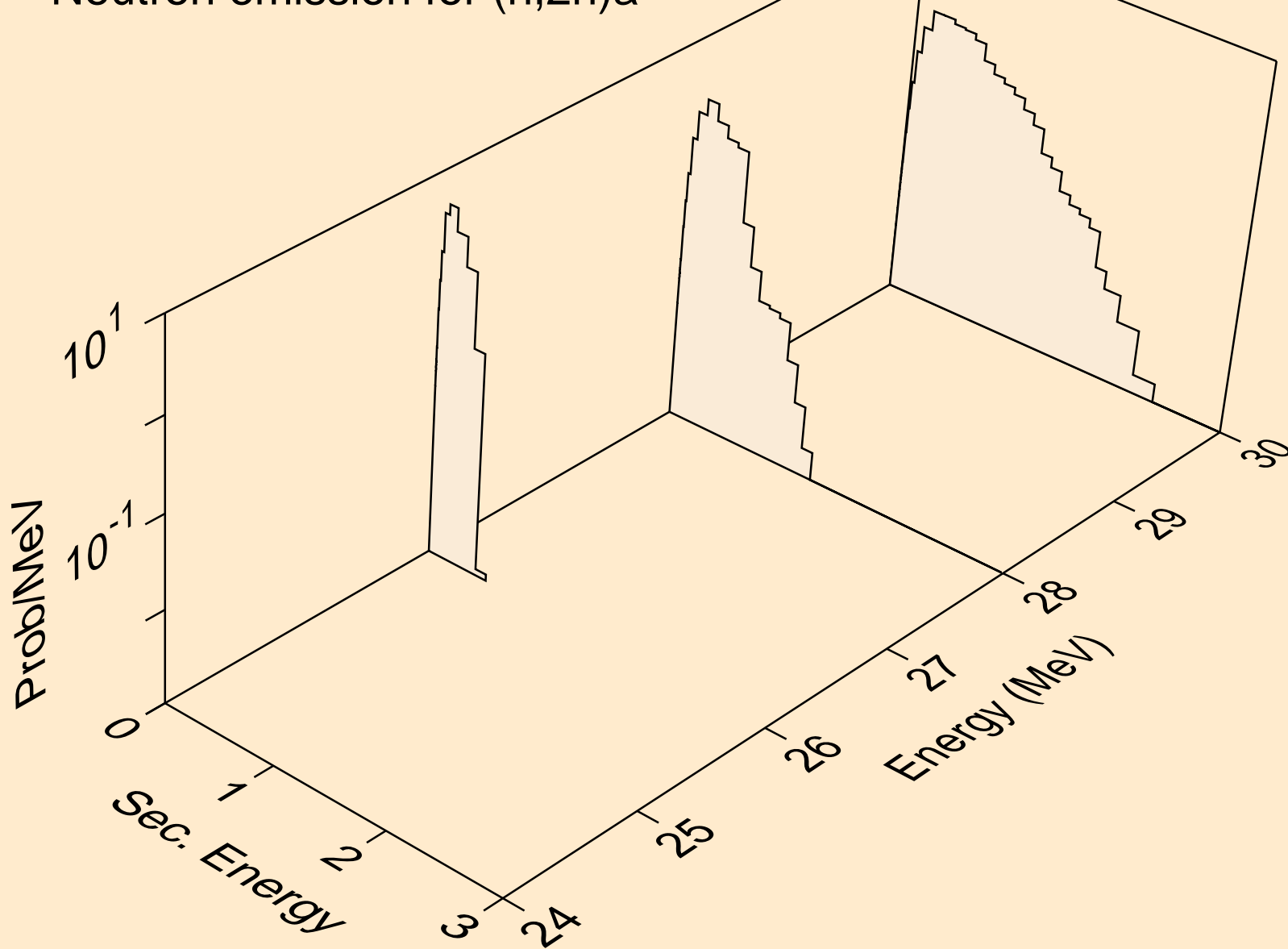

S032 NEUTRON ACER TENDL-2019 LIBRARY; T=293.16K  
Neutron emission for (n,n\*)p

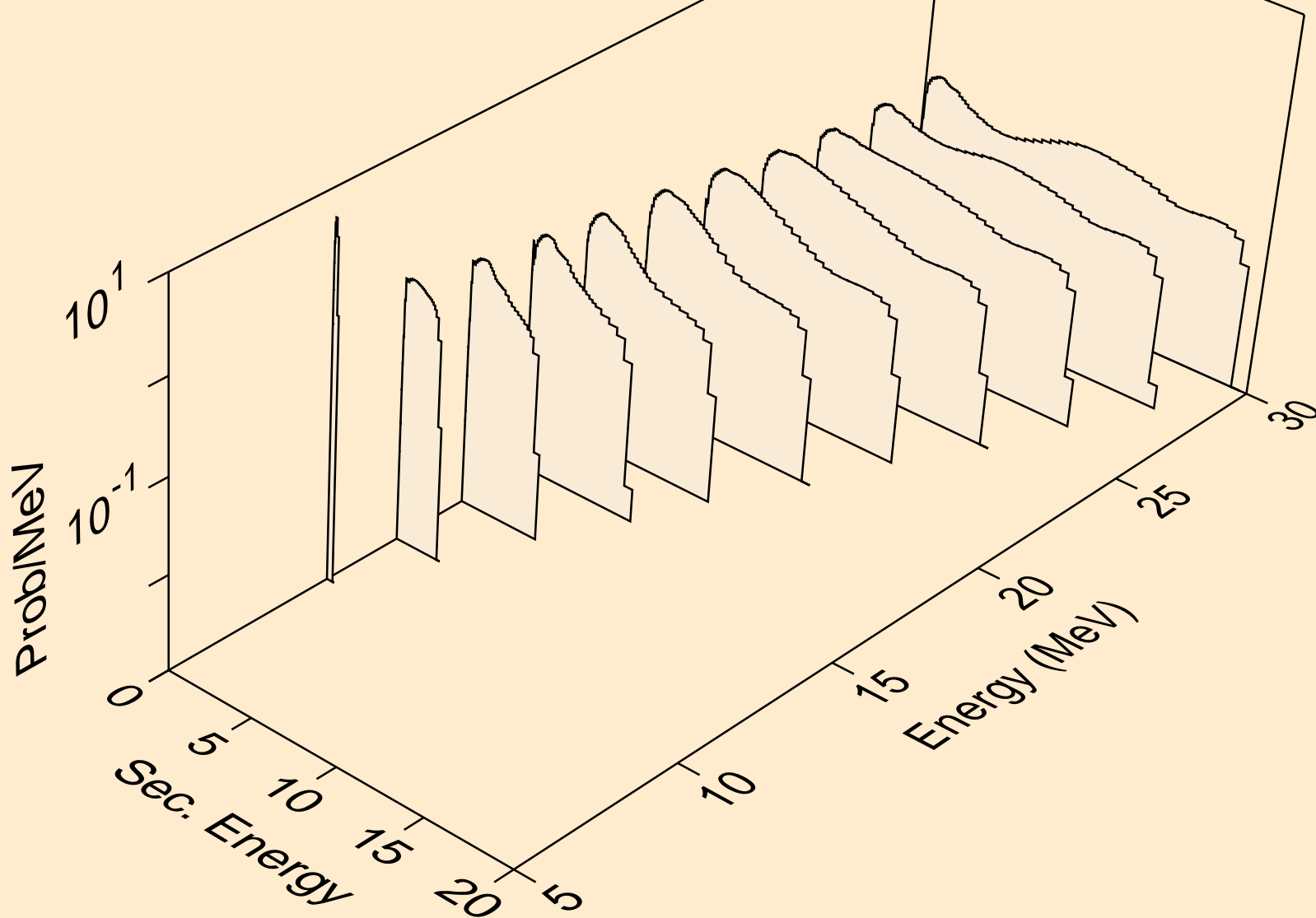

S032 NEUTRON ACER TENDL-2019 LIBRARY; T=293.16K  
Neutron emission for (n,n\*)2a

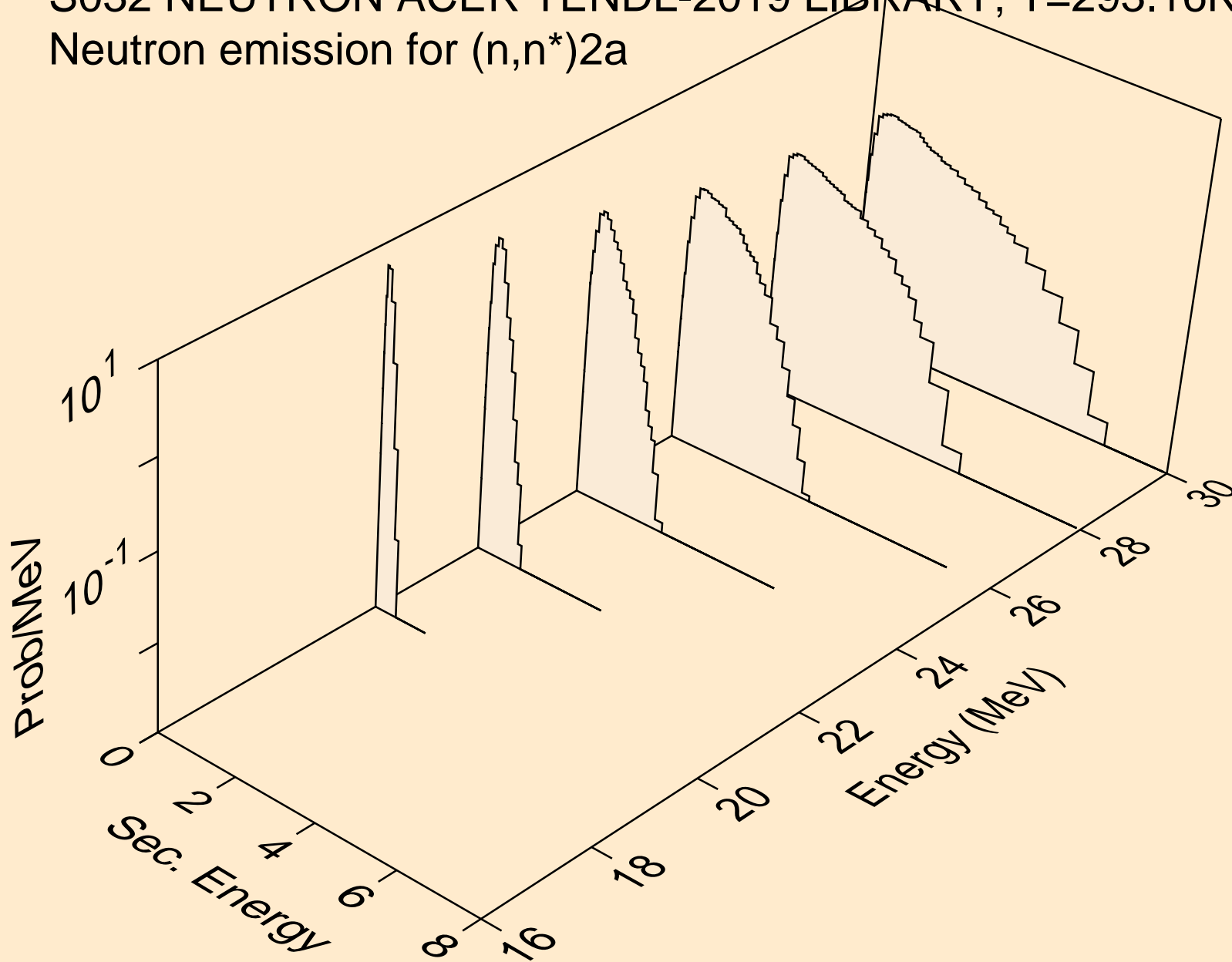

S032 NEUTRON ACER TENDL-2019 LIBRARY; T=293.16K  
Neutron emission for (n,n\*)d

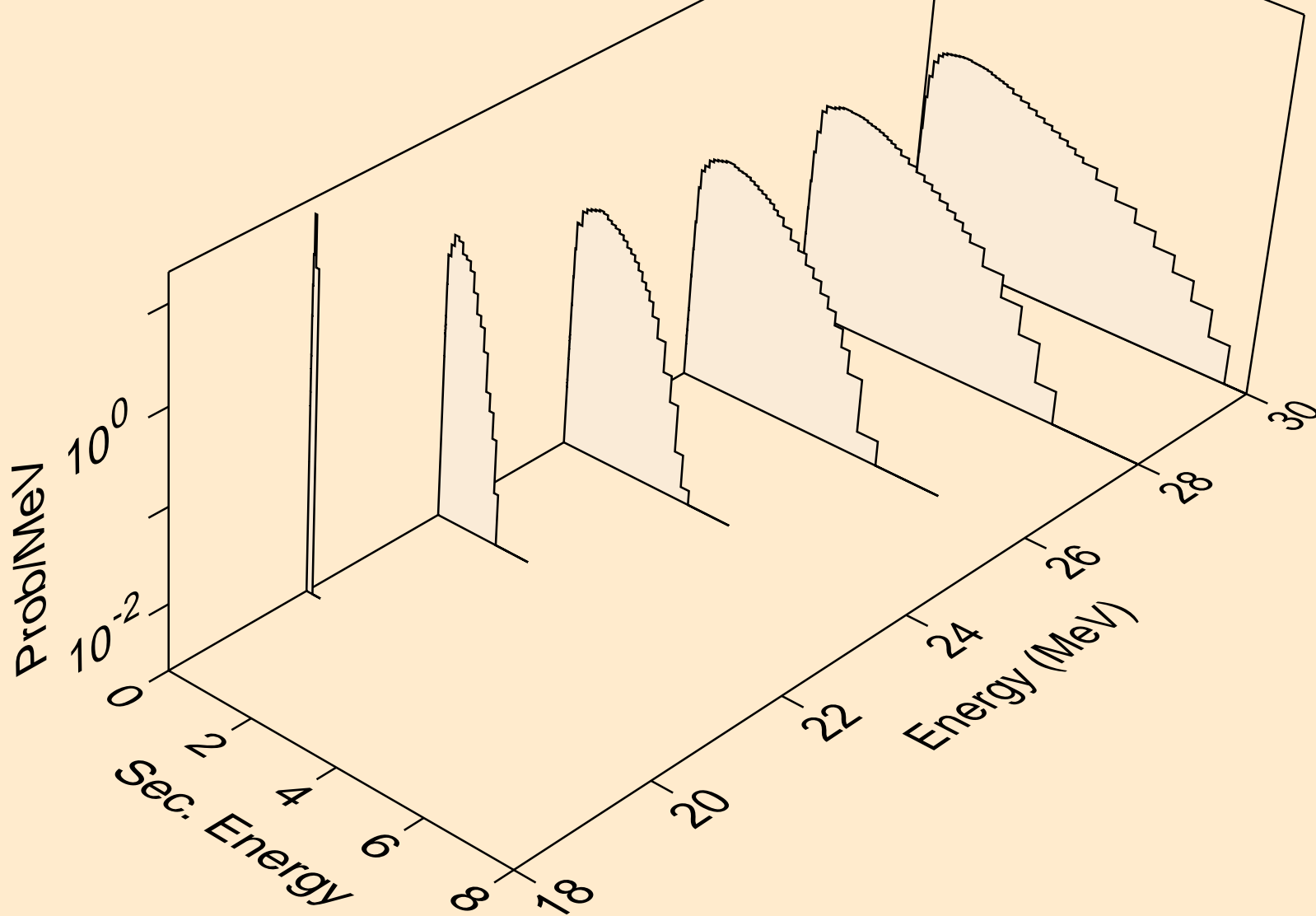



S032 NEUTRON ACER TENDL-2019 LIBRARY; T=293.16K  
Neutron emission for (n,n\*)t

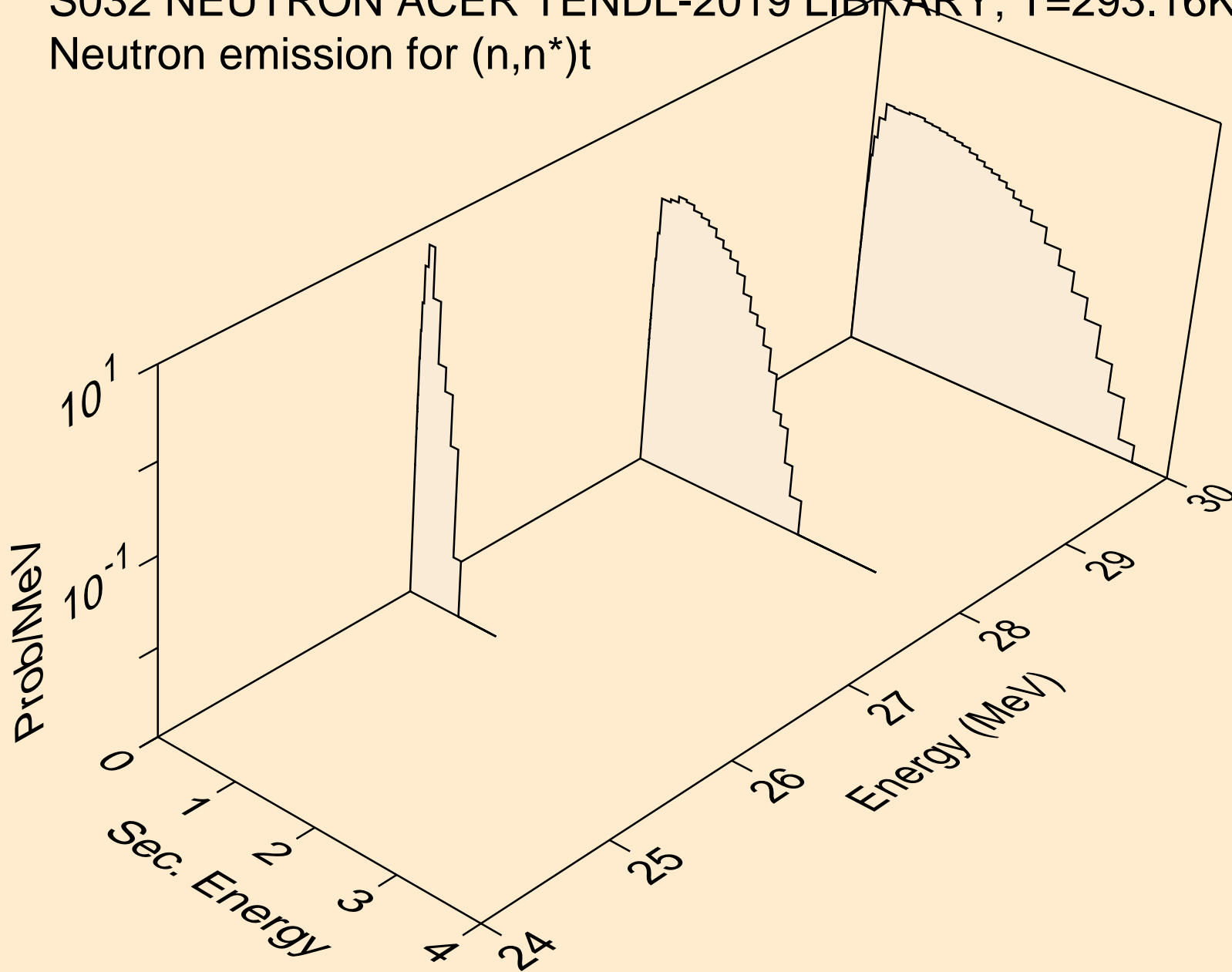

S032 NEUTRON ACER TENDL-2019 LIBRARY; T=293.16K  
Neutron emission for (n,n\*)he3

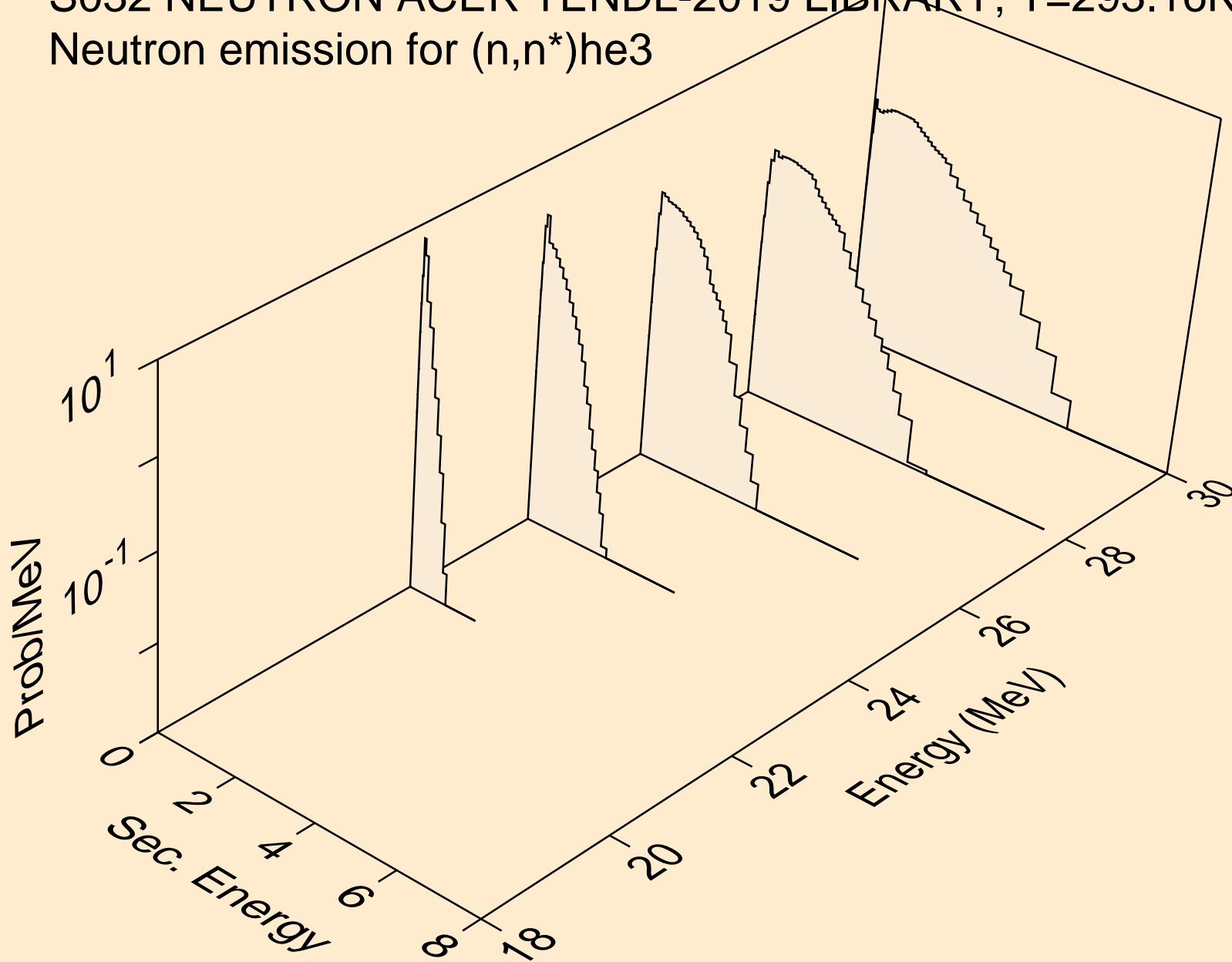

S032 NEUTRON ACER TENDL-2019 LIBRARY; T=293.16K  
Neutron emission for (n,2np)

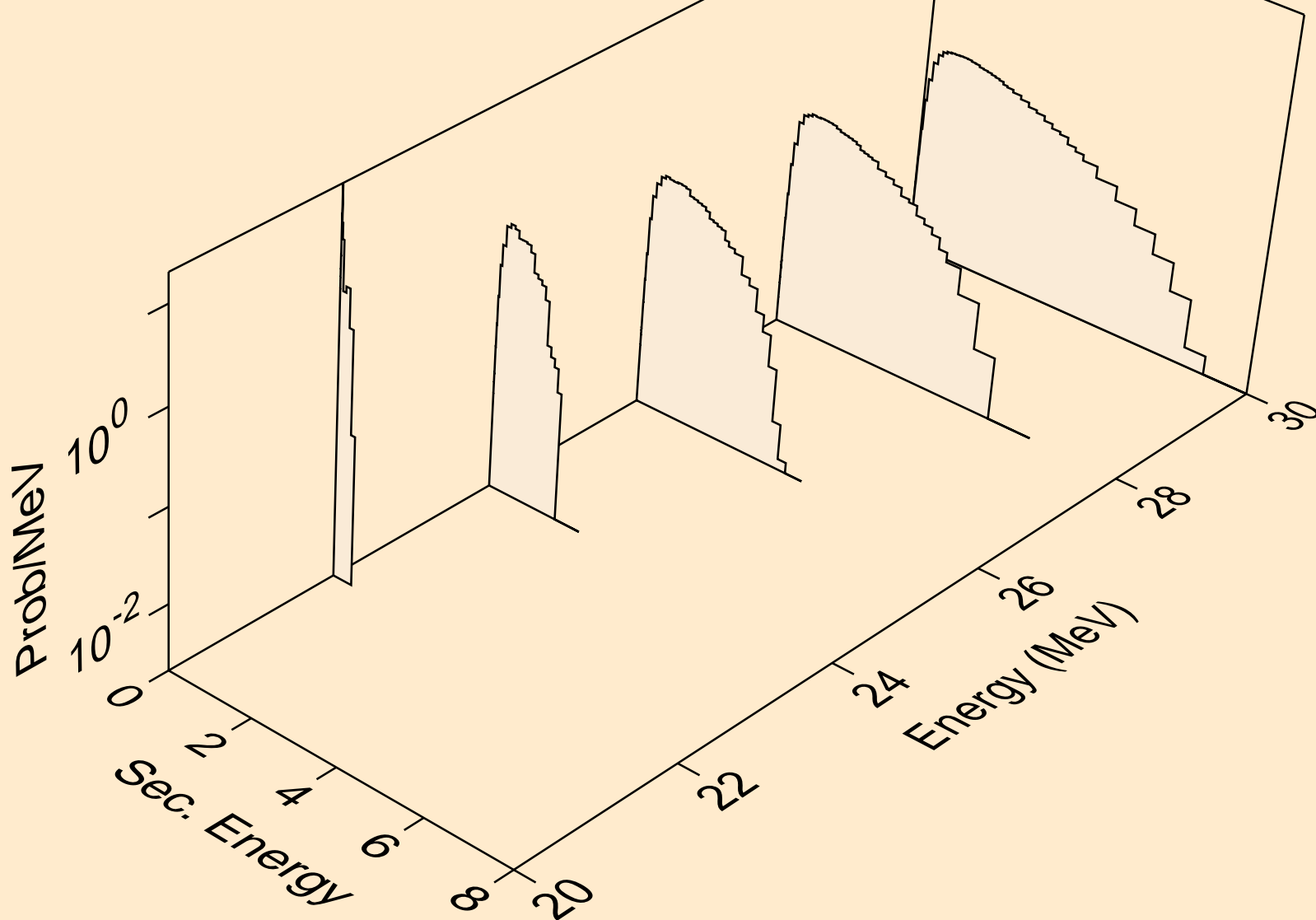

S032 NEUTRON ACER TENDL-2019 LIBRARY; T=293.16K  
Neutron emission for (n,2np)

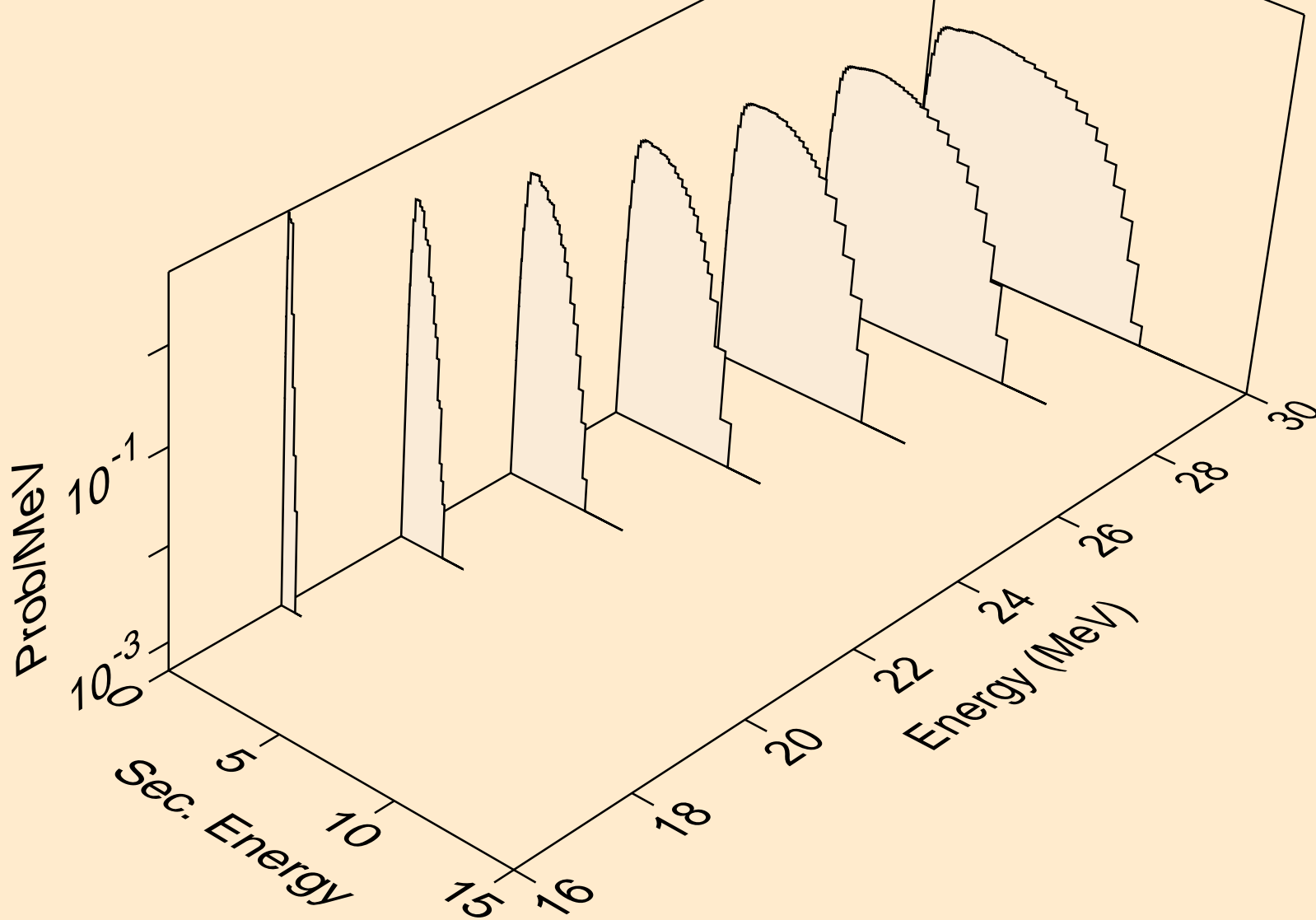

S032 NEUTRON ACER TENDL-2019 LIBRARY; T=293.16K  
Neutron emission for (n,npa)

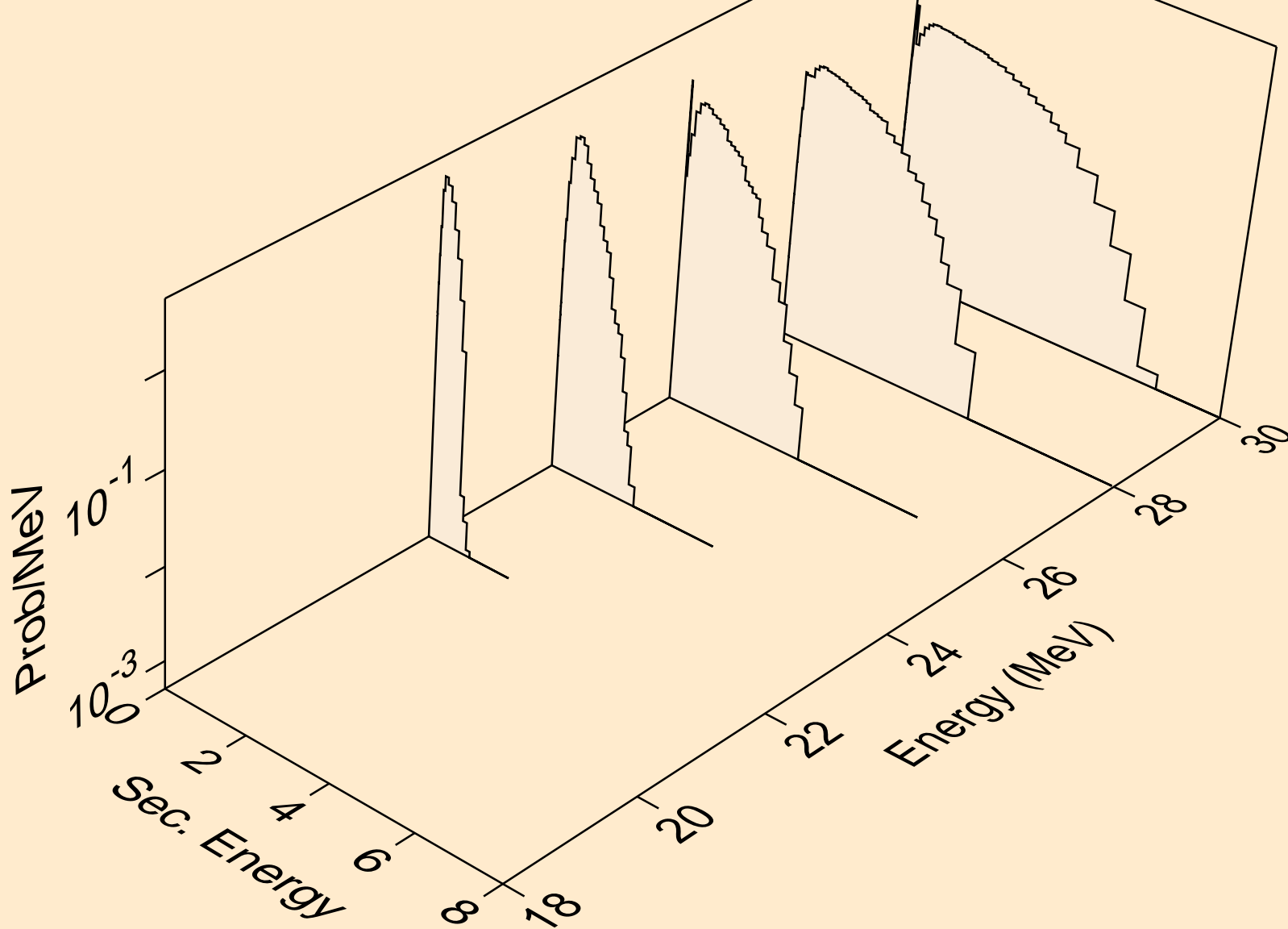

S032 NEUTRON ACER TENDL-2019 LIBRARY; T=293.16K  
Neutron emission for (n,n\*c)

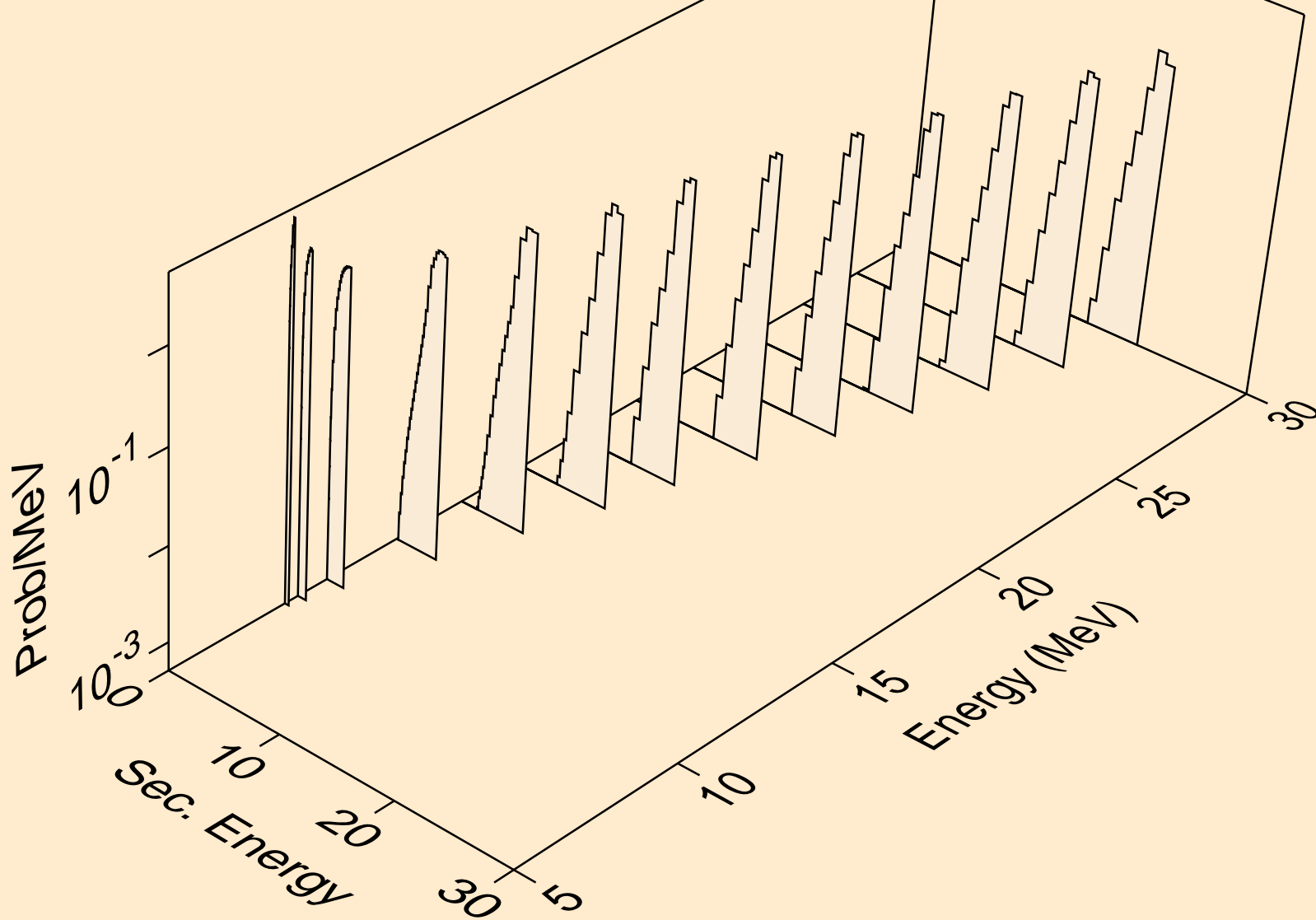

S032 NEUTRON ACER TENDL-2019 LIBRARY; T=293.16K  
Photon emission for (n,x)

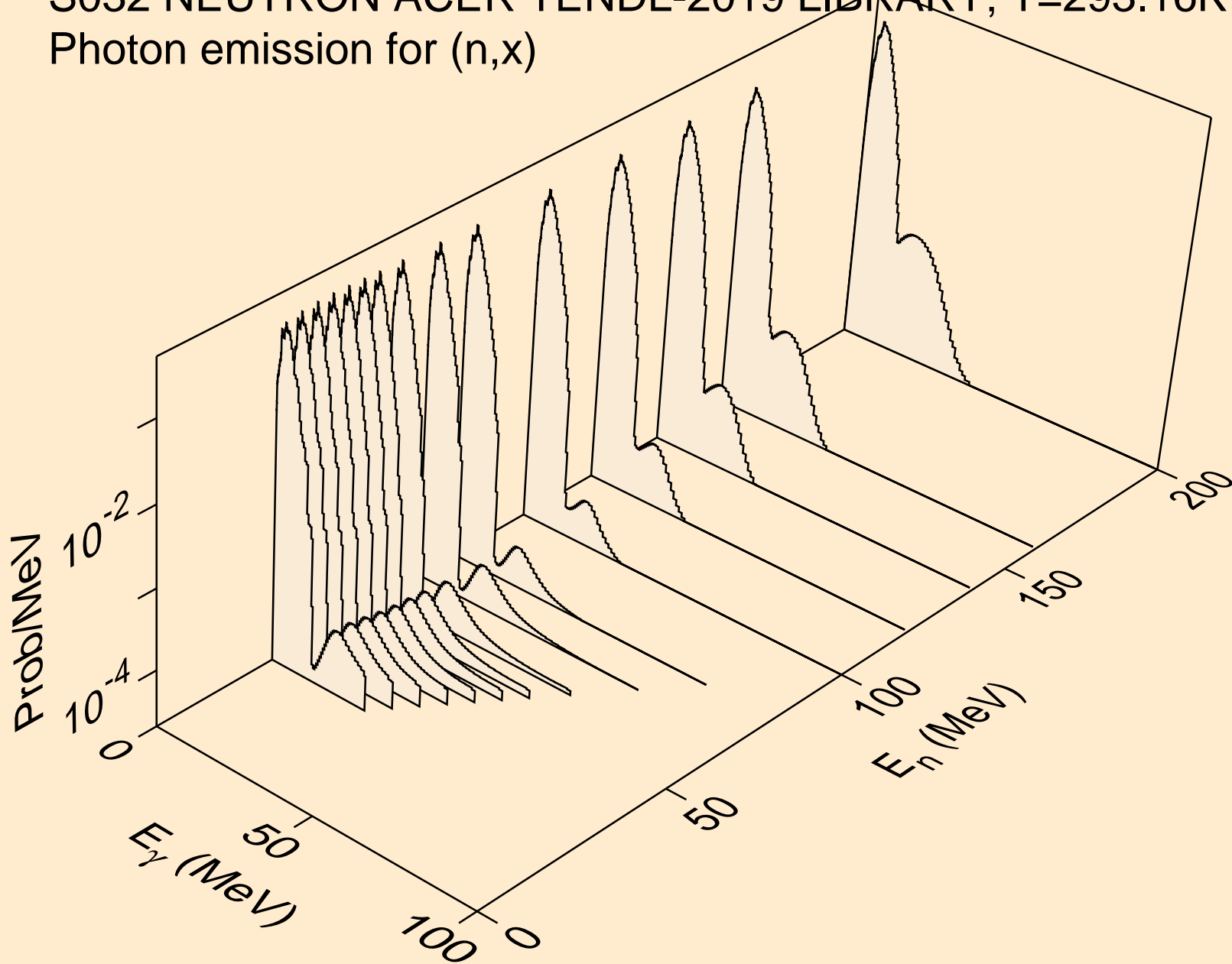

S032 NEUTRON ACER TENDL-2019 LIBRARY; T=293.16K  
Photon emission for (n,2n)

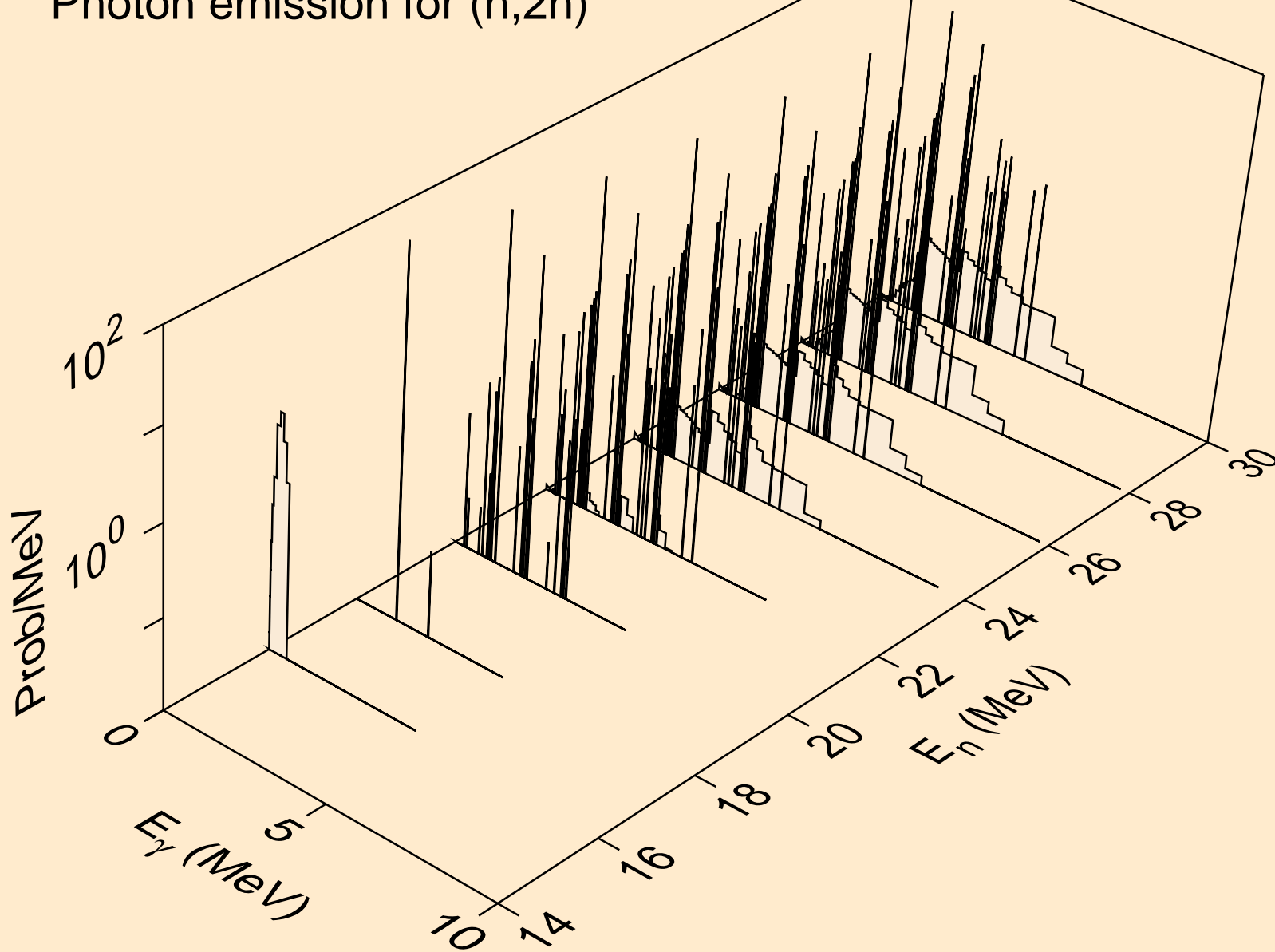



S032 NEUTRON ACER TENDL-2019 LIBRARY; T=293.16K  
Photon emission for (n,3n)

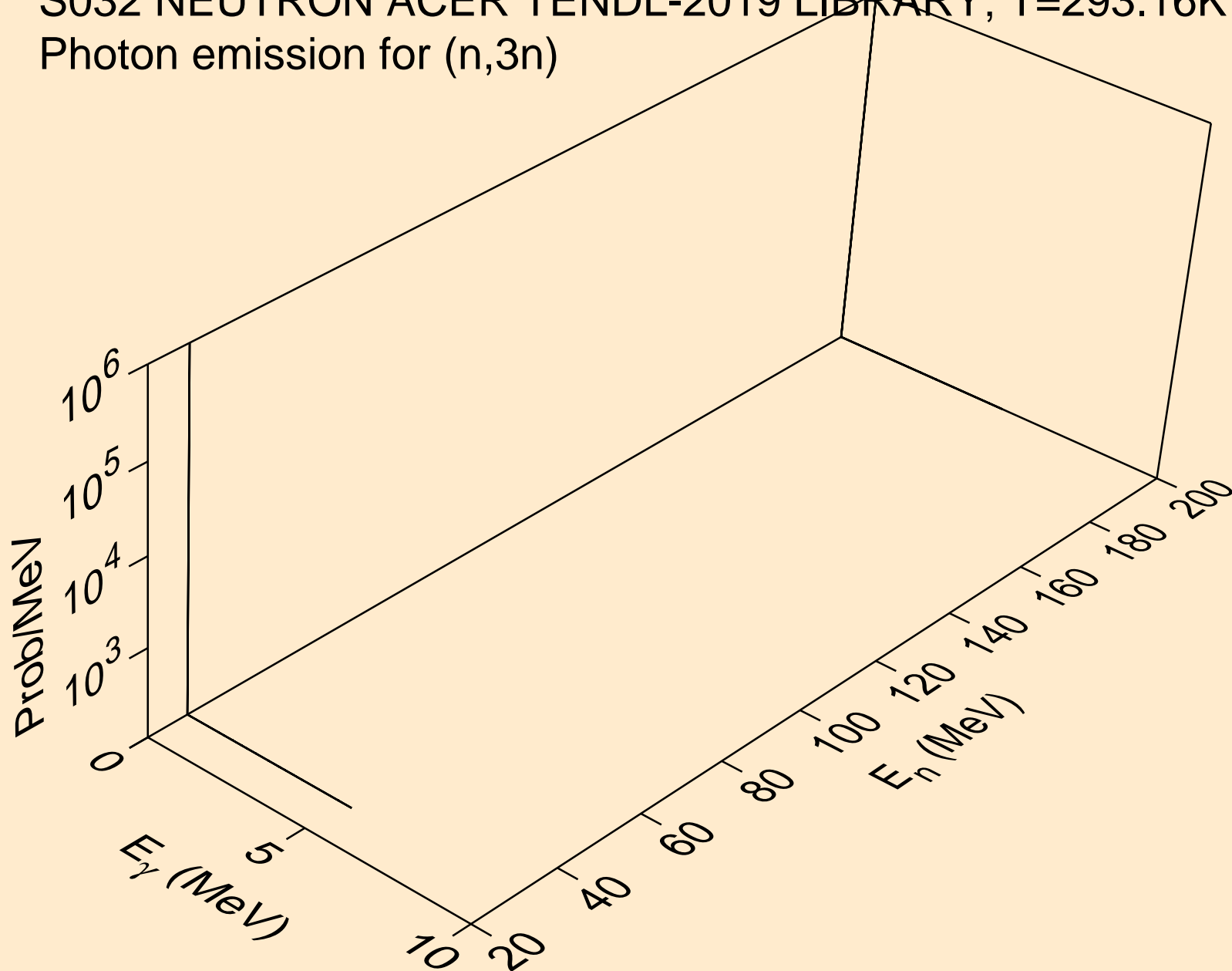

S032 NEUTRON ACER TENDL-2019 LIBRARY; T=293.16K  
Photon emission for (n,n\*)a

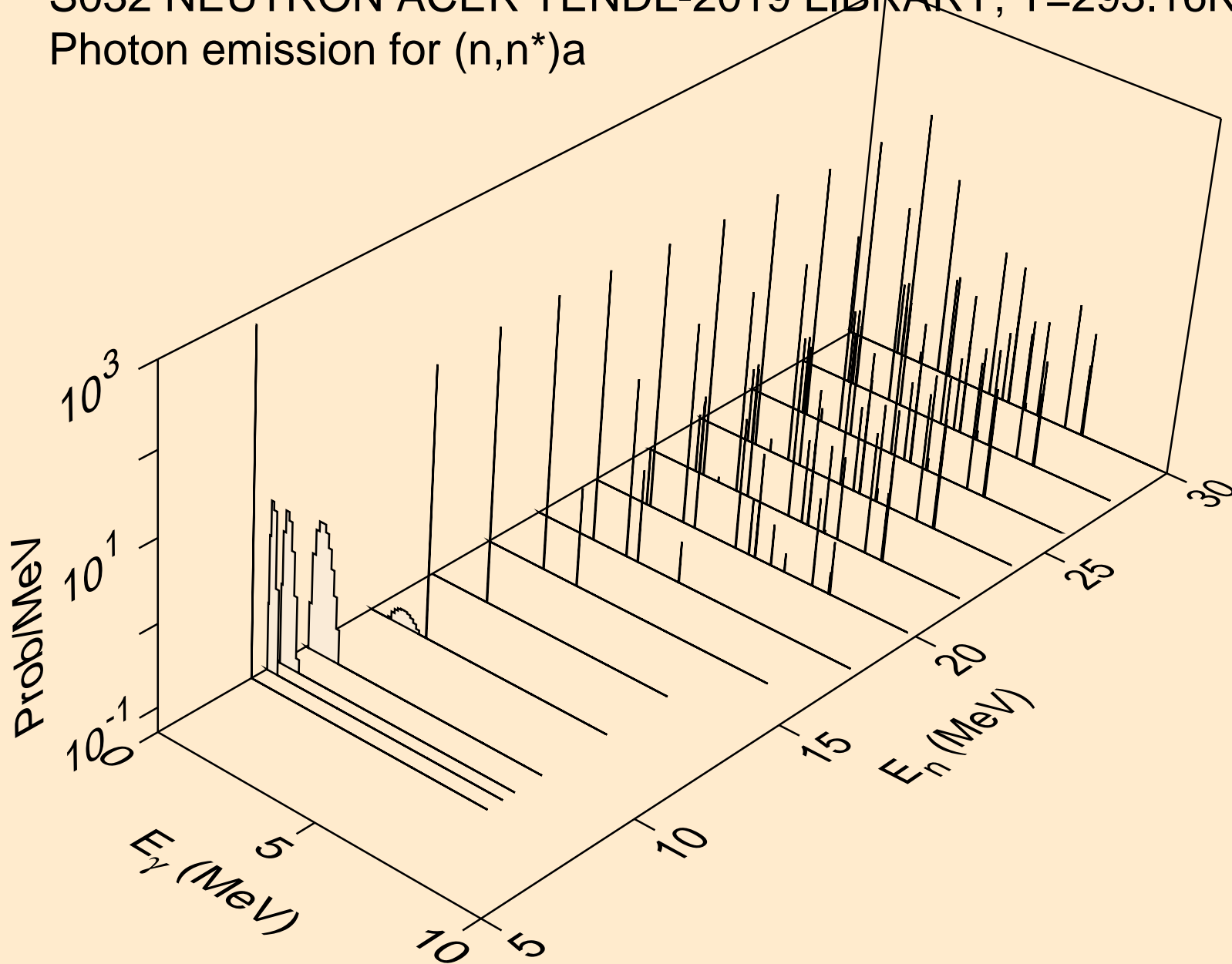

S032 NEUTRON ACER TENDL-2019 LIBRARY; T=293.16K  
Photon emission for (n,2n)a

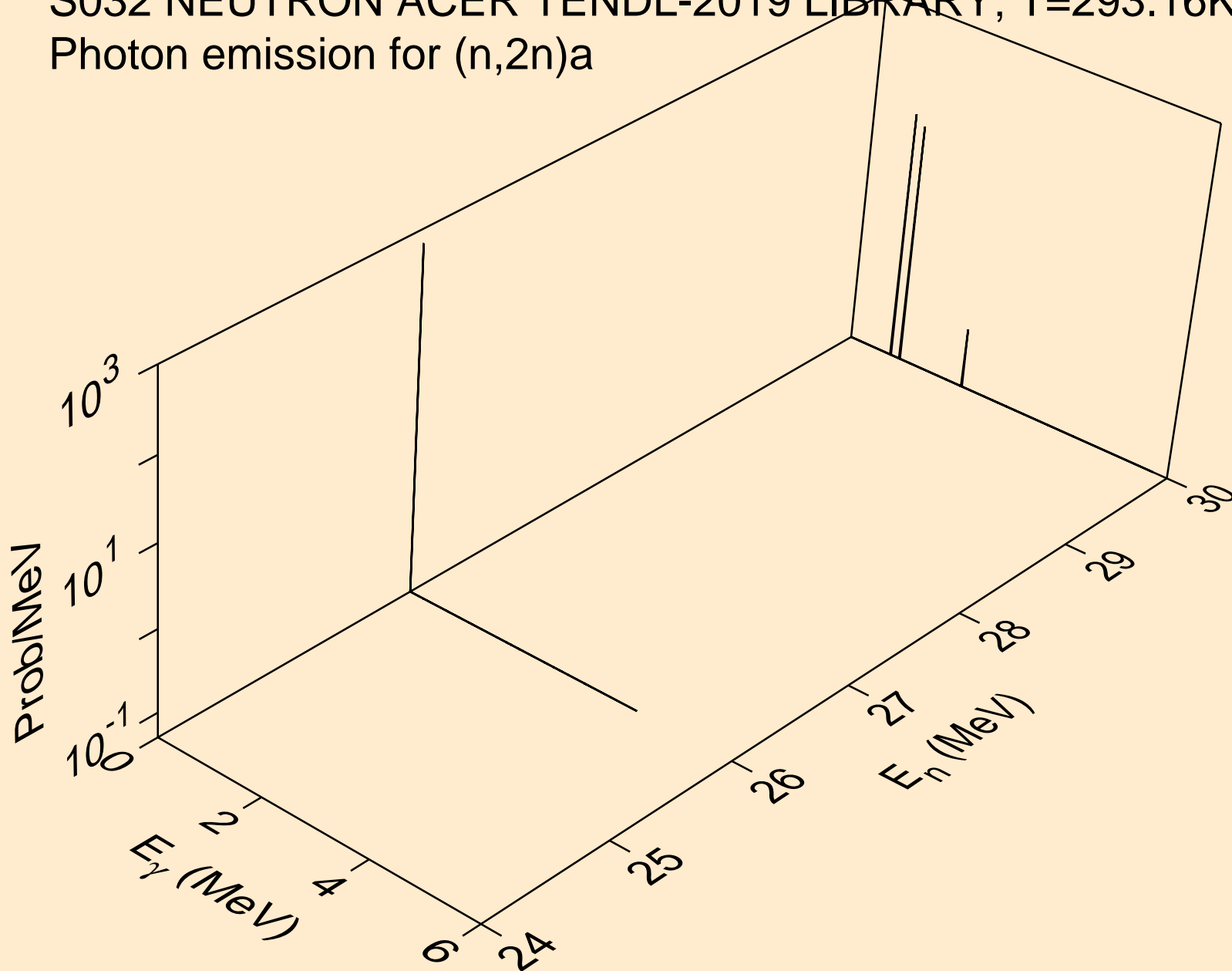

S032 NEUTRON ACER TENDL-2019 LIBRARY; T=293.16K  
Photon emission for (n,n\*)p

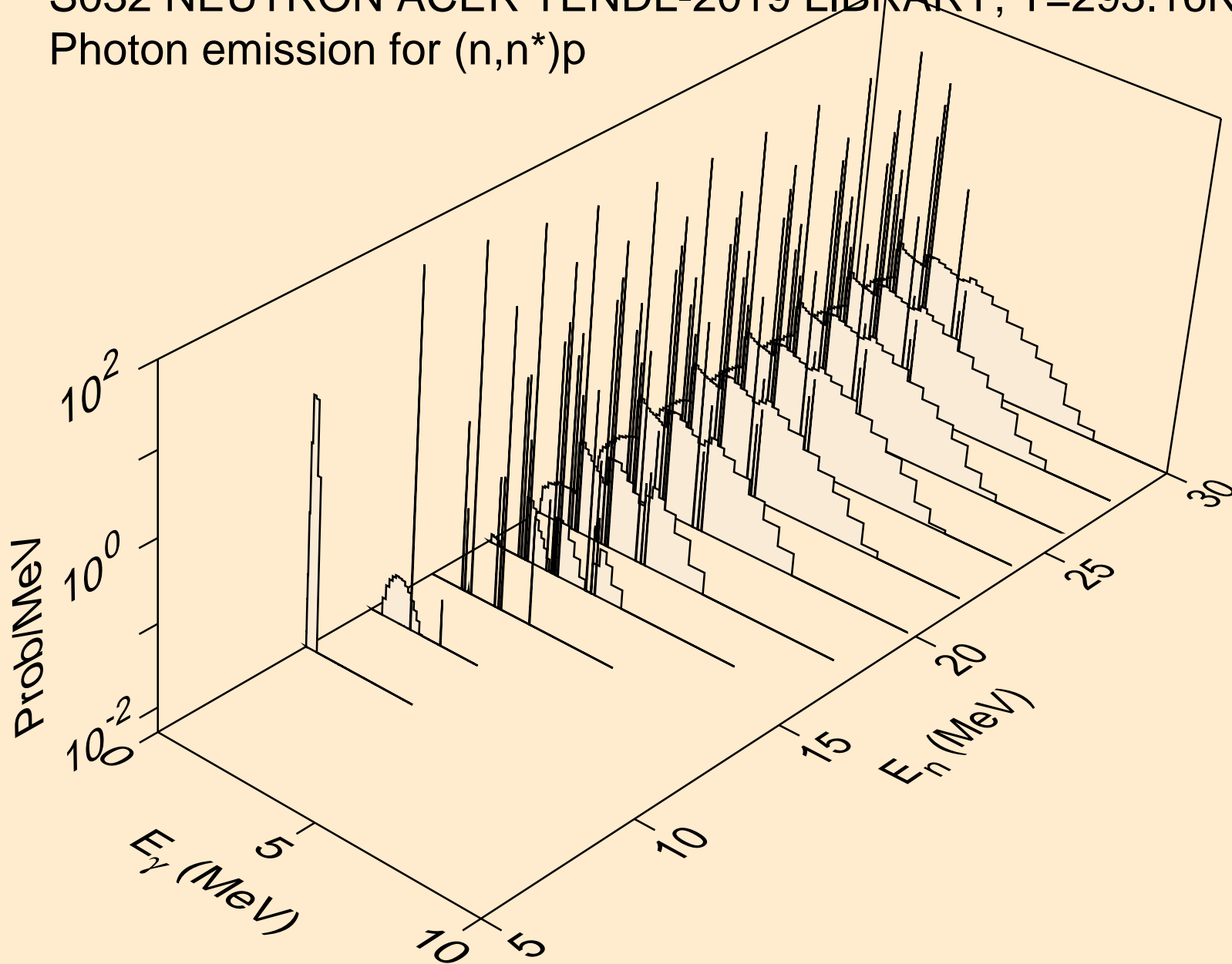

S032 NEUTRON ACER TENDL-2019 LIBRARY; T=293.16K  
Photon emission for (n,n\*)2a

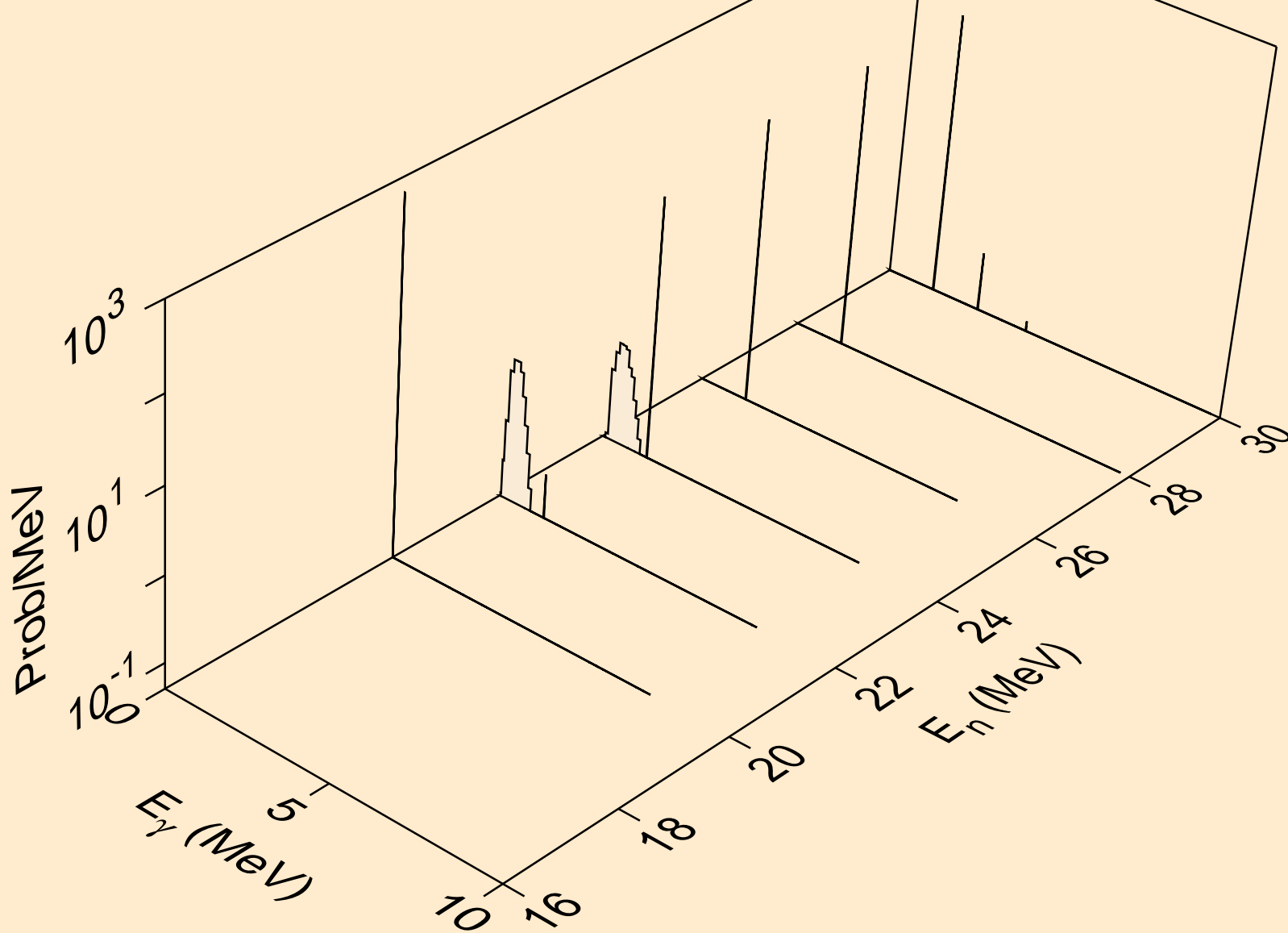

S032 NEUTRON ACER TENDL-2019 LIBRARY; T=293.16K  
Photon emission for (n,n\*)d

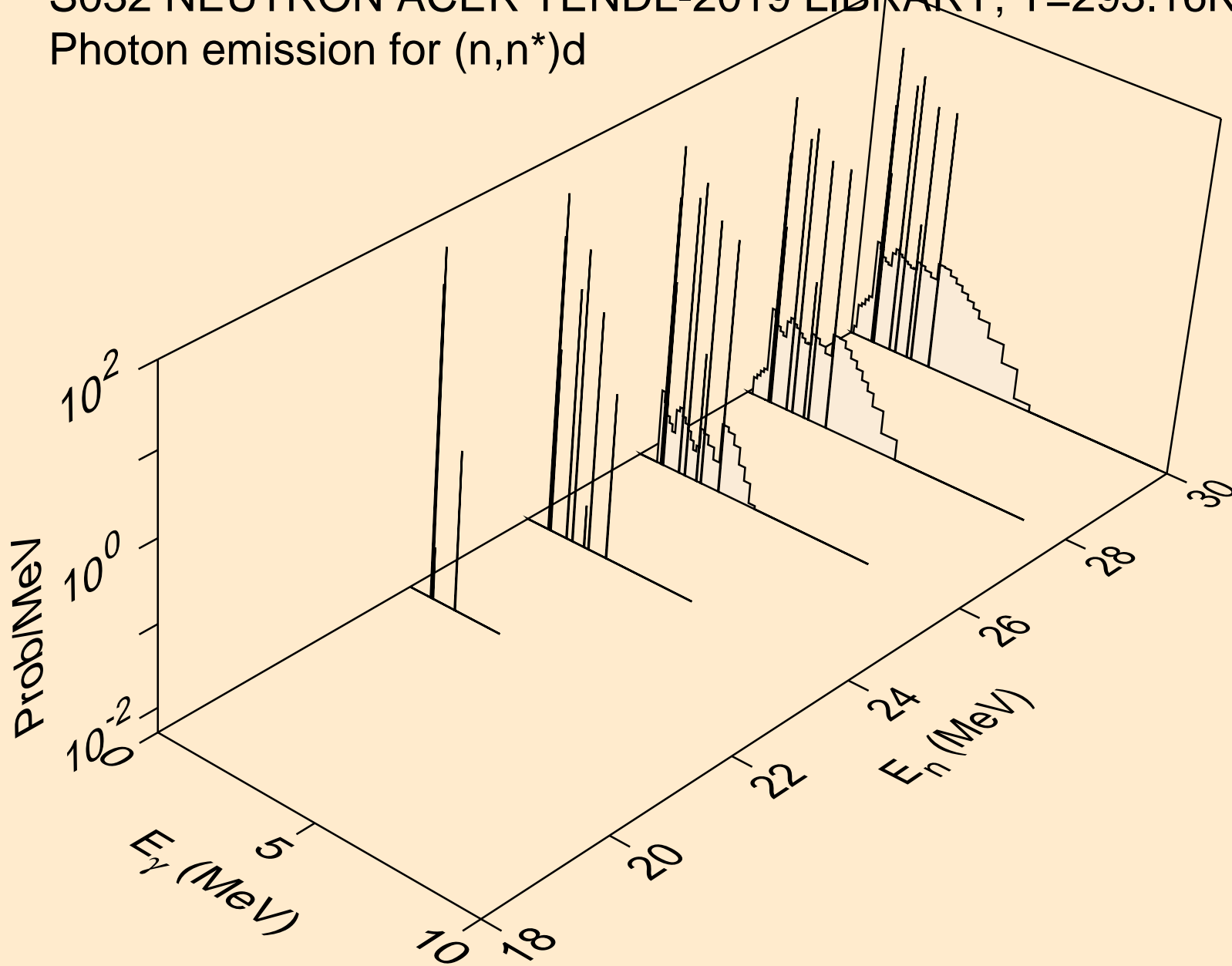

S032 NEUTRON ACER TENDL-2019 LIBRARY; T=293.16K  
Photon emission for (n,n\*)t

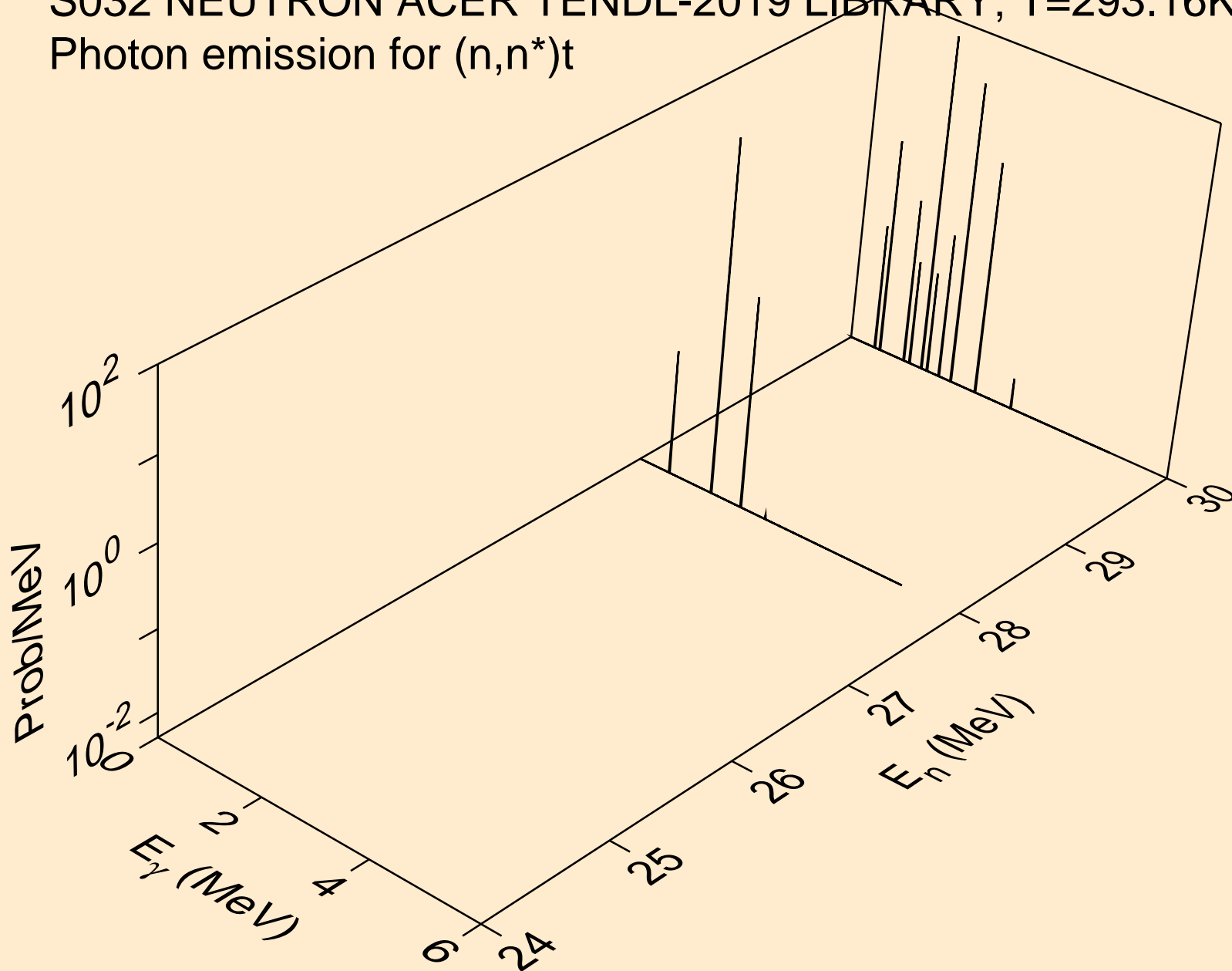

S032 NEUTRON ACER TENDL-2019 LIBRARY; T=293.16K  
Photon emission for (n,n\*)he3

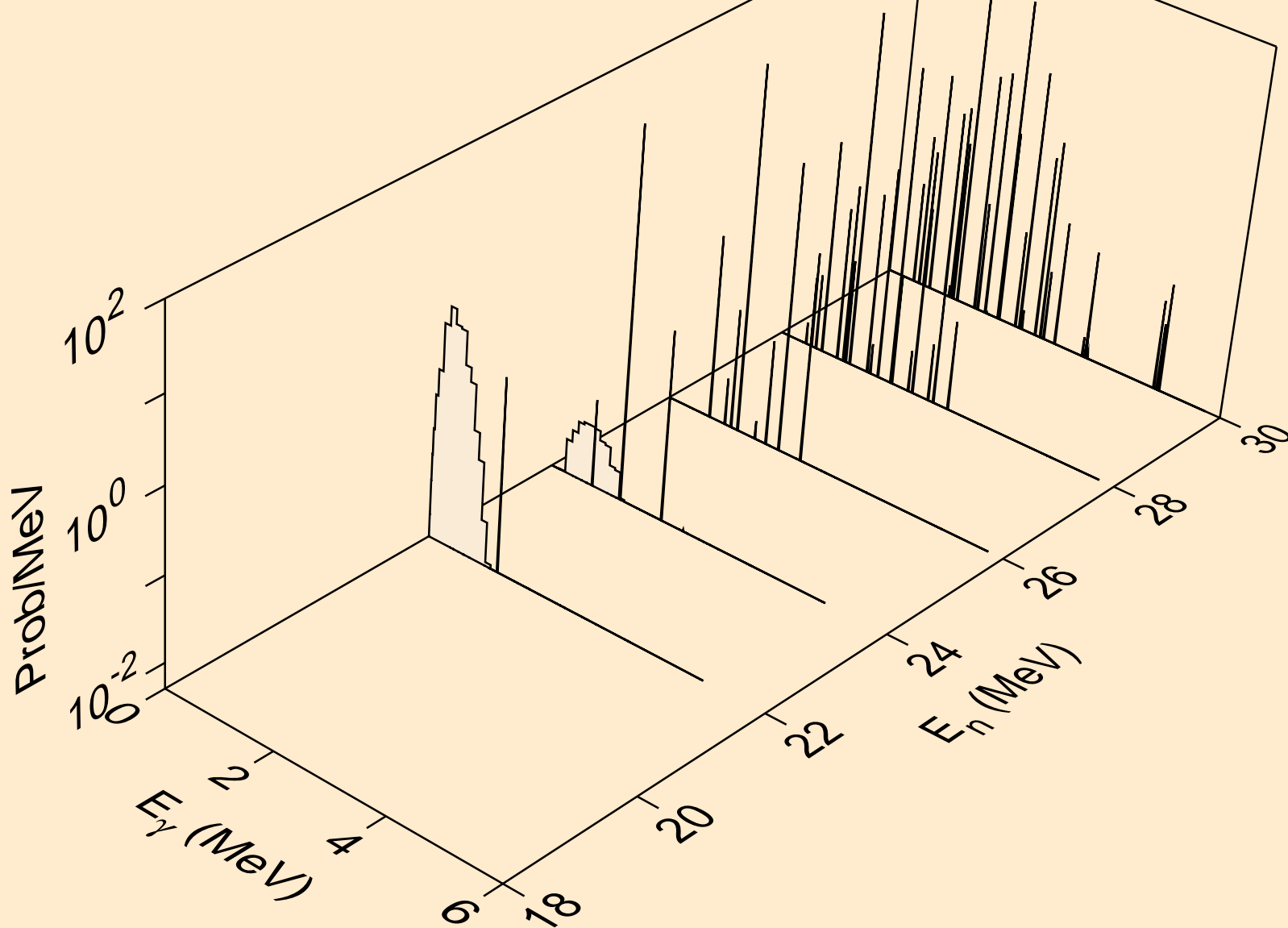



S032 NEUTRON ACER TENDL-2019 LIBRARY; T=293.16K  
Photon emission for (n,2np)

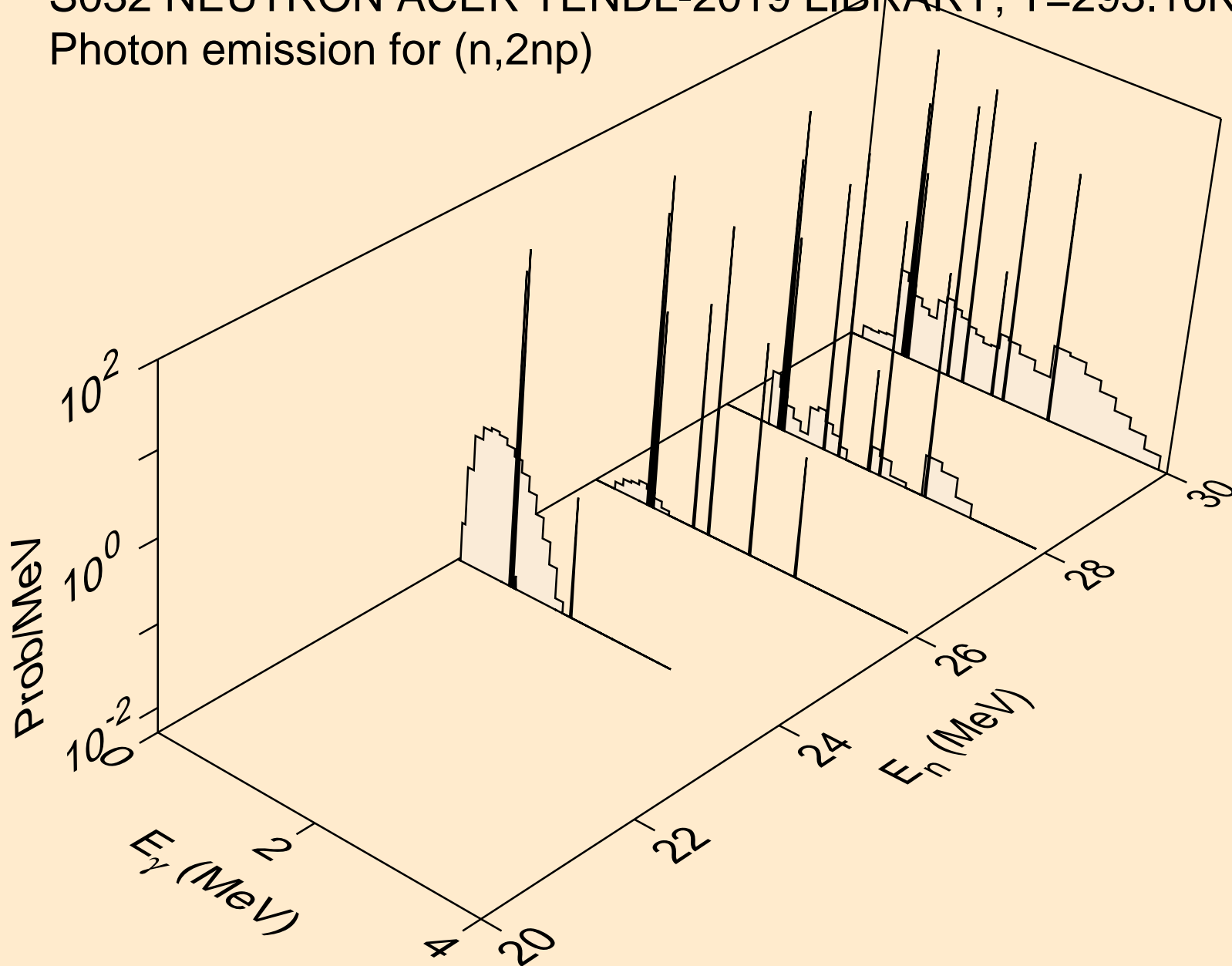

S032 NEUTRON ACER TENDL-2019 LIBRARY; T=293.16K  
Photon emission for (n,2np)

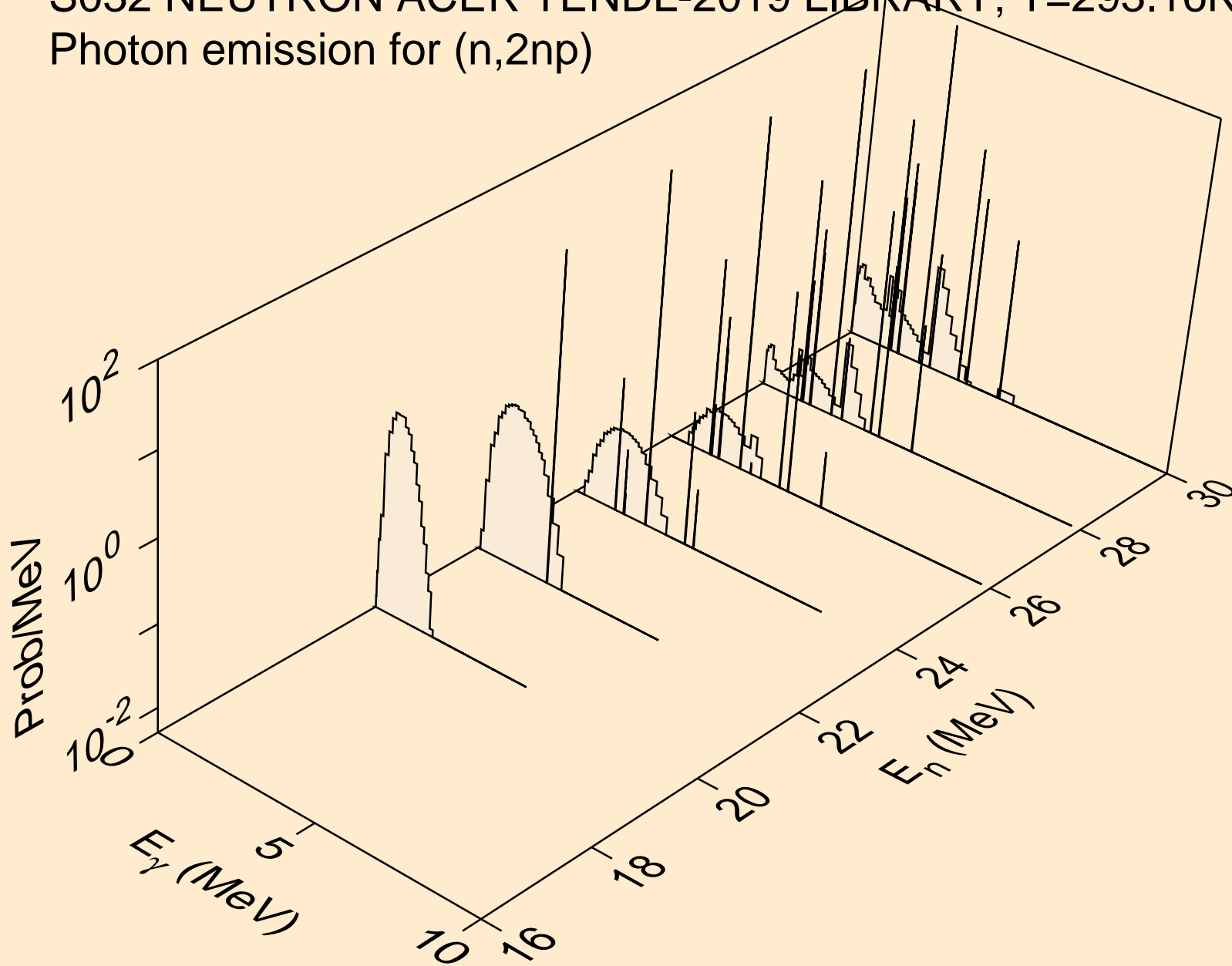

S032 NEUTRON ACER TENDL-2019 LIBRARY; T=293.16K  
Photon emission for (n,npa)

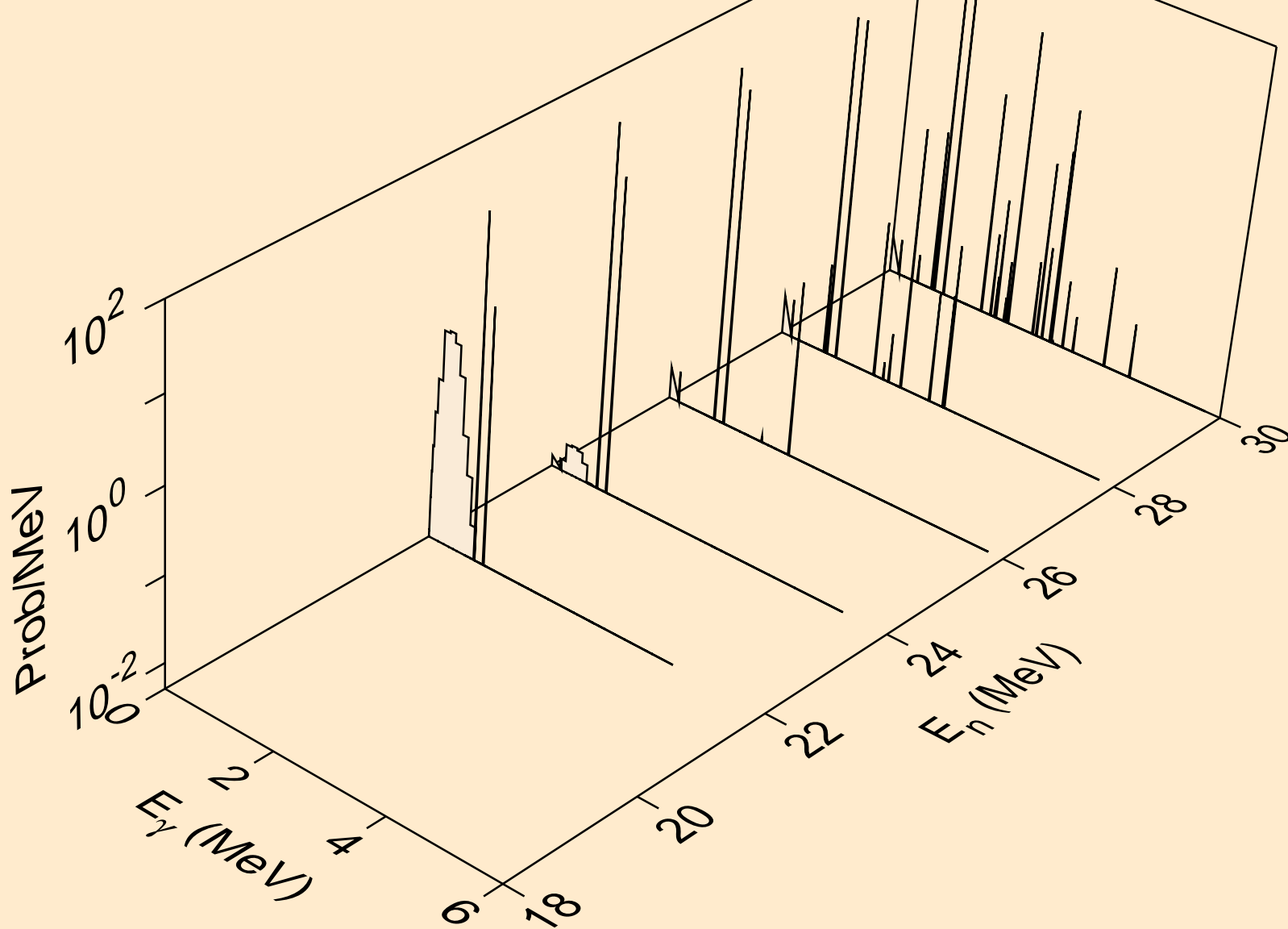

S032 NEUTRON ACER TENDL-2019 LIBRARY; T=293.16K  
Photon emission for (n,n\*c)

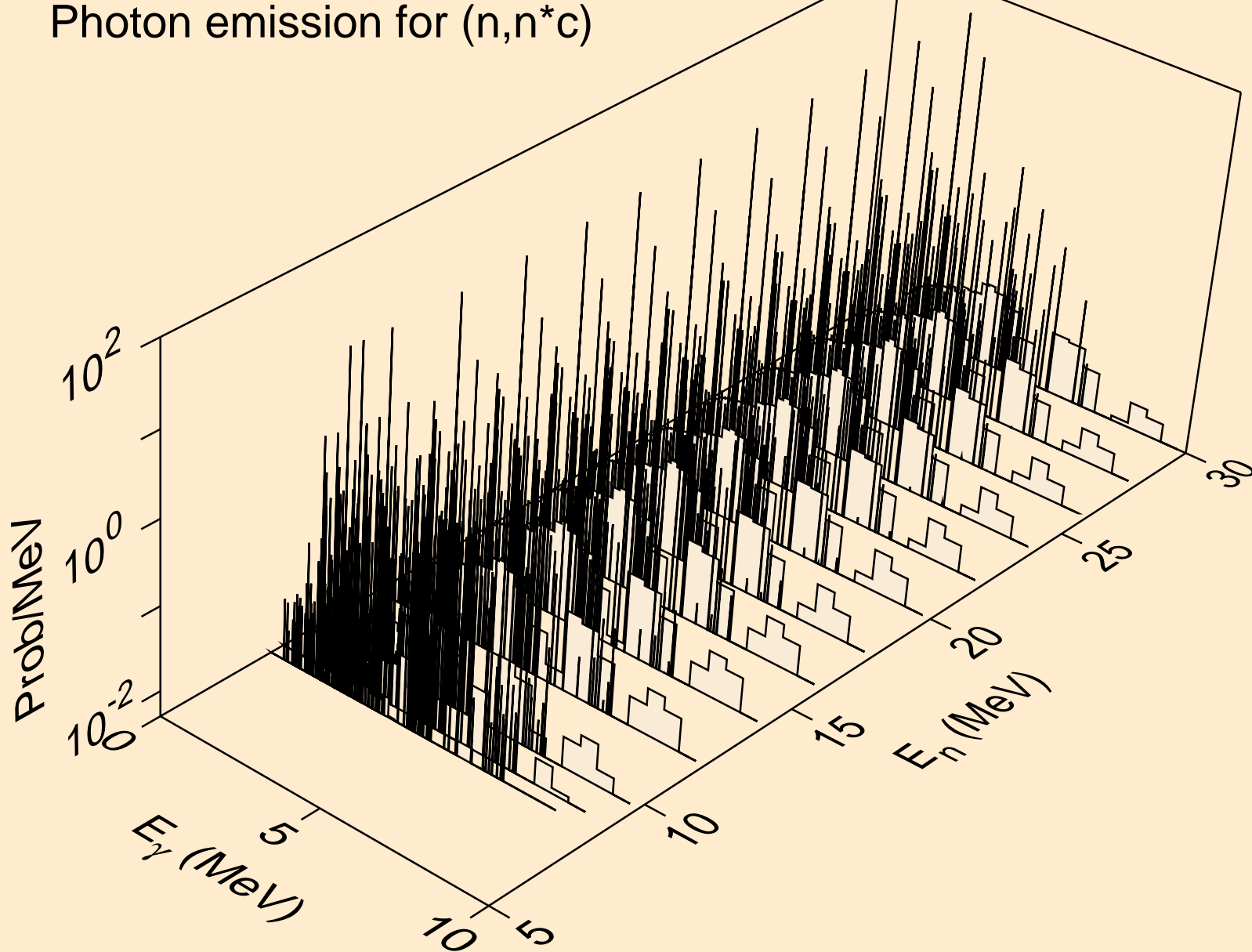

S032 NEUTRON ACER TENDL-2019 LIBRARY; T=293.16K  
Photon emission for (n,gma)

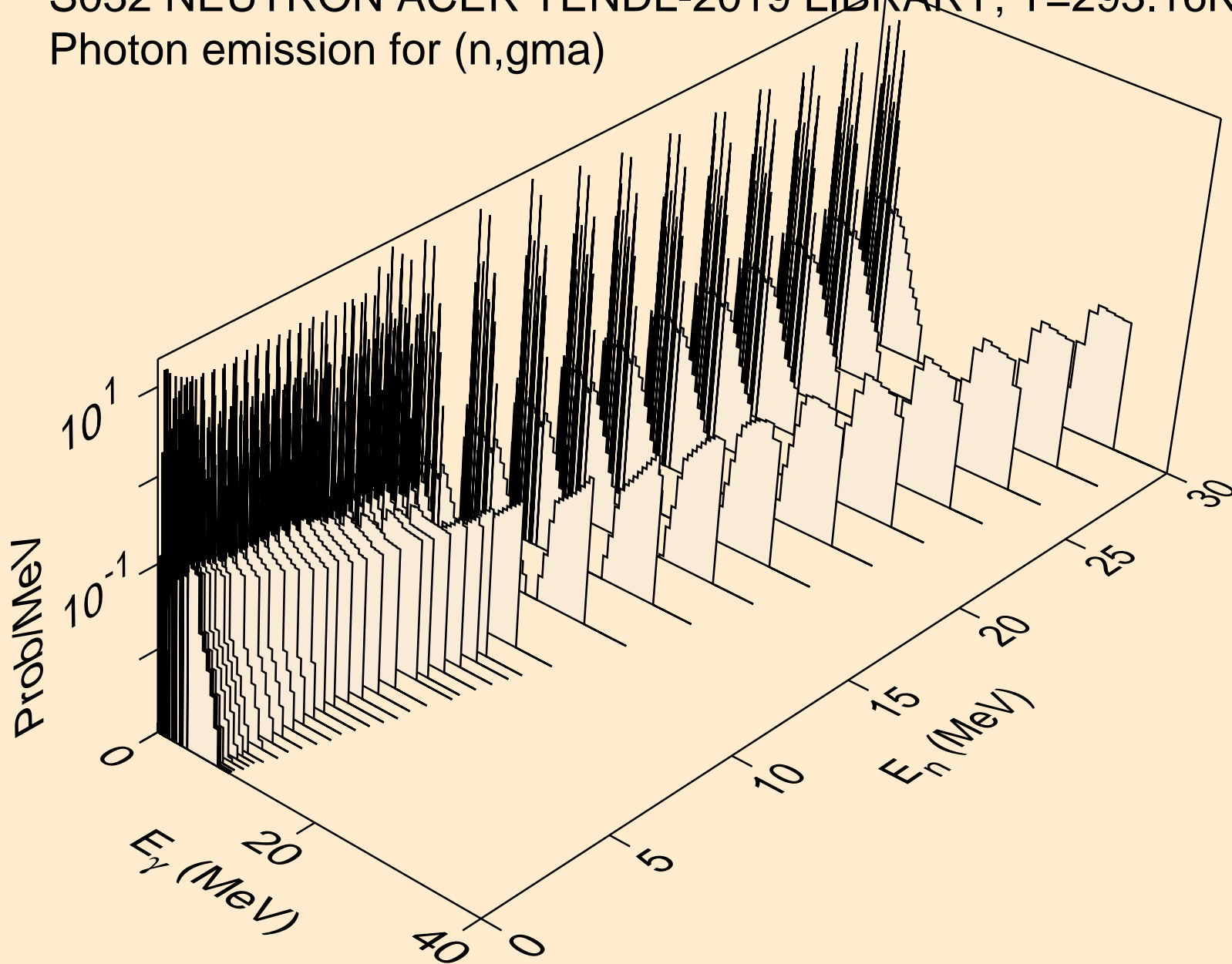

S032 NEUTRON ACER TENDL-2019 LIBRARY; T=293.16K  
Photon emission for (n,p)

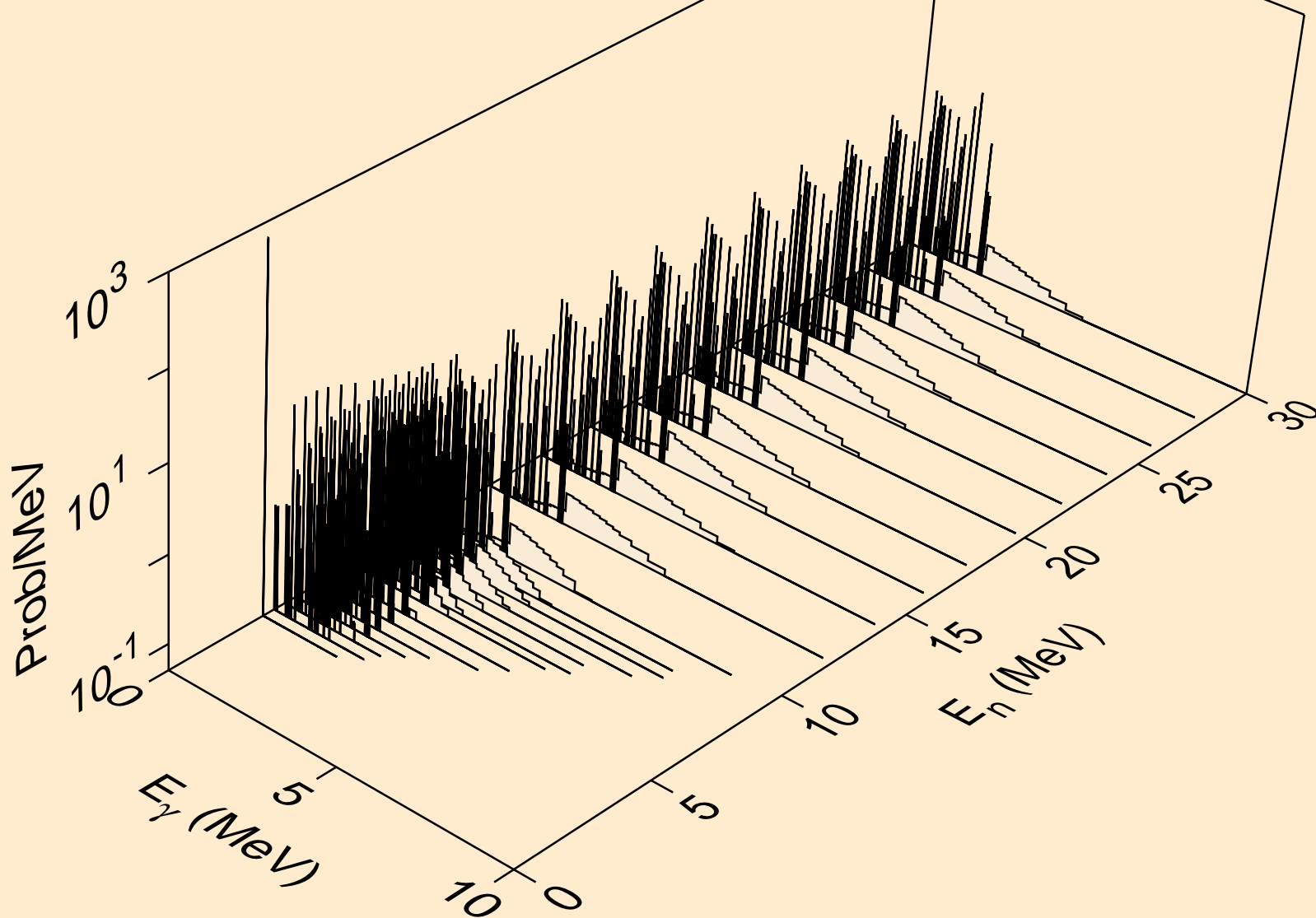

S032 NEUTRON ACER TENDL-2019 LIBRARY; T=293.16K  
Photon emission for (n,d)

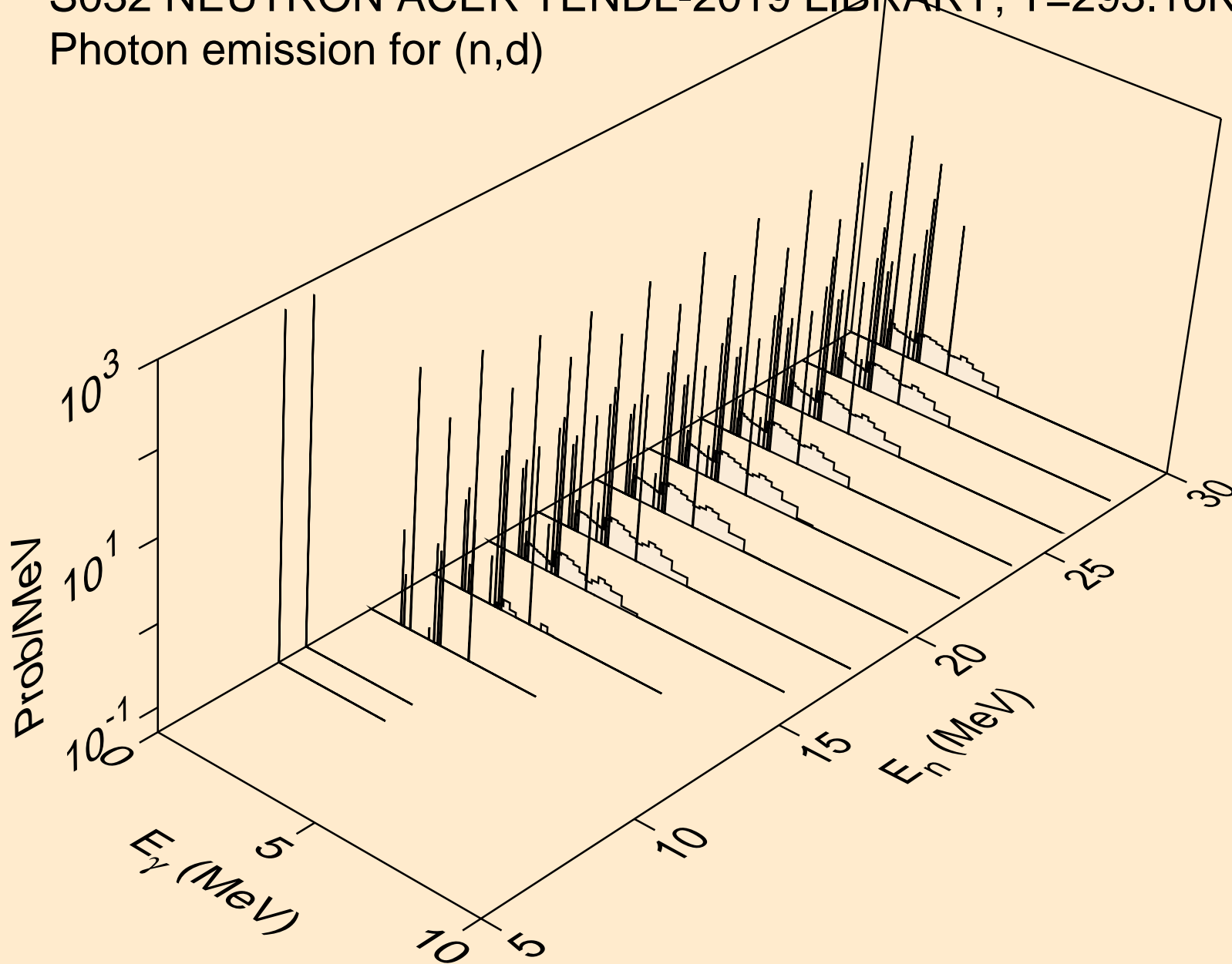

S032 NEUTRON ACER TENDL-2019 LIBRARY; T=293.16K  
Photon emission for (n,t)

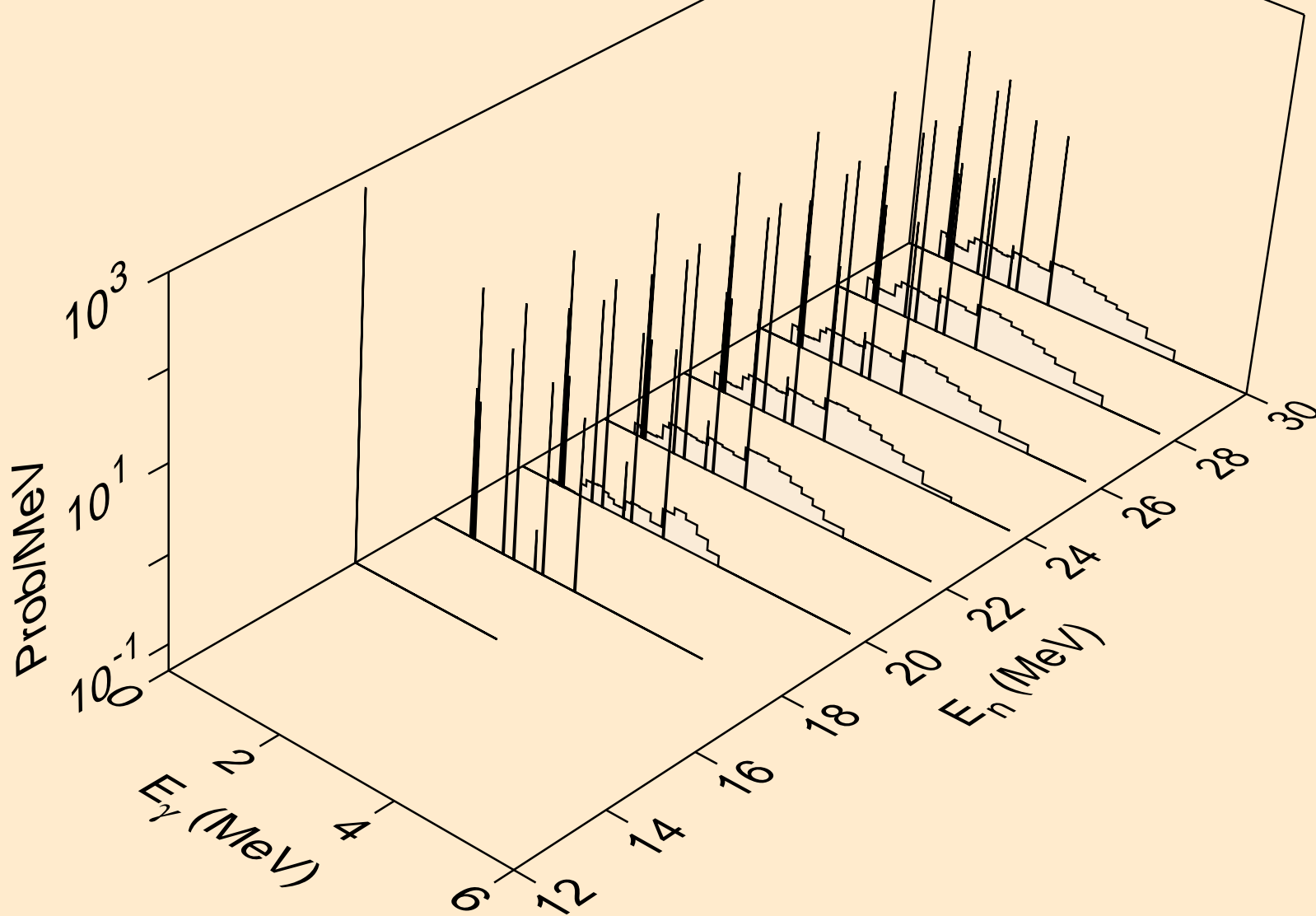



S032 NEUTRON ACER TENDL-2019 LIBRARY; T=293.16K  
Photon emission for (n,he3)

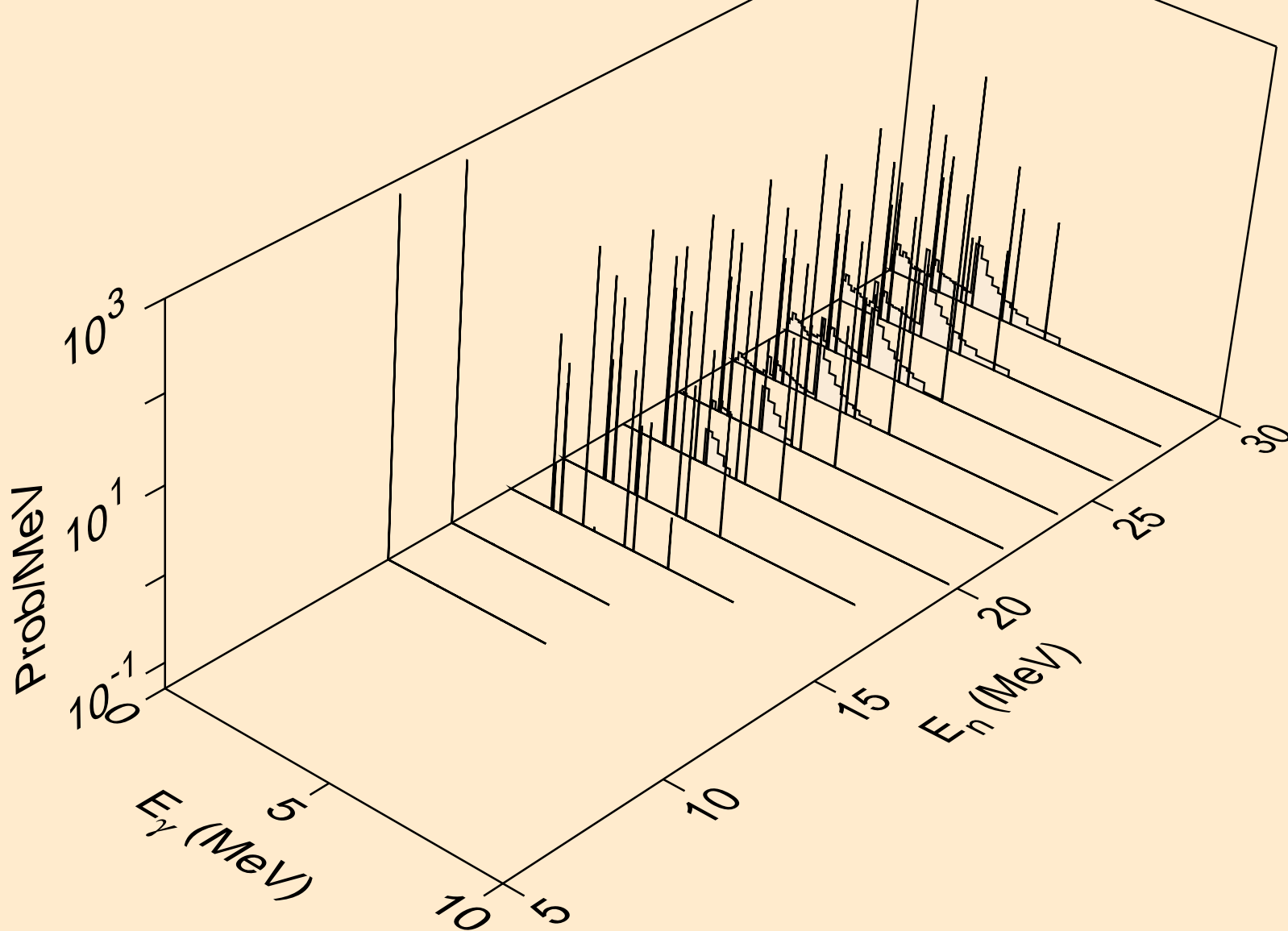

S032 NEUTRON ACER TENDL-2019 LIBRARY; T=293.16K  
Photon emission for (n,a)

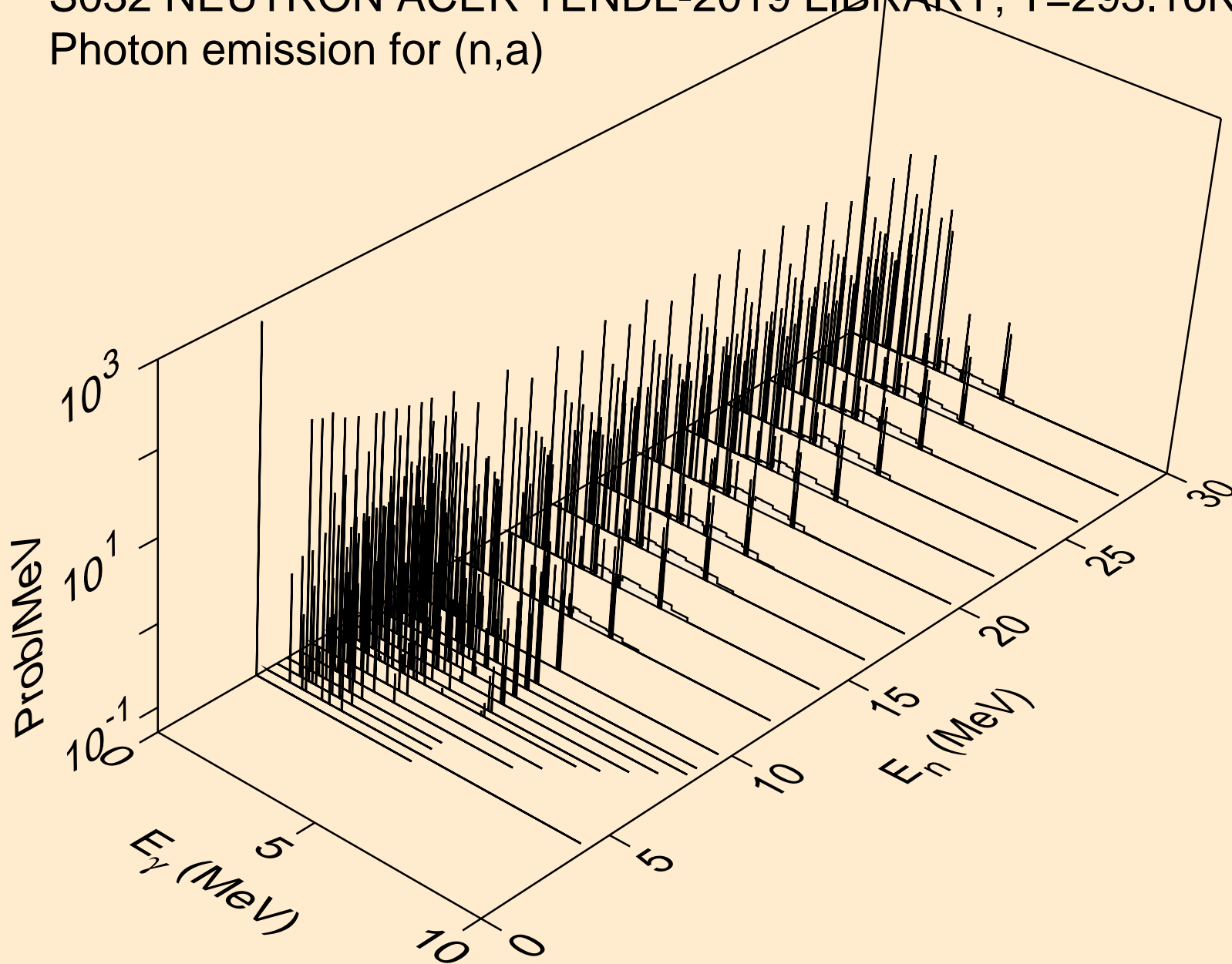

S032 NEUTRON ACER TENDL-2019 LIBRARY; T=293.16K  
Photon emission for (n,2a)

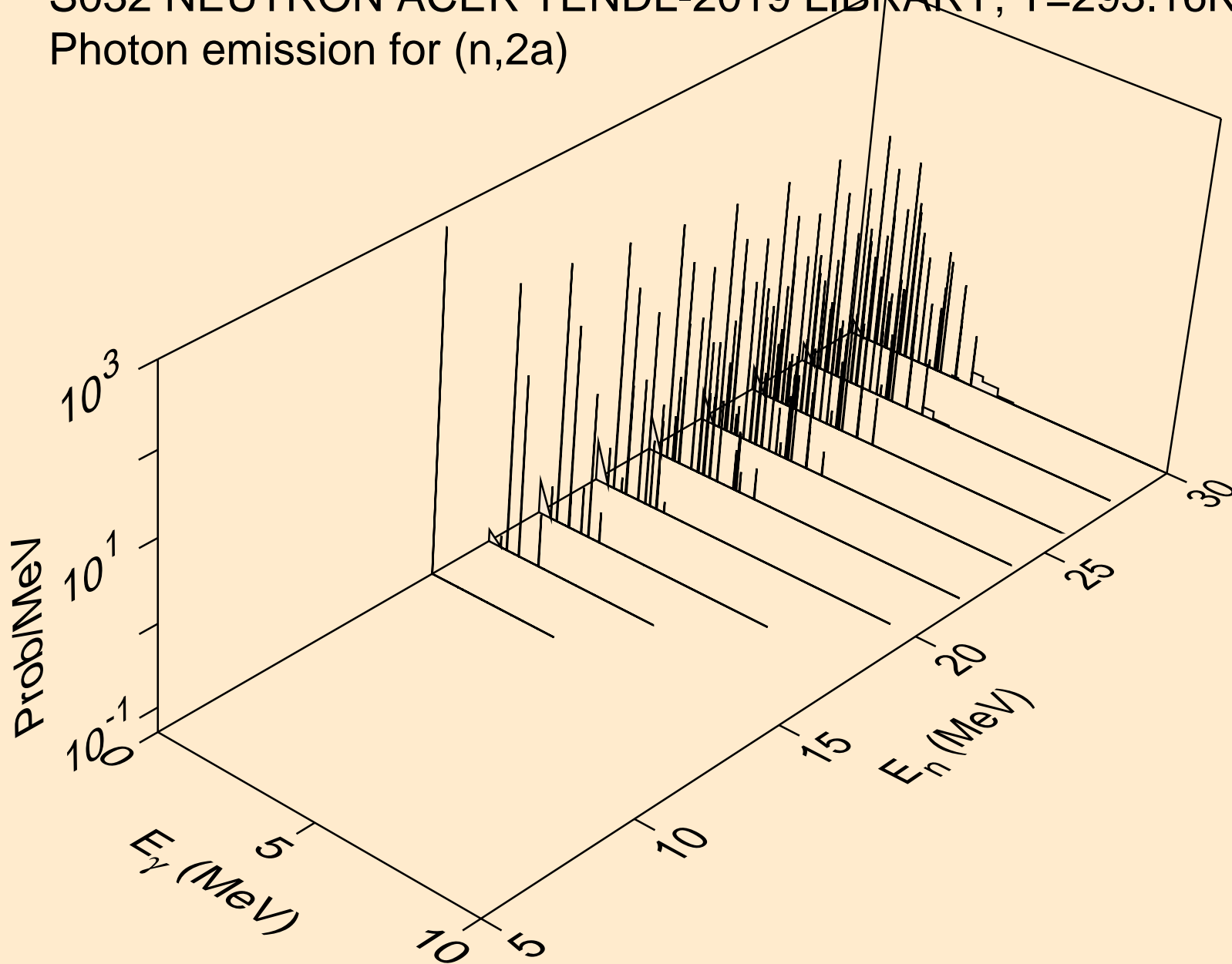

S032 NEUTRON ACER TENDL-2019 LIBRARY; T=293.16K  
Photon emission for (n,2p)

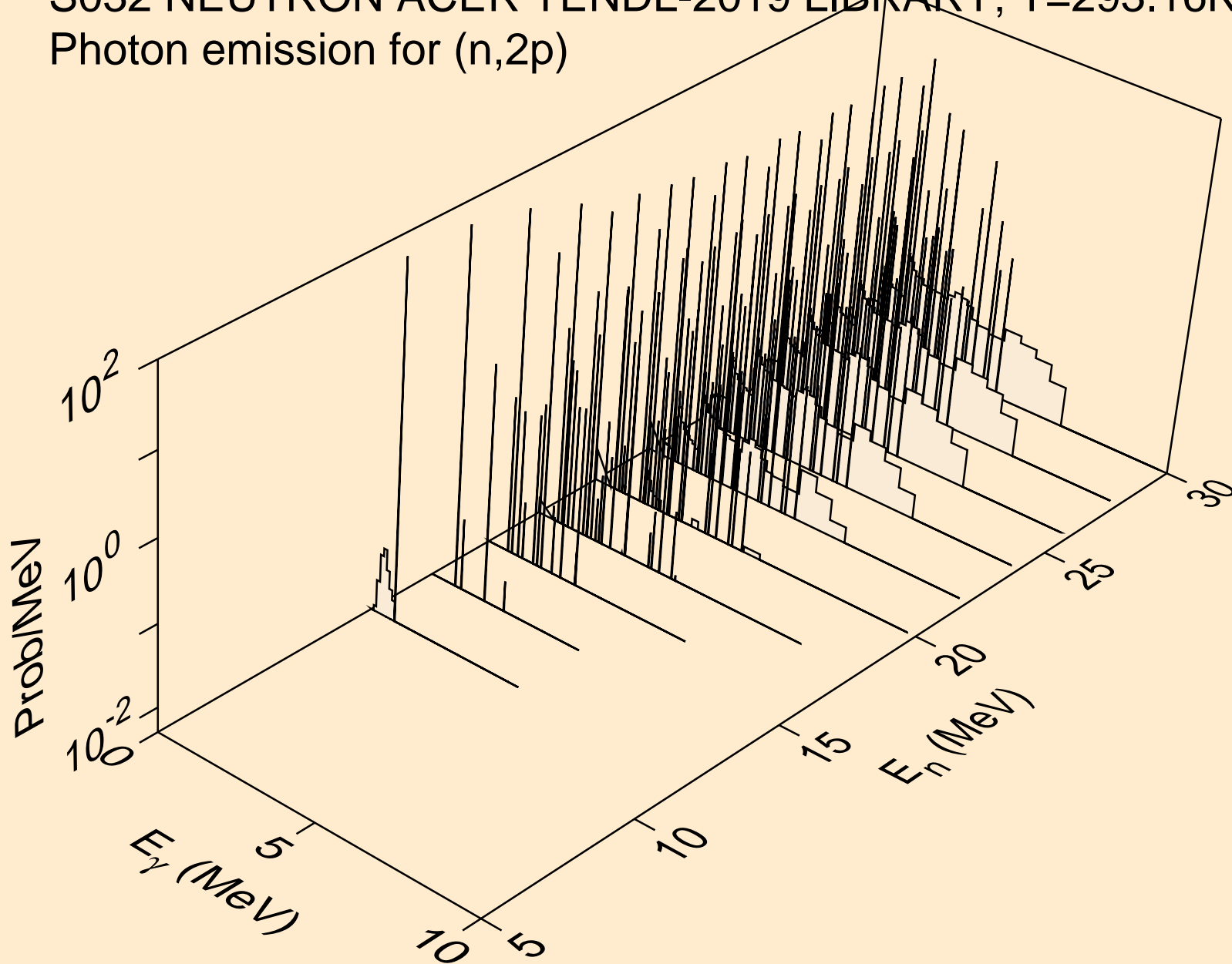

S032 NEUTRON ACER TENDL-2019 LIBRARY; T=293.16K  
Photon emission for (n,p $\alpha$ )

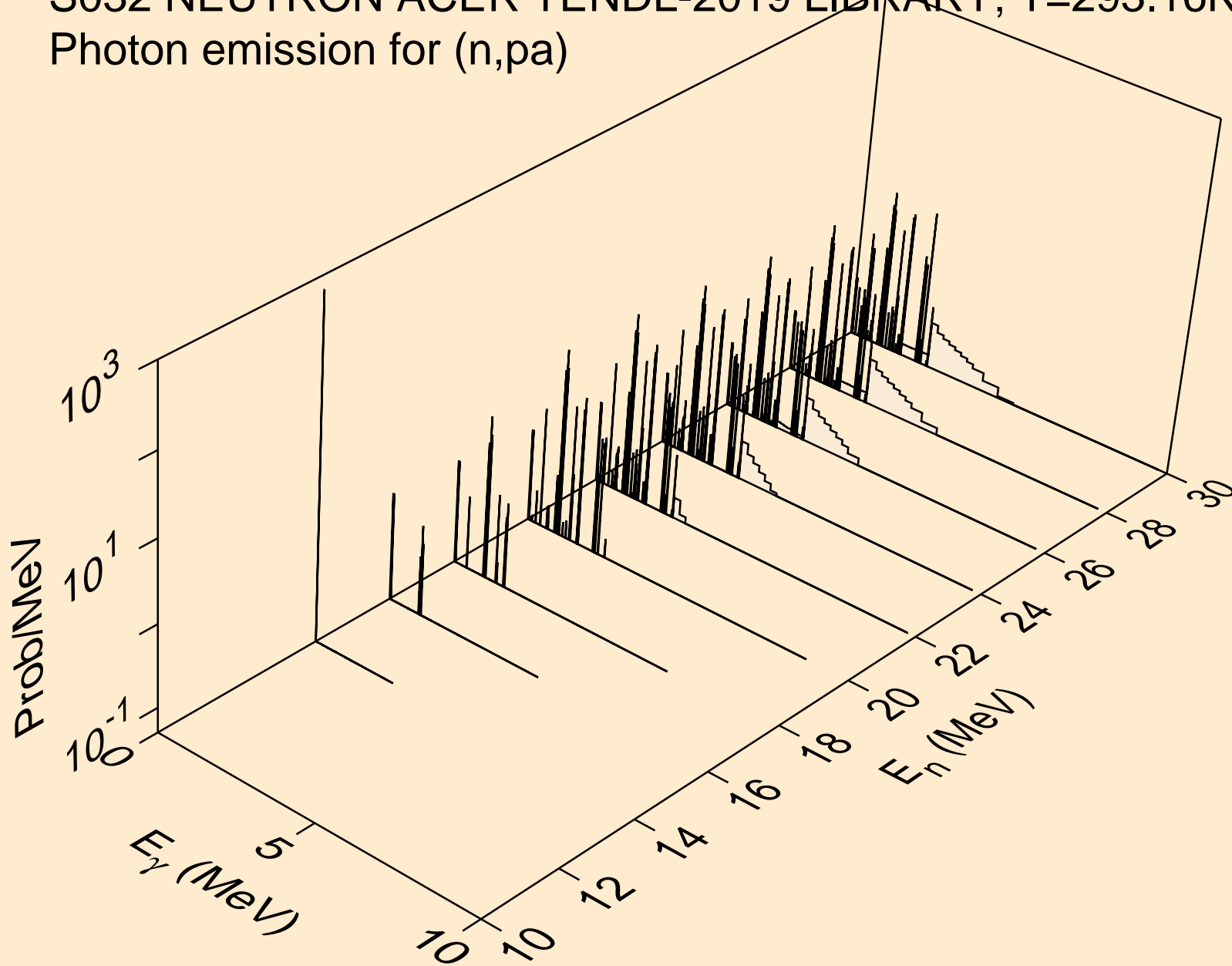

S032 NEUTRON ACER TENDL-2019 LIBRARY; T=293.16K  
Photon emission for (n,pd)

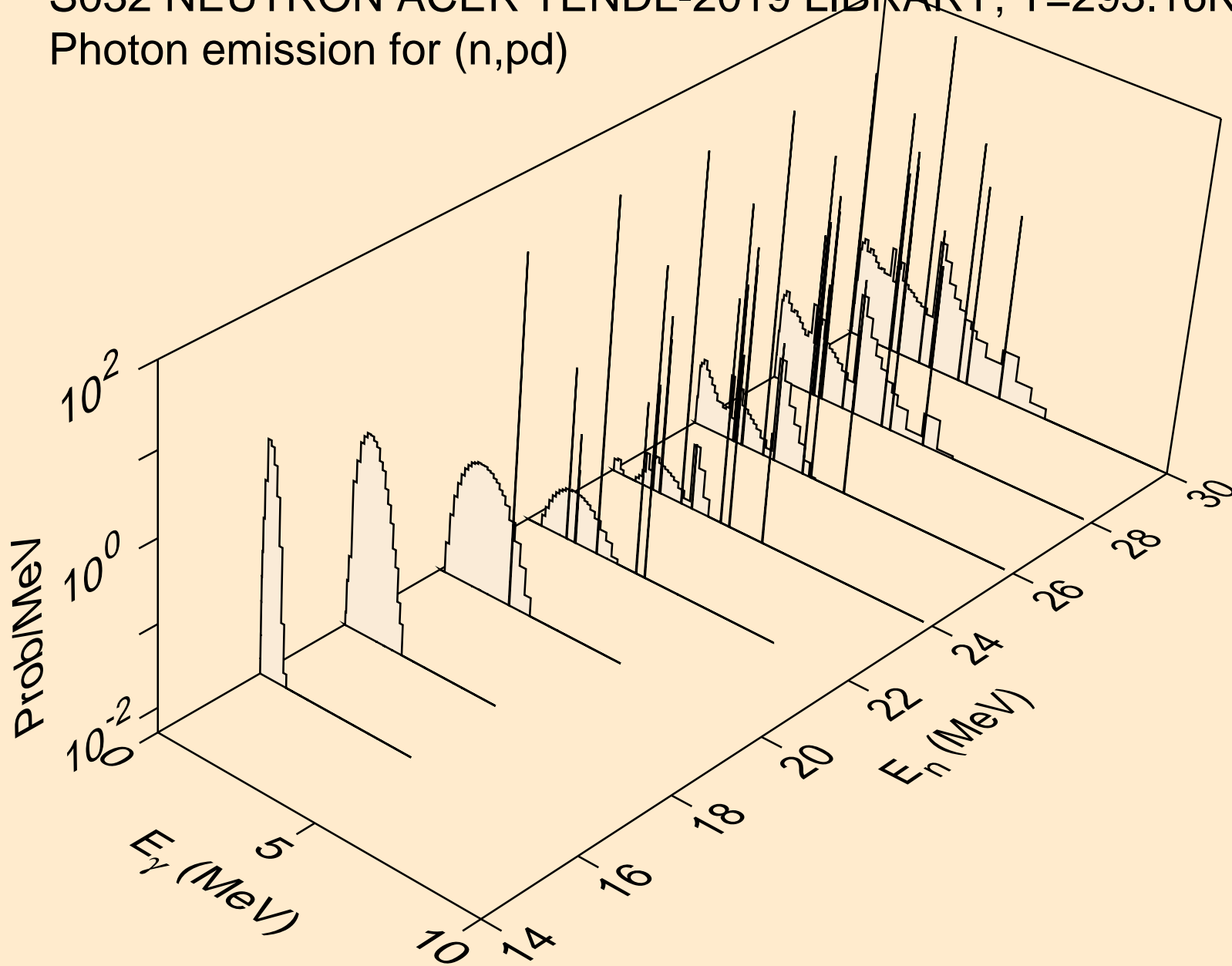

S032 NEUTRON ACER TENDL-2019 LIBRARY; T=293.16K  
Photon emission for (n,pt)

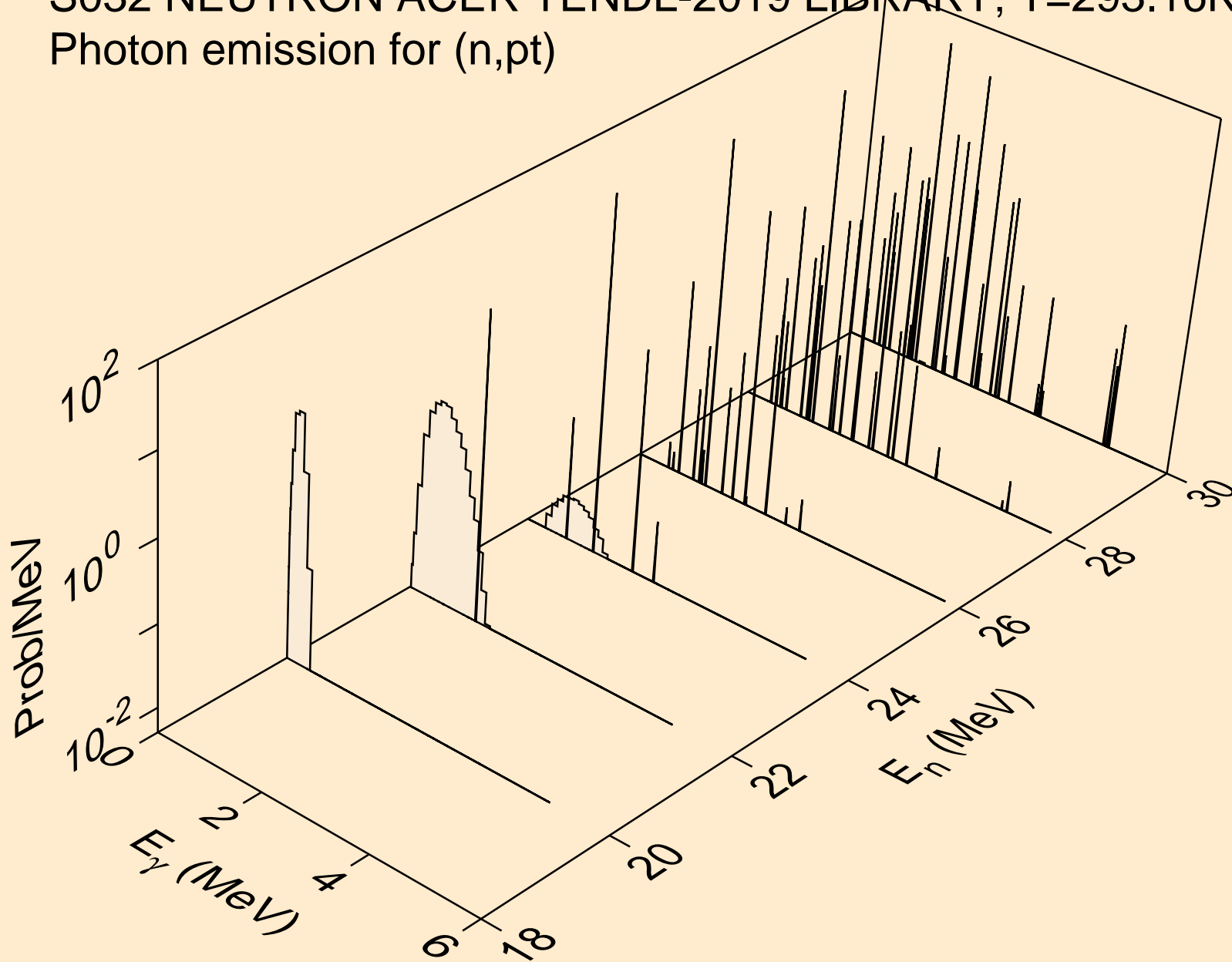

S032 NEUTRON ACER TENDL-2019 LIBRARY; T=293.16K  
Photon emission for (n,da)

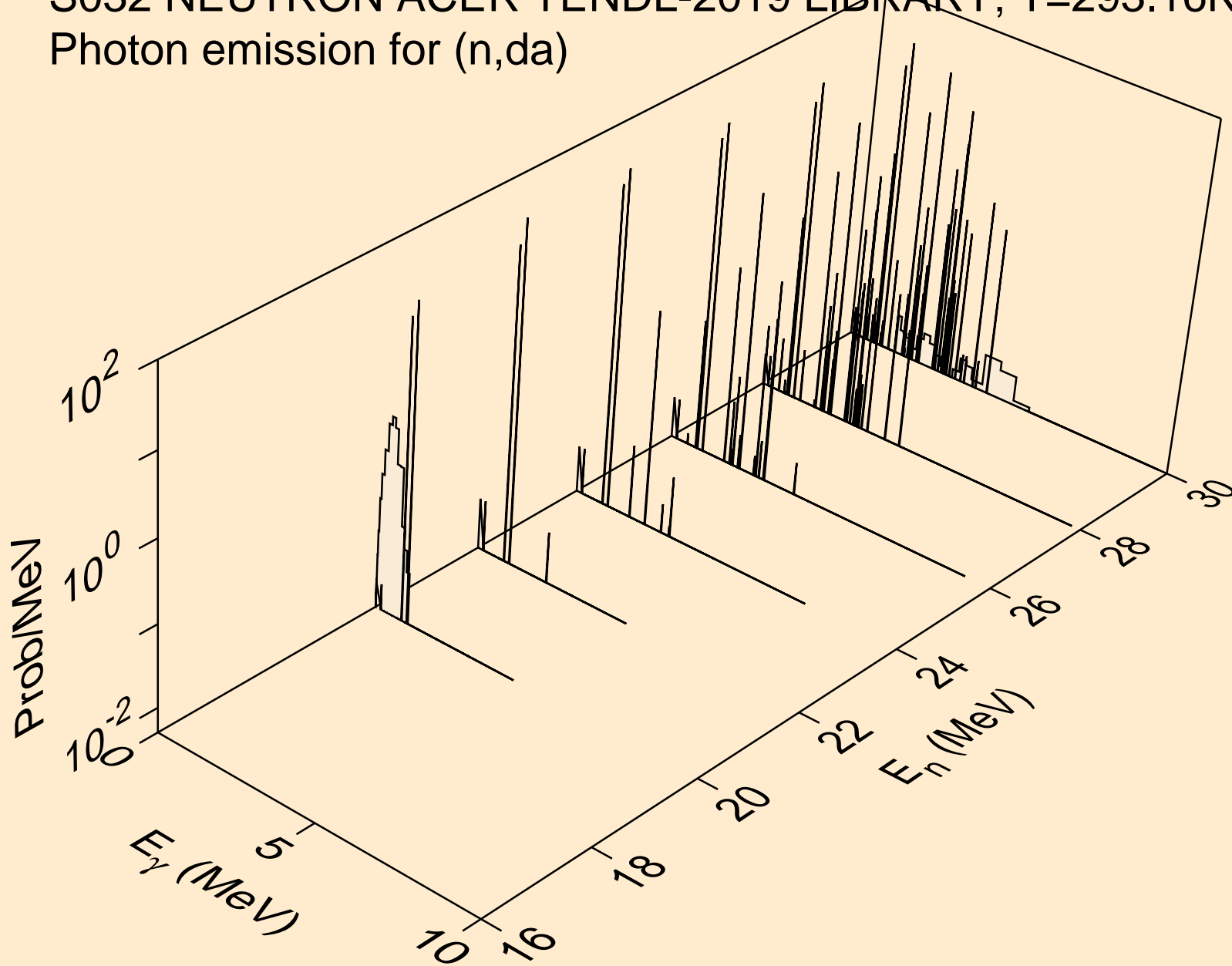



S032 NEUTRON ACER TENDL-2019 LIBRARY; T=293.16K  
thermal capture photon spectrum

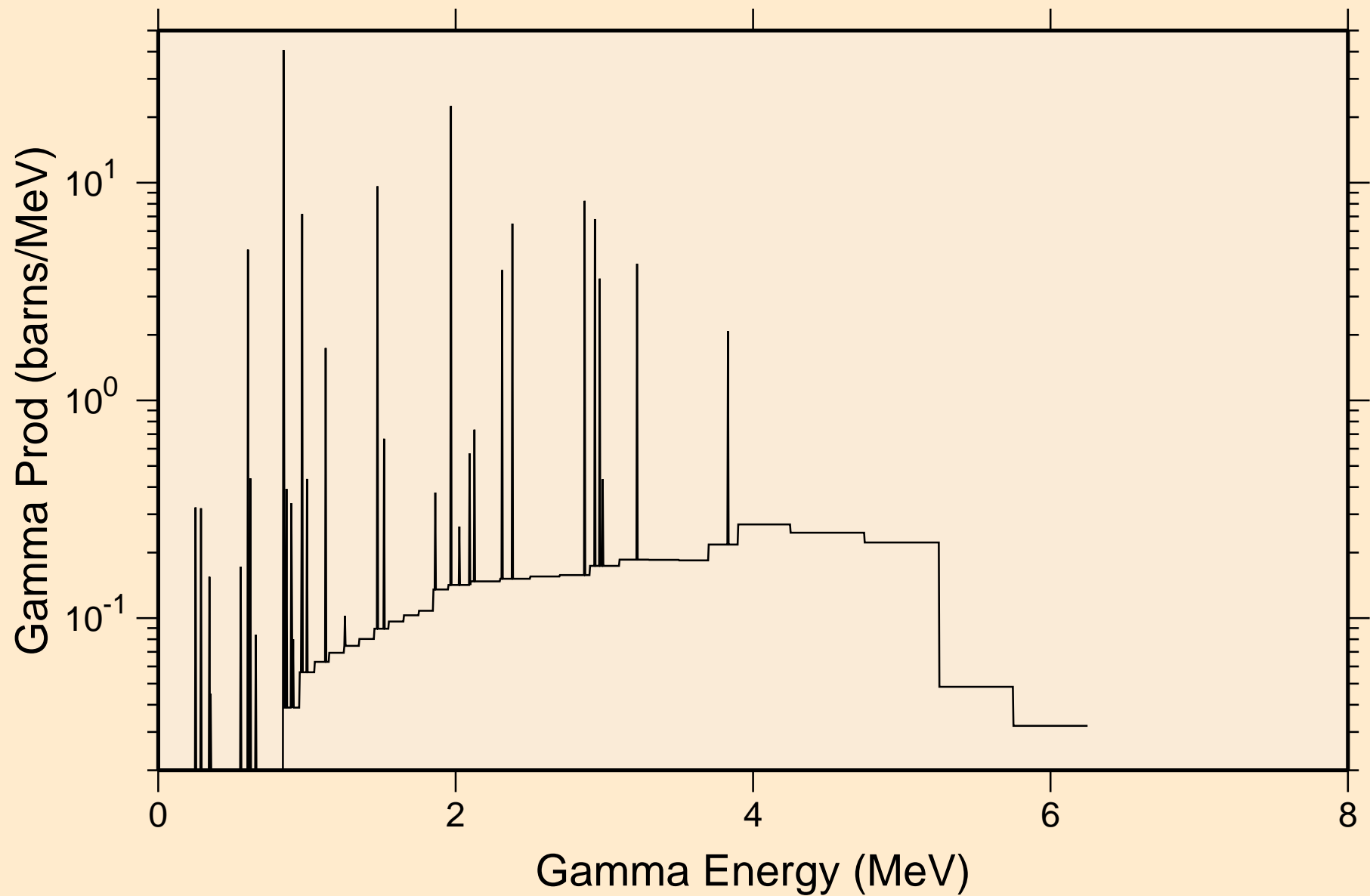

S032 NEUTRON ACER TENDL-2019 LIBRARY; T=293.16K  
14 MeV photon spectrum

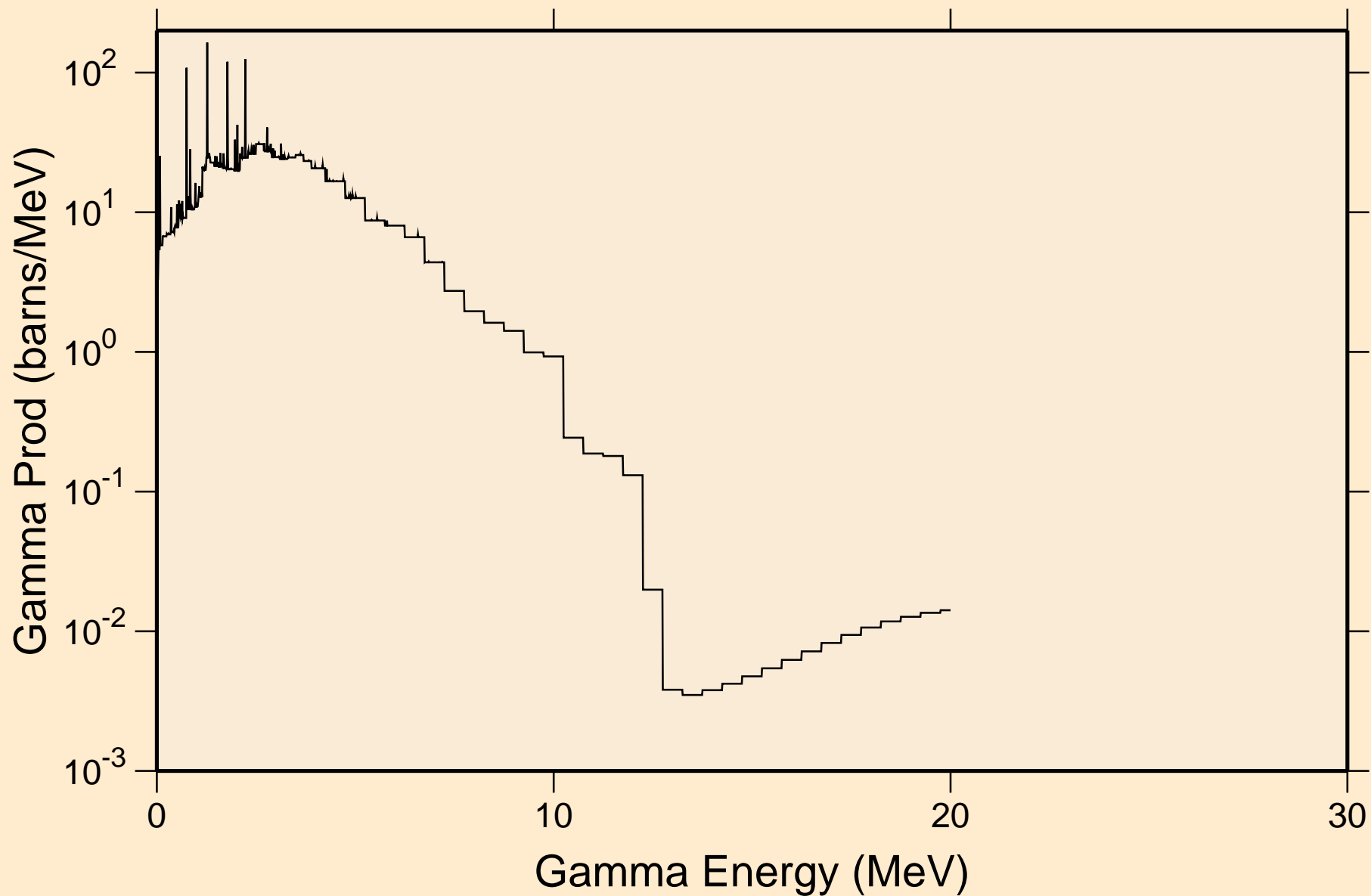

# S032 NEUTRON ACER TENDL-2019 LIBRARY; T=293.16K

## Particle heating contributions

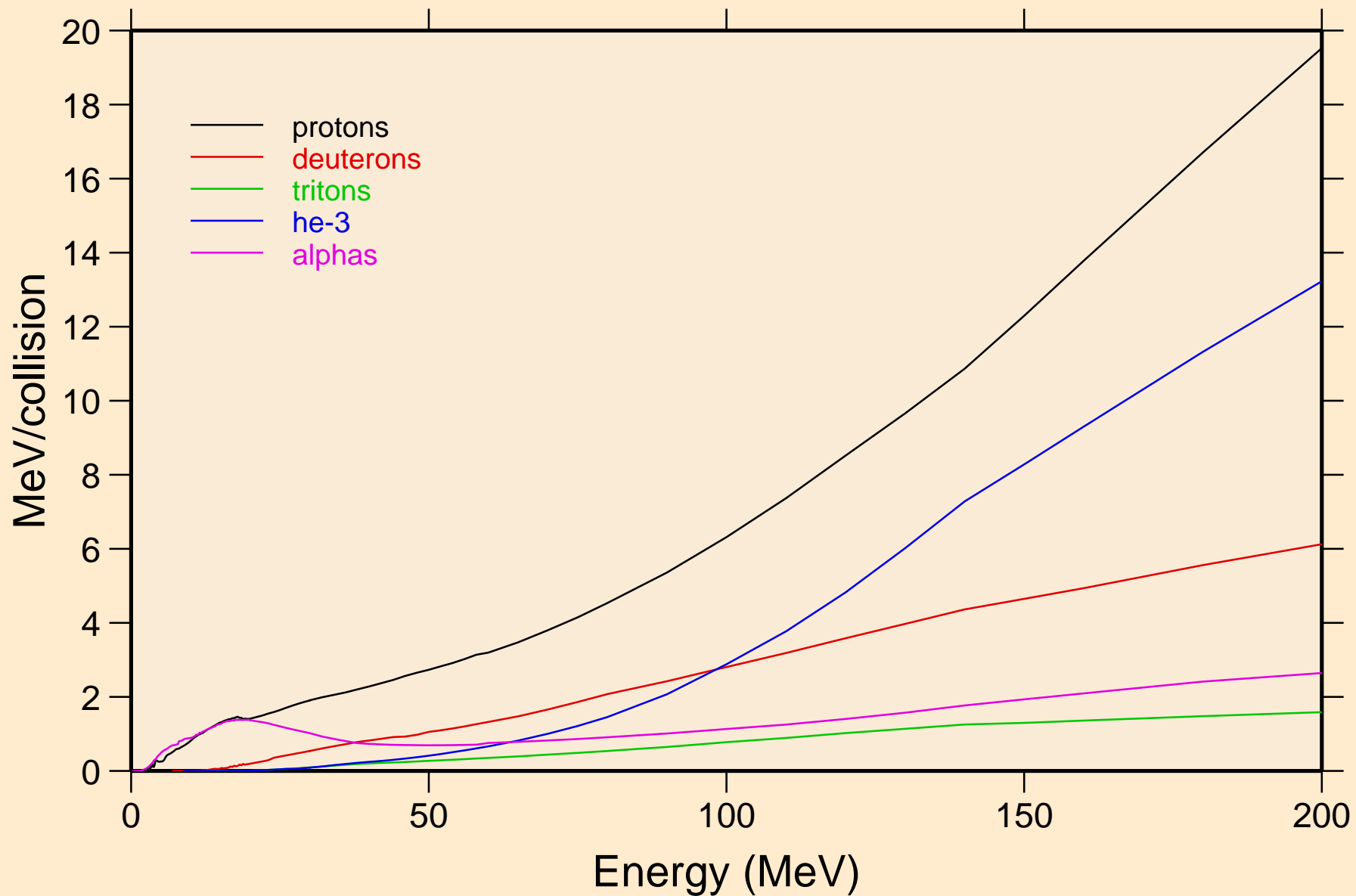

S032 NEUTRON ACER TENDL-2019 LIBRARY; T=293.16K  
Recoil Heating

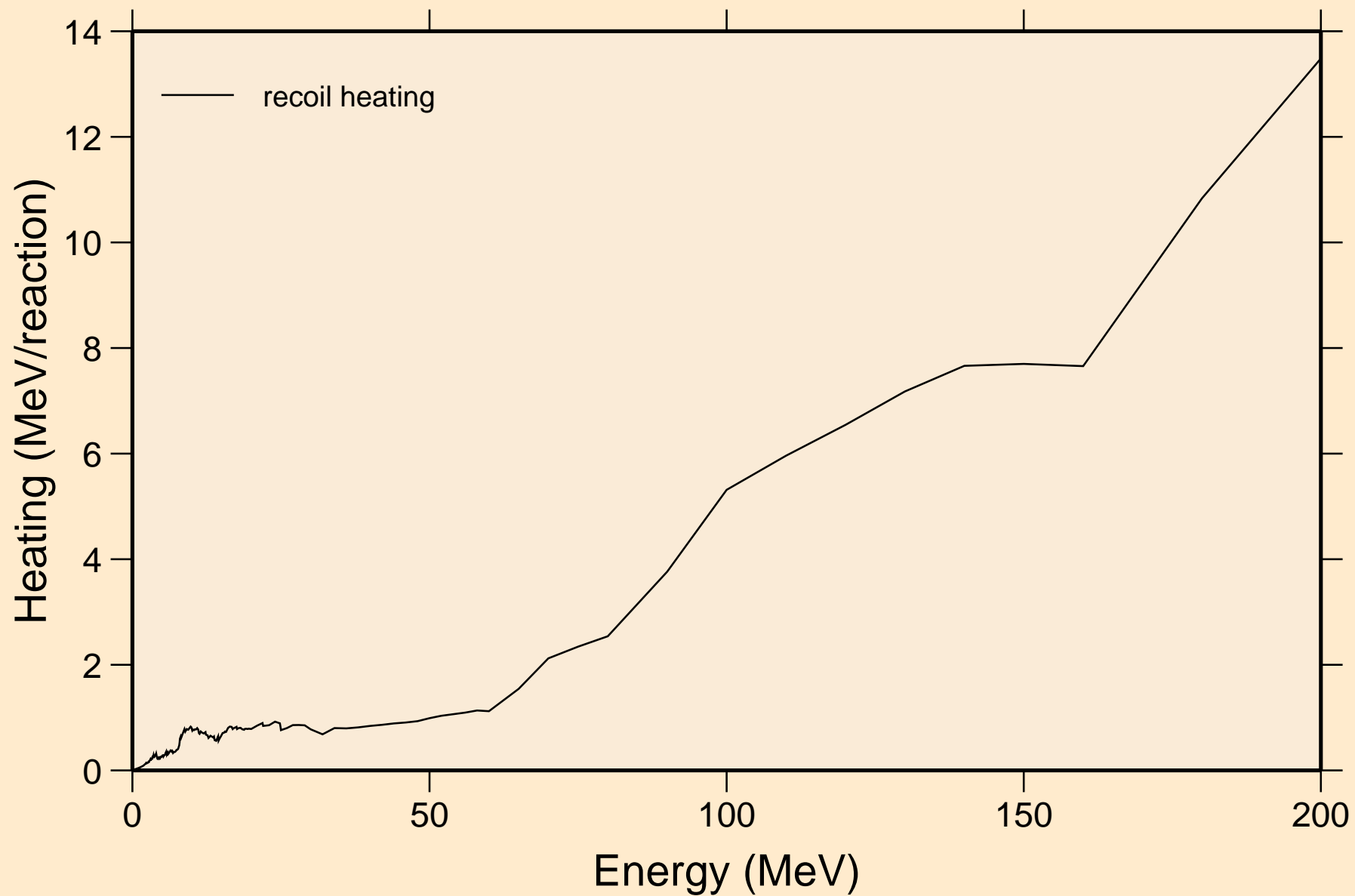

S032 NEUTRON ACER TENDL-2019 LIBRARY; T=293.16K  
Particle production cross sections

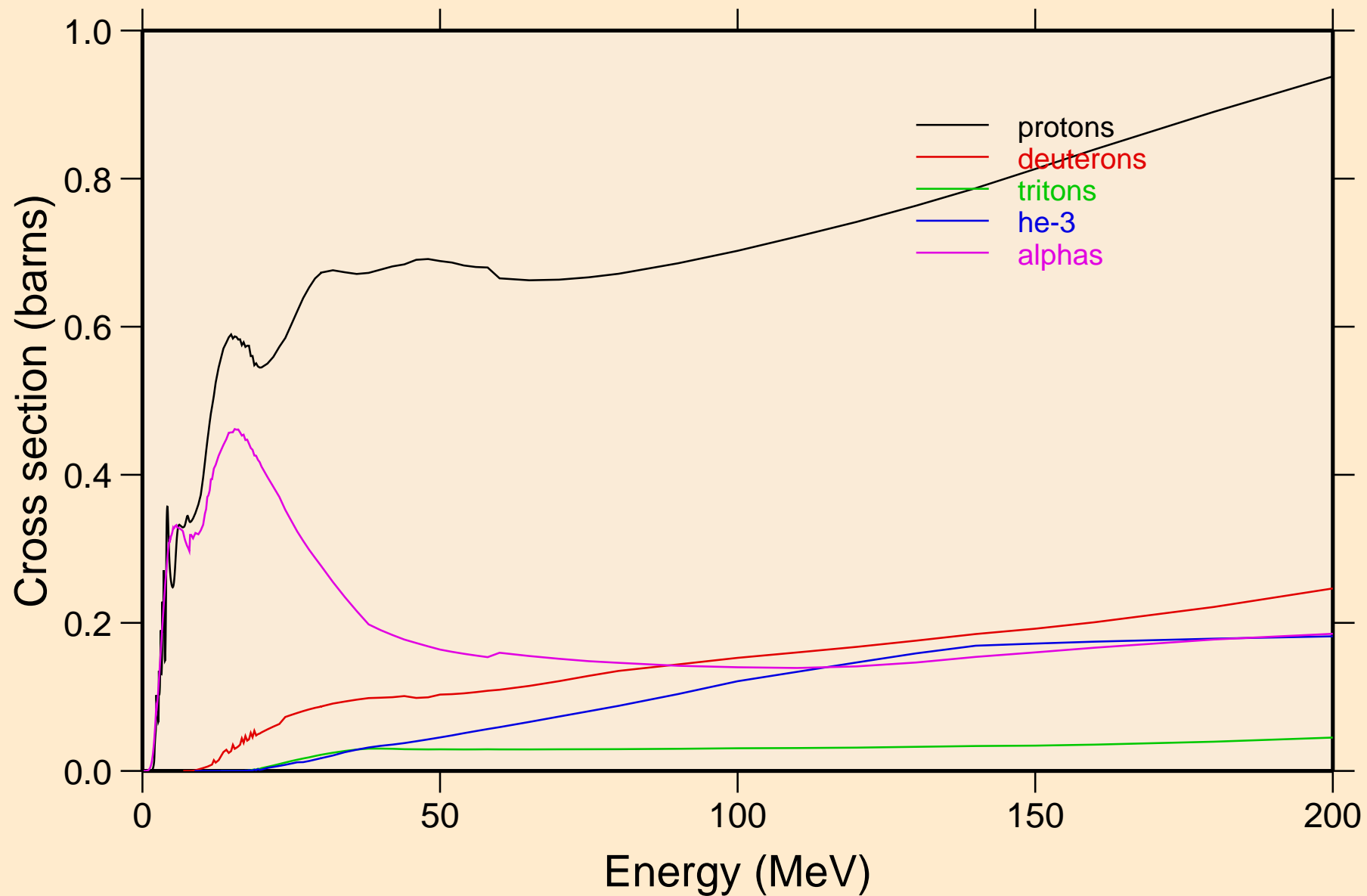

S032 NEUTRON ACER TENDL-2019 LIBRARY; T=293.16K  
protons from (n,x)

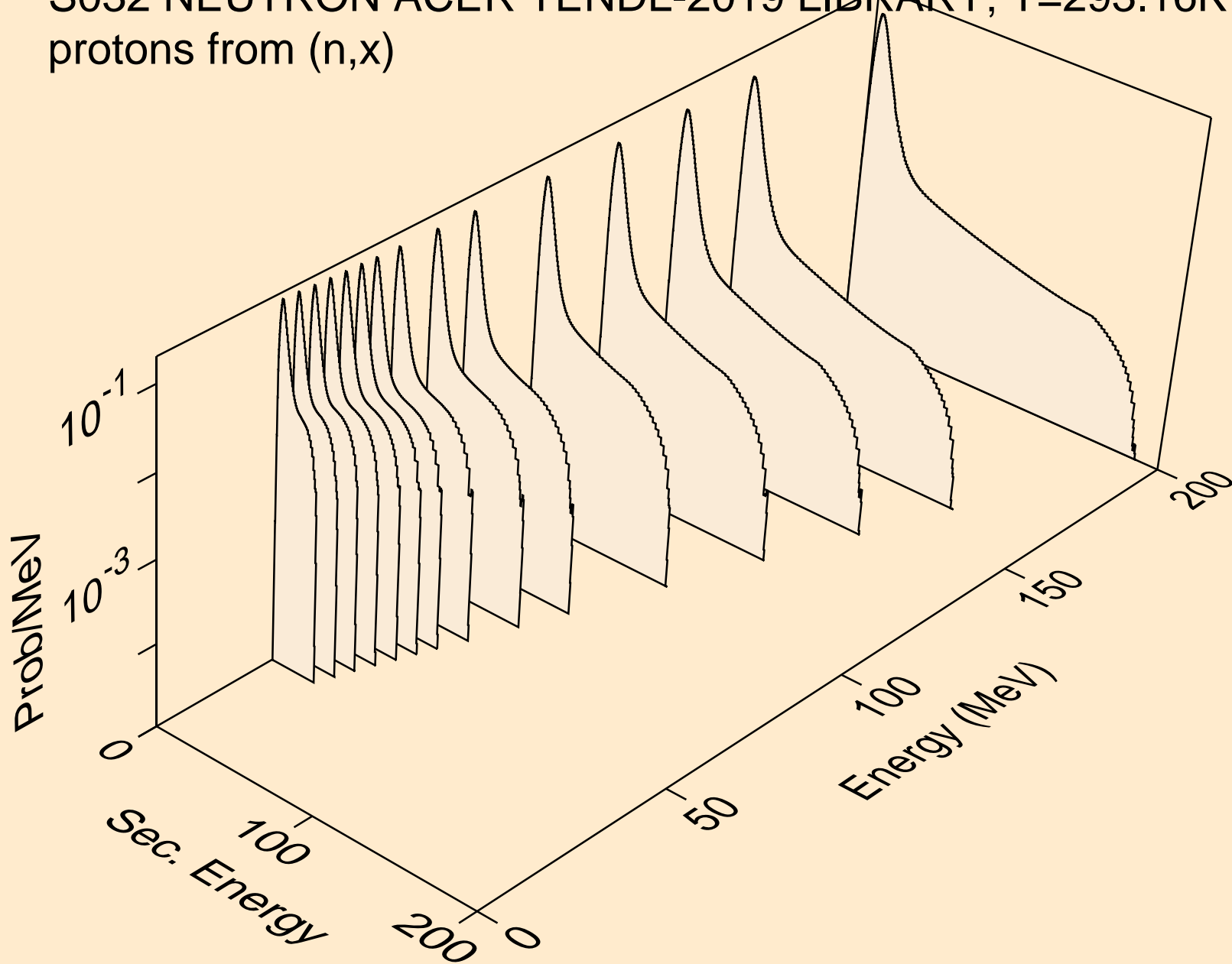

S032 NEUTRON ACER TENDL-2019 LIBRARY; T=293.16K  
protons from (n,n\*)p

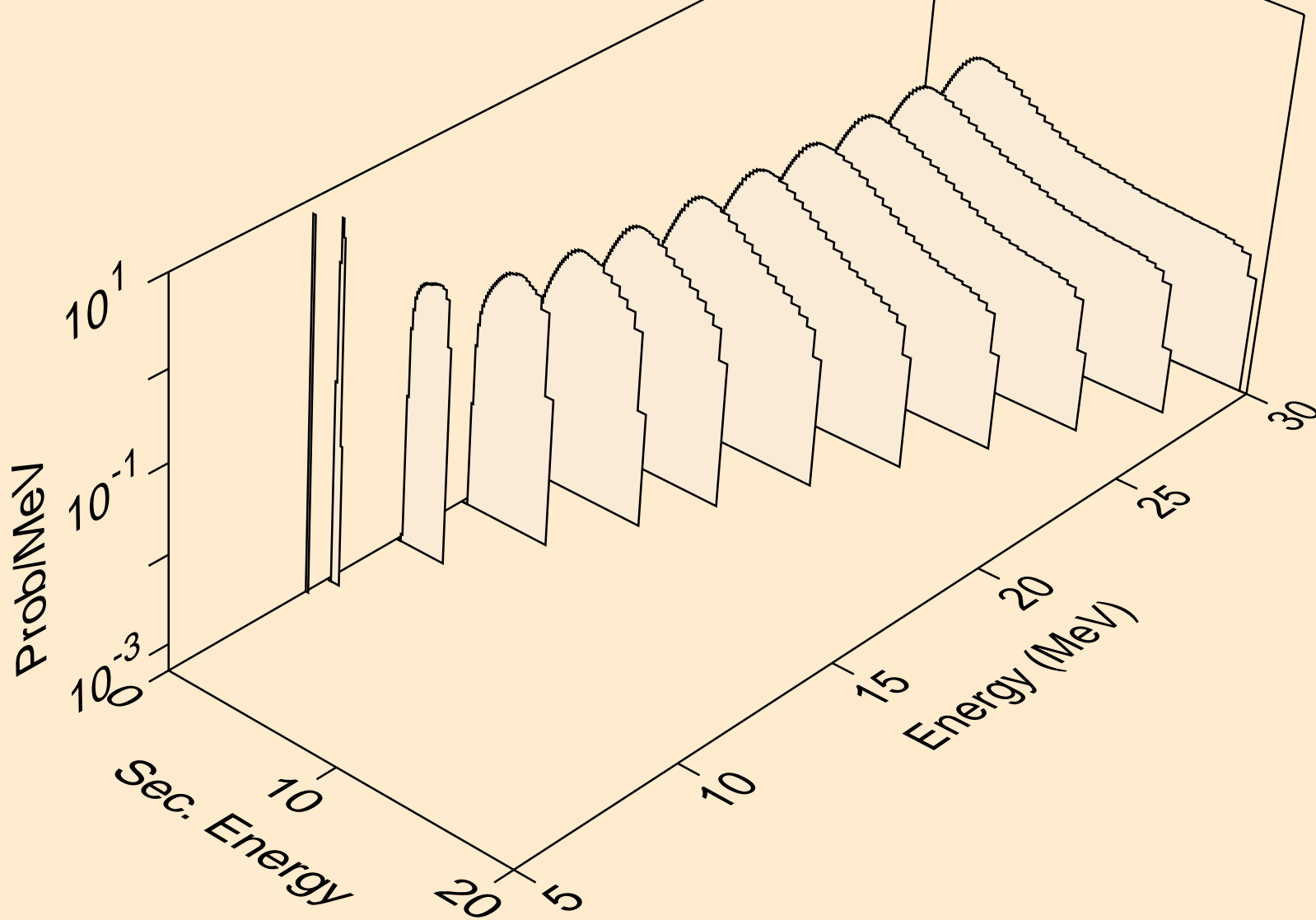

S032 NEUTRON ACER TENDL-2019 LIBRARY; T=293.16K  
protons from (n,2np)

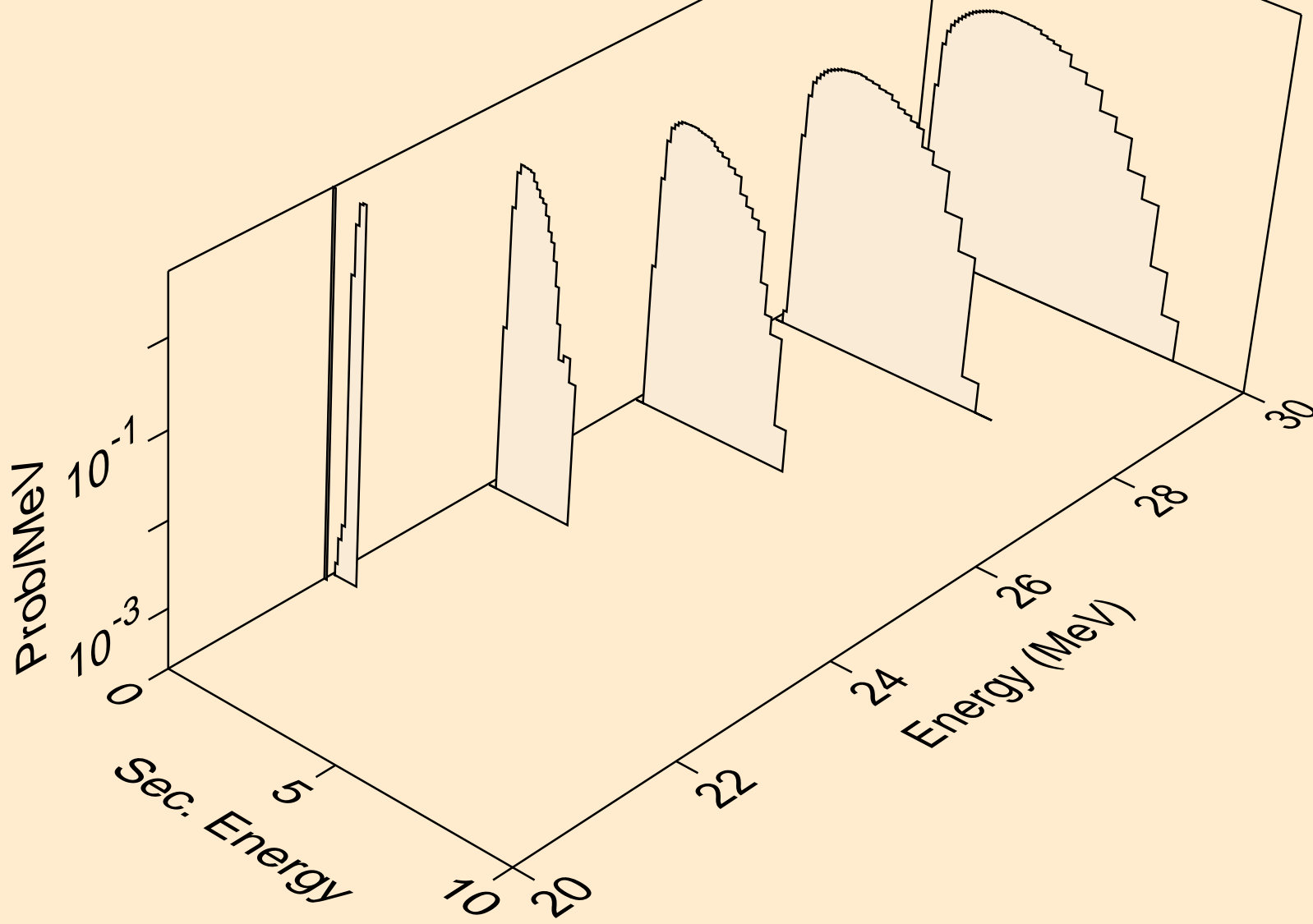



S032 NEUTRON ACER TENDL-2019 LIBRARY; T=293.16K  
protons from (n,2np)

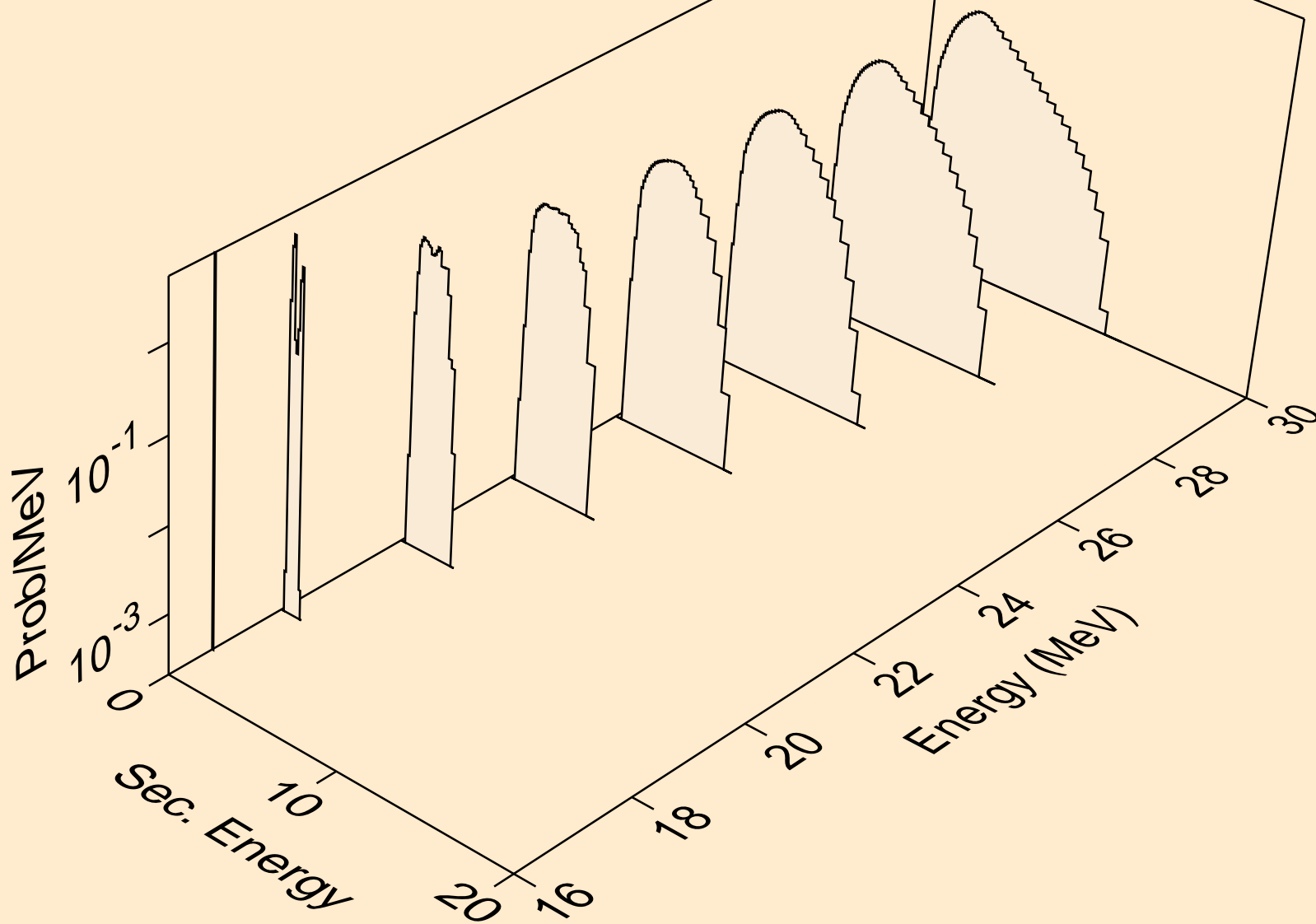

S032 NEUTRON ACER TENDL-2019 LIBRARY; T=293.16K  
protons from (n,npa)

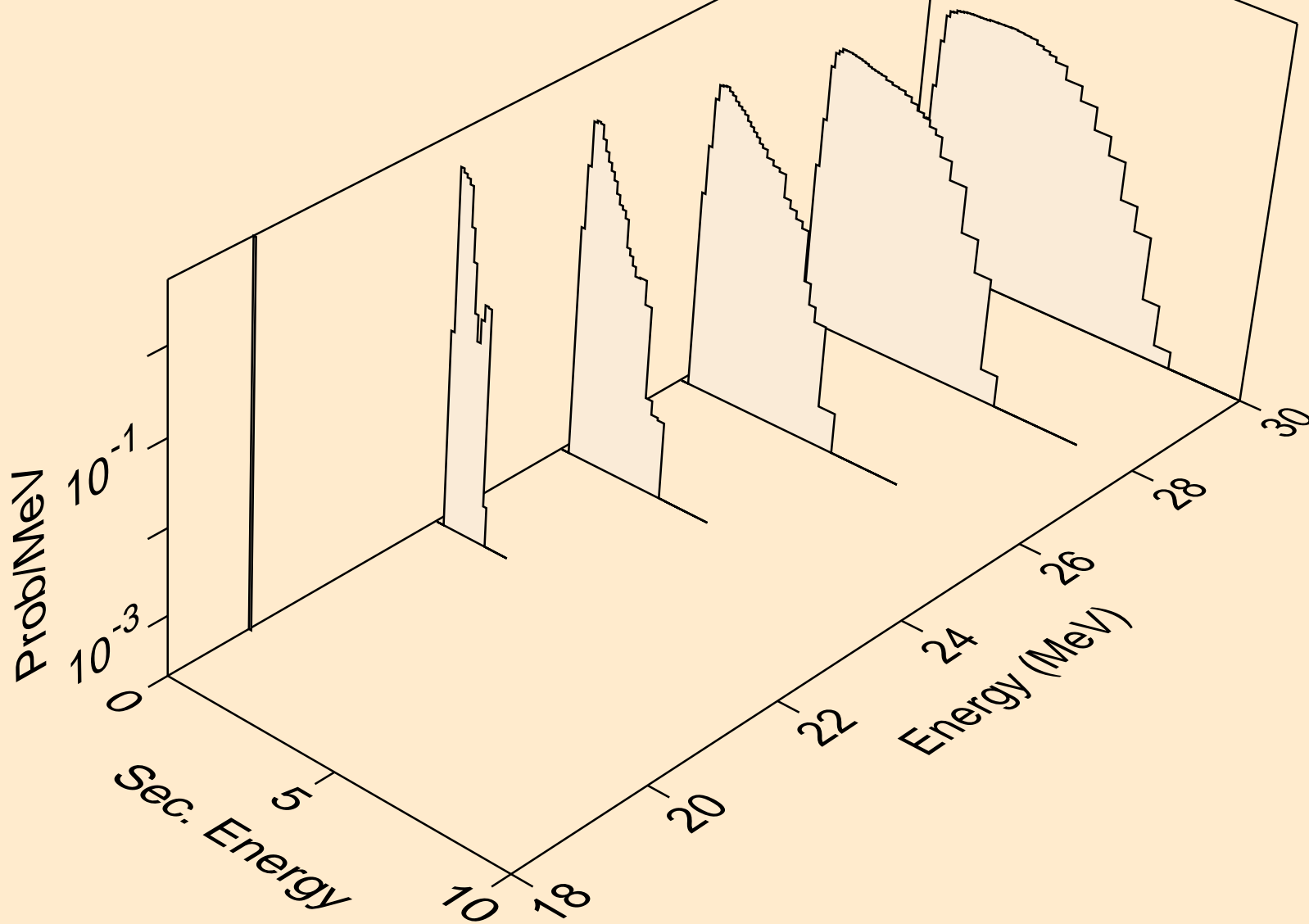

S032 NEUTRON ACER TENDL-2019 LIBRARY; T=293.16K  
protons from (n,p)

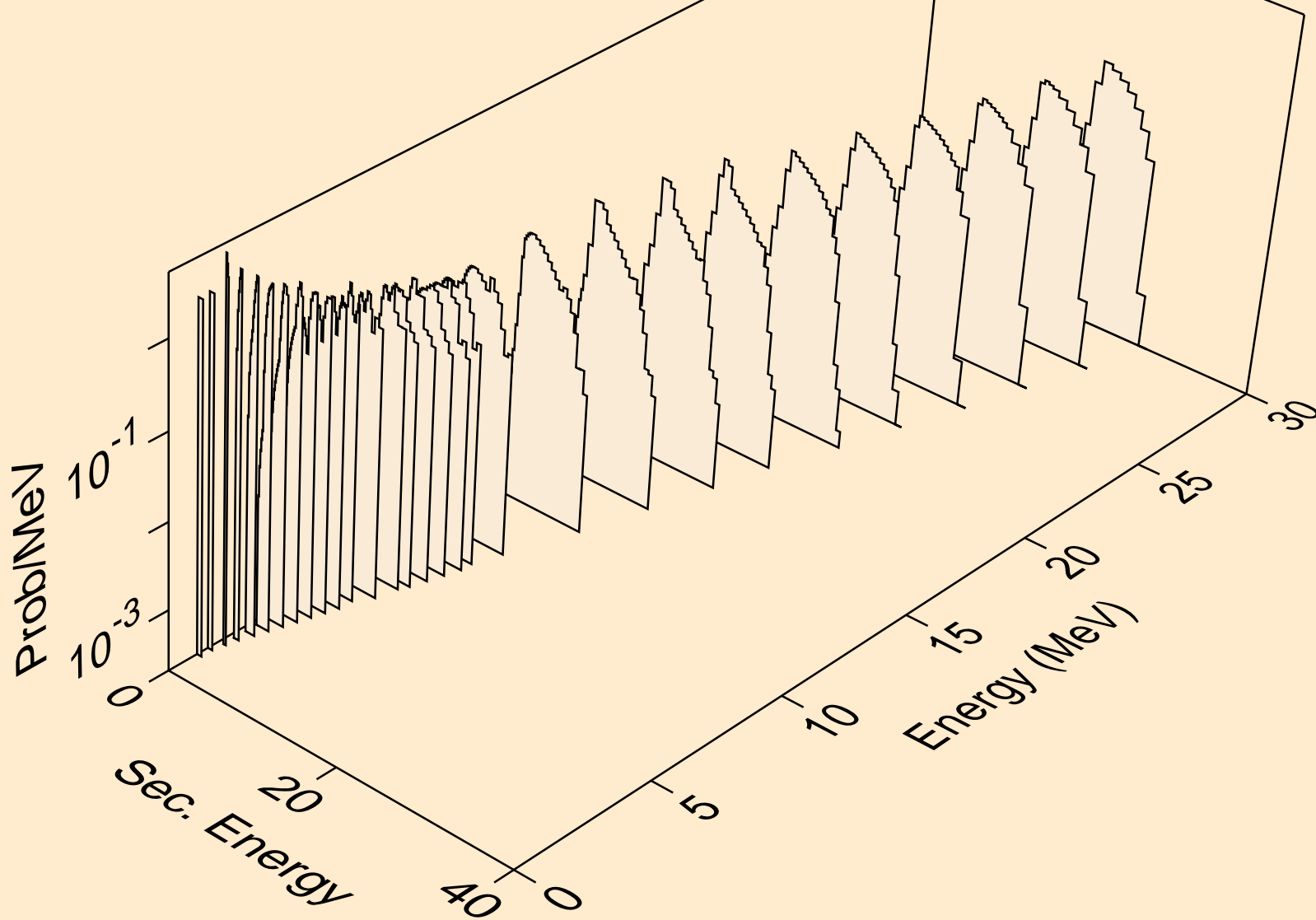

S032 NEUTRON ACER TENDL-2019 LIBRARY; T=293.16K  
protons from (n,2p)

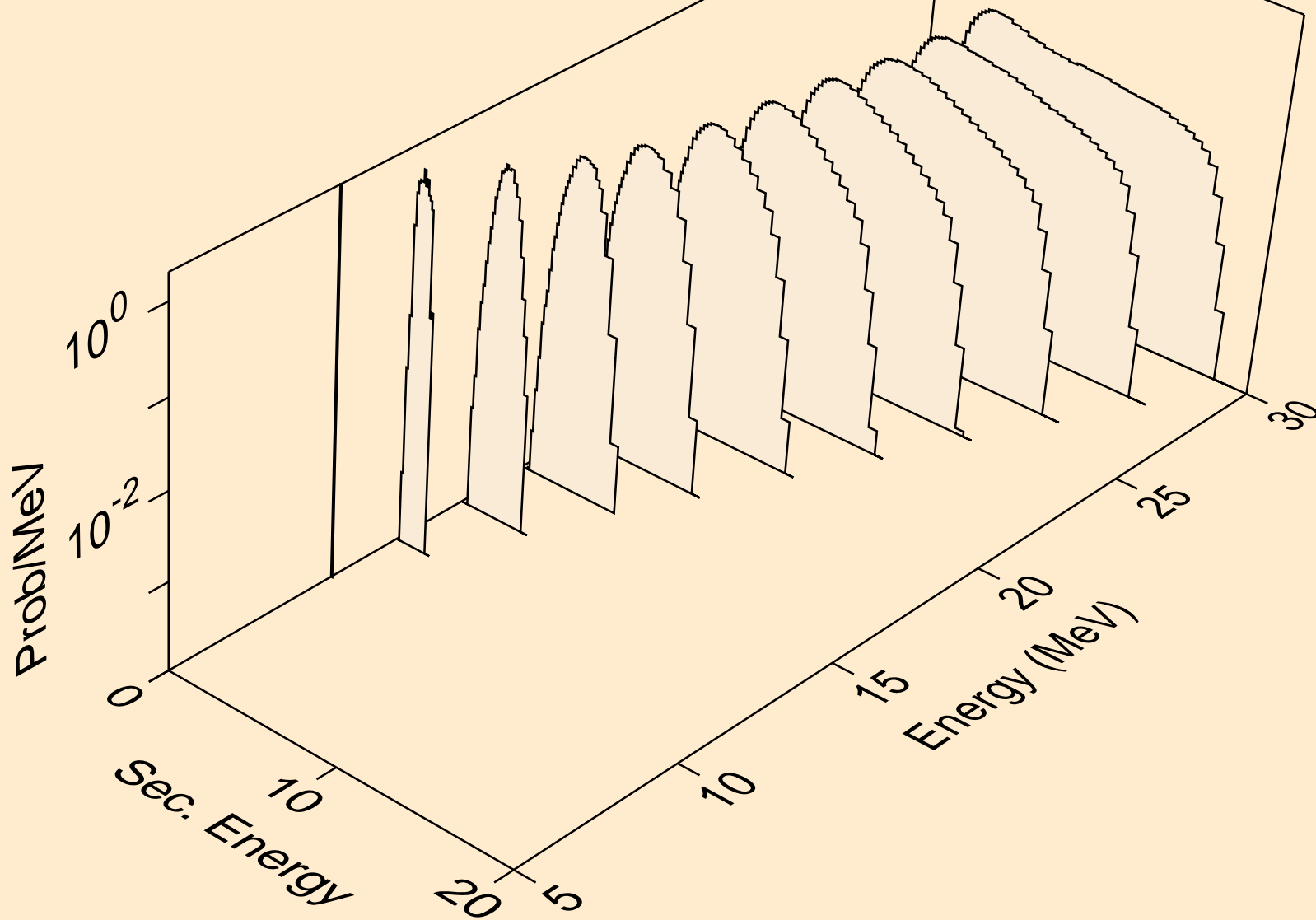

S032 NEUTRON ACER TENDL-2019 LIBRARY; T=293.16K  
protons from (n,p)

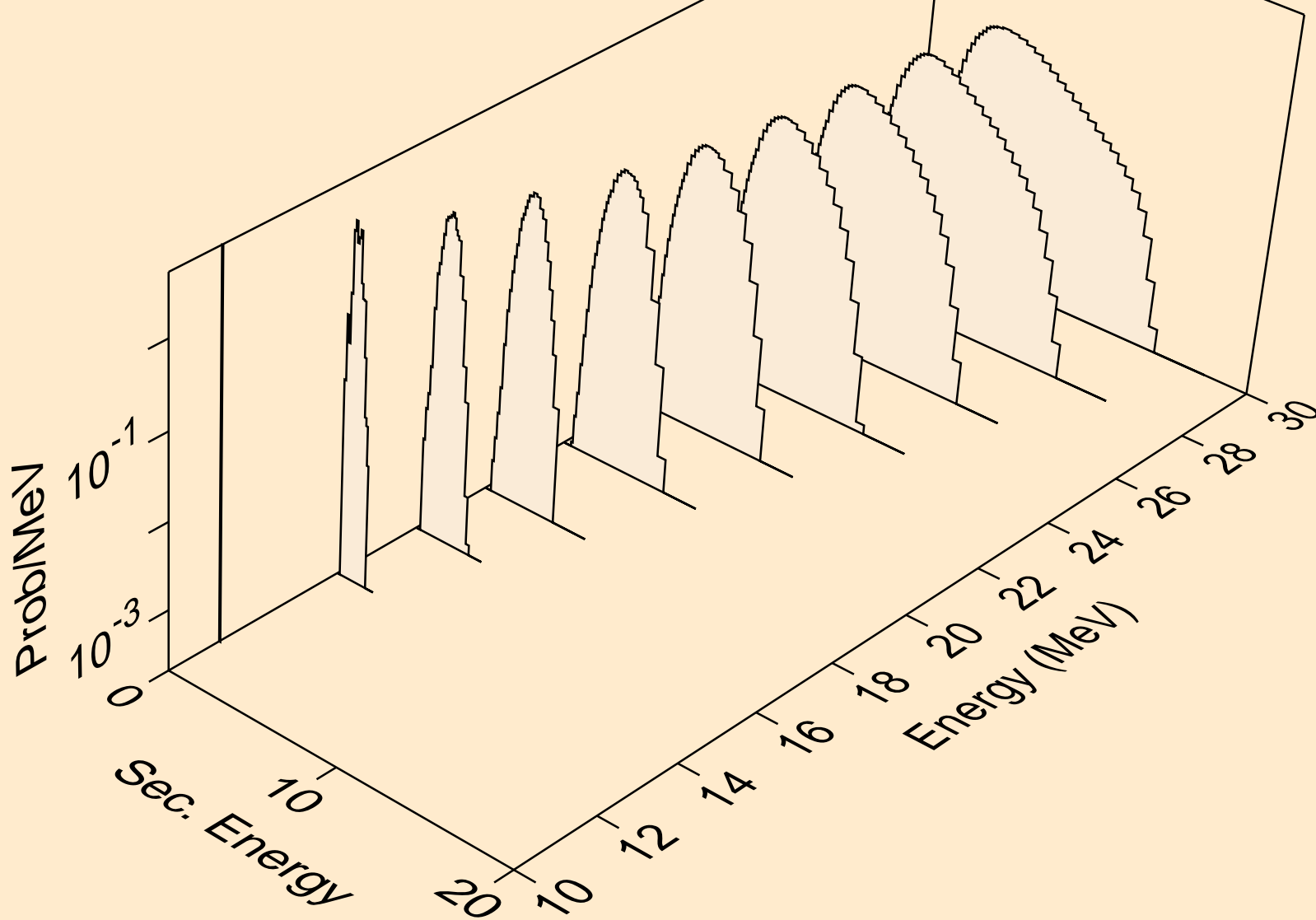

S032 NEUTRON ACER TENDL-2019 LIBRARY; T=293.16K  
protons from (n,pd)

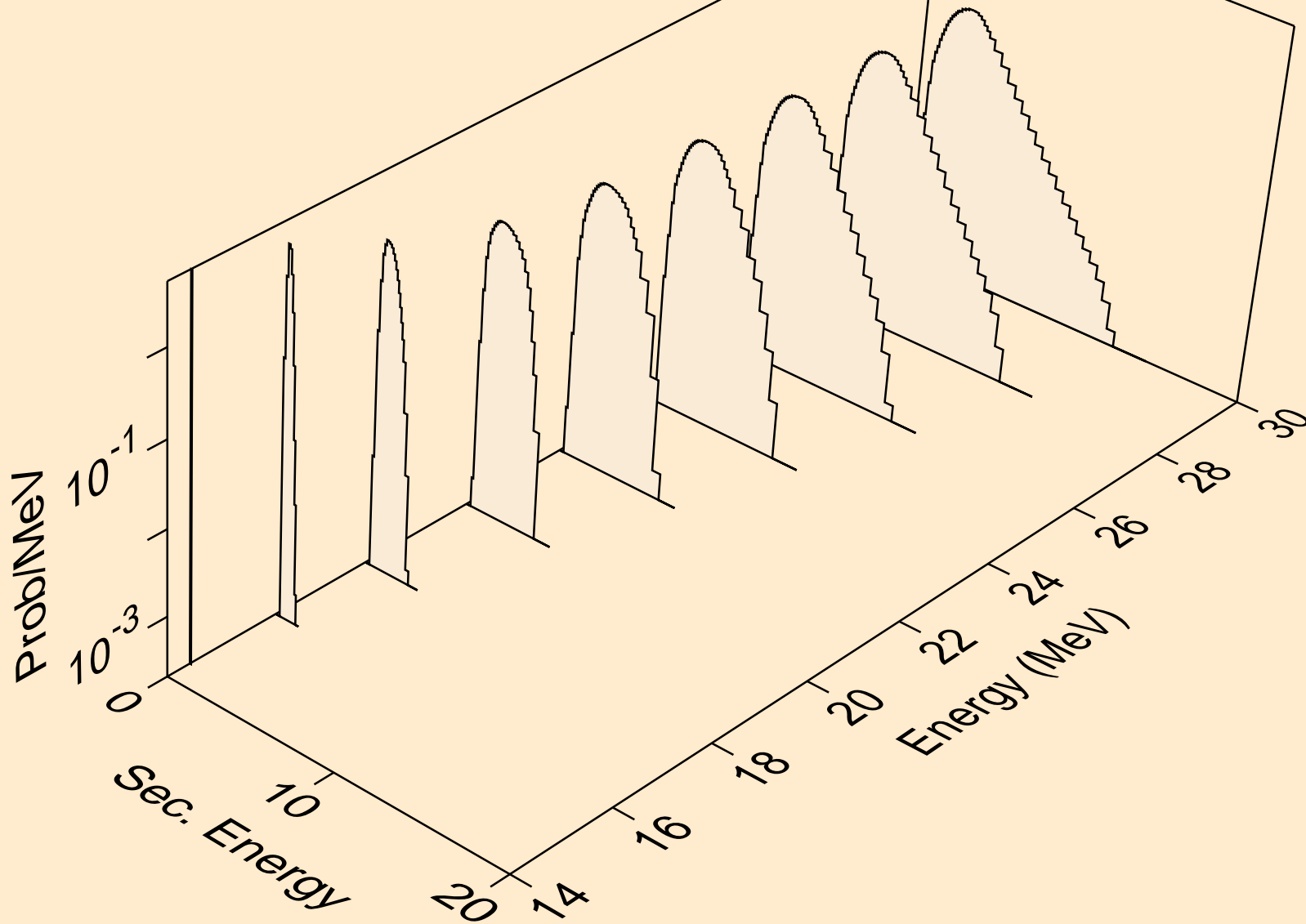

S032 NEUTRON ACER TENDL-2019 LIBRARY; T=293.16K  
protons from (n,pt)

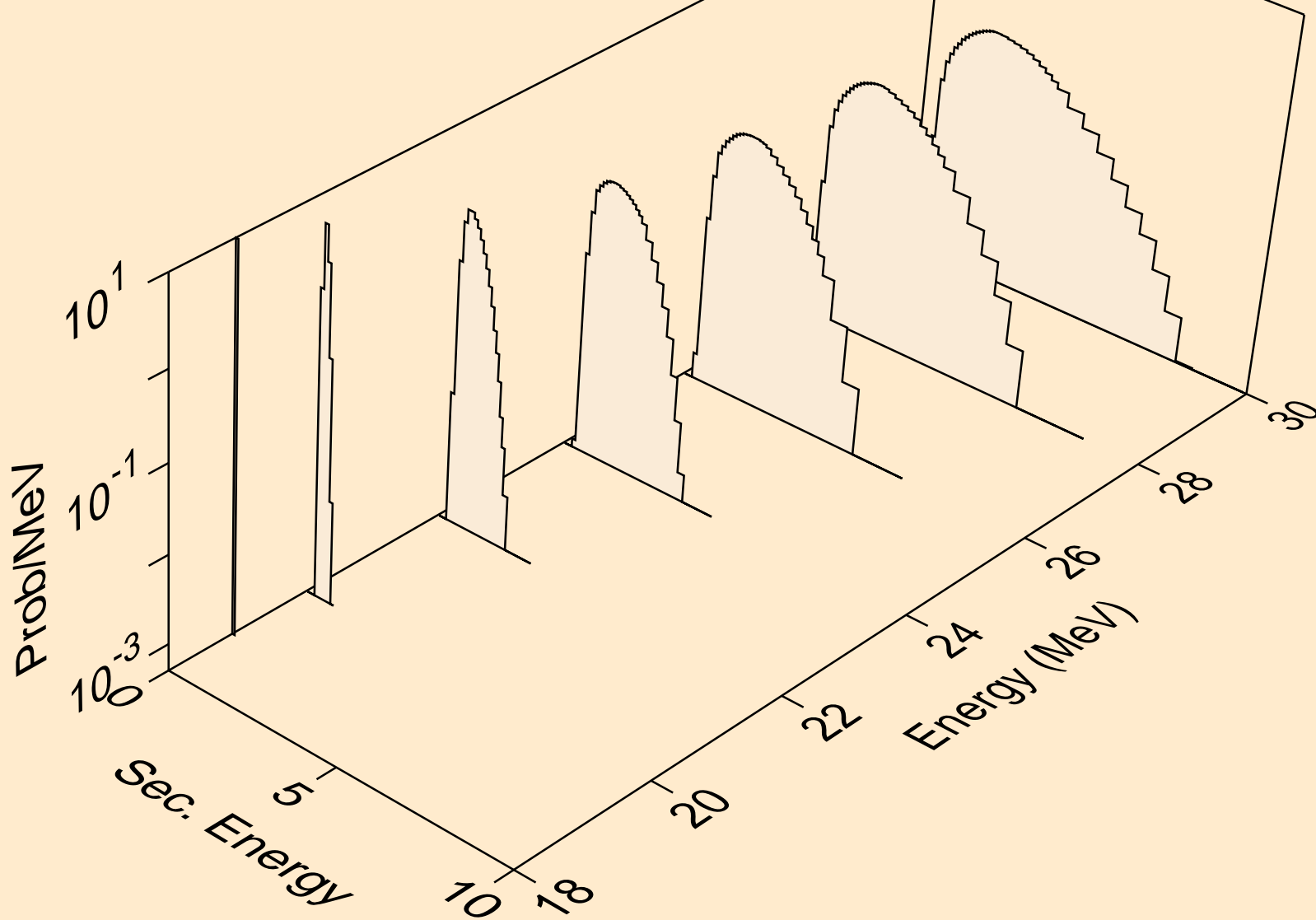

S032 NEUTRON ACER TENDL-2019 LIBRARY; T=293.16K  
deuterons from (n,x)

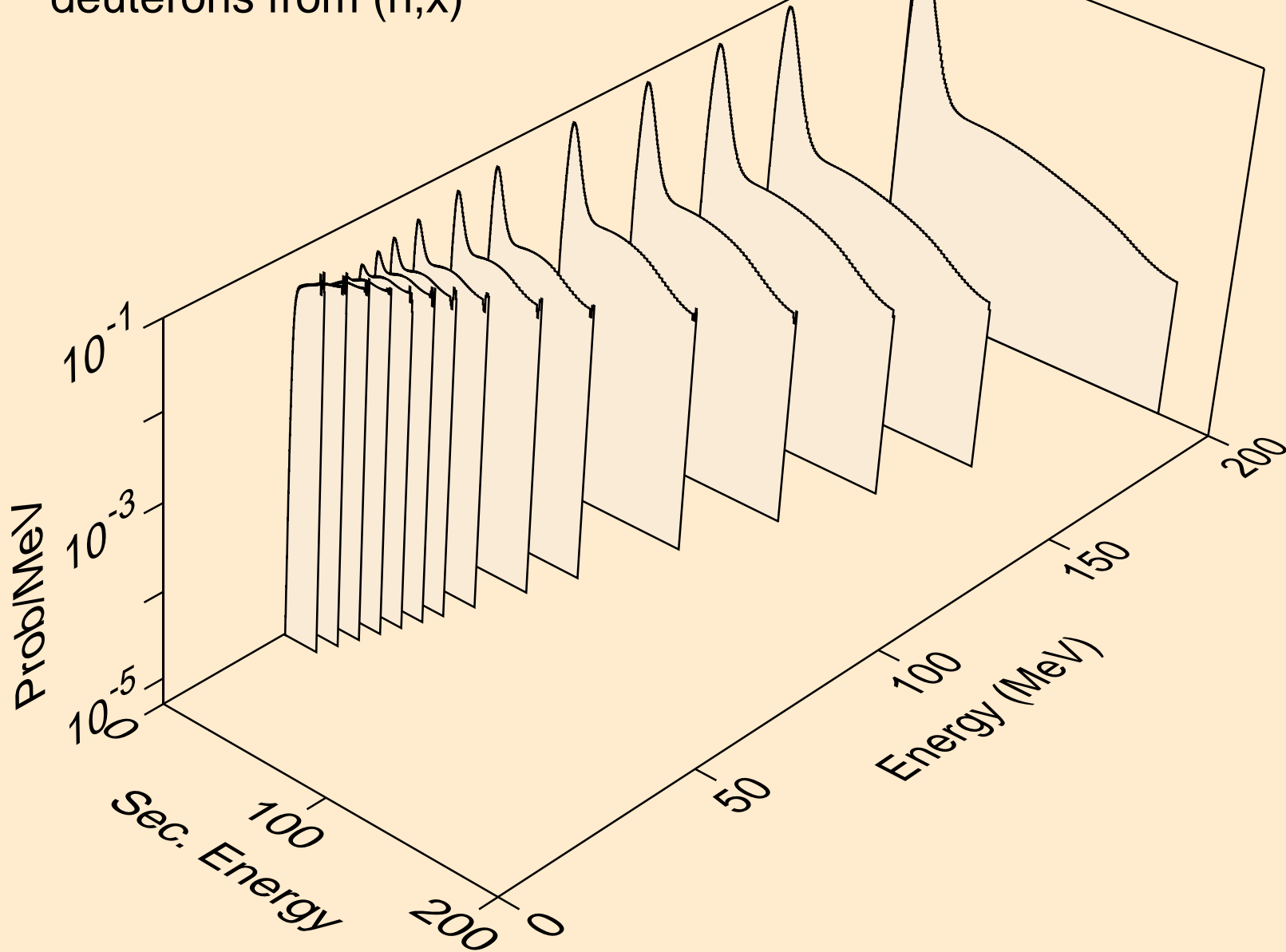



S032 NEUTRON ACER TENDL-2019 LIBRARY; T=293.16K  
deuterons from (n,n\*)d

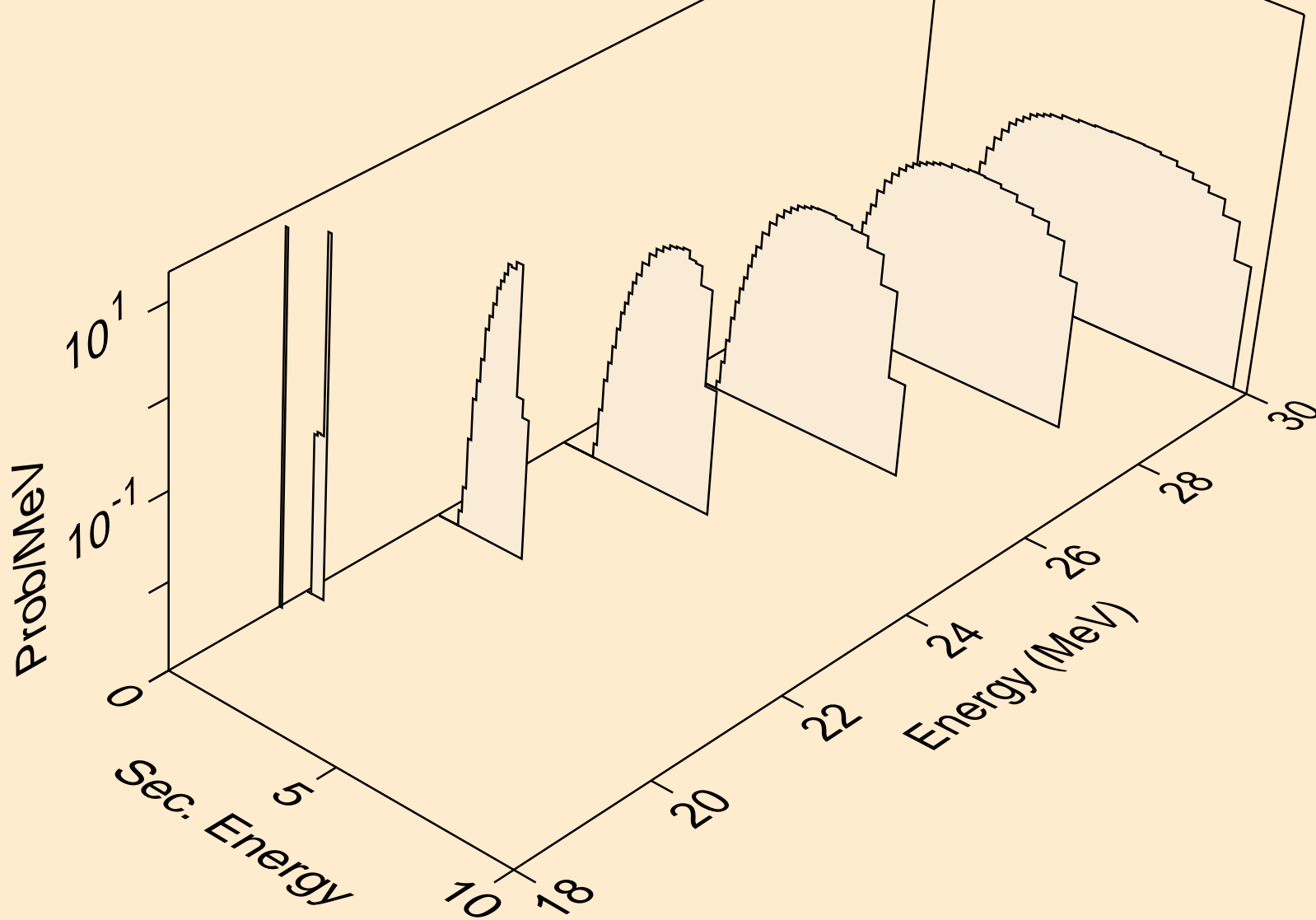

S032 NEUTRON ACER TENDL-2019 LIBRARY; T=293.16K  
deuterons from (n,d)

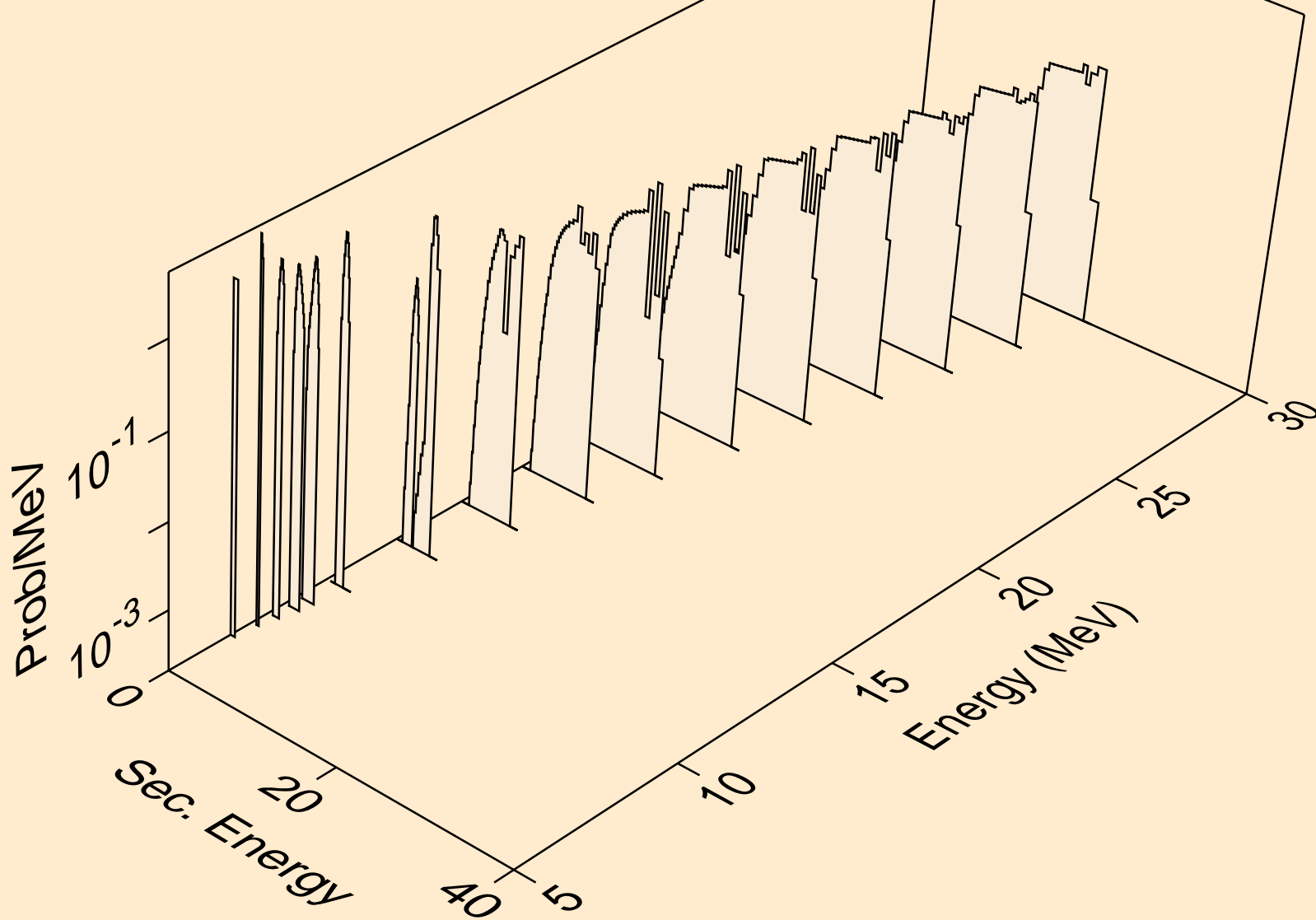

S032 NEUTRON ACER TENDL-2019 LIBRARY; T=293.16K  
deuterons from (n,pd)

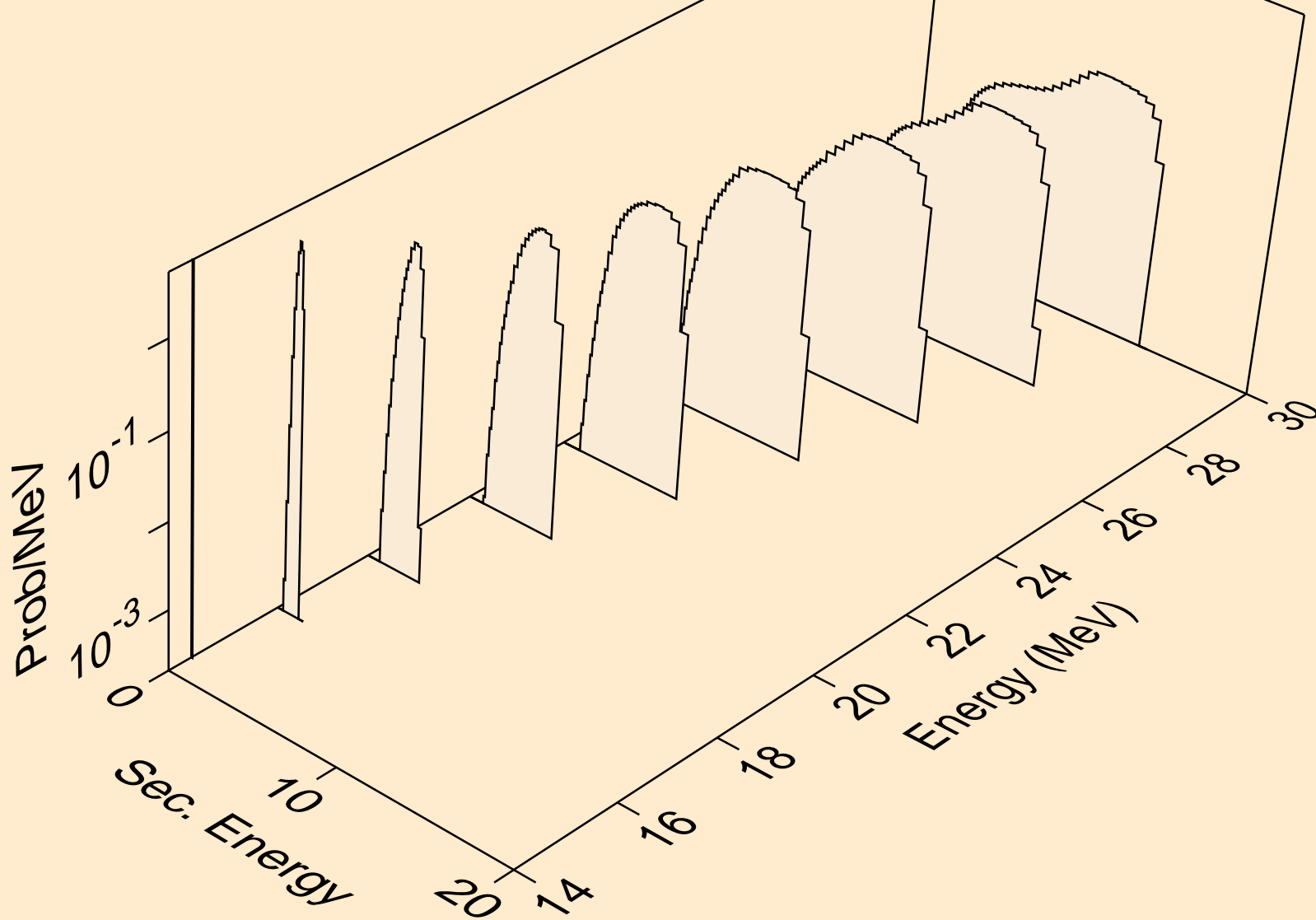

S032 NEUTRON ACER TENDL-2019 LIBRARY; T=293.16K  
deuterons from (n,da)

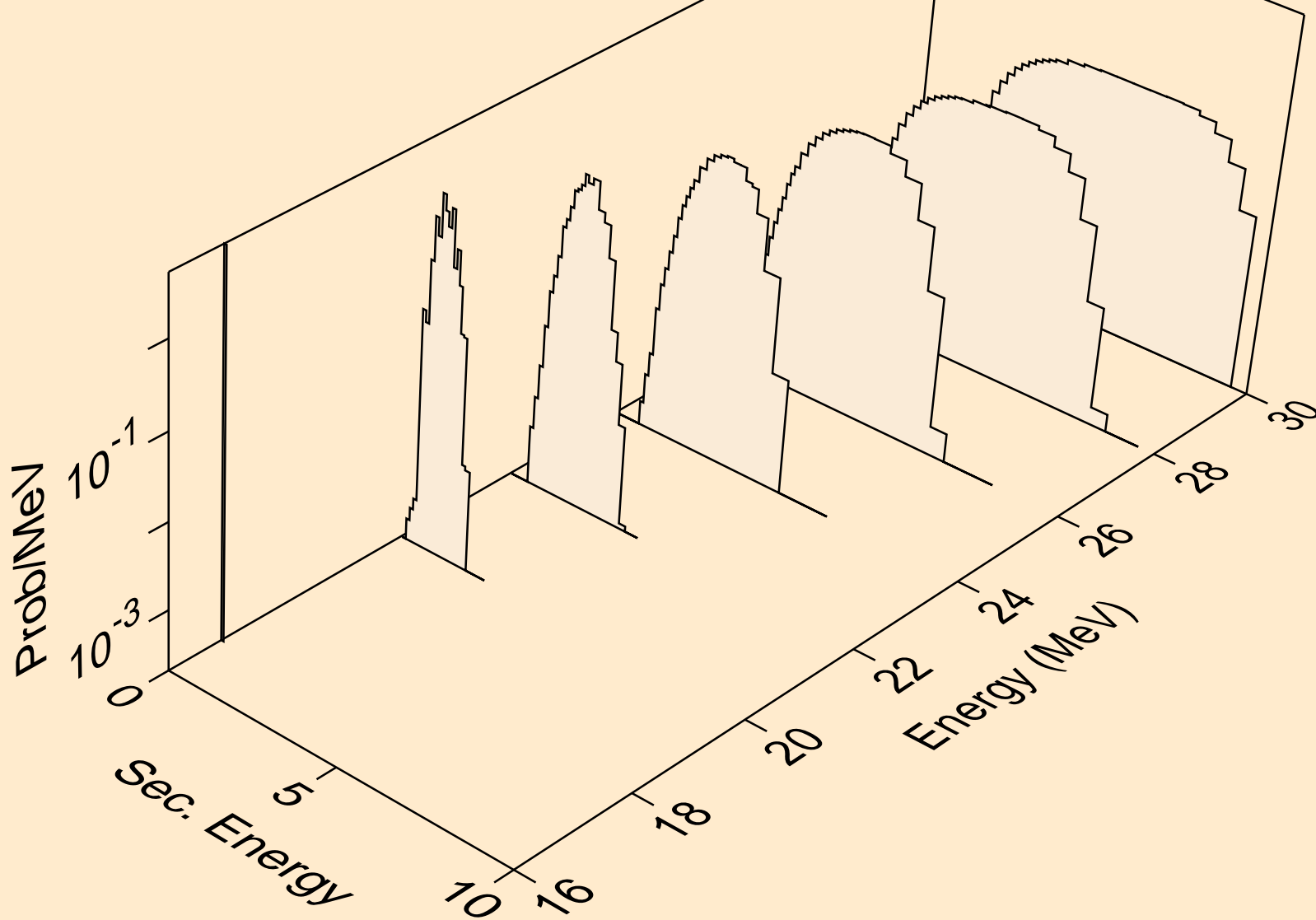

S032 NEUTRON ACER TENDL-2019 LIBRARY; T=293.16K  
tritons from (n,x)

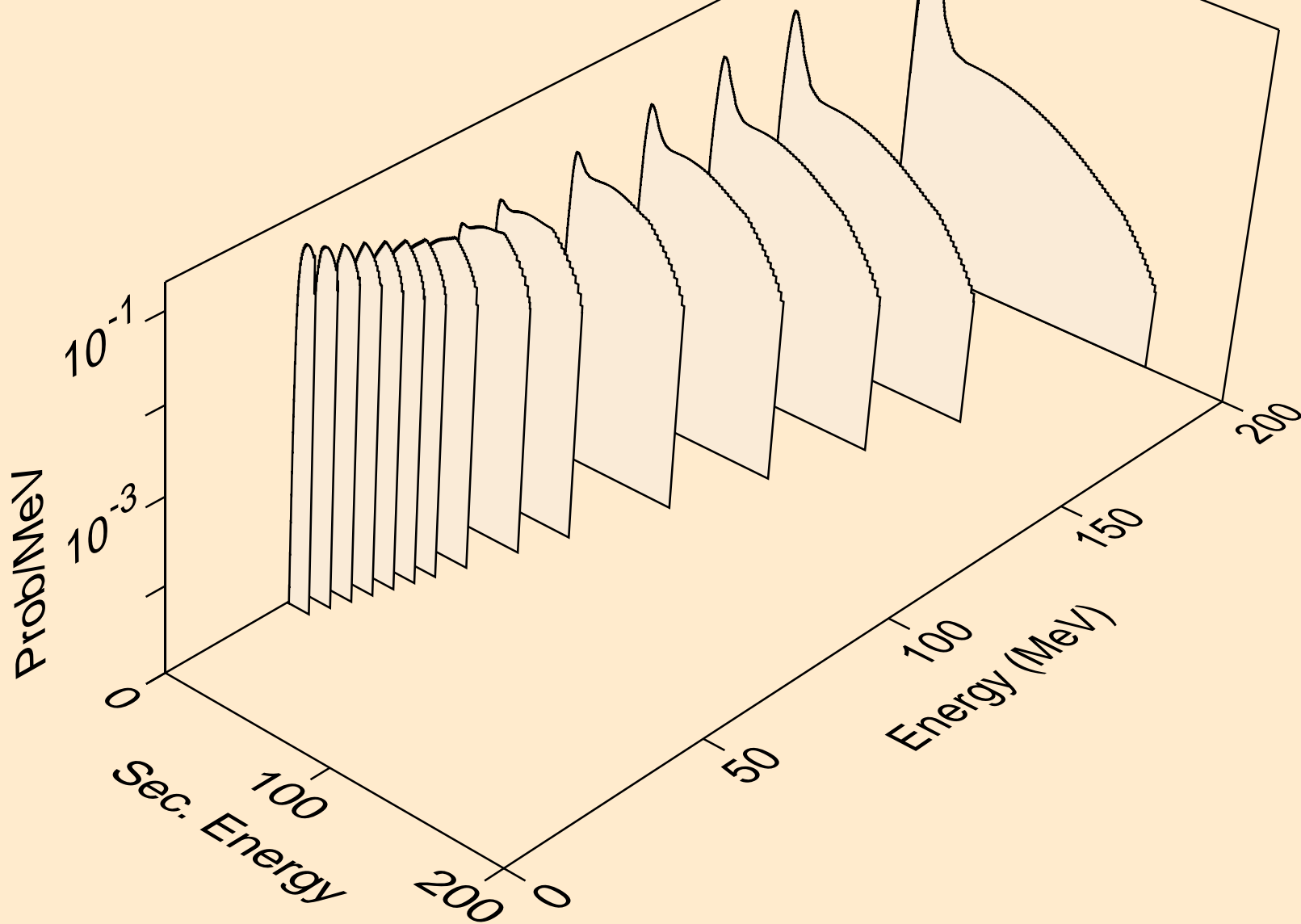

S032 NEUTRON ACER TENDL-2019 LIBRARY; T=293.16K  
tritons from (n,n\*)t

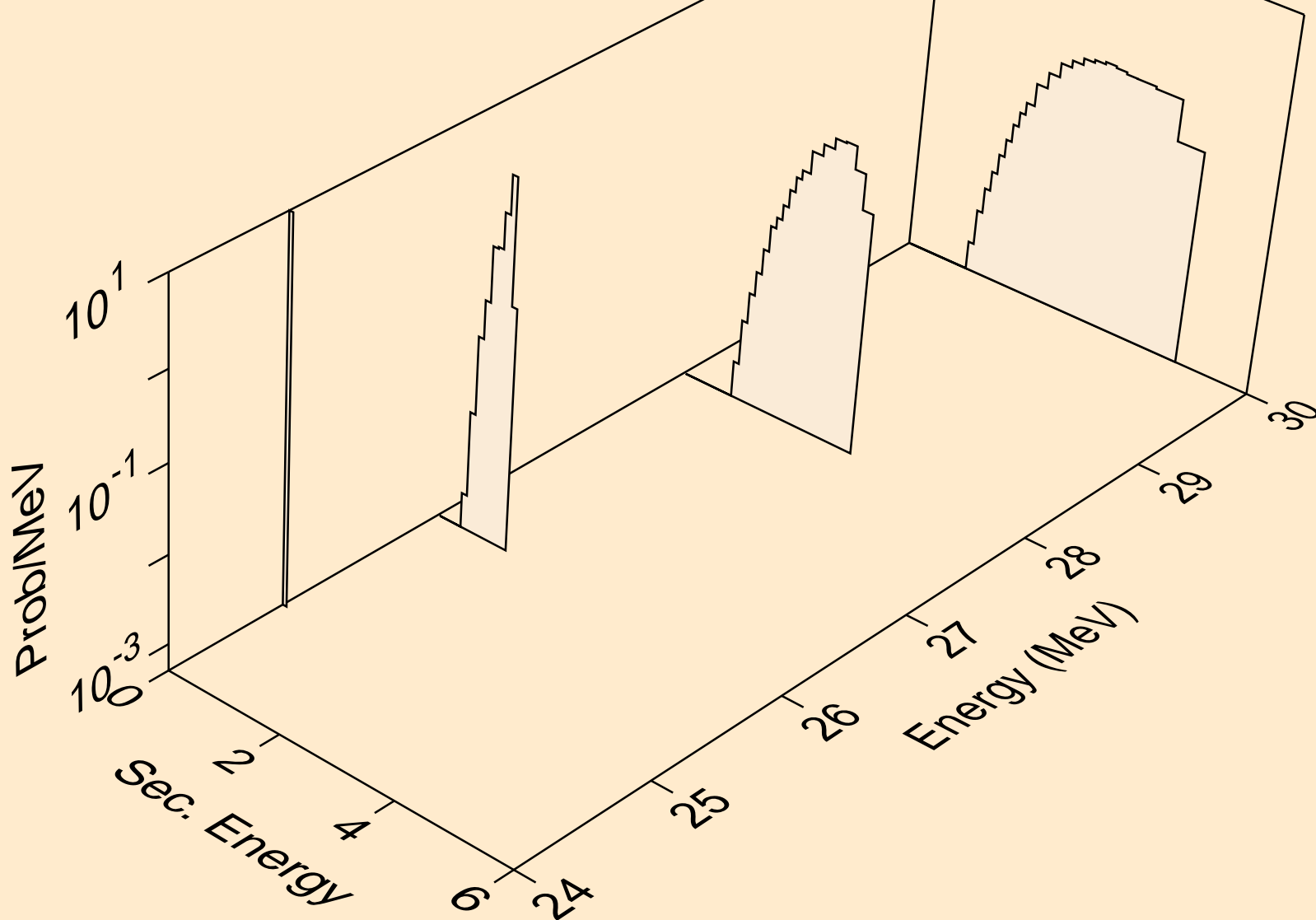

S032 NEUTRON ACER TENDL-2019 LIBRARY; T=293.16K  
tritons from (n,t)

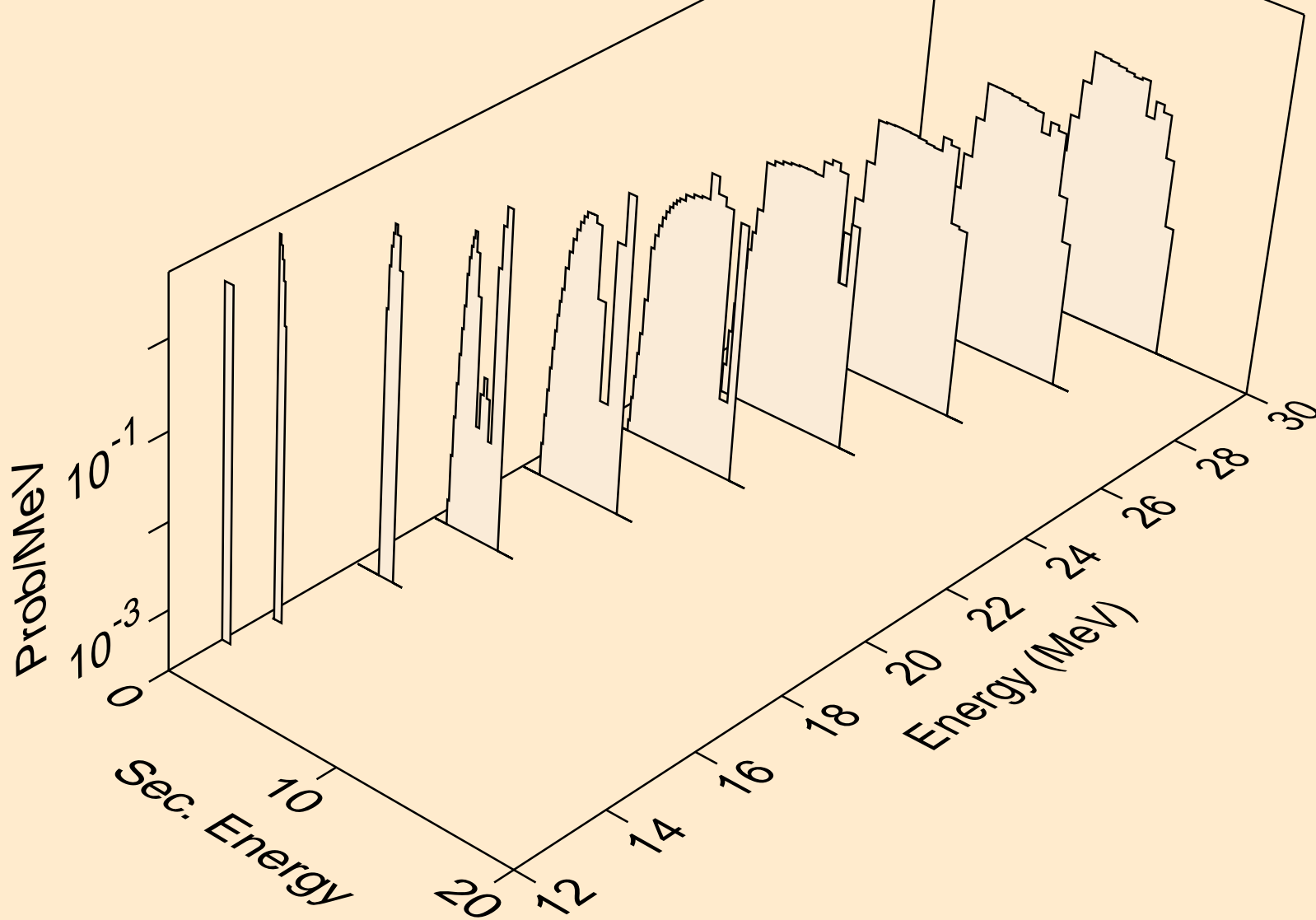

S032 NEUTRON ACER TENDL-2019 LIBRARY; T=293.16K  
tritons from (n,pt)

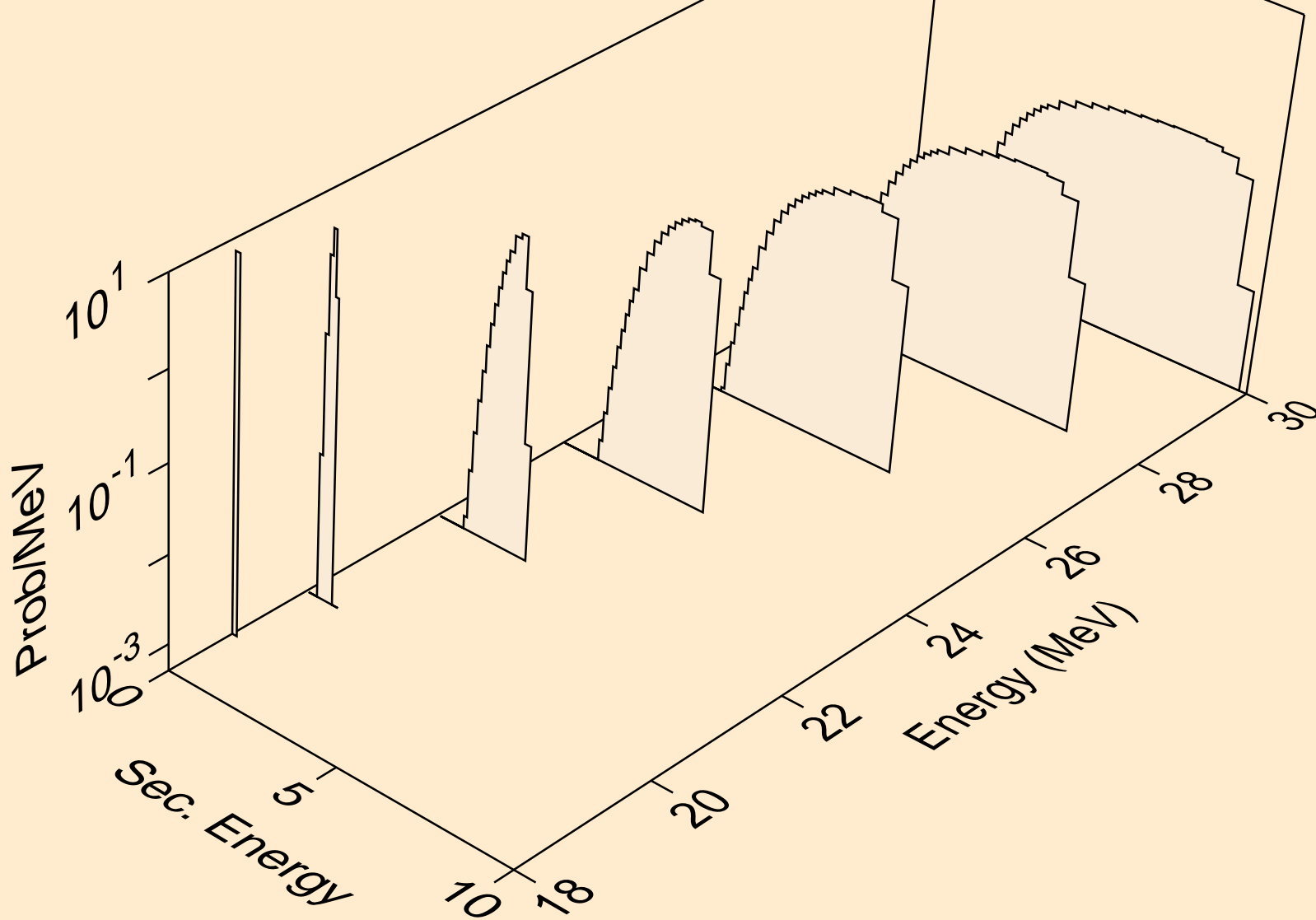



S032 NEUTRON ACER TENDL-2019 LIBRARY; T=293.16K  
he3s from (n,x)

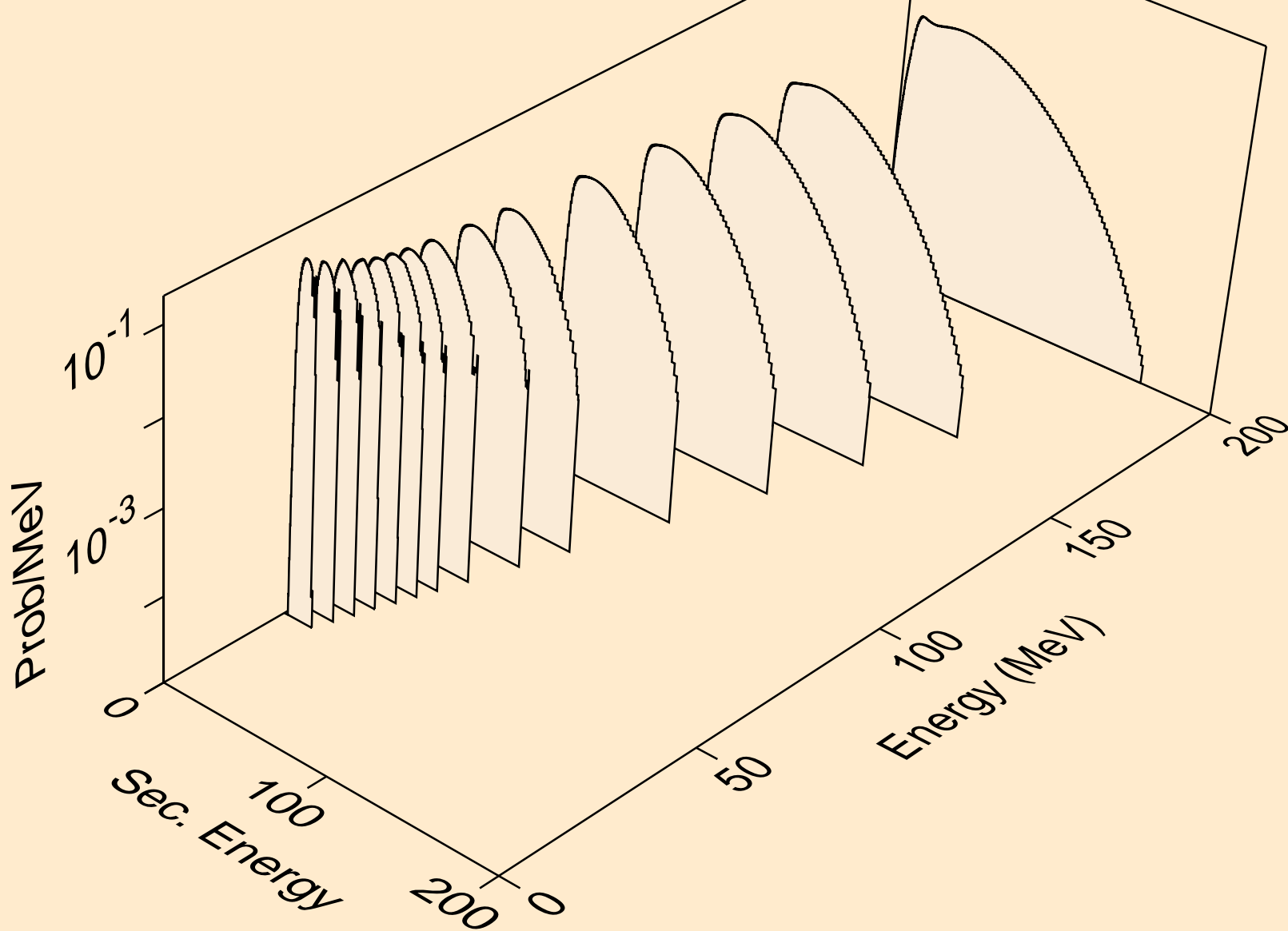

S032 NEUTRON ACER TENDL-2019 LIBRARY; T=293.16K  
he3s from (n,n\*)he3

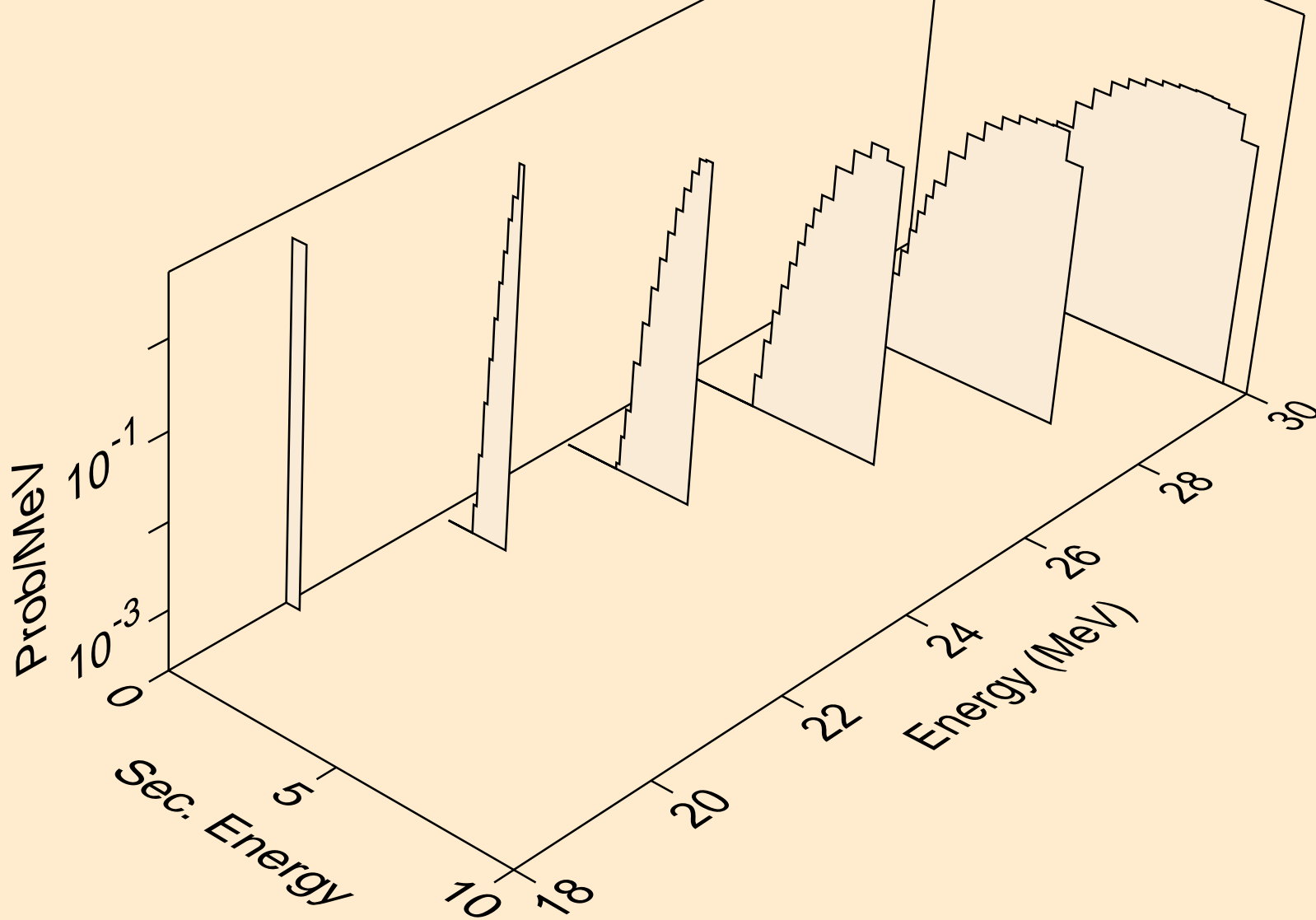

S032 NEUTRON ACER TENDL-2019 LIBRARY; T=293.16K  
he3s from (n,he3)

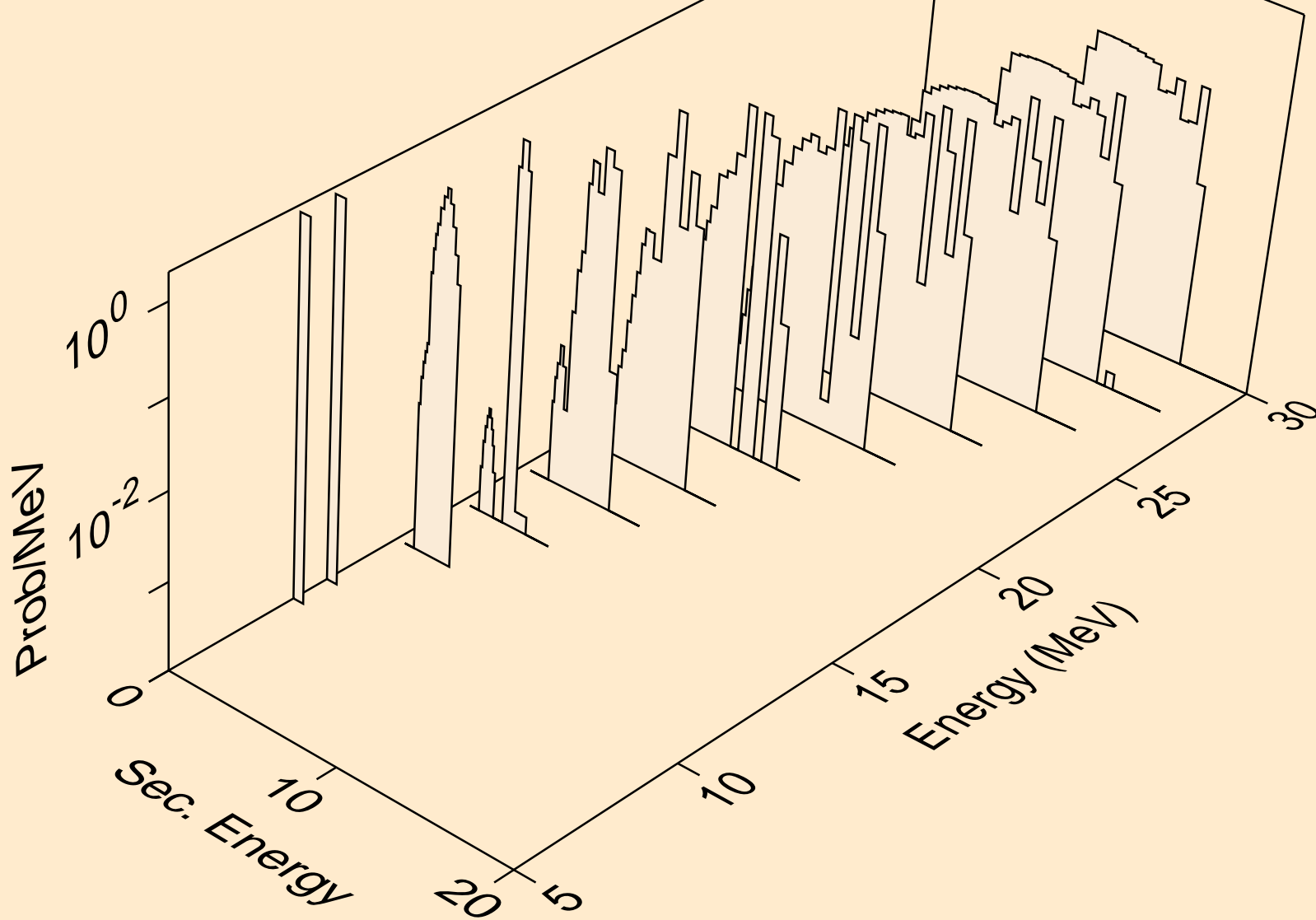

S032 NEUTRON ACER TENDL-2019 LIBRARY; T=293.16K  
alphas from (n,x)

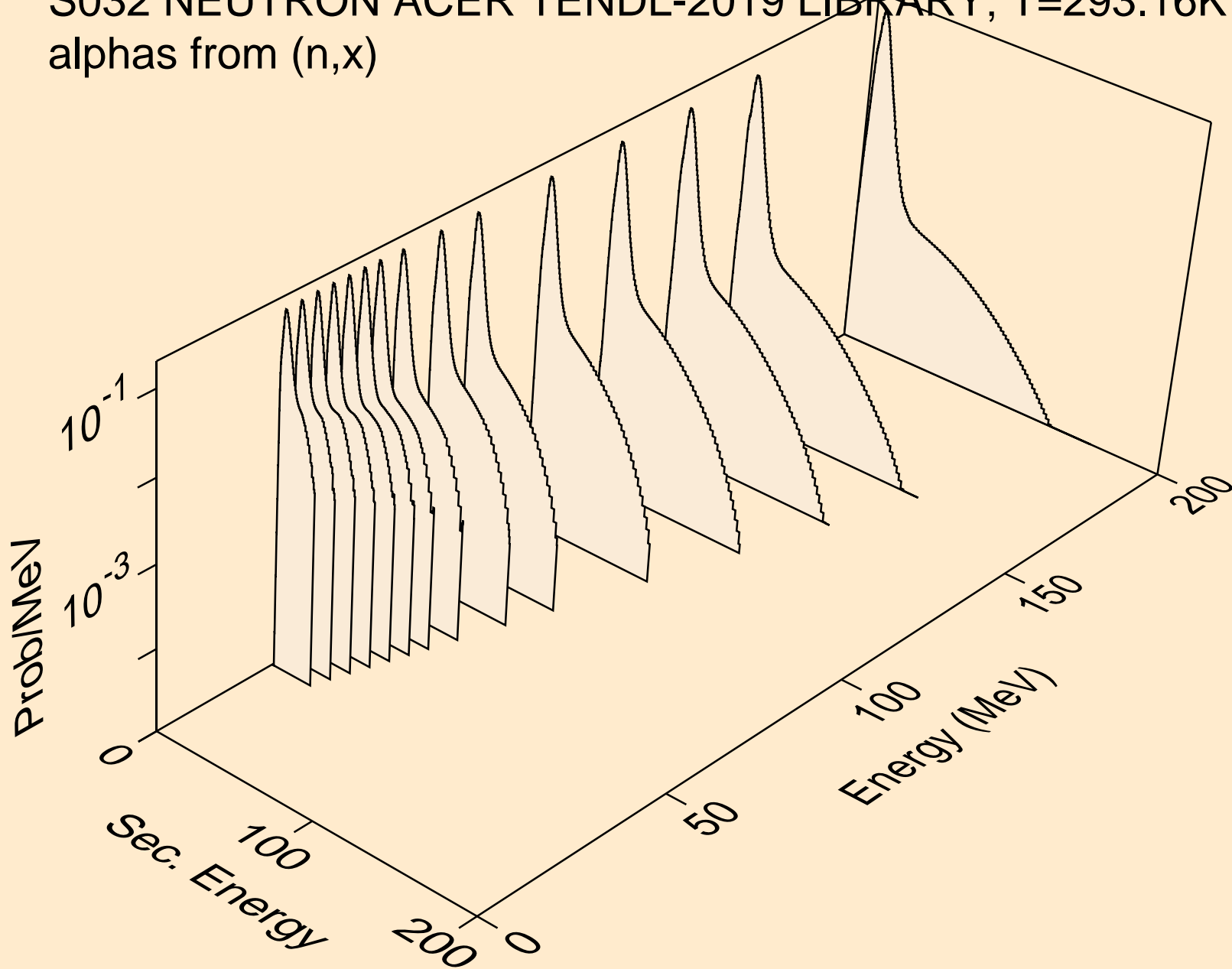

S032 NEUTRON ACER TENDL-2019 LIBRARY; T=293.16K  
alphas from (n,n\*)a

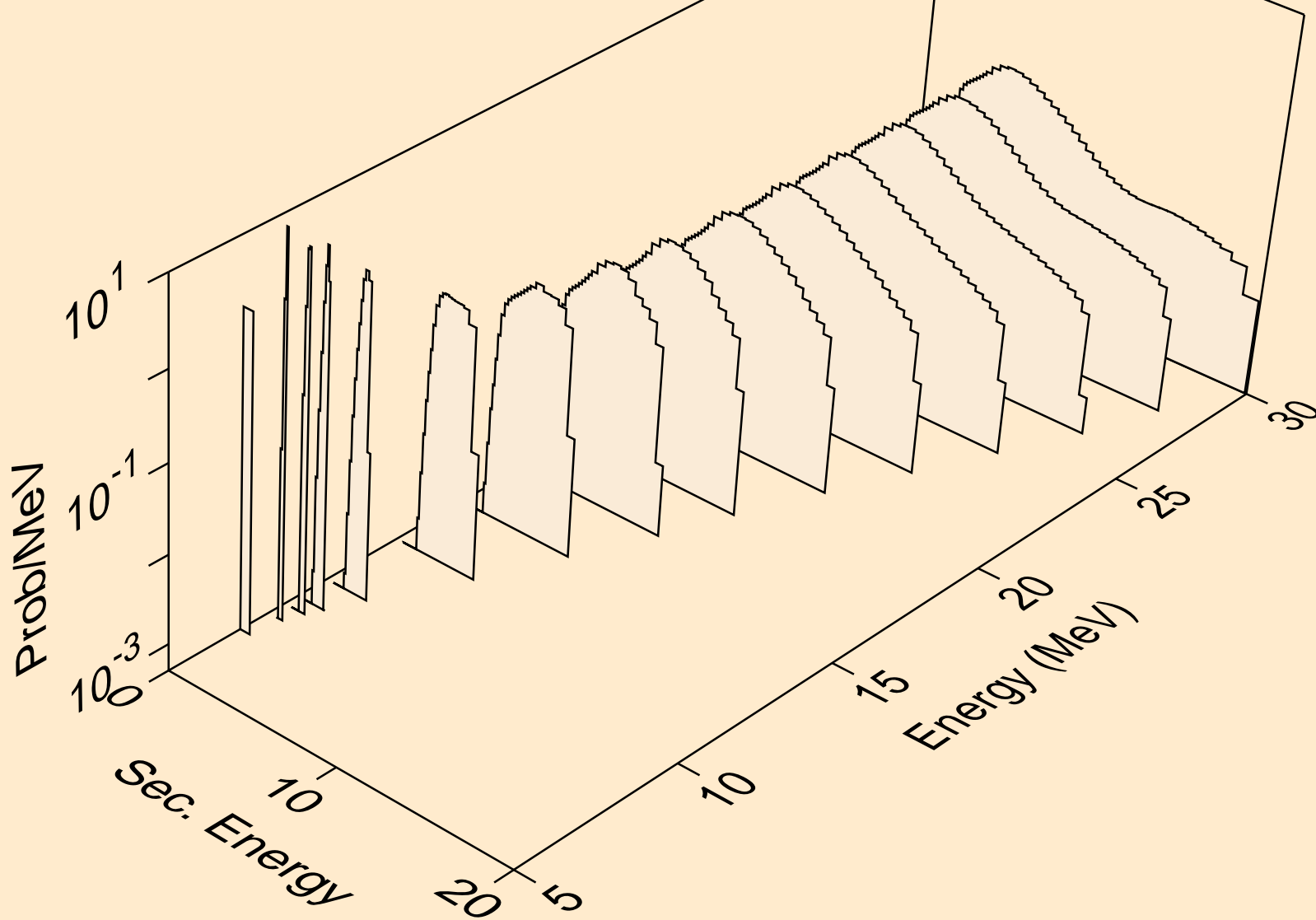

S032 NEUTRON ACER TENDL-2019 LIBRARY; T=293.16K  
alphas from (n,2n)a

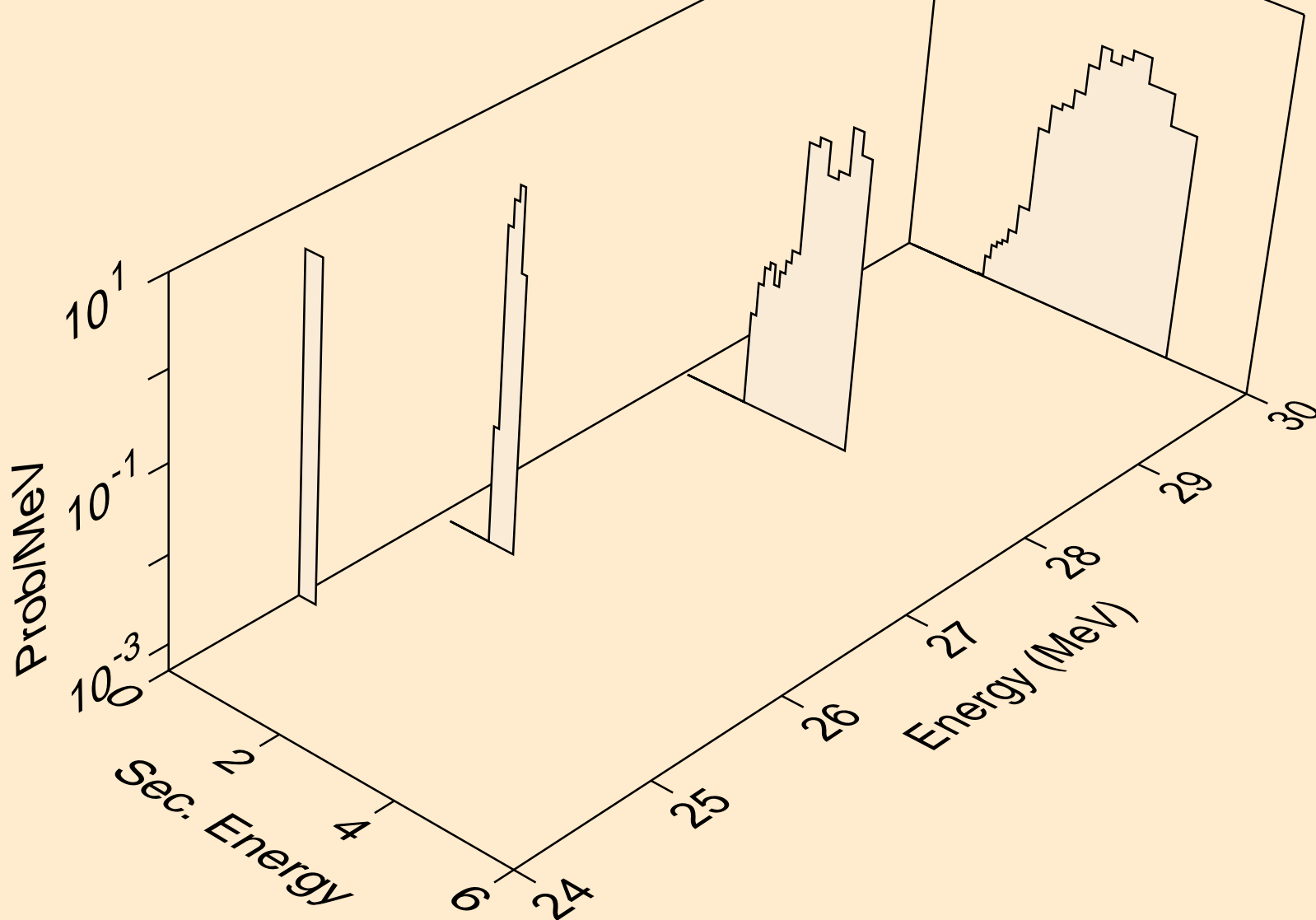

S032 NEUTRON ACER TENDL-2019 LIBRARY; T=293.16K  
alphas from (n,n\*)2a

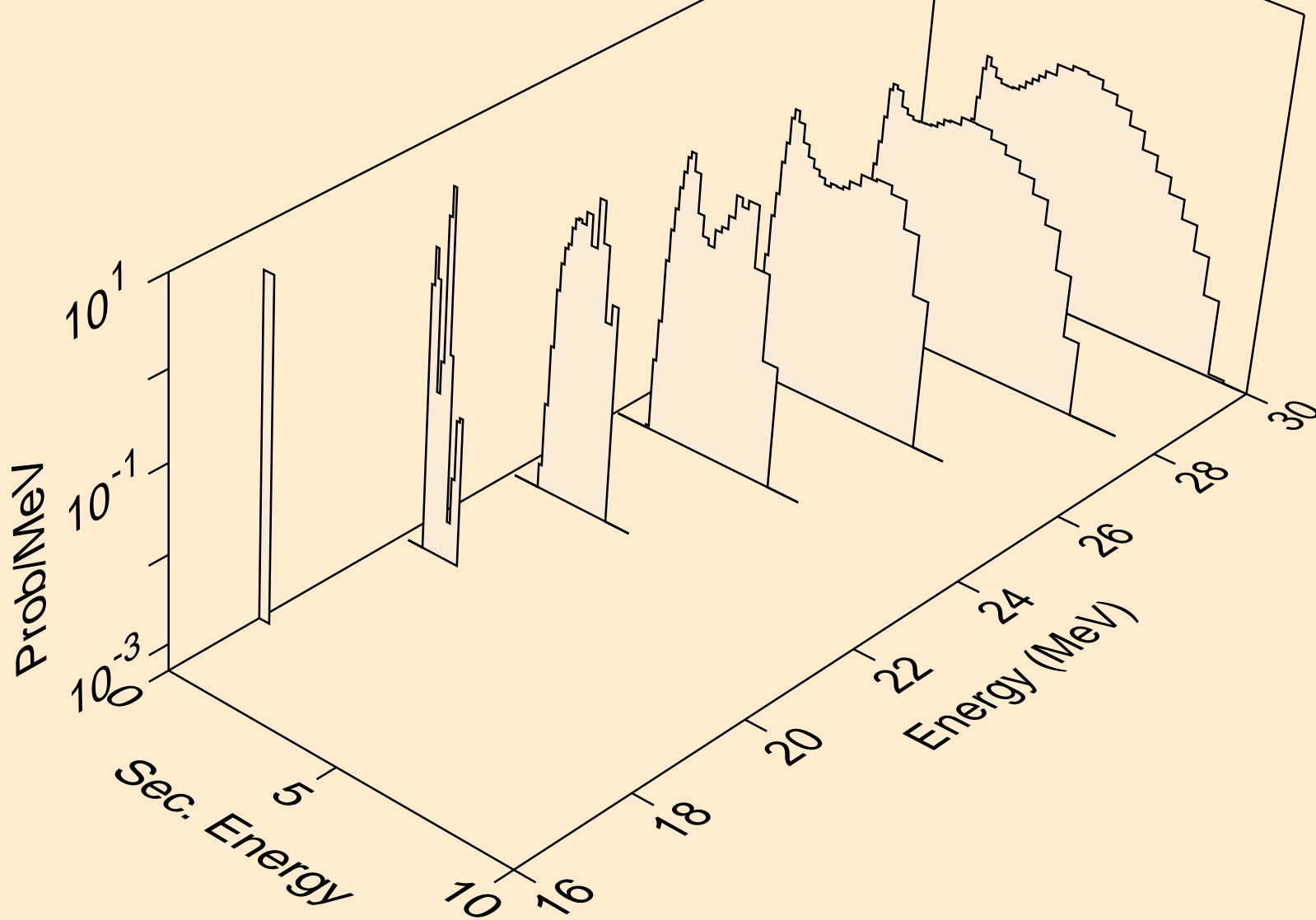

S032 NEUTRON ACER TENDL-2019 LIBRARY; T=293.16K  
alphas from (n,npa)

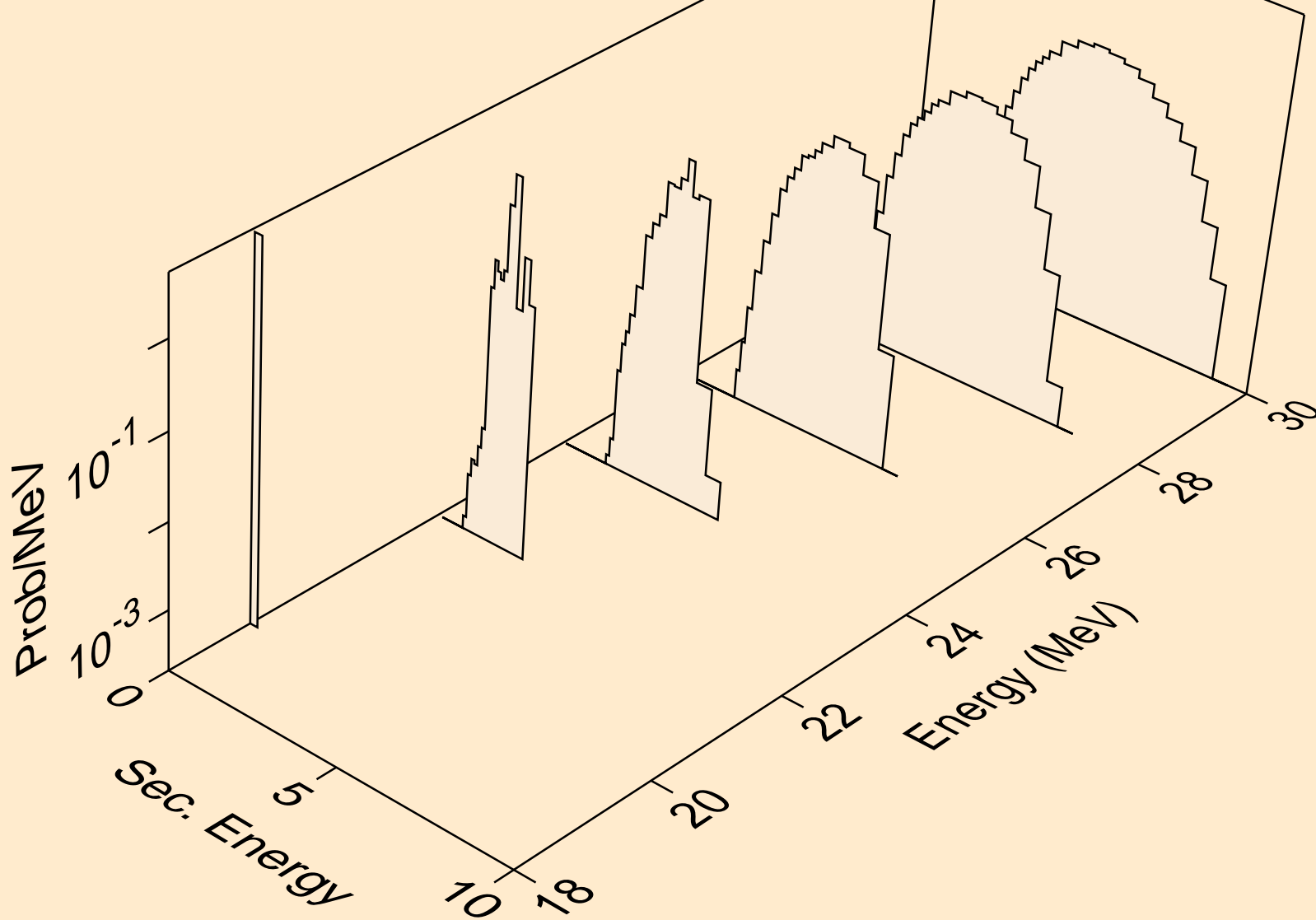



S032 NEUTRON ACER TENDL-2019 LIBRARY; T=293.16K  
alphas from (n,a)

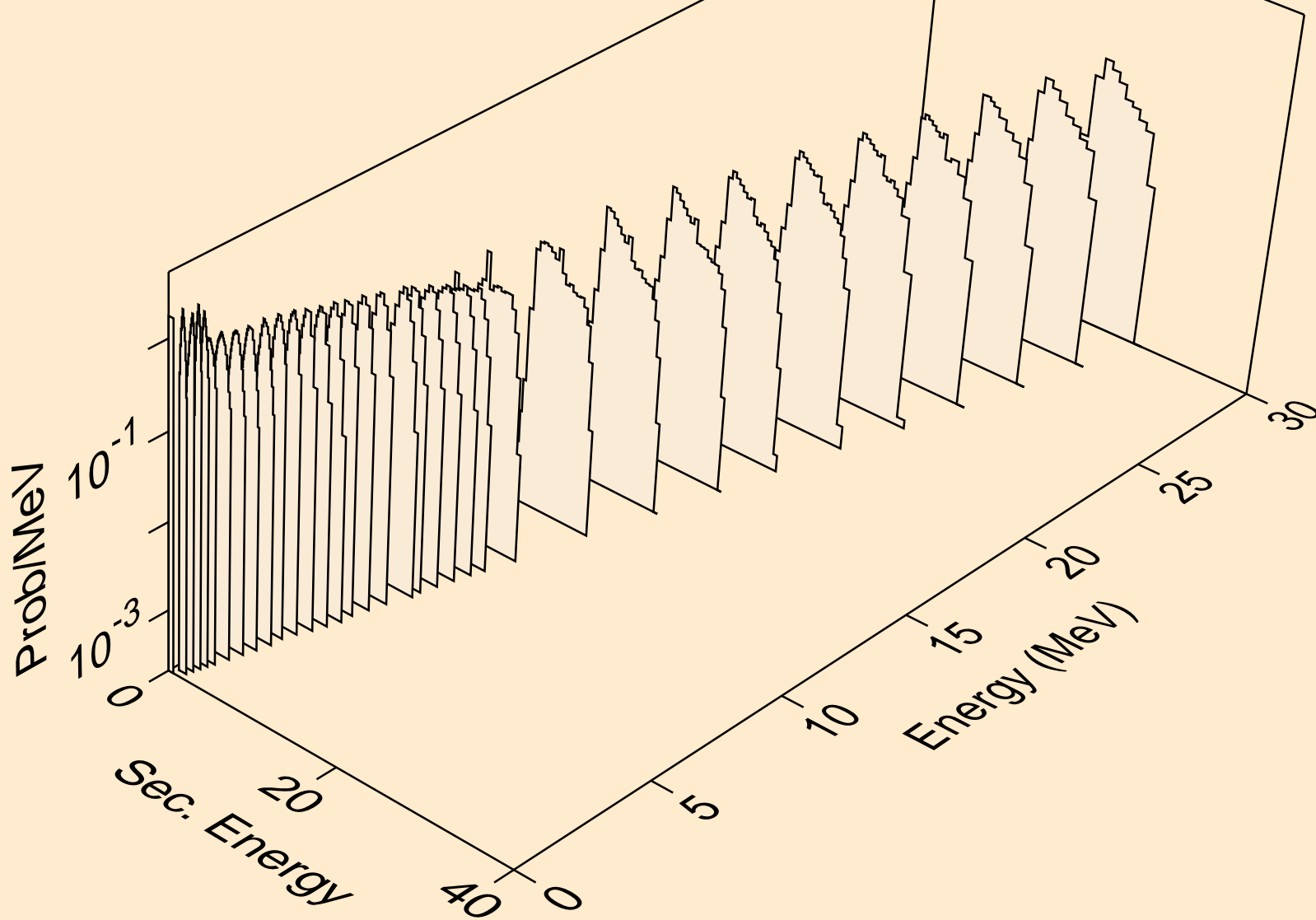

S032 NEUTRON ACER TENDL-2019 LIBRARY; T=293.16K  
alphas from (n,2a)

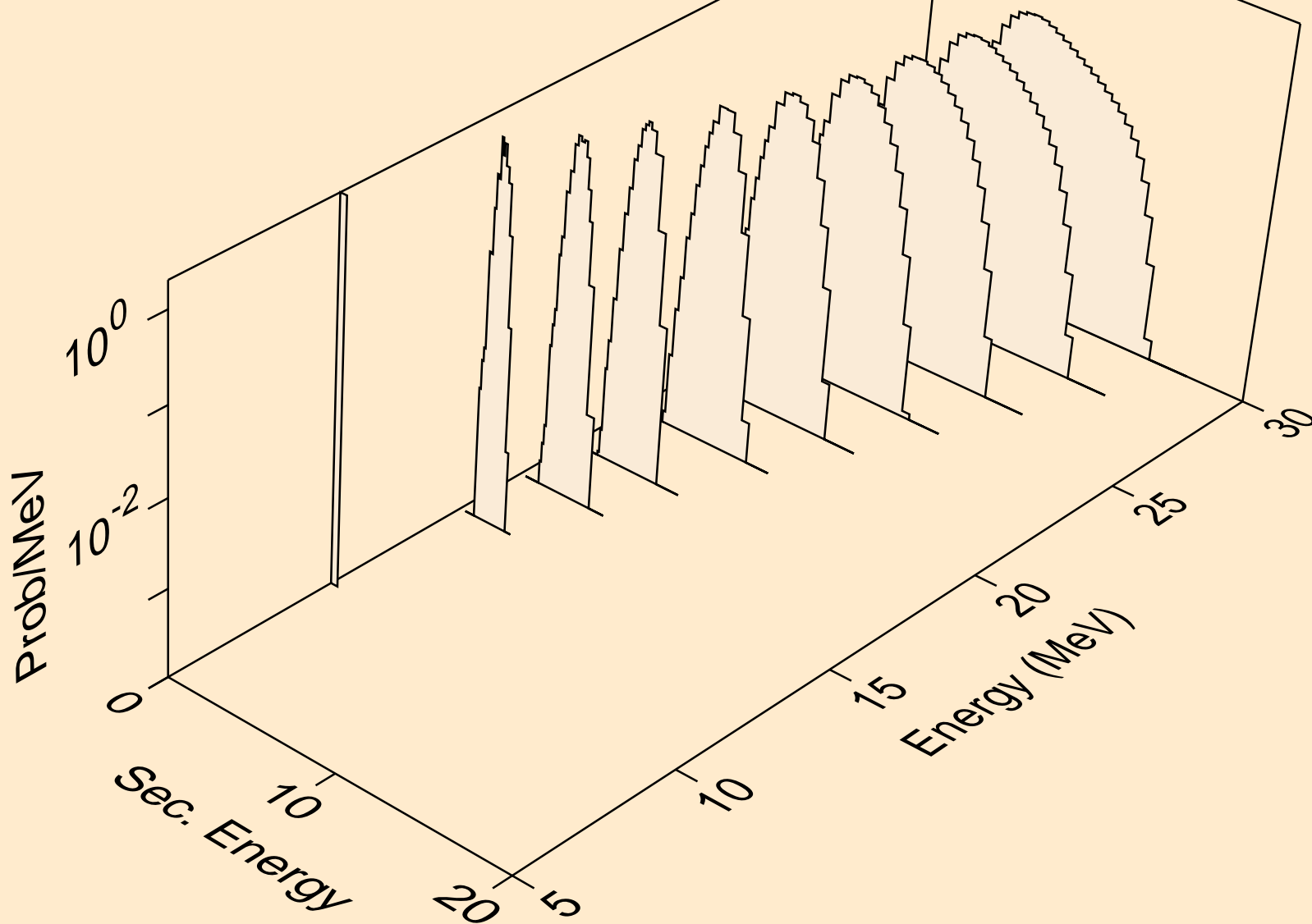

S032 NEUTRON ACER TENDL-2019 LIBRARY; T=293.16K  
alphas from (n,pa)

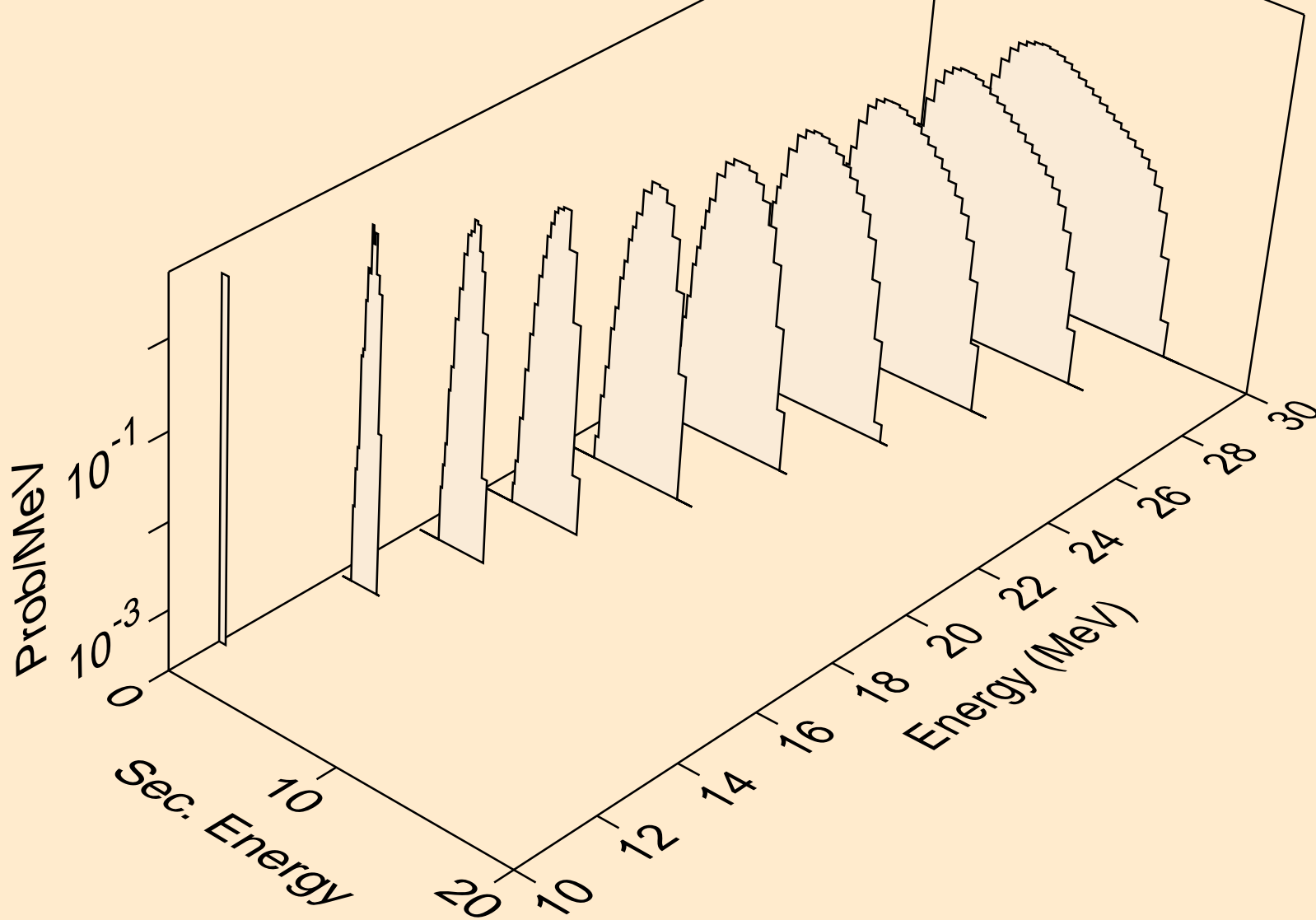

S032 NEUTRON ACER TENDL-2019 LIBRARY; T=293.16K  
alphas from (n,da)

