

S038 NEUTRON ACER TENDL-2019 LIBRARY; T=293.16K  
Principal cross sections

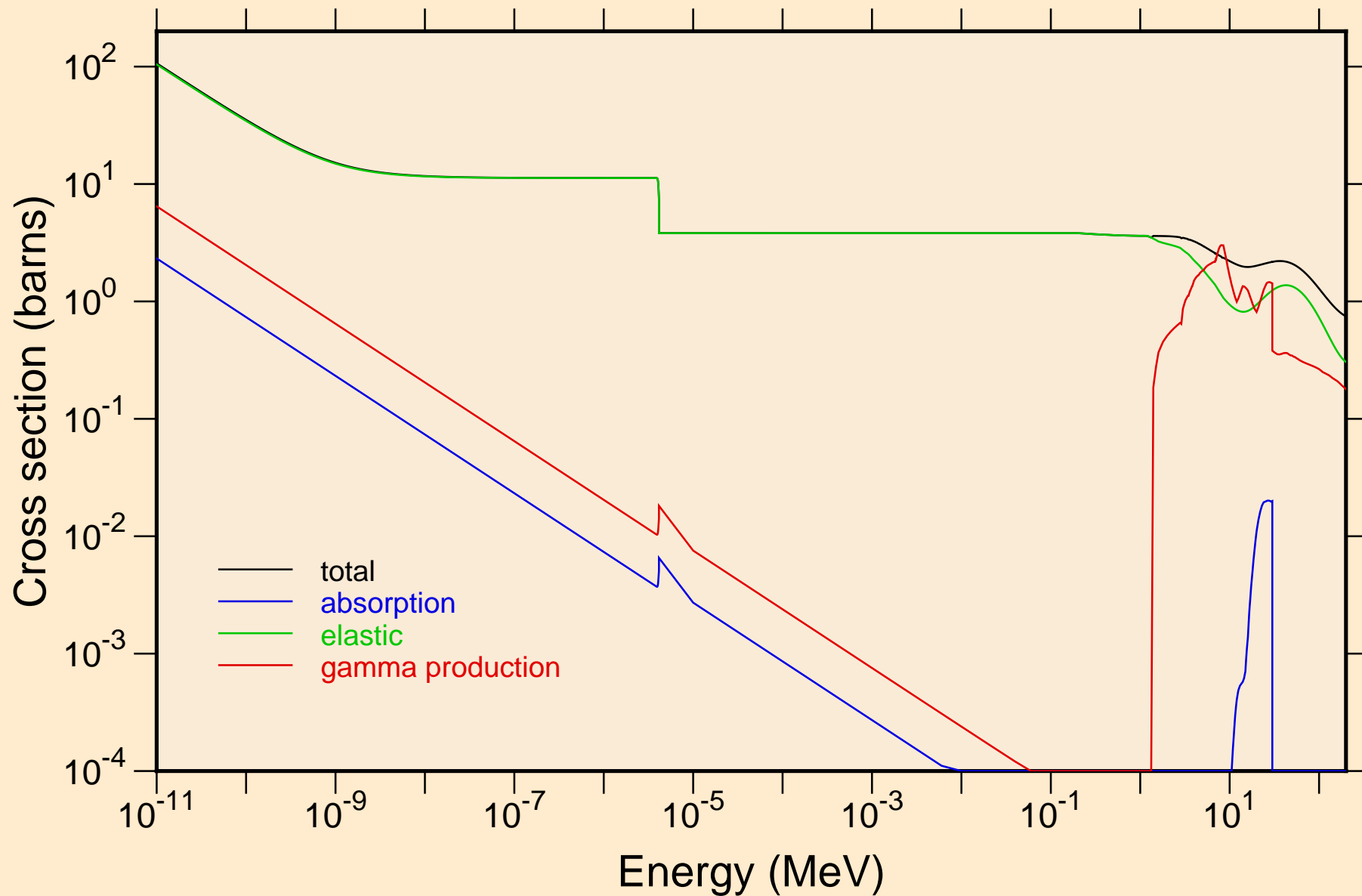

S038 NEUTRON ACER TENDL-2019 LIBRARY; T=293.16K  
Heating

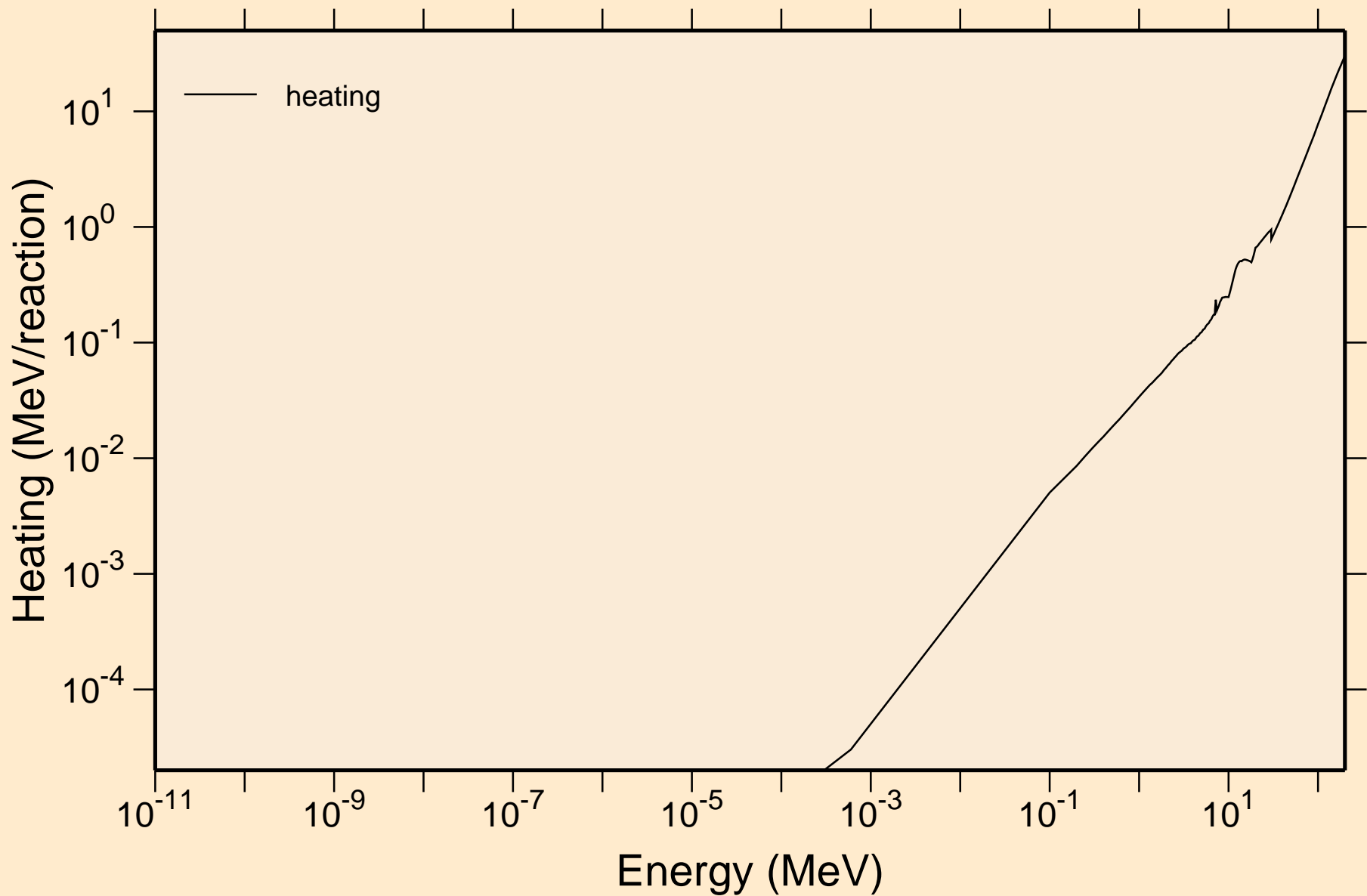

S038 NEUTRON ACER TENDL-2019 LIBRARY; T=293.16K  
Damage

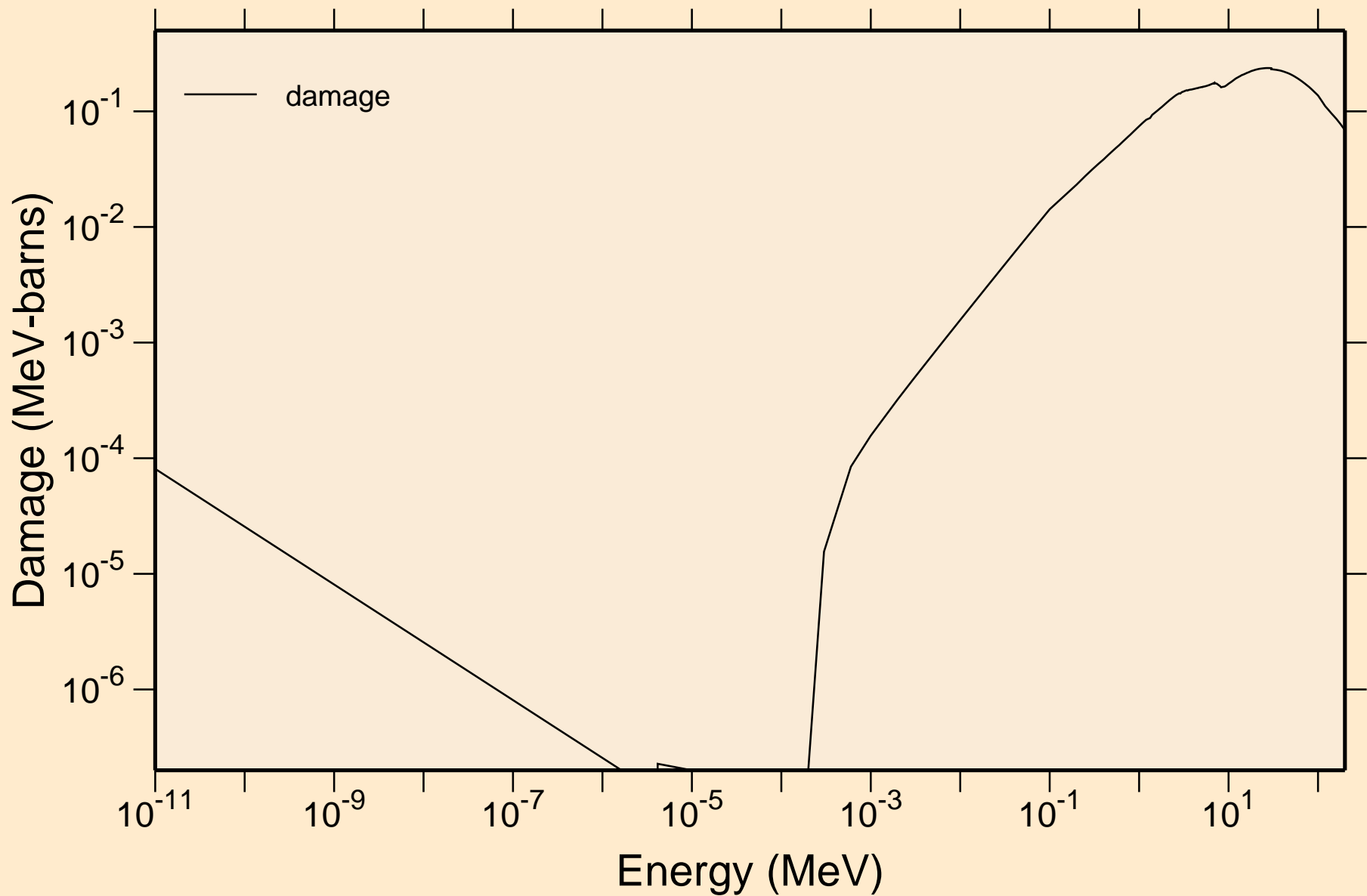

S038 NEUTRON ACER TENDL-2019 LIBRARY; T=293.16K  
Non-threshold reactions

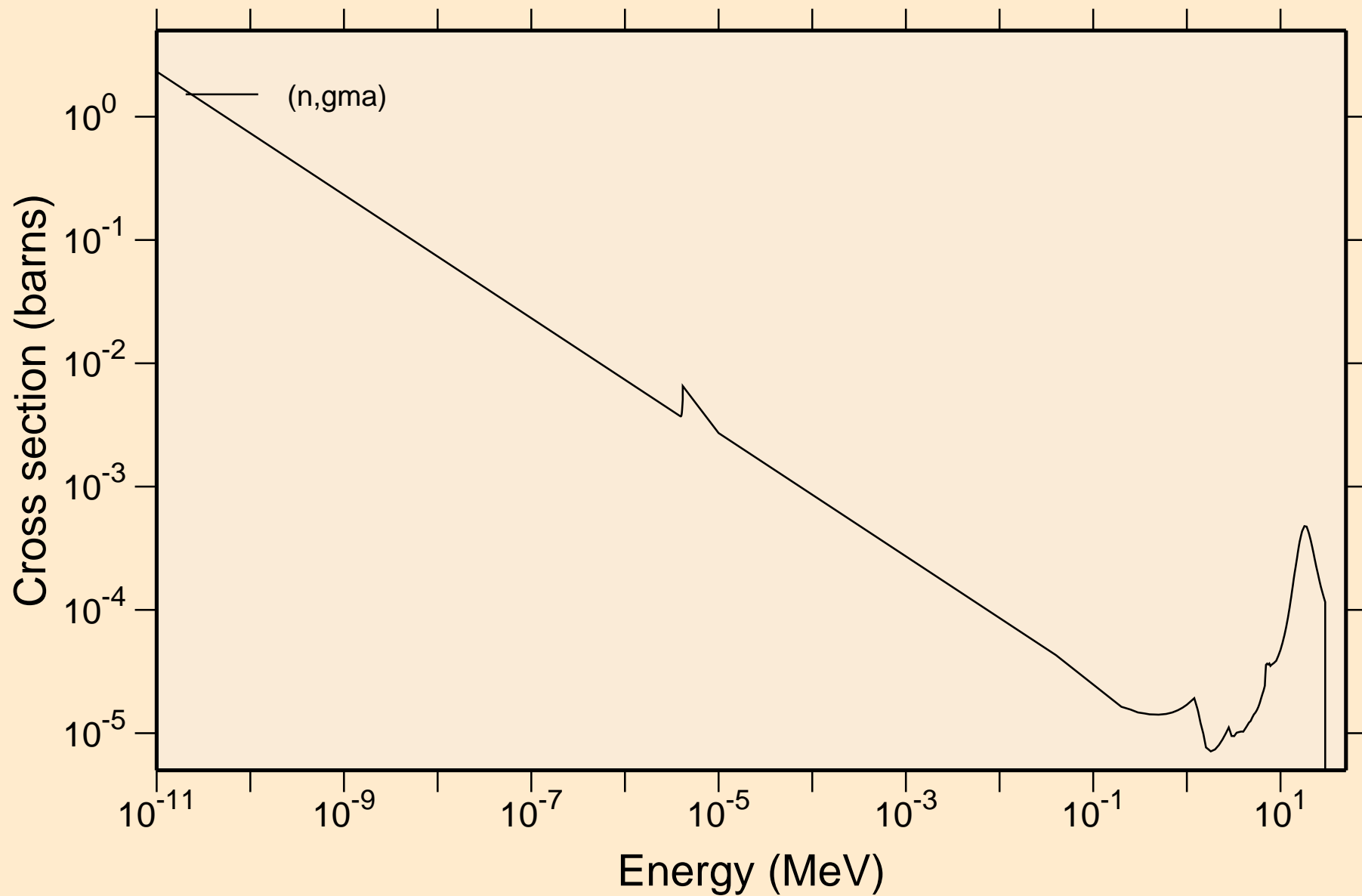

# S038 NEUTRON ACER TENDL-2019 LIBRARY; T=293.16K

## Principal cross sections

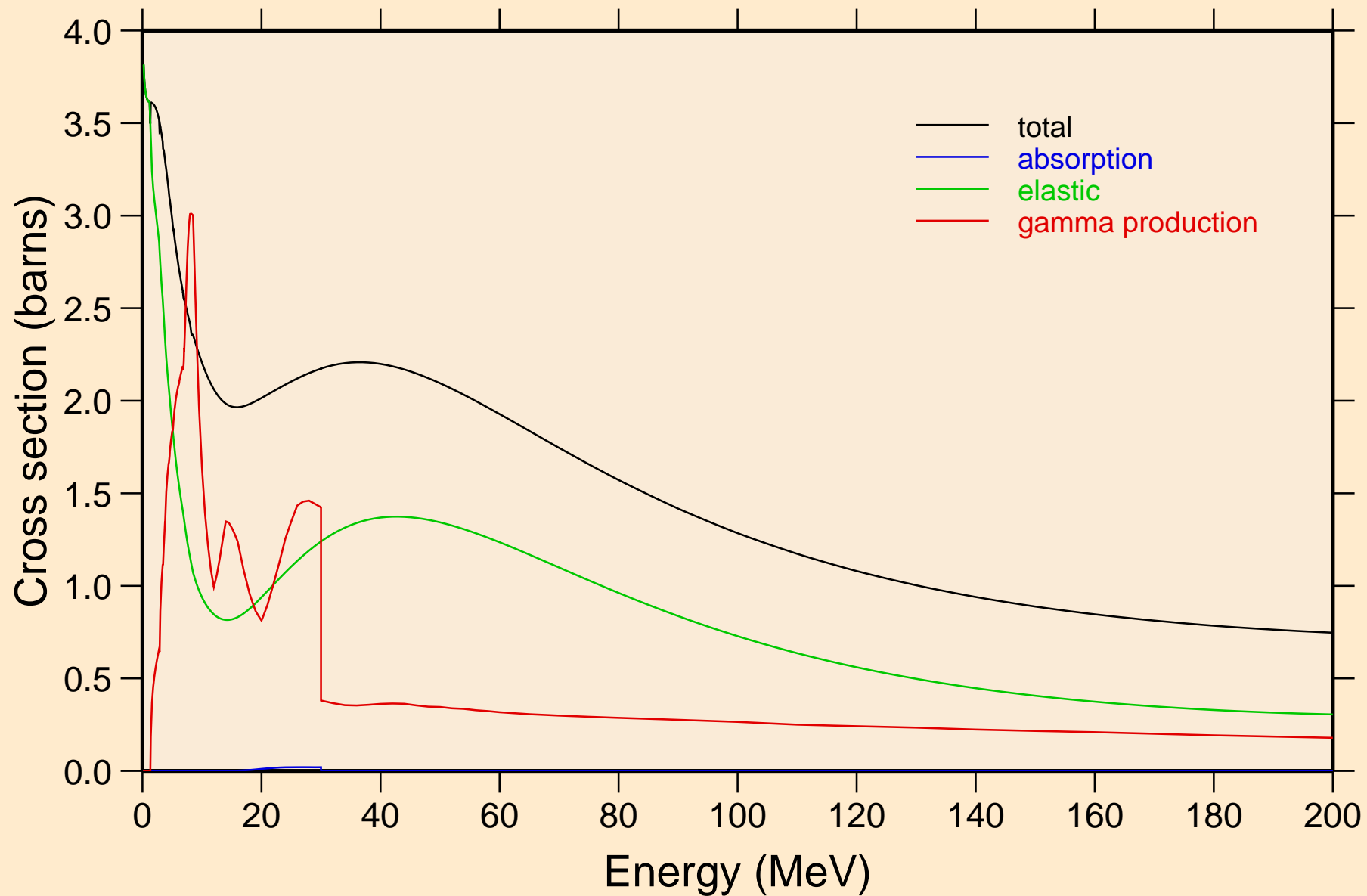

S038 NEUTRON ACER TENDL-2019 LIBRARY; T=293.16K  
Heating

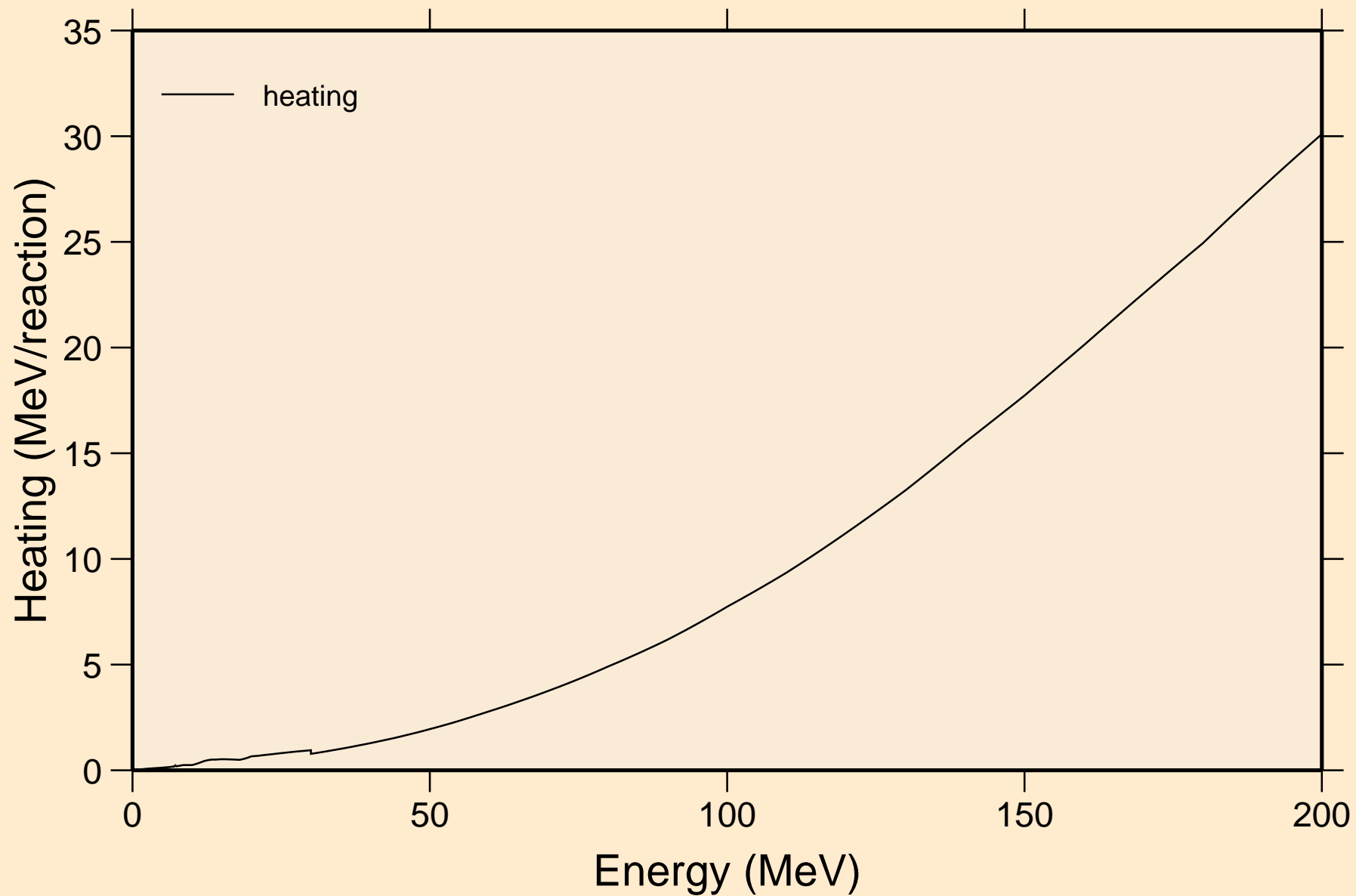

S038 NEUTRON ACER TENDL-2019 LIBRARY; T=293.16K  
Damage

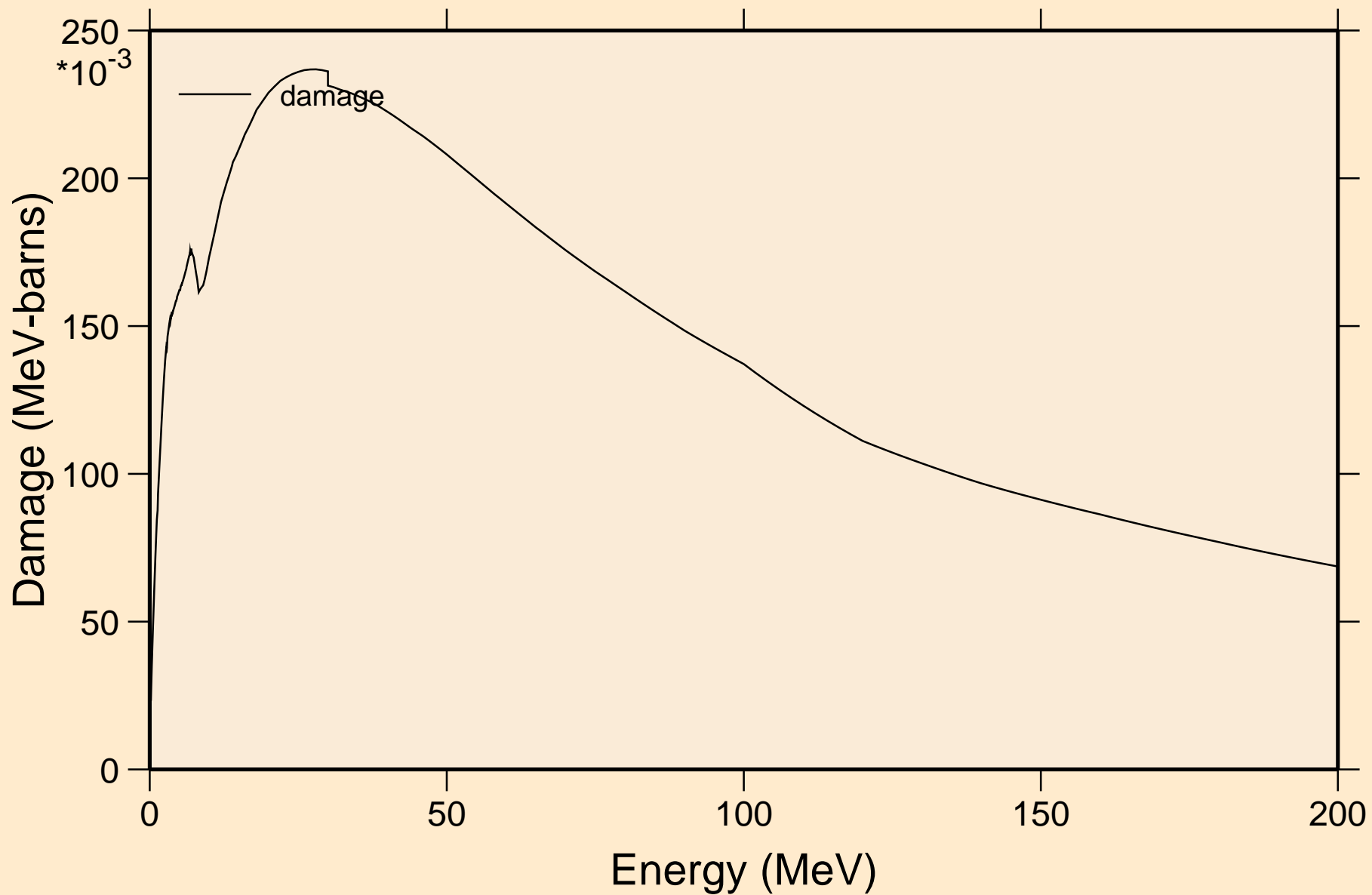

S038 NEUTRON ACER TENDL-2019 LIBRARY; T=293.16K  
Non-threshold reactions

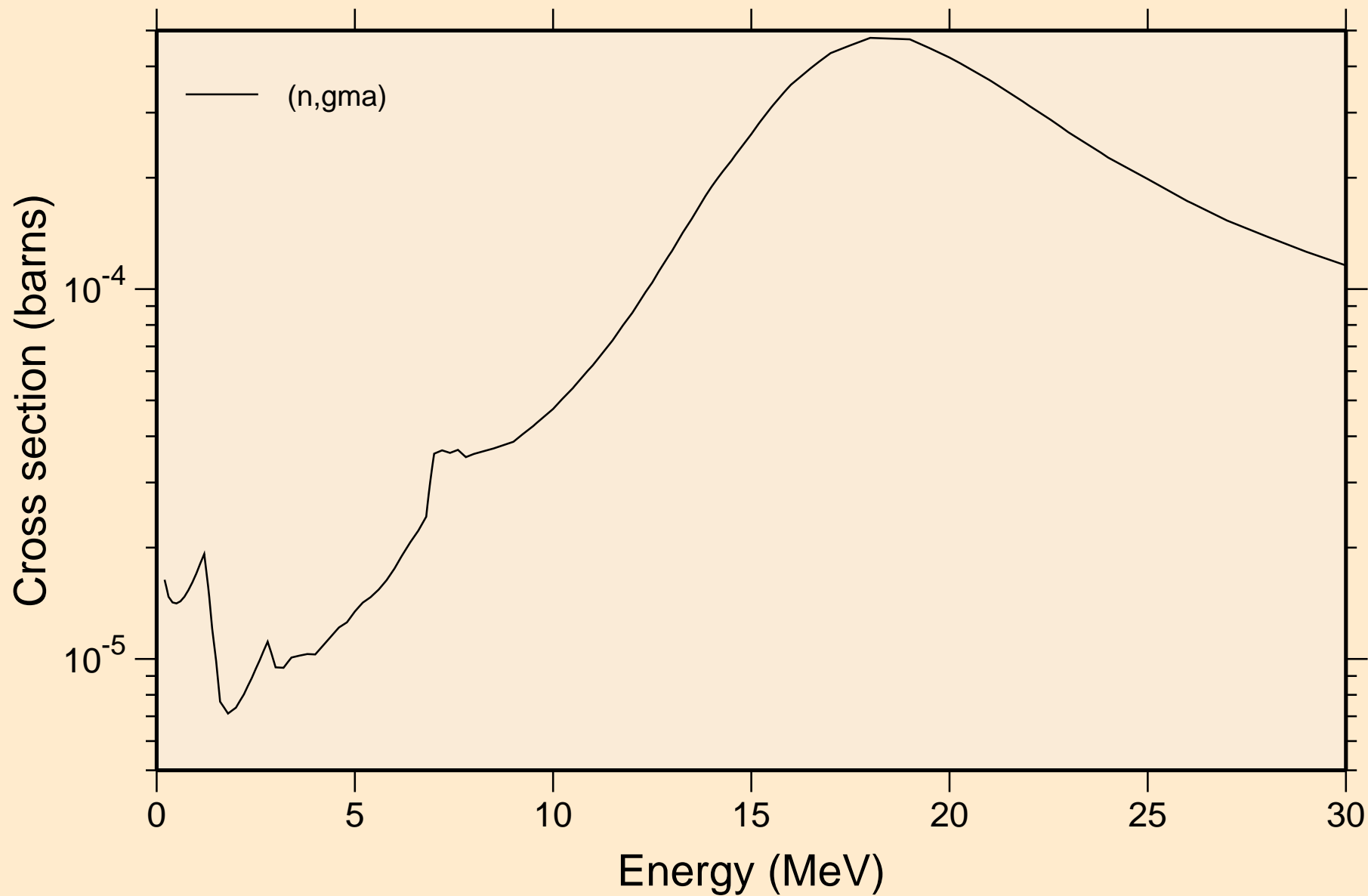



S038 NEUTRON ACER TENDL-2019 LIBRARY; T=293.16K  
Inelastic levels

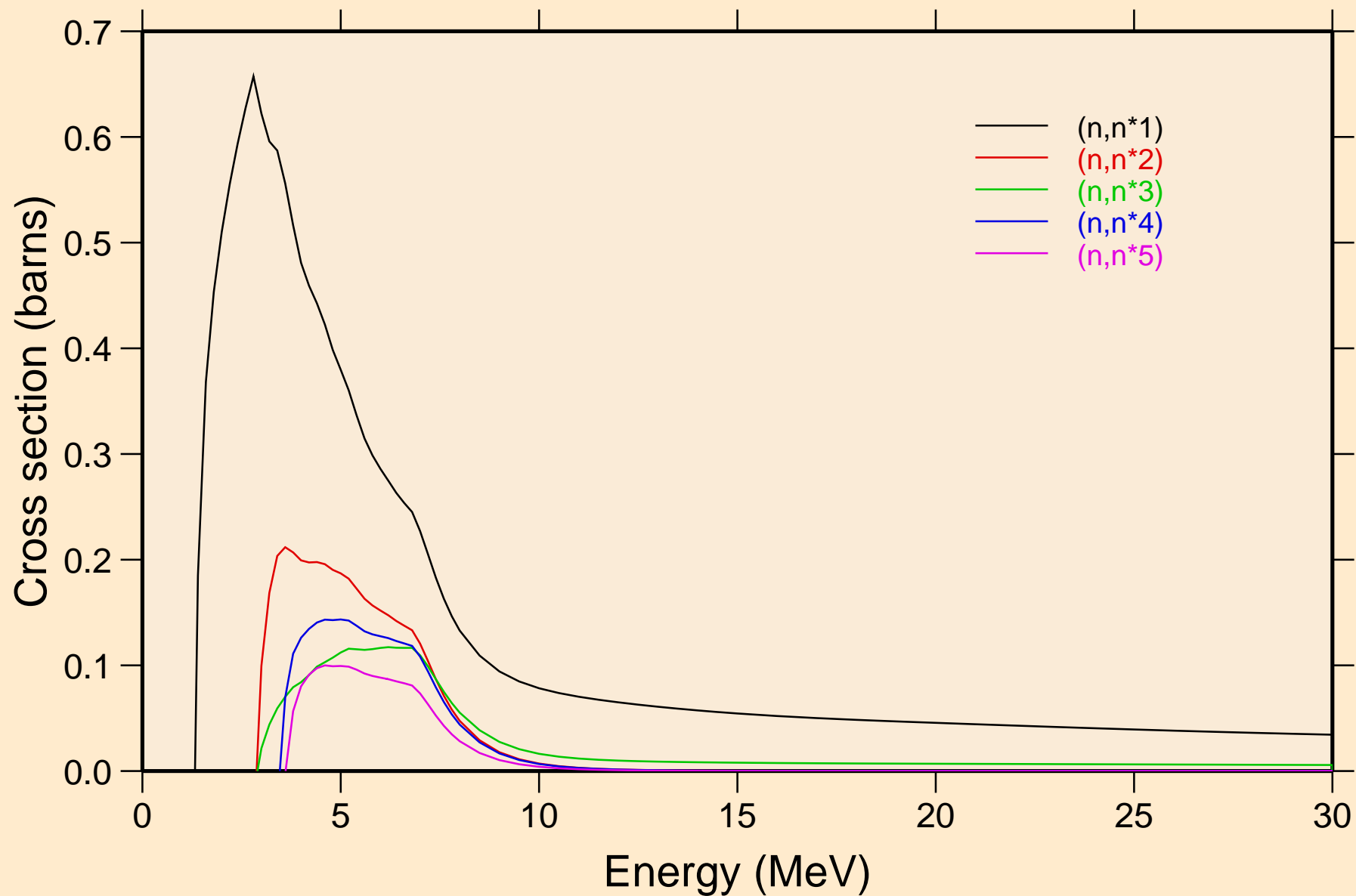

S038 NEUTRON ACER TENDL-2019 LIBRARY; T=293.16K  
Inelastic levels

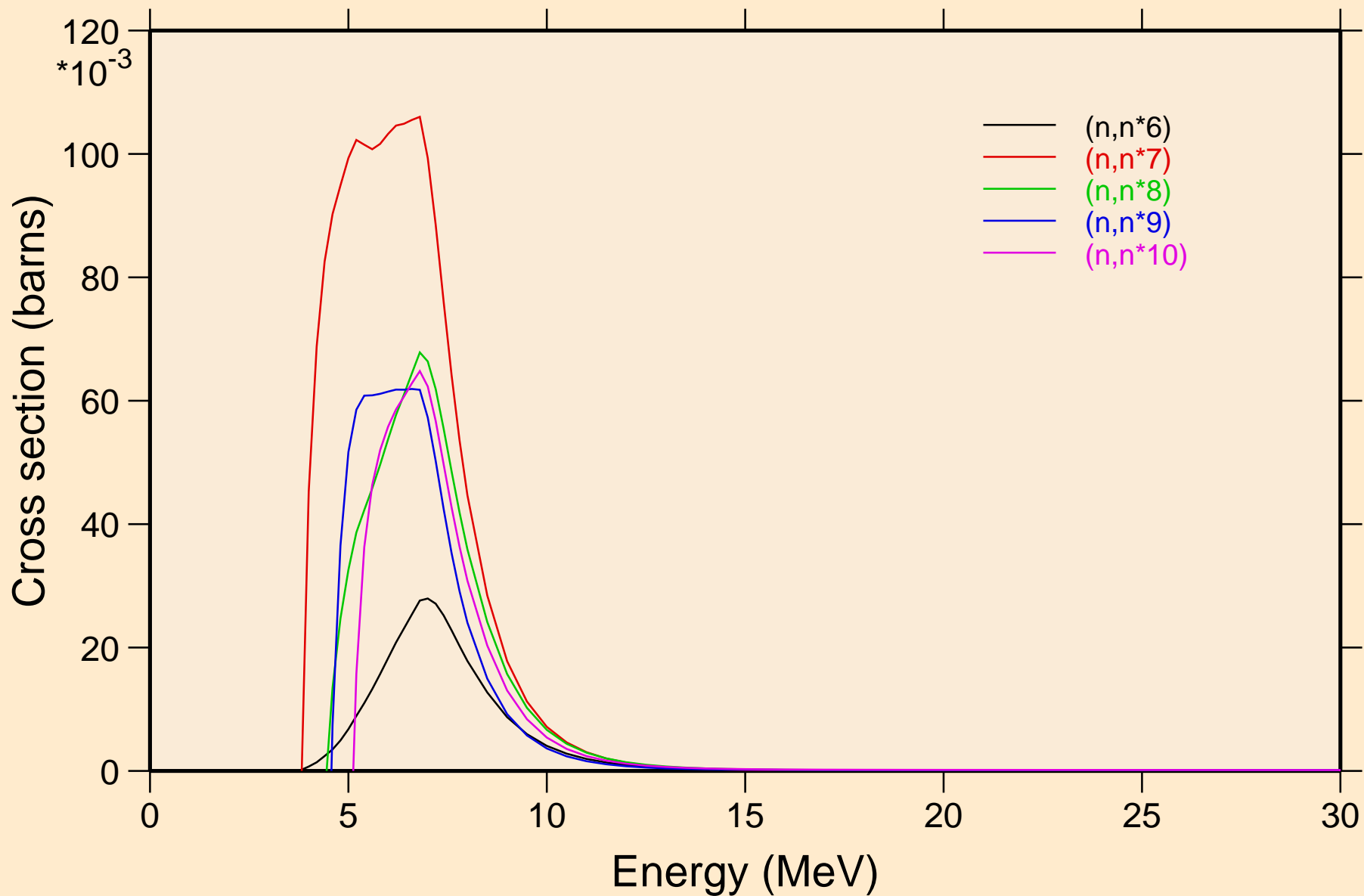

S038 NEUTRON ACER TENDL-2019 LIBRARY; T=293.16K  
Inelastic levels

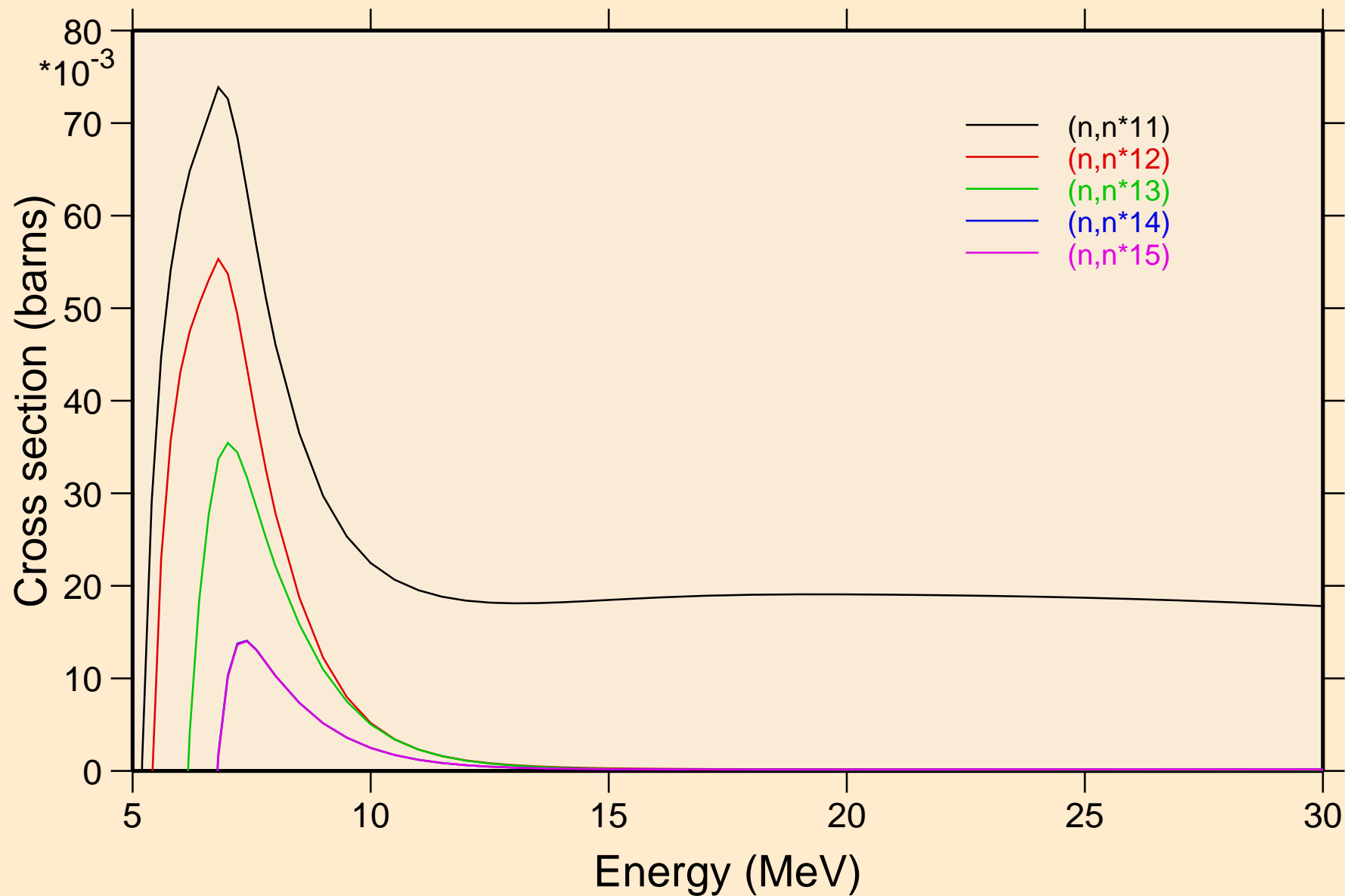

S038 NEUTRON ACER TENDL-2019 LIBRARY; T=293.16K  
Inelastic levels

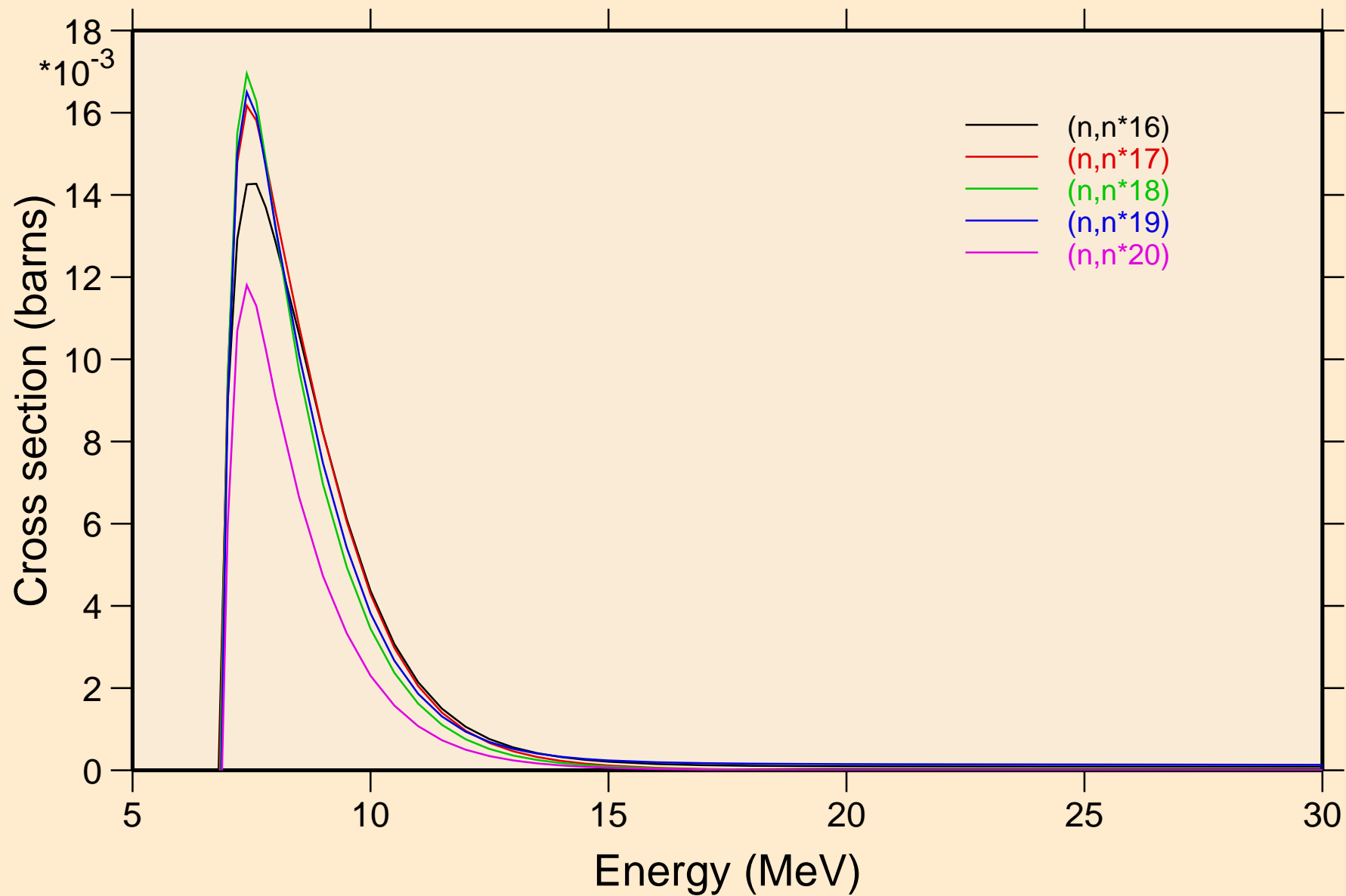

S038 NEUTRON ACER TENDL-2019 LIBRARY; T=293.16K  
Inelastic levels

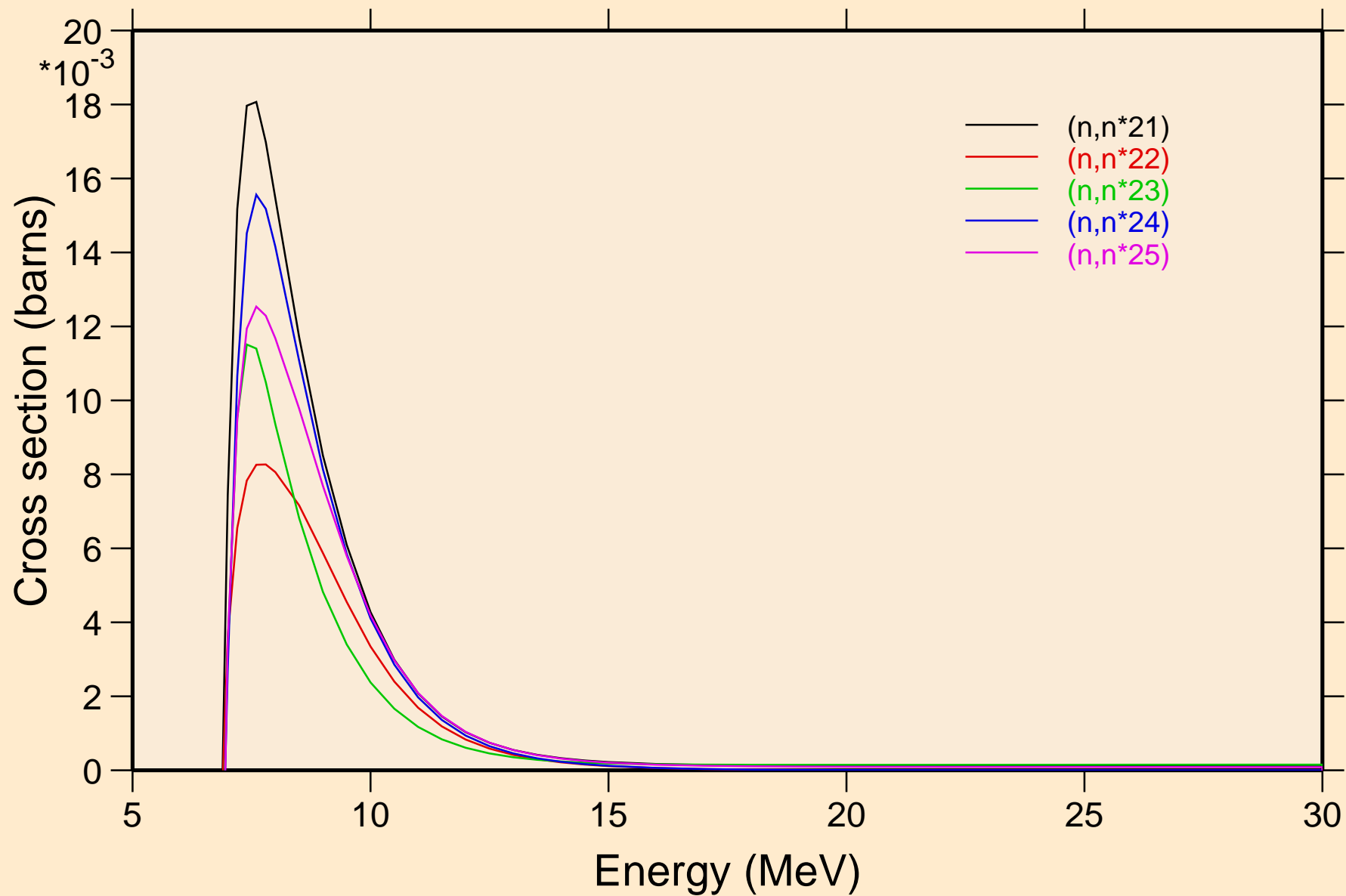

S038 NEUTRON ACER TENDL-2019 LIBRARY; T=293.16K  
Inelastic levels

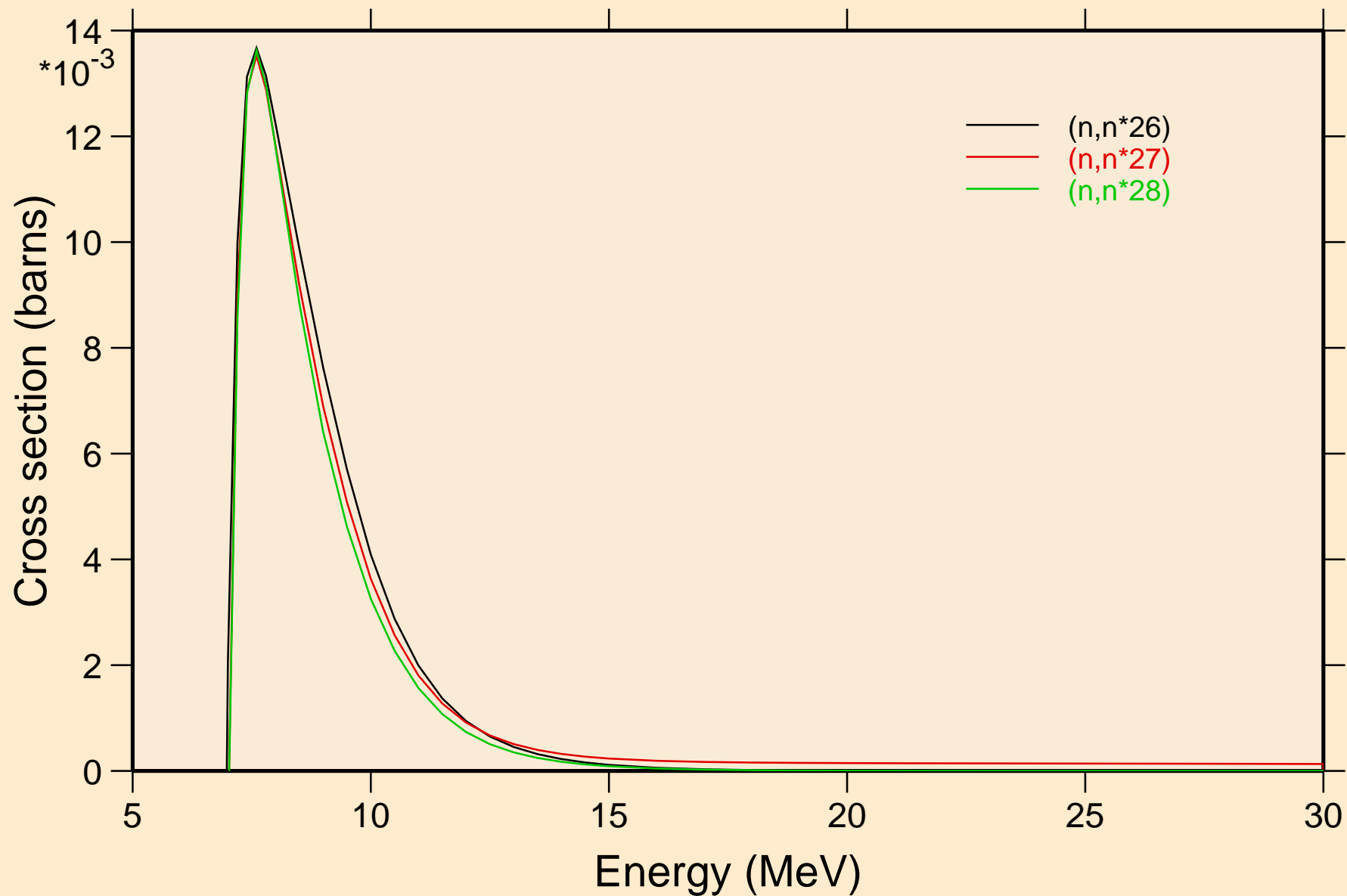

S038 NEUTRON ACER TENDL-2019 LIBRARY; T=293.16K  
Threshold reactions

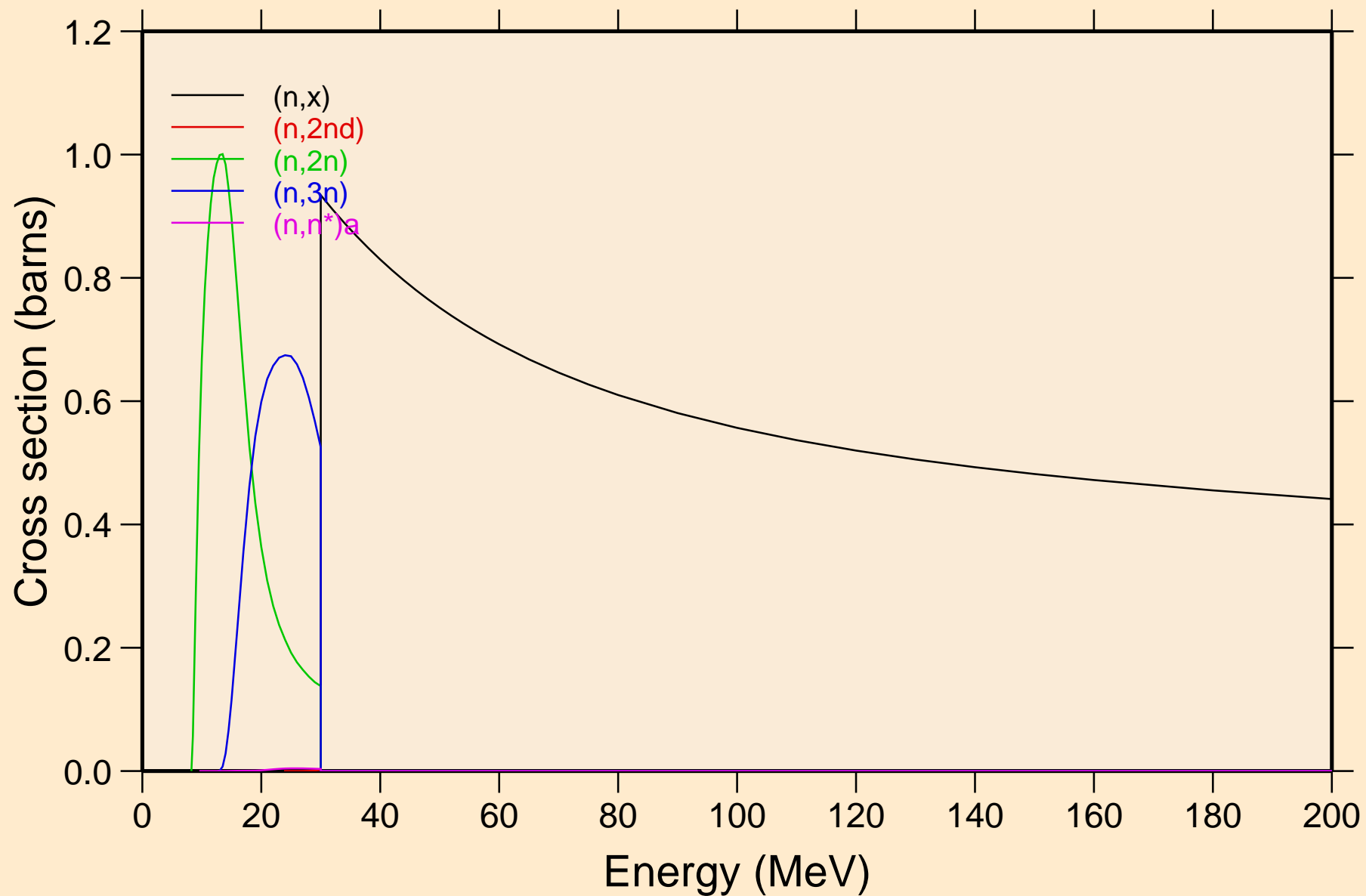

S038 NEUTRON ACER TENDL-2019 LIBRARY; T=293.16K  
Threshold reactions

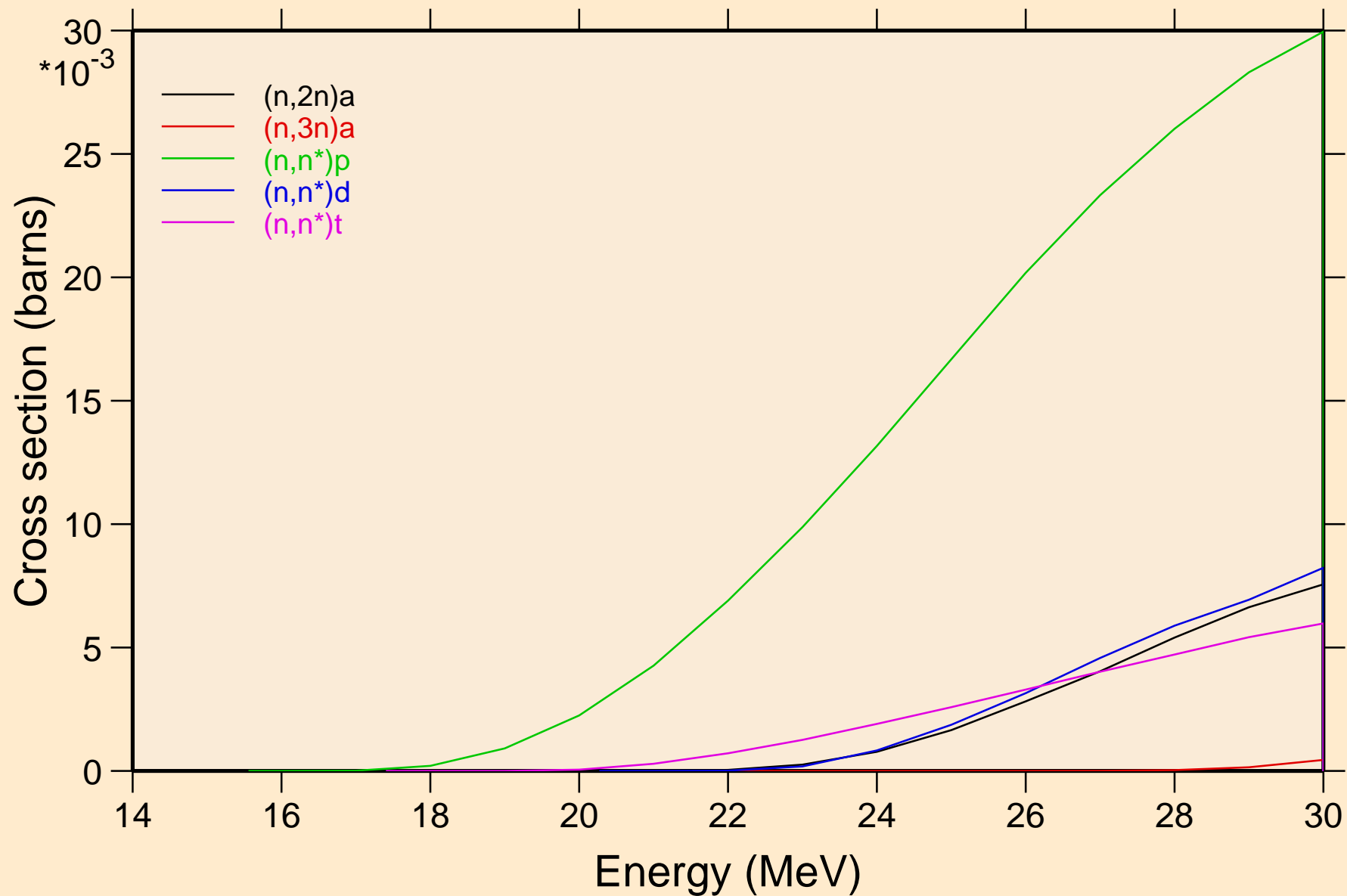



S038 NEUTRON ACER TENDL-2019 LIBRARY; T=293.16K  
Threshold reactions

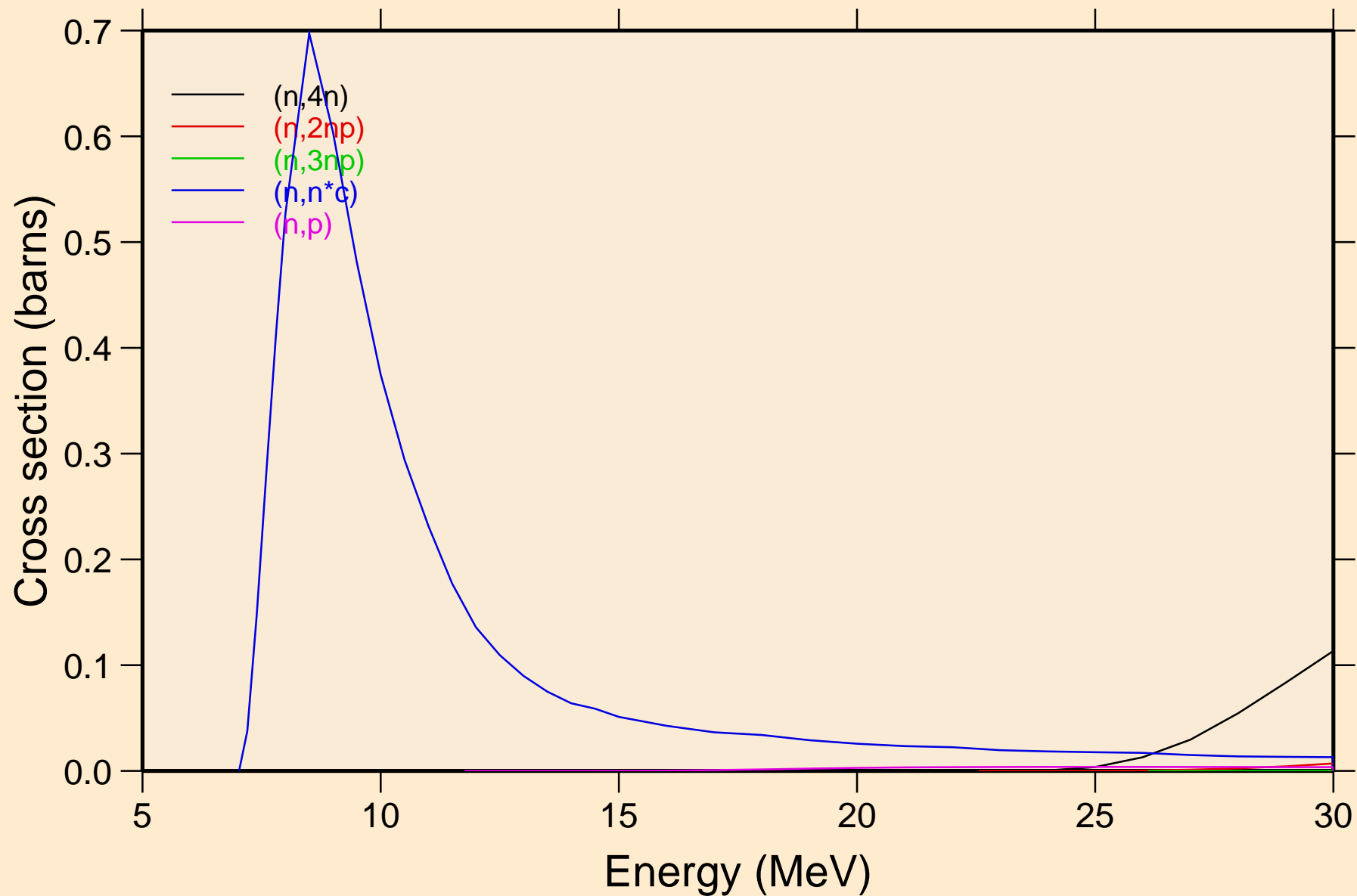

S038 NEUTRON ACER TENDL-2019 LIBRARY; T=293.16K  
Threshold reactions

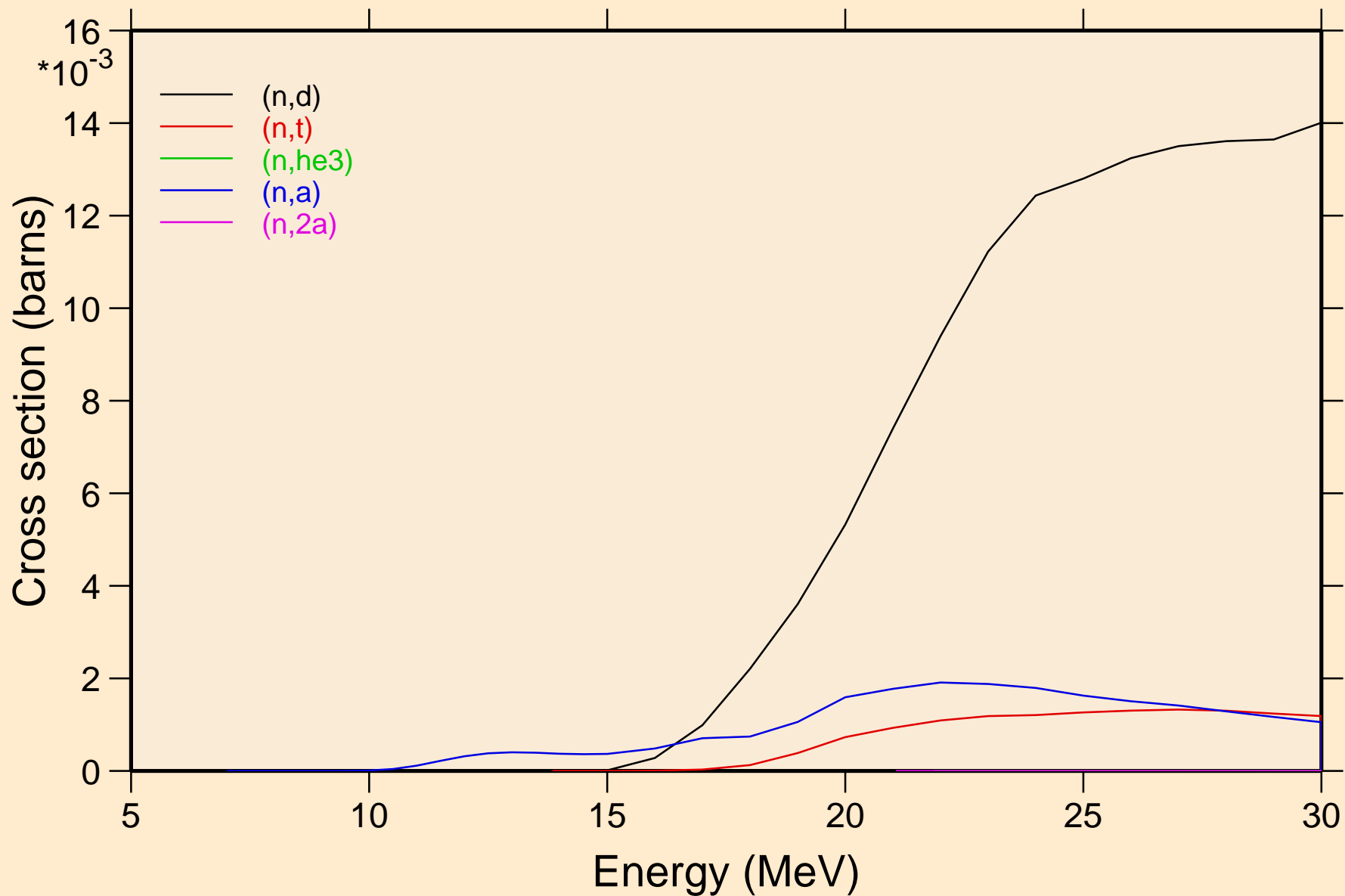

S038 NEUTRON ACER TENDL-2019 LIBRARY; T=293.16K  
Threshold reactions

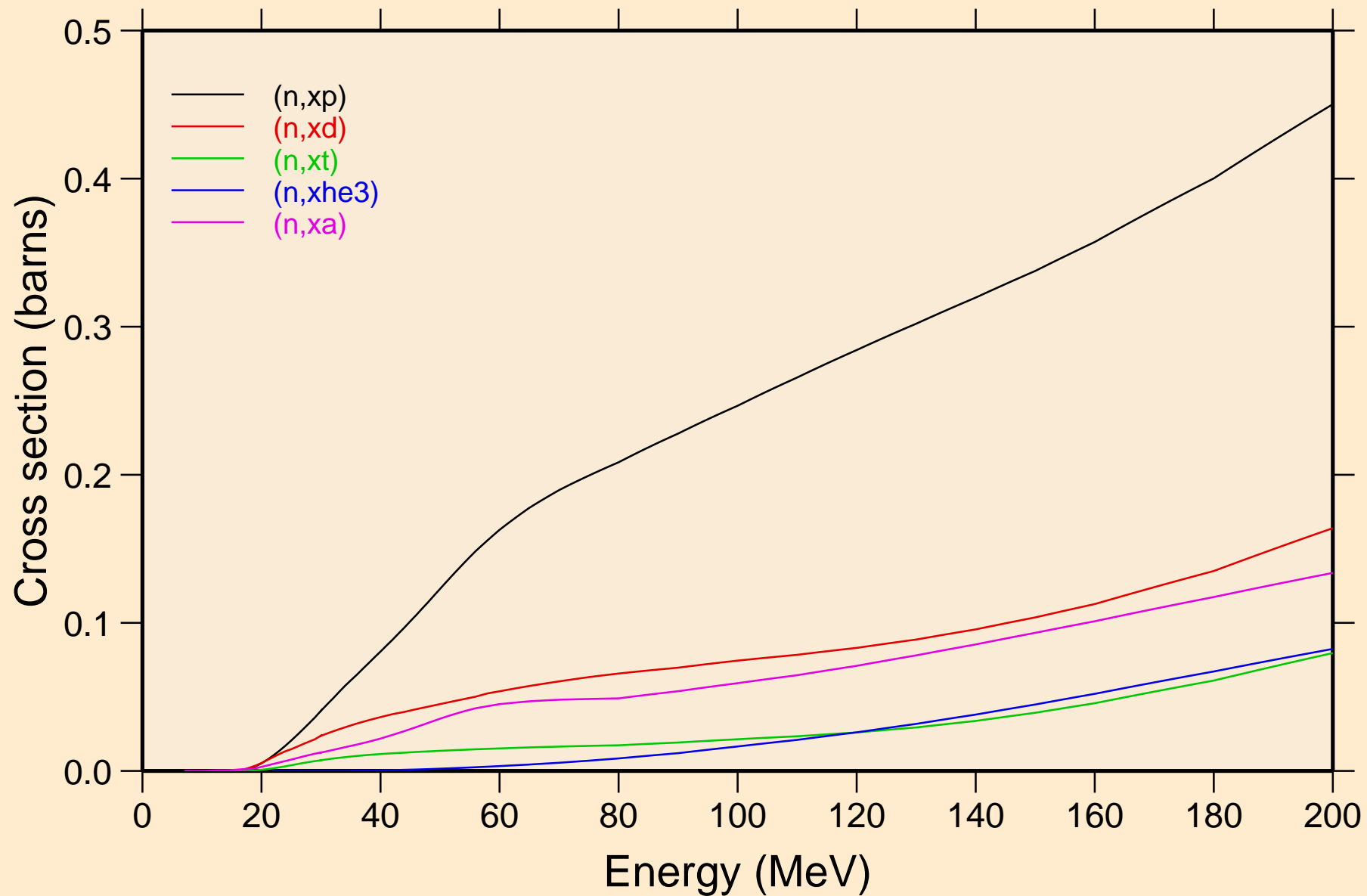

S038 NEUTRON ACER TENDL-2019 LIBRARY; T=293.16K  
angular distribution for elastic

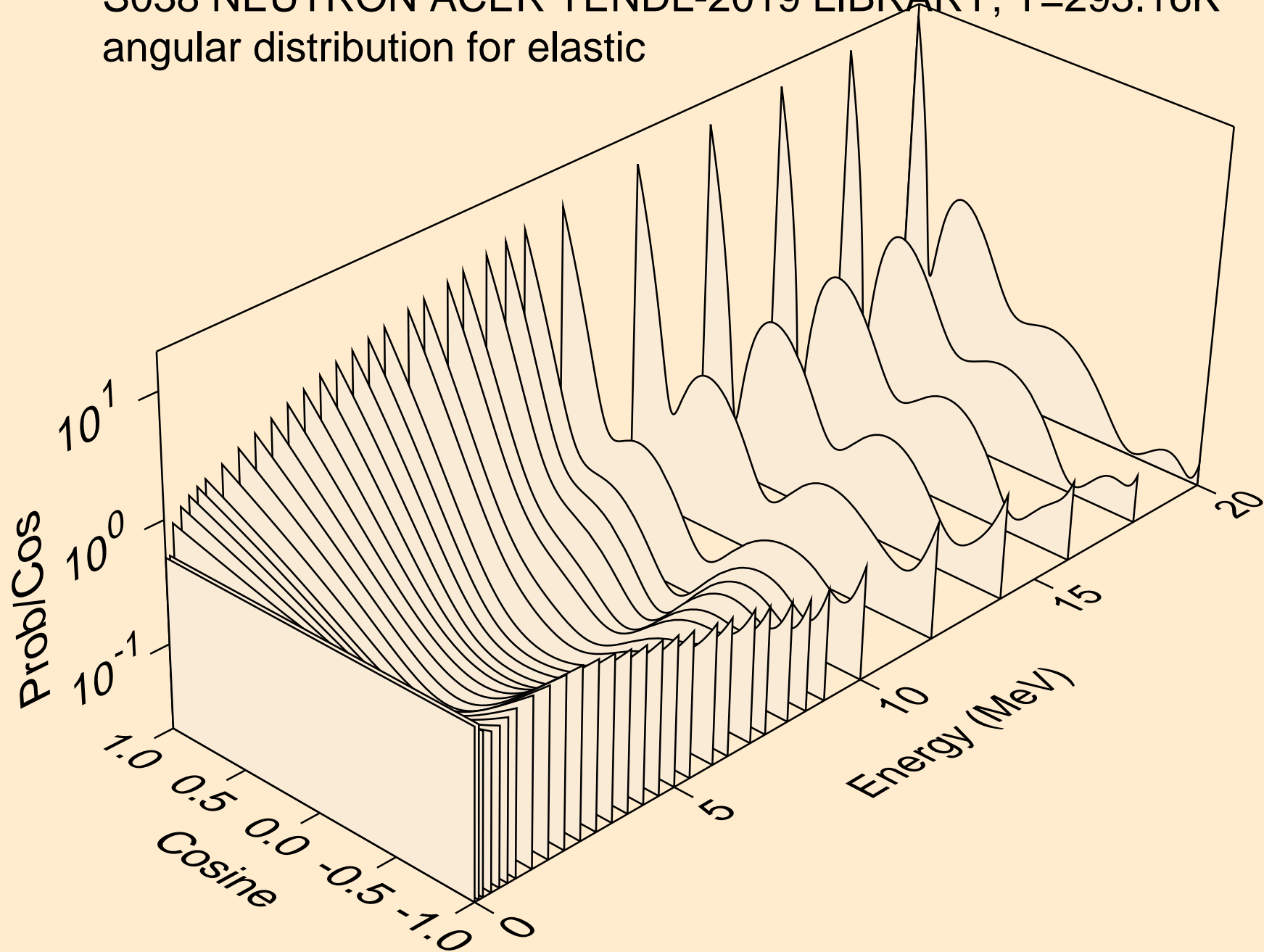

S038 NEUTRON ACER TENDL-2019 LIBRARY; T=293.16K  
angular distribution for elastic

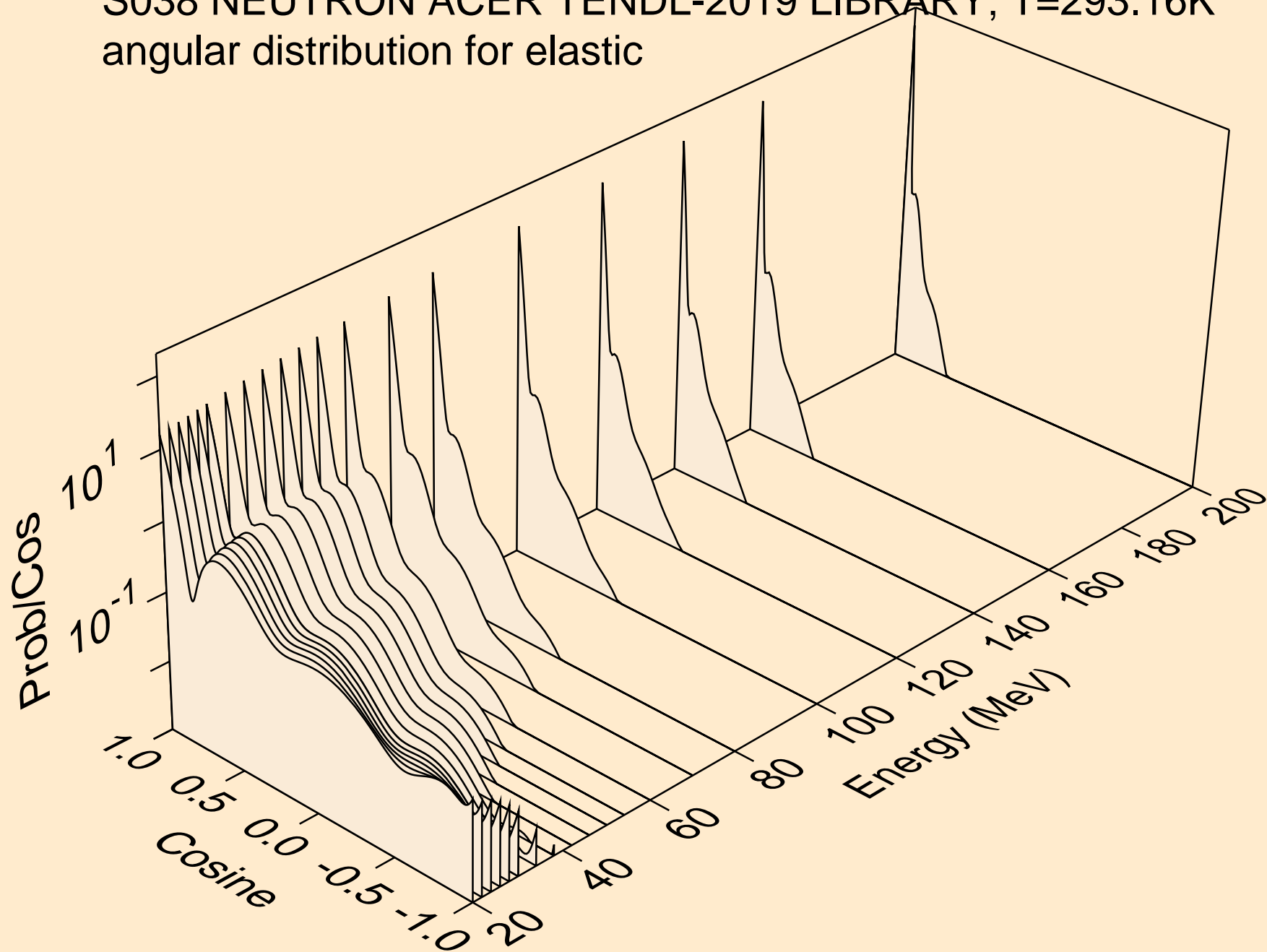

S038 NEUTRON ACER TENDL-2019 LIBRARY; T=293.16K  
angular distribution for (n,n\*1)

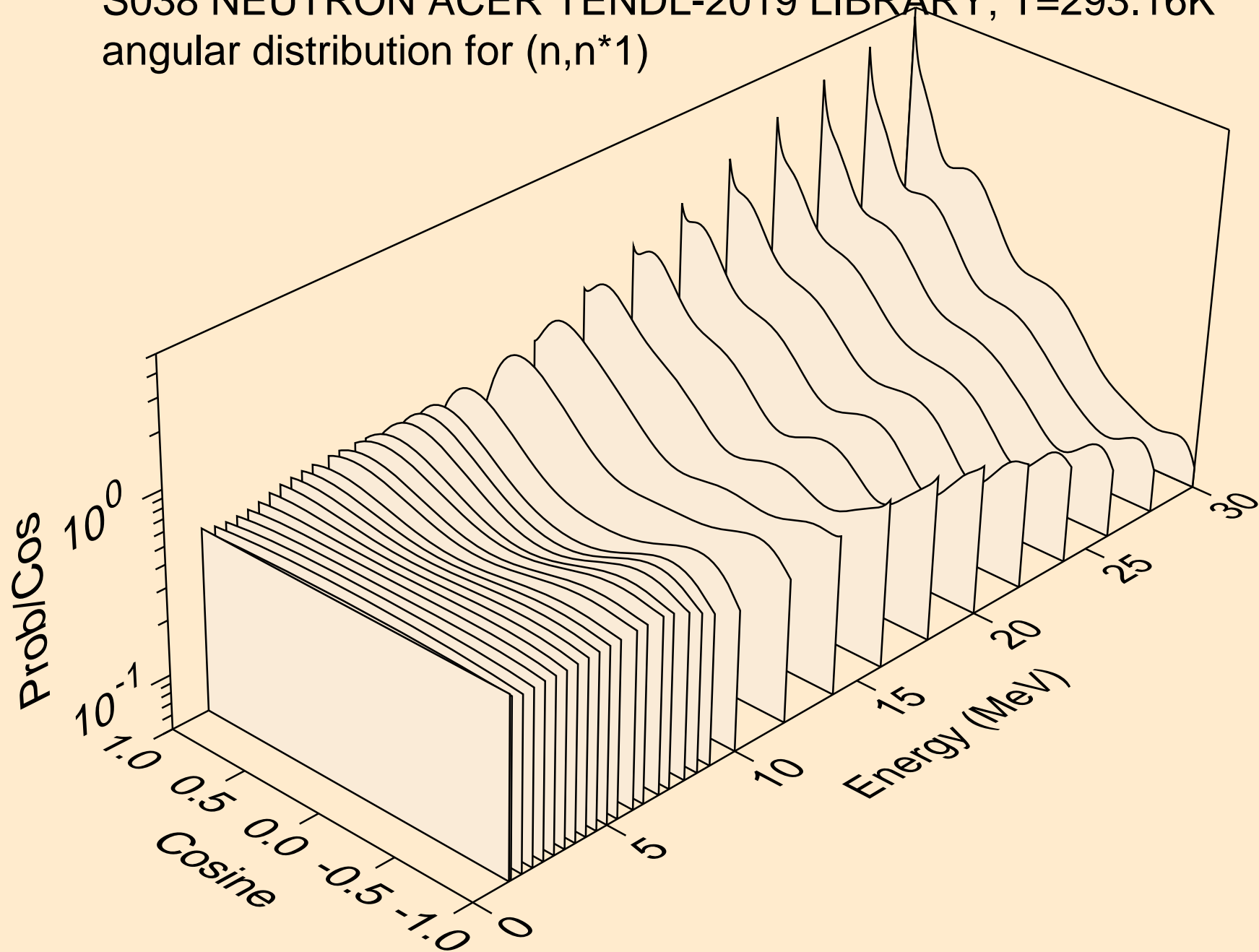

S038 NEUTRON ACER TENDL-2019 LIBRARY; T=293.16K  
angular distribution for (n,n\*2)

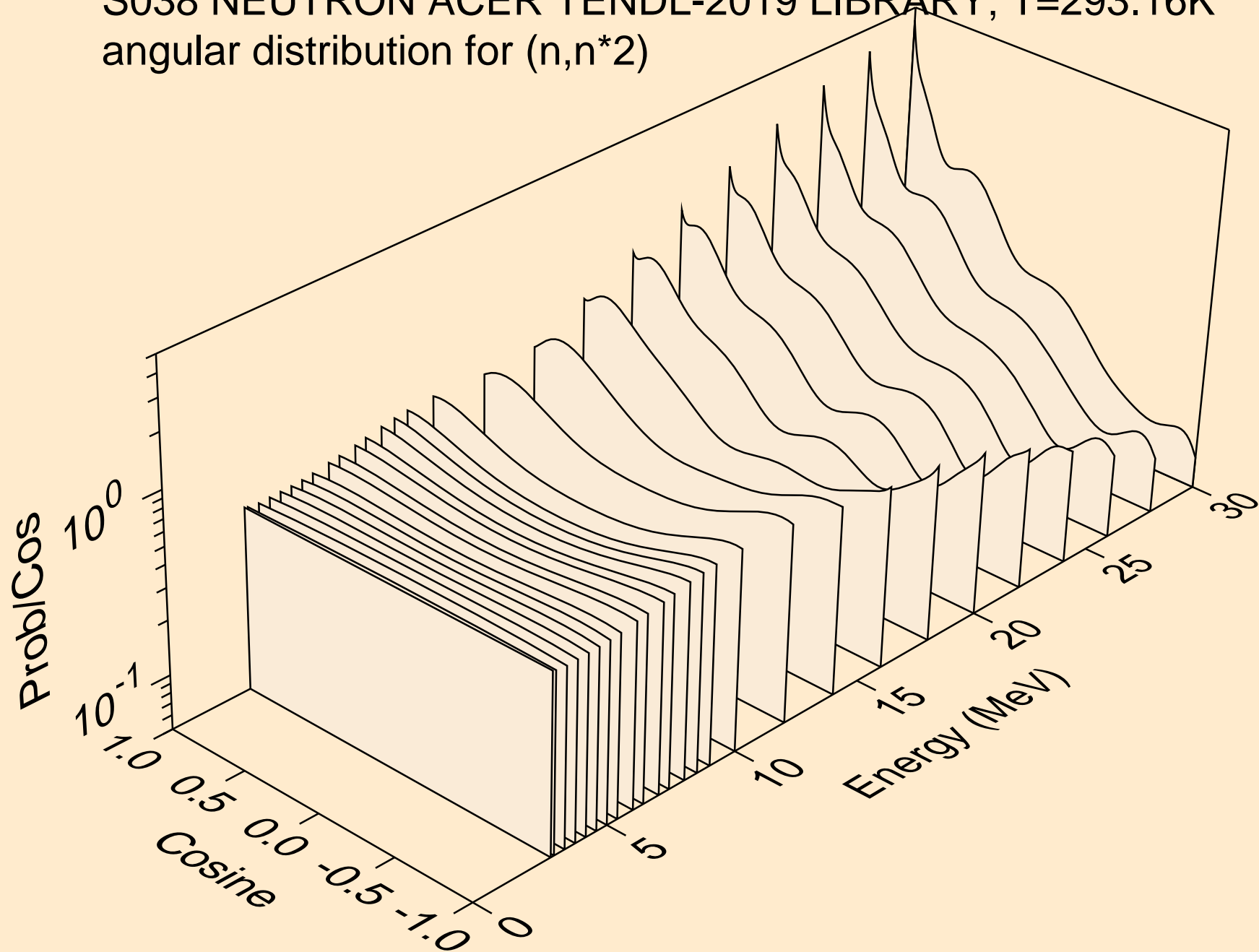

S038 NEUTRON ACER TENDL-2019 LIBRARY; T=293.16K  
angular distribution for (n,n\*3)

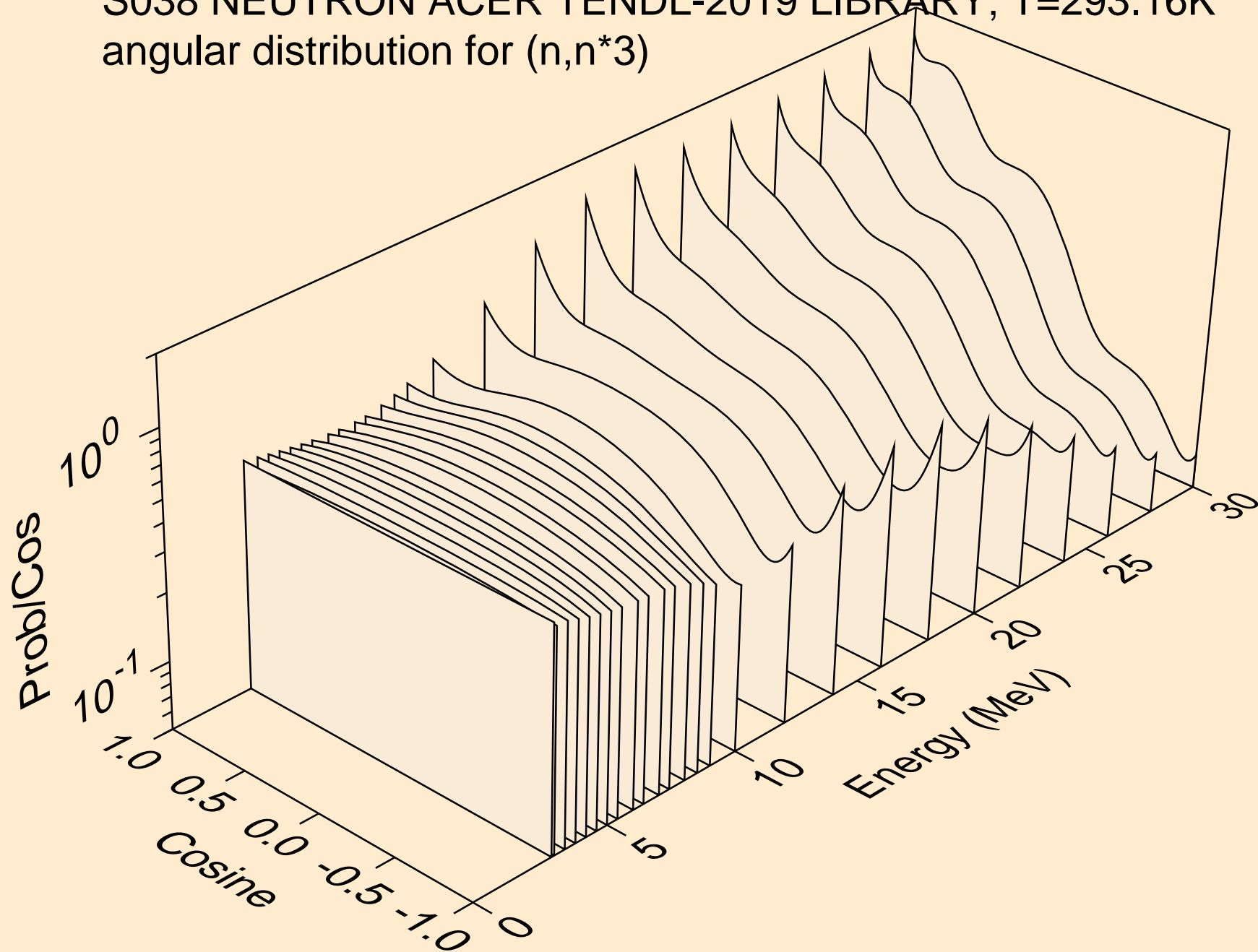



S038 NEUTRON ACER TENDL-2019 LIBRARY; T=293.16K  
angular distribution for (n,n\*4)

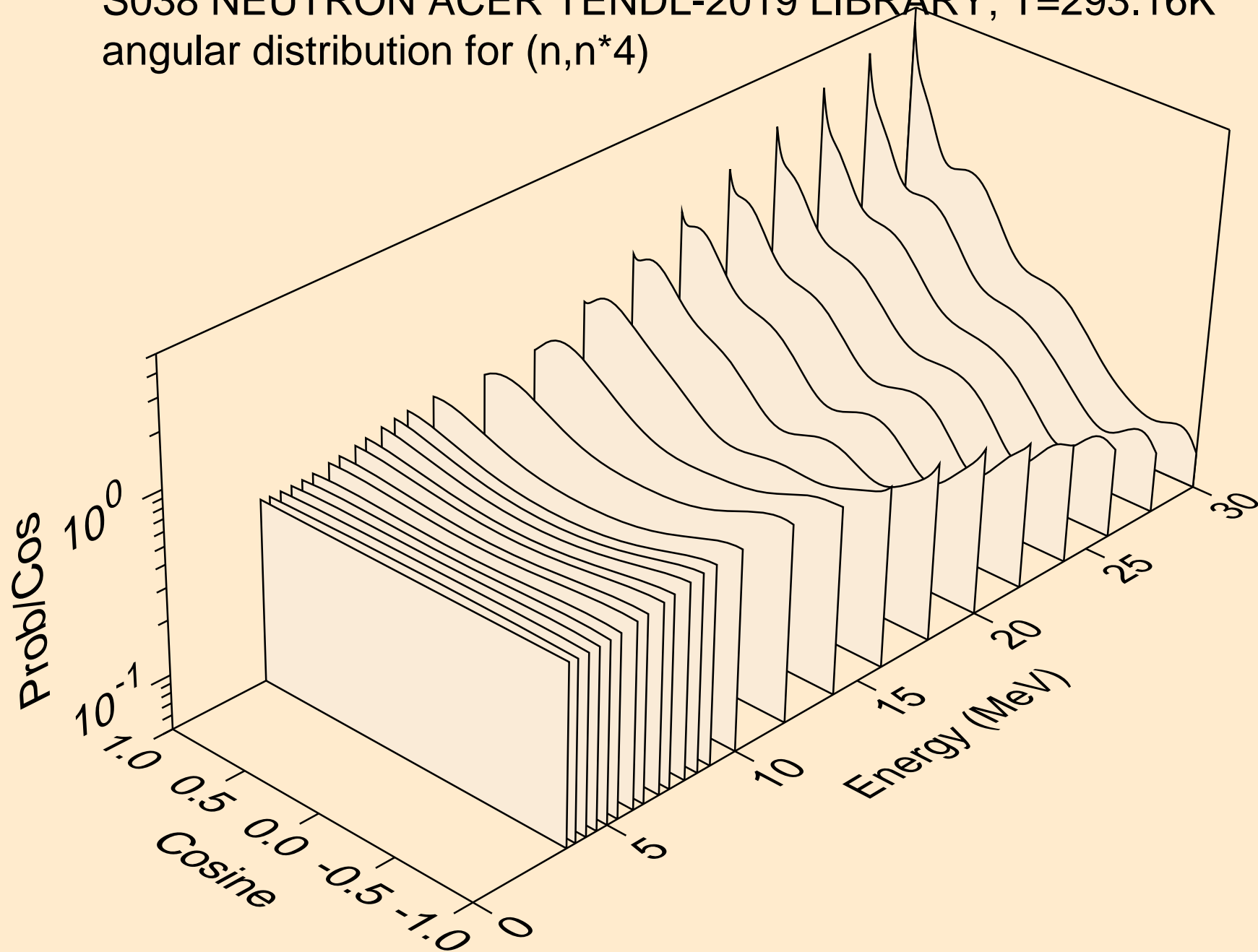

S038 NEUTRON ACER TENDL-2019 LIBRARY; T=293.16K  
angular distribution for (n,n\*5)

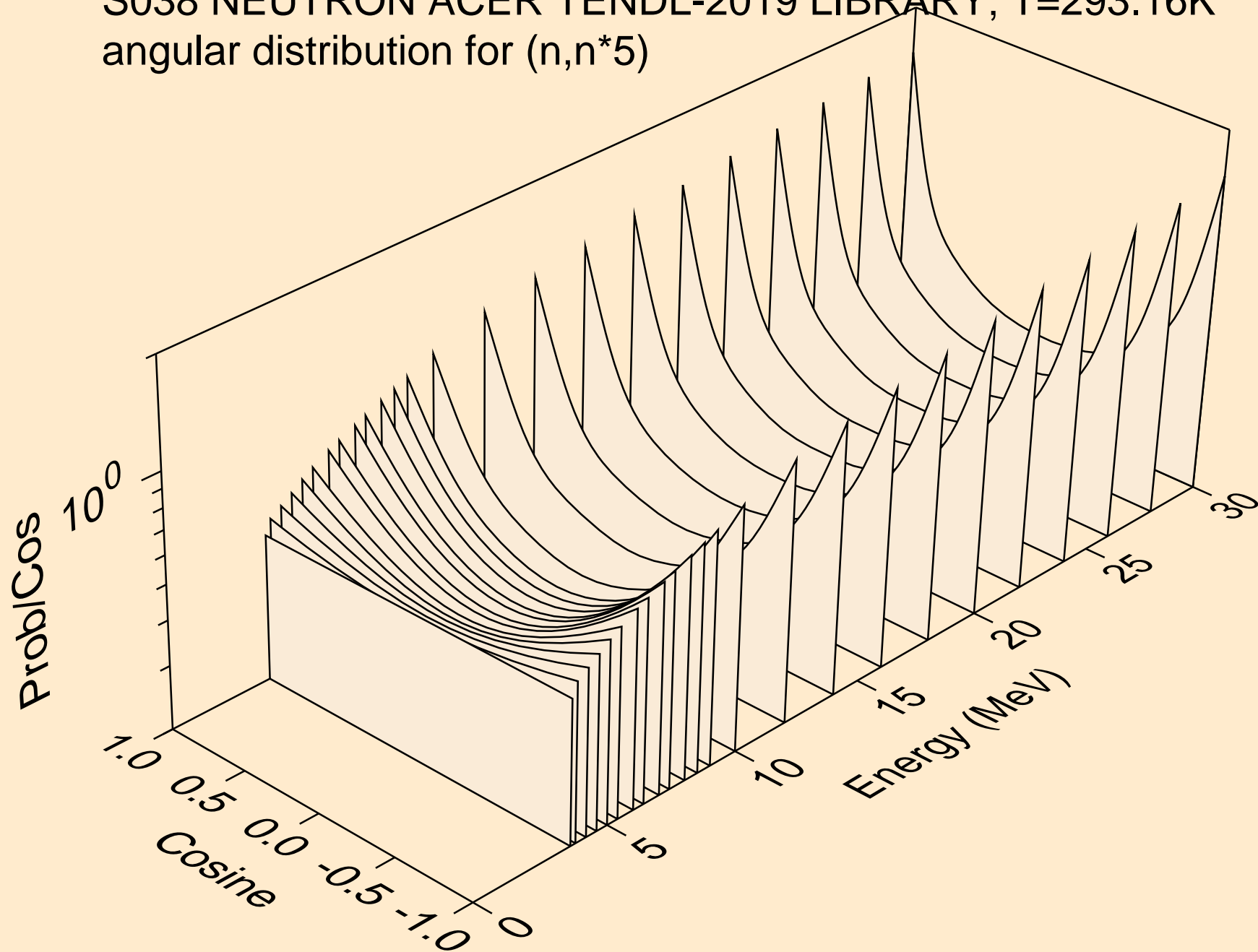

S038 NEUTRON ACER TENDL-2019 LIBRARY; T=293.16K  
angular distribution for (n,n\*6)

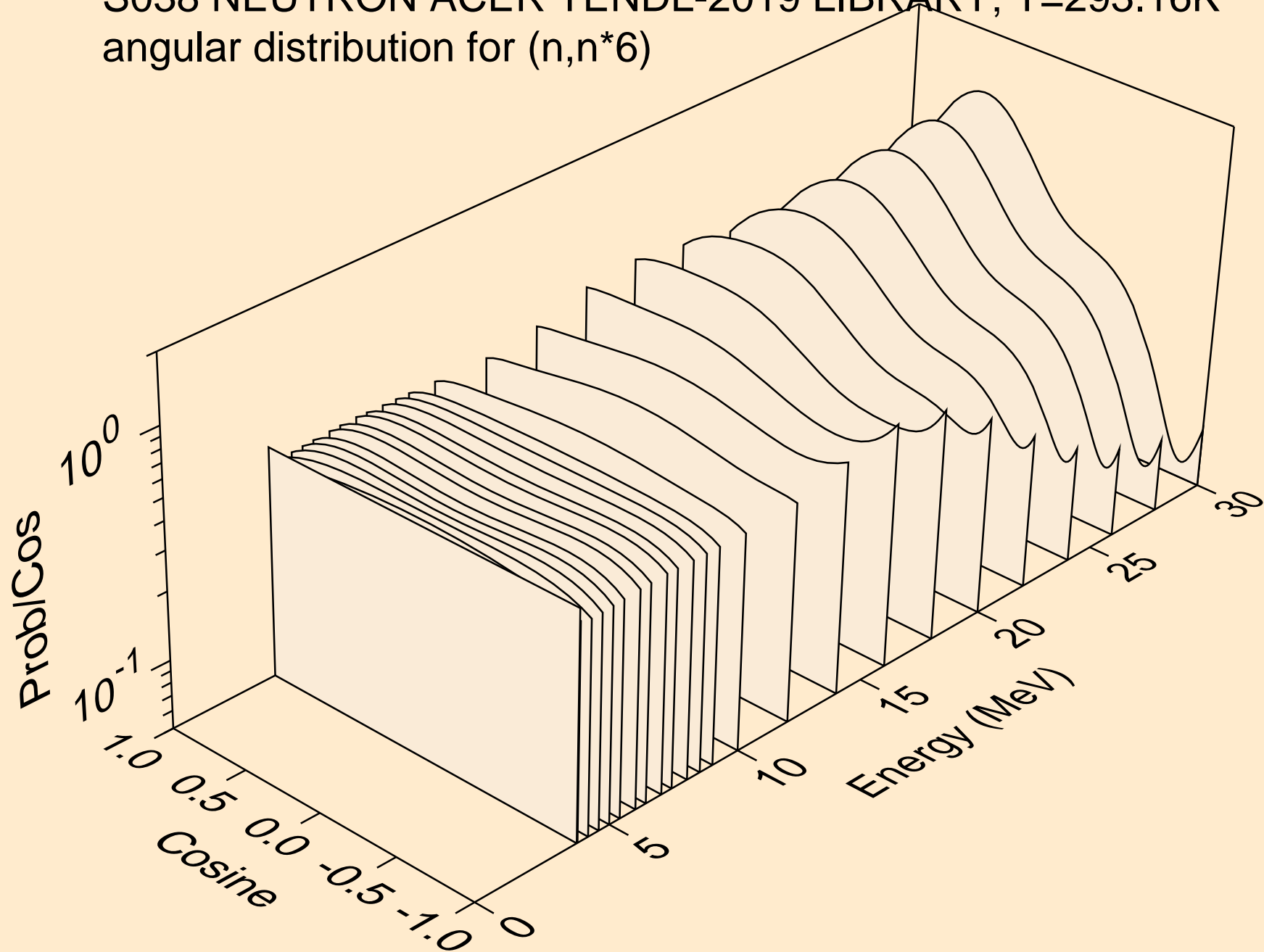

S038 NEUTRON ACER TENDL-2019 LIBRARY; T=293.16K  
angular distribution for (n,n\*7)

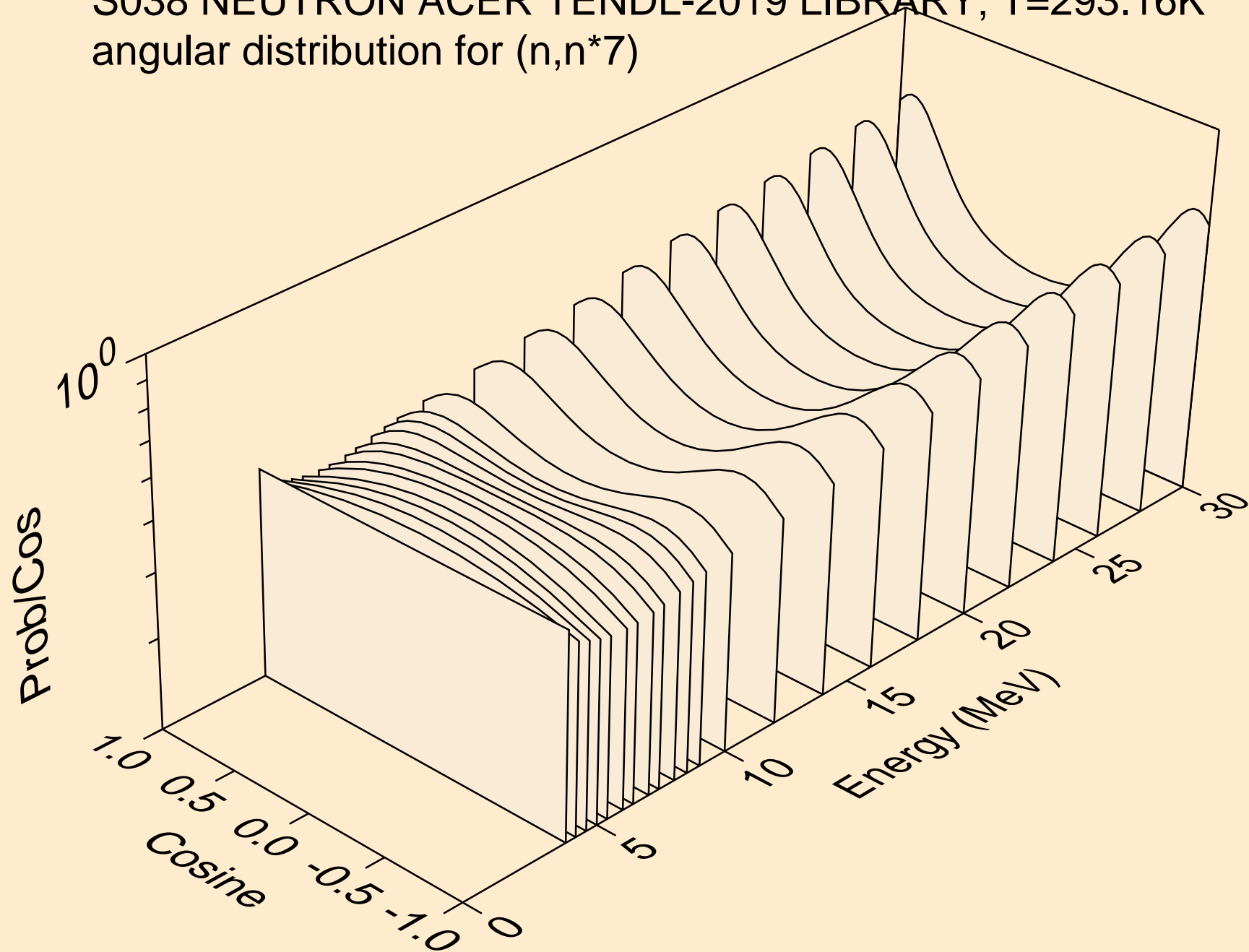

S038 NEUTRON ACER TENDL-2019 LIBRARY; T=293.16K  
angular distribution for (n,n\*8)

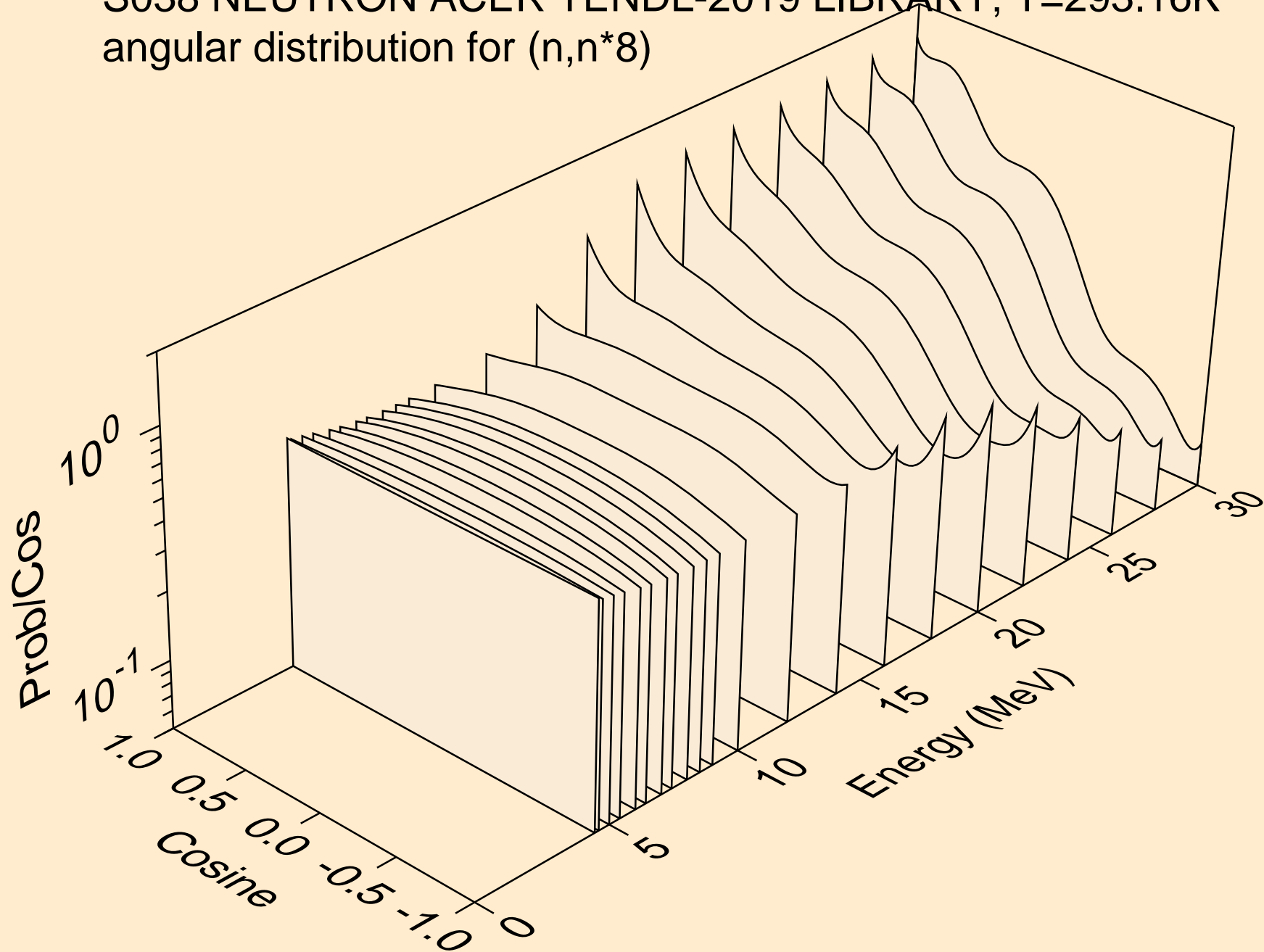

S038 NEUTRON ACER TENDL-2019 LIBRARY; T=293.16K  
angular distribution for (n,n\*9)

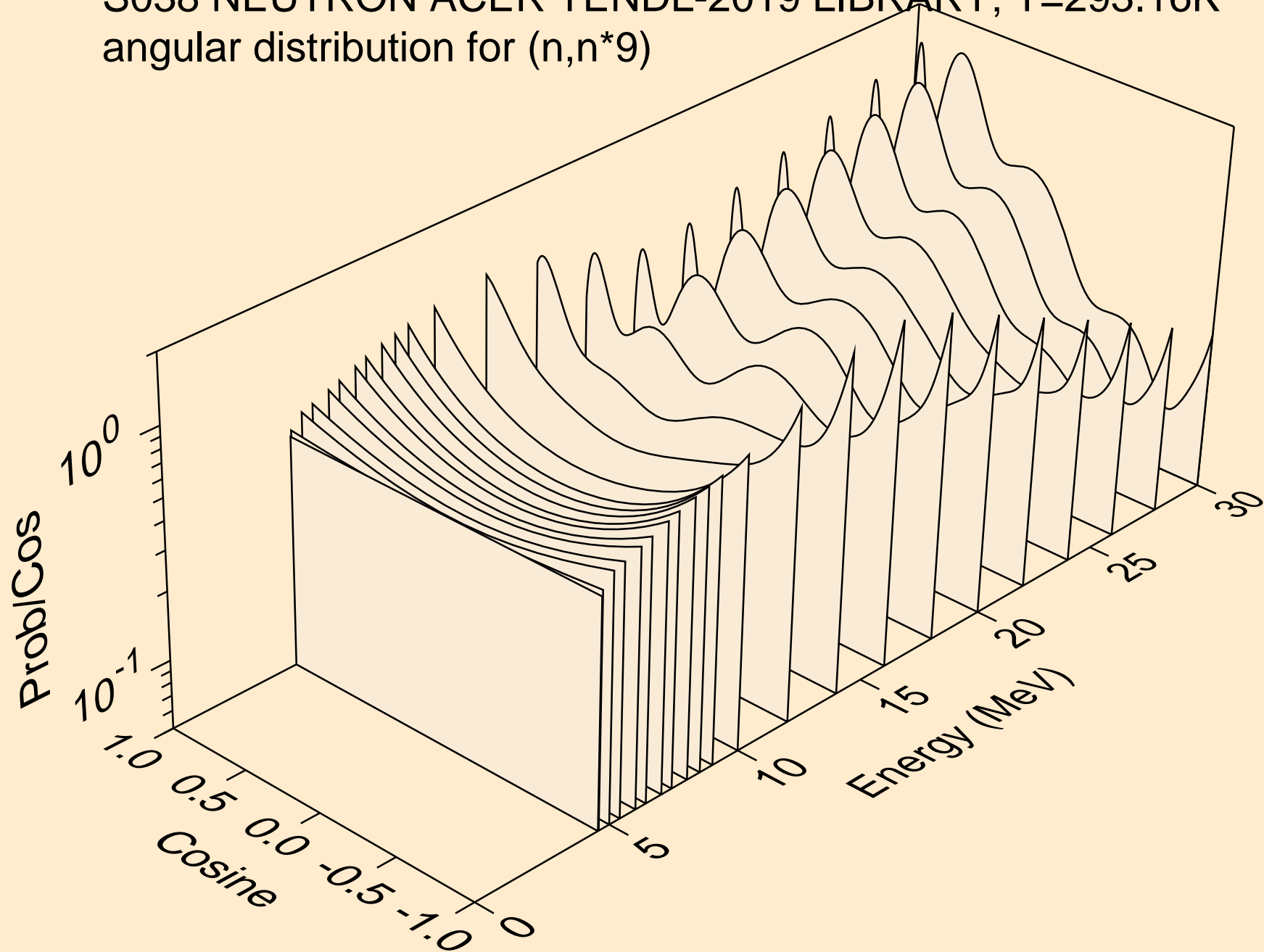

S038 NEUTRON ACER TENDL-2019 LIBRARY; T=293.16K  
angular distribution for (n,n\*10)

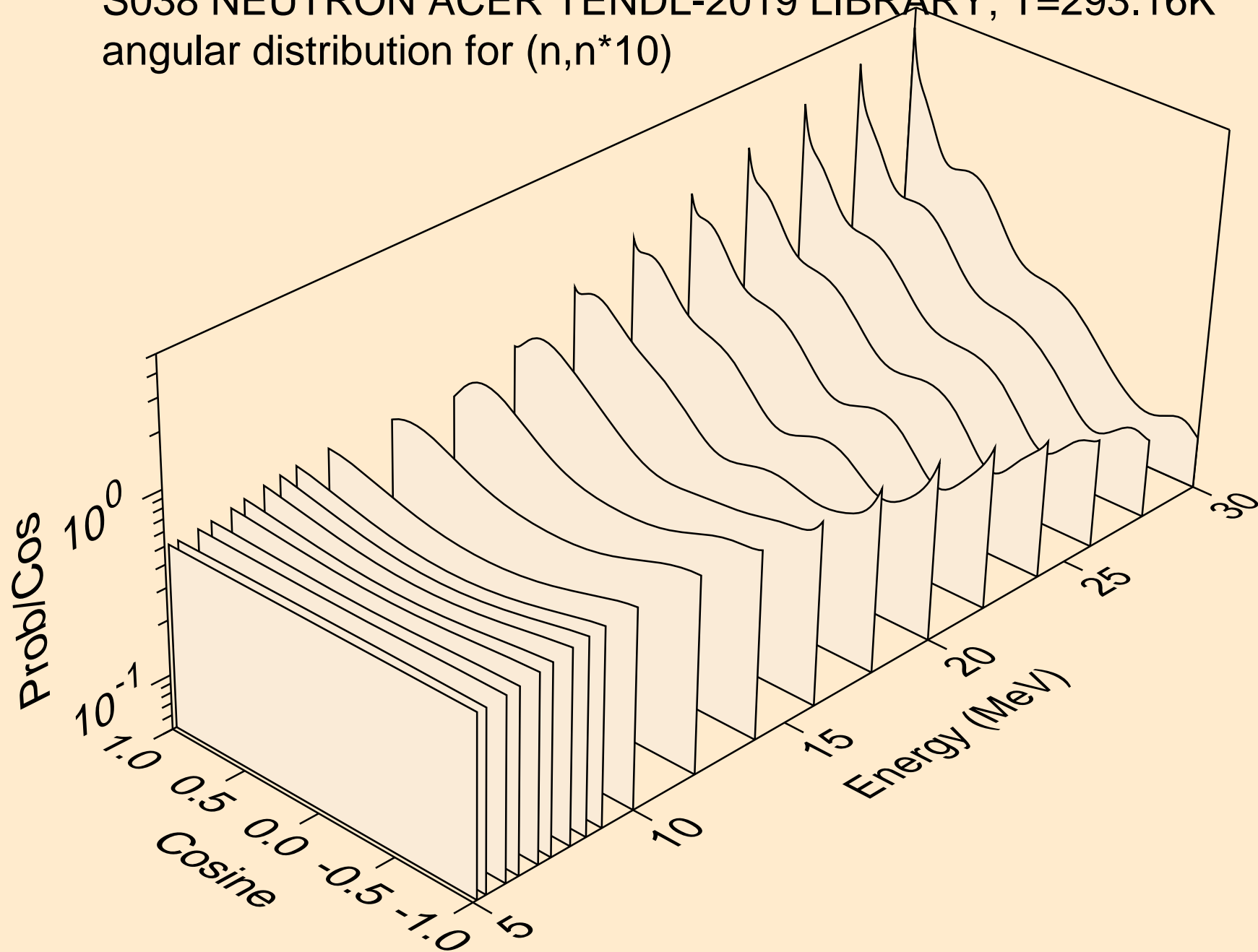

S038 NEUTRON ACER TENDL-2019 LIBRARY; T=293.16K  
angular distribution for (n,n\*11)

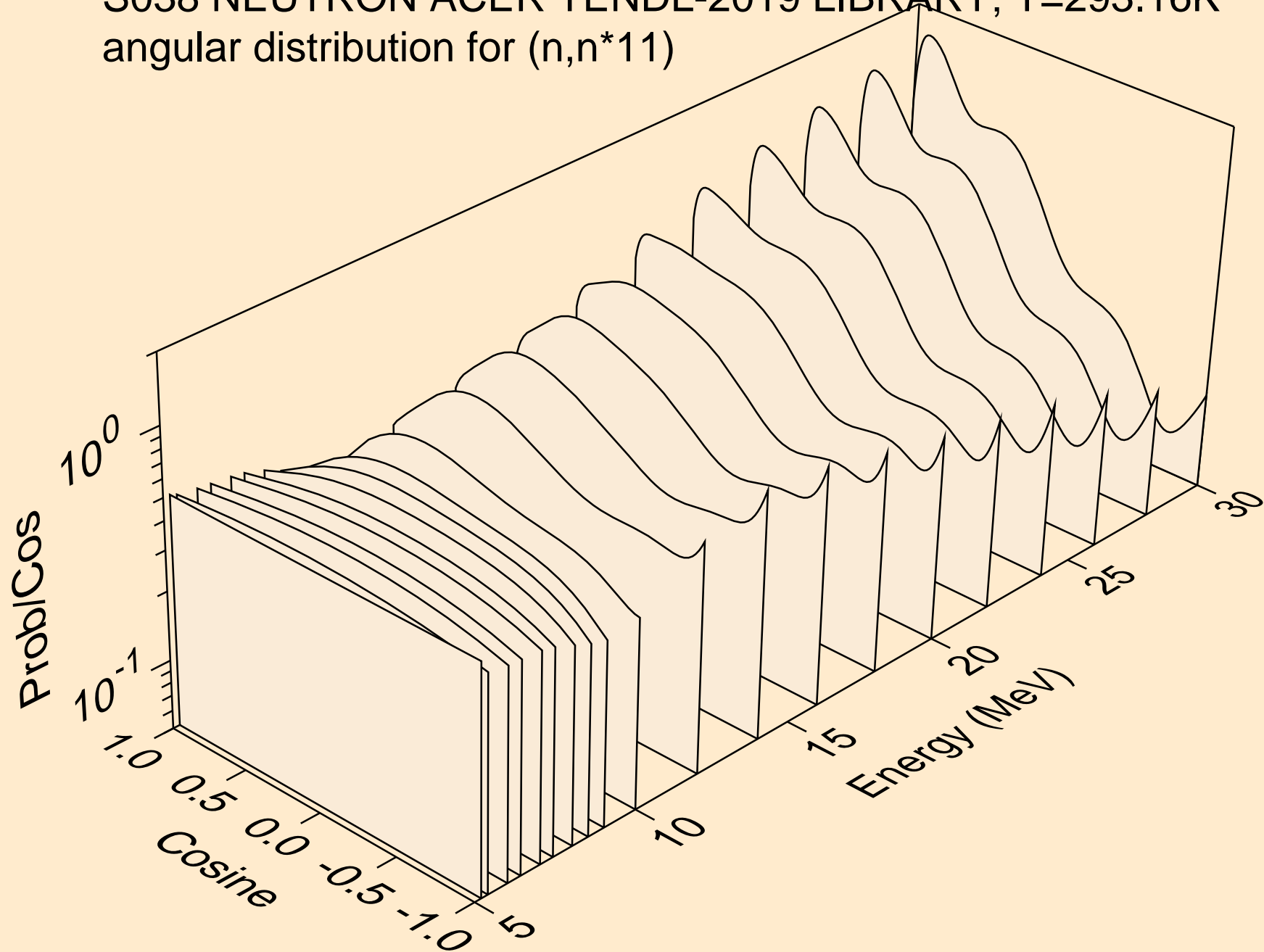



S038 NEUTRON ACER TENDL-2019 LIBRARY; T=293.16K  
angular distribution for (n,n\*12)

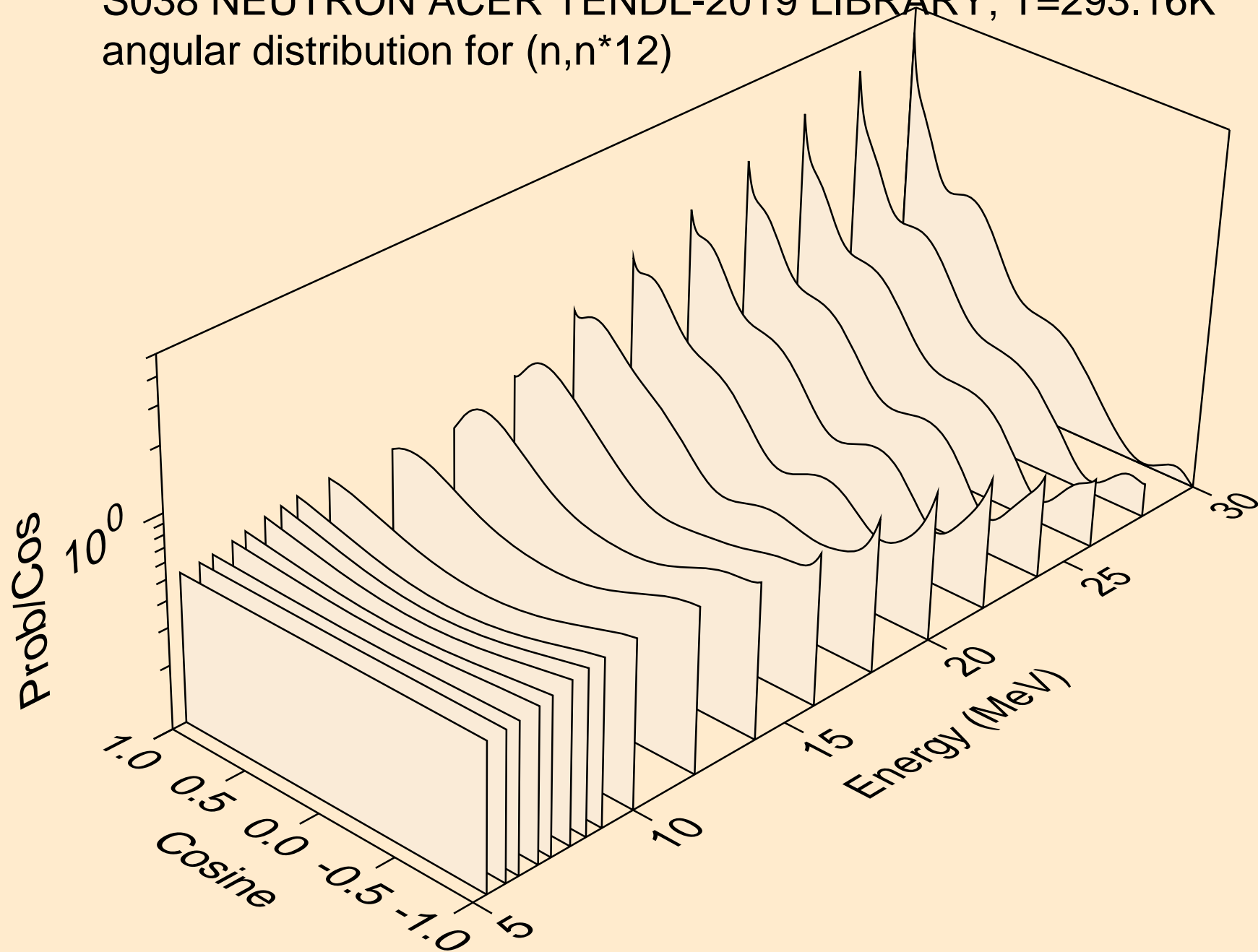

S038 NEUTRON ACER TENDL-2019 LIBRARY; T=293.16K  
angular distribution for (n,n\*13)

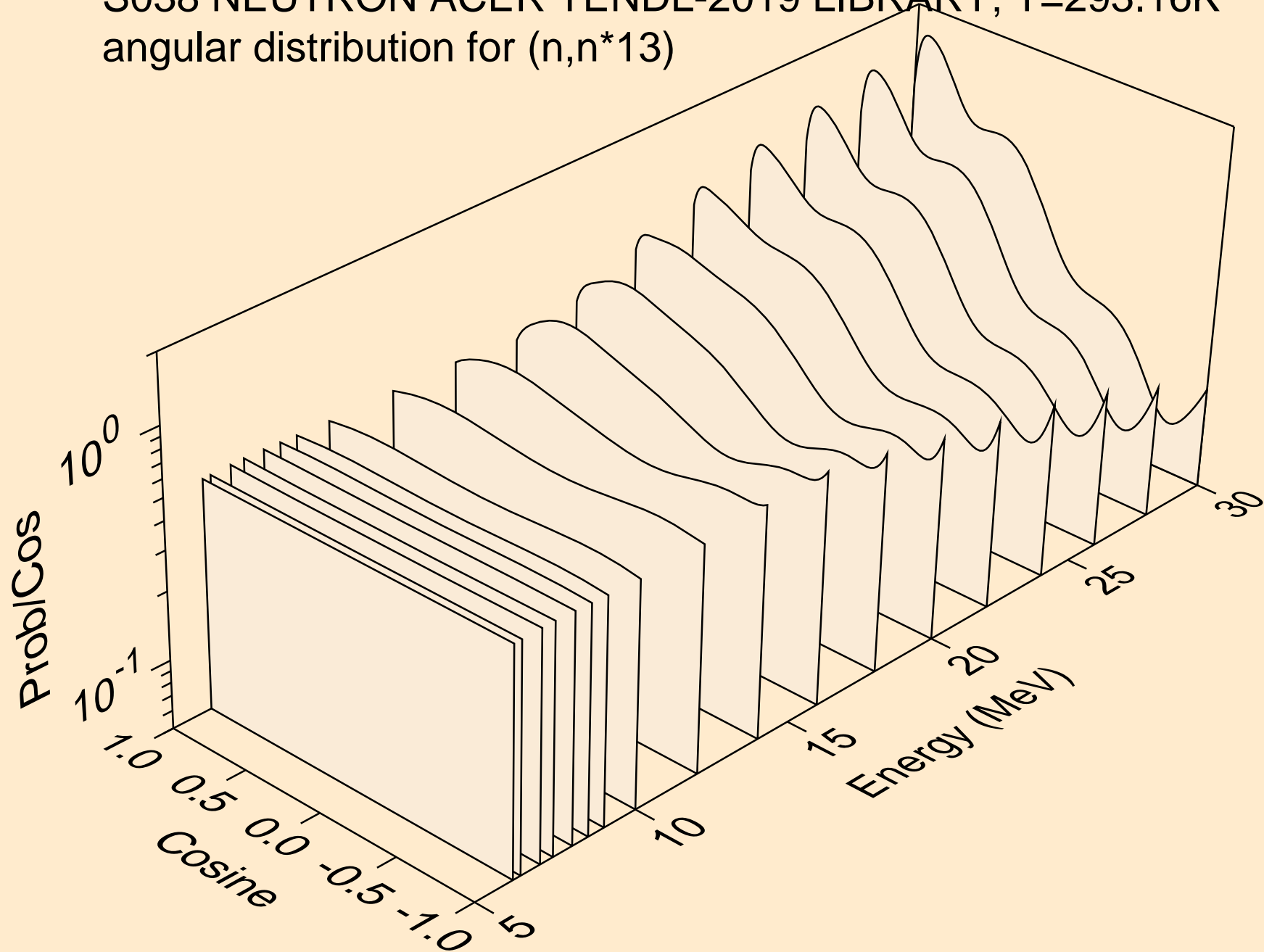

S038 NEUTRON ACER TENDL-2019 LIBRARY; T=293.16K  
angular distribution for (n,n\*14)

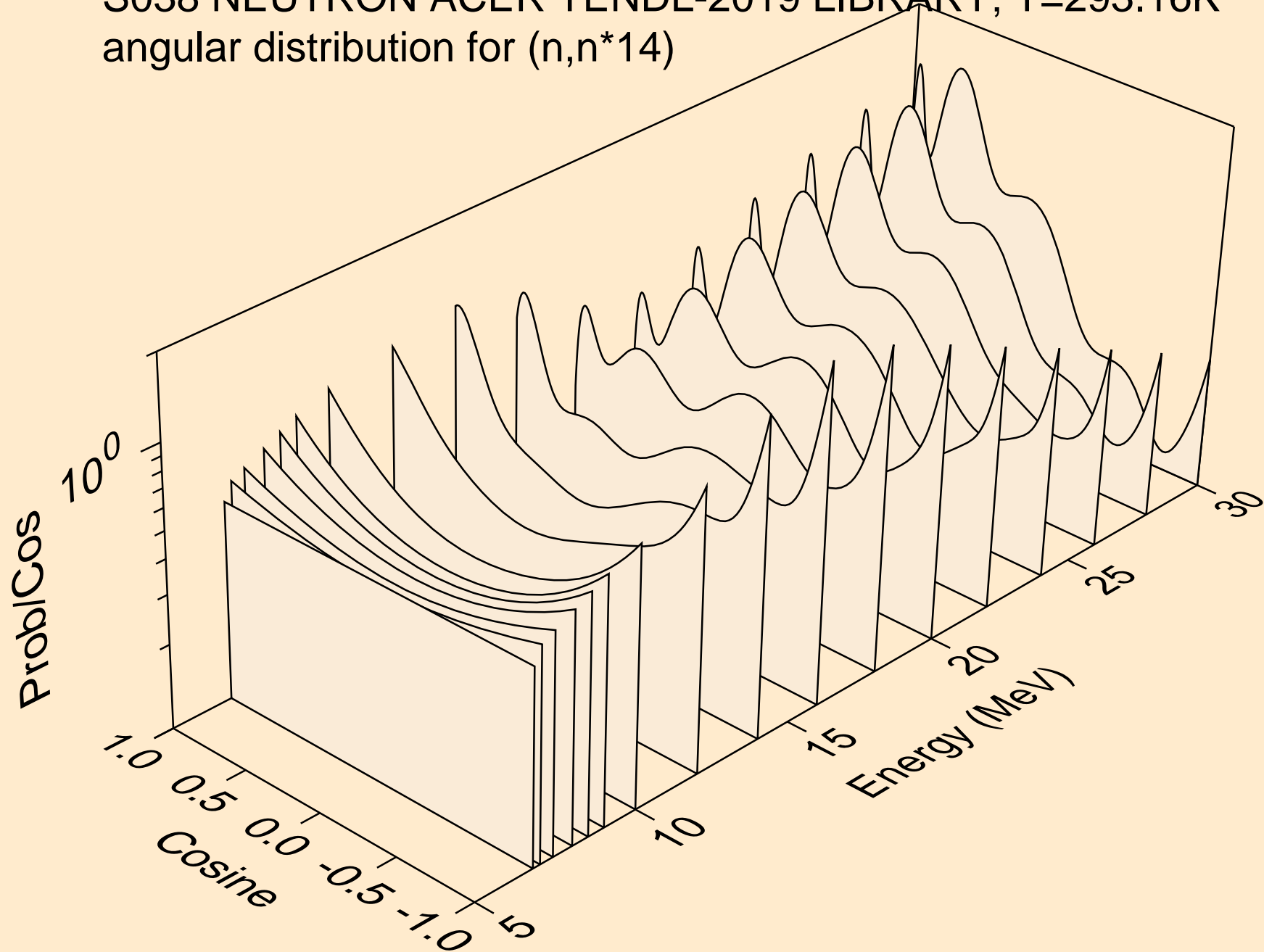

S038 NEUTRON ACER TENDL-2019 LIBRARY; T=293.16K  
angular distribution for (n,n\*15)

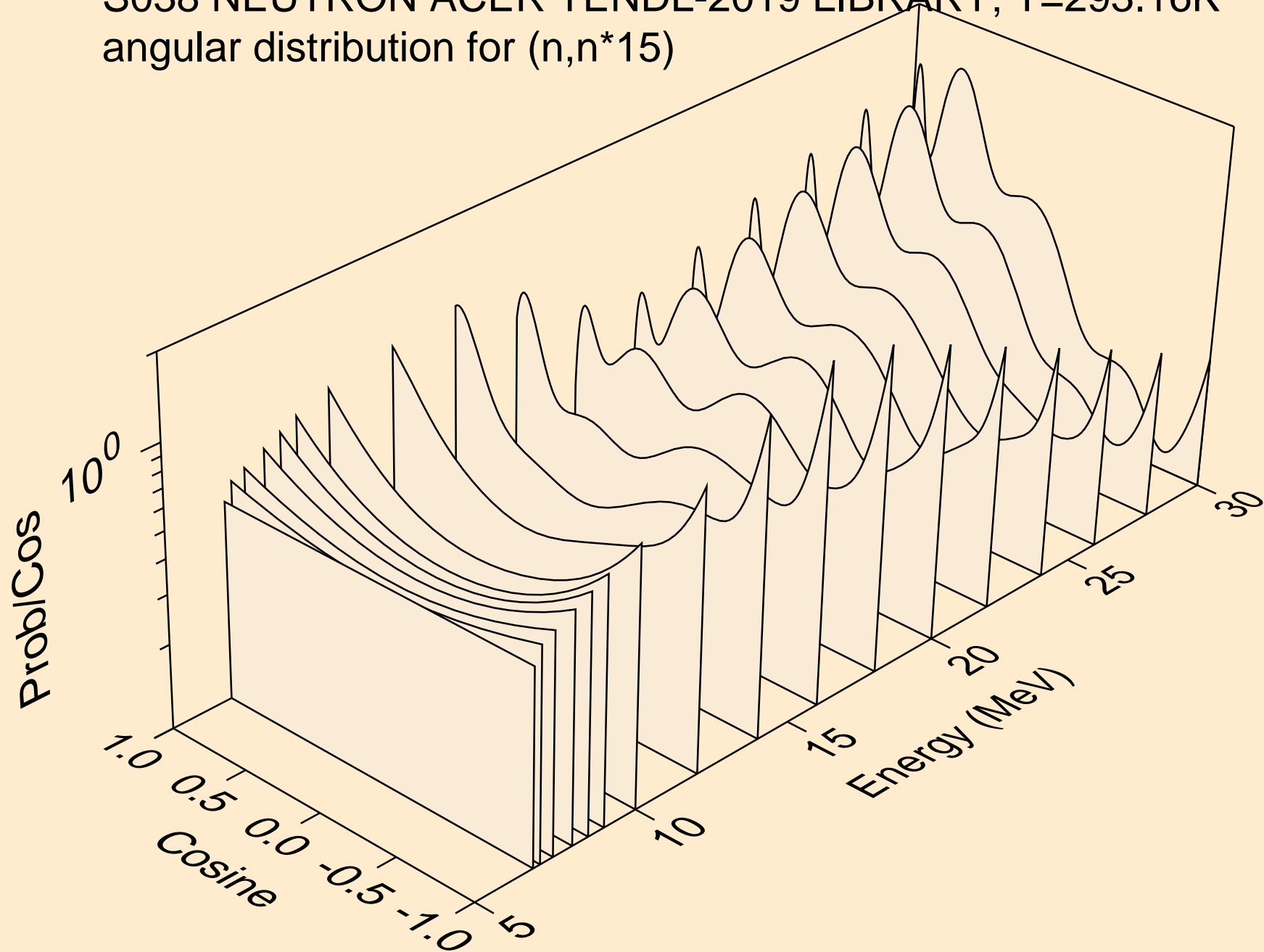

S038 NEUTRON ACER TENDL-2019 LIBRARY; T=293.16K  
angular distribution for (n,n\*16)

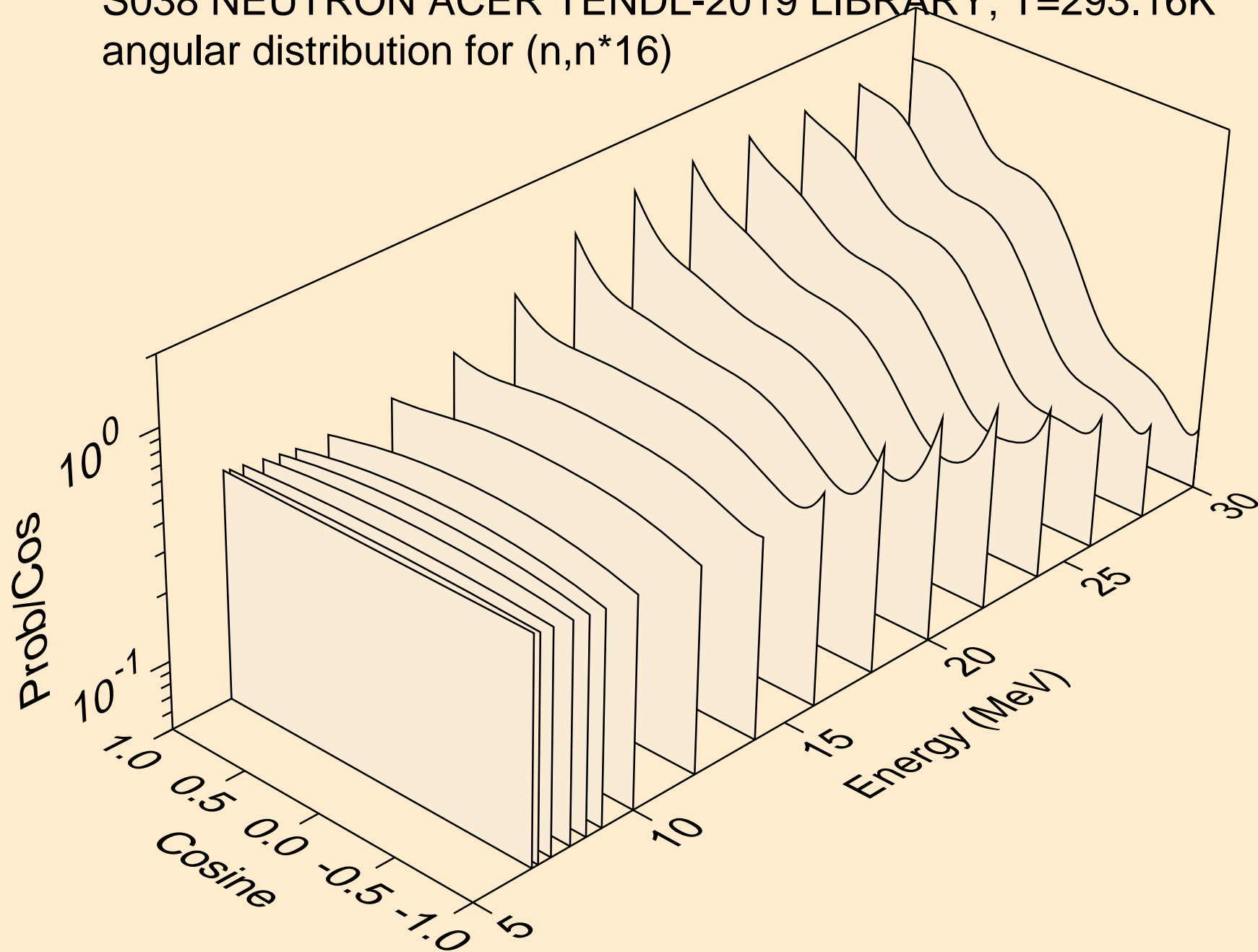

S038 NEUTRON ACER TENDL-2019 LIBRARY; T=293.16K  
angular distribution for (n,n\*17)

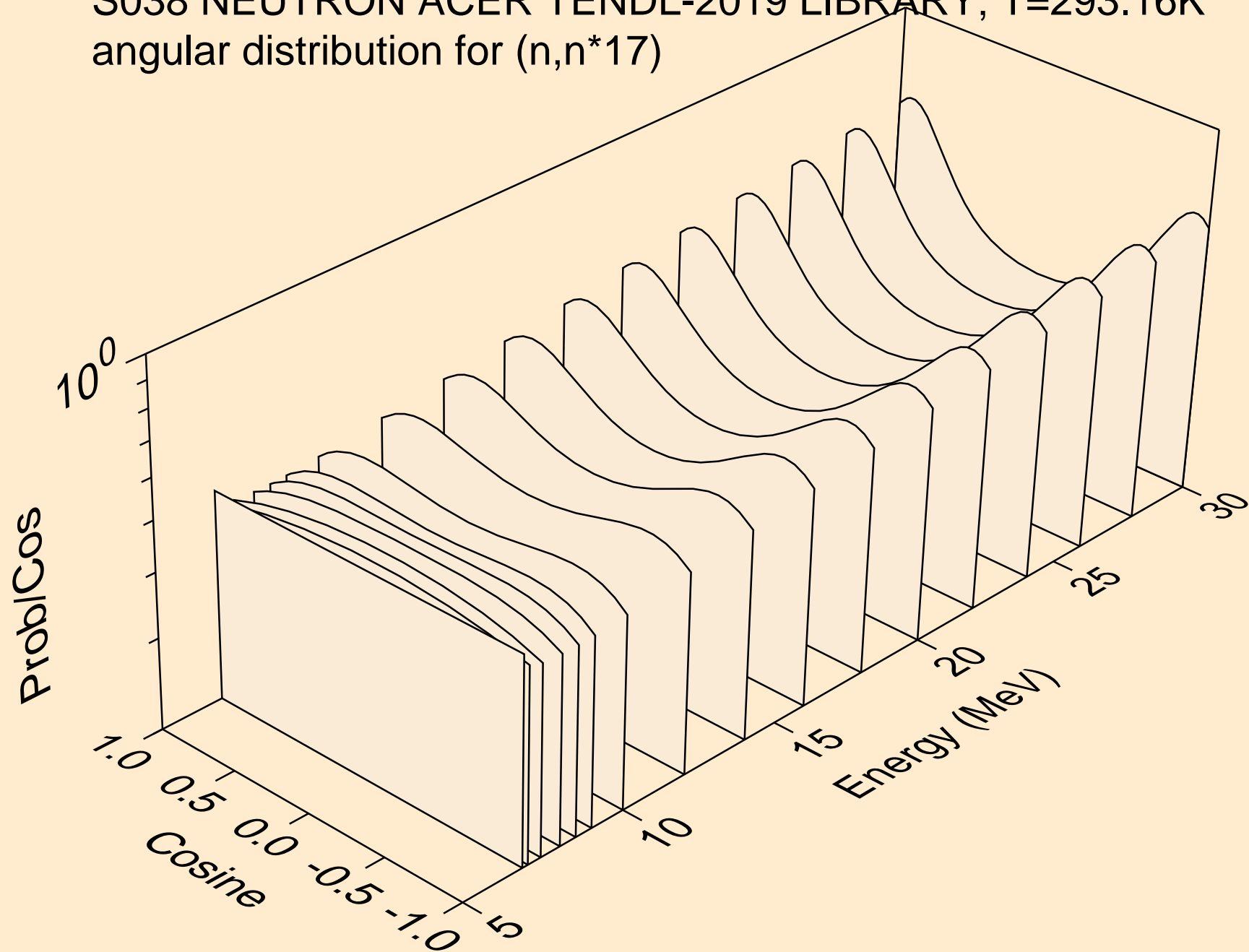

S038 NEUTRON ACER TENDL-2019 LIBRARY; T=293.16K  
angular distribution for (n,n\*18)

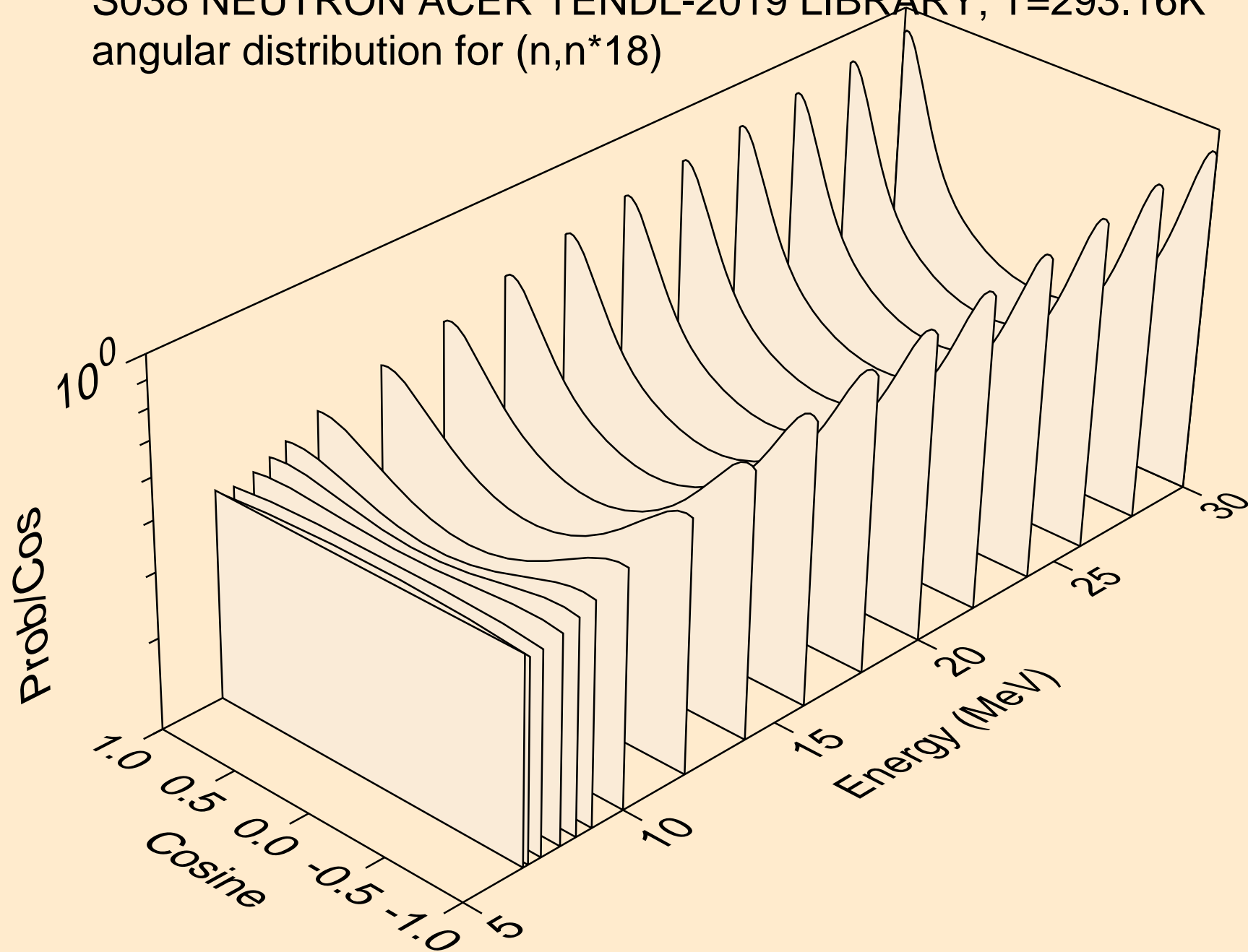

S038 NEUTRON ACER TENDL-2019 LIBRARY; T=293.16K  
angular distribution for (n,n\*19)

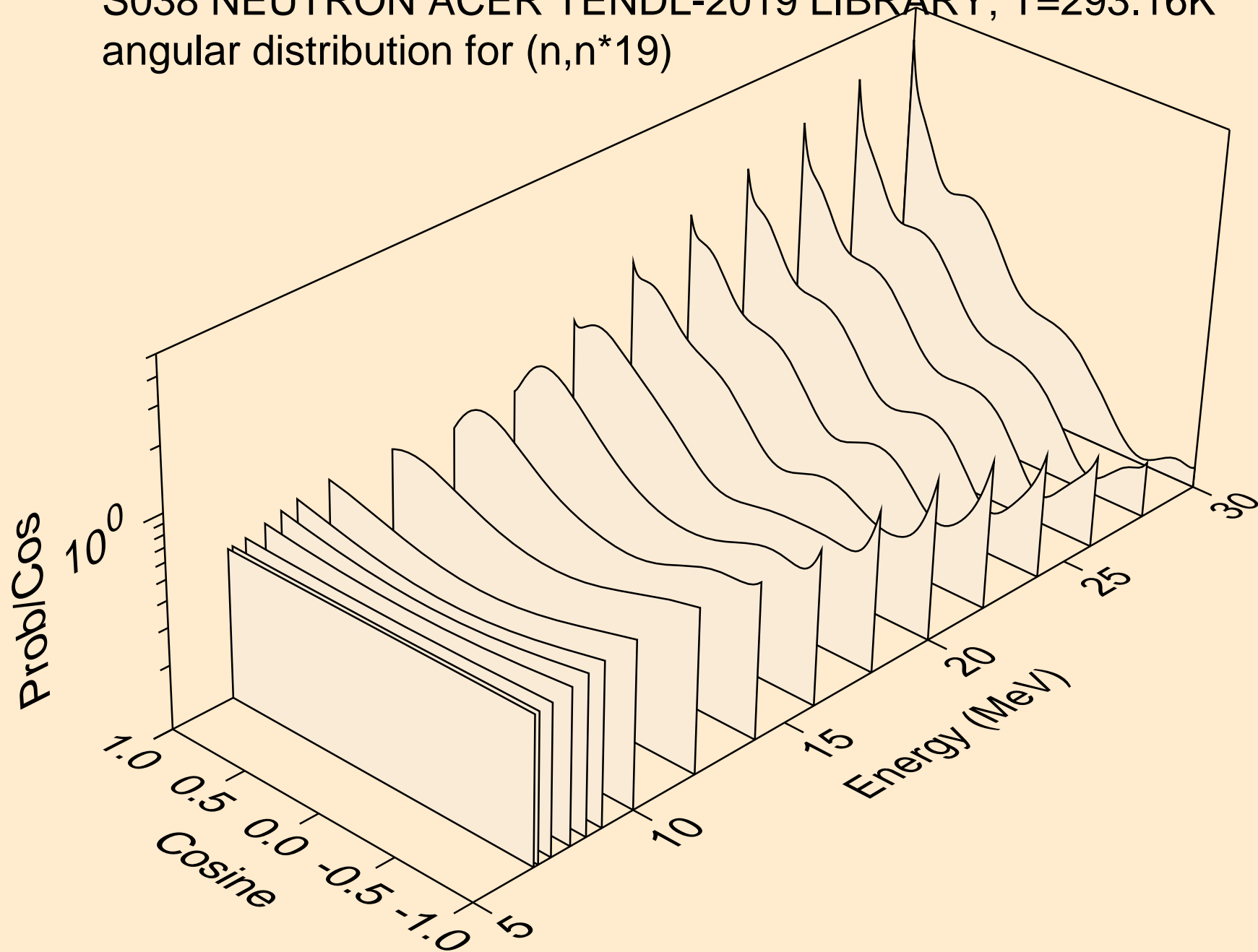



S038 NEUTRON ACER TENDL-2019 LIBRARY; T=293.16K  
angular distribution for (n,n\*20)

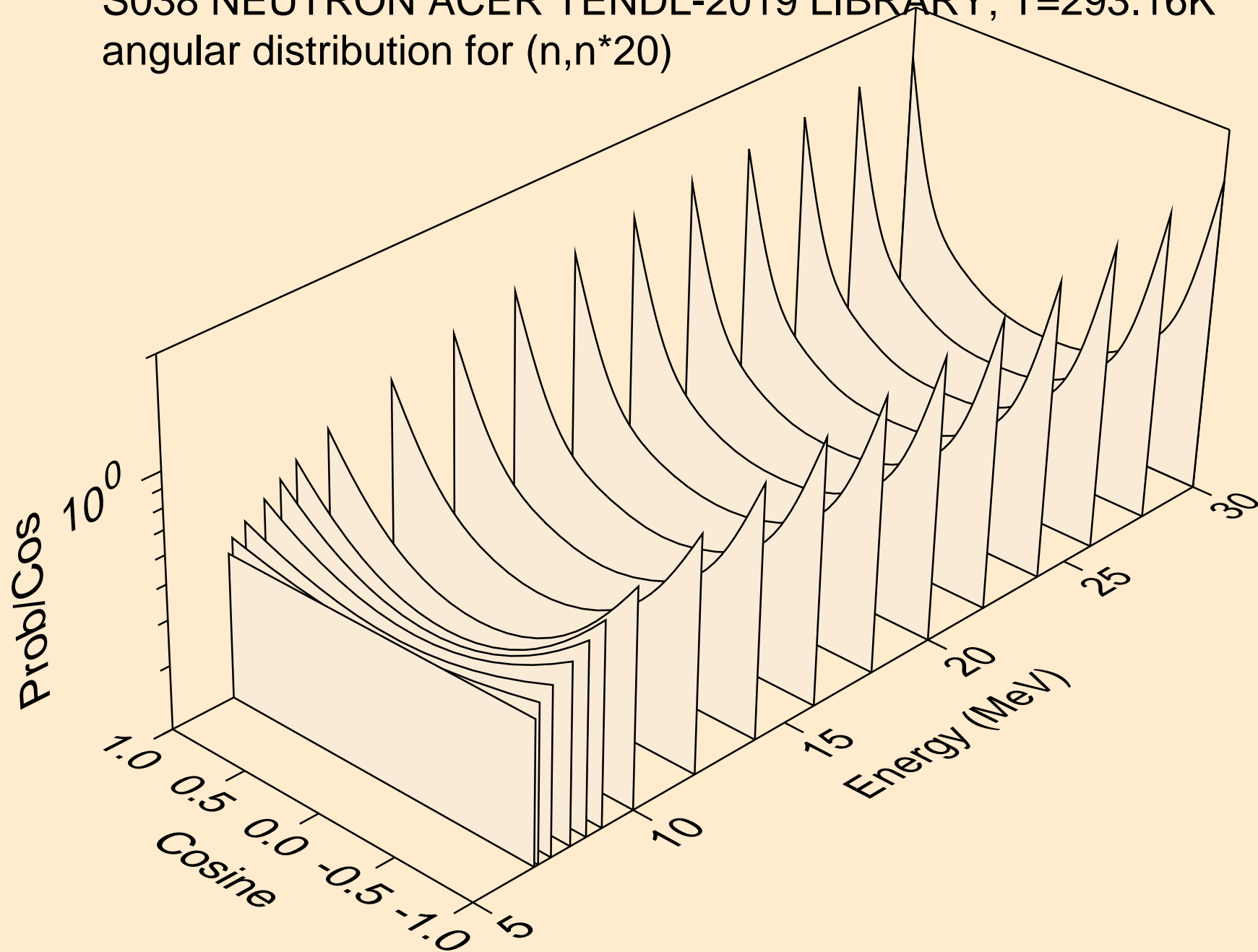

S038 NEUTRON ACER TENDL-2019 LIBRARY; T=293.16K  
angular distribution for (n,n\*21)

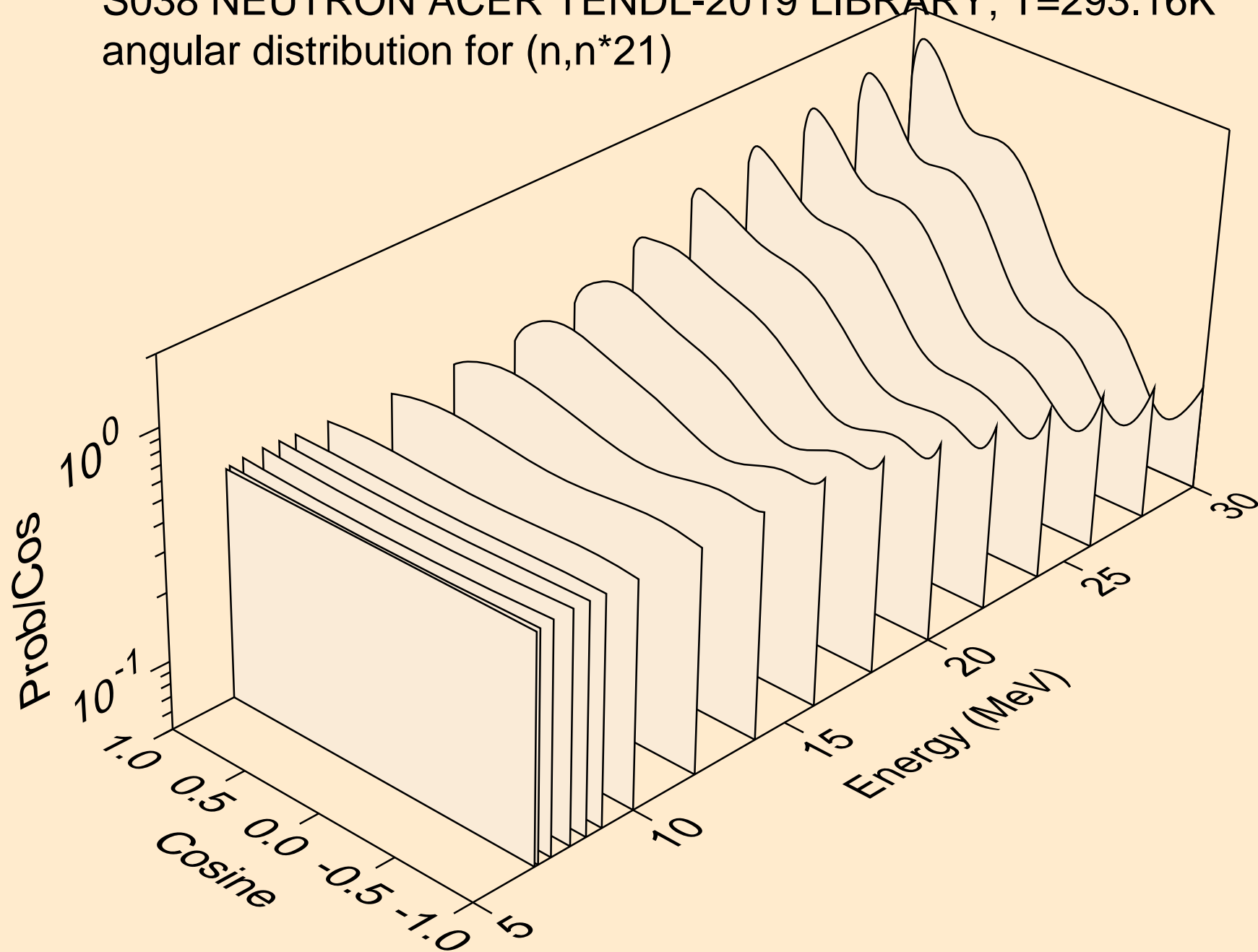

S038 NEUTRON ACER TENDL-2019 LIBRARY; T=293.16K  
angular distribution for (n,n\*22)

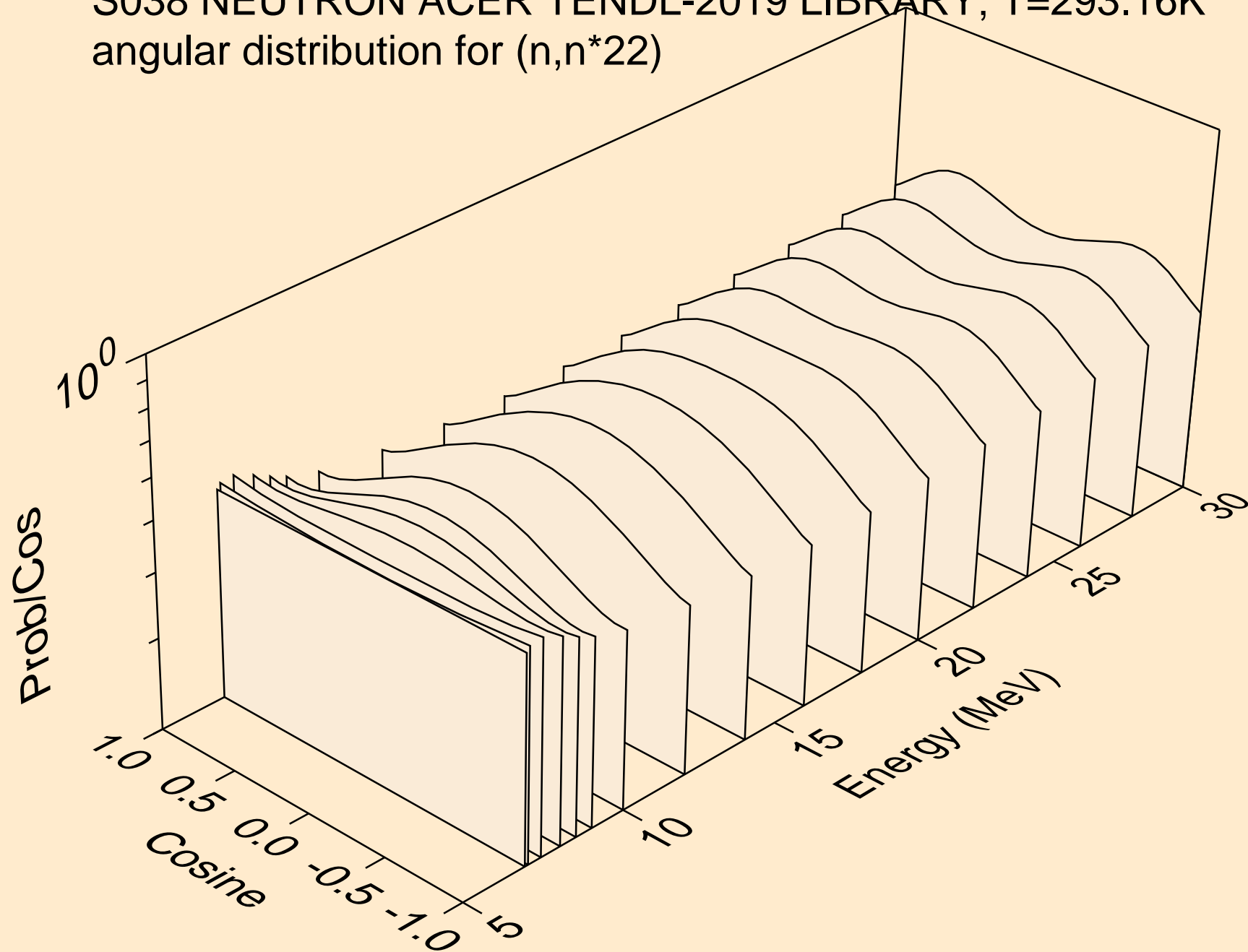

S038 NEUTRON ACER TENDL-2019 LIBRARY; T=293.16K  
angular distribution for (n,n\*23)

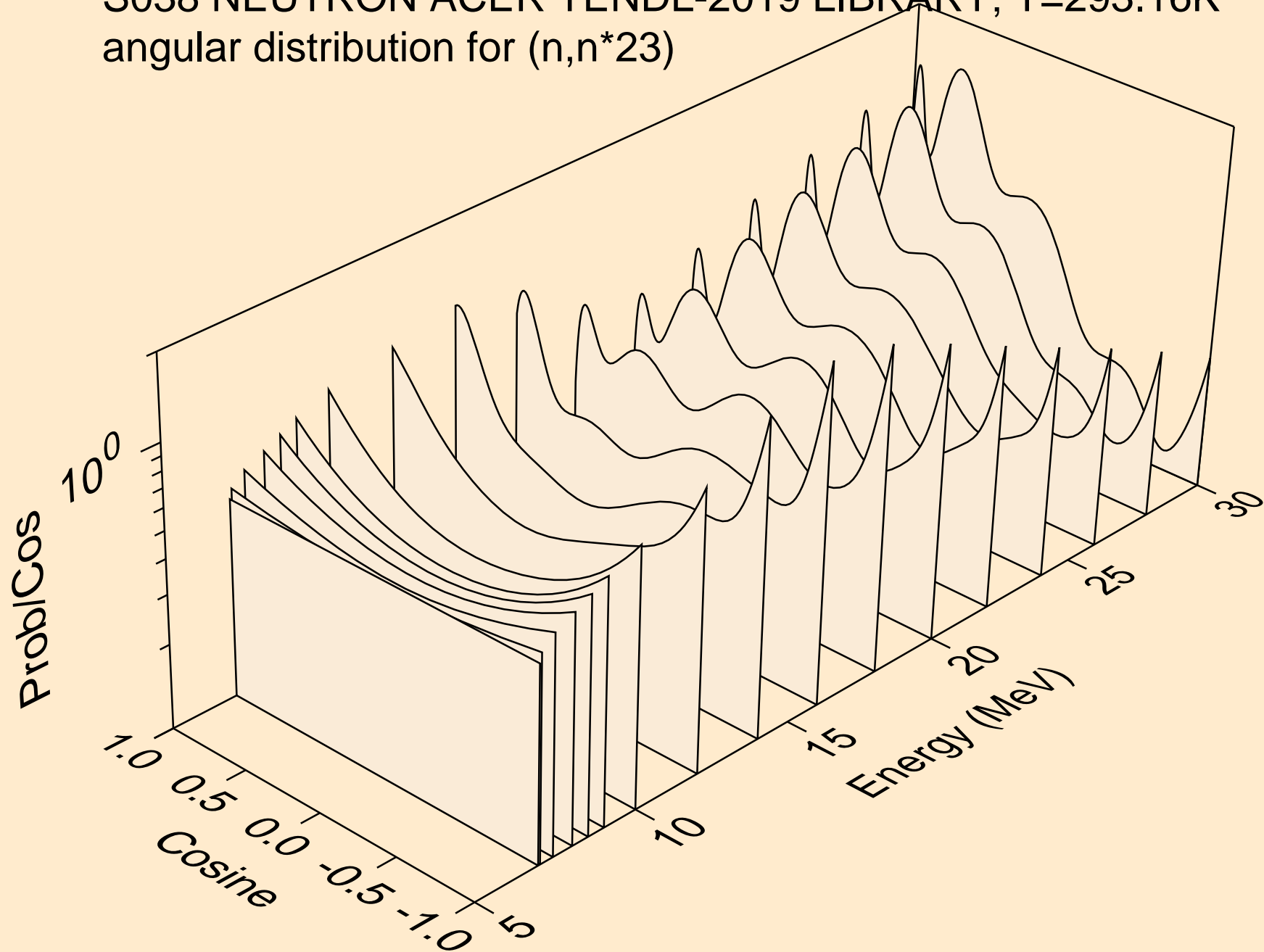

S038 NEUTRON ACER TENDL-2019 LIBRARY; T=293.16K  
angular distribution for (n,n\*24)

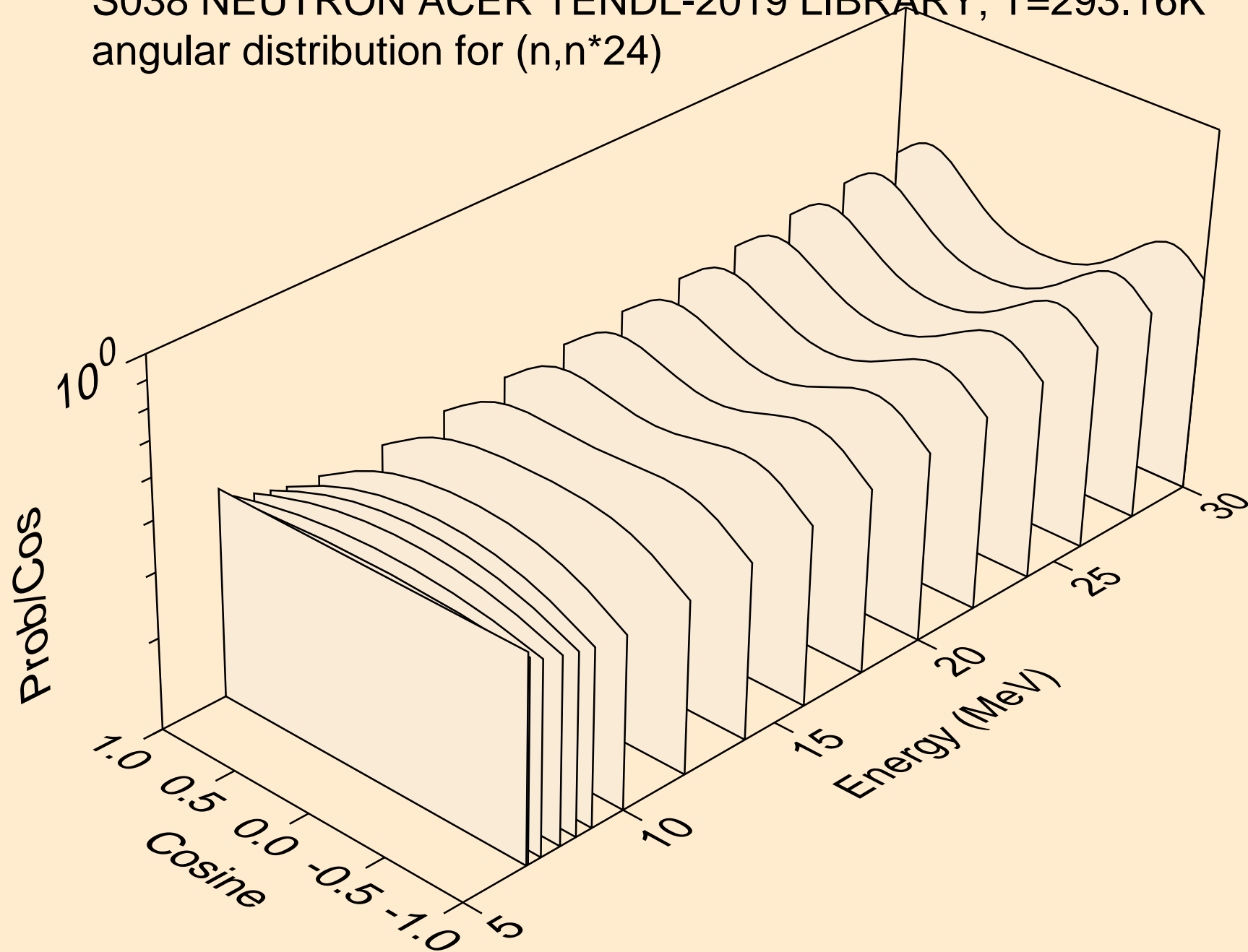

S038 NEUTRON ACER TENDL-2019 LIBRARY; T=293.16K  
angular distribution for (n,n\*25)

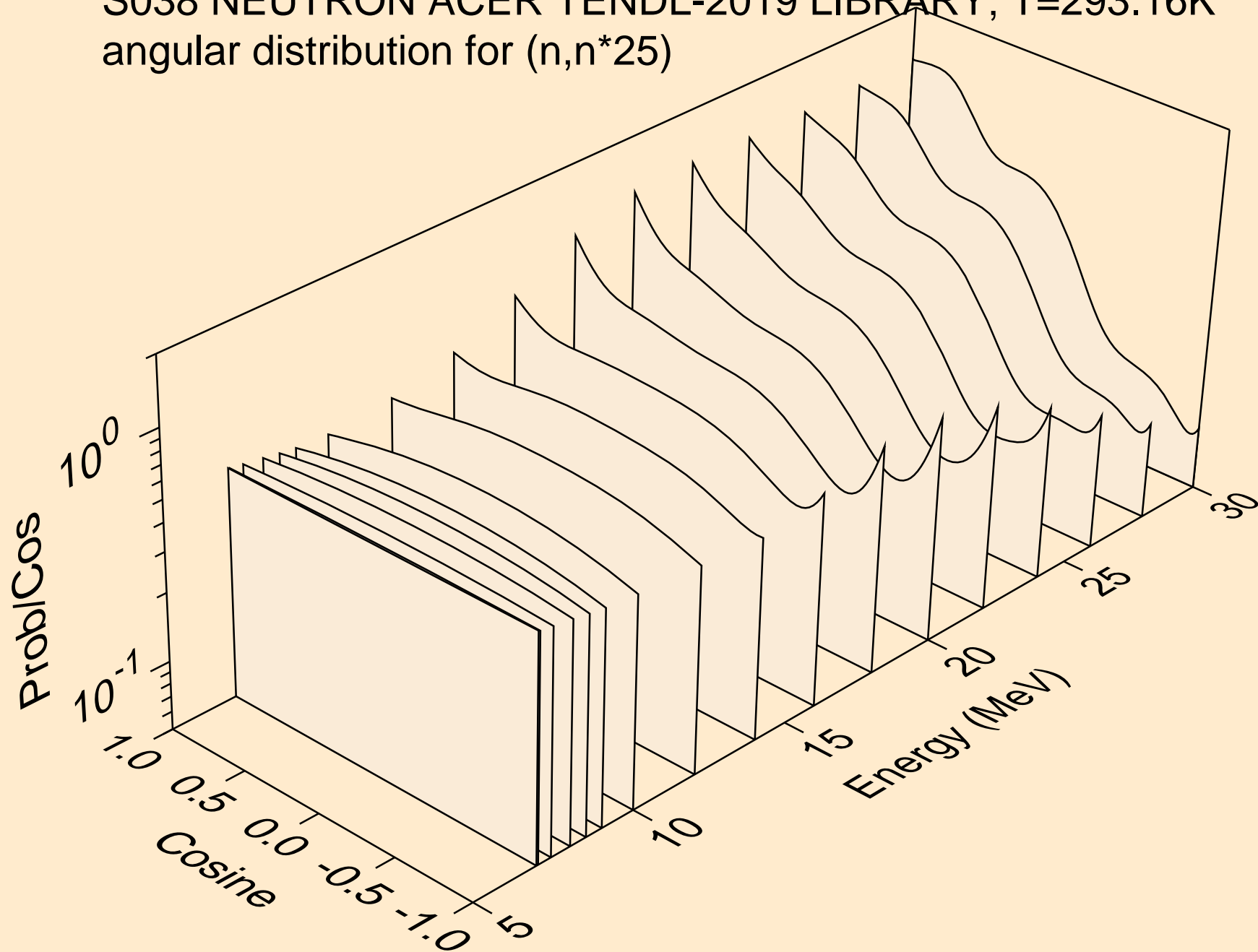

S038 NEUTRON ACER TENDL-2019 LIBRARY; T=293.16K  
angular distribution for (n,n\*26)

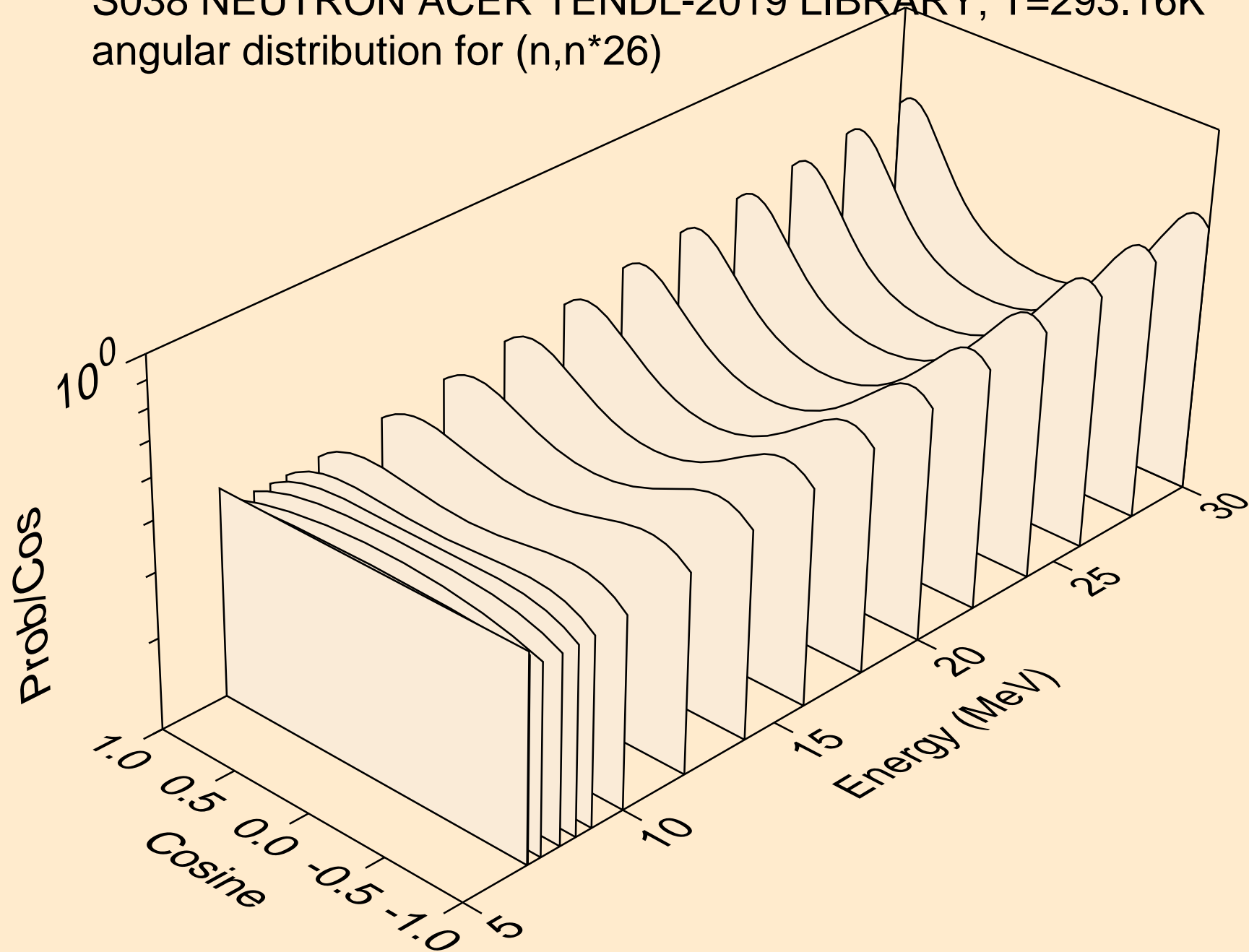

S038 NEUTRON ACER TENDL-2019 LIBRARY; T=293.16K  
angular distribution for (n,n\*27)

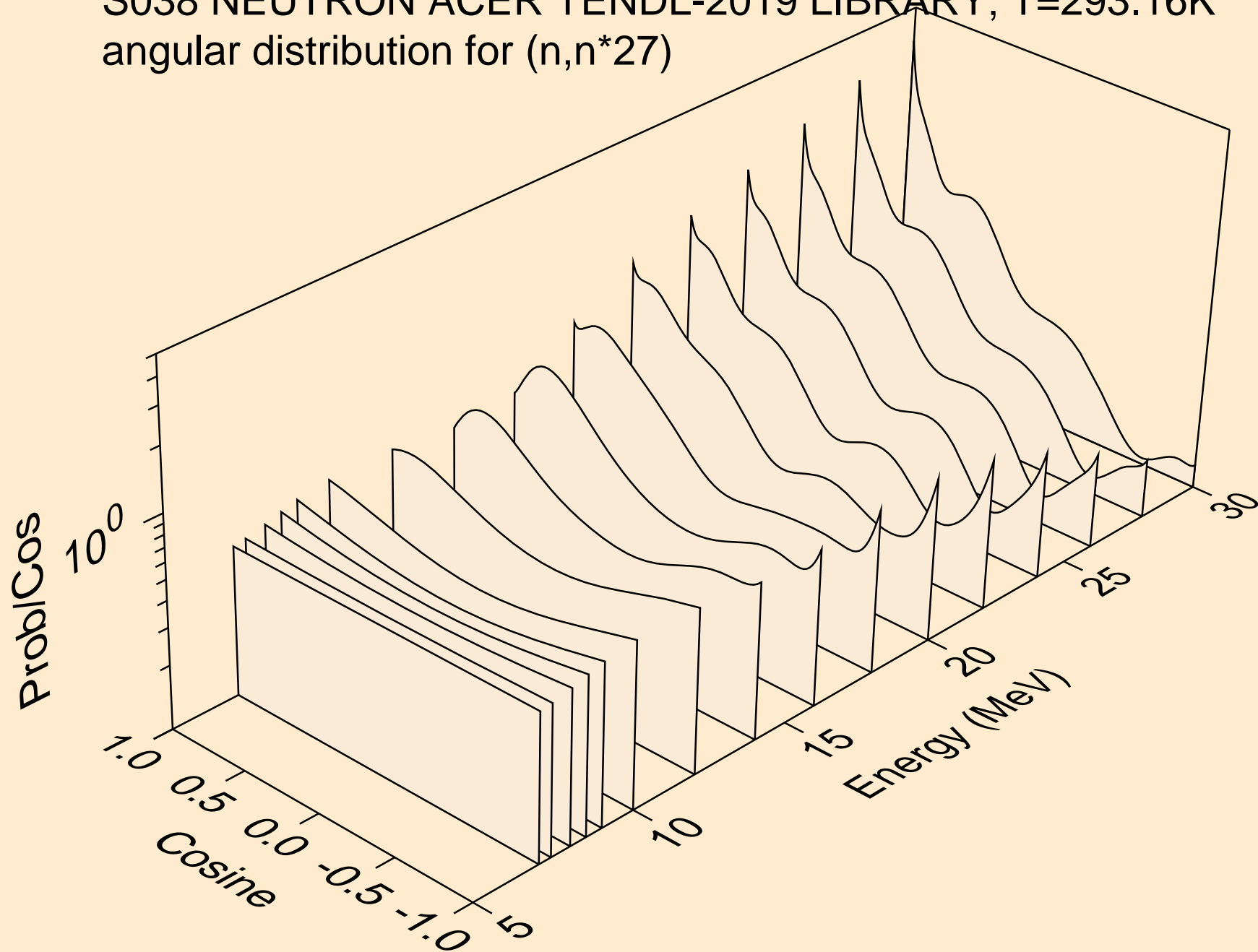



S038 NEUTRON ACER TENDL-2019 LIBRARY; T=293.16K  
angular distribution for (n,n\*28)

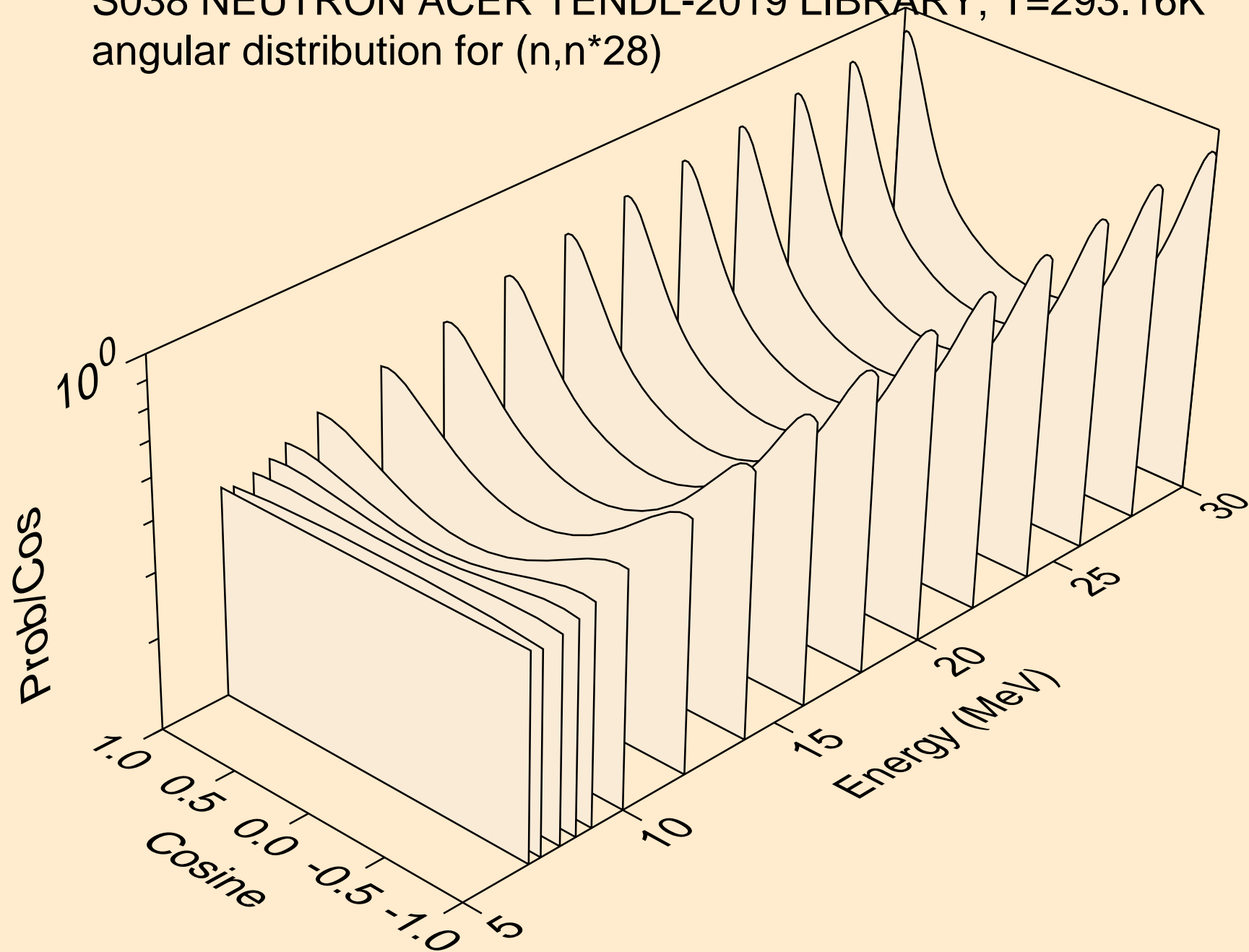

S038 NEUTRON ACER TENDL-2019 LIBRARY; T=293.16K  
Neutron emission for (n,x)

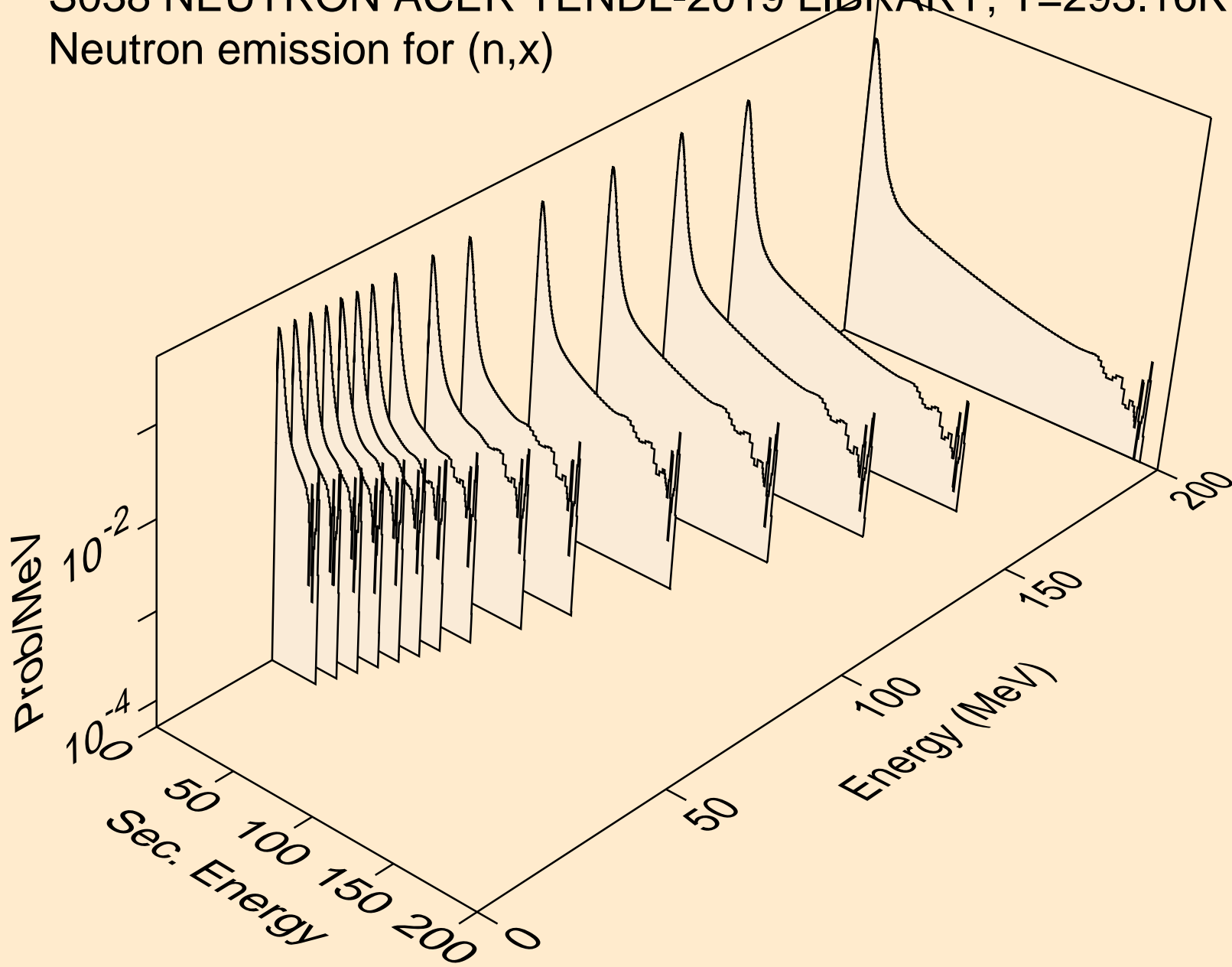

S038 NEUTRON ACER TENDL-2019 LIBRARY; T=293.16K  
Neutron emission for (n,2nd)

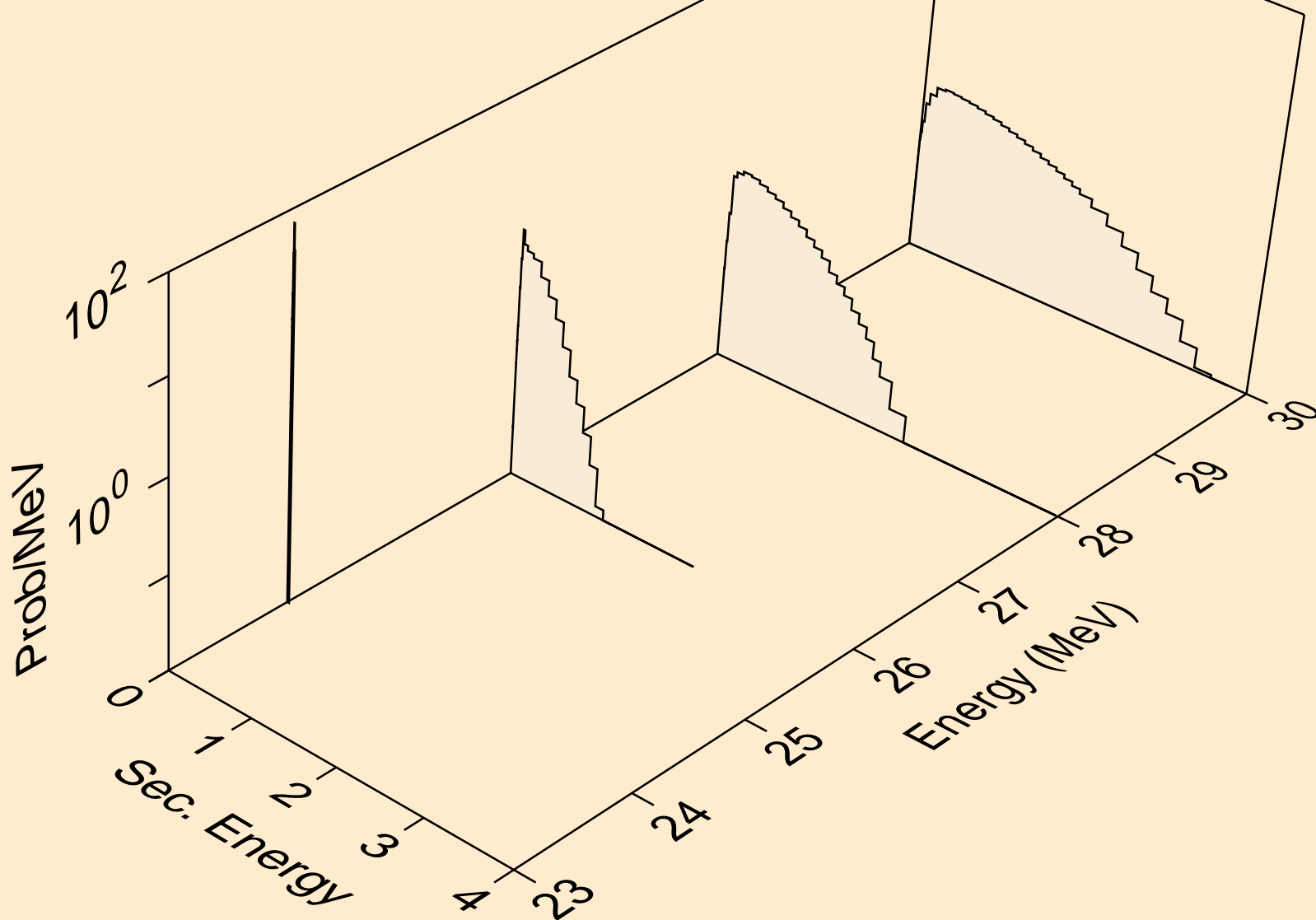

S038 NEUTRON ACER TENDL-2019 LIBRARY; T=293.16K  
Neutron emission for (n,2n)

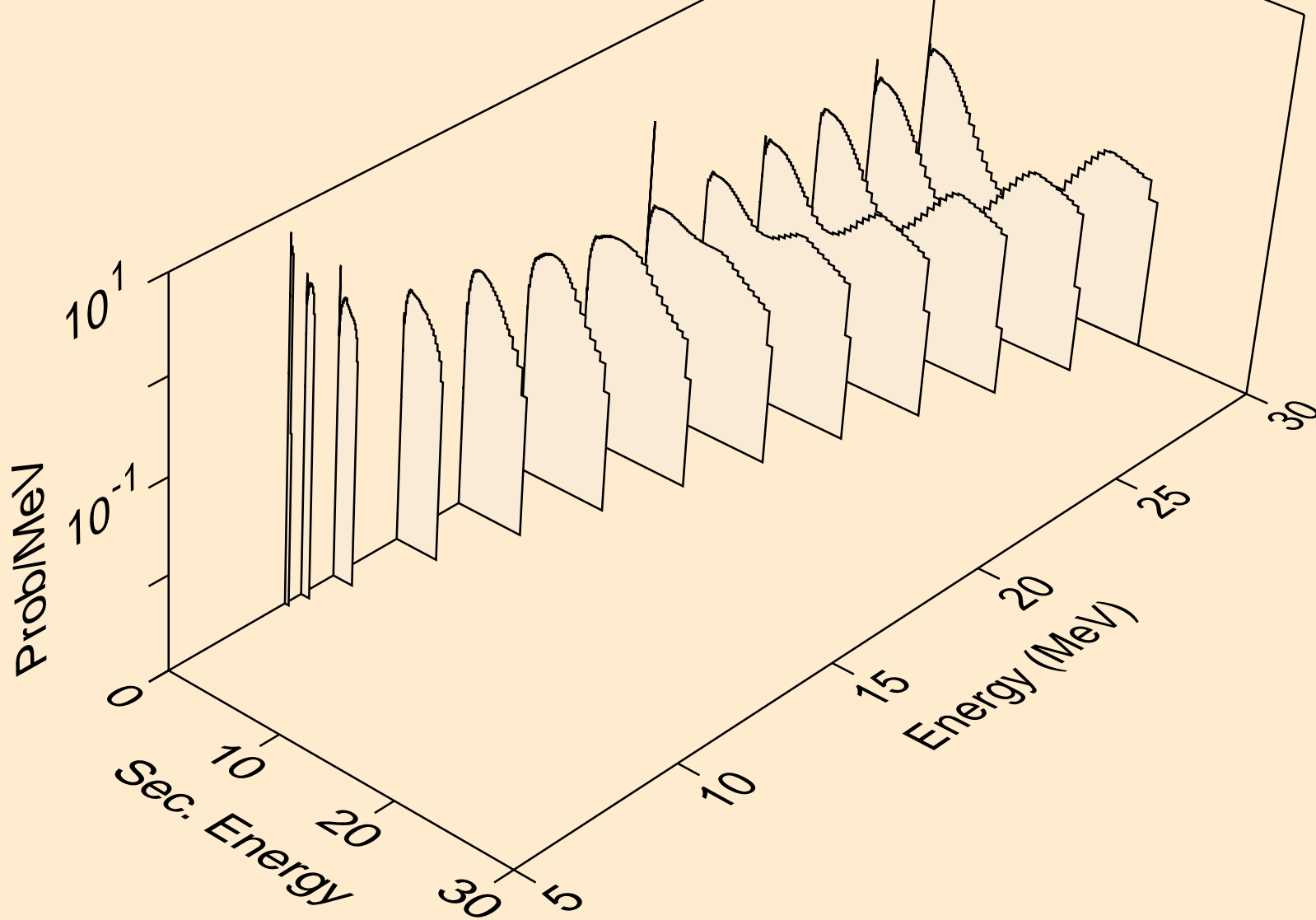

S038 NEUTRON ACER TENDL-2019 LIBRARY; T=293.16K  
Neutron emission for (n,3n)

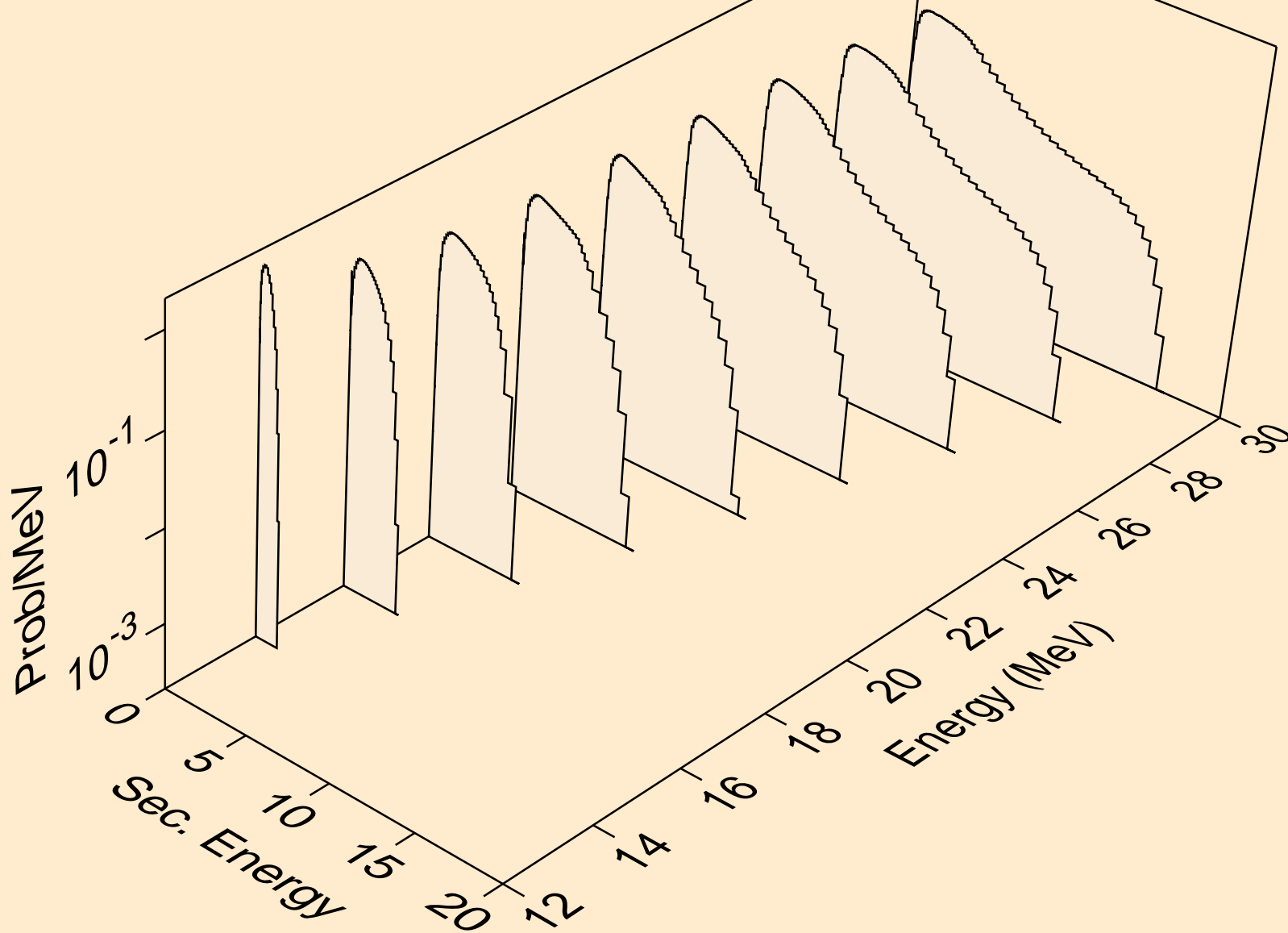

S038 NEUTRON ACER TENDL-2019 LIBRARY; T=293.16K  
Neutron emission for (n,n\*)a

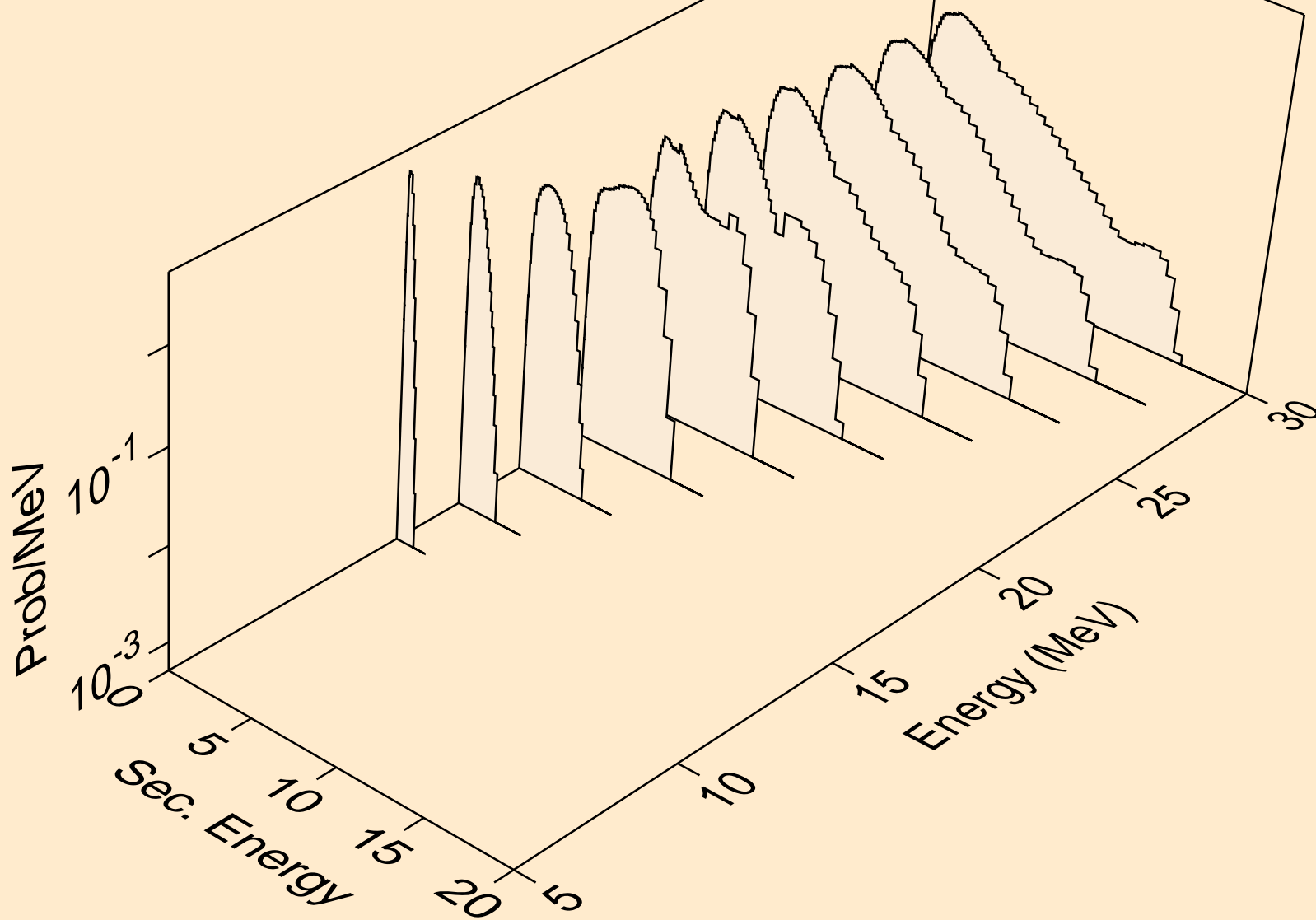

S038 NEUTRON ACER TENDL-2019 LIBRARY; T=293.16K  
Neutron emission for (n,2n)a

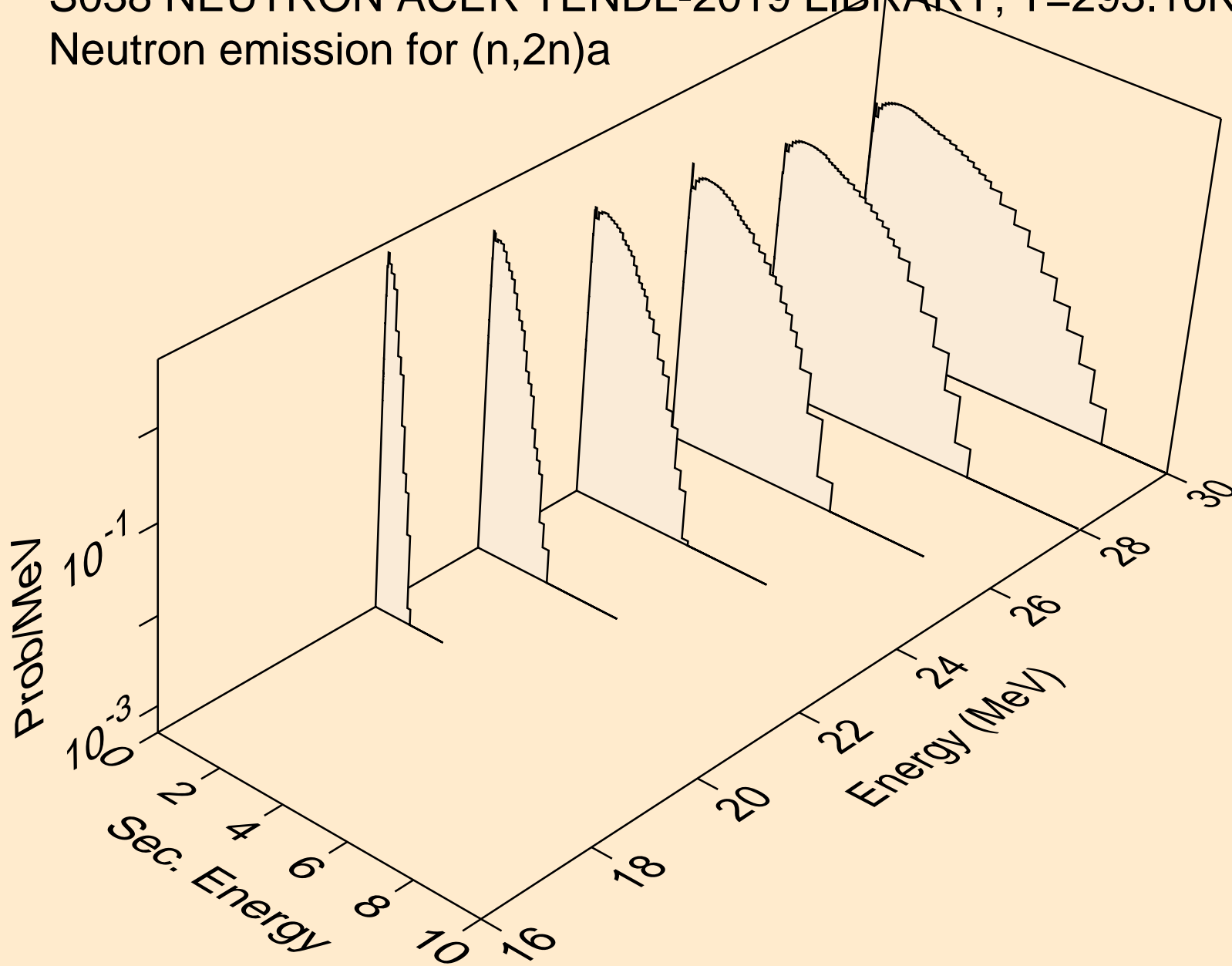

S038 NEUTRON ACER TENDL-2019 LIBRARY; T=293.16K  
Neutron emission for (n,3n)a

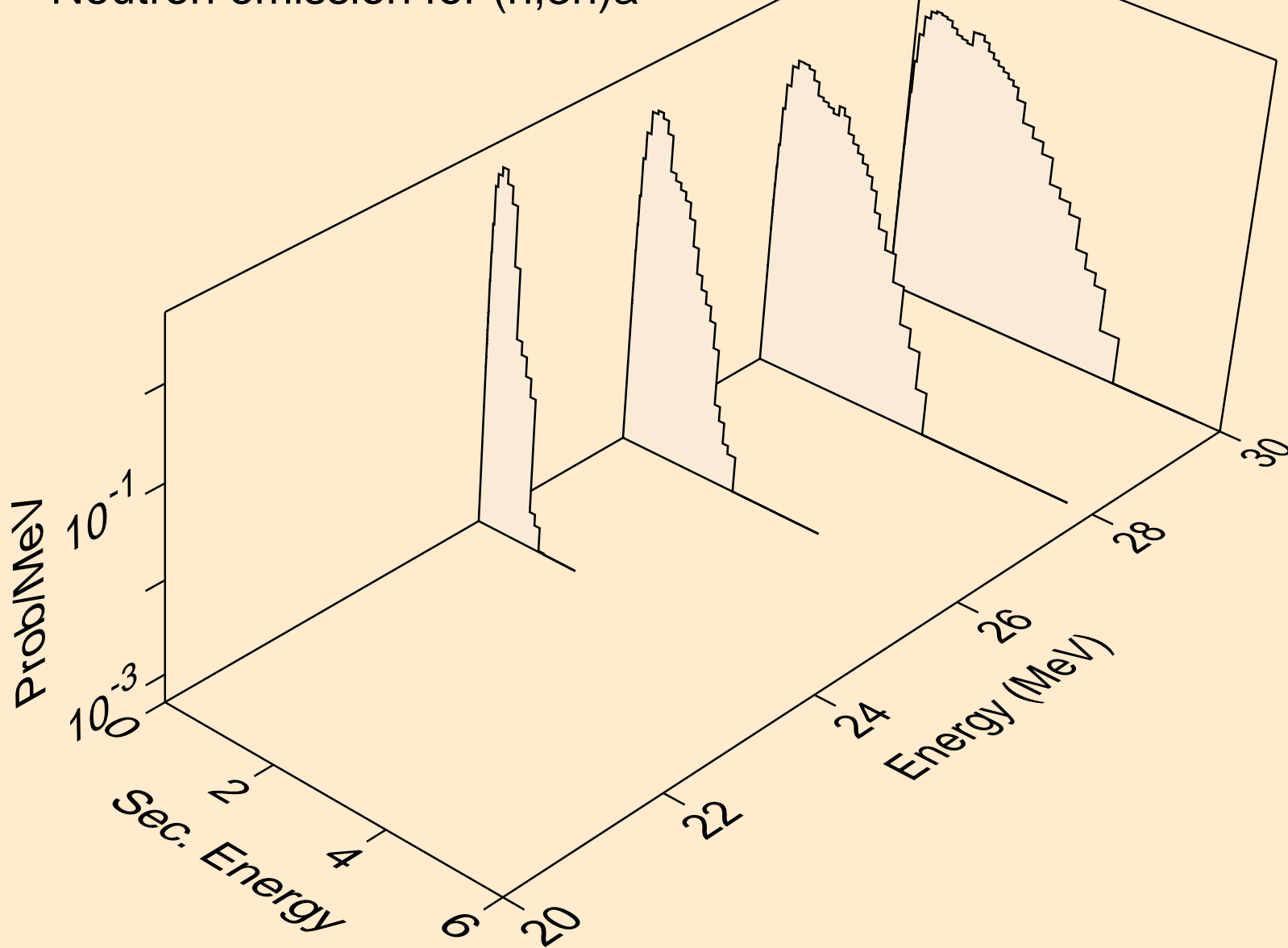



S038 NEUTRON ACER TENDL-2019 LIBRARY; T=293.16K  
Neutron emission for (n,n\*)p

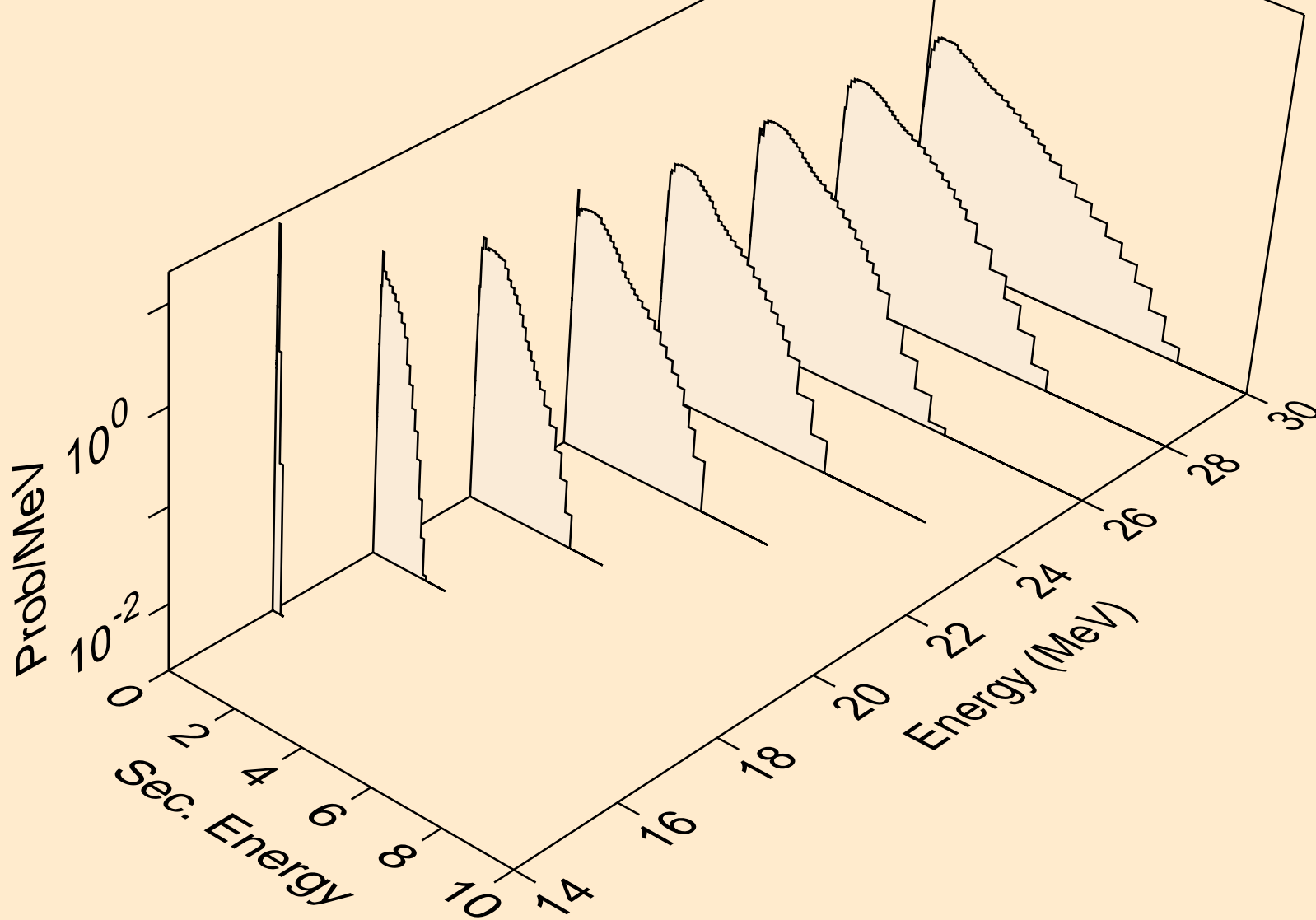

S038 NEUTRON ACER TENDL-2019 LIBRARY; T=293.16K  
Neutron emission for (n,n\*)d

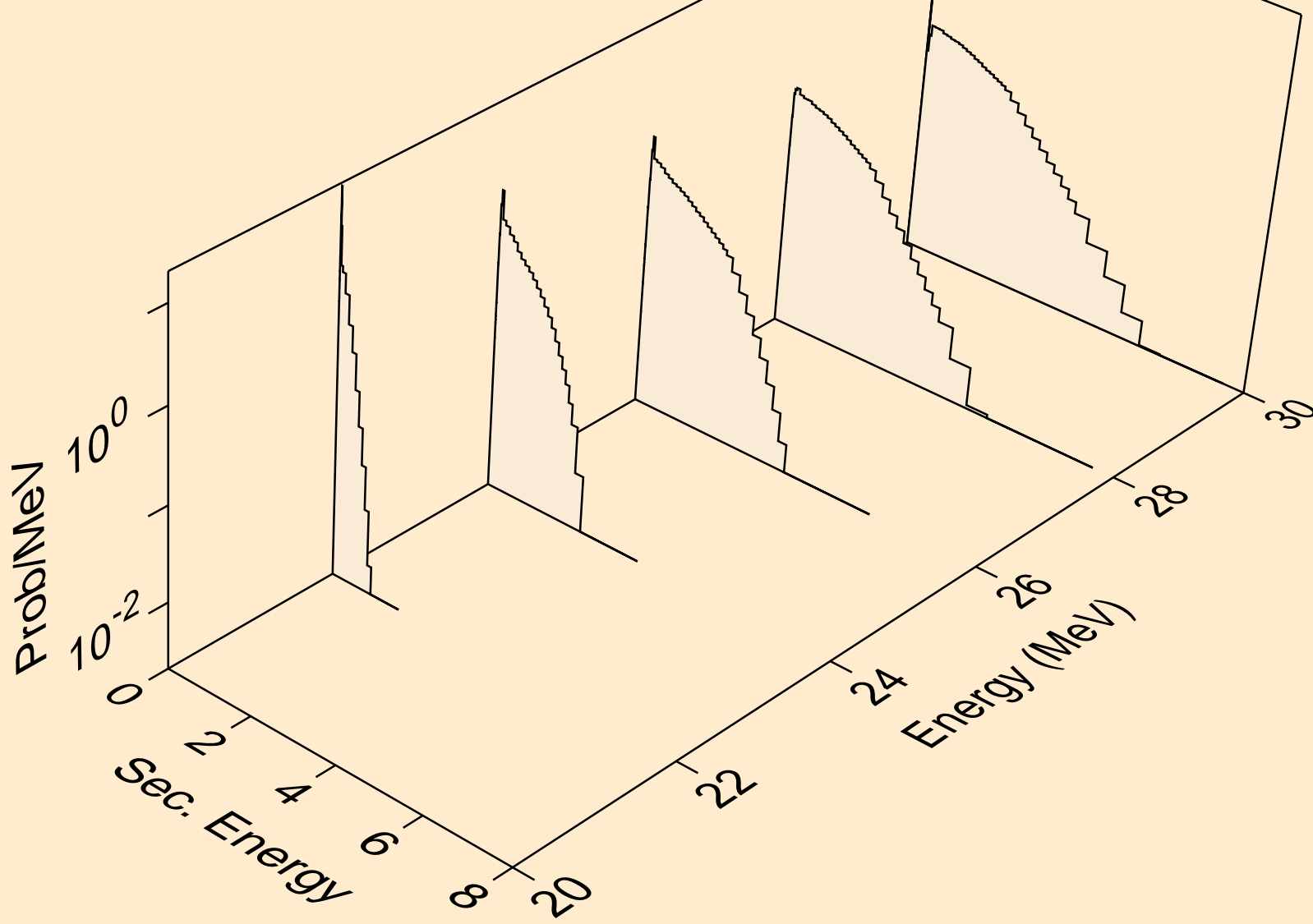

S038 NEUTRON ACER TENDL-2019 LIBRARY; T=293.16K  
Neutron emission for (n,n\*)t

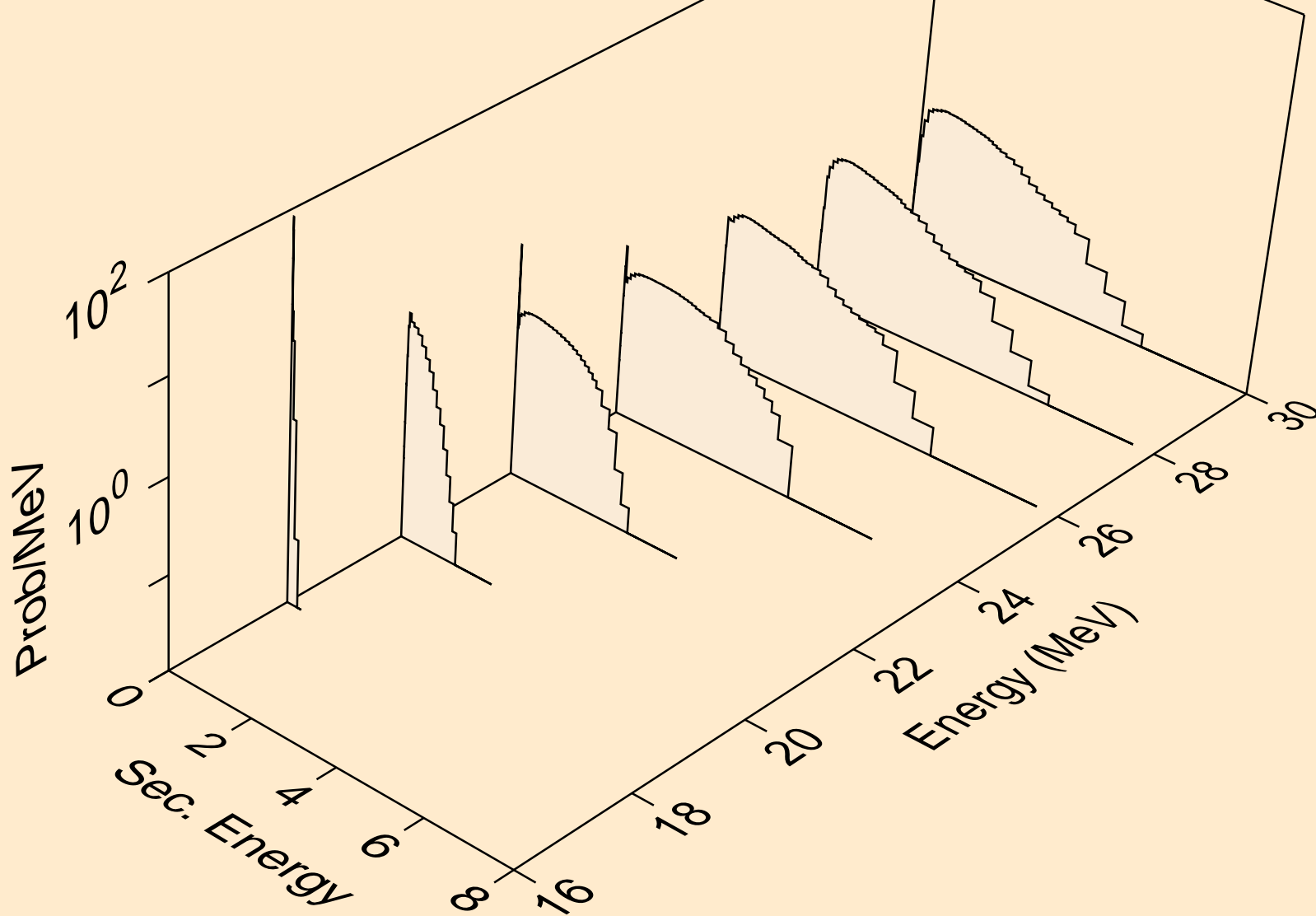

S038 NEUTRON ACER TENDL-2019 LIBRARY; T=293.16K  
Neutron emission for (n,4n)

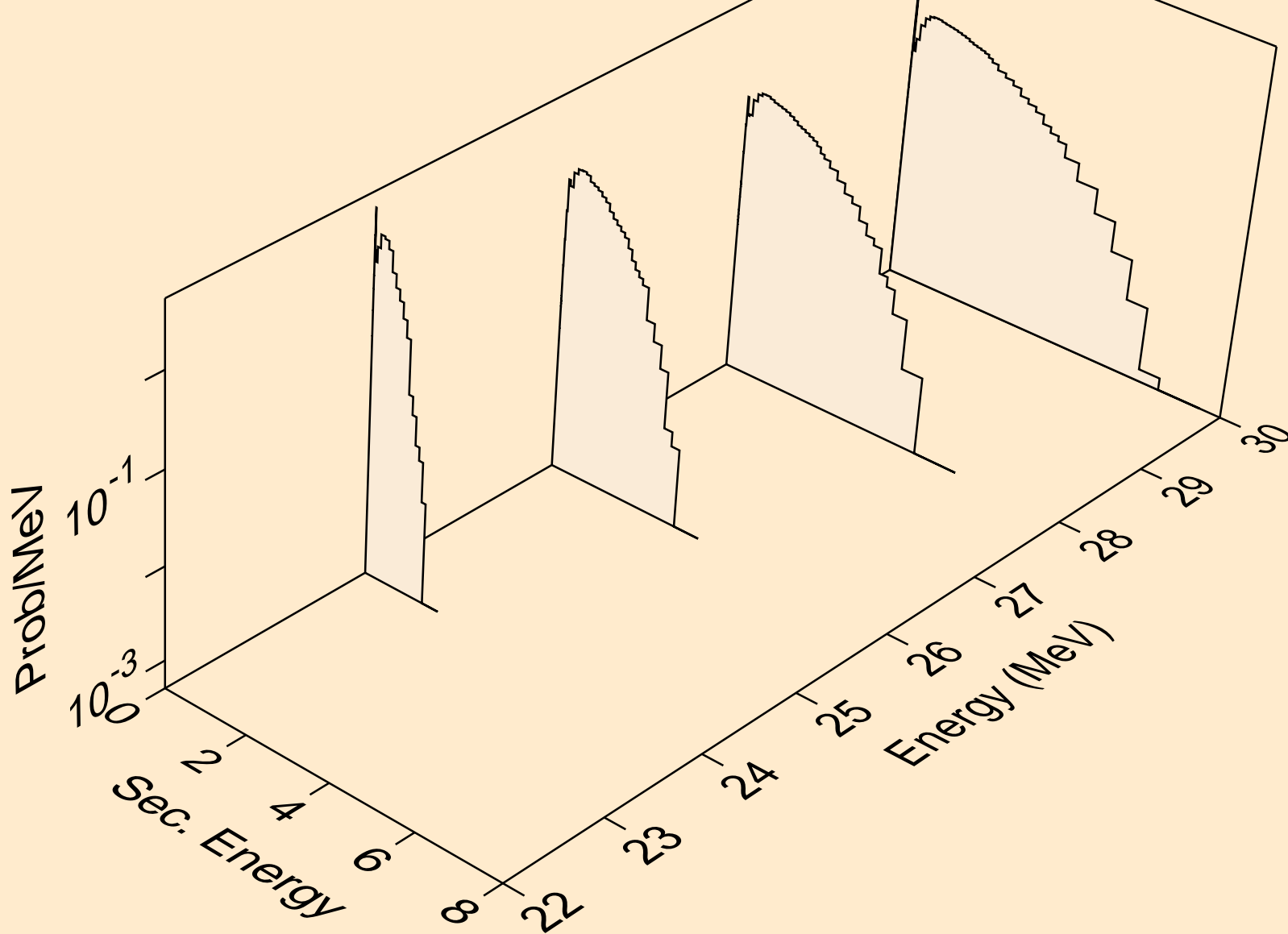

S038 NEUTRON ACER TENDL-2019 LIBRARY; T=293.16K  
Neutron emission for (n,2np)

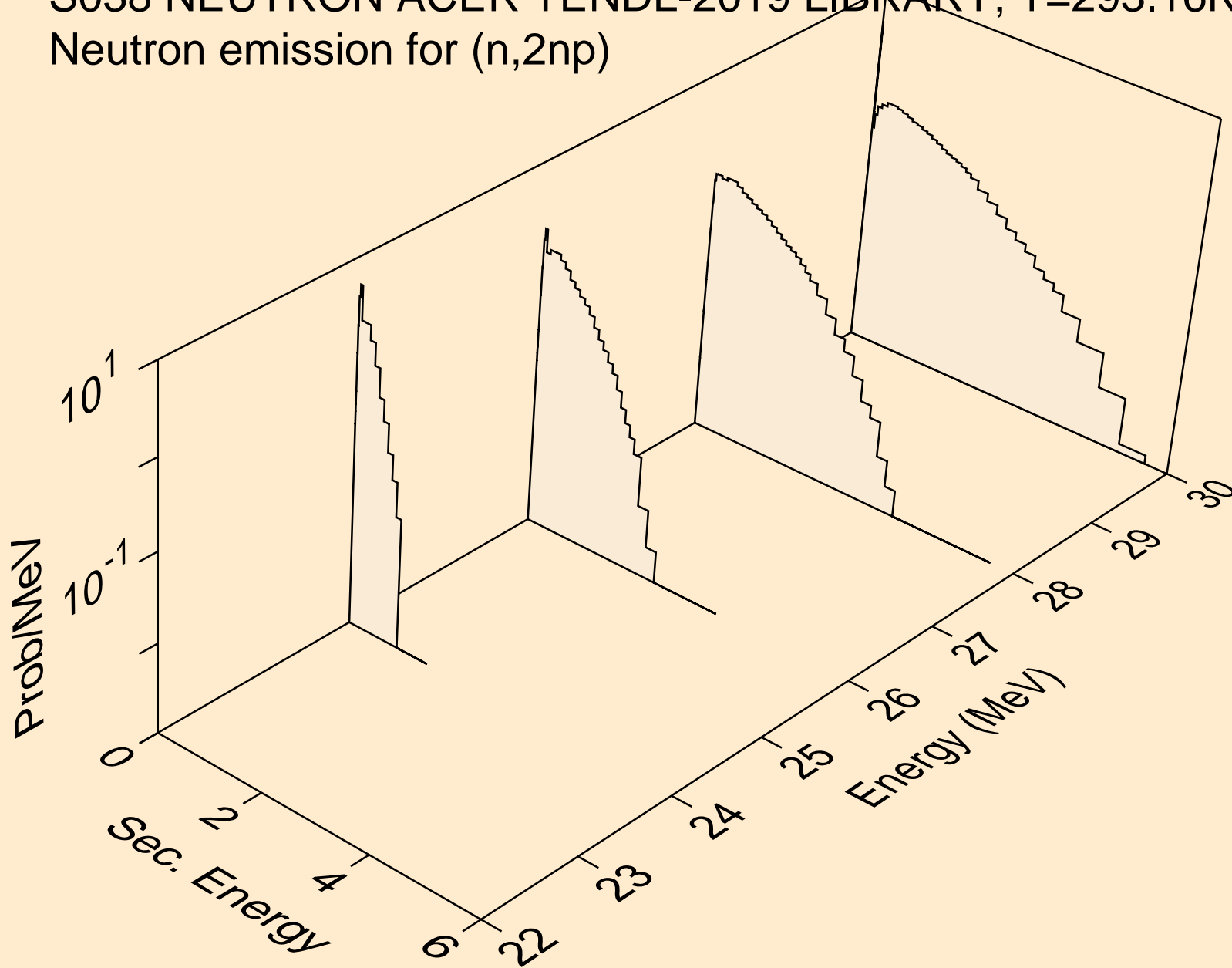

S038 NEUTRON ACER TENDL-2019 LIBRARY; T=293.16K  
Neutron emission for (n,3np)

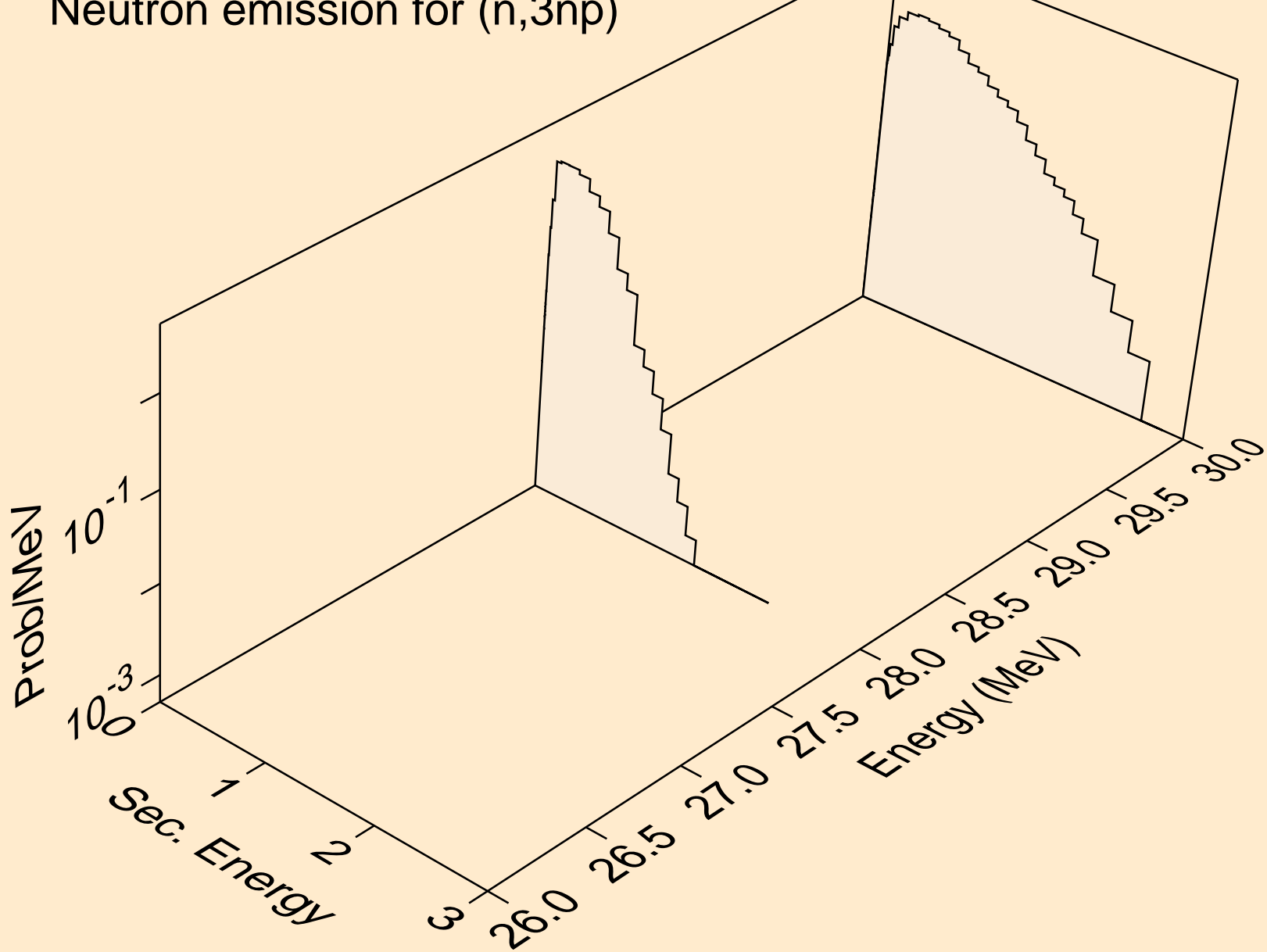

S038 NEUTRON ACER TENDL-2019 LIBRARY; T=293.16K  
Neutron emission for (n,n\*c)

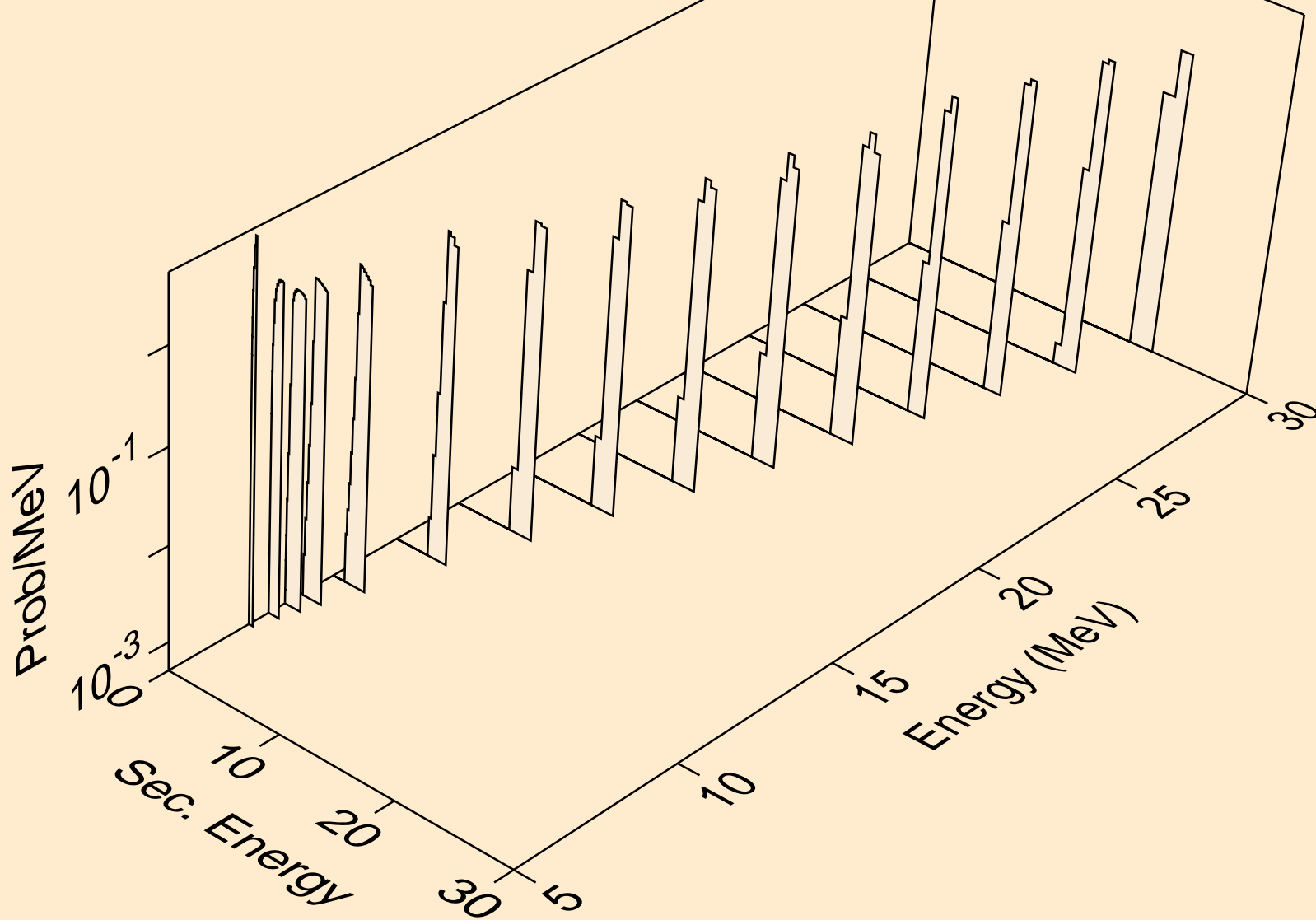

S038 NEUTRON ACER TENDL-2019 LIBRARY; T=293.16K  
Photon emission for (n,x)

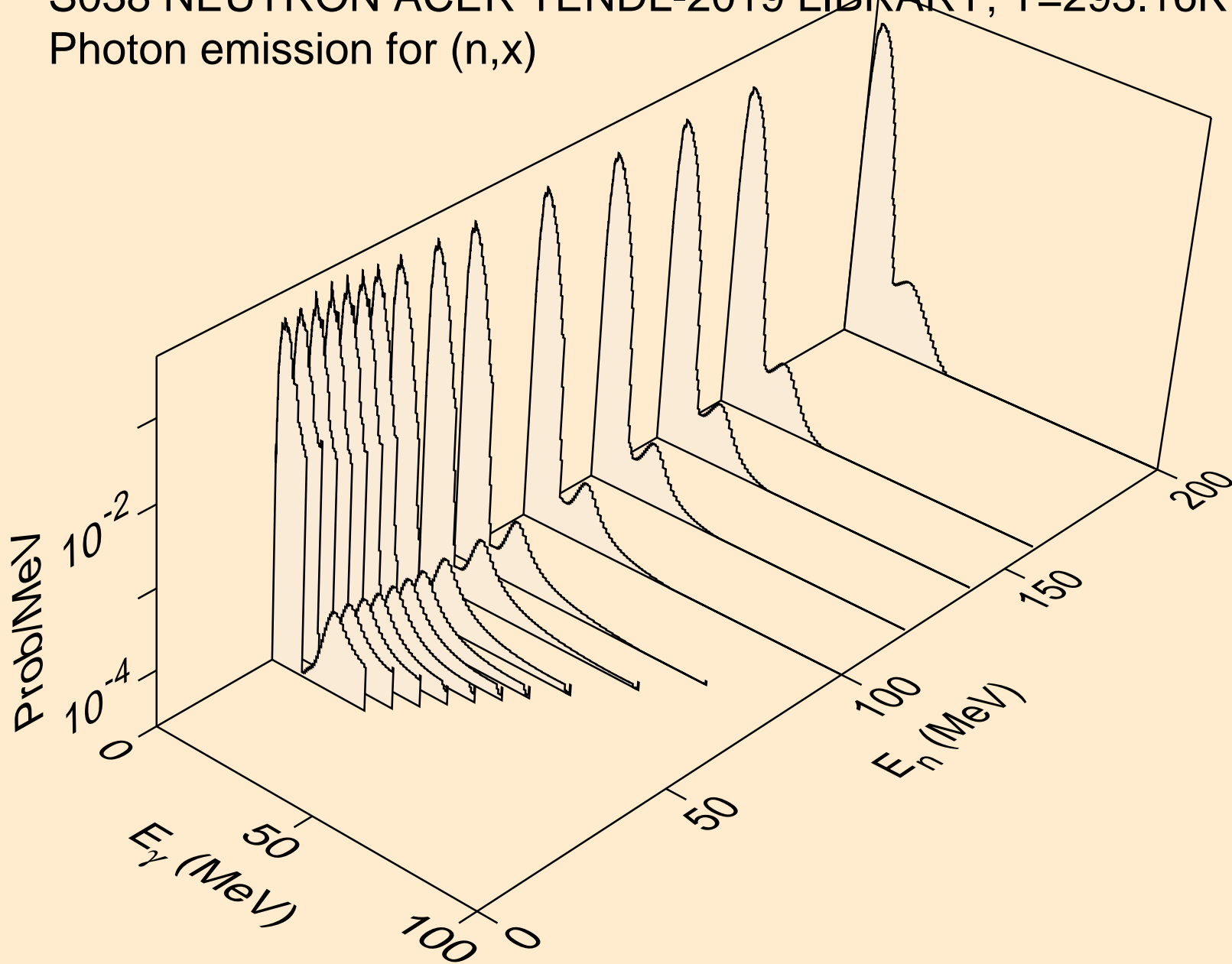



S038 NEUTRON ACER TENDL-2019 LIBRARY; T=293.16K  
Photon emission for (n,2nd)

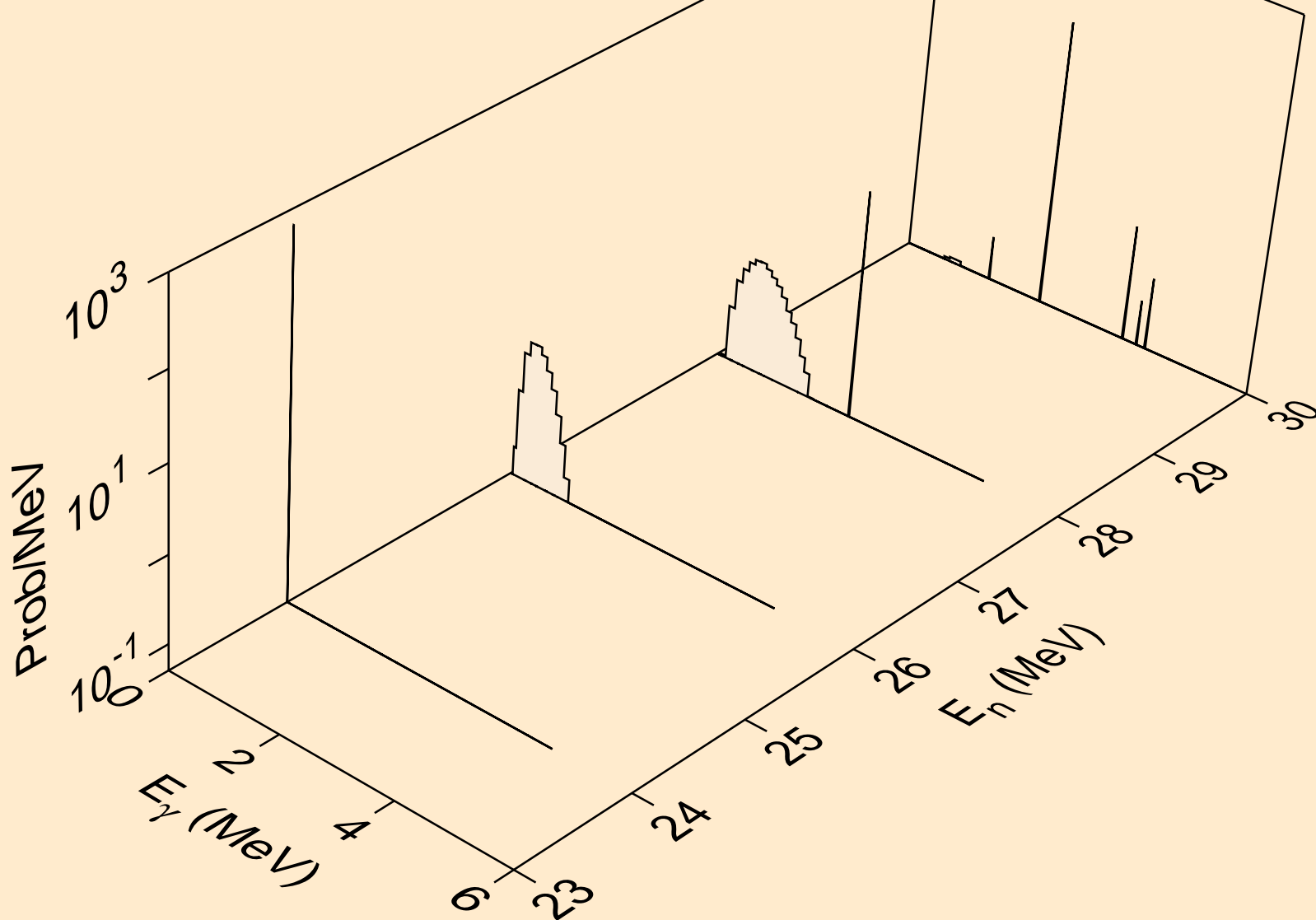

S038 NEUTRON ACER TENDL-2019 LIBRARY; T=293.16K  
Photon emission for (n,2n)

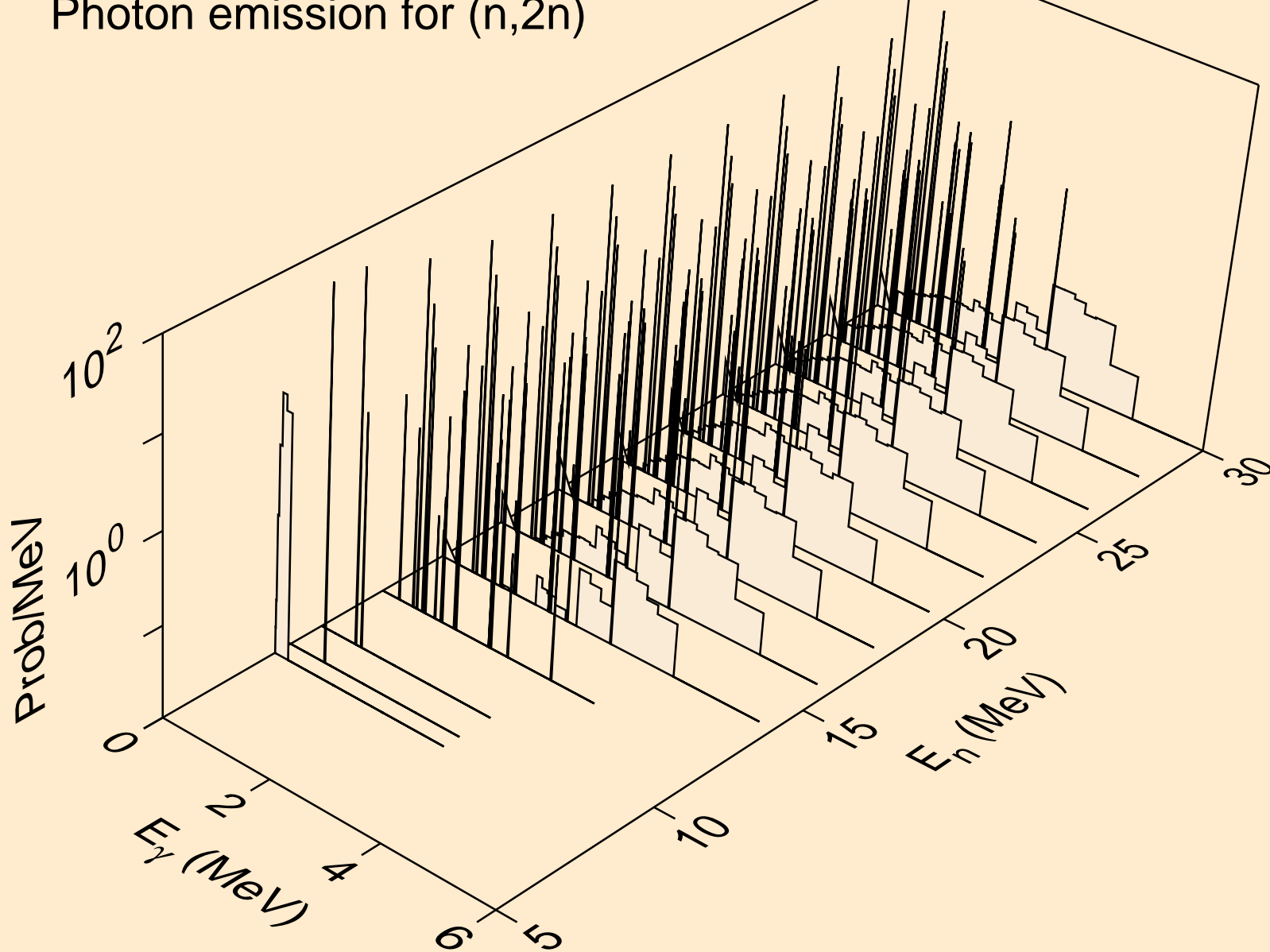

S038 NEUTRON ACER TENDL-2019 LIBRARY; T=293.16K  
Photon emission for (n,3n)

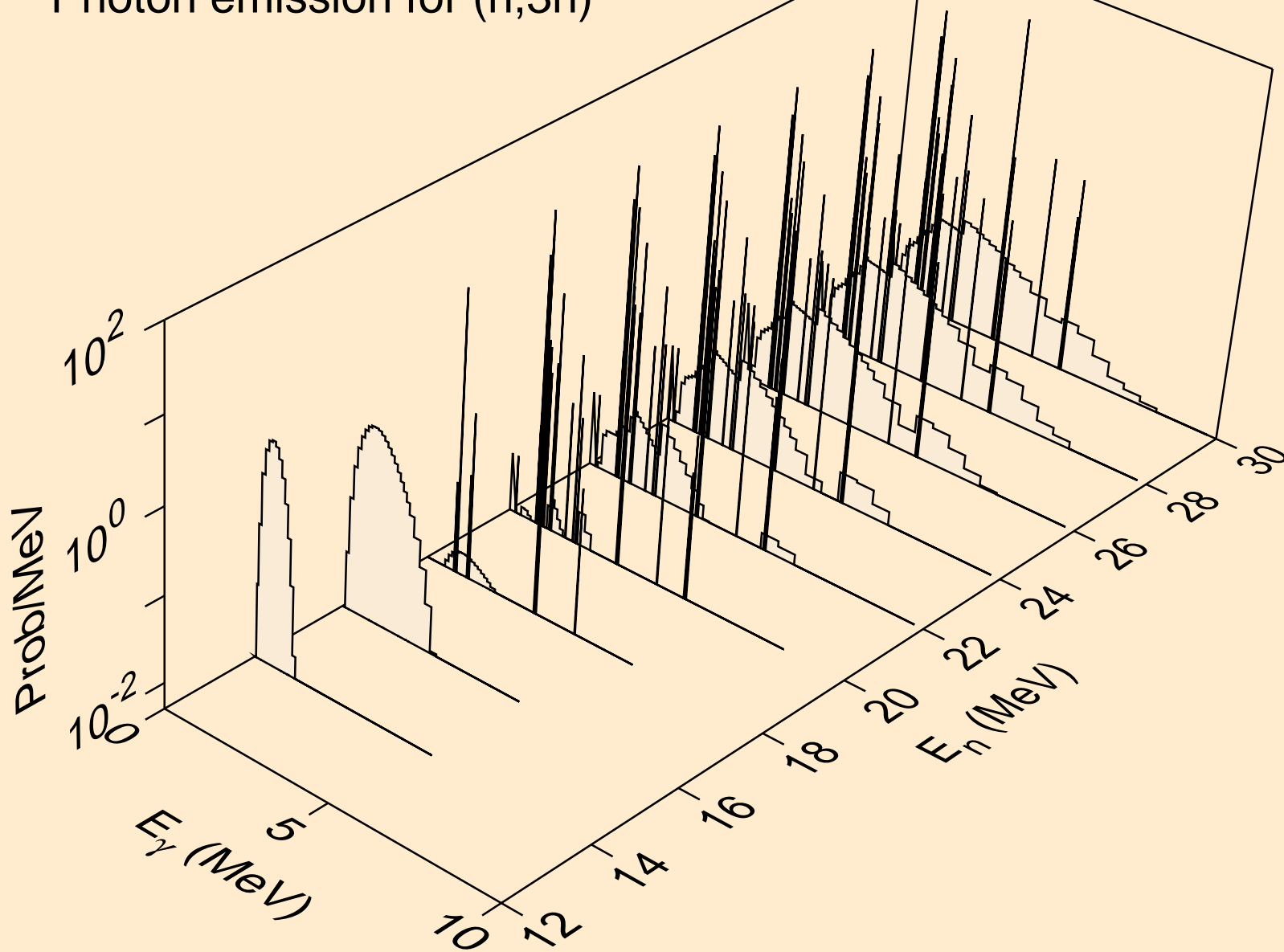

S038 NEUTRON ACER TENDL-2019 LIBRARY; T=293.16K  
Photon emission for (n,n\*)a

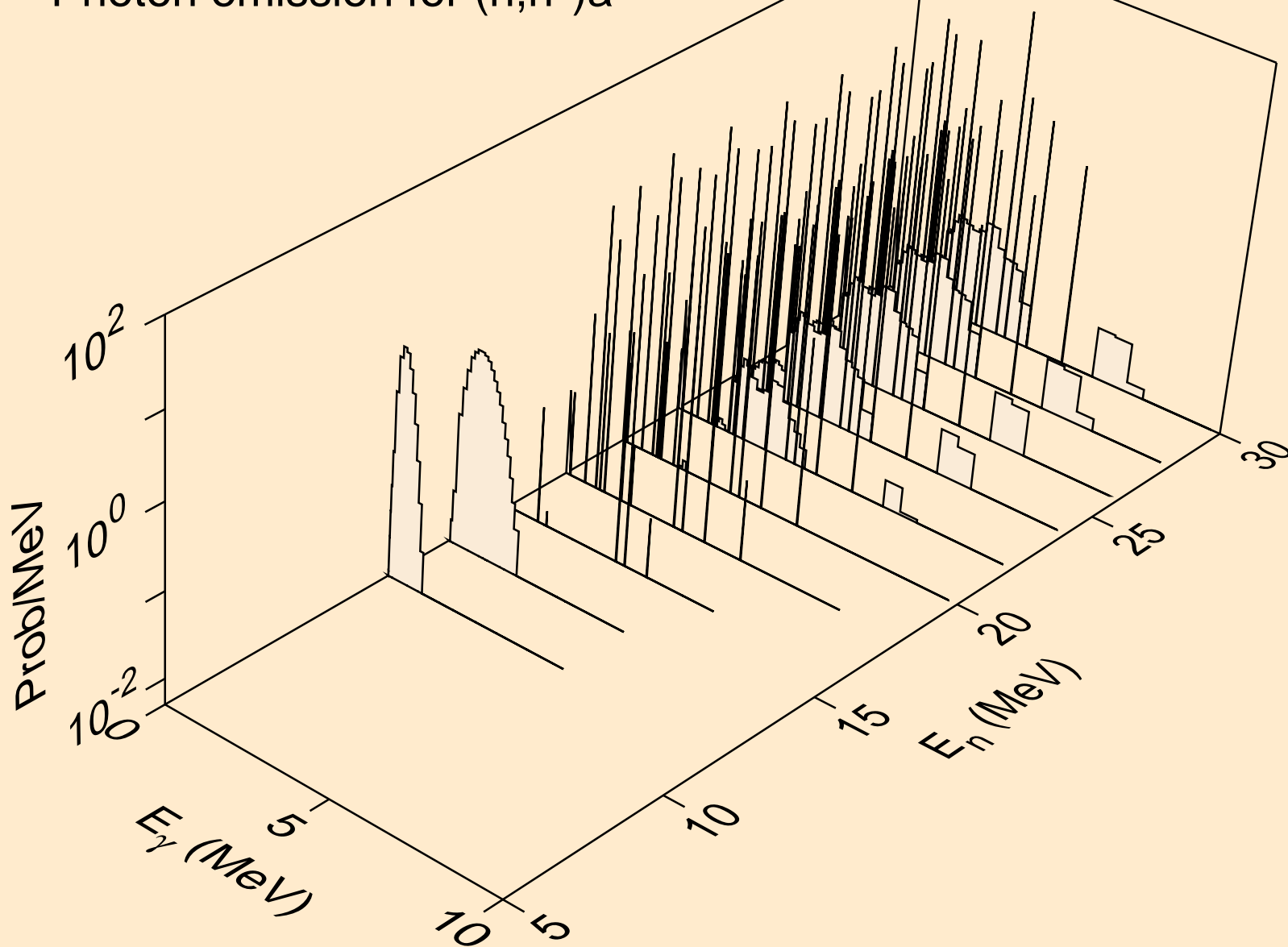

S038 NEUTRON ACER TENDL-2019 LIBRARY; T=293.16K  
Photon emission for (n,2n)a

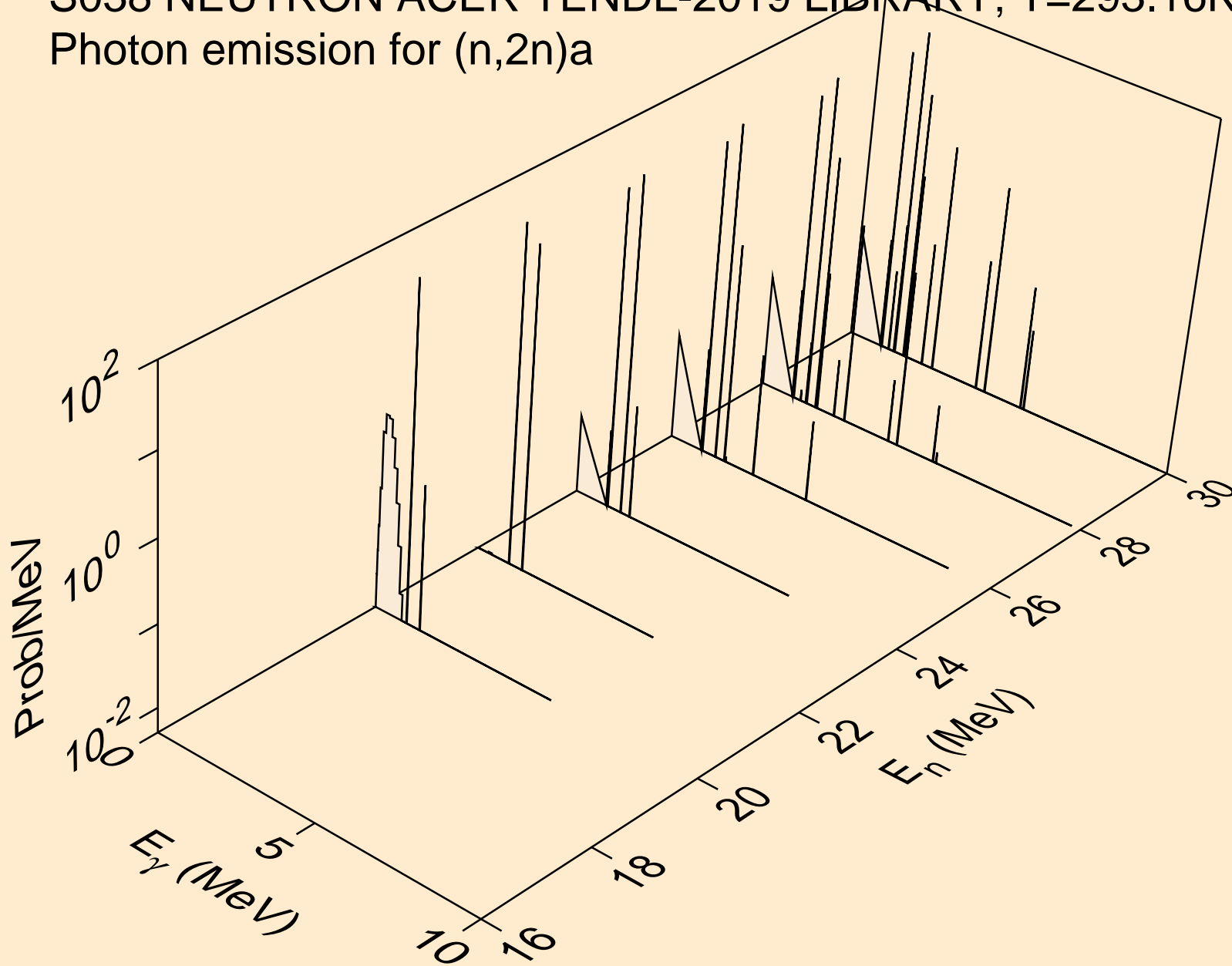

S038 NEUTRON ACER TENDL-2019 LIBRARY; T=293.16K  
Photon emission for (n,3n)a

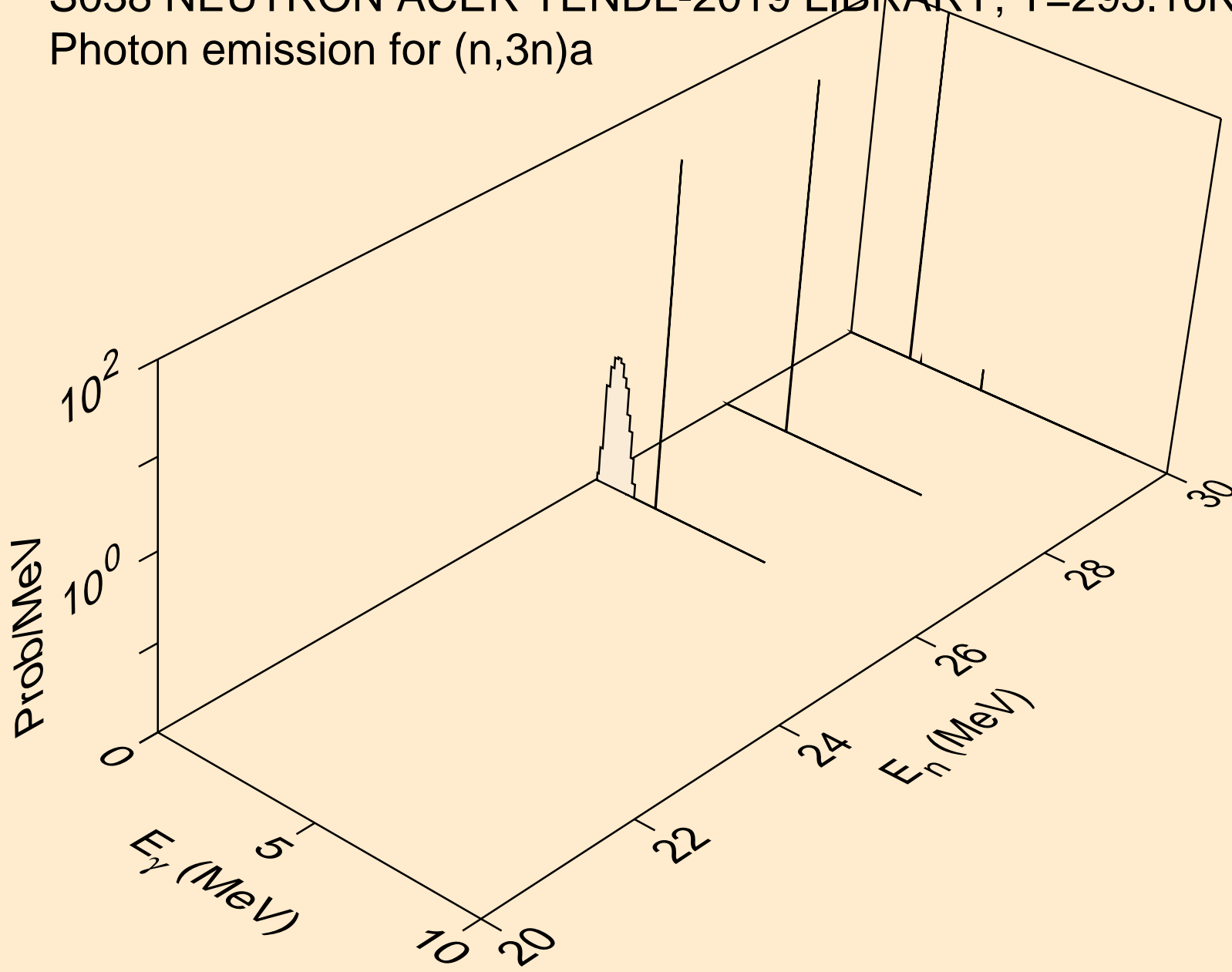

S038 NEUTRON ACER TENDL-2019 LIBRARY; T=293.16K  
Photon emission for (n,n\*)p

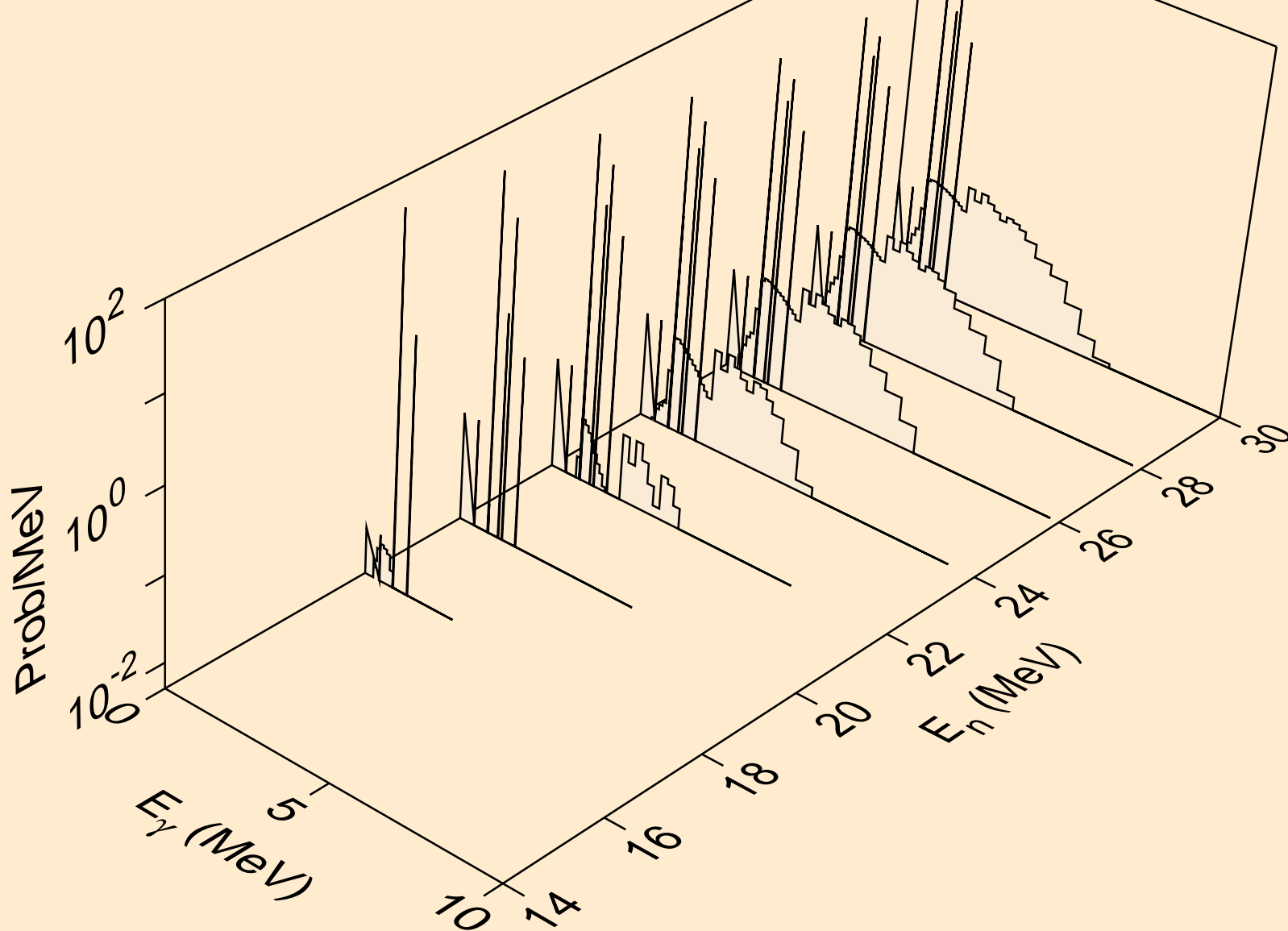

S038 NEUTRON ACER TENDL-2019 LIBRARY; T=293.16K  
Photon emission for (n,n\*)d

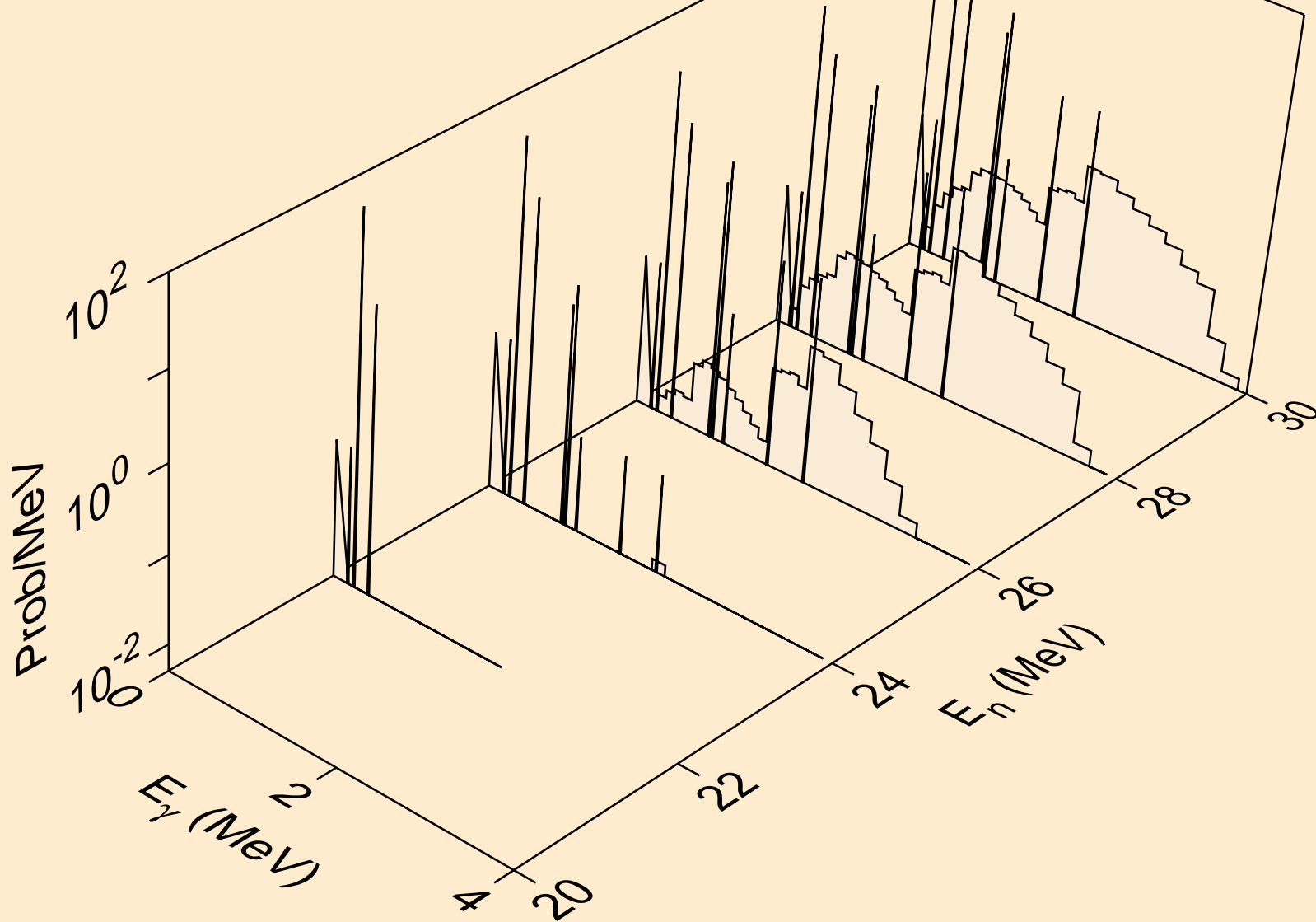



S038 NEUTRON ACER TENDL-2019 LIBRARY; T=293.16K  
Photon emission for (n,n\*)t

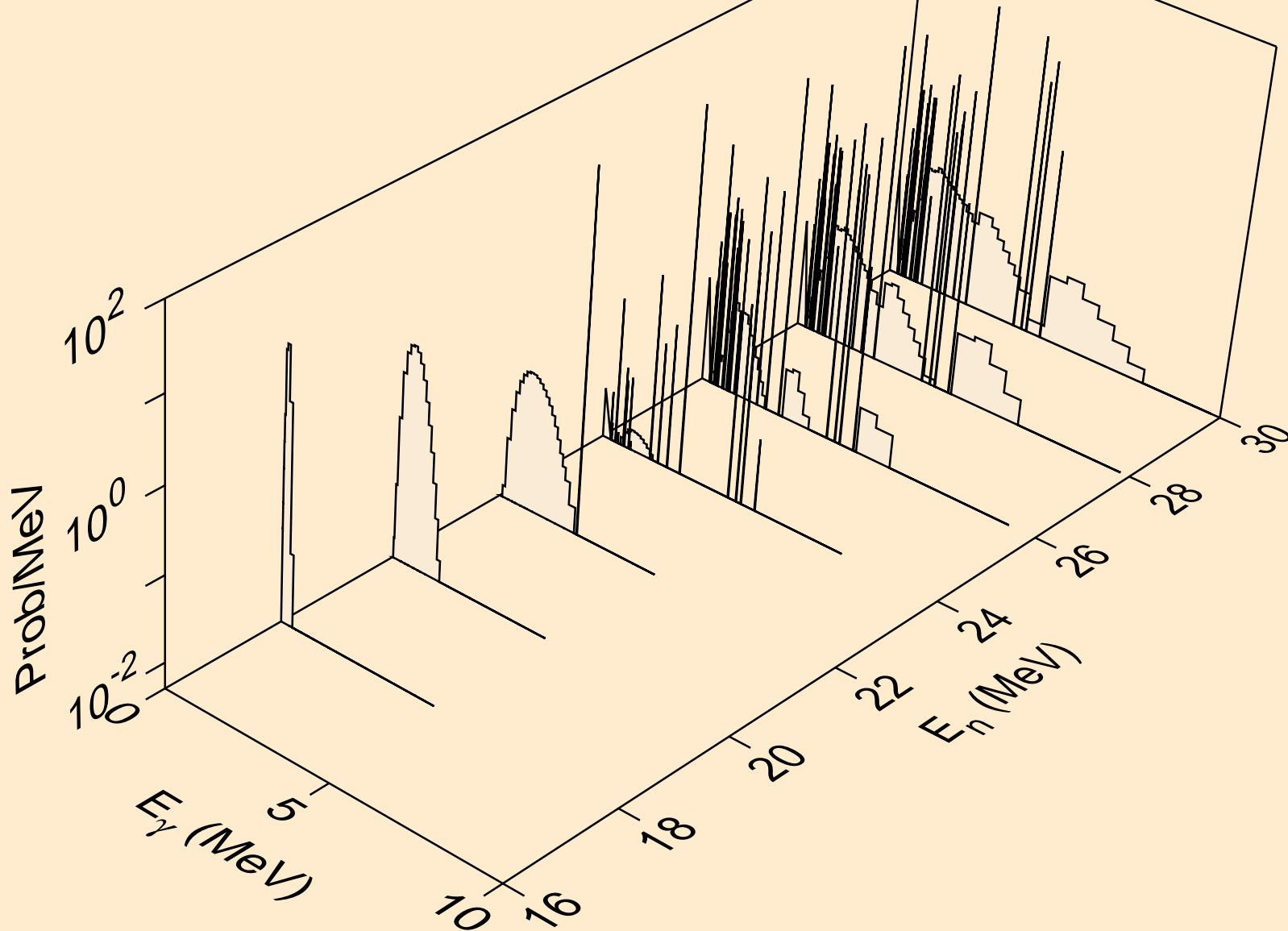

S038 NEUTRON ACER TENDL-2019 LIBRARY; T=293.16K  
Photon emission for (n,4n)

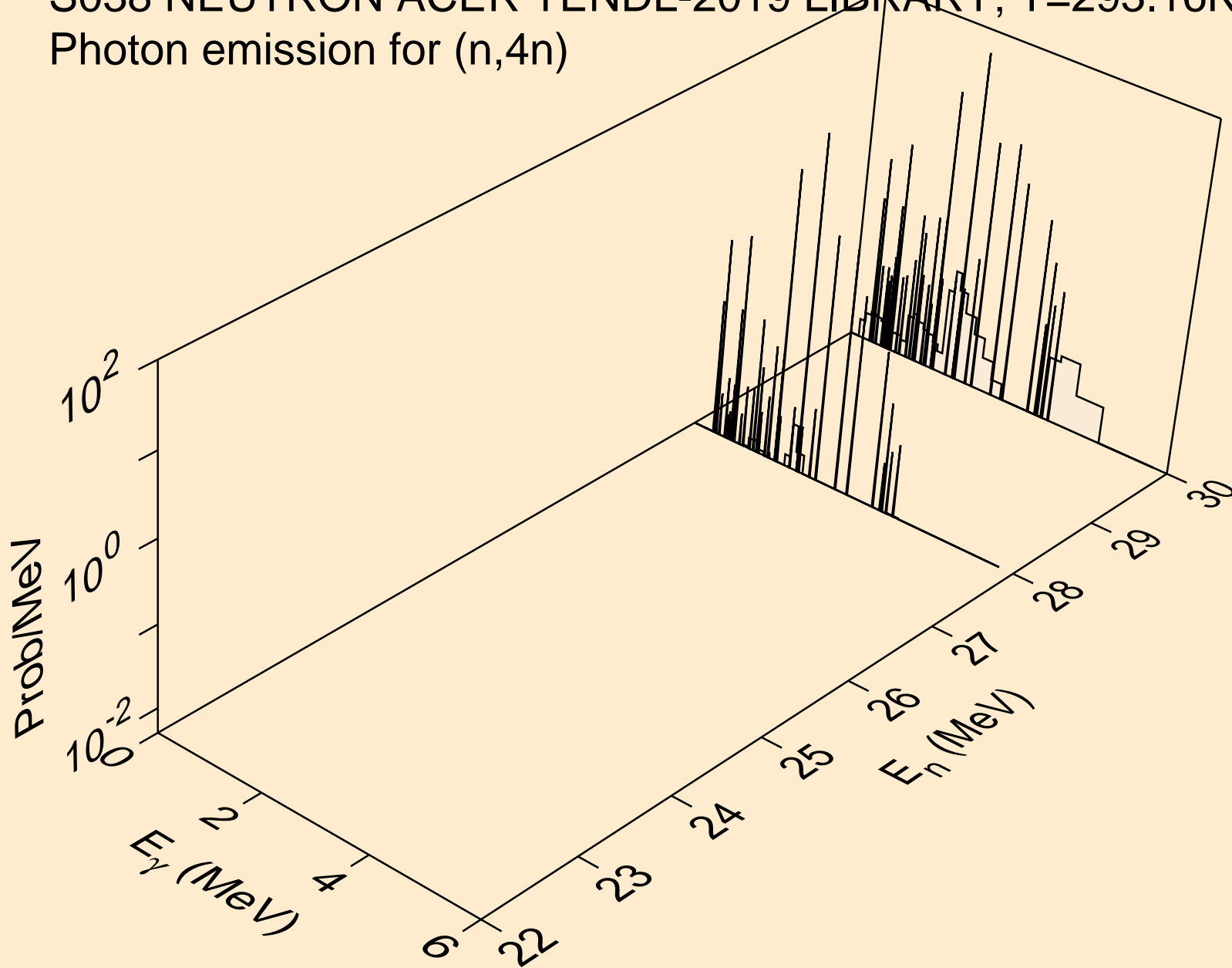

S038 NEUTRON ACER TENDL-2019 LIBRARY; T=293.16K  
Photon emission for (n,2np)

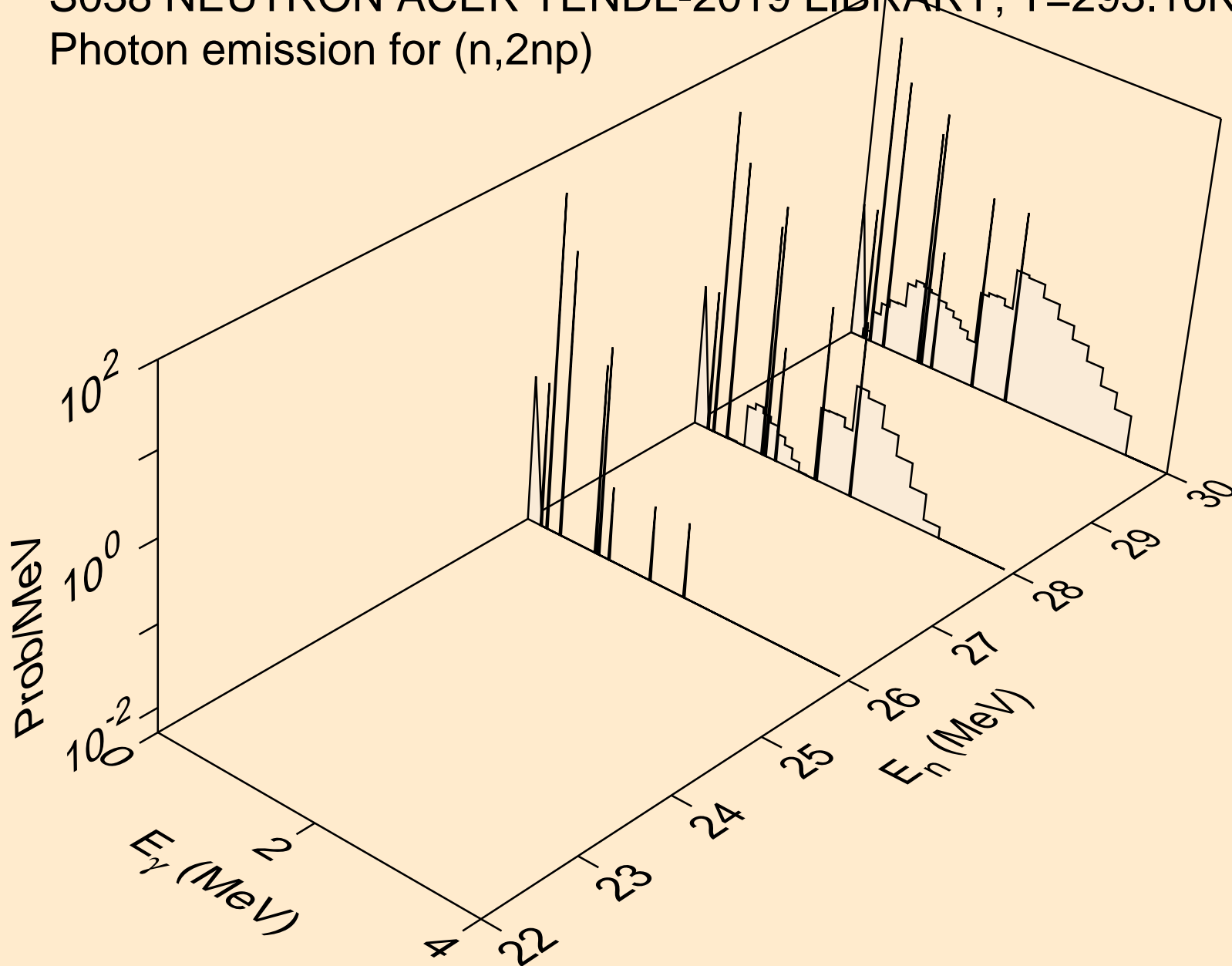

S038 NEUTRON ACER TENDL-2019 LIBRARY; T=293.16K  
Photon emission for (n,3np)

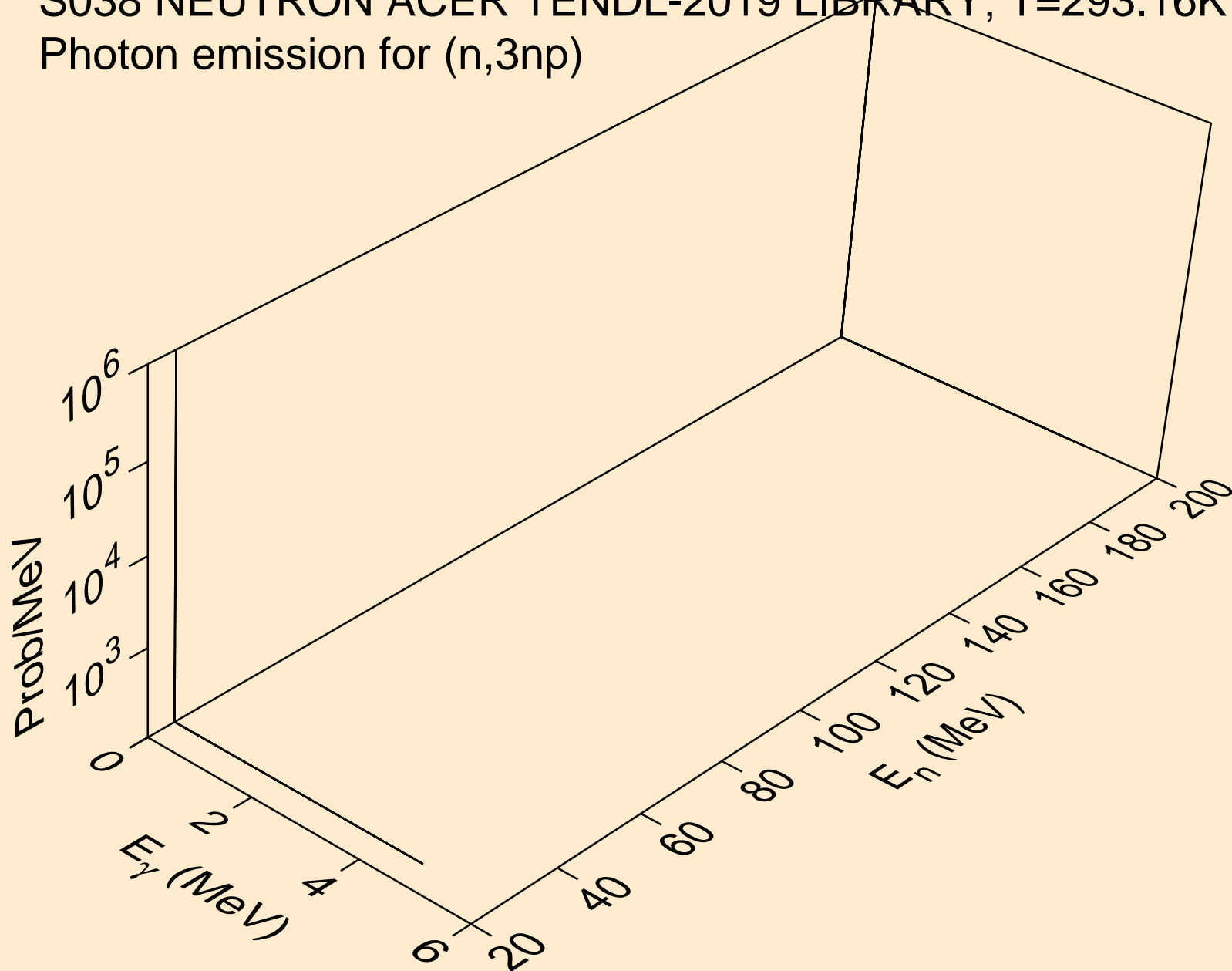

S038 NEUTRON ACER TENDL-2019 LIBRARY; T=293.16K  
Photon emission for (n,n\*c)

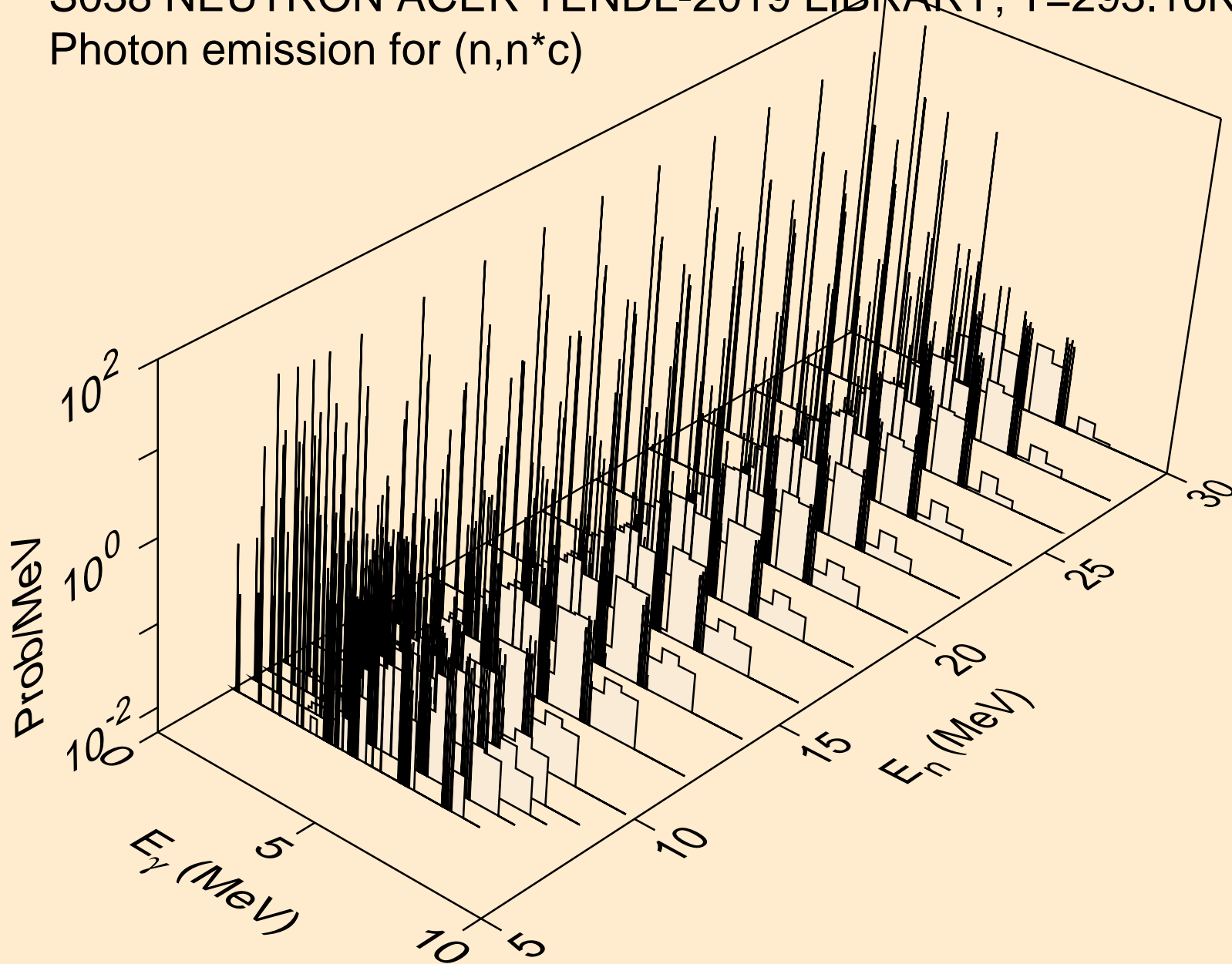

S038 NEUTRON ACER TENDL-2019 LIBRARY; T=293.16K  
Photon emission for (n,gma)

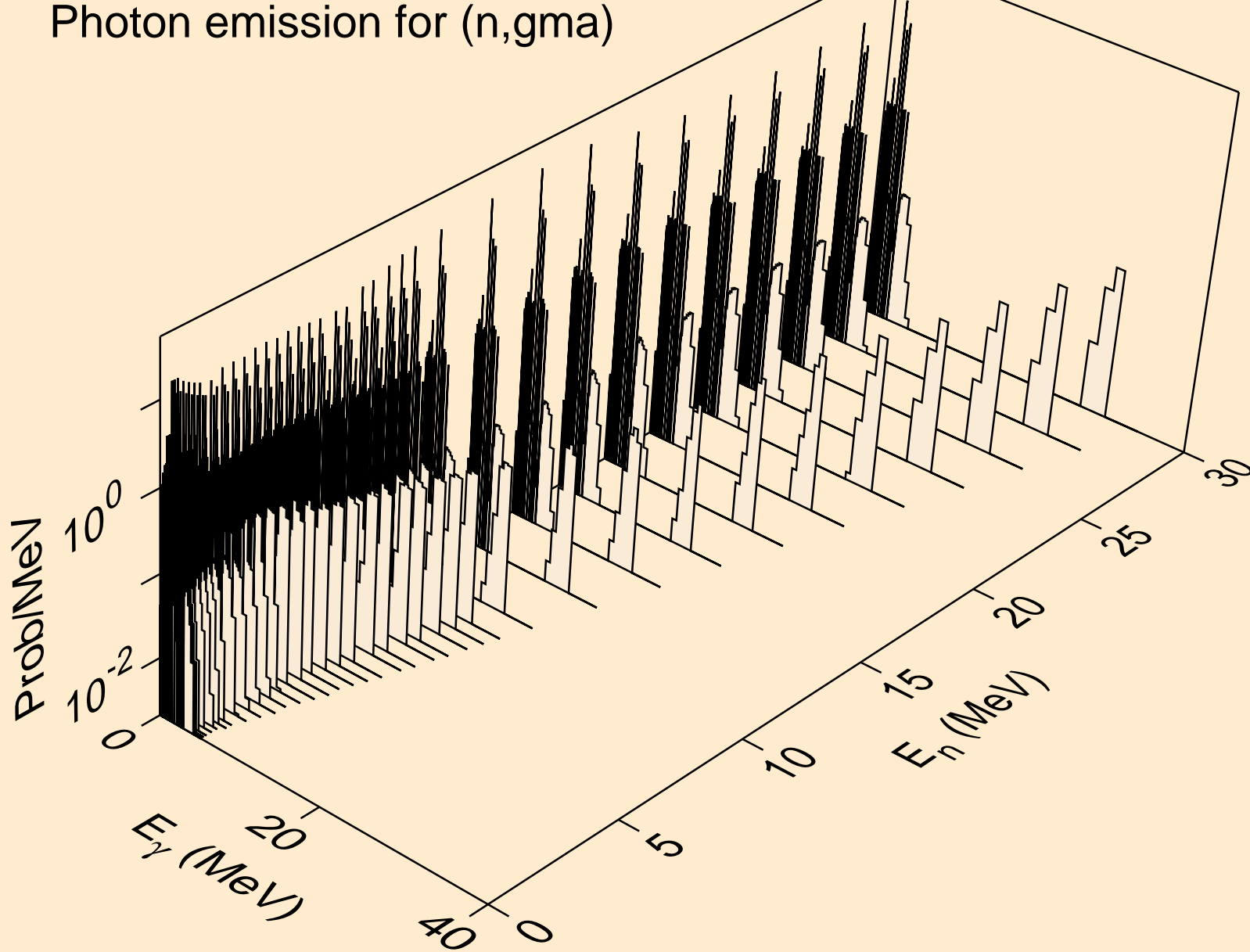

S038 NEUTRON ACER TENDL-2019 LIBRARY; T=293.16K  
Photon emission for (n,p)

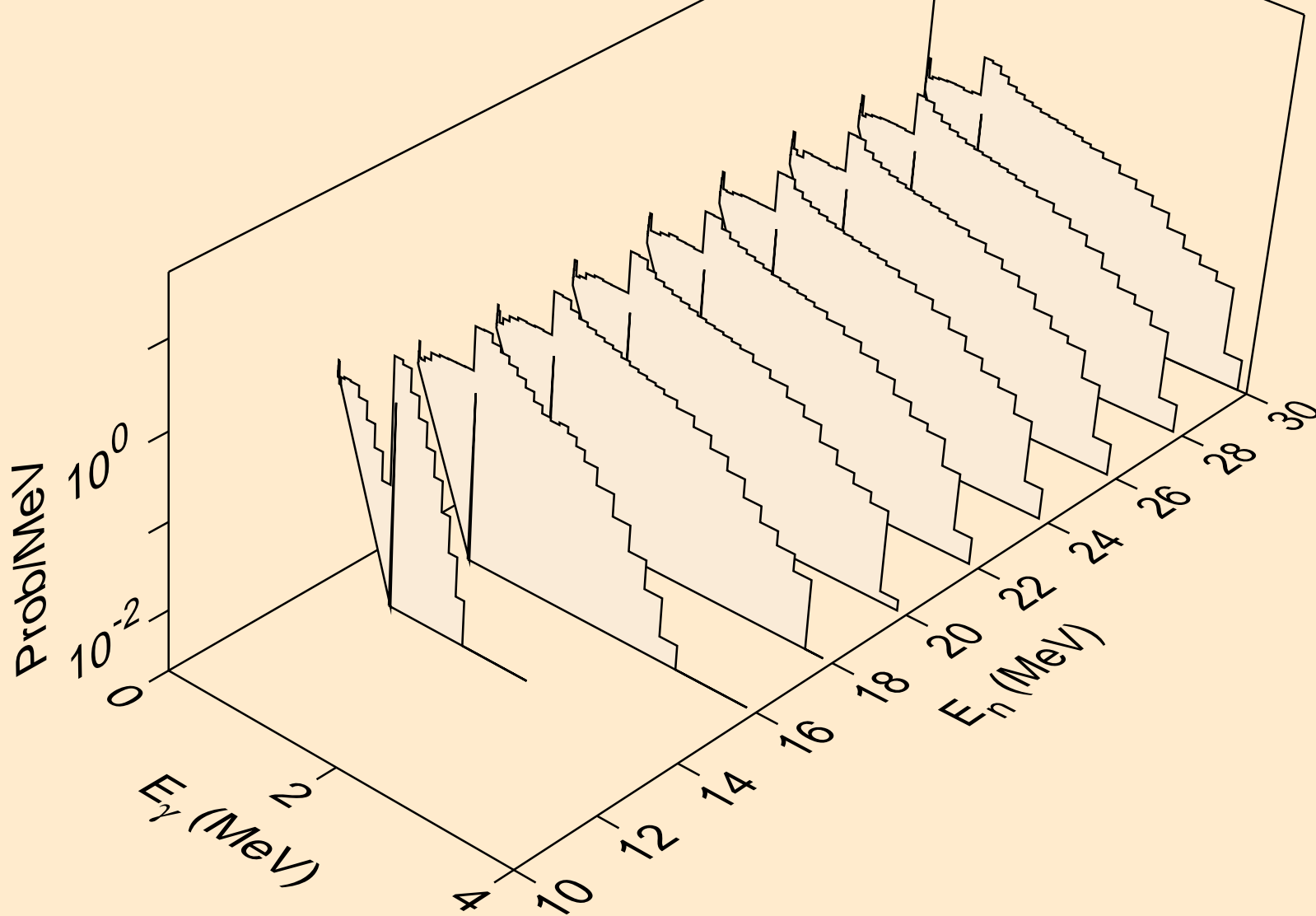

S038 NEUTRON ACER TENDL-2019 LIBRARY; T=293.16K  
Photon emission for (n,d)

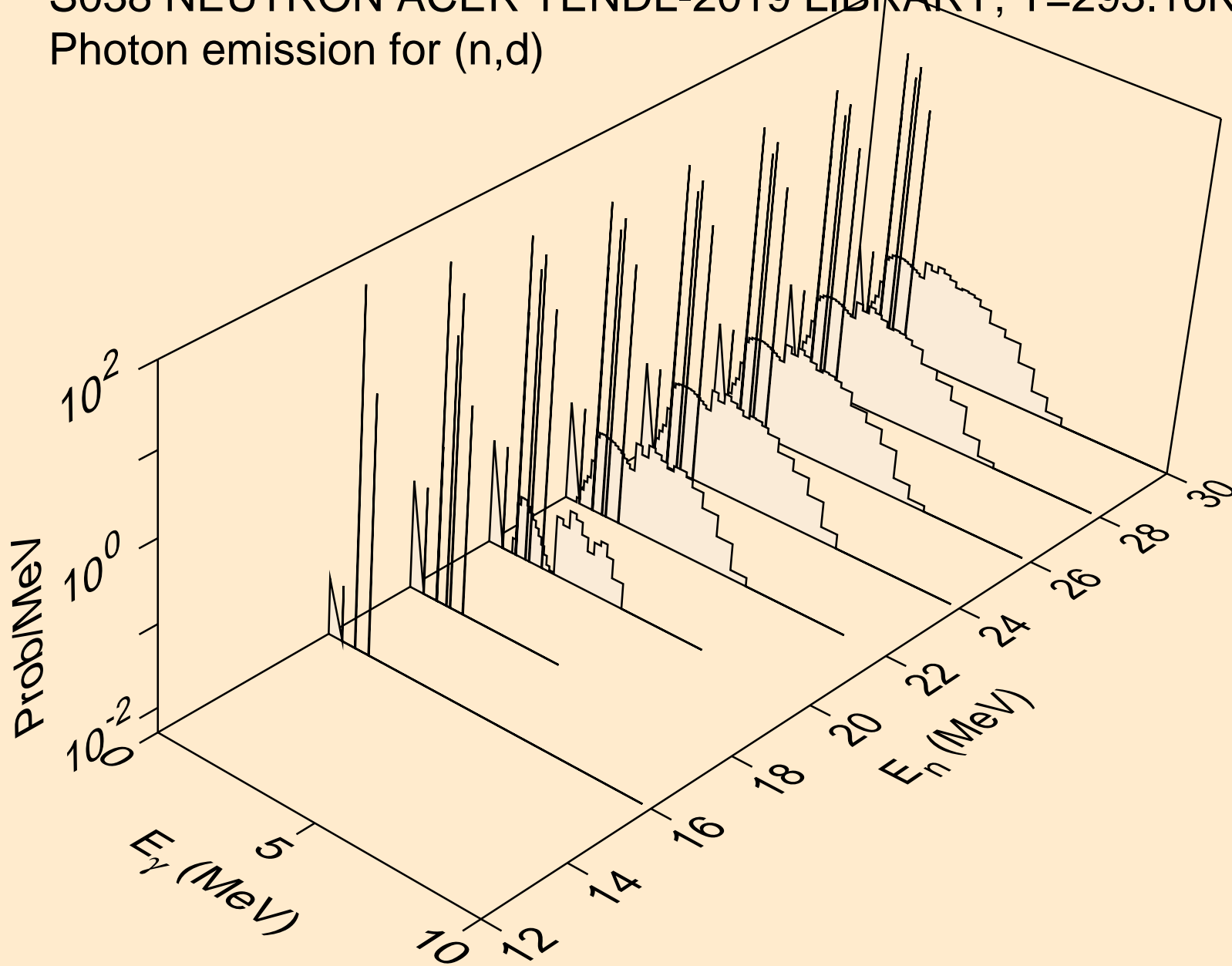



S038 NEUTRON ACER TENDL-2019 LIBRARY; T=293.16K  
Photon emission for (n,t)

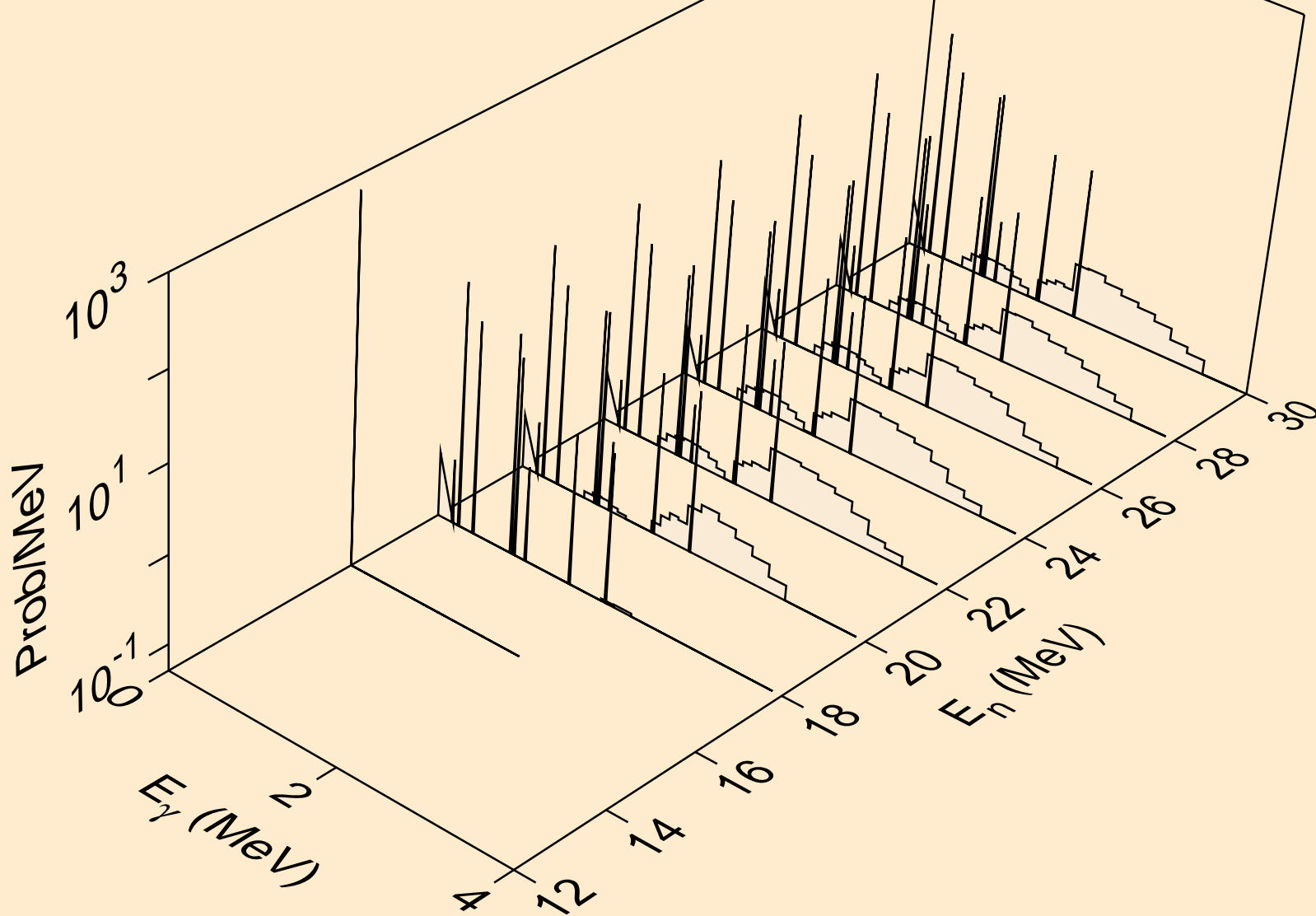

S038 NEUTRON ACER TENDL-2019 LIBRARY; T=293.16K  
Photon emission for (n,he3)

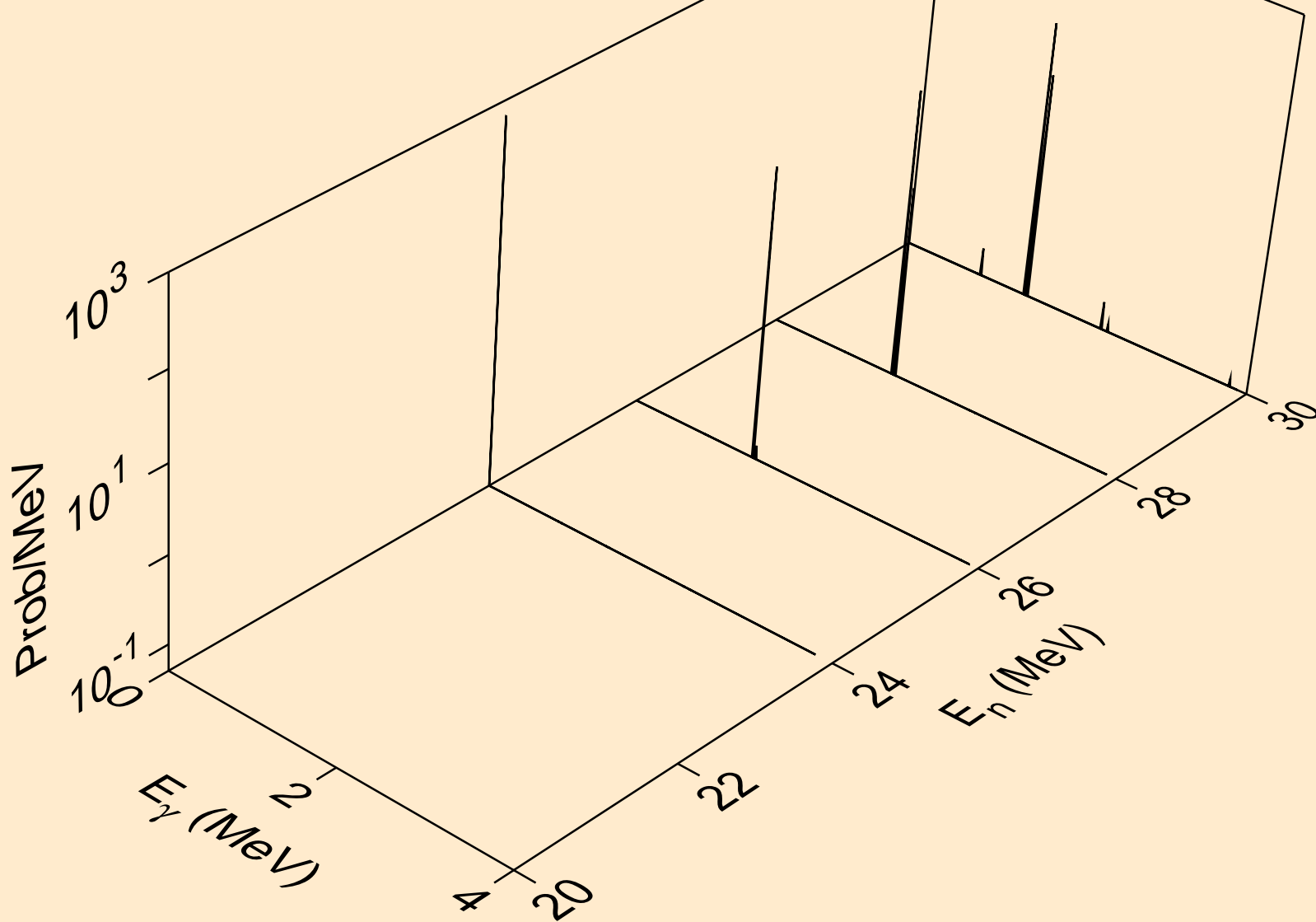

S038 NEUTRON ACER TENDL-2019 LIBRARY; T=293.16K  
Photon emission for (n,a)

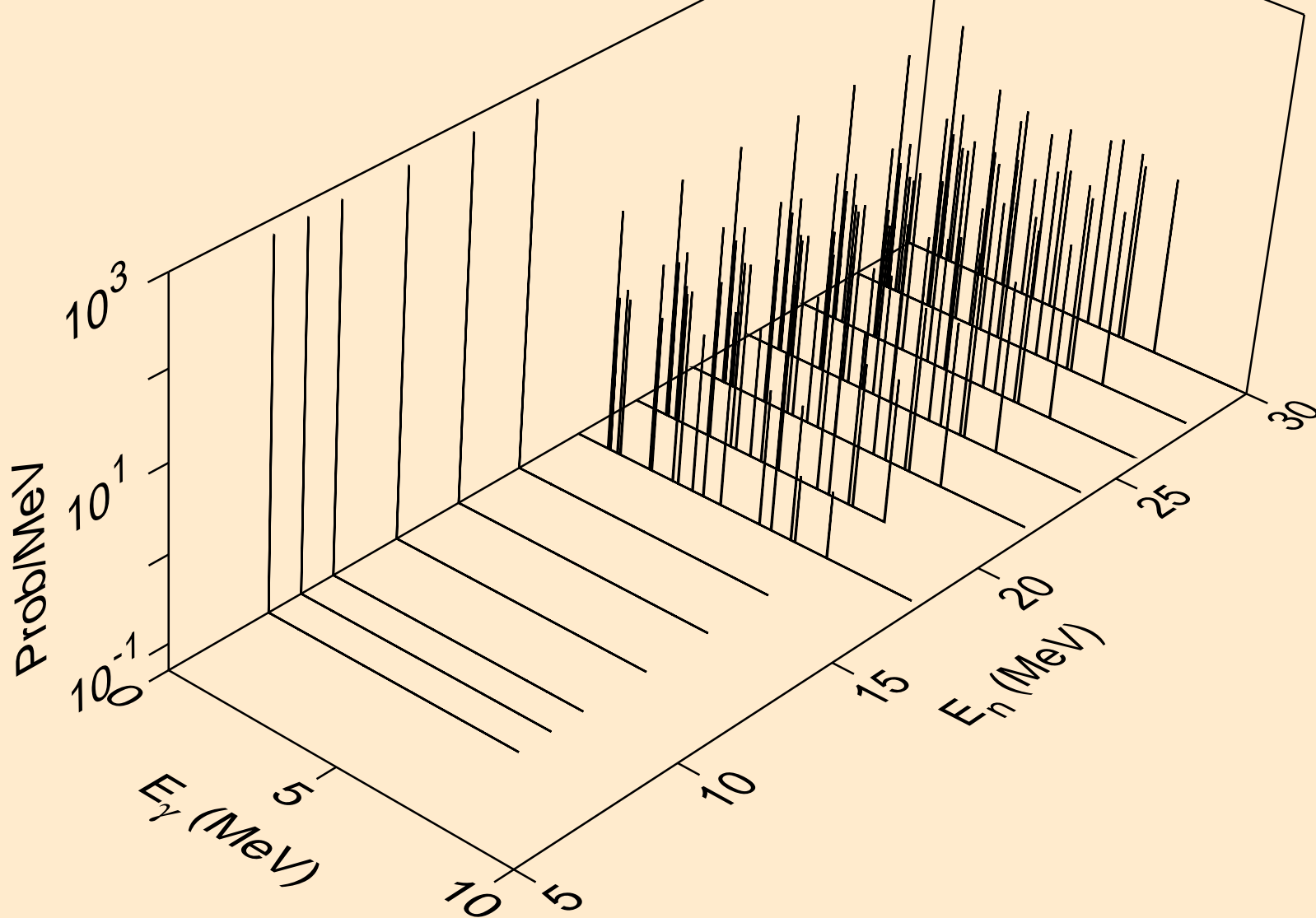

S038 NEUTRON ACER TENDL-2019 LIBRARY; T=293.16K  
Photon emission for (n,2a)

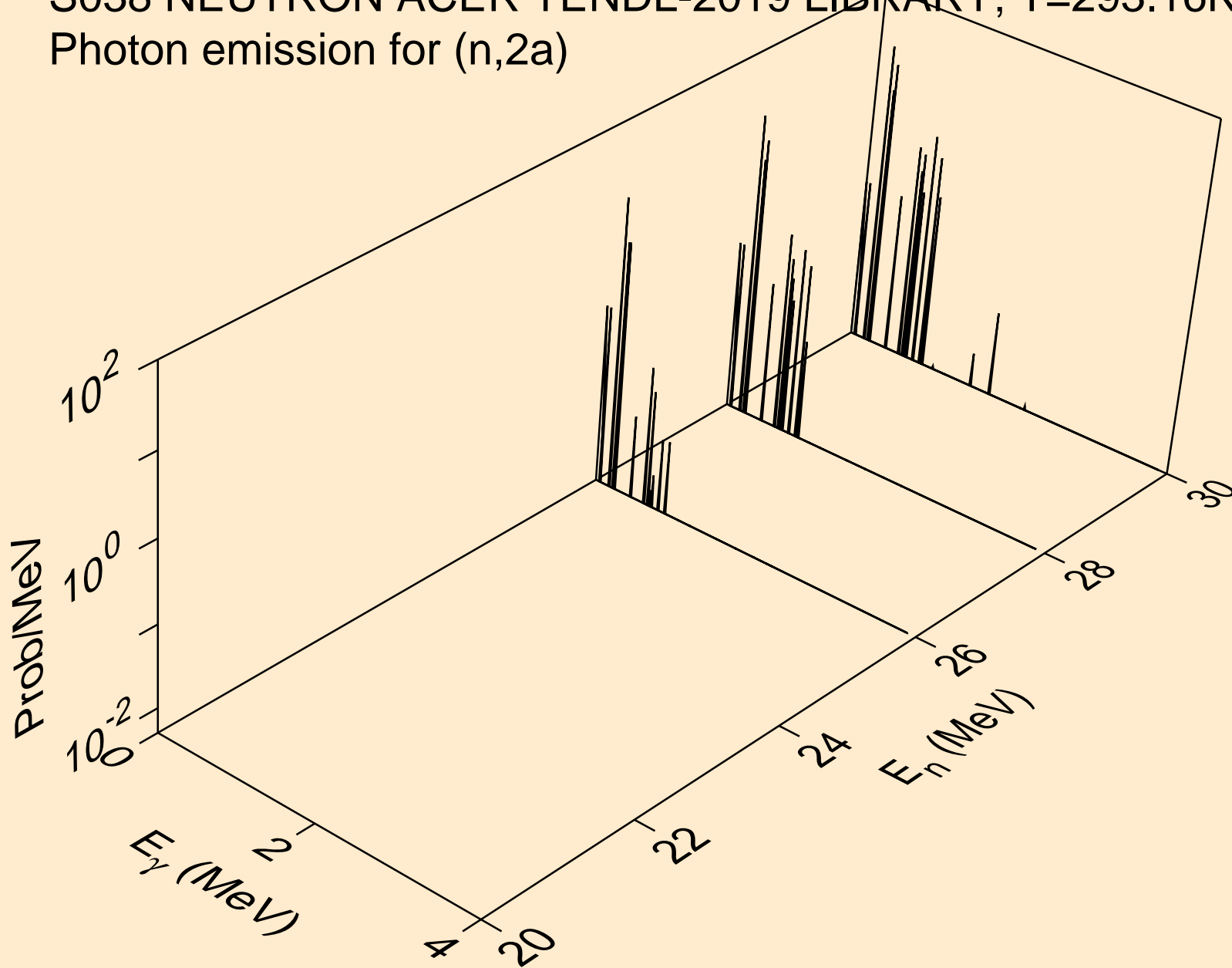

S038 NEUTRON ACER TENDL-2019 LIBRARY; T=293.16K  
thermal capture photon spectrum

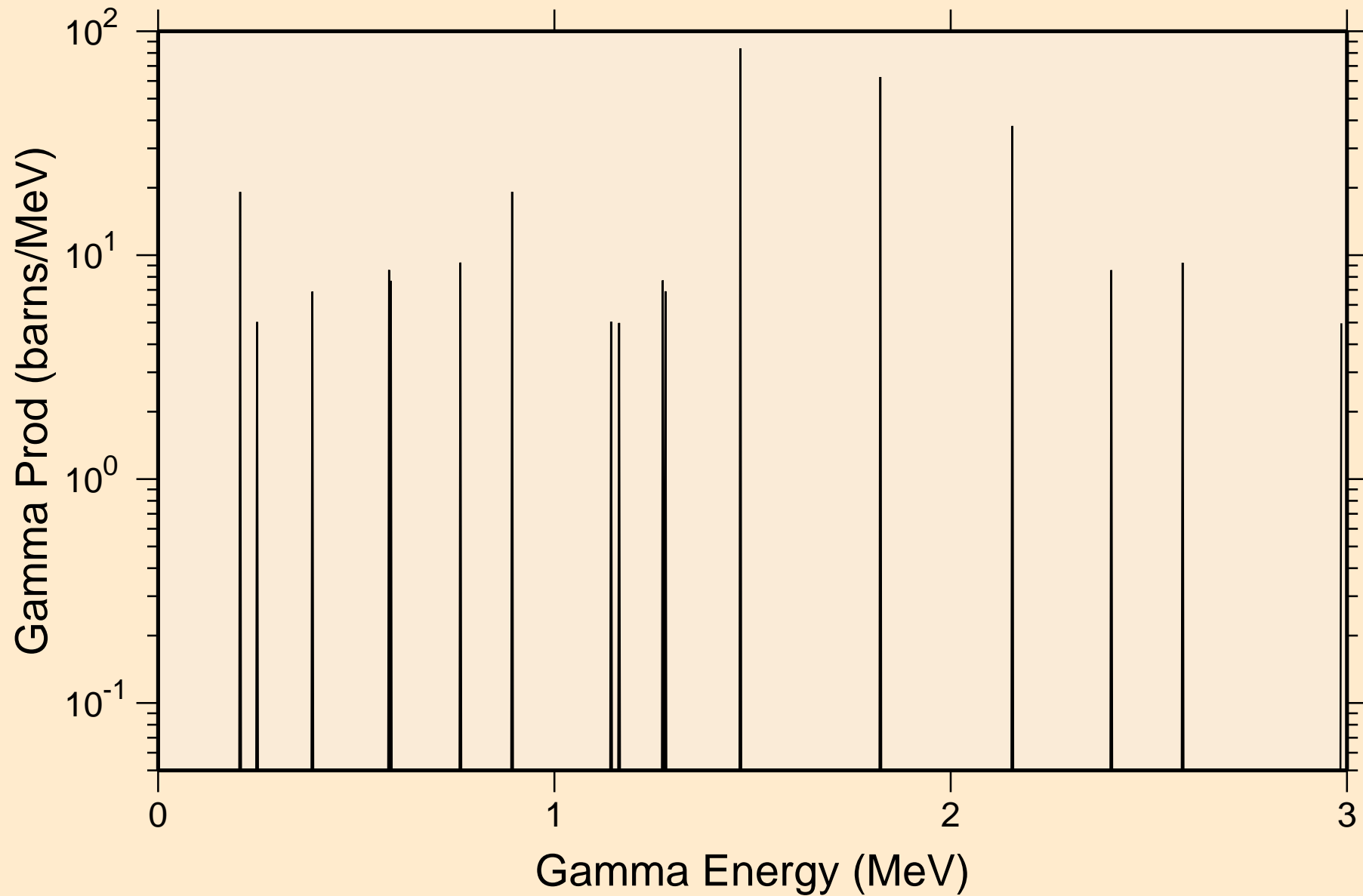

S038 NEUTRON ACER TENDL-2019 LIBRARY; T=293.16K  
14 MeV photon spectrum

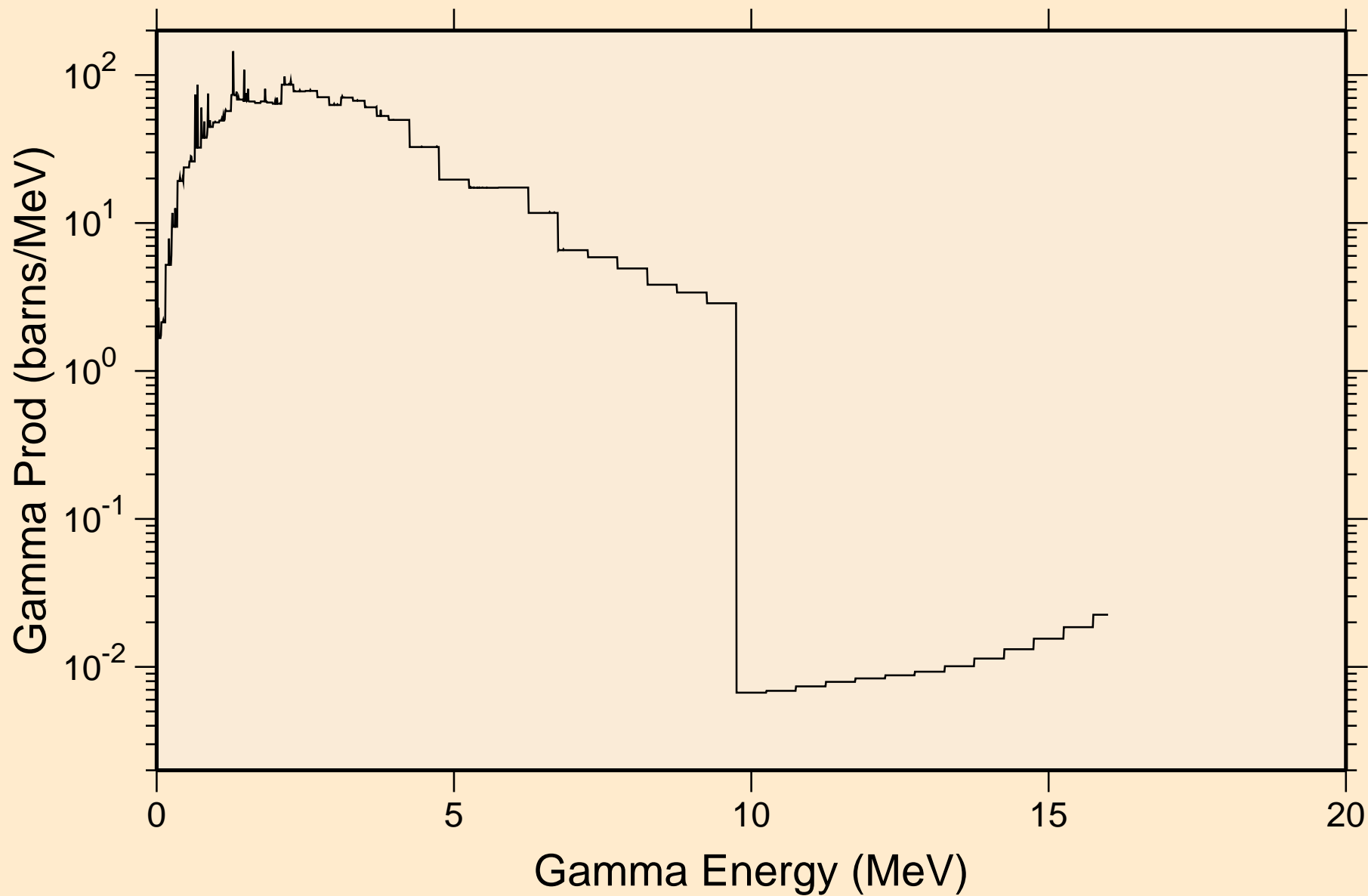

S038 NEUTRON ACER TENDL-2019 LIBRARY; T=293.16K  
Particle heating contributions

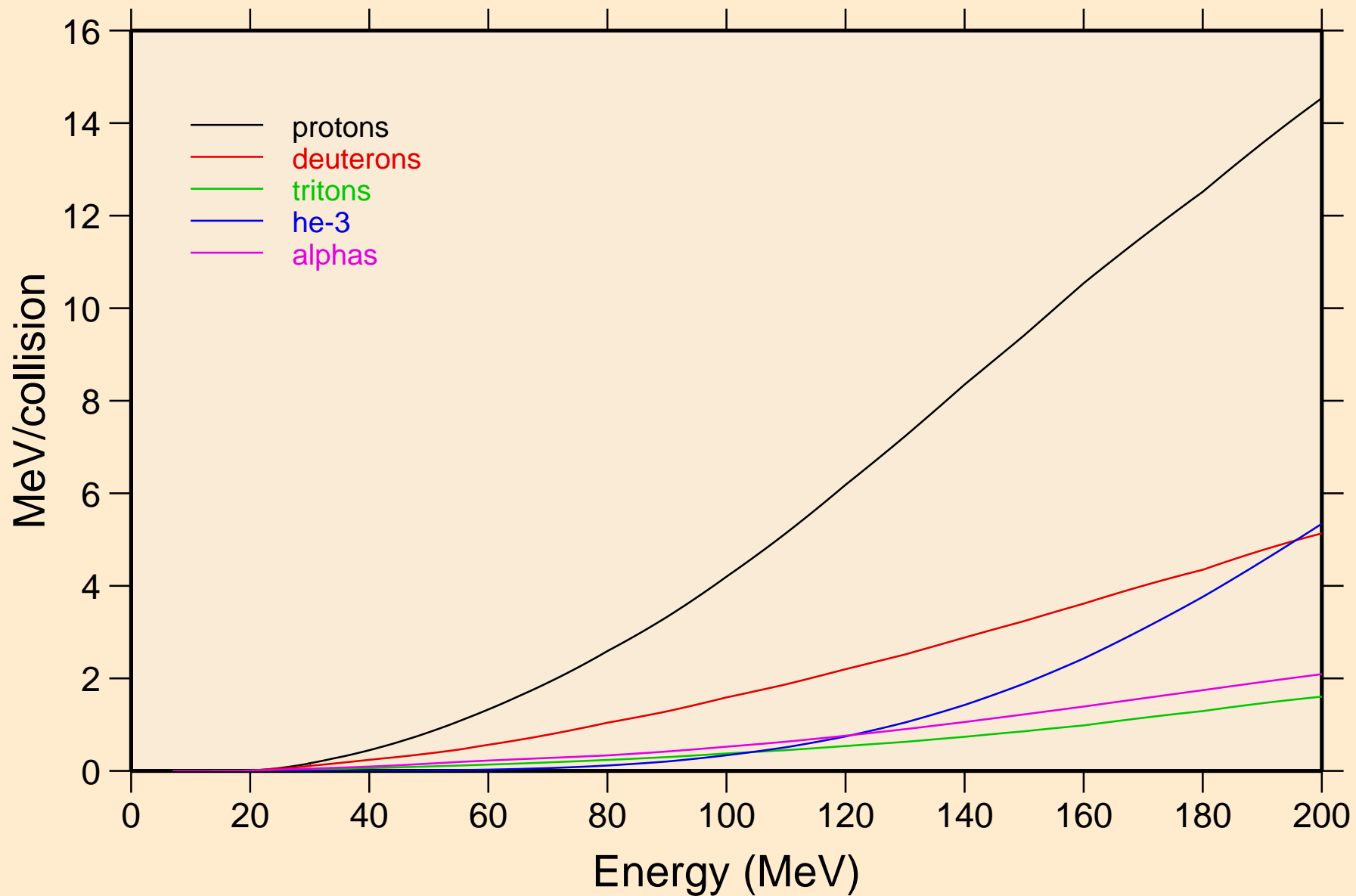

S038 NEUTRON ACER TENDL-2019 LIBRARY; T=293.16K  
Recoil Heating

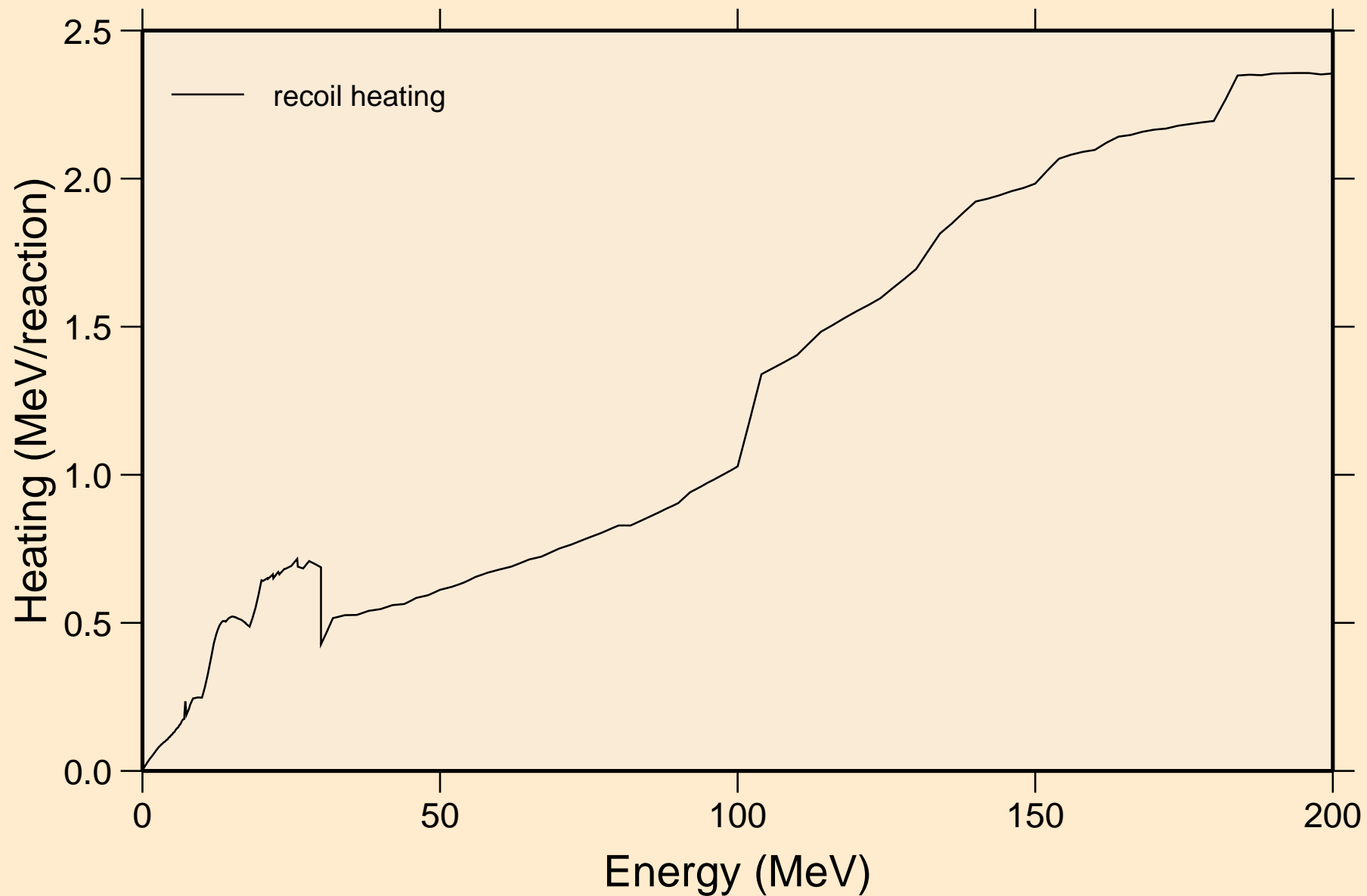



S038 NEUTRON ACER TENDL-2019 LIBRARY; T=293.16K  
Particle production cross sections

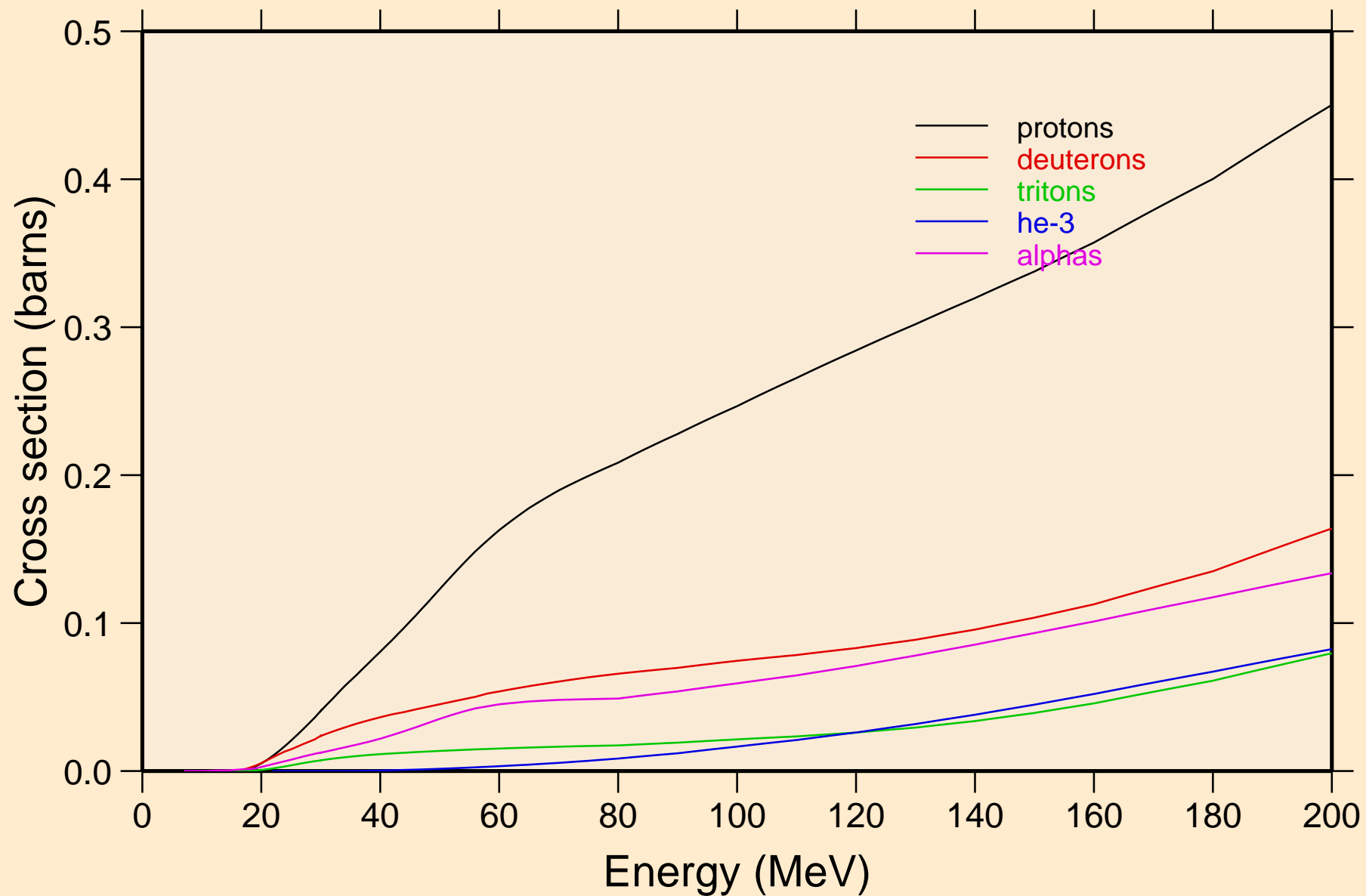

S038 NEUTRON ACER TENDL-2019 LIBRARY; T=293.16K  
protons from (n,x)

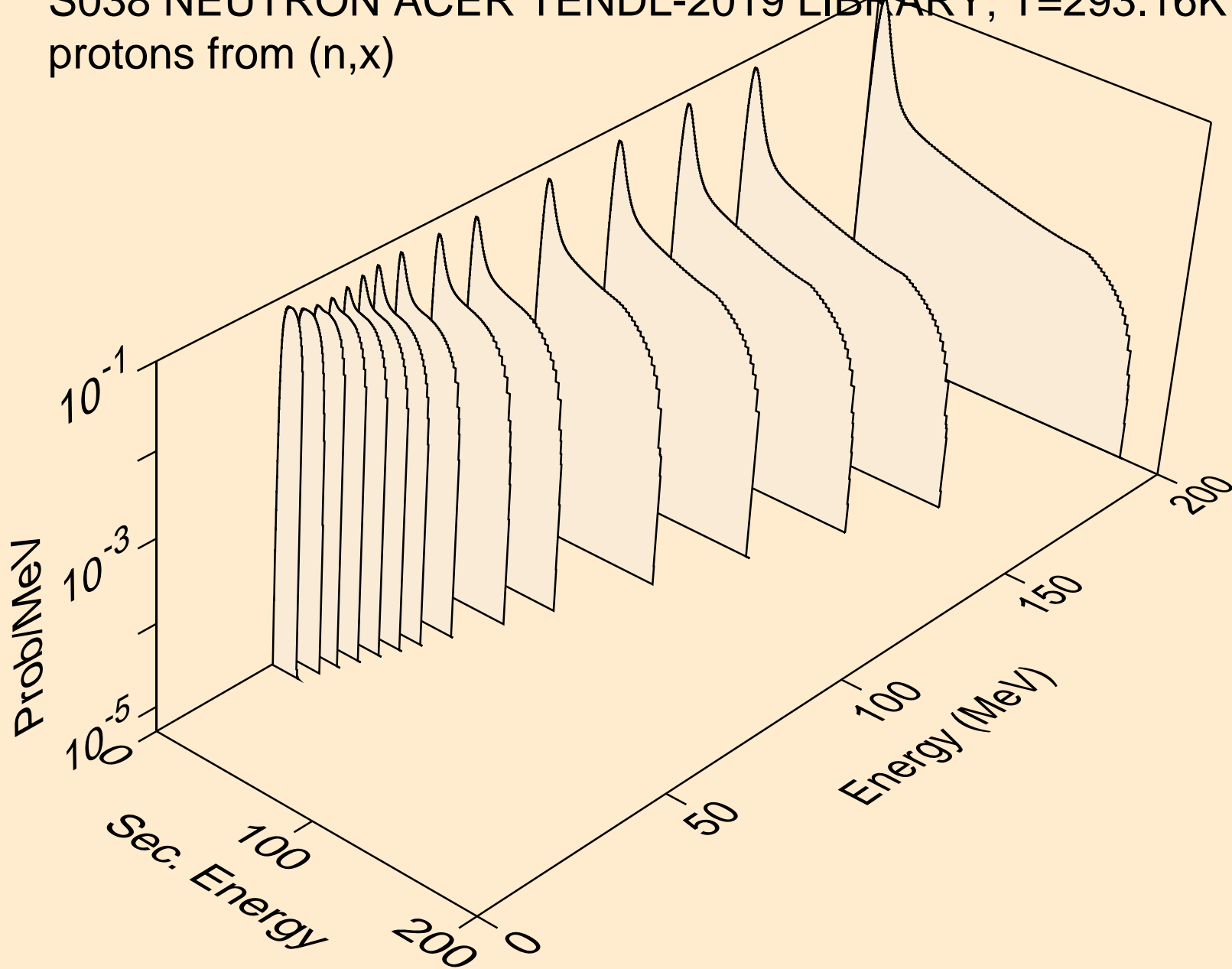

S038 NEUTRON ACER TENDL-2019 LIBRARY; T=293.16K  
protons from (n,n\*)p

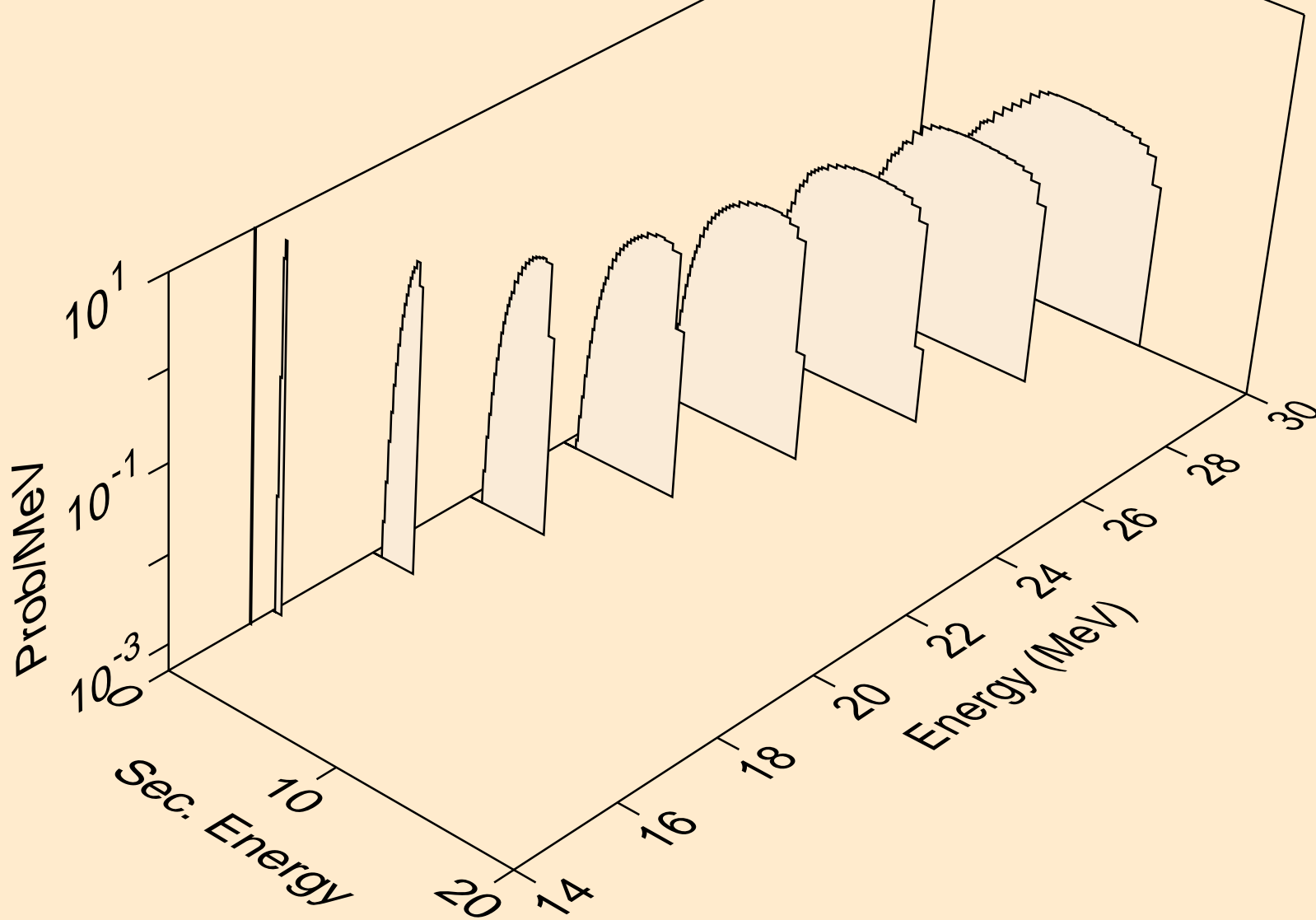

S038 NEUTRON ACER TENDL-2019 LIBRARY; T=293.16K  
protons from (n,2np)

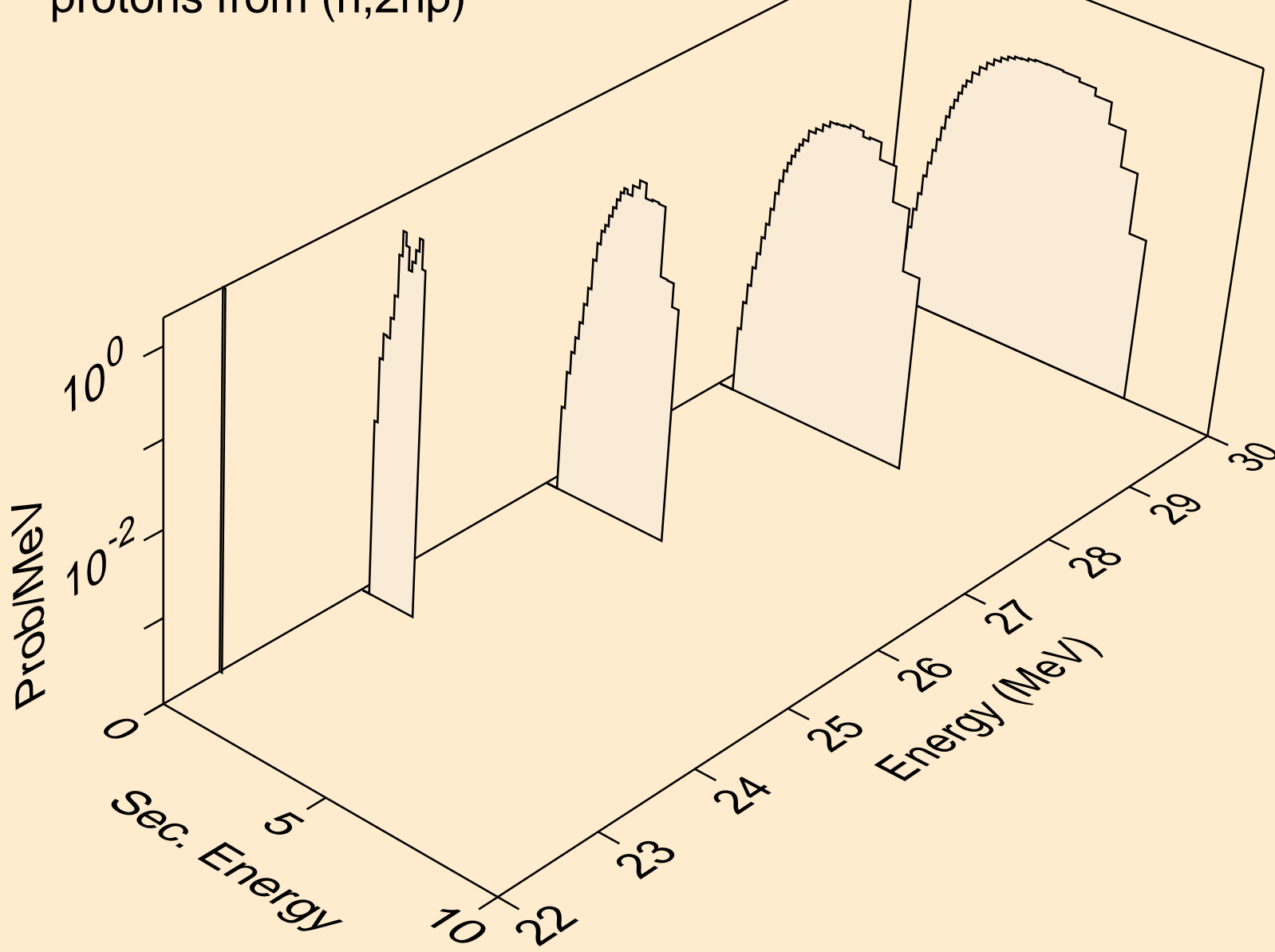

S038 NEUTRON ACER TENDL-2019 LIBRARY; T=293.16K  
protons from (n,3np)

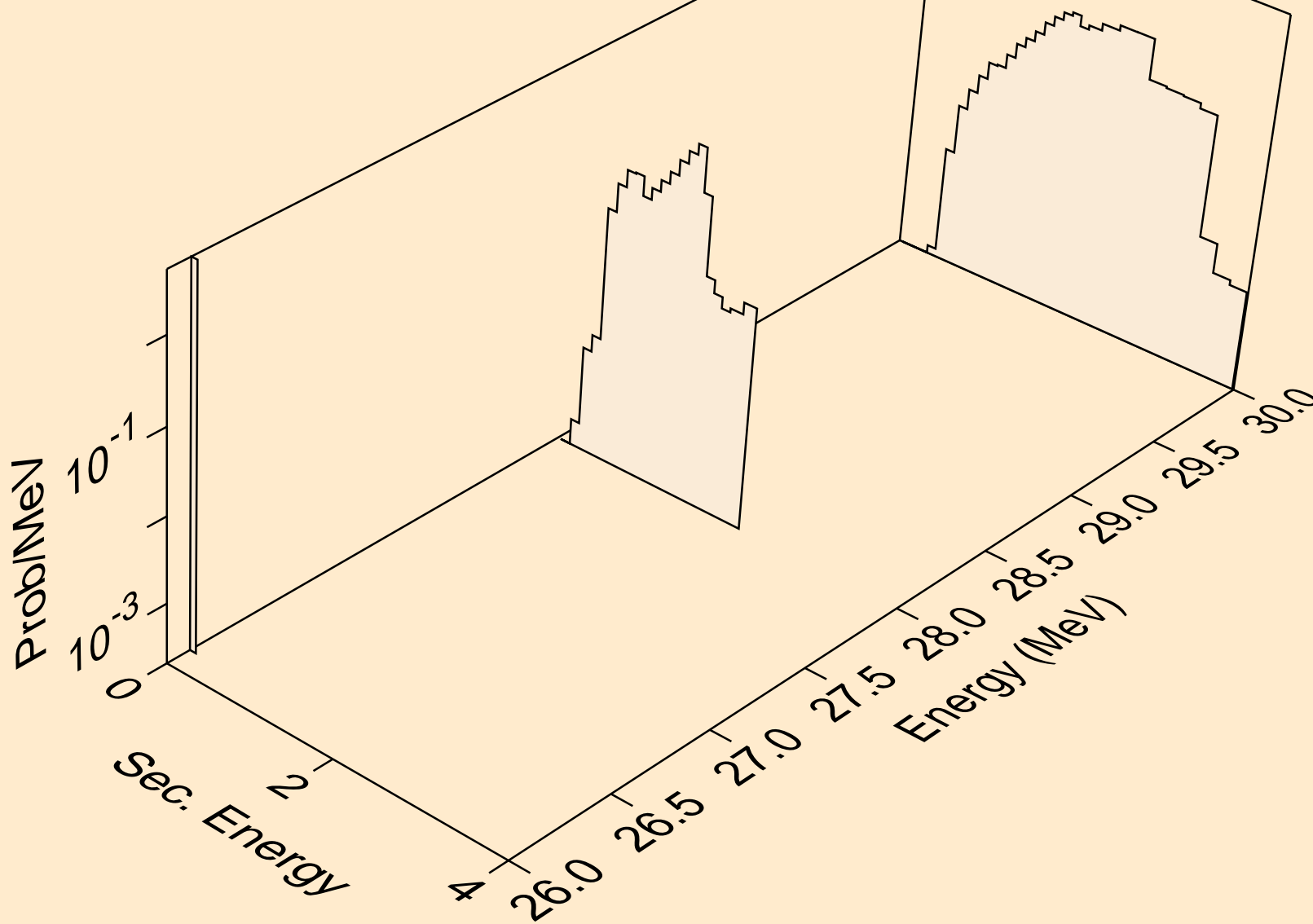

S038 NEUTRON ACER TENDL-2019 LIBRARY; T=293.16K  
protons from (n,p)

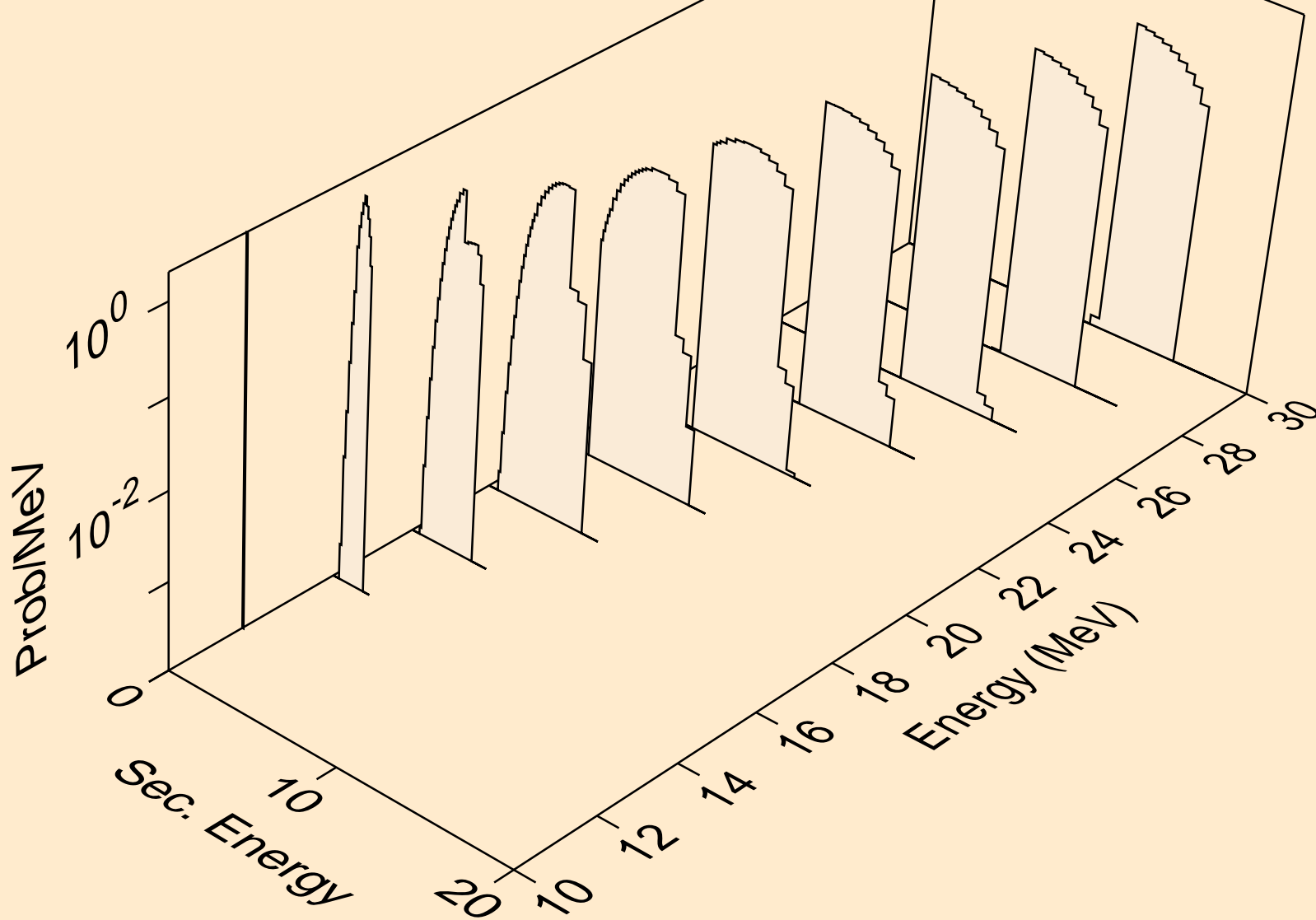

S038 NEUTRON ACER TENDL-2019 LIBRARY; T=293.16K  
deuterons from (n,x)

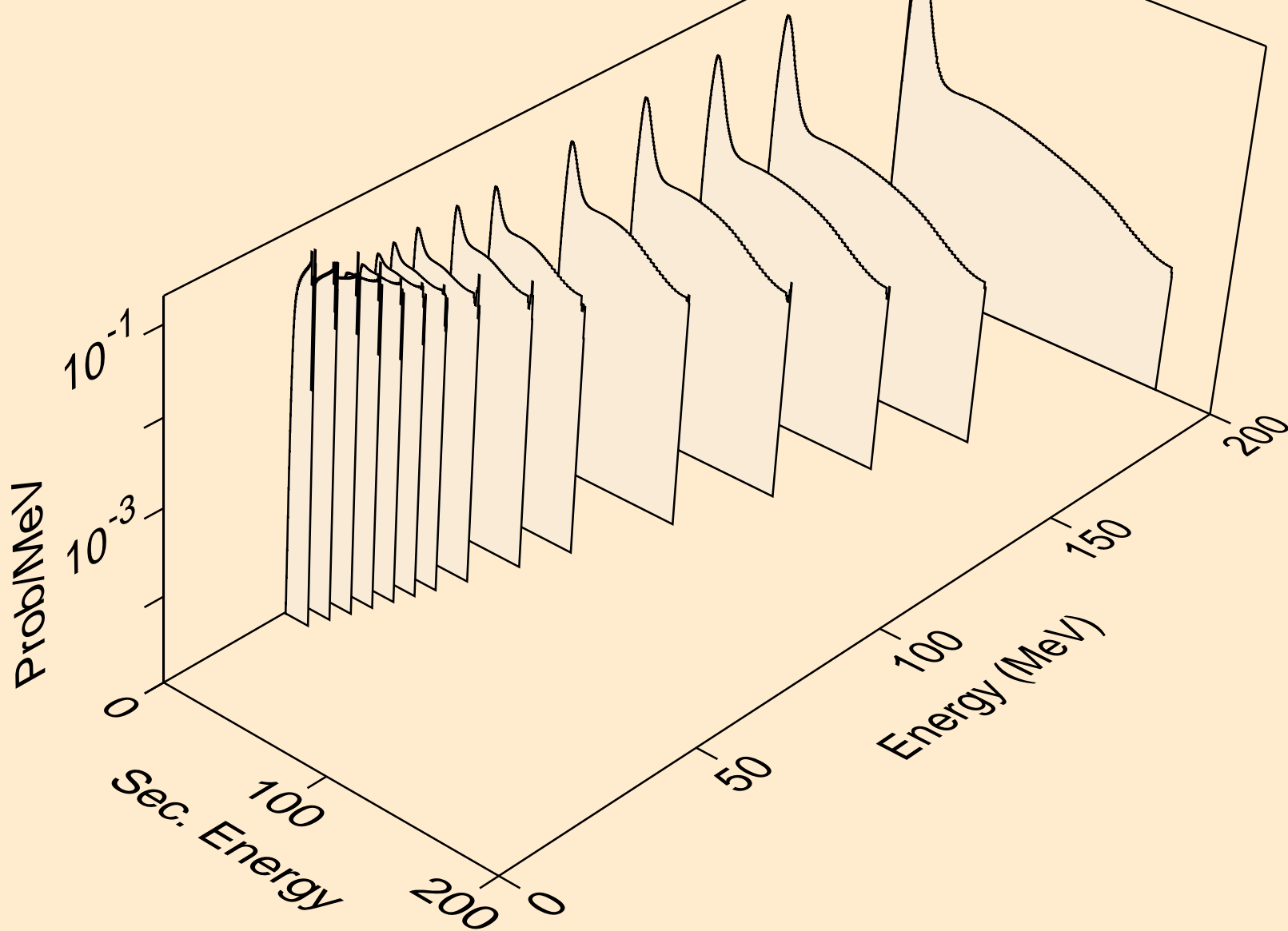

S038 NEUTRON ACER TENDL-2019 LIBRARY; T=293.16K  
deuterons from (n,2nd)

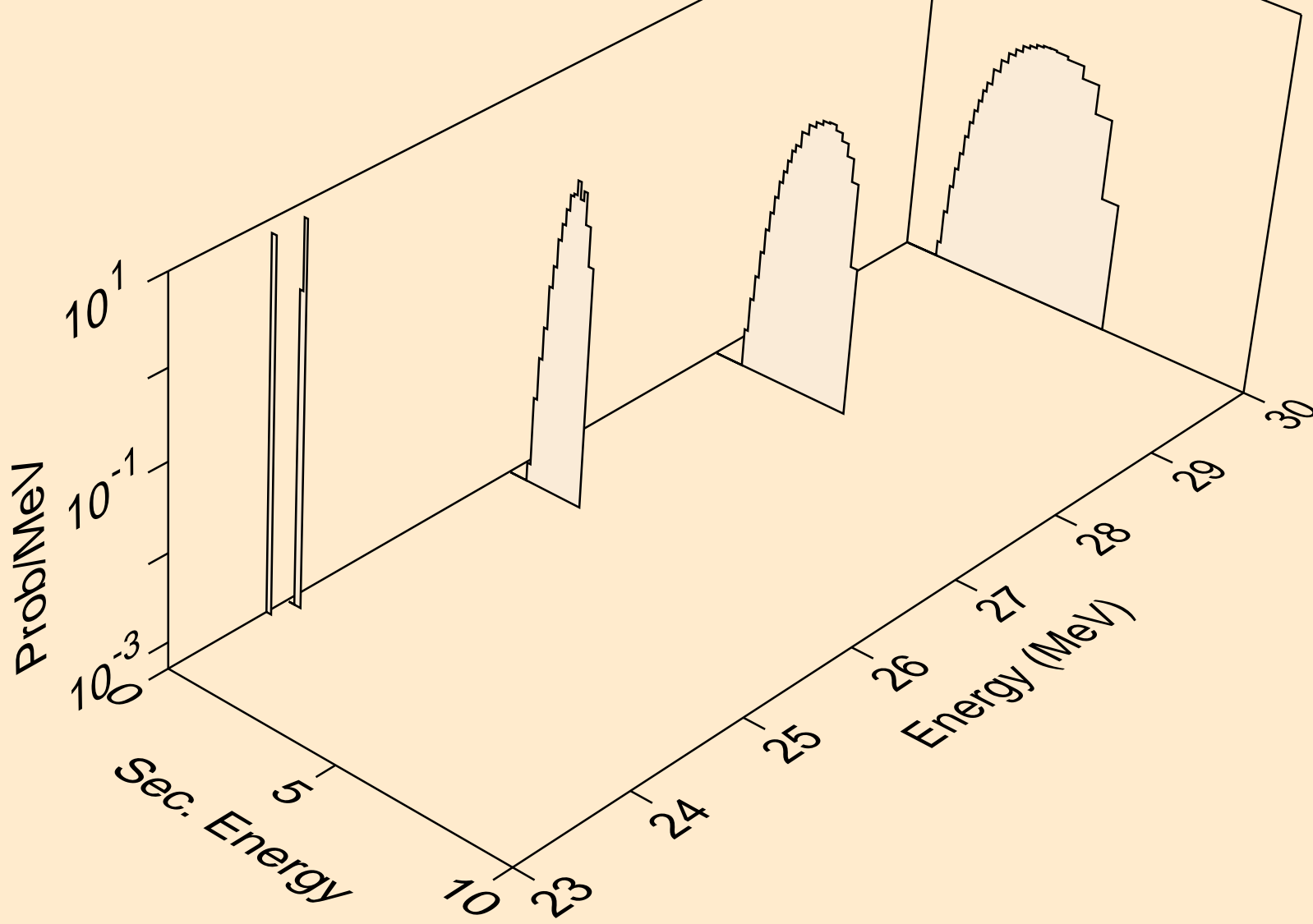



S038 NEUTRON ACER TENDL-2019 LIBRARY; T=293.16K  
deuterons from (n,n\*)d

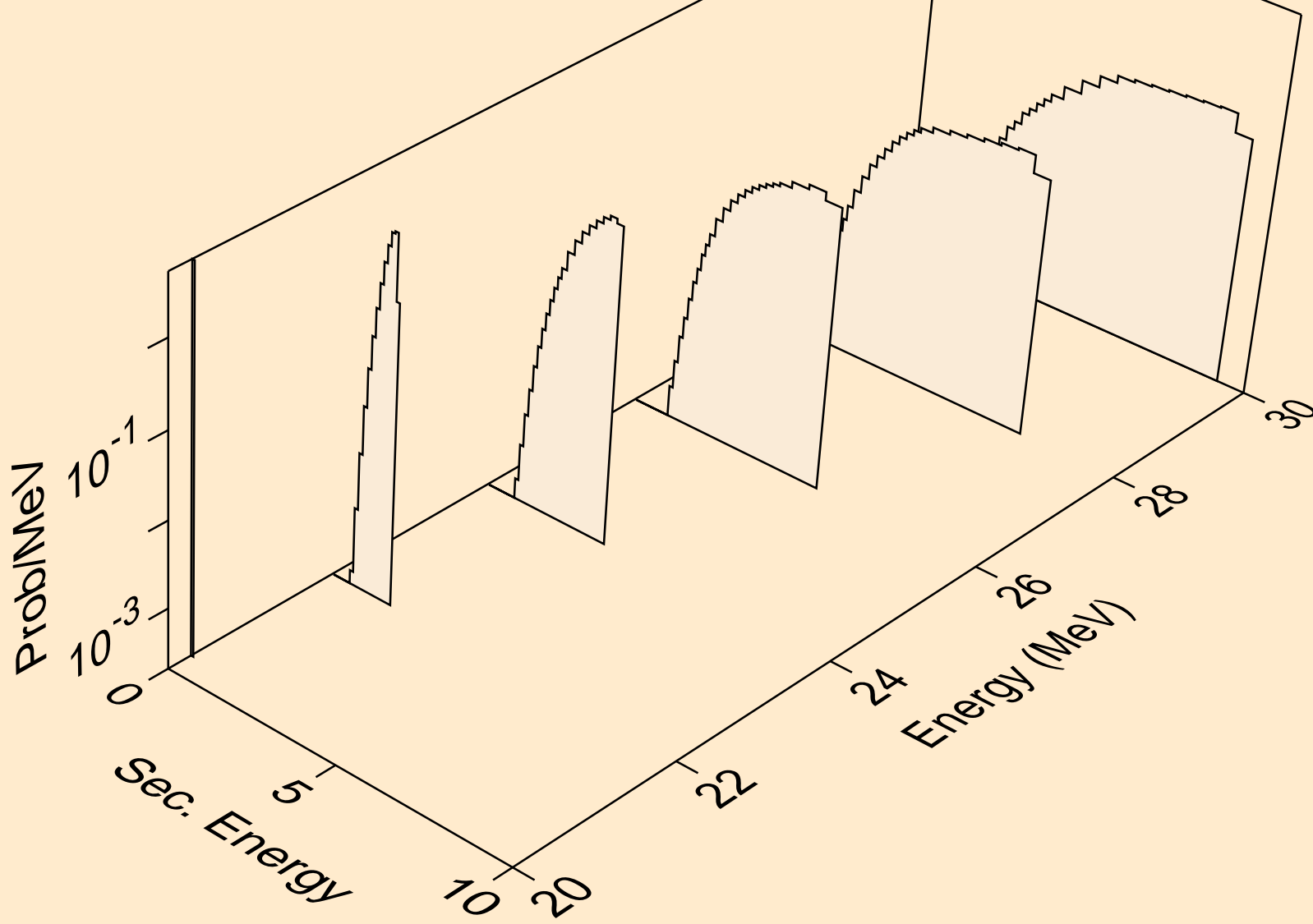

S038 NEUTRON ACER TENDL-2019 LIBRARY; T=293.16K  
deuterons from (n,d)

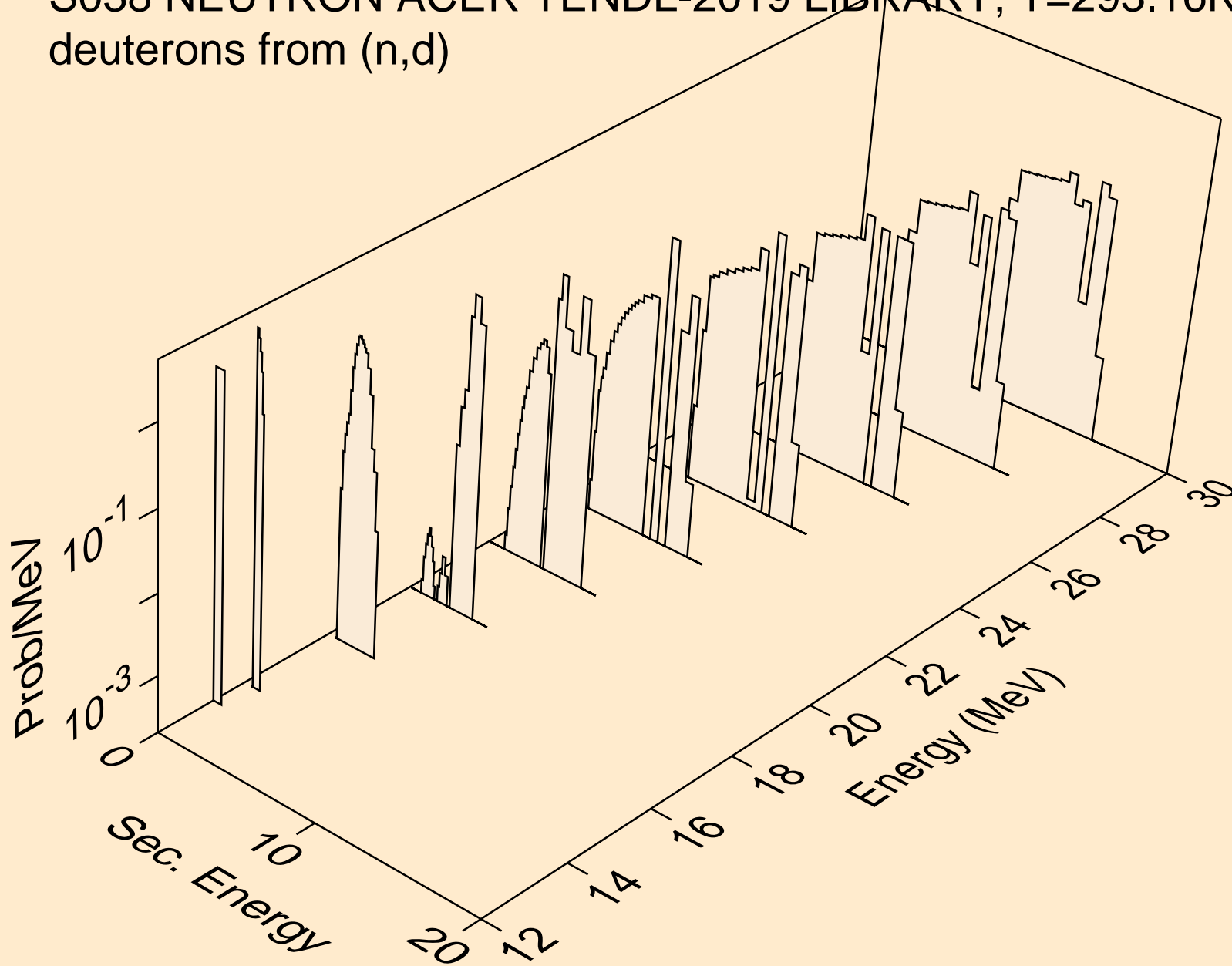

S038 NEUTRON ACER TENDL-2019 LIBRARY; T=293.16K  
tritons from (n,x)

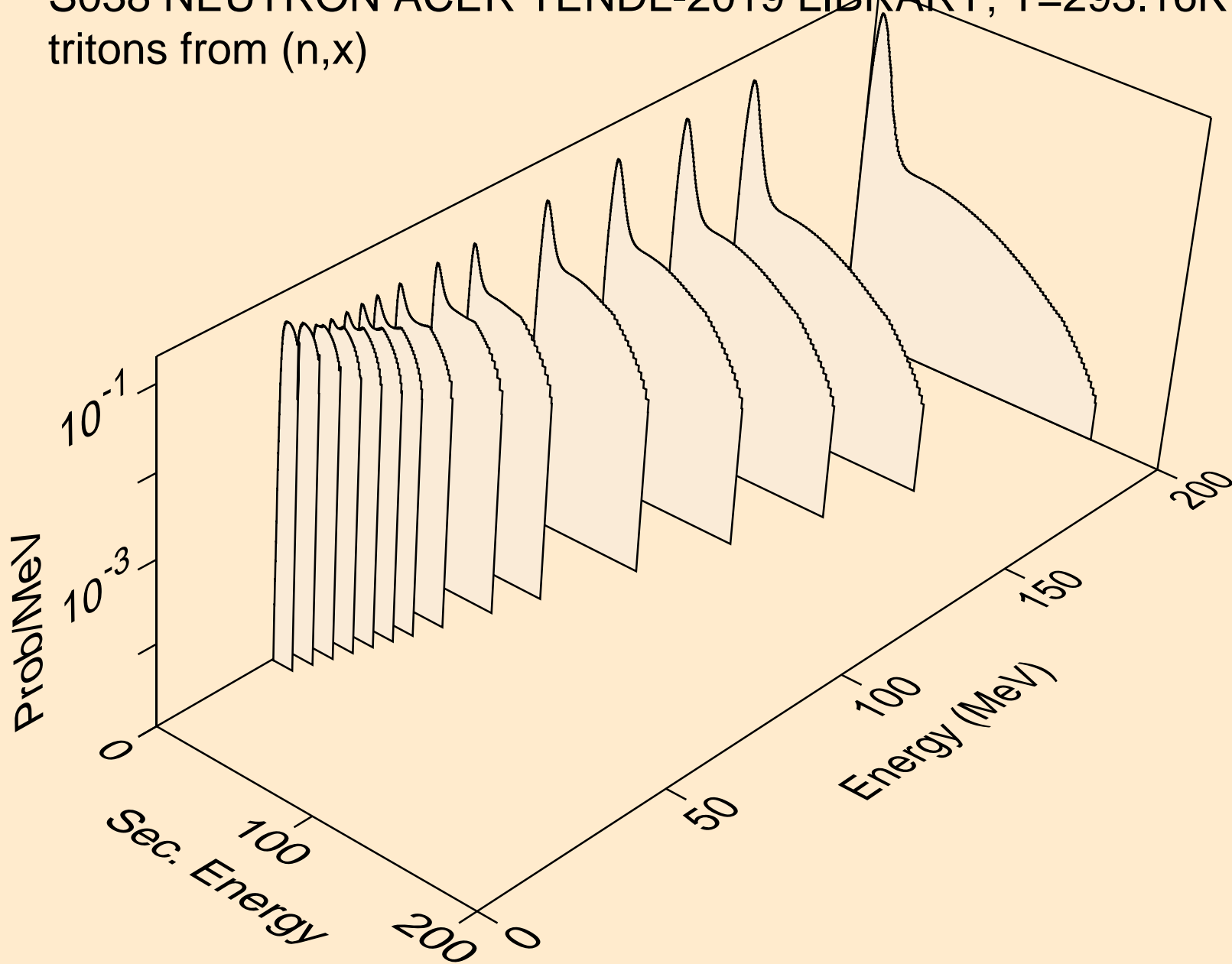

S038 NEUTRON ACER TENDL-2019 LIBRARY; T=293.16K  
tritons from (n,n\*)t

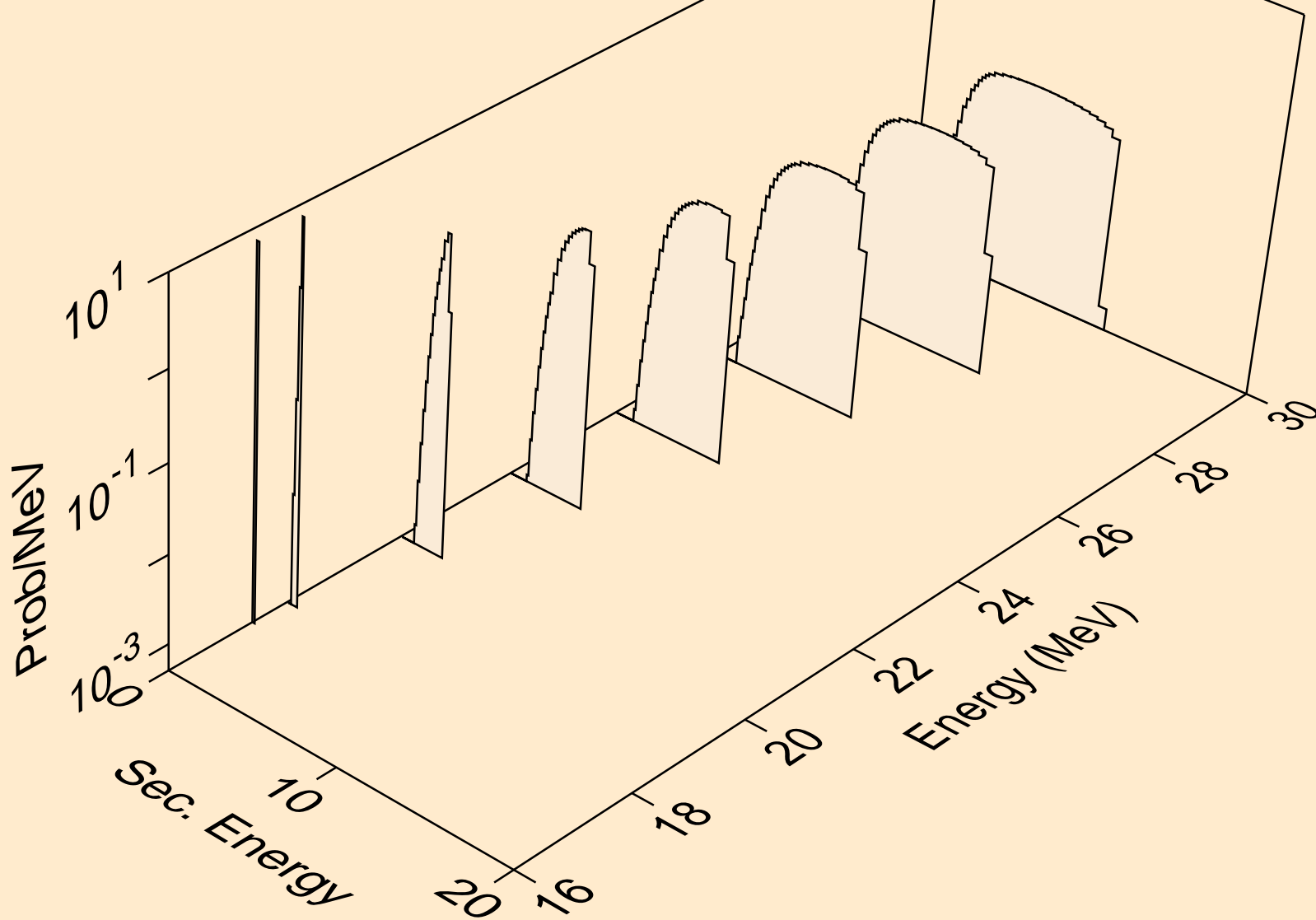

S038 NEUTRON ACER TENDL-2019 LIBRARY; T=293.16K  
tritons from (n,t)

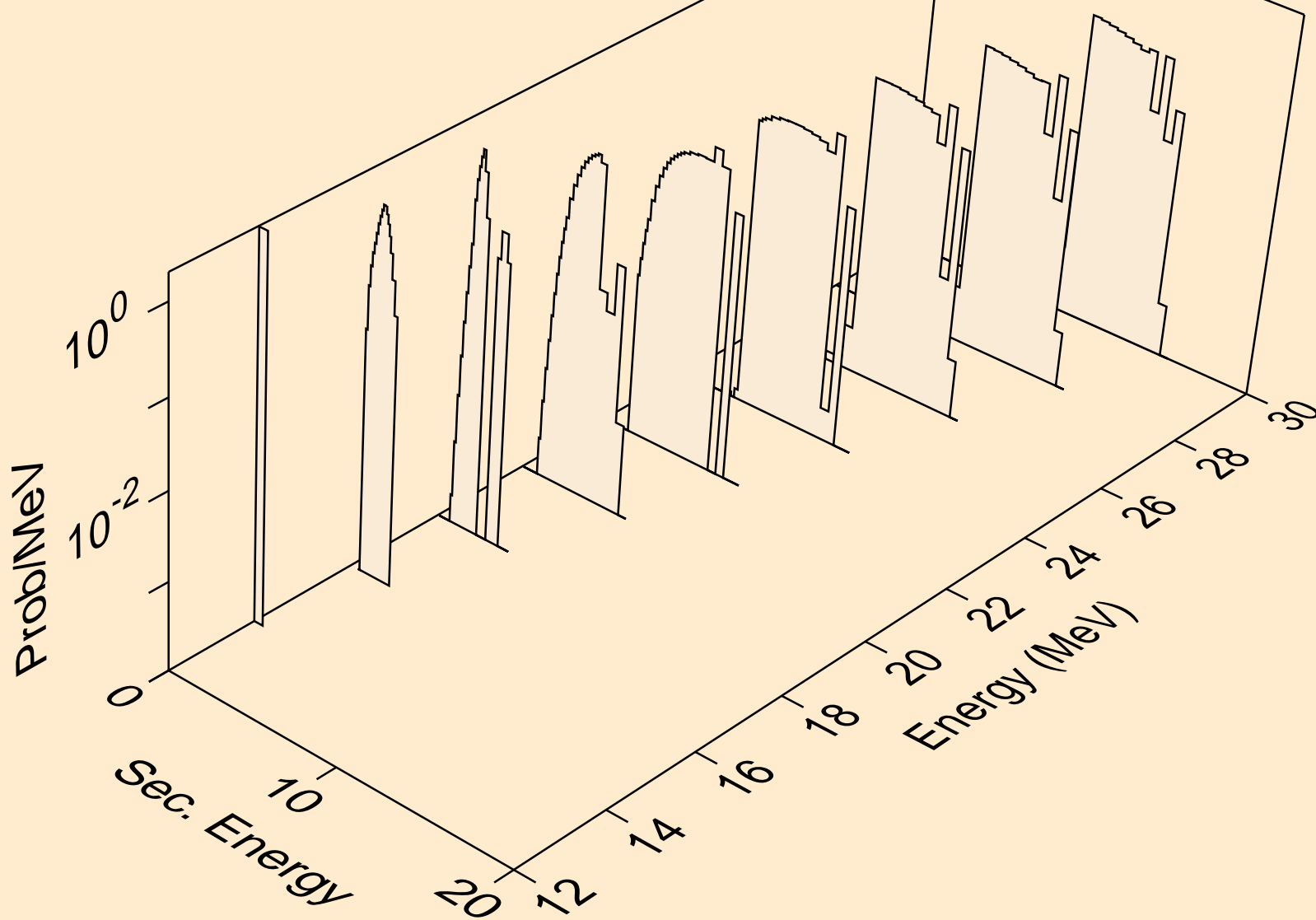

S038 NEUTRON ACER TENDL-2019 LIBRARY; T=293.16K  
he3s from (n,x)

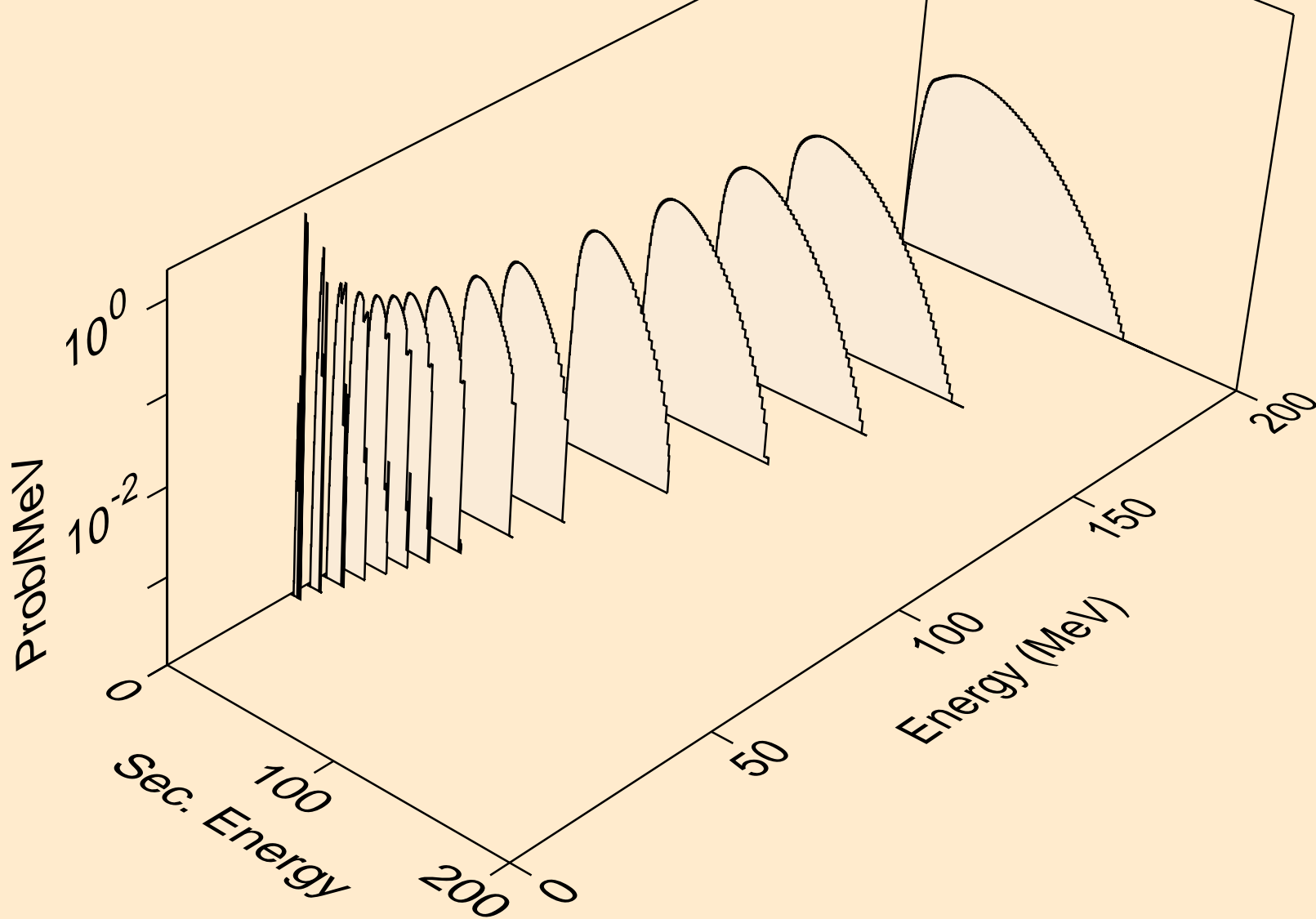

S038 NEUTRON ACER TENDL-2019 LIBRARY; T=293.16K  
he3s from (n,he3)

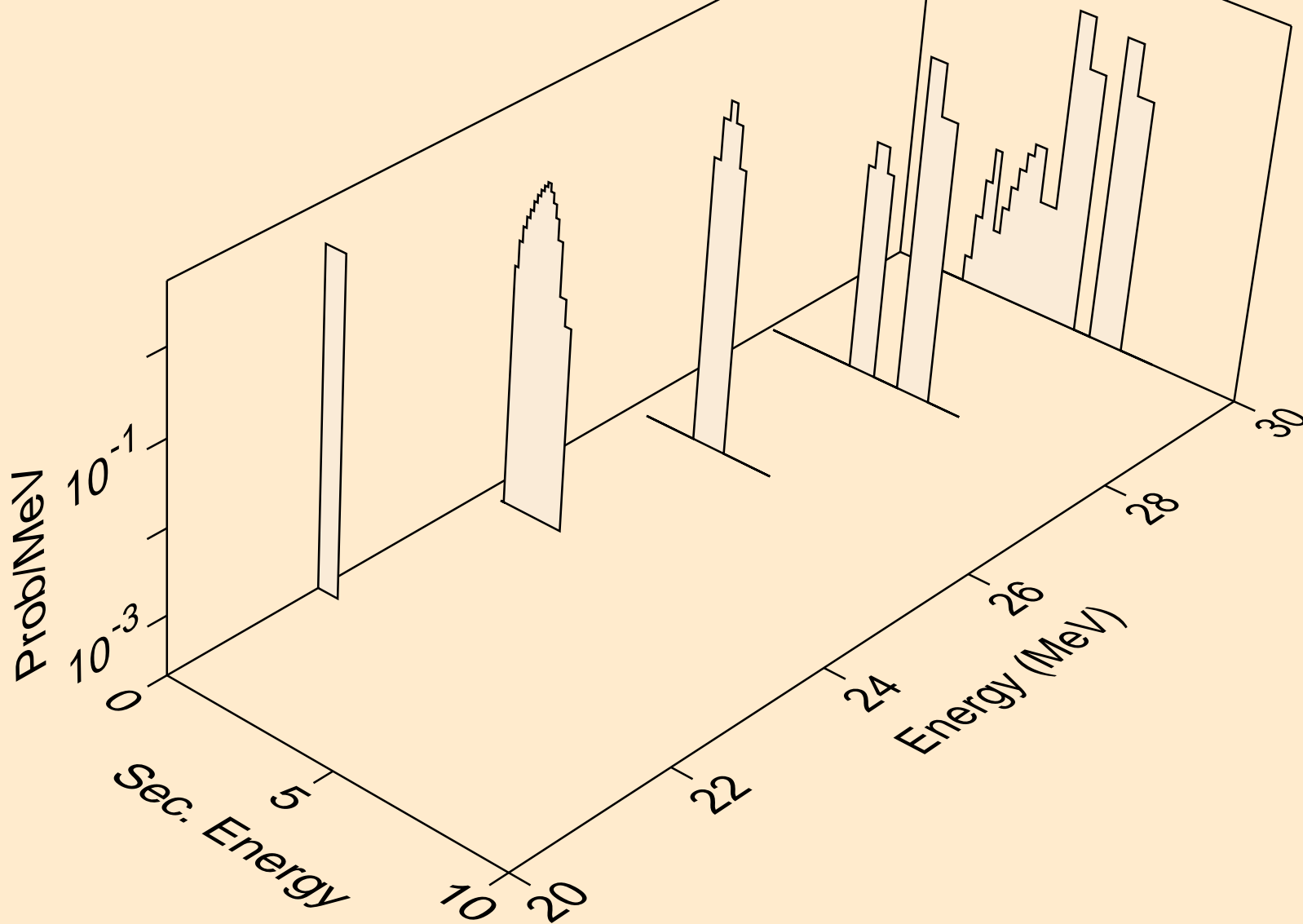

S038 NEUTRON ACER TENDL-2019 LIBRARY; T=293.16K  
alphas from (n,x)

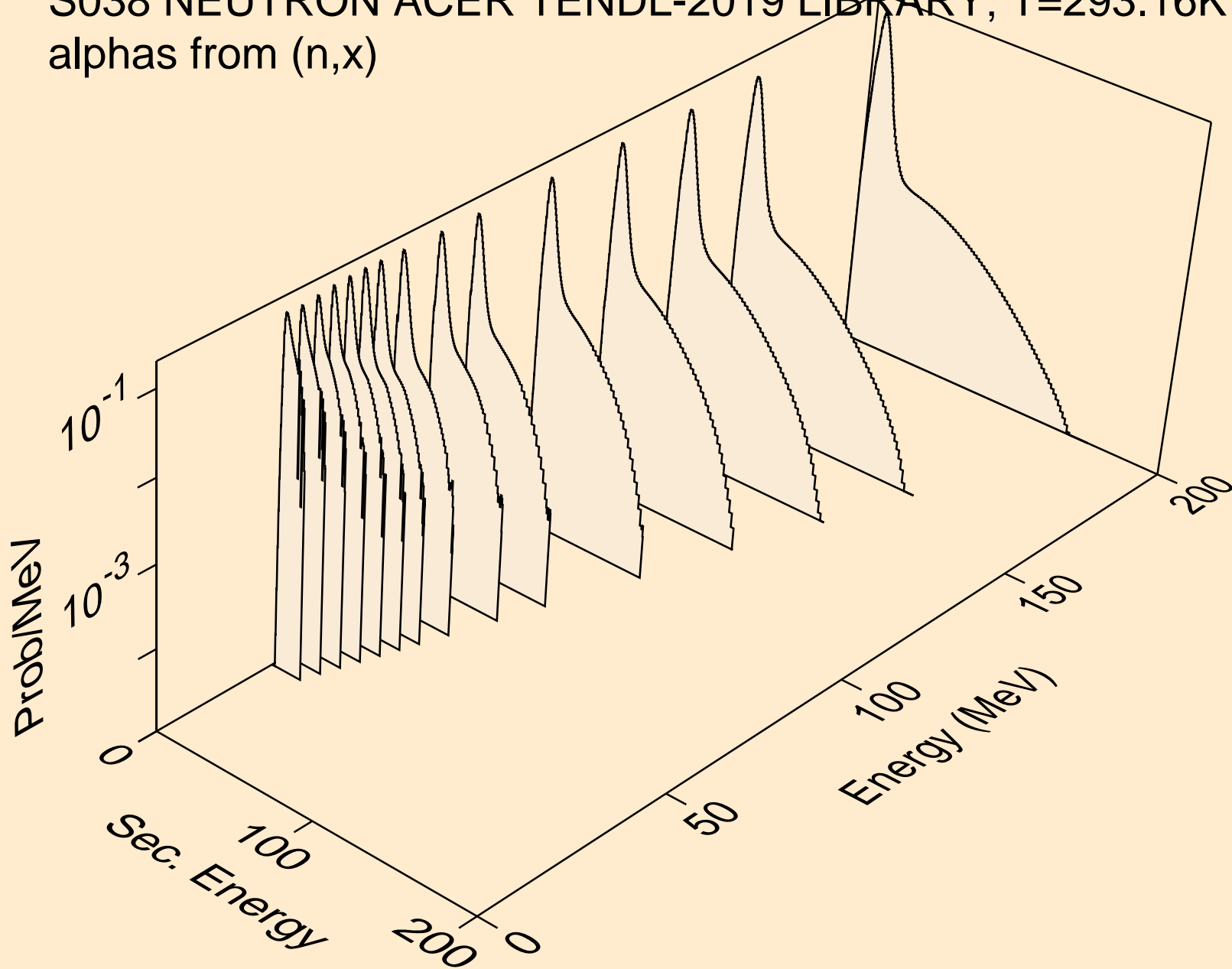



S038 NEUTRON ACER TENDL-2019 LIBRARY; T=293.16K  
alphas from (n,n\*)a

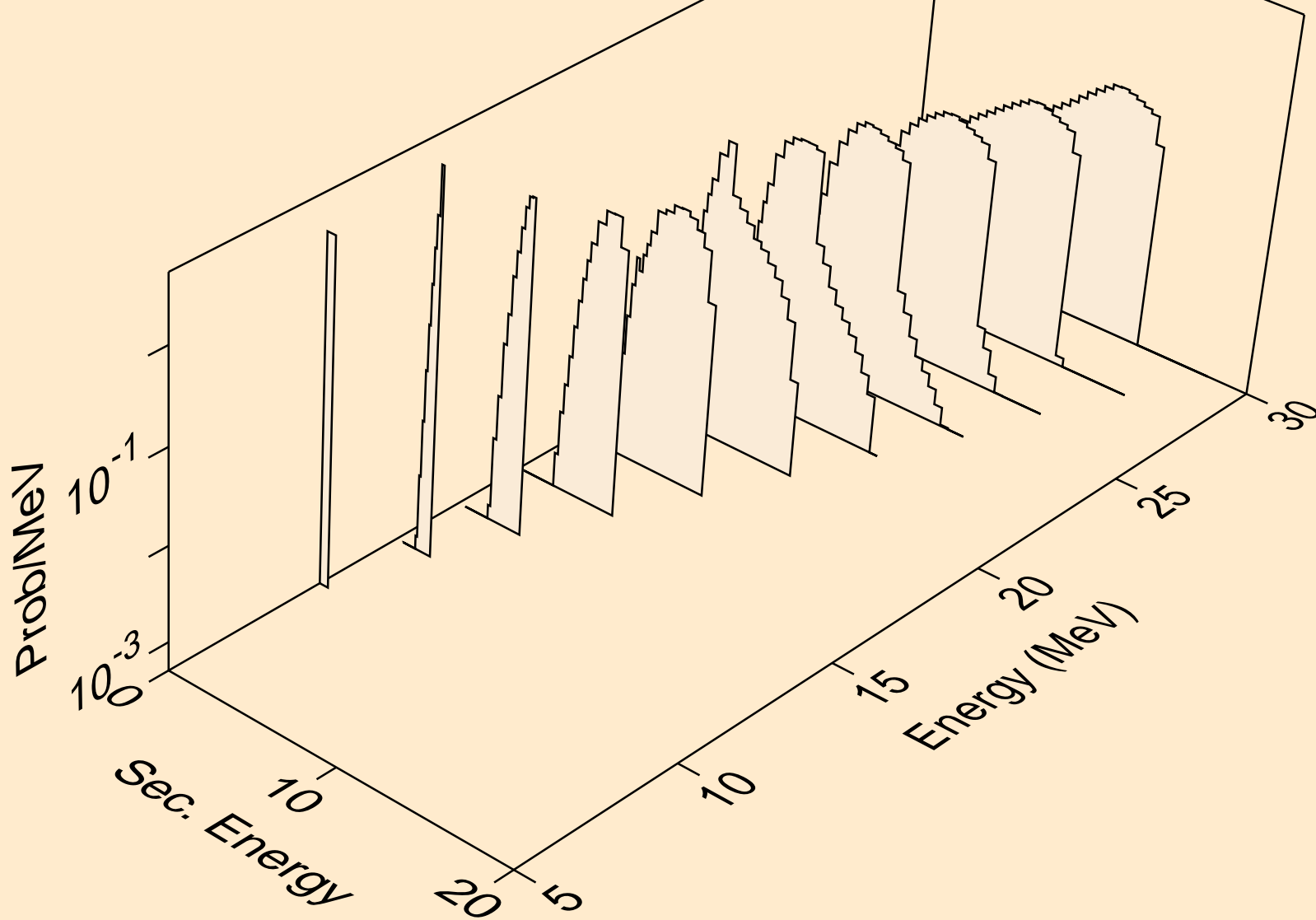

S038 NEUTRON ACER TENDL-2019 LIBRARY; T=293.16K  
alphas from (n,2n)a

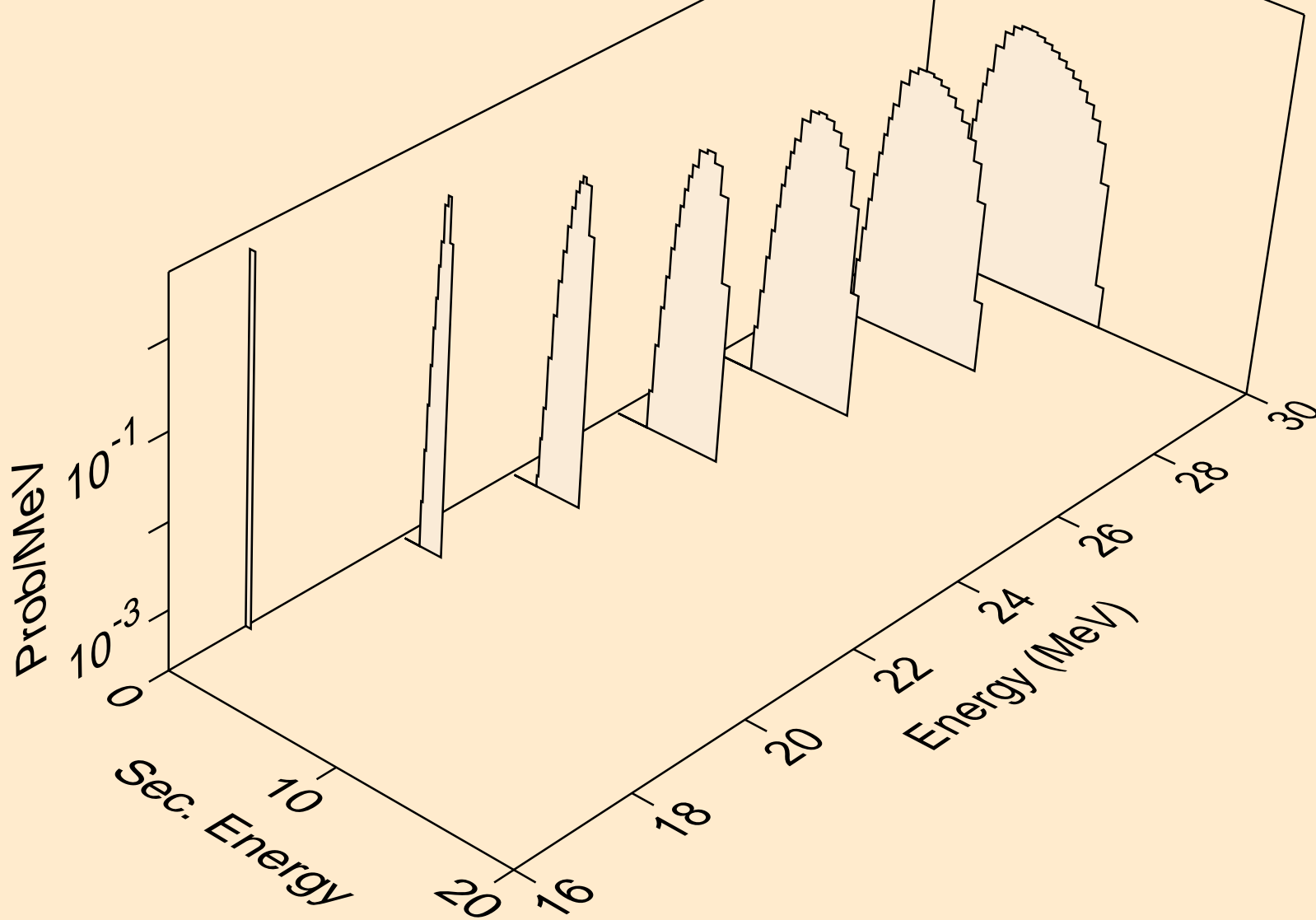

S038 NEUTRON ACER TENDL-2019 LIBRARY; T=293.16K  
alphas from (n,3n)a

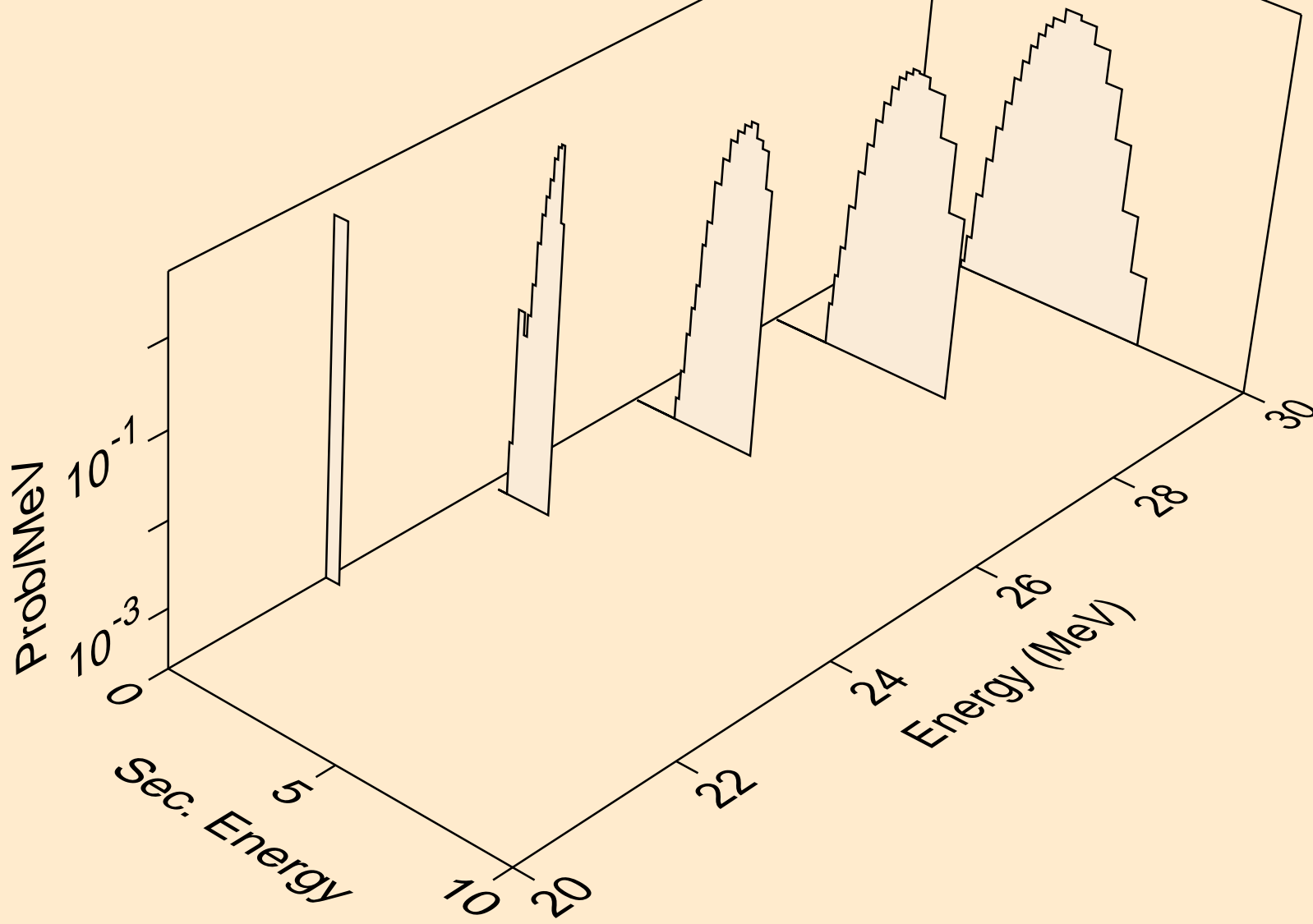

S038 NEUTRON ACER TENDL-2019 LIBRARY; T=293.16K  
alphas from (n,a)

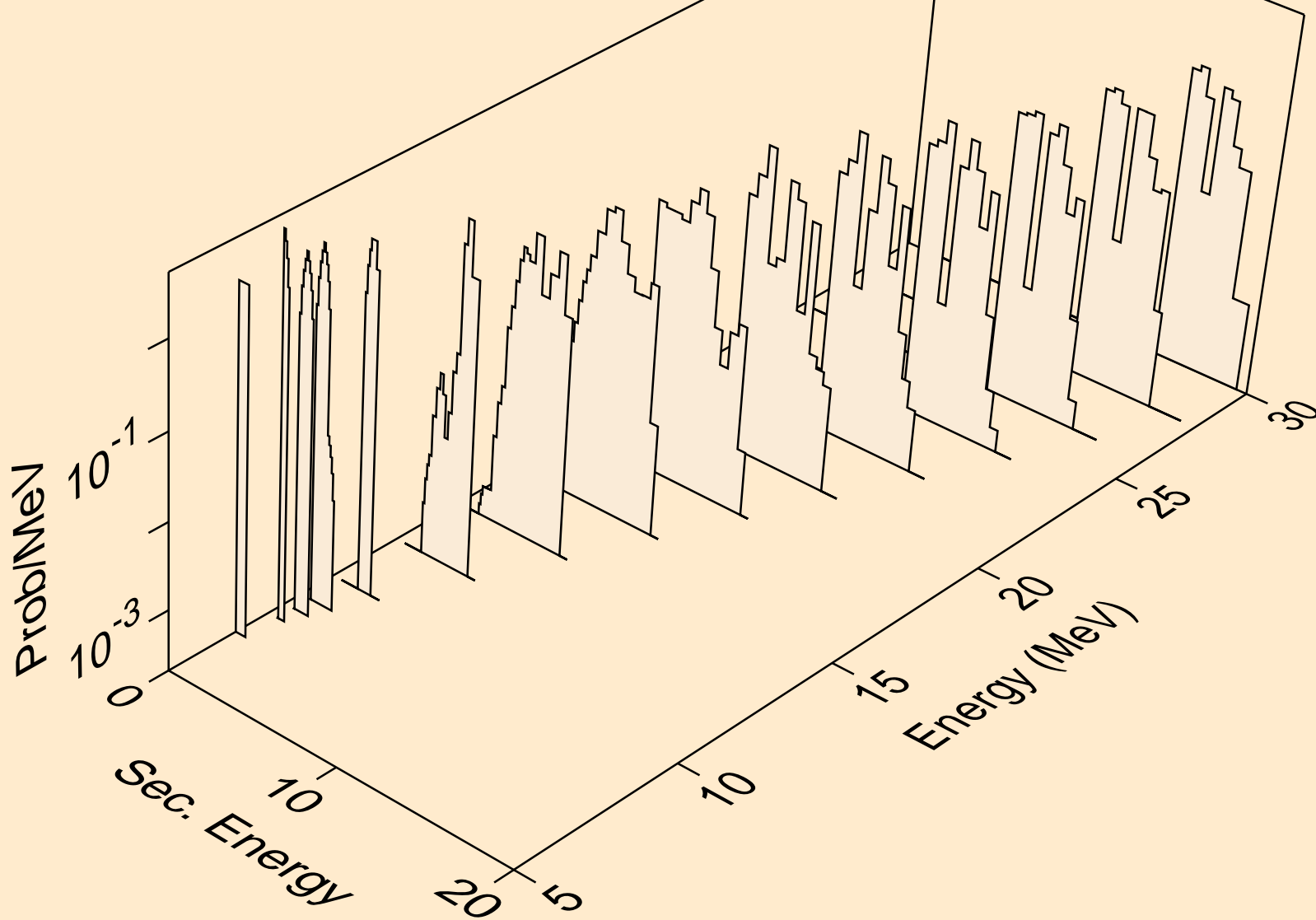

S038 NEUTRON ACER TENDL-2019 LIBRARY; T=293.16K  
alphas from (n,2a)

