

SB118M NEUTRON ACER TENDL-2019 LIBRARY; T=293.16K
Principal cross sections

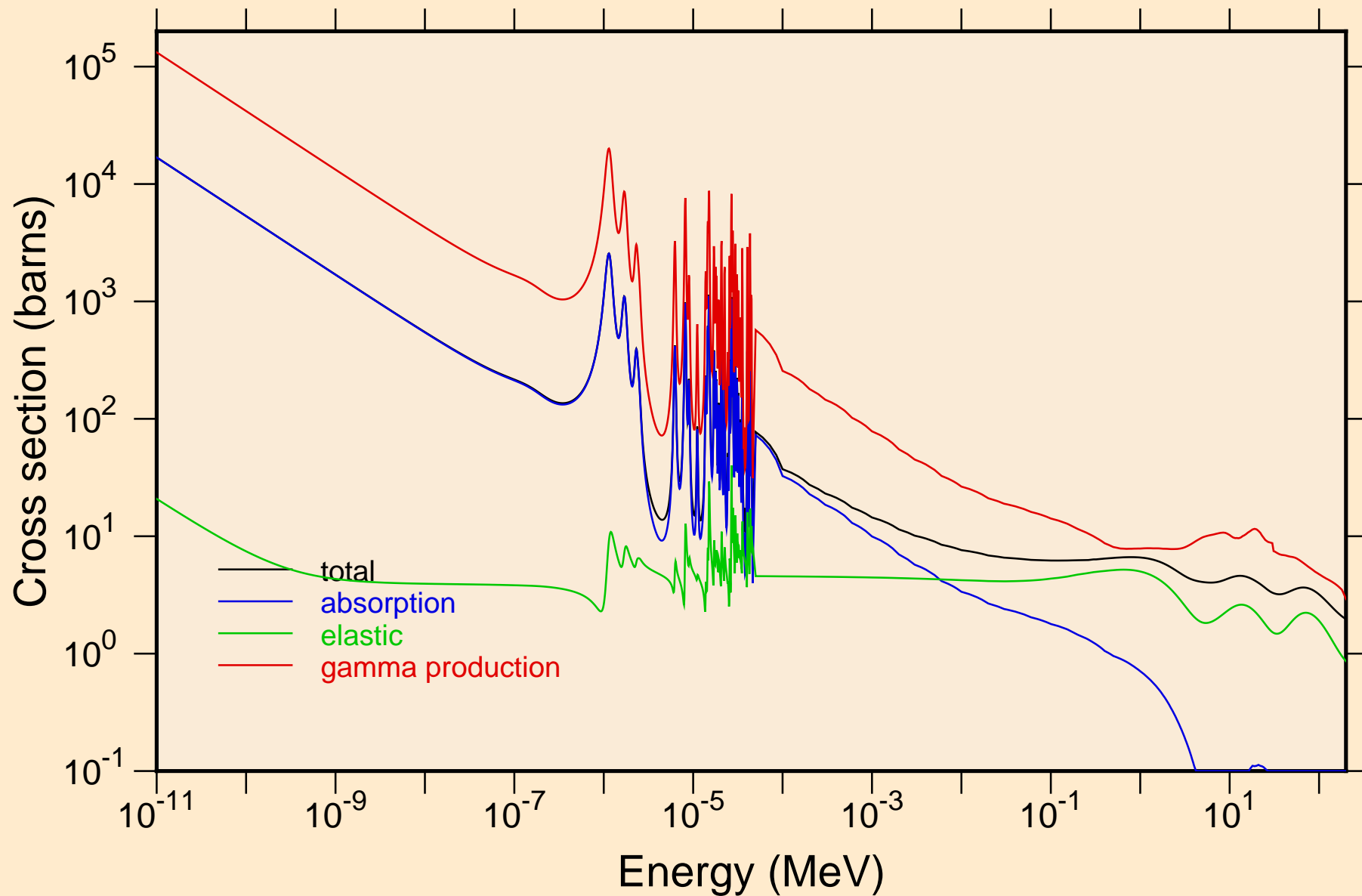

SB118M NEUTRON ACER TENDL-2019 LIBRARY; T=293.16K
resonance total cross section

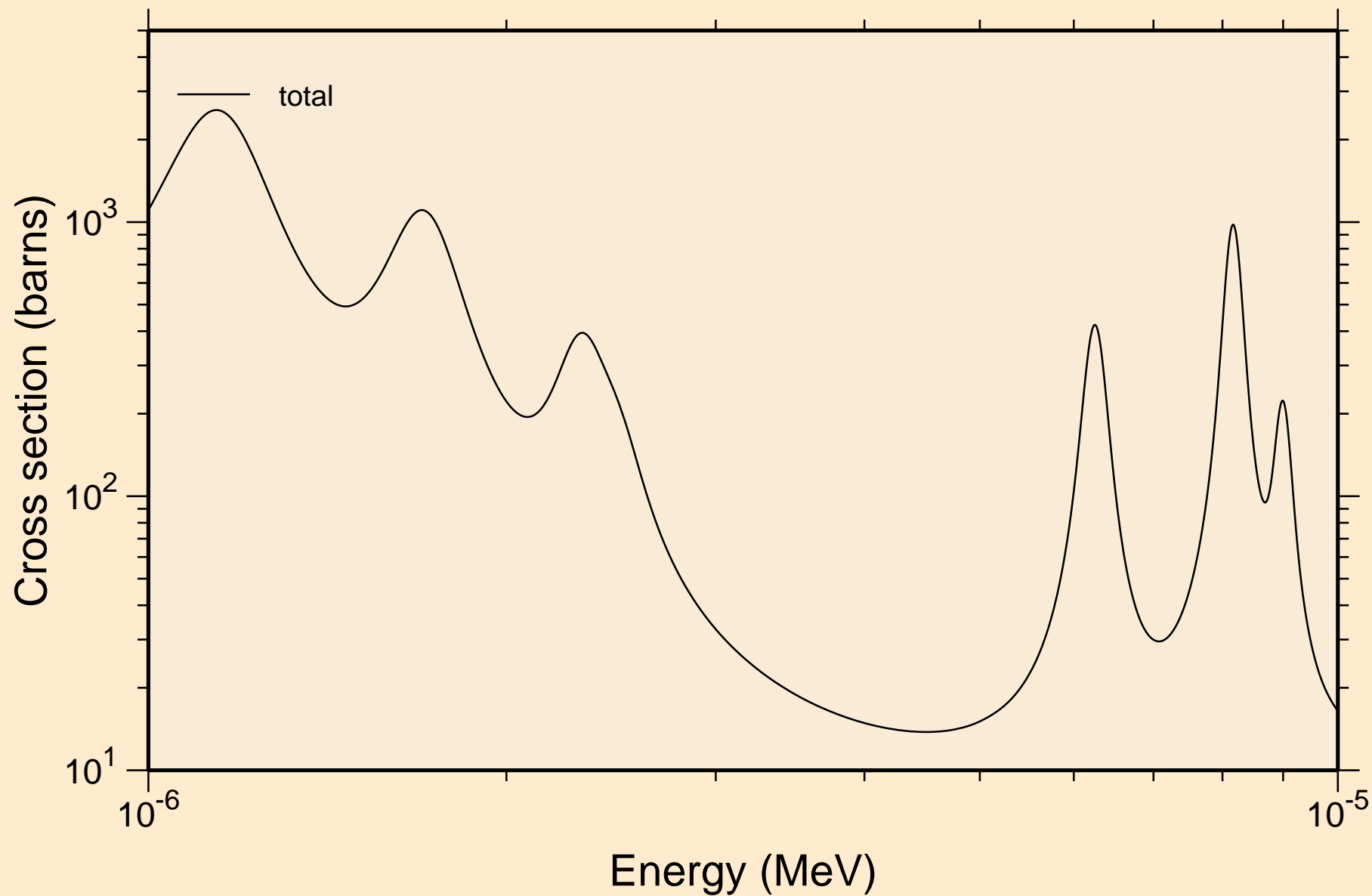

SB118M NEUTRON ACER TENDL-2019 LIBRARY; T=293.16K
resonance total cross section

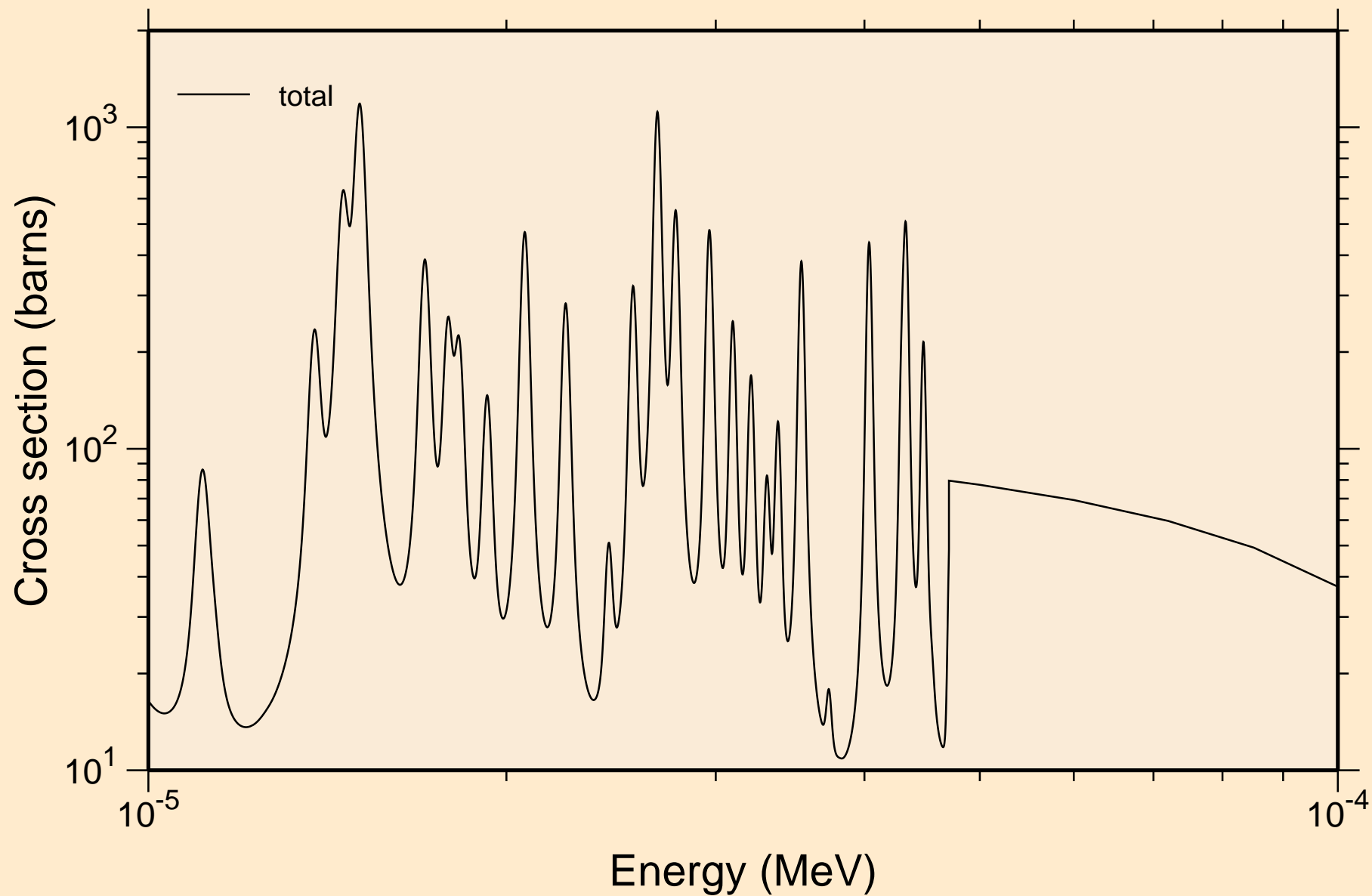

S \bar{B} 118M NEUTRON ACER TENDL-2019 LIBRARY; T=293.16K
resonance total cross section

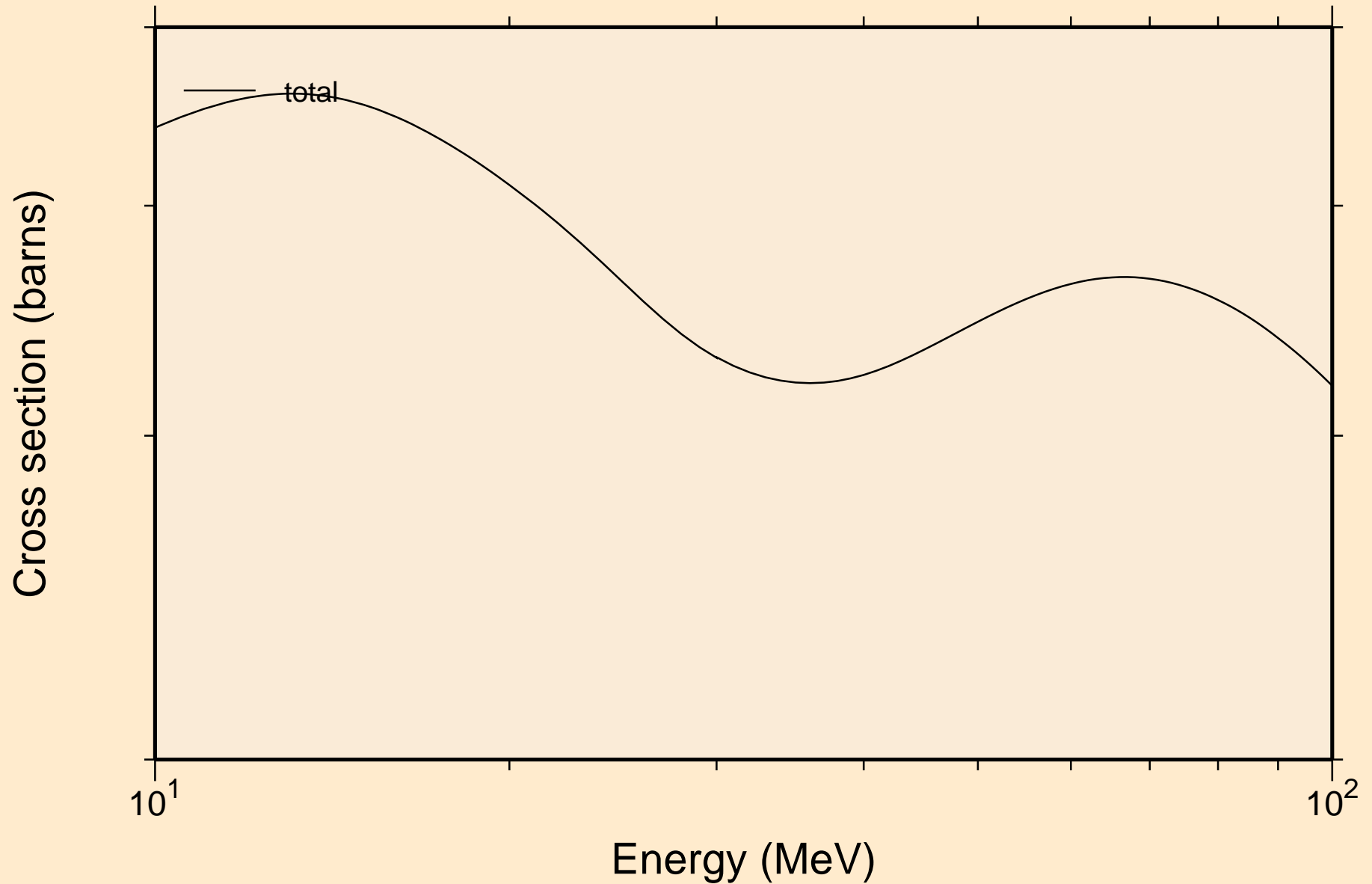

SB118M NEUTRON ACER TENDL-2019 LIBRARY; T=293.16K
resonance absorption cross sections

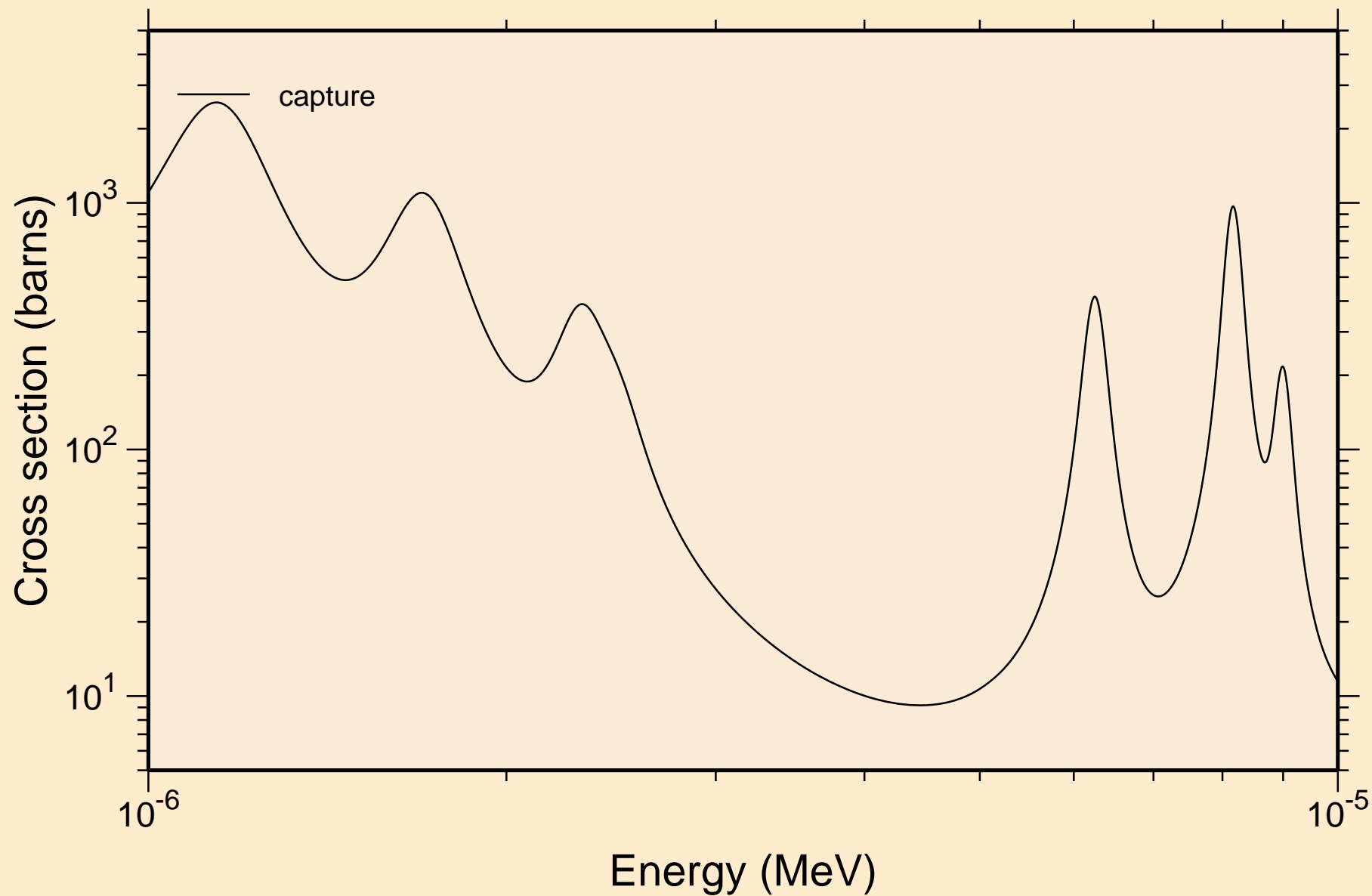

SB118M NEUTRON ACER TENDL-2019 LIBRARY; T=293.16K
resonance absorption cross sections

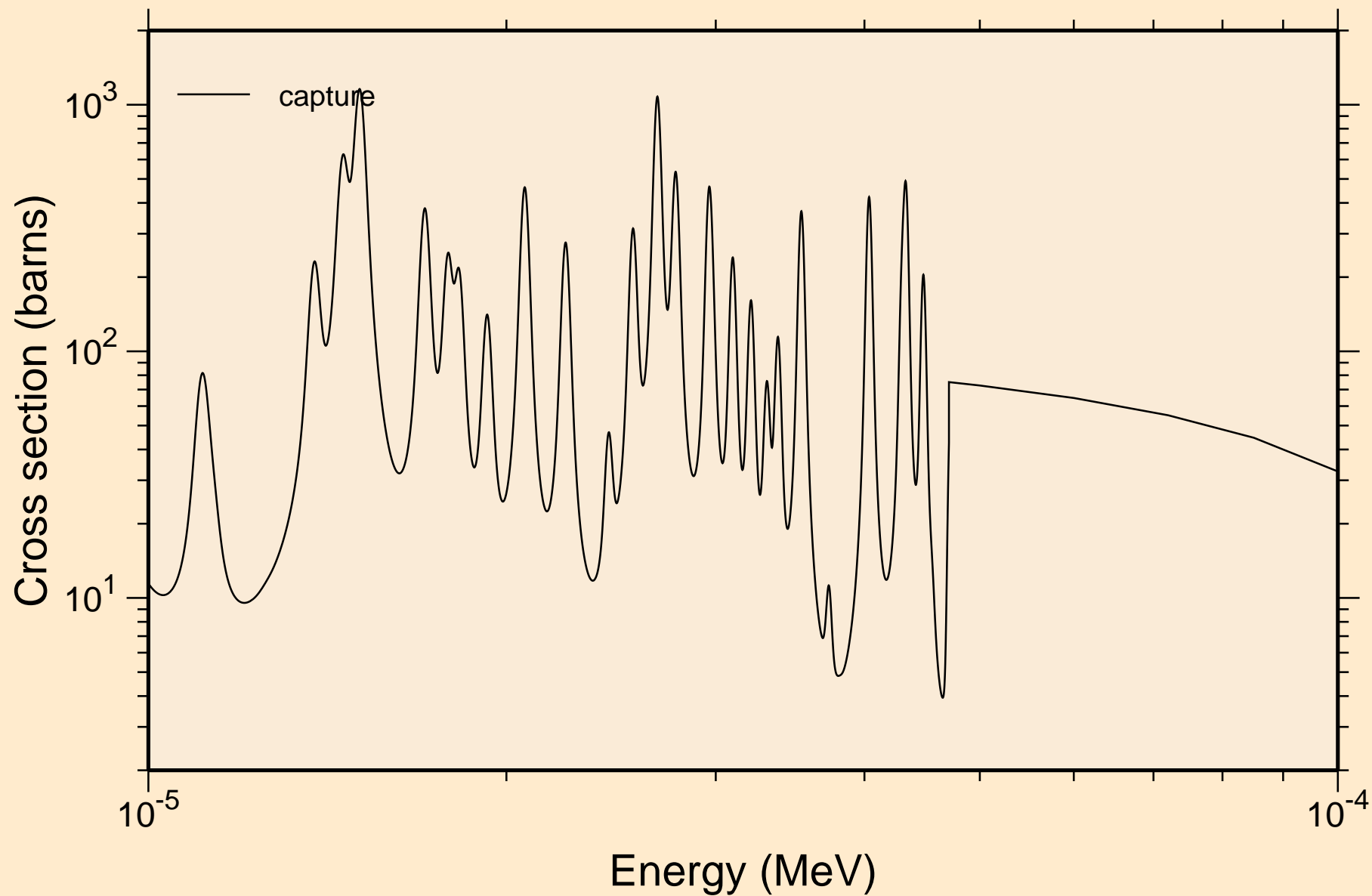

SB118M NEUTRON ACER TENDL-2019 LIBRARY; T=293.16K
resonance absorption cross sections

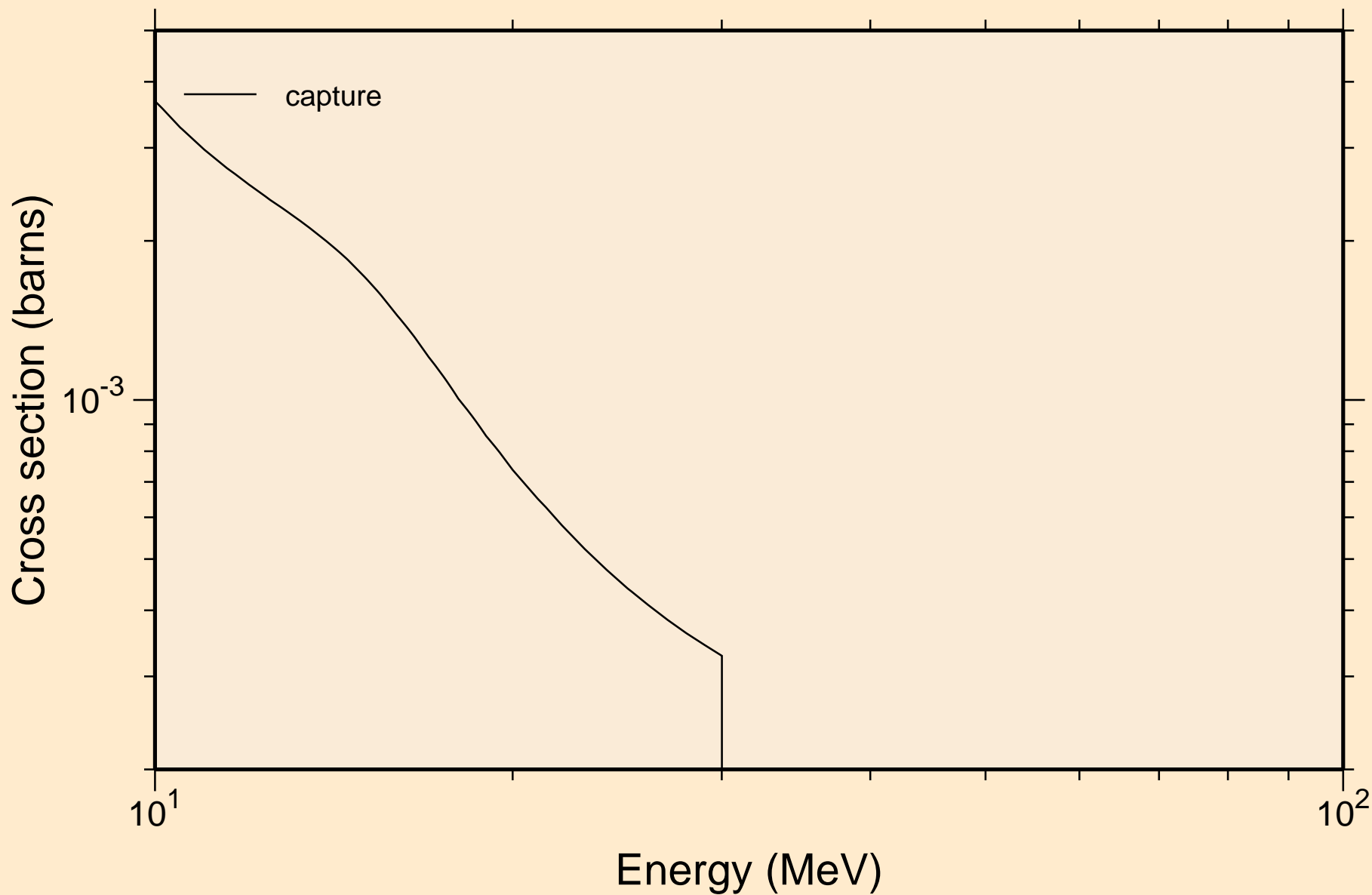

SB118M NEUTRON ACER TENDL-2019 LIBRARY; T=293.16K
Heating

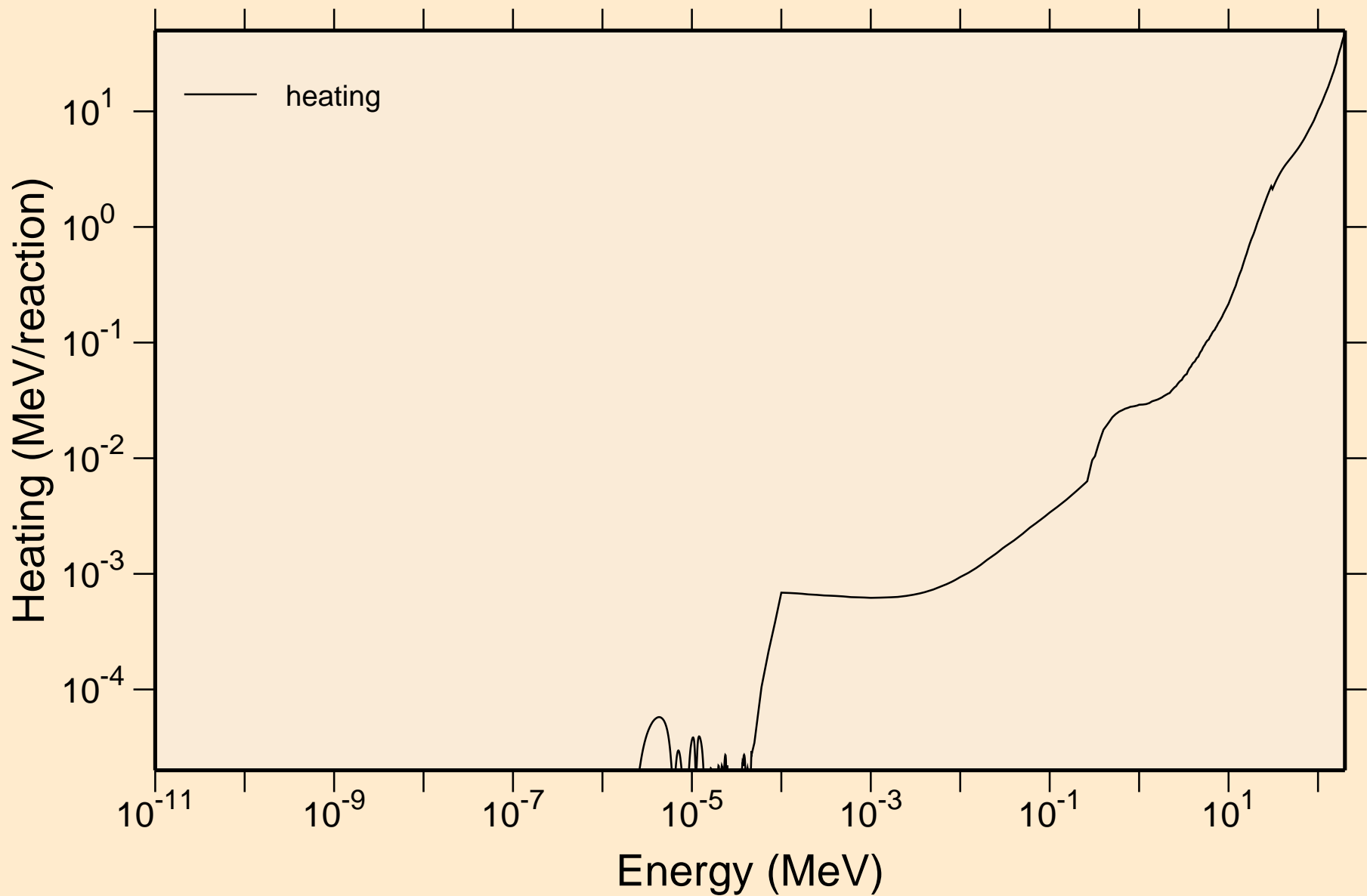

SB118M NEUTRON ACER TENDL-2019 LIBRARY; T=293.16K
Damage

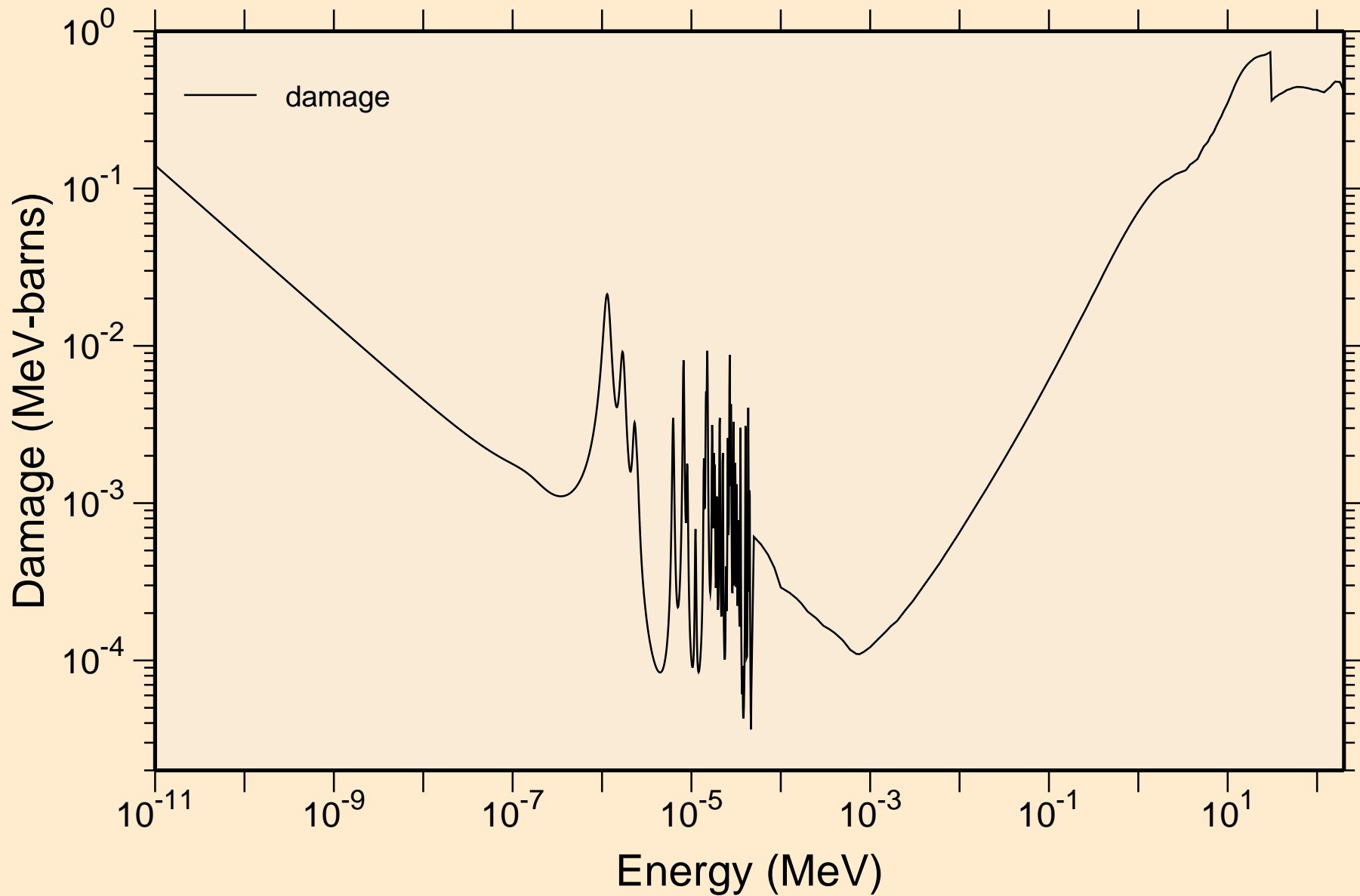

SB118M NEUTRON ACER TENDL-2019 LIBRARY; T=293.16K
Non-threshold reactions

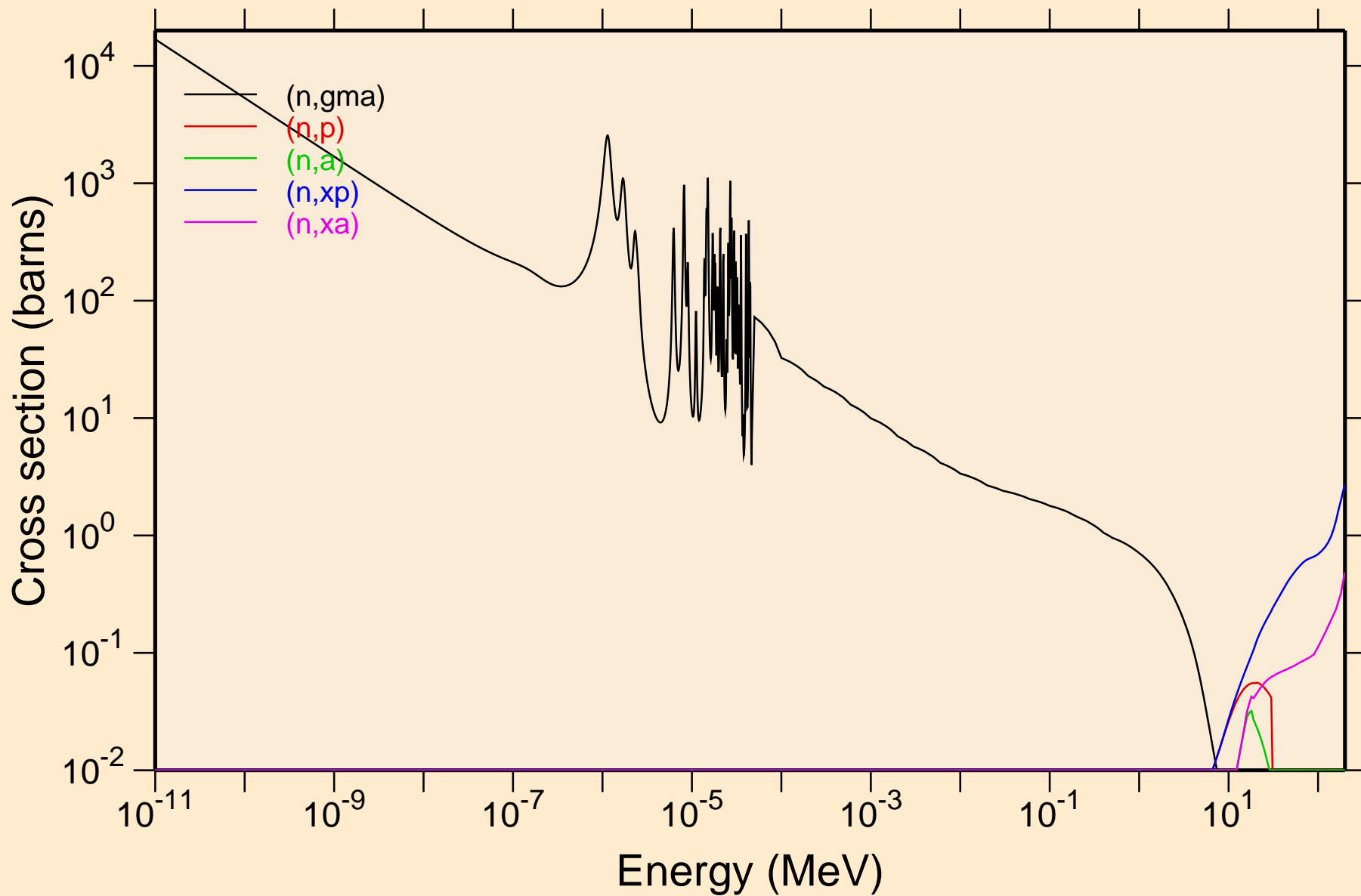

SB118M NEUTRON ACER TENDL-2019 LIBRARY; T=293.16K
Principal cross sections

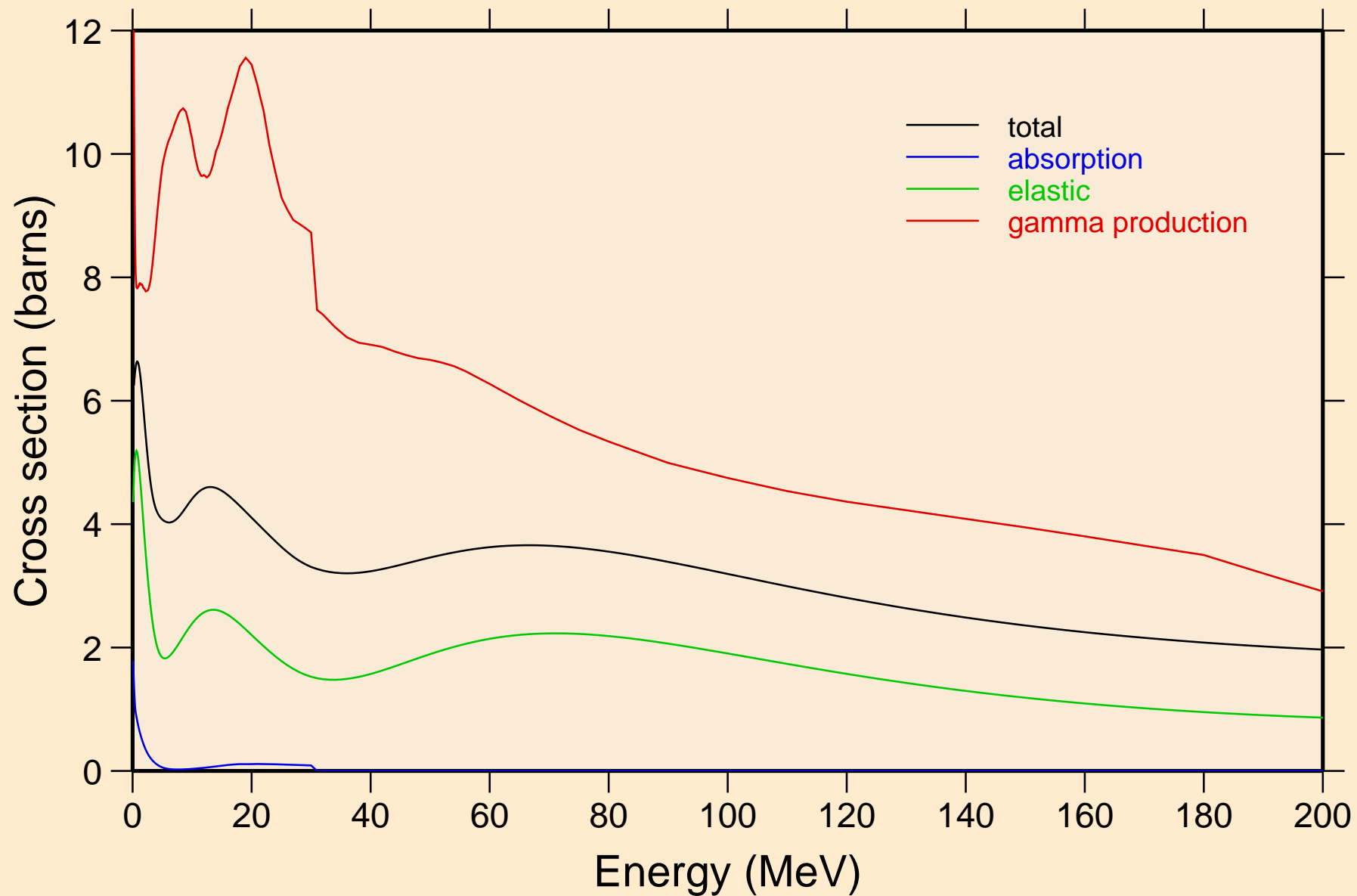

SB118M NEUTRON ACER TENDL-2019 LIBRARY; T=293.16K
Heating

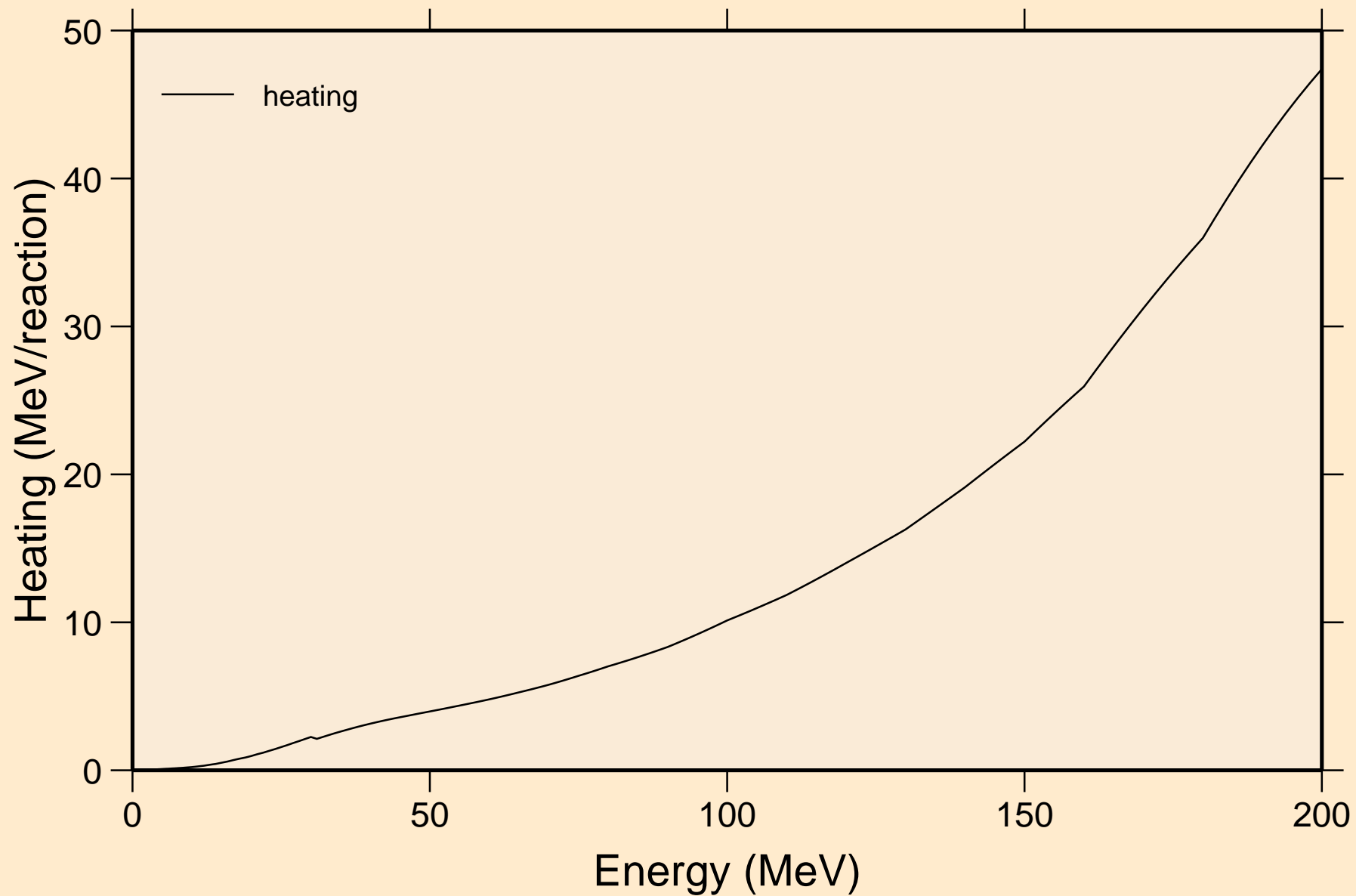

SB118M NEUTRON ACER TENDL-2019 LIBRARY; T=293.16K
Damage

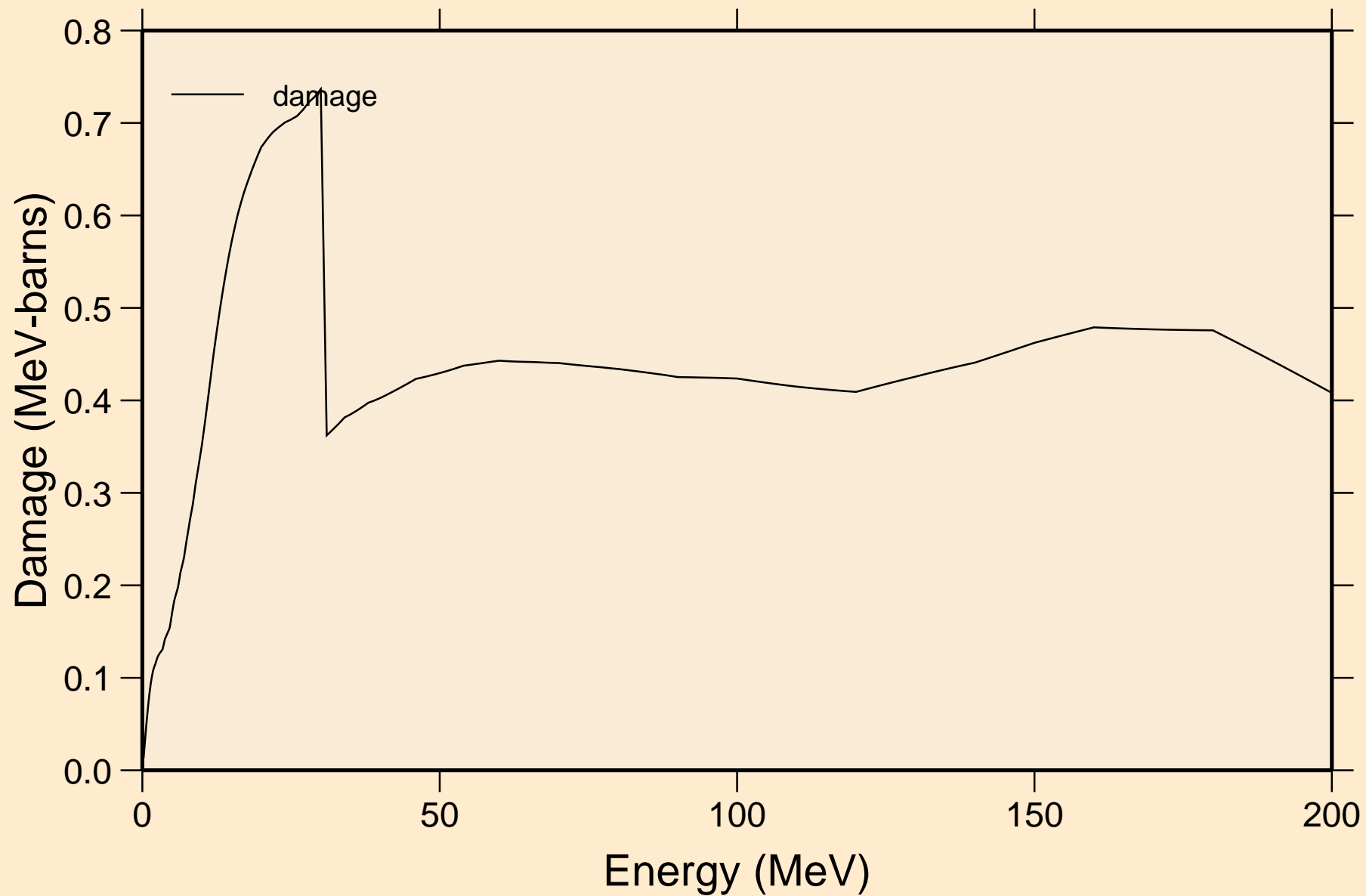

SB118M NEUTRON ACER TENDL-2019 LIBRARY; T=293.16K
Non-threshold reactions

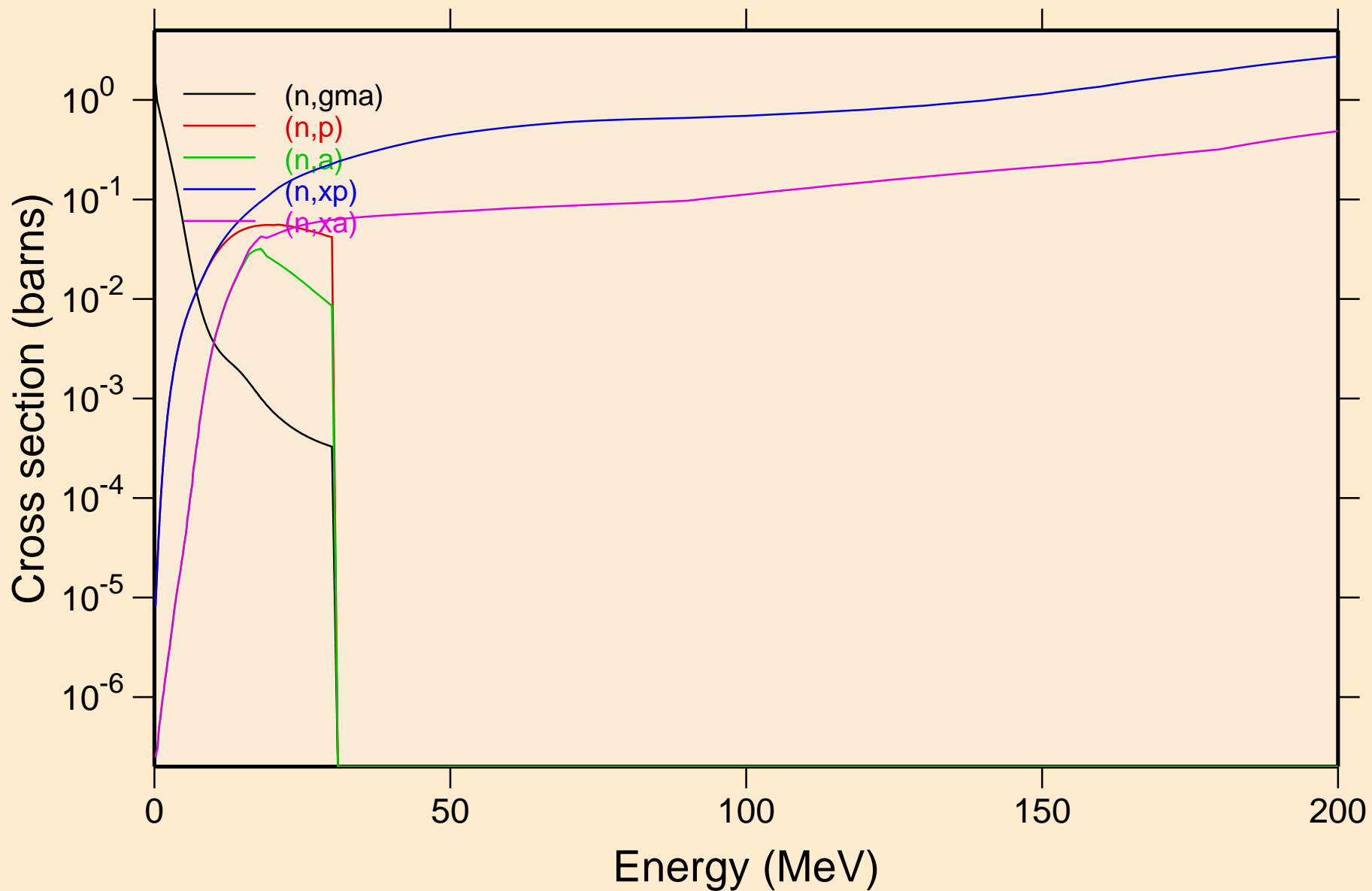

SB118M NEUTRON ACER TENDL-2019 LIBRARY; T=293.16K
Inelastic levels

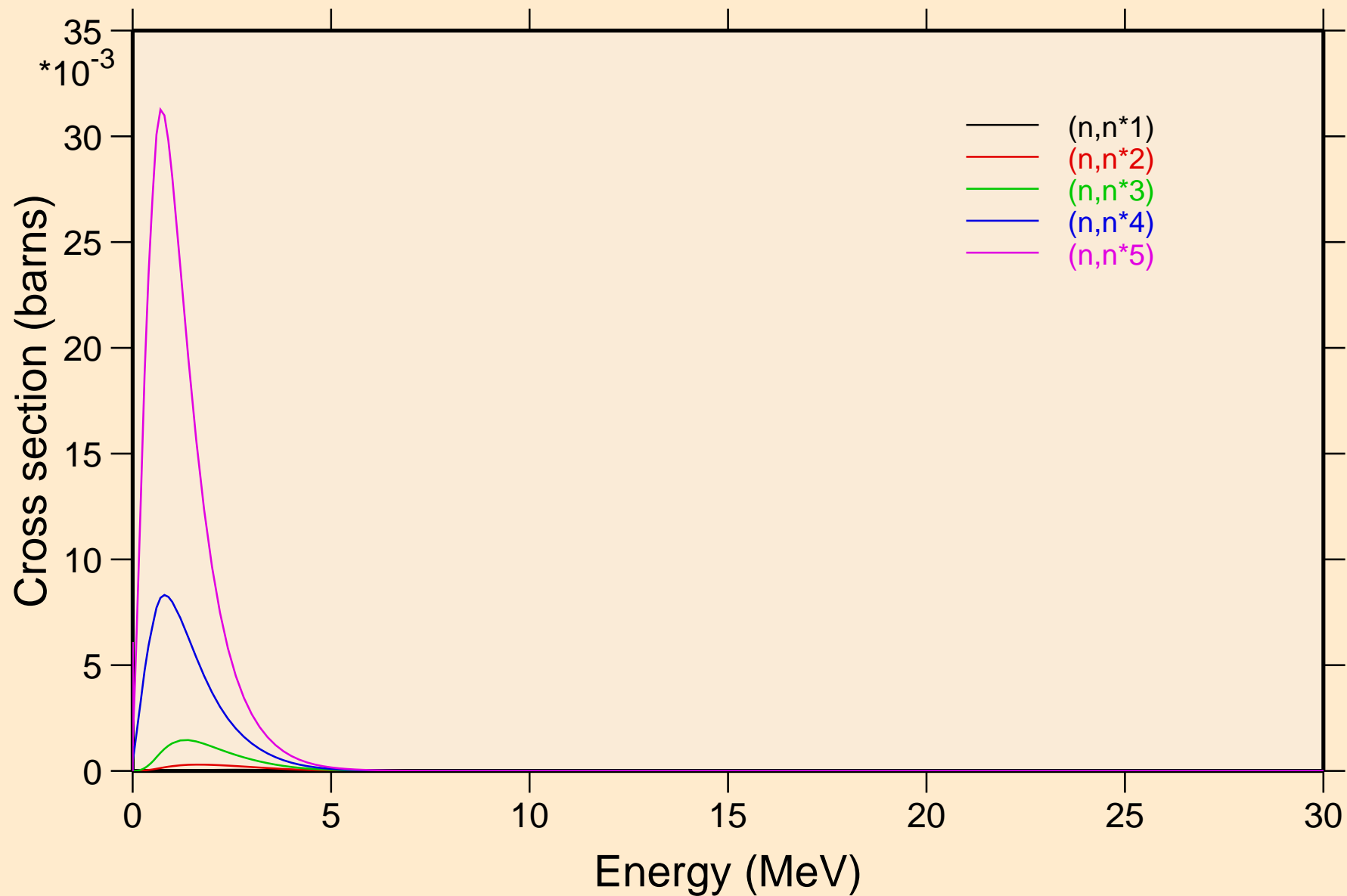

SB118M NEUTRON ACER TENDL-2019 LIBRARY; T=293.16K
Inelastic levels

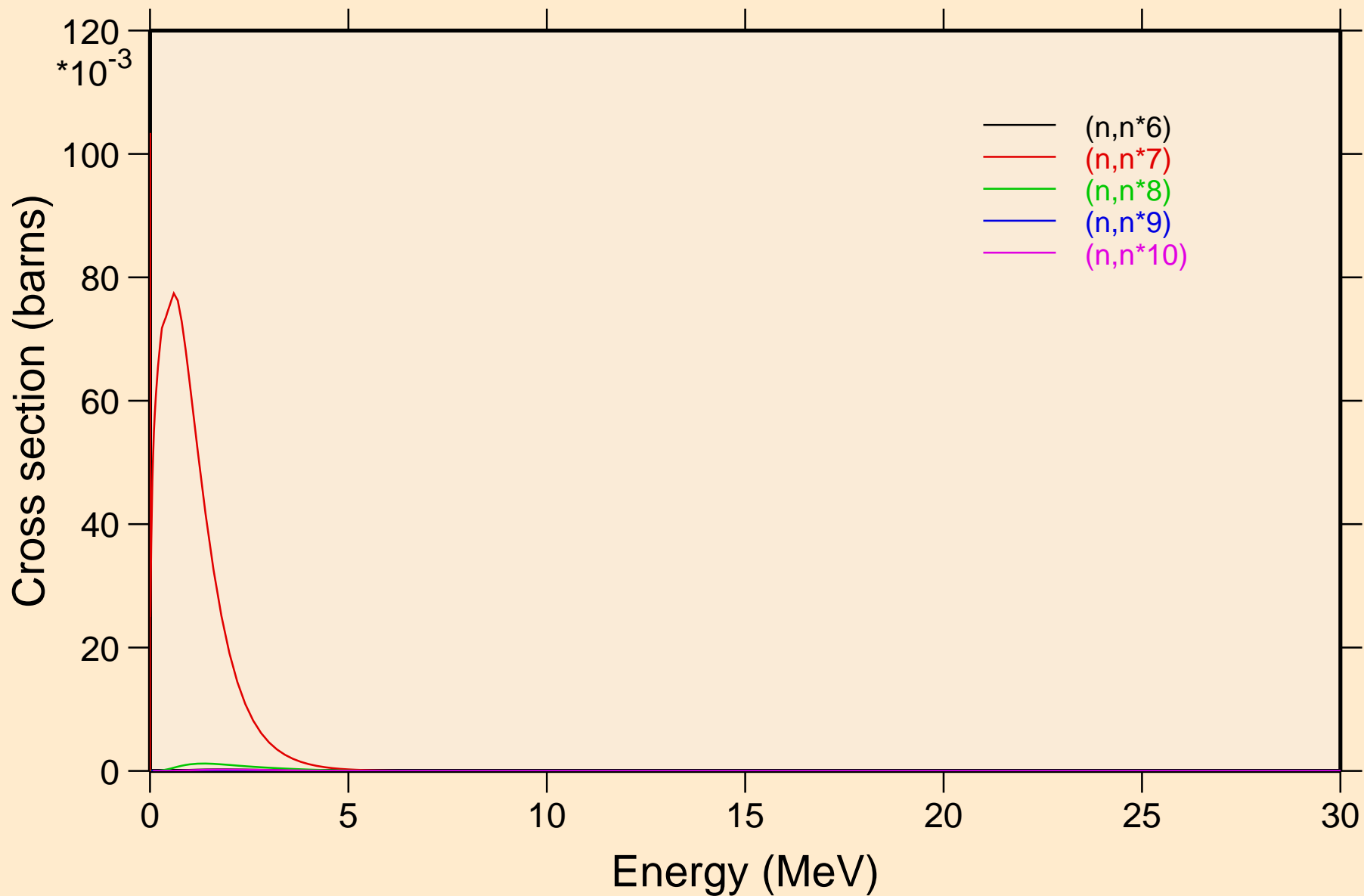

SB118M NEUTRON ACER TENDL-2019 LIBRARY; T=293.16K
Inelastic levels

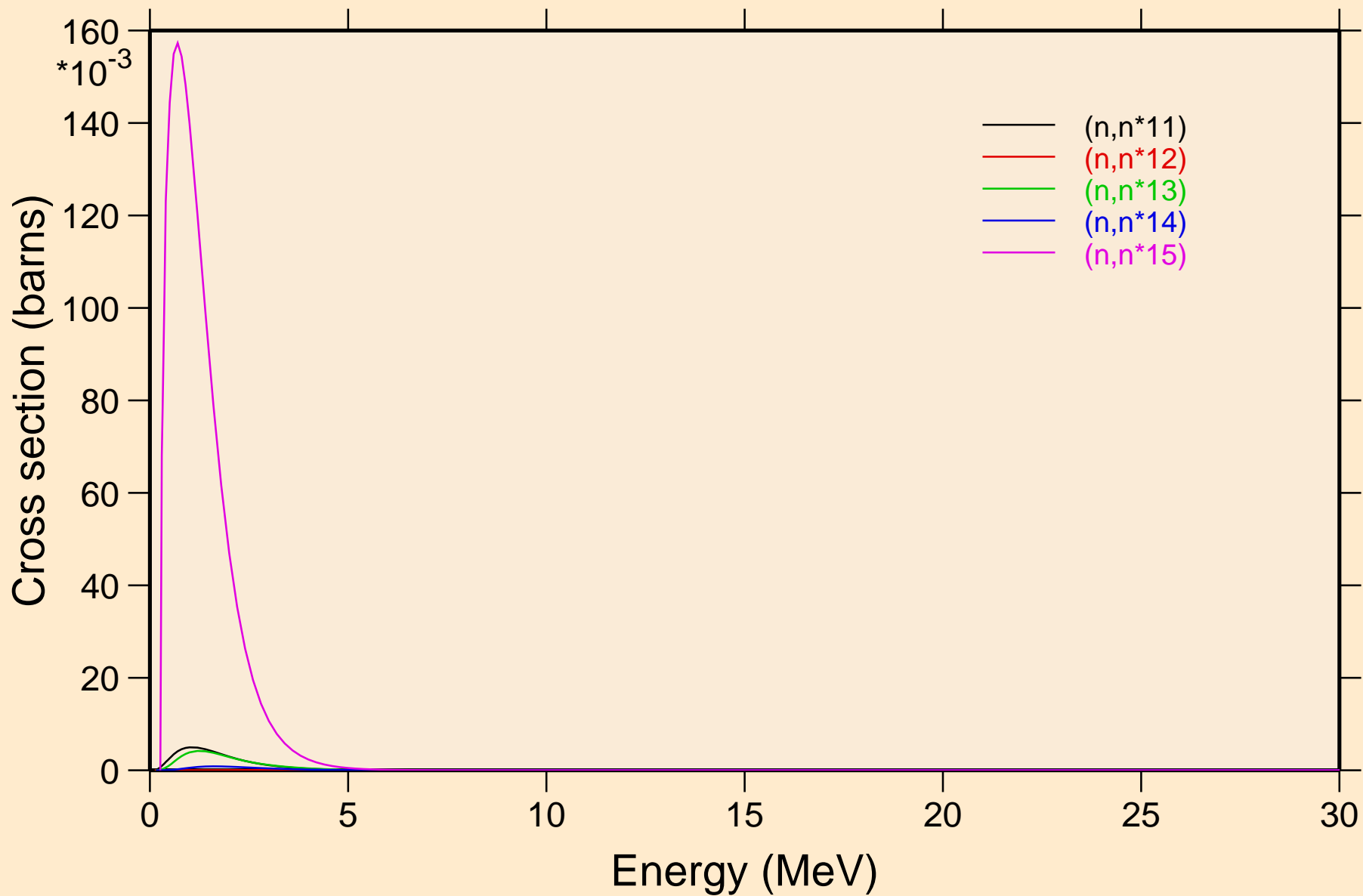

SB118M NEUTRON ACER TENDL-2019 LIBRARY; T=293.16K
Inelastic levels

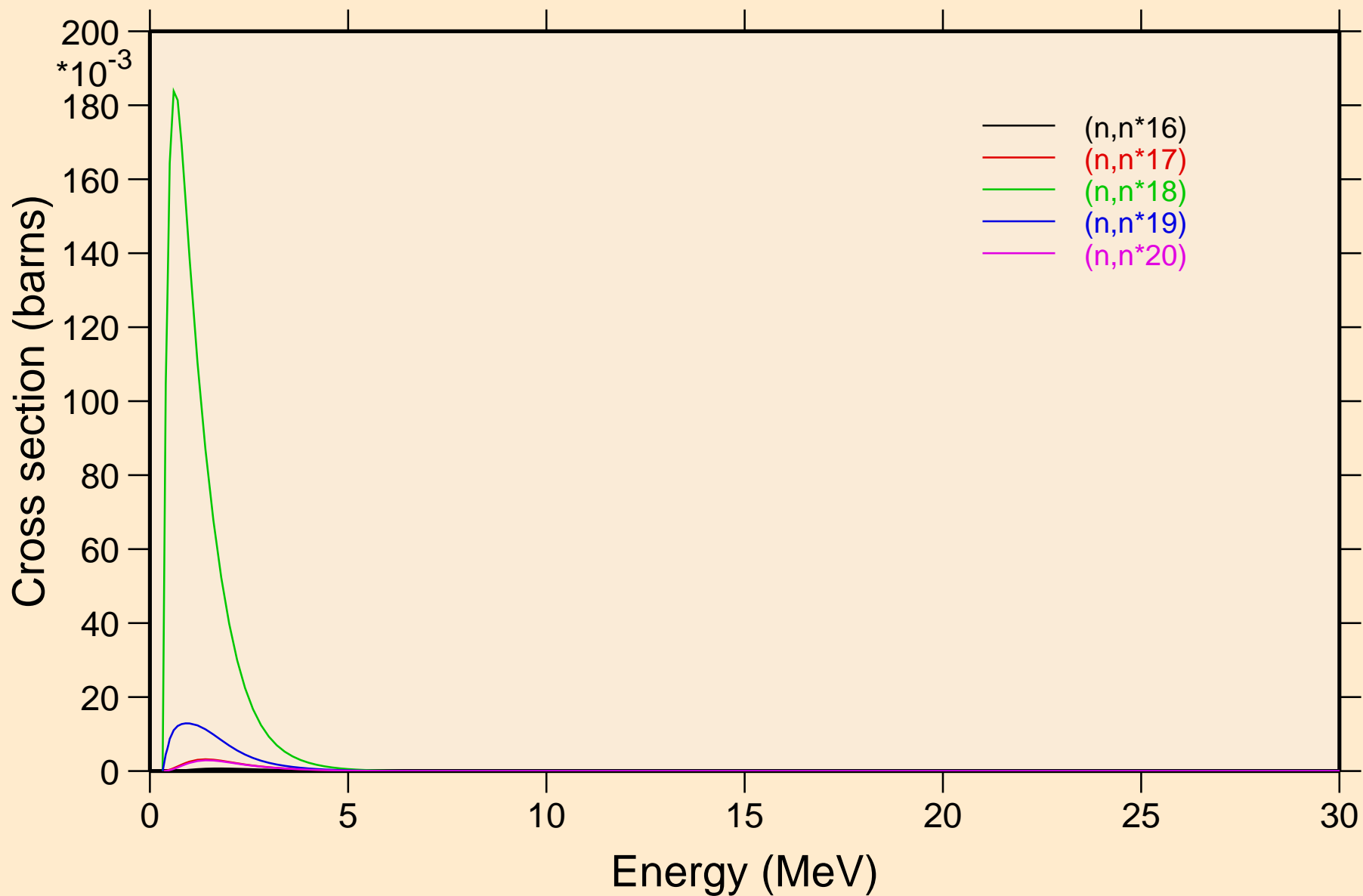

SB118M NEUTRON ACER TENDL-2019 LIBRARY; T=293.16K
Inelastic levels

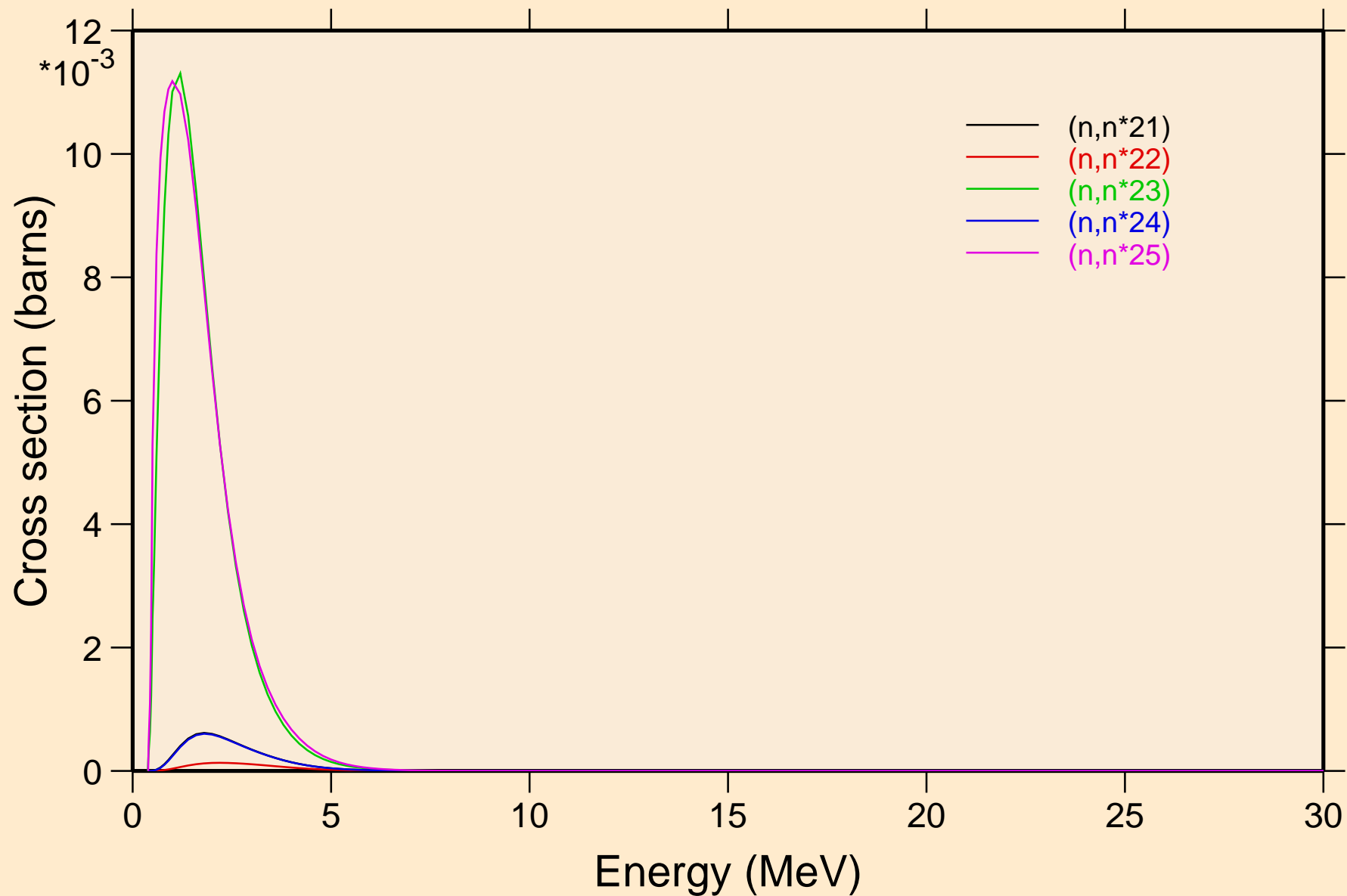

SB118M NEUTRON ACER TENDL-2019 LIBRARY; T=293.16K
Threshold reactions

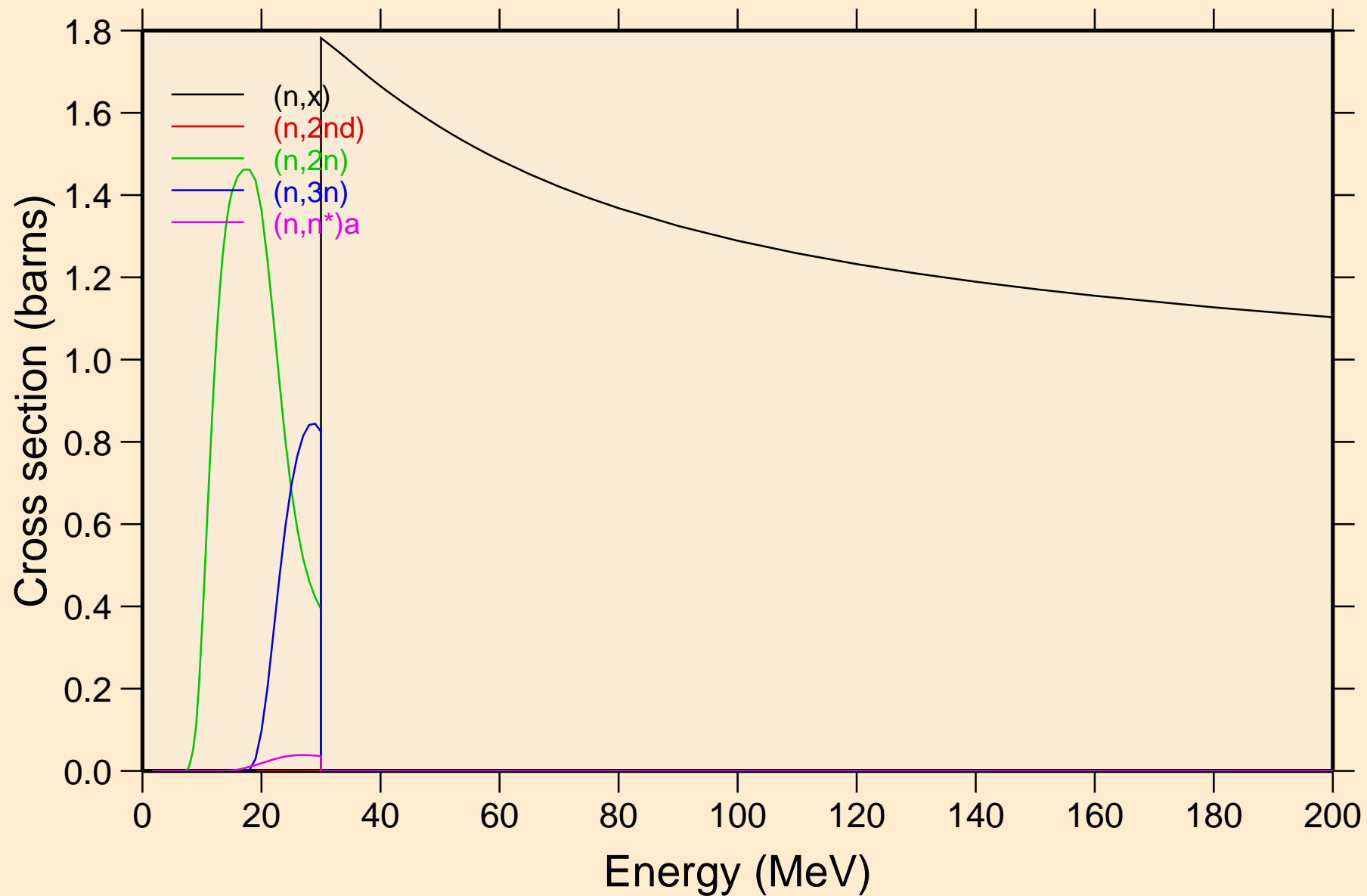

SB118M NEUTRON ACER TENDL-2019 LIBRARY; T=293.16K
Threshold reactions

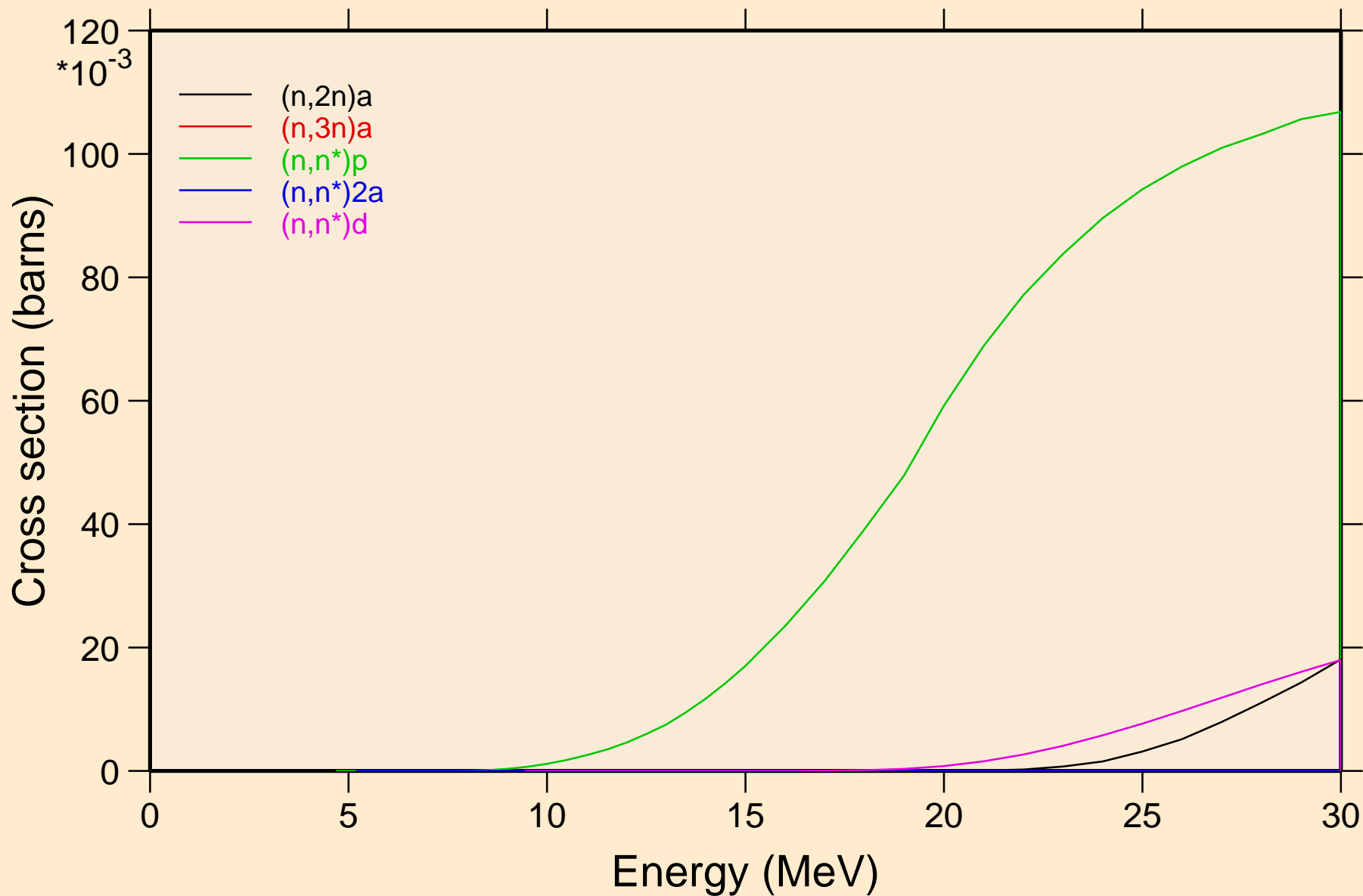

SB118M NEUTRON ACER TENDL-2019 LIBRARY; T=293.16K
Threshold reactions

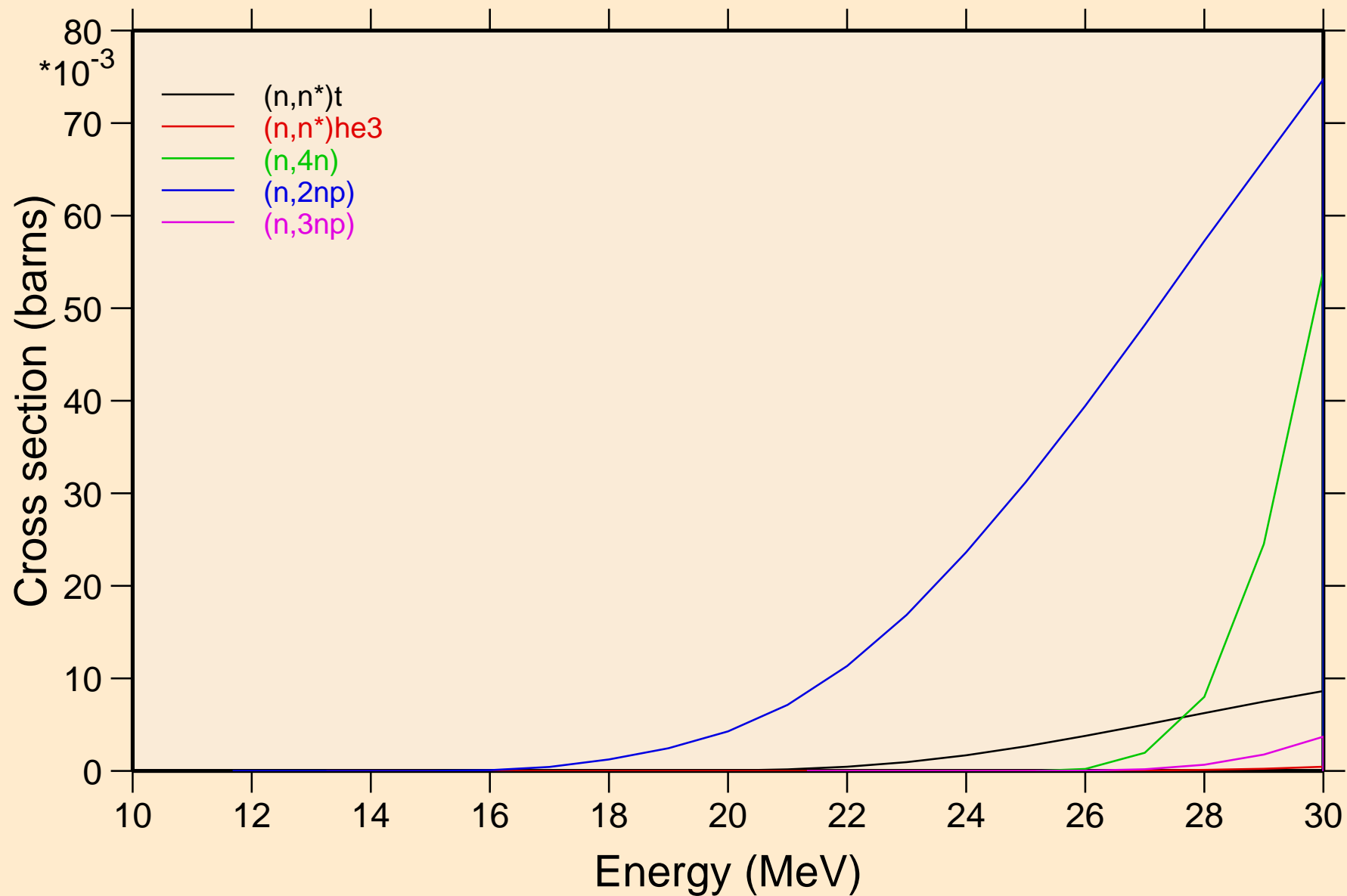

SB118M NEUTRON ACER TENDL-2019 LIBRARY; T=293.16K
Threshold reactions

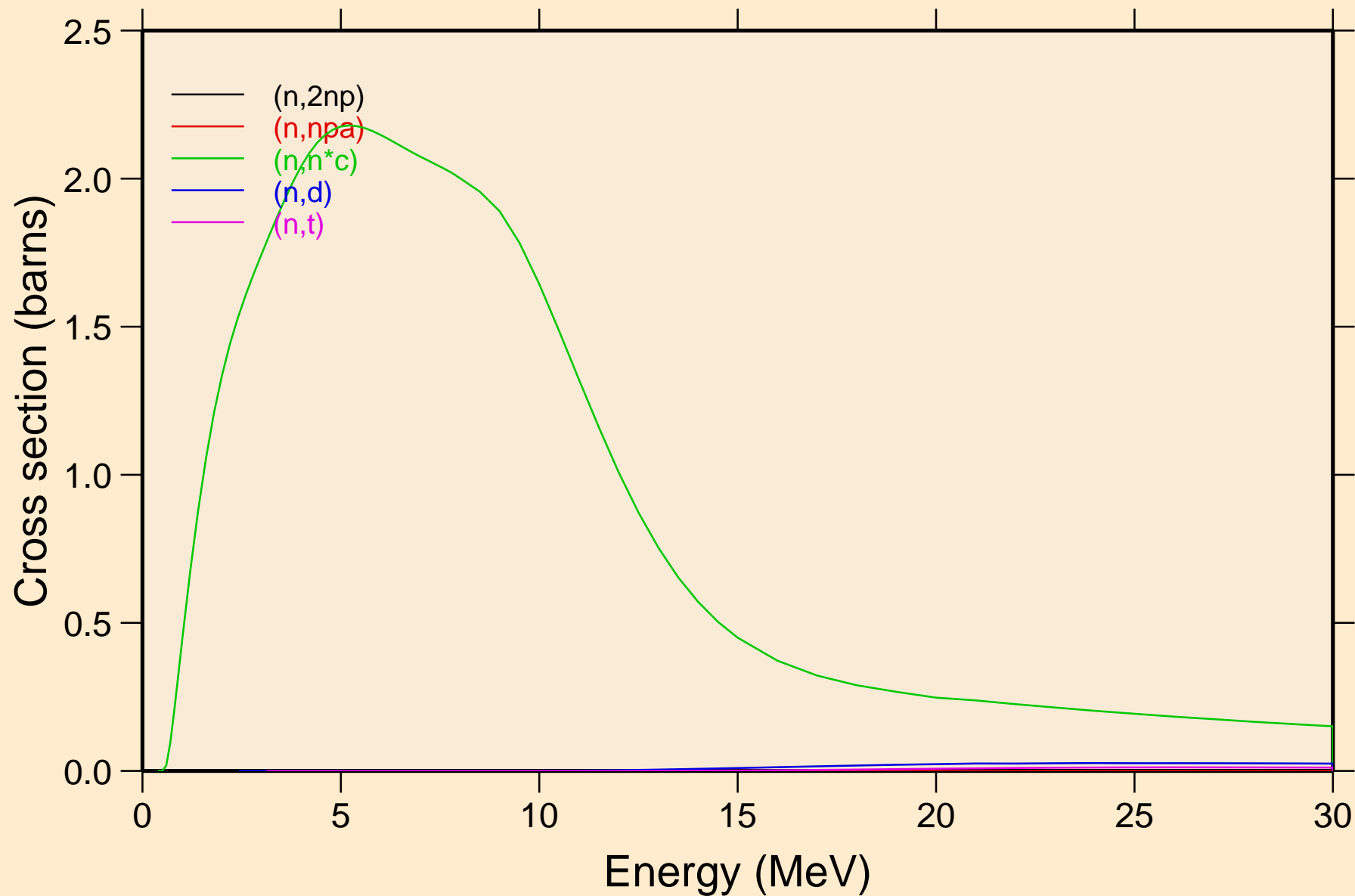

SB118M NEUTRON ACER TENDL-2019 LIBRARY; T=293.16K
Threshold reactions

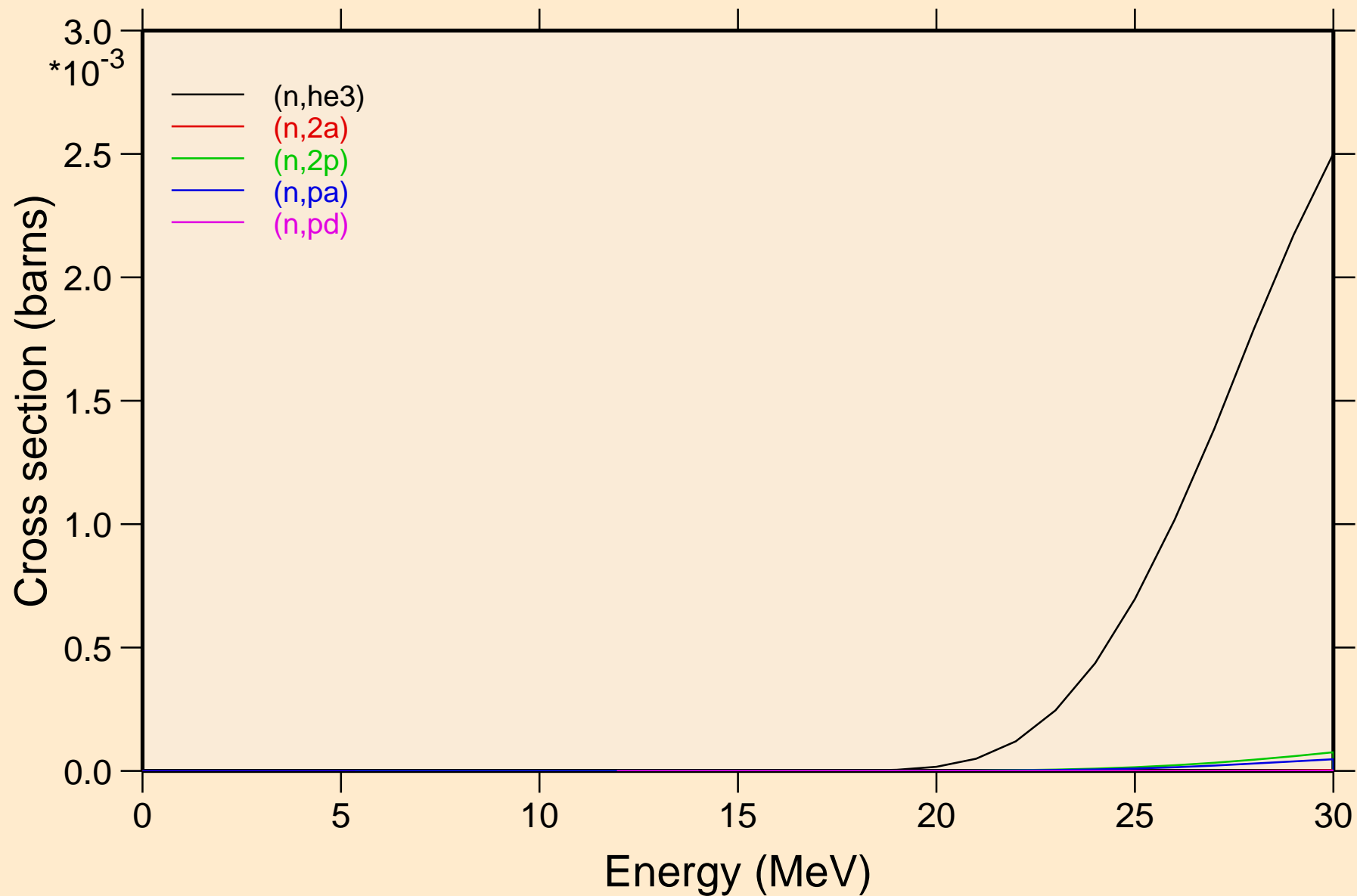

SB118M NEUTRON ACER TENDL-2019 LIBRARY; T=293.16K
Threshold reactions

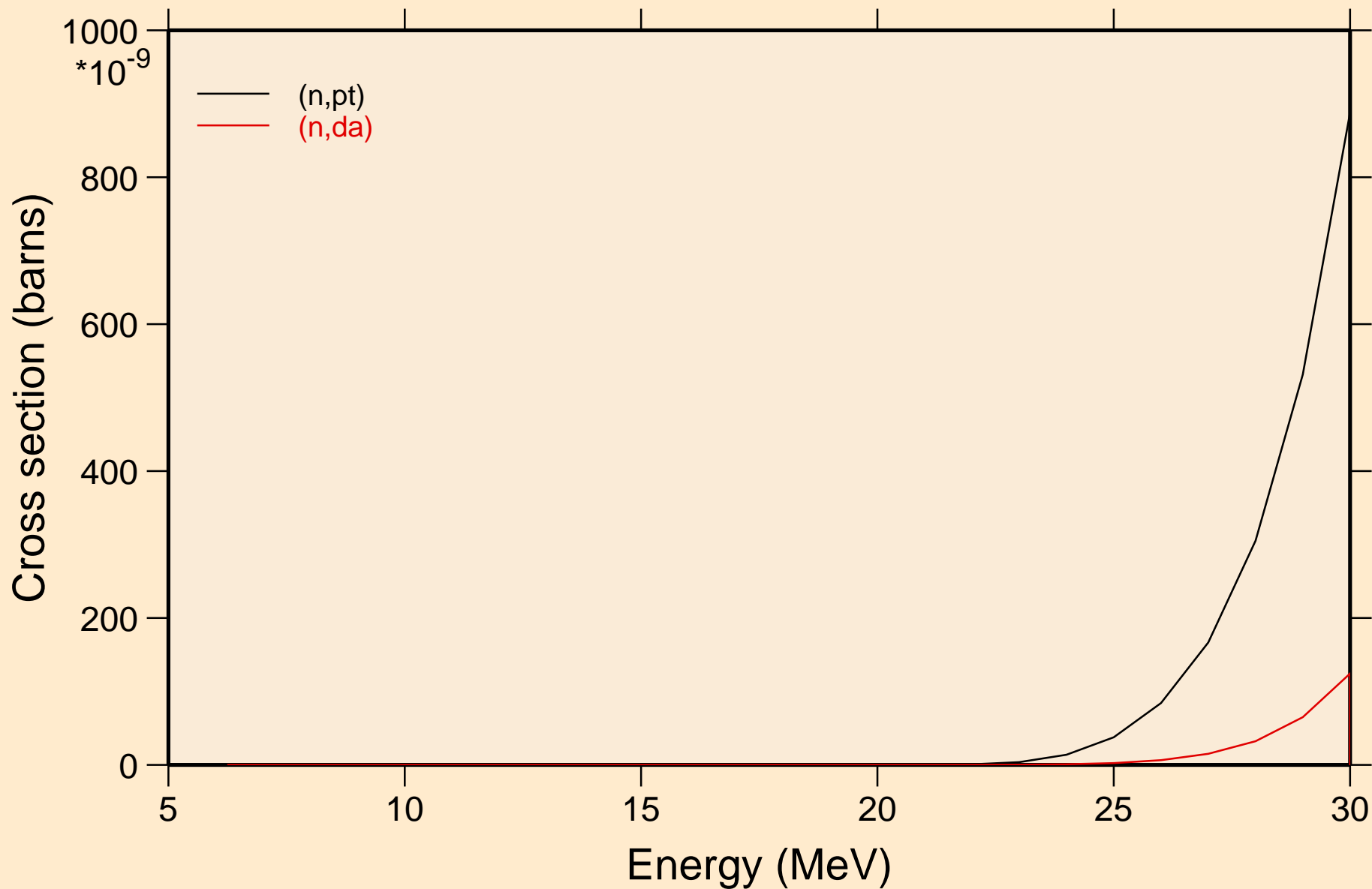

SB118M NEUTRON ACER TENDL-2019 LIBRARY; T=293.16K
Threshold reactions

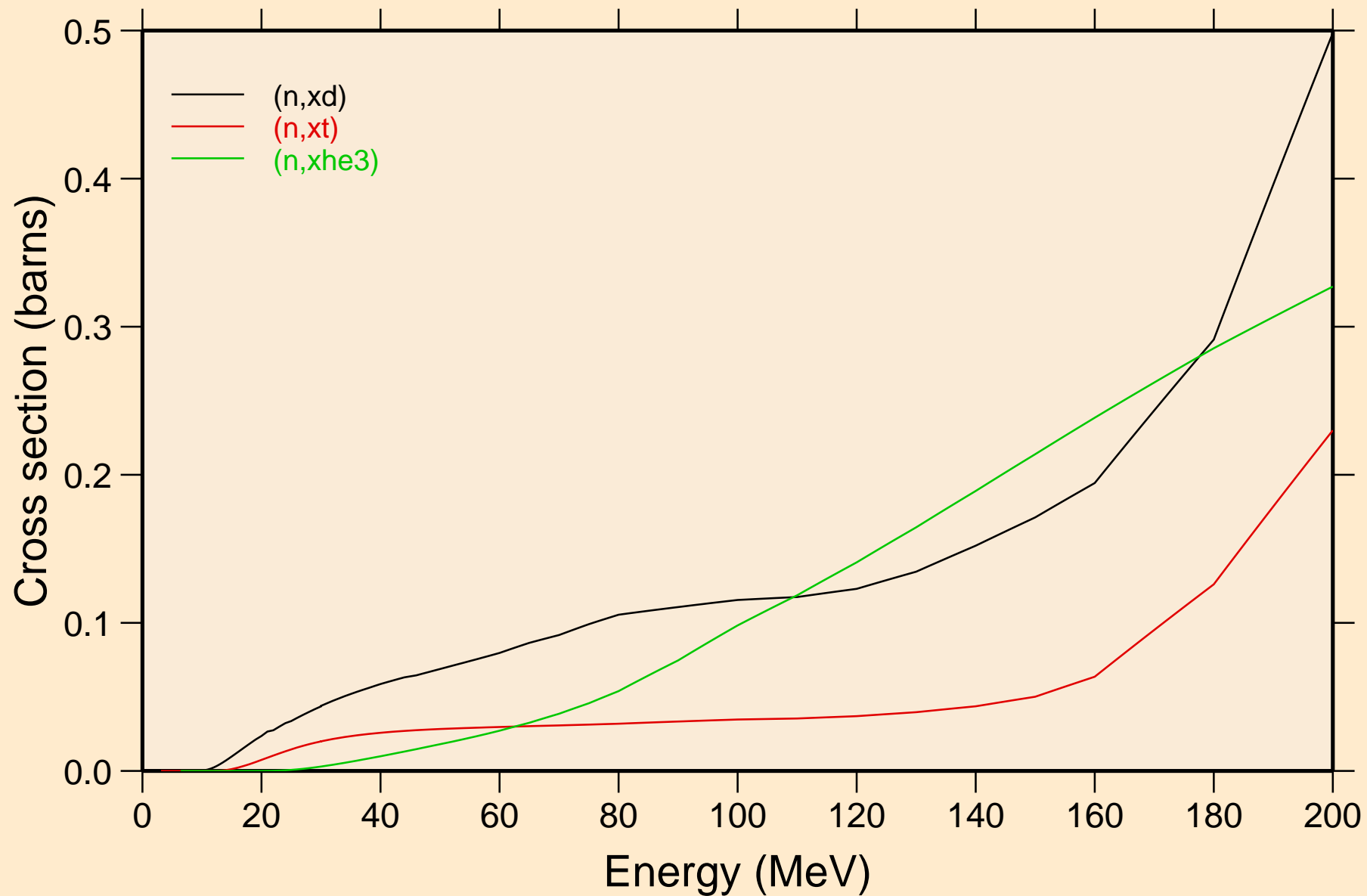

SB118M NEUTRON ACER TENDL-2019 LIBRARY; T=293.16K
angular distribution for elastic

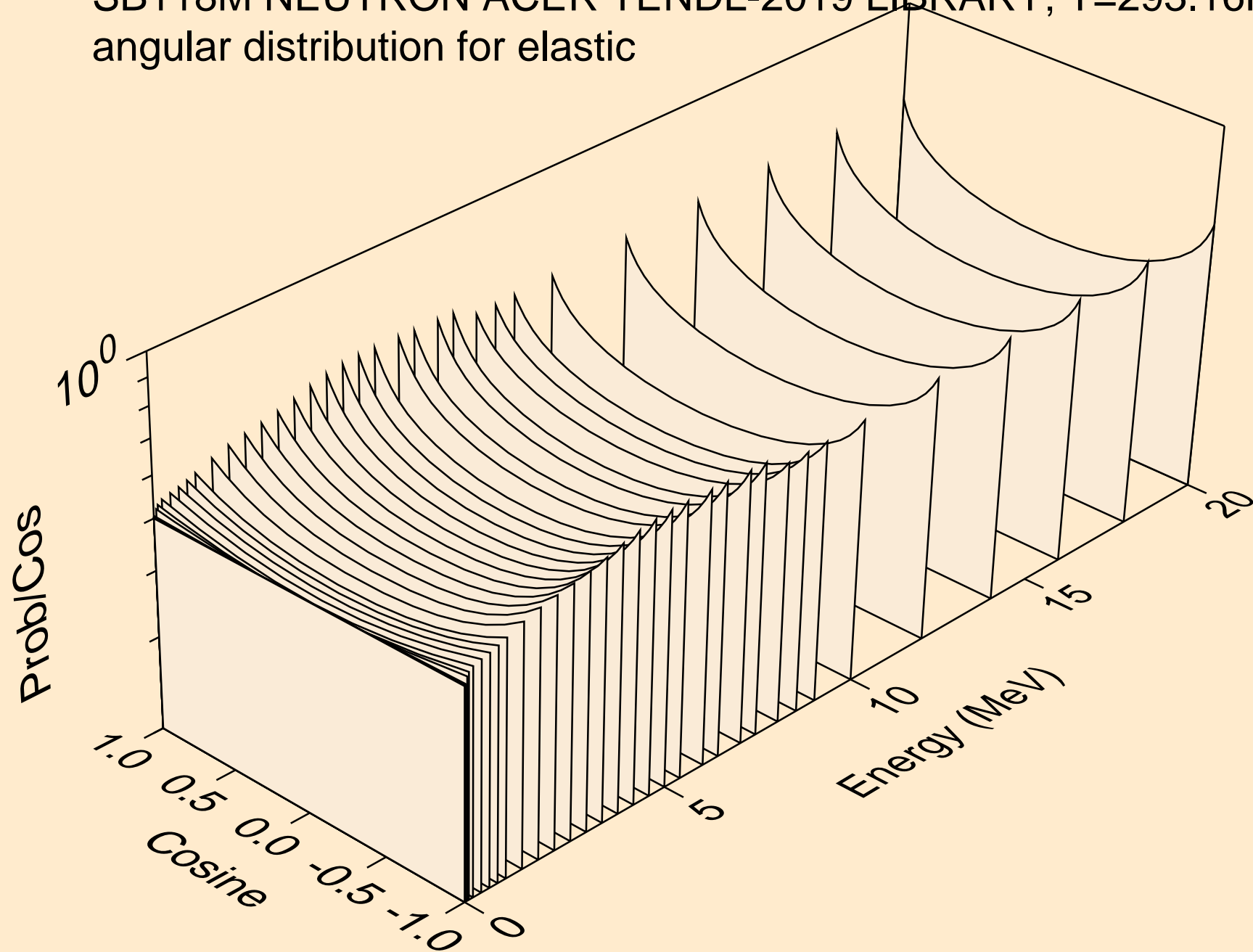

SB118M NEUTRON ACER TENDL-2019 LIBRARY; T=293.16K
angular distribution for elastic

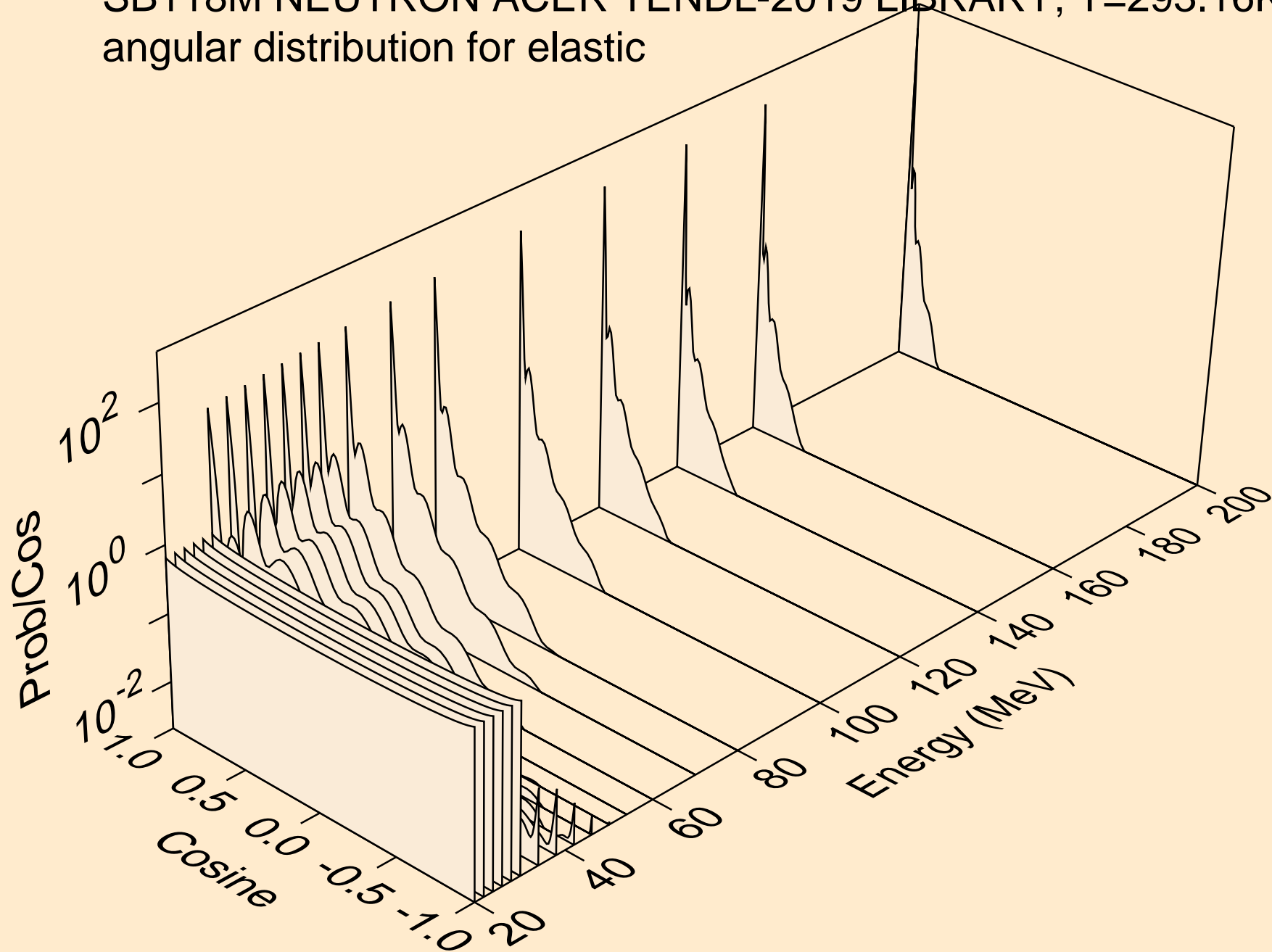

SB118M NEUTRON ACER TENDL-2019 LIBRARY; T=293.16K
angular distribution for (n,n*1)

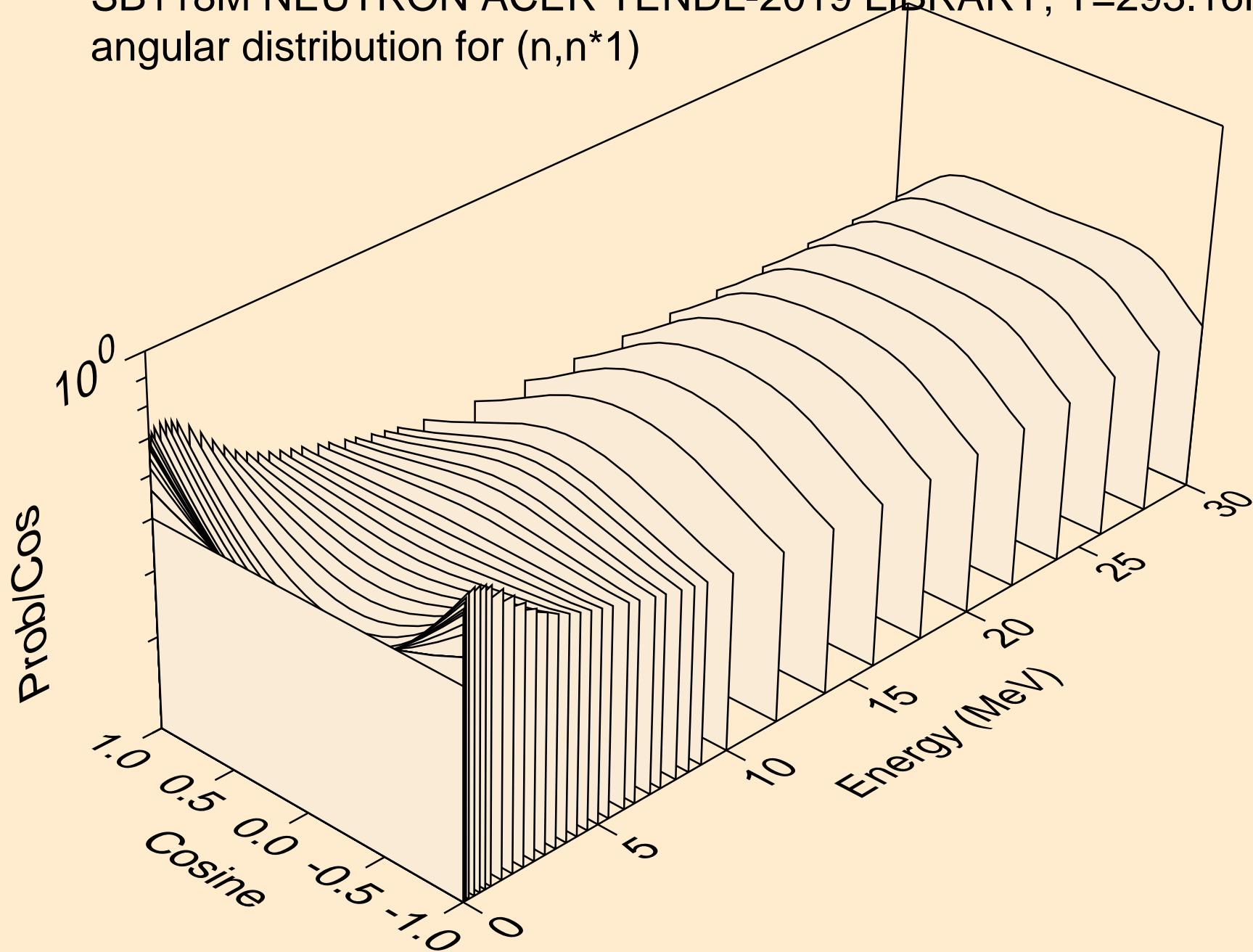

SB118M NEUTRON ACER TENDL-2019 LIBRARY; T=293.16K
angular distribution for (n,n*2)

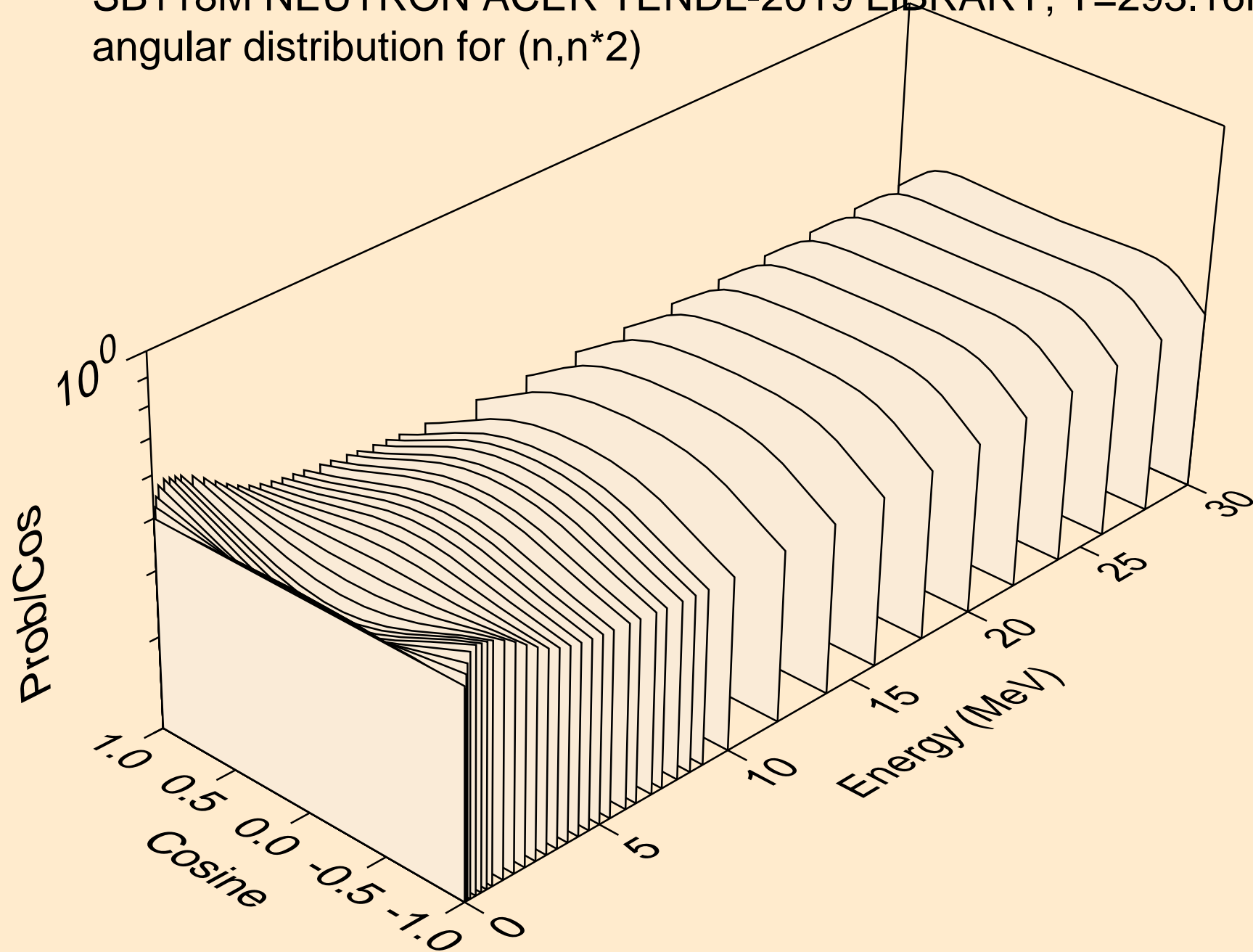

SB118M NEUTRON ACER TENDL-2019 LIBRARY; T=293.16K
angular distribution for (n,n*3)

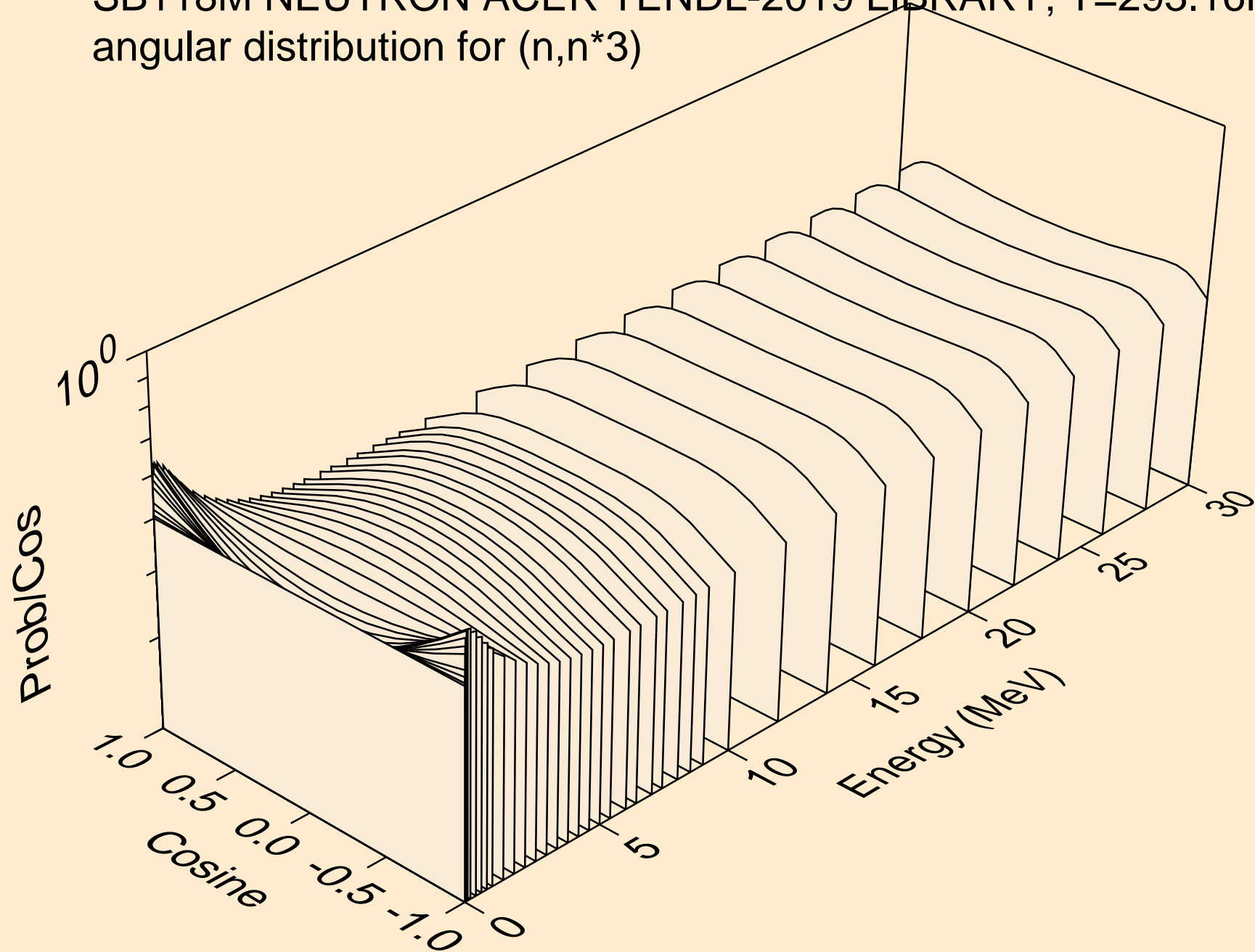

SB118M NEUTRON ACER TENDL-2019 LIBRARY; T=293.16K
angular distribution for (n,n*4)

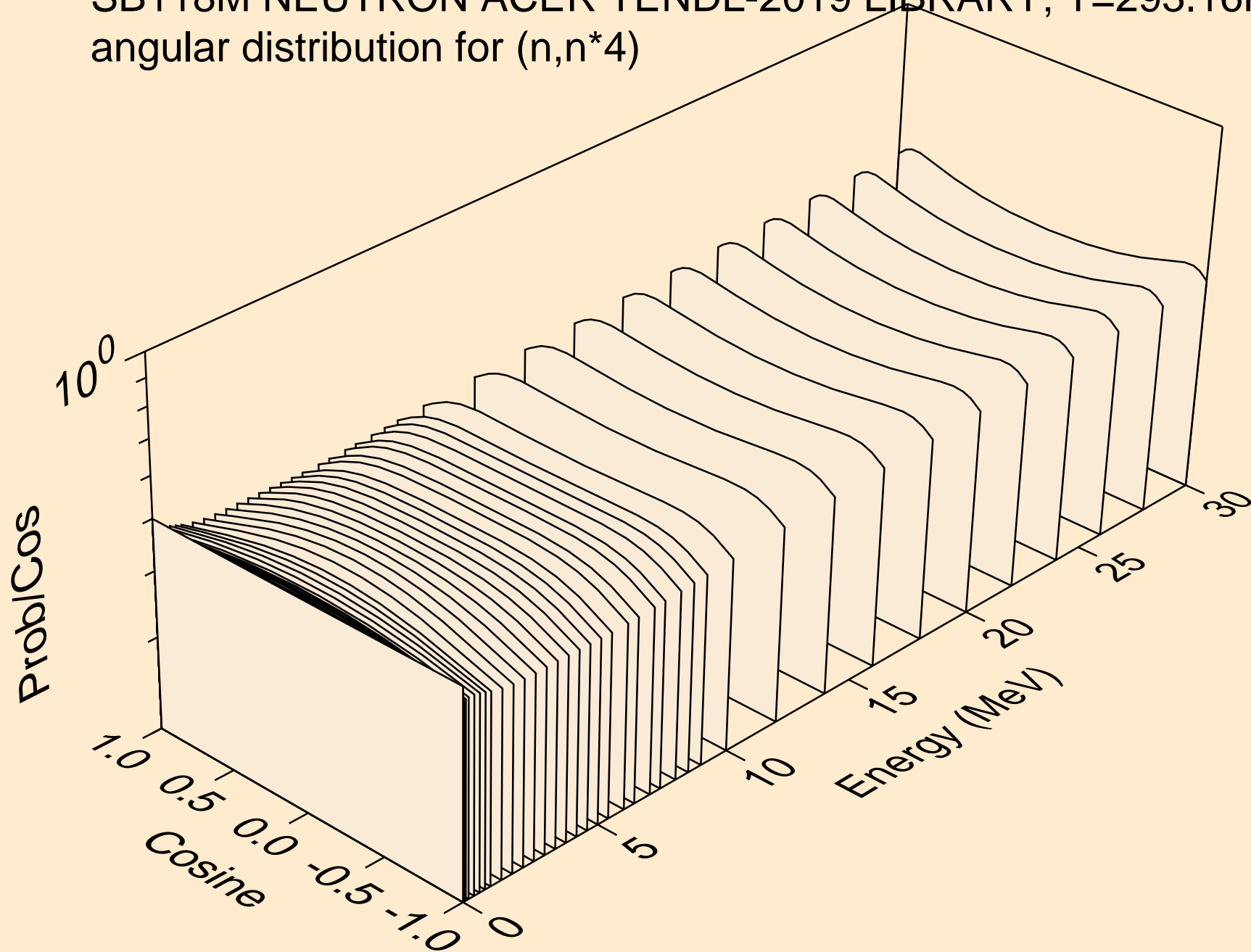

SB118M NEUTRON ACER TENDL-2019 LIBRARY; T=293.16K
angular distribution for (n,n*5)

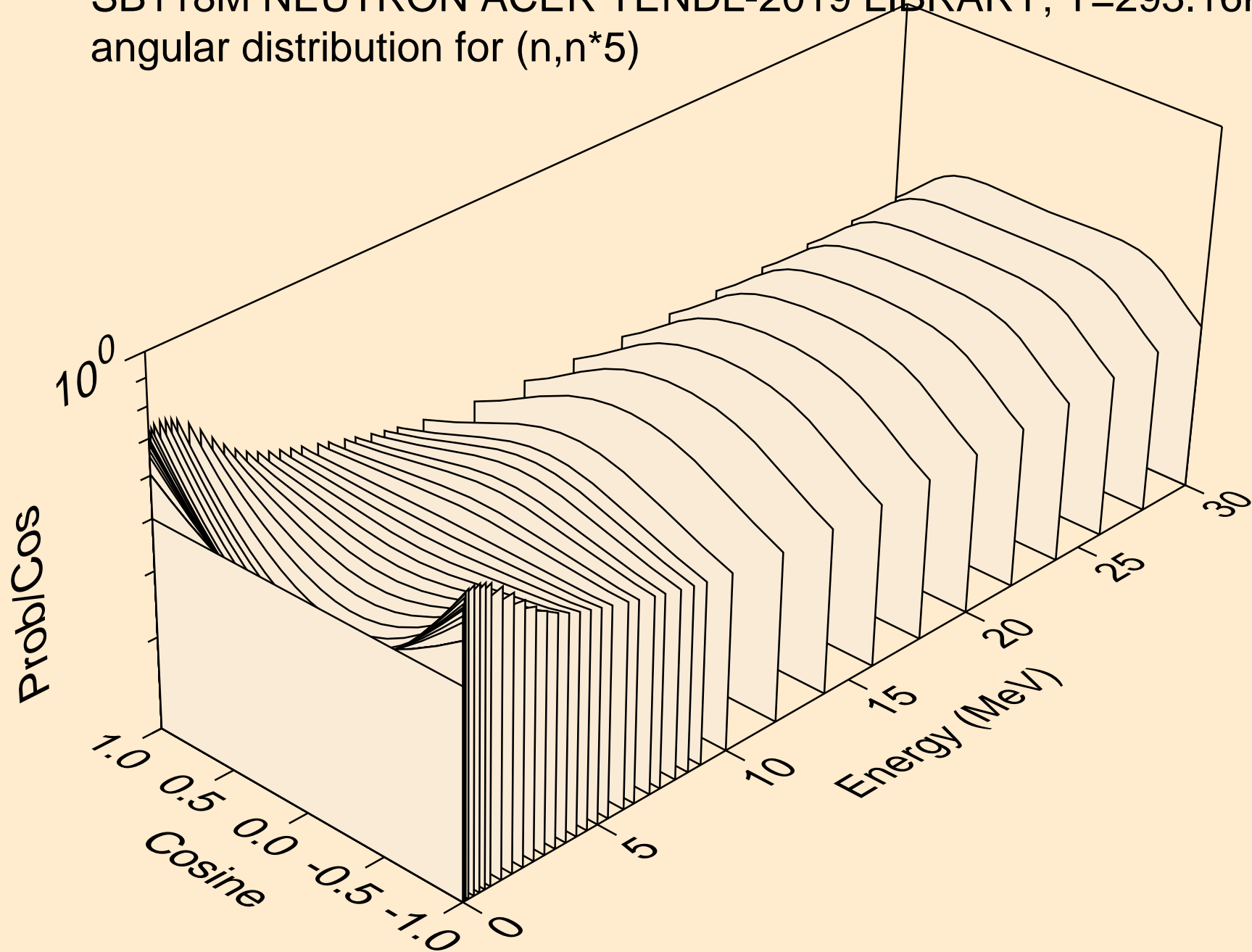

SB118M NEUTRON ACER TENDL-2019 LIBRARY; T=293.16K
angular distribution for (n,n*6)

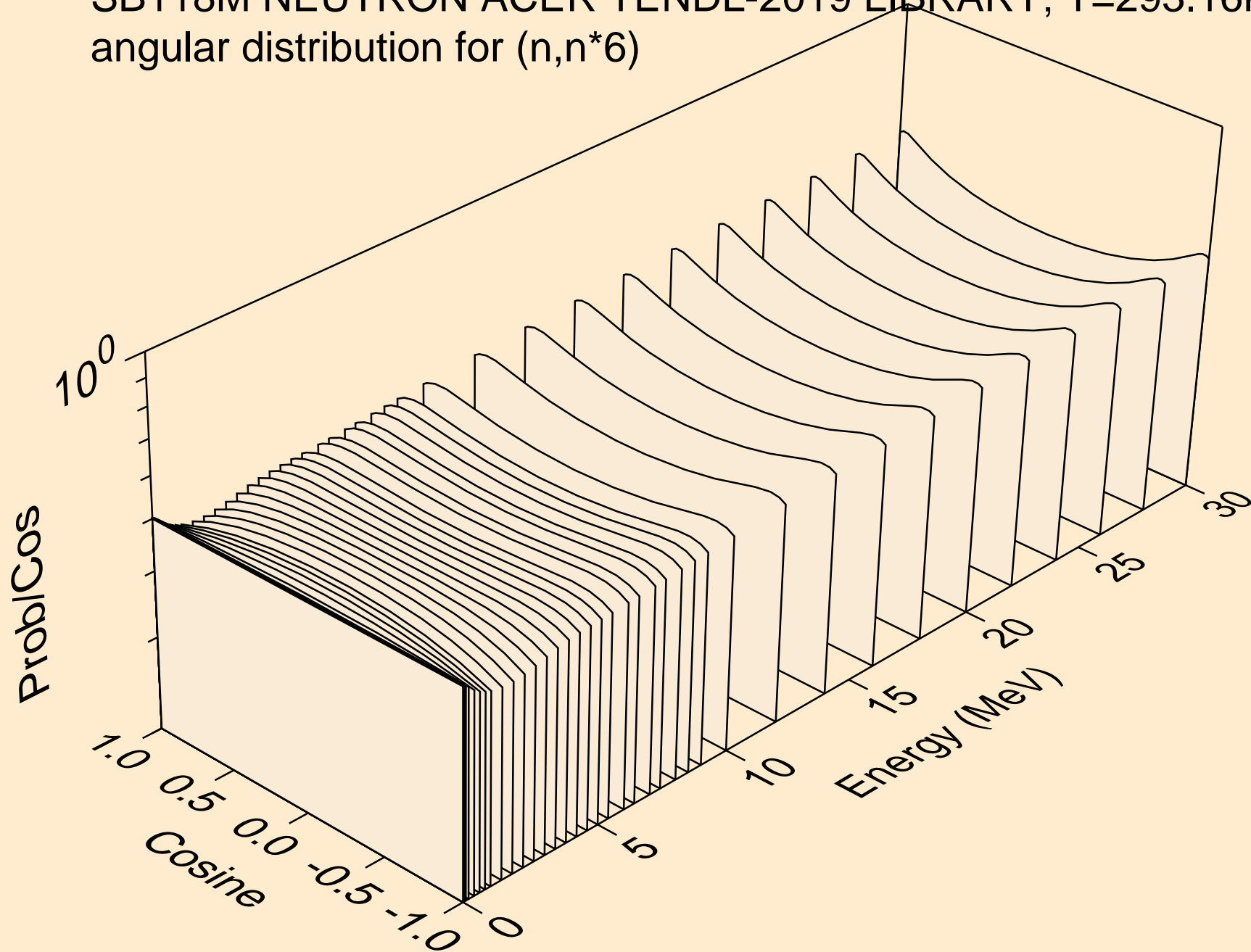

SB118M NEUTRON ACER TENDL-2019 LIBRARY; T=293.16K
angular distribution for (n,n*7)

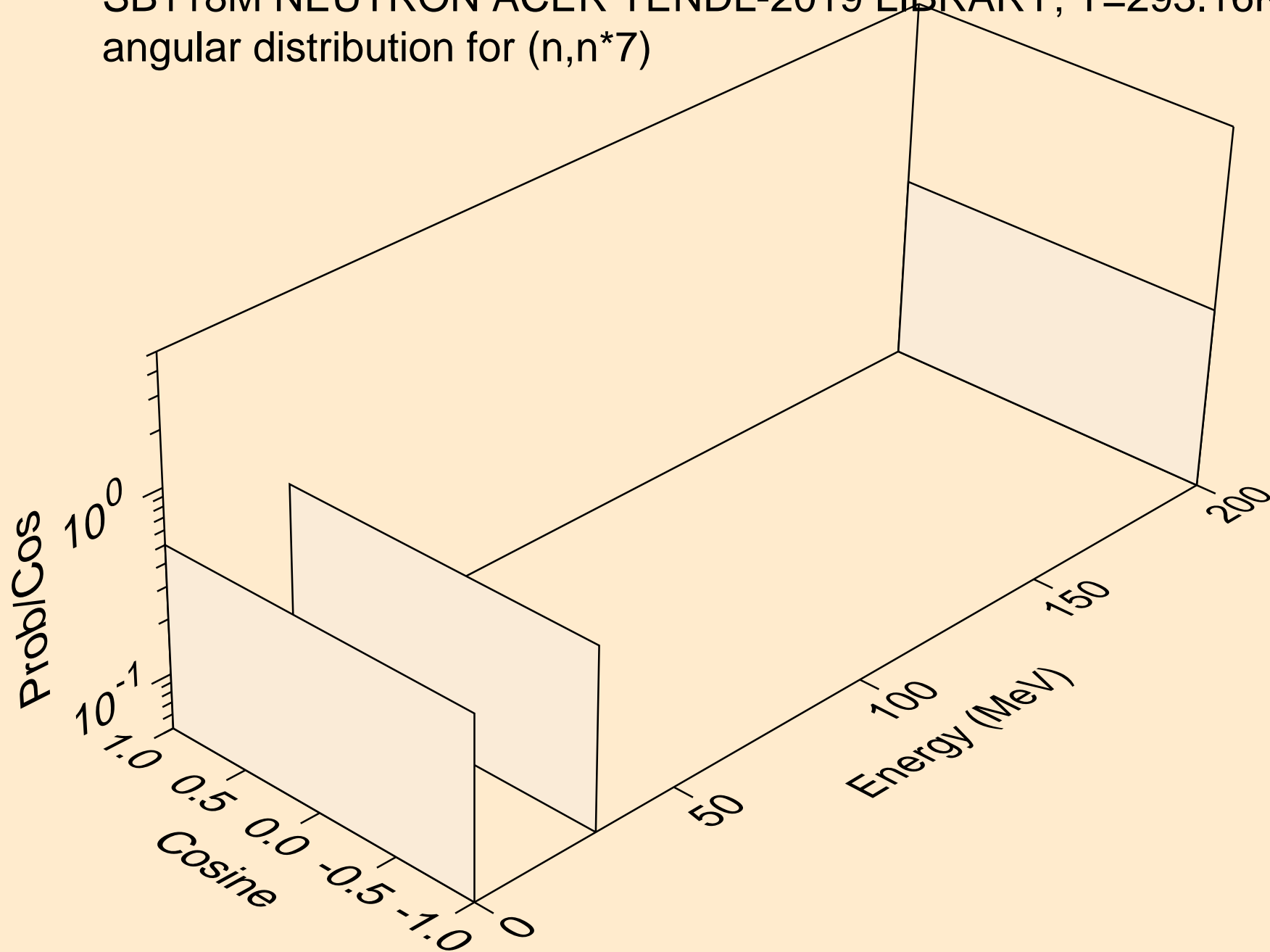

SB118M NEUTRON ACER TENDL-2019 LIBRARY; T=293.16K
angular distribution for (n,n*8)

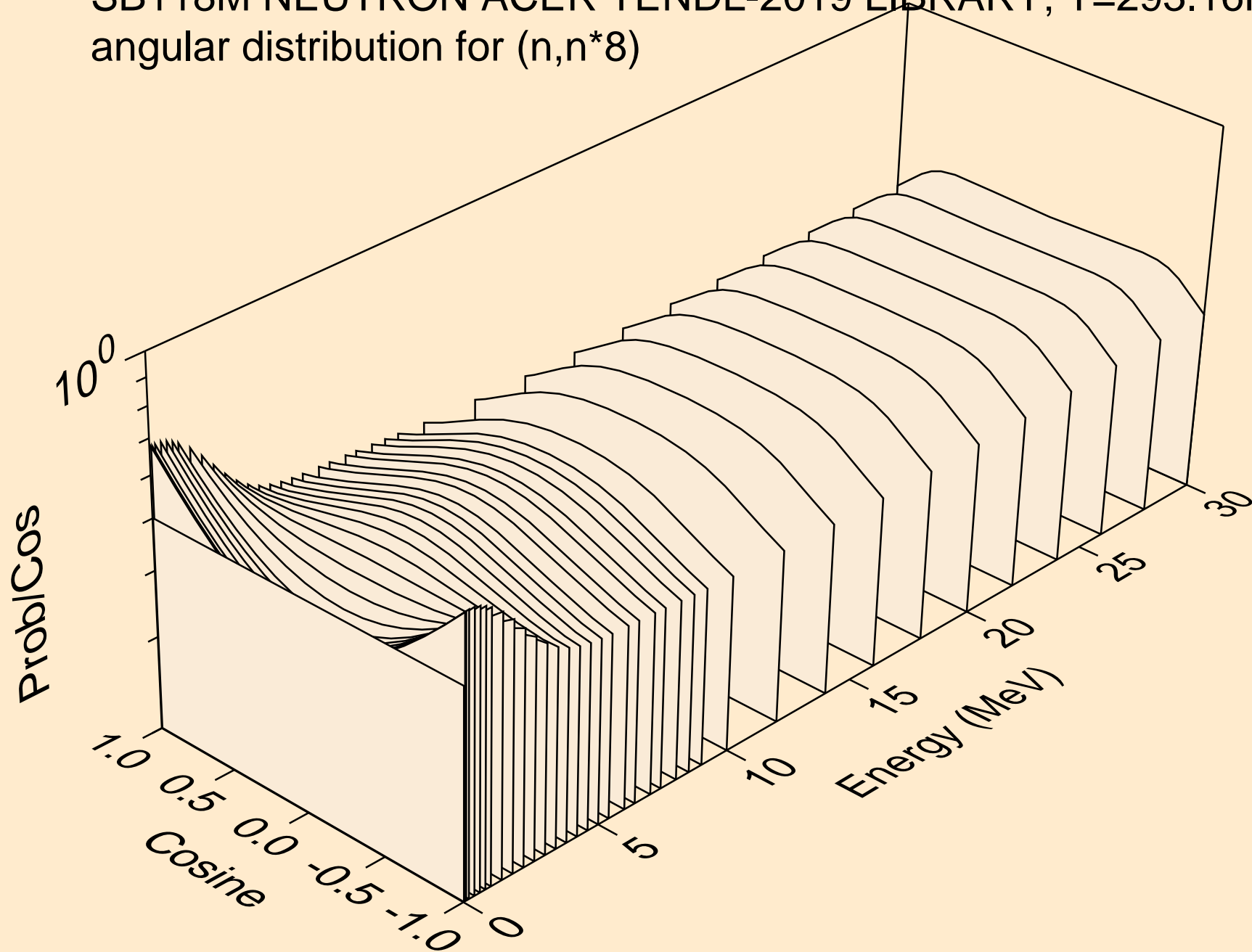

SB118M NEUTRON ACER TENDL-2019 LIBRARY; T=293.16K
angular distribution for (n,n*9)

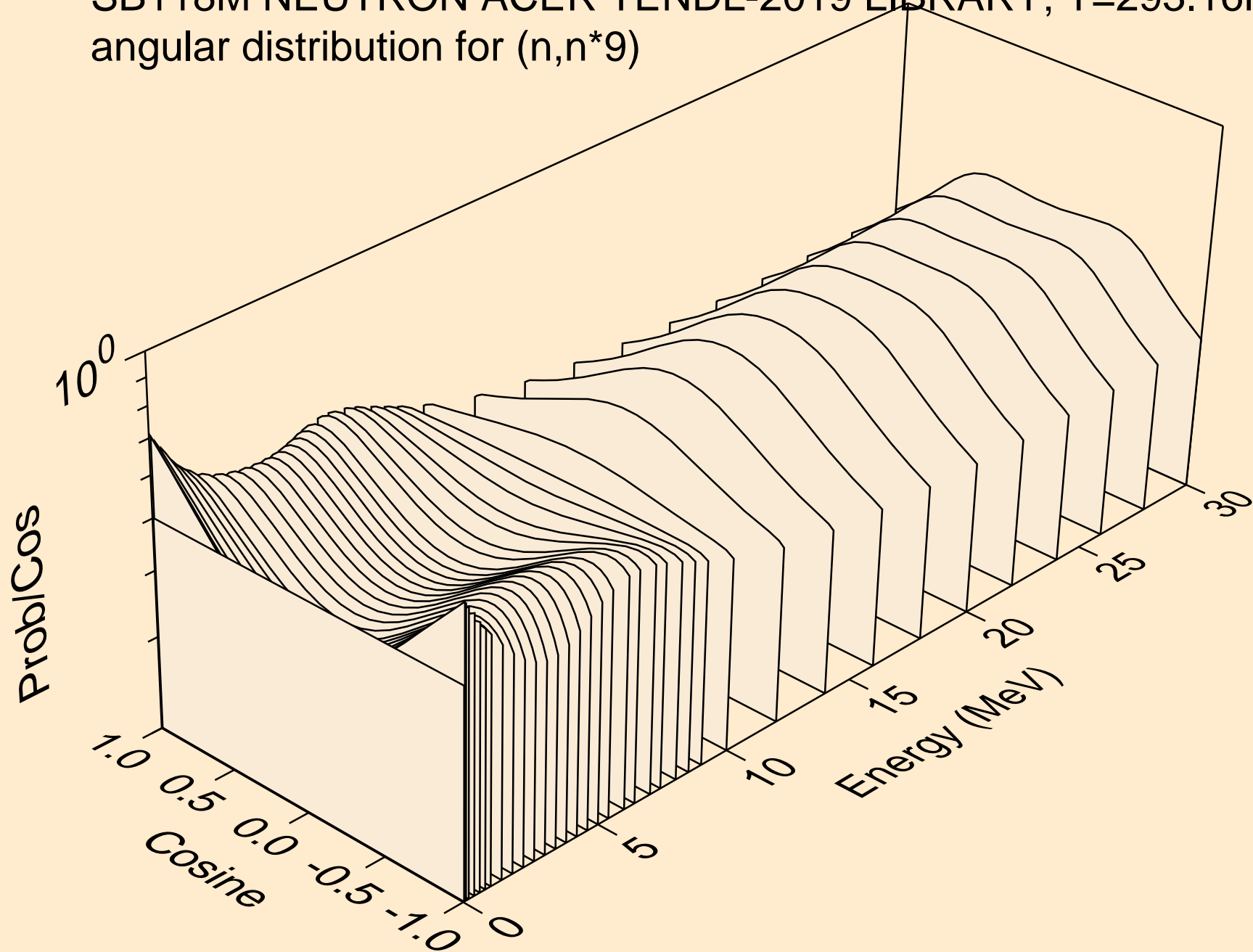

SB118M NEUTRON ACER TENDL-2019 LIBRARY; T=293.16K
angular distribution for (n,n*10)

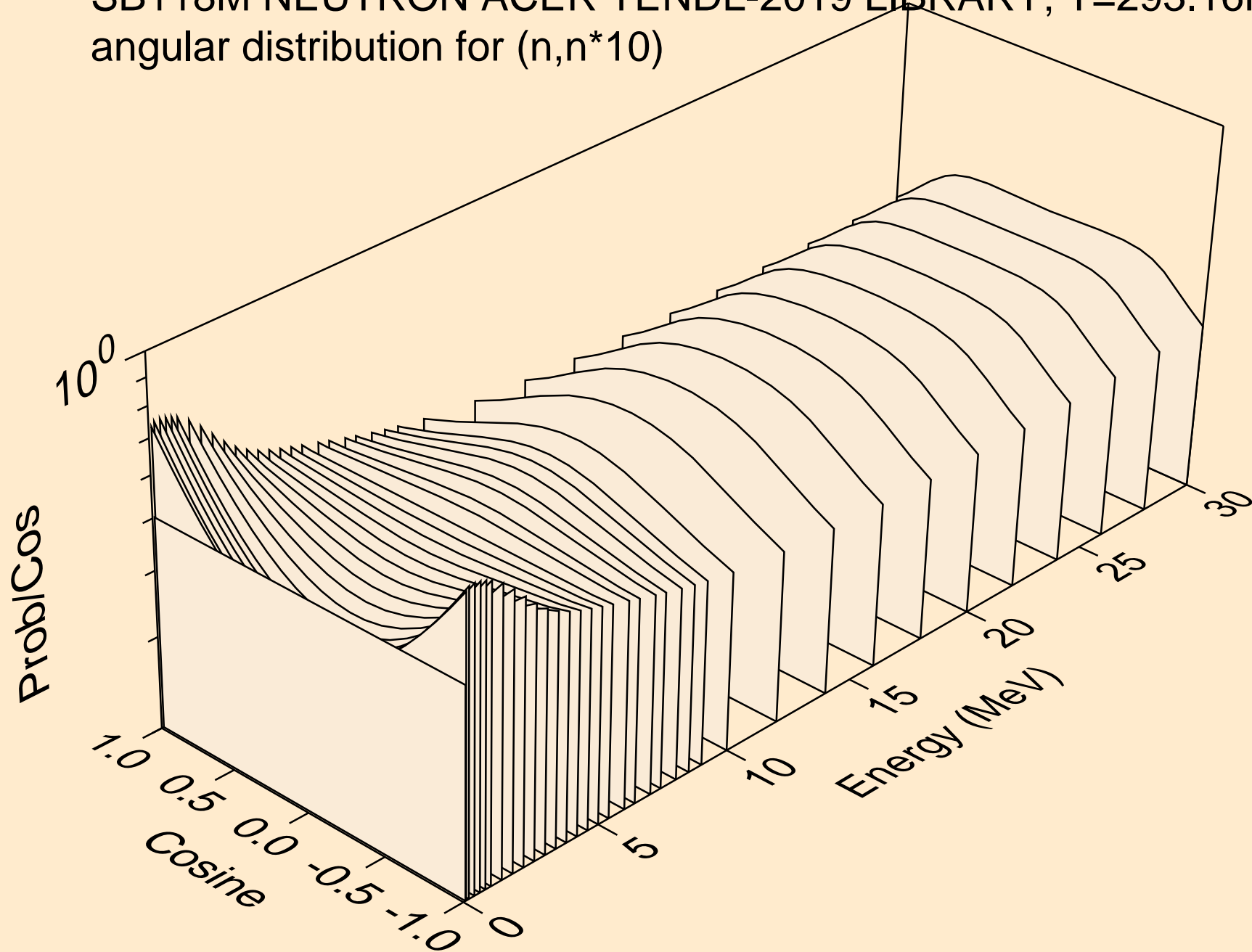

SB118M NEUTRON ACER TENDL-2019 LIBRARY; T=293.16K
angular distribution for (n,n*11)

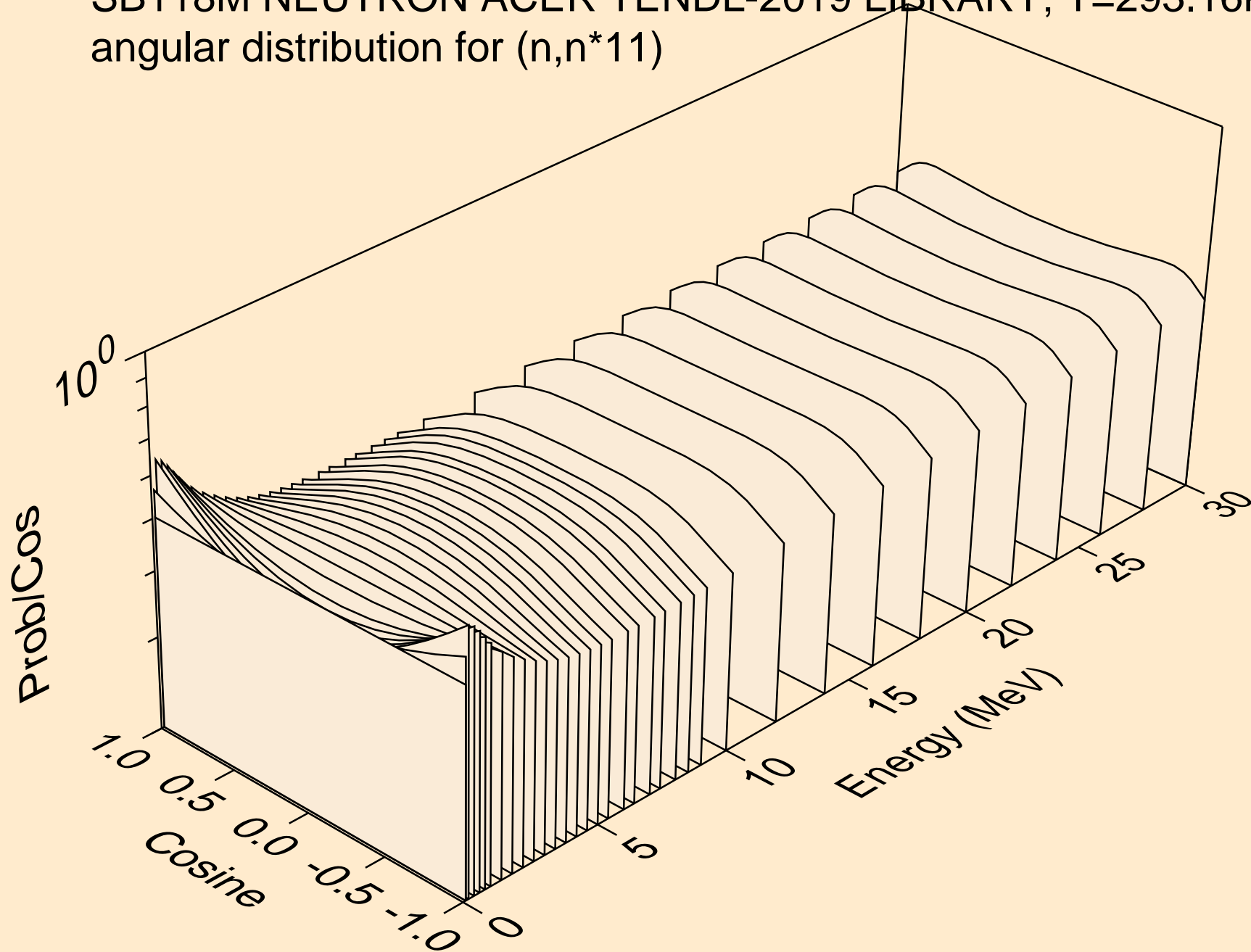

SB118M NEUTRON ACER TENDL-2019 LIBRARY; T=293.16K
angular distribution for (n,n*12)

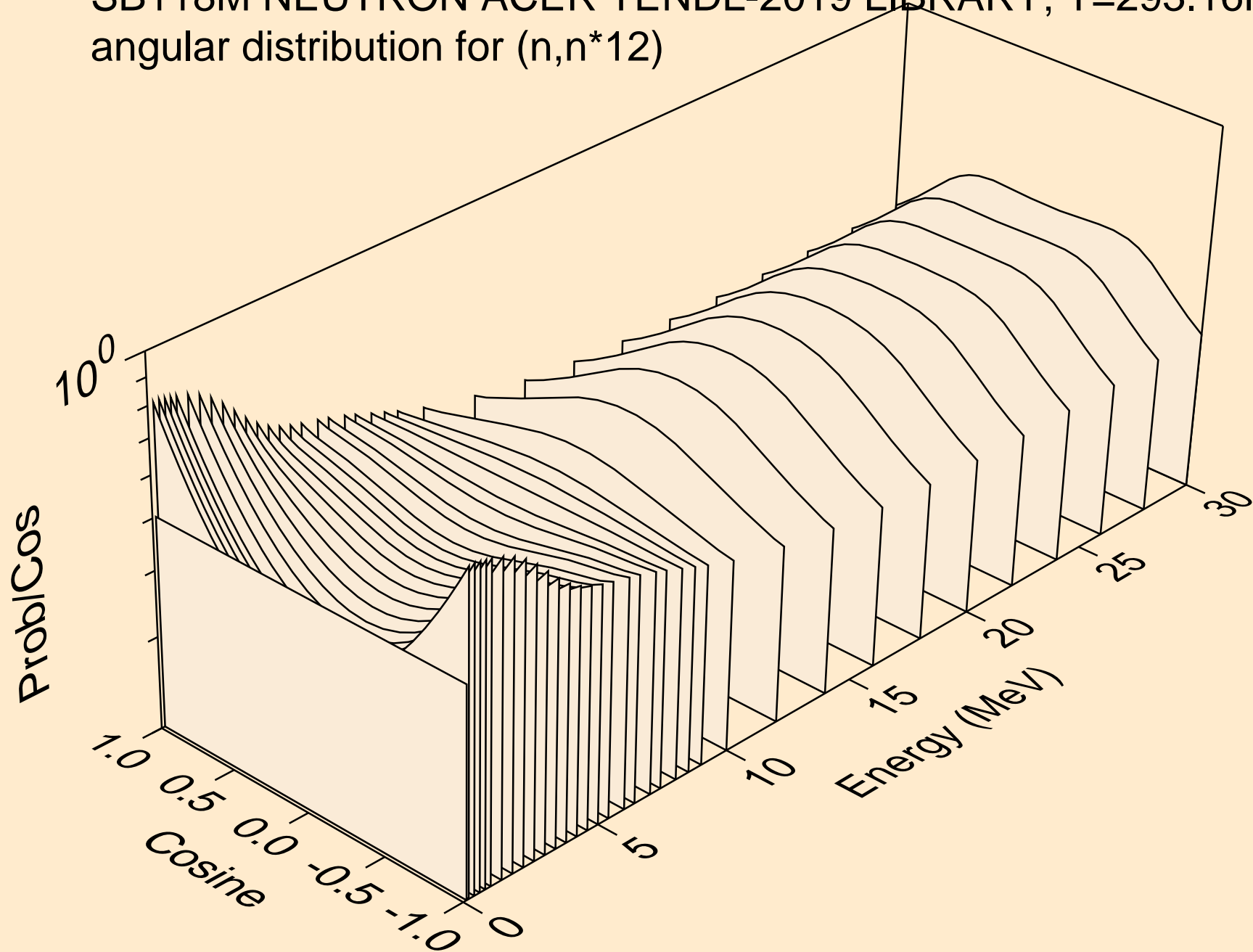

SB118M NEUTRON ACER TENDL-2019 LIBRARY; T=293.16K
angular distribution for (n,n*13)

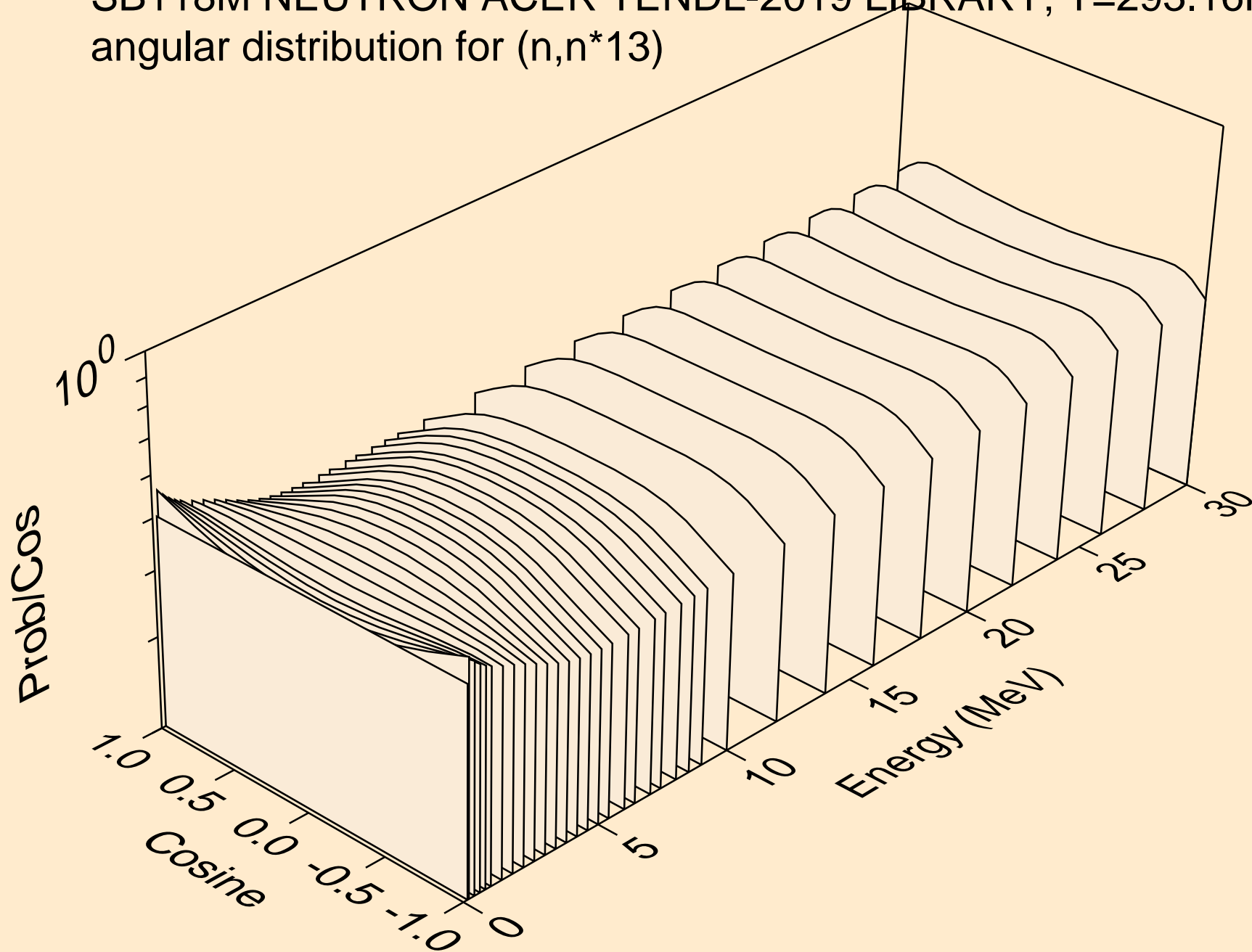

SB118M NEUTRON ACER TENDL-2019 LIBRARY; T=293.16K
angular distribution for (n,n*14)

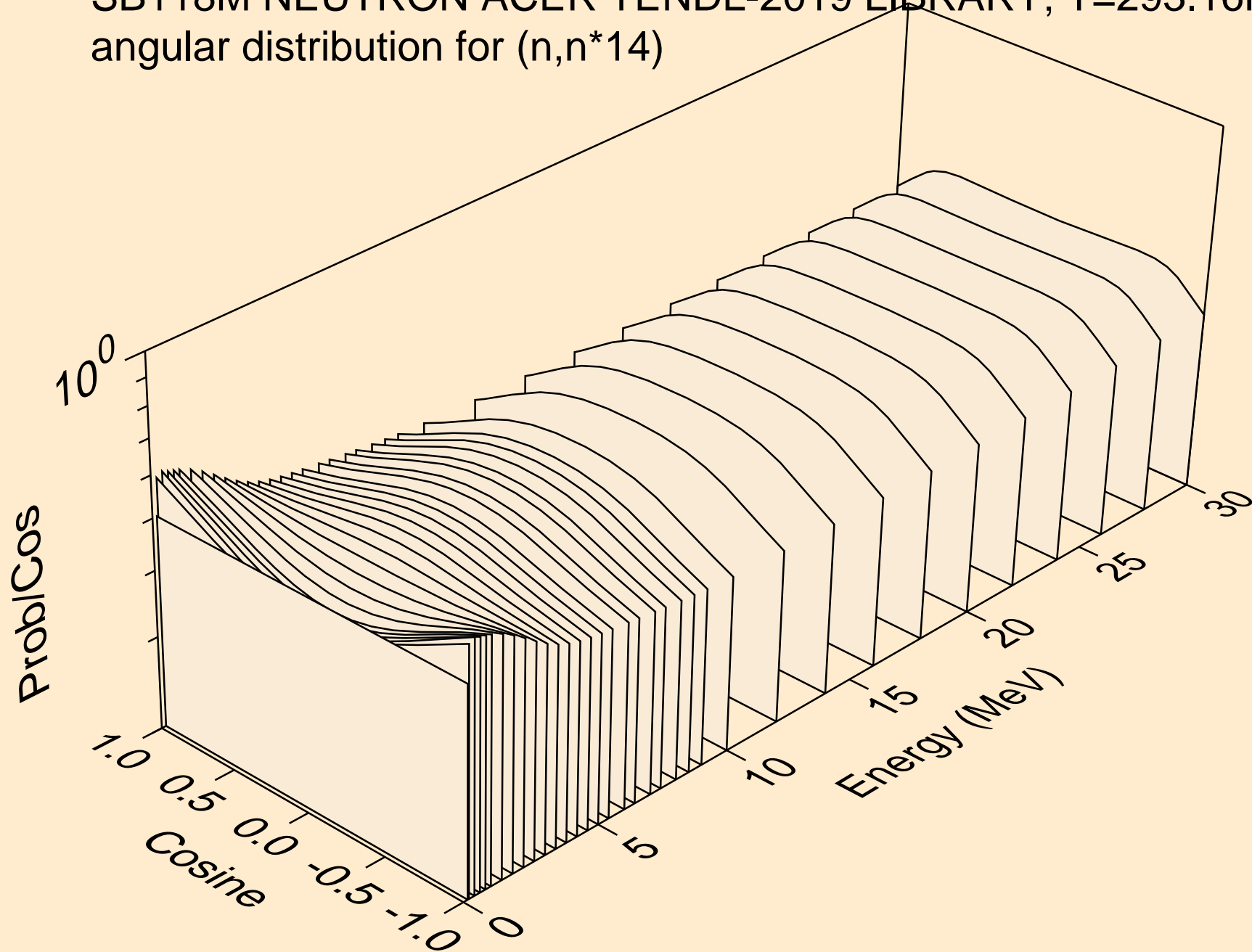

SB118M NEUTRON ACER TENDL-2019 LIBRARY; T=293.16K
angular distribution for (n,n*15)

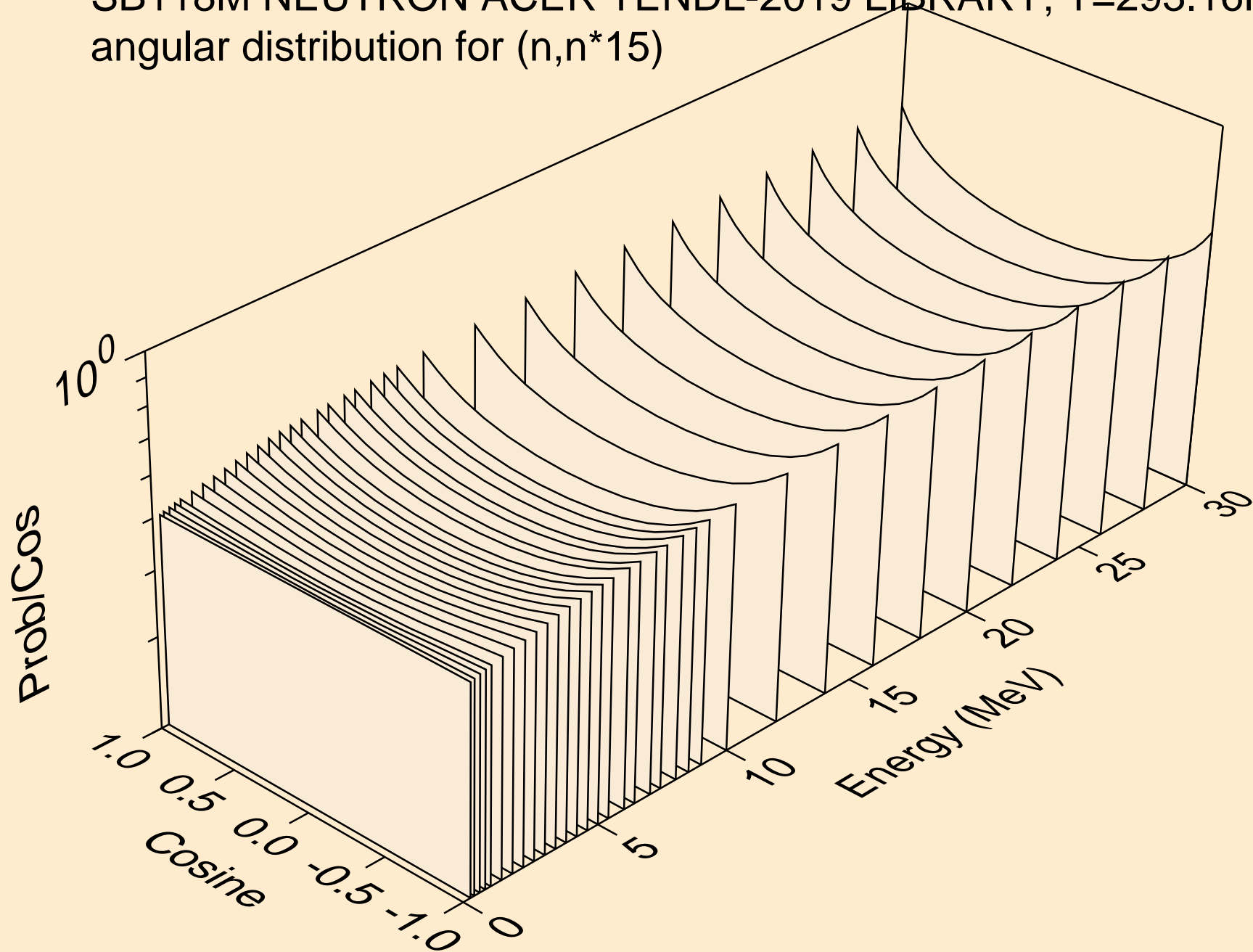

SB118M NEUTRON ACER TENDL-2019 LIBRARY; T=293.16K
angular distribution for (n,n*16)

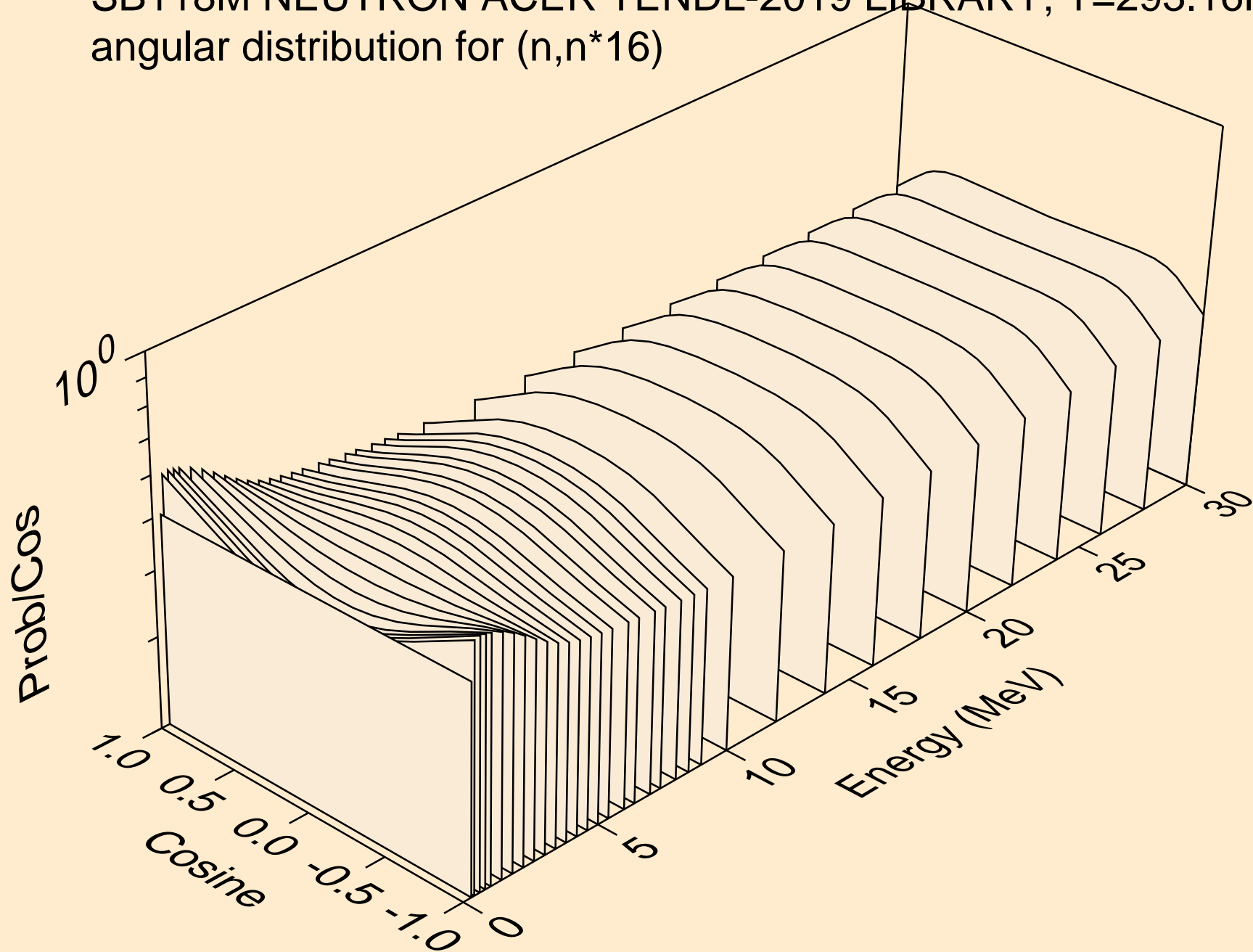

SB118M NEUTRON ACER TENDL-2019 LIBRARY; T=293.16K
angular distribution for (n,n*17)

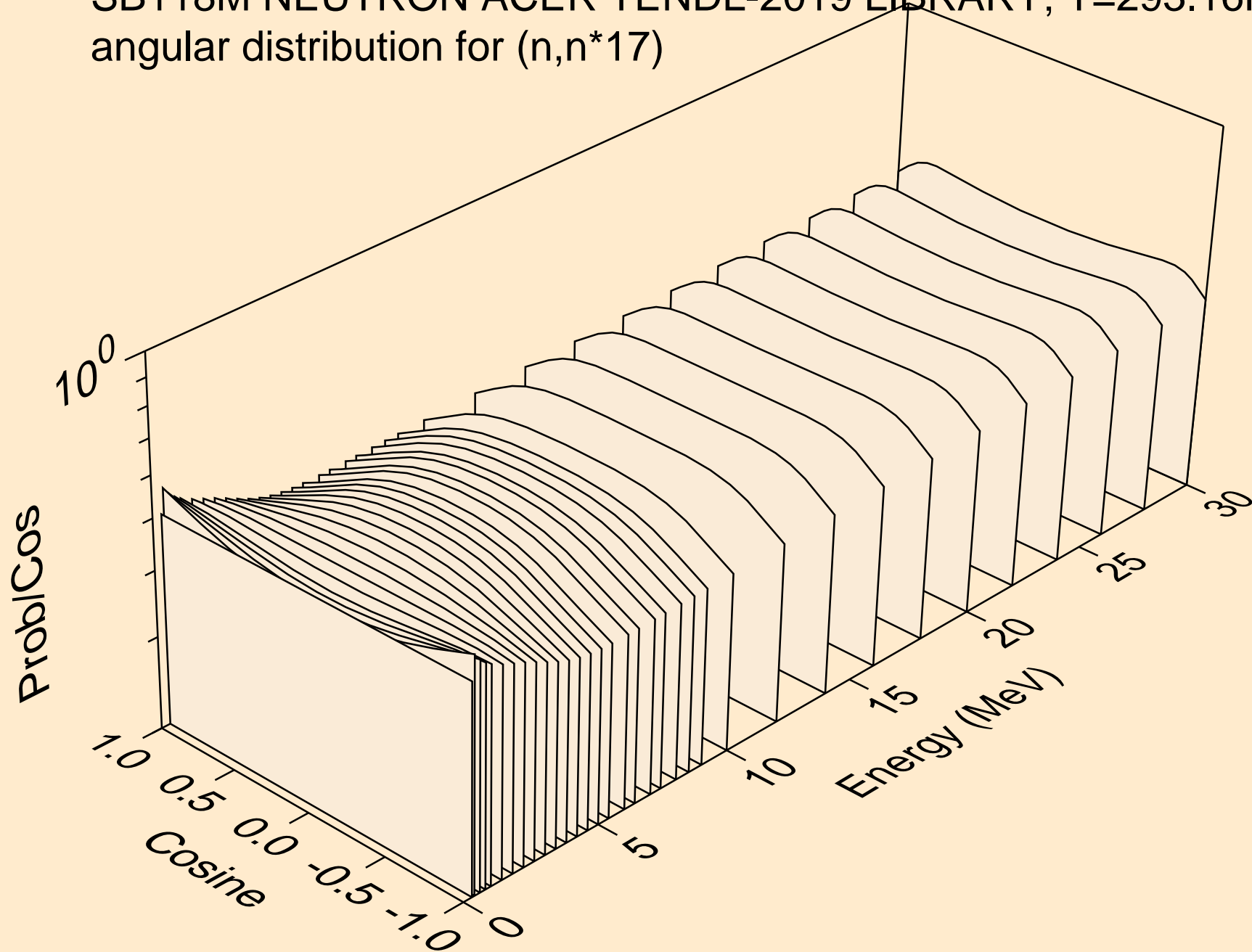

SB118M NEUTRON ACER TENDL-2019 LIBRARY; T=293.16K
angular distribution for (n,n*18)

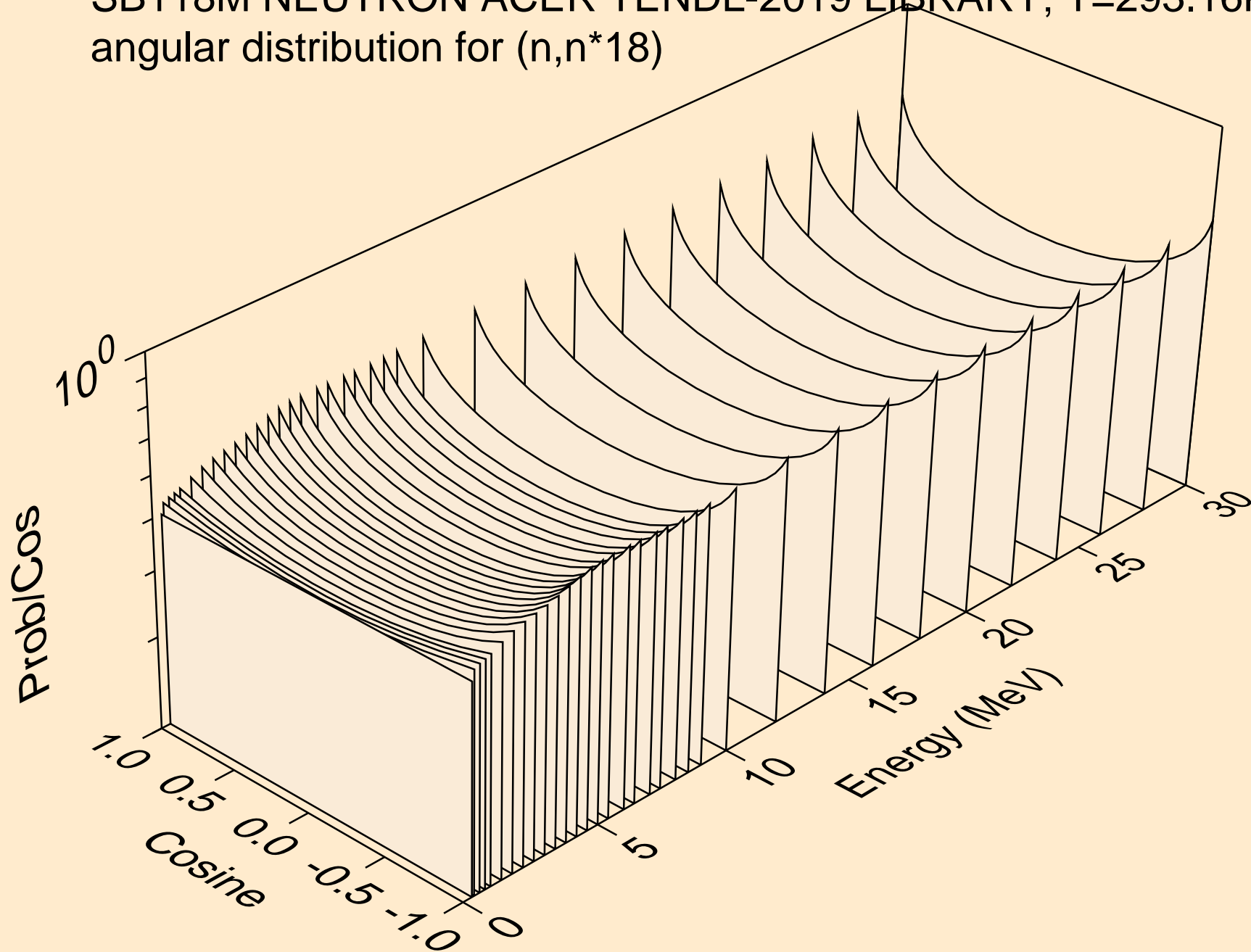

SB118M NEUTRON ACER TENDL-2019 LIBRARY; T=293.16K
angular distribution for (n,n*19)

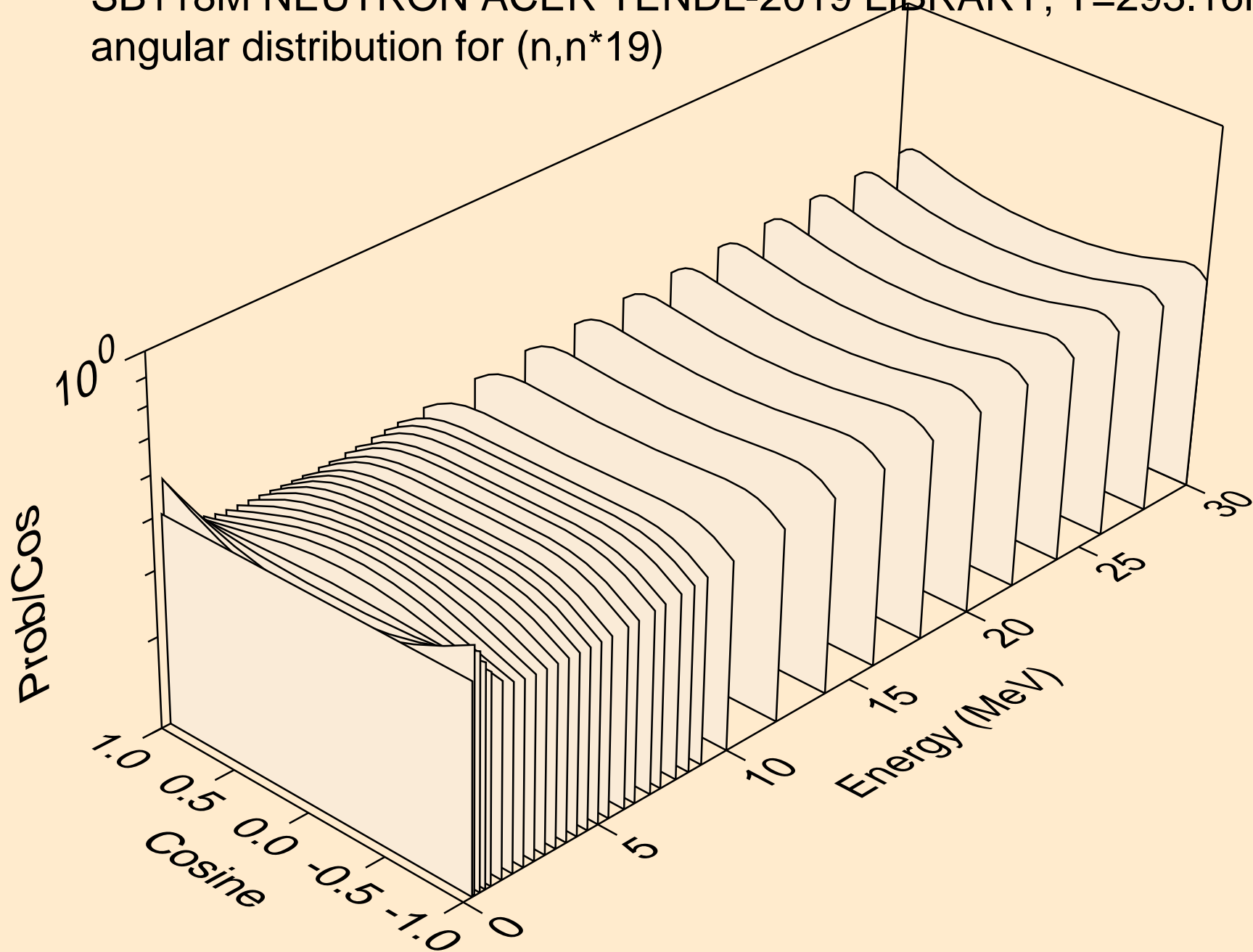

SB118M NEUTRON ACER TENDL-2019 LIBRARY; T=293.16K
angular distribution for (n,n*20)

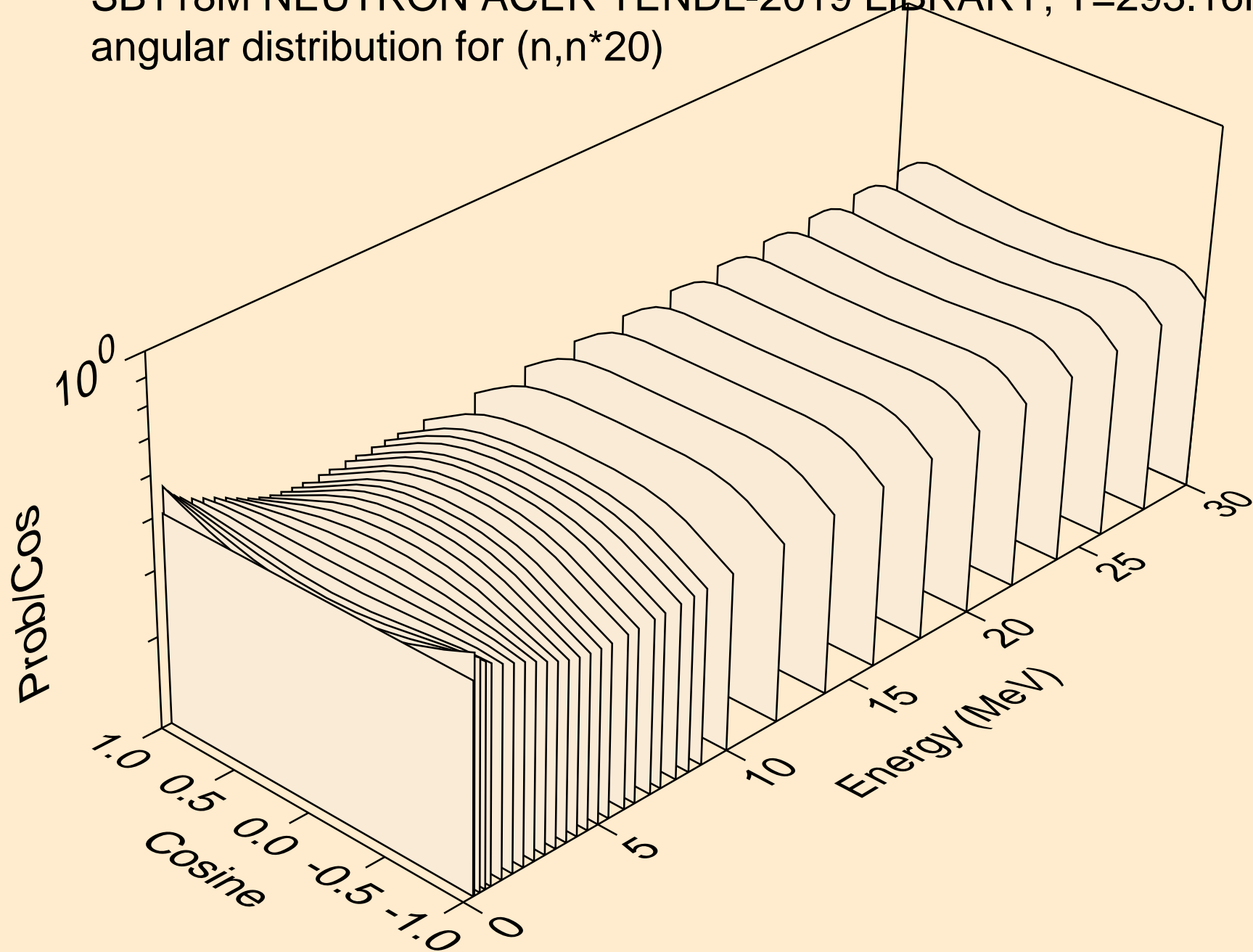

SB118M NEUTRON ACER TENDL-2019 LIBRARY; T=293.16K
angular distribution for (n,n*21)

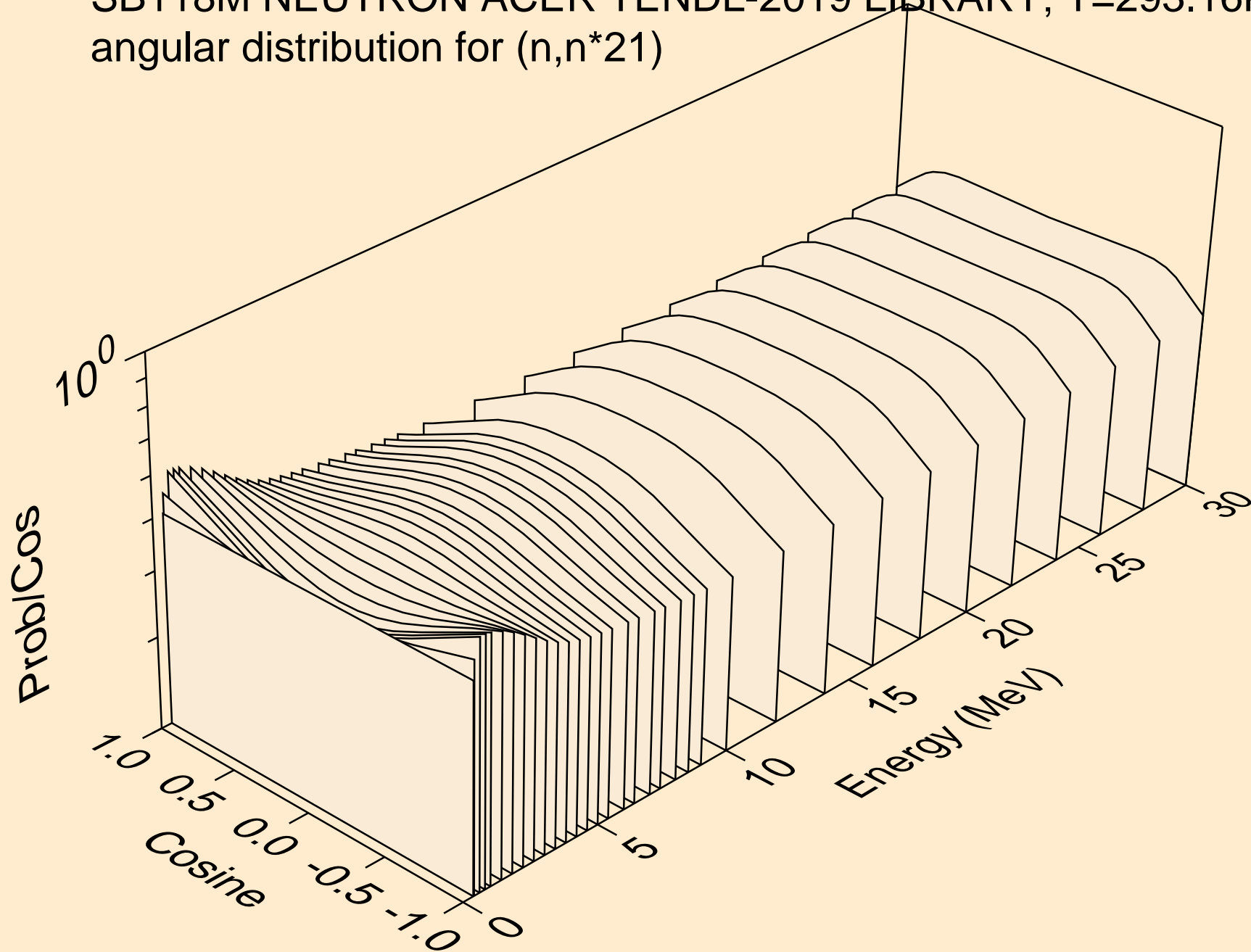

SB118M NEUTRON ACER TENDL-2019 LIBRARY; T=293.16K
angular distribution for (n,n*22)

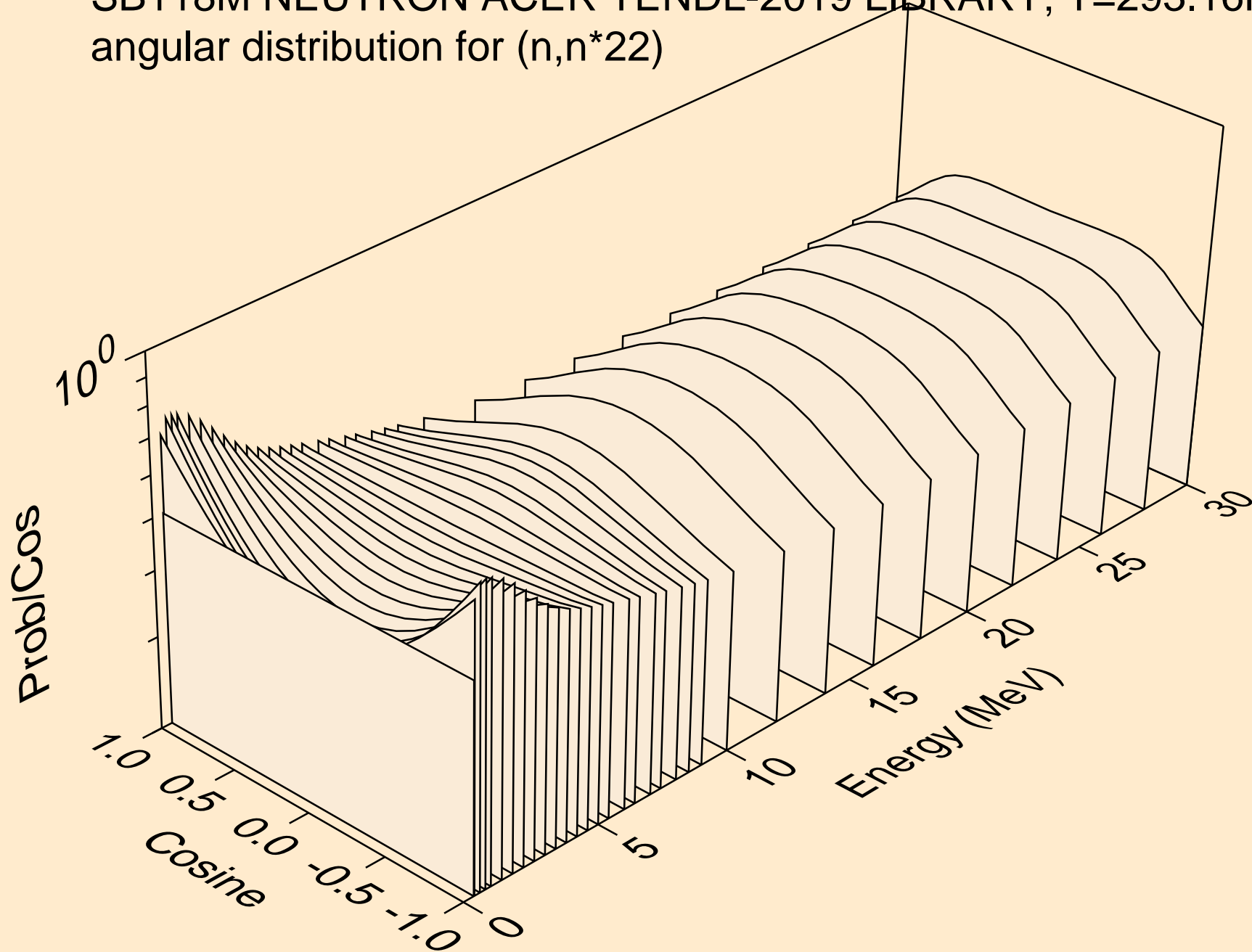

SB118M NEUTRON ACER TENDL-2019 LIBRARY; T=293.16K
angular distribution for (n,n*23)

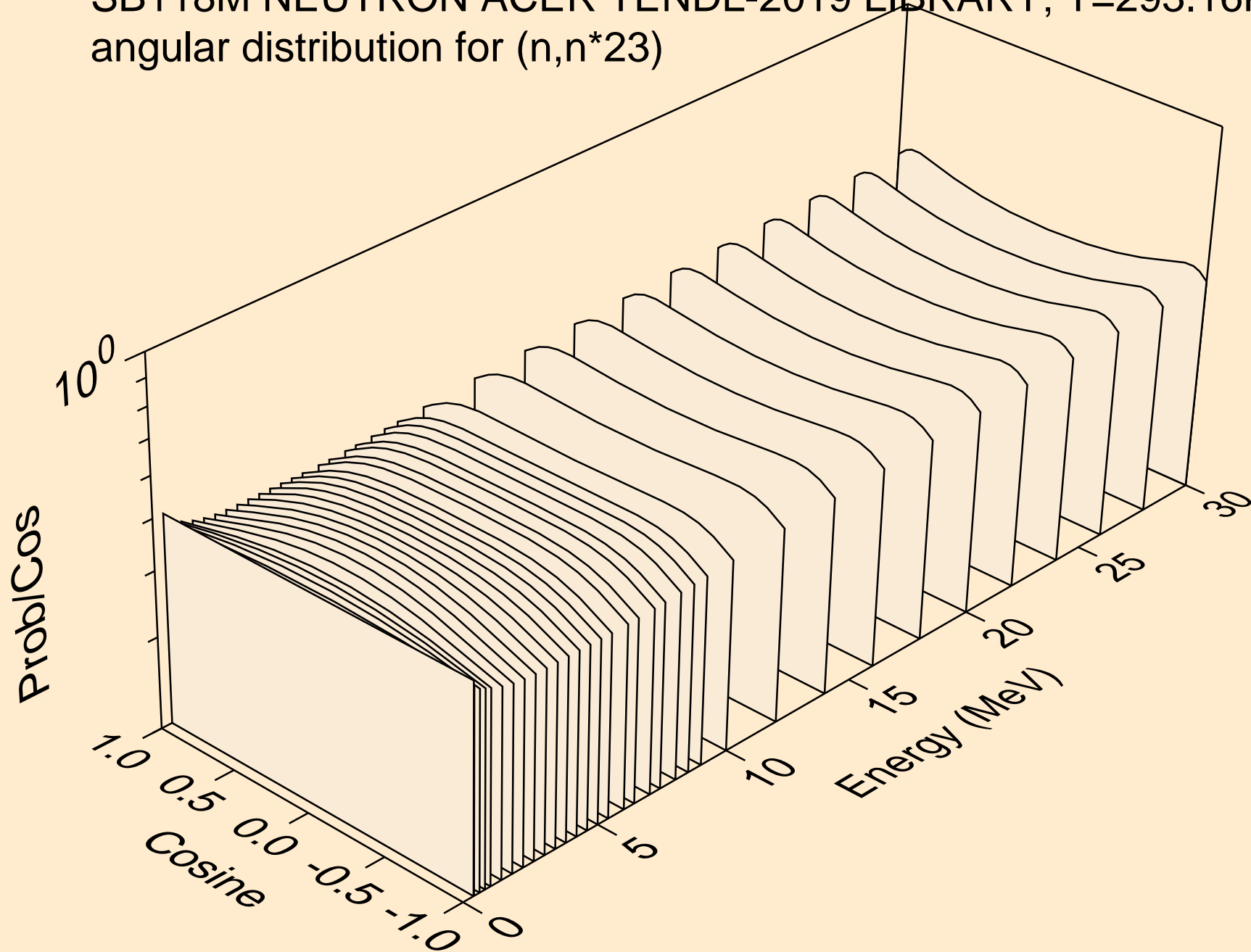

SB118M NEUTRON ACER TENDL-2019 LIBRARY; T=293.16K
angular distribution for (n,n*24)

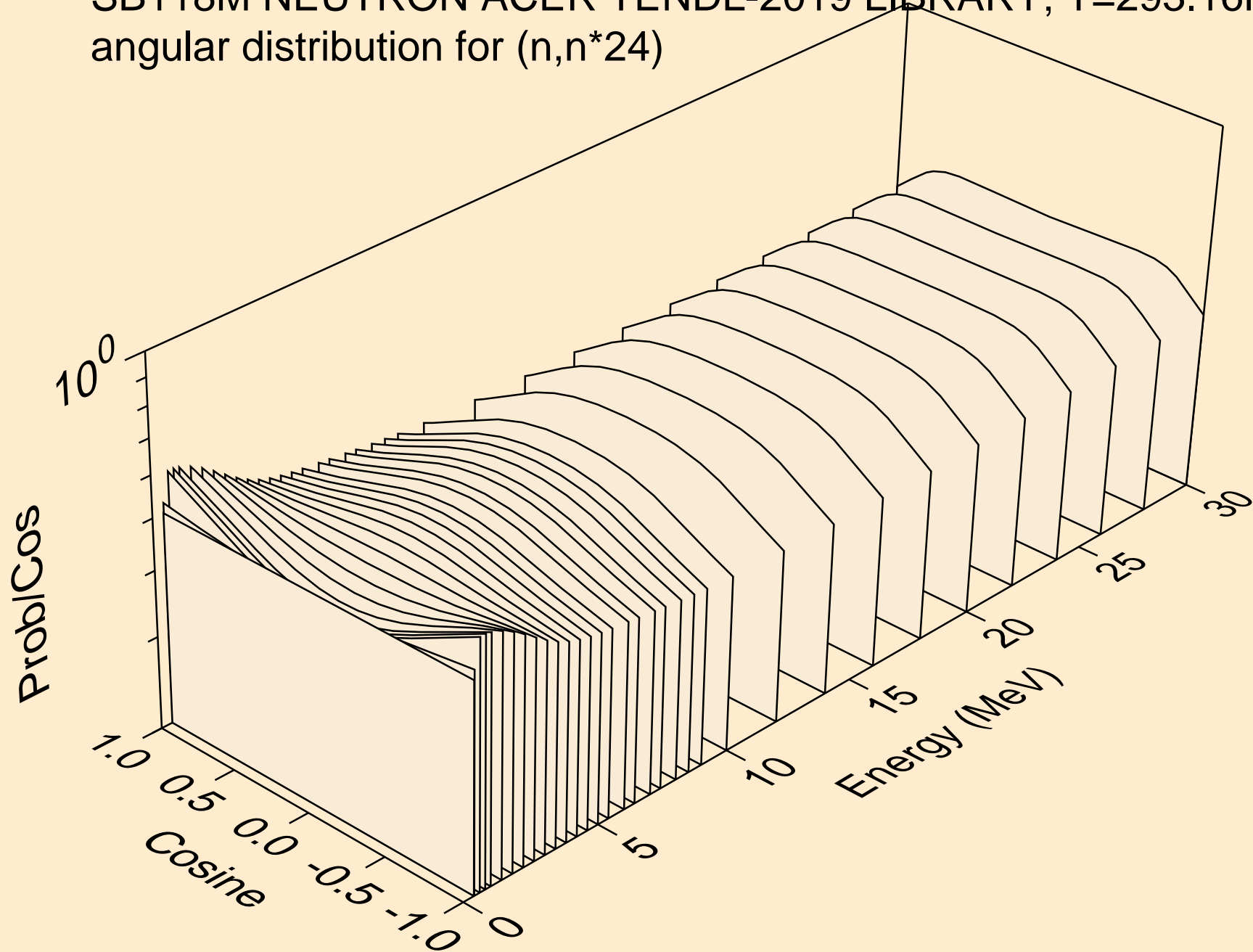

SB118M NEUTRON ACER TENDL-2019 LIBRARY; T=293.16K
angular distribution for (n,n*25)

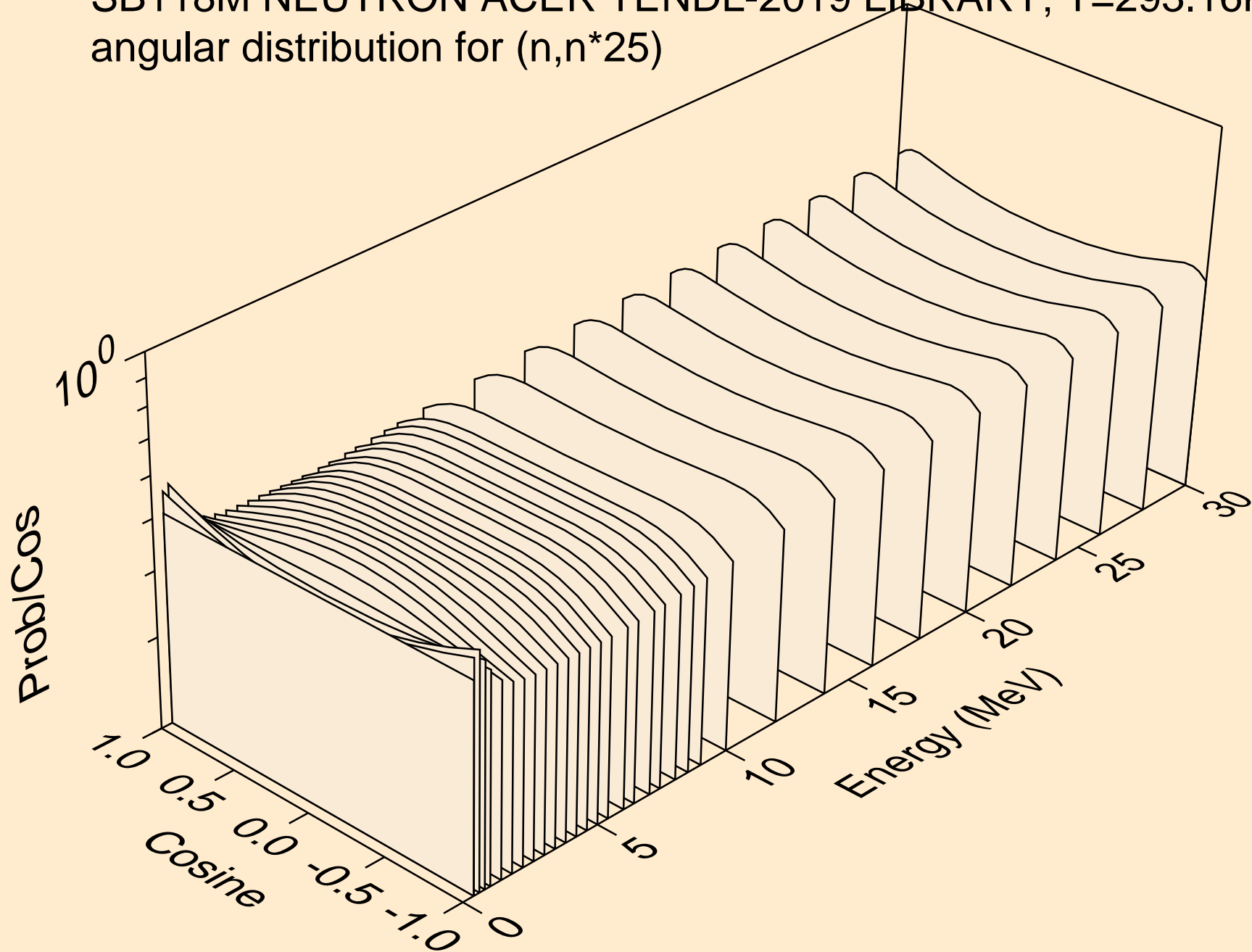

SB118M NEUTRON ACER TENDL-2019 LIBRARY; T=293.16K
Neutron emission for (n,x)

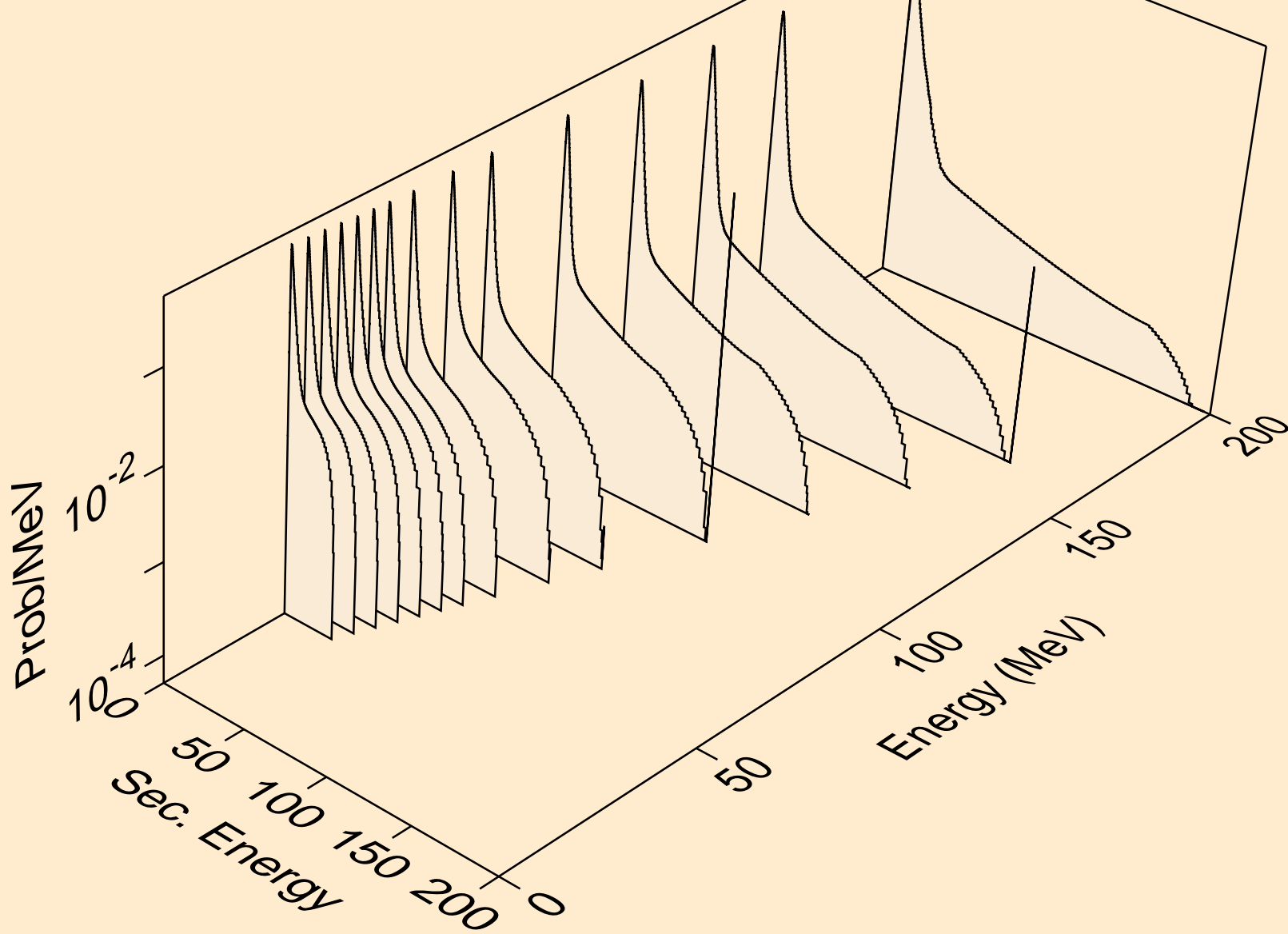

SB118M NEUTRON ACER TENDL-2019 LIBRARY; T=293.16K
Neutron emission for (n,2nd)

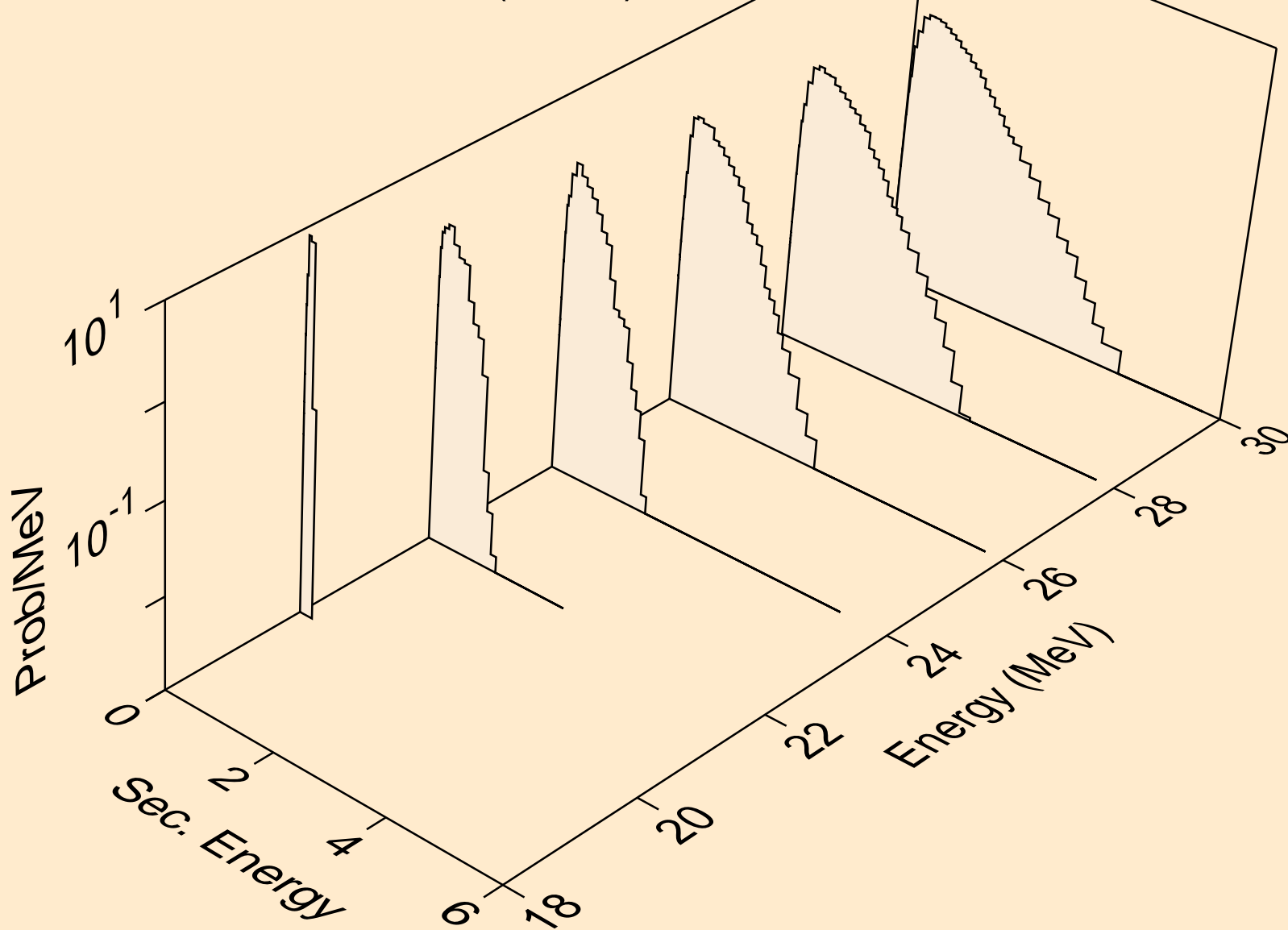

SB118M NEUTRON ACER TENDL-2019 LIBRARY; T=293.16K
Neutron emission for (n,2n)

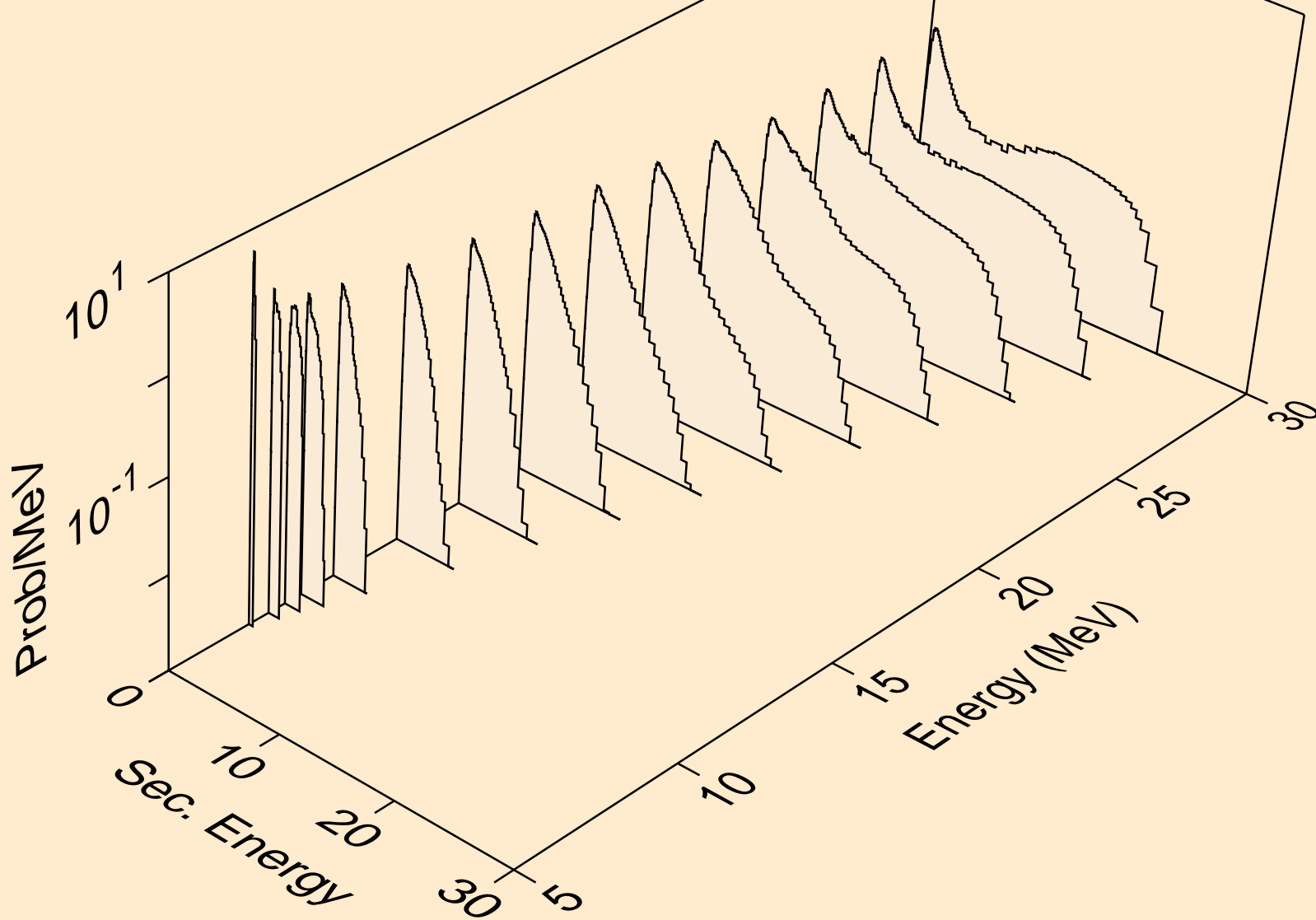

SB118M NEUTRON ACER TENDL-2019 LIBRARY; T=293.16K
Neutron emission for (n,3n)

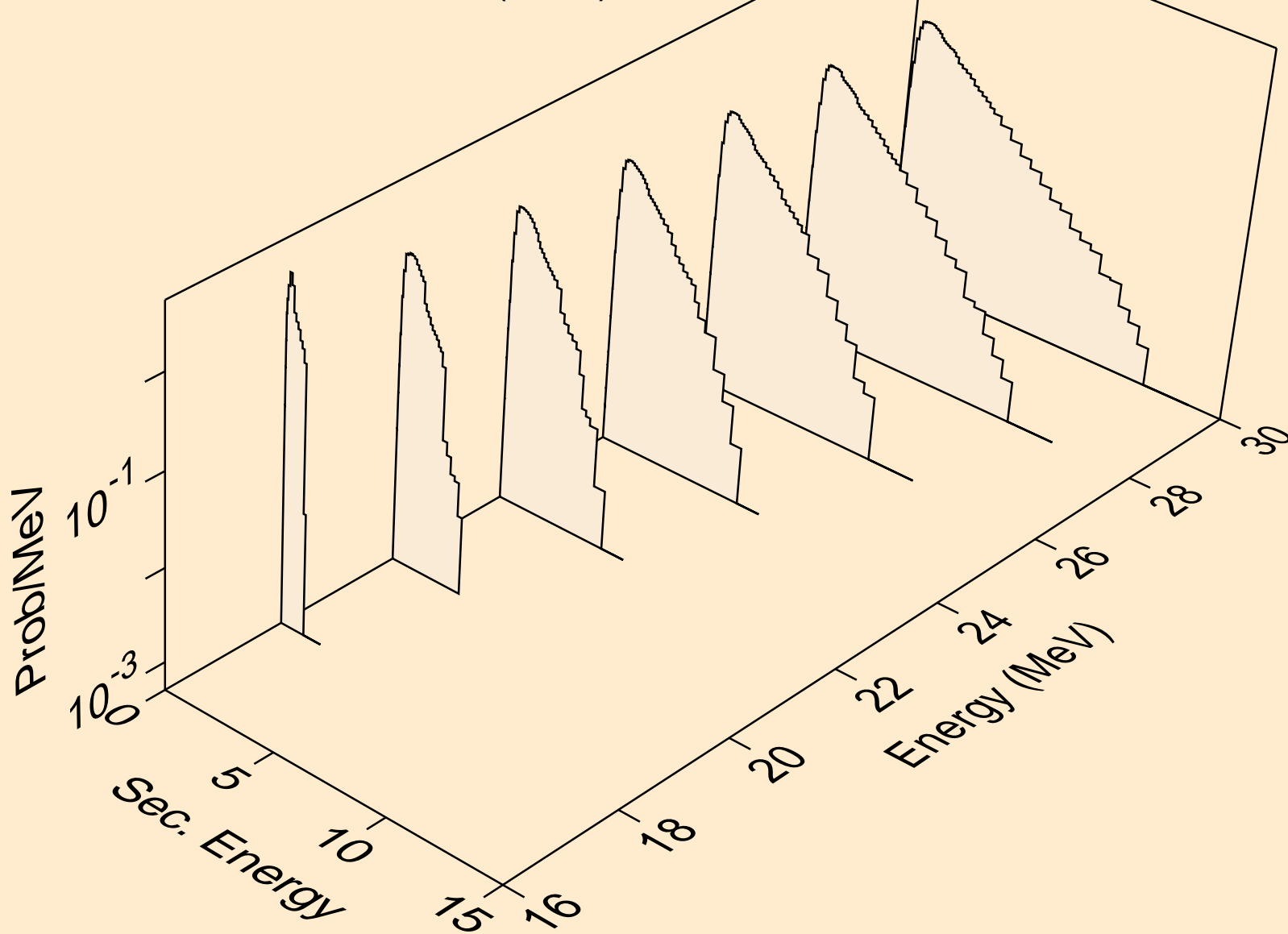

SB118M NEUTRON ACER TENDL-2019 LIBRARY; T=293.16K
Neutron emission for (n,n*)a

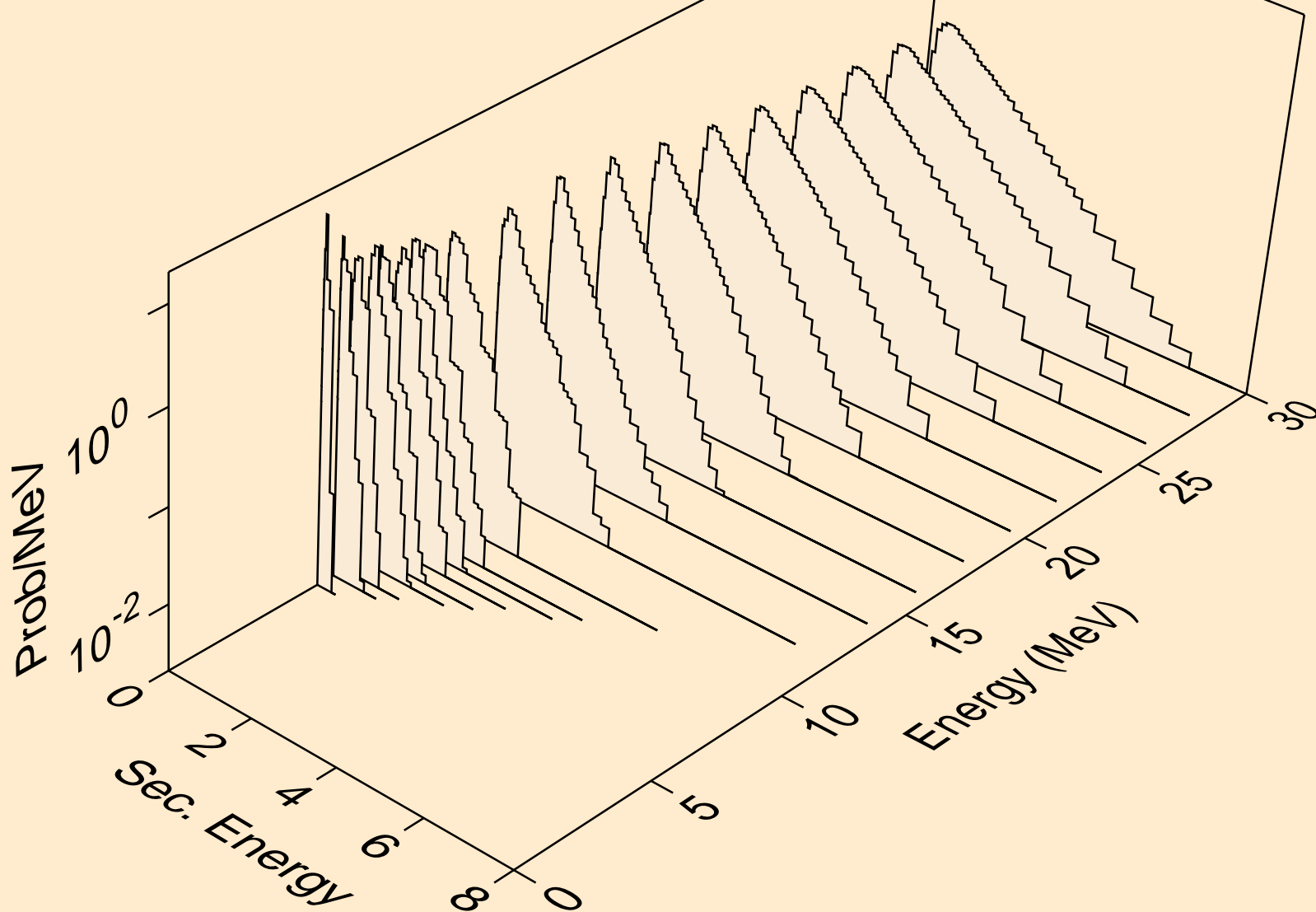

SB118M NEUTRON ACER TENDL-2019 LIBRARY; T=293.16K
Neutron emission for (n,2n)a

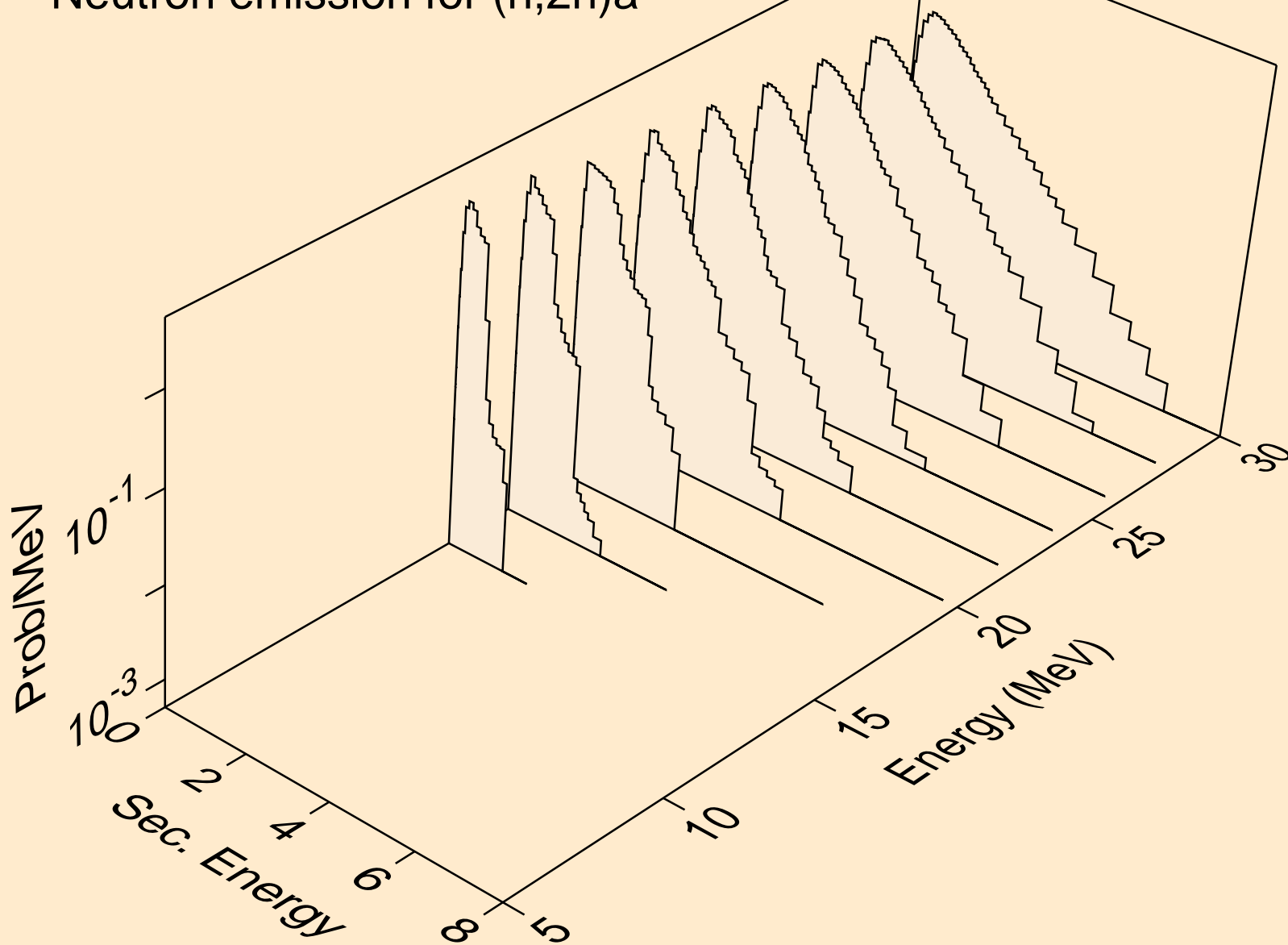

SB118M NEUTRON ACER TENDL-2019 LIBRARY; T=293.16K
Neutron emission for (n,3n)a

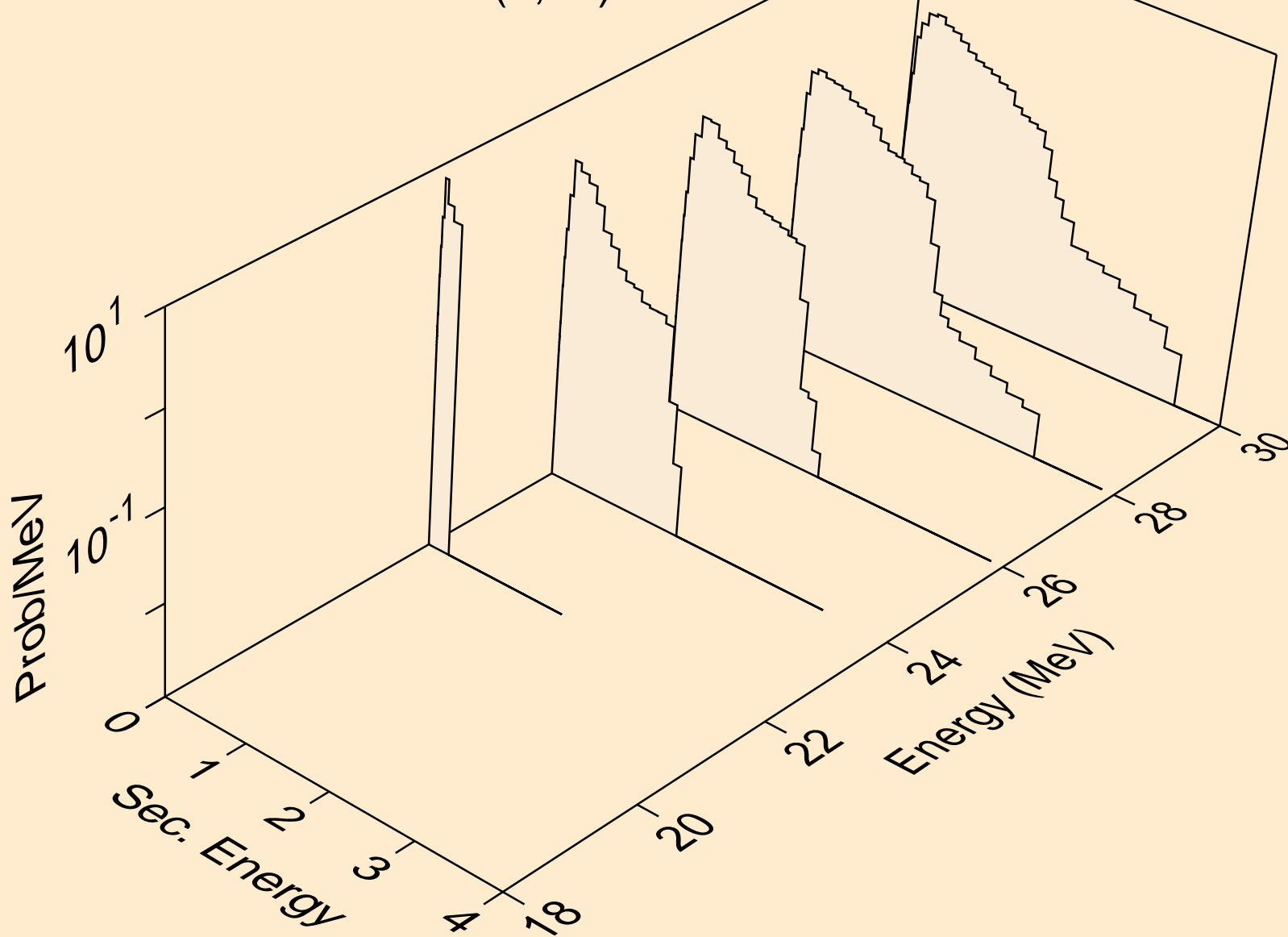

SB118M NEUTRON ACER TENDL-2019 LIBRARY; T=293.16K
Neutron emission for (n,n*)p

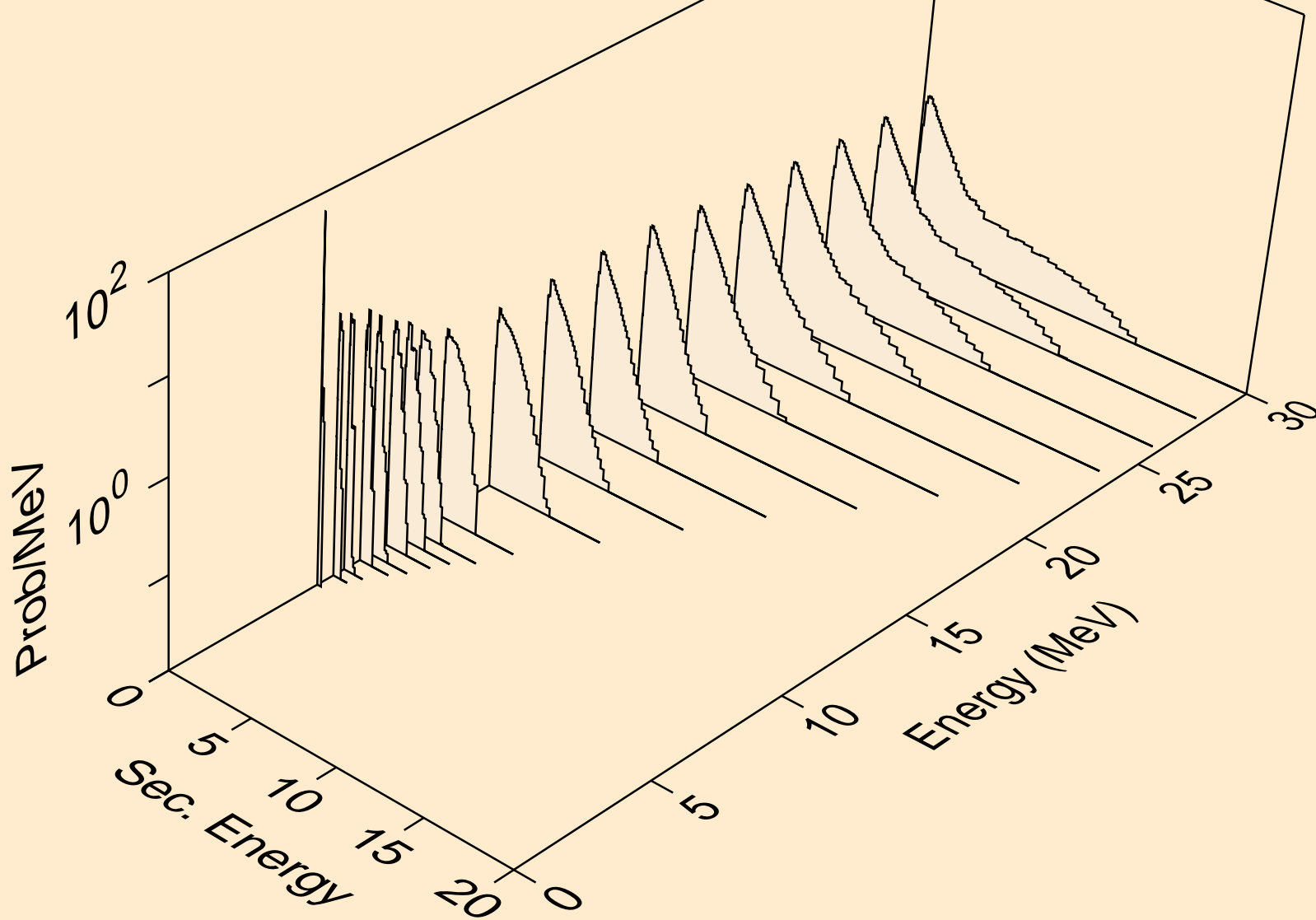

SB118M NEUTRON ACER TENDL-2019 LIBRARY; T=293.16K
Neutron emission for (n,n*)2a

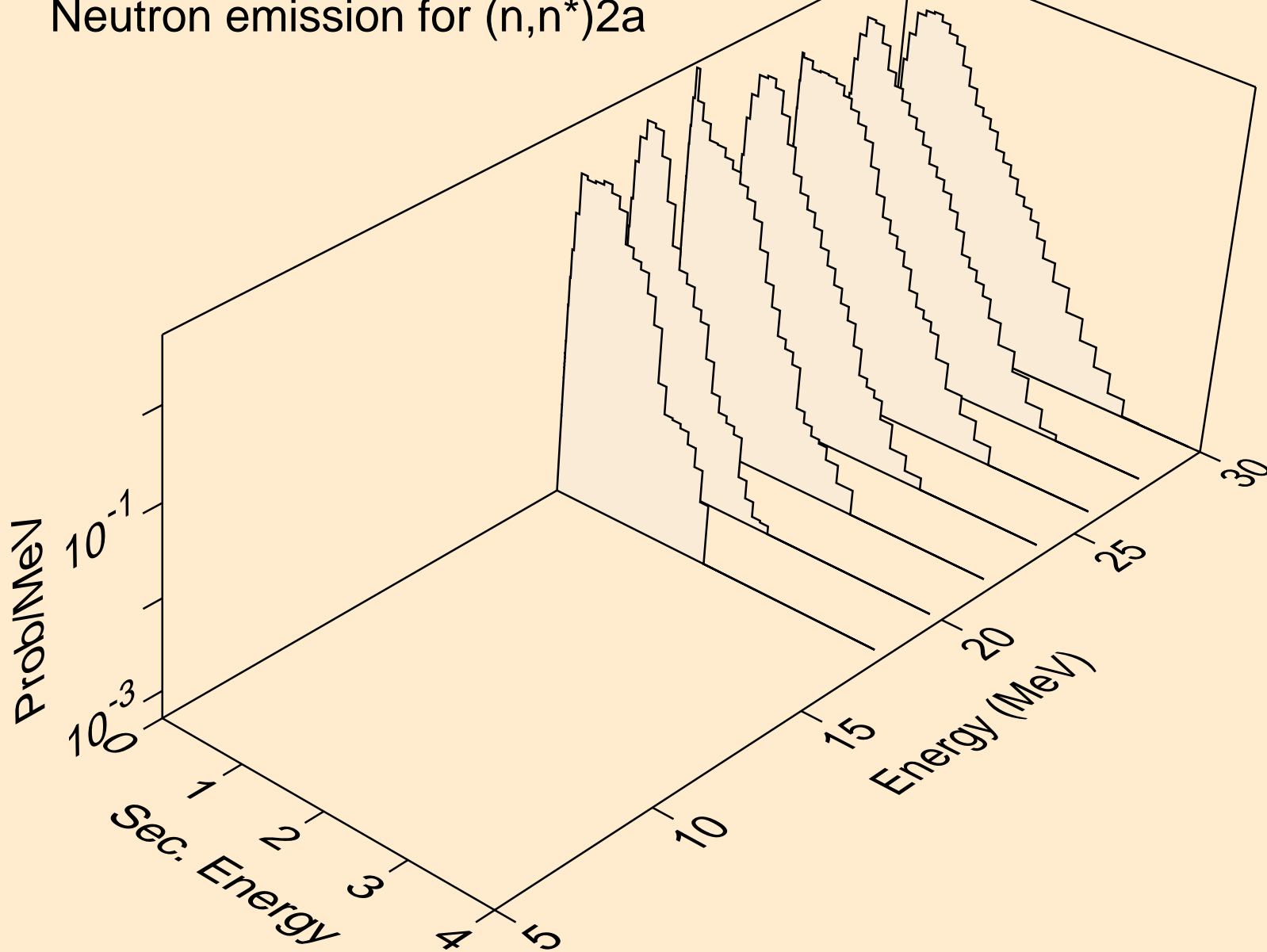

SB118M NEUTRON ACER TENDL-2019 LIBRARY; T=293.16K
Neutron emission for (n,n*)d

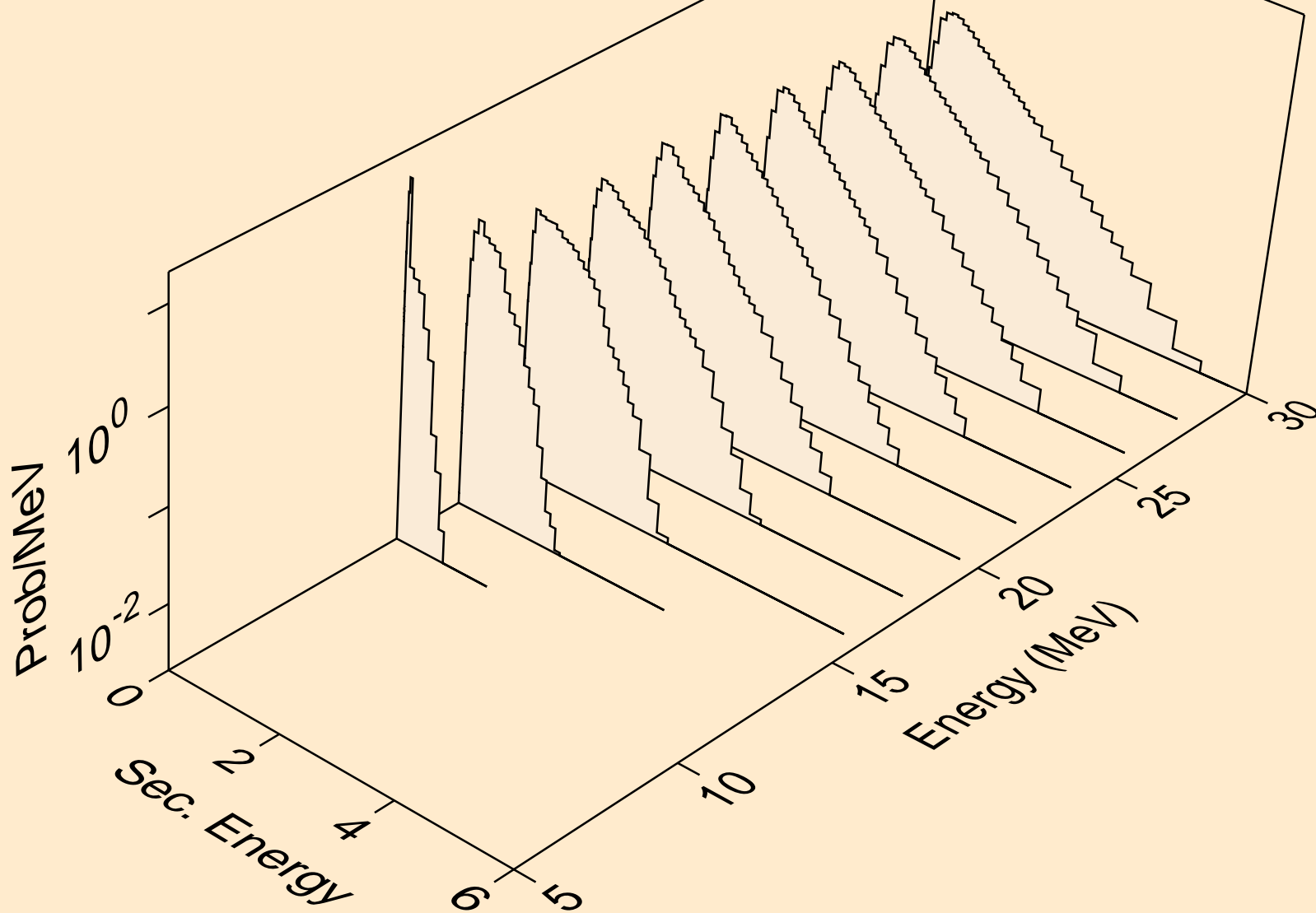

SB118M NEUTRON ACER TENDL-2019 LIBRARY; T=293.16K
Neutron emission for (n,n*)t

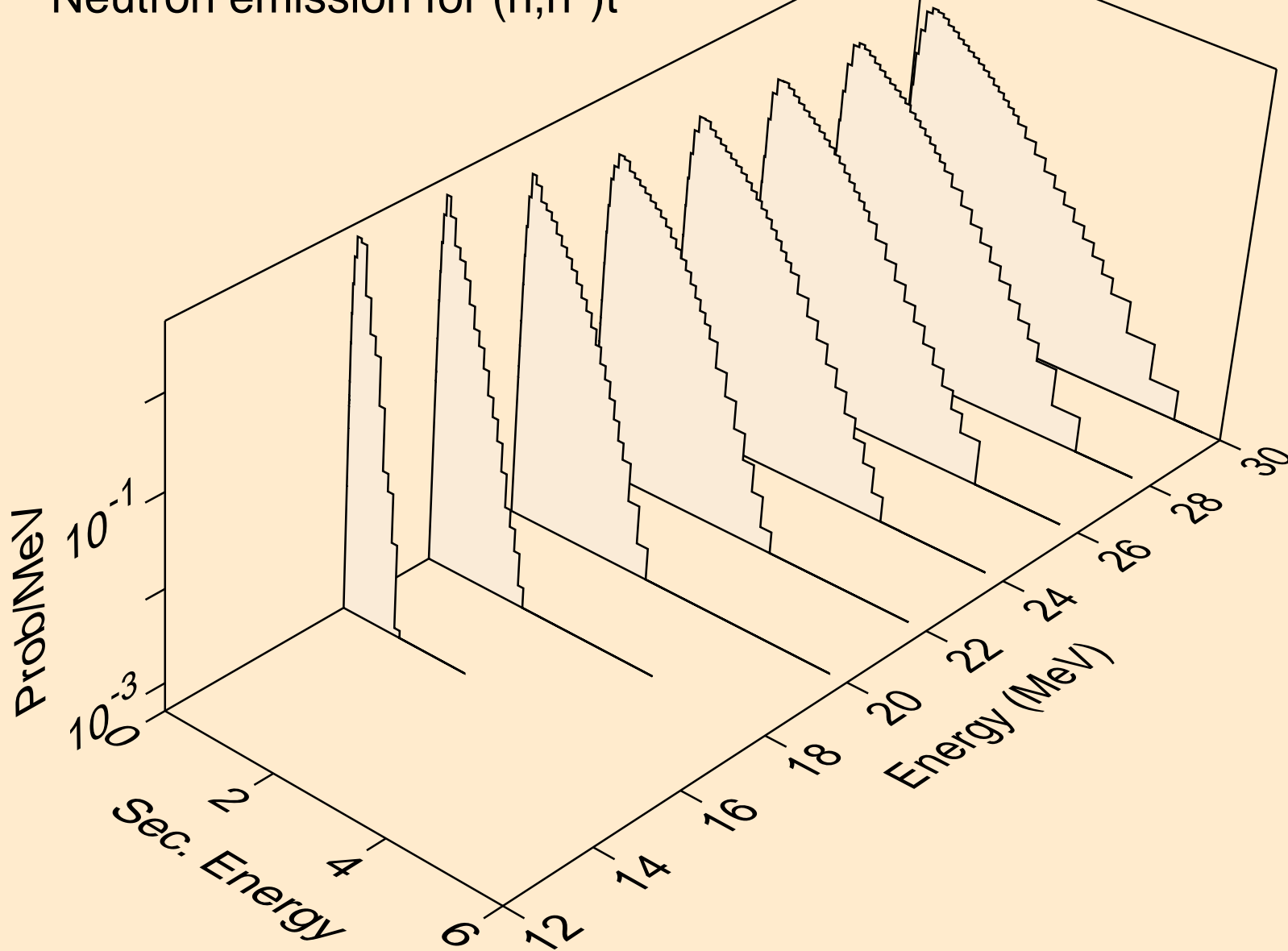

SB118M NEUTRON ACER TENDL-2019 LIBRARY; T=293.16K
Neutron emission for (n,n*)he3

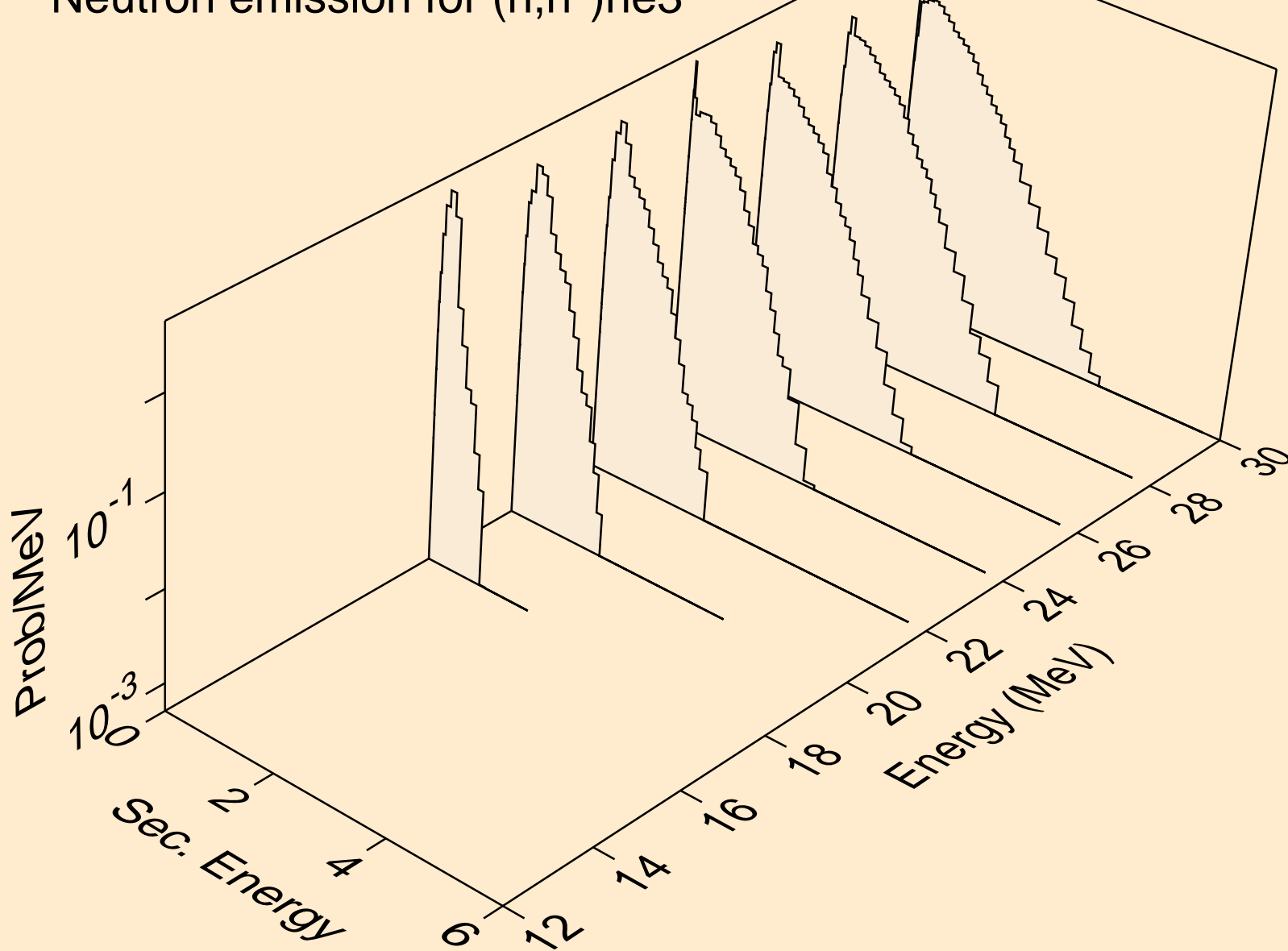

SB118M NEUTRON ACER TENDL-2019 LIBRARY; T=293.16K
Neutron emission for (n,4n)

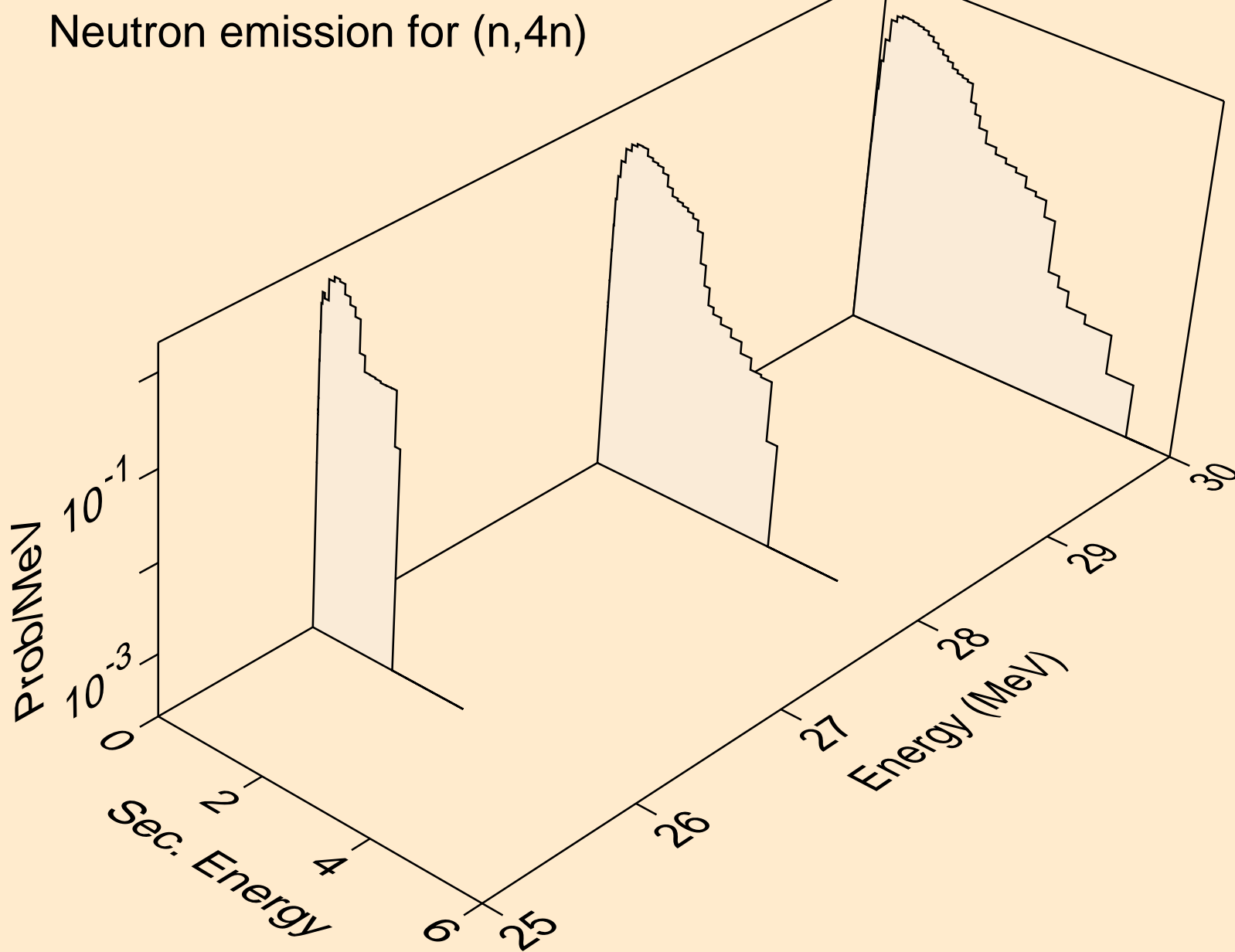

SB118M NEUTRON ACER TENDL-2019 LIBRARY; T=293.16K
Neutron emission for (n,2np)

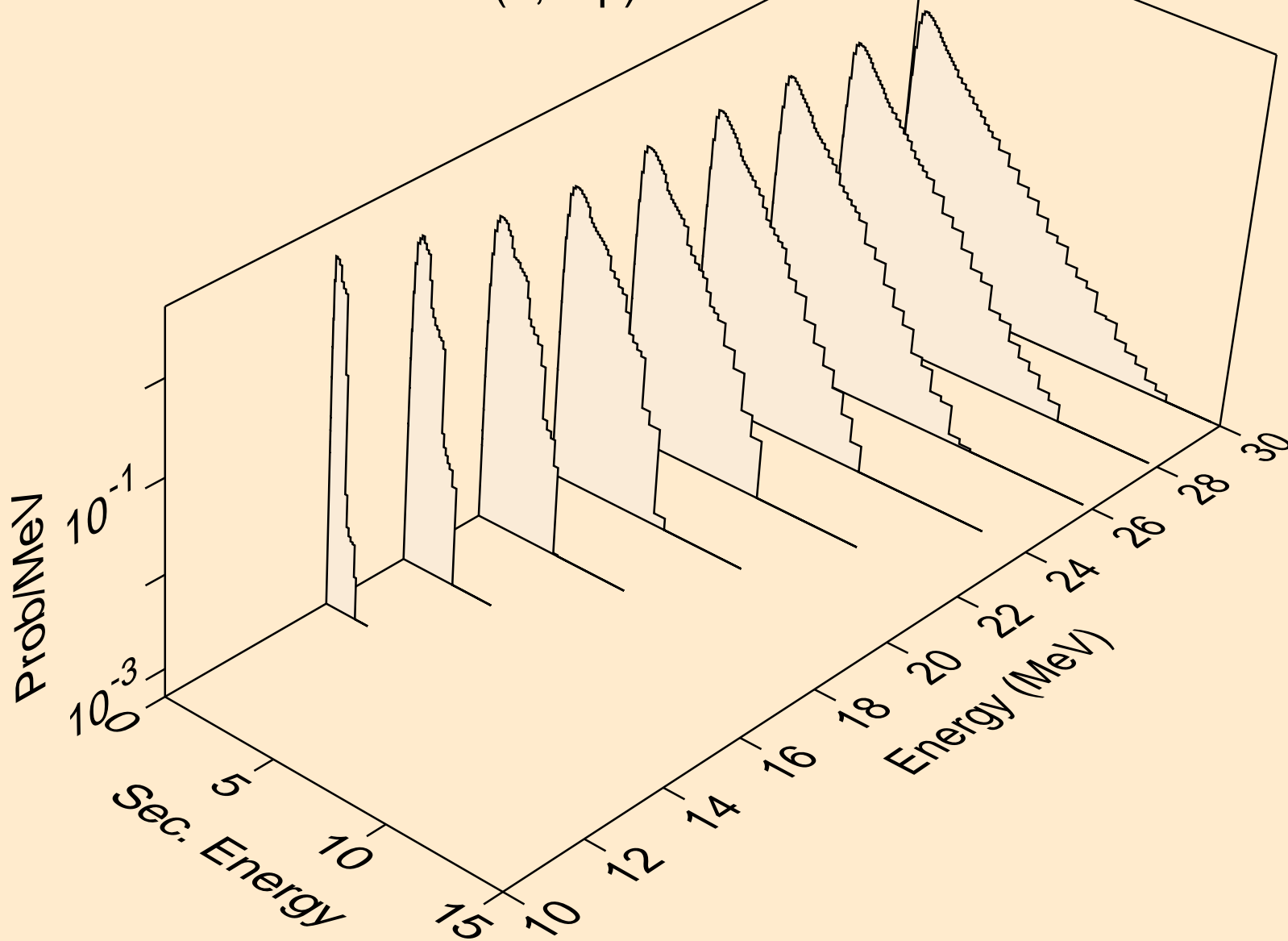

SB118M NEUTRON ACER TENDL-2019 LIBRARY; T=293.16K
Neutron emission for (n,3np)

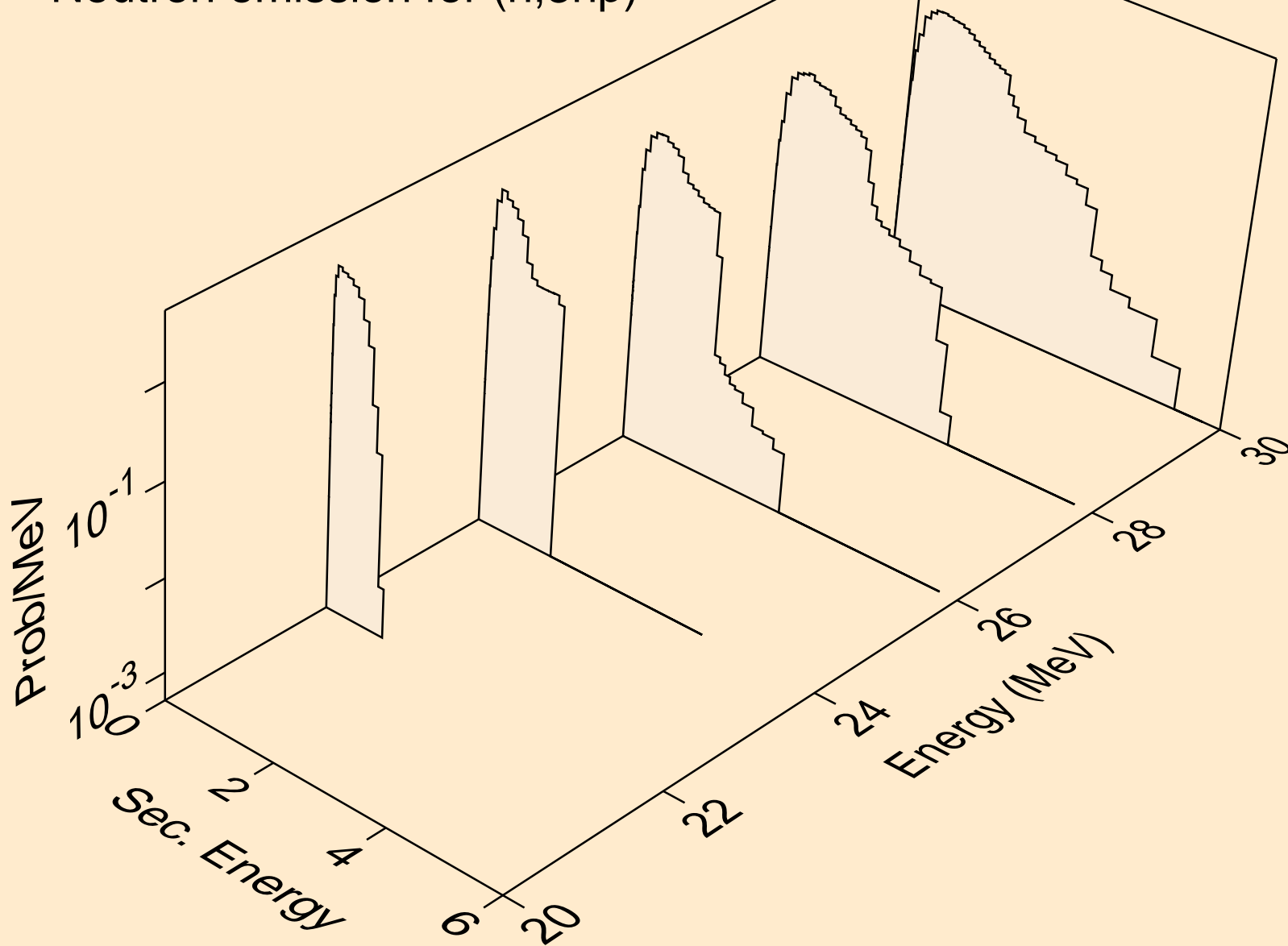

SB118M NEUTRON ACER TENDL-2019 LIBRARY; T=293.16K
Neutron emission for (n,2np)

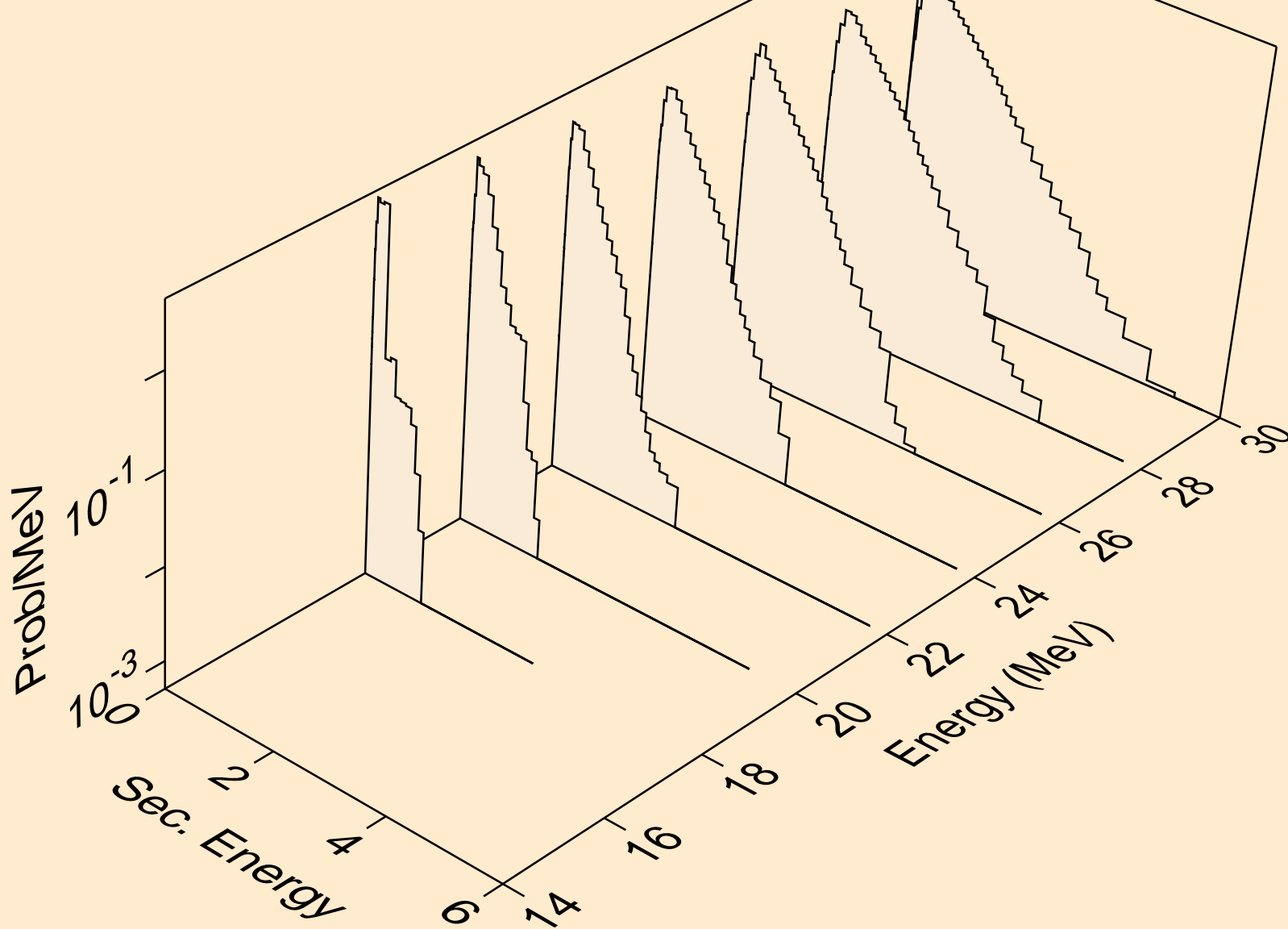

SB118M NEUTRON ACER TENDL-2019 LIBRARY; T=293.16K
Neutron emission for (n,npa)

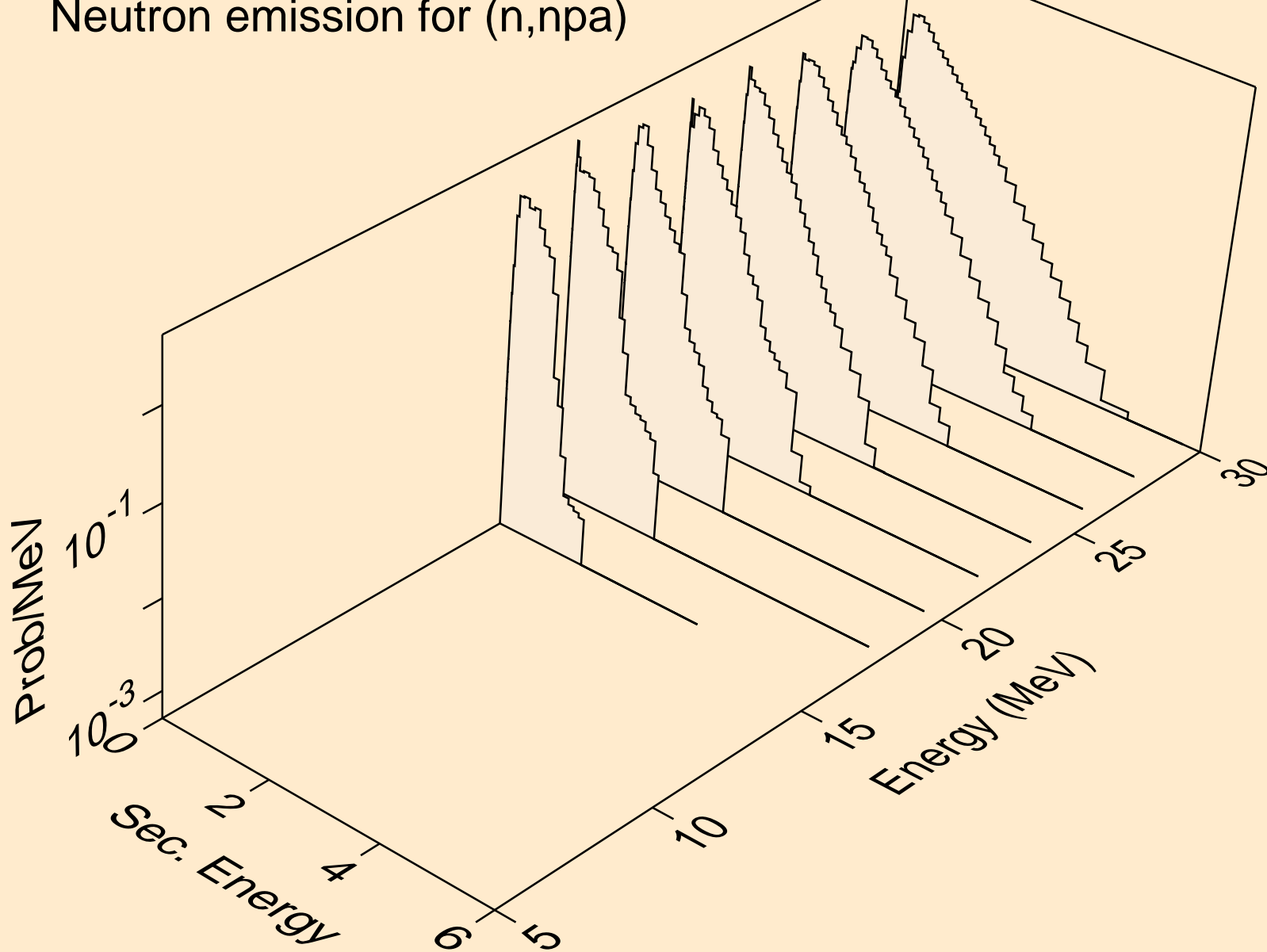

SB118M NEUTRON ACER TENDL-2019 LIBRARY; T=293.16K
Neutron emission for (n,n*c)

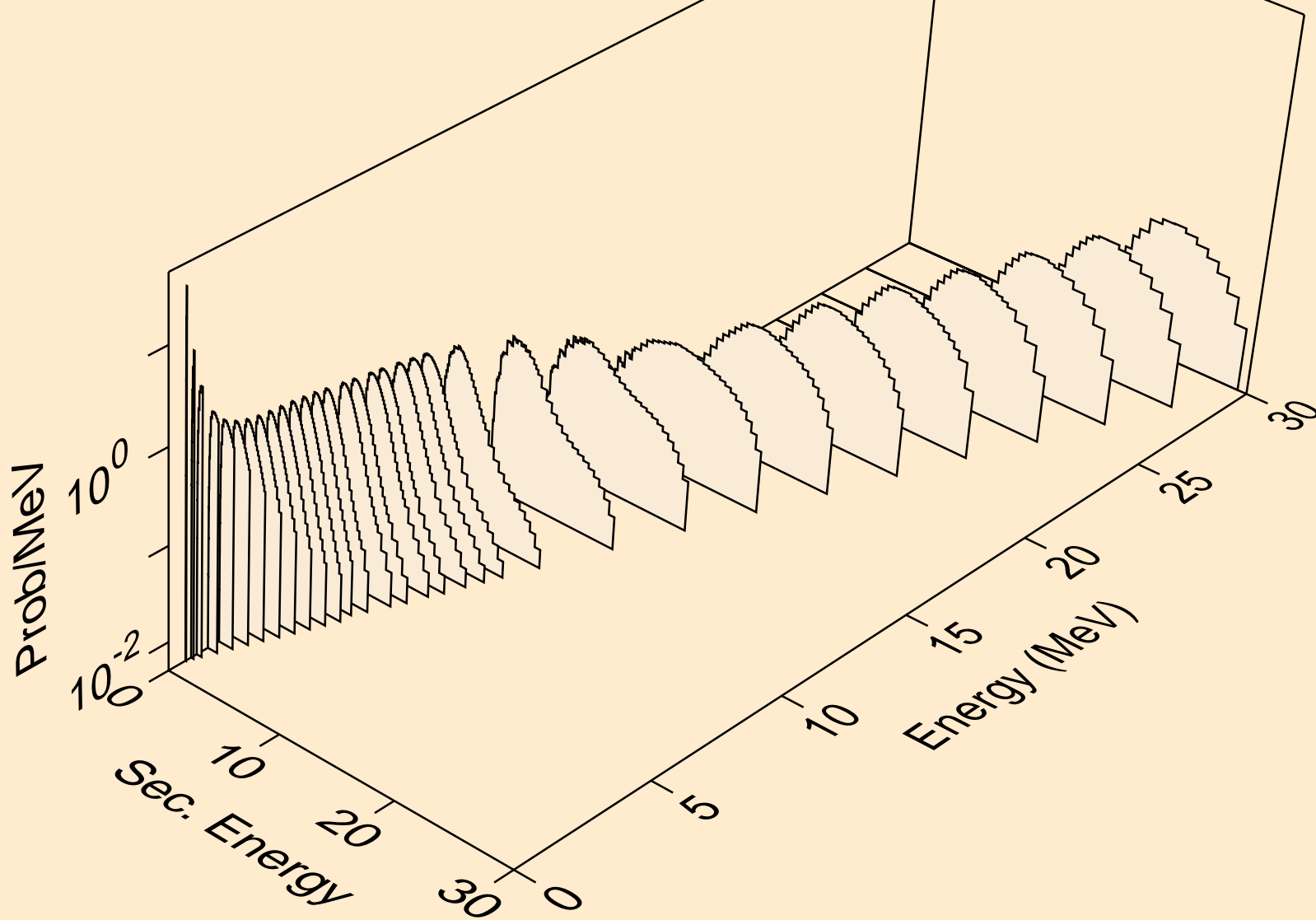

SB118M NEUTRON ACER TENDL-2019 LIBRARY; T=293.16K
Photon emission for (n,x)

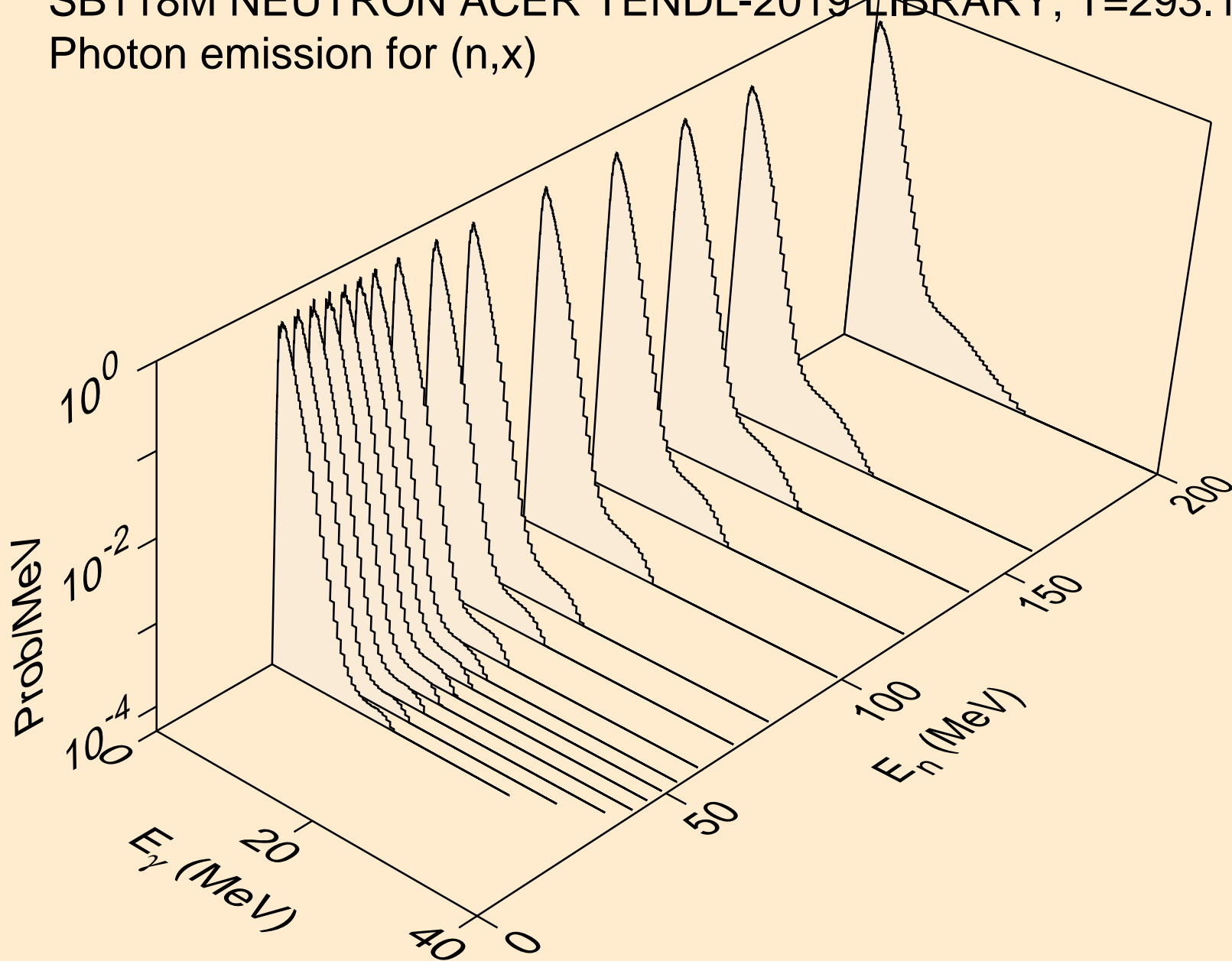

SB118M NEUTRON ACER TENDL-2019 LIBRARY; T=293.16K
Photon emission for (n,2nd)

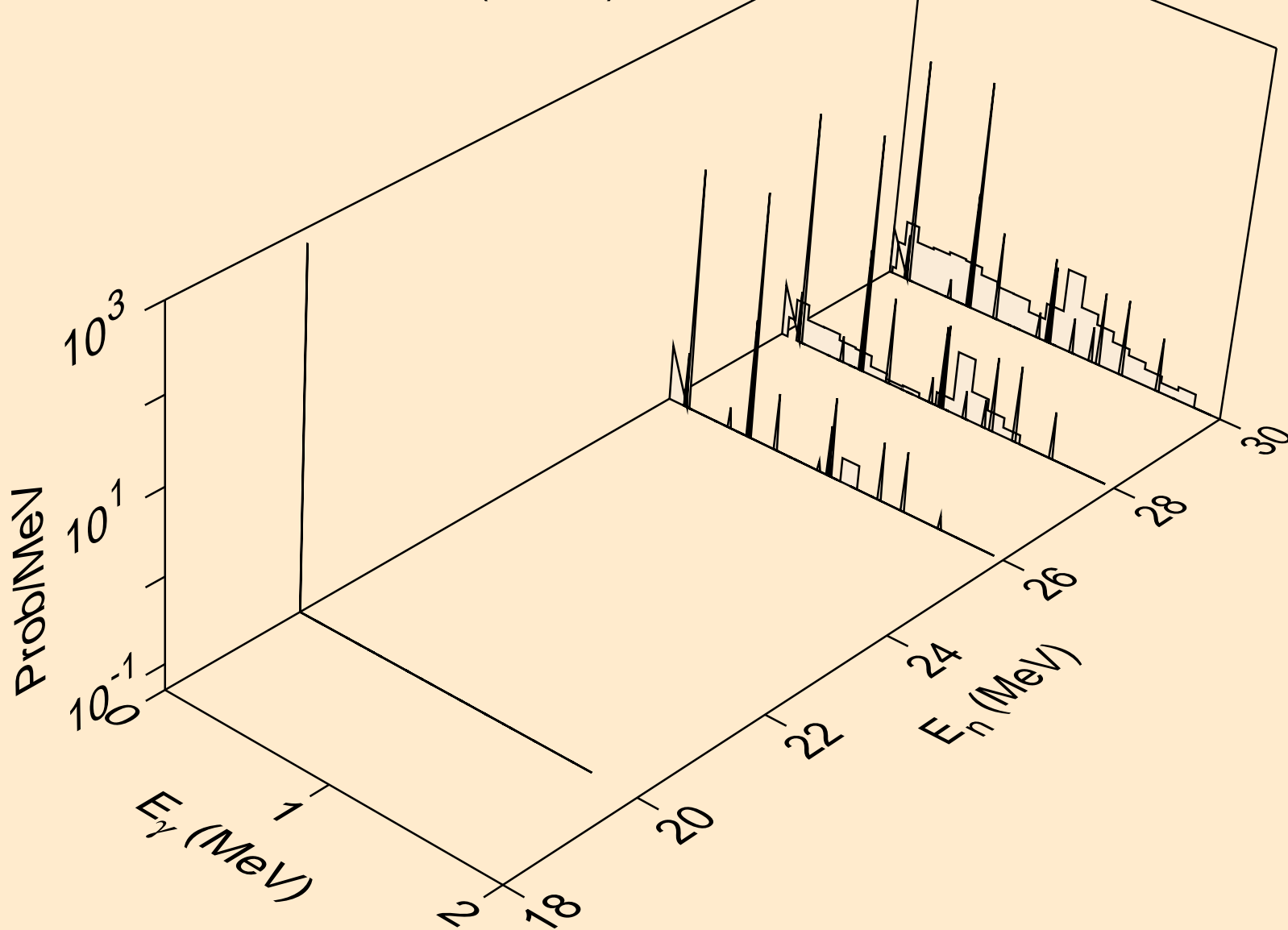

SB118M NEUTRON ACER TENDL-2019 LIBRARY; T=293.16K
Photon emission for (n,2n)

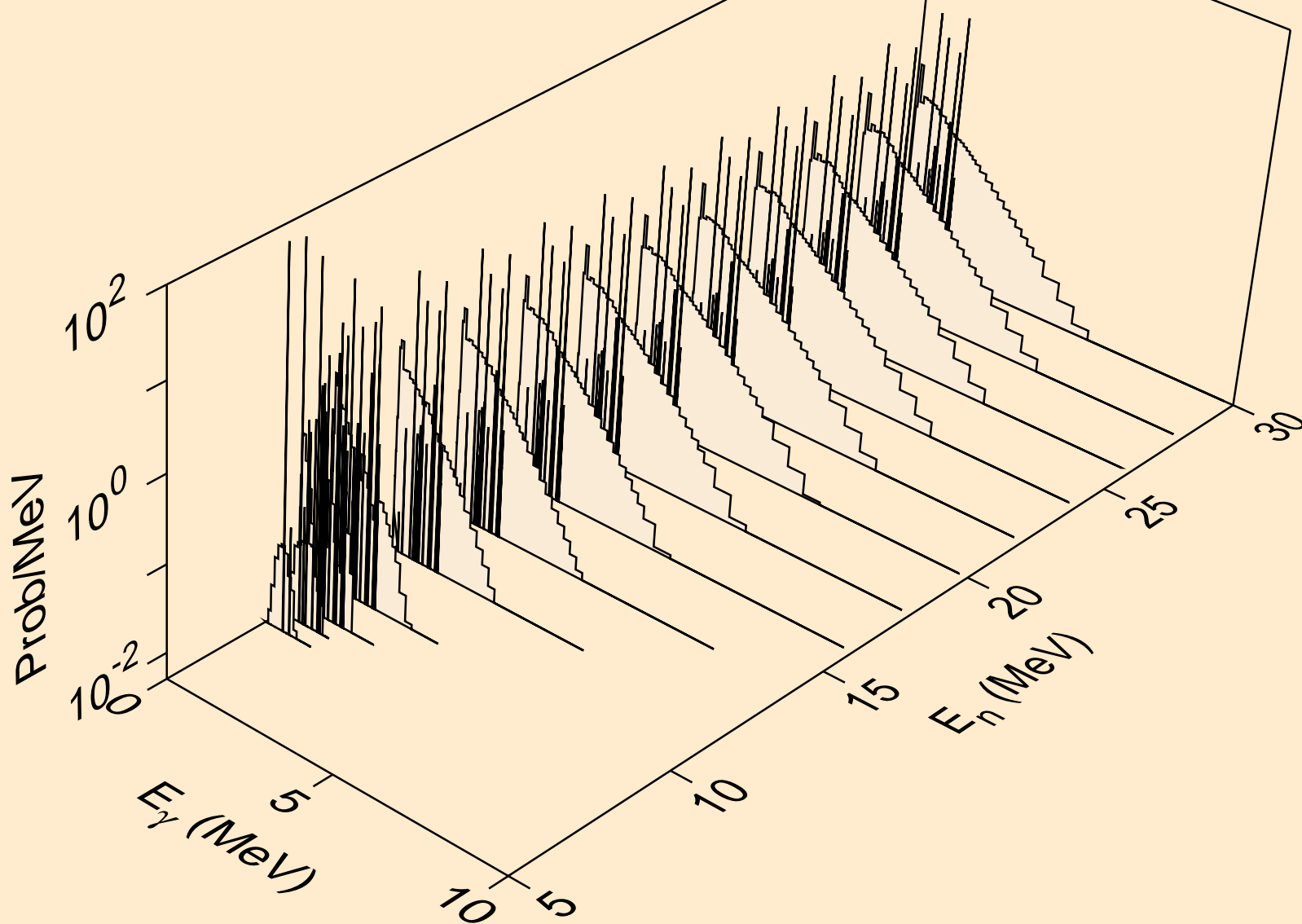

SB118M NEUTRON ACER TENDL-2019 LIBRARY; T=293.16K
Photon emission for (n,3n)

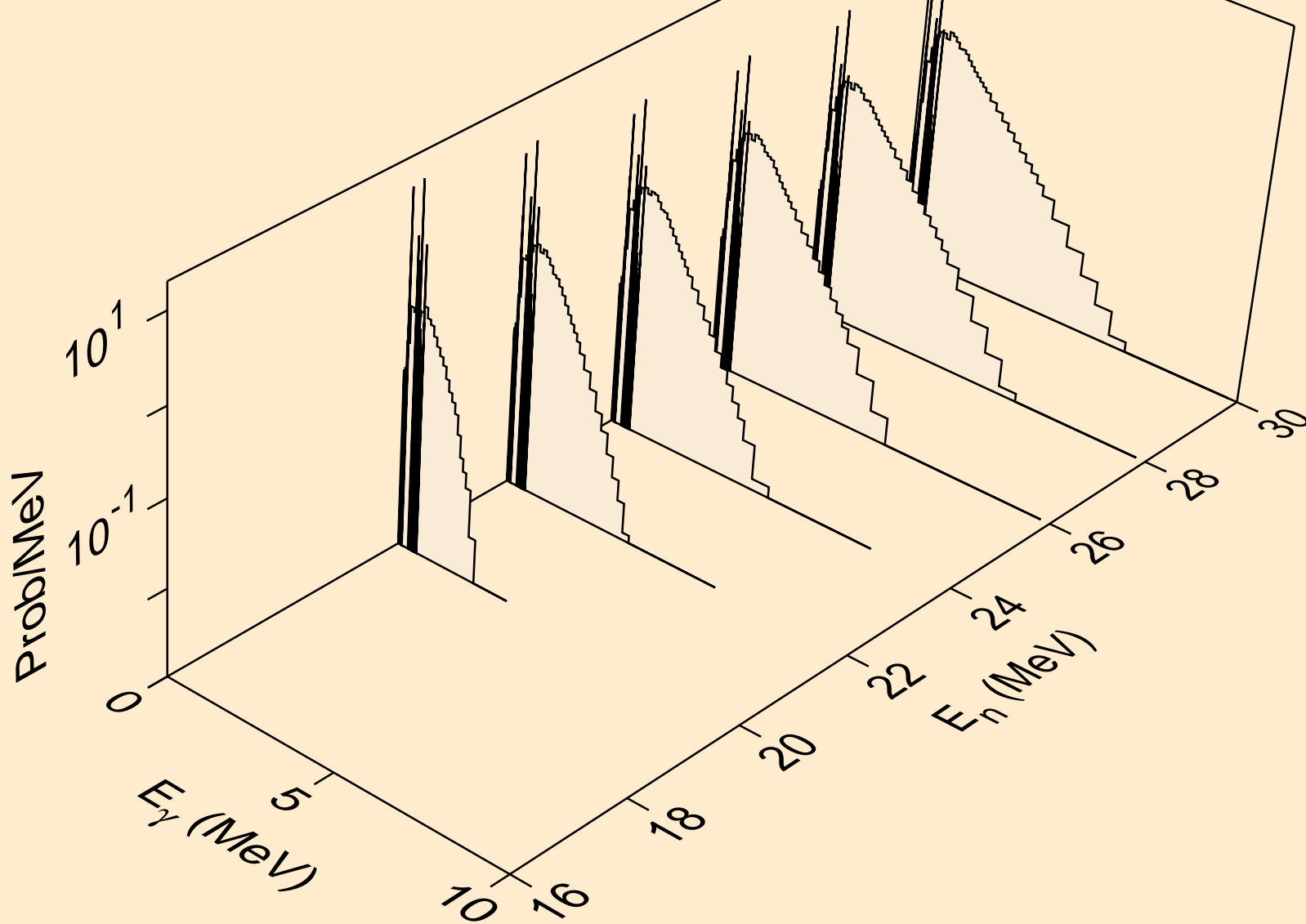

SB118M NEUTRON ACER TENDL-2019 LIBRARY; T=293.16K
Photon emission for (n,n*)a

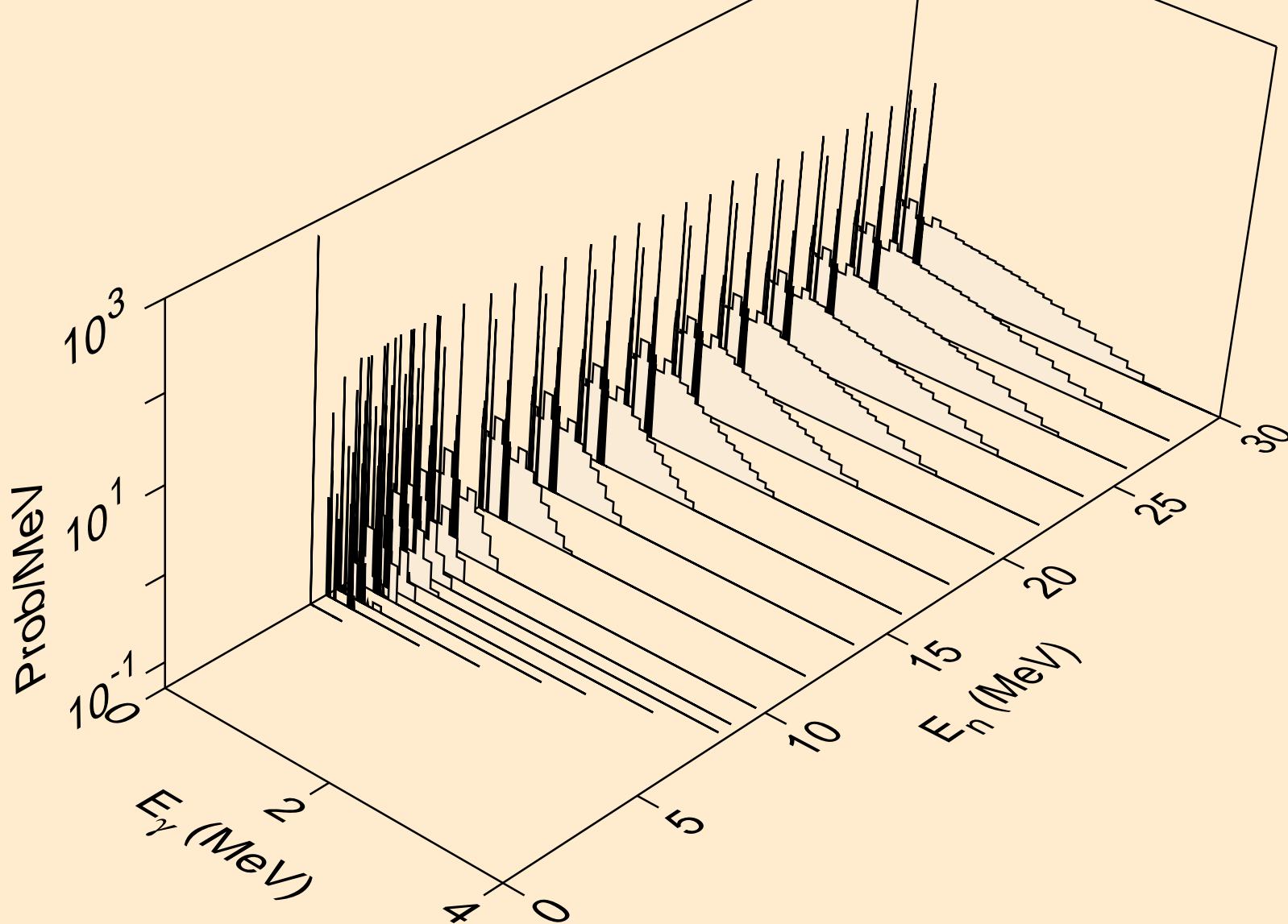

SB118M NEUTRON ACER TENDL-2019 LIBRARY; T=293.16K
Photon emission for (n,2n)a

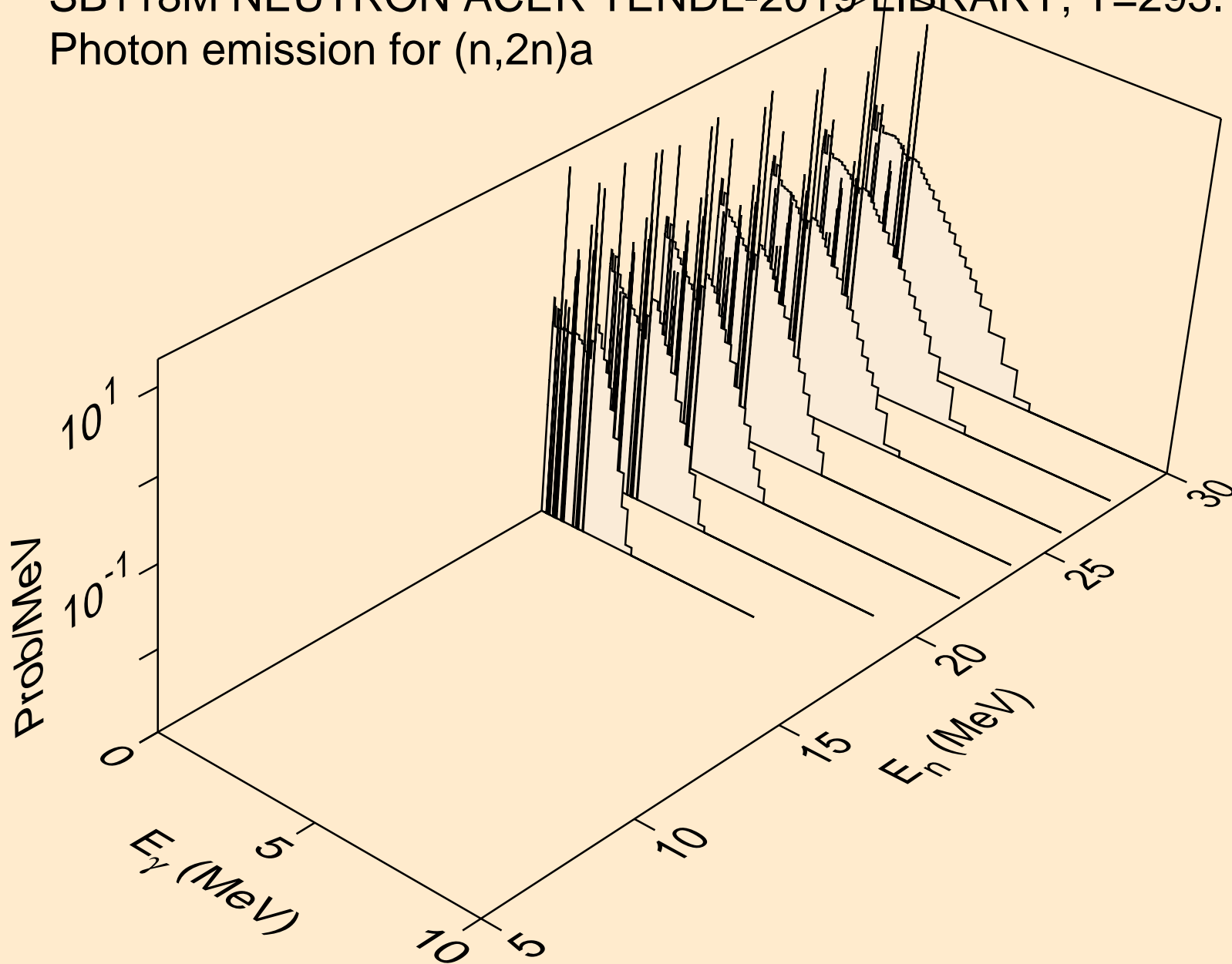

SB118M NEUTRON ACER TENDL-2019 LIBRARY; T=293.16K
Photon emission for (n,3n)a

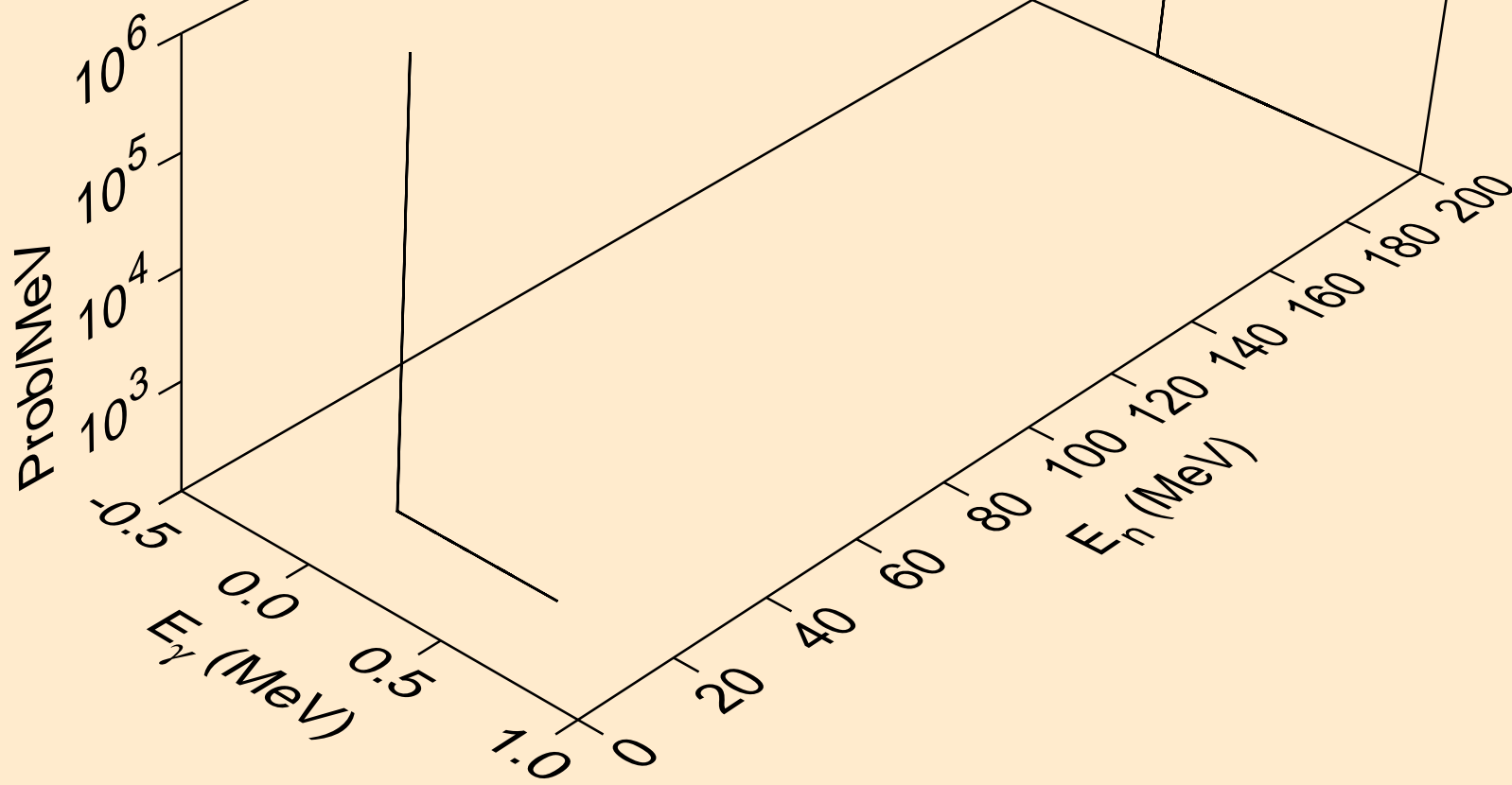

SB118M NEUTRON ACER TENDL-2019 LIBRARY; T=293.16K
Photon emission for (n,n*)p

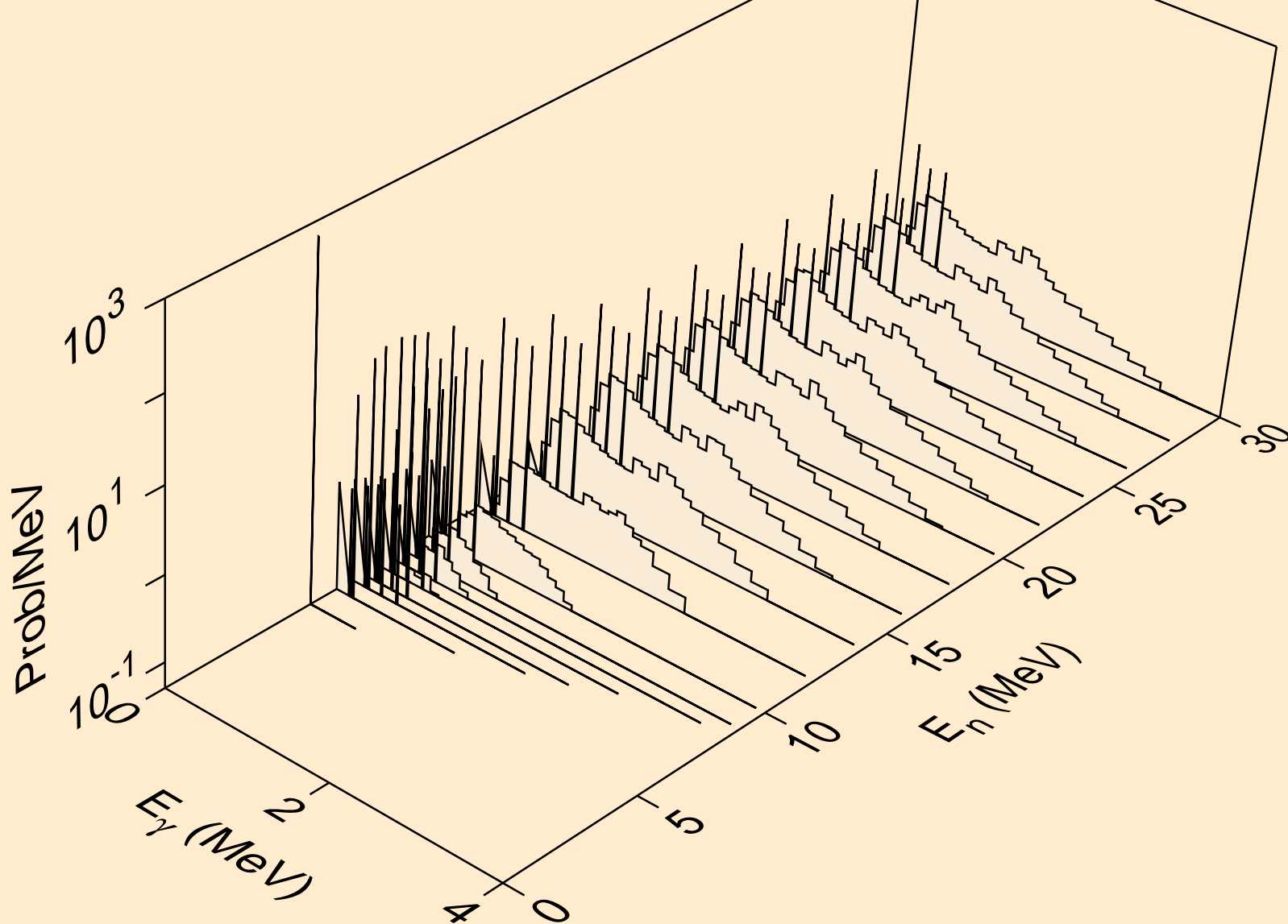

SB118M NEUTRON ACER TENDL-2019 LIBRARY; T=293.16K
Photon emission for (n,n*)2a

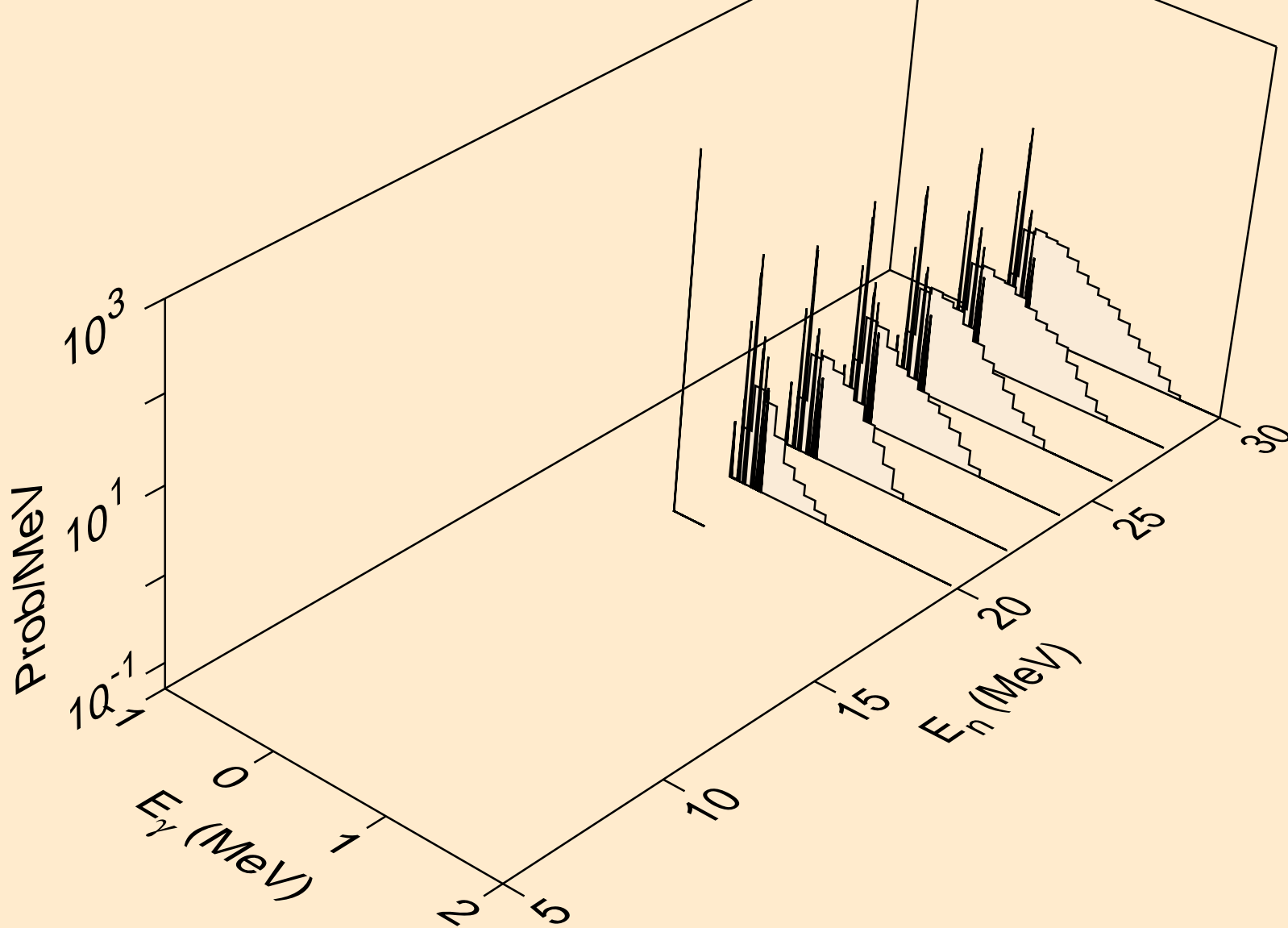

SB118M NEUTRON ACER TENDL-2019 LIBRARY; T=293.16K
Photon emission for (n,n*)d

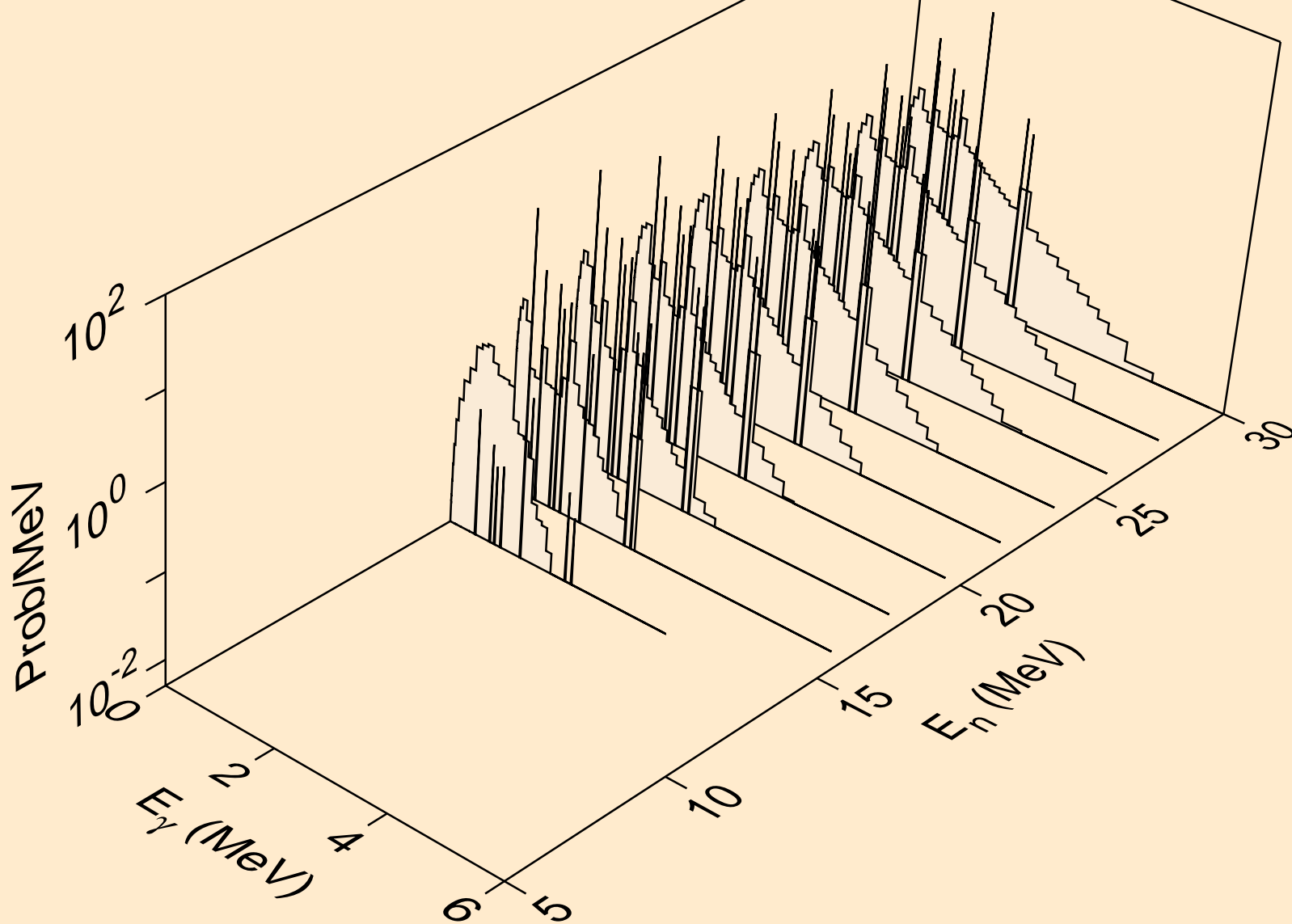

SB118M NEUTRON ACER TENDL-2019 LIBRARY; T=293.16K
Photon emission for (n,n*)t

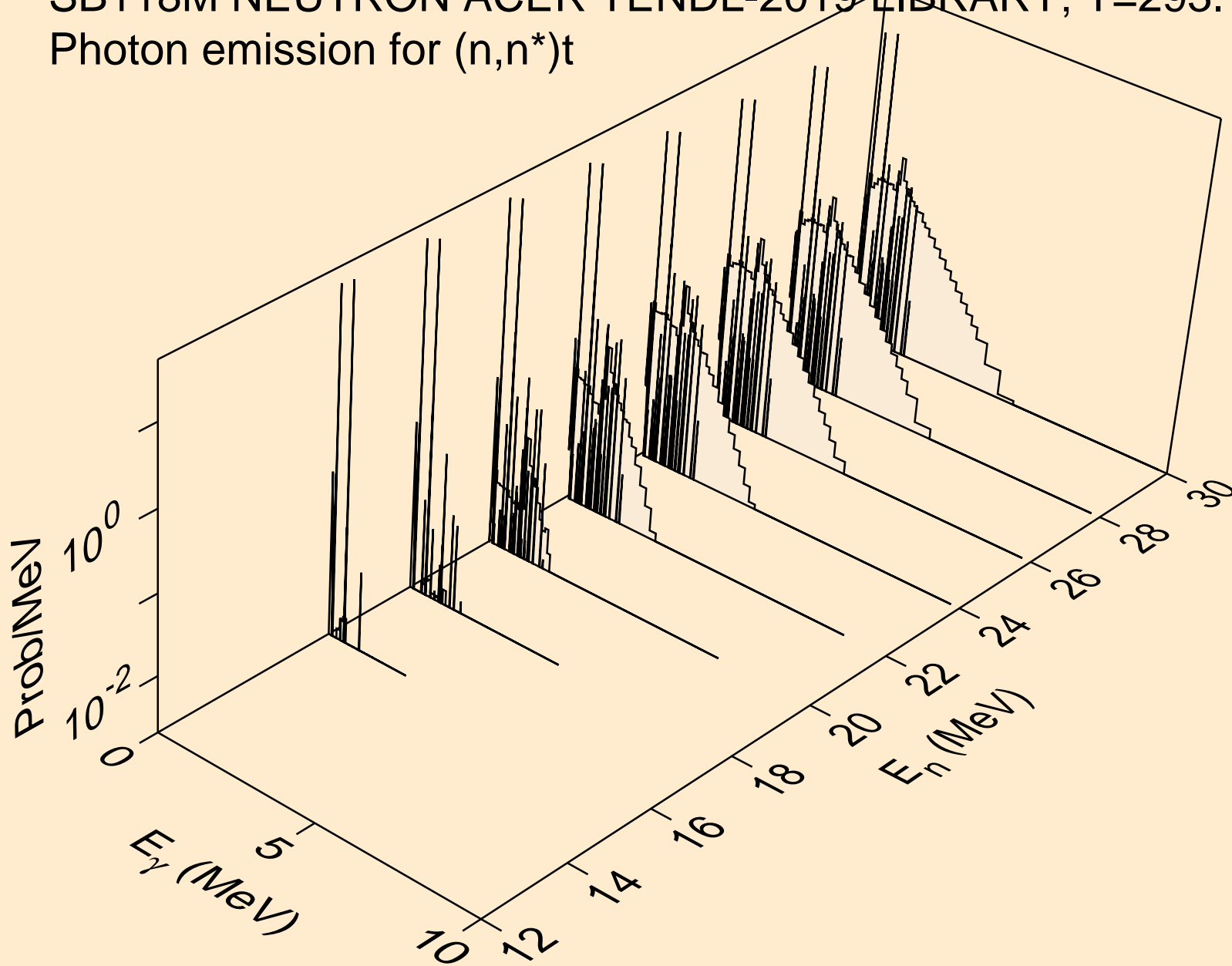

SB118M NEUTRON ACER TENDL-2019 LIBRARY; T=293.16K
Photon emission for (n,n*)he3

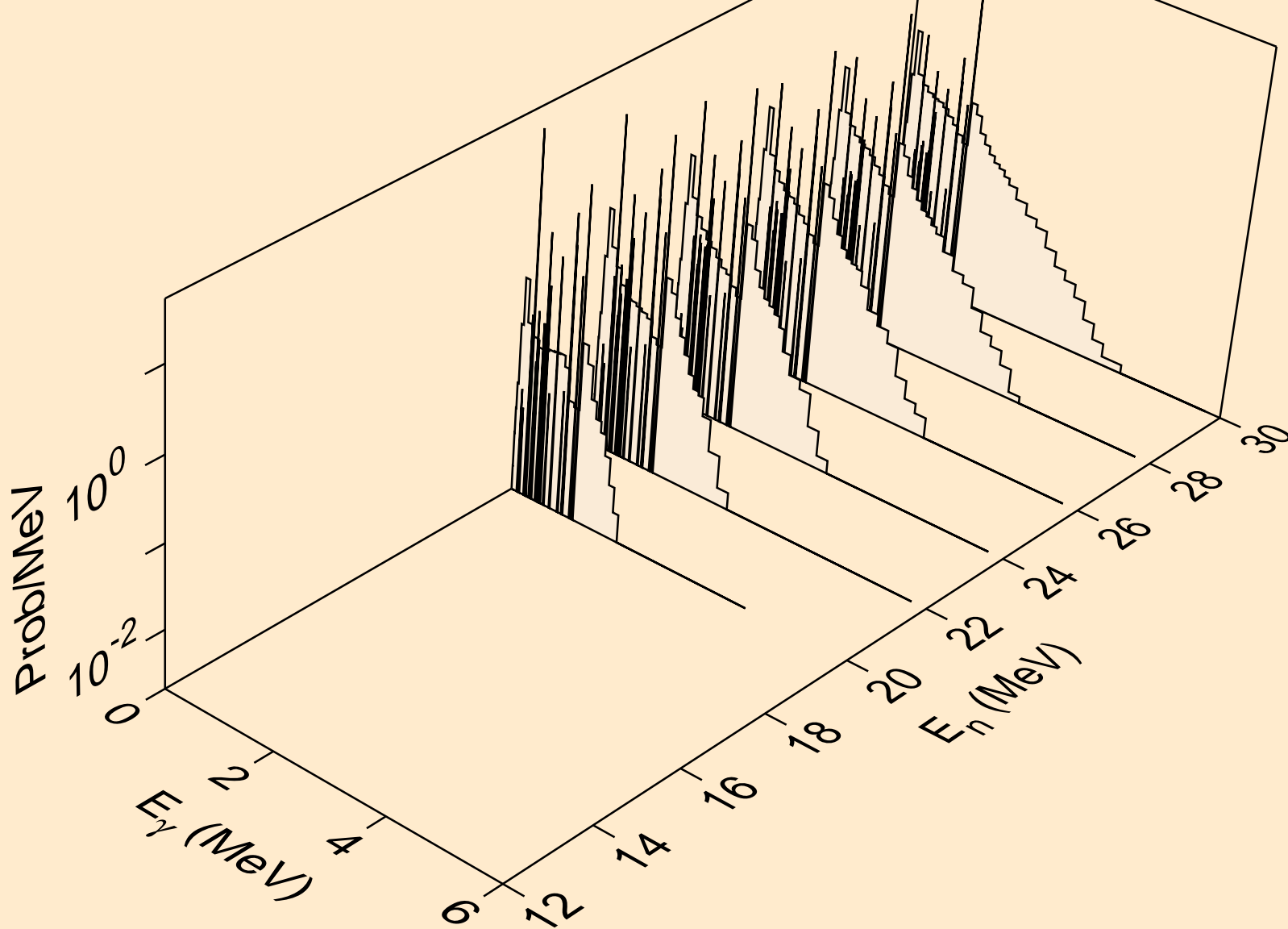

SB118M NEUTRON ACER TENDL-2019 LIBRARY; T=293.16K
Photon emission for (n,4n)

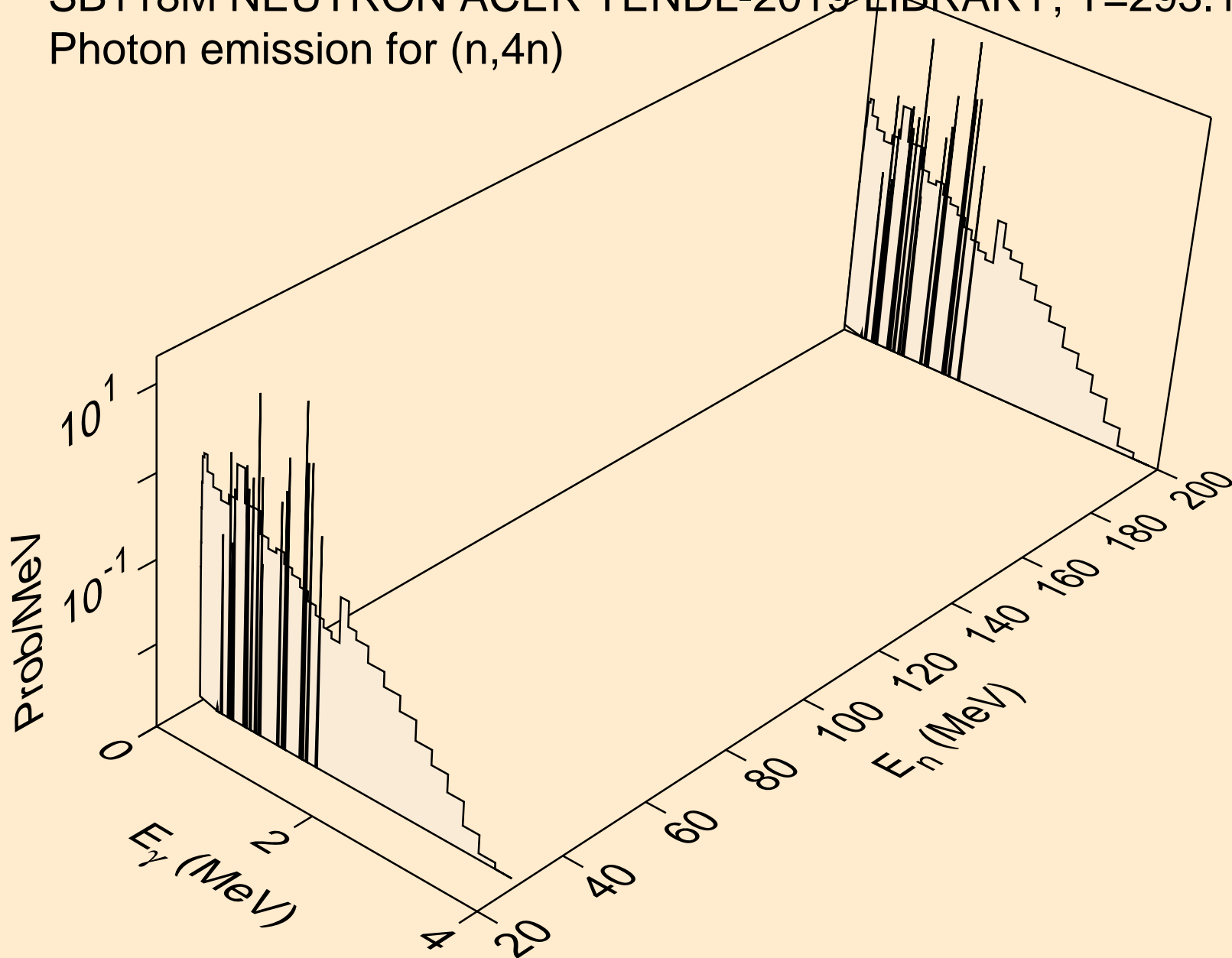

SB118M NEUTRON ACER TENDL-2019 LIBRARY; T=293.16K
Photon emission for (n,2np)

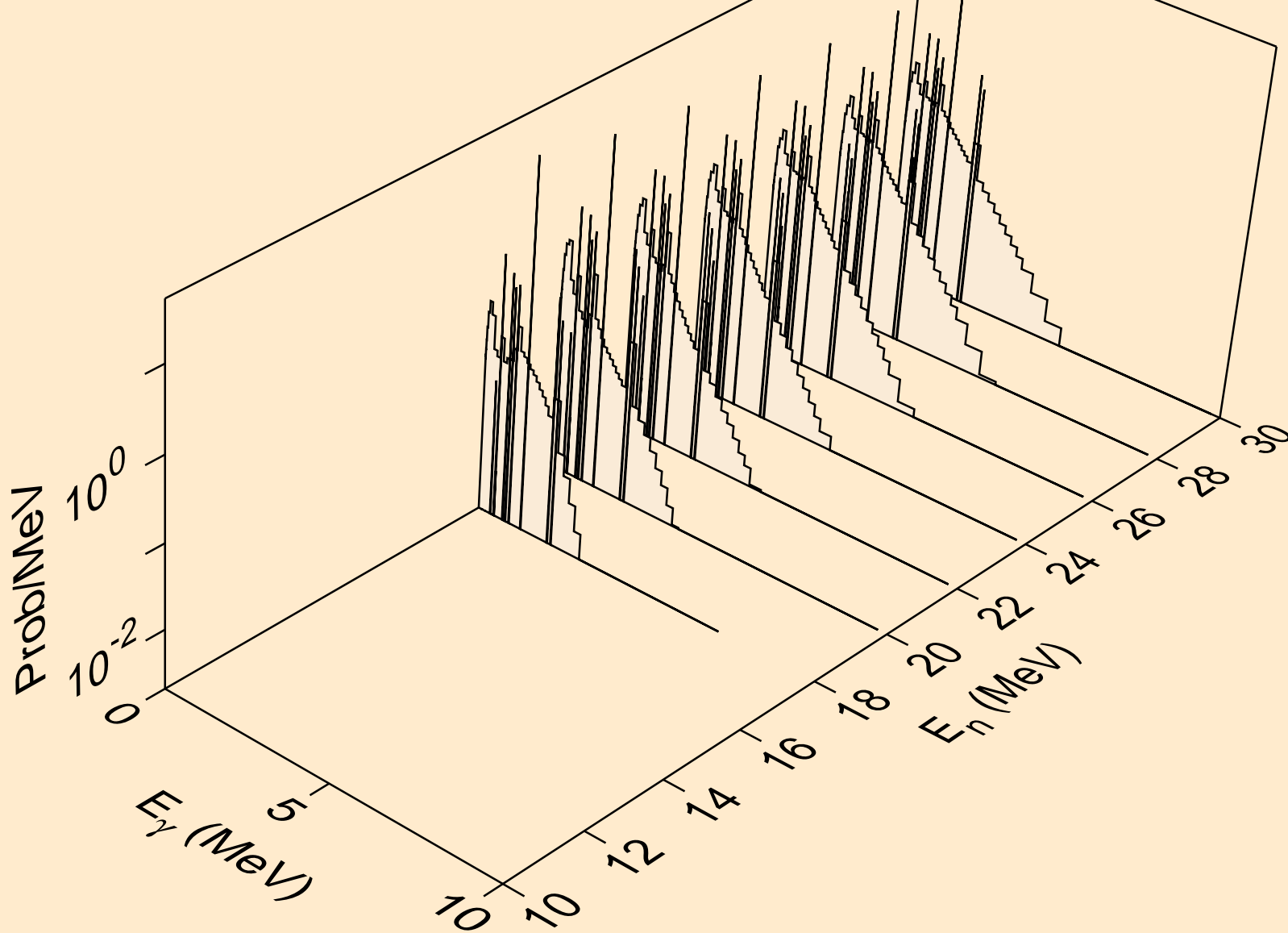

SB118M NEUTRON ACER TENDL-2019 LIBRARY; T=293.16K
Photon emission for (n,3np)

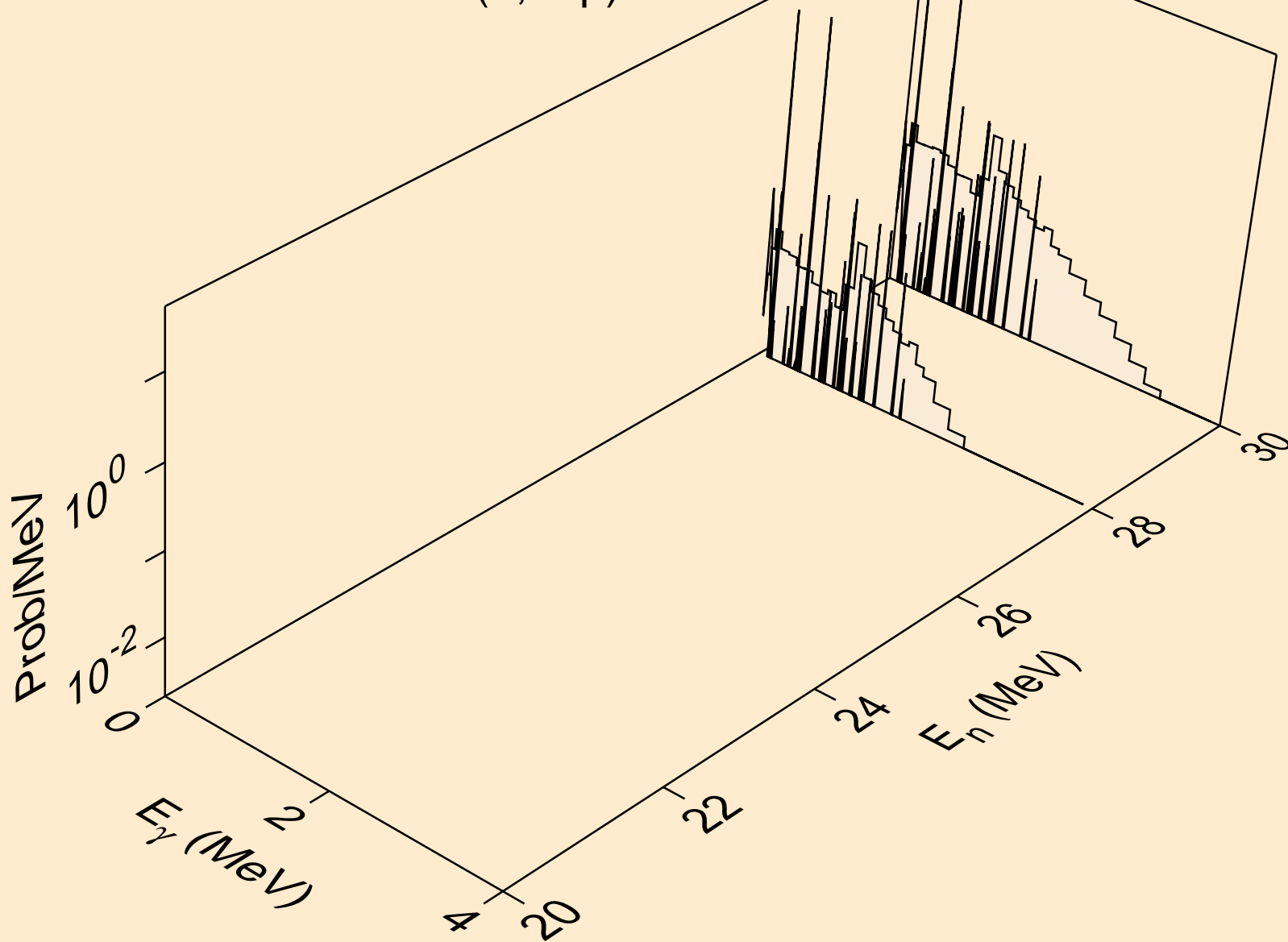

SB118M NEUTRON ACER TENDL-2019 LIBRARY; T=293.16K
Photon emission for (n,2np)

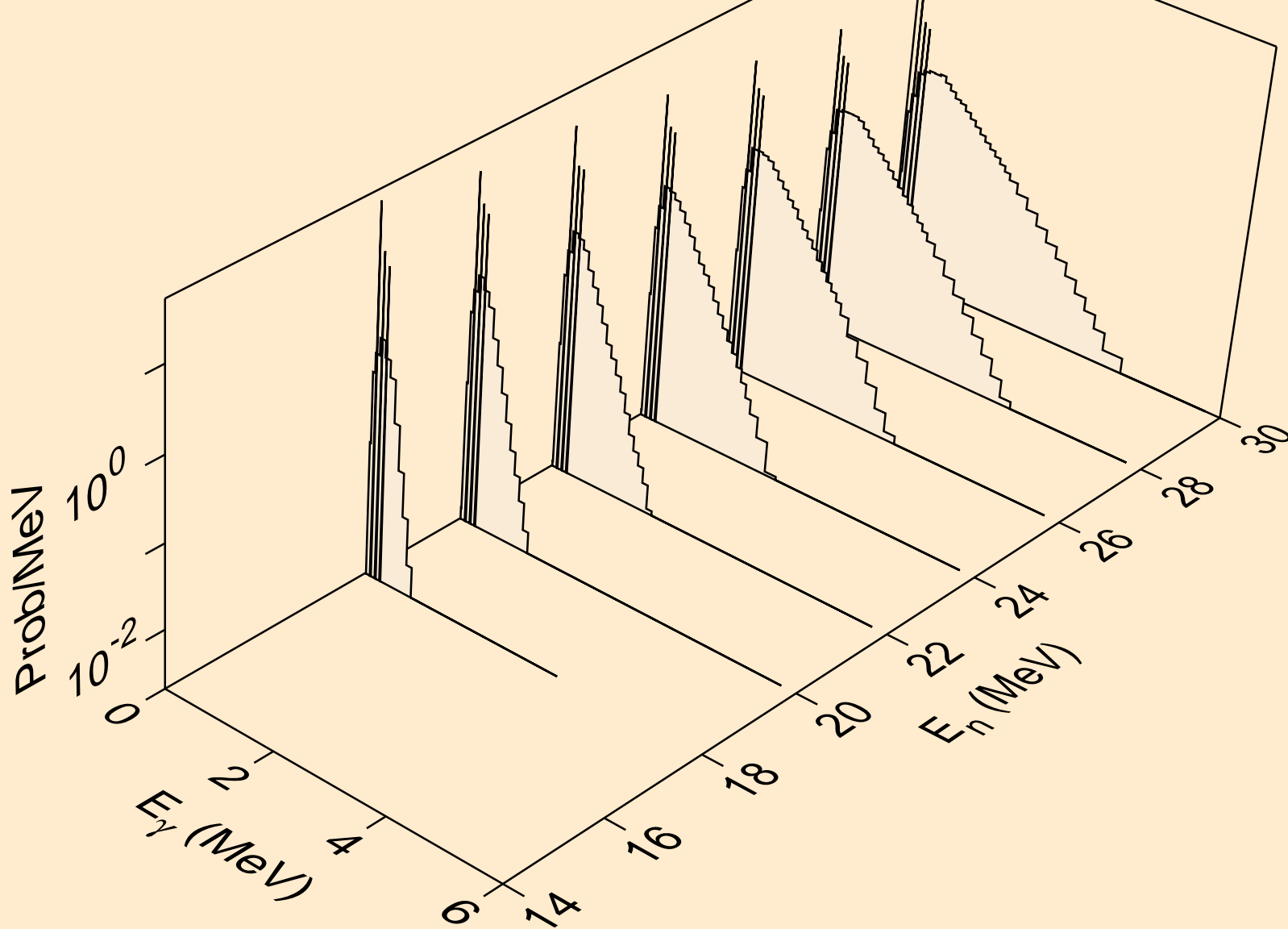

SB118M NEUTRON ACER TENDL-2019 LIBRARY; T=293.16K
Photon emission for (n,npa)

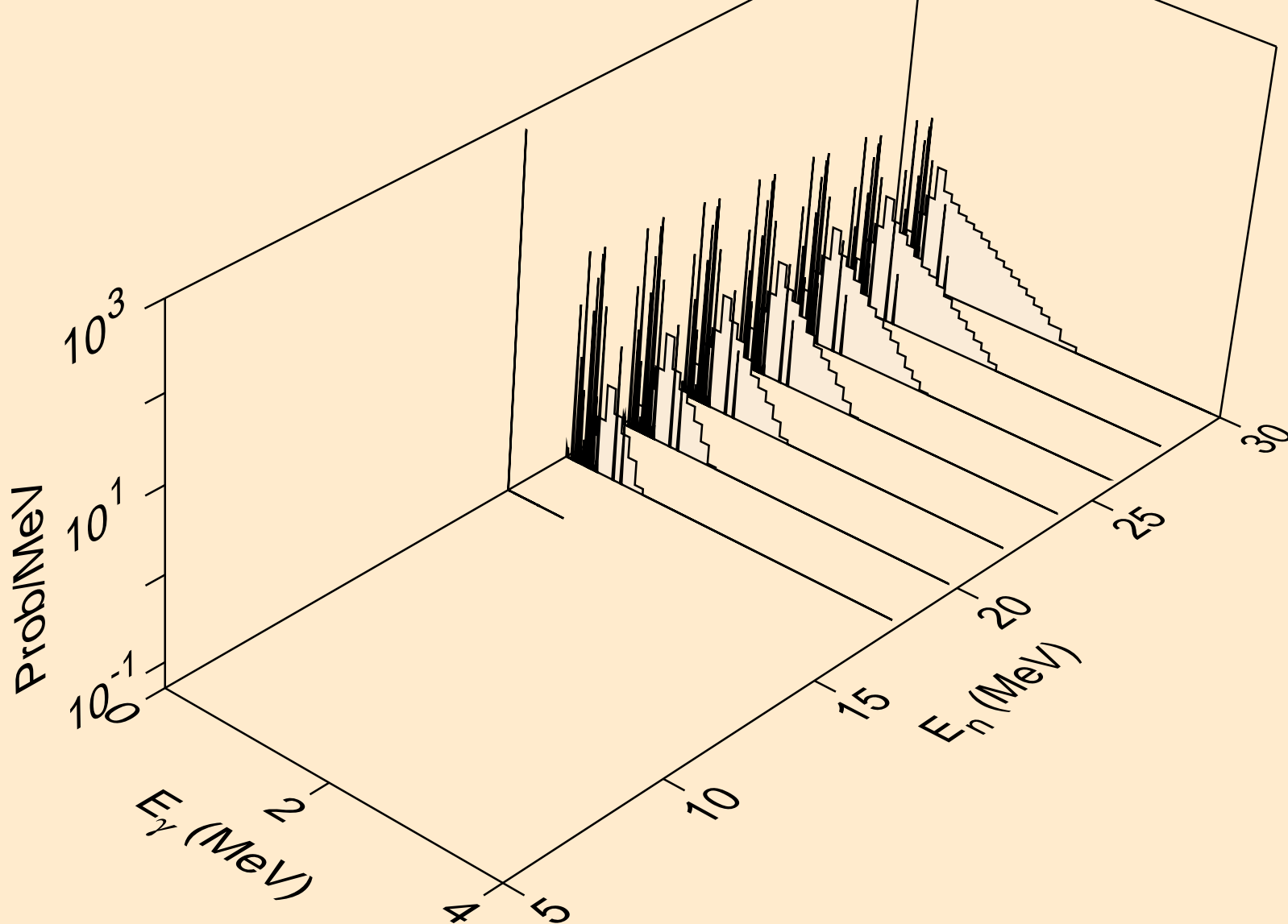

SB118M NEUTRON ACER TENDL-2019 LIBRARY; T=293.16K
Photon emission for (n,n*1)

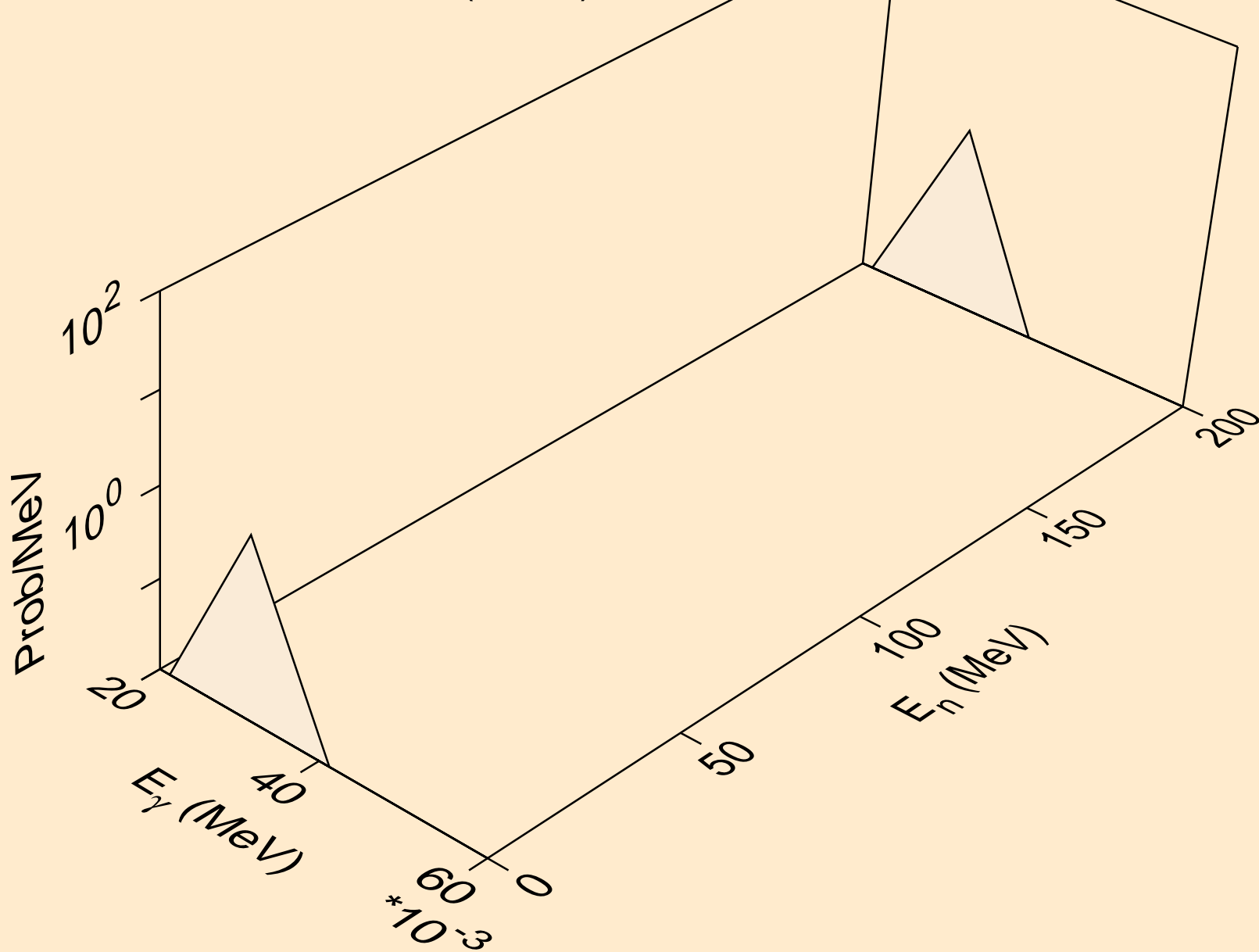

SB118M NEUTRON ACER TENDL-2019 LIBRARY; T=293.16K
Photon emission for (n,n*2)

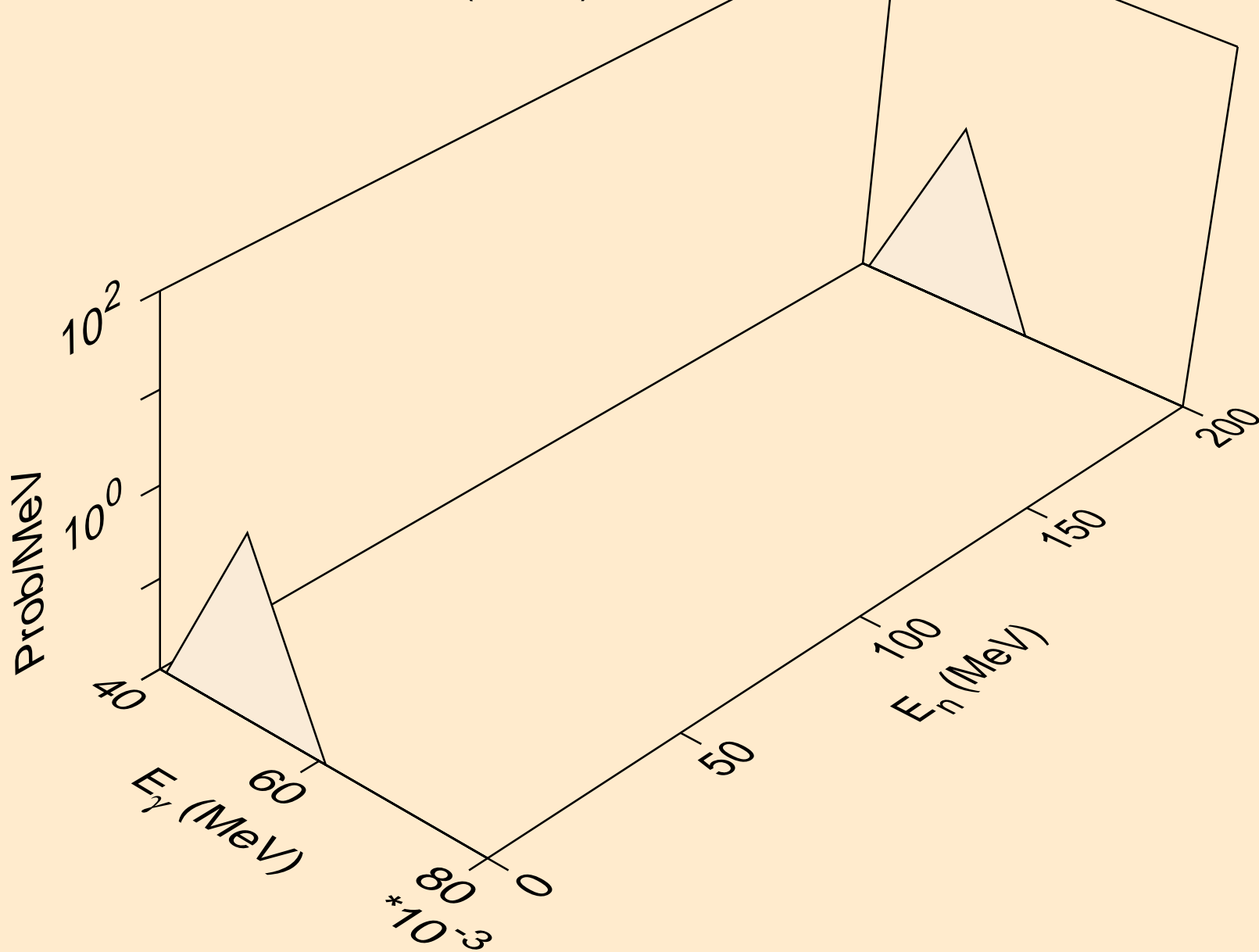

SB118M NEUTRON ACER TENDL-2019 LIBRARY; T=293.16K
Photon emission for (n,n*3)

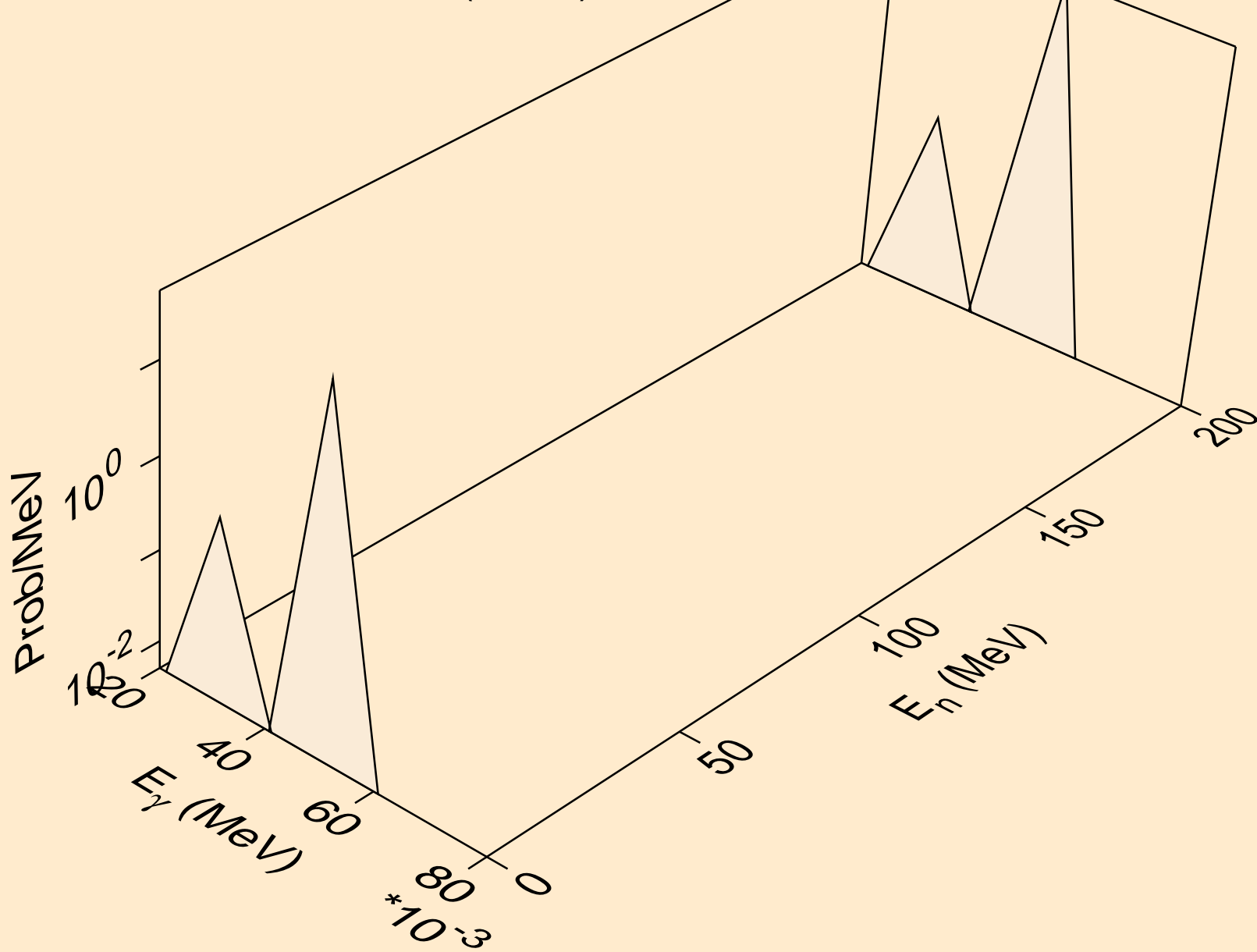

SB118M NEUTRON ACER TENDL-2019 LIBRARY; T=293.16K
Photon emission for (n,n*4)

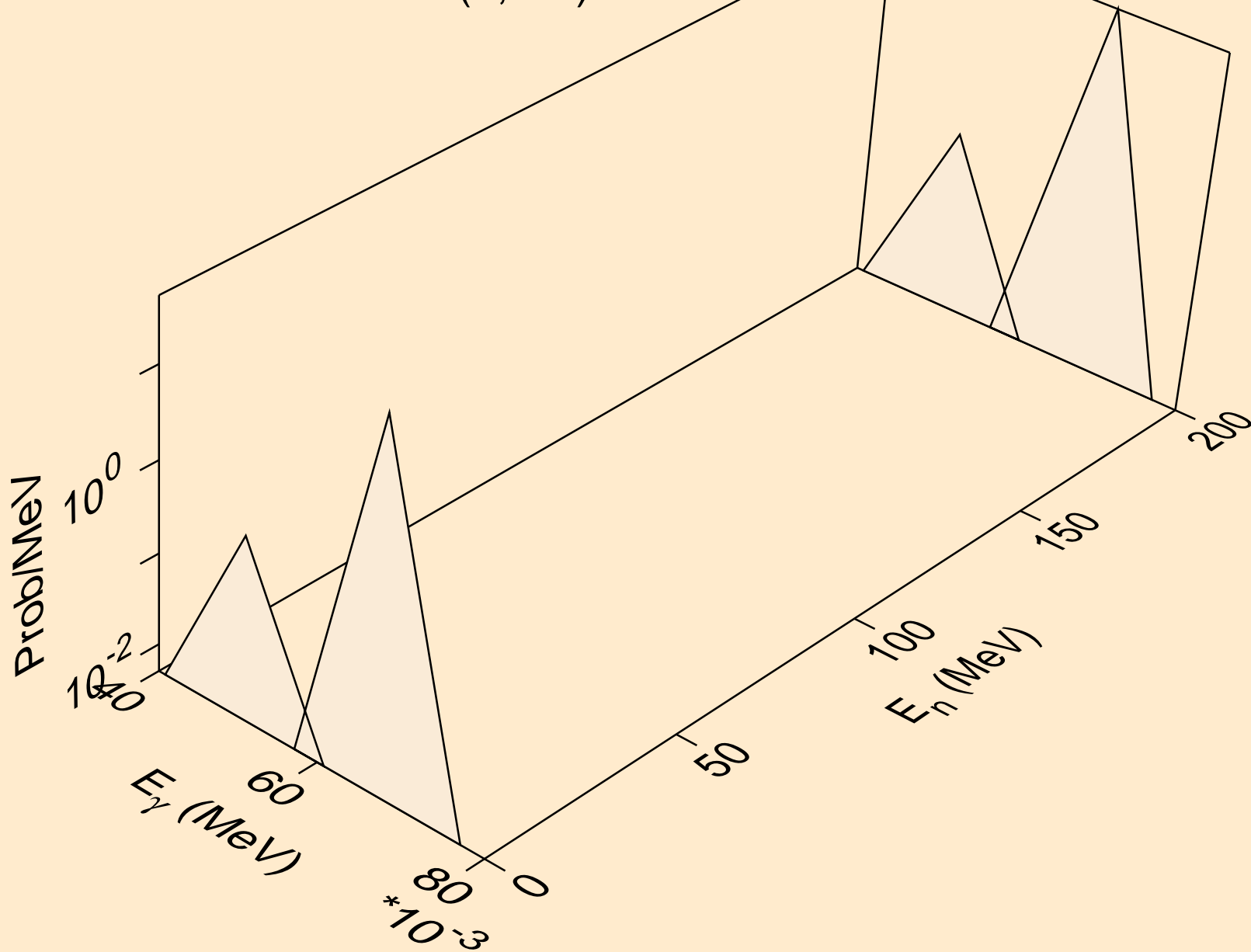

SB118M NEUTRON ACER TENDL-2019 LIBRARY; T=293.16K
Photon emission for (n,n*5)

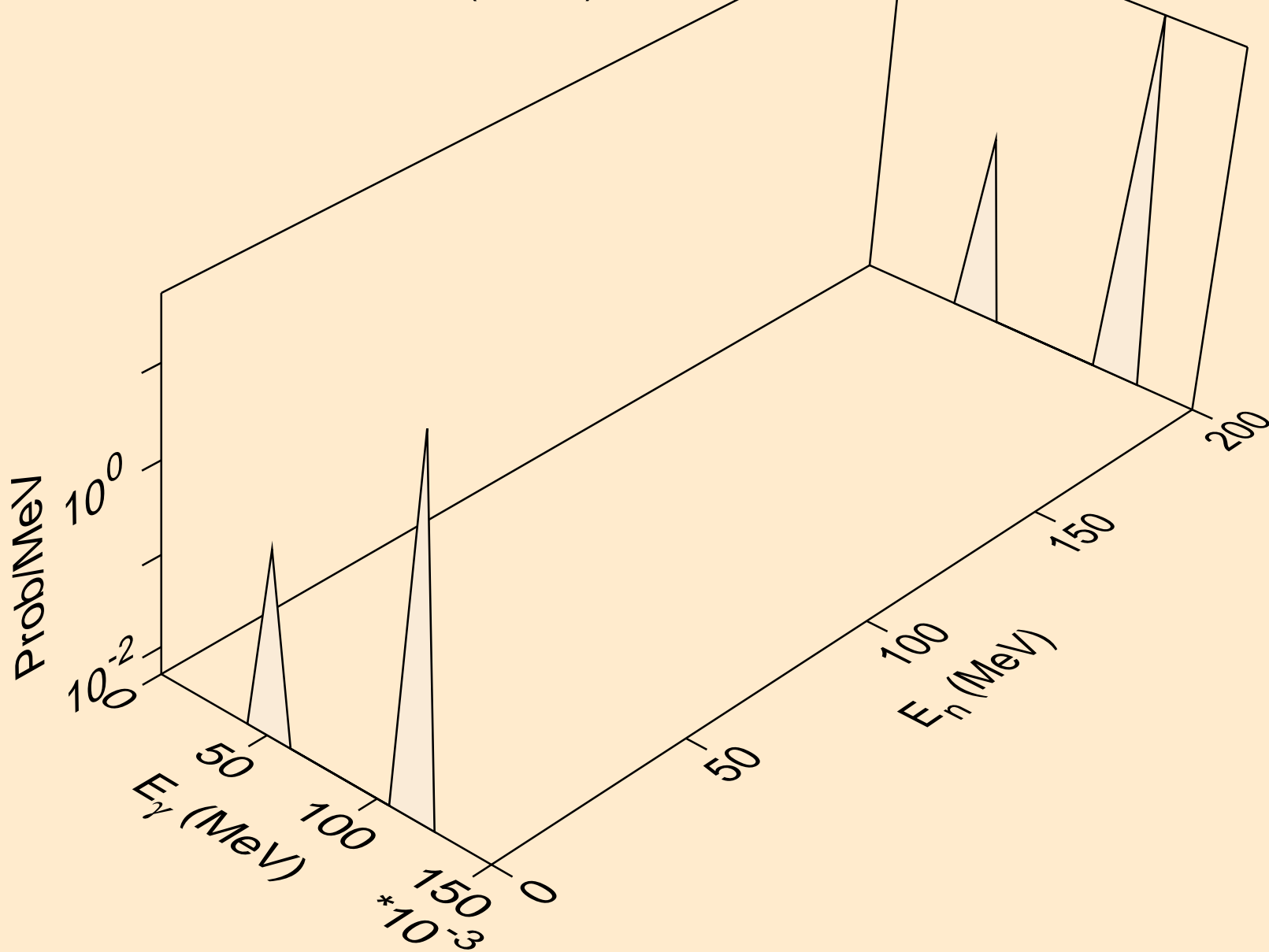

SB118M NEUTRON ACER TENDL-2019 LIBRARY; T=293.16K
Photon emission for (n,n*6)

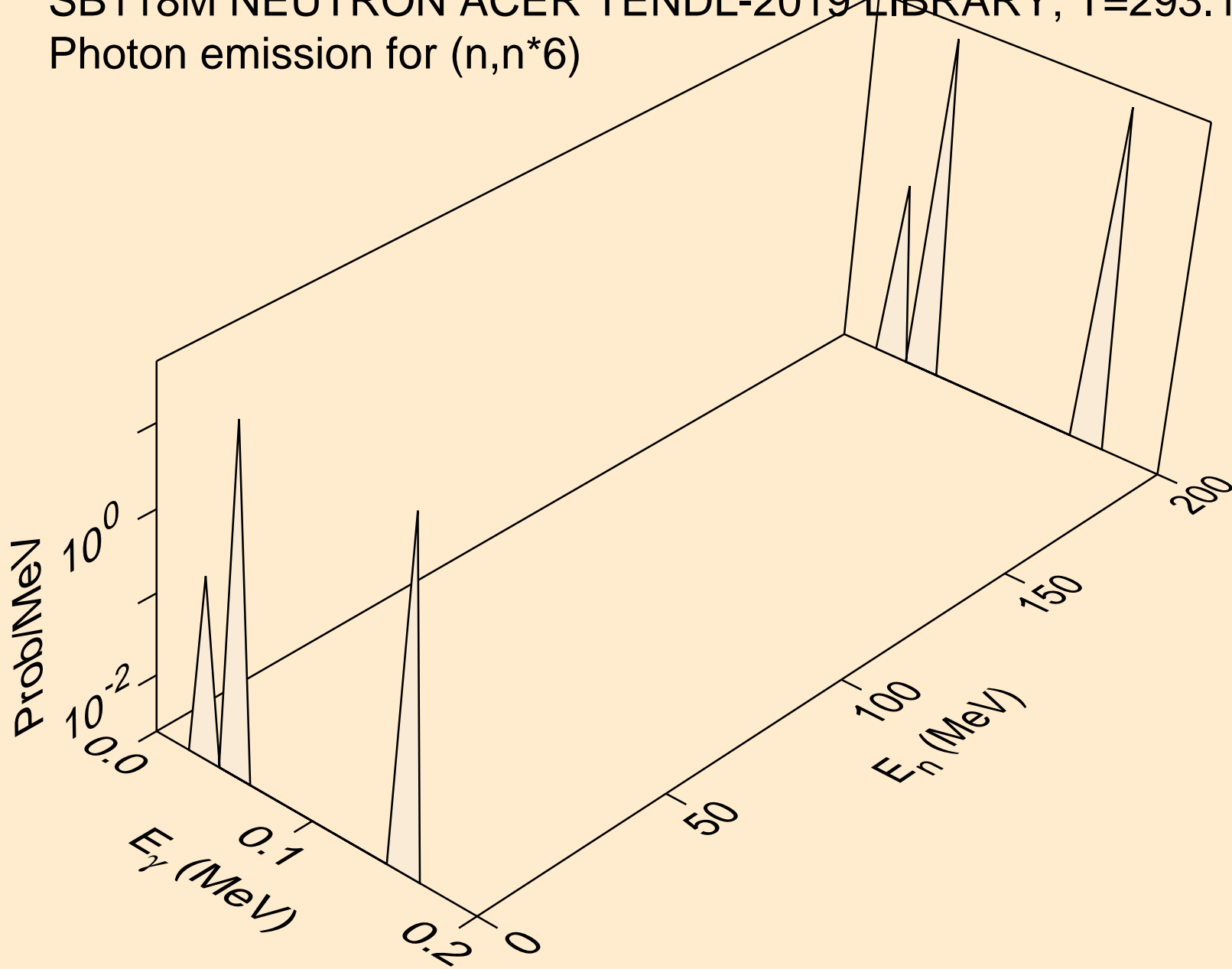

SB118M NEUTRON ACER TENDL-2019 LIBRARY; T=293.16K
Photon emission for (n,n*8)

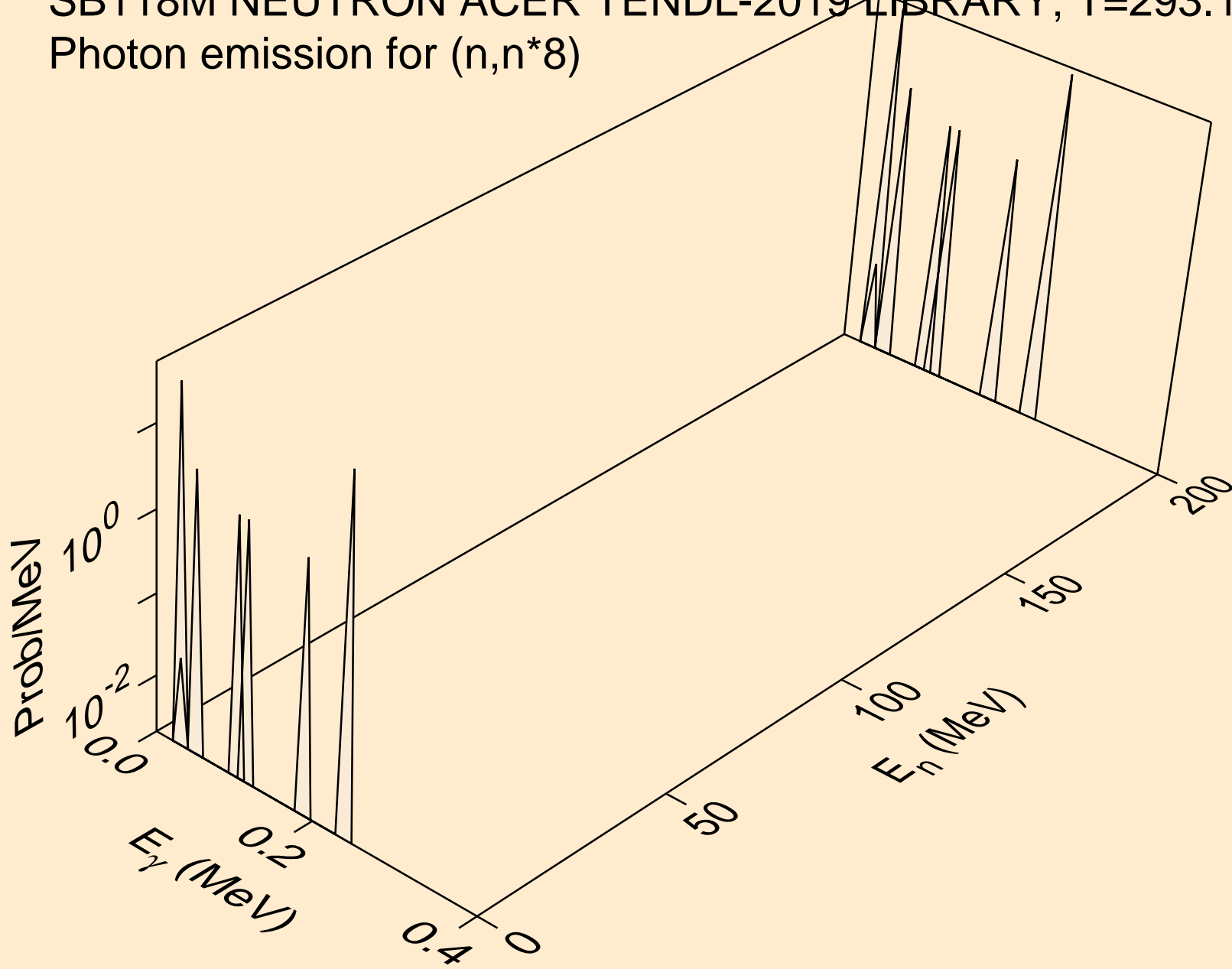

SB118M NEUTRON ACER TENDL-2019 LIBRARY; T=293.16K
Photon emission for (n,n*9)

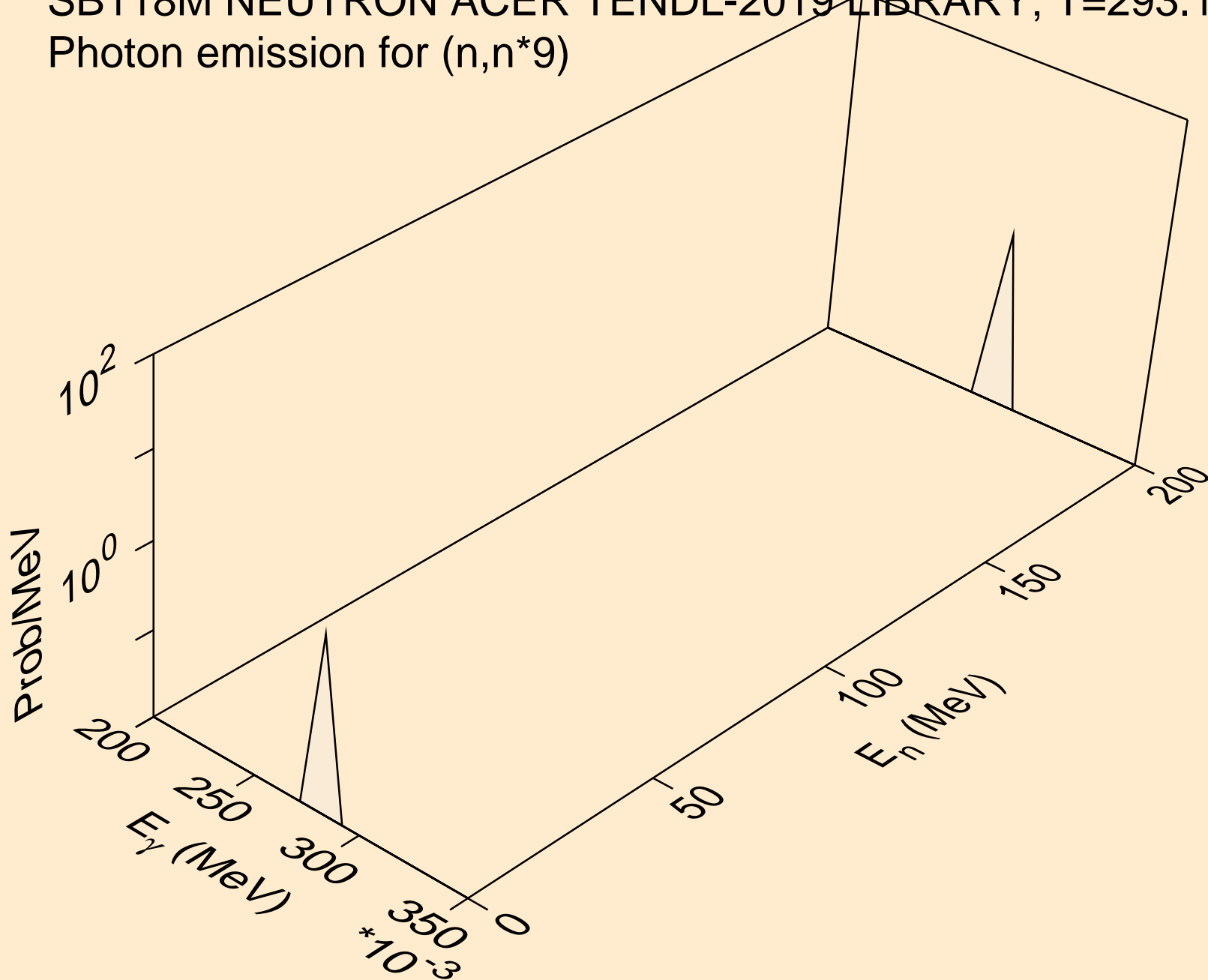

SB118M NEUTRON ACER TENDL-2019 LIBRARY; T=293.16K
Photon emission for (n,n*10)

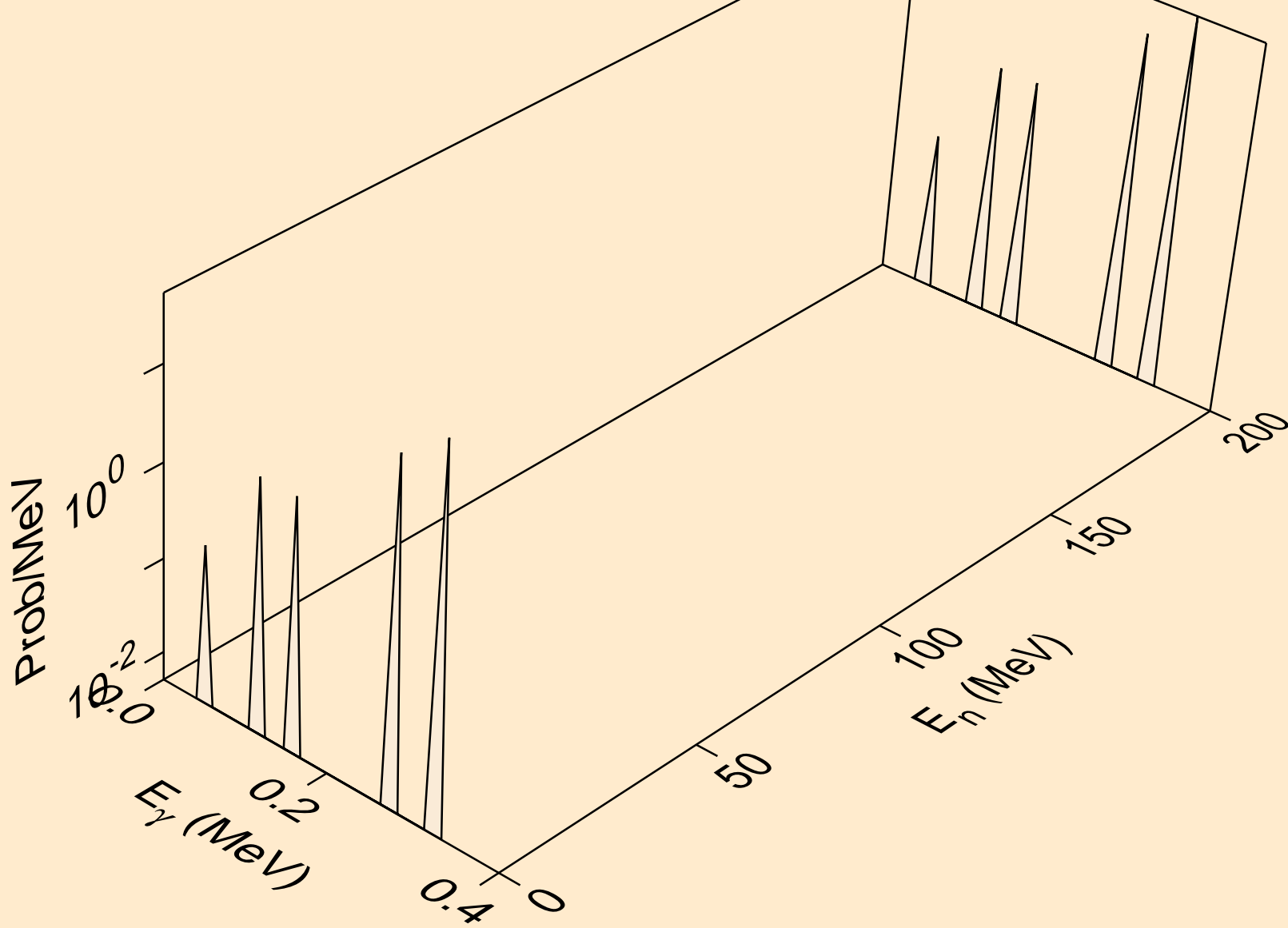

SB118M NEUTRON ACER TENDL-2019 LIBRARY; T=293.16K
Photon emission for (n,n*11)

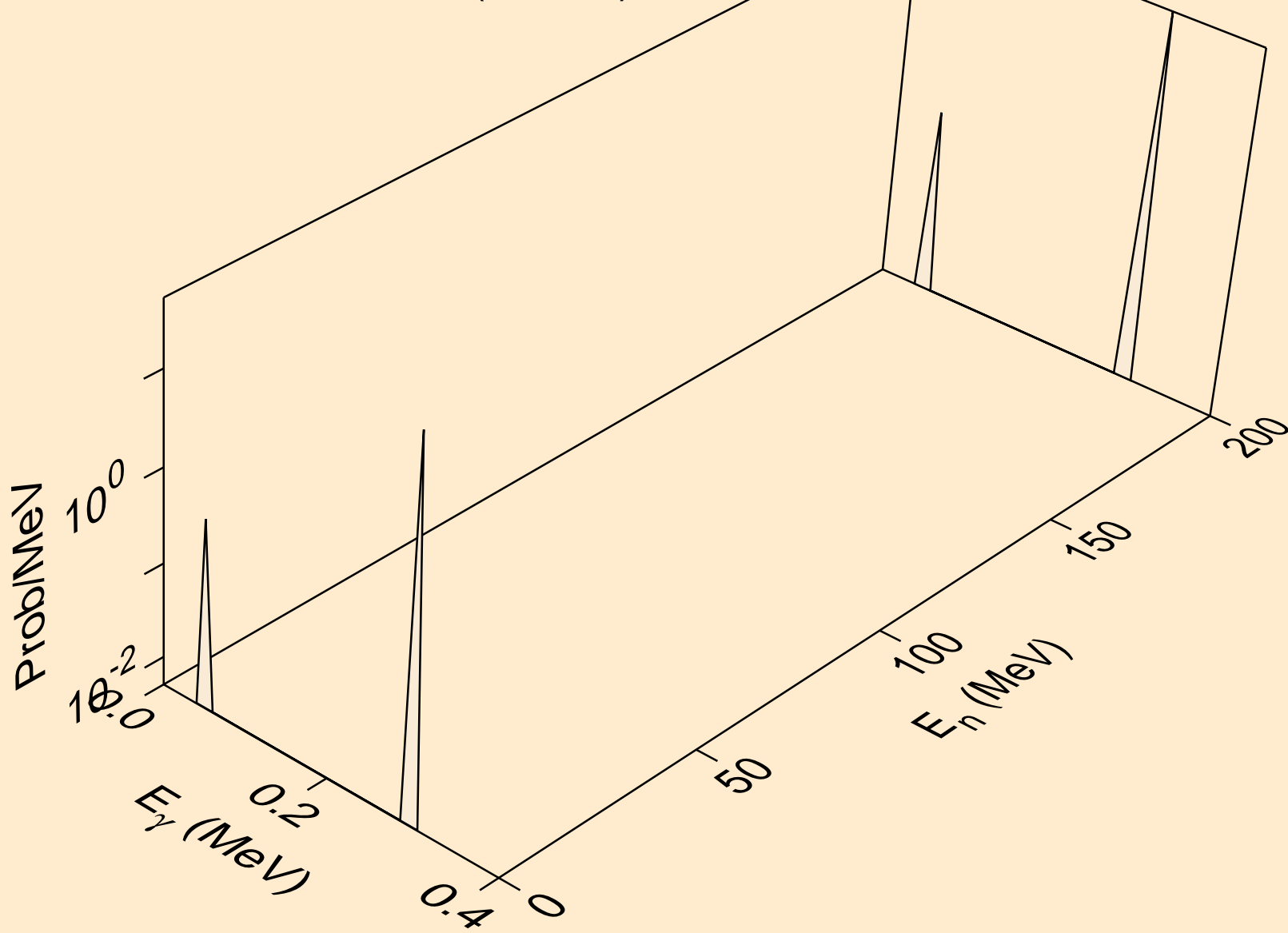

SB118M NEUTRON ACER TENDL-2019 LIBRARY; T=293.16K
Photon emission for (n,n*12)

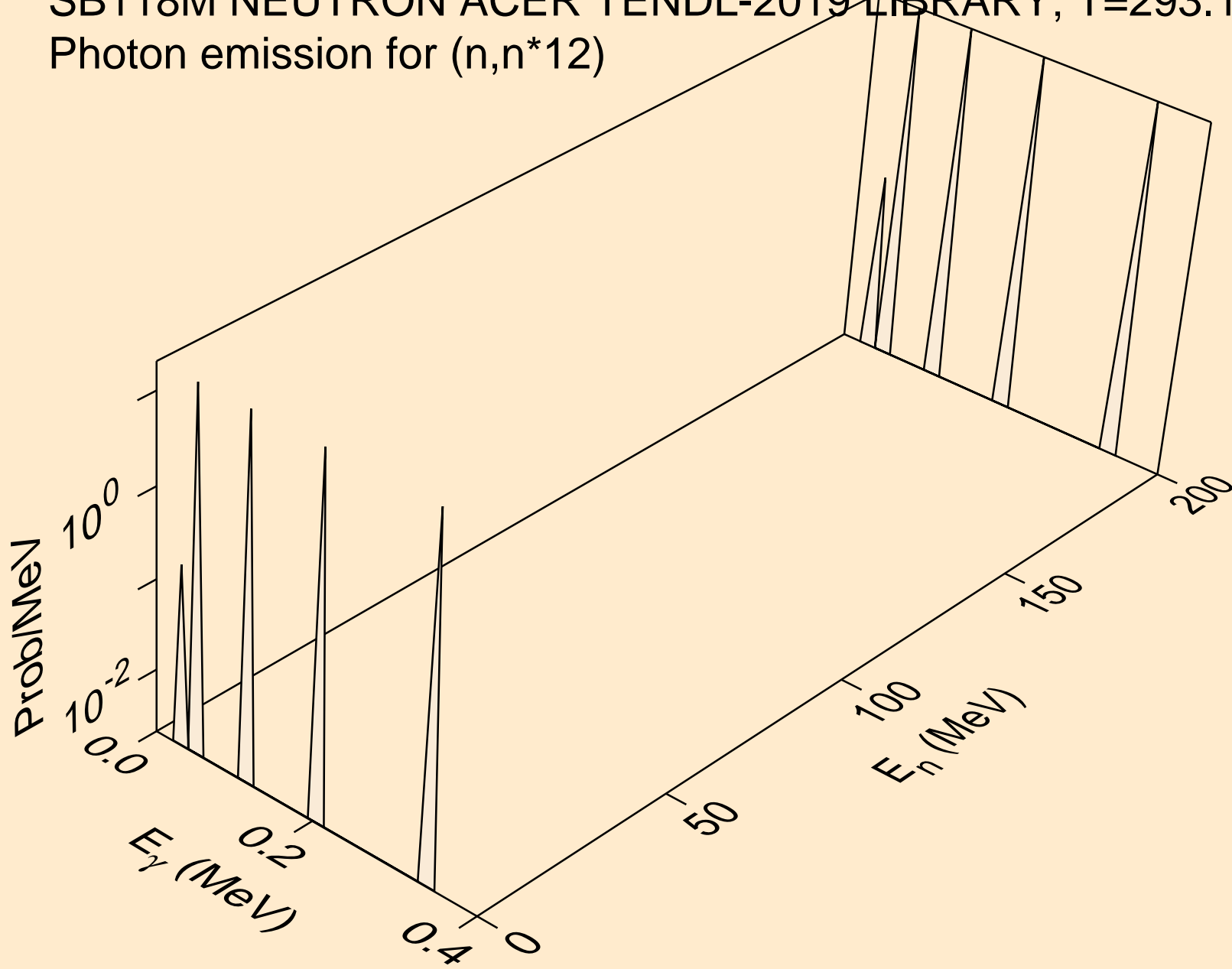

SB118M NEUTRON ACER TENDL-2019 LIBRARY; T=293.16K
Photon emission for (n,n*13)

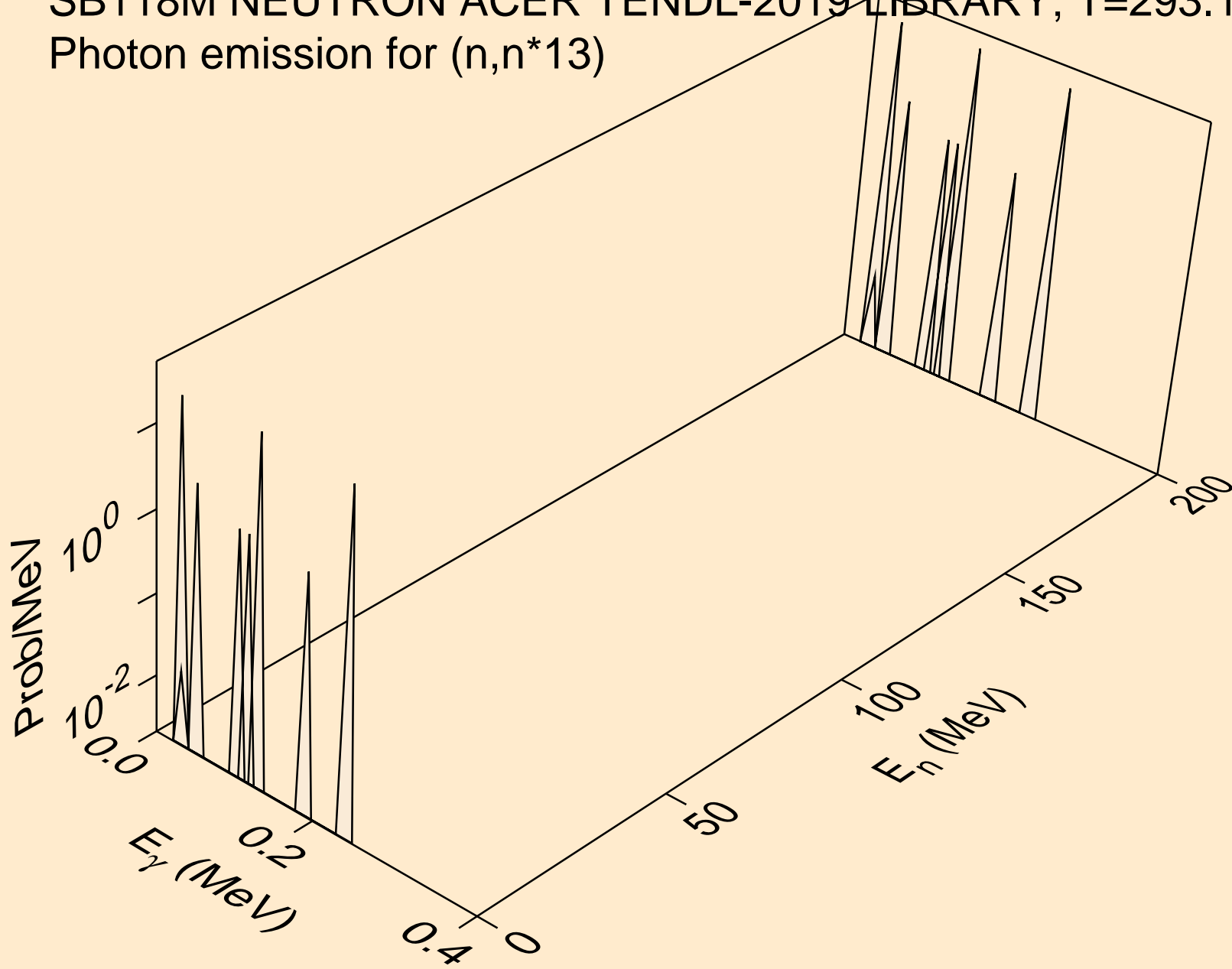

SB118M NEUTRON ACER TENDL-2019 LIBRARY; T=293.16K
Photon emission for (n,n*14)

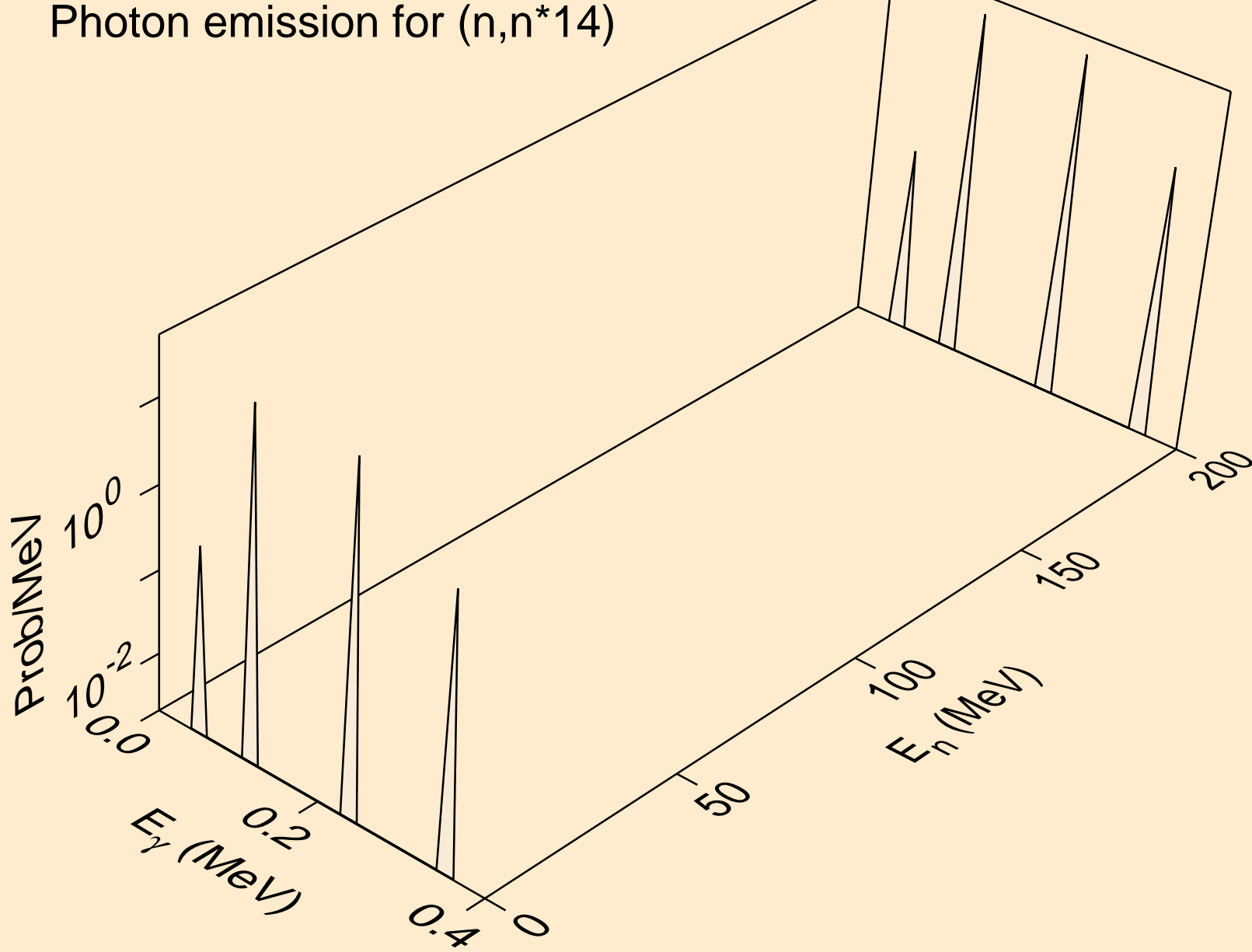

SB118M NEUTRON ACER TENDL-2019 LIBRARY; T=293.16K
Photon emission for (n,n*15)

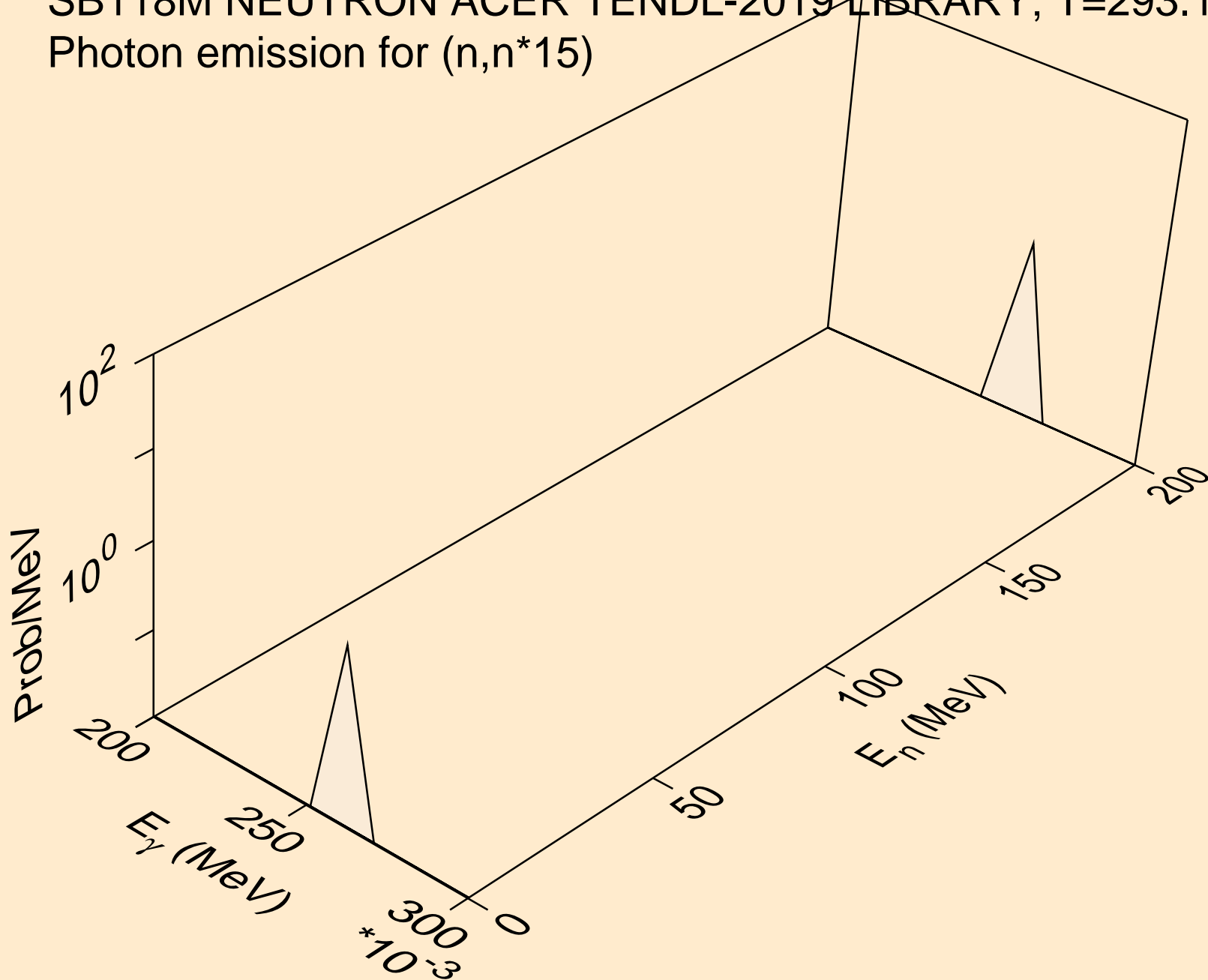

SB118M NEUTRON ACER TENDL-2019 LIBRARY; T=293.16K
Photon emission for (n,n*16)

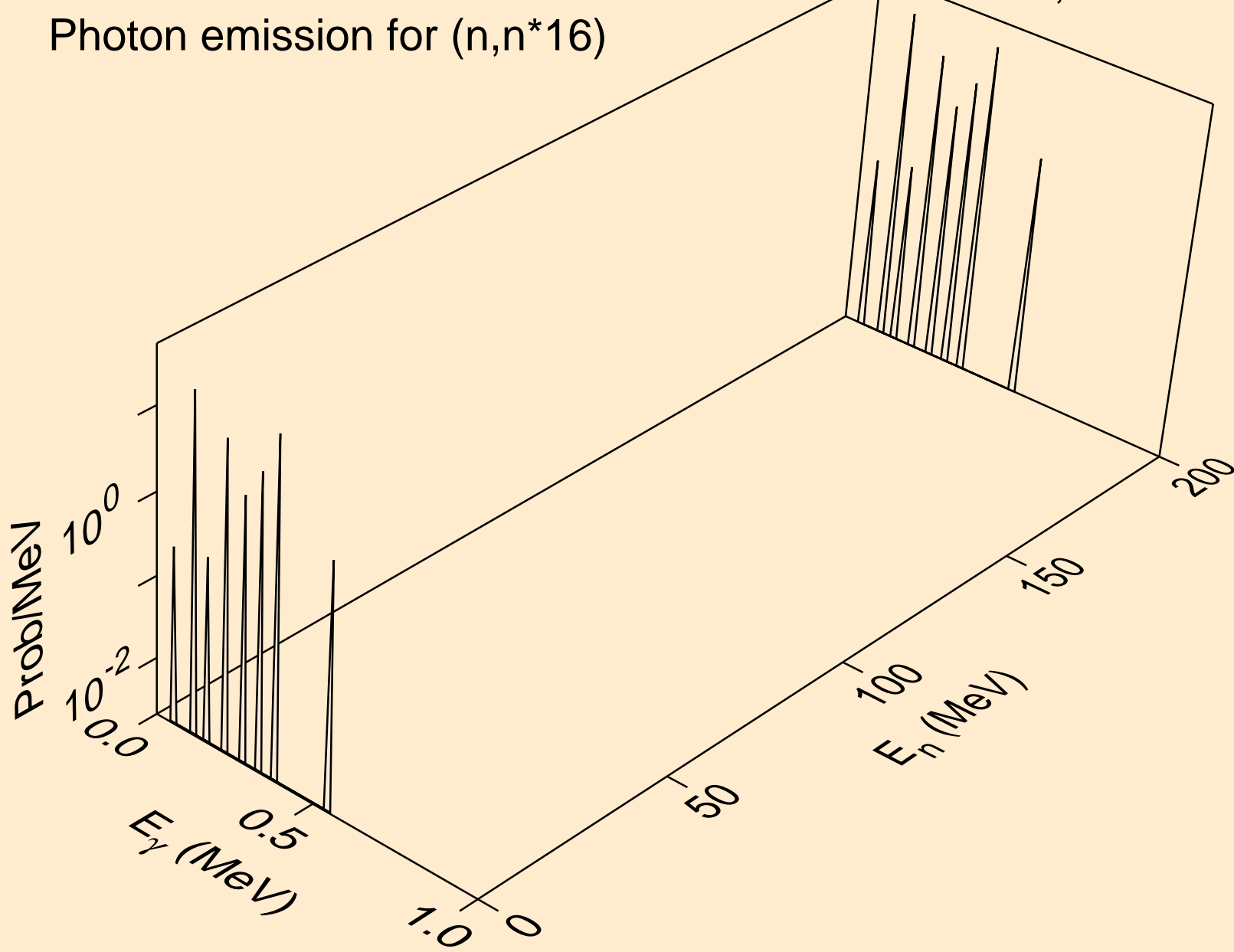

SB118M NEUTRON ACER TENDL-2019 LIBRARY; T=293.16K
Photon emission for (n,n*17)

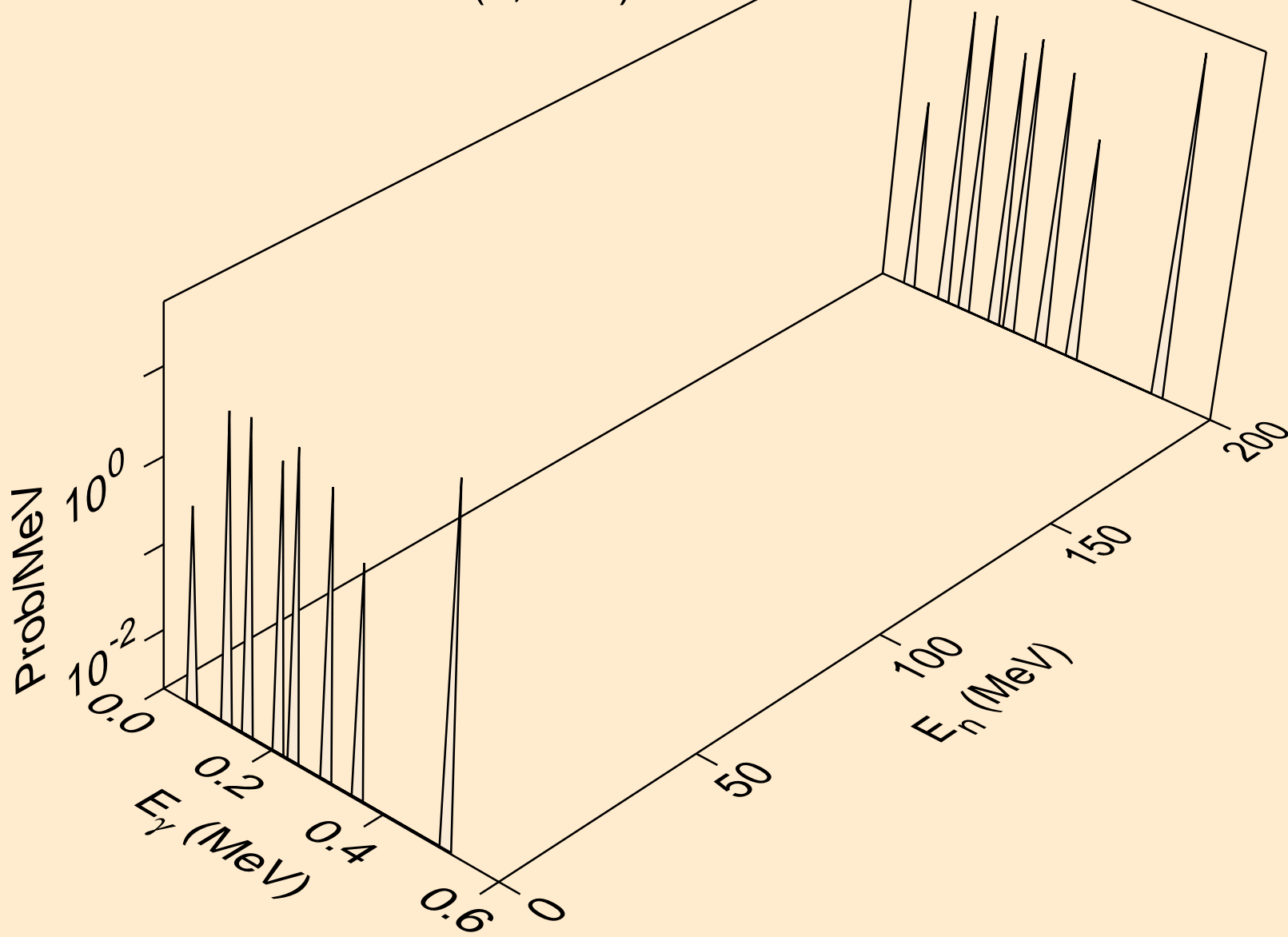

SB118M NEUTRON ACER TENDL-2019 LIBRARY; T=293.16K
Photon emission for (n,n*18)

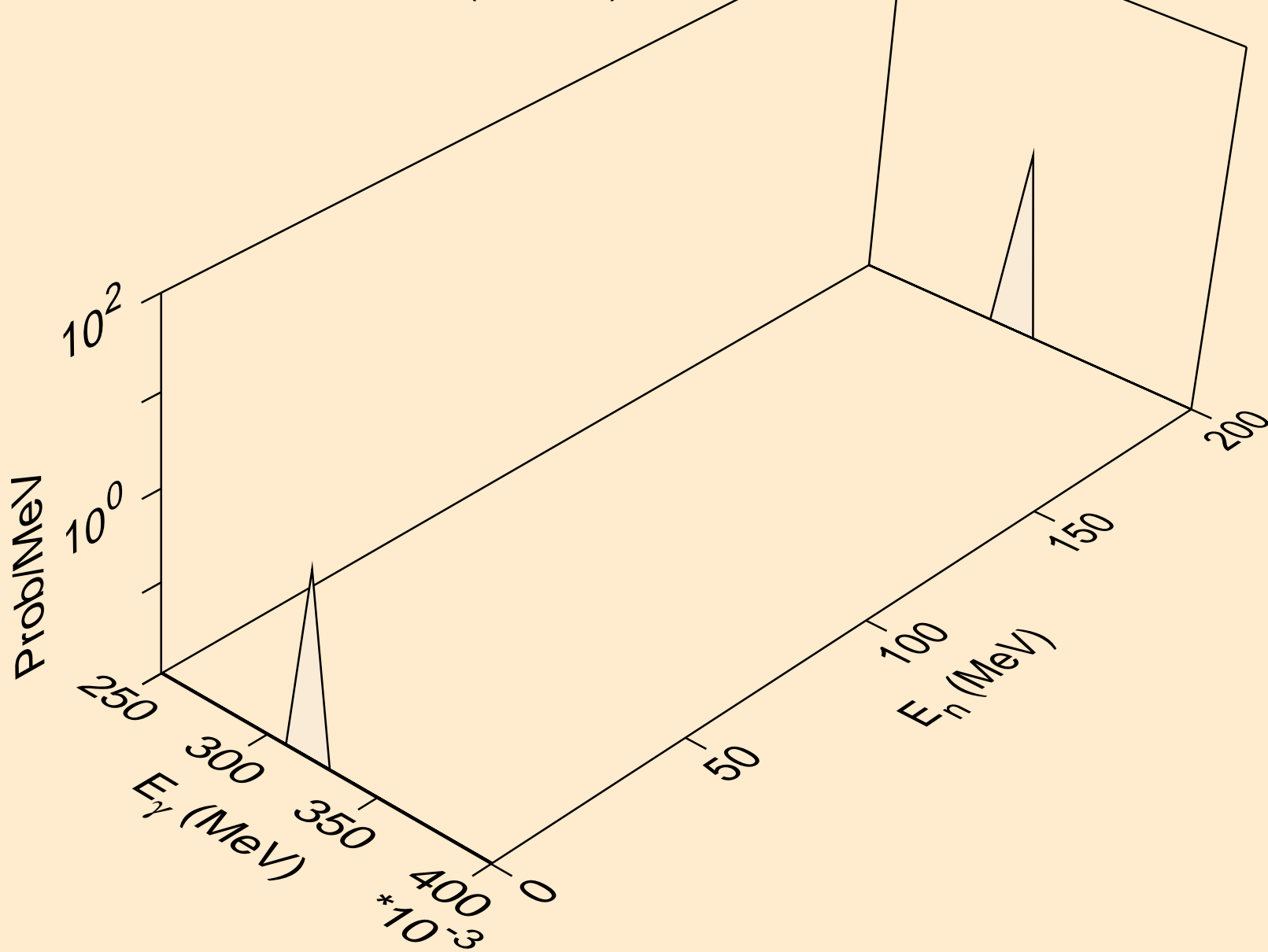

SB118M NEUTRON ACER TENDL-2019 LIBRARY; T=293.16K
Photon emission for (n,n*19)

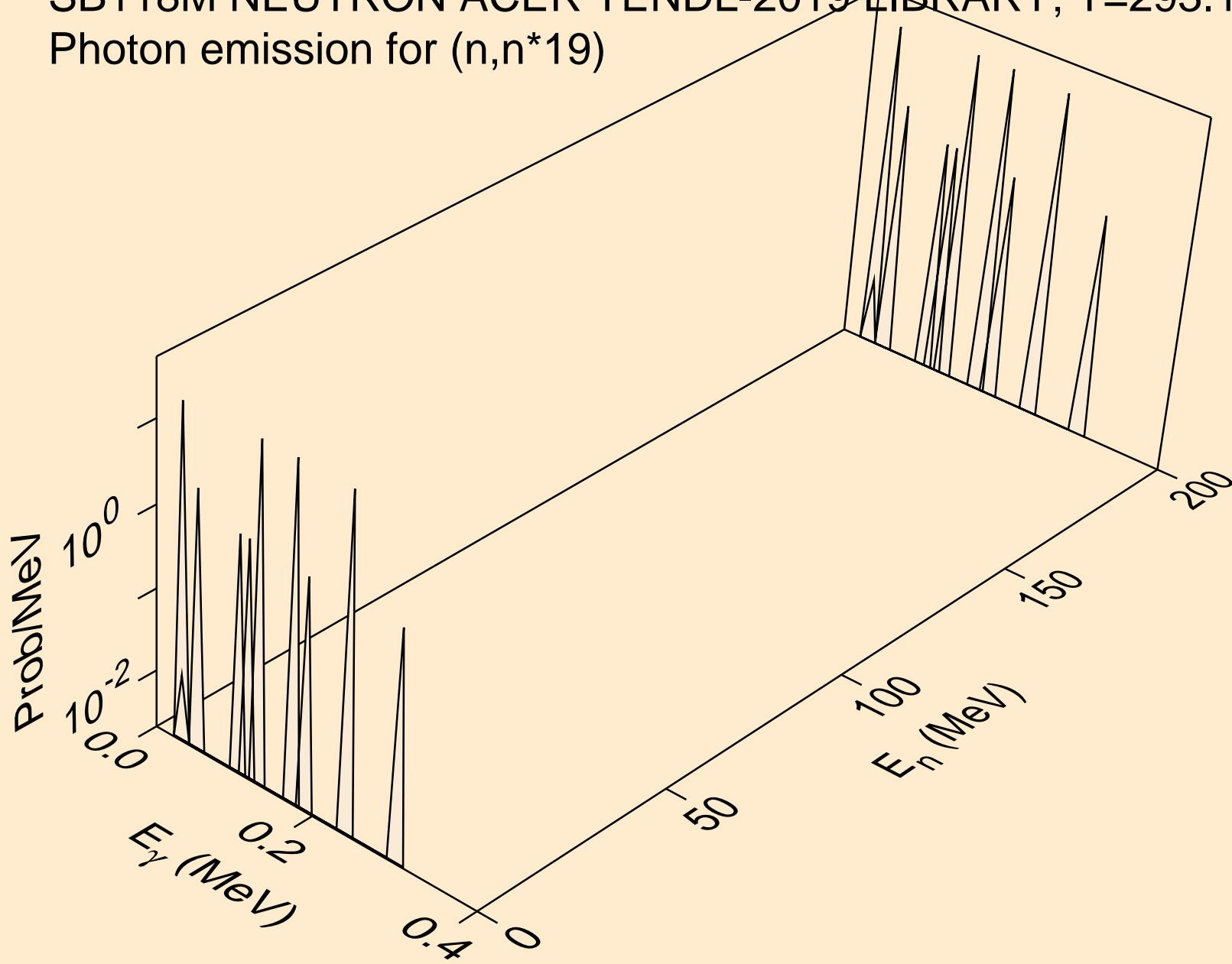

SB118M NEUTRON ACER TENDL-2019 LIBRARY; T=293.16K
Photon emission for (n,n*20)

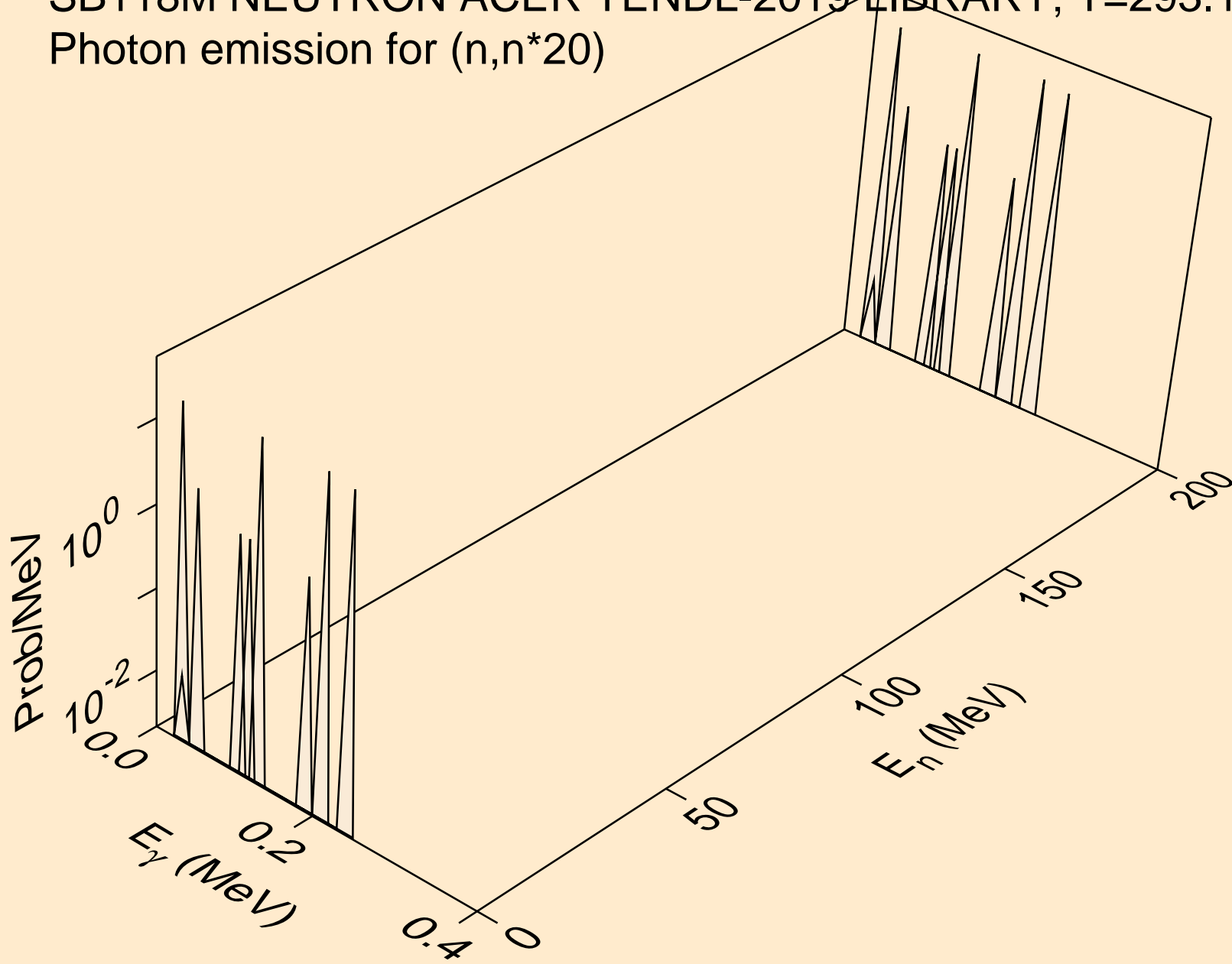

SB118M NEUTRON ACER TENDL-2019 LIBRARY; T=293.16K
Photon emission for (n,n*21)

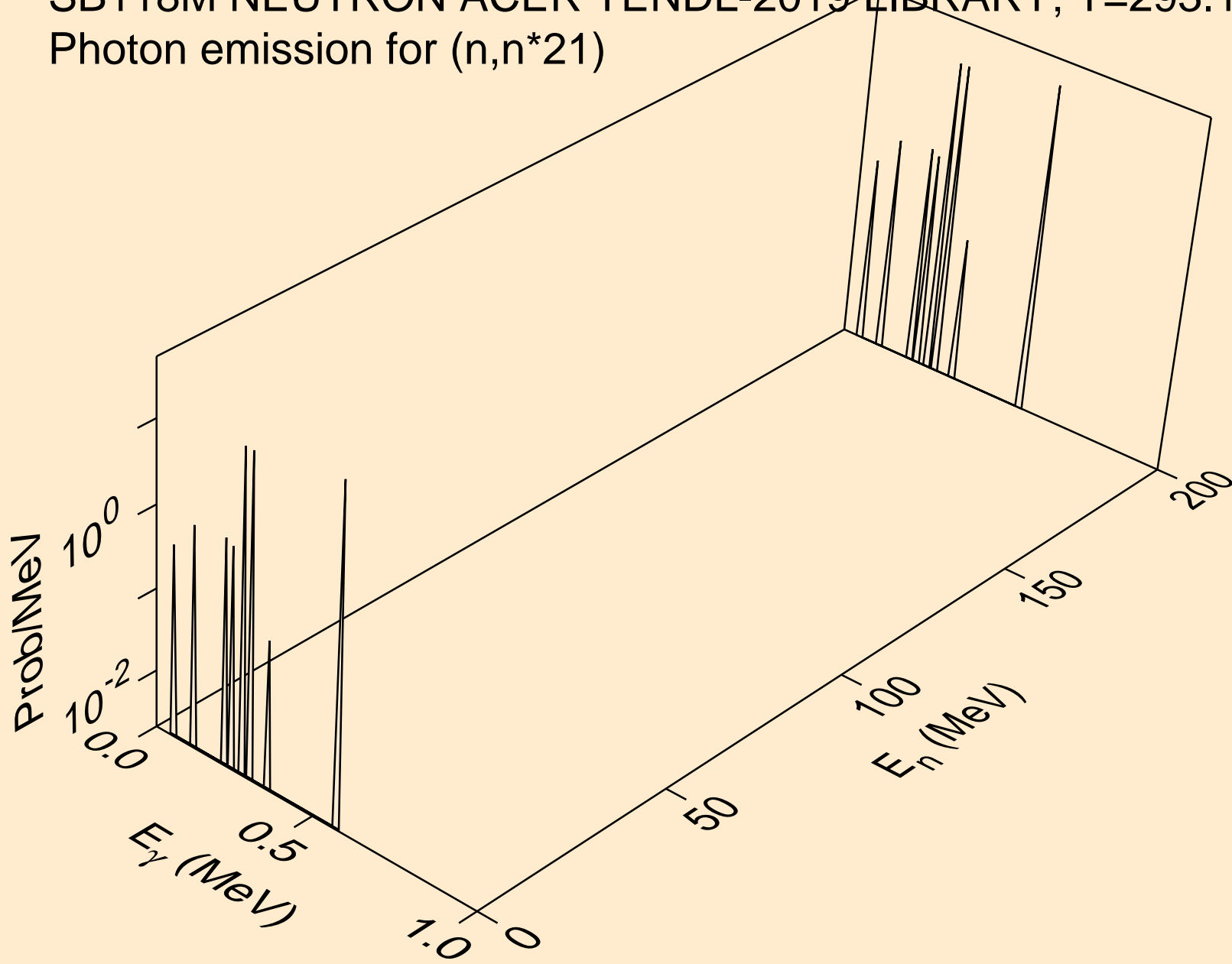

SB118M NEUTRON ACER TENDL-2019 LIBRARY; T=293.16K
Photon emission for (n,n*22)

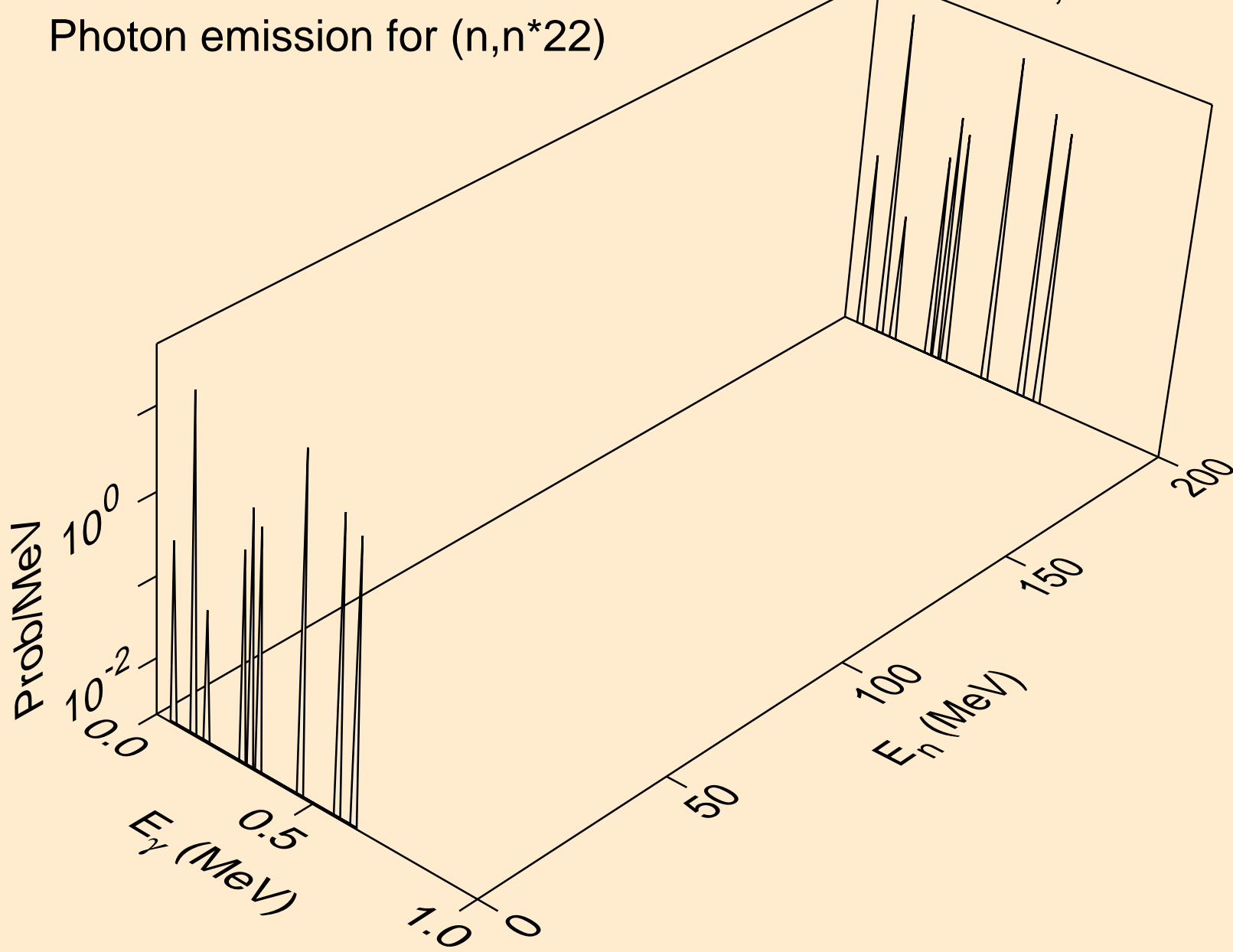

SB118M NEUTRON ACER TENDL-2019 LIBRARY; T=293.16K
Photon emission for (n,n*23)

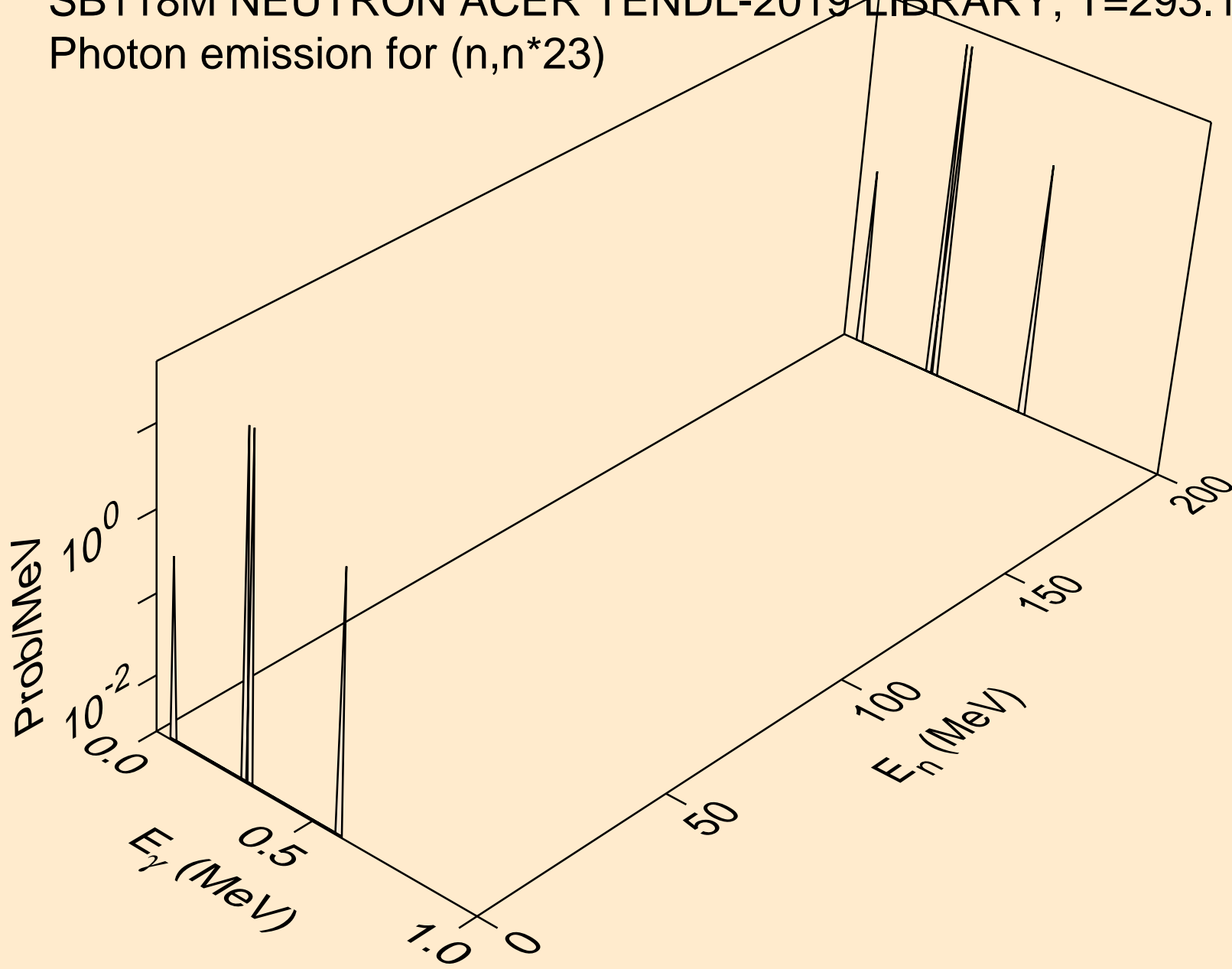

SB118M NEUTRON ACER TENDL-2019 LIBRARY; T=293.16K
Photon emission for (n,n*24)

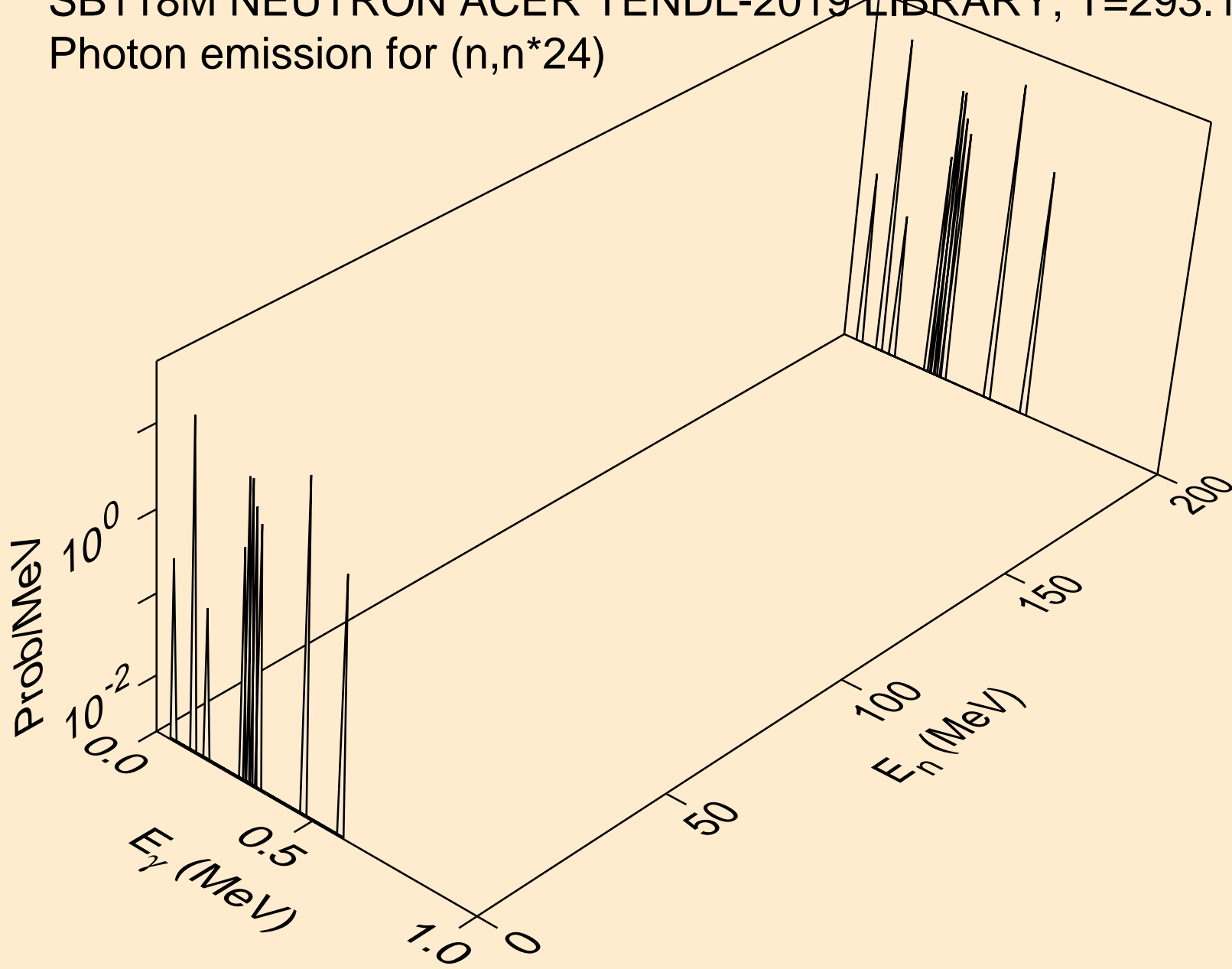

SB118M NEUTRON ACER TENDL-2019 LIBRARY; T=293.16K
Photon emission for (n,n*25)

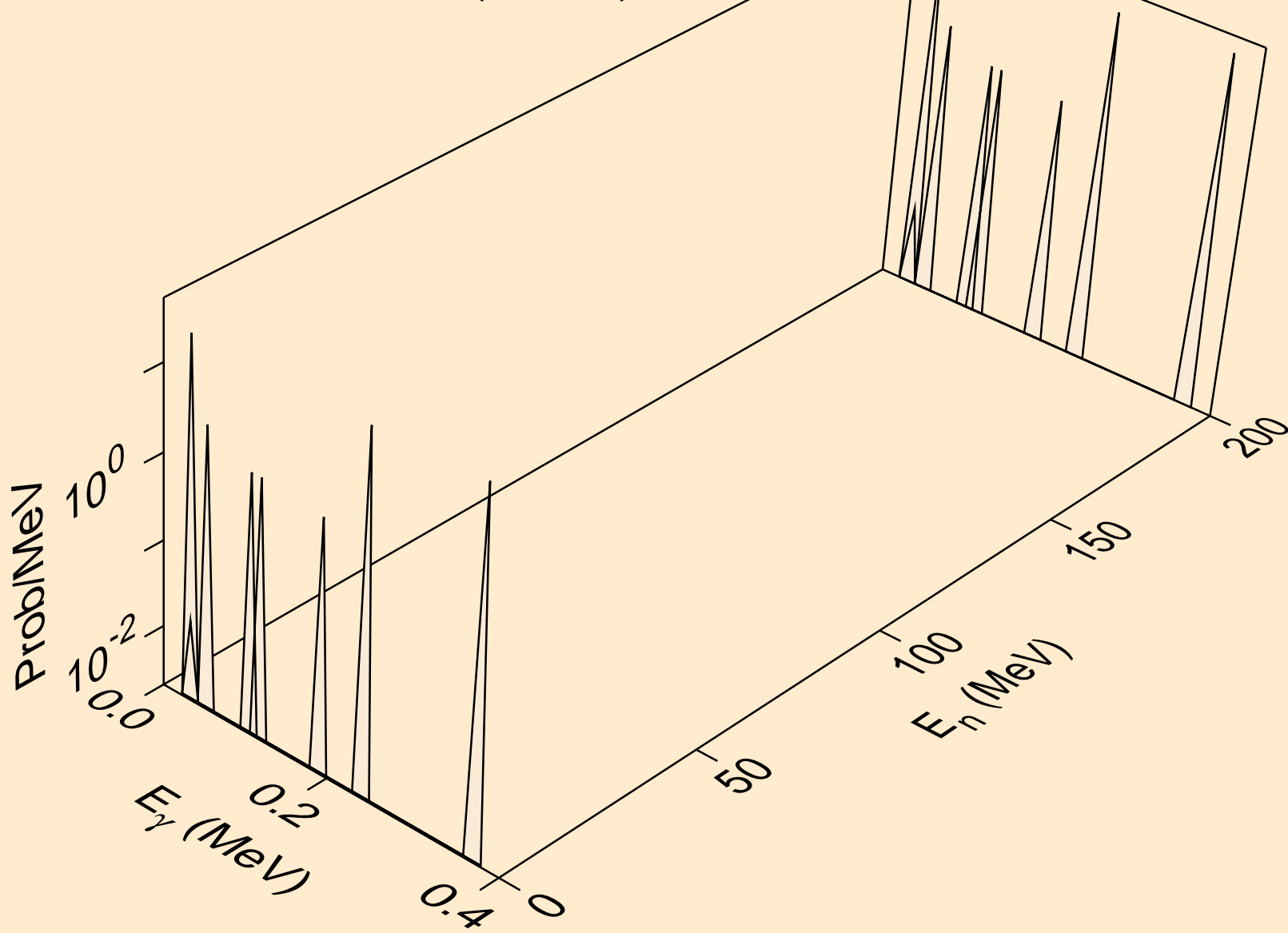

SB118M NEUTRON ACER TENDL-2019 LIBRARY; T=293.16K
Photon emission for (n,n*c)

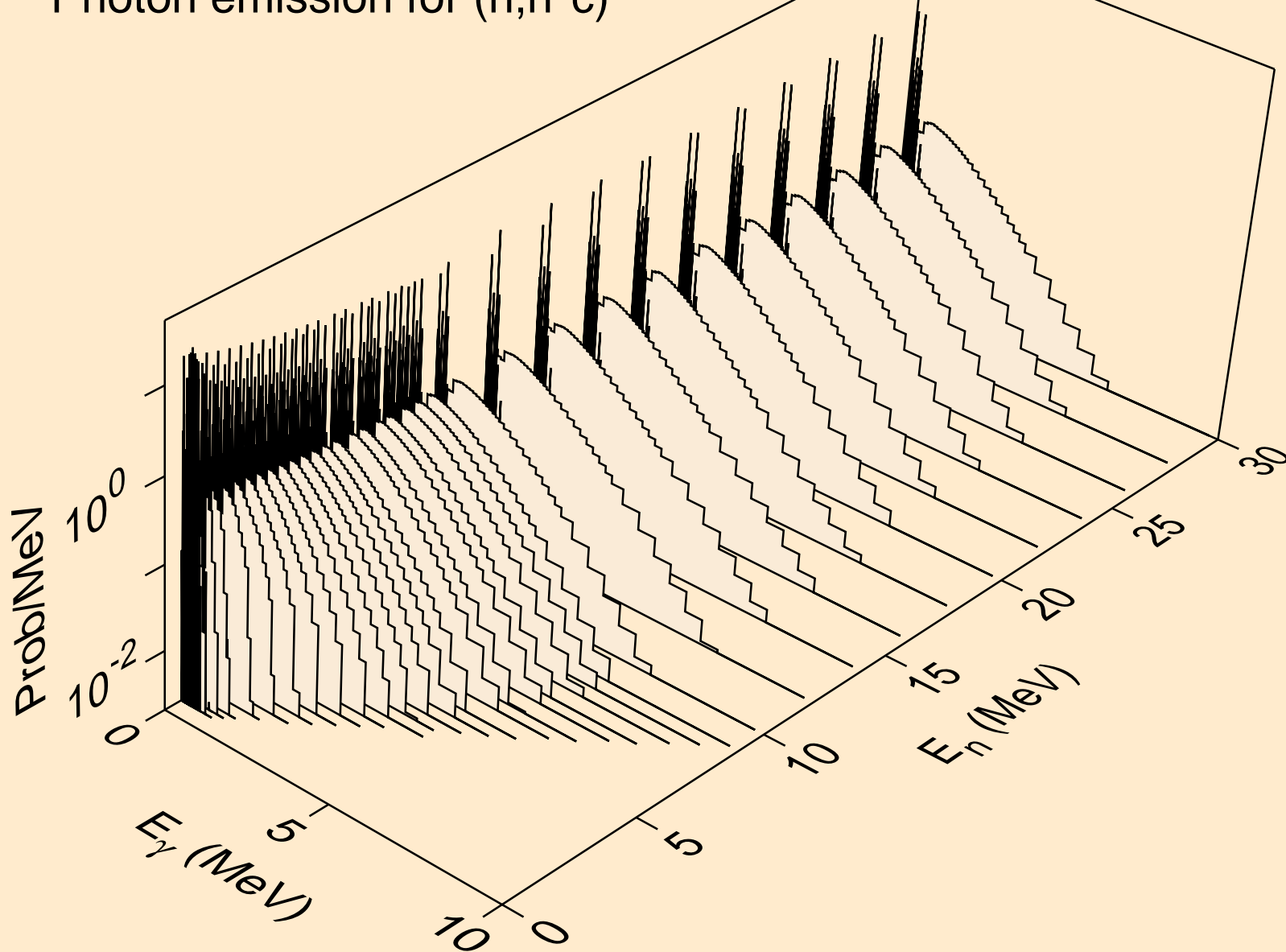

SB118M NEUTRON ACER TENDL-2019 LIBRARY; T=293.16K
Photon emission for (n,gma)

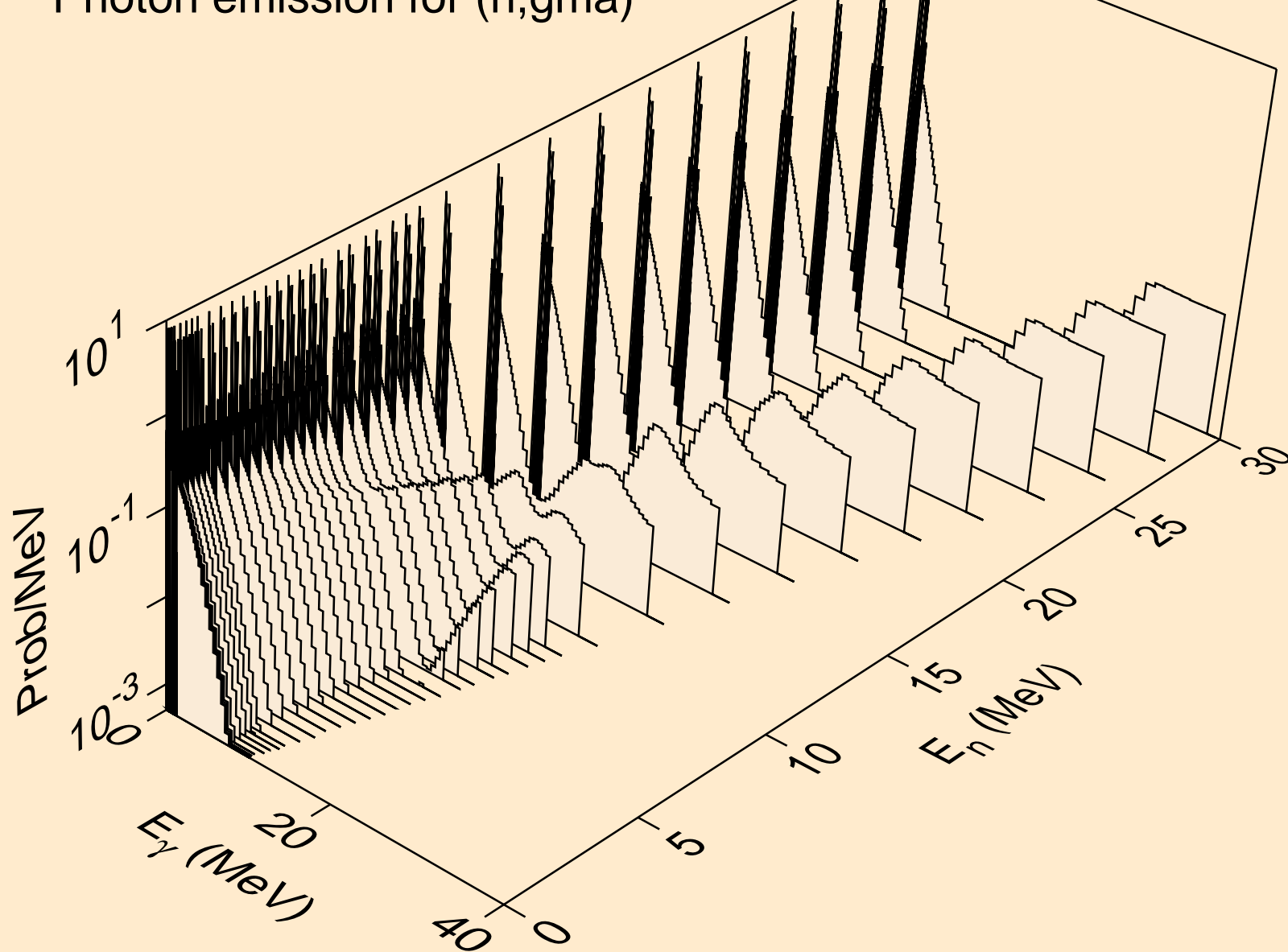

SB118M NEUTRON ACER TENDL-2019 LIBRARY; T=293.16K
Photon emission for (n,p)

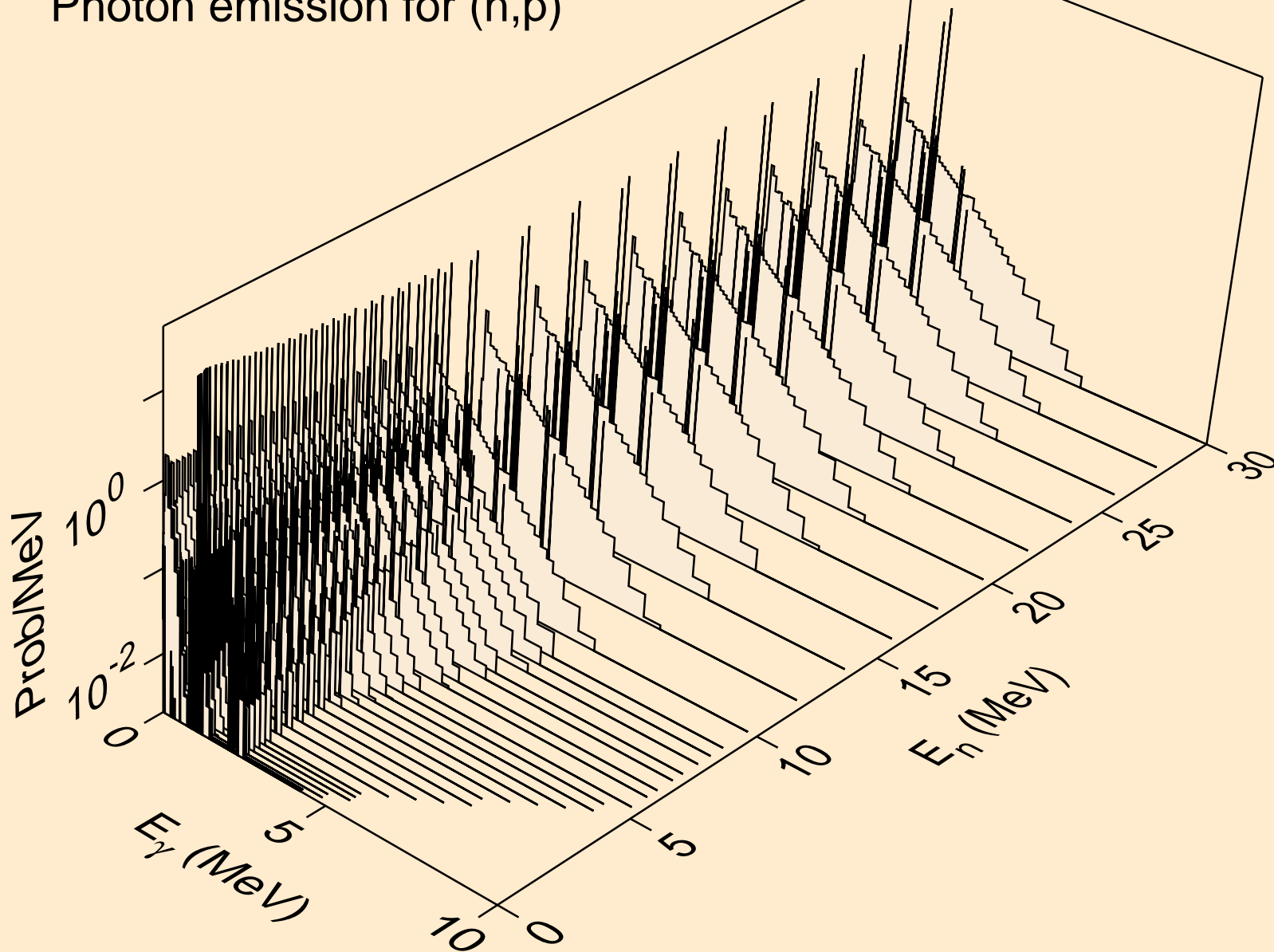

SB118M NEUTRON ACER TENDL-2019 LIBRARY; T=293.16K
Photon emission for (n,d)

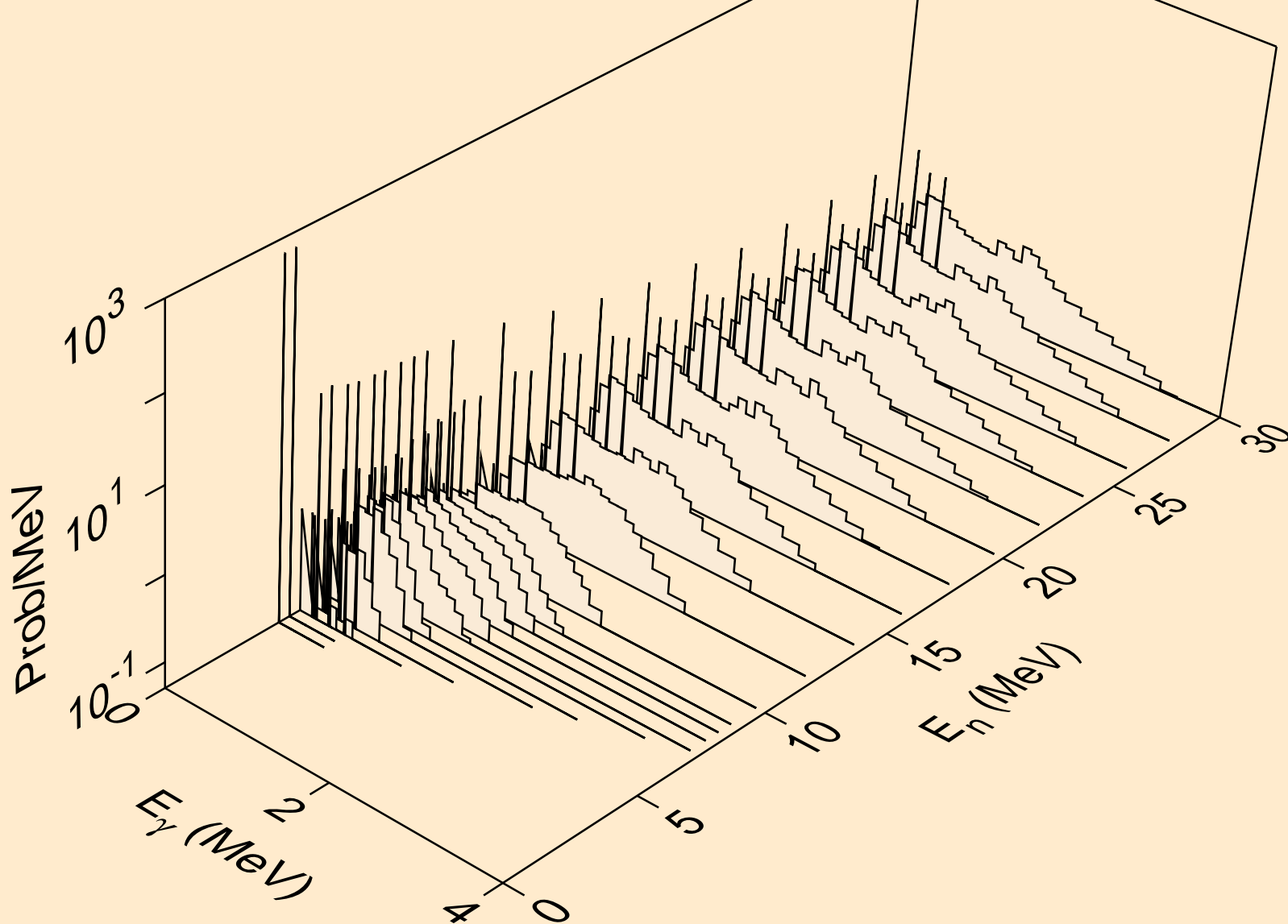

SB118M NEUTRON ACER TENDL-2019 LIBRARY; T=293.16K
Photon emission for (n,t)

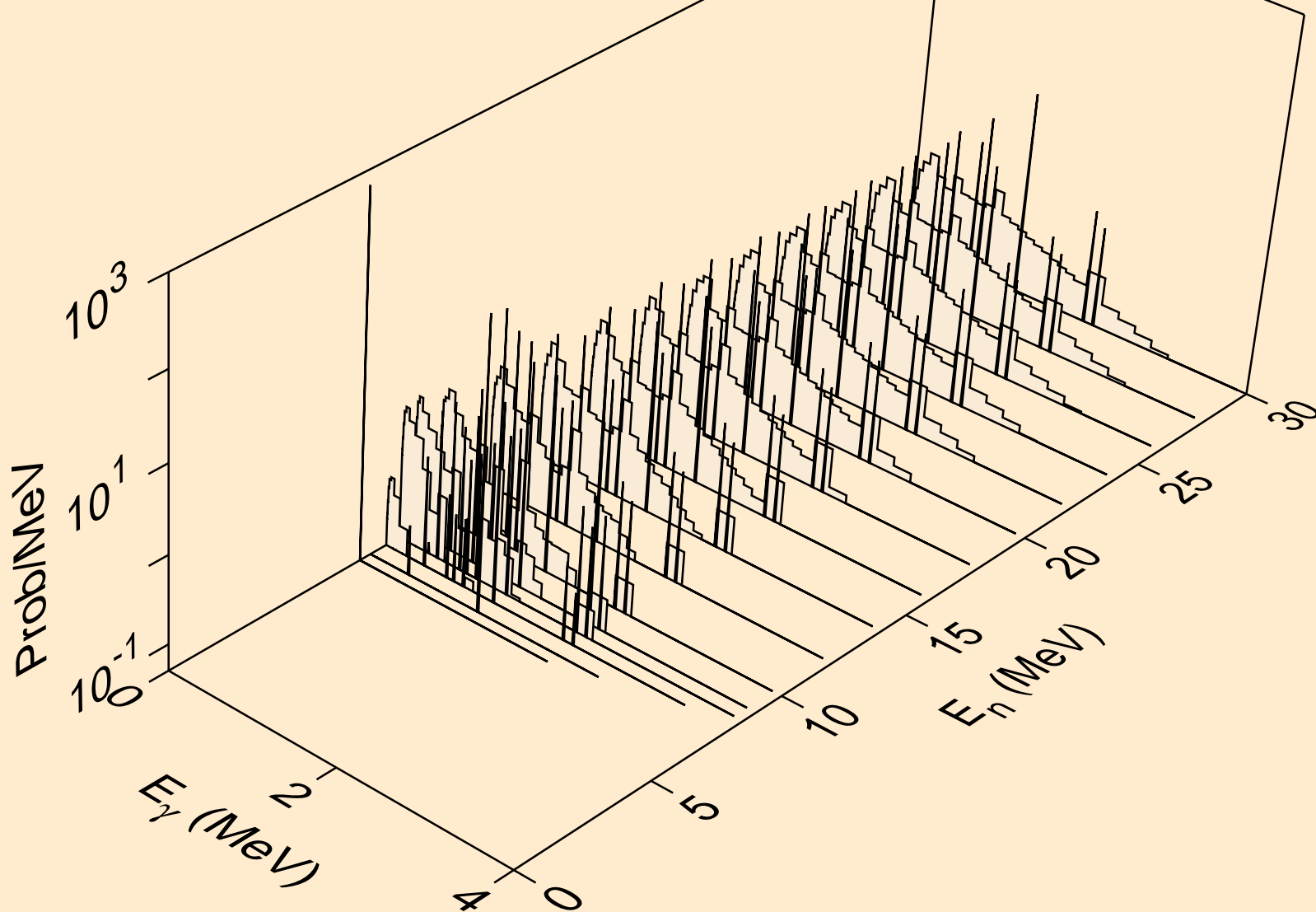

SB118M NEUTRON ACER TENDL-2019 LIBRARY; T=293.16K
Photon emission for (n,he3)

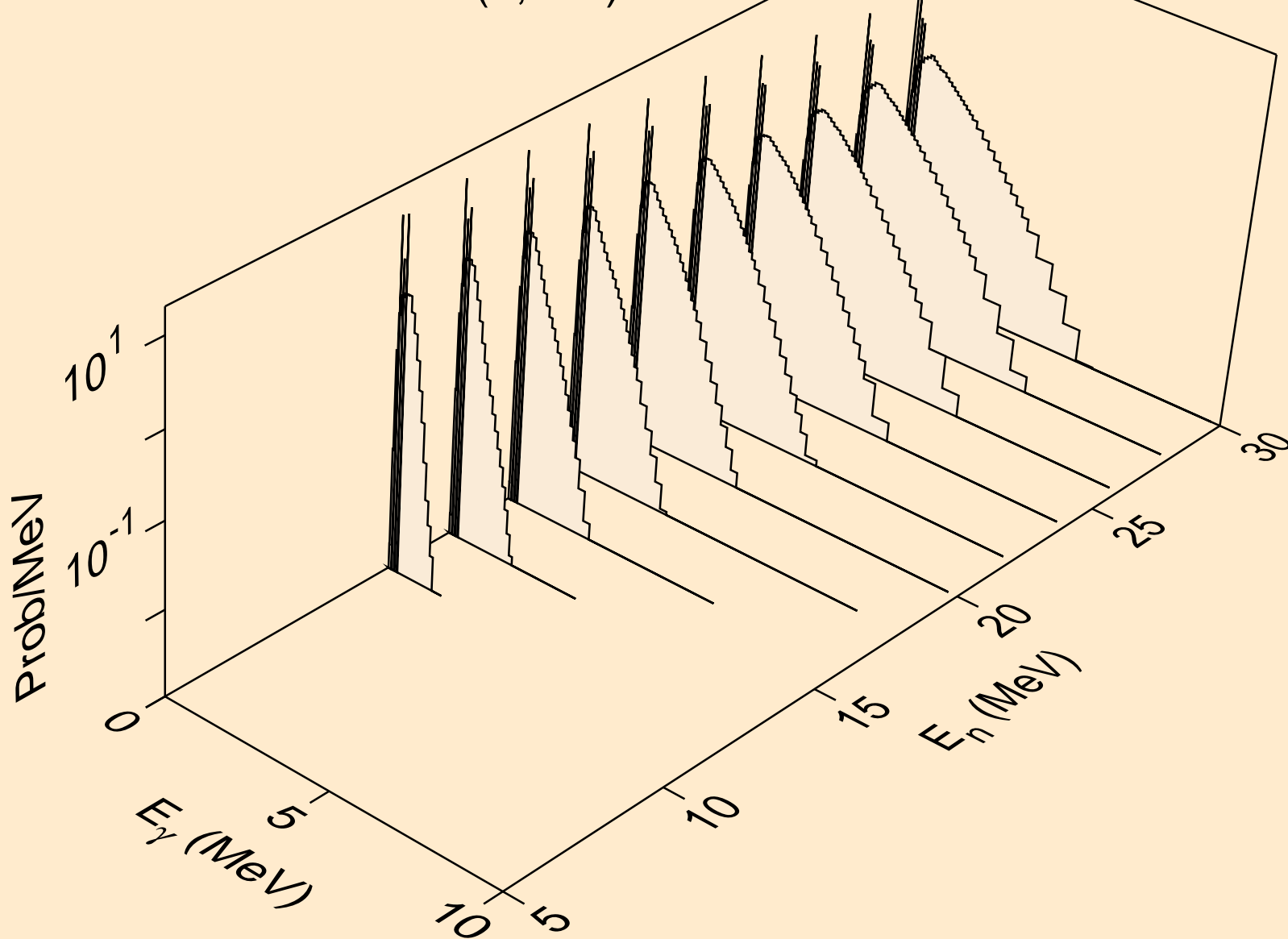

SB118M NEUTRON ACER TENDL-2019 LIBRARY; T=293.16K
Photon emission for (n,a)

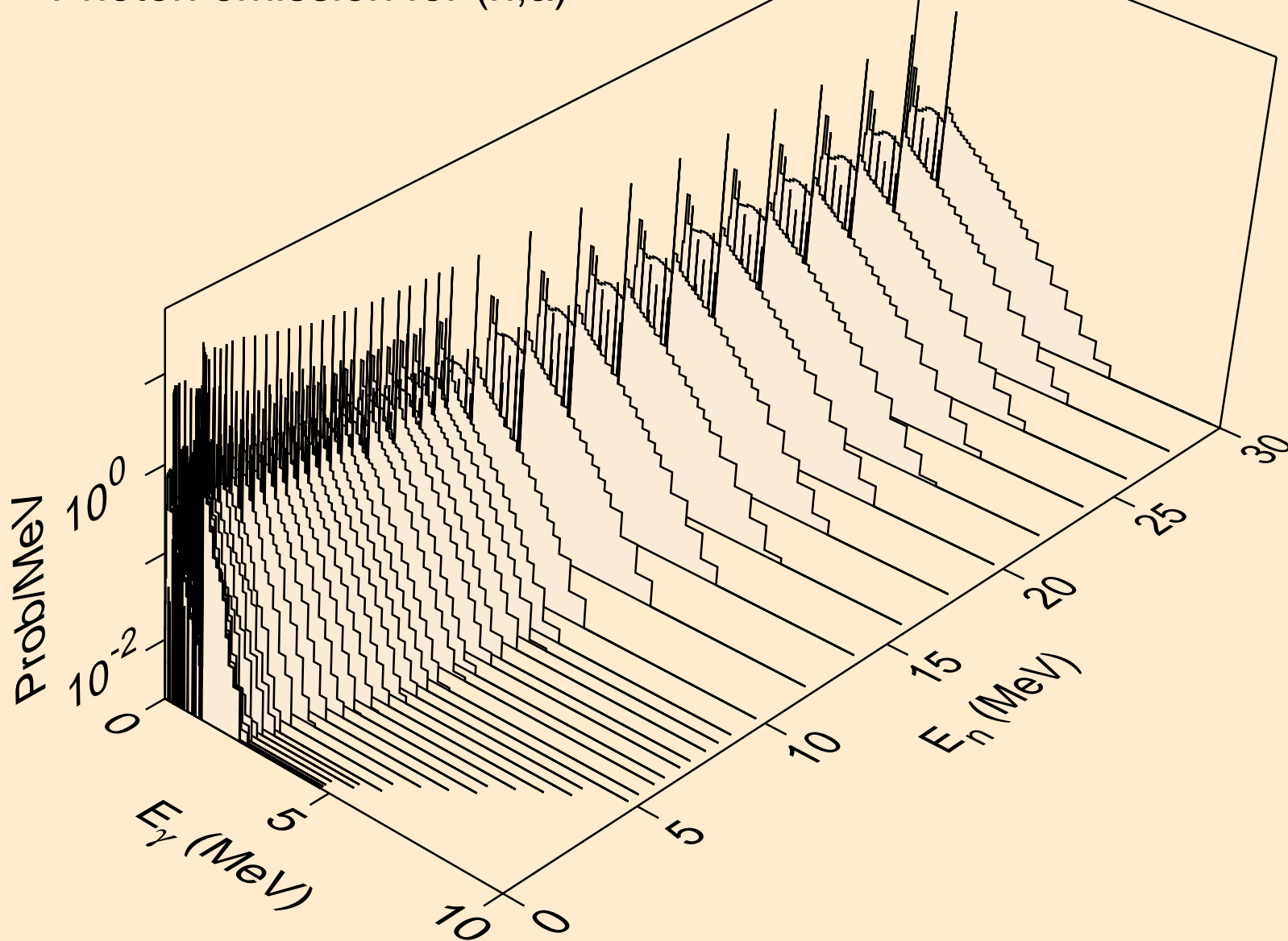

SB118M NEUTRON ACER TENDL-2019 LIBRARY; T=293.16K
Photon emission for (n,2a)

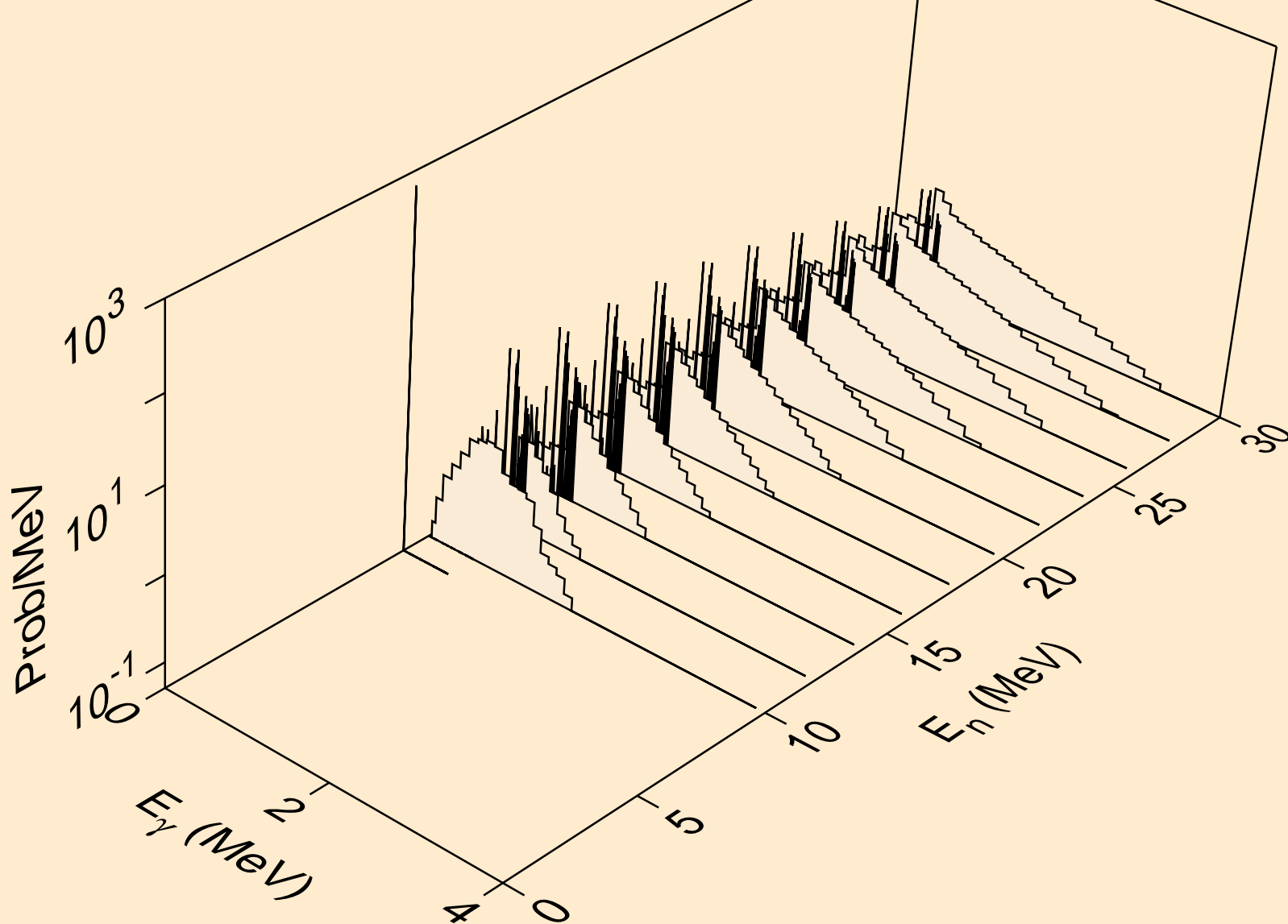

SB118M NEUTRON ACER TENDL-2019 LIBRARY; T=293.16K
Photon emission for (n,2p)

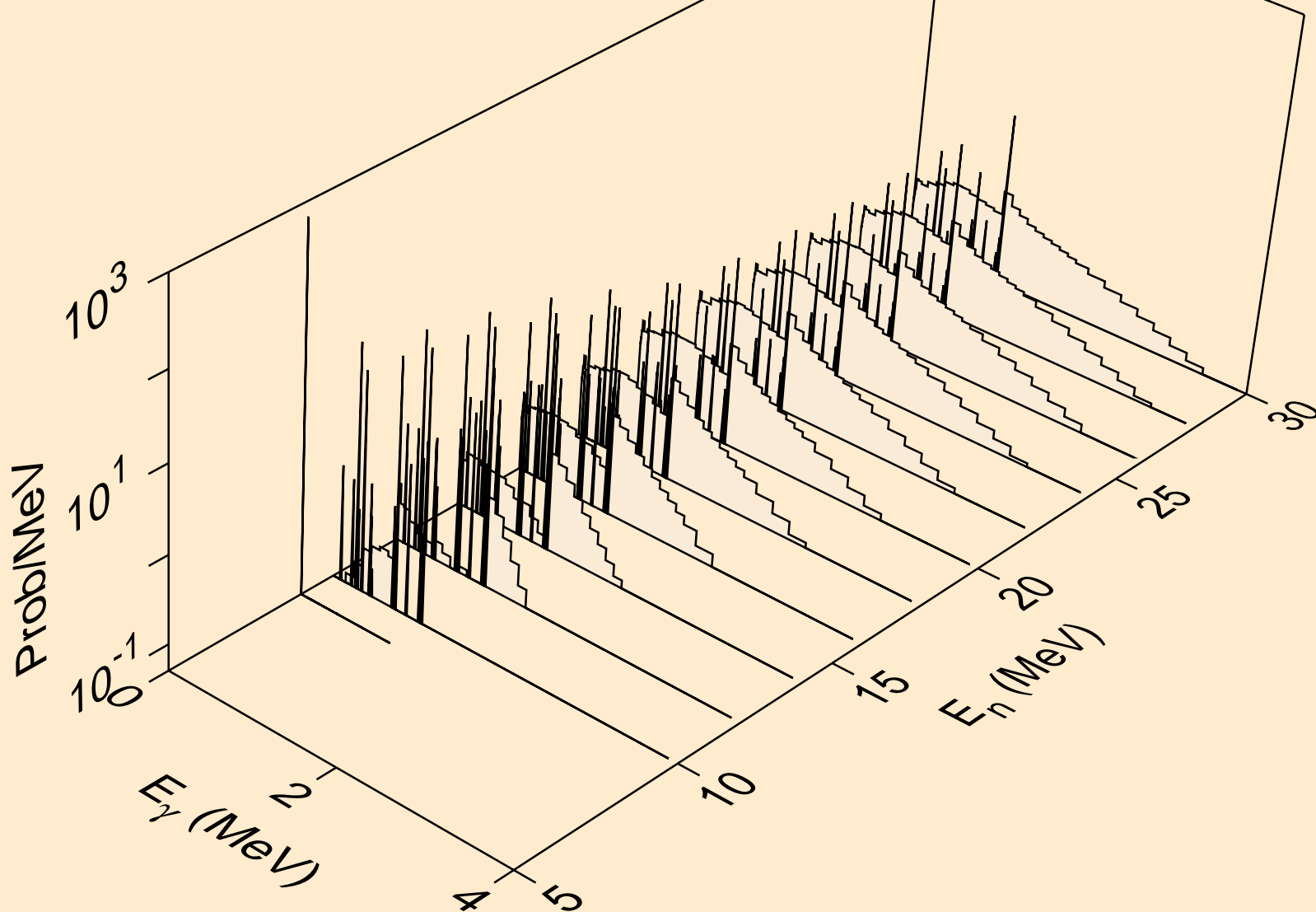

SB118M NEUTRON ACER TENDL-2019 LIBRARY; T=293.16K
Photon emission for (n,p)

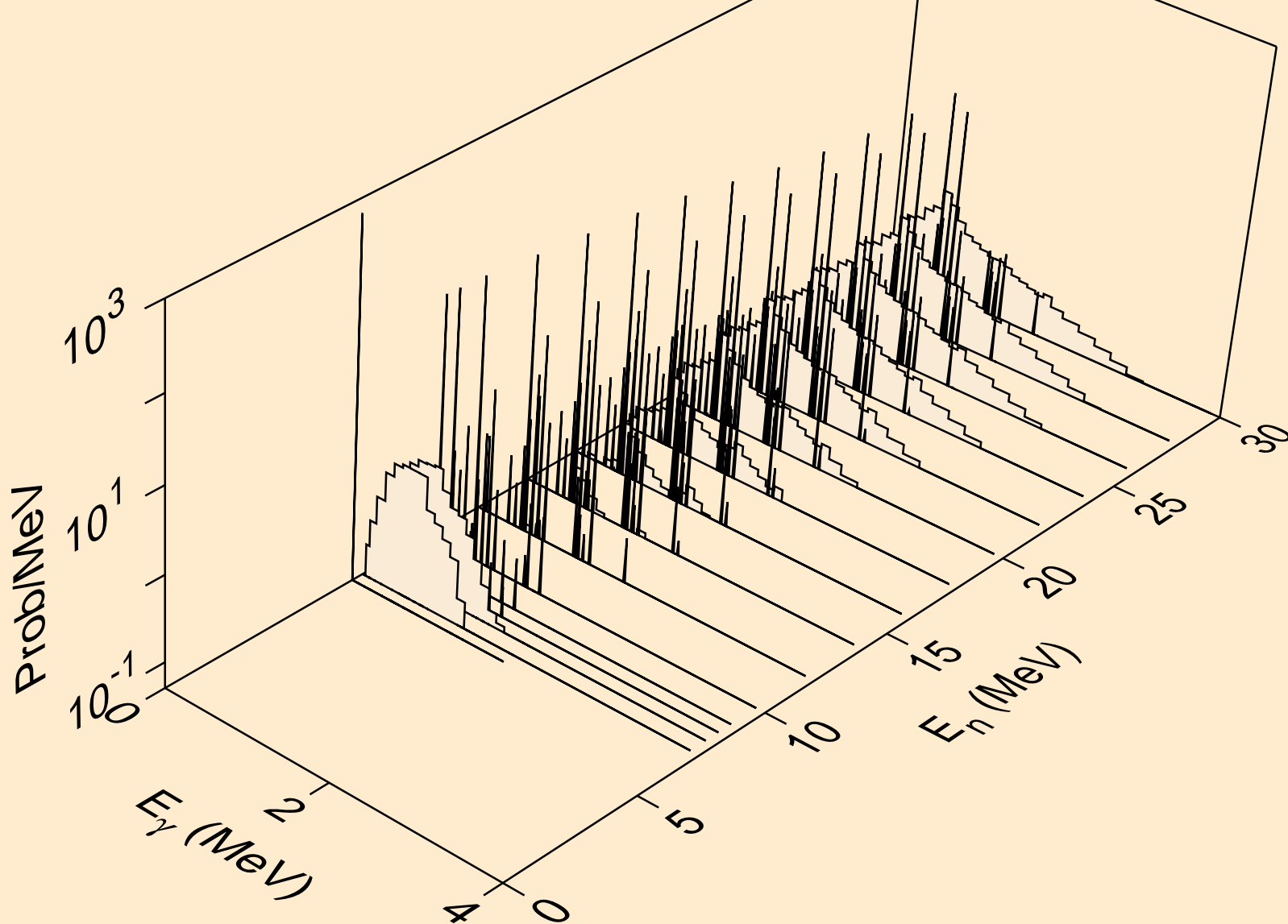

SB118M NEUTRON ACER TENDL-2019 LIBRARY; T=293.16K
Photon emission for (n,pd)

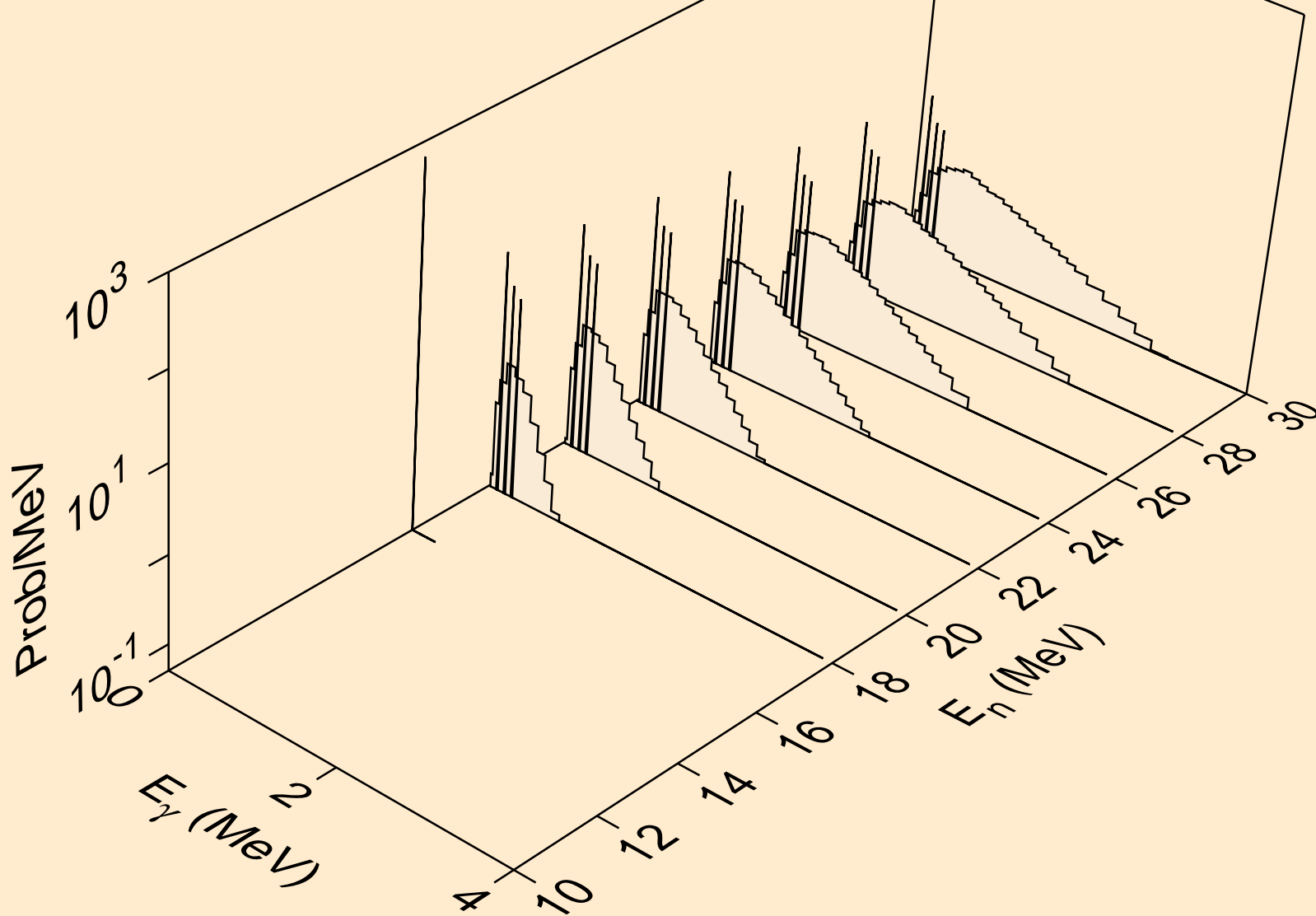

SB118M NEUTRON ACER TENDL-2019 LIBRARY; T=293.16K
Photon emission for (n,pt)

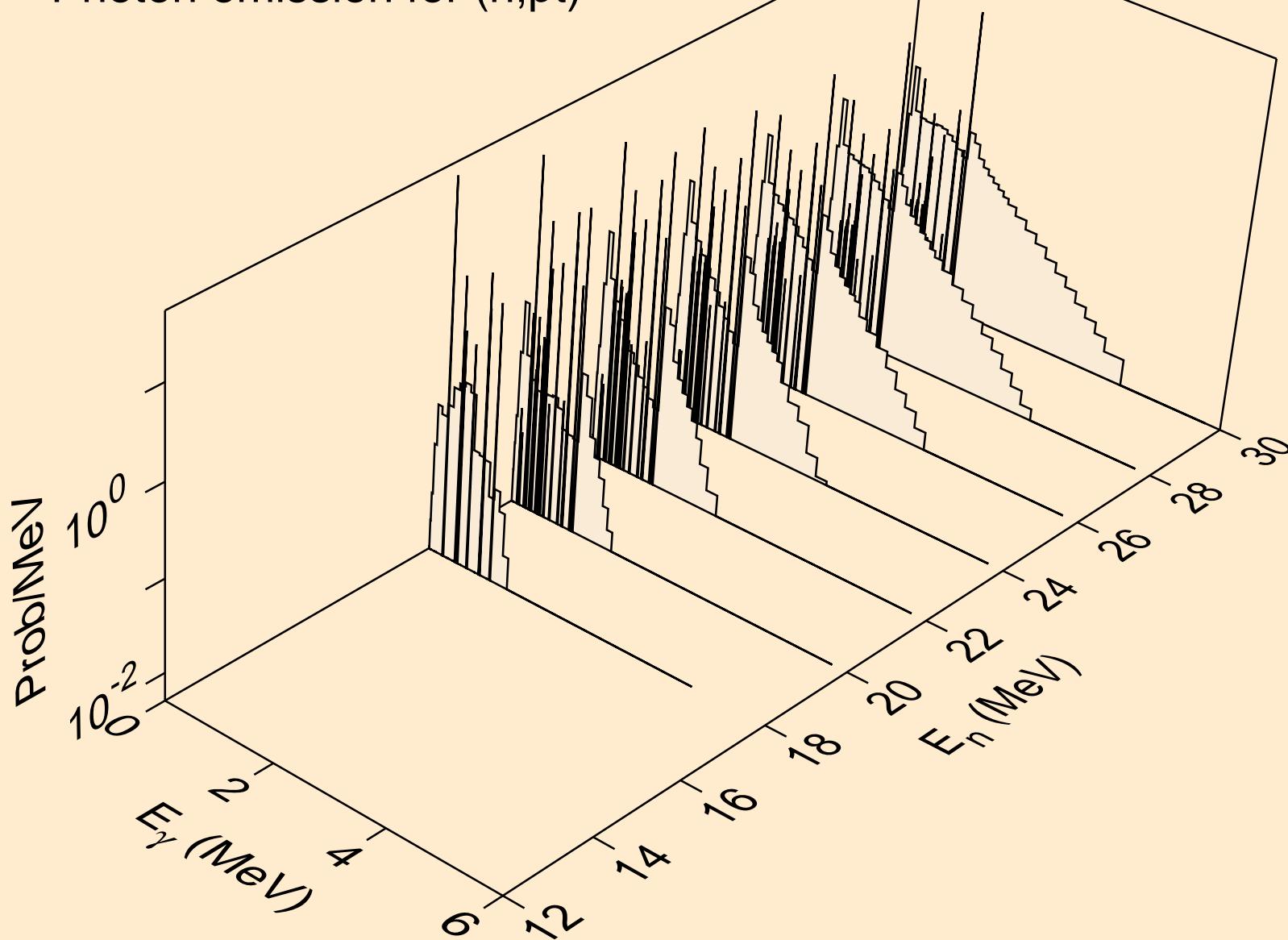

SB118M NEUTRON ACER TENDL-2019 LIBRARY; T=293.16K
Photon emission for (n,da)

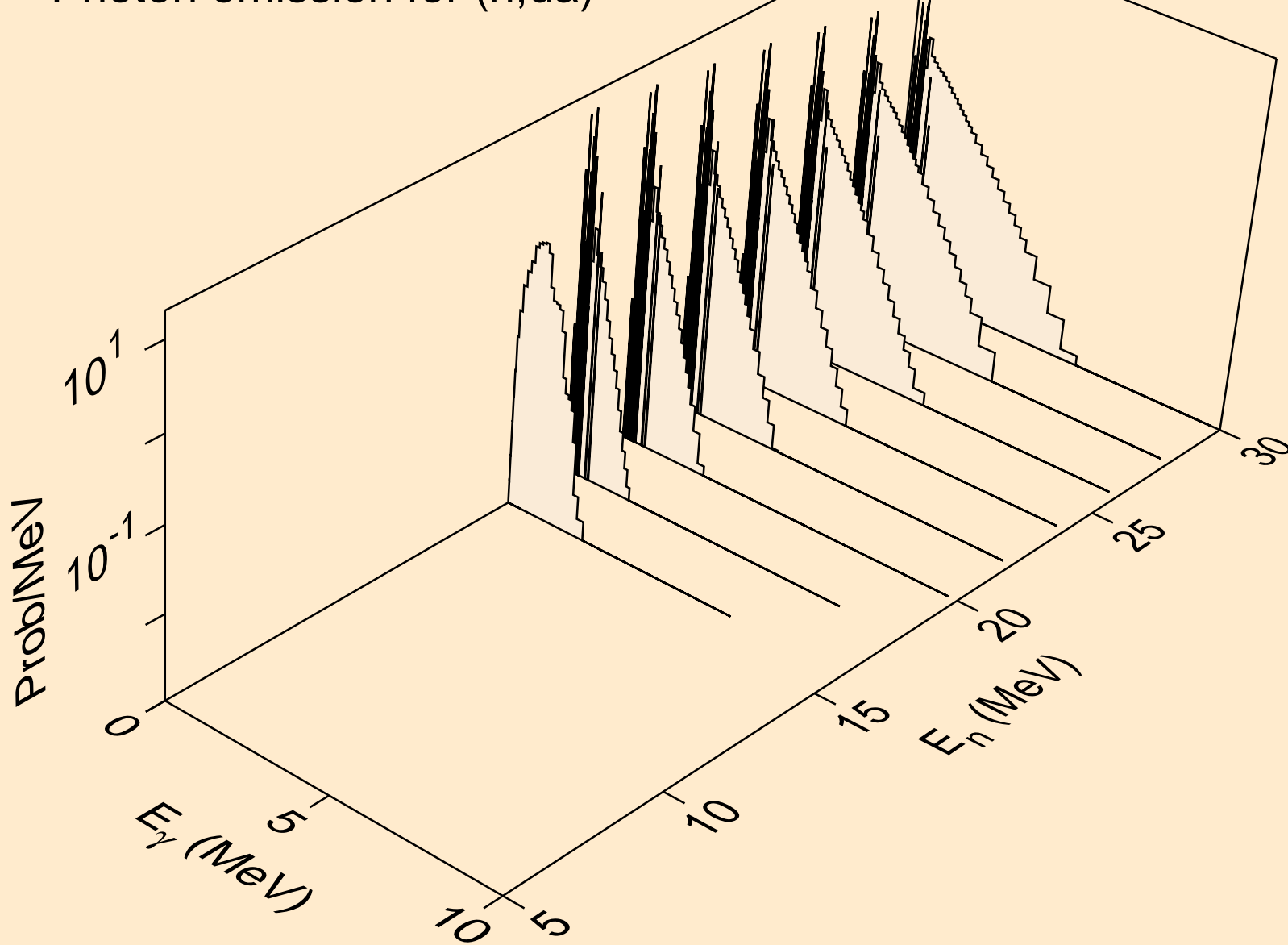

SB118M NEUTRON ACER TENDL-2019 LIBRARY; T=293.16K
thermal capture photon spectrum

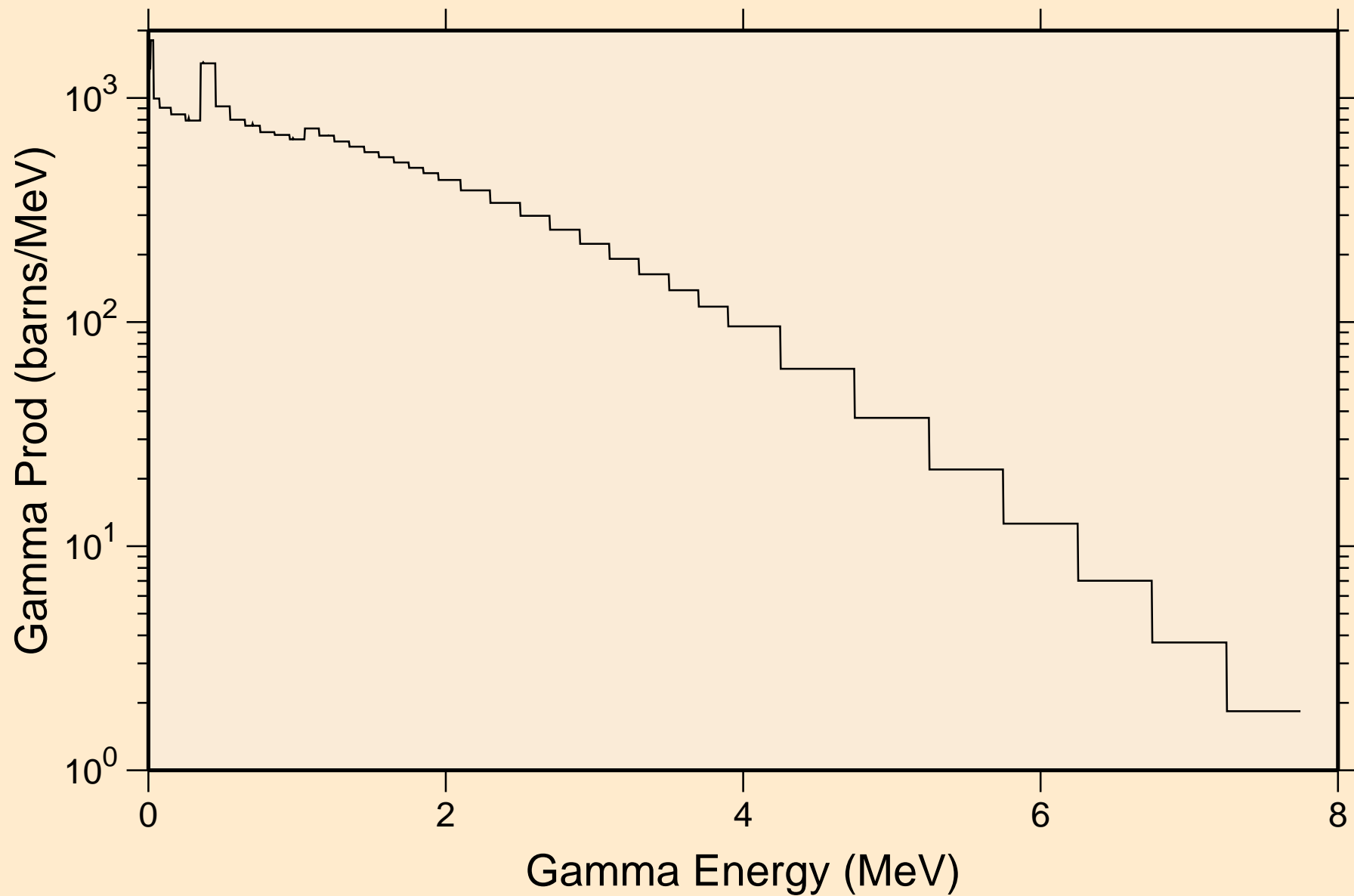

SB118M NEUTRON ACER TENDL-2019 LIBRARY; T=293.16K
14 MeV photon spectrum

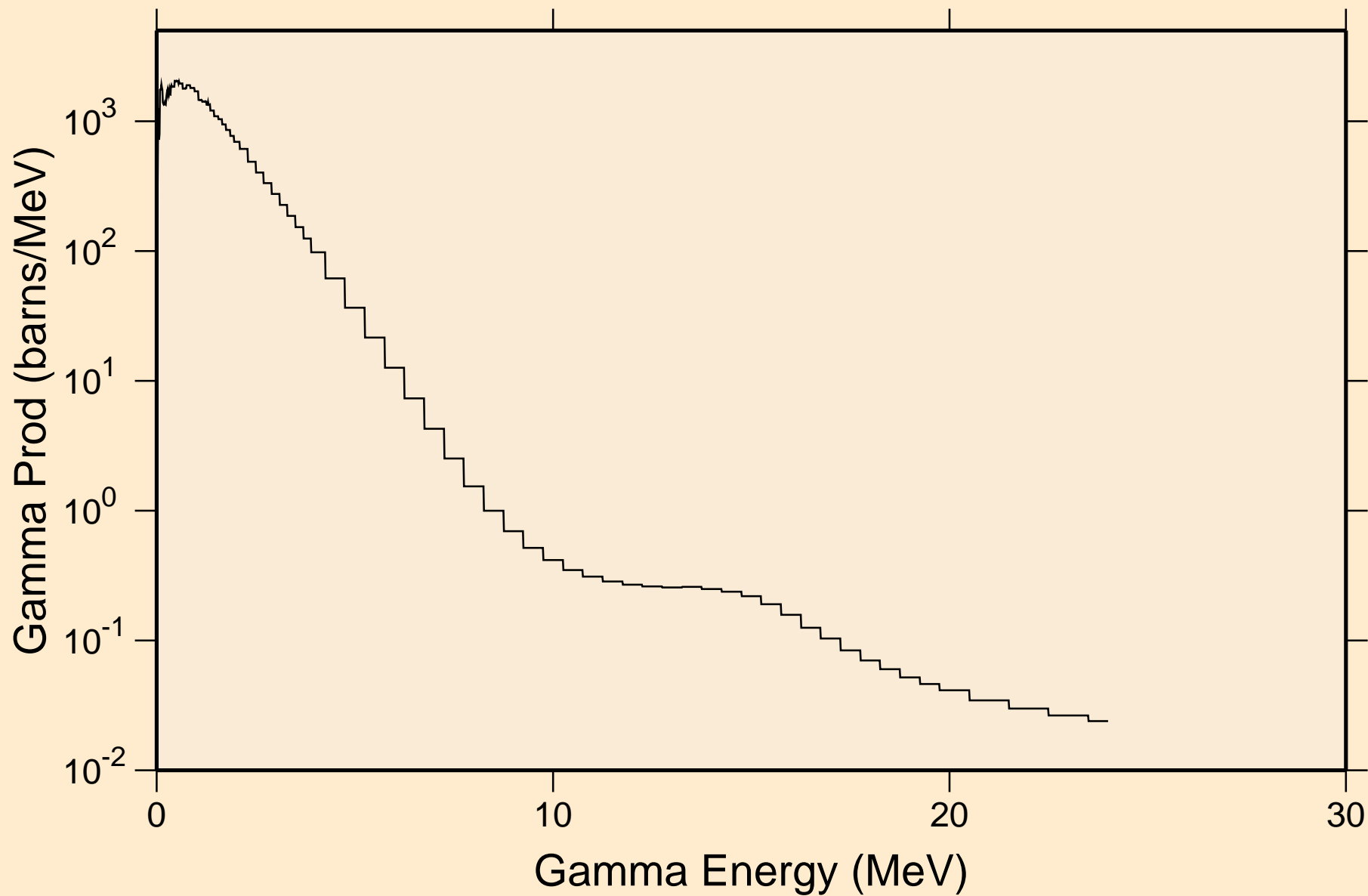

SB118M NEUTRON ACER TENDL-2019 LIBRARY; T=293.16K

Particle heating contributions

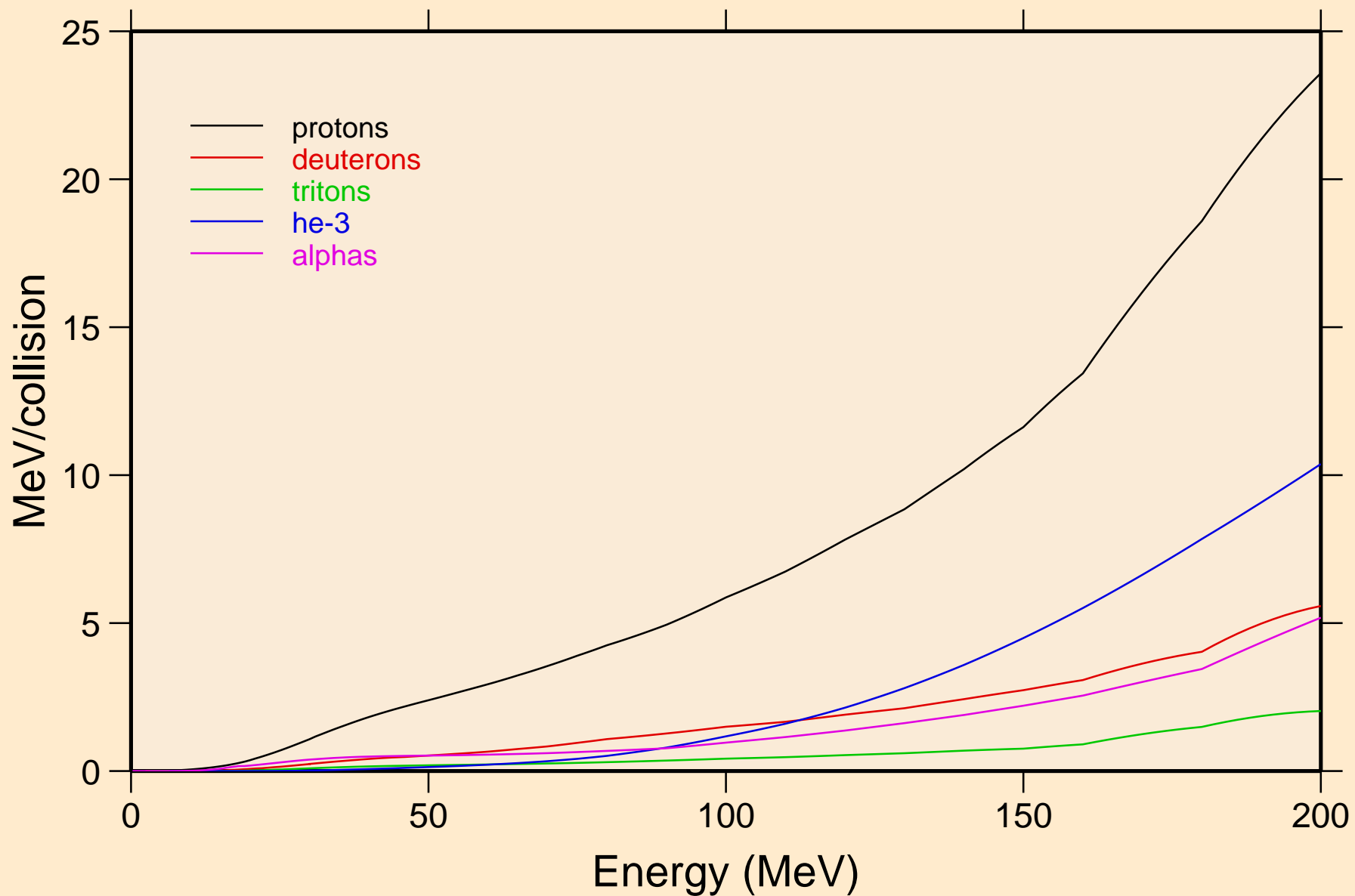

SB118M NEUTRON ACER TENDL-2019 LIBRARY; T=293.16K
Recoil Heating

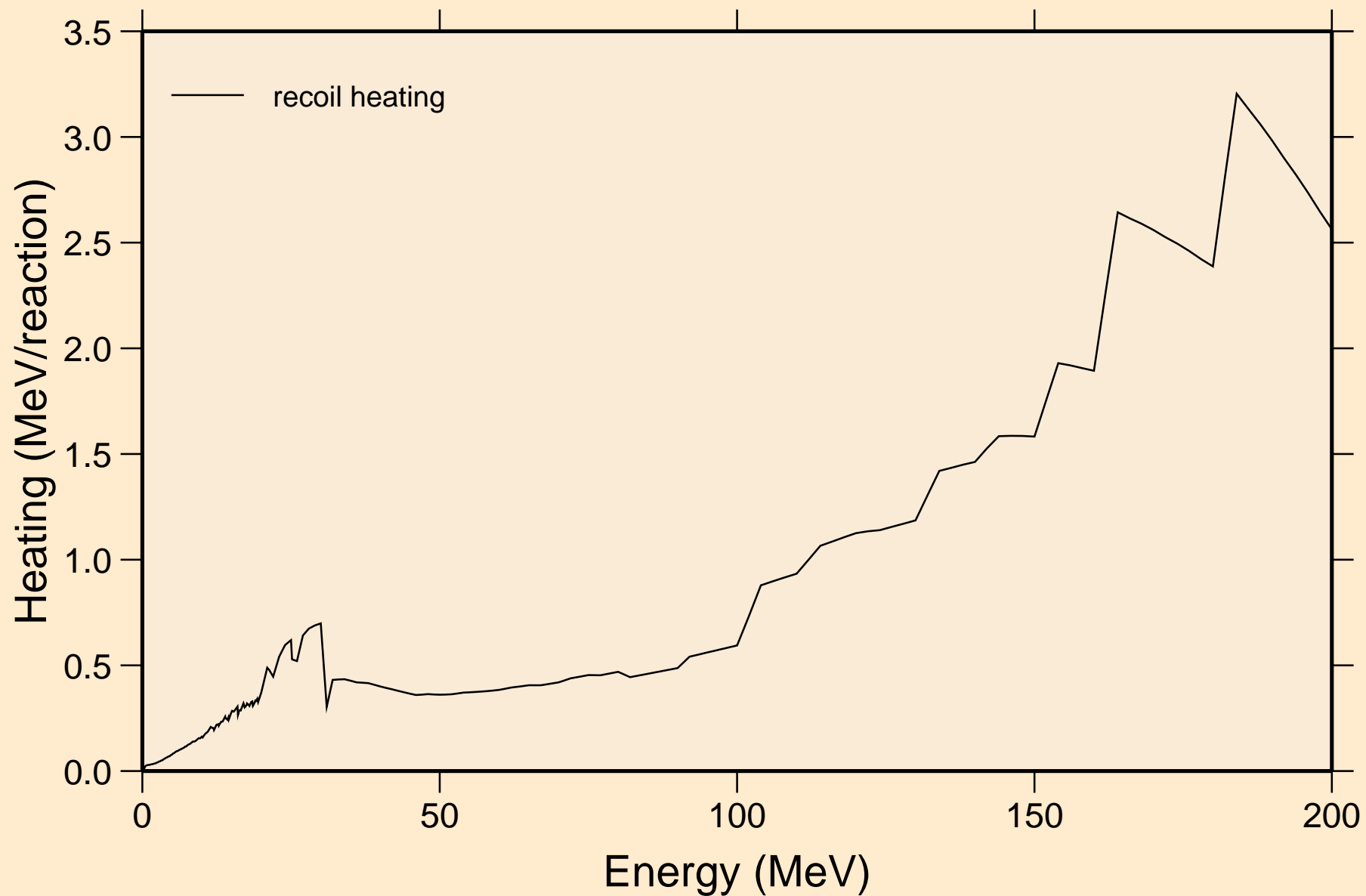

SB118M NEUTRON ACER TENDL-2019 LIBRARY; T=293.16K
Particle production cross sections

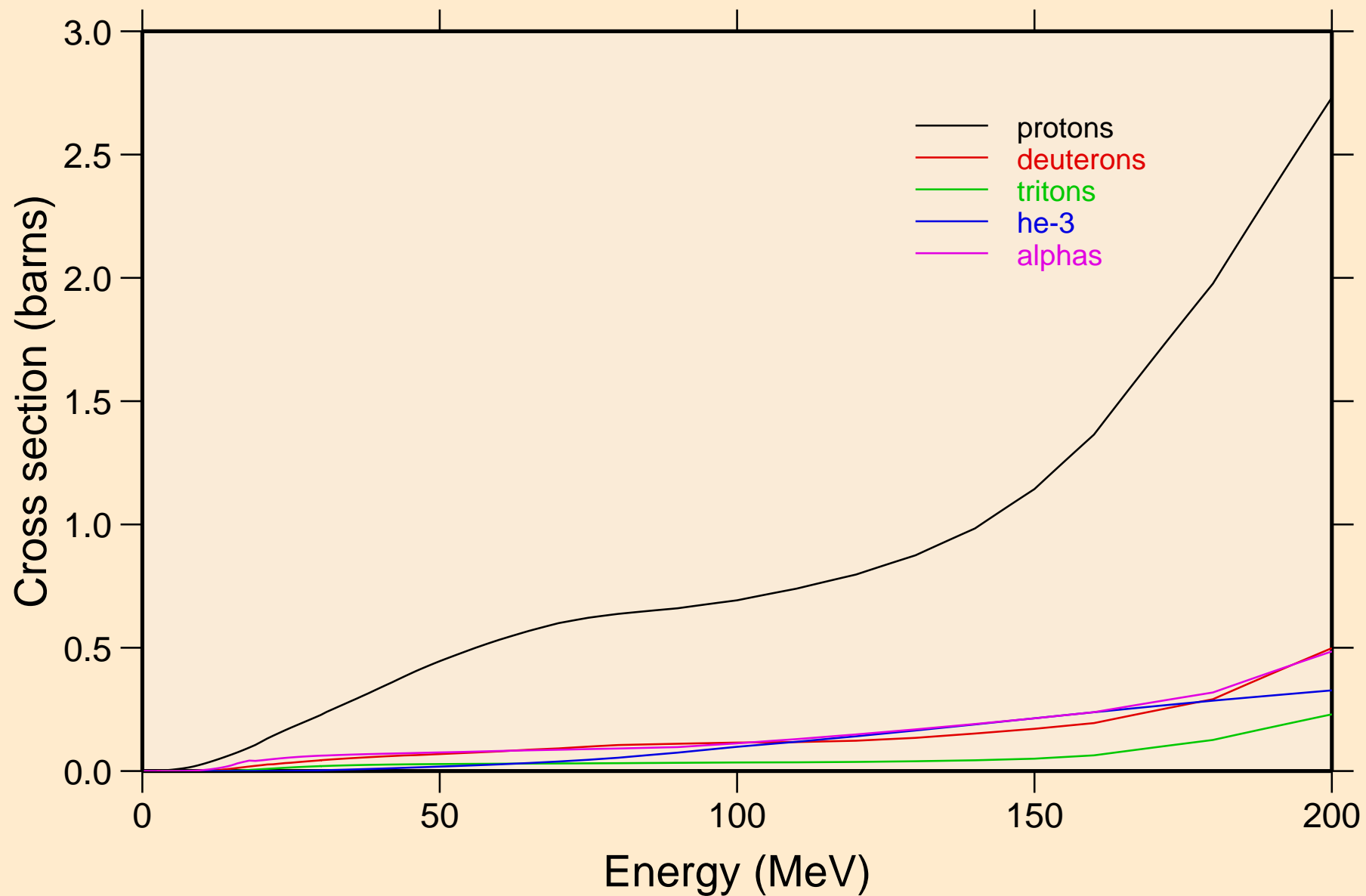

SB118M NEUTRON ACER TENDL-2019 LIBRARY; T=293.16K
protons from (n,x)

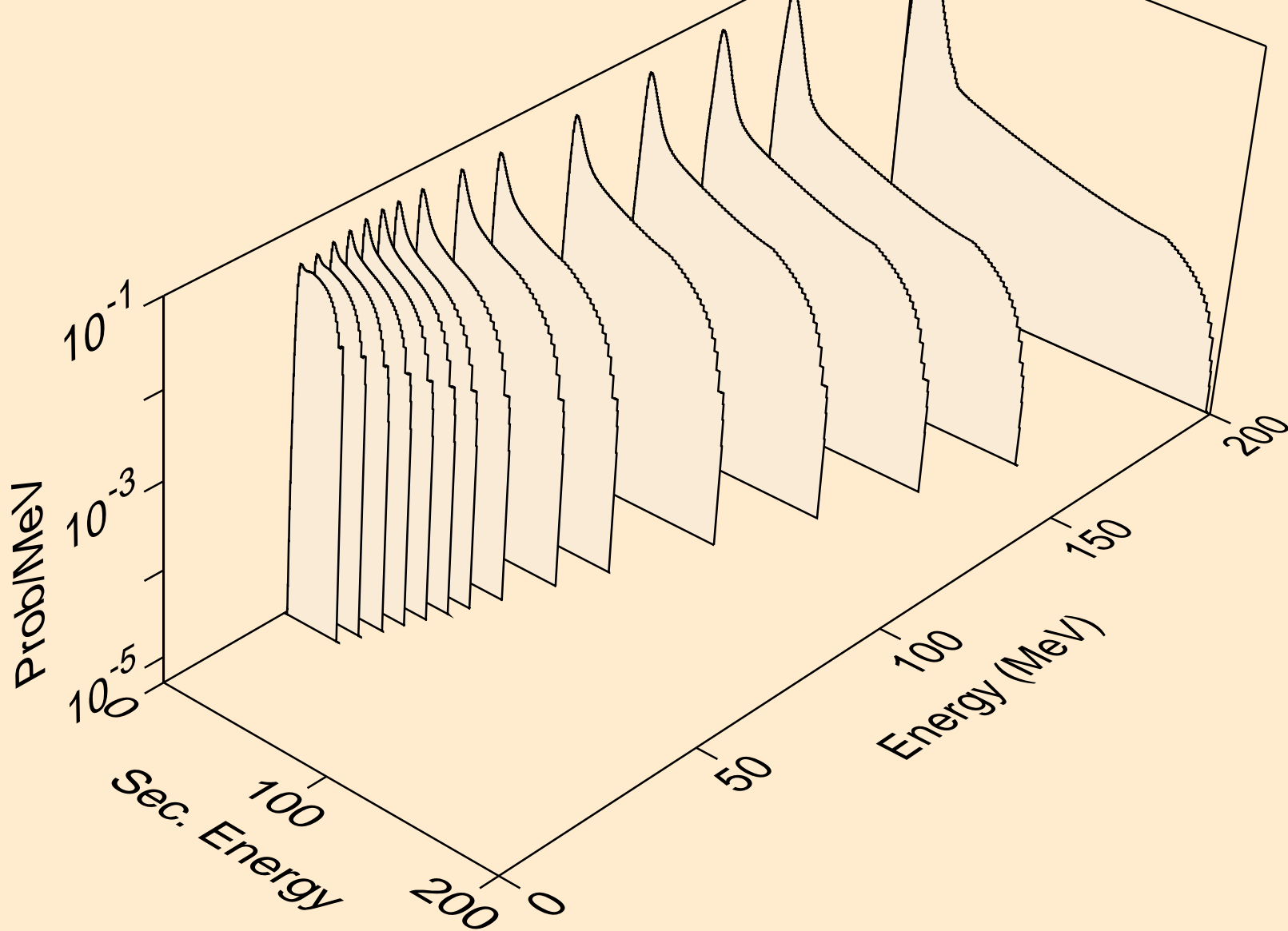

SB118M NEUTRON ACER TENDL-2019 LIBRARY; T=293.16K
protons from (n,n*)p

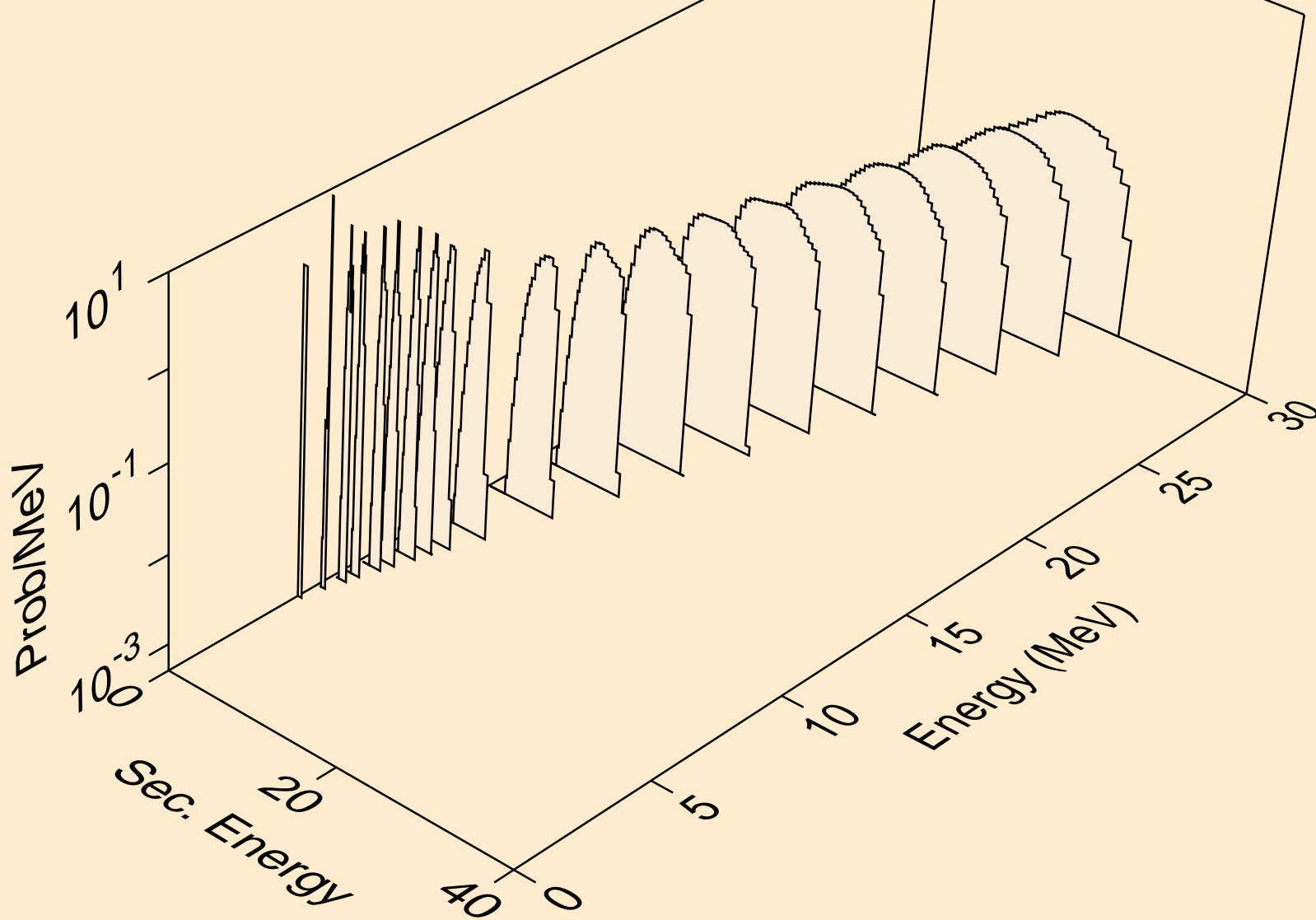

SB118M NEUTRON ACER TENDL-2019 LIBRARY; T=293.16K
protons from (n,2np)

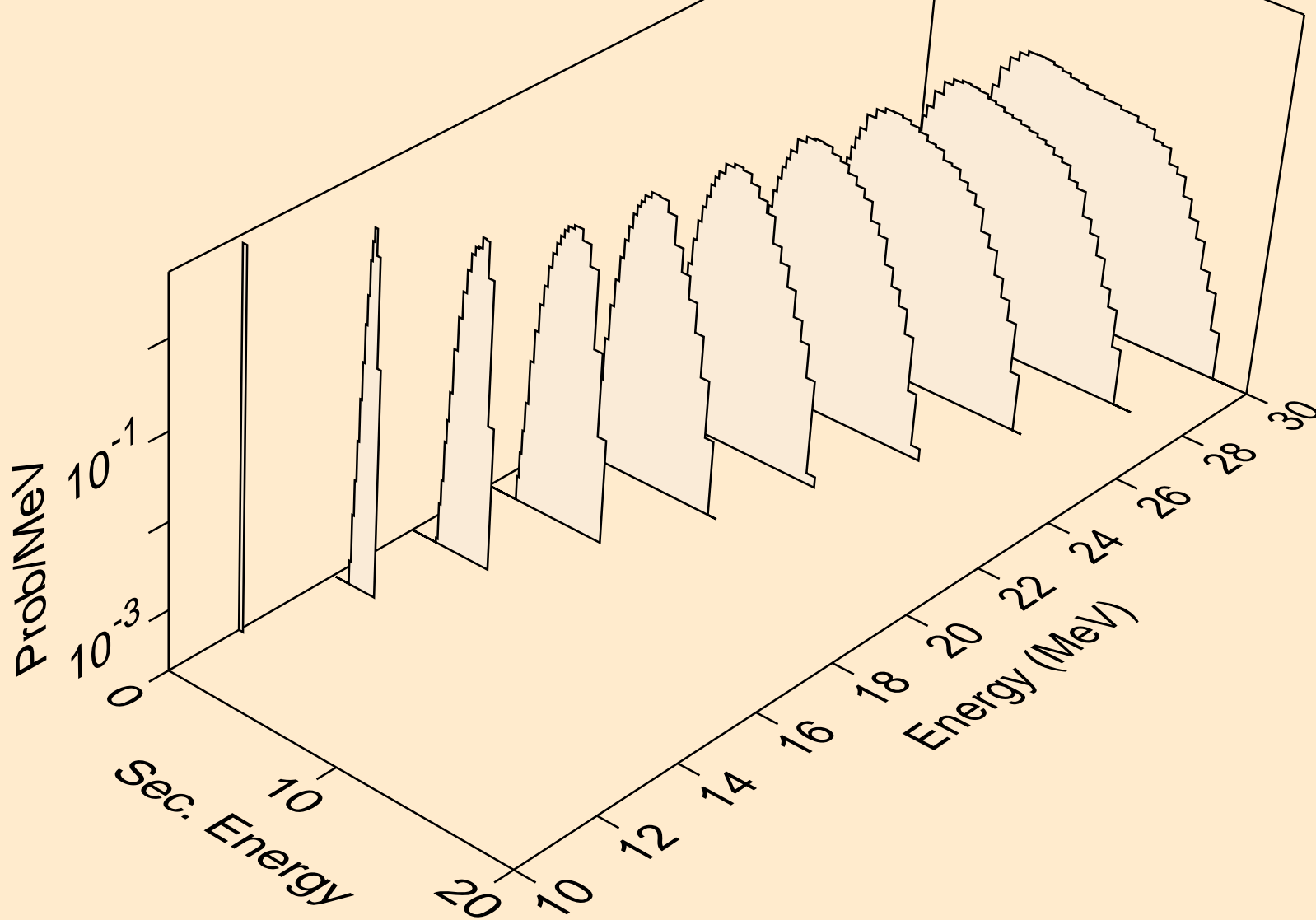

SB118M NEUTRON ACER TENDL-2019 LIBRARY; T=293.16K
protons from (n,3np)

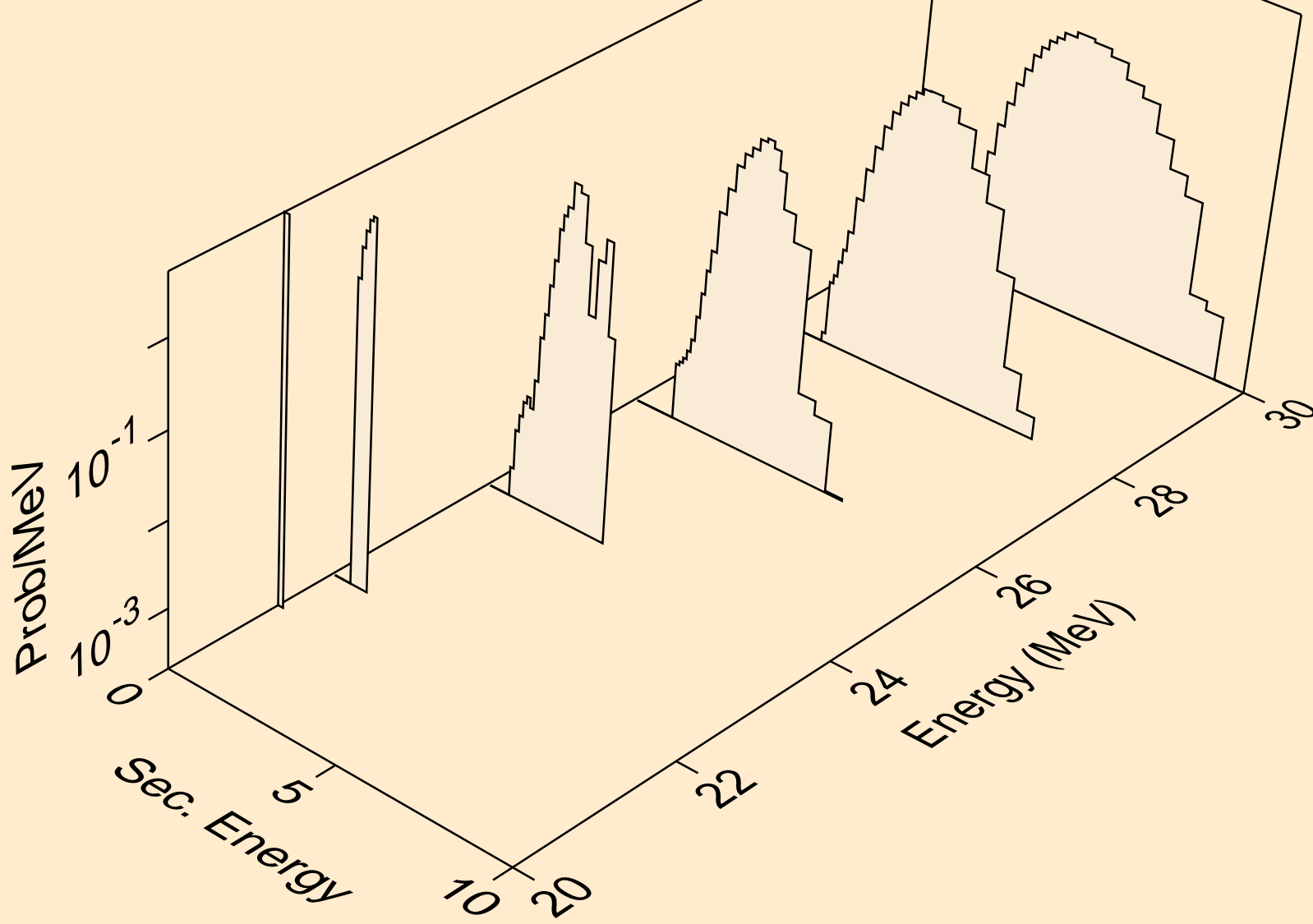

SB118M NEUTRON ACER TENDL-2019 LIBRARY; T=293.16K
protons from (n,2np)

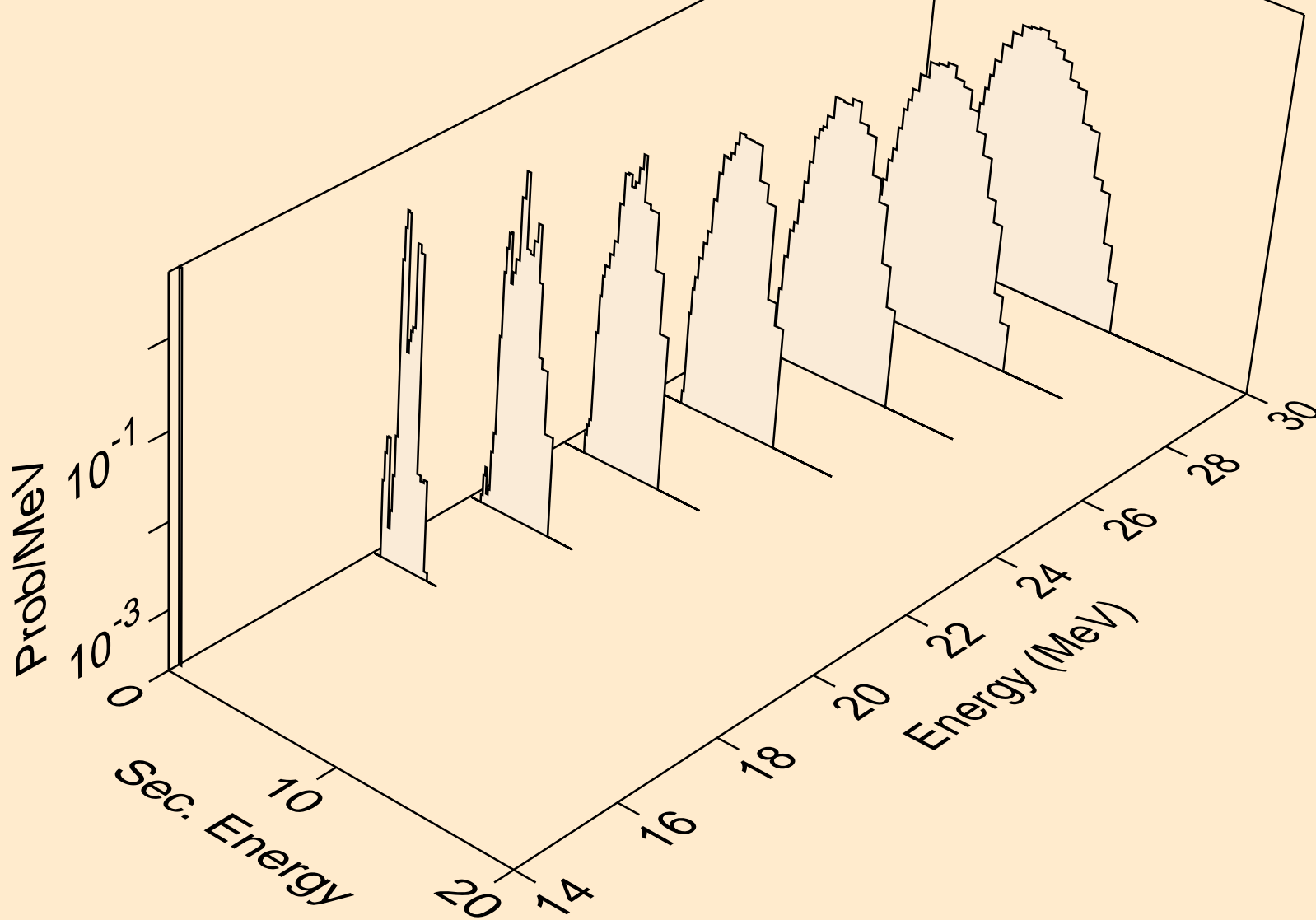

SB118M NEUTRON ACER TENDL-2019 LIBRARY; T=293.16K
protons from (n,npa)

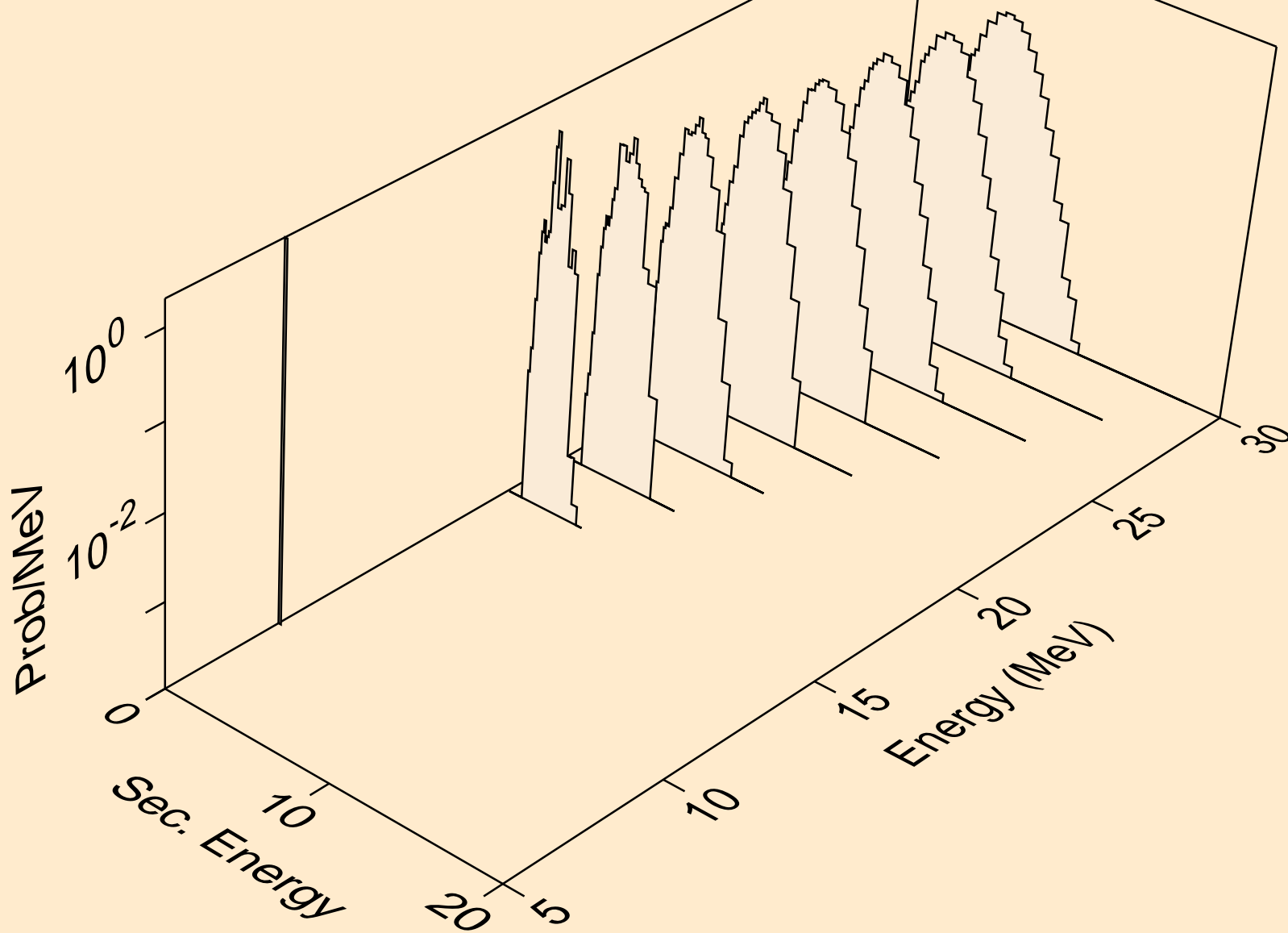

SB118M NEUTRON ACER TENDL-2019 LIBRARY; T=293.16K
protons from (n,p)

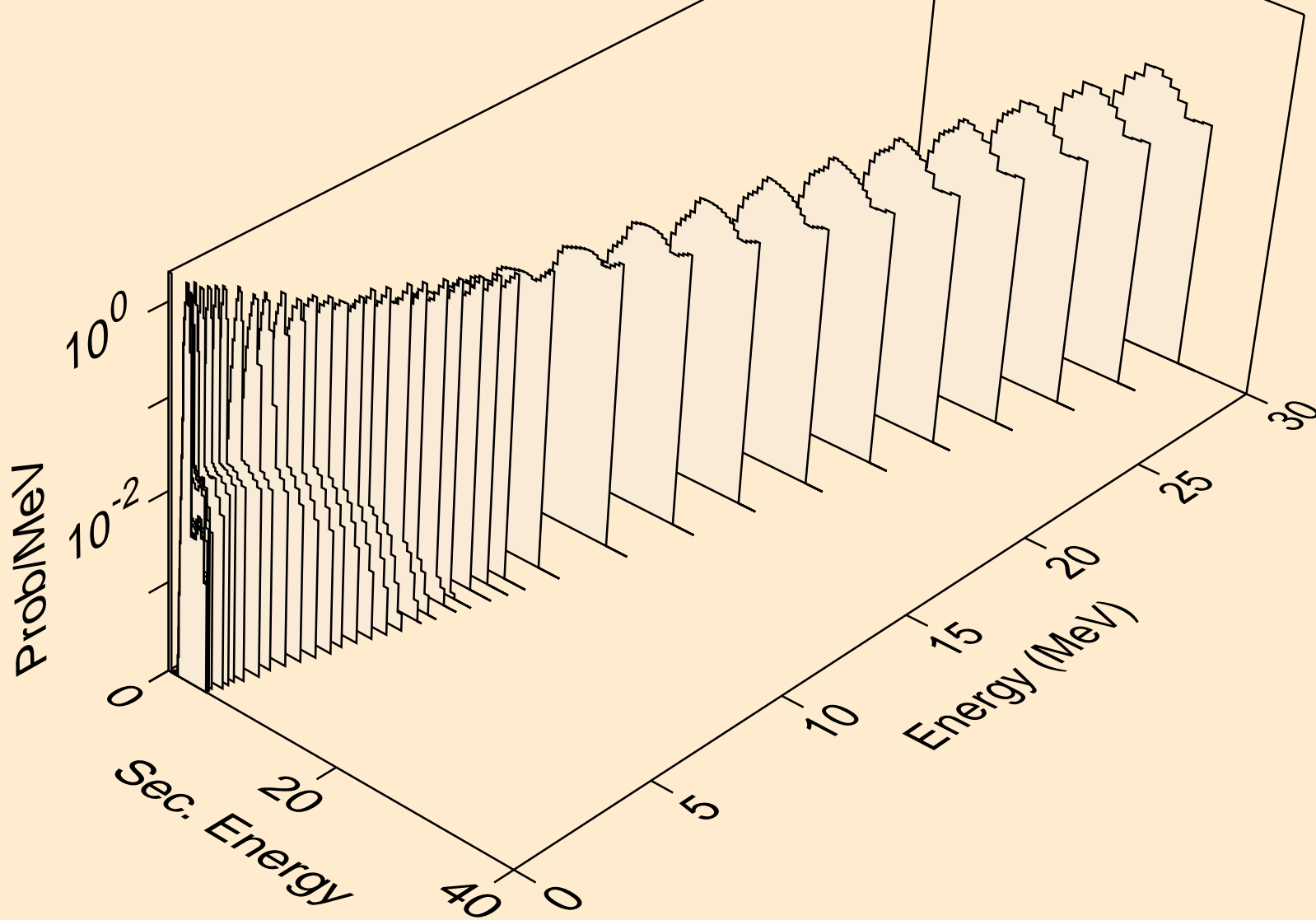

SB118M NEUTRON ACER TENDL-2019 LIBRARY; T=293.16K
protons from (n,2p)

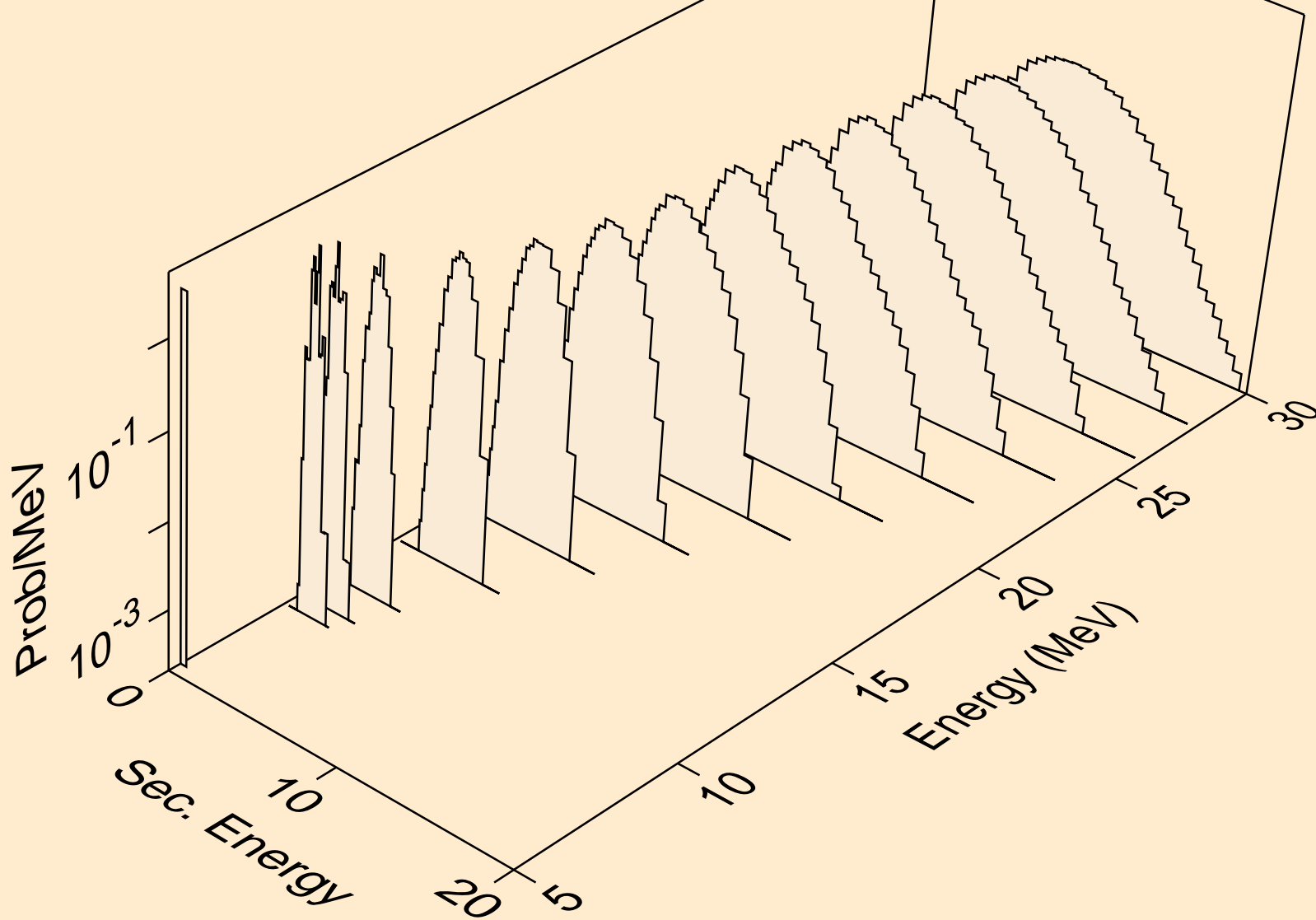

SB118M NEUTRON ACER TENDL-2019 LIBRARY; T=293.16K
protons from (n,p)

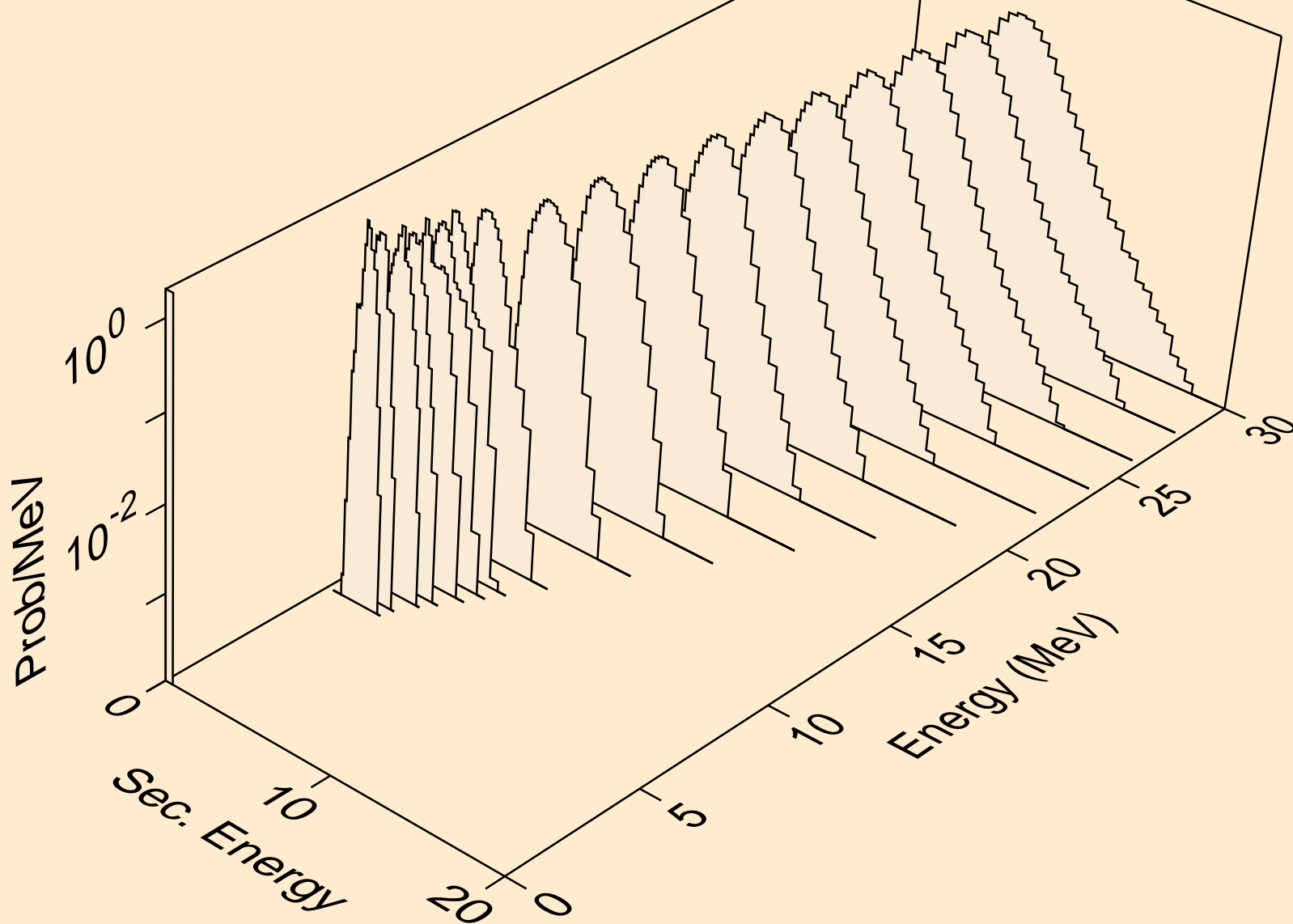

SB118M NEUTRON ACER TENDL-2019 LIBRARY; T=293.16K
protons from (n,pd)

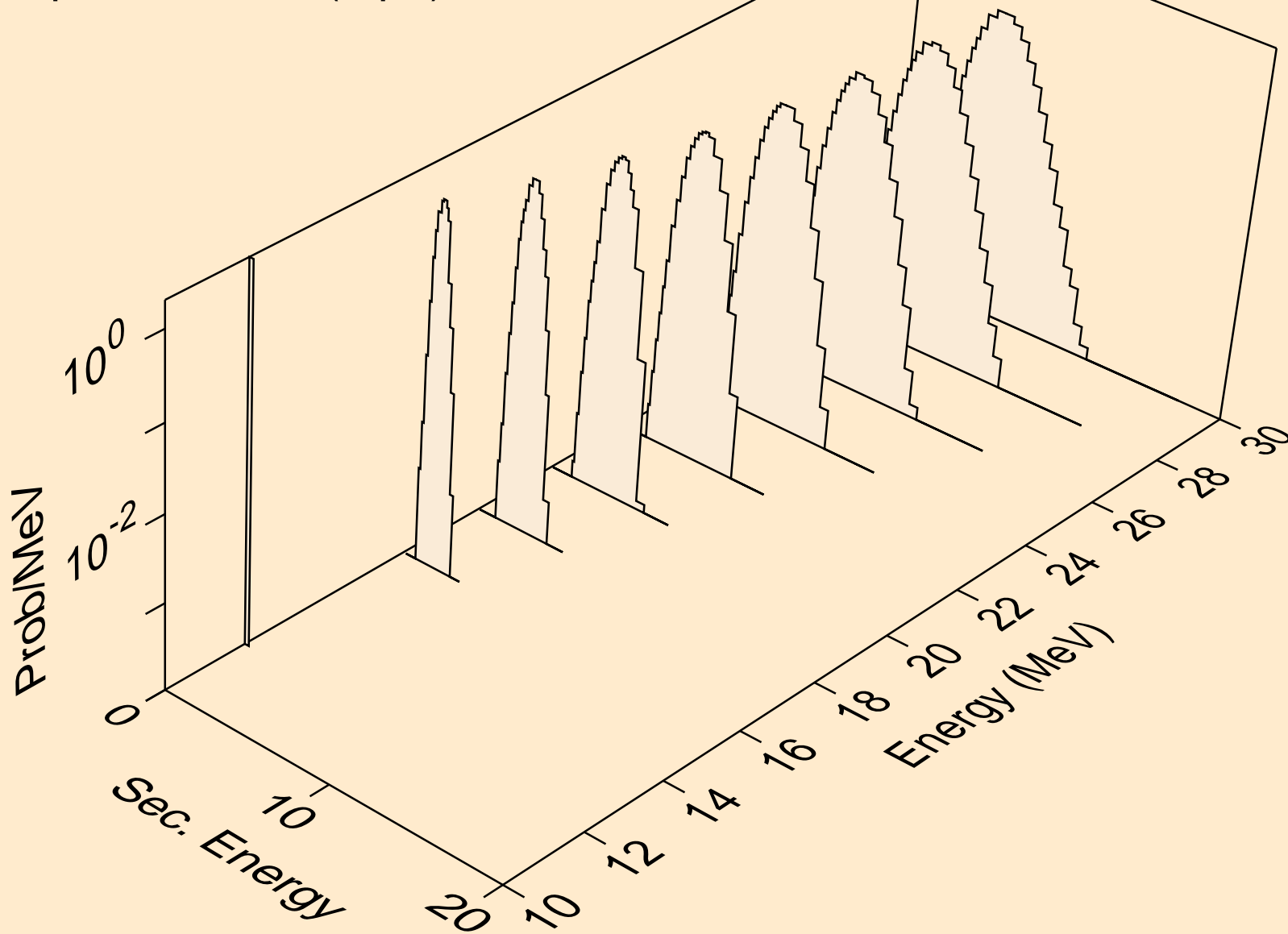

SB118M NEUTRON ACER TENDL-2019 LIBRARY; T=293.16K
protons from (n,pt)

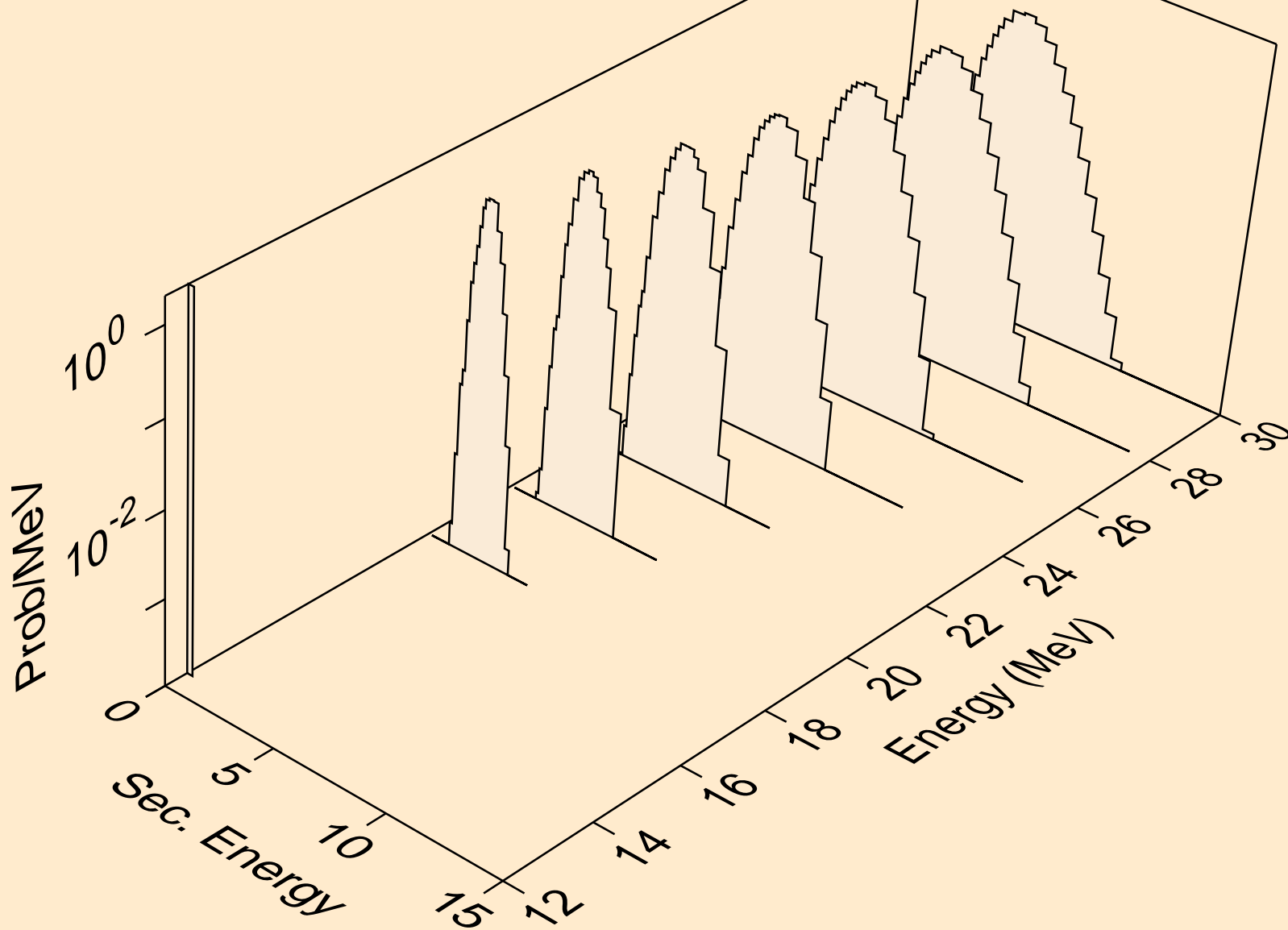

SB118M NEUTRON ACER TENDL-2019 LIBRARY; T=293.16K
deuterons from (n,x)

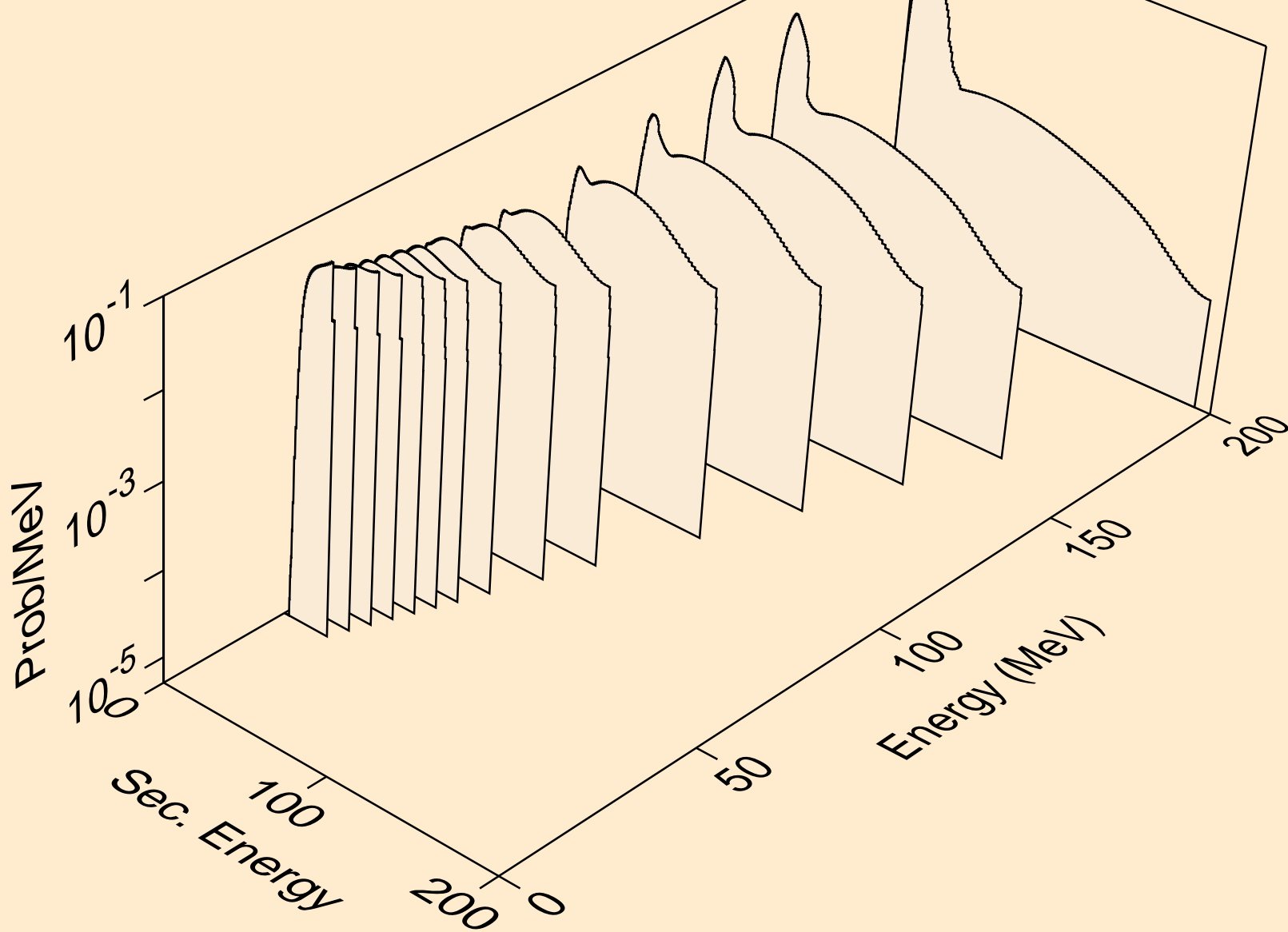

SB118M NEUTRON ACER TENDL-2019 LIBRARY; T=293.16K
deuterons from (n,2nd)

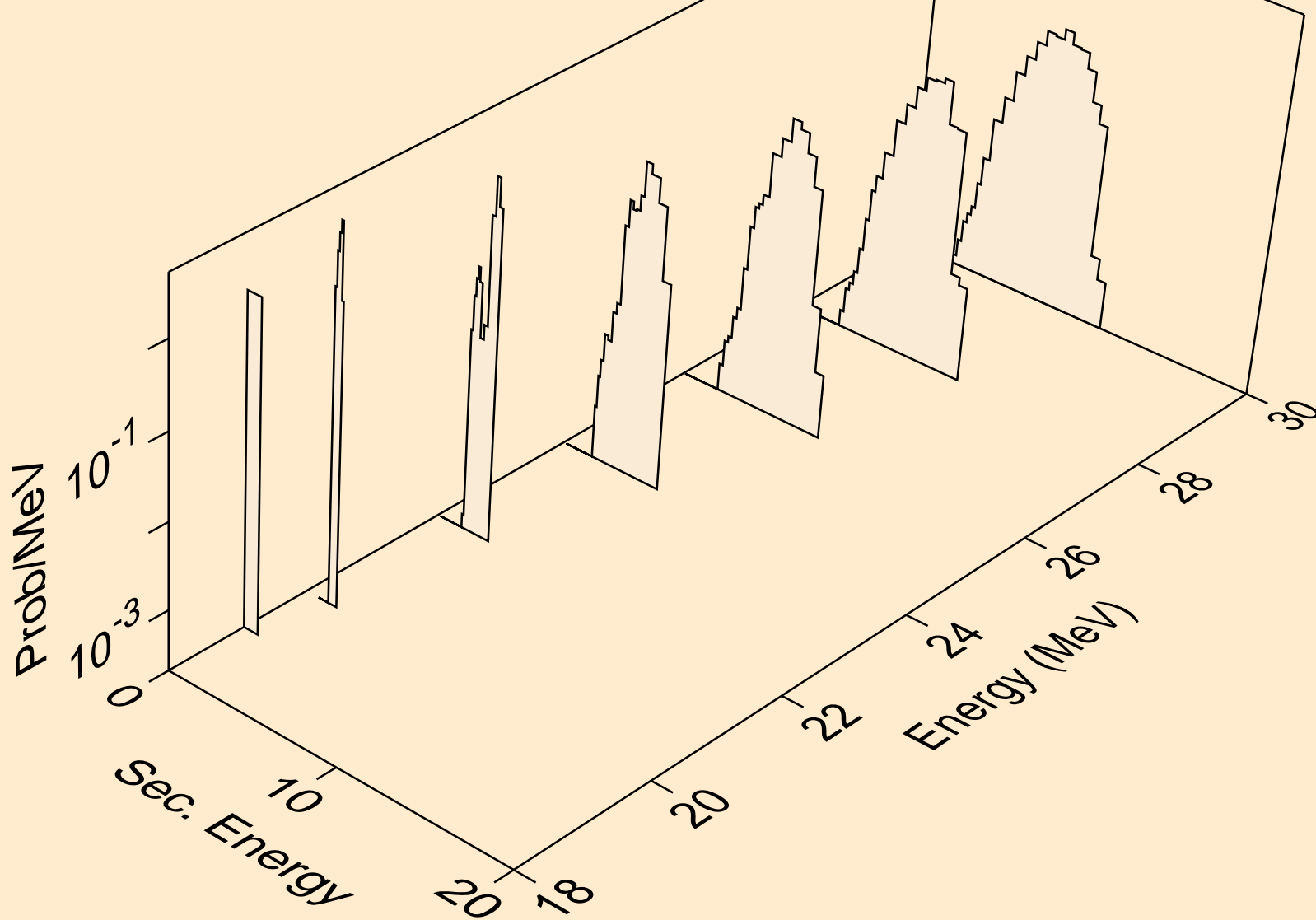

SB118M NEUTRON ACER TENDL-2019 LIBRARY; T=293.16K
deuterons from (n,n*)d

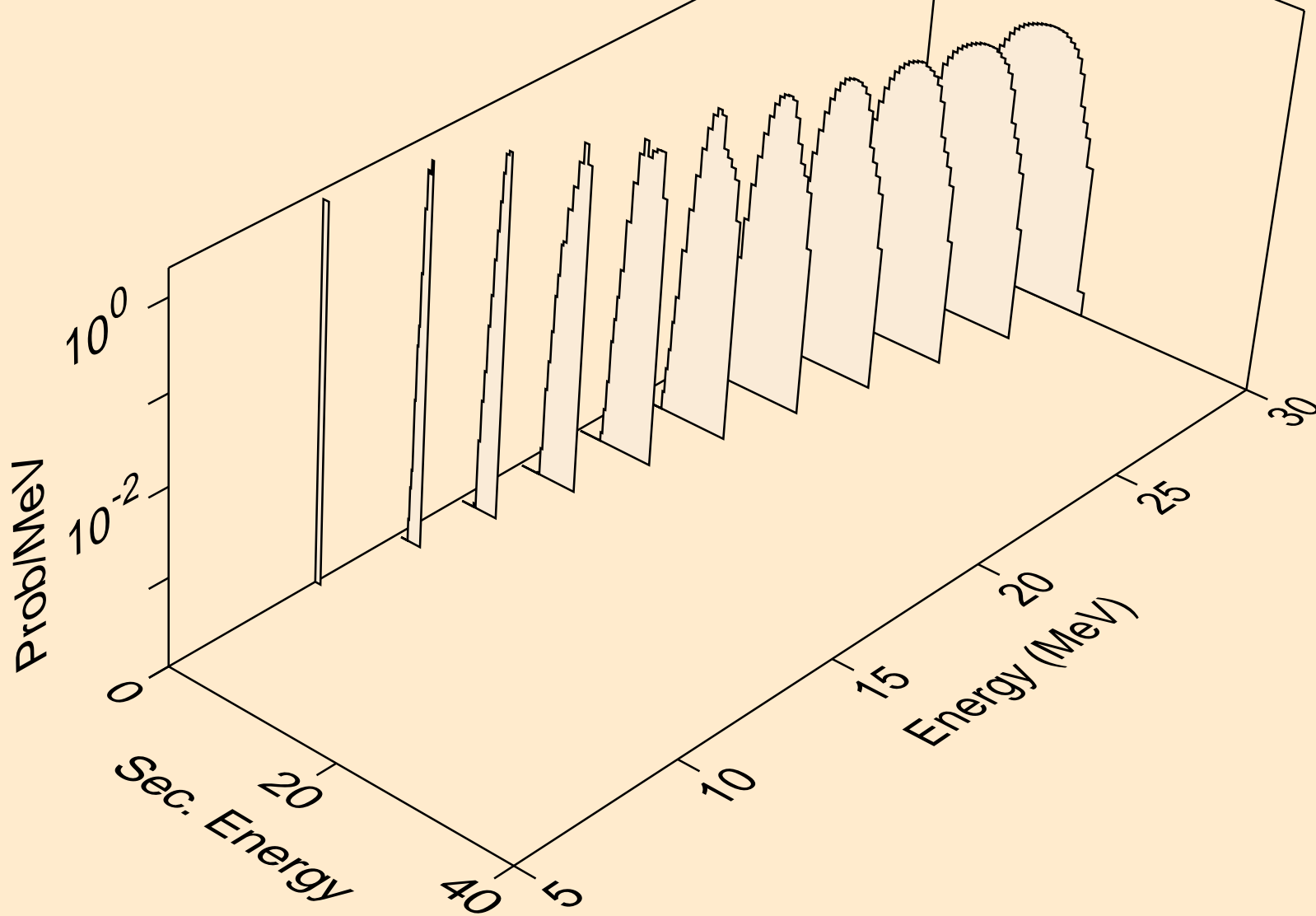

SB118M NEUTRON ACER TENDL-2019 LIBRARY; T=293.16K
deuterons from (n,d)

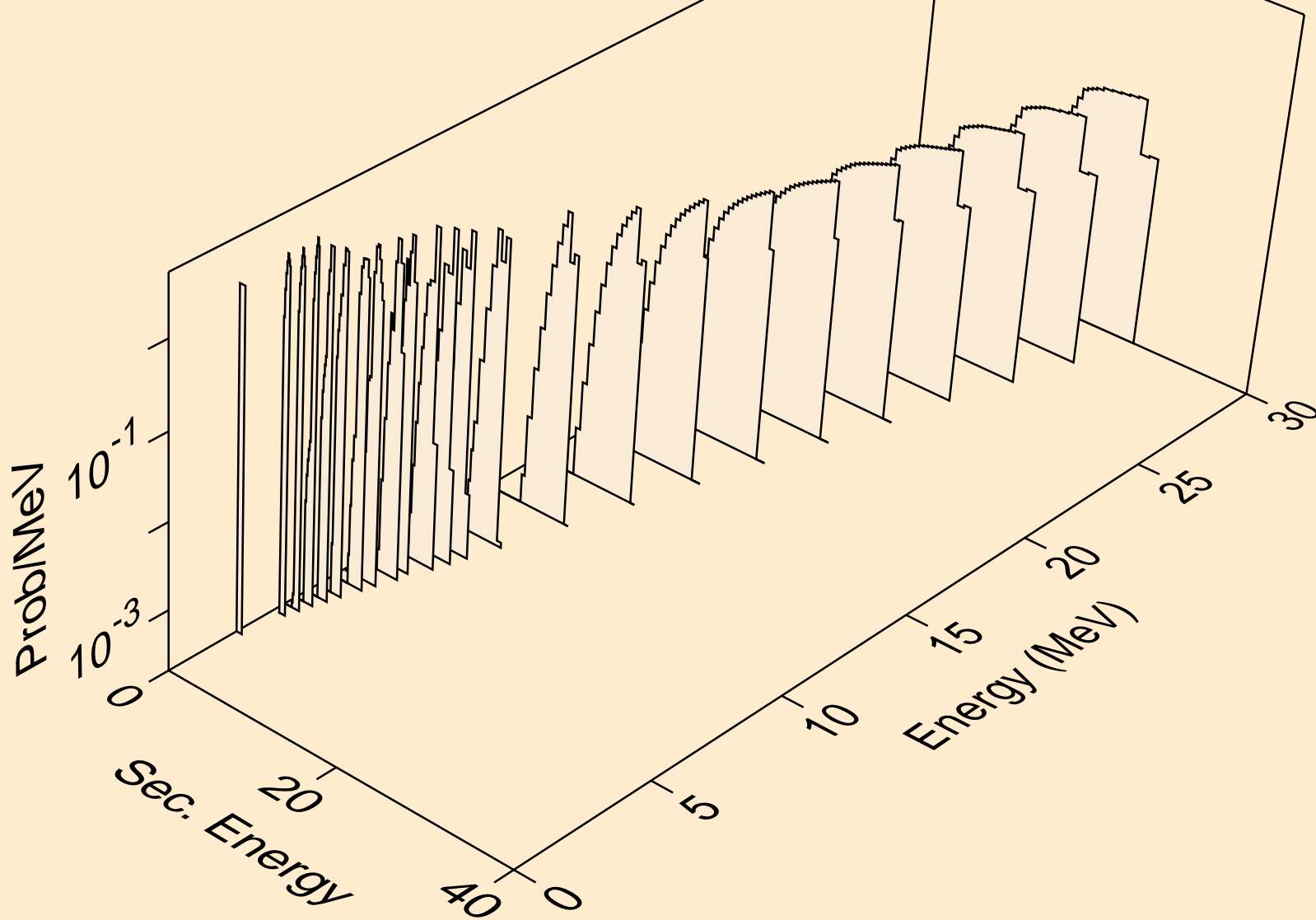

SB118M NEUTRON ACER TENDL-2019 LIBRARY; T=293.16K
deuterons from (n,pd)

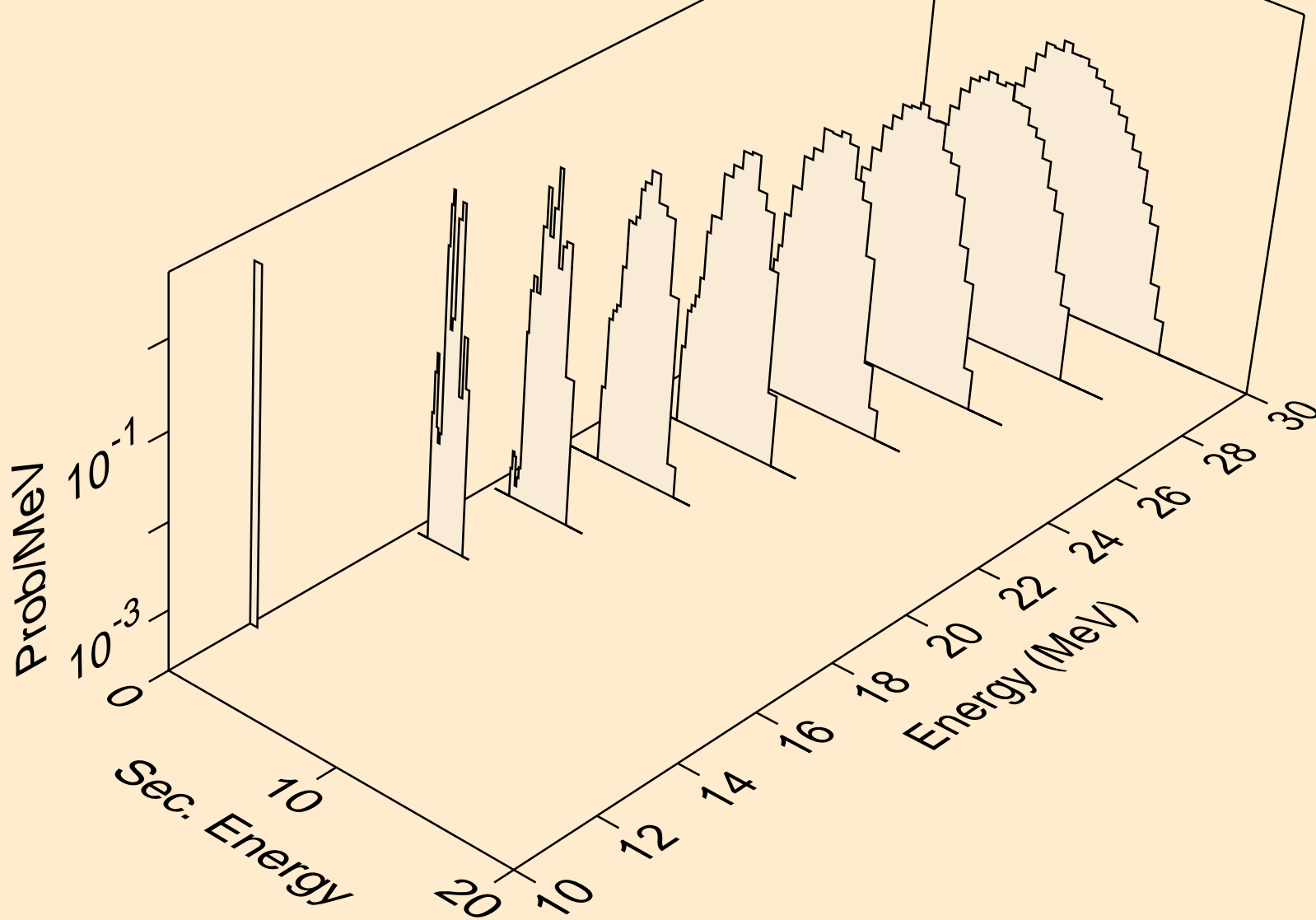

SB118M NEUTRON ACER TENDL-2019 LIBRARY; T=293.16K
deuterons from (n,da)

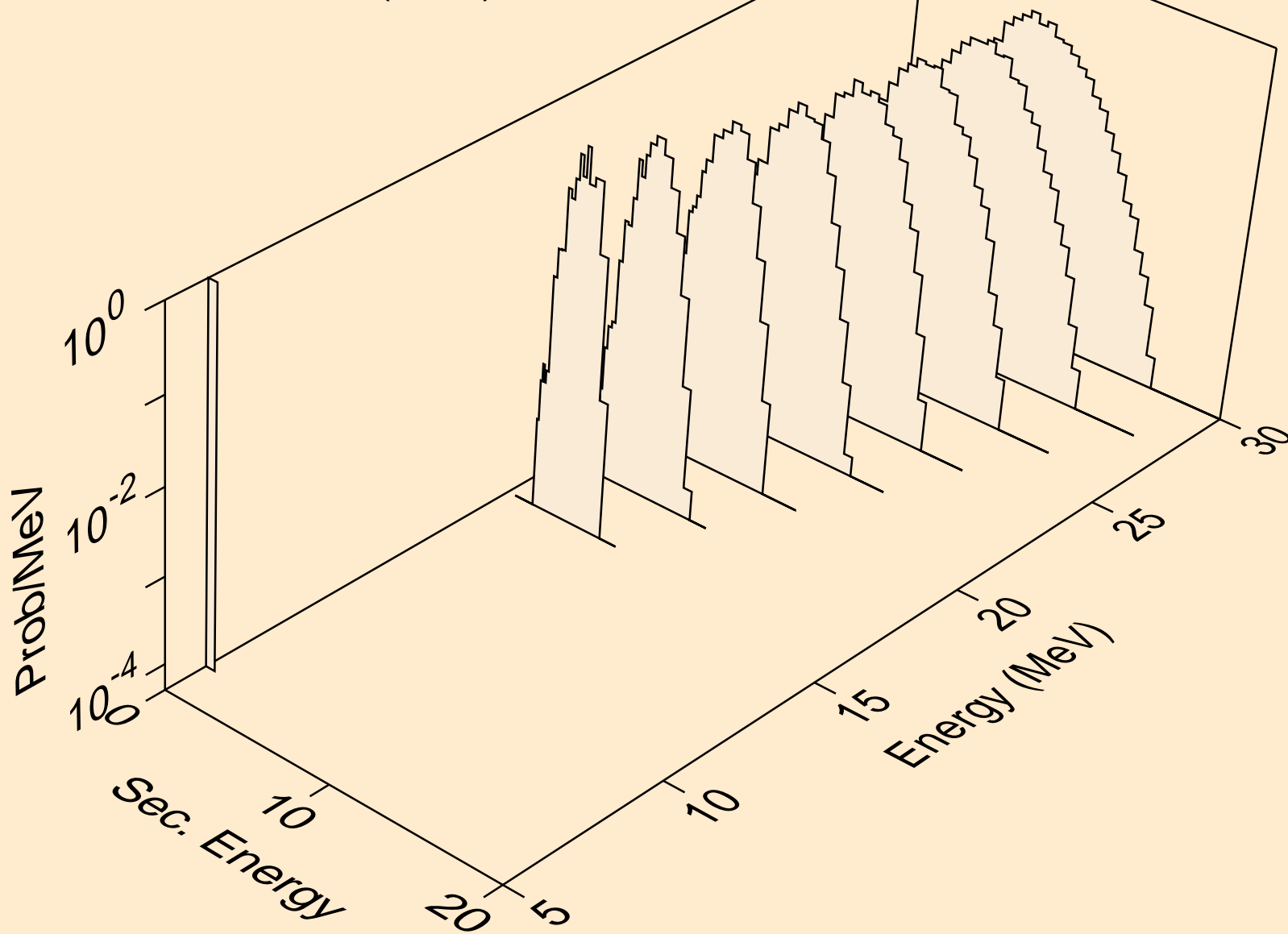

SB118M NEUTRON ACER TENDL-2019 LIBRARY; T=293.16K
tritons from (n,x)

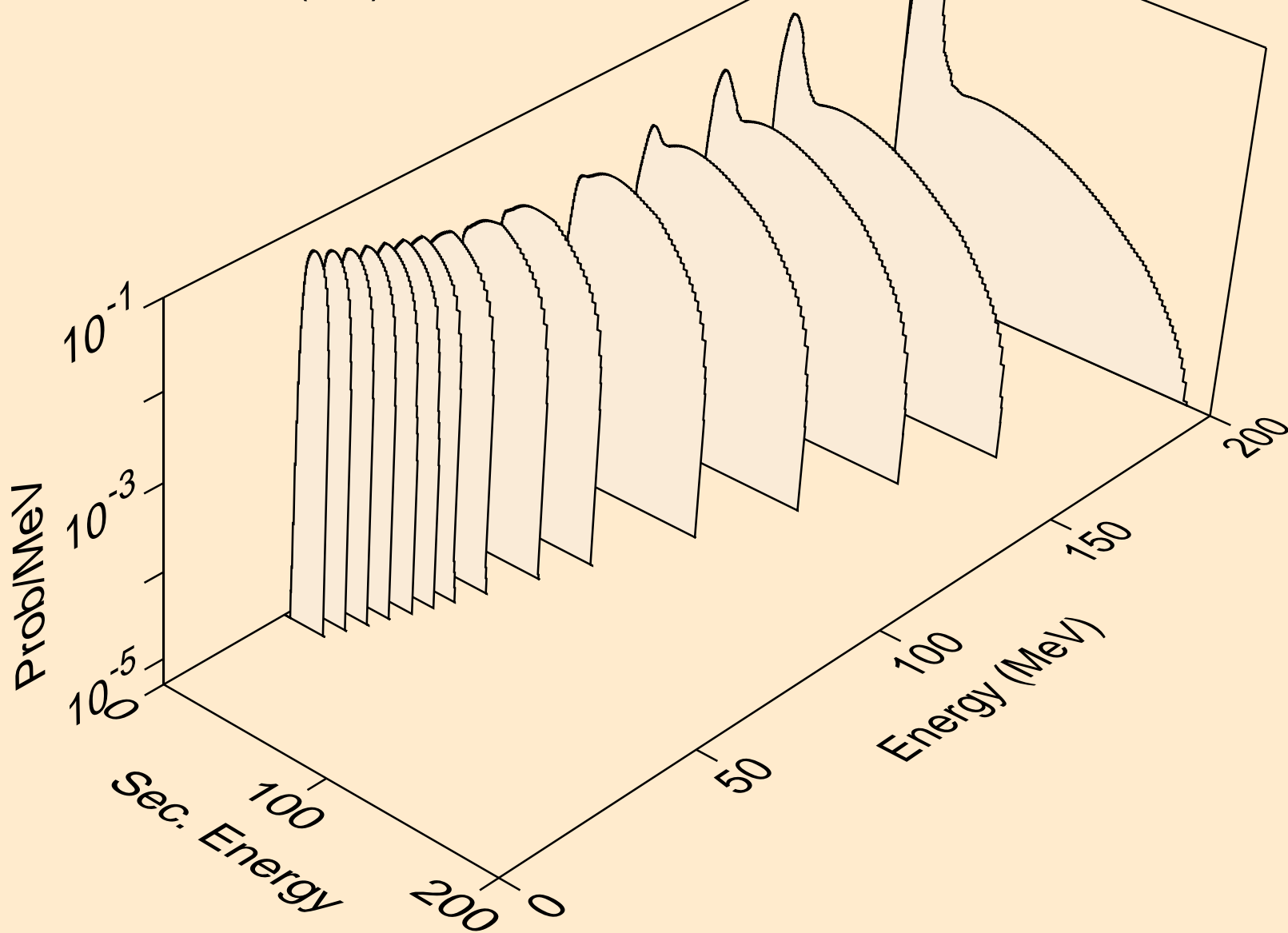

SB118M NEUTRON ACER TENDL-2019 LIBRARY; T=293.16K
tritons from (n,n*)t

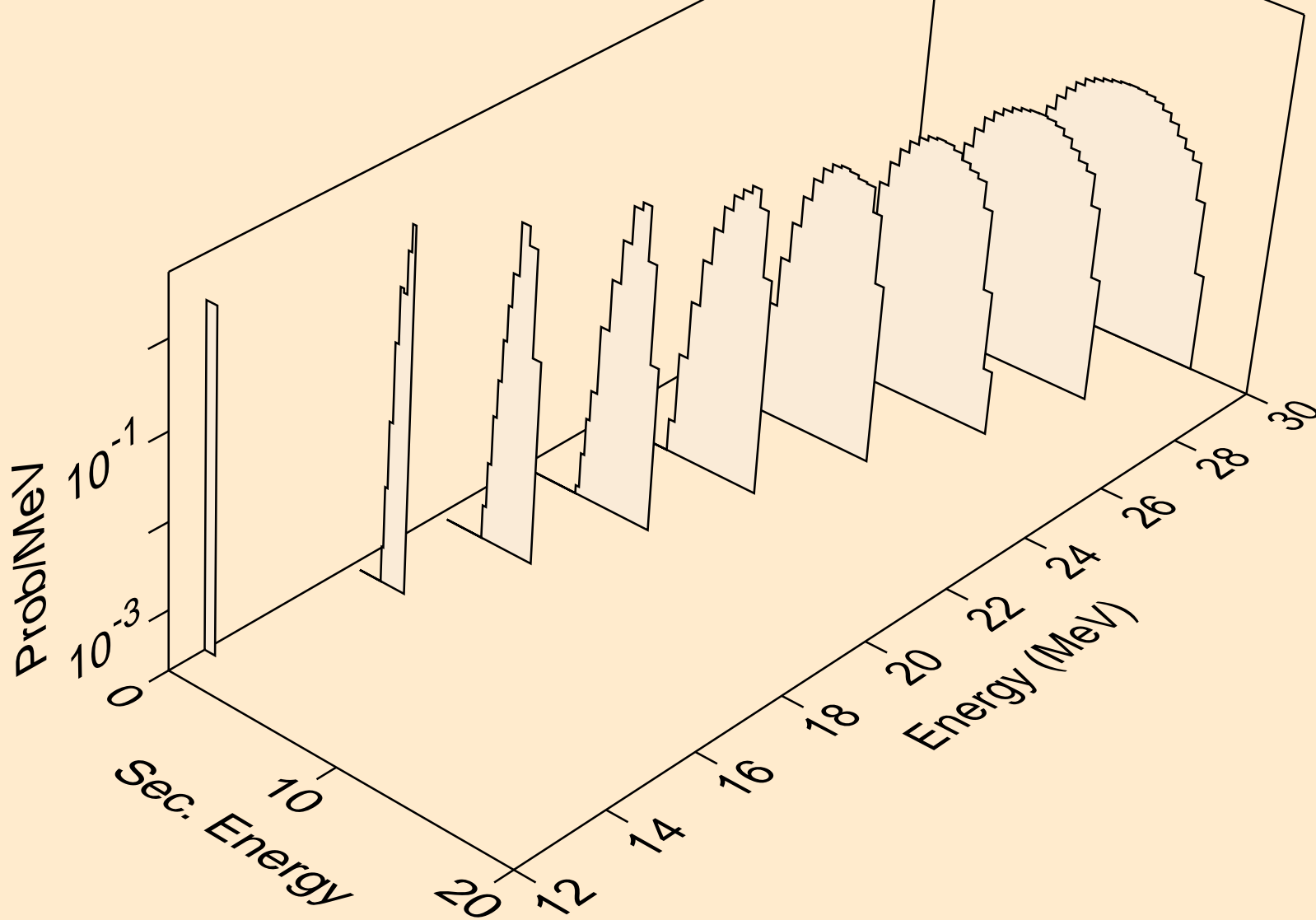

SB118M NEUTRON ACER TENDL-2019 LIBRARY; T=293.16K
tritons from (n,t)

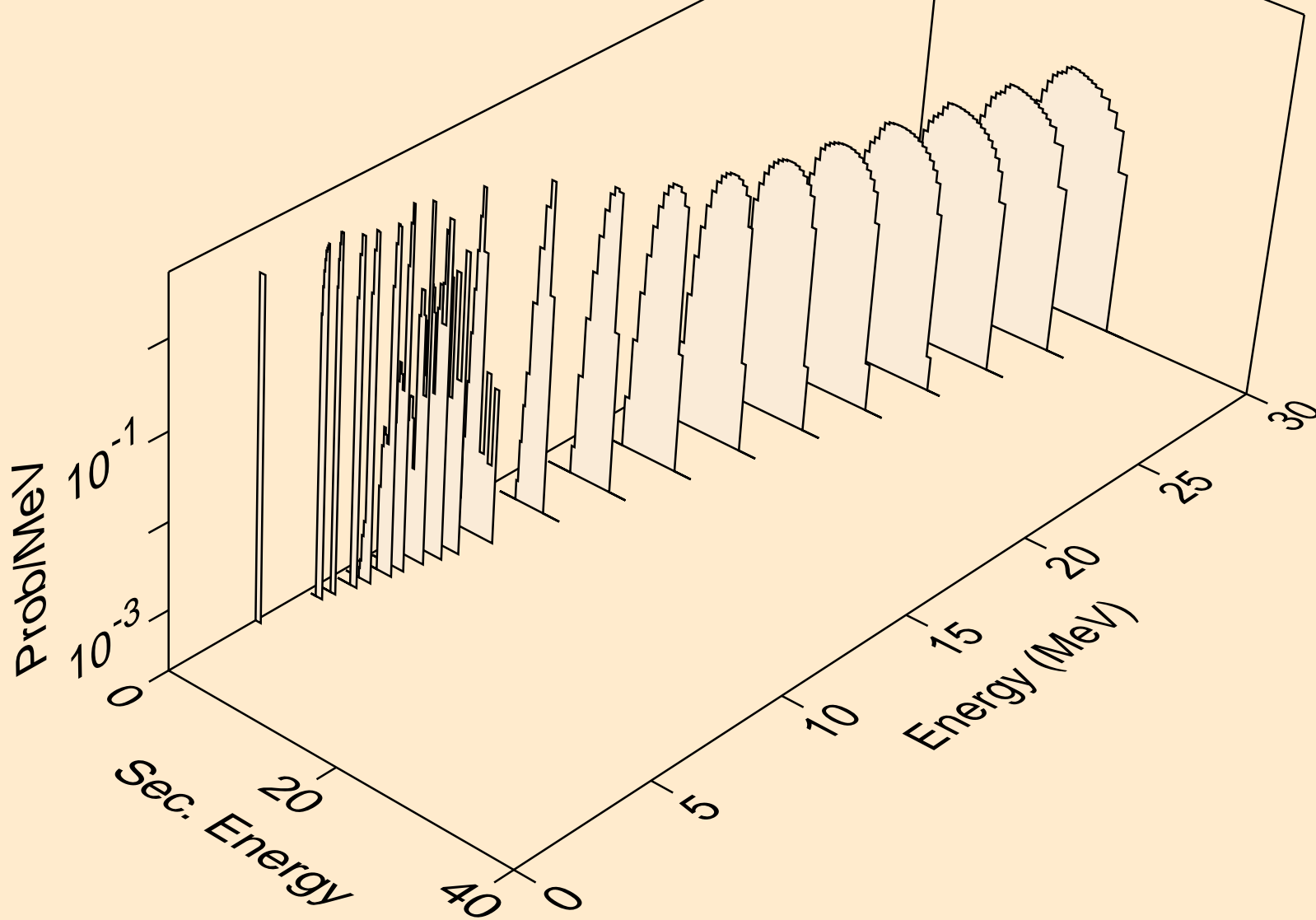

SB118M NEUTRON ACER TENDL-2019 LIBRARY; T=293.16K
tritons from (n,pt)

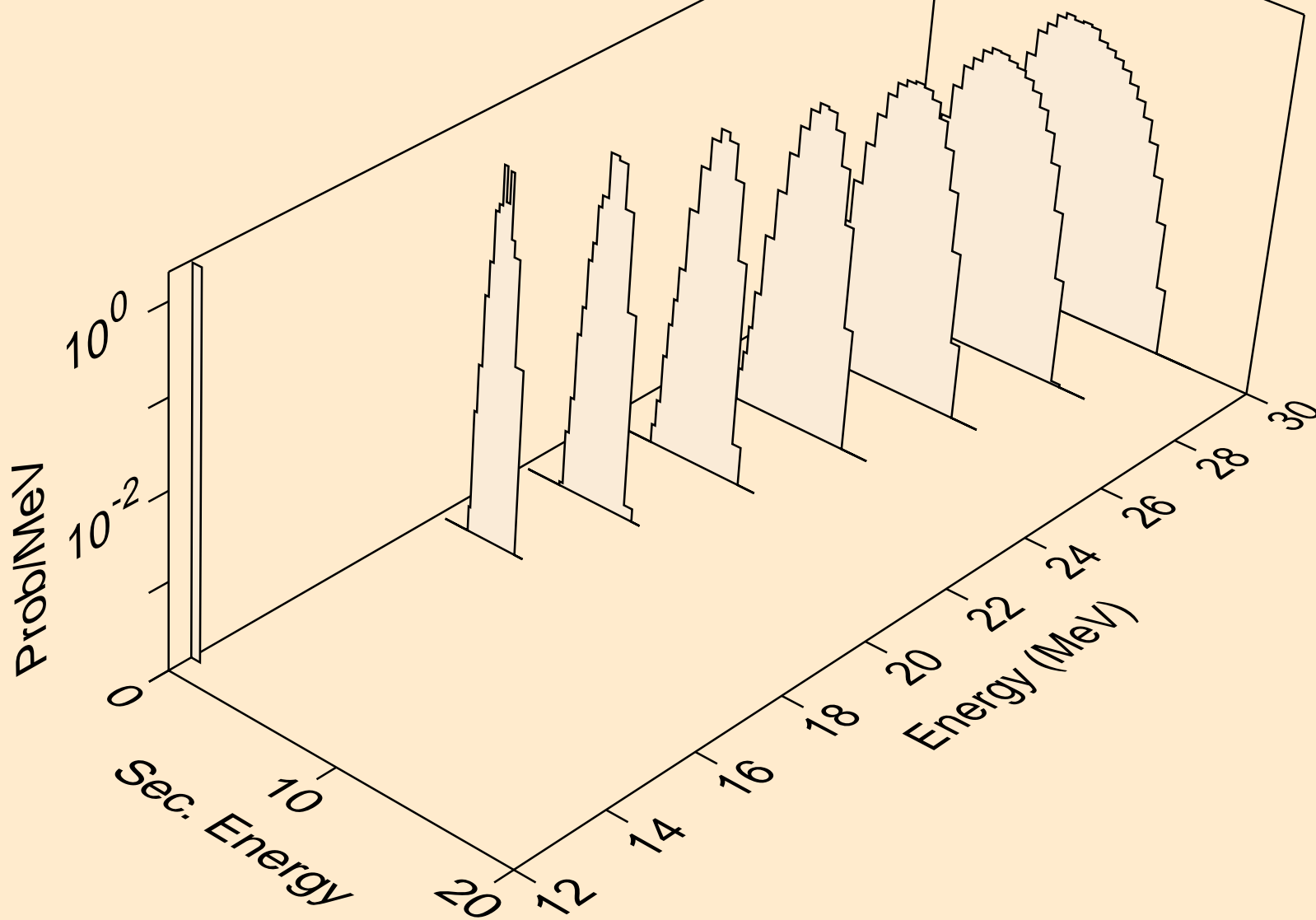

SB118M NEUTRON ACER TENDL-2019 LIBRARY; T=293.16K
he3s from (n,x)

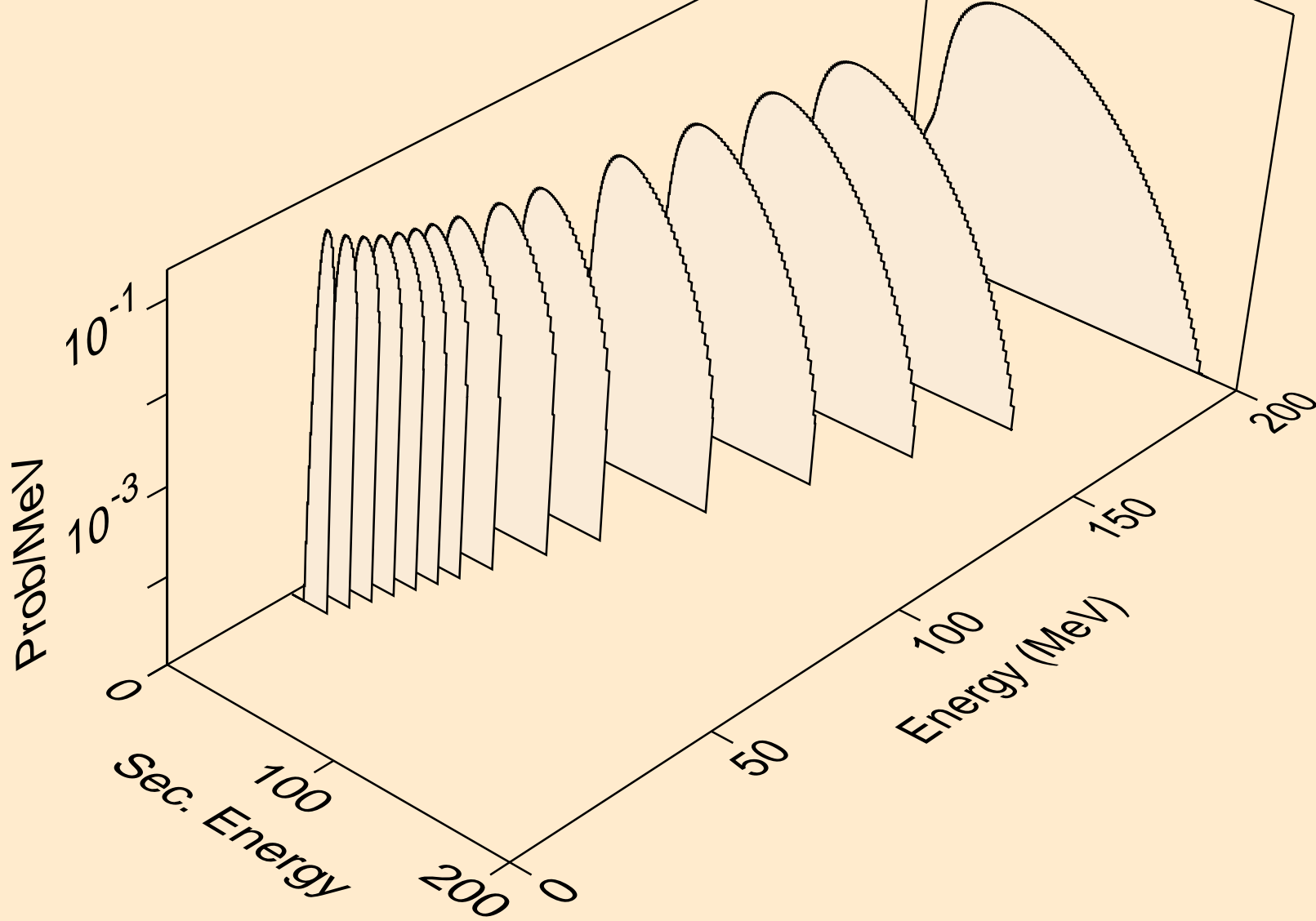

SB118M NEUTRON ACER TENDL-2019 LIBRARY; T=293.16K
he3s from (n,n*)he3

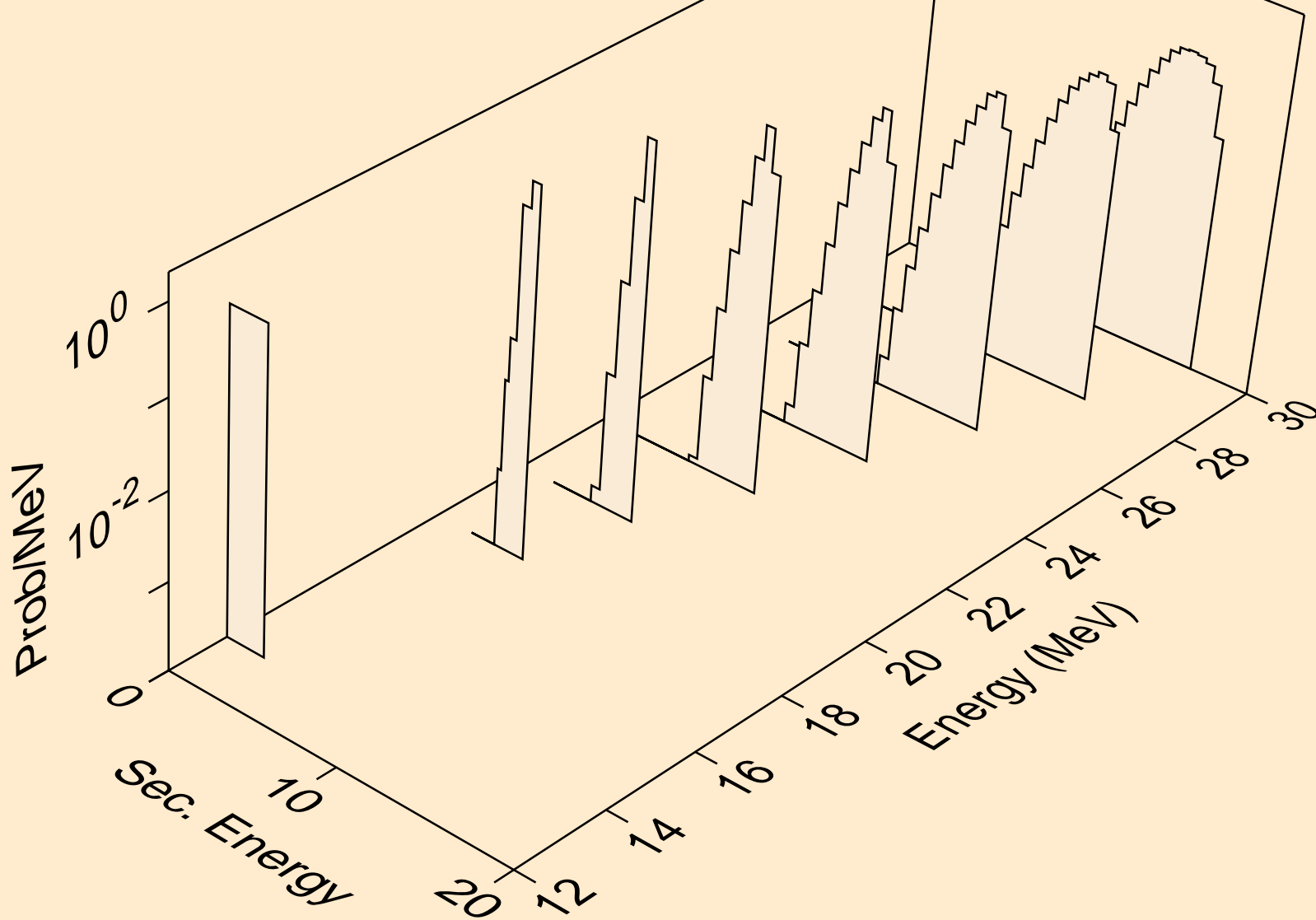

SB118M NEUTRON ACER TENDL-2019 LIBRARY; T=293.16K
he3s from (n,he3)

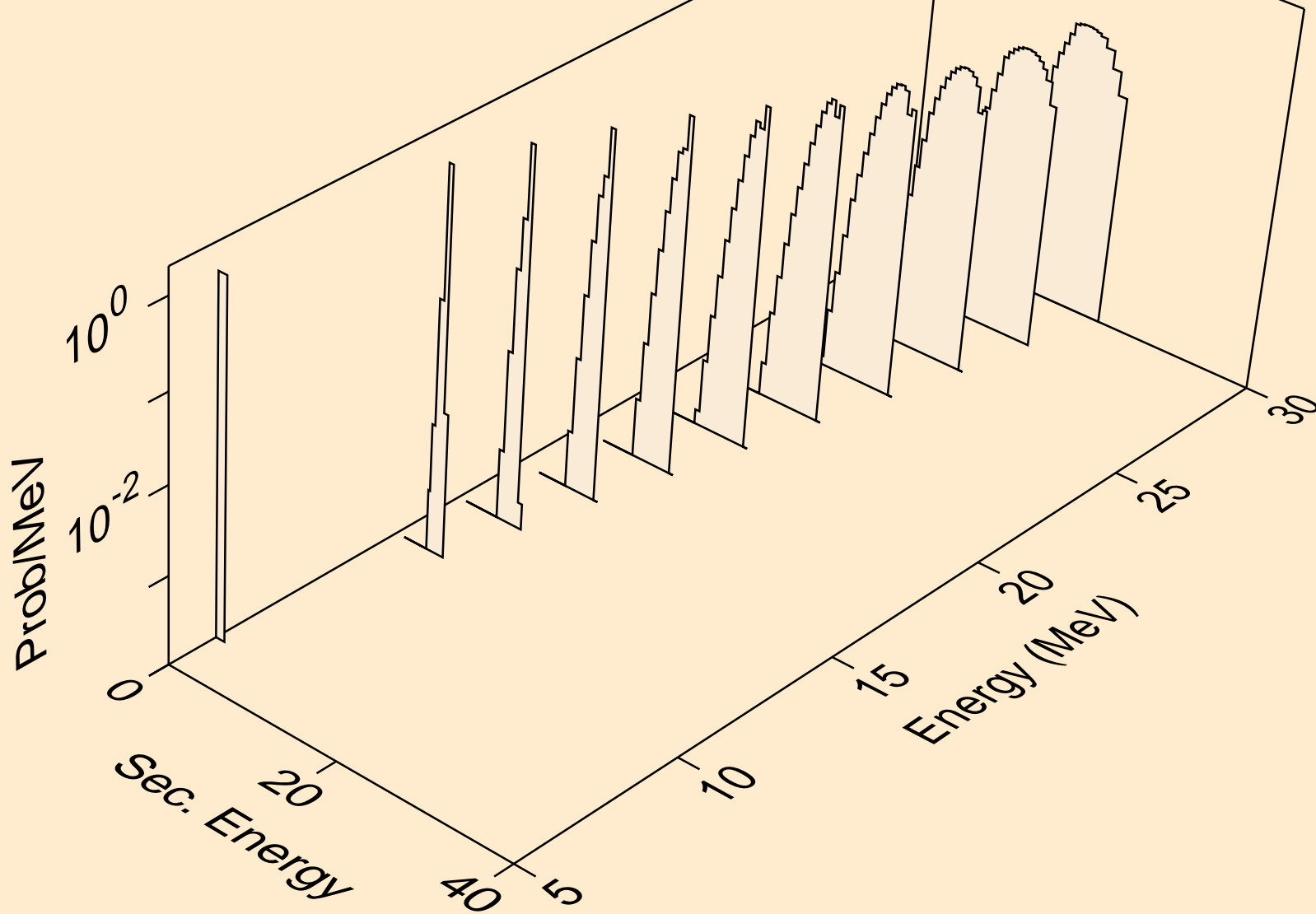

SB118M NEUTRON ACER TENDL-2019 LIBRARY; T=293.16K
alphas from (n,x)

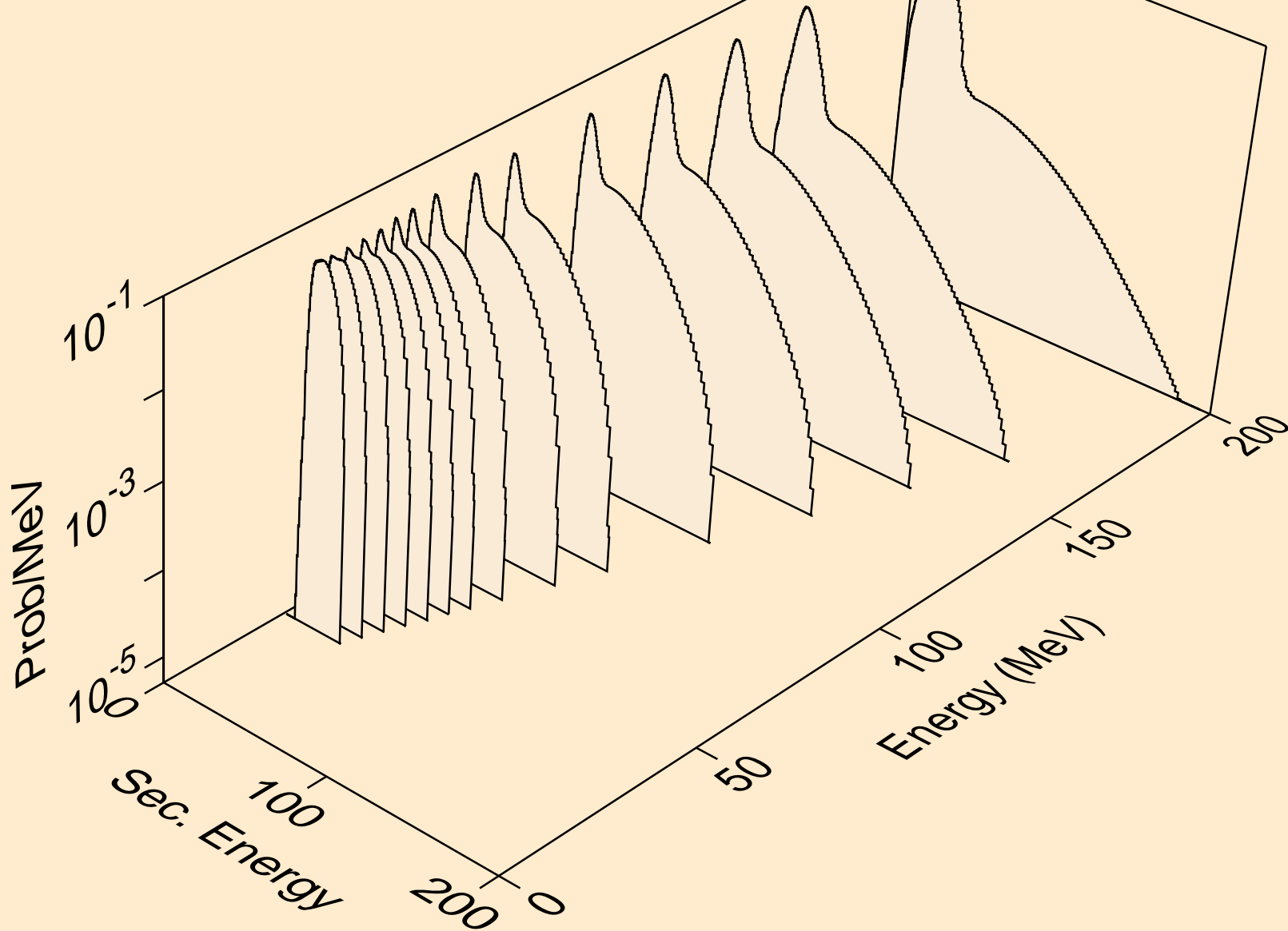

SB118M NEUTRON ACER TENDL-2019 LIBRARY; T=293.16K
alphas from (n,n*)a

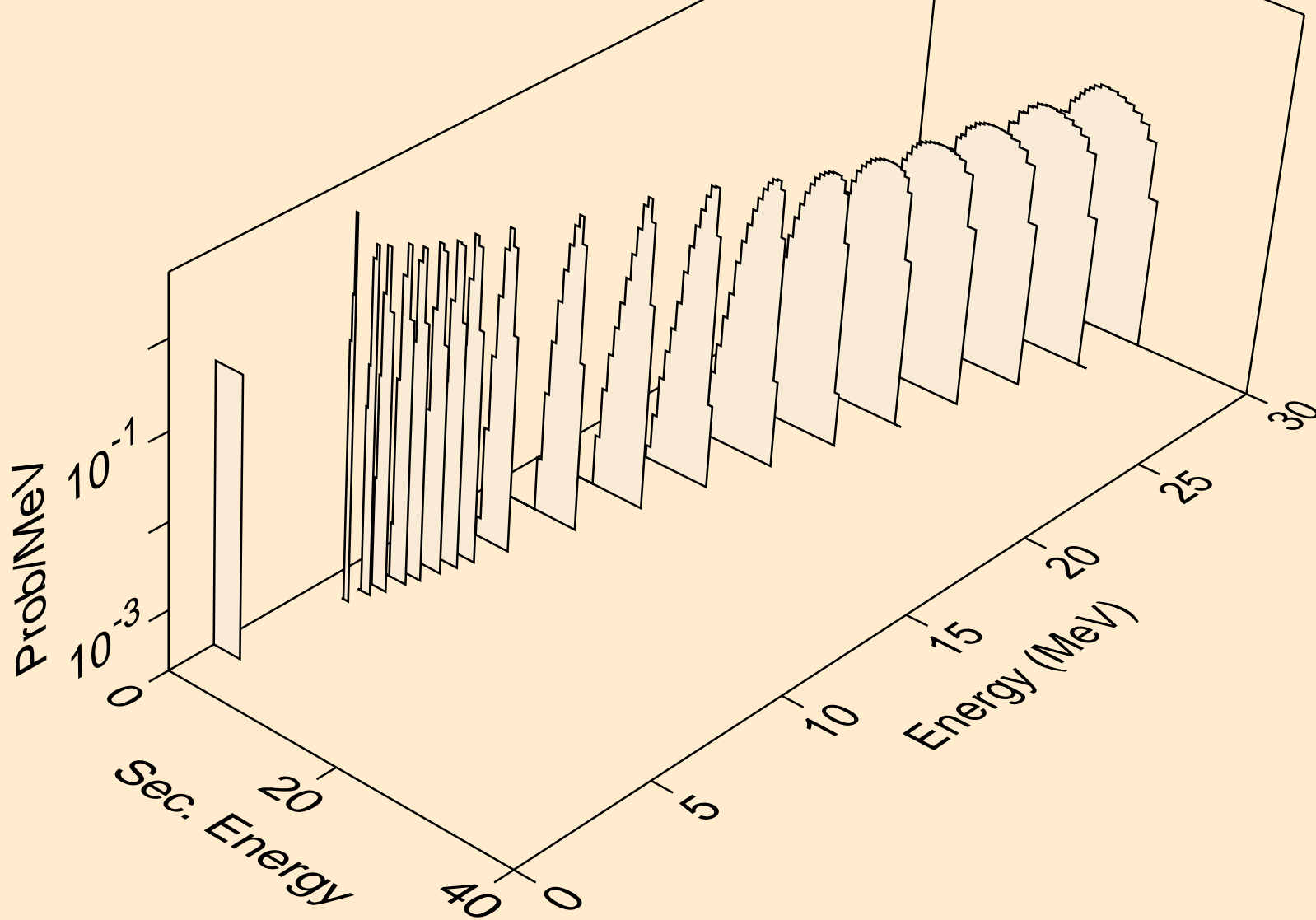

SB118M NEUTRON ACER TENDL-2019 LIBRARY; T=293.16K
alphas from (n,2n)a

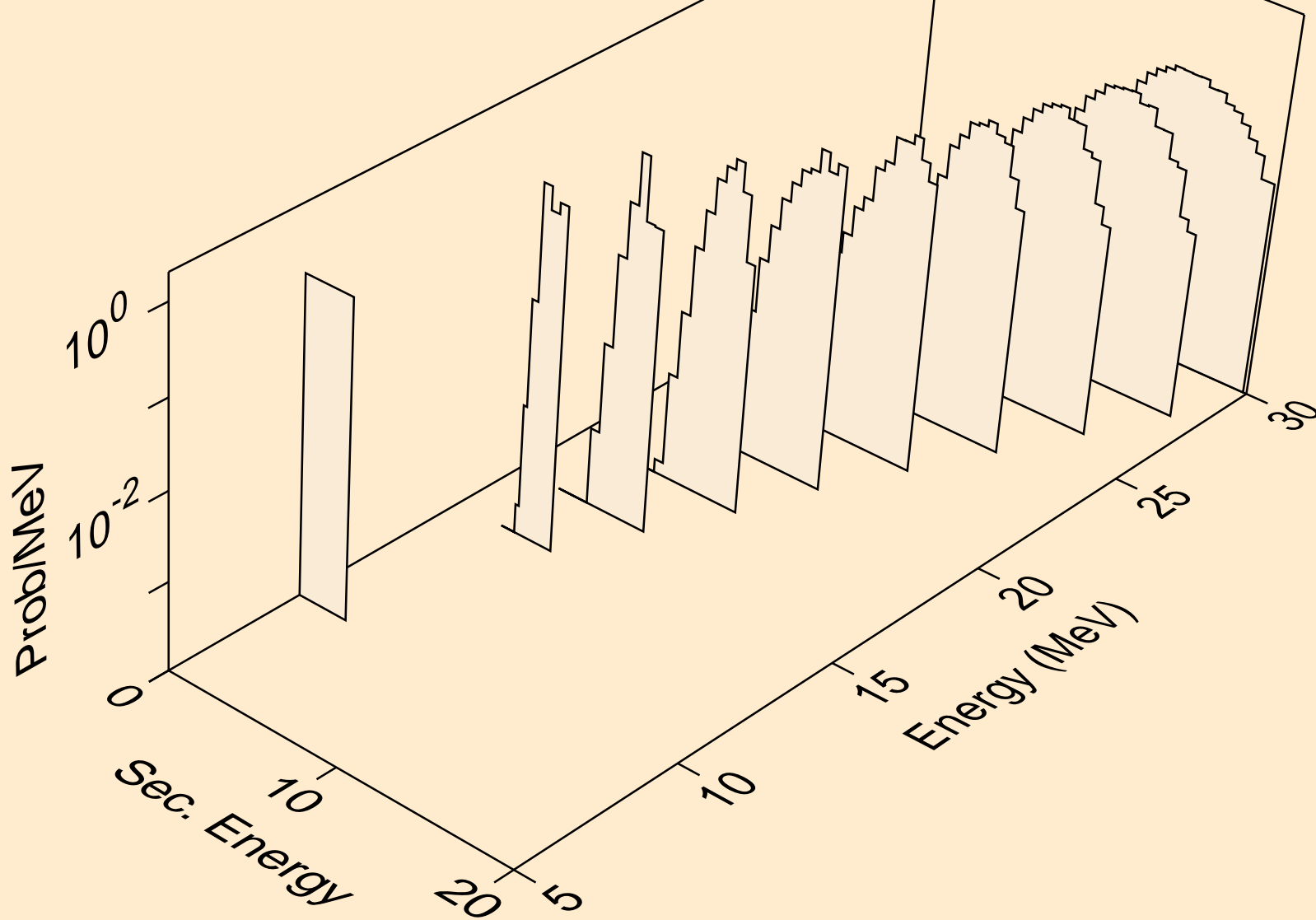

SB118M NEUTRON ACER TENDL-2019 LIBRARY; T=293.16K
alphas from (n,3n)a

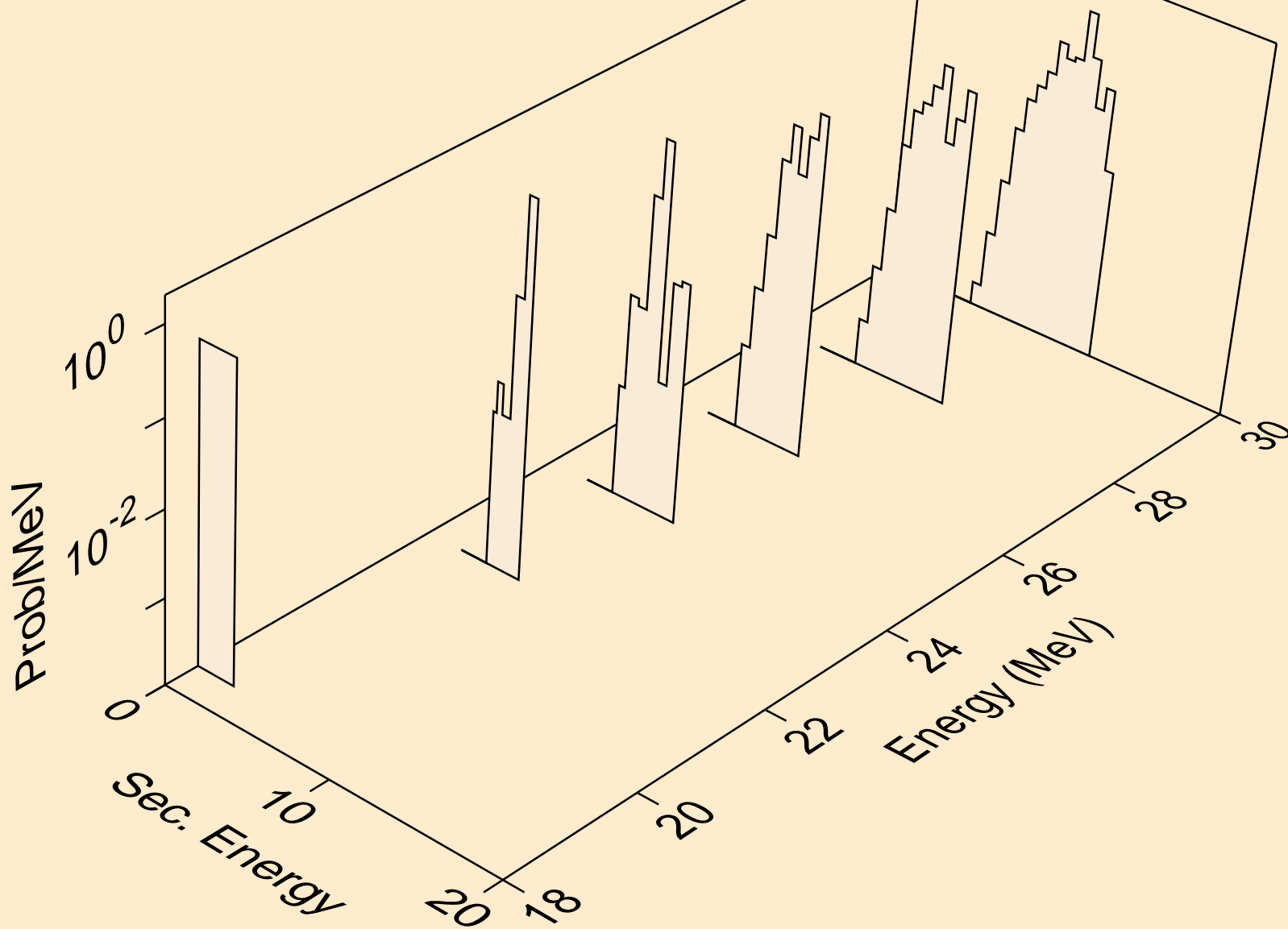

SB118M NEUTRON ACER TENDL-2019 LIBRARY; T=293.16K
alphas from (n,n*)2a

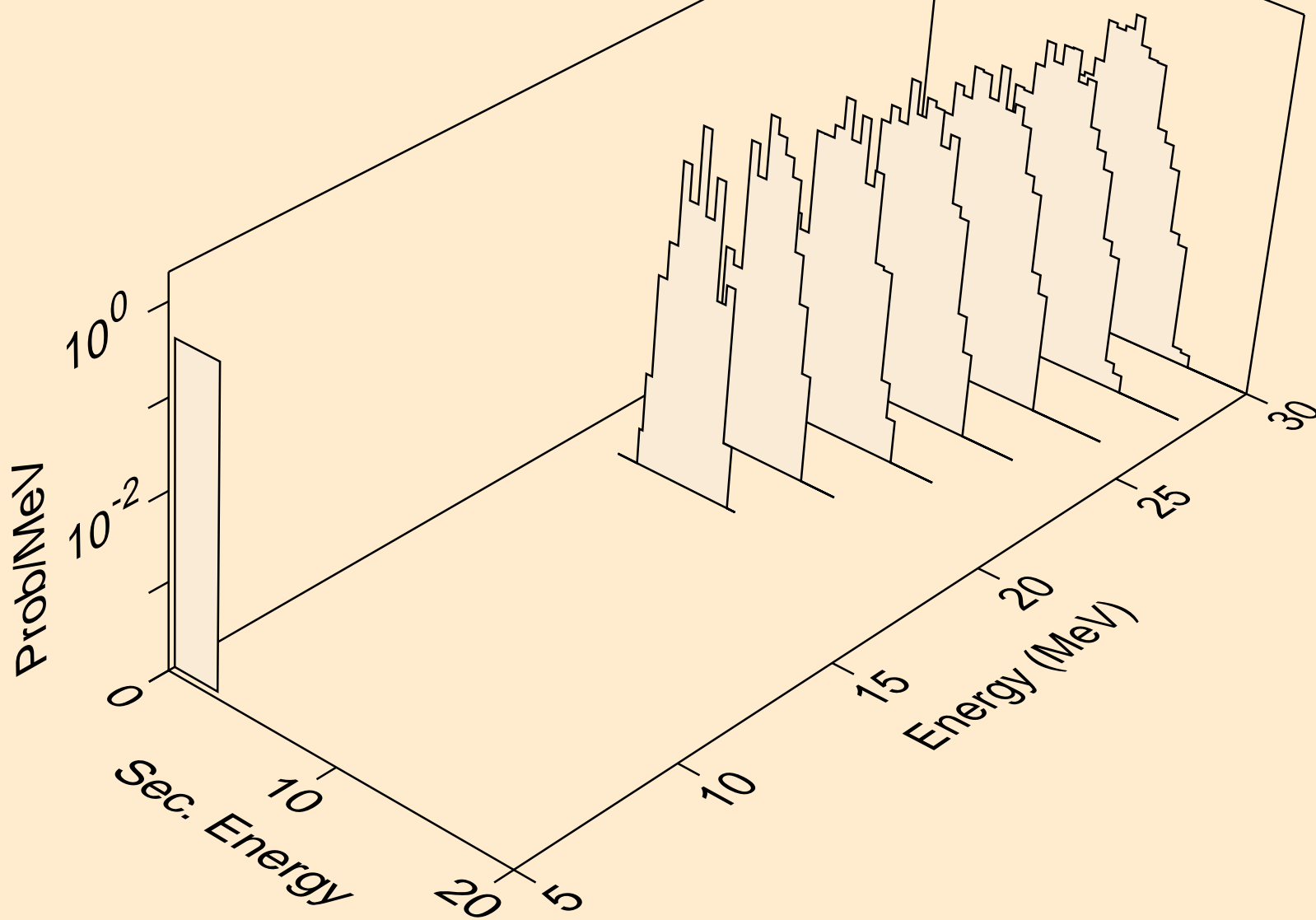

SB118M NEUTRON ACER TENDL-2019 LIBRARY; T=293.16K
alphas from (n,npa)

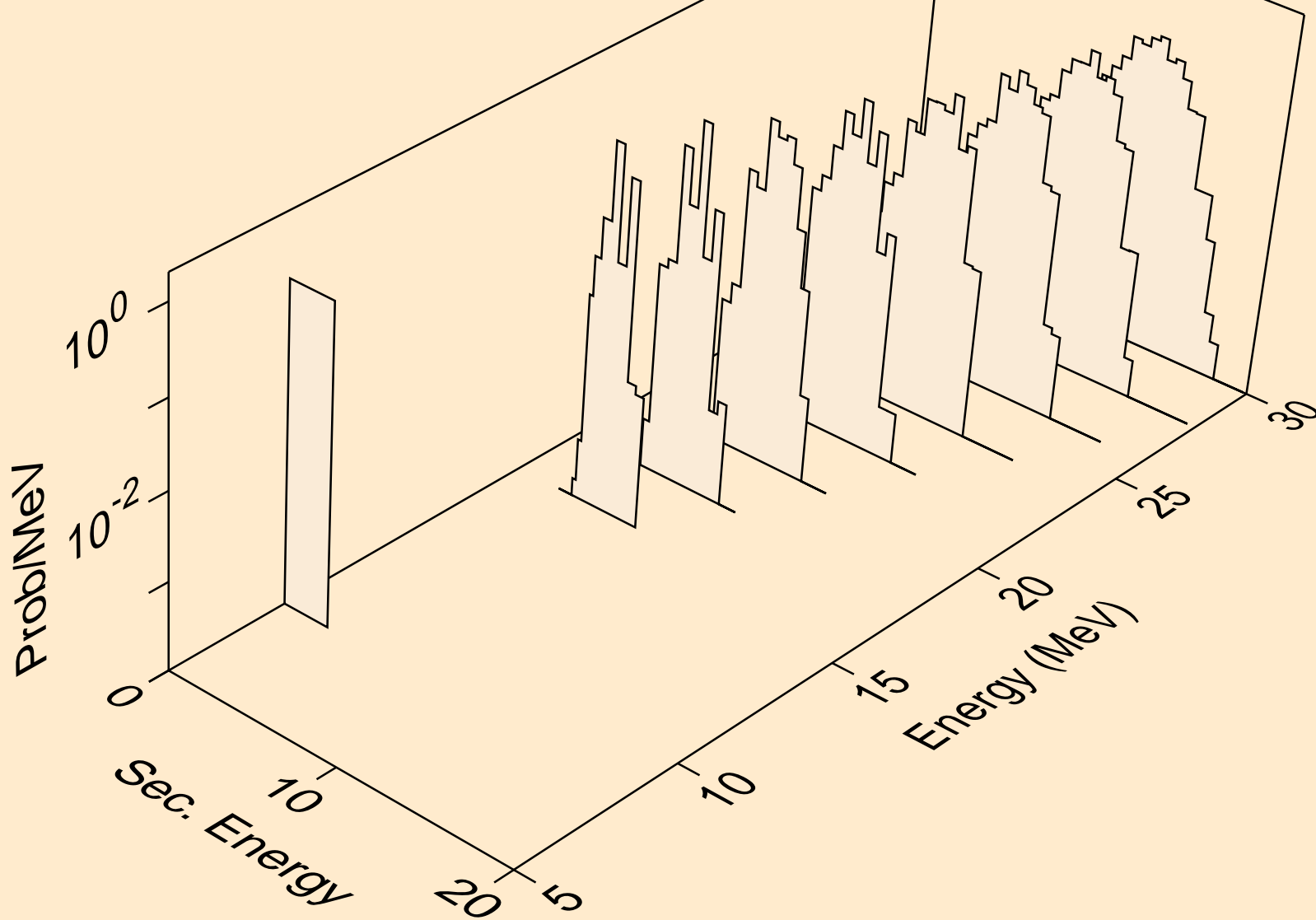

SB118M NEUTRON ACER TENDL-2019 LIBRARY; T=293.16K
alphas from (n,a)

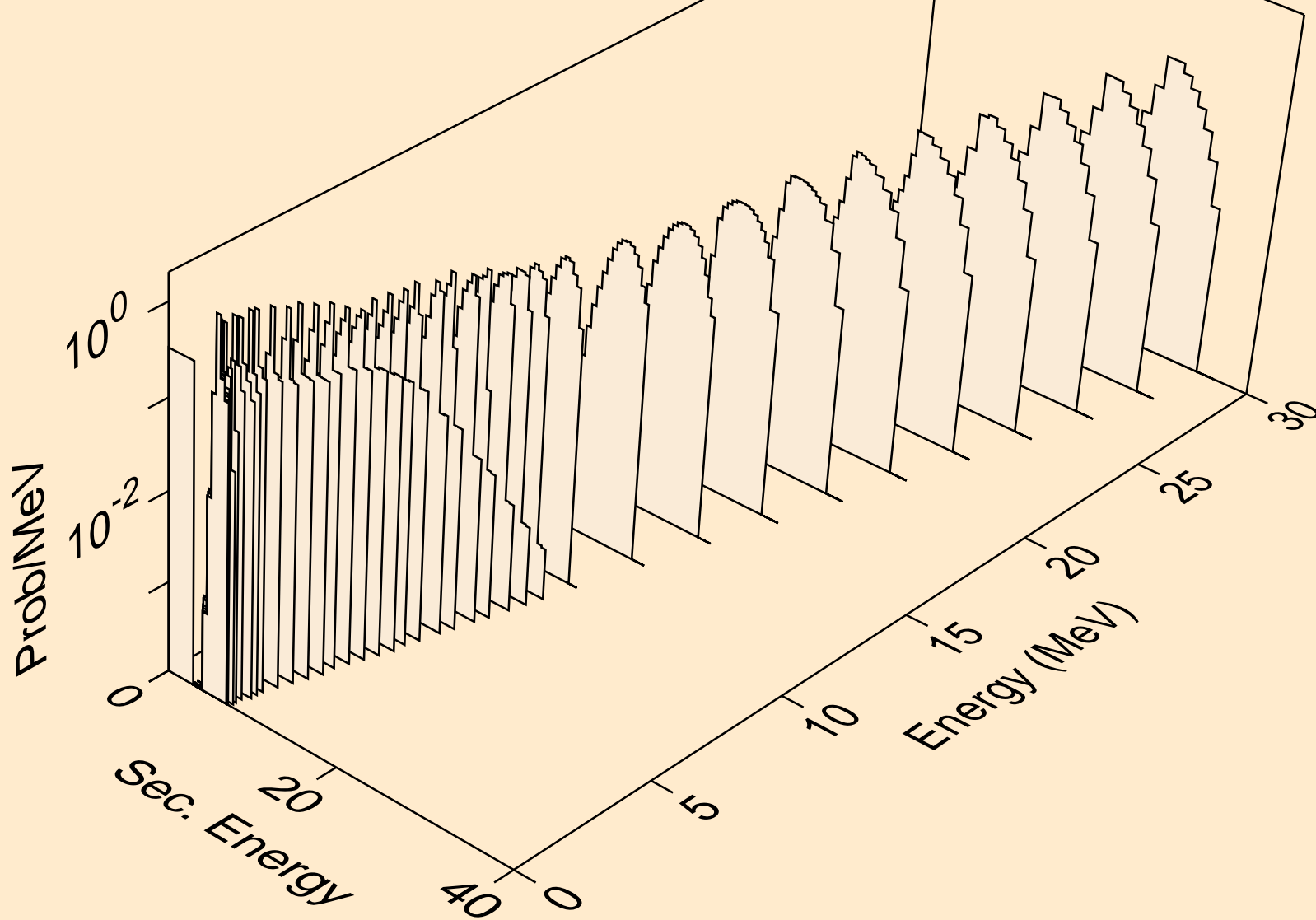

SB118M NEUTRON ACER TENDL-2019 LIBRARY; T=293.16K
alphas from (n,2a)

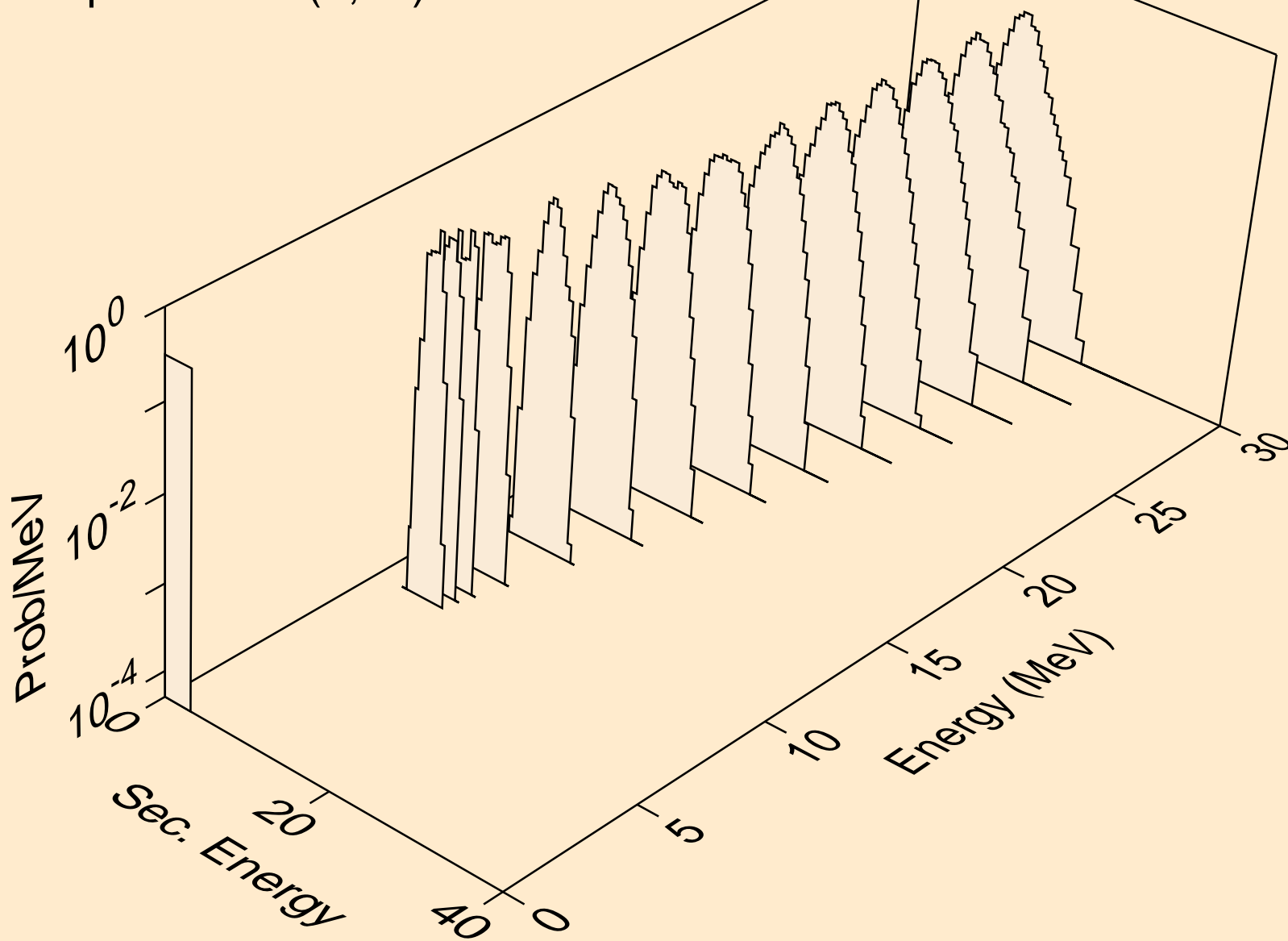

SB118M NEUTRON ACER TENDL-2019 LIBRARY; T=293.16K
alphas from (n,pa)

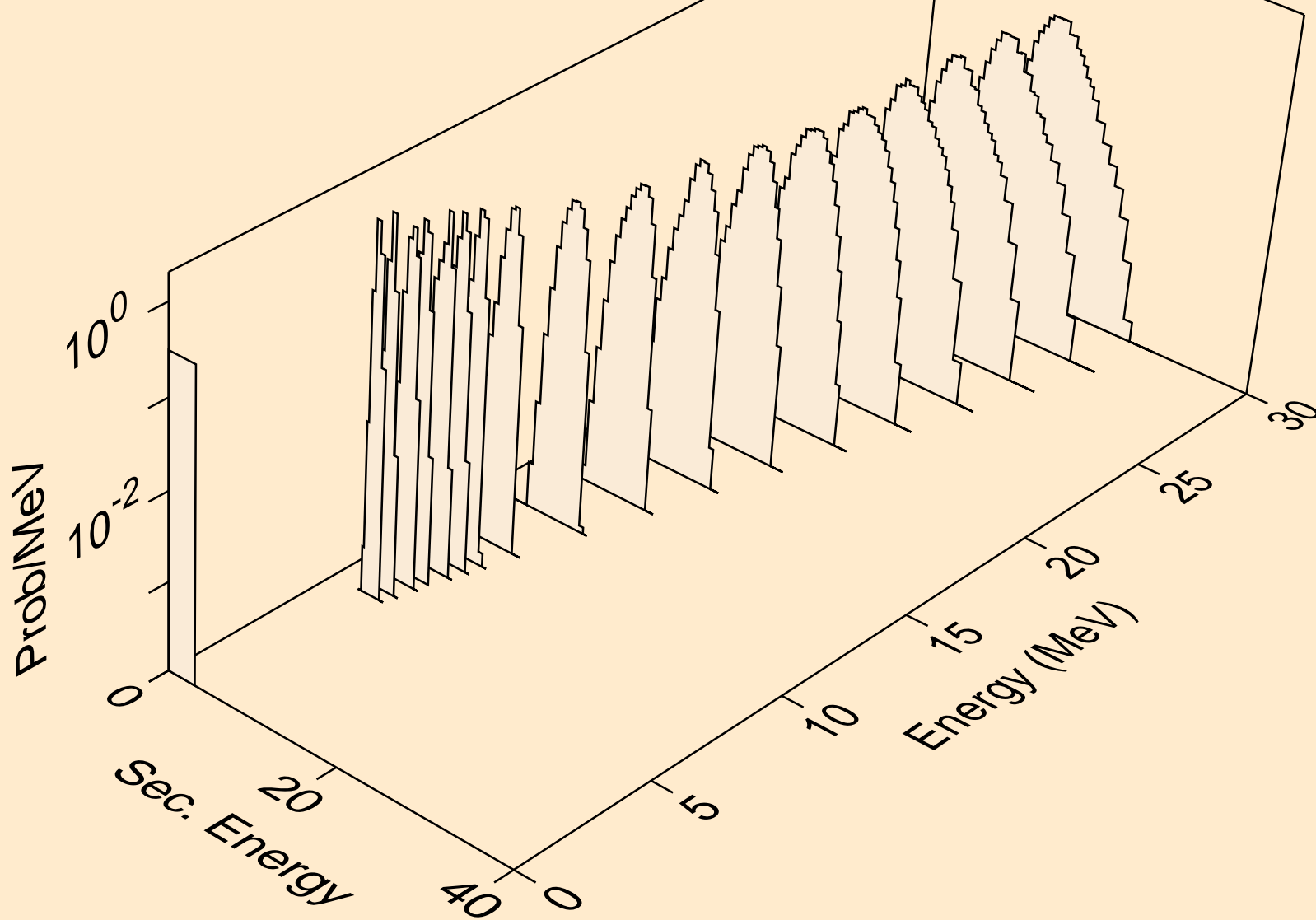

SB118M NEUTRON ACER TENDL-2019 LIBRARY; T=293.16K
alphas from (n,da)

