

# SB124N NEUTRON ACER TENDL-2019 LIBRARY; T=293.16K

## Principal cross sections

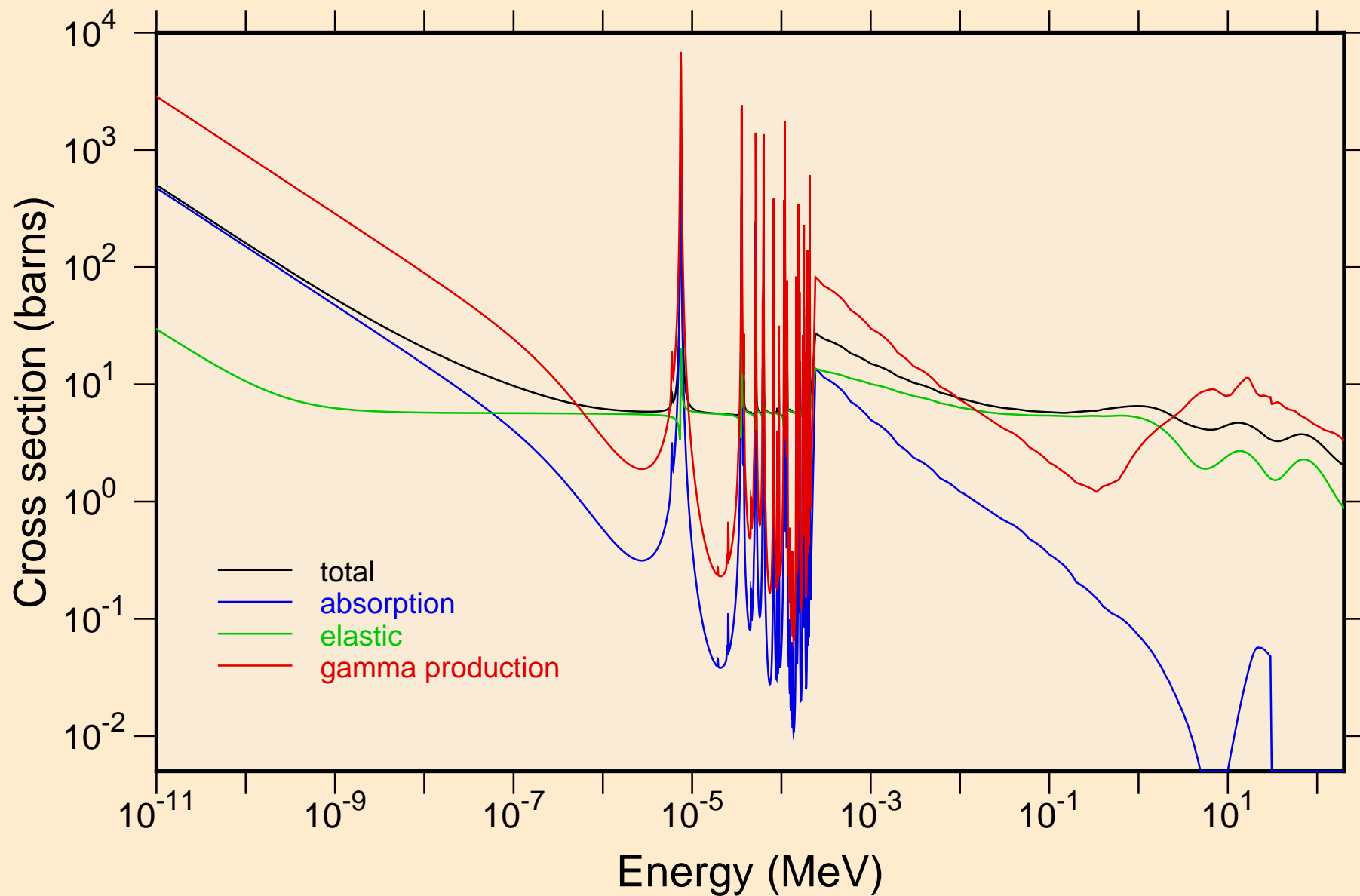

SB124N NEUTRON ACER TENDL-2019 LIBRARY; T=293.16K  
resonance total cross section

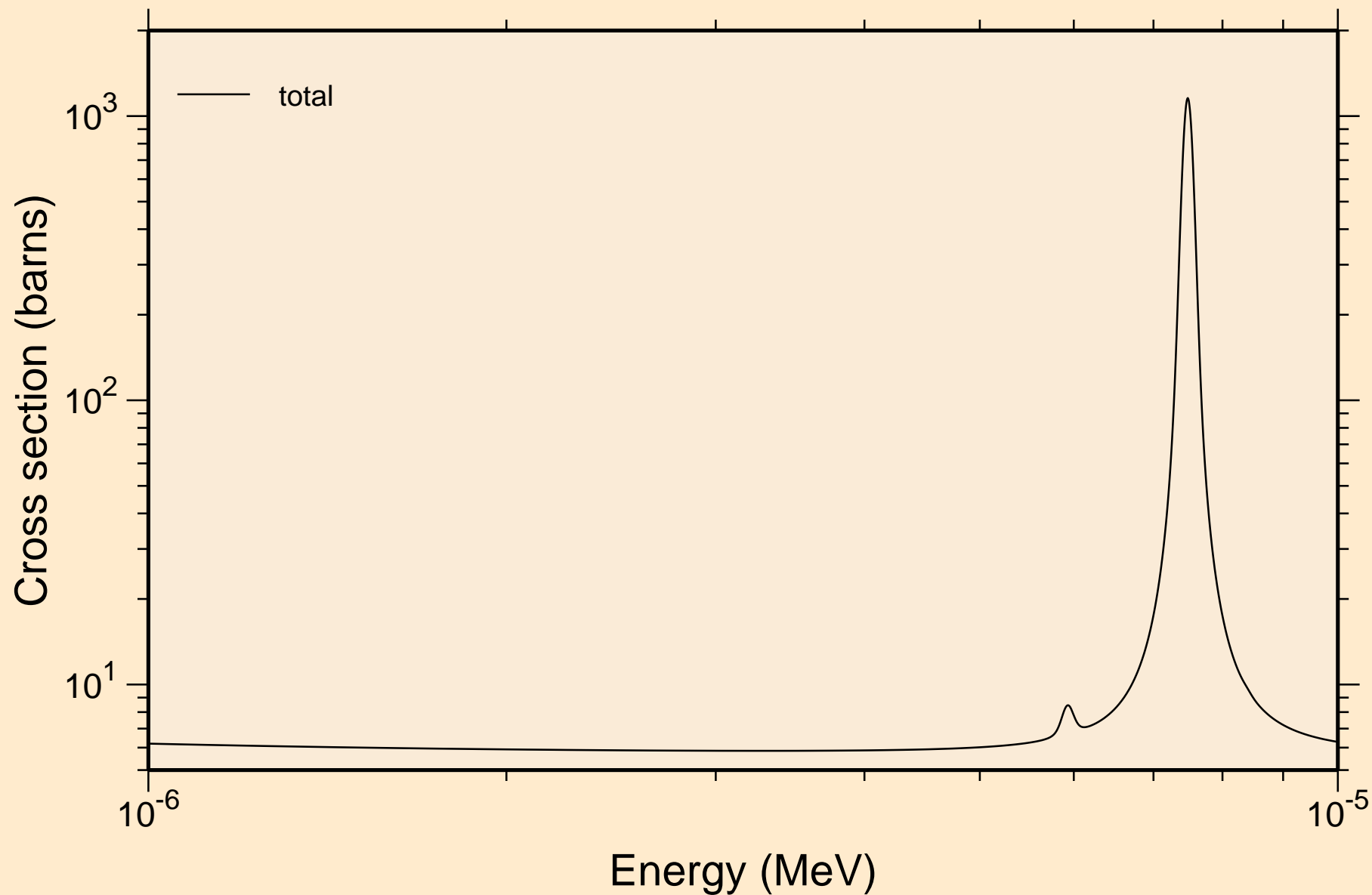

SB124N NEUTRON ACER TENDL-2019 LIBRARY; T=293.16K  
resonance total cross section

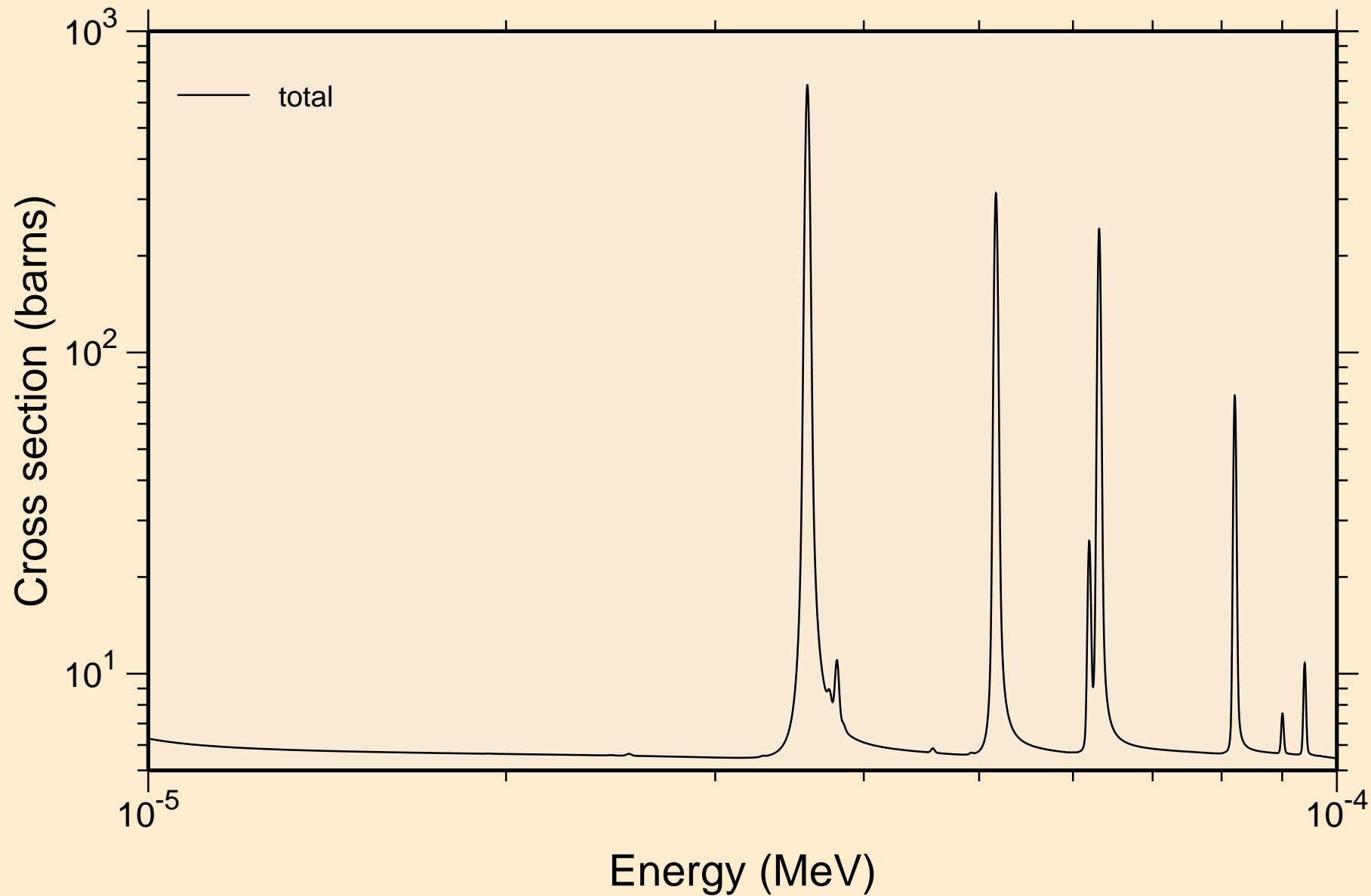

SB124N NEUTRON ACER TENDL-2019 LIBRARY; T=293.16K  
resonance total cross section

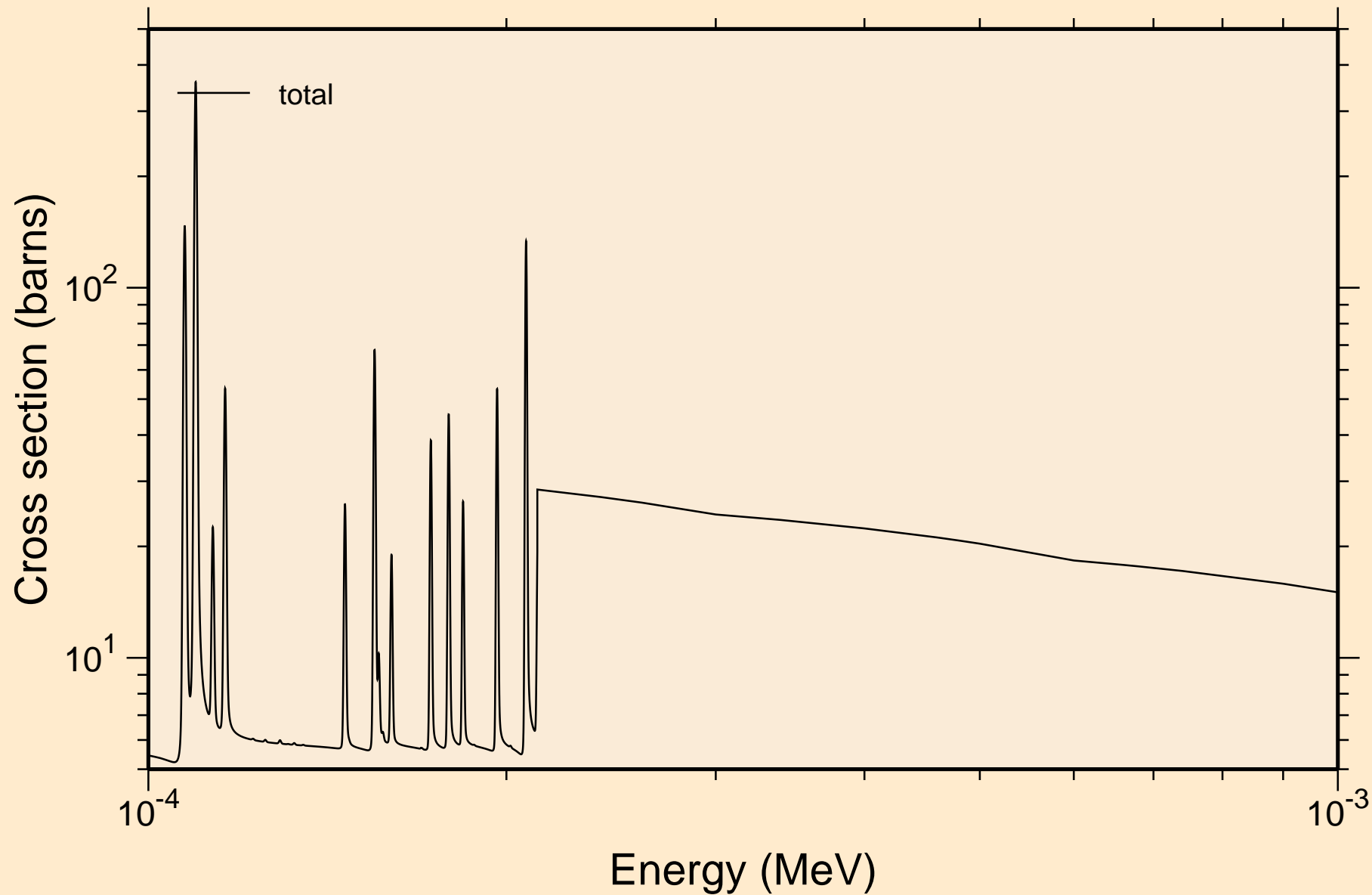

S $\bar{B}$ 124N NEUTRON ACER TENDL-2019 LIBRARY; T=293.16K  
resonance total cross section

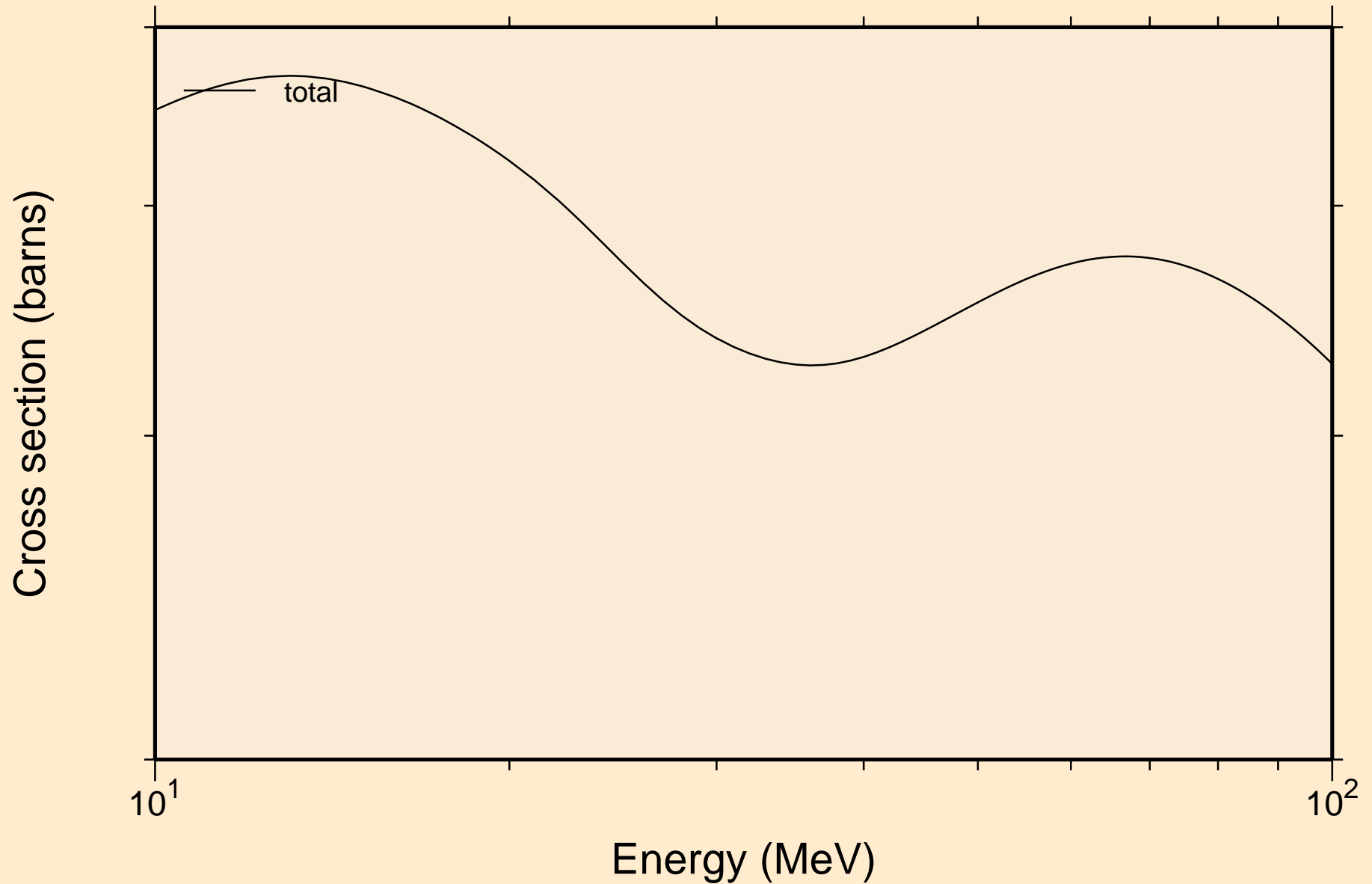

SB124N NEUTRON ACER TENDL-2019 LIBRARY; T=293.16K  
resonance absorption cross sections

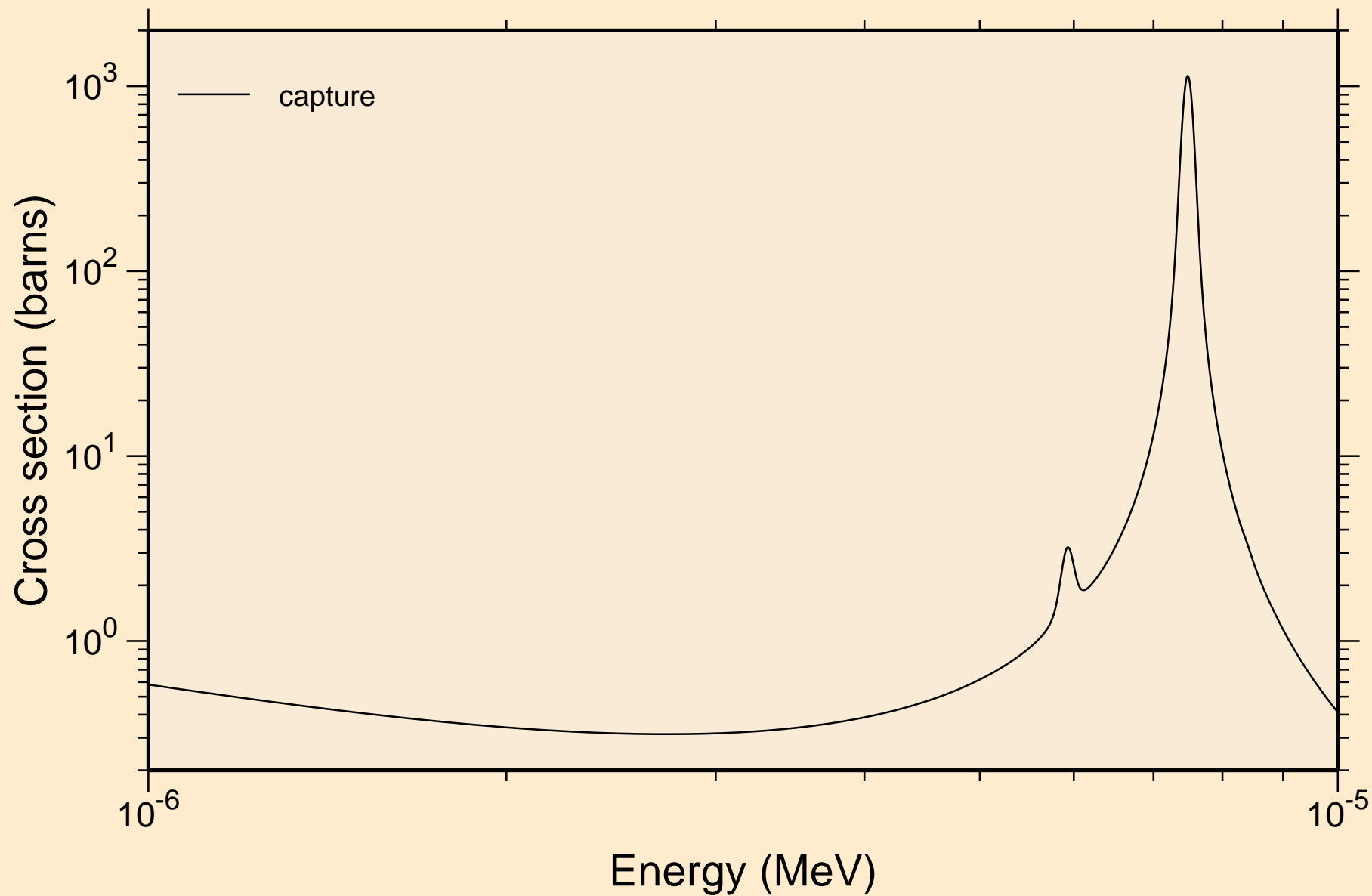

SB124N NEUTRON ACER TENDL-2019 LIBRARY; T=293.16K  
resonance absorption cross sections

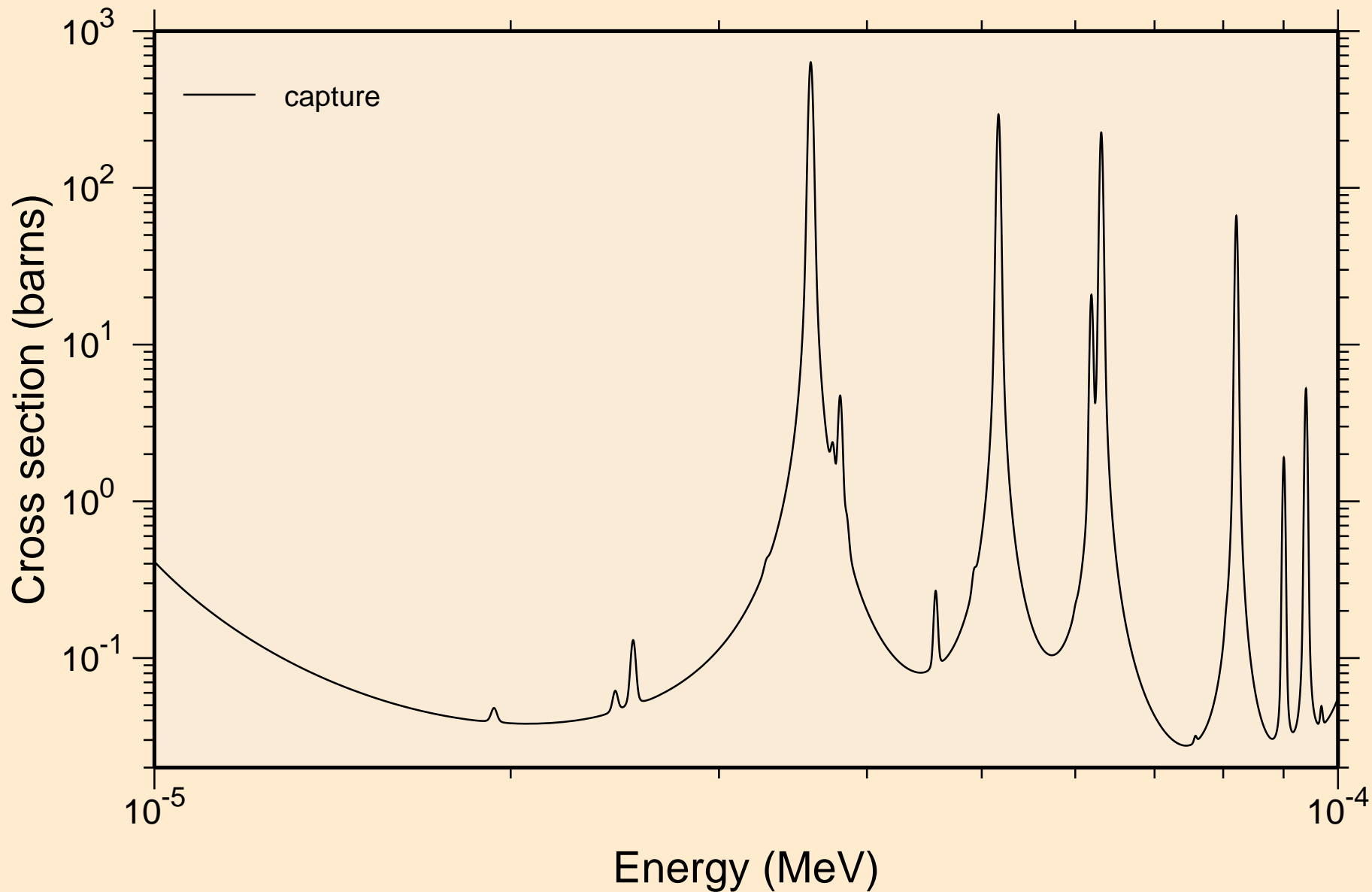

SB124N NEUTRON ACER TENDL-2019 LIBRARY; T=293.16K  
resonance absorption cross sections

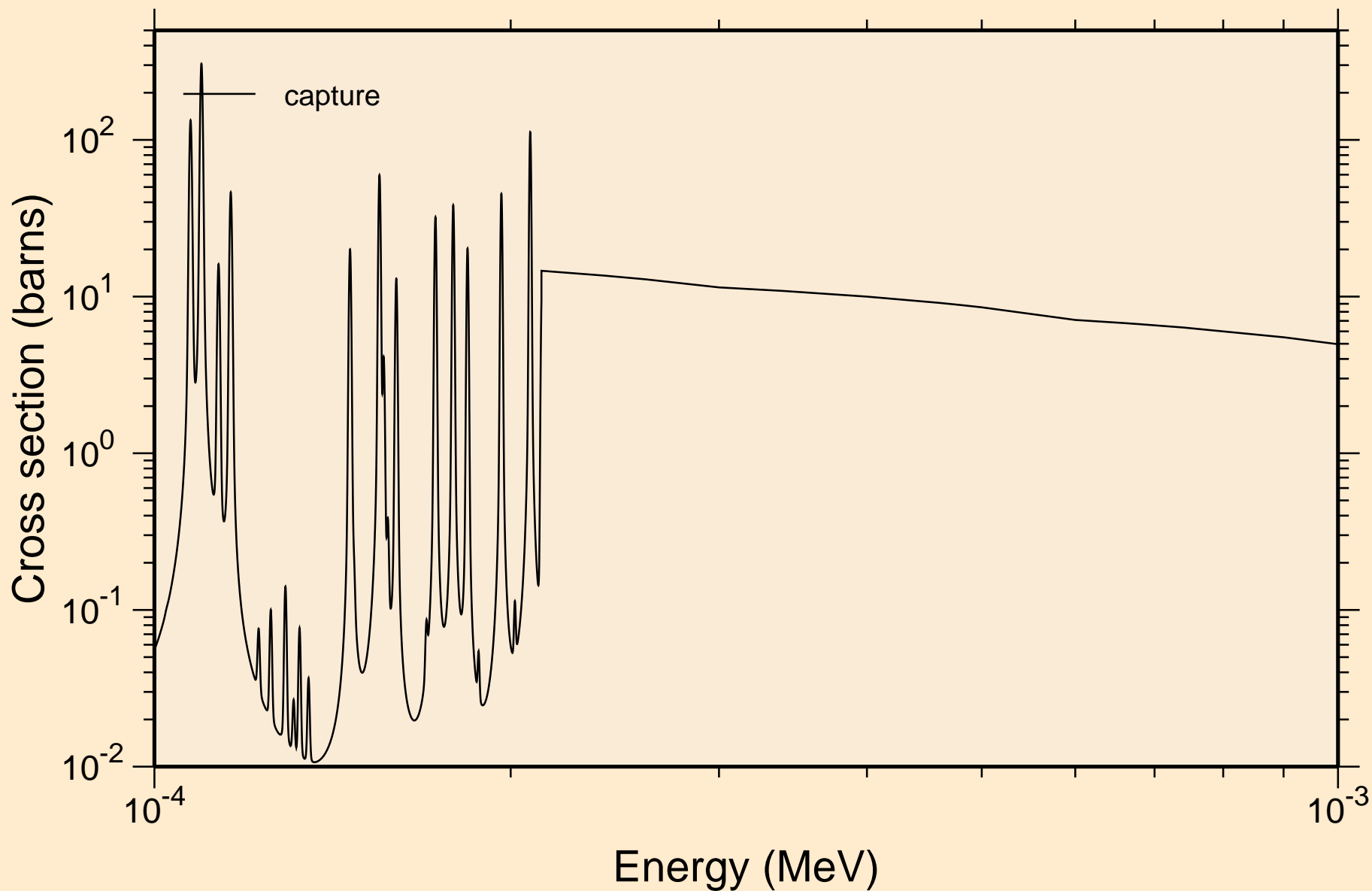



SB124N NEUTRON ACER TENDL-2019 LIBRARY; T=293.16K  
resonance absorption cross sections

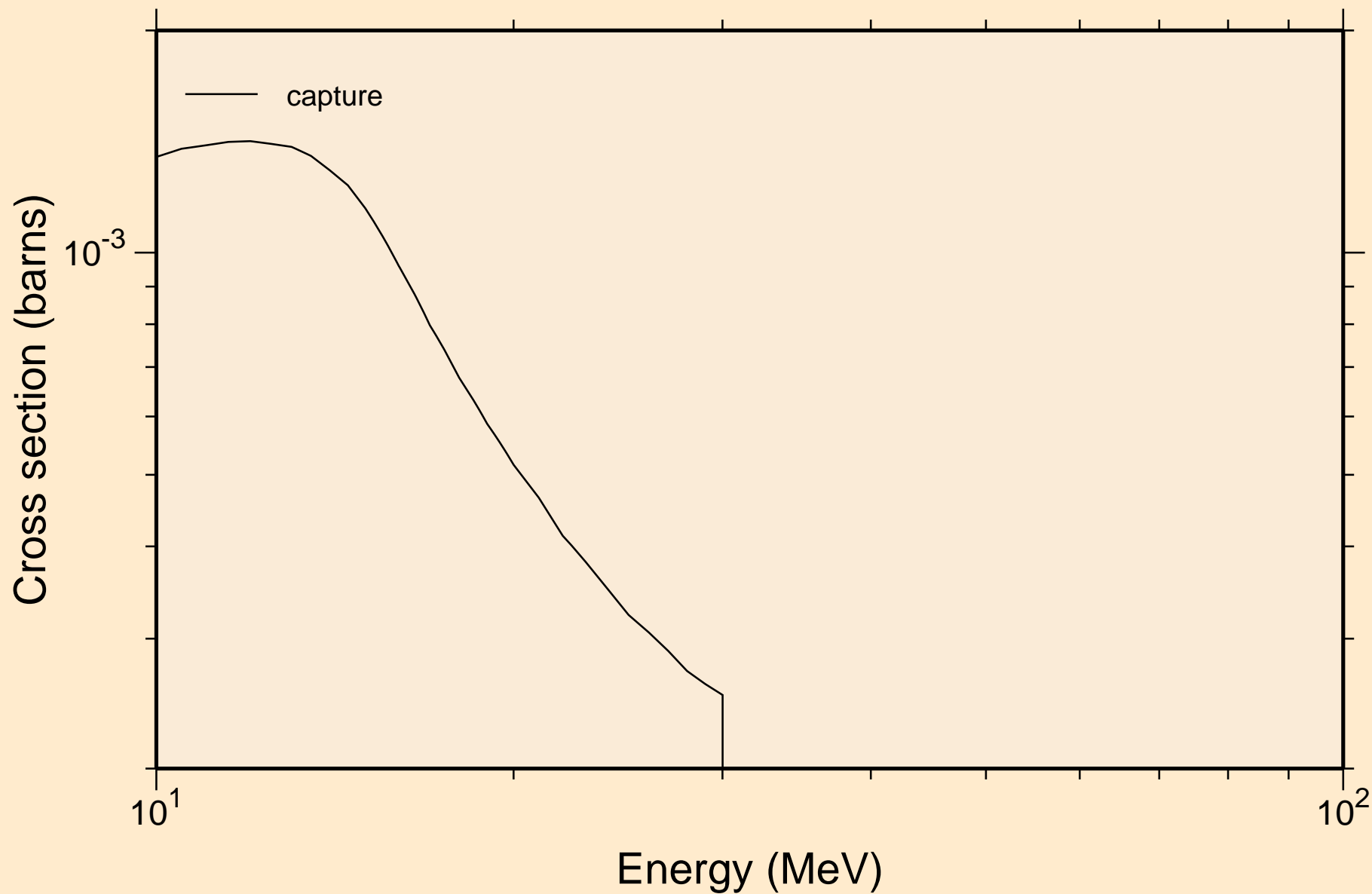

SB124N NEUTRON ACER TENDL-2019 LIBRARY; T=293.16K  
Heating

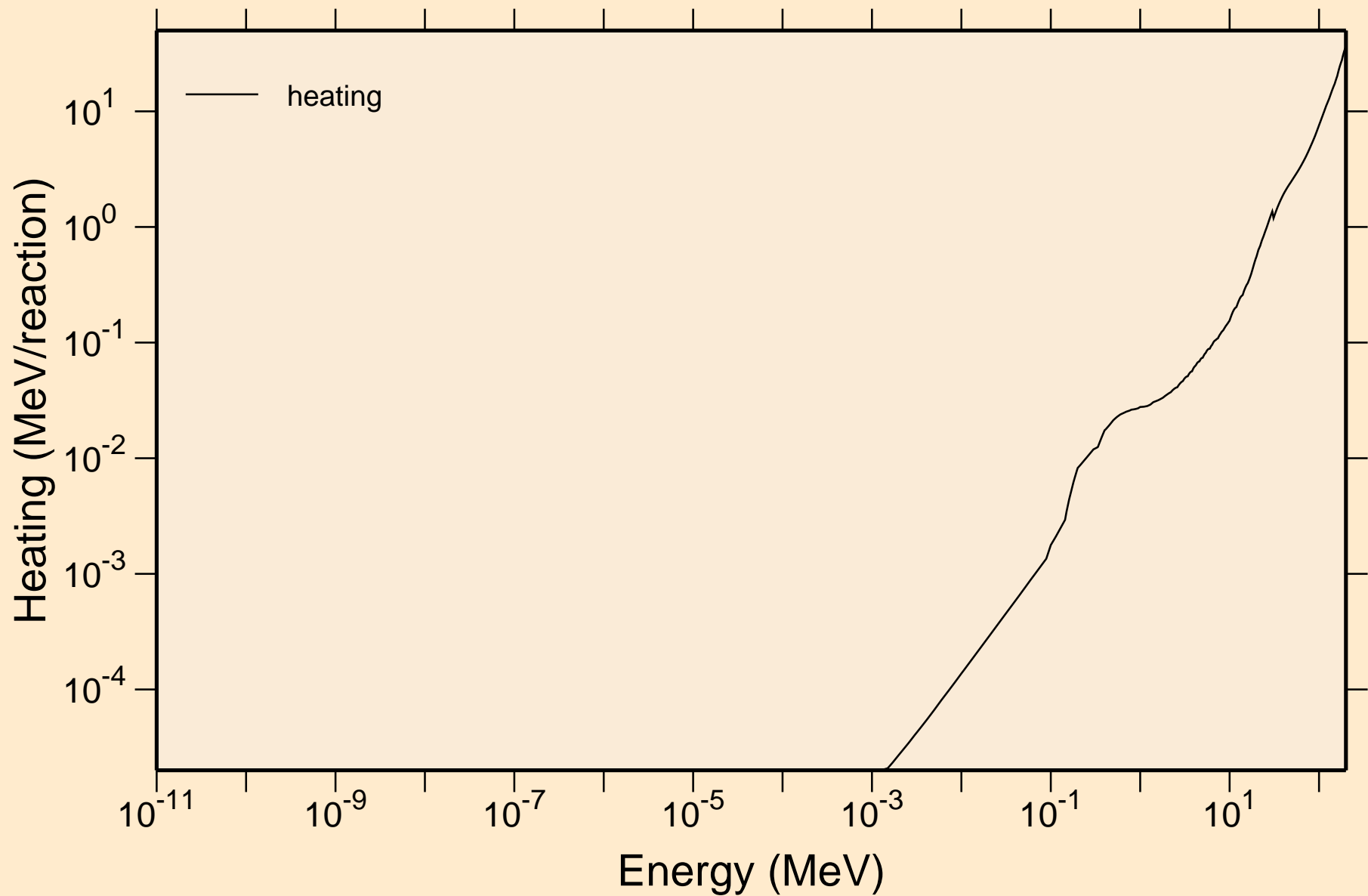

# SB124N NEUTRON ACER TENDL-2019 LIBRARY; T=293.16K Damage

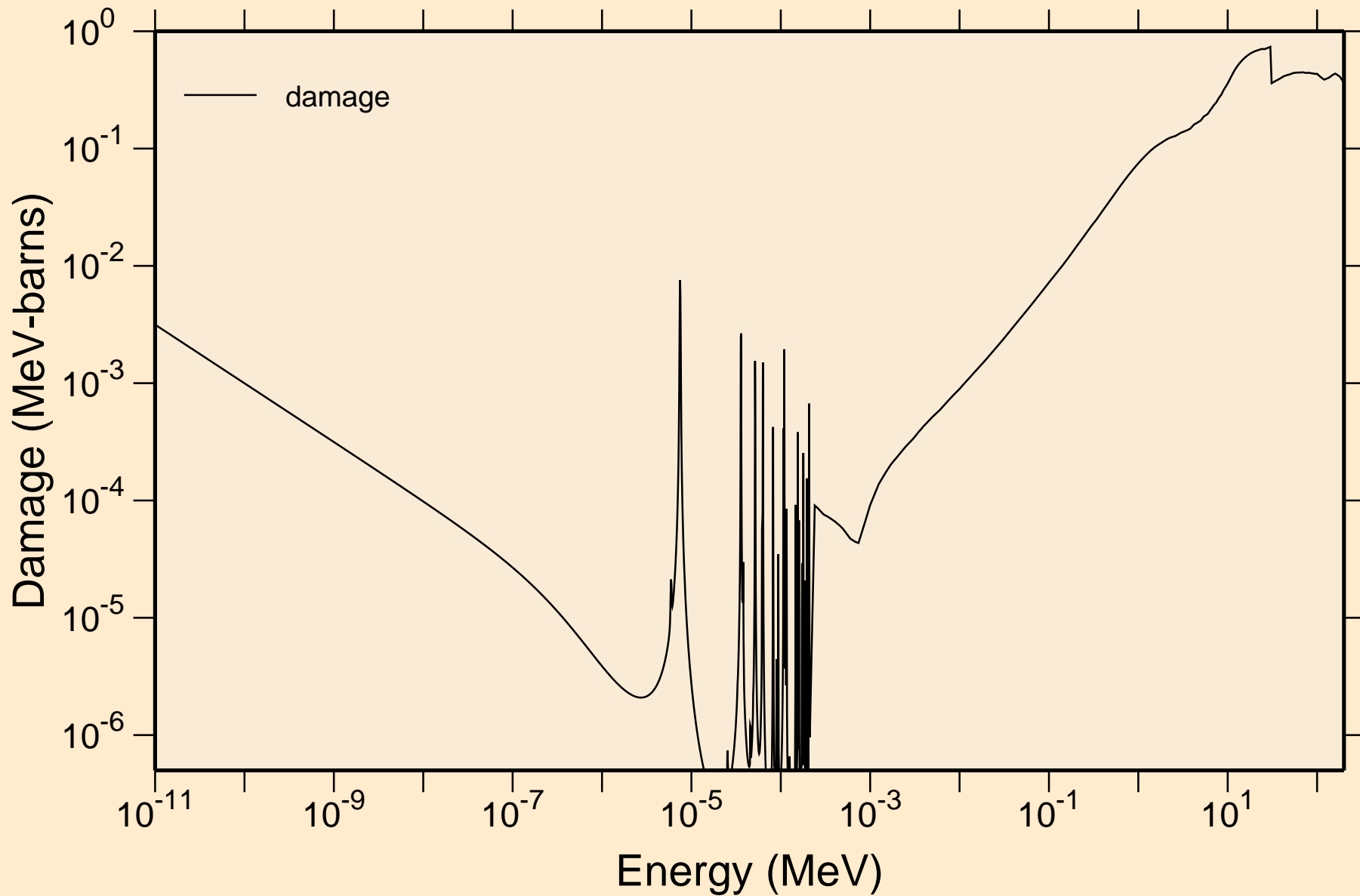

SB124N NEUTRON ACER TENDL-2019 LIBRARY; T=293.16K  
Non-threshold reactions

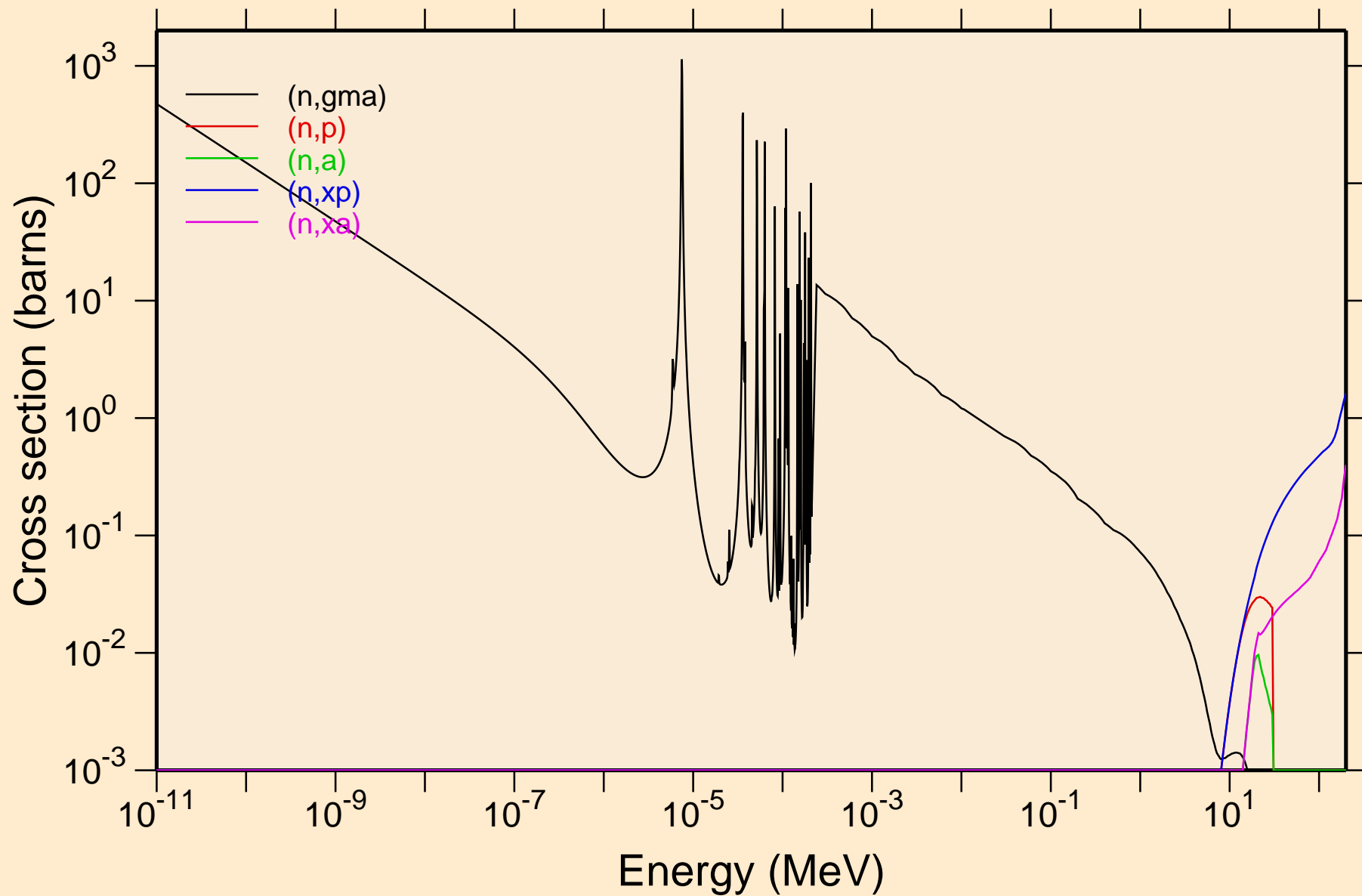

SB124N NEUTRON ACER TENDL-2019 LIBRARY; T=293.16K  
Principal cross sections

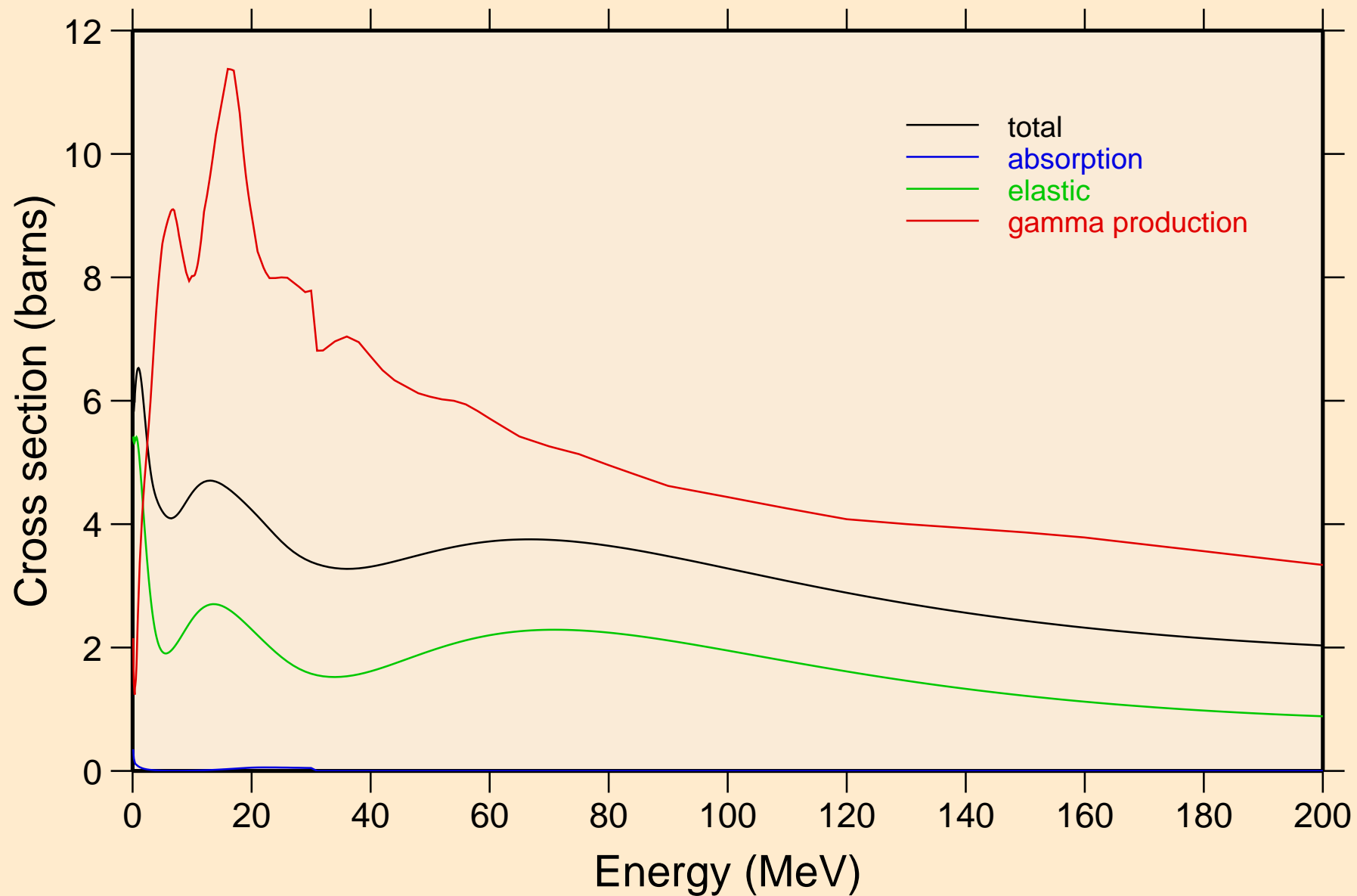

SB124N NEUTRON ACER TENDL-2019 LIBRARY; T=293.16K  
Heating

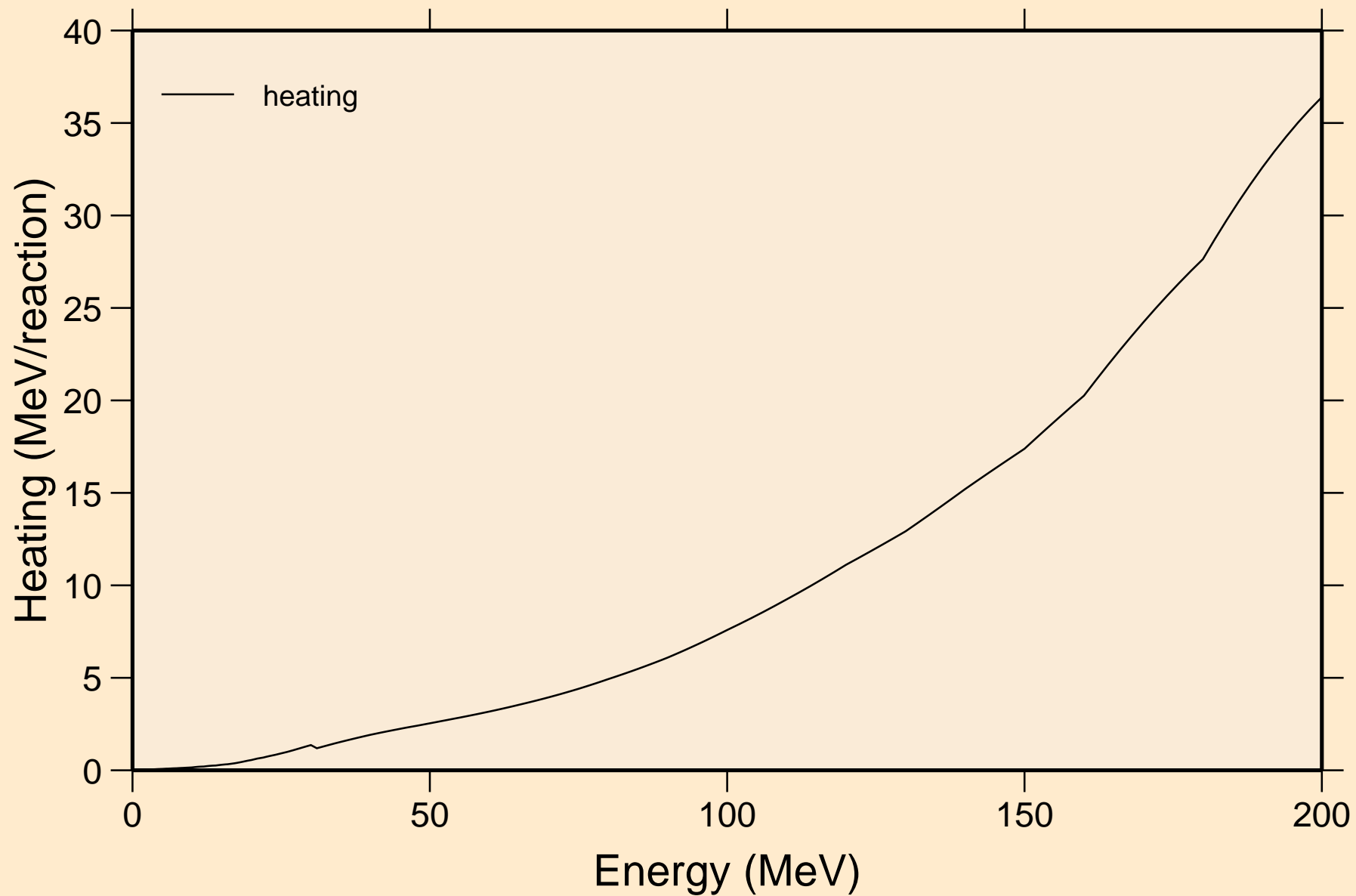

SB124N NEUTRON ACER TENDL-2019 LIBRARY; T=293.16K  
Damage

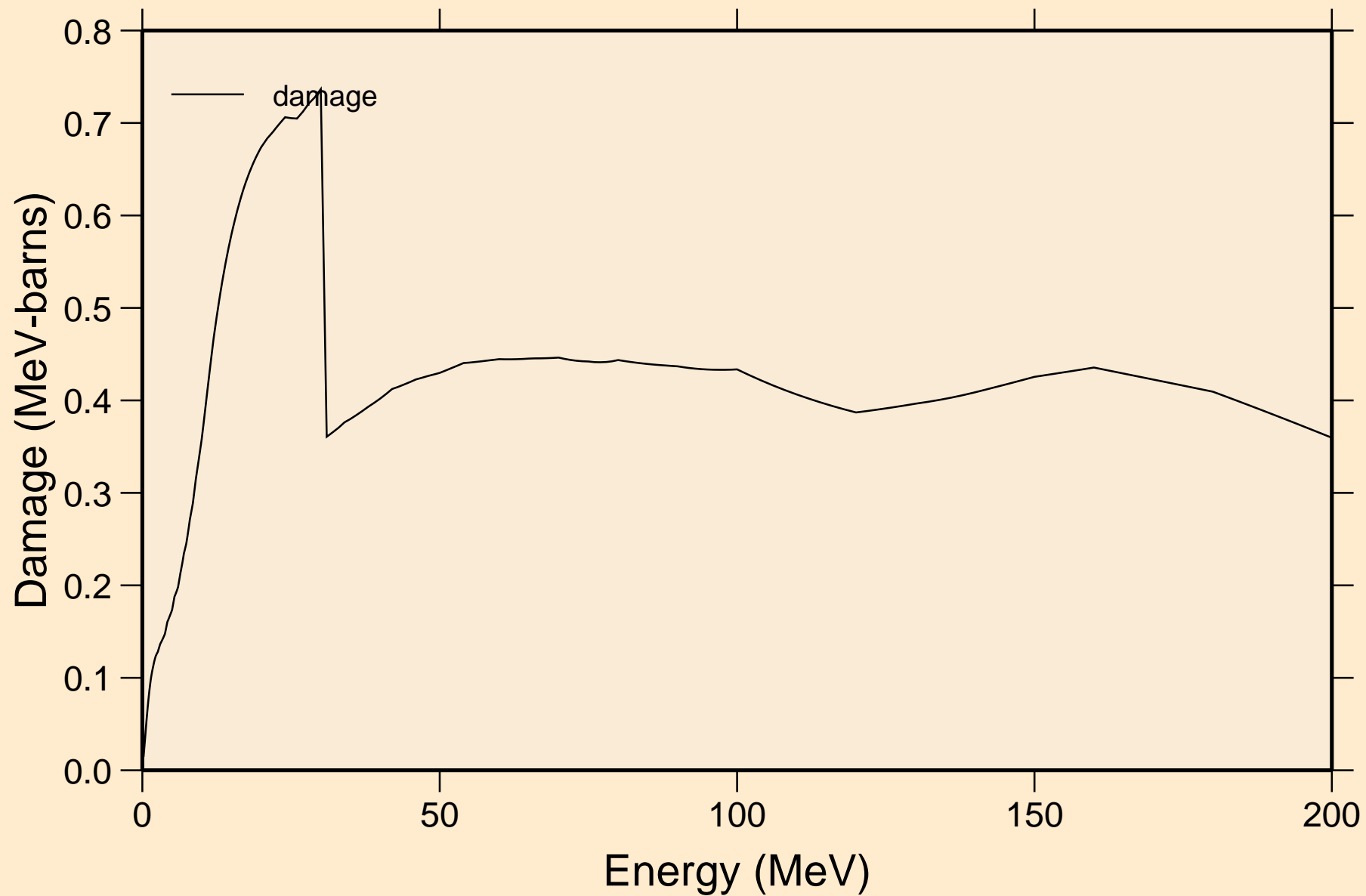

SB124N NEUTRON ACER TENDL-2019 LIBRARY; T=293.16K  
Non-threshold reactions

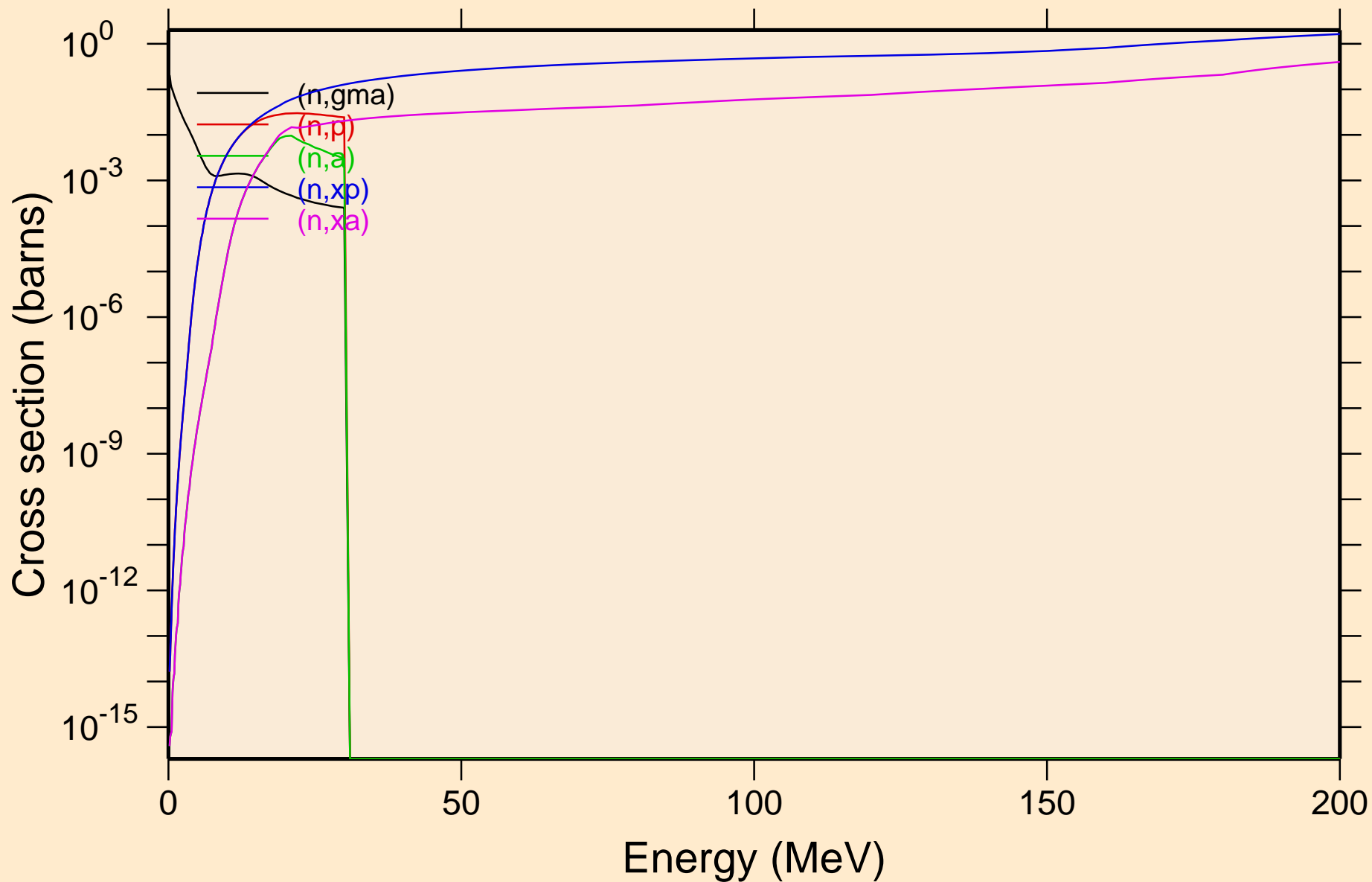



SB124N NEUTRON ACER TENDL-2019 LIBRARY; T=293.16K  
Inelastic levels

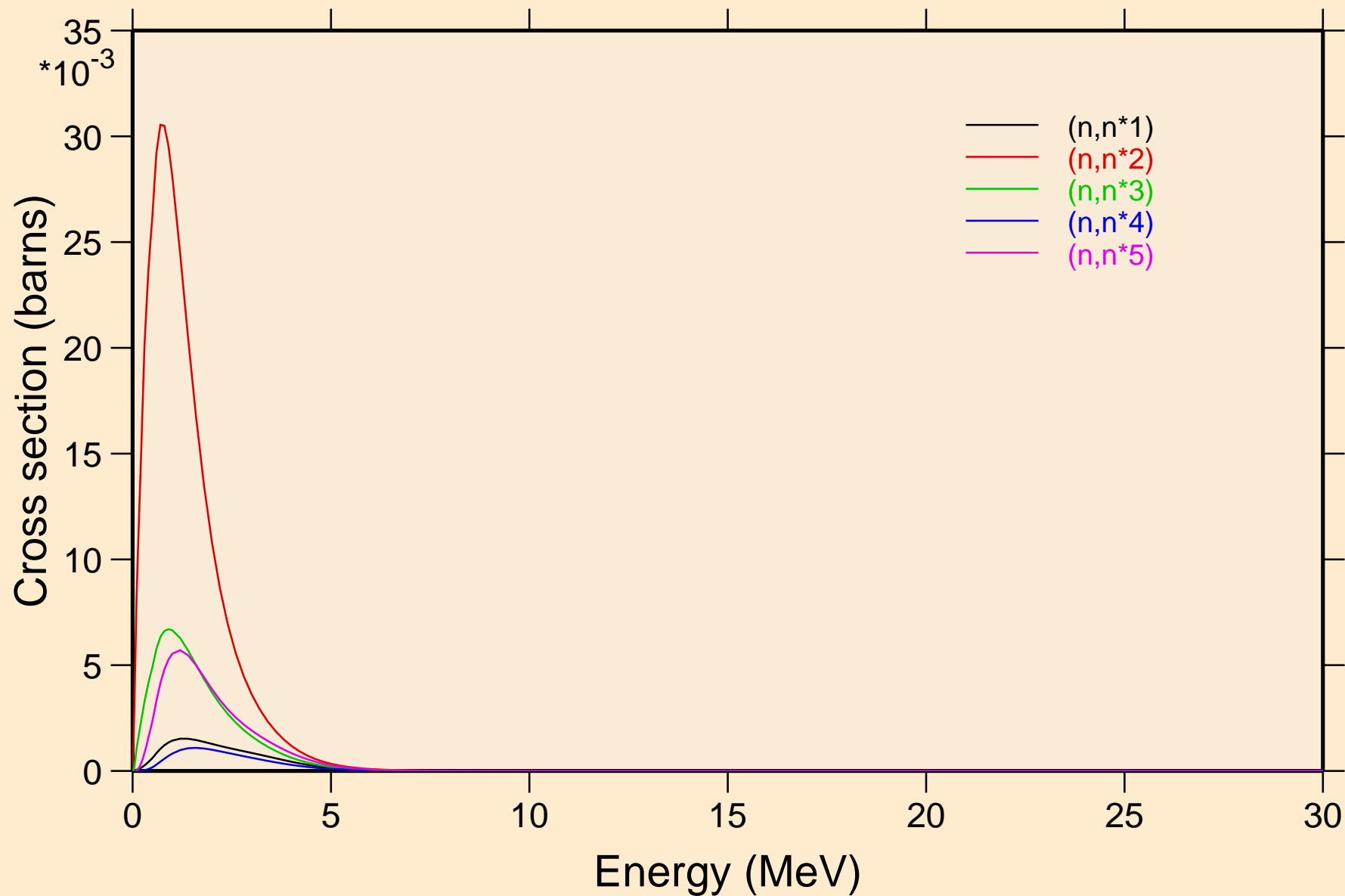

SB124N NEUTRON ACER TENDL-2019 LIBRARY; T=293.16K  
Inelastic levels

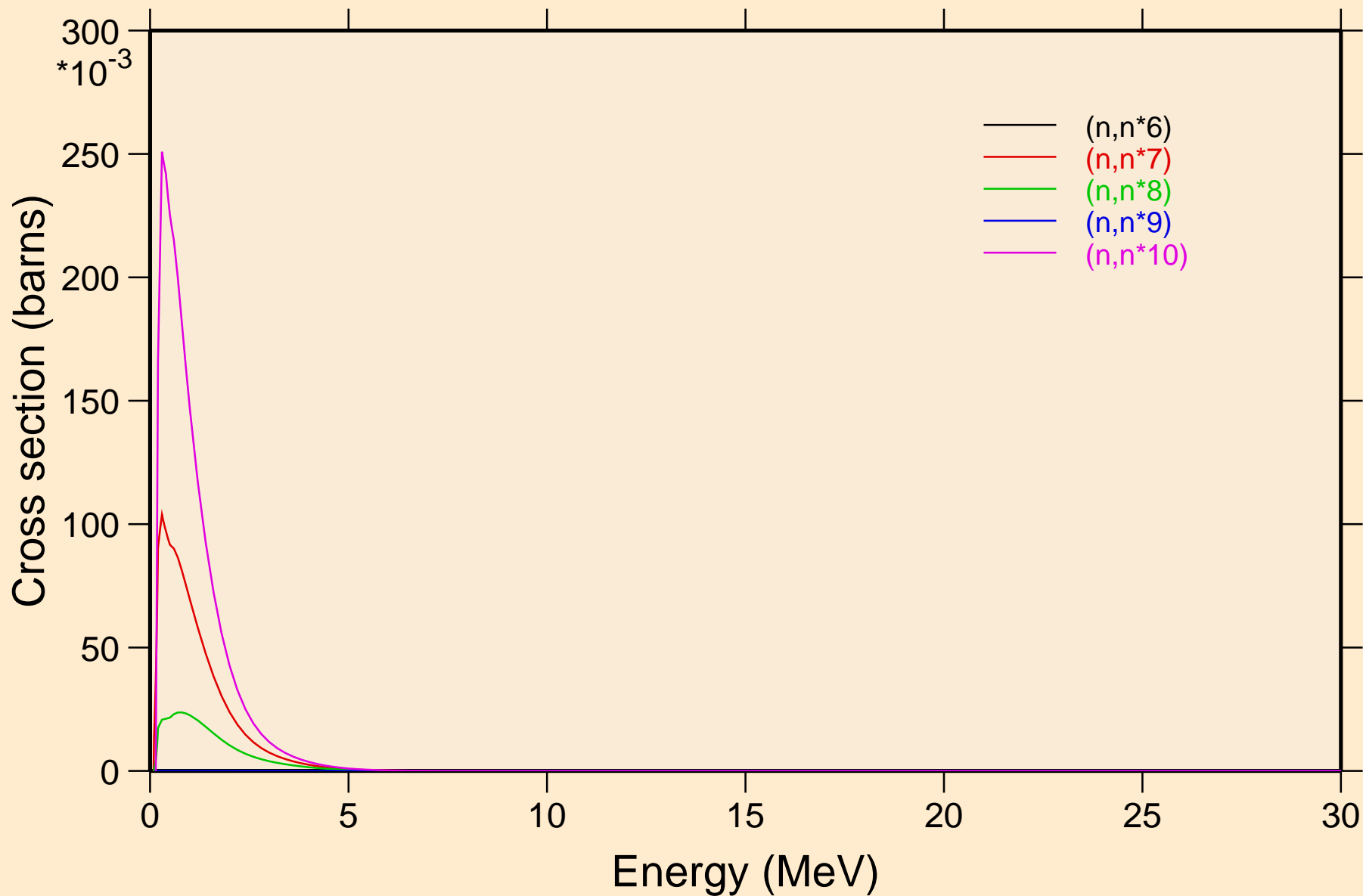

SB124N NEUTRON ACER TENDL-2019 LIBRARY; T=293.16K  
Inelastic levels

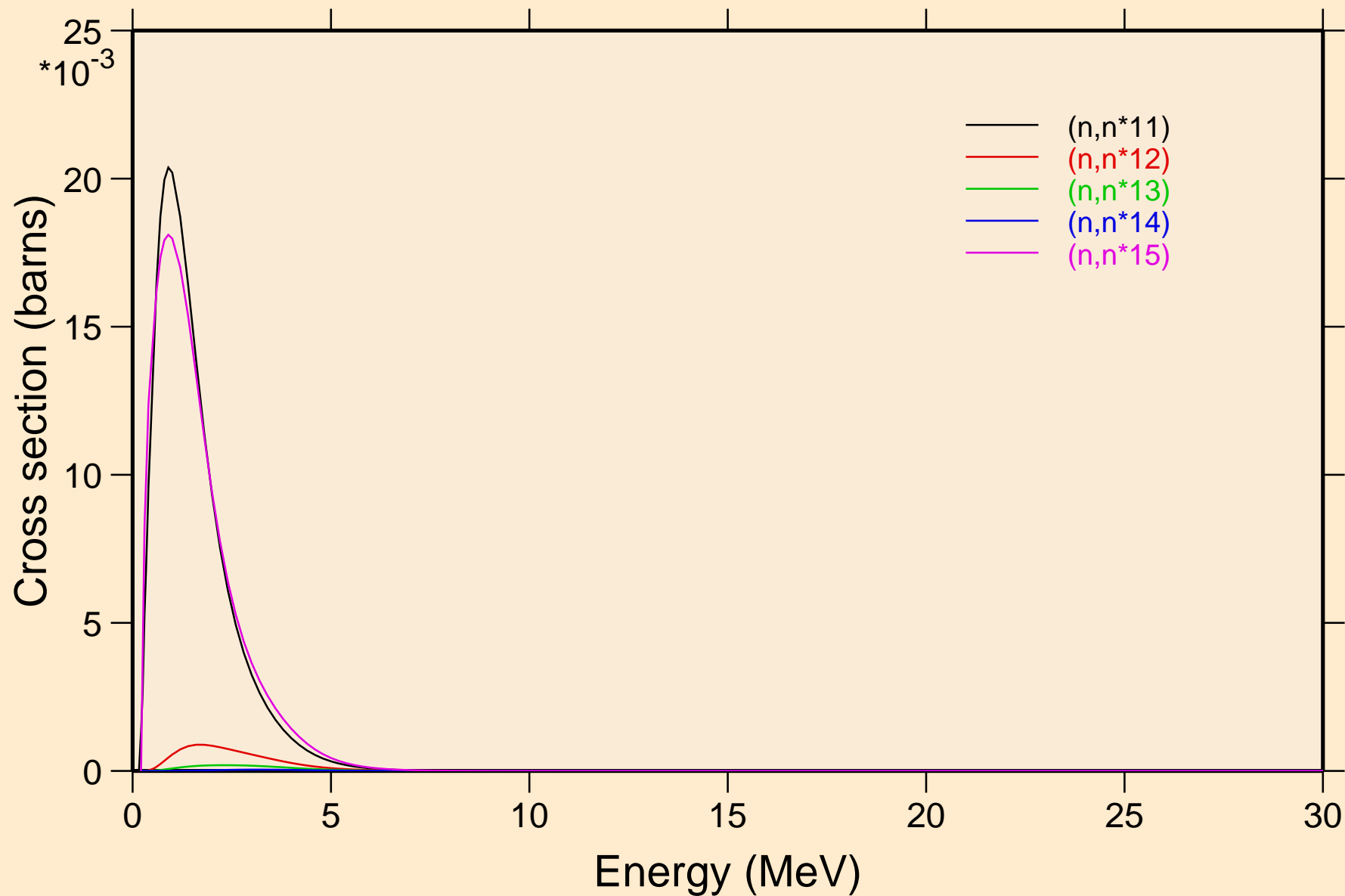

SB124N NEUTRON ACER TENDL-2019 LIBRARY; T=293.16K  
Inelastic levels

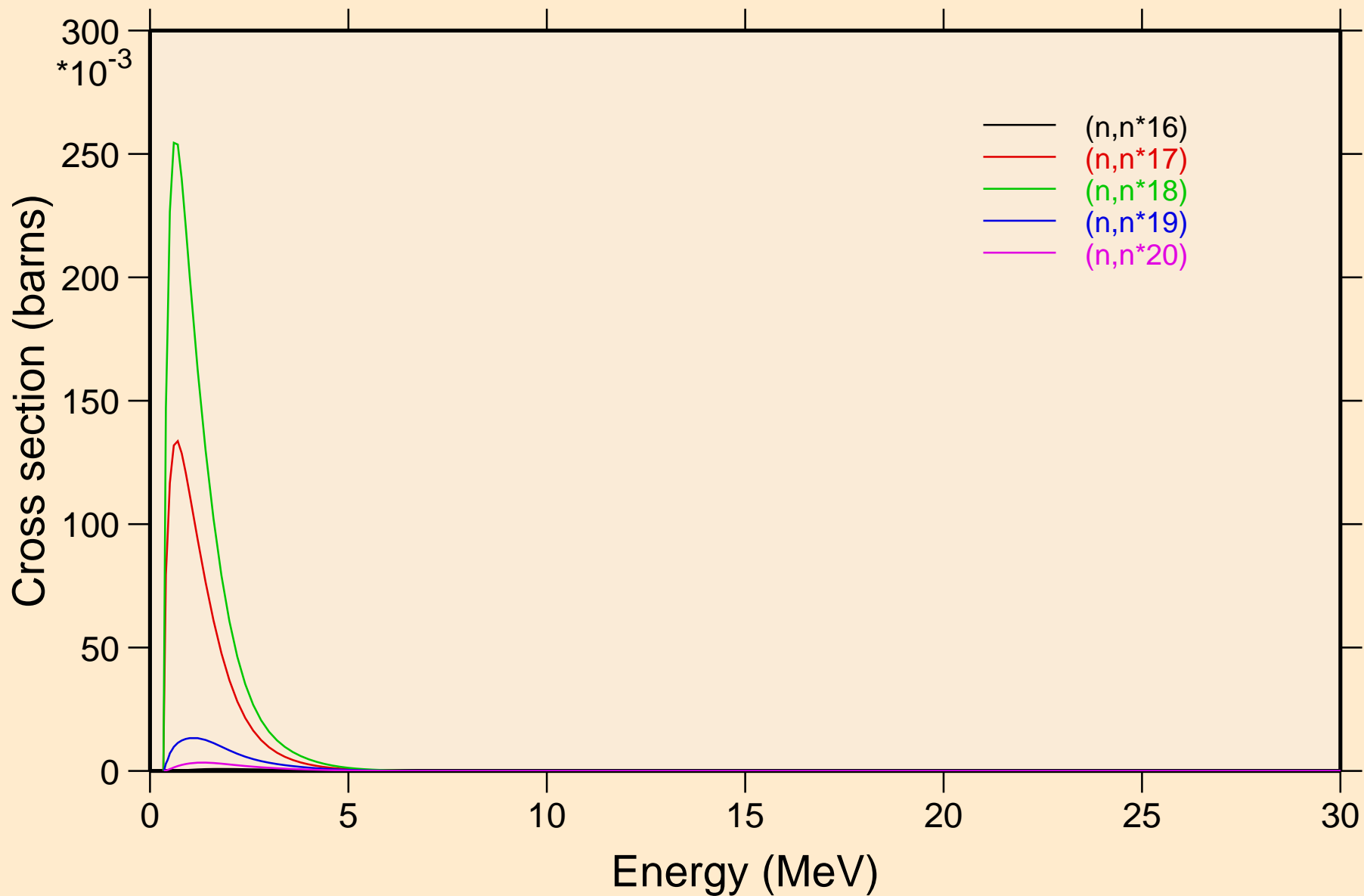

SB124N NEUTRON ACER TENDL-2019 LIBRARY; T=293.16K  
Inelastic levels

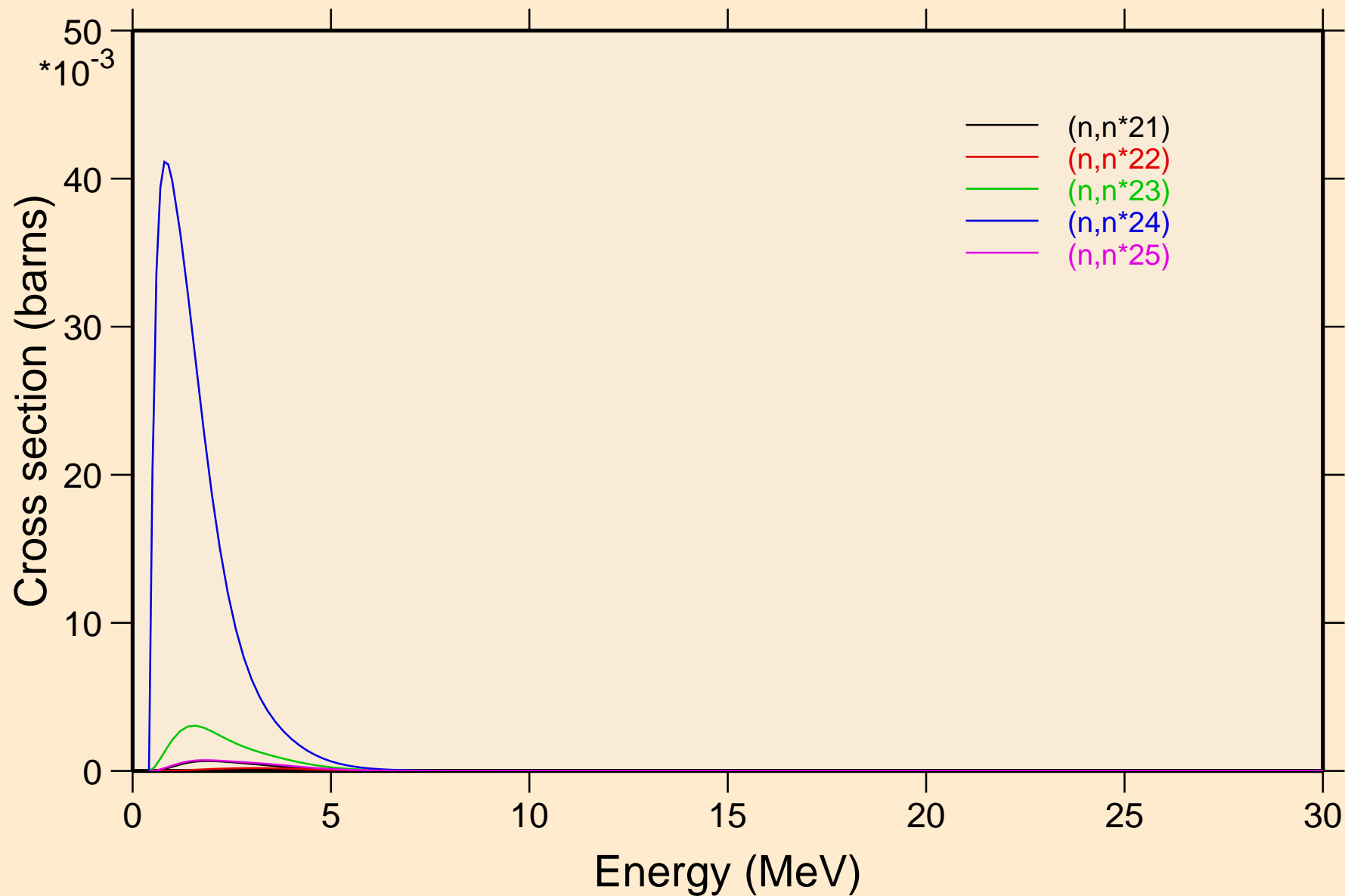

SB124N NEUTRON ACER TENDL-2019 LIBRARY; T=293.16K  
Inelastic levels

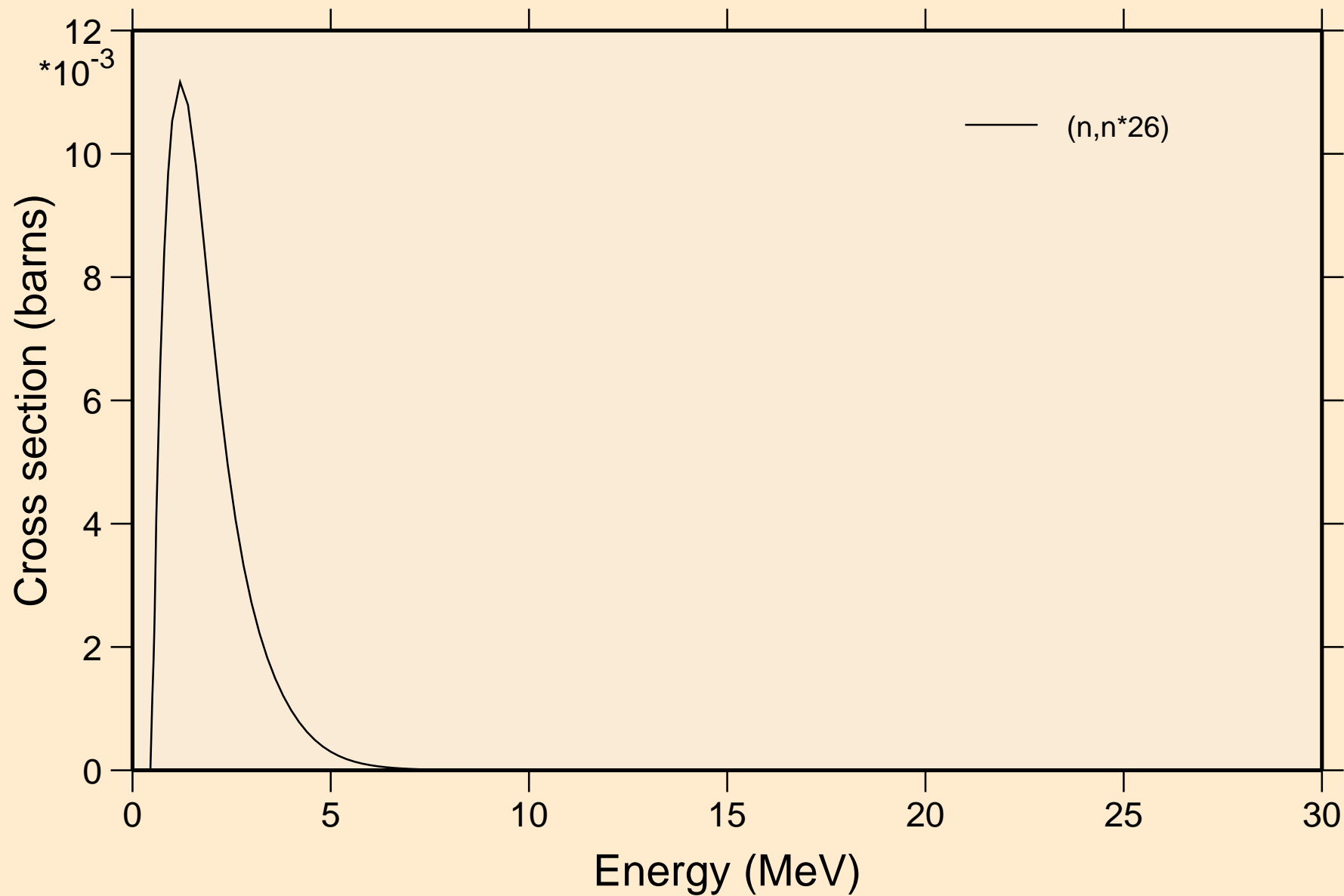

SB124N NEUTRON ACER TENDL-2019 LIBRARY; T=293.16K  
Threshold reactions

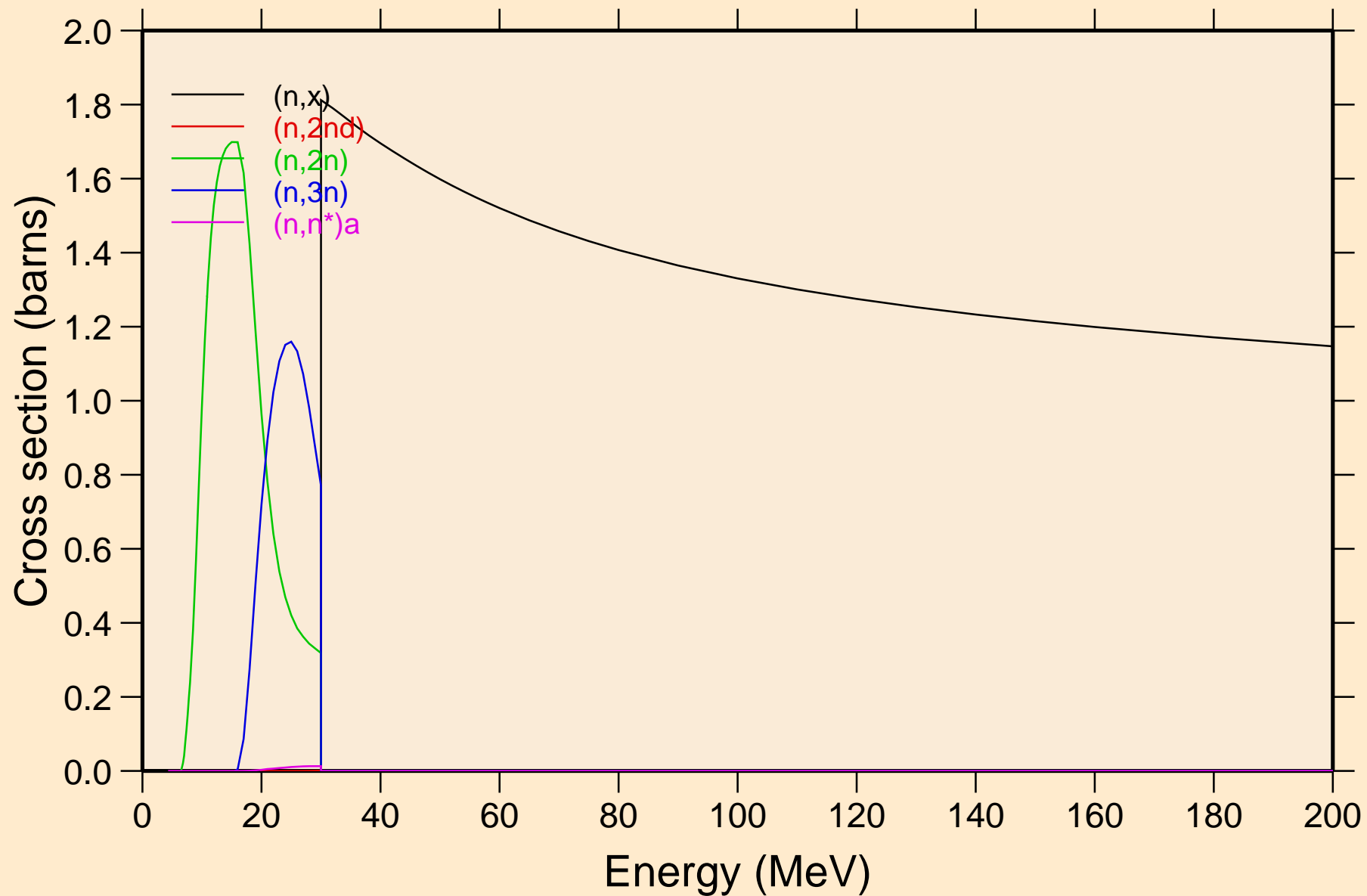

SB124N NEUTRON ACER TENDL-2019 LIBRARY; T=293.16K  
Threshold reactions

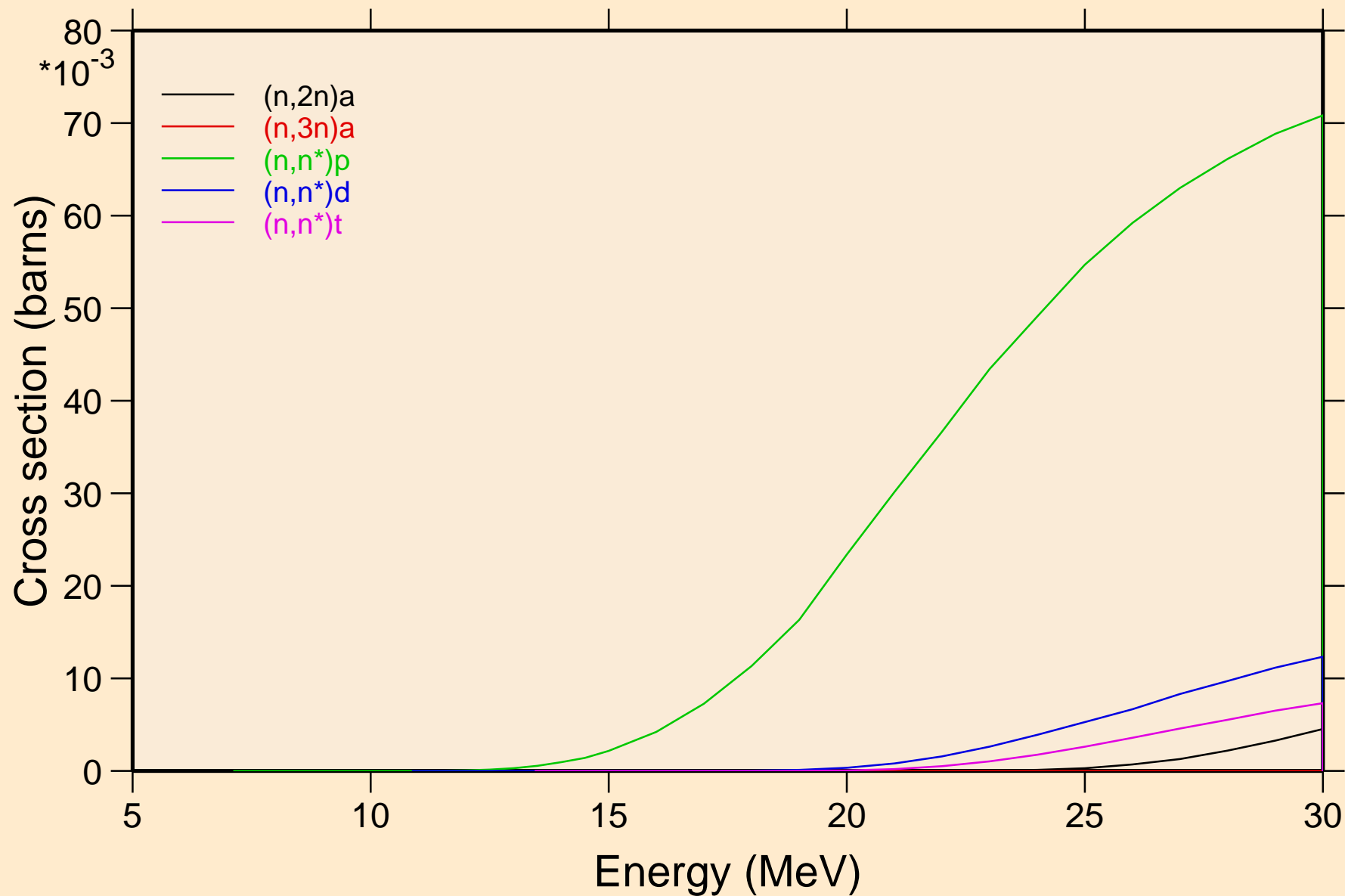



SB124N NEUTRON ACER TENDL-2019 LIBRARY; T=293.16K  
Threshold reactions

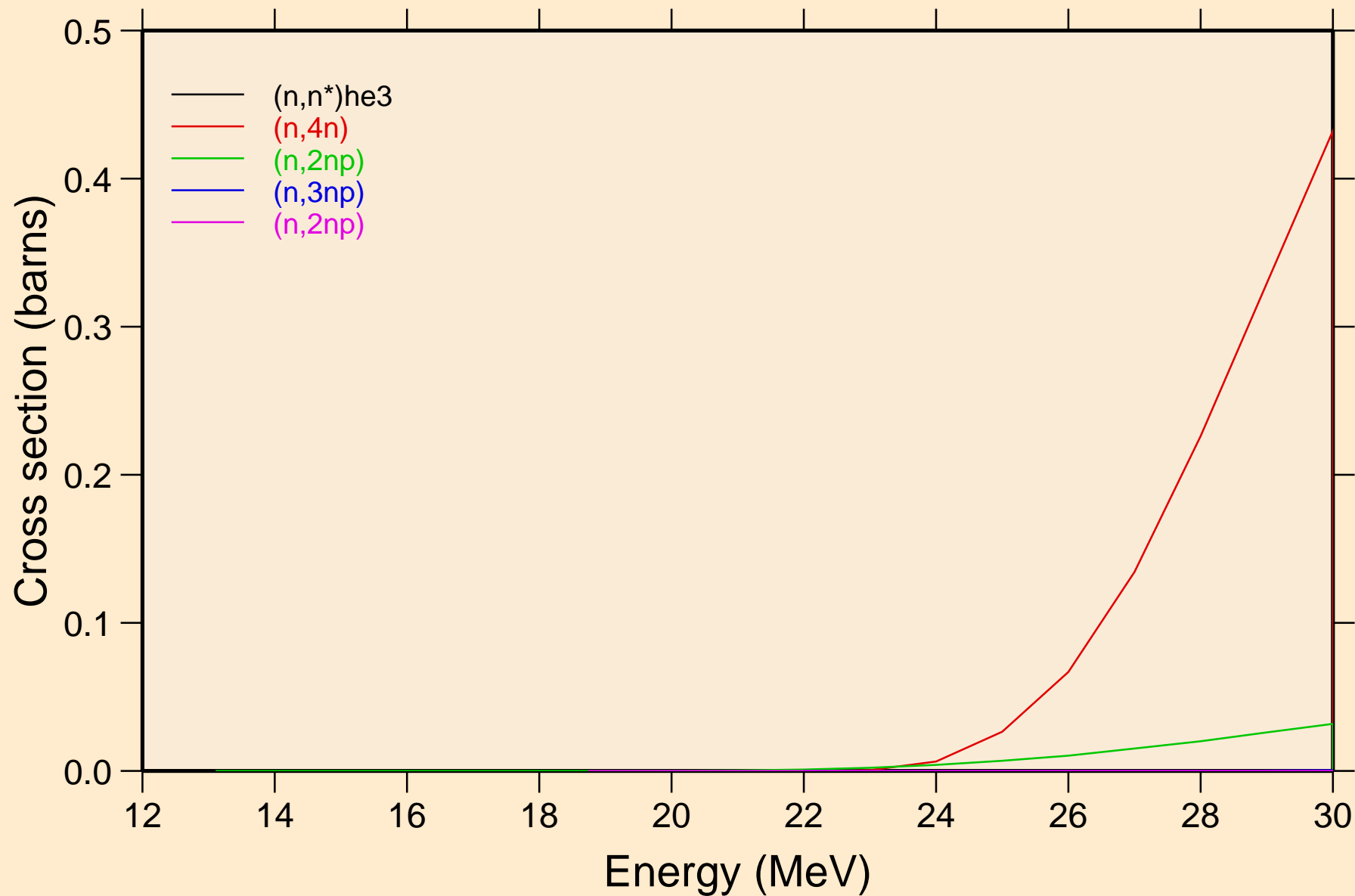

SB124N NEUTRON ACER TENDL-2019 LIBRARY; T=293.16K  
Threshold reactions

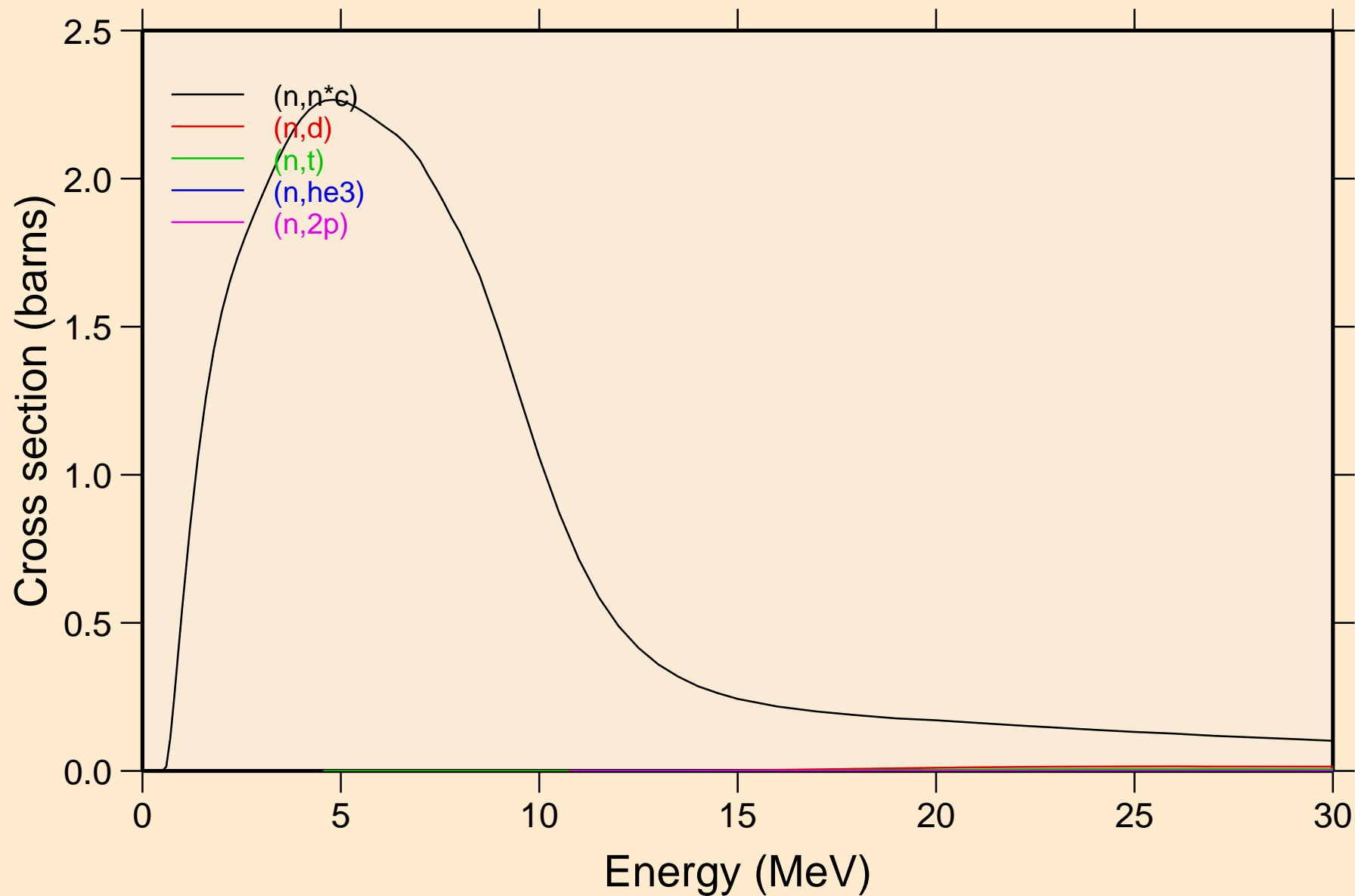

SB124N NEUTRON ACER TENDL-2019 LIBRARY; T=293.16K  
Threshold reactions

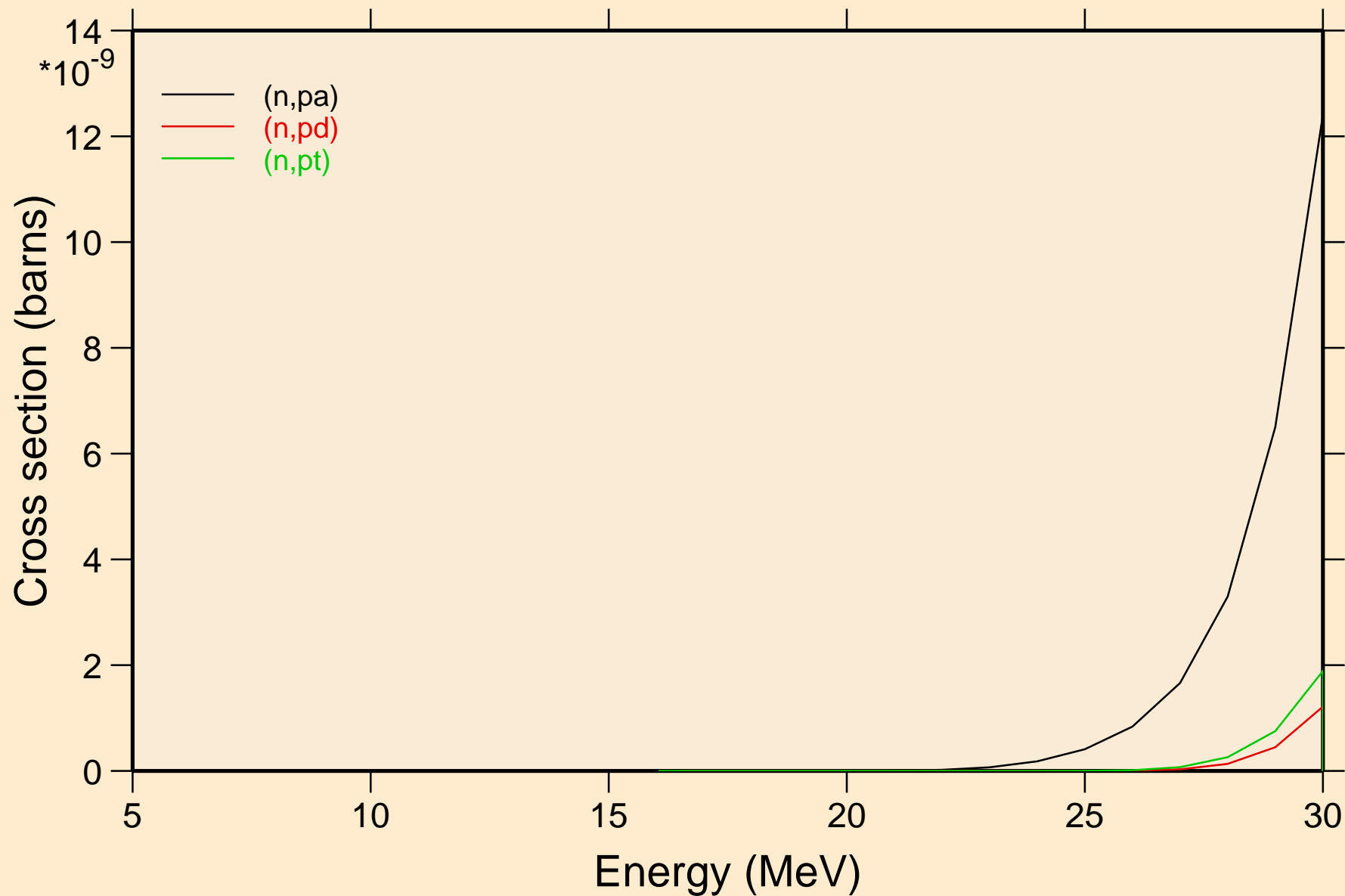

SB124N NEUTRON ACER TENDL-2019 LIBRARY; T=293.16K  
Threshold reactions

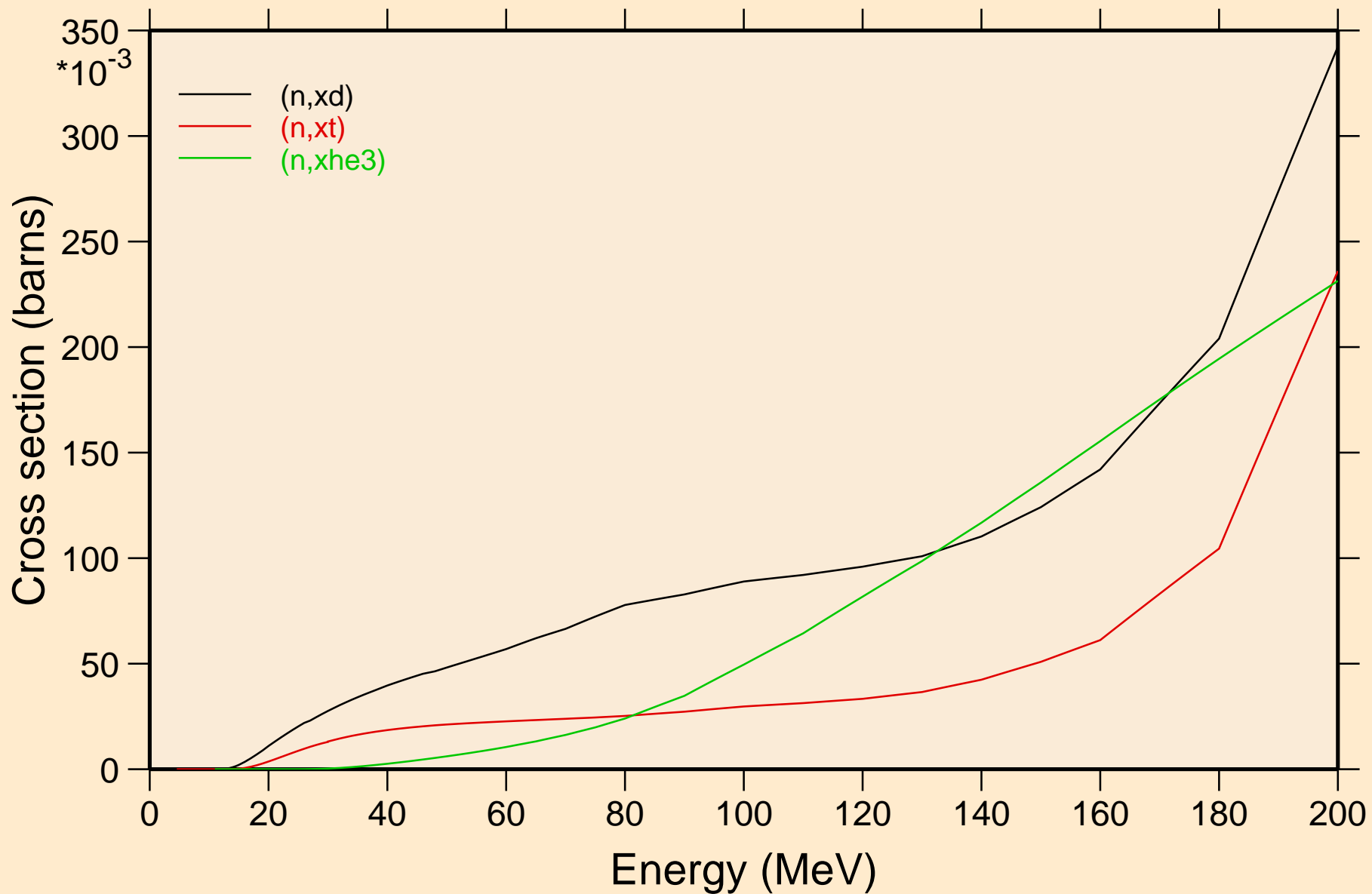

SB124N NEUTRON ACER TENDL-2019 LIBRARY; T=293.16K  
angular distribution for elastic

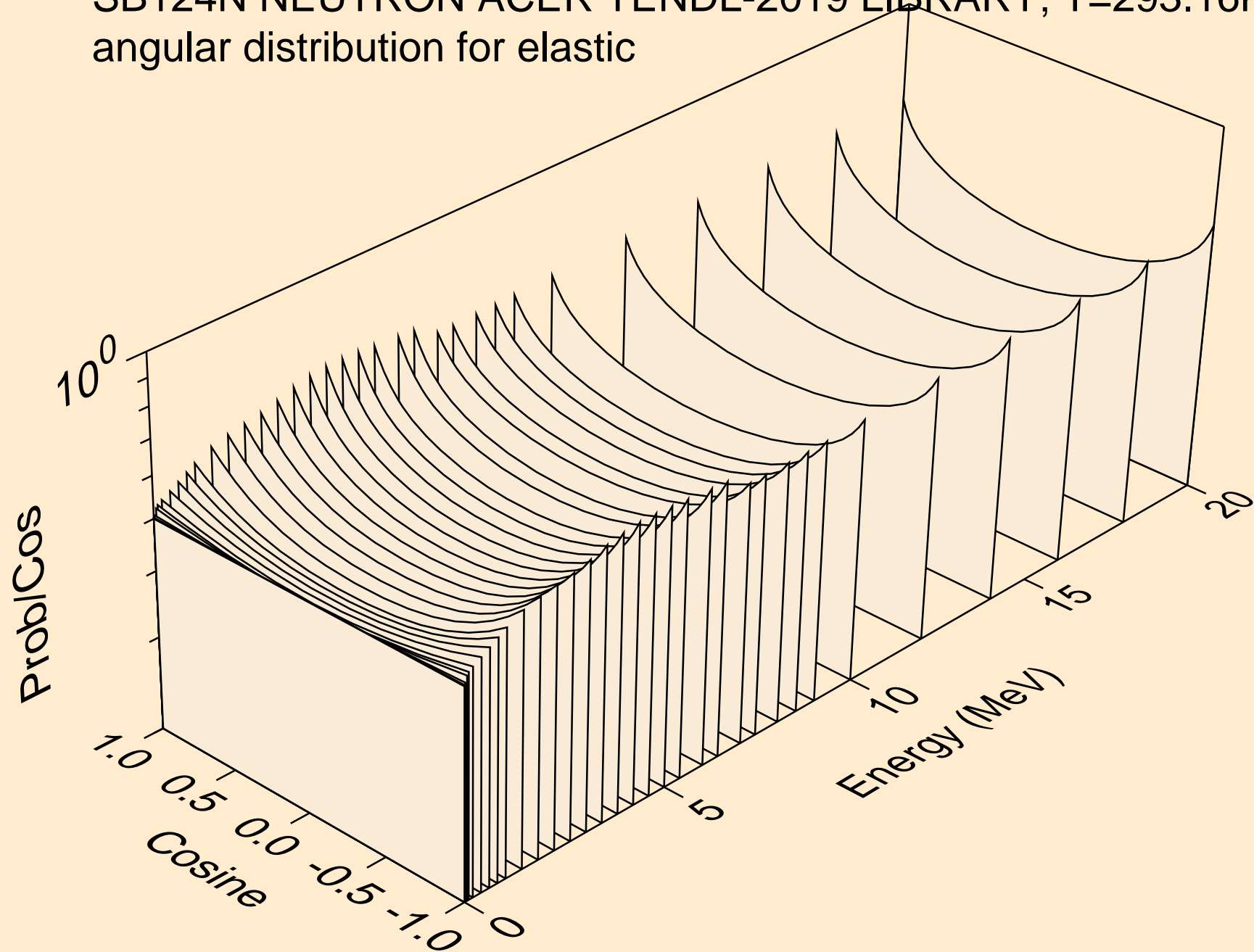

SB124N NEUTRON ACER TENDL-2019 LIBRARY; T=293.16K  
angular distribution for elastic

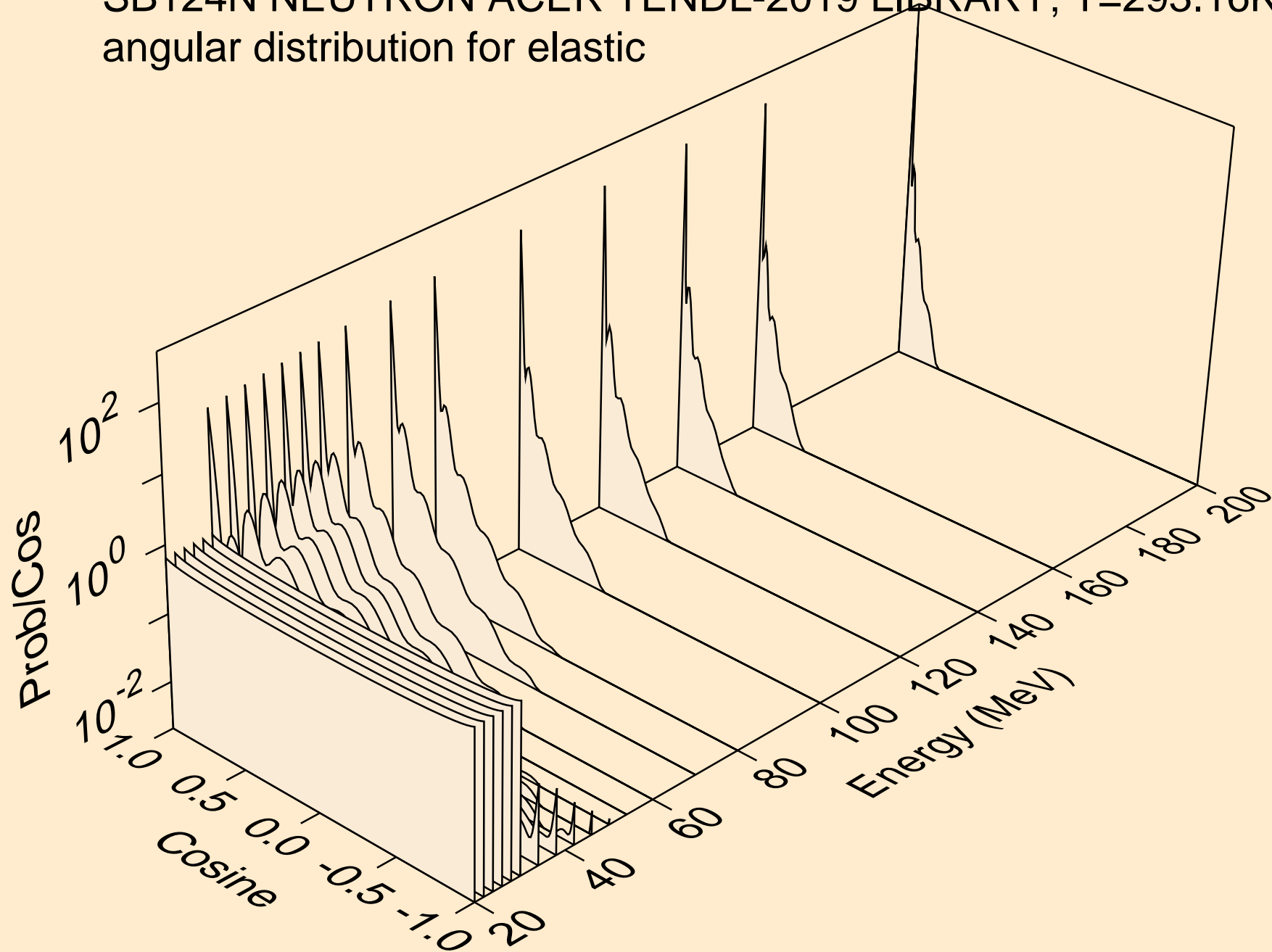

SB124N NEUTRON ACER TENDL-2019 LIBRARY; T=293.16K  
angular distribution for (n,n\*1)

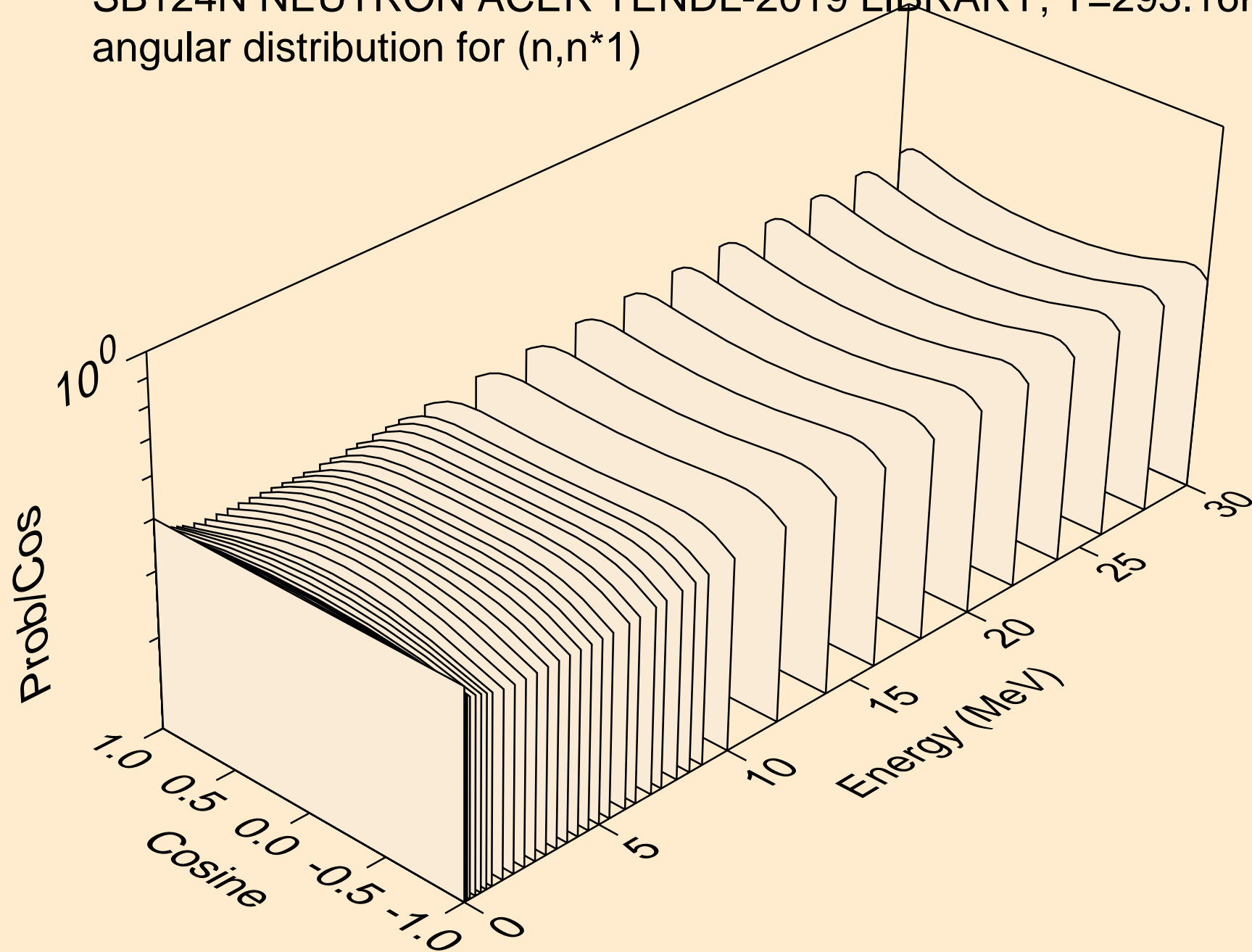

SB124N NEUTRON ACER TENDL-2019 LIBRARY; T=293.16K  
angular distribution for (n,n\*2)

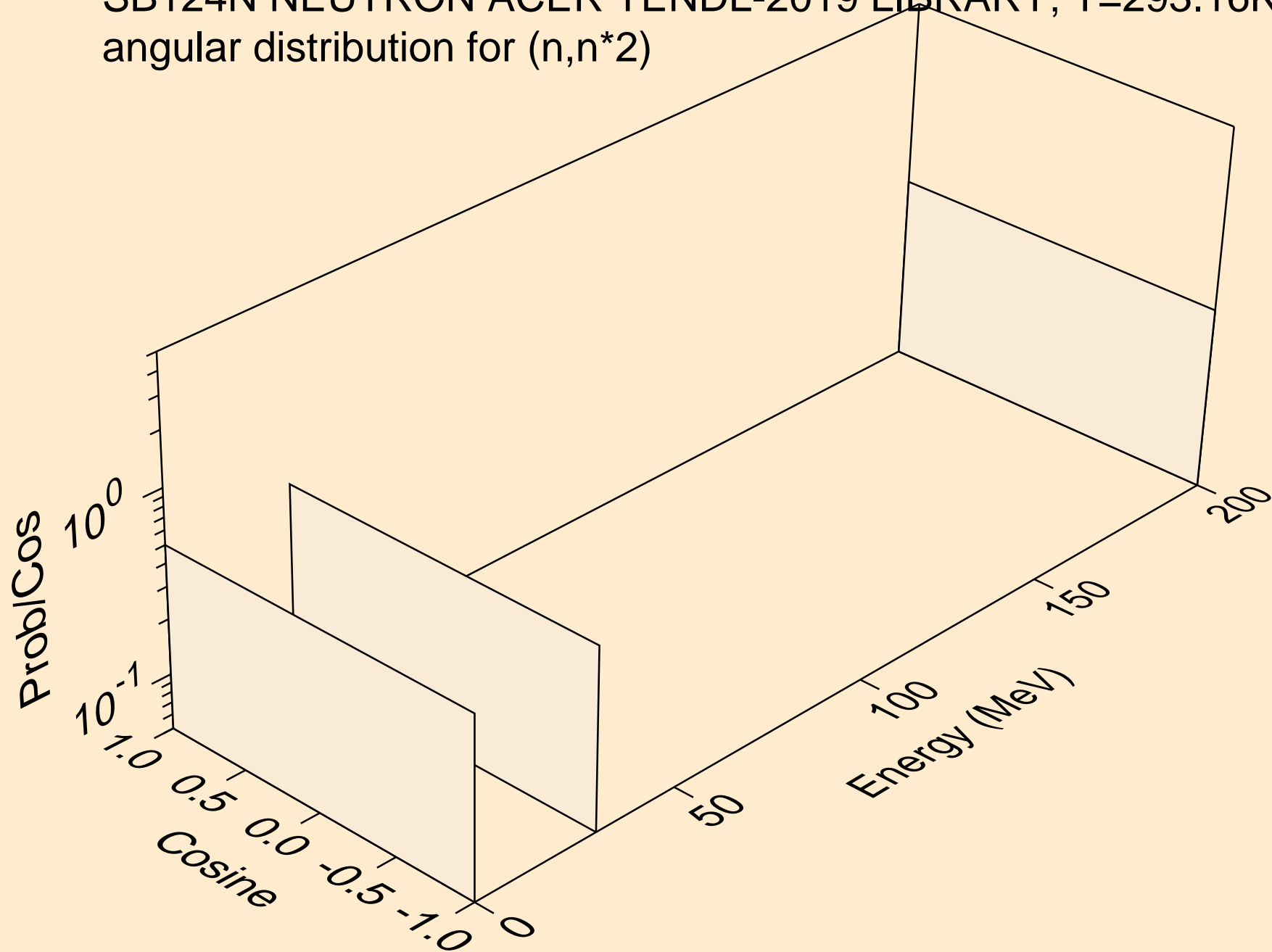



SB124N NEUTRON ACER TENDL-2019 LIBRARY; T=293.16K  
angular distribution for (n,n\*3)

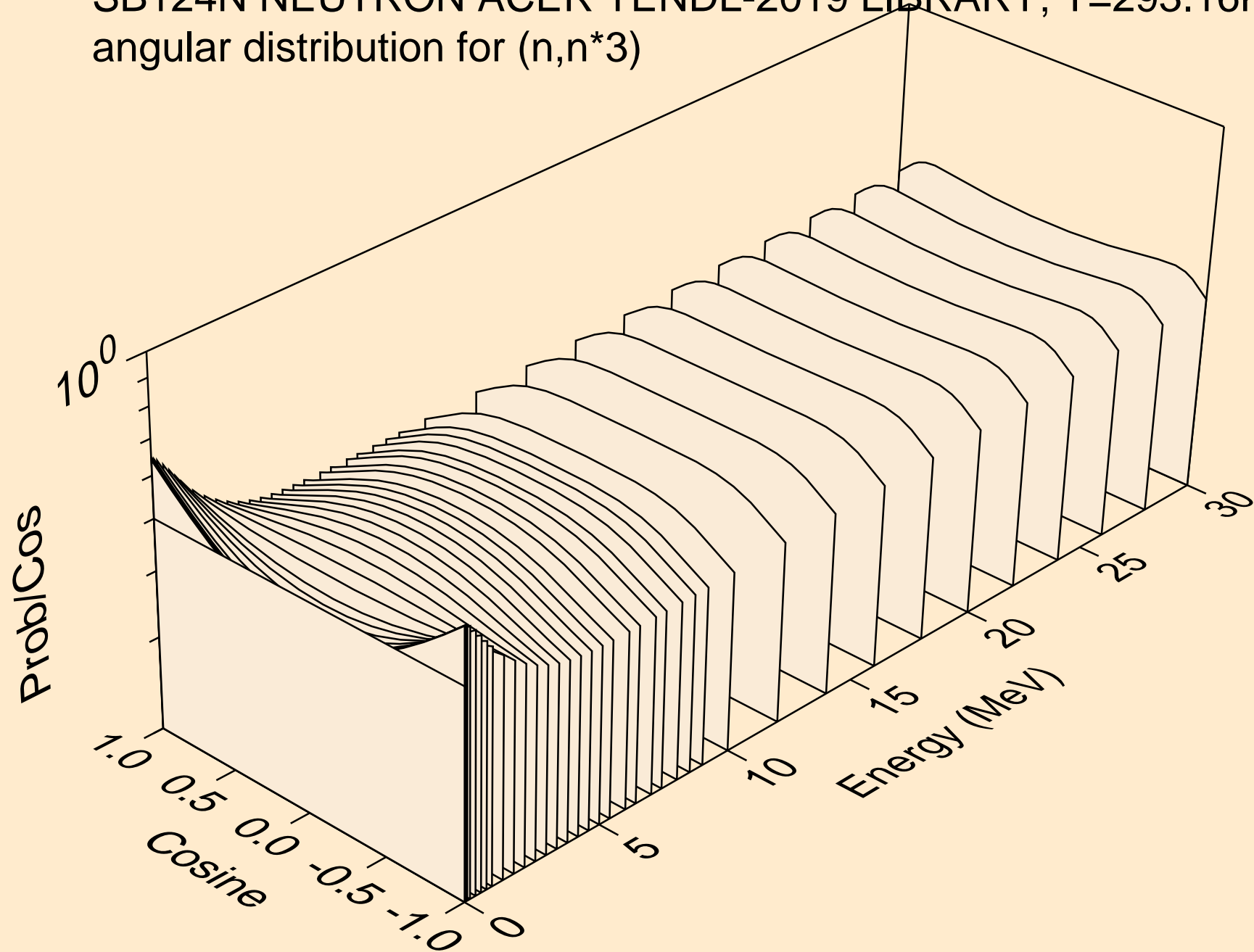

SB124N NEUTRON ACER TENDL-2019 LIBRARY; T=293.16K  
angular distribution for (n,n\*4)

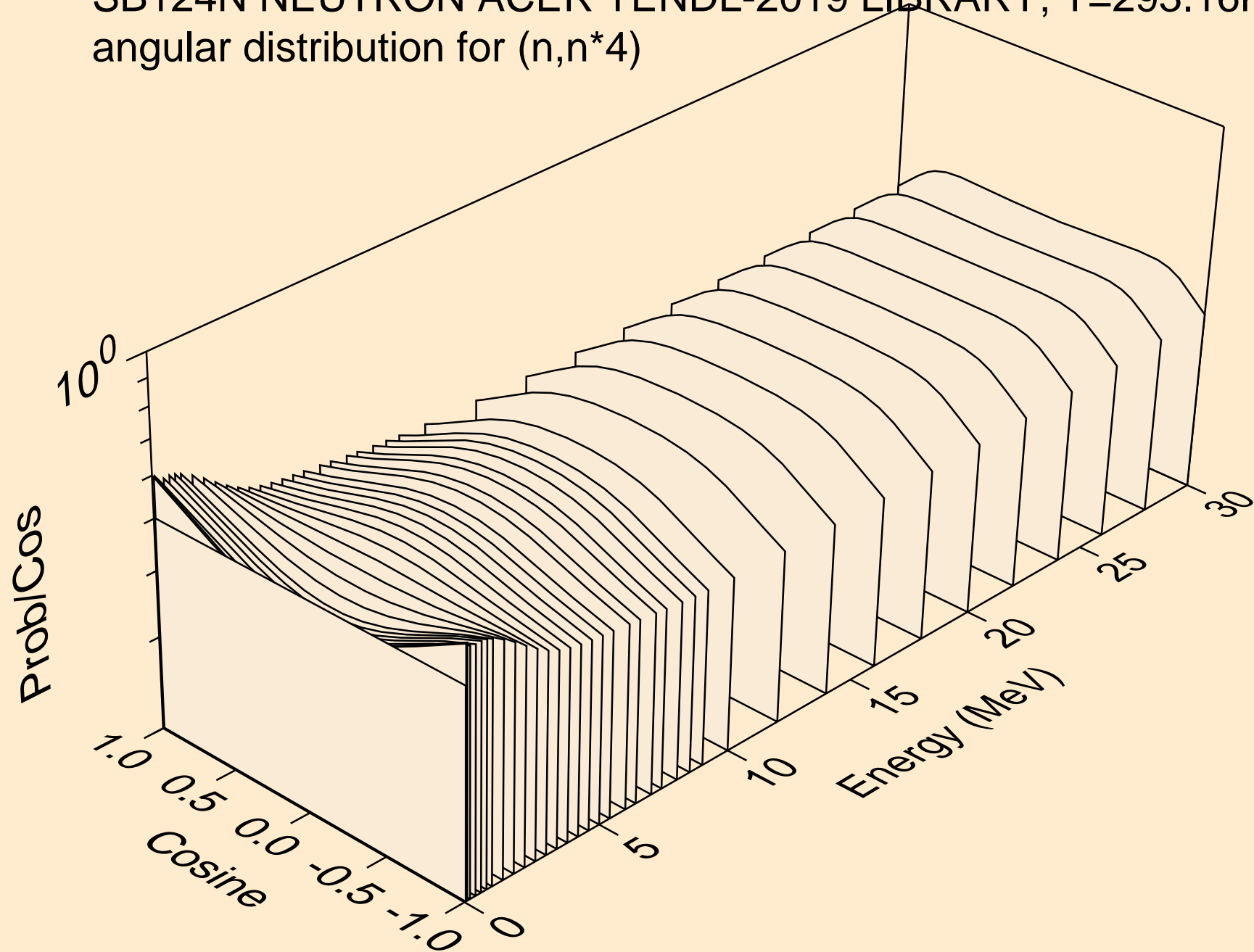

SB124N NEUTRON ACER TENDL-2019 LIBRARY; T=293.16K  
angular distribution for (n,n\*5)

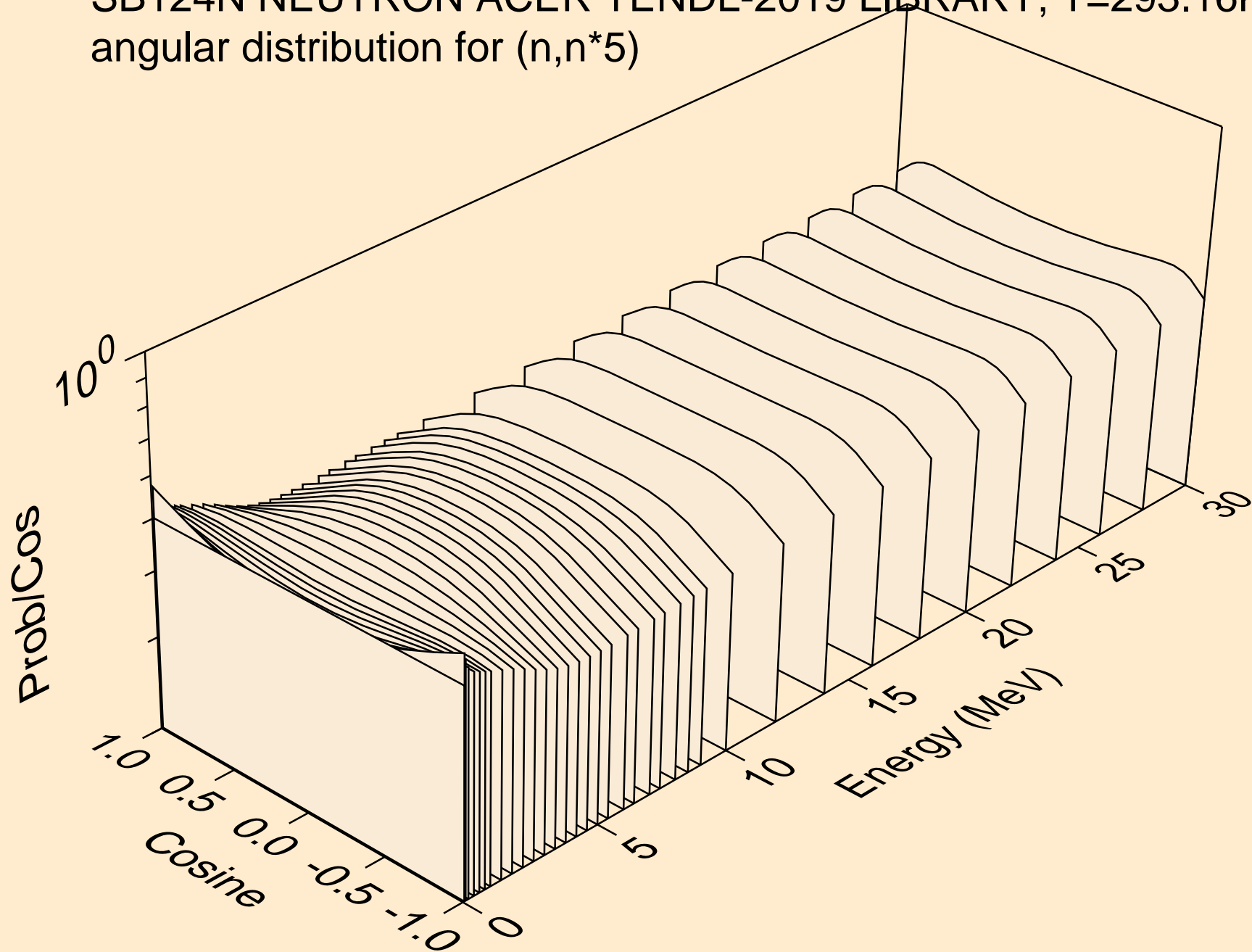

SB124N NEUTRON ACER TENDL-2019 LIBRARY; T=293.16K  
angular distribution for (n,n\*6)

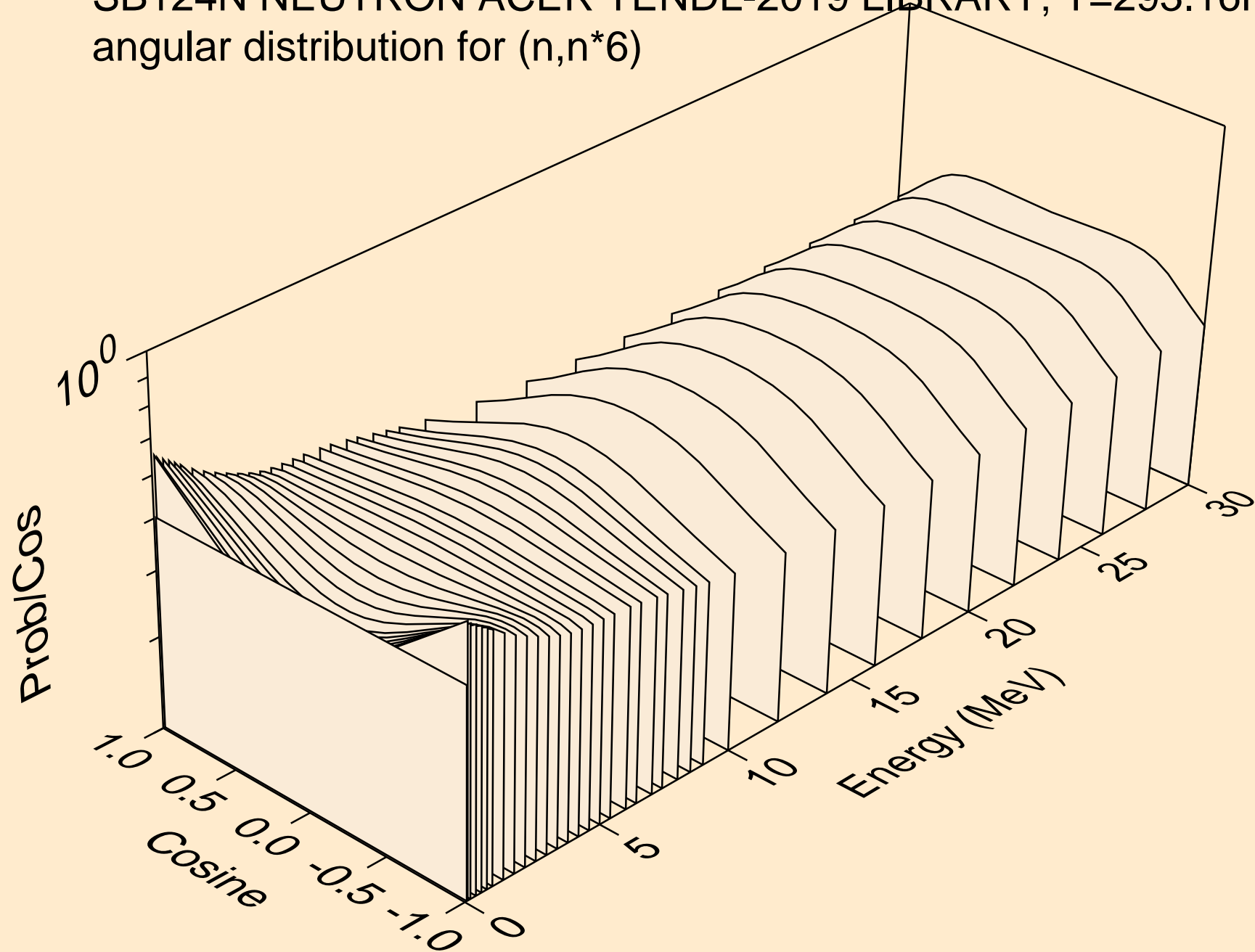

SB124N NEUTRON ACER TENDL-2019 LIBRARY; T=293.16K  
angular distribution for (n,n\*7)

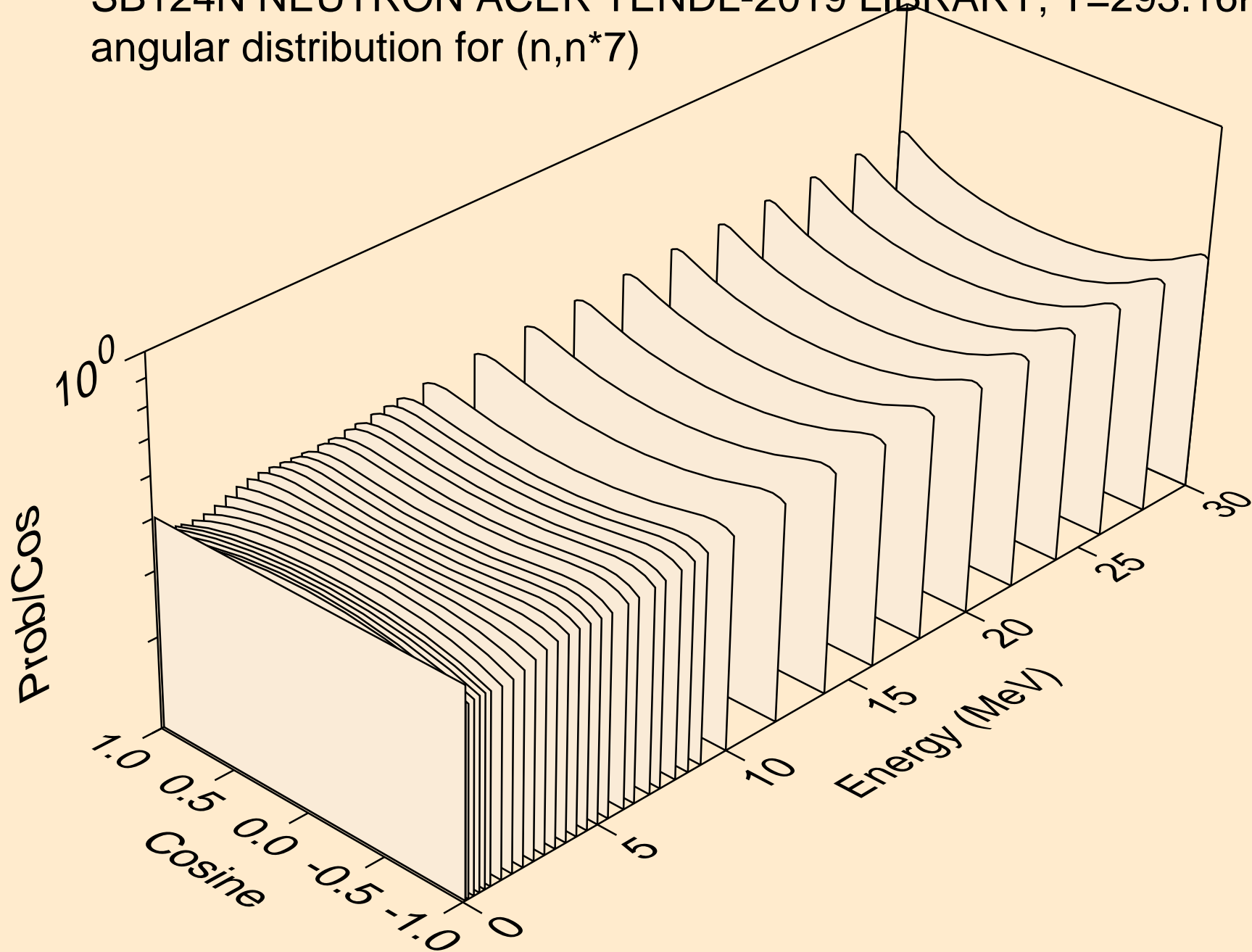

SB124N NEUTRON ACER TENDL-2019 LIBRARY; T=293.16K  
angular distribution for (n,n\*8)

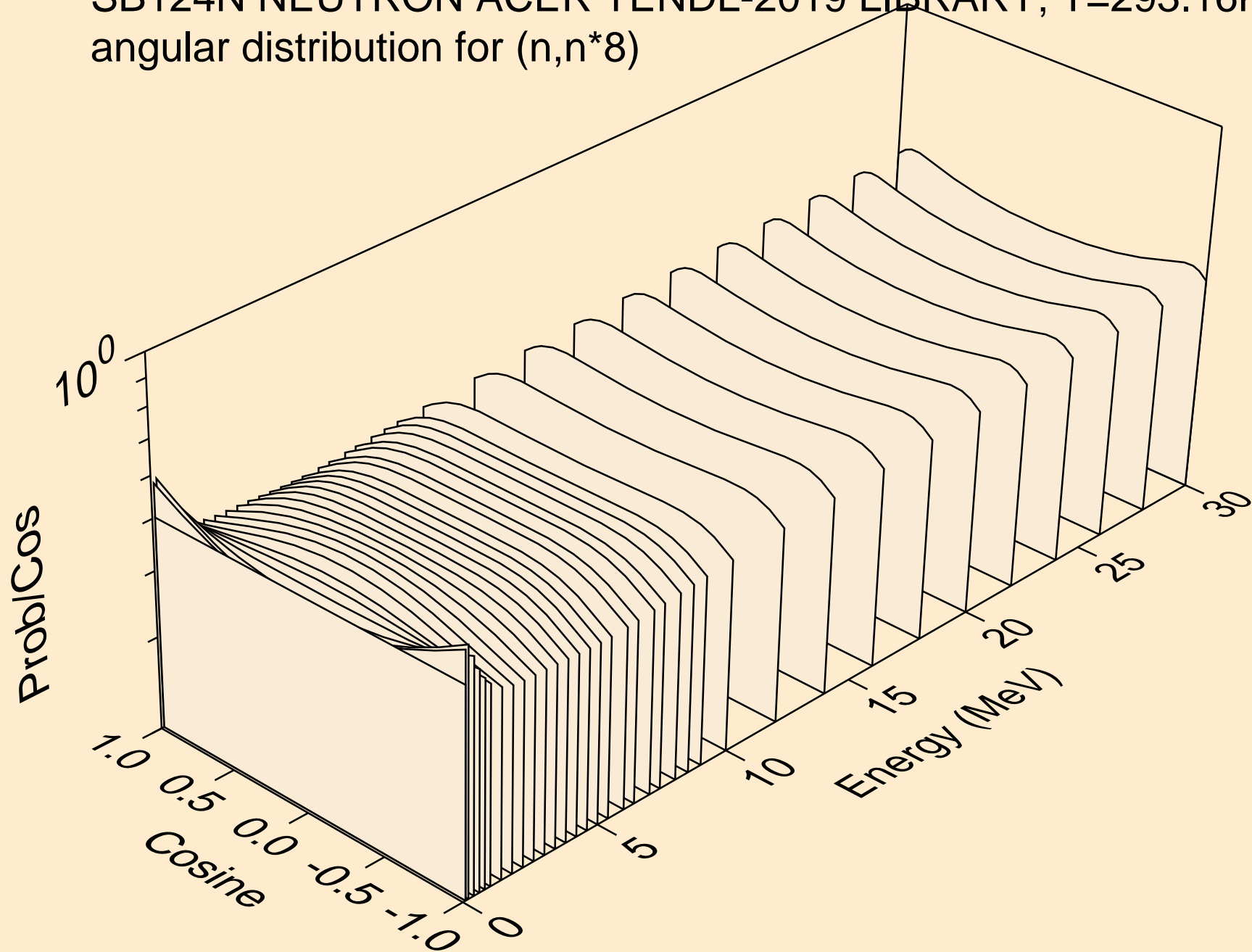

SB124N NEUTRON ACER TENDL-2019 LIBRARY; T=293.16K  
angular distribution for (n,n\*9)

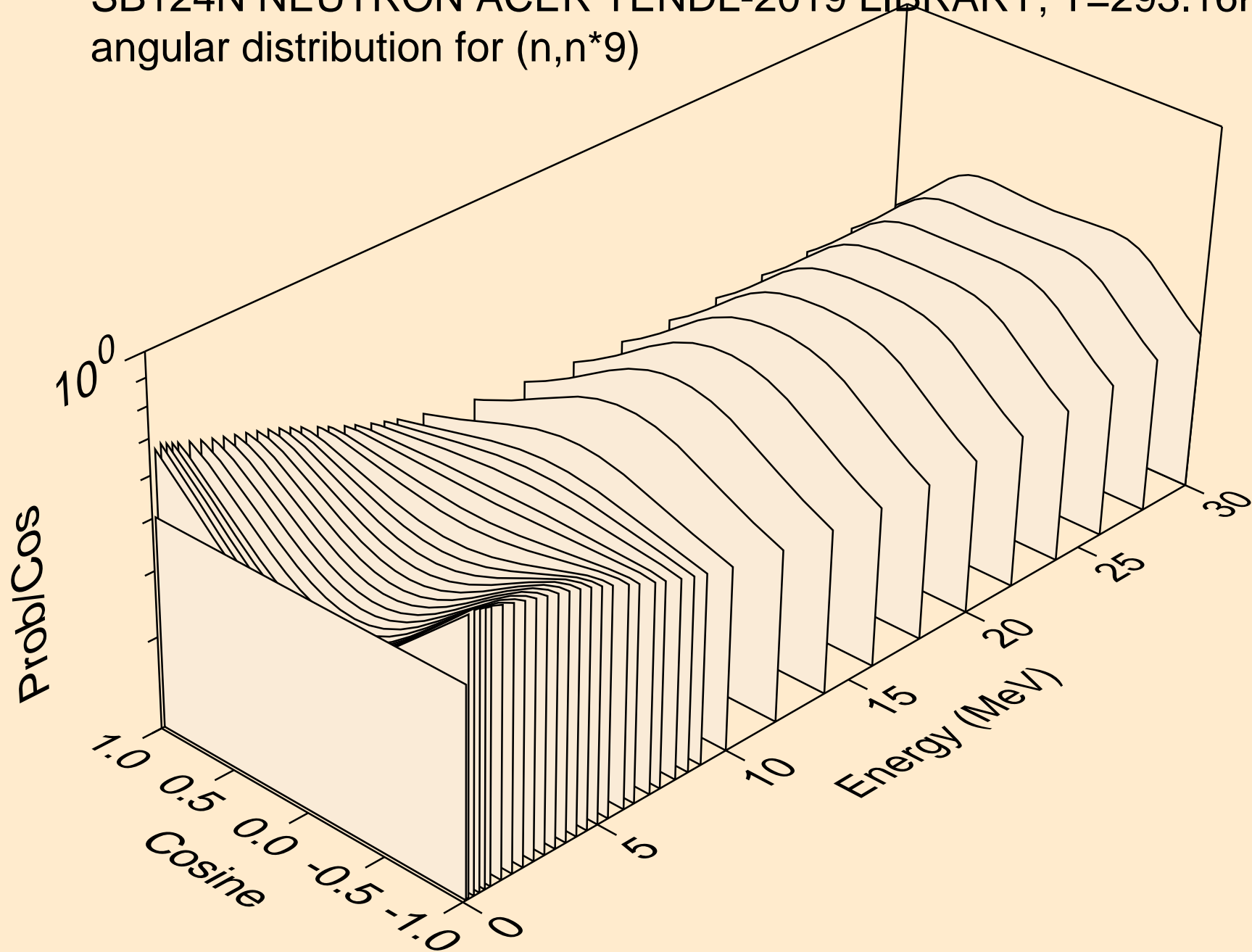

SB124N NEUTRON ACER TENDL-2019 LIBRARY; T=293.16K  
angular distribution for (n,n\*10)

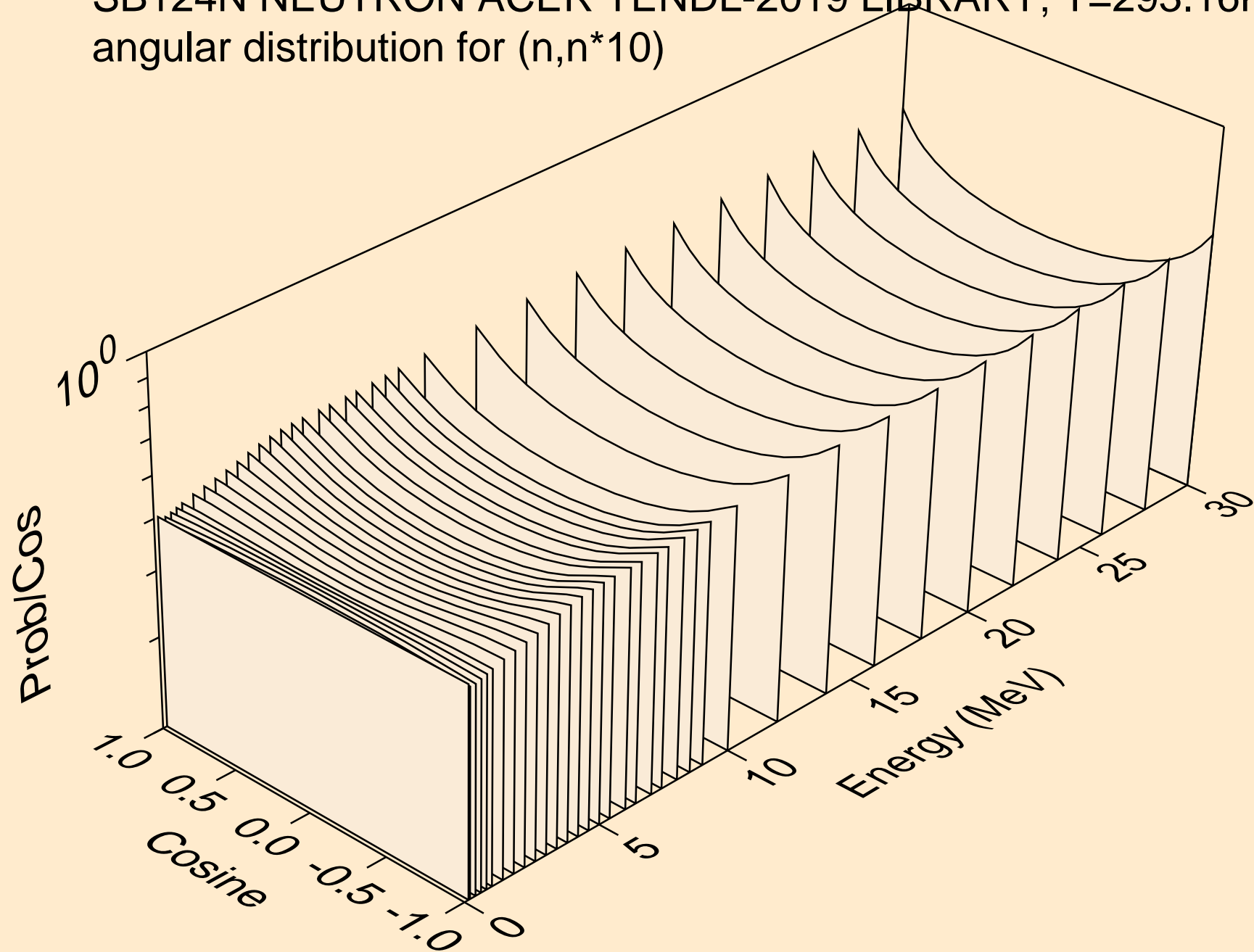



SB124N NEUTRON ACER TENDL-2019 LIBRARY; T=293.16K  
angular distribution for (n,n\*11)

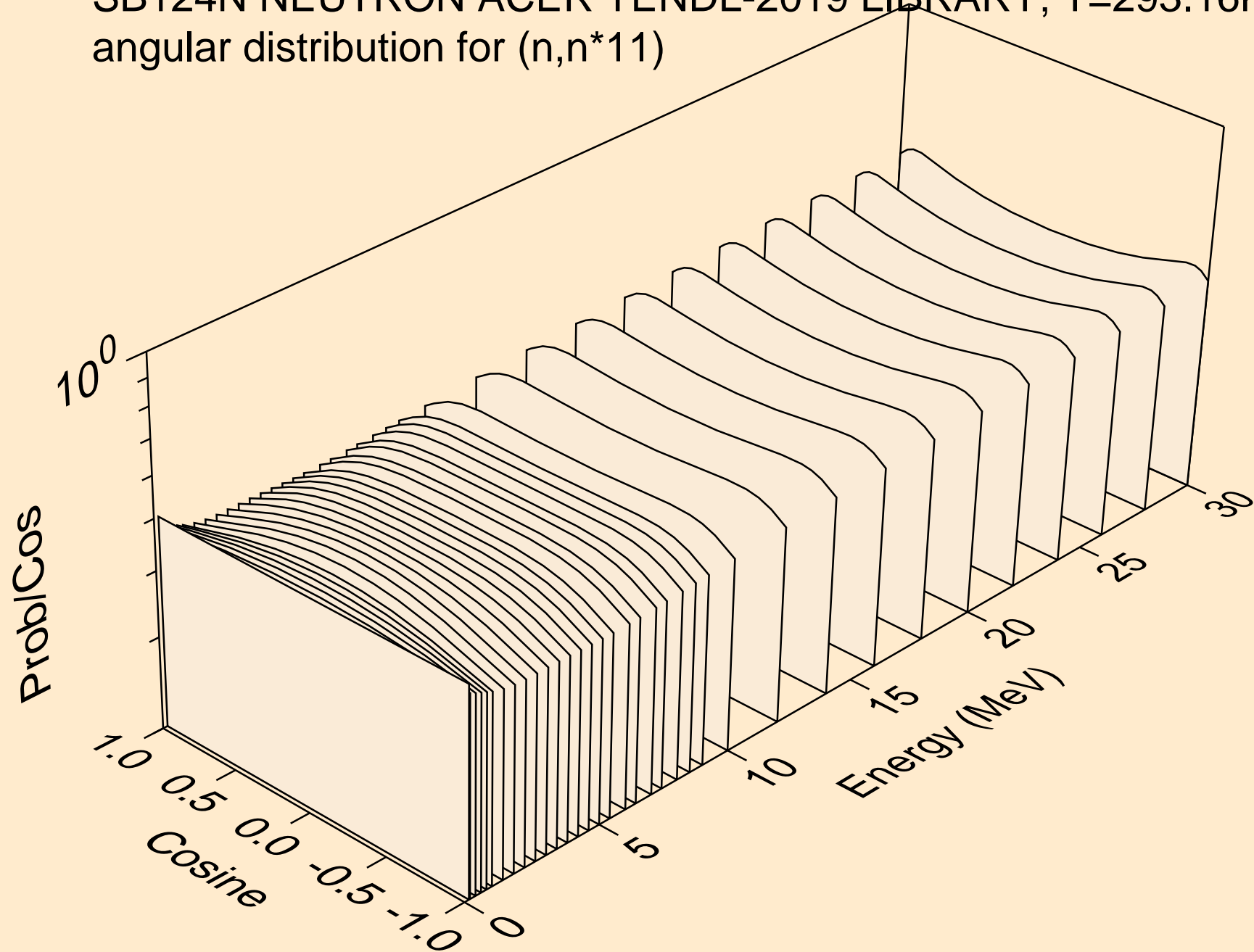

SB124N NEUTRON ACER TENDL-2019 LIBRARY; T=293.16K  
angular distribution for (n,n\*12)

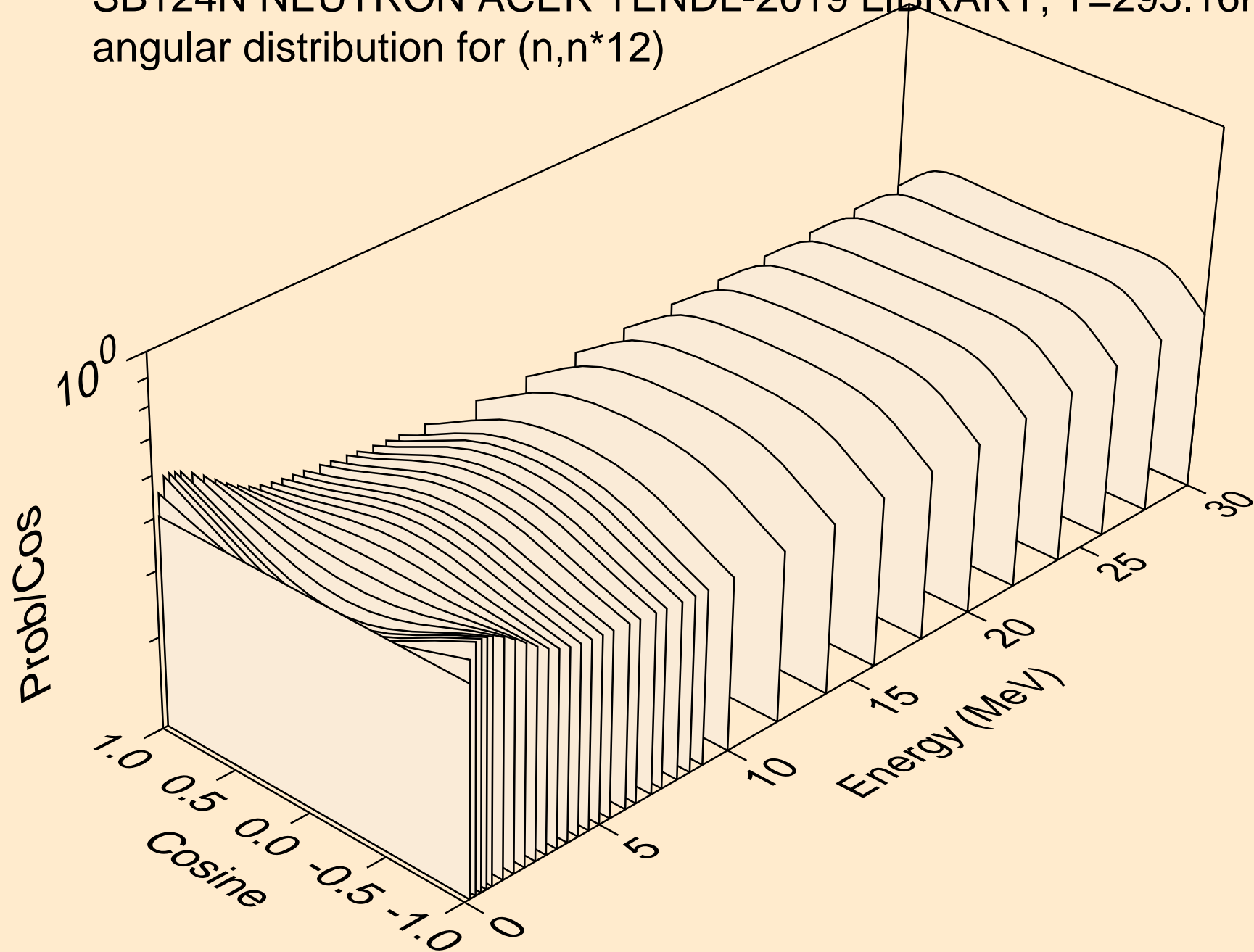

SB124N NEUTRON ACER TENDL-2019 LIBRARY; T=293.16K  
angular distribution for (n,n\*13)

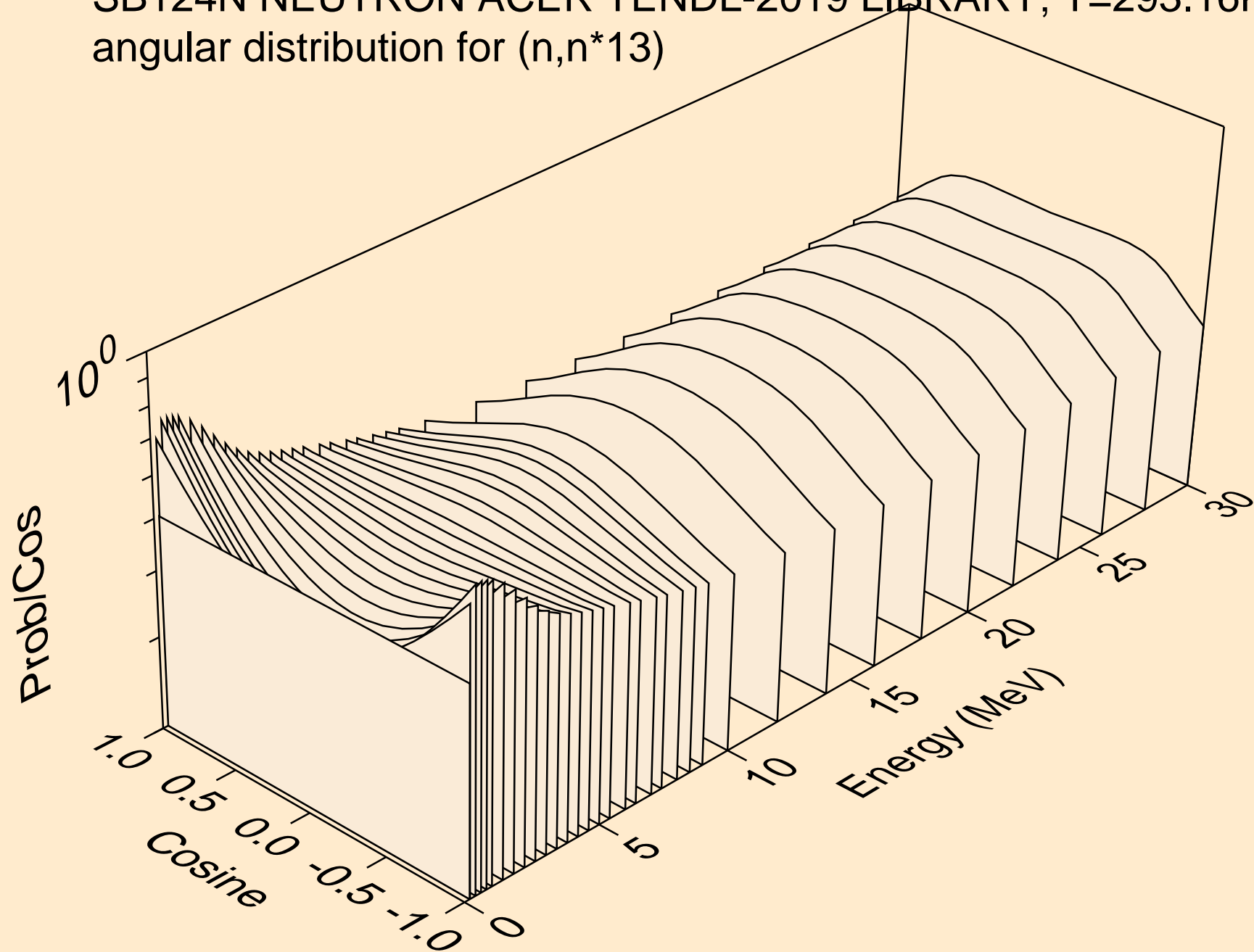

SB124N NEUTRON ACER TENDL-2019 LIBRARY; T=293.16K  
angular distribution for (n,n\*14)

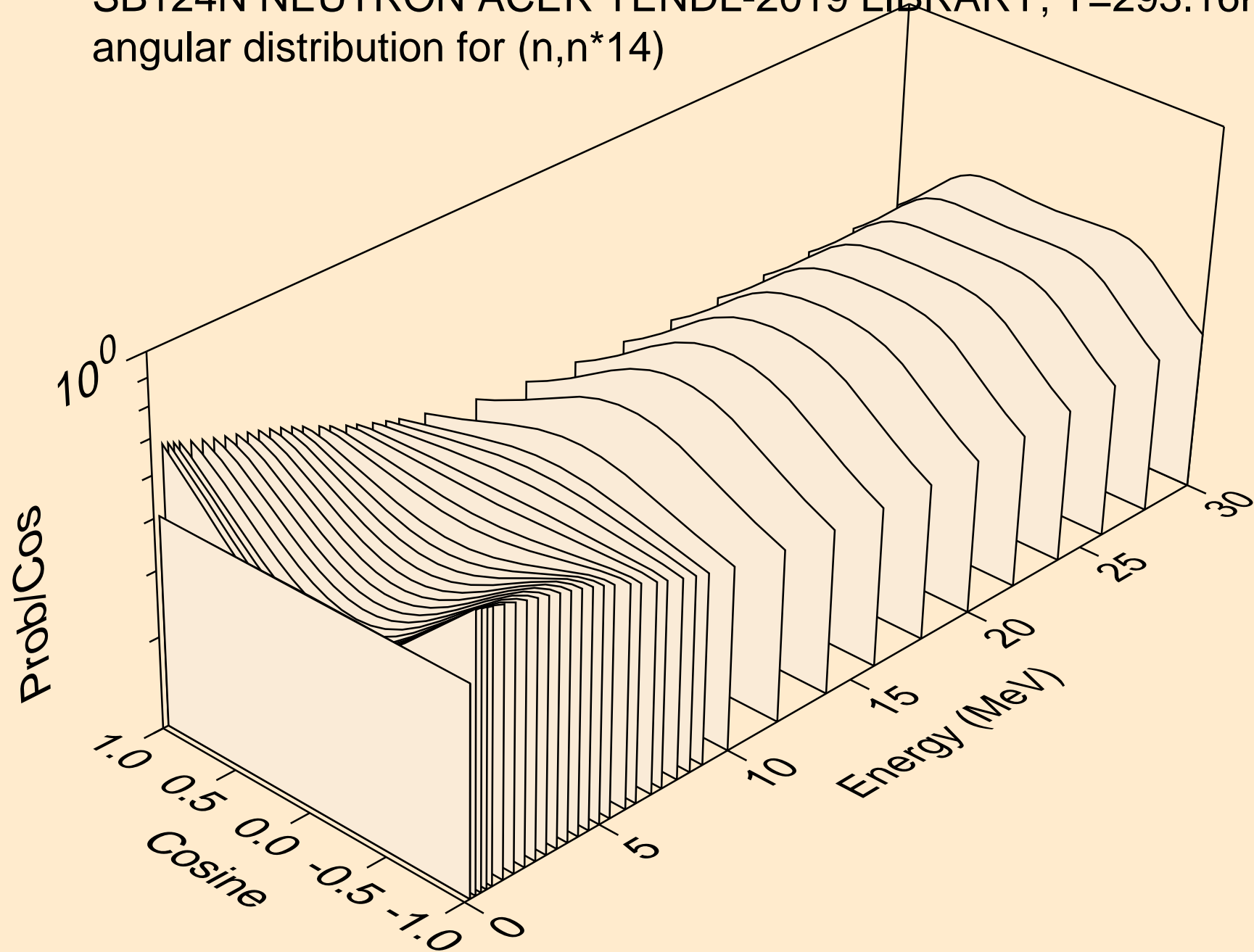

SB124N NEUTRON ACER TENDL-2019 LIBRARY; T=293.16K  
angular distribution for (n,n\*15)

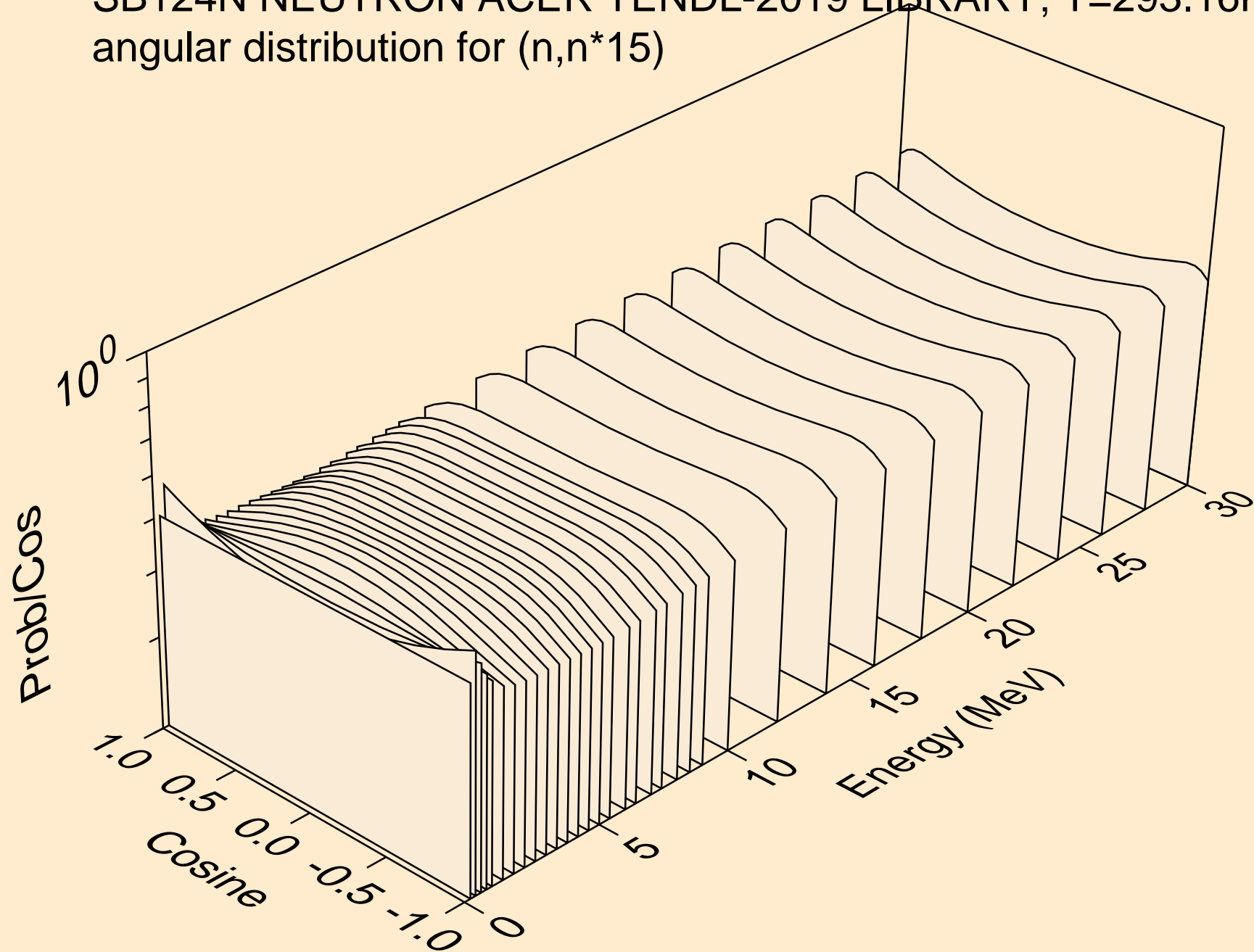

SB124N NEUTRON ACER TENDL-2019 LIBRARY; T=293.16K  
angular distribution for (n,n\*16)

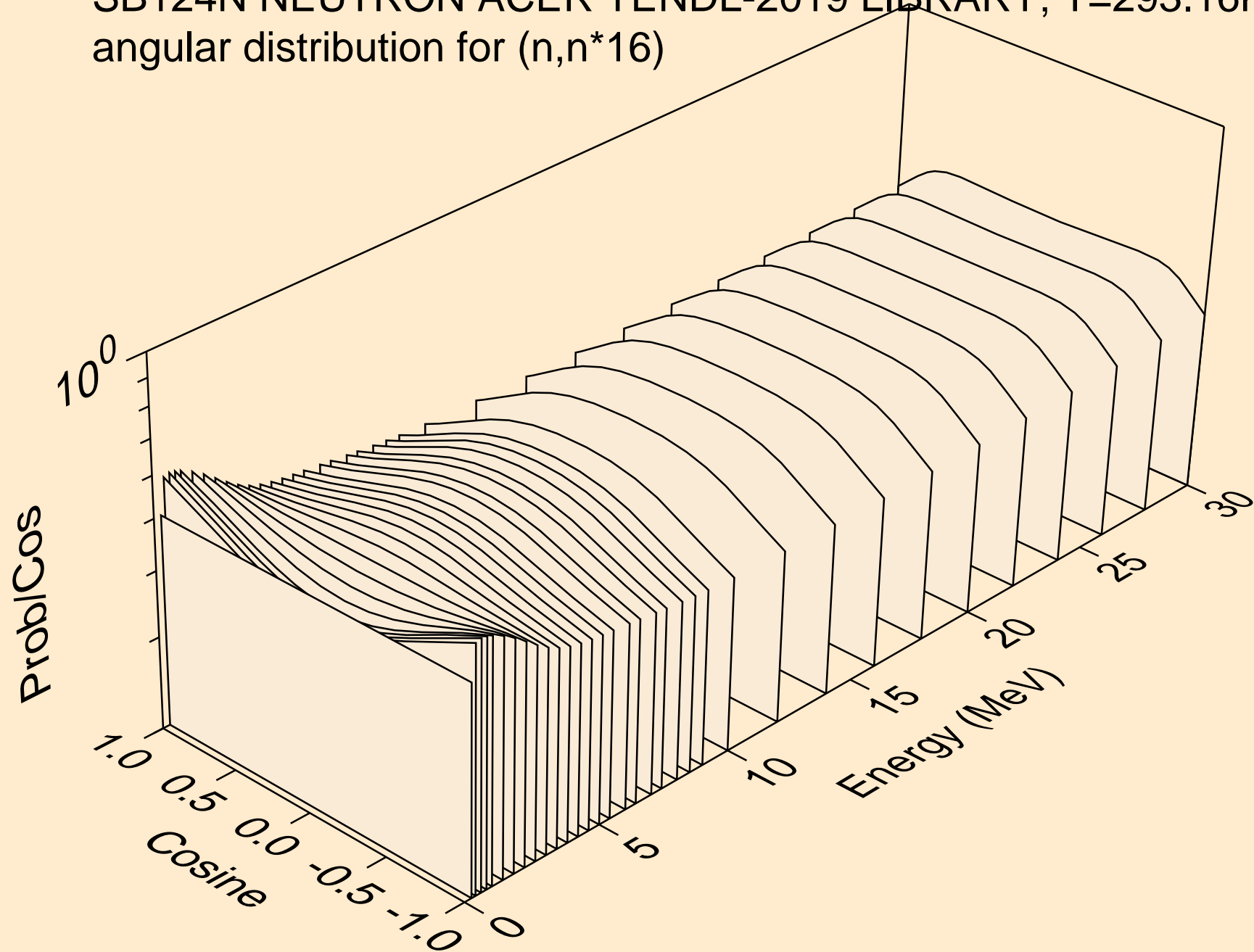

SB124N NEUTRON ACER TENDL-2019 LIBRARY; T=293.16K  
angular distribution for (n,n\*17)

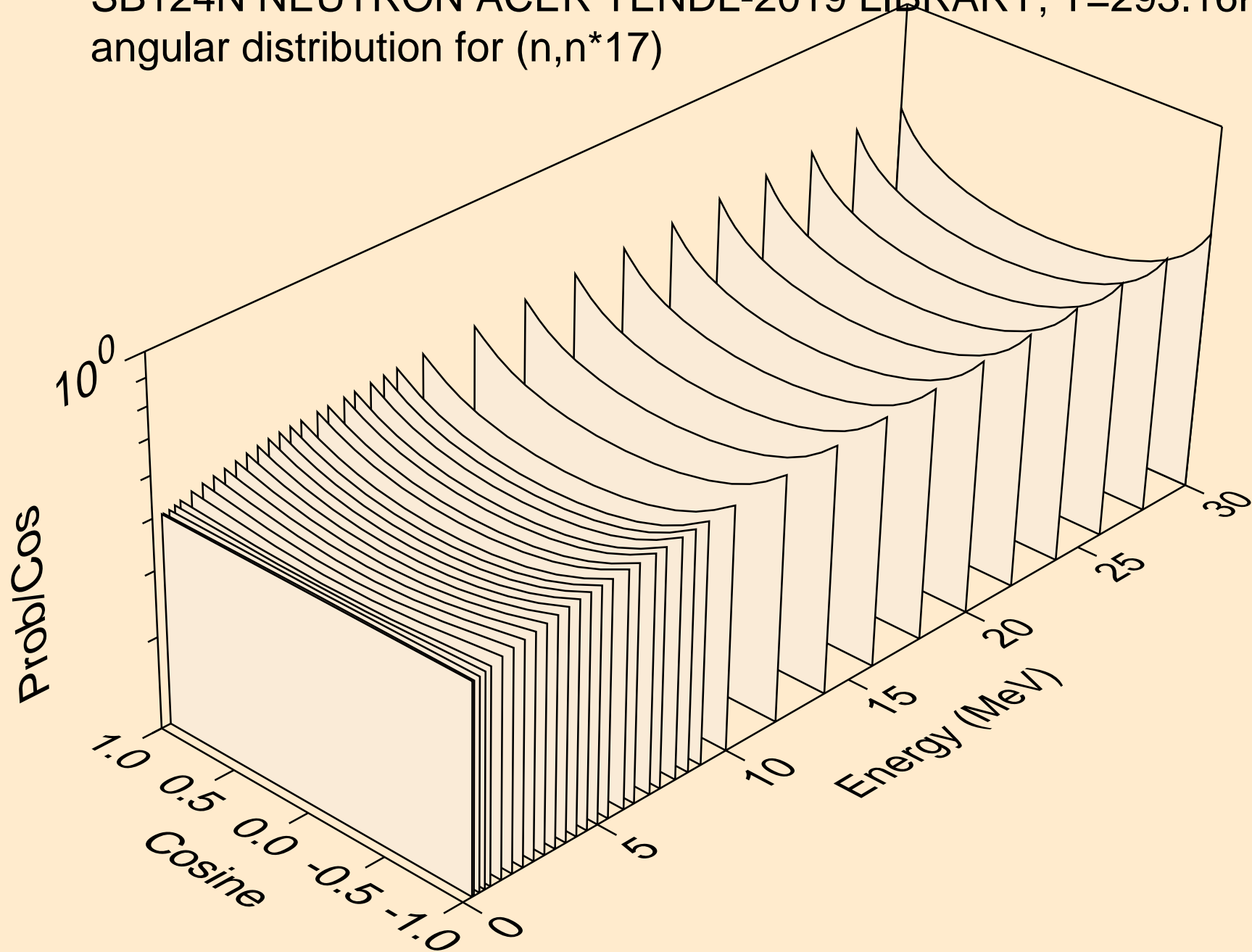

SB124N NEUTRON ACER TENDL-2019 LIBRARY; T=293.16K  
angular distribution for (n,n\*18)

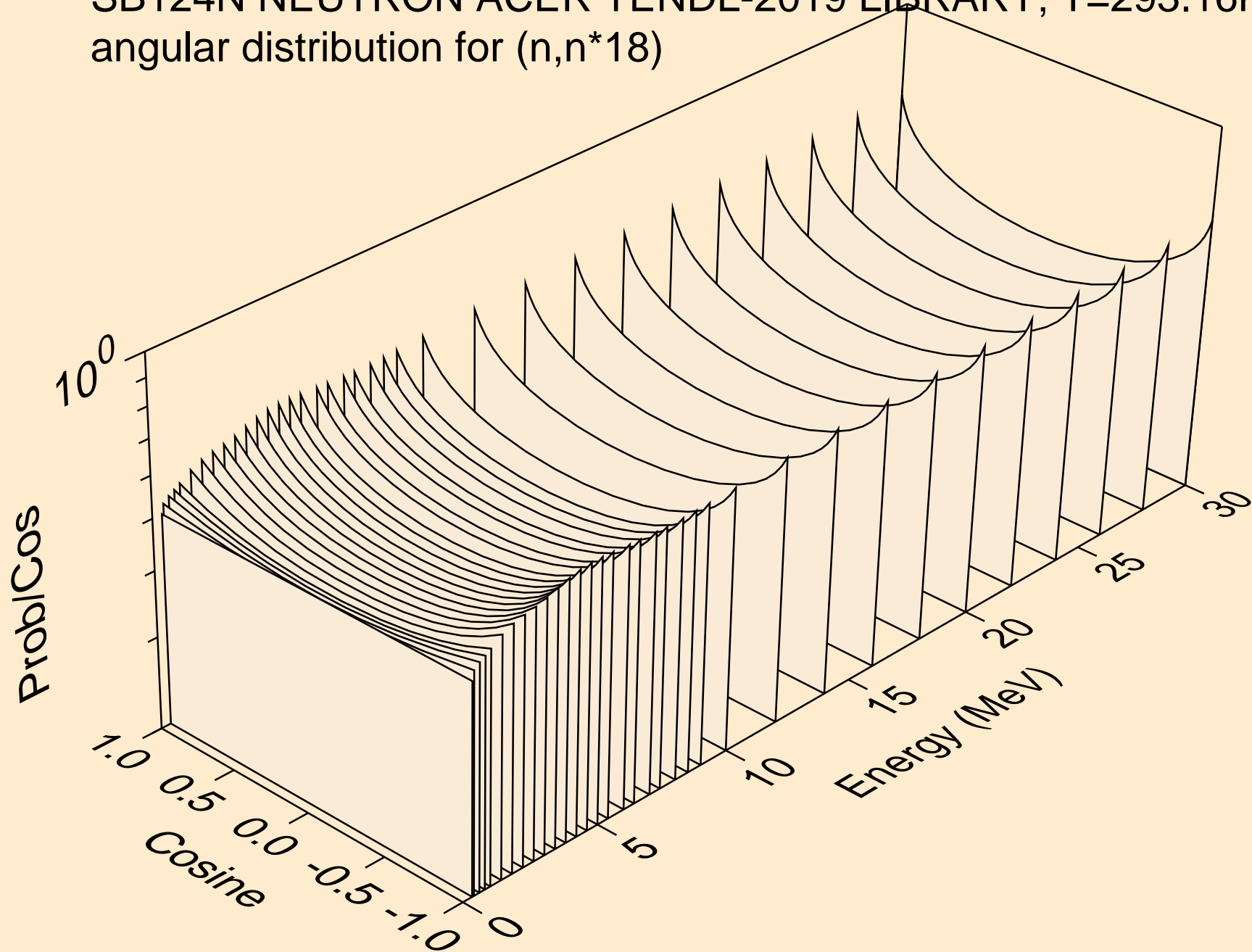



SB124N NEUTRON ACER TENDL-2019 LIBRARY; T=293.16K  
angular distribution for (n,n\*19)

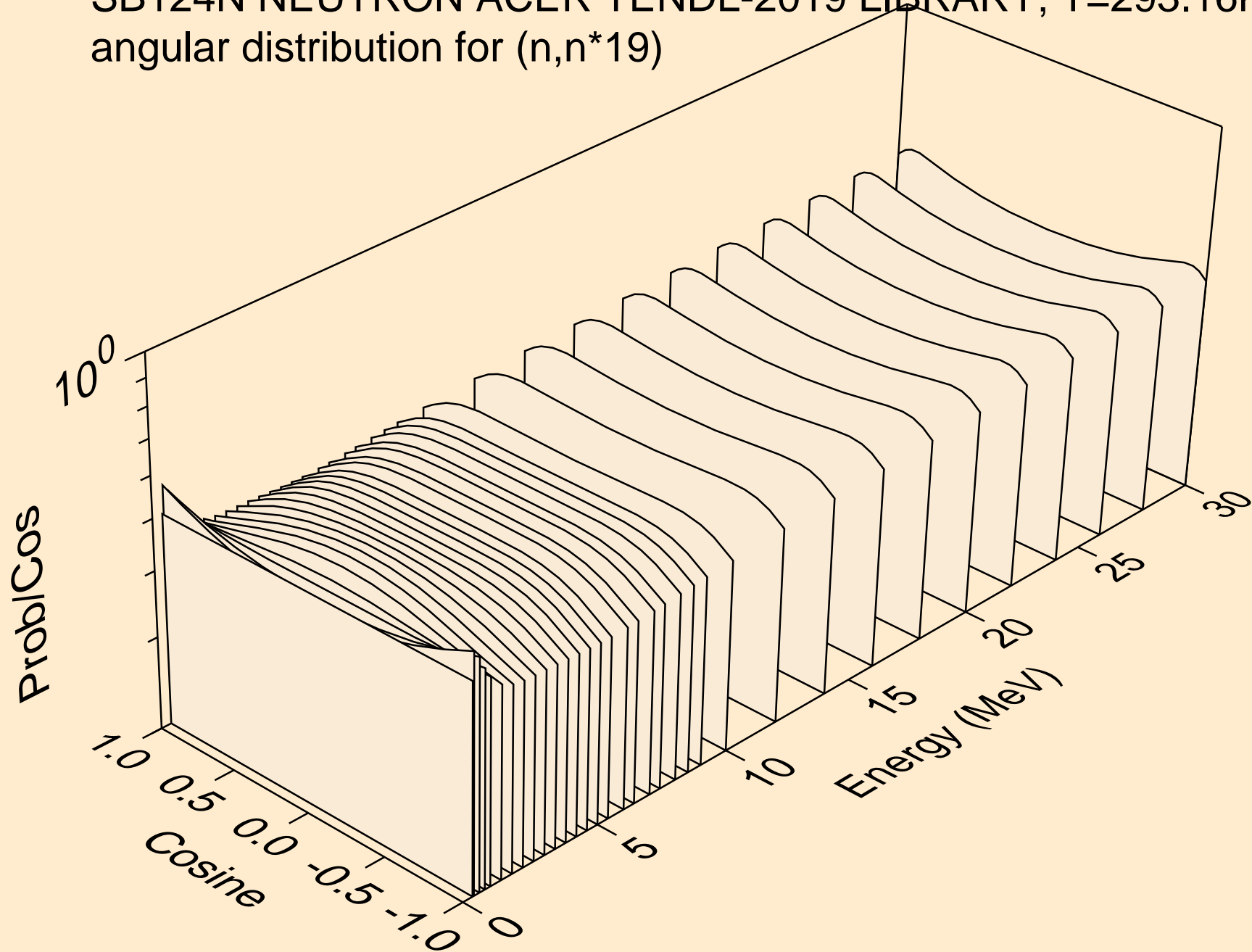

SB124N NEUTRON ACER TENDL-2019 LIBRARY; T=293.16K  
angular distribution for (n,n\*20)

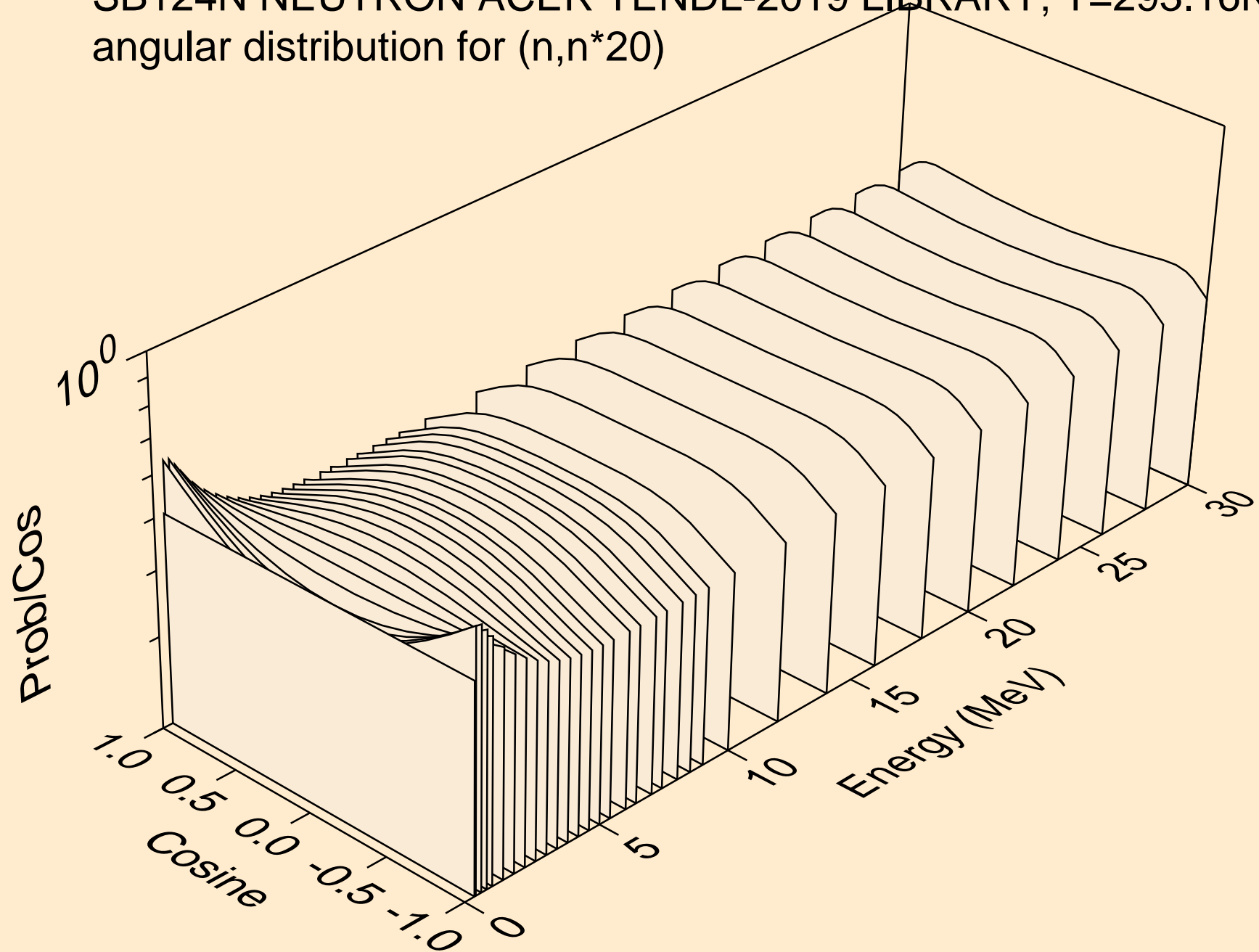

SB124N NEUTRON ACER TENDL-2019 LIBRARY; T=293.16K  
angular distribution for (n,n\*21)

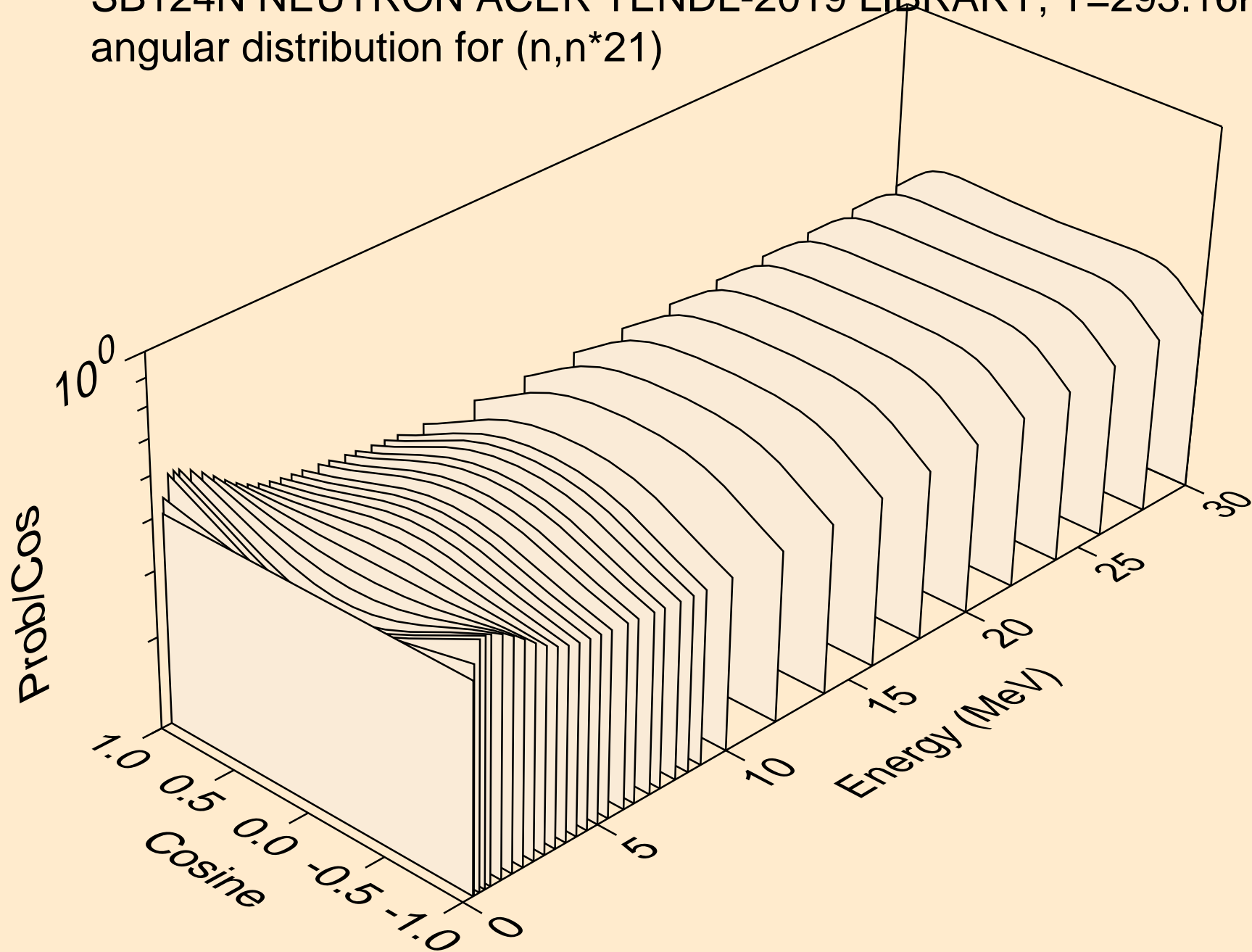

SB124N NEUTRON ACER TENDL-2019 LIBRARY; T=293.16K  
angular distribution for (n,n\*22)

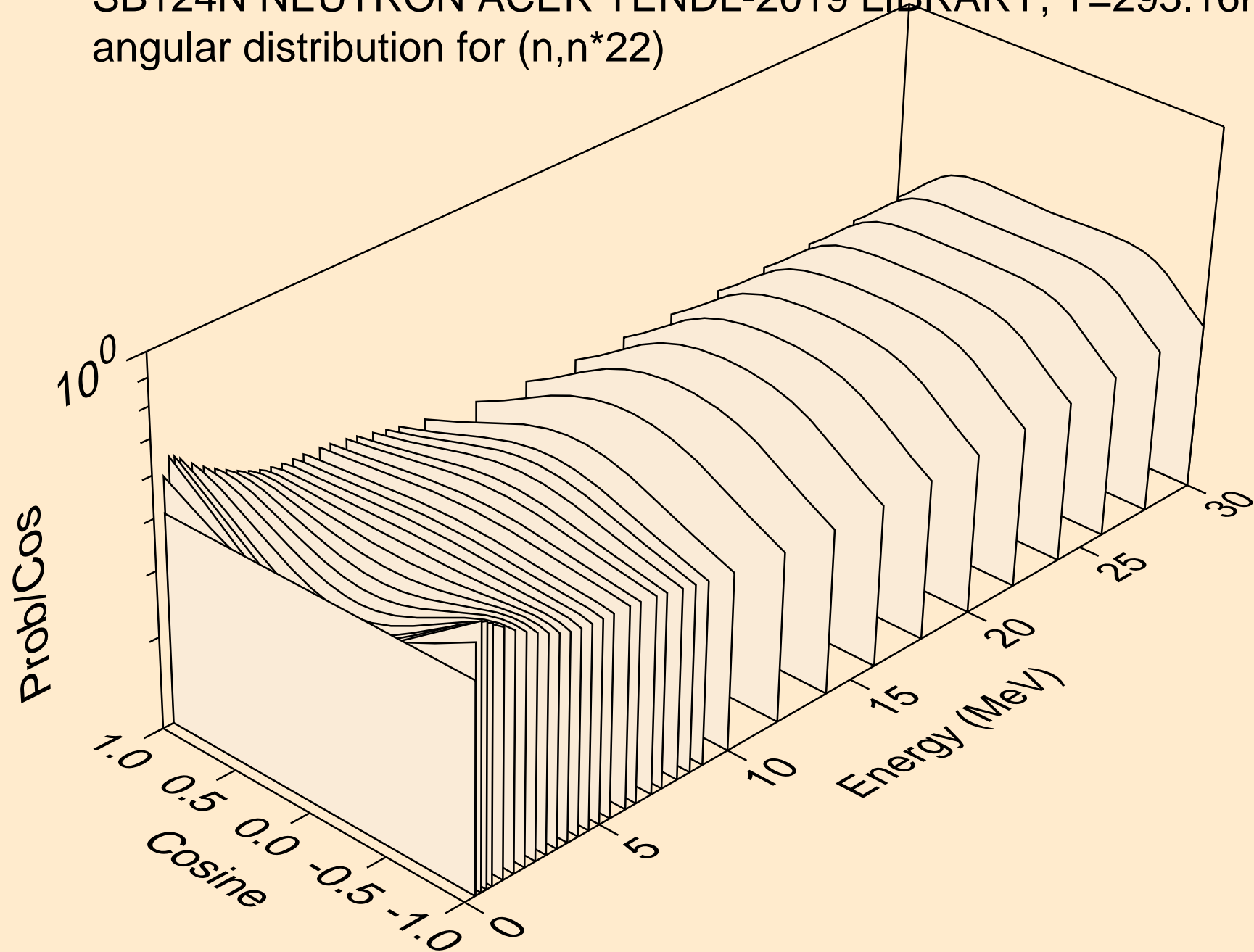

SB124N NEUTRON ACER TENDL-2019 LIBRARY; T=293.16K  
angular distribution for (n,n\*23)

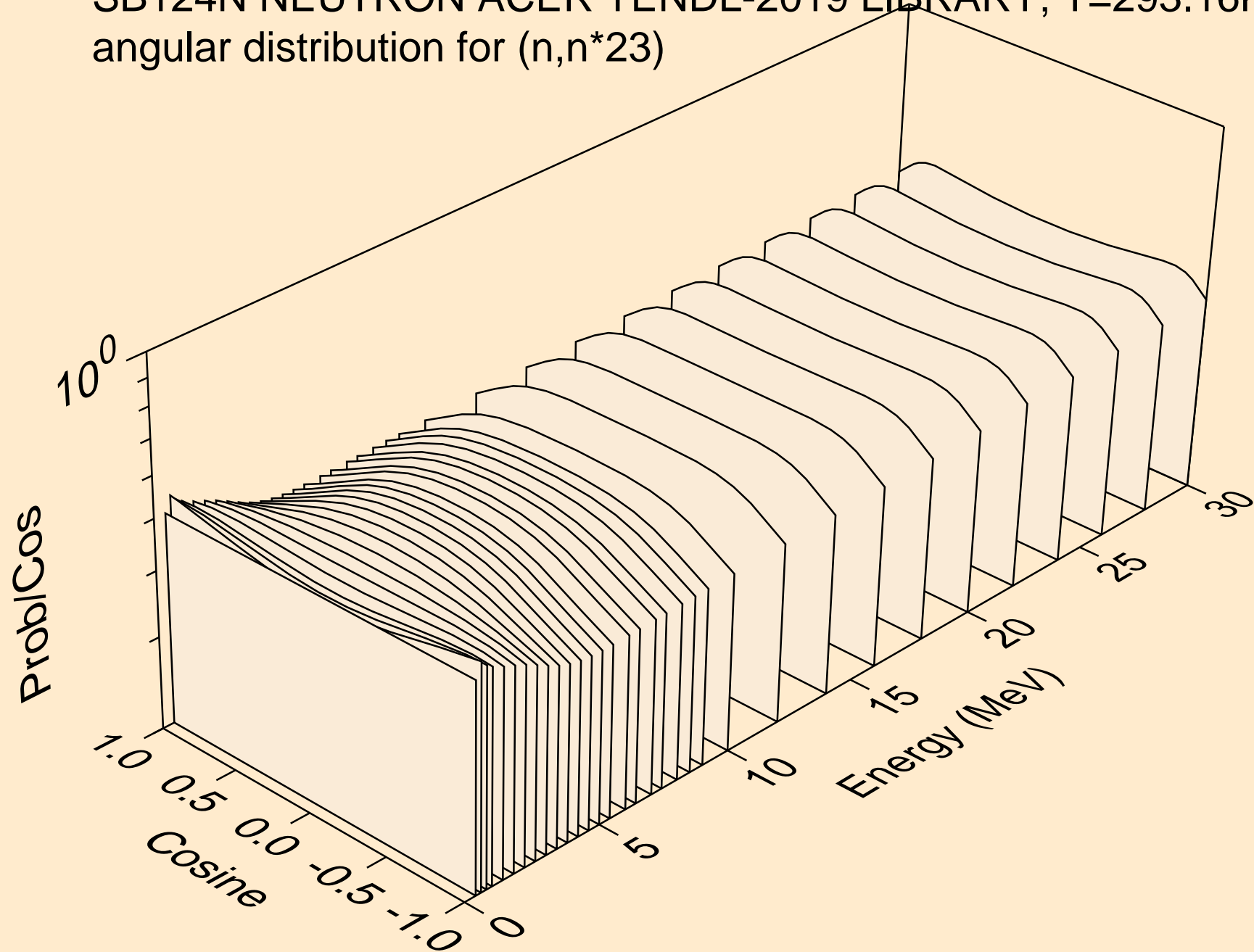

SB124N NEUTRON ACER TENDL-2019 LIBRARY; T=293.16K  
angular distribution for (n,n\*24)

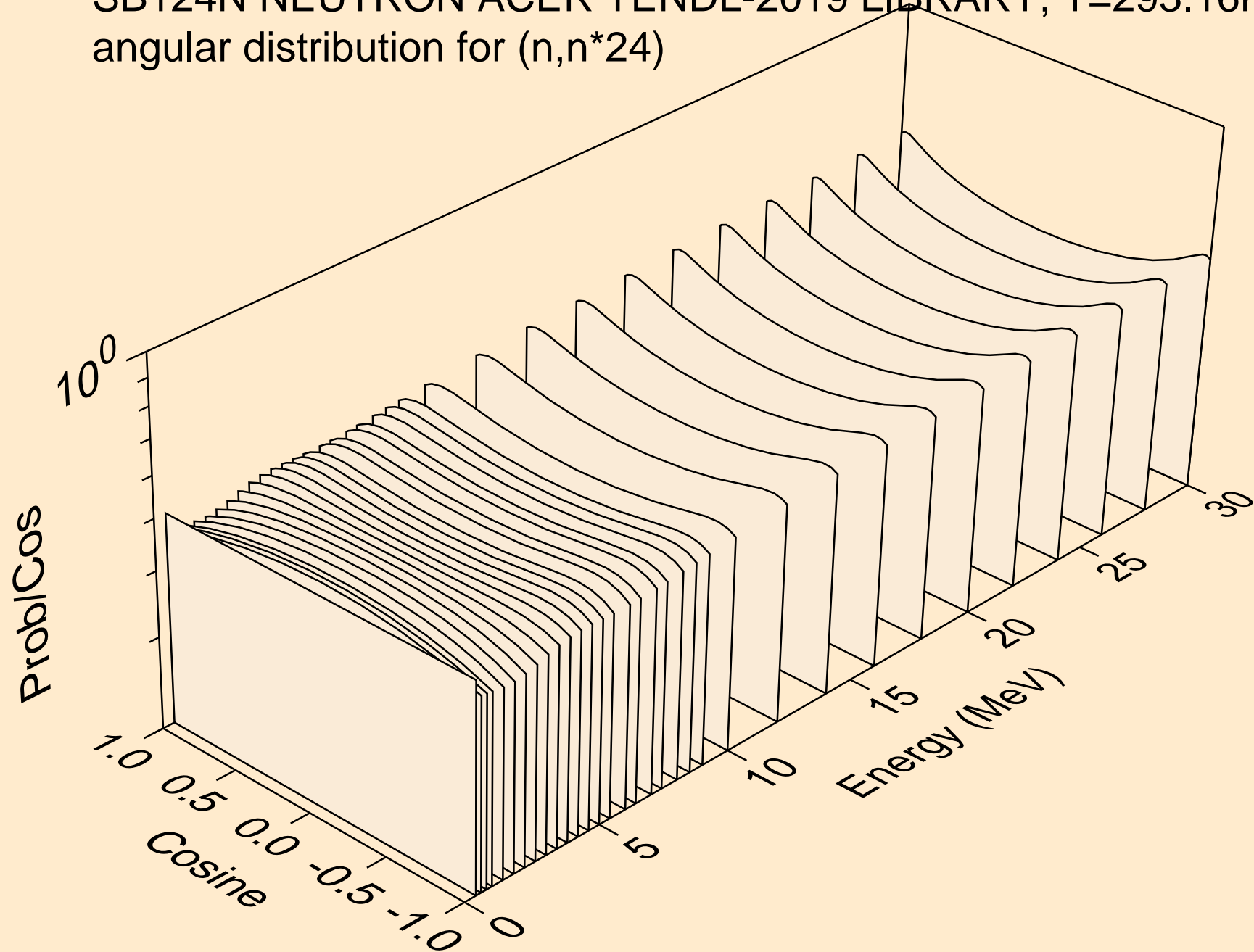

SB124N NEUTRON ACER TENDL-2019 LIBRARY; T=293.16K  
angular distribution for (n,n\*25)

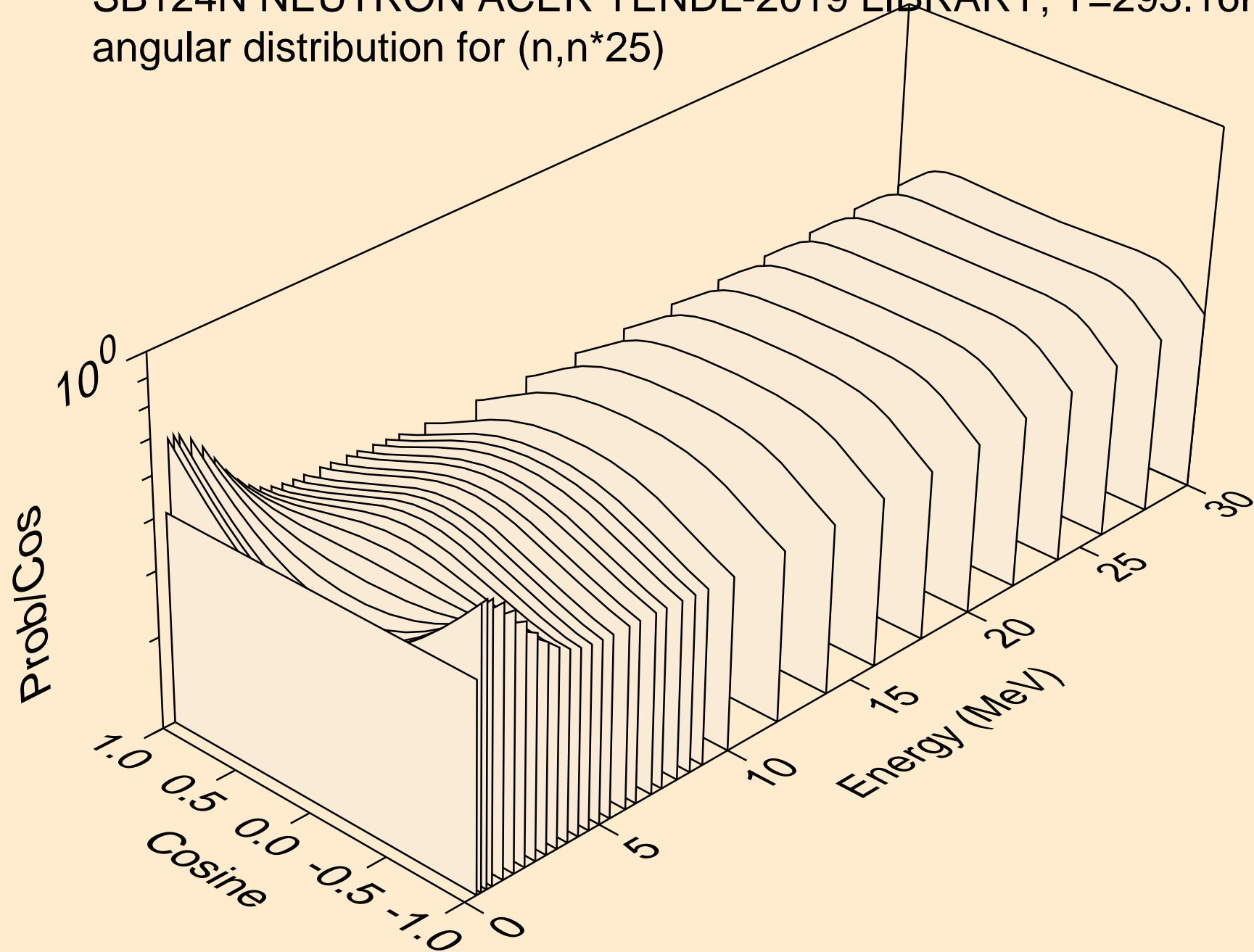

SB124N NEUTRON ACER TENDL-2019 LIBRARY; T=293.16K  
angular distribution for (n,n\*26)

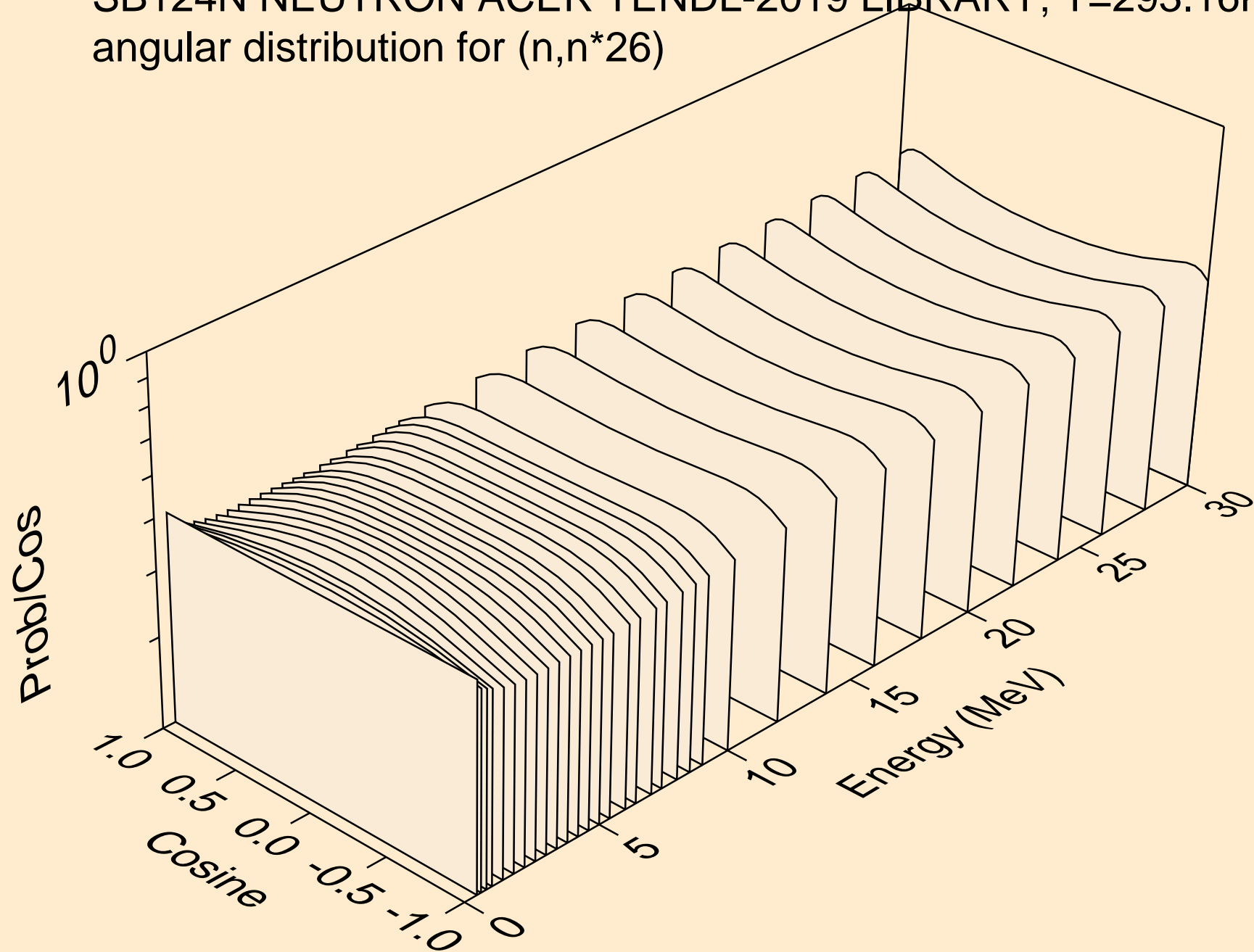



SB124N NEUTRON ACER TENDL-2019 LIBRARY; T=293.16K  
Neutron emission for (n,x)

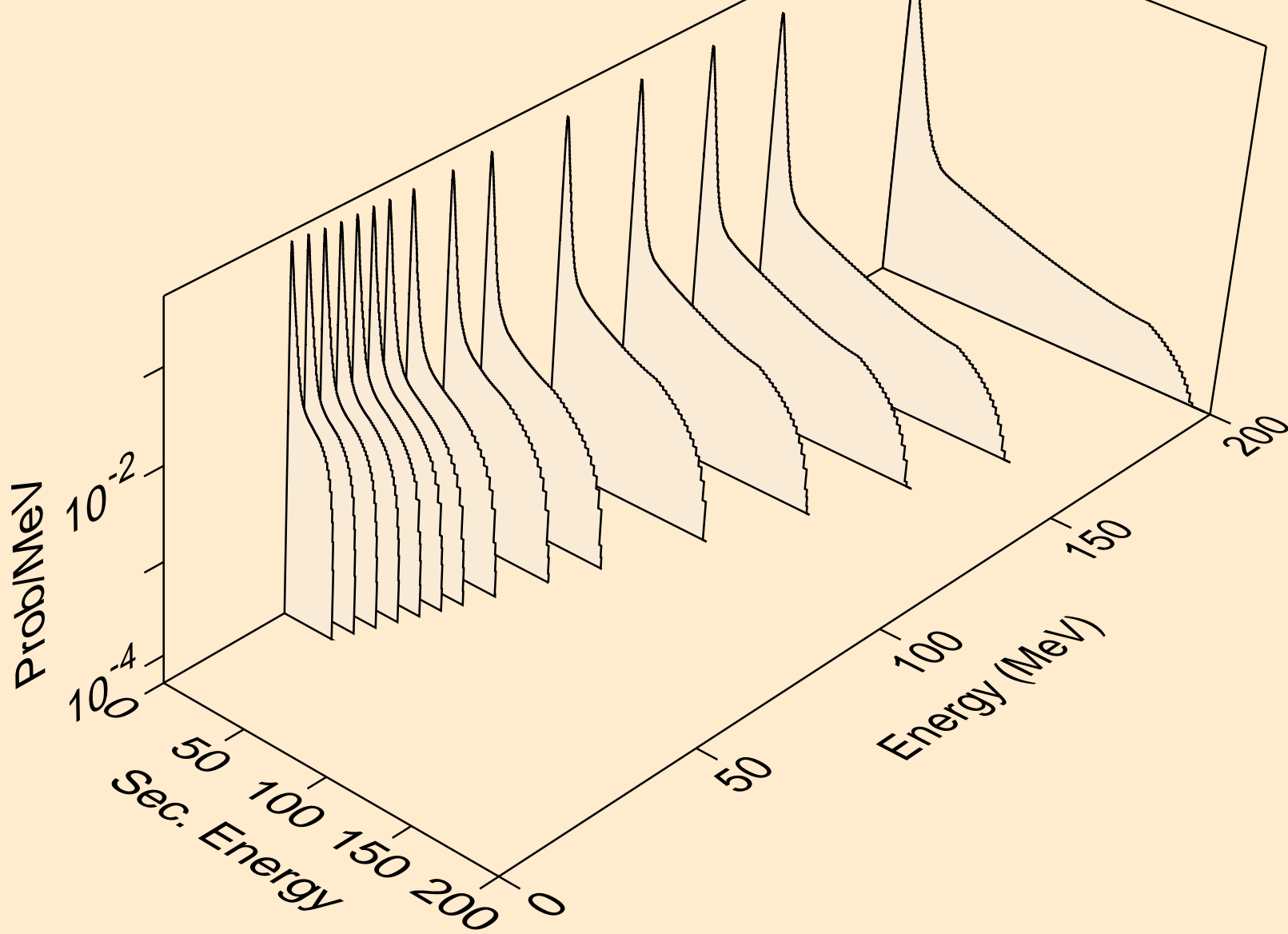

SB124N NEUTRON ACER TENDL-2019 LIBRARY; T=293.16K  
Neutron emission for (n,2nd)

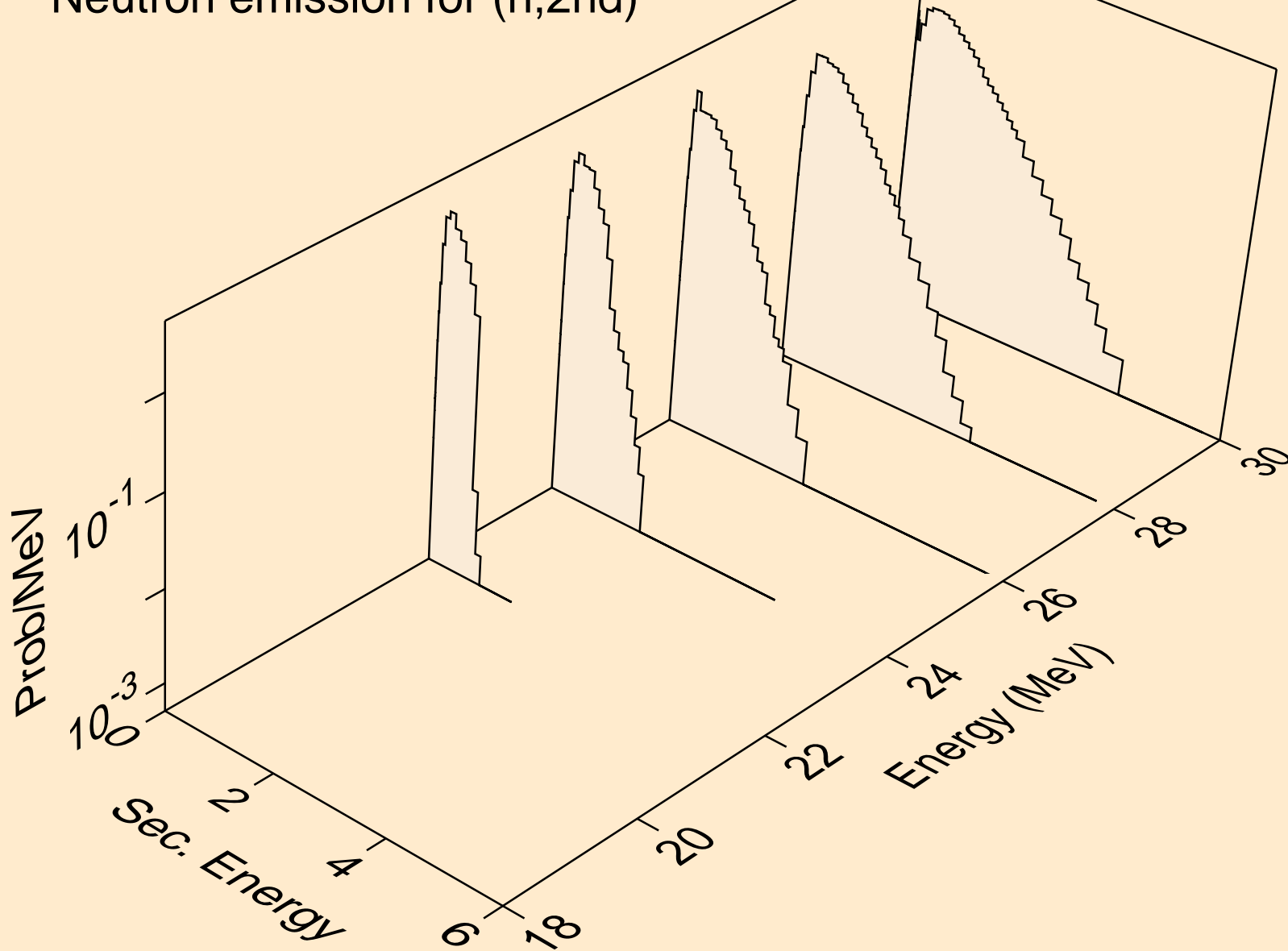

SB124N NEUTRON ACER TENDL-2019 LIBRARY; T=293.16K  
Neutron emission for (n,2n)

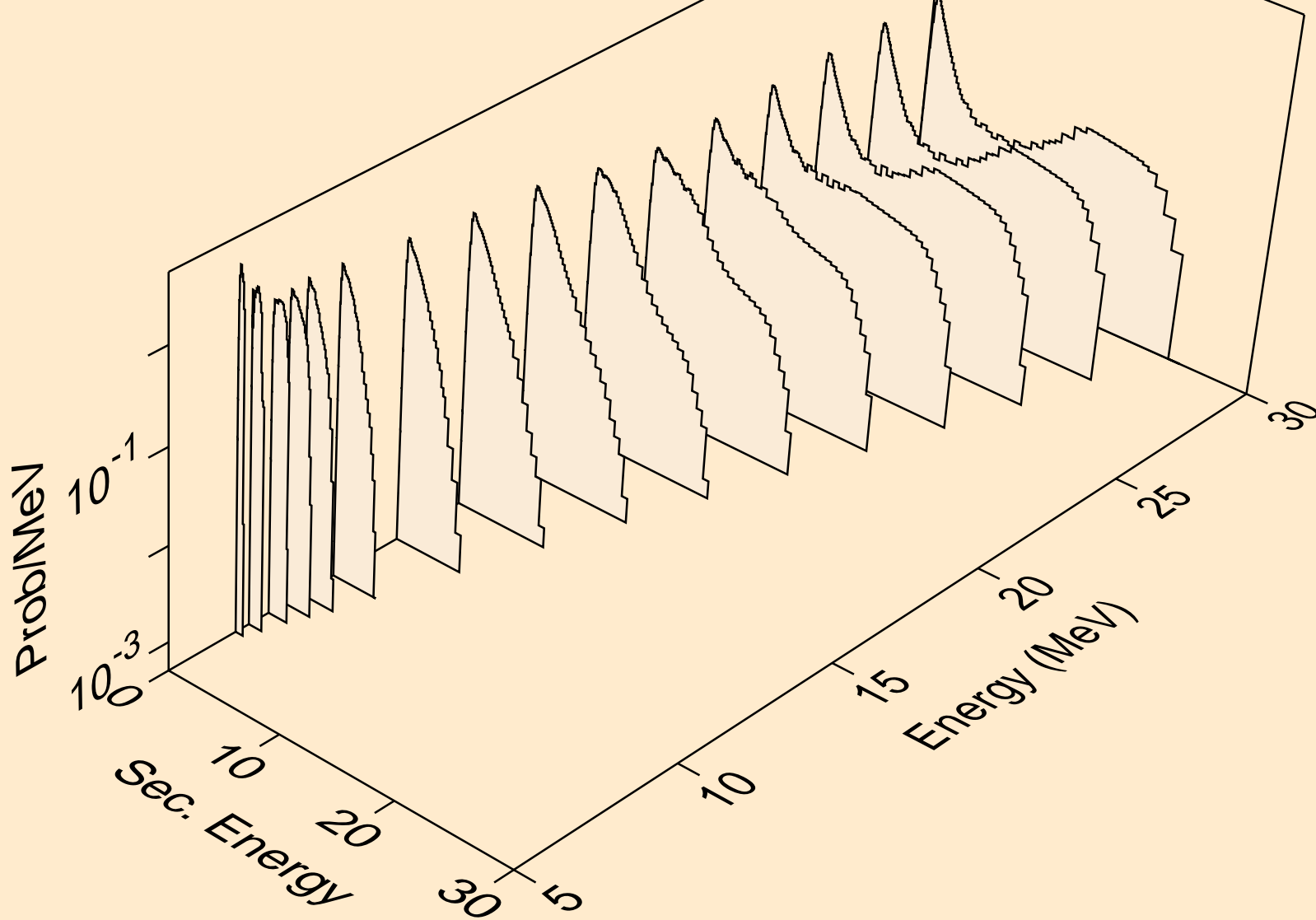

SB124N NEUTRON ACER TENDL-2019 LIBRARY; T=293.16K  
Neutron emission for (n,3n)

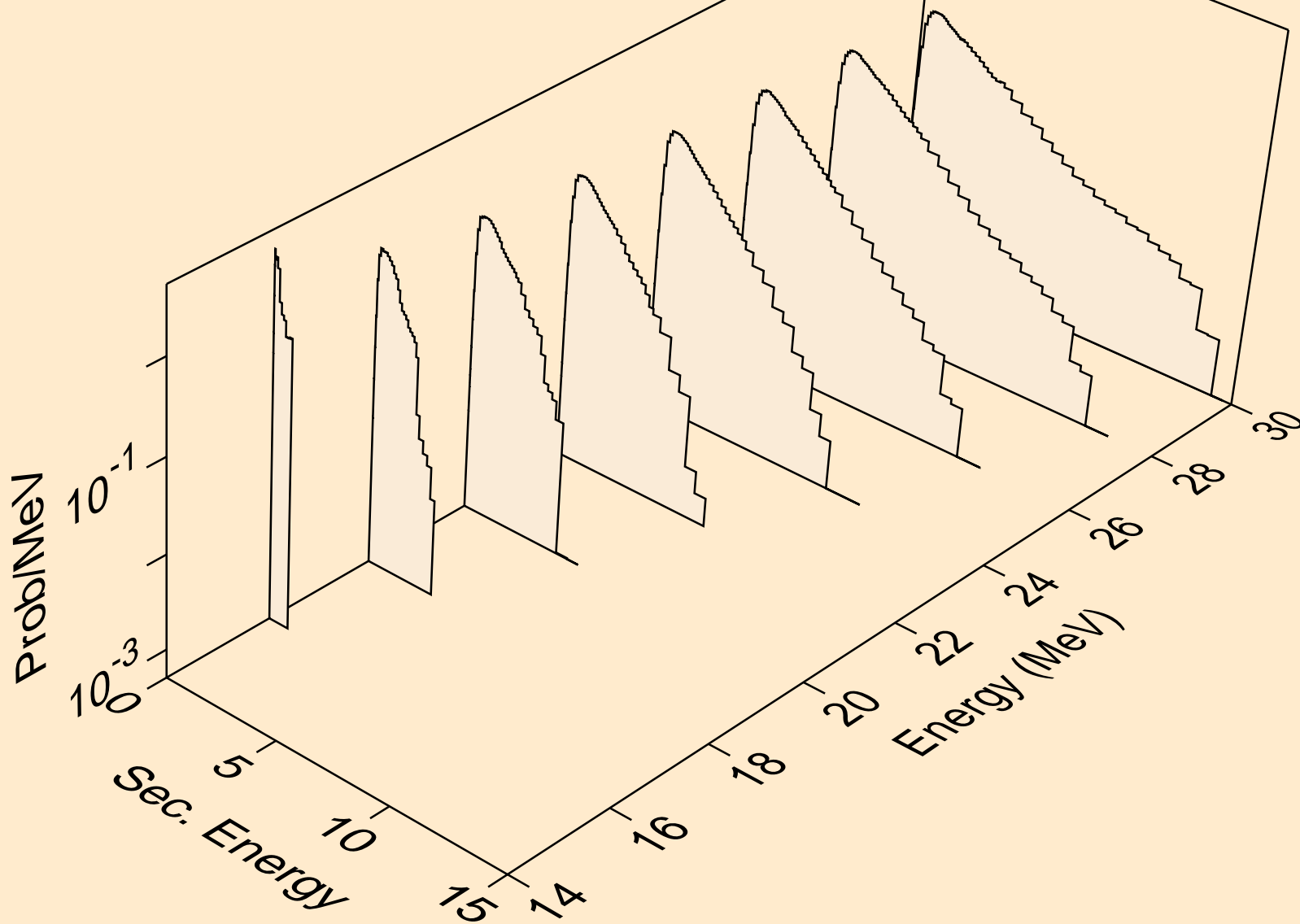

SB124N NEUTRON ACER TENDL-2019 LIBRARY; T=293.16K  
Neutron emission for (n,n\*)a

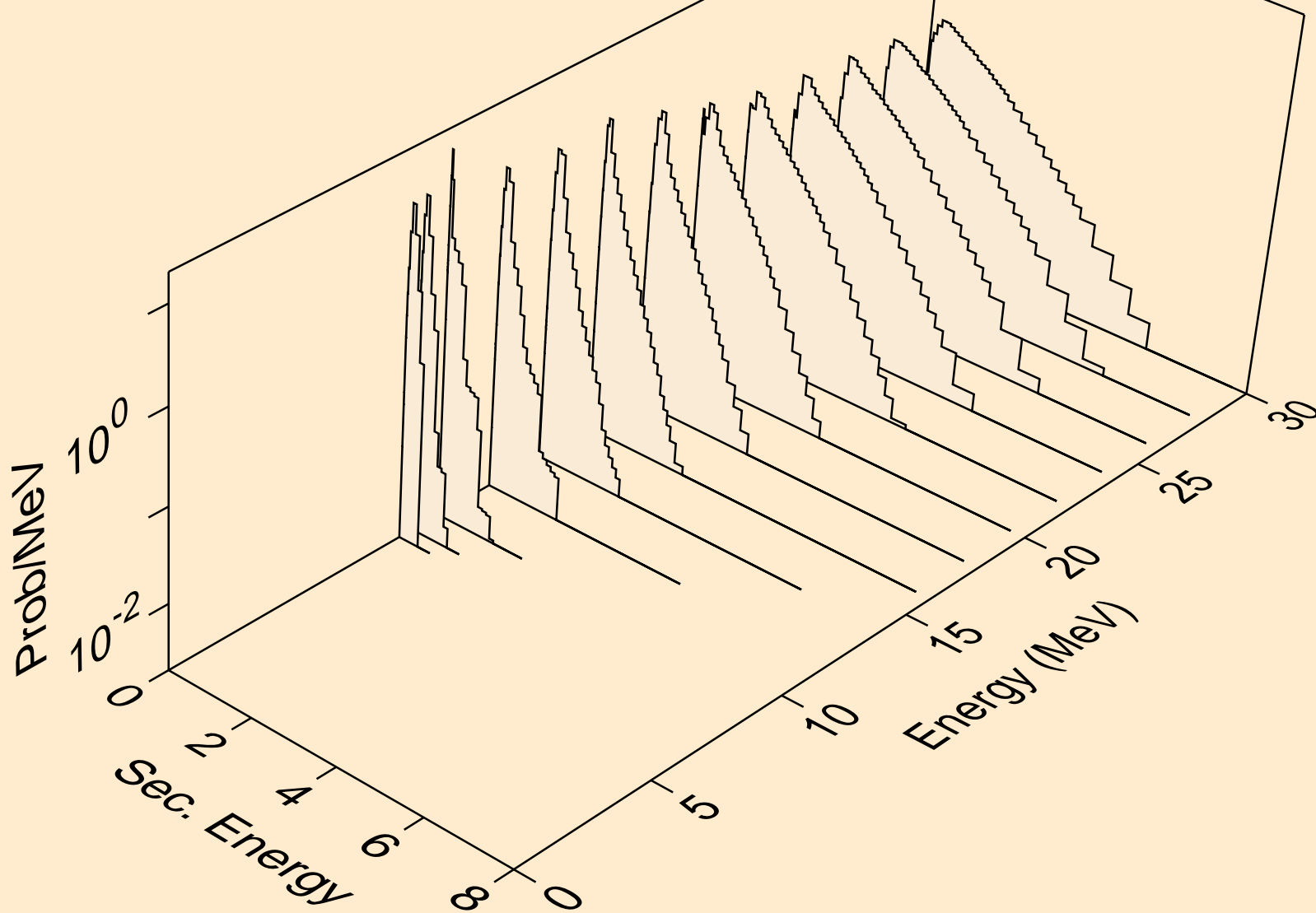

SB124N NEUTRON ACER TENDL-2019 LIBRARY; T=293.16K  
Neutron emission for (n,2n)a

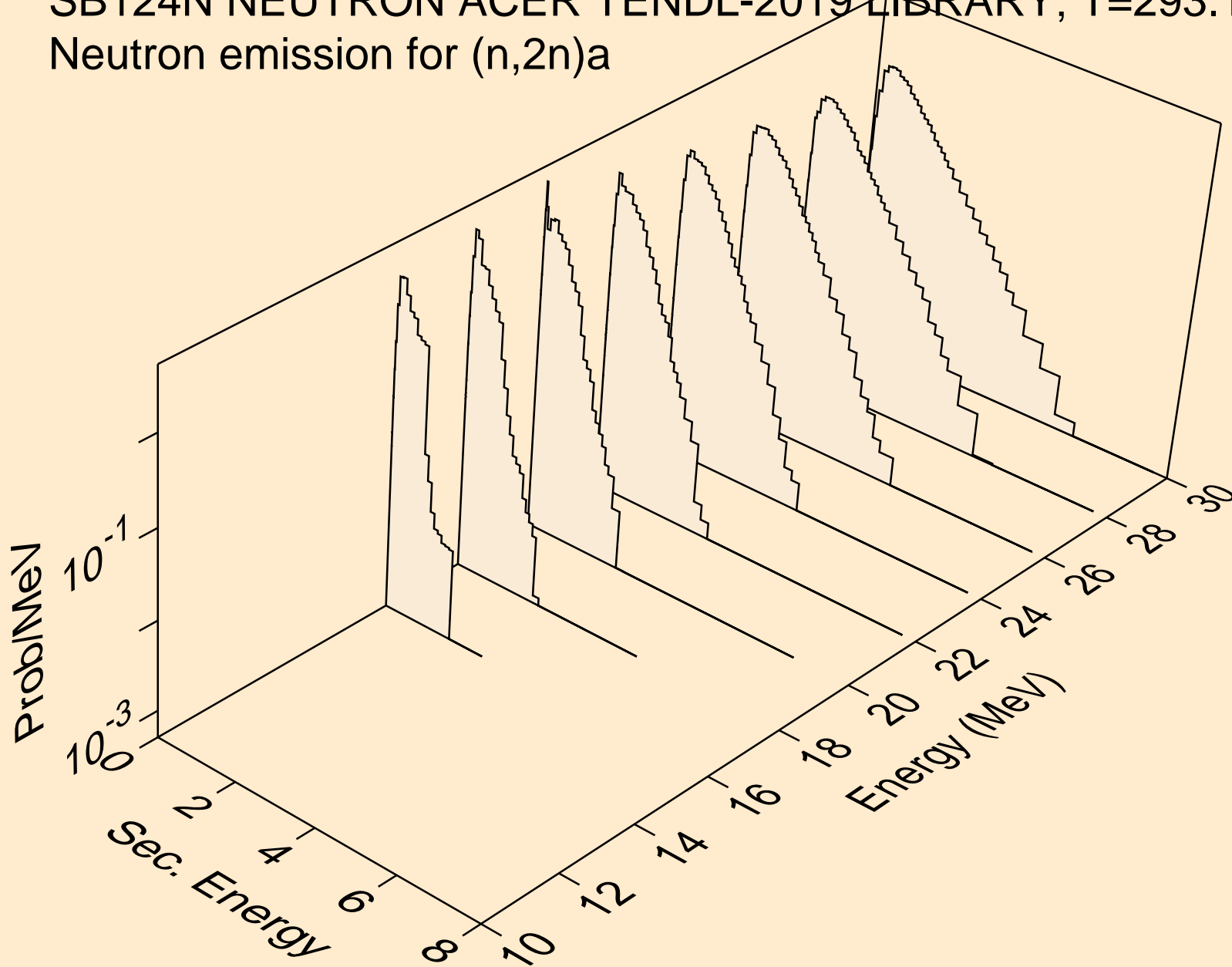

SB124N NEUTRON ACER TENDL-2019 LIBRARY; T=293.16K  
Neutron emission for (n,3n)a

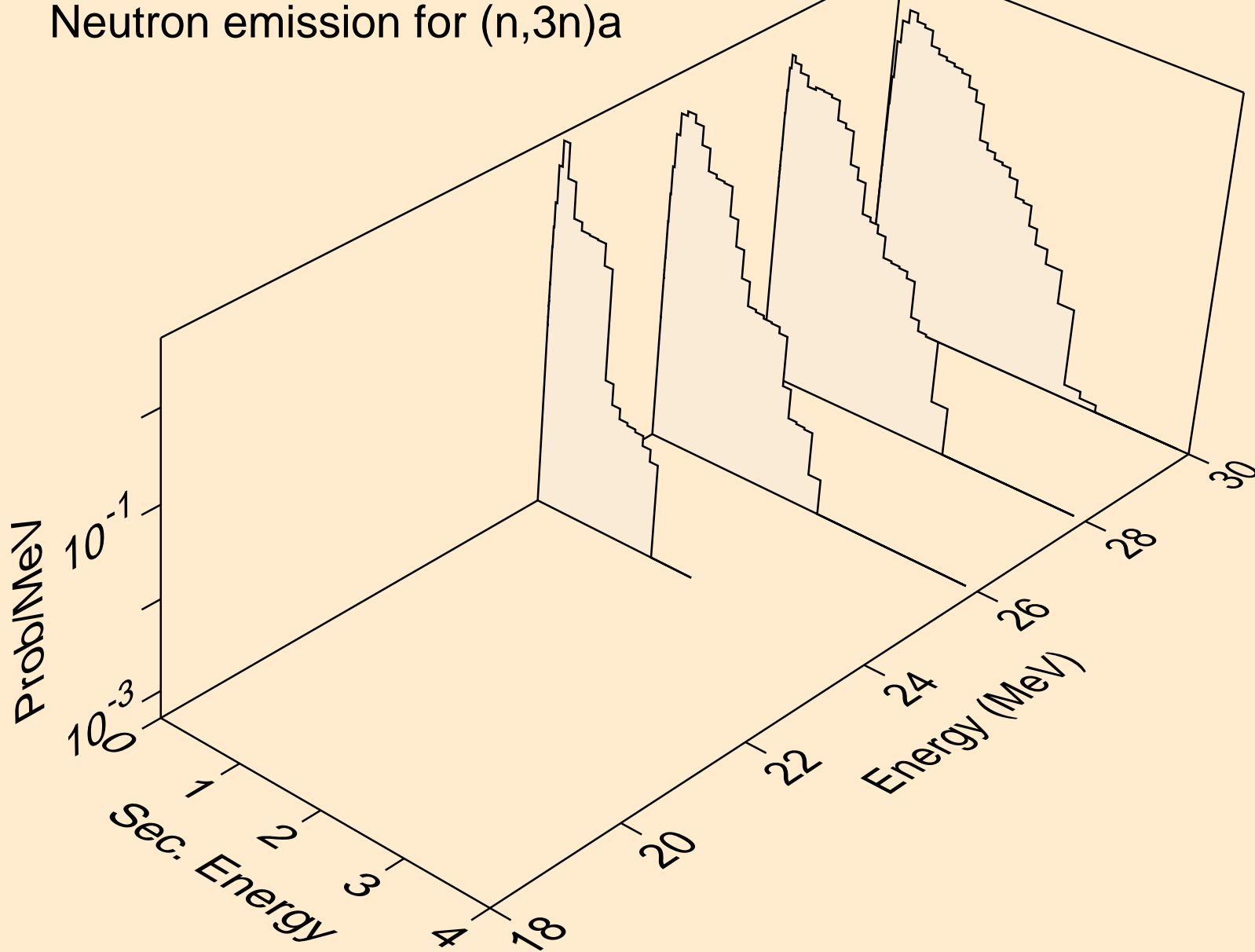

SB124N NEUTRON ACER TENDL-2019 LIBRARY; T=293.16K  
Neutron emission for (n,n\*)p

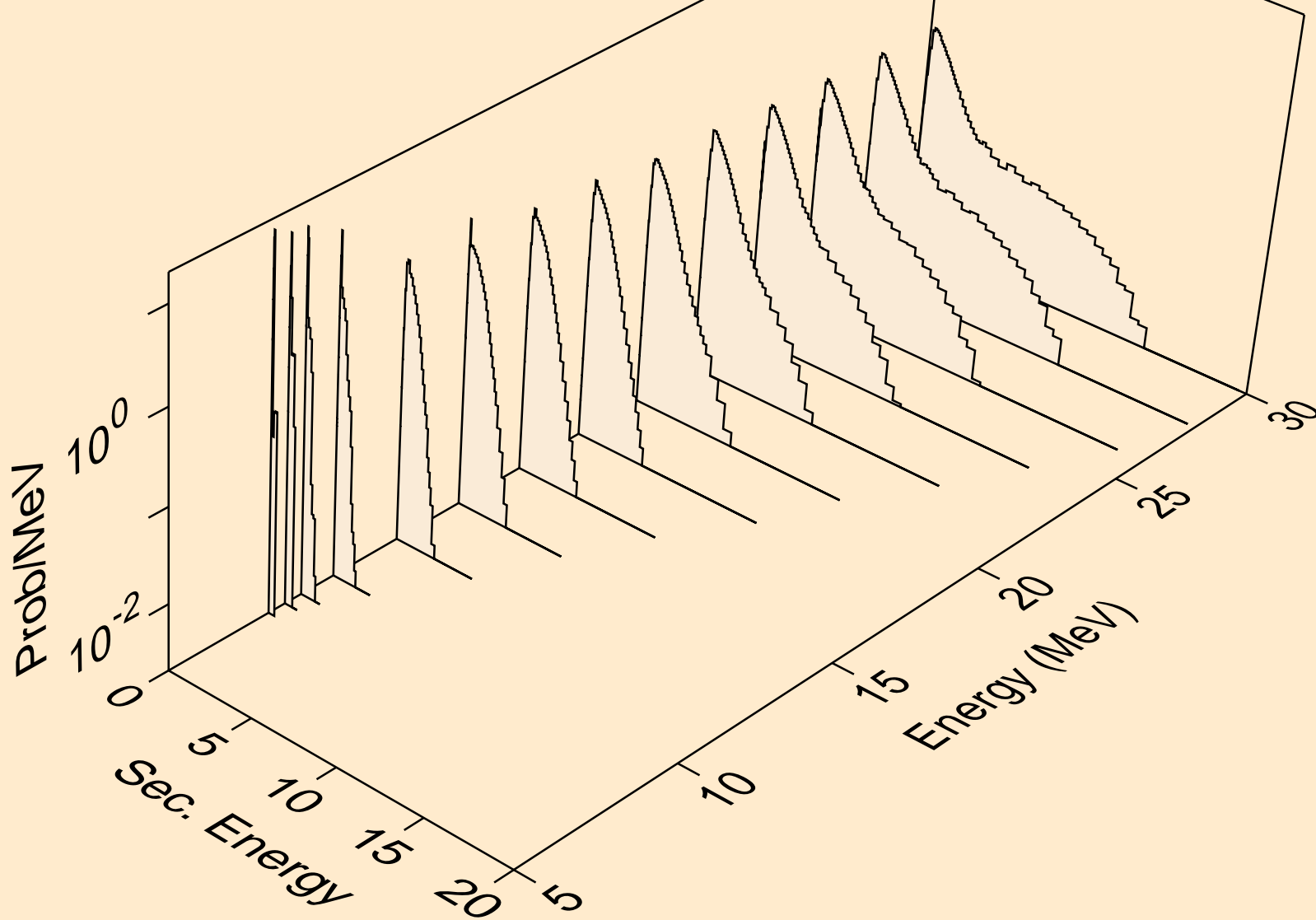



SB124N NEUTRON ACER TENDL-2019 LIBRARY; T=293.16K  
Neutron emission for (n,n\*)d

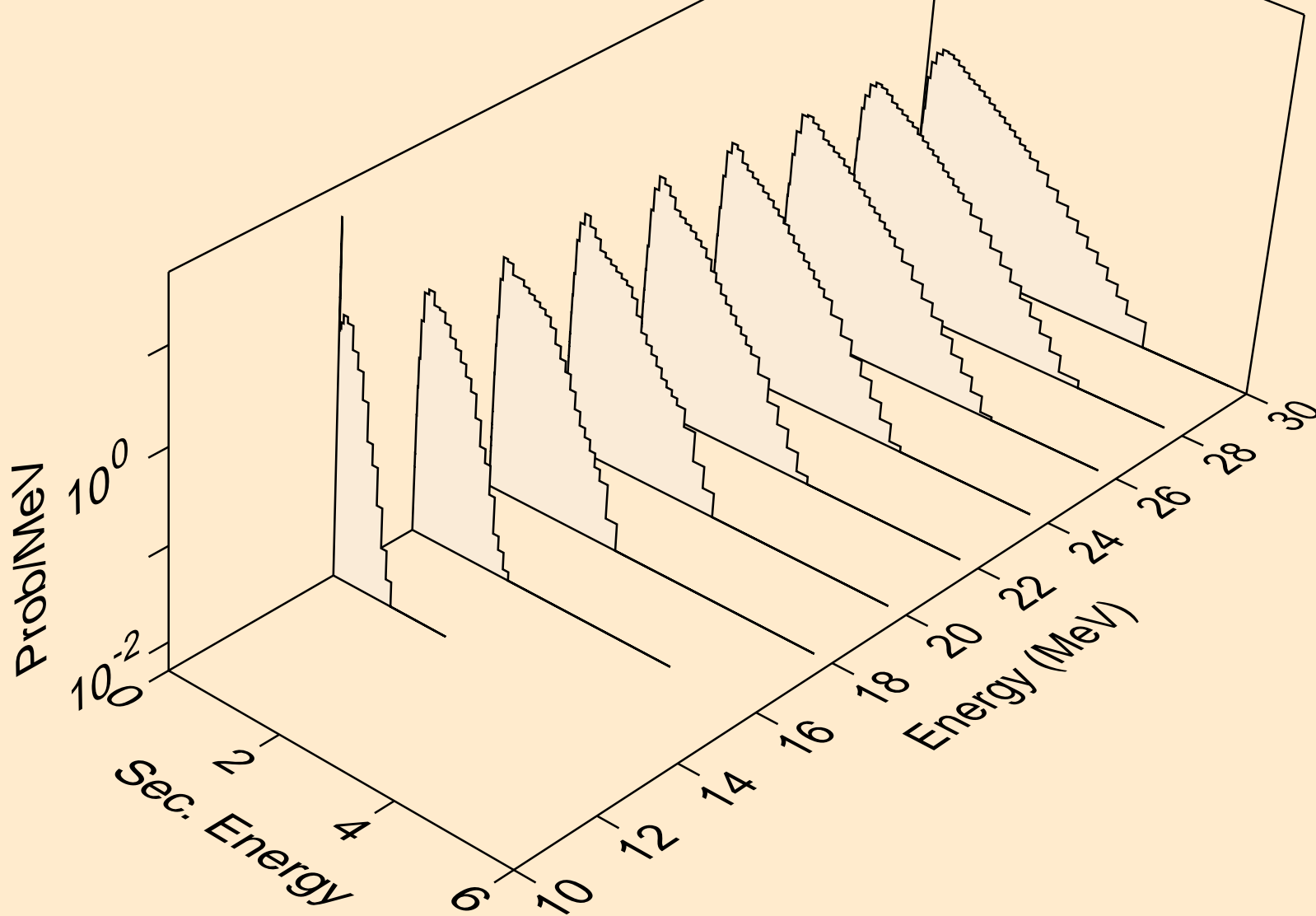

SB124N NEUTRON ACER TENDL-2019 LIBRARY; T=293.16K  
Neutron emission for (n,n\*)t

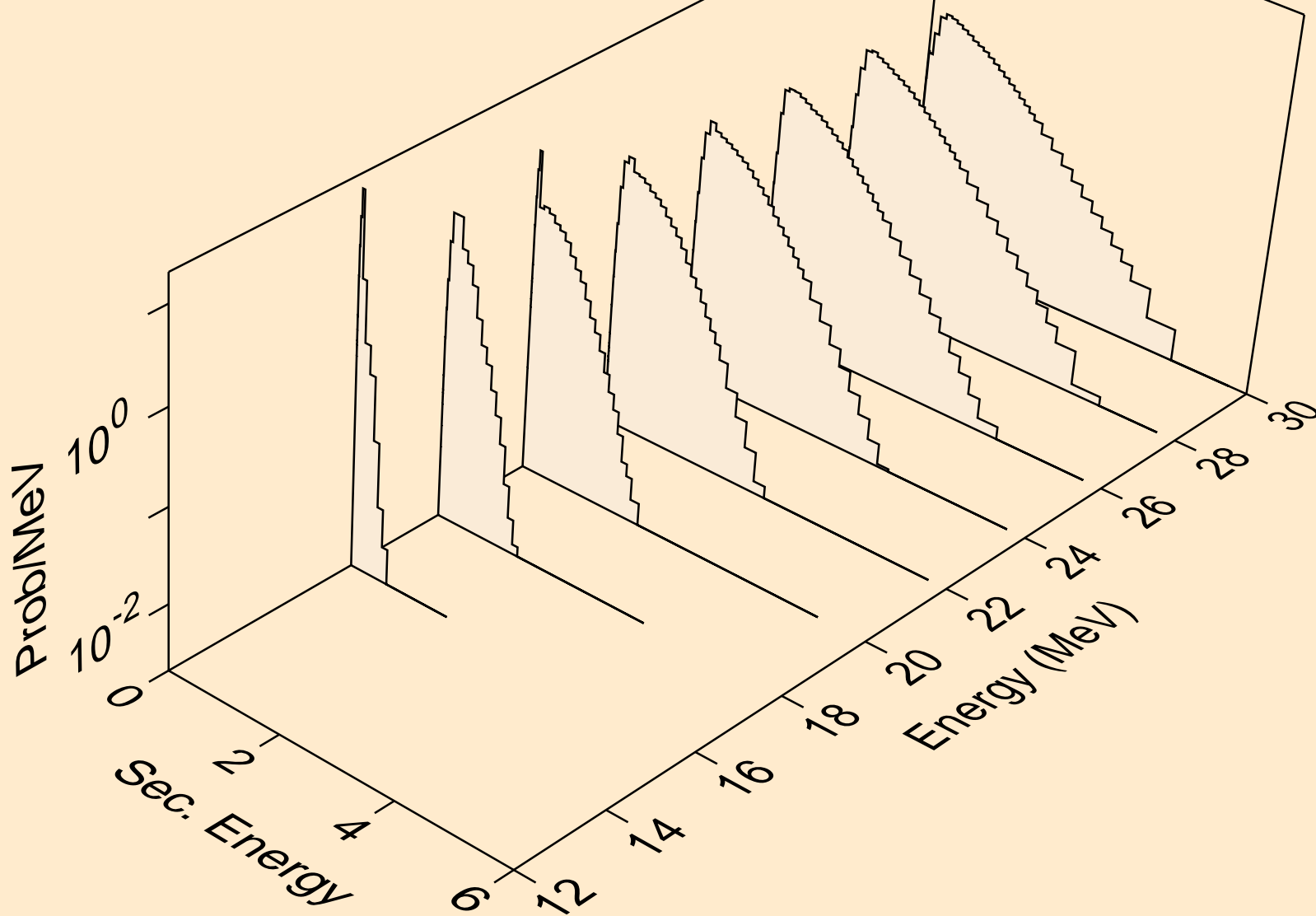

SB124N NEUTRON ACER TENDL-2019 LIBRARY; T=293.16K  
Neutron emission for (n,n\*)he3

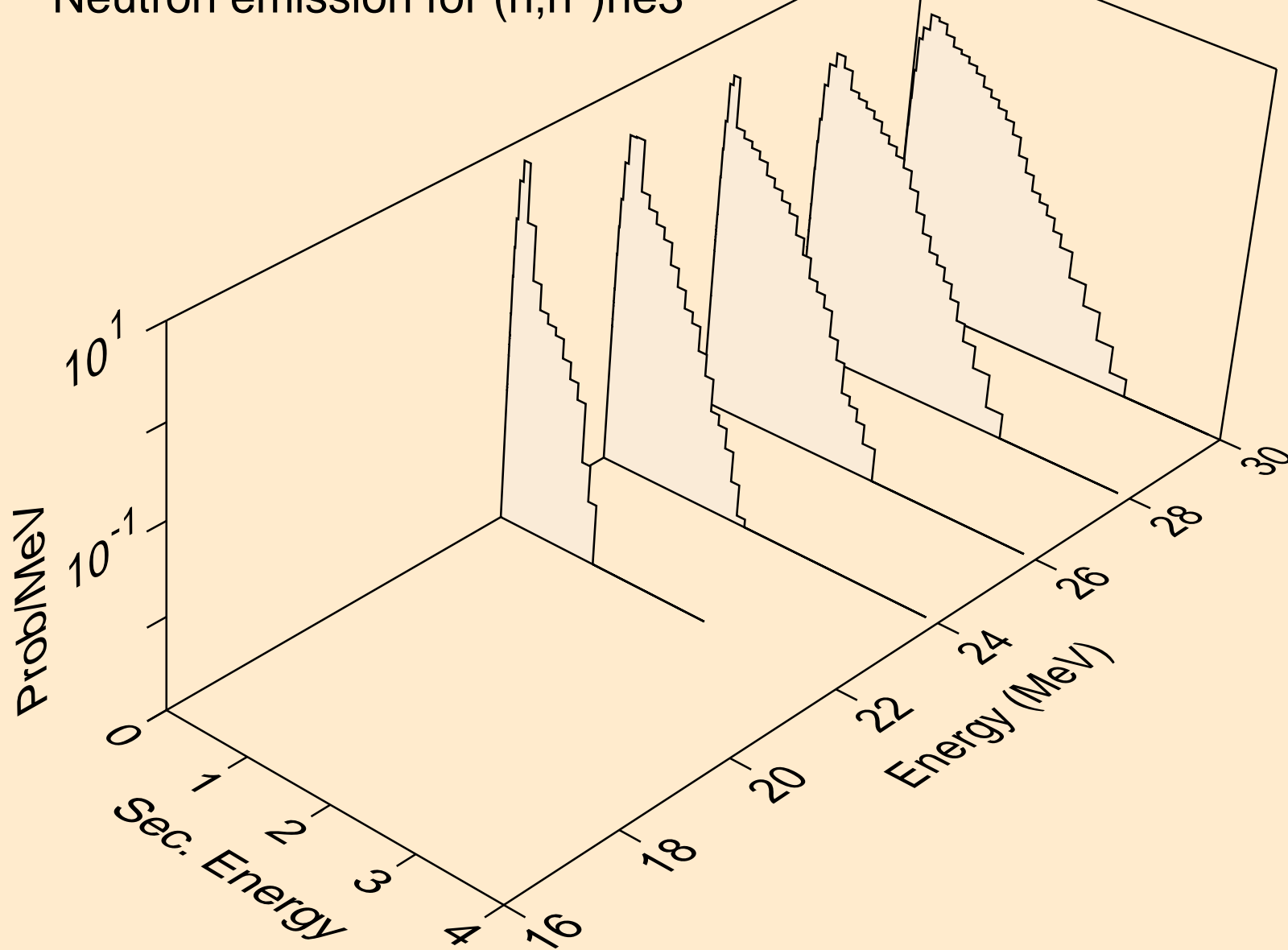

SB124N NEUTRON ACER TENDL-2019 LIBRARY; T=293.16K  
Neutron emission for (n,4n)

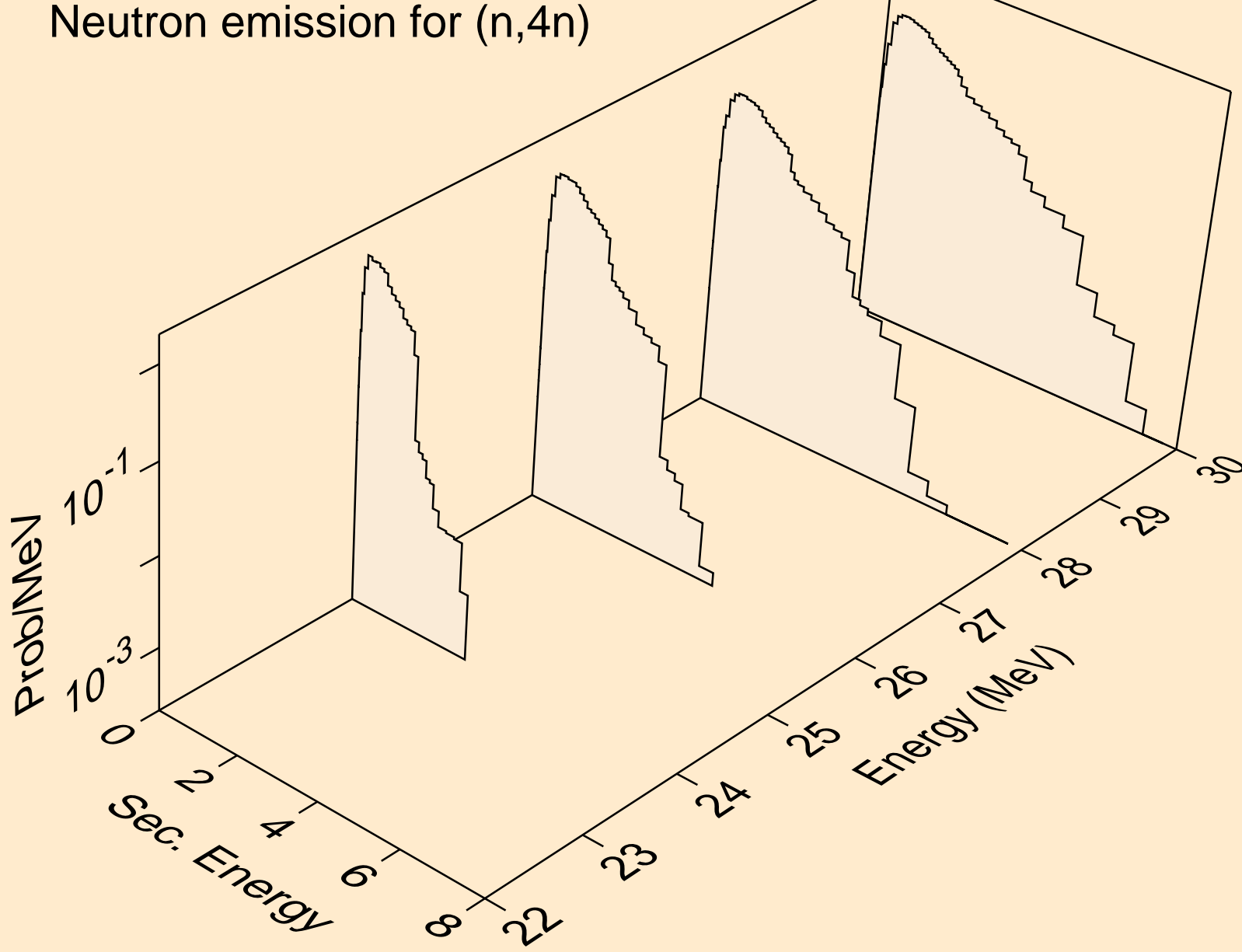

SB124N NEUTRON ACER TENDL-2019 LIBRARY; T=293.16K  
Neutron emission for (n,2np)

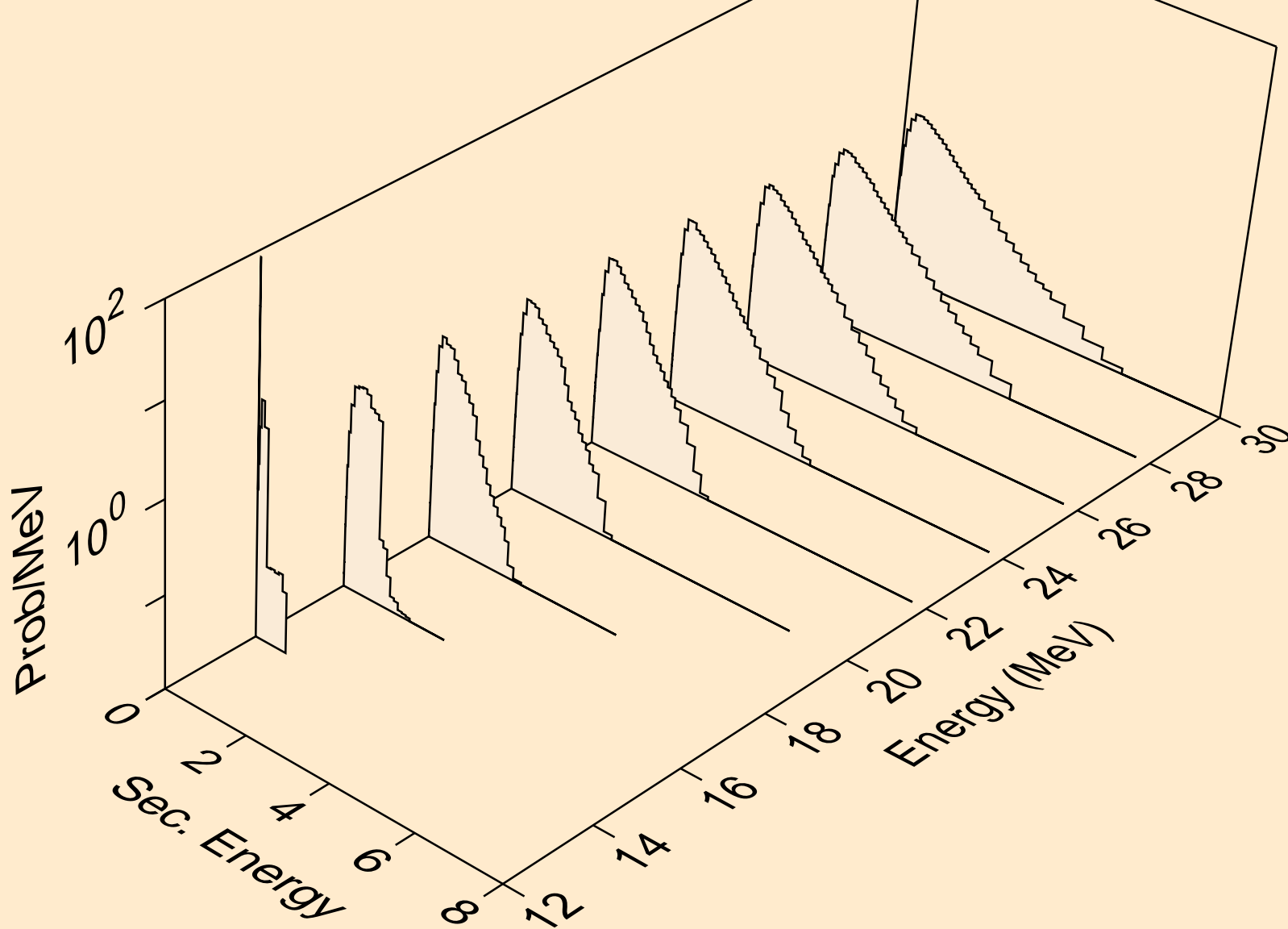

SB124N NEUTRON ACER TENDL-2019 LIBRARY; T=293.16K  
Neutron emission for (n,3np)

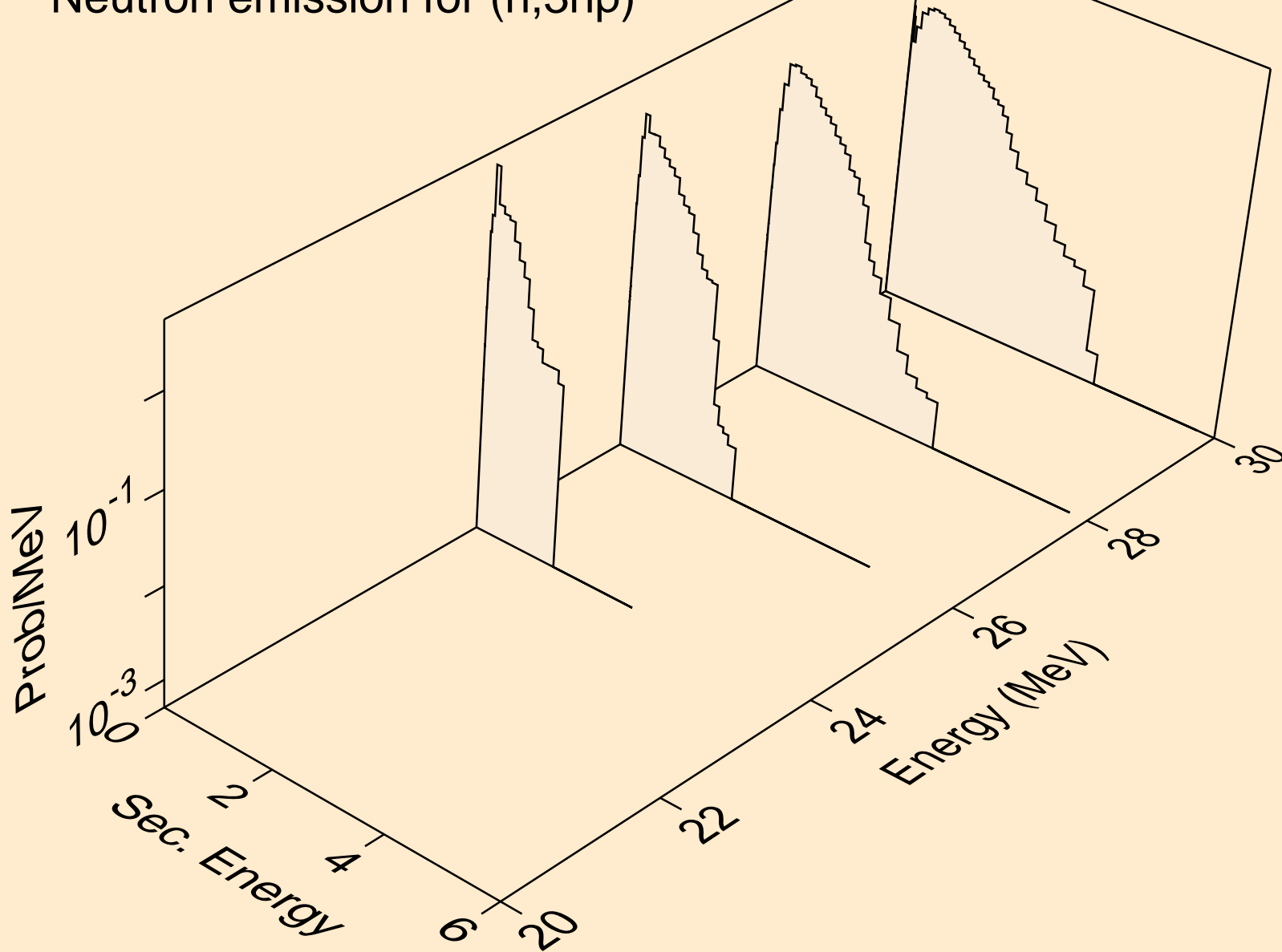

SB124N NEUTRON ACER TENDL-2019 LIBRARY; T=293.16K  
Neutron emission for (n,2np)

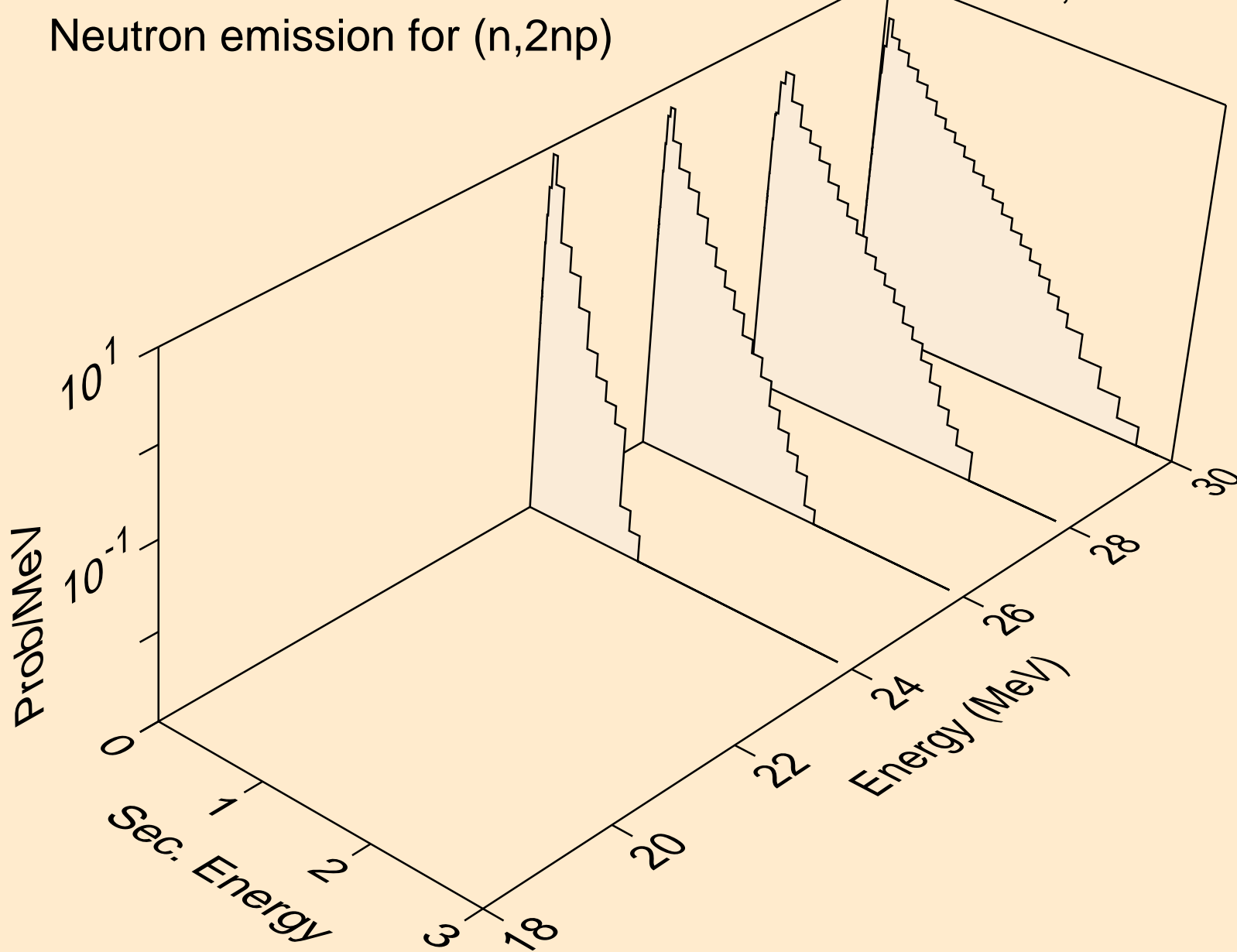

SB124N NEUTRON ACER TENDL-2019 LIBRARY; T=293.16K  
Neutron emission for (n,n\*c)

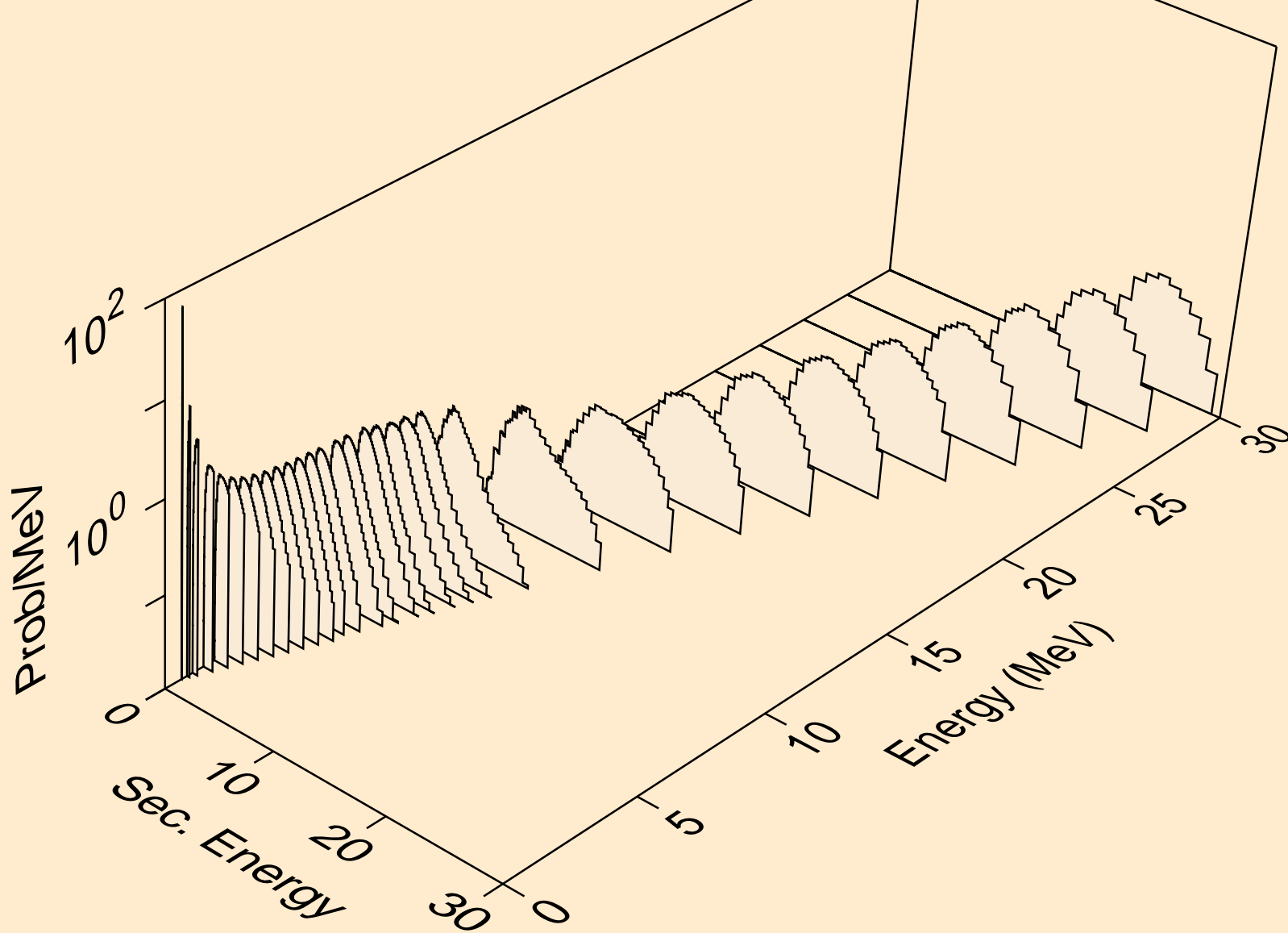



SB124N NEUTRON ACER TENDL-2019 LIBRARY; T=293.16K  
Photon emission for (n,x)

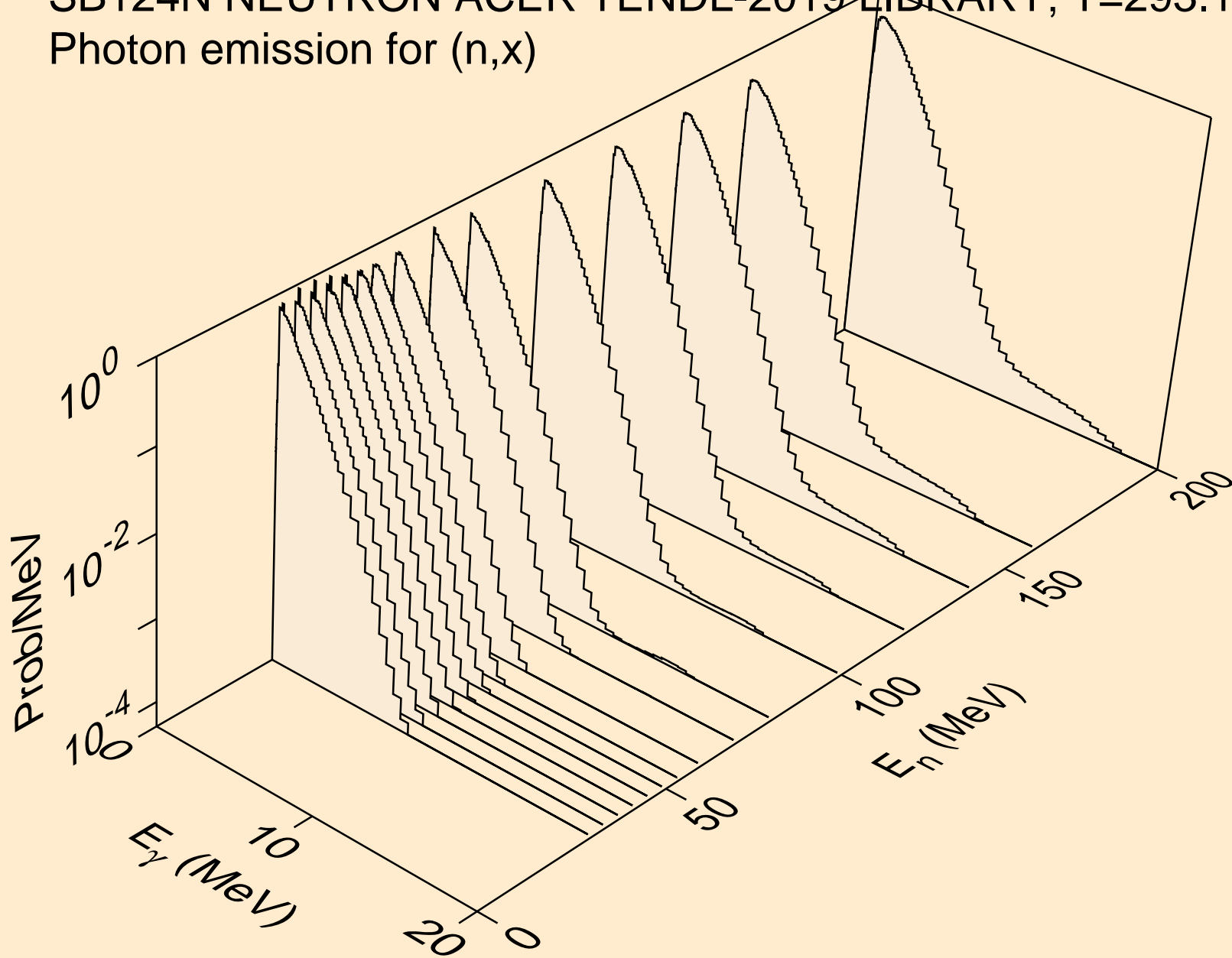

SB124N NEUTRON ACER TENDL-2019 LIBRARY; T=293.16K  
Photon emission for (n,2nd)

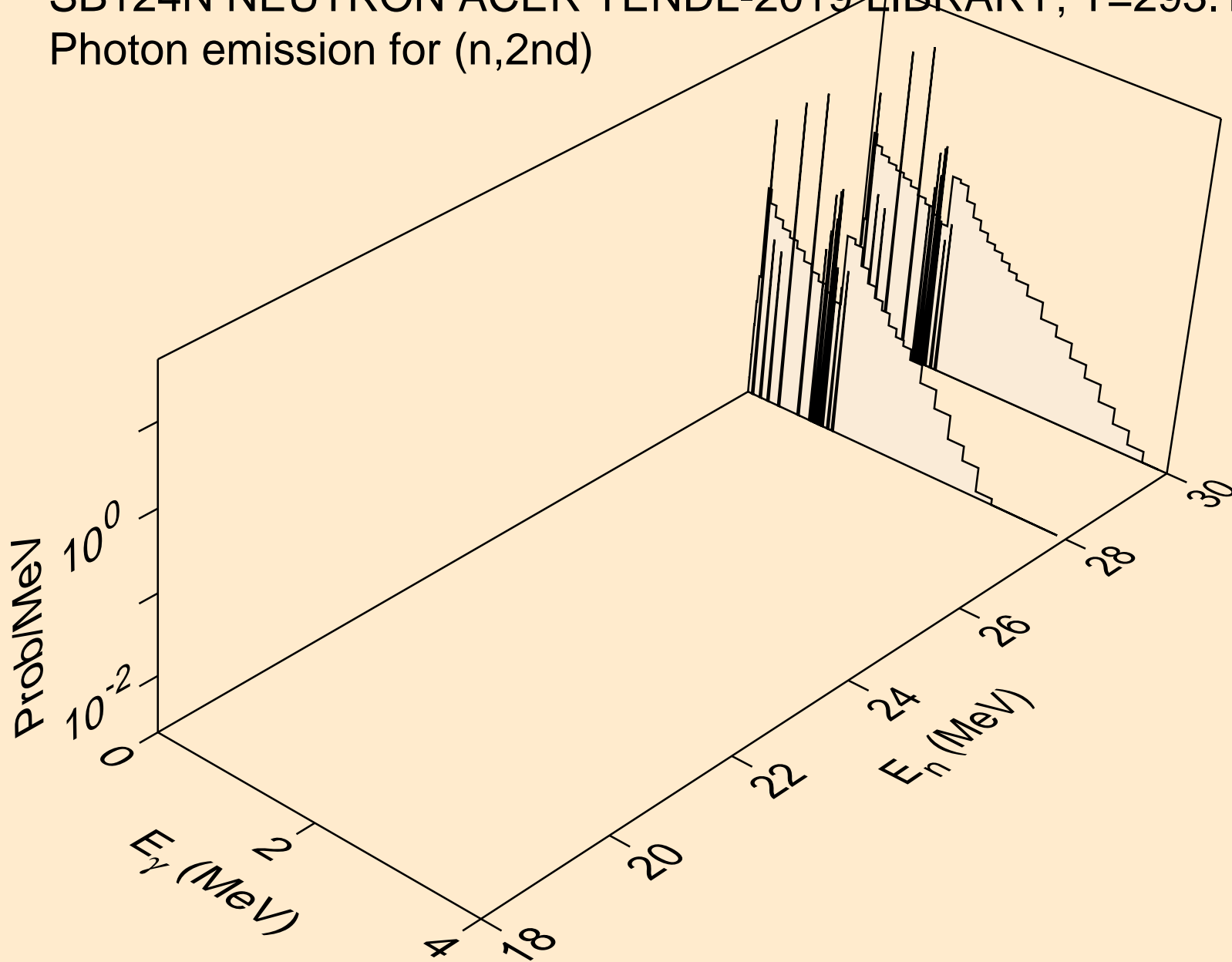

SB124N NEUTRON ACER TENDL-2019 LIBRARY; T=293.16K  
Photon emission for (n,2n)

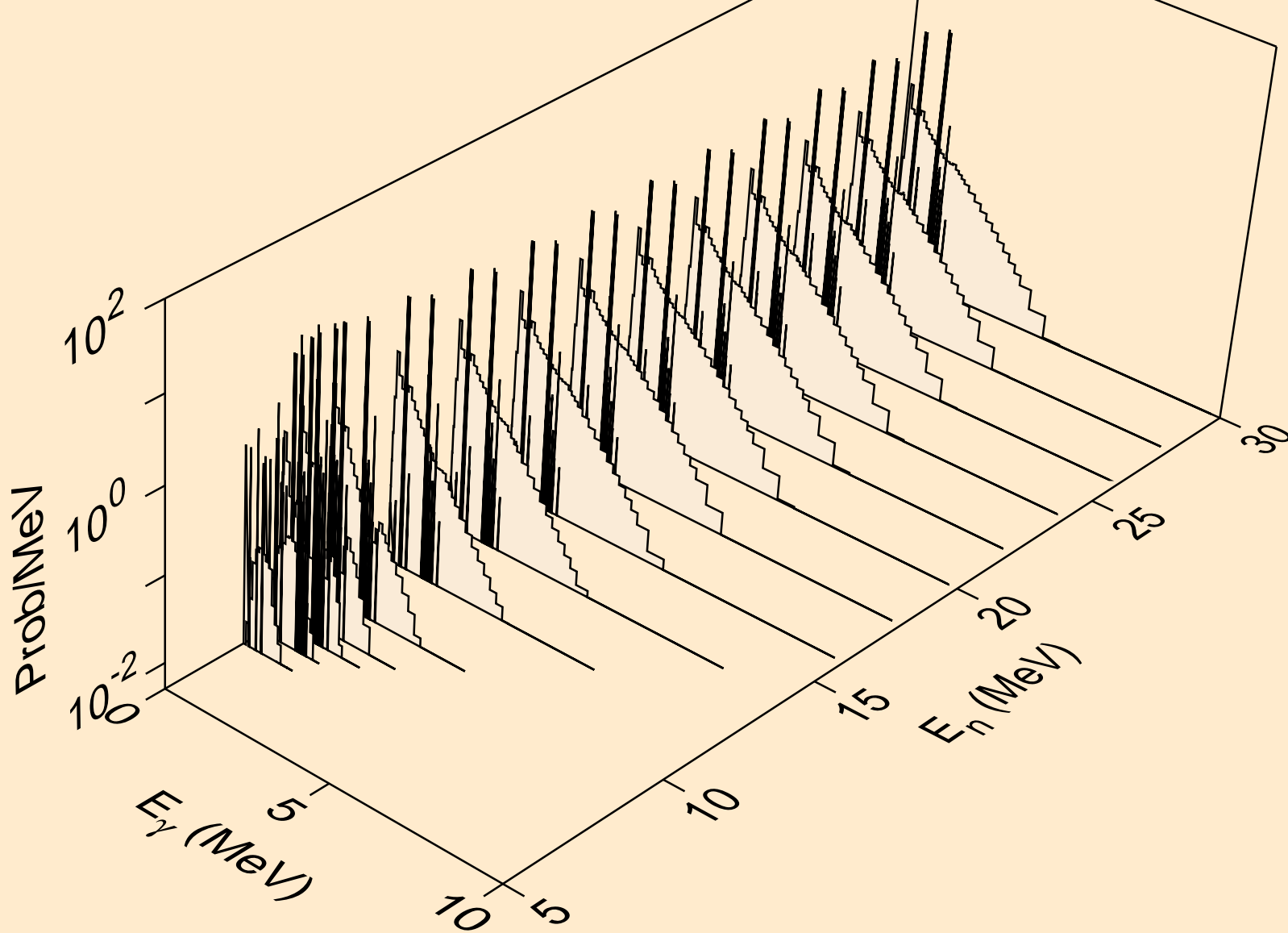

SB124N NEUTRON ACER TENDL-2019 LIBRARY; T=293.16K  
Photon emission for (n,3n)

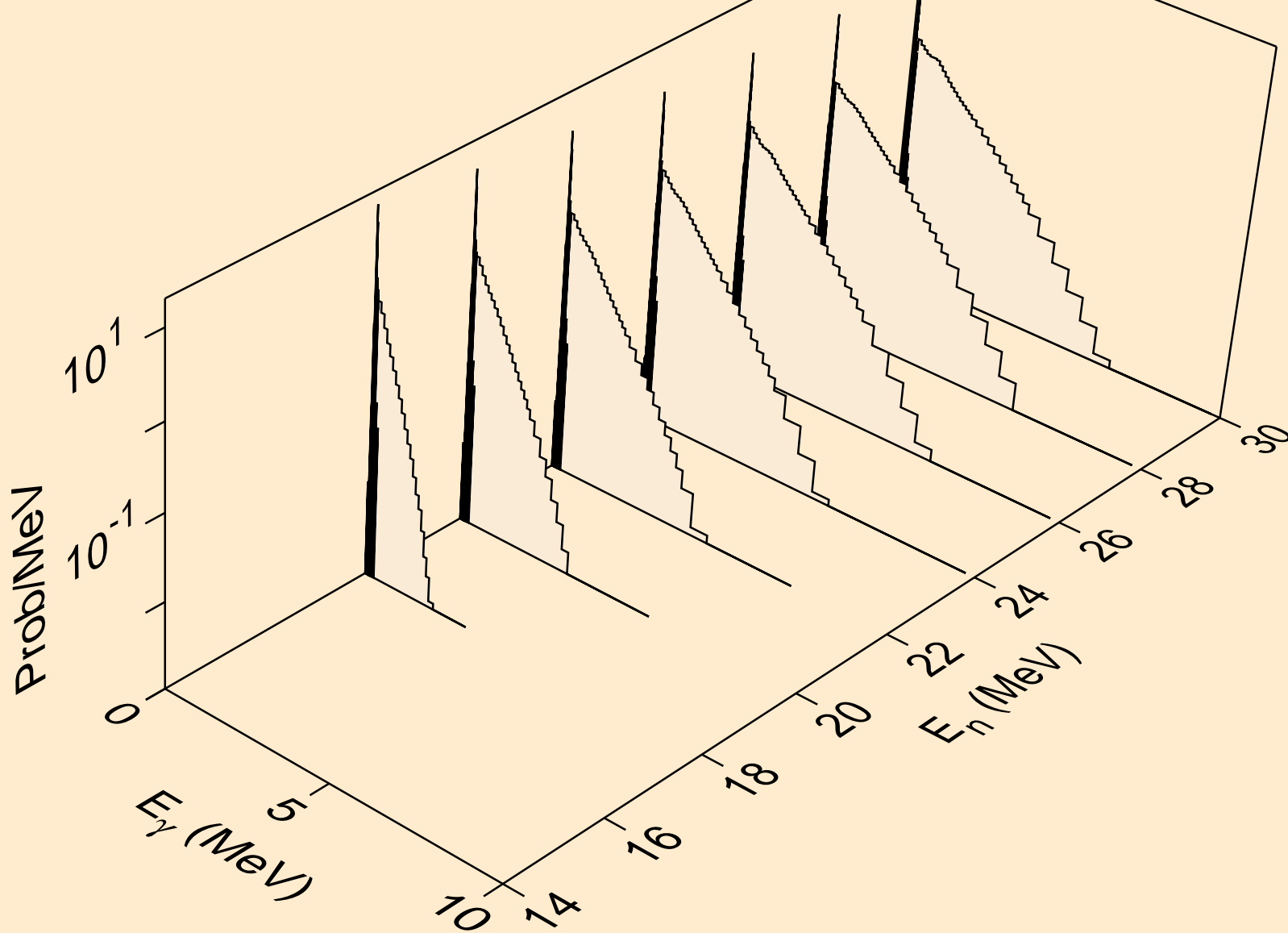

SB124N NEUTRON ACER TENDL-2019 LIBRARY; T=293.16K  
Photon emission for (n,n\*)a

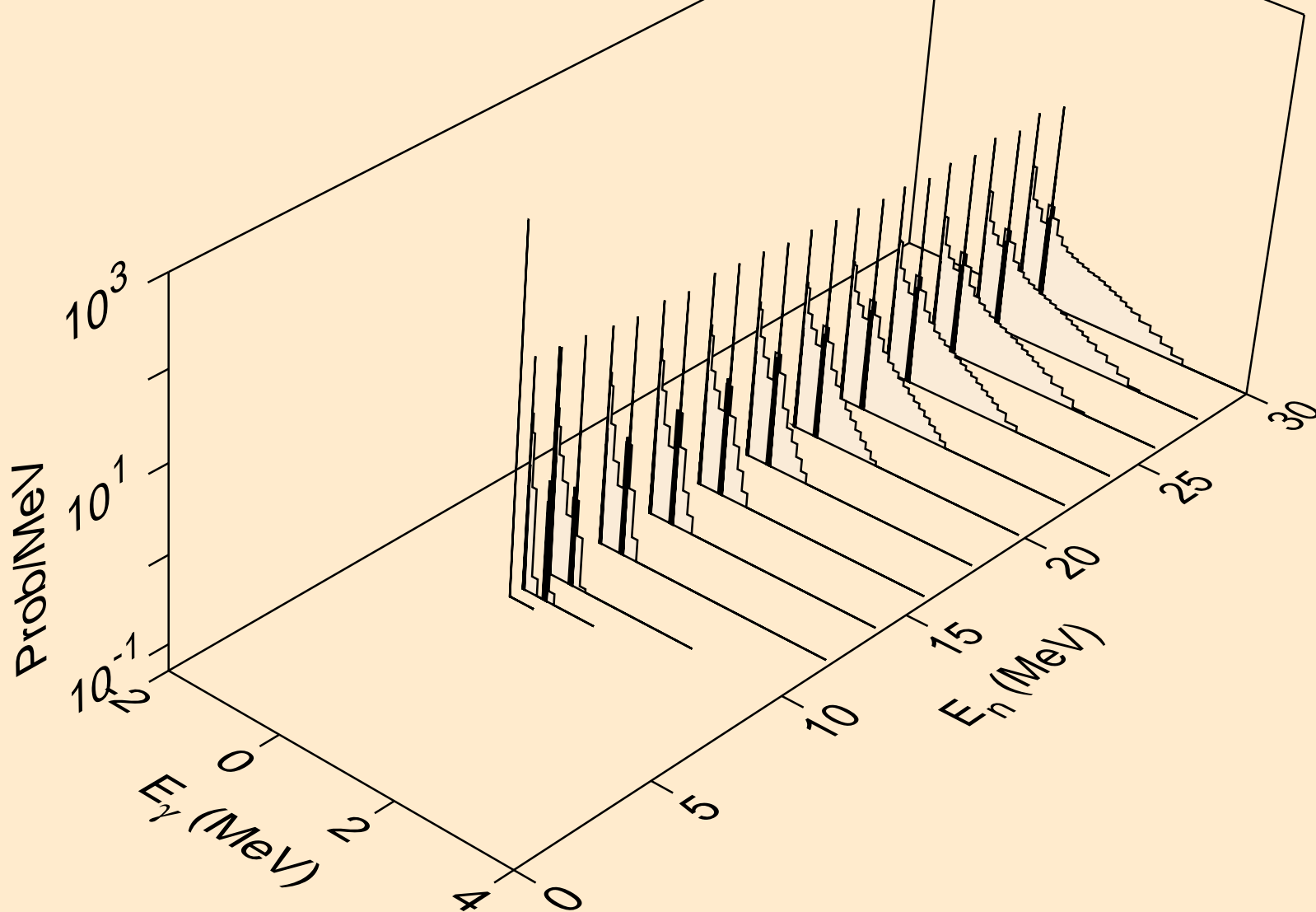

SB124N NEUTRON ACER TENDL-2019 LIBRARY; T=293.16K  
Photon emission for (n,2n)a

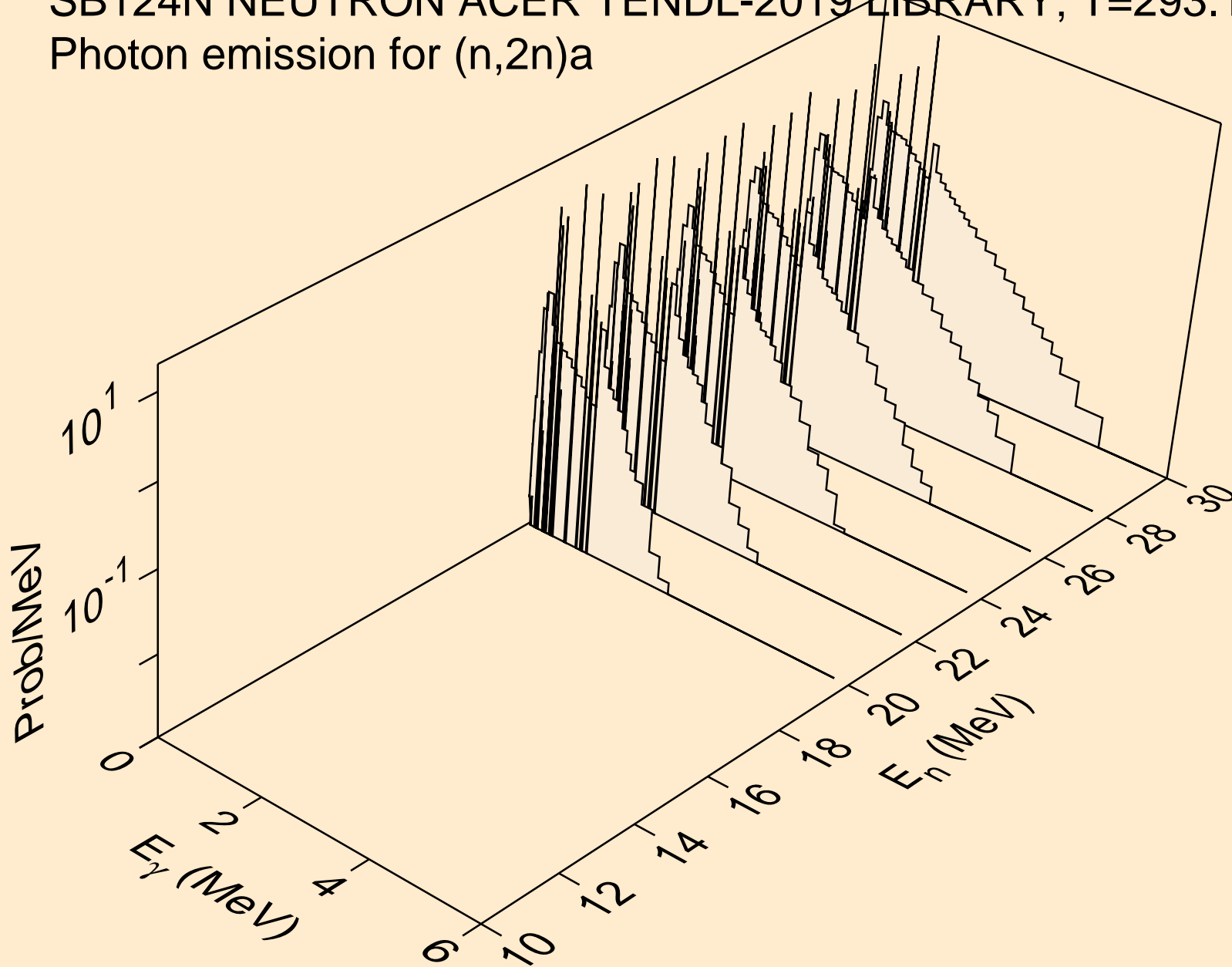

SB124N NEUTRON ACER TENDL-2019 LIBRARY; T=293.16K  
Photon emission for (n,3n)a

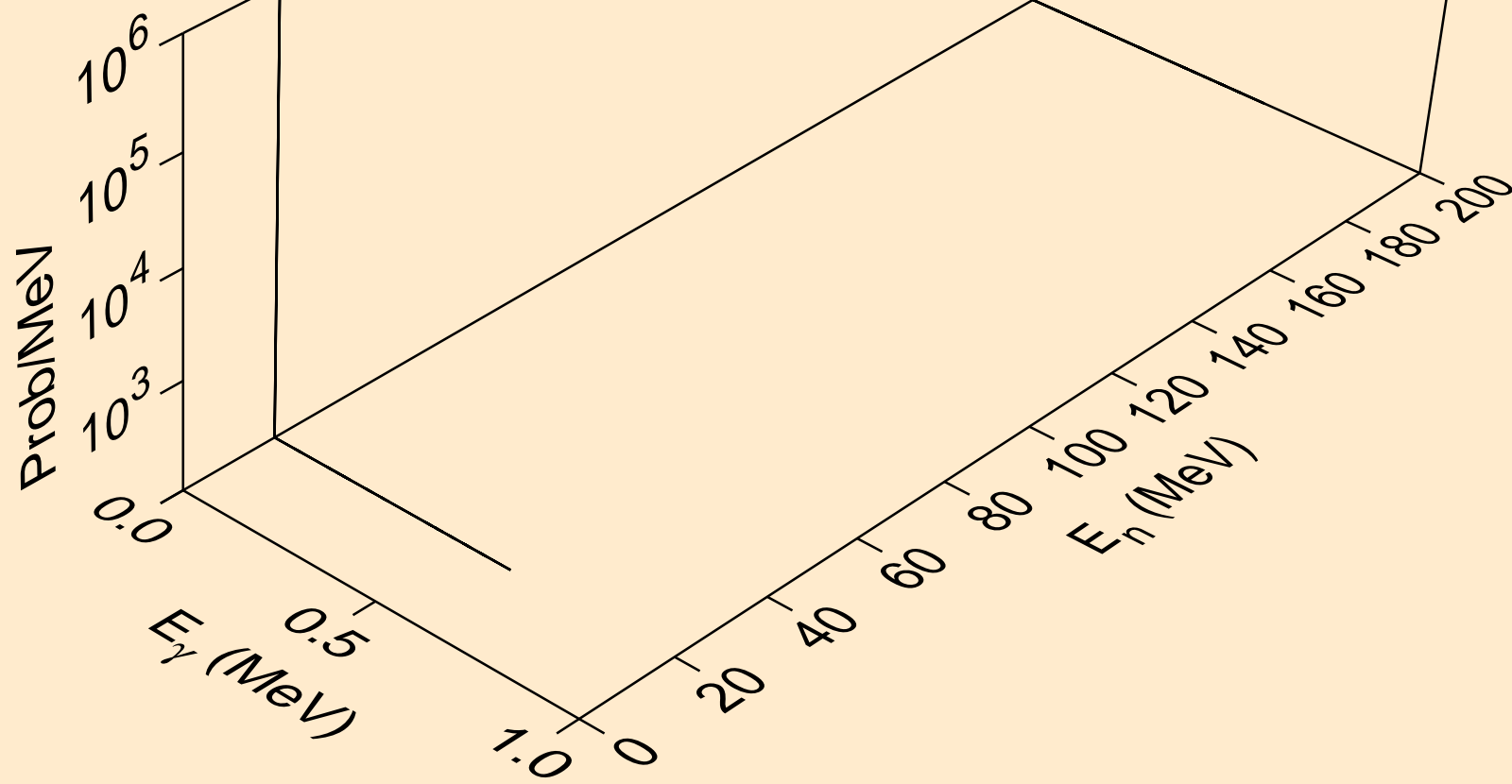

SB124N NEUTRON ACER TENDL-2019 LIBRARY; T=293.16K  
Photon emission for (n,n\*)p

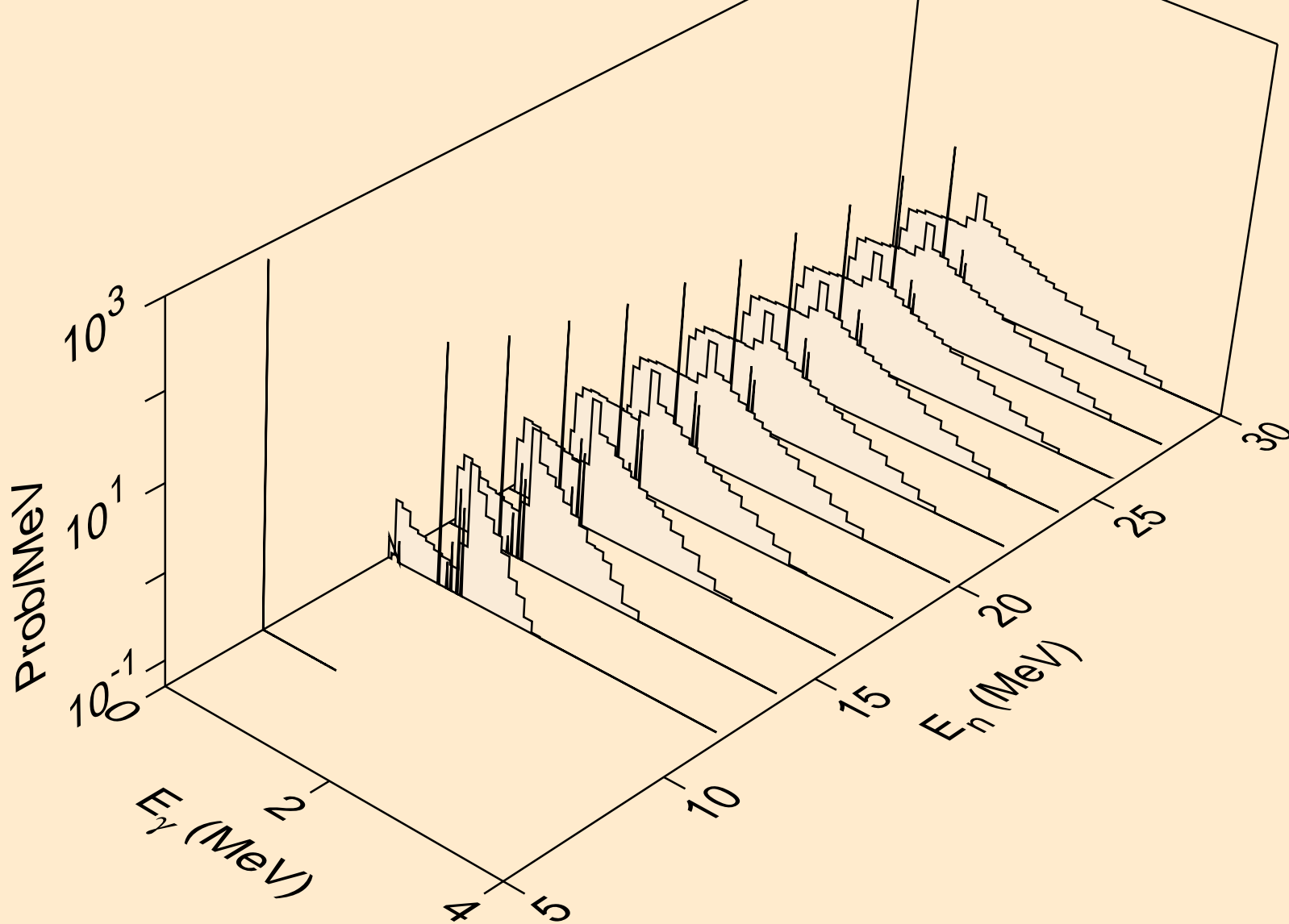



SB124N NEUTRON ACER TENDL-2019 LIBRARY; T=293.16K  
Photon emission for (n,n\*)d

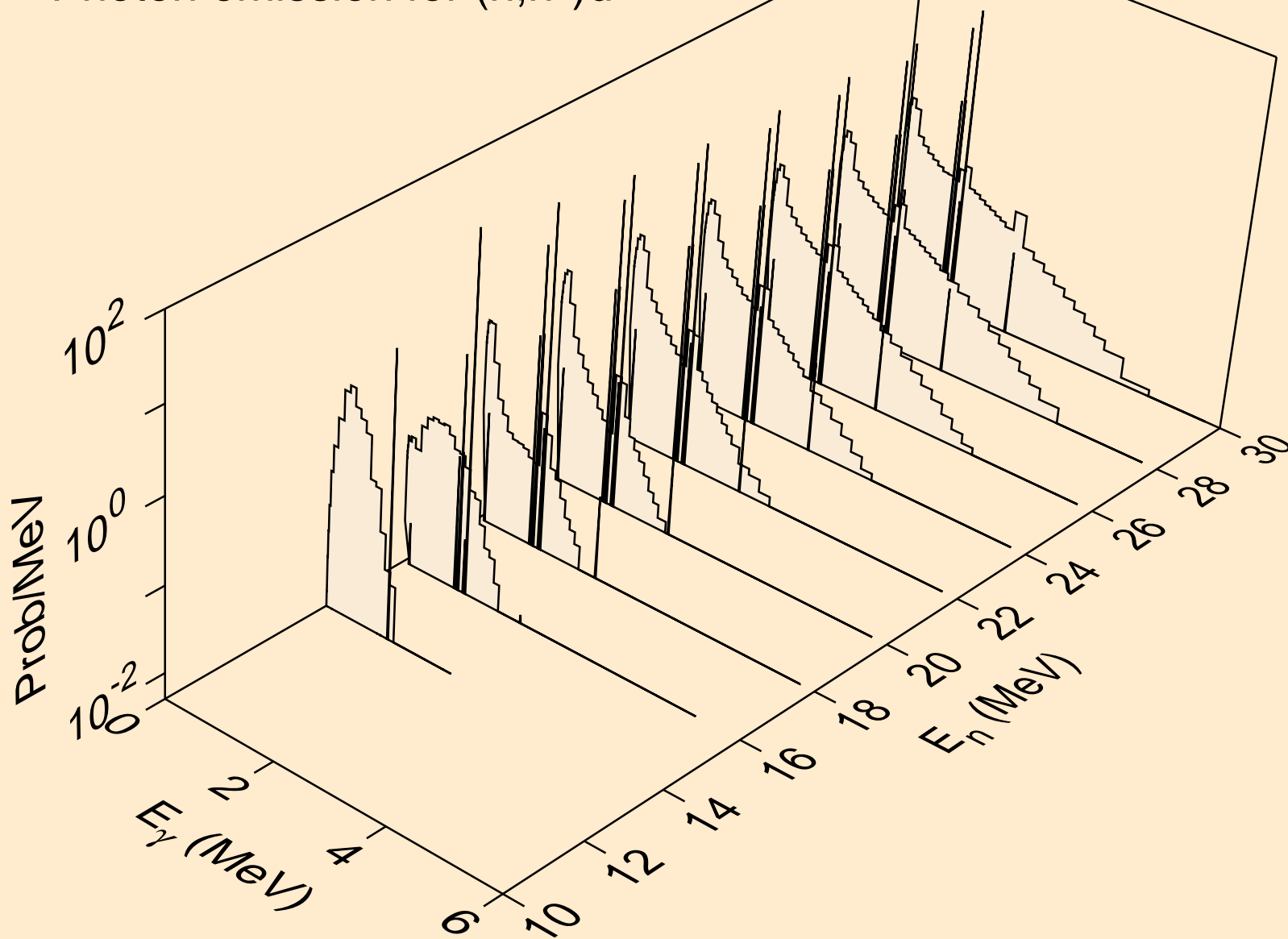

SB124N NEUTRON ACER TENDL-2019 LIBRARY; T=293.16K  
Photon emission for (n,n\*)t

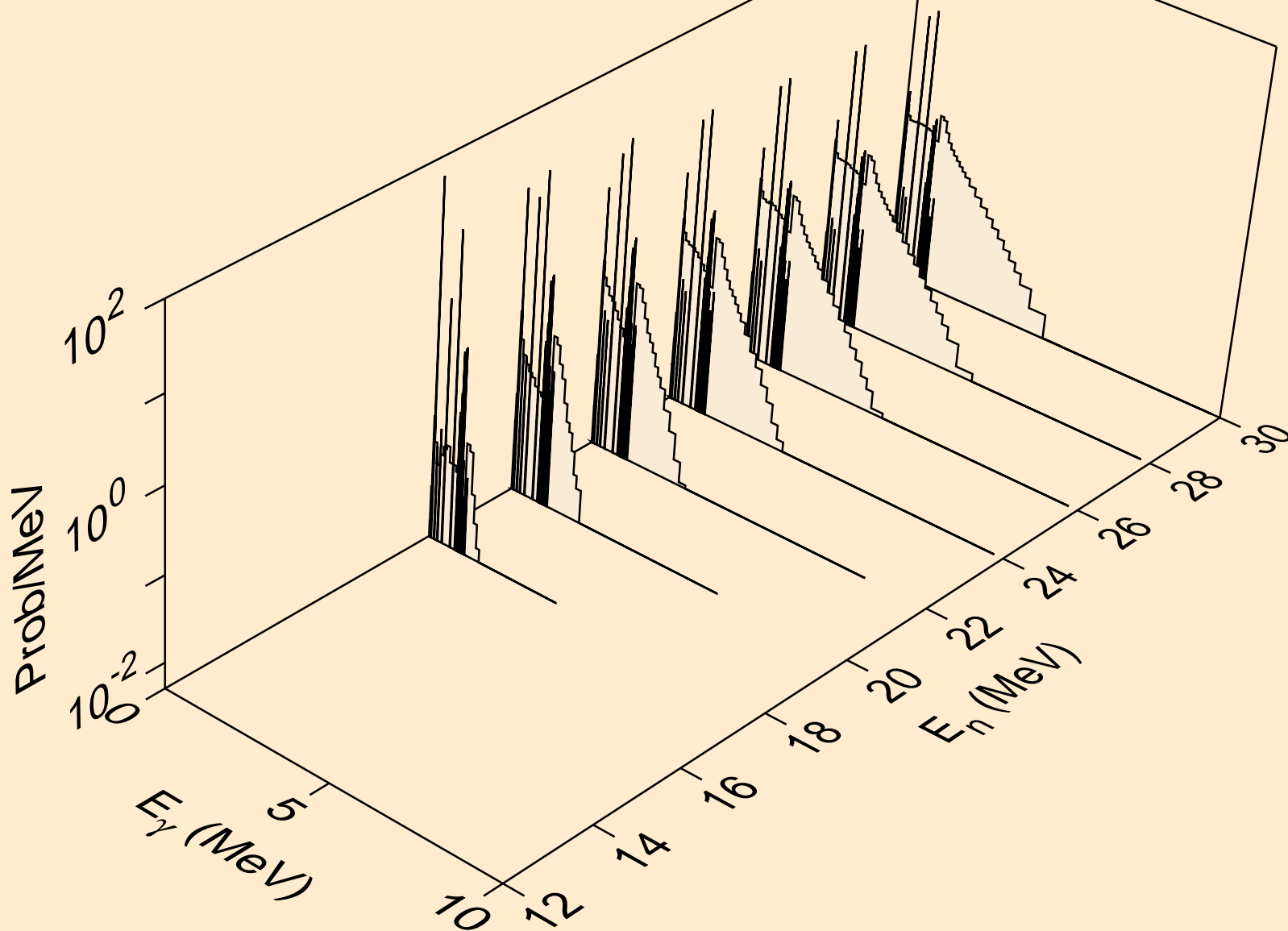

SB124N NEUTRON ACER TENDL-2019 LIBRARY; T=293.16K  
Photon emission for (n,n\*)he3

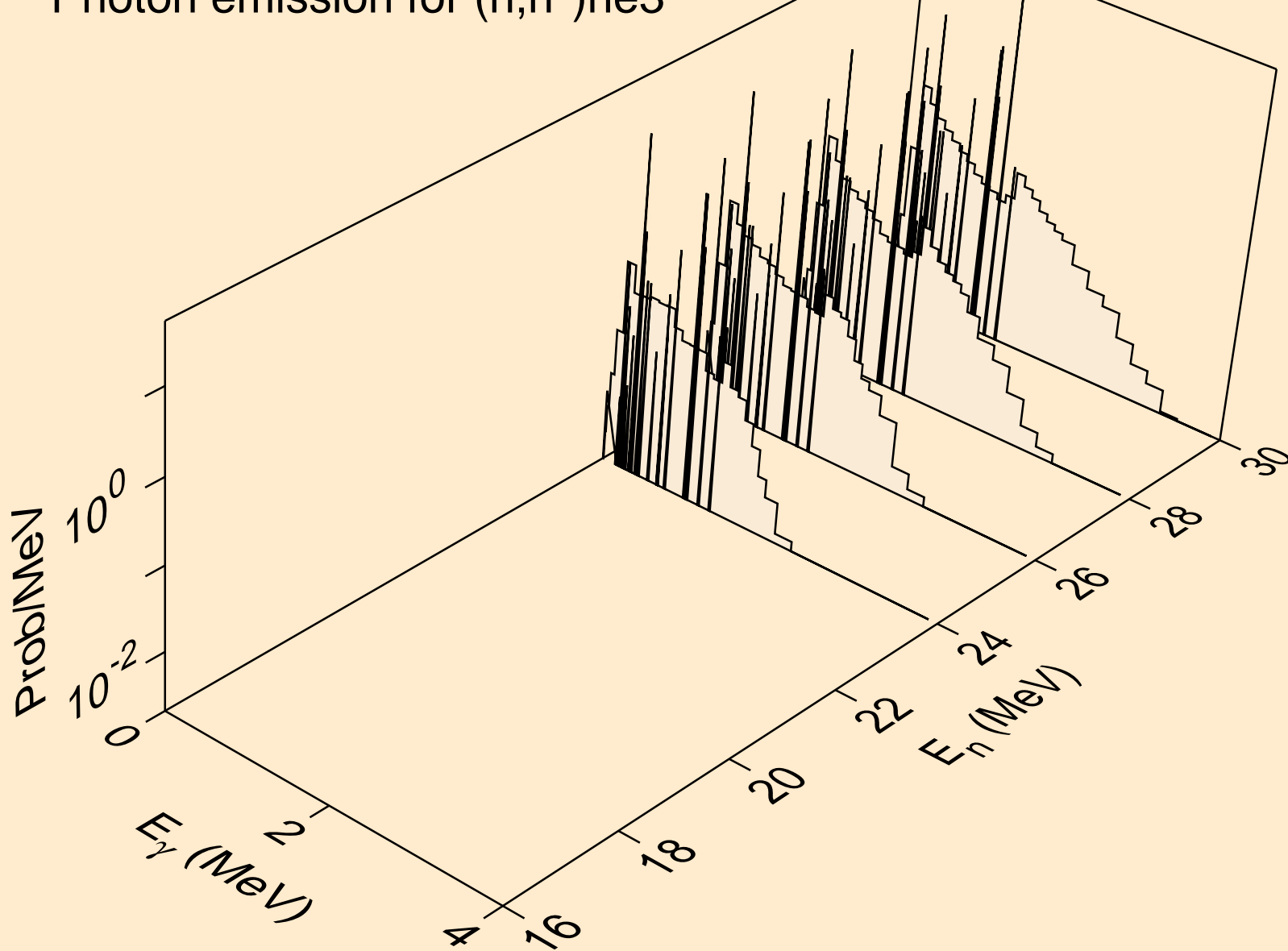

SB124N NEUTRON ACER TENDL-2019 LIBRARY; T=293.16K  
Photon emission for (n,4n)

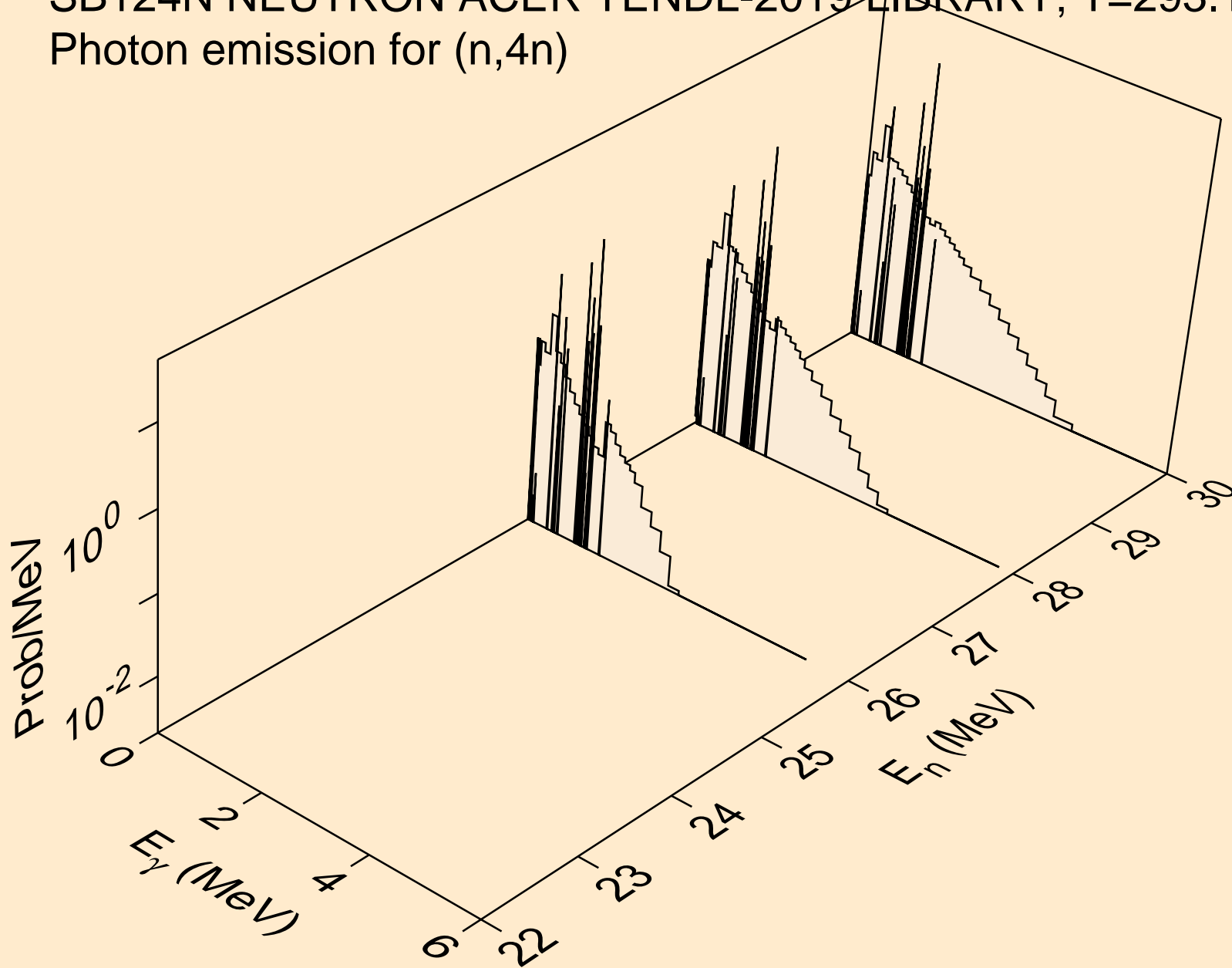

SB124N NEUTRON ACER TENDL-2019 LIBRARY; T=293.16K  
Photon emission for (n,2np)

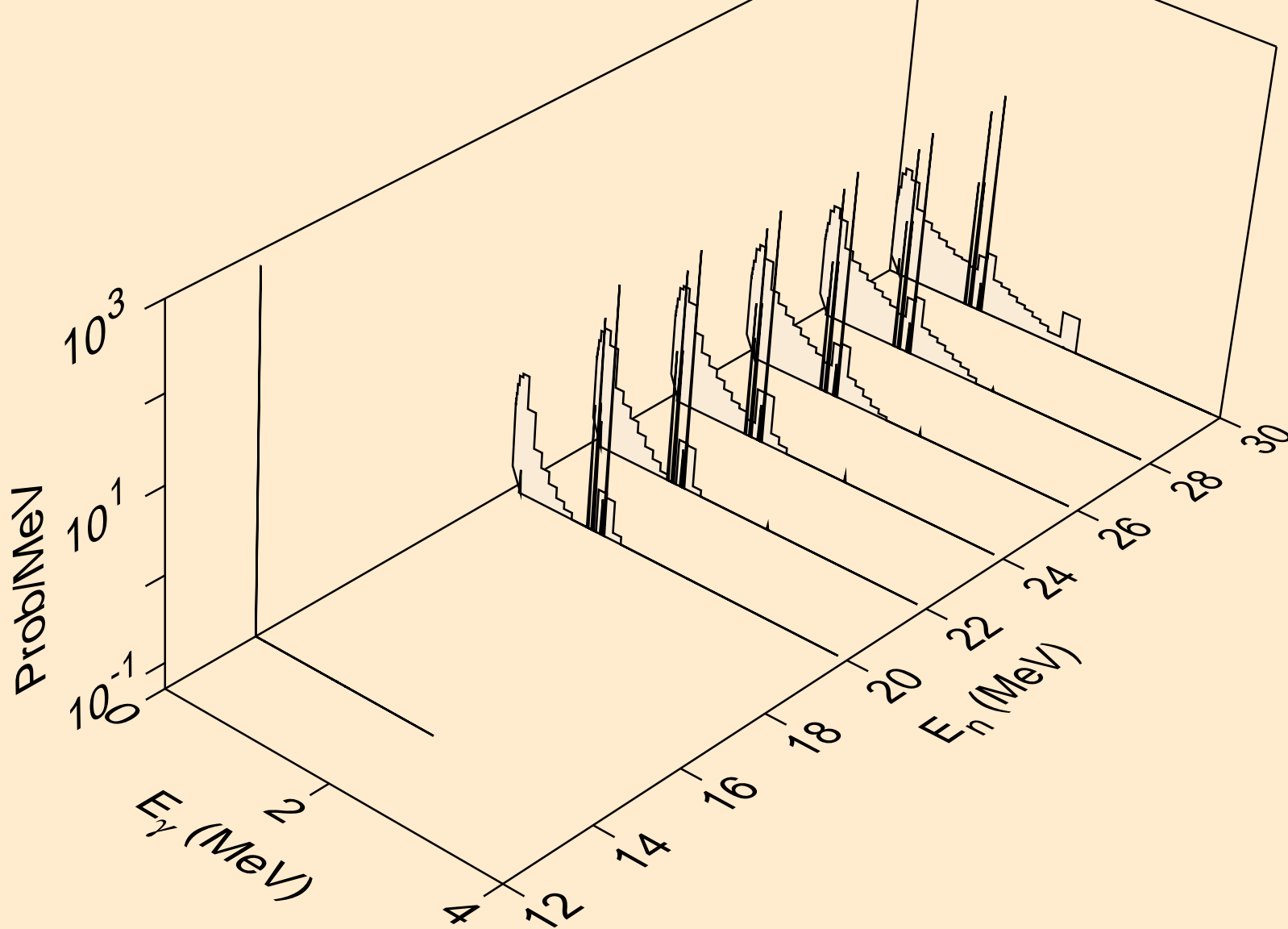

SB124N NEUTRON ACER TENDL-2019 LIBRARY; T=293.16K  
Photon emission for (n,3np)

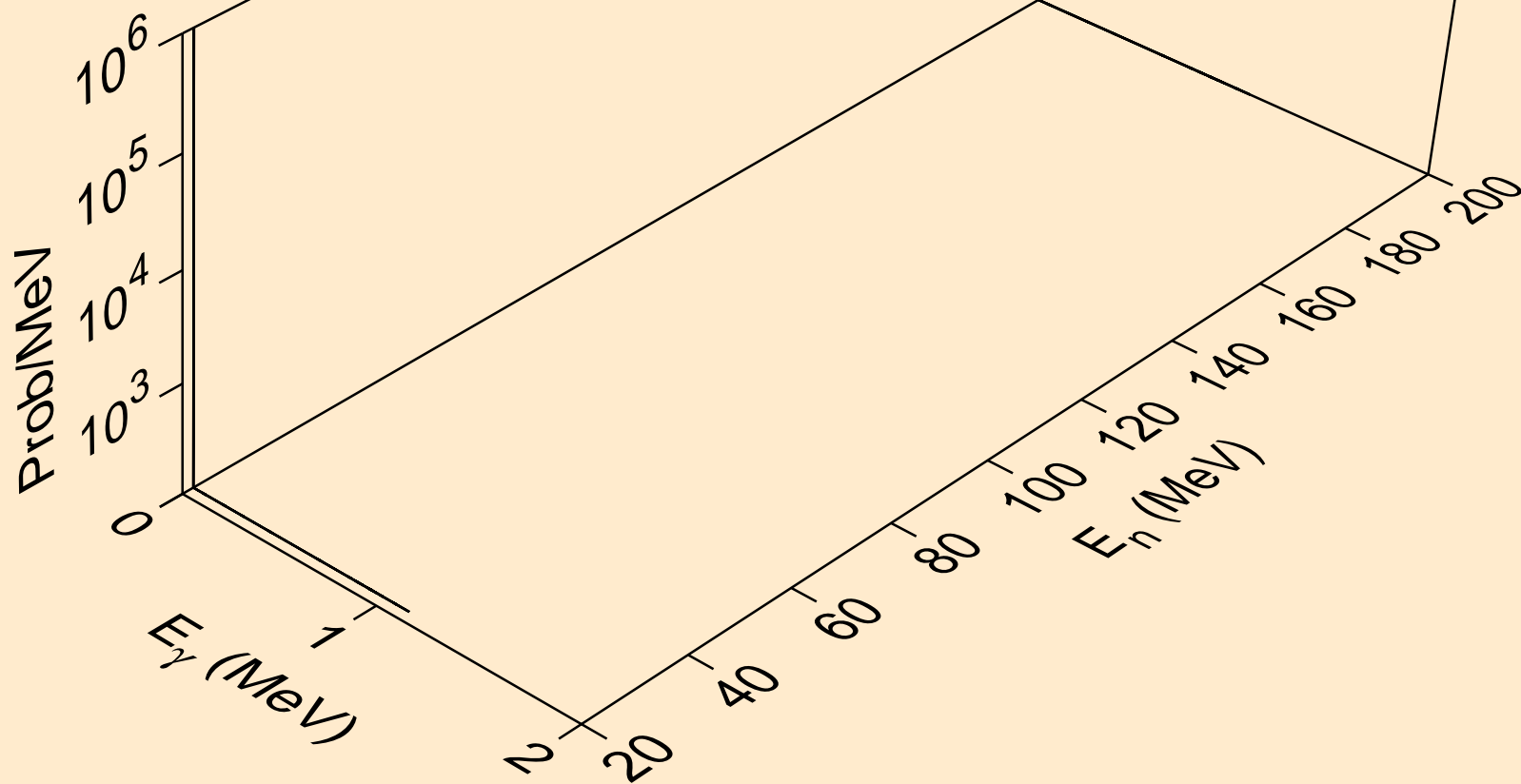

SB124N NEUTRON ACER TENDL-2019 LIBRARY; T=293.16K  
Photon emission for (n,2np)

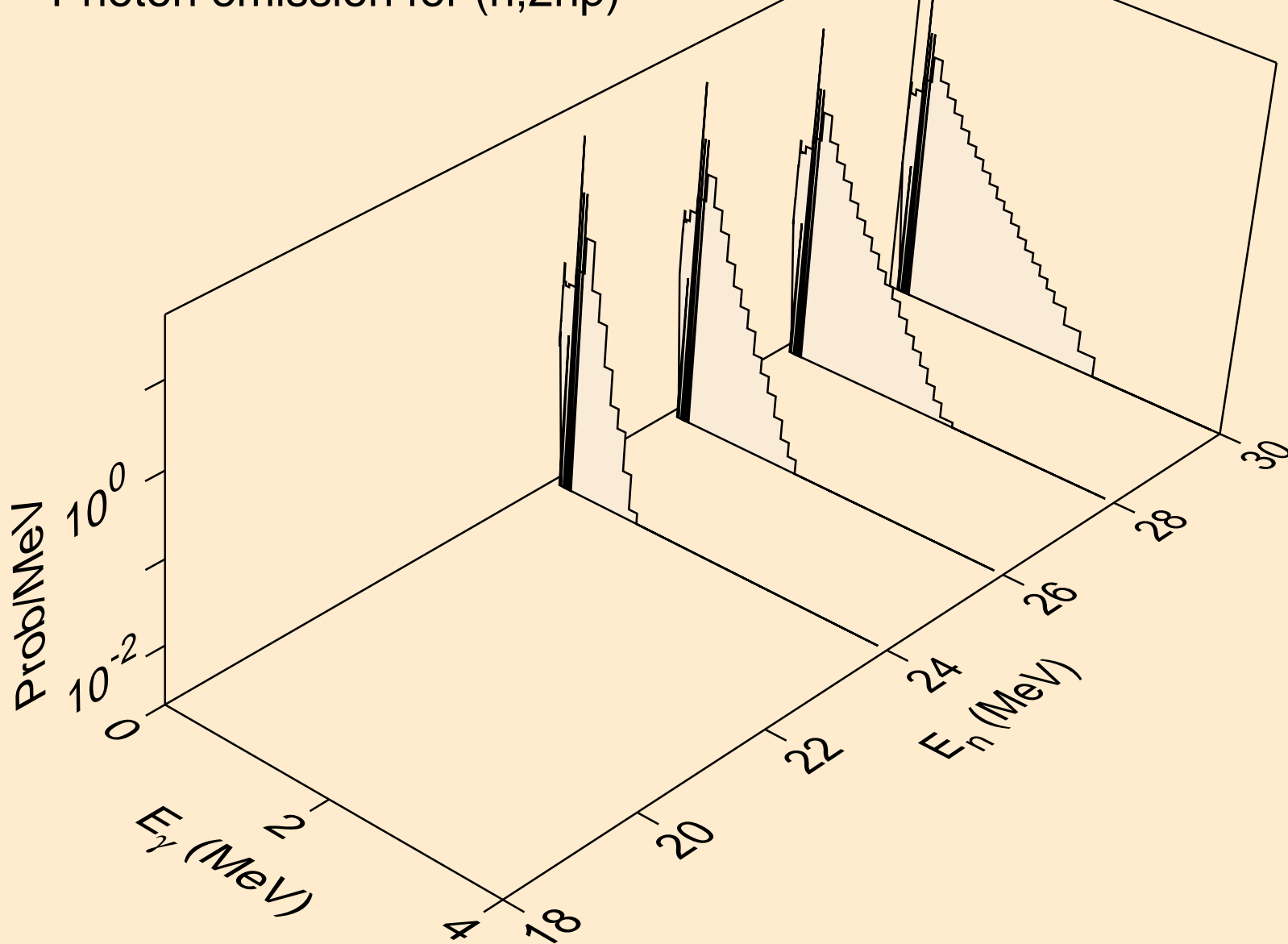

SB124N NEUTRON ACER TENDL-2019 LIBRARY; T=293.16K  
Photon emission for (n,n\*3)

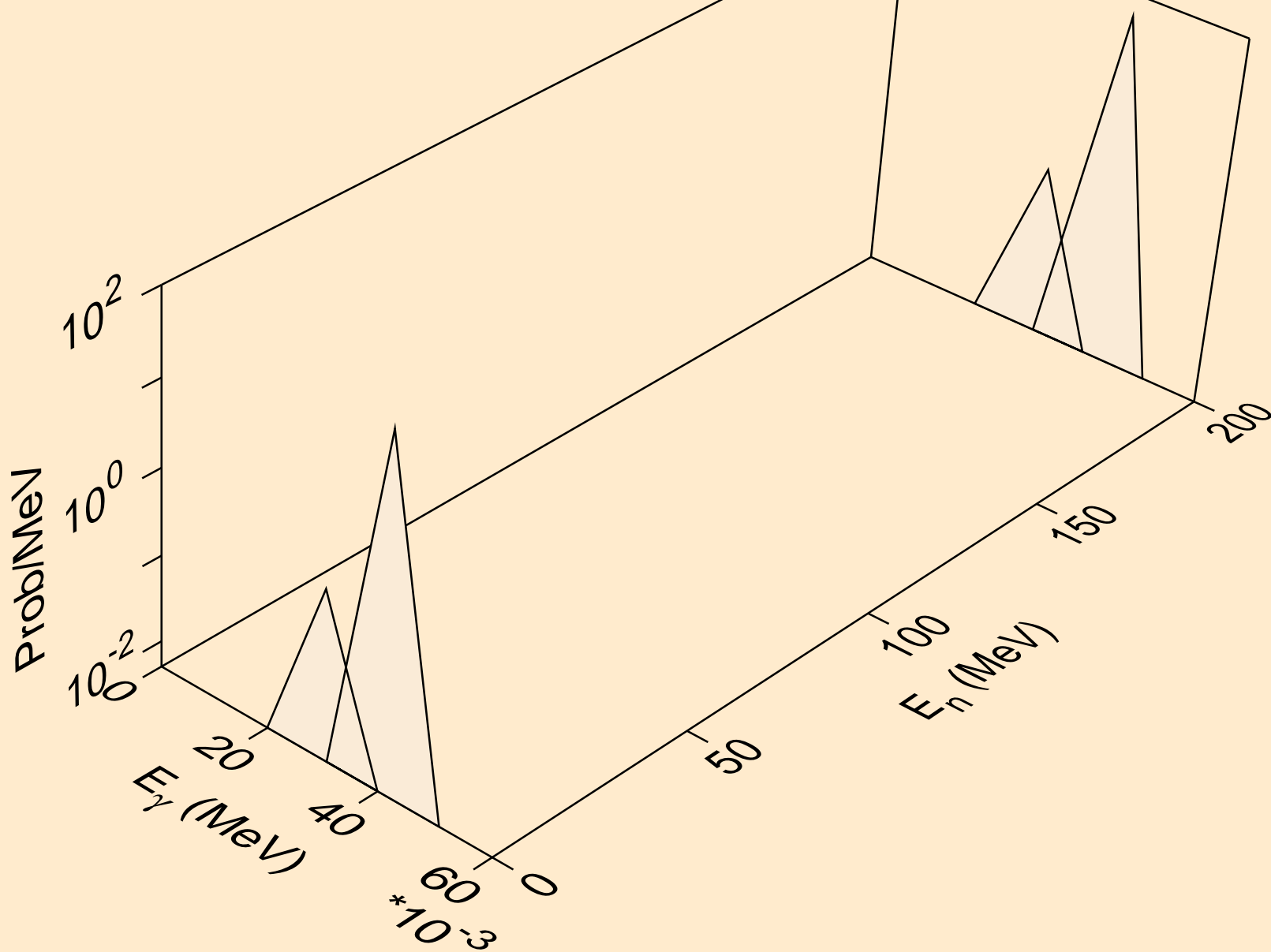



SB124N NEUTRON ACER TENDL-2019 LIBRARY; T=293.16K  
Photon emission for (n,n\*4)

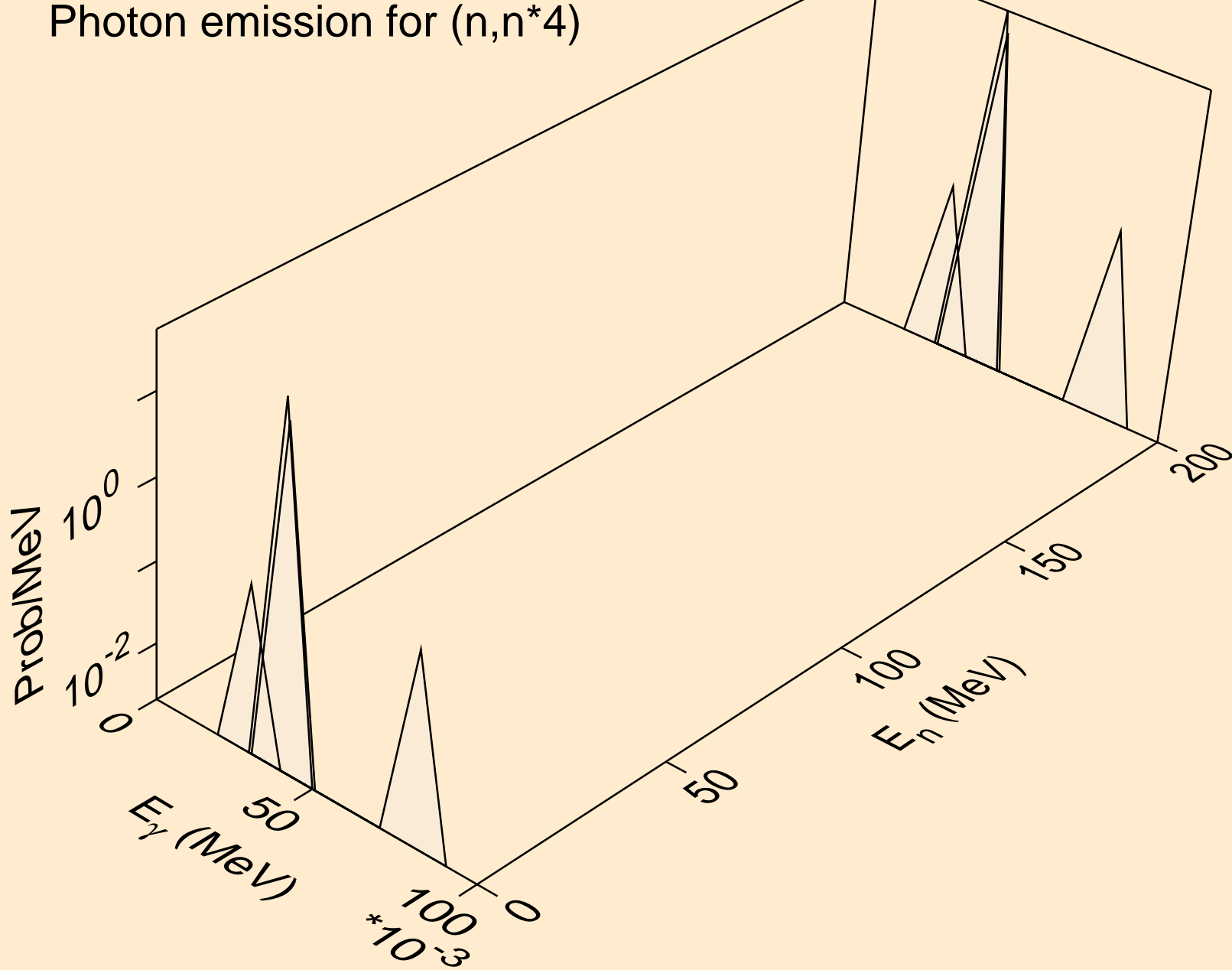

SB124N NEUTRON ACER TENDL-2019 LIBRARY; T=293.16K  
Photon emission for (n,n\*5)

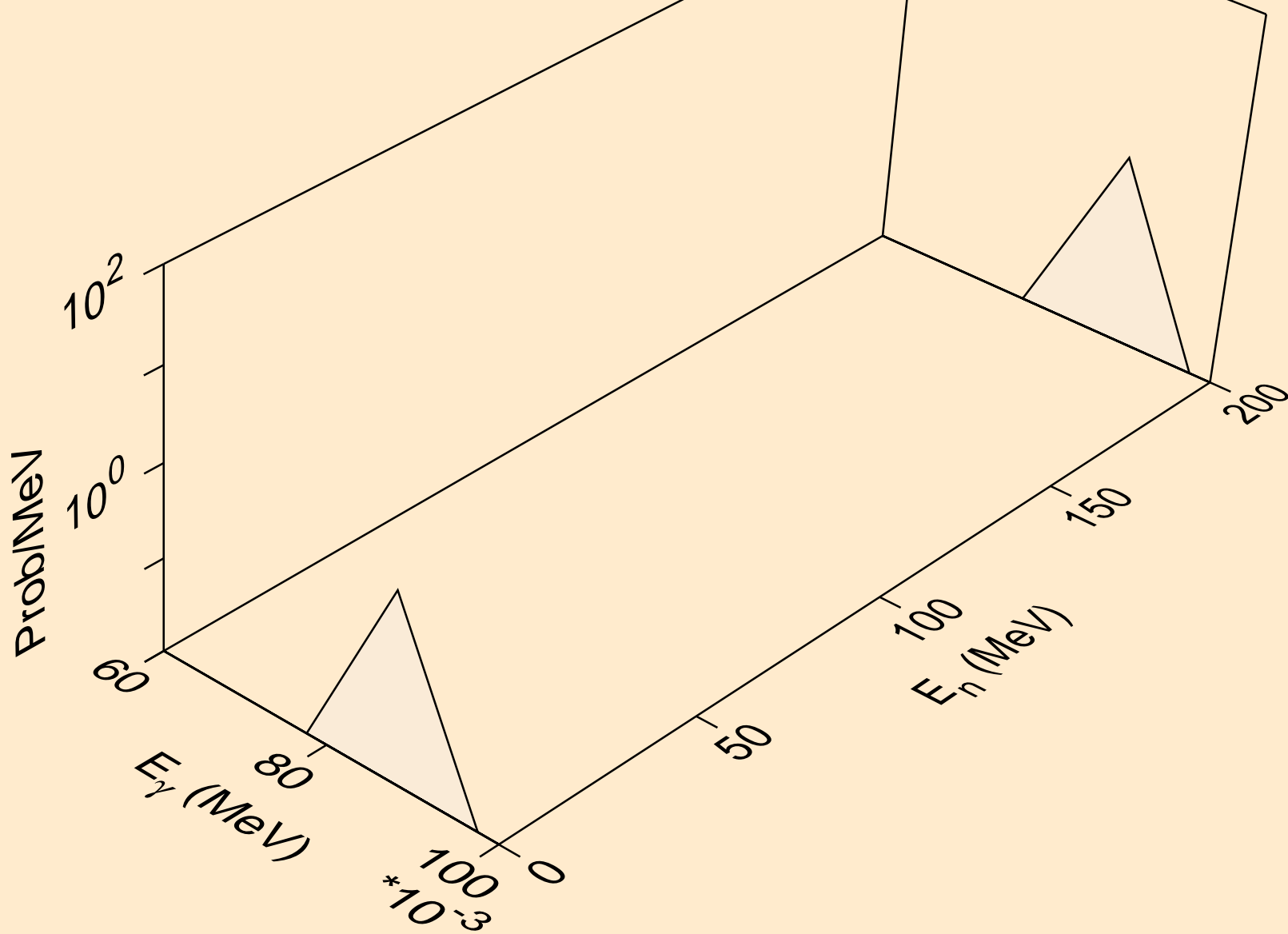

SB124N NEUTRON ACER TENDL-2019 LIBRARY; T=293.16K  
Photon emission for (n,n\*6)

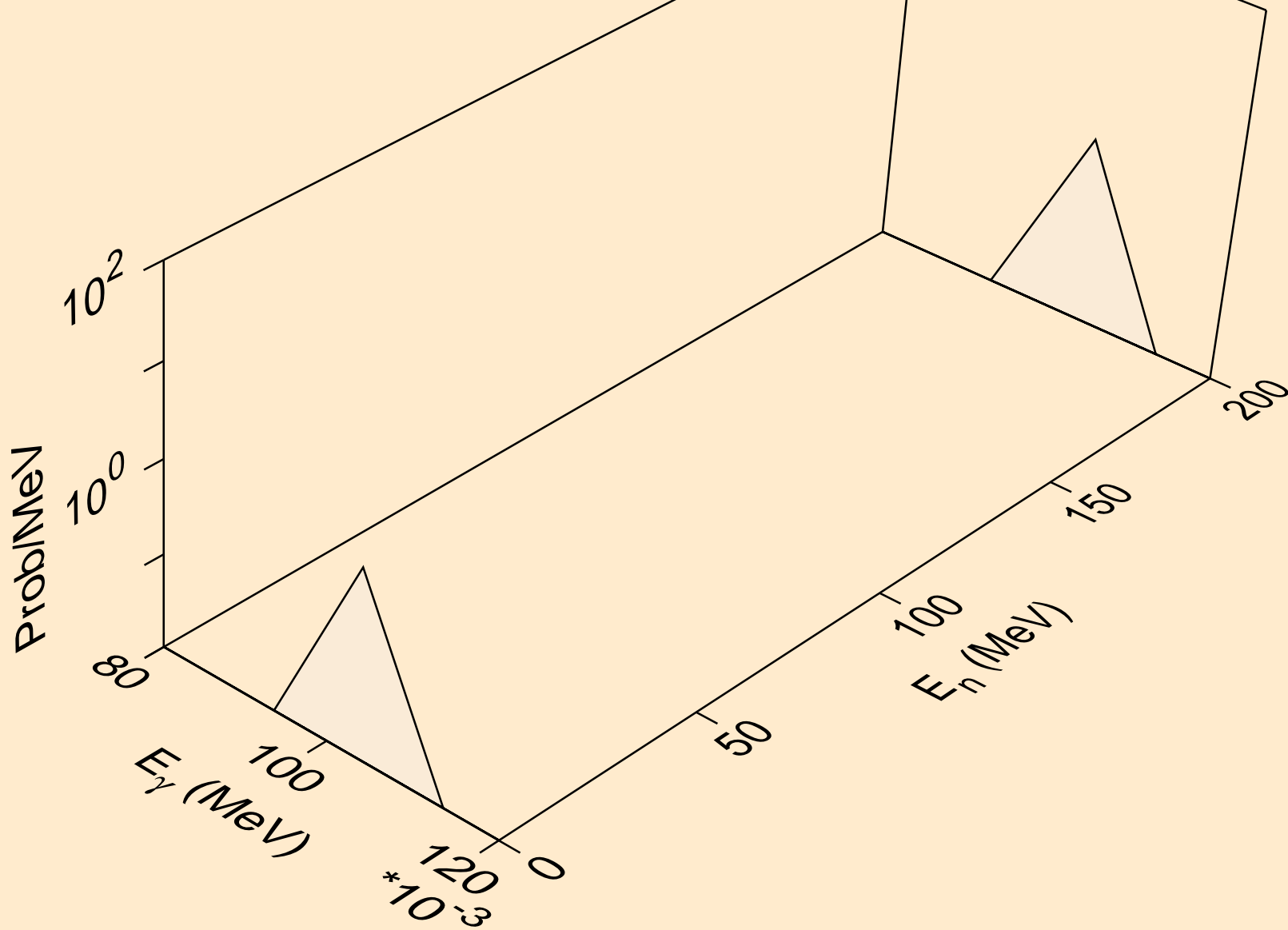

SB124N NEUTRON ACER TENDL-2019 LIBRARY; T=293.16K  
Photon emission for (n,n\*7)

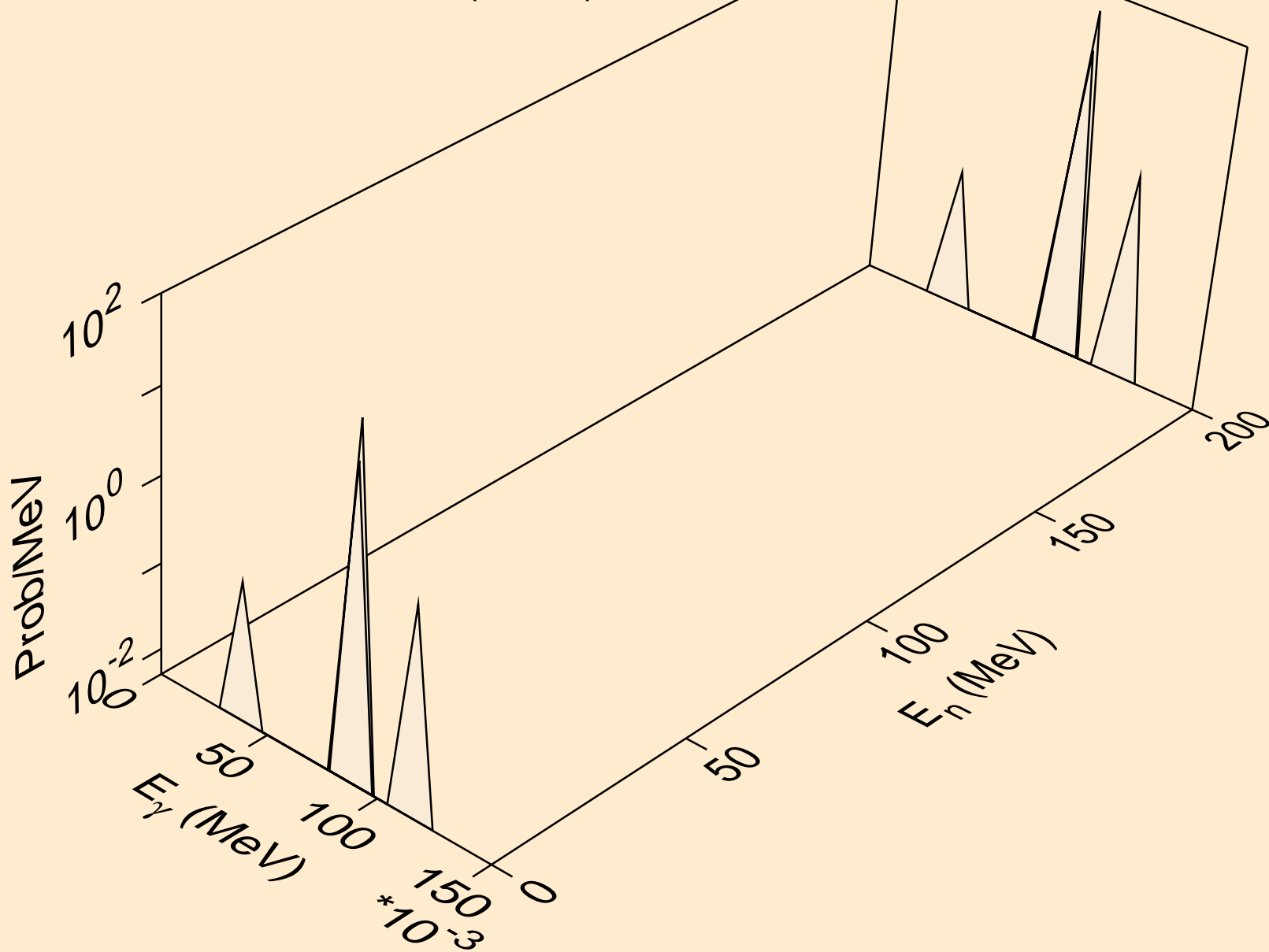

SB124N NEUTRON ACER TENDL-2019 LIBRARY; T=293.16K  
Photon emission for (n,n\*8)

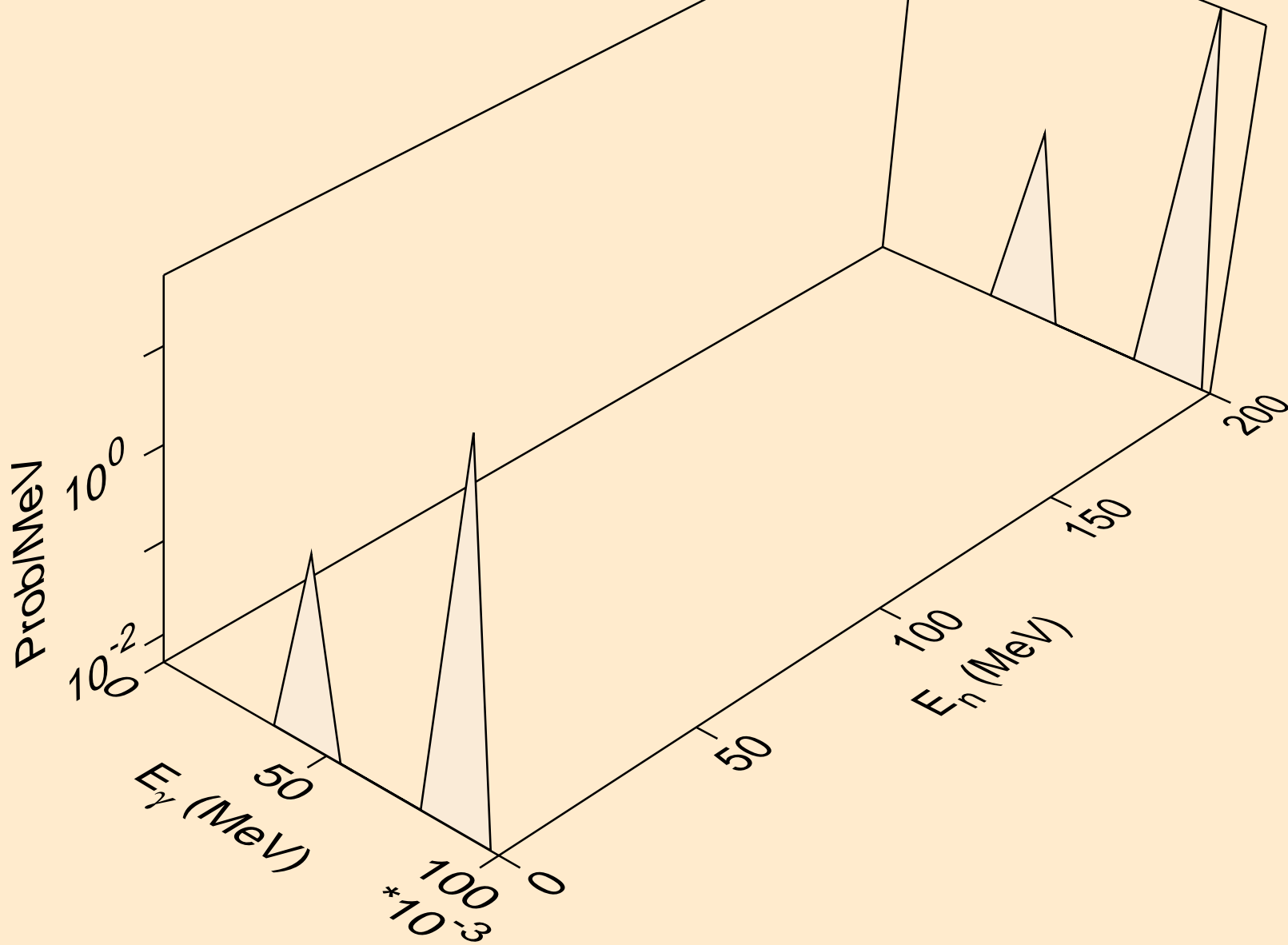

SB124N NEUTRON ACER TENDL-2019 LIBRARY; T=293.16K  
Photon emission for (n,n\*9)

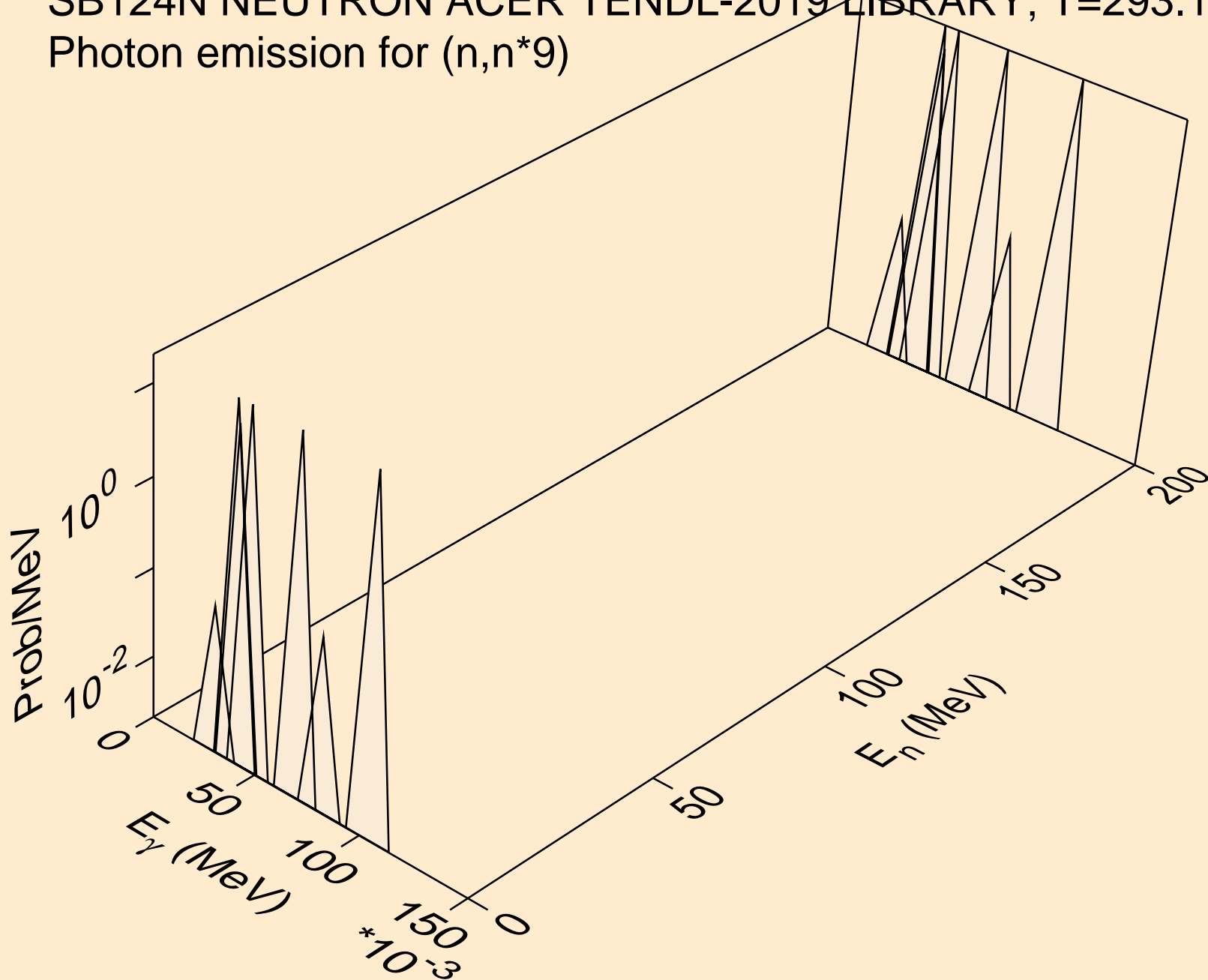

SB124N NEUTRON ACER TENDL-2019 LIBRARY; T=293.16K  
Photon emission for (n,n\*10)

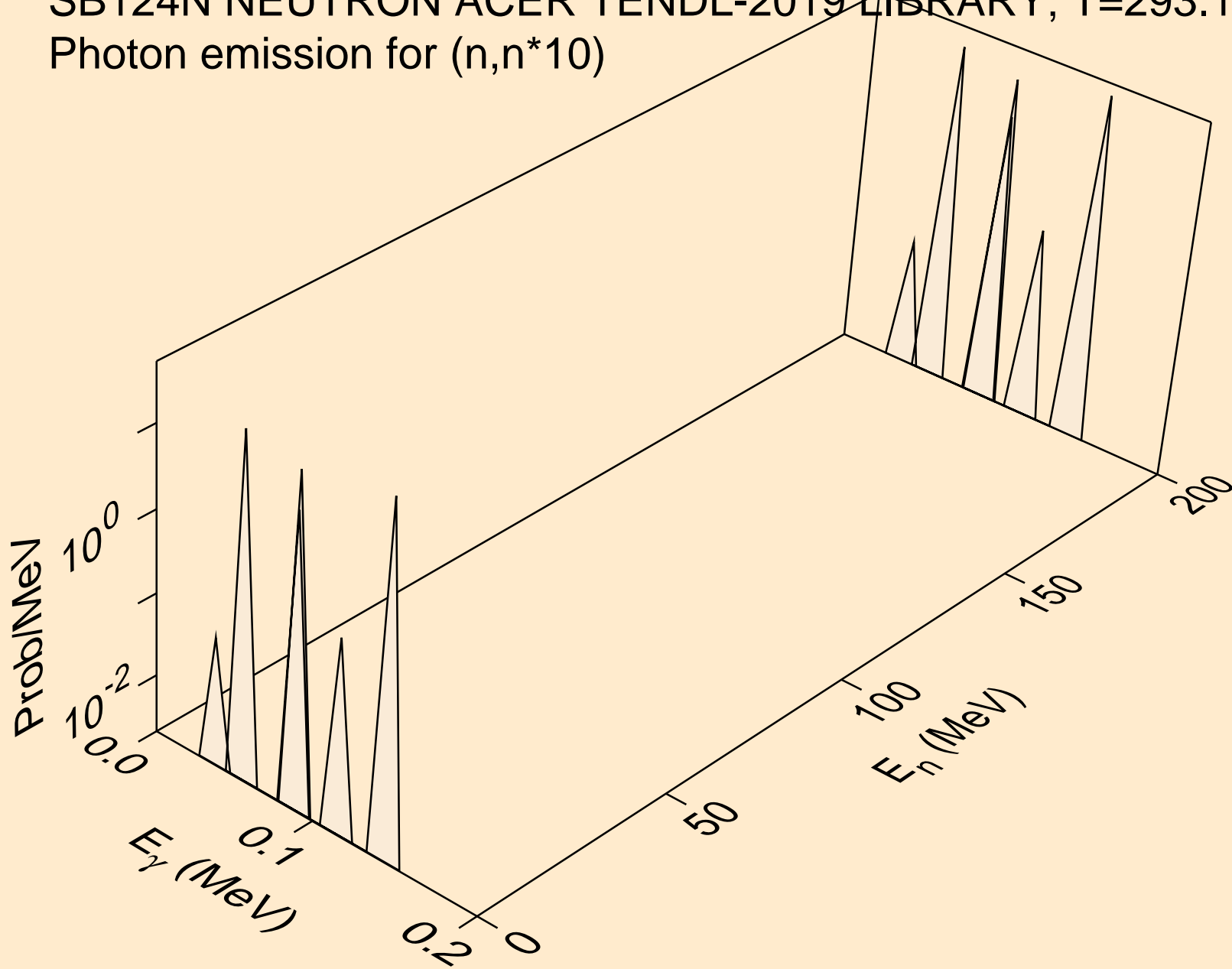

SB124N NEUTRON ACER TENDL-2019 LIBRARY; T=293.16K  
Photon emission for (n,n\*11)

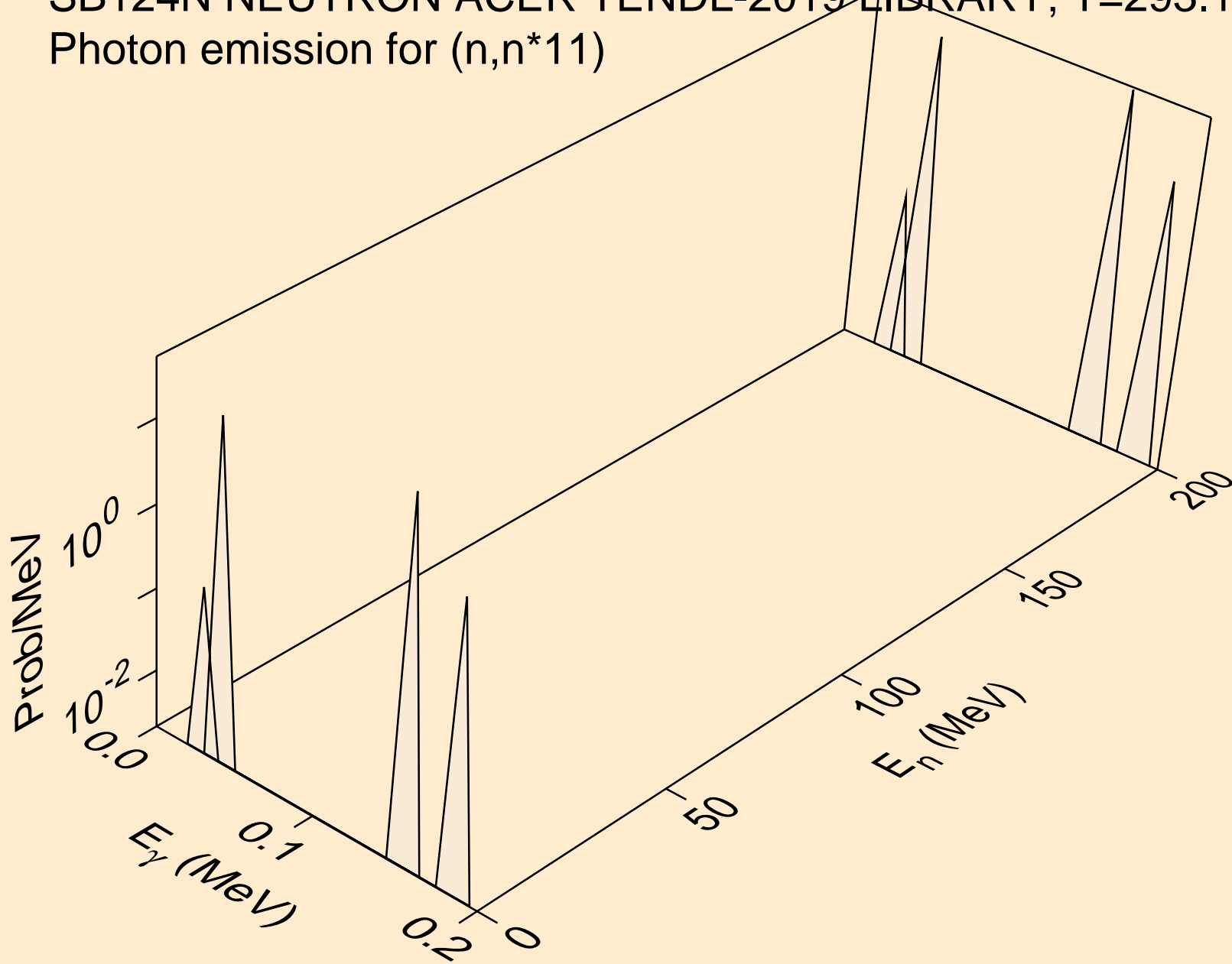



SB124N NEUTRON ACER TENDL-2019 LIBRARY; T=293.16K  
Photon emission for (n,n\*12)

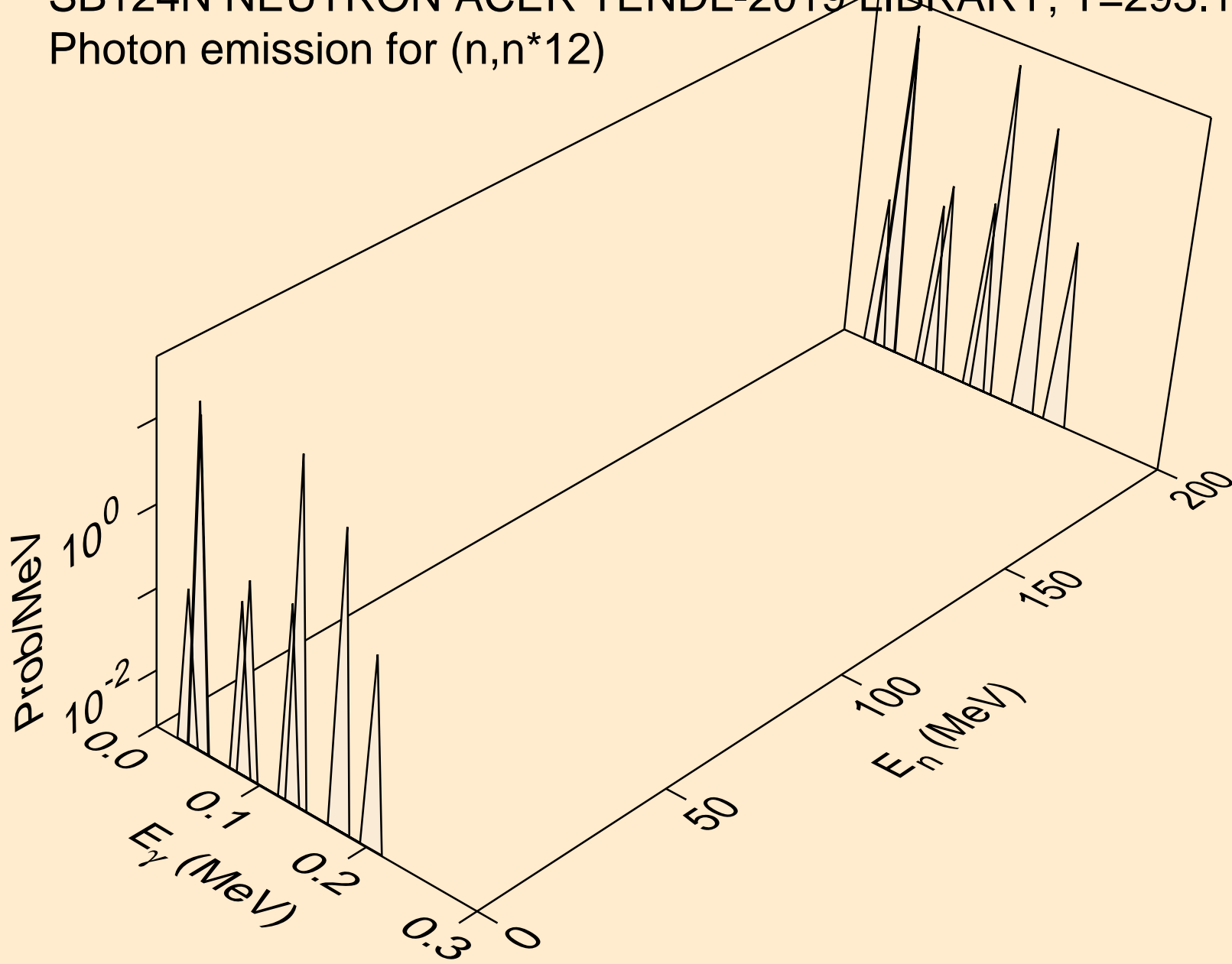

SB124N NEUTRON ACER TENDL-2019 LIBRARY; T=293.16K  
Photon emission for (n,n\*13)

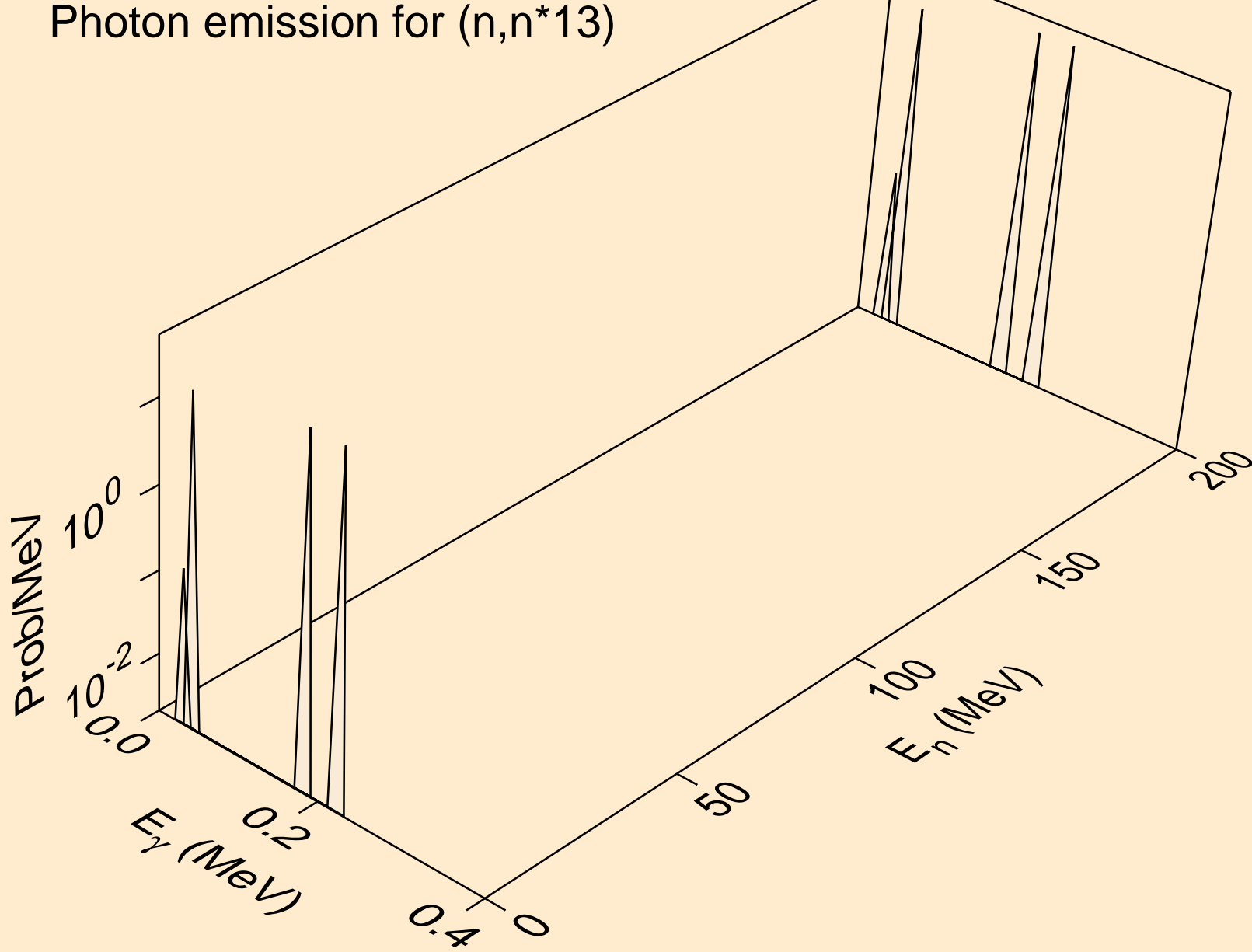

SB124N NEUTRON ACER TENDL-2019 LIBRARY; T=293.16K  
Photon emission for (n,n\*14)

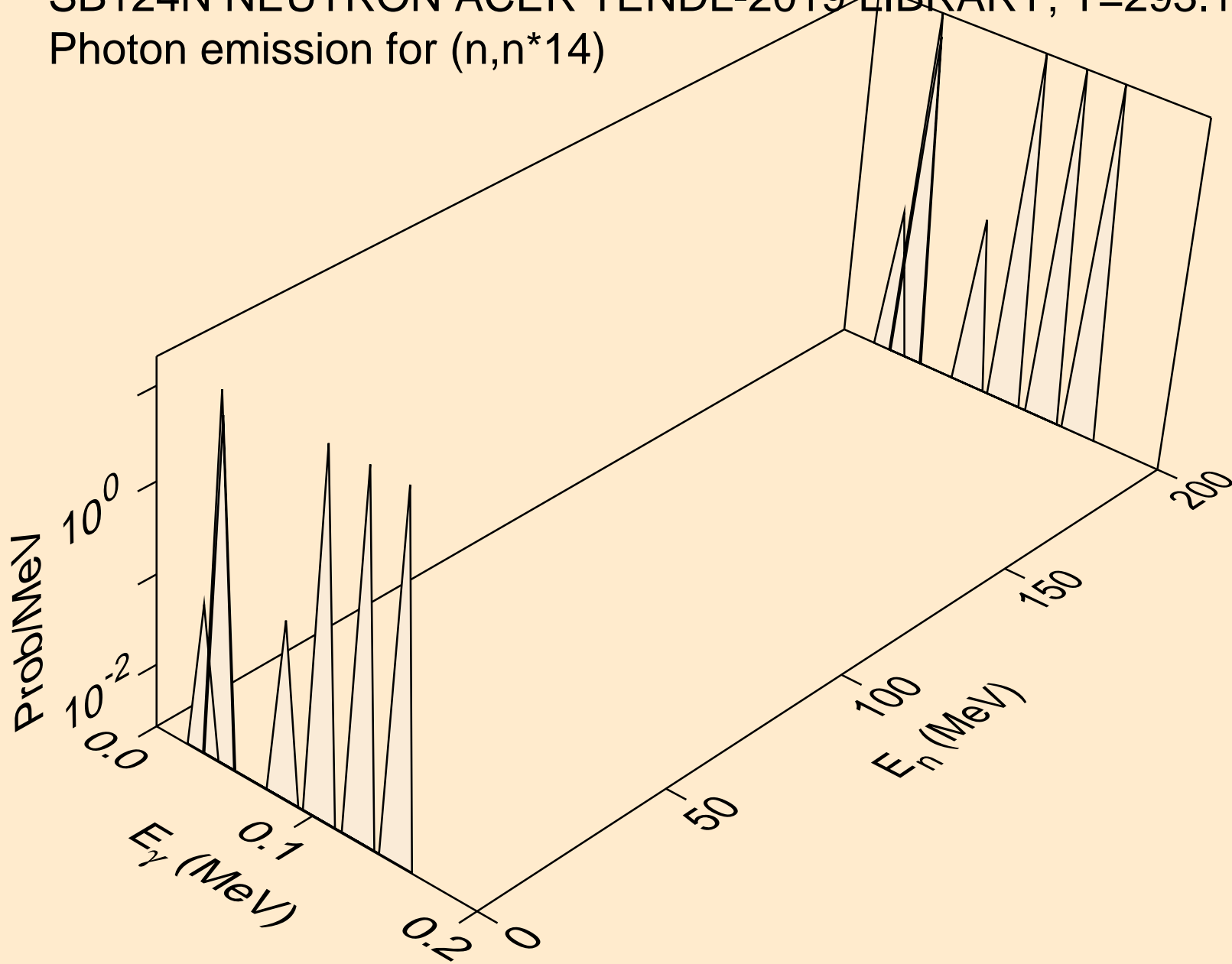

SB124N NEUTRON ACER TENDL-2019 LIBRARY; T=293.16K  
Photon emission for (n,n\*15)

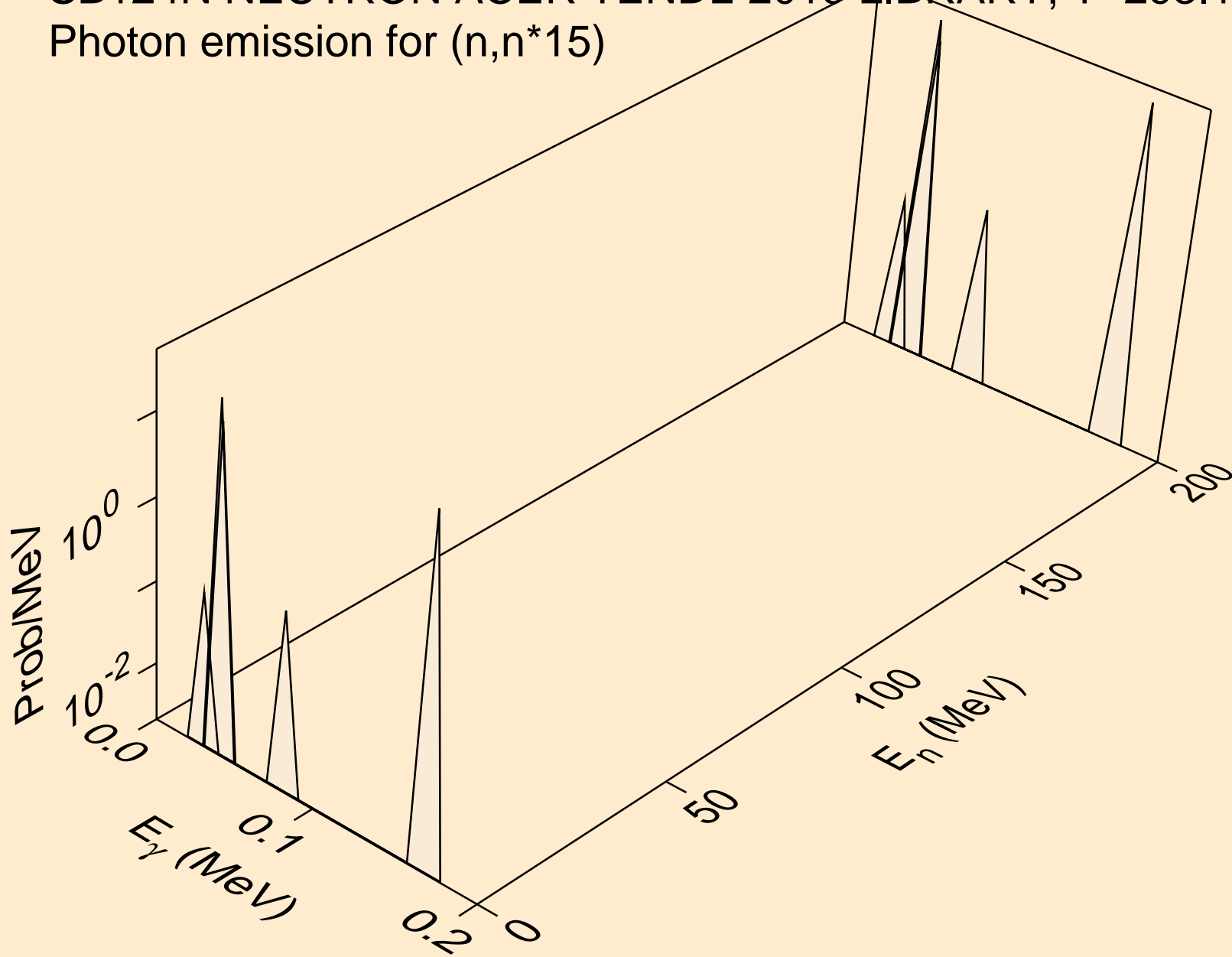

SB124N NEUTRON ACER TENDL-2019 LIBRARY; T=293.16K  
Photon emission for (n,n\*16)

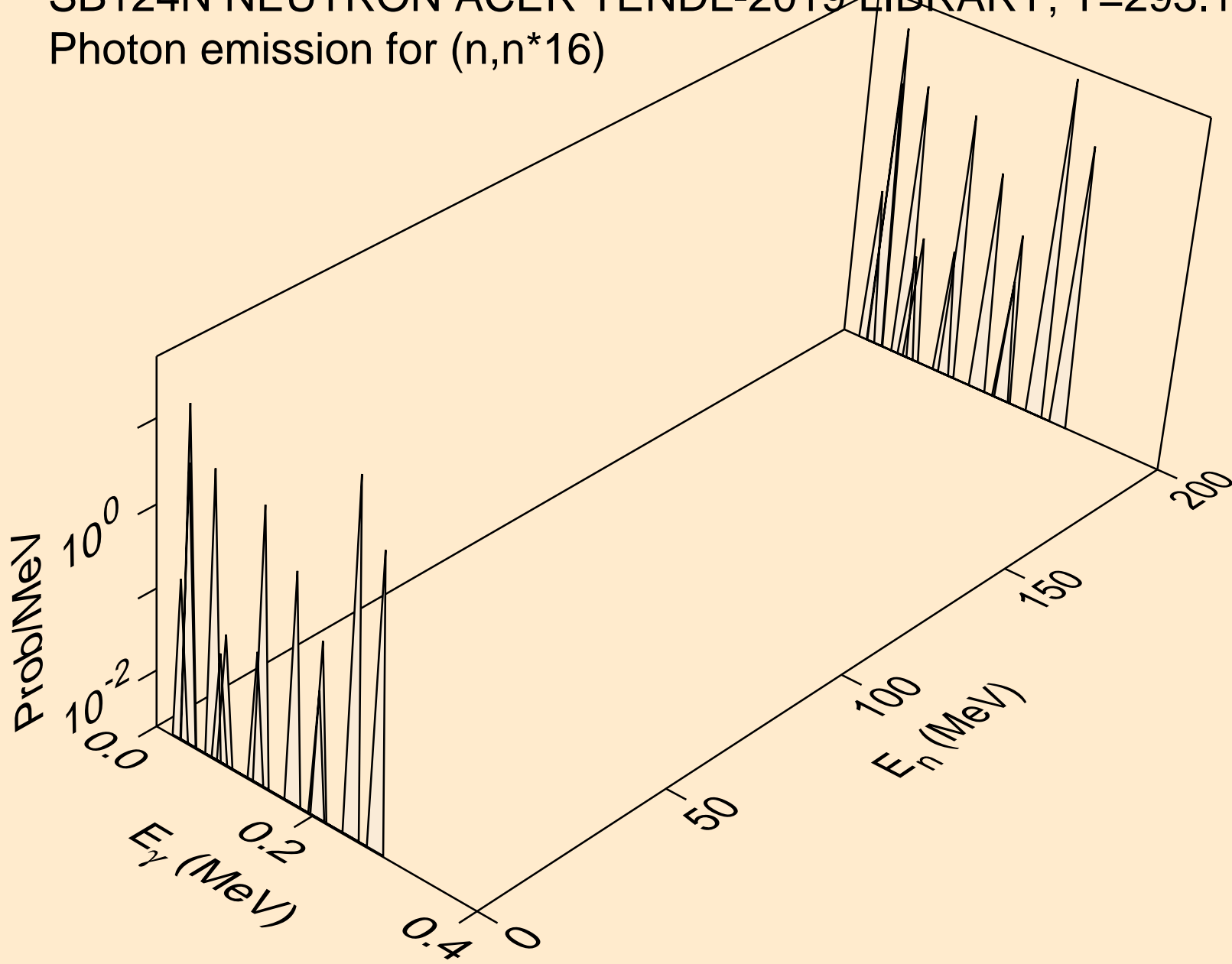

SB124N NEUTRON ACER TENDL-2019 LIBRARY; T=293.16K  
Photon emission for (n,n\*17)

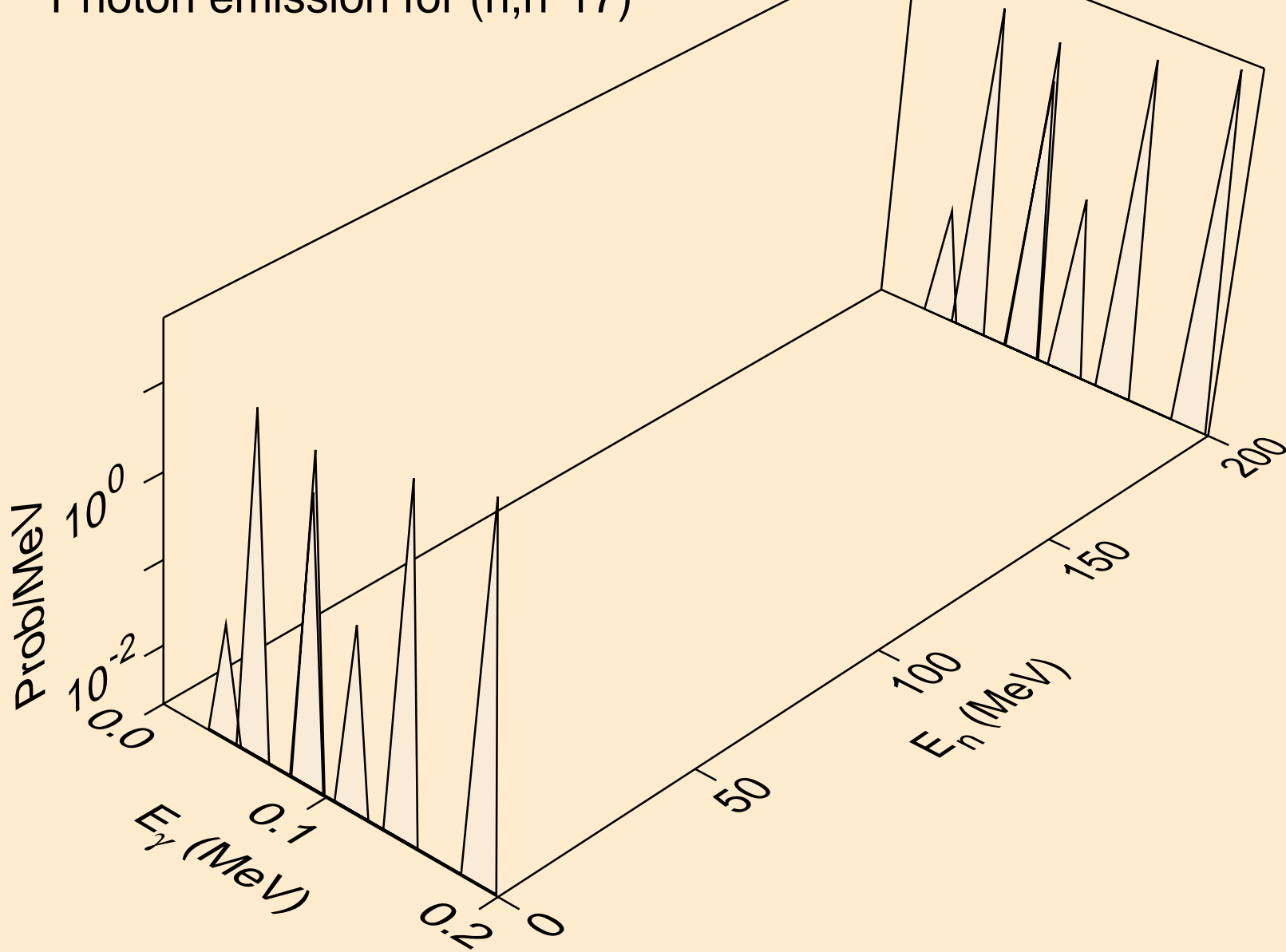

SB124N NEUTRON ACER TENDL-2019 LIBRARY; T=293.16K  
Photon emission for (n,n\*18)

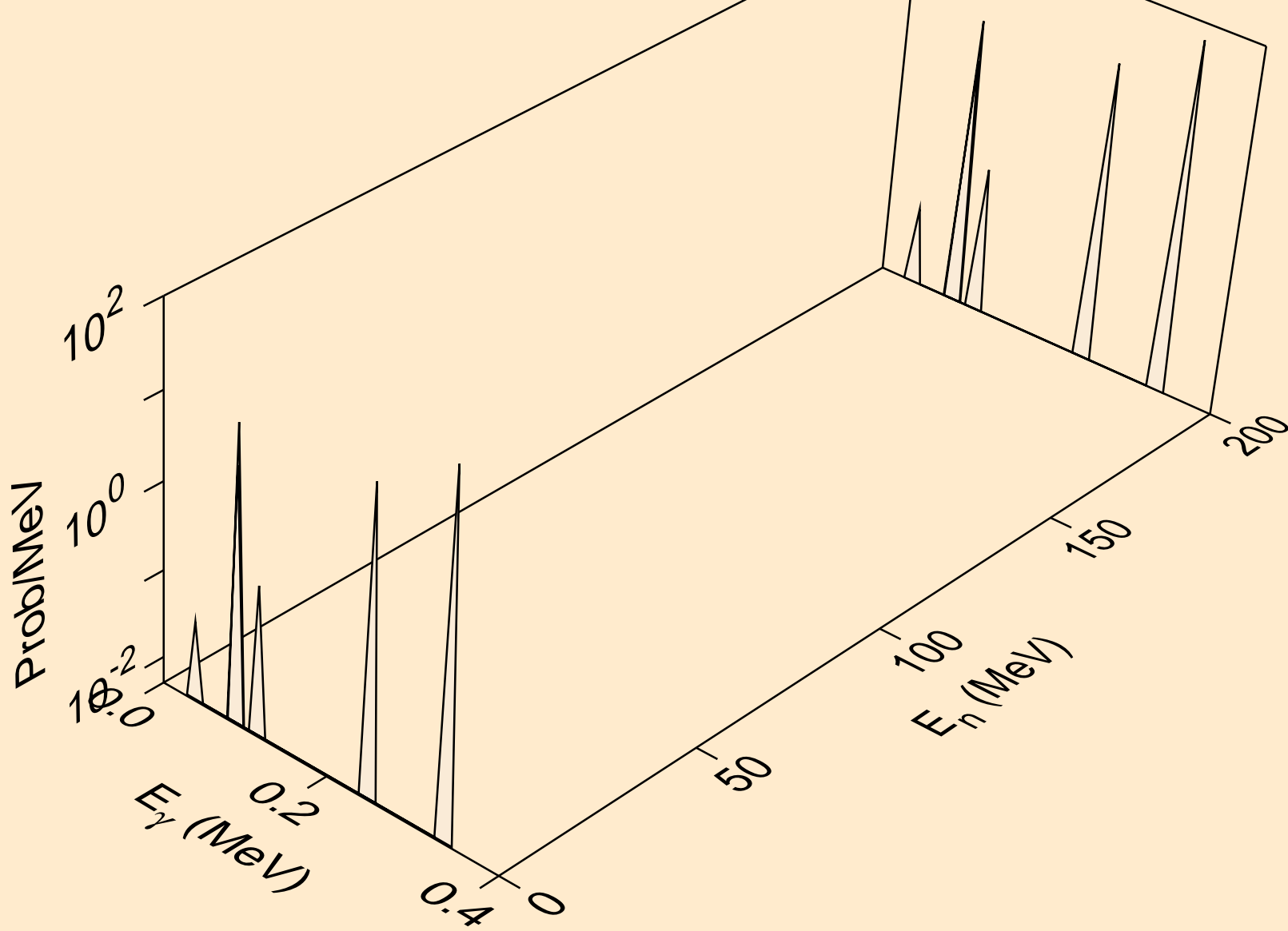

SB124N NEUTRON ACER TENDL-2019 LIBRARY; T=293.16K  
Photon emission for (n,n\*19)

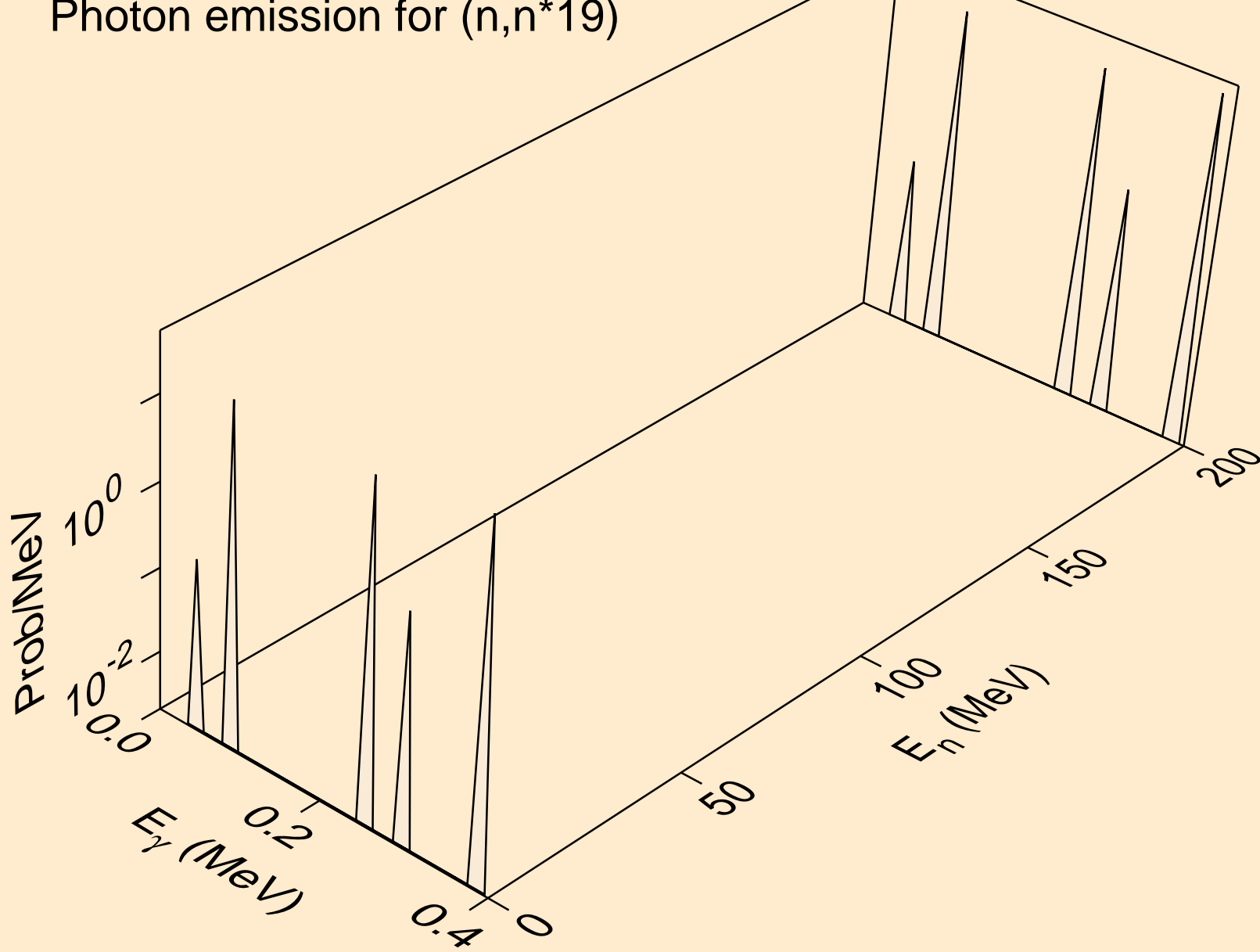



SB124N NEUTRON ACER TENDL-2019 LIBRARY; T=293.16K  
Photon emission for (n,n\*20)

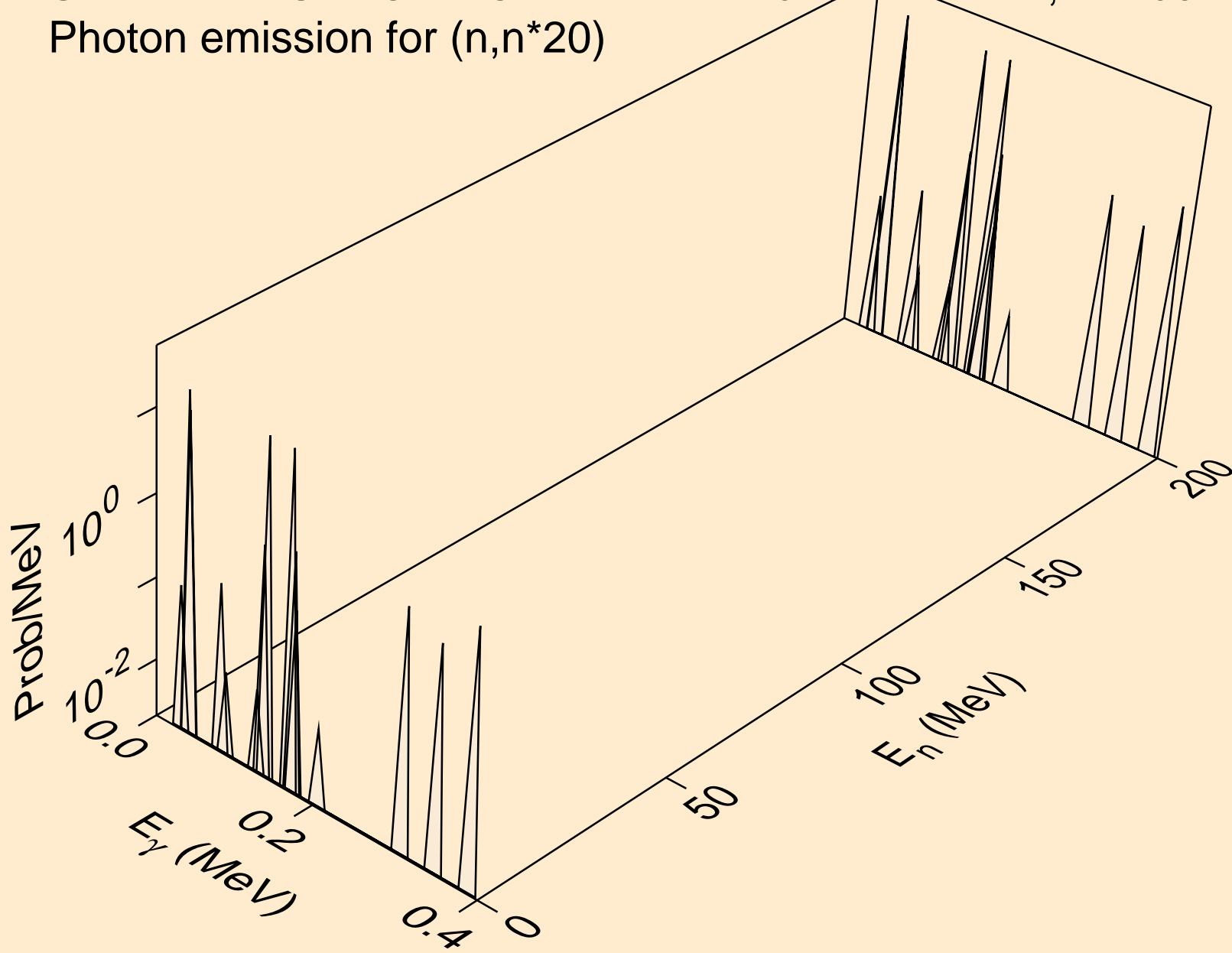

SB124N NEUTRON ACER TENDL-2019 LIBRARY; T=293.16K  
Photon emission for (n,n\*21)

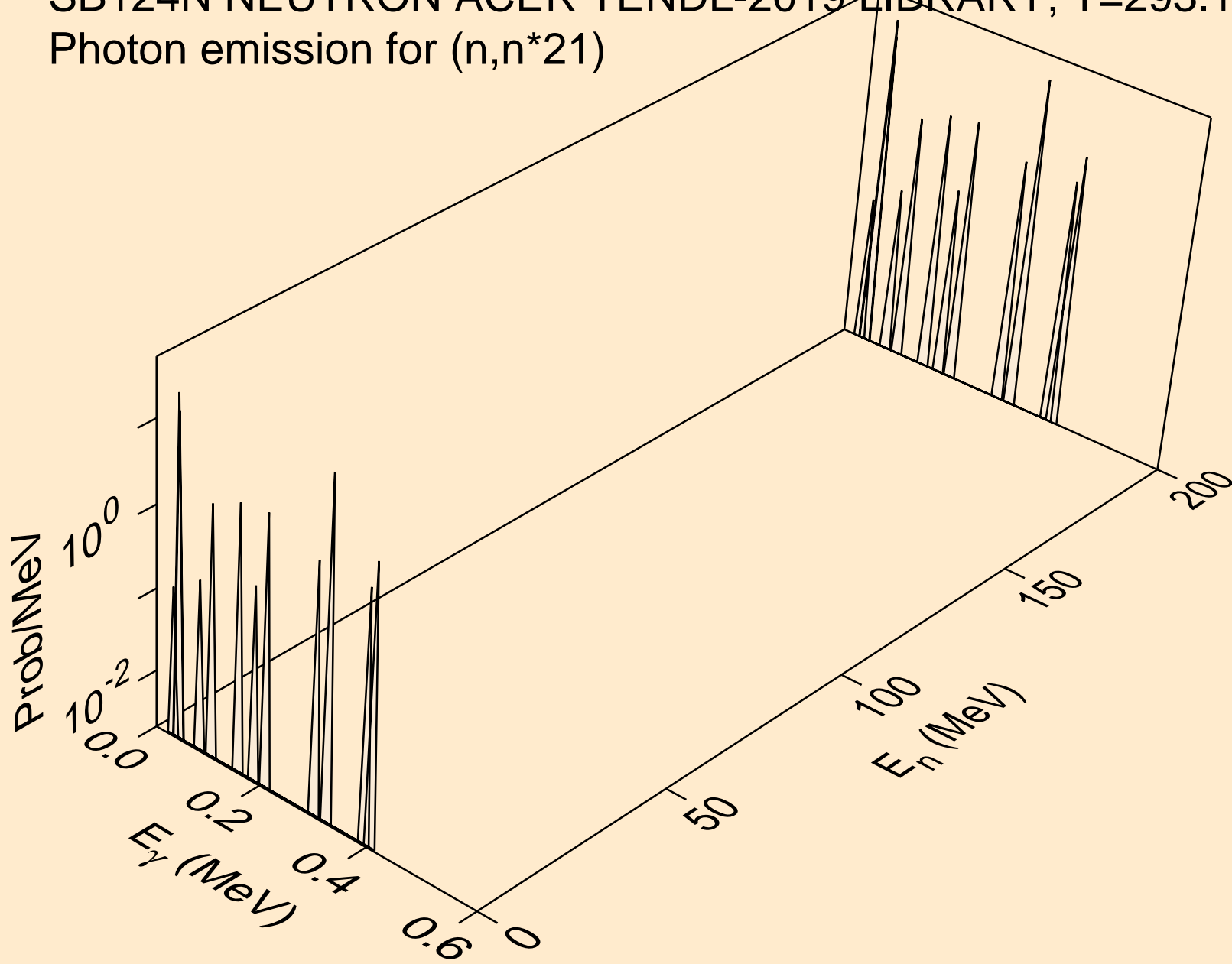

SB124N NEUTRON ACER TENDL-2019 LIBRARY; T=293.16K  
Photon emission for (n,n\*22)

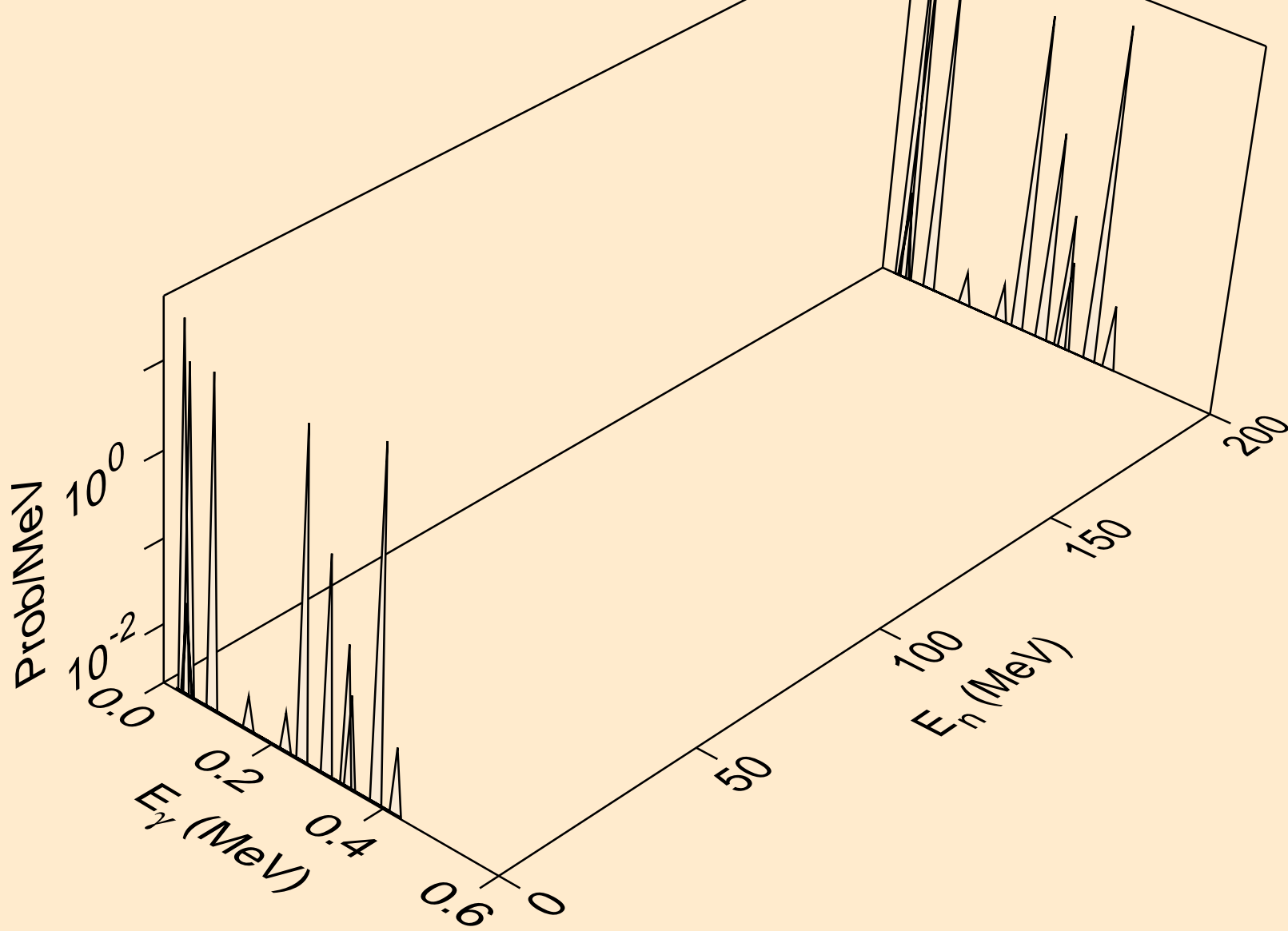

SB124N NEUTRON ACER TENDL-2019 LIBRARY; T=293.16K  
Photon emission for (n,n\*23)

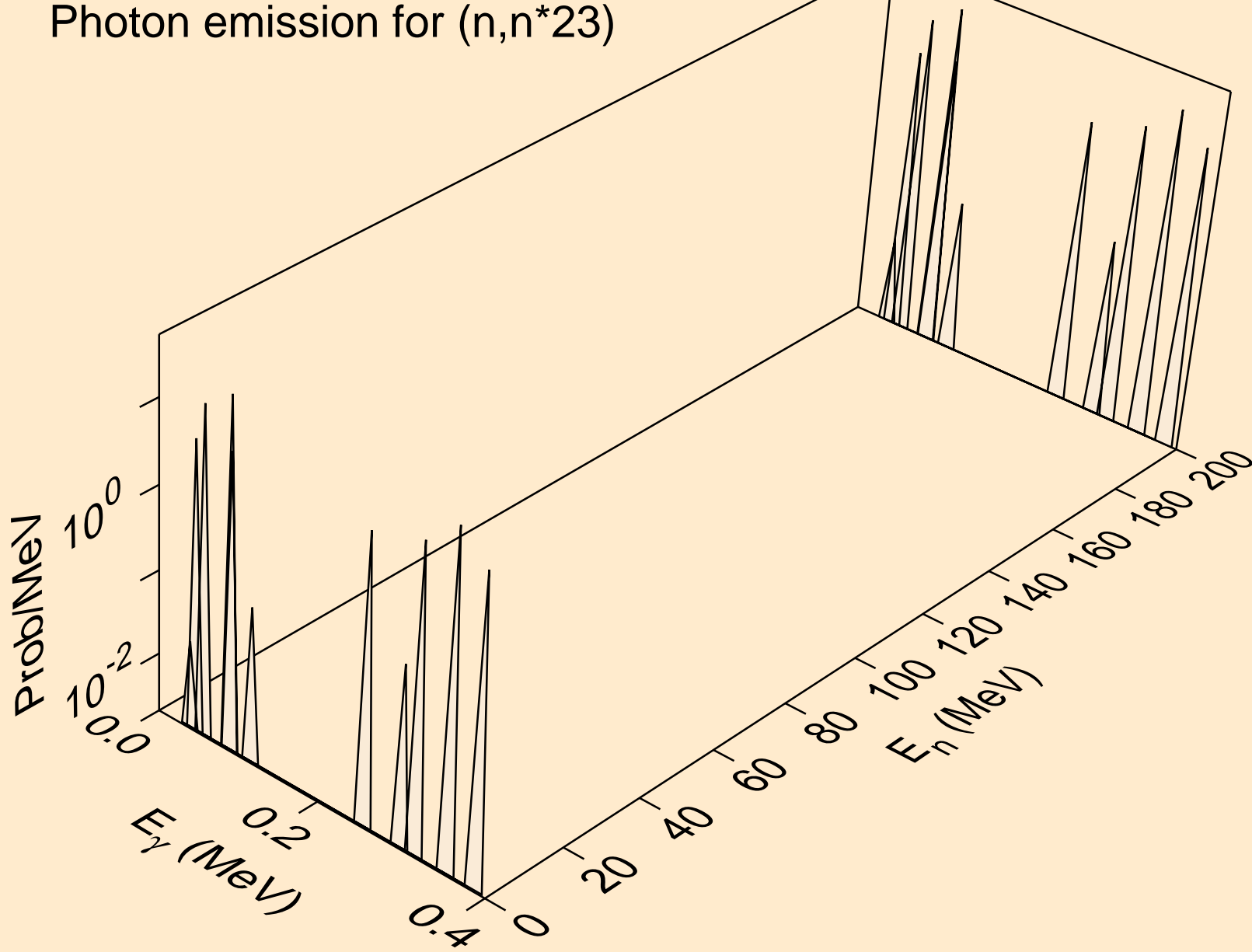

SB124N NEUTRON ACER TENDL-2019 LIBRARY; T=293.16K  
Photon emission for (n,n\*24)

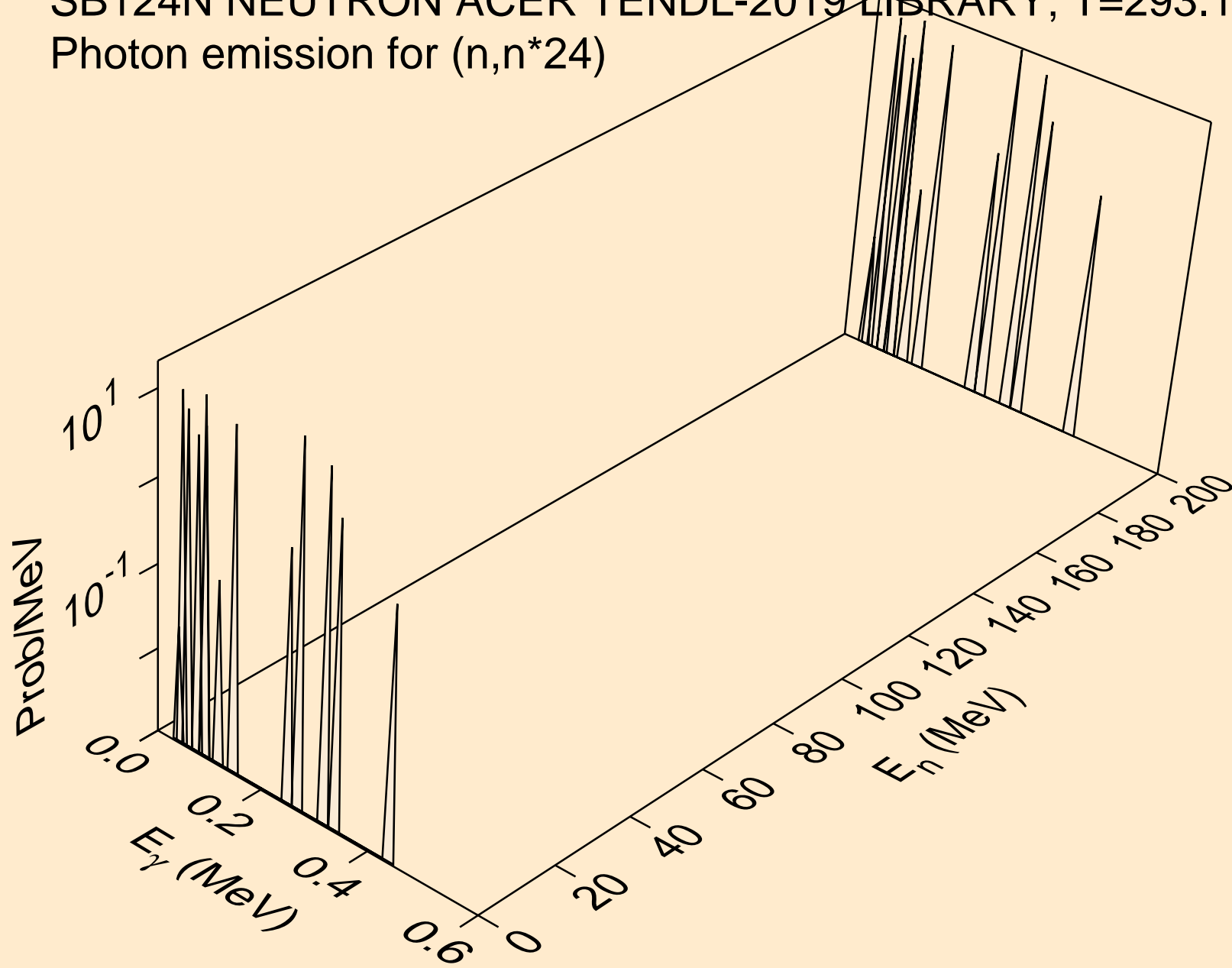

SB124N NEUTRON ACER TENDL-2019 LIBRARY; T=293.16K  
Photon emission for (n,n\*25)

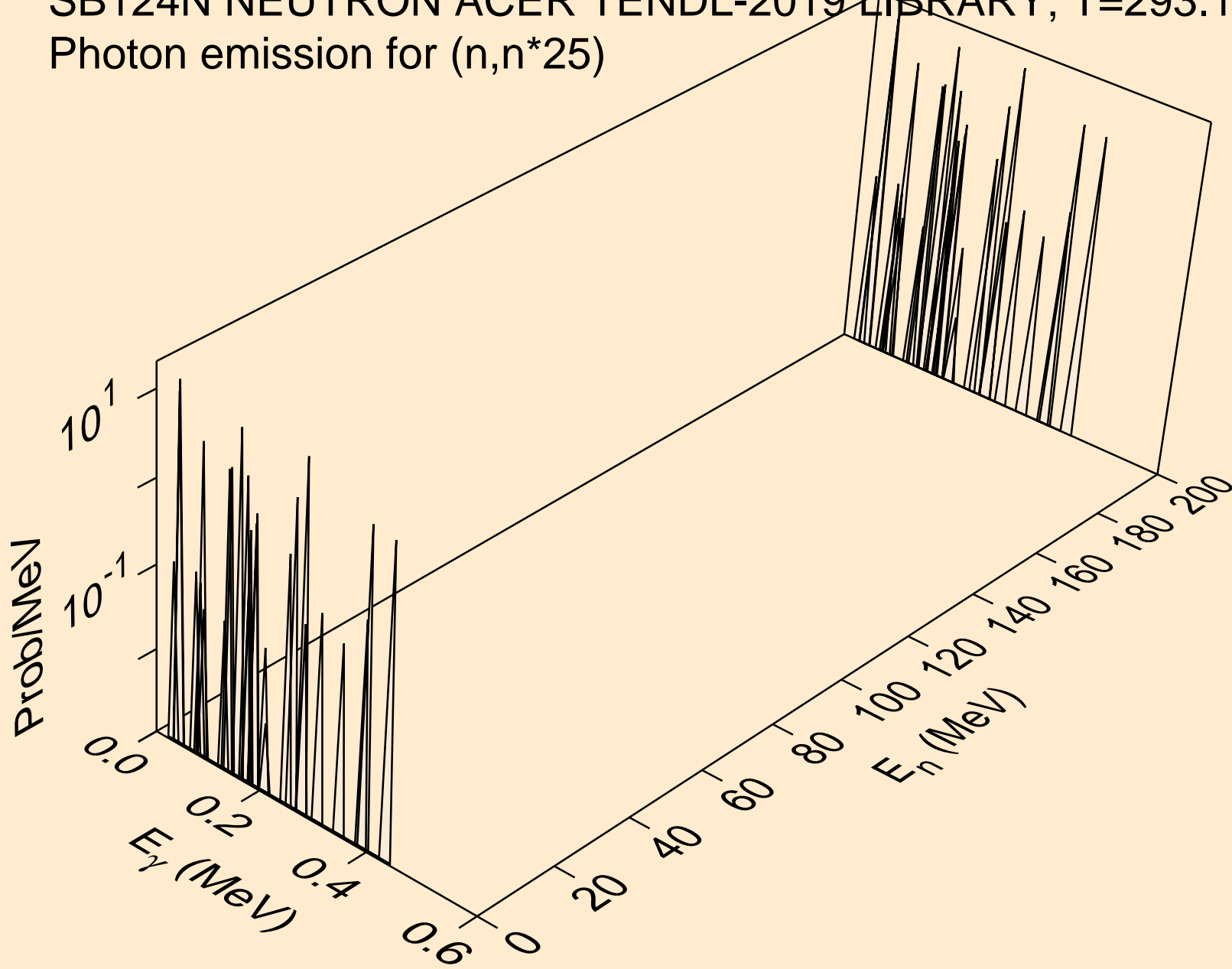

SB124N NEUTRON ACER TENDL-2019 LIBRARY; T=293.16K  
Photon emission for (n,n\*26)

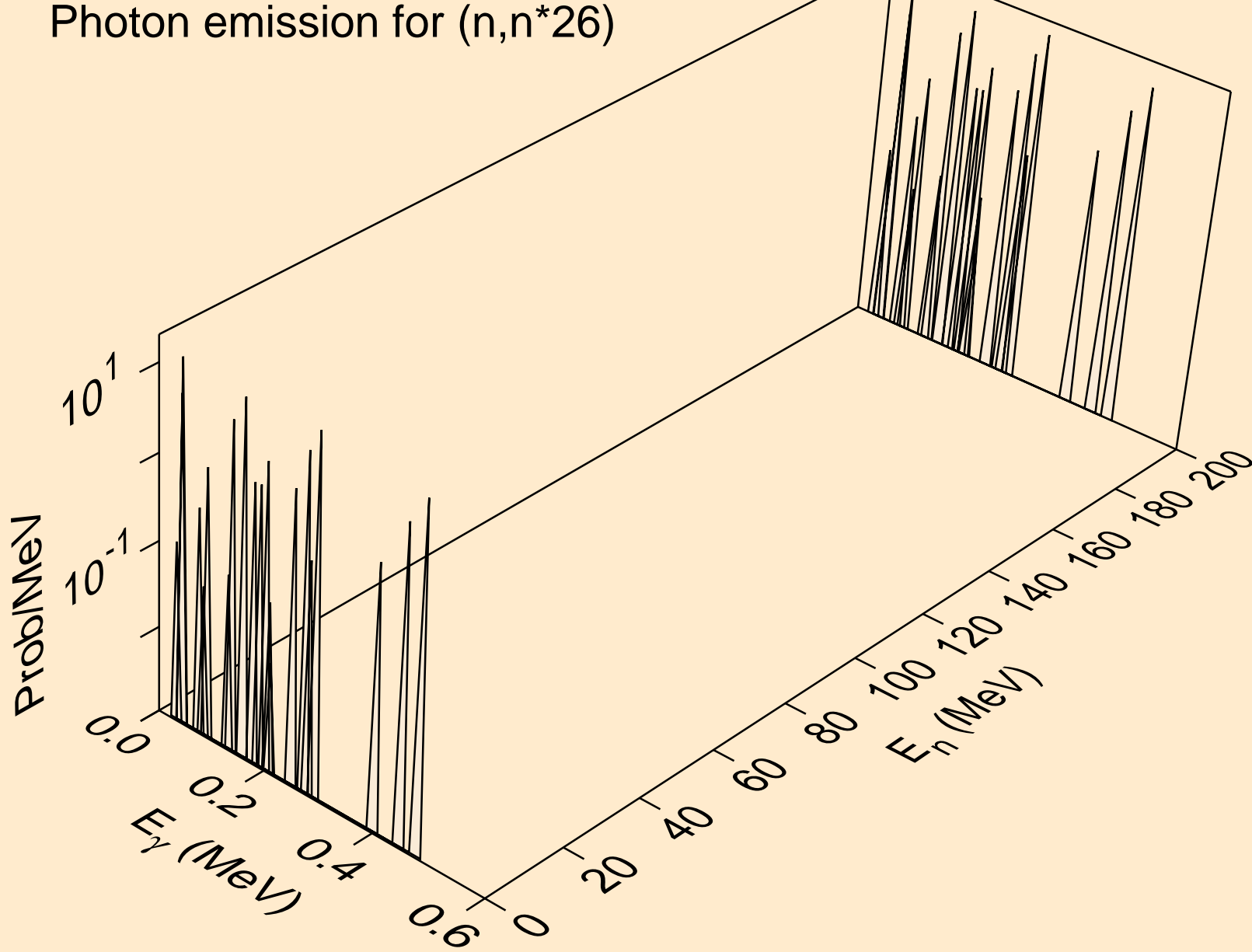

SB124N NEUTRON ACER TENDL-2019 LIBRARY; T=293.16K  
Photon emission for (n,n\*c)

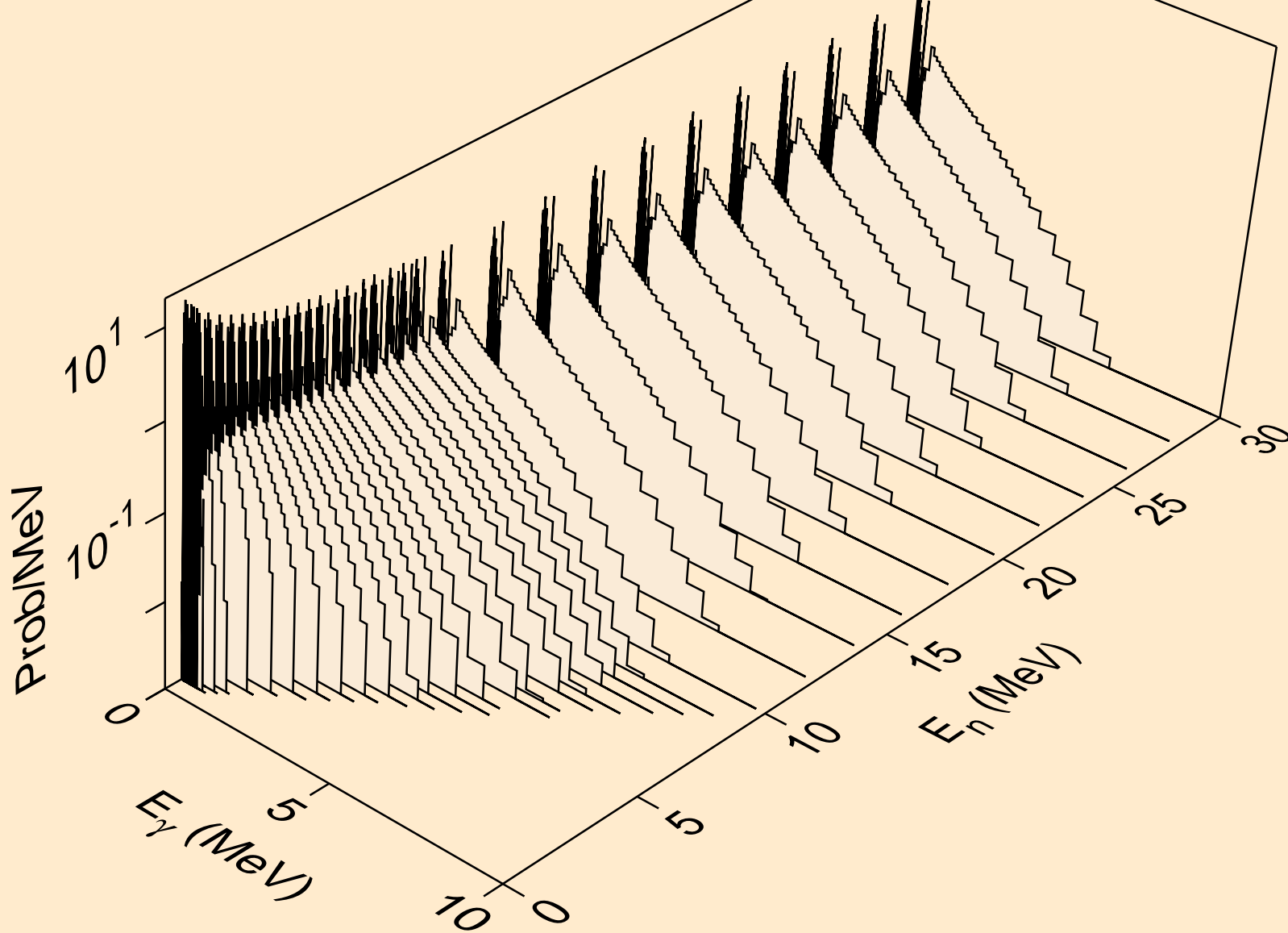



SB124N NEUTRON ACER TENDL-2019 LIBRARY; T=293.16K  
Photon emission for (n,gma)

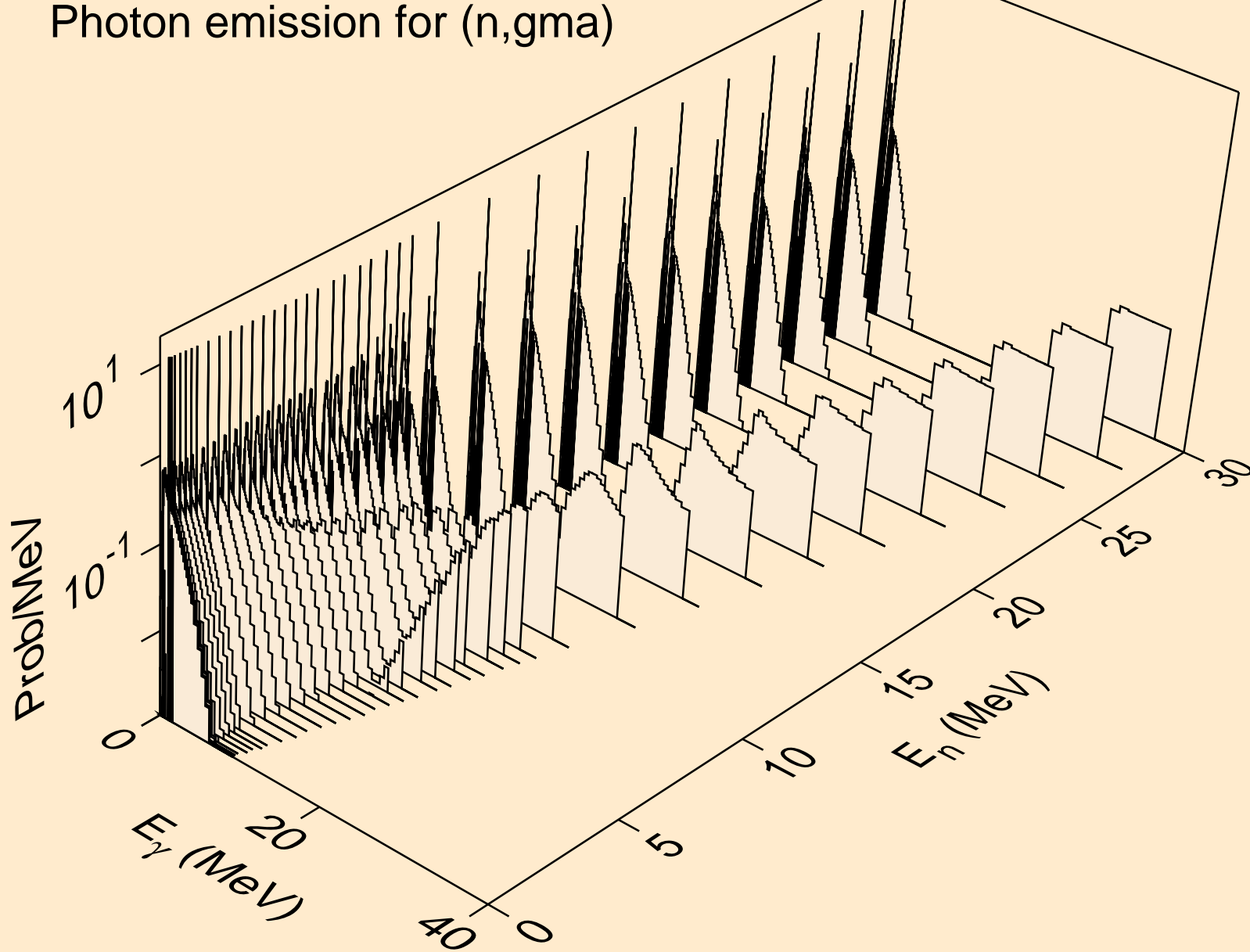

SB124N NEUTRON ACER TENDL-2019 LIBRARY; T=293.16K  
Photon emission for (n,p)

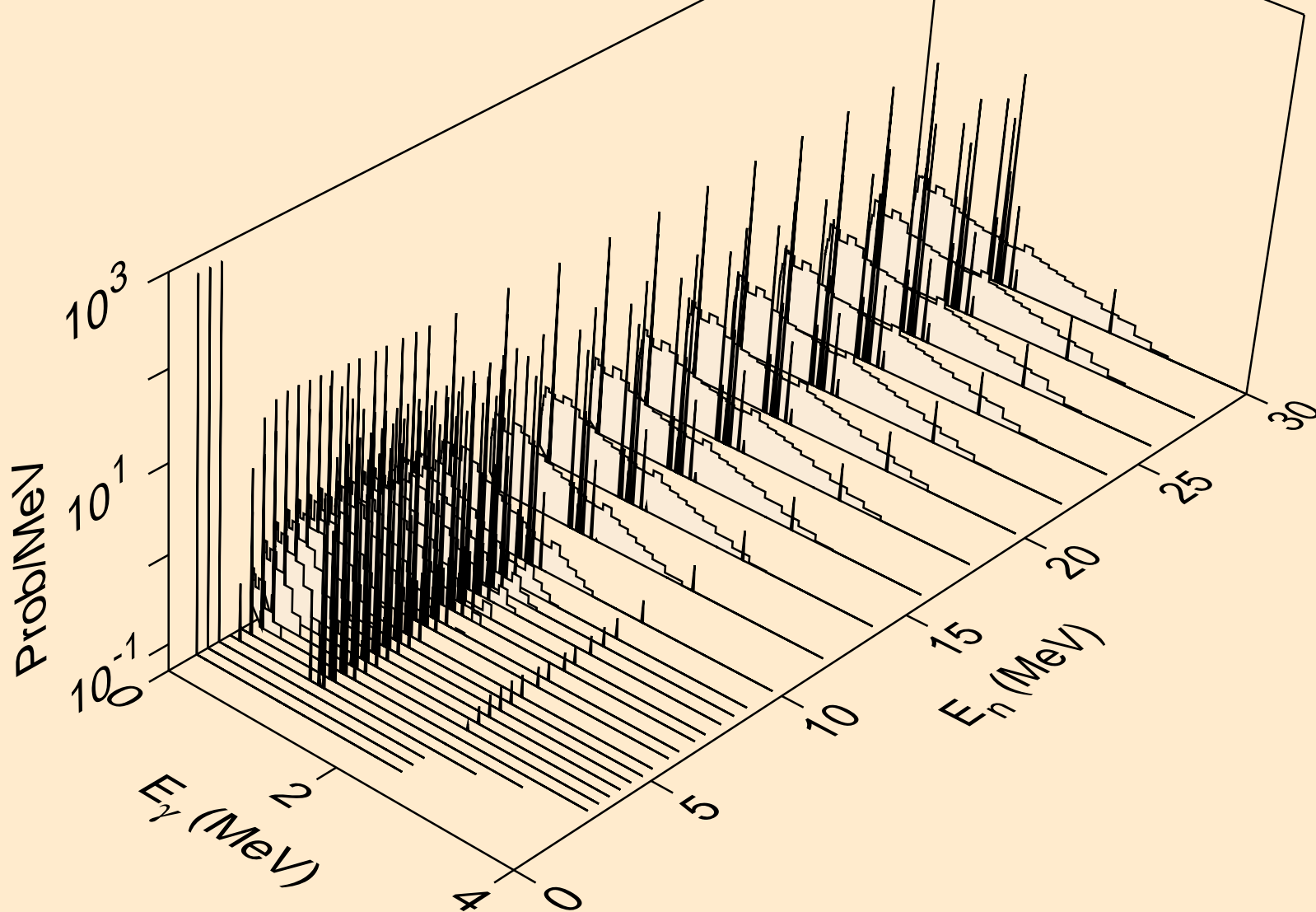

SB124N NEUTRON ACER TENDL-2019 LIBRARY; T=293.16K  
Photon emission for (n,d)

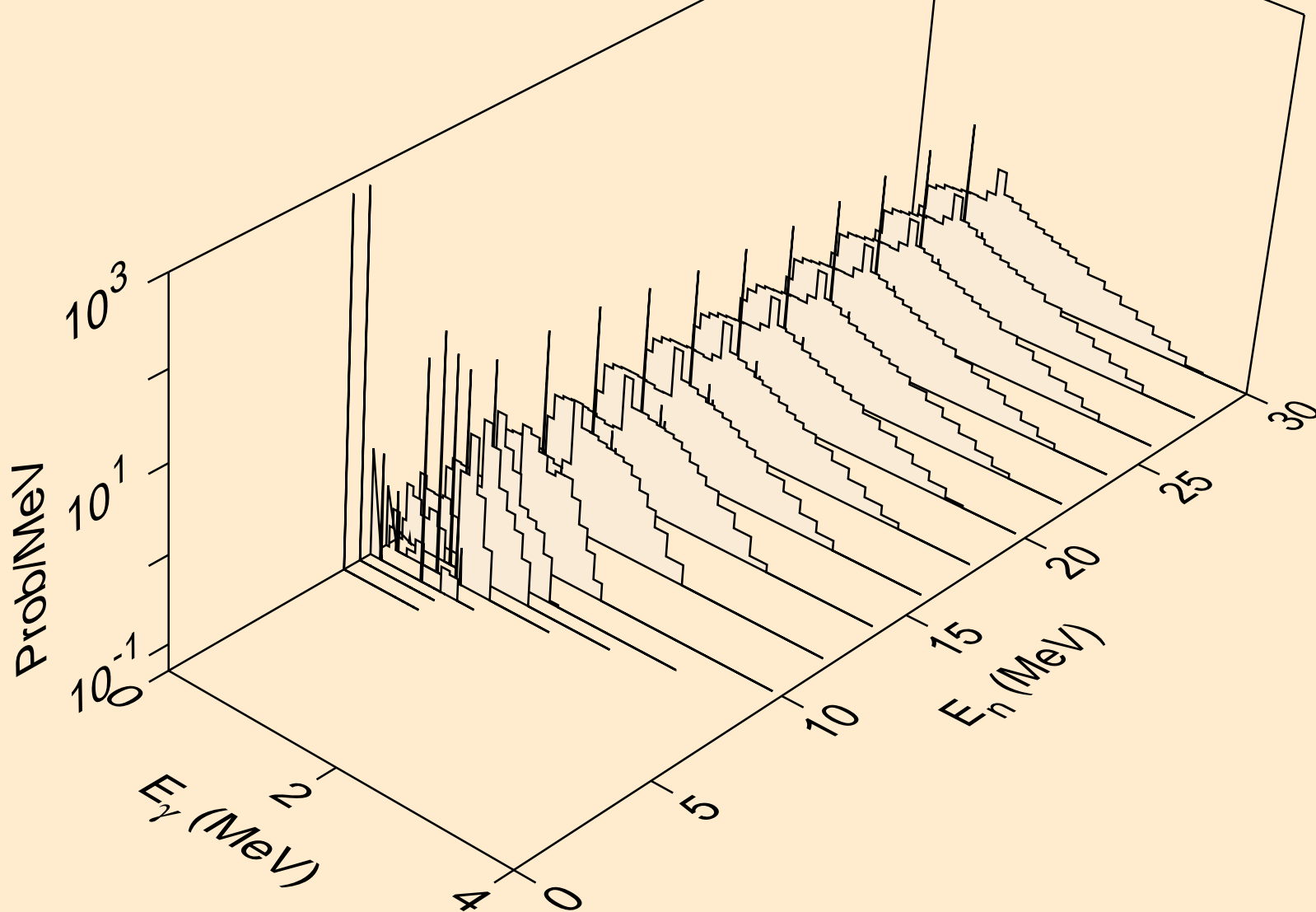

SB124N NEUTRON ACER TENDL-2019 LIBRARY; T=293.16K  
Photon emission for (n,t)

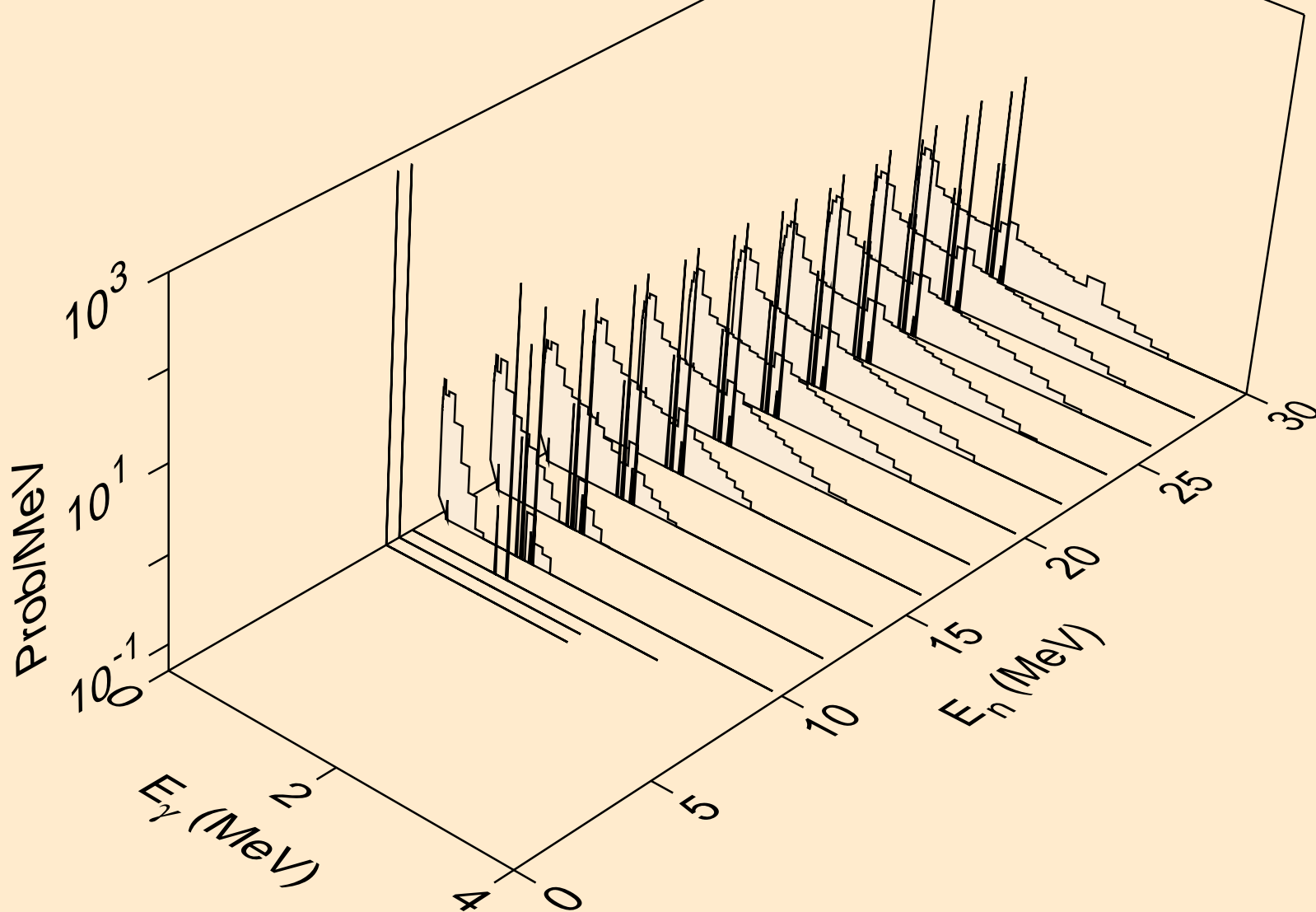

SB124N NEUTRON ACER TENDL-2019 LIBRARY; T=293.16K  
Photon emission for (n,he3)

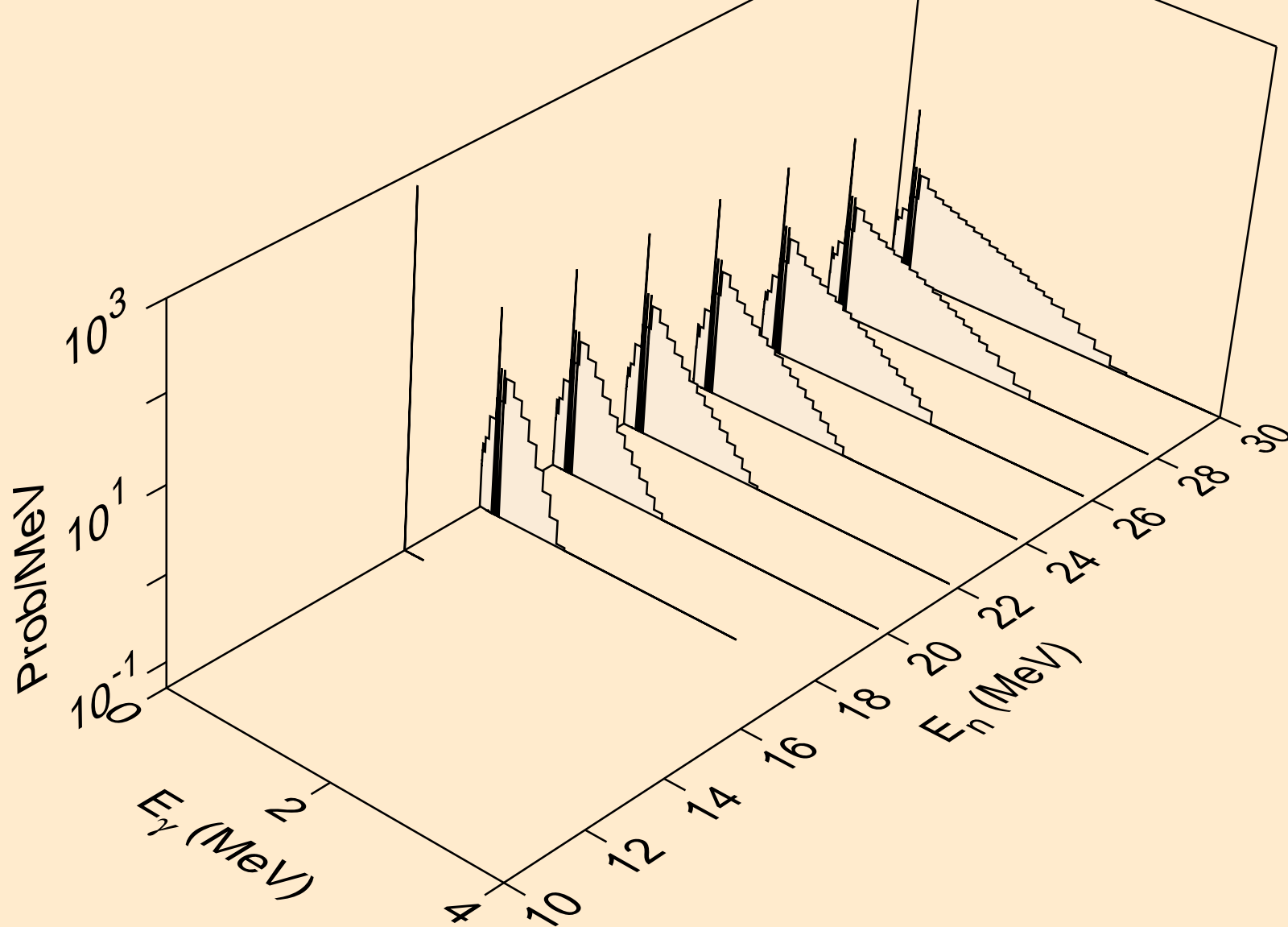

SB124N NEUTRON ACER TENDL-2019 LIBRARY; T=293.16K  
Photon emission for (n,a)

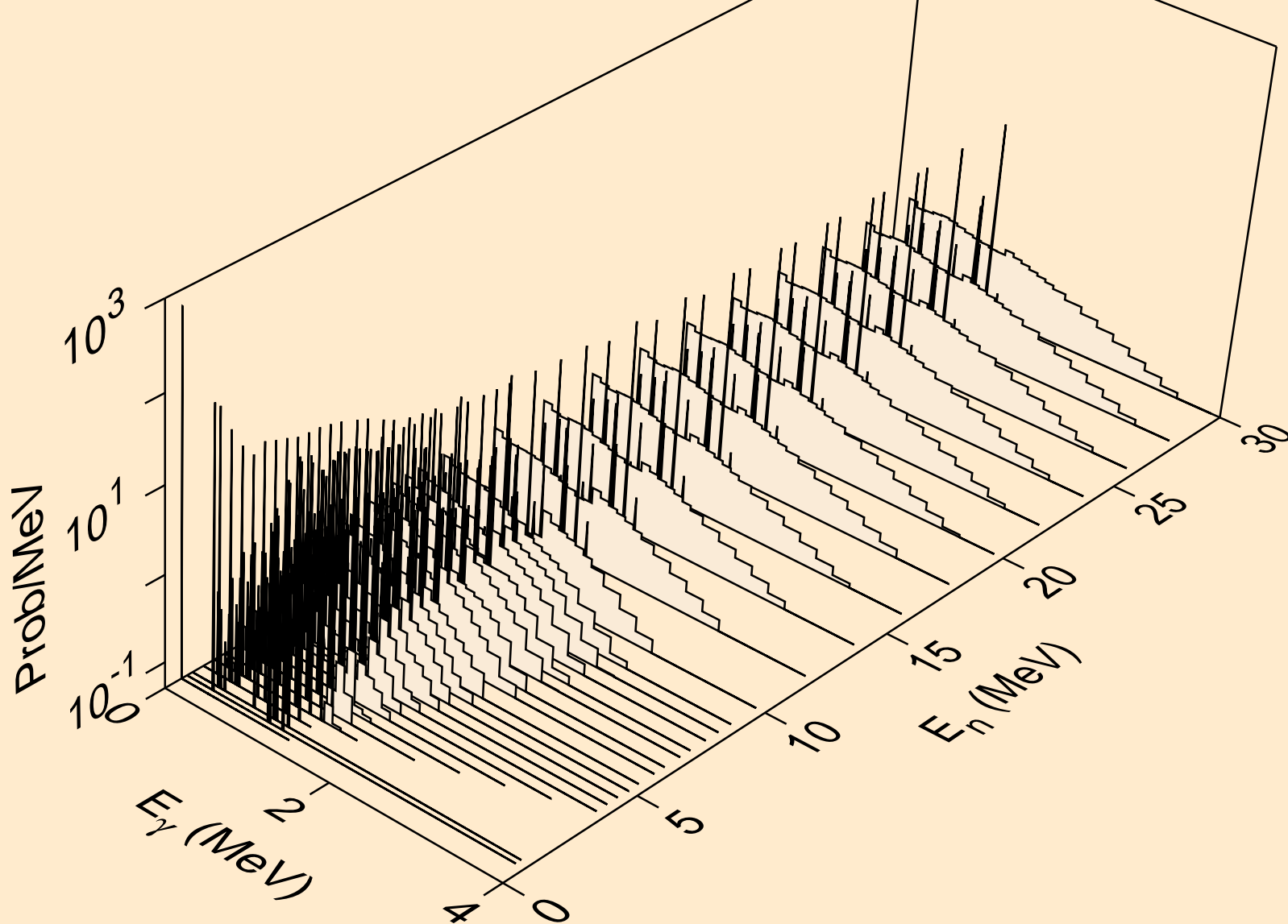

SB124N NEUTRON ACER TENDL-2019 LIBRARY; T=293.16K  
Photon emission for (n,2p)

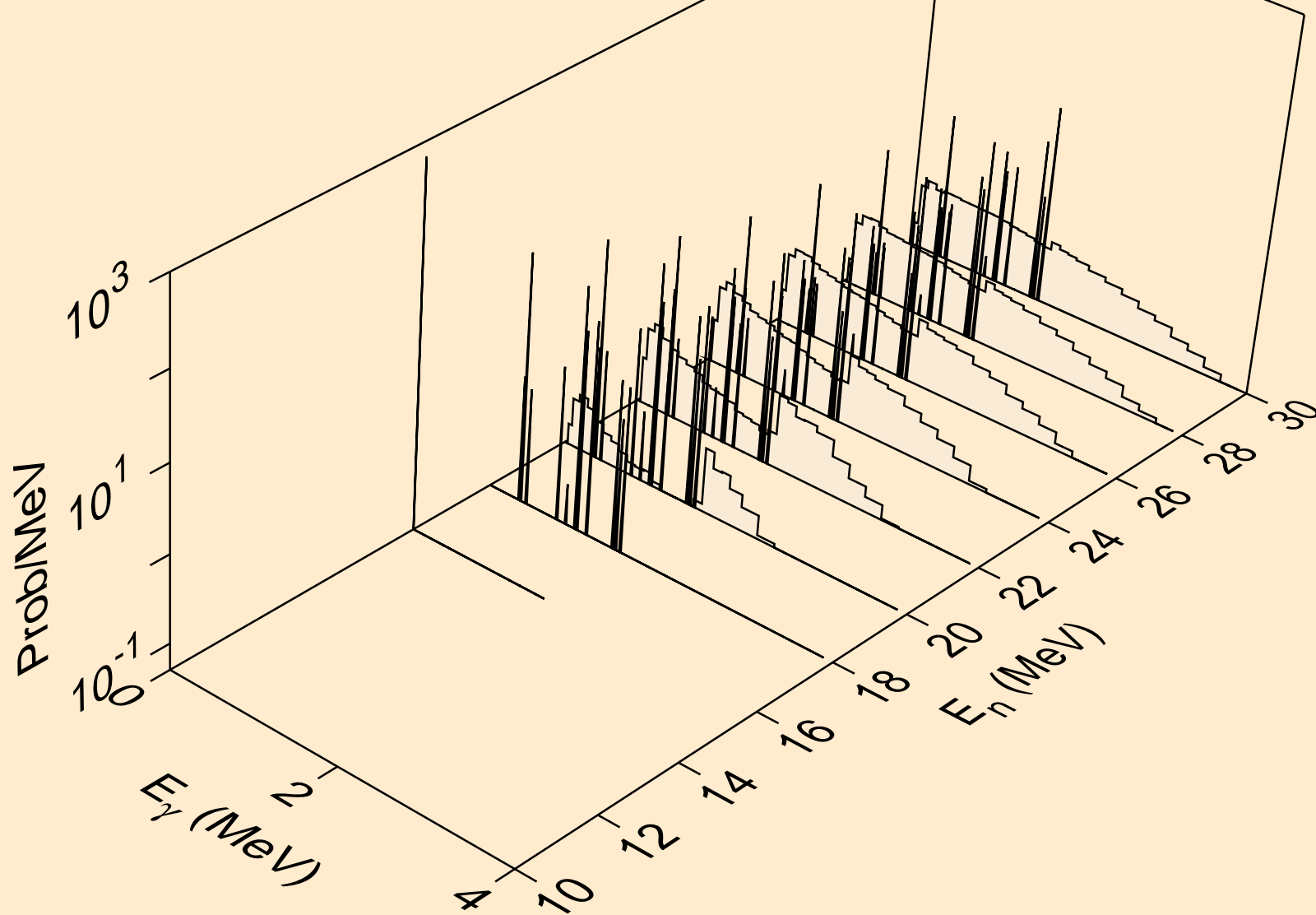

SB124N NEUTRON ACER TENDL-2019 LIBRARY; T=293.16K  
Photon emission for (n,p $\alpha$ )

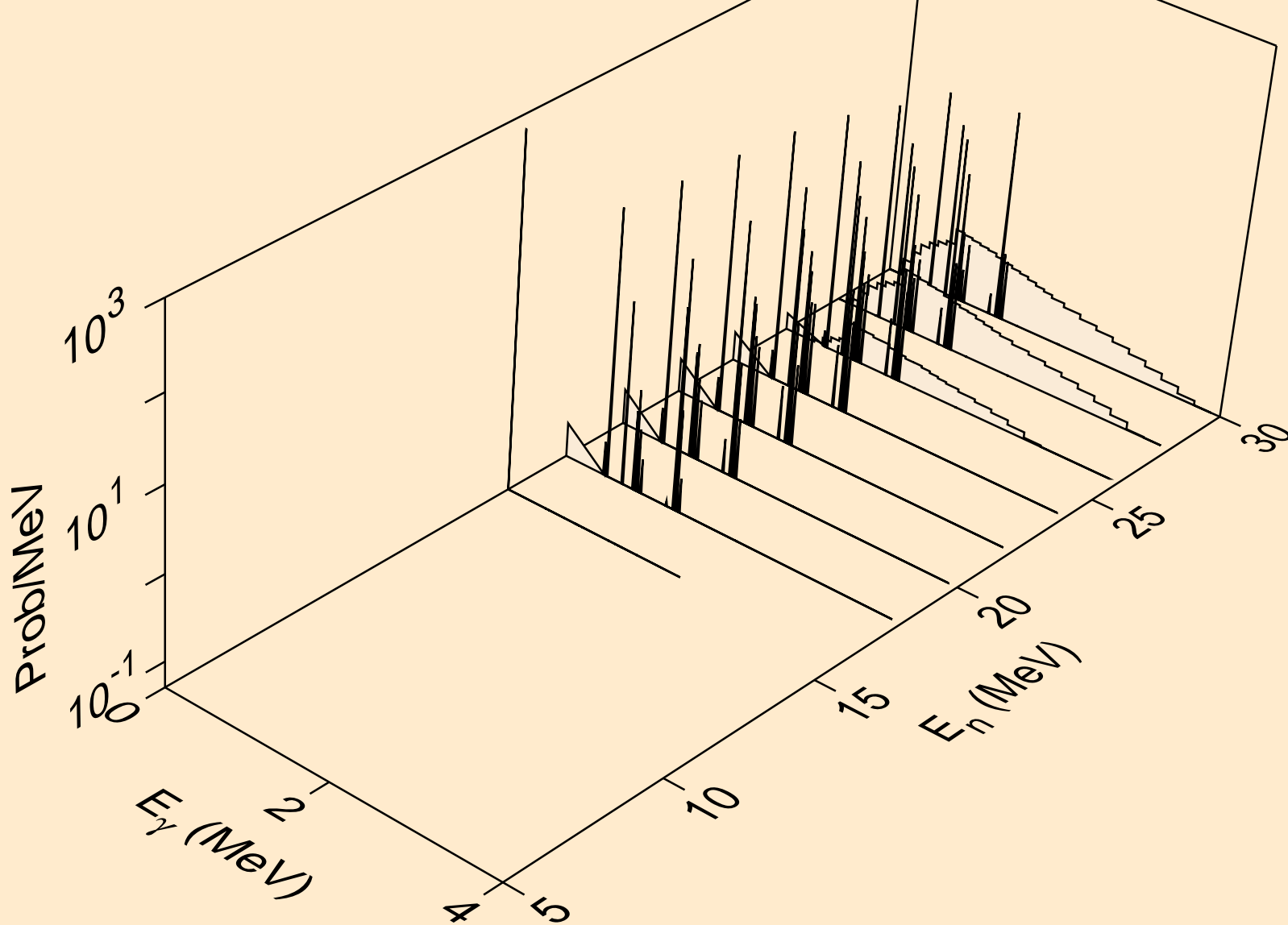



SB124N NEUTRON ACER TENDL-2019 LIBRARY; T=293.16K  
Photon emission for (n,pd)

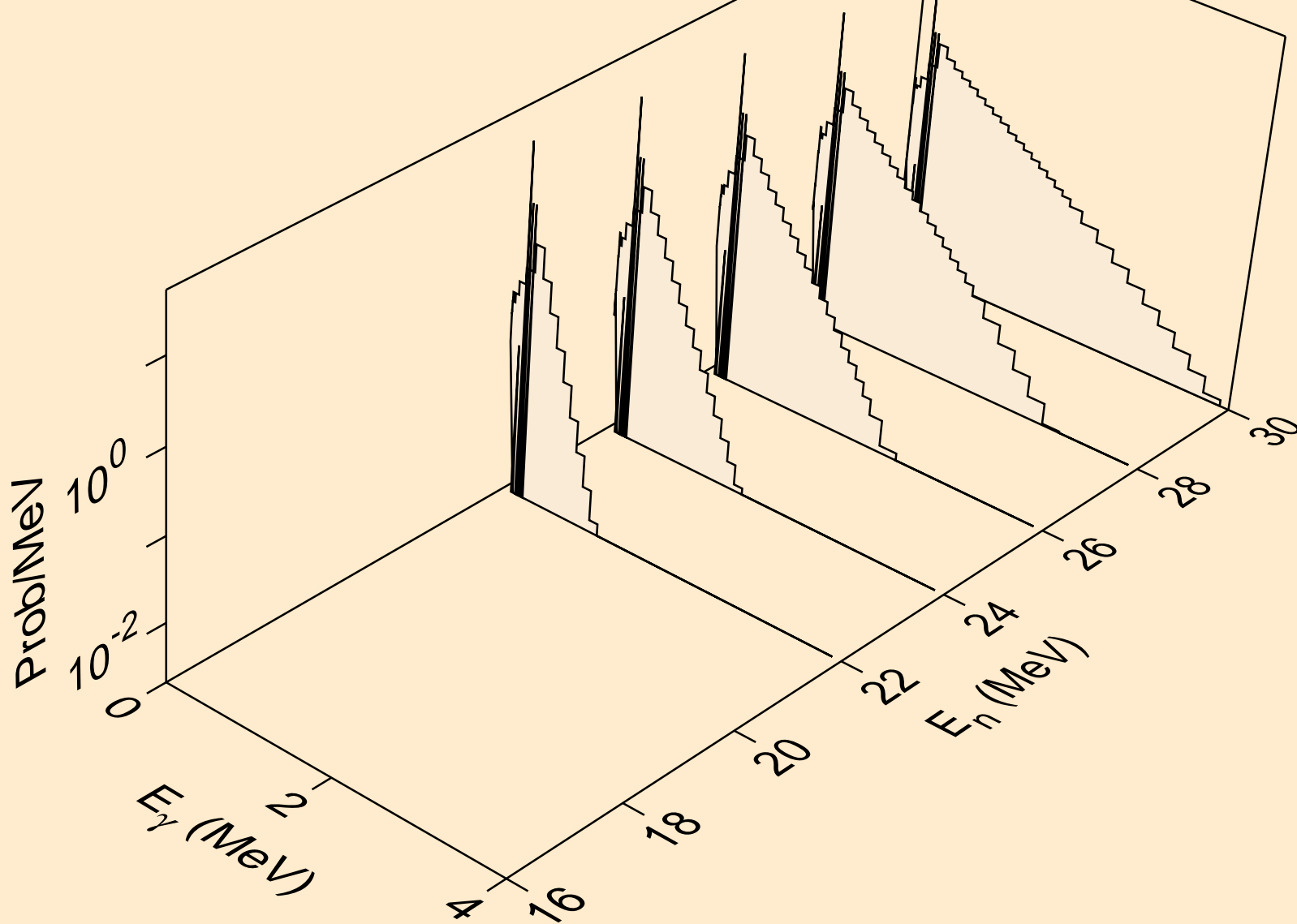

SB124N NEUTRON ACER TENDL-2019 LIBRARY; T=293.16K  
Photon emission for (n,pt)

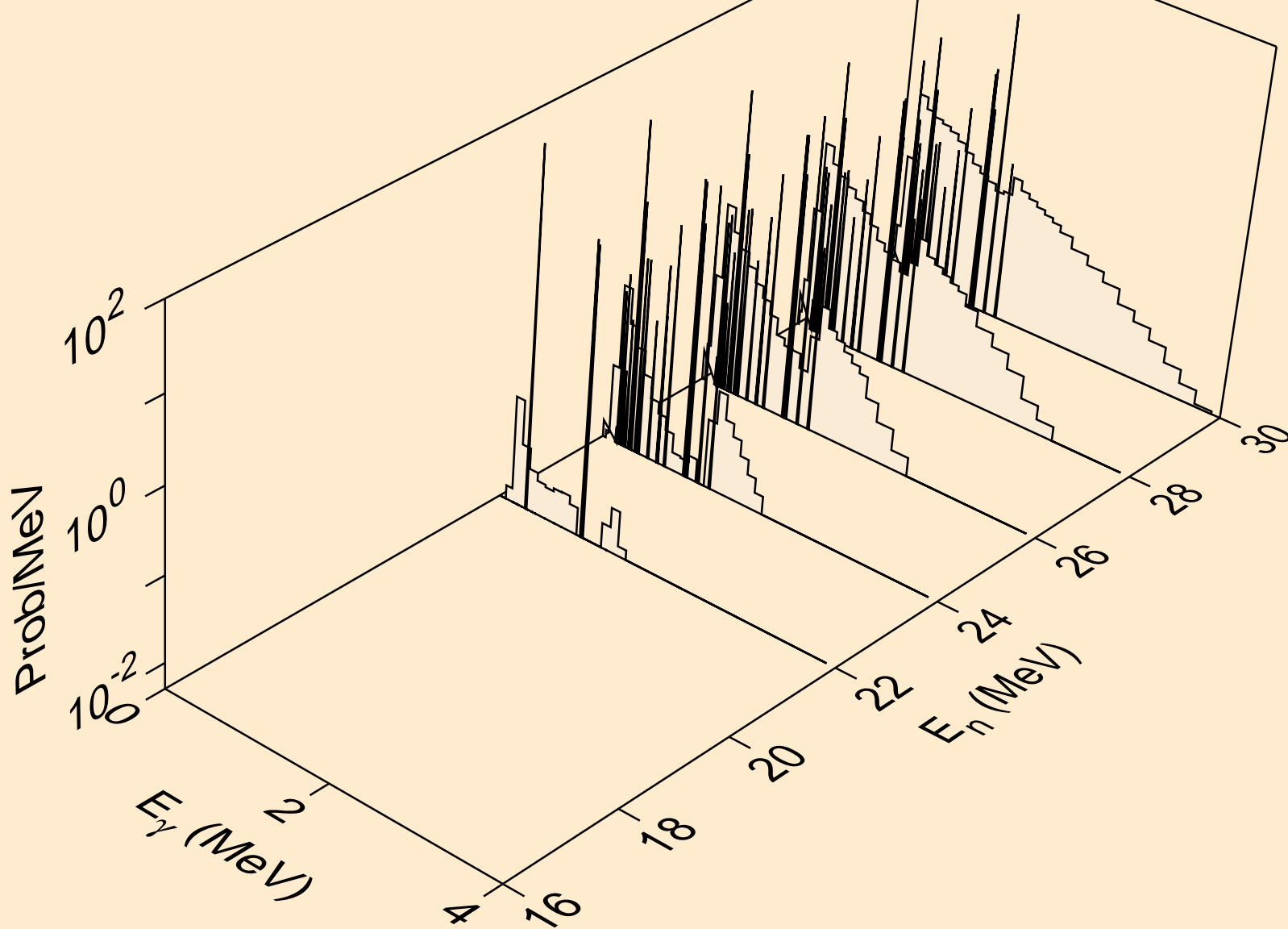

SB124N NEUTRON ACER TENDL-2019 LIBRARY; T=293.16K  
thermal capture photon spectrum

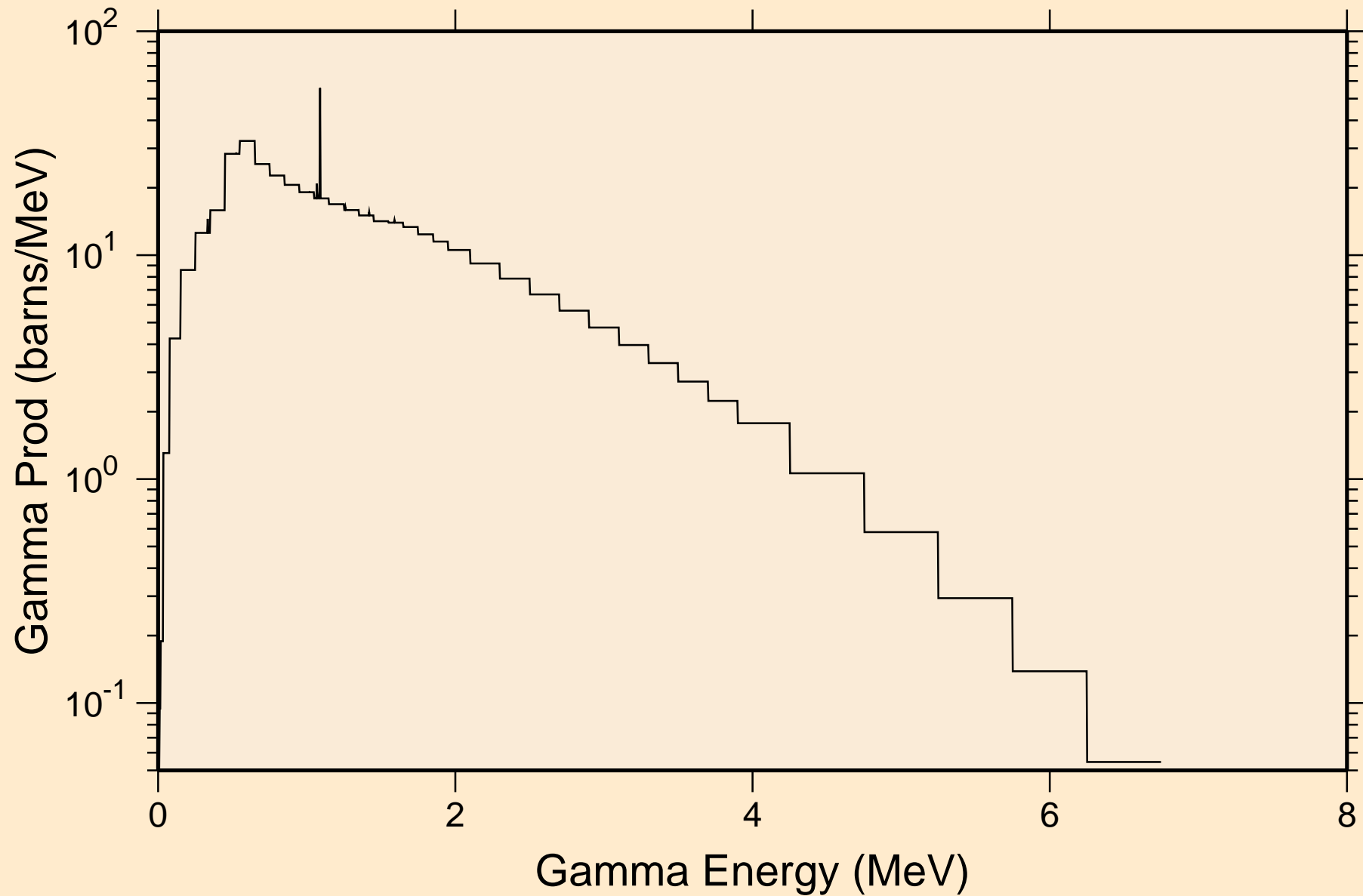

SB124N NEUTRON ACER TENDL-2019 LIBRARY; T=293.16K  
14 MeV photon spectrum

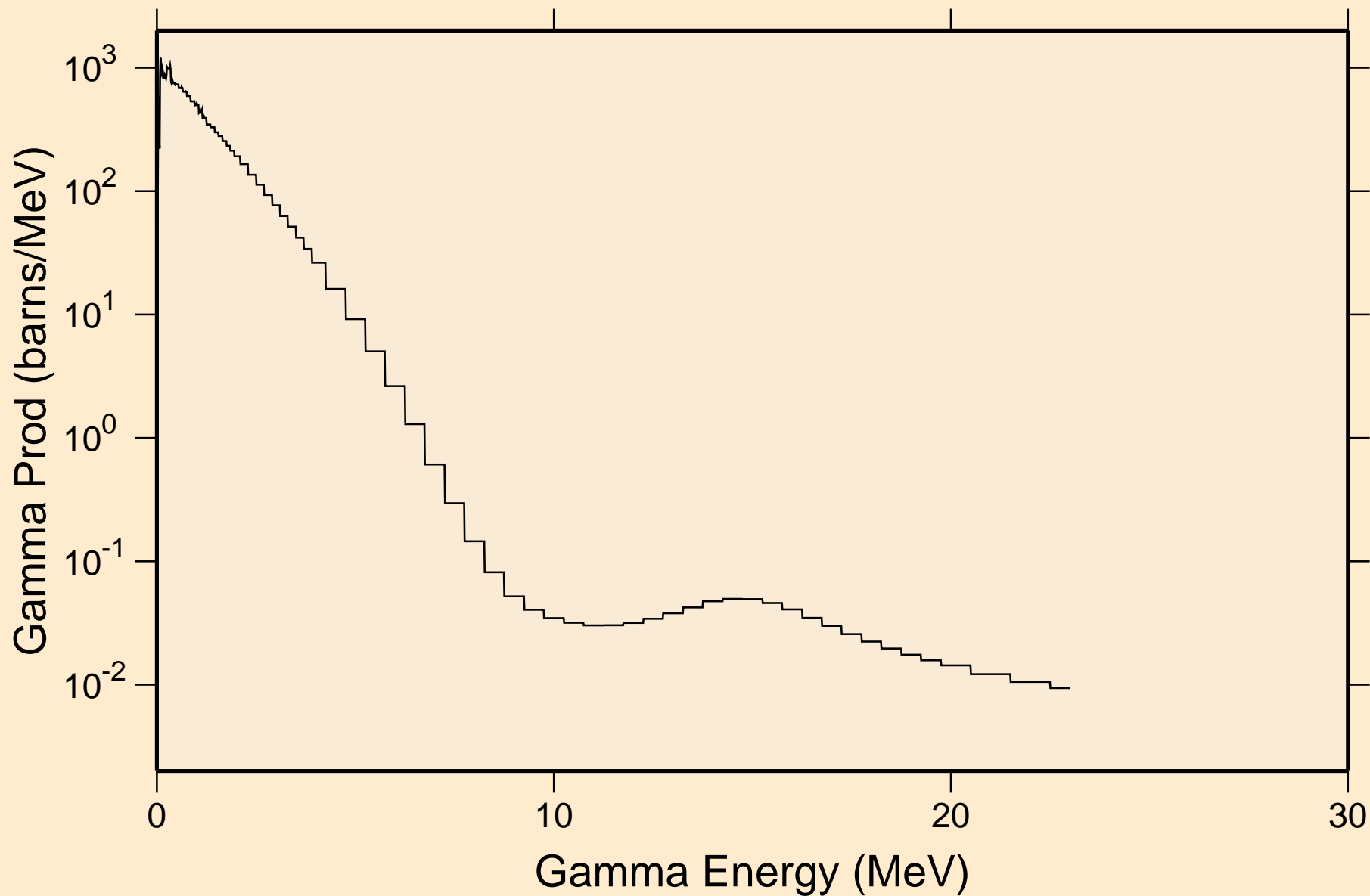

# SB124N NEUTRON ACER TENDL-2019 LIBRARY; T=293.16K

## Particle heating contributions

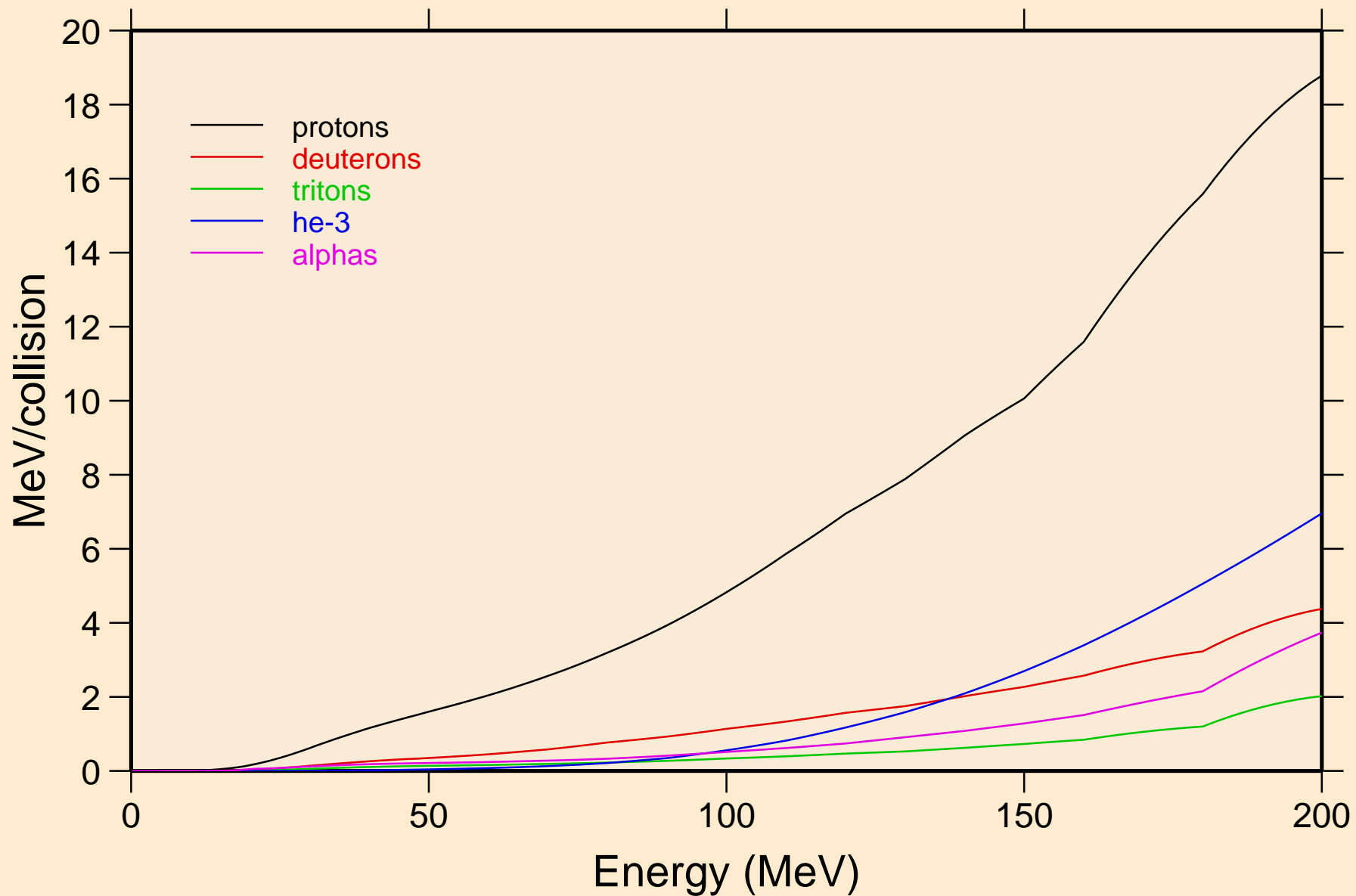

SB124N NEUTRON ACER TENDL-2019 LIBRARY; T=293.16K  
Recoil Heating

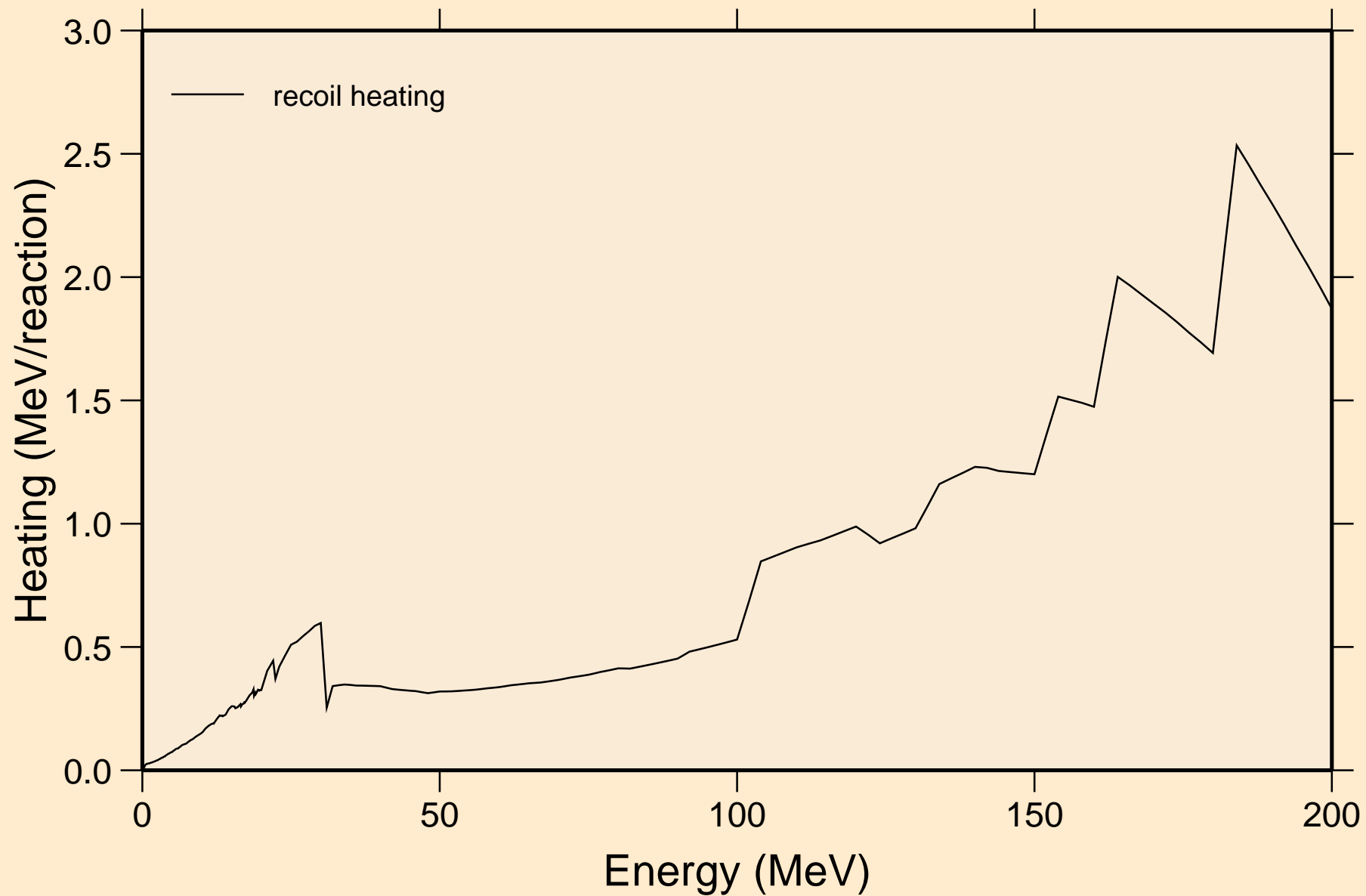

SB124N NEUTRON ACER TENDL-2019 LIBRARY; T=293.16K  
Particle production cross sections

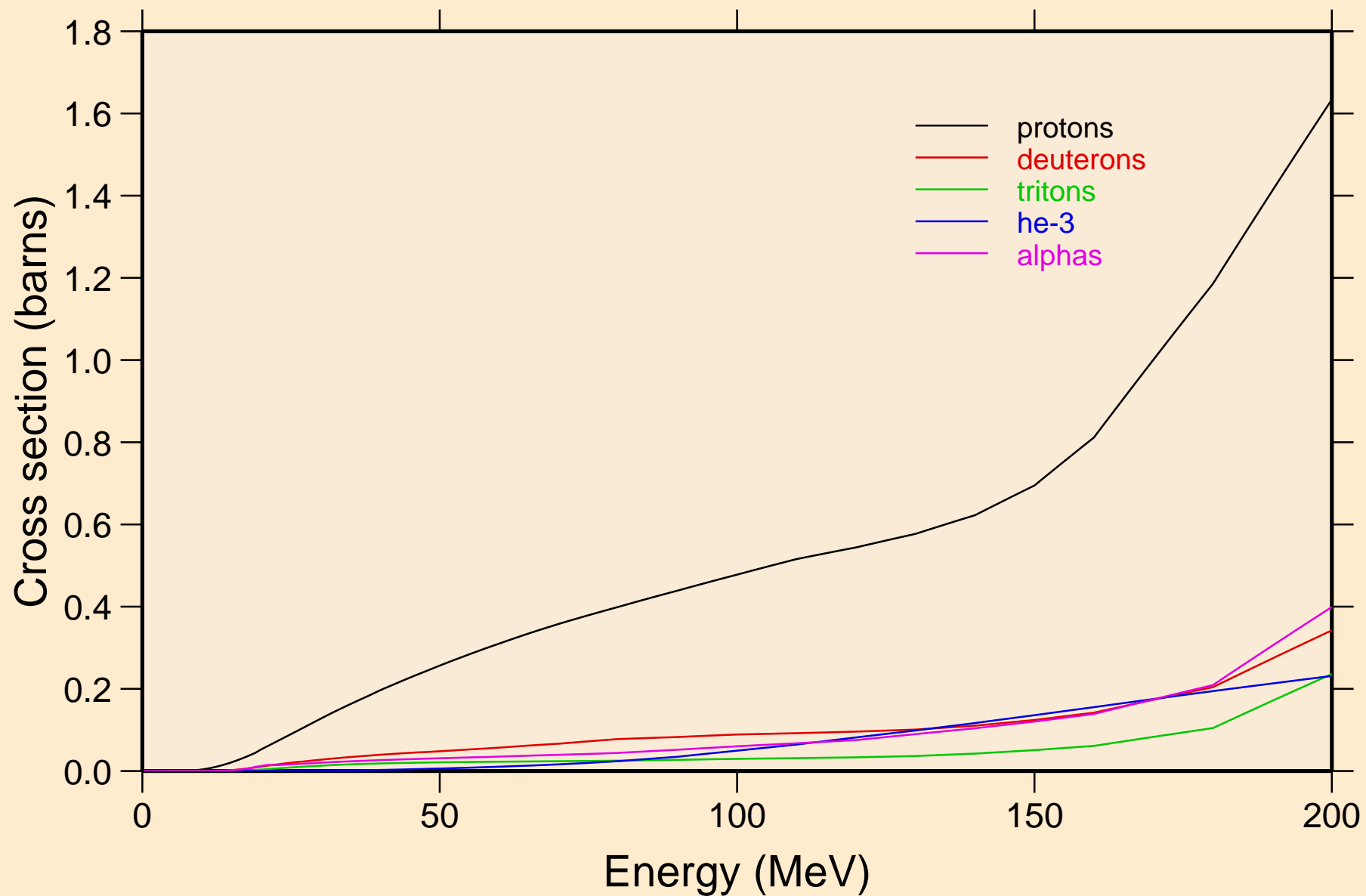

SB124N NEUTRON ACER TENDL-2019 LIBRARY; T=293.16K  
protons from (n,x)

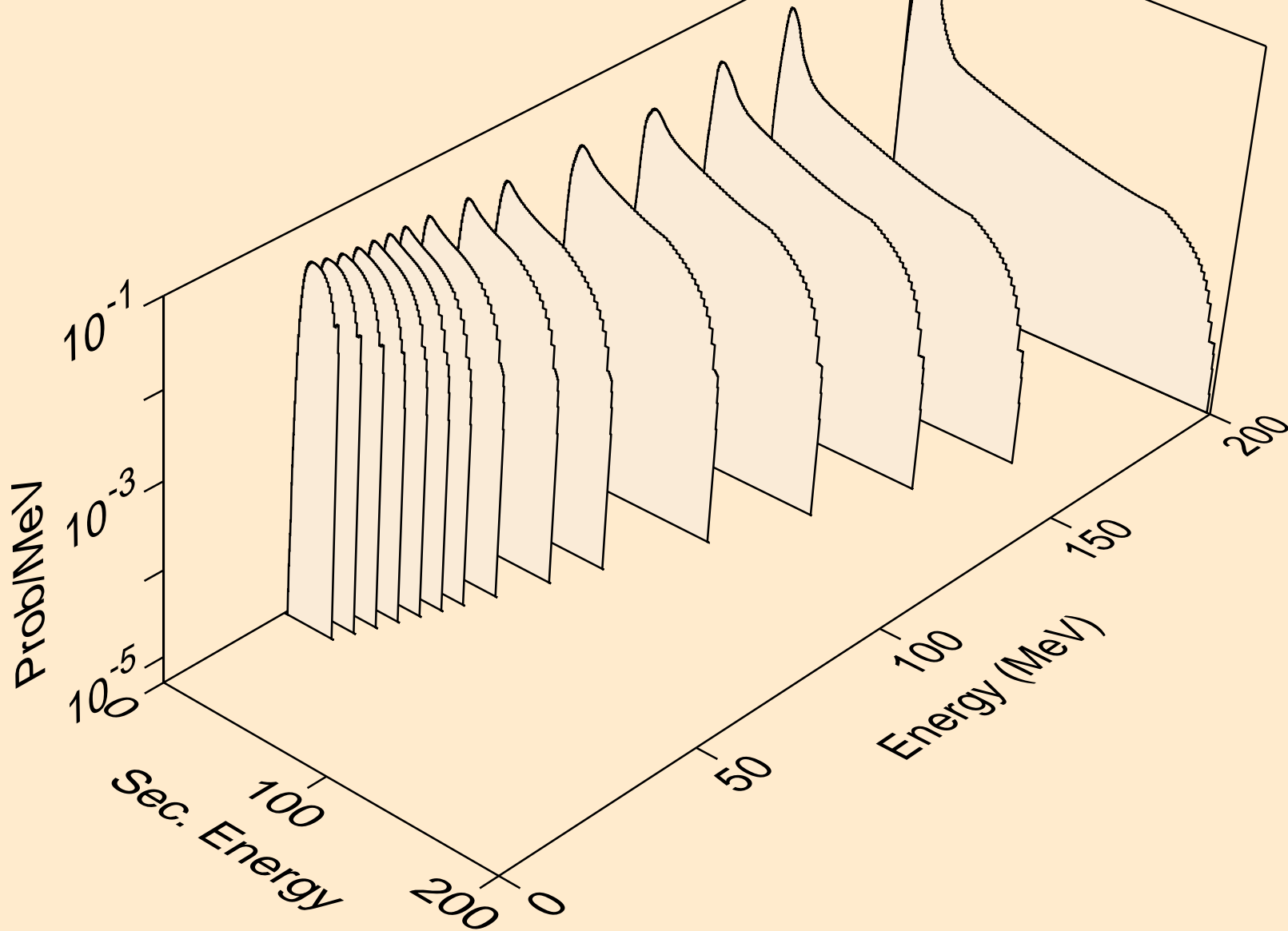



SB124N NEUTRON ACER TENDL-2019 LIBRARY; T=293.16K  
protons from (n,n\*)p

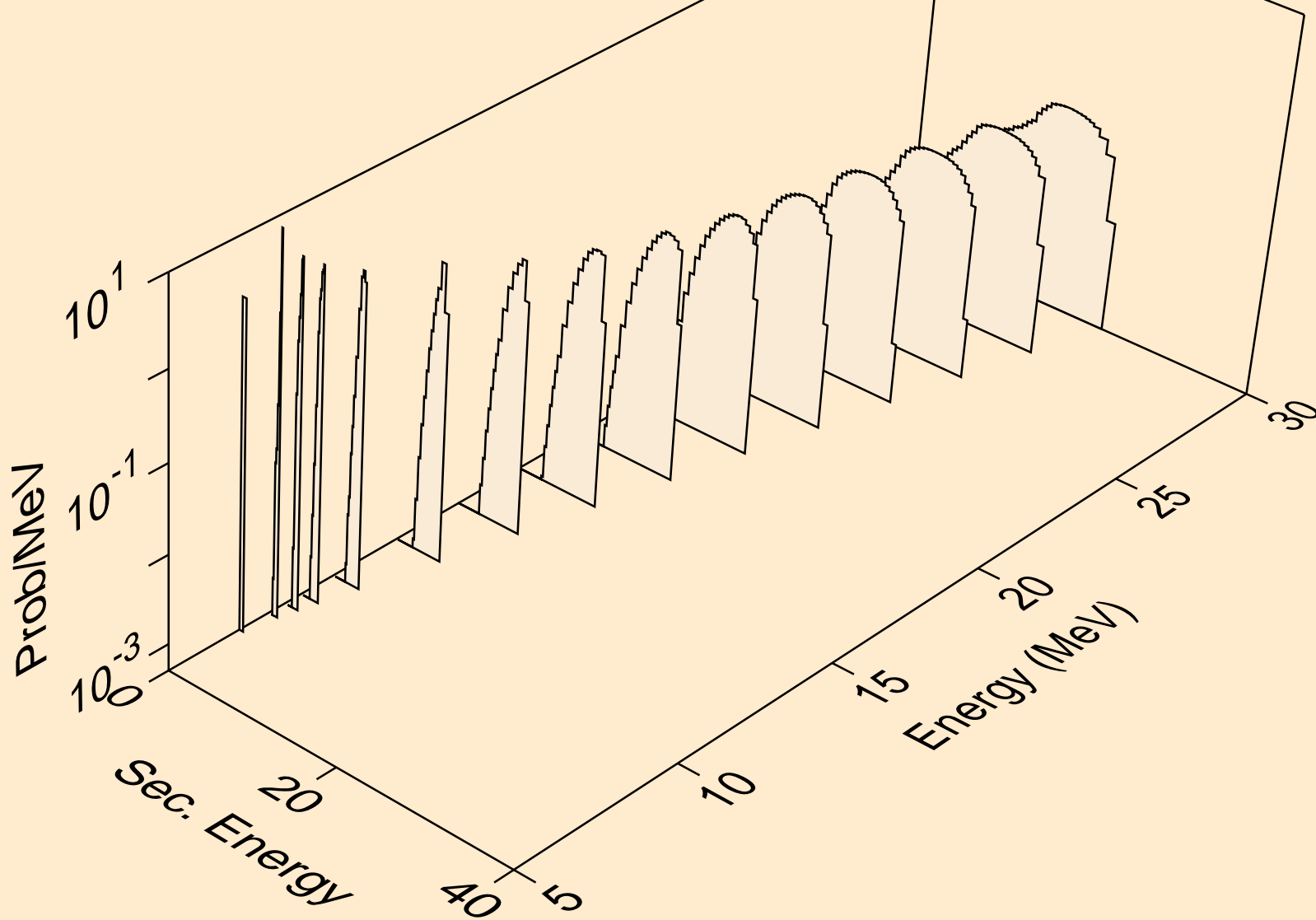

SB124N NEUTRON ACER TENDL-2019 LIBRARY; T=293.16K  
protons from (n,2np)

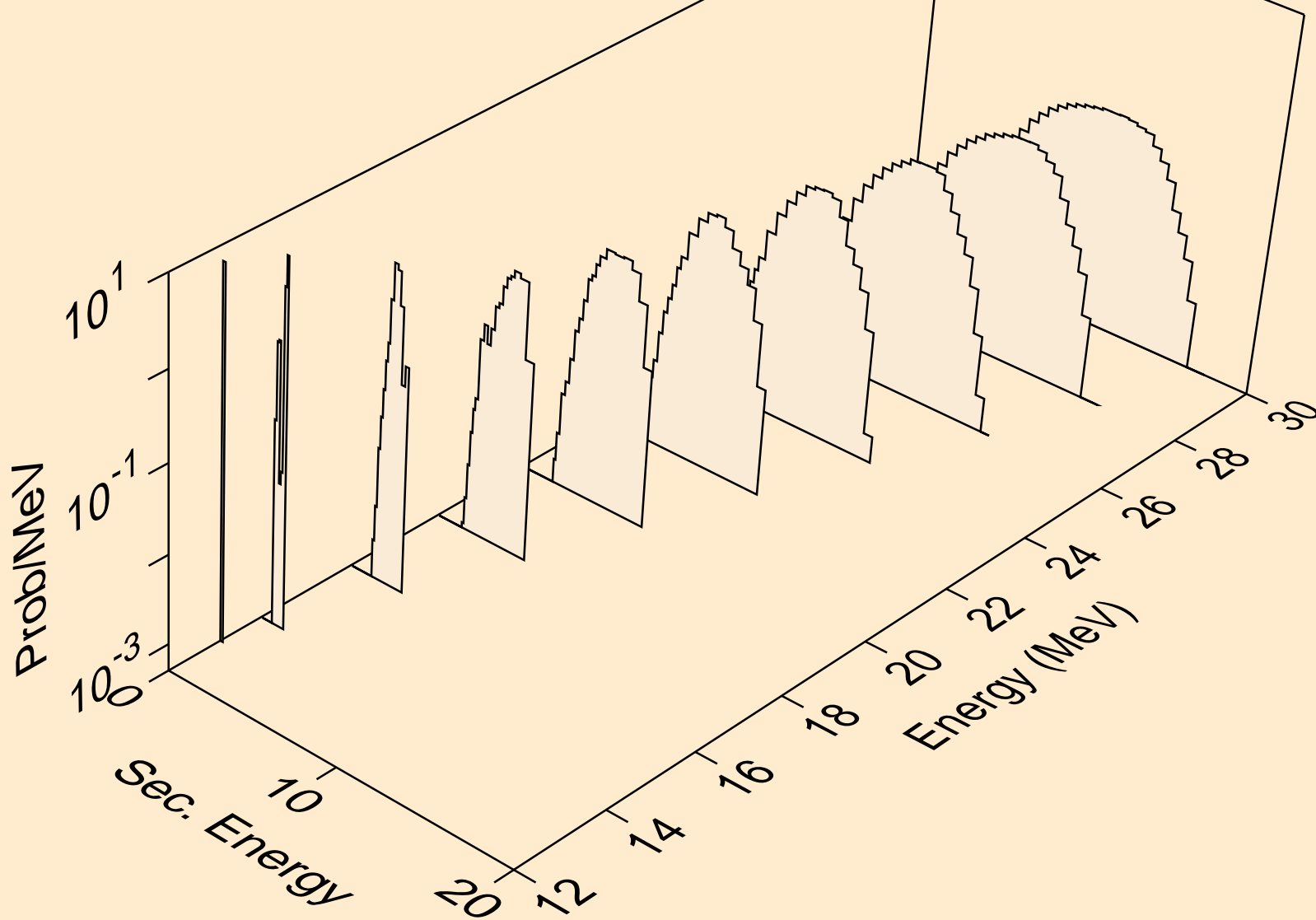

SB124N NEUTRON ACER TENDL-2019 LIBRARY; T=293.16K  
protons from (n,3np)

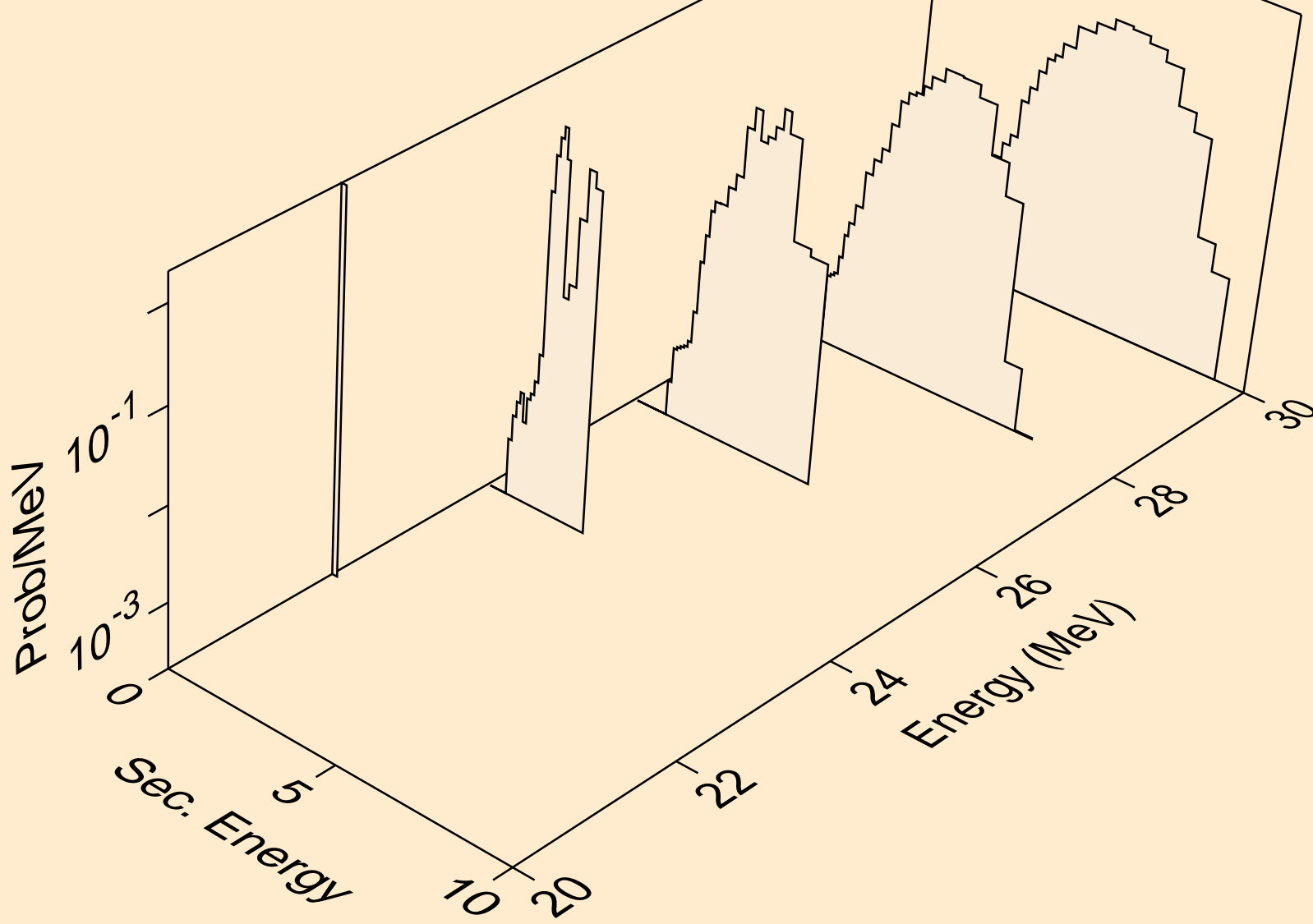

SB124N NEUTRON ACER TENDL-2019 LIBRARY; T=293.16K  
protons from (n,2np)

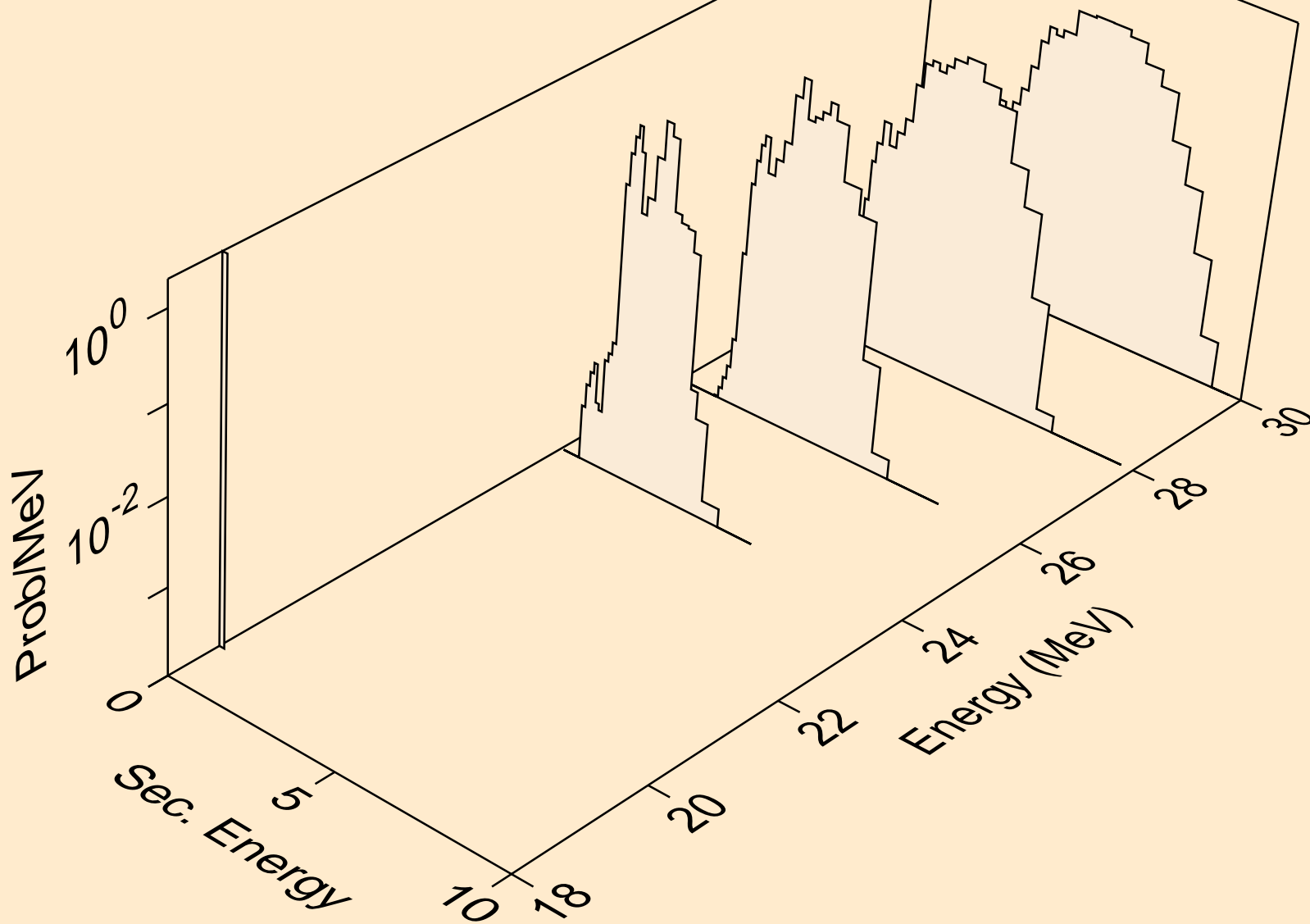

SB124N NEUTRON ACER TENDL-2019 LIBRARY; T=293.16K  
protons from (n,p)

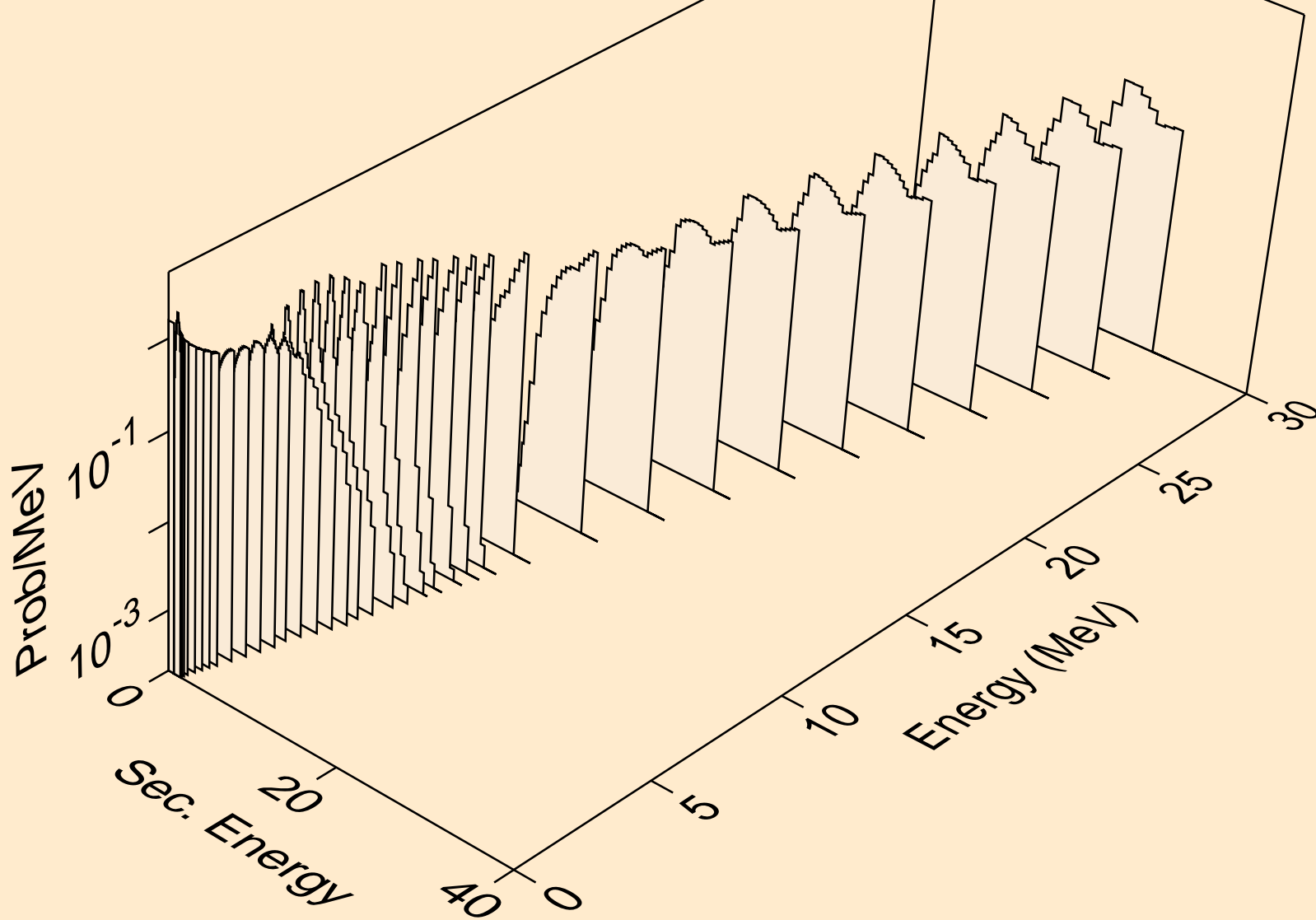

SB124N NEUTRON ACER TENDL-2019 LIBRARY; T=293.16K  
protons from (n,2p)

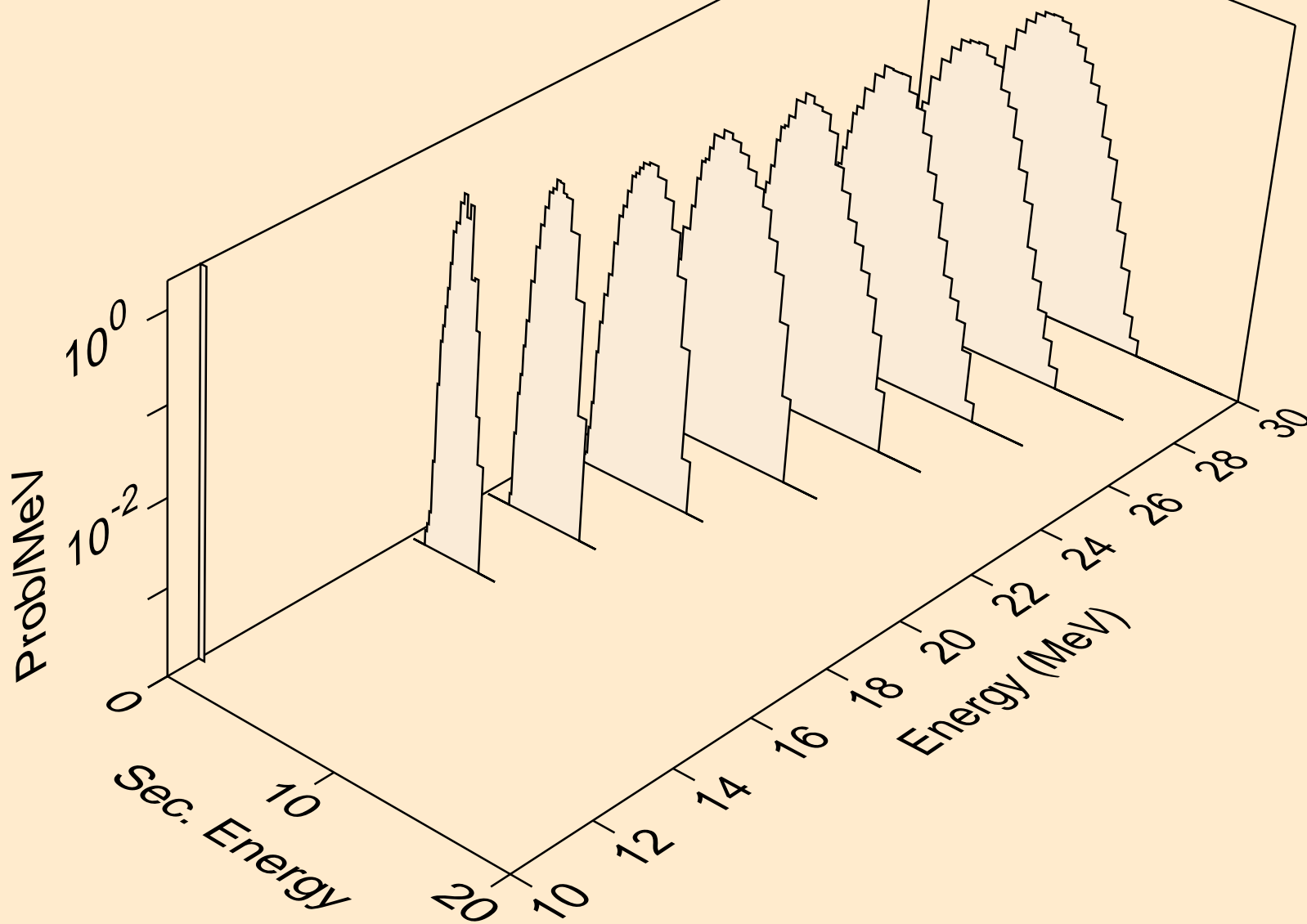

SB124N NEUTRON ACER TENDL-2019 LIBRARY; T=293.16K  
protons from (n,p)

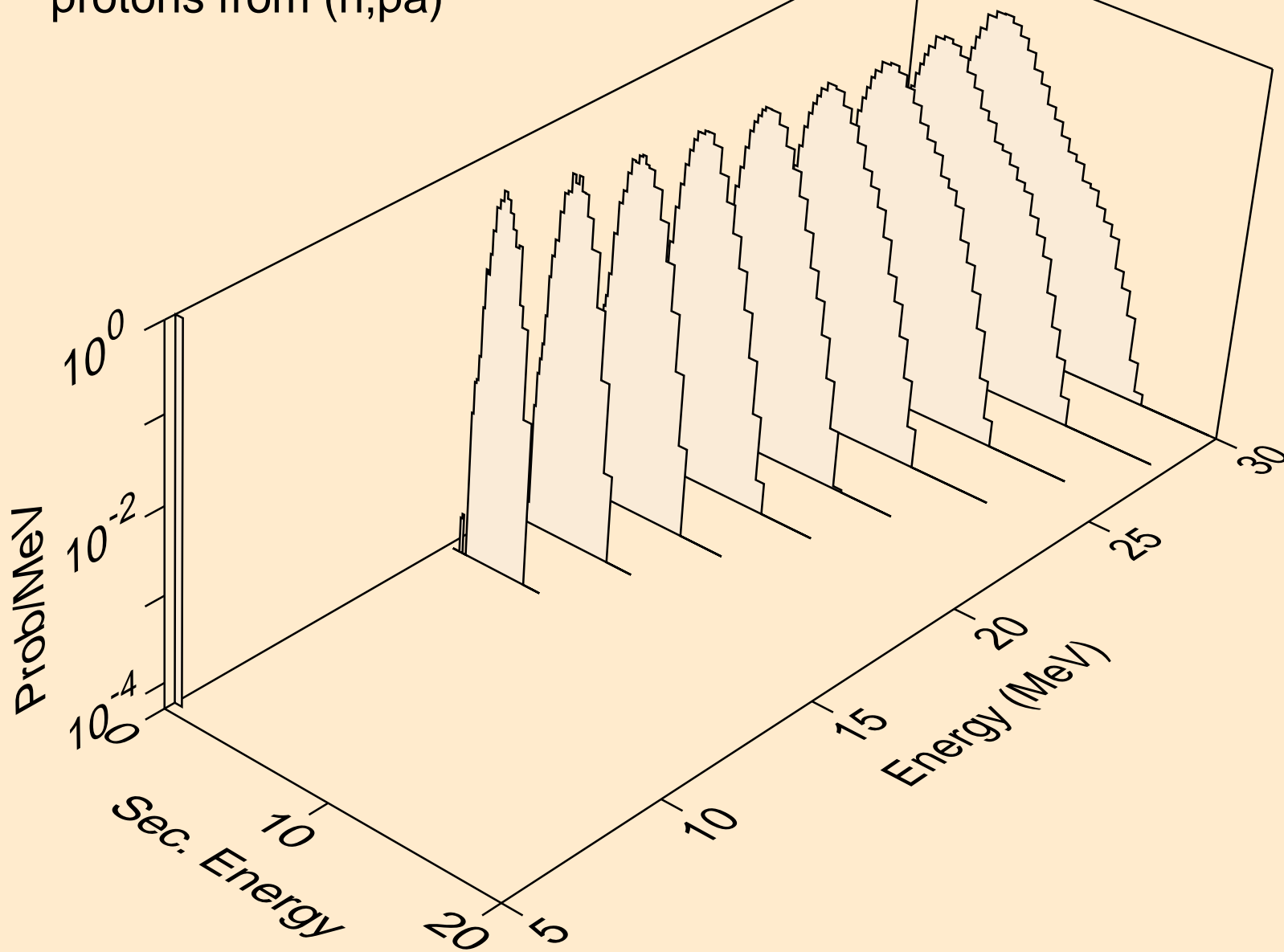

SB124N NEUTRON ACER TENDL-2019 LIBRARY; T=293.16K  
protons from (n,pd)

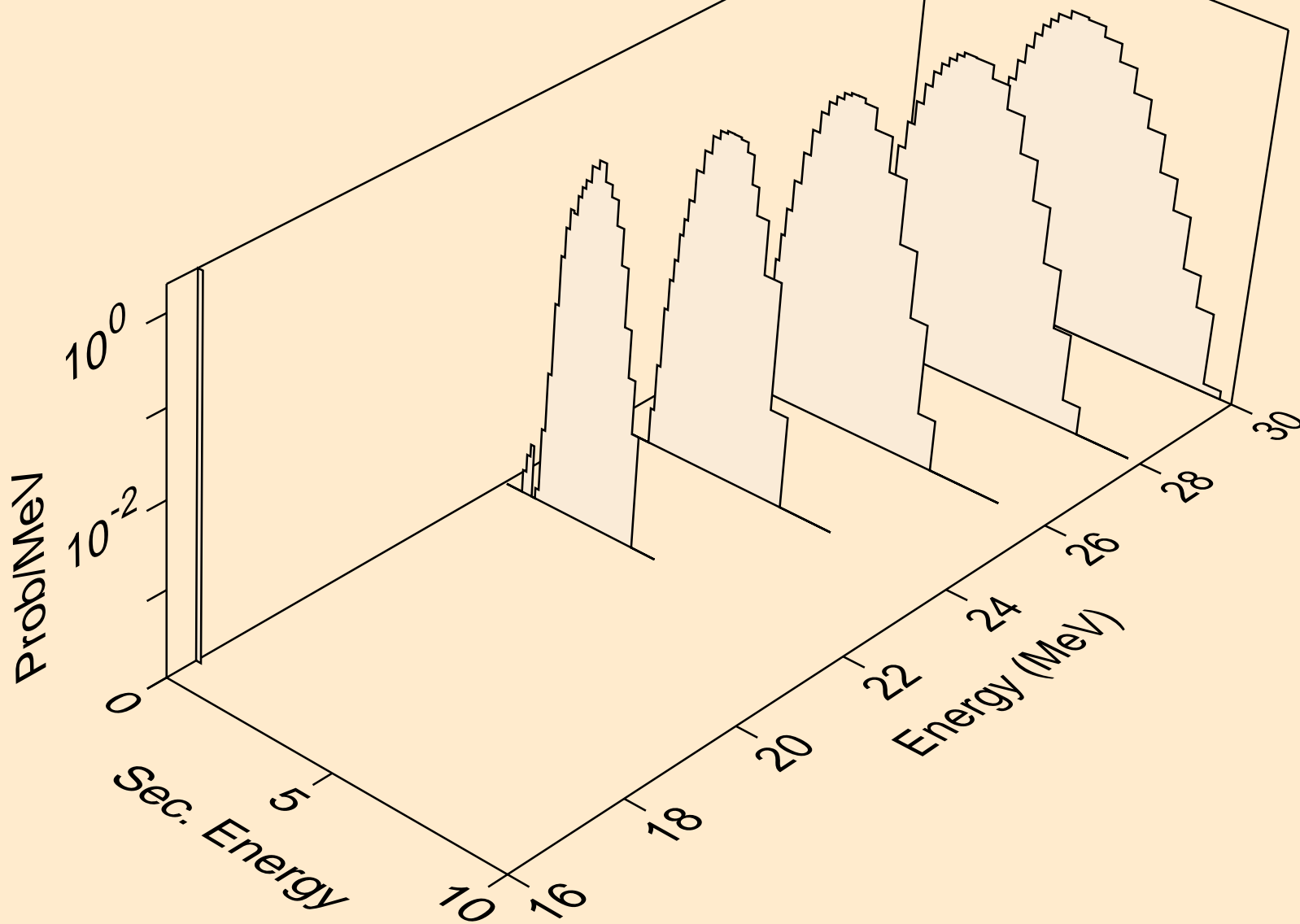



SB124N NEUTRON ACER TENDL-2019 LIBRARY; T=293.16K  
protons from (n,pt)

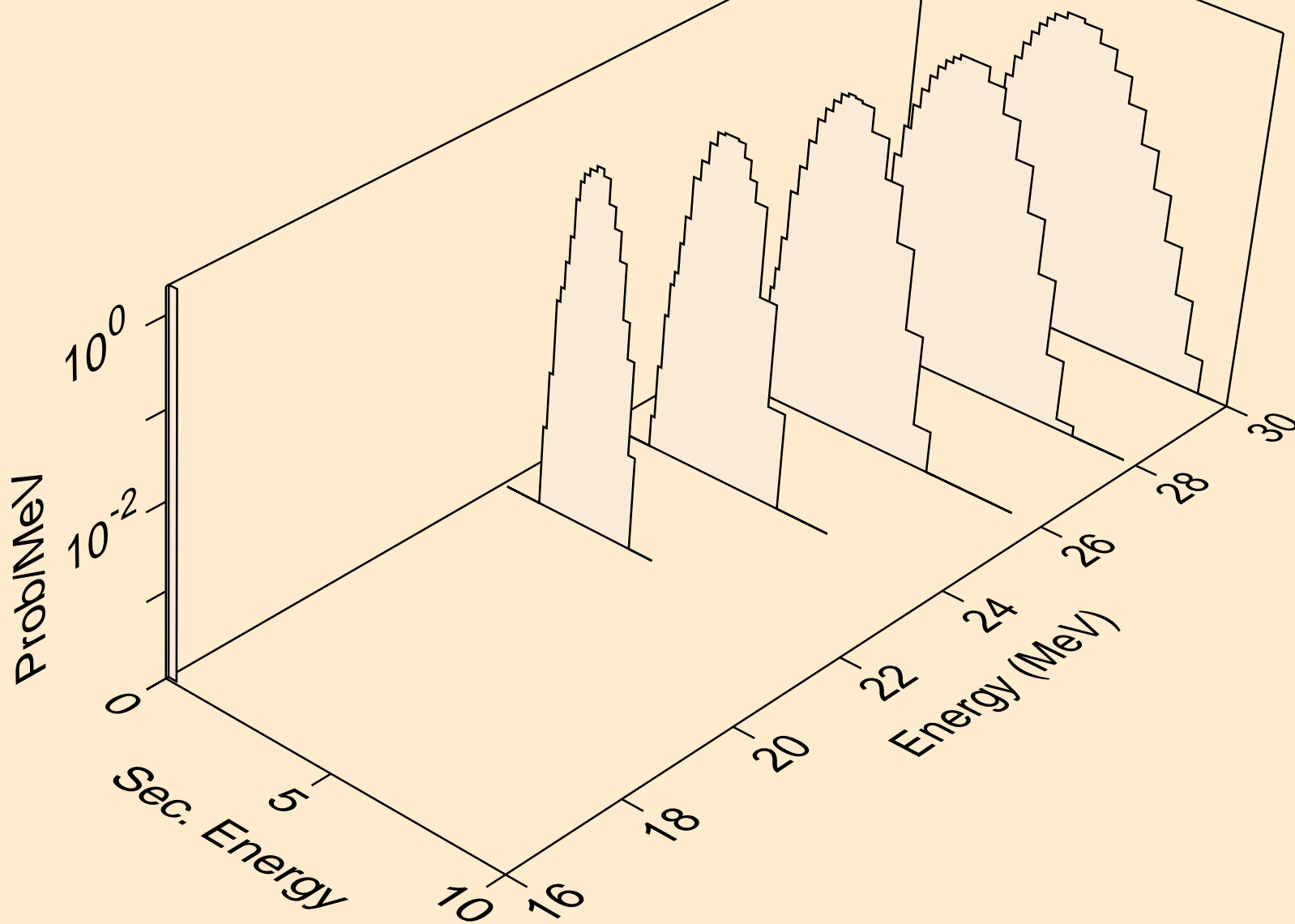

SB124N NEUTRON ACER TENDL-2019 LIBRARY; T=293.16K  
deuterons from (n,x)

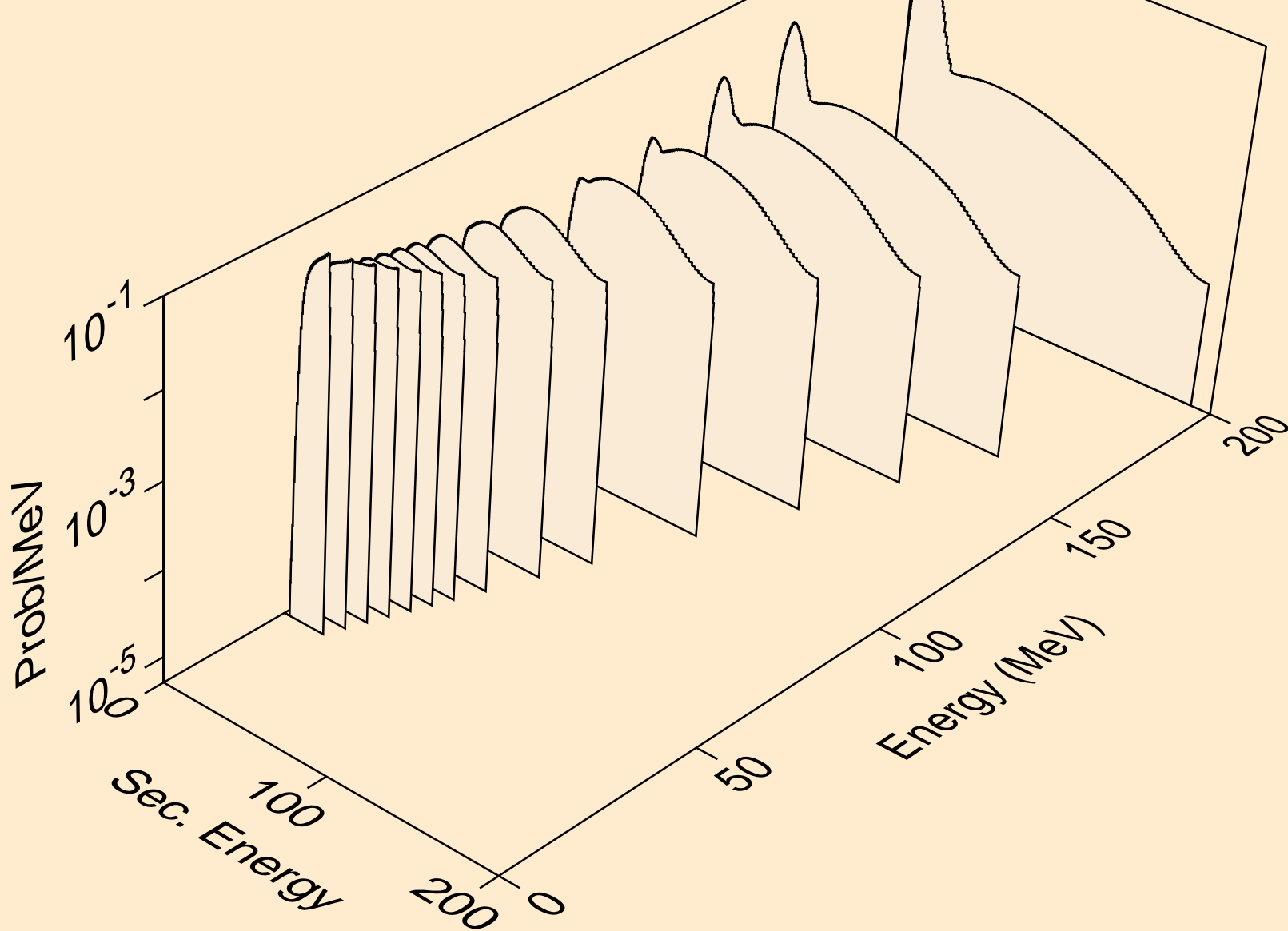

SB124N NEUTRON ACER TENDL-2019 LIBRARY; T=293.16K  
deuterons from (n,2nd)

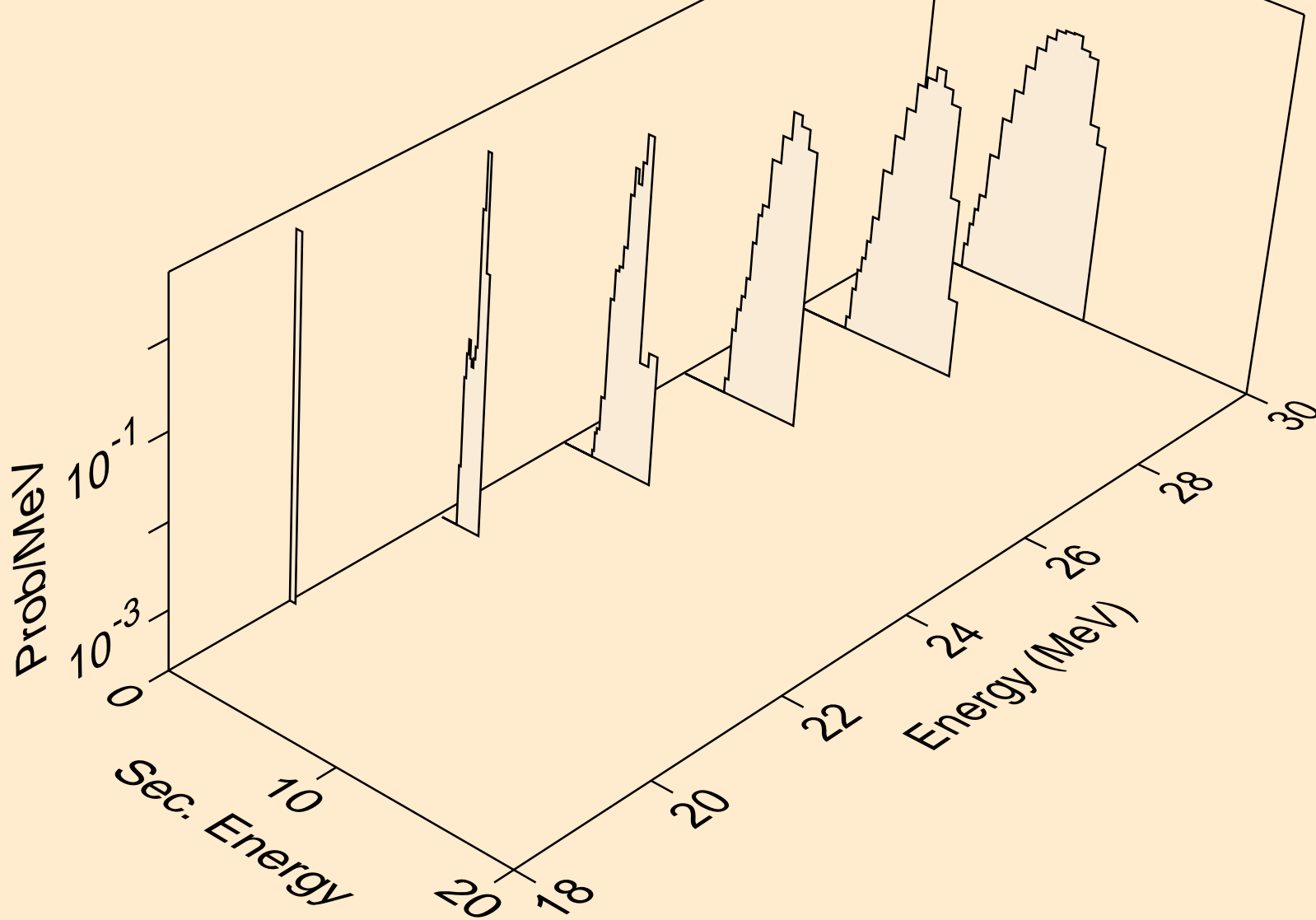

SB124N NEUTRON ACER TENDL-2019 LIBRARY; T=293.16K  
deuterons from (n,n\*)d

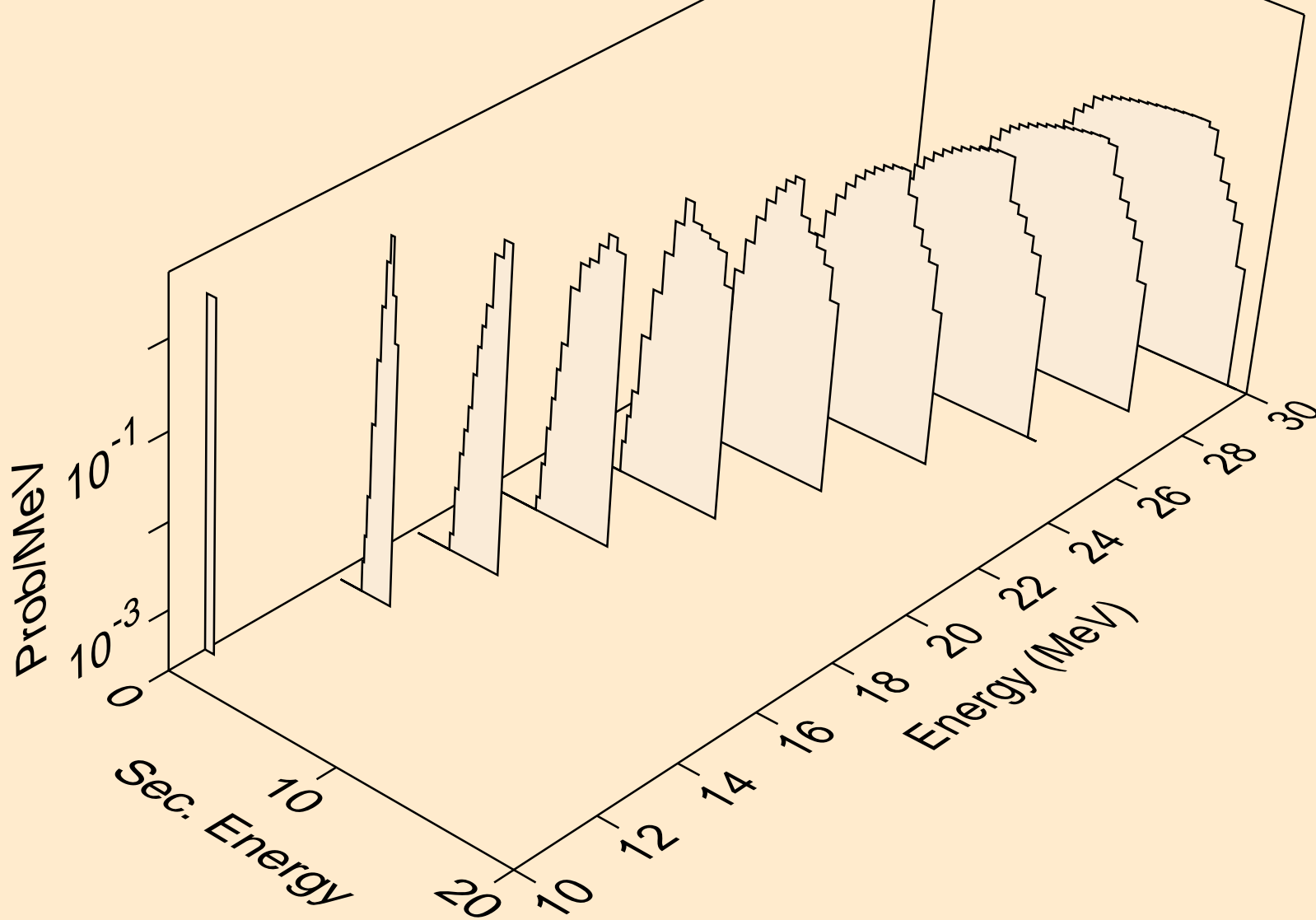

SB124N NEUTRON ACER TENDL-2019 LIBRARY; T=293.16K  
deuterons from (n,d)

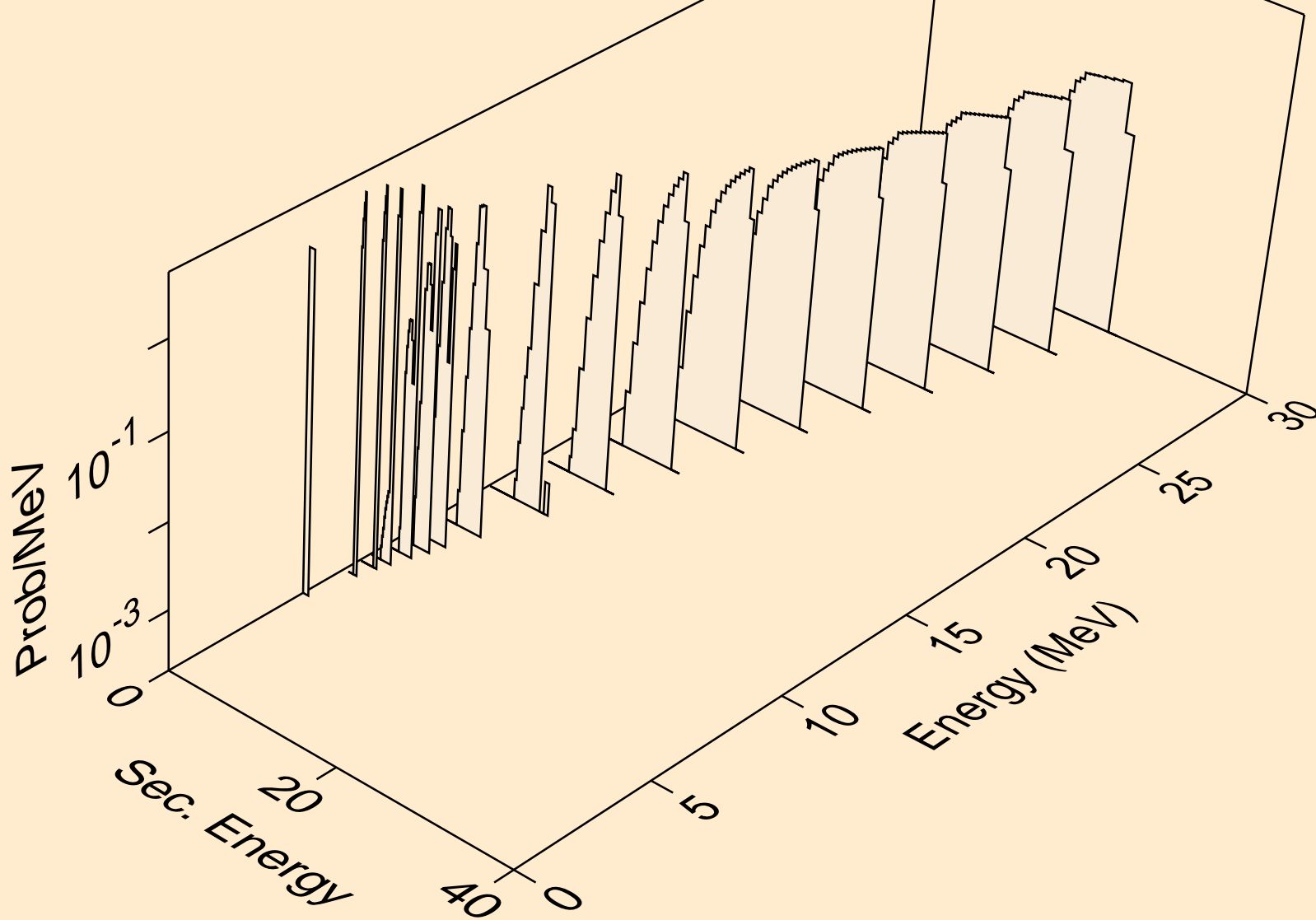

SB124N NEUTRON ACER TENDL-2019 LIBRARY; T=293.16K  
deuterons from (n,pd)

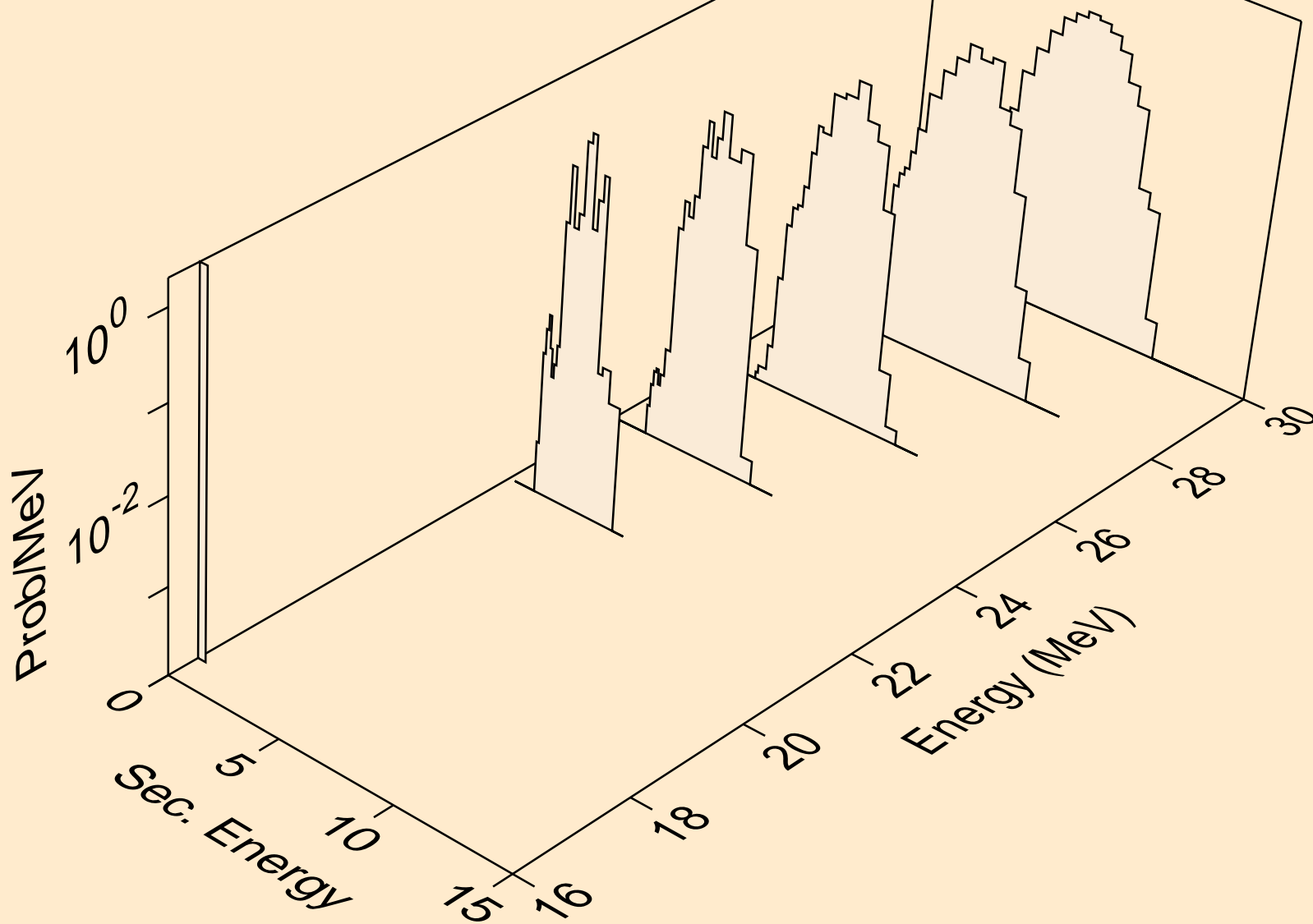

SB124N NEUTRON ACER TENDL-2019 LIBRARY; T=293.16K  
tritons from (n,x)

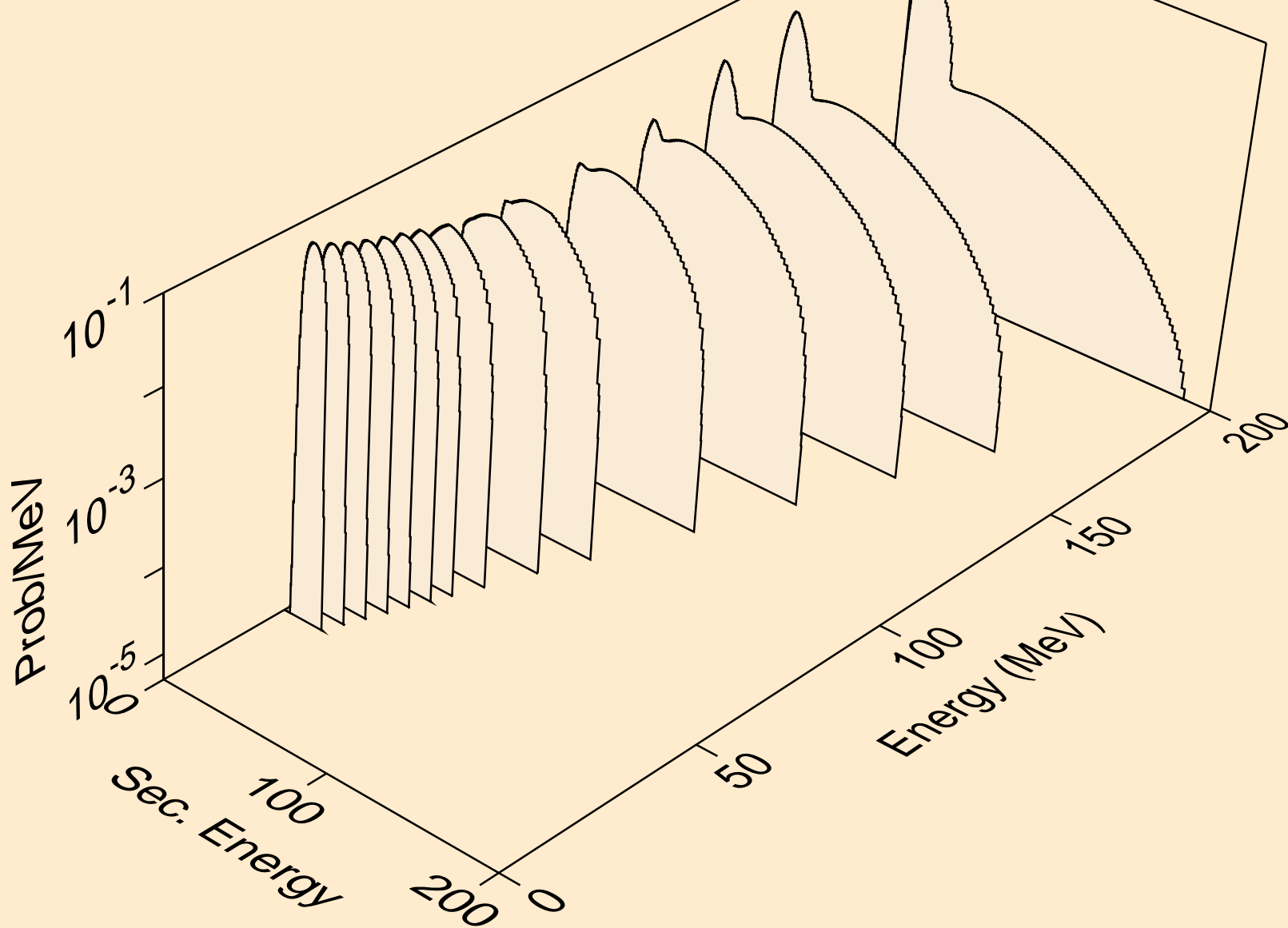

SB124N NEUTRON ACER TENDL-2019 LIBRARY; T=293.16K  
tritons from (n,n\*)t

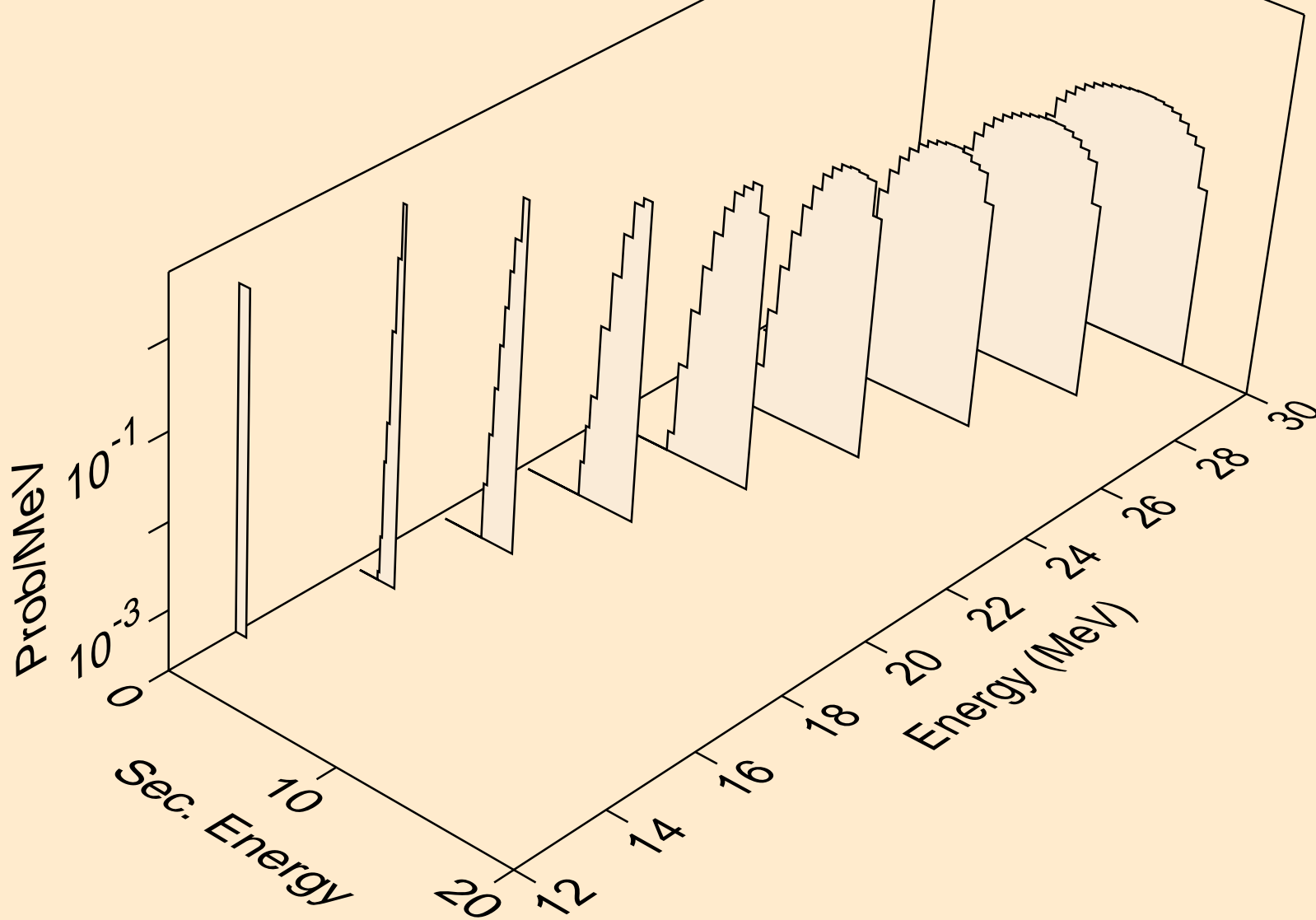



SB124N NEUTRON ACER TENDL-2019 LIBRARY; T=293.16K  
tritons from (n,t)

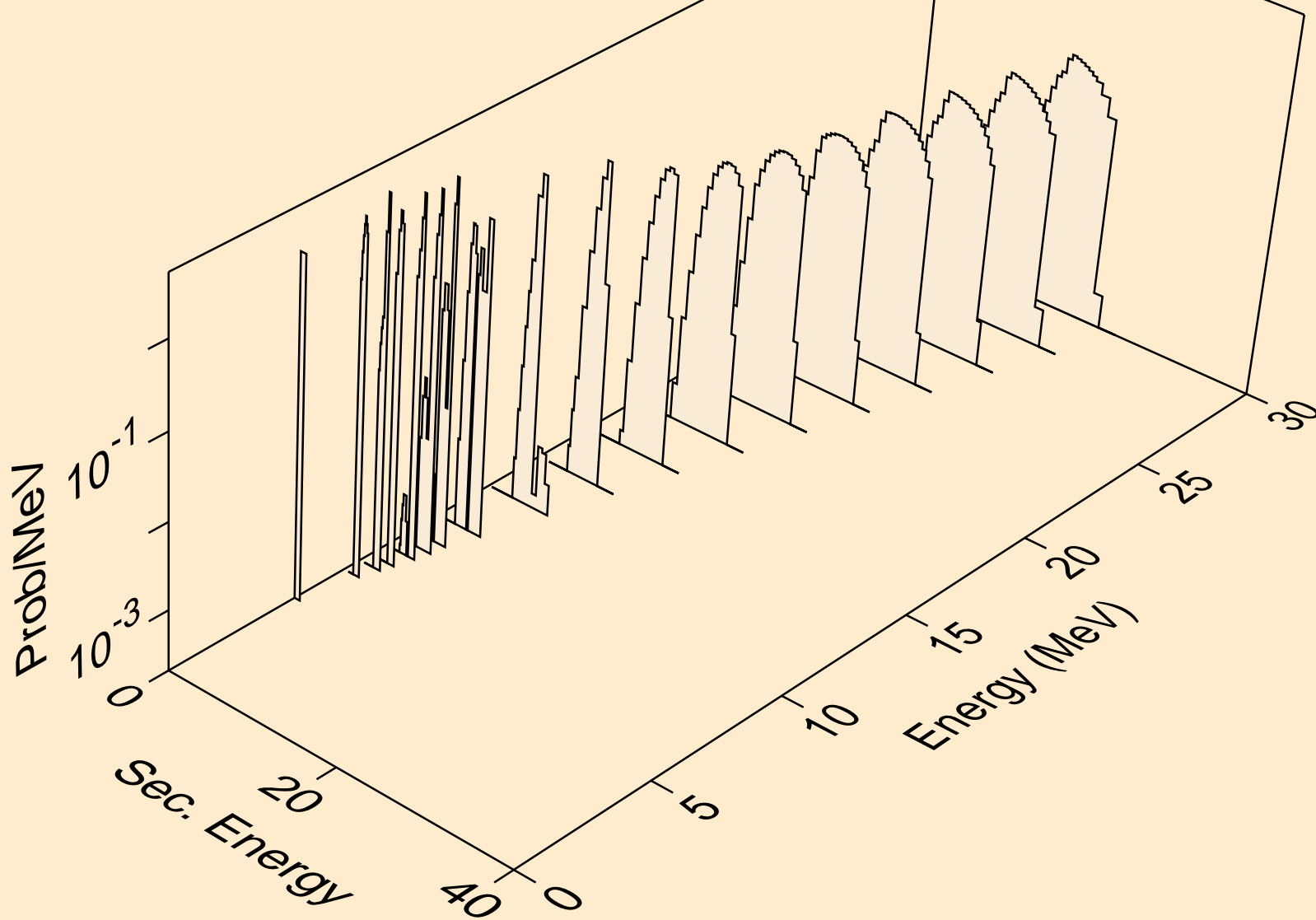

SB124N NEUTRON ACER TENDL-2019 LIBRARY; T=293.16K  
tritons from (n,pt)

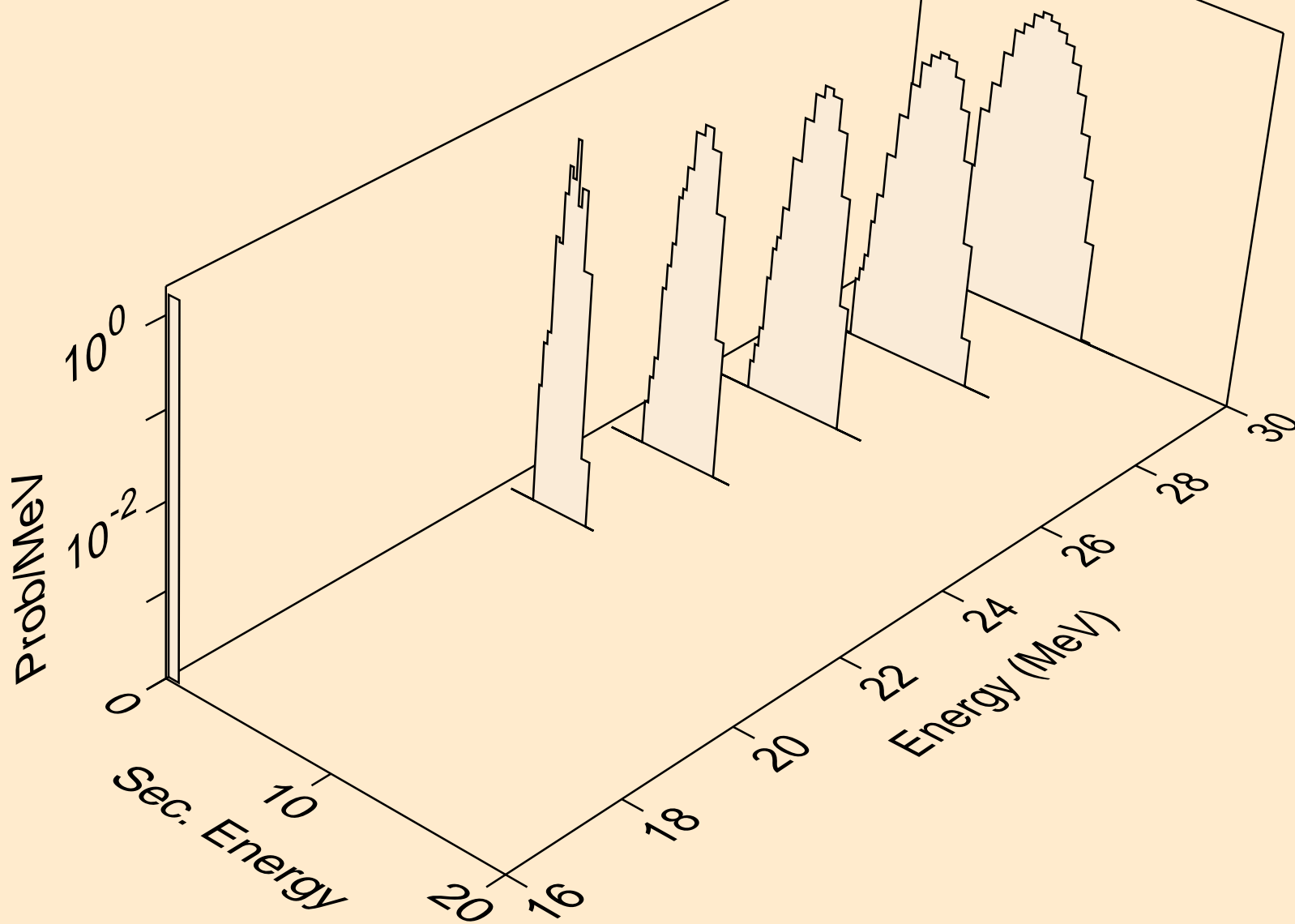

SB124N NEUTRON ACER TENDL-2019 LIBRARY; T=293.16K  
he3s from (n,x)

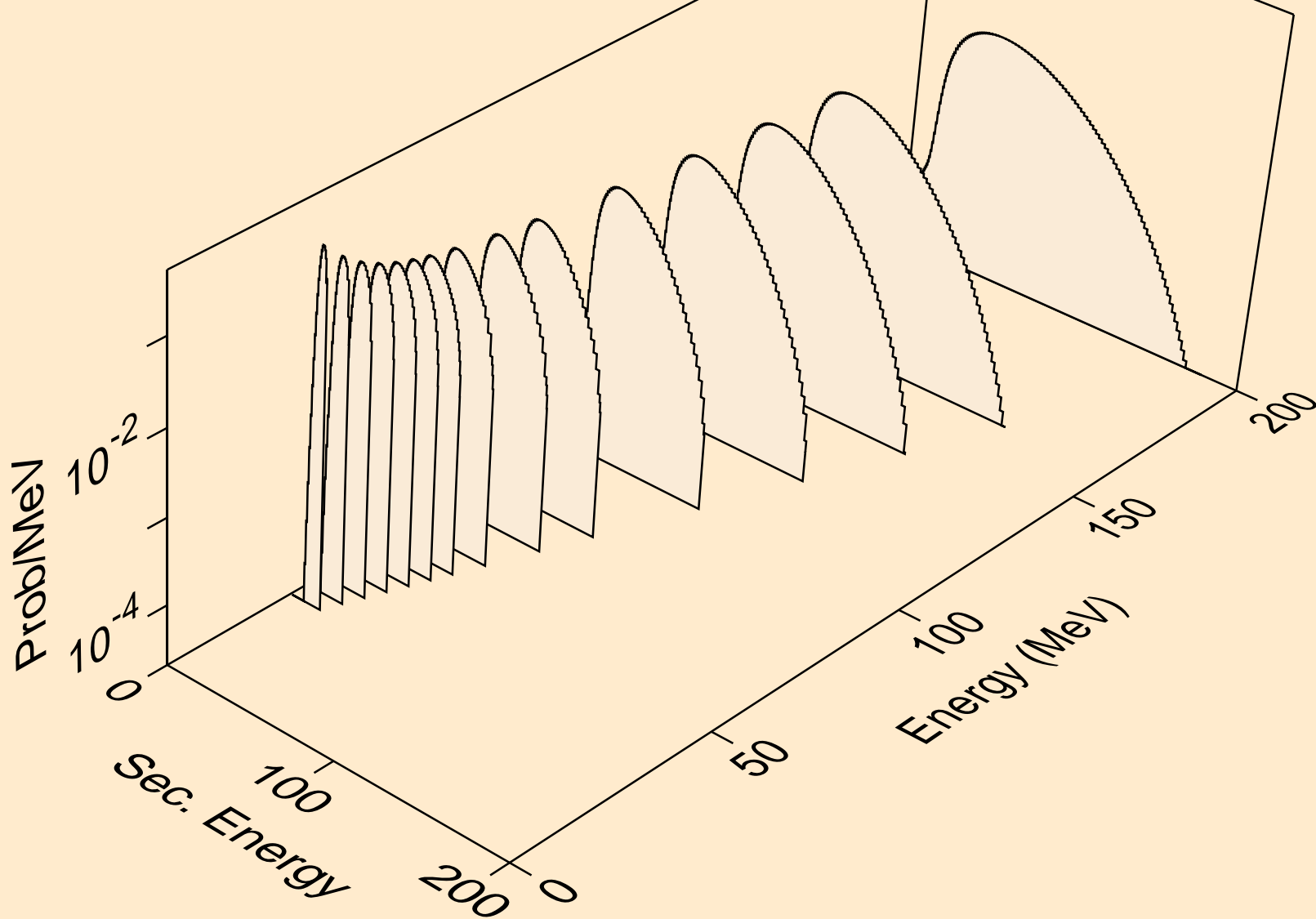

SB124N NEUTRON ACER TENDL-2019 LIBRARY; T=293.16K  
he3s from (n,n\*)he3

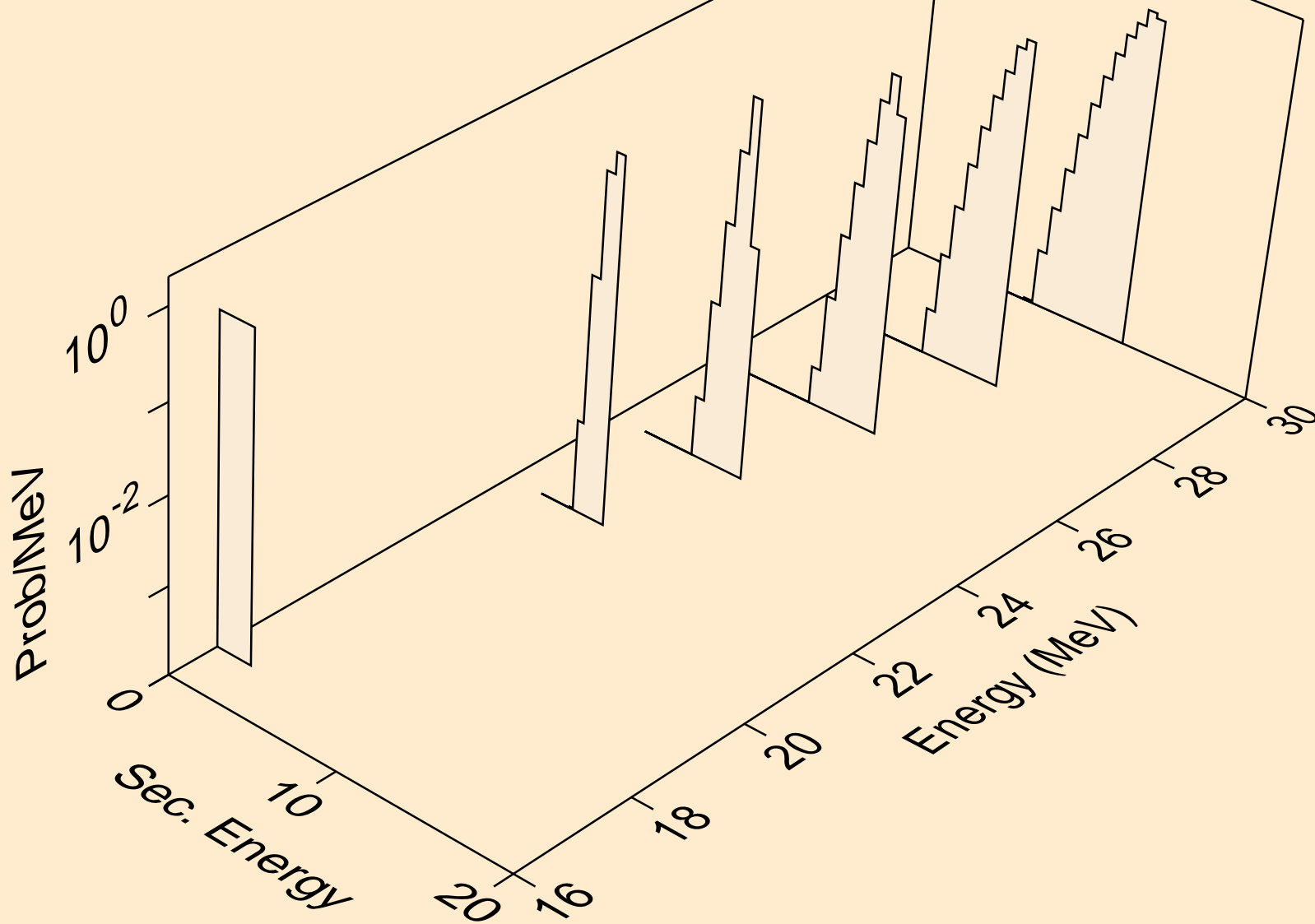

SB124N NEUTRON ACER TENDL-2019 LIBRARY; T=293.16K  
he3s from (n,he3)

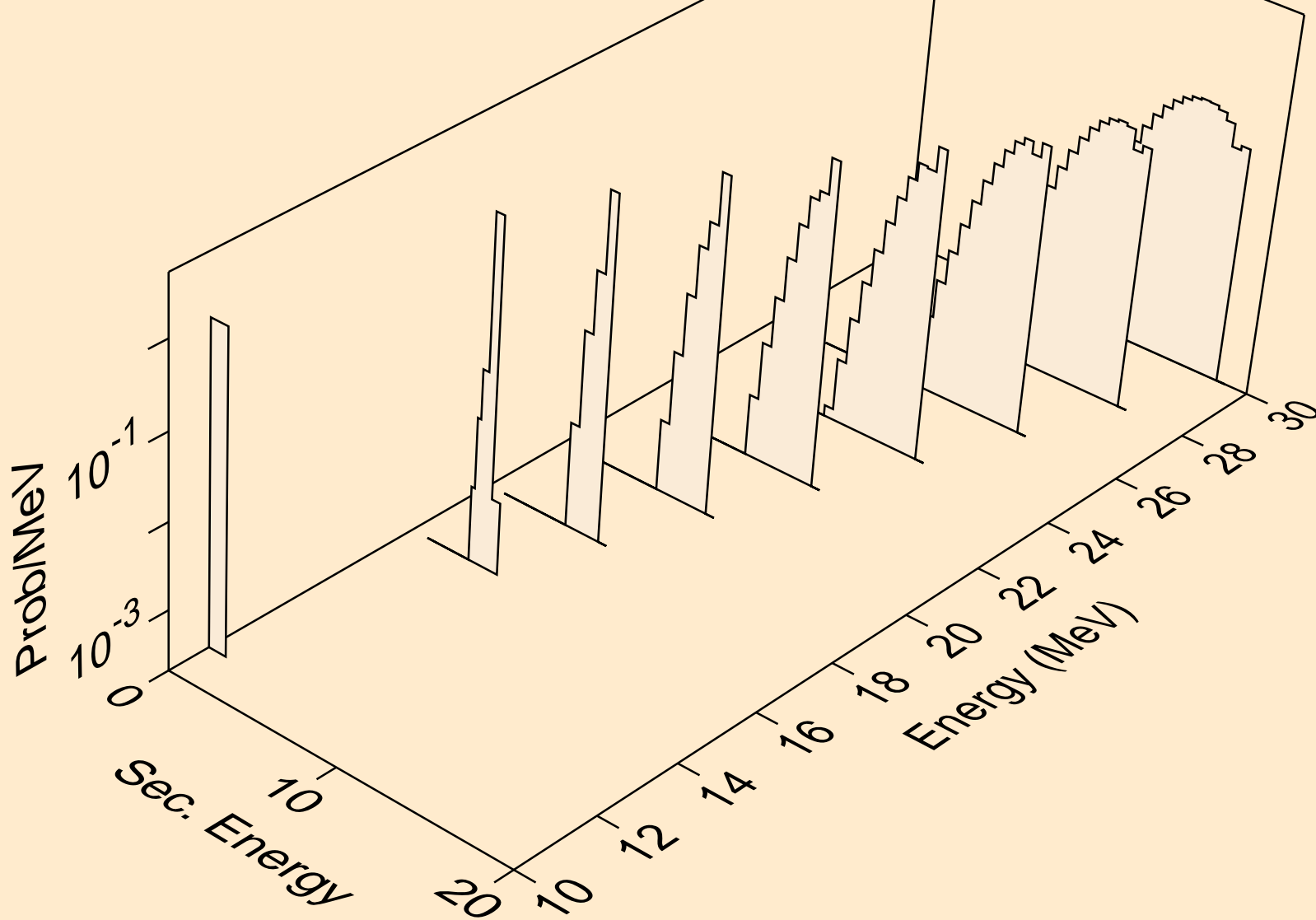

SB124N NEUTRON ACER TENDL-2019 LIBRARY; T=293.16K  
alphas from (n,x)

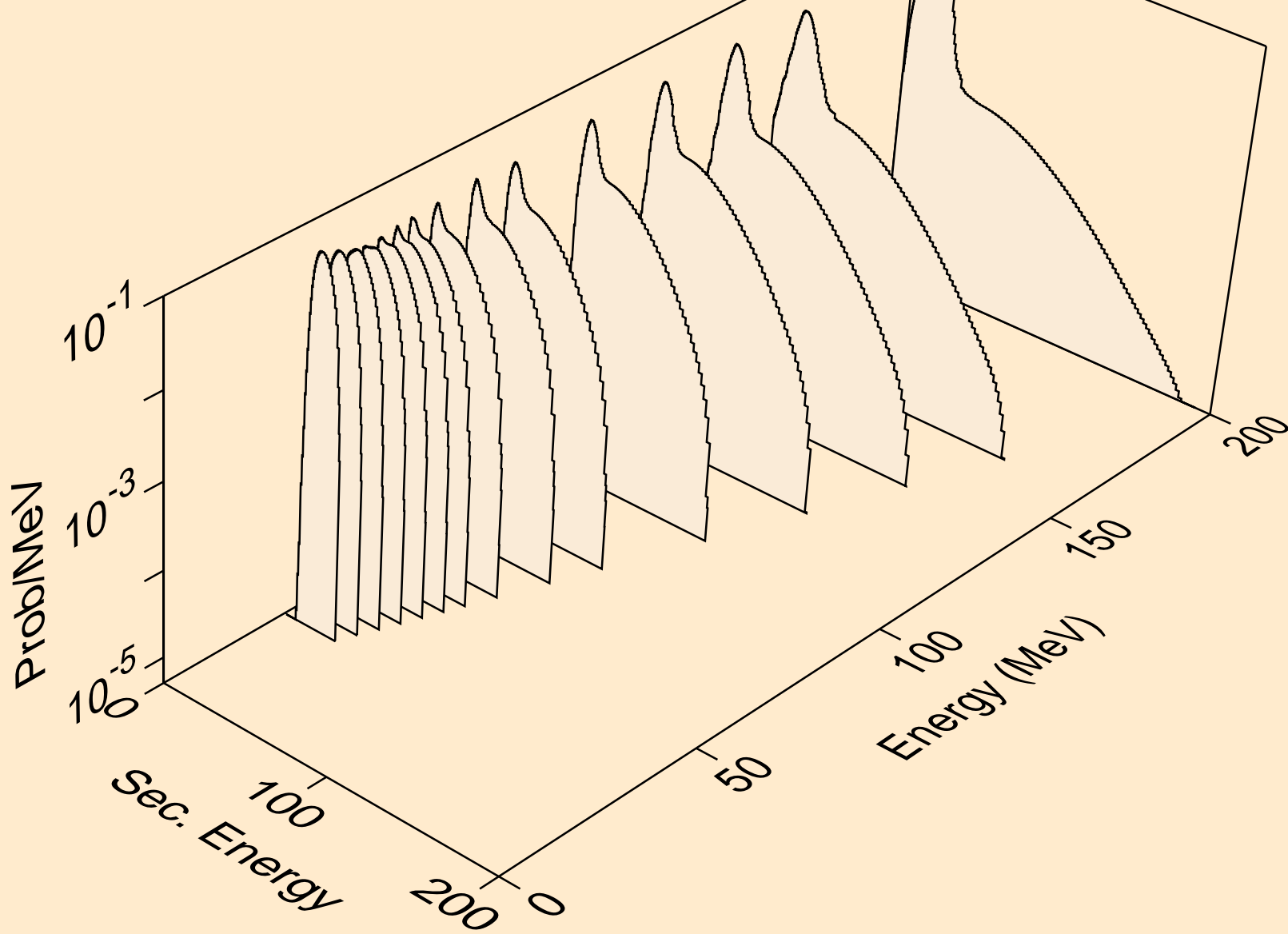

SB124N NEUTRON ACER TENDL-2019 LIBRARY; T=293.16K  
alphas from (n,n\*)a

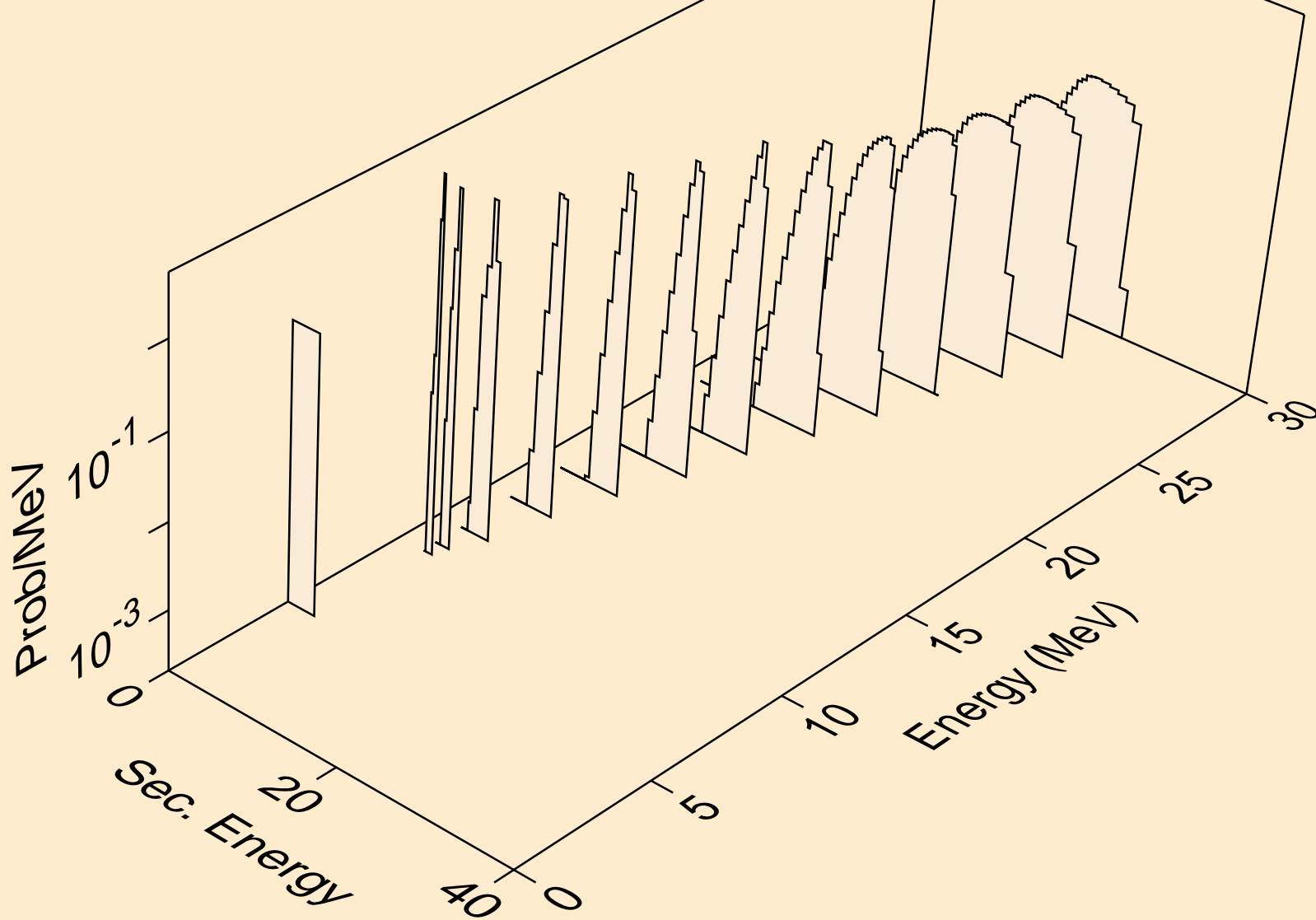

SB124N NEUTRON ACER TENDL-2019 LIBRARY; T=293.16K  
alphas from (n,2n)a

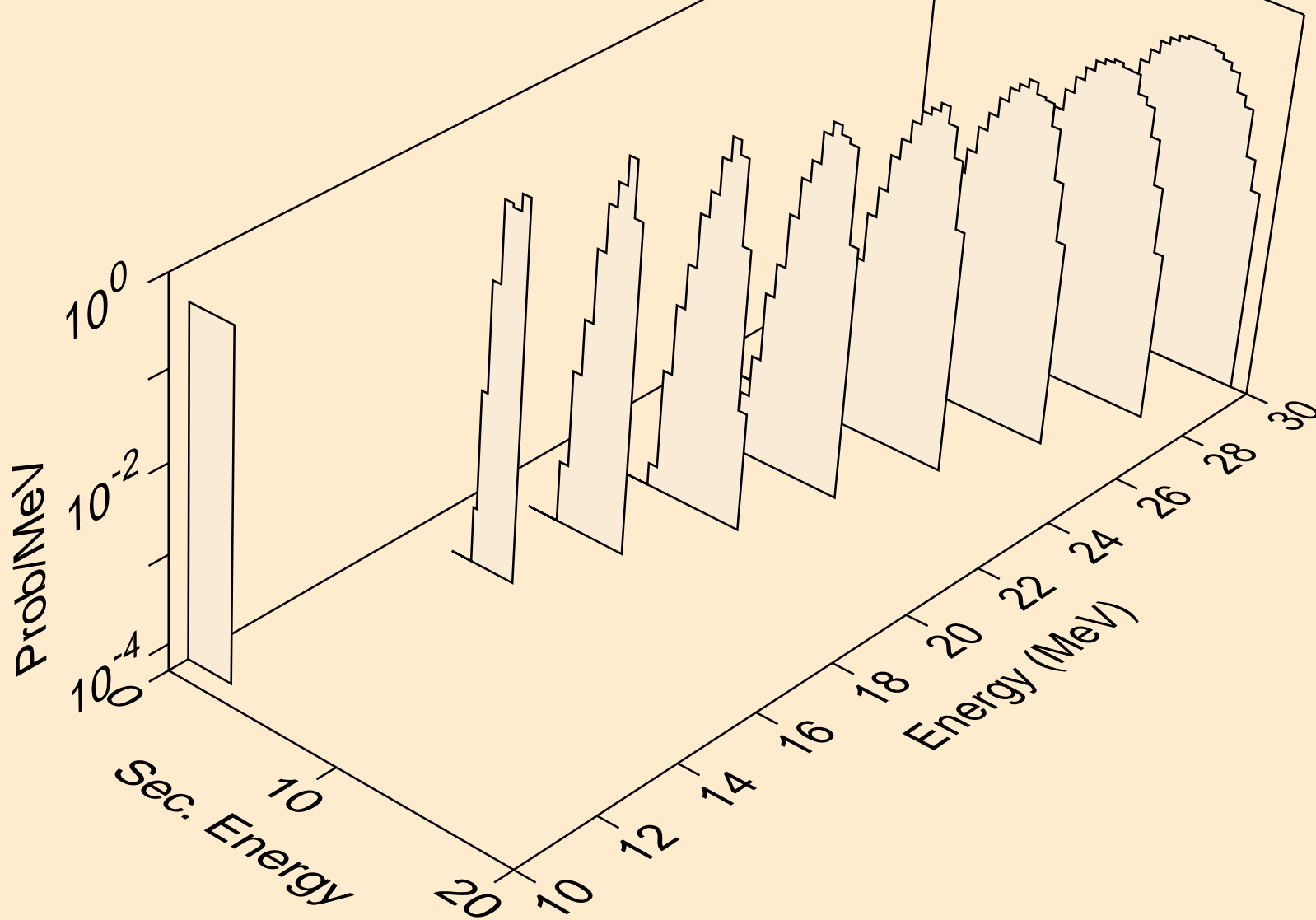



SB124N NEUTRON ACER TENDL-2019 LIBRARY; T=293.16K  
alphas from (n,3n)a



SB124N NEUTRON ACER TENDL-2019 LIBRARY; T=293.16K  
alphas from (n,a)

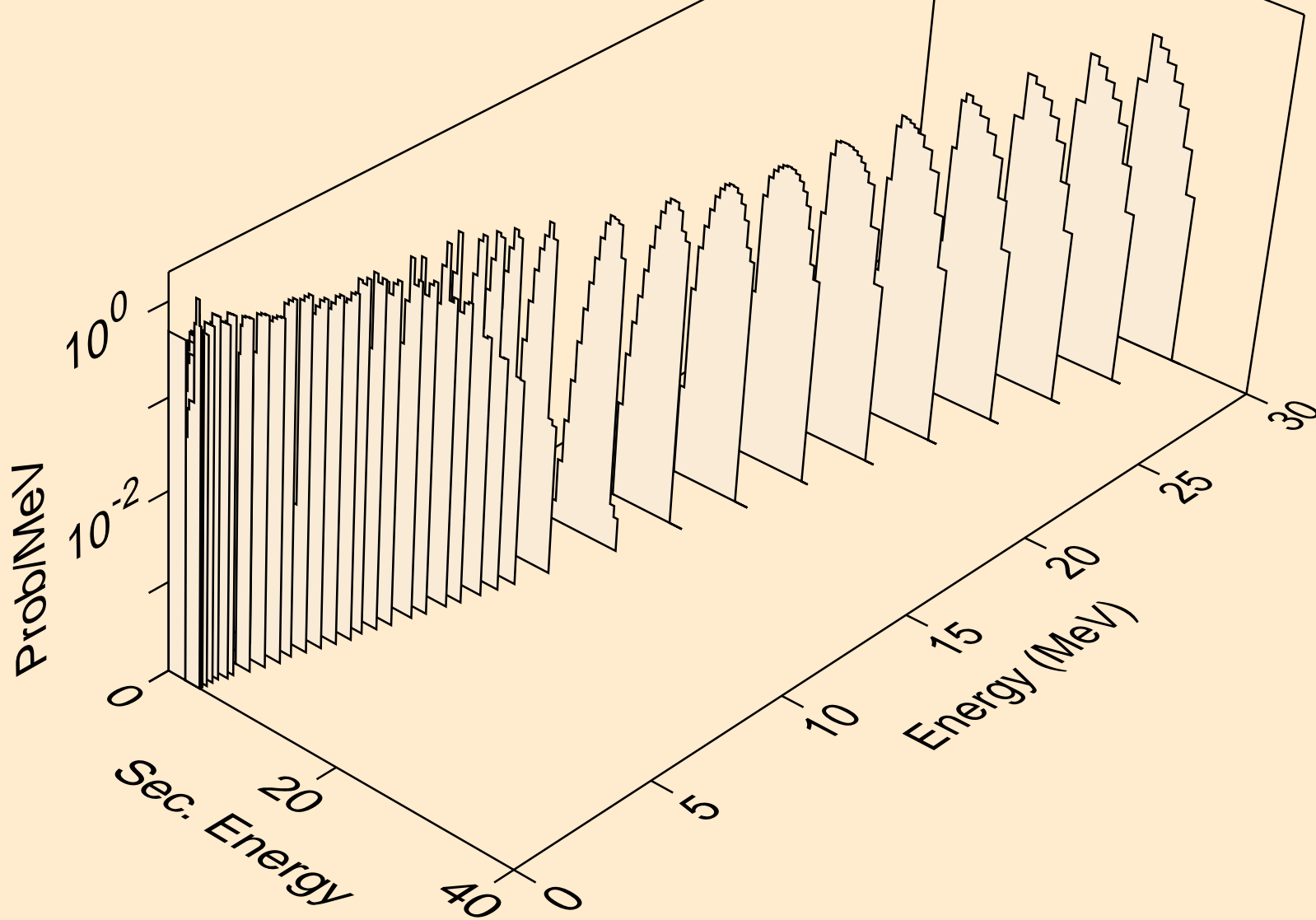

SB124N NEUTRON ACER TENDL-2019 LIBRARY; T=293.16K  
alphas from (n,pa)

