

SG265 NEUTRON ACER TENDL-2019 LIBRARY; T=293.16K
Principal cross sections

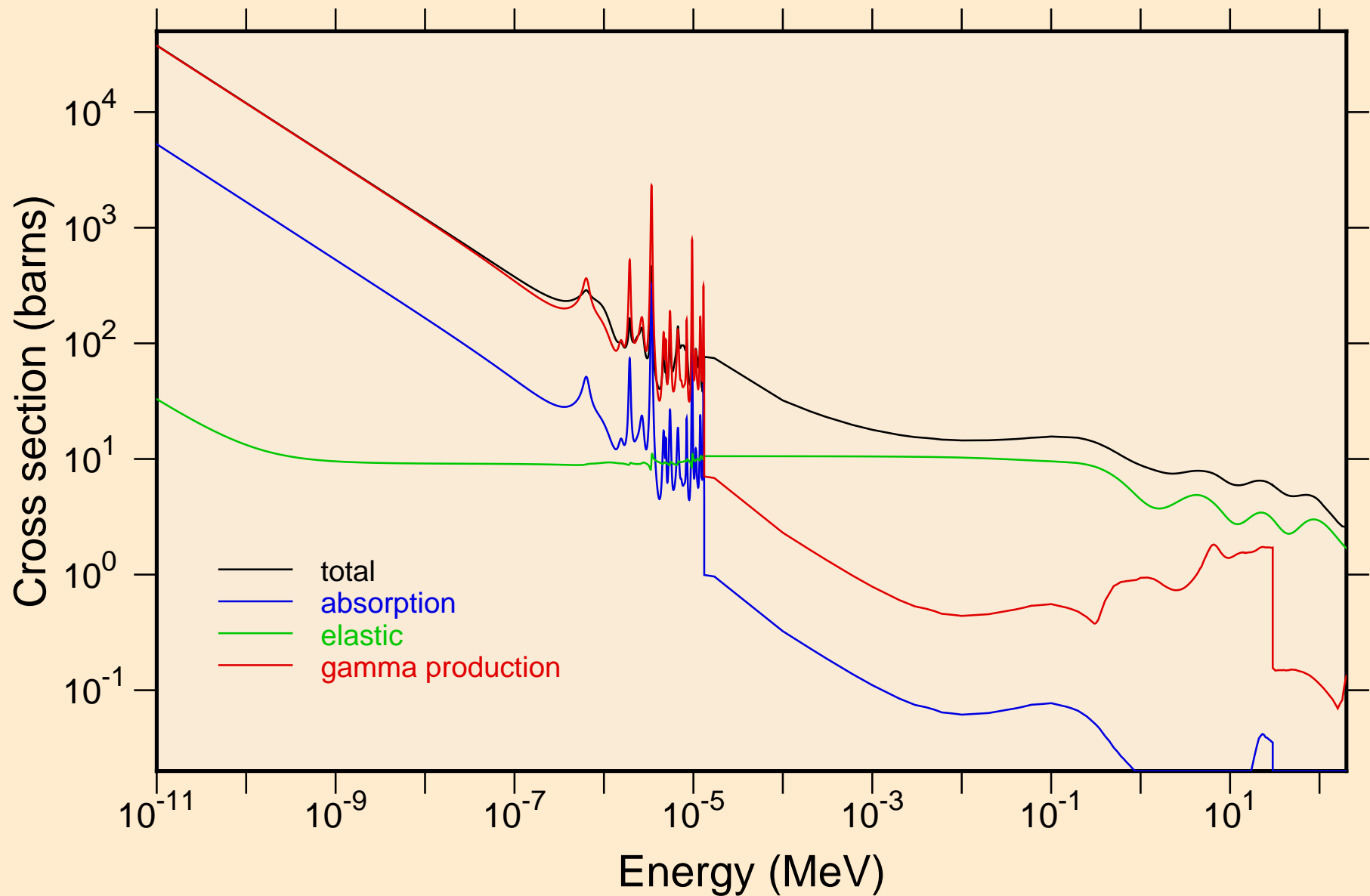

SG265 NEUTRON ACER TENDL-2019 LIBRARY; T=293.16K
resonance total cross section

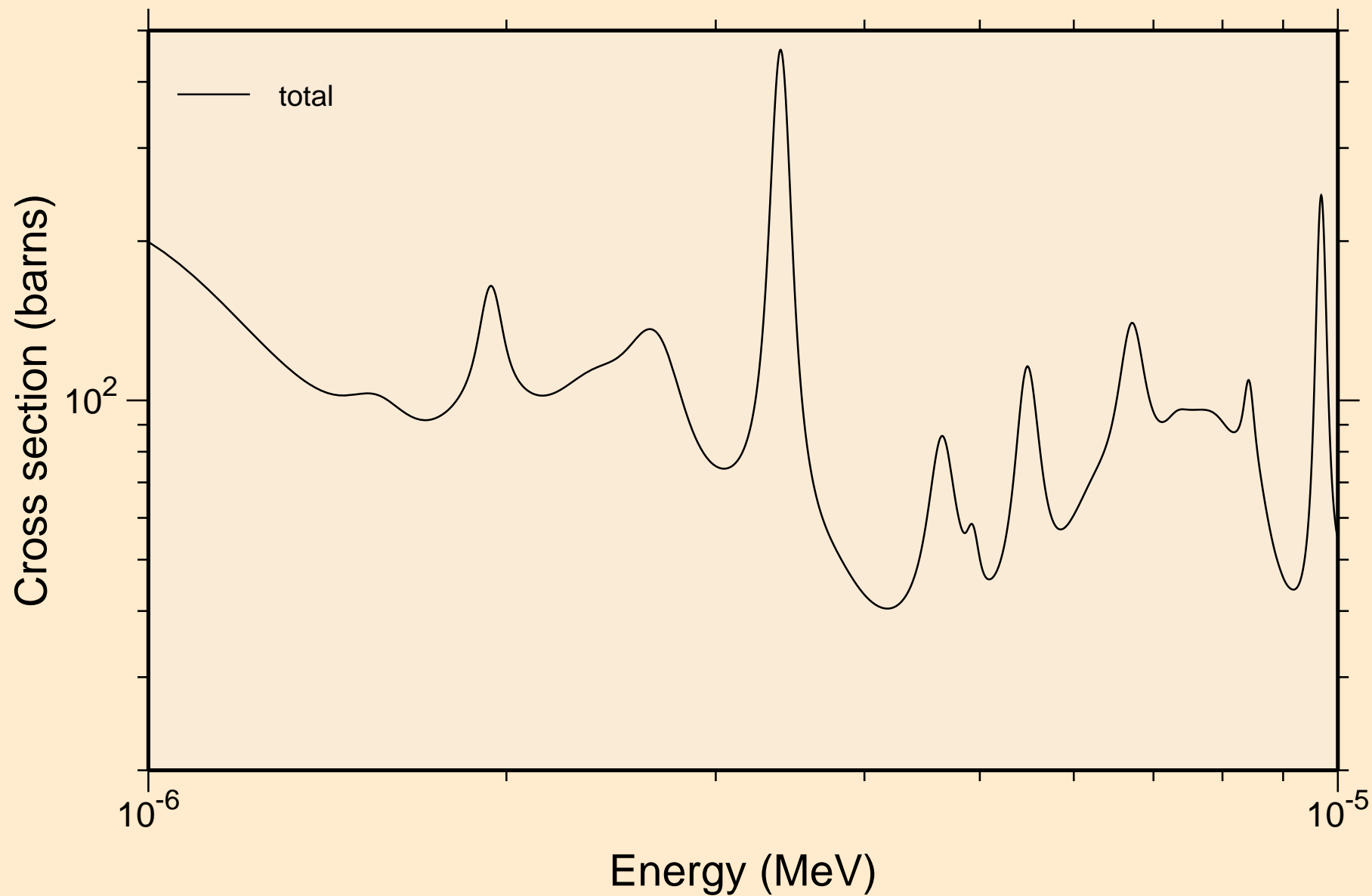

SG265 NEUTRON ACER TENDL-2019 LIBRARY; T=293.16K
resonance total cross section

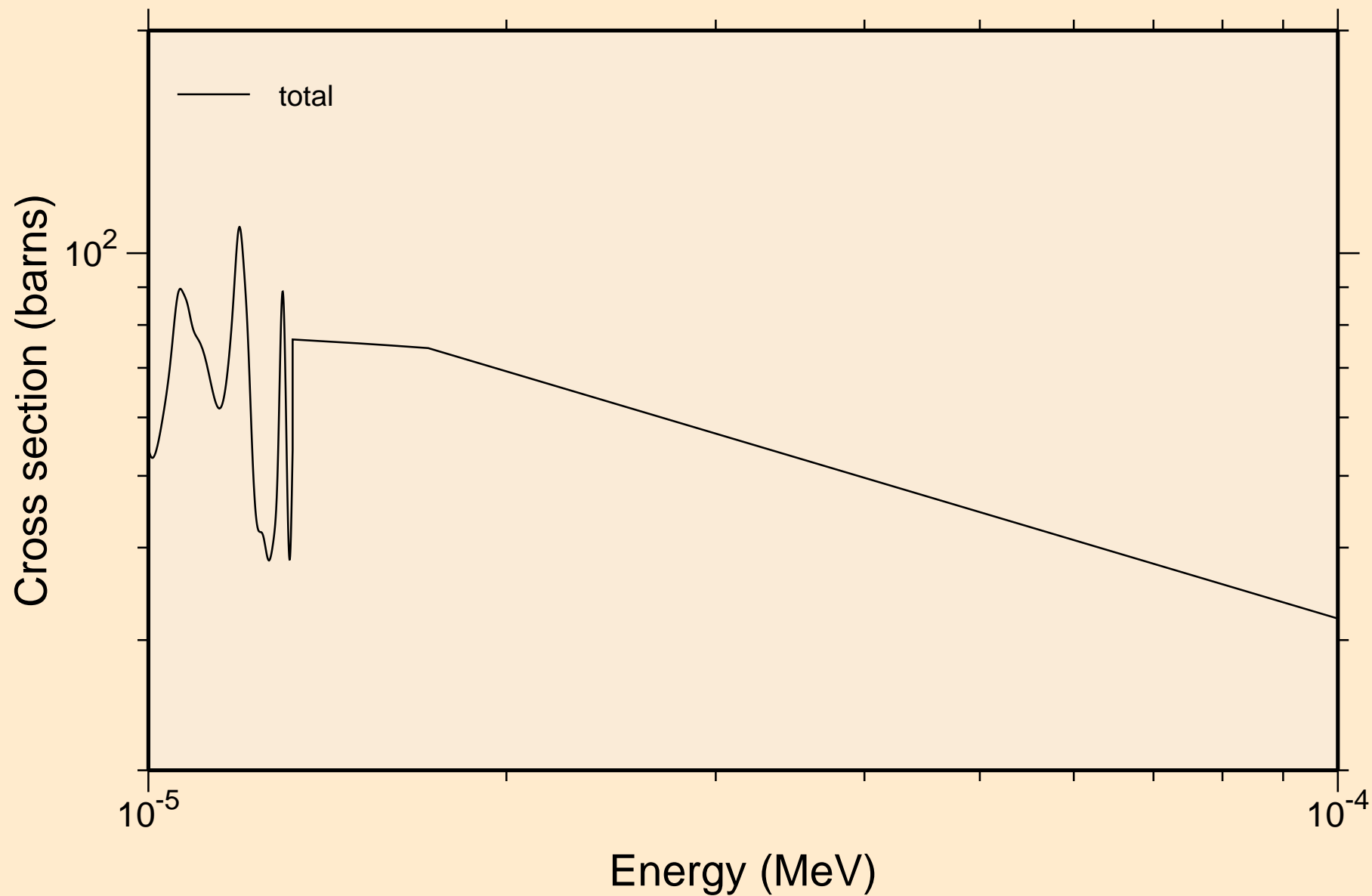

SG265 NEUTRON ACER TENDL-2019 LIBRARY; T=293.16K
resonance total cross section

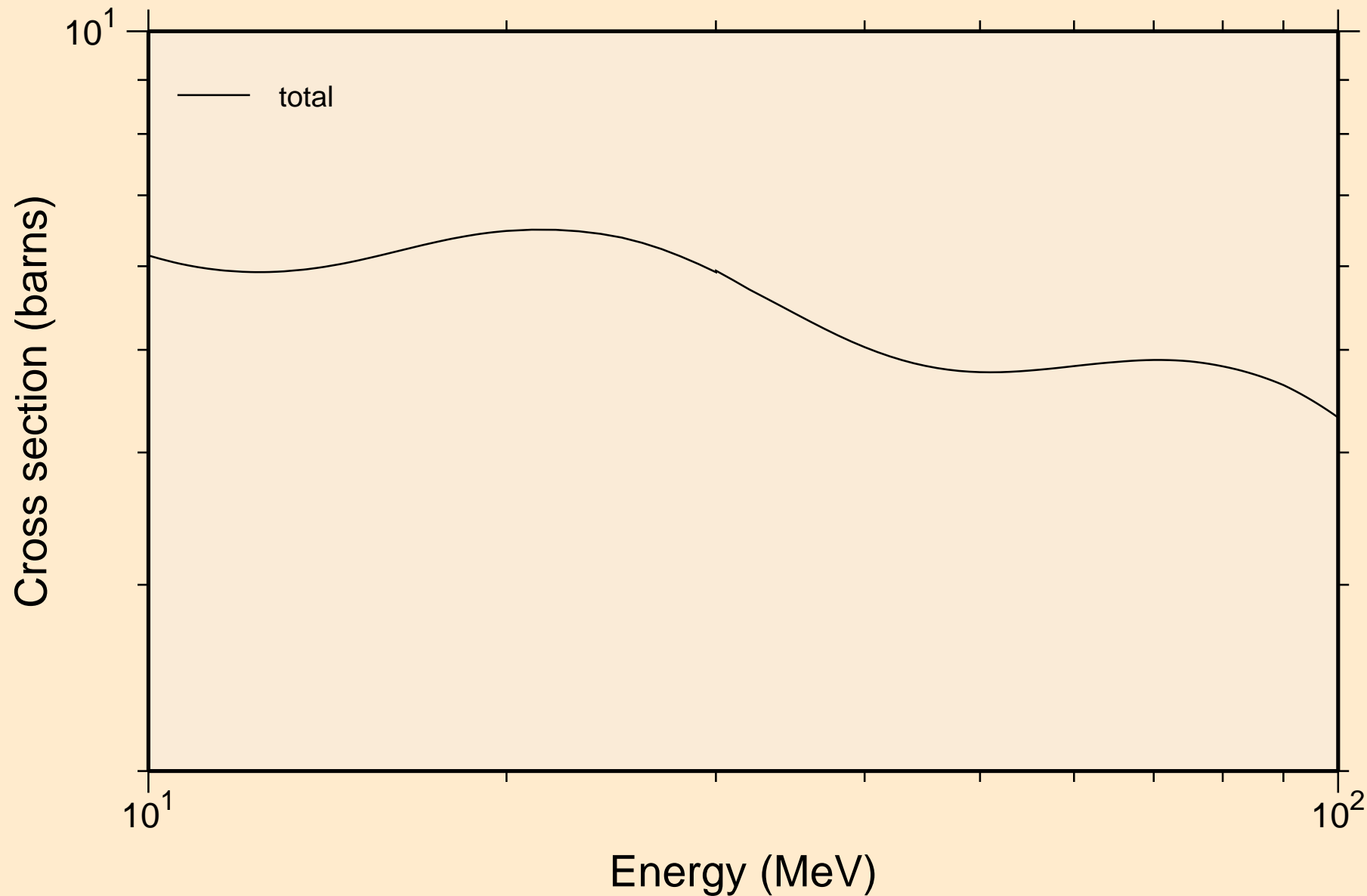

SG265 NEUTRON ACER TENDL-2019 LIBRARY; T=293.16K
resonance absorption cross sections

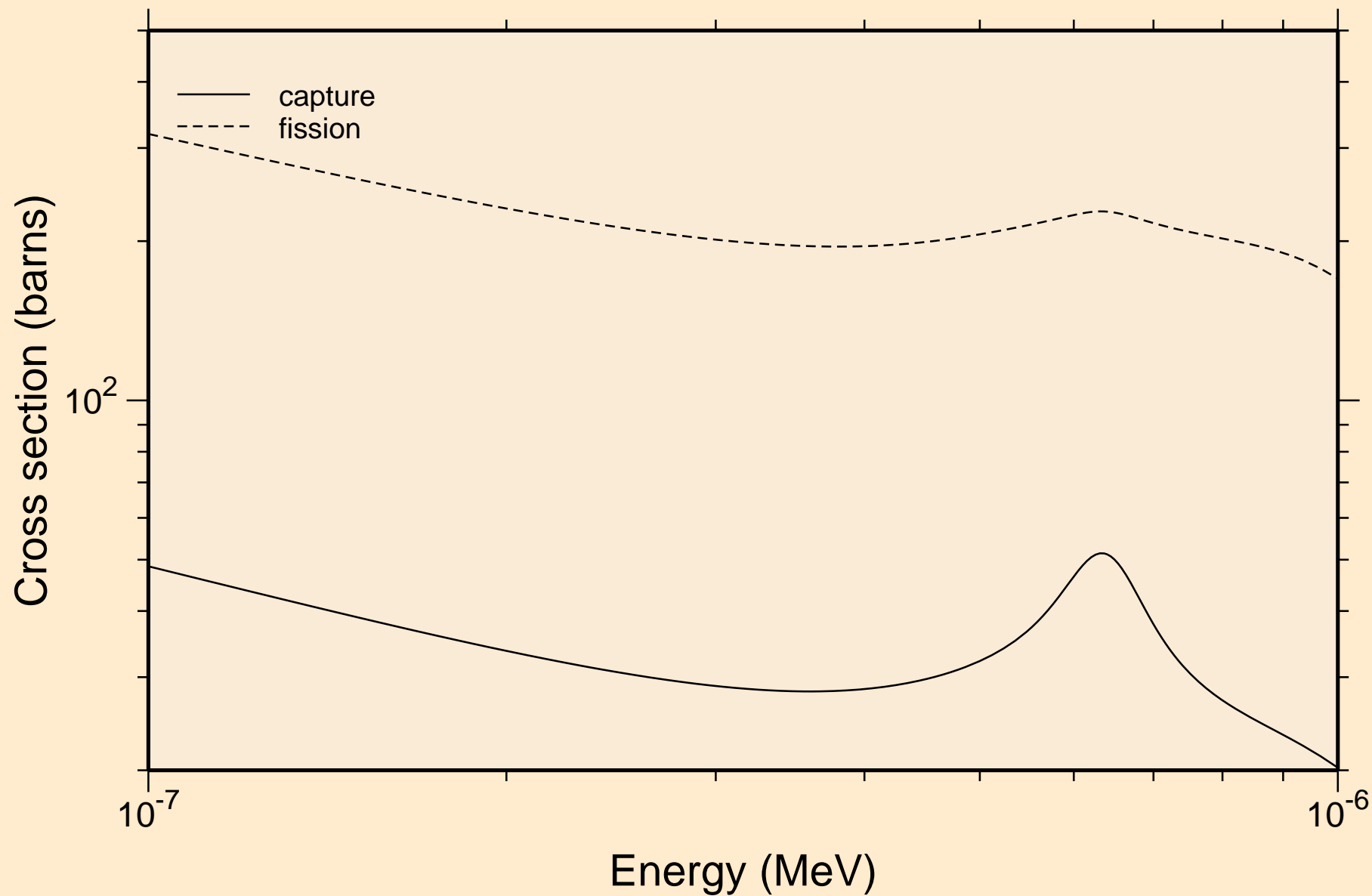

SG265 NEUTRON ACER TENDL-2019 LIBRARY; T=293.16K
resonance absorption cross sections

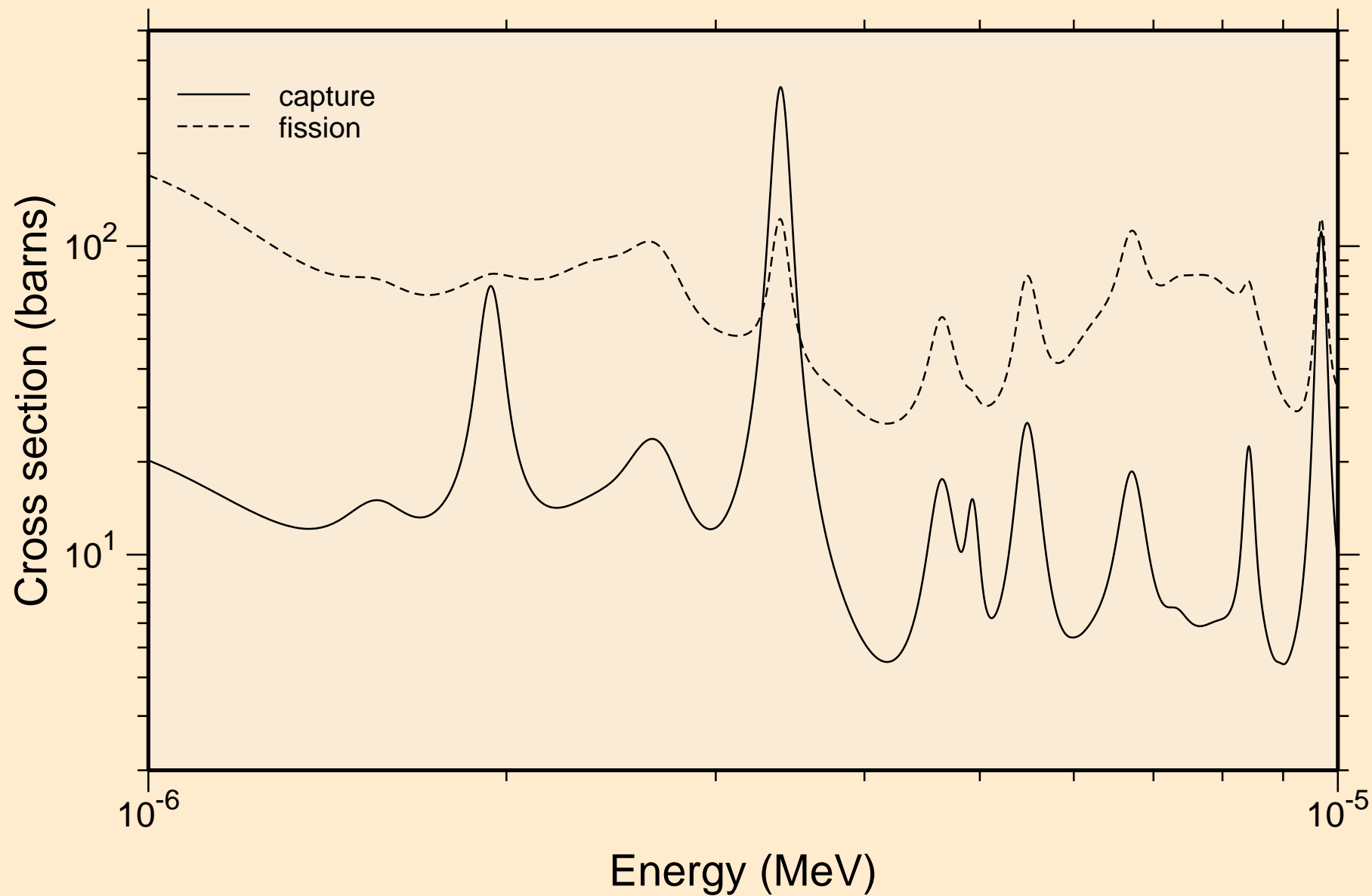

SG265 NEUTRON ACER TENDL-2019 LIBRARY; T=293.16K
resonance absorption cross sections

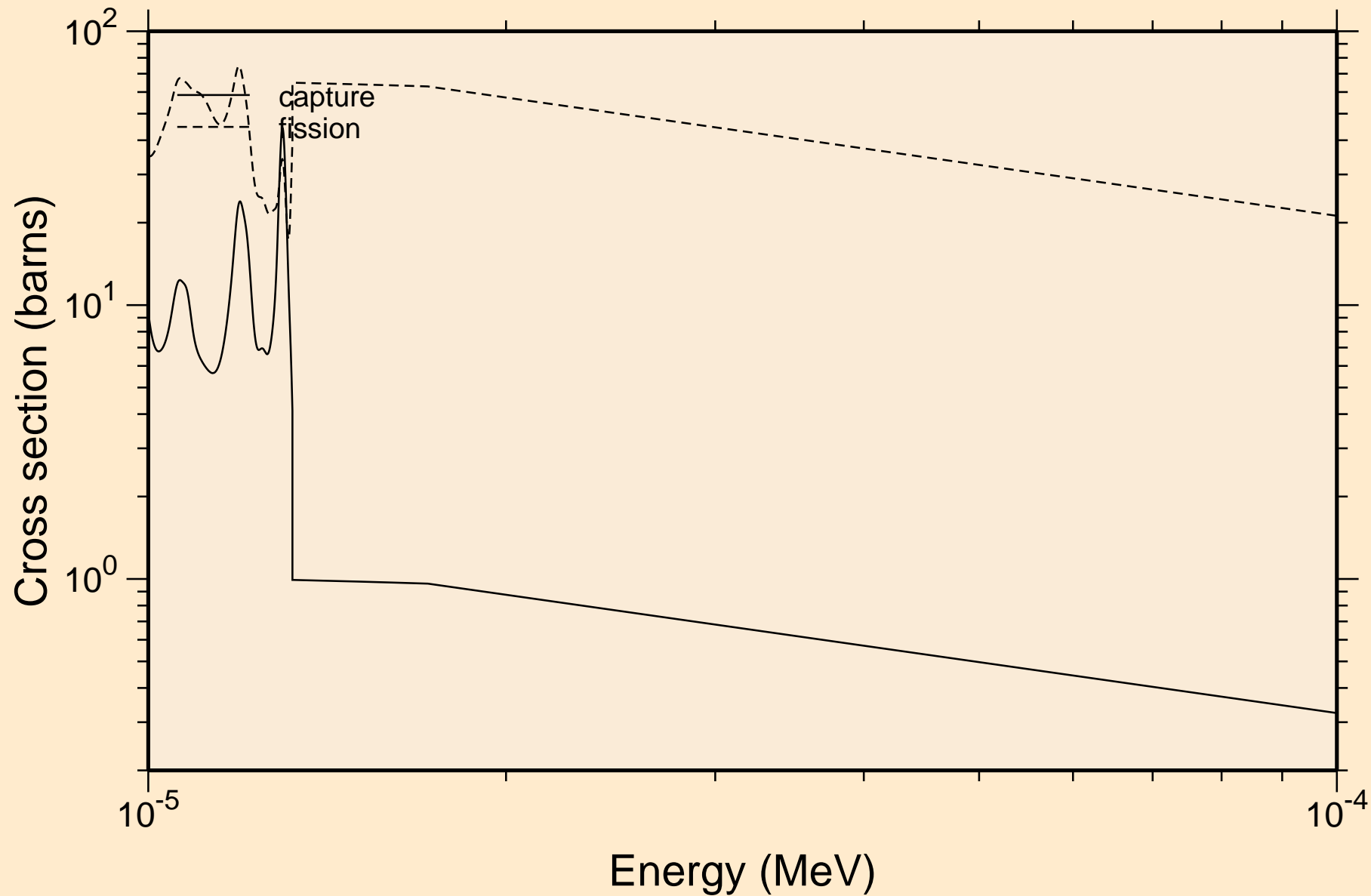

SG265 NEUTRON ACER TENDL-2019 LIBRARY; T=293.16K
resonance absorption cross sections

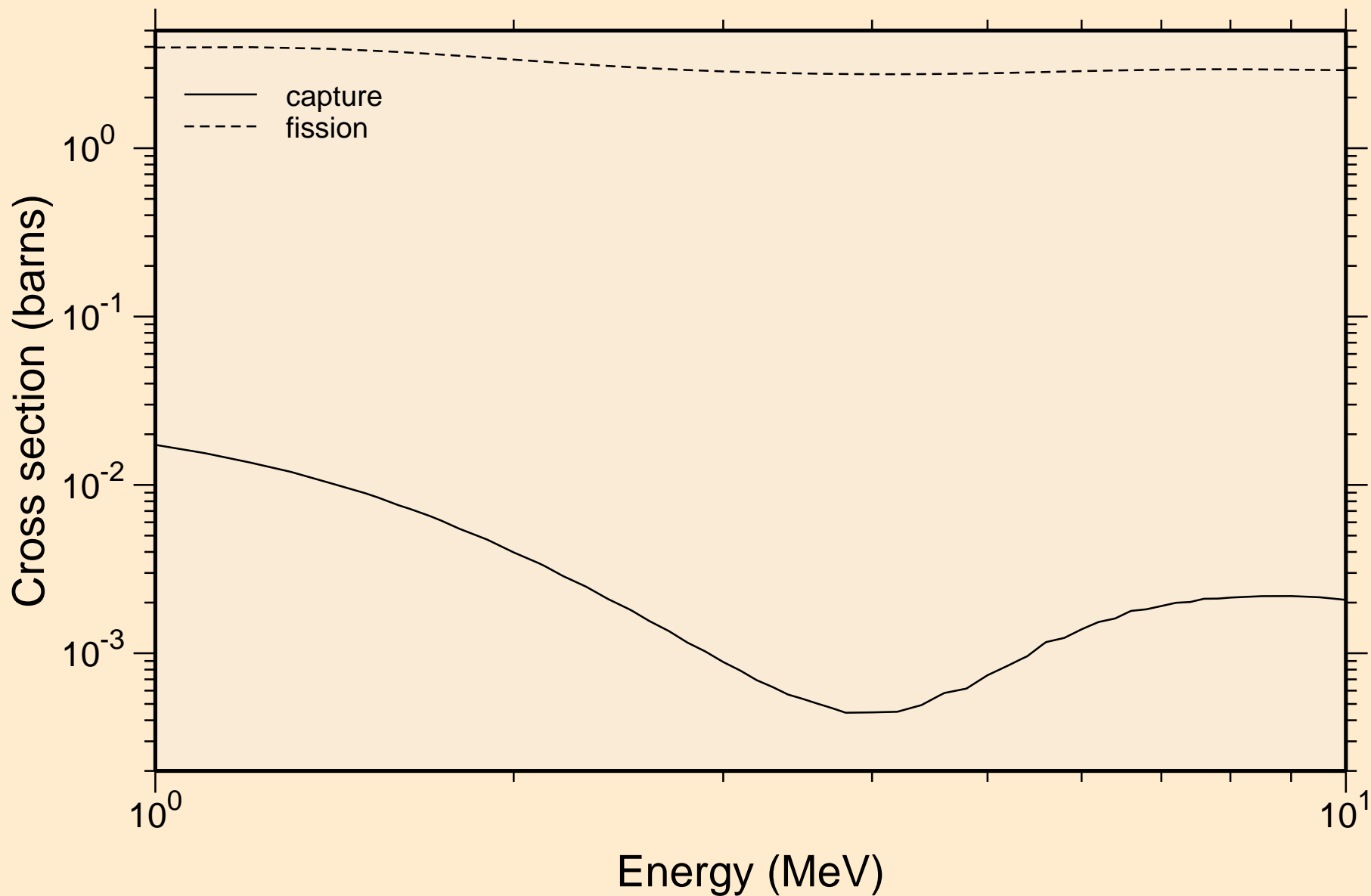

SG265 NEUTRON ACER TENDL-2019 LIBRARY; T=293.16K
Heating

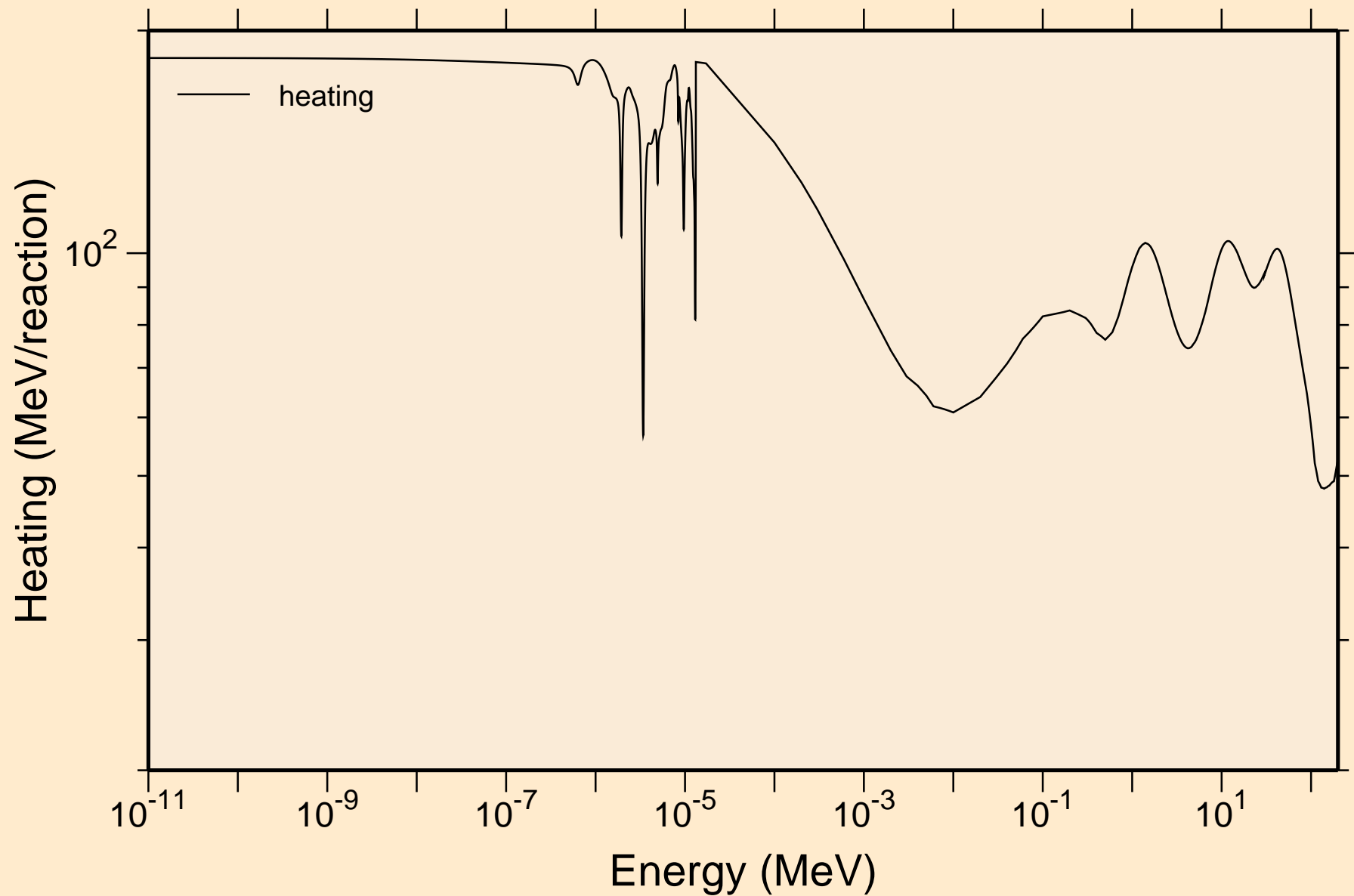

SG265 NEUTRON ACER TENDL-2019 LIBRARY; T=293.16K Damage

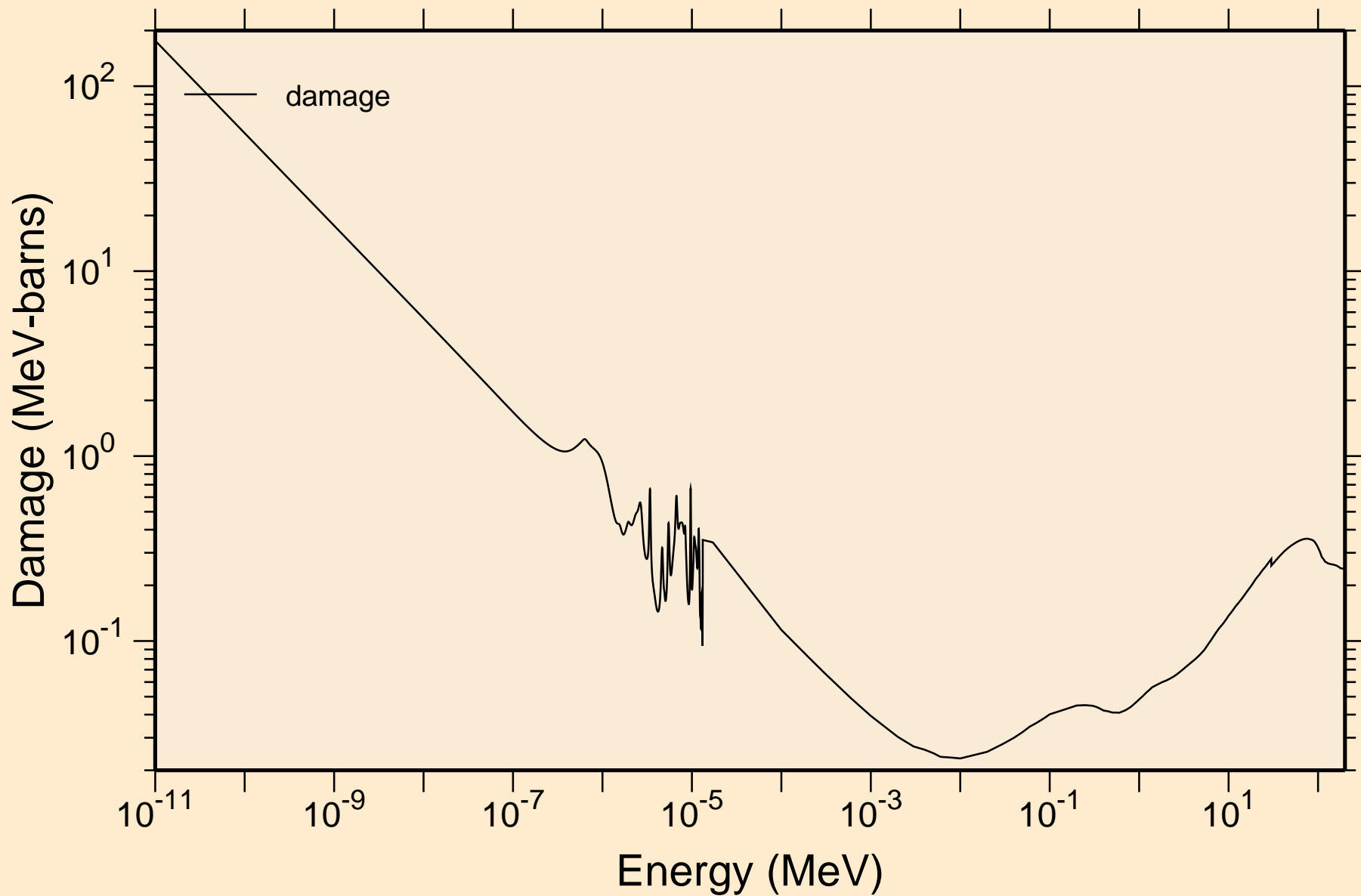

SG265 NEUTRON ACER TENDL-2019 LIBRARY; T=293.16K
Non-threshold reactions

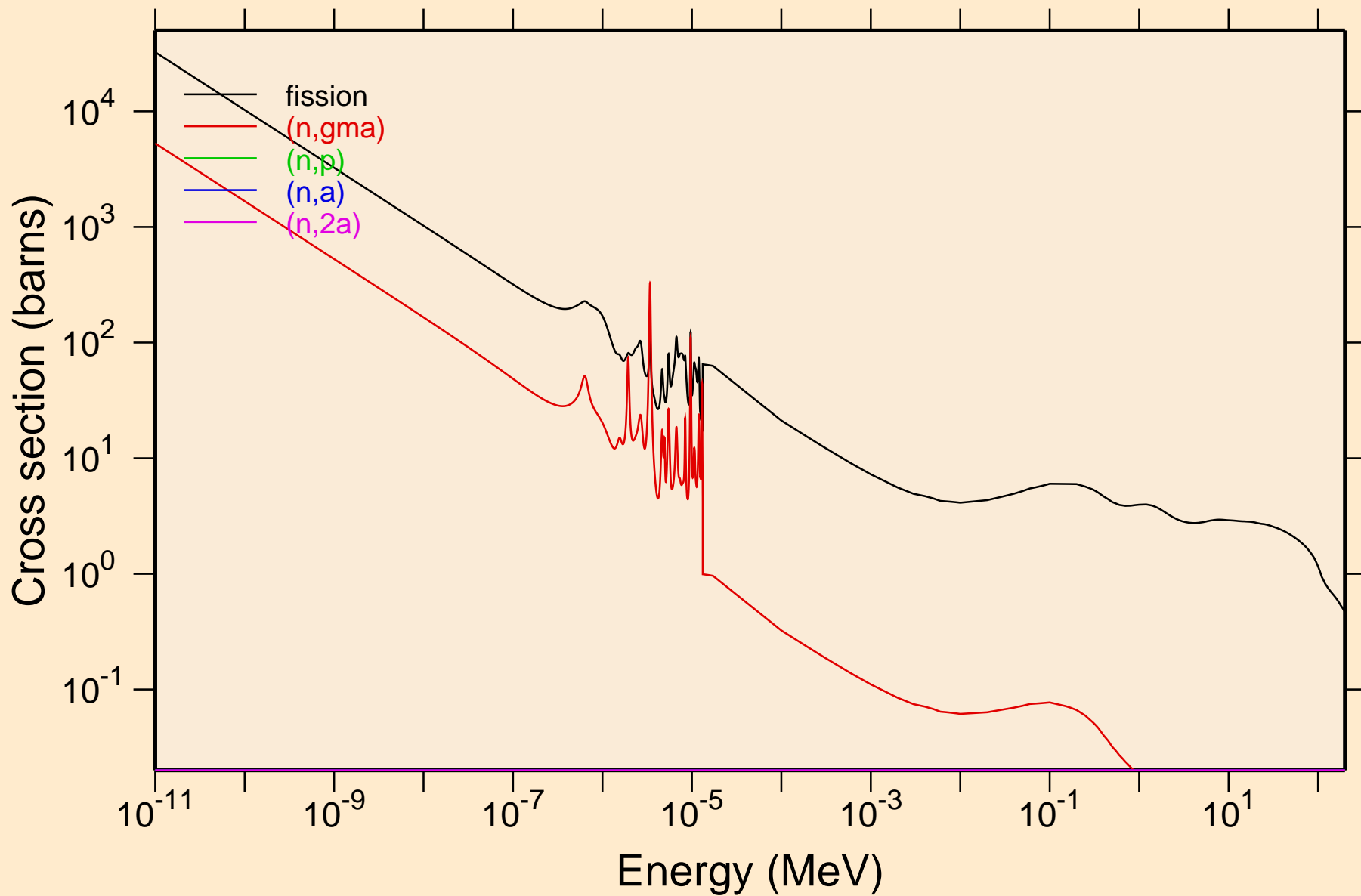

SG265 NEUTRON ACER TENDL-2019 LIBRARY; T=293.16K
Non-threshold reactions

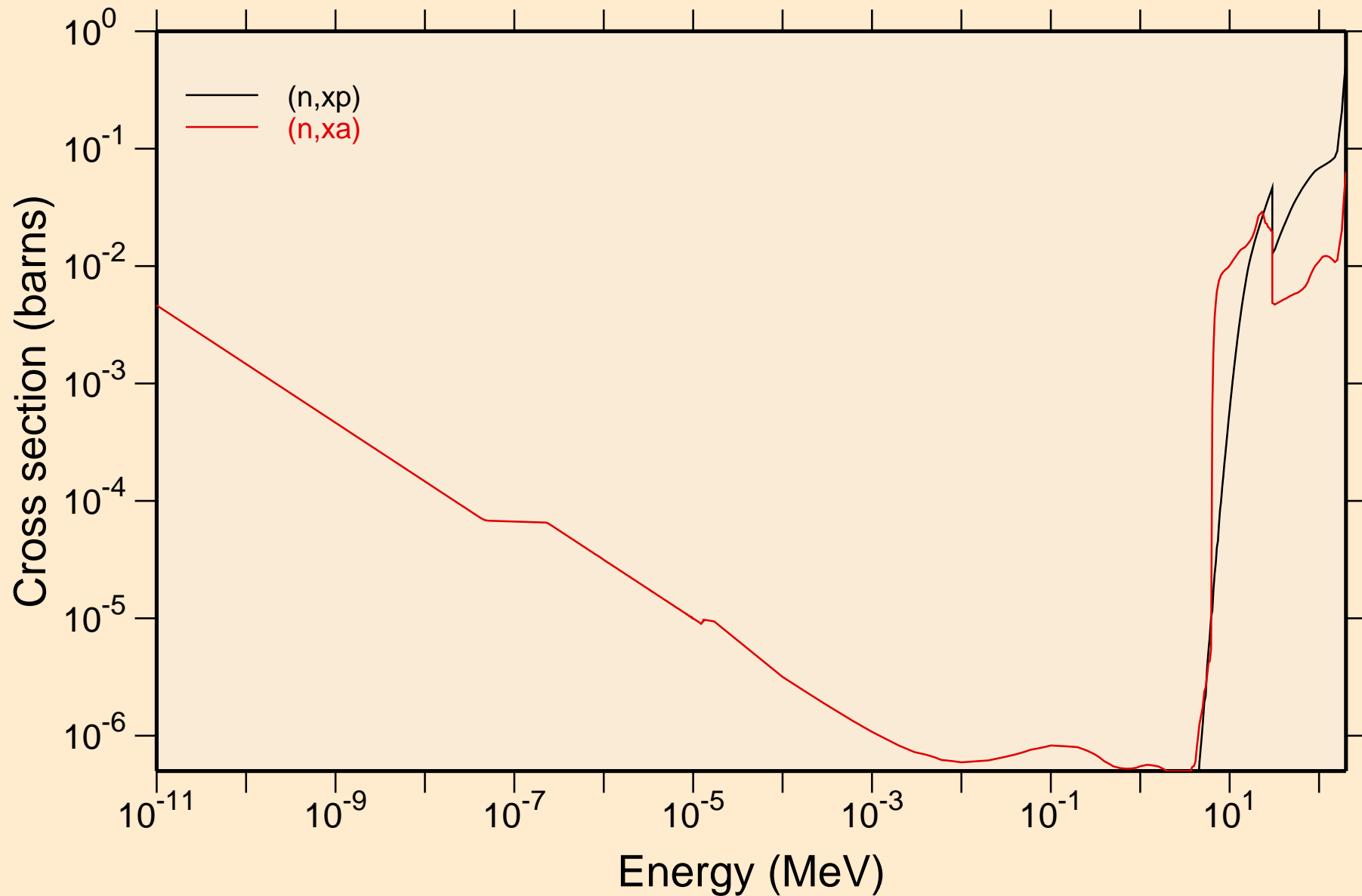

SG265 NEUTRON ACER TENDL-2019 LIBRARY; T=293.16K

Principal cross sections

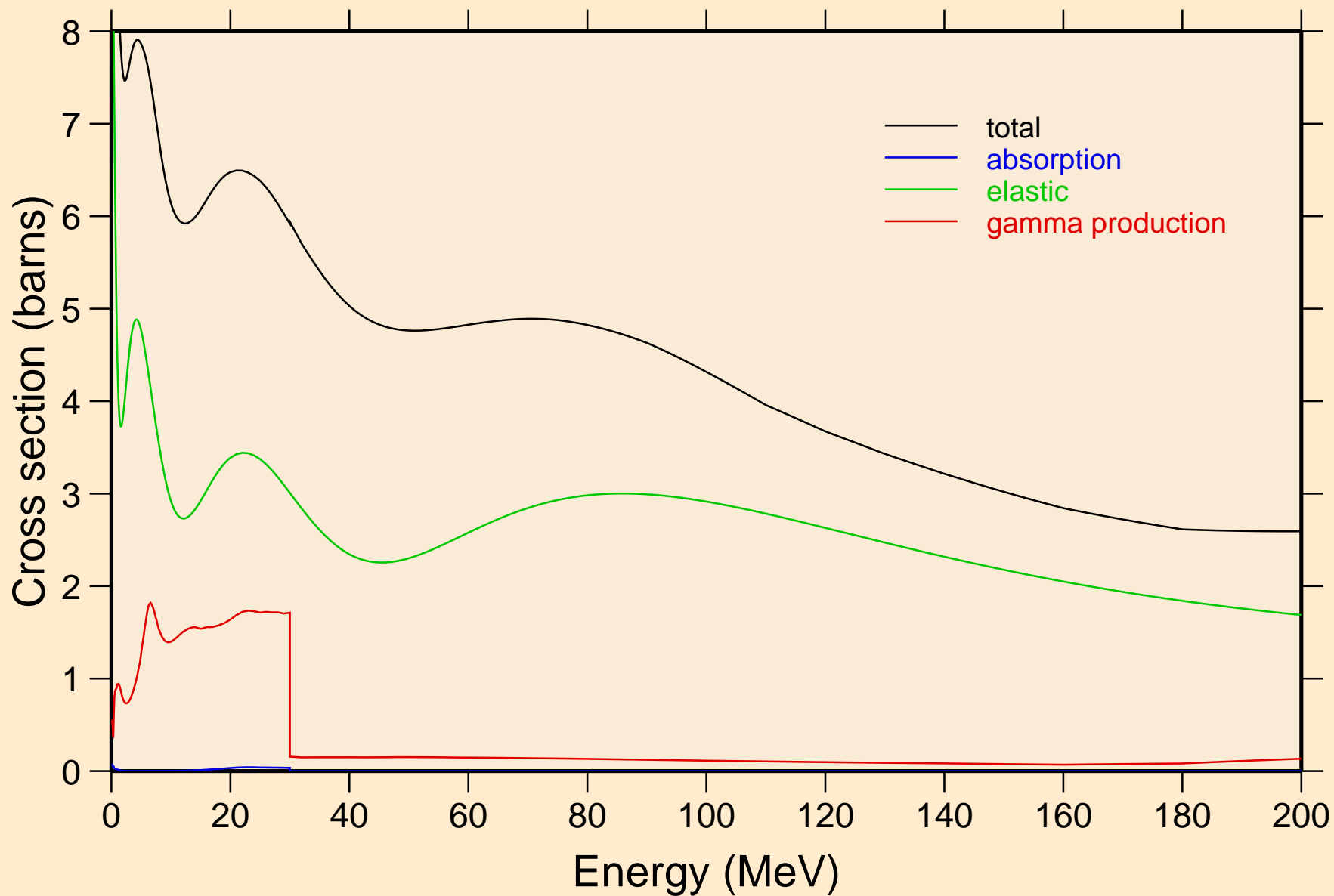

SG265 NEUTRON ACER TENDL-2019 LIBRARY; T=293.16K
Heating

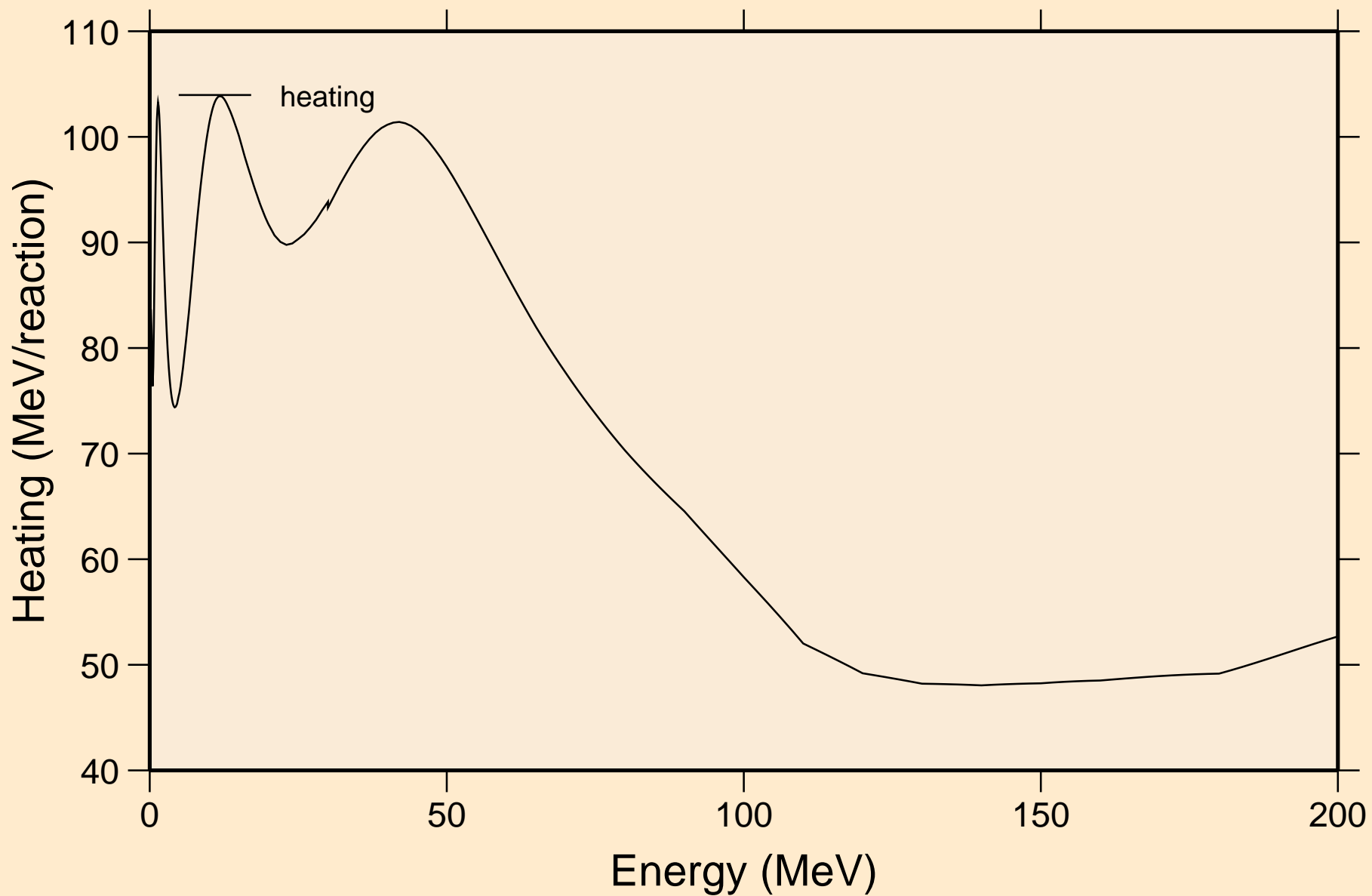

SG265 NEUTRON ACER TENDL-2019 LIBRARY; T=293.16K Damage

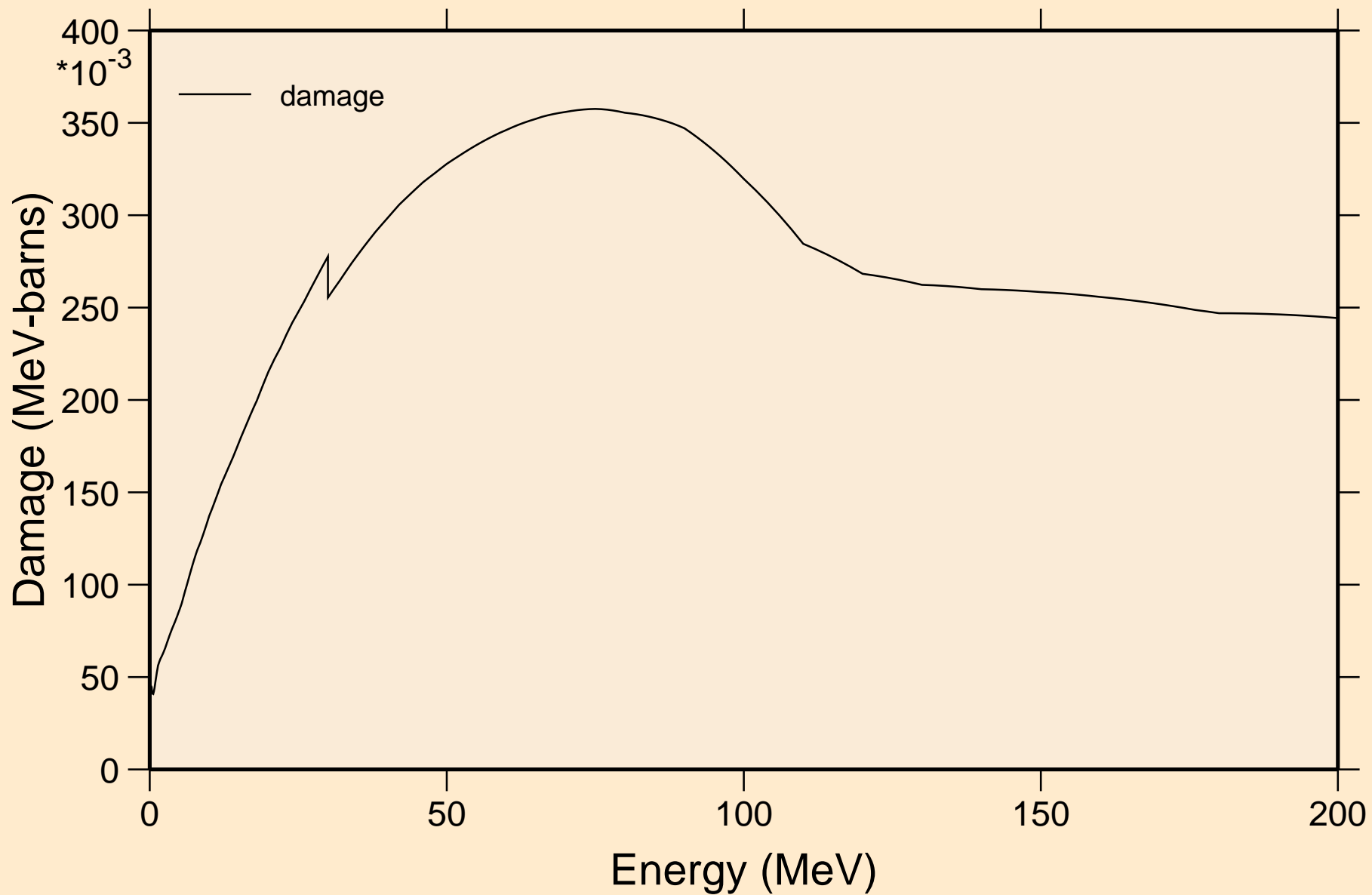

SG265 NEUTRON ACER TENDL-2019 LIBRARY; T=293.16K
Non-threshold reactions

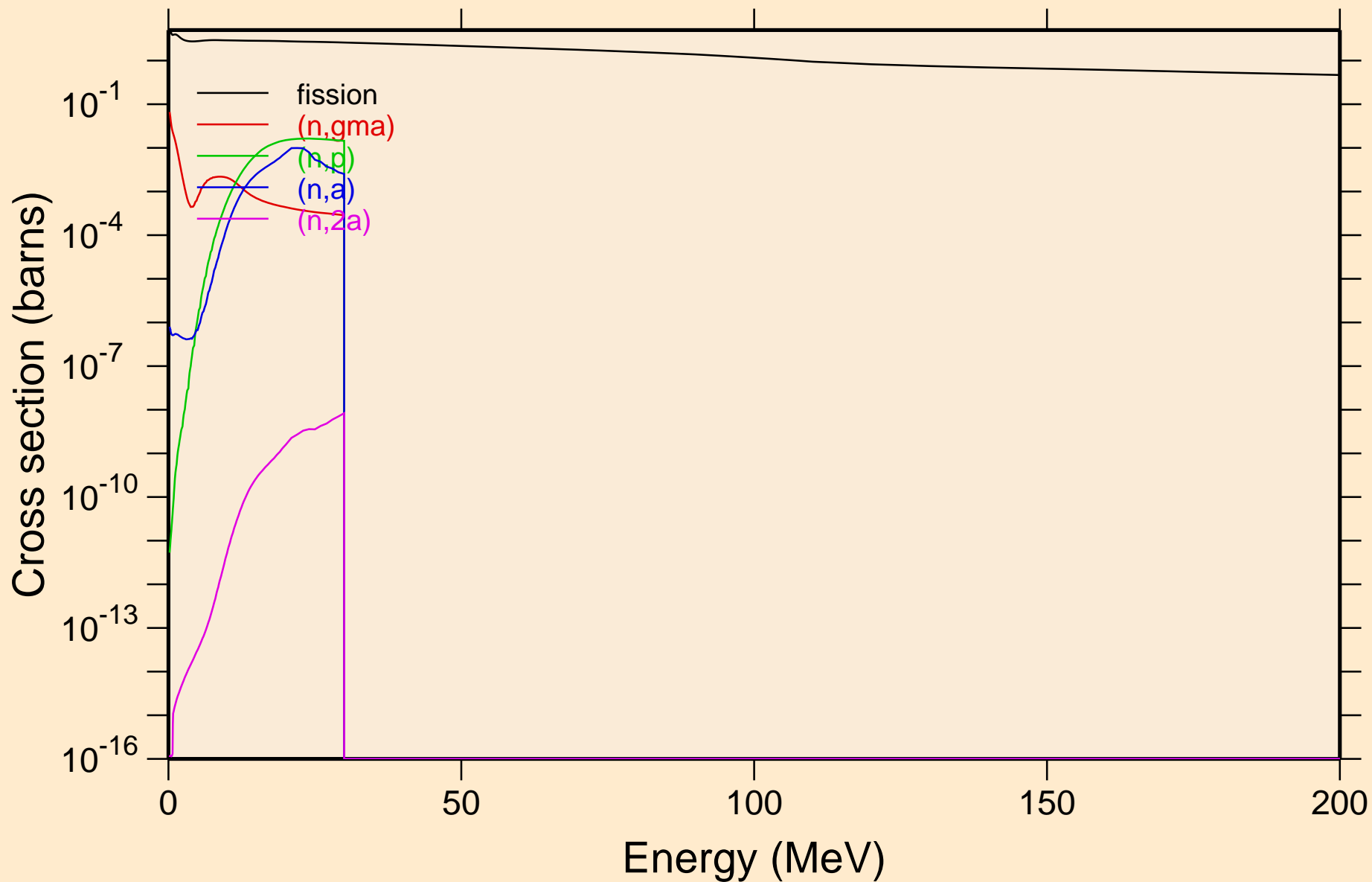

SG265 NEUTRON ACER TENDL-2019 LIBRARY; T=293.16K
Non-threshold reactions

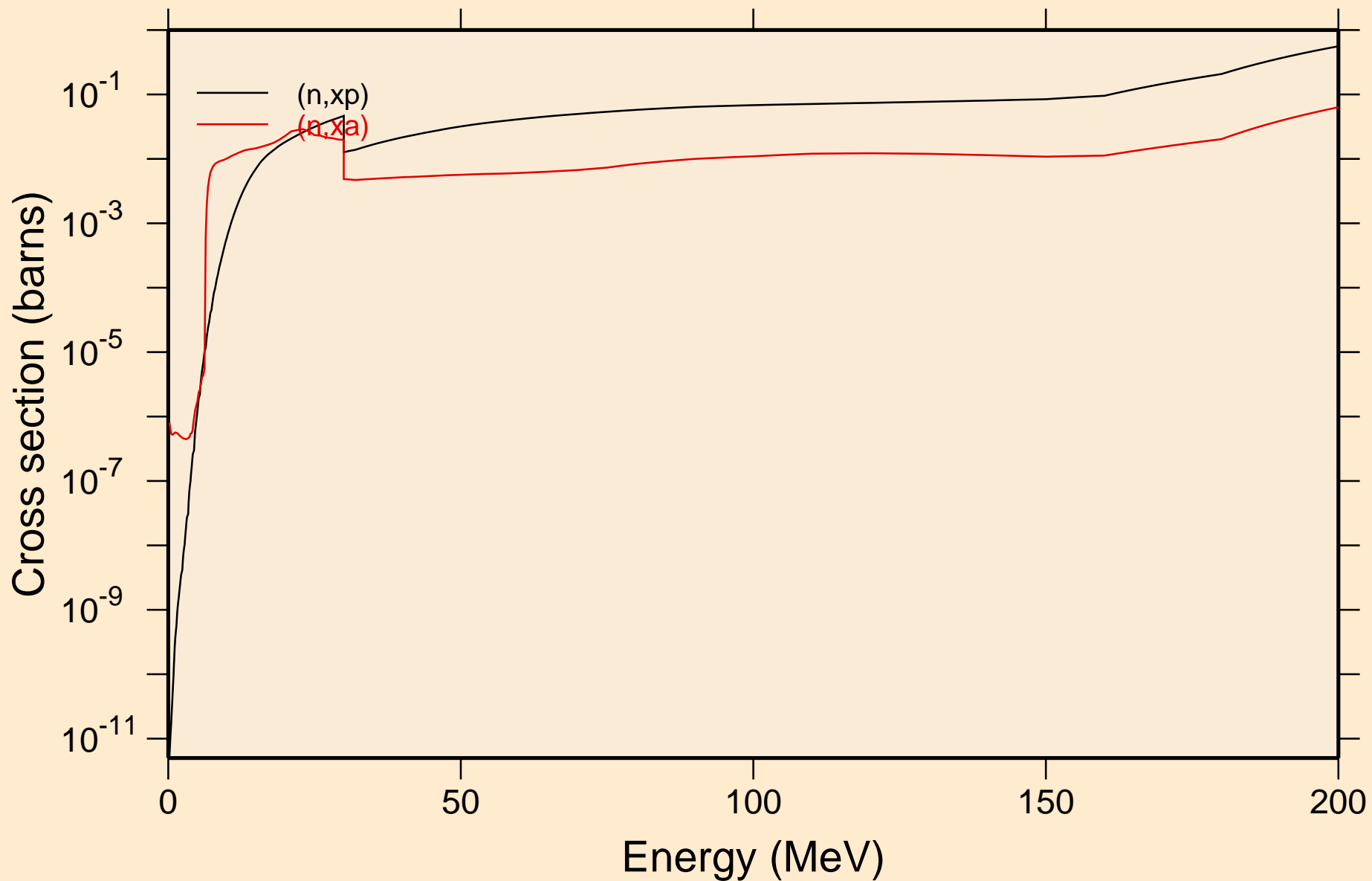

SG265 NEUTRON ACER TENDL-2019 LIBRARY; T=293.16K
Inelastic levels

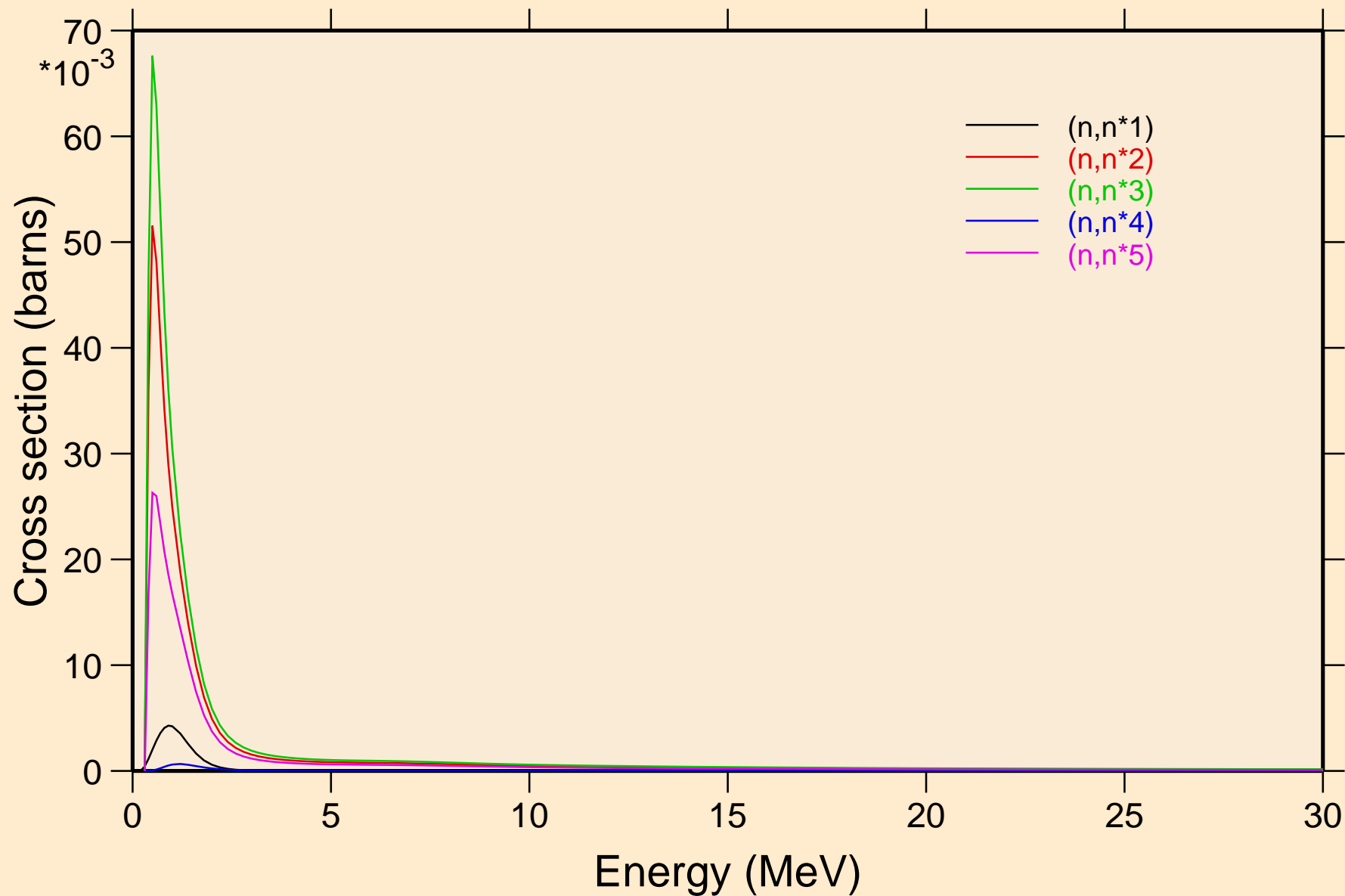

SG265 NEUTRON ACER TENDL-2019 LIBRARY; T=293.16K
Inelastic levels

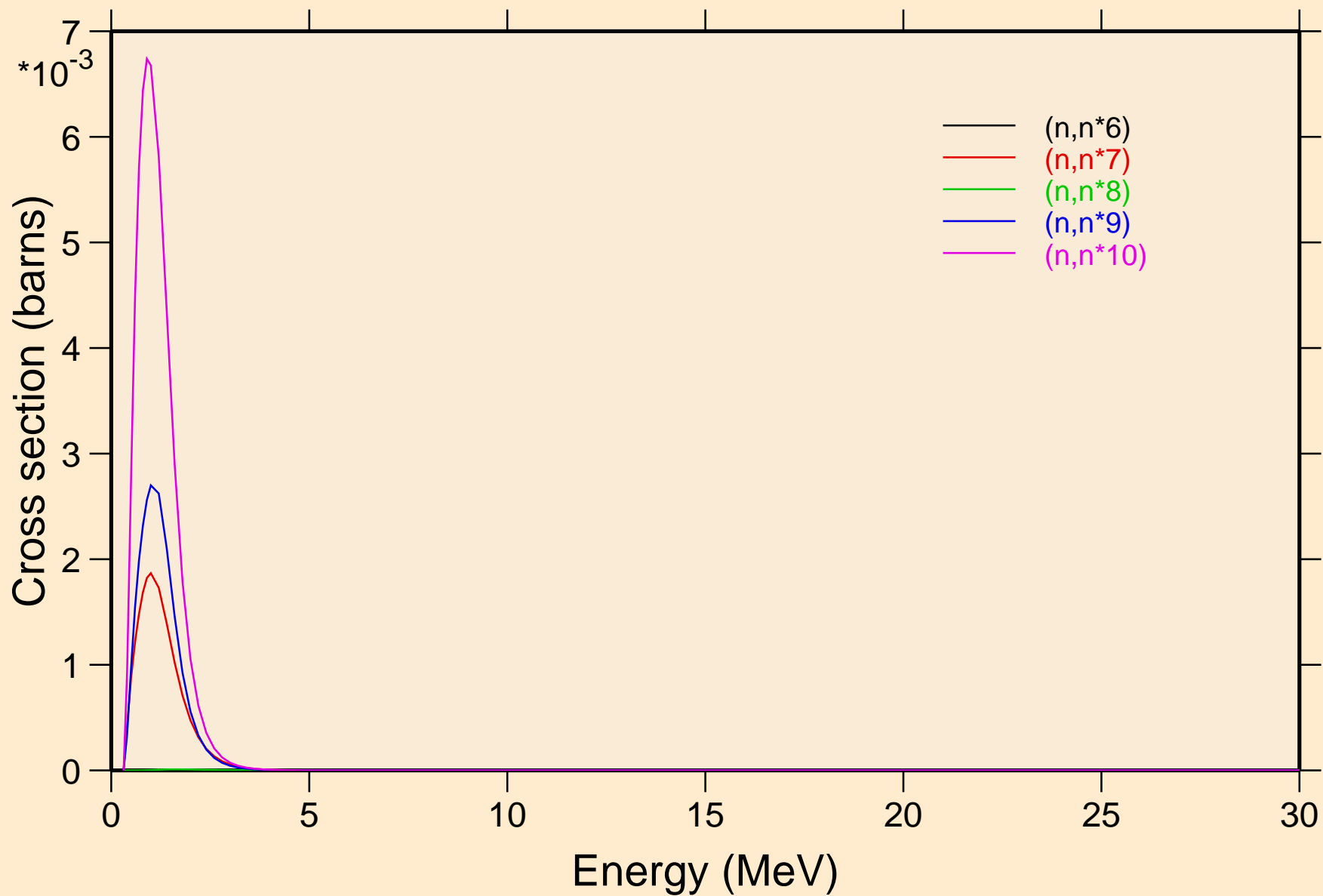

SG265 NEUTRON ACER TENDL-2019 LIBRARY; T=293.16K
Inelastic levels

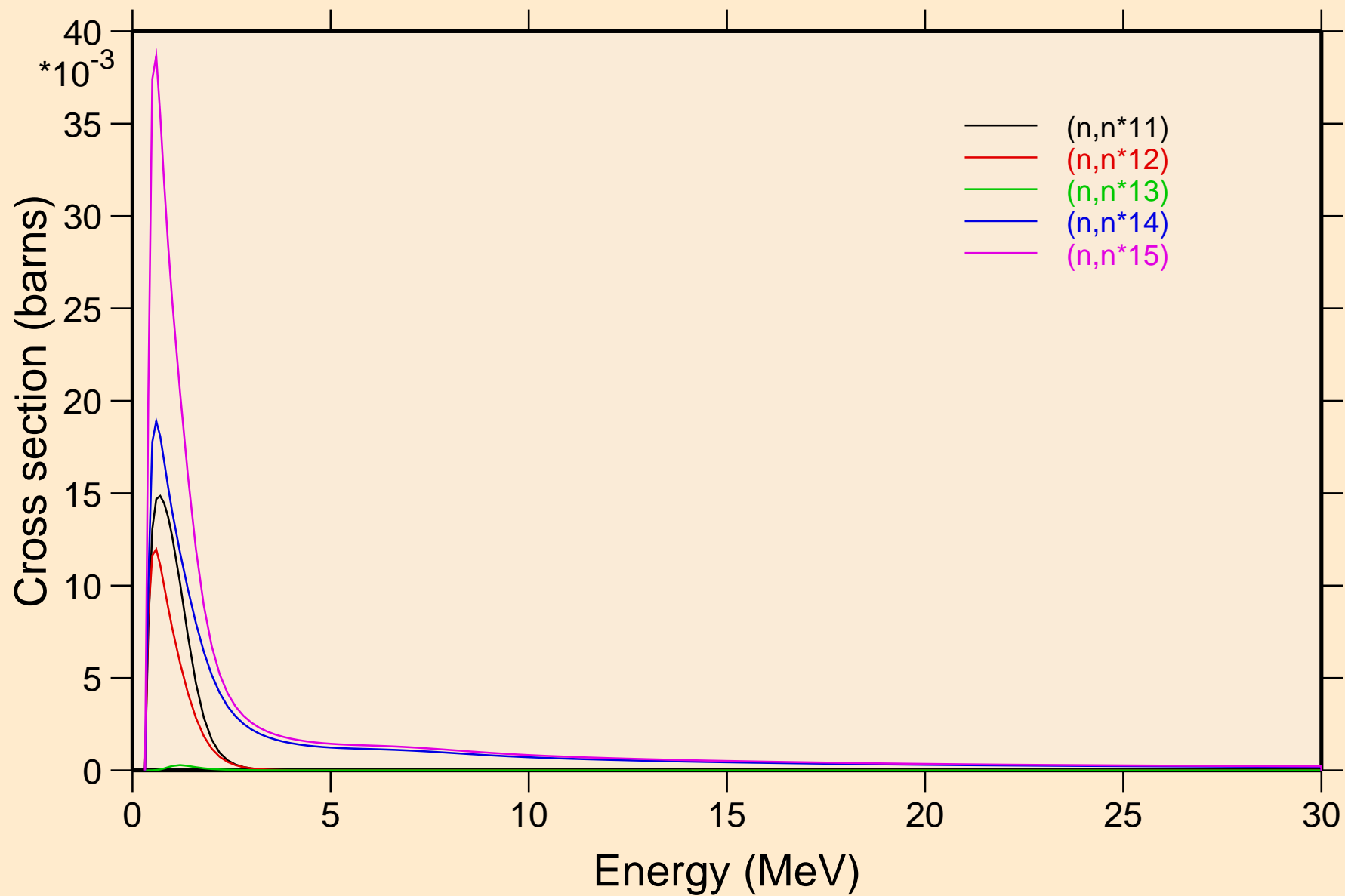

SG265 NEUTRON ACER TENDL-2019 LIBRARY; T=293.16K
Inelastic levels

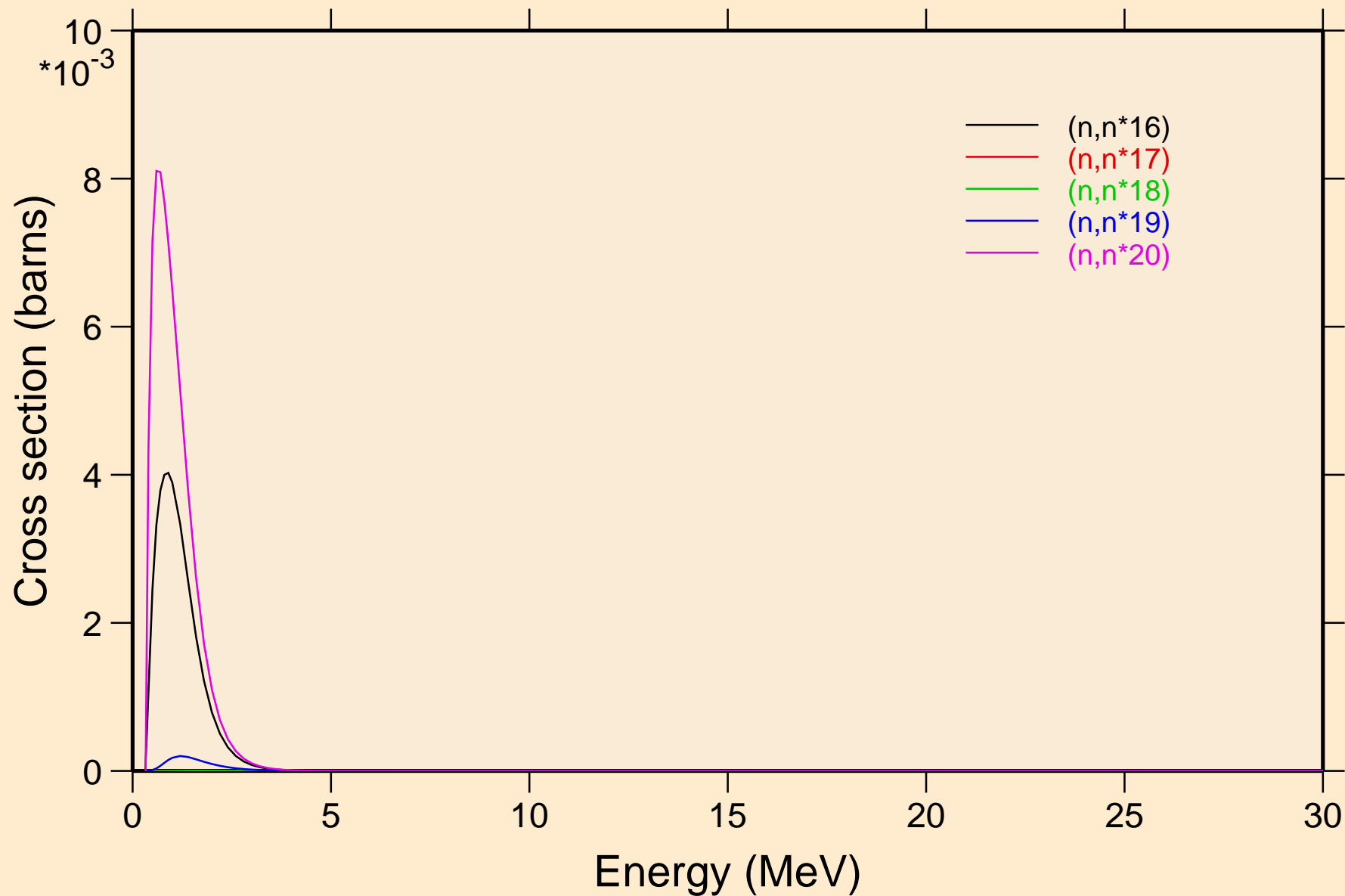

SG265 NEUTRON ACER TENDL-2019 LIBRARY; T=293.16K
Inelastic levels

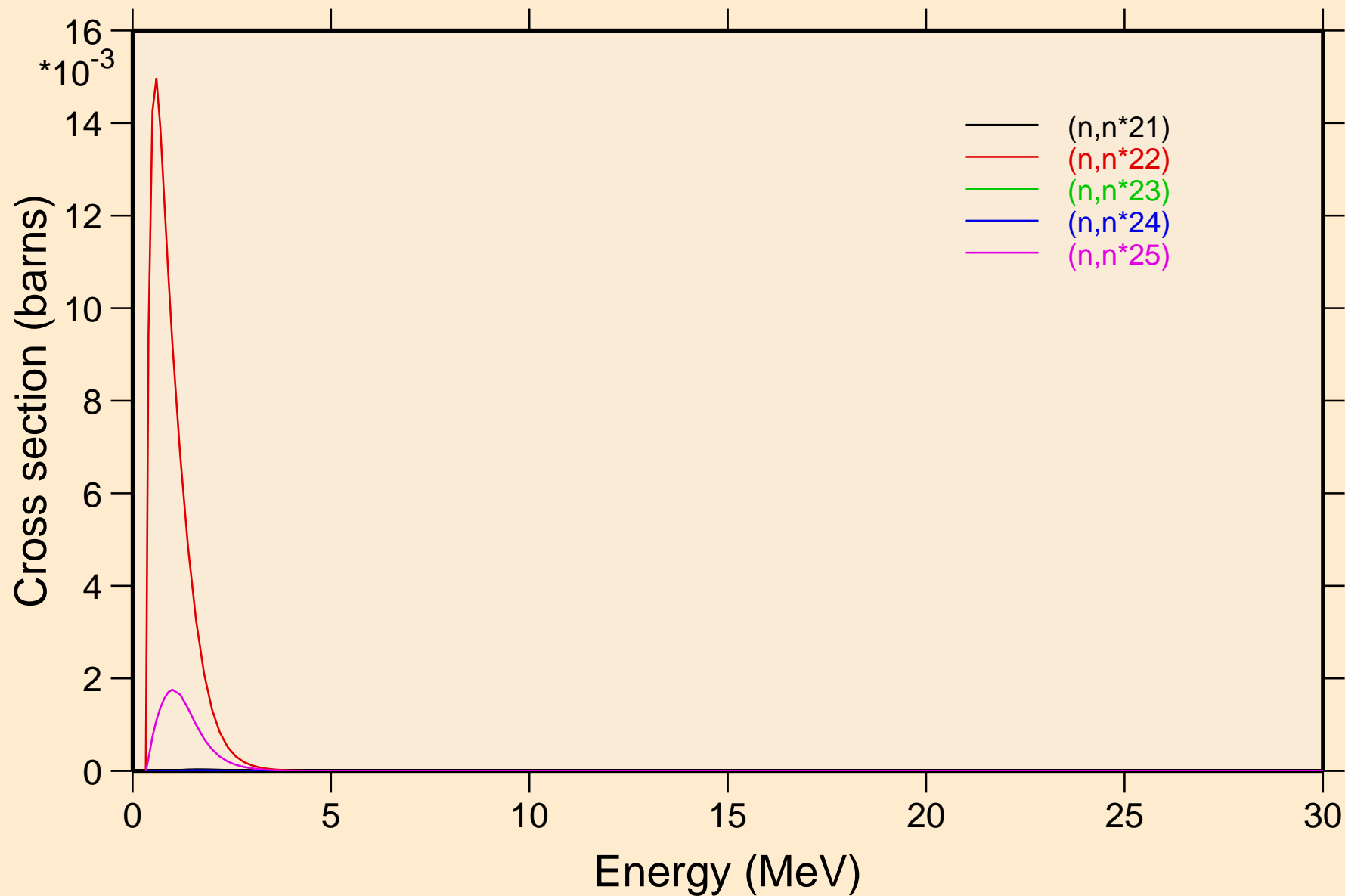

SG265 NEUTRON ACER TENDL-2019 LIBRARY; T=293.16K
Inelastic levels

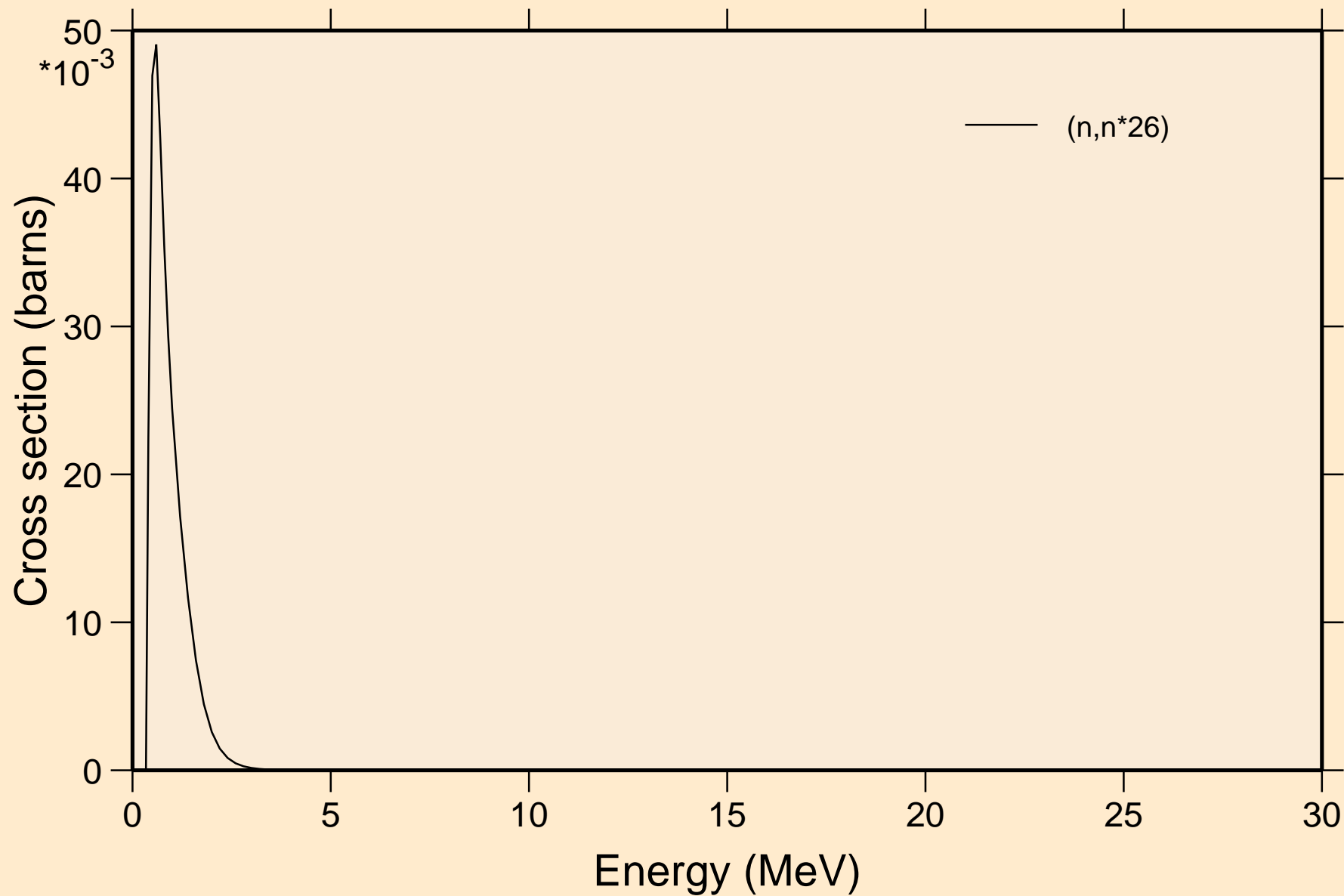

SG265 NEUTRON ACER TENDL-2019 LIBRARY; T=293.16K

Threshold reactions

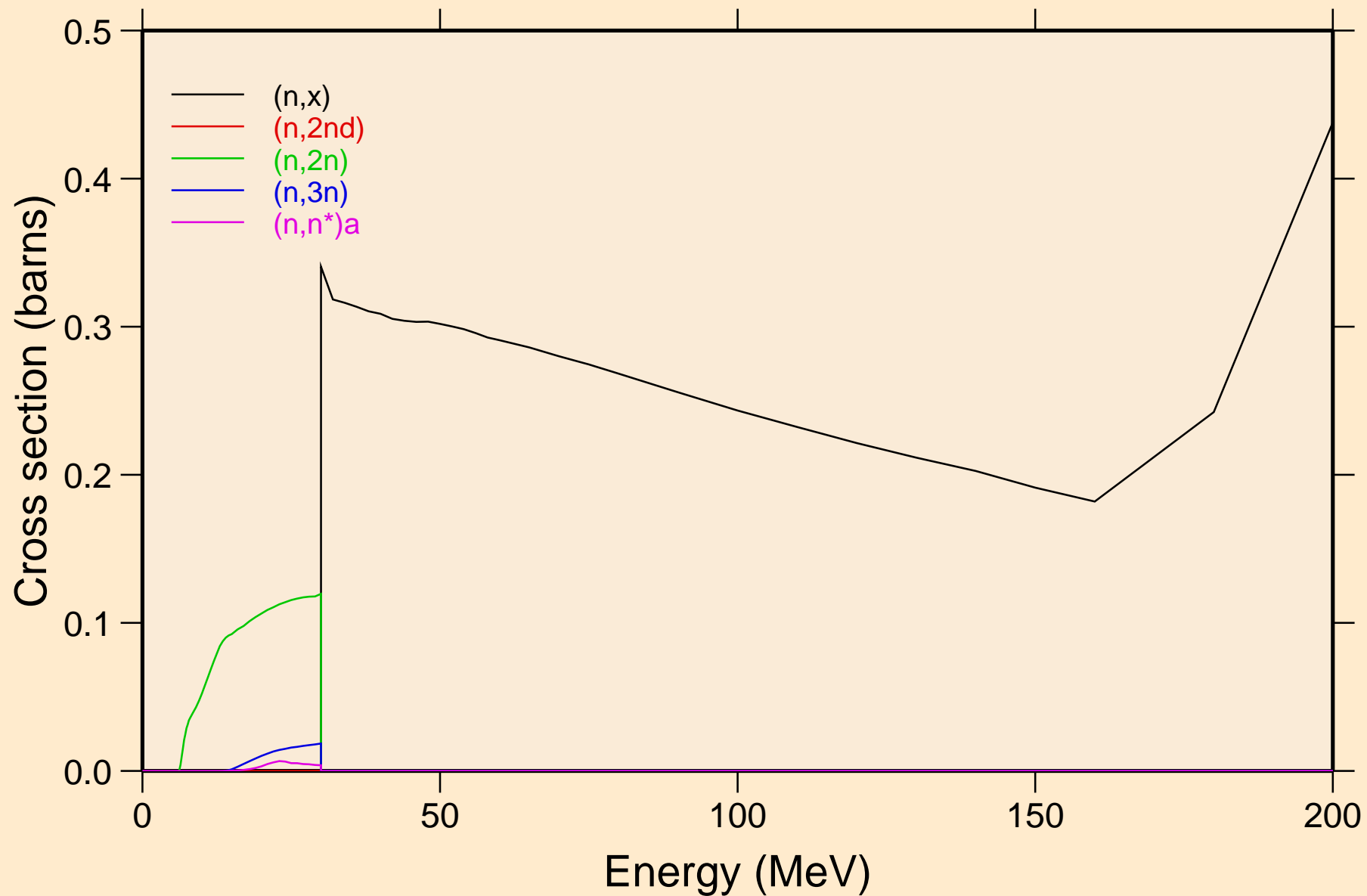

SG265 NEUTRON ACER TENDL-2019 LIBRARY; T=293.16K
Threshold reactions

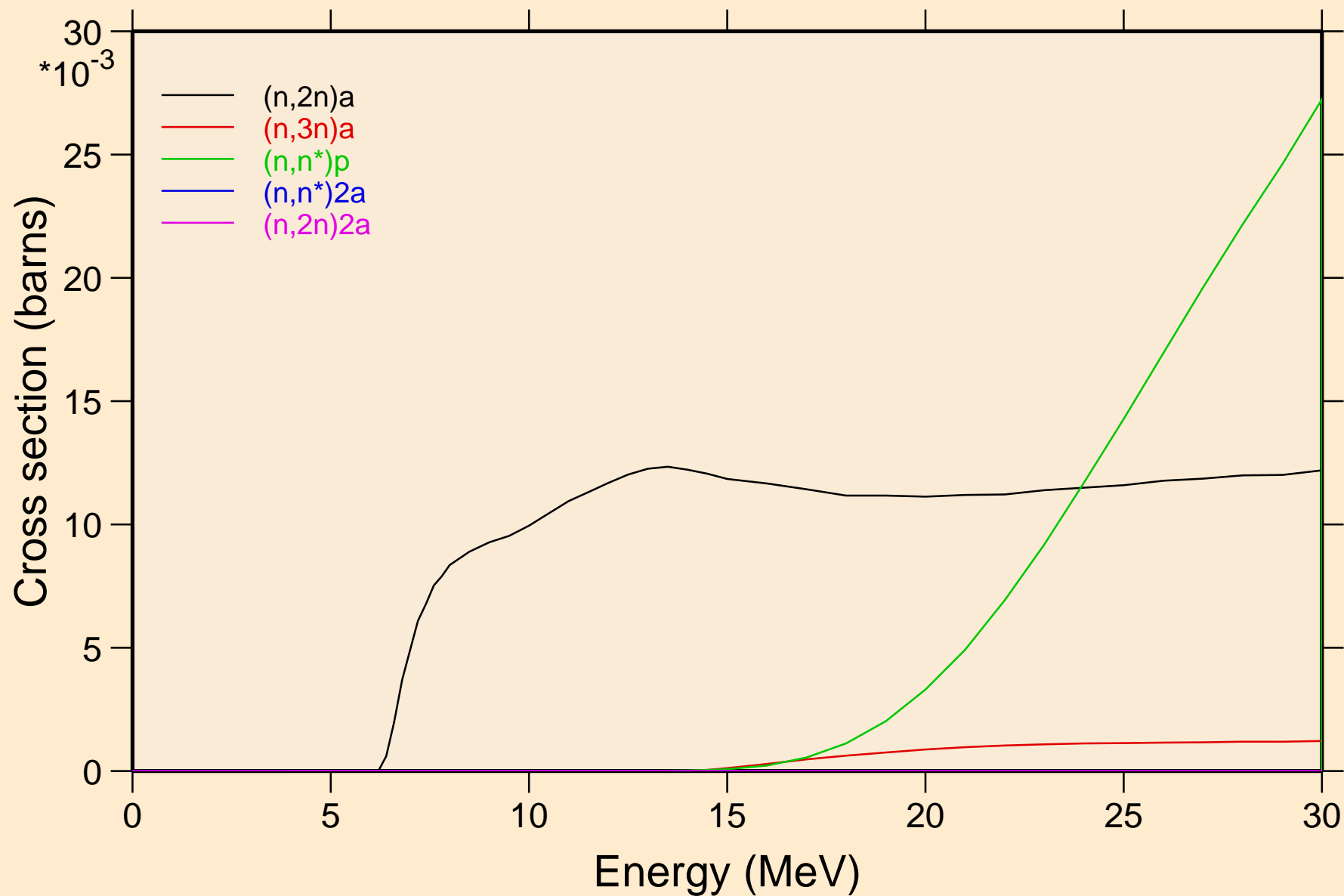

SG265 NEUTRON ACER TENDL-2019 LIBRARY; T=293.16K

Threshold reactions

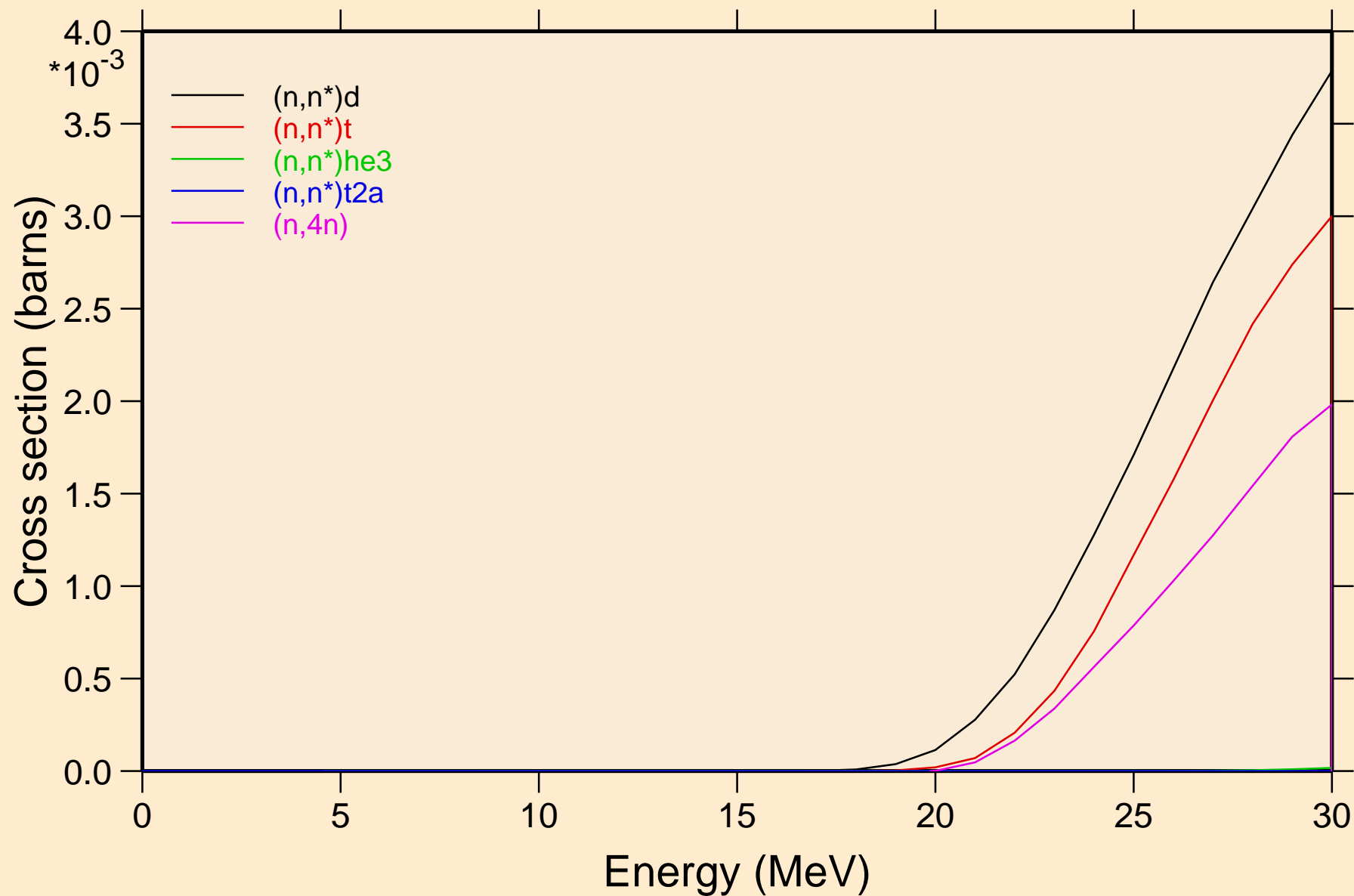

SG265 NEUTRON ACER TENDL-2019 LIBRARY; T=293.16K

Threshold reactions

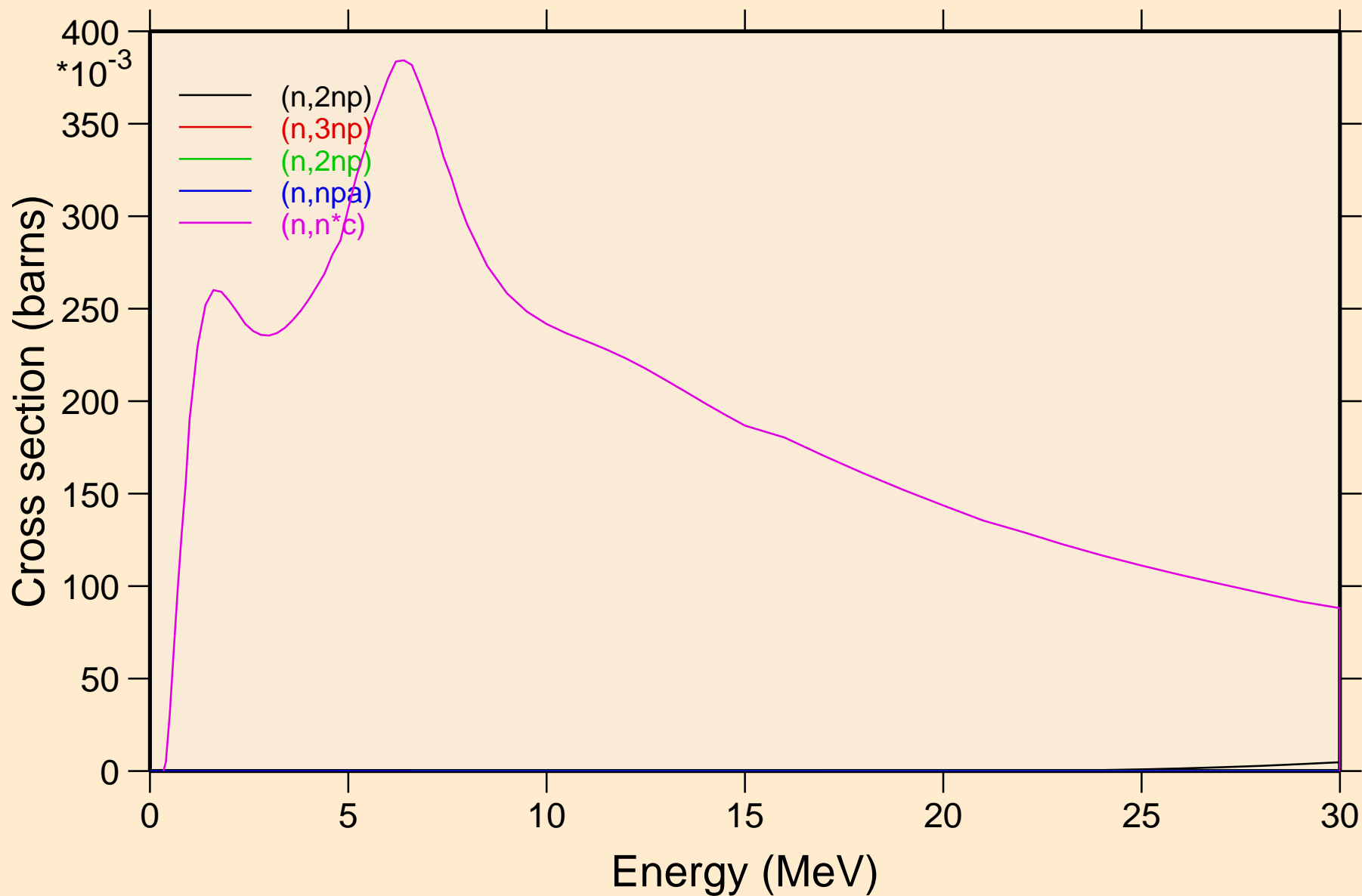

SG265 NEUTRON ACER TENDL-2019 LIBRARY; T=293.16K
Threshold reactions

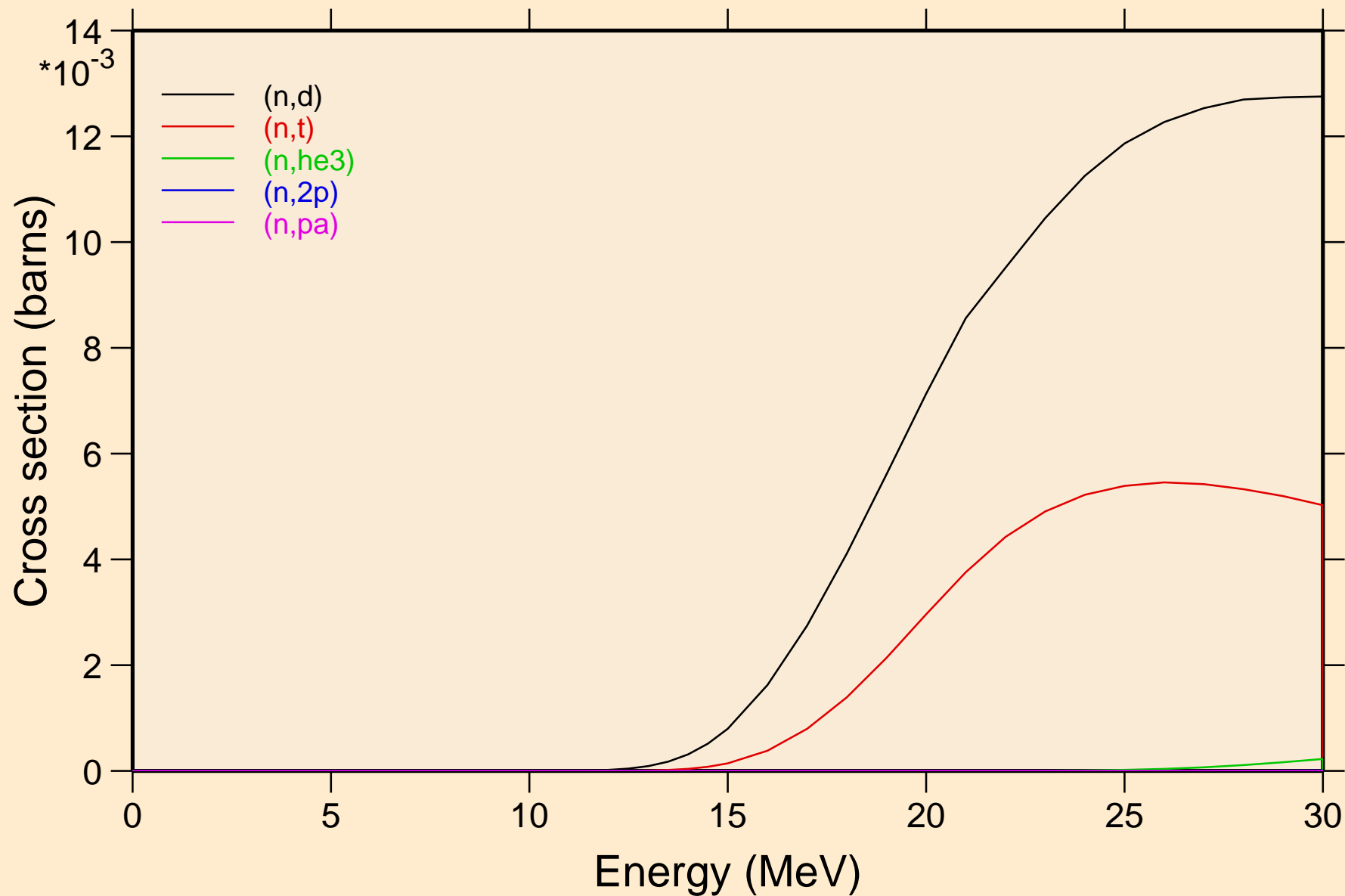

SG265 NEUTRON ACER TENDL-2019 LIBRARY; T=293.16K
Threshold reactions

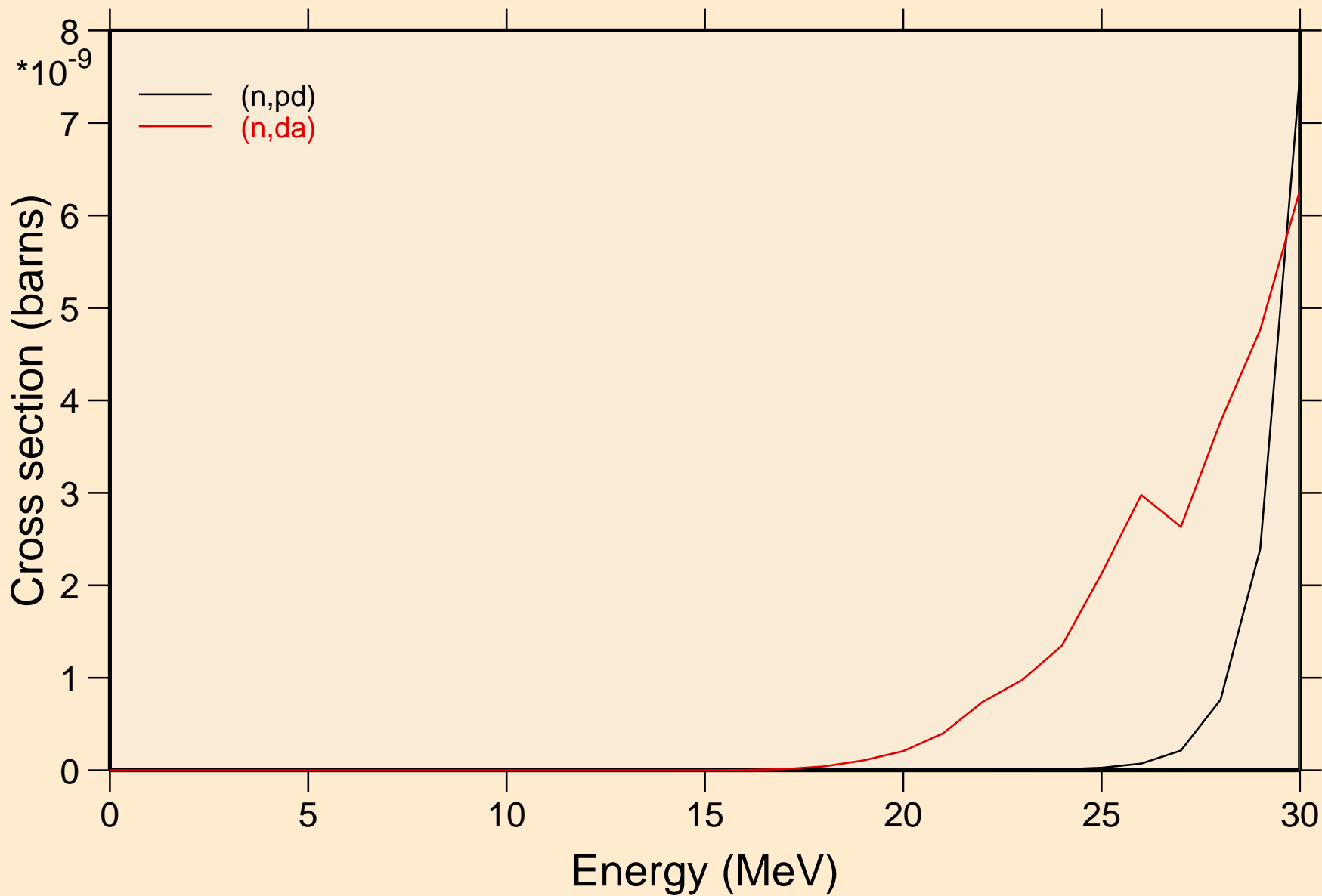

SG265 NEUTRON ACER TENDL-2019 LIBRARY; T=293.16K

Threshold reactions

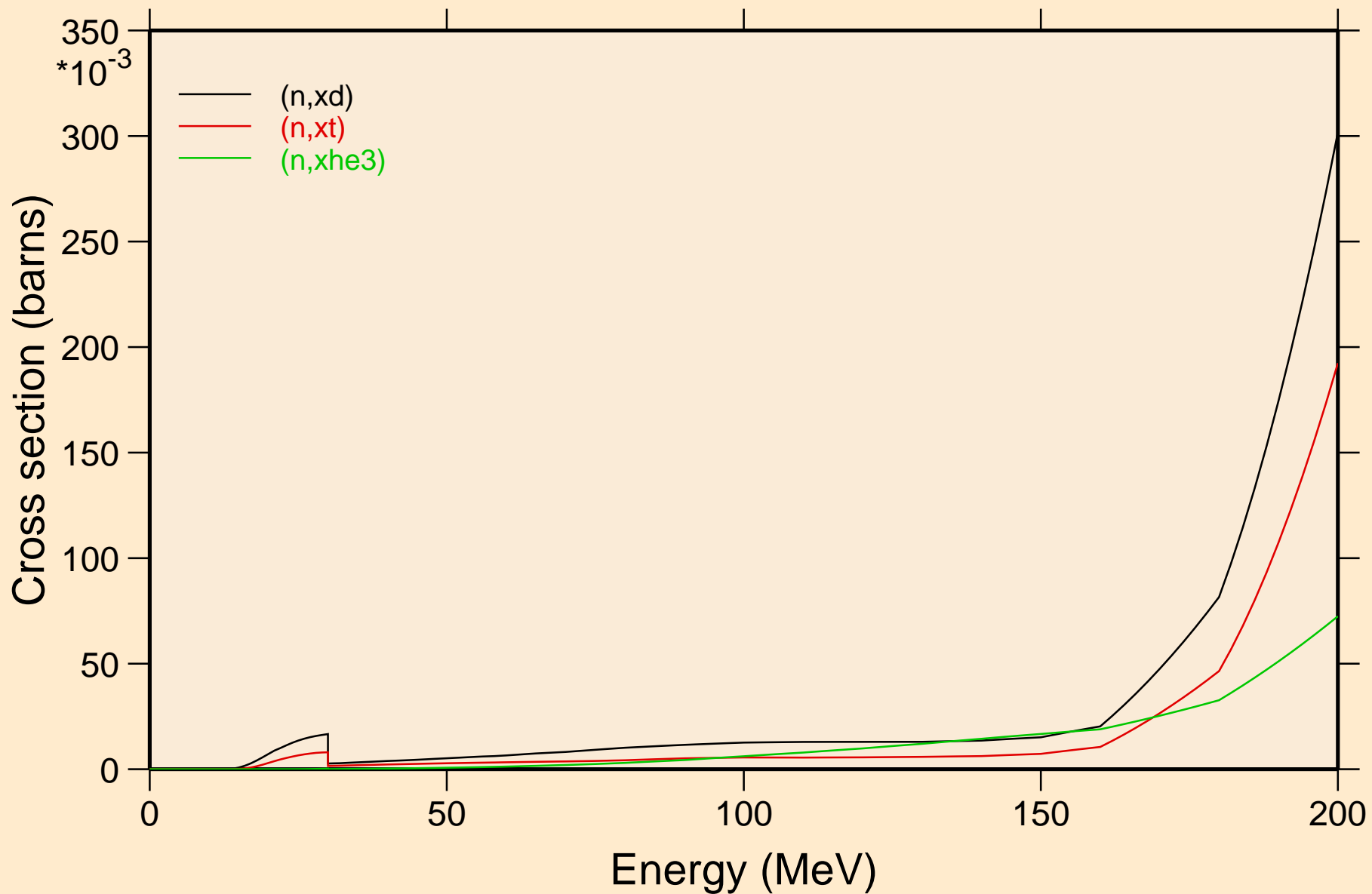

SG265 NEUTRON ACER TENDL-2019 LIBRARY; T=293.16K
angular distribution for elastic

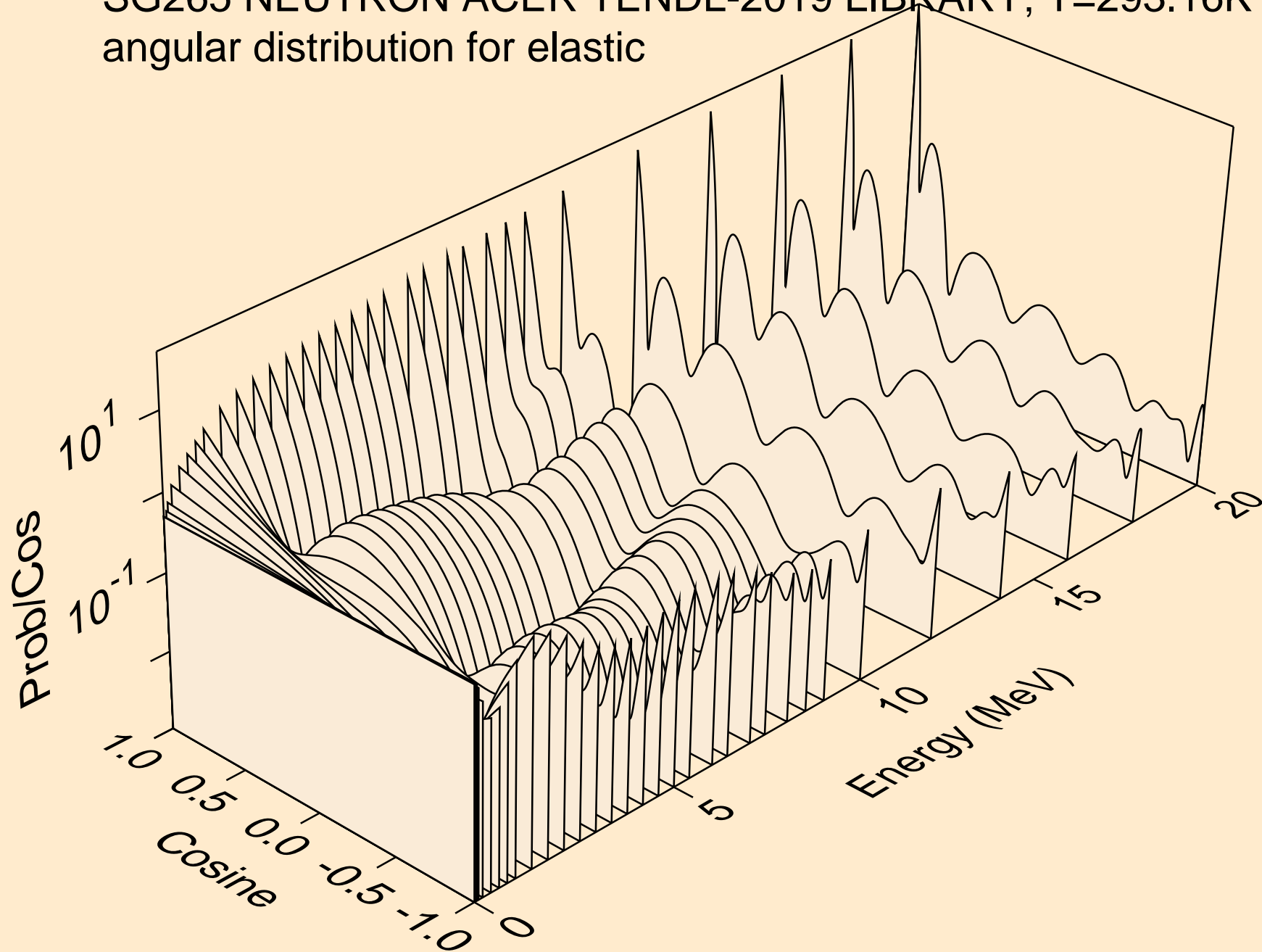

SG265 NEUTRON ACER TENDL-2019 LIBRARY; T=293.16K
angular distribution for elastic

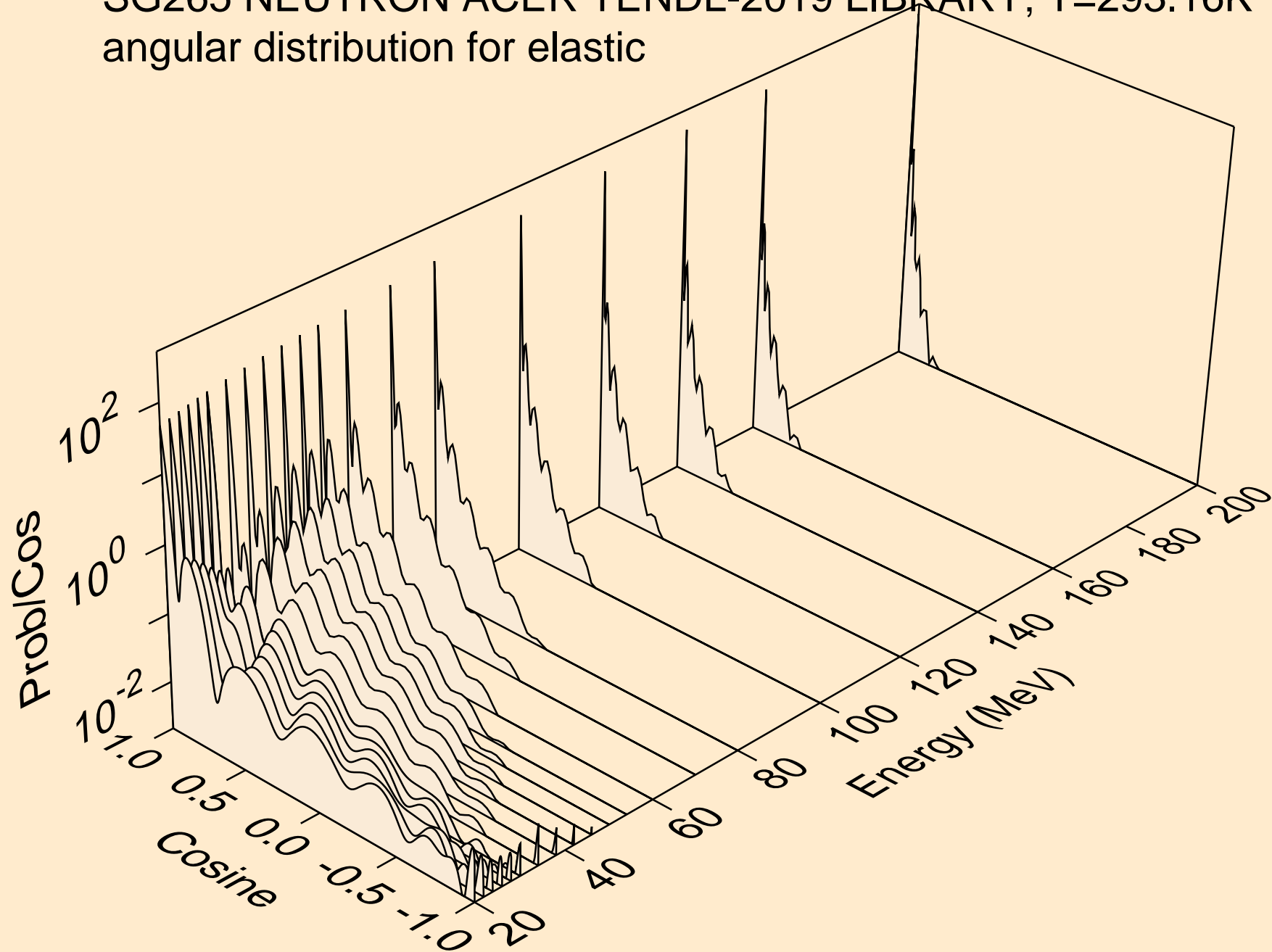

SG265 NEUTRON ACER TENDL-2019 LIBRARY; T=293.16K
angular distribution for (n,n*1)

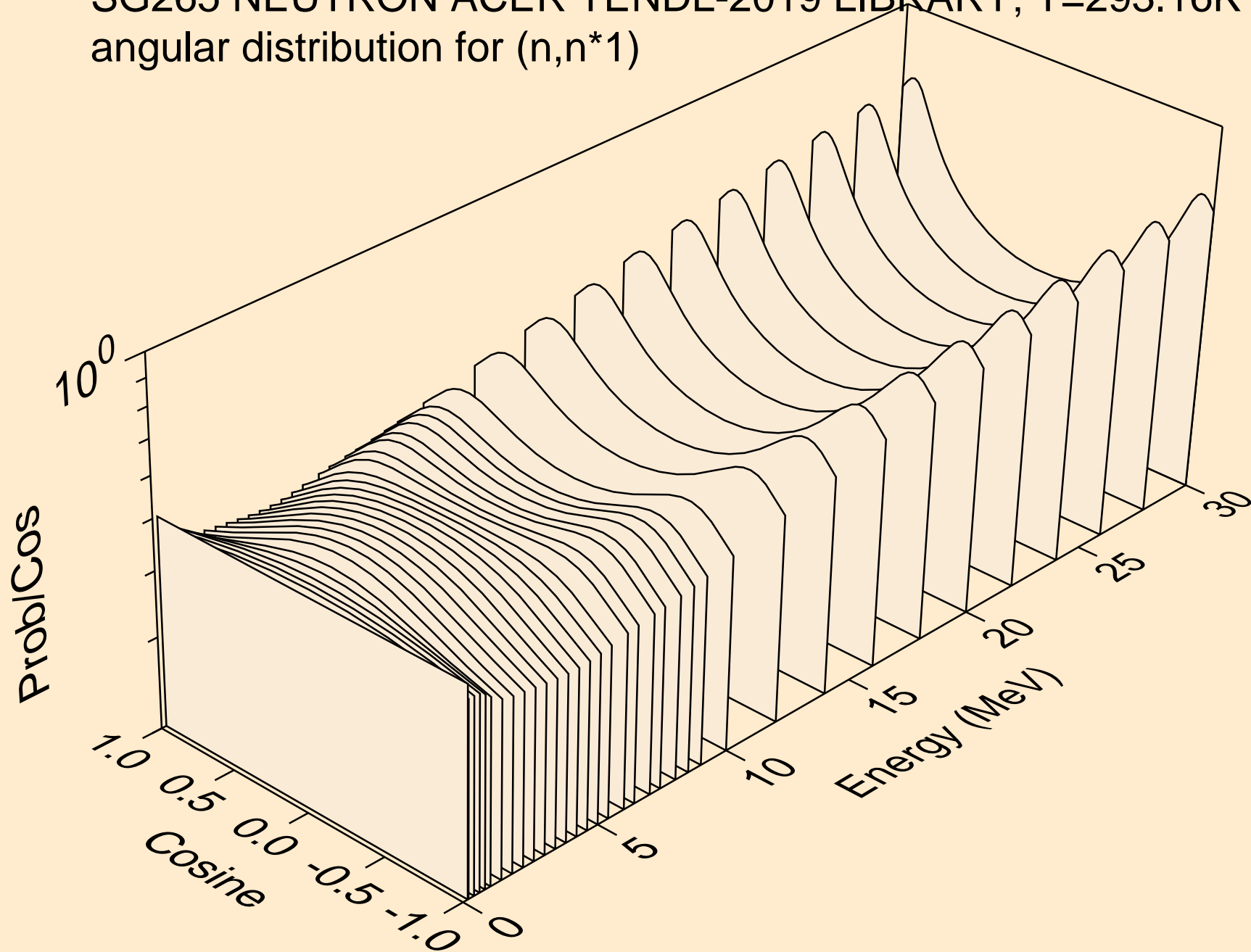

SG265 NEUTRON ACER TENDL-2019 LIBRARY; T=293.16K
angular distribution for (n,n*2)

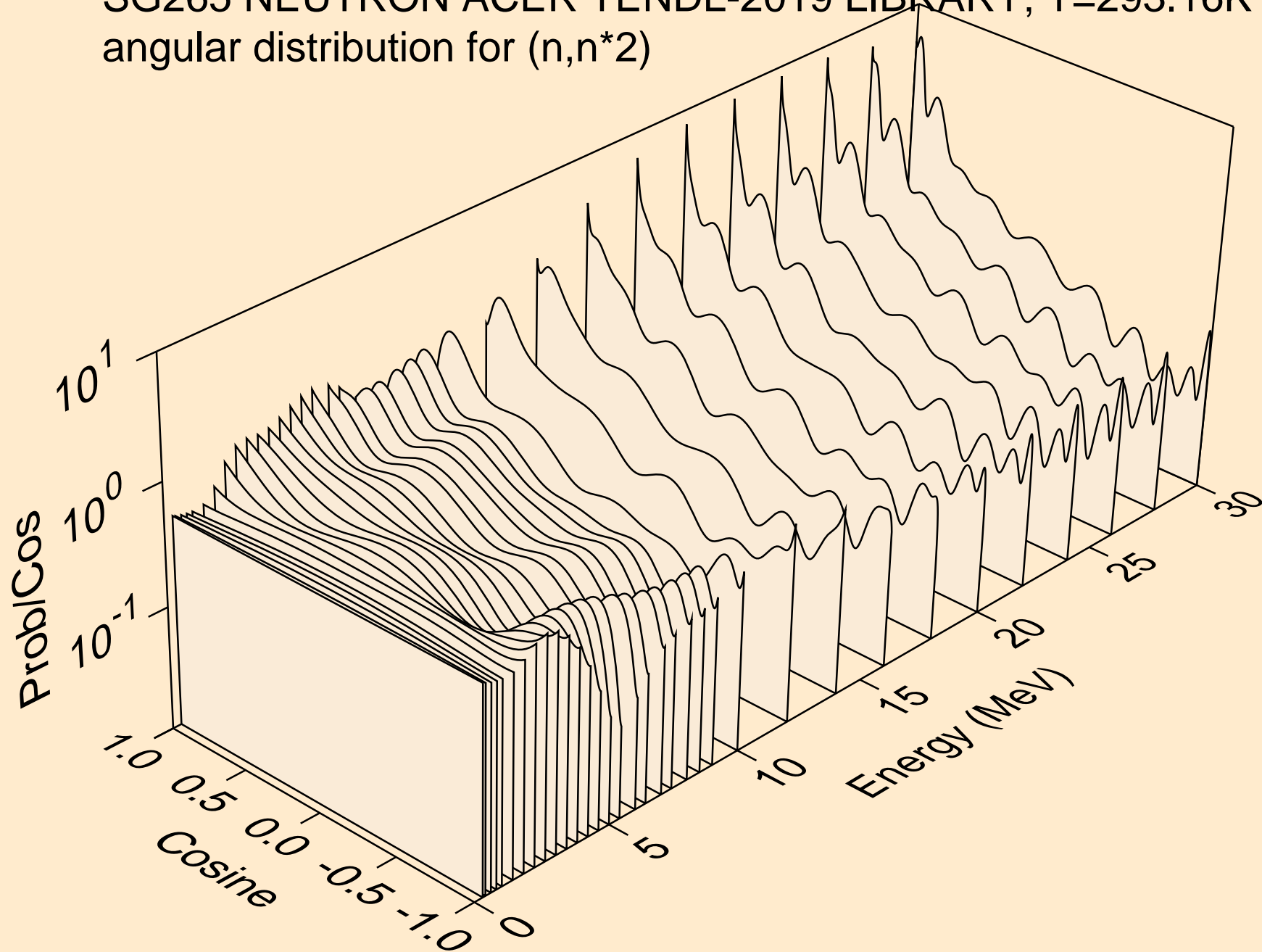

SG265 NEUTRON ACER TENDL-2019 LIBRARY; T=293.16K
angular distribution for (n,n*3)

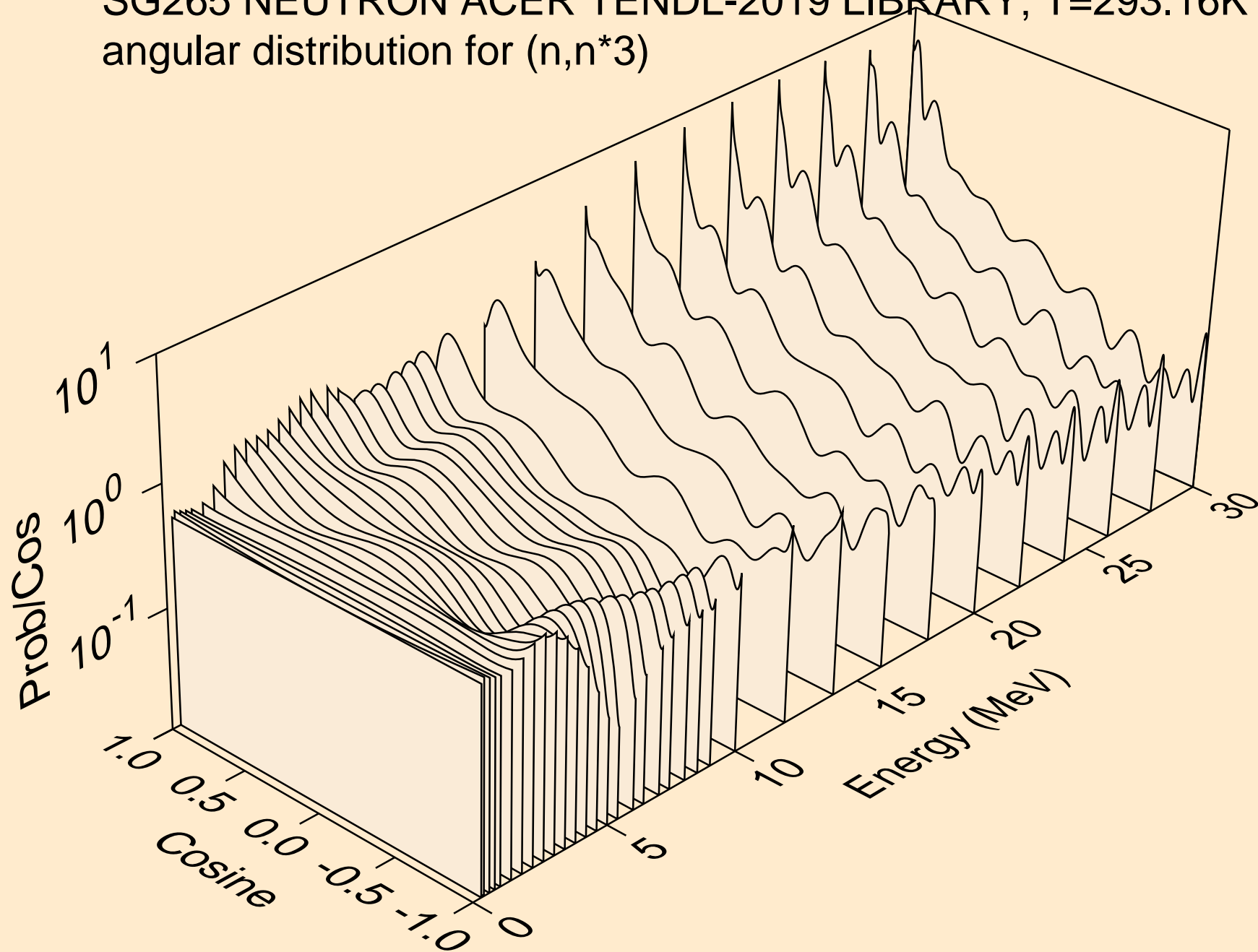

SG265 NEUTRON ACER TENDL-2019 LIBRARY; T=293.16K
angular distribution for (n,n*4)

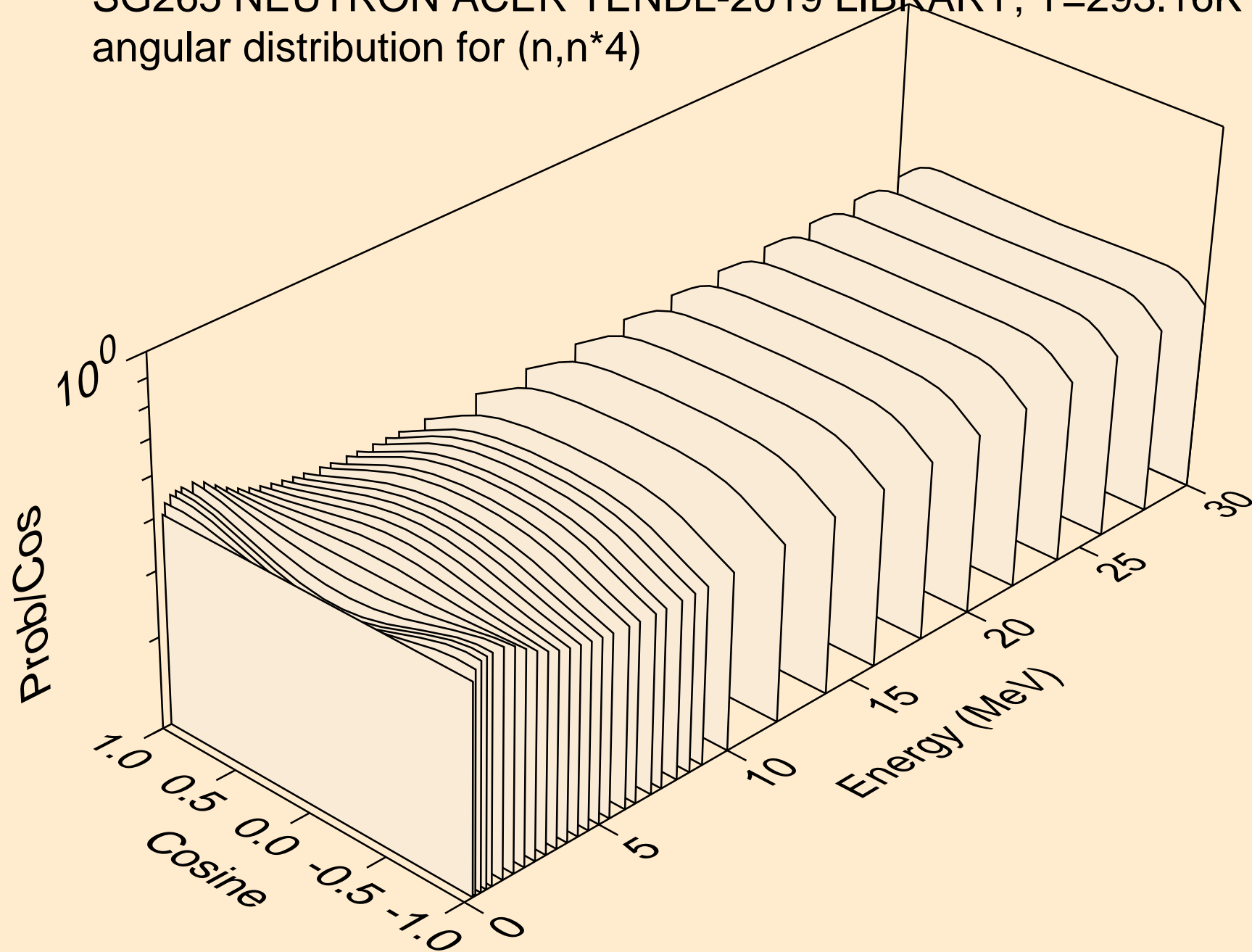

SG265 NEUTRON ACER TENDL-2019 LIBRARY; T=293.16K
angular distribution for (n,n*5)

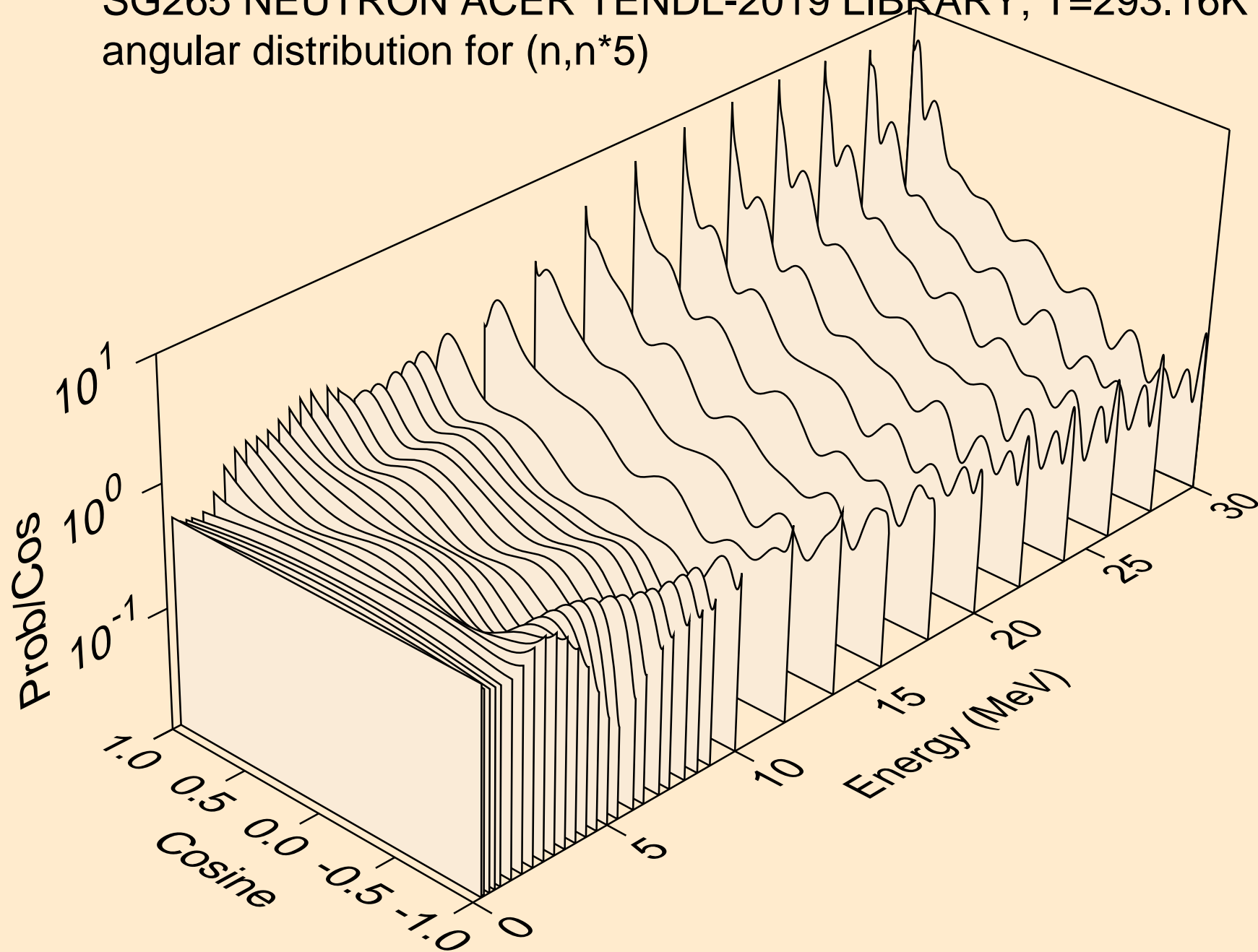

SG265 NEUTRON ACER TENDL-2019 LIBRARY; T=293.16K
angular distribution for (n,n*6)

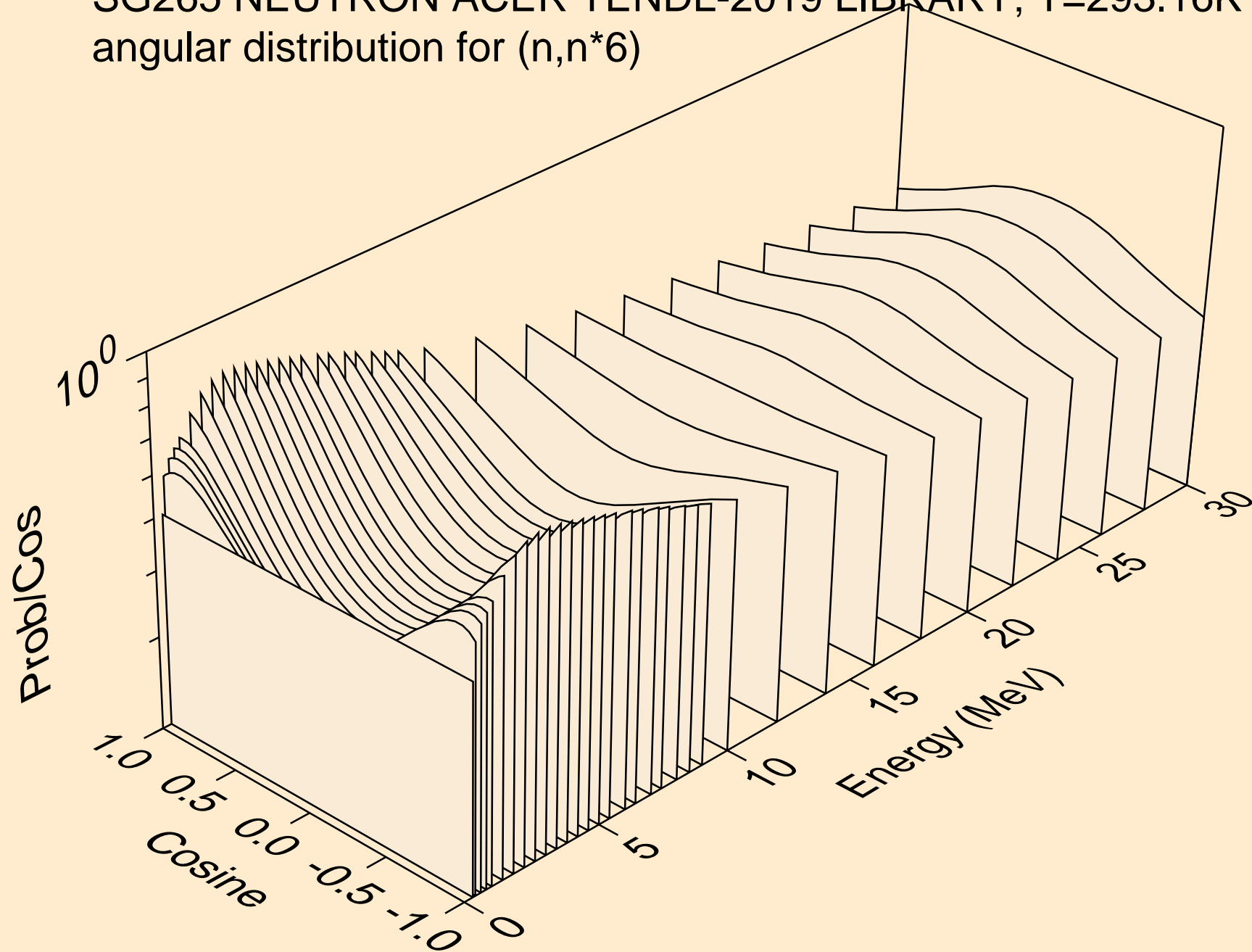

SG265 NEUTRON ACER TENDL-2019 LIBRARY; T=293.16K
angular distribution for (n,n*7)

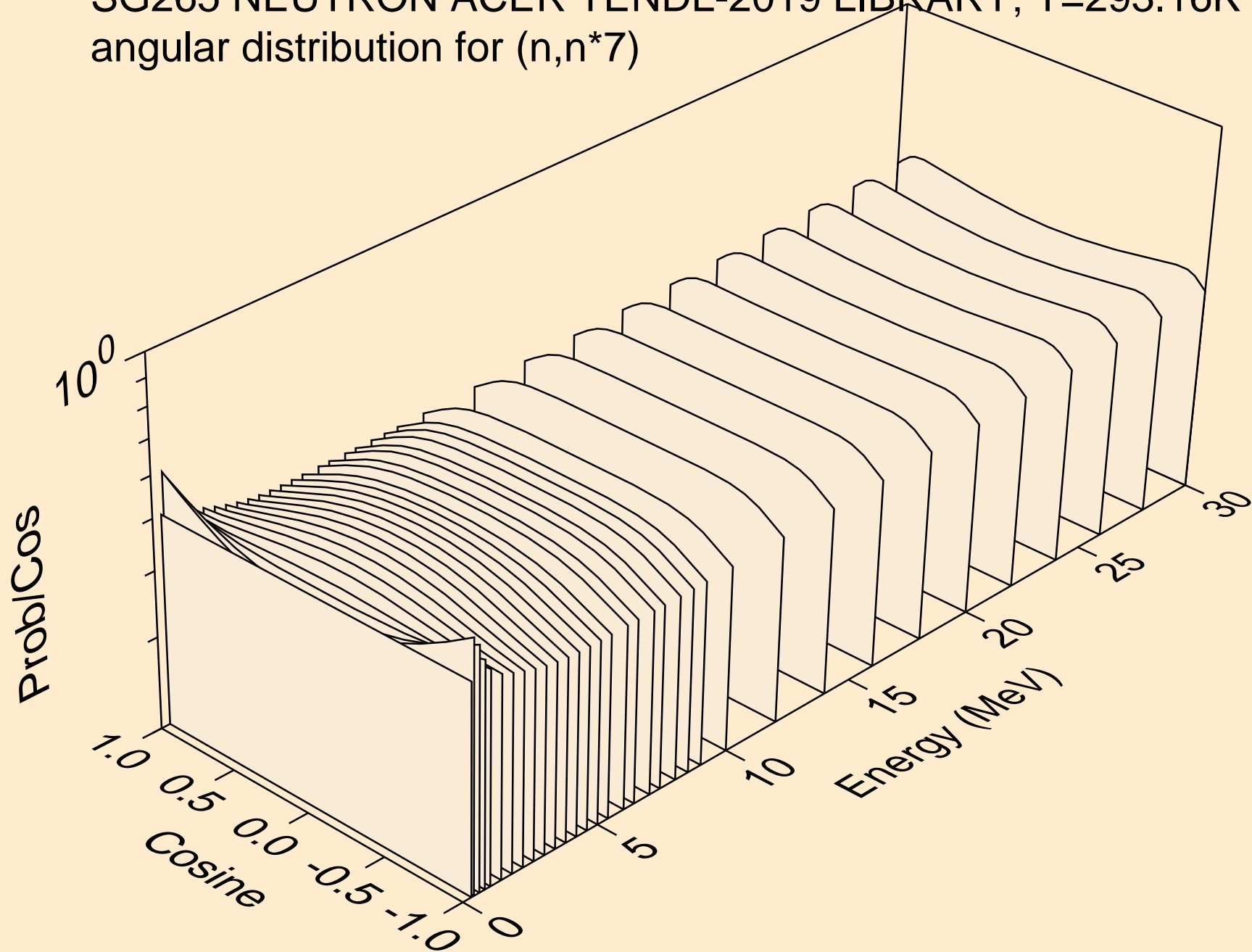

SG265 NEUTRON ACER TENDL-2019 LIBRARY; T=293.16K
angular distribution for (n,n*8)

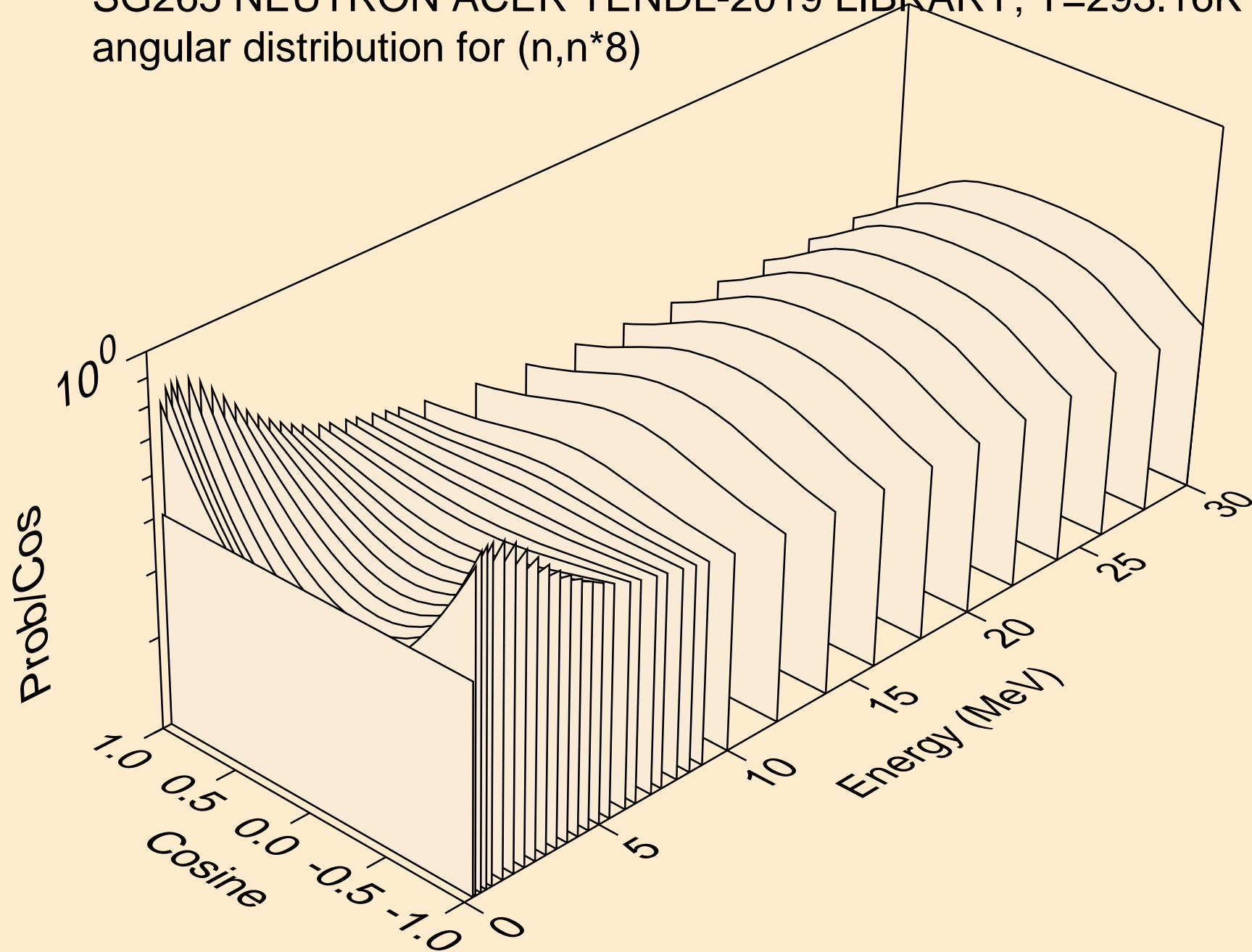

SG265 NEUTRON ACER TENDL-2019 LIBRARY; T=293.16K
angular distribution for (n,n*9)

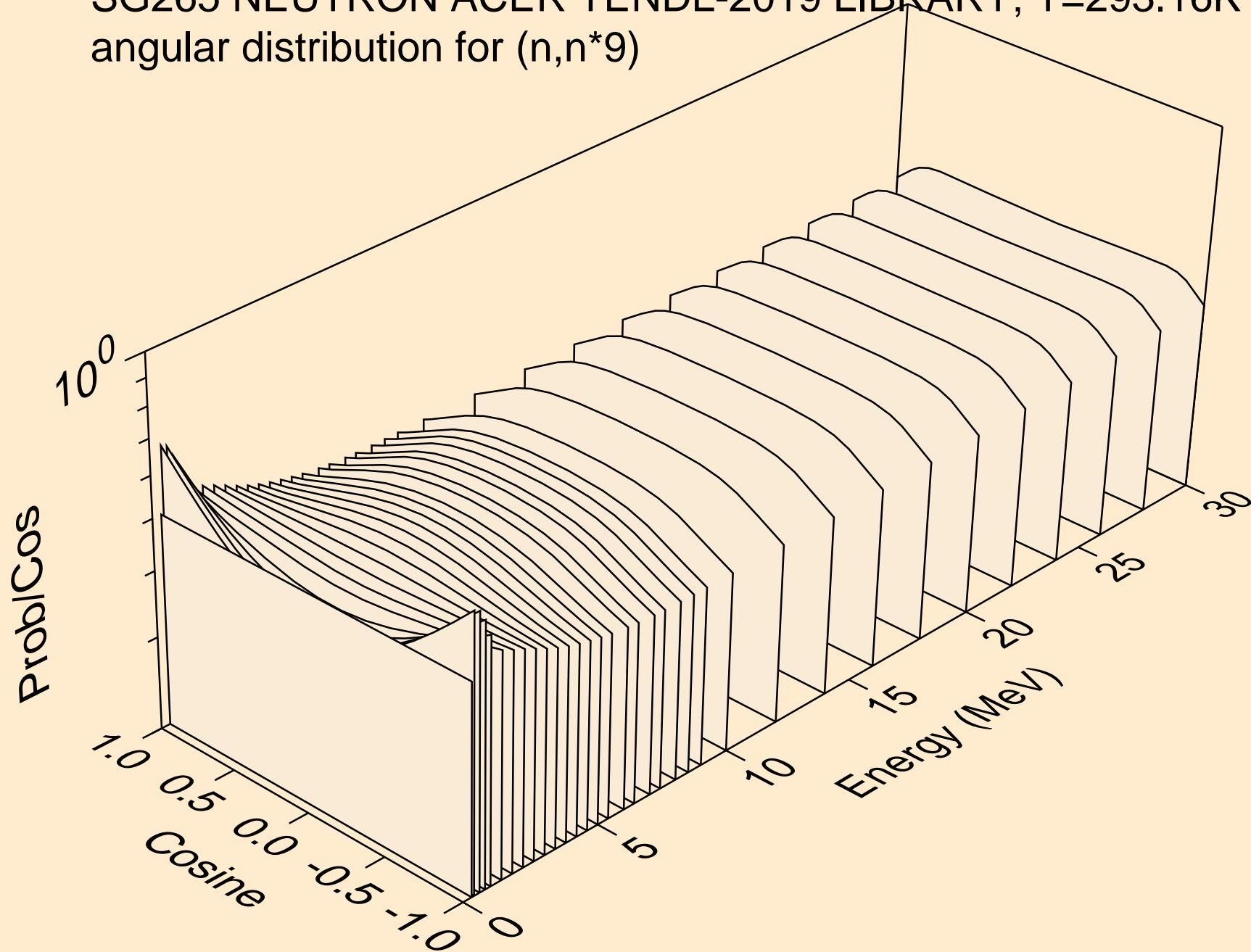

SG265 NEUTRON ACER TENDL-2019 LIBRARY; T=293.16K
angular distribution for (n,n*10)

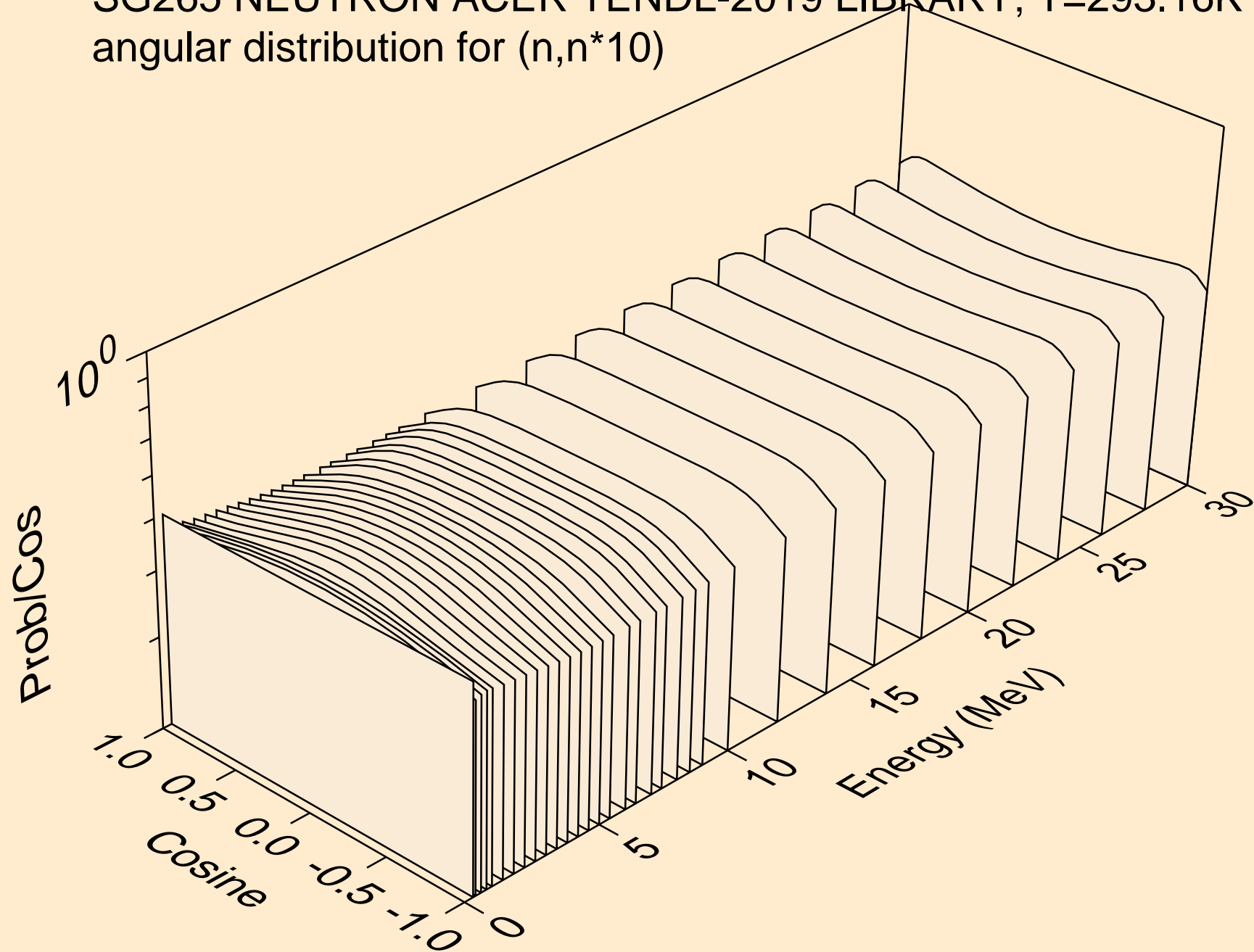

SG265 NEUTRON ACER TENDL-2019 LIBRARY; T=293.16K
angular distribution for (n,n*11)

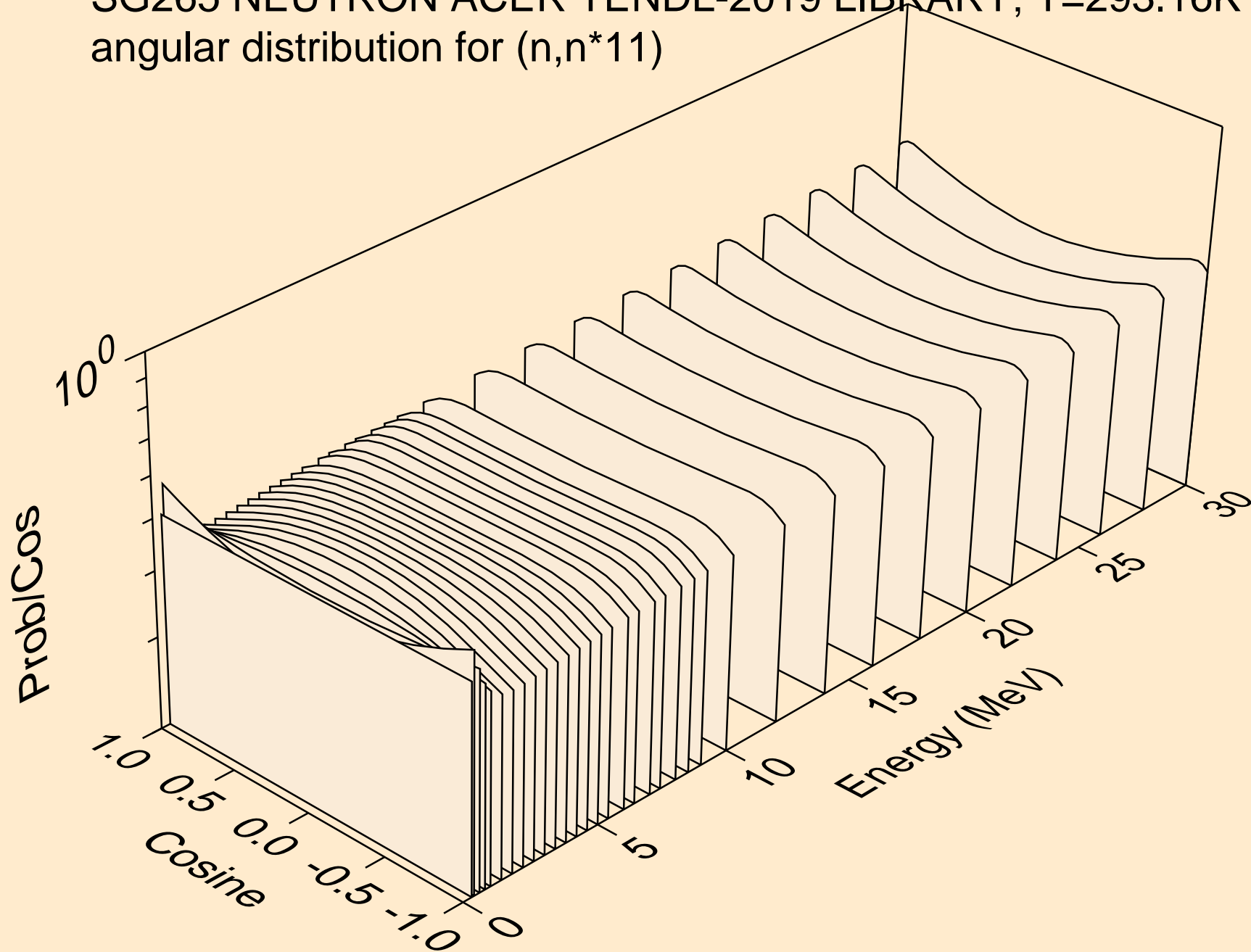

SG265 NEUTRON ACER TENDL-2019 LIBRARY; T=293.16K
angular distribution for (n,n*12)

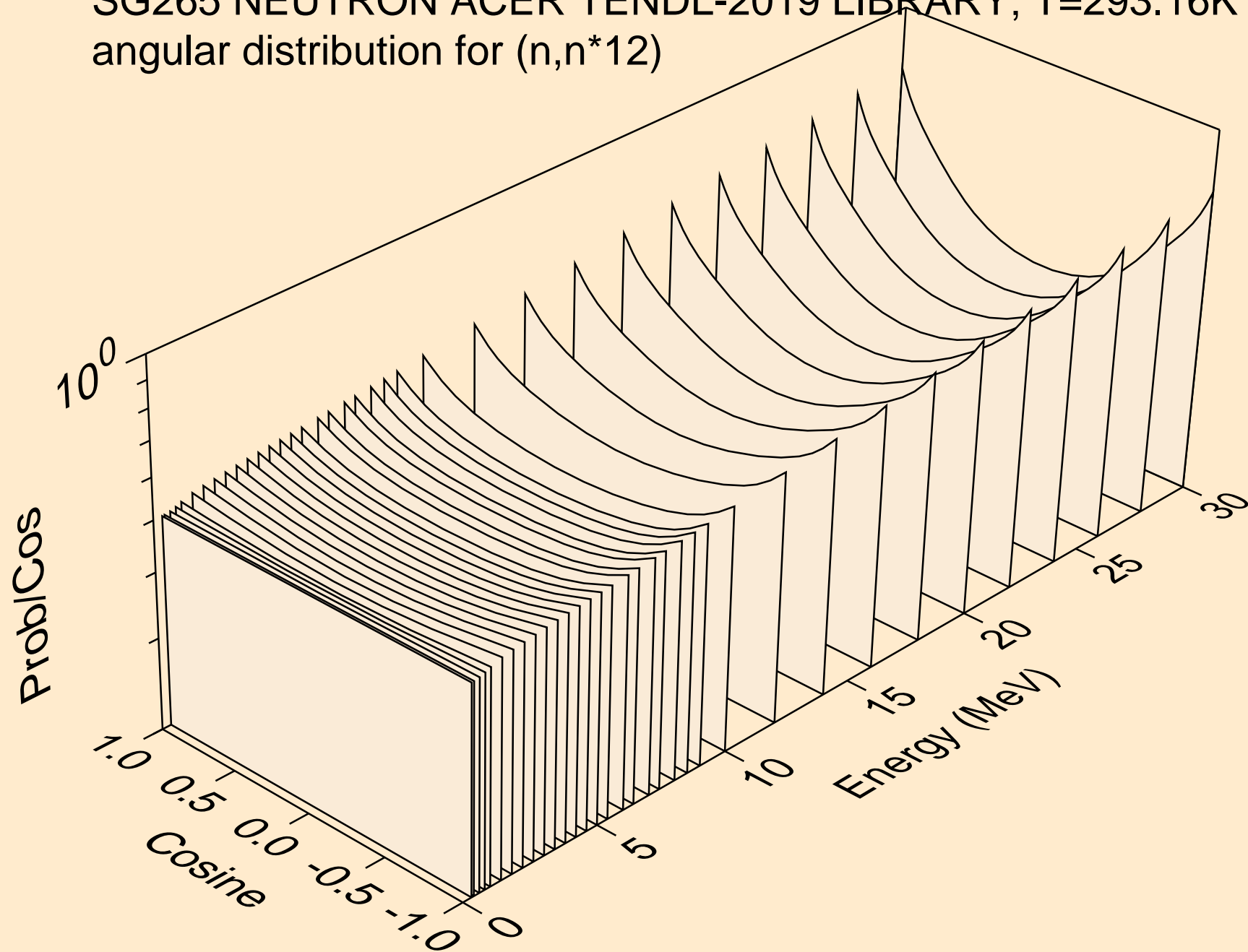

SG265 NEUTRON ACER TENDL-2019 LIBRARY; T=293.16K
angular distribution for (n,n*13)

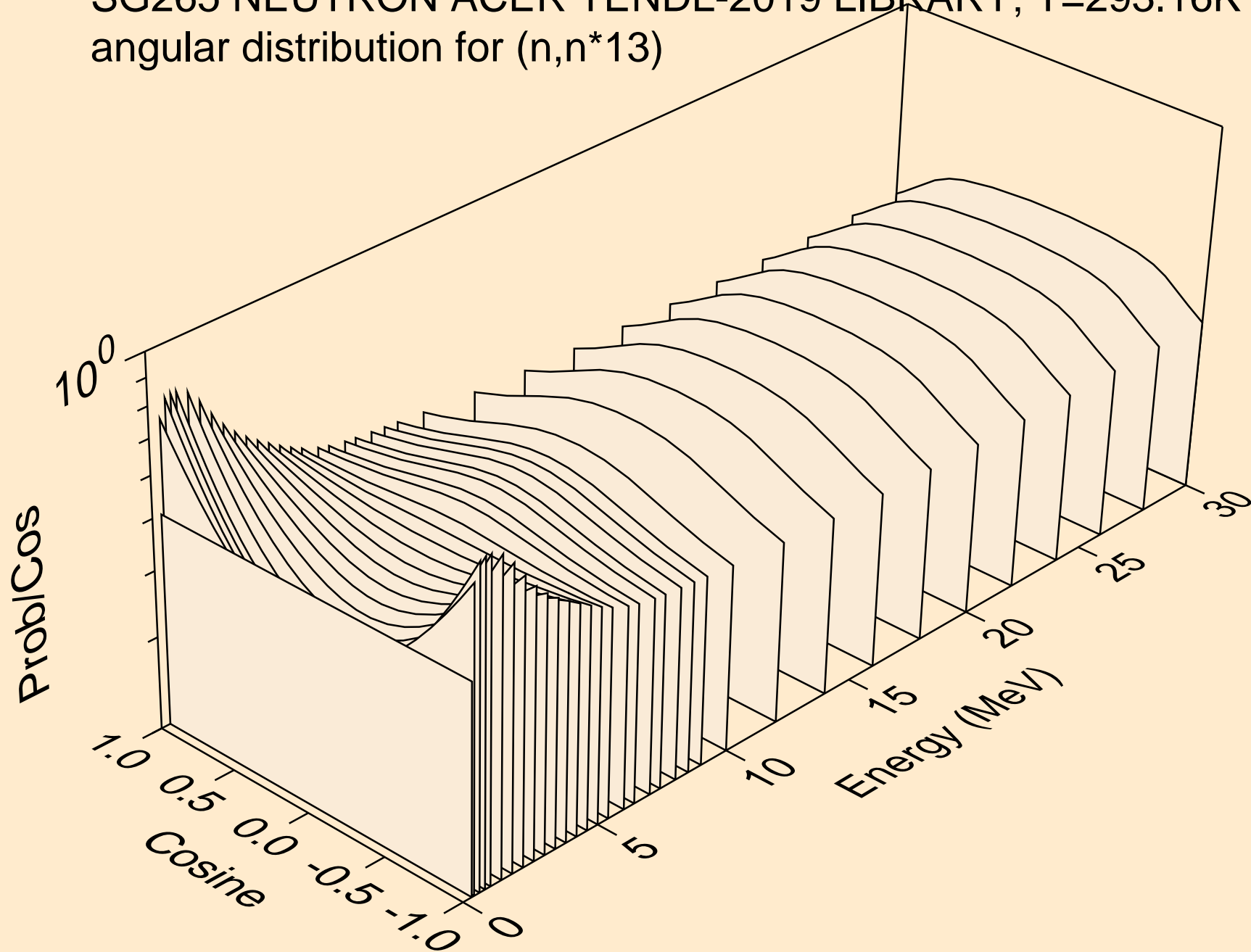

SG265 NEUTRON ACER TENDL-2019 LIBRARY; T=293.16K
angular distribution for (n,n*14)

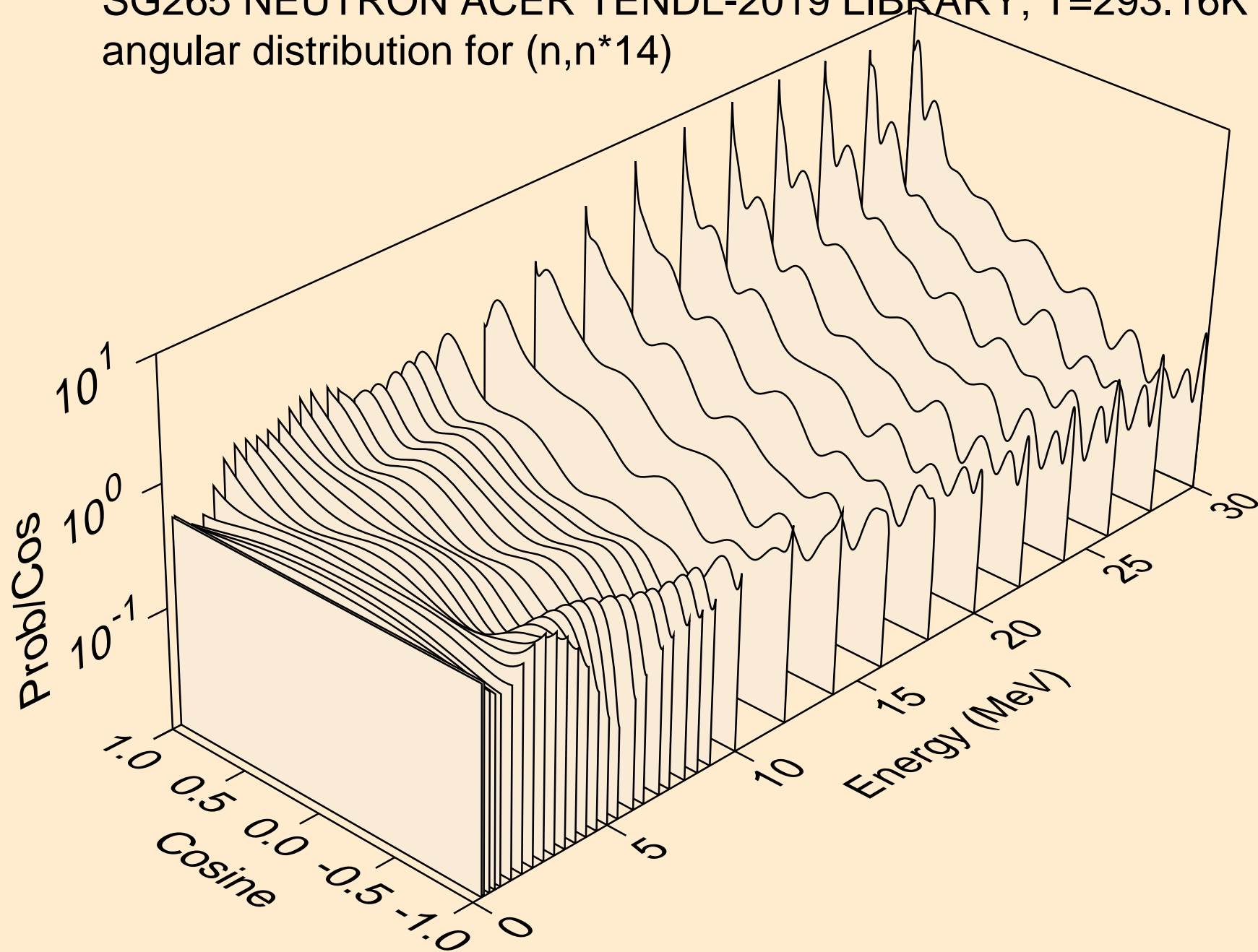

SG265 NEUTRON ACER TENDL-2019 LIBRARY; T=293.16K
angular distribution for (n,n*15)

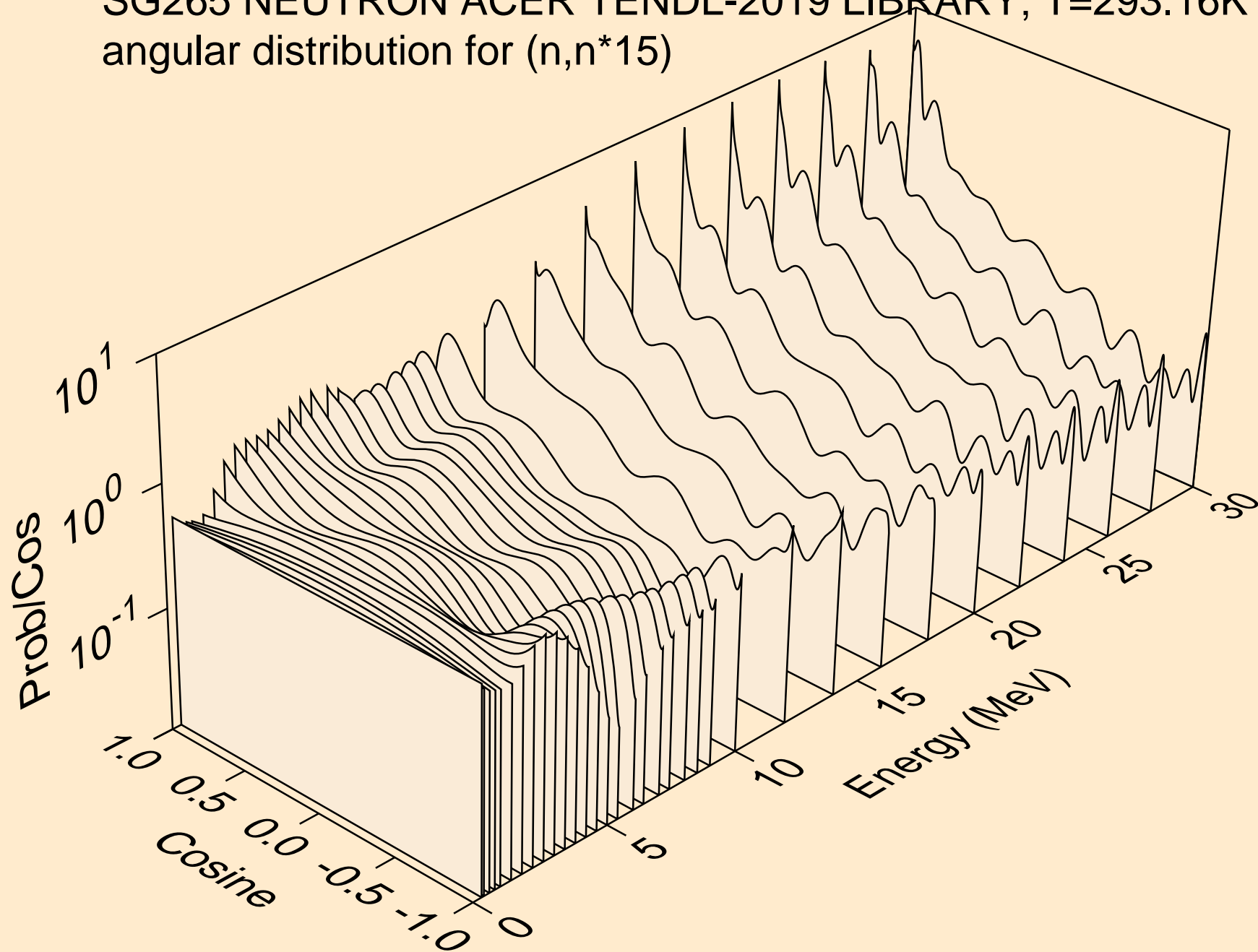

SG265 NEUTRON ACER TENDL-2019 LIBRARY; T=293.16K
angular distribution for (n,n*16)

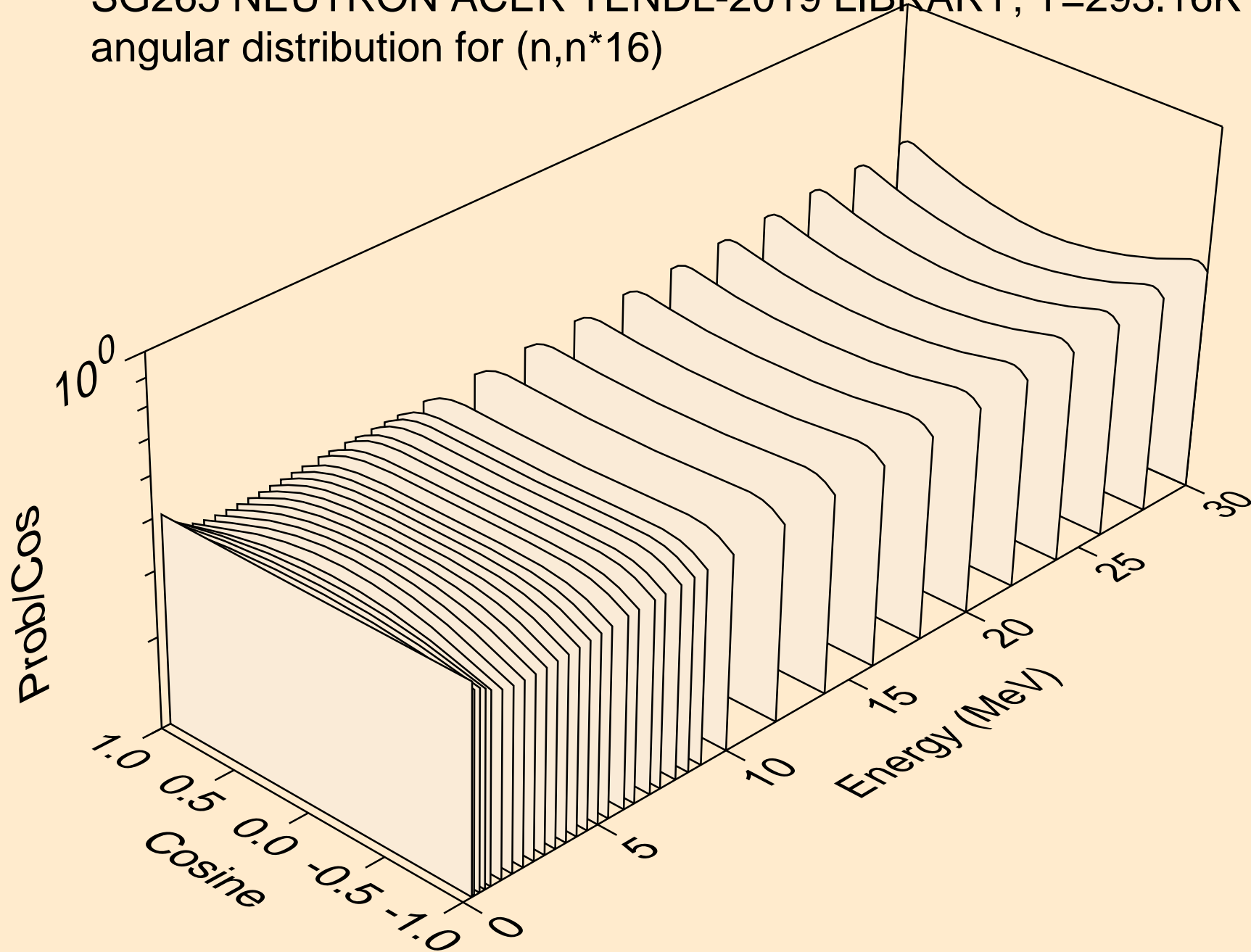

SG265 NEUTRON ACER TENDL-2019 LIBRARY; T=293.16K
angular distribution for (n,n*17)

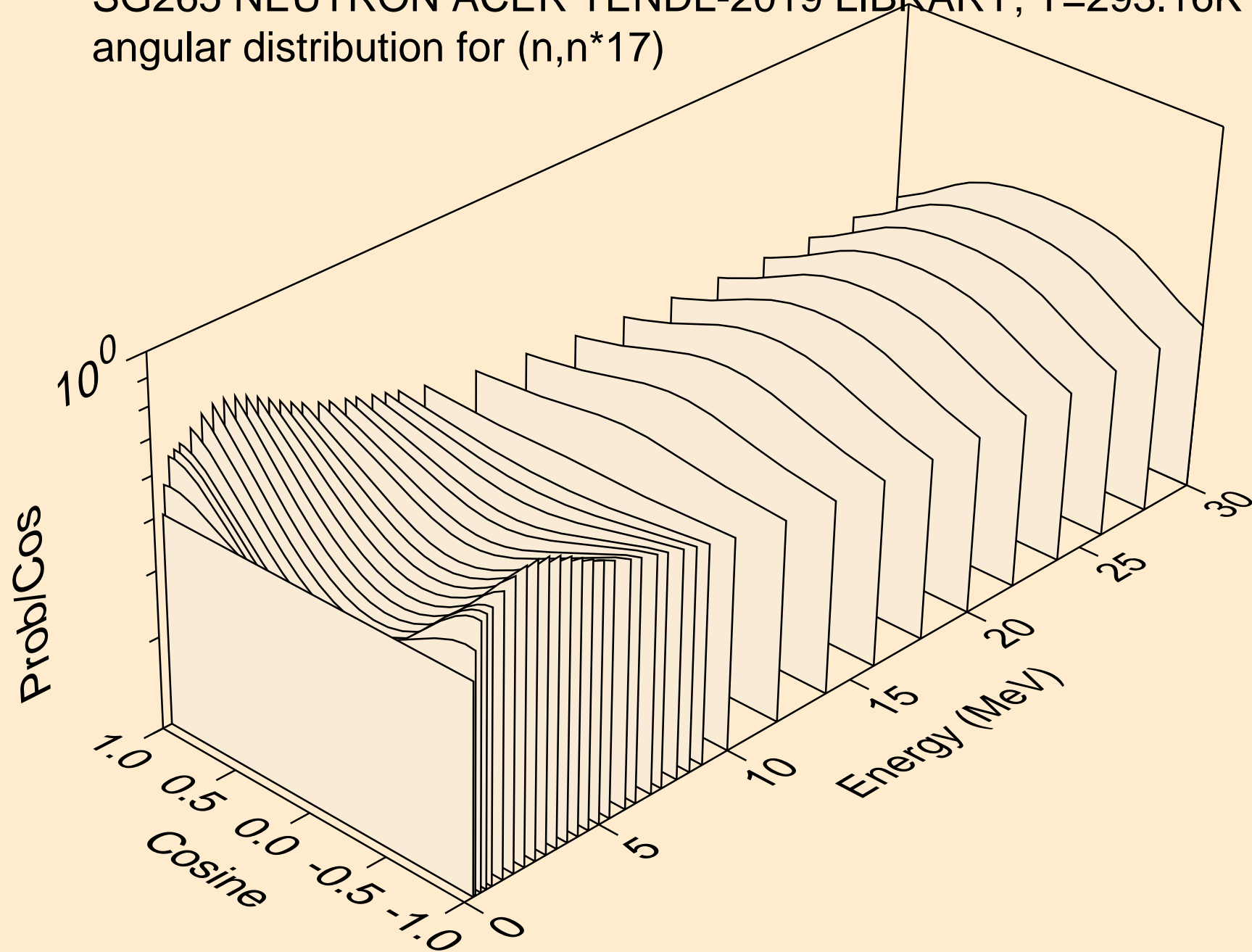

SG265 NEUTRON ACER TENDL-2019 LIBRARY; T=293.16K
angular distribution for (n,n*18)

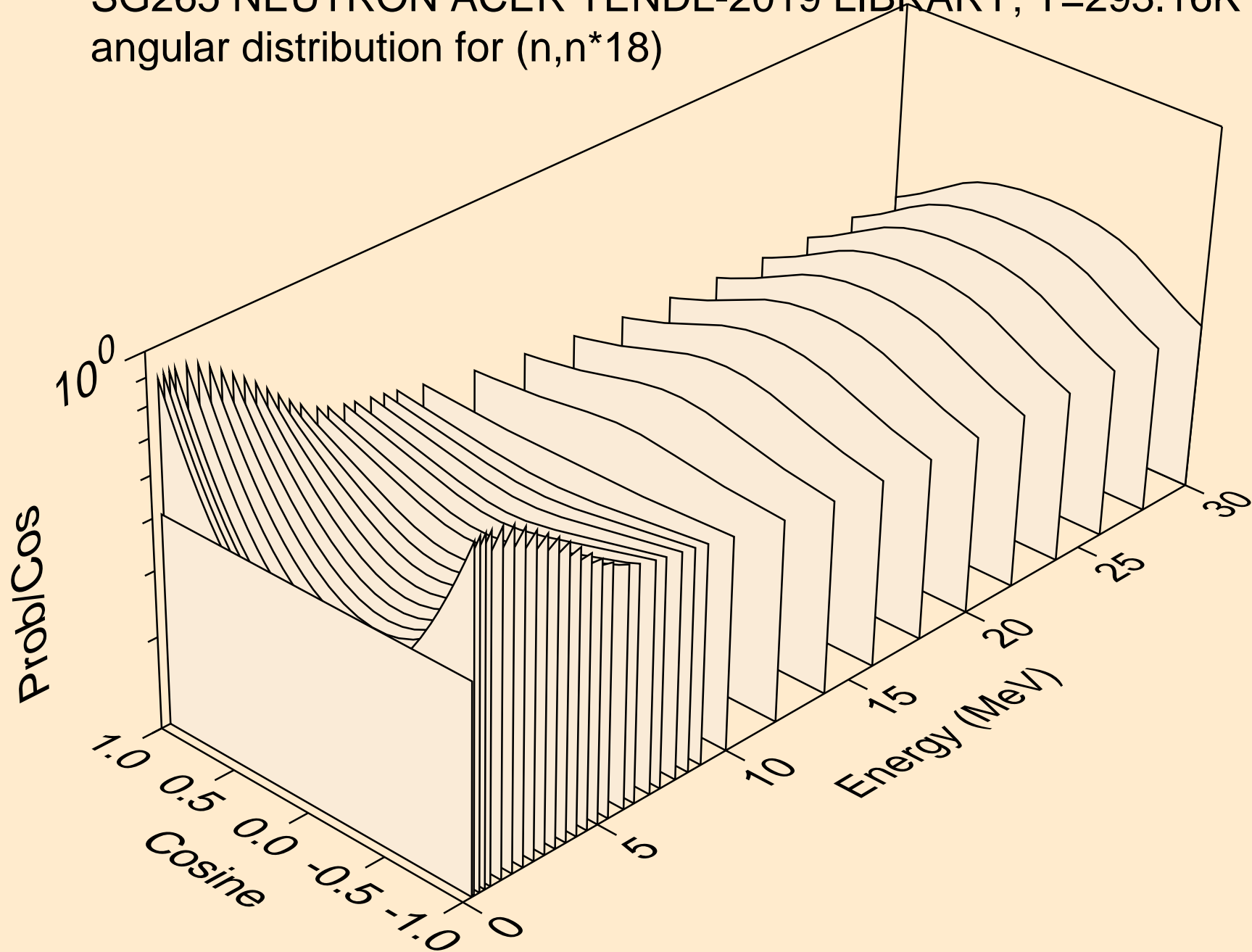

SG265 NEUTRON ACER TENDL-2019 LIBRARY; T=293.16K
angular distribution for (n,n*19)

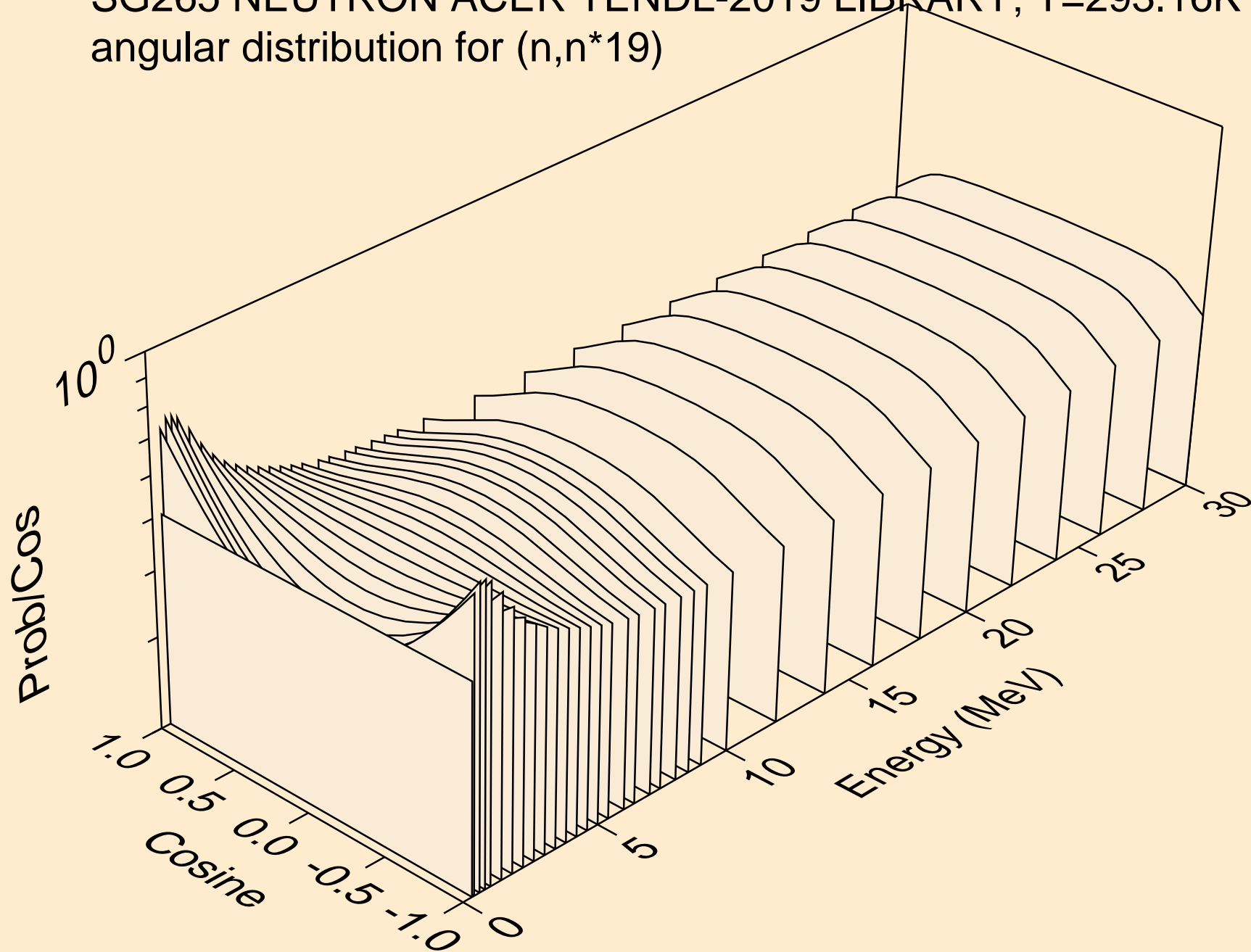

SG265 NEUTRON ACER TENDL-2019 LIBRARY; T=293.16K
angular distribution for (n,n*20)

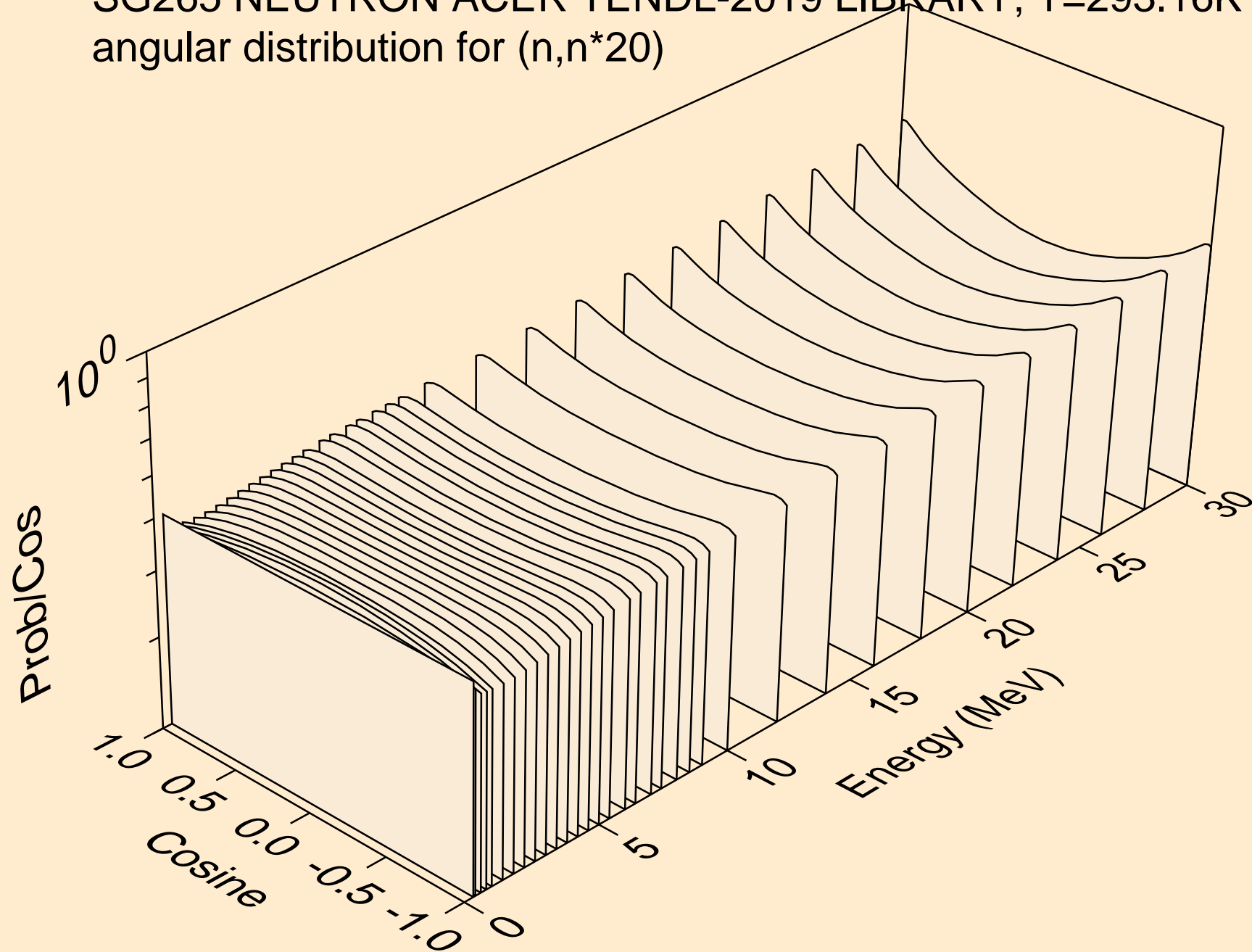

SG265 NEUTRON ACER TENDL-2019 LIBRARY; T=293.16K
angular distribution for (n,n*21)

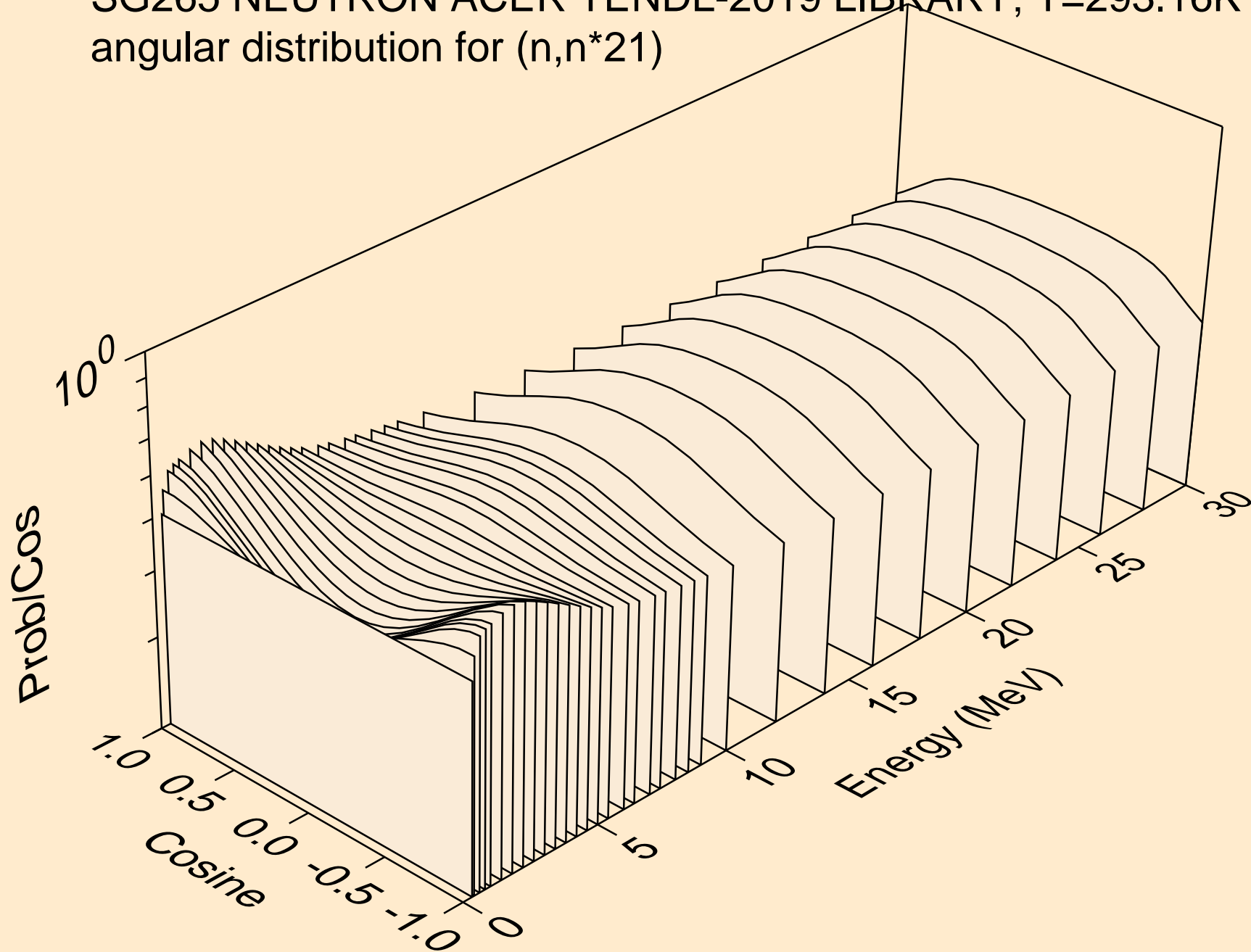

SG265 NEUTRON ACER TENDL-2019 LIBRARY; T=293.16K
angular distribution for (n,n*22)

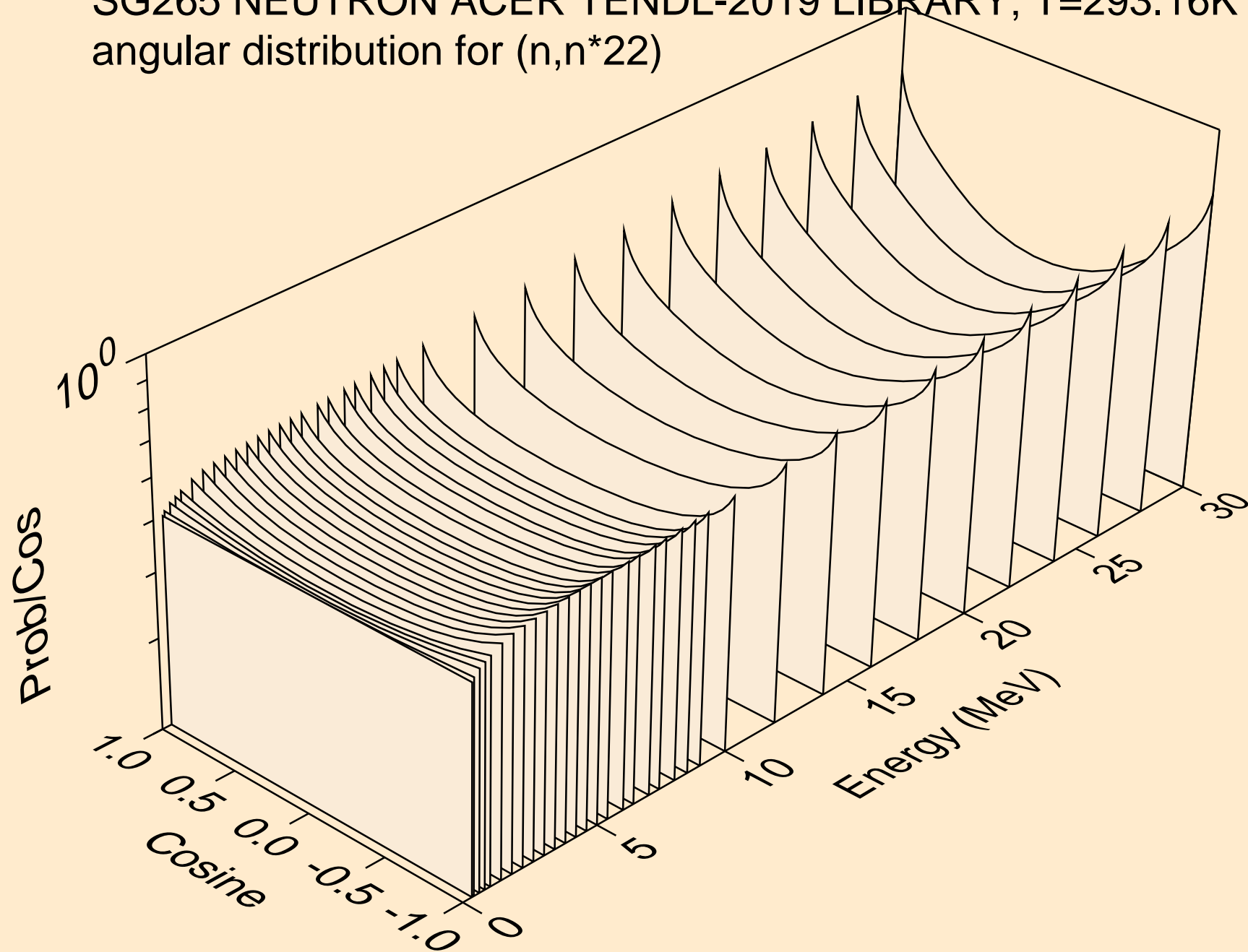

SG265 NEUTRON ACER TENDL-2019 LIBRARY; T=293.16K
angular distribution for (n,n*23)

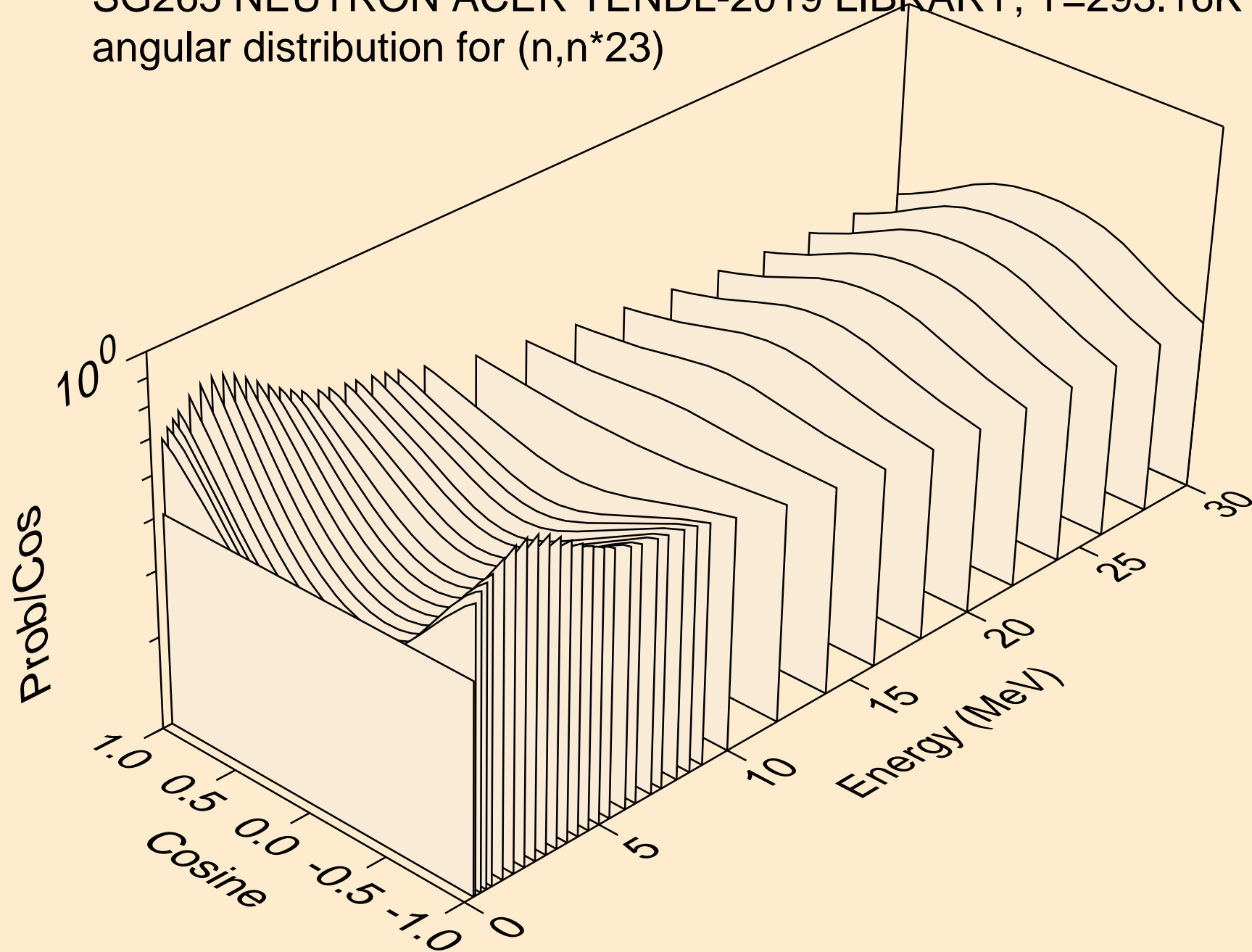

SG265 NEUTRON ACER TENDL-2019 LIBRARY; T=293.16K
angular distribution for (n,n*24)

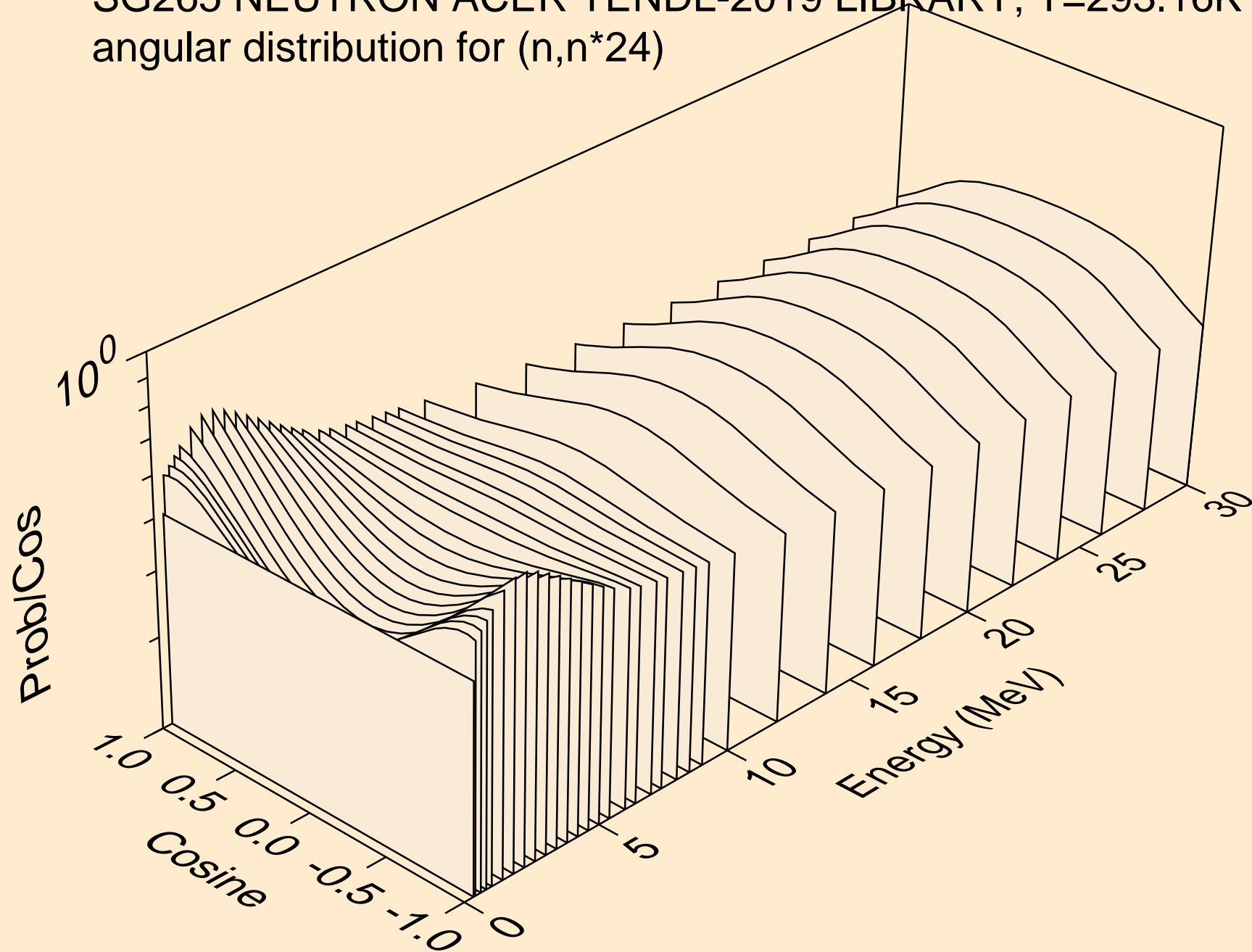

SG265 NEUTRON ACER TENDL-2019 LIBRARY; T=293.16K
angular distribution for (n,n*25)

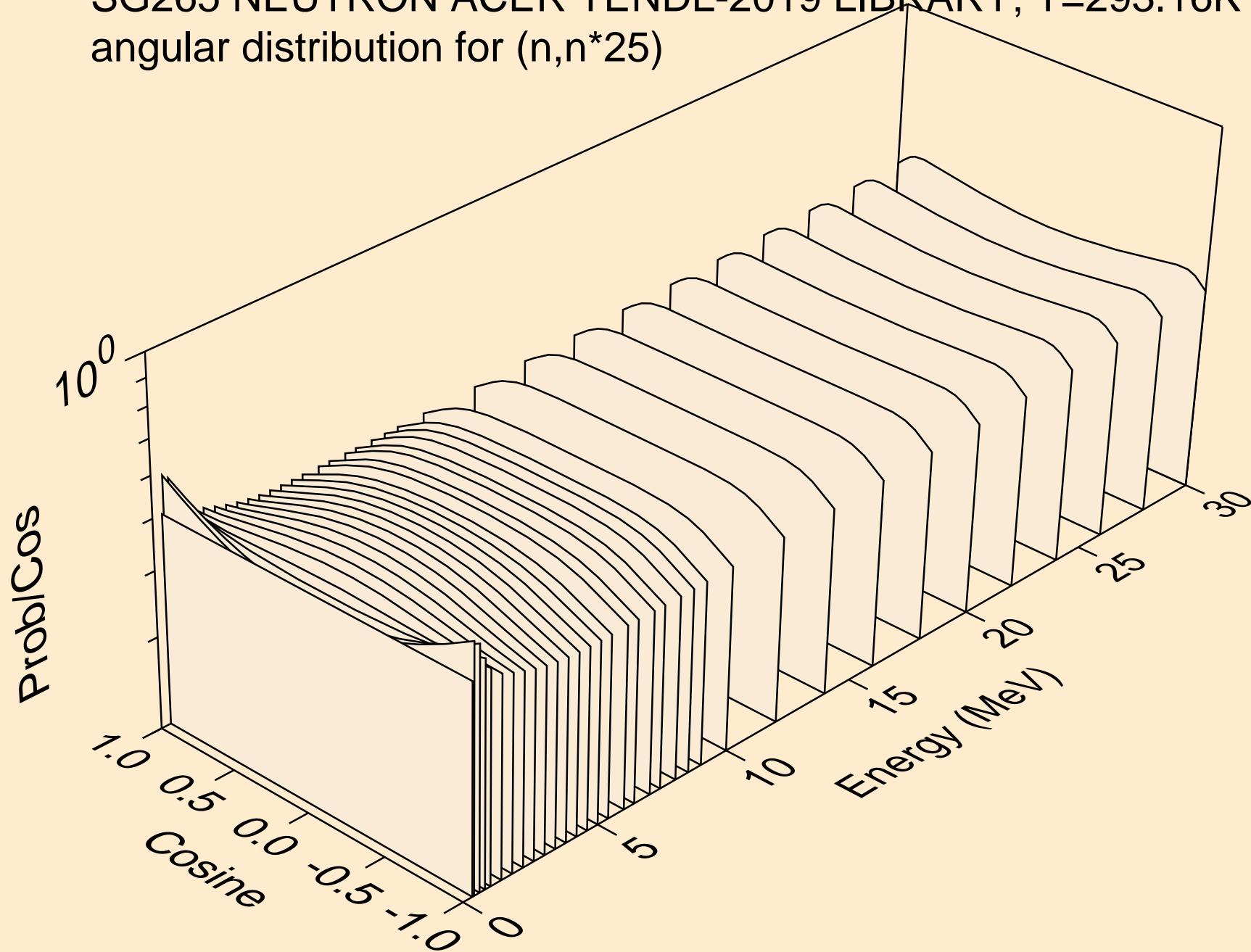

SG265 NEUTRON ACER TENDL-2019 LIBRARY; T=293.16K
angular distribution for (n,n*26)

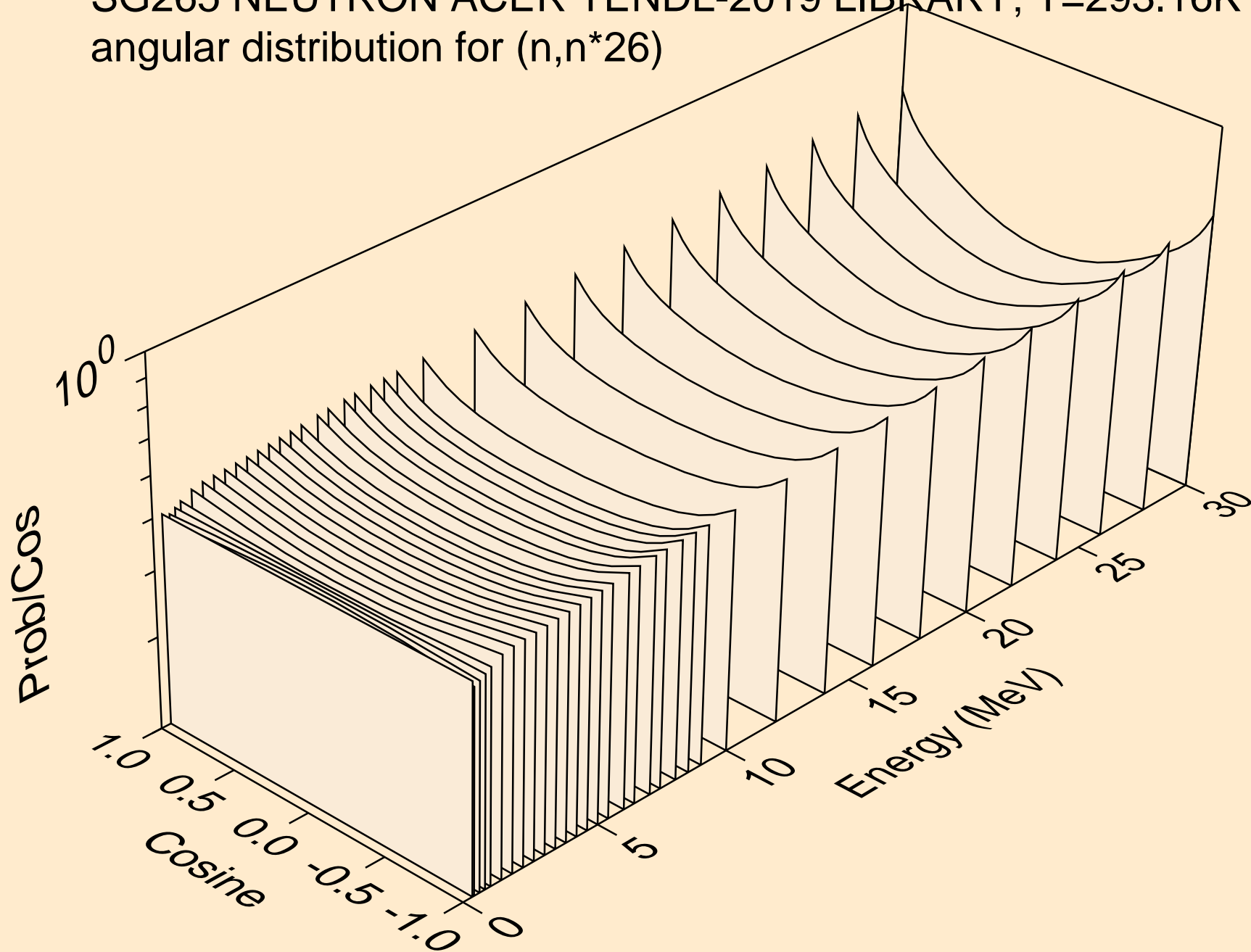

SG265 NEUTRON ACER TENDL-2019 LIBRARY; T=293.16K

Total fission nubar

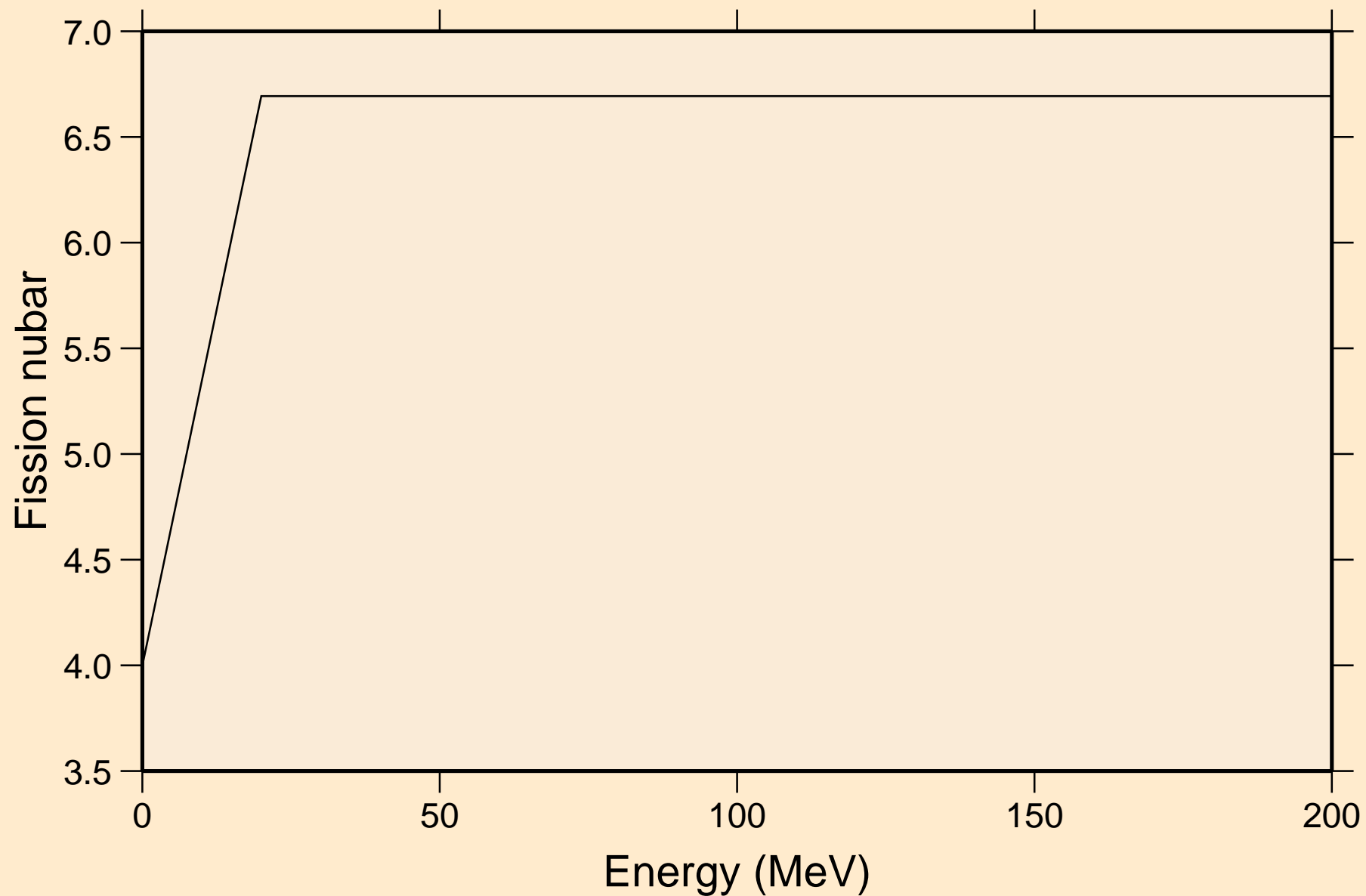

SG265 NEUTRON ACER TENDL-2019 LIBRARY; T=293.16K
Neutron emission for (n,x)

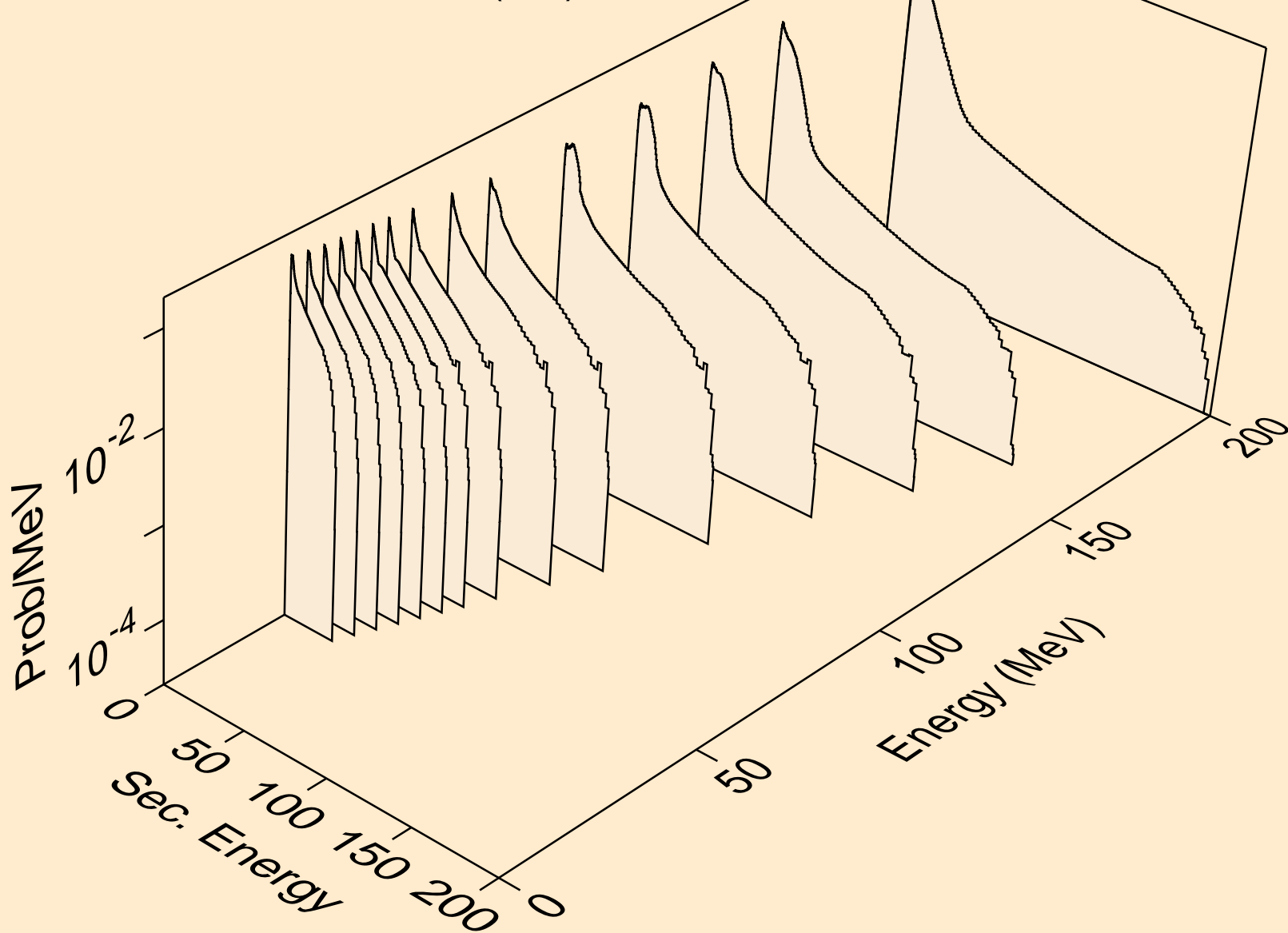

SG265 NEUTRON ACER TENDL-2019 LIBRARY; T=293.16K
Neutron emission for (n,2nd)

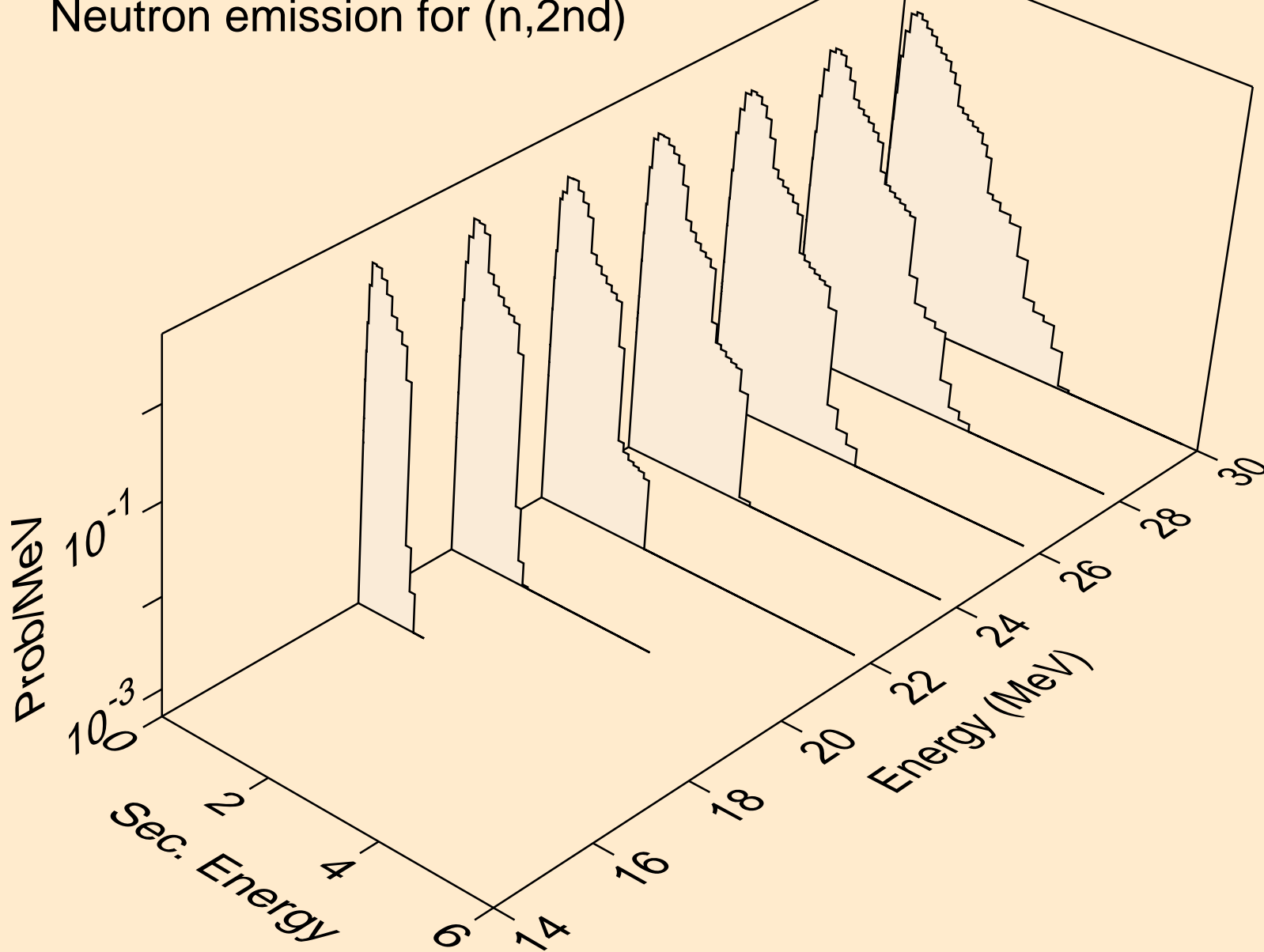

SG265 NEUTRON ACER TENDL-2019 LIBRARY; T=293.16K
Neutron emission for (n,2n)

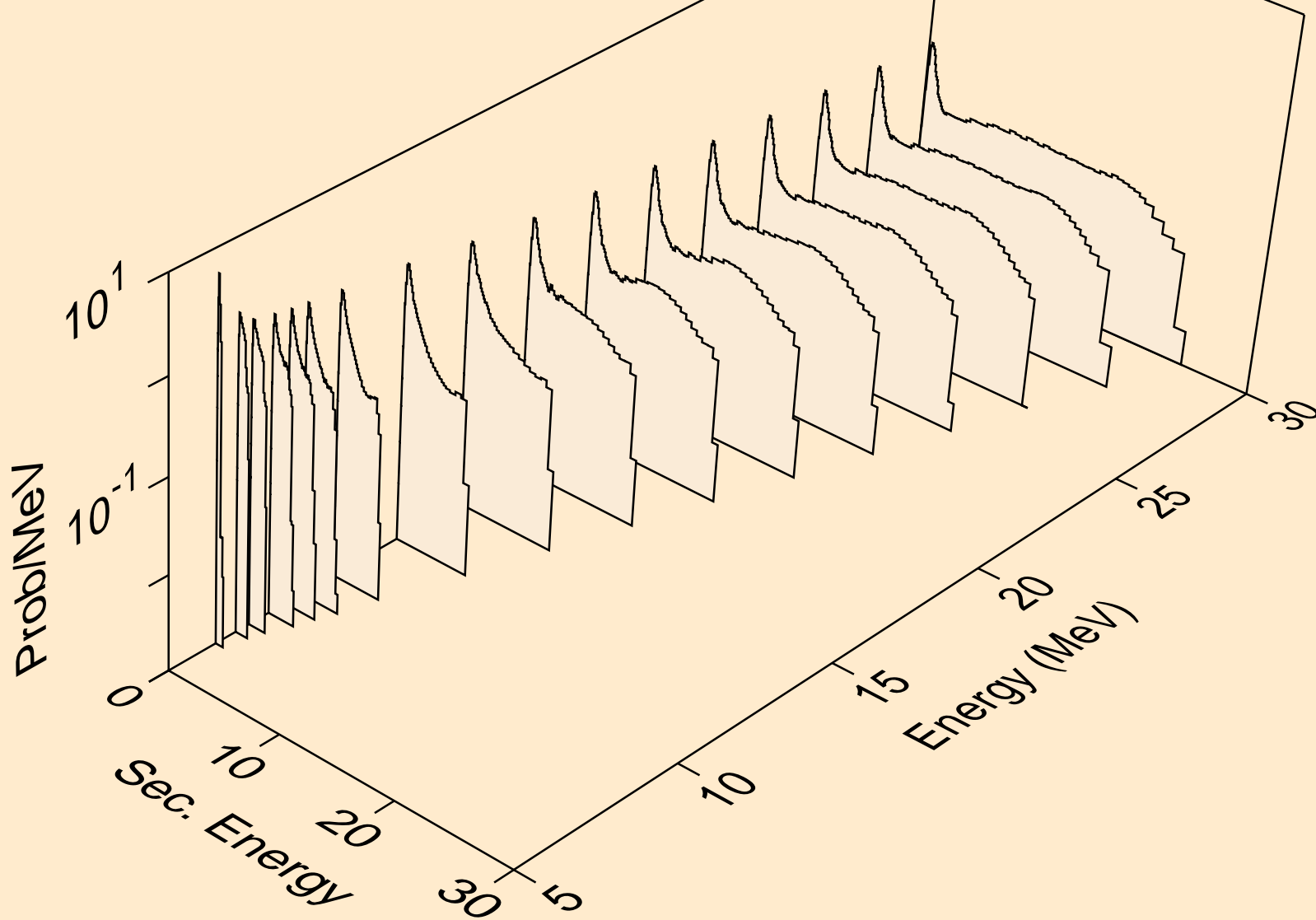

SG265 NEUTRON ACER TENDL-2019 LIBRARY; T=293.16K
Neutron emission for (n,3n)

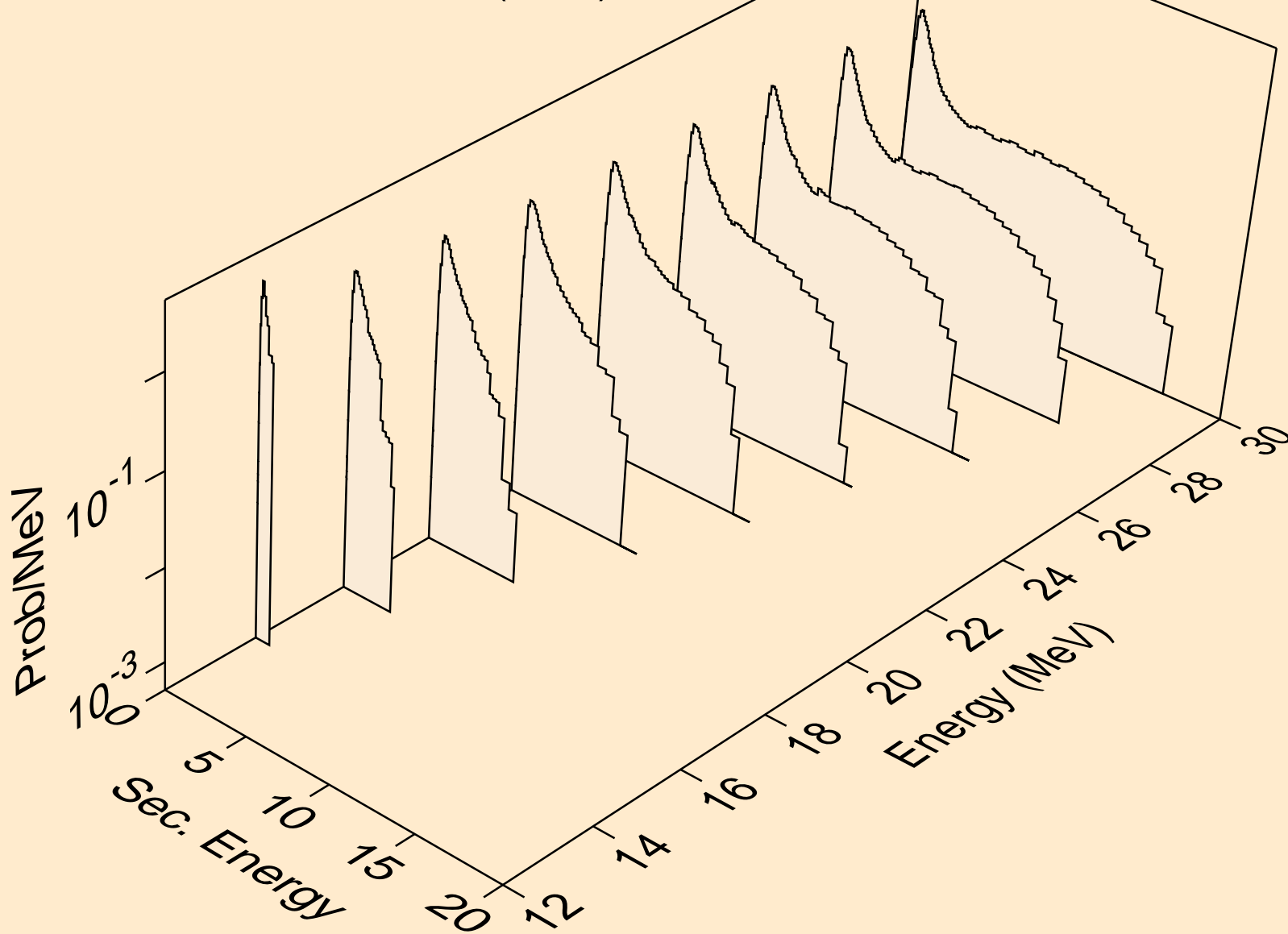

SG265 NEUTRON ACER TENDL-2019 LIBRARY; T=293.16K
Neutron emission for fission

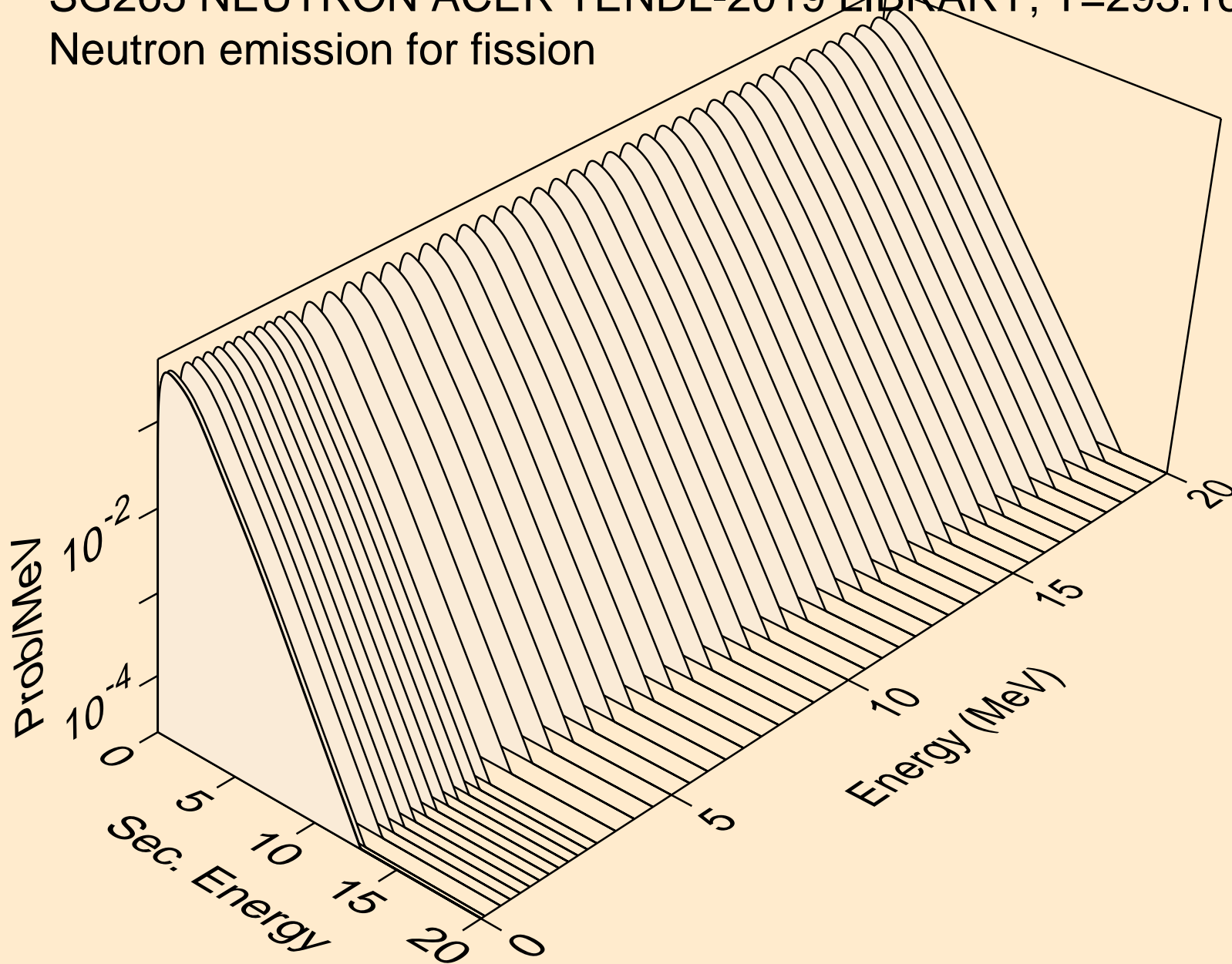

SG265 NEUTRON ACER TENDL-2019 LIBRARY; T=293.16K
Neutron emission for (n,n*)a

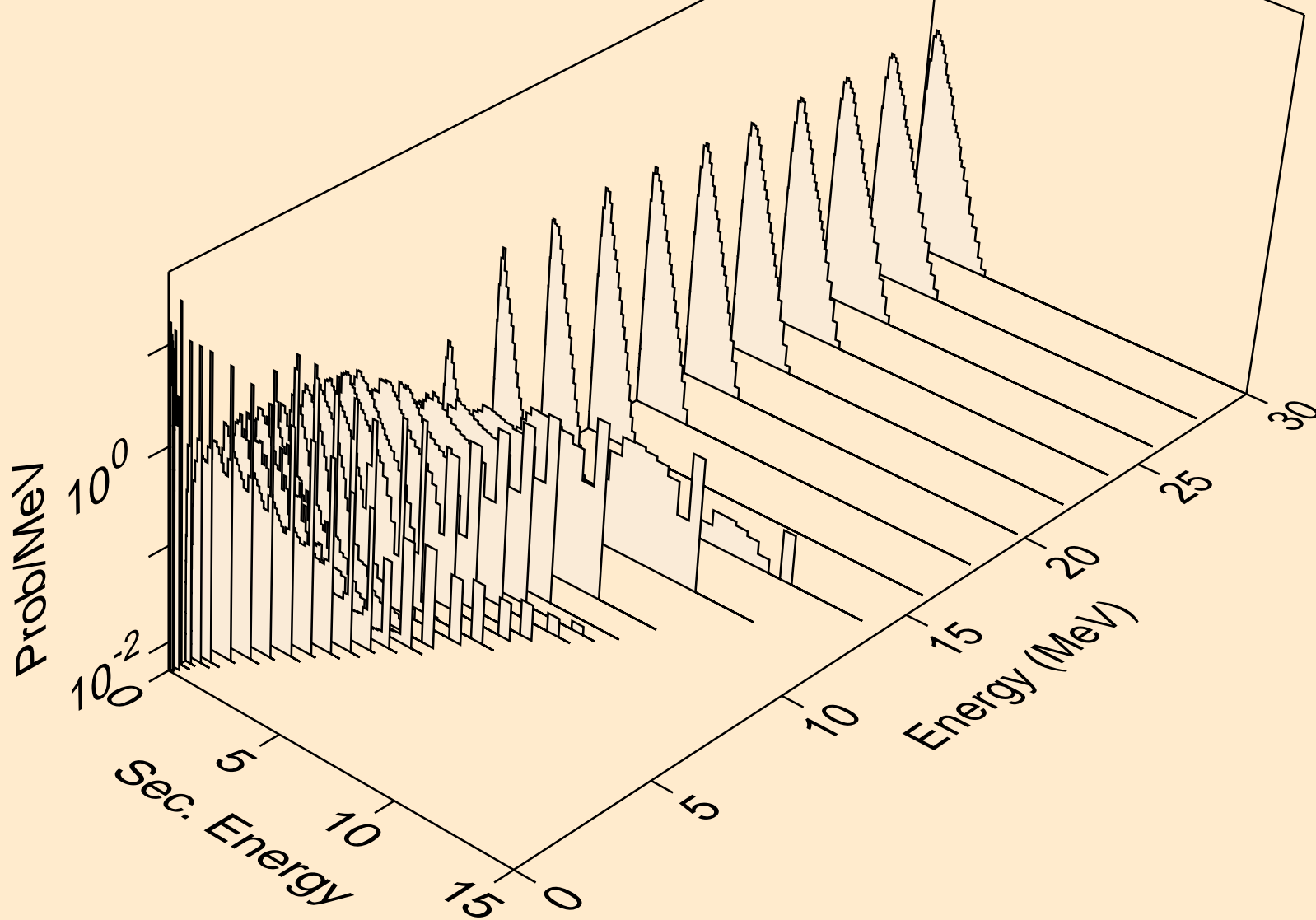

SG265 NEUTRON ACER TENDL-2019 LIBRARY; T=293.16K
Neutron emission for (n,2n)a

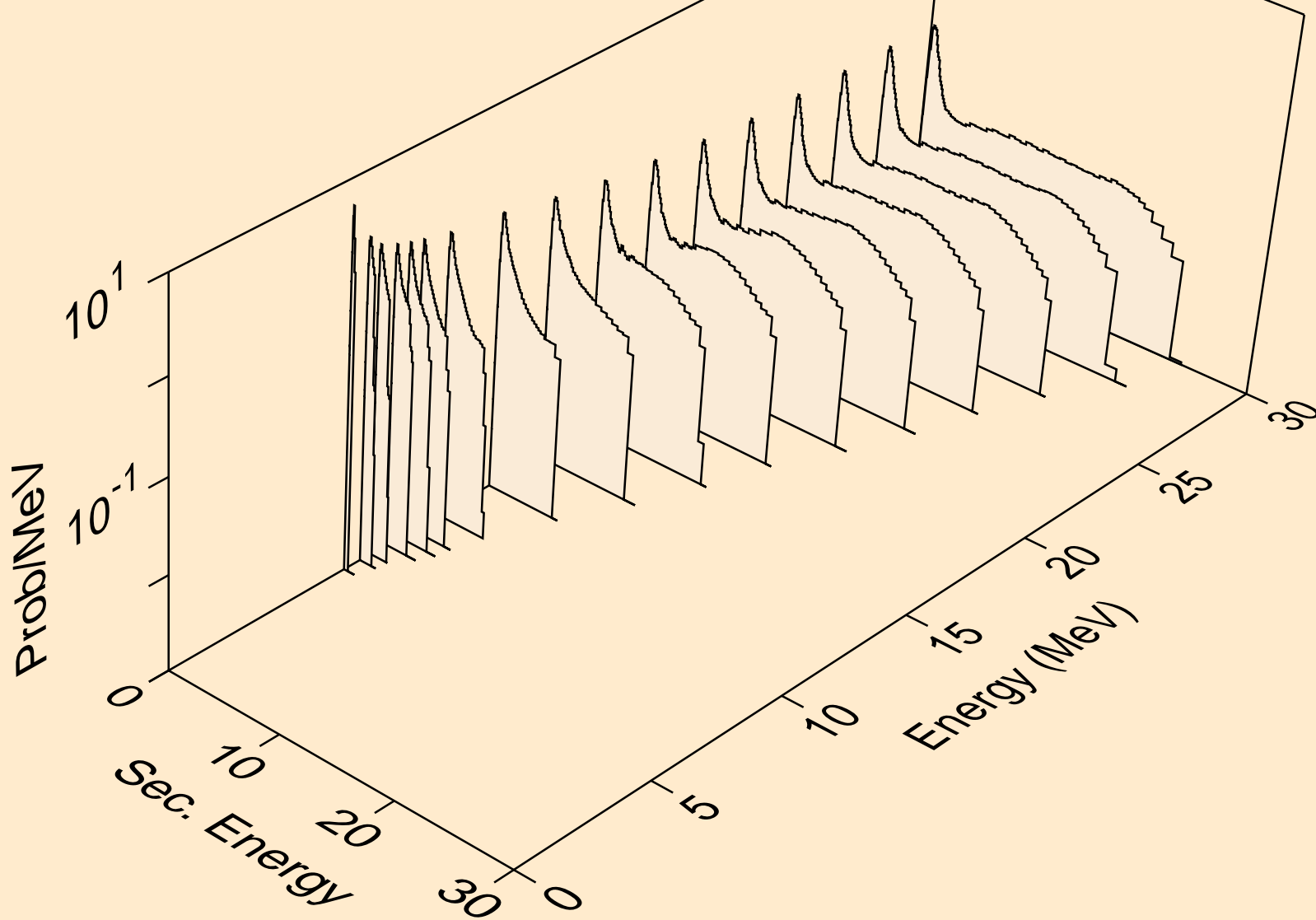

SG265 NEUTRON ACER TENDL-2019 LIBRARY; T=293.16K
Neutron emission for (n,3n)a

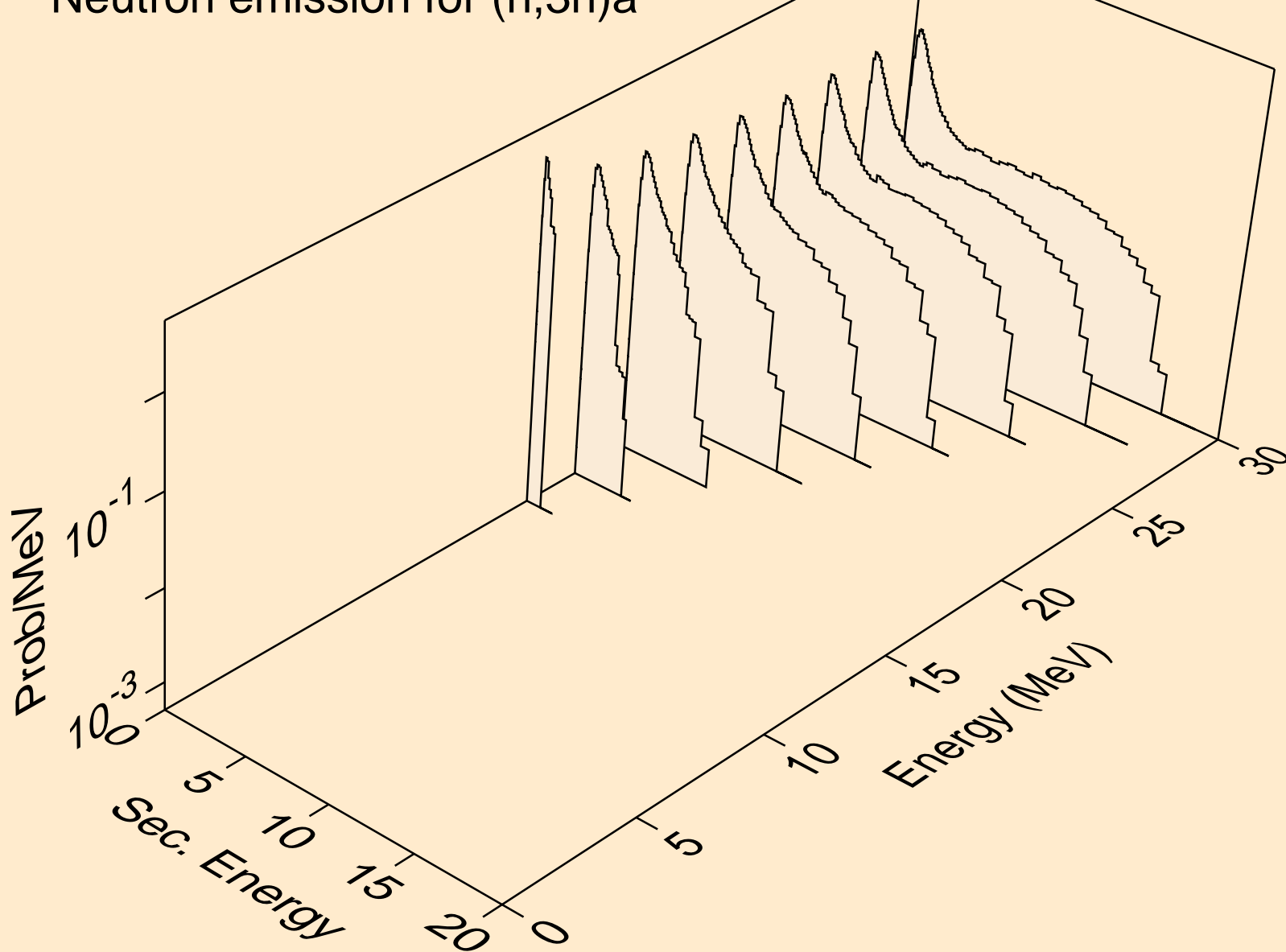

SG265 NEUTRON ACER TENDL-2019 LIBRARY; T=293.16K
Neutron emission for (n,n*)p

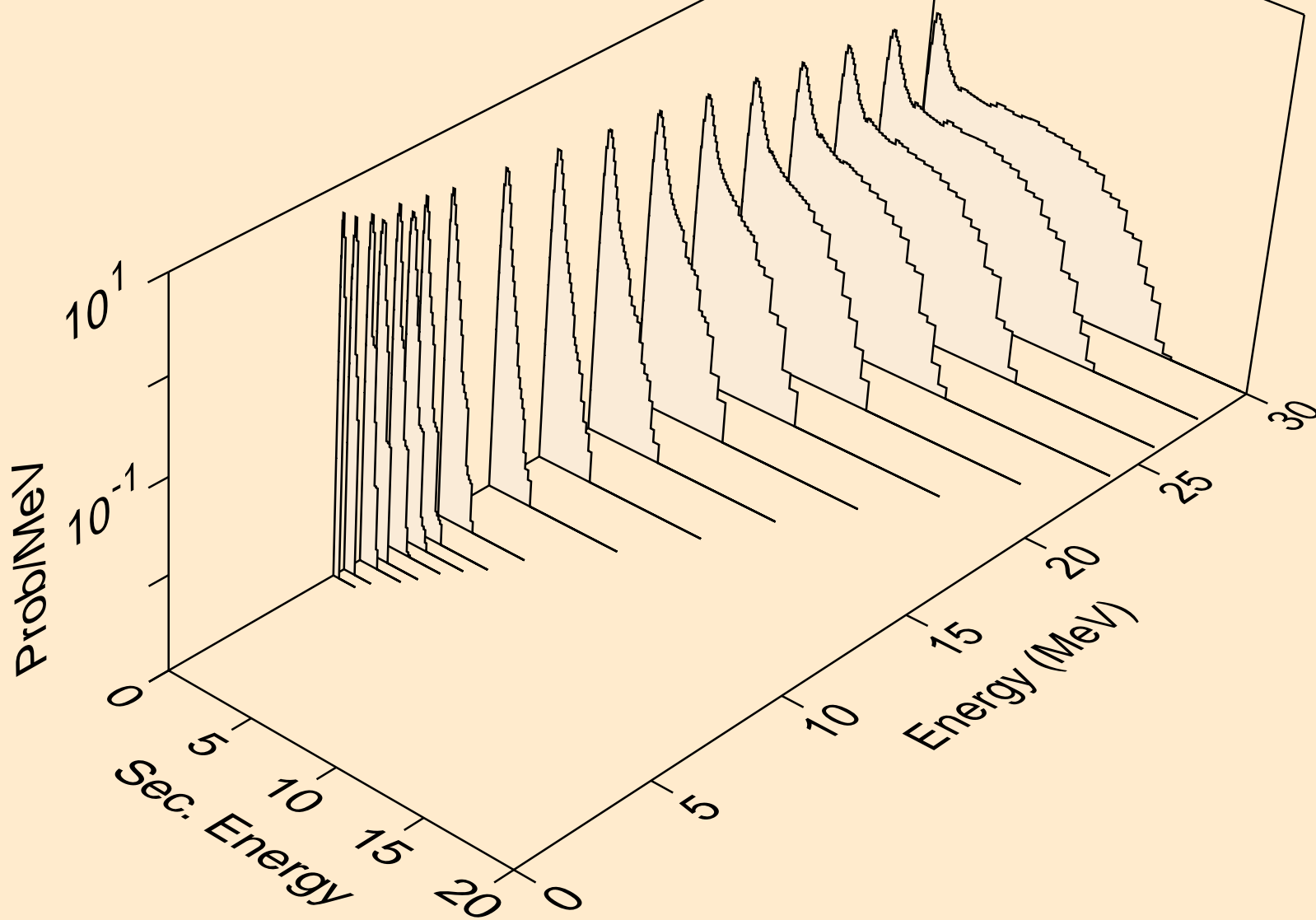

SG265 NEUTRON ACER TENDL-2019 LIBRARY; T=293.16K
Neutron emission for (n,n*)2a

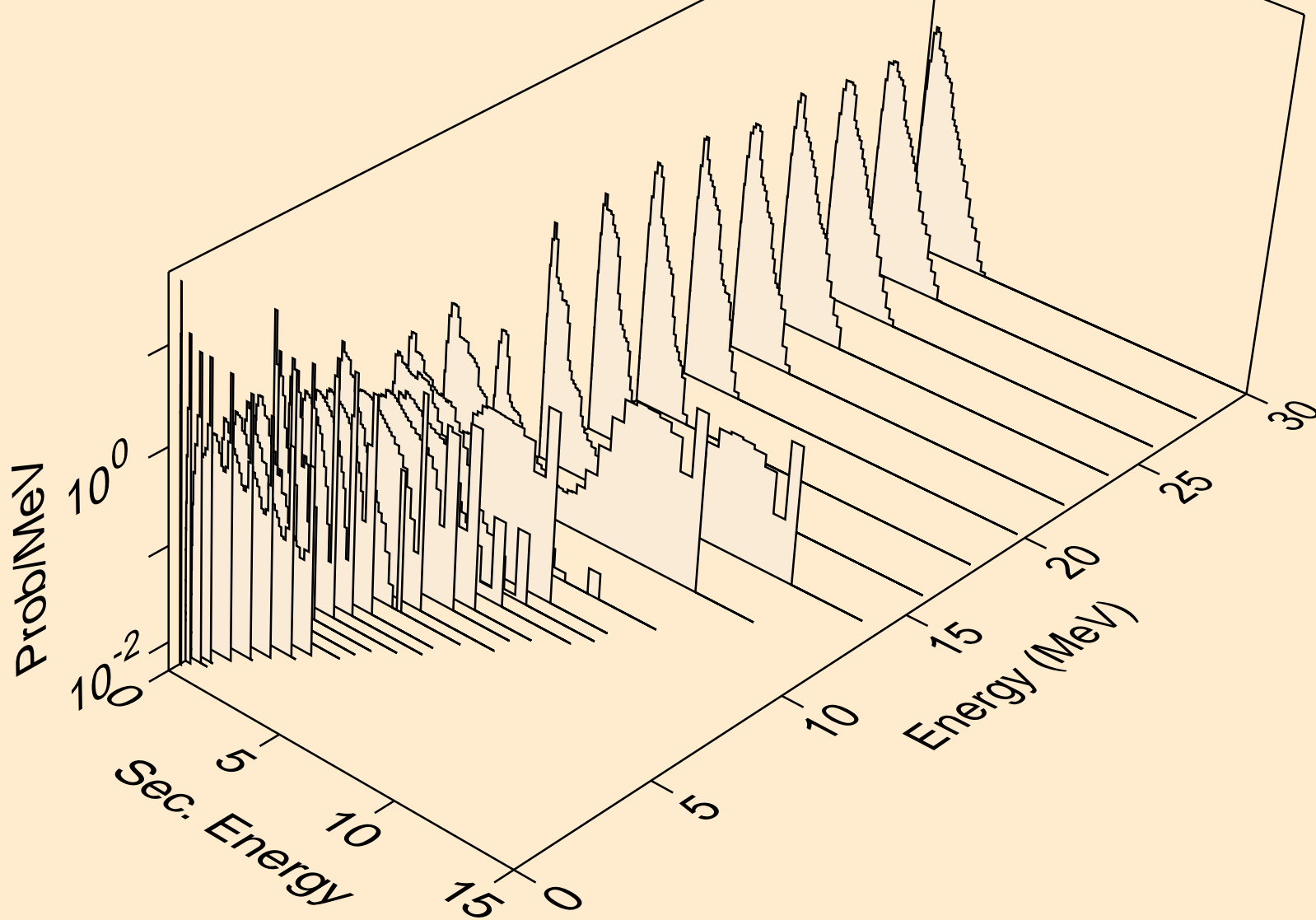

SG265 NEUTRON ACER TENDL-2019 LIBRARY; T=293.16K
Neutron emission for (n,2n)2a

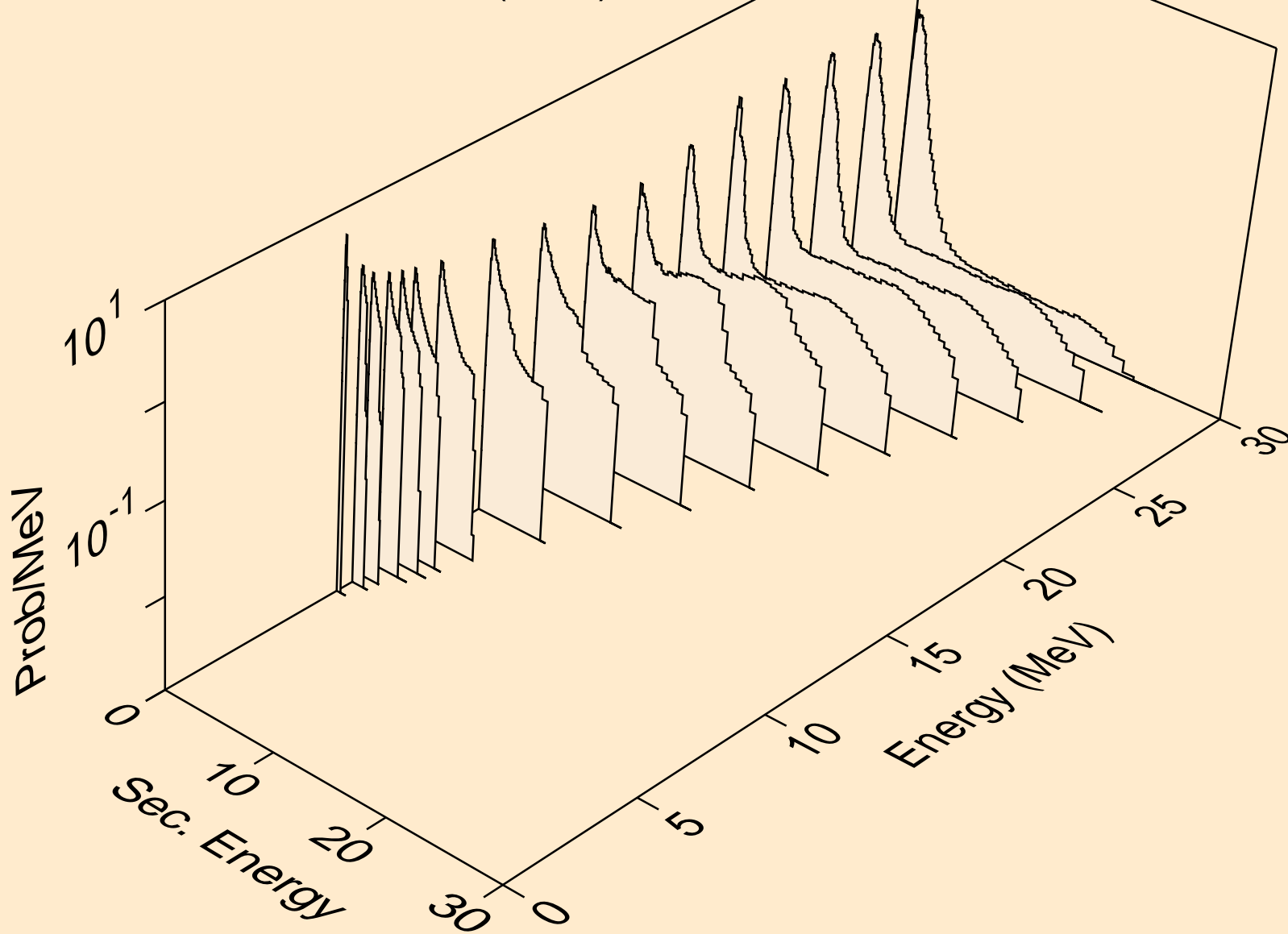

SG265 NEUTRON ACER TENDL-2019 LIBRARY; T=293.16K
Neutron emission for (n,n*)d

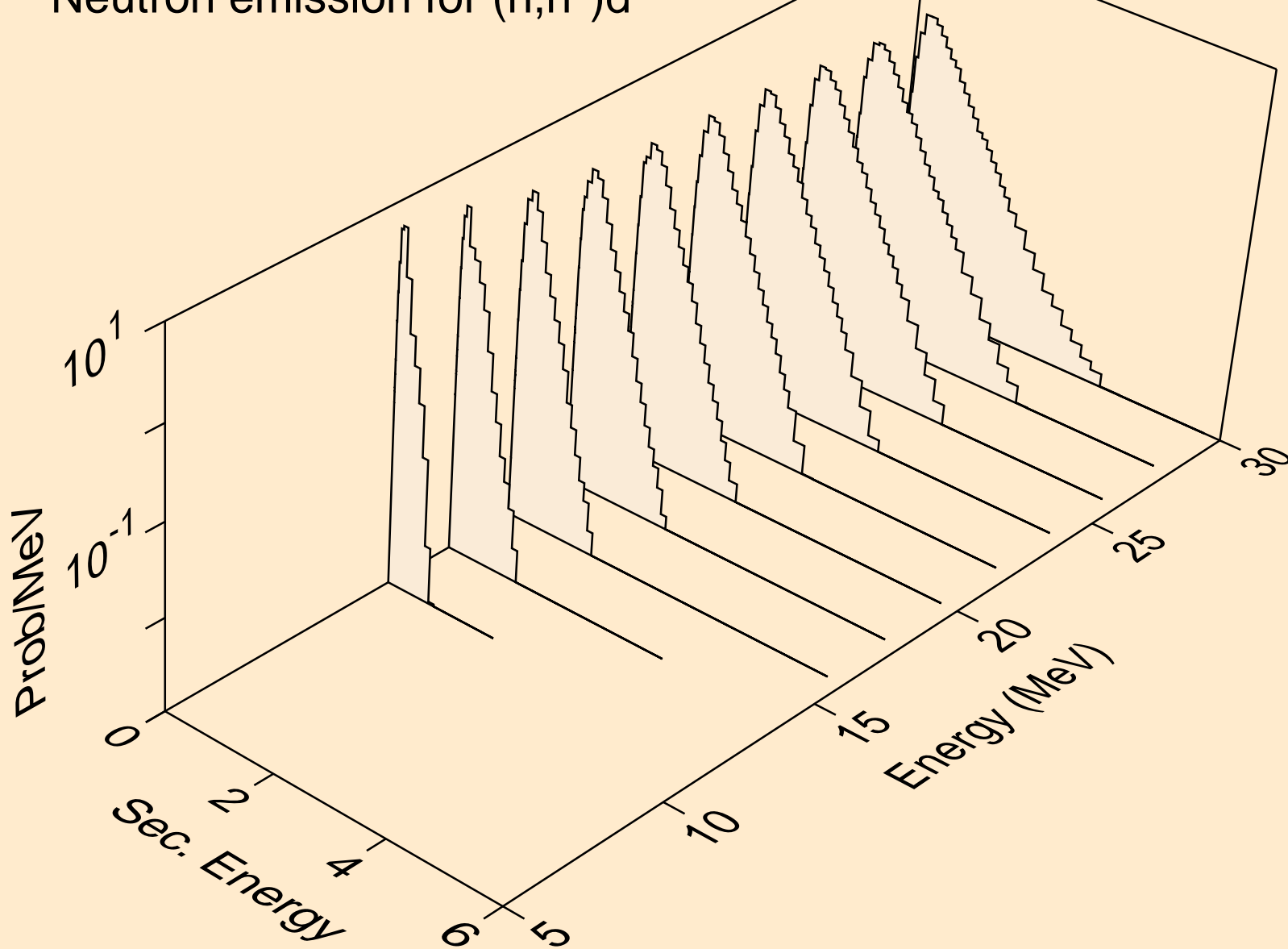

SG265 NEUTRON ACER TENDL-2019 LIBRARY; T=293.16K
Neutron emission for (n,n*)t

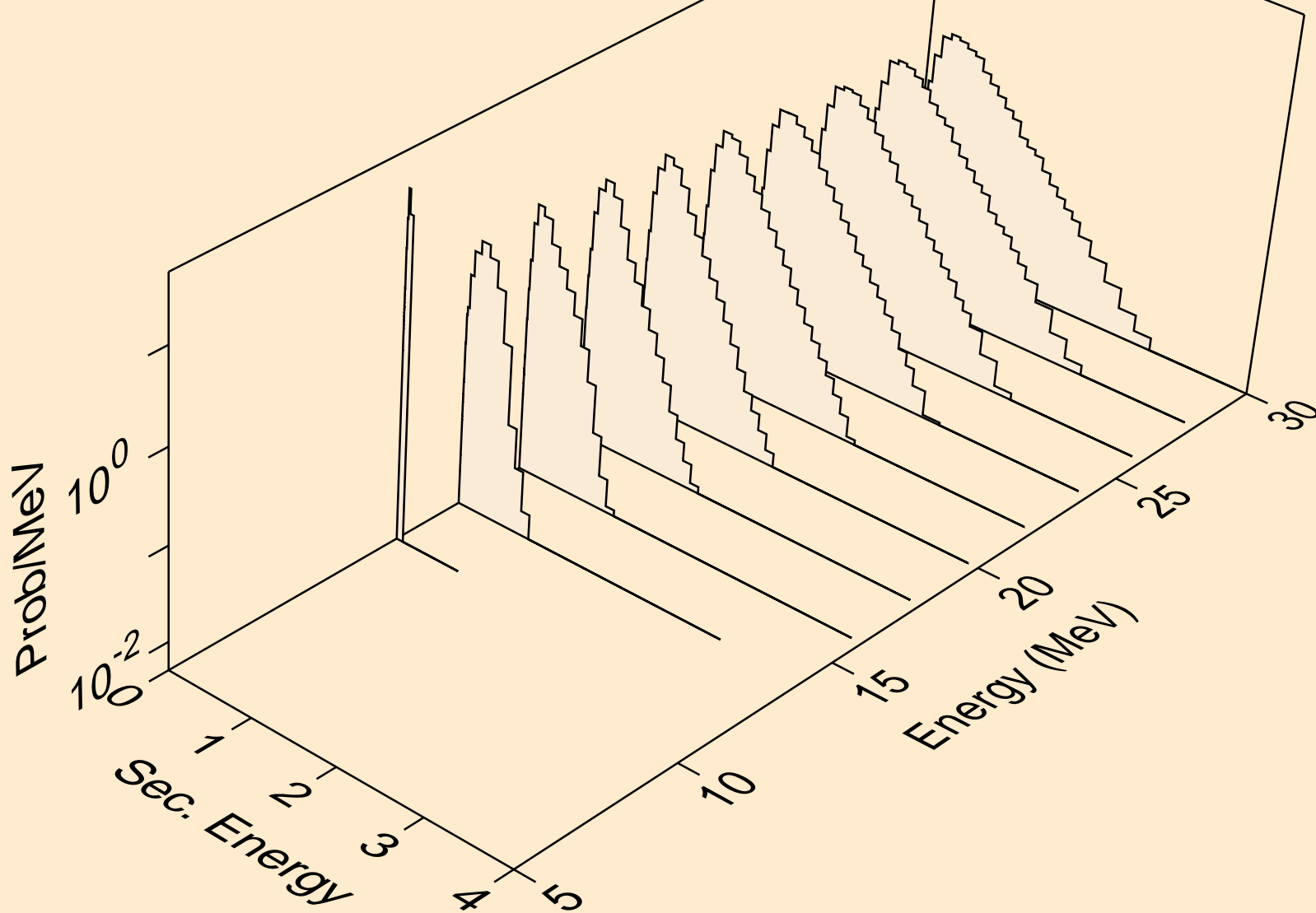

SG265 NEUTRON ACER TENDL-2019 LIBRARY; T=293.16K
Neutron emission for (n,n*)he3

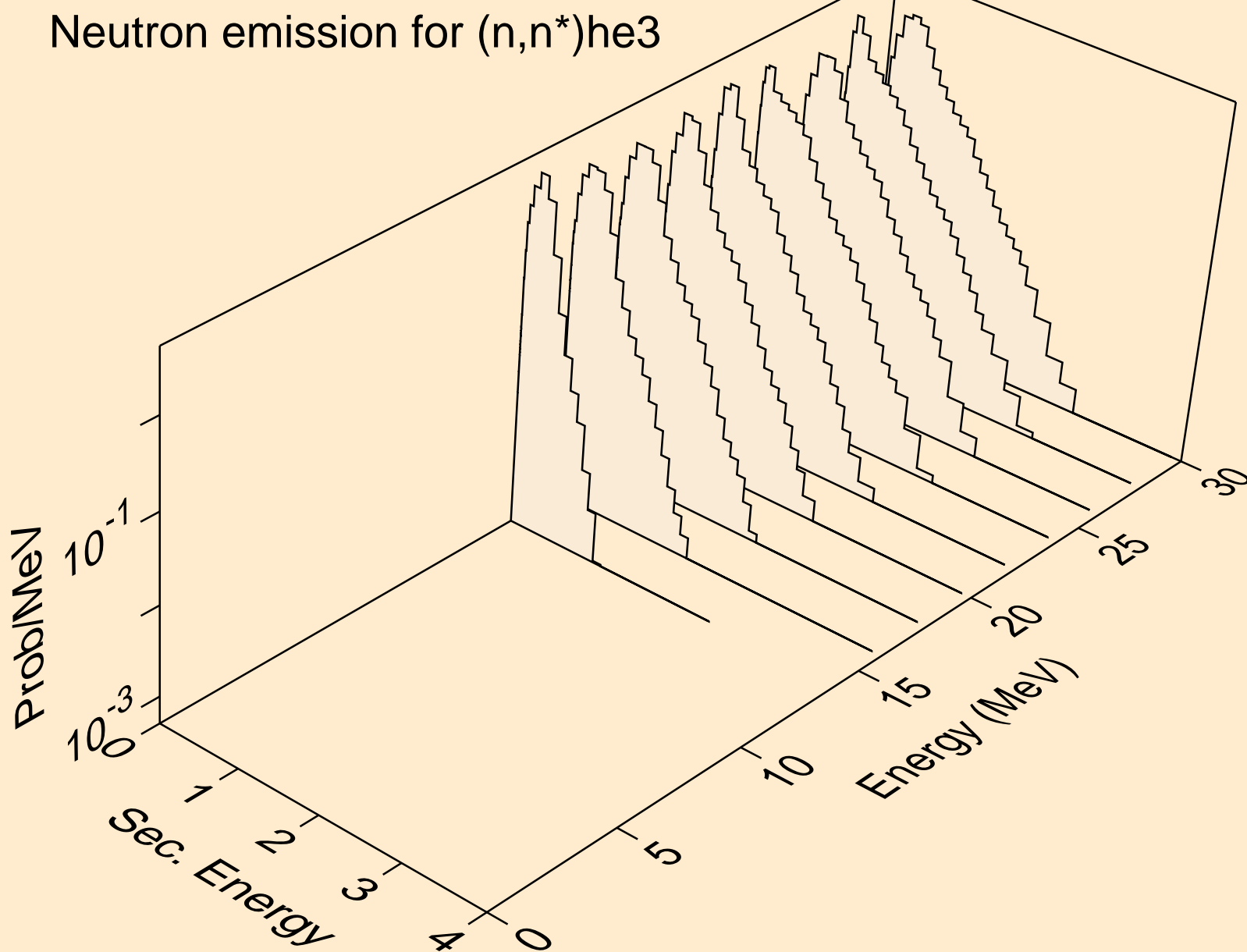

SG265 NEUTRON ACER TENDL-2019 LIBRARY; T=293.16K
Neutron emission for (n,n*)t2a

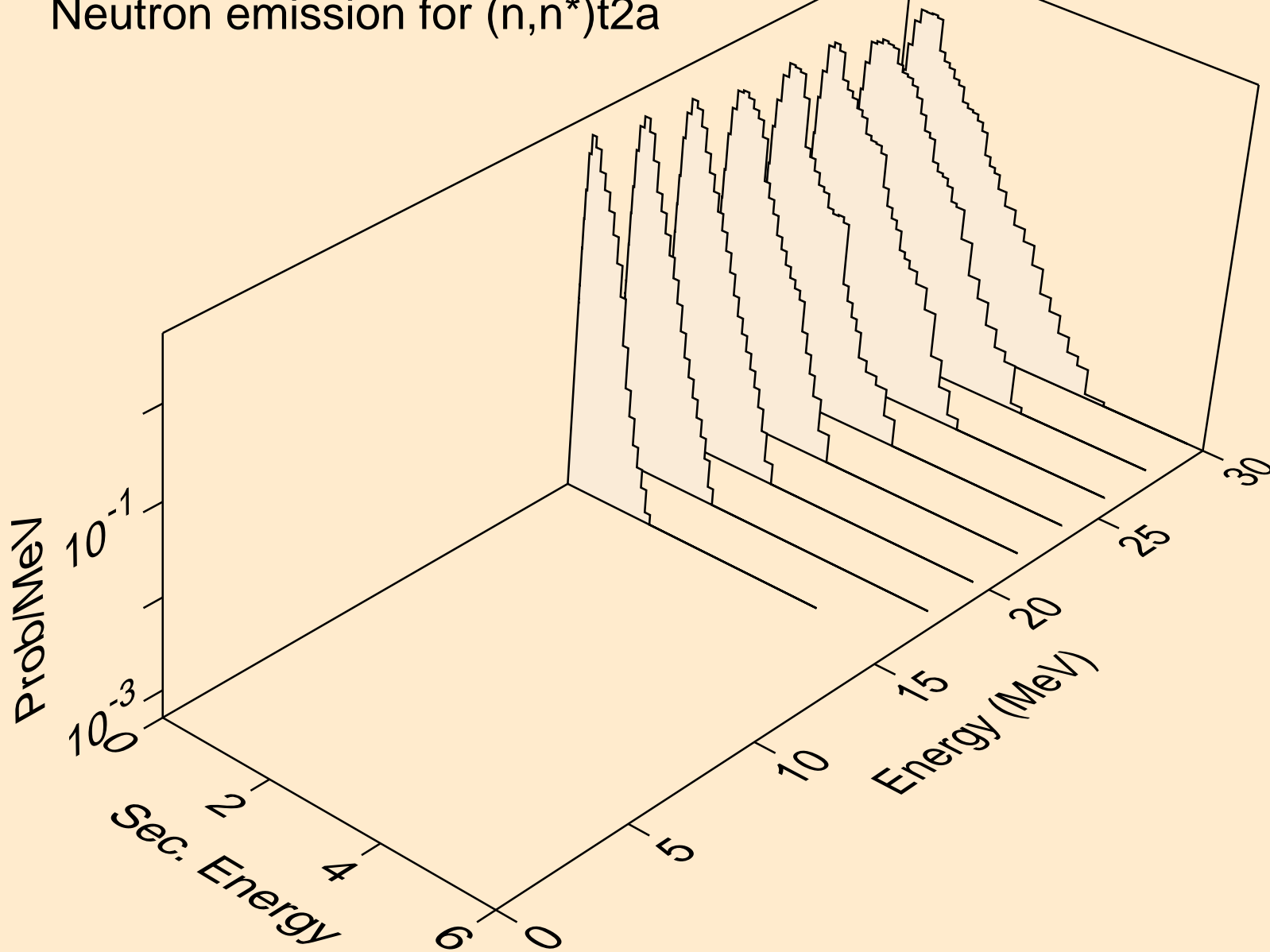

SG265 NEUTRON ACER TENDL-2019 LIBRARY; T=293.16K
Neutron emission for (n,4n)

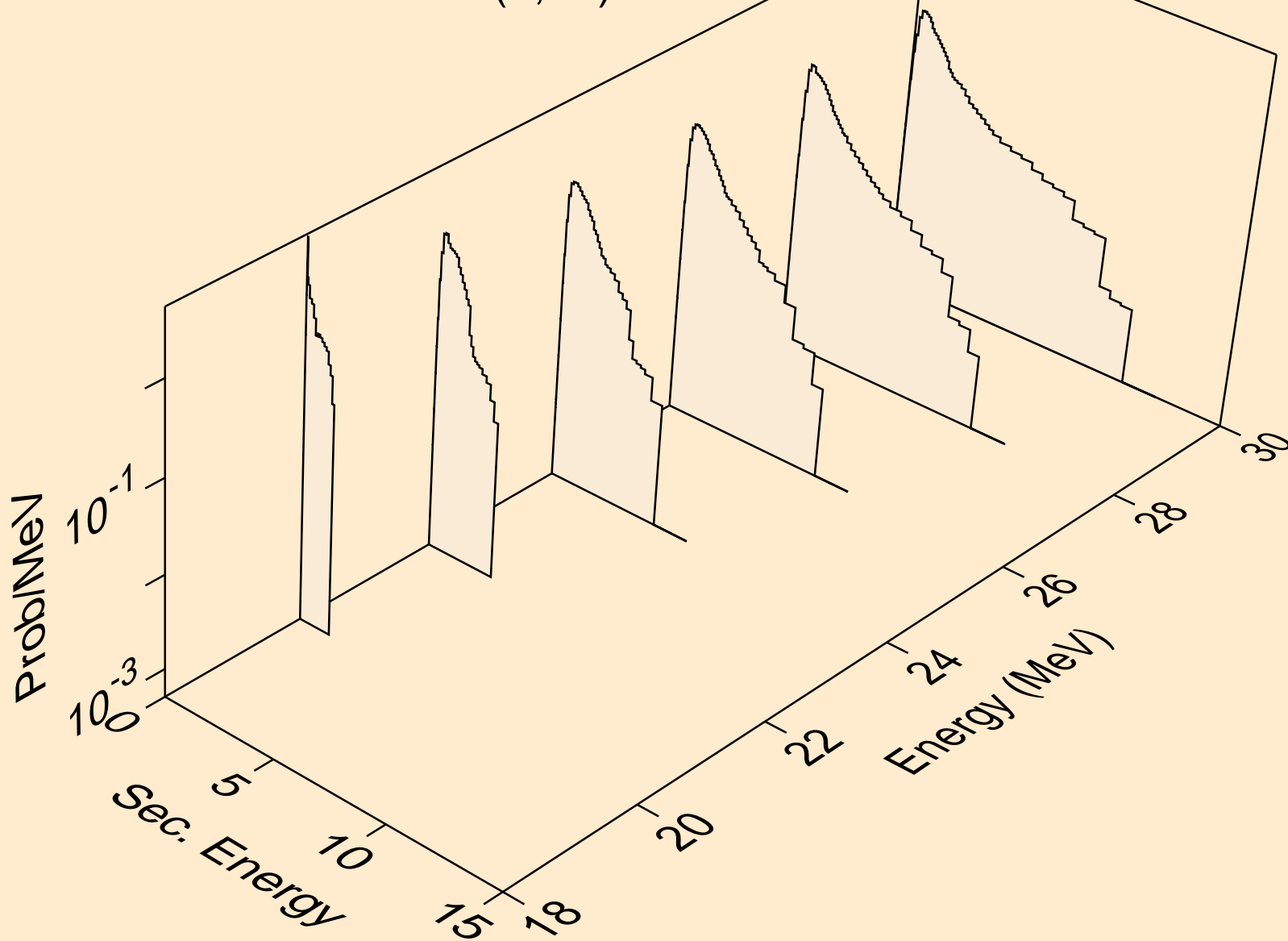

SG265 NEUTRON ACER TENDL-2019 LIBRARY; T=293.16K
Neutron emission for (n,2np)

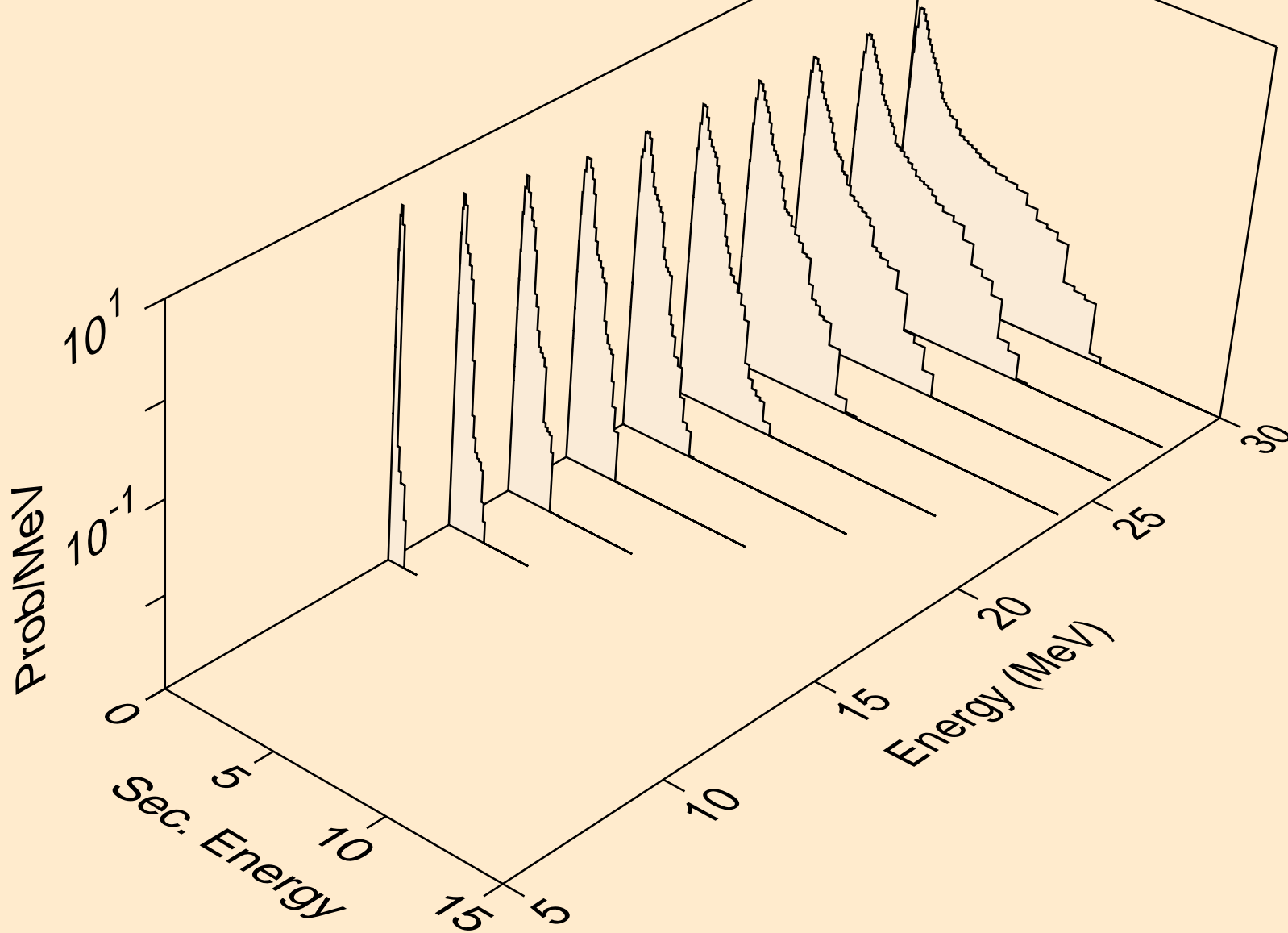

SG265 NEUTRON ACER TENDL-2019 LIBRARY; T=293.16K
Neutron emission for (n,3np)

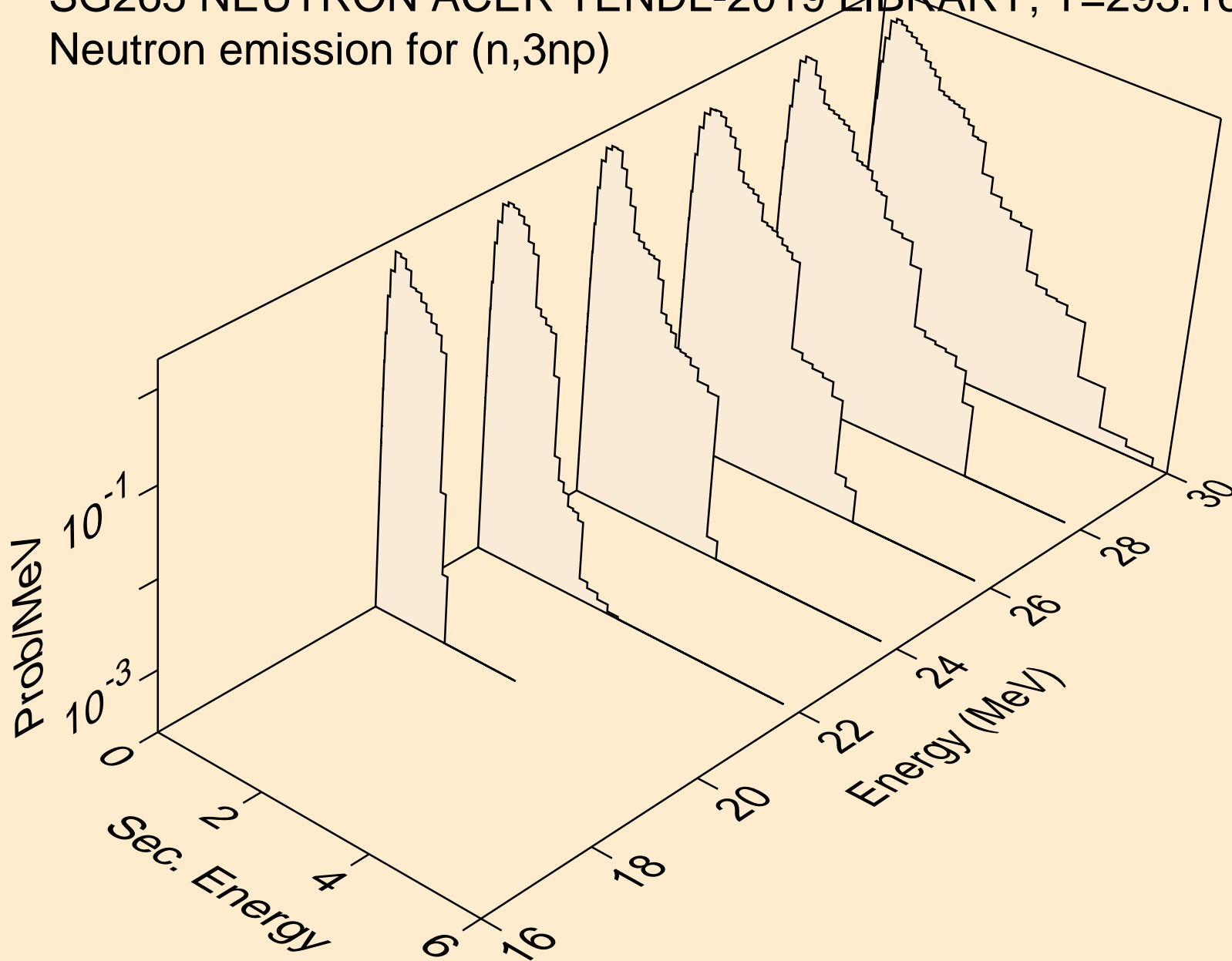

SG265 NEUTRON ACER TENDL-2019 LIBRARY; T=293.16K
Neutron emission for (n,2np)

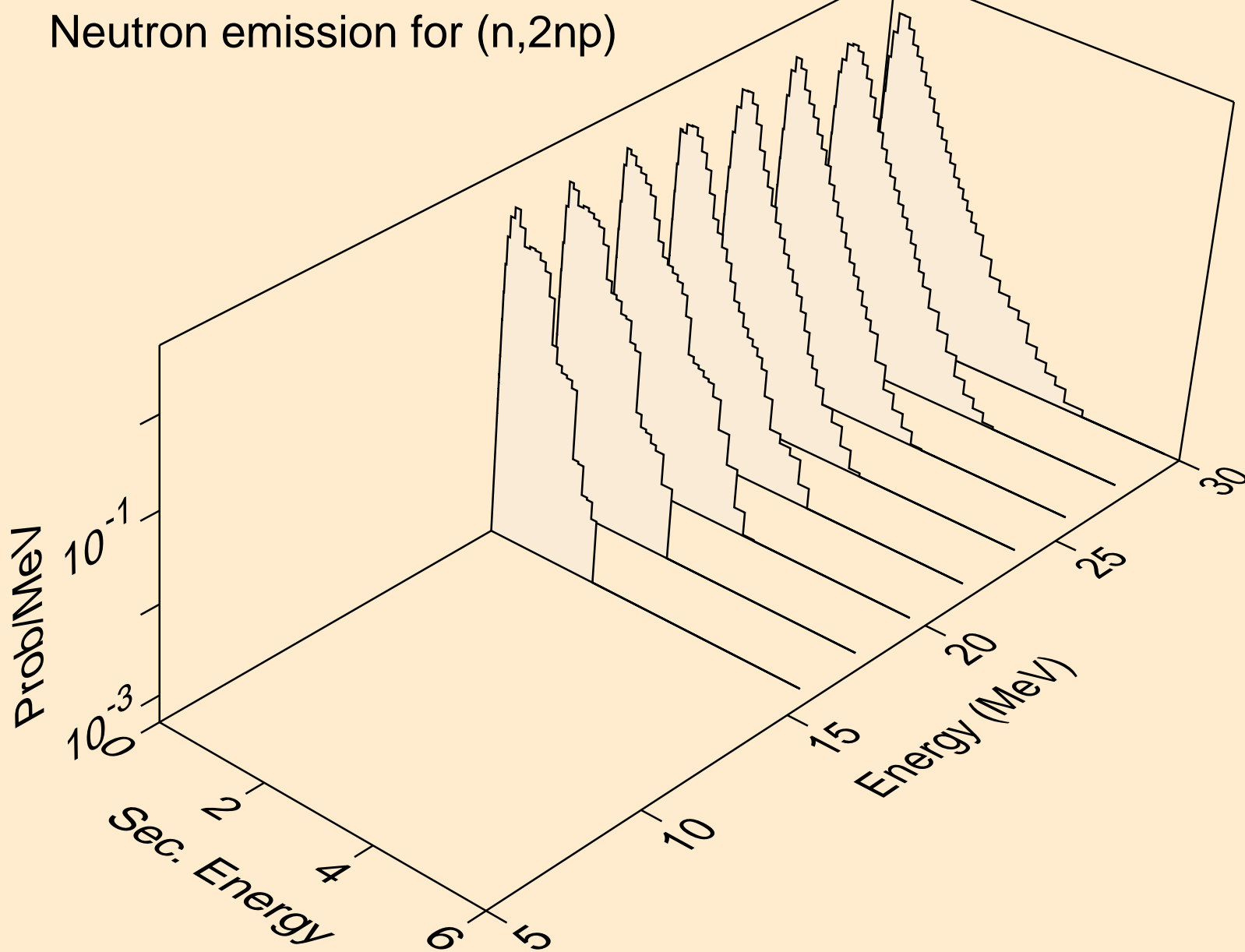

SG265 NEUTRON ACER TENDL-2019 LIBRARY; T=293.16K
Neutron emission for (n,npa)

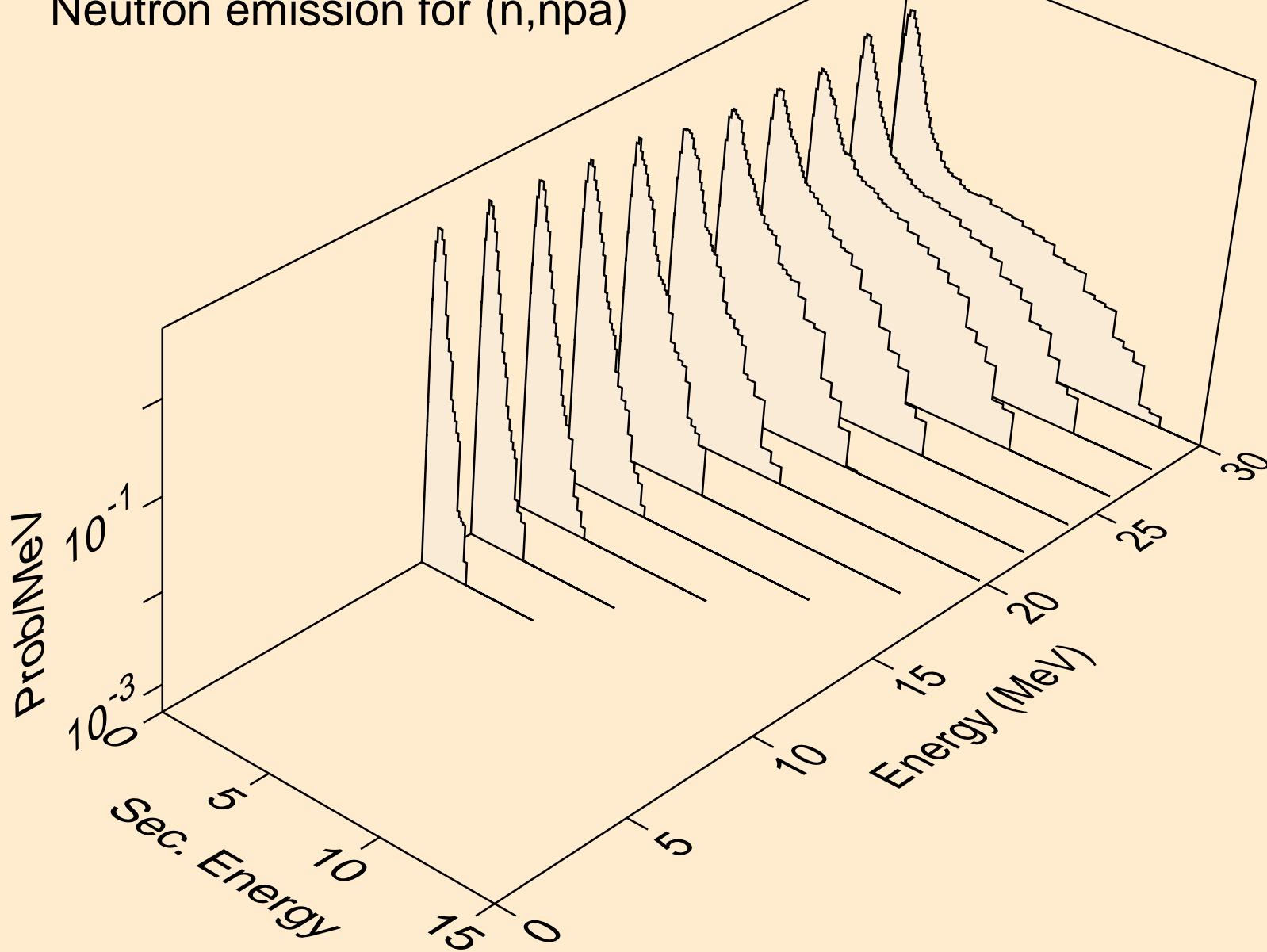

SG265 NEUTRON ACER TENDL-2019 LIBRARY; T=293.16K
Neutron emission for (n,n*c)

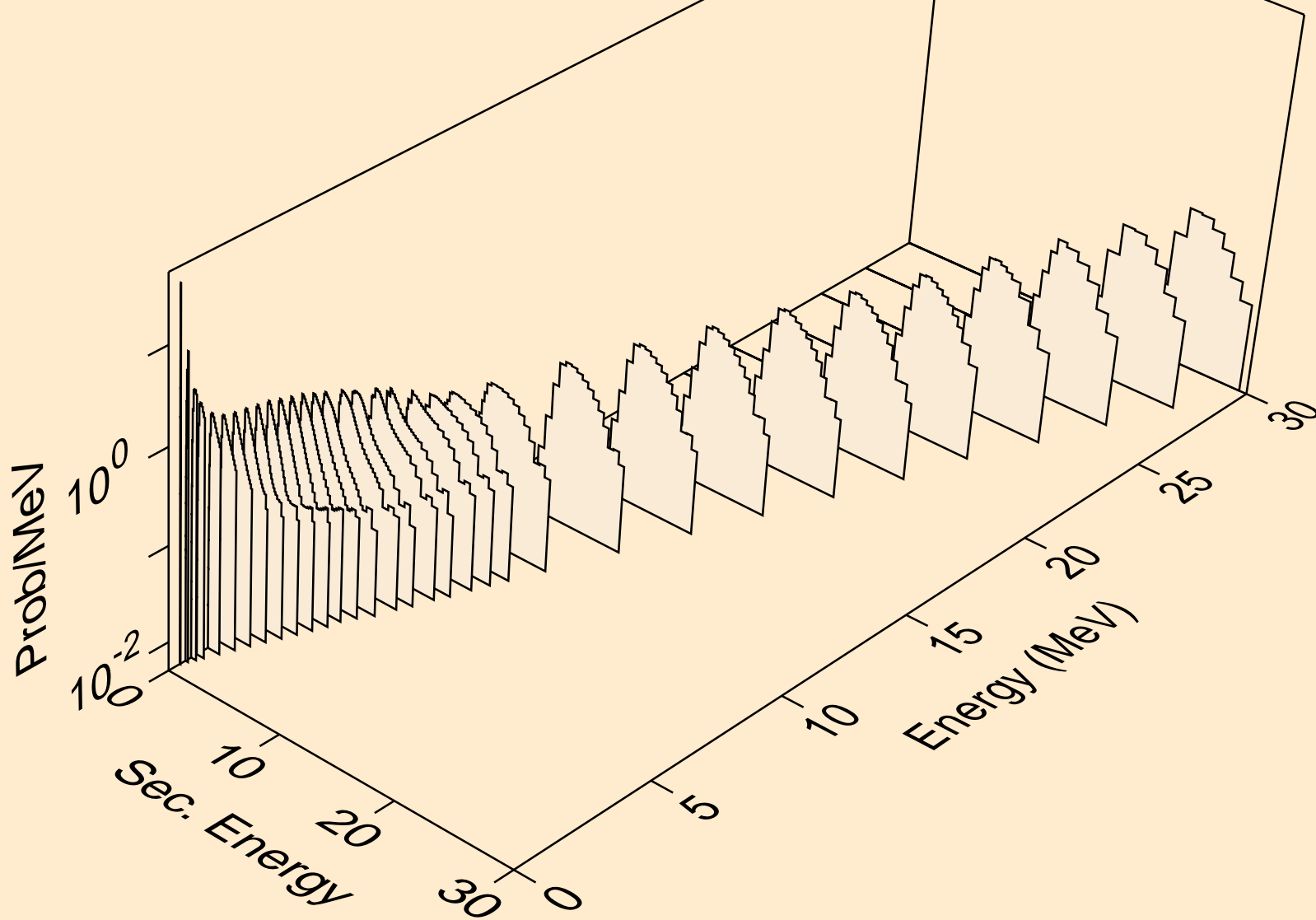

SG265 NEUTRON ACER TENDL-2019 LIBRARY; T=293.16K

Delayed nubar

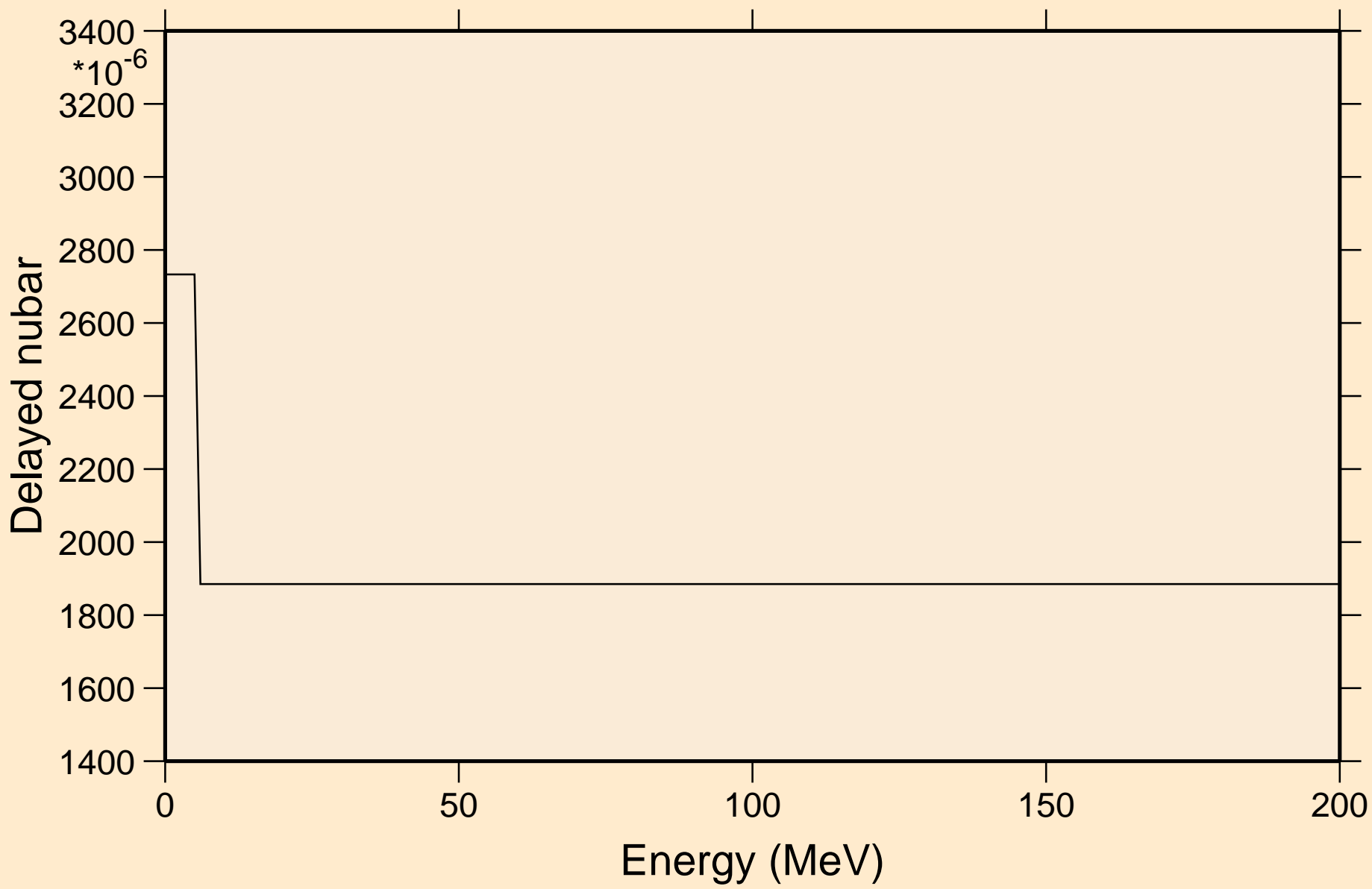

SG265 NEUTRON ACER TENDL-2019 LIBRARY; T=293.16K

Delayed neutron spectra

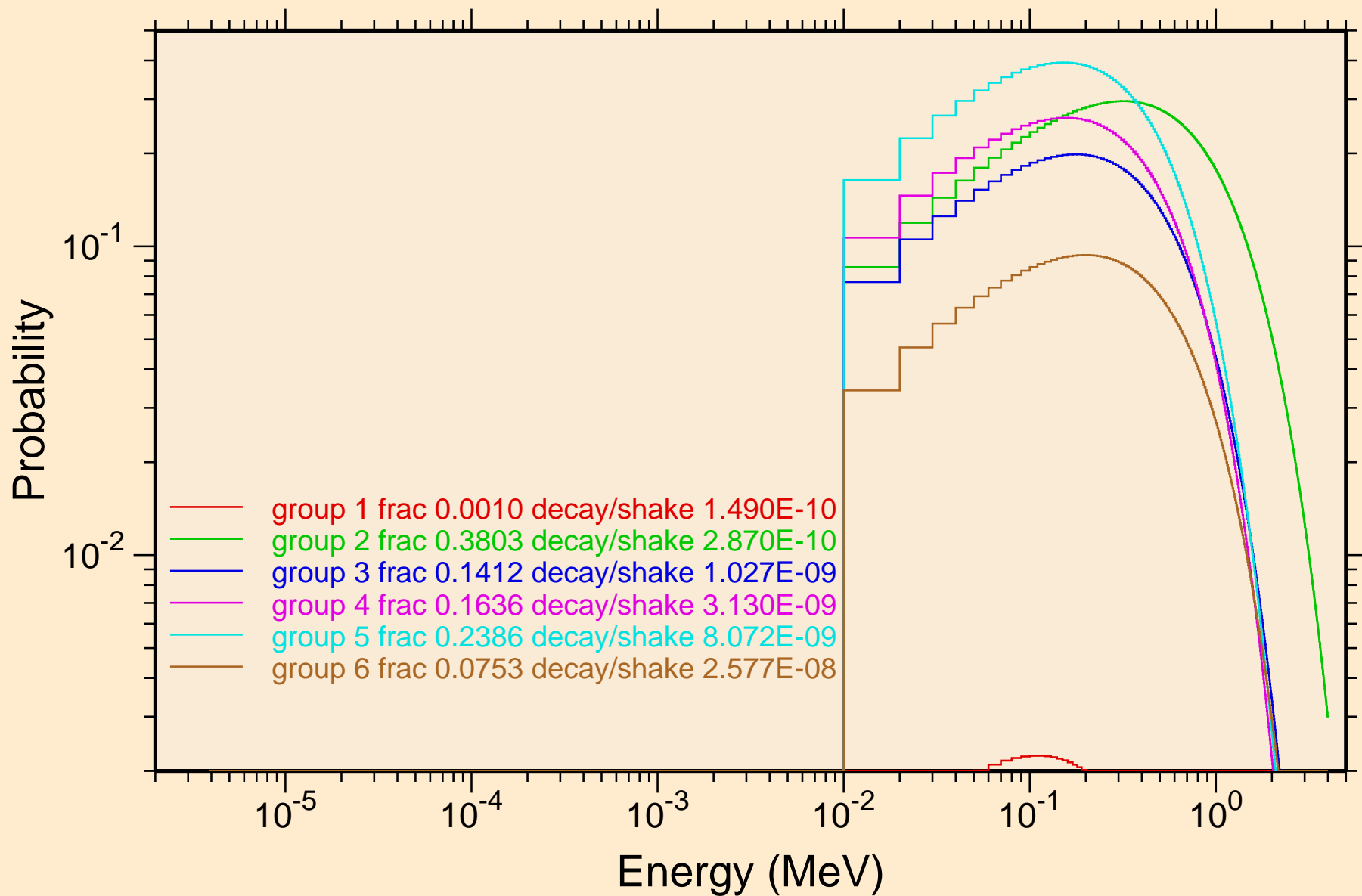

SG265 NEUTRON ACER TENDL-2019 LIBRARY; T=293.16K
Photon emission for (n,x)

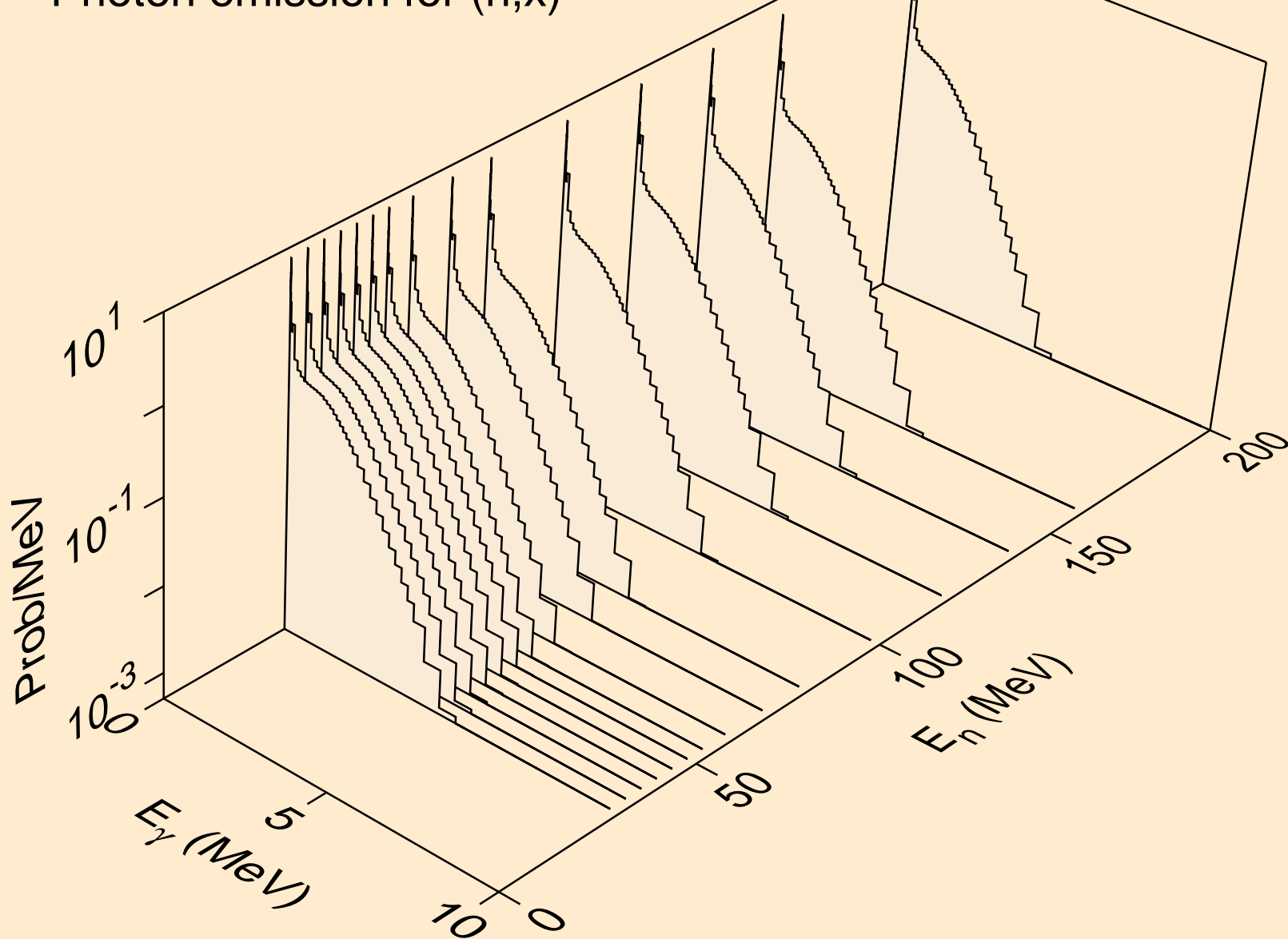

SG265 NEUTRON ACER TENDL-2019 LIBRARY; T=293.16K
Photon emission for (n,2nd)

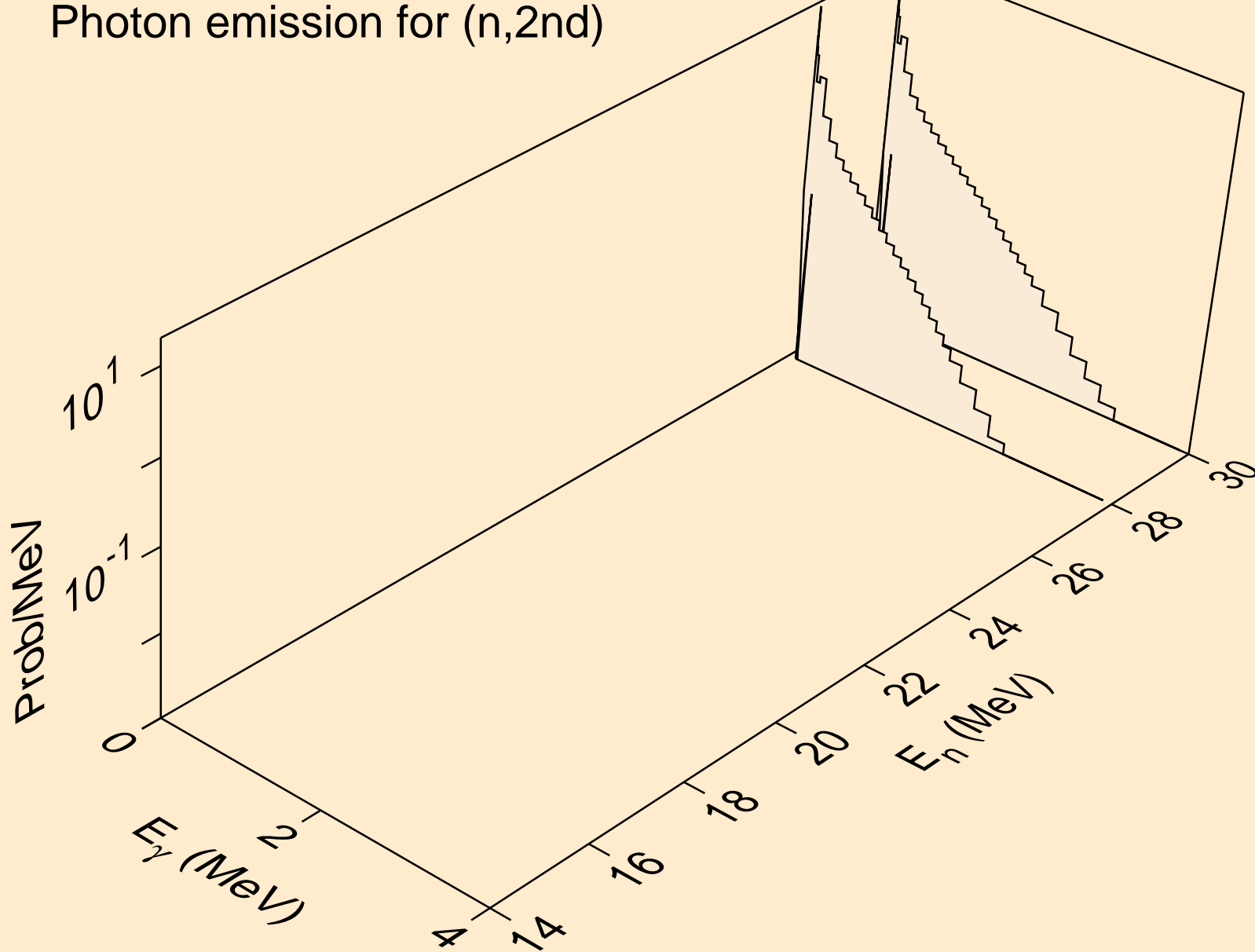

SG265 NEUTRON ACER TENDL-2019 LIBRARY; T=293.16K
Photon emission for (n,2n)

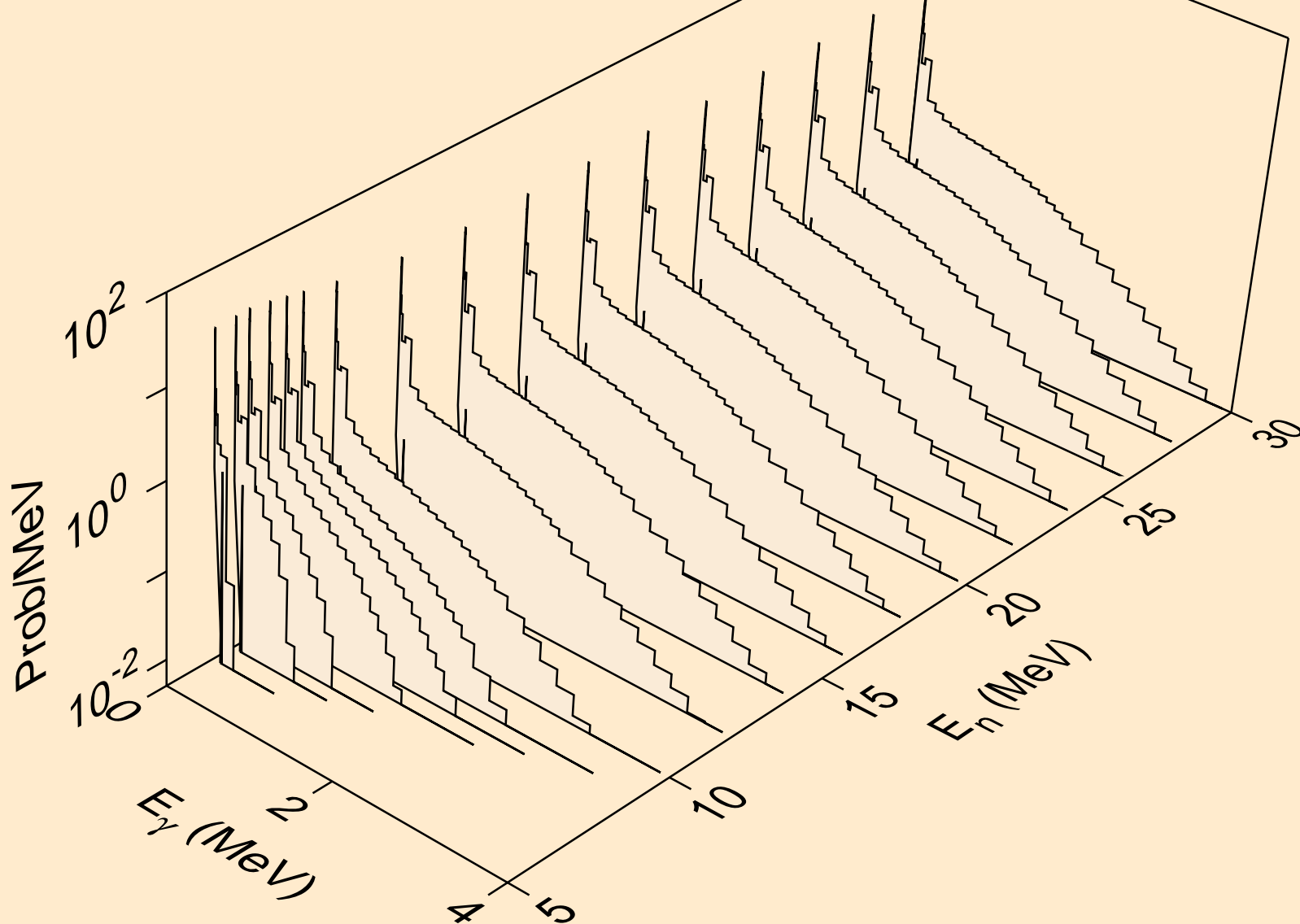

SG265 NEUTRON ACER TENDL-2019 LIBRARY; T=293.16K
Photon emission for (n,3n)

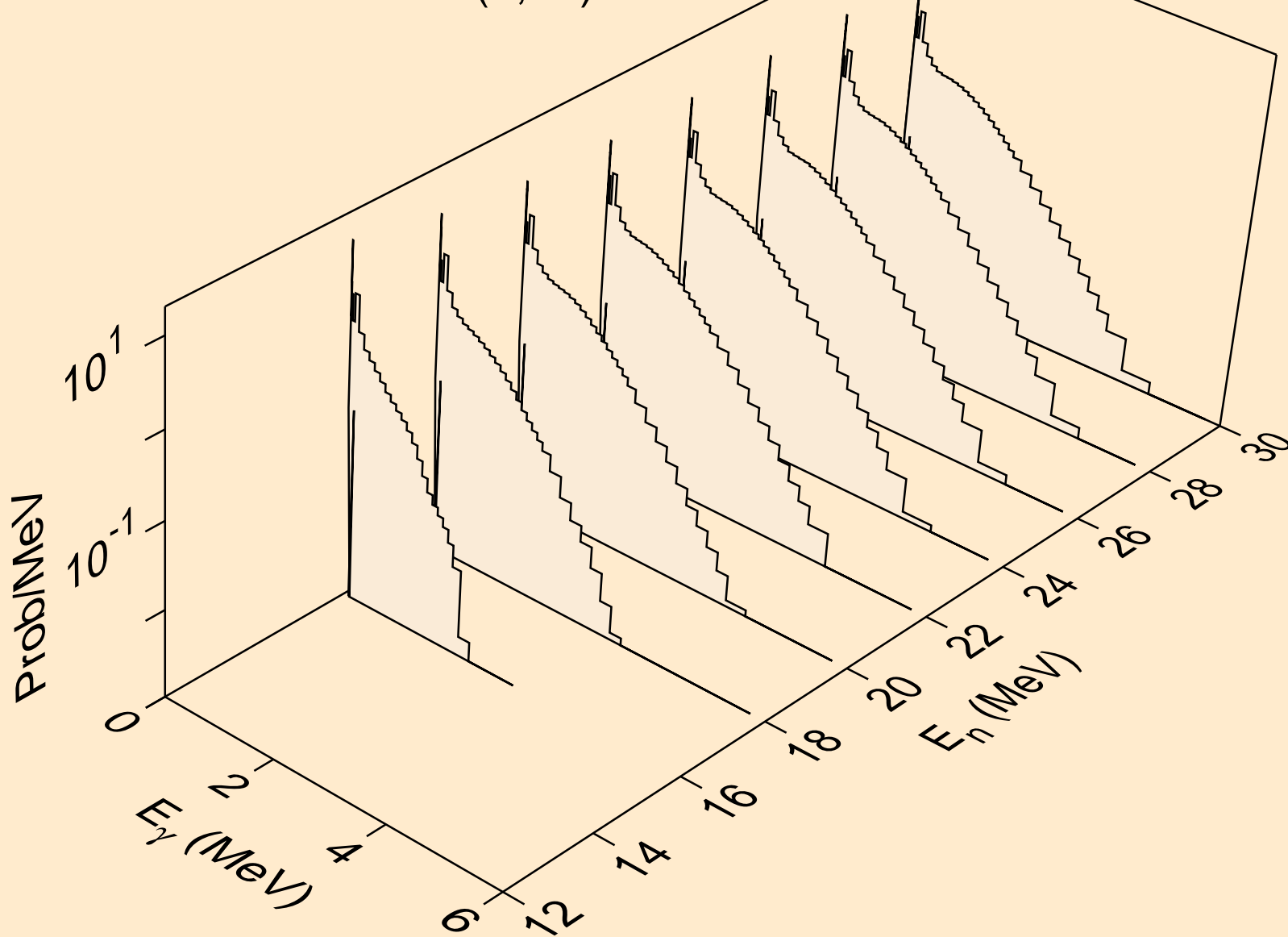

SG265 NEUTRON ACER TENDL-2019 LIBRARY; T=293.16K
Photon emission for (n,n*)a

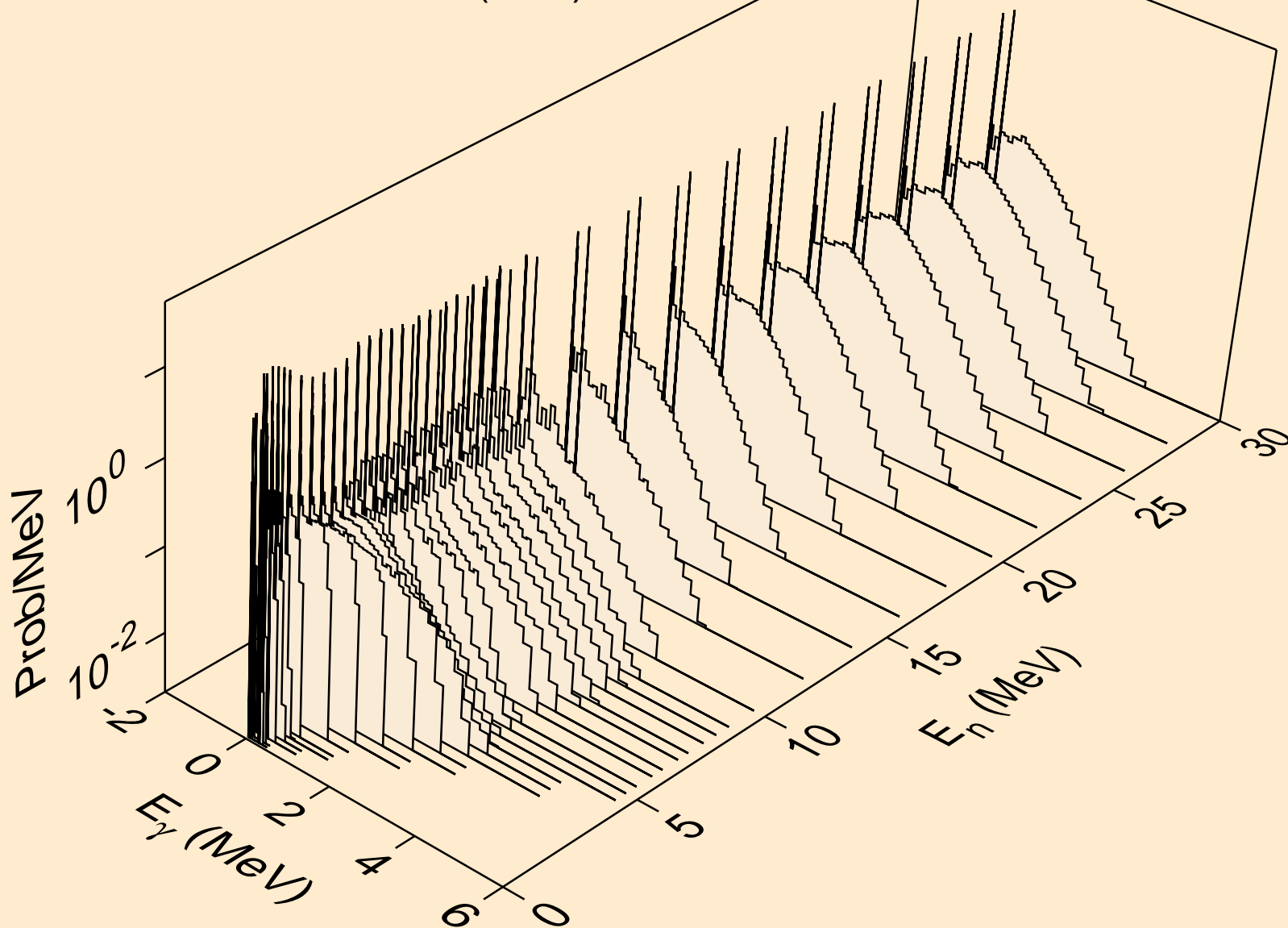

SG265 NEUTRON ACER TENDL-2019 LIBRARY; T=293.16K
Photon emission for (n,2n)a

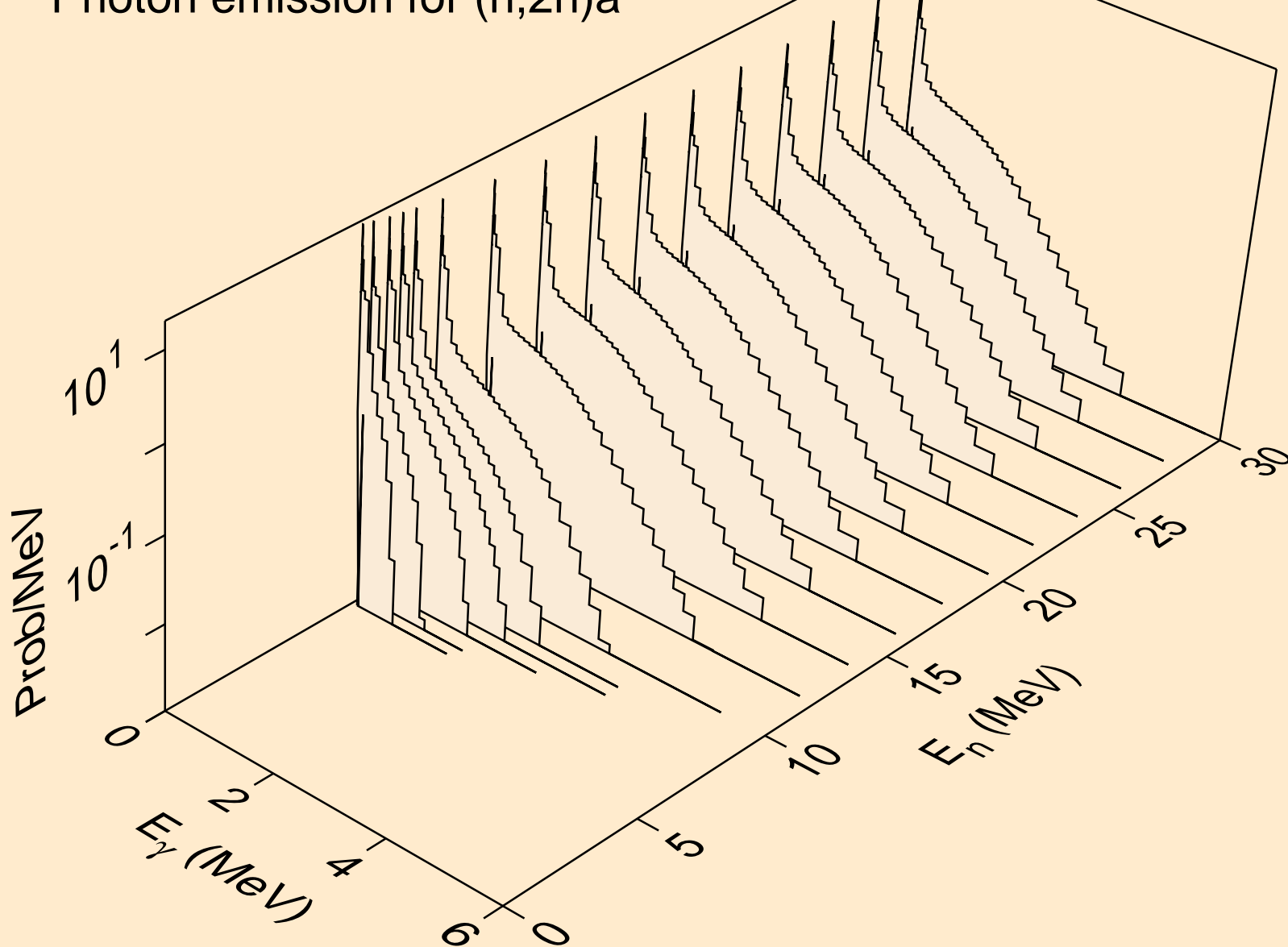

SG265 NEUTRON ACER TENDL-2019 LIBRARY; T=293.16K
Photon emission for (n,3n)a

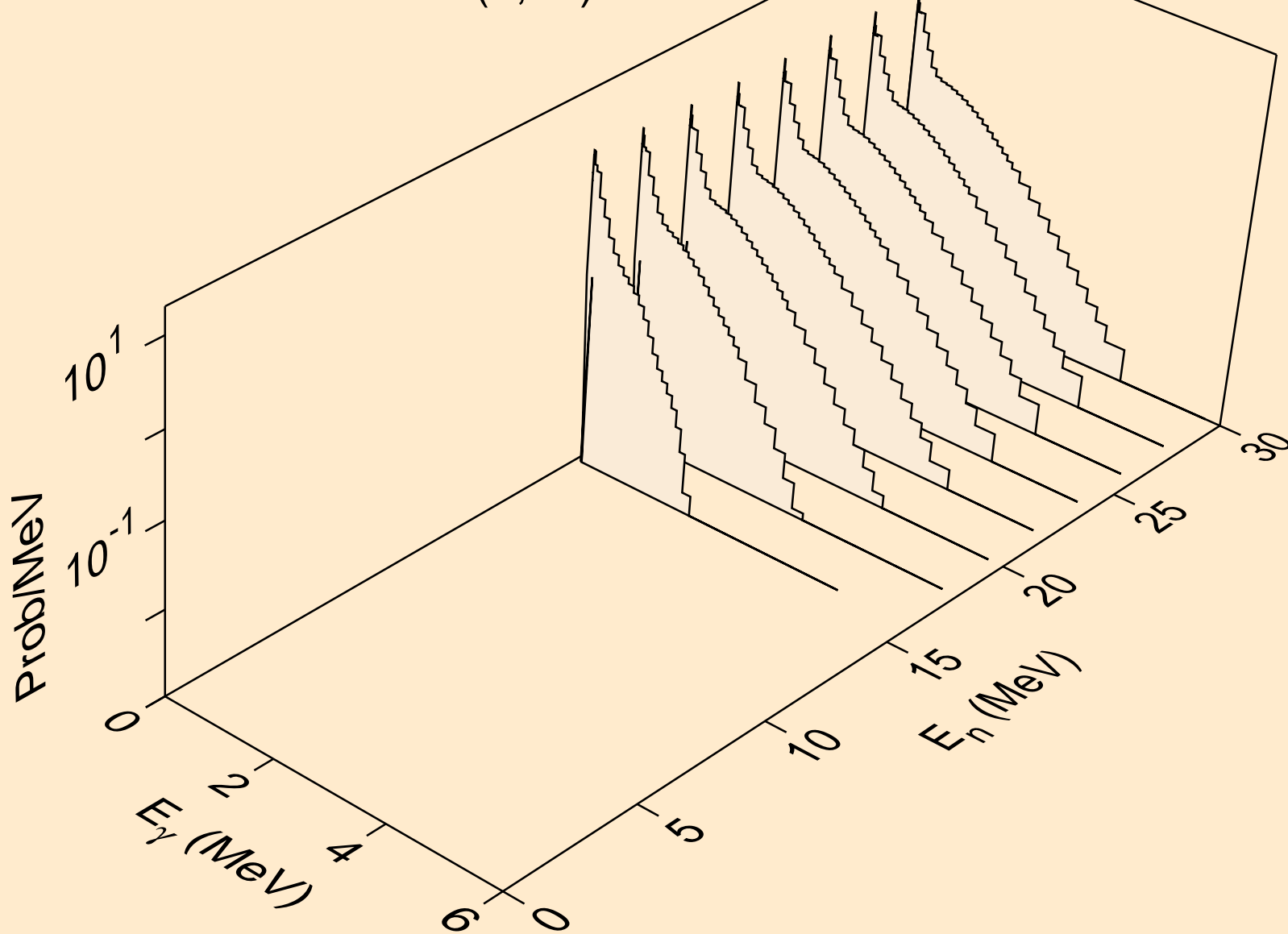

SG265 NEUTRON ACER TENDL-2019 LIBRARY; T=293.16K
Photon emission for (n,n*)p

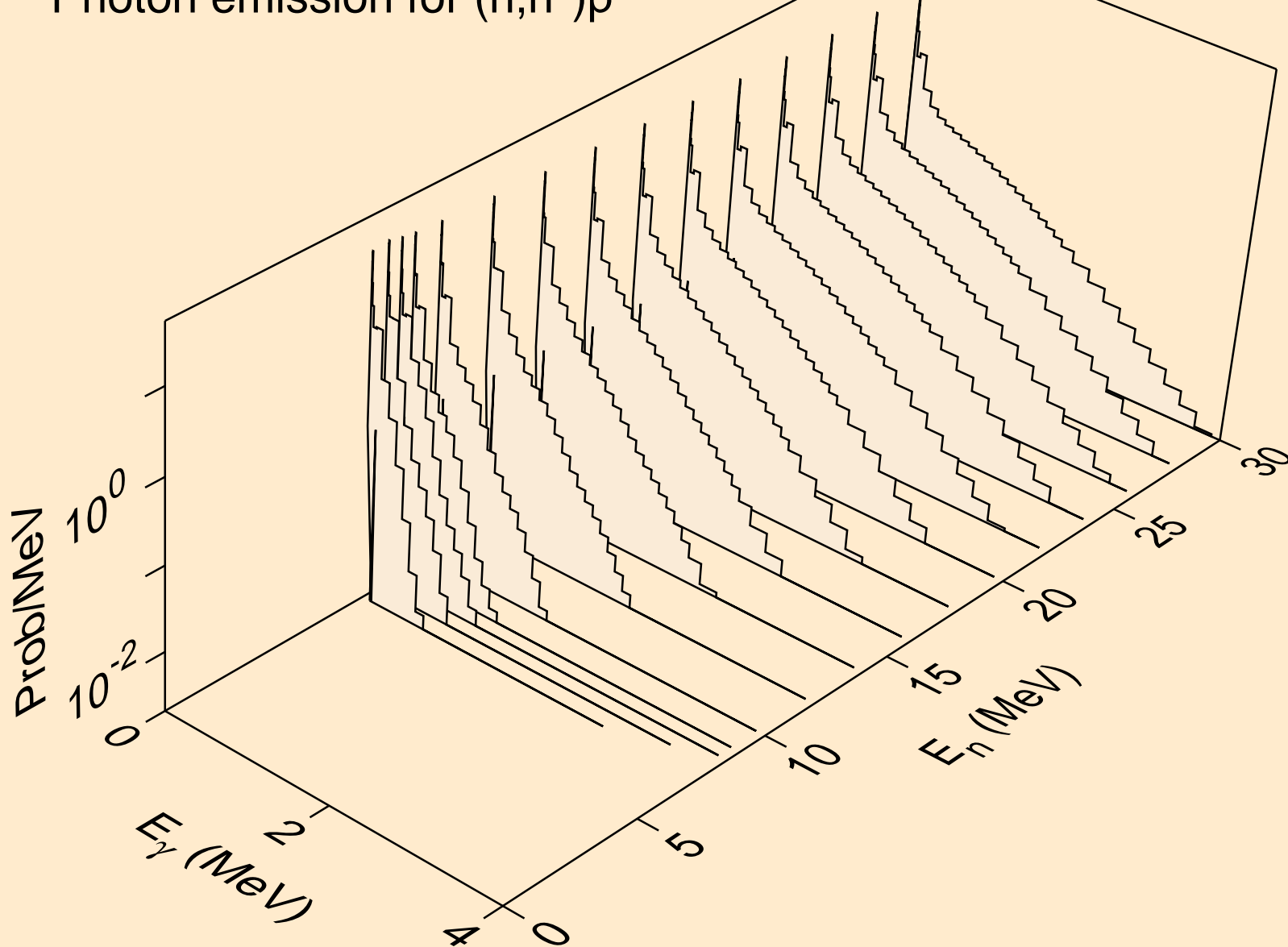

SG265 NEUTRON ACER TENDL-2019 LIBRARY; T=293.16K
Photon emission for (n,n*)2a

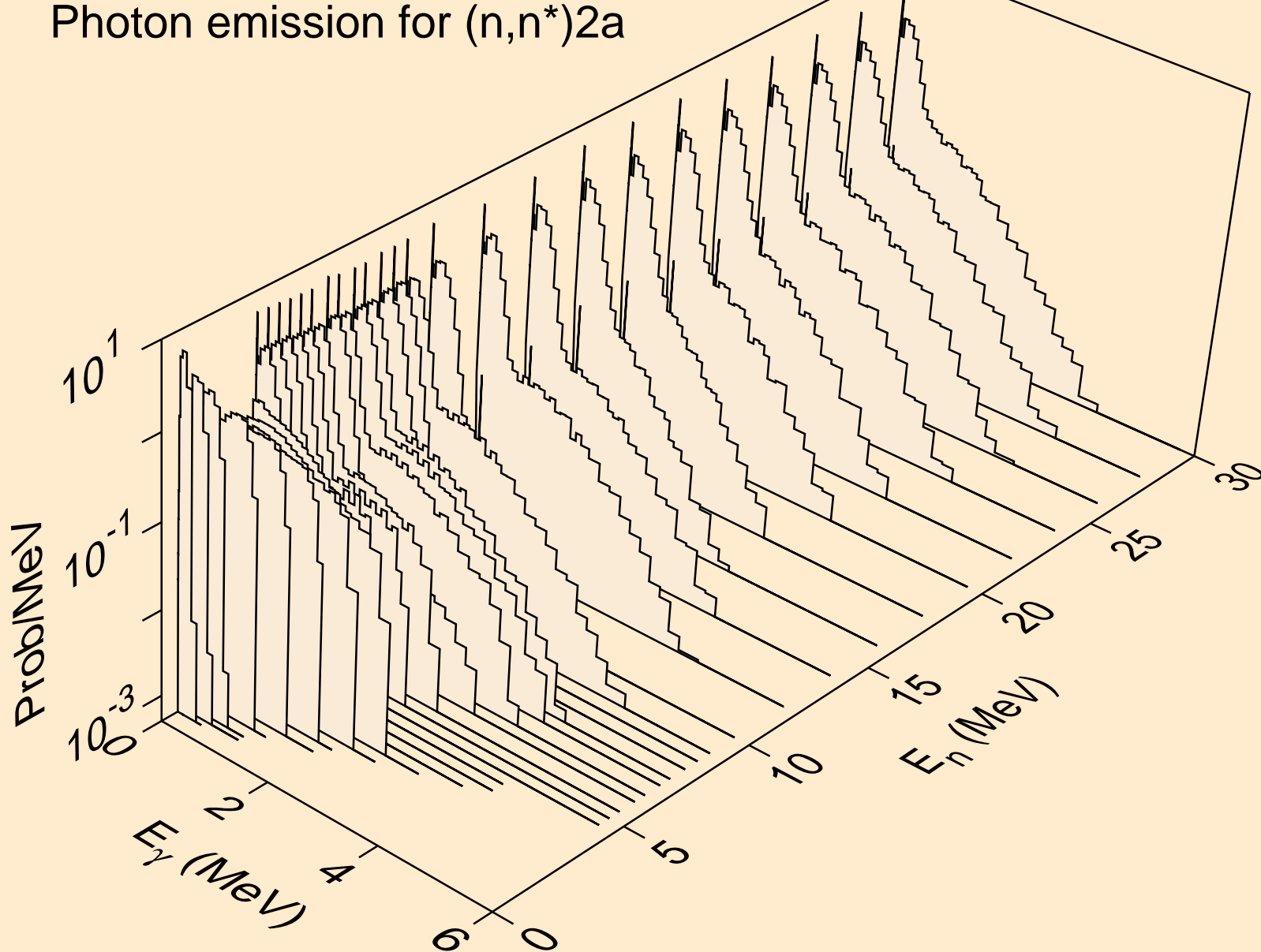

SG265 NEUTRON ACER TENDL-2019 LIBRARY; T=293.16K
Photon emission for (n,2n)2a

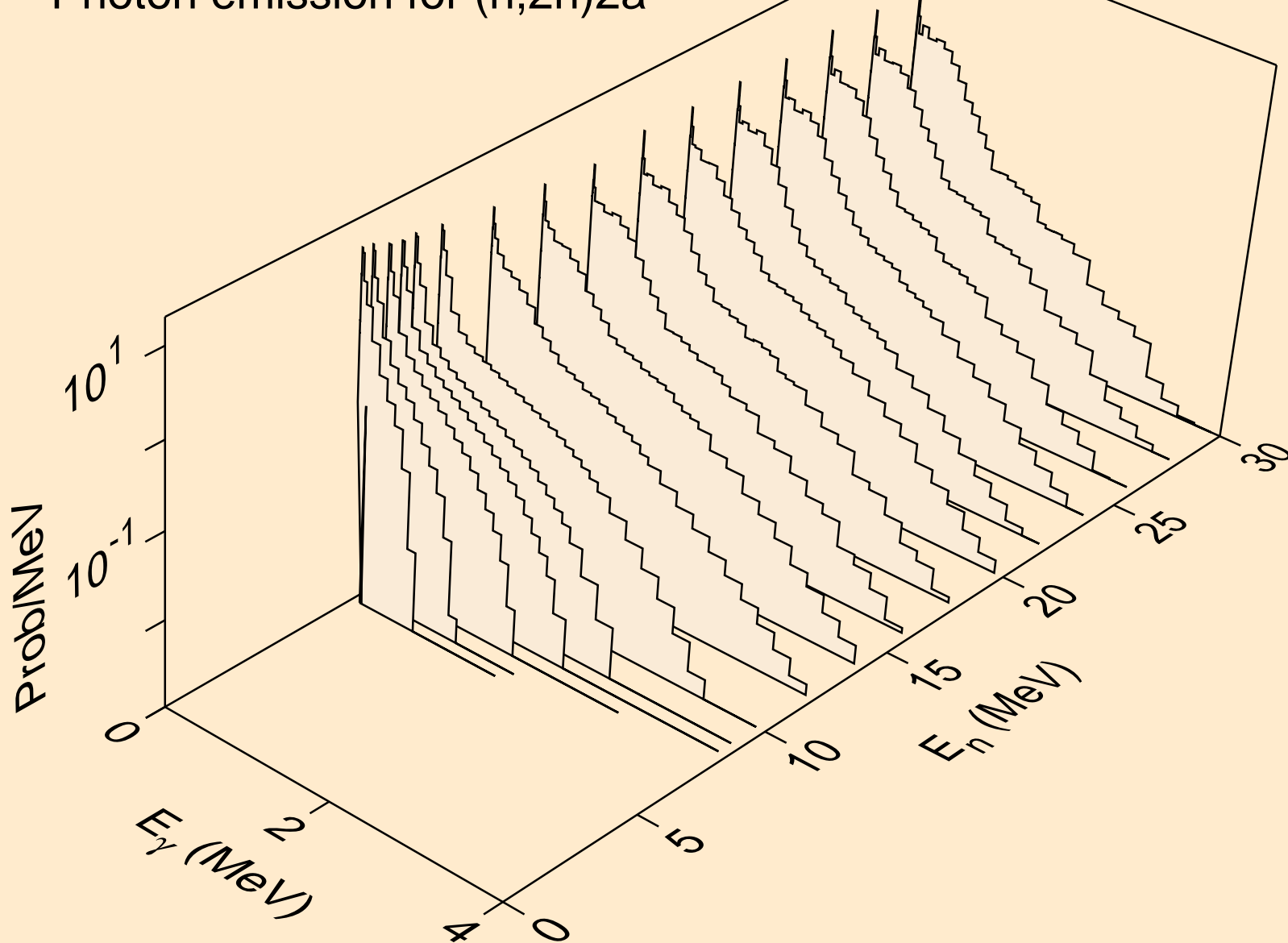

SG265 NEUTRON ACER TENDL-2019 LIBRARY; T=293.16K
Photon emission for (n,n*)d

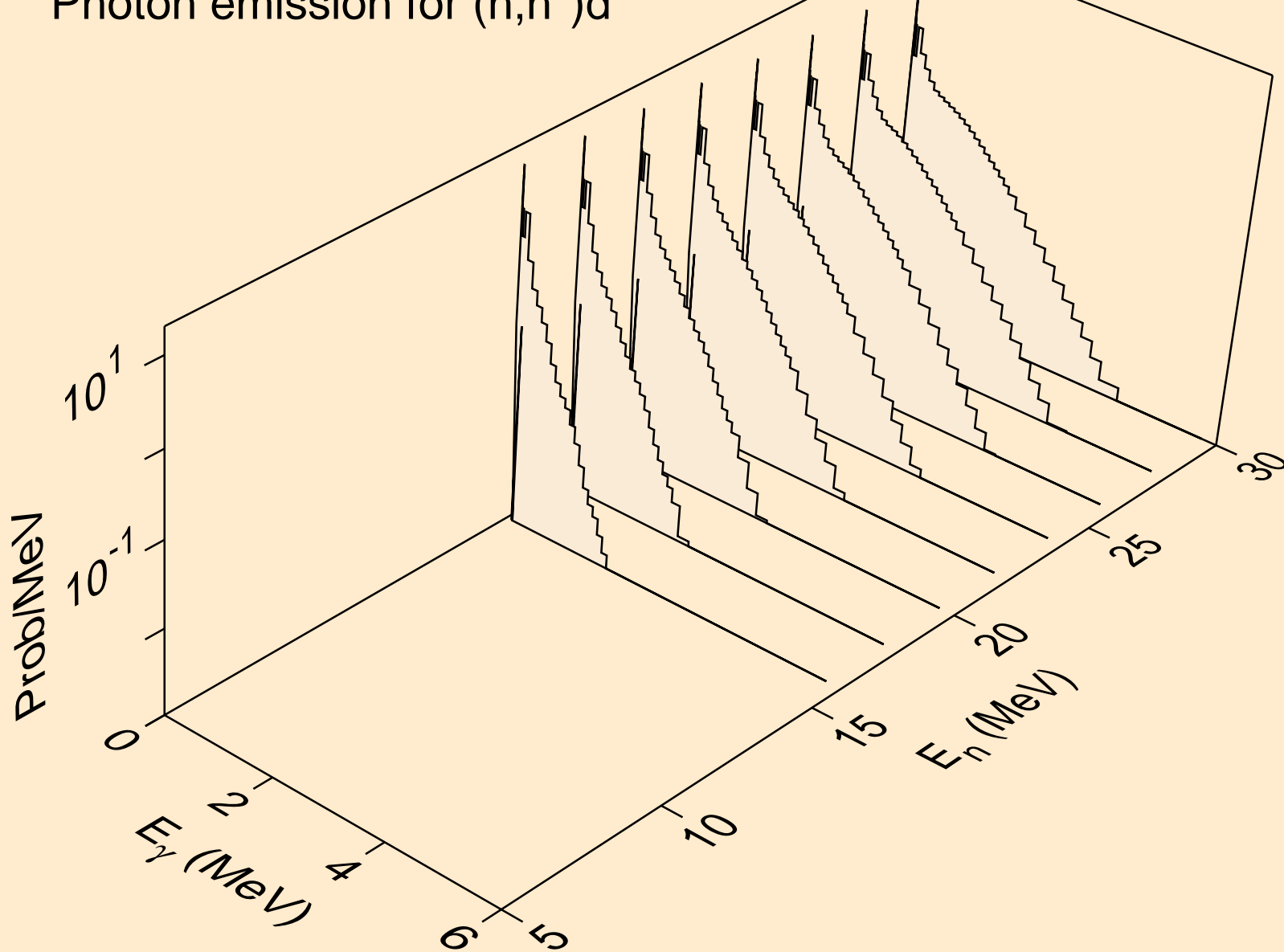

SG265 NEUTRON ACER TENDL-2019 LIBRARY; T=293.16K
Photon emission for (n,n*)t

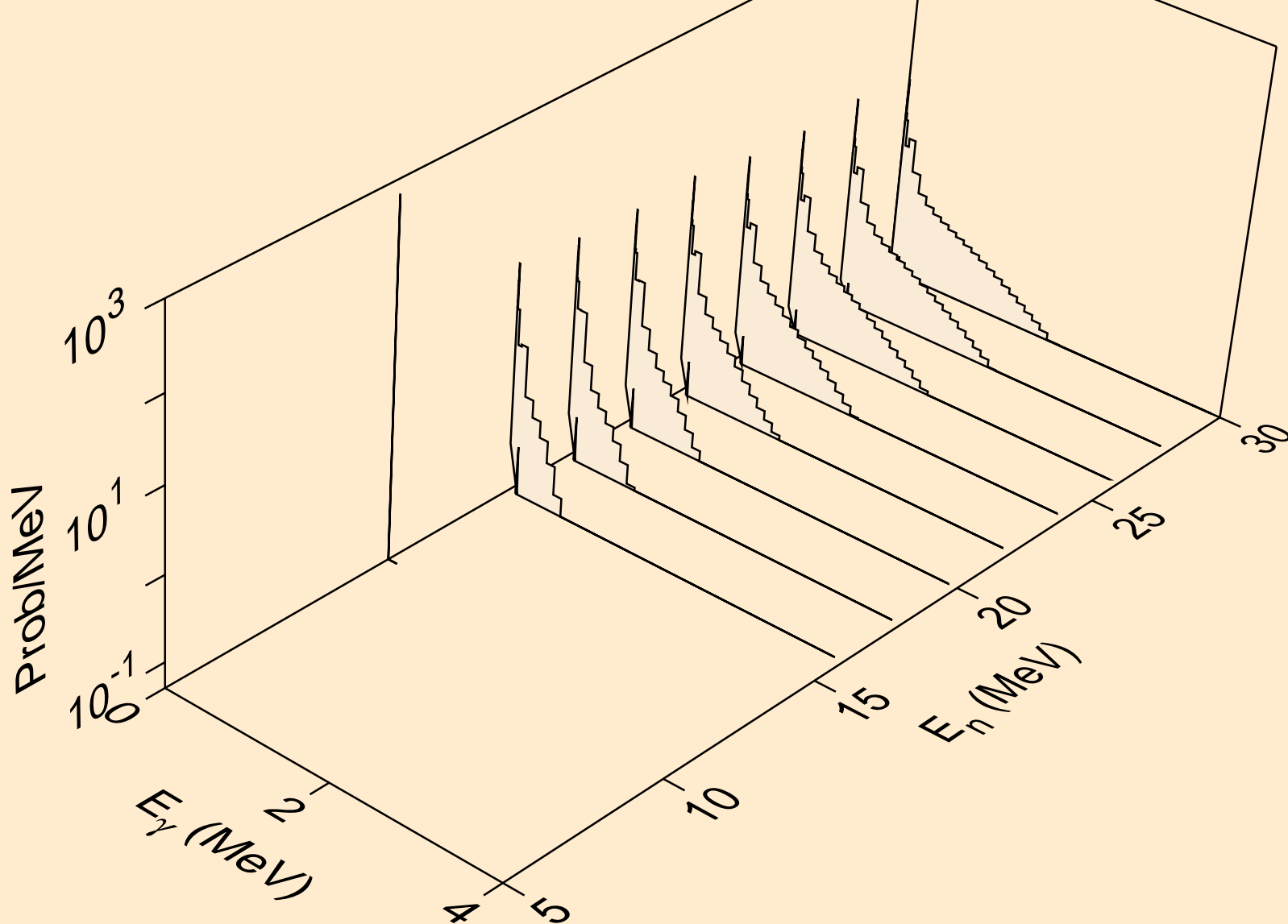

SG265 NEUTRON ACER TENDL-2019 LIBRARY; T=293.16K
Photon emission for (n,n*)he3

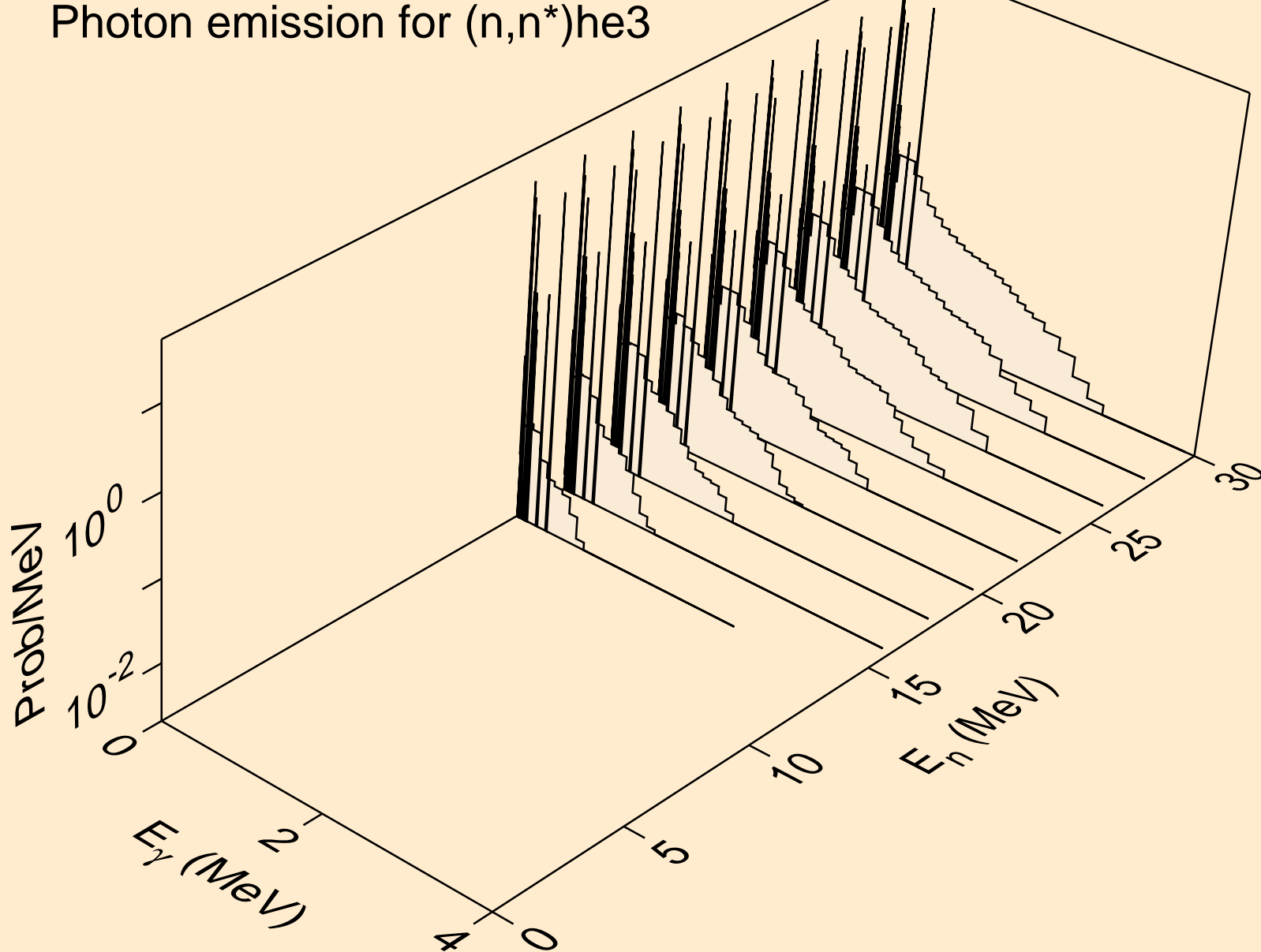

SG265 NEUTRON ACER TENDL-2019 LIBRARY; T=293.16K
Photon emission for (n,n*)t2a

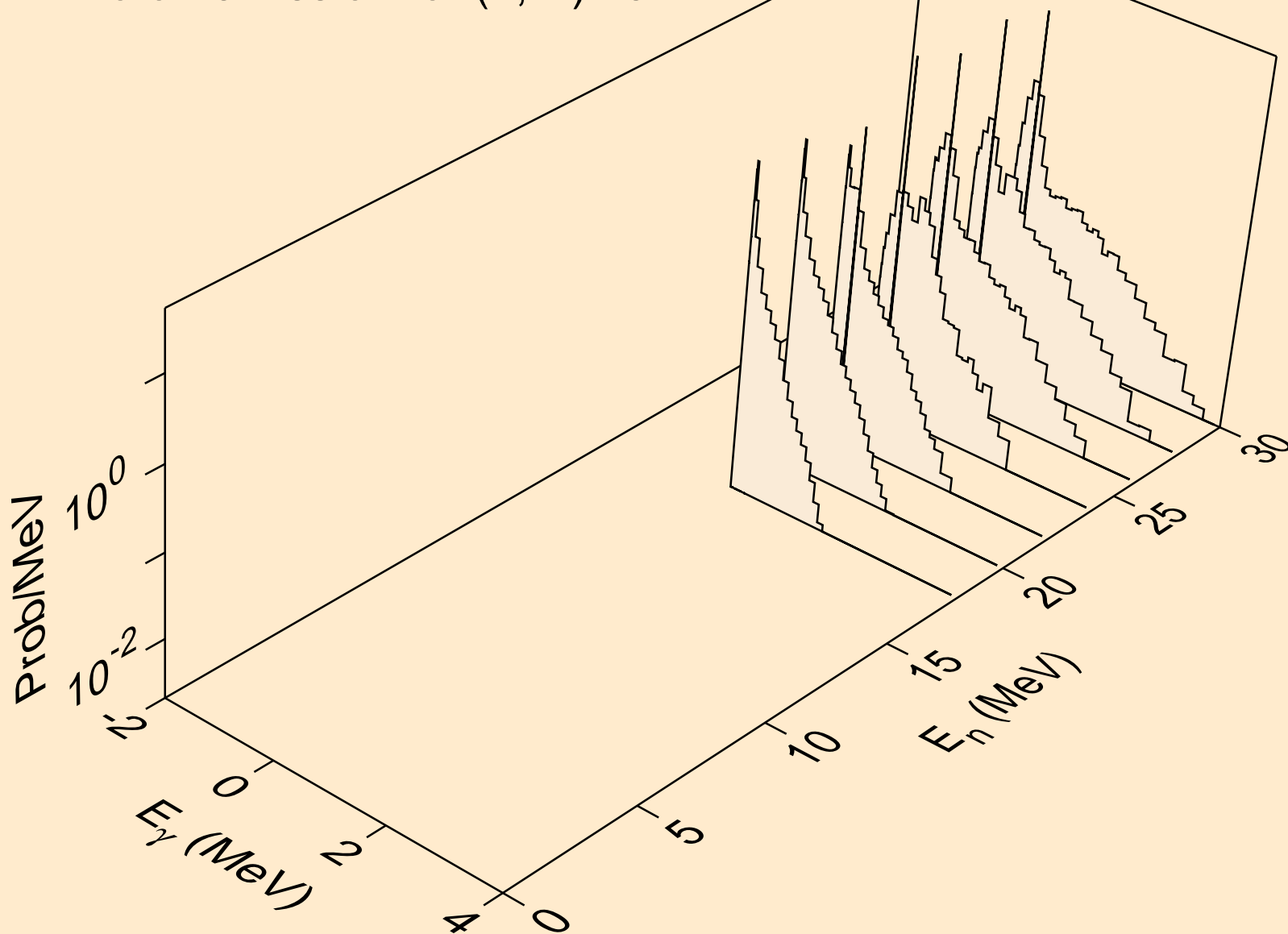

SG265 NEUTRON ACER TENDL-2019 LIBRARY; T=293.16K
Photon emission for (n,4n)

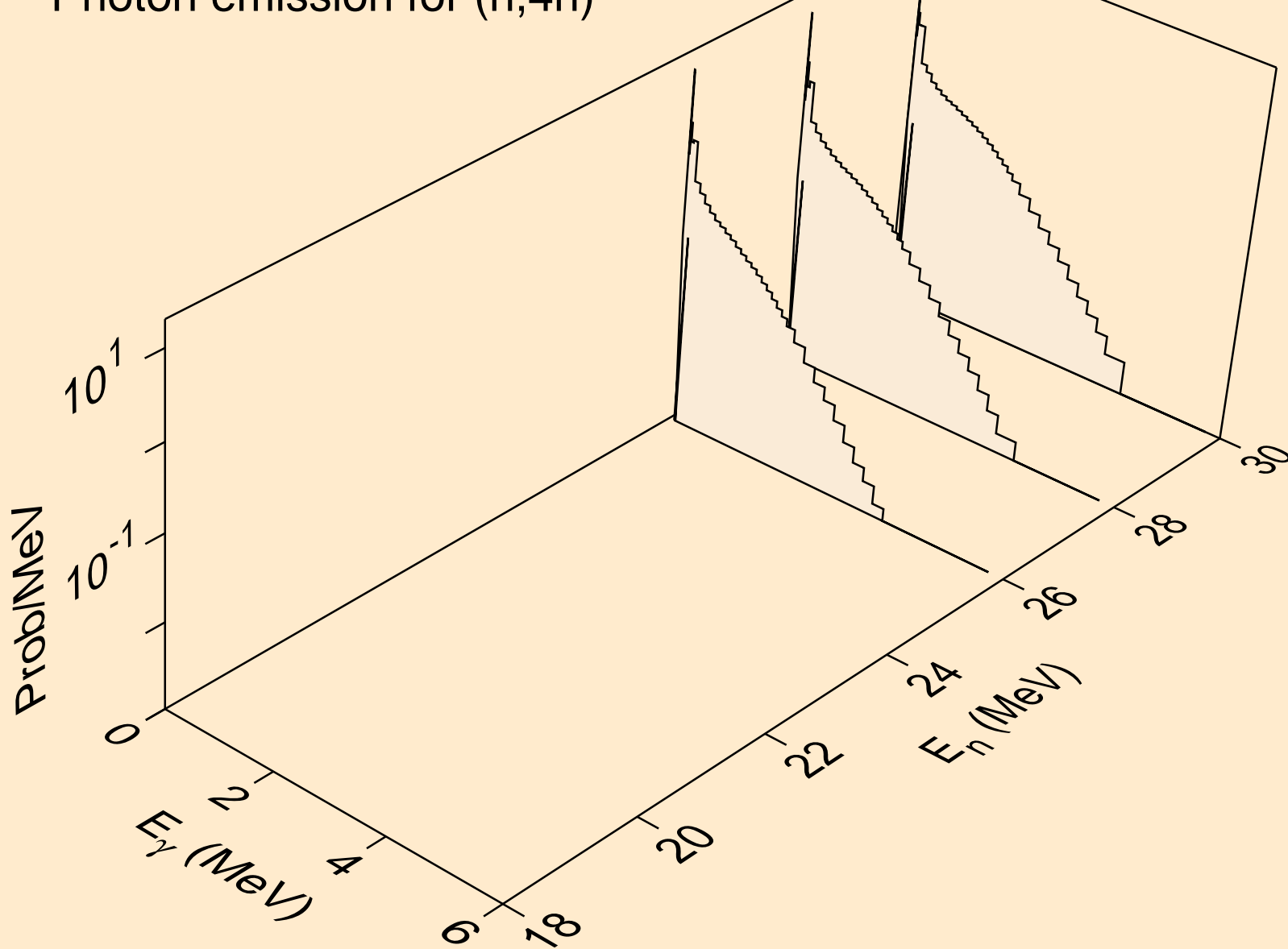

SG265 NEUTRON ACER TENDL-2019 LIBRARY; T=293.16K
Photon emission for (n,2np)

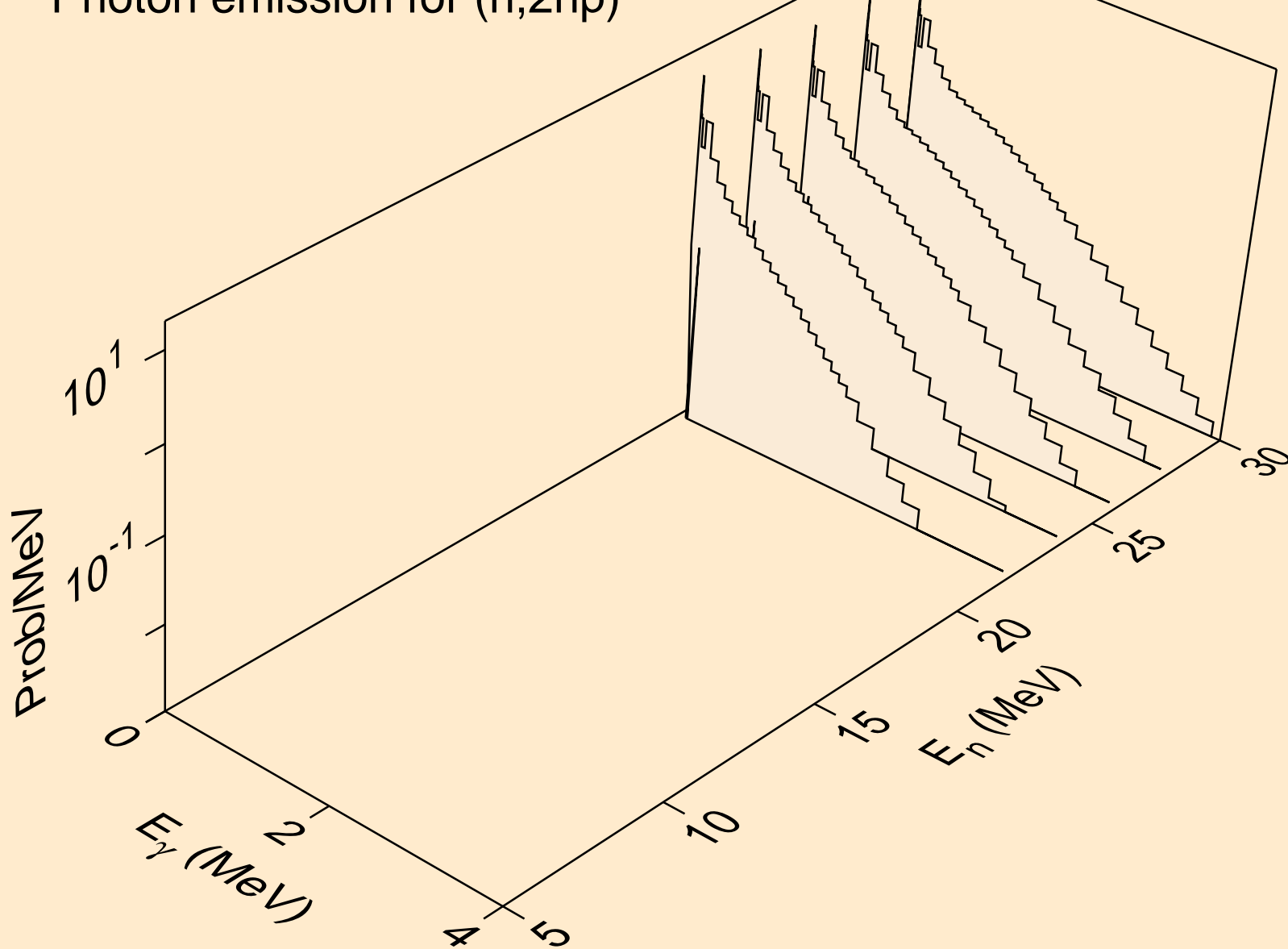

SG265 NEUTRON ACER TENDL-2019 LIBRARY; T=293.16K
Photon emission for (n,3np)

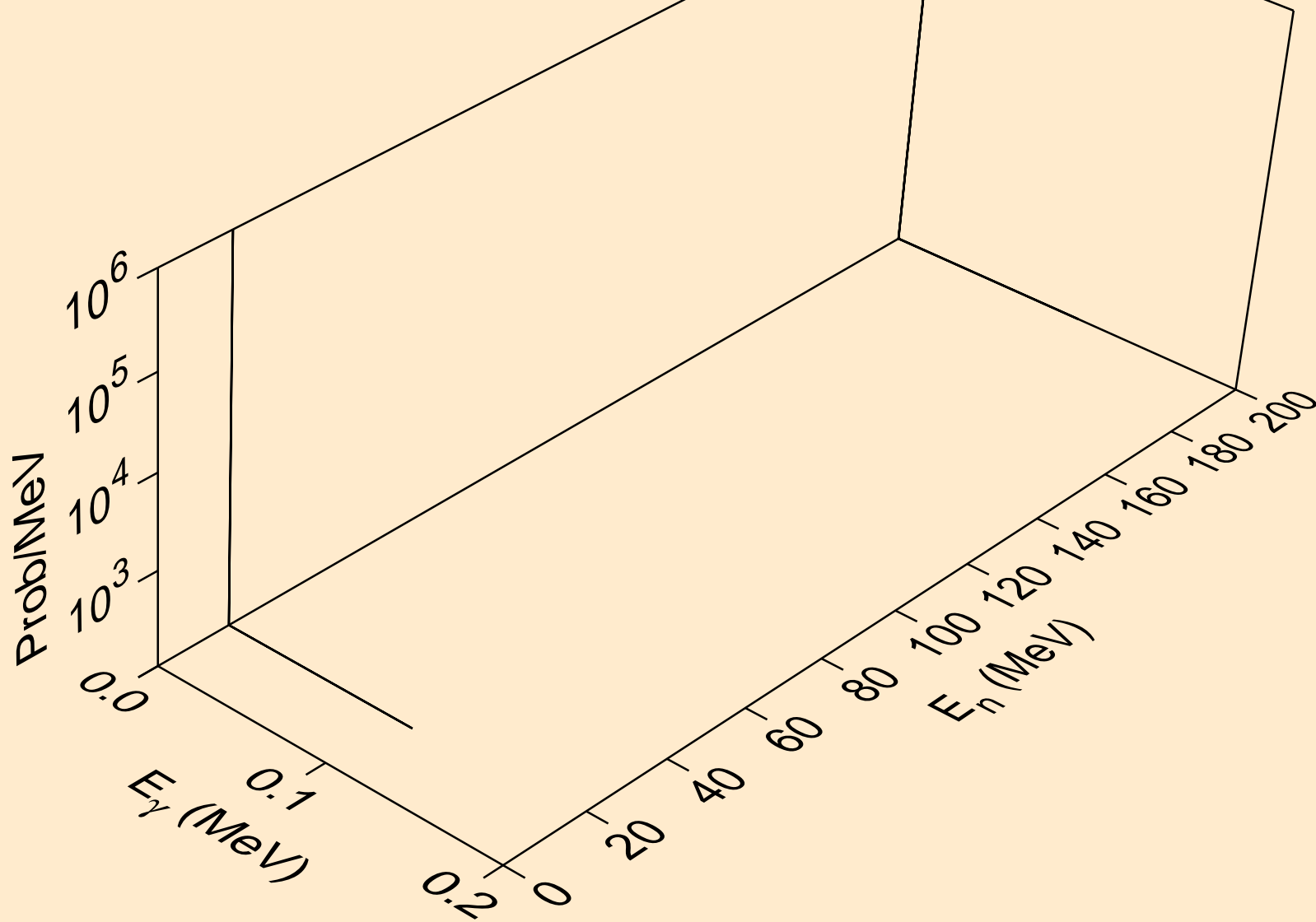

SG265 NEUTRON ACER TENDL-2019 LIBRARY; T=293.16K
Photon emission for (n,2np)

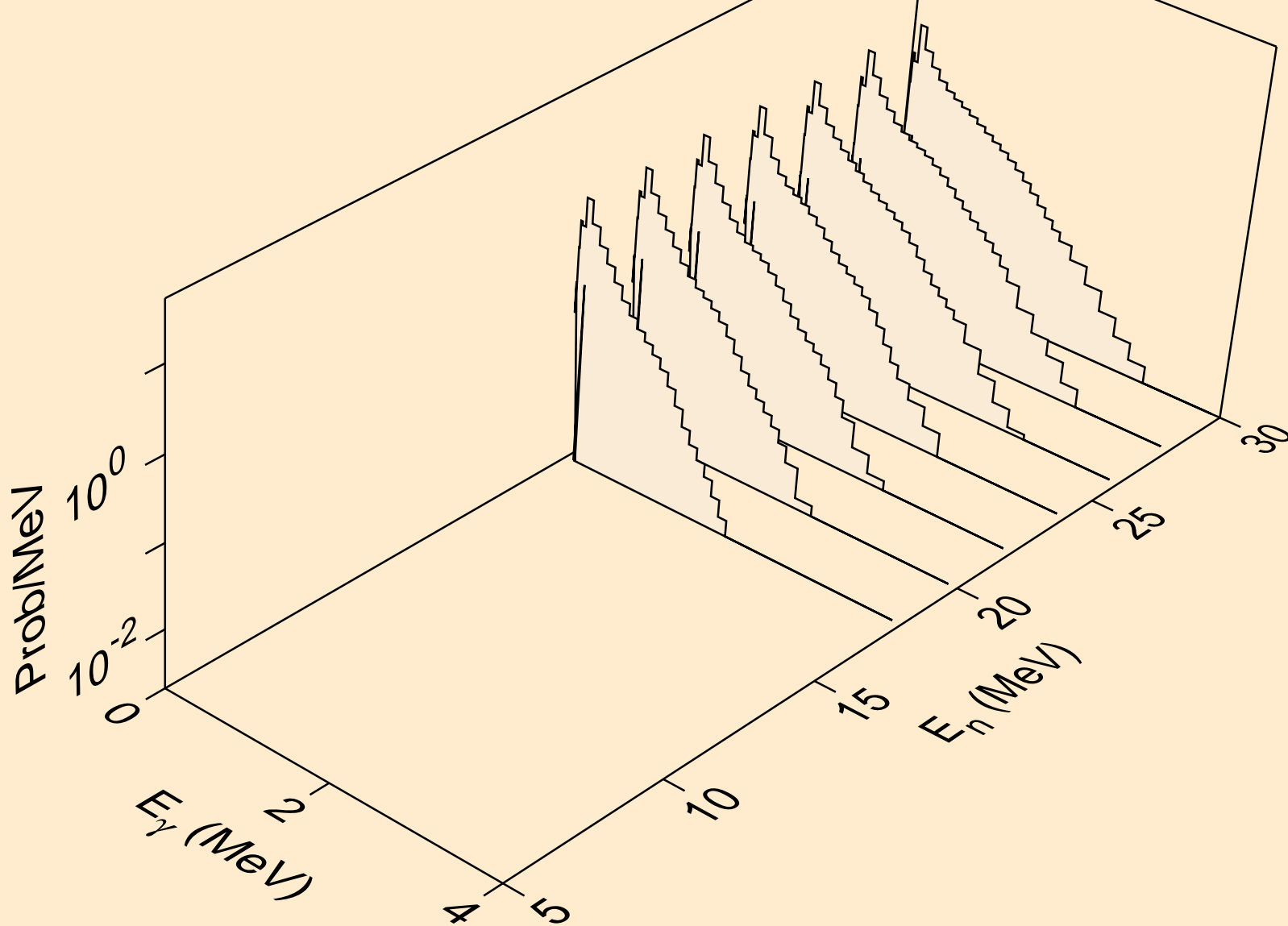

SG265 NEUTRON ACER TENDL-2019 LIBRARY; T=293.16K
Photon emission for (n,npa)

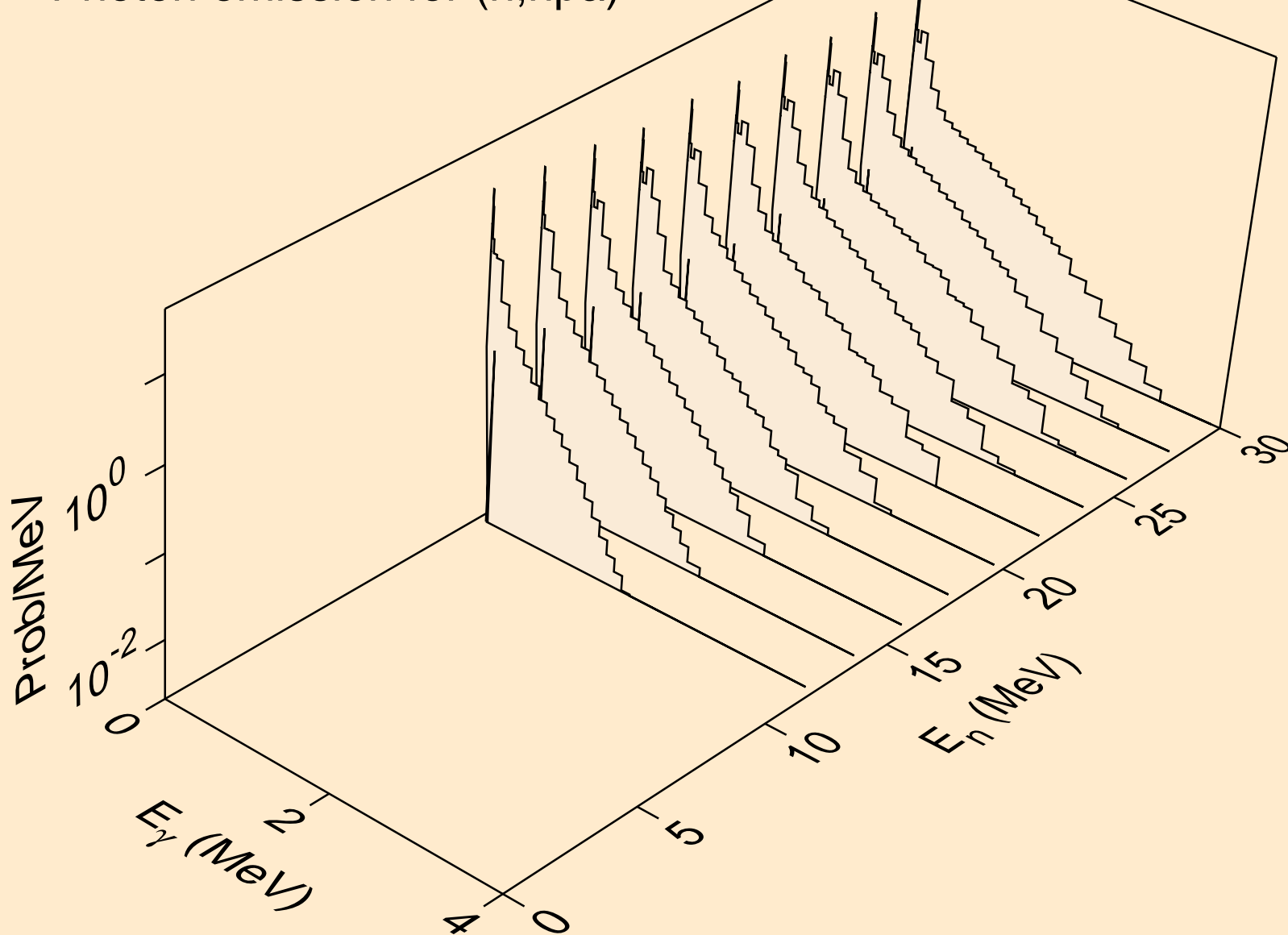

SG265 NEUTRON ACER TENDL-2019 LIBRARY; T=293.16K
Photon emission for (n,n*c)

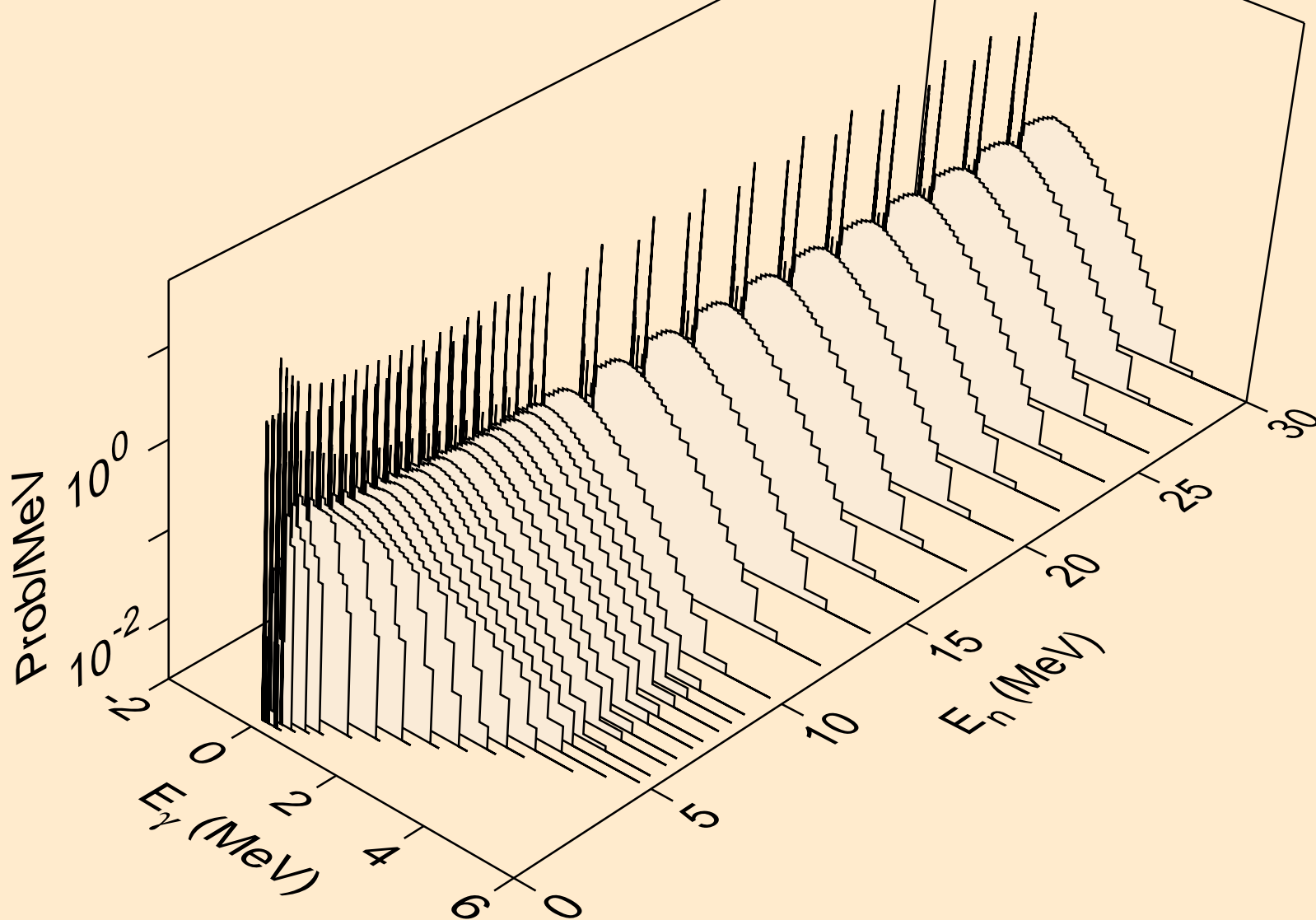

SG265 NEUTRON ACER TENDL-2019 LIBRARY; T=293.16K
Photon emission for (n,gma)

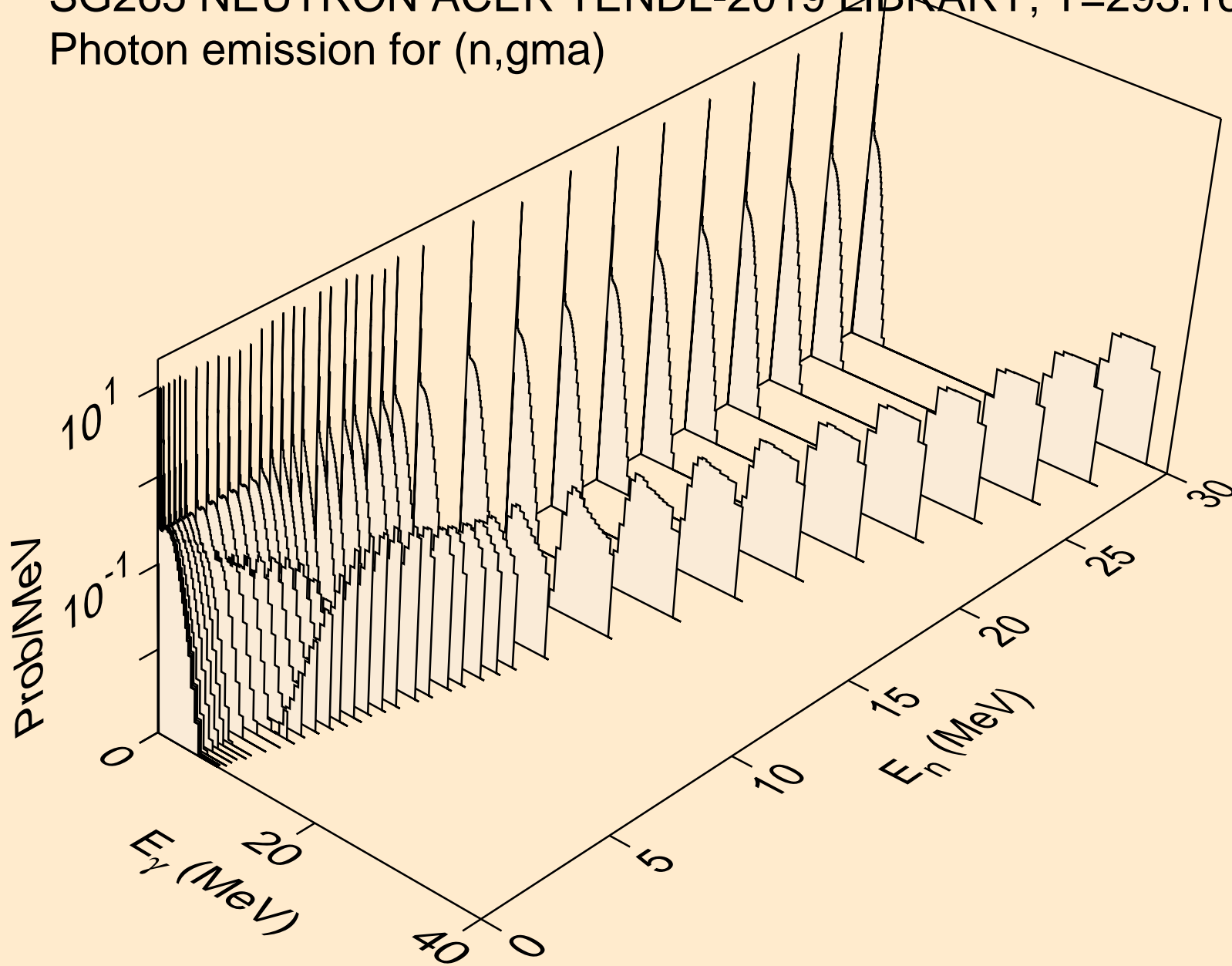

SG265 NEUTRON ACER TENDL-2019 LIBRARY; T=293.16K
Photon emission for (n,p)

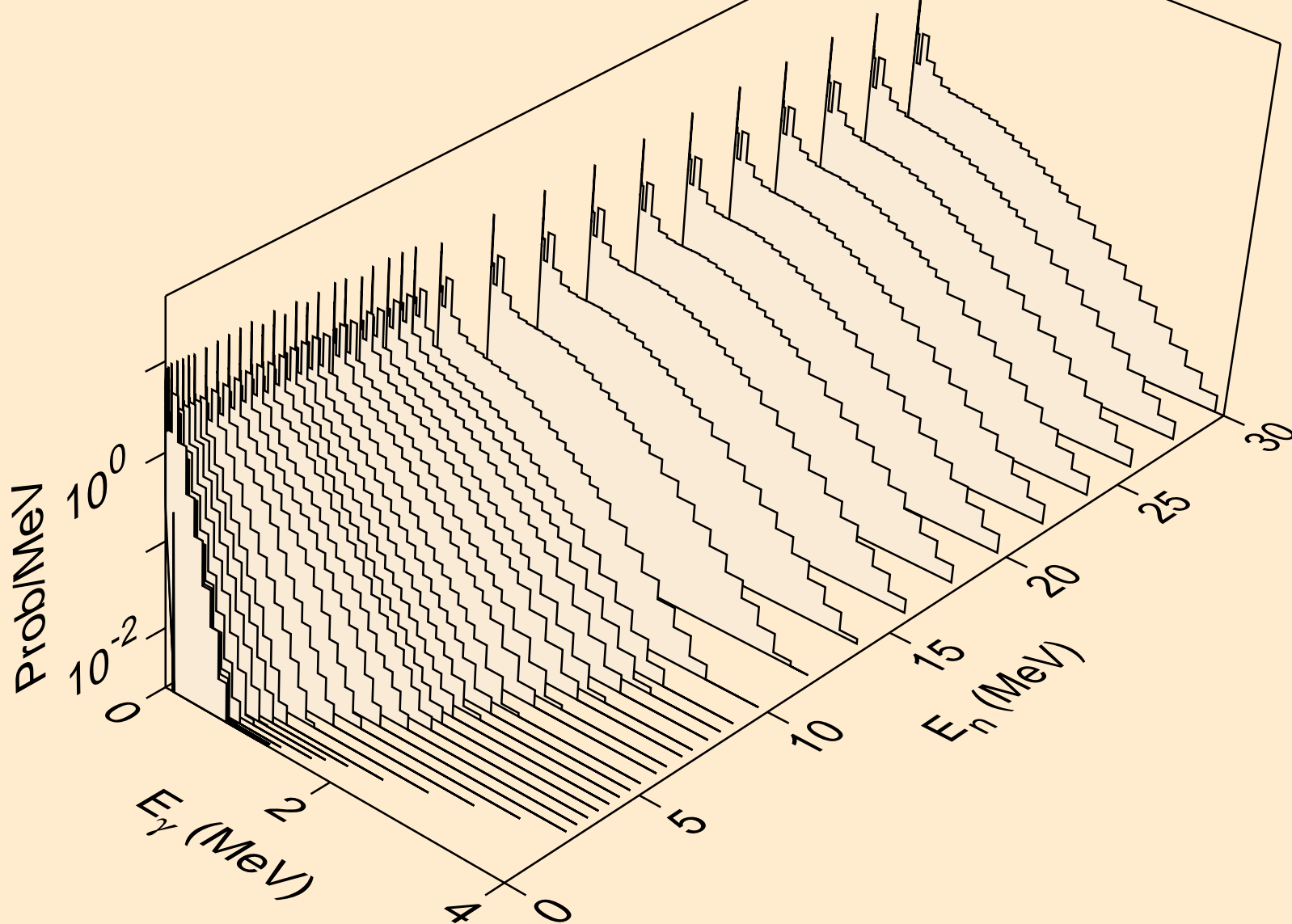

SG265 NEUTRON ACER TENDL-2019 LIBRARY; T=293.16K
Photon emission for (n,d)

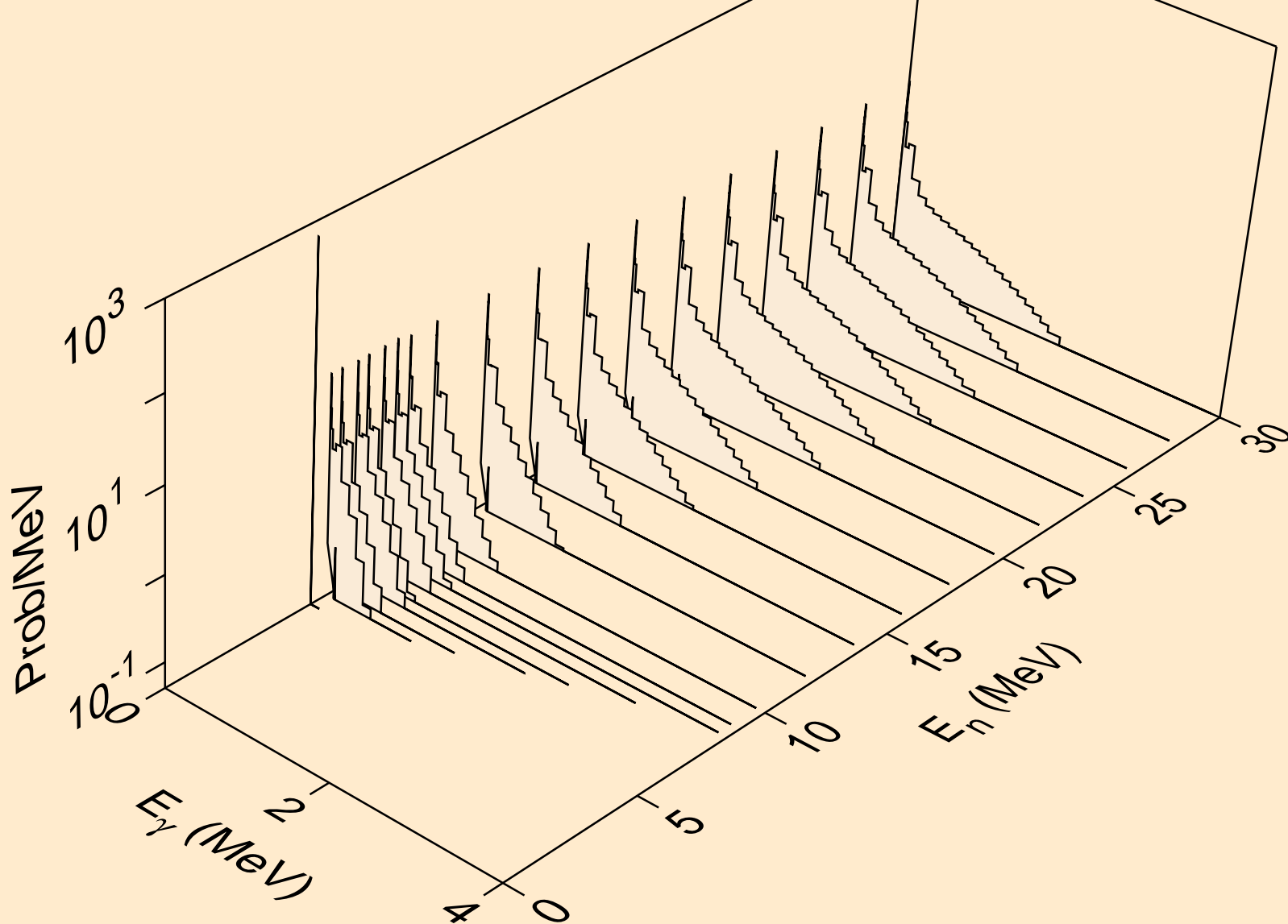

SG265 NEUTRON ACER TENDL-2019 LIBRARY; T=293.16K
Photon emission for (n,t)

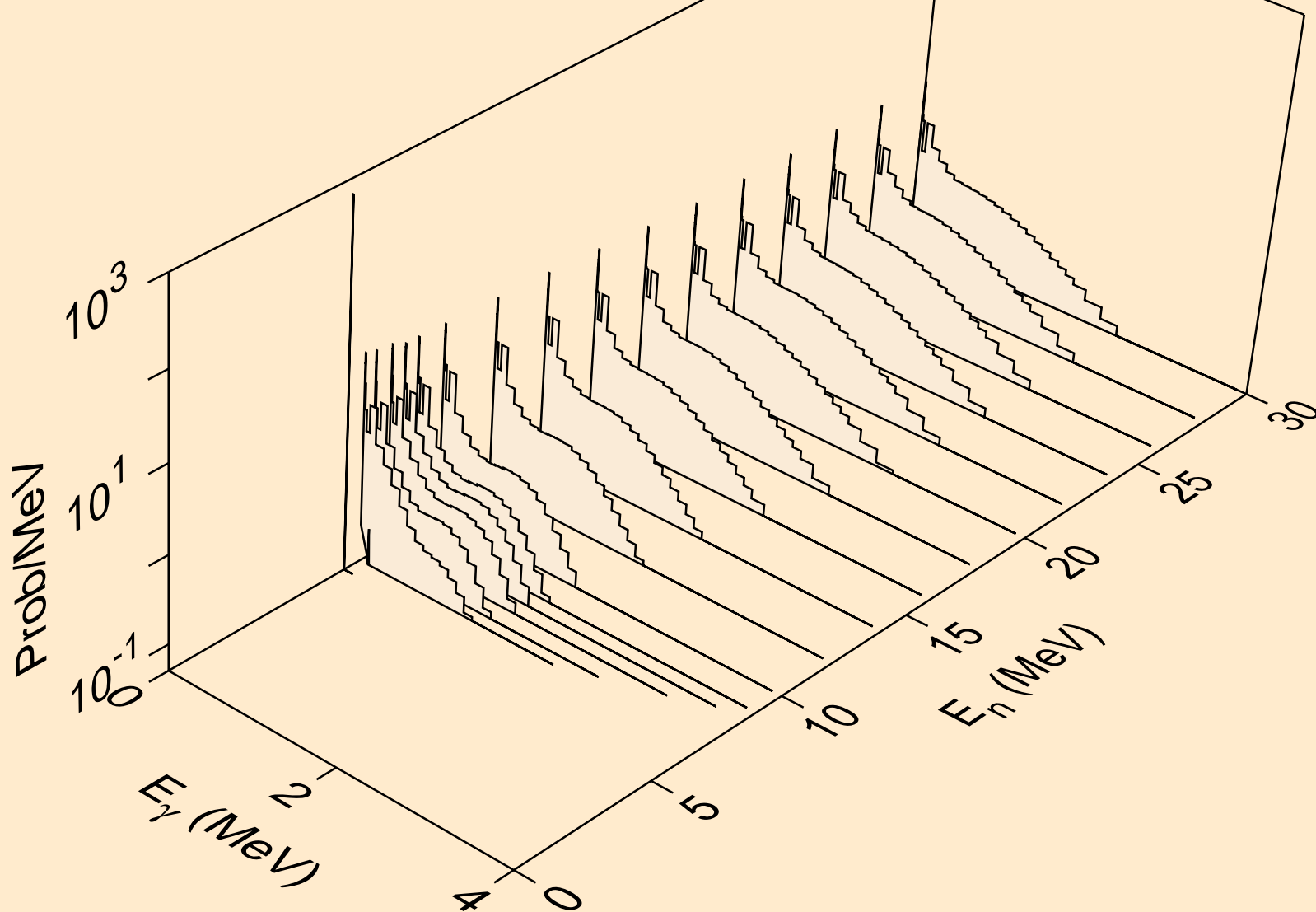

SG265 NEUTRON ACER TENDL-2019 LIBRARY; T=293.16K
Photon emission for (n,he3)

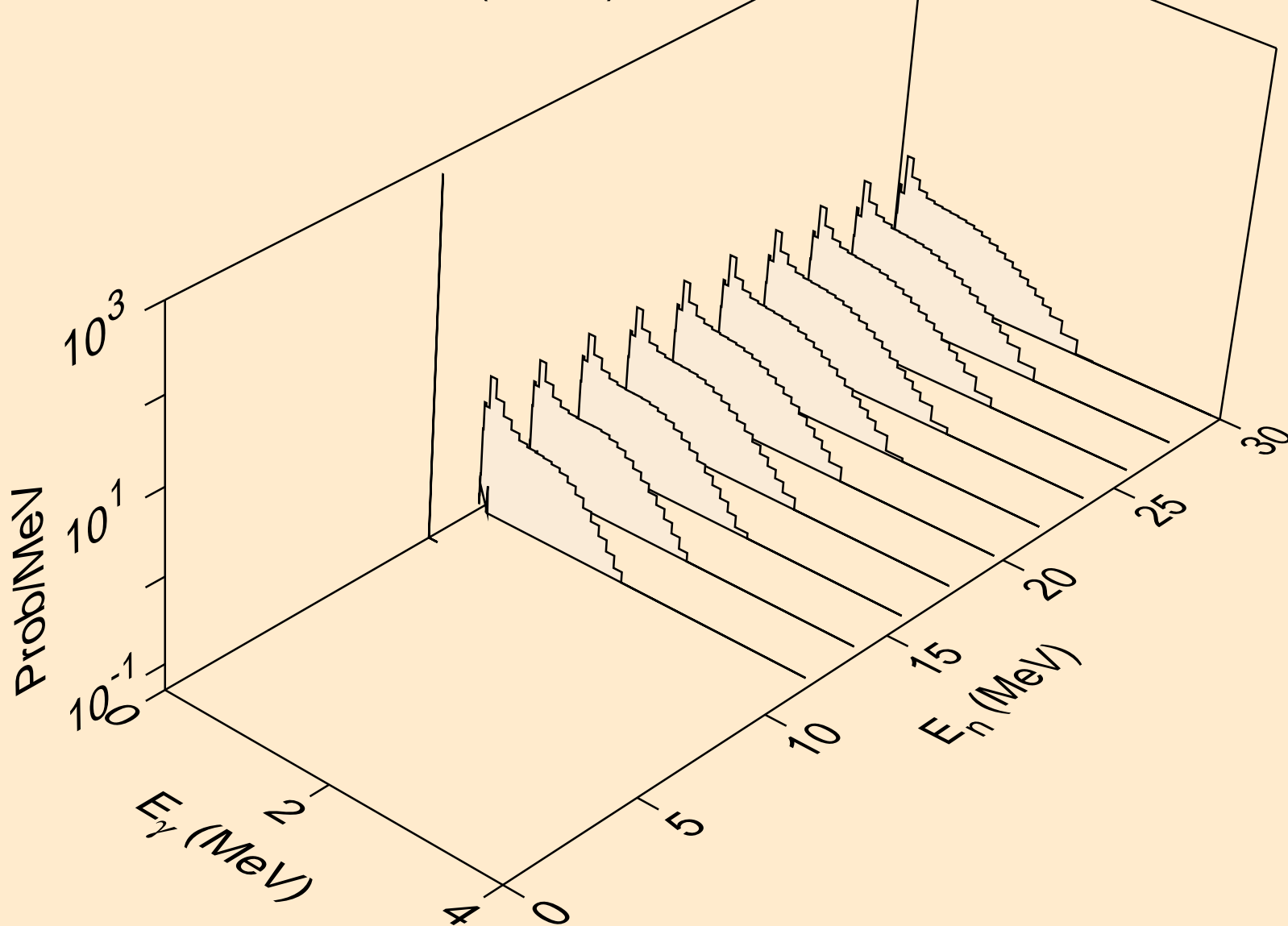

SG265 NEUTRON ACER TENDL-2019 LIBRARY; T=293.16K
Photon emission for (n,a)

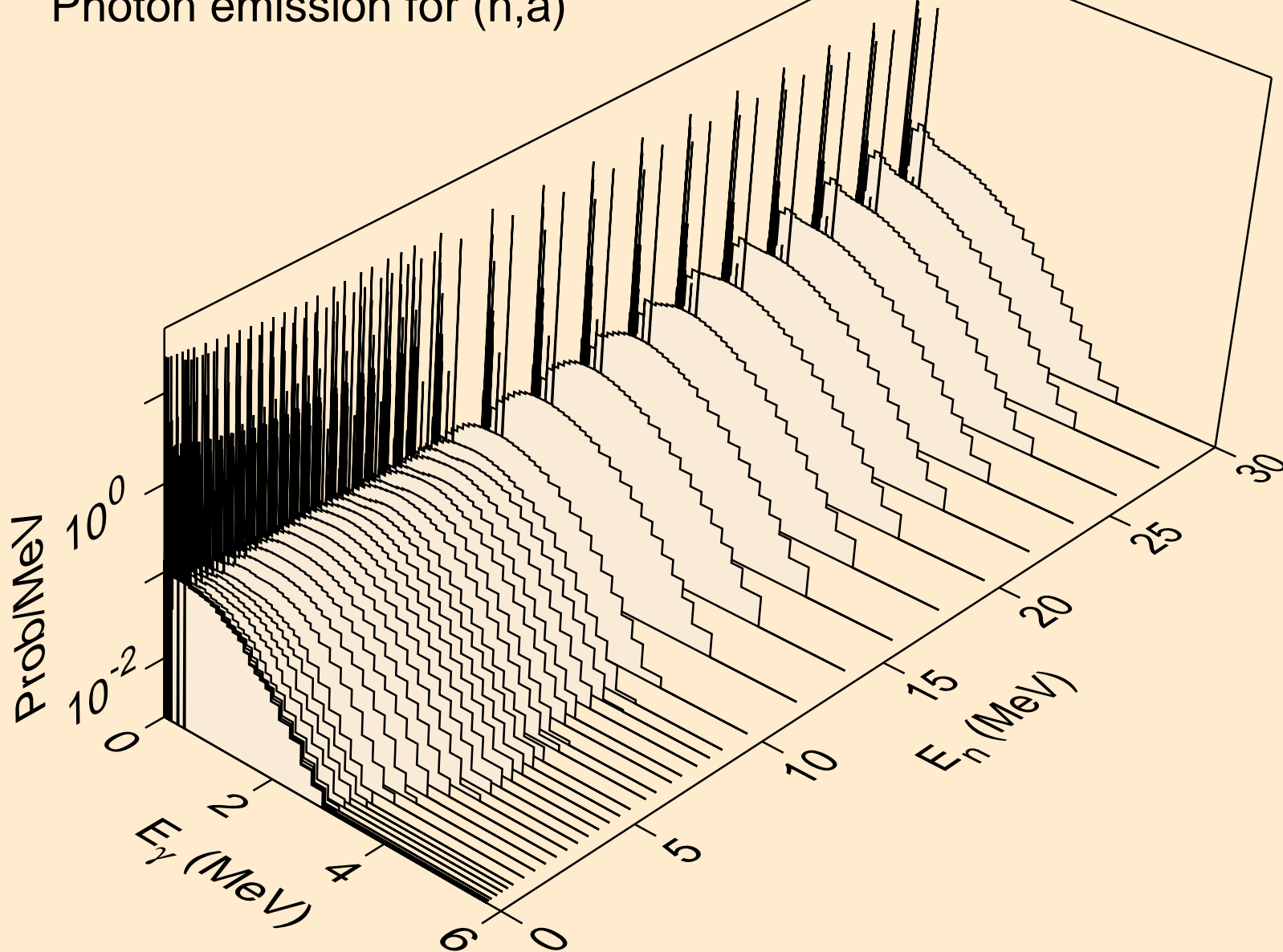

SG265 NEUTRON ACER TENDL-2019 LIBRARY; T=293.16K
Photon emission for (n,2a)

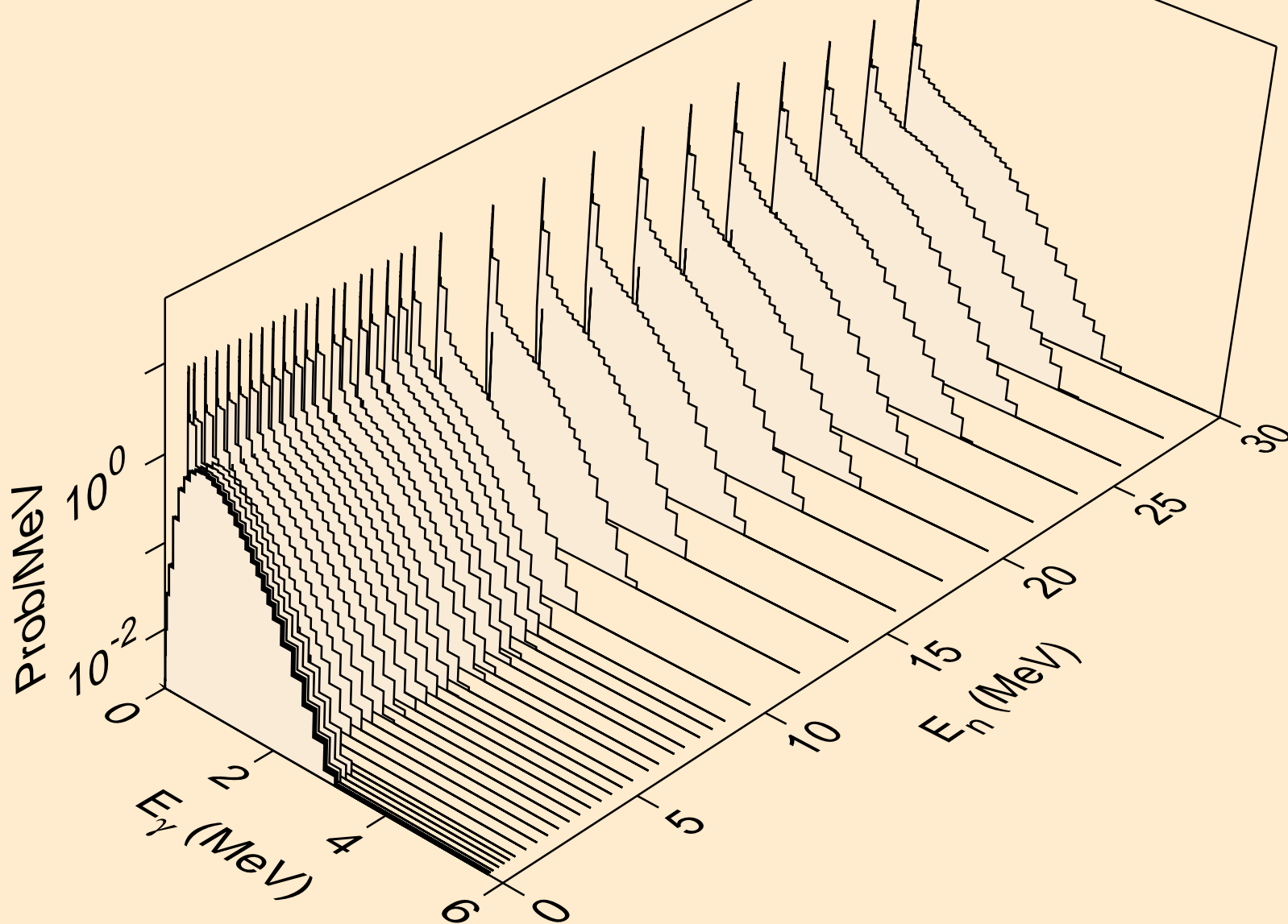

SG265 NEUTRON ACER TENDL-2019 LIBRARY; T=293.16K
Photon emission for (n,2p)

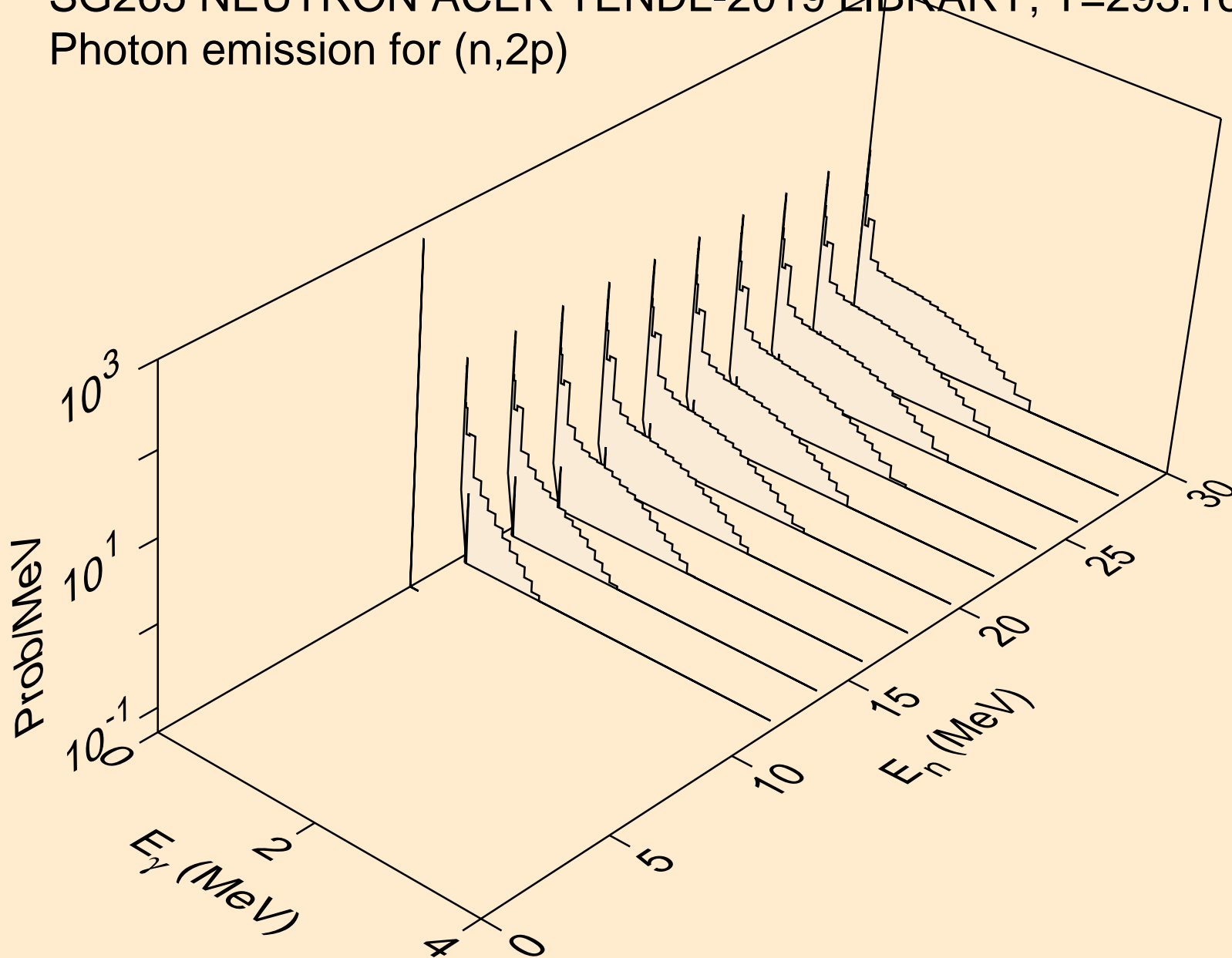

SG265 NEUTRON ACER TENDL-2019 LIBRARY; T=293.16K
Photon emission for (n,p α)

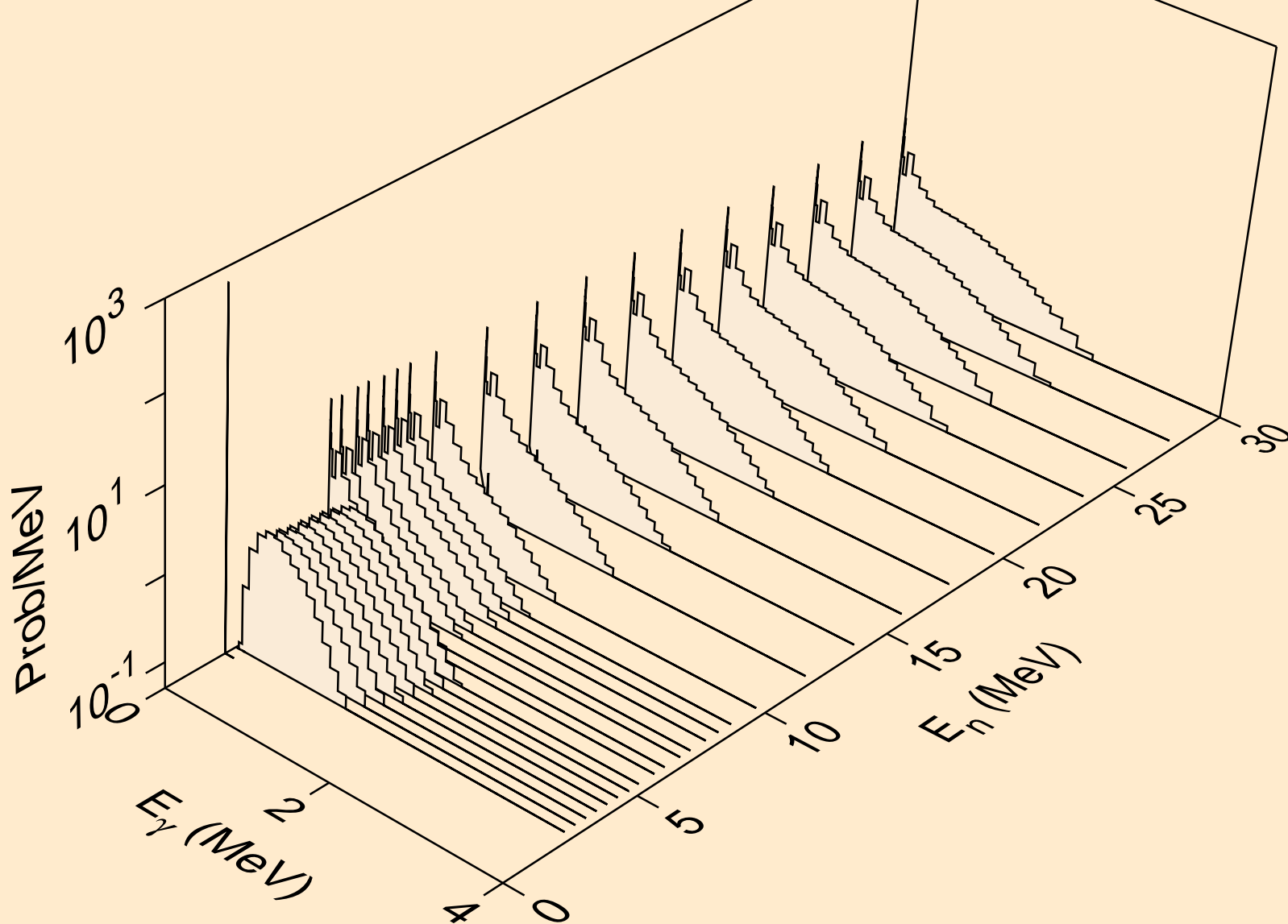

SG265 NEUTRON ACER TENDL-2019 LIBRARY; T=293.16K
Photon emission for (n,pd)

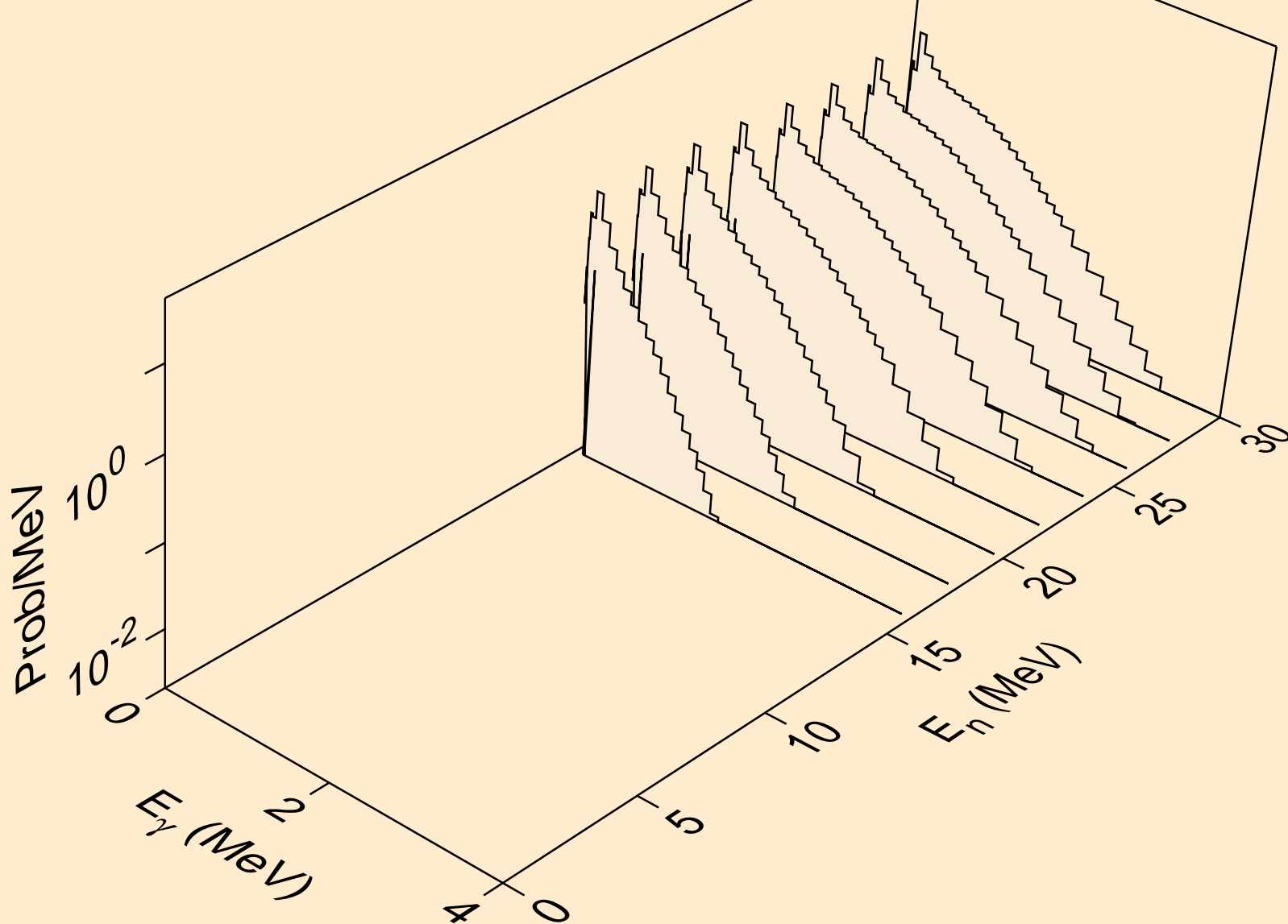

SG265 NEUTRON ACER TENDL-2019 LIBRARY; T=293.16K
Photon emission for (n,da)

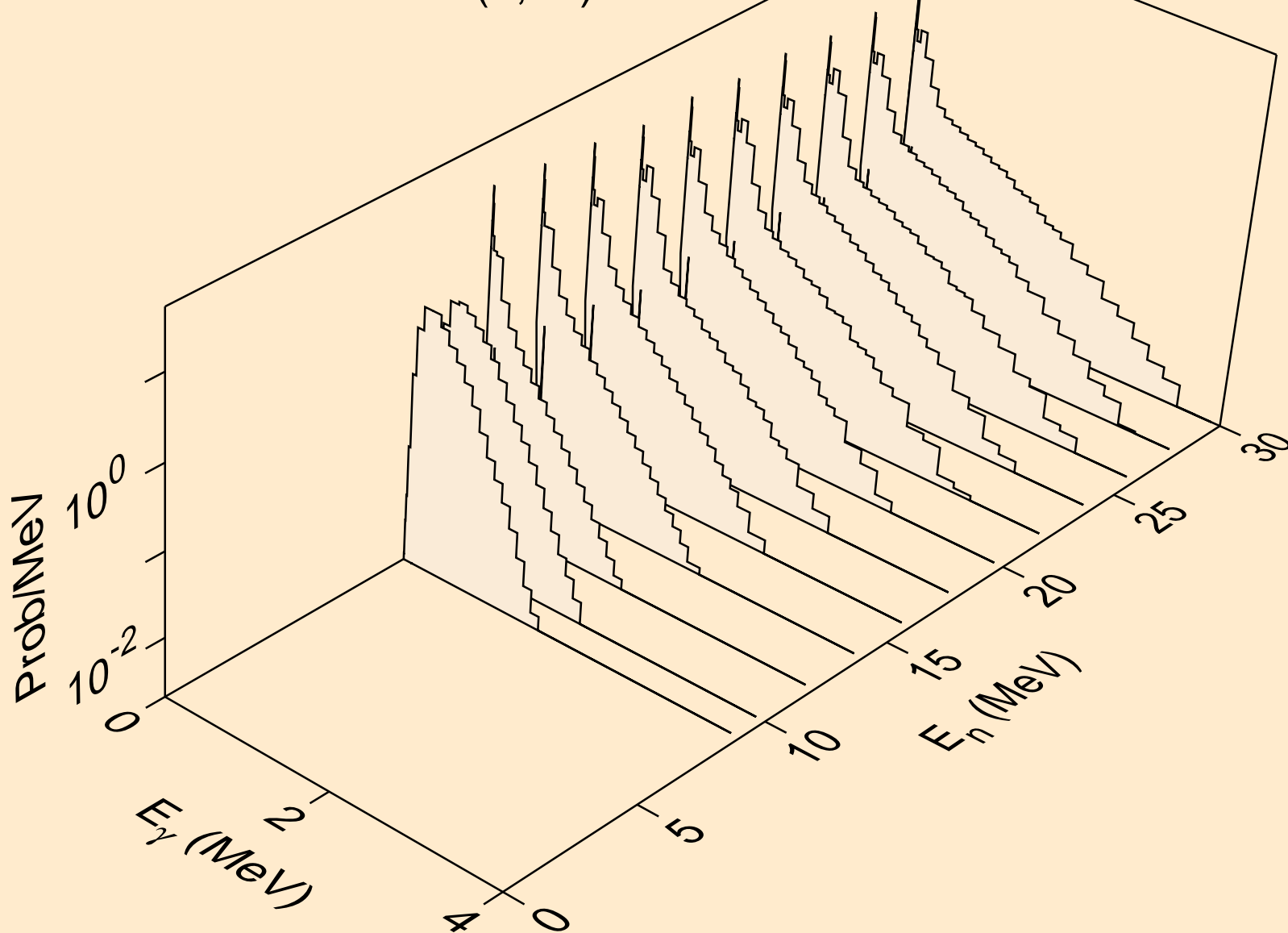

SG265 NEUTRON ACER TENDL-2019 LIBRARY; T=293.16K
thermal capture photon spectrum

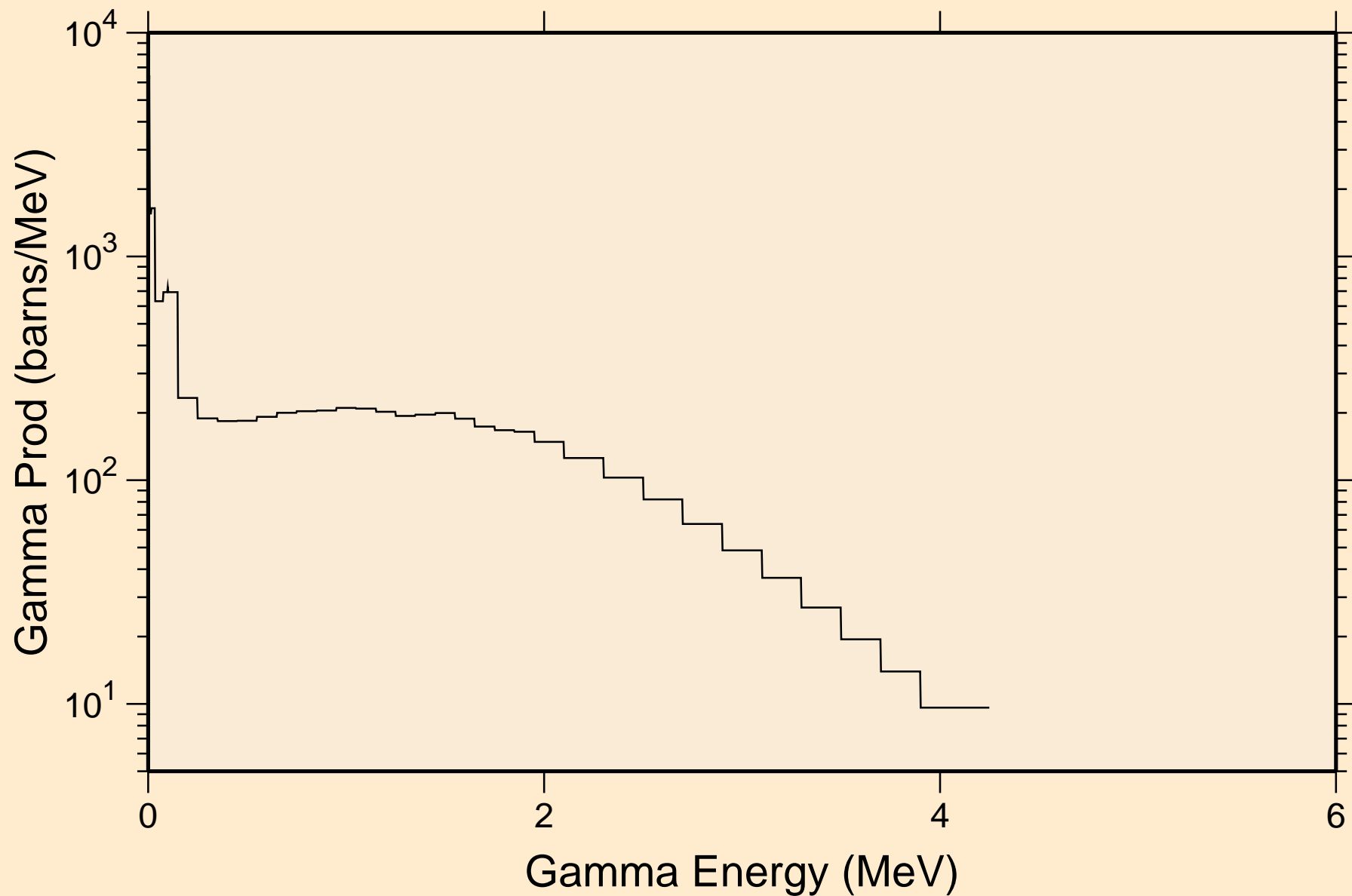

SG265 NEUTRON ACER TENDL-2019 LIBRARY; T=293.16K
14 MeV photon spectrum

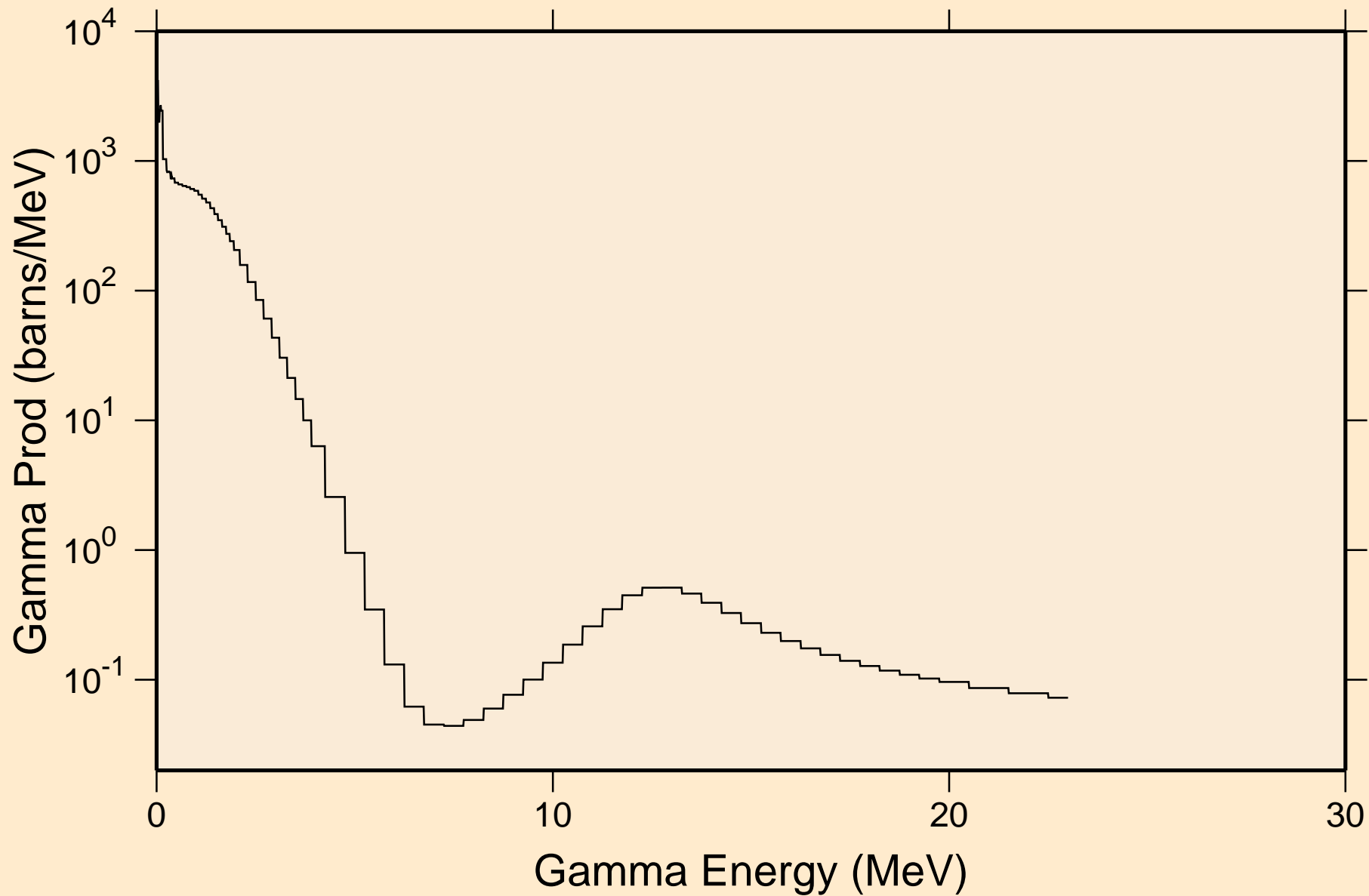

SG265 NEUTRON ACER TENDL-2019 LIBRARY; T=293.16K
Particle heating contributions

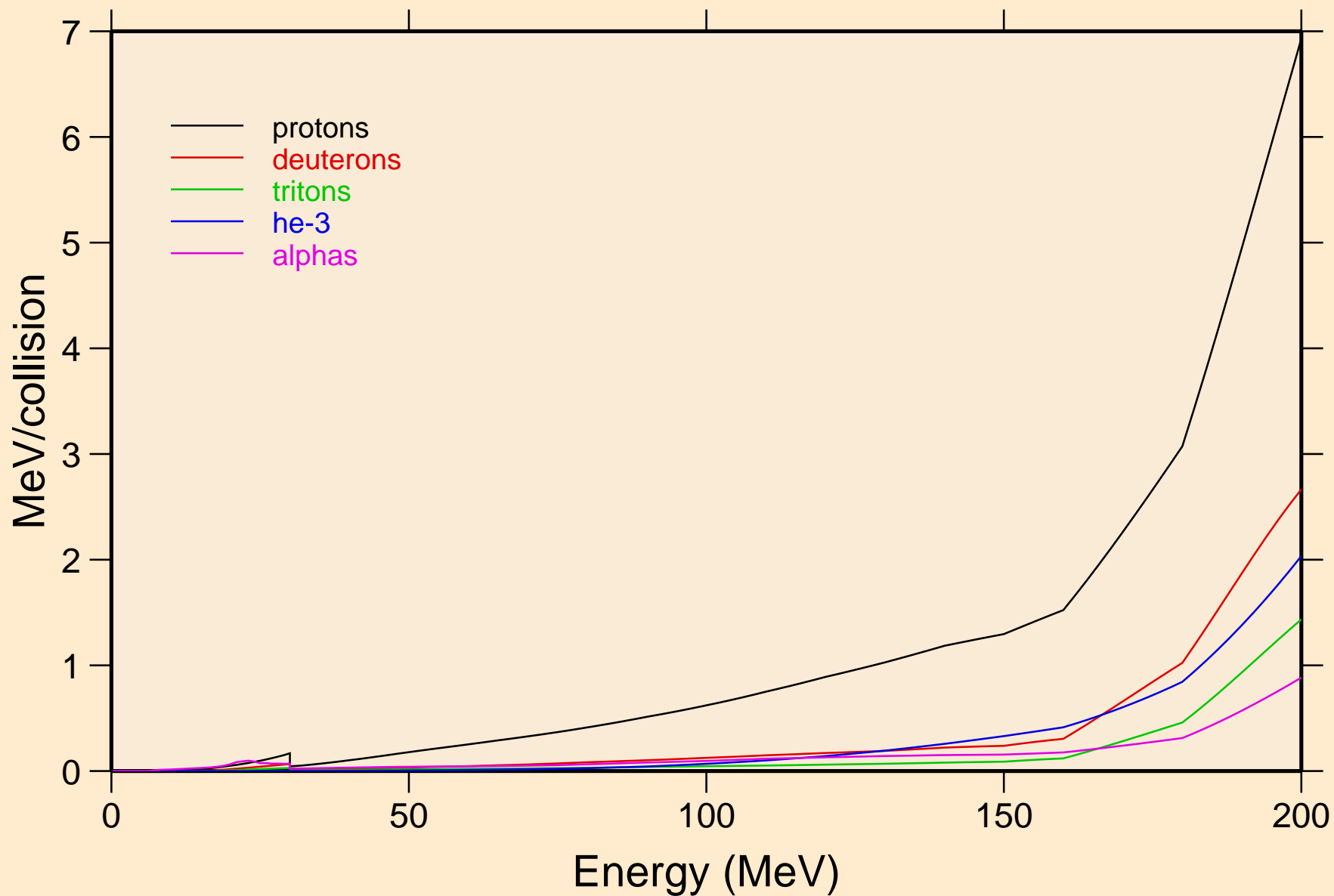

SG265 NEUTRON ACER TENDL-2019 LIBRARY; T=293.16K
Recoil Heating

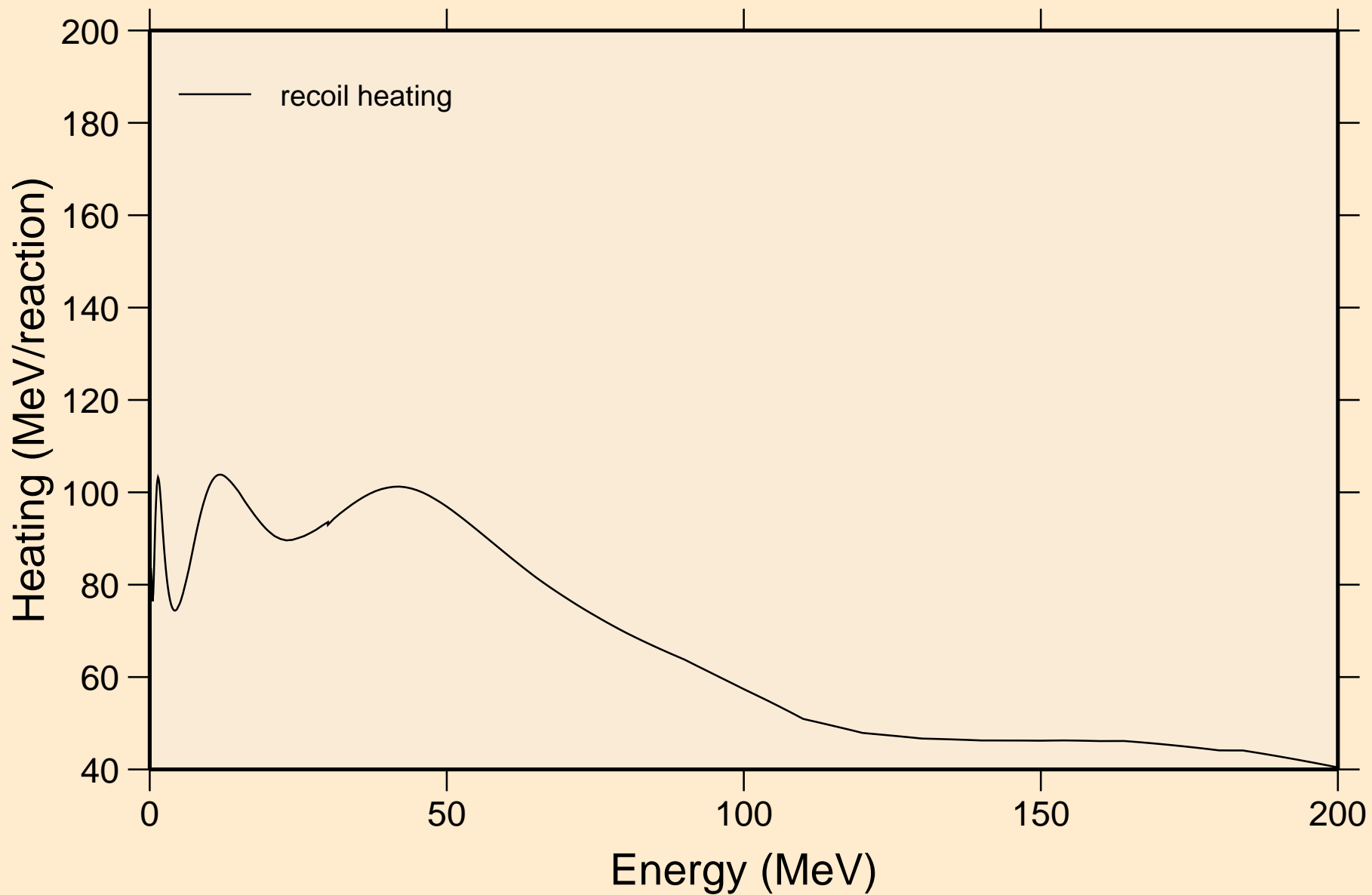

SG265 NEUTRON ACER TENDL-2019 LIBRARY; T=293.16K

Particle production cross sections

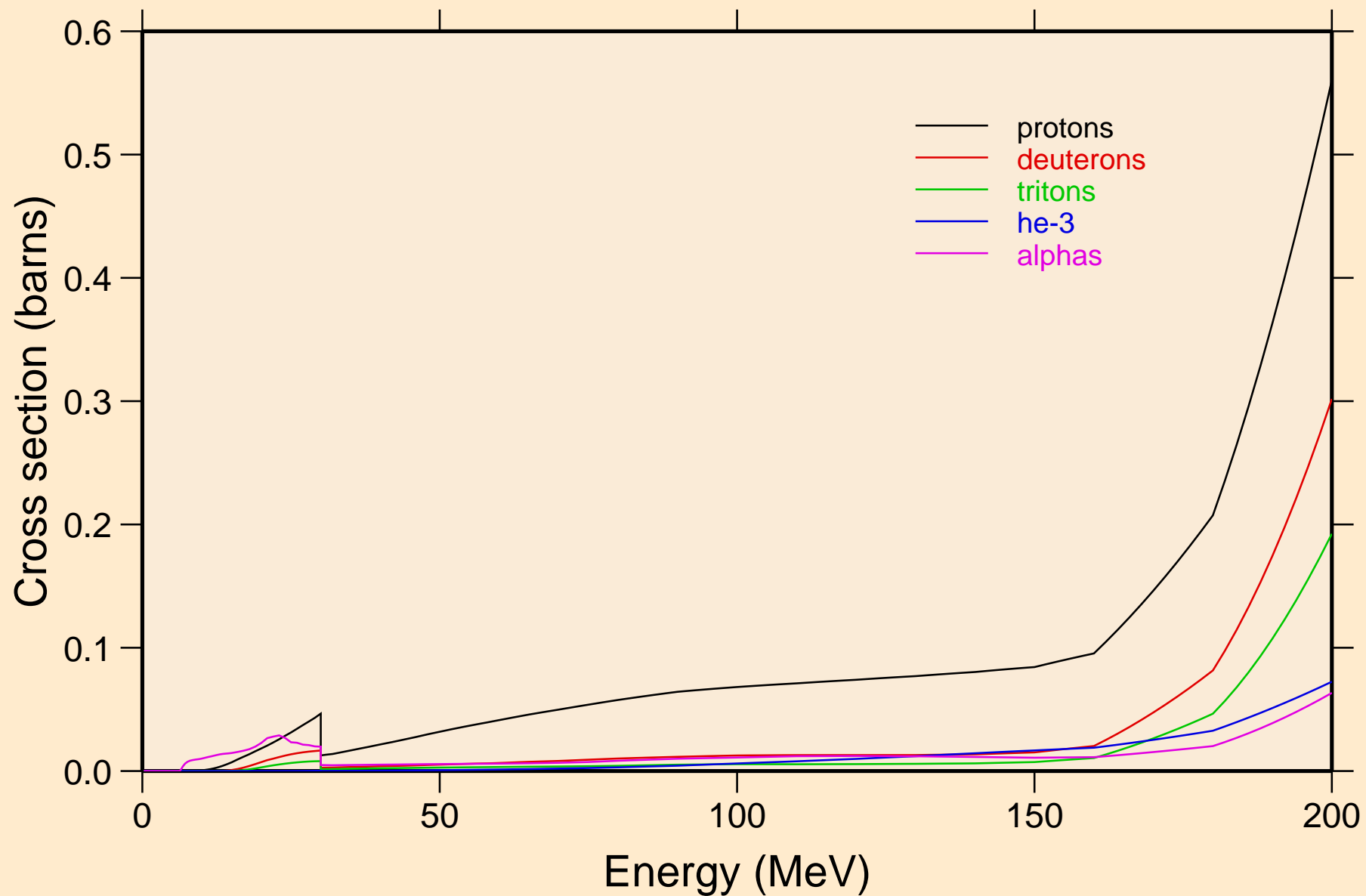

SG265 NEUTRON ACER TENDL-2019 LIBRARY; T=293.16K
protons from (n,x)

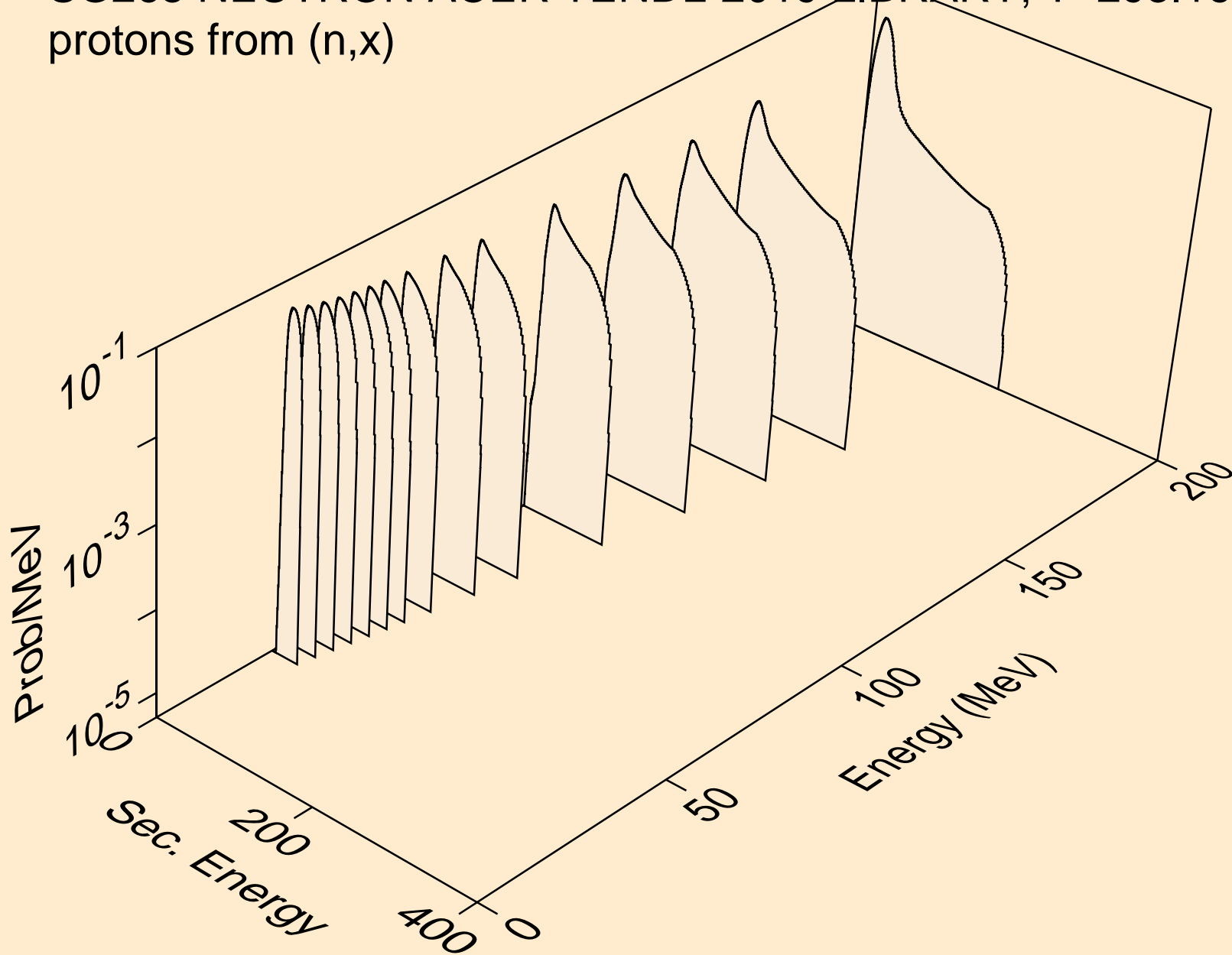

SG265 NEUTRON ACER TENDL-2019 LIBRARY; T=293.16K
protons from (n,n*)p

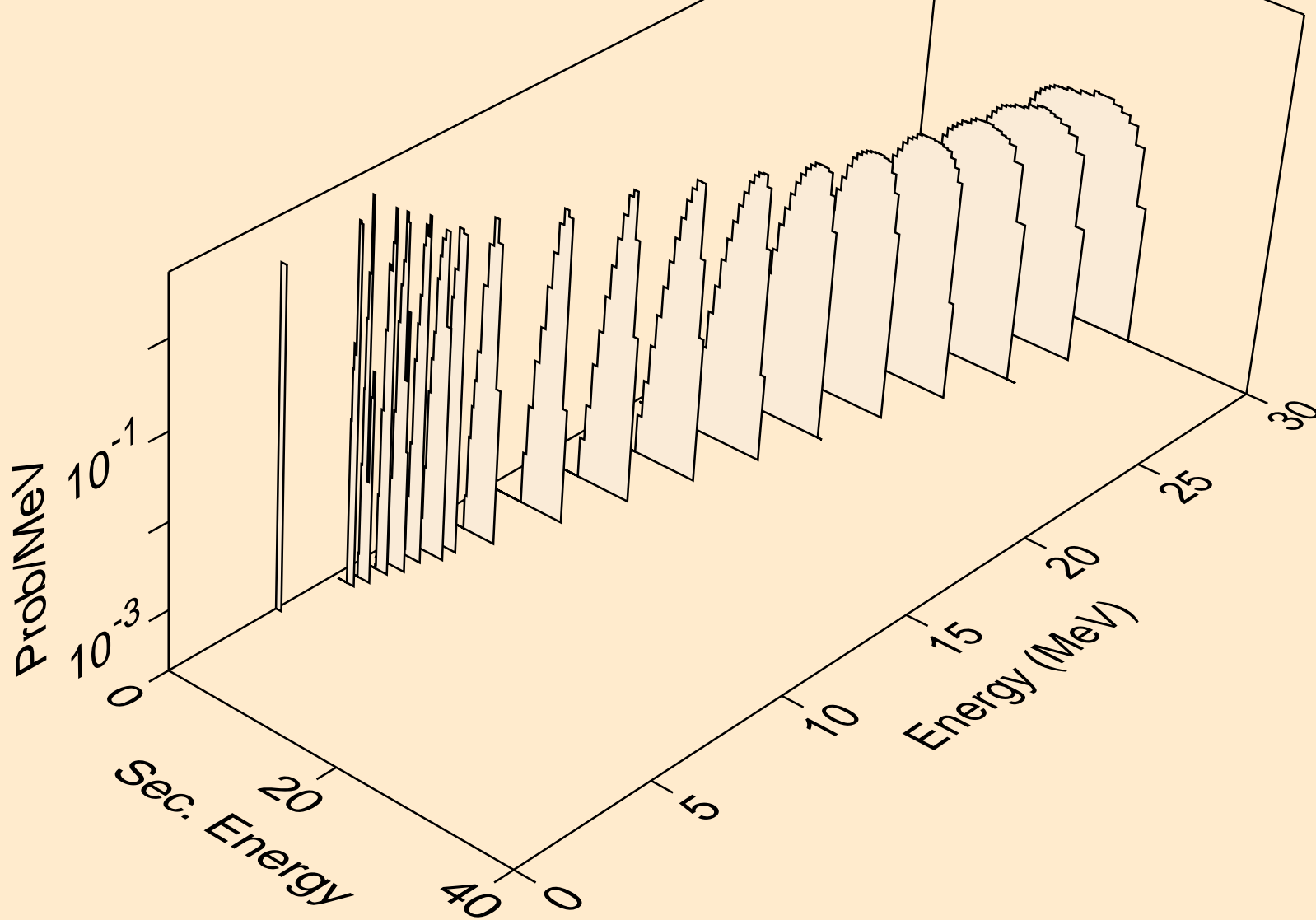

SG265 NEUTRON ACER TENDL-2019 LIBRARY; T=293.16K
protons from (n,2np)

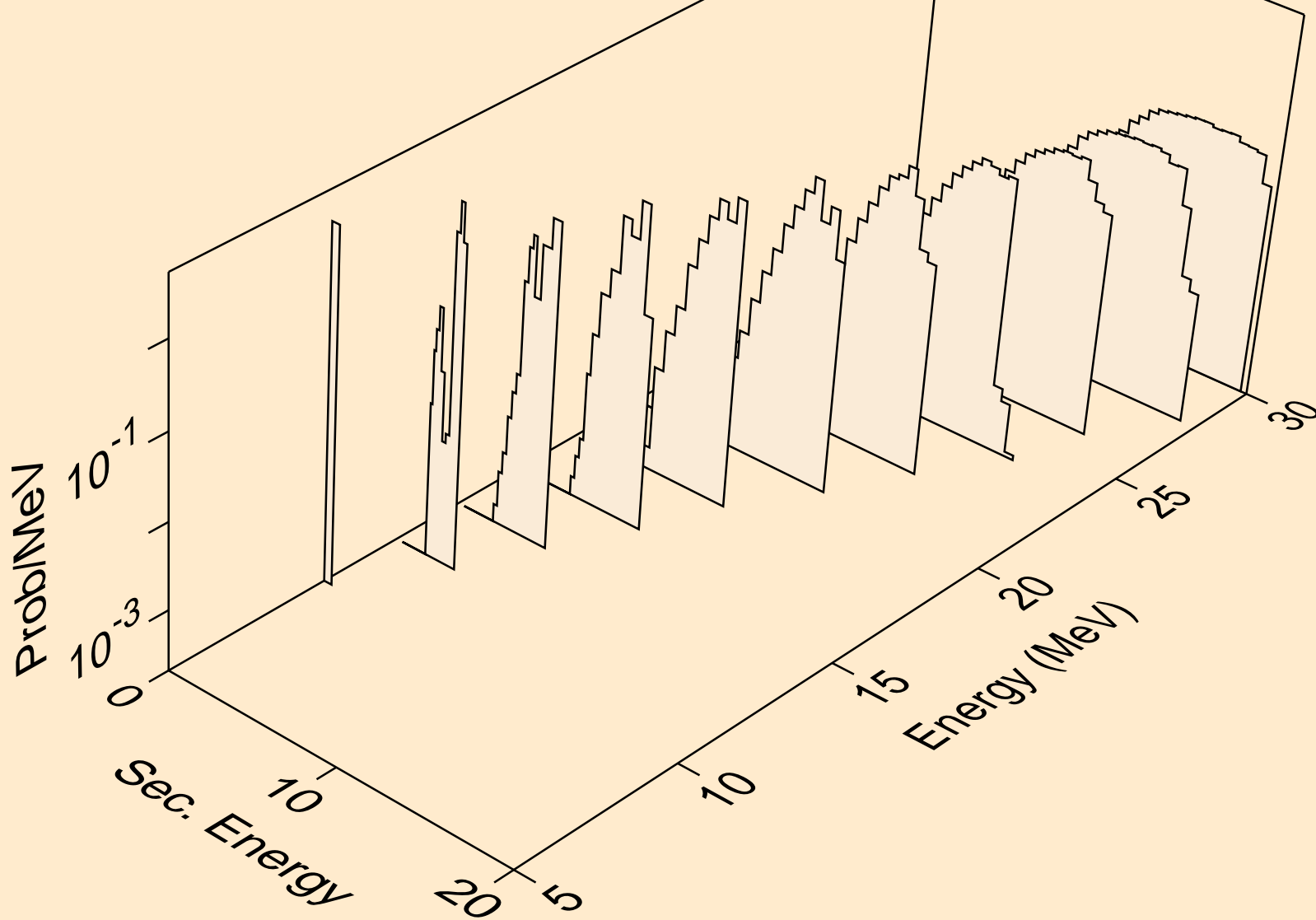

SG265 NEUTRON ACER TENDL-2019 LIBRARY; T=293.16K
protons from (n,3np)

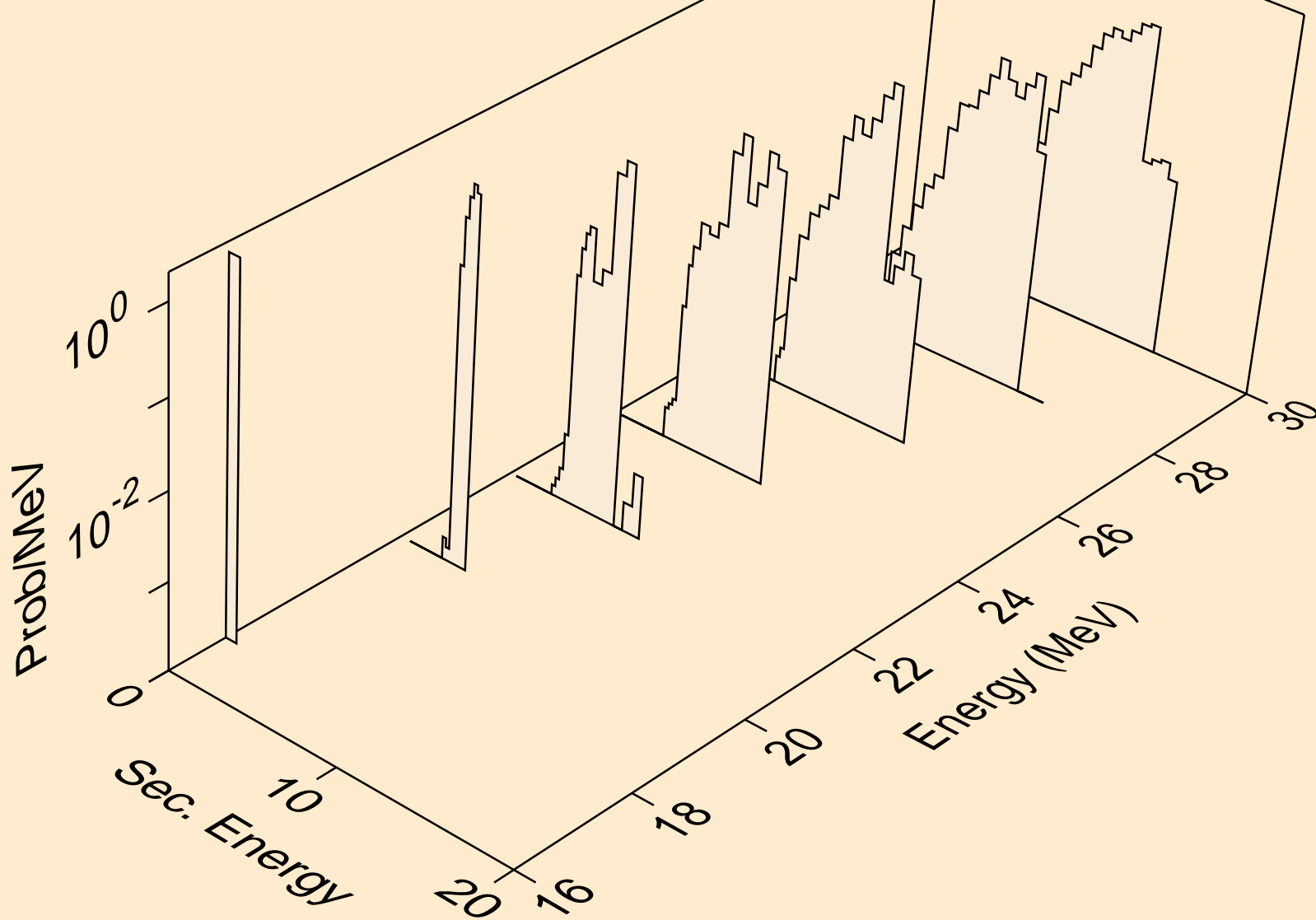

SG265 NEUTRON ACER TENDL-2019 LIBRARY; T=293.16K
protons from (n,2np)

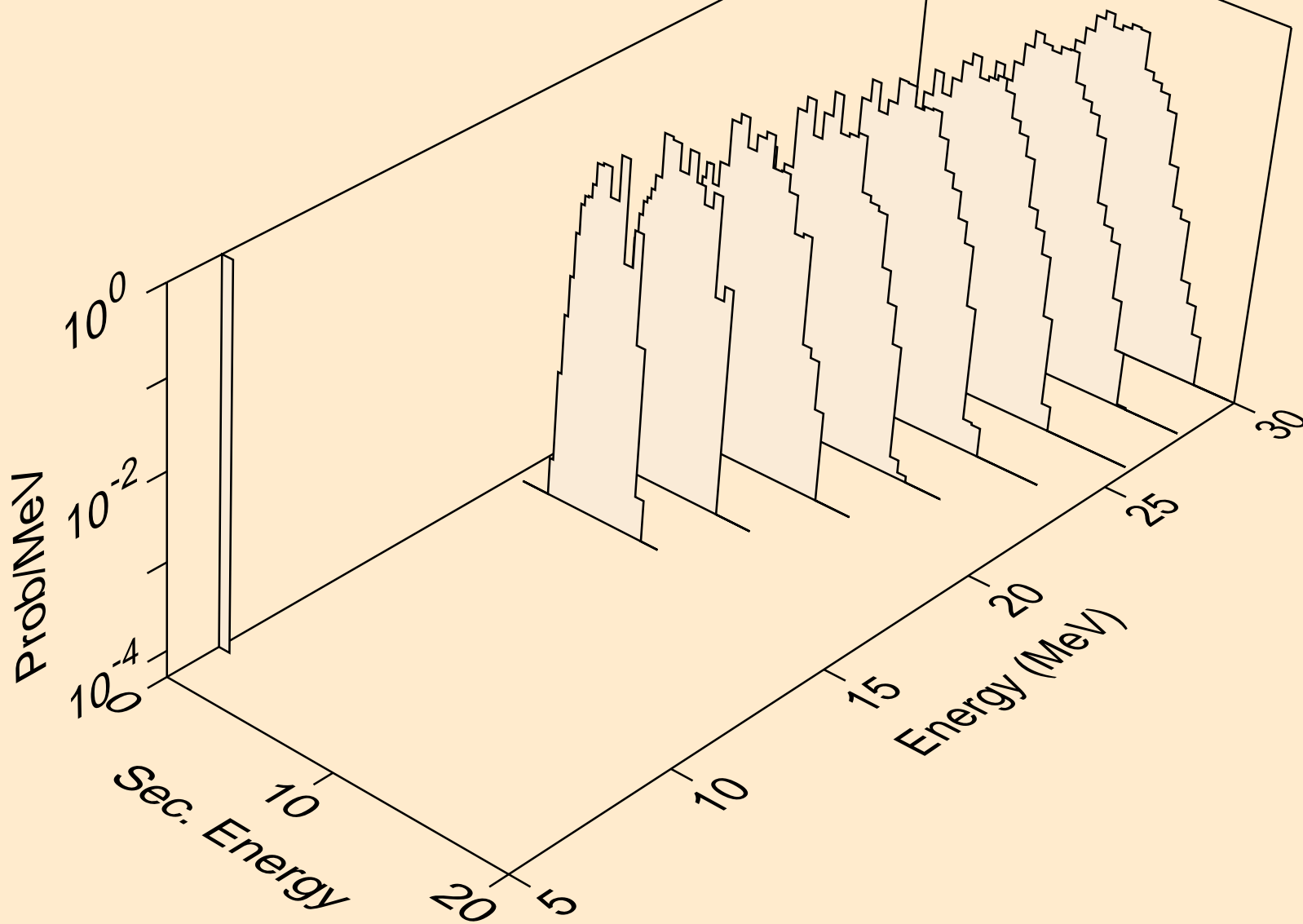

SG265 NEUTRON ACER TENDL-2019 LIBRARY; T=293.16K
protons from (n,npa)

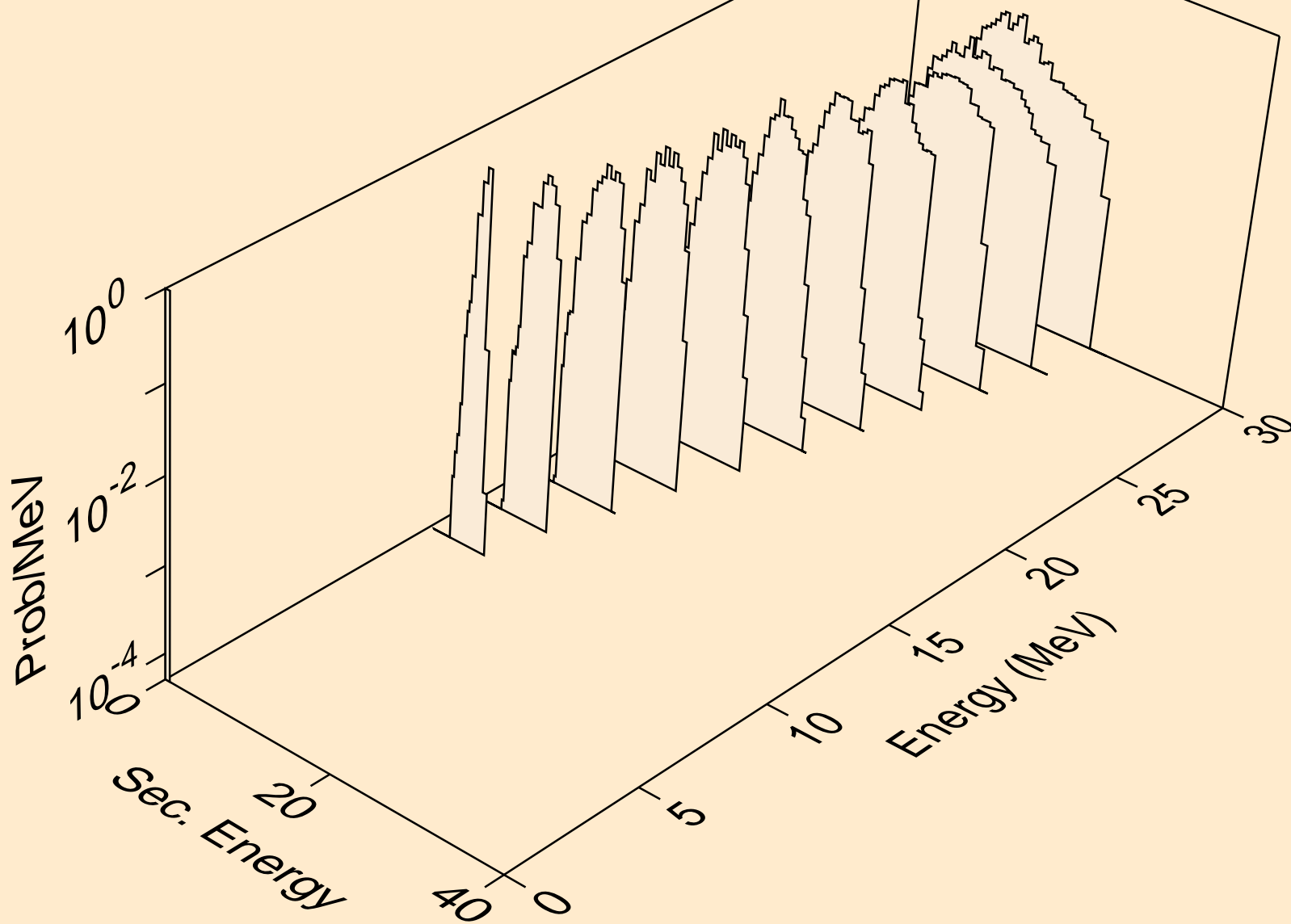

SG265 NEUTRON ACER TENDL-2019 LIBRARY; T=293.16K
protons from (n,p)

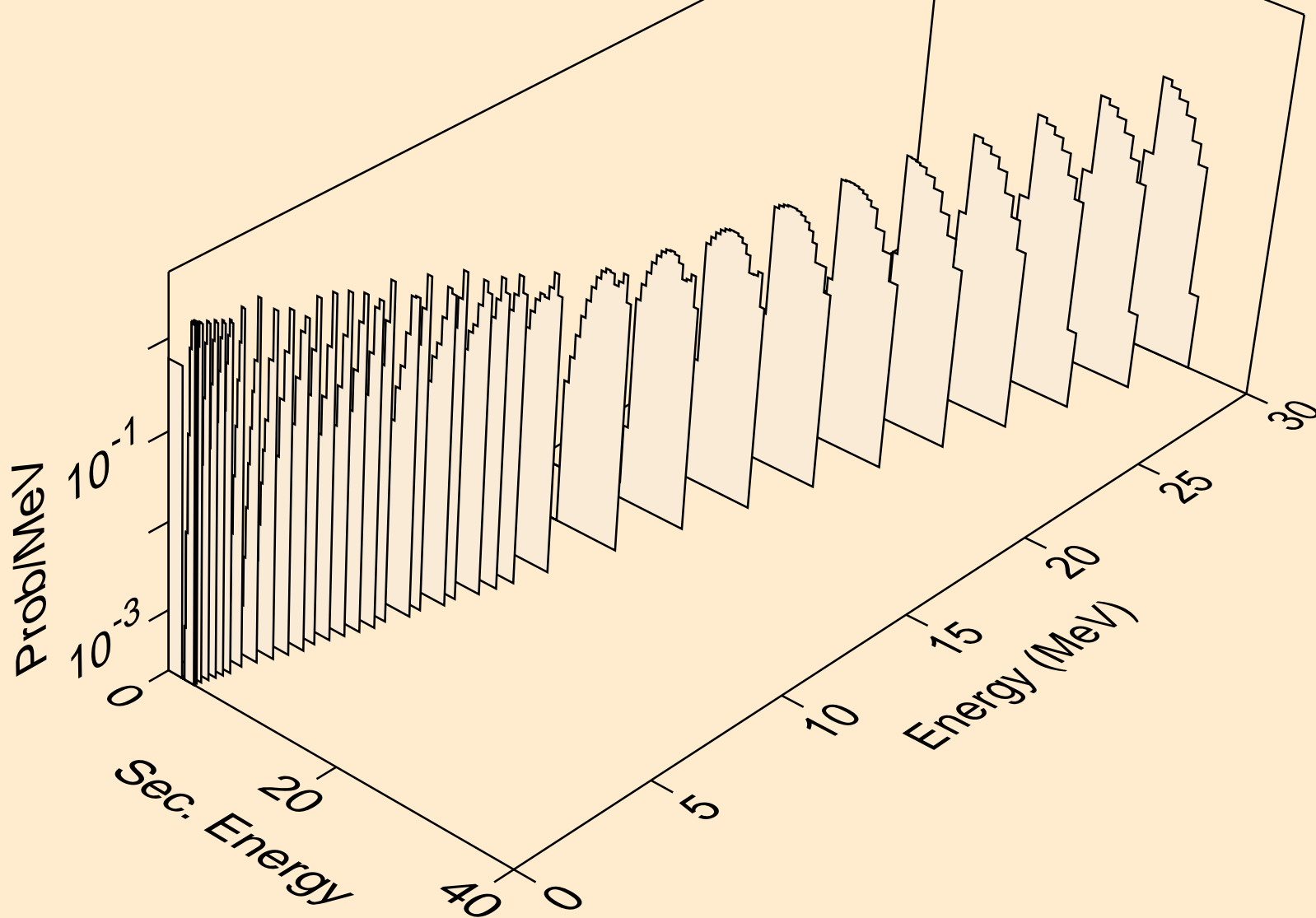

SG265 NEUTRON ACER TENDL-2019 LIBRARY; T=293.16K
protons from (n,2p)

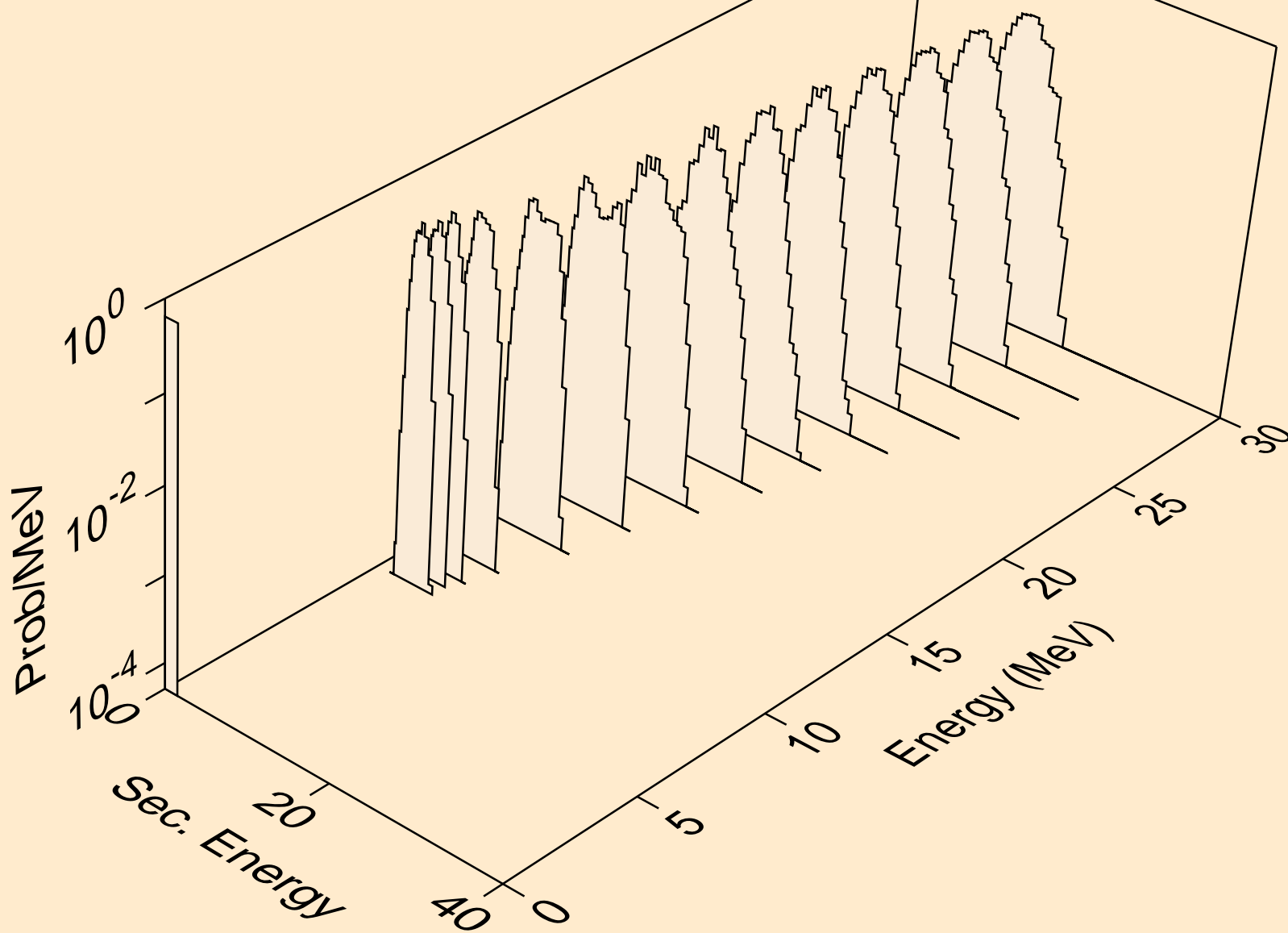

SG265 NEUTRON ACER TENDL-2019 LIBRARY; T=293.16K
protons from (n,p)

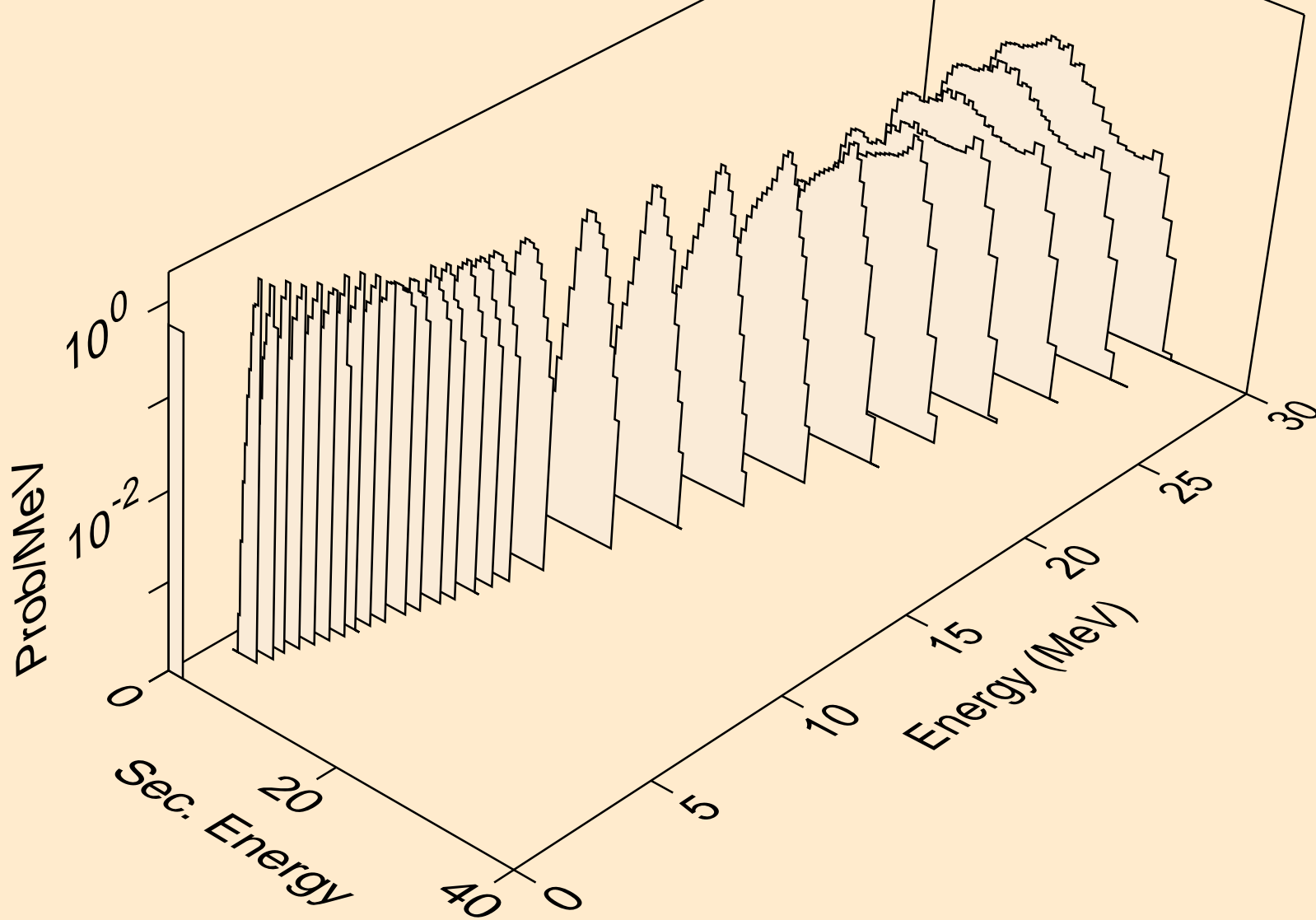

SG265 NEUTRON ACER TENDL-2019 LIBRARY; T=293.16K
protons from (n,pd)

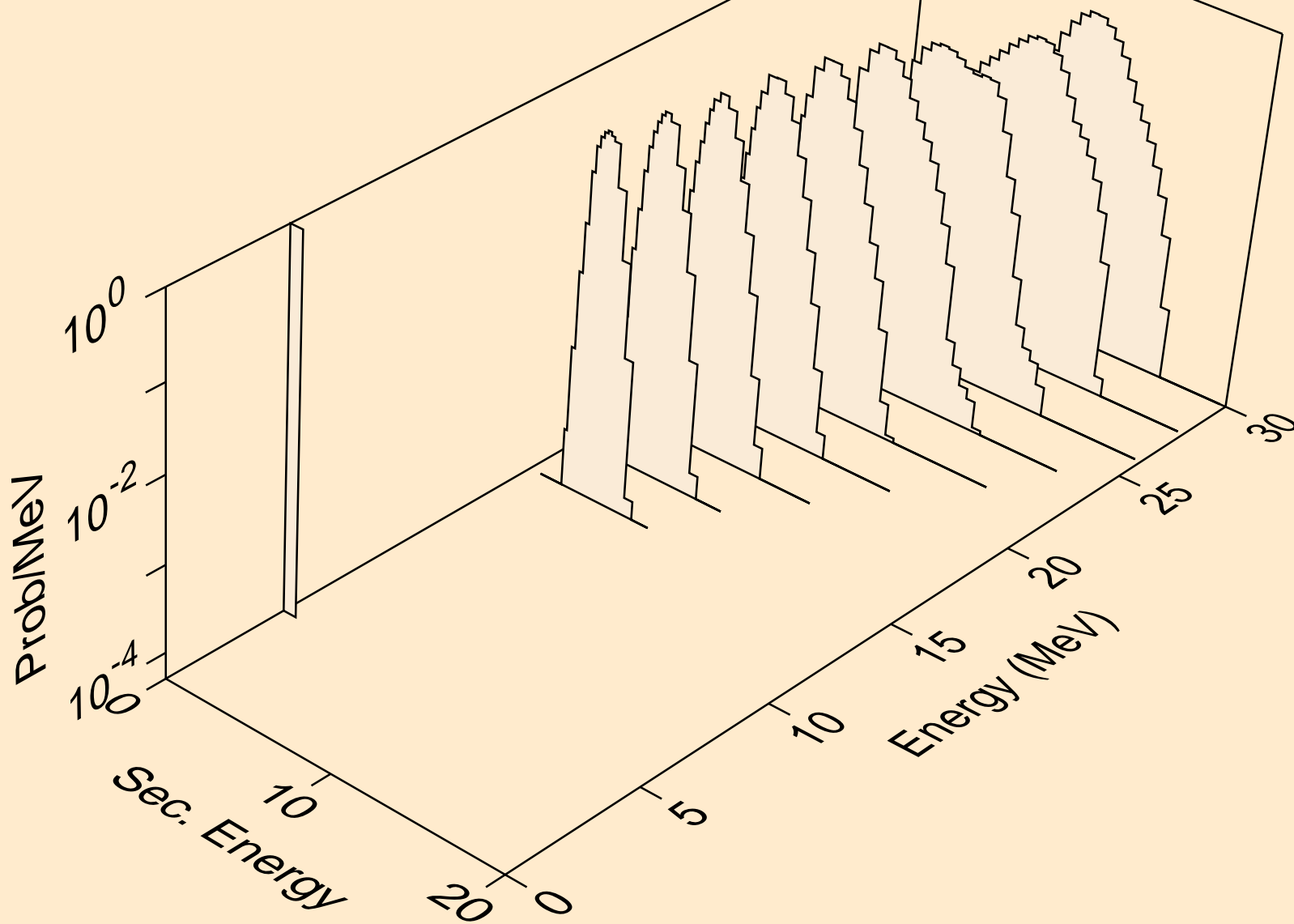

SG265 NEUTRON ACER TENDL-2019 LIBRARY; T=293.16K
deuterons from (n,x)

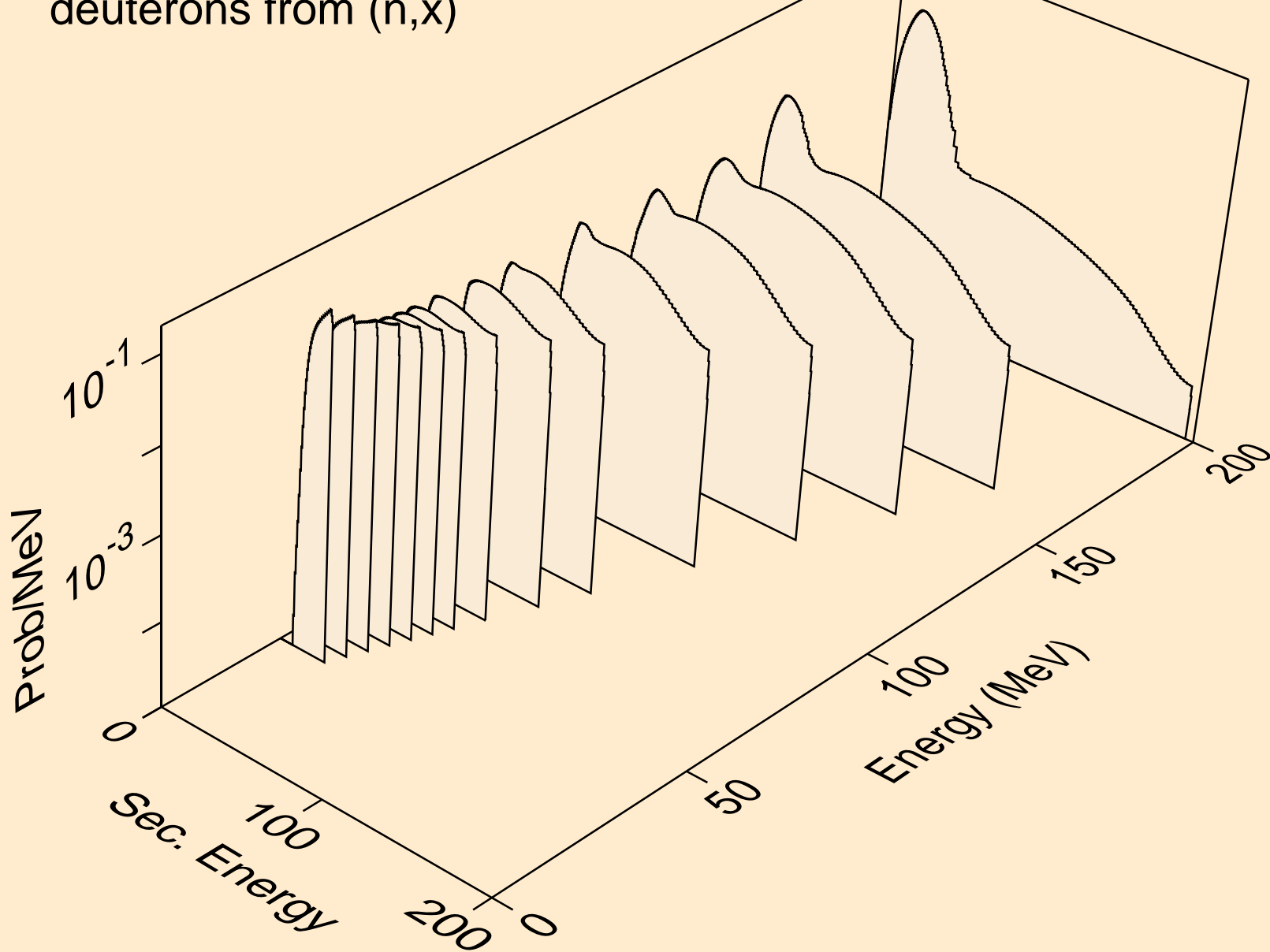

SG265 NEUTRON ACER TENDL-2019 LIBRARY; T=293.16K
deuterons from (n,2nd)

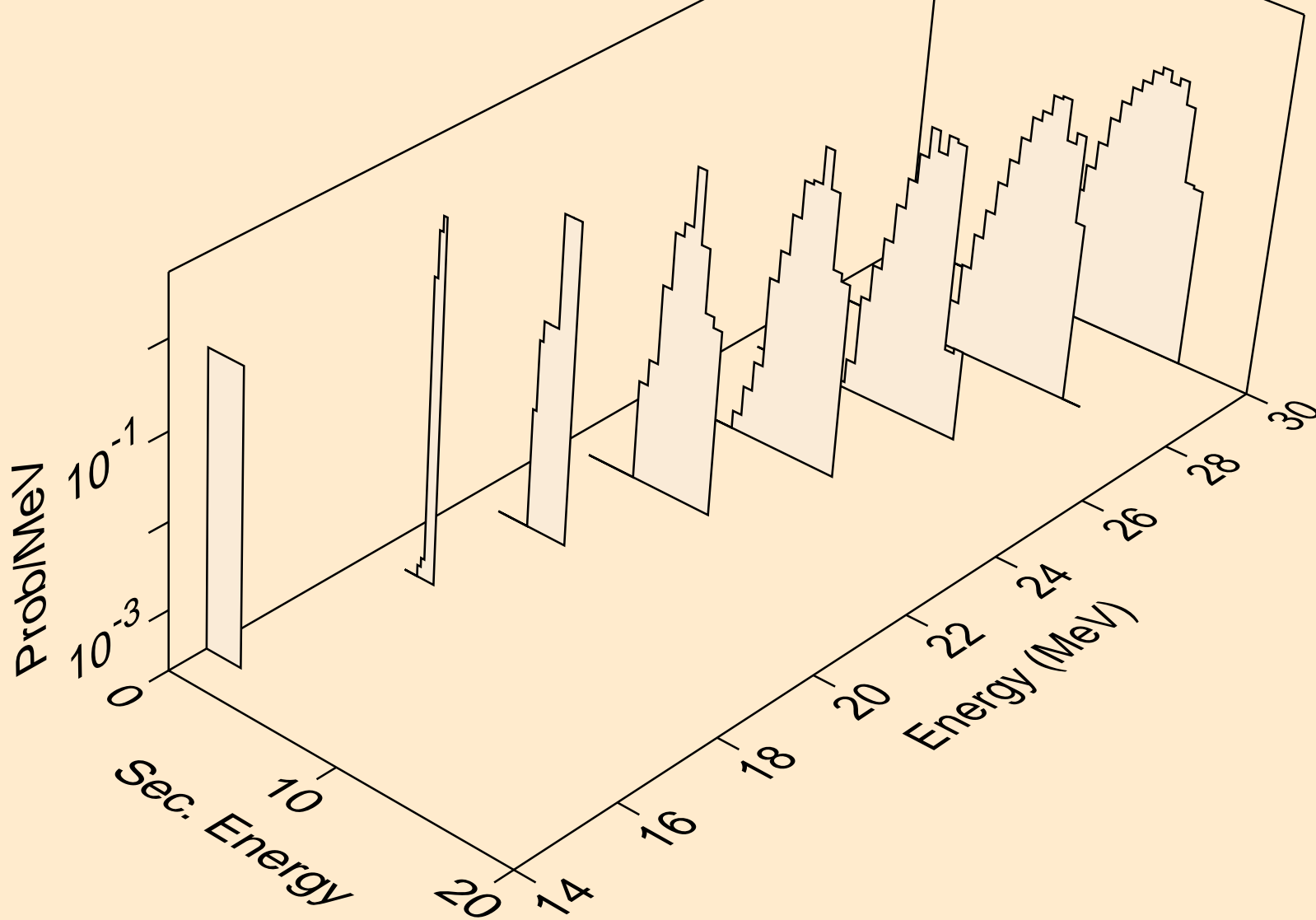

SG265 NEUTRON ACER TENDL-2019 LIBRARY; T=293.16K
deuterons from (n,n*)d

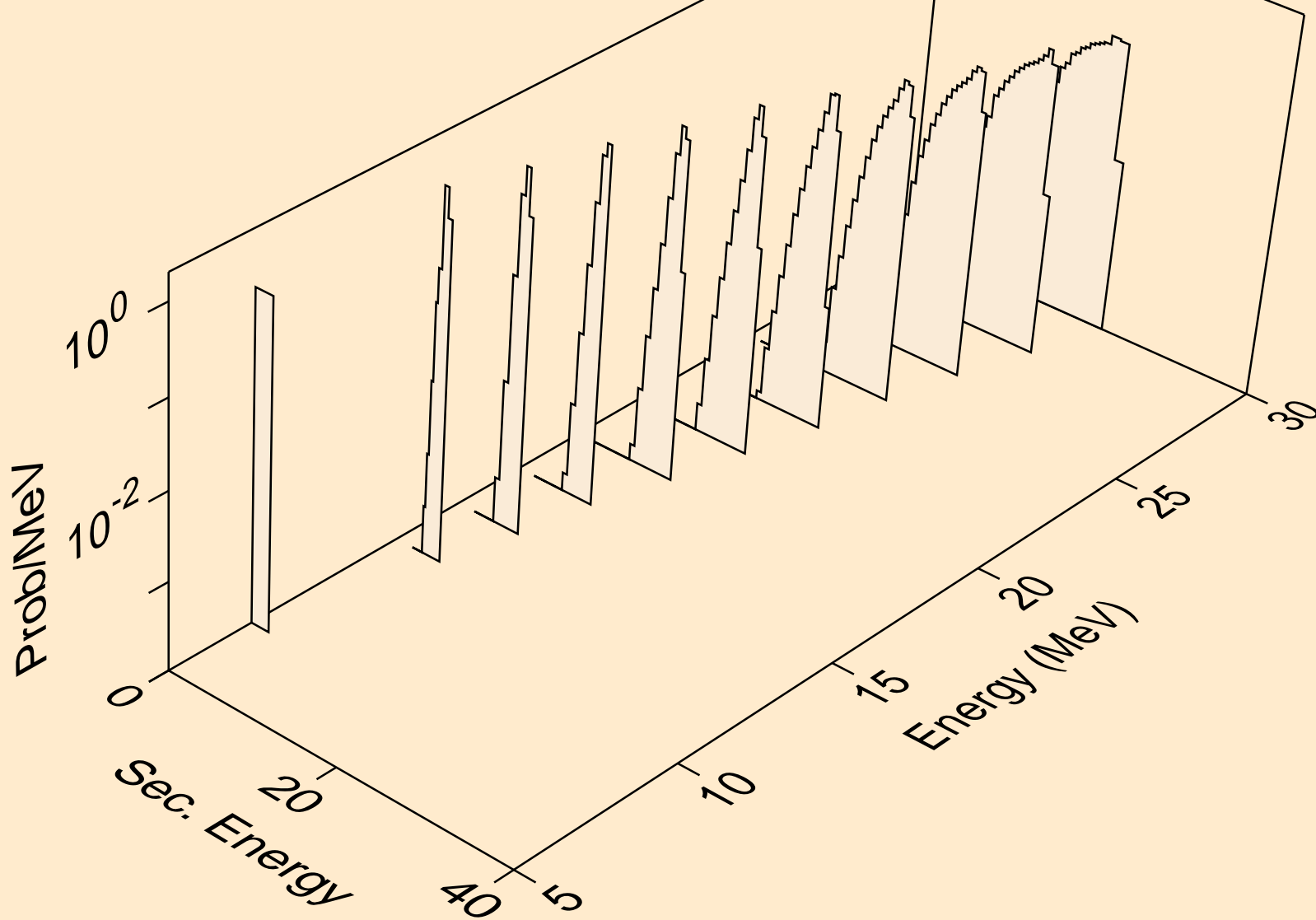

SG265 NEUTRON ACER TENDL-2019 LIBRARY; T=293.16K
deuterons from (n,d)

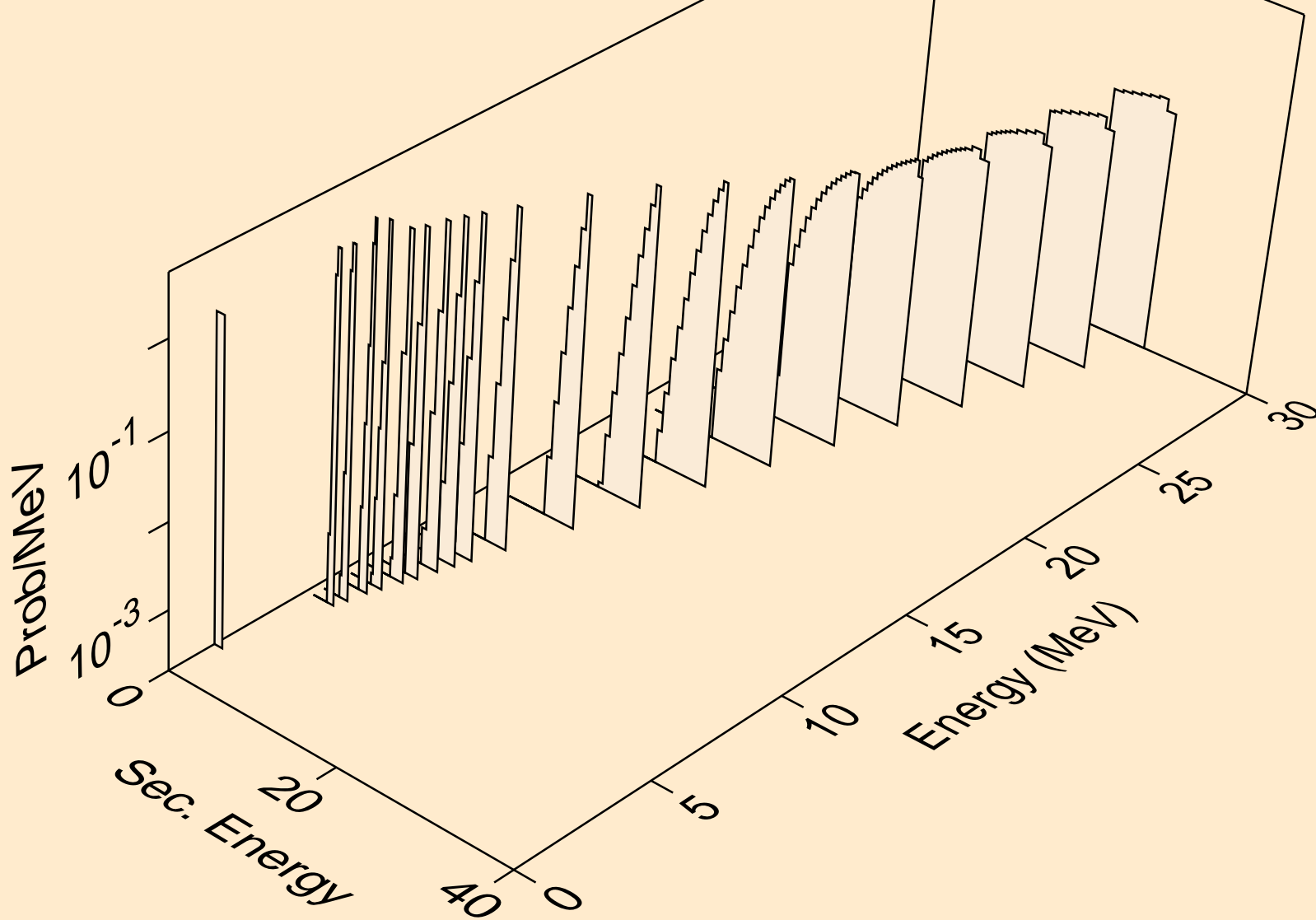

SG265 NEUTRON ACER TENDL-2019 LIBRARY; T=293.16K
deuterons from (n,pd)

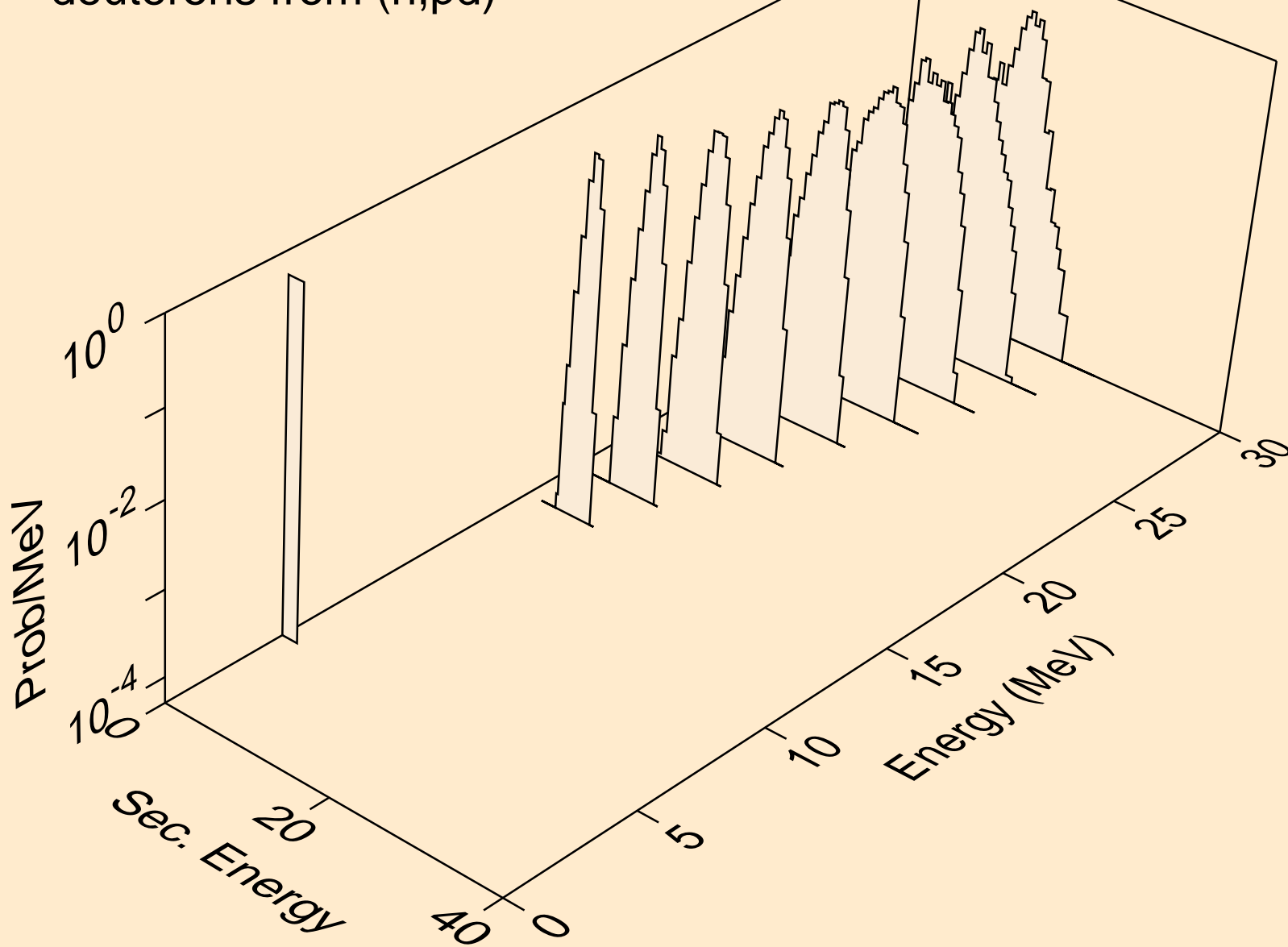

SG265 NEUTRON ACER TENDL-2019 LIBRARY; T=293.16K
deuterons from (n,da)

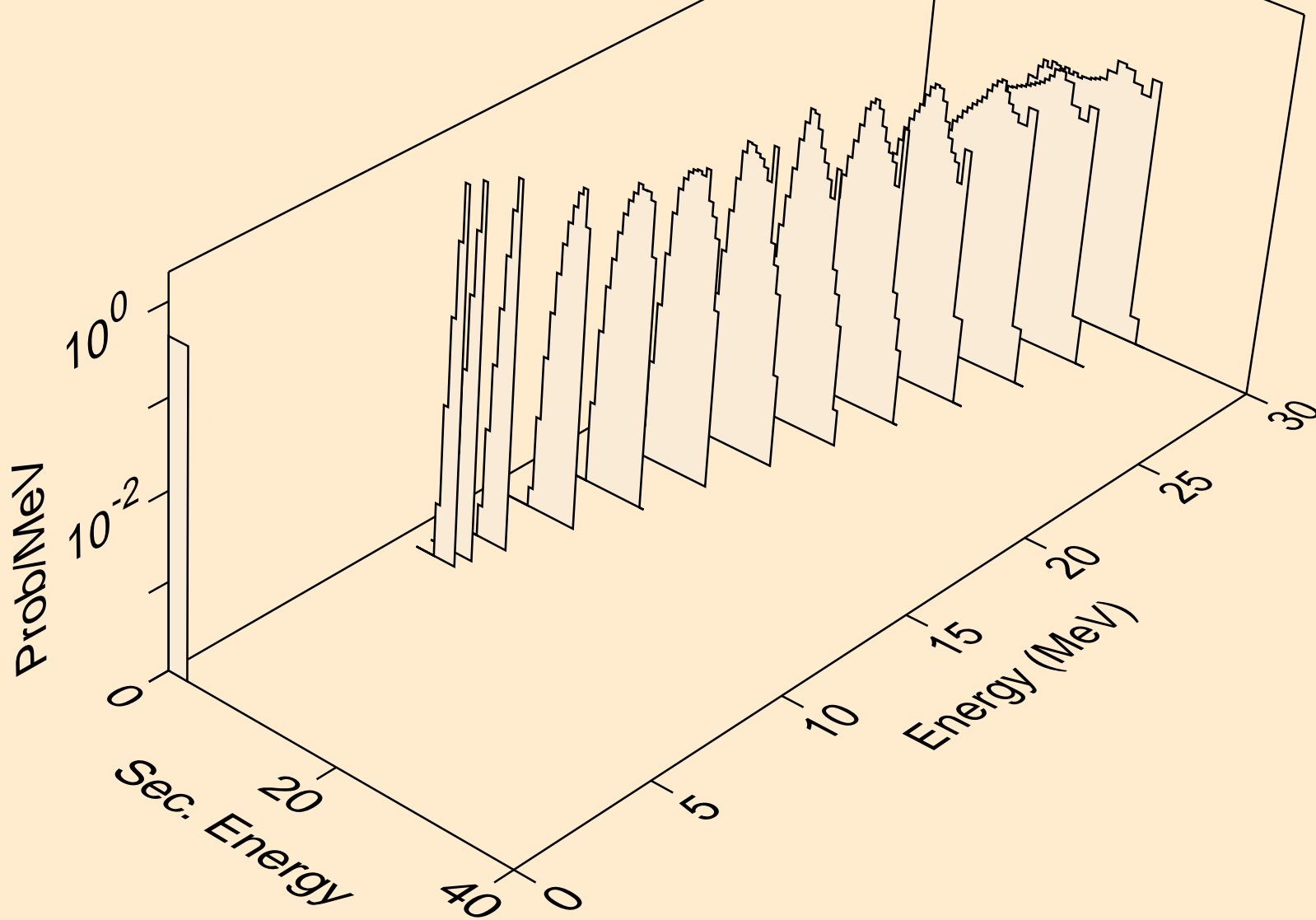

SG265 NEUTRON ACER TENDL-2019 LIBRARY; T=293.16K
tritons from (n,x)

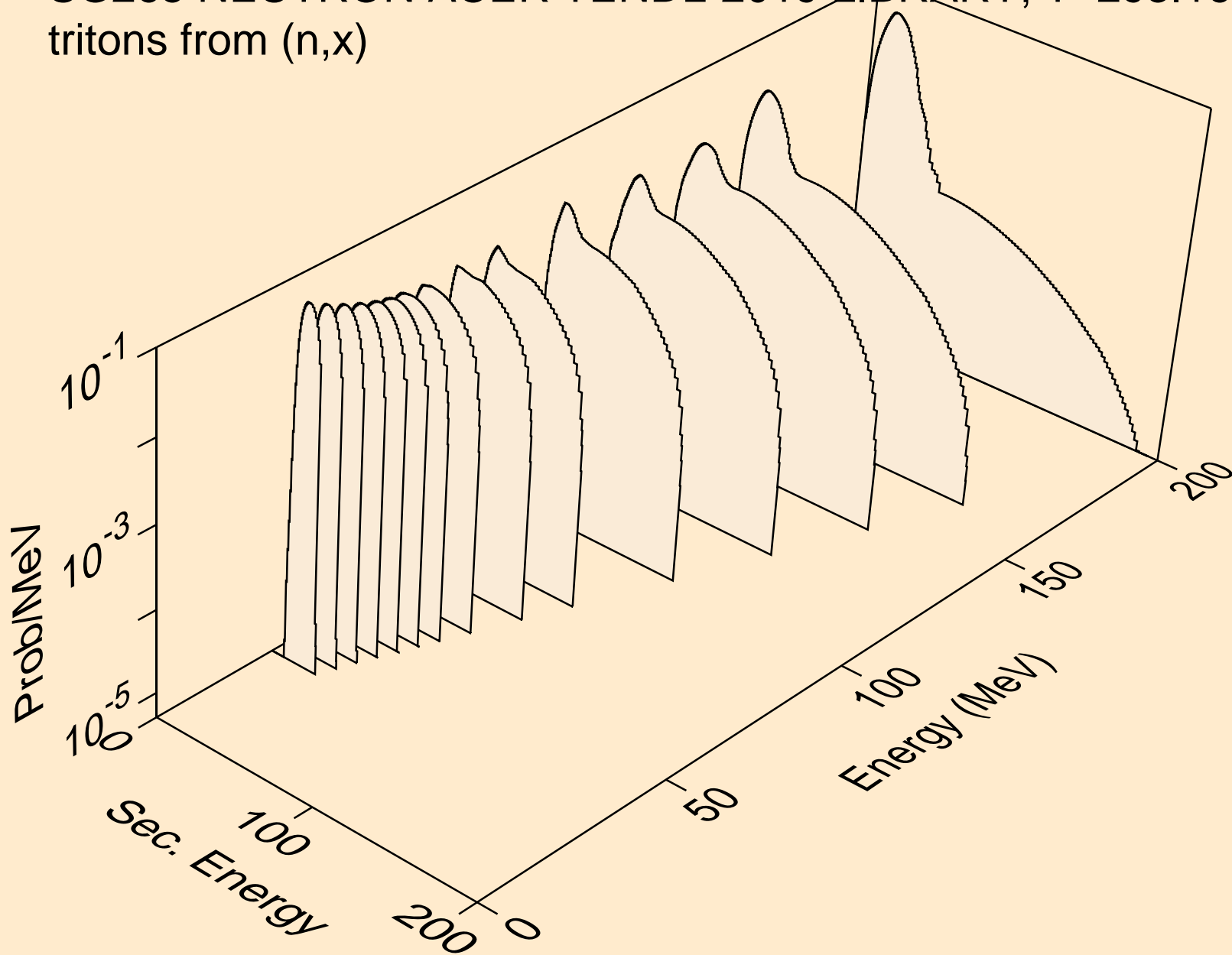

SG265 NEUTRON ACER TENDL-2019 LIBRARY; T=293.16K
tritons from (n,n*)t

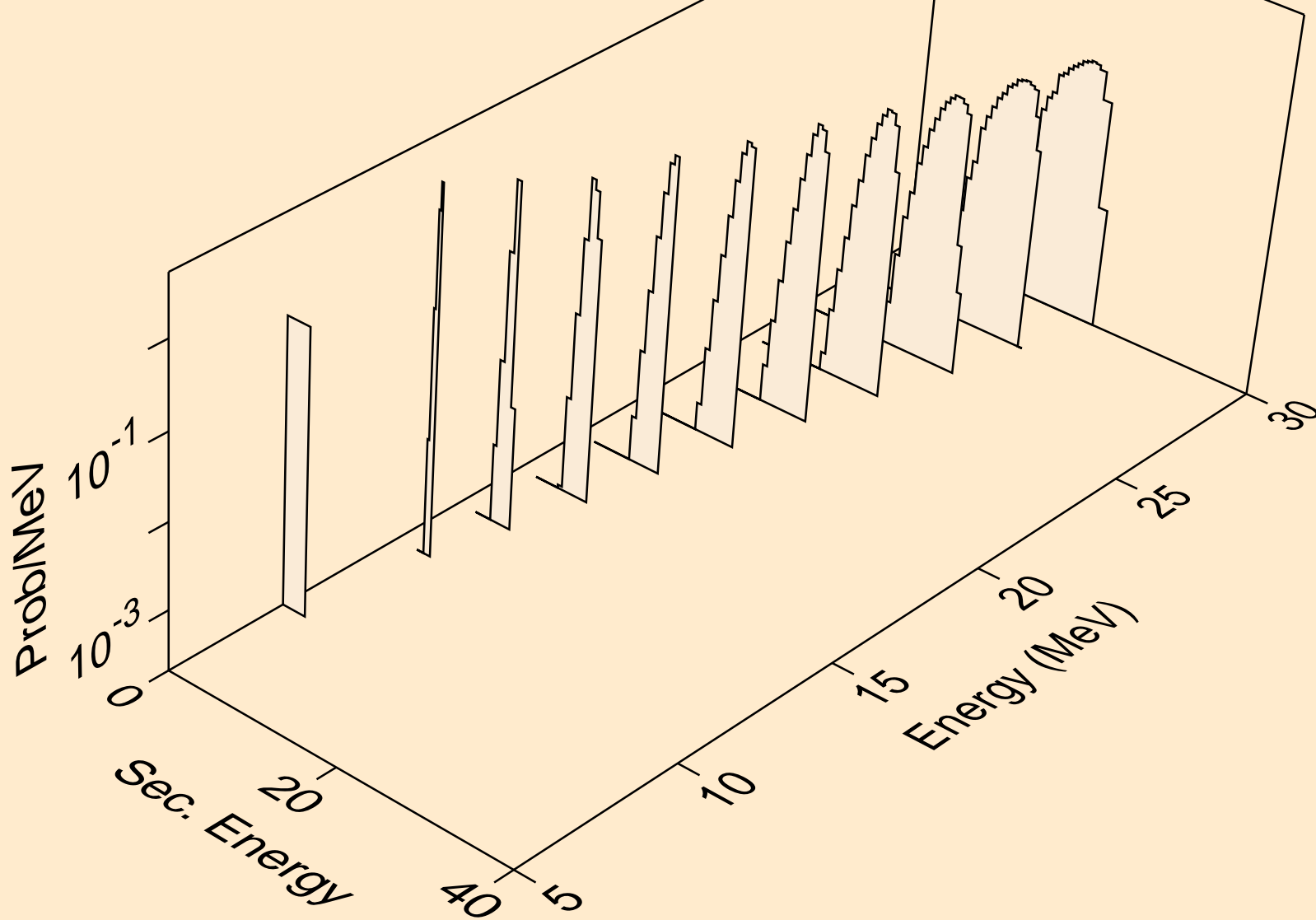

SG265 NEUTRON ACER TENDL-2019 LIBRARY; T=293.16K
tritons from (n,n*)t2a

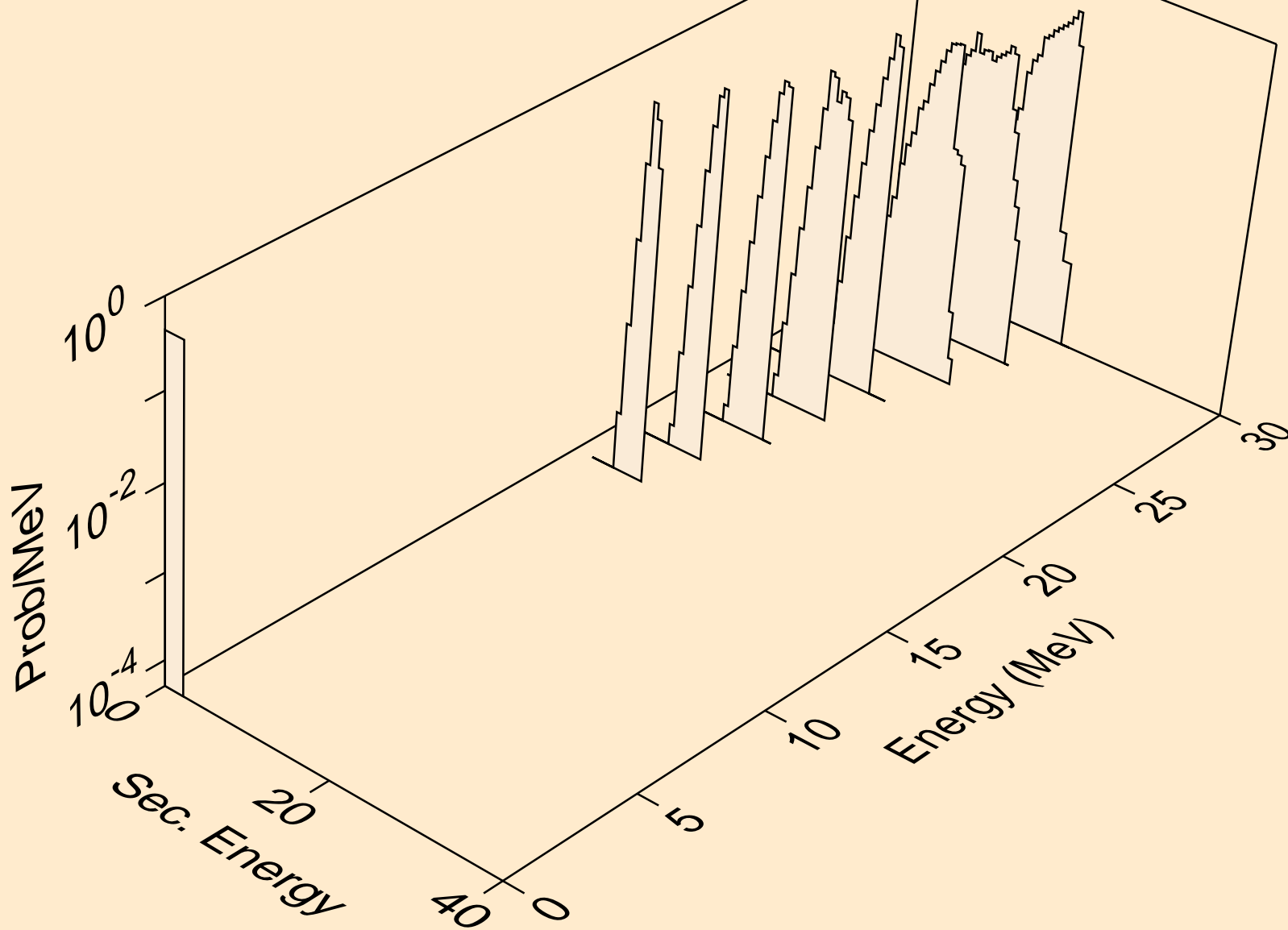

SG265 NEUTRON ACER TENDL-2019 LIBRARY; T=293.16K
tritons from (n,t)

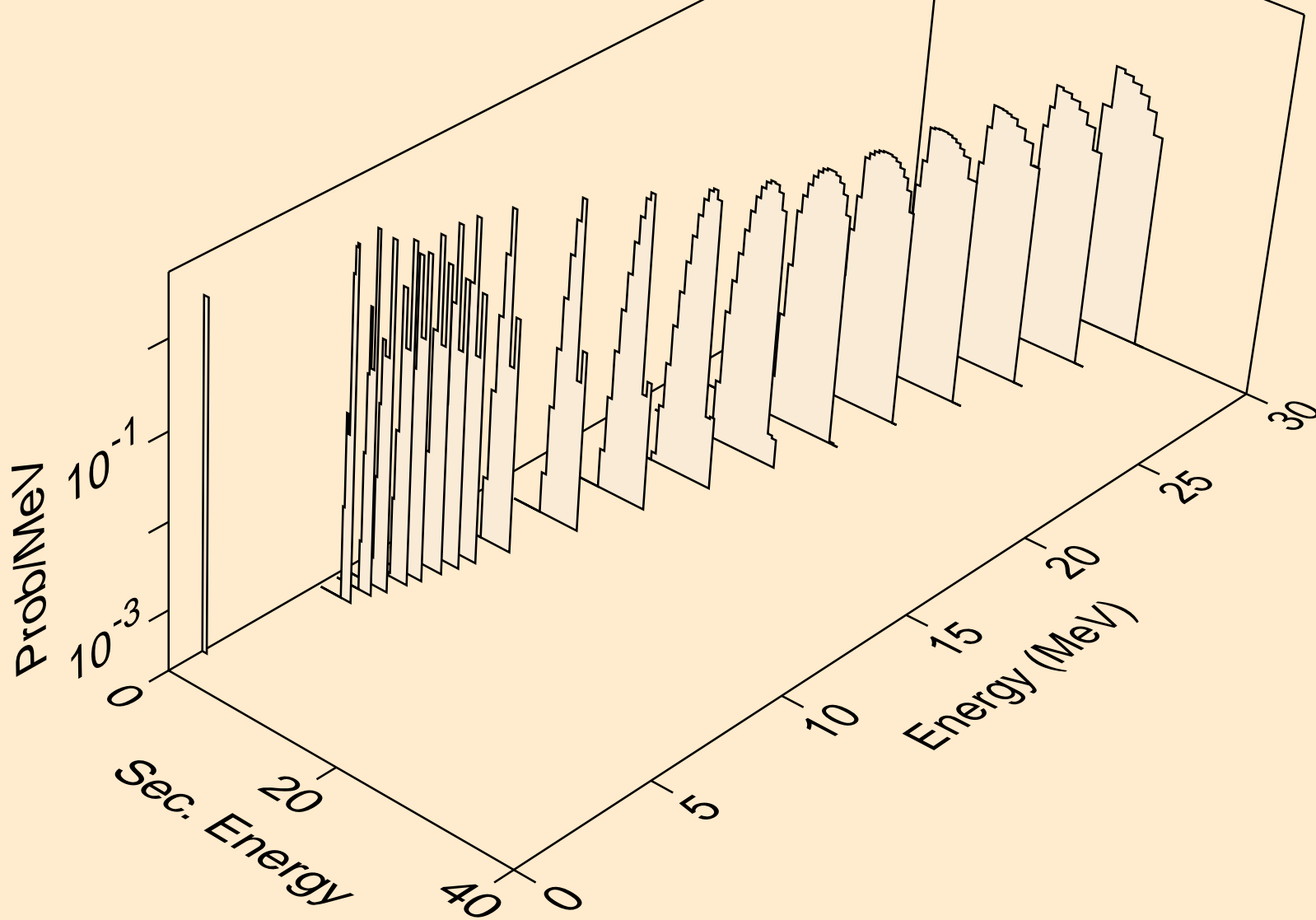

SG265 NEUTRON ACER TENDL-2019 LIBRARY; T=293.16K
he3s from (n,x)

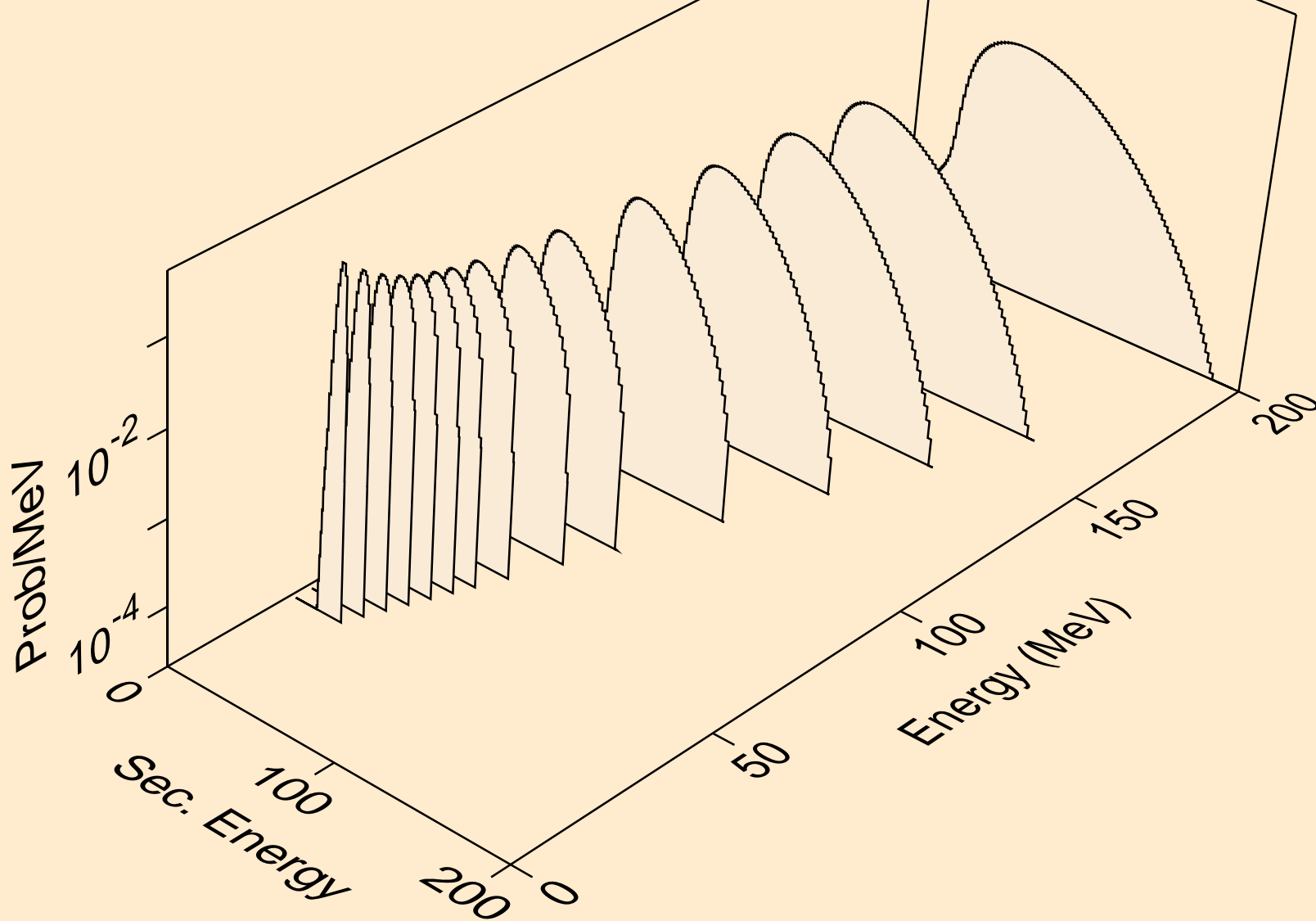

SG265 NEUTRON ACER TENDL-2019 LIBRARY; T=293.16K
he3s from (n,n*)he3

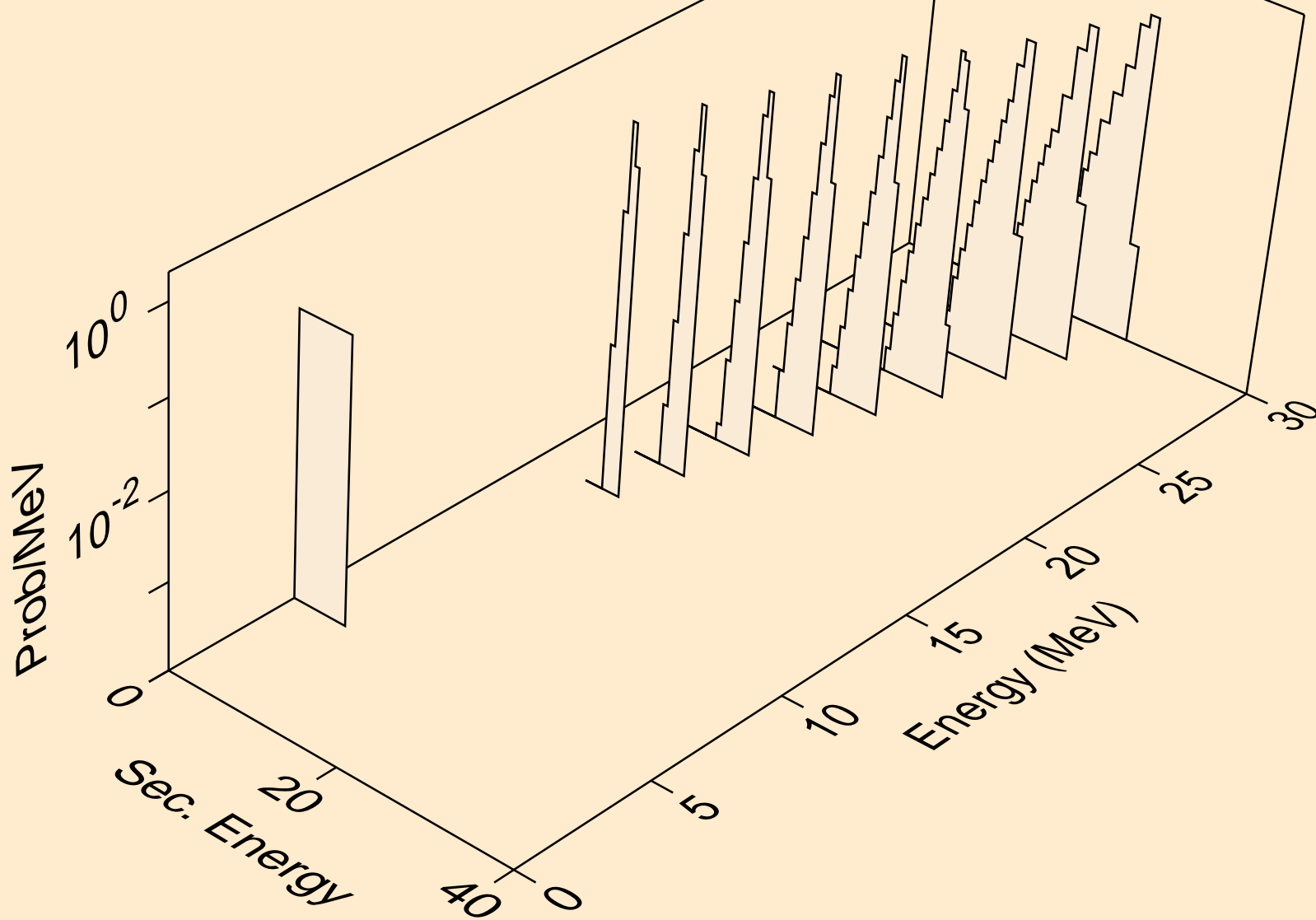

SG265 NEUTRON ACER TENDL-2019 LIBRARY; T=293.16K
he3s from (n,he3)

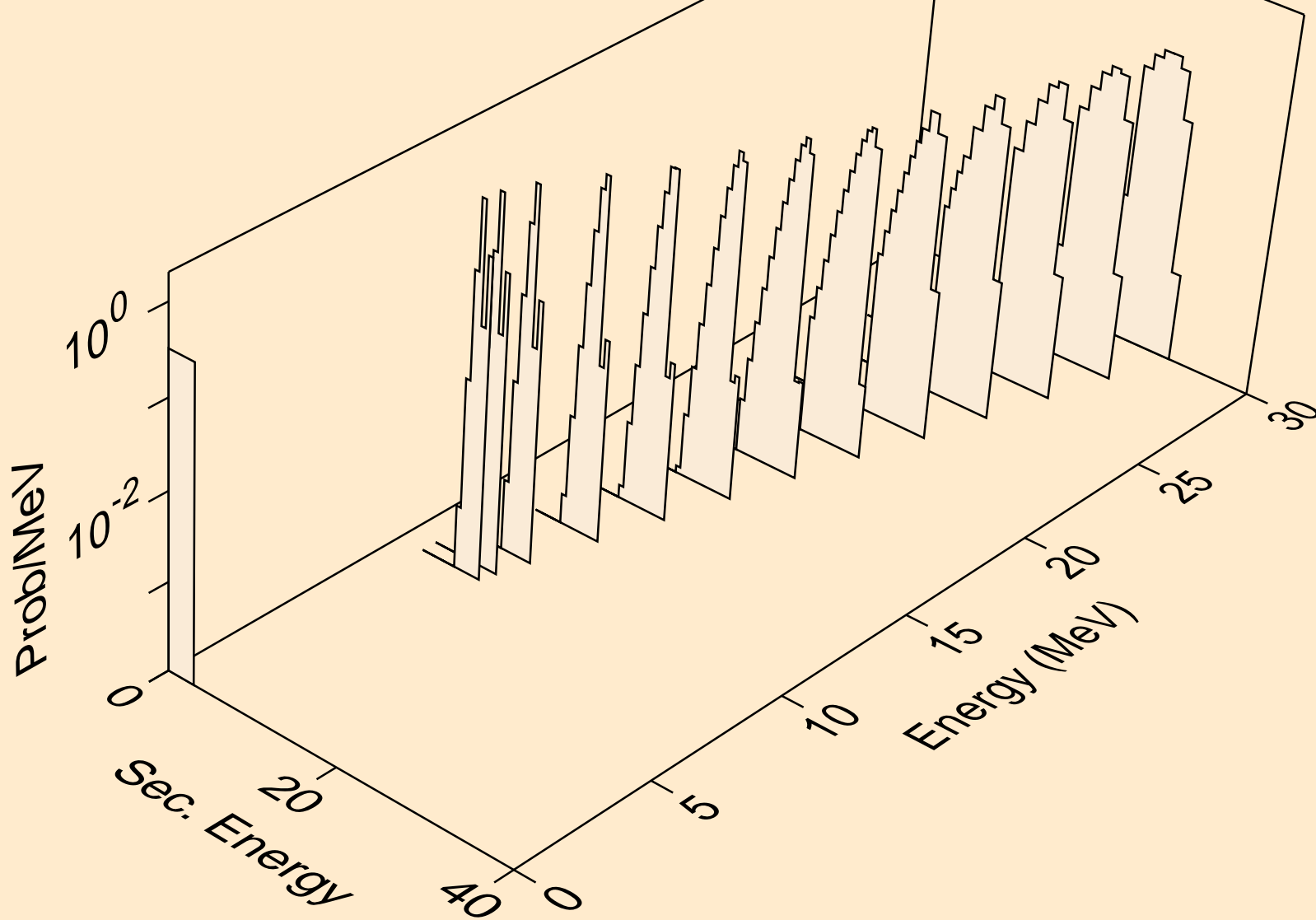

SG265 NEUTRON ACER TENDL-2019 LIBRARY; T=293.16K
alphas from (n,x)

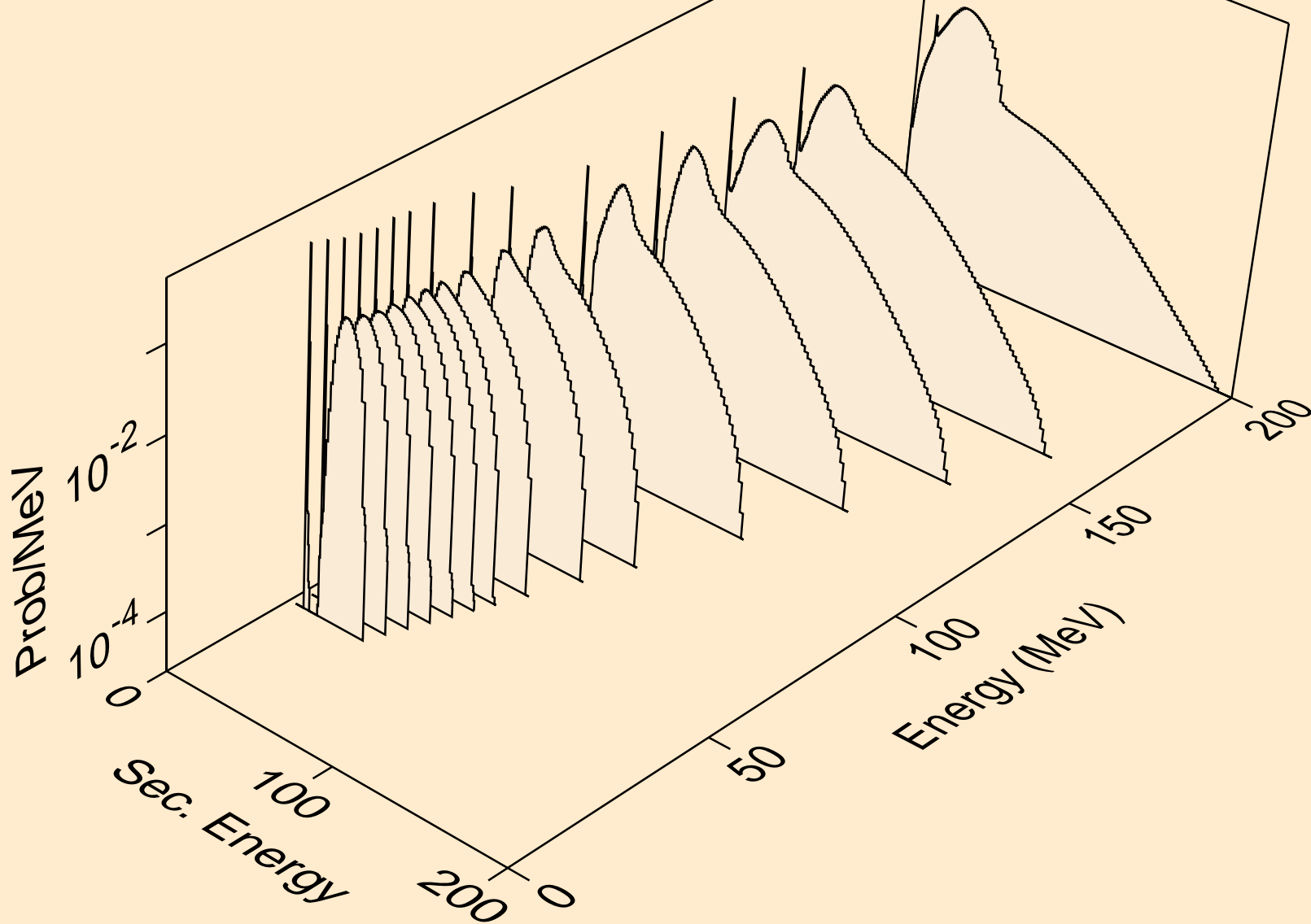

SG265 NEUTRON ACER TENDL-2019 LIBRARY; T=293.16K
alphas from (n,n*)a

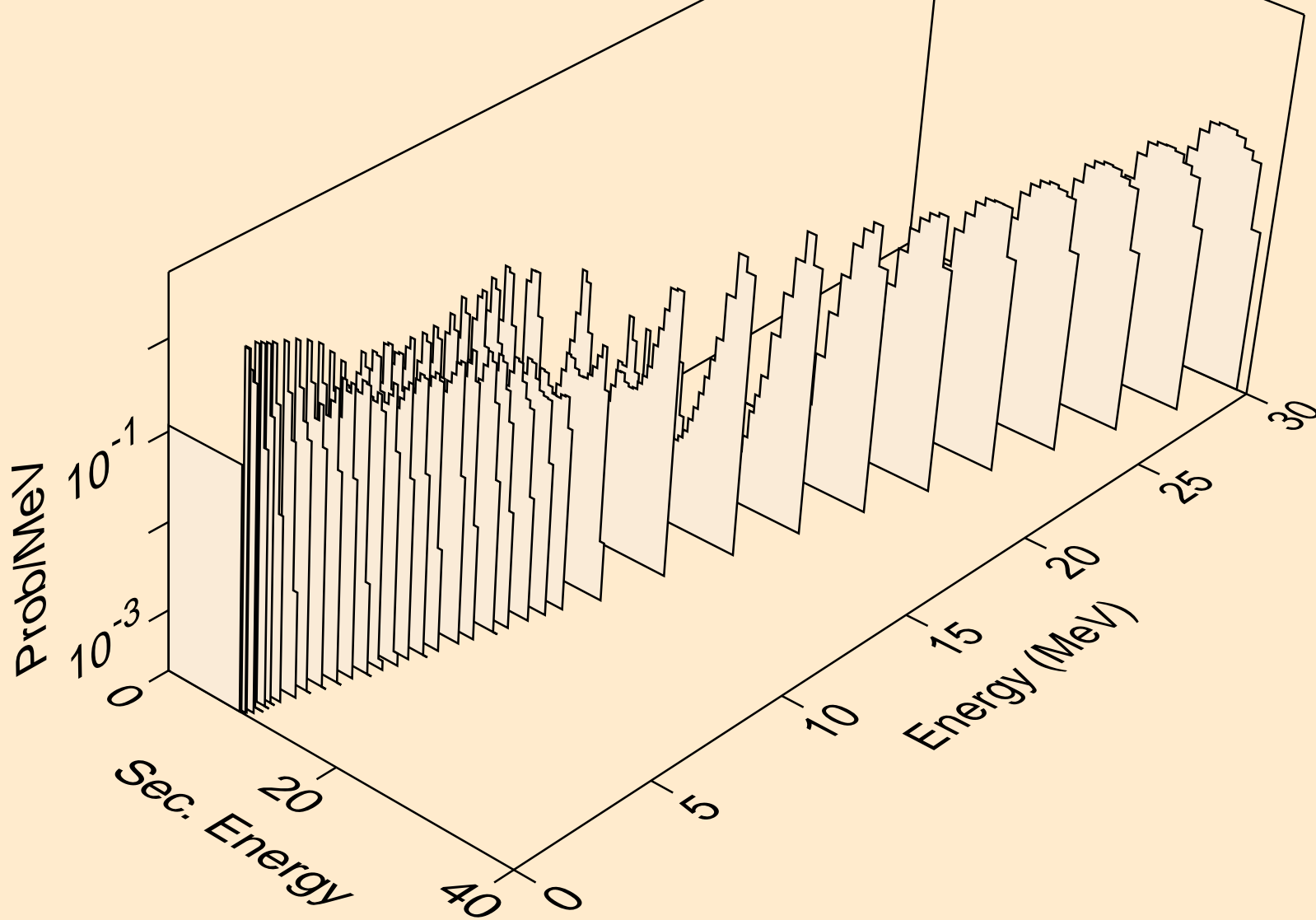

SG265 NEUTRON ACER TENDL-2019 LIBRARY; T=293.16K
alphas from (n,2n)a

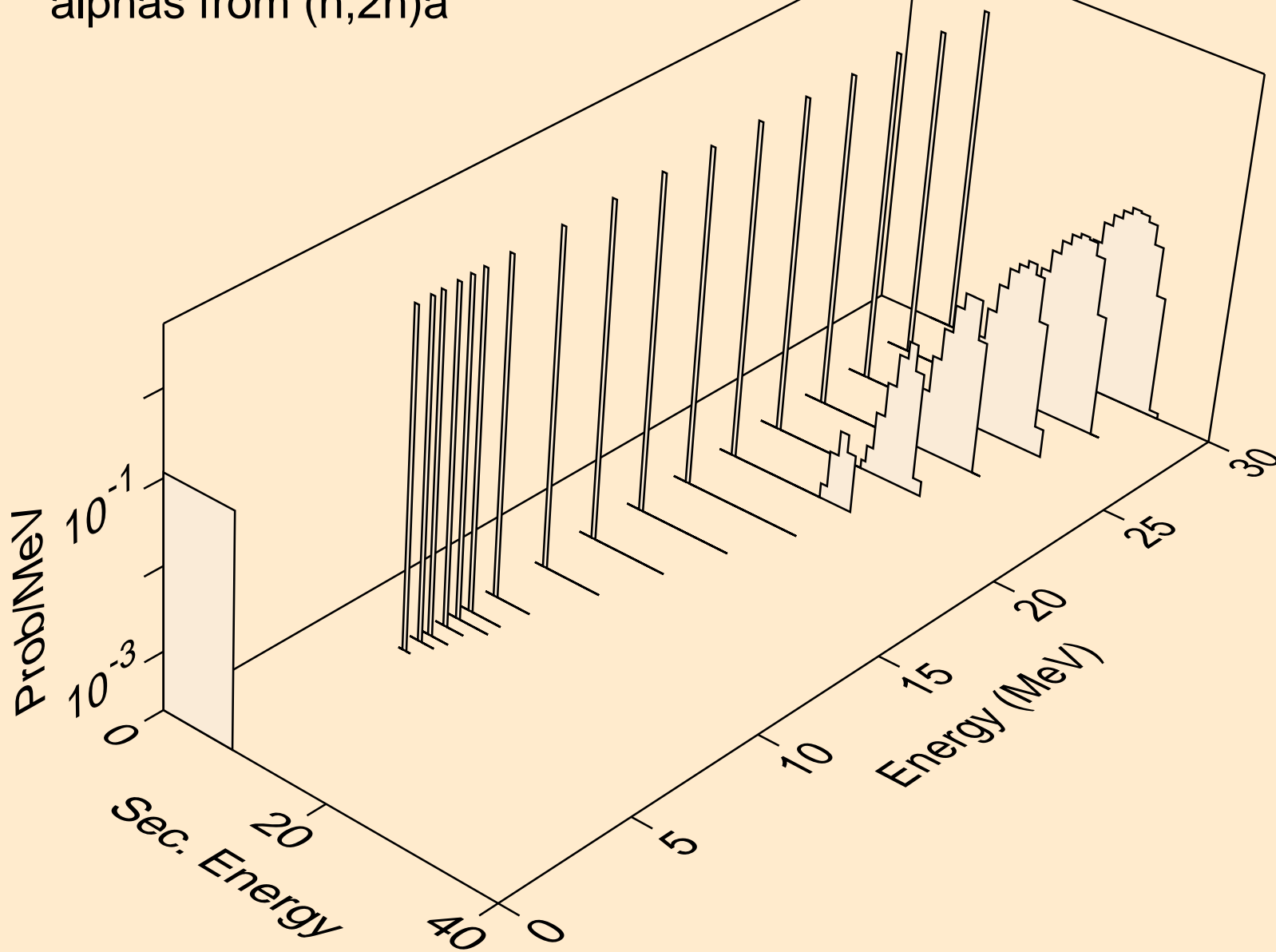

SG265 NEUTRON ACER TENDL-2019 LIBRARY; T=293.16K
alphas from (n,3n)a

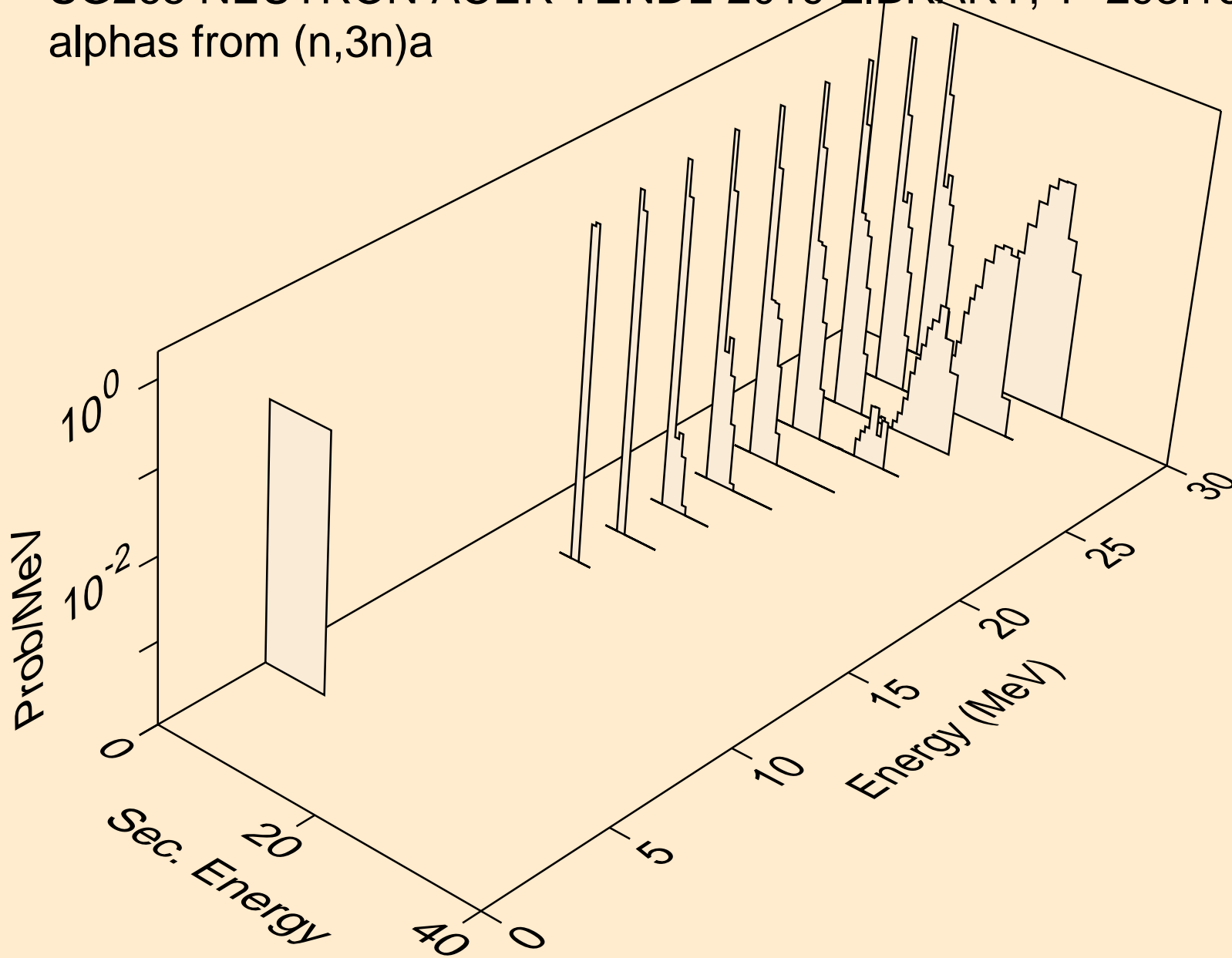

SG265 NEUTRON ACER TENDL-2019 LIBRARY; T=293.16K
alphas from (n,n*)2a

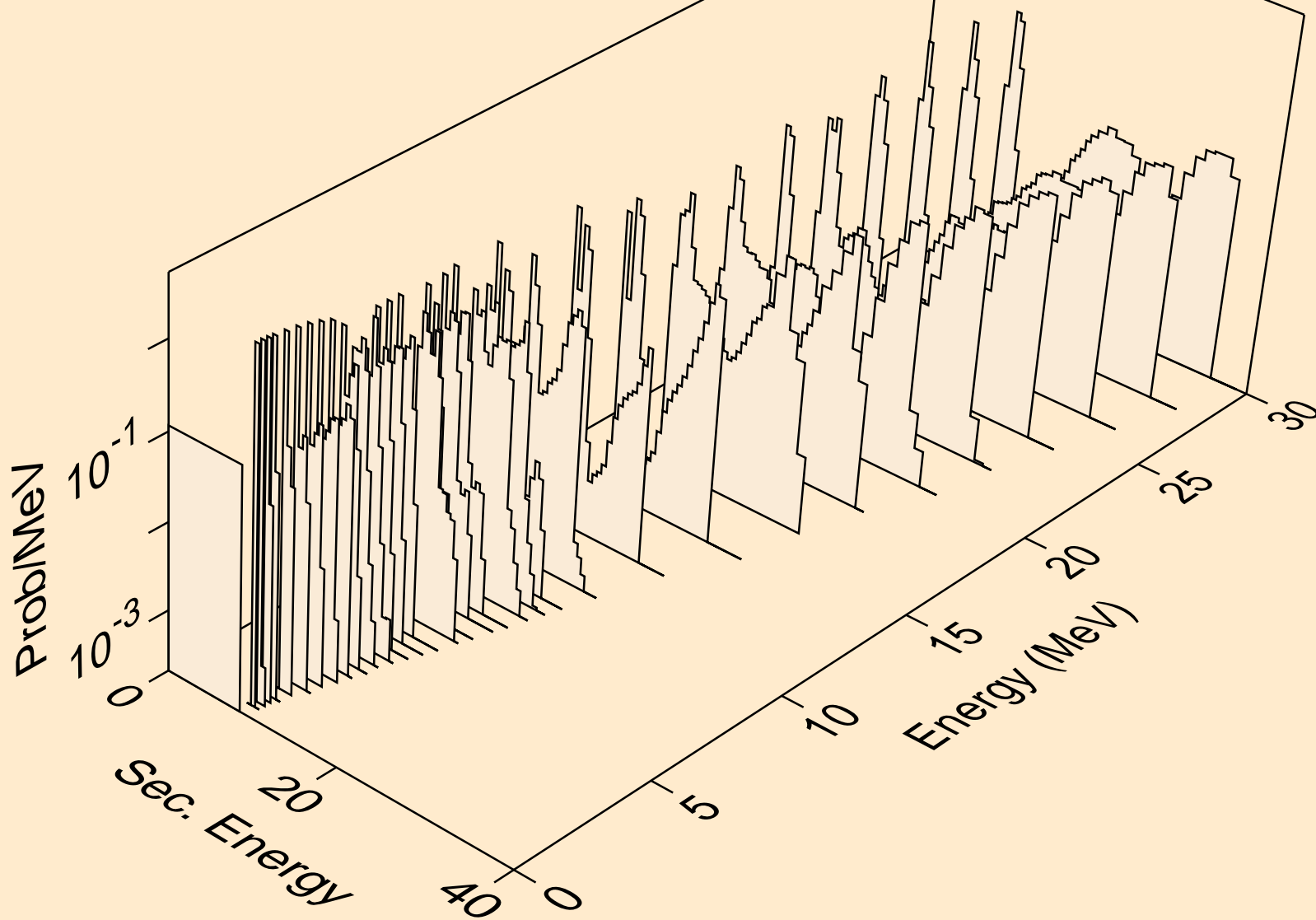

SG265 NEUTRON ACER TENDL-2019 LIBRARY; T=293.16K
alphas from (n,2n)2a

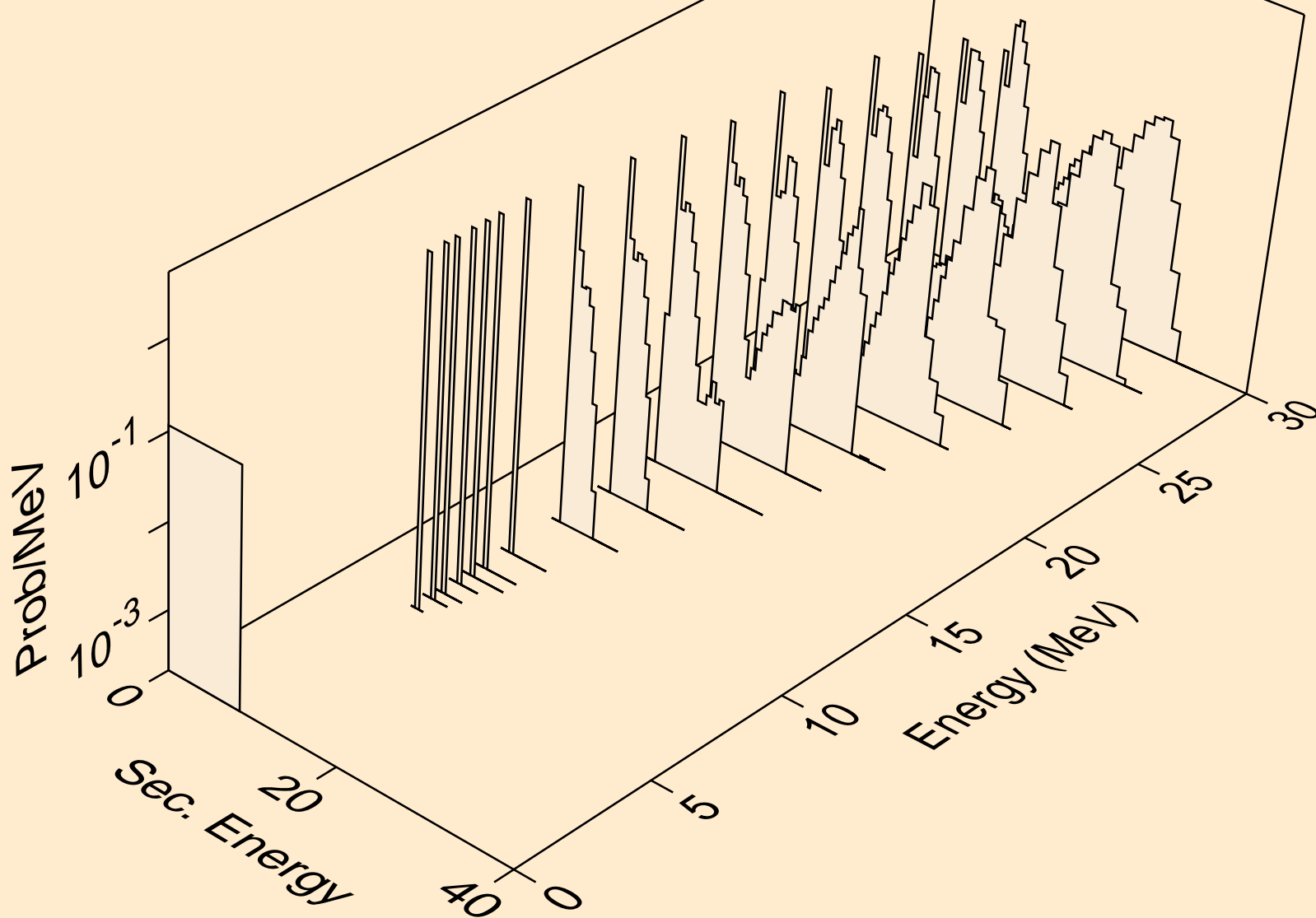

SG265 NEUTRON ACER TENDL-2019 LIBRARY; T=293.16K
alphas from (n,n*)t2a

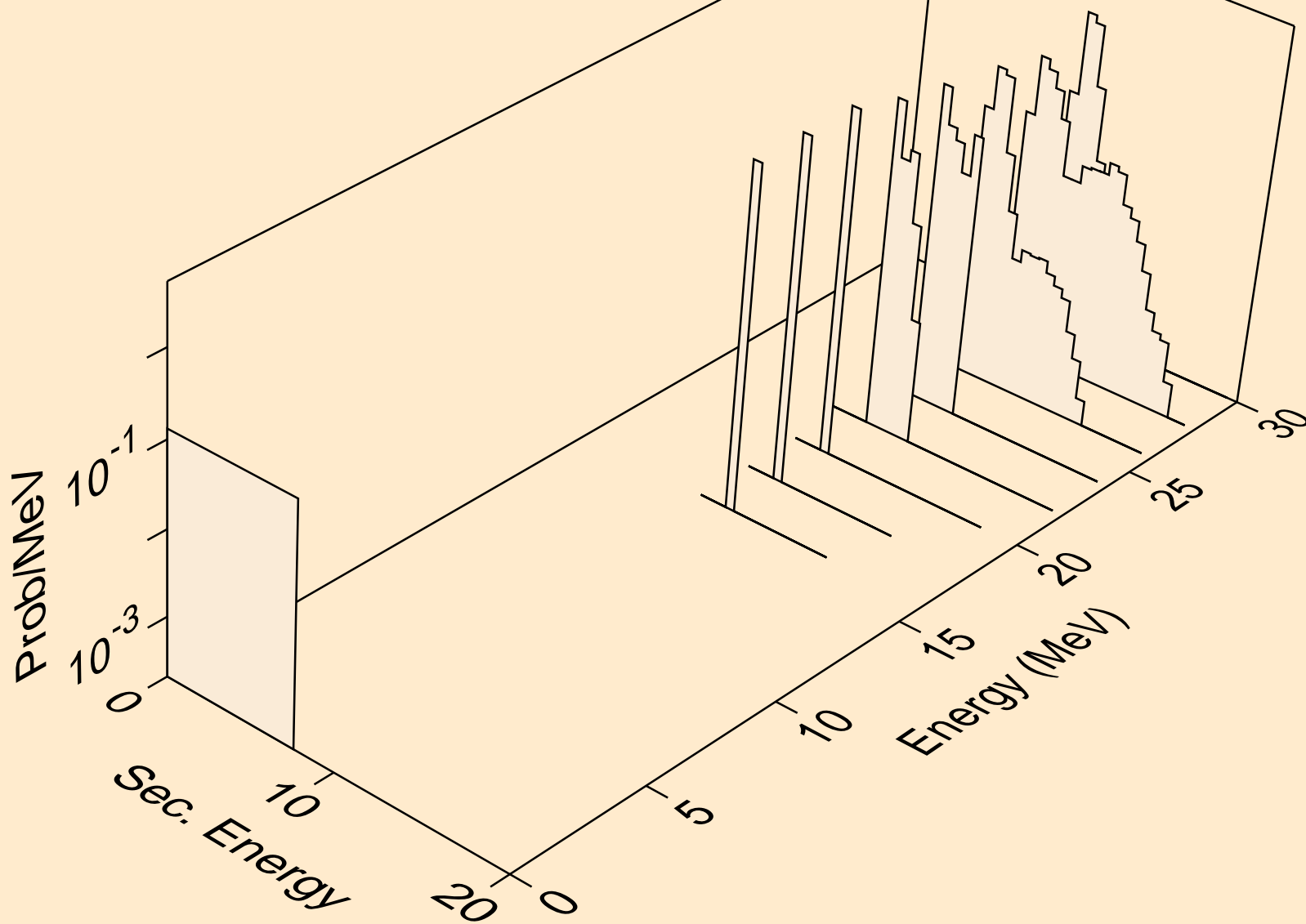

SG265 NEUTRON ACER TENDL-2019 LIBRARY; T=293.16K
alphas from (n,npa)

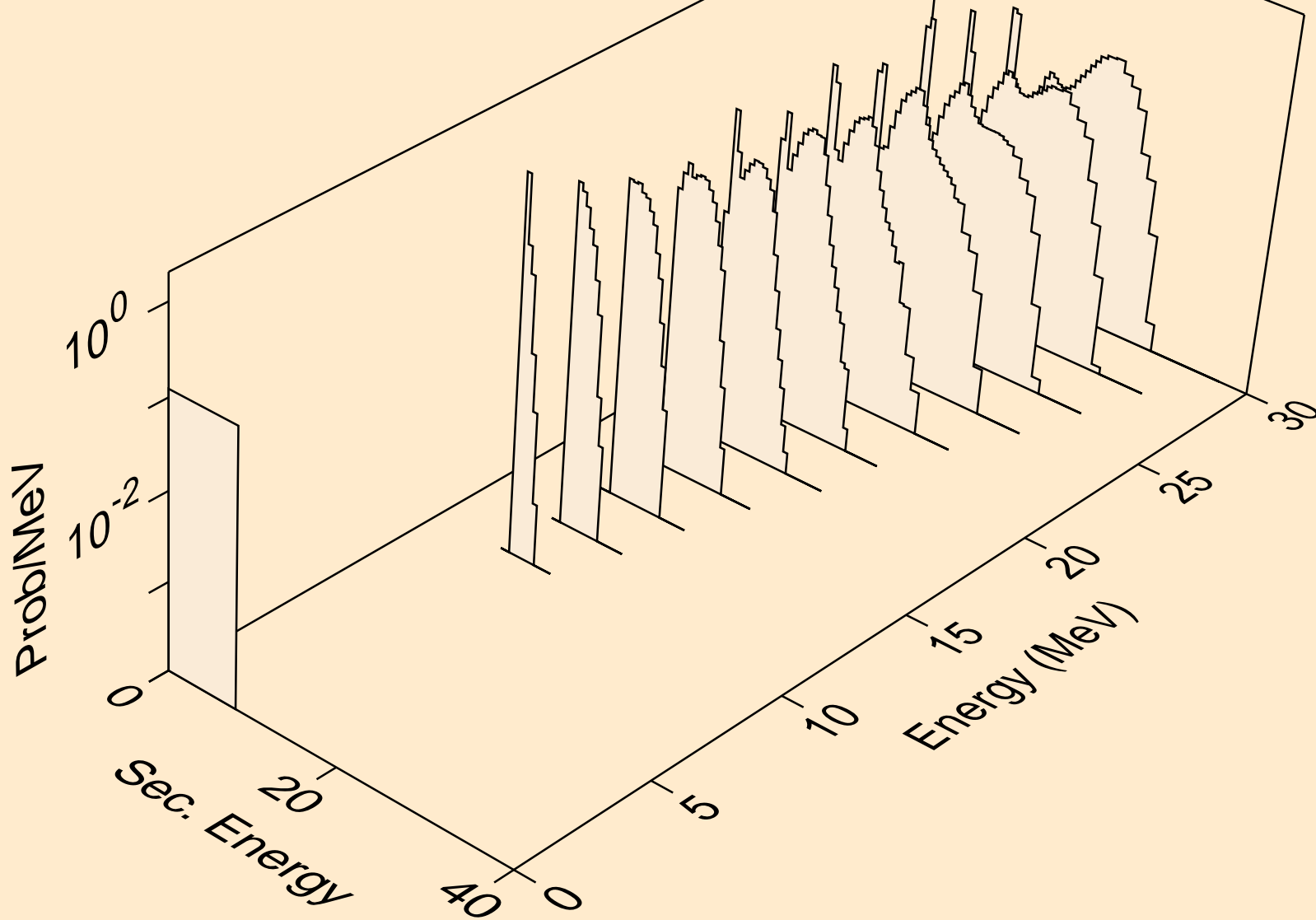

SG265 NEUTRON ACER TENDL-2019 LIBRARY; T=293.16K
alphas from (n,a)

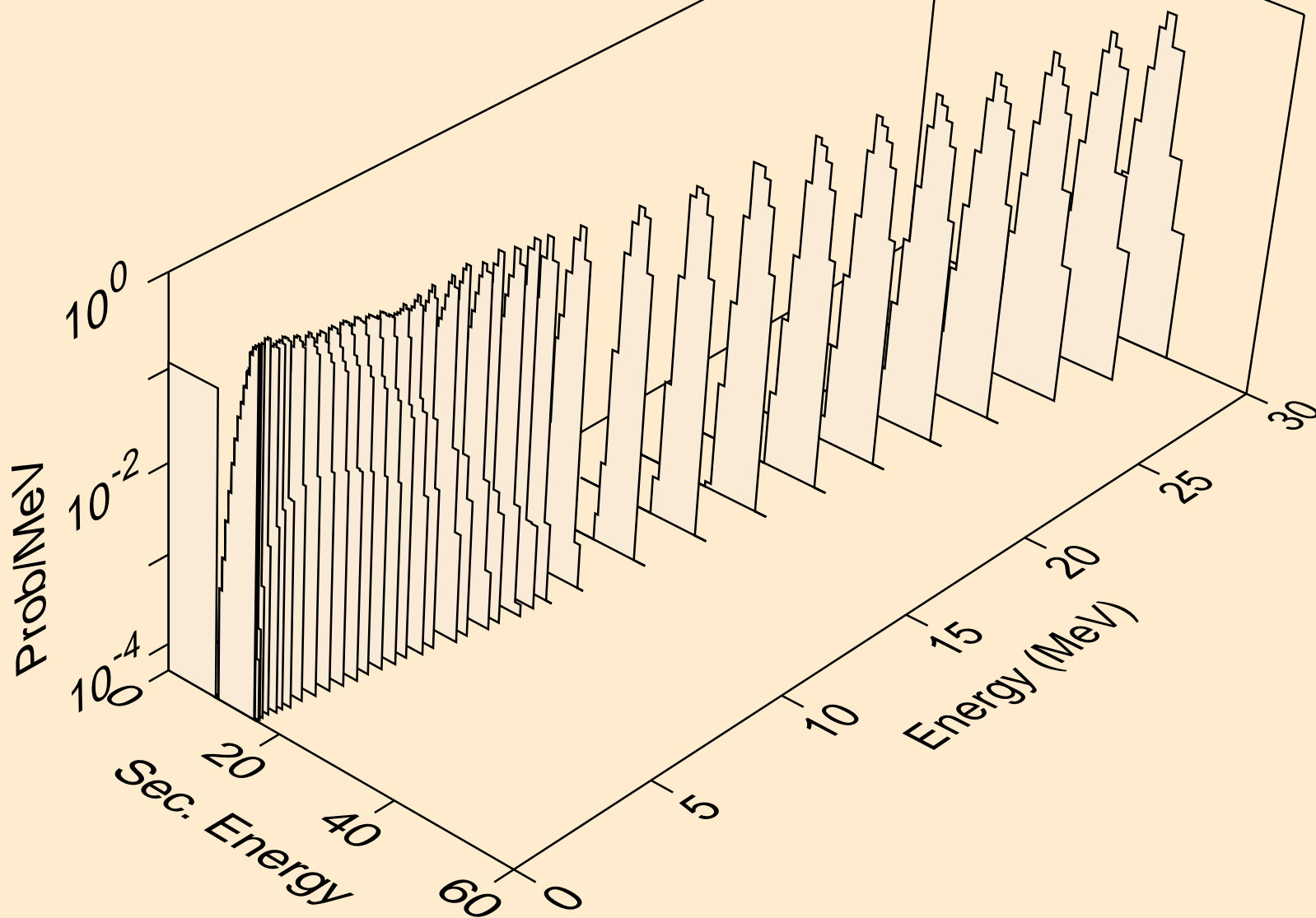

SG265 NEUTRON ACER TENDL-2019 LIBRARY; T=293.16K
alphas from (n,2a)

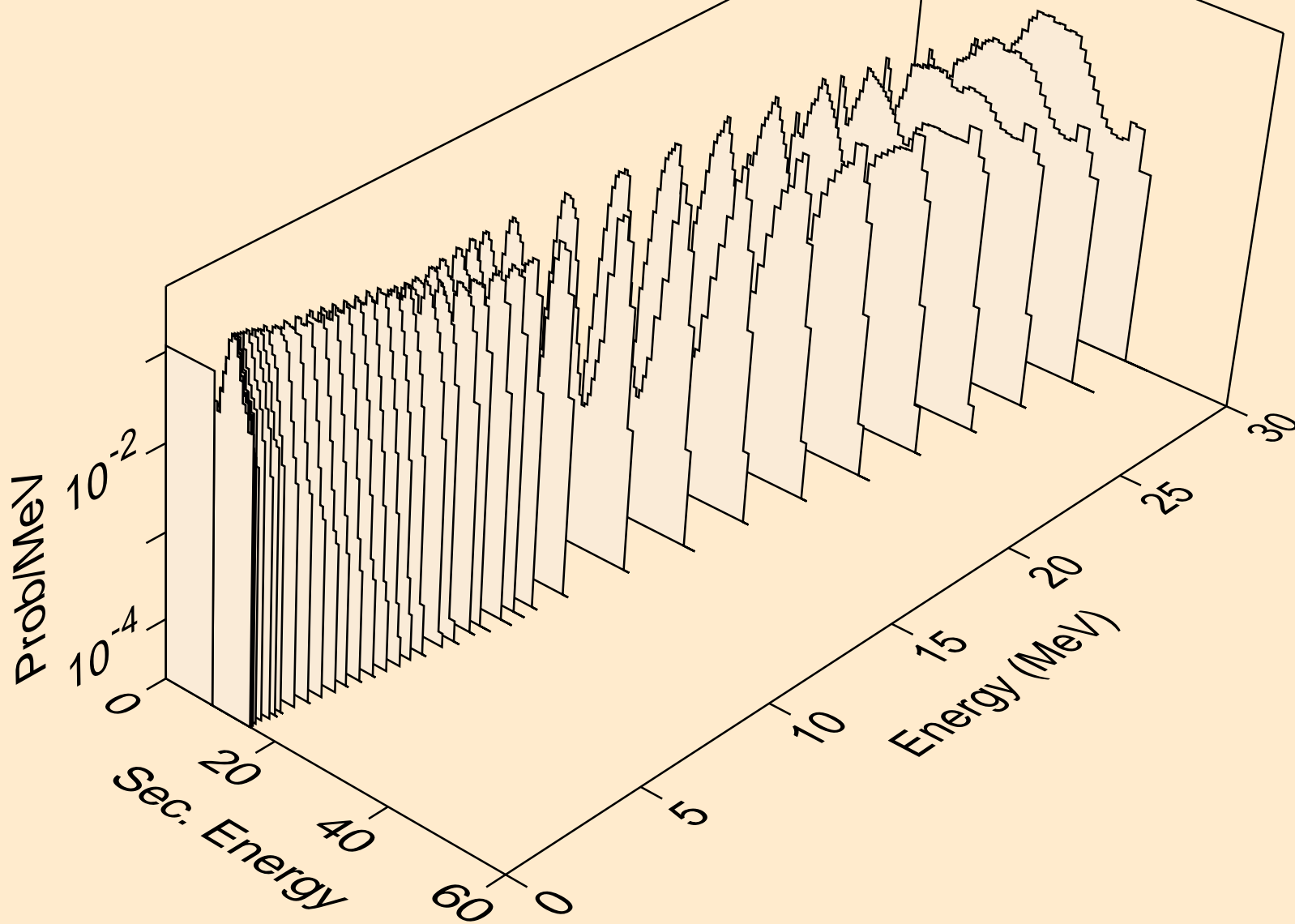

SG265 NEUTRON ACER TENDL-2019 LIBRARY; T=293.16K
alphas from (n,pa)

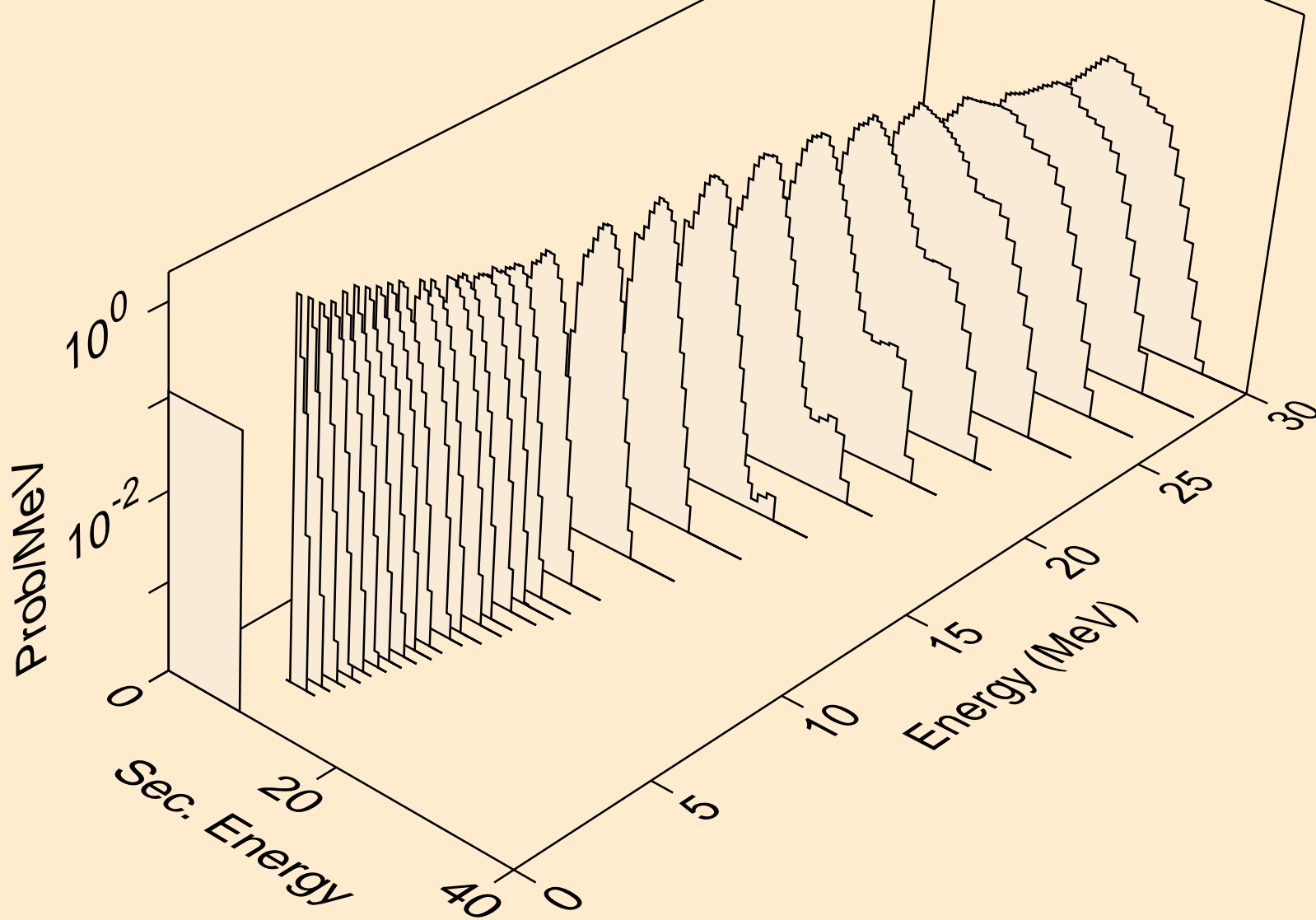

SG265 NEUTRON ACER TENDL-2019 LIBRARY; T=293.16K
alphas from (n,da)

