

SG271 NEUTRON ACER TENDL-2019 LIBRARY; T=293.16K

Principal cross sections

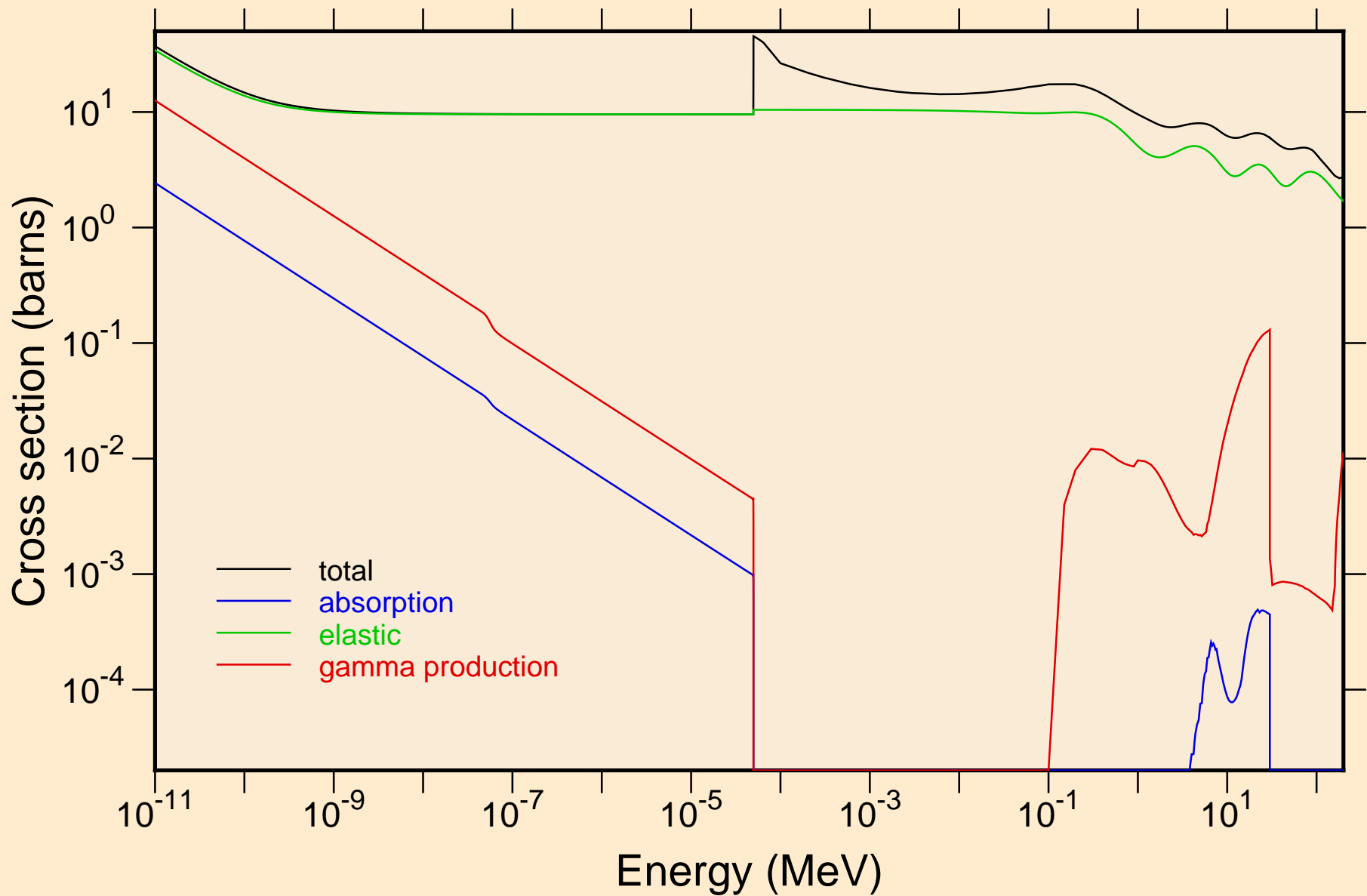

SG271 NEUTRON ACER TENDL-2019 LIBRARY; T=293.16K
Heating

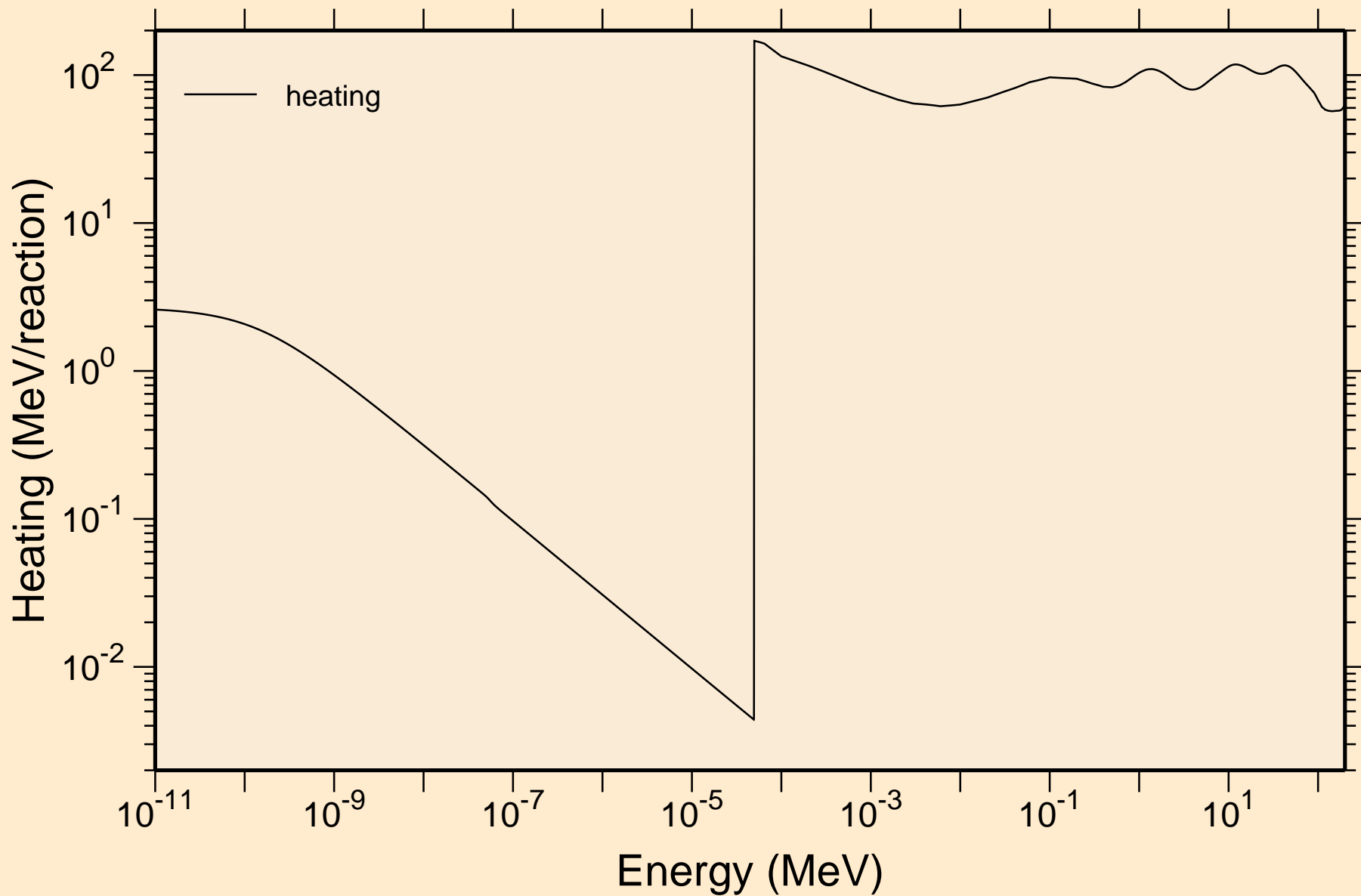

SG271 NEUTRON ACER TENDL-2019 LIBRARY; T=293.16K

Damage

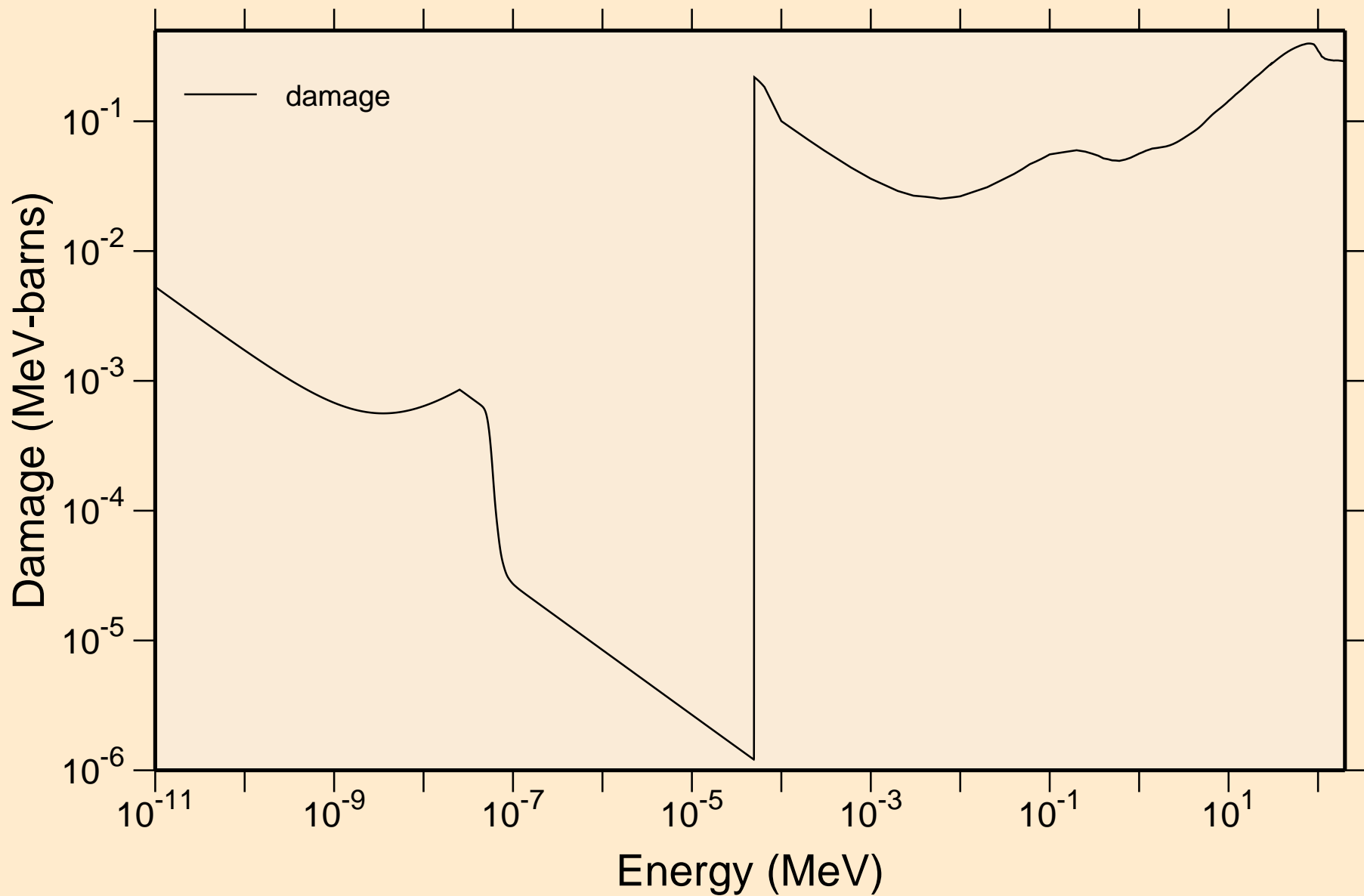

SG271 NEUTRON ACER TENDL-2019 LIBRARY; T=293.16K
Non-threshold reactions

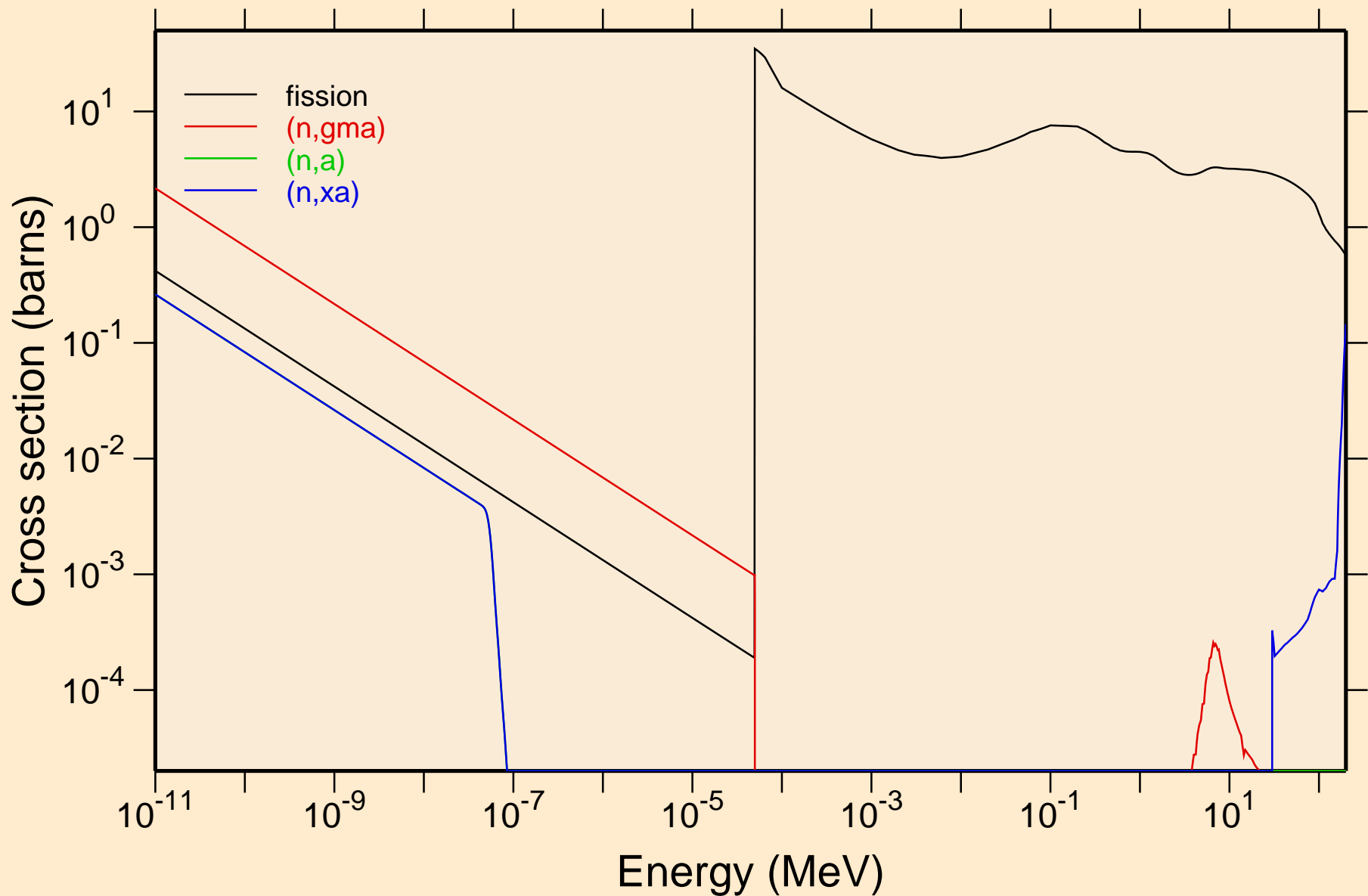

SG271 NEUTRON ACER TENDL-2019 LIBRARY; T=293.16K

Principal cross sections

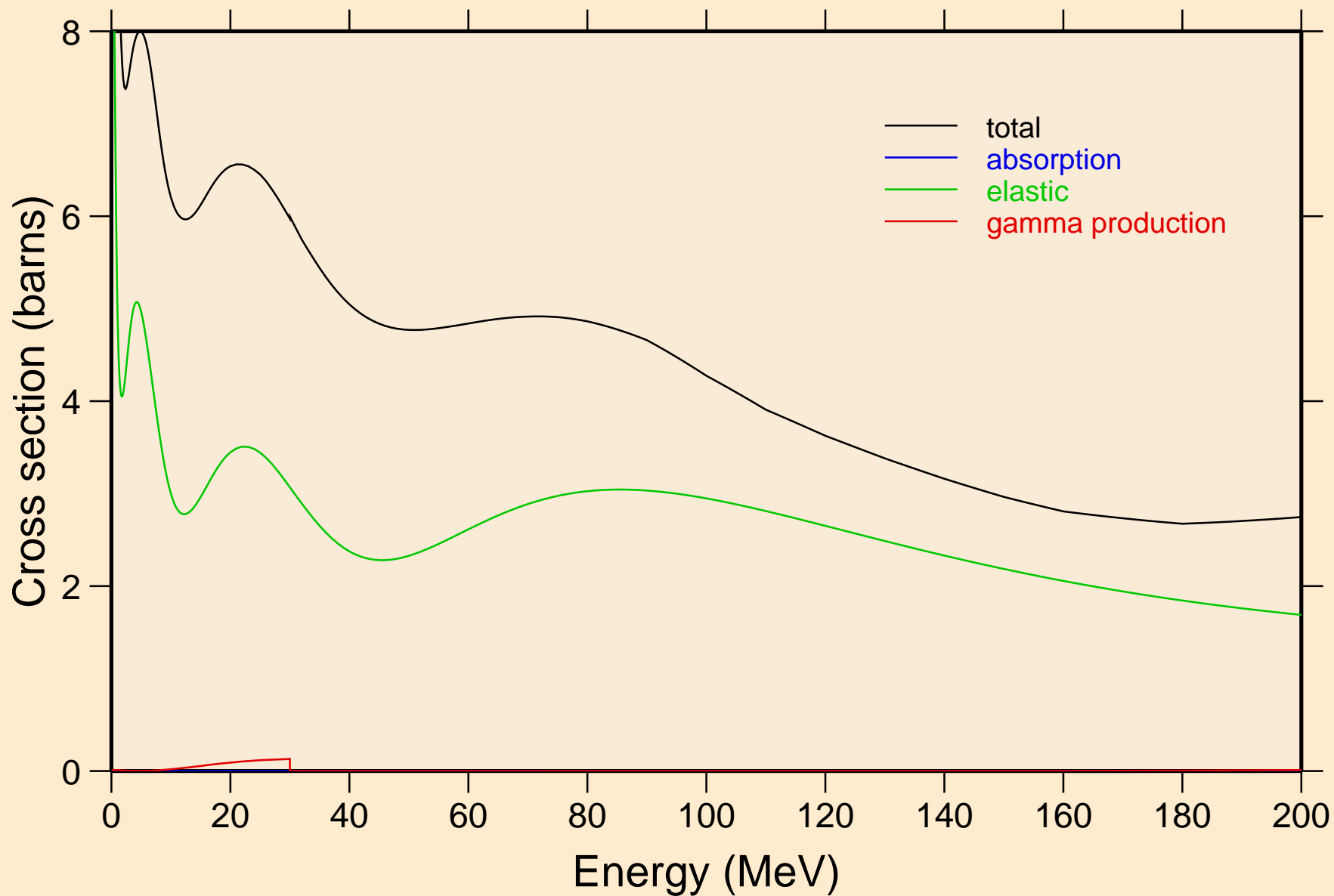

SG271 NEUTRON ACER TENDL-2019 LIBRARY; T=293.16K
Heating

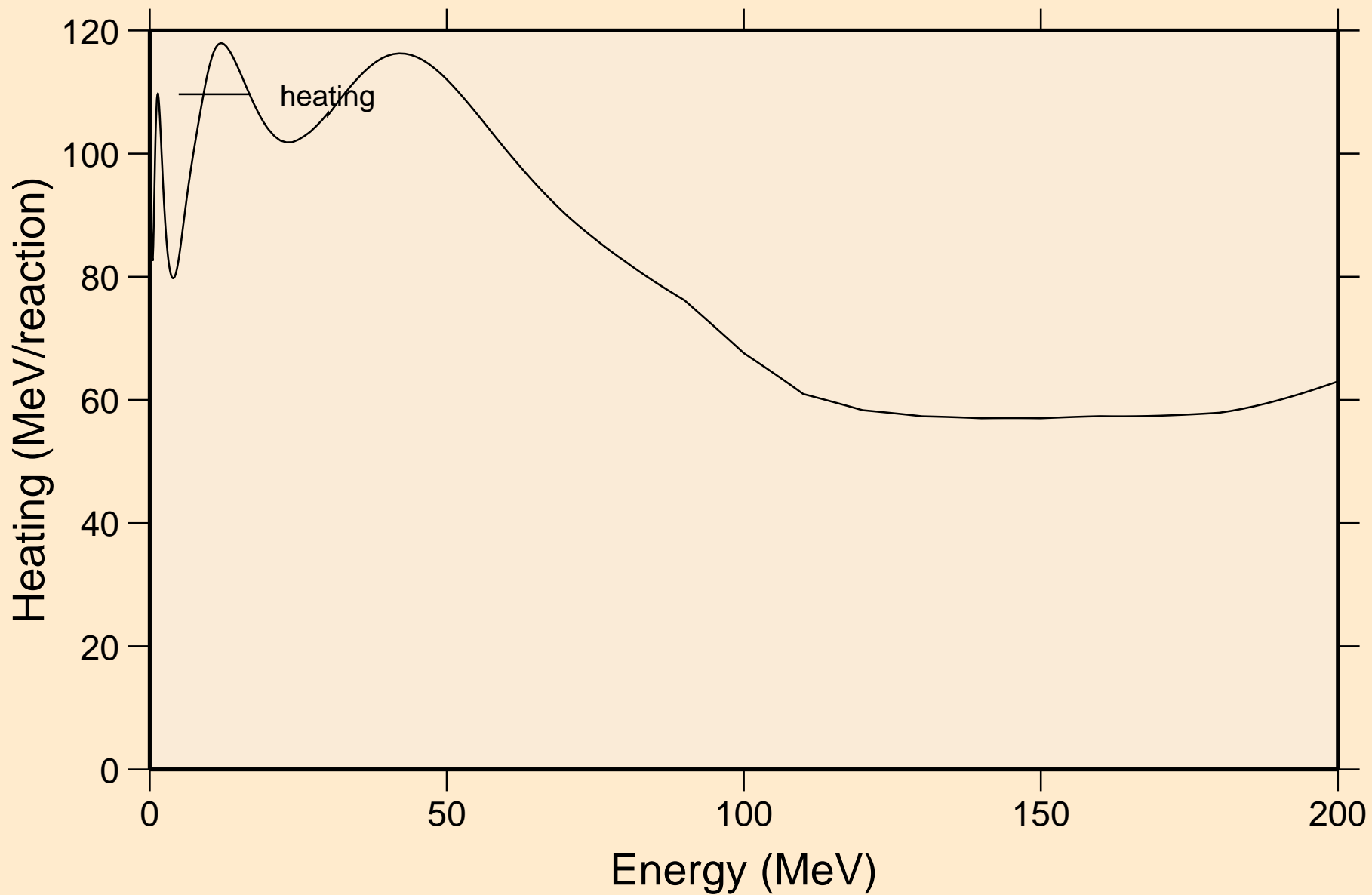

SG271 NEUTRON ACER TENDL-2019 LIBRARY; T=293.16K
Damage

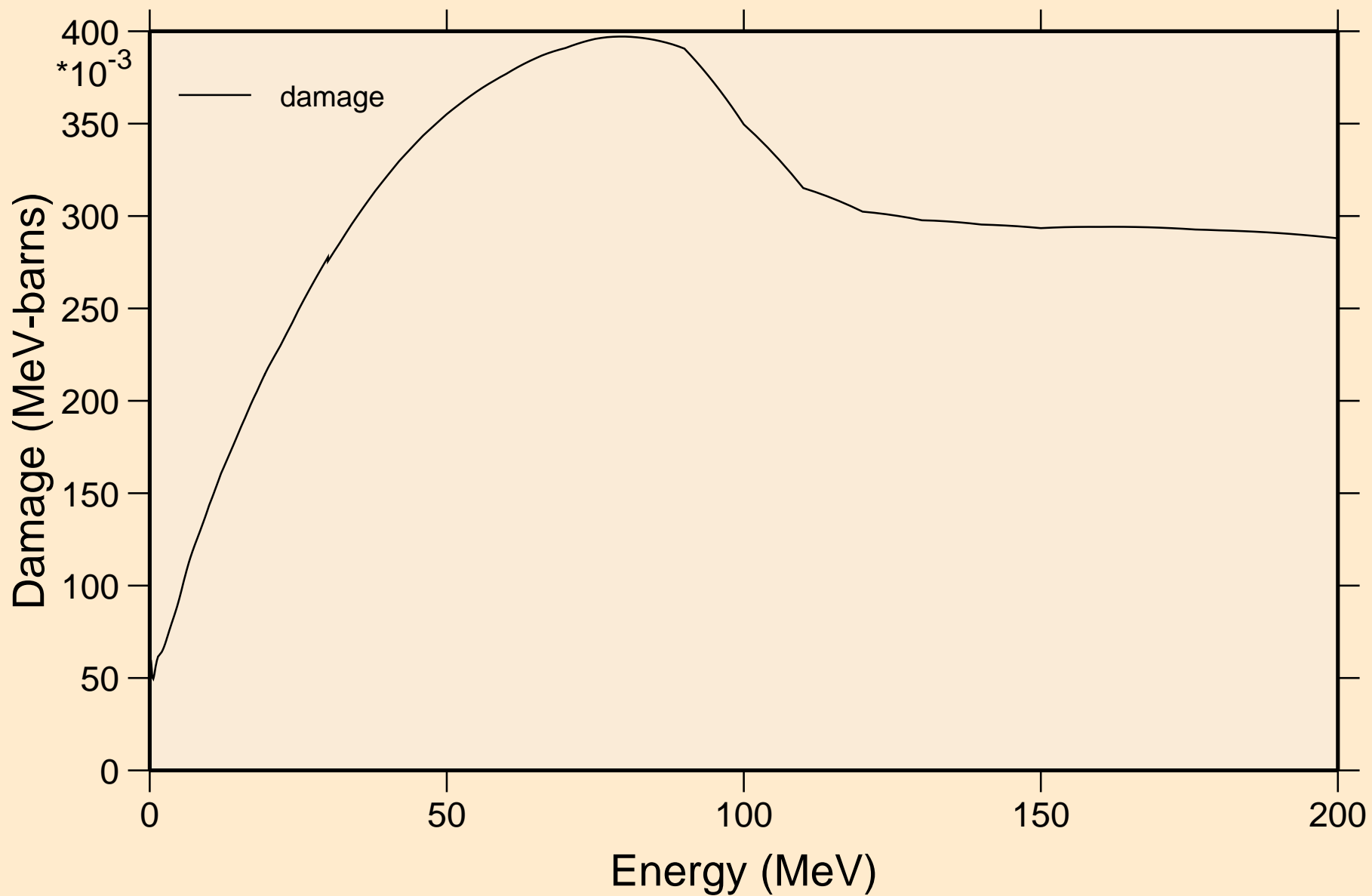

SG271 NEUTRON ACER TENDL-2019 LIBRARY; T=293.16K

Non-threshold reactions

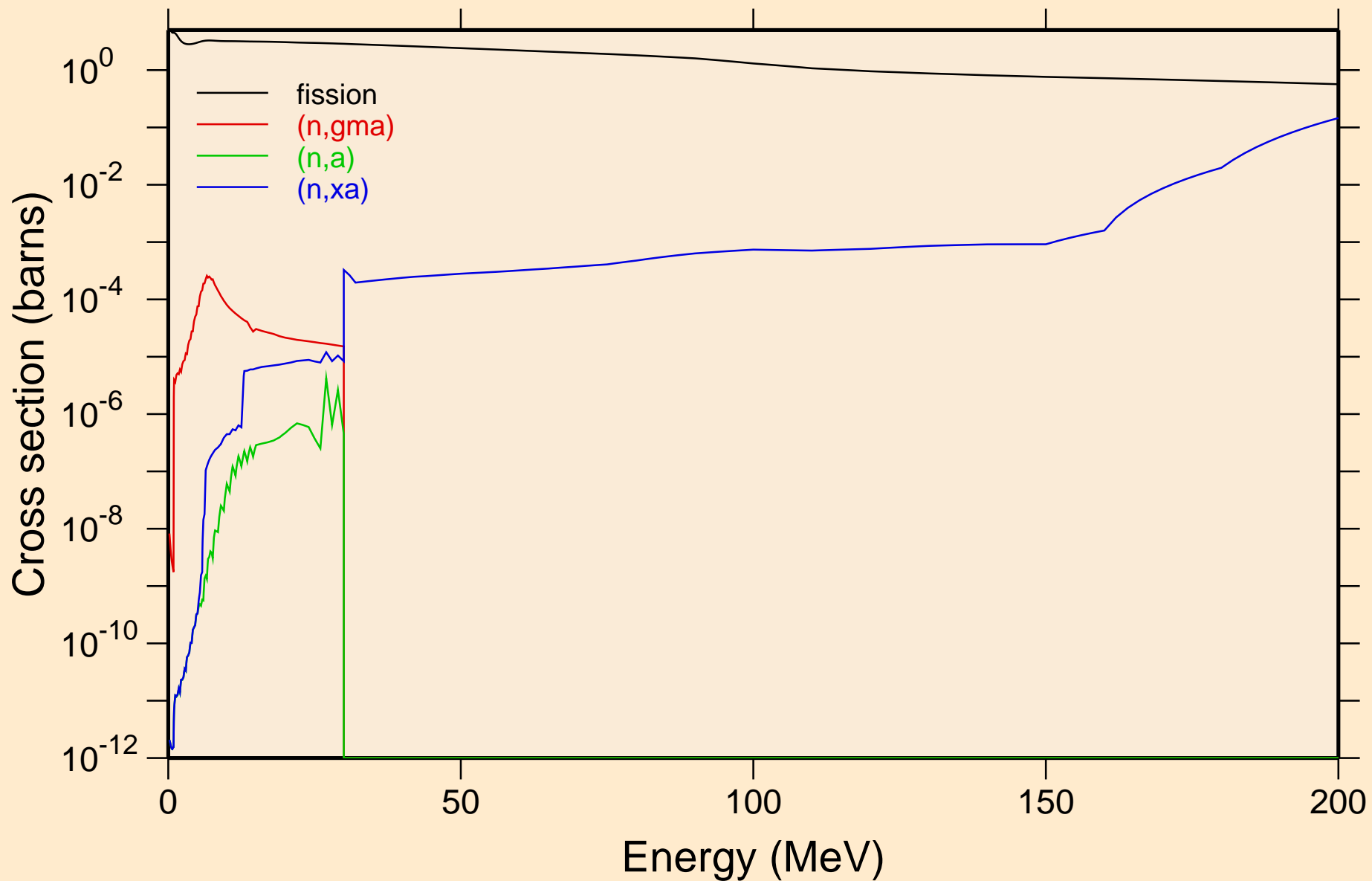

SG271 NEUTRON ACER TENDL-2019 LIBRARY; T=293.16K
Inelastic levels

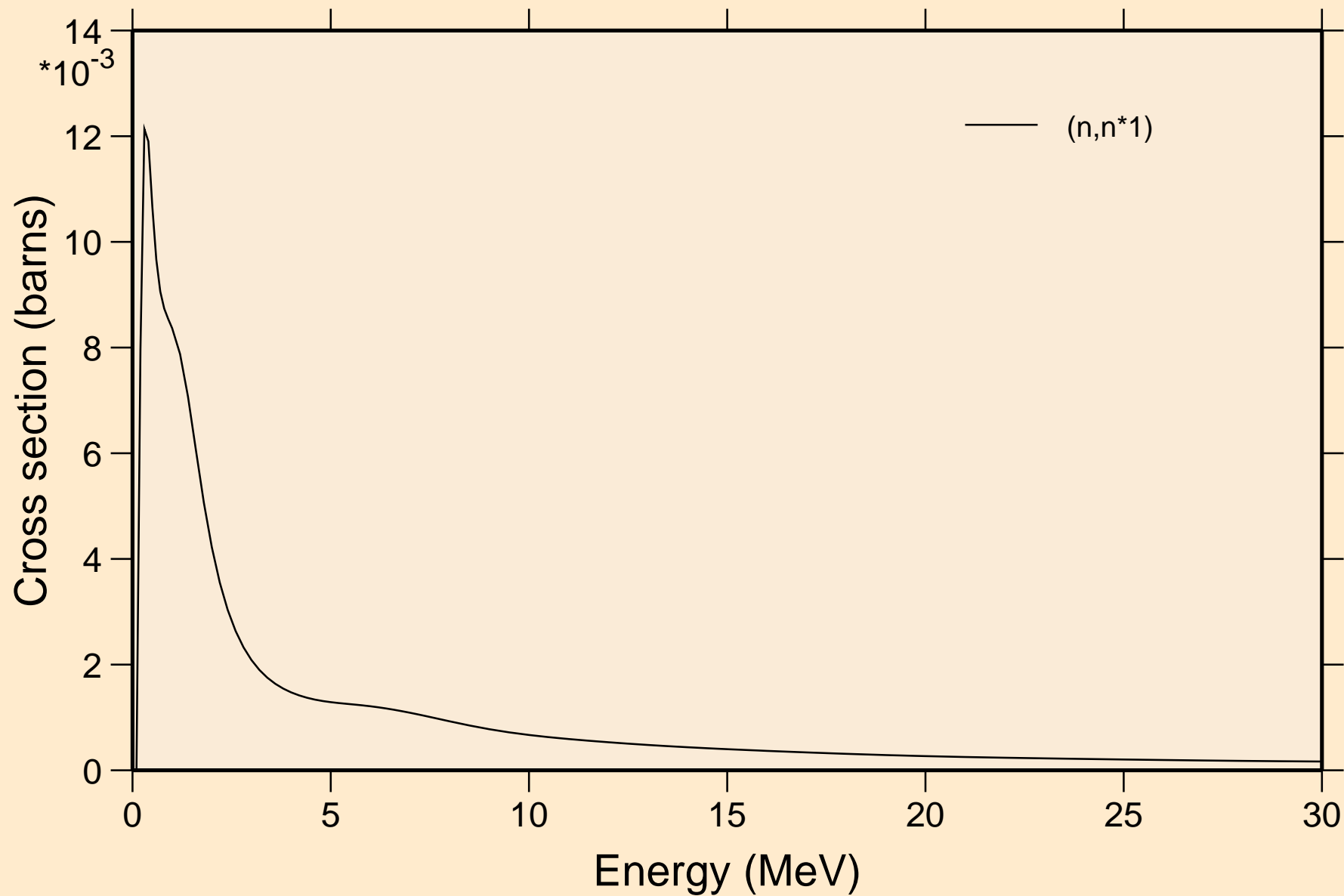

SG271 NEUTRON ACER TENDL-2019 LIBRARY; T=293.16K
Threshold reactions

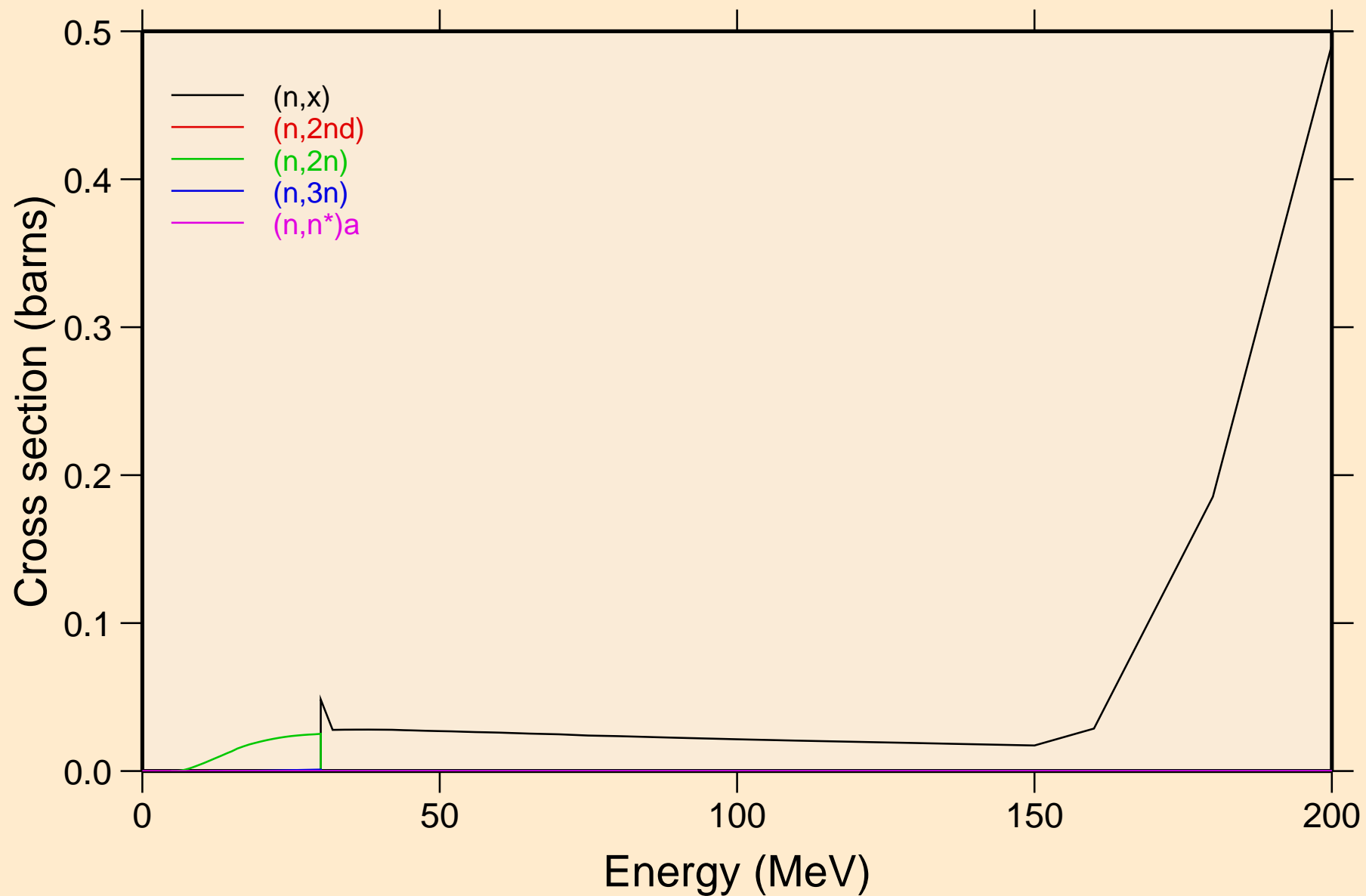

SG271 NEUTRON ACER TENDL-2019 LIBRARY; T=293.16K
Threshold reactions

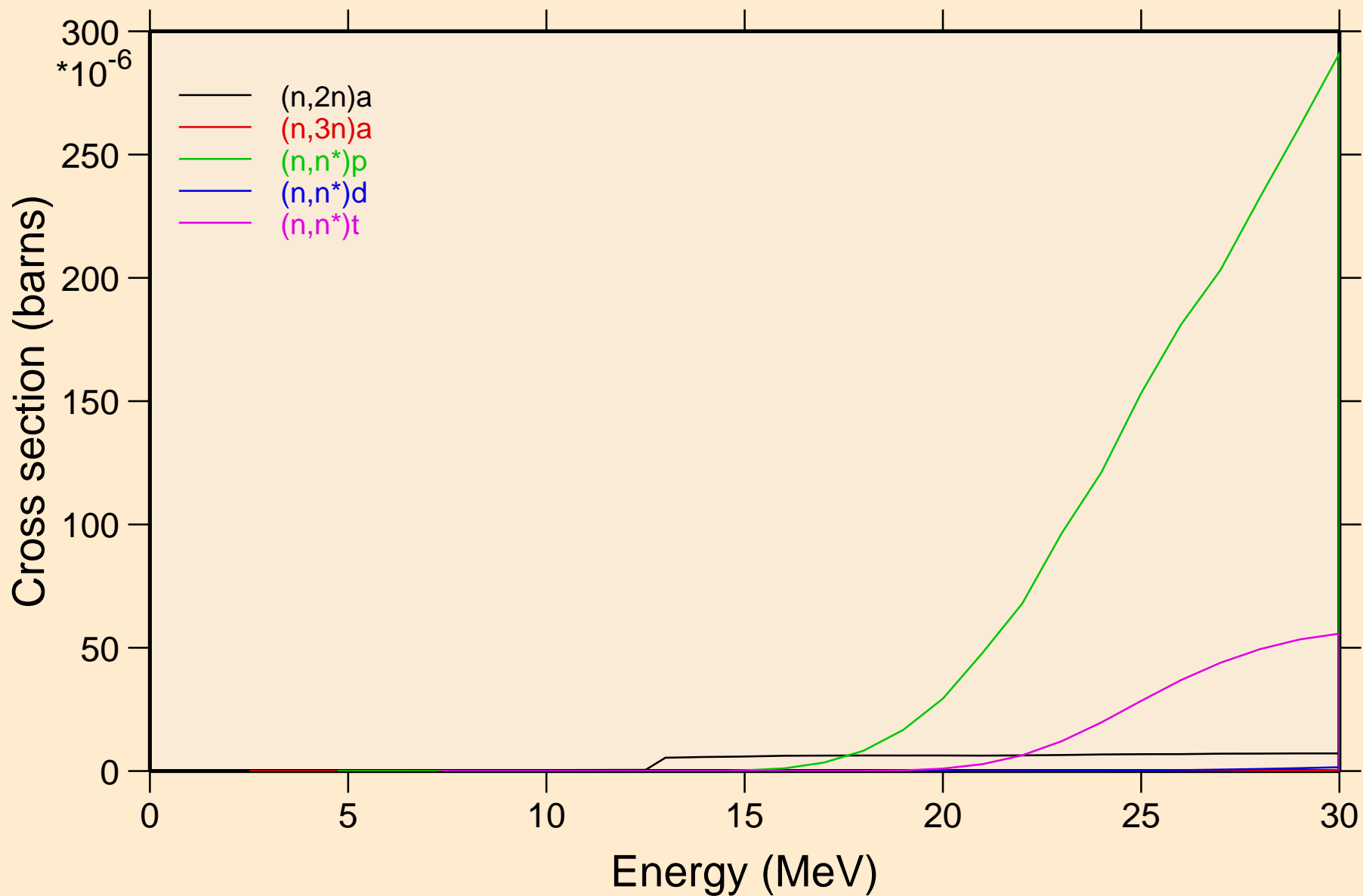

SG271 NEUTRON ACER TENDL-2019 LIBRARY; T=293.16K
Threshold reactions

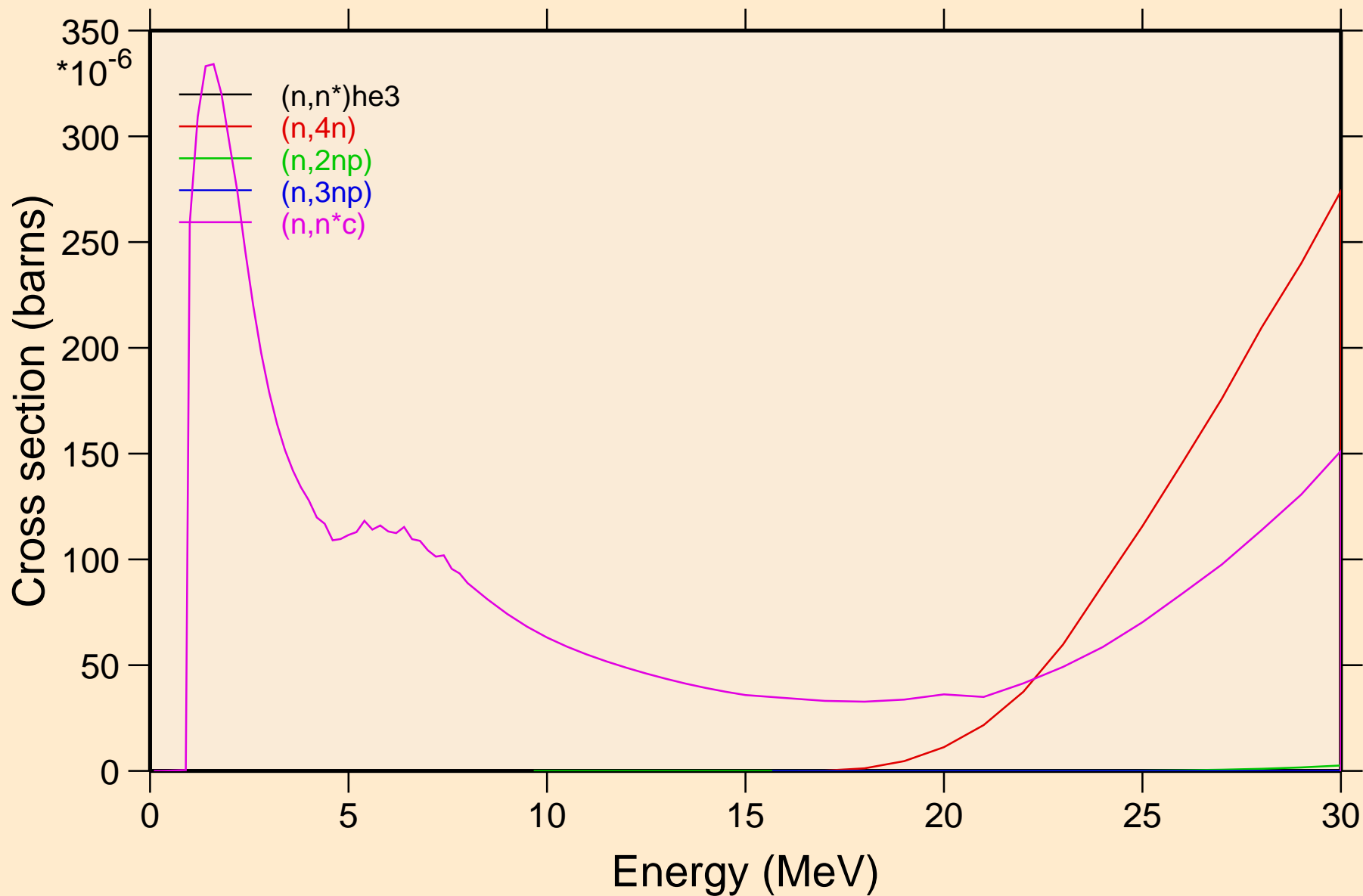

SG271 NEUTRON ACER TENDL-2019 LIBRARY; T=293.16K
Threshold reactions

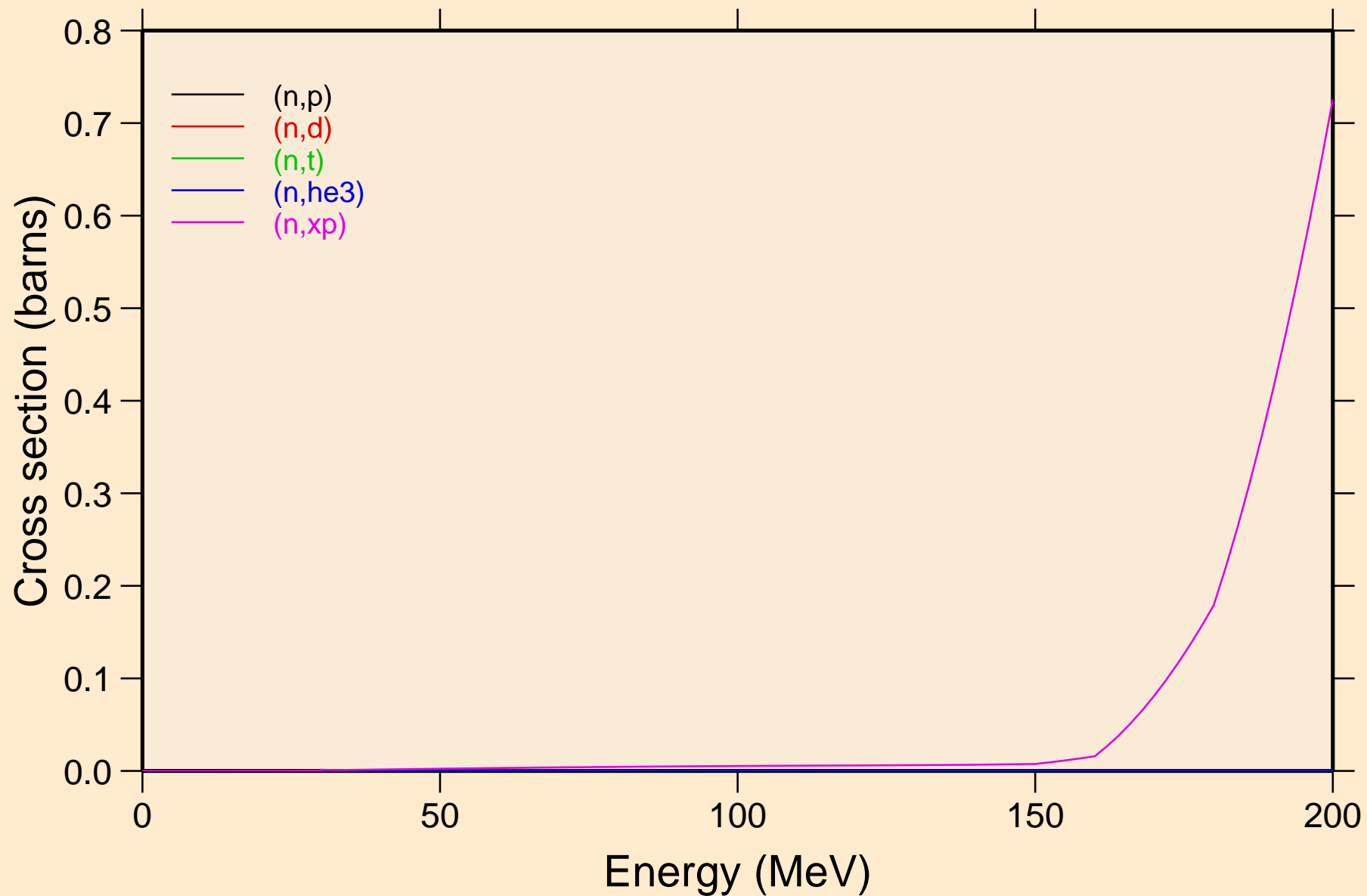

SG271 NEUTRON ACER TENDL-2019 LIBRARY; T=293.16K
Threshold reactions

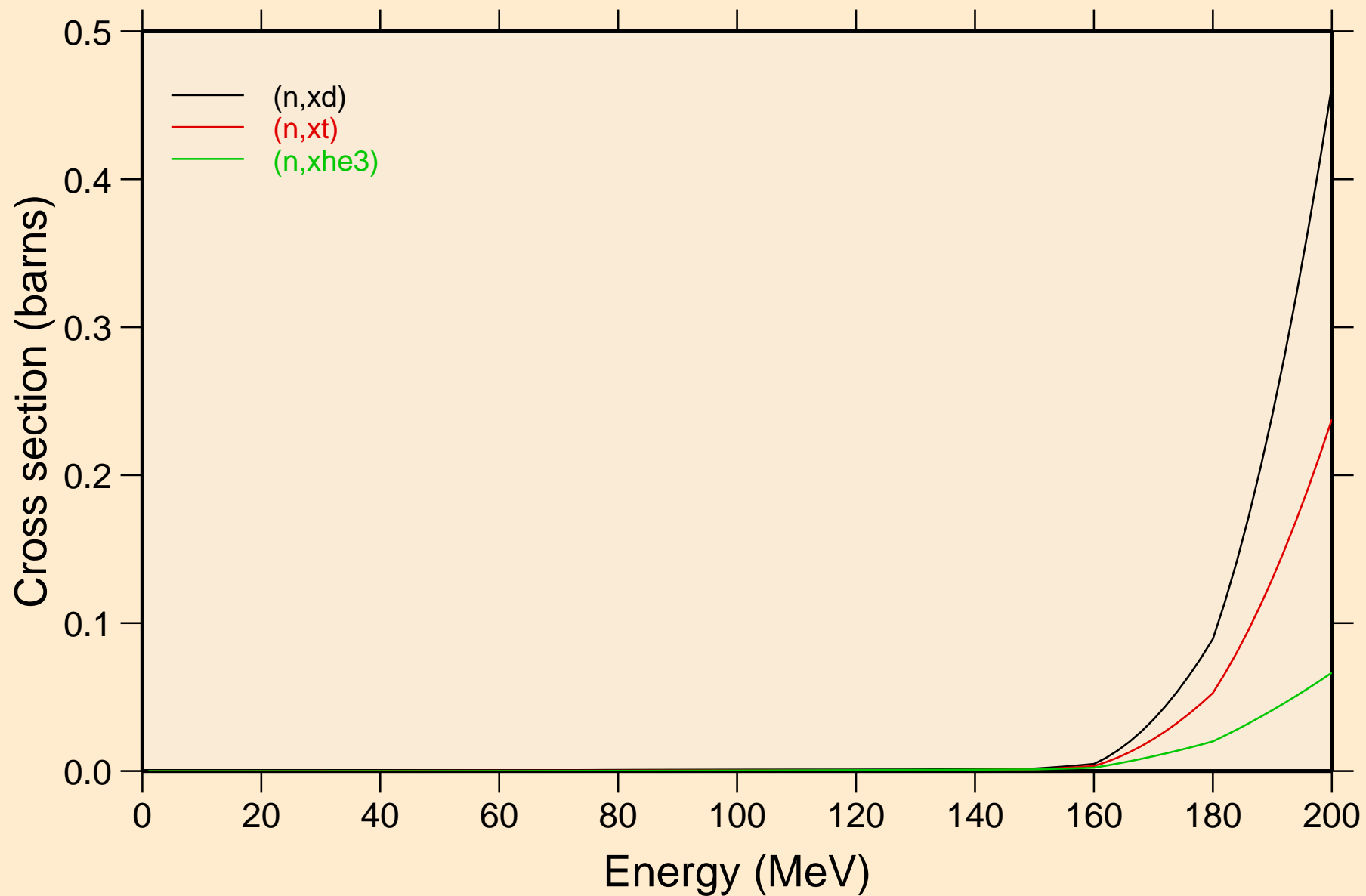

SG271 NEUTRON ACER TENDL-2019 LIBRARY; T=293.16K
angular distribution for elastic

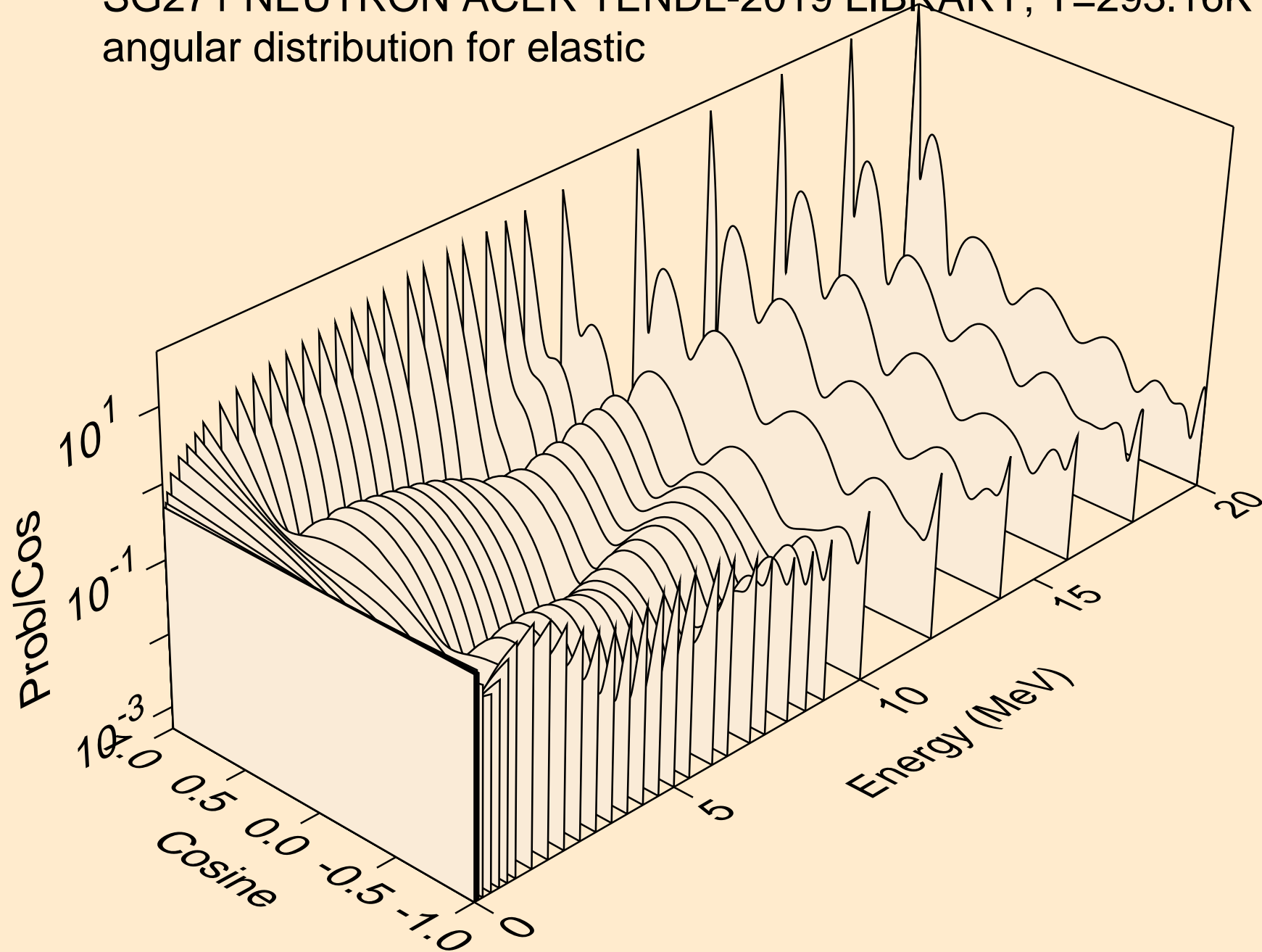

SG271 NEUTRON ACER TENDL-2019 LIBRARY; T=293.16K
angular distribution for elastic

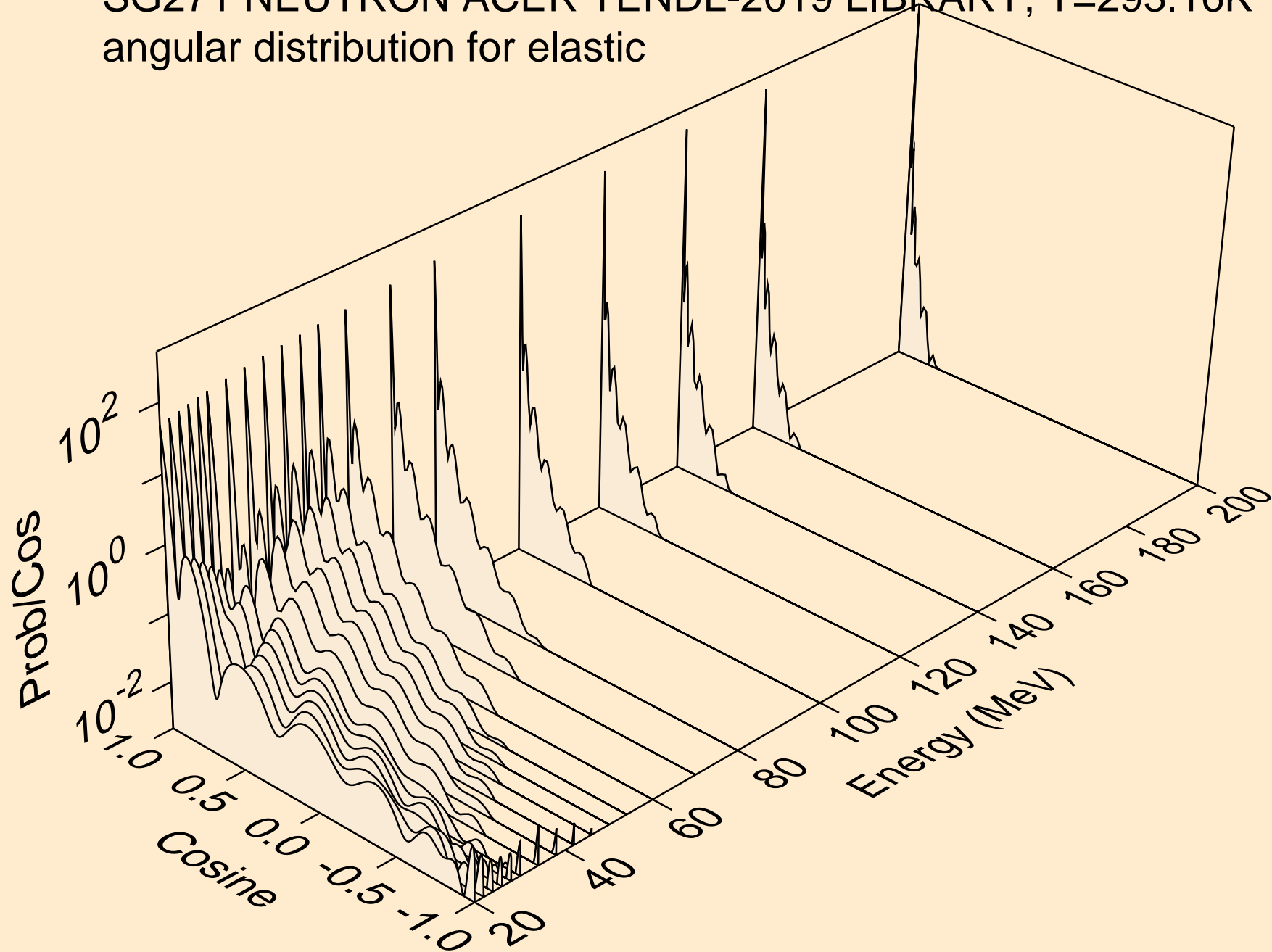

SG271 NEUTRON ACER TENDL-2019 LIBRARY; T=293.16K
angular distribution for (n,n*1)

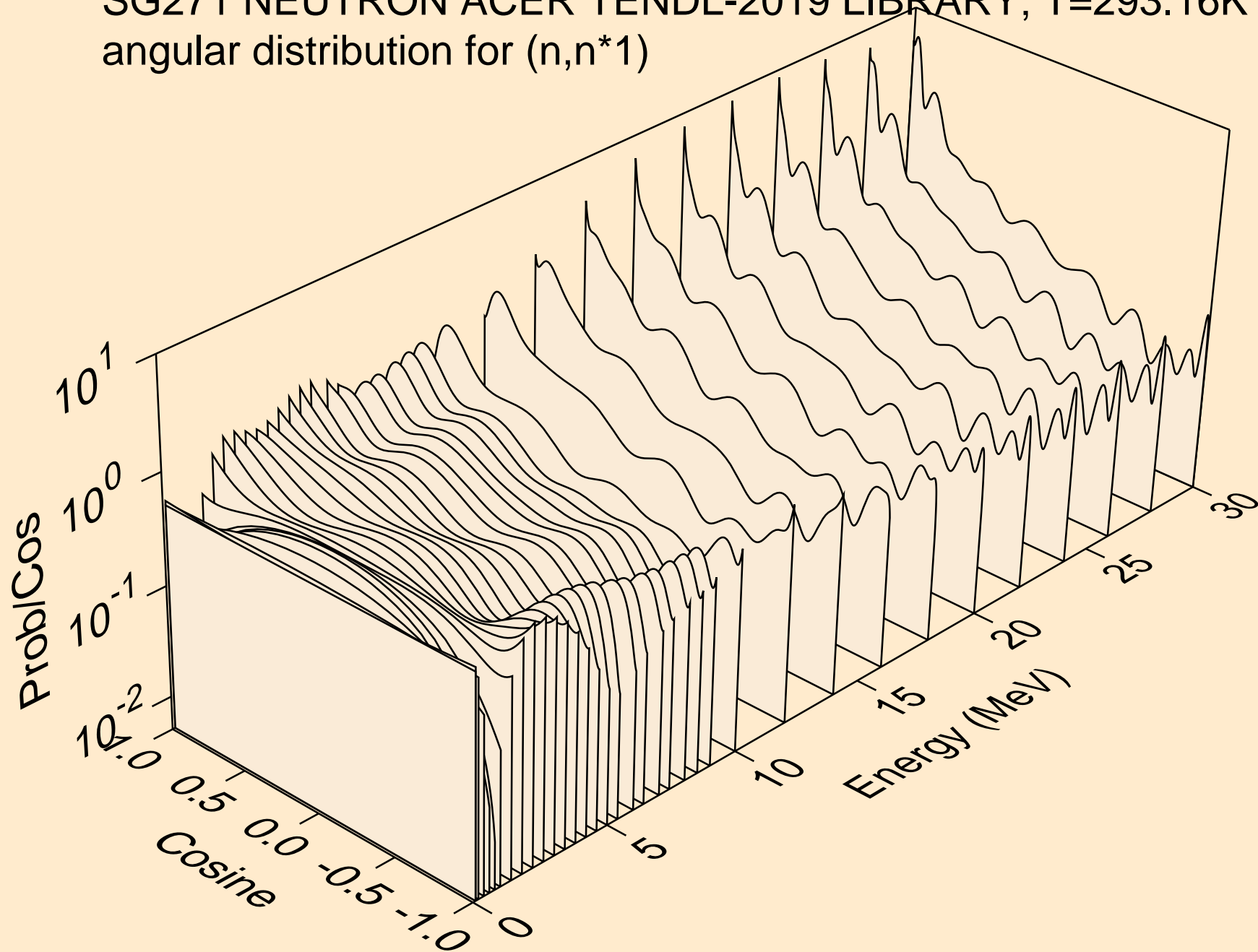

SG271 NEUTRON ACER TENDL-2019 LIBRARY; T=293.16K

Total fission nuubar

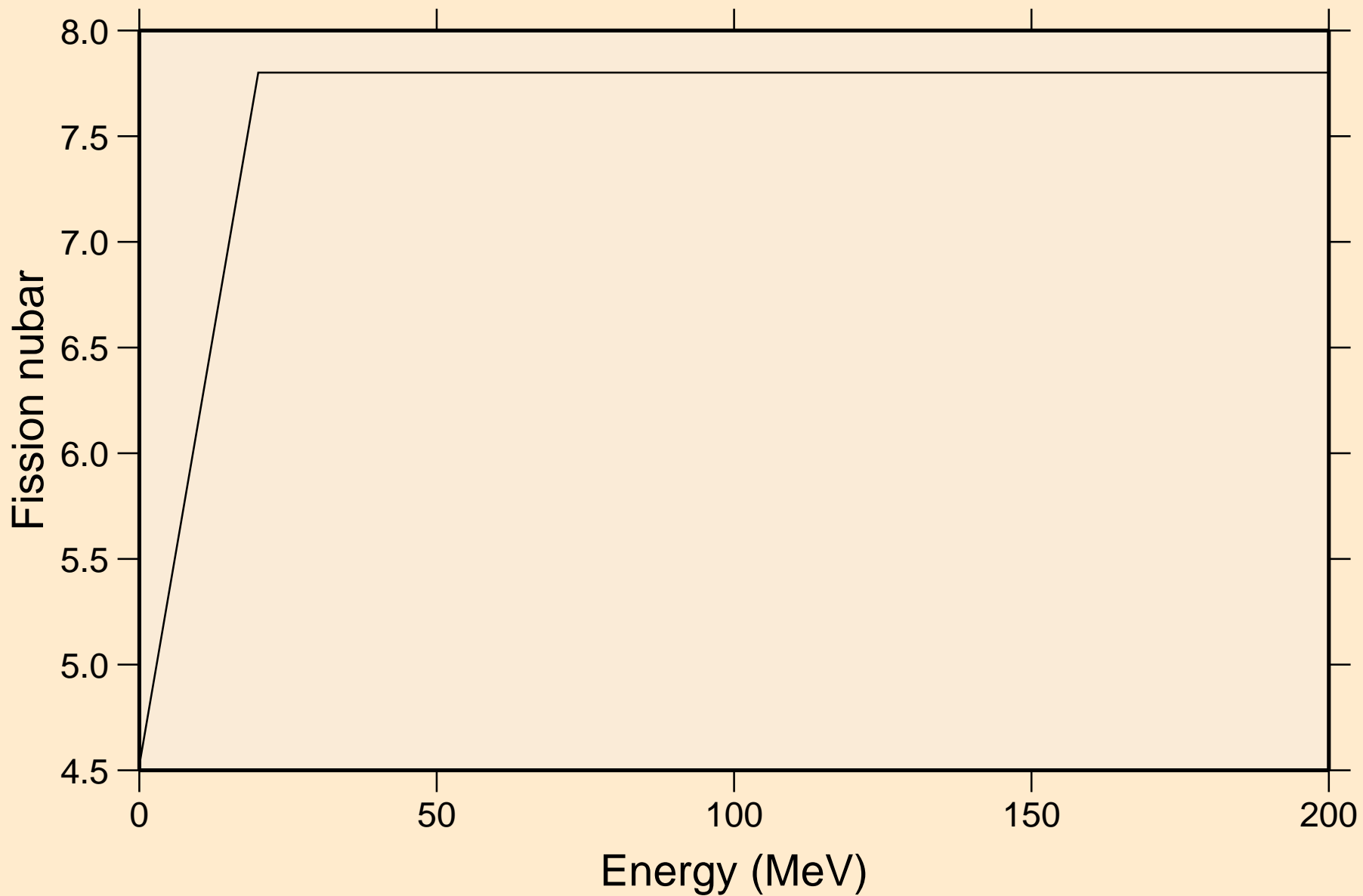

SG271 NEUTRON ACER TENDL-2019 LIBRARY; T=293.16K
Neutron emission for (n,x)

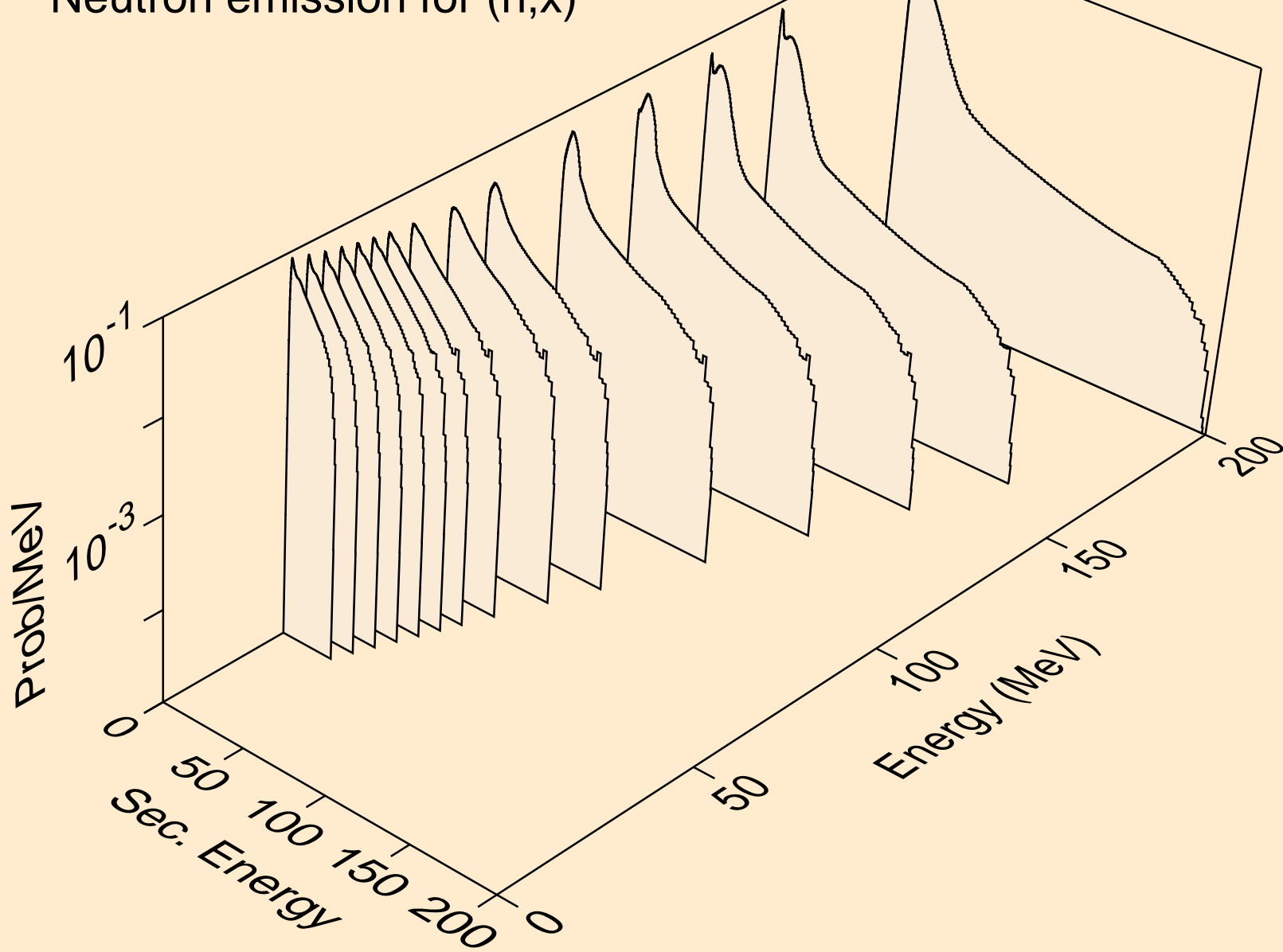

SG271 NEUTRON ACER TENDL-2019 LIBRARY; T=293.16K
Neutron emission for (n,2nd)

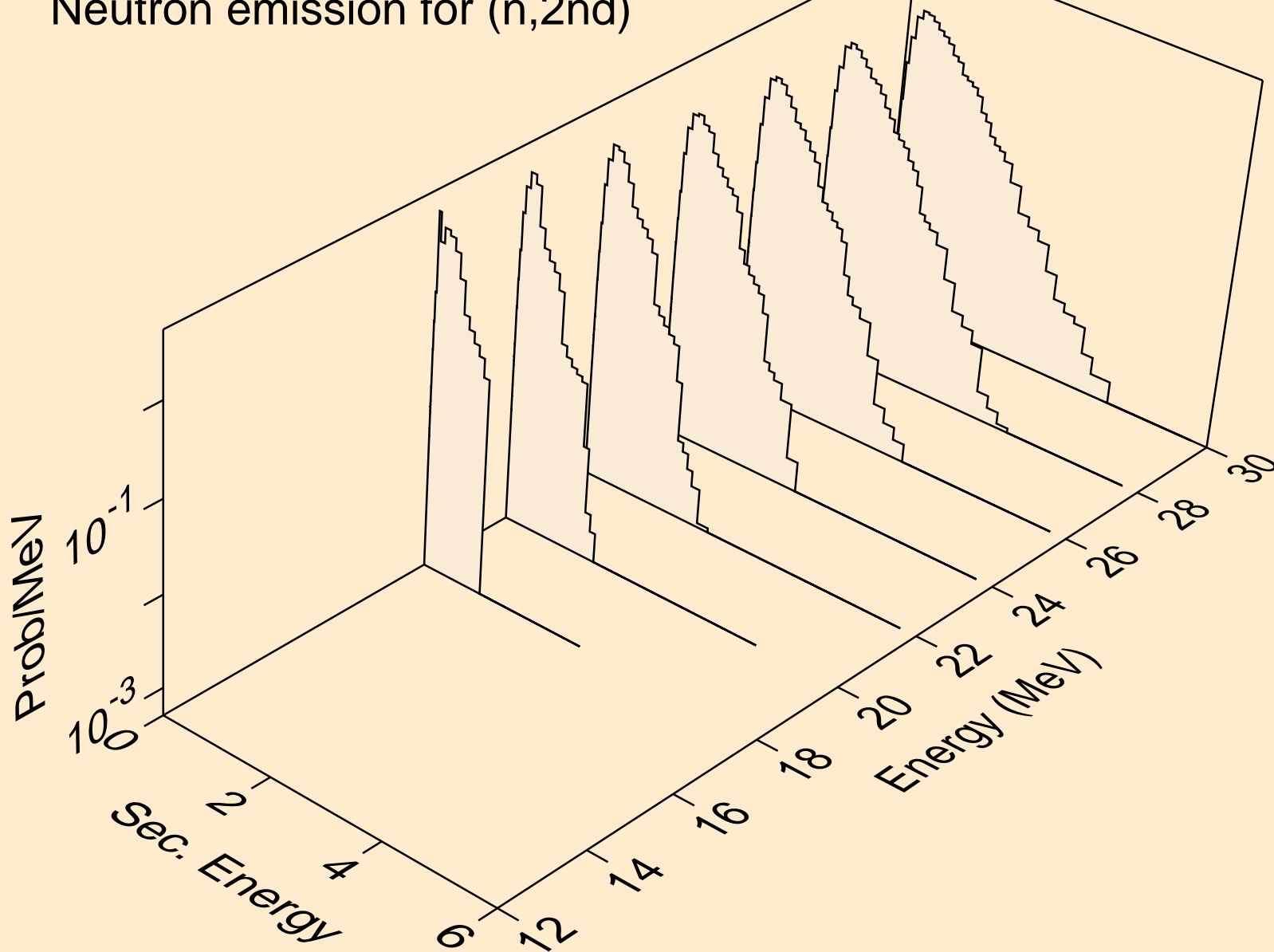

SG271 NEUTRON ACER TENDL-2019 LIBRARY; T=293.16K
Neutron emission for (n,2n)

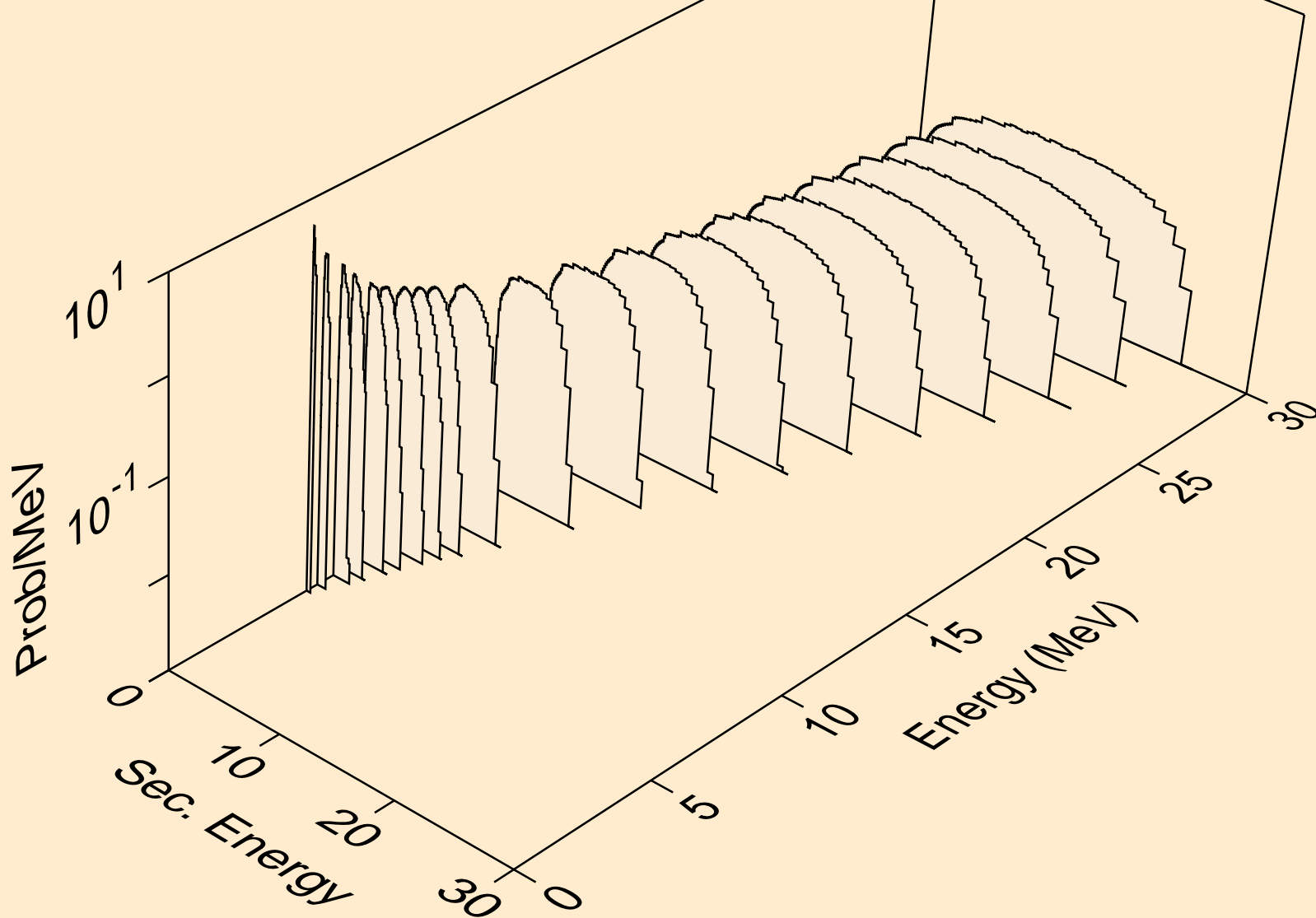

SG271 NEUTRON ACER TENDL-2019 LIBRARY; T=293.16K
Neutron emission for (n,3n)

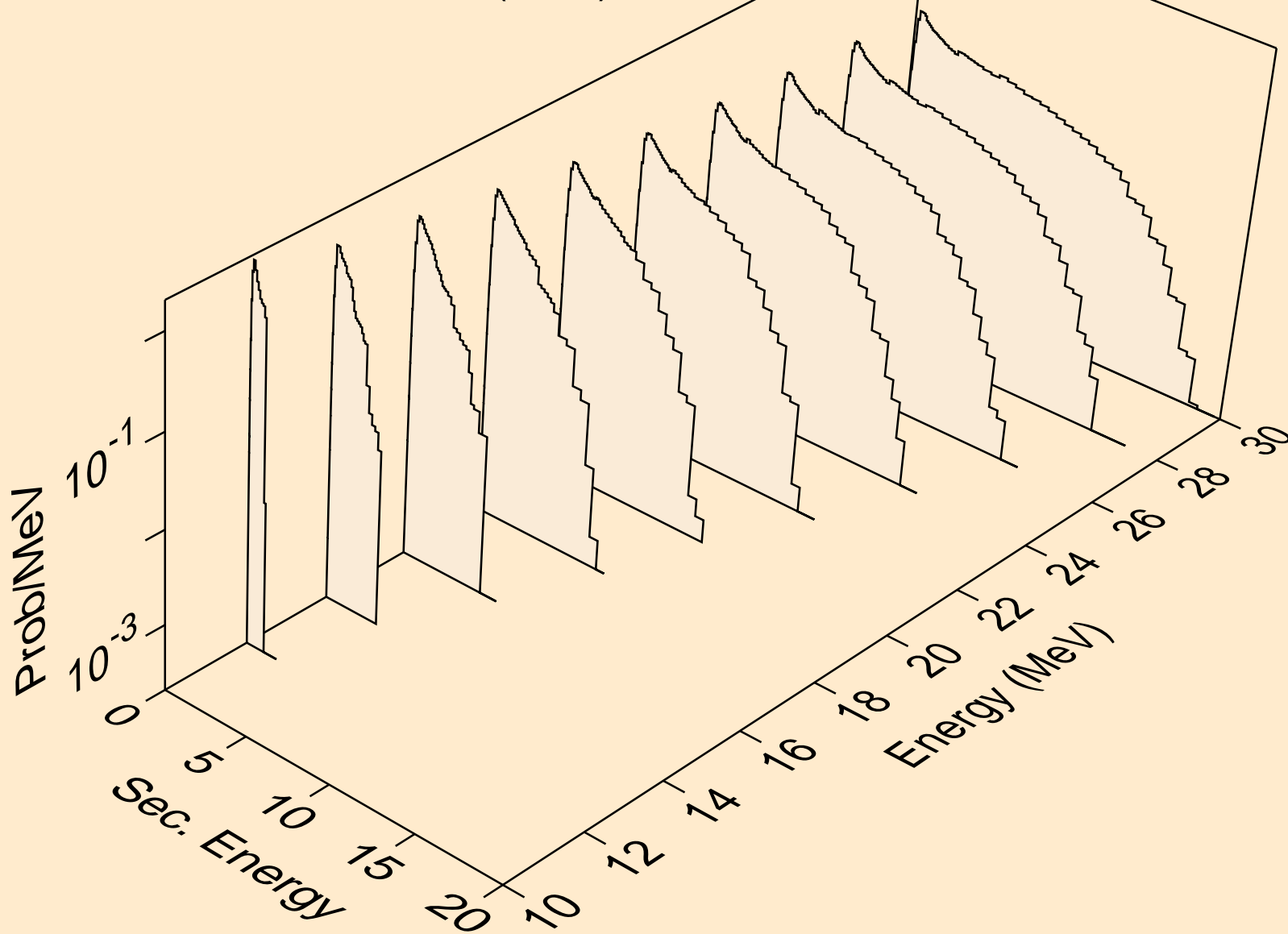

SG271 NEUTRON ACER TENDL-2019 LIBRARY; T=293.16K
Neutron emission for fission

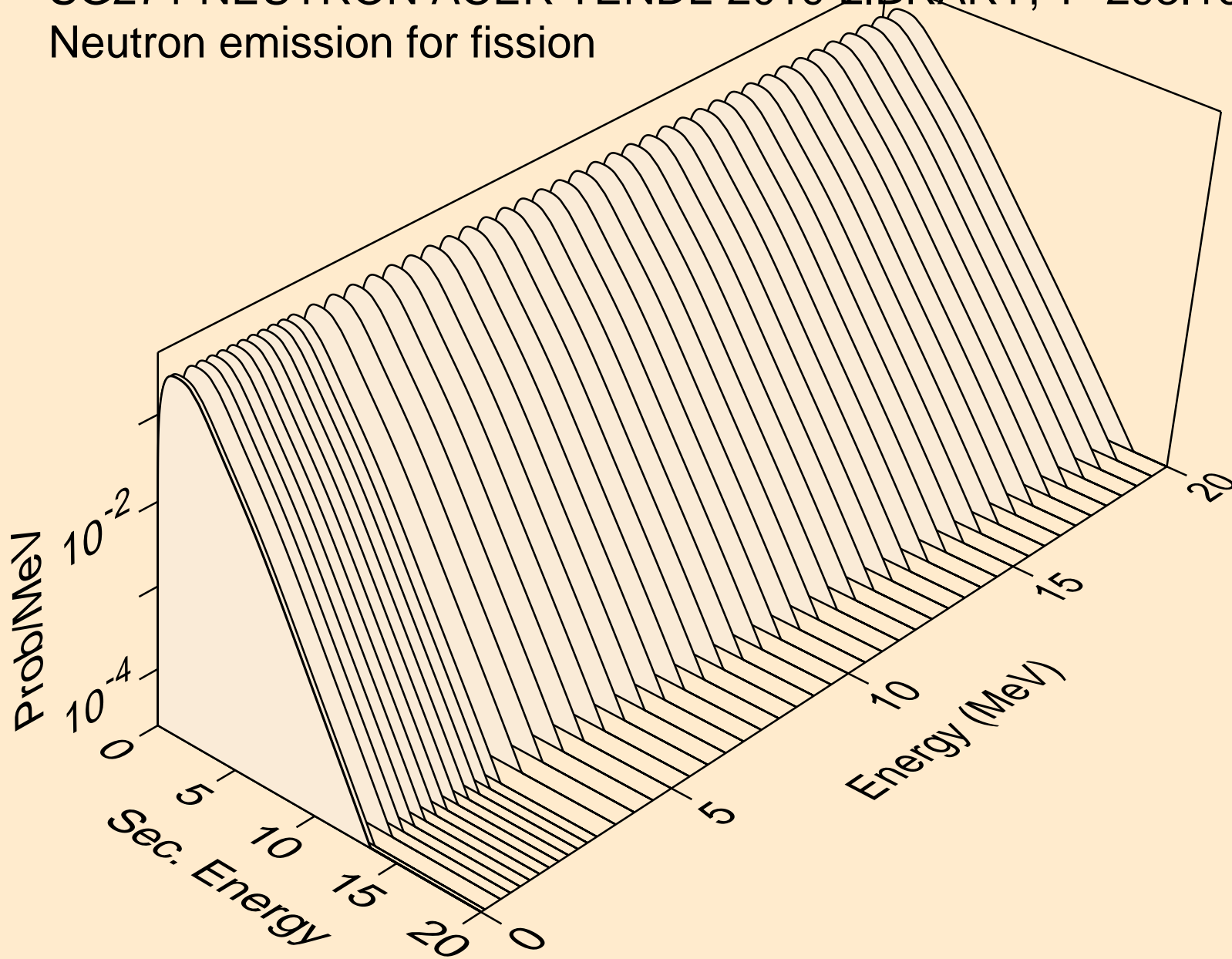

SG271 NEUTRON ACER TENDL-2019 LIBRARY; T=293.16K
Neutron emission for (n,n*)a

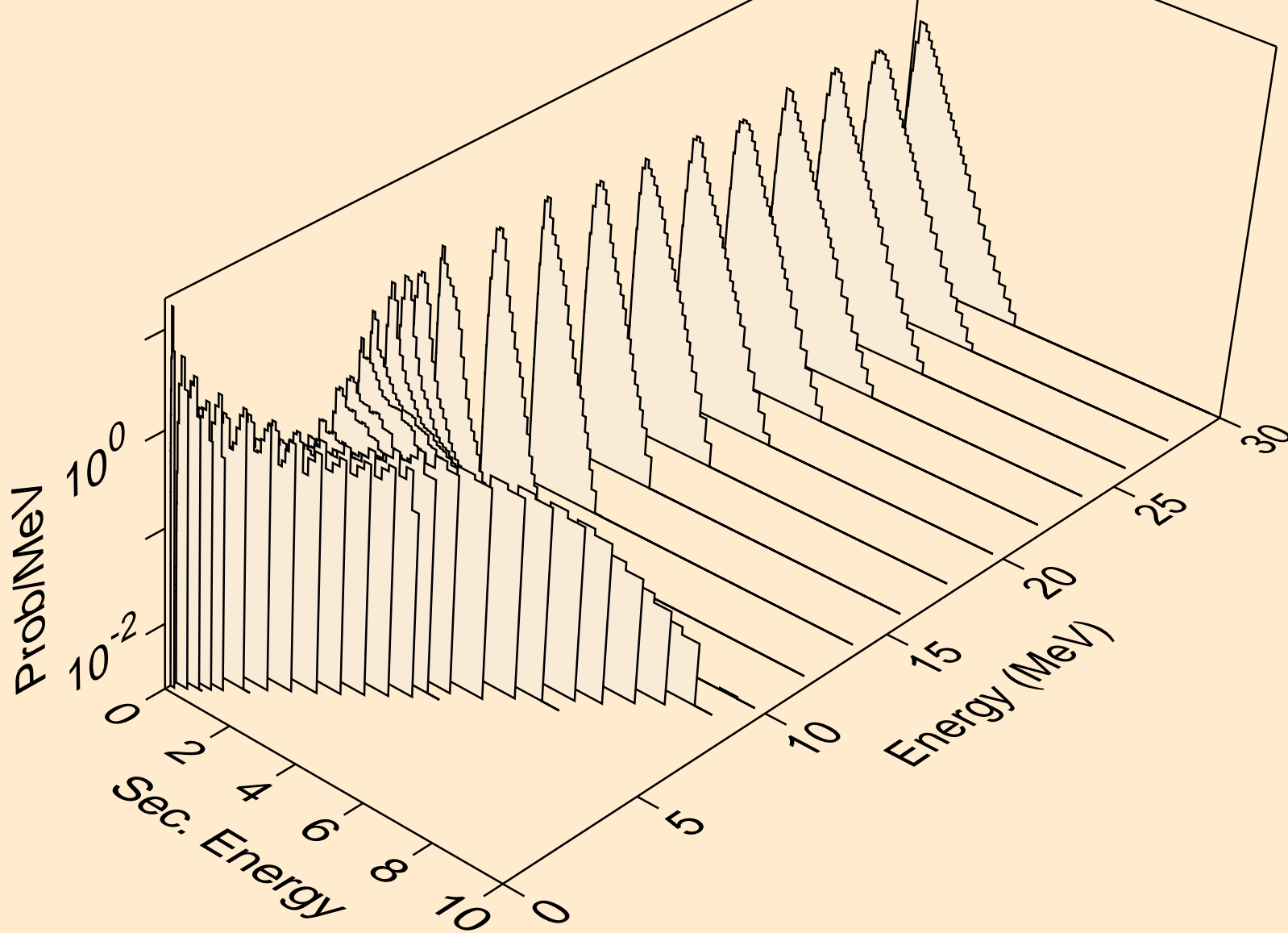

SG271 NEUTRON ACER TENDL-2019 LIBRARY; T=293.16K
Neutron emission for (n,2n)a

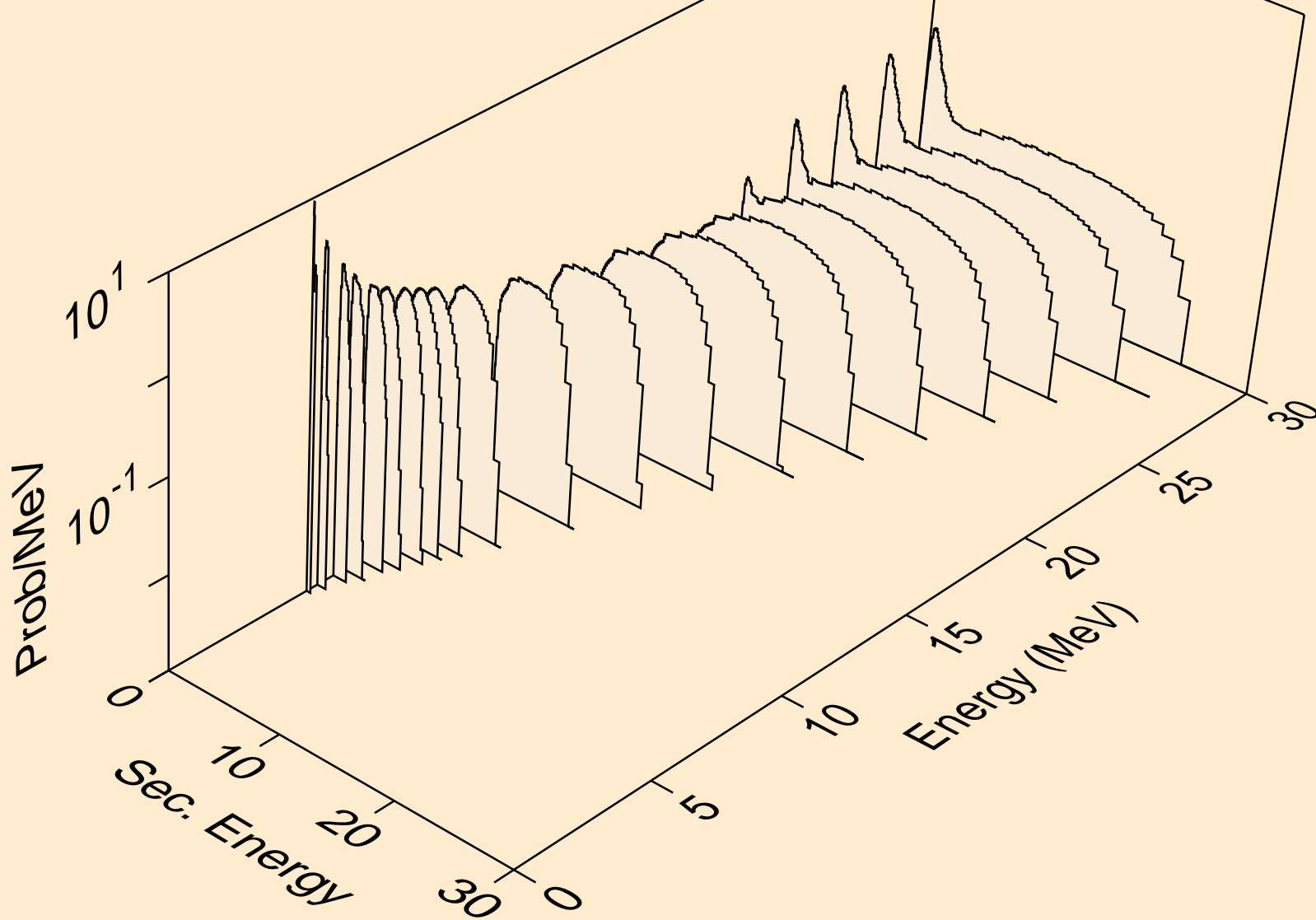

SG271 NEUTRON ACER TENDL-2019 LIBRARY; T=293.16K
Neutron emission for (n,3n)a

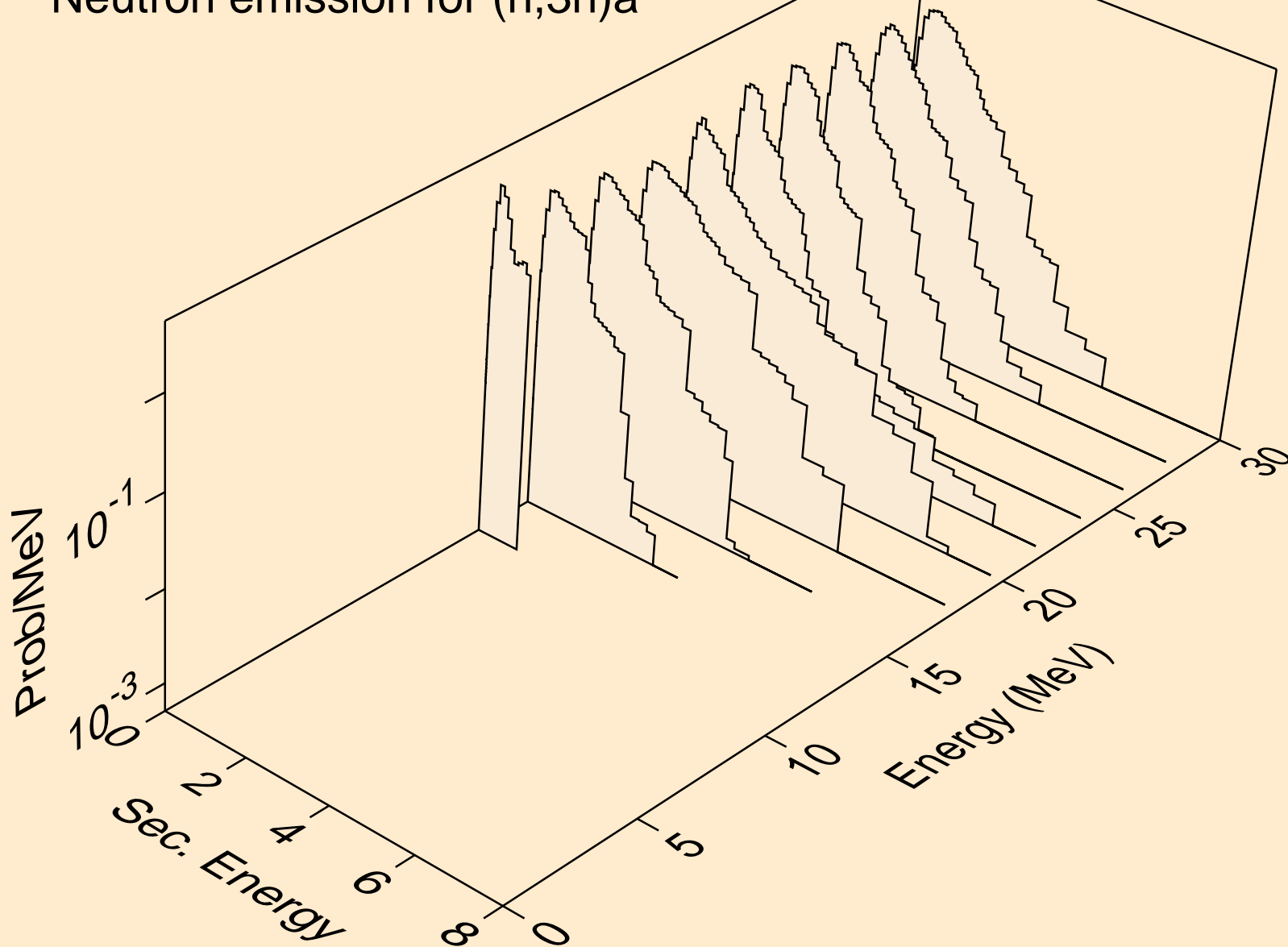

SG271 NEUTRON ACER TENDL-2019 LIBRARY; T=293.16K
Neutron emission for (n,n*)p

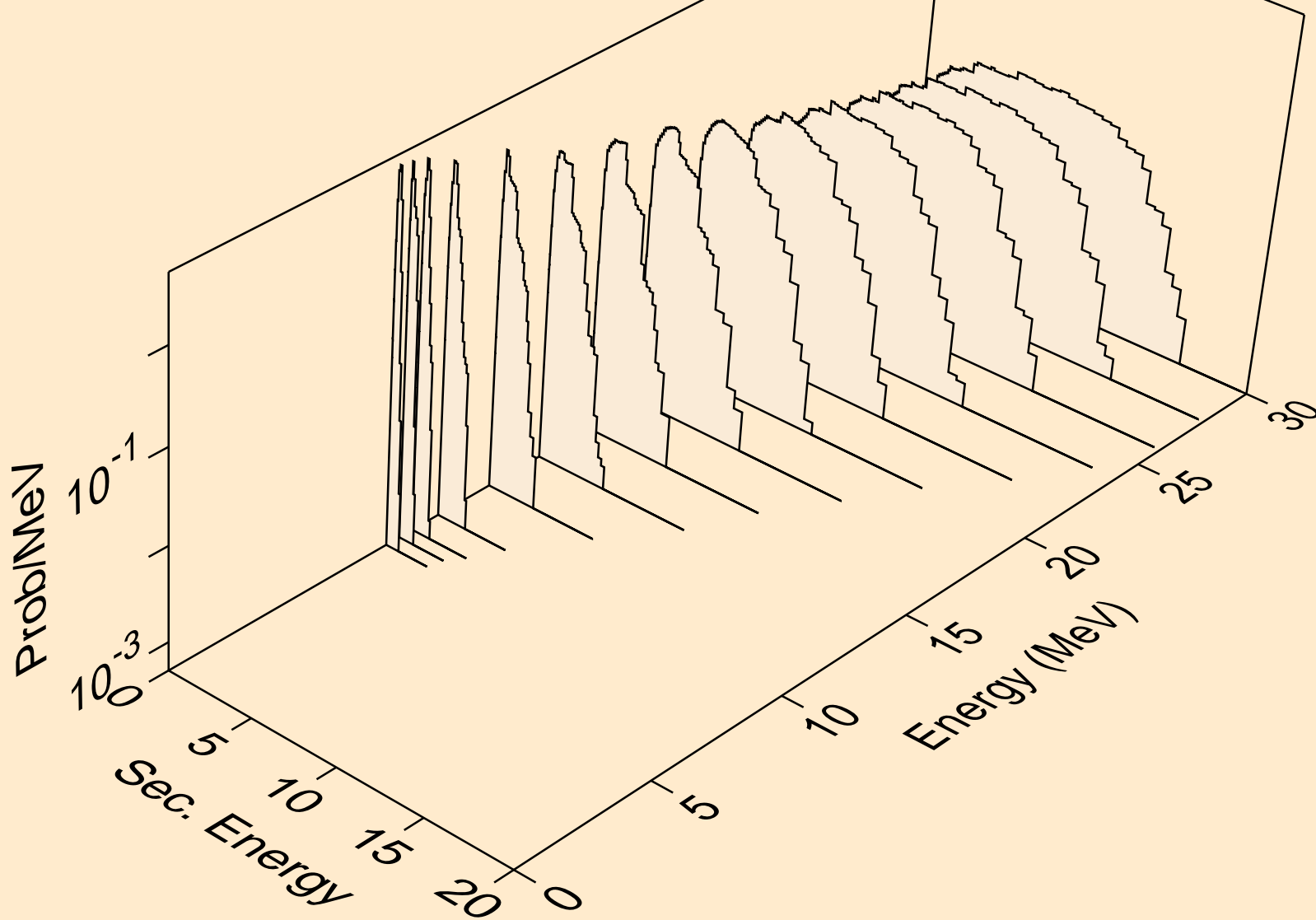

SG271 NEUTRON ACER TENDL-2019 LIBRARY; T=293.16K
Neutron emission for (n,n*)d

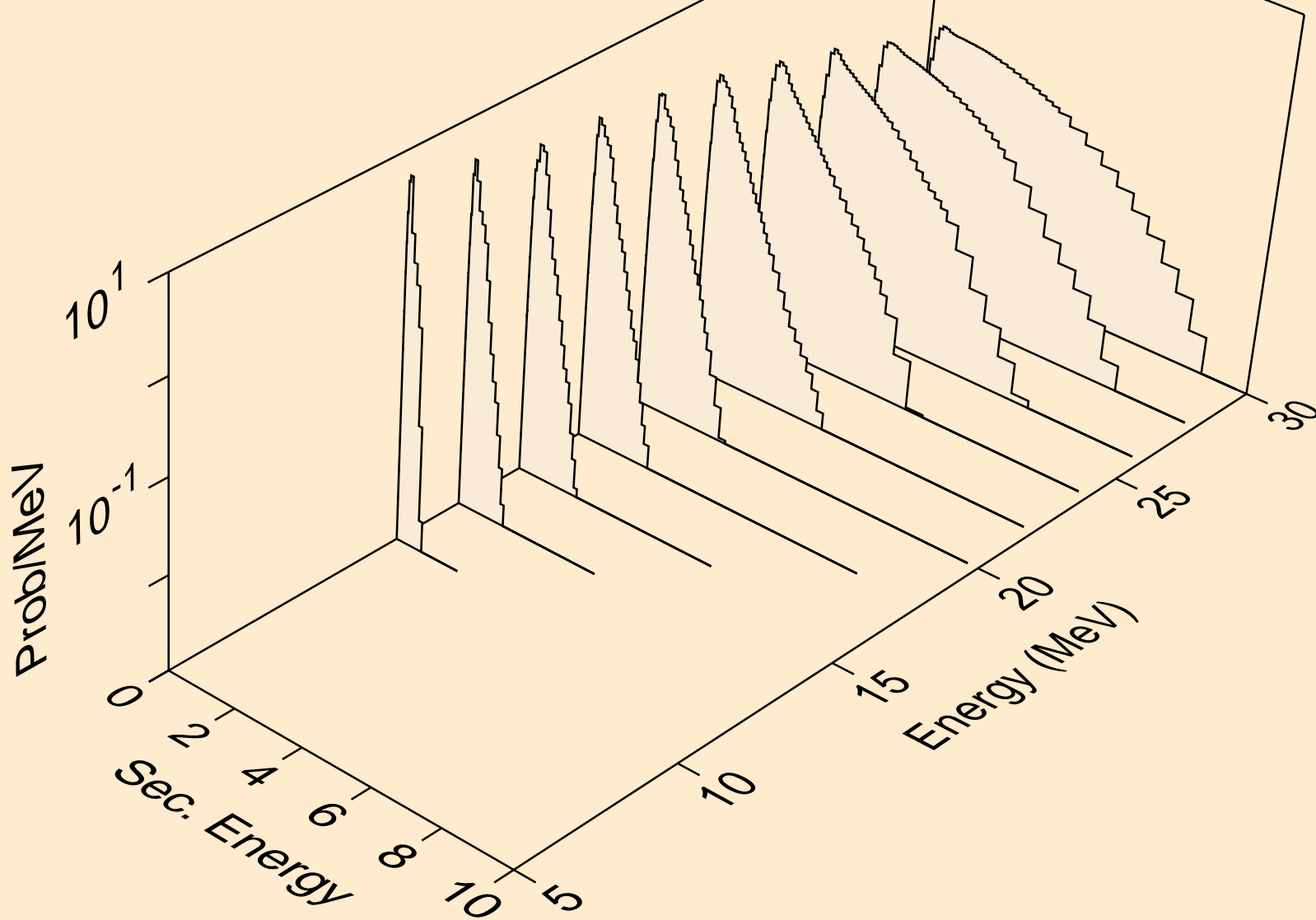

SG271 NEUTRON ACER TENDL-2019 LIBRARY; T=293.16K
Neutron emission for (n,n*)t

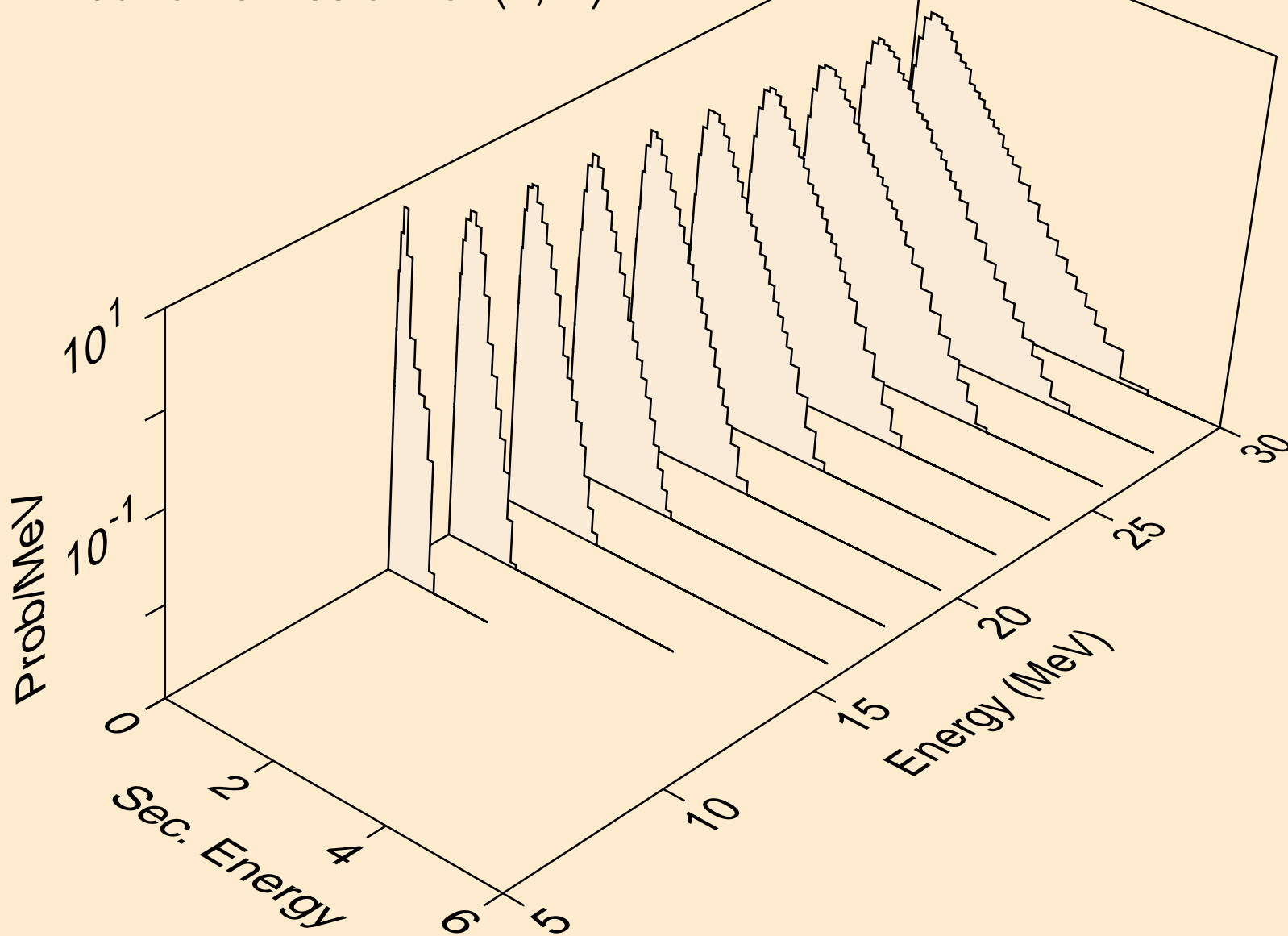

SG271 NEUTRON ACER TENDL-2019 LIBRARY; T=293.16K
Neutron emission for (n,n*)he3

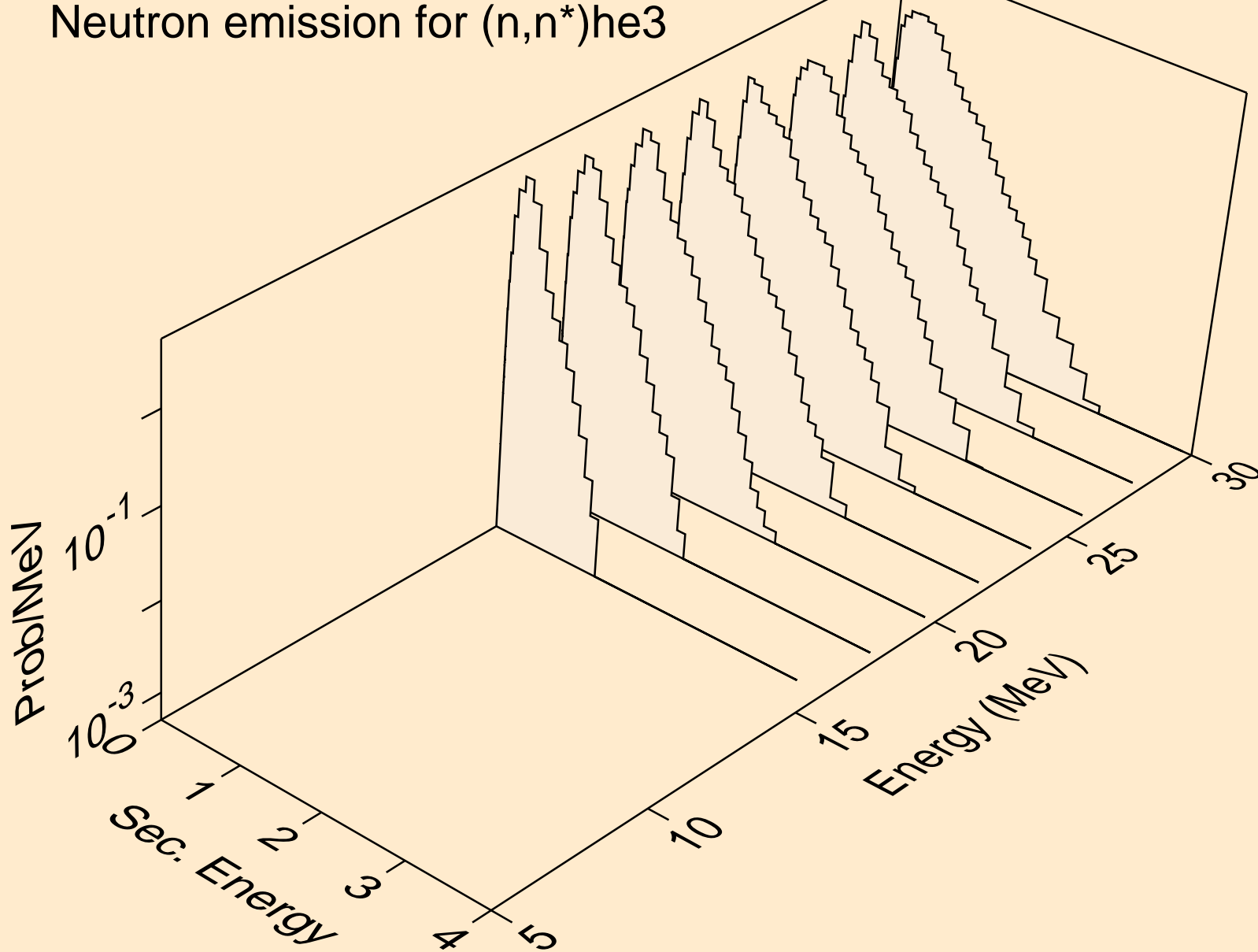

SG271 NEUTRON ACER TENDL-2019 LIBRARY; T=293.16K
Neutron emission for (n,4n)

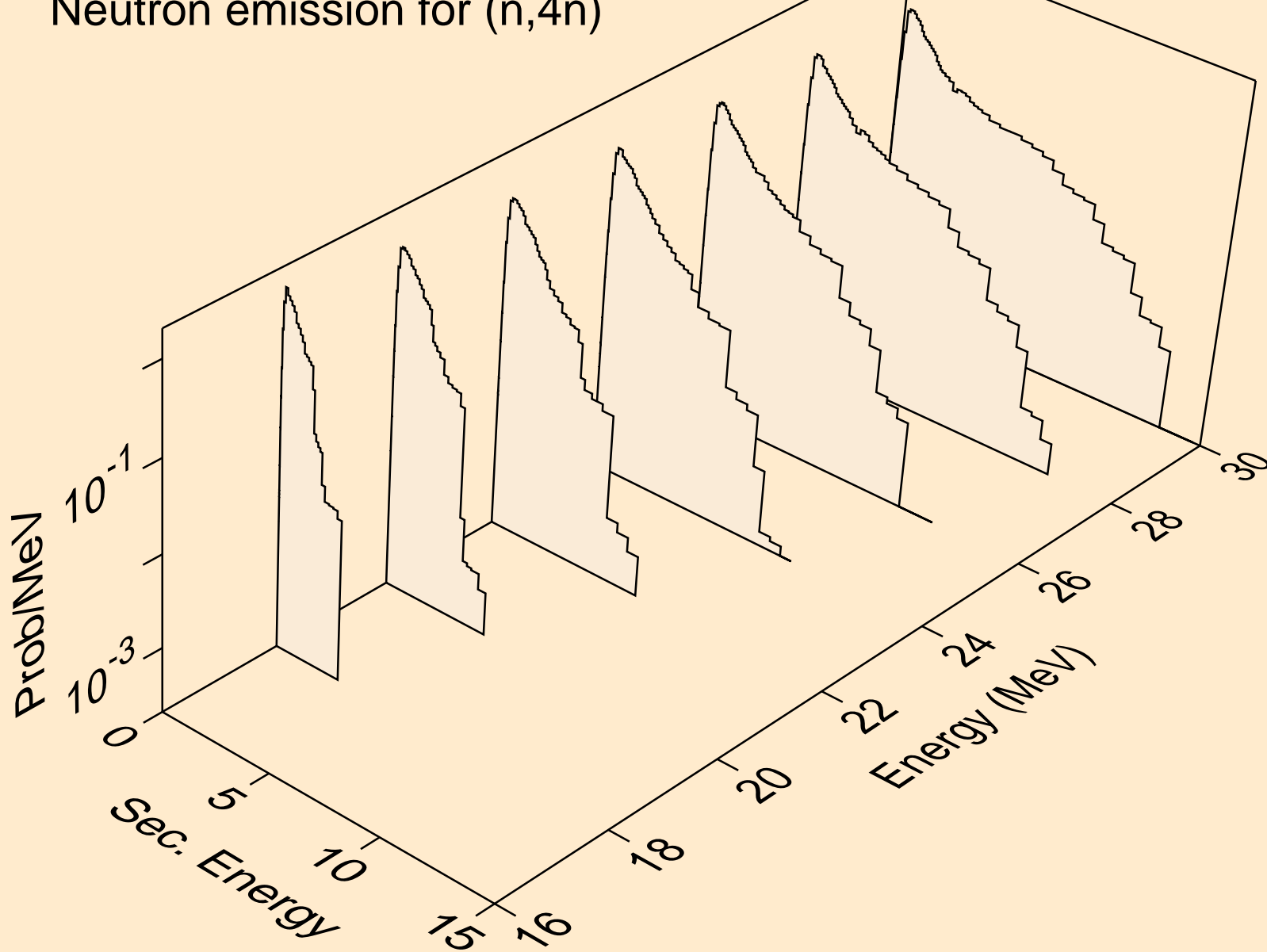

SG271 NEUTRON ACER TENDL-2019 LIBRARY; T=293.16K
Neutron emission for (n,2np)

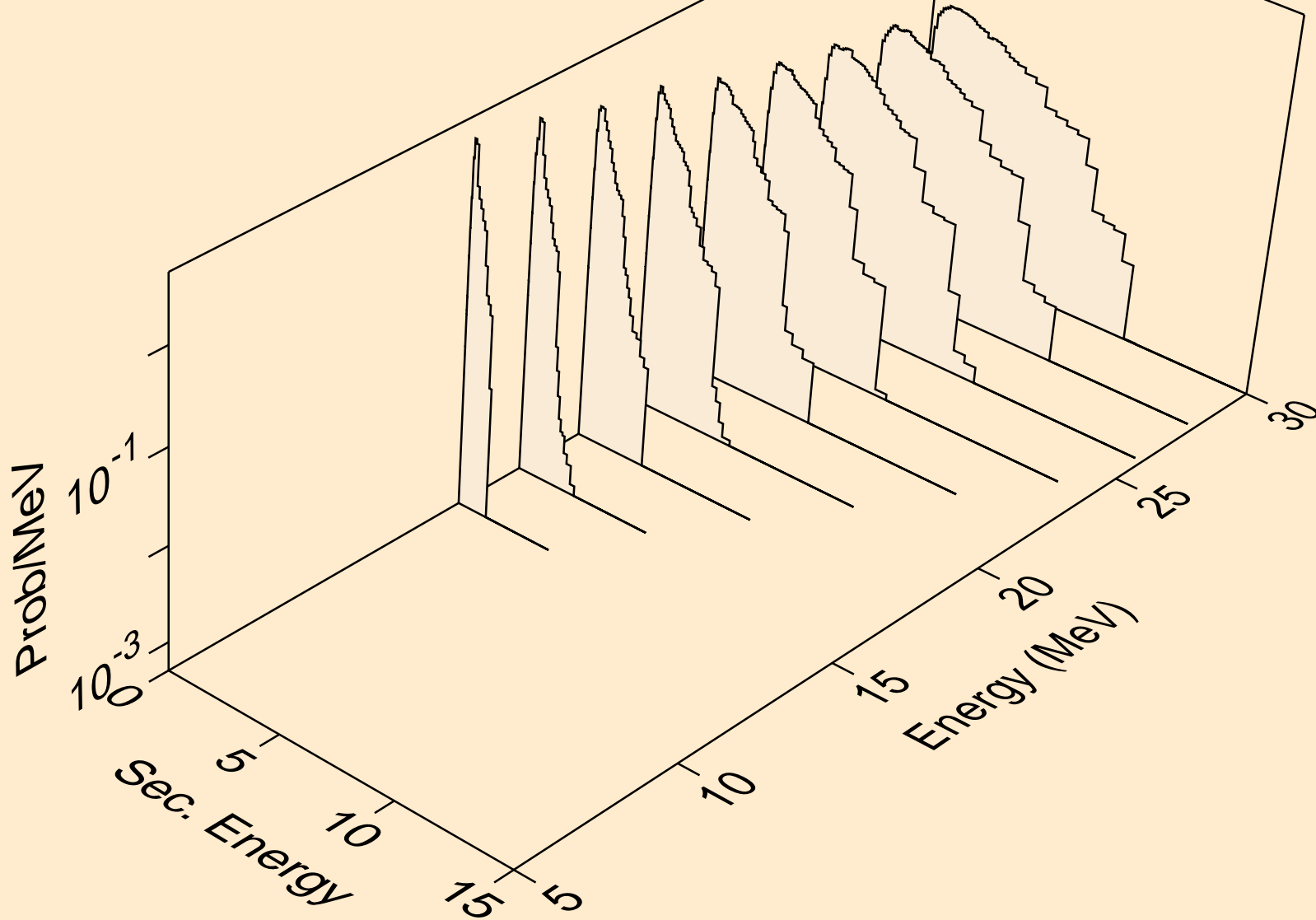

SG271 NEUTRON ACER TENDL-2019 LIBRARY; T=293.16K
Neutron emission for (n,3np)

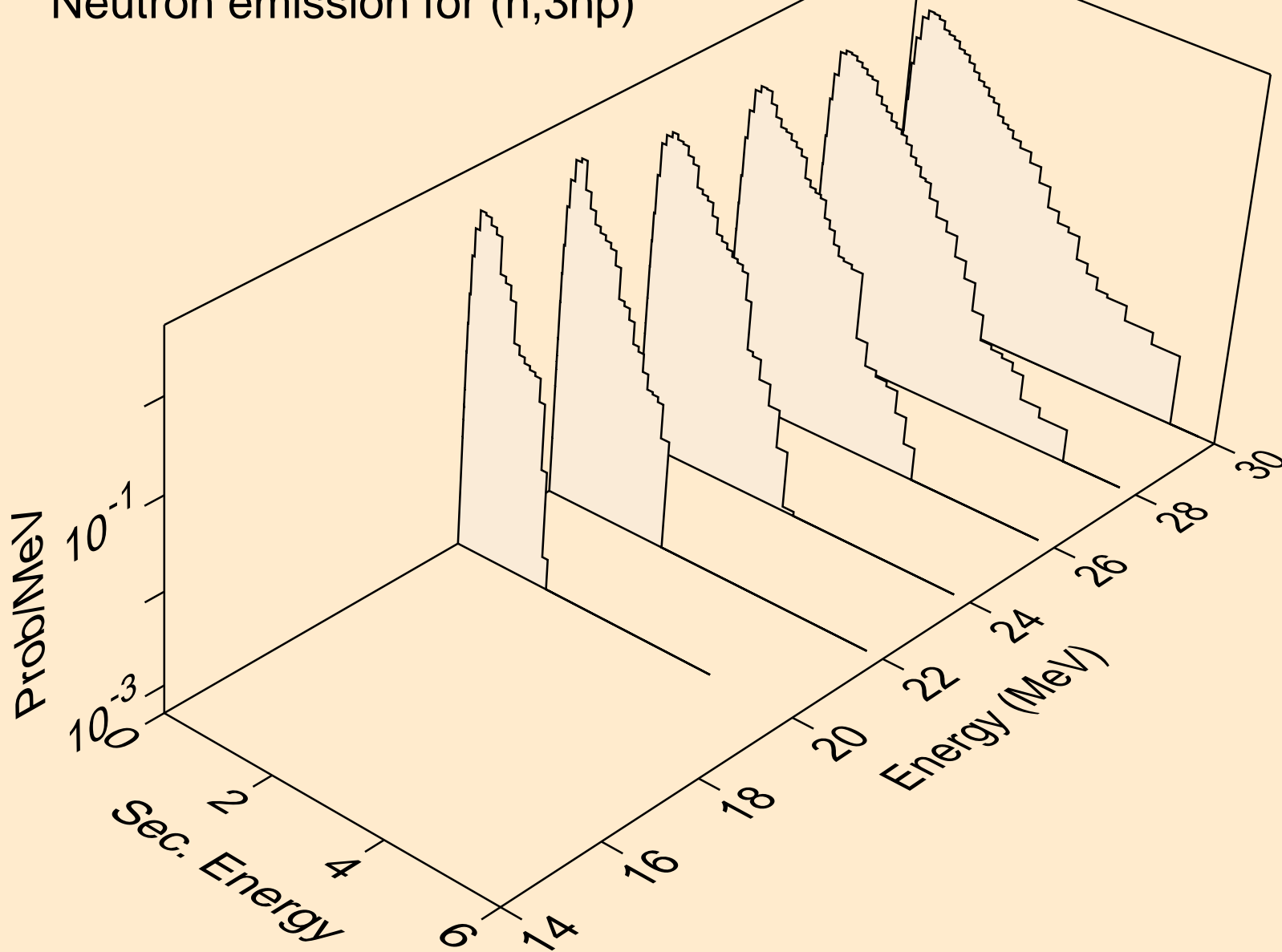

SG271 NEUTRON ACER TENDL-2019 LIBRARY; T=293.16K
Neutron emission for (n,n*c)

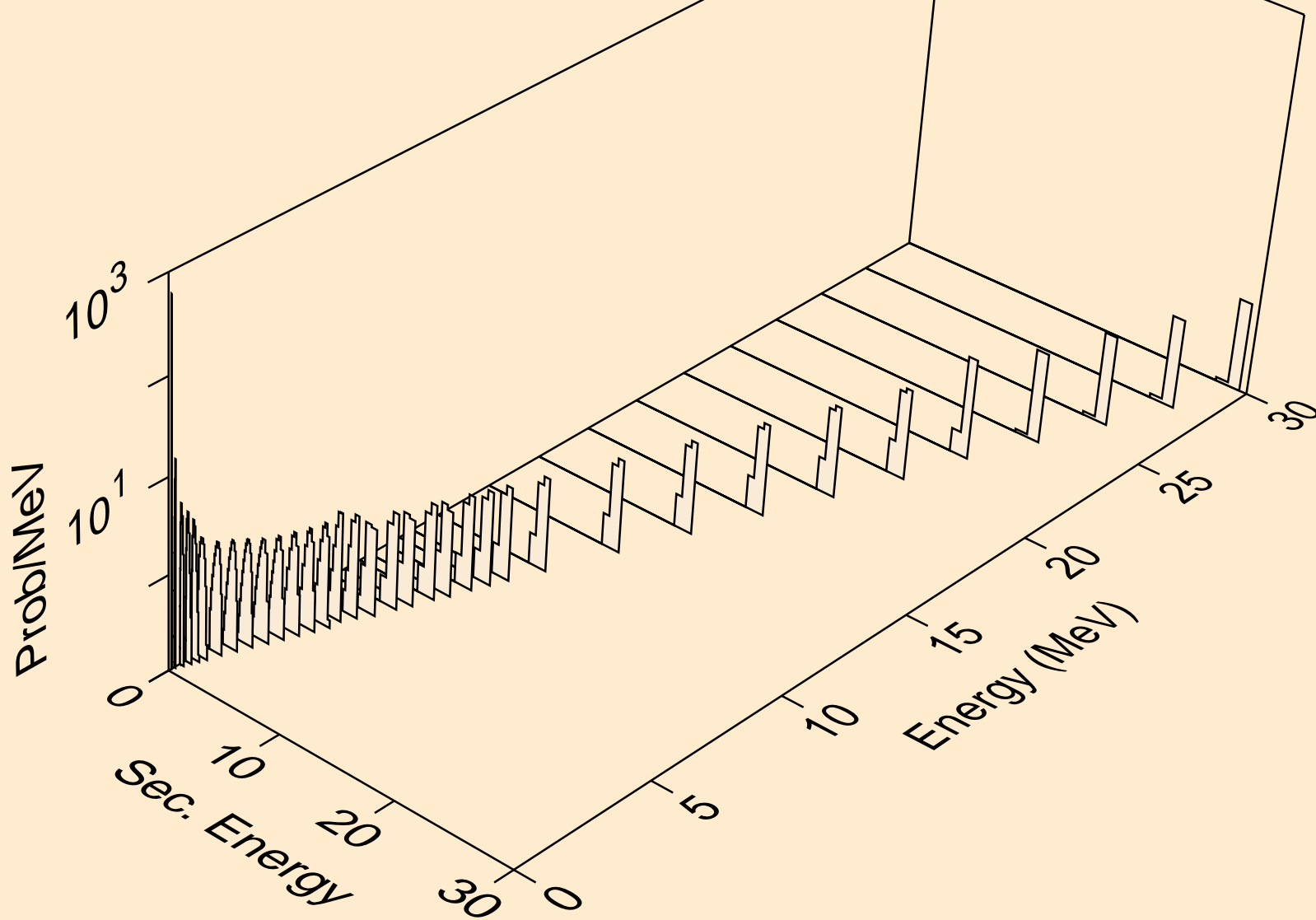

SG271 NEUTRON ACER TENDL-2019 LIBRARY; T=293.16K

Delayed nubar

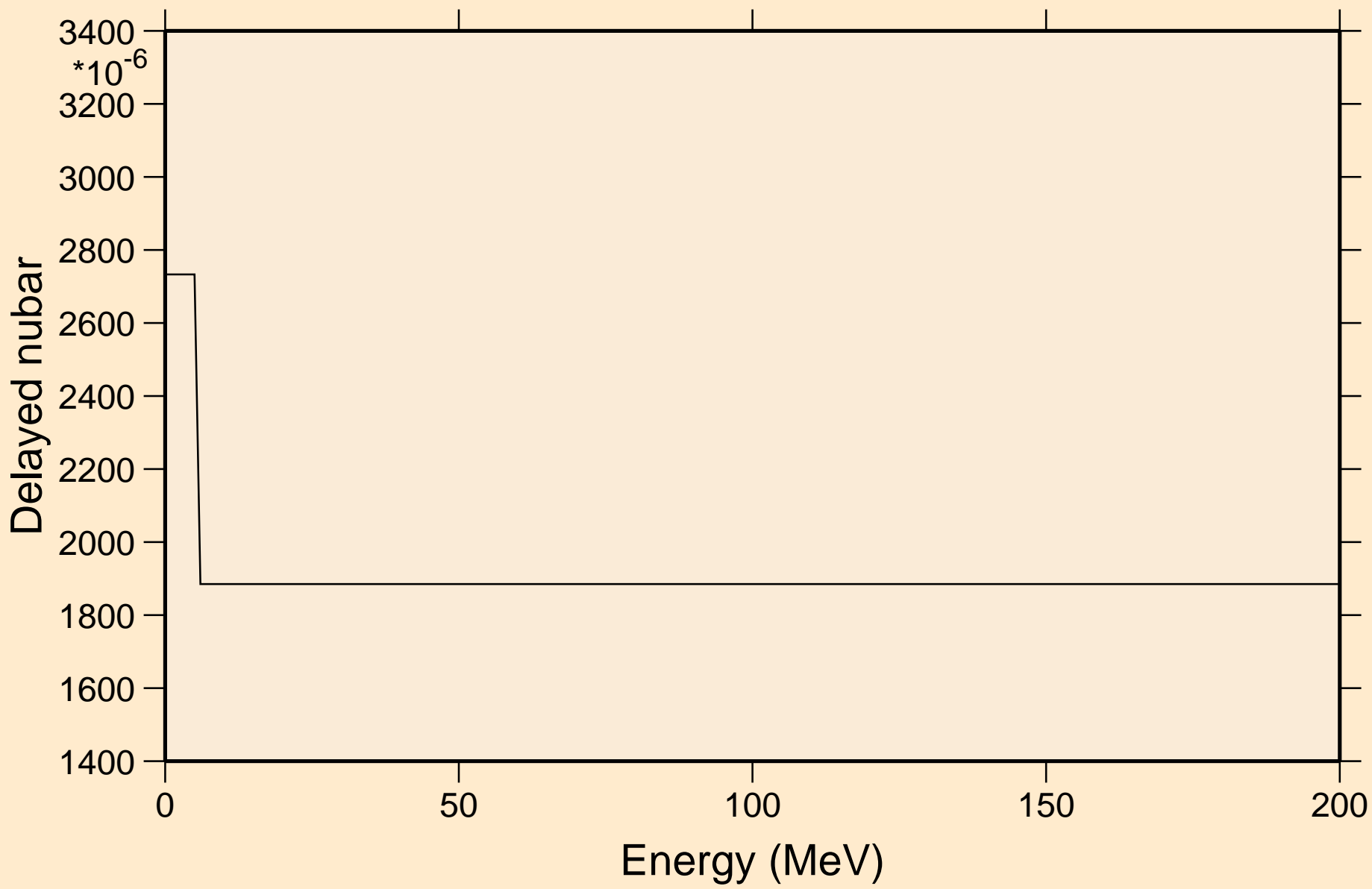

SG271 NEUTRON ACER TENDL-2019 LIBRARY; T=293.16K

Delayed neutron spectra

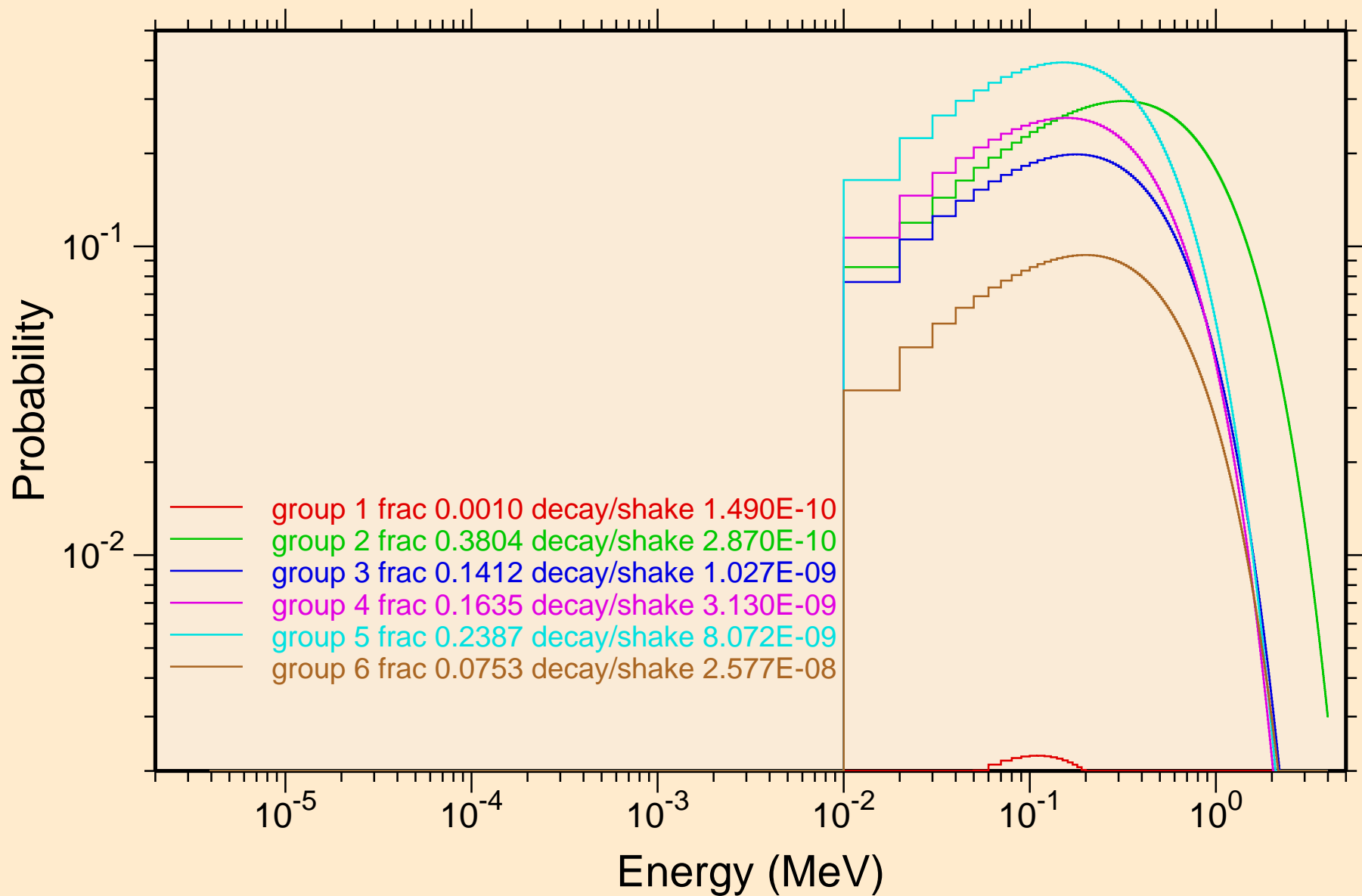

SG271 NEUTRON ACER TENDL-2019 LIBRARY; T=293.16K
Photon emission for (n,x)

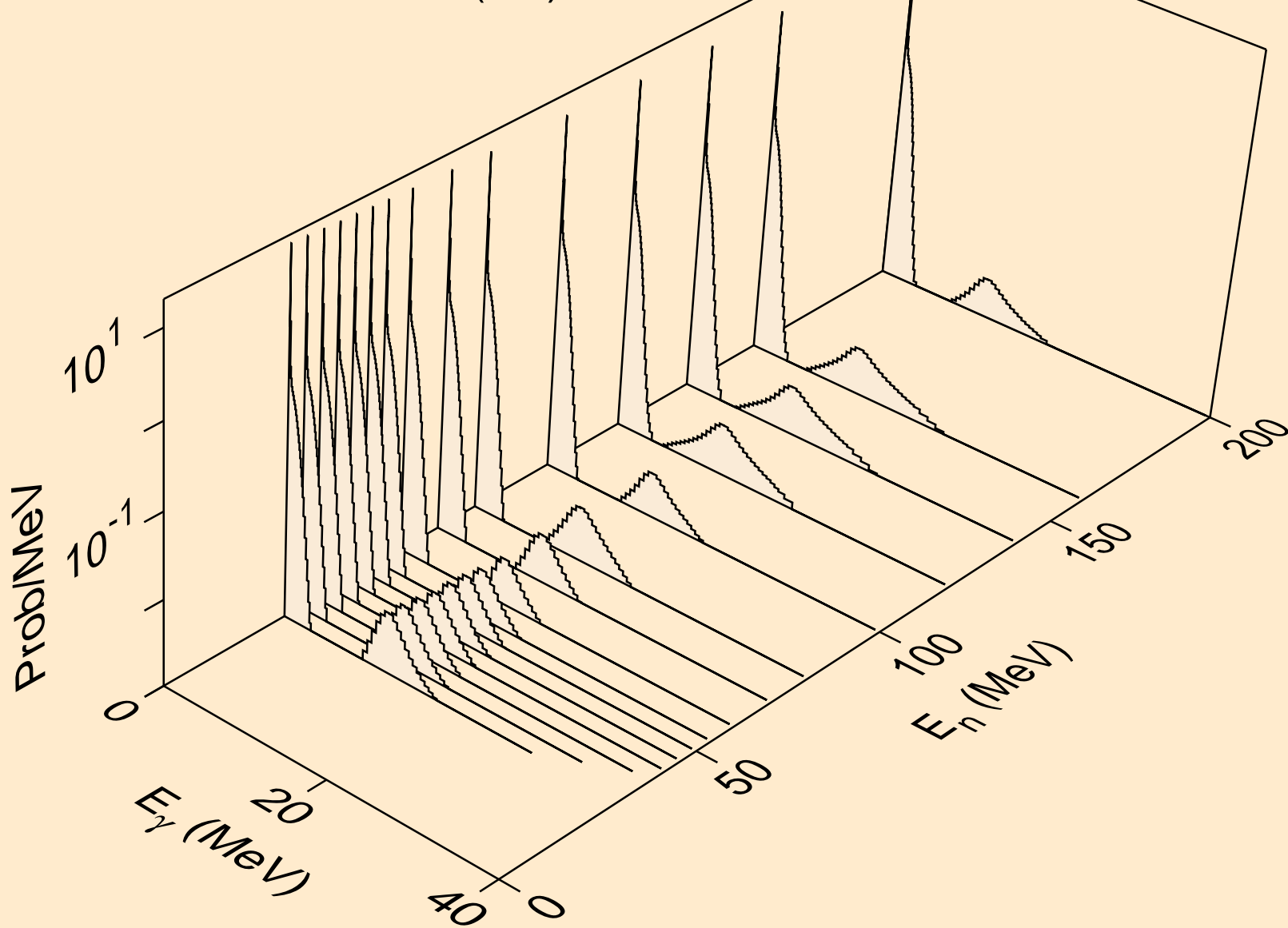

SG271 NEUTRON ACER TENDL-2019 LIBRARY; T=293.16K
Photon emission for (n,2nd)

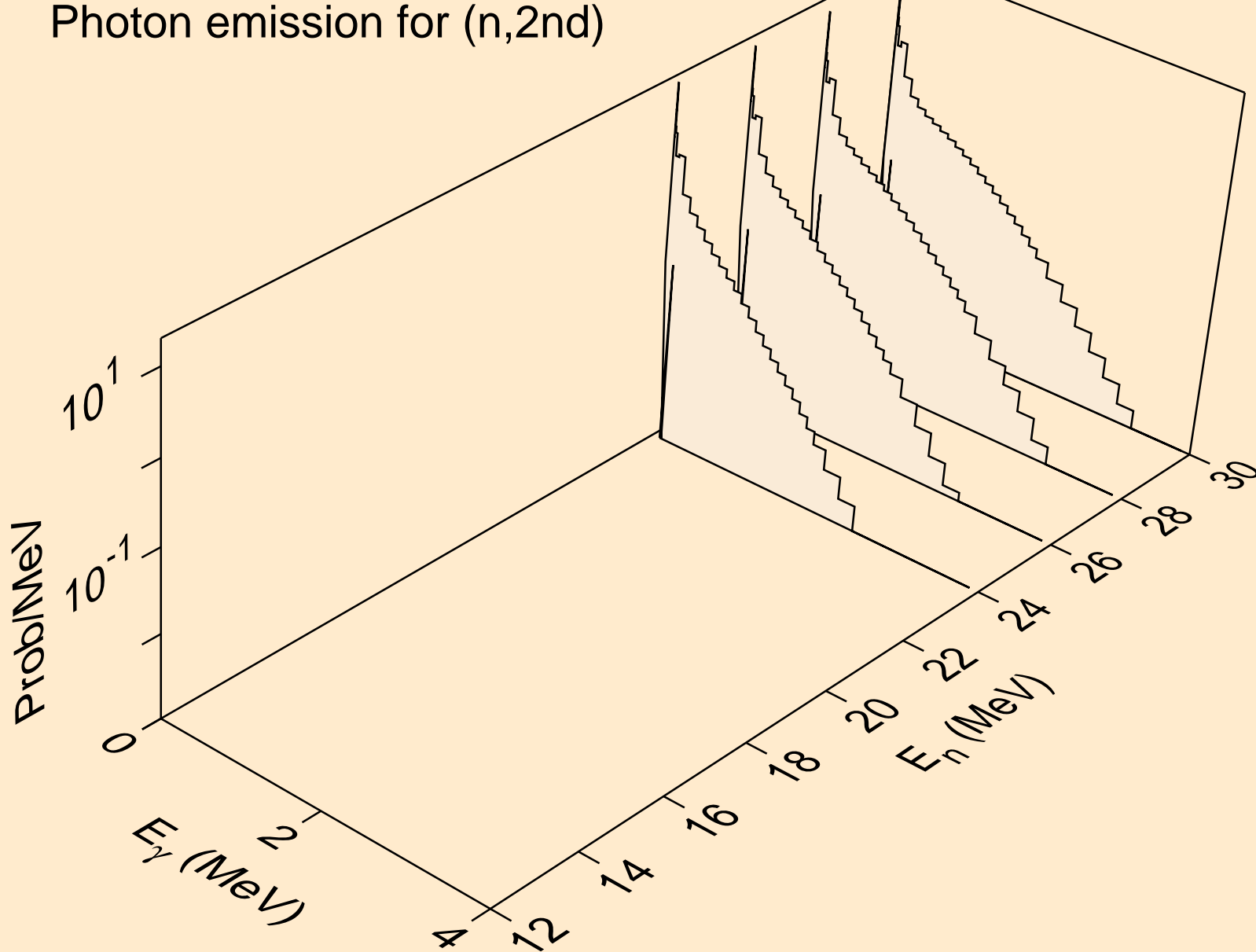

SG271 NEUTRON ACER TENDL-2019 LIBRARY; T=293.16K
Photon emission for (n,2n)

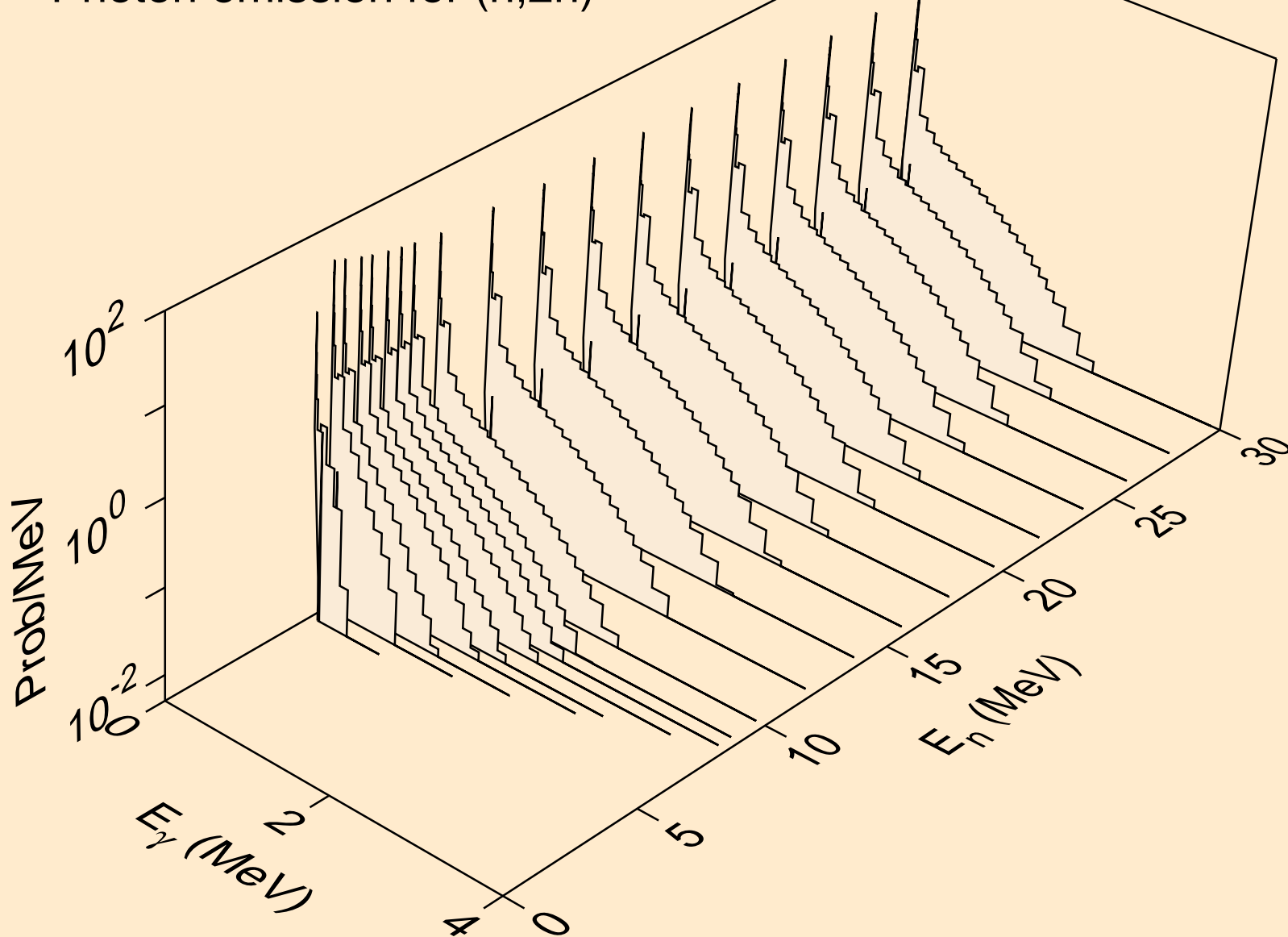

SG271 NEUTRON ACER TENDL-2019 LIBRARY; T=293.16K
Photon emission for (n,3n)

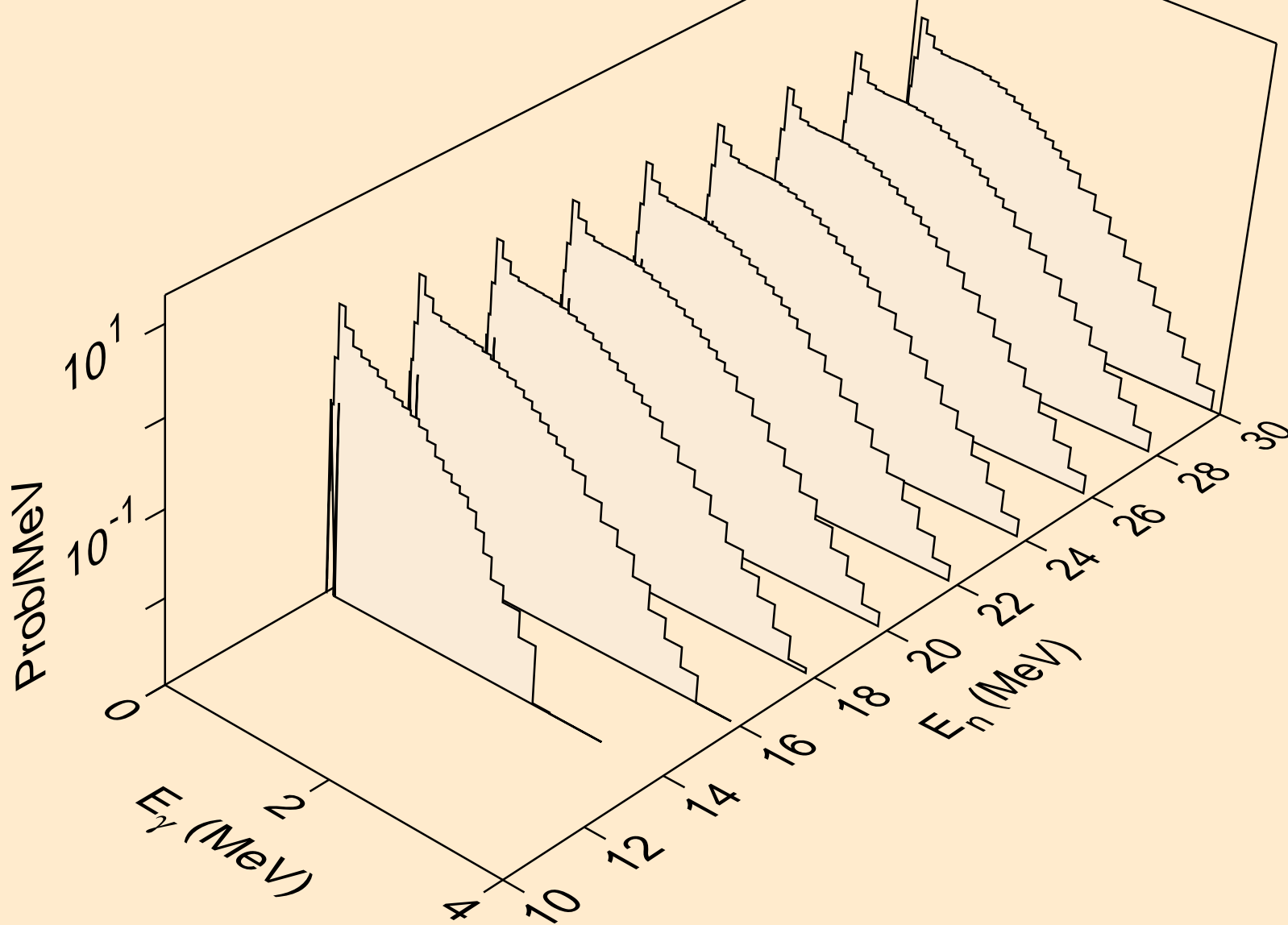

SG271 NEUTRON ACER TENDL-2019 LIBRARY; T=293.16K
Photon emission for (n,n*)a

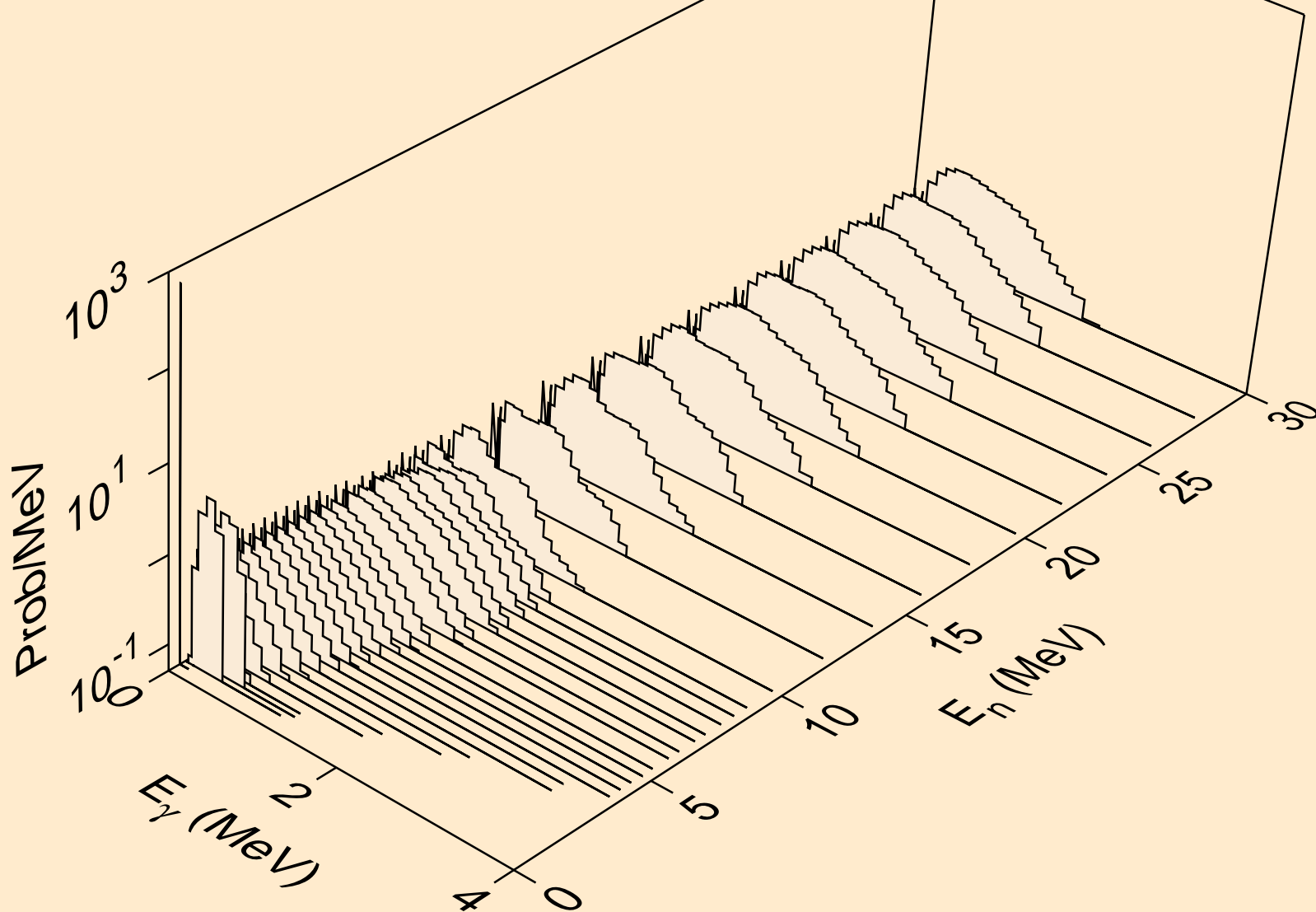

SG271 NEUTRON ACER TENDL-2019 LIBRARY; T=293.16K
Photon emission for (n,2n)a

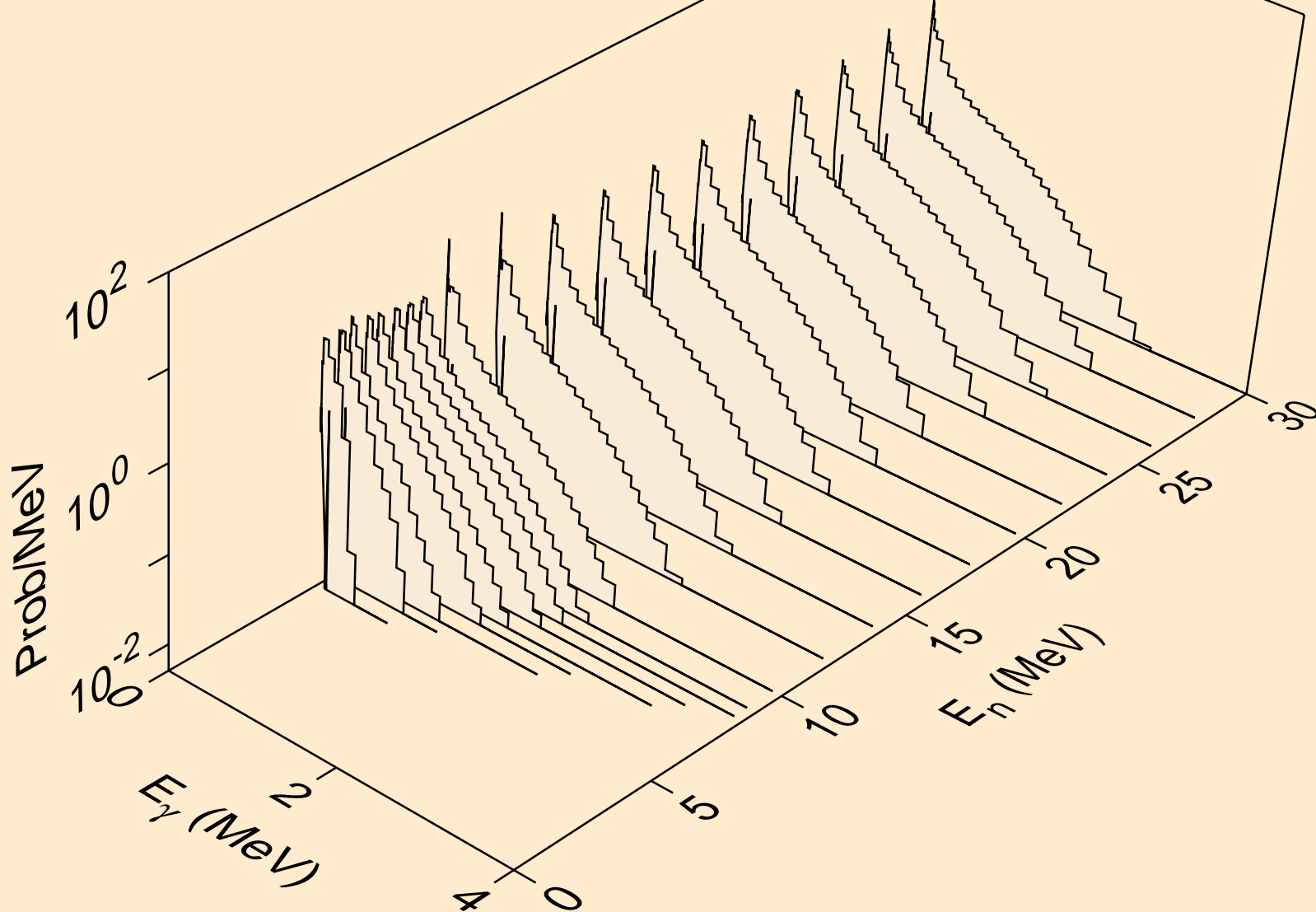

SG271 NEUTRON ACER TENDL-2019 LIBRARY; T=293.16K
Photon emission for (n,3n)a

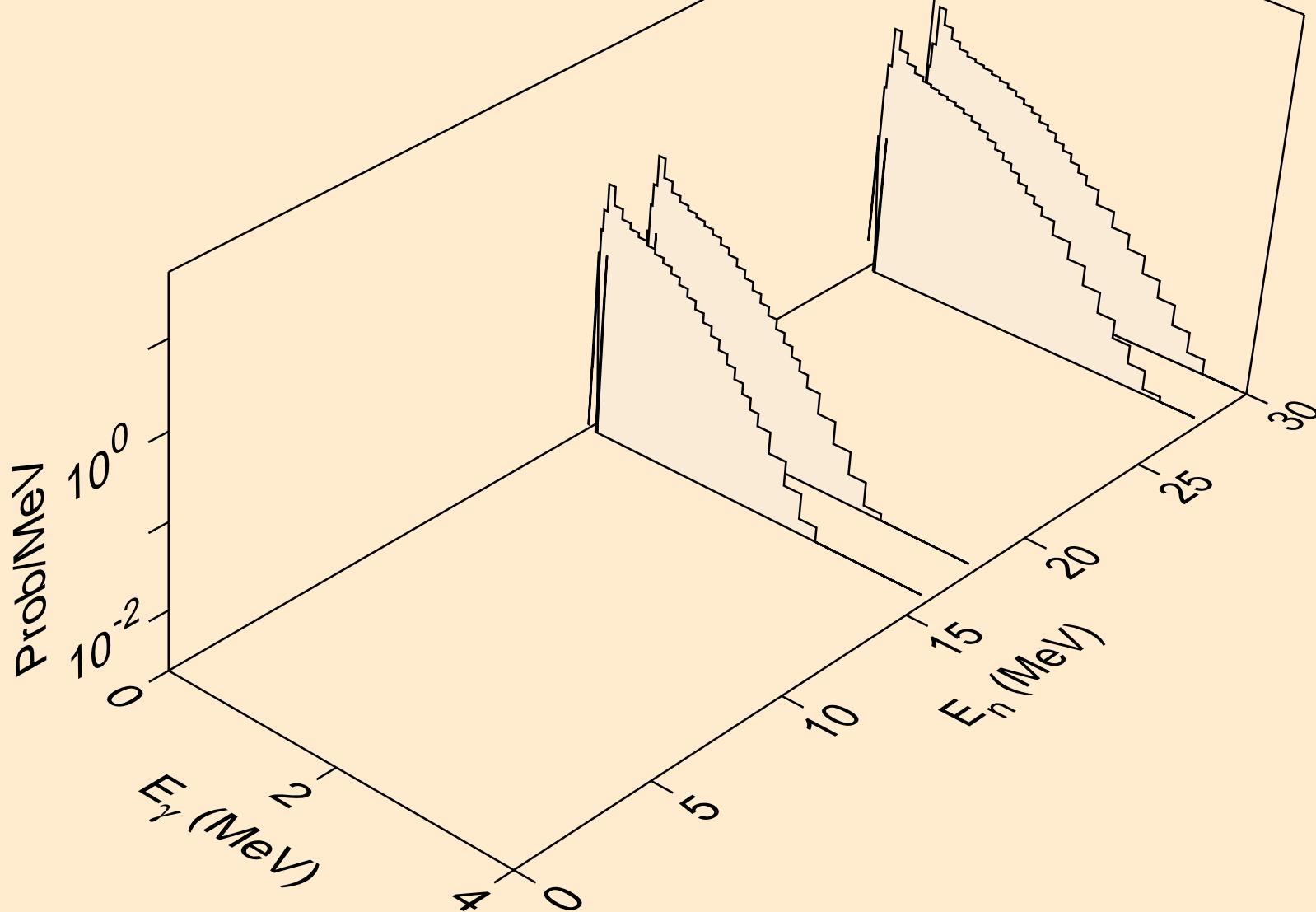

SG271 NEUTRON ACER TENDL-2019 LIBRARY; T=293.16K
Photon emission for (n,n*)p

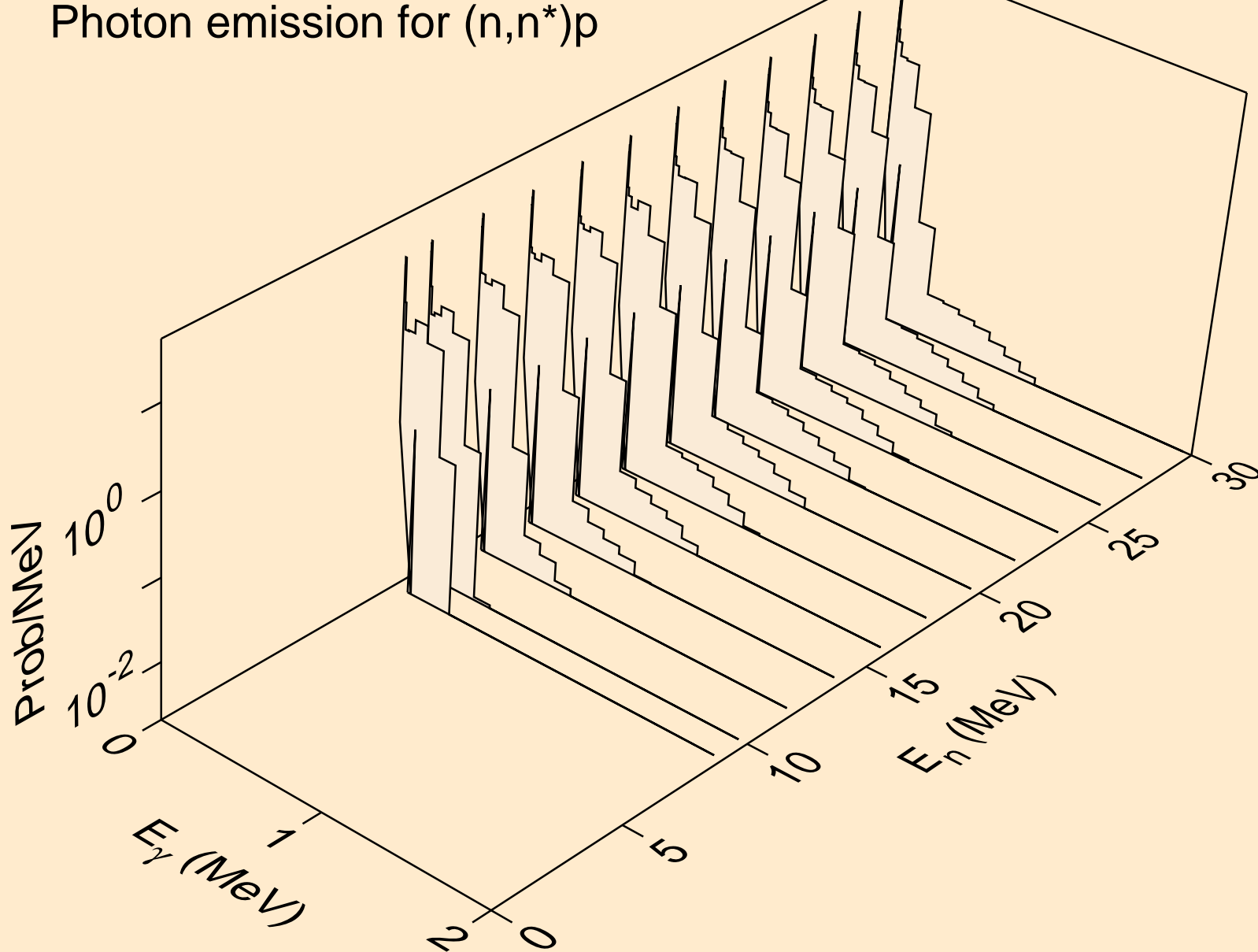

SG271 NEUTRON ACER TENDL-2019 LIBRARY; T=293.16K
Photon emission for (n,n*)d

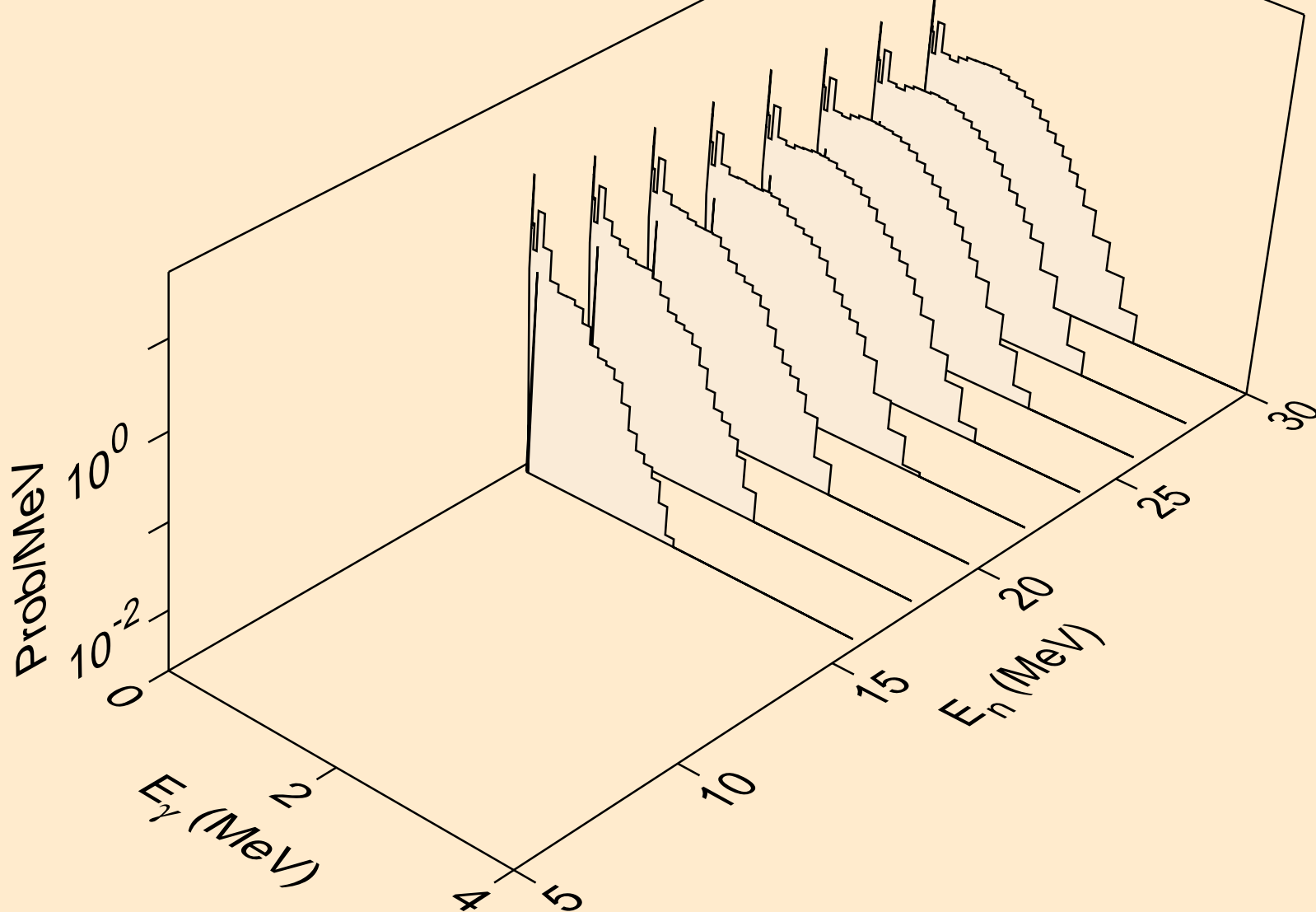

SG271 NEUTRON ACER TENDL-2019 LIBRARY; T=293.16K
Photon emission for (n,n*)t

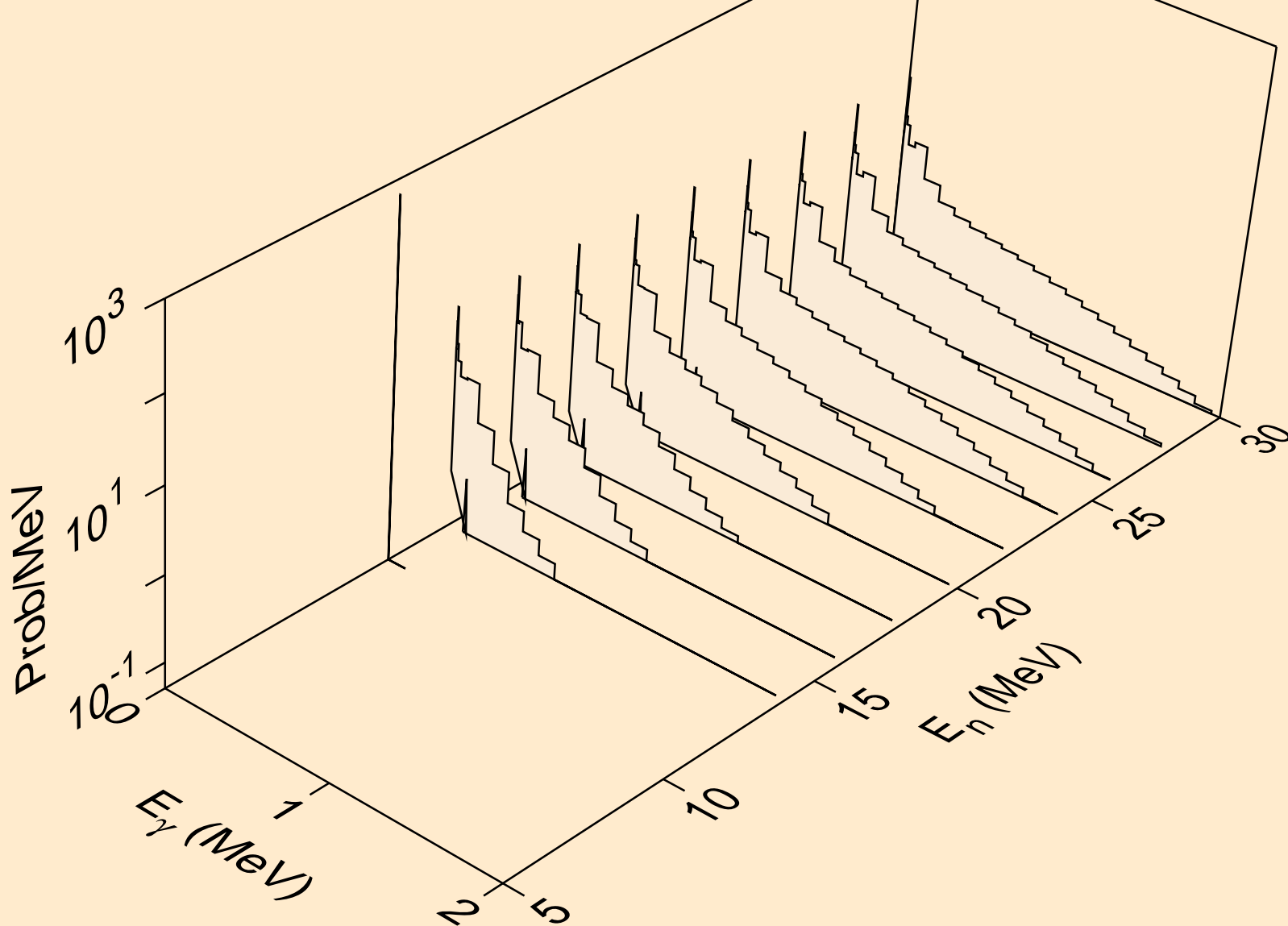

SG271 NEUTRON ACER TENDL-2019 LIBRARY; T=293.16K
Photon emission for (n,n*)he3

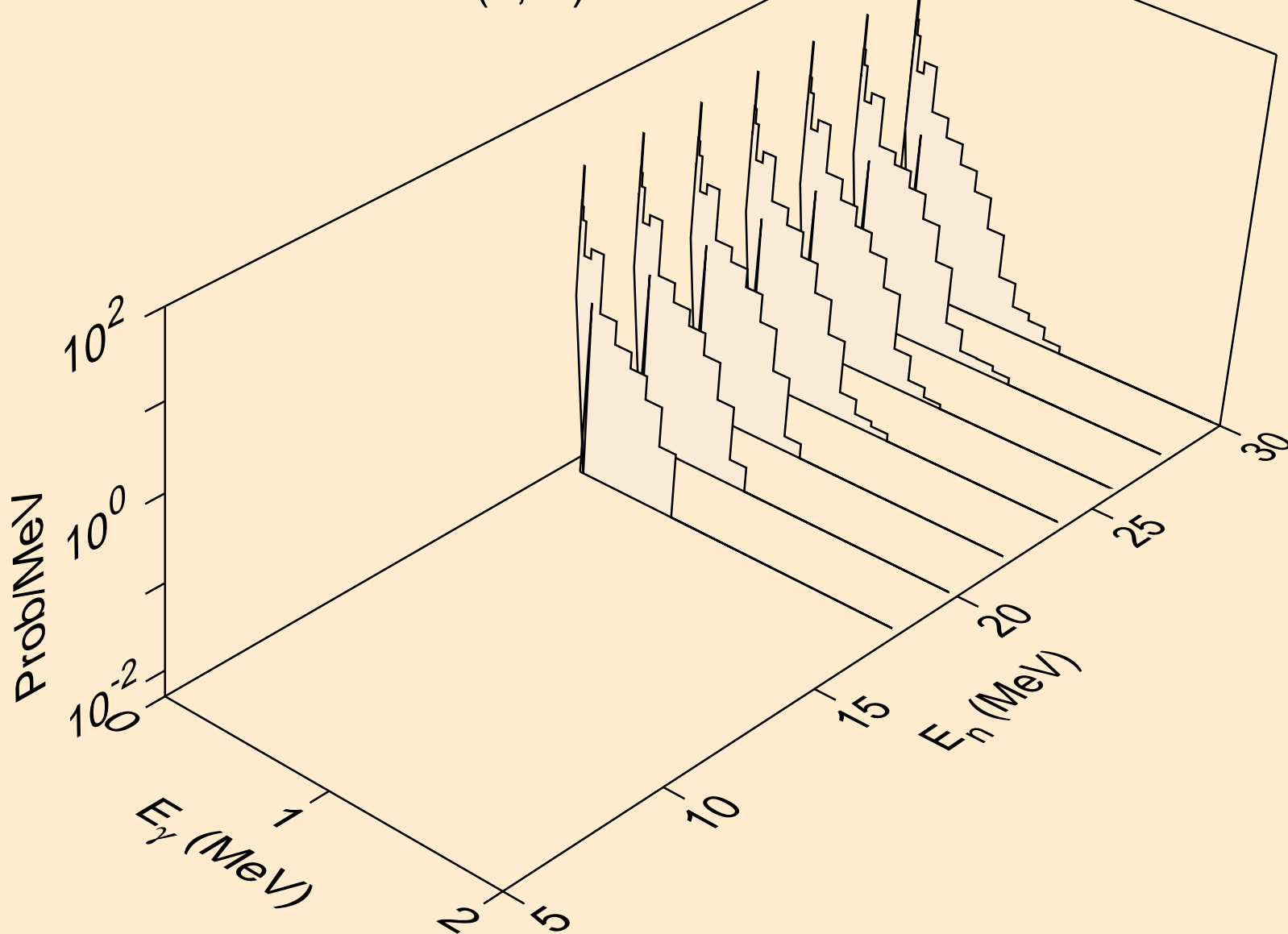

SG271 NEUTRON ACER TENDL-2019 LIBRARY; T=293.16K
Photon emission for (n,4n)

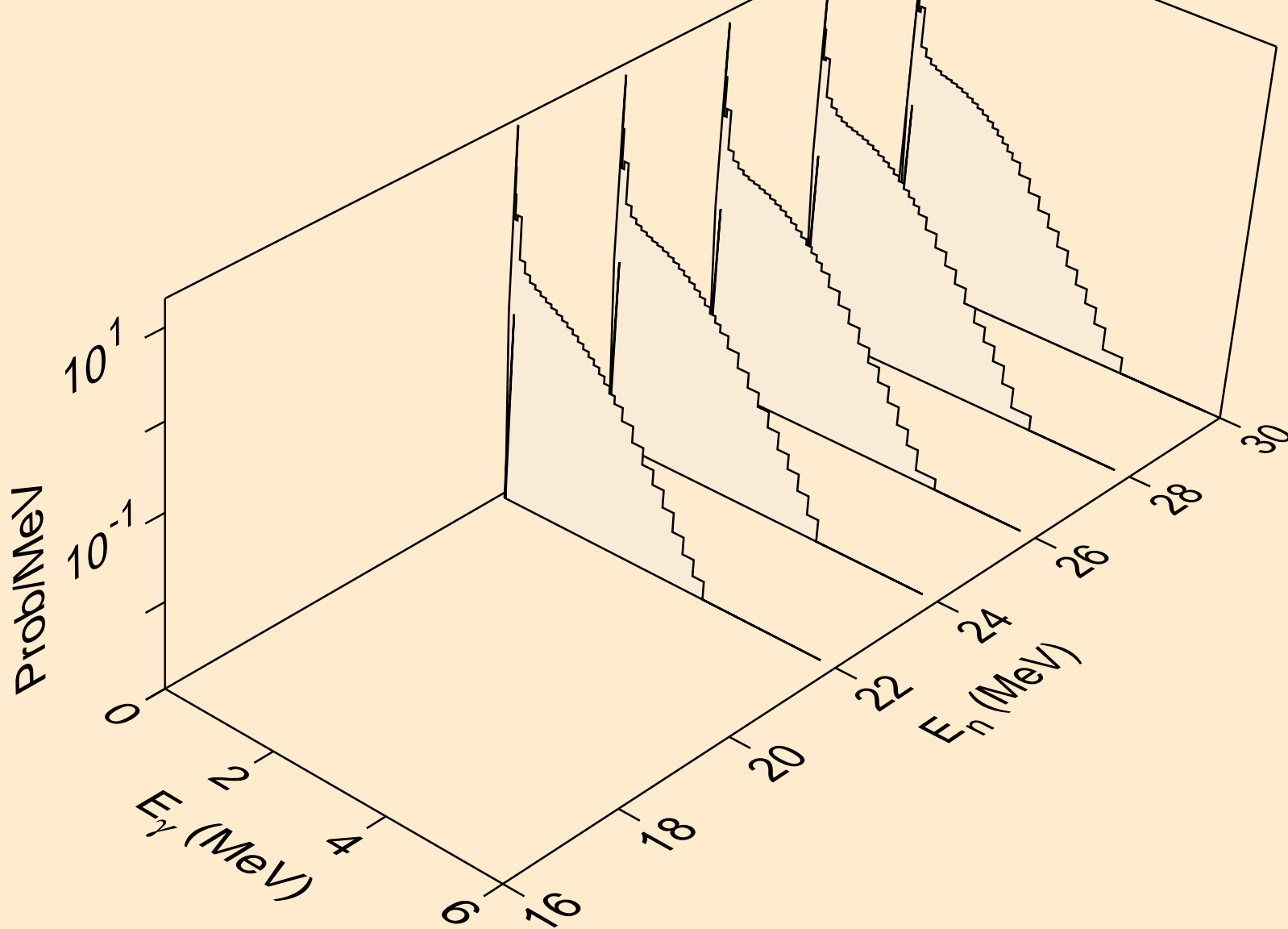

SG271 NEUTRON ACER TENDL-2019 LIBRARY; T=293.16K
Photon emission for (n,2np)

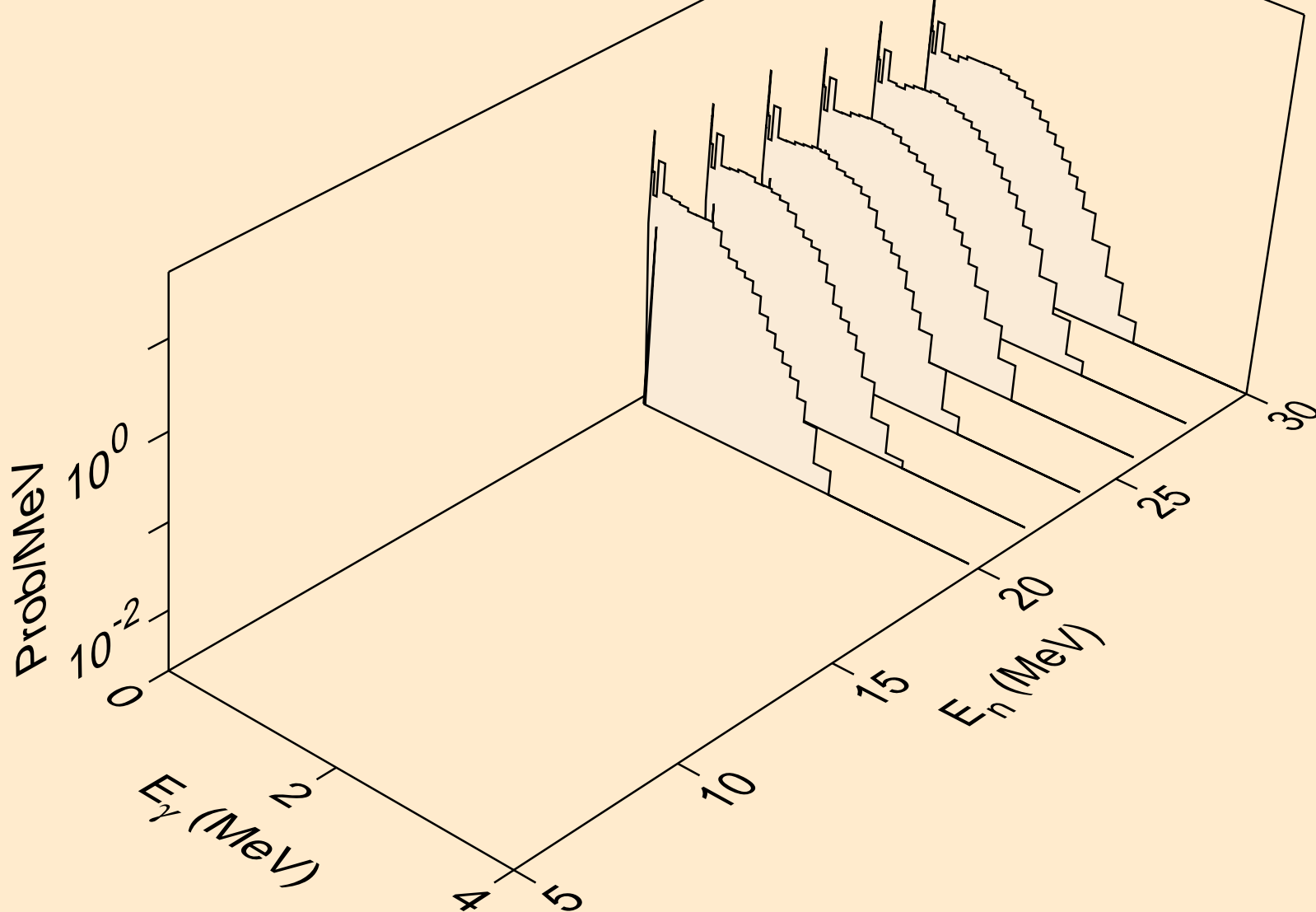

SG271 NEUTRON ACER TENDL-2019 LIBRARY; T=293.16K
Photon emission for (n,3np)

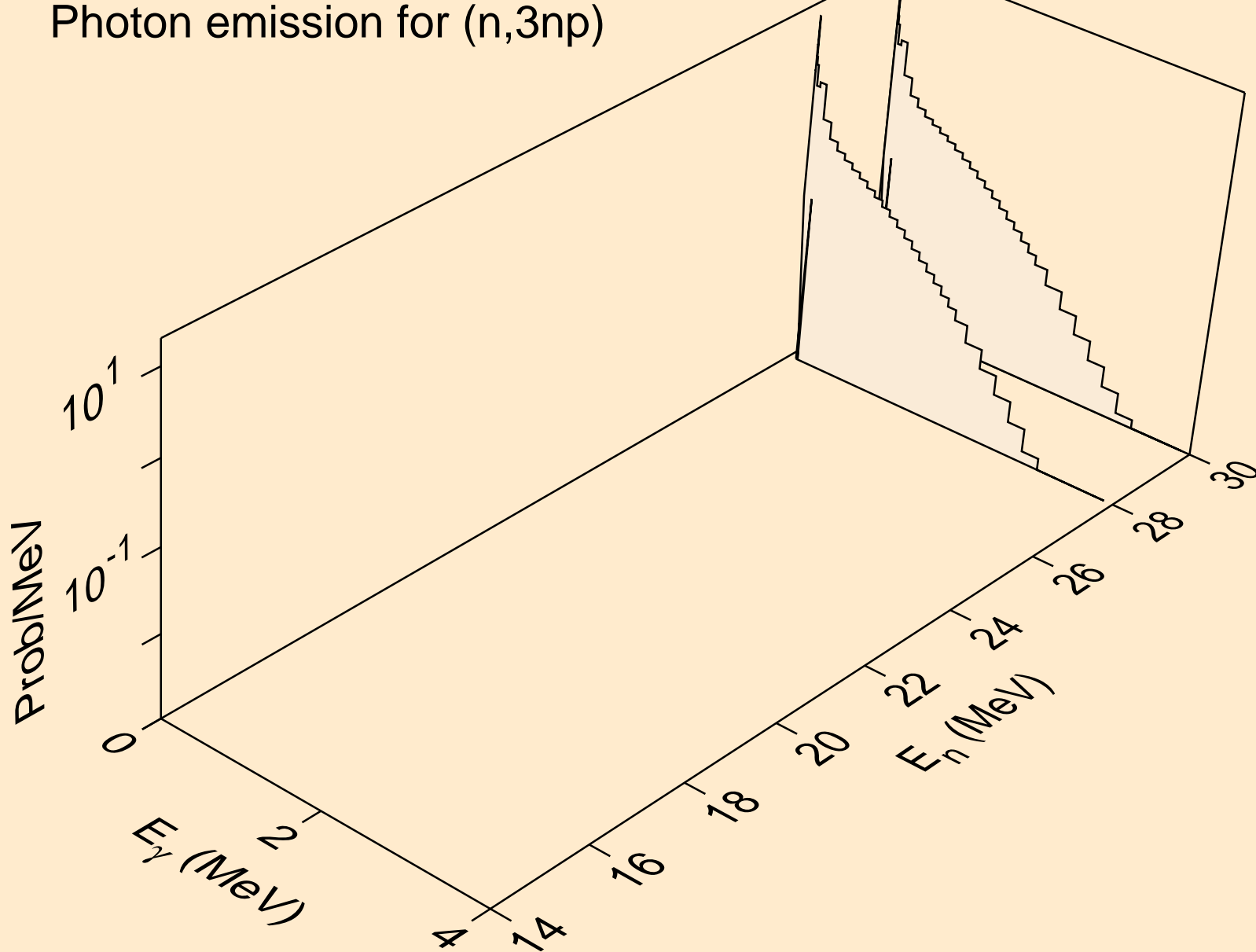

SG271 NEUTRON ACER TENDL-2019 LIBRARY; T=293.16K
Photon emission for (n,n*c)

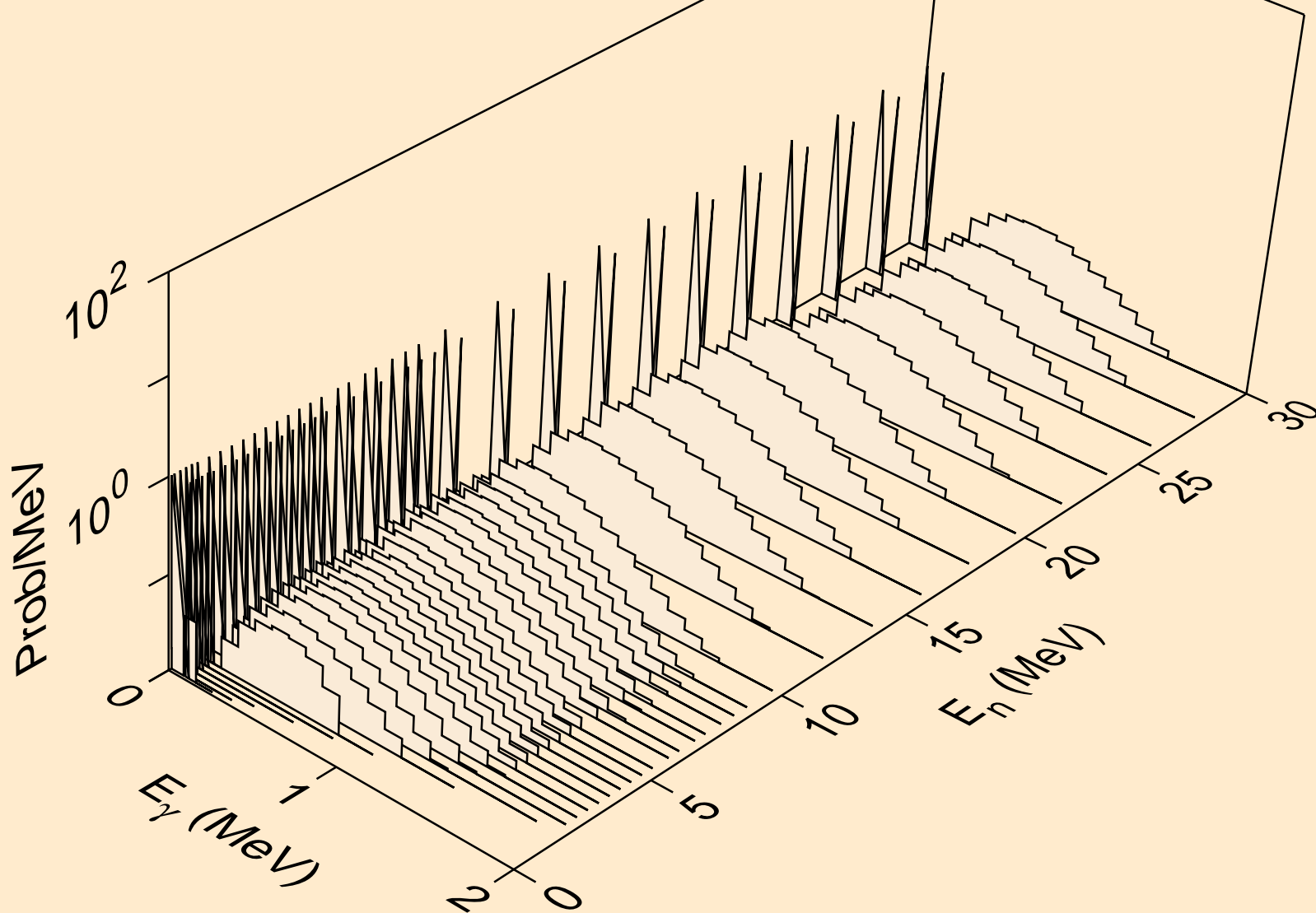

SG271 NEUTRON ACER TENDL-2019 LIBRARY; T=293.16K
Photon emission for (n,gma)

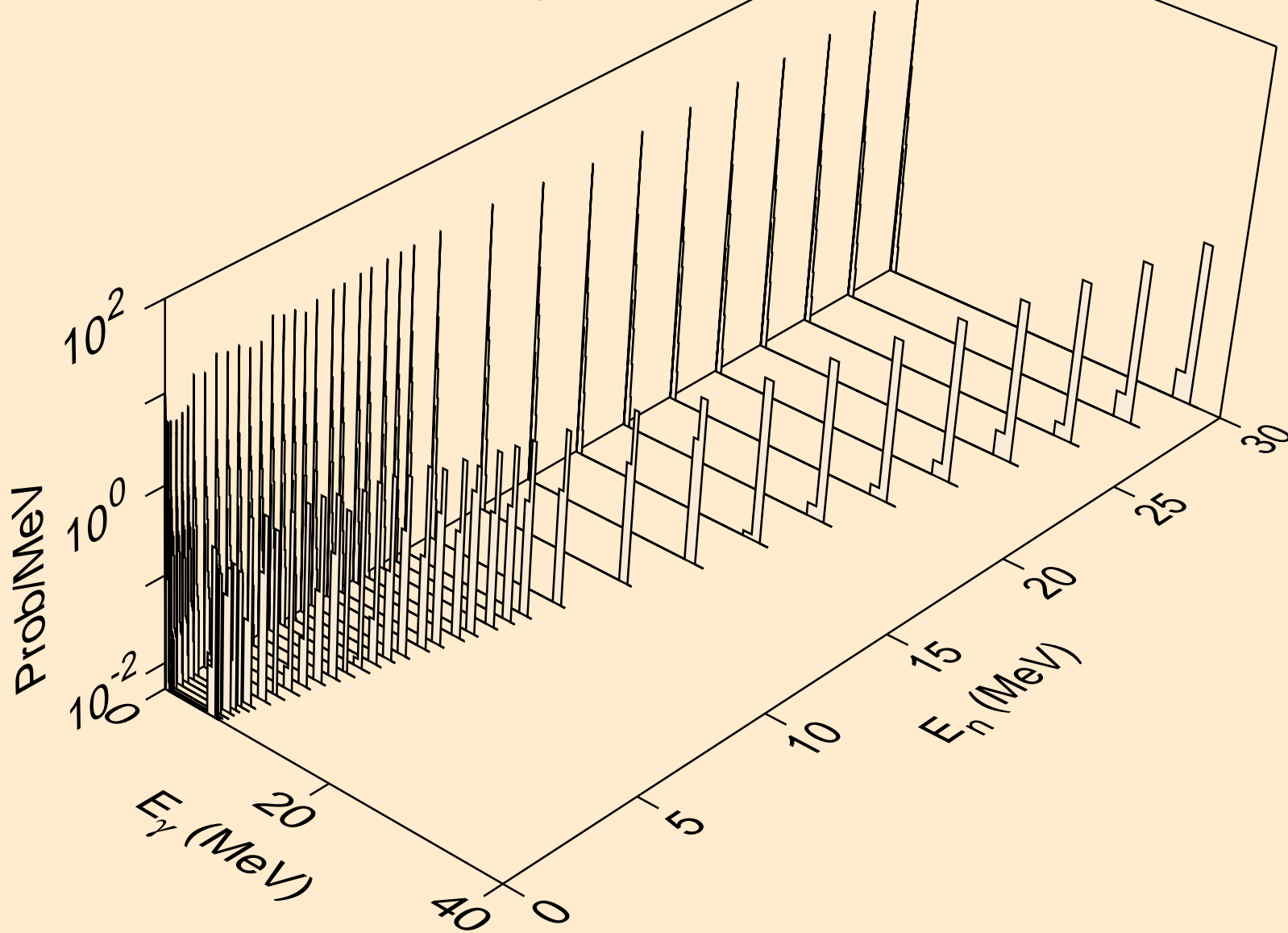

SG271 NEUTRON ACER TENDL-2019 LIBRARY; T=293.16K
Photon emission for (n,p)

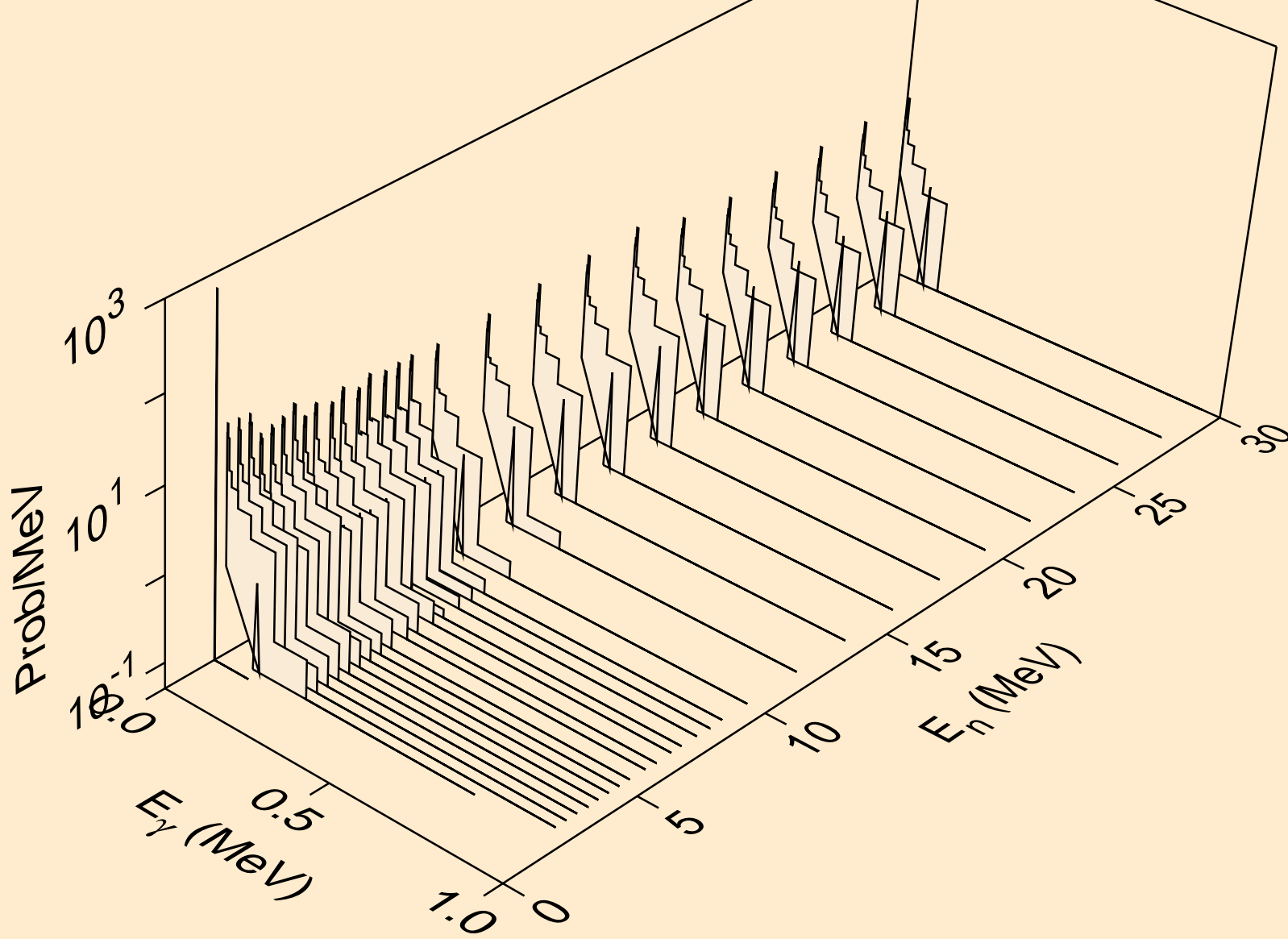

SG271 NEUTRON ACER TENDL-2019 LIBRARY; T=293.16K
Photon emission for (n,d)

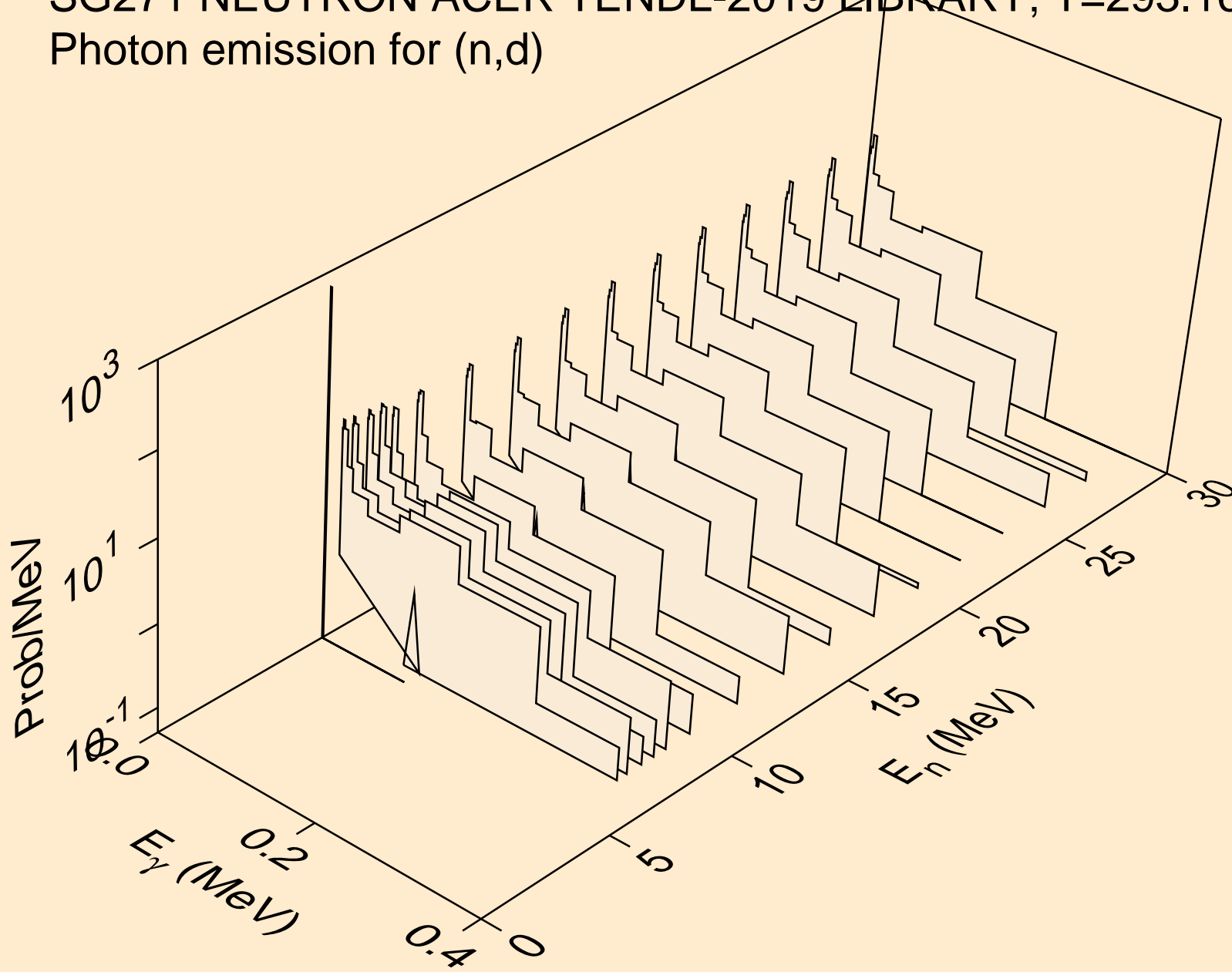

SG271 NEUTRON ACER TENDL-2019 LIBRARY; T=293.16K
Photon emission for (n,t)

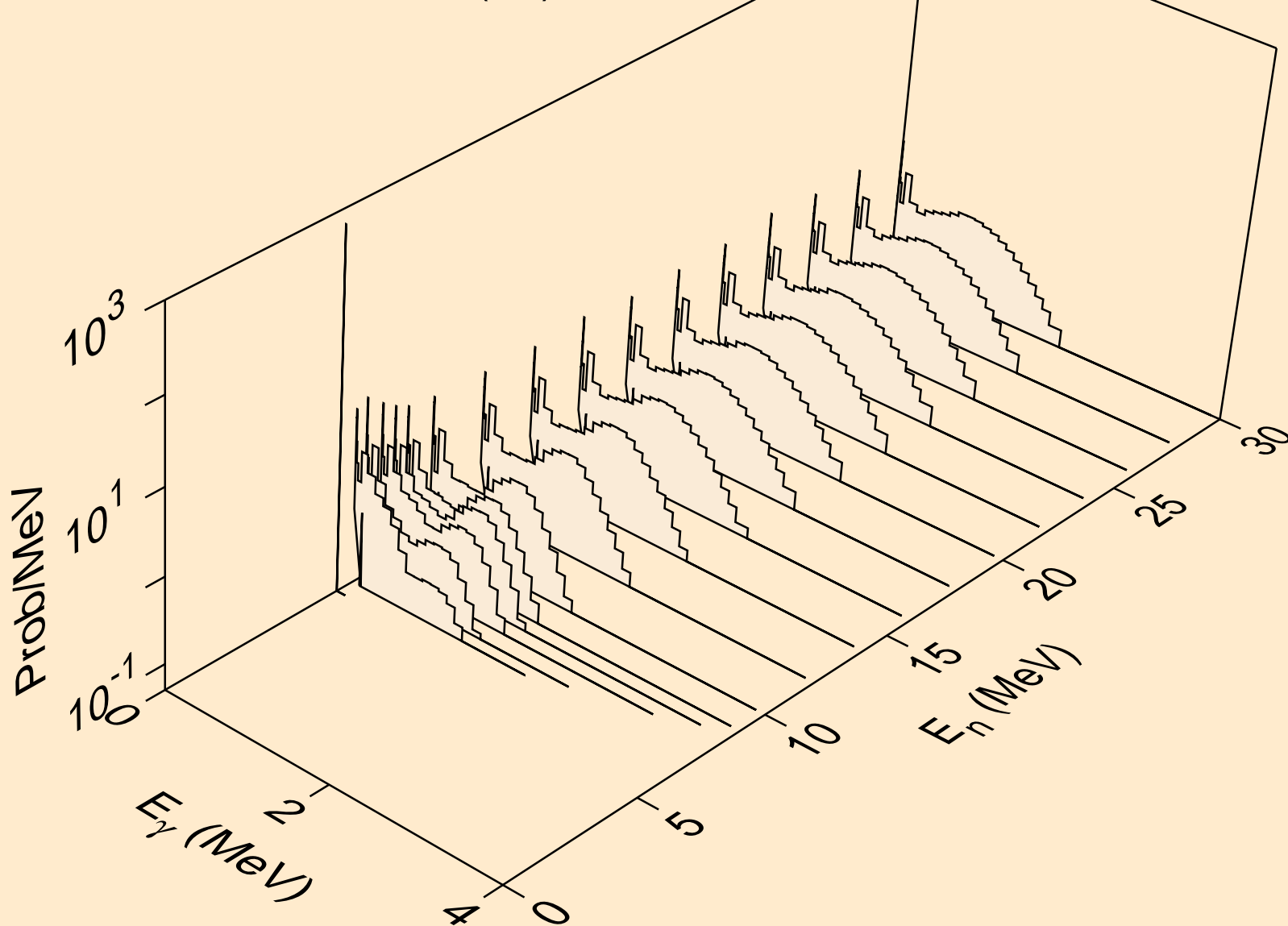

SG271 NEUTRON ACER TENDL-2019 LIBRARY; T=293.16K
Photon emission for (n,he3)

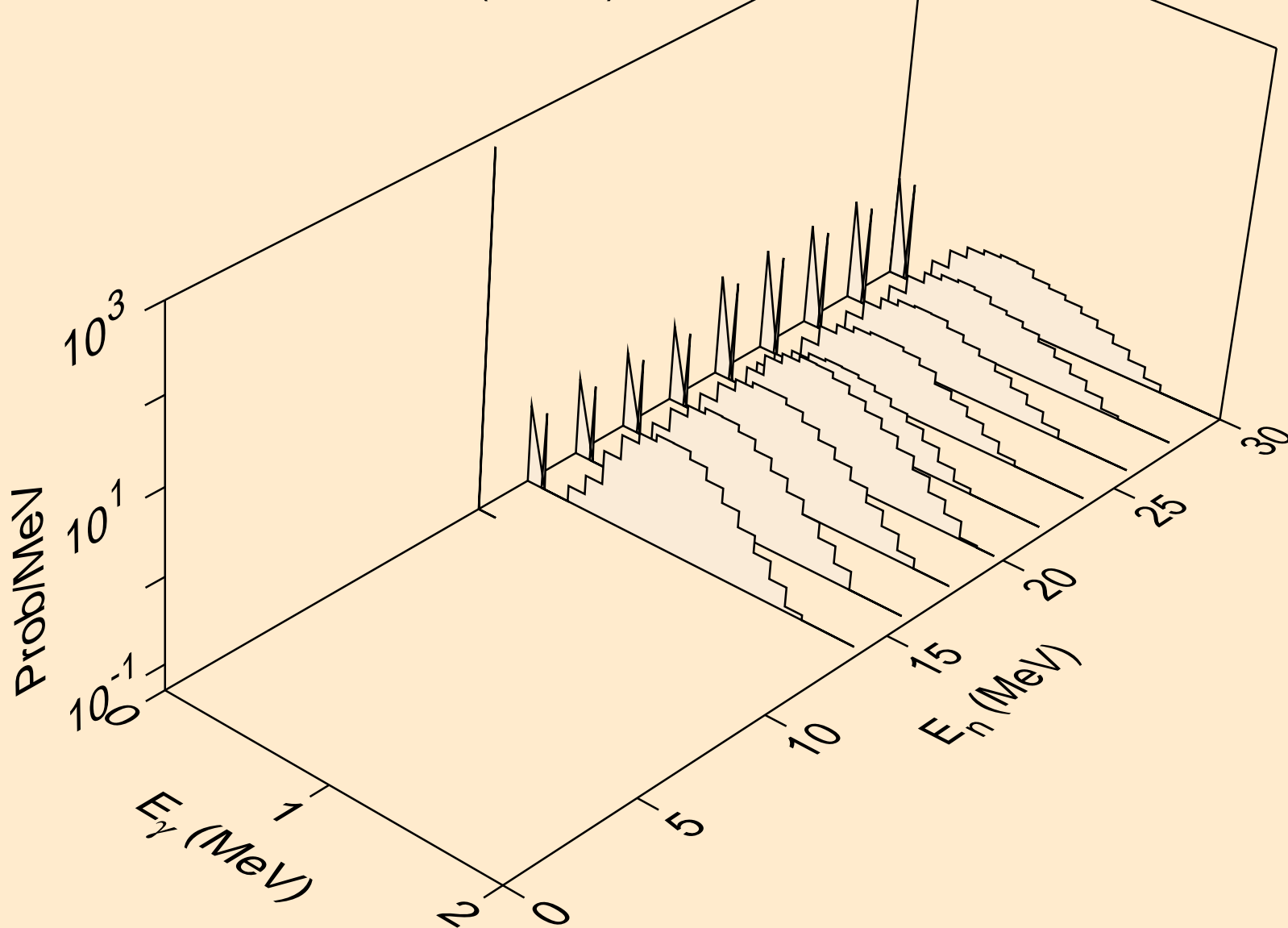

SG271 NEUTRON ACER TENDL-2019 LIBRARY; T=293.16K
Photon emission for (n,a)

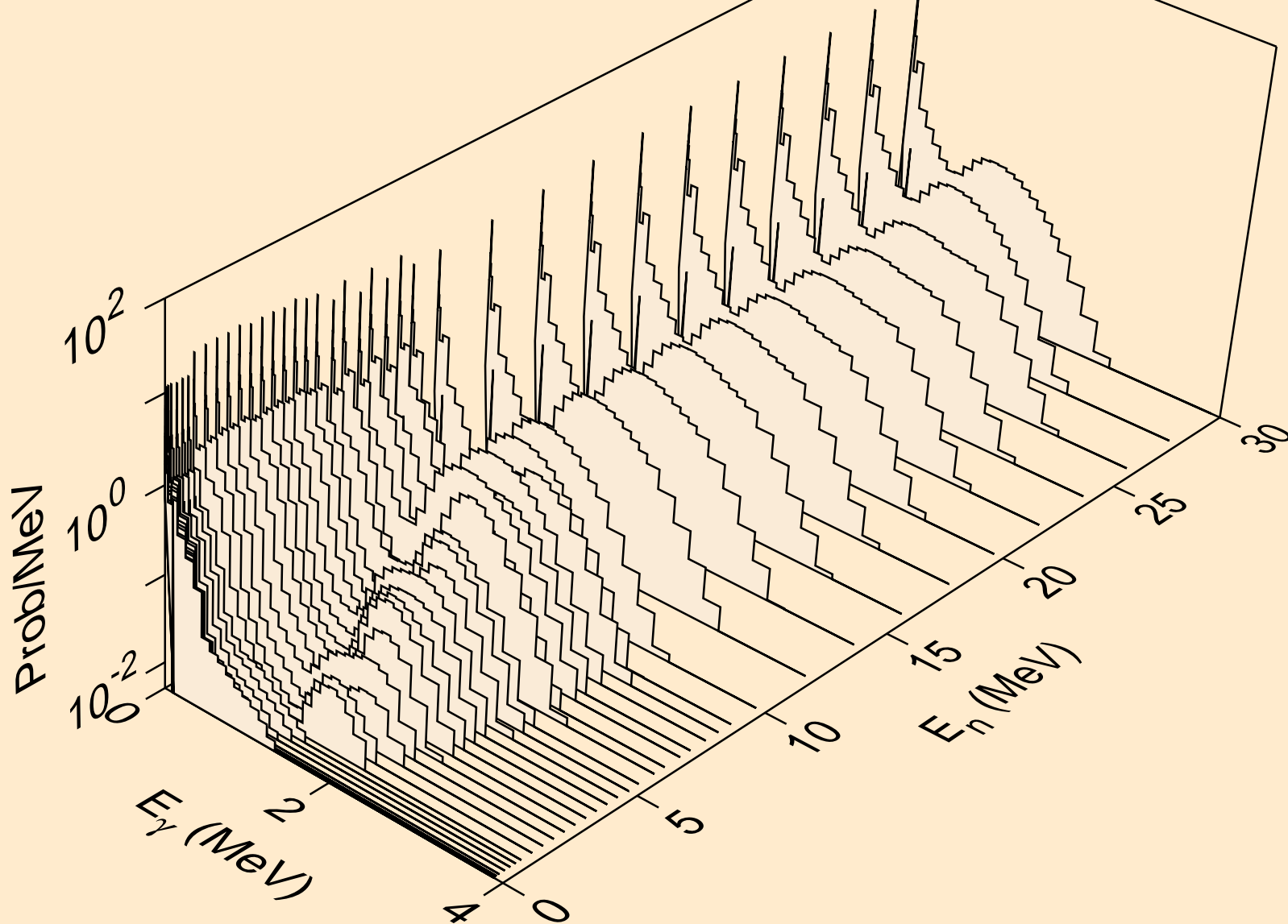

SG271 NEUTRON ACER TENDL-2019 LIBRARY; T=293.16K
thermal capture photon spectrum

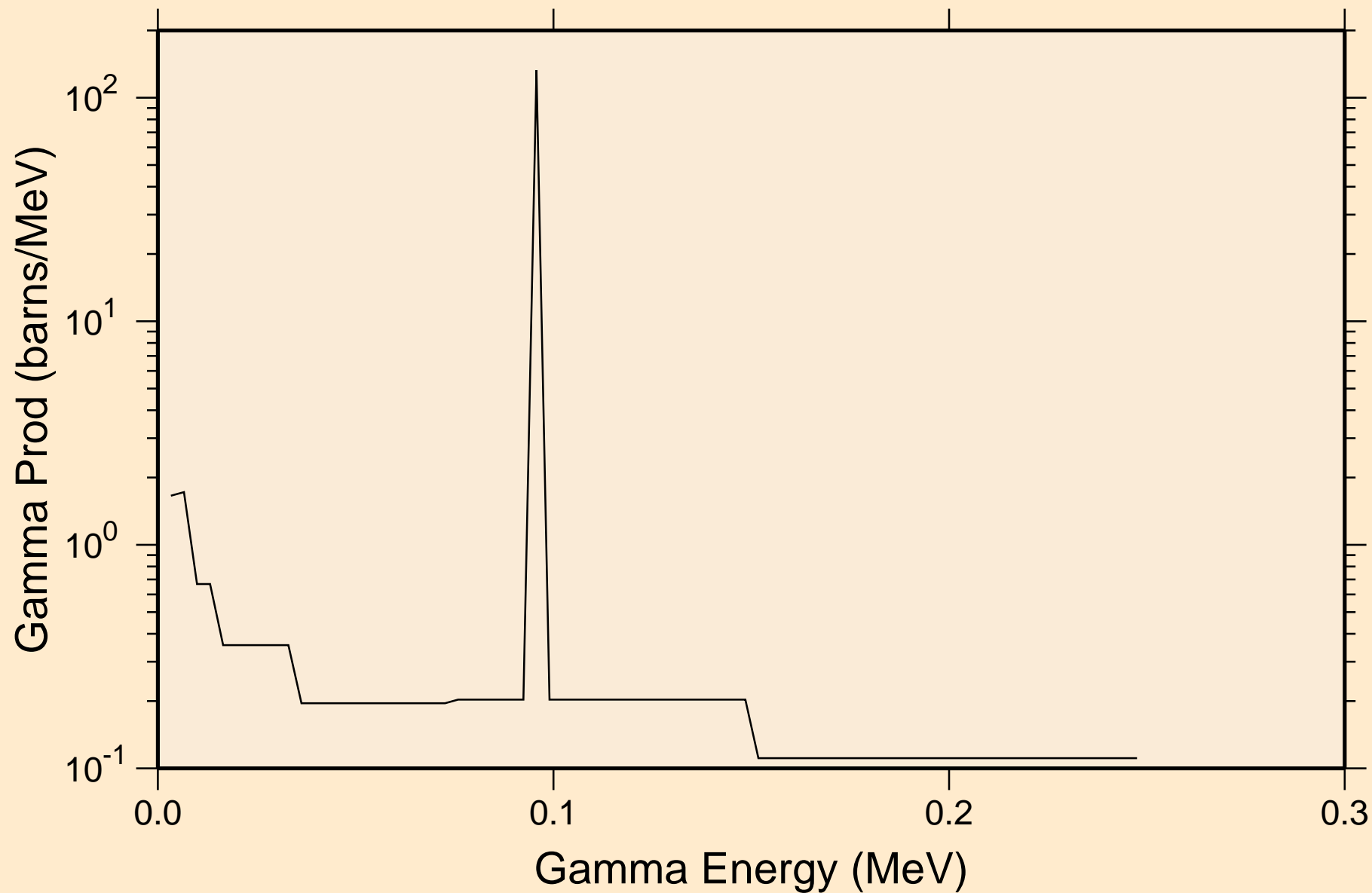

SG271 NEUTRON ACER TENDL-2019 LIBRARY; T=293.16K
14 MeV photon spectrum

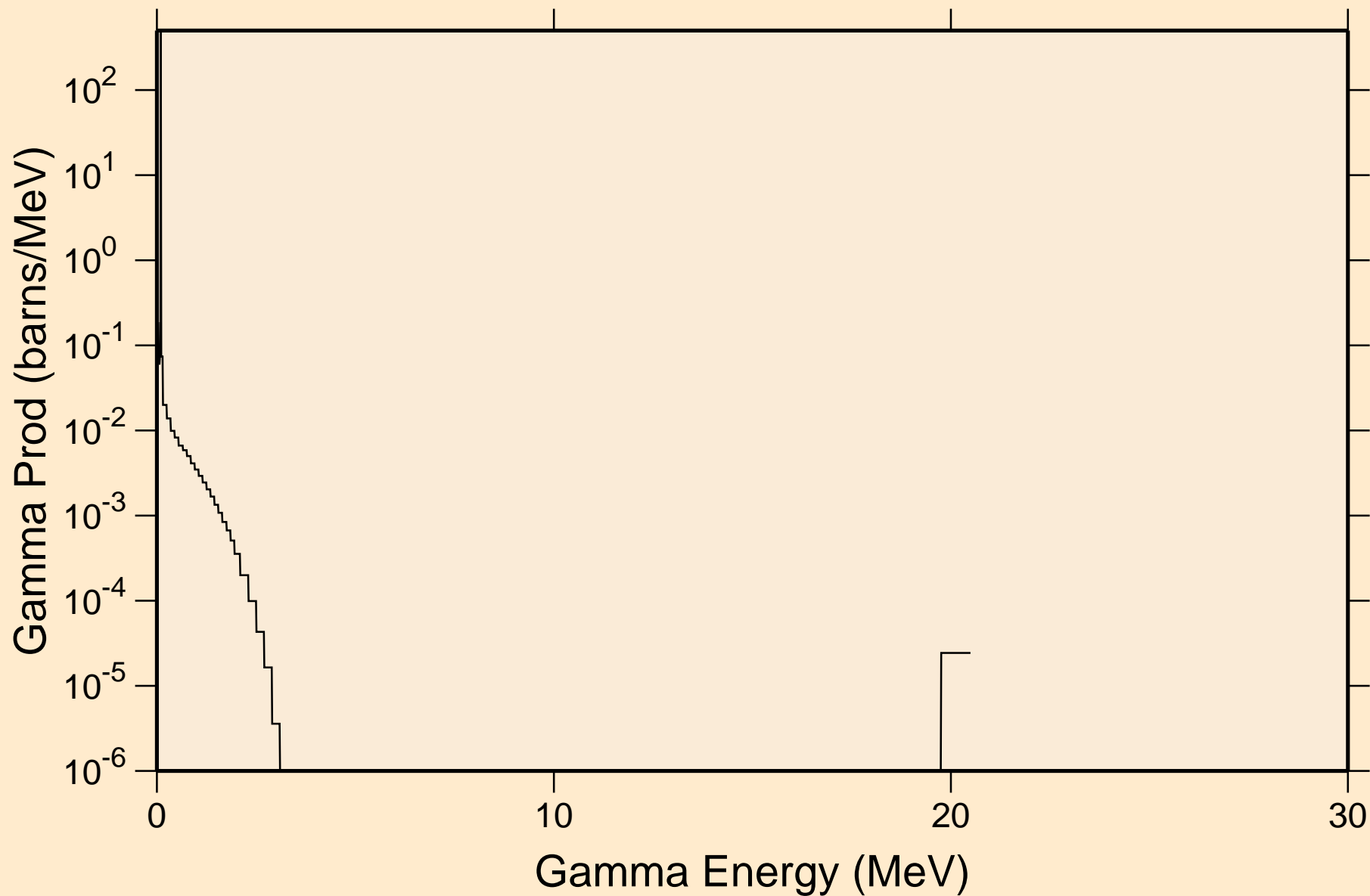

SG271 NEUTRON ACER TENDL-2019 LIBRARY; T=293.16K

Particle heating contributions

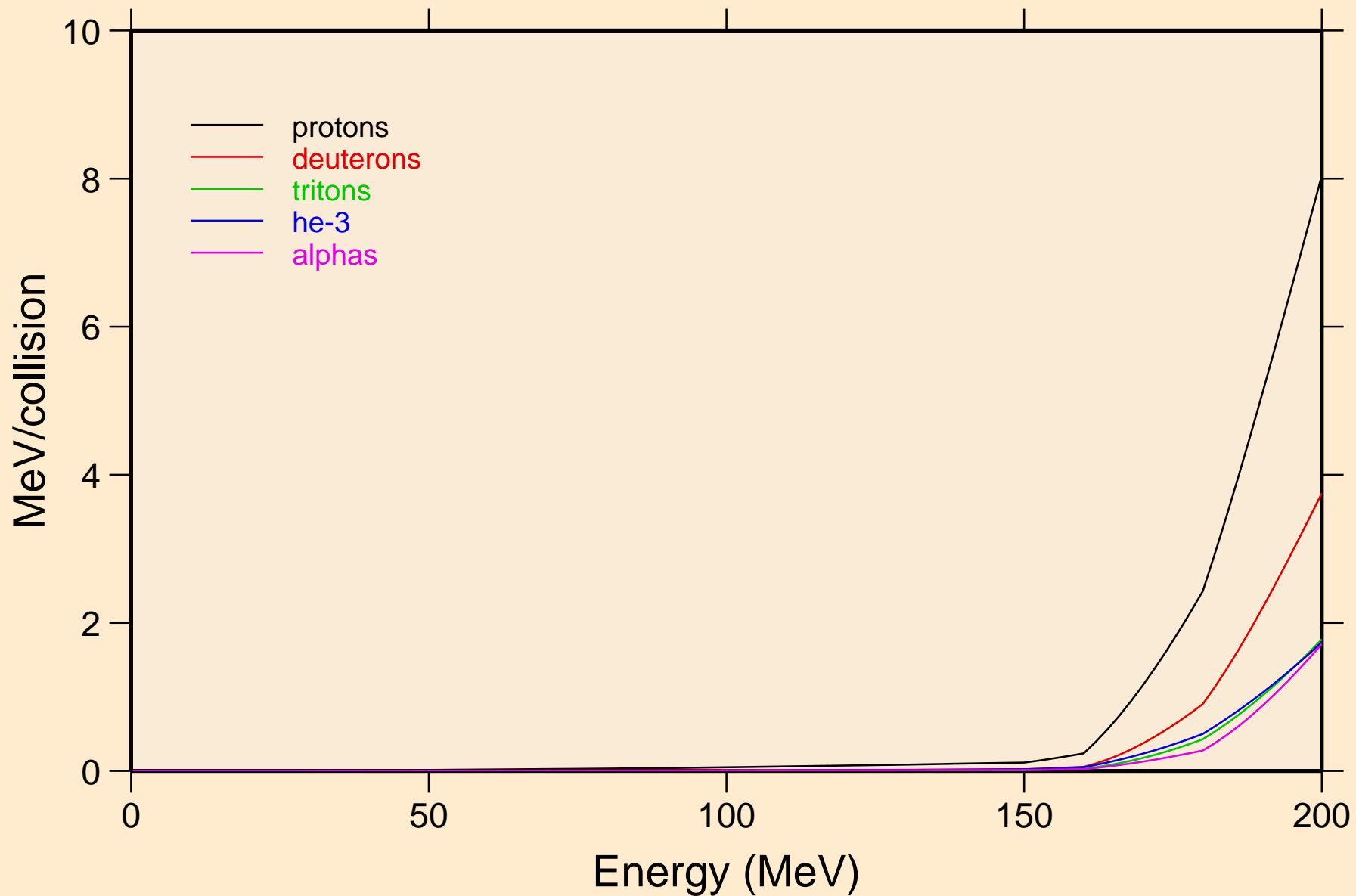

SG271 NEUTRON ACER TENDL-2019 LIBRARY; T=293.16K
Recoil Heating

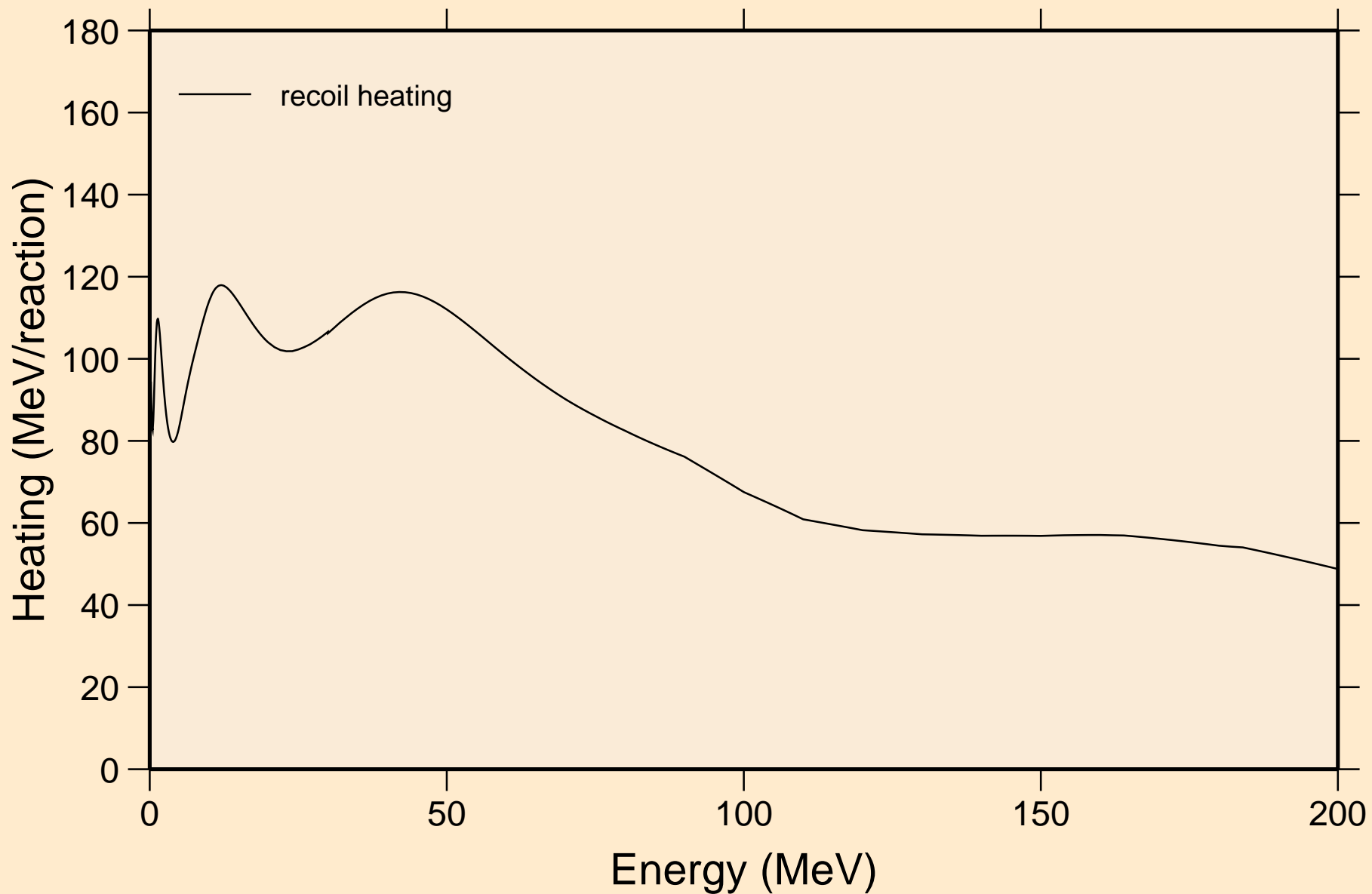

SG271 NEUTRON ACER TENDL-2019 LIBRARY; T=293.16K

Particle production cross sections

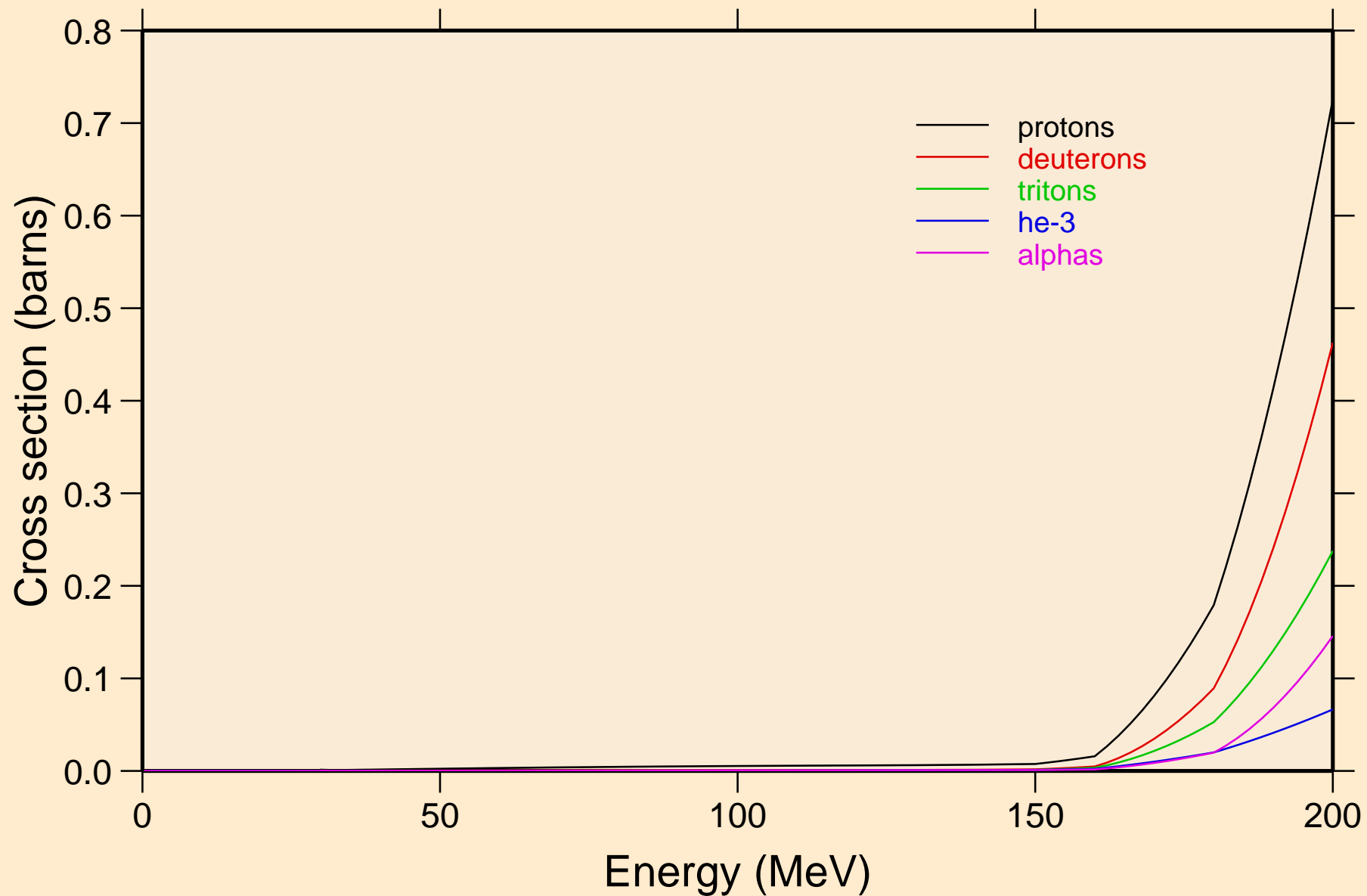

SG271 NEUTRON ACER TENDL-2019 LIBRARY; T=293.16K
protons from (n,x)

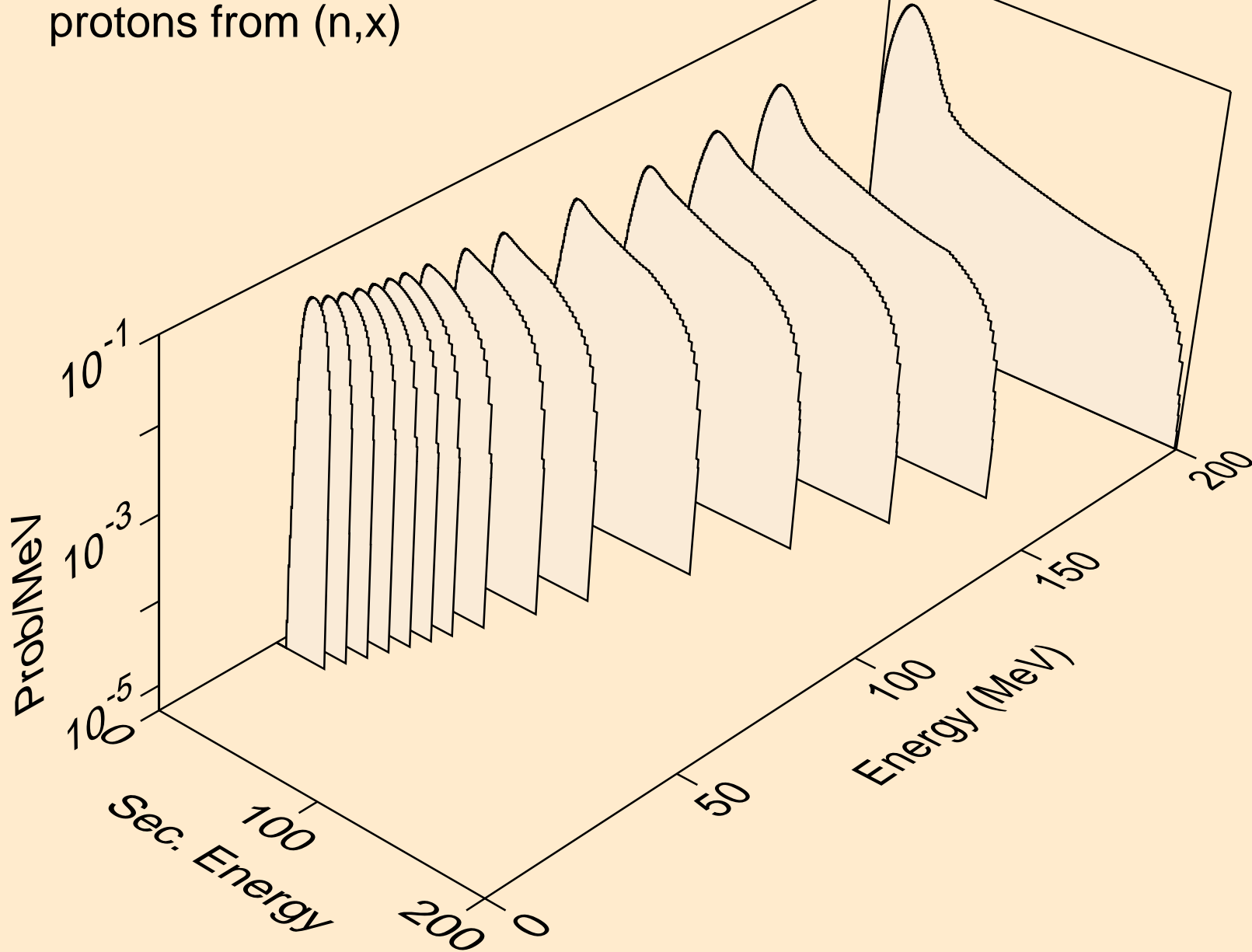

SG271 NEUTRON ACER TENDL-2019 LIBRARY; T=293.16K
protons from (n,n*)p

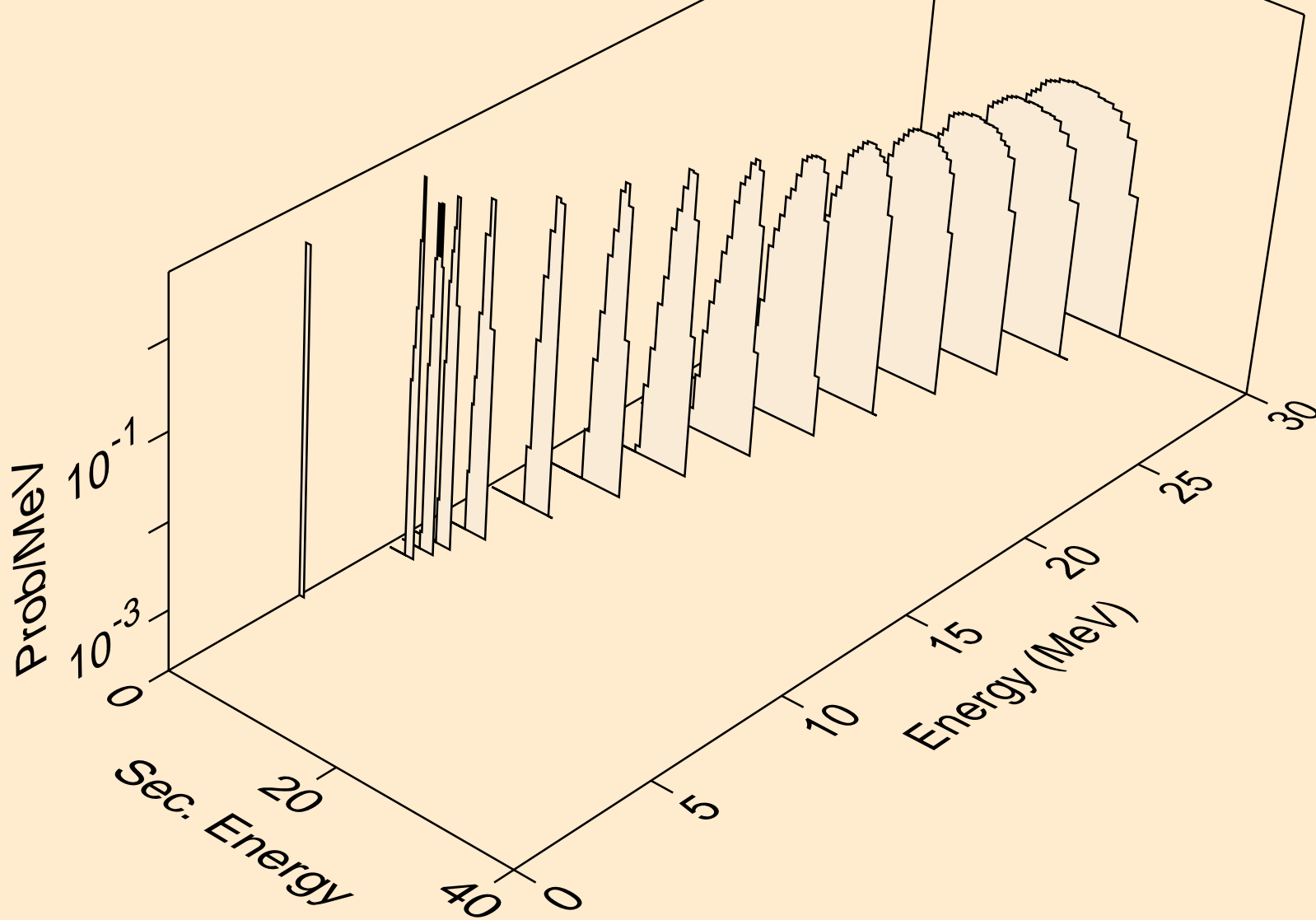

SG271 NEUTRON ACER TENDL-2019 LIBRARY; T=293.16K
protons from (n,2np)

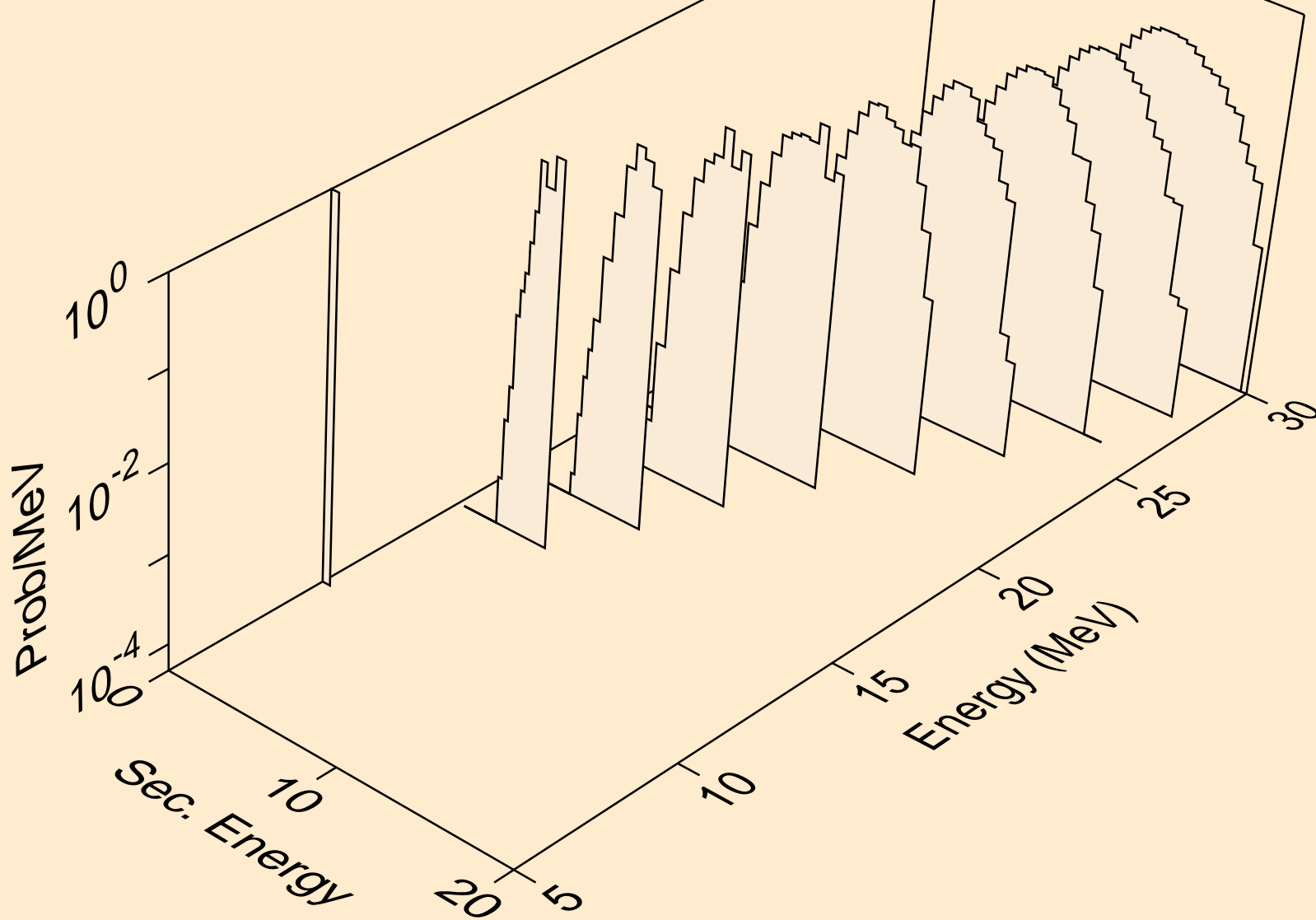

SG271 NEUTRON ACER TENDL-2019 LIBRARY; T=293.16K
protons from (n,3np)

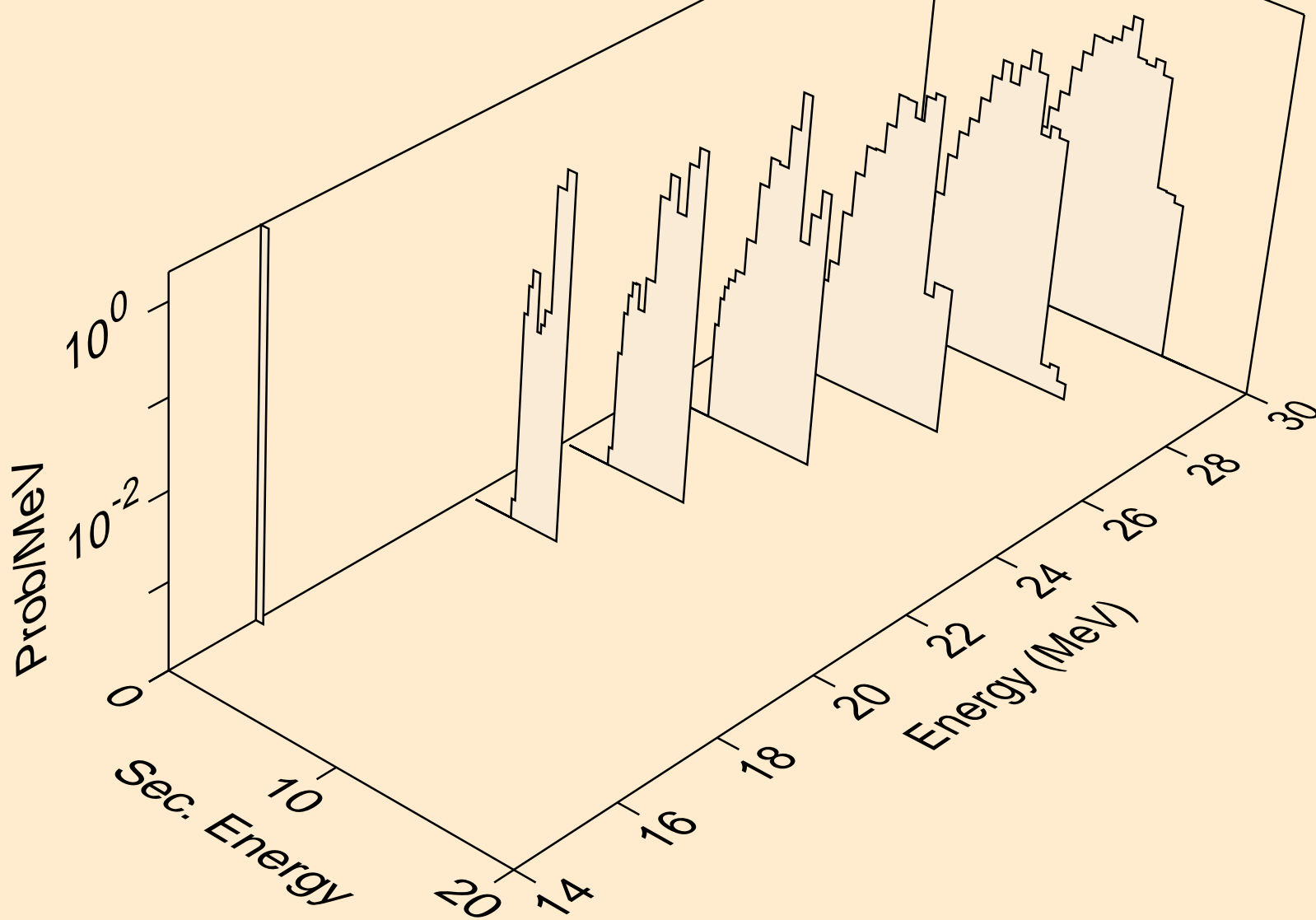

SG271 NEUTRON ACER TENDL-2019 LIBRARY; T=293.16K
protons from (n,p)

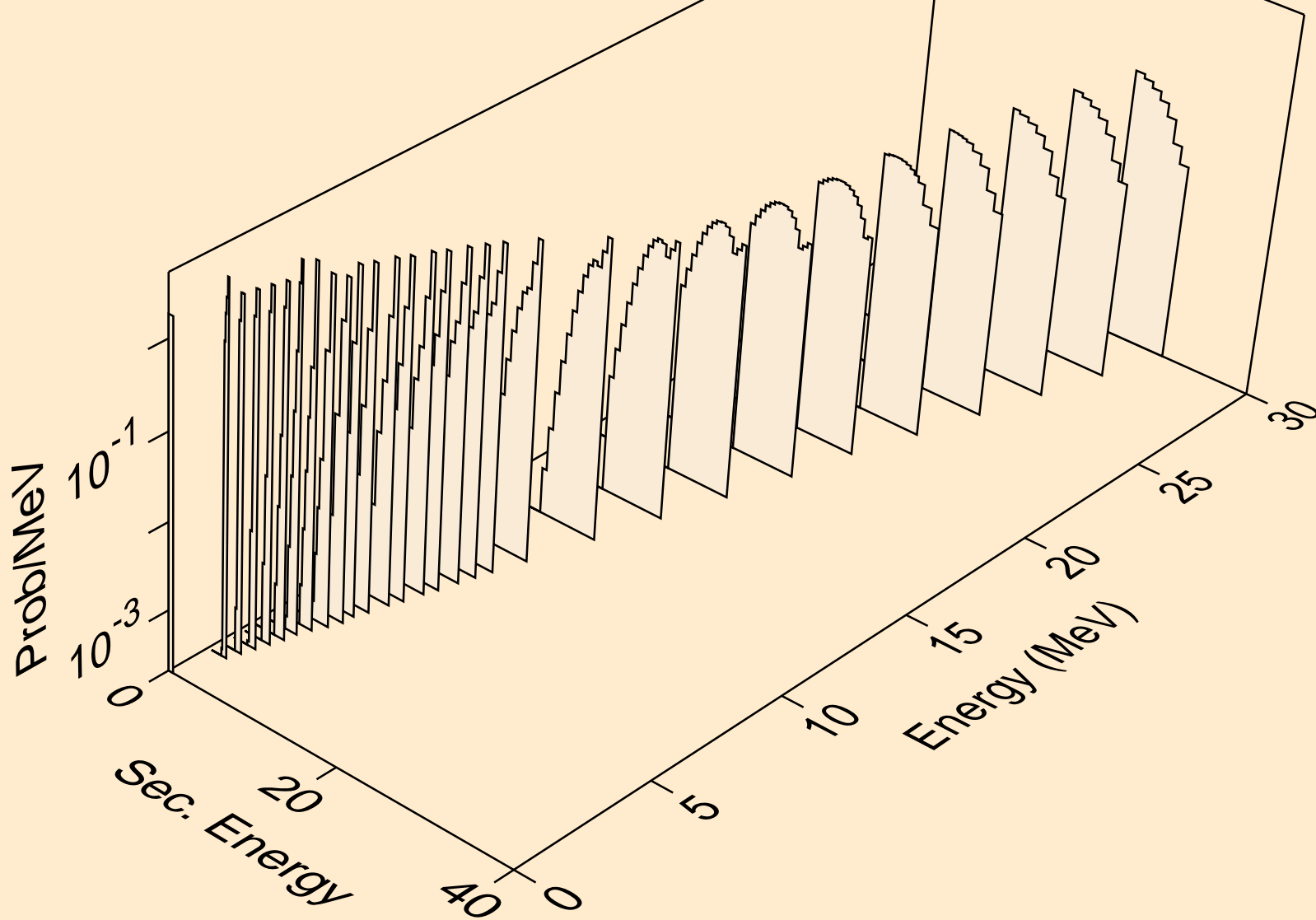

SG271 NEUTRON ACER TENDL-2019 LIBRARY; T=293.16K
deuterons from (n,x)

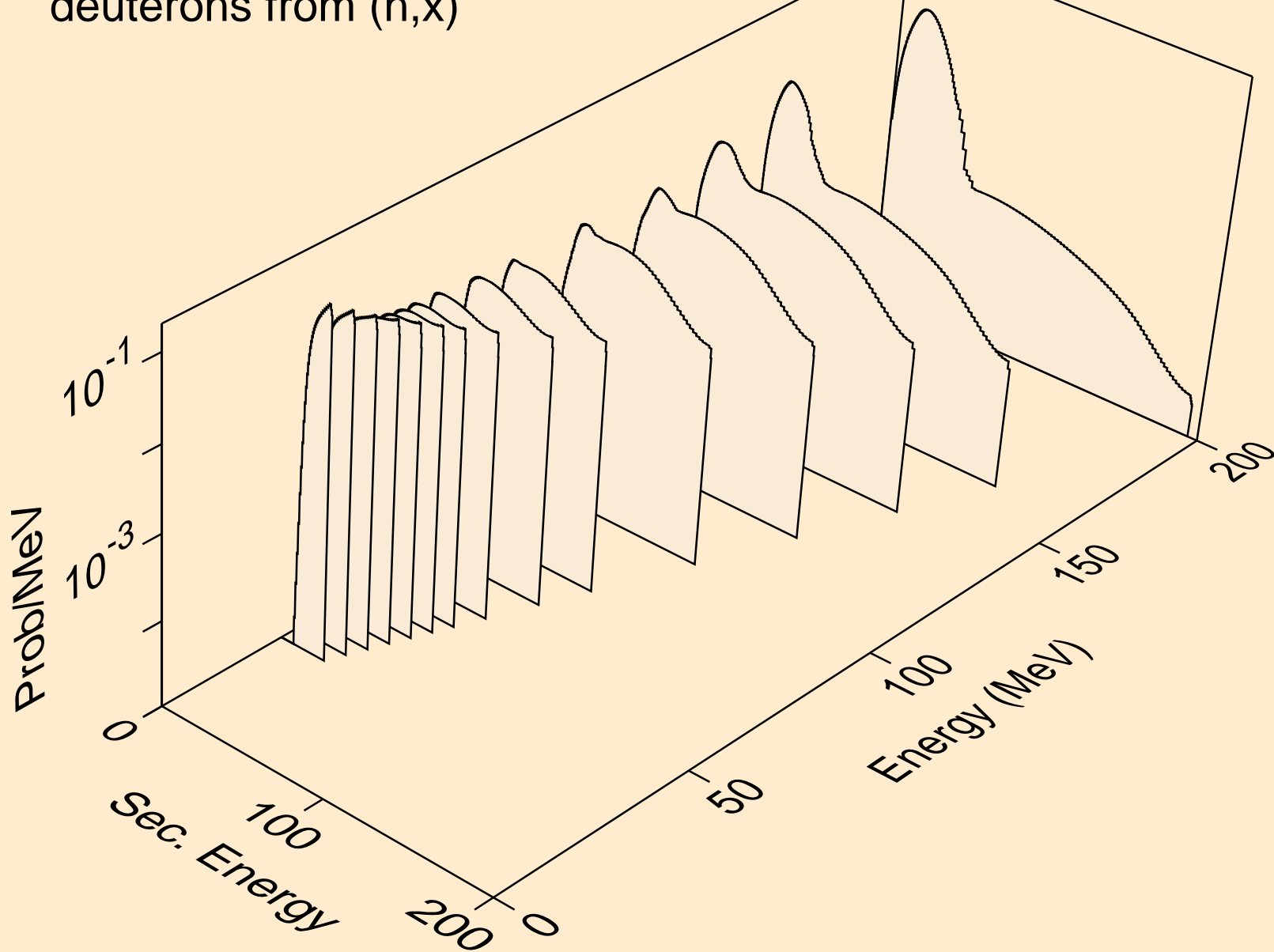

SG271 NEUTRON ACER TENDL-2019 LIBRARY; T=293.16K
deuterons from (n,2nd)

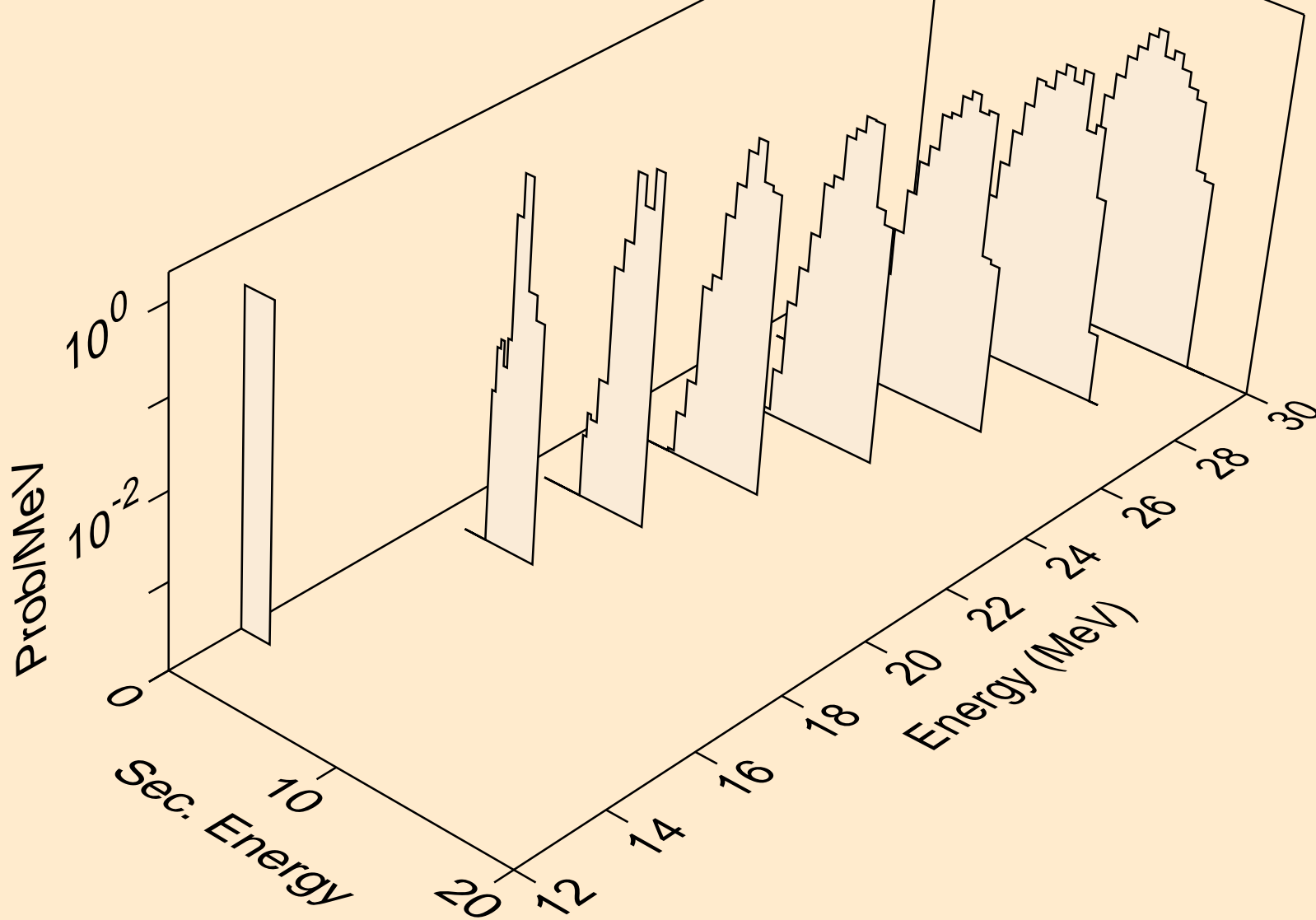

SG271 NEUTRON ACER TENDL-2019 LIBRARY; T=293.16K
deuterons from (n,n*)d

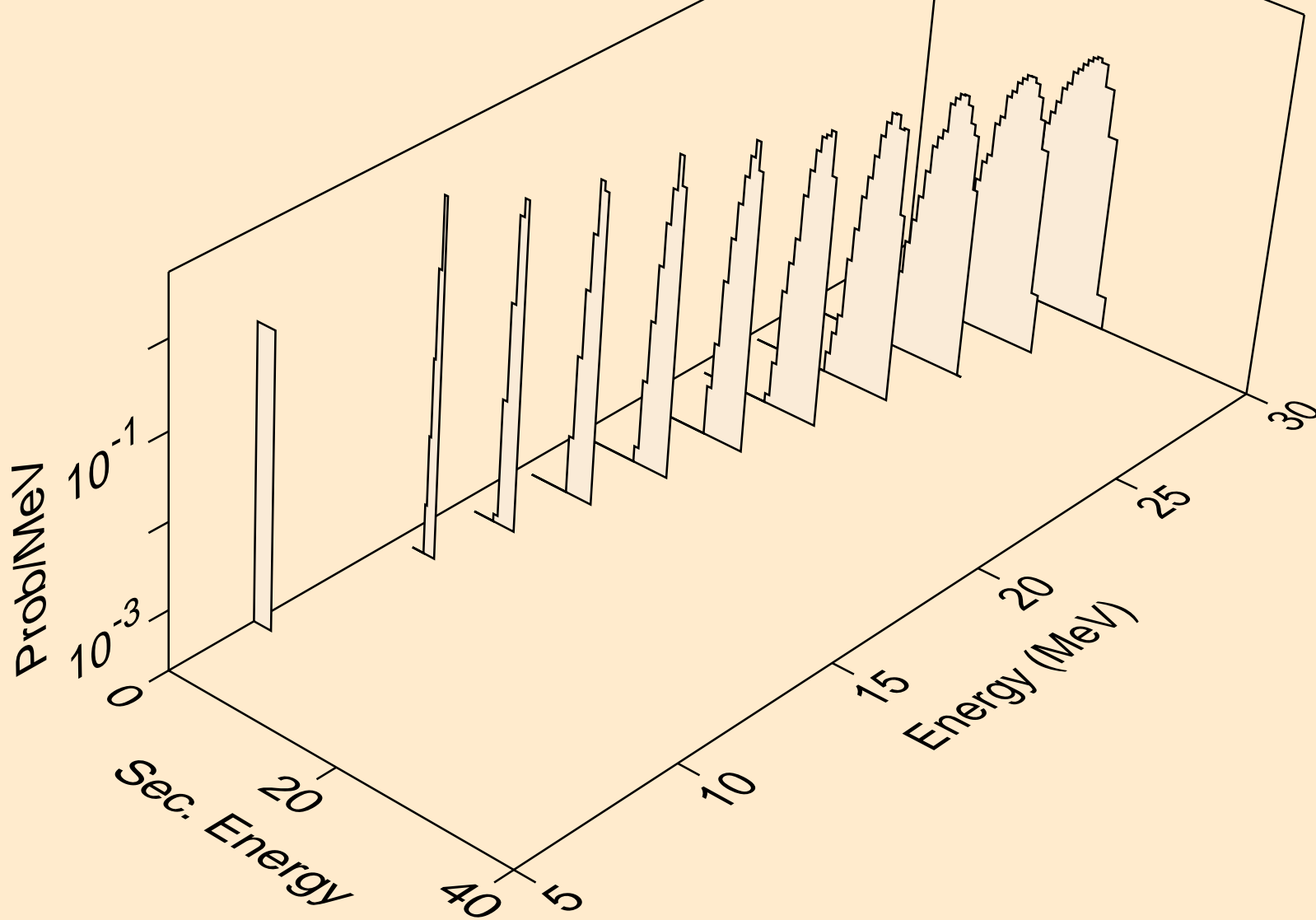

SG271 NEUTRON ACER TENDL-2019 LIBRARY; T=293.16K
deuterons from (n,d)

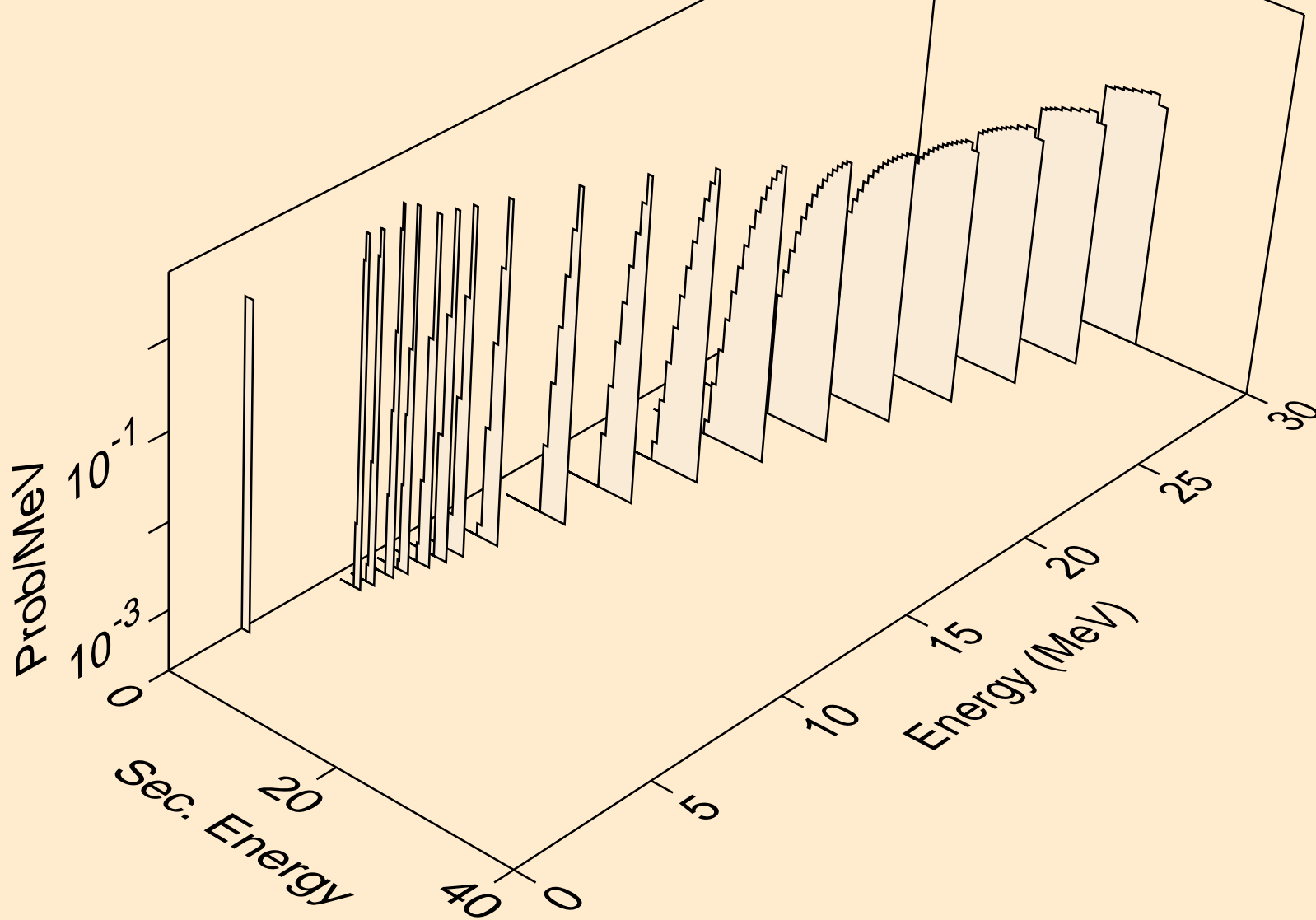

SG271 NEUTRON ACER TENDL-2019 LIBRARY; T=293.16K
tritons from (n,x)

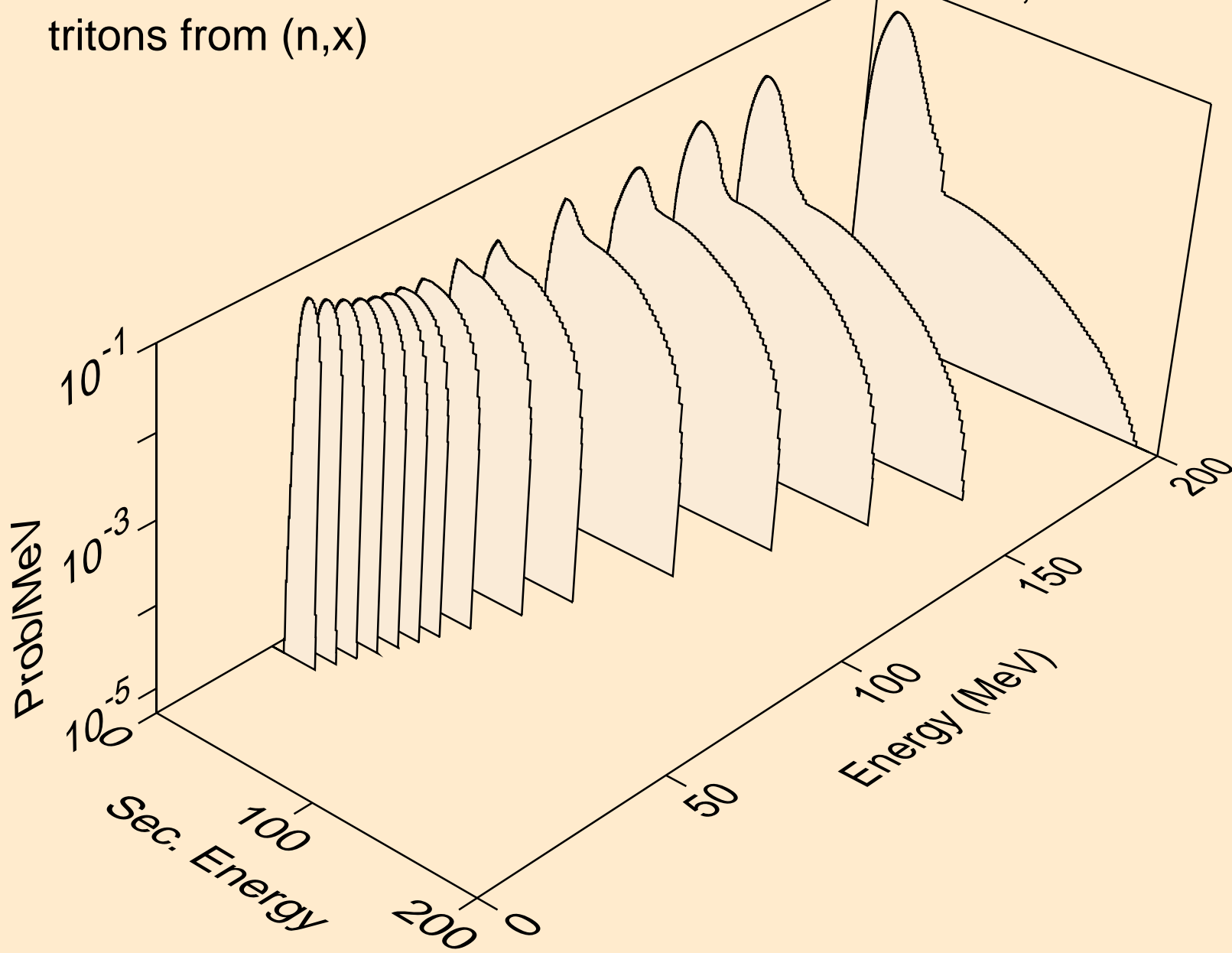

SG271 NEUTRON ACER TENDL-2019 LIBRARY; T=293.16K
tritons from (n,n*)t

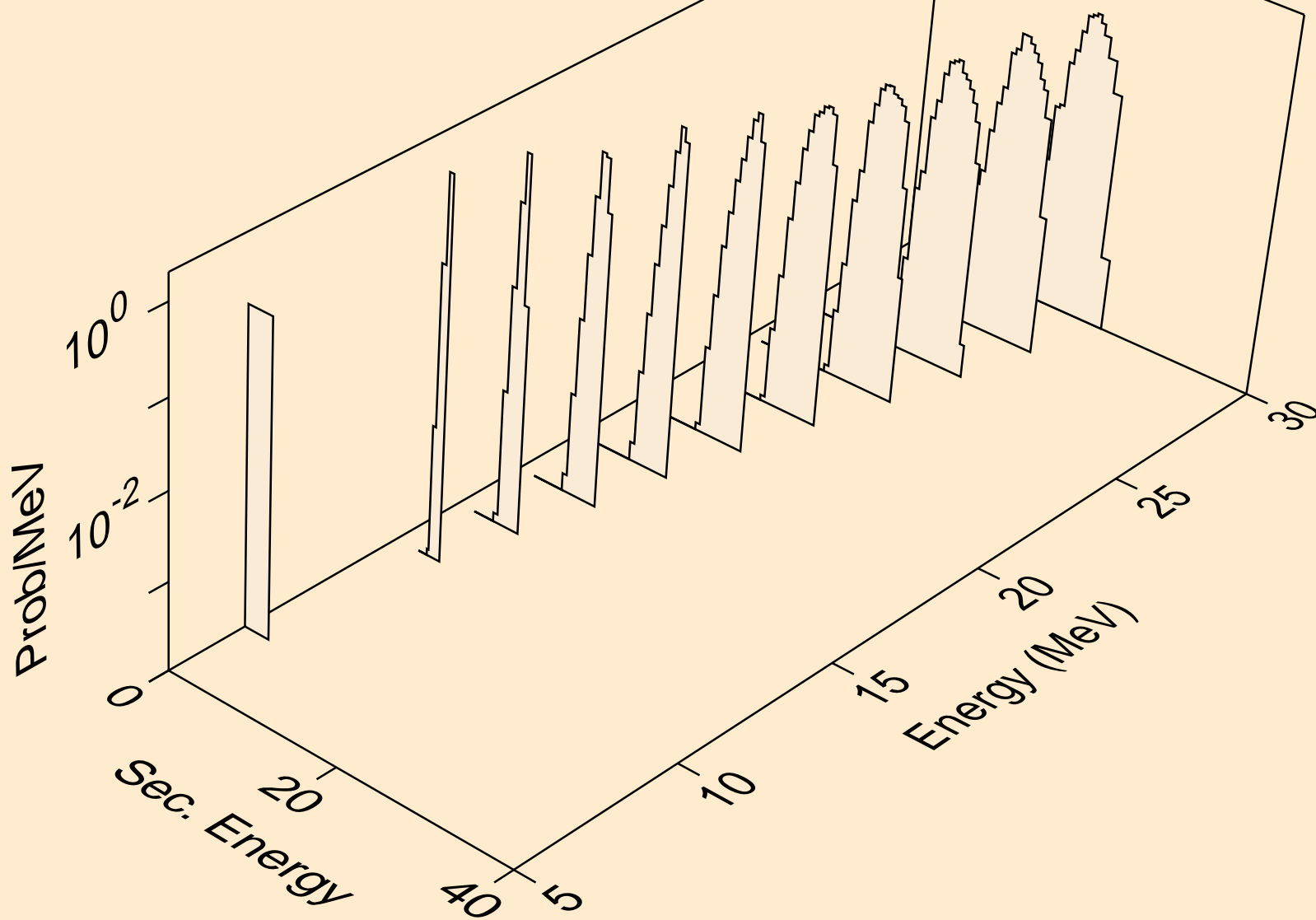

SG271 NEUTRON ACER TENDL-2019 LIBRARY; T=293.16K
tritons from (n,t)

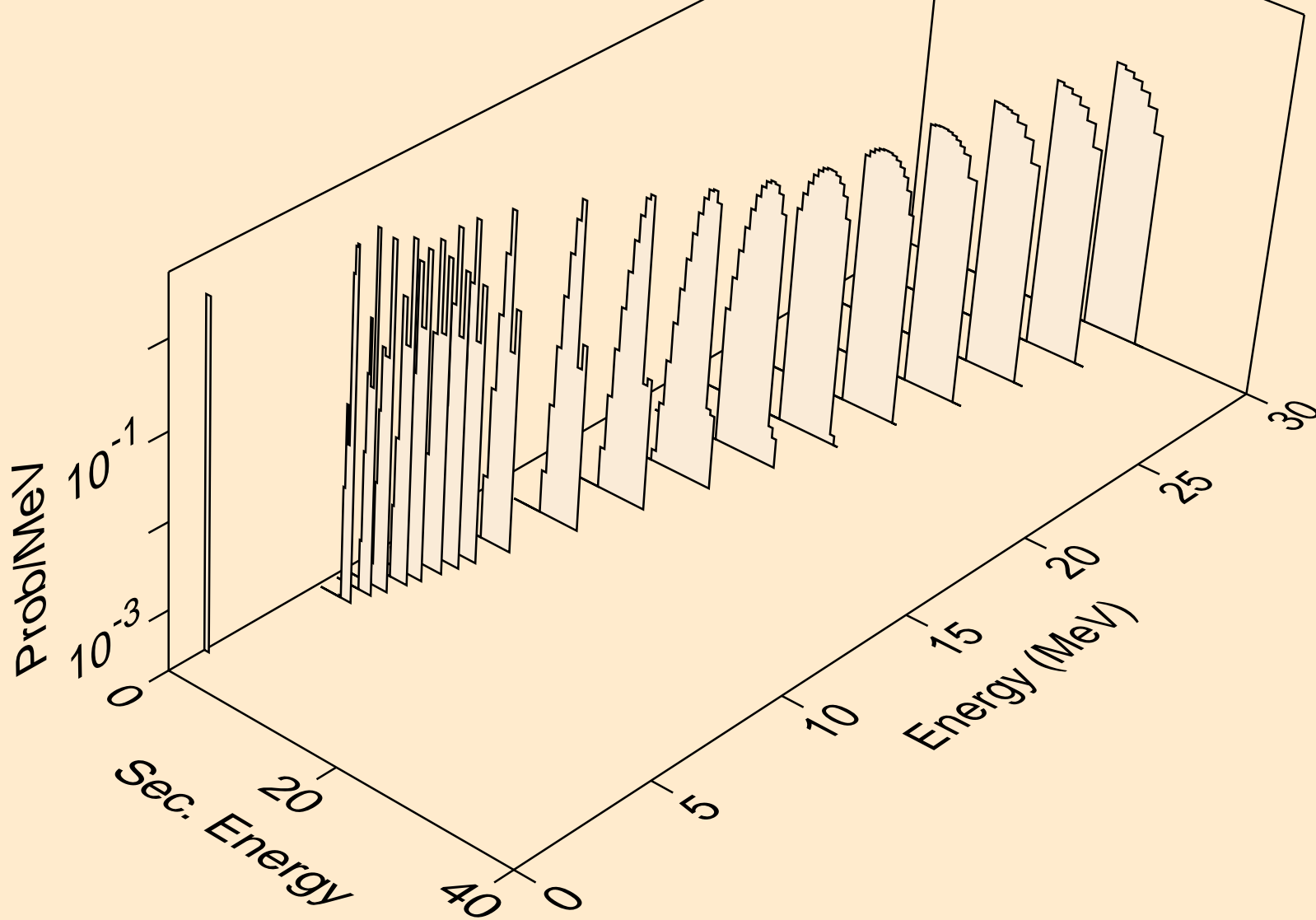

SG271 NEUTRON ACER TENDL-2019 LIBRARY; T=293.16K
he3s from (n,x)

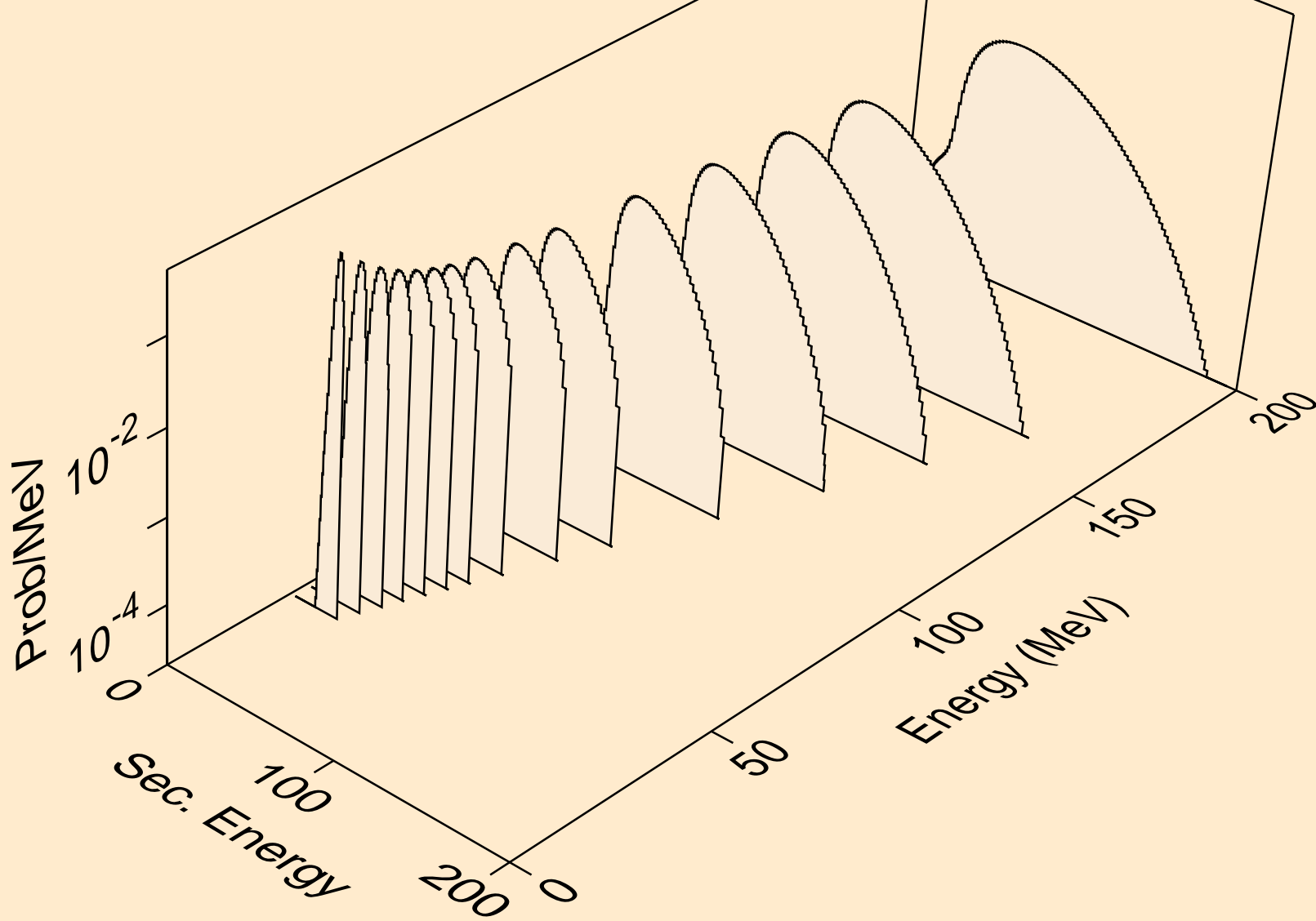

SG271 NEUTRON ACER TENDL-2019 LIBRARY; T=293.16K
he3s from (n,n*)he3

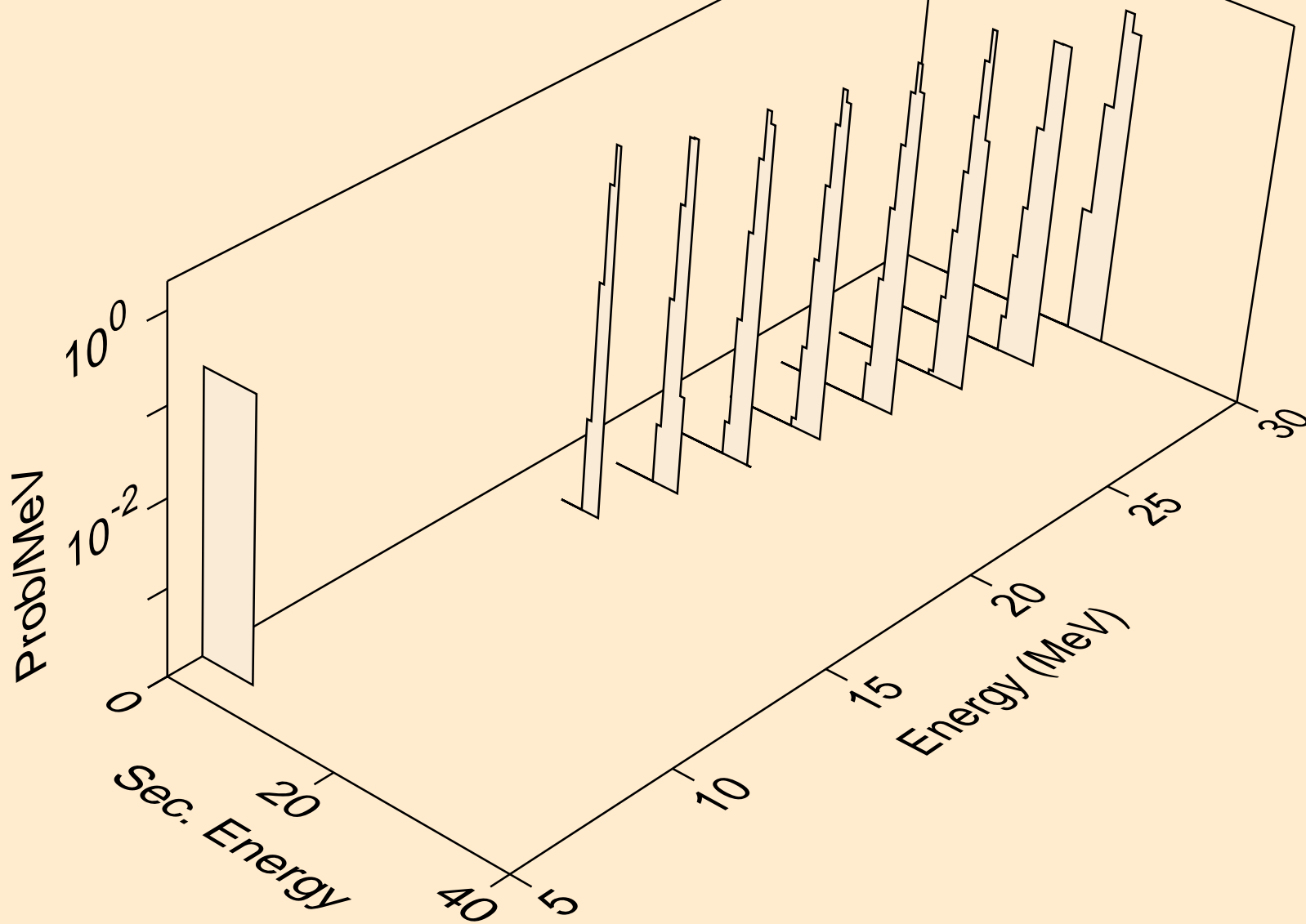

SG271 NEUTRON ACER TENDL-2019 LIBRARY; T=293.16K
he3s from (n,he3)

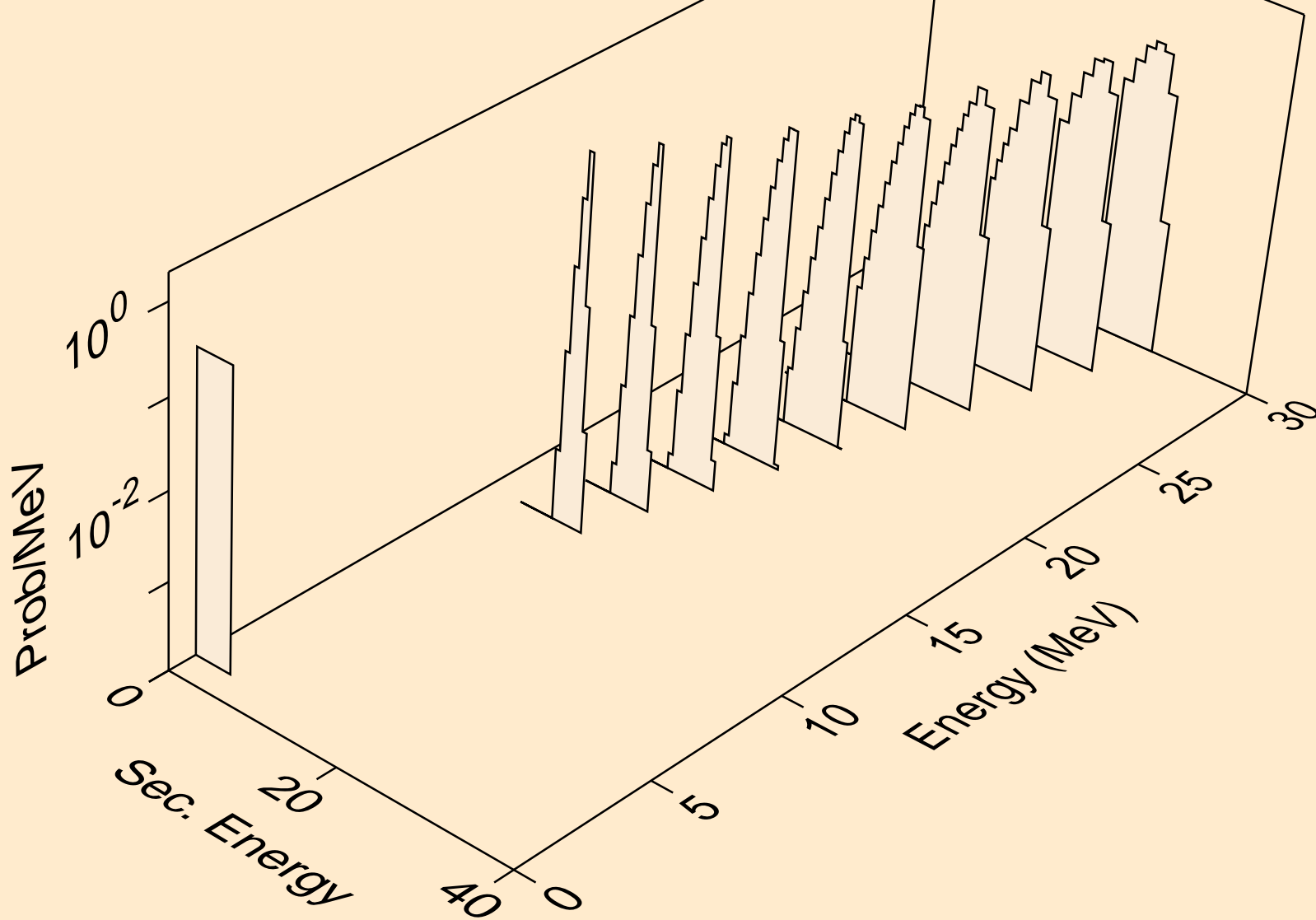

SG271 NEUTRON ACER TENDL-2019 LIBRARY; T=293.16K
alphas from (n,x)

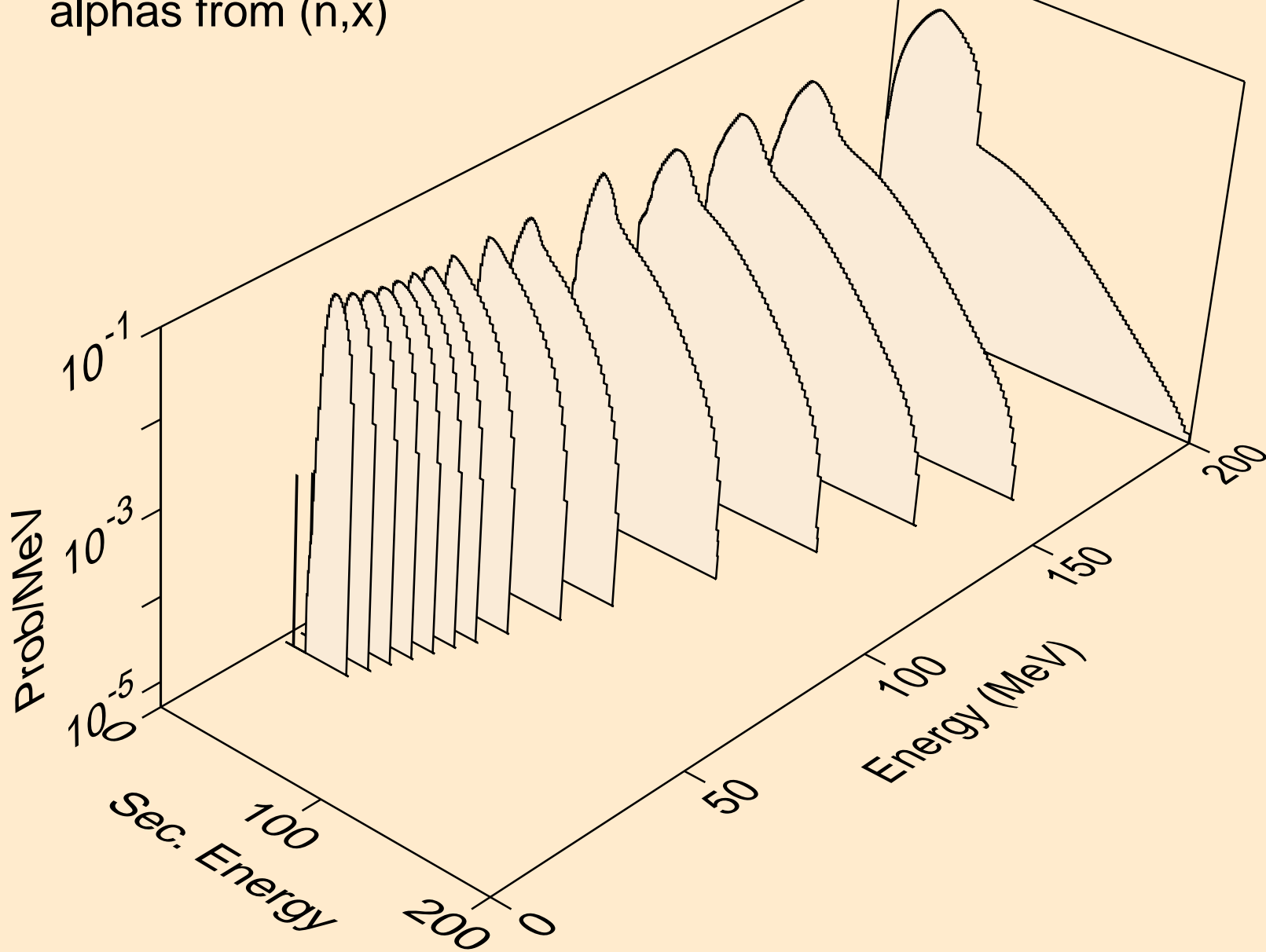

SG271 NEUTRON ACER TENDL-2019 LIBRARY; T=293.16K
alphas from (n,n*)a

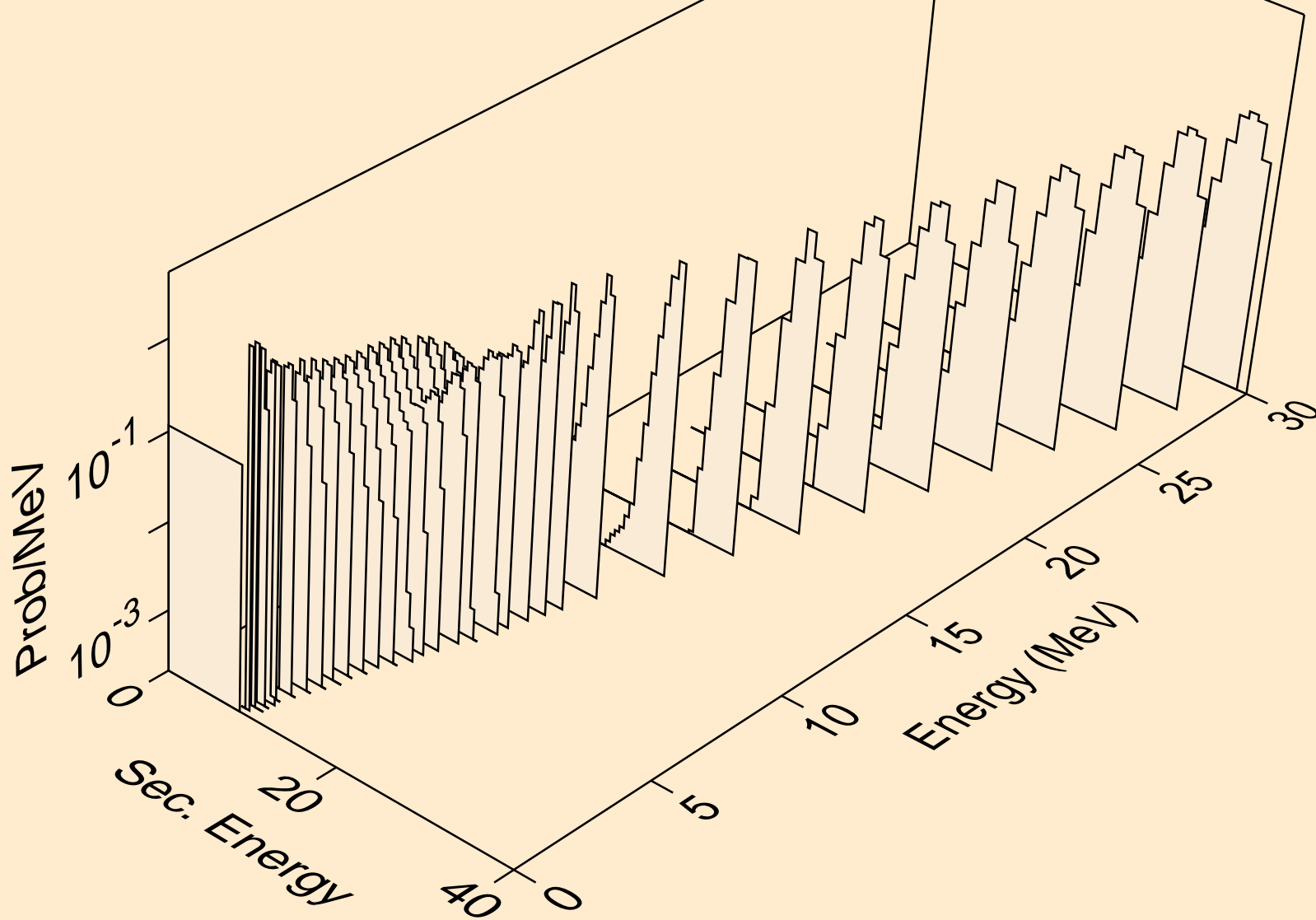

SG271 NEUTRON ACER TENDL-2019 LIBRARY; T=293.16K
alphas from (n,2n)a

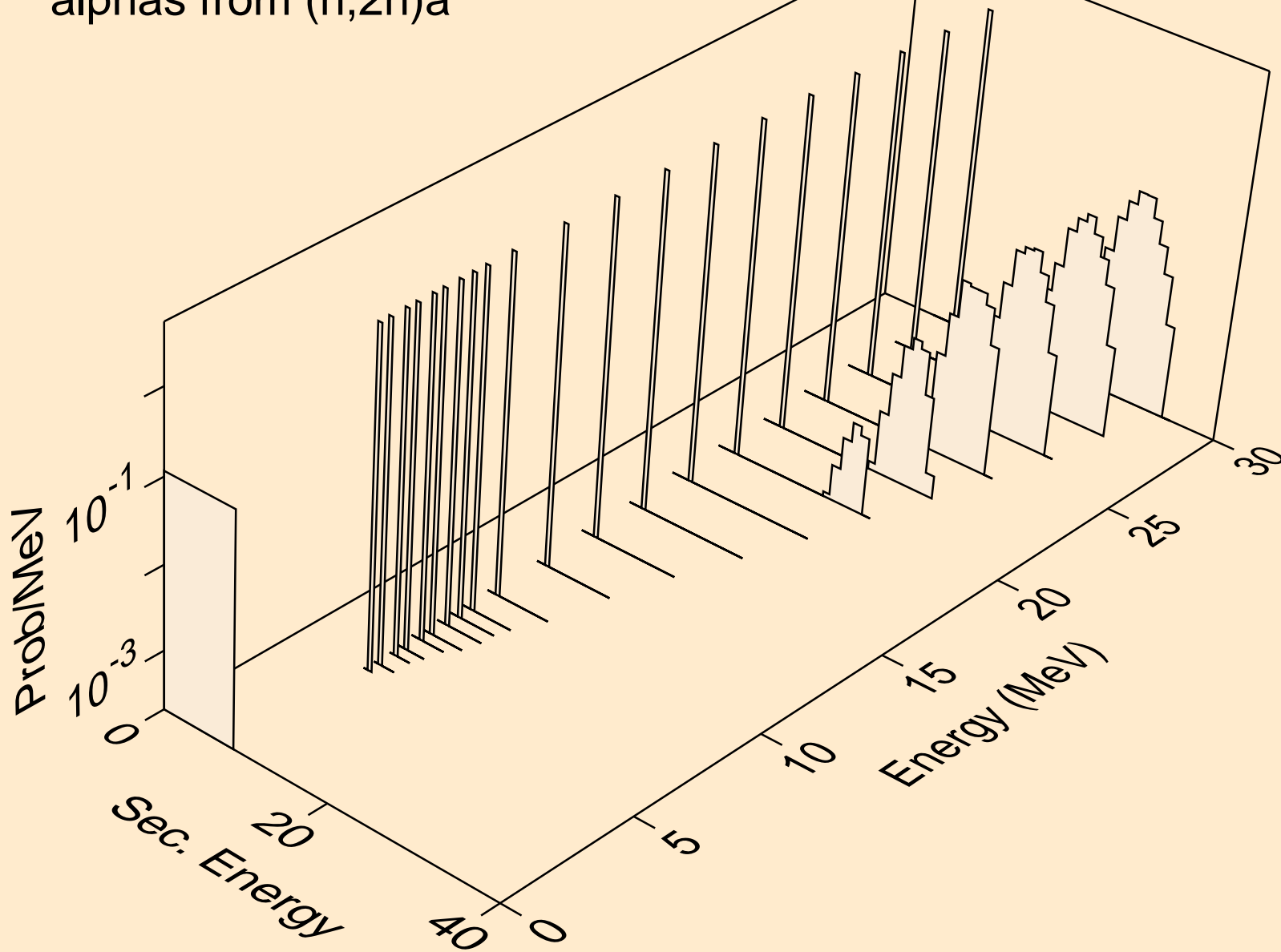

SG271 NEUTRON ACER TENDL-2019 LIBRARY; T=293.16K
alphas from (n,3n)a

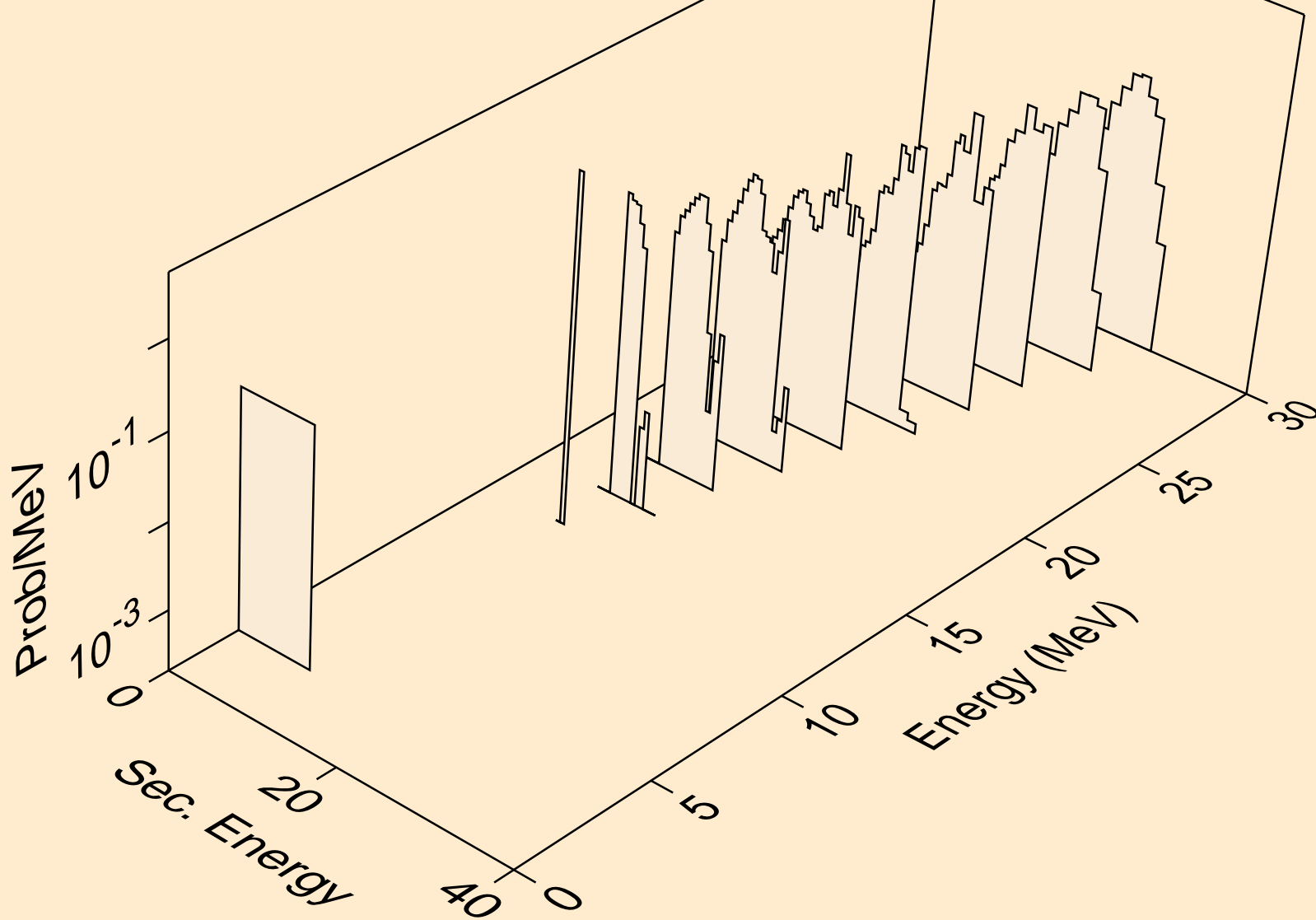

SG271 NEUTRON ACER TENDL-2019 LIBRARY; T=293.16K
alphas from (n,a)

