

SG273 NEUTRON ACER TENDL-2019 LIBRARY; T=293.16K
Principal cross sections

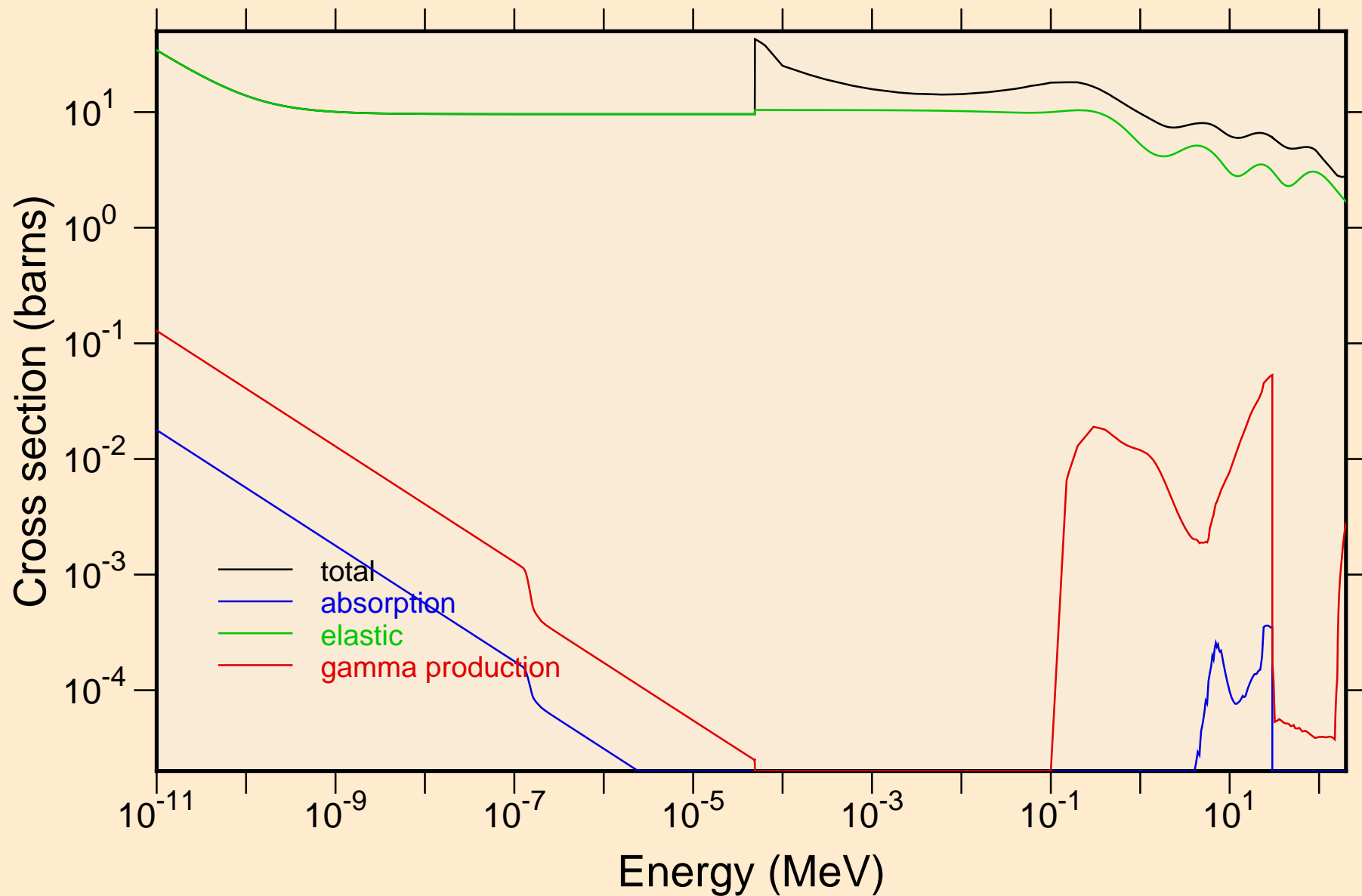

SG273 NEUTRON ACER TENDL-2019 LIBRARY; T=293.16K
Heating

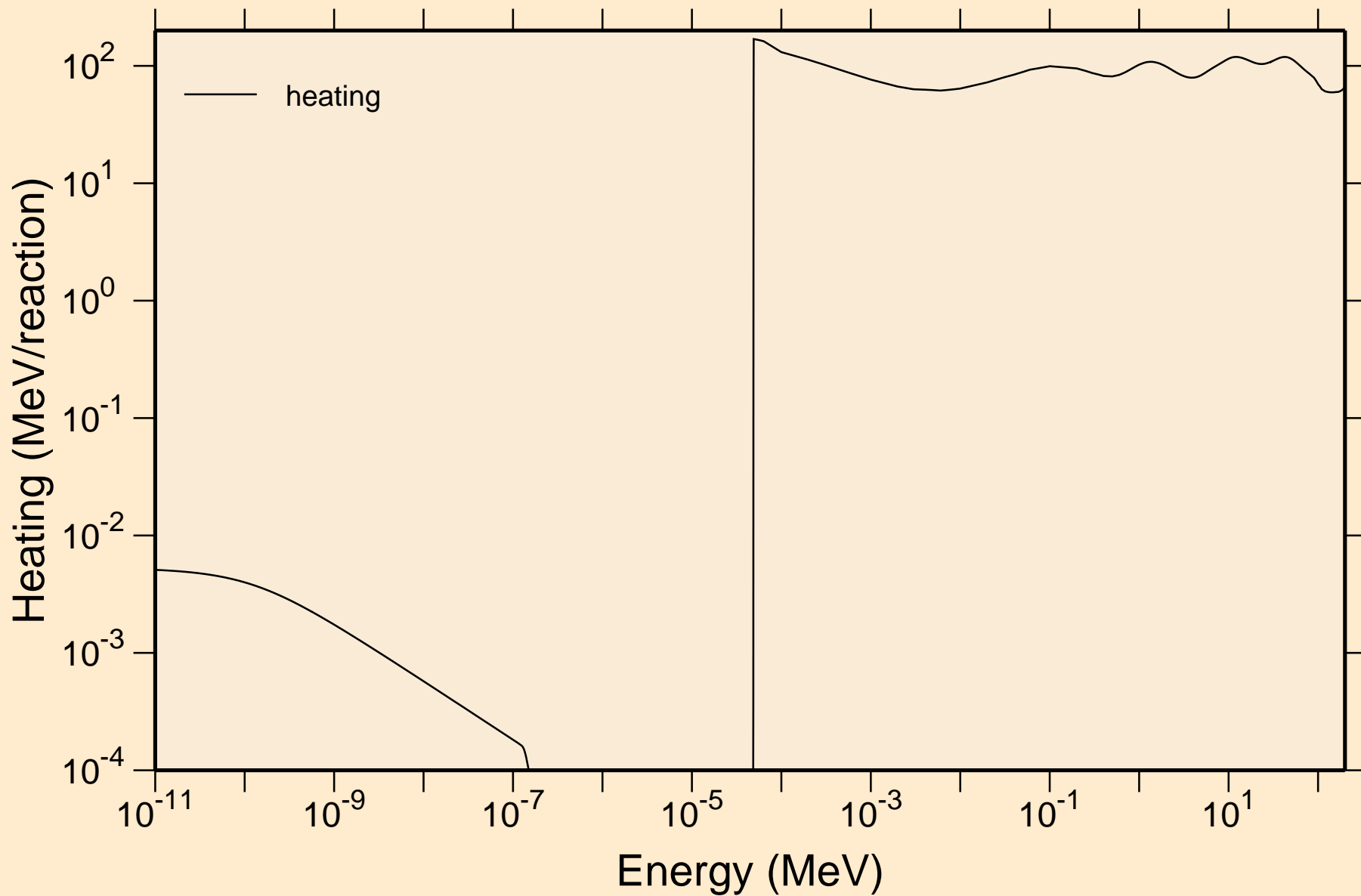

SG273 NEUTRON ACER TENDL-2019 LIBRARY; T=293.16K

Damage

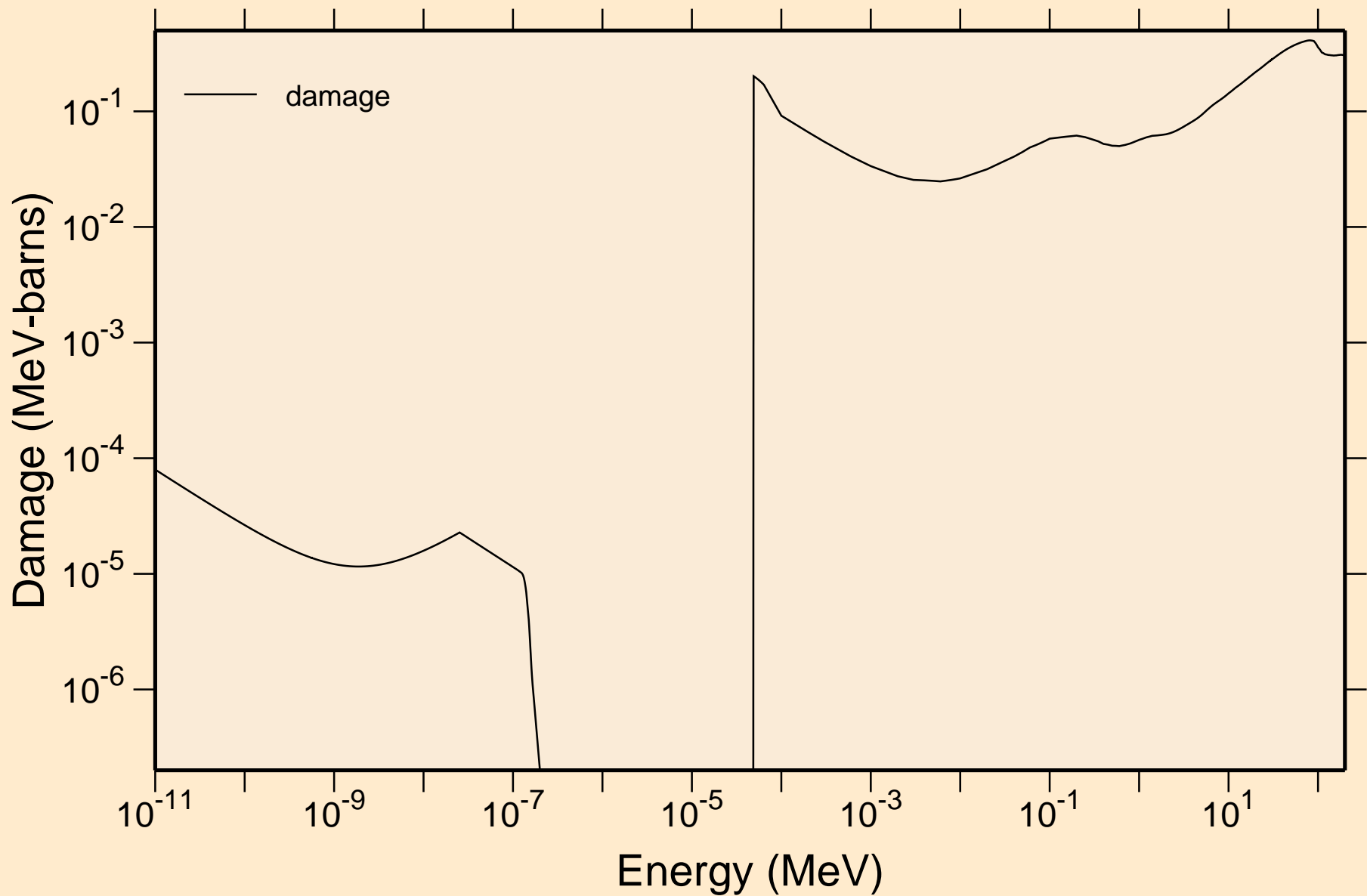

SG273 NEUTRON ACER TENDL-2019 LIBRARY; T=293.16K

Non-threshold reactions

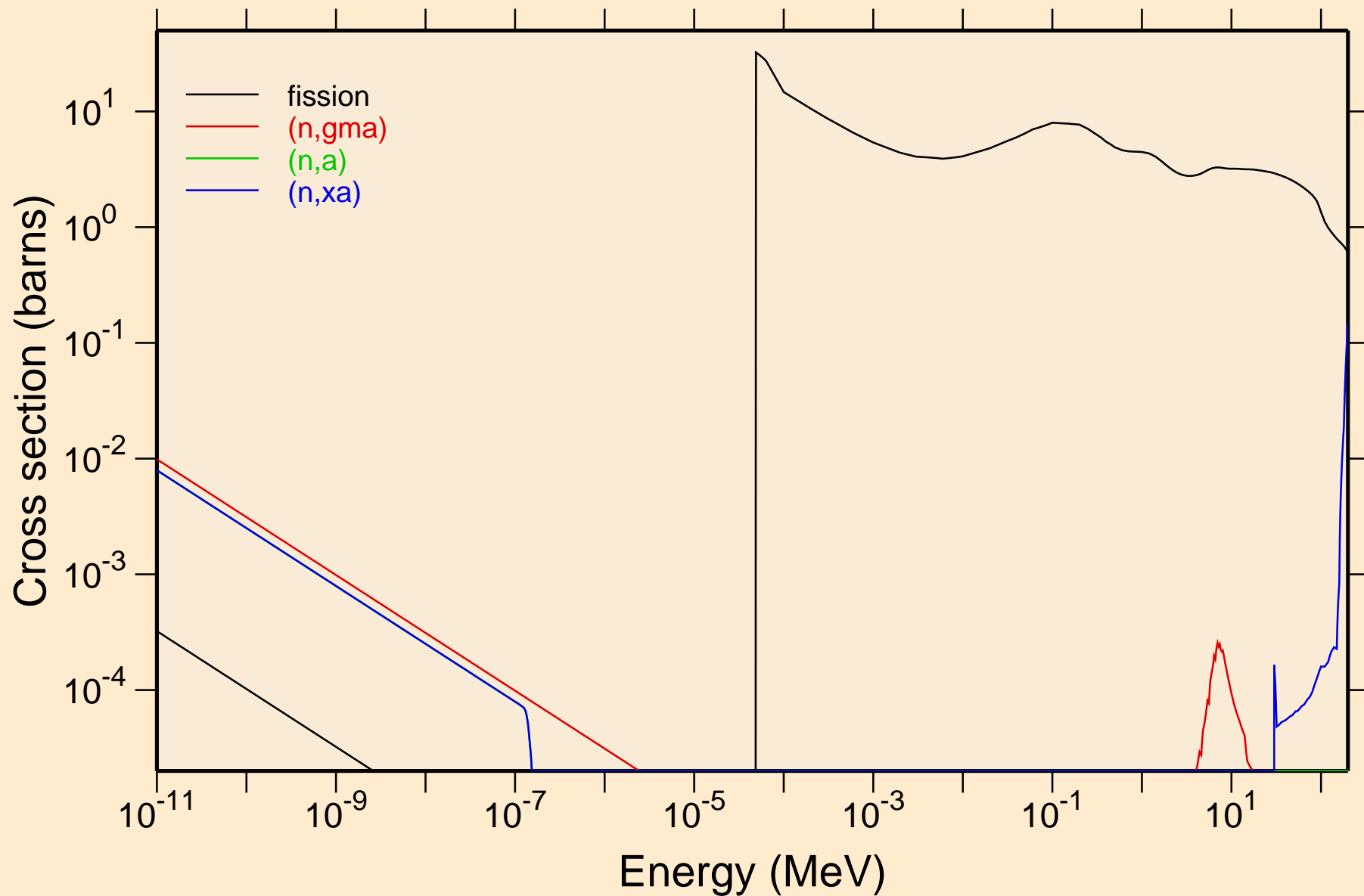

SG273 NEUTRON ACER TENDL-2019 LIBRARY; T=293.16K
Principal cross sections

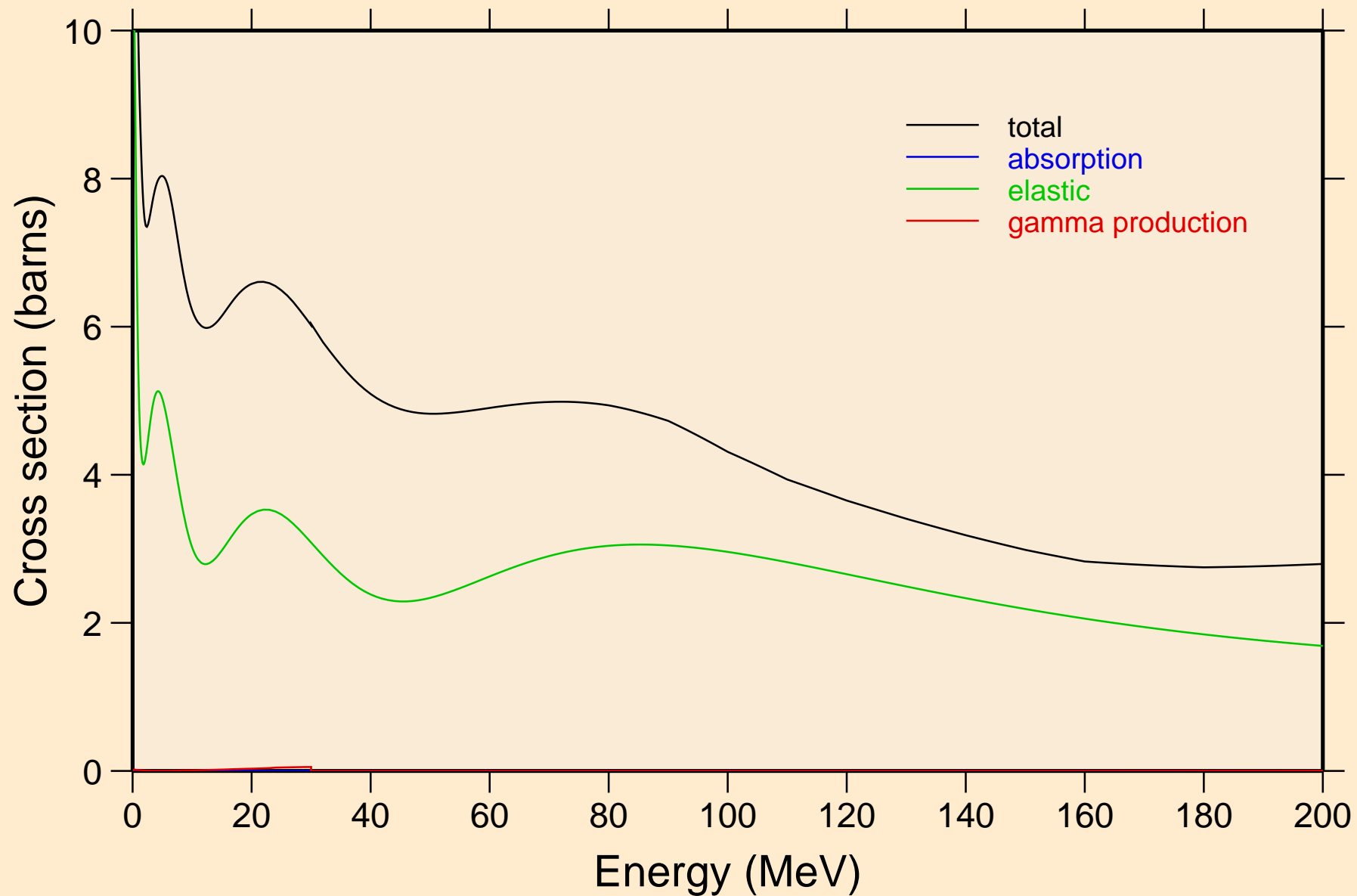

SG273 NEUTRON ACER TENDL-2019 LIBRARY; T=293.16K
Heating

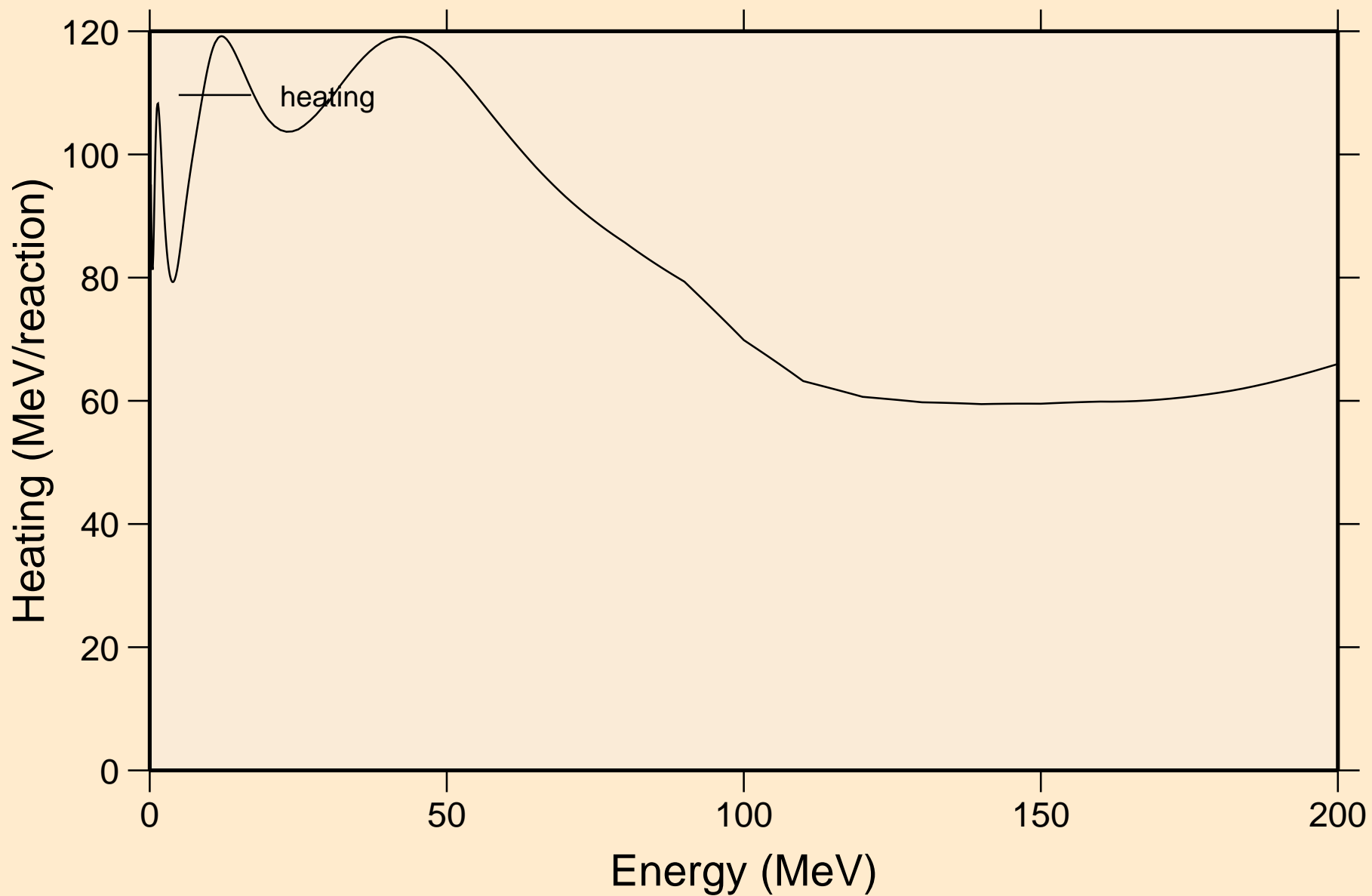

SG273 NEUTRON ACER TENDL-2019 LIBRARY; T=293.16K
Damage

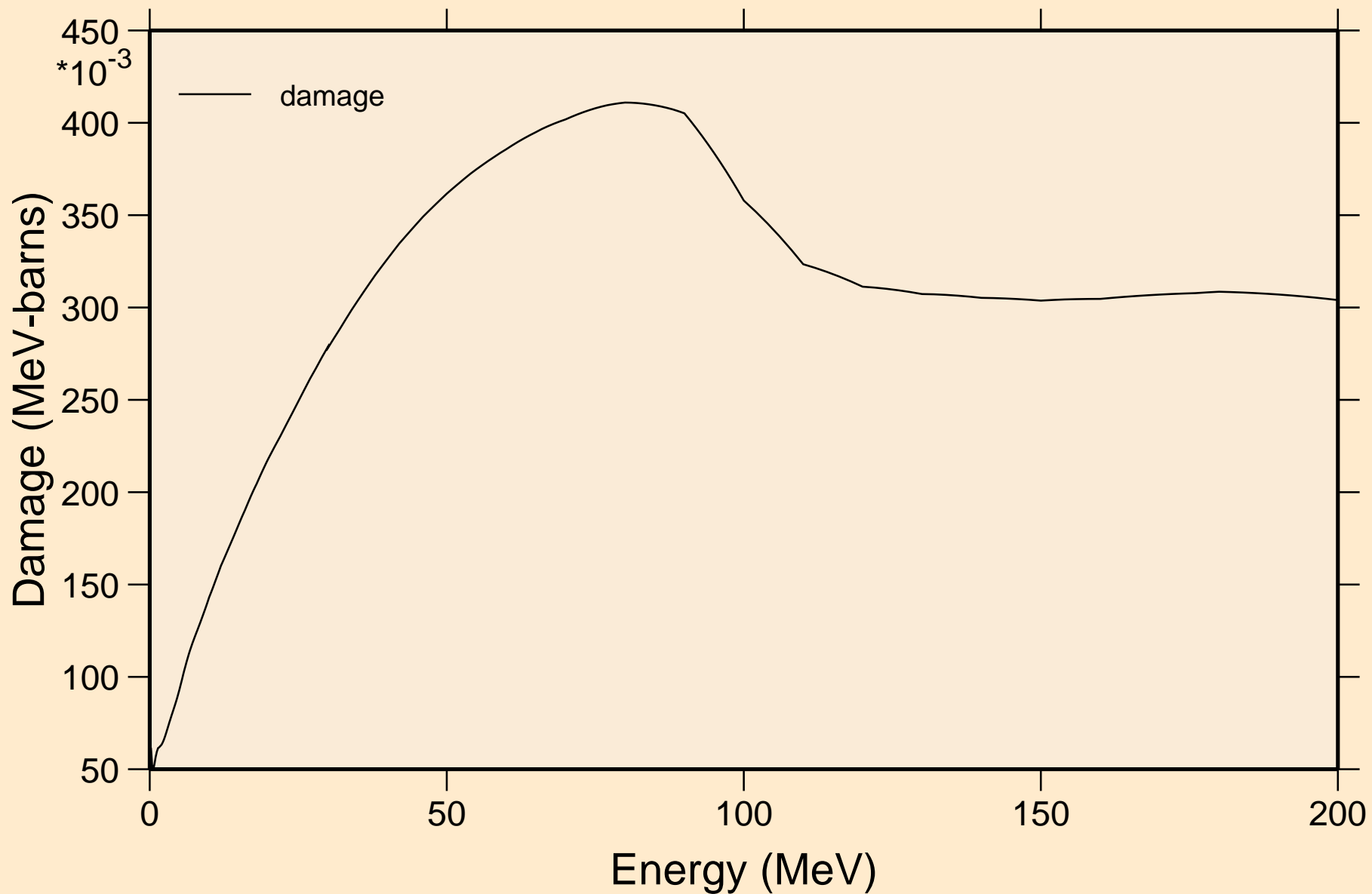

SG273 NEUTRON ACER TENDL-2019 LIBRARY; T=293.16K
Non-threshold reactions

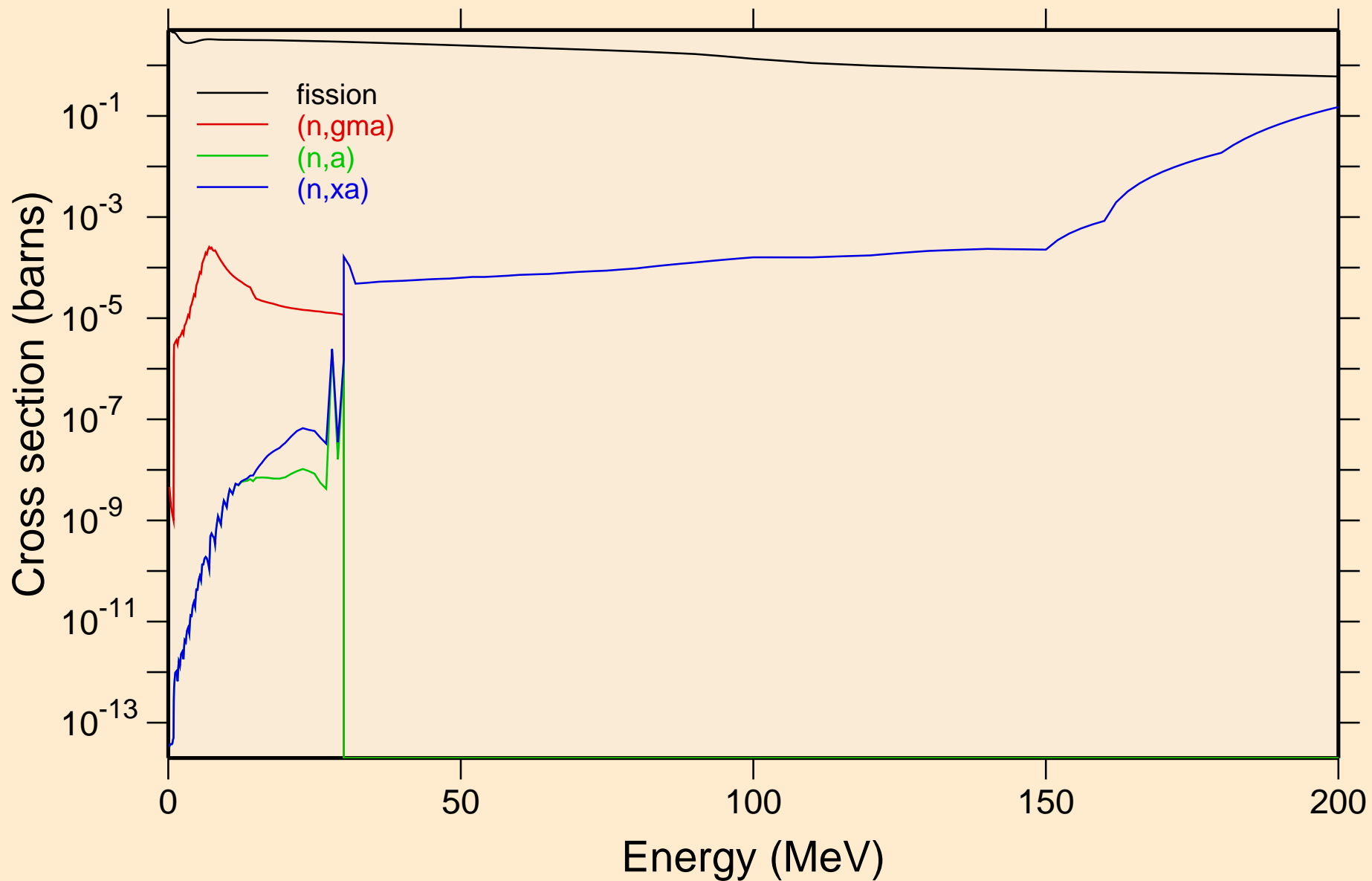

SG273 NEUTRON ACER TENDL-2019 LIBRARY; T=293.16K
Inelastic levels

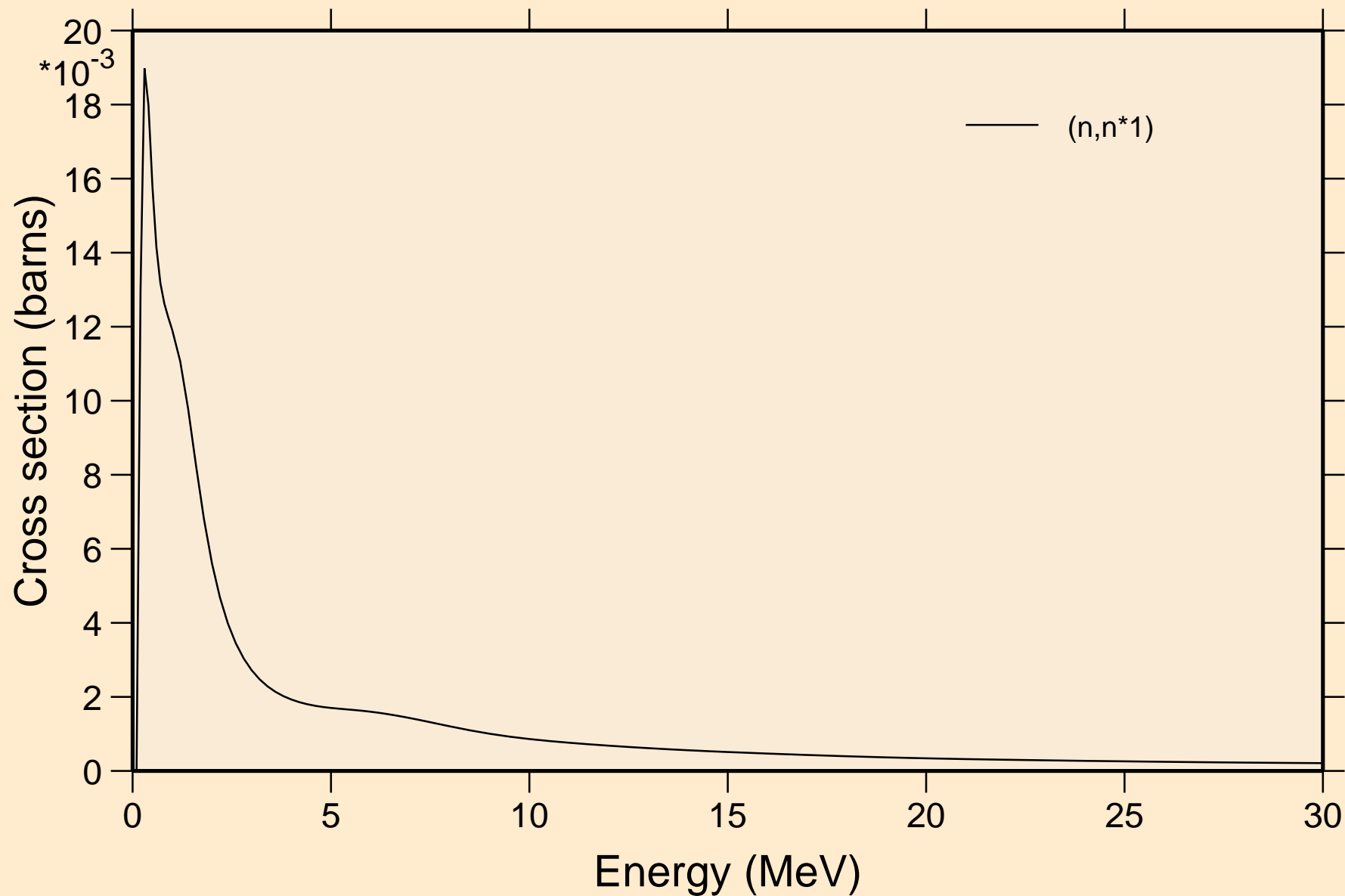

SG273 NEUTRON ACER TENDL-2019 LIBRARY; T=293.16K
Threshold reactions

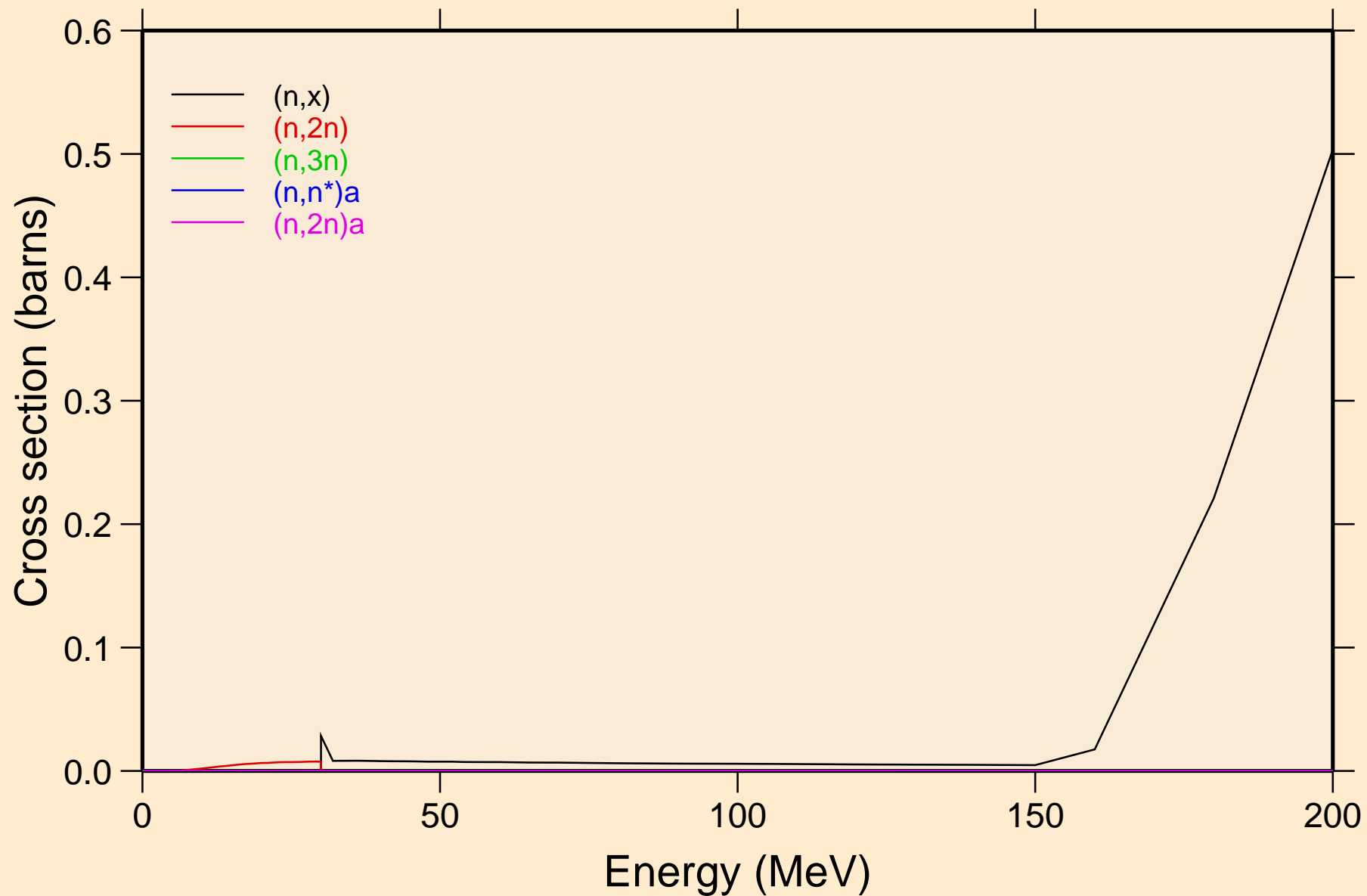

SG273 NEUTRON ACER TENDL-2019 LIBRARY; T=293.16K
Threshold reactions

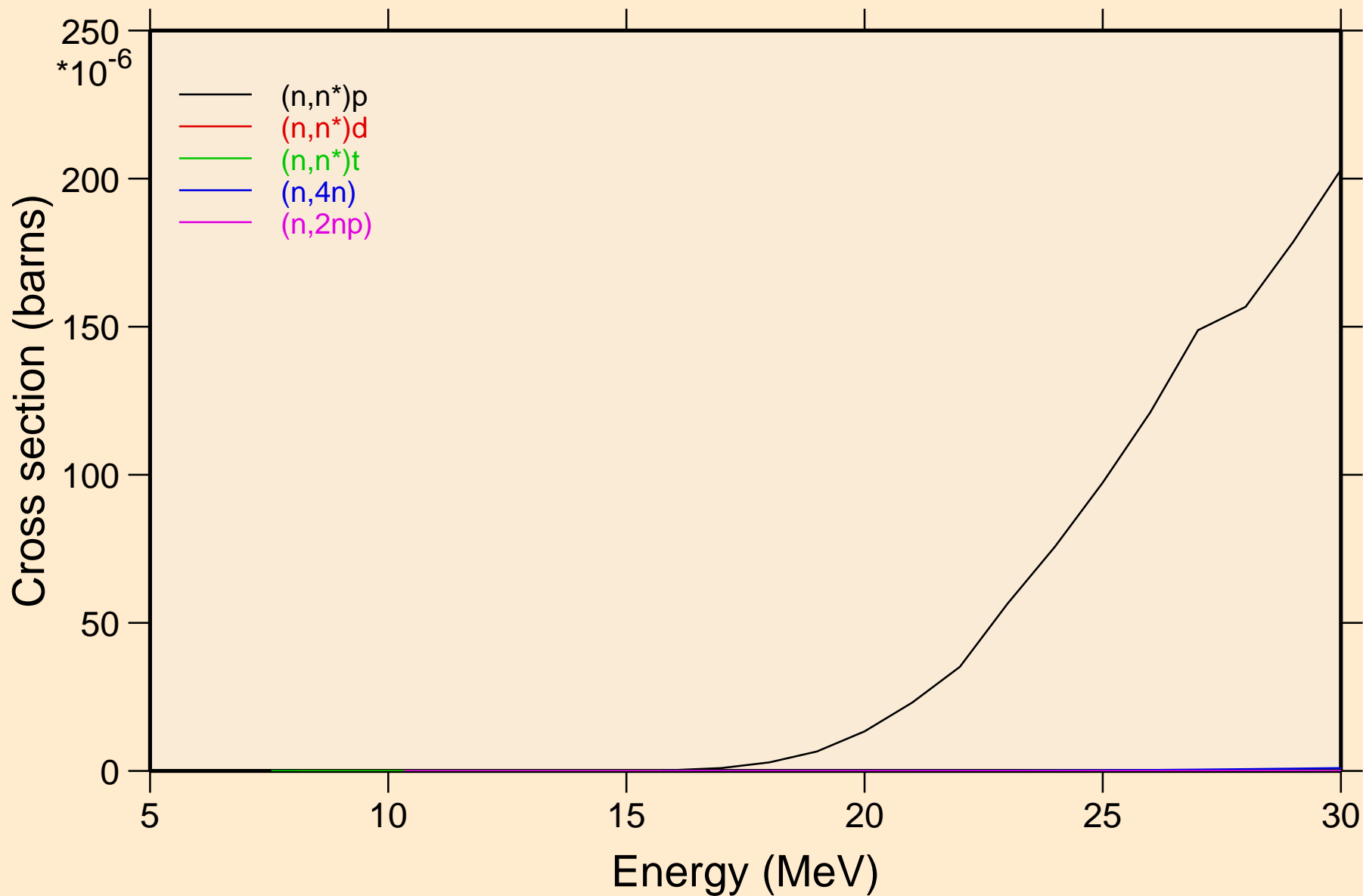

SG273 NEUTRON ACER TENDL-2019 LIBRARY; T=293.16K
Threshold reactions

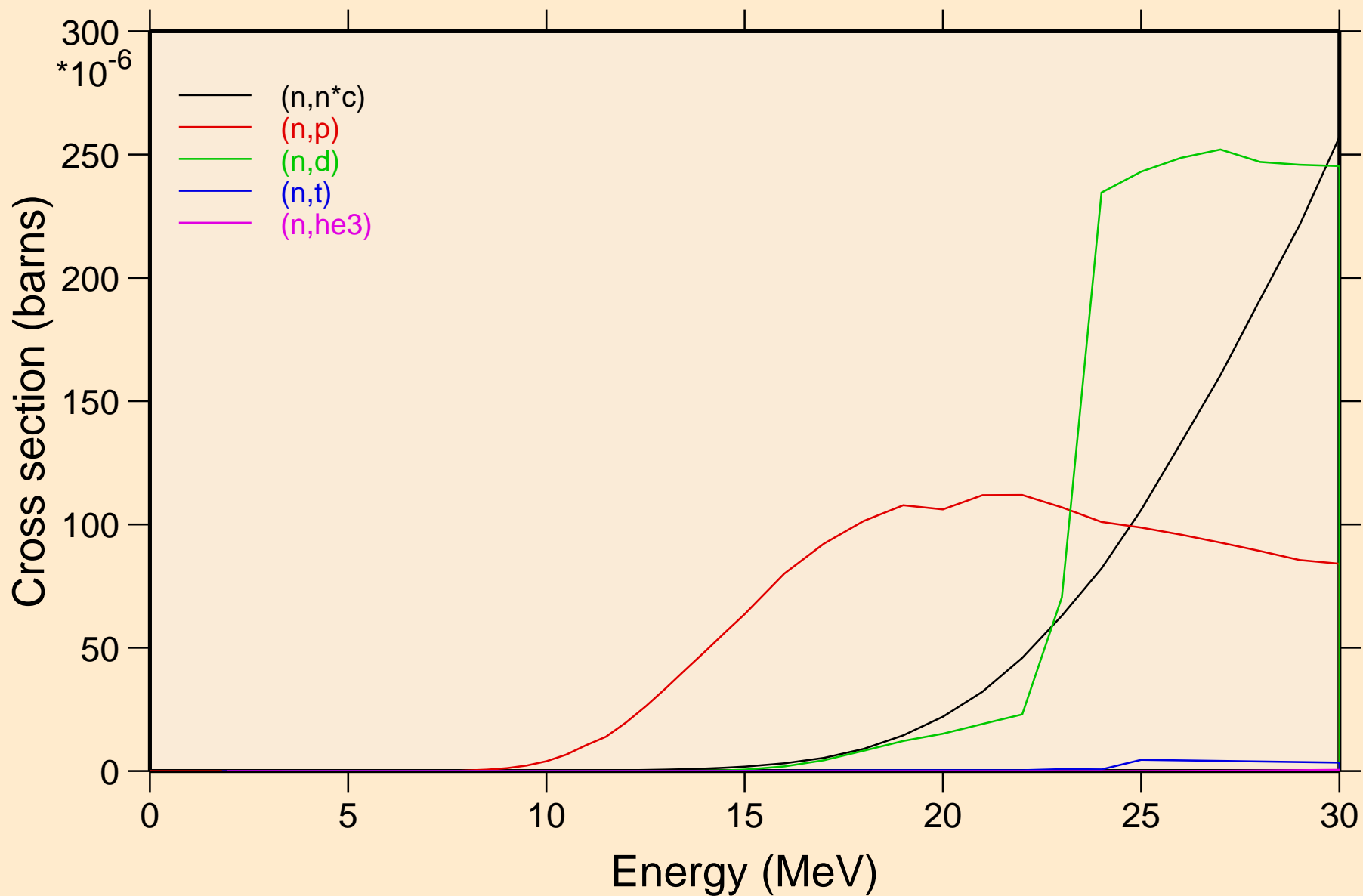

SG273 NEUTRON ACER TENDL-2019 LIBRARY; T=293.16K
Threshold reactions

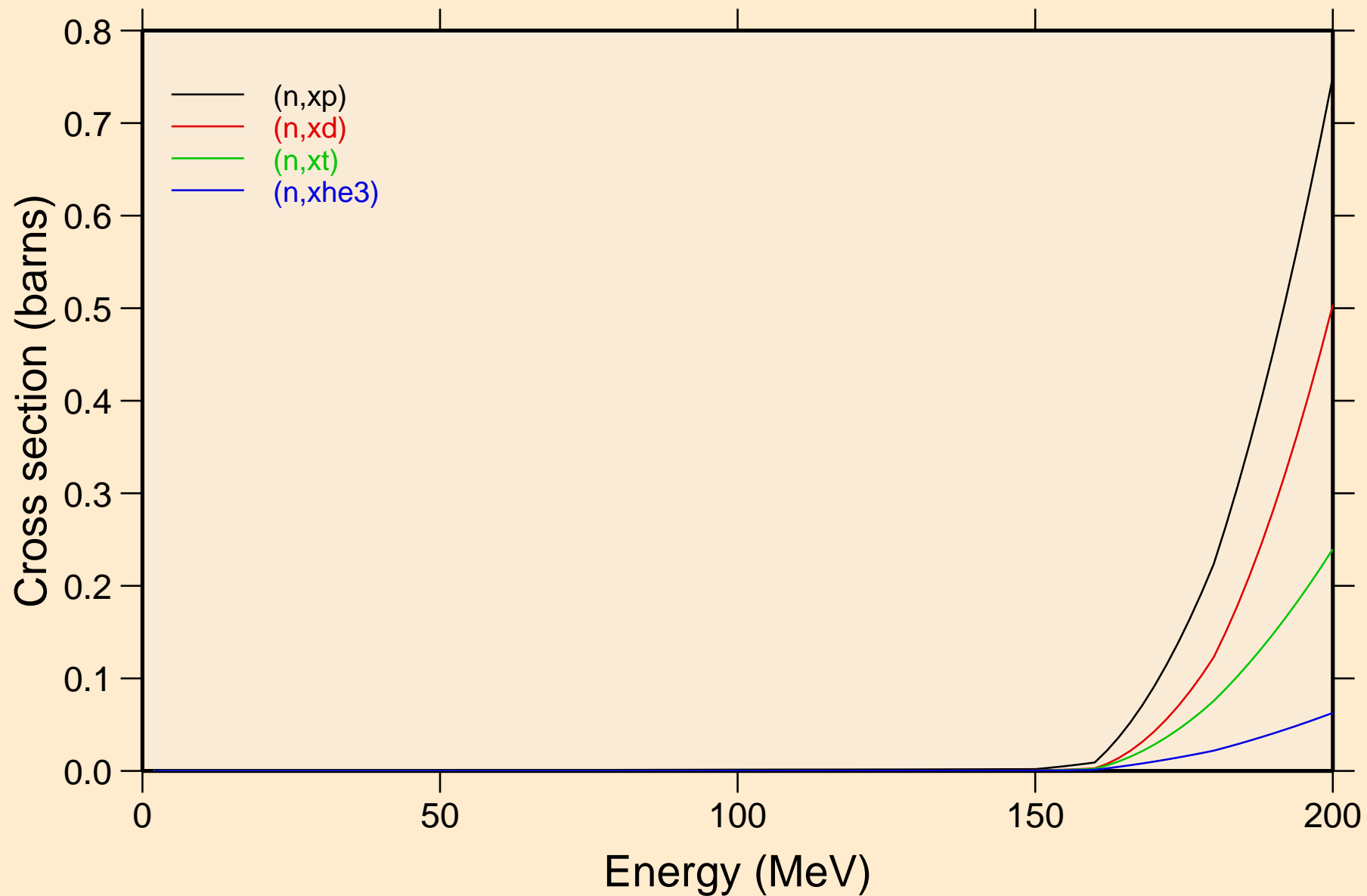

SG273 NEUTRON ACER TENDL-2019 LIBRARY; T=293.16K
angular distribution for elastic

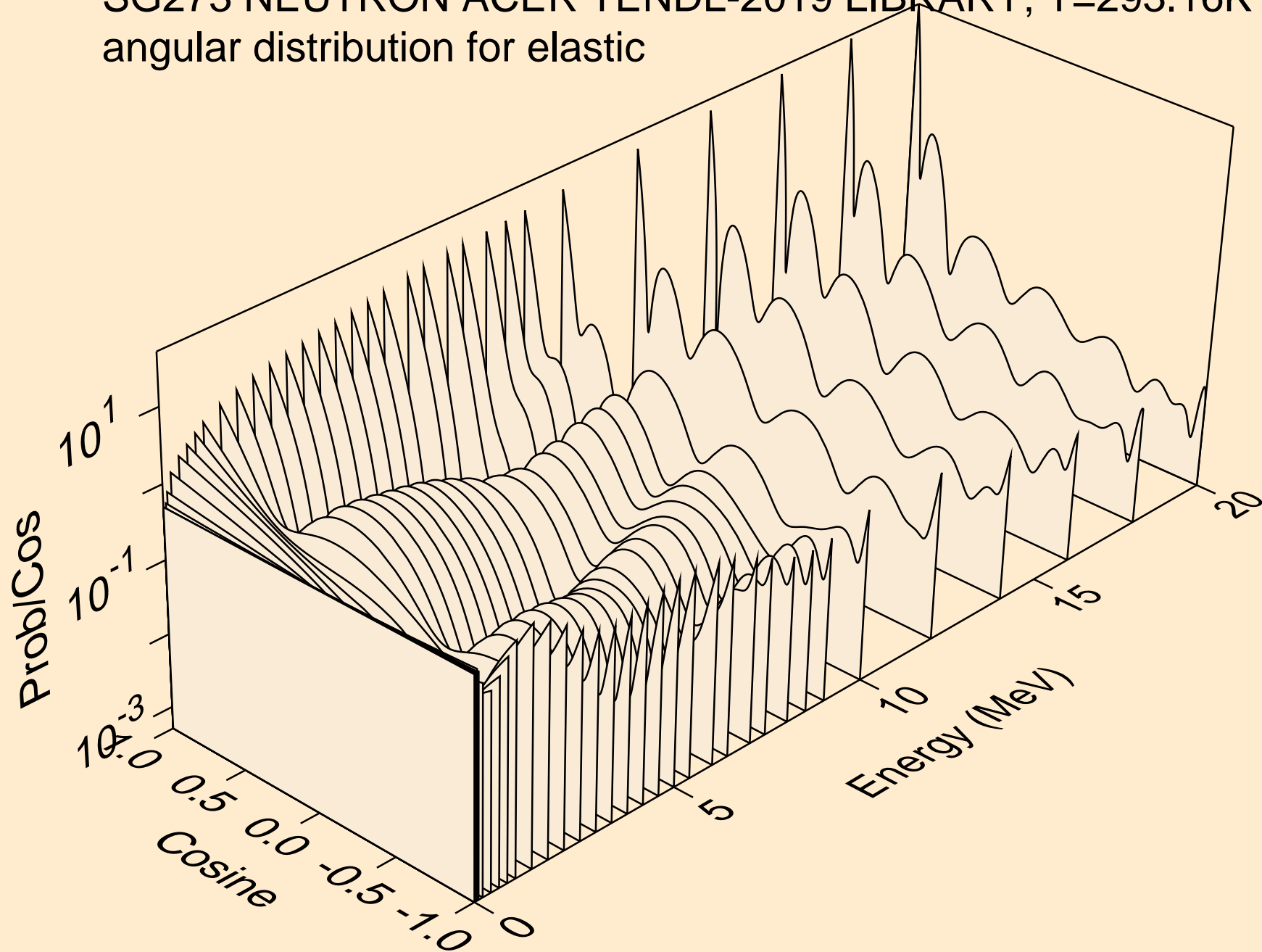

SG273 NEUTRON ACER TENDL-2019 LIBRARY; T=293.16K
angular distribution for elastic

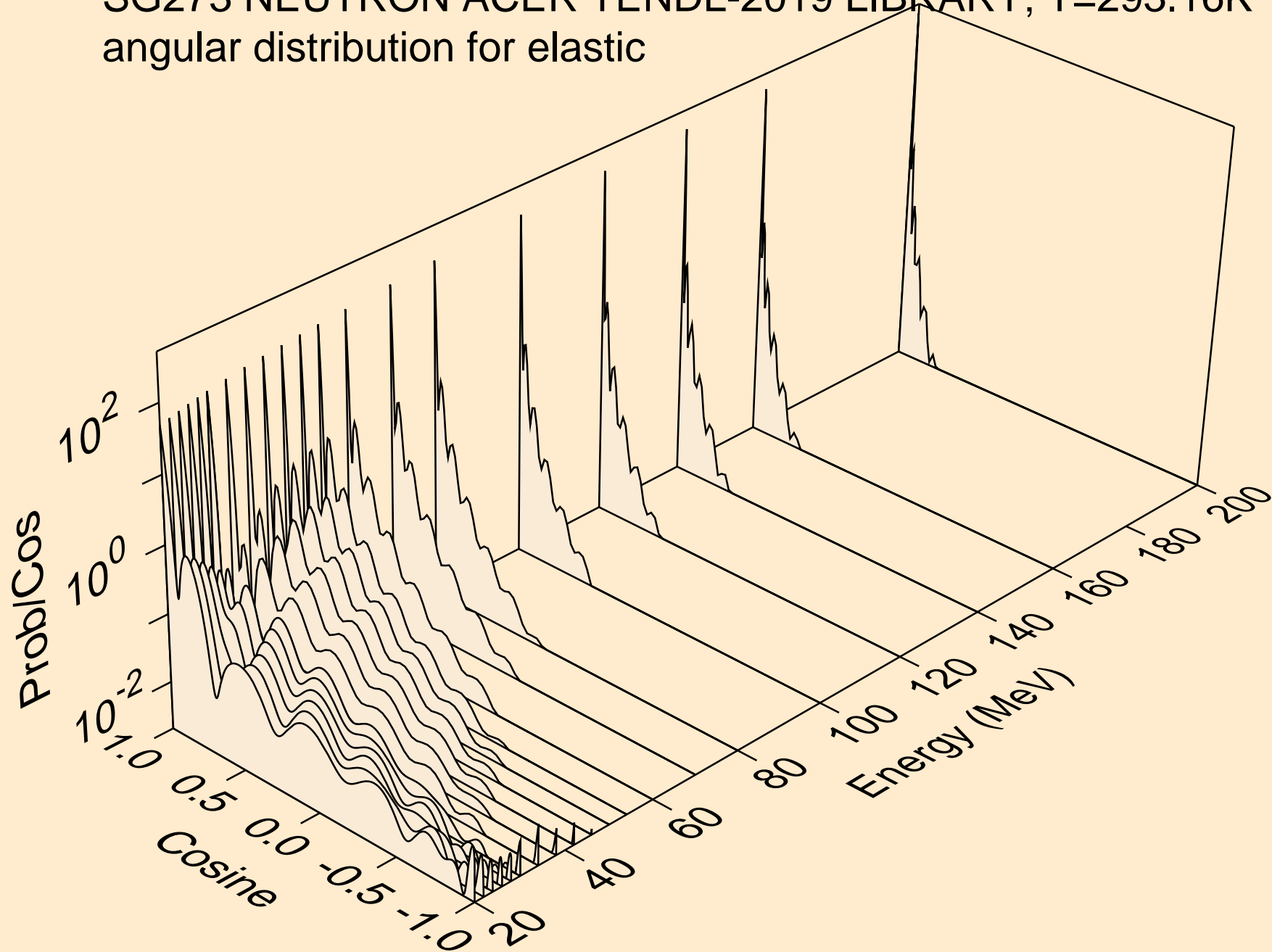

SG273 NEUTRON ACER TENDL-2019 LIBRARY; T=293.16K
angular distribution for (n,n*1)

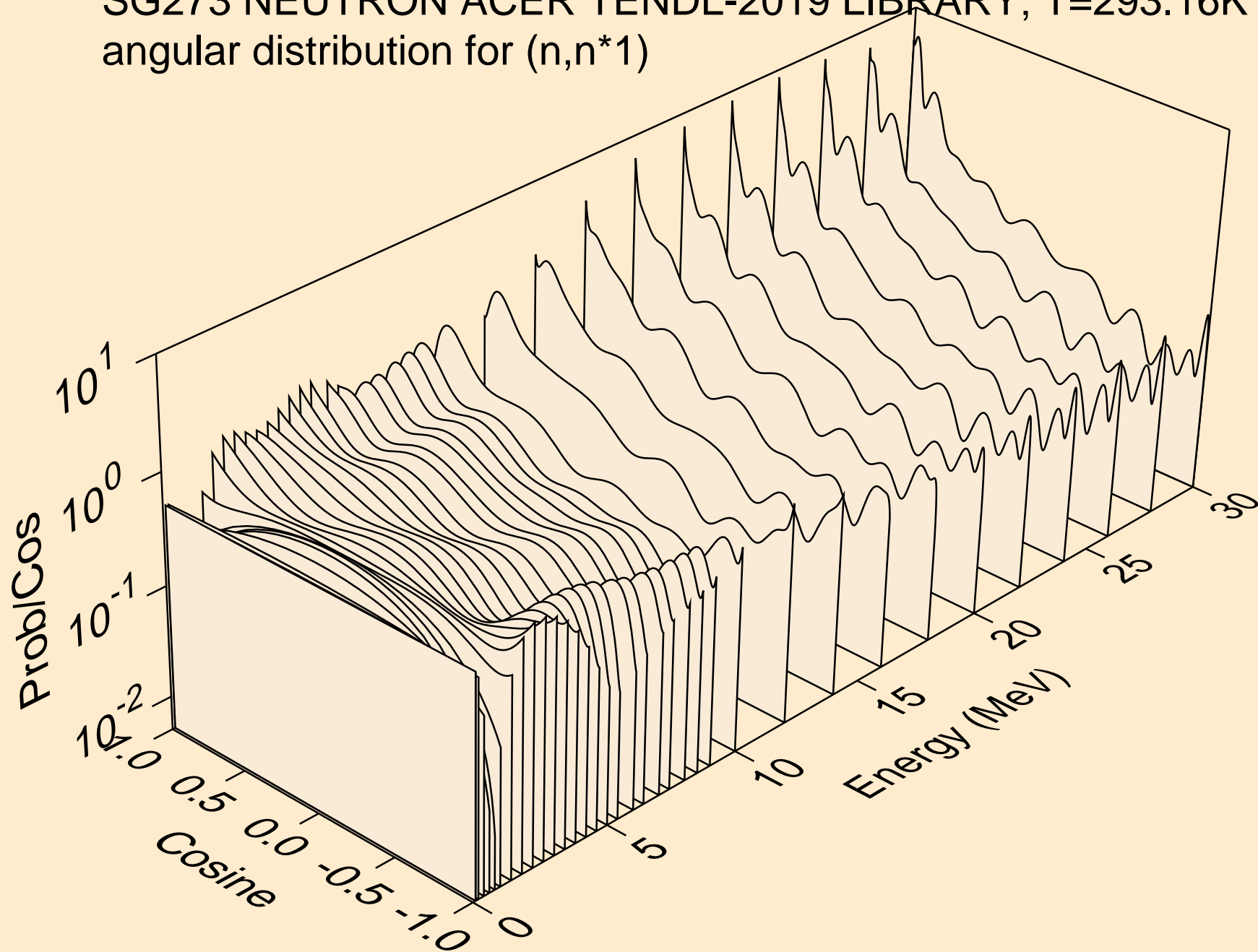

SG273 NEUTRON ACER TENDL-2019 LIBRARY; T=293.16K

Total fission nuubar

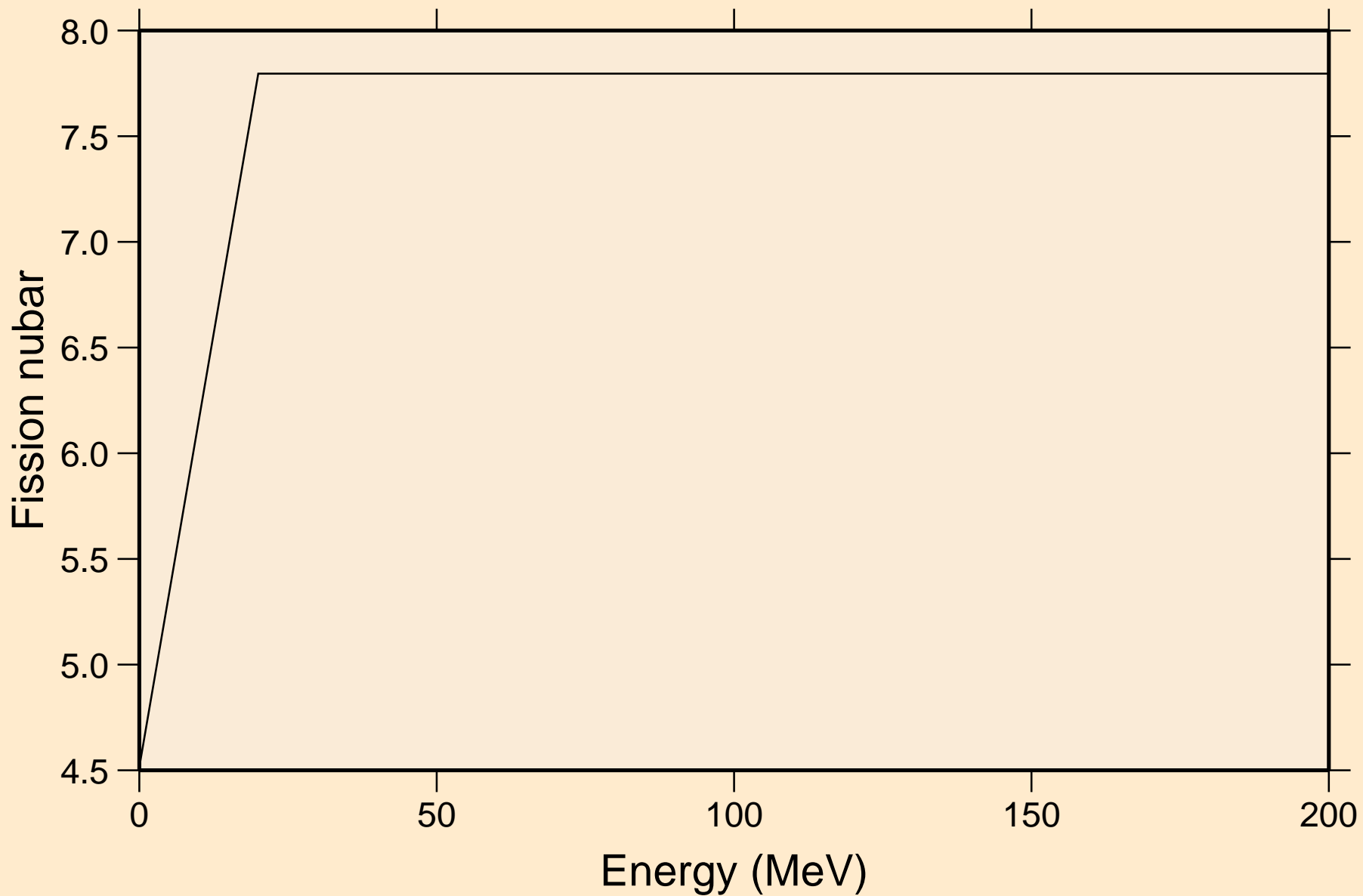

SG273 NEUTRON ACER TENDL-2019 LIBRARY; T=293.16K
Neutron emission for (n,x)

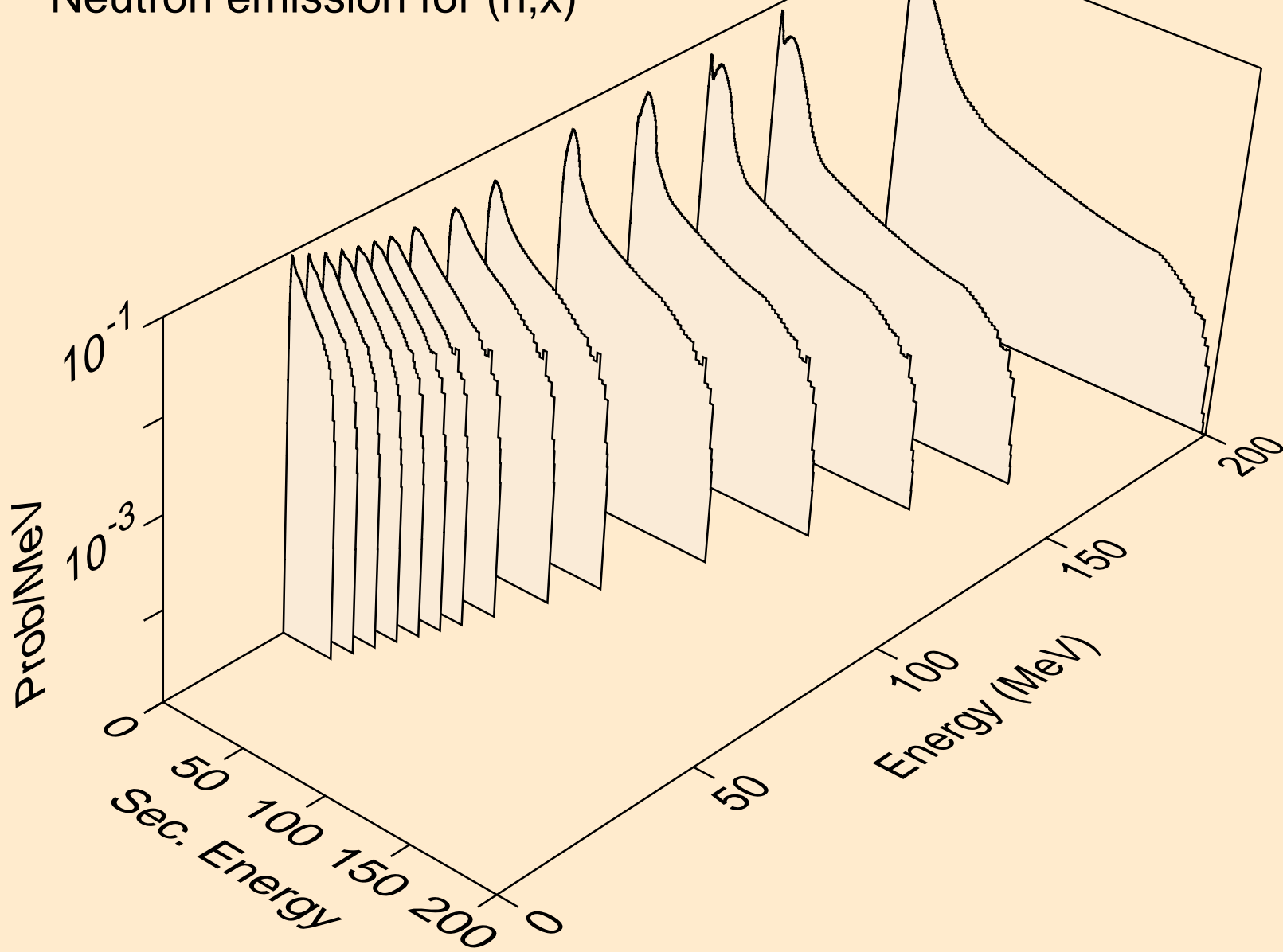

SG273 NEUTRON ACER TENDL-2019 LIBRARY; T=293.16K
Neutron emission for (n,2n)

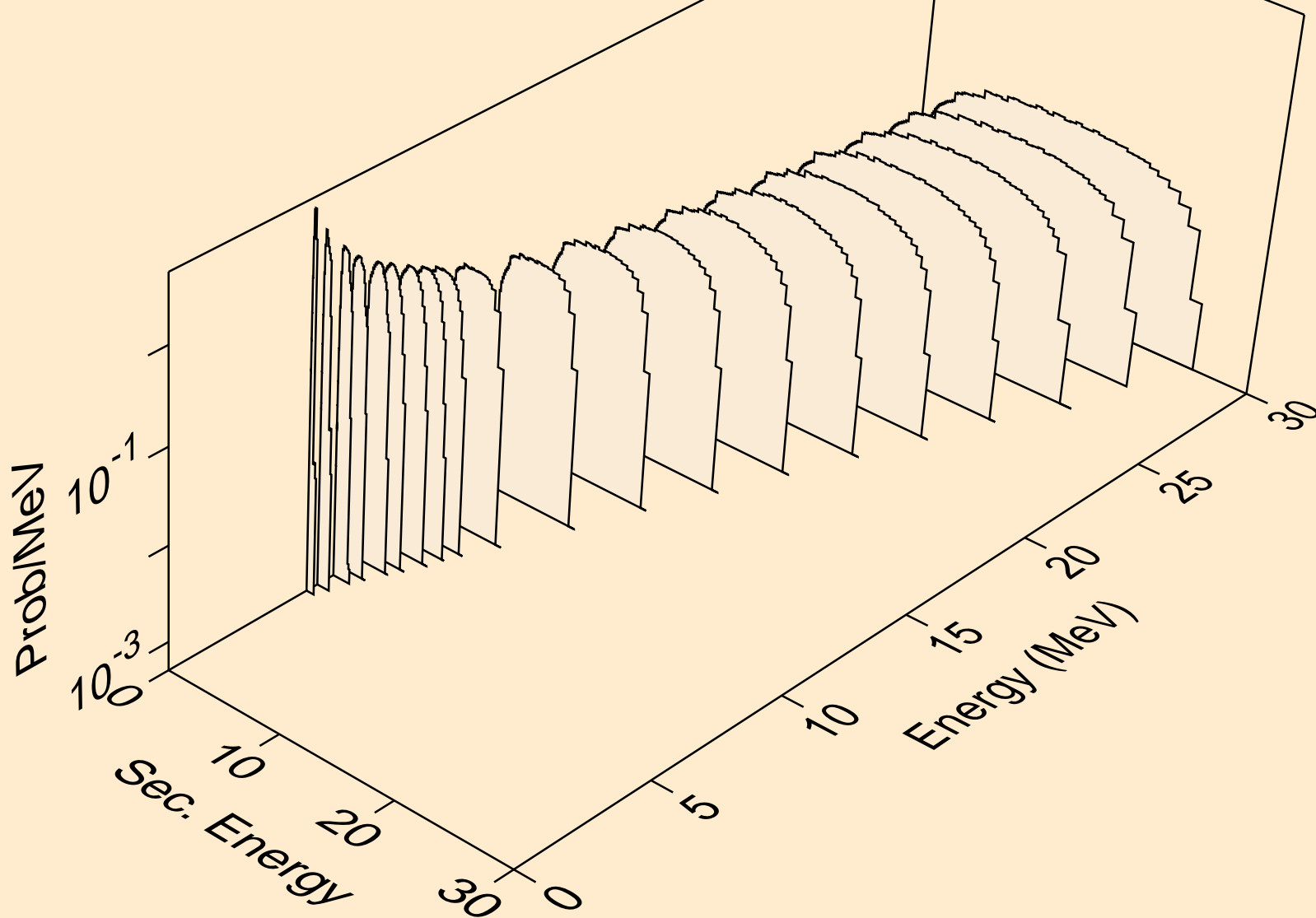

SG273 NEUTRON ACER TENDL-2019 LIBRARY; T=293.16K
Neutron emission for (n,3n)

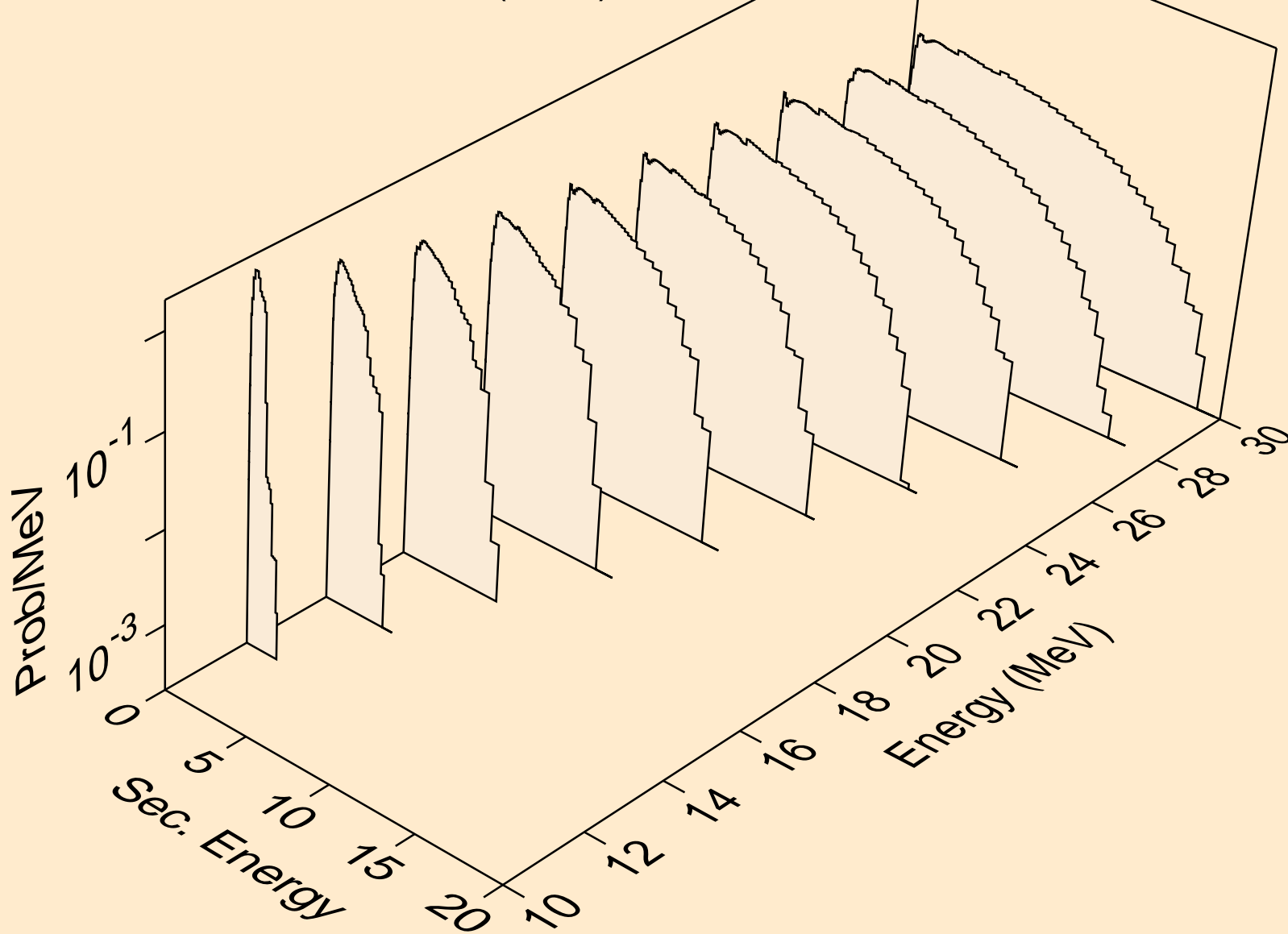

SG273 NEUTRON ACER TENDL-2019 LIBRARY; T=293.16K
Neutron emission for fission

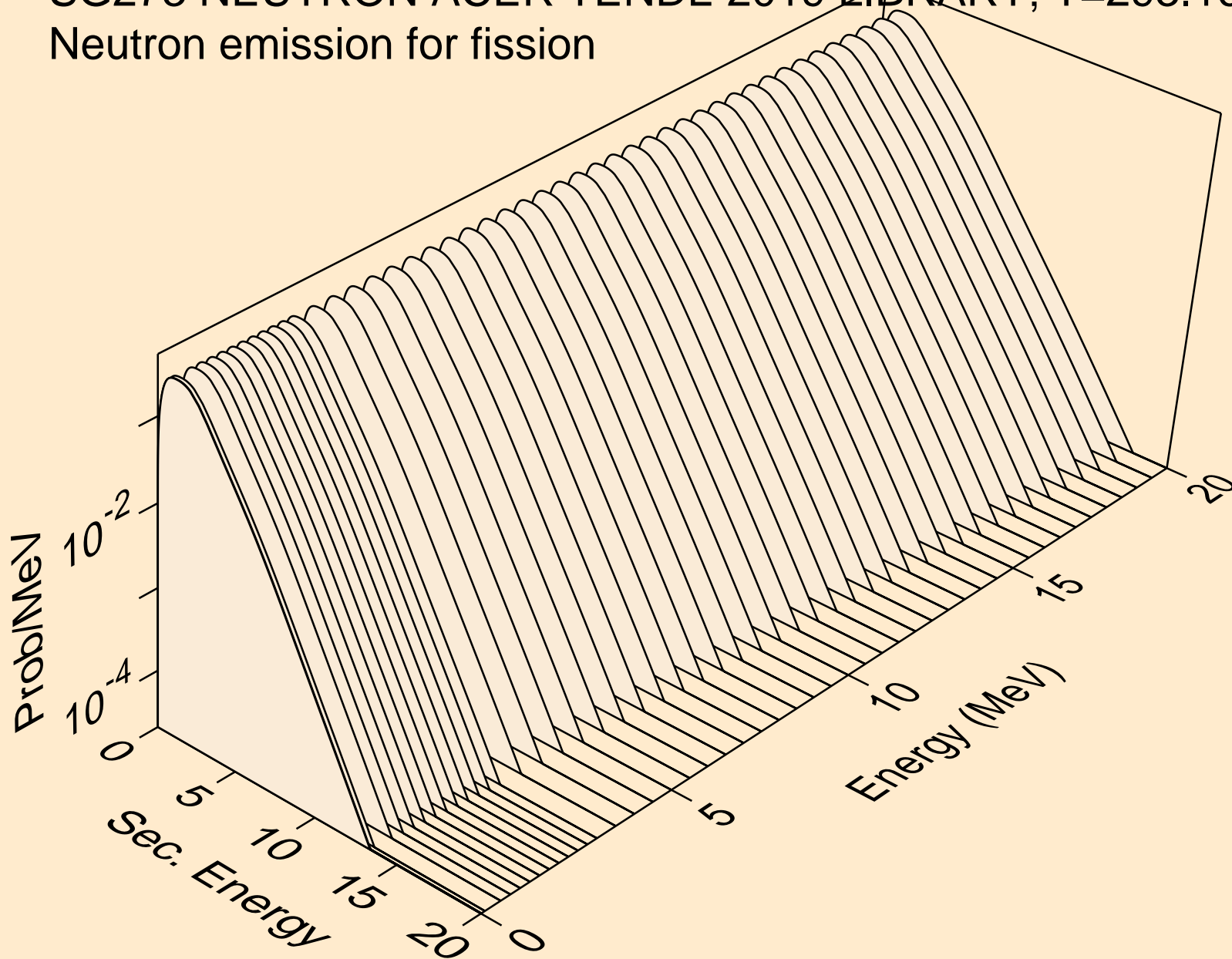

SG273 NEUTRON ACER TENDL-2019 LIBRARY; T=293.16K
Neutron emission for (n,n*)a

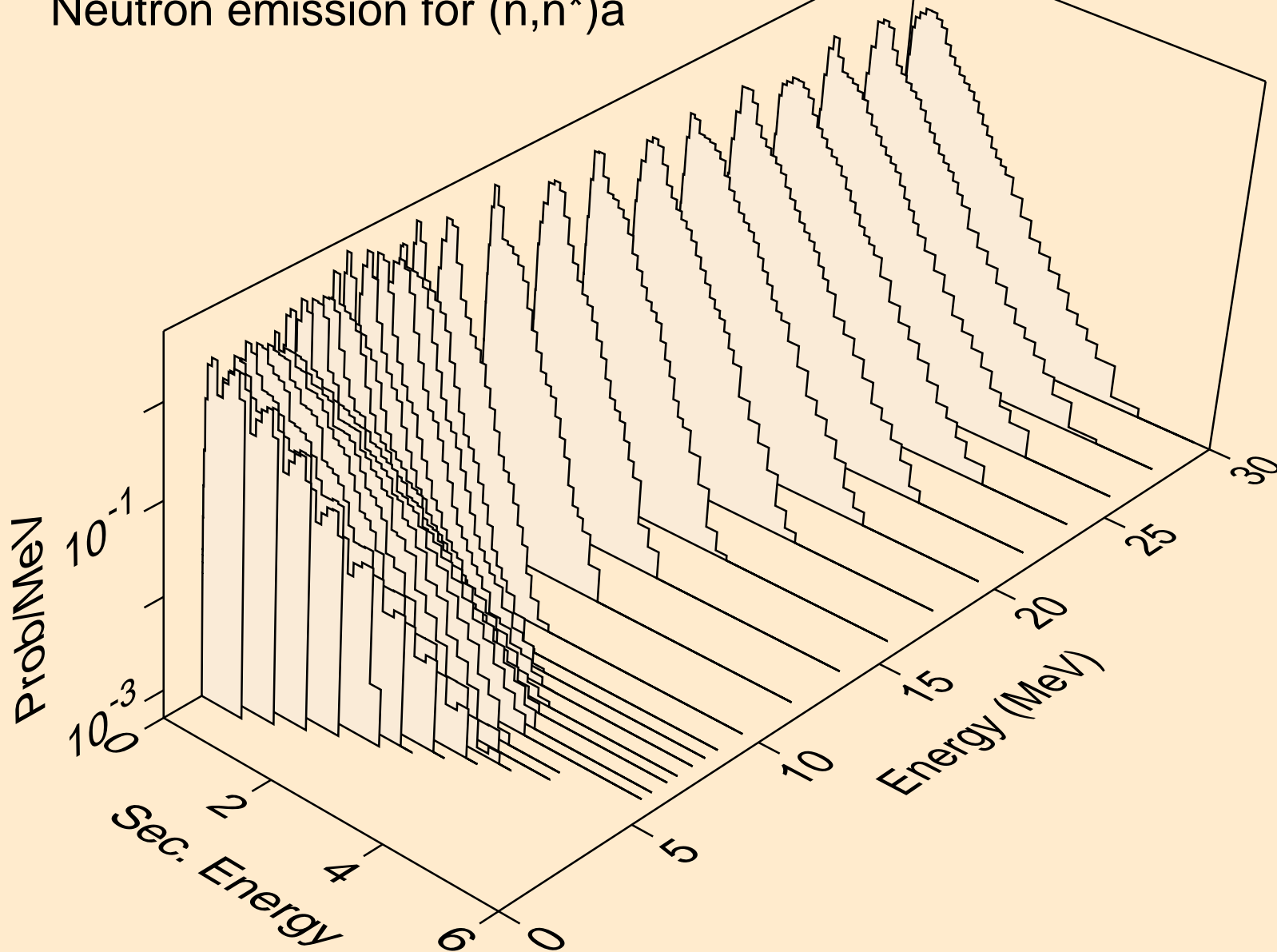

SG273 NEUTRON ACER TENDL-2019 LIBRARY; T=293.16K
Neutron emission for (n,2n)a

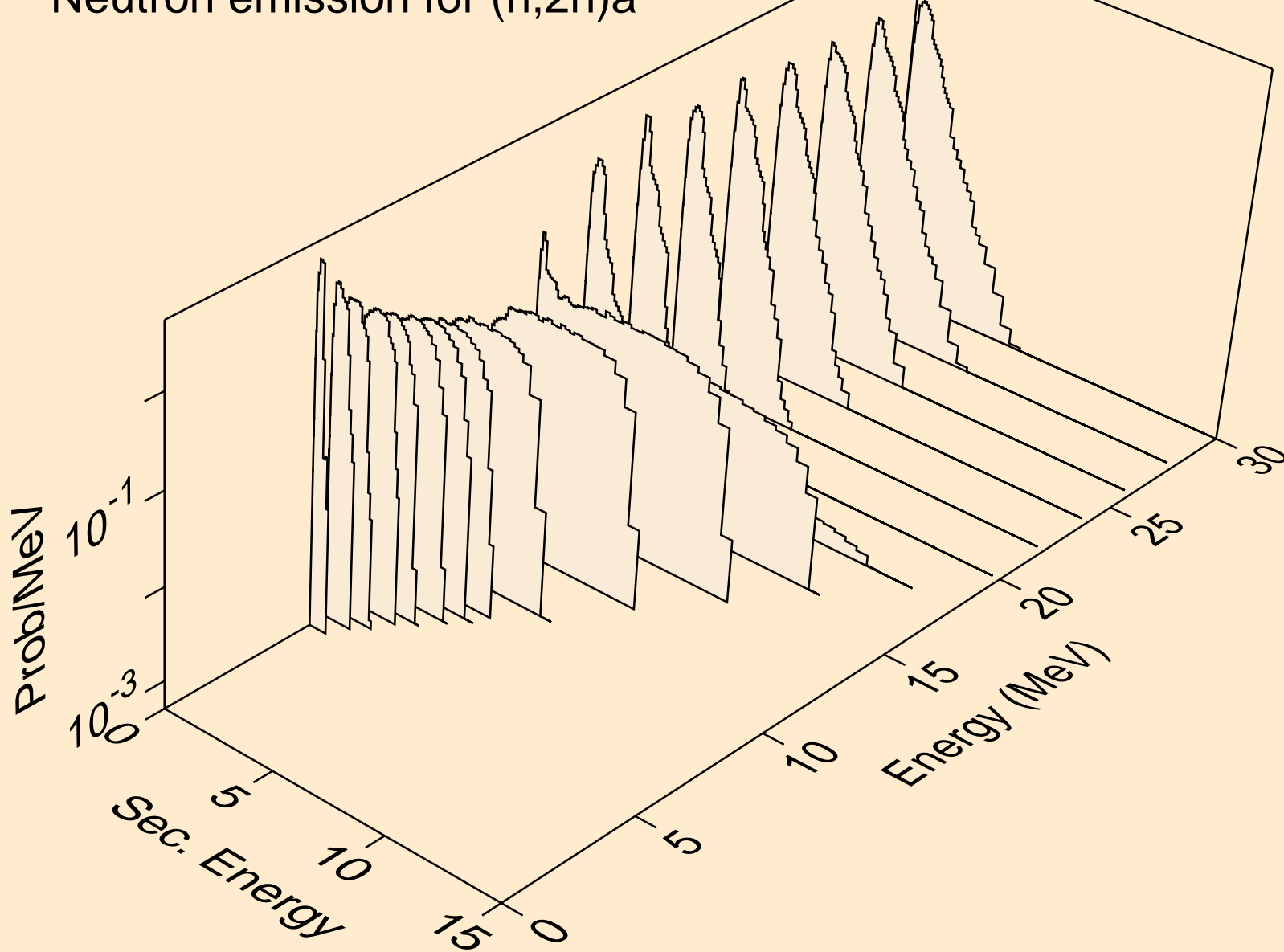

SG273 NEUTRON ACER TENDL-2019 LIBRARY; T=293.16K
Neutron emission for (n,n*)p

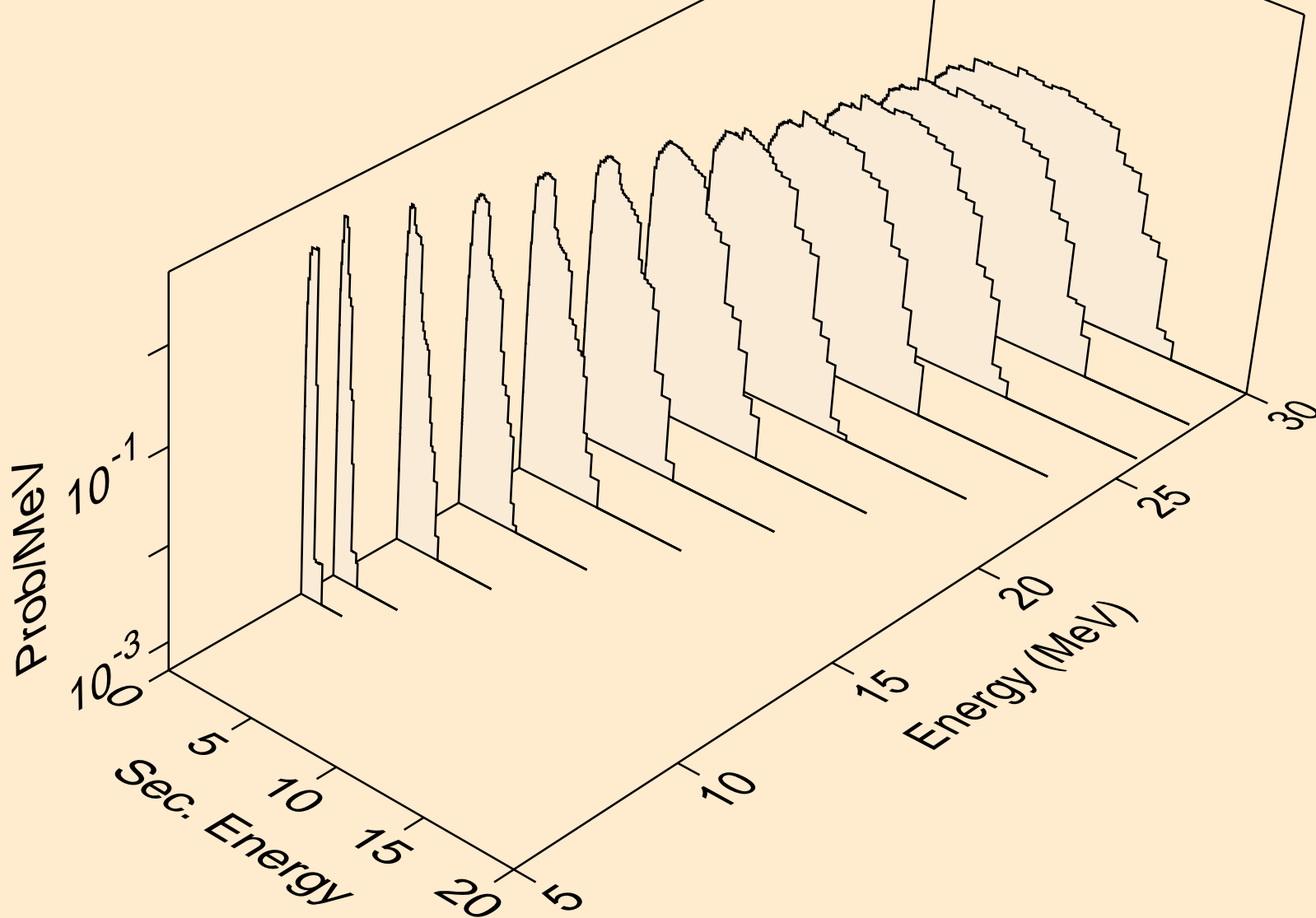

SG273 NEUTRON ACER TENDL-2019 LIBRARY; T=293.16K
Neutron emission for (n,n*)d

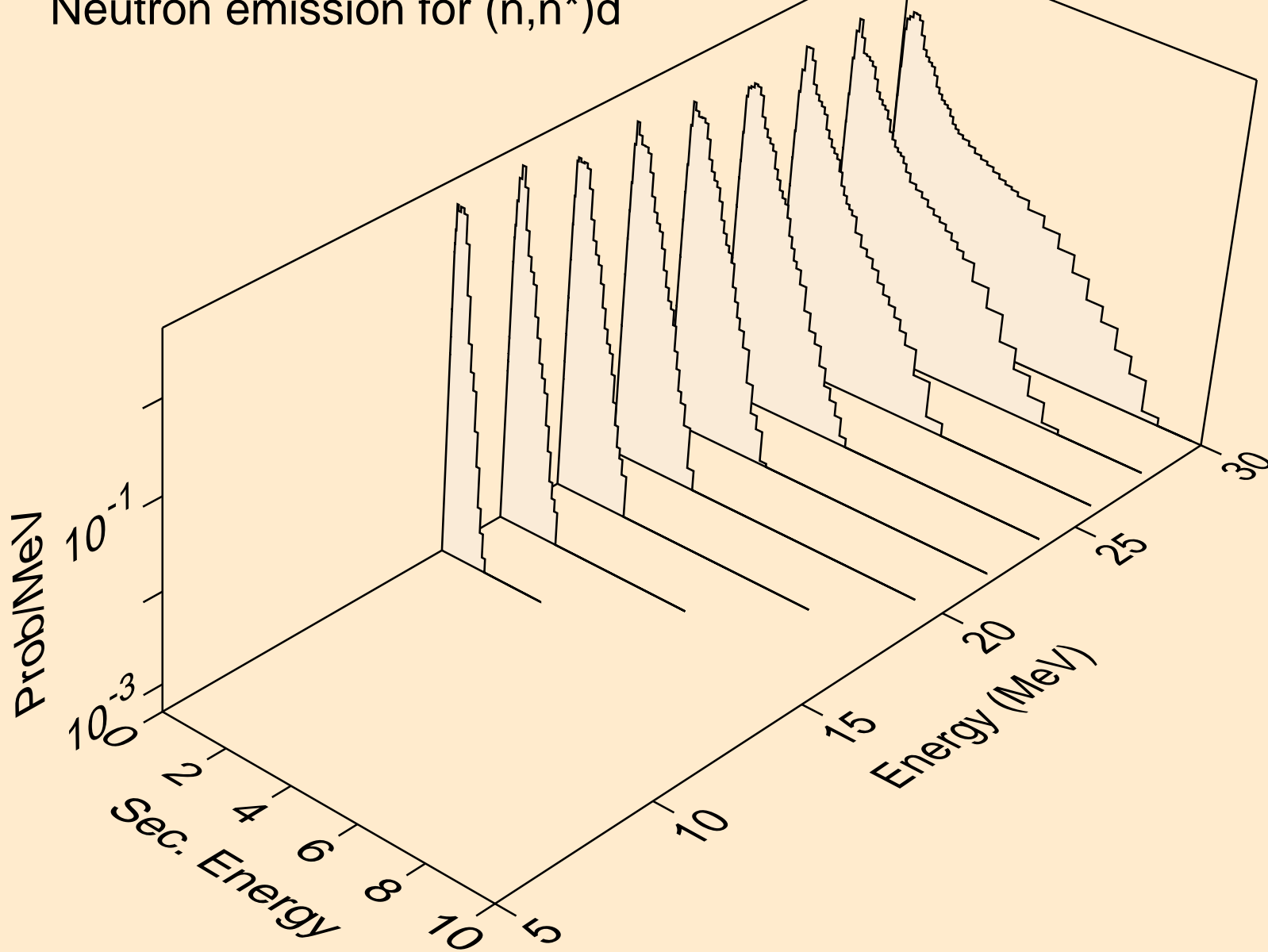

SG273 NEUTRON ACER TENDL-2019 LIBRARY; T=293.16K
Neutron emission for (n,n*)t

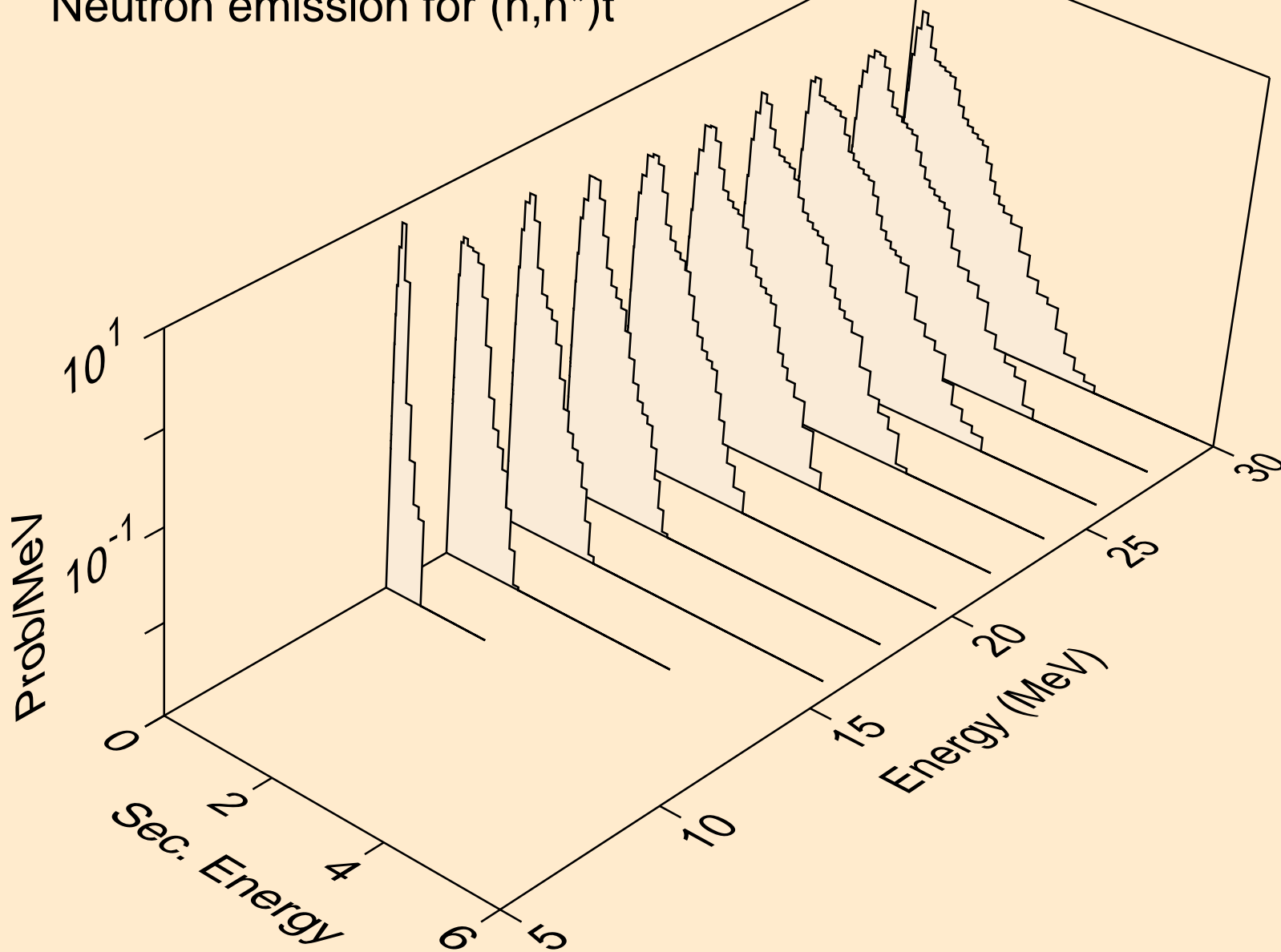

SG273 NEUTRON ACER TENDL-2019 LIBRARY; T=293.16K
Neutron emission for (n,4n)

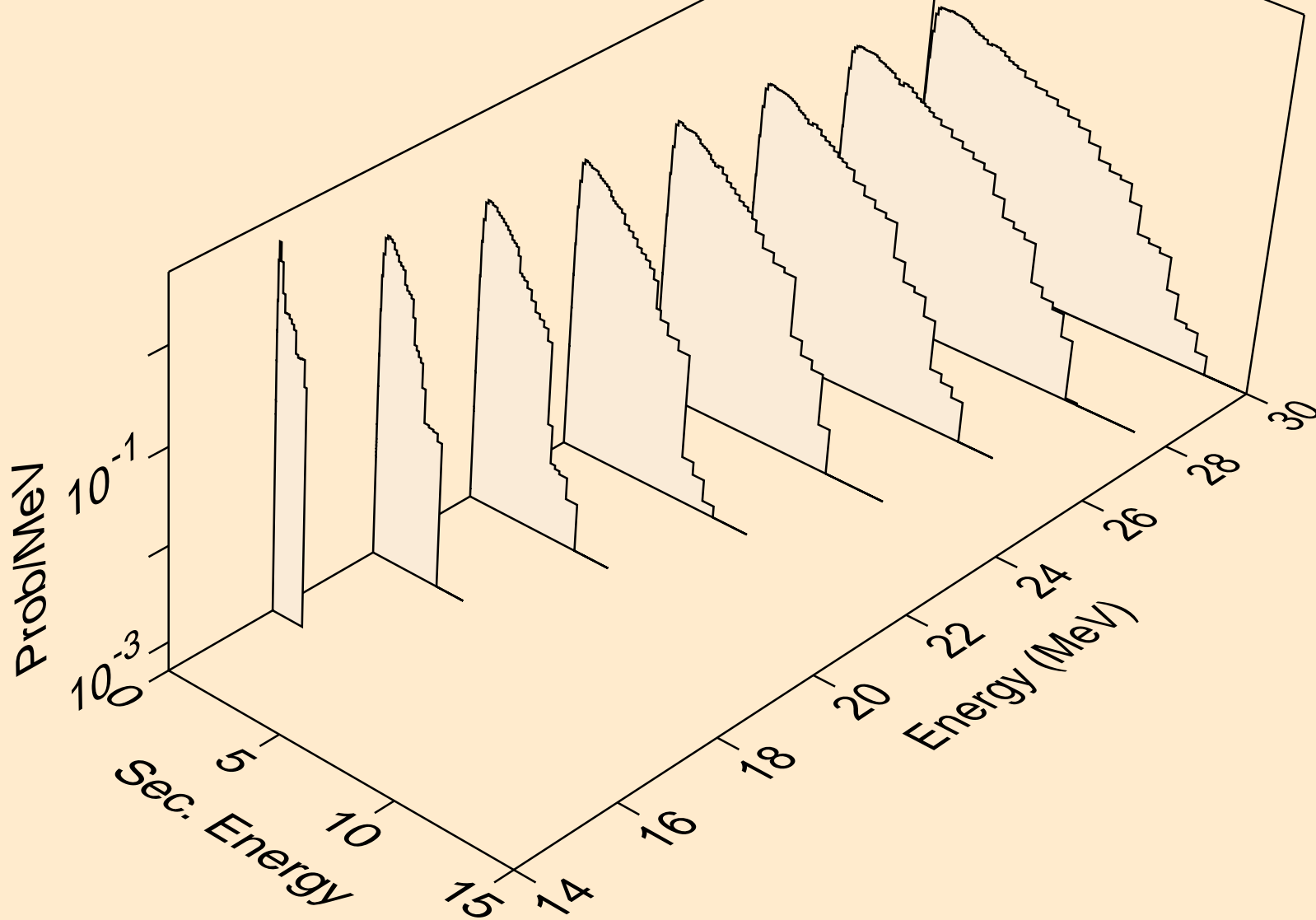

SG273 NEUTRON ACER TENDL-2019 LIBRARY; T=293.16K
Neutron emission for (n,2np)

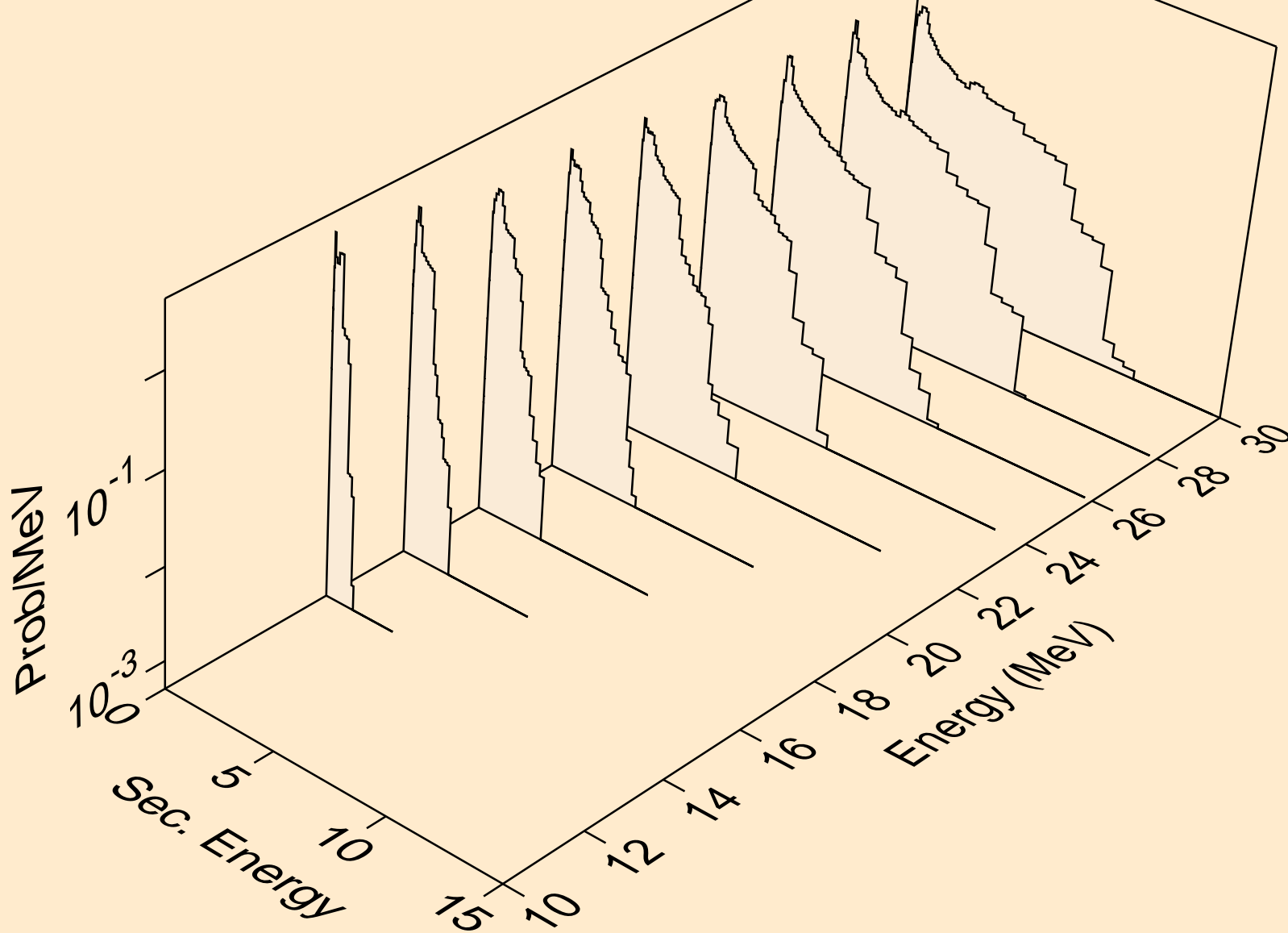

SG273 NEUTRON ACER TENDL-2019 LIBRARY; T=293.16K
Neutron emission for (n,n*c)

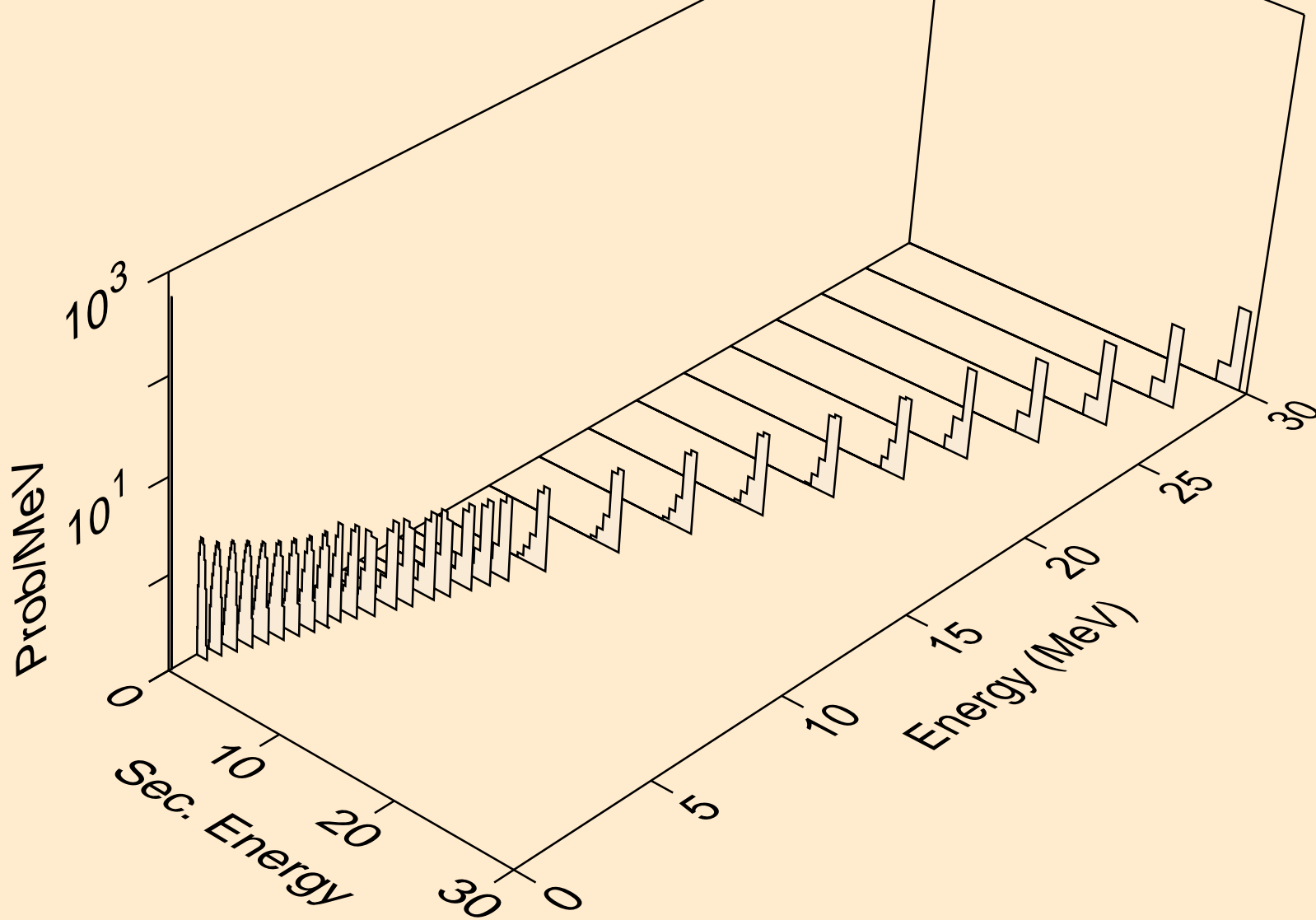

SG273 NEUTRON ACER TENDL-2019 LIBRARY; T=293.16K

Delayed nubar

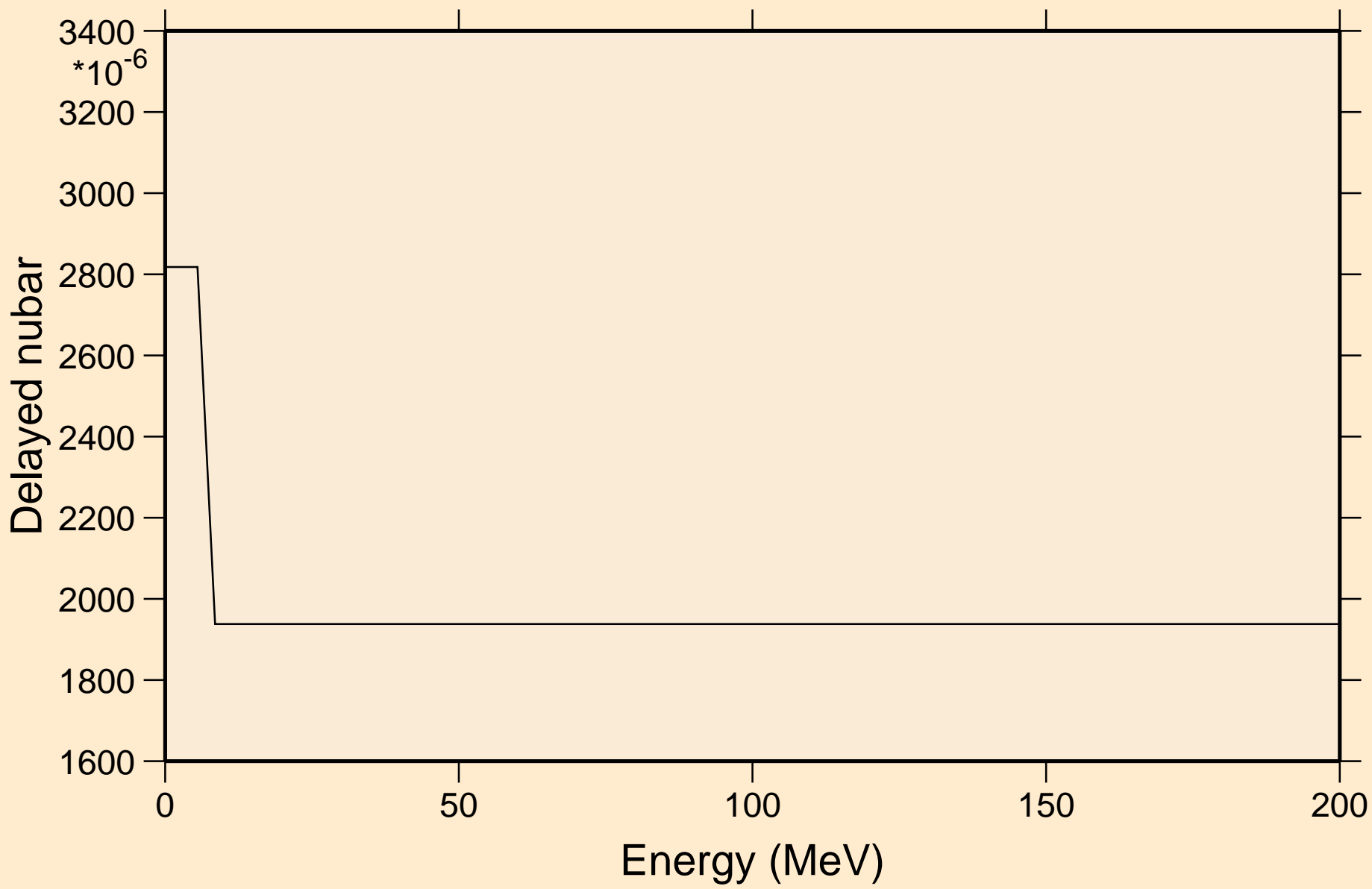

SG273 NEUTRON ACER TENDL-2019 LIBRARY; T=293.16K

Delayed neutron spectra

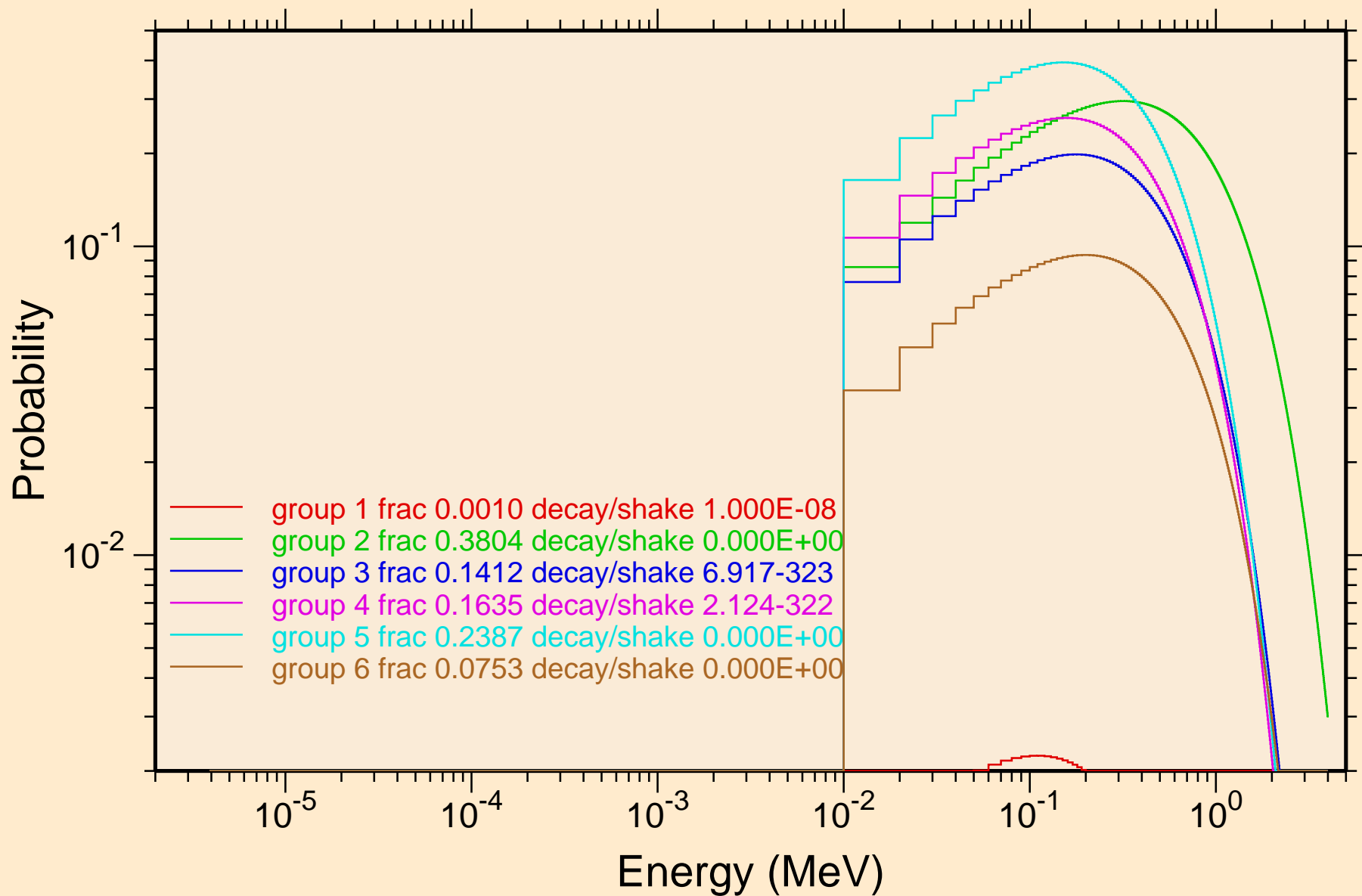

SG273 NEUTRON ACER TENDL-2019 LIBRARY; T=293.16K
Photon emission for (n,x)

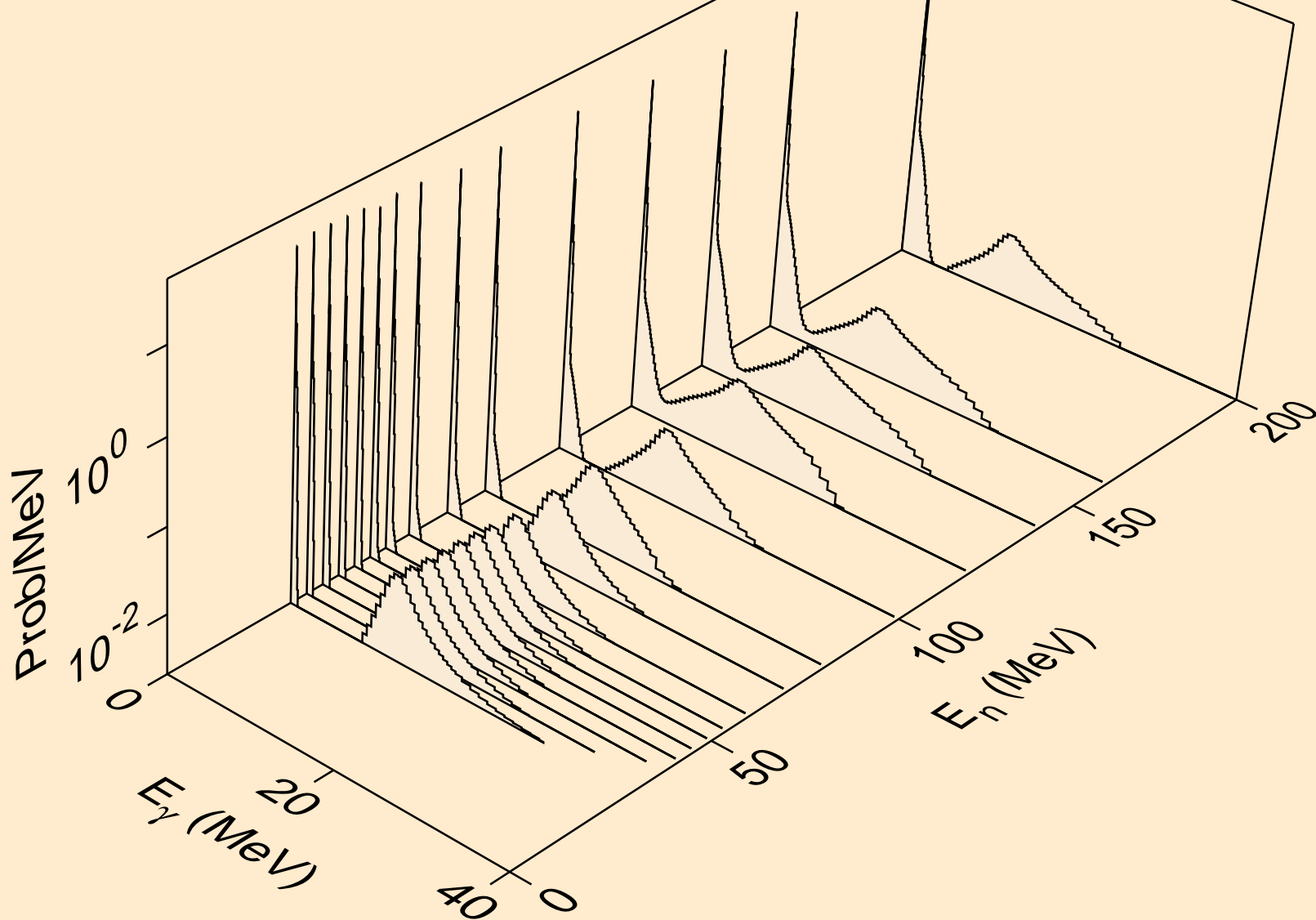

SG273 NEUTRON ACER TENDL-2019 LIBRARY; T=293.16K
Photon emission for (n,2n)

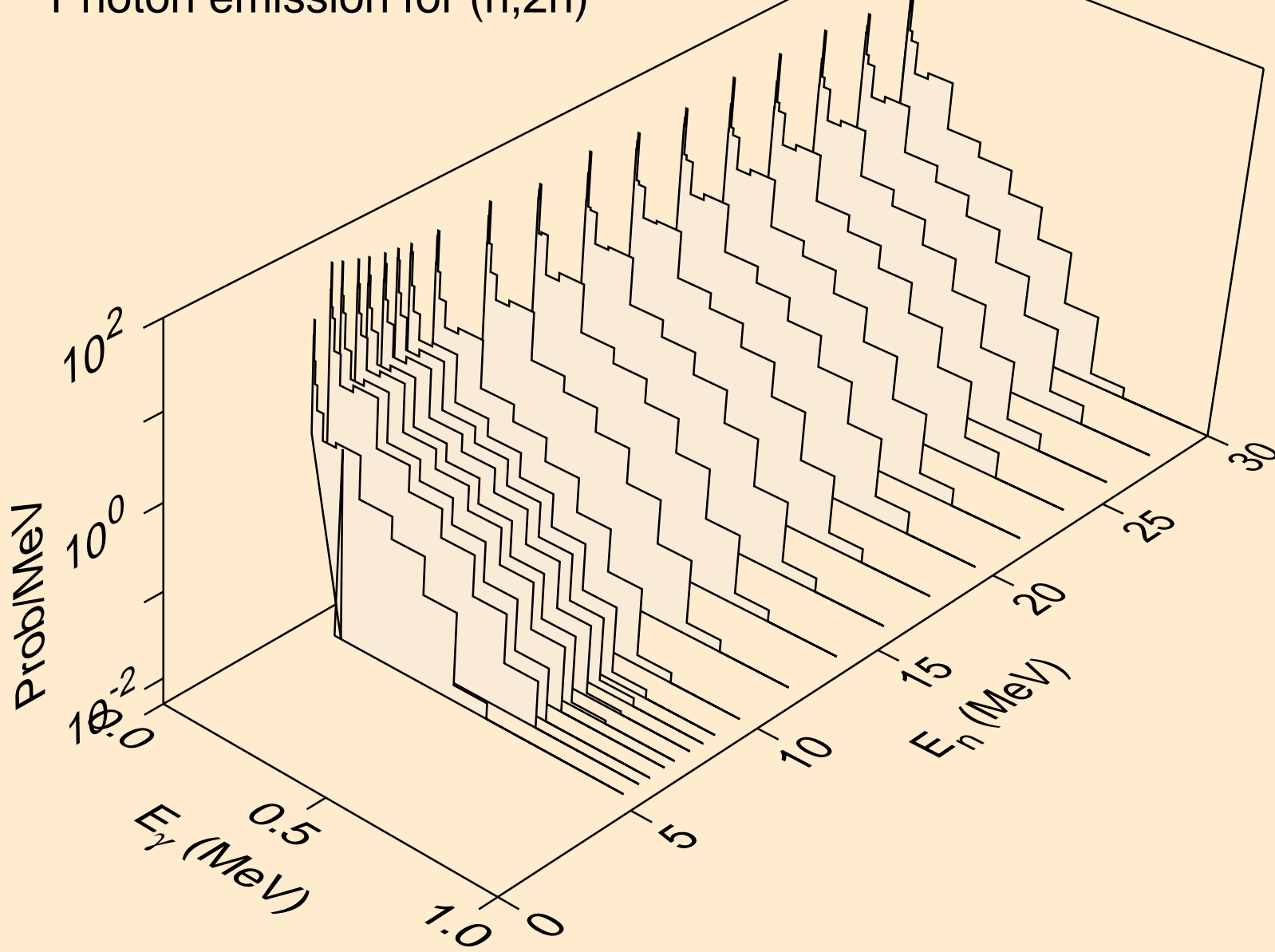

SG273 NEUTRON ACER TENDL-2019 LIBRARY; T=293.16K
Photon emission for (n,3n)

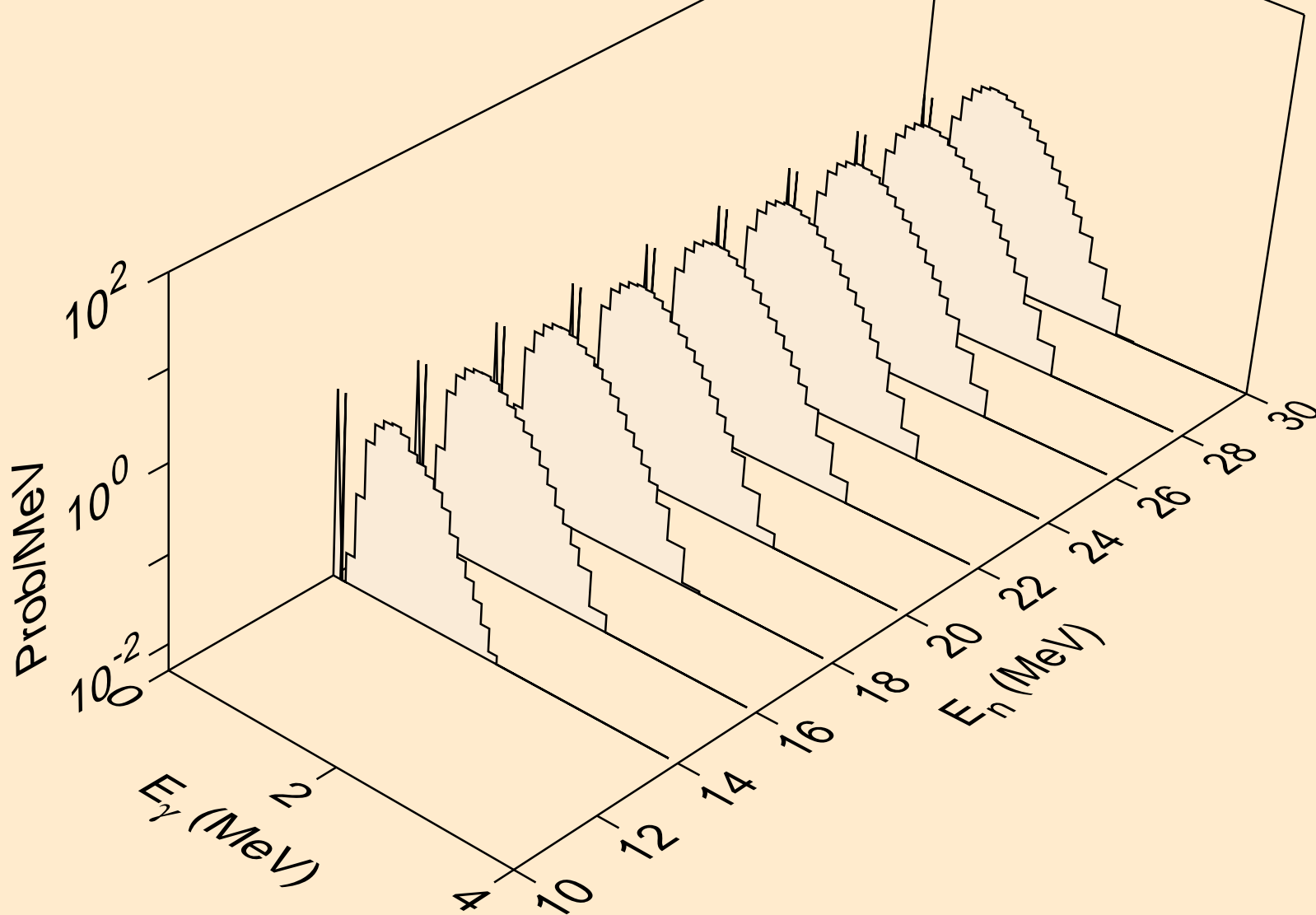

SG273 NEUTRON ACER TENDL-2019 LIBRARY; T=293.16K
Photon emission for (n,n*)a

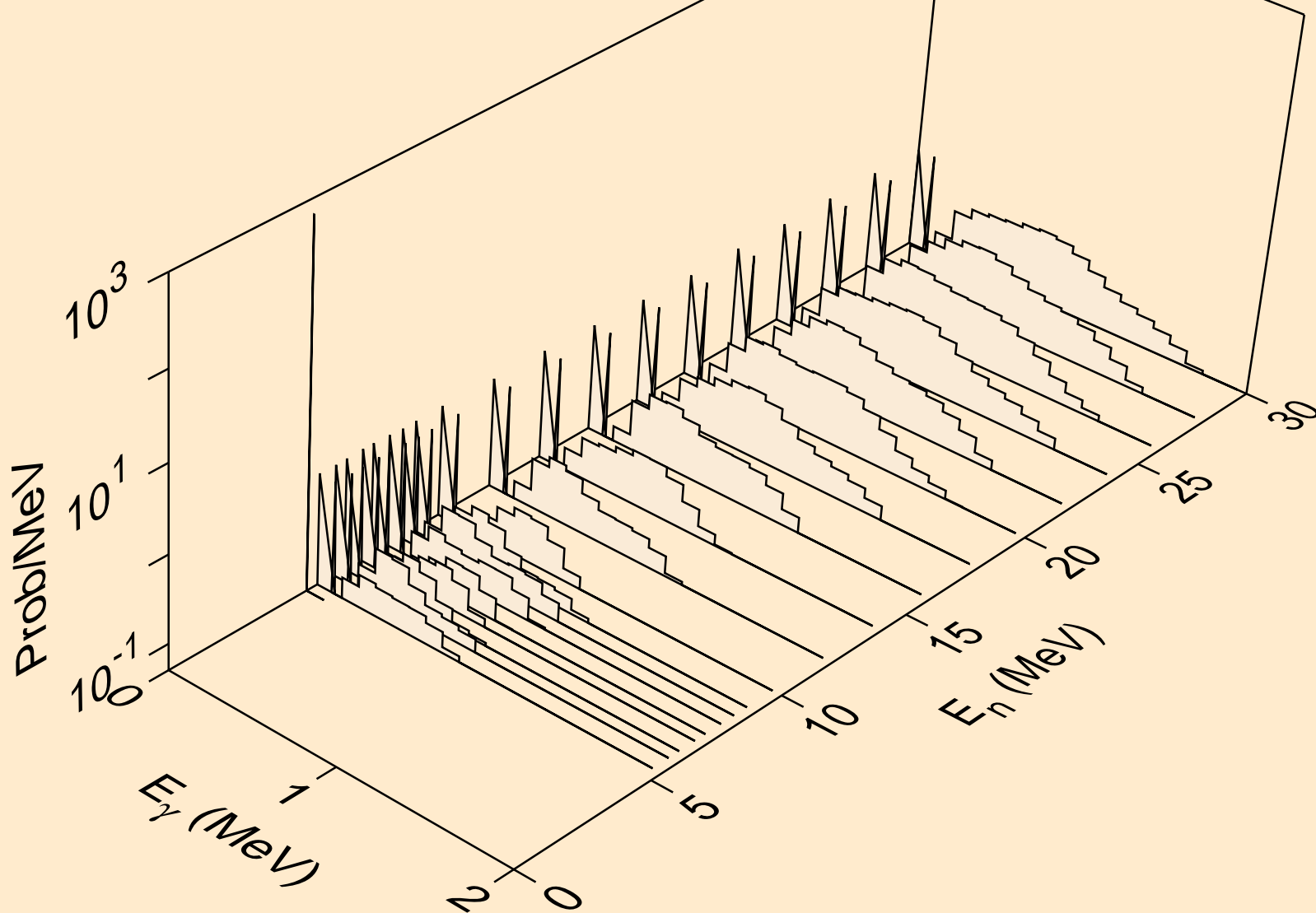

SG273 NEUTRON ACER TENDL-2019 LIBRARY; T=293.16K
Photon emission for (n,2n)a

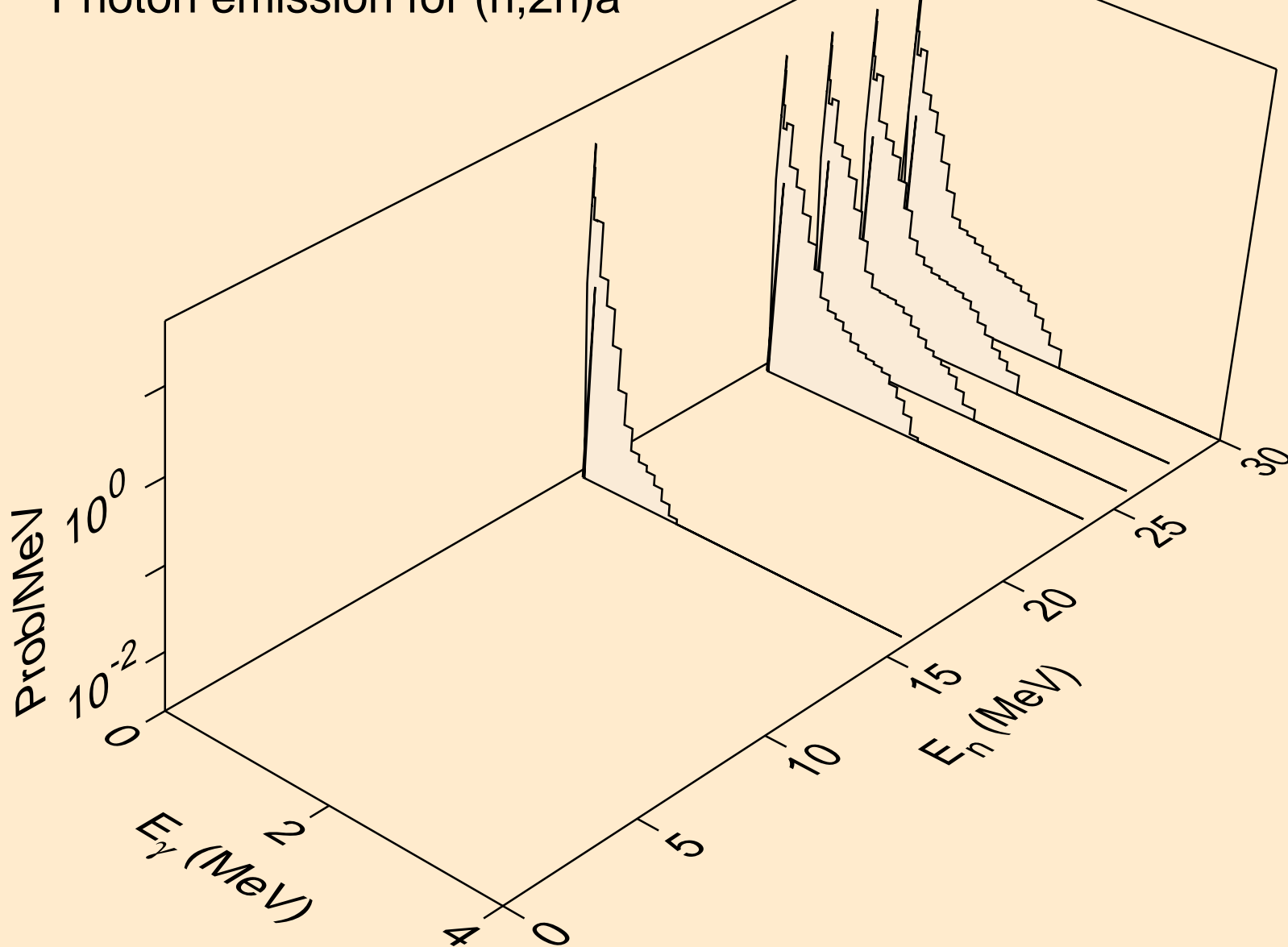

SG273 NEUTRON ACER TENDL-2019 LIBRARY; T=293.16K
Photon emission for (n,n*)p

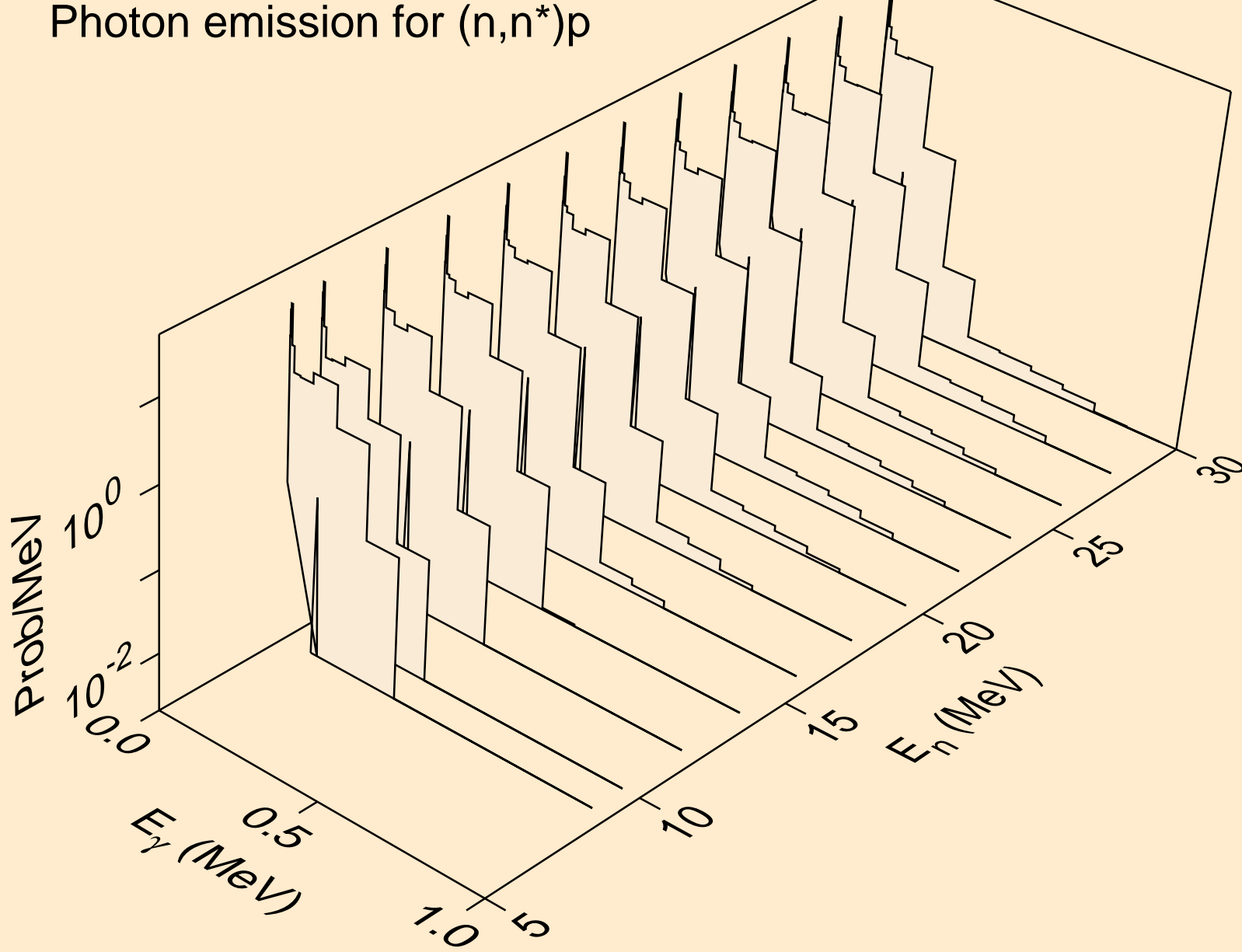

SG273 NEUTRON ACER TENDL-2019 LIBRARY; T=293.16K
Photon emission for (n,n*)d

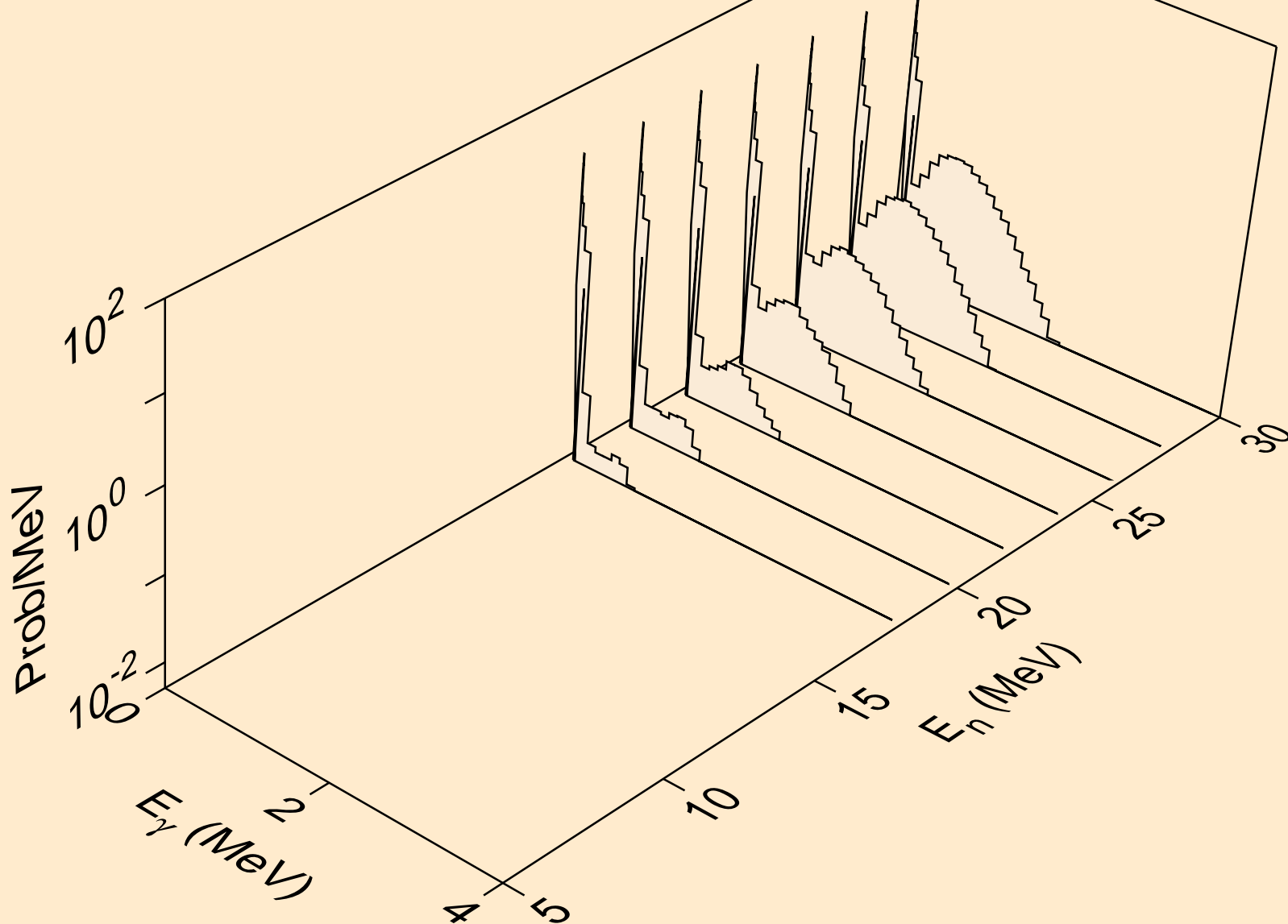

SG273 NEUTRON ACER TENDL-2019 LIBRARY; T=293.16K
Photon emission for (n,n*)t

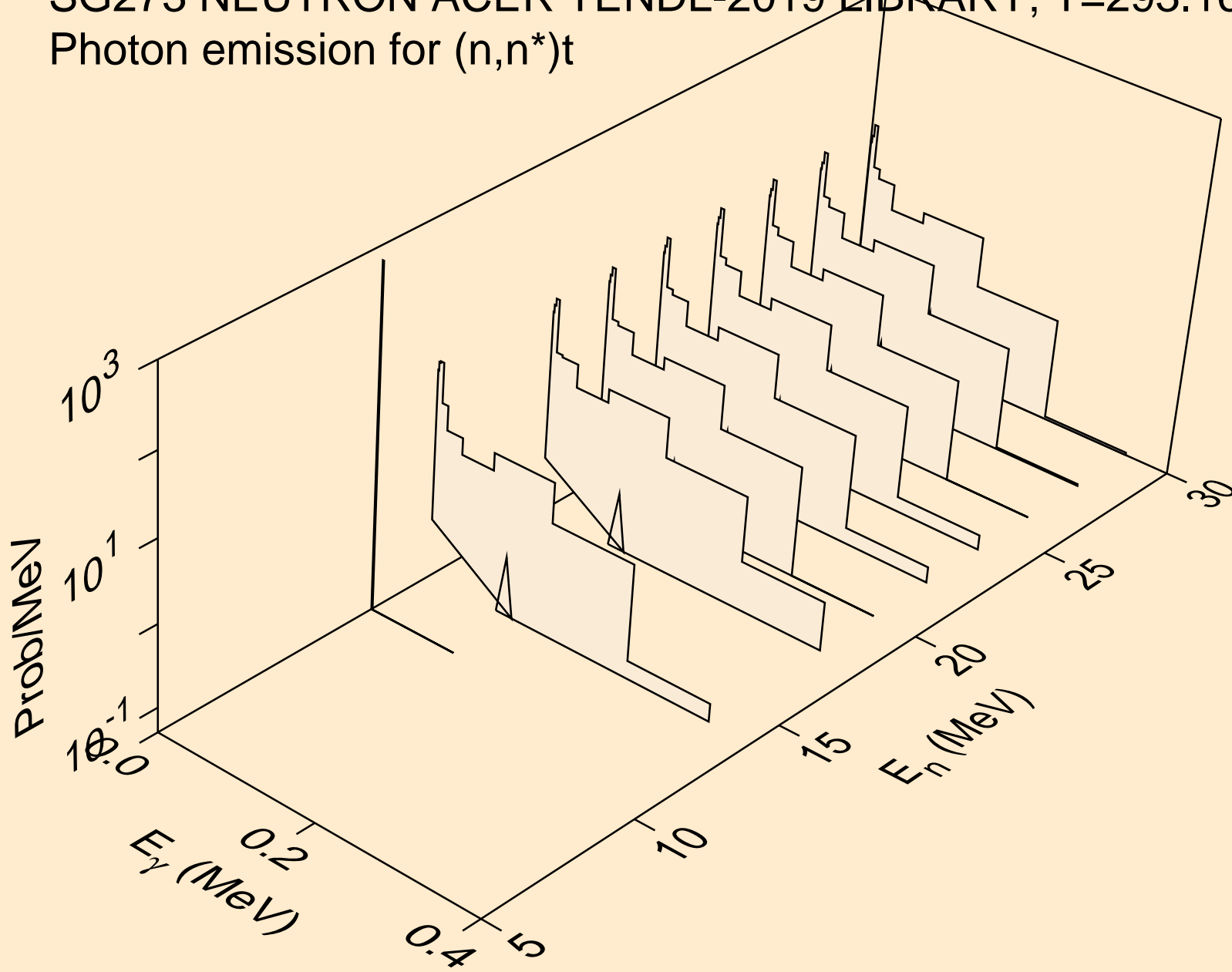

SG273 NEUTRON ACER TENDL-2019 LIBRARY; T=293.16K
Photon emission for (n,4n)

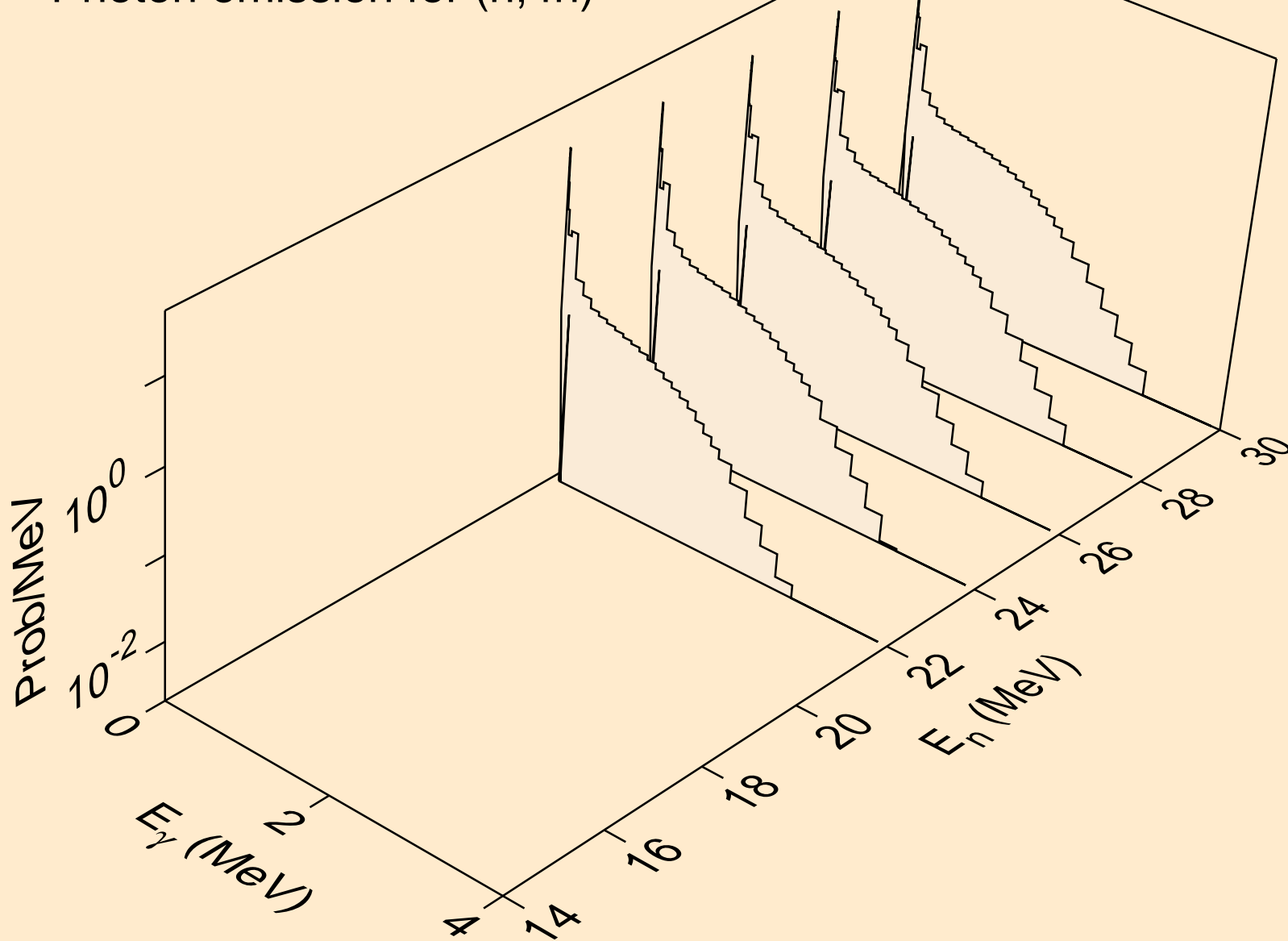

SG273 NEUTRON ACER TENDL-2019 LIBRARY; T=293.16K
Photon emission for (n,2np)

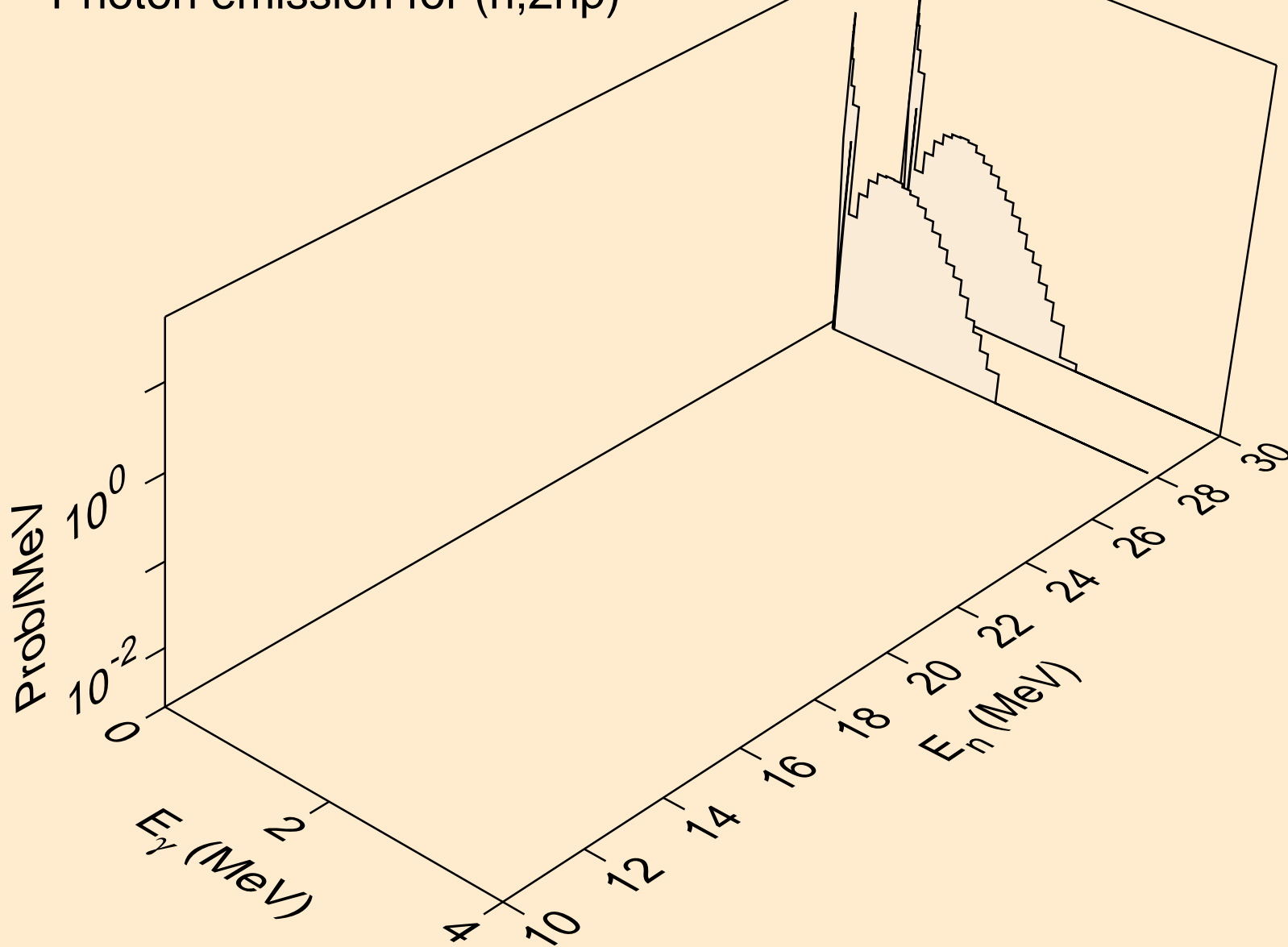

SG273 NEUTRON ACER TENDL-2019 LIBRARY; T=293.16K
Photon emission for (n,n*c)

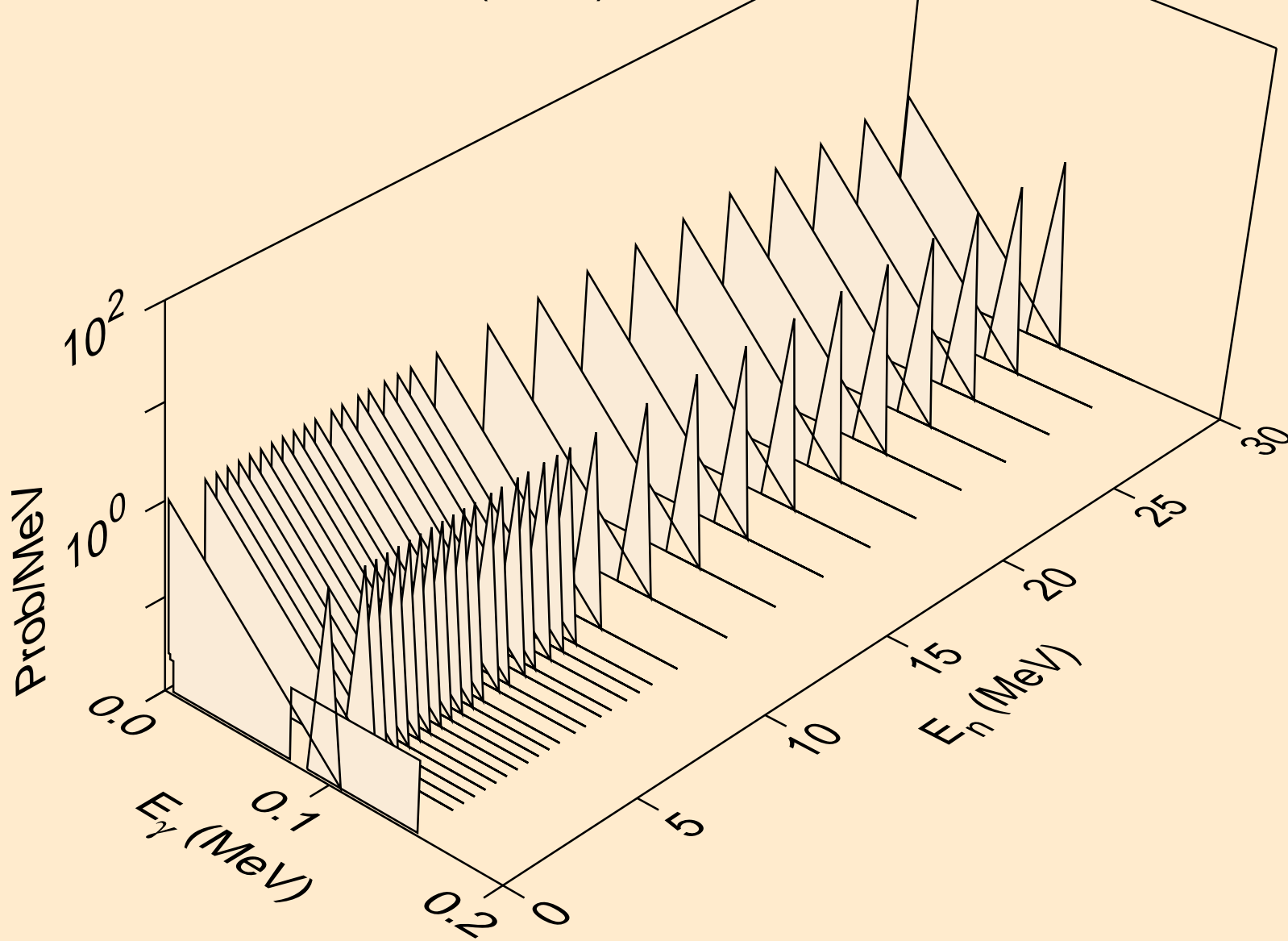

SG273 NEUTRON ACER TENDL-2019 LIBRARY; T=293.16K
Photon emission for (n,gma)

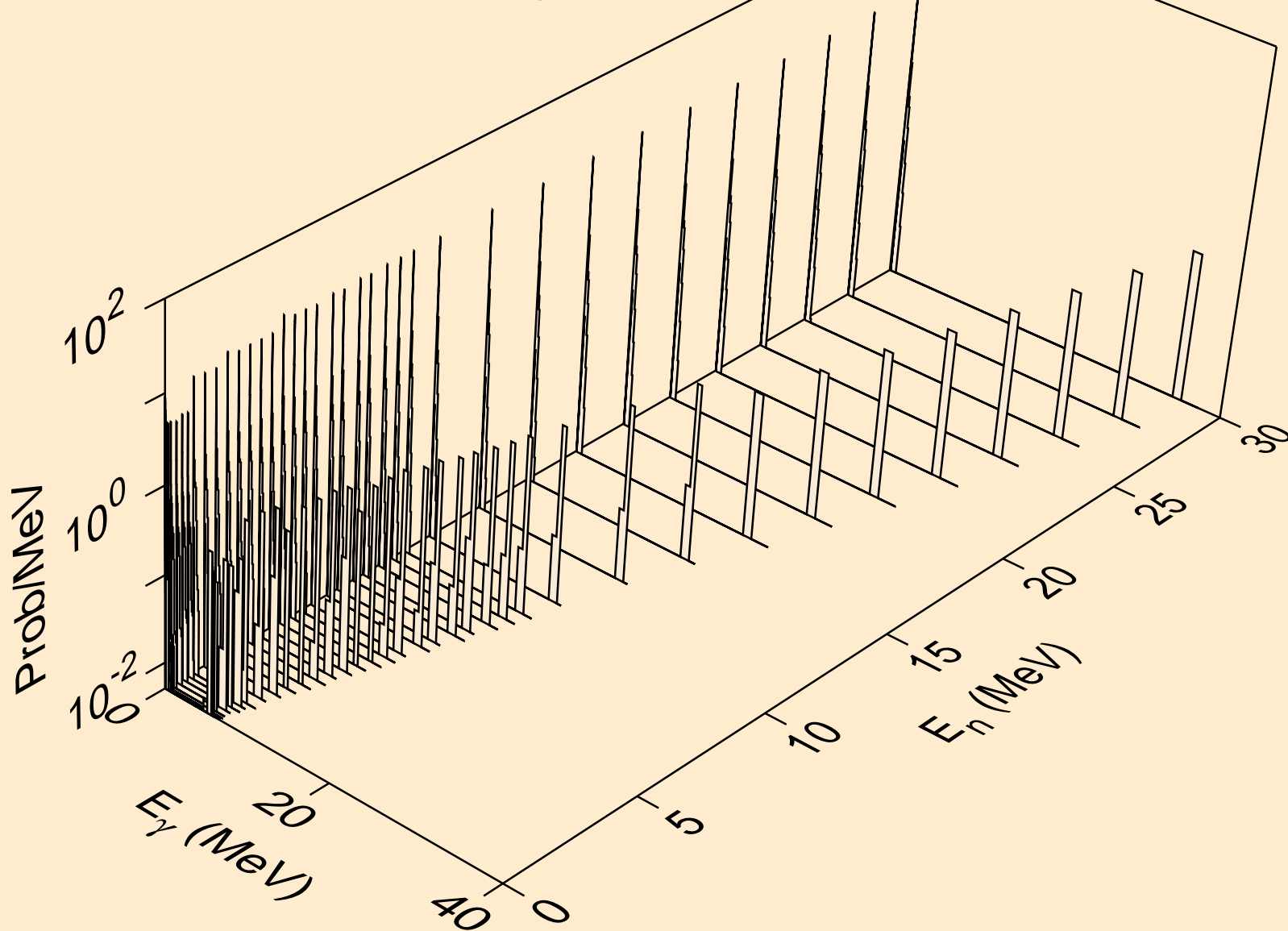

SG273 NEUTRON ACER TENDL-2019 LIBRARY; T=293.16K
Photon emission for (n,p)

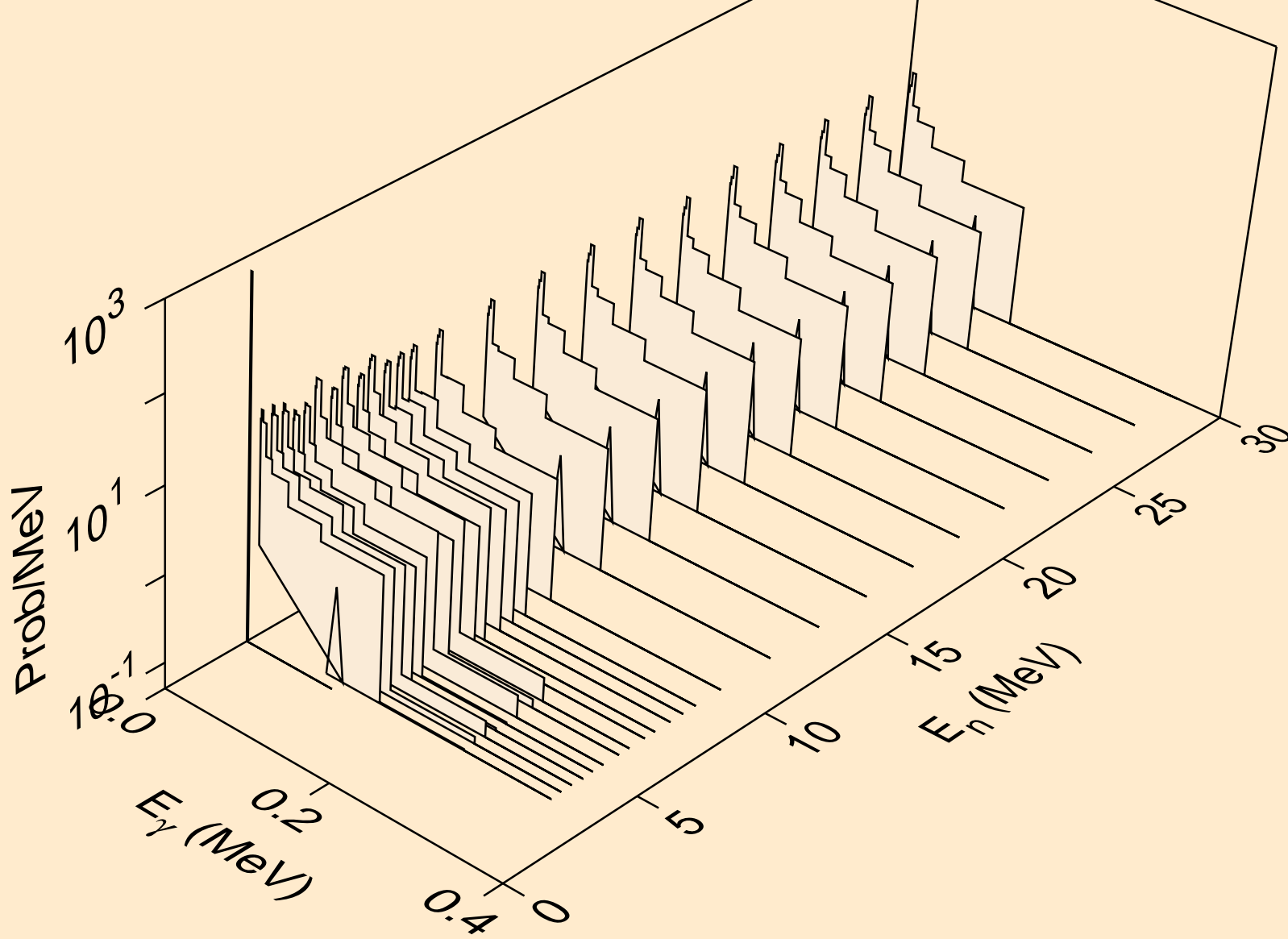

SG273 NEUTRON ACER TENDL-2019 LIBRARY; T=293.16K
Photon emission for (n,d)

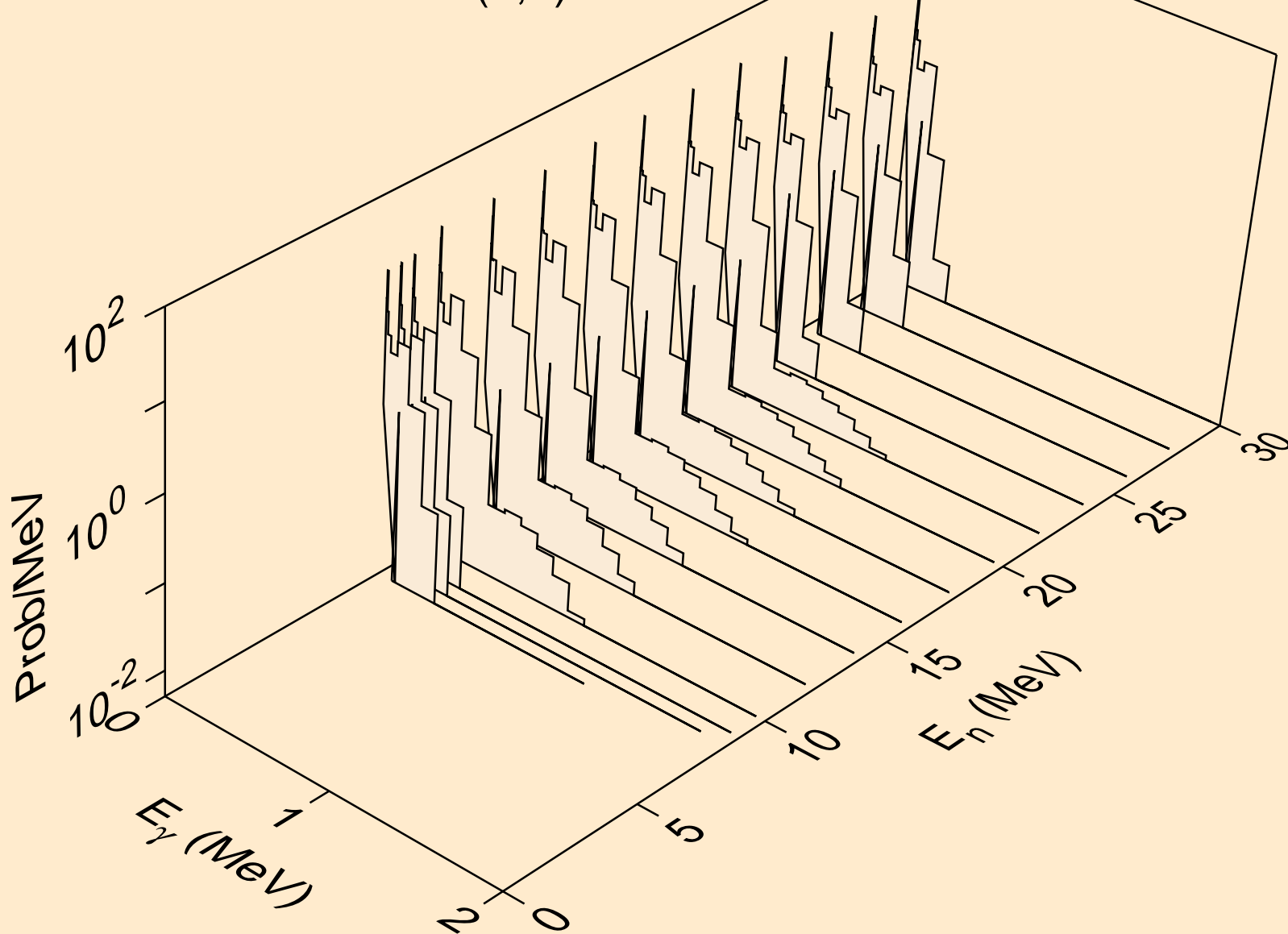

SG273 NEUTRON ACER TENDL-2019 LIBRARY; T=293.16K
Photon emission for (n,t)

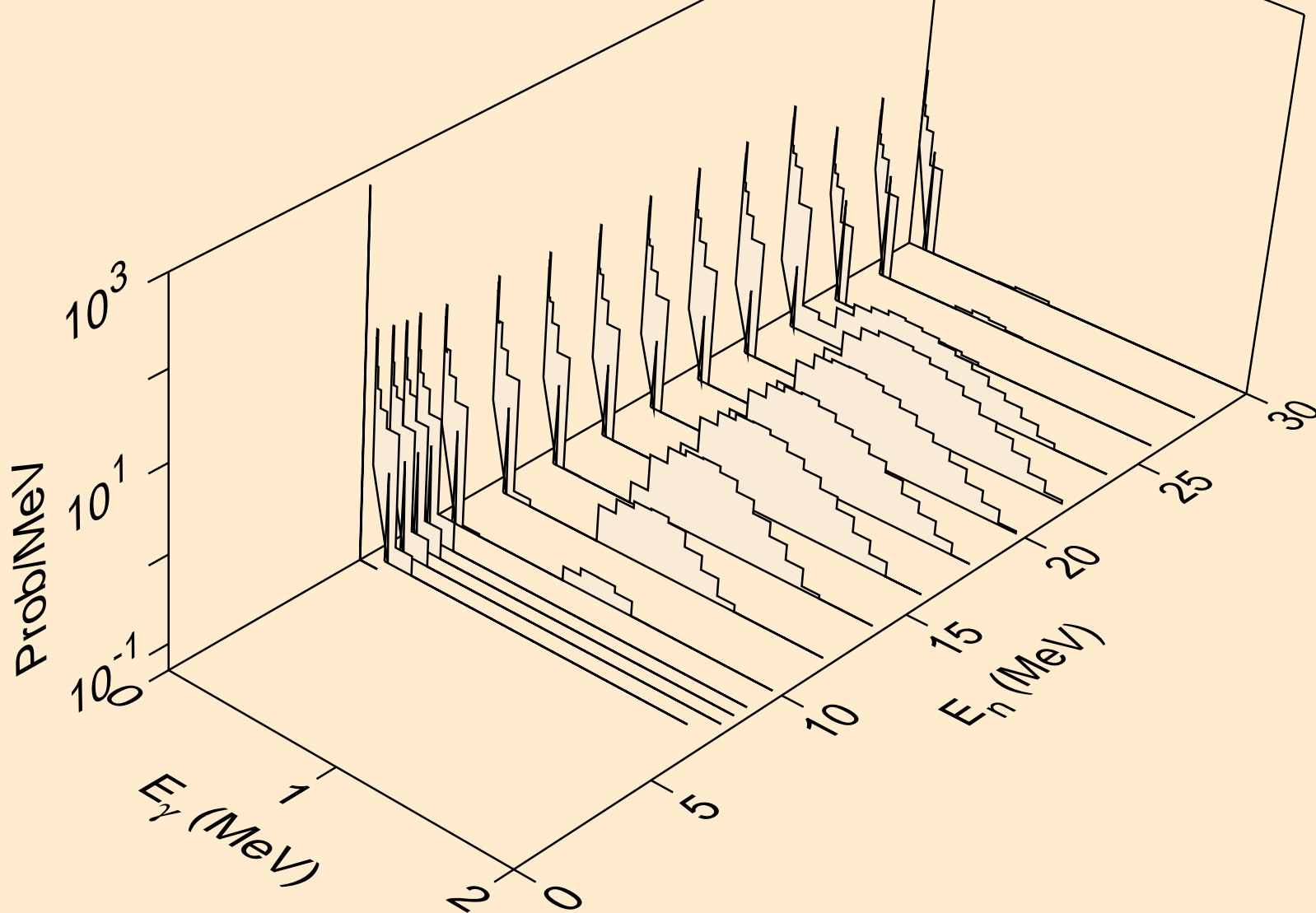

SG273 NEUTRON ACER TENDL-2019 LIBRARY; T=293.16K
Photon emission for (n,he3)

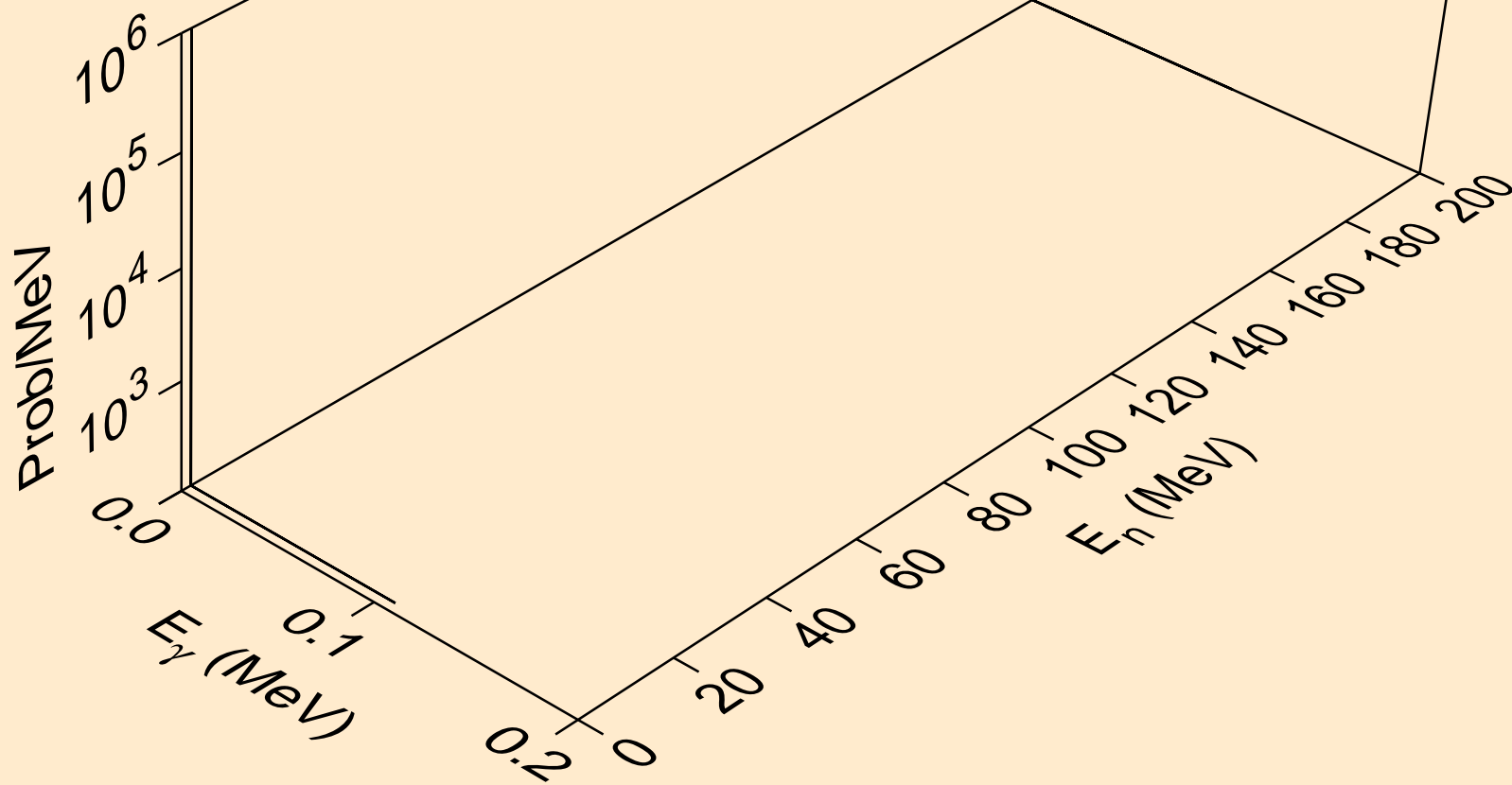

SG273 NEUTRON ACER TENDL-2019 LIBRARY; T=293.16K
Photon emission for (n,a)

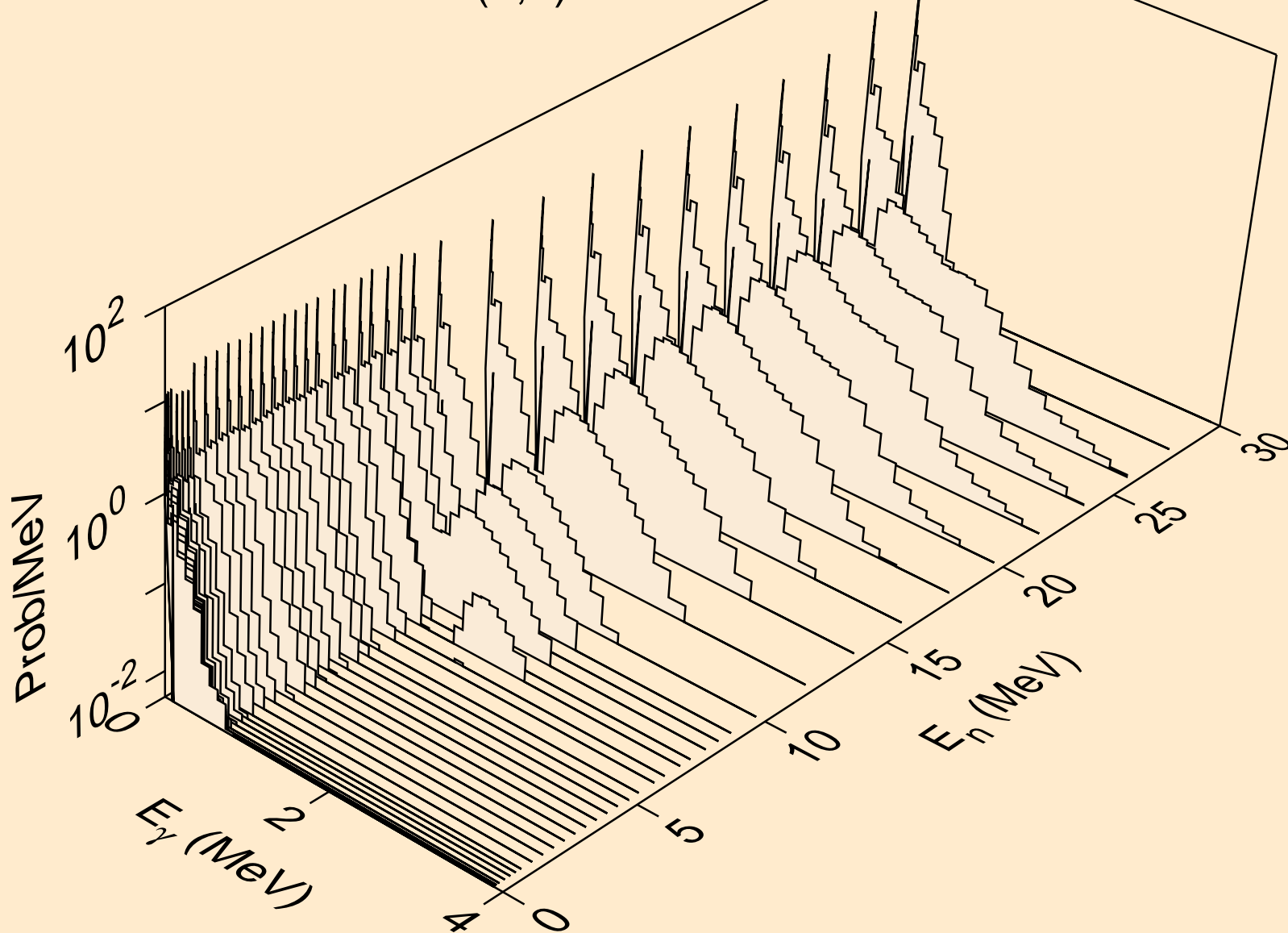

SG273 NEUTRON ACER TENDL-2019 LIBRARY; T=293.16K
thermal capture photon spectrum

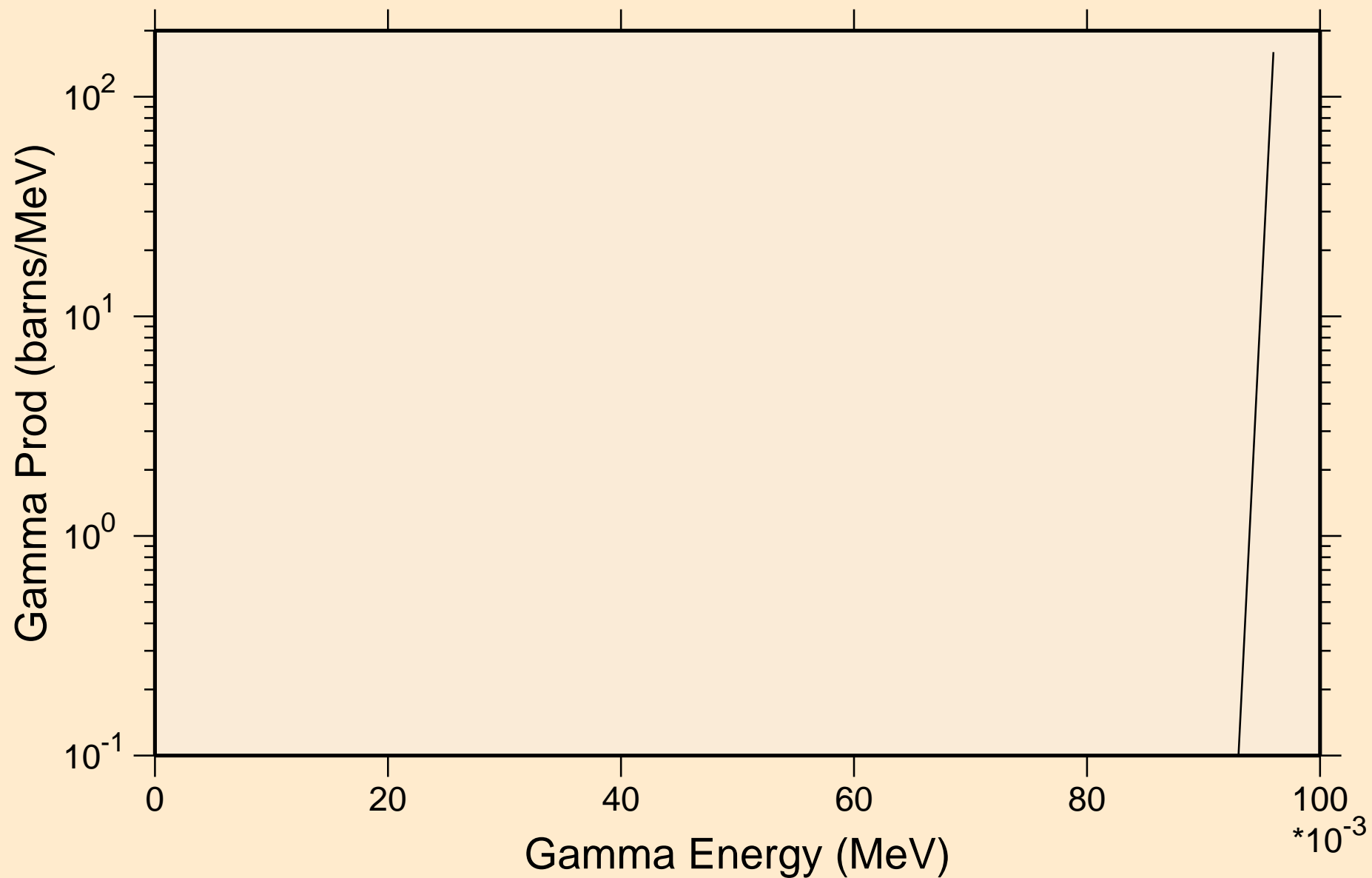

SG273 NEUTRON ACER TENDL-2019 LIBRARY; T=293.16K
14 MeV photon spectrum

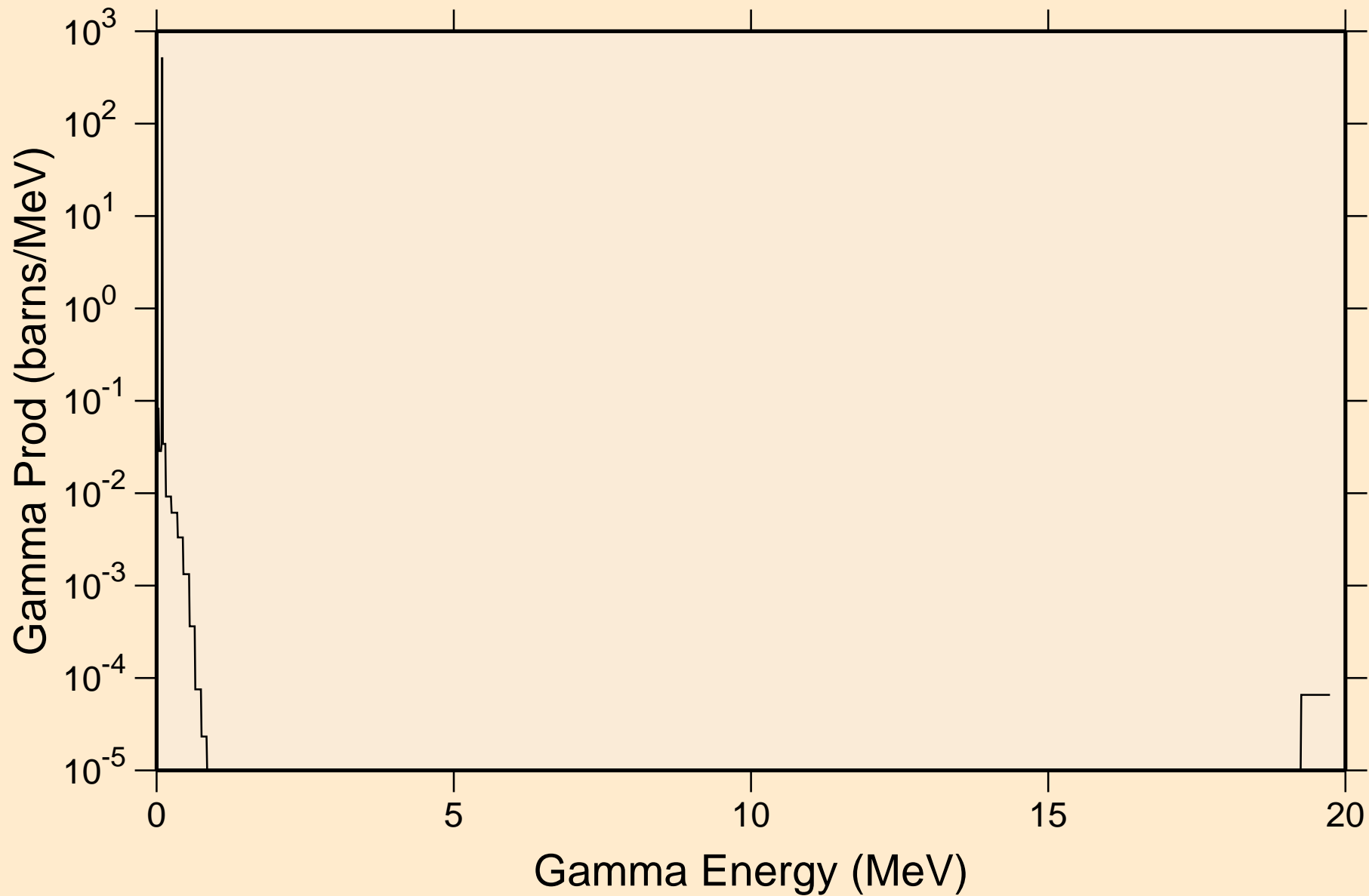

SG273 NEUTRON ACER TENDL-2019 LIBRARY; T=293.16K
Particle heating contributions

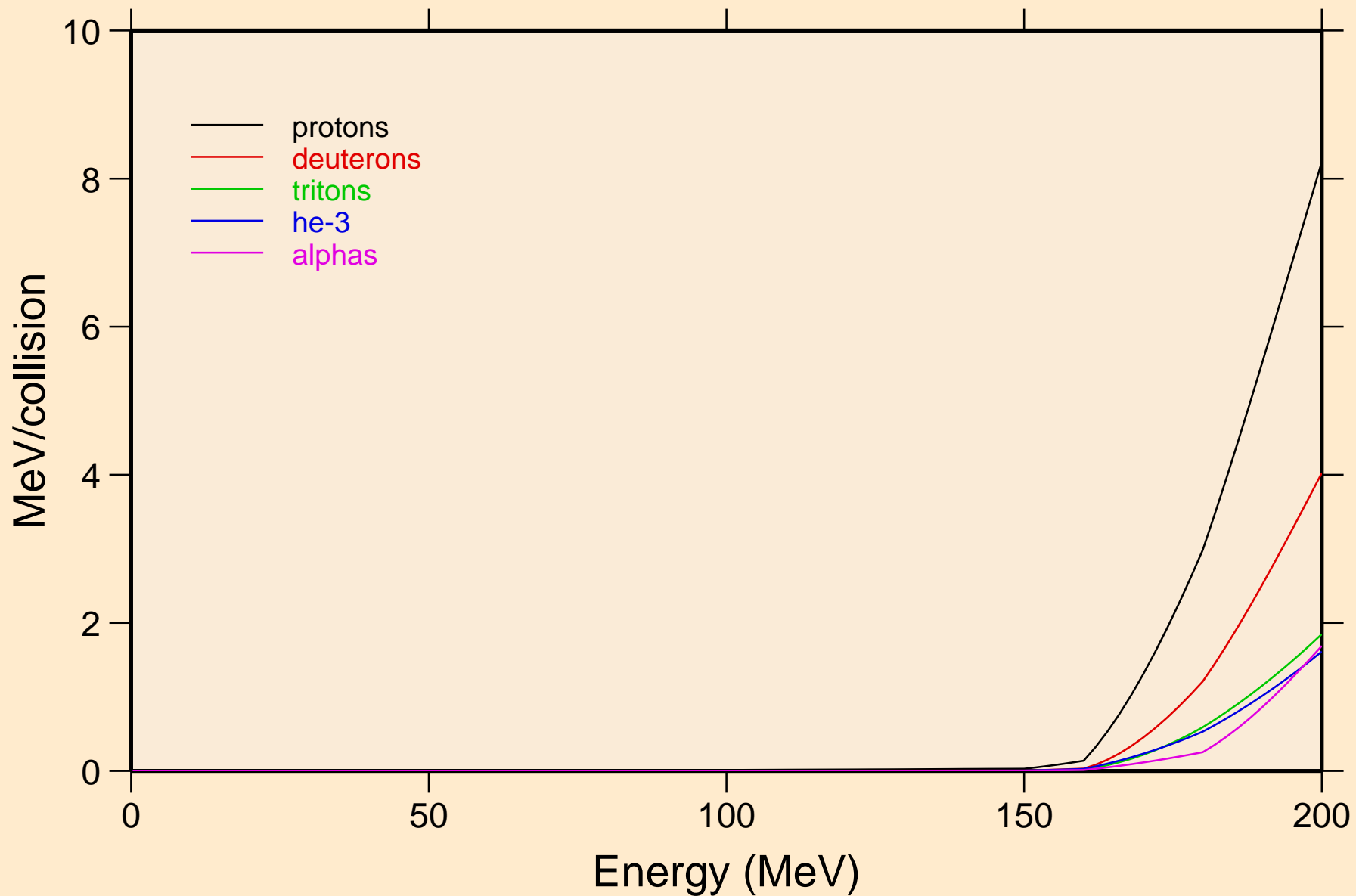

SG273 NEUTRON ACER TENDL-2019 LIBRARY; T=293.16K
Recoil Heating

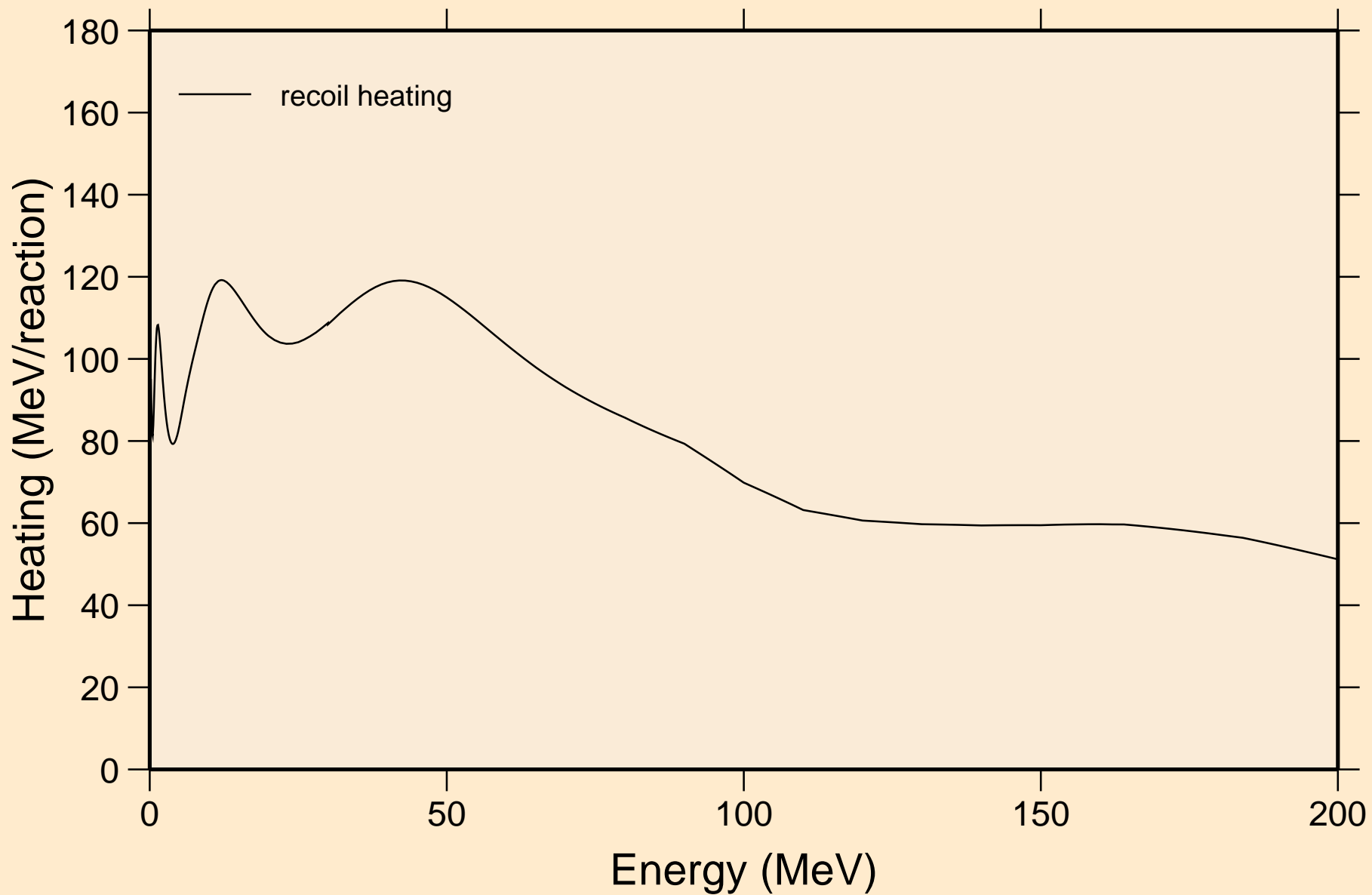

SG273 NEUTRON ACER TENDL-2019 LIBRARY; T=293.16K

Particle production cross sections

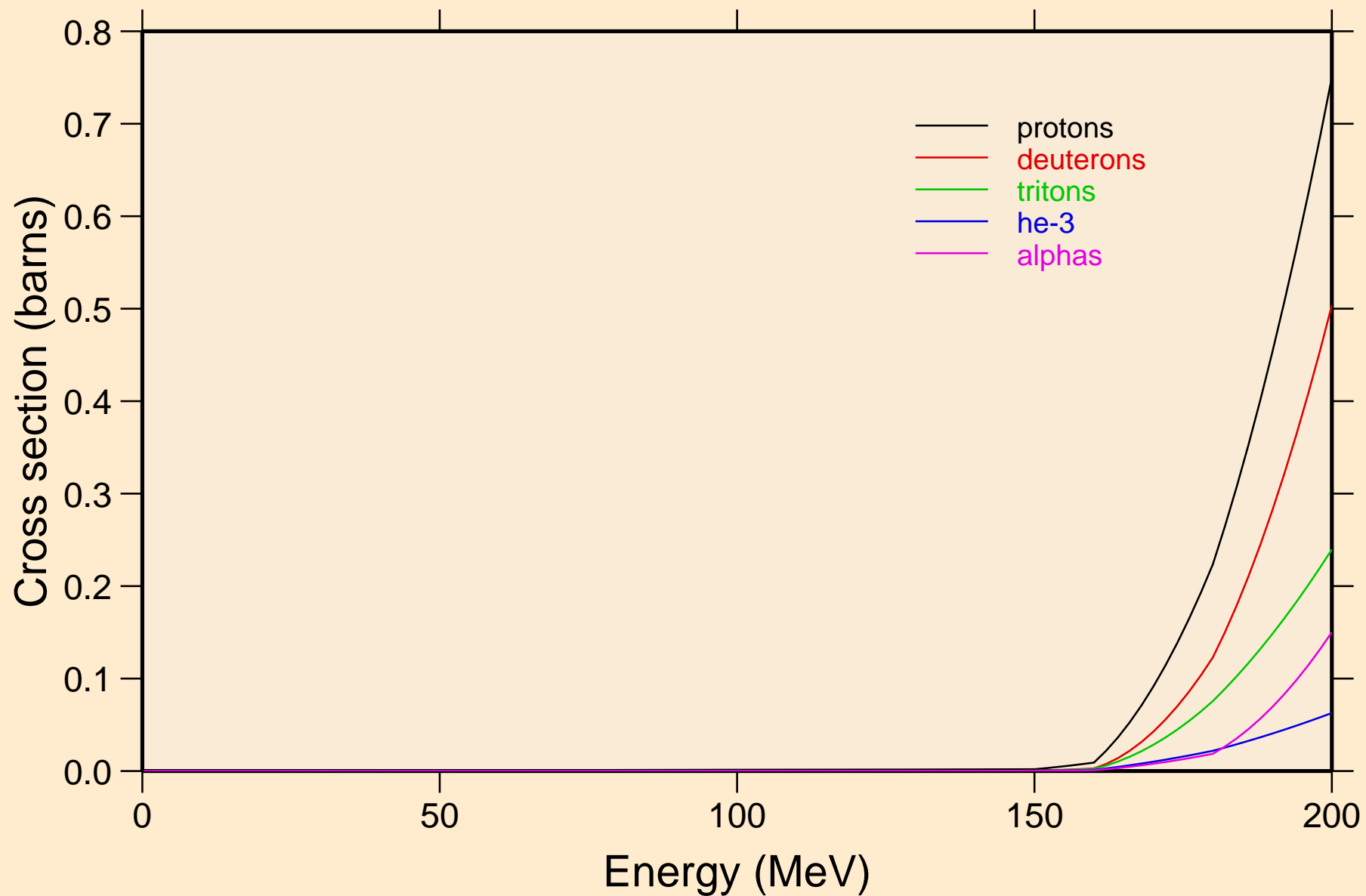

SG273 NEUTRON ACER TENDL-2019 LIBRARY; T=293.16K
protons from (n,x)

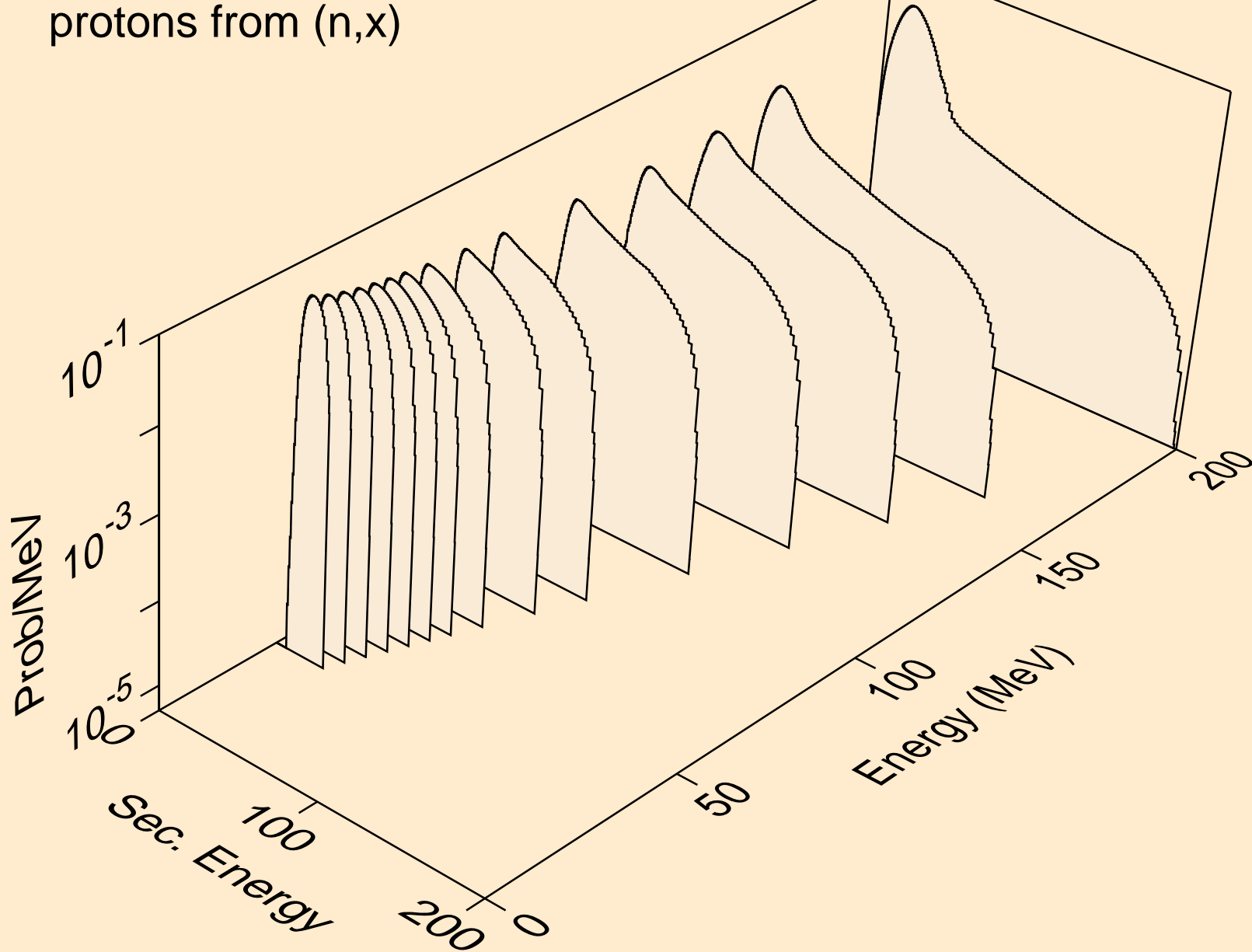

SG273 NEUTRON ACER TENDL-2019 LIBRARY; T=293.16K
protons from (n,n*)p

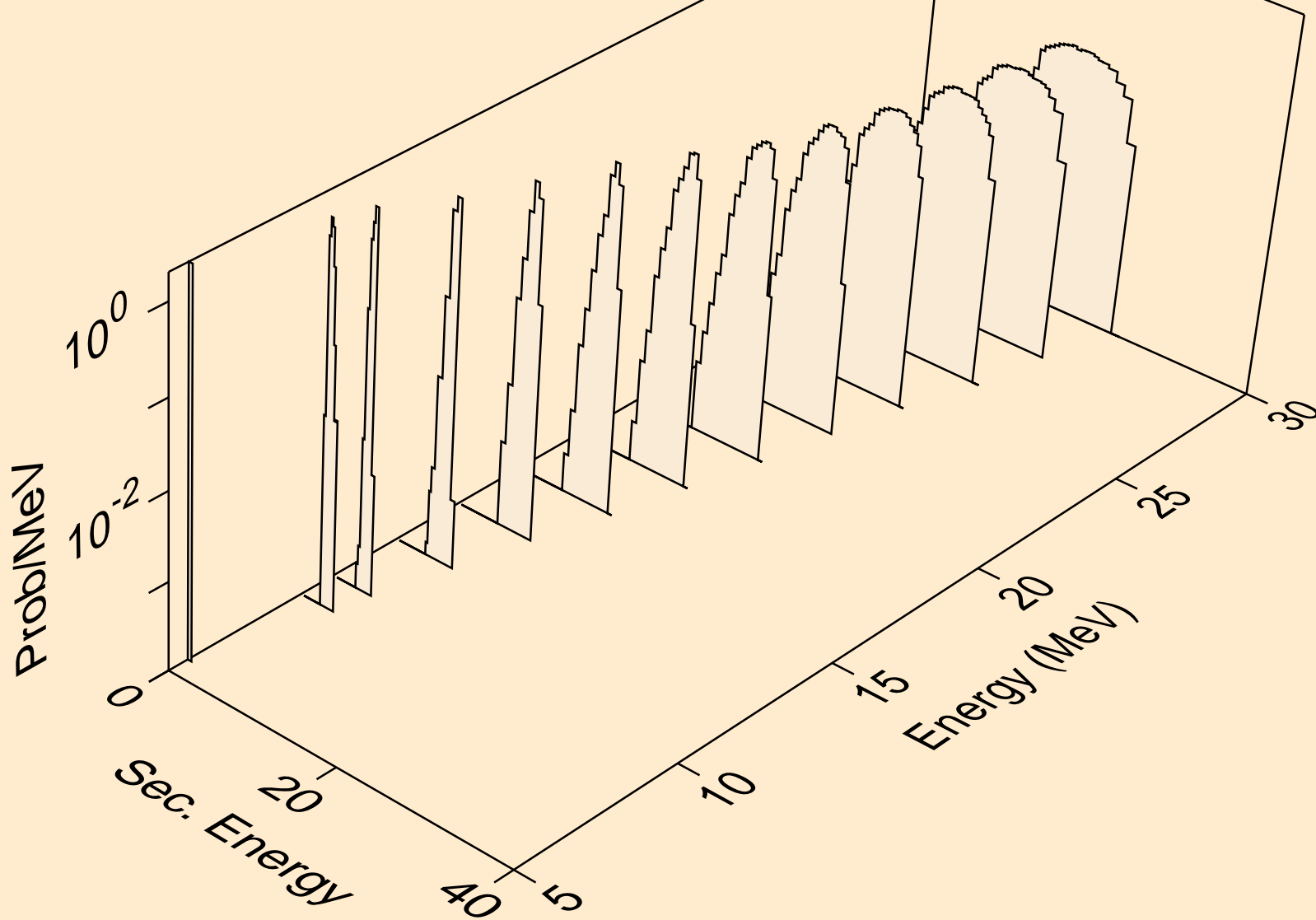

SG273 NEUTRON ACER TENDL-2019 LIBRARY; T=293.16K
protons from (n,2np)

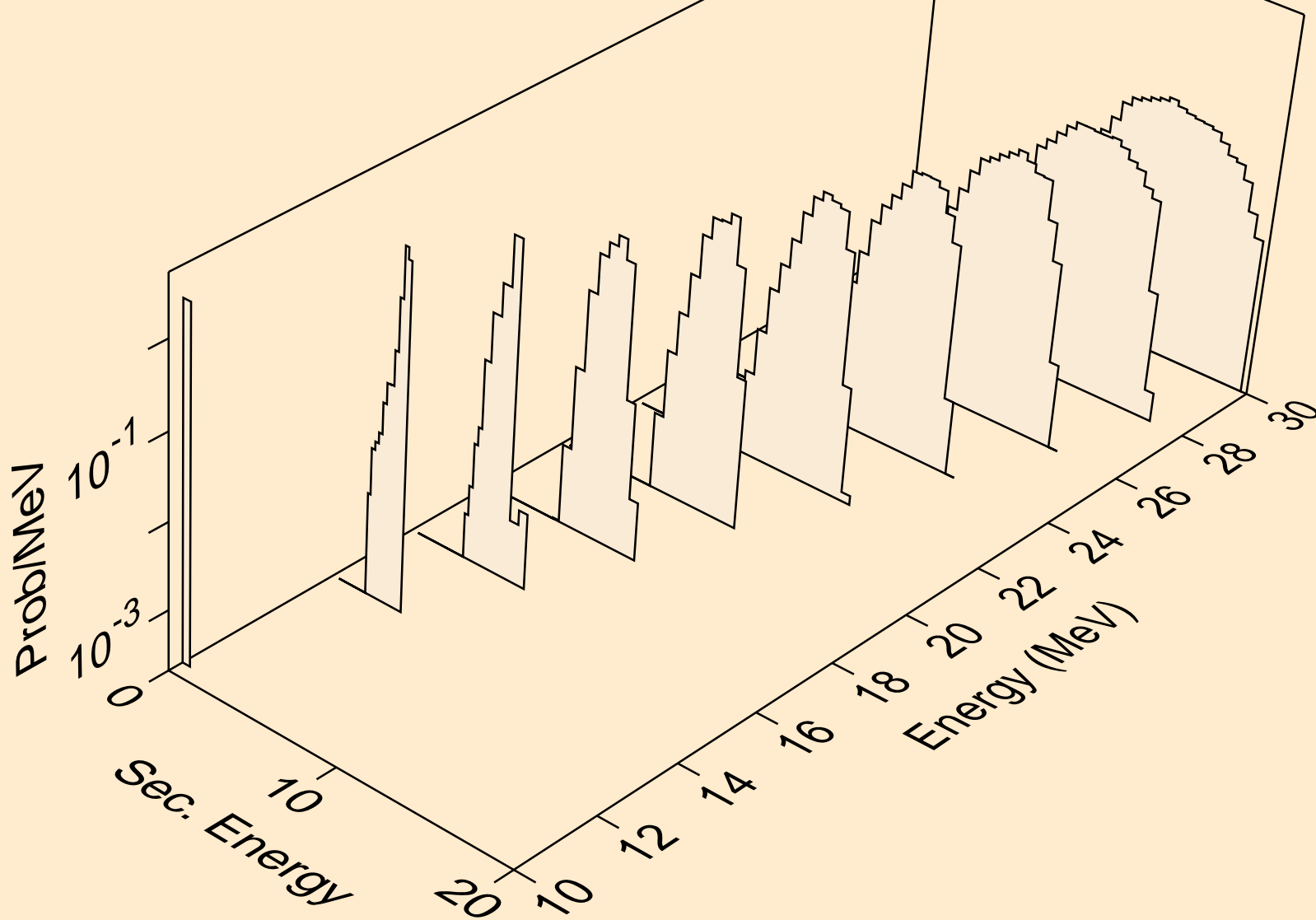

SG273 NEUTRON ACER TENDL-2019 LIBRARY; T=293.16K
protons from (n,p)

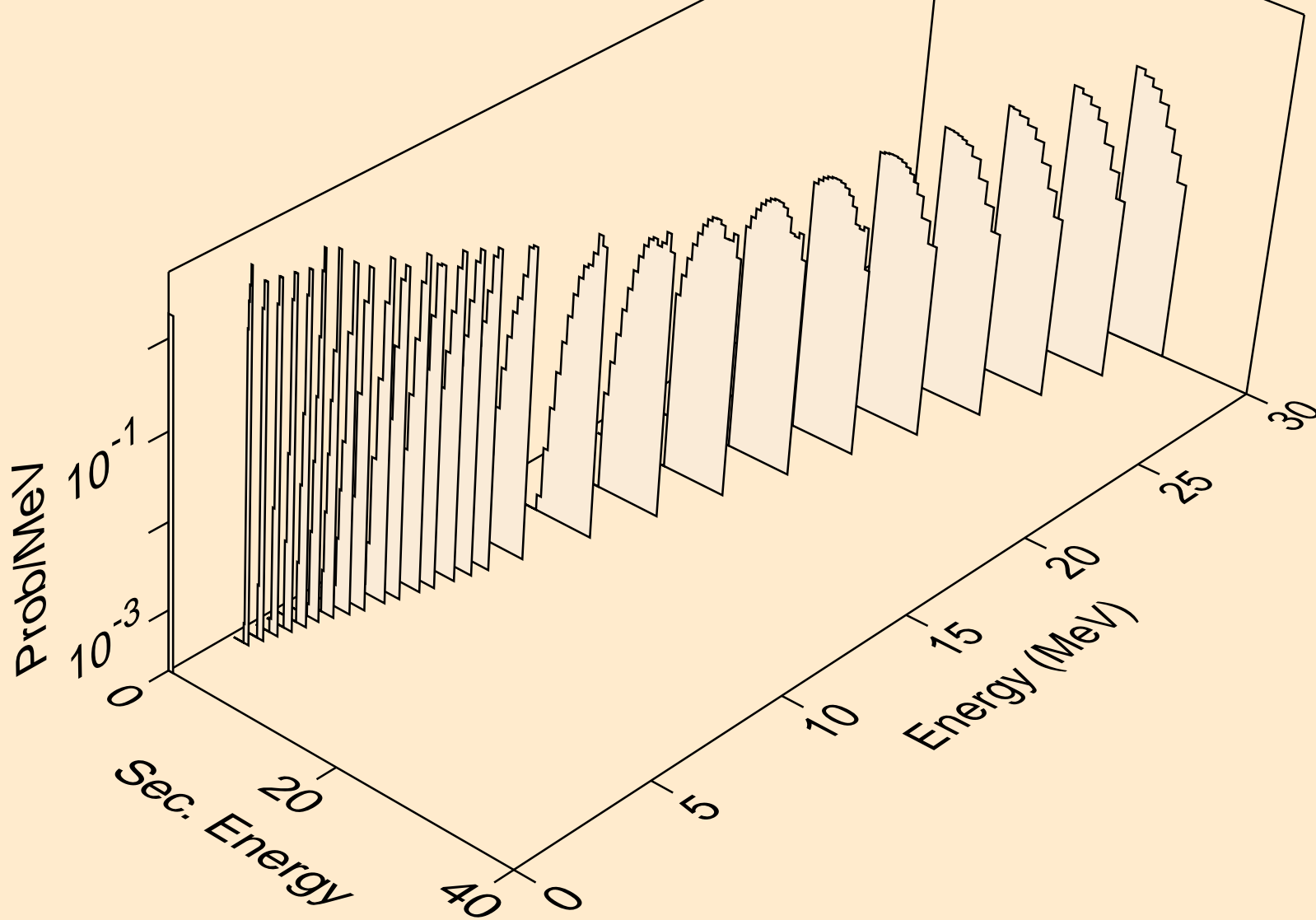

SG273 NEUTRON ACER TENDL-2019 LIBRARY; T=293.16K
deuterons from (n,x)

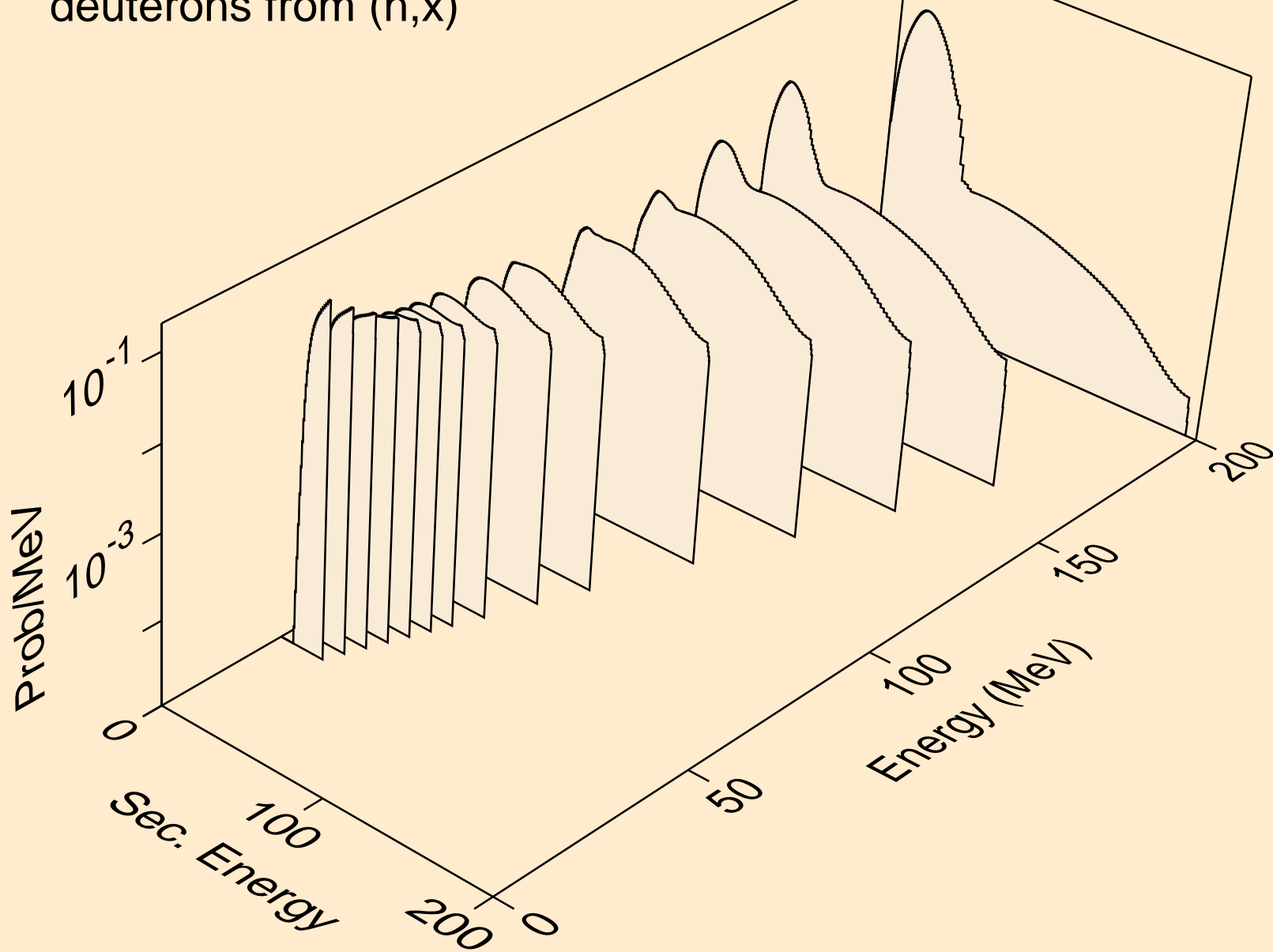

SG273 NEUTRON ACER TENDL-2019 LIBRARY; T=293.16K
deuterons from (n,n*)d

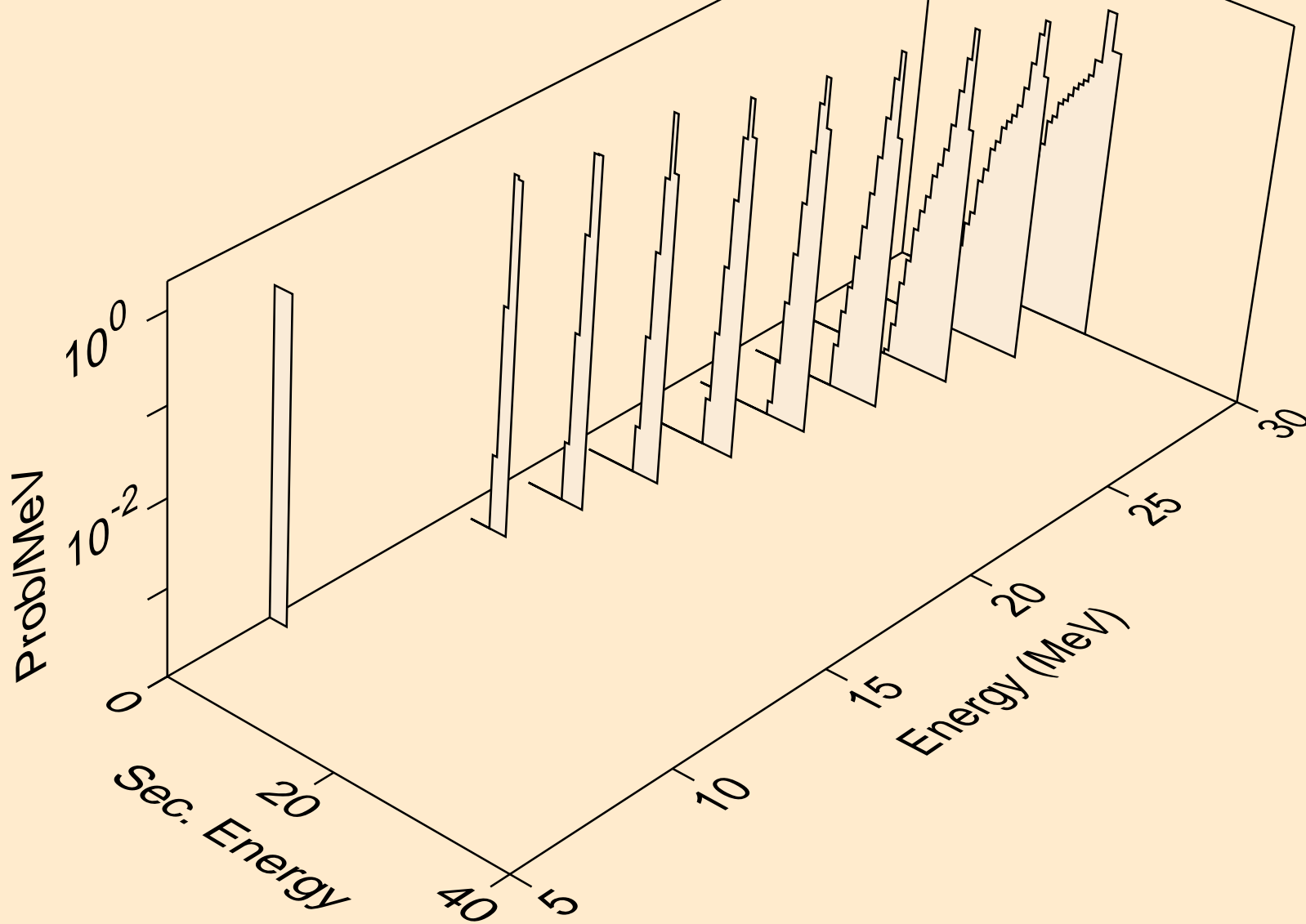

SG273 NEUTRON ACER TENDL-2019 LIBRARY; T=293.16K
deuterons from (n,d)

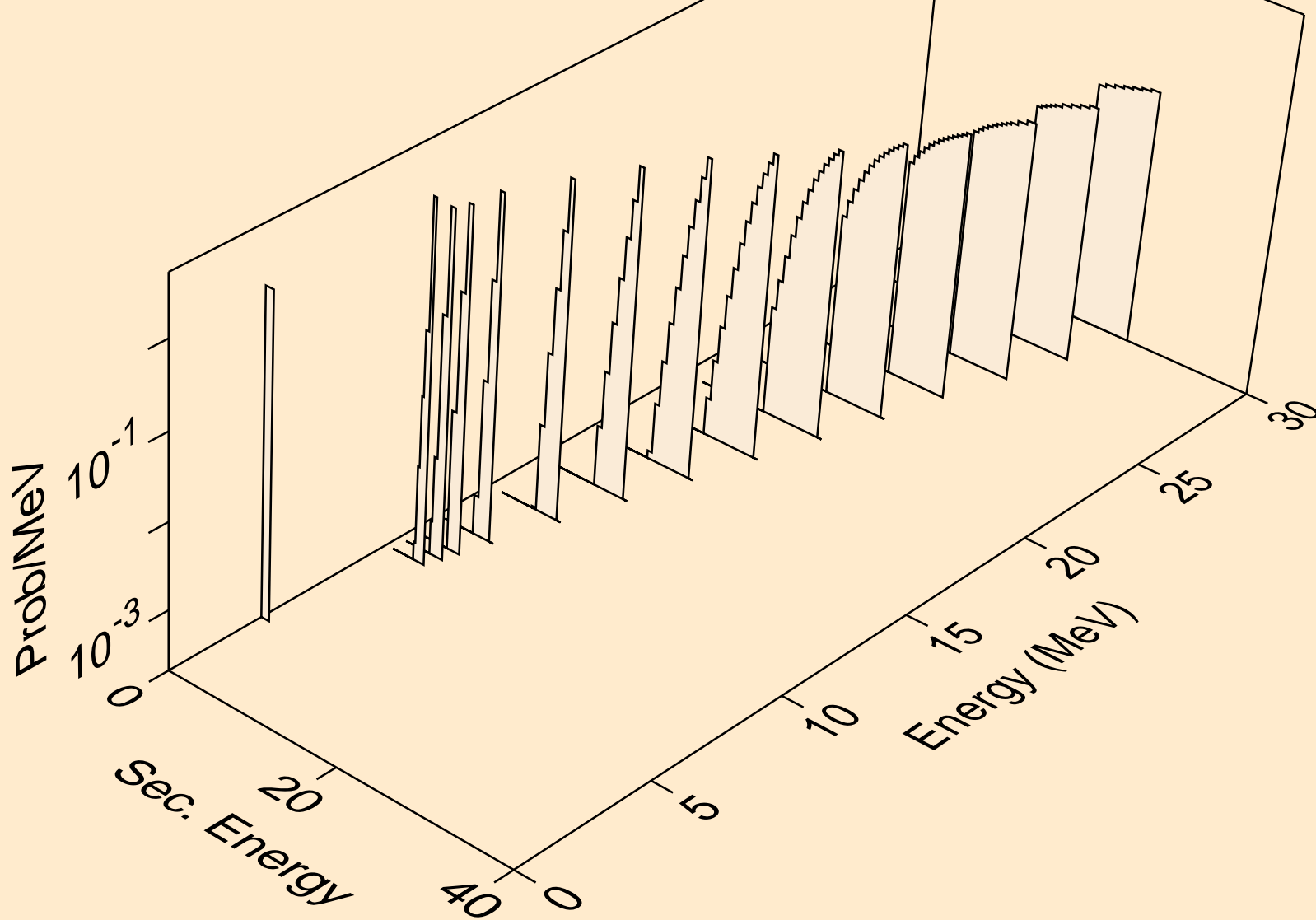

SG273 NEUTRON ACER TENDL-2019 LIBRARY; T=293.16K
tritons from (n,x)

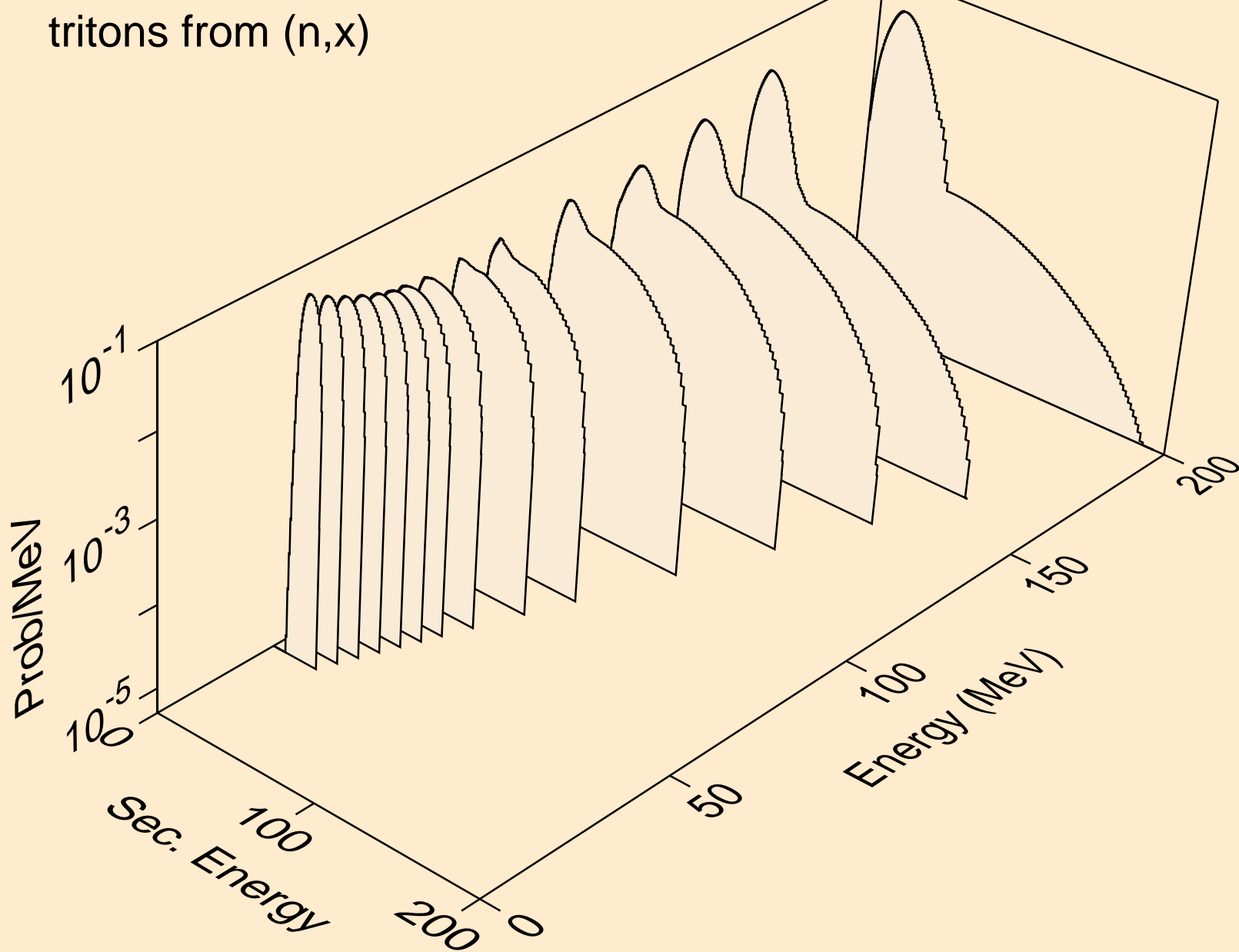

SG273 NEUTRON ACER TENDL-2019 LIBRARY; T=293.16K
tritons from (n,n*)t

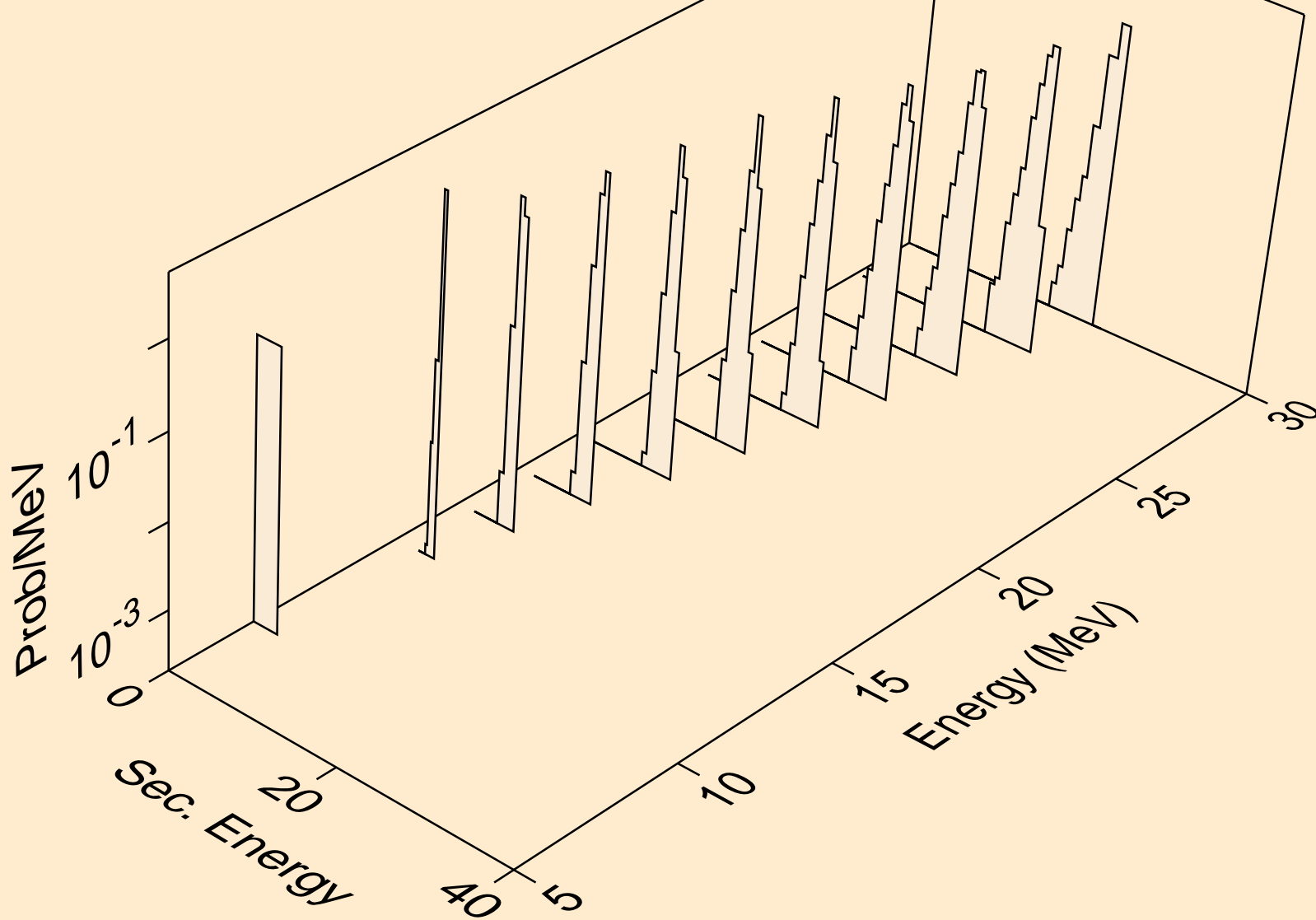

SG273 NEUTRON ACER TENDL-2019 LIBRARY; T=293.16K
tritons from (n,t)

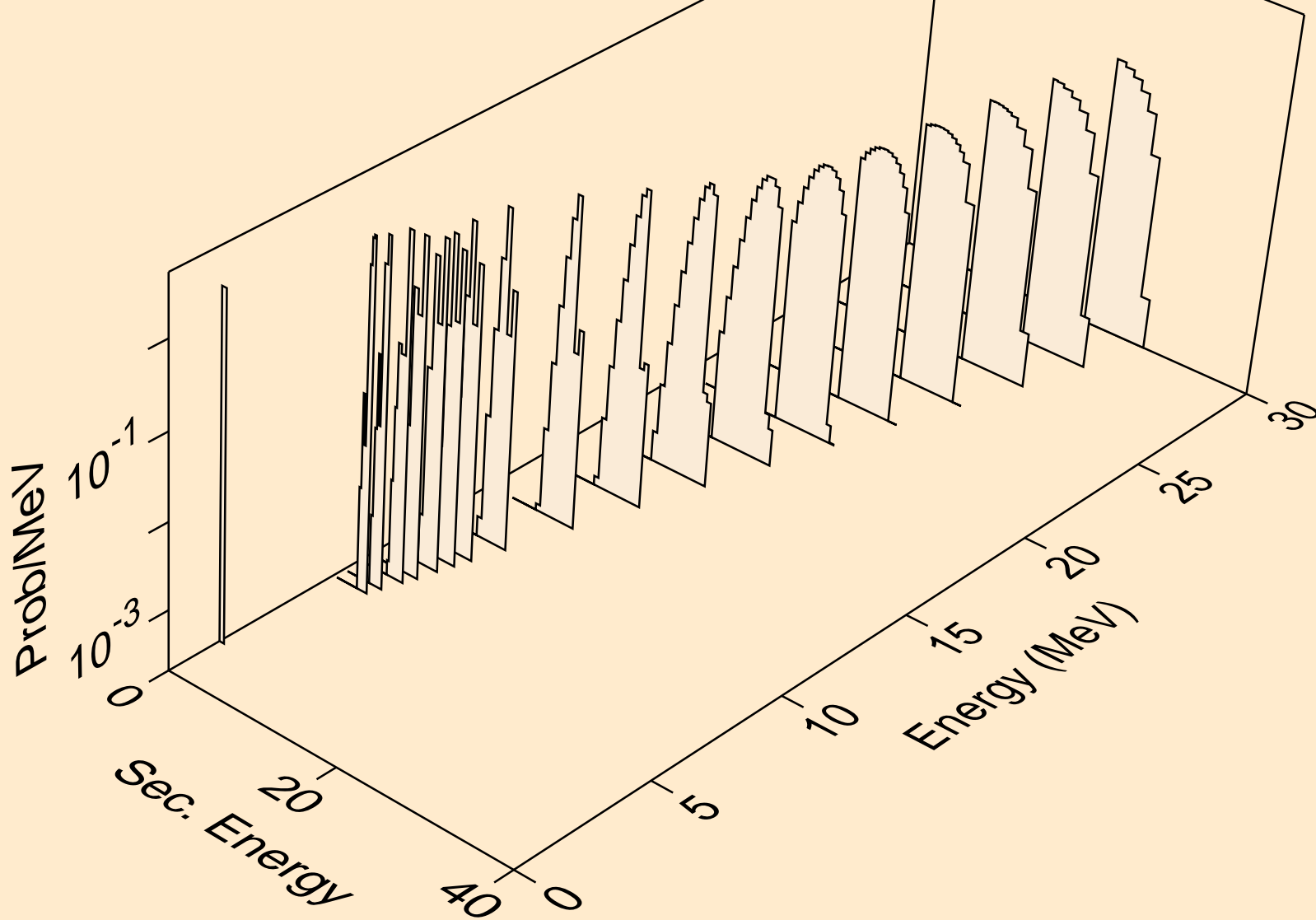

SG273 NEUTRON ACER TENDL-2019 LIBRARY; T=293.16K
he3s from (n,x)

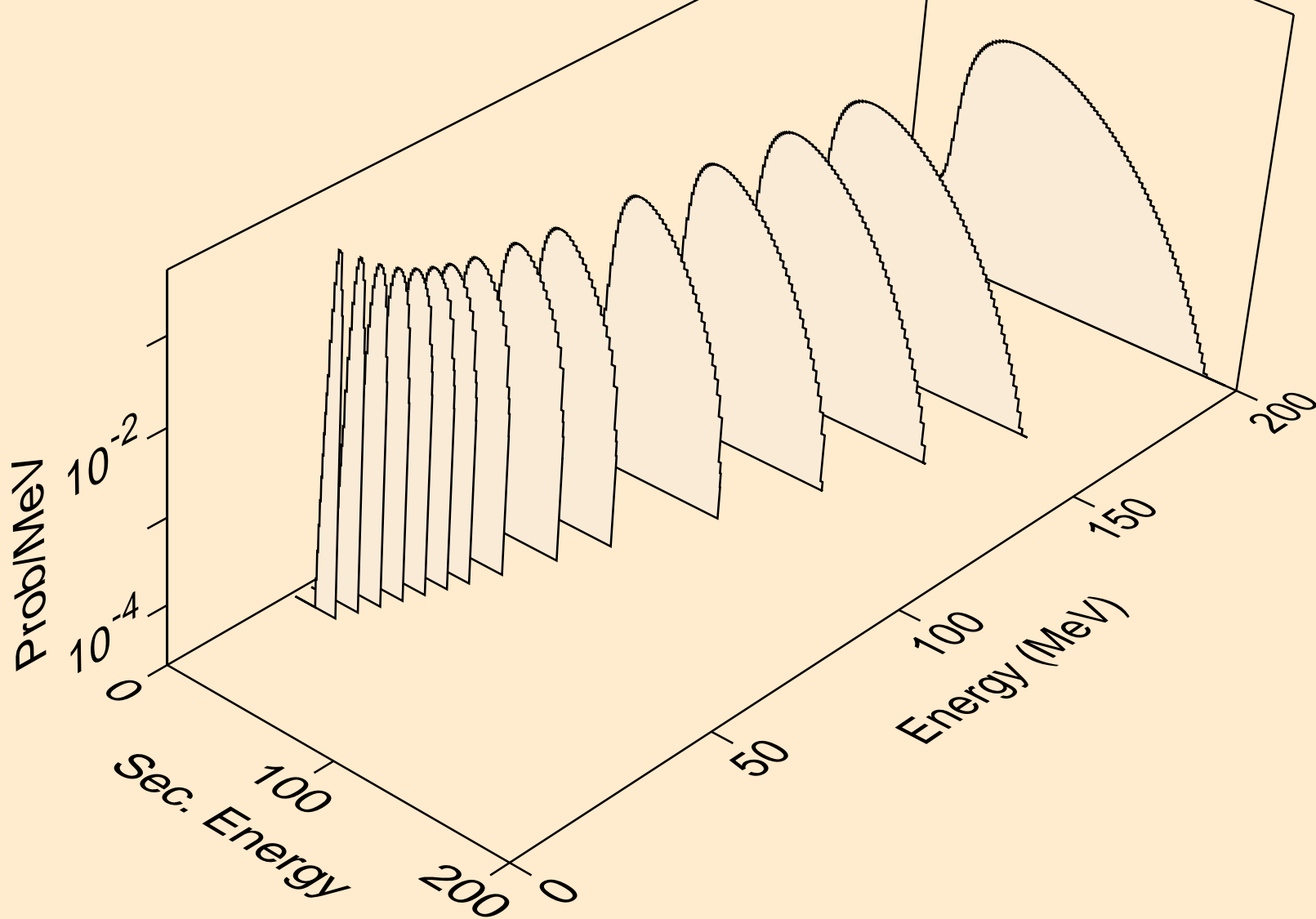

SG273 NEUTRON ACER TENDL-2019 LIBRARY; T=293.16K
he3s from (n,he3)

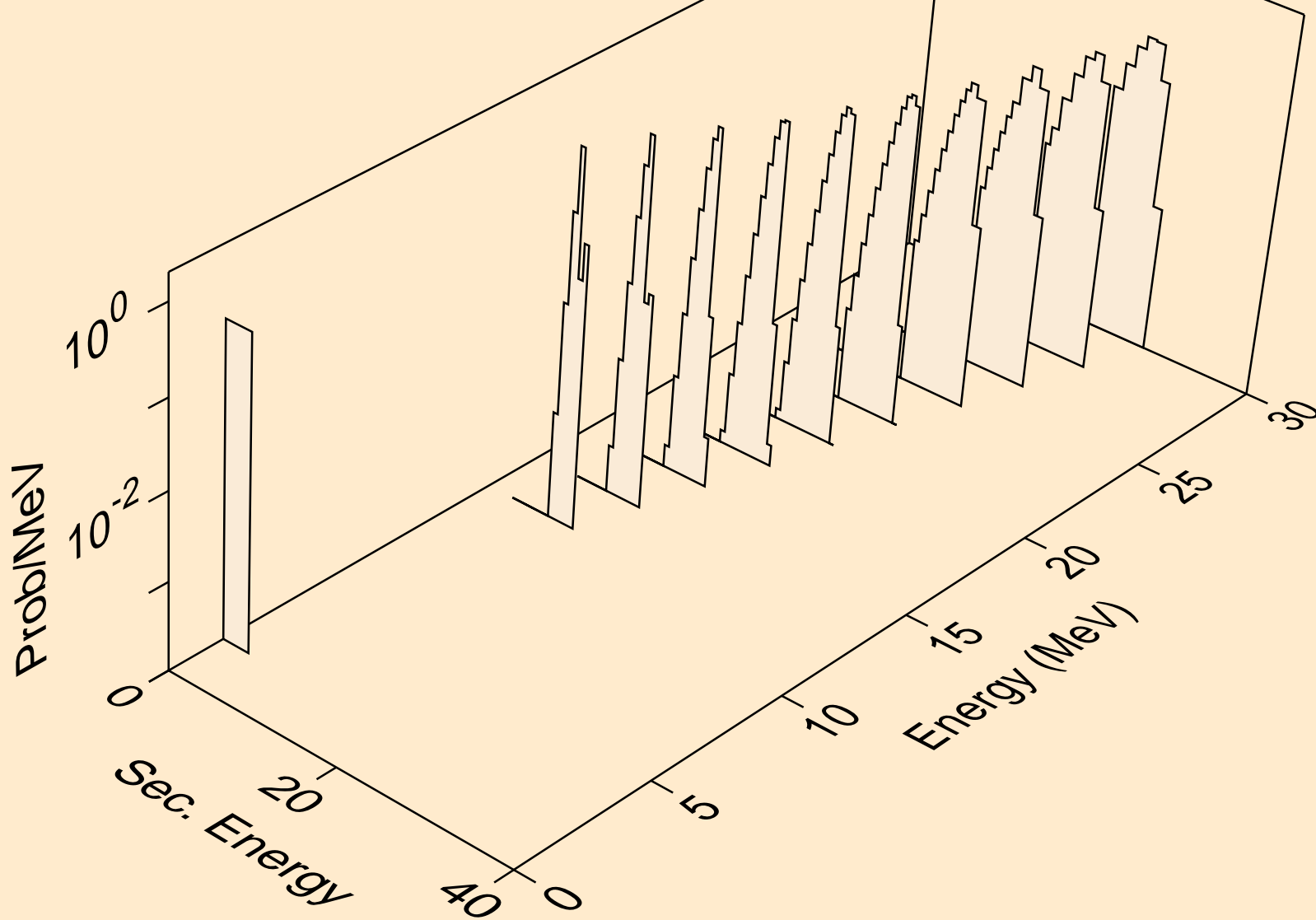

SG273 NEUTRON ACER TENDL-2019 LIBRARY; T=293.16K
alphas from (n,x)

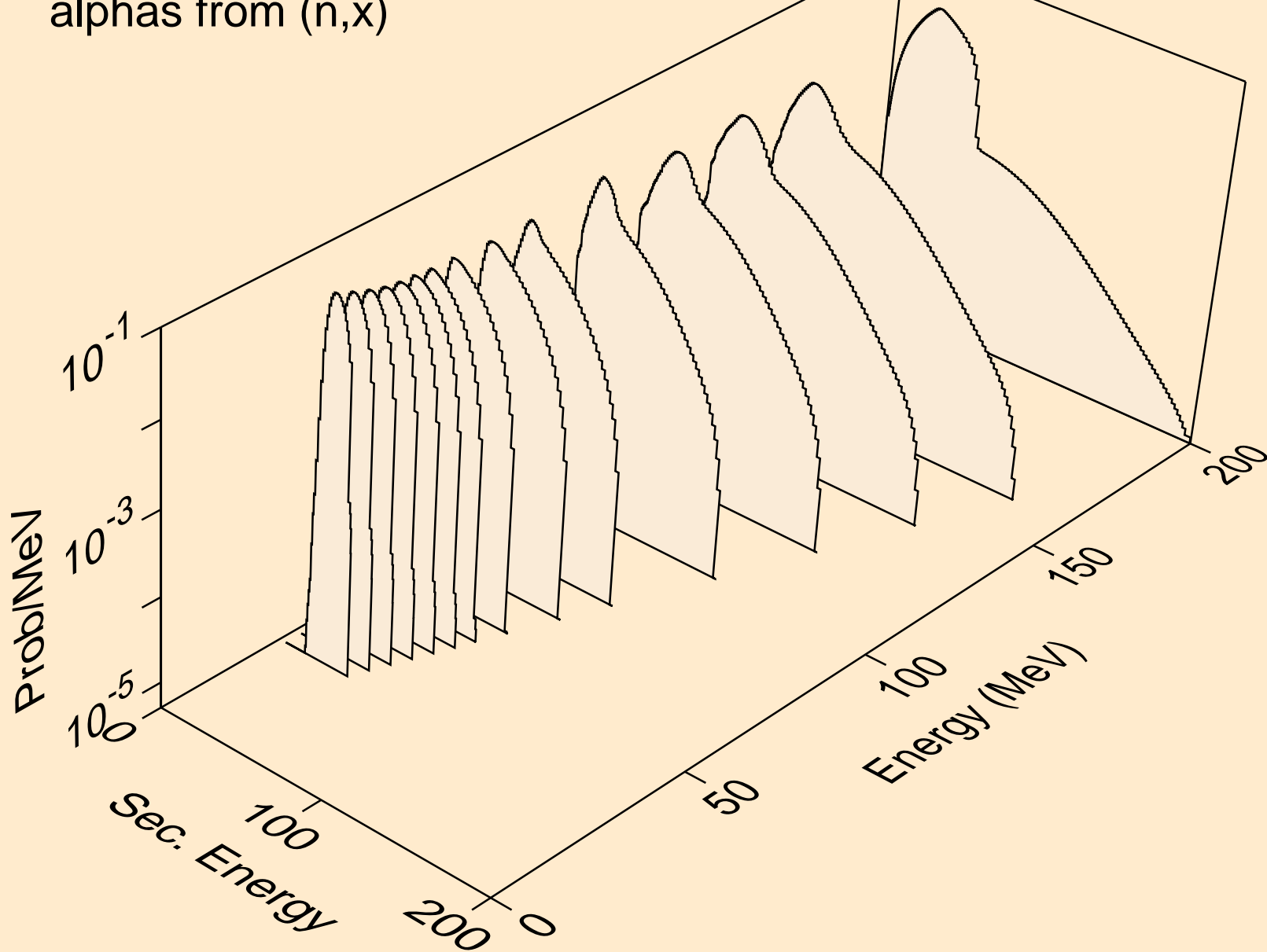

SG273 NEUTRON ACER TENDL-2019 LIBRARY; T=293.16K
alphas from (n,n*)a

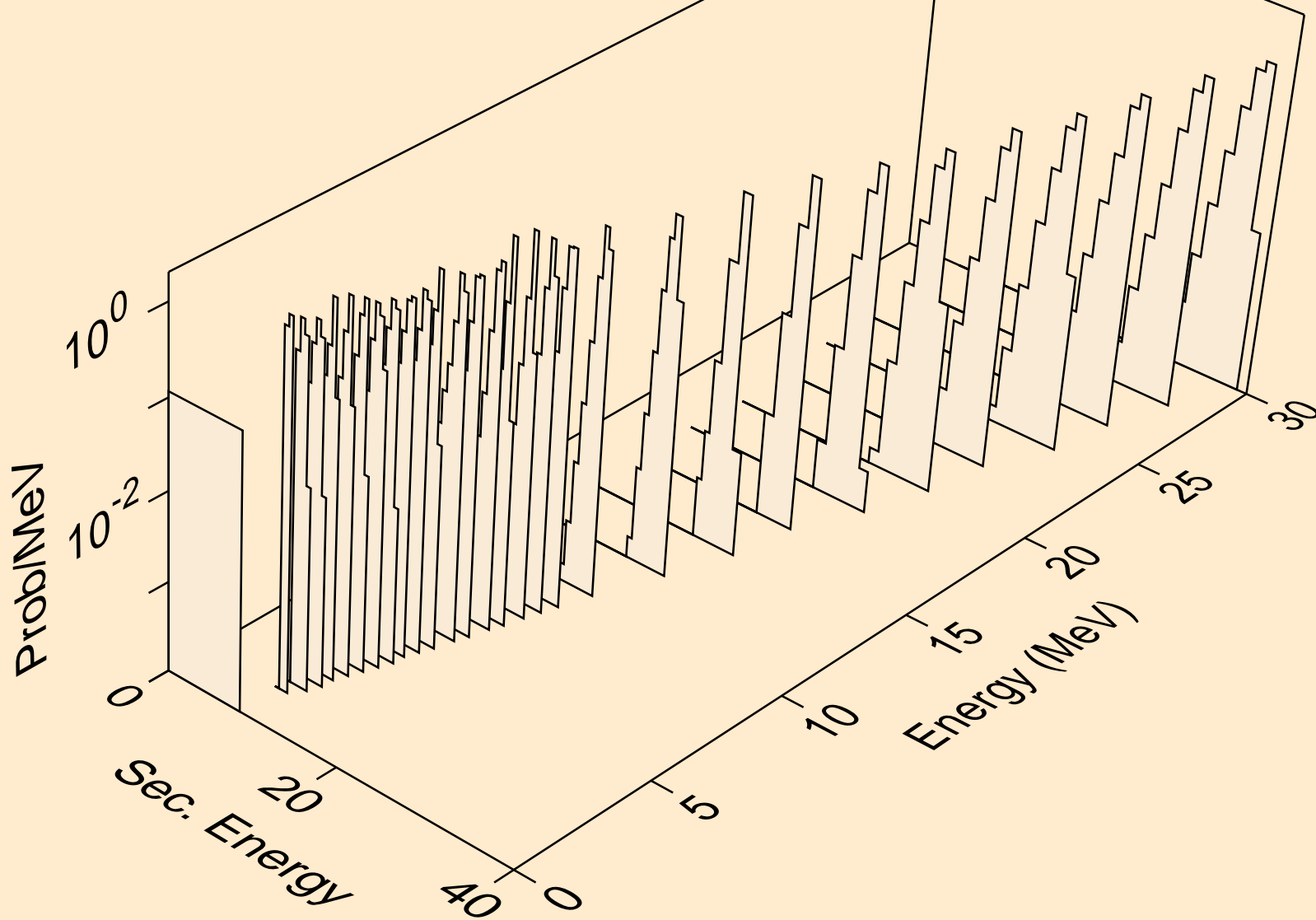

SG273 NEUTRON ACER TENDL-2019 LIBRARY; T=293.16K
alphas from (n,2n)a

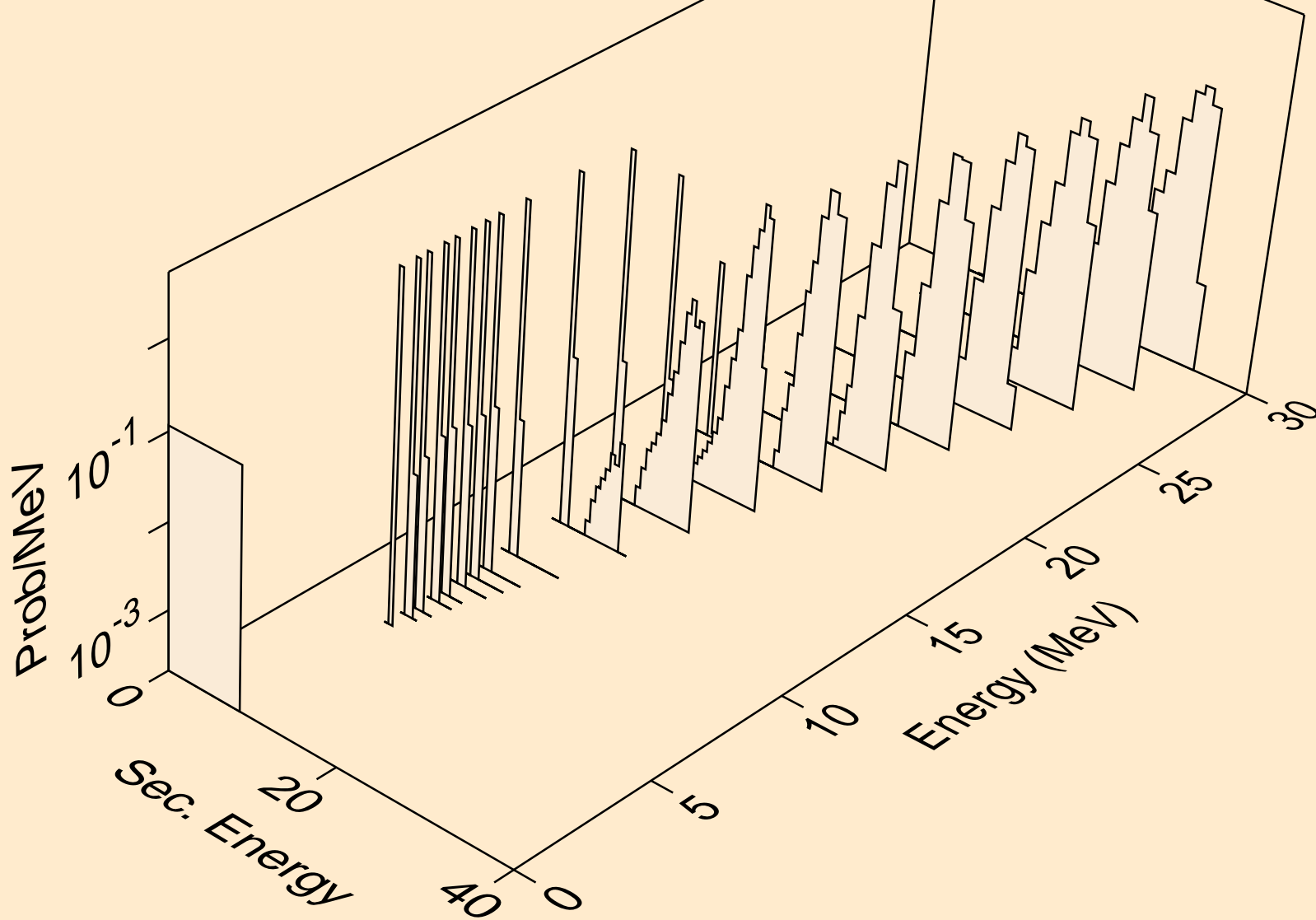

SG273 NEUTRON ACER TENDL-2019 LIBRARY; T=293.16K
alphas from (n,a)

