

SI028 NEUTRON ACER TENDL-2019 LIBRARY; T=293.16K
Principal cross sections

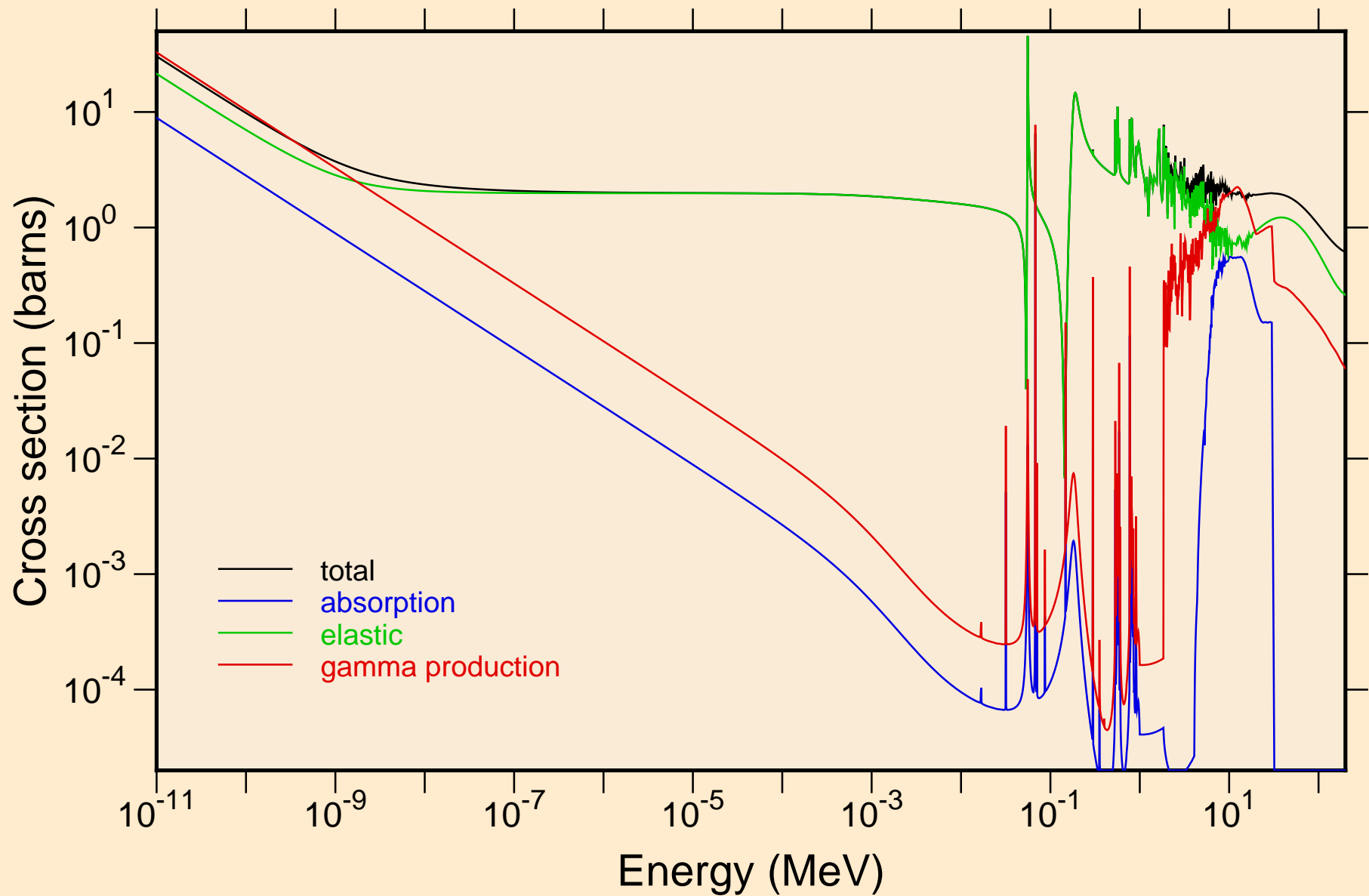

SI028 NEUTRON ACER TENDL-2019 LIBRARY; T=293.16K
resonance total cross section

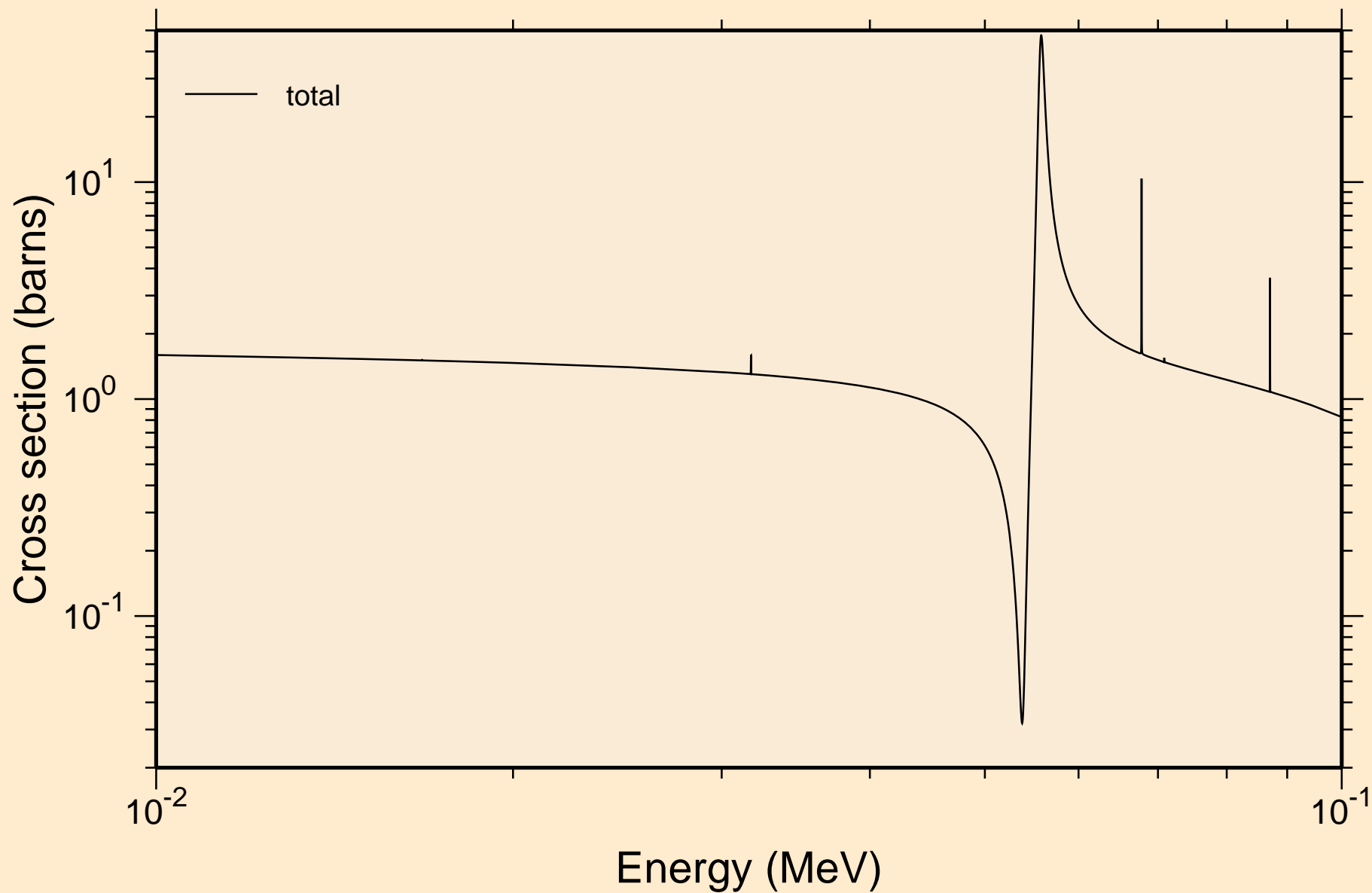

SI028 NEUTRON ACER TENDL-2019 LIBRARY; T=293.16K
resonance total cross section

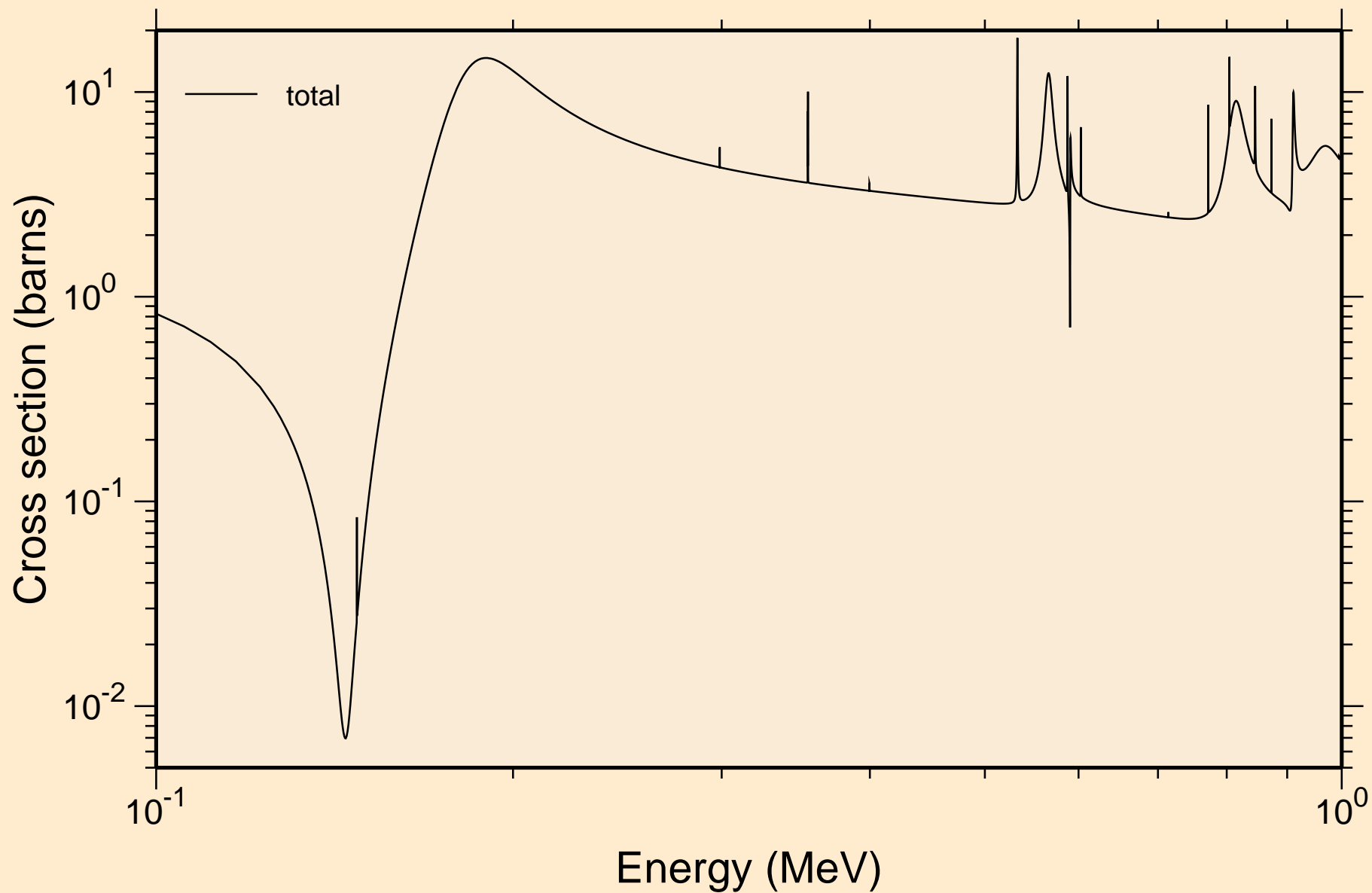

SI028 NEUTRON ACER TENDL-2019 LIBRARY; T=293.16K
resonance total cross section

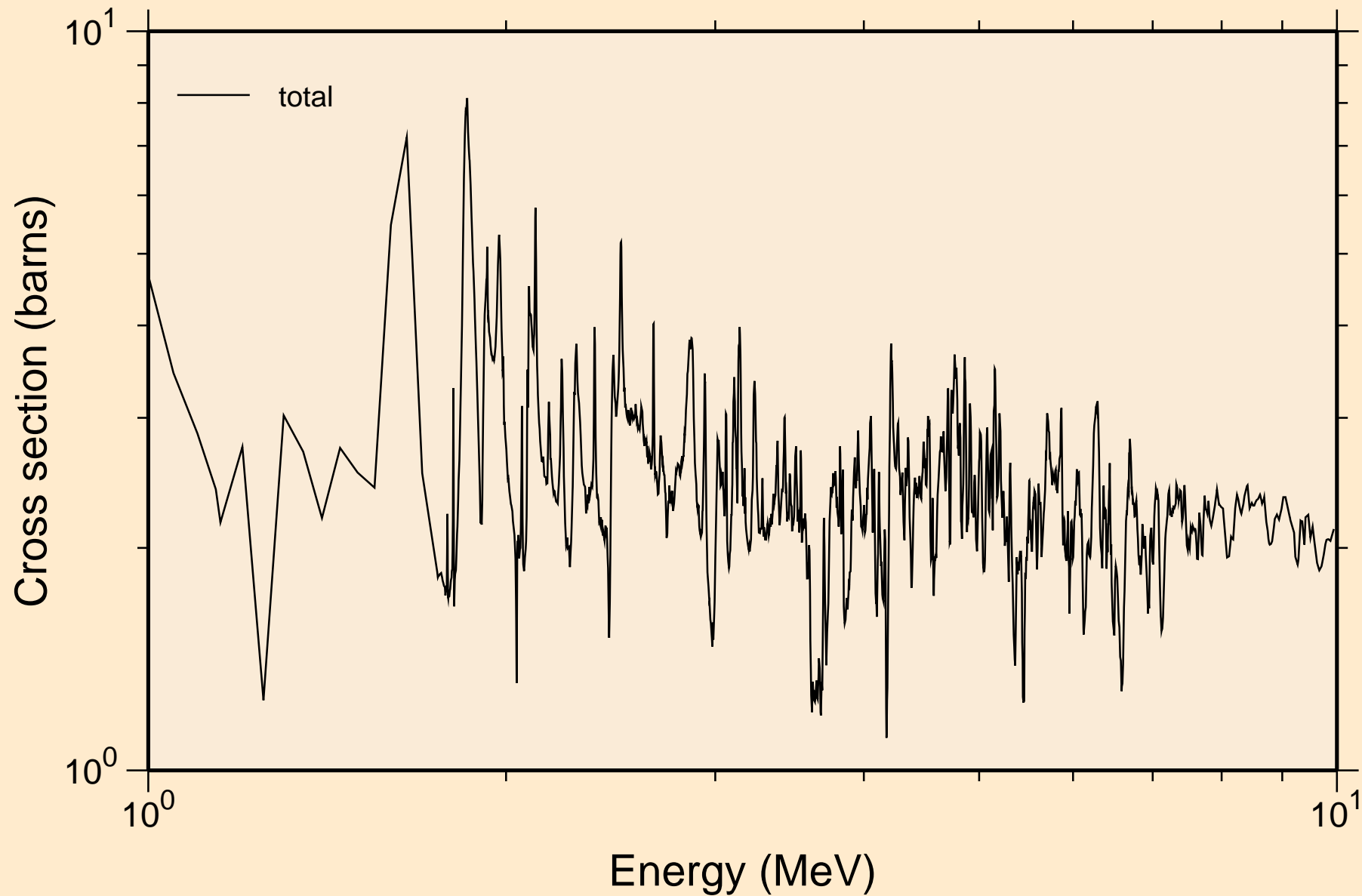

SI028 NEUTRON ACER TENDL-2019 LIBRARY; T=293.16K
resonance absorption cross sections

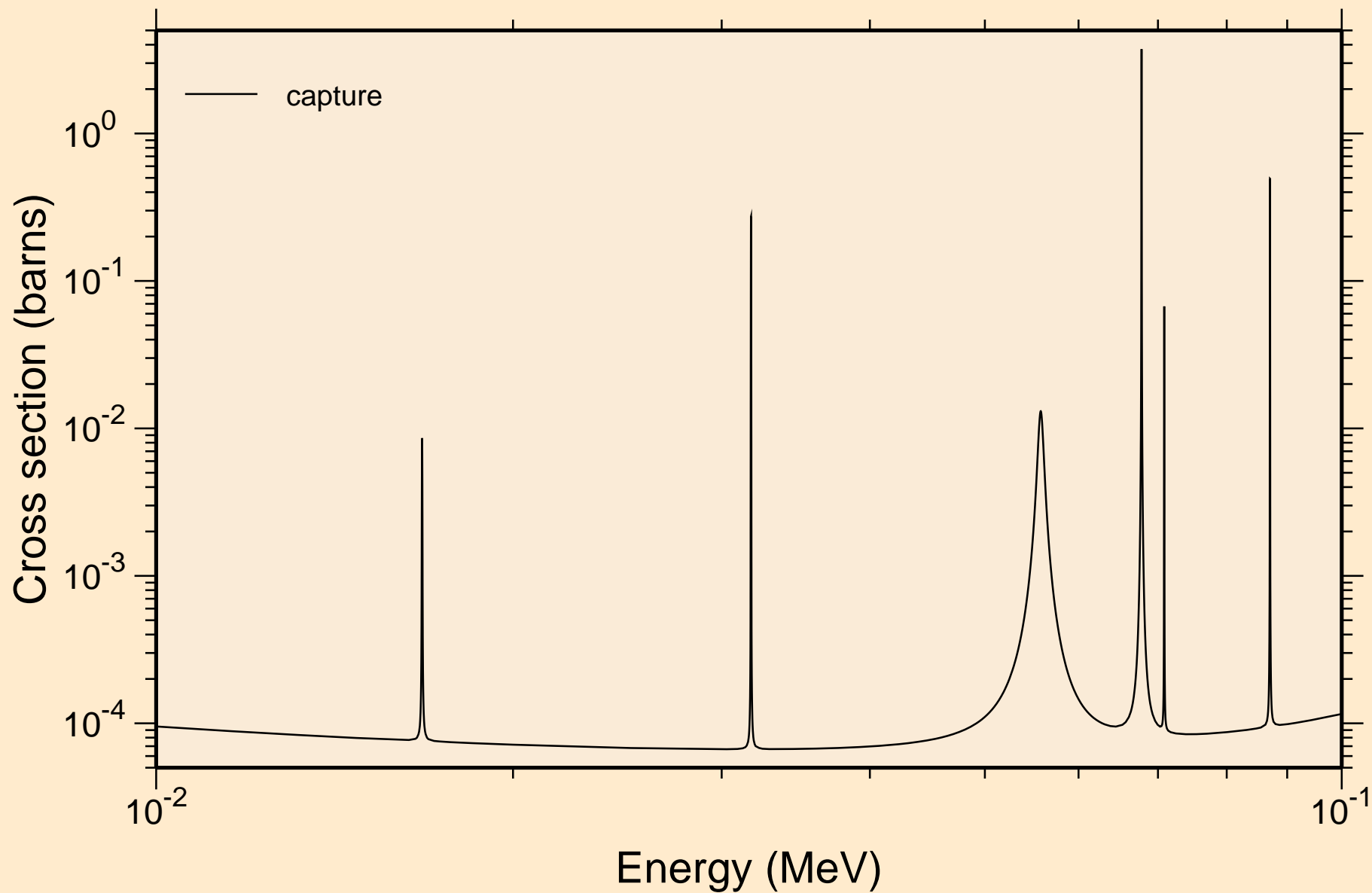

SI028 NEUTRON ACER TENDL-2019 LIBRARY; T=293.16K
resonance absorption cross sections

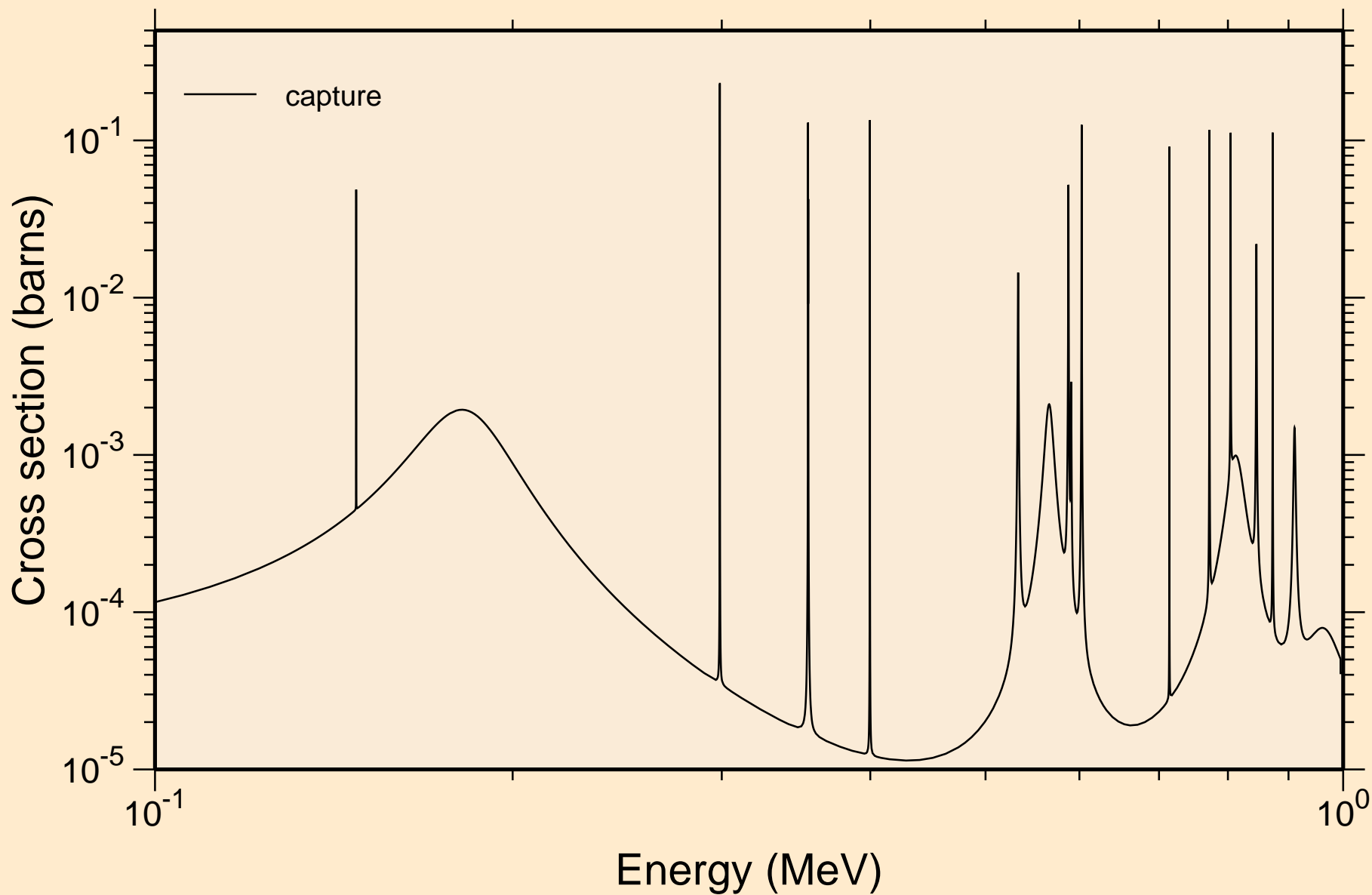

SI028 NEUTRON ACER TENDL-2019 LIBRARY; T=293.16K
resonance absorption cross sections

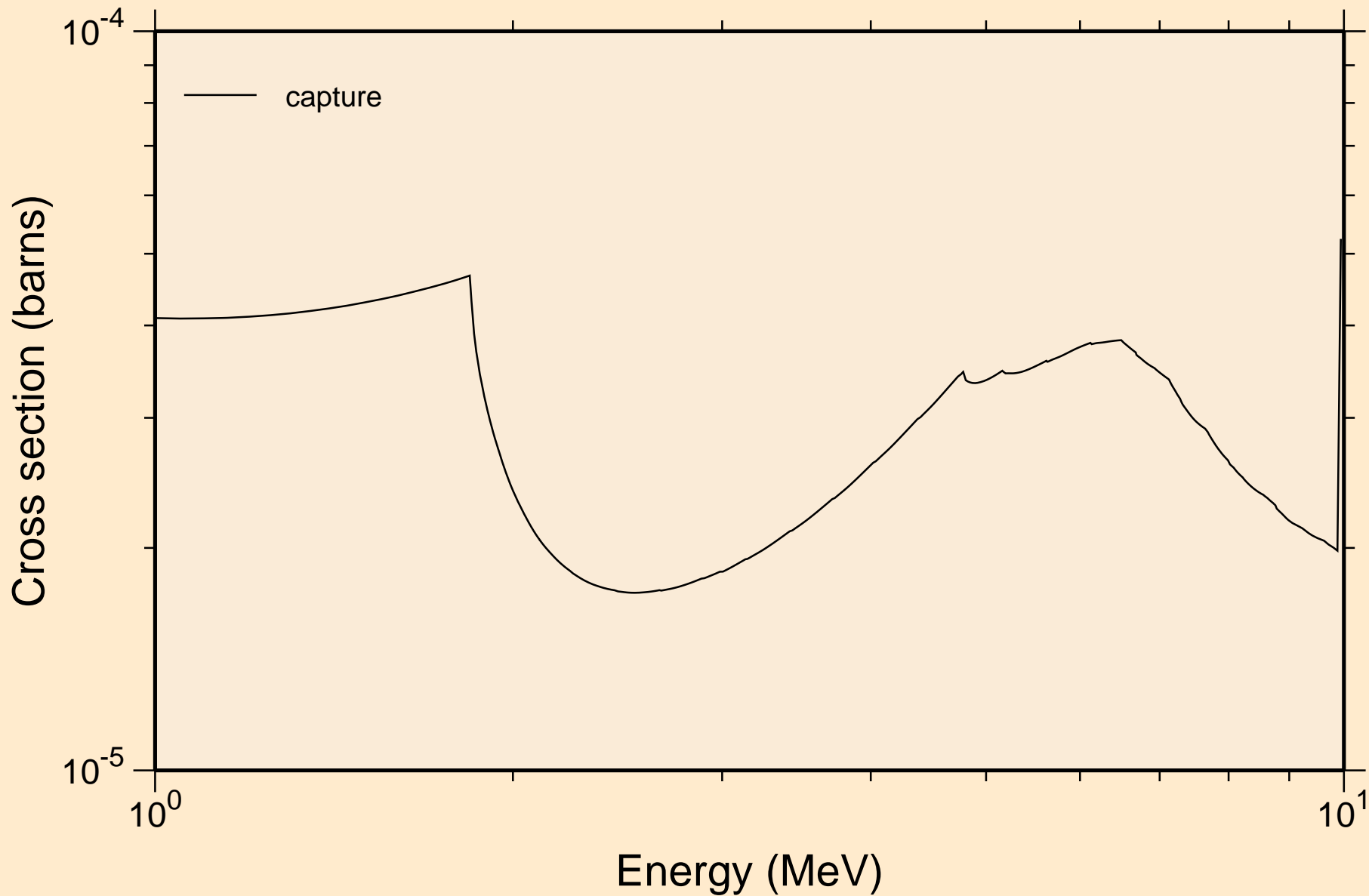

SI028 NEUTRON ACER TENDL-2019 LIBRARY; T=293.16K
Heating

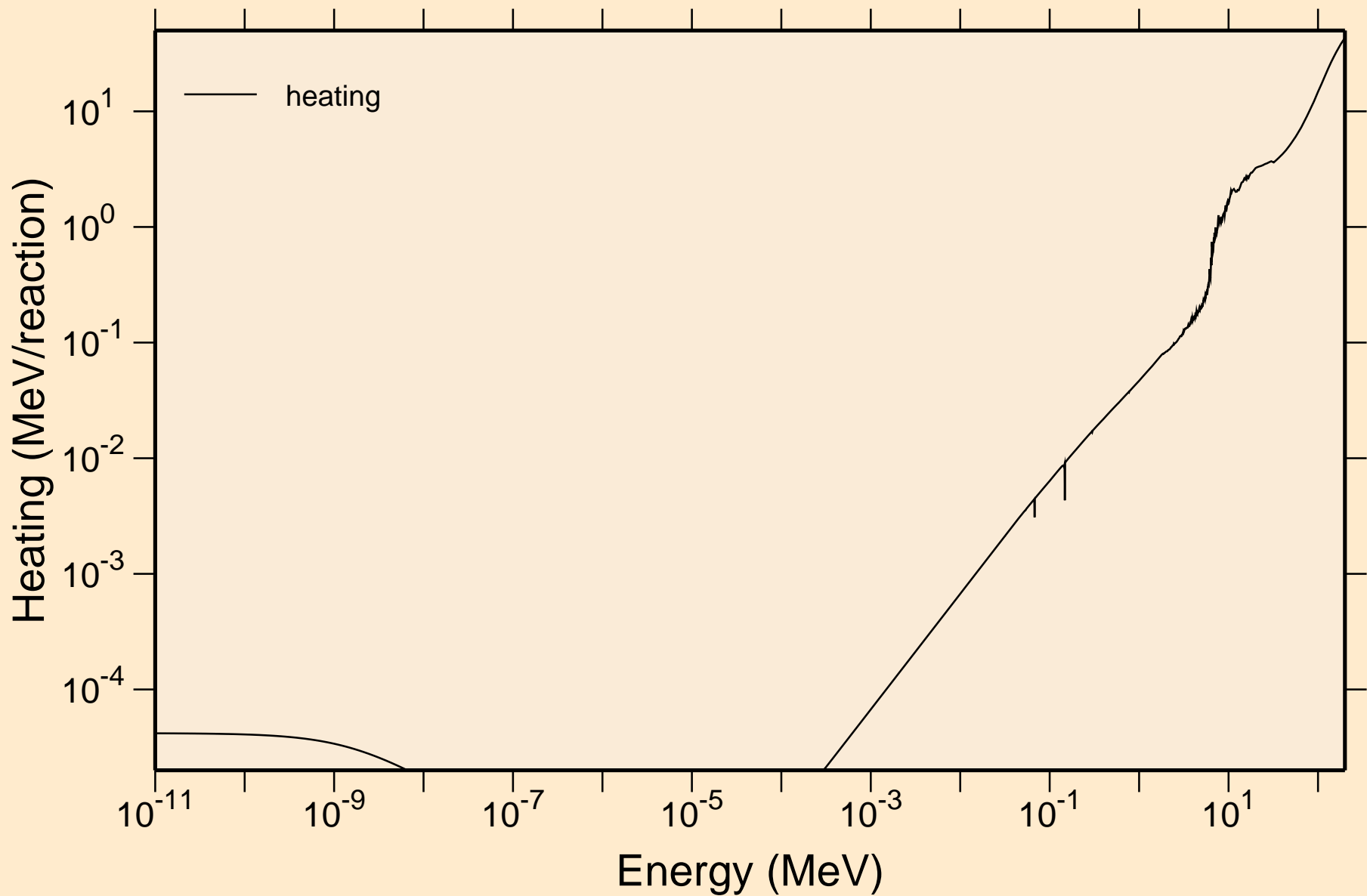

SI028 NEUTRON ACER TENDL-2019 LIBRARY; T=293.16K
Damage

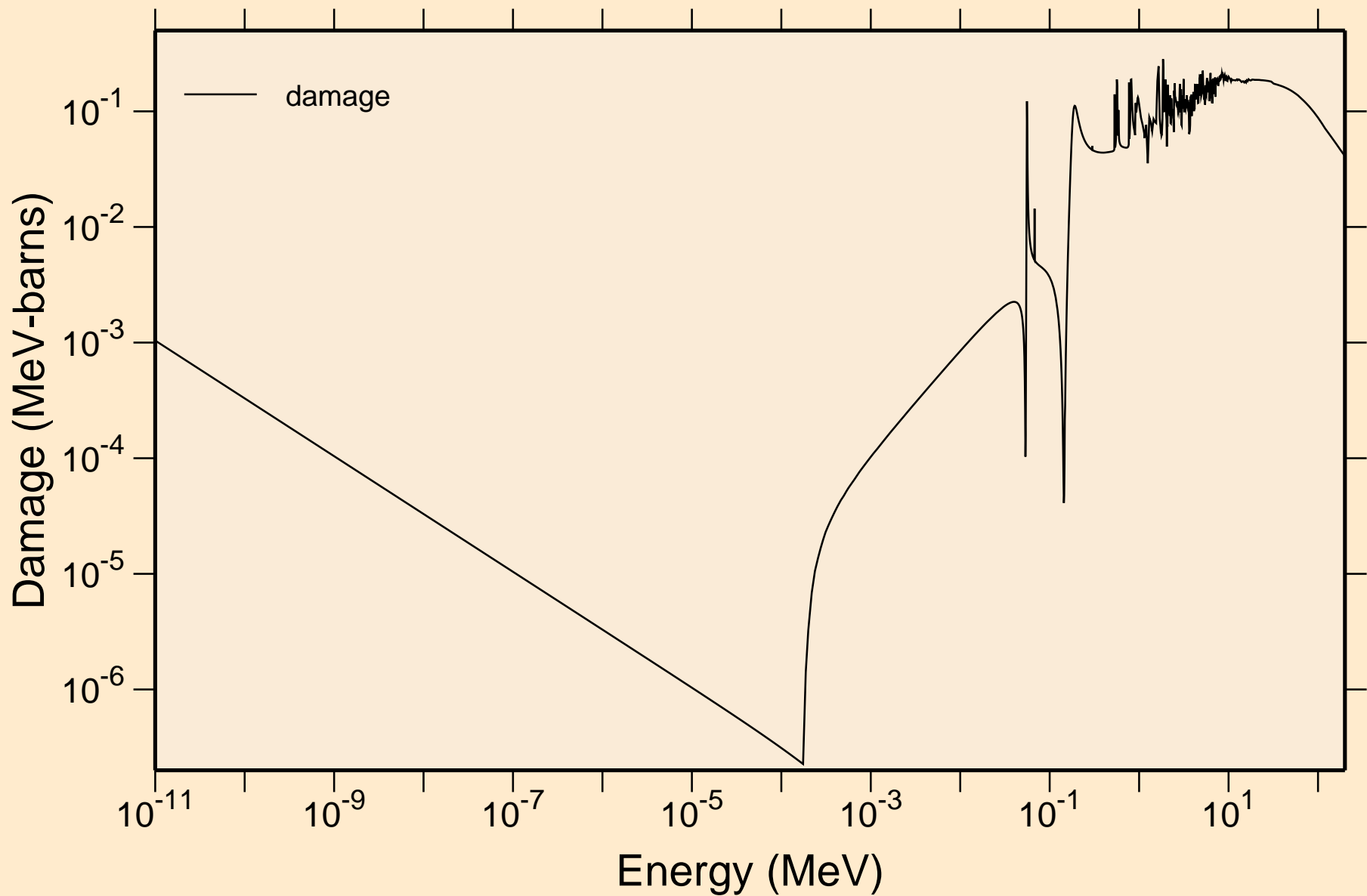

SI028 NEUTRON ACER TENDL-2019 LIBRARY; T=293.16K
Non-threshold reactions

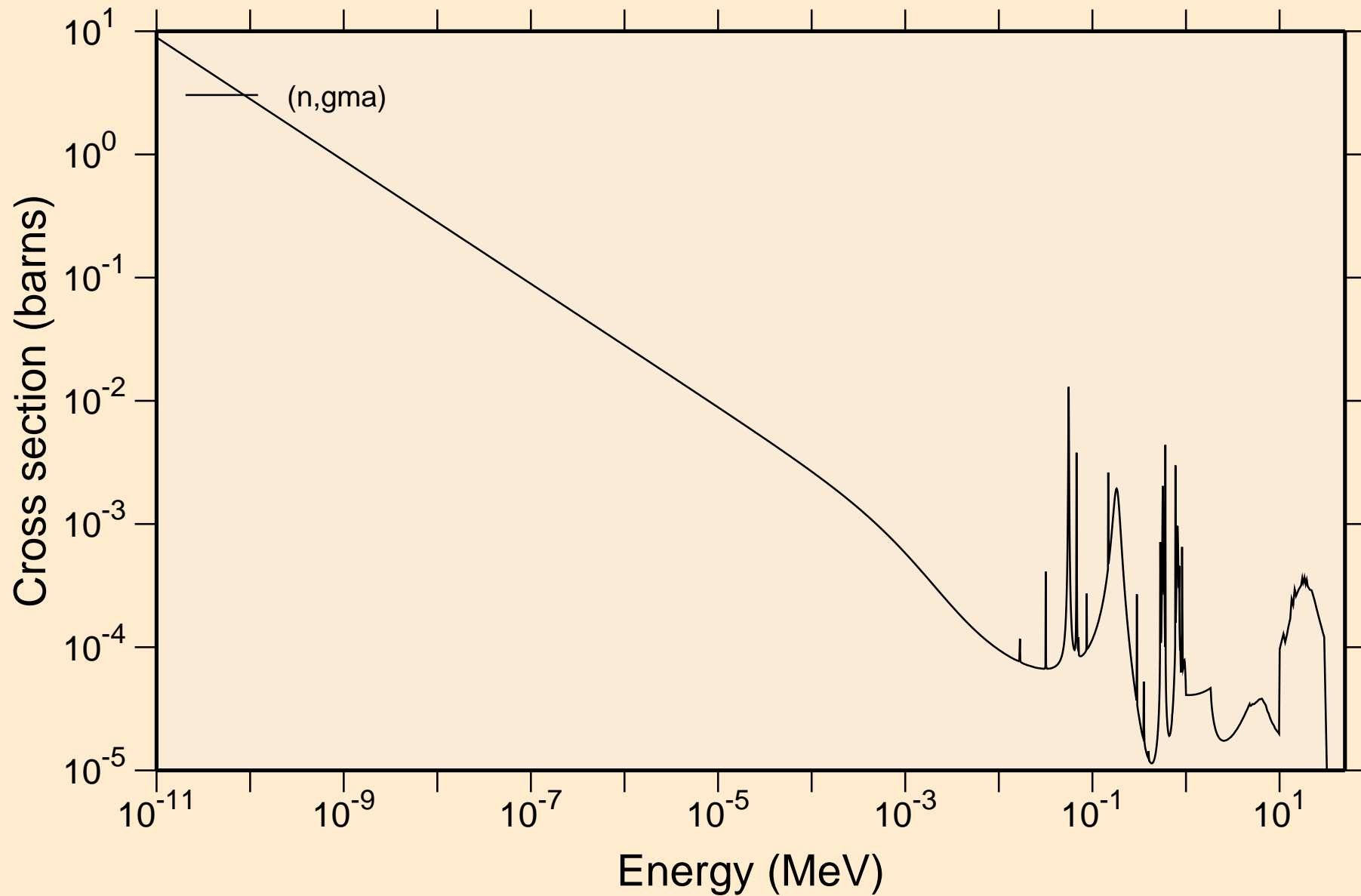

SI028 NEUTRON ACER TENDL-2019 LIBRARY; T=293.16K

Principal cross sections

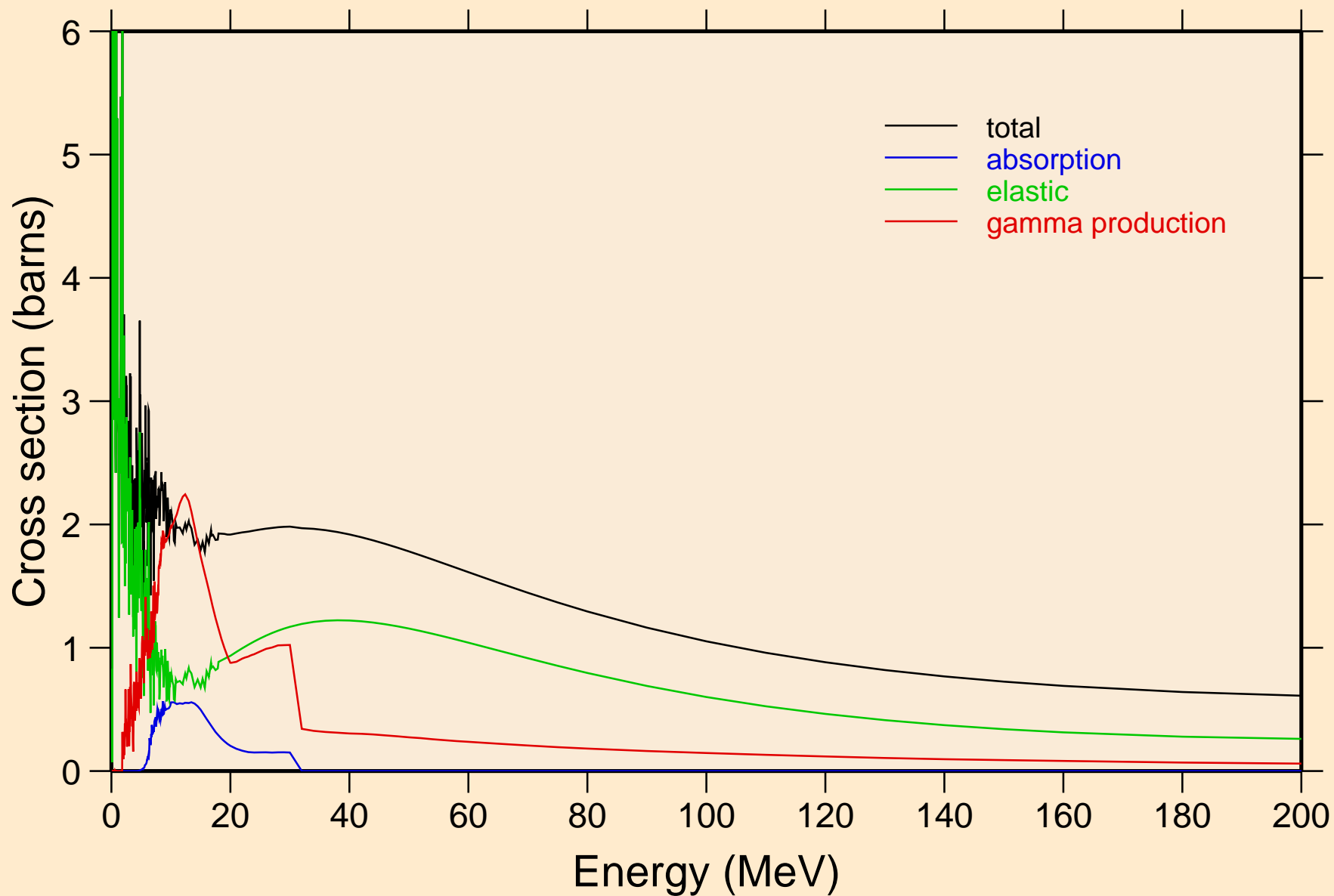

SI028 NEUTRON ACER TENDL-2019 LIBRARY; T=293.16K
Heating

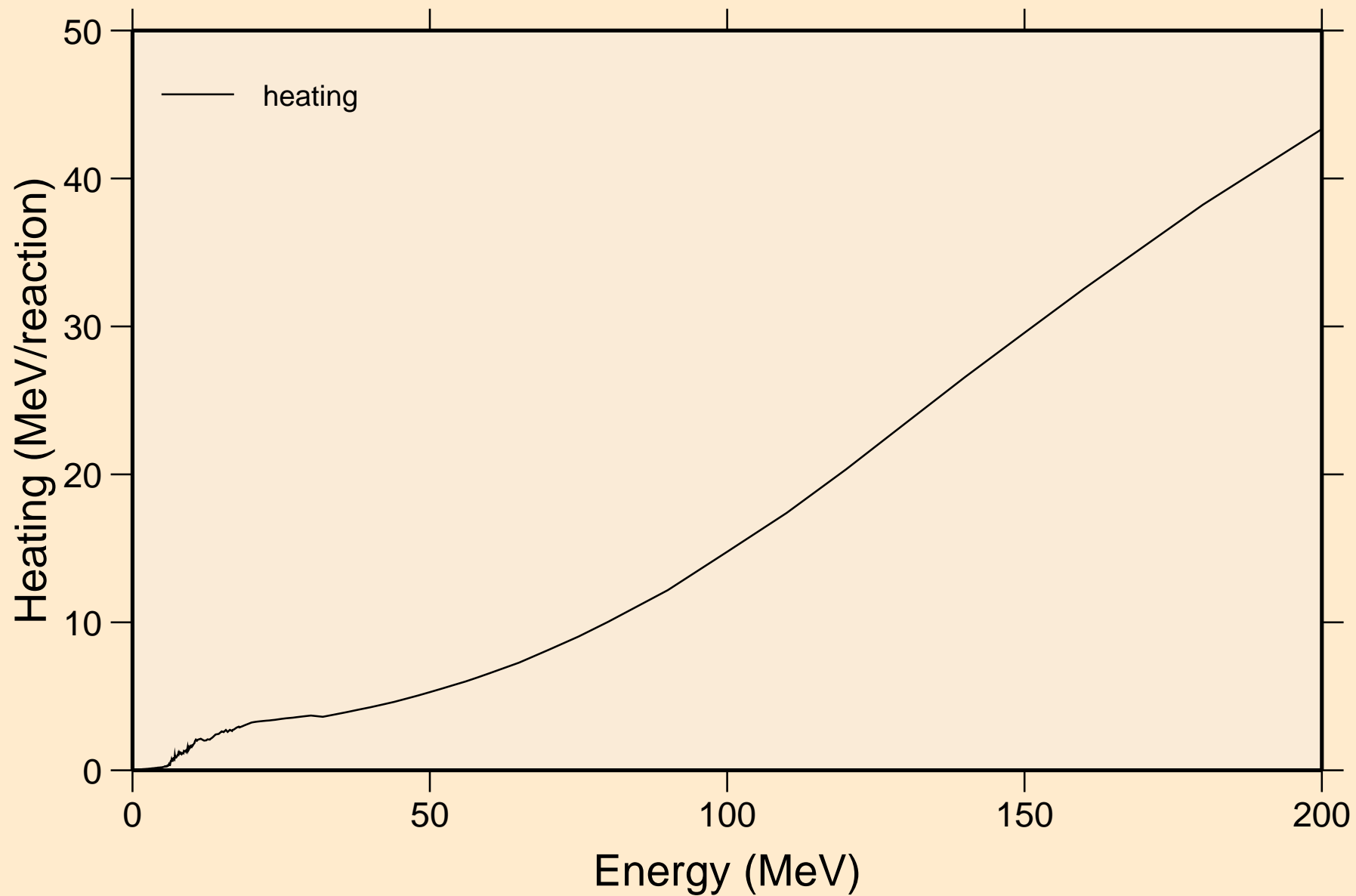

SI028 NEUTRON ACER TENDL-2019 LIBRARY; T=293.16K
Damage

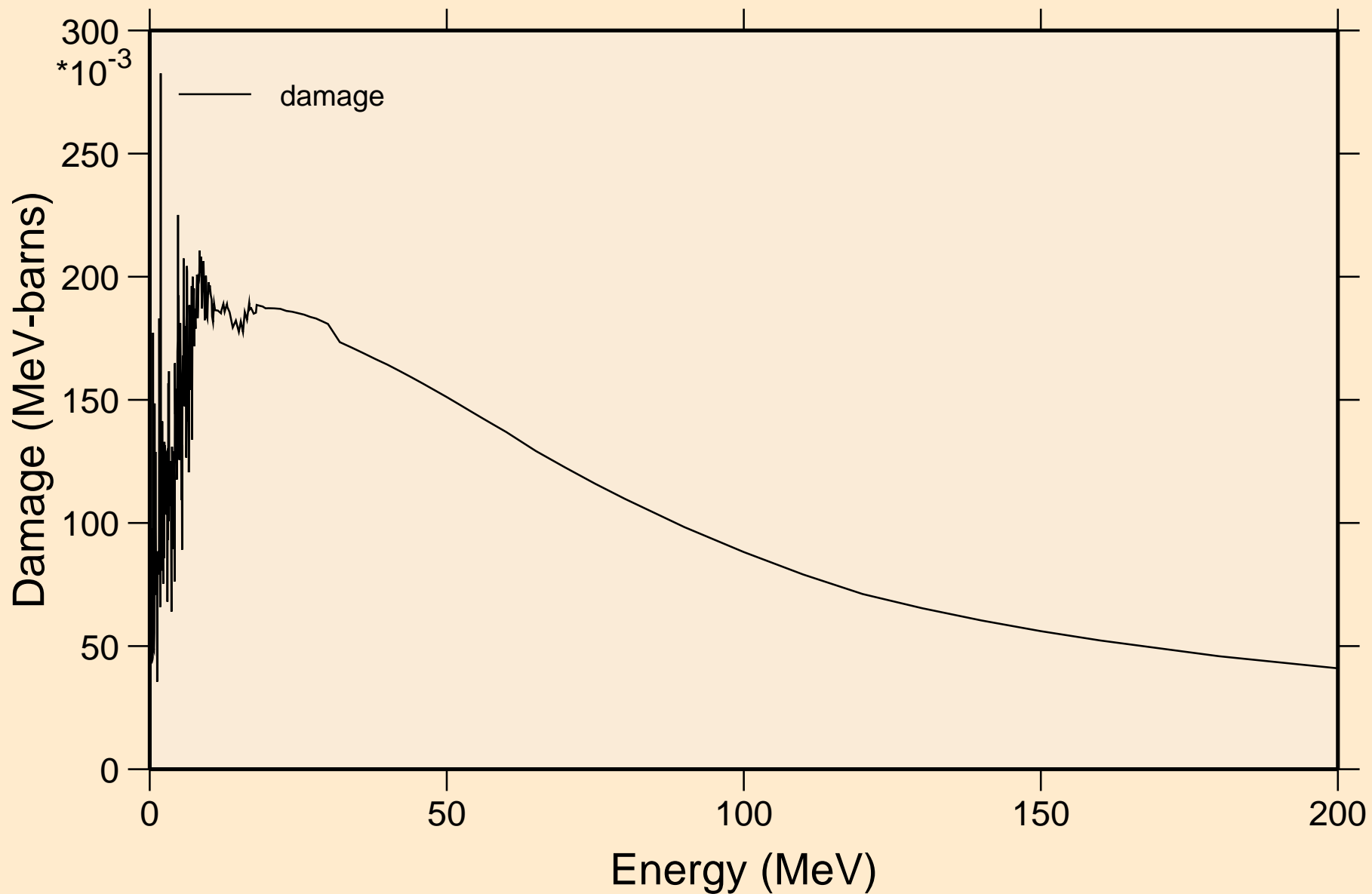

SI028 NEUTRON ACER TENDL-2019 LIBRARY; T=293.16K
Non-threshold reactions

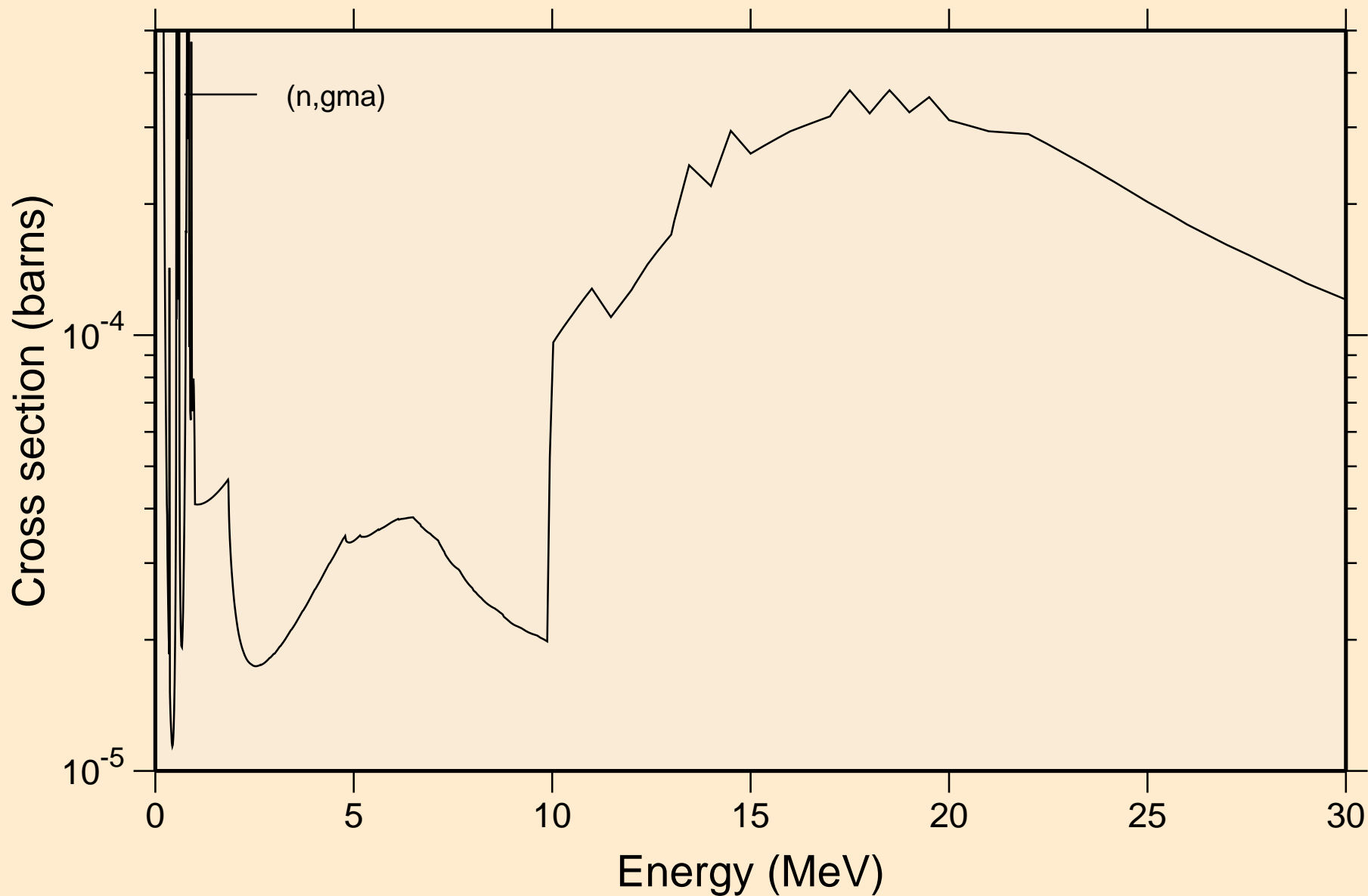

SI028 NEUTRON ACER TENDL-2019 LIBRARY; T=293.16K
Inelastic levels

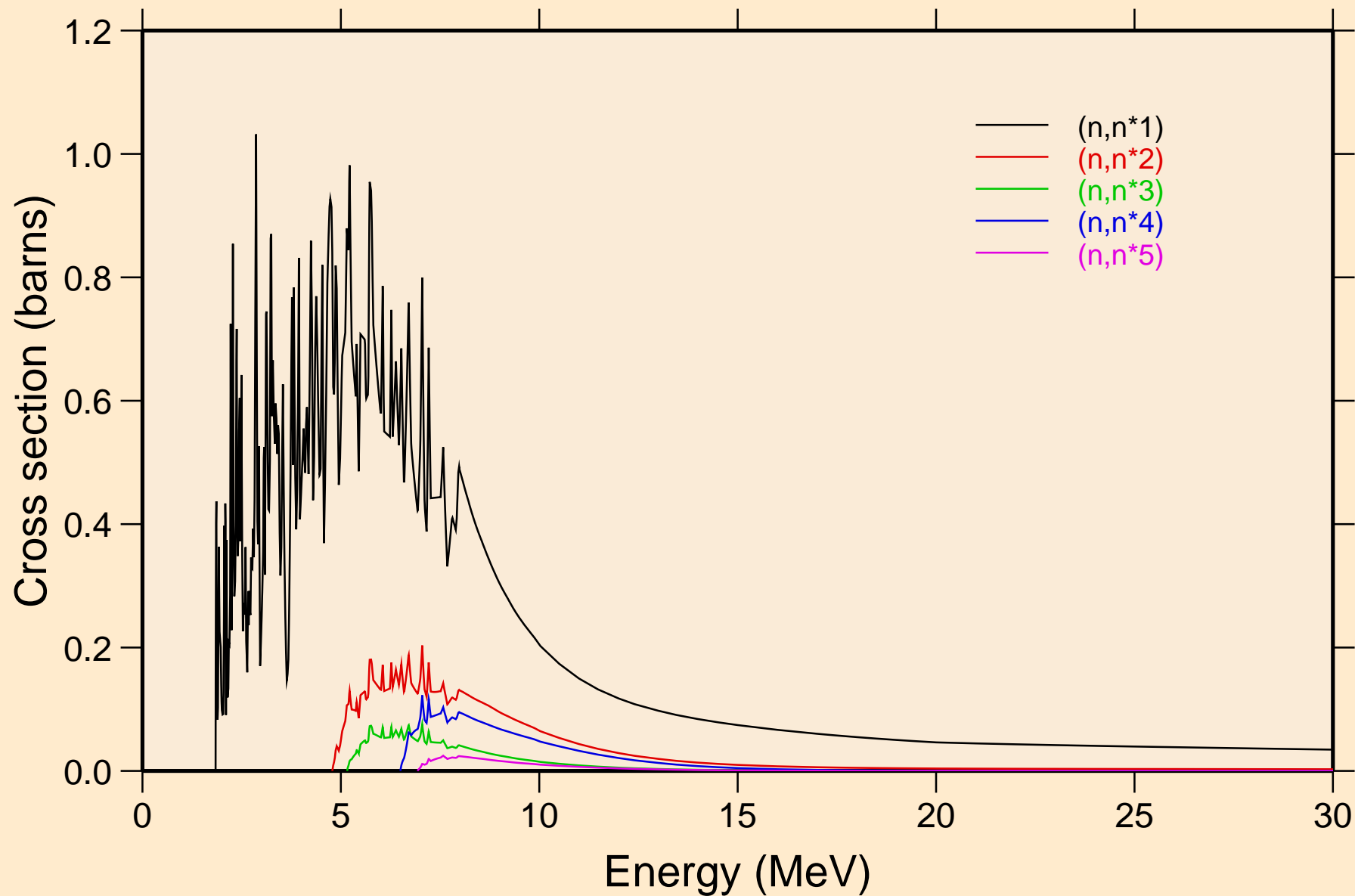

SI028 NEUTRON ACER TENDL-2019 LIBRARY; T=293.16K
Inelastic levels

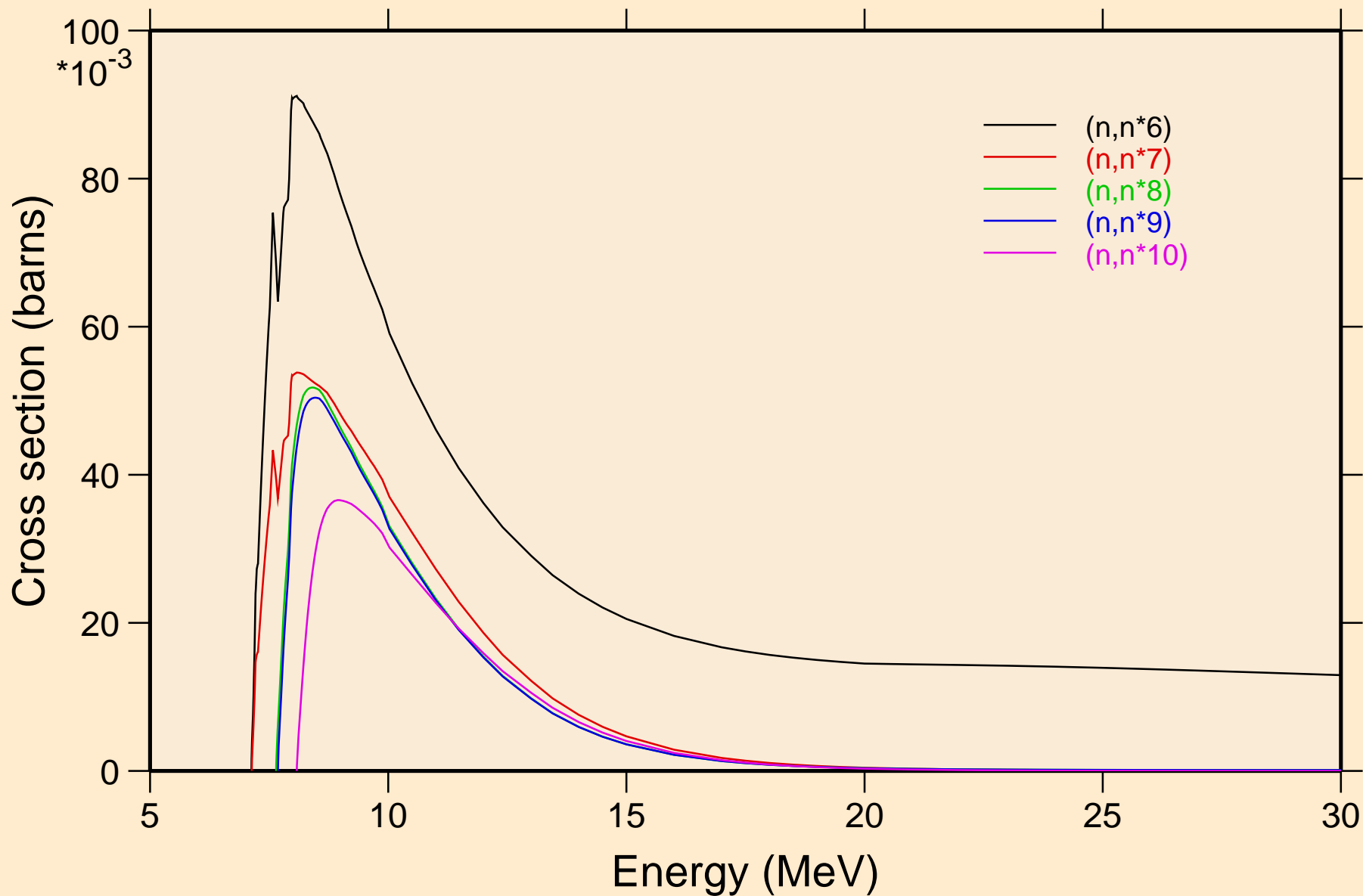

SI028 NEUTRON ACER TENDL-2019 LIBRARY; T=293.16K
Inelastic levels

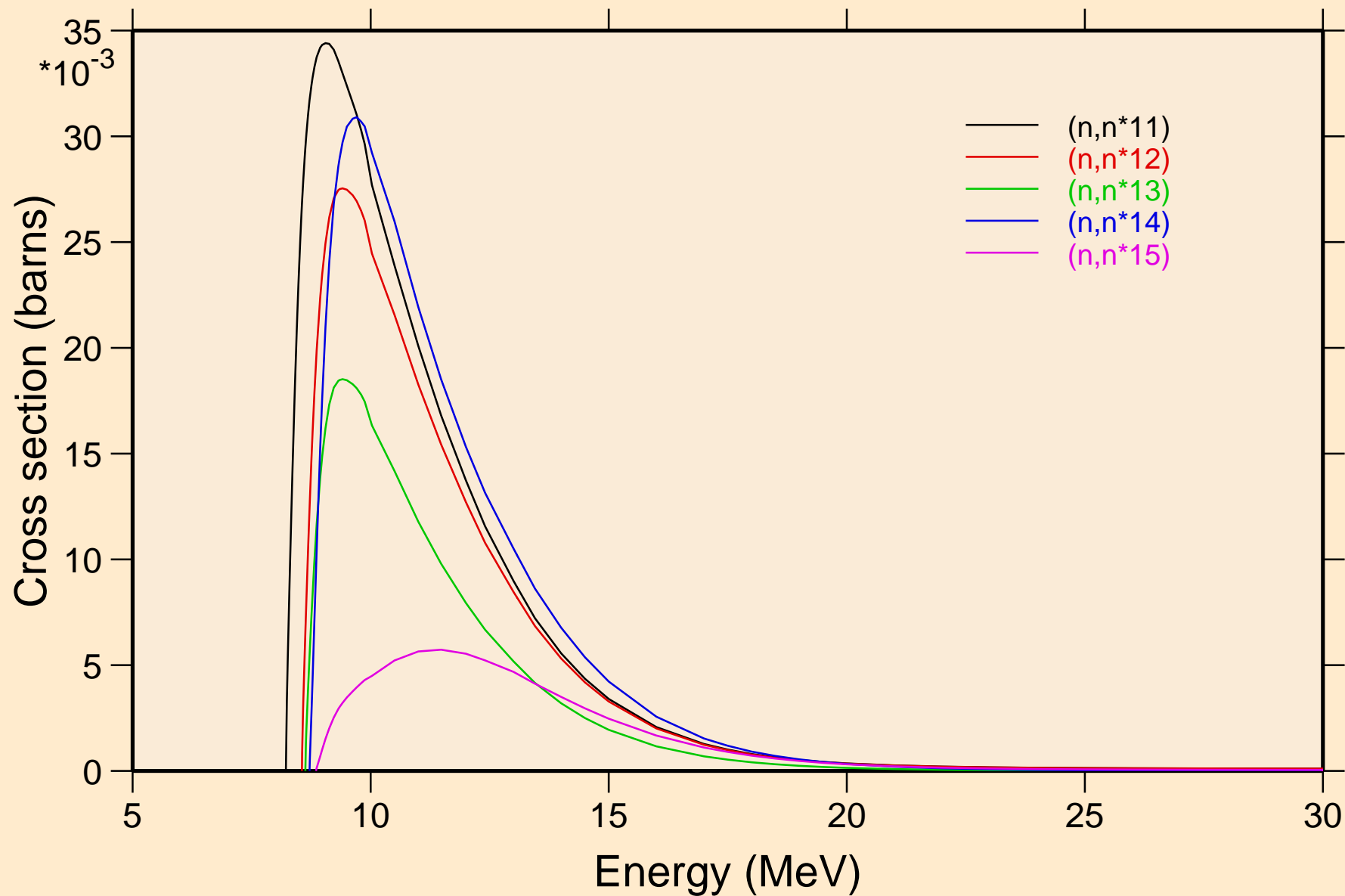

SI028 NEUTRON ACER TENDL-2019 LIBRARY; T=293.16K
Inelastic levels

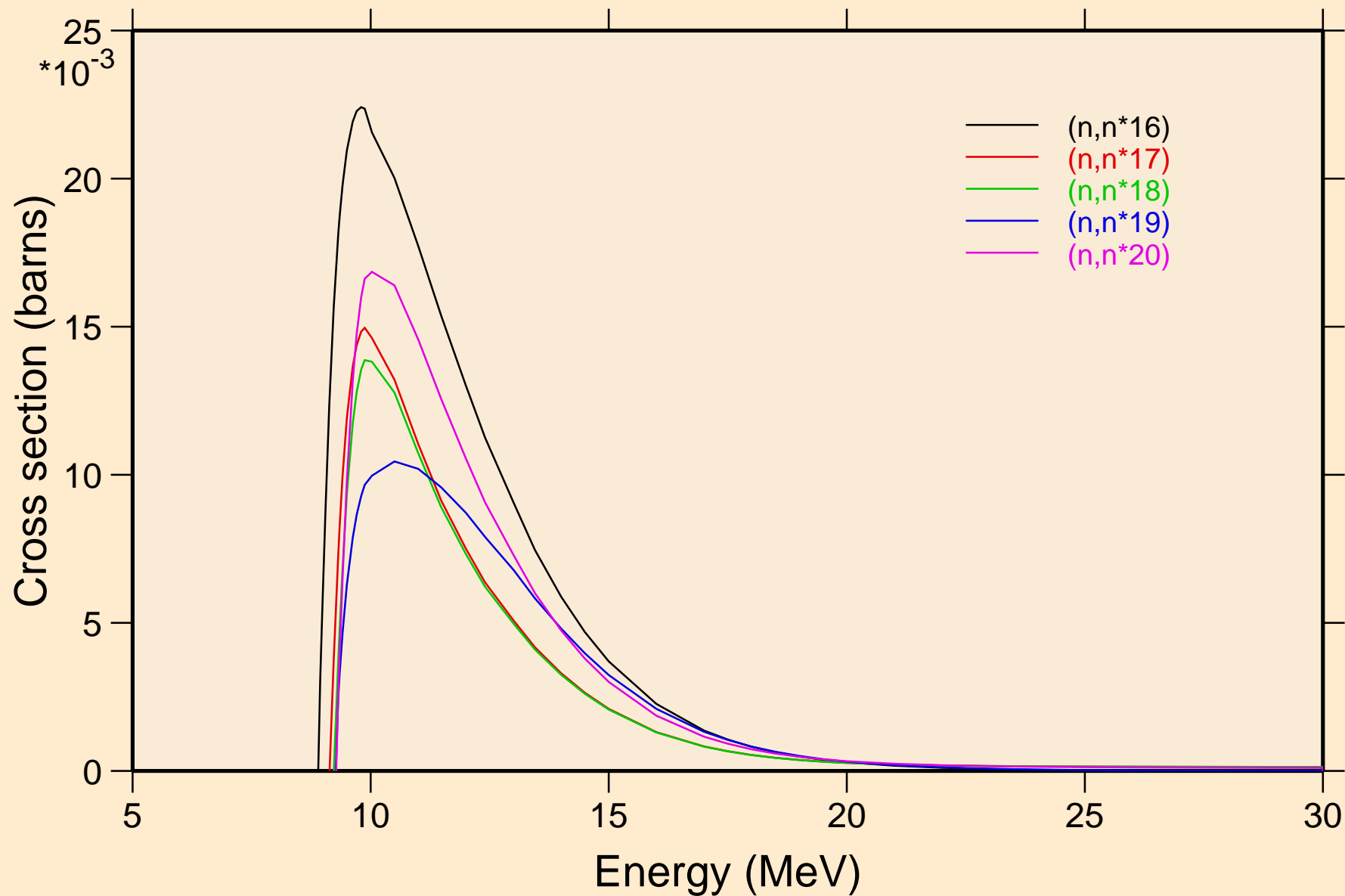

SI028 NEUTRON ACER TENDL-2019 LIBRARY; T=293.16K
Inelastic levels

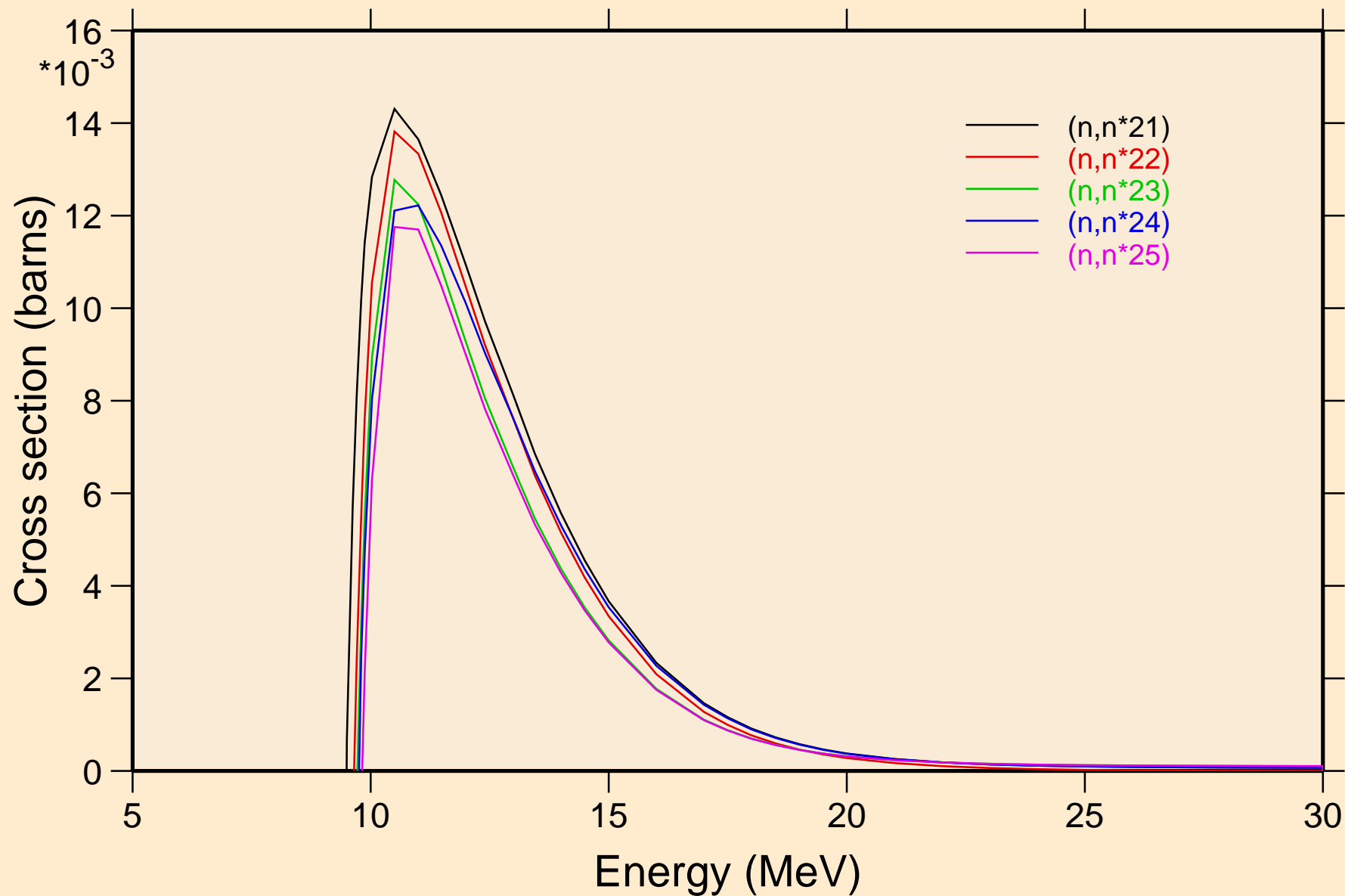

SI028 NEUTRON ACER TENDL-2019 LIBRARY; T=293.16K
Inelastic levels

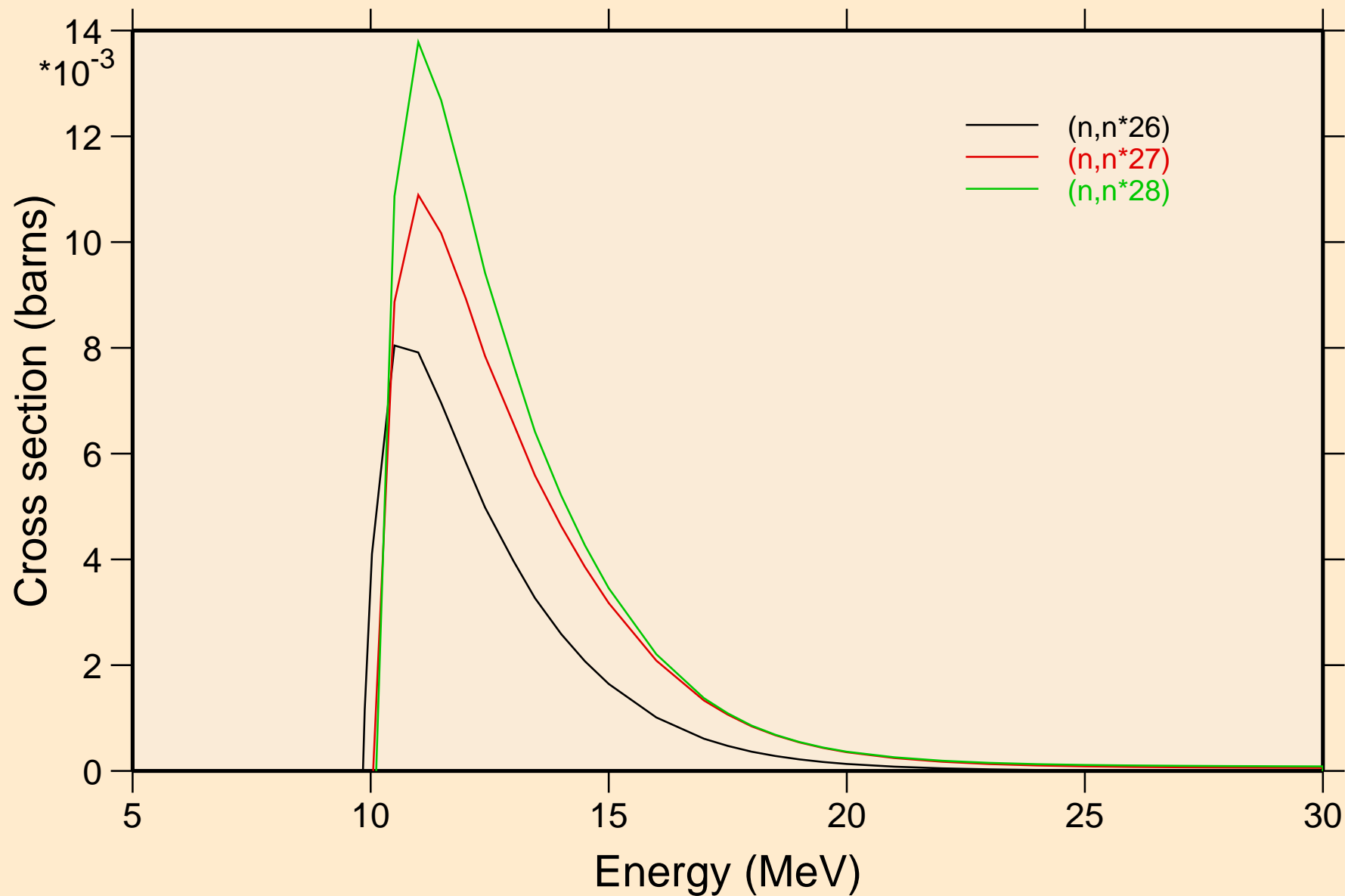

SI028 NEUTRON ACER TENDL-2019 LIBRARY; T=293.16K
Threshold reactions

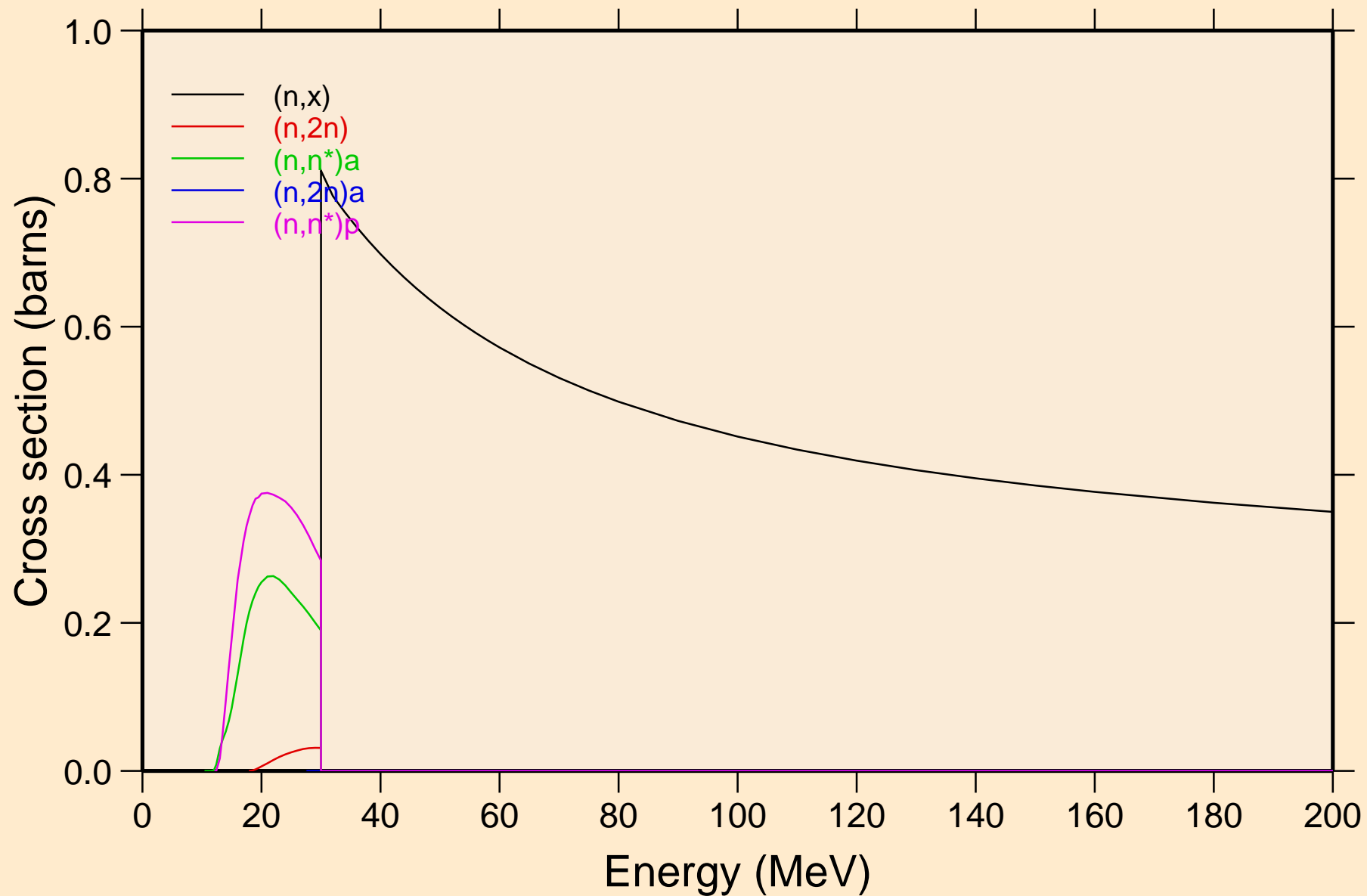

SI028 NEUTRON ACER TENDL-2019 LIBRARY; T=293.16K
Threshold reactions

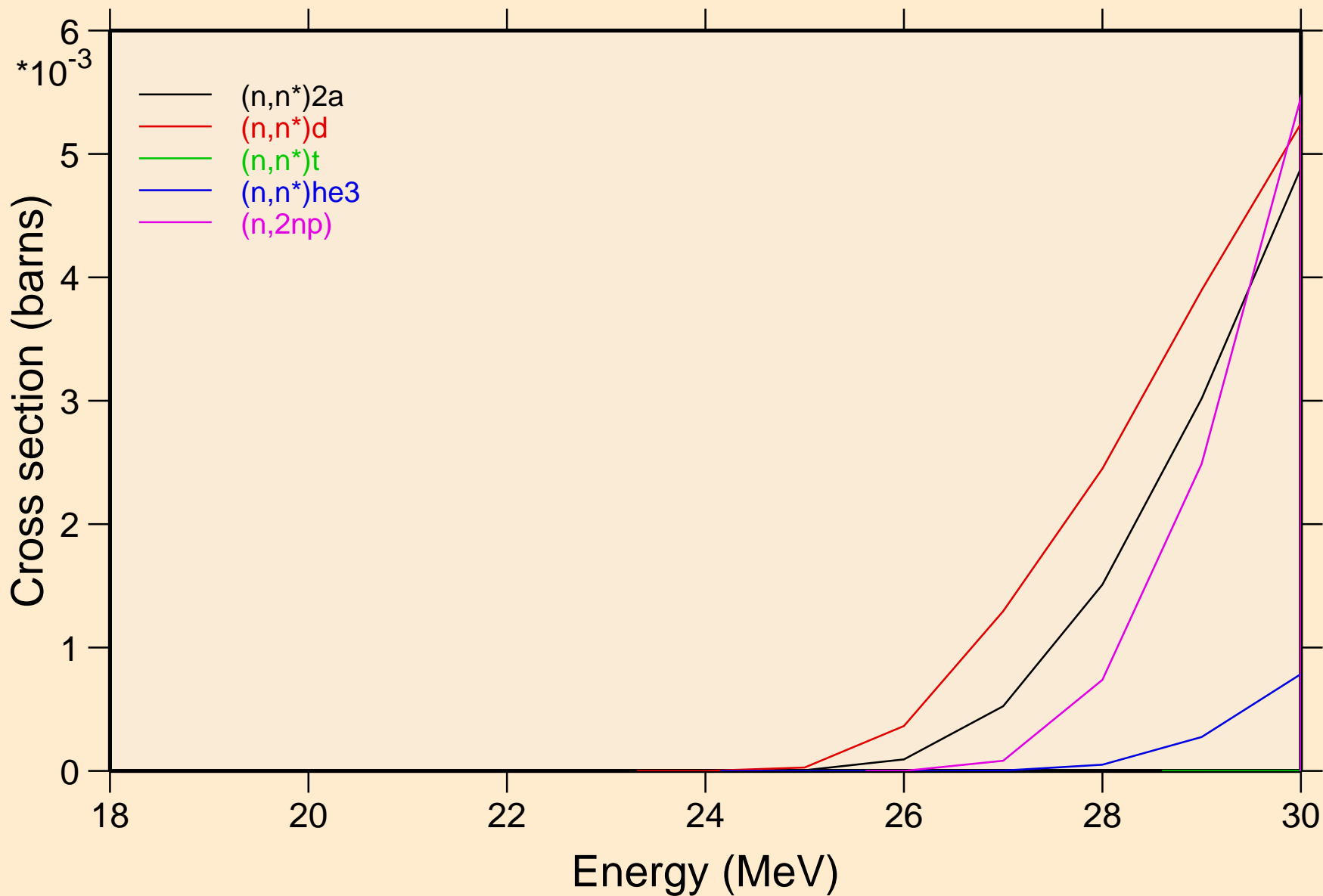

SI028 NEUTRON ACER TENDL-2019 LIBRARY; T=293.16K

Threshold reactions

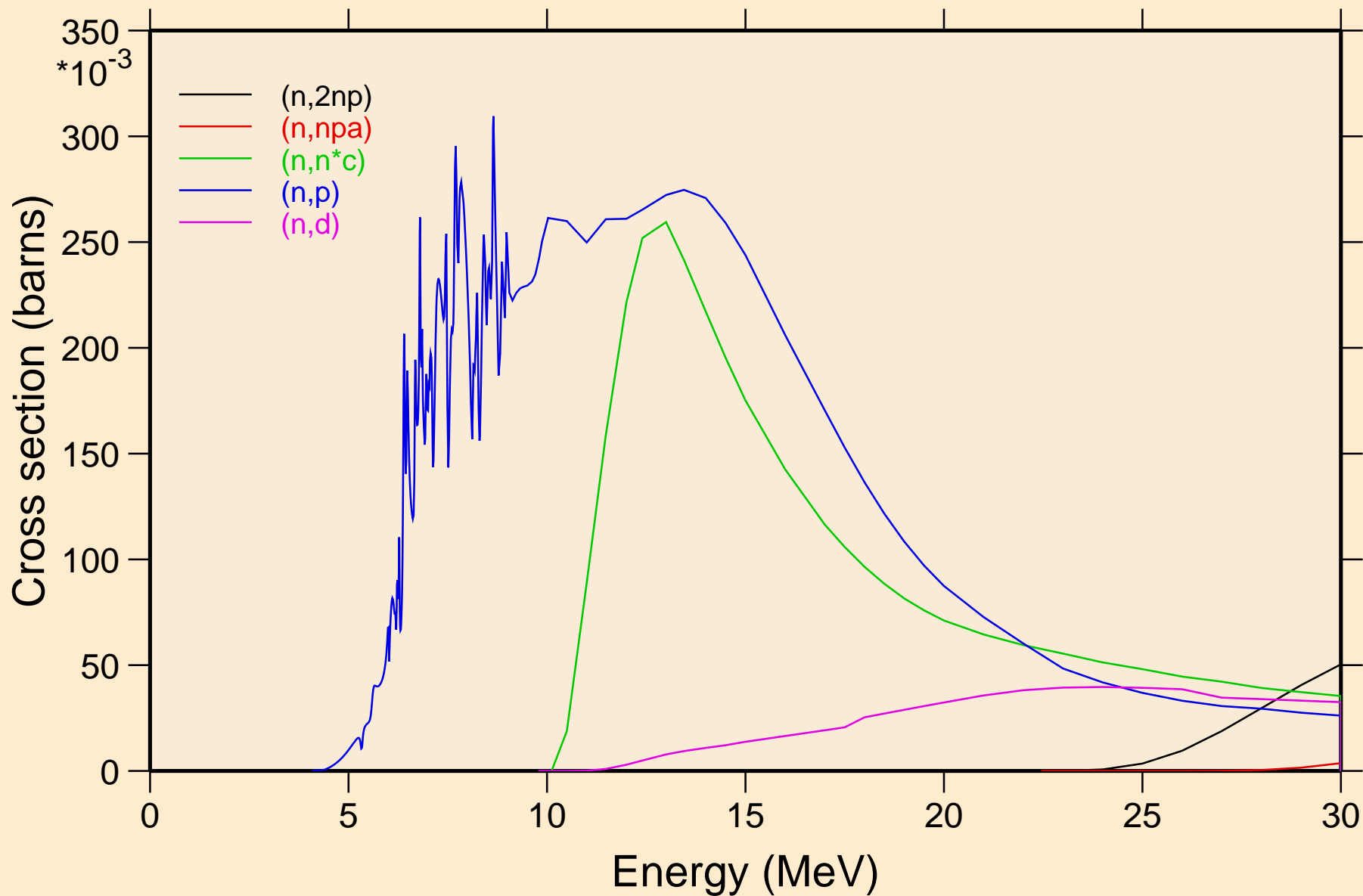

SI028 NEUTRON ACER TENDL-2019 LIBRARY; T=293.16K
Threshold reactions

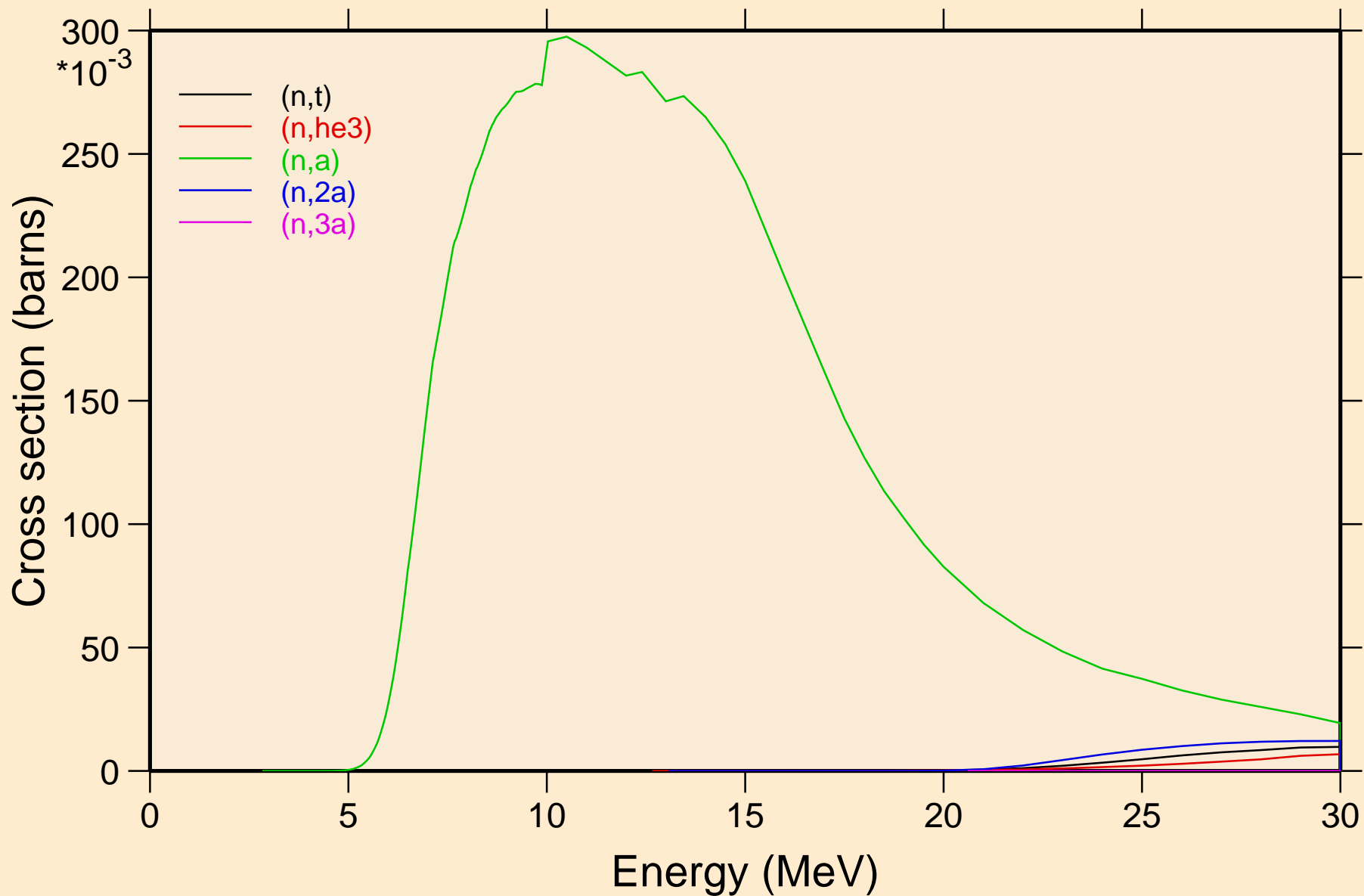

SI028 NEUTRON ACER TENDL-2019 LIBRARY; T=293.16K
Threshold reactions

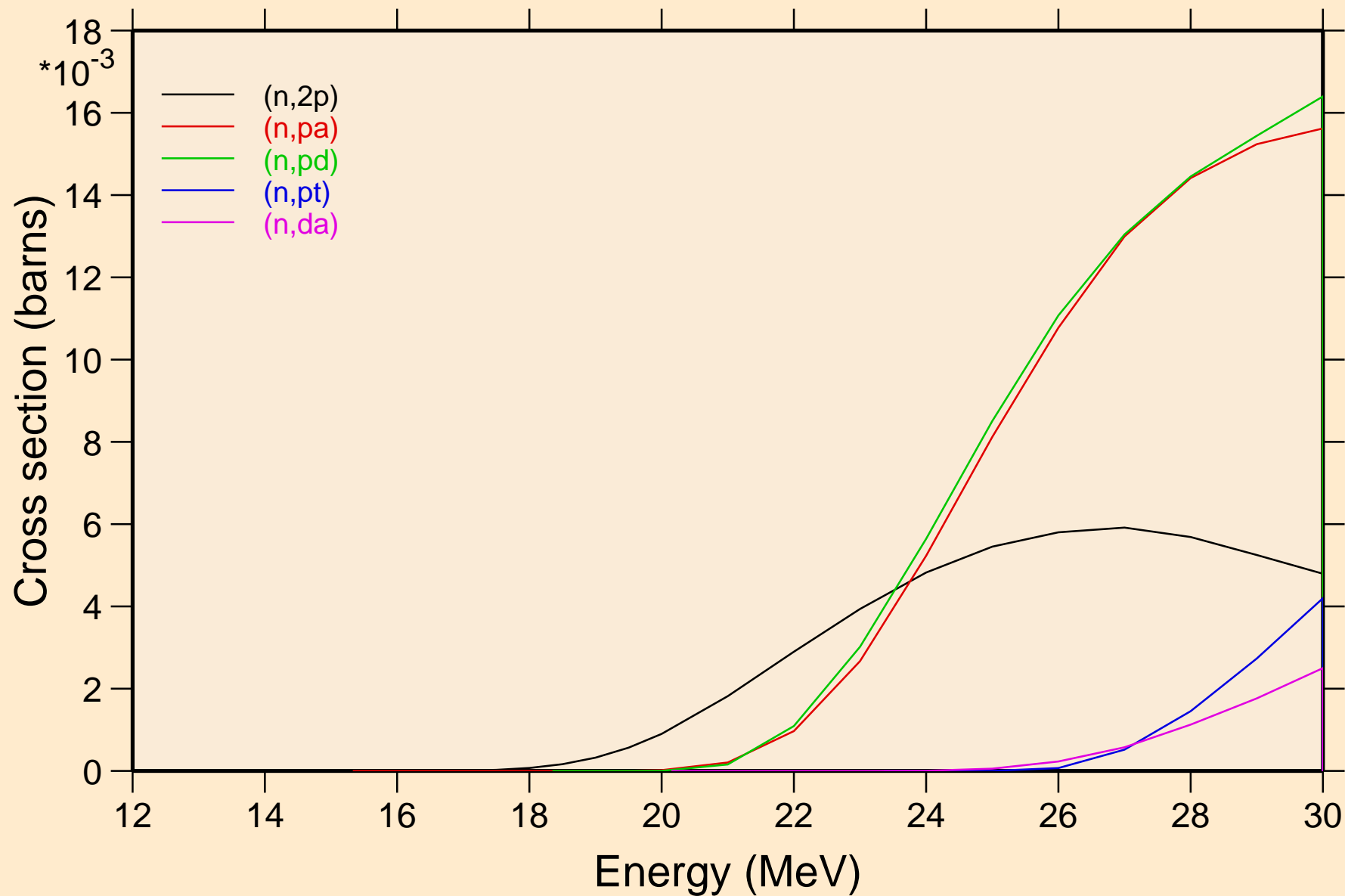

SI028 NEUTRON ACER TENDL-2019 LIBRARY; T=293.16K
Threshold reactions

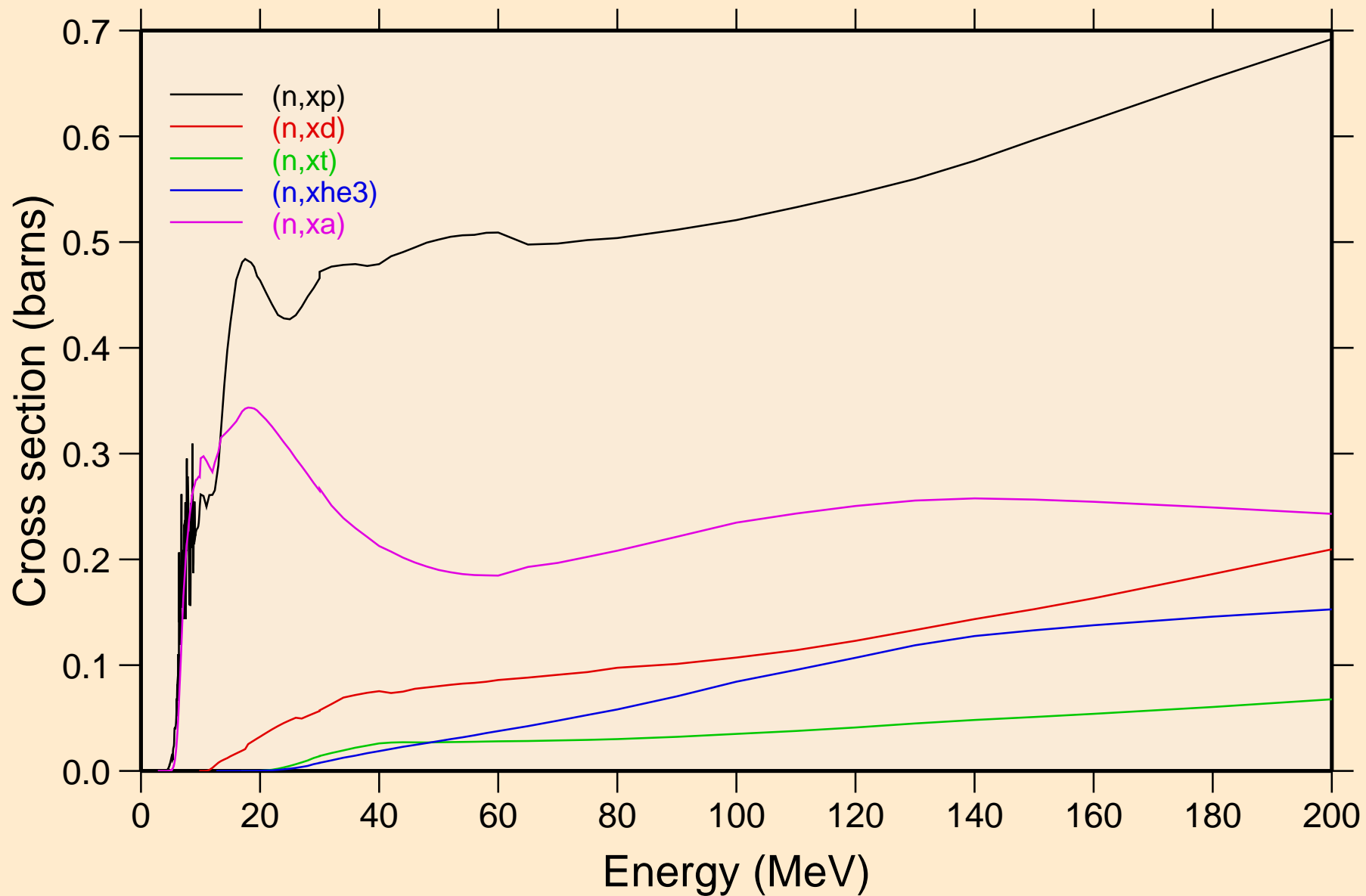

SI028 NEUTRON ACER TENDL-2019 LIBRARY; T=293.16K
angular distribution for elastic

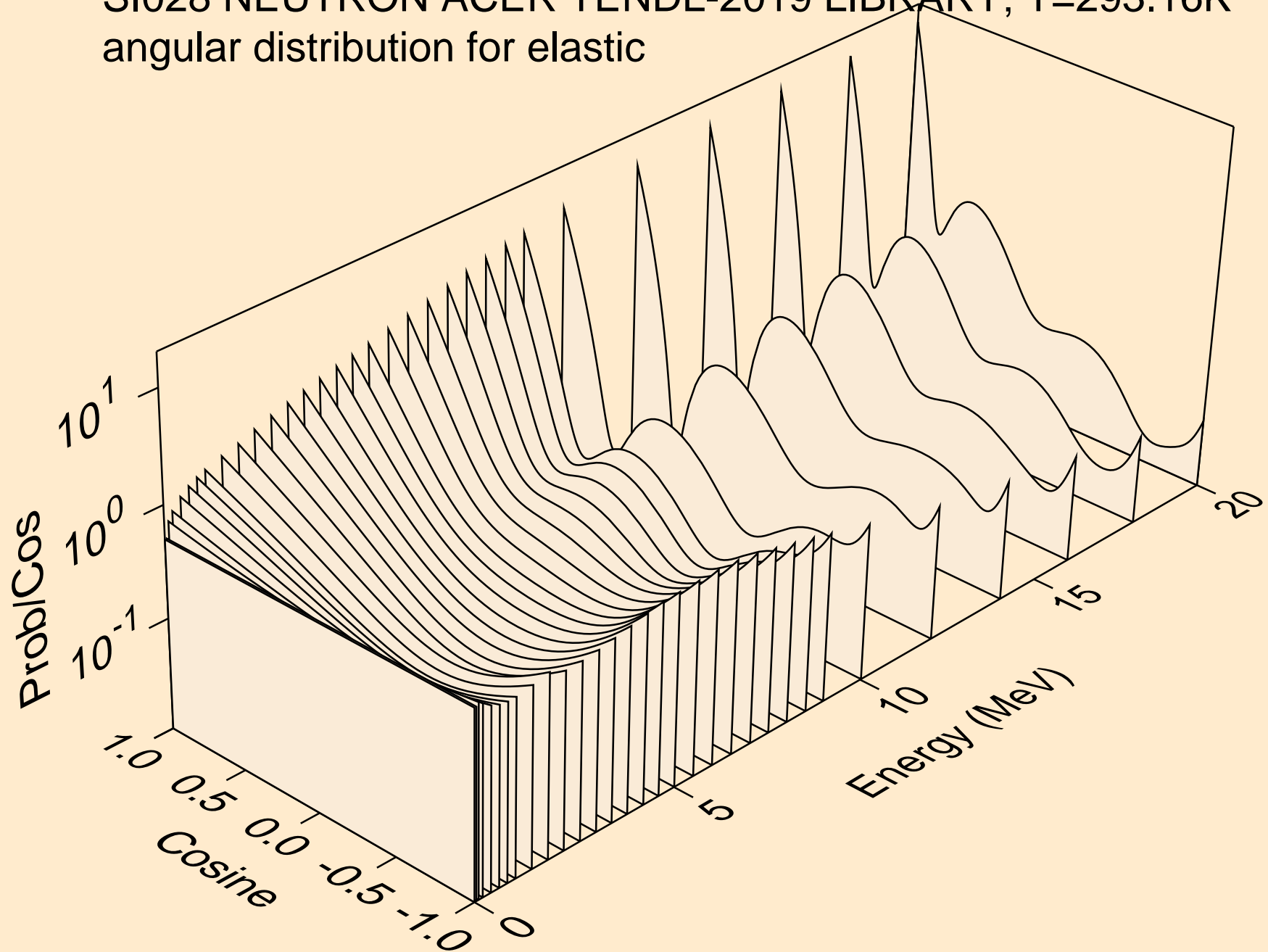

SI028 NEUTRON ACER TENDL-2019 LIBRARY; T=293.16K
angular distribution for elastic

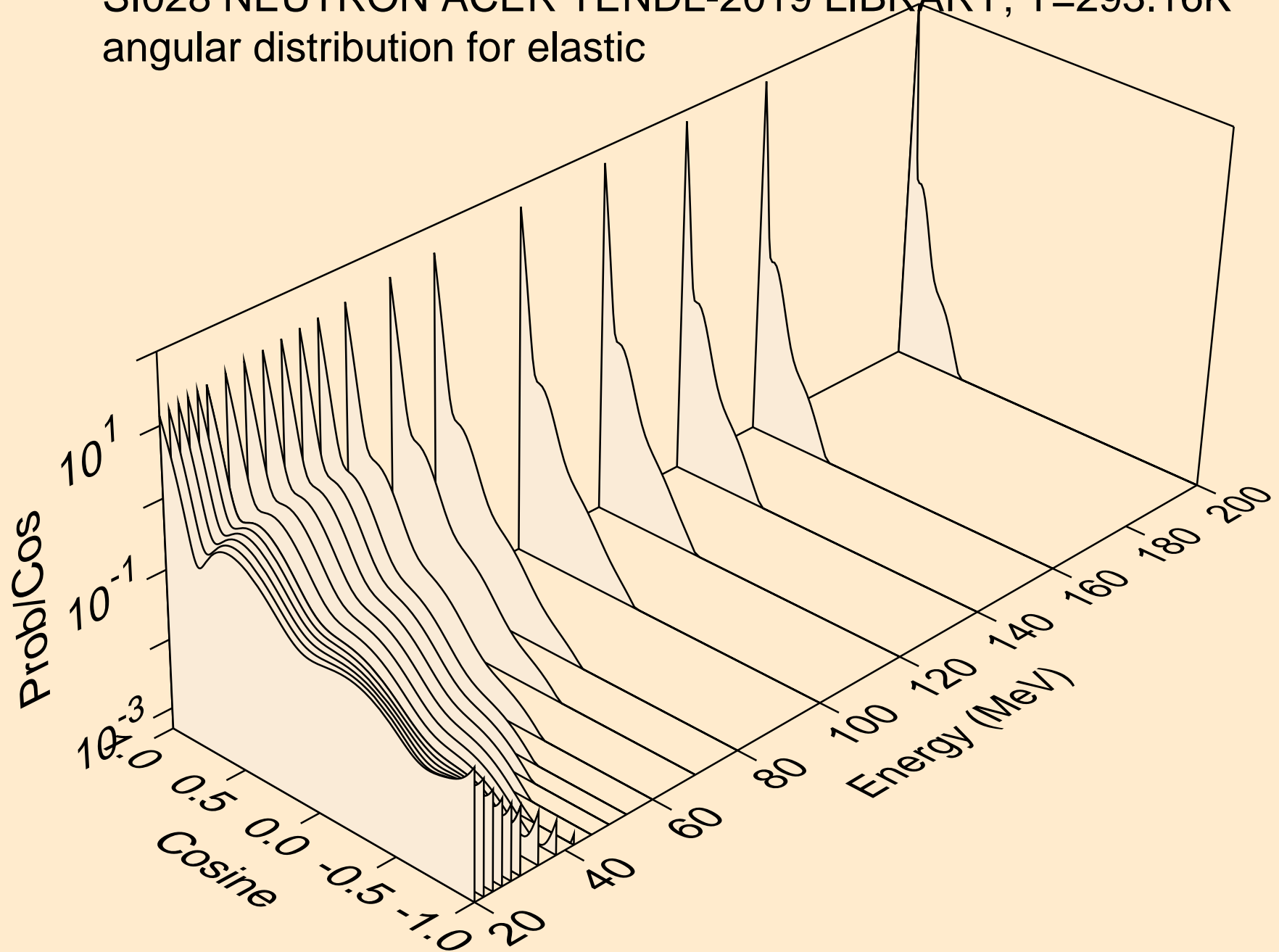

SI028 NEUTRON ACER TENDL-2019 LIBRARY; T=293.16K
angular distribution for (n,n*1)

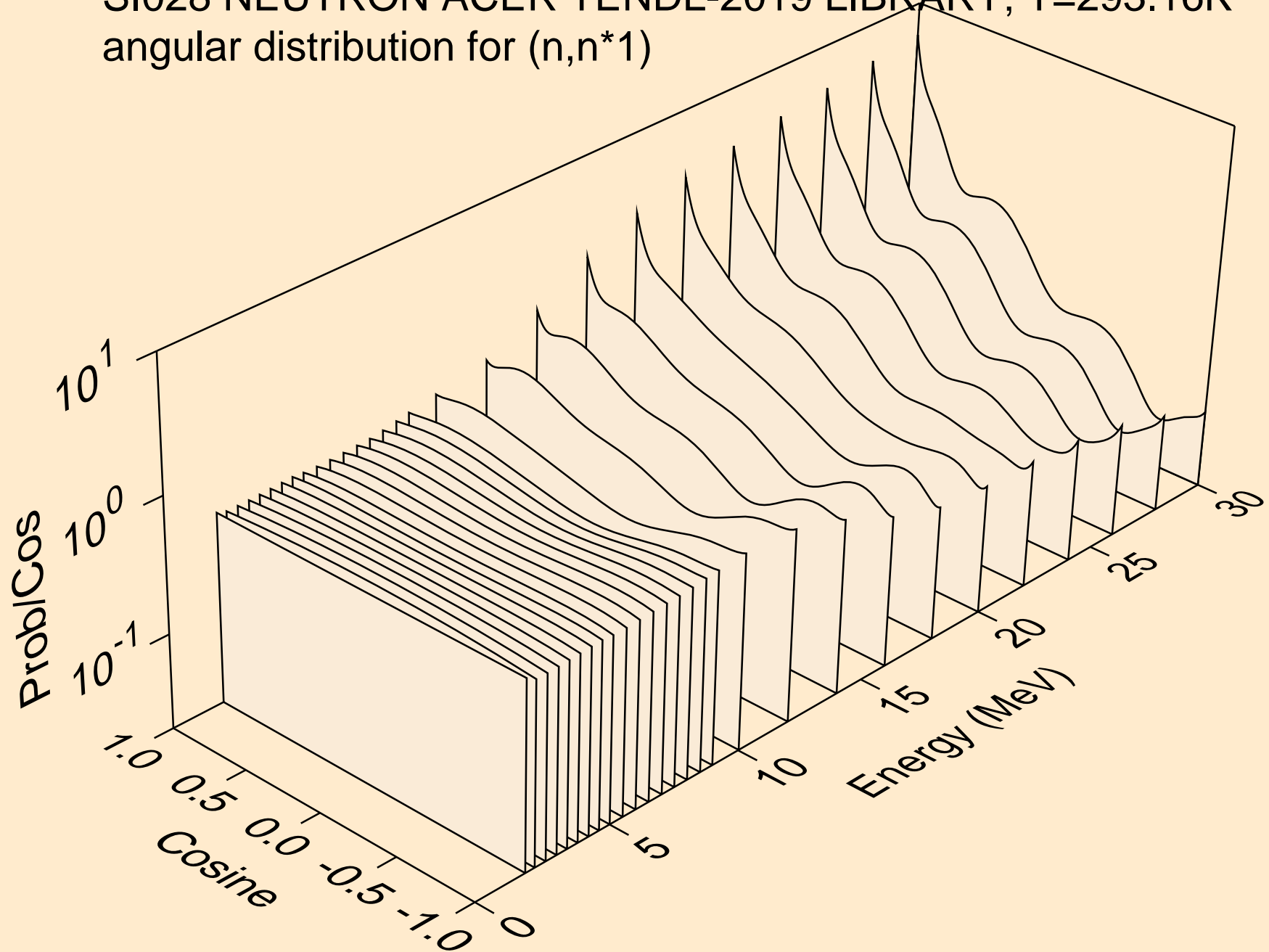

SI028 NEUTRON ACER TENDL-2019 LIBRARY; T=293.16K
angular distribution for (n,n*2)

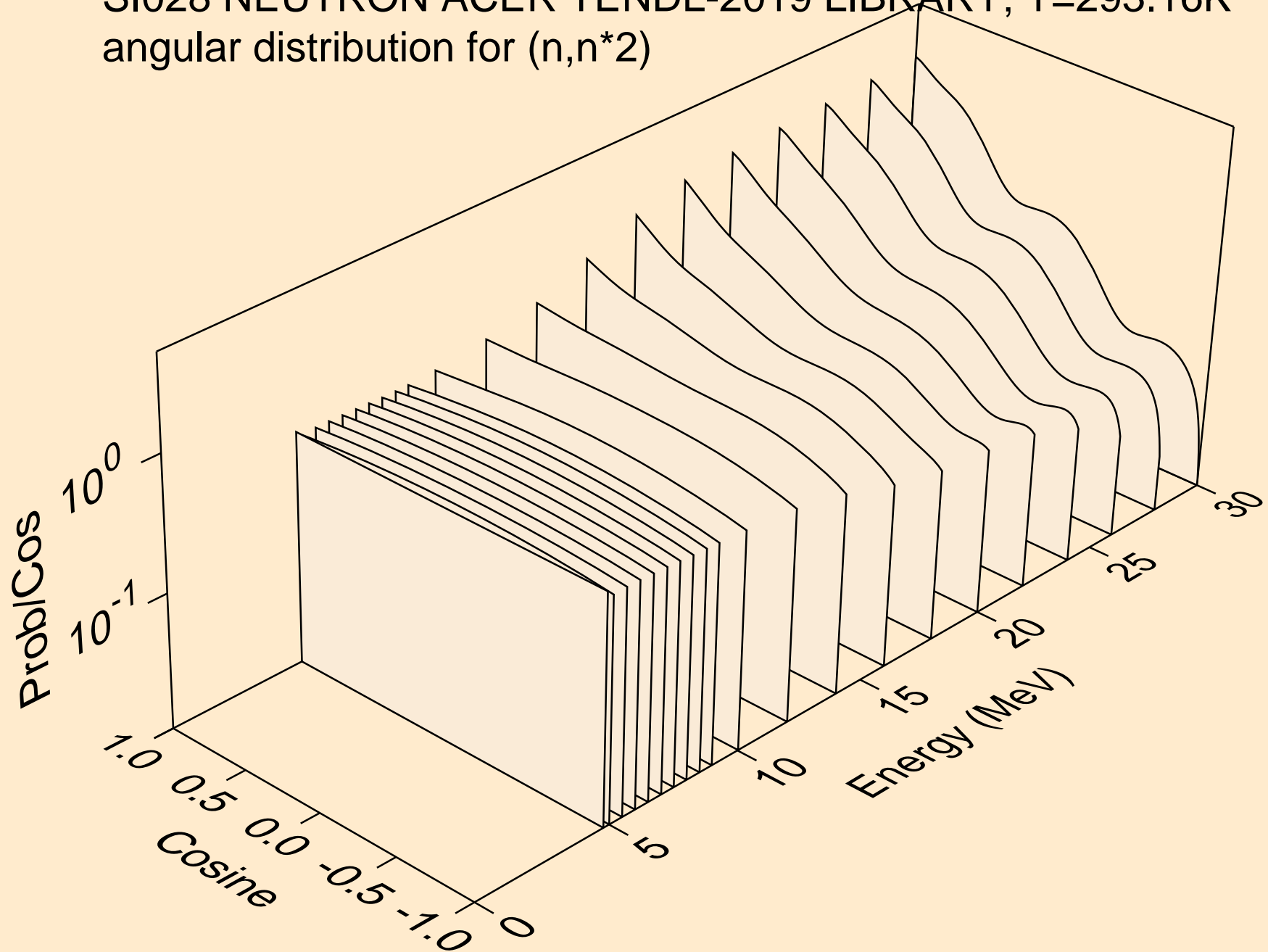

SI028 NEUTRON ACER TENDL-2019 LIBRARY; T=293.16K
angular distribution for (n,n*3)

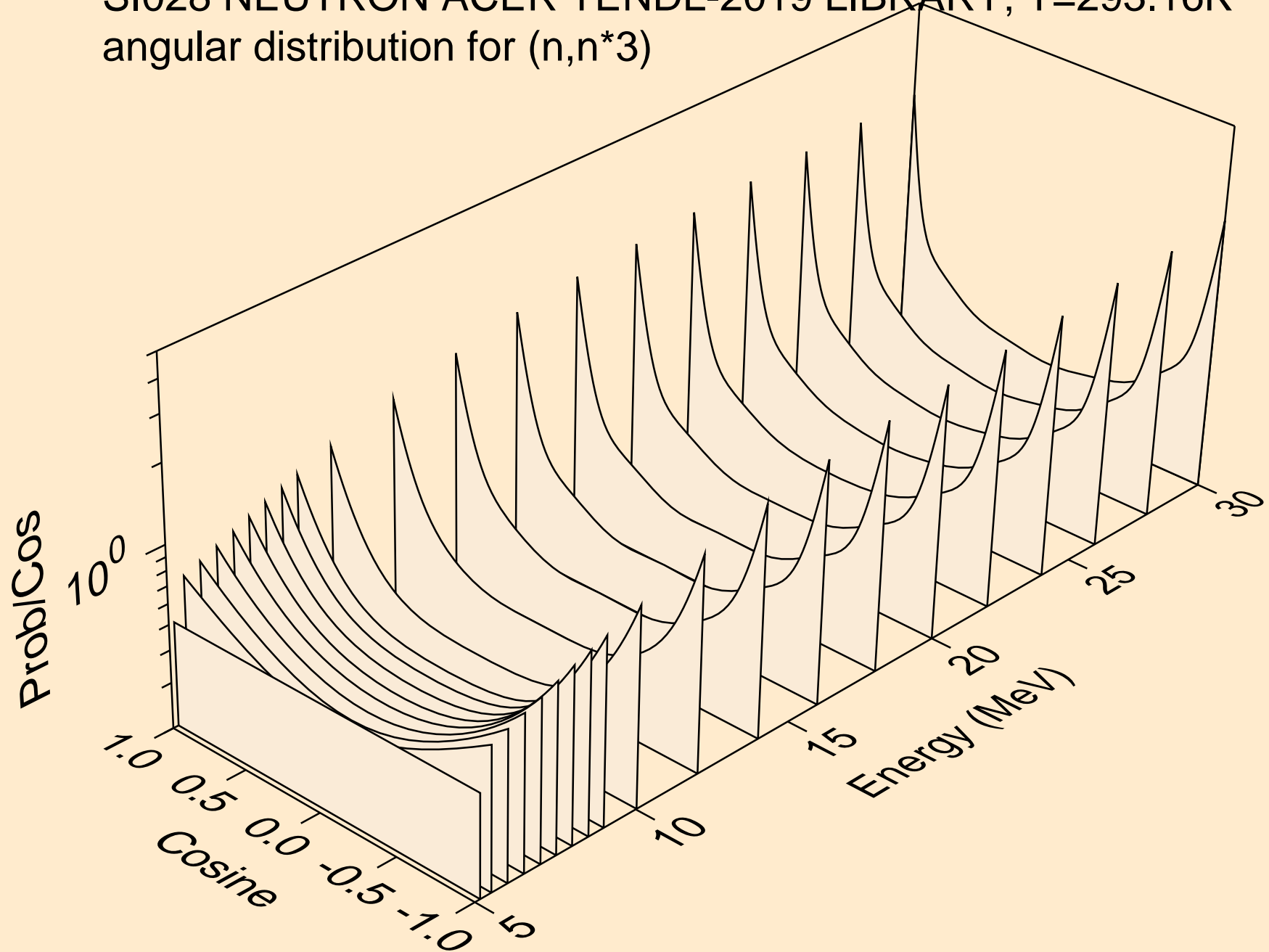

SI028 NEUTRON ACER TENDL-2019 LIBRARY; T=293.16K
angular distribution for (n,n*4)

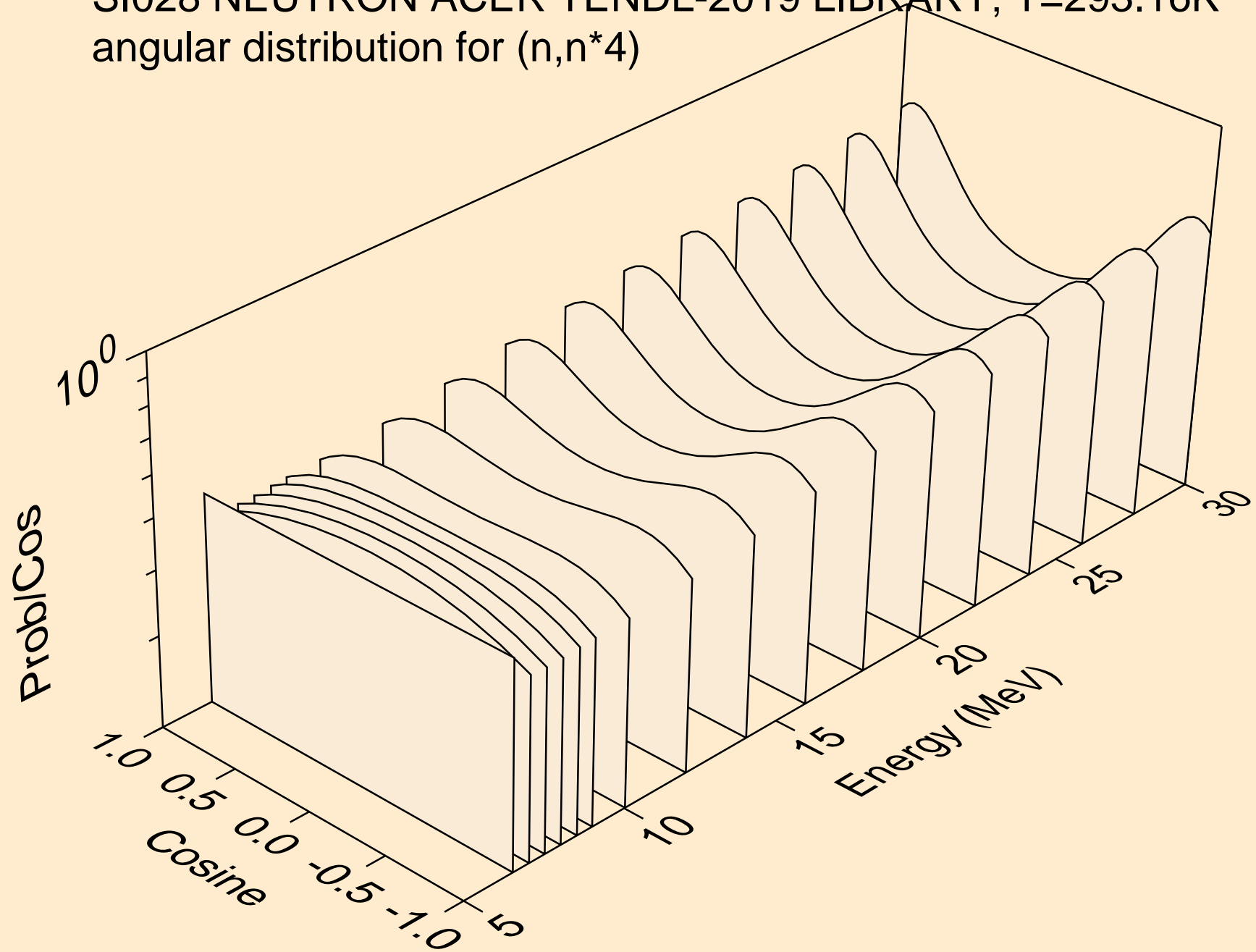

SI028 NEUTRON ACER TENDL-2019 LIBRARY; T=293.16K
angular distribution for (n,n*5)

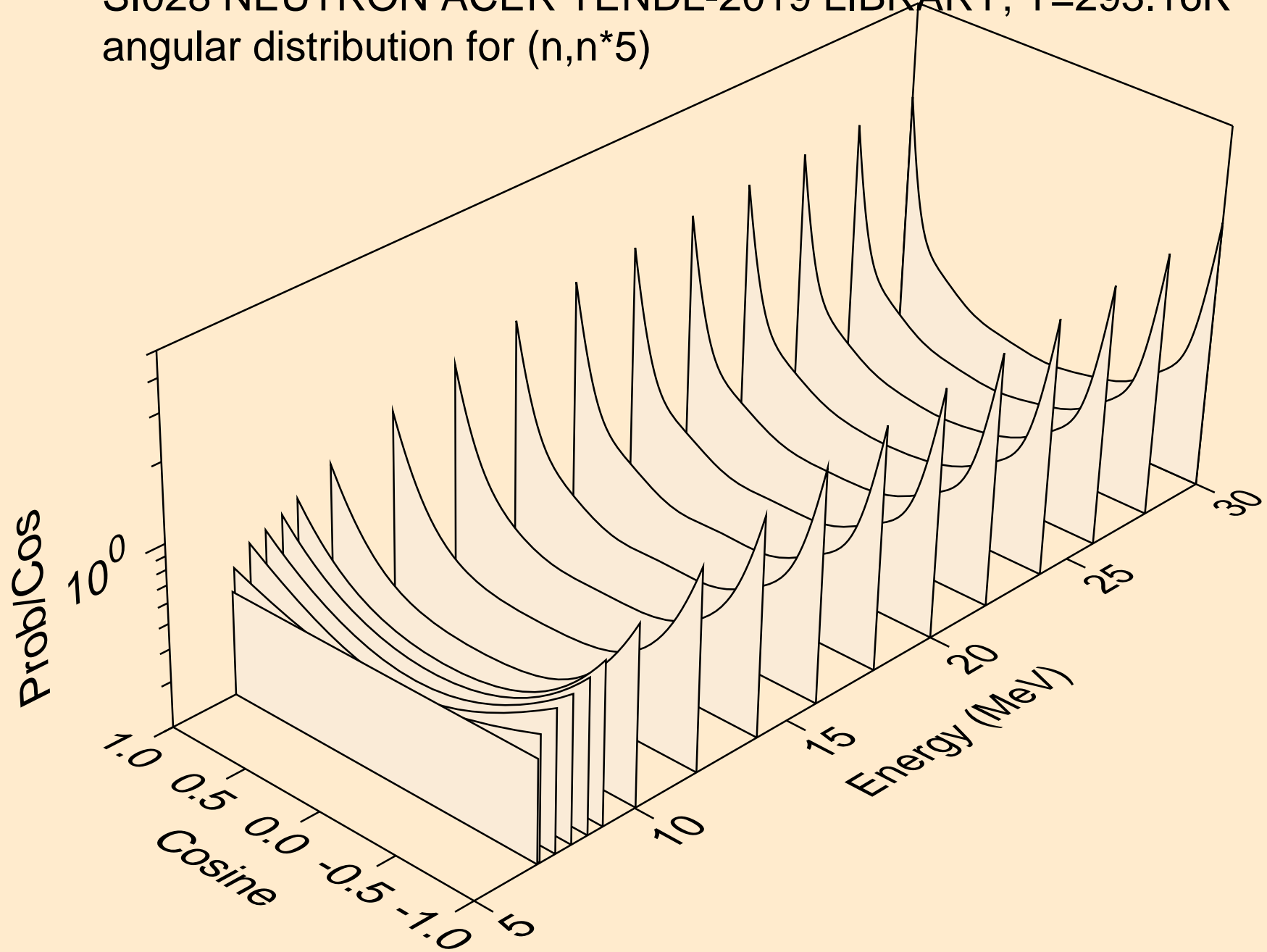

SI028 NEUTRON ACER TENDL-2019 LIBRARY; T=293.16K
angular distribution for (n,n*6)

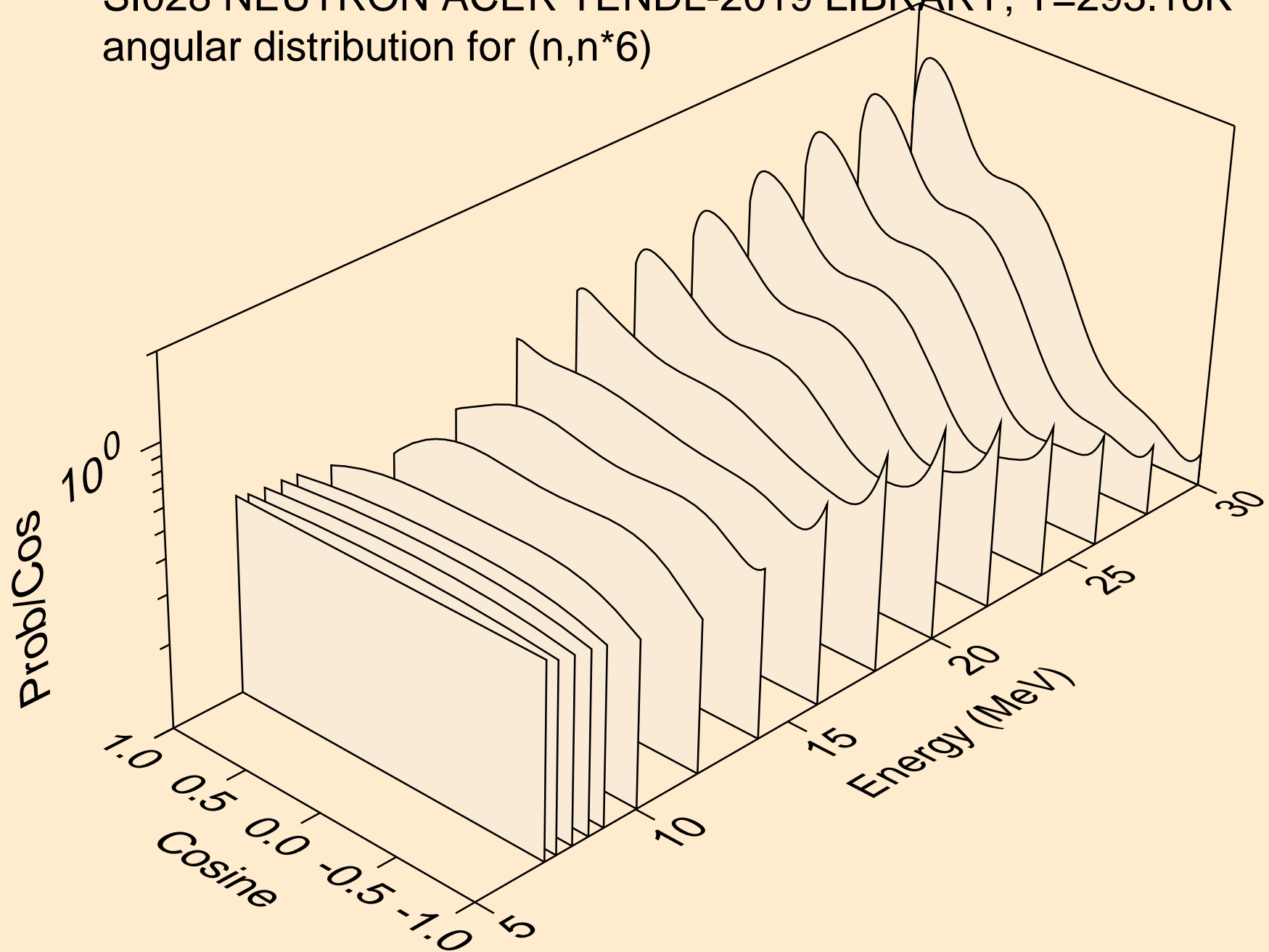

SI028 NEUTRON ACER TENDL-2019 LIBRARY; T=293.16K
angular distribution for (n,n*7)

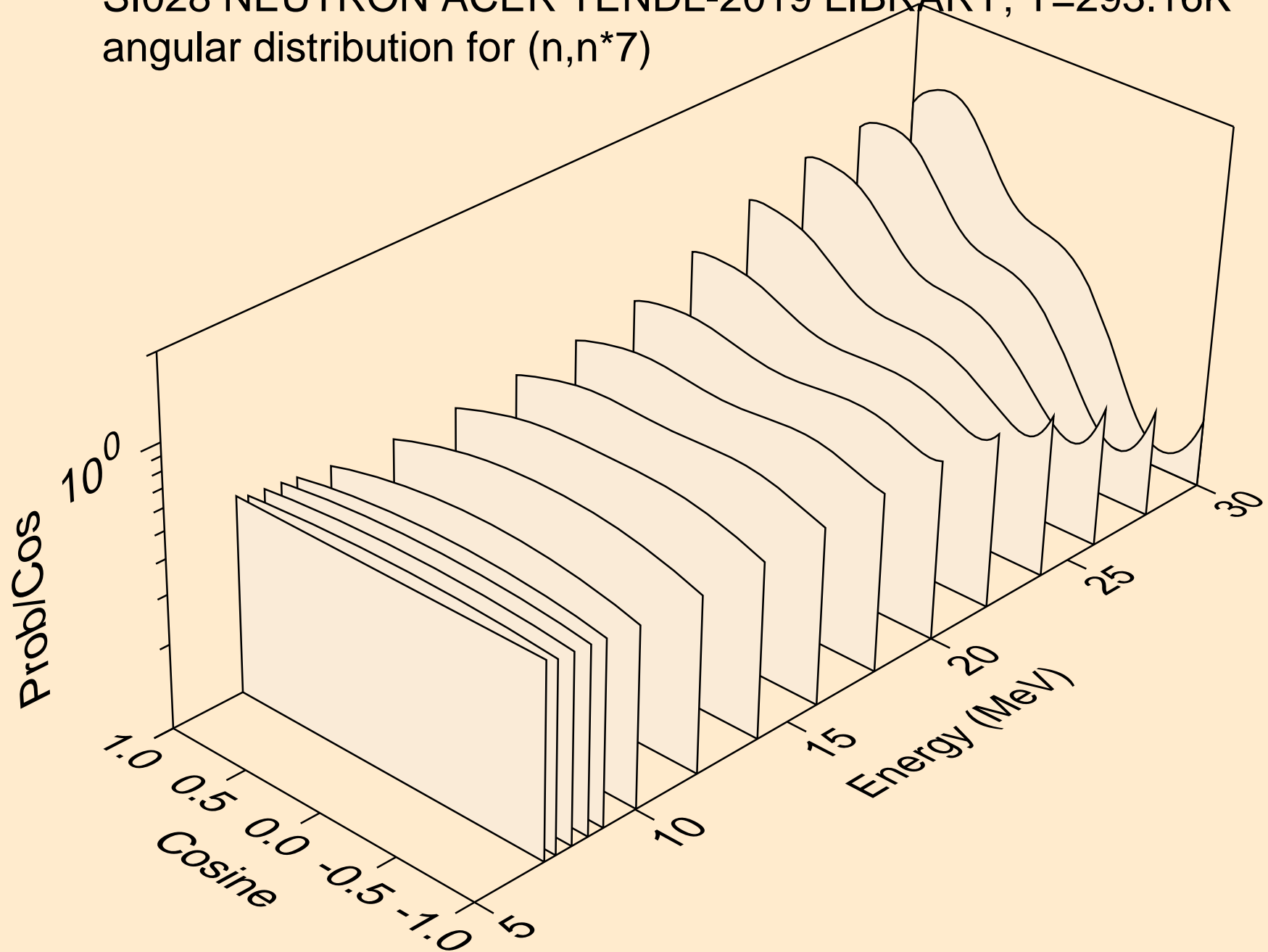

SI028 NEUTRON ACER TENDL-2019 LIBRARY; T=293.16K
angular distribution for (n,n*8)

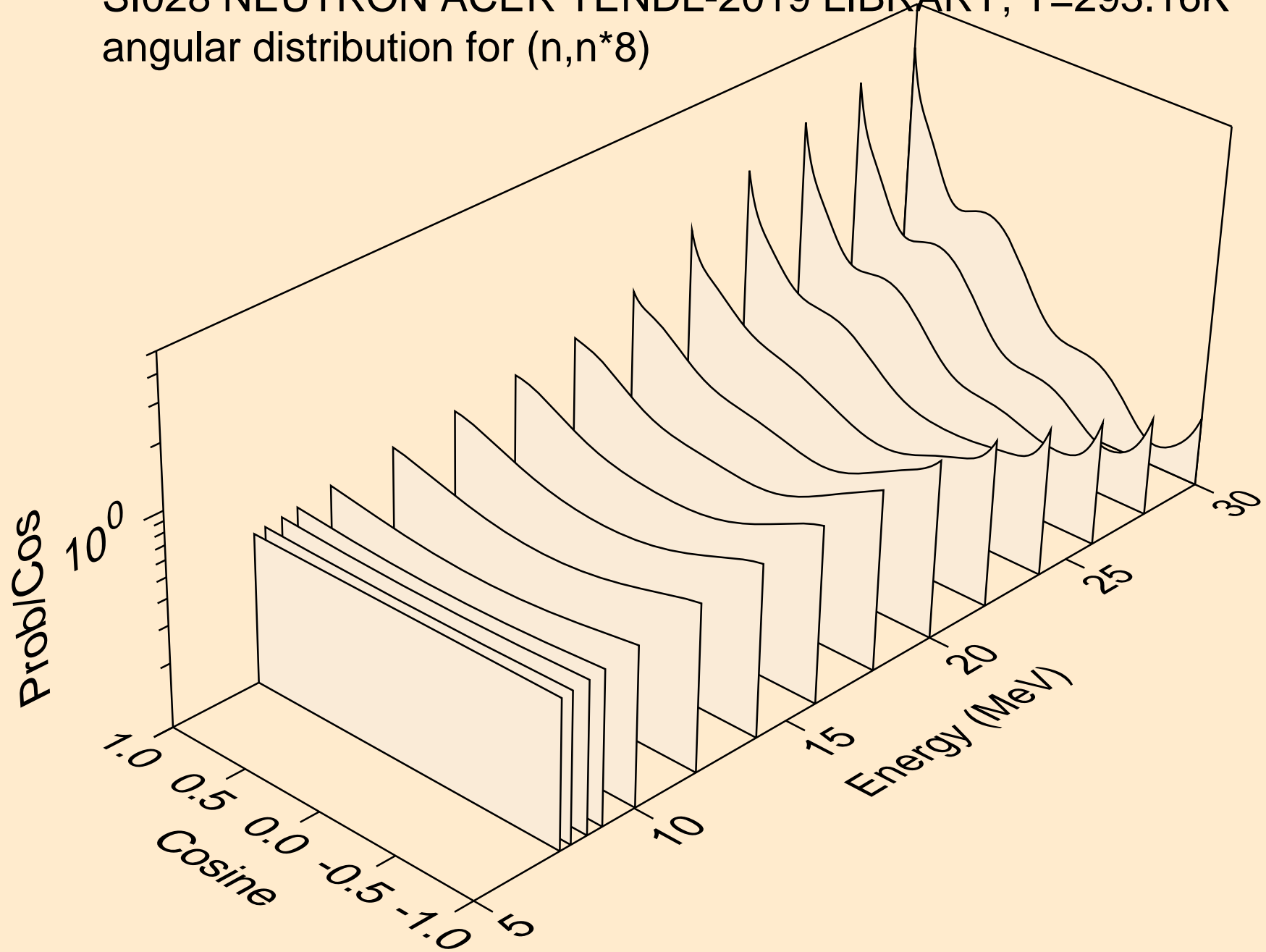

SI028 NEUTRON ACER TENDL-2019 LIBRARY; T=293.16K
angular distribution for (n,n*9)

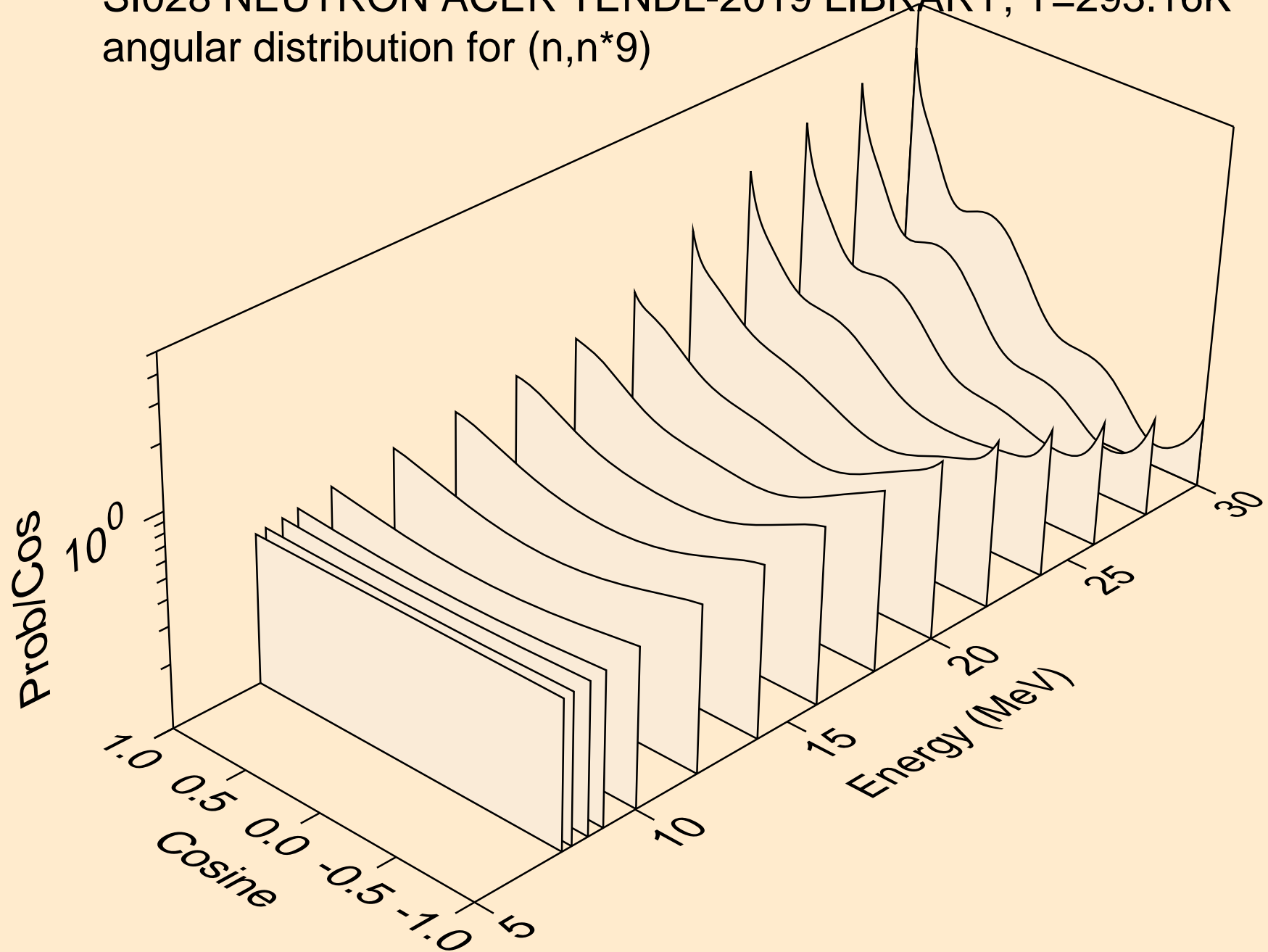

SI028 NEUTRON ACER TENDL-2019 LIBRARY; T=293.16K
angular distribution for (n,n*10)

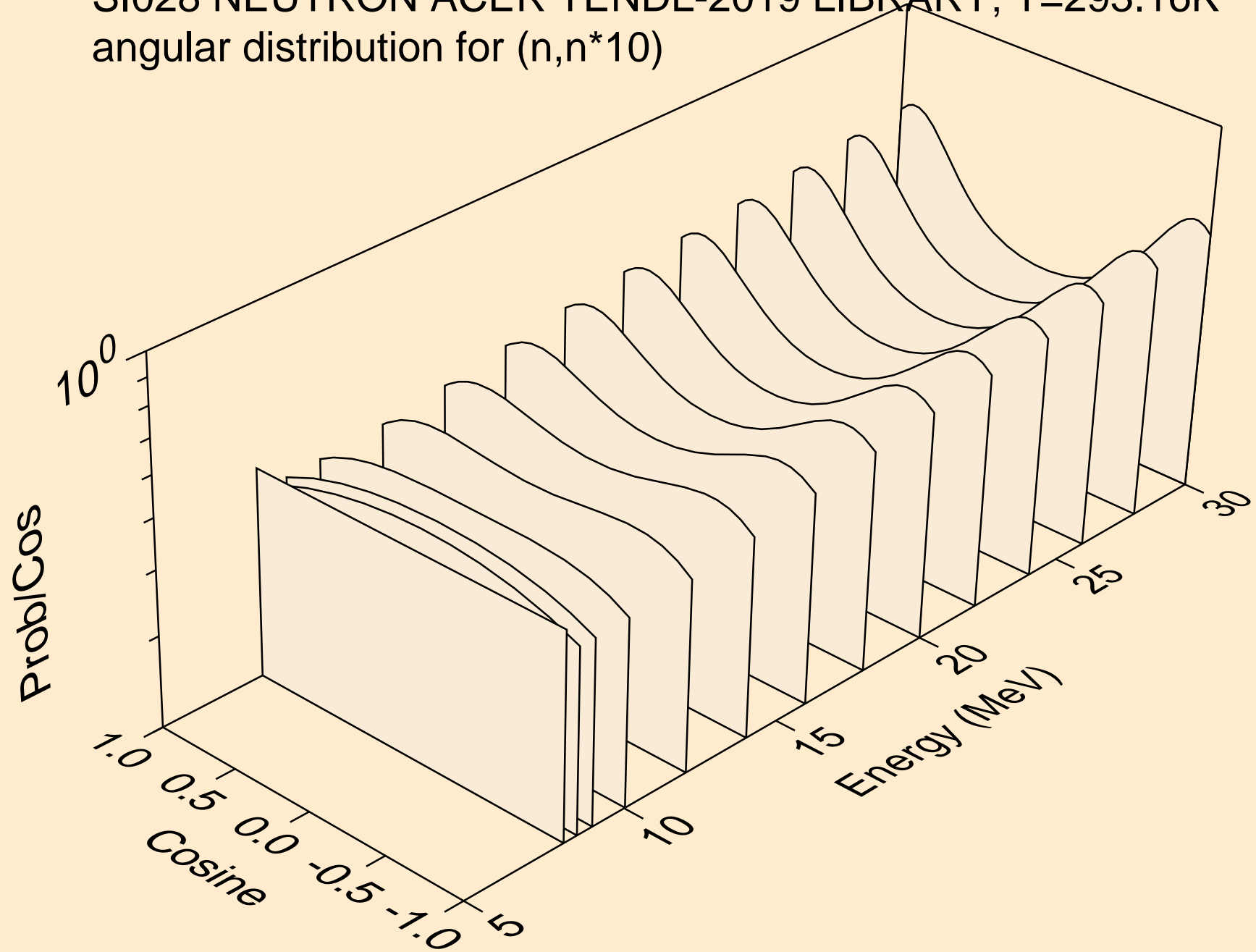

SI028 NEUTRON ACER TENDL-2019 LIBRARY; T=293.16K
angular distribution for (n,n*11)

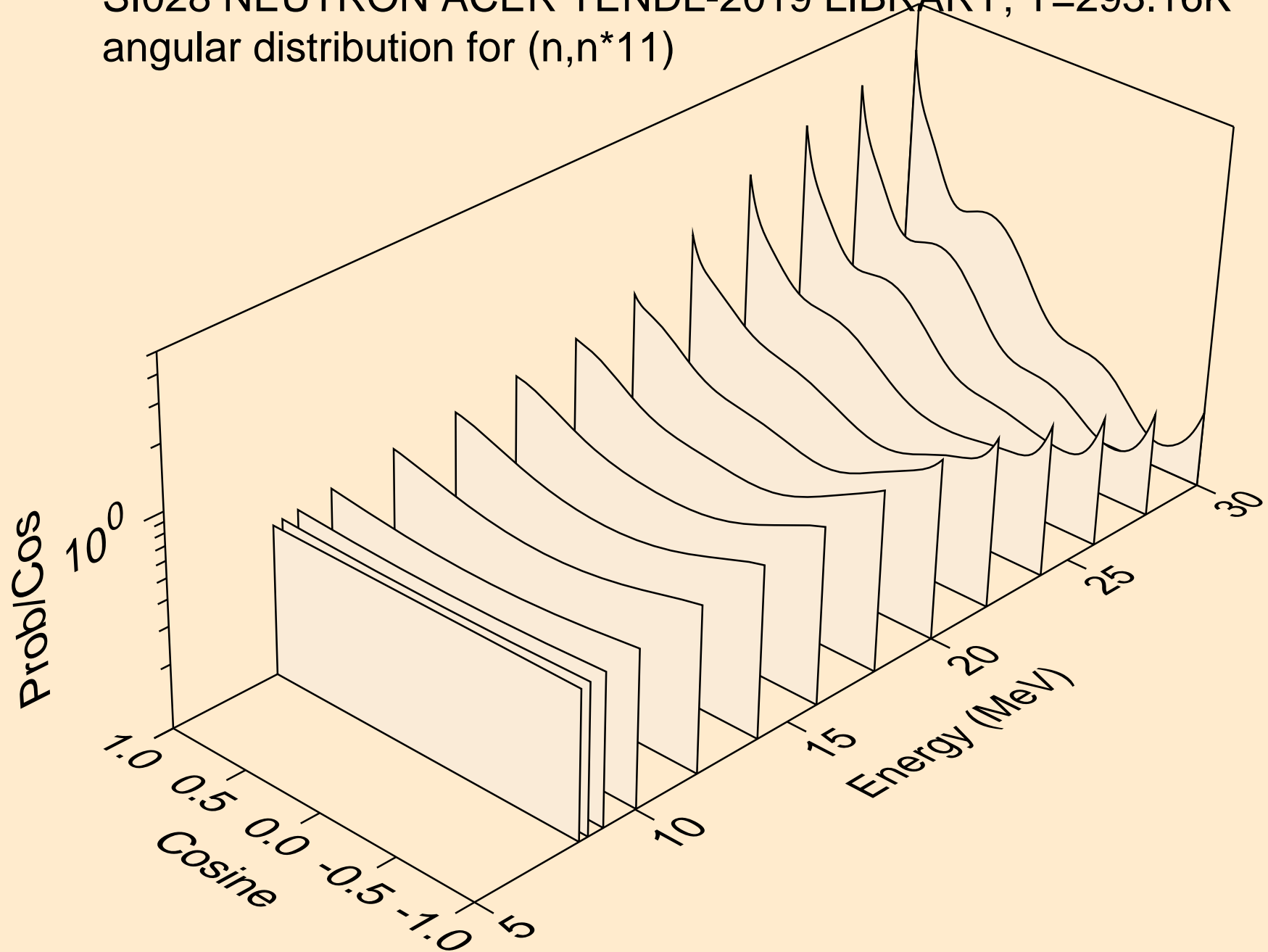

SI028 NEUTRON ACER TENDL-2019 LIBRARY; T=293.16K
angular distribution for (n,n*12)

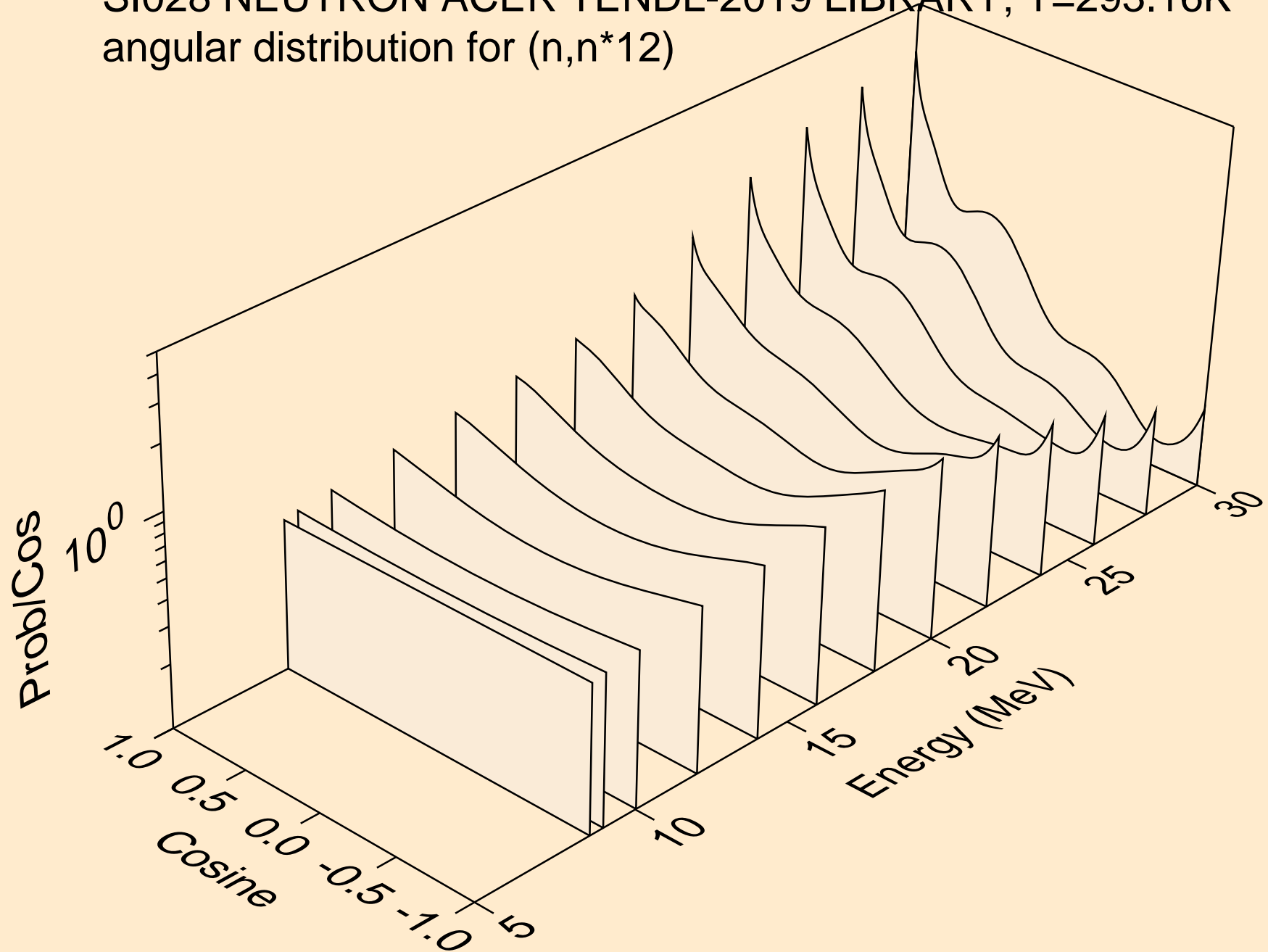

SI028 NEUTRON ACER TENDL-2019 LIBRARY; T=293.16K
angular distribution for (n,n*13)

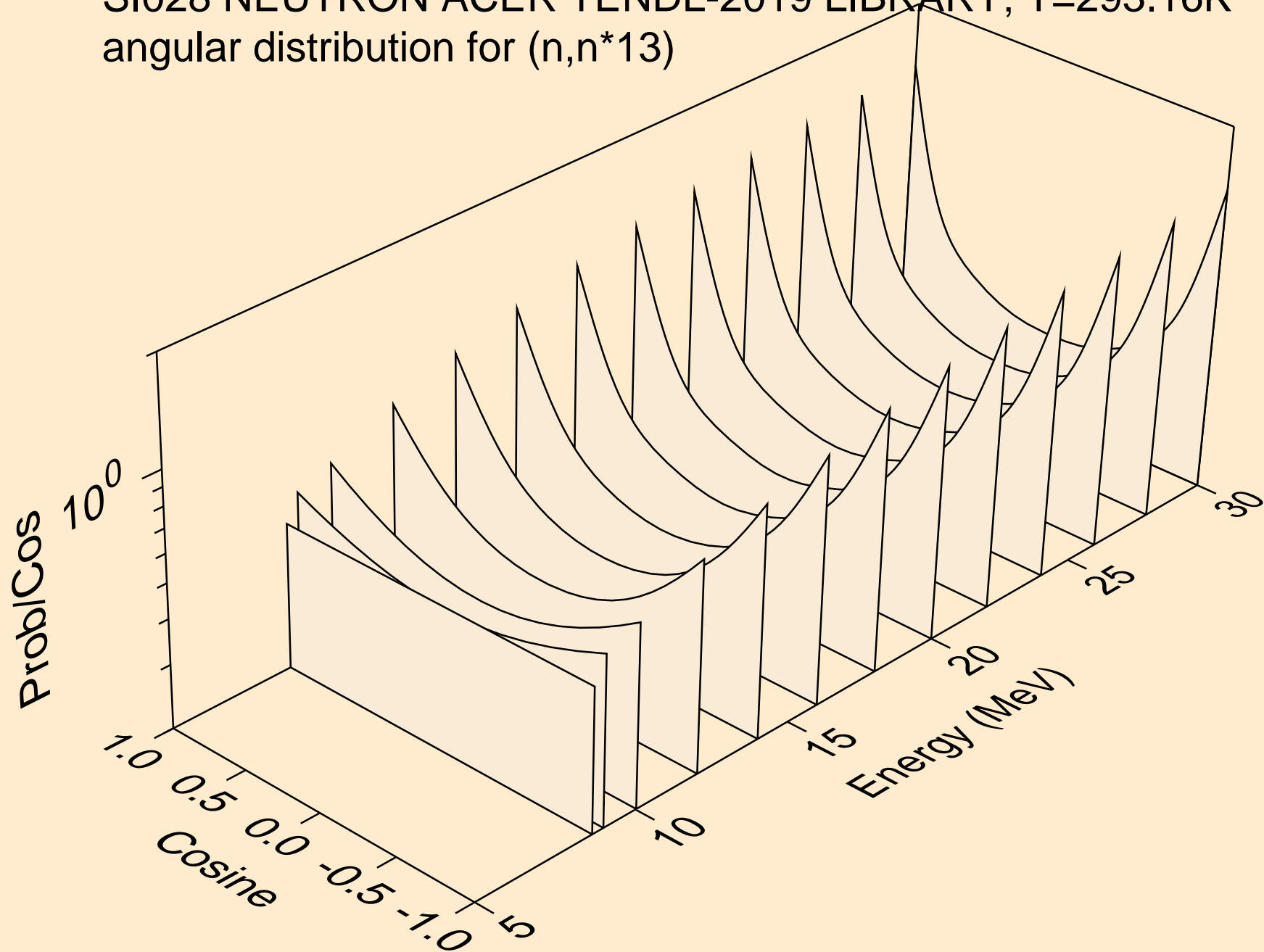

SI028 NEUTRON ACER TENDL-2019 LIBRARY; T=293.16K
angular distribution for (n,n*14)

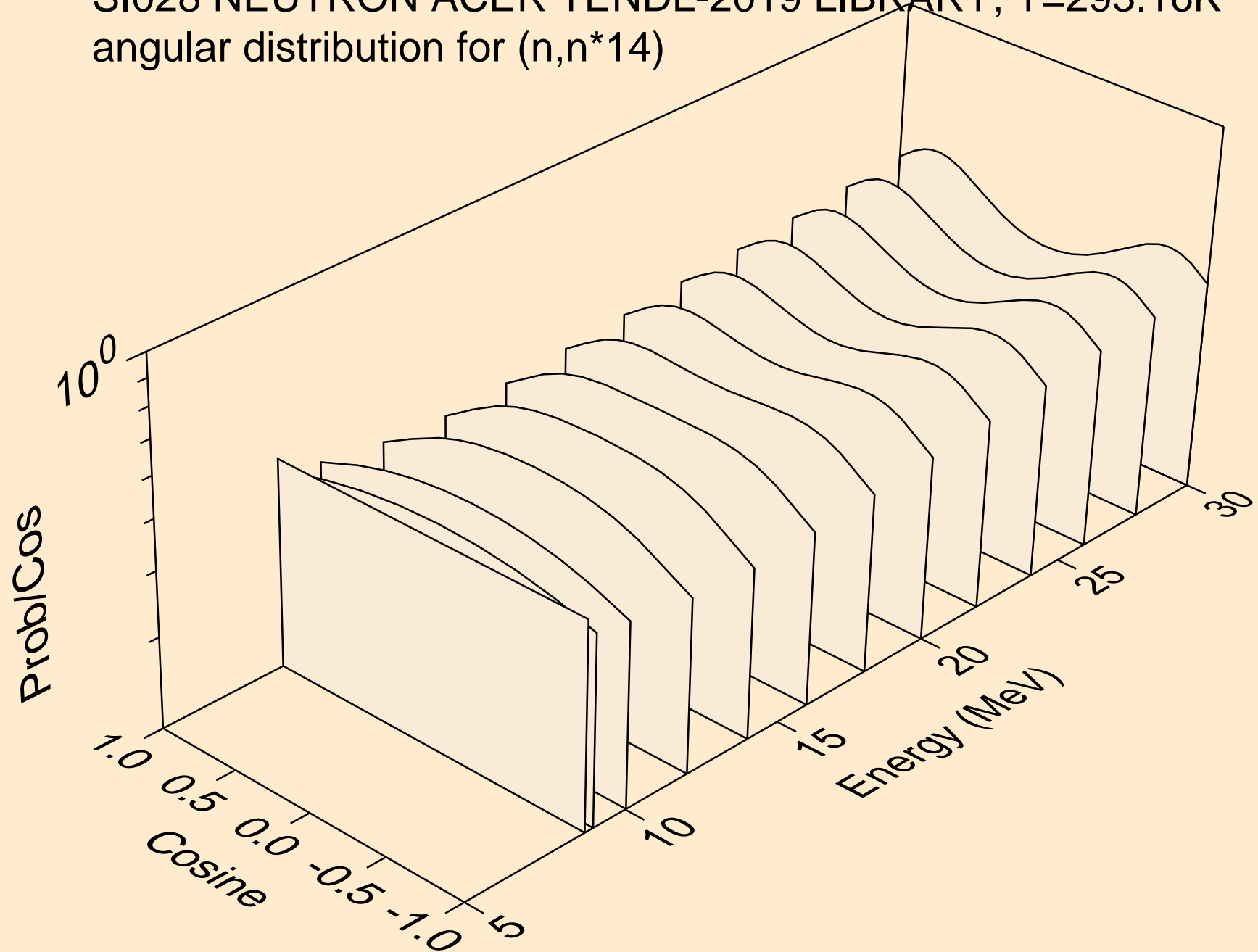

SI028 NEUTRON ACER TENDL-2019 LIBRARY; T=293.16K
angular distribution for (n,n*15)

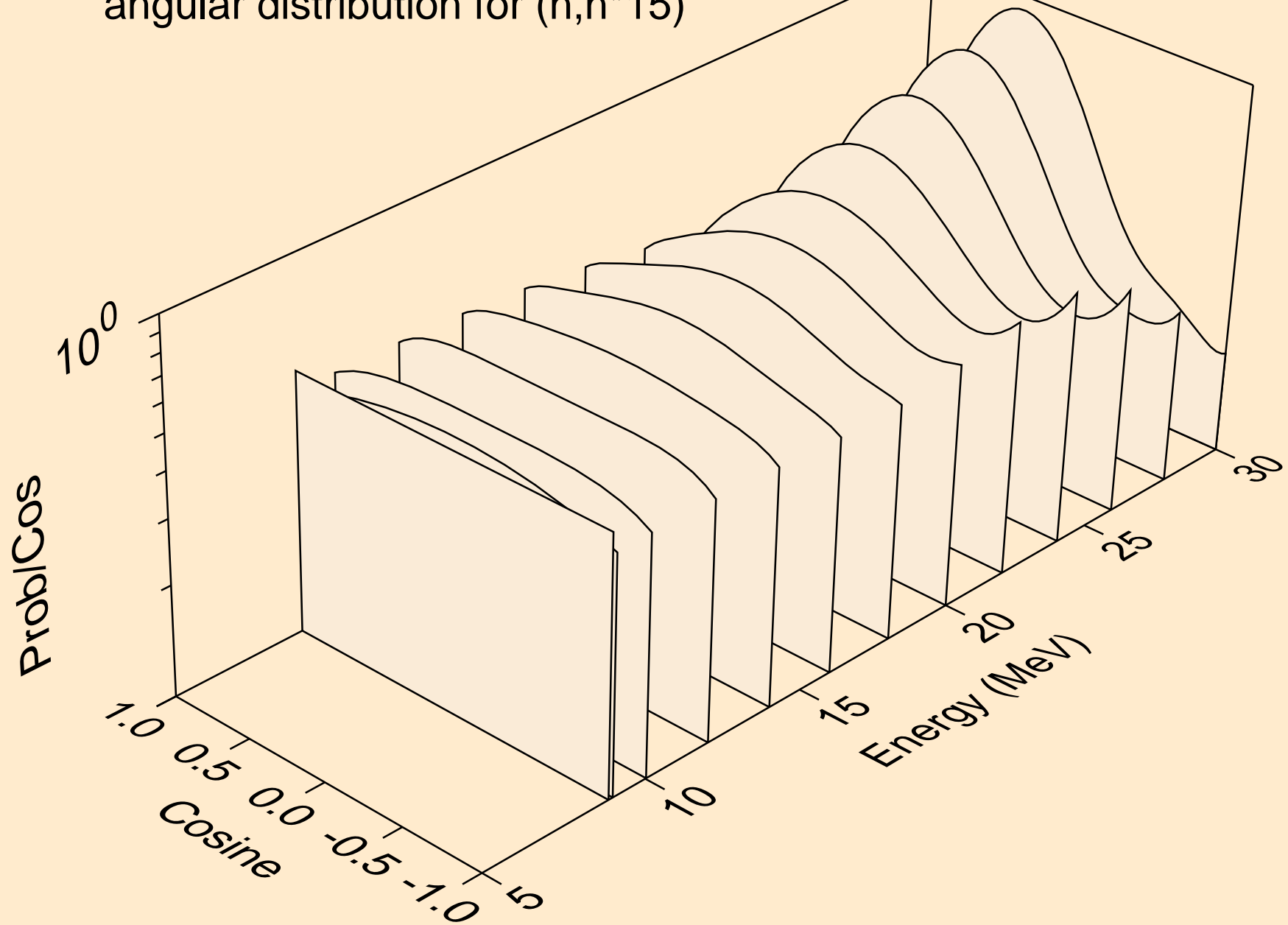

SI028 NEUTRON ACER TENDL-2019 LIBRARY; T=293.16K
angular distribution for (n,n*16)

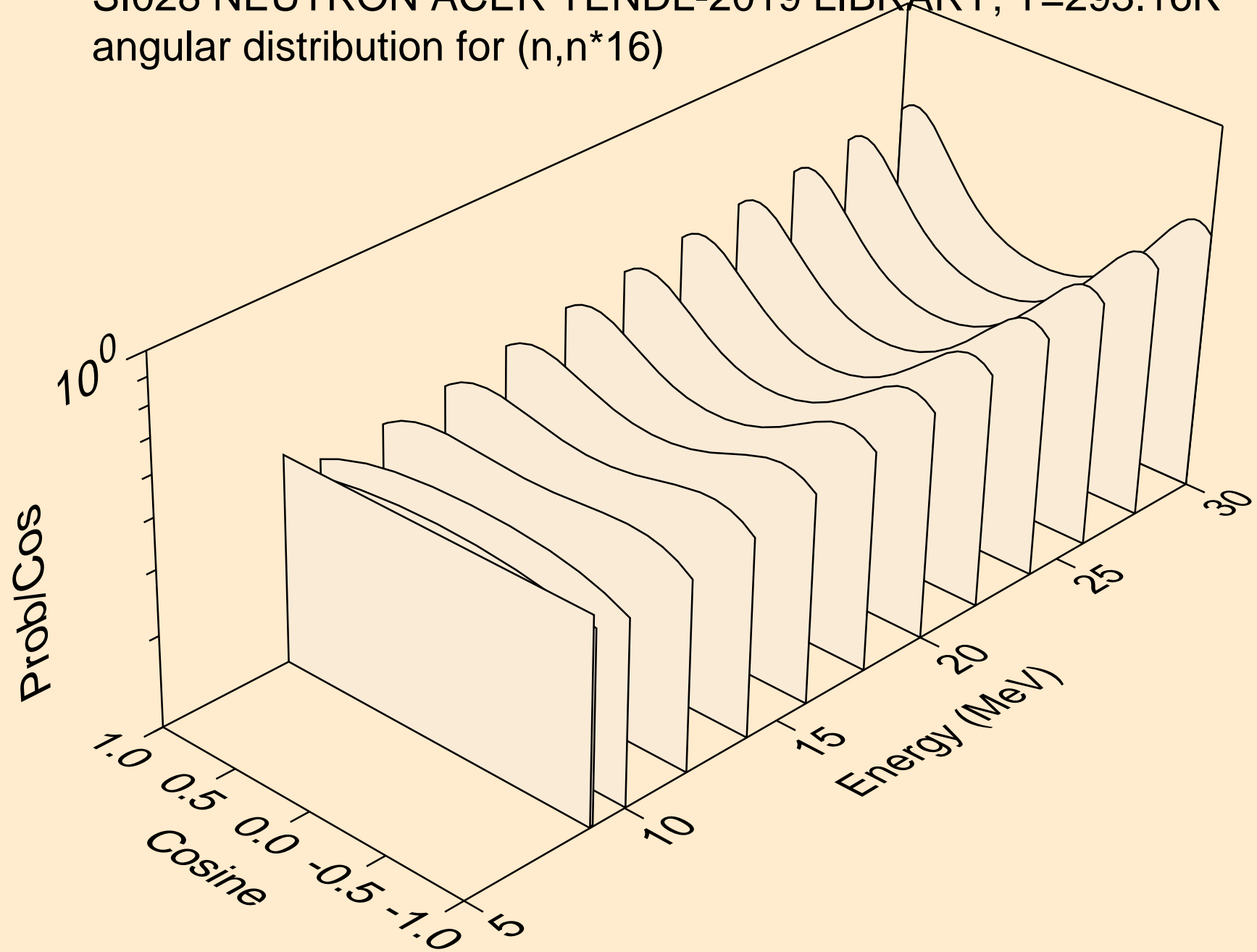

SI028 NEUTRON ACER TENDL-2019 LIBRARY; T=293.16K
angular distribution for (n,n*17)

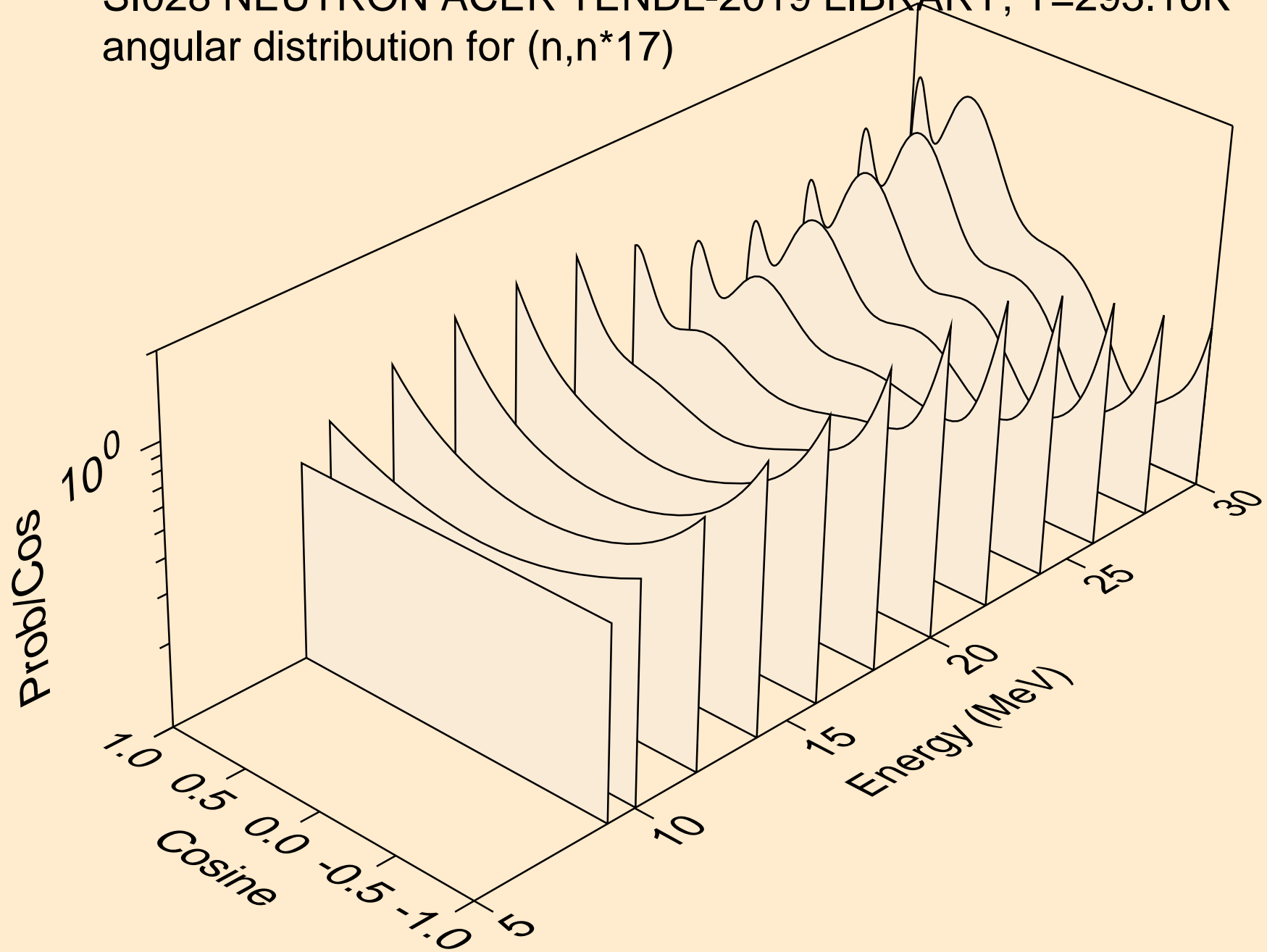

SI028 NEUTRON ACER TENDL-2019 LIBRARY; T=293.16K
angular distribution for (n,n*18)

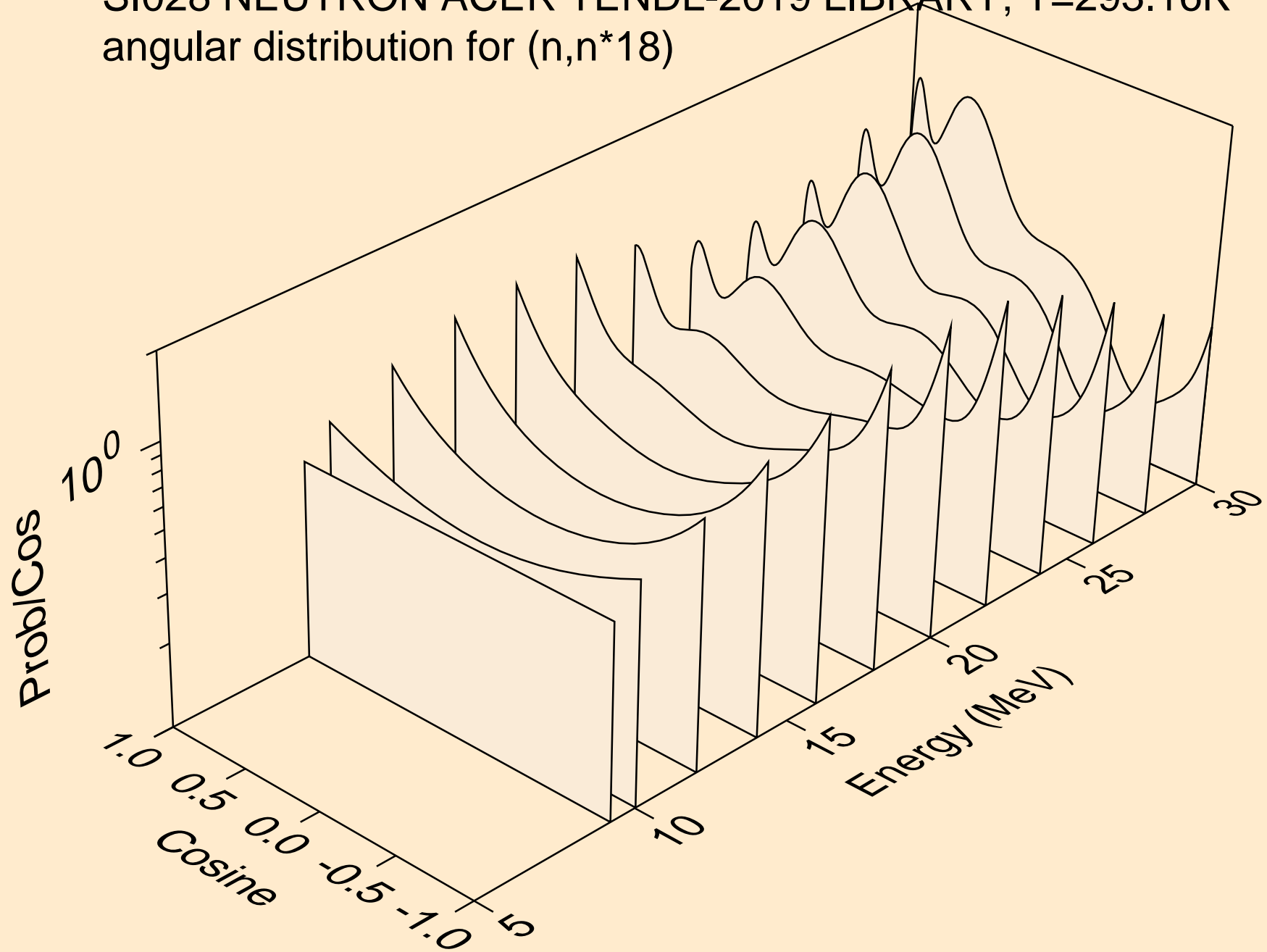

SI028 NEUTRON ACER TENDL-2019 LIBRARY; T=293.16K
angular distribution for (n,n*19)

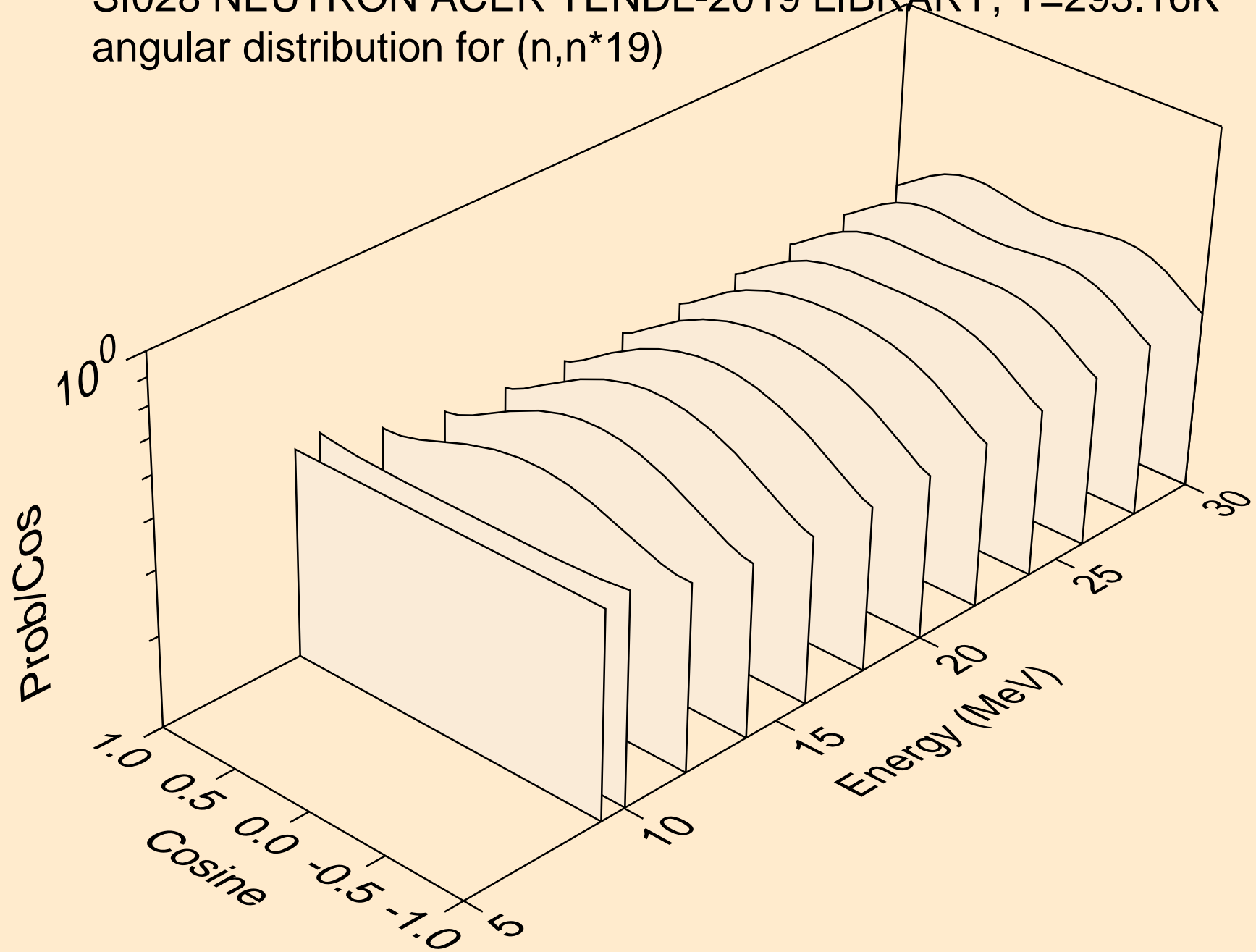

SI028 NEUTRON ACER TENDL-2019 LIBRARY; T=293.16K
angular distribution for (n,n*20)

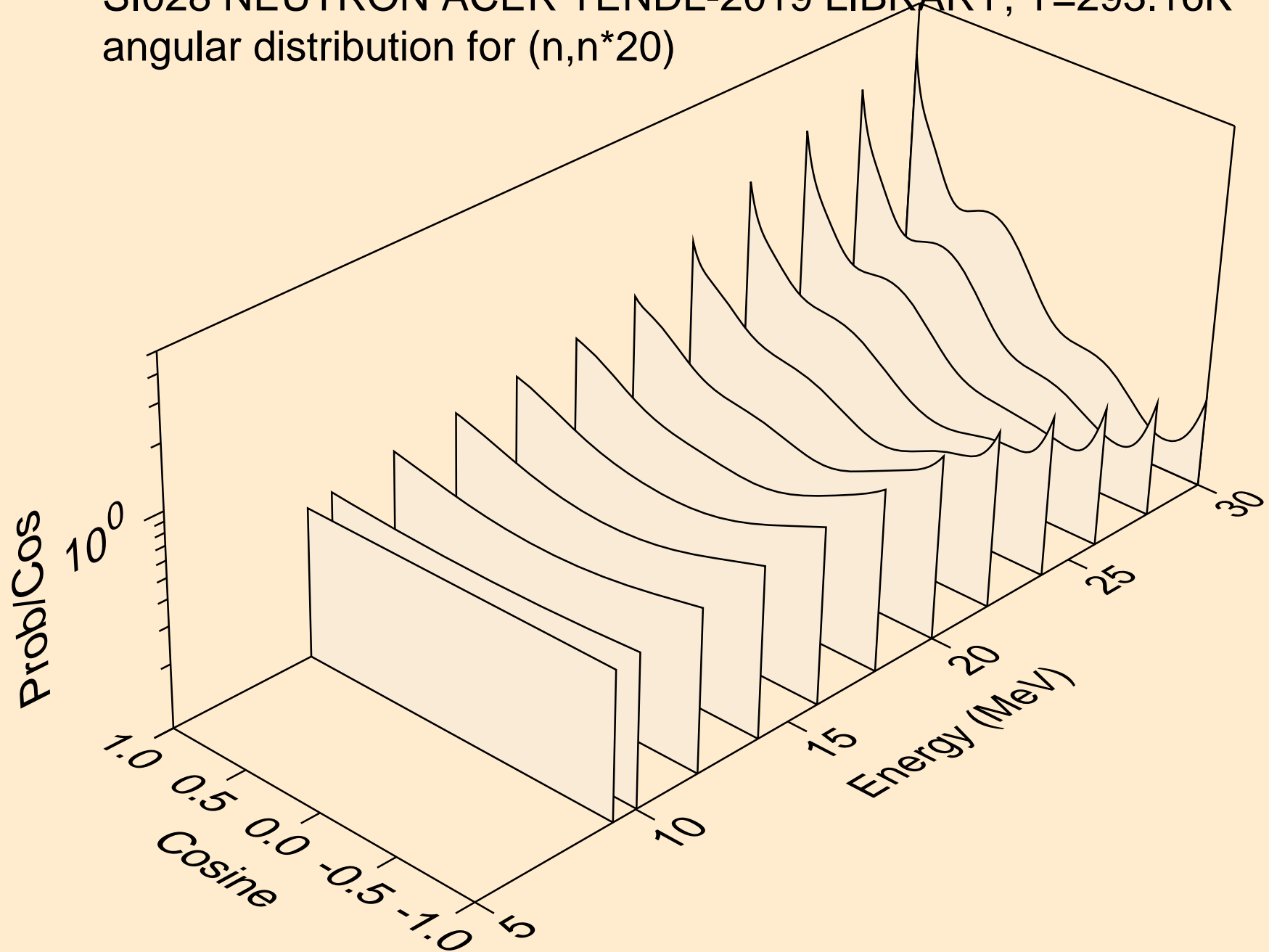

SI028 NEUTRON ACER TENDL-2019 LIBRARY; T=293.16K
angular distribution for (n,n*21)

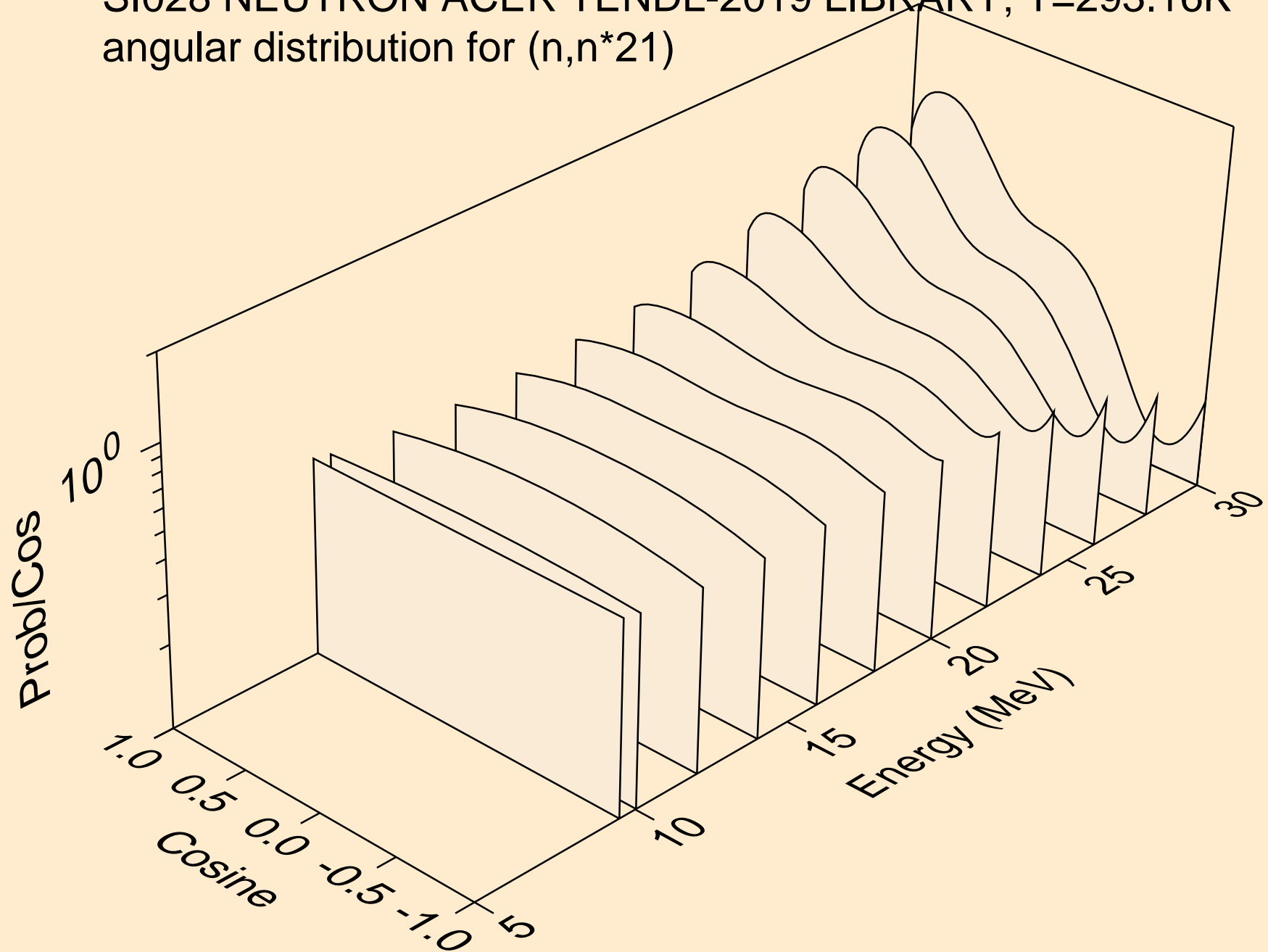

SI028 NEUTRON ACER TENDL-2019 LIBRARY; T=293.16K
angular distribution for (n,n*22)

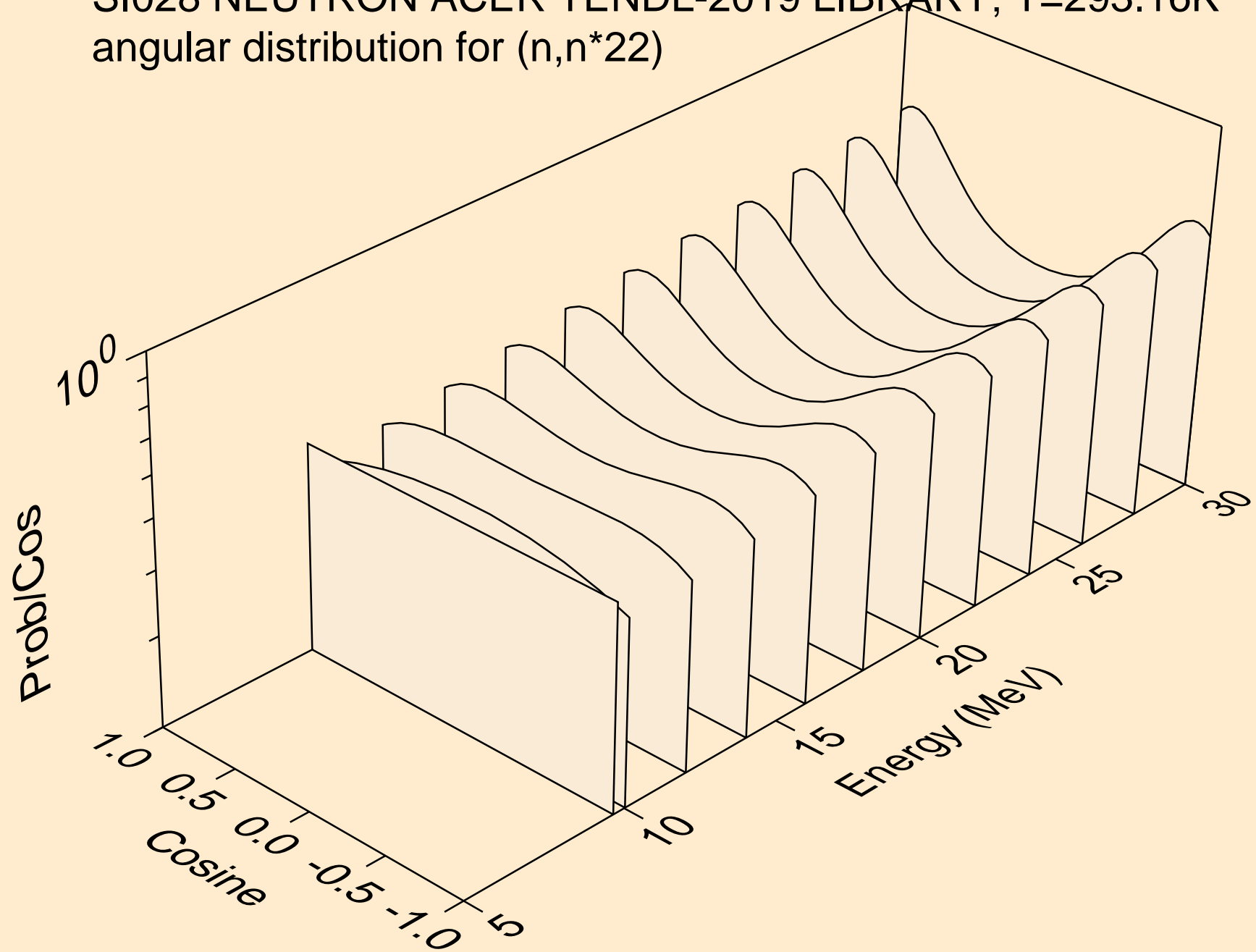

SI028 NEUTRON ACER TENDL-2019 LIBRARY; T=293.16K
angular distribution for (n,n*23)

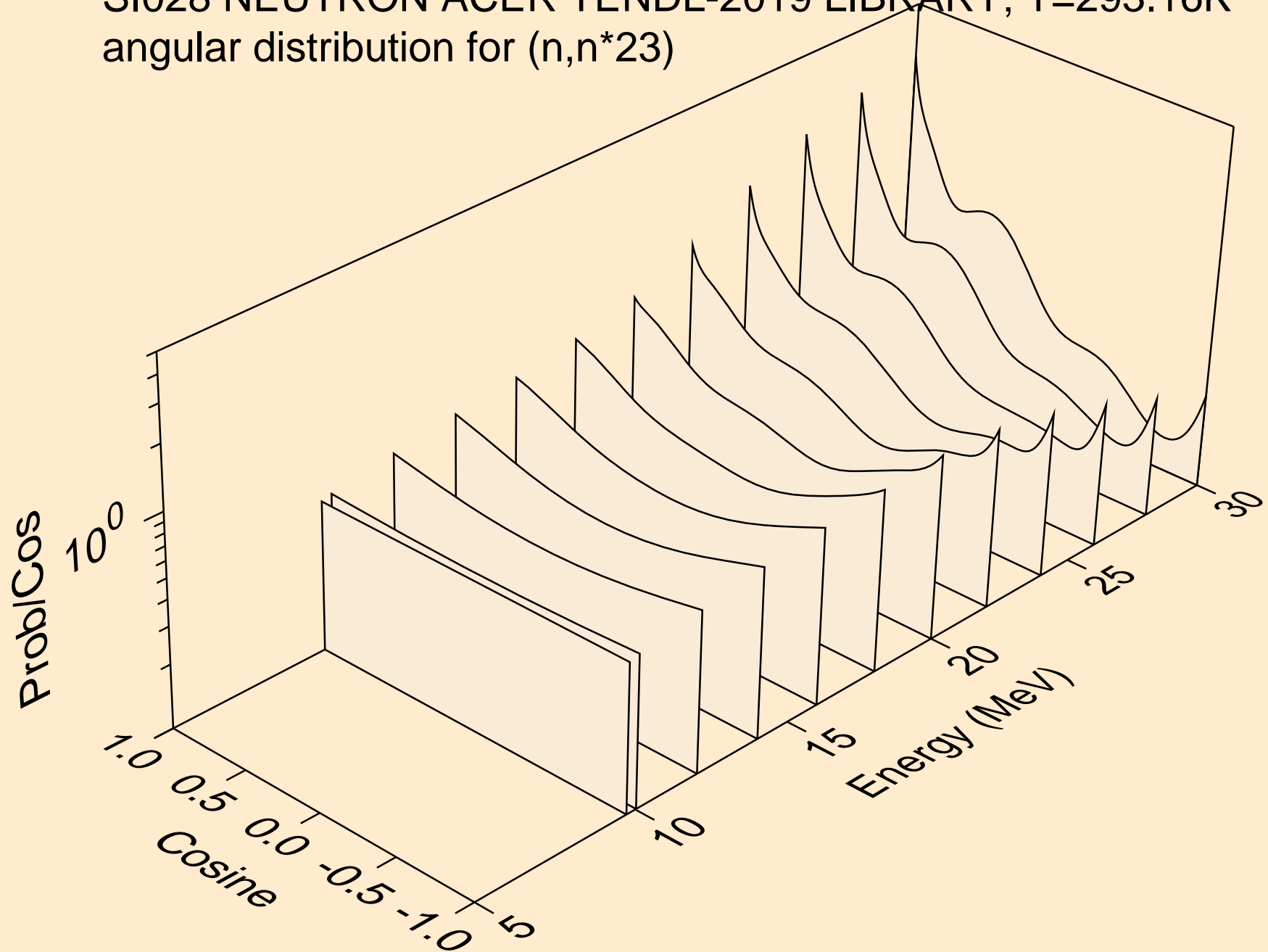

SI028 NEUTRON ACER TENDL-2019 LIBRARY; T=293.16K
angular distribution for (n,n*24)

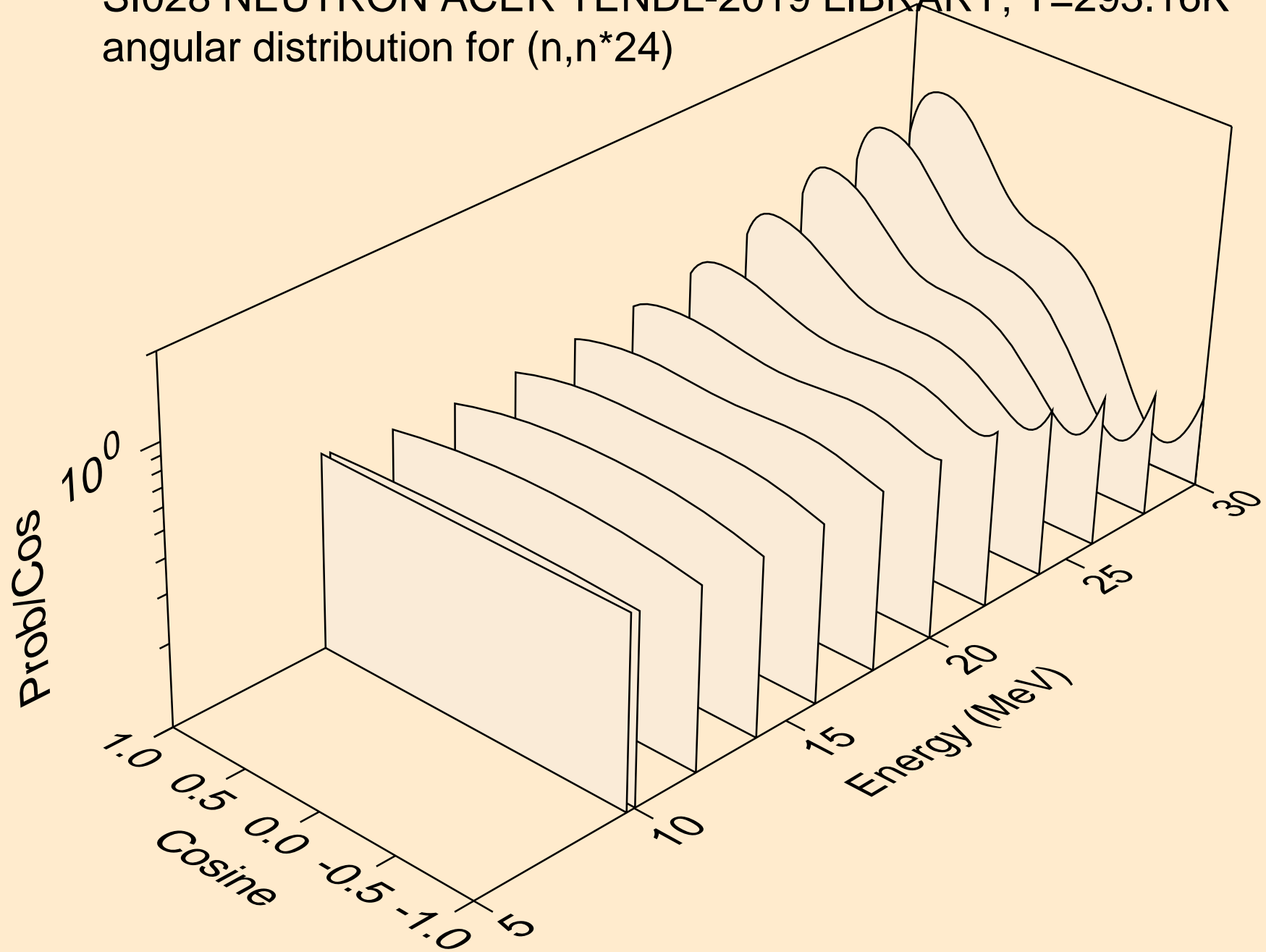

SI028 NEUTRON ACER TENDL-2019 LIBRARY; T=293.16K
angular distribution for (n,n*25)

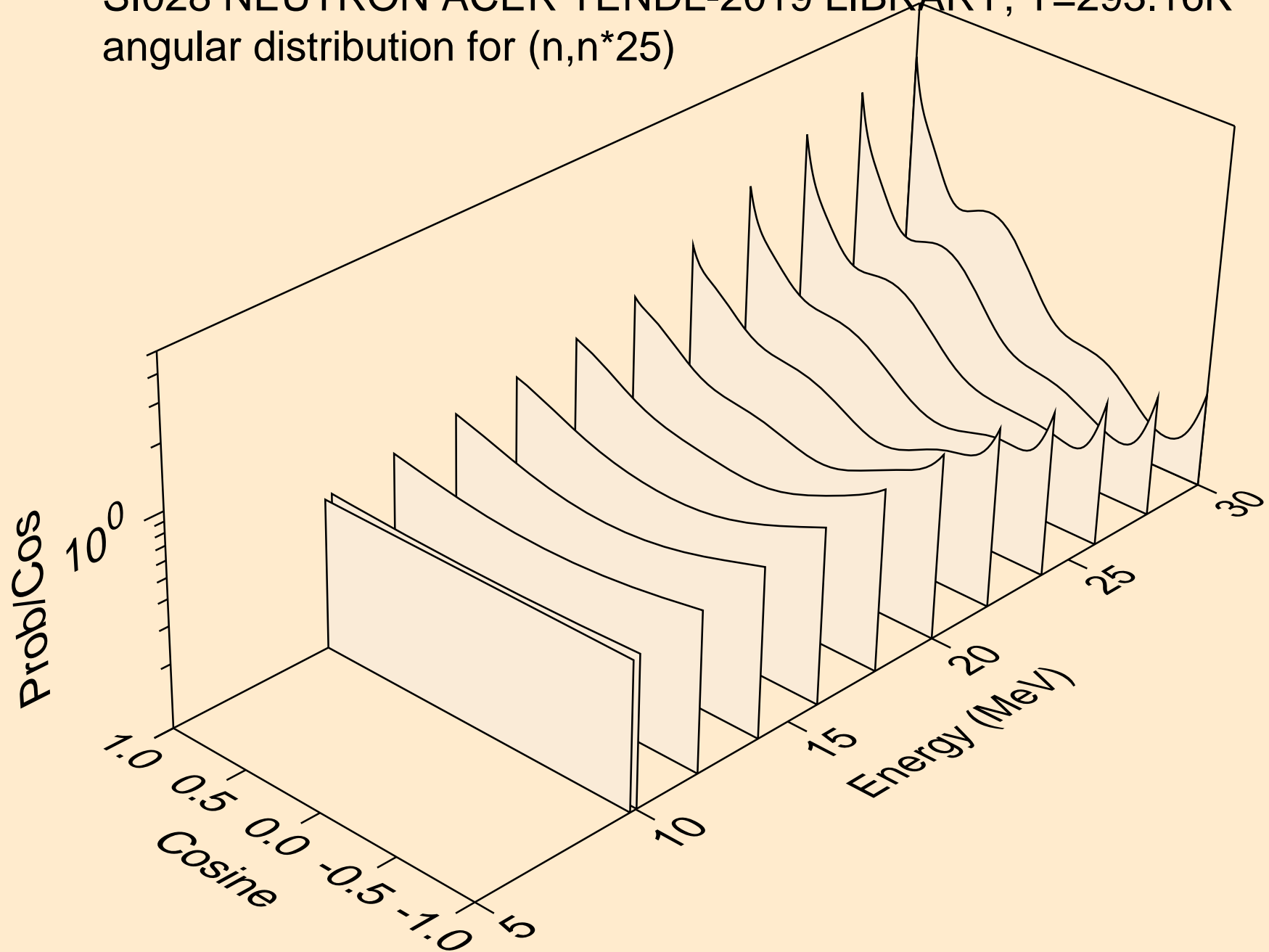

SI028 NEUTRON ACER TENDL-2019 LIBRARY; T=293.16K
angular distribution for (n,n*26)

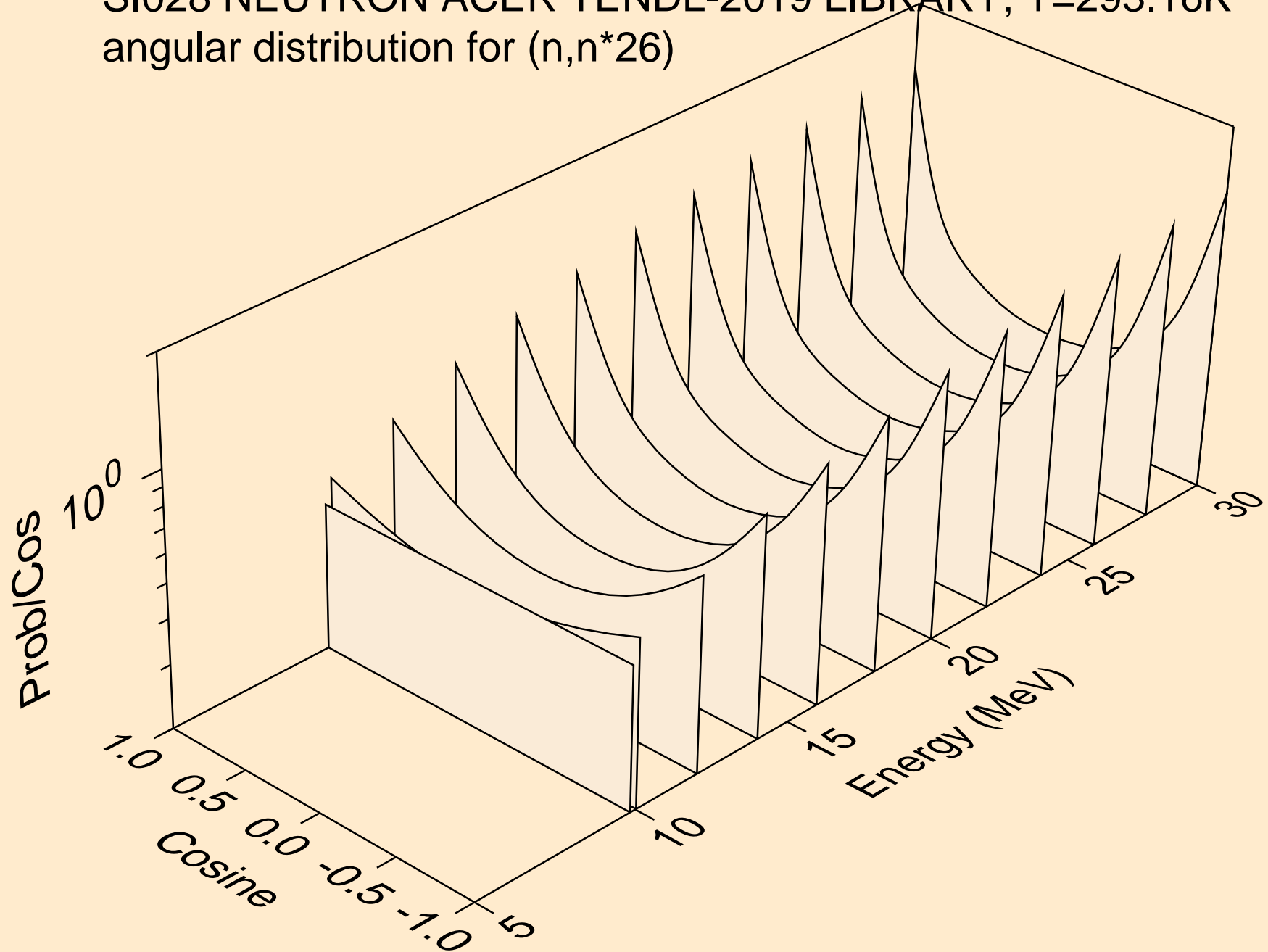

SI028 NEUTRON ACER TENDL-2019 LIBRARY; T=293.16K
angular distribution for (n,n*27)

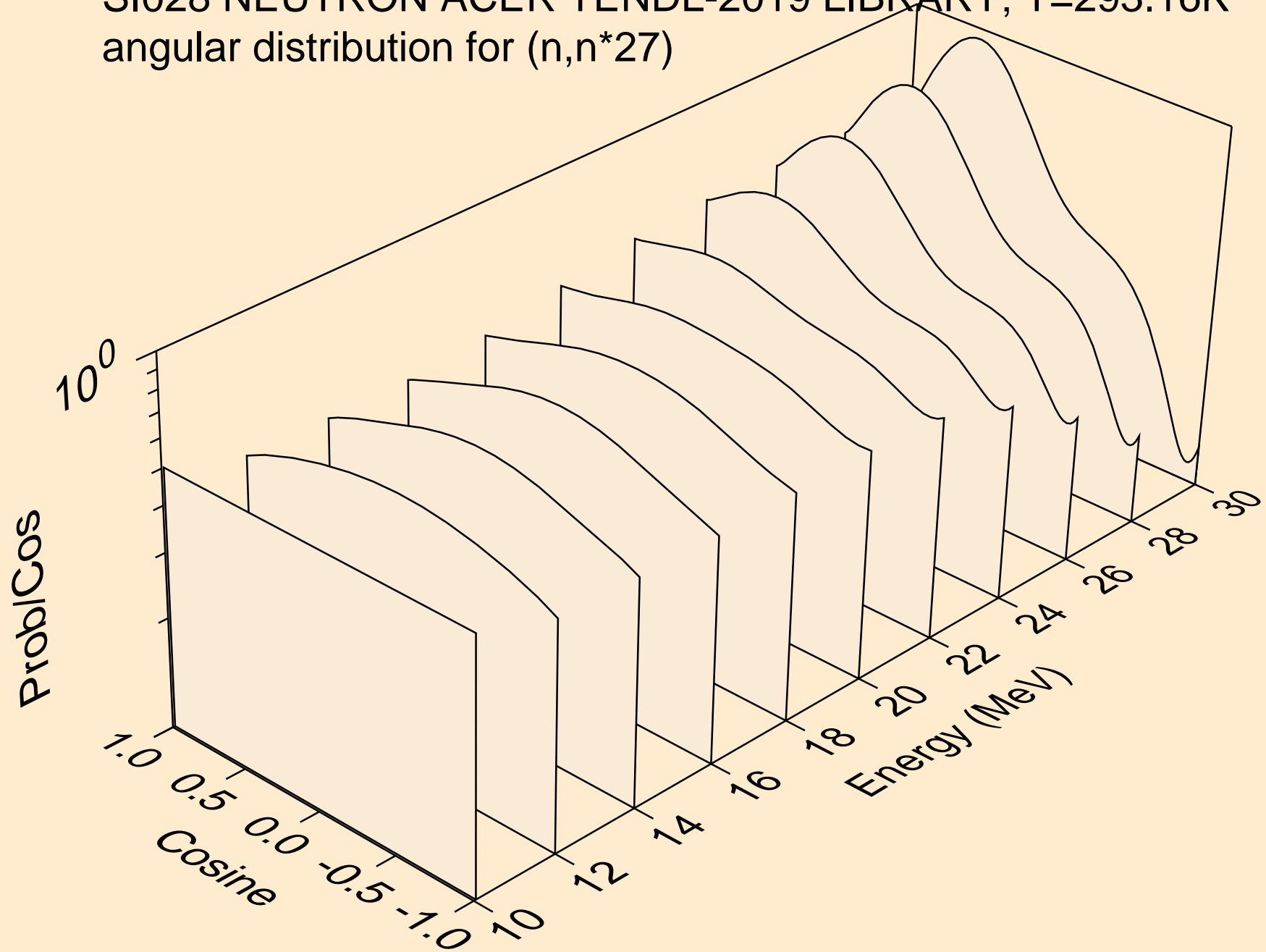

SI028 NEUTRON ACER TENDL-2019 LIBRARY; T=293.16K
angular distribution for (n,n*28)

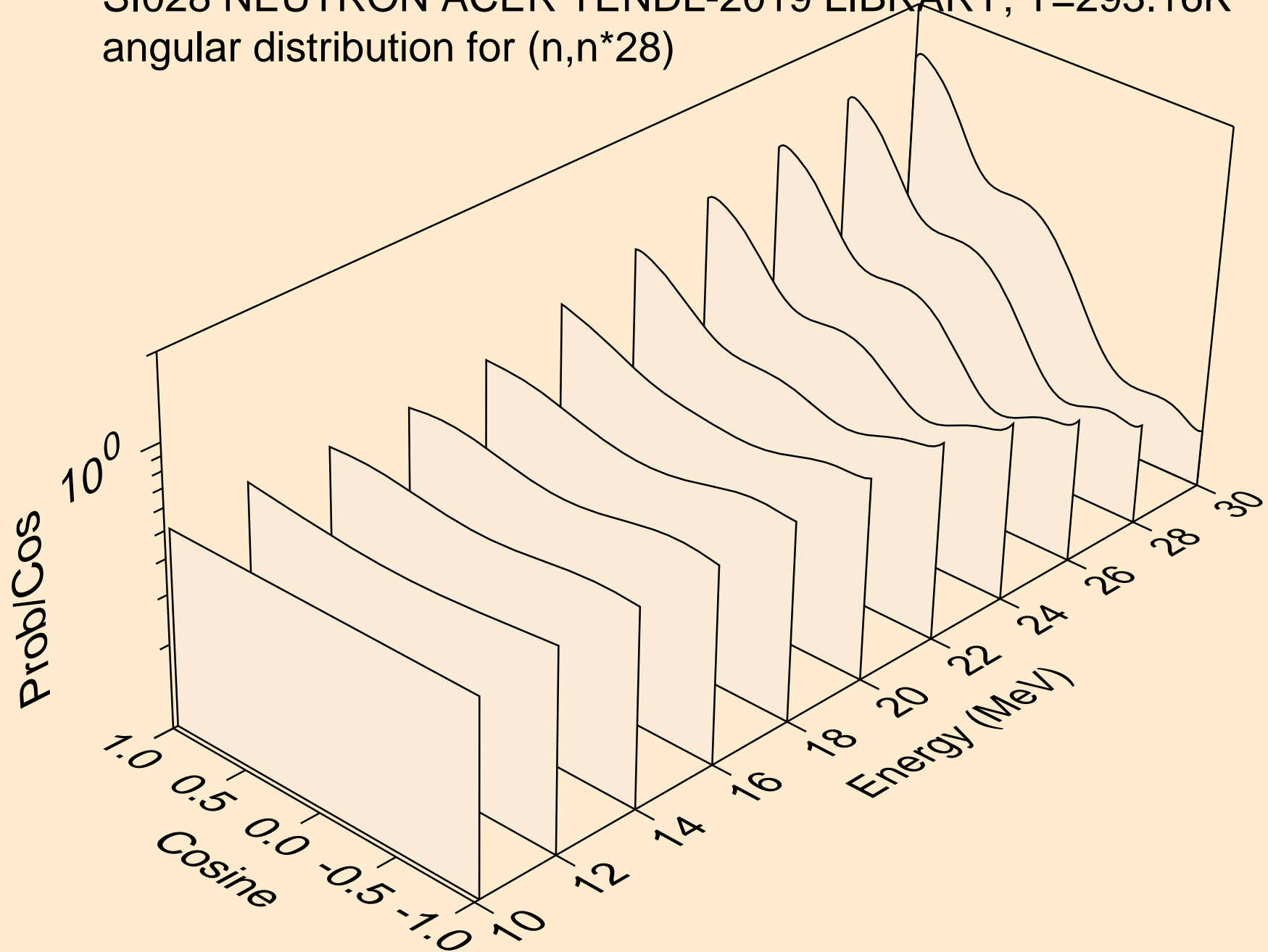

SI028 NEUTRON ACER TENDL-2019 LIBRARY; T=293.16K
Neutron emission for (n,x)

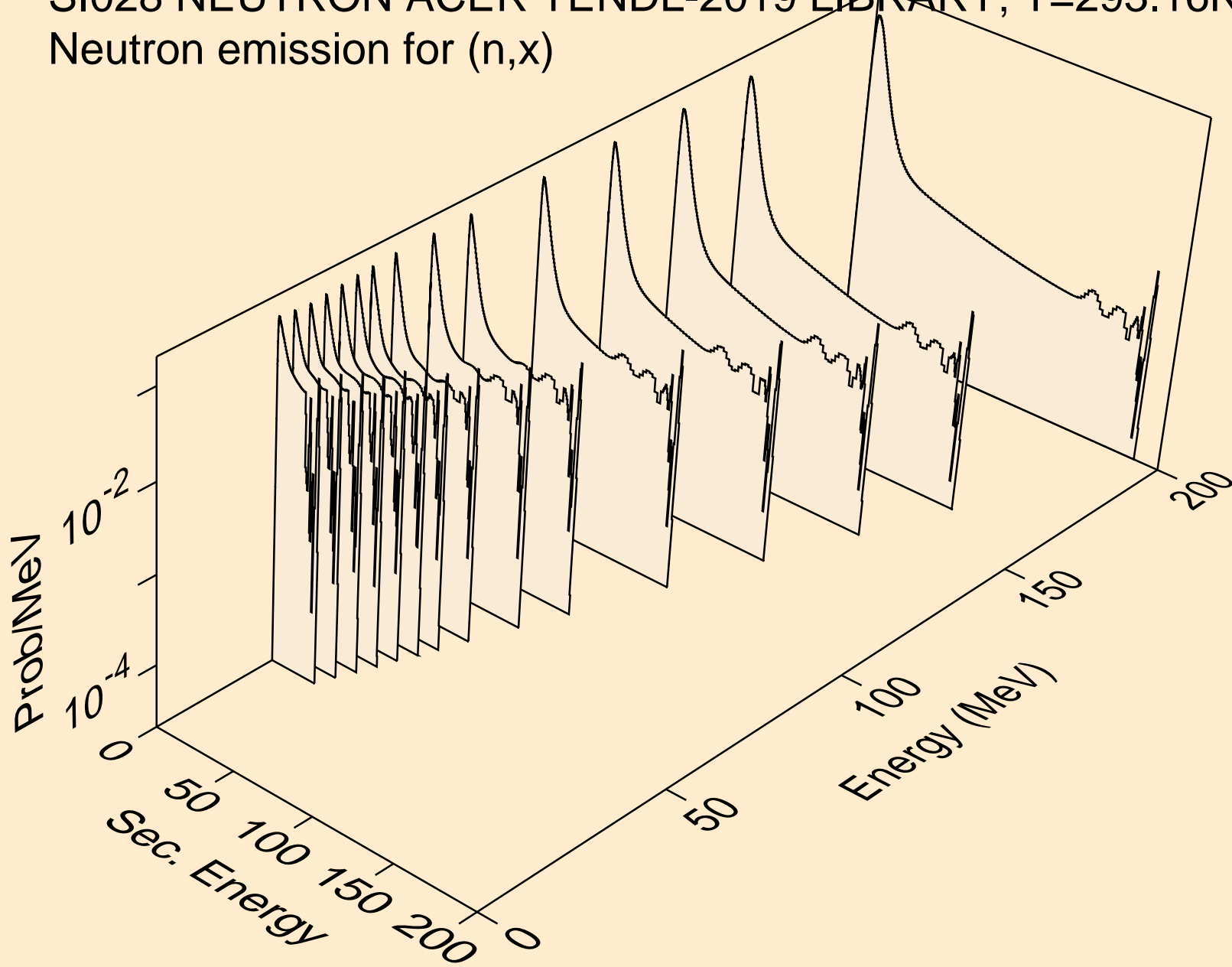

SI028 NEUTRON ACER TENDL-2019 LIBRARY; T=293.16K
Neutron emission for (n,2n)

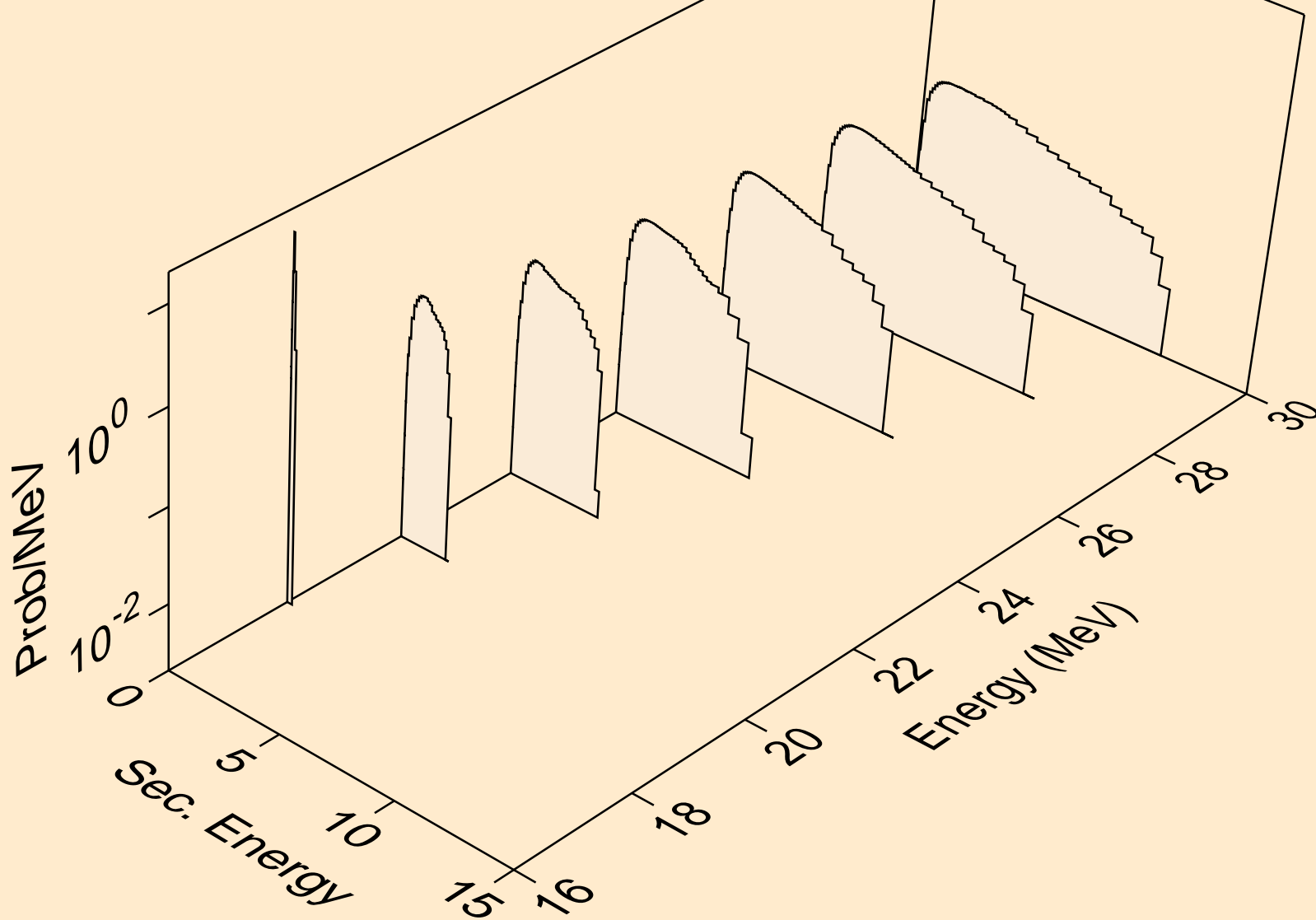

SI028 NEUTRON ACER TENDL-2019 LIBRARY; T=293.16K
Neutron emission for (n,n*)a

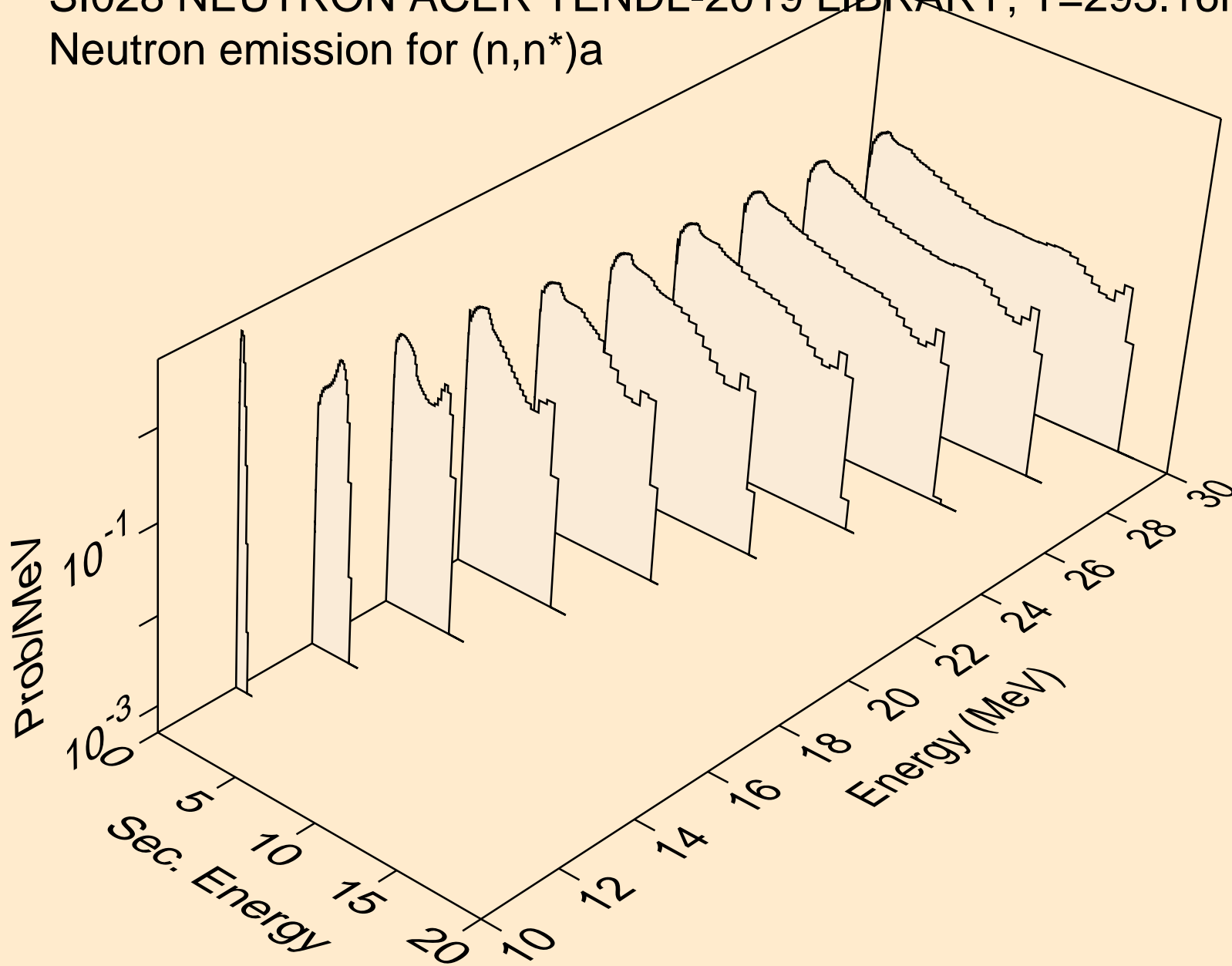

SI028 NEUTRON ACER TENDL-2019 LIBRARY; T=293.16K
Neutron emission for (n,2n)a

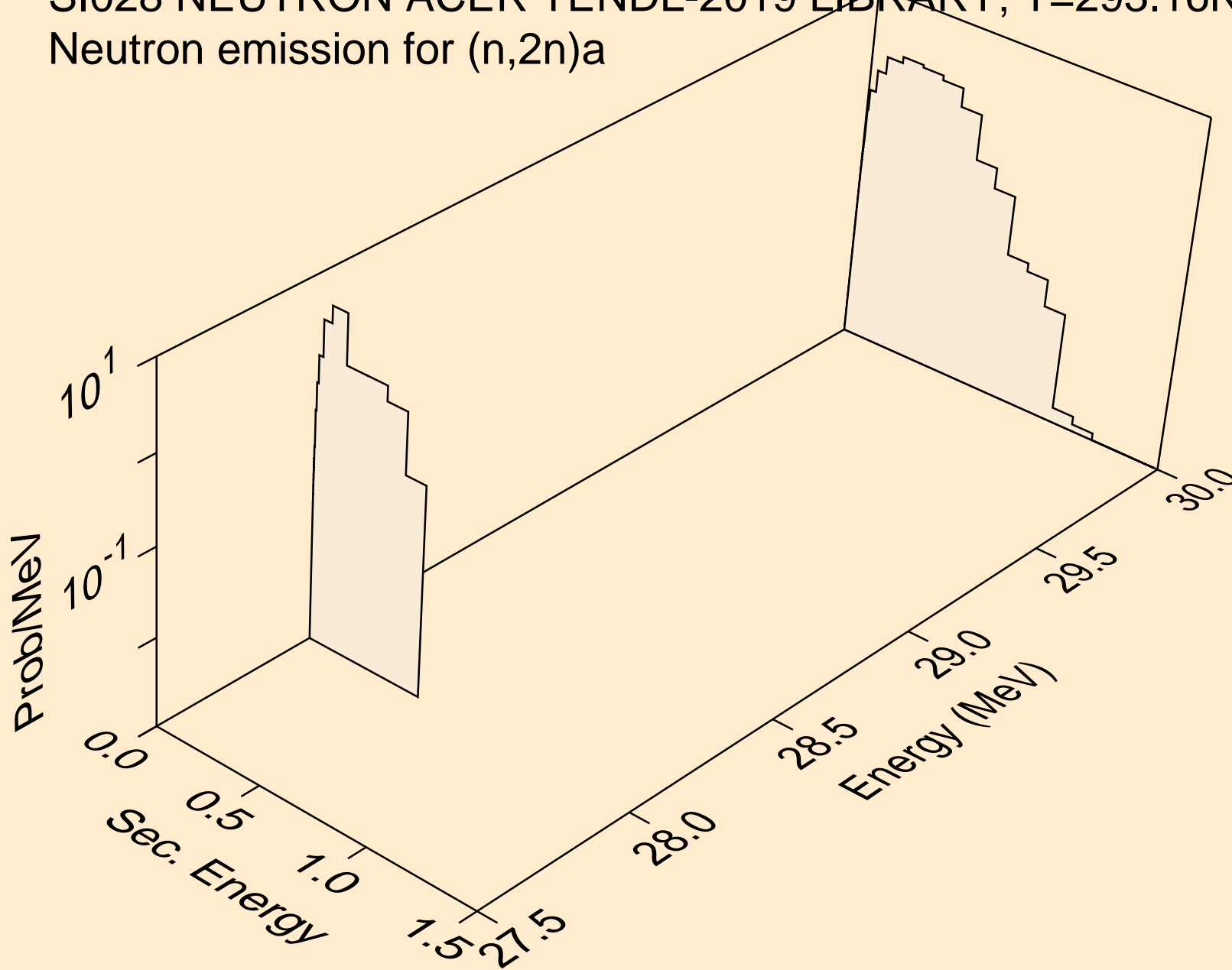

SI028 NEUTRON ACER TENDL-2019 LIBRARY; T=293.16K
Neutron emission for (n,n*)p

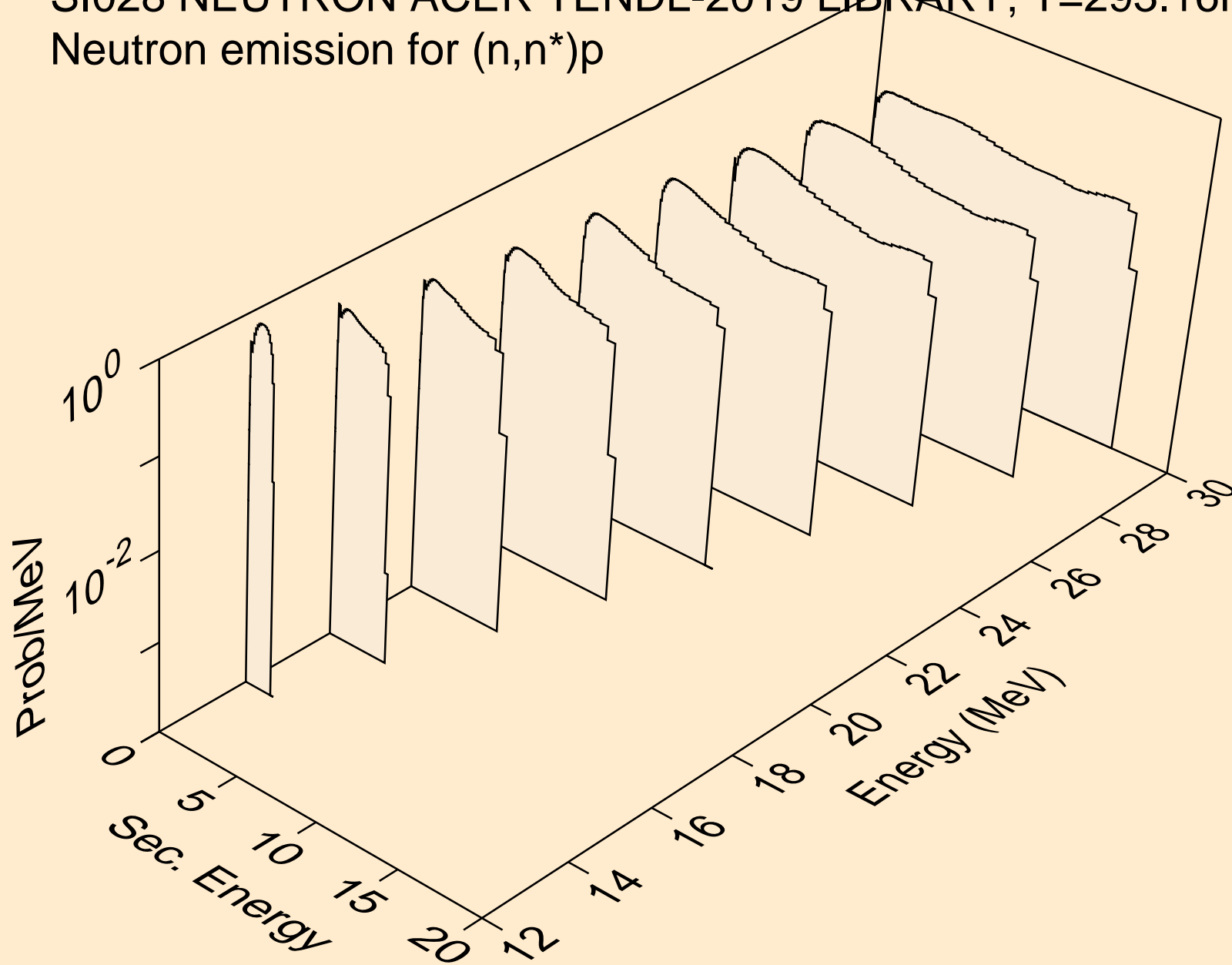

SI028 NEUTRON ACER TENDL-2019 LIBRARY; T=293.16K
Neutron emission for (n,n*)2a

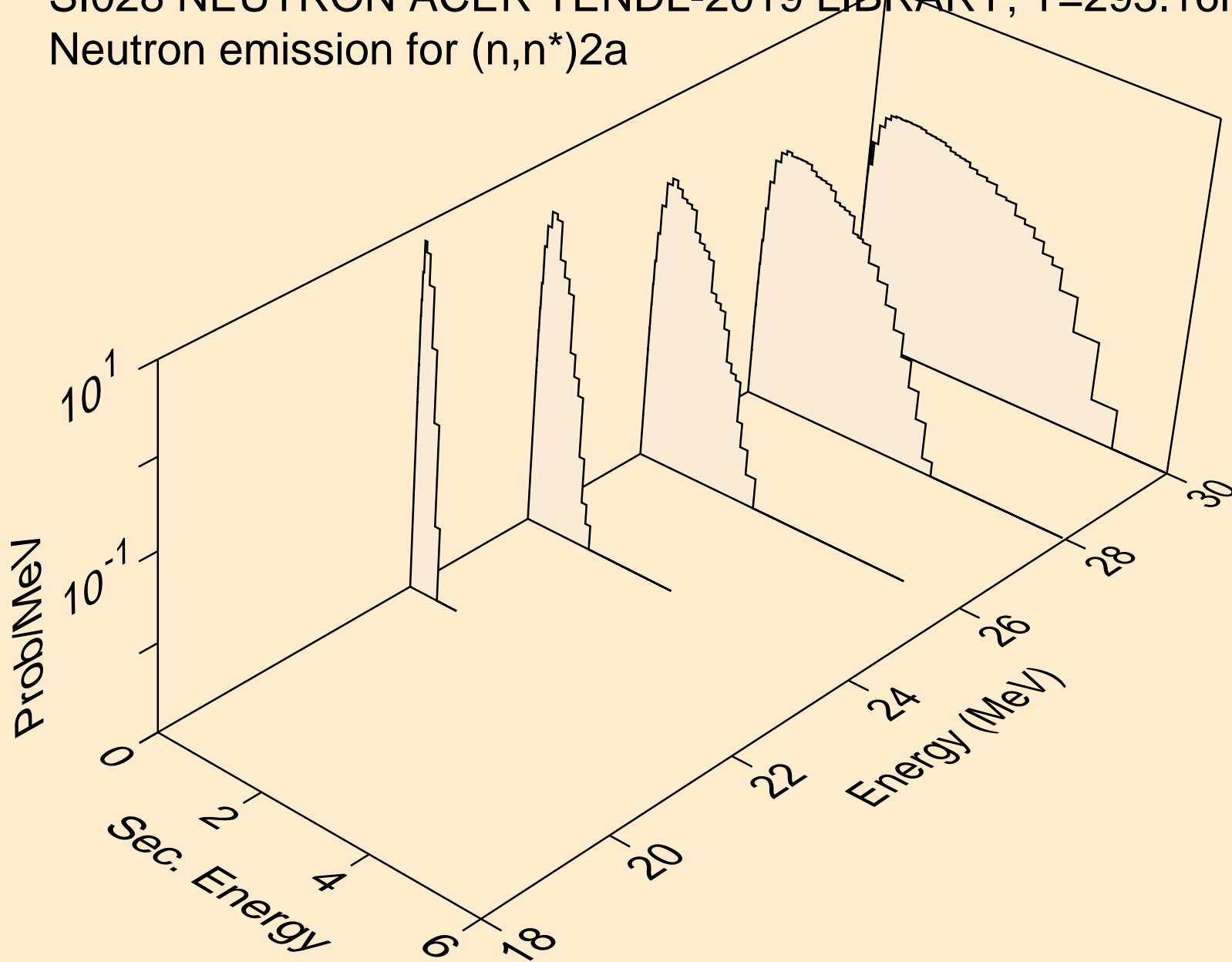

SI028 NEUTRON ACER TENDL-2019 LIBRARY; T=293.16K
Neutron emission for (n,n*)d

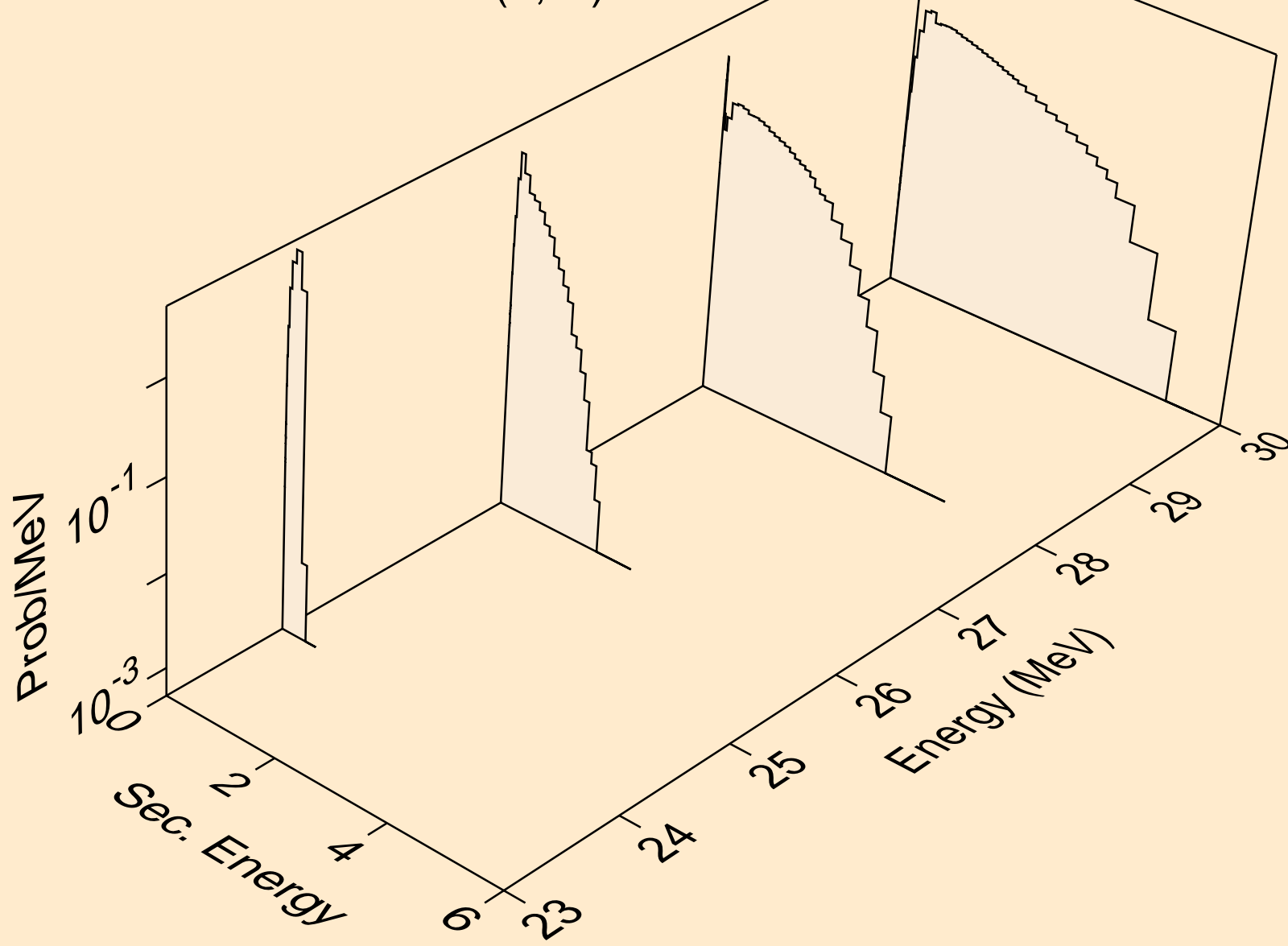

SI028 NEUTRON ACER TENDL-2019 LIBRARY; T=293.16K
Neutron emission for (n,n*)t

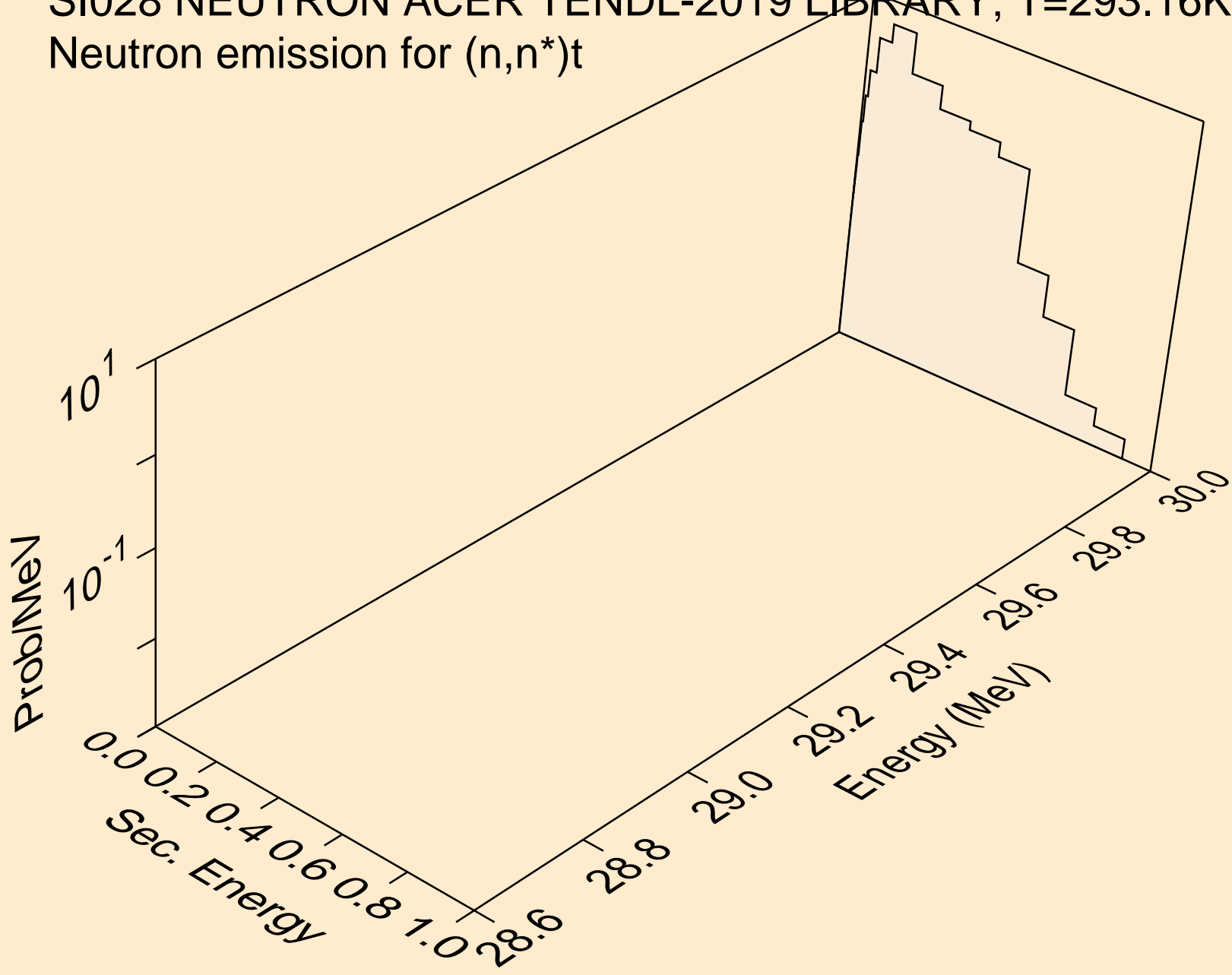

SI028 NEUTRON ACER TENDL-2019 LIBRARY; T=293.16K
Neutron emission for (n,n*)he3

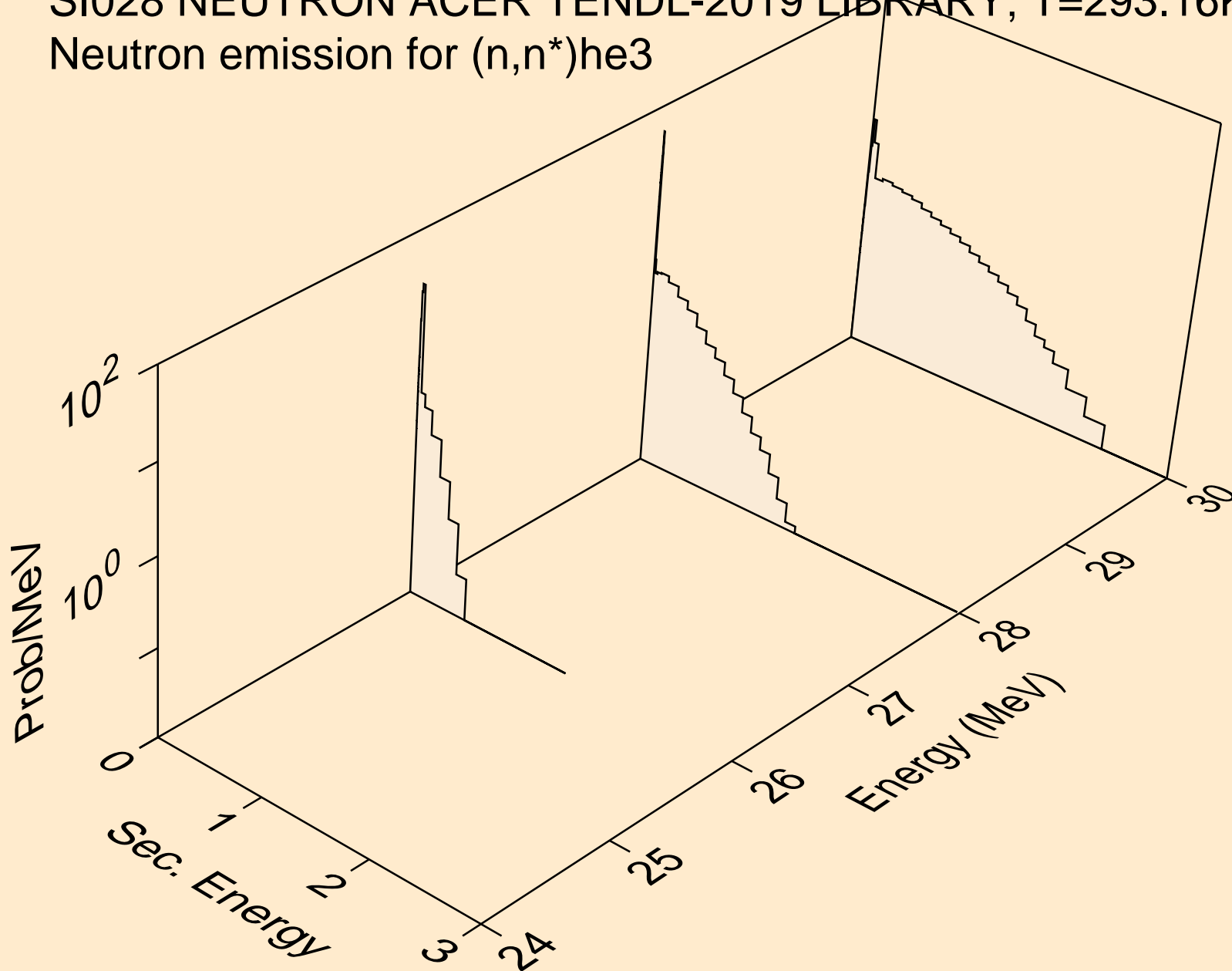

SI028 NEUTRON ACER TENDL-2019 LIBRARY; T=293.16K
Neutron emission for (n,2np)

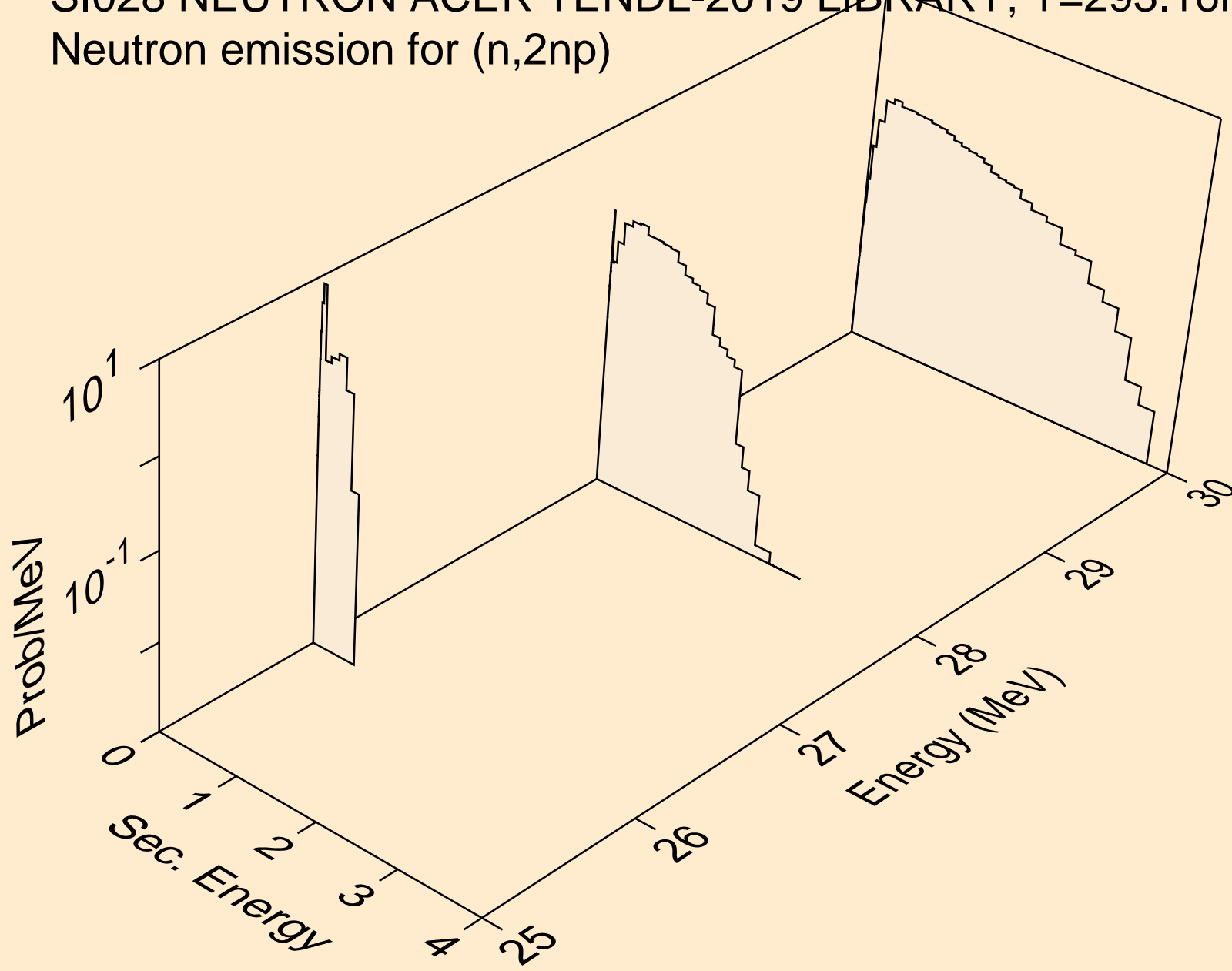

SI028 NEUTRON ACER TENDL-2019 LIBRARY; T=293.16K
Neutron emission for (n,2np)

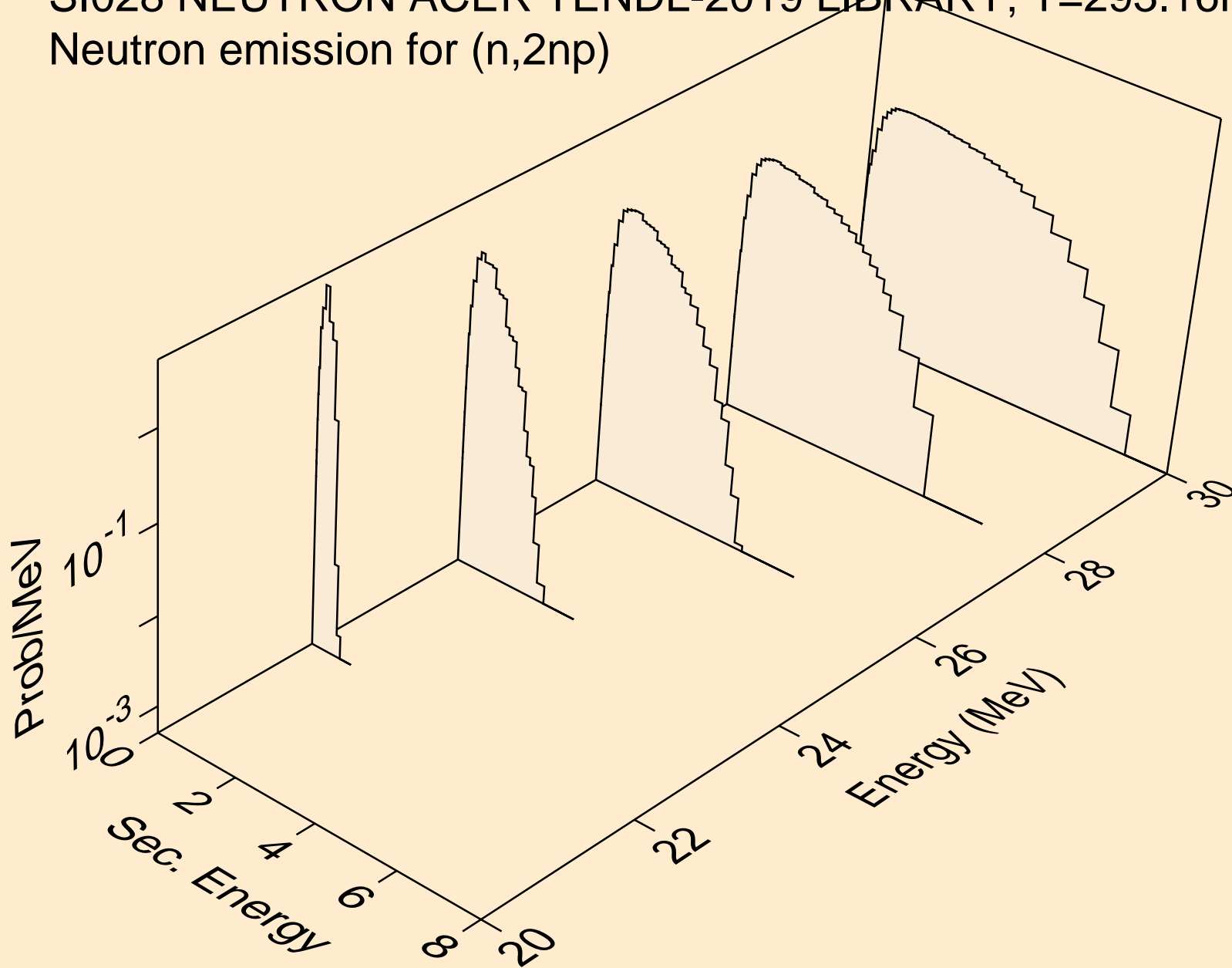

SI028 NEUTRON ACER TENDL-2019 LIBRARY; T=293.16K
Neutron emission for (n,npa)

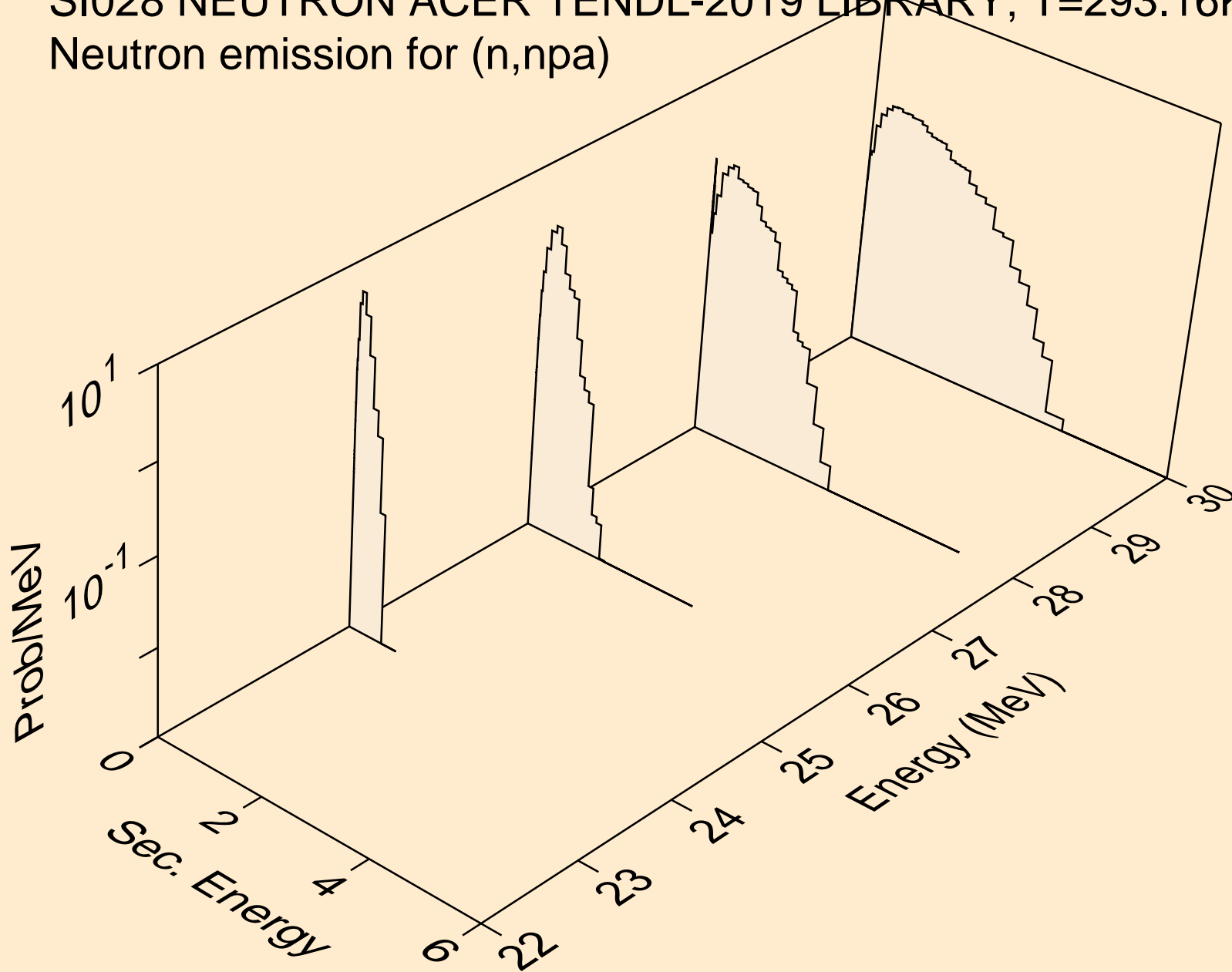

SI028 NEUTRON ACER TENDL-2019 LIBRARY; T=293.16K
Neutron emission for (n,n*c)

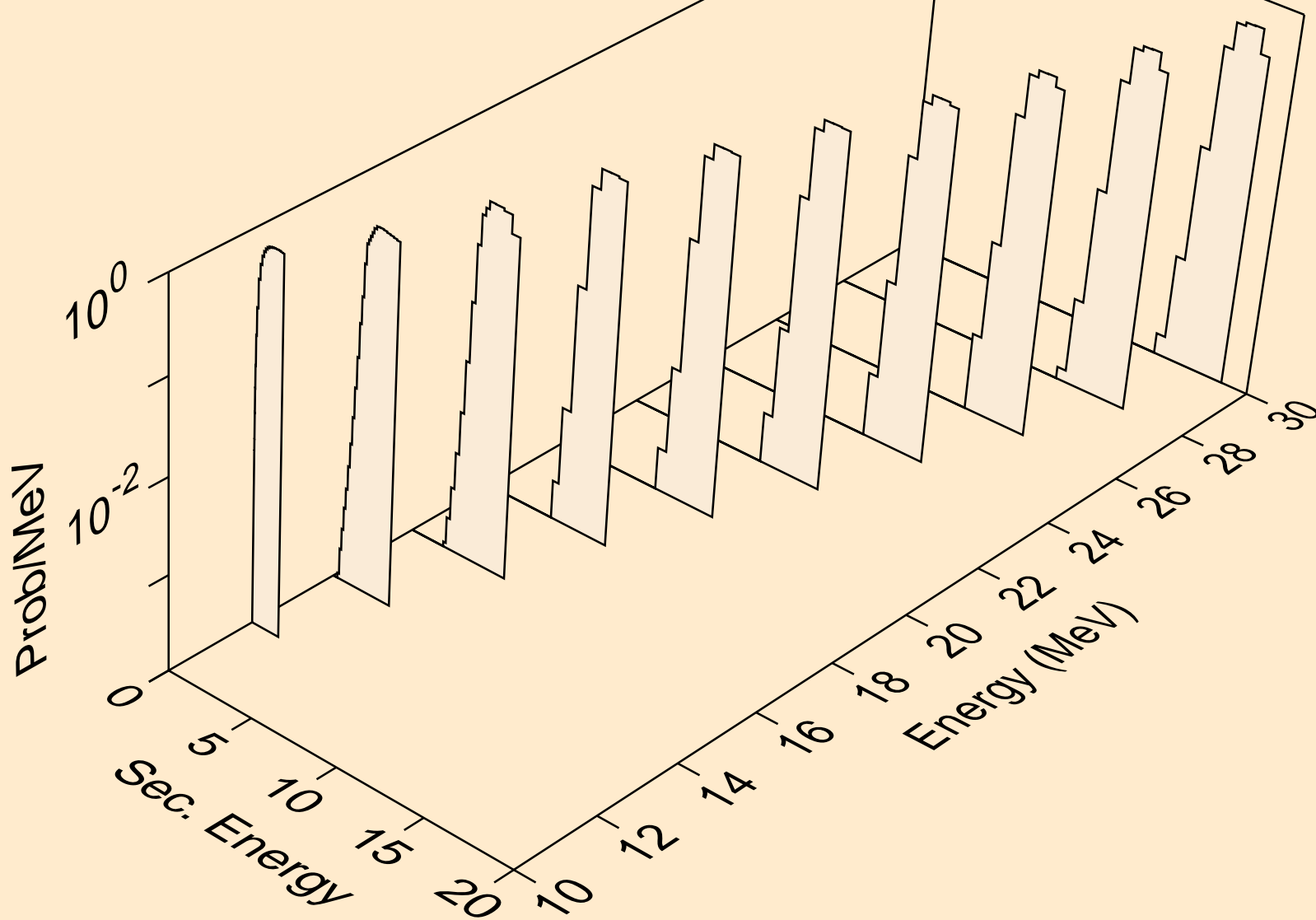

SI028 NEUTRON ACER TENDL-2019 LIBRARY; T=293.16K
Photon emission for (n,x)

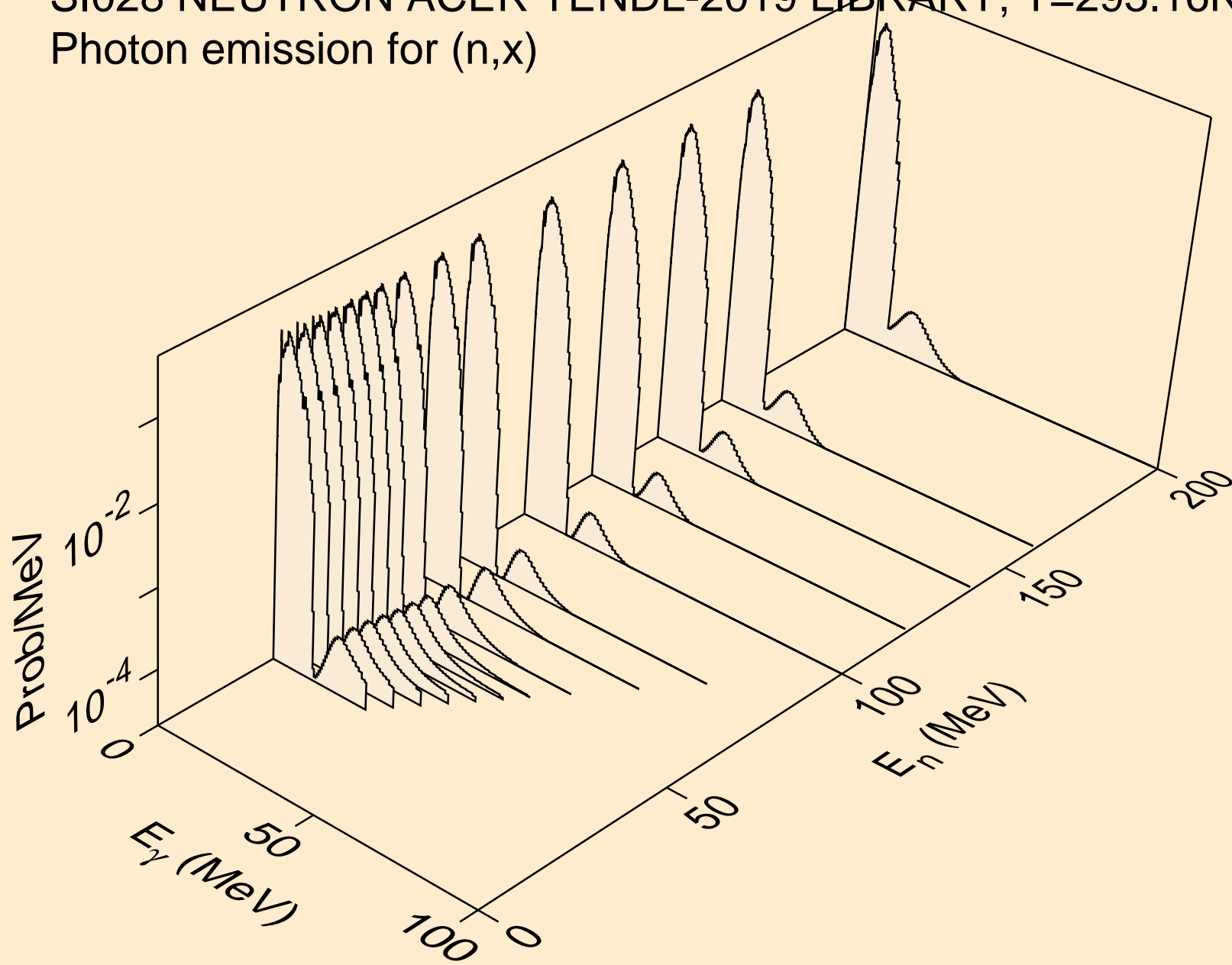

SI028 NEUTRON ACER TENDL-2019 LIBRARY; T=293.16K
Photon emission for (n,2n)

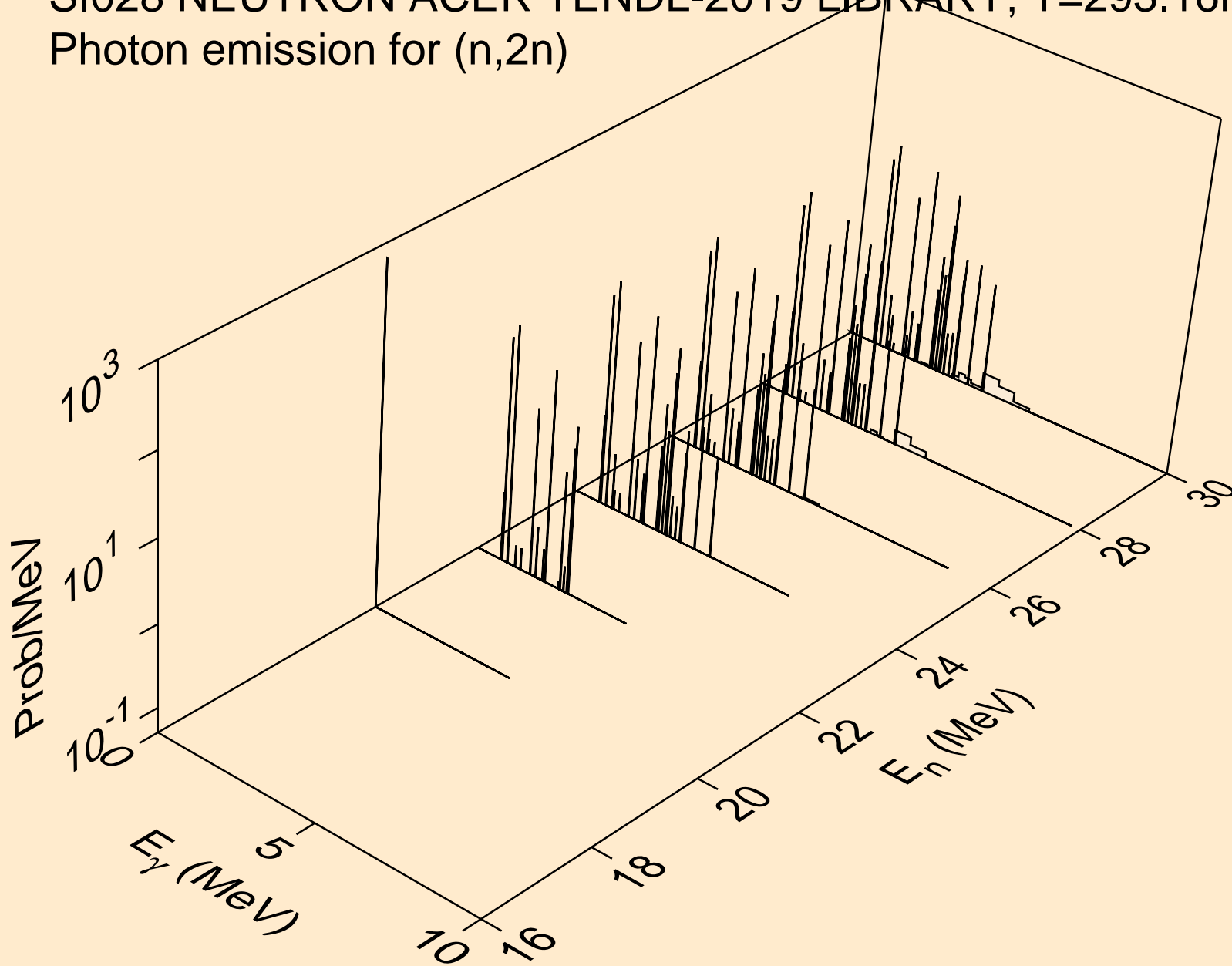

SI028 NEUTRON ACER TENDL-2019 LIBRARY; T=293.16K
Photon emission for (n,n*)a

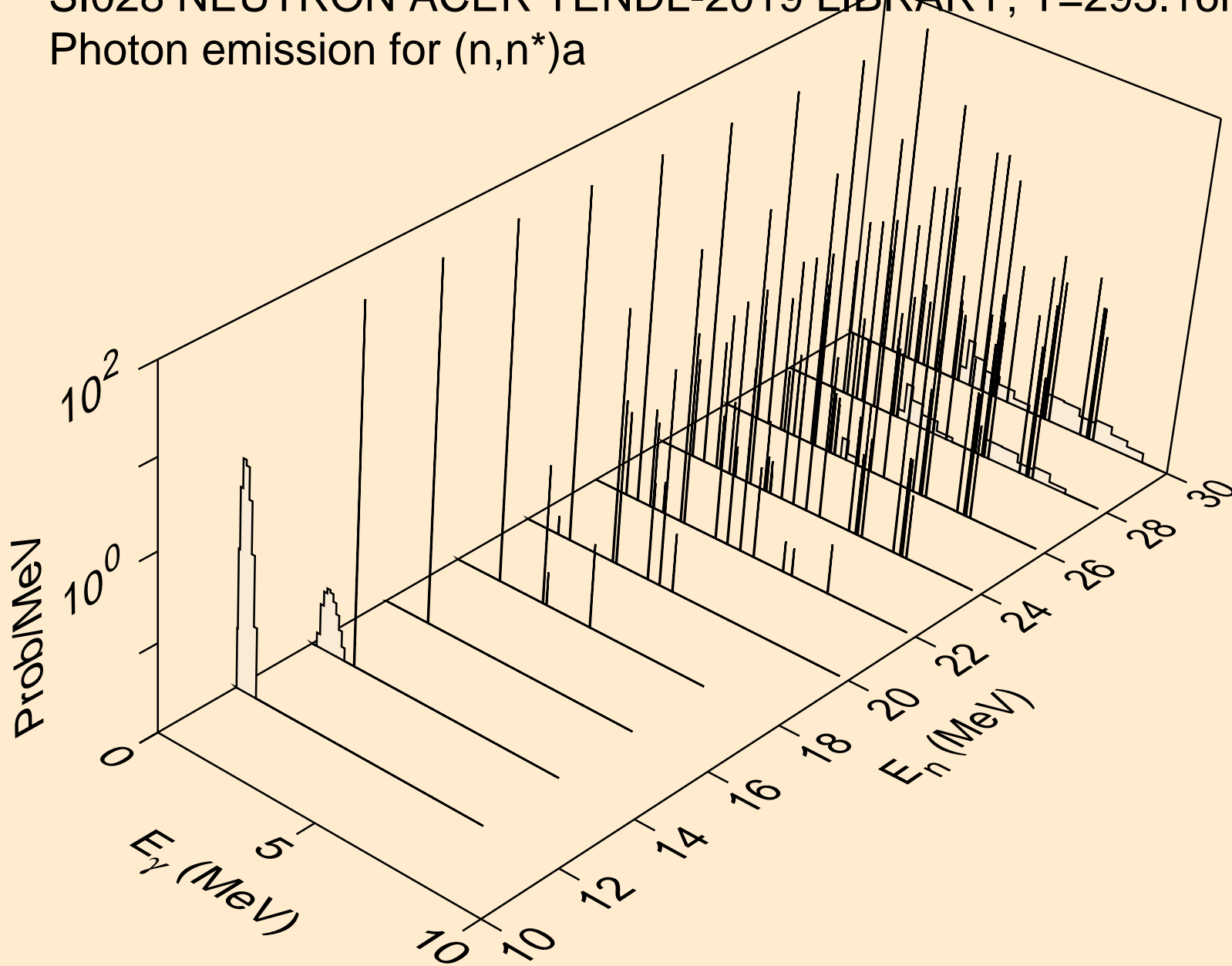

SI028 NEUTRON ACER TENDL-2019 LIBRARY; T=293.16K
Photon emission for (n,2n)a

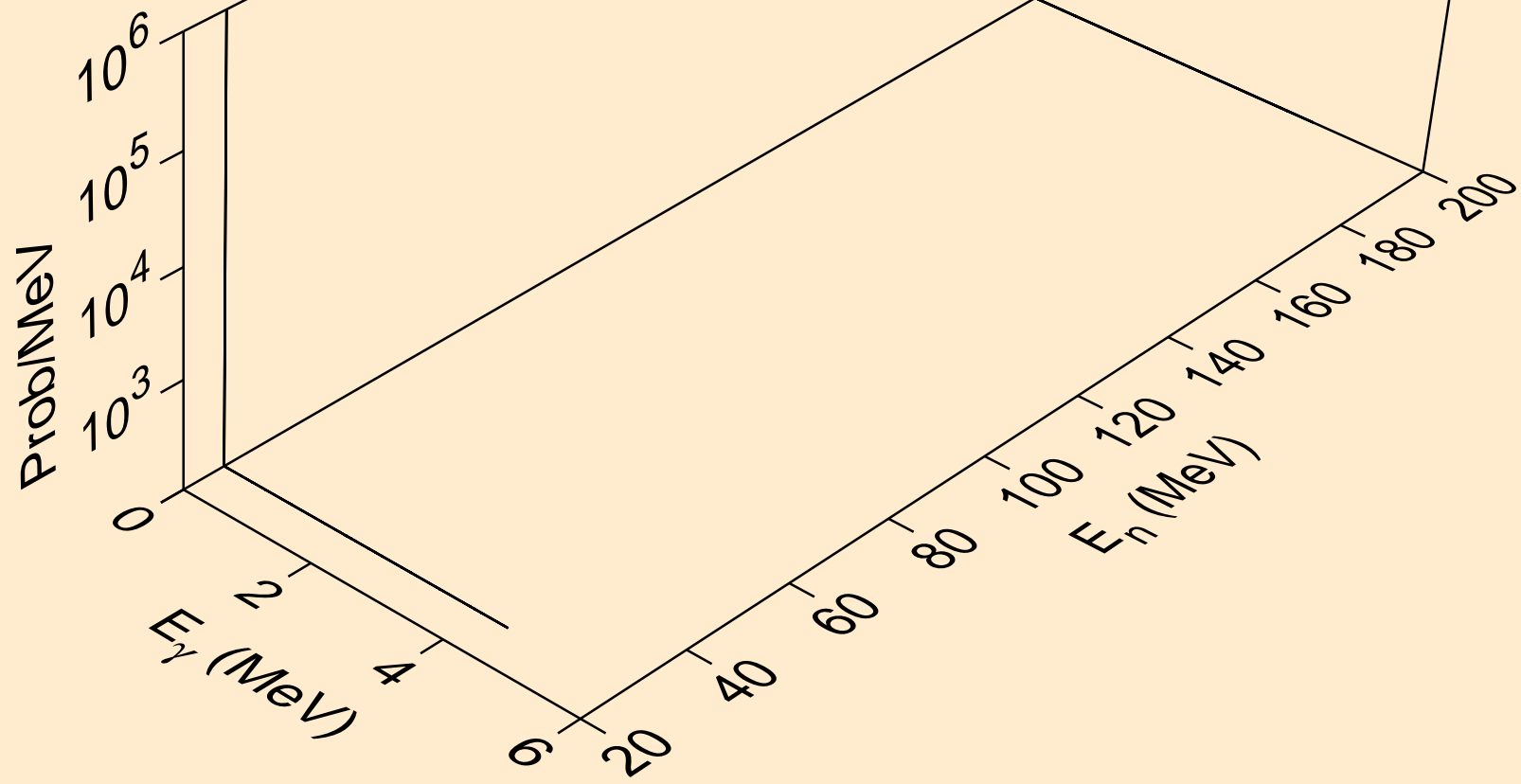

SI028 NEUTRON ACER TENDL-2019 LIBRARY; T=293.16K
Photon emission for (n,n*)p

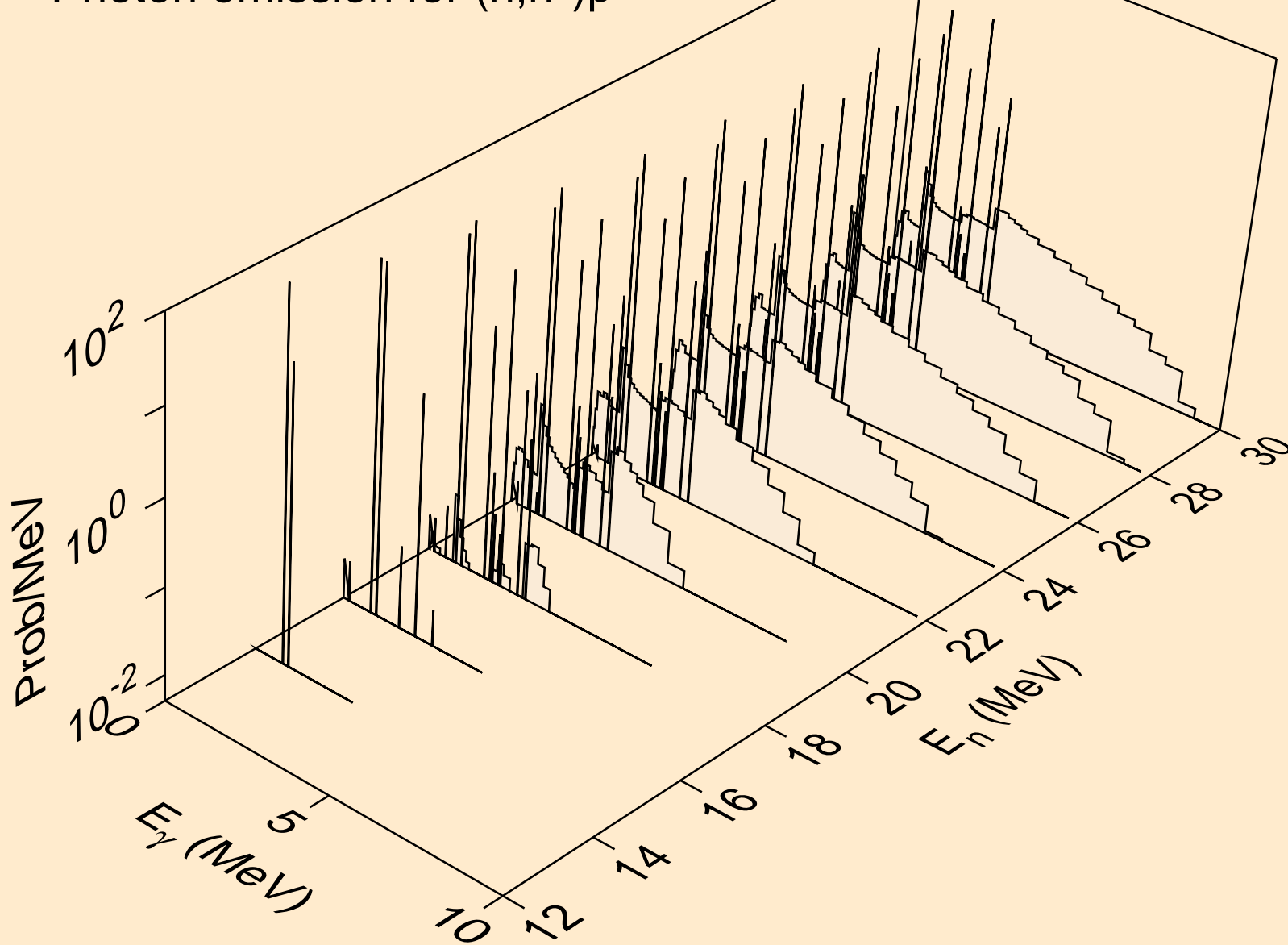

SI028 NEUTRON ACER TENDL-2019 LIBRARY; T=293.16K
Photon emission for (n,n*)2a

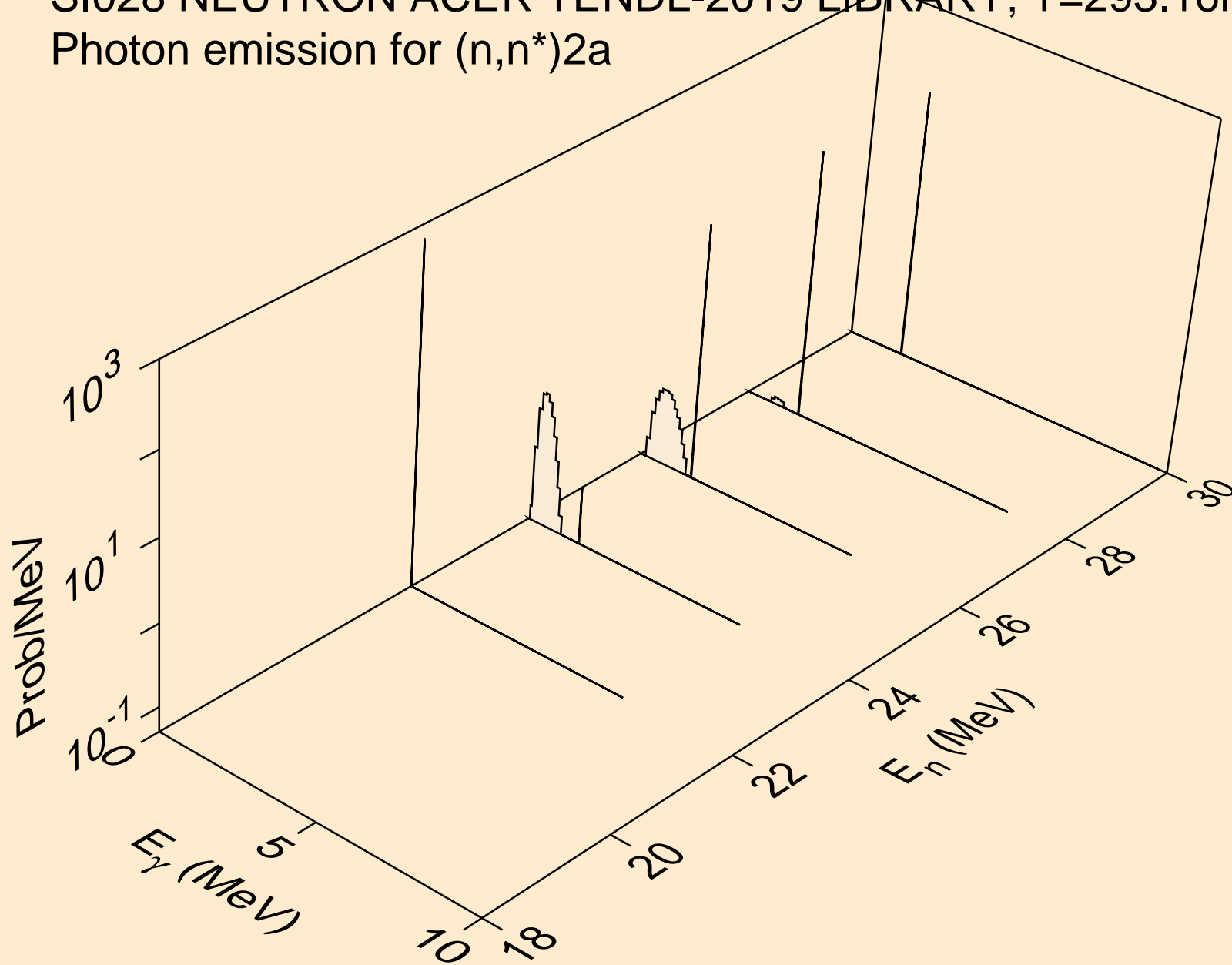

SI028 NEUTRON ACER TENDL-2019 LIBRARY; T=293.16K
Photon emission for (n,n*)d

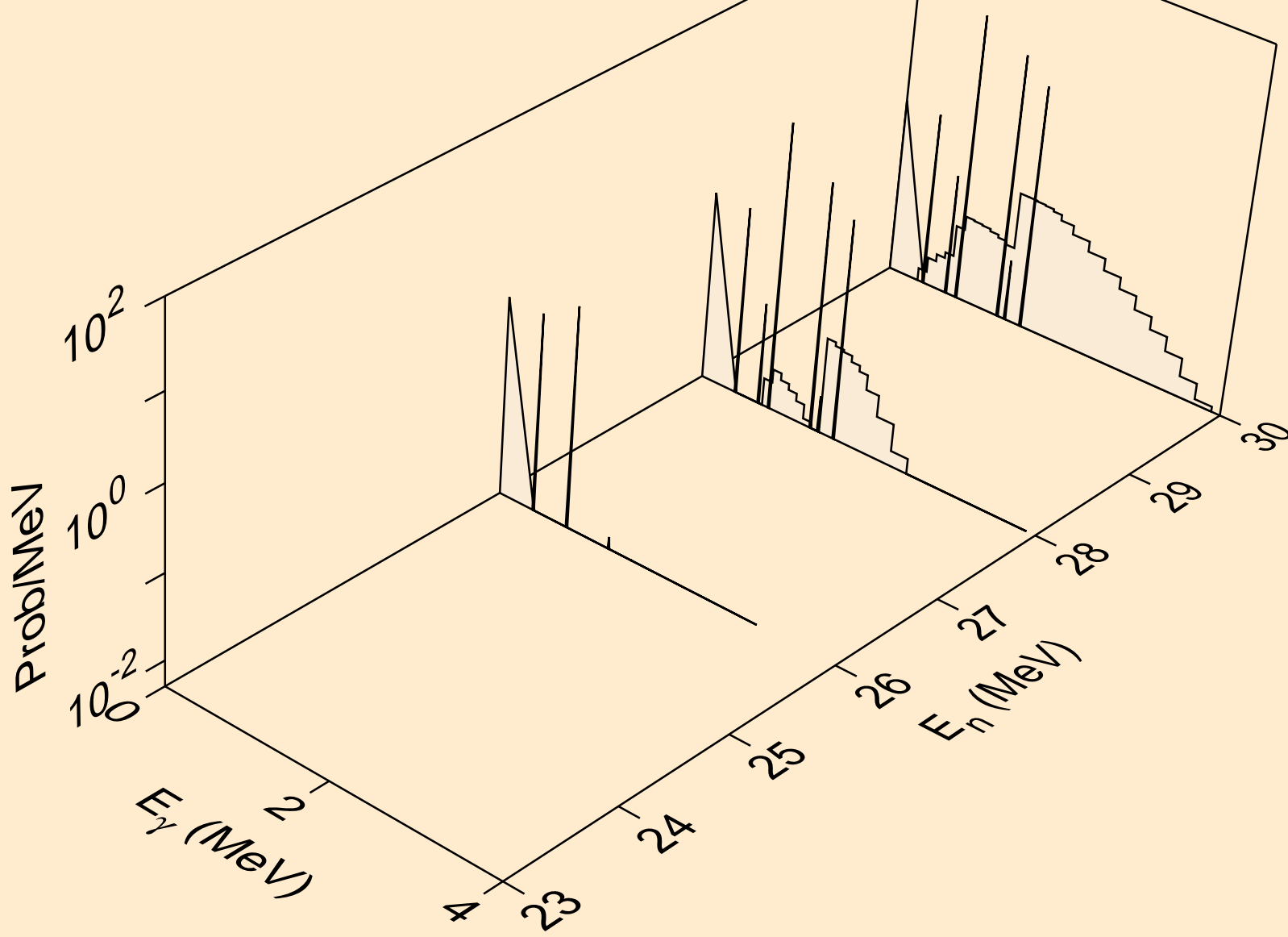

SI028 NEUTRON ACER TENDL-2019 LIBRARY; T=293.16K
Photon emission for (n,n*)t

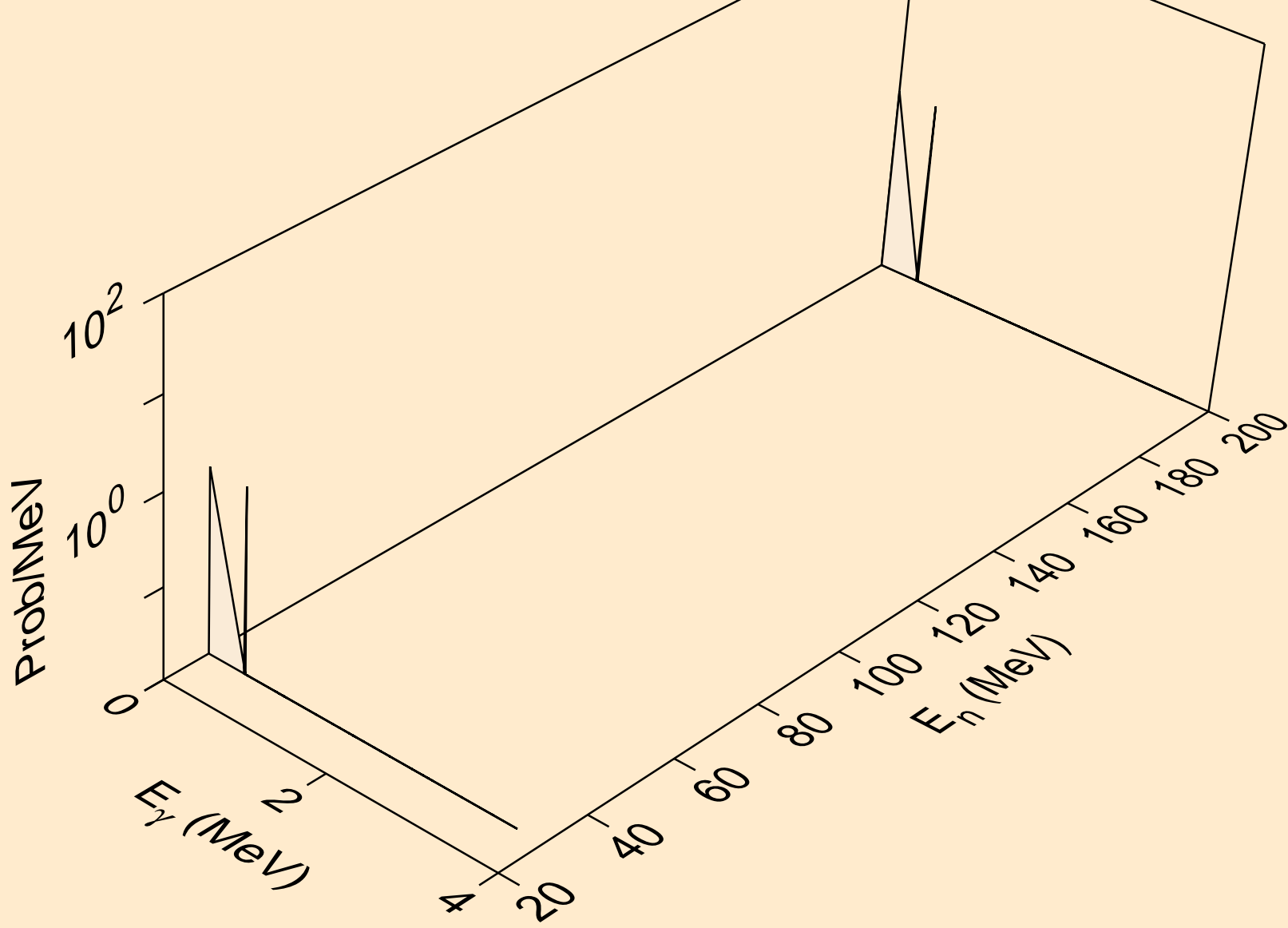

SI028 NEUTRON ACER TENDL-2019 LIBRARY; T=293.16K
Photon emission for (n,n*)he3

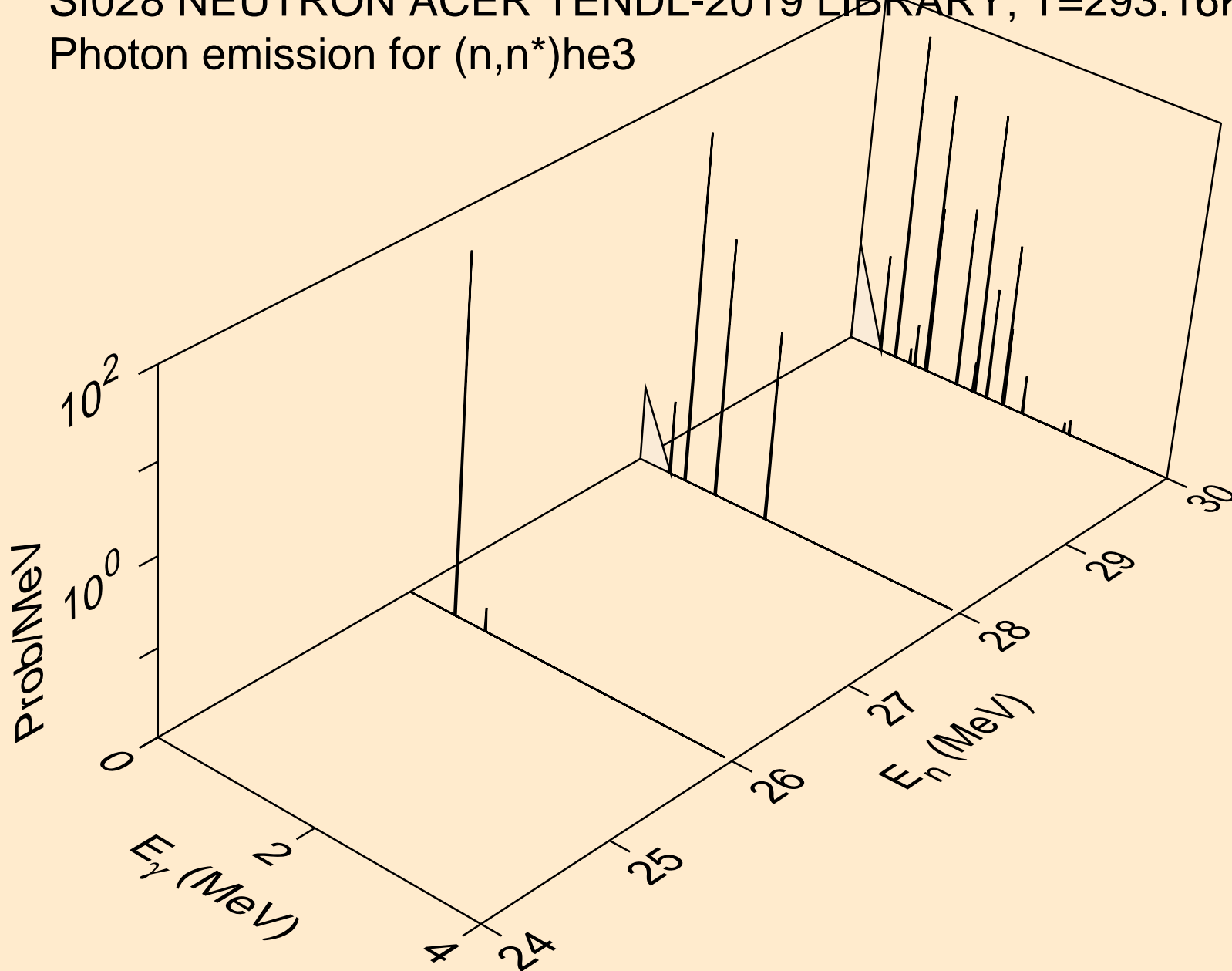

SI028 NEUTRON ACER TENDL-2019 LIBRARY; T=293.16K
Photon emission for (n,2np)

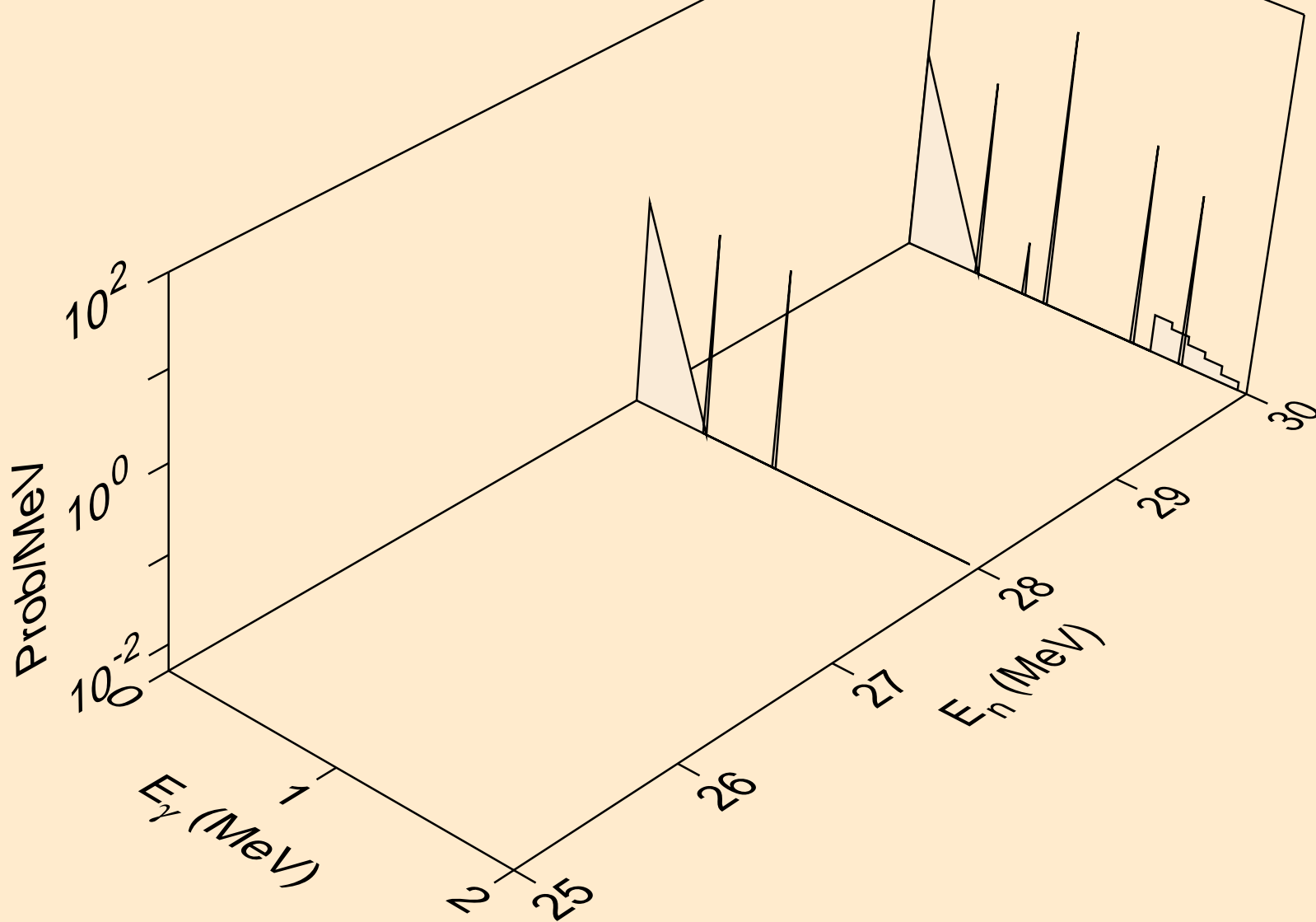

SI028 NEUTRON ACER TENDL-2019 LIBRARY; T=293.16K
Photon emission for (n,2np)

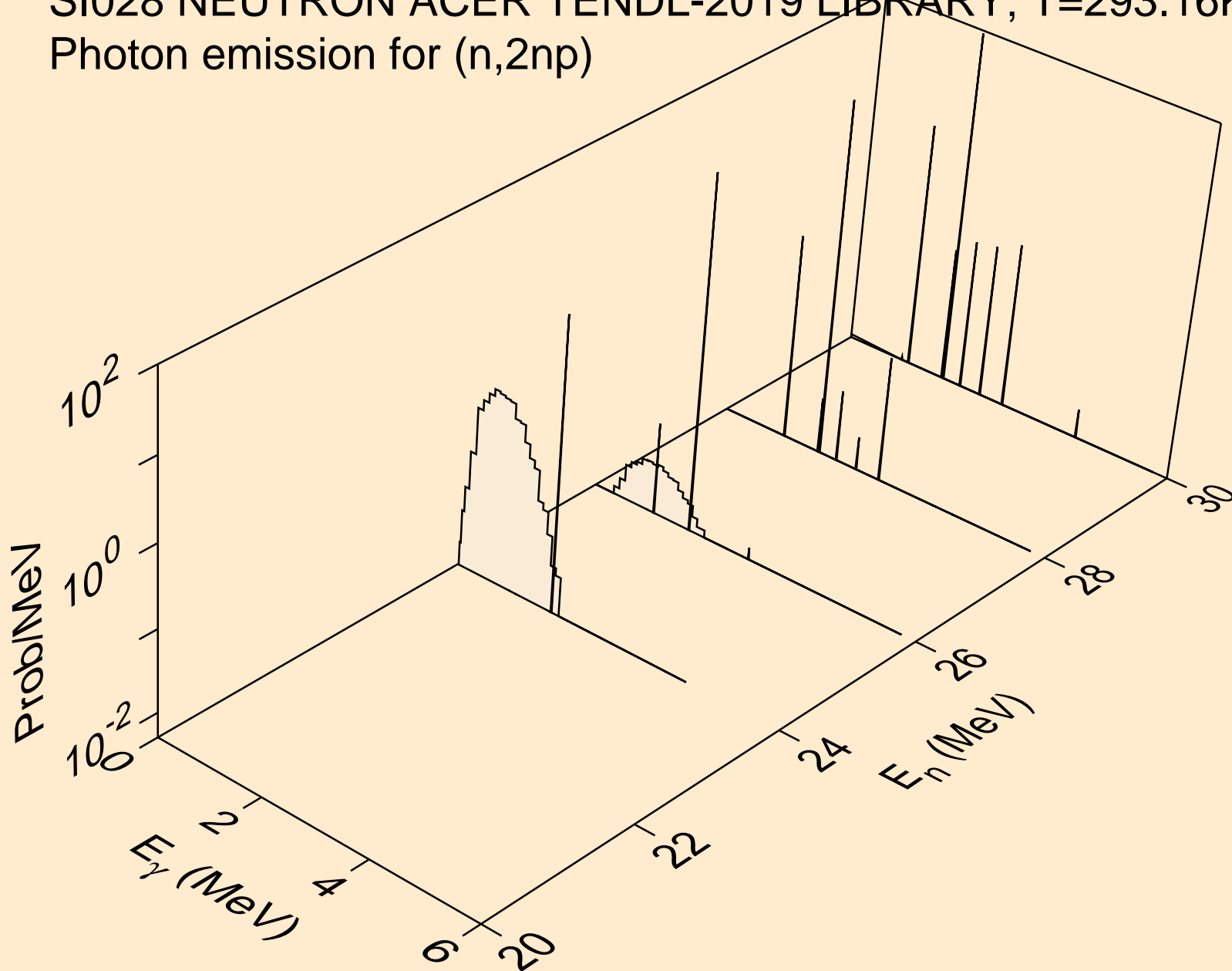

SI028 NEUTRON ACER TENDL-2019 LIBRARY; T=293.16K
Photon emission for (n,npa)

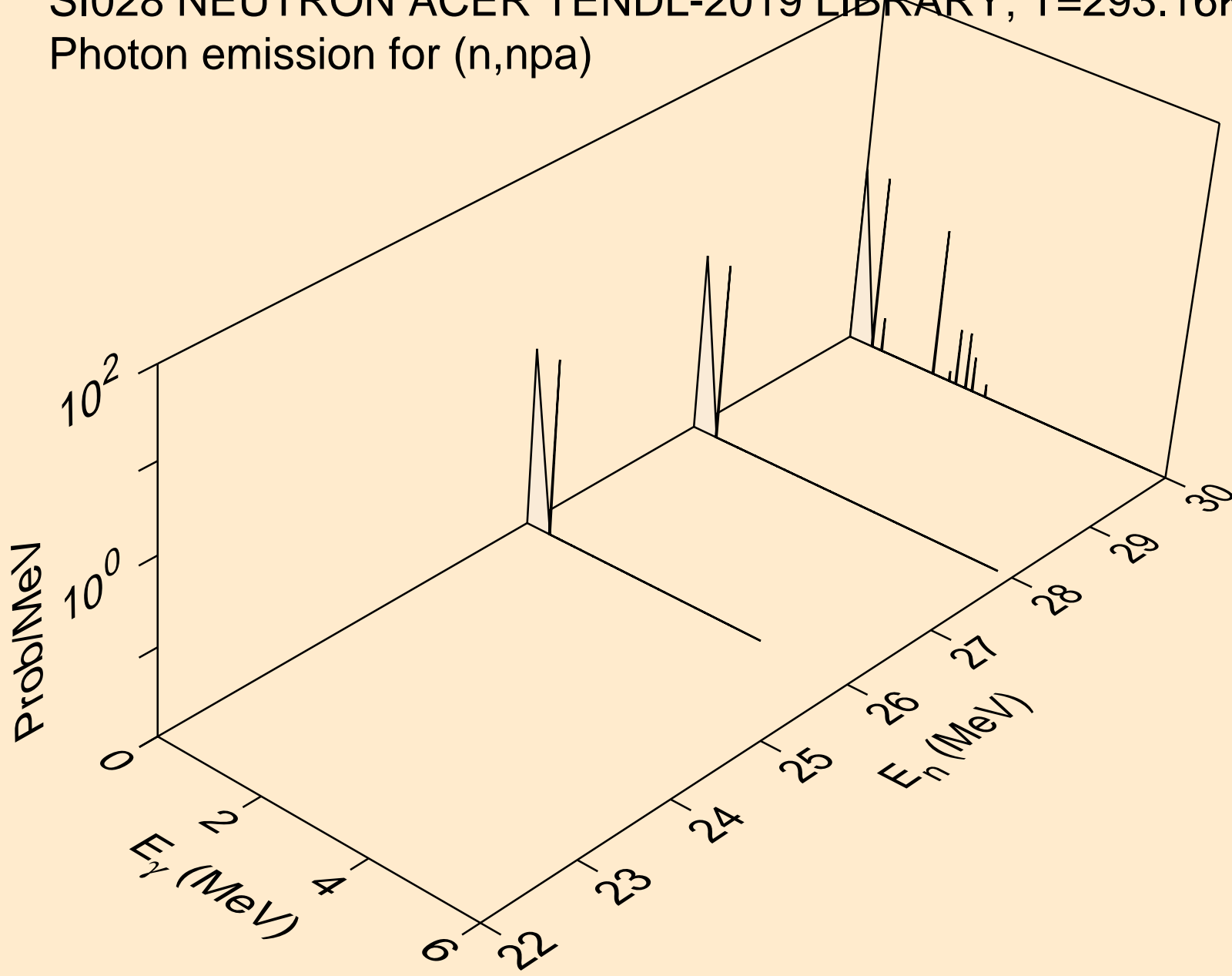

SI028 NEUTRON ACER TENDL-2019 LIBRARY; T=293.16K
Photon emission for (n,n*c)

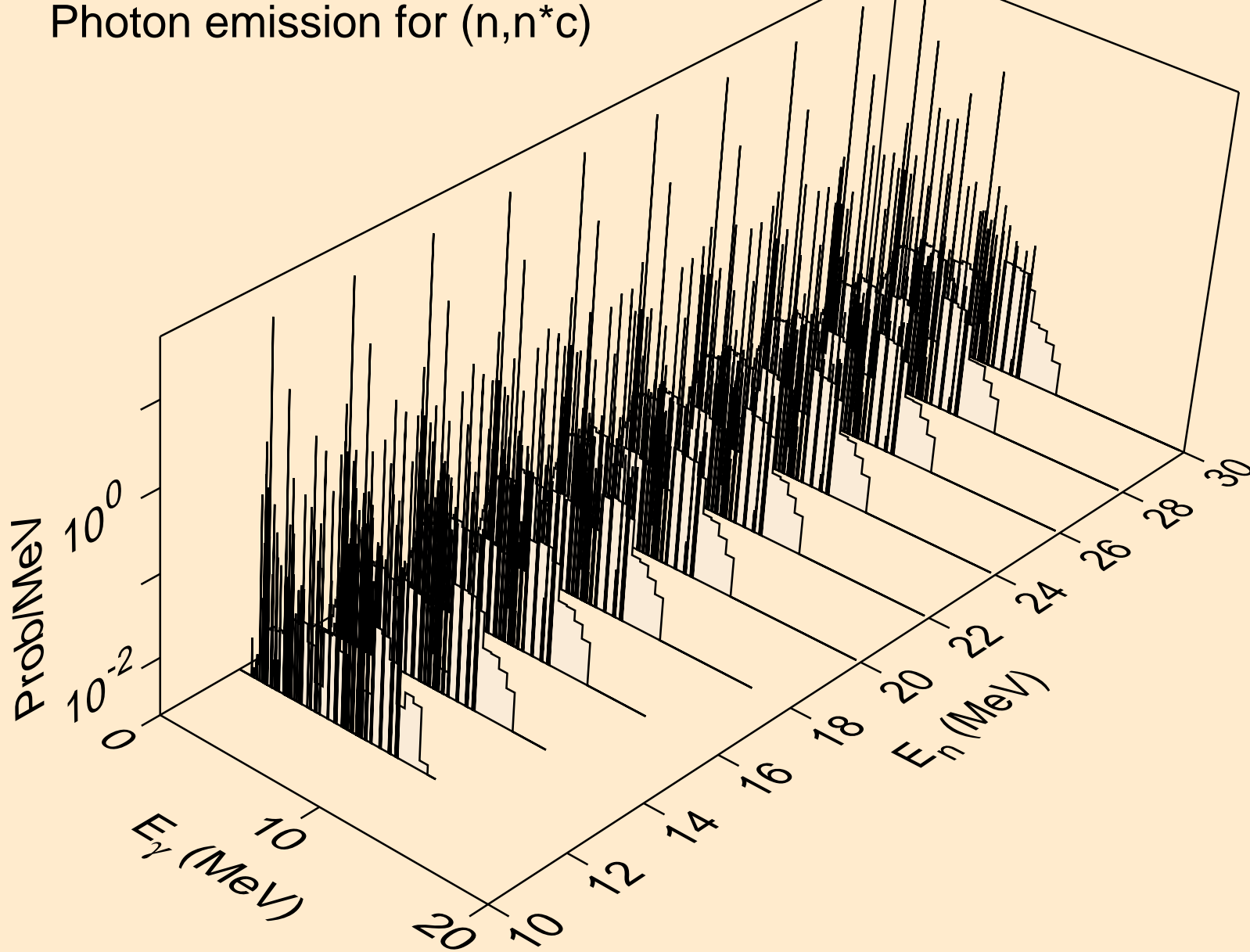

SI028 NEUTRON ACER TENDL-2019 LIBRARY; T=293.16K
Photon emission for (n,gma)

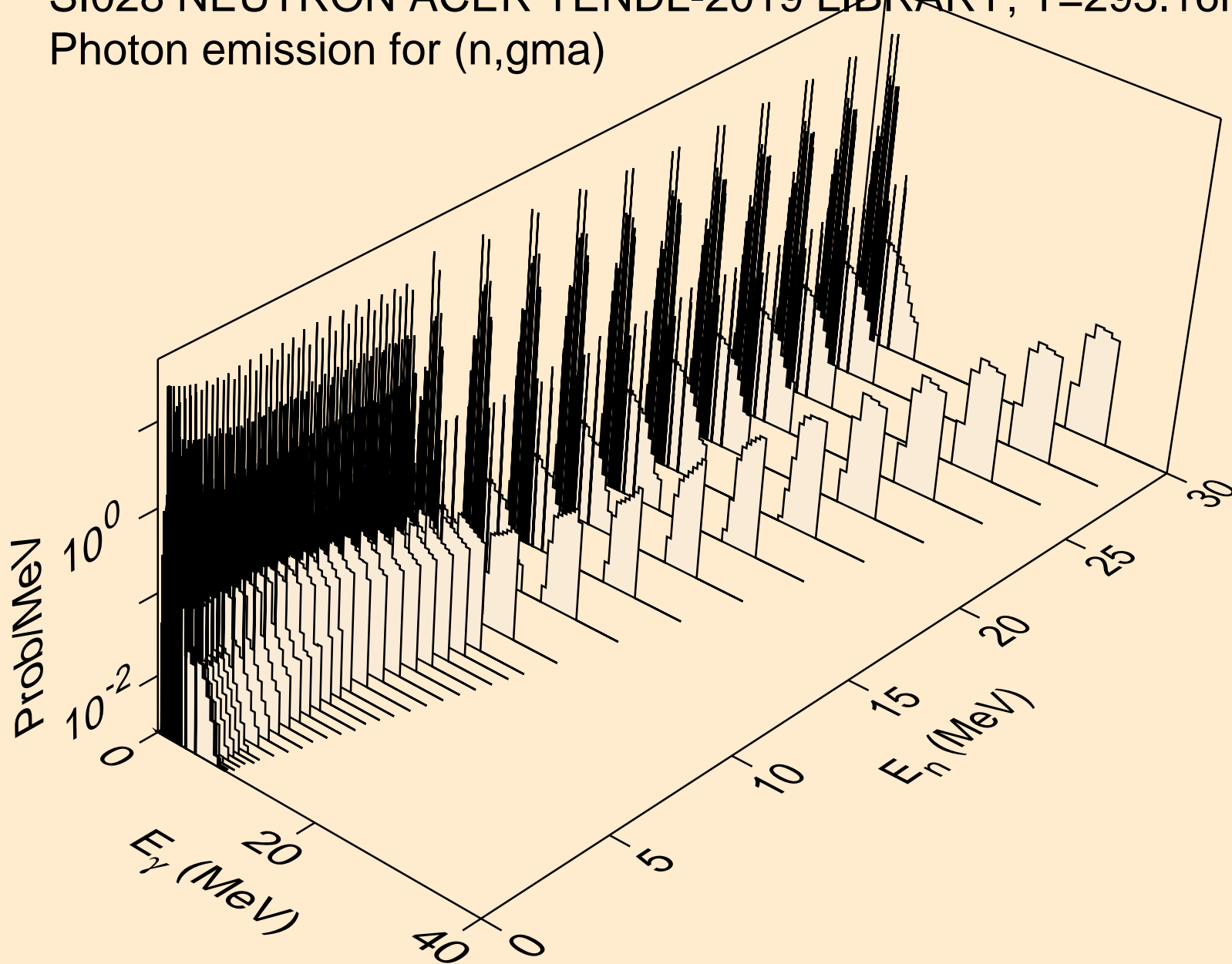

SI028 NEUTRON ACER TENDL-2019 LIBRARY; T=293.16K
Photon emission for (n,p)

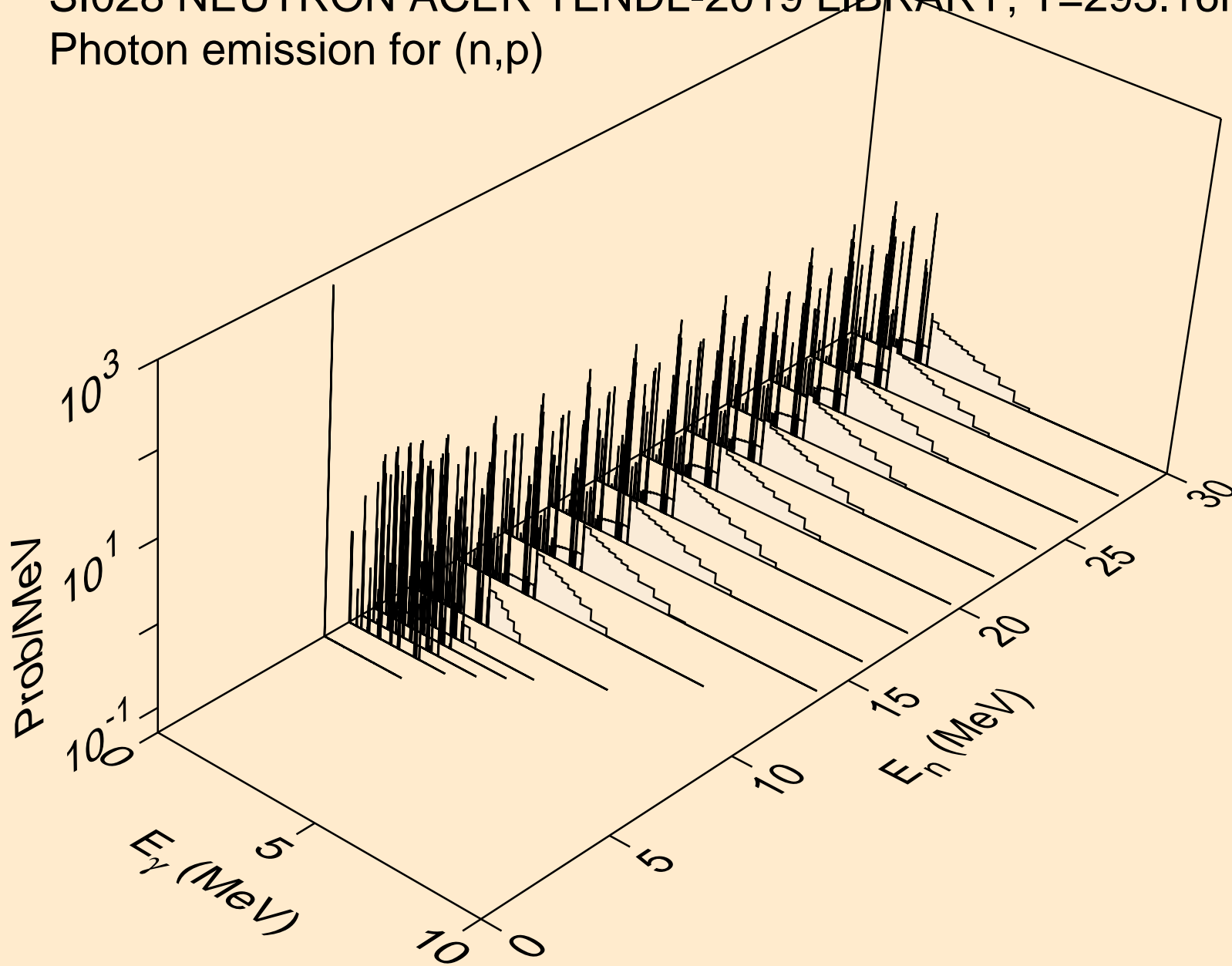

SI028 NEUTRON ACER TENDL-2019 LIBRARY; T=293.16K
Photon emission for (n,d)

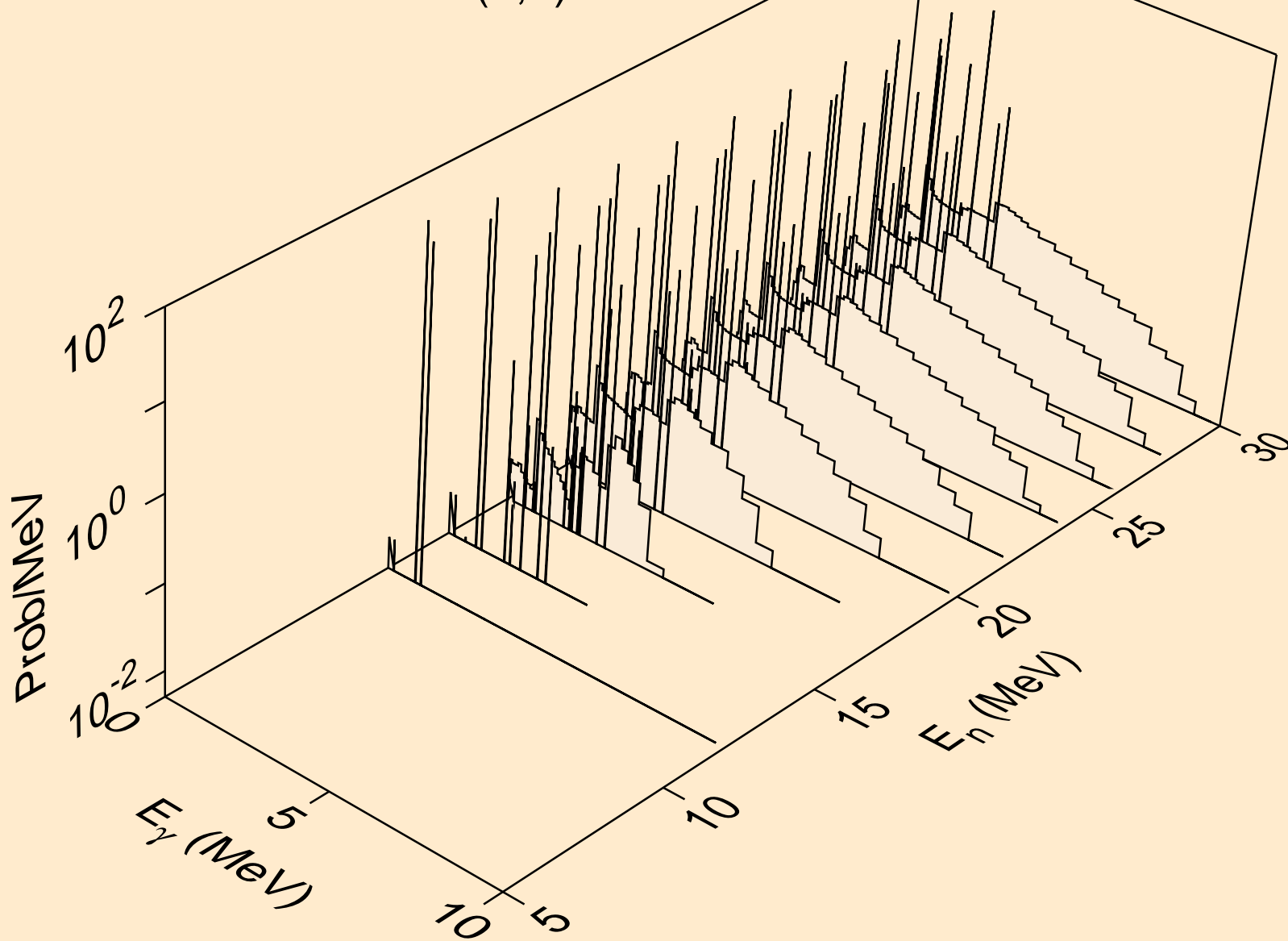

SI028 NEUTRON ACER TENDL-2019 LIBRARY; T=293.16K
Photon emission for (n,t)

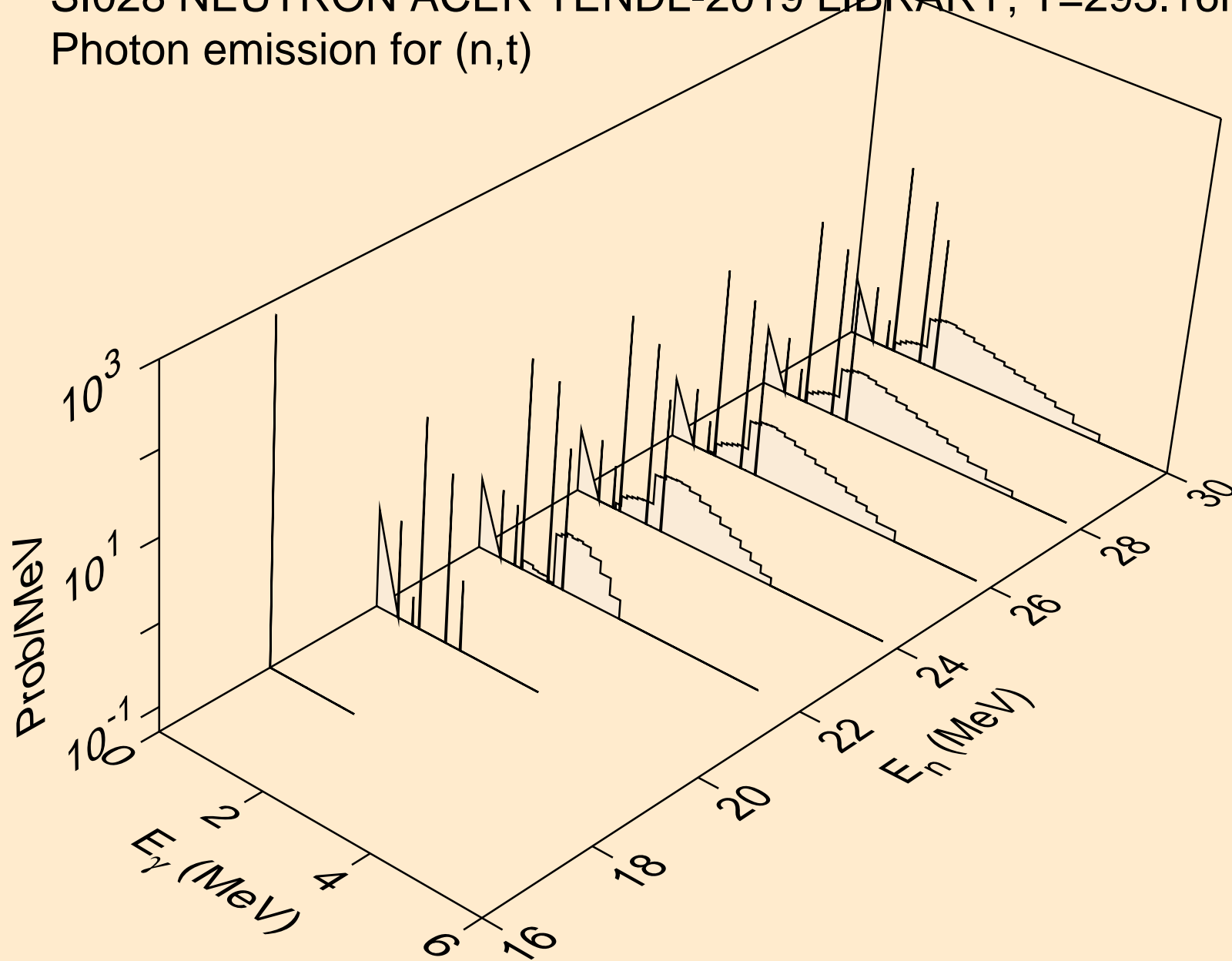

SI028 NEUTRON ACER TENDL-2019 LIBRARY; T=293.16K
Photon emission for (n,he3)

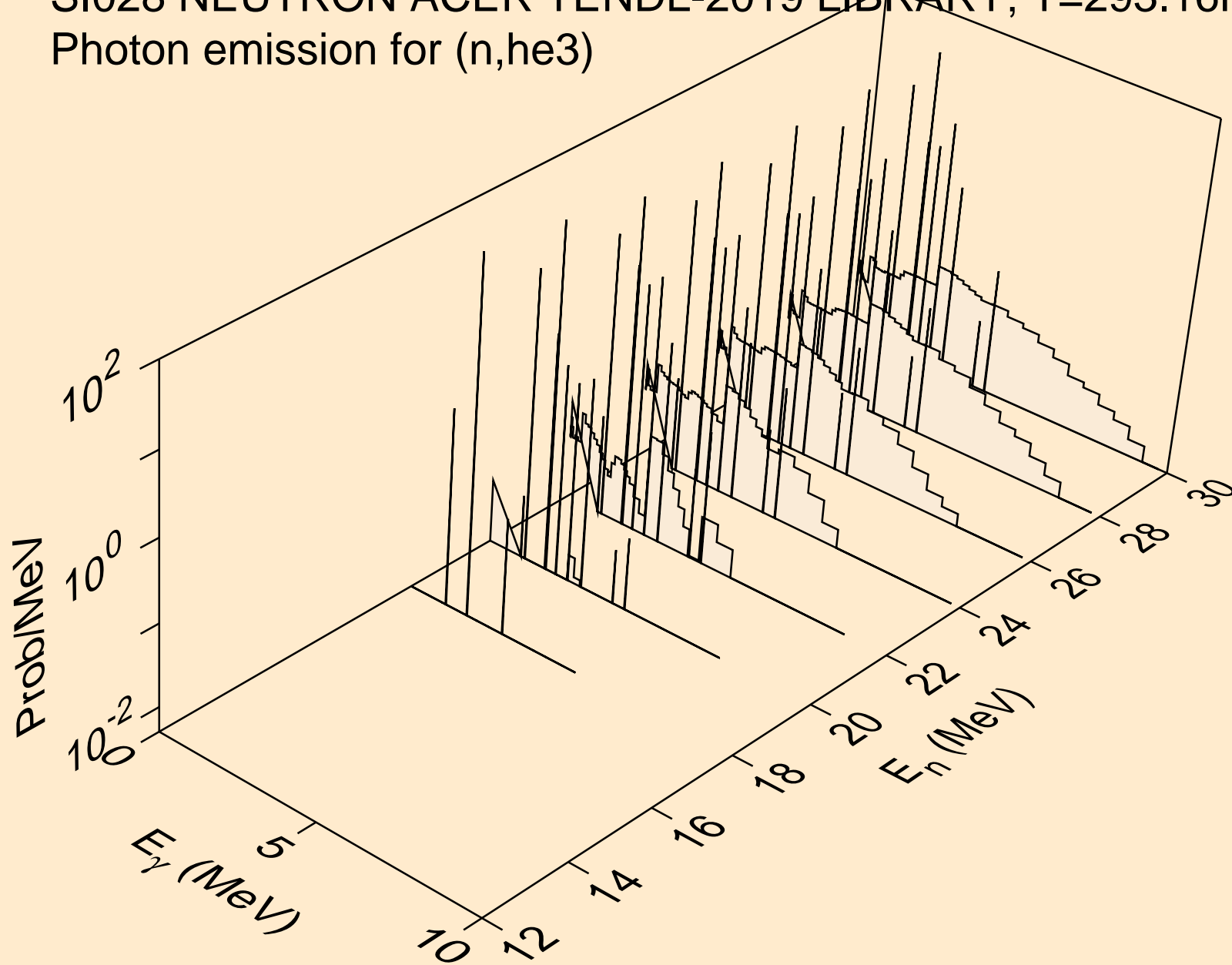

SI028 NEUTRON ACER TENDL-2019 LIBRARY; T=293.16K
Photon emission for (n,a)

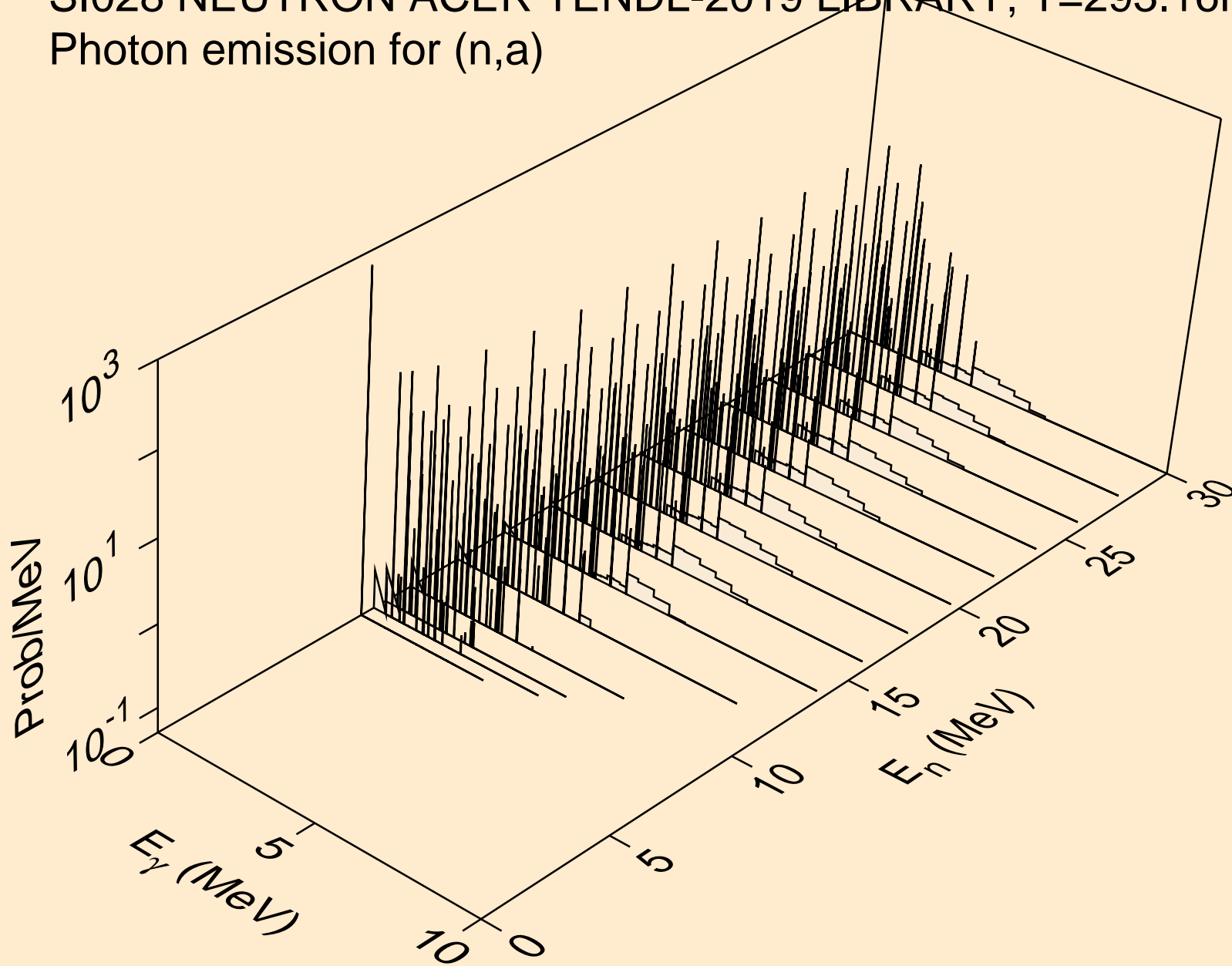

SI028 NEUTRON ACER TENDL-2019 LIBRARY; T=293.16K
Photon emission for (n,2a)

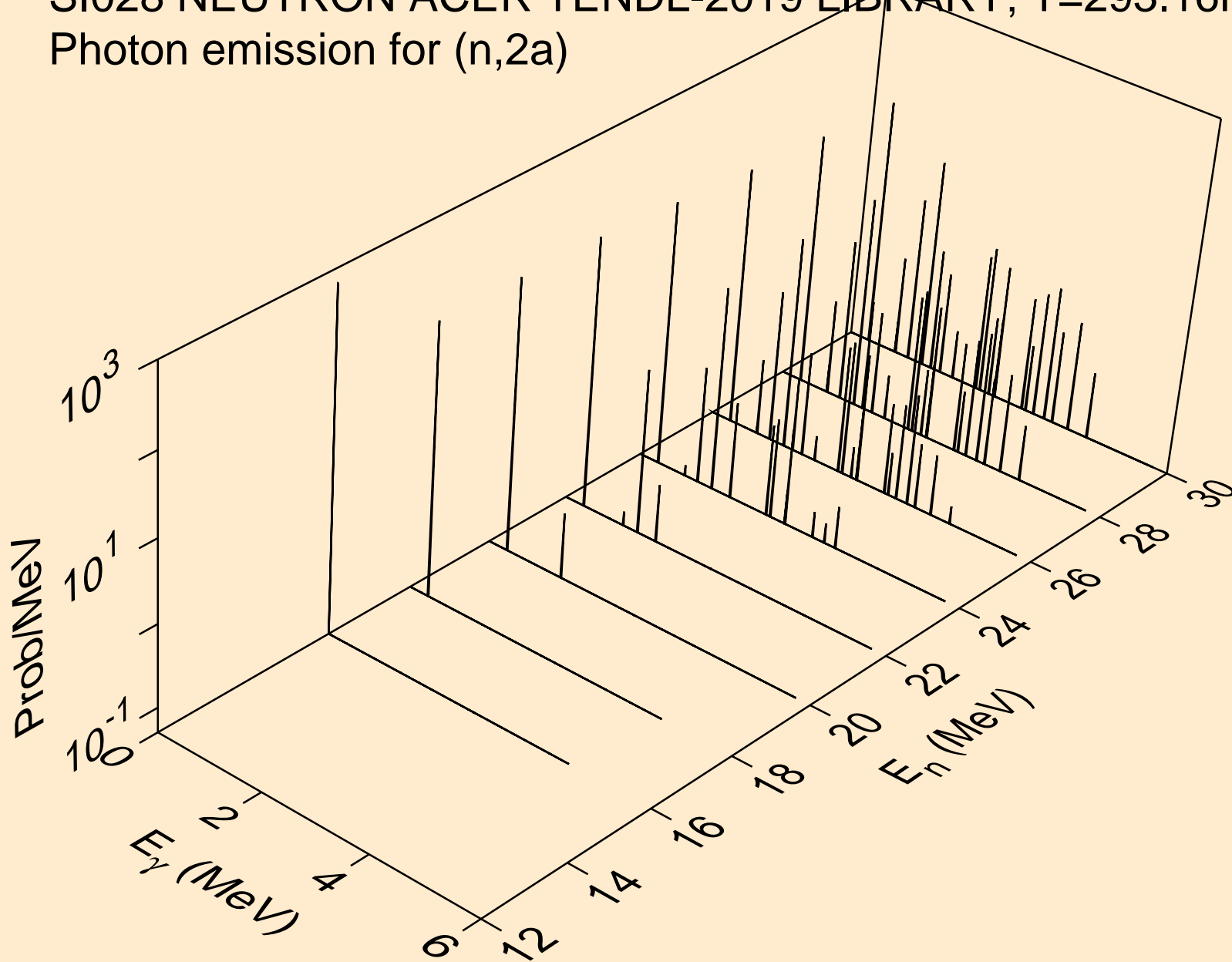

SI028 NEUTRON ACER TENDL-2019 LIBRARY; T=293.16K
Photon emission for (n,3a)

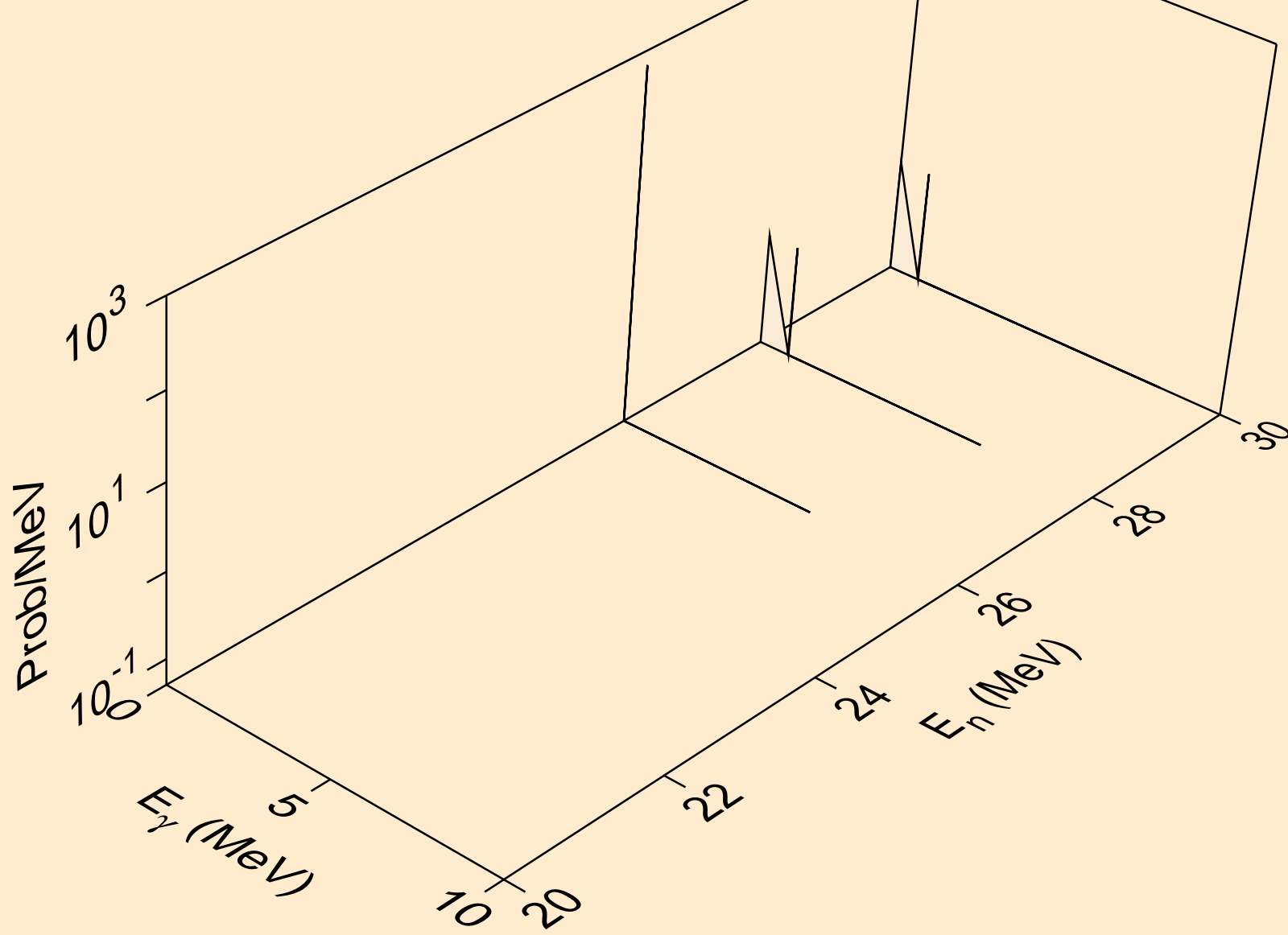

SI028 NEUTRON ACER TENDL-2019 LIBRARY; T=293.16K
Photon emission for (n,2p)

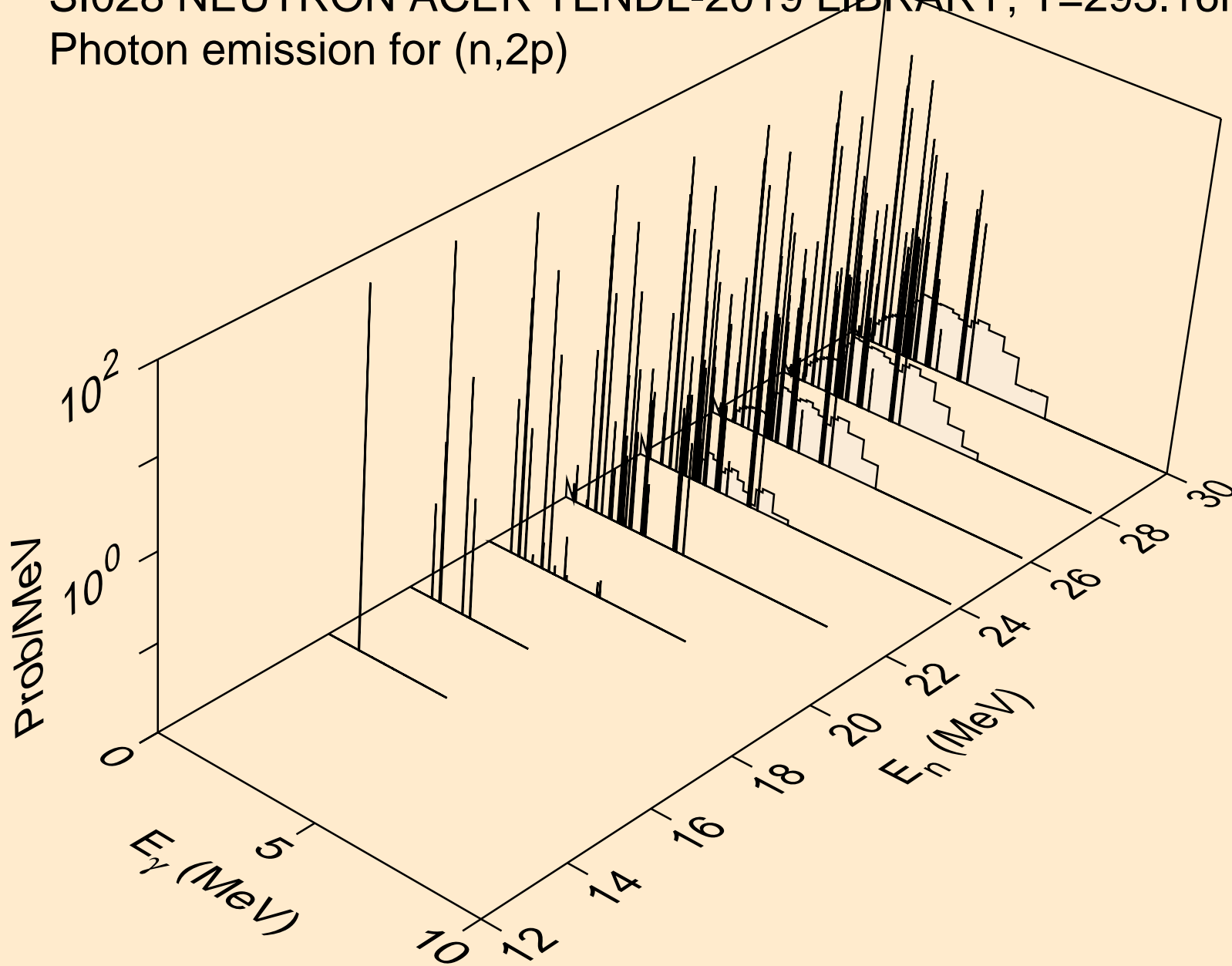

SI028 NEUTRON ACER TENDL-2019 LIBRARY; T=293.16K
Photon emission for (n,p α)

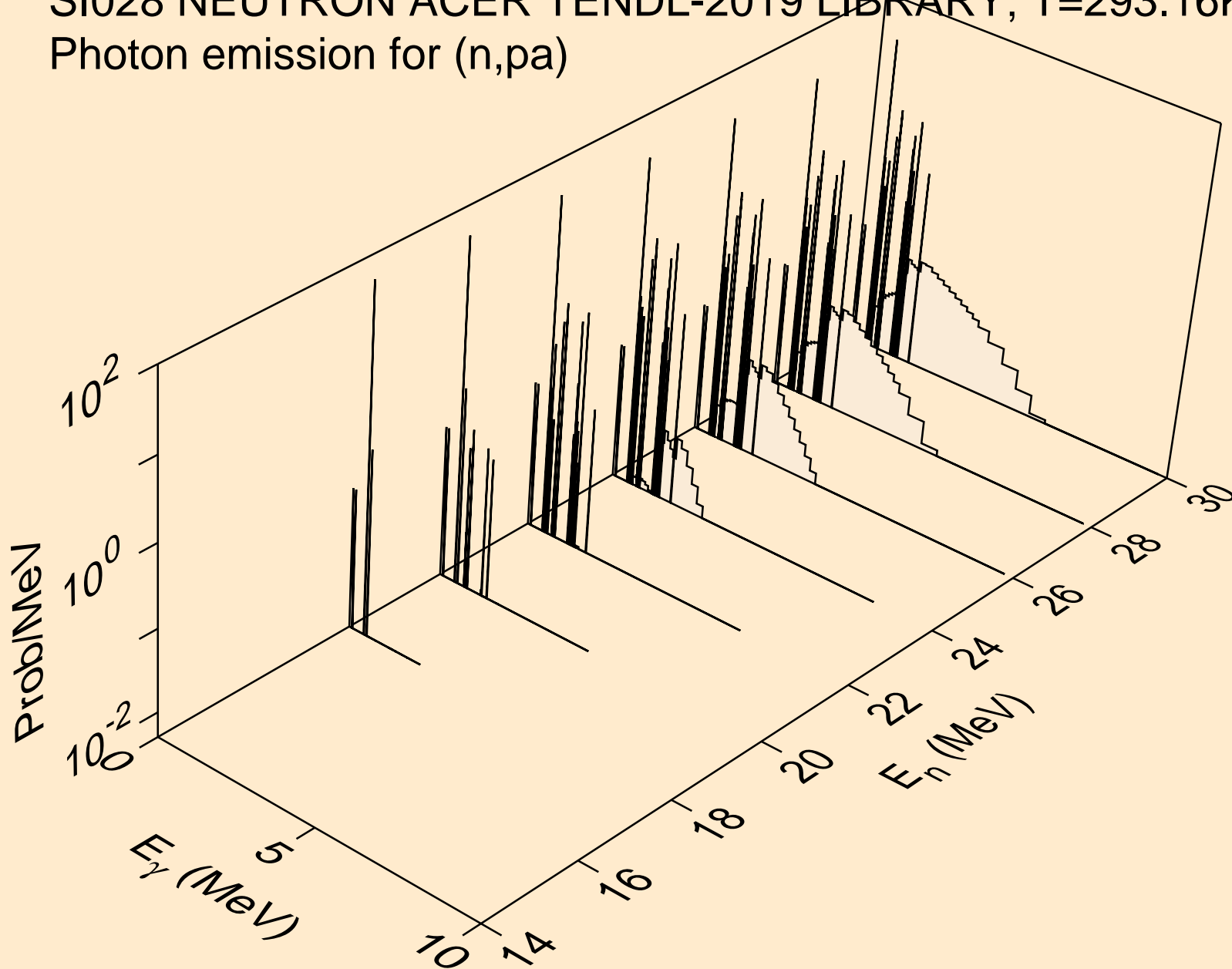

SI028 NEUTRON ACER TENDL-2019 LIBRARY; T=293.16K
Photon emission for (n,pd)

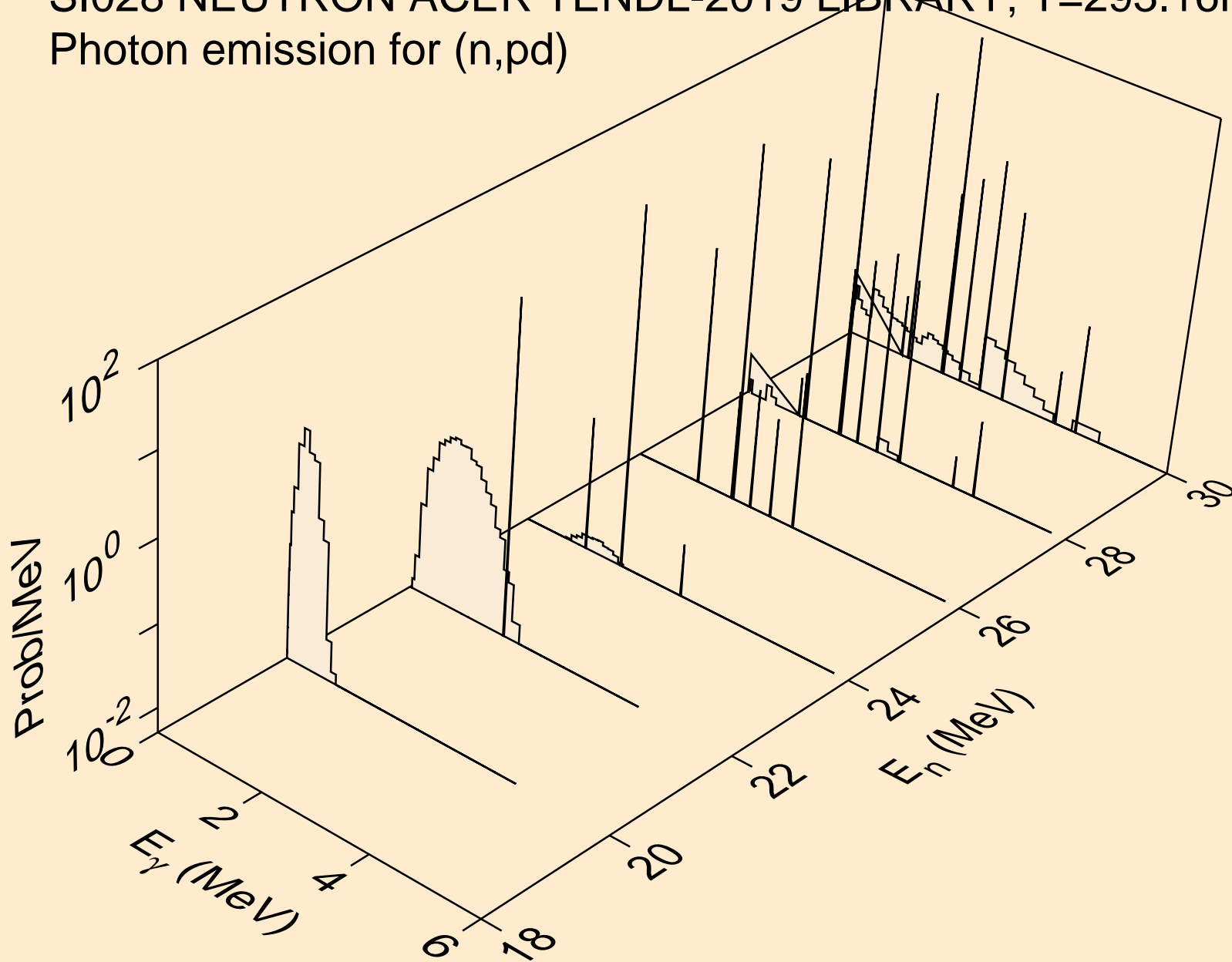

SI028 NEUTRON ACER TENDL-2019 LIBRARY; T=293.16K
Photon emission for (n,pt)

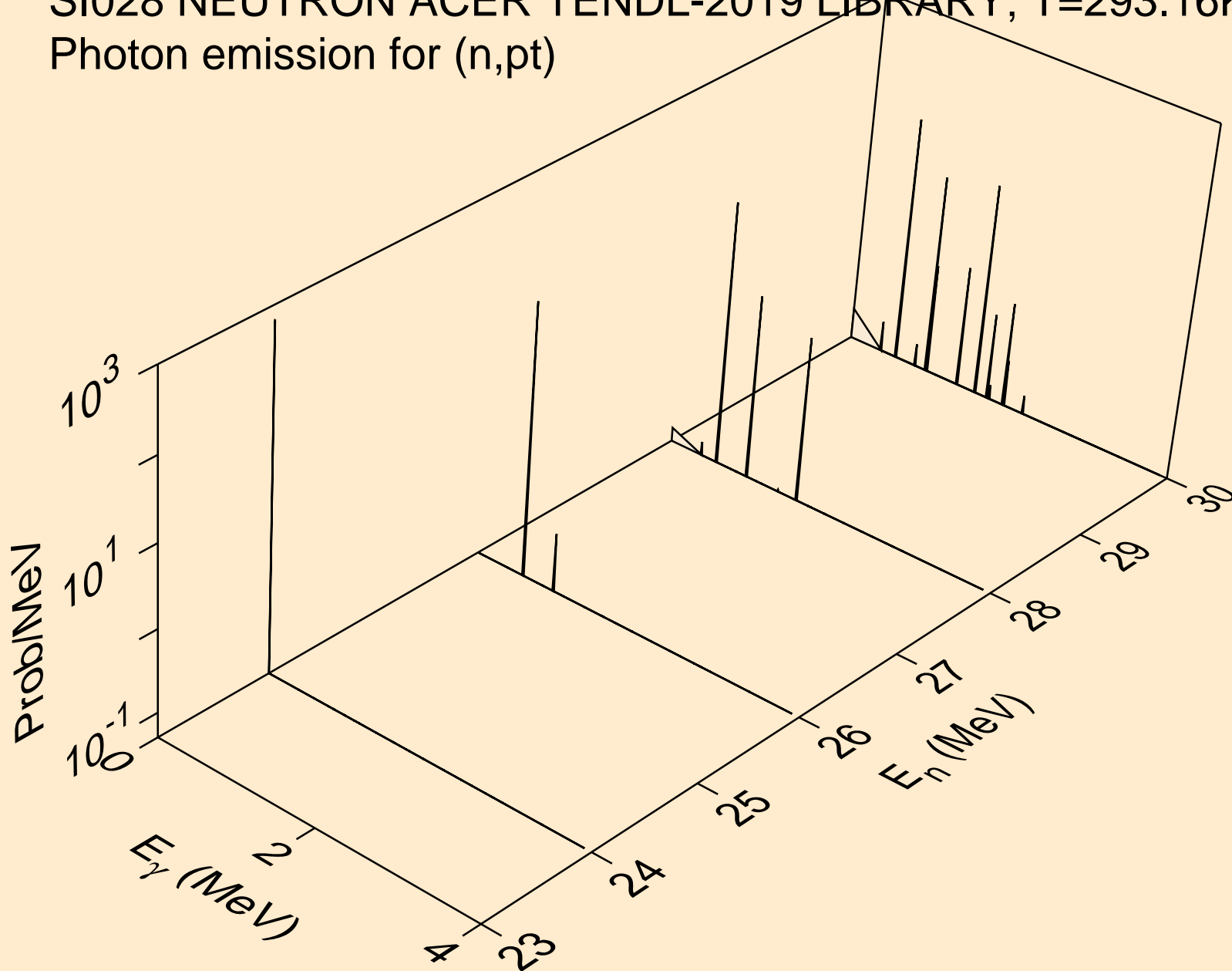

SI028 NEUTRON ACER TENDL-2019 LIBRARY; T=293.16K
Photon emission for (n,da)

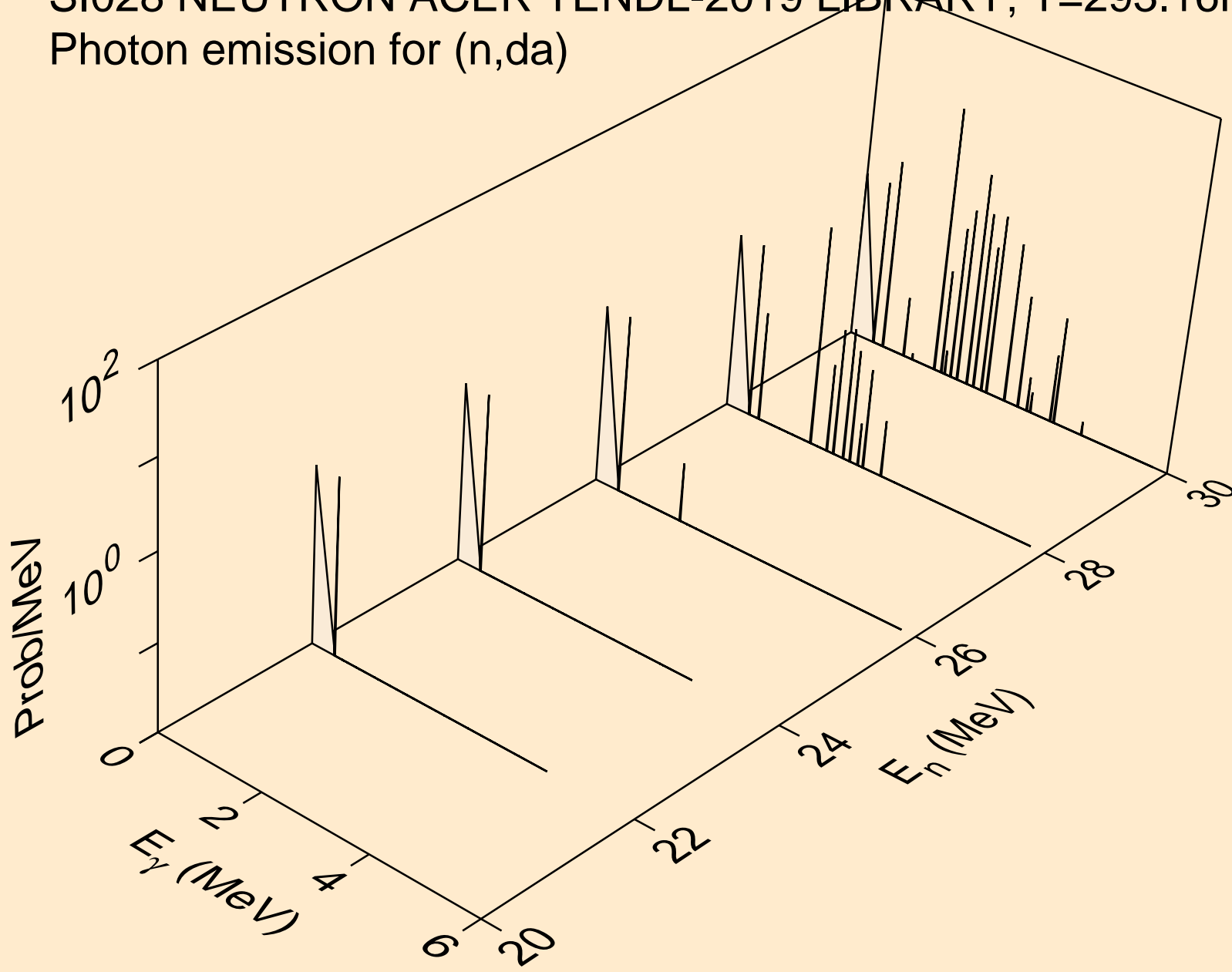

SI028 NEUTRON ACER TENDL-2019 LIBRARY; T=293.16K
thermal capture photon spectrum

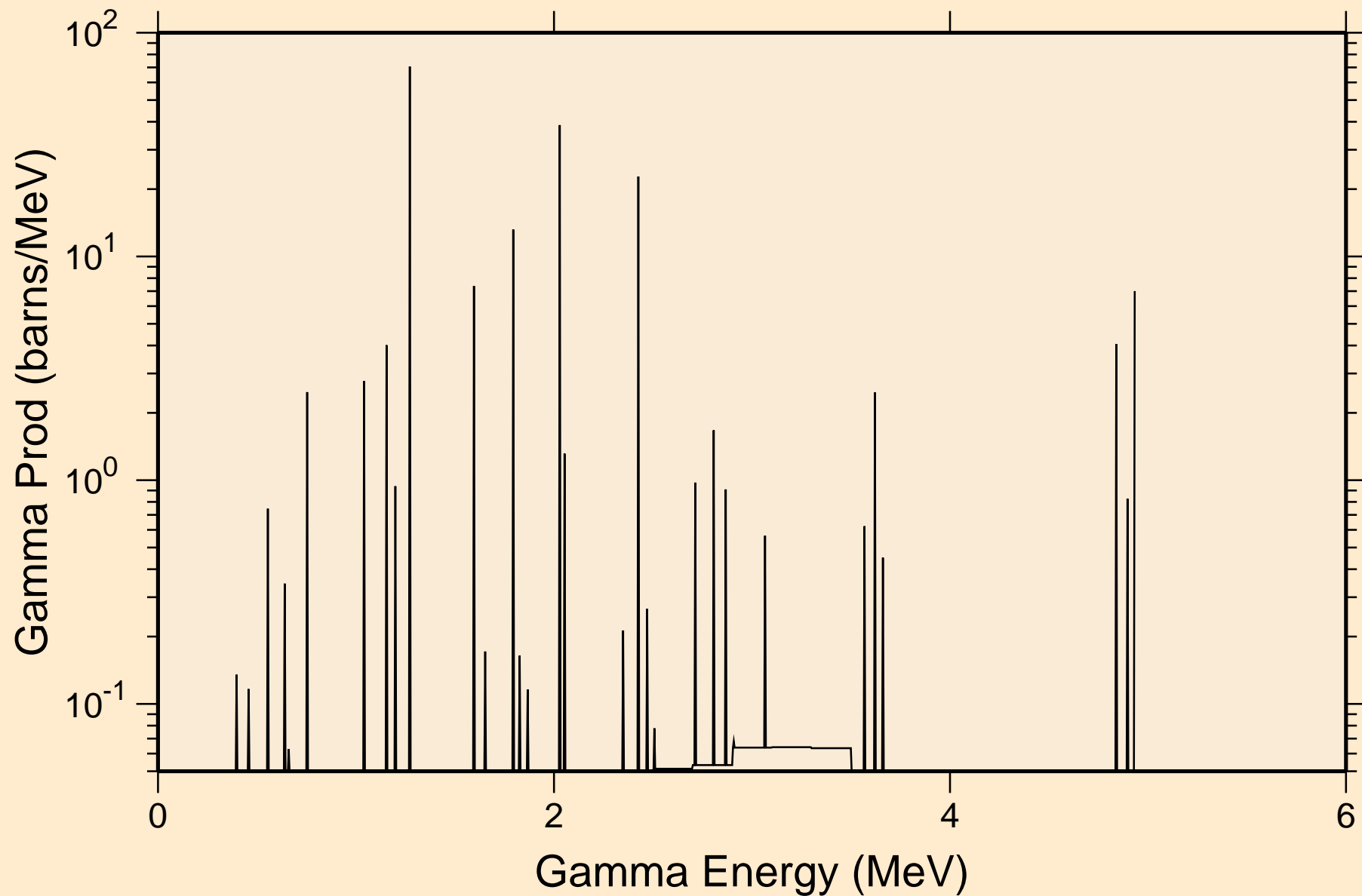

SI028 NEUTRON ACER TENDL-2019 LIBRARY; T=293.16K
14 MeV photon spectrum

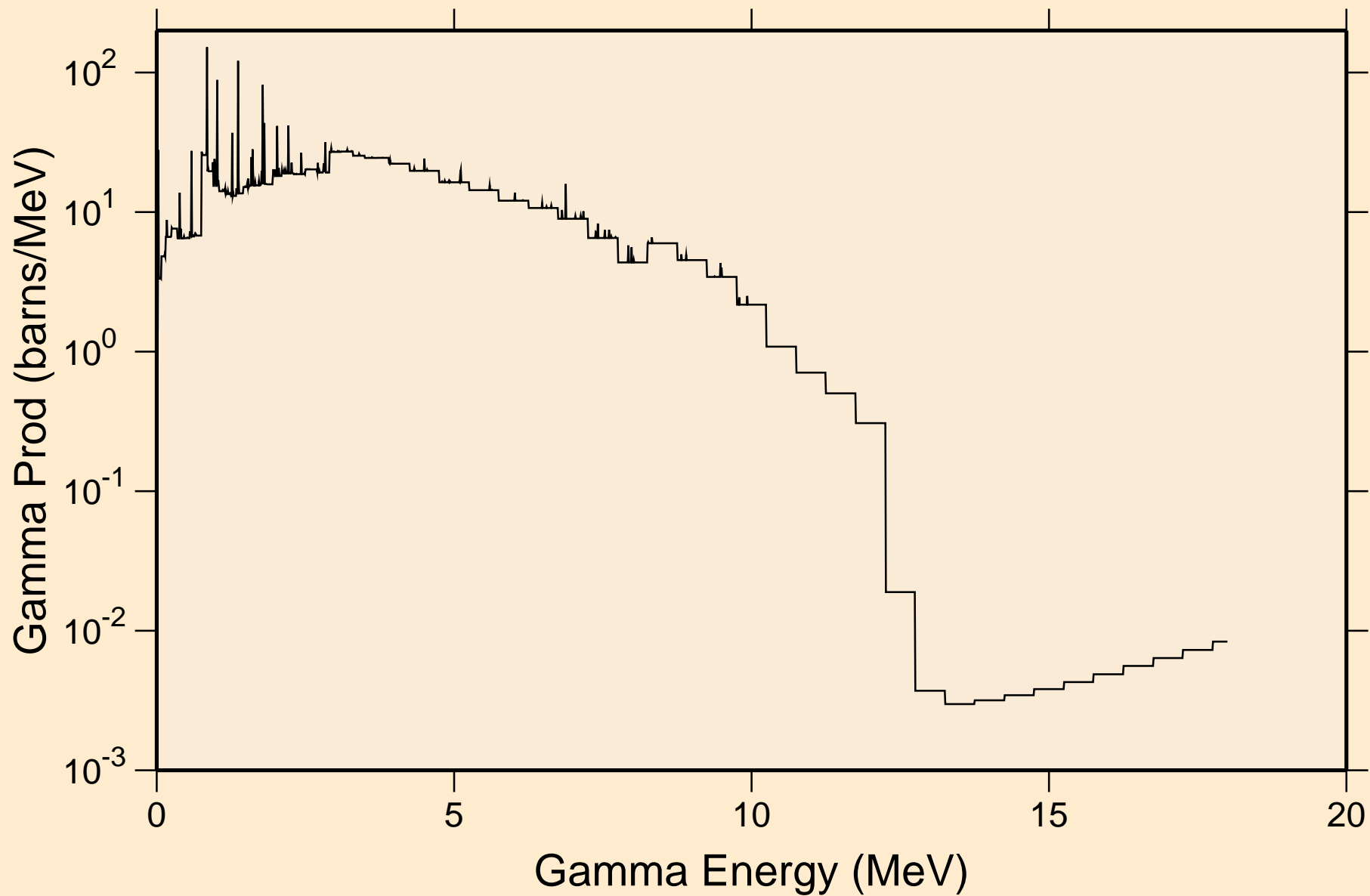

SI028 NEUTRON ACER TENDL-2019 LIBRARY; T=293.16K

Particle heating contributions

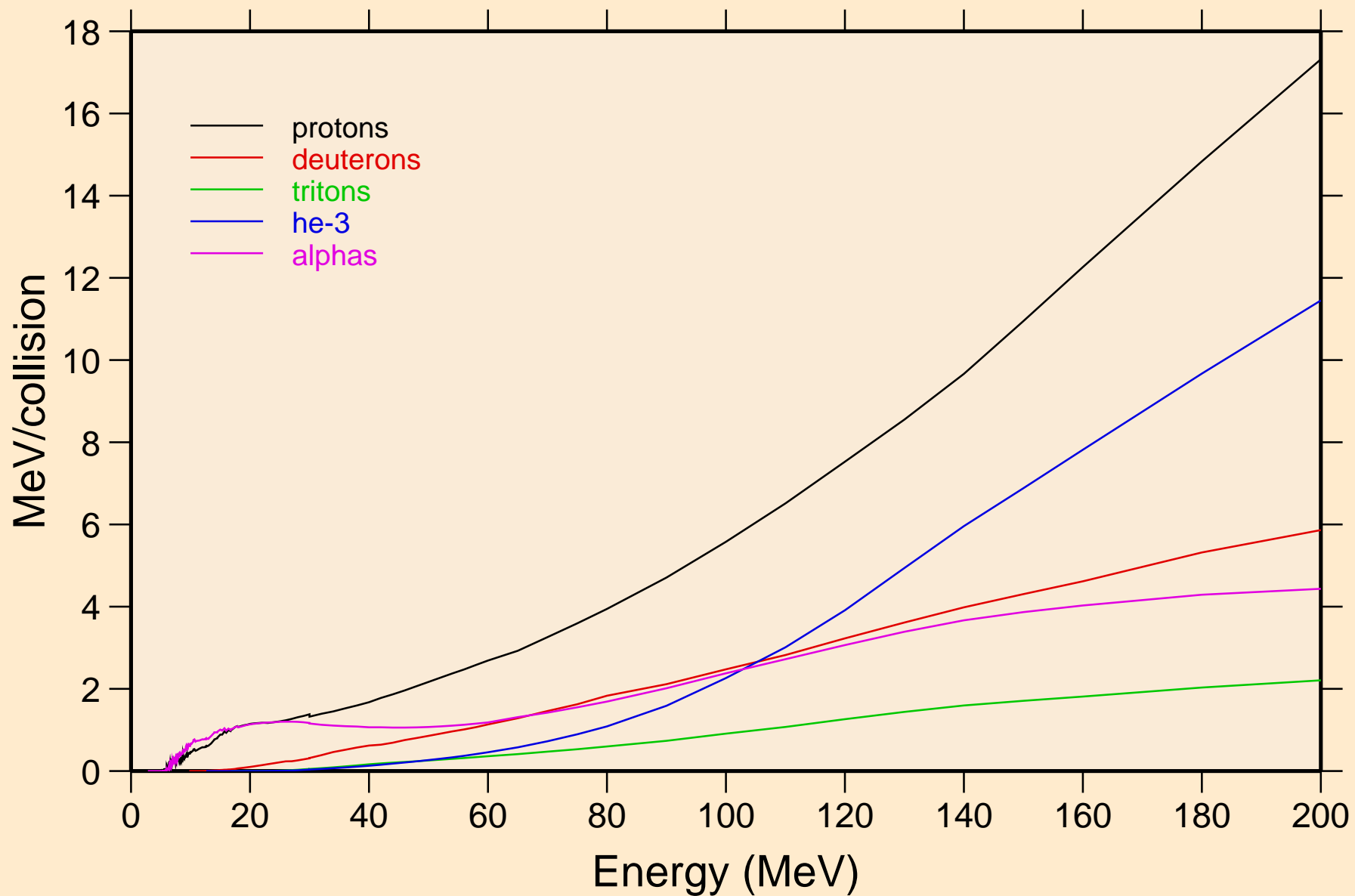

SI028 NEUTRON ACER TENDL-2019 LIBRARY; T=293.16K
Recoil Heating

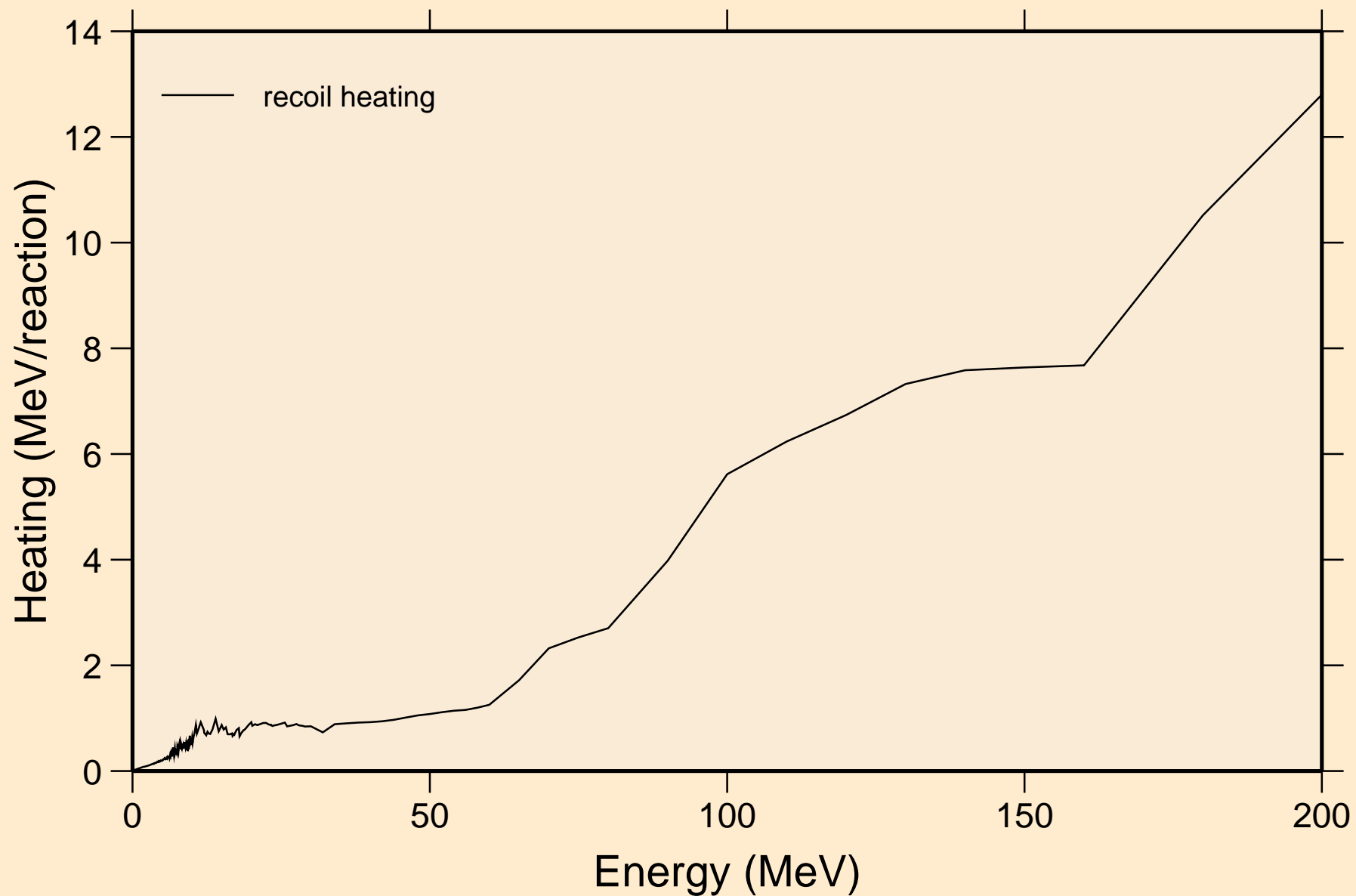

SI028 NEUTRON ACER TENDL-2019 LIBRARY; T=293.16K
Particle production cross sections

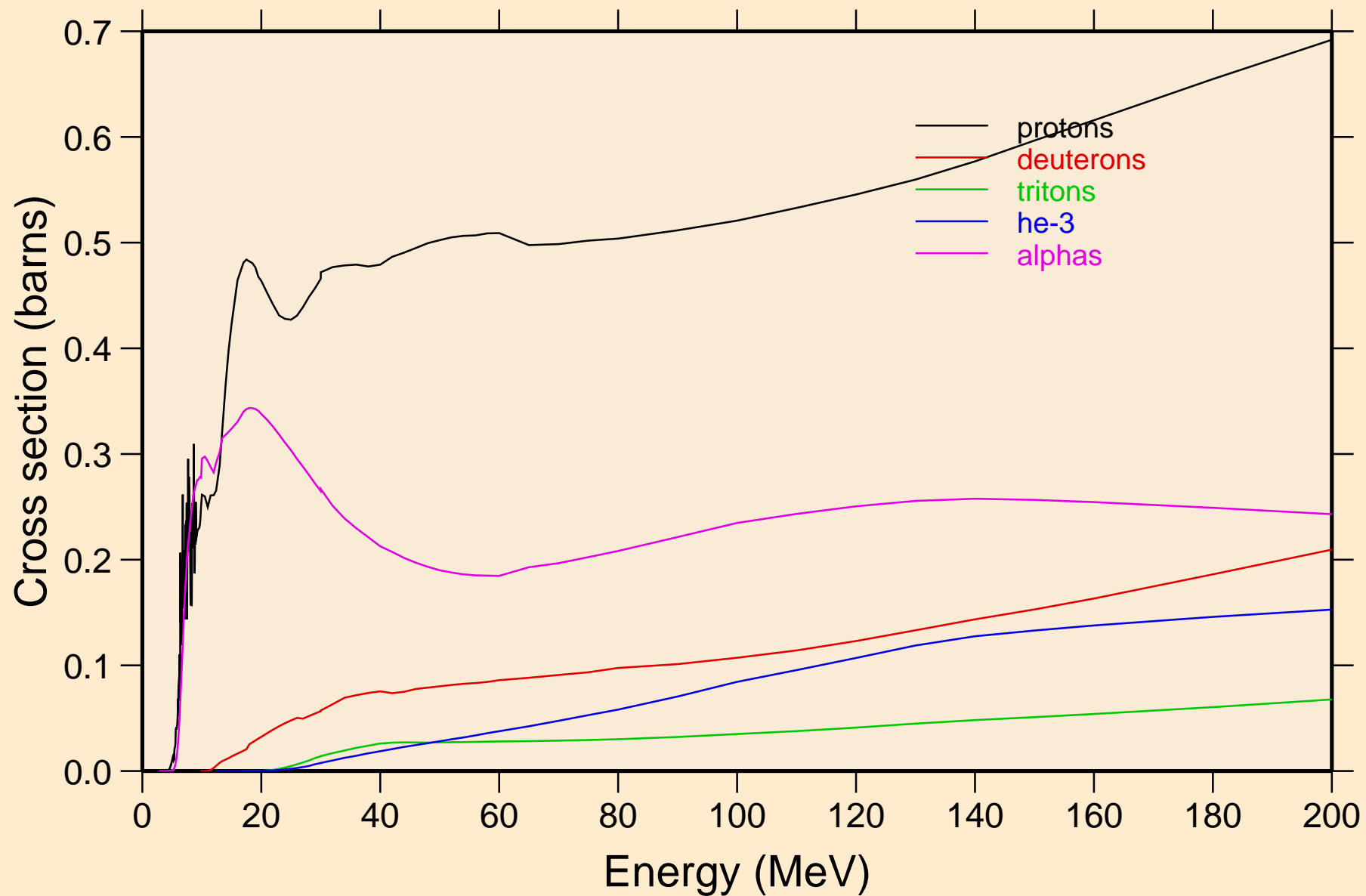

SI028 NEUTRON ACER TENDL-2019 LIBRARY; T=293.16K
protons from (n,x)

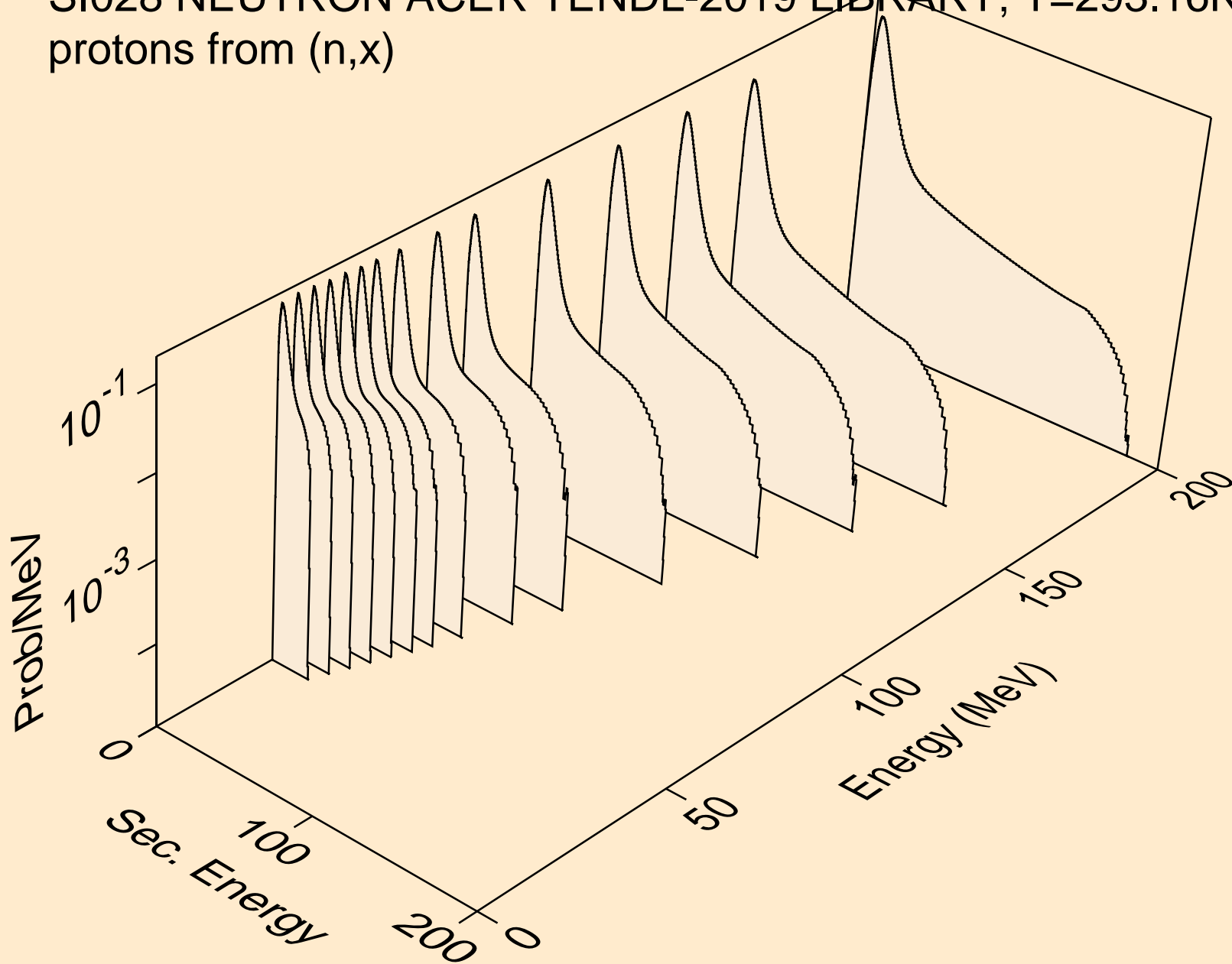

SI028 NEUTRON ACER TENDL-2019 LIBRARY; T=293.16K
protons from (n,n*)p

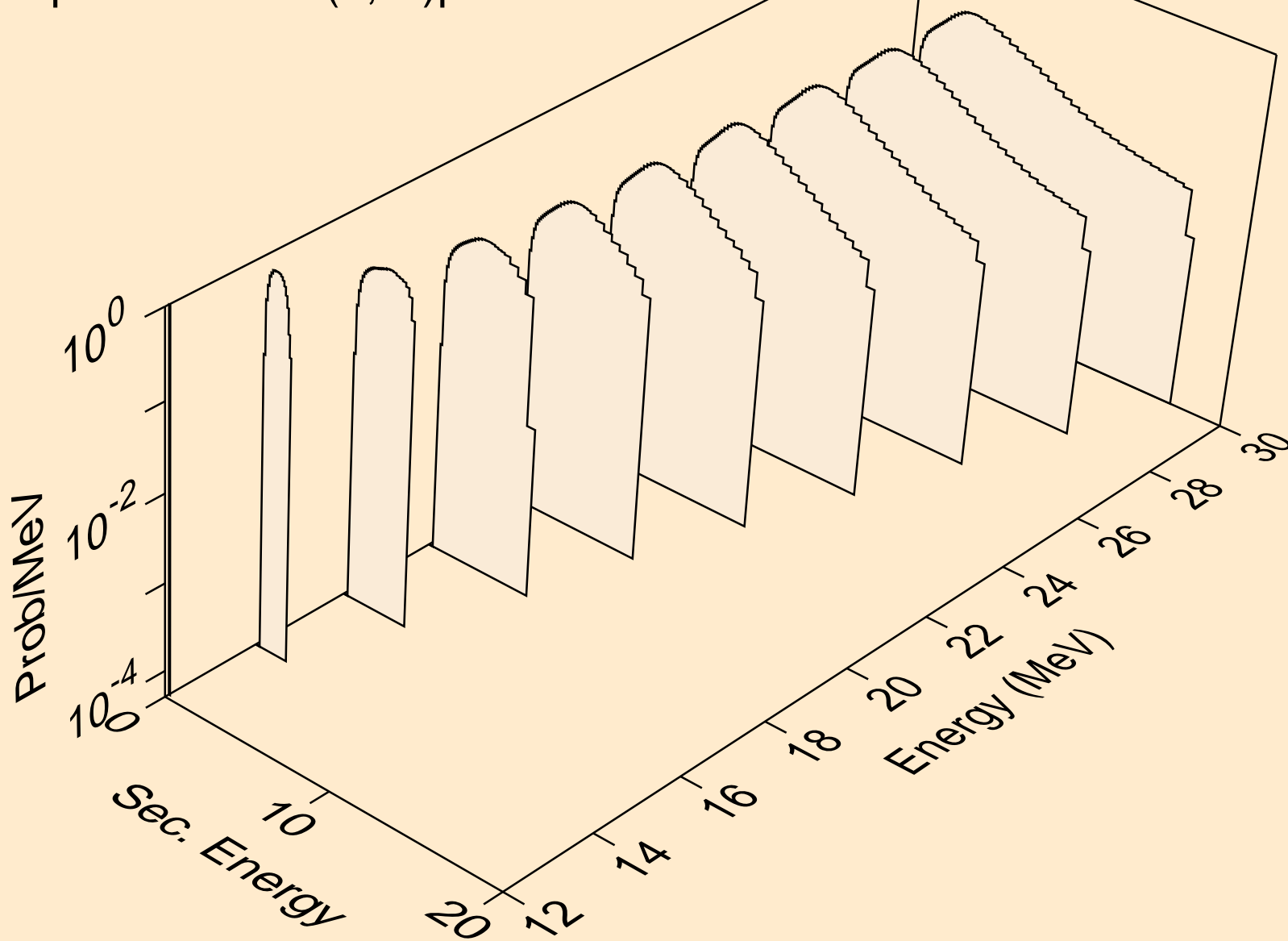

SI028 NEUTRON ACER TENDL-2019 LIBRARY; T=293.16K
protons from (n,2np)

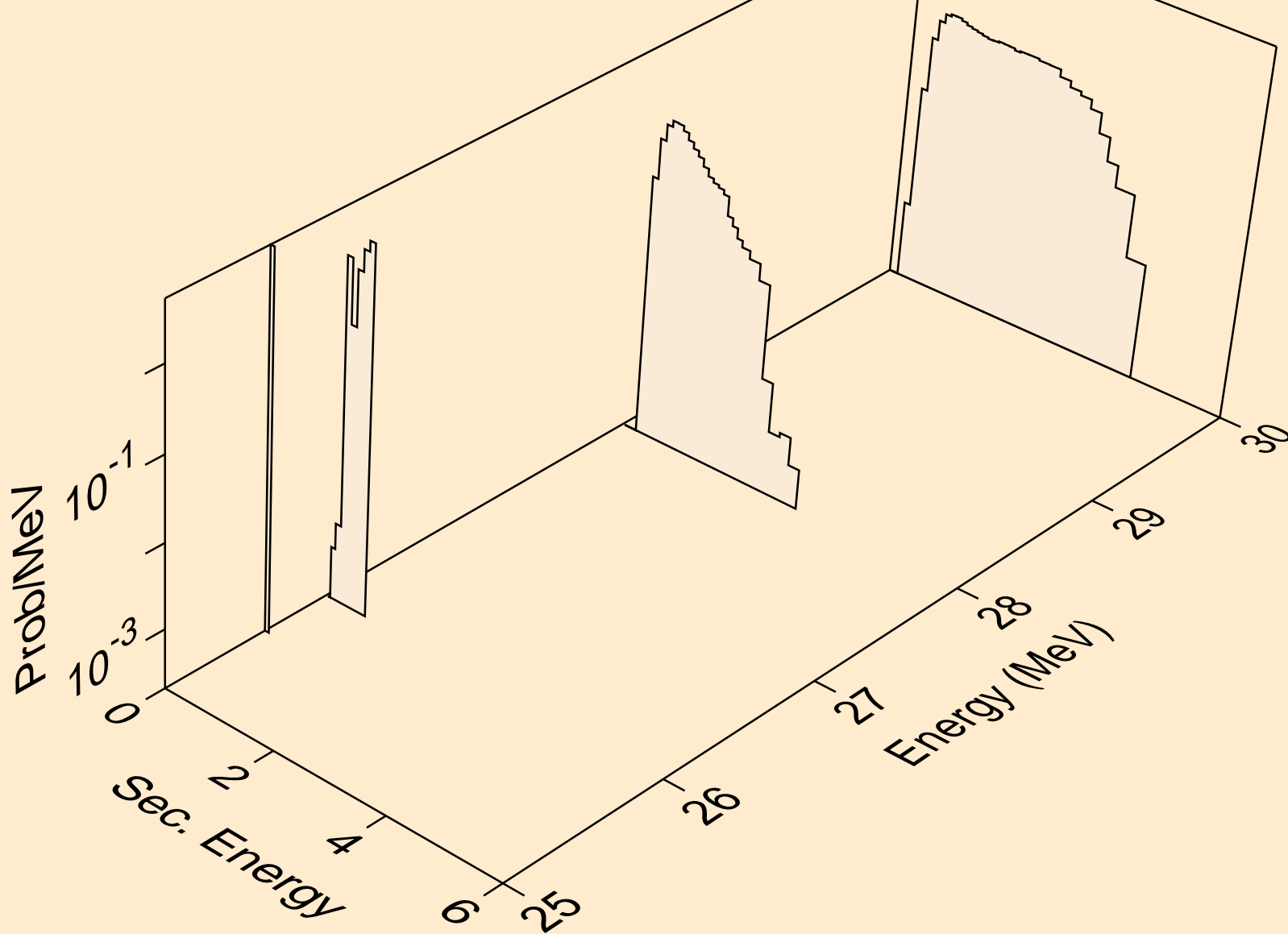

SI028 NEUTRON ACER TENDL-2019 LIBRARY; T=293.16K
protons from (n,2np)

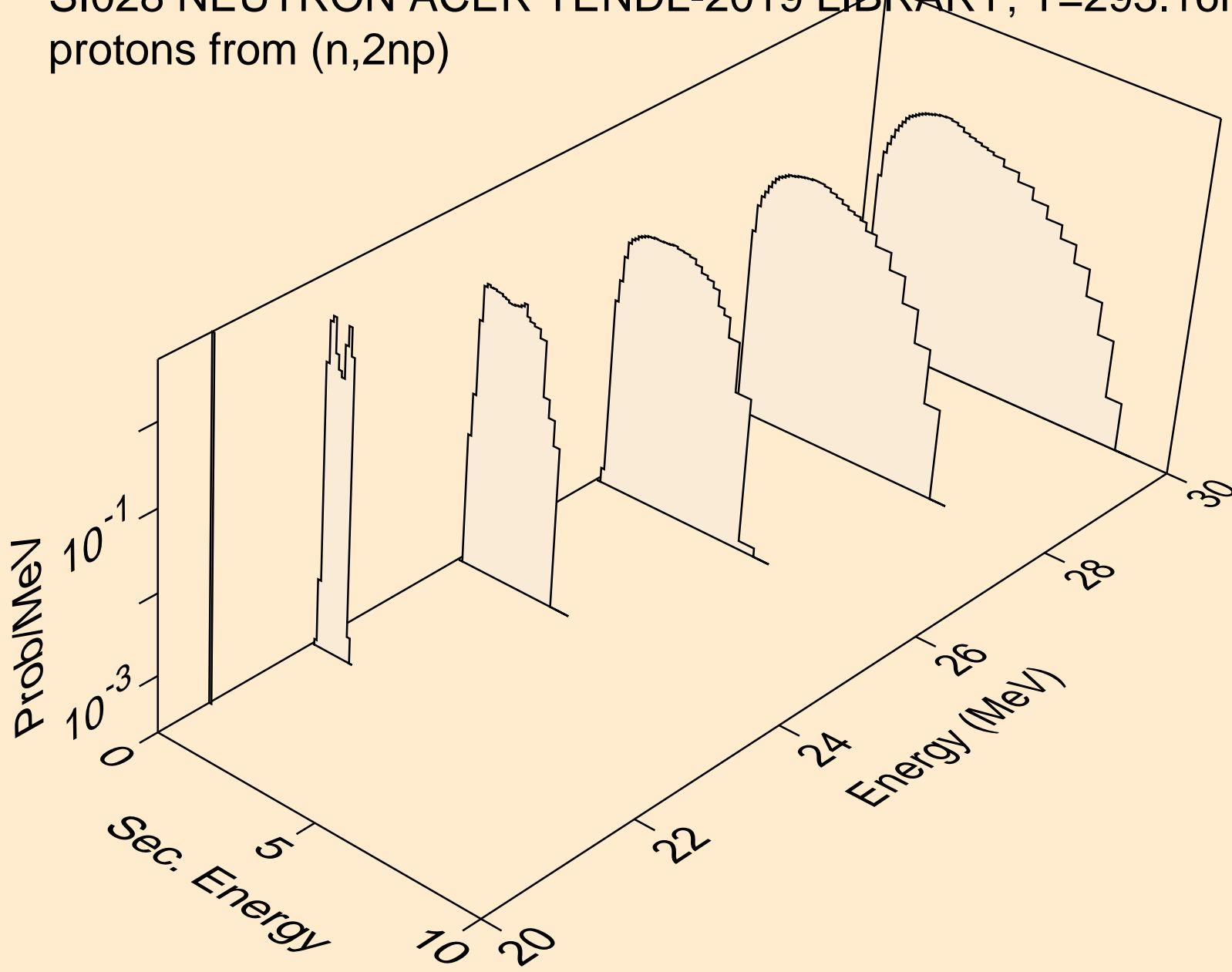

SI028 NEUTRON ACER TENDL-2019 LIBRARY; T=293.16K
protons from (n,npa)

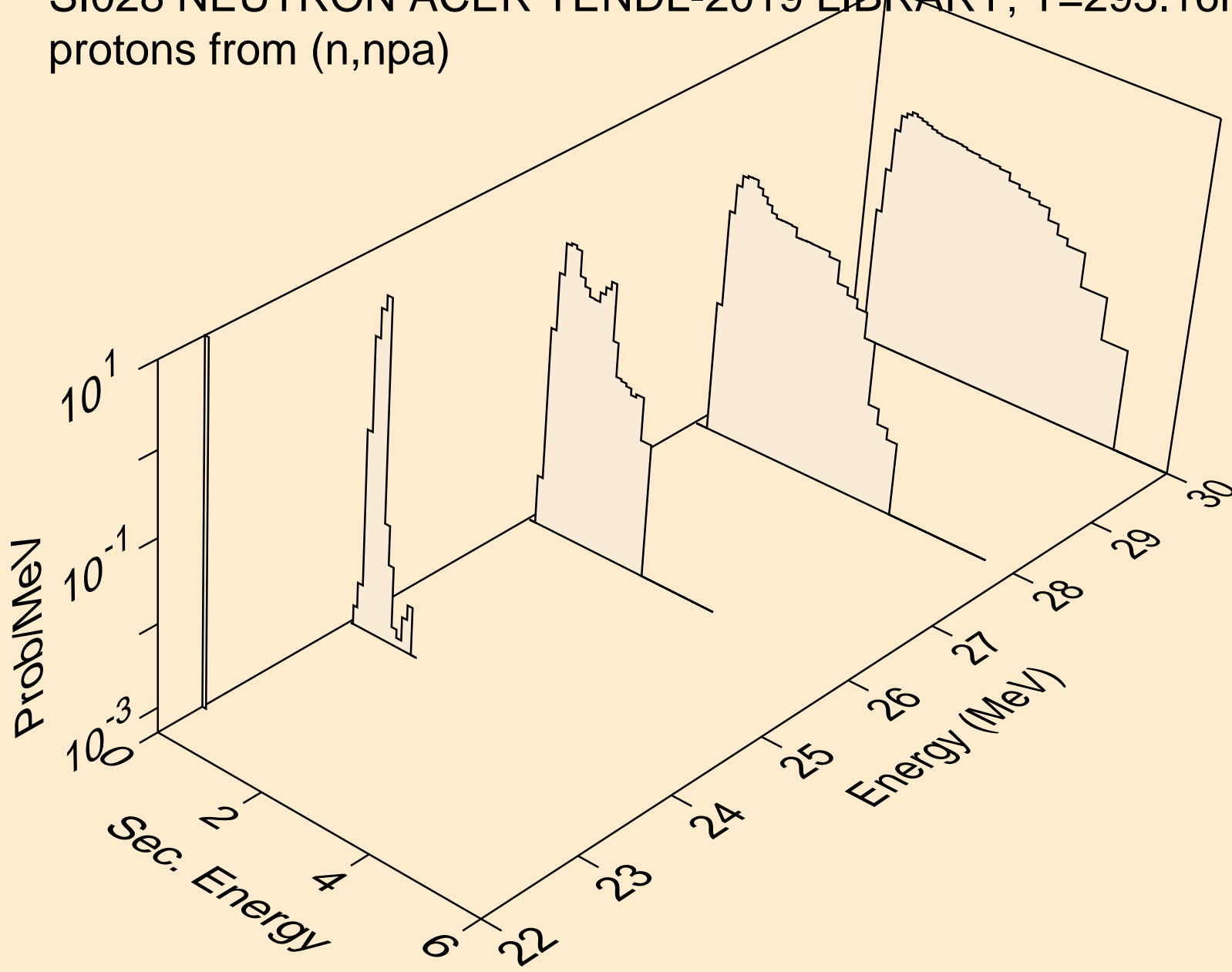

SI028 NEUTRON ACER TENDL-2019 LIBRARY; T=293.16K
protons from (n,p)

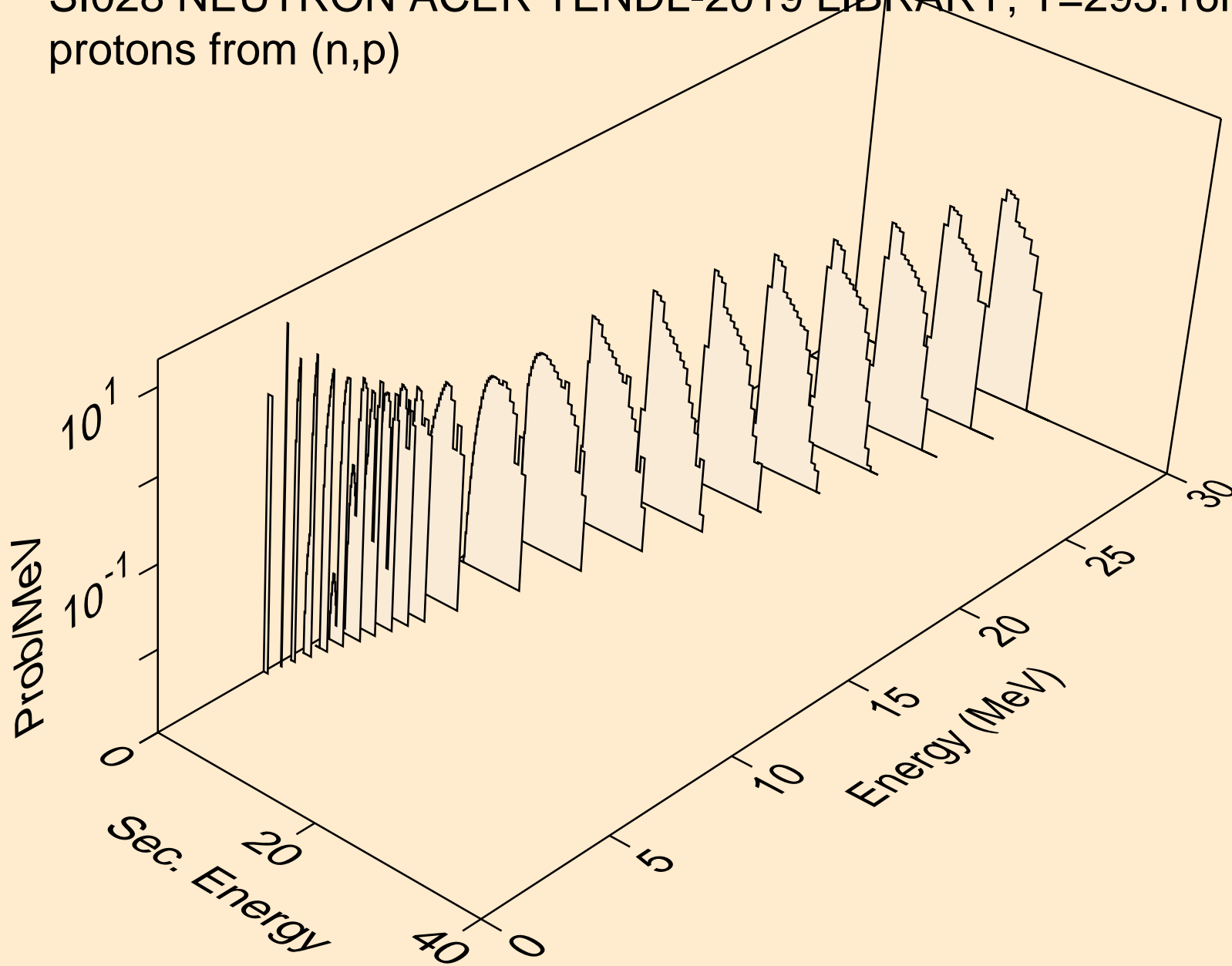

SI028 NEUTRON ACER TENDL-2019 LIBRARY; T=293.16K
protons from (n,2p)

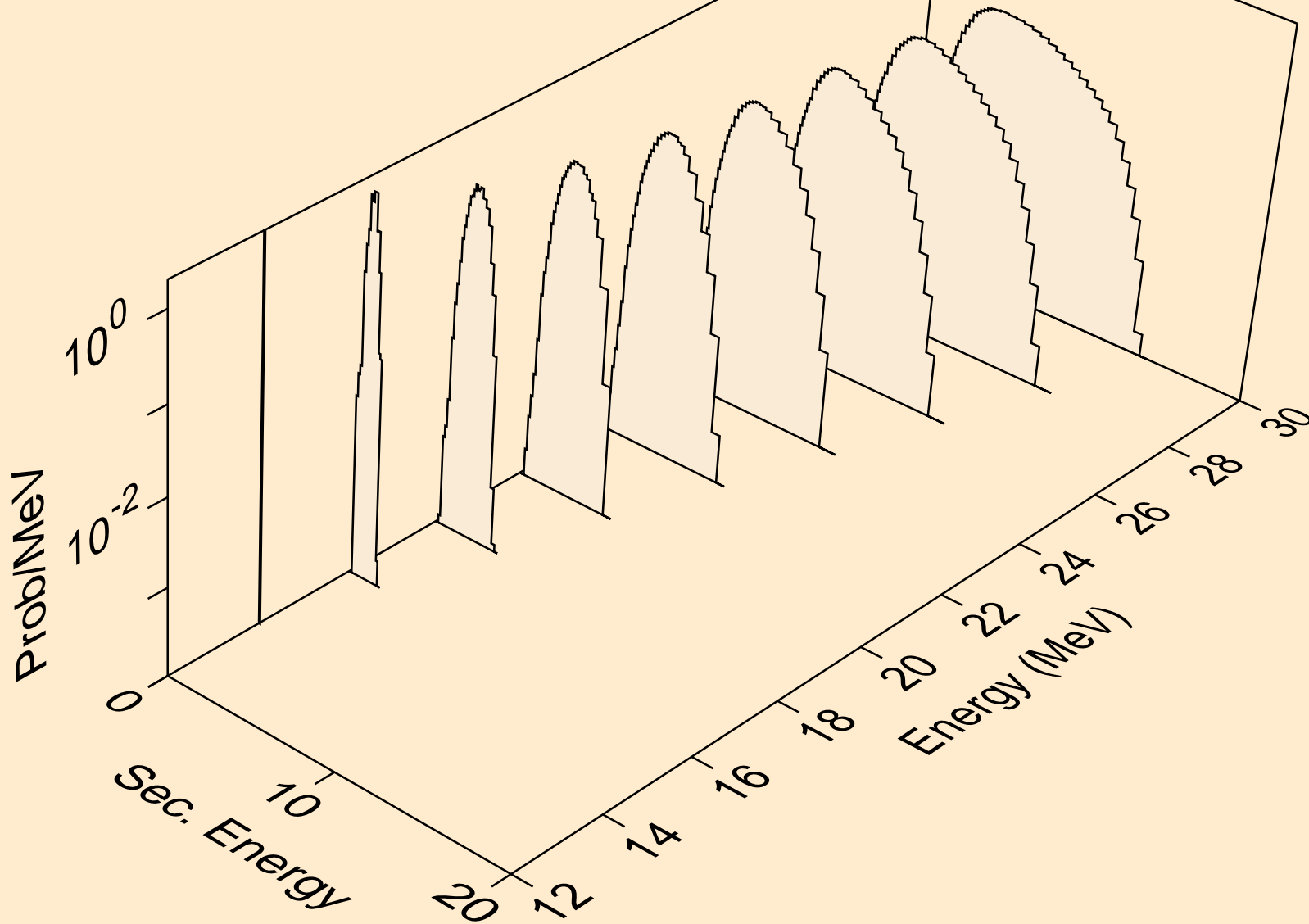

SI028 NEUTRON ACER TENDL-2019 LIBRARY; T=293.16K
protons from (n,p)

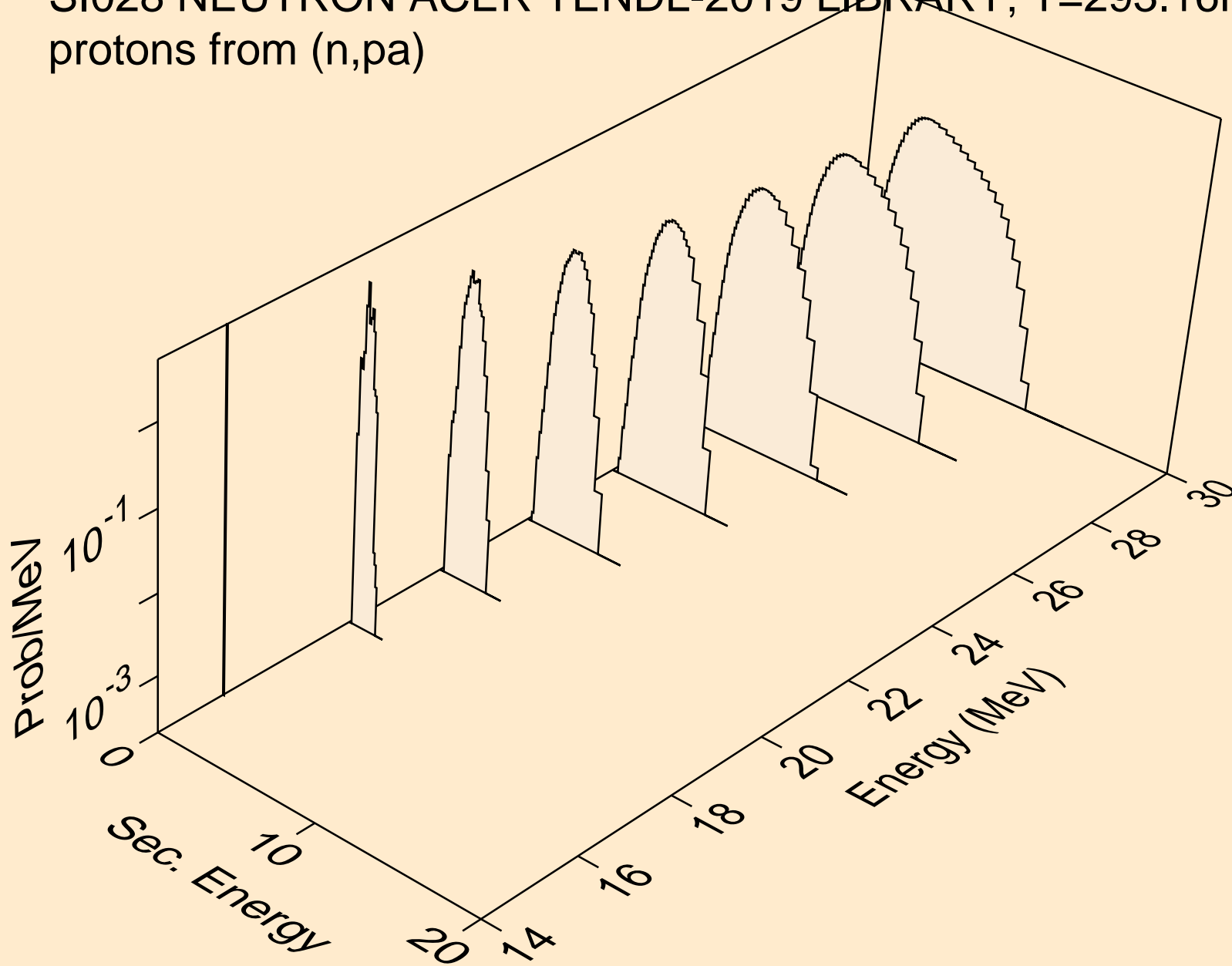

SI028 NEUTRON ACER TENDL-2019 LIBRARY; T=293.16K
protons from (n,pd)

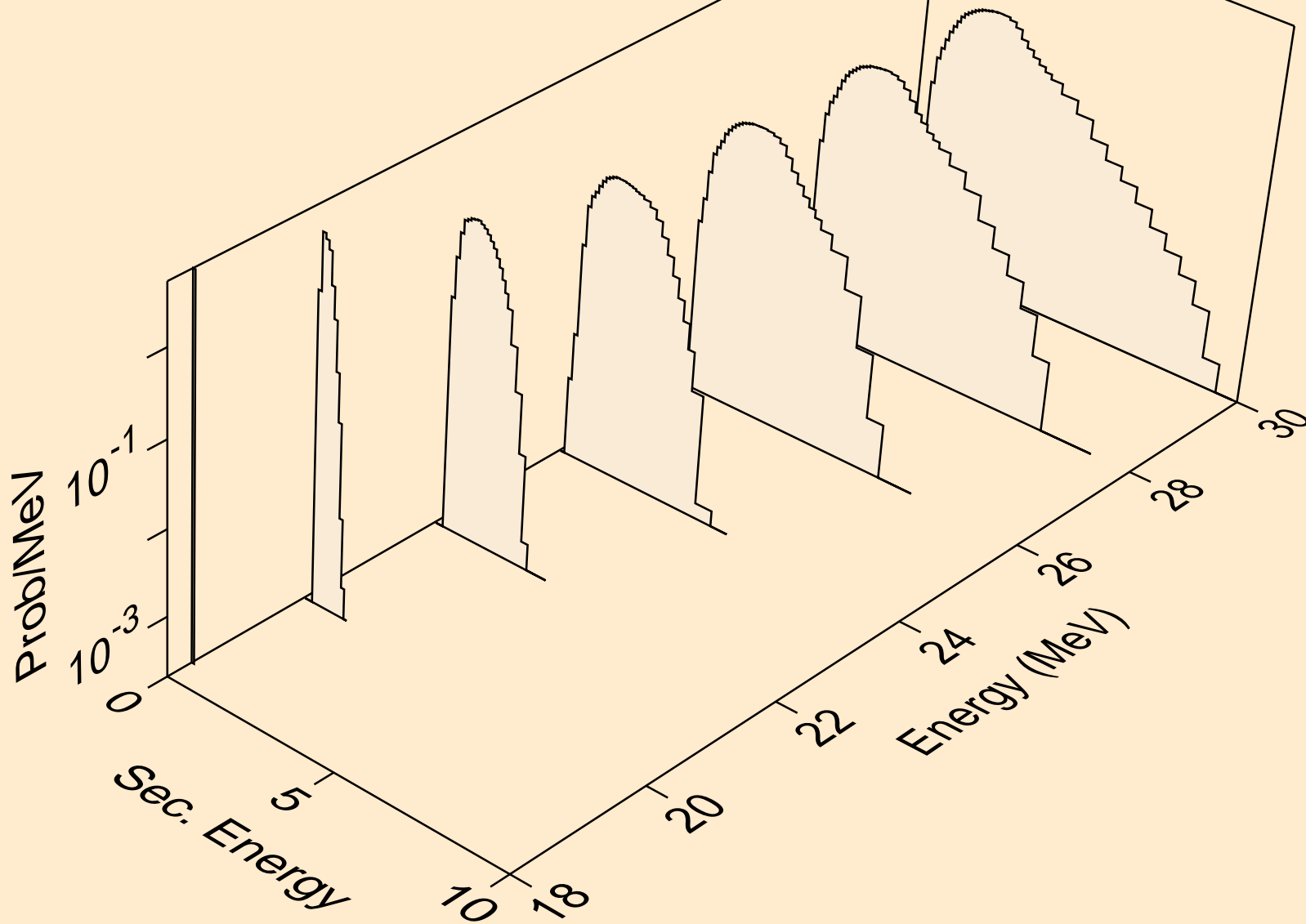

SI028 NEUTRON ACER TENDL-2019 LIBRARY; T=293.16K
protons from (n,pt)

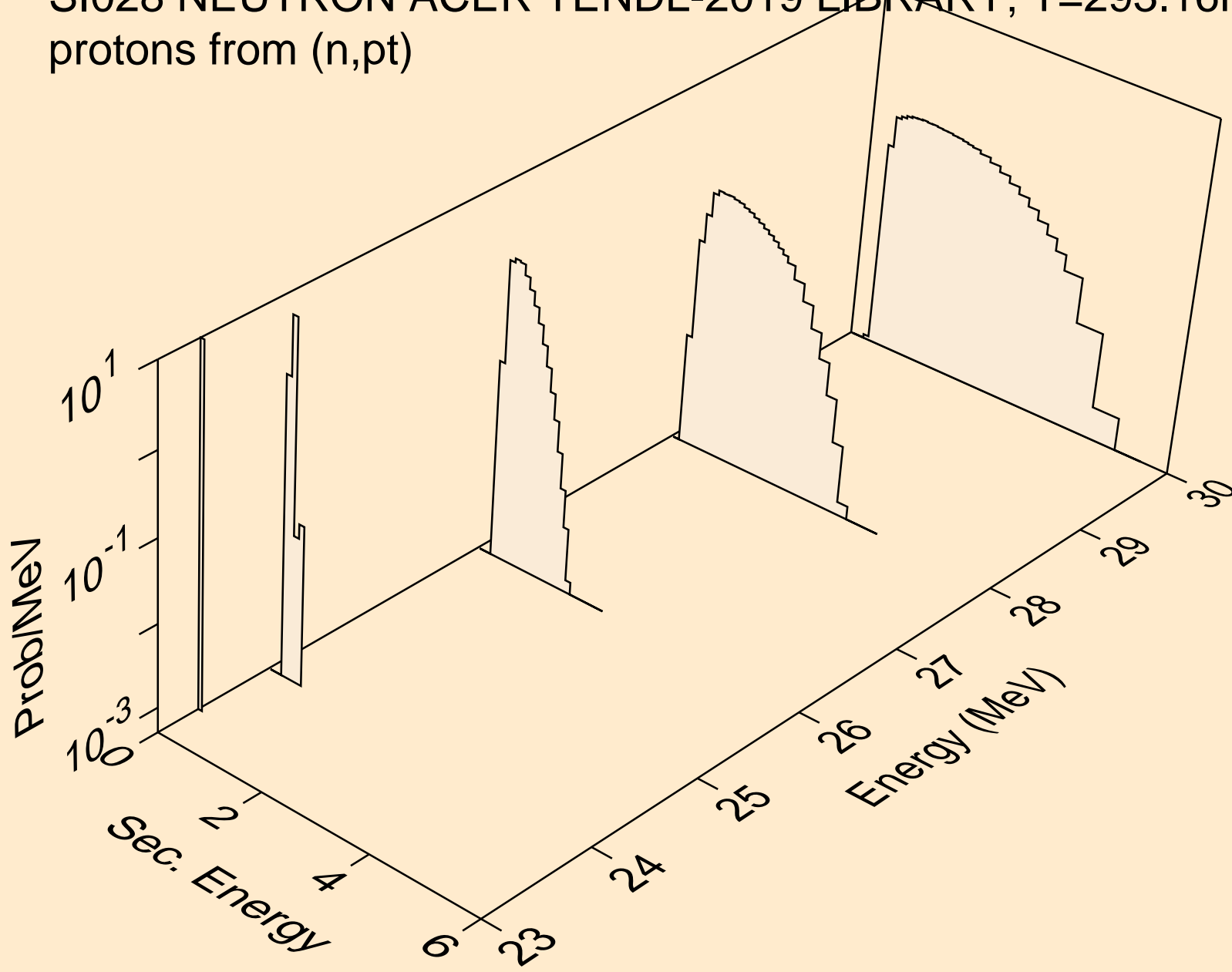

SI028 NEUTRON ACER TENDL-2019 LIBRARY; T=293.16K
deuterons from (n,x)

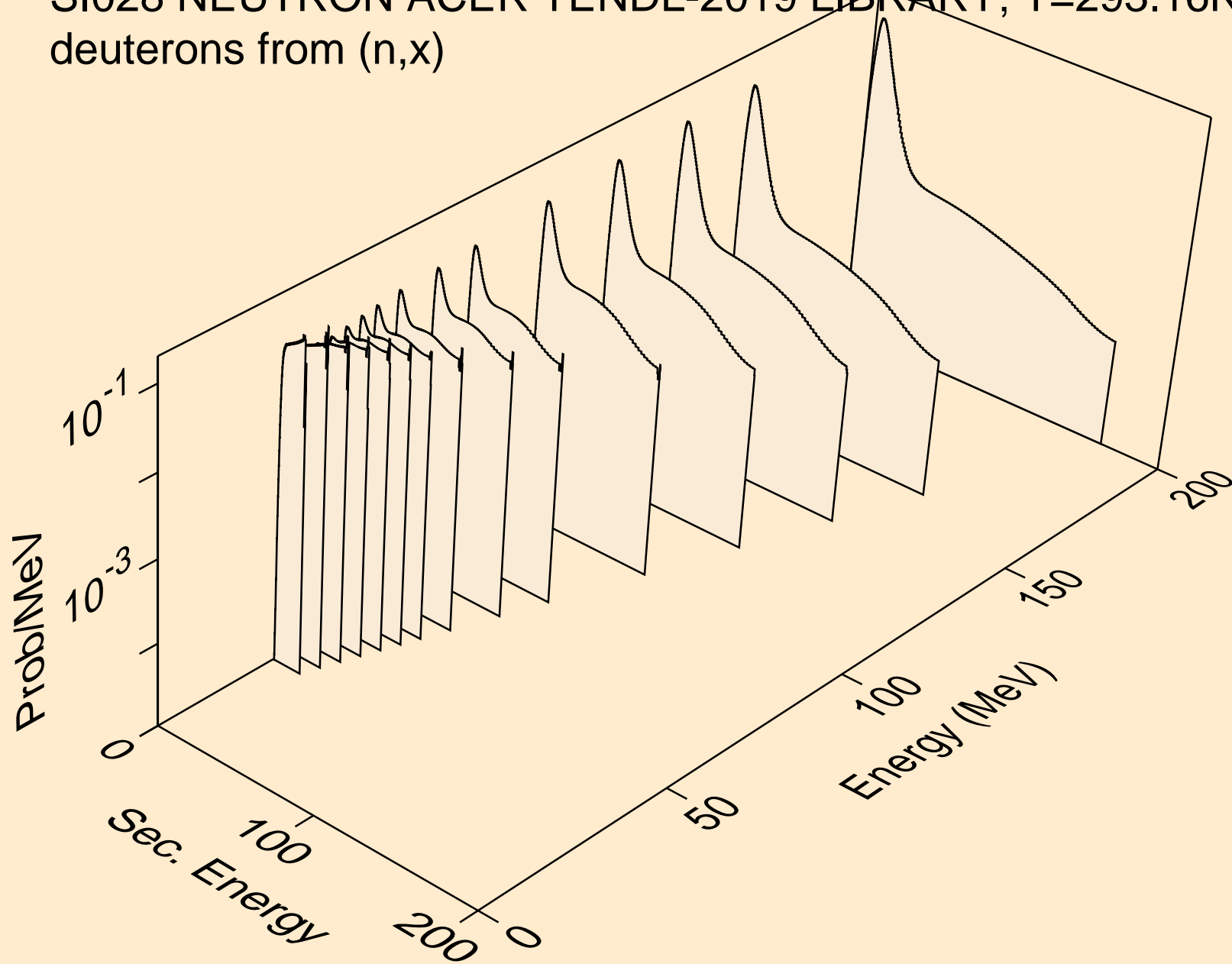

SI028 NEUTRON ACER TENDL-2019 LIBRARY; T=293.16K
deuterons from (n,n*)d

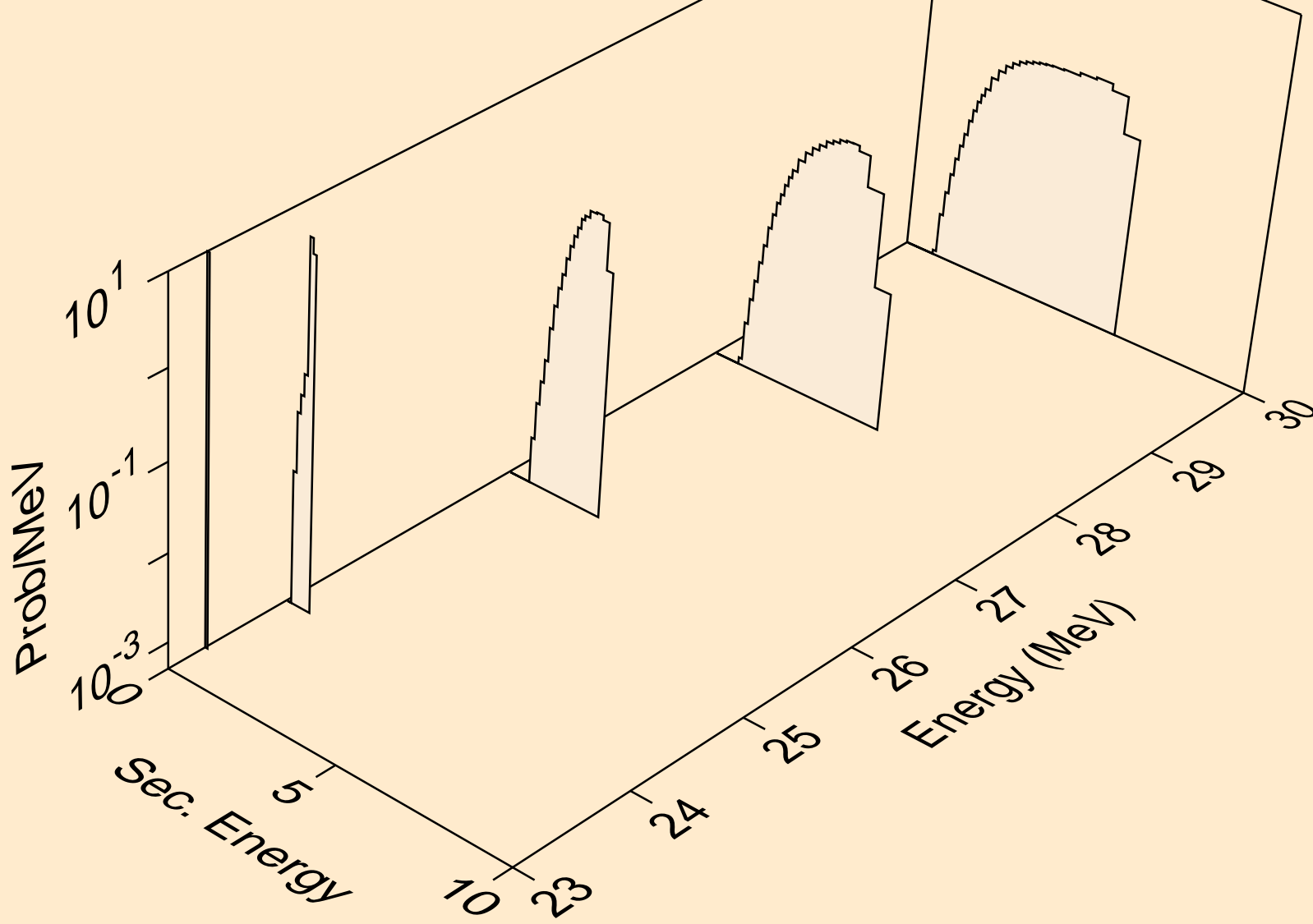

SI028 NEUTRON ACER TENDL-2019 LIBRARY; T=293.16K
deuterons from (n,d)

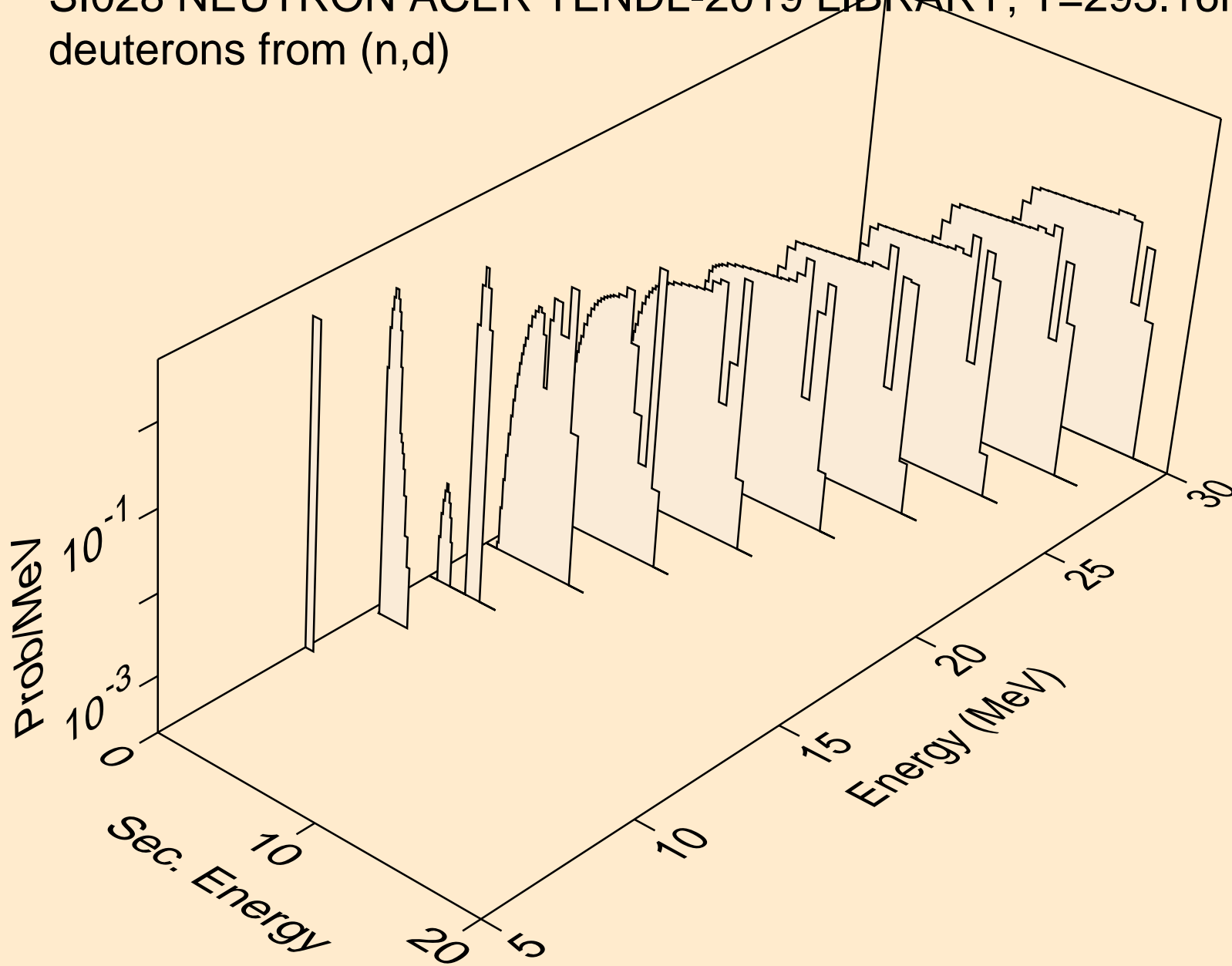

SI028 NEUTRON ACER TENDL-2019 LIBRARY; T=293.16K
deuterons from (n,pd)

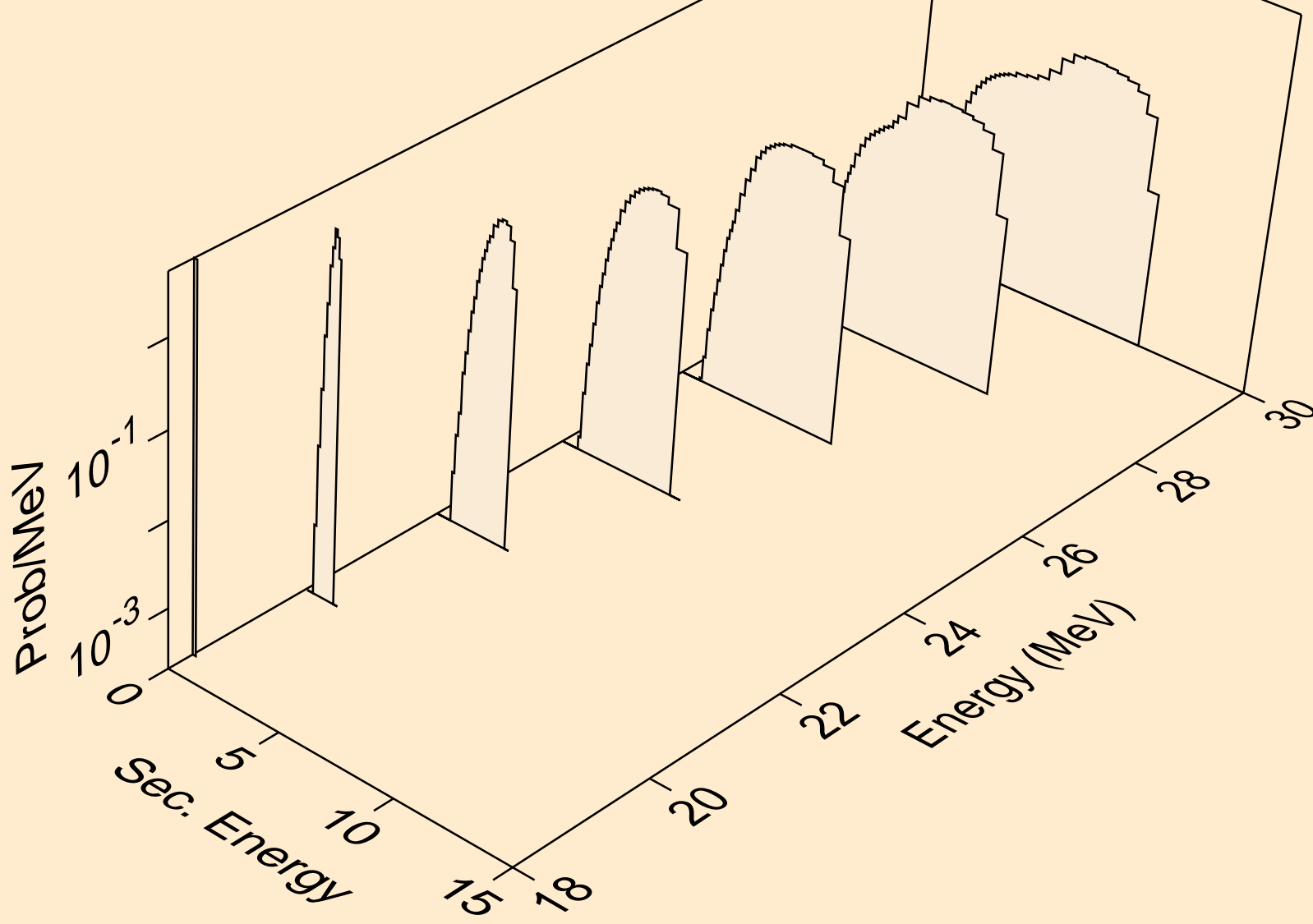

SI028 NEUTRON ACER TENDL-2019 LIBRARY; T=293.16K
deuterons from (n,da)

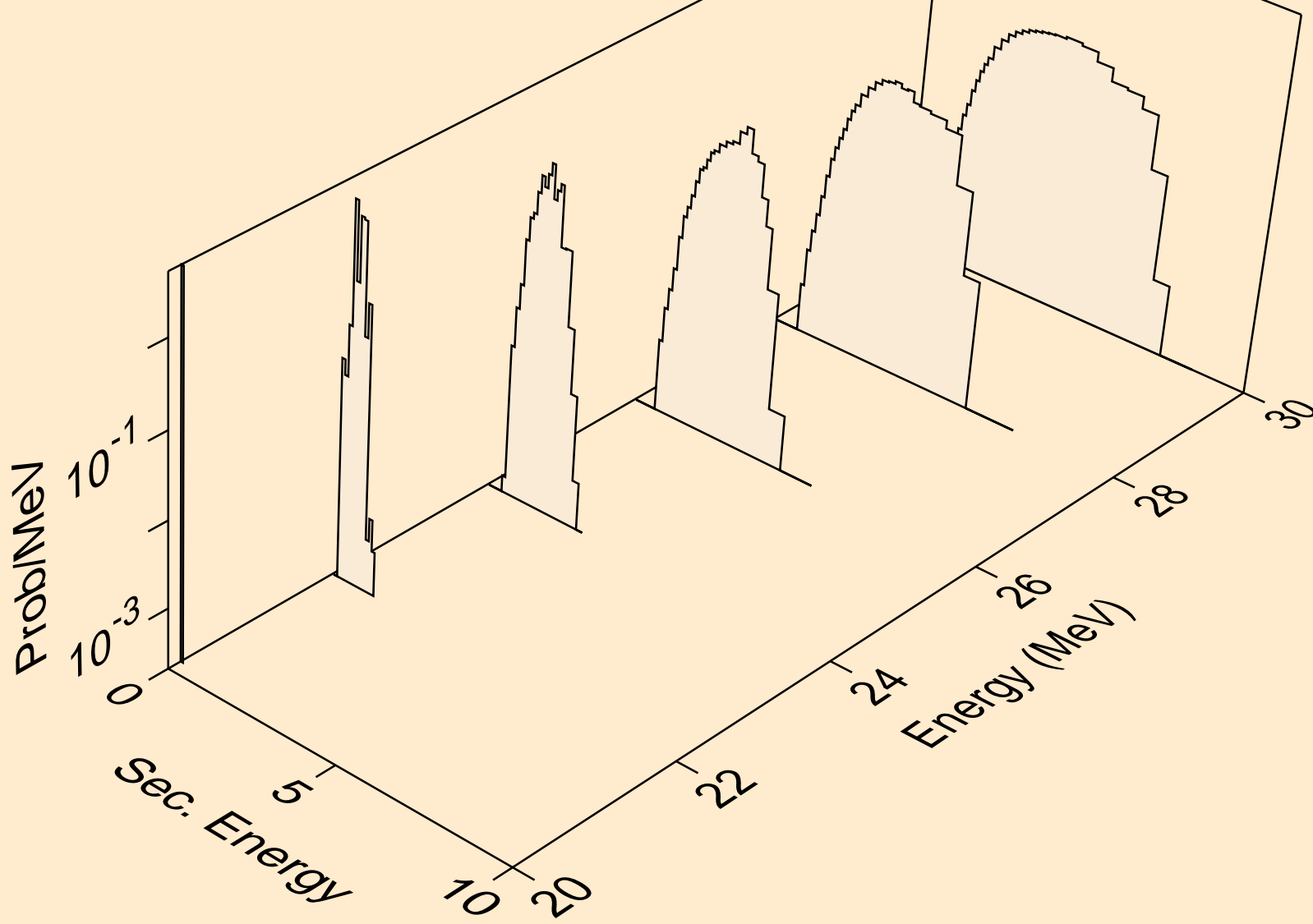

SI028 NEUTRON ACER TENDL-2019 LIBRARY; T=293.16K
tritons from (n,x)

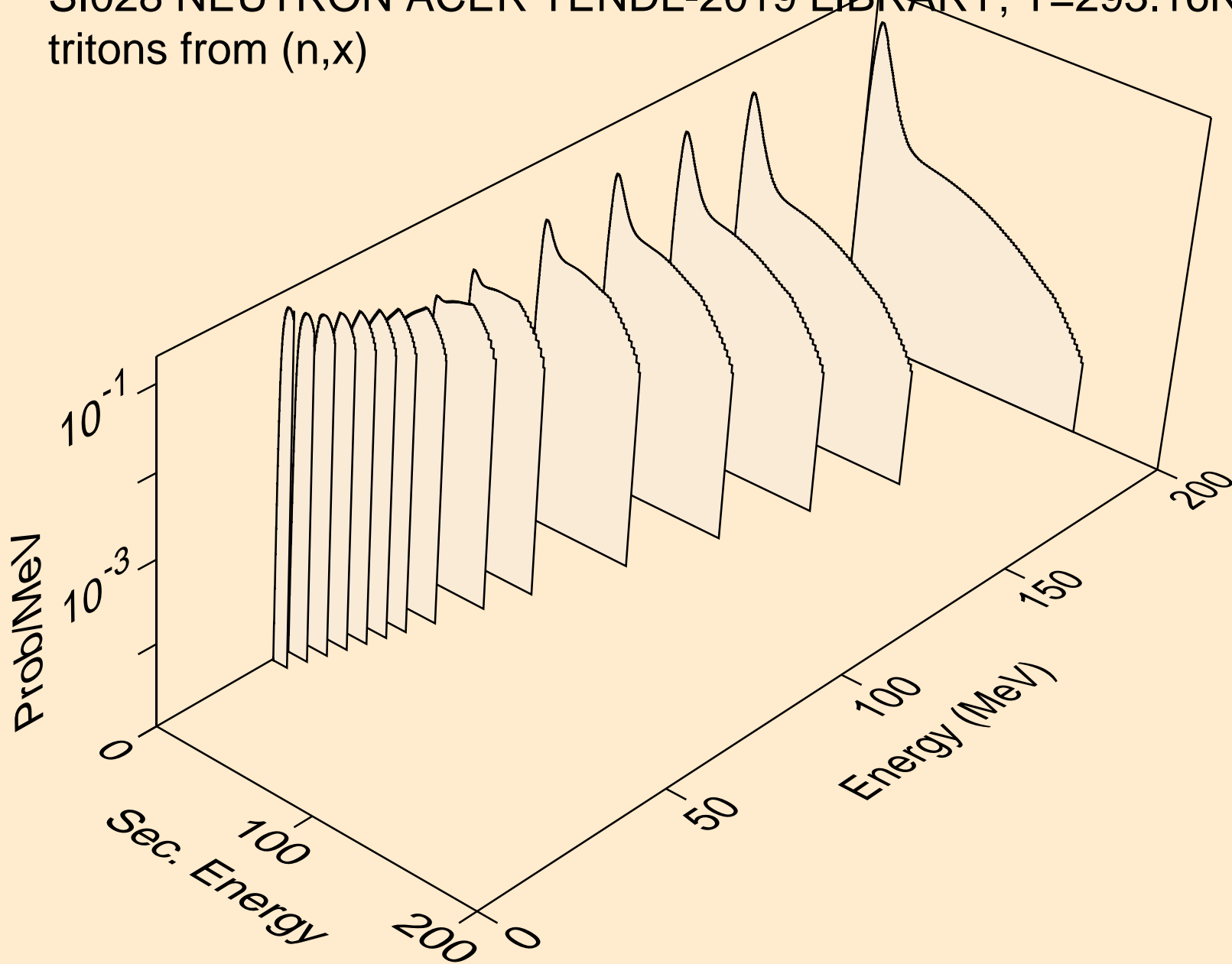

SI028 NEUTRON ACER TENDL-2019 LIBRARY; T=293.16K
tritons from (n,n*)t

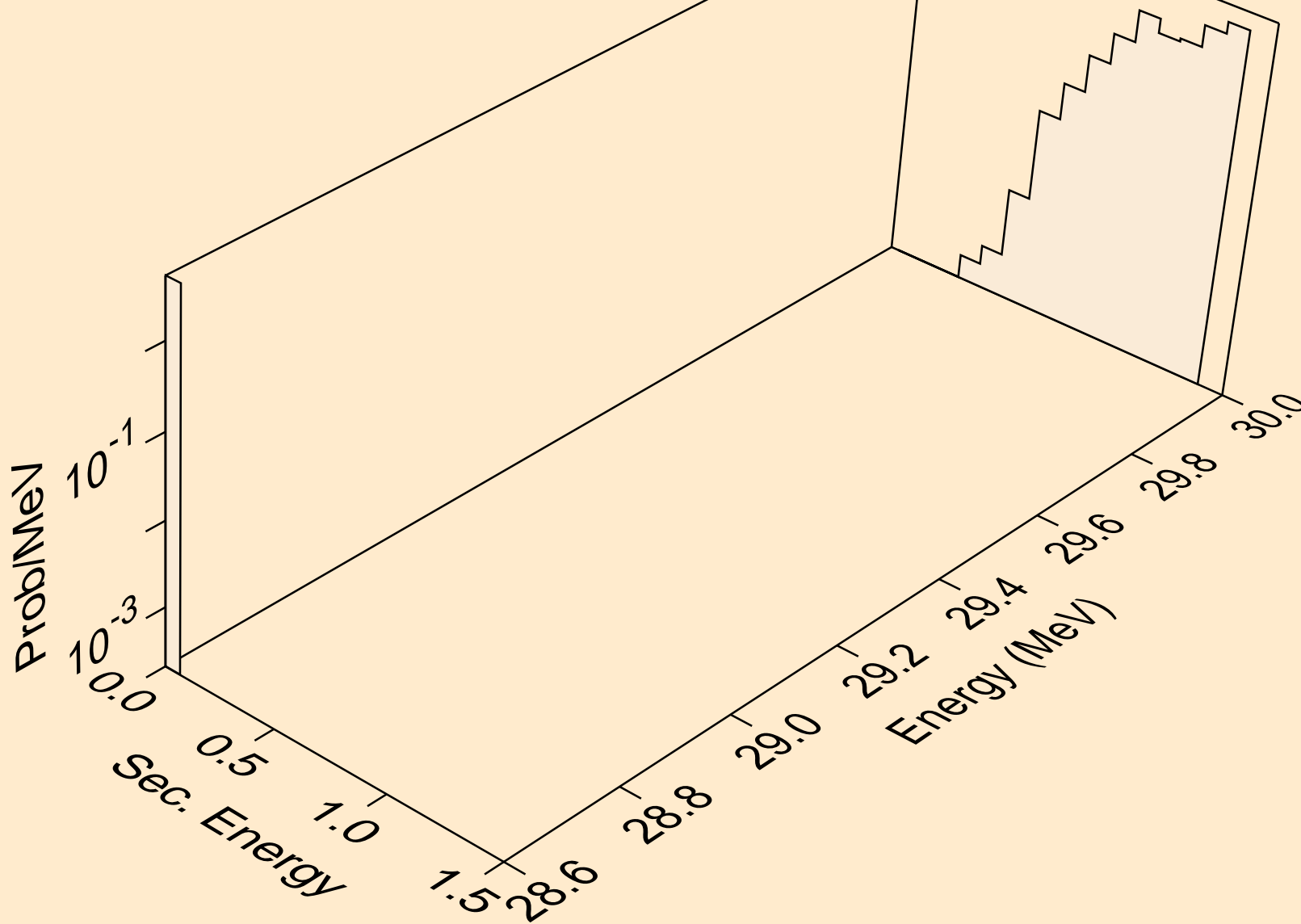

SI028 NEUTRON ACER TENDL-2019 LIBRARY; T=293.16K
tritons from (n,t)

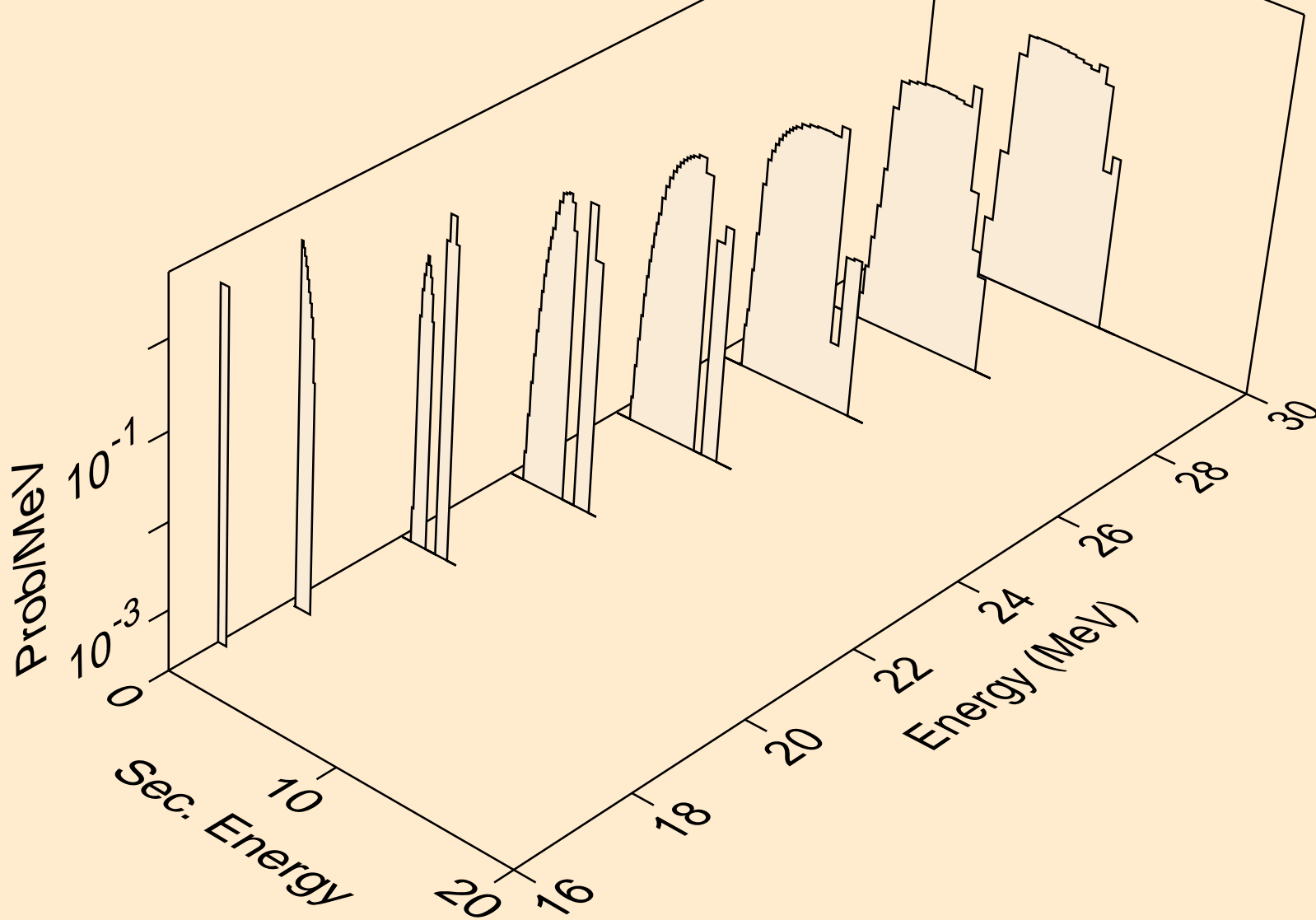

SI028 NEUTRON ACER TENDL-2019 LIBRARY; T=293.16K
tritons from (n,pt)

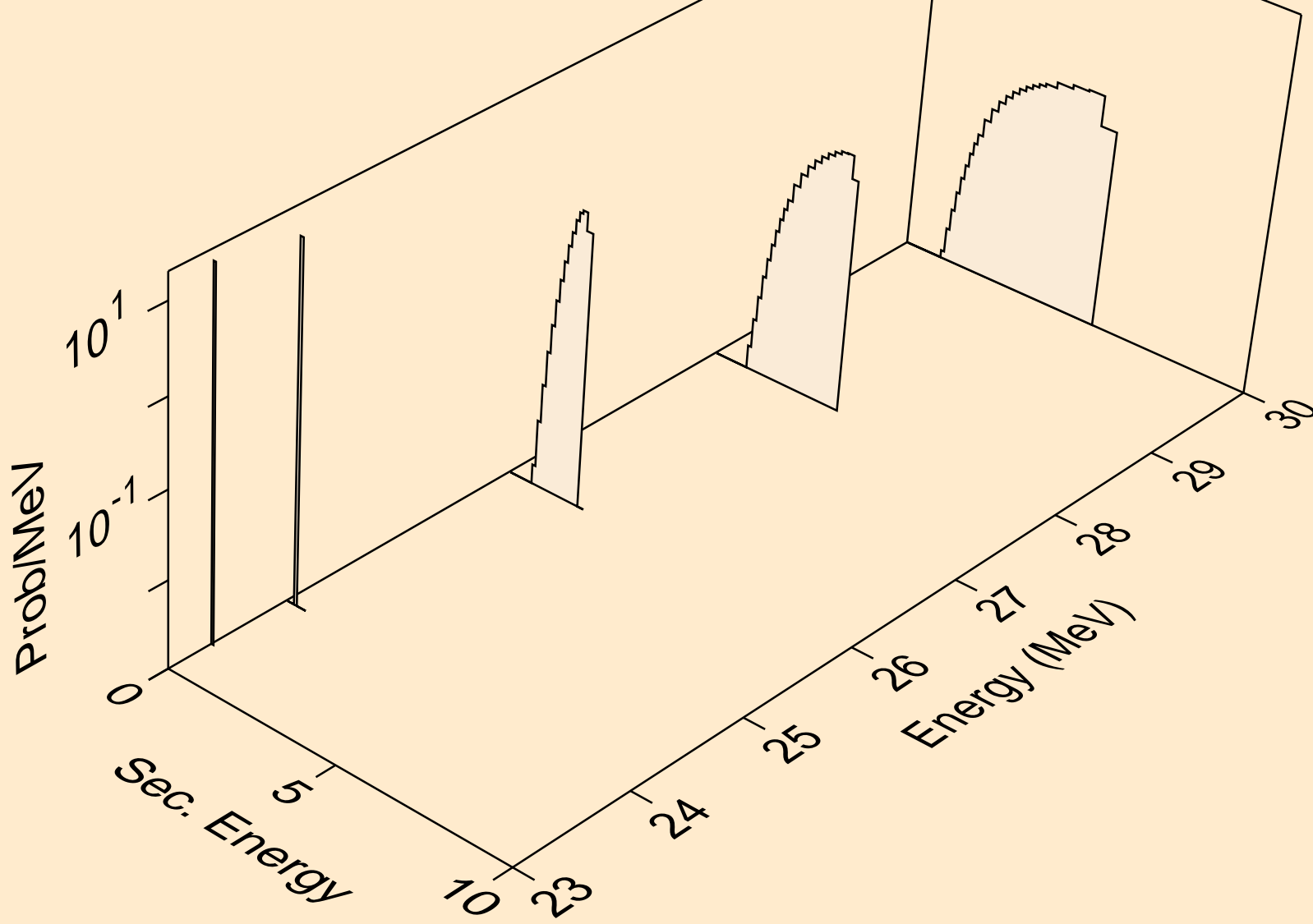

SI028 NEUTRON ACER TENDL-2019 LIBRARY; T=293.16K
he3s from (n,x)

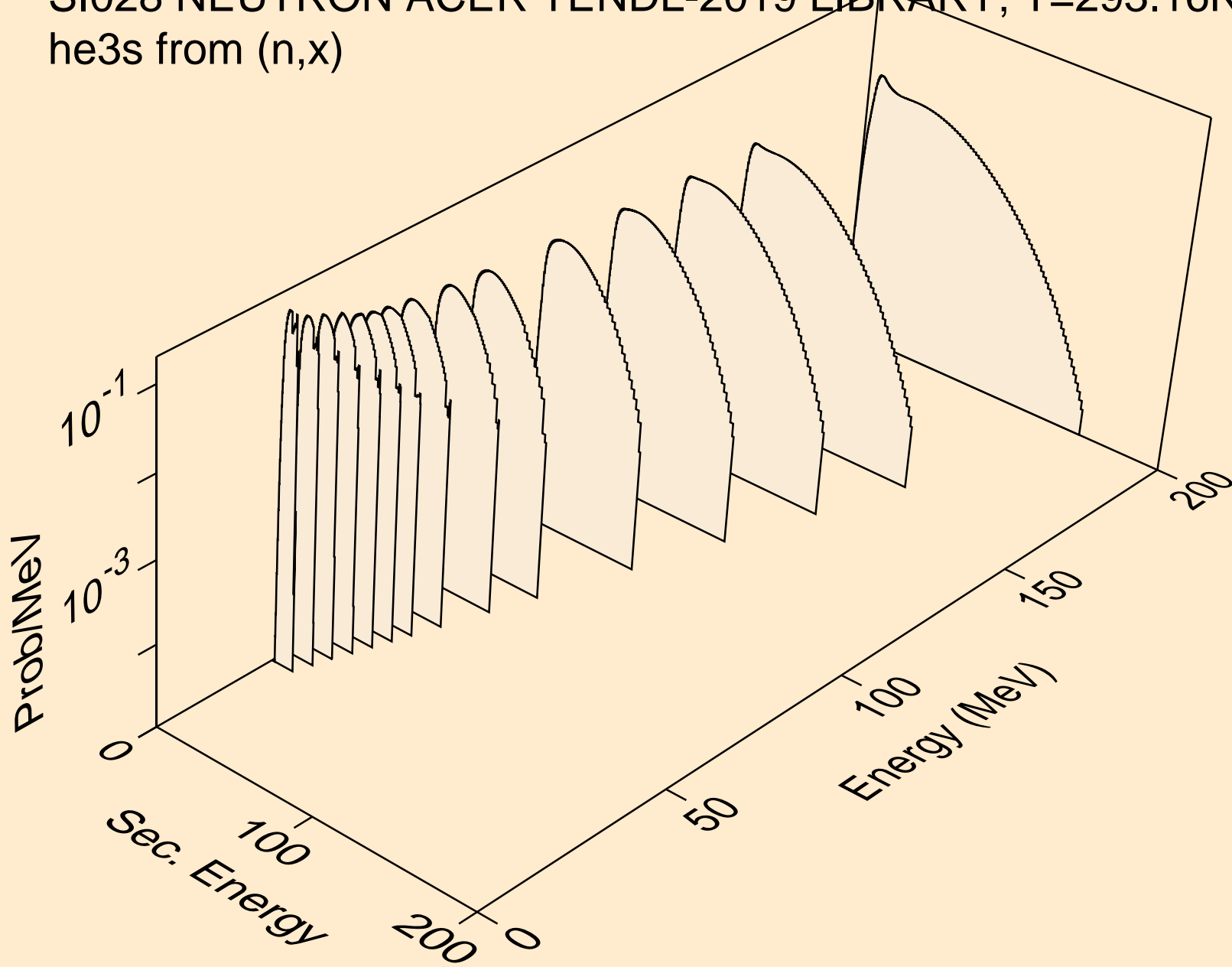

SI028 NEUTRON ACER TENDL-2019 LIBRARY; T=293.16K
he3s from (n,n*)he3

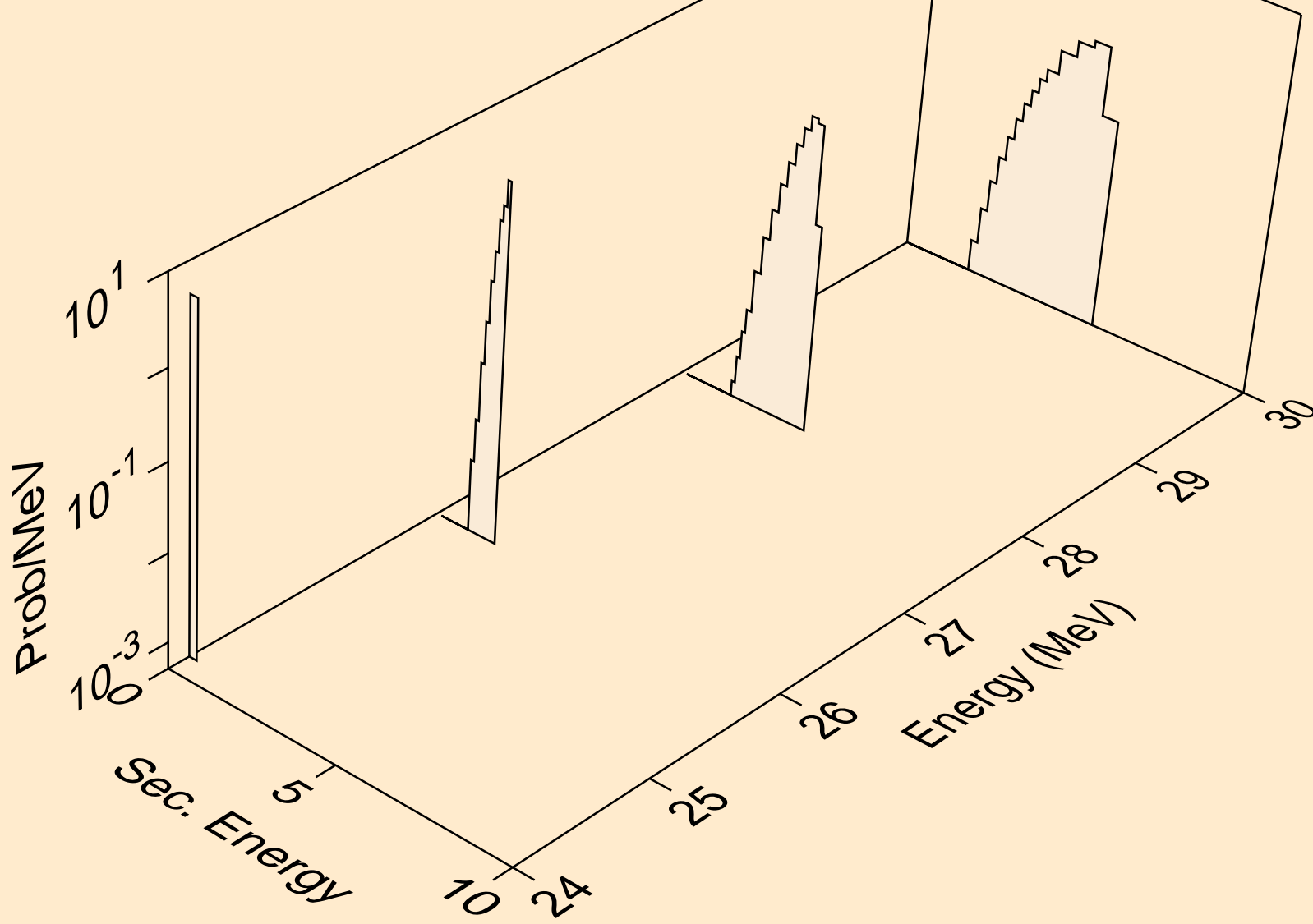

SI028 NEUTRON ACER TENDL-2019 LIBRARY; T=293.16K
he3s from (n,he3)

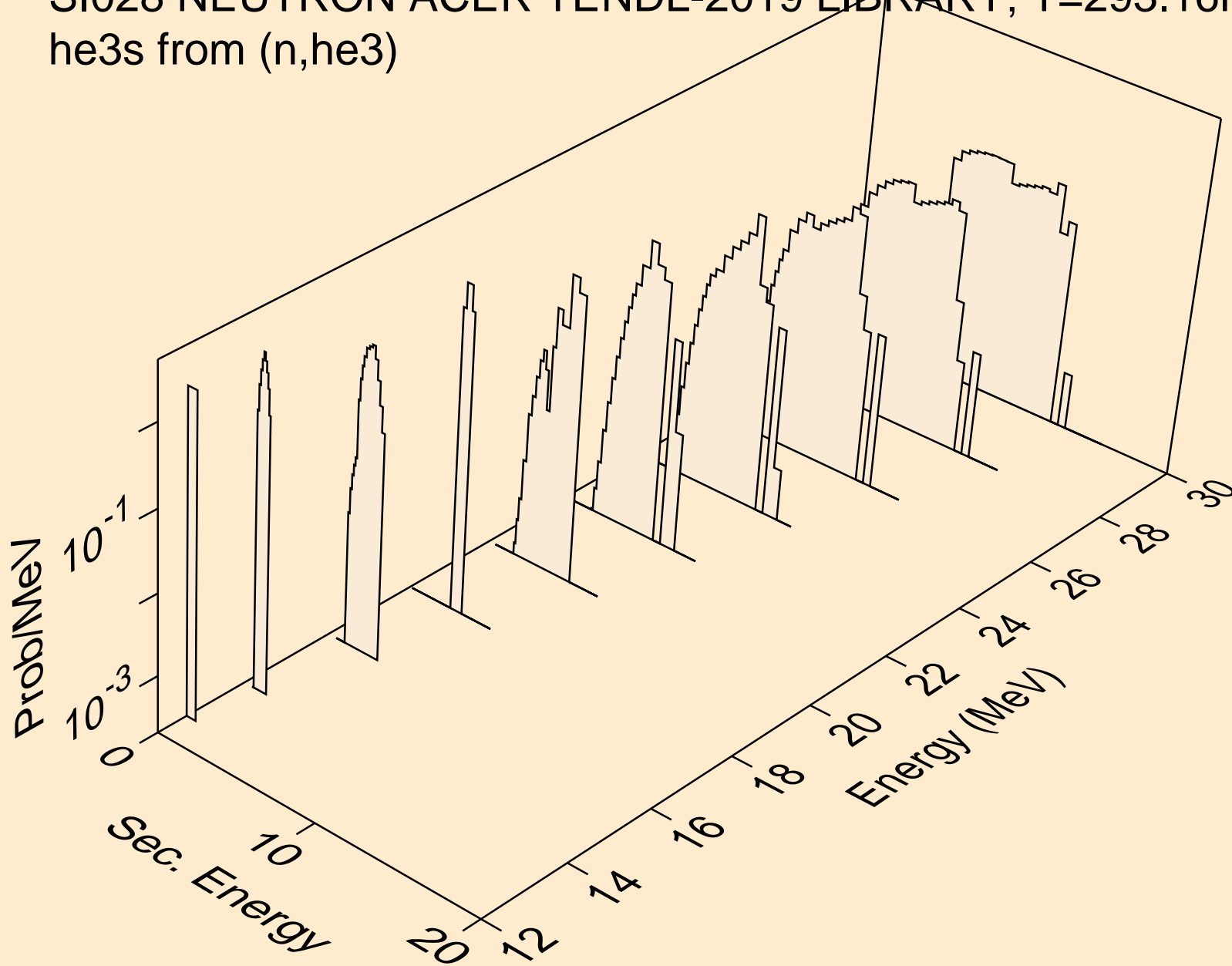

SI028 NEUTRON ACER TENDL-2019 LIBRARY; T=293.16K
alphas from (n,x)

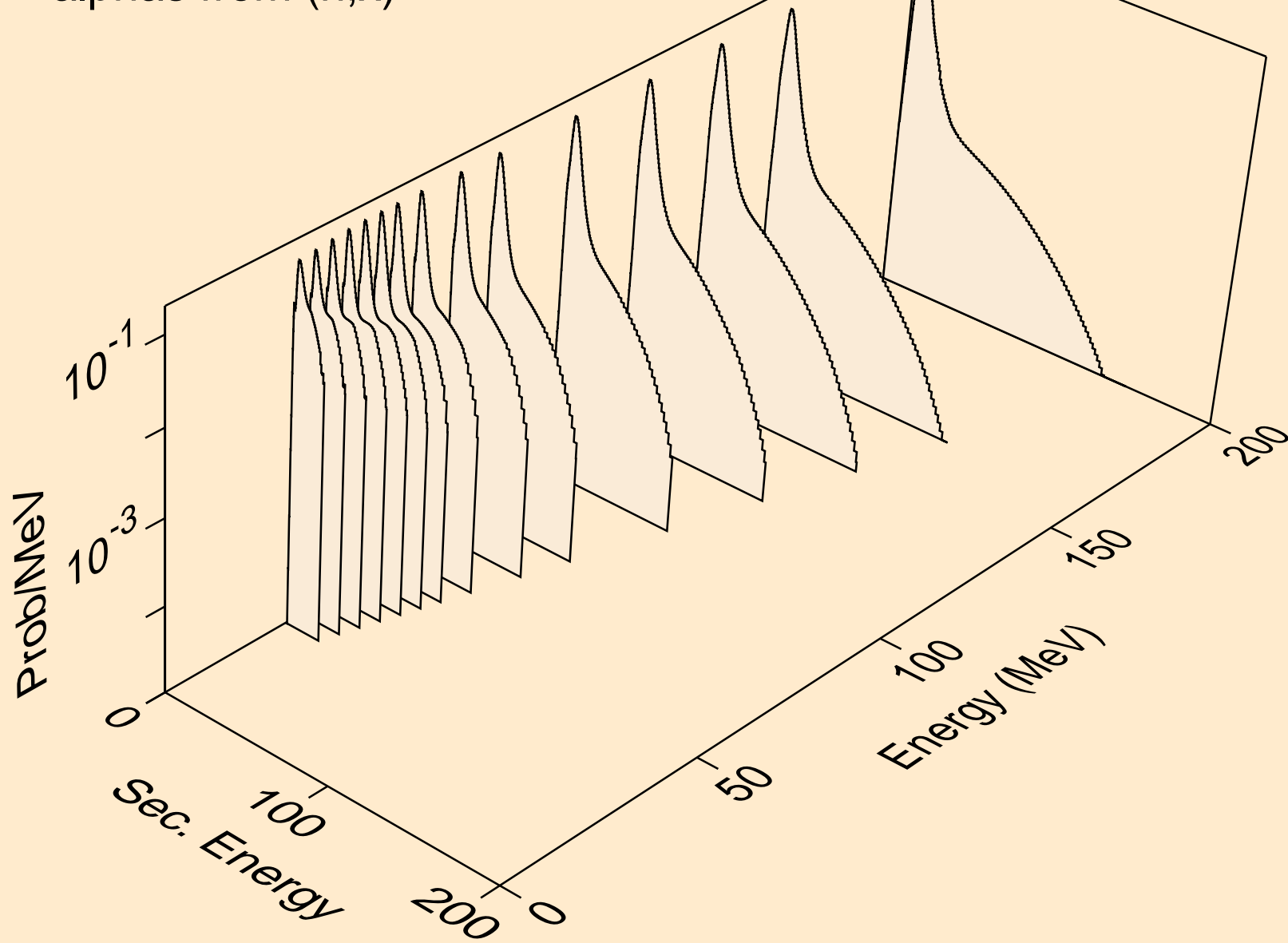

SI028 NEUTRON ACER TENDL-2019 LIBRARY; T=293.16K
alphas from (n,n*)a

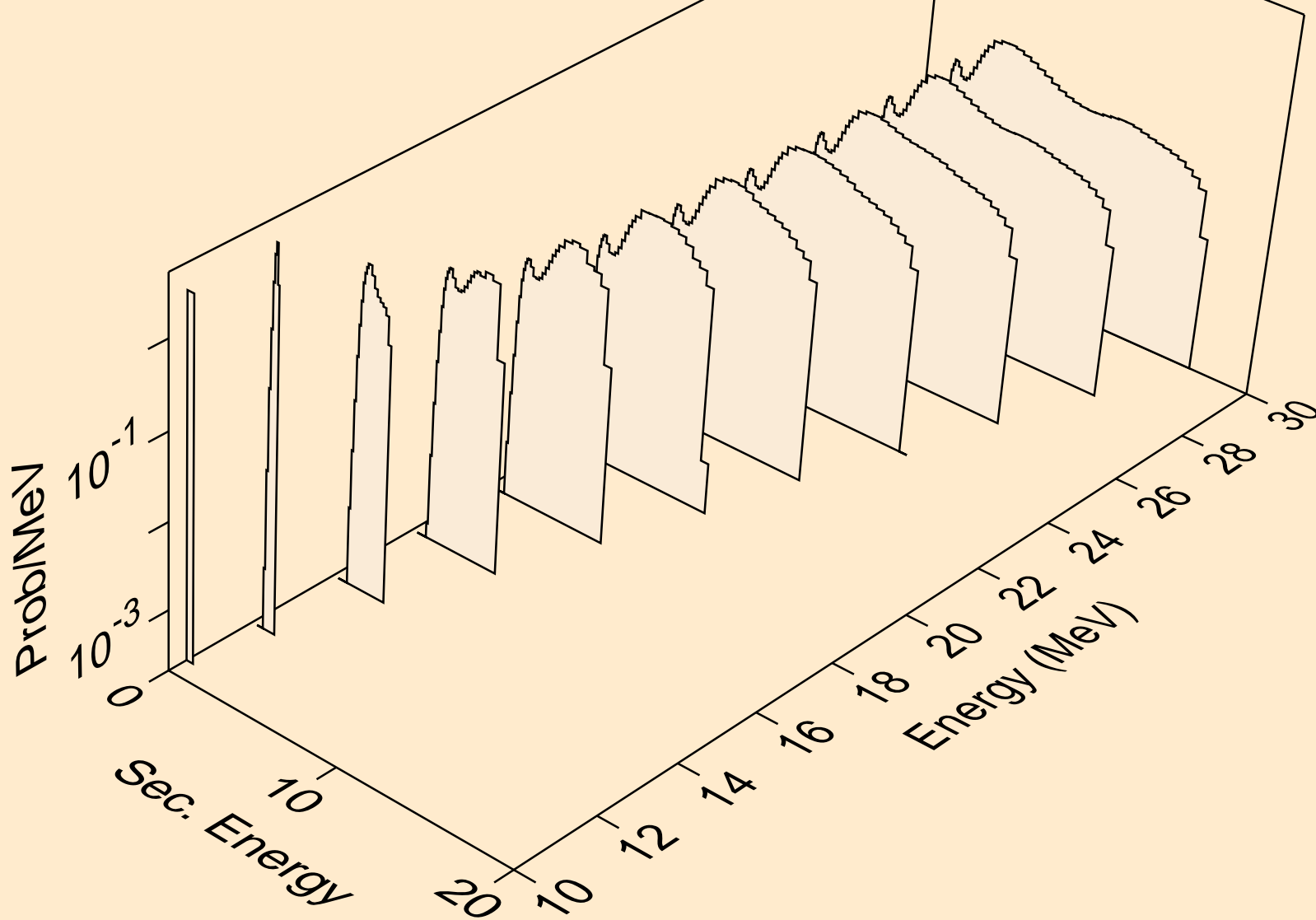

SI028 NEUTRON ACER TENDL-2019 LIBRARY; T=293.16K
alphas from (n,2n)a

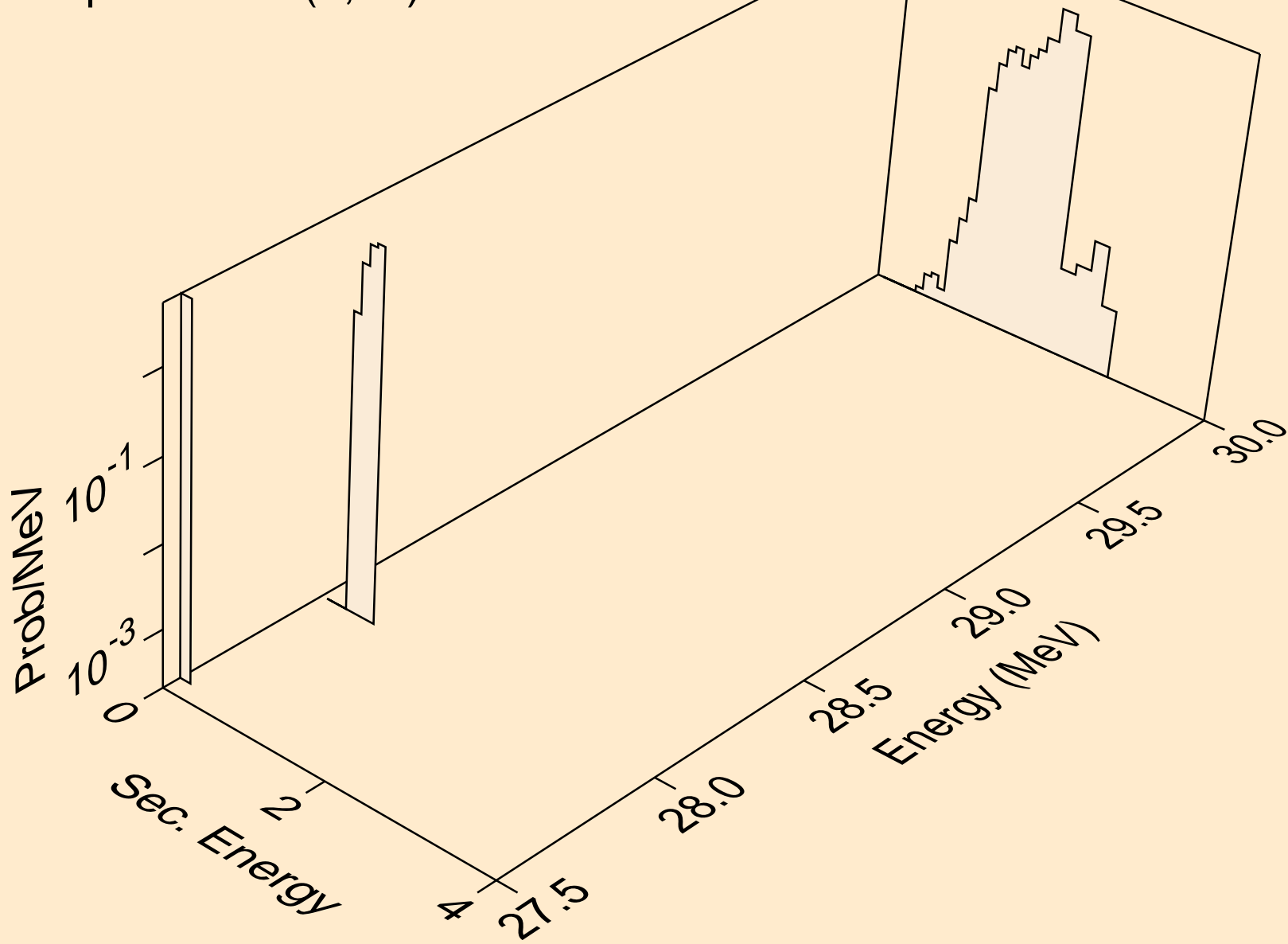

SI028 NEUTRON ACER TENDL-2019 LIBRARY; T=293.16K
alphas from (n,n*)2a

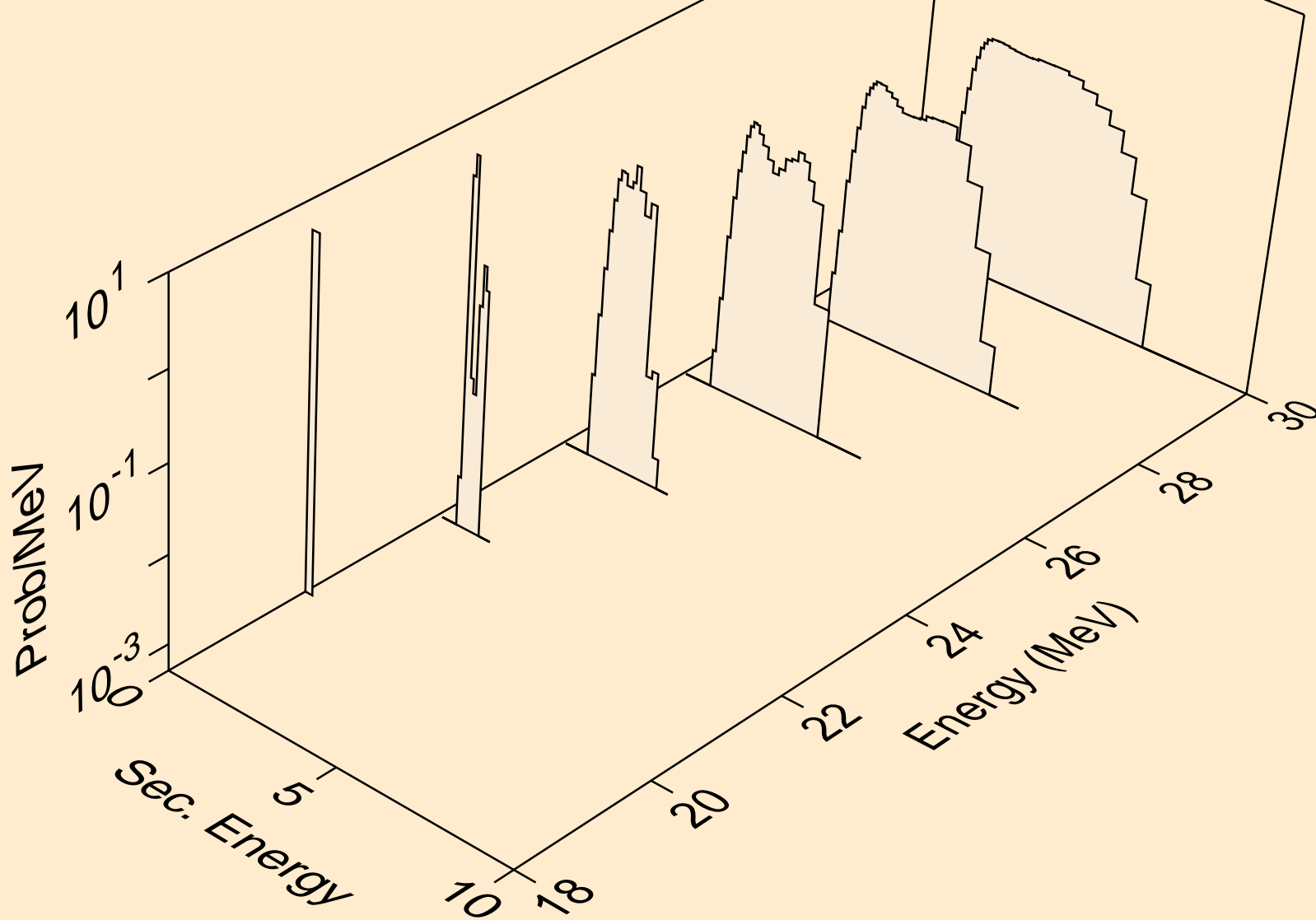

SI028 NEUTRON ACER TENDL-2019 LIBRARY; T=293.16K
alphas from (n,npa)

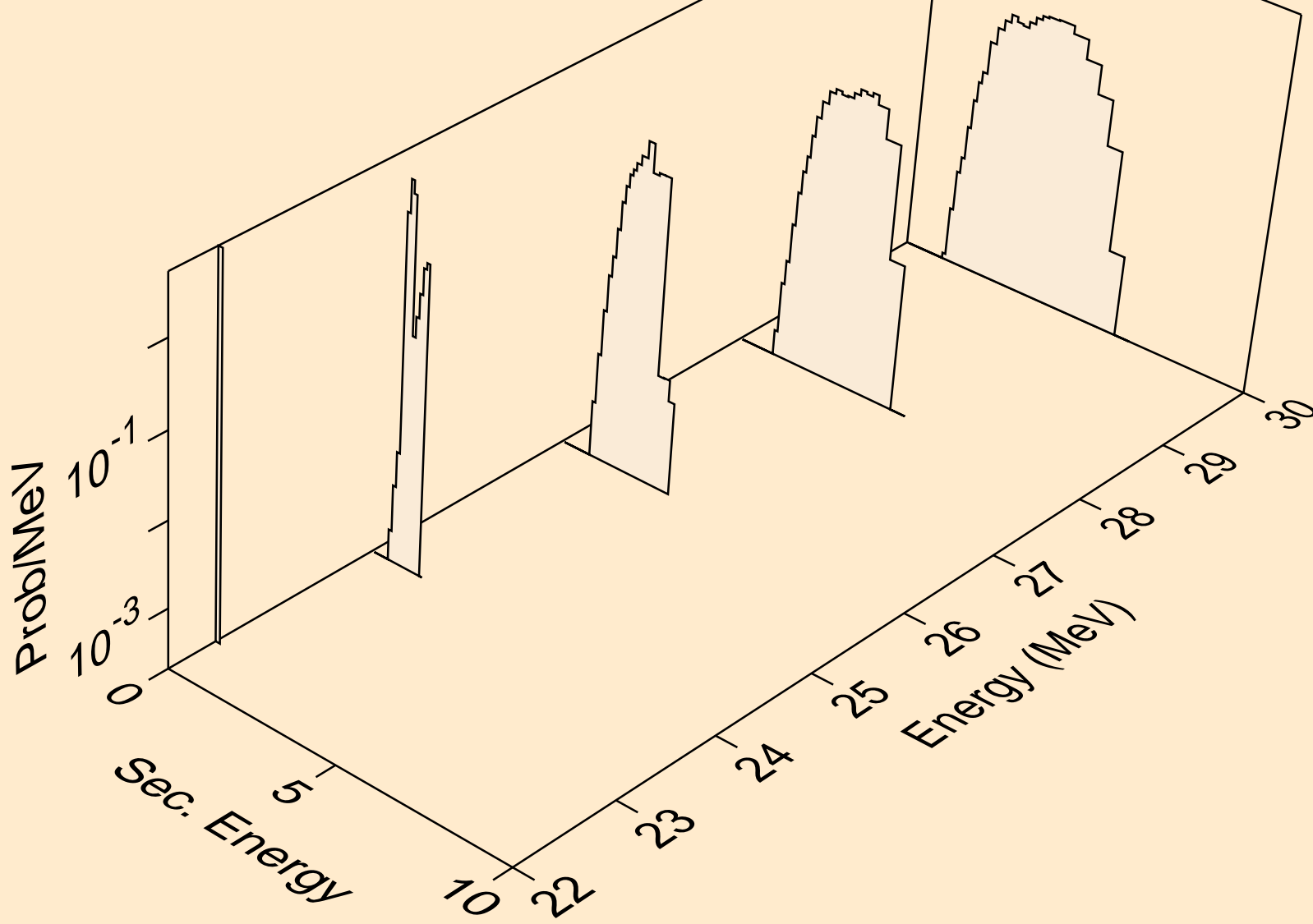

SI028 NEUTRON ACER TENDL-2019 LIBRARY; T=293.16K
alphas from (n,a)

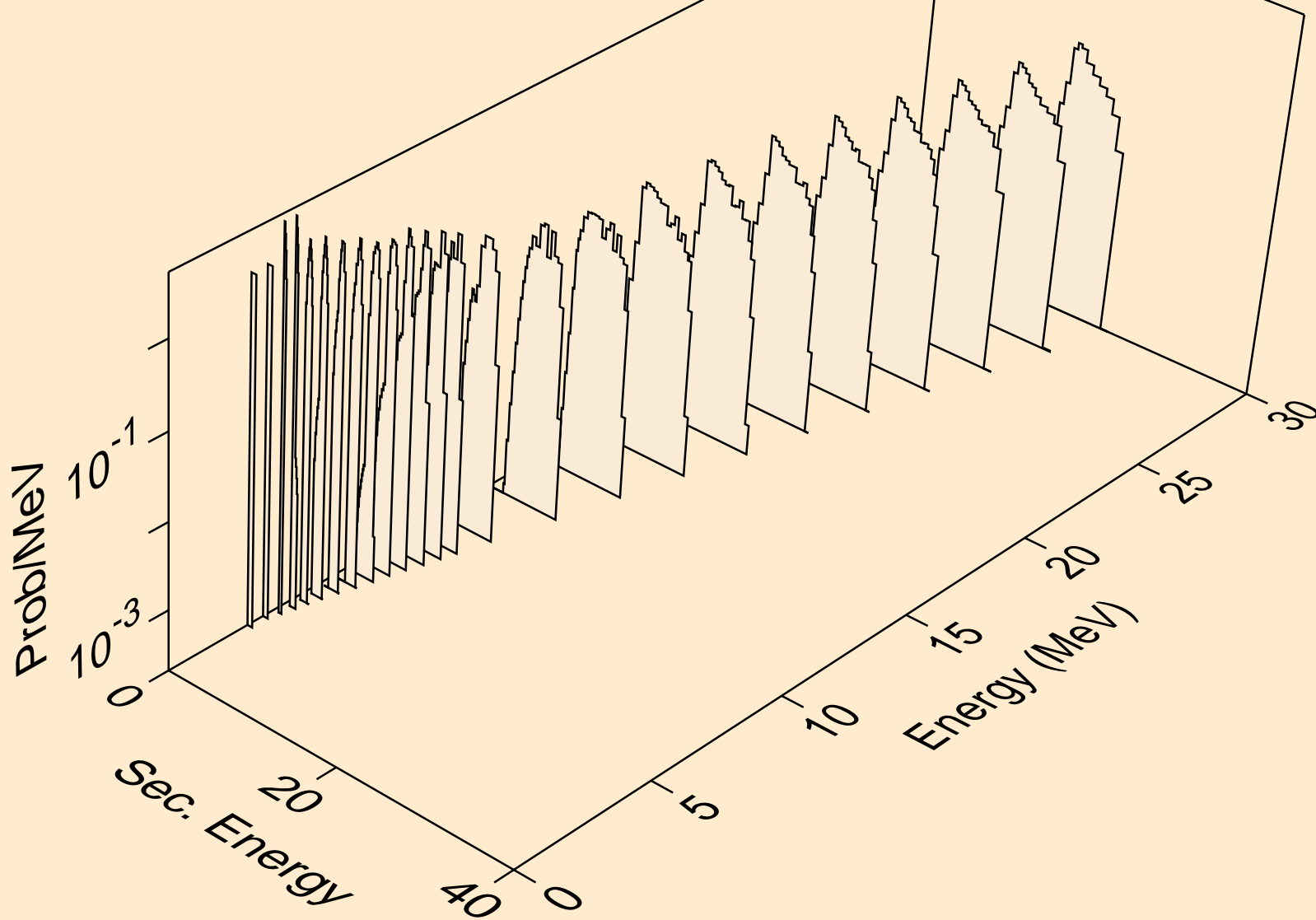

SI028 NEUTRON ACER TENDL-2019 LIBRARY; T=293.16K
alphas from (n,2a)

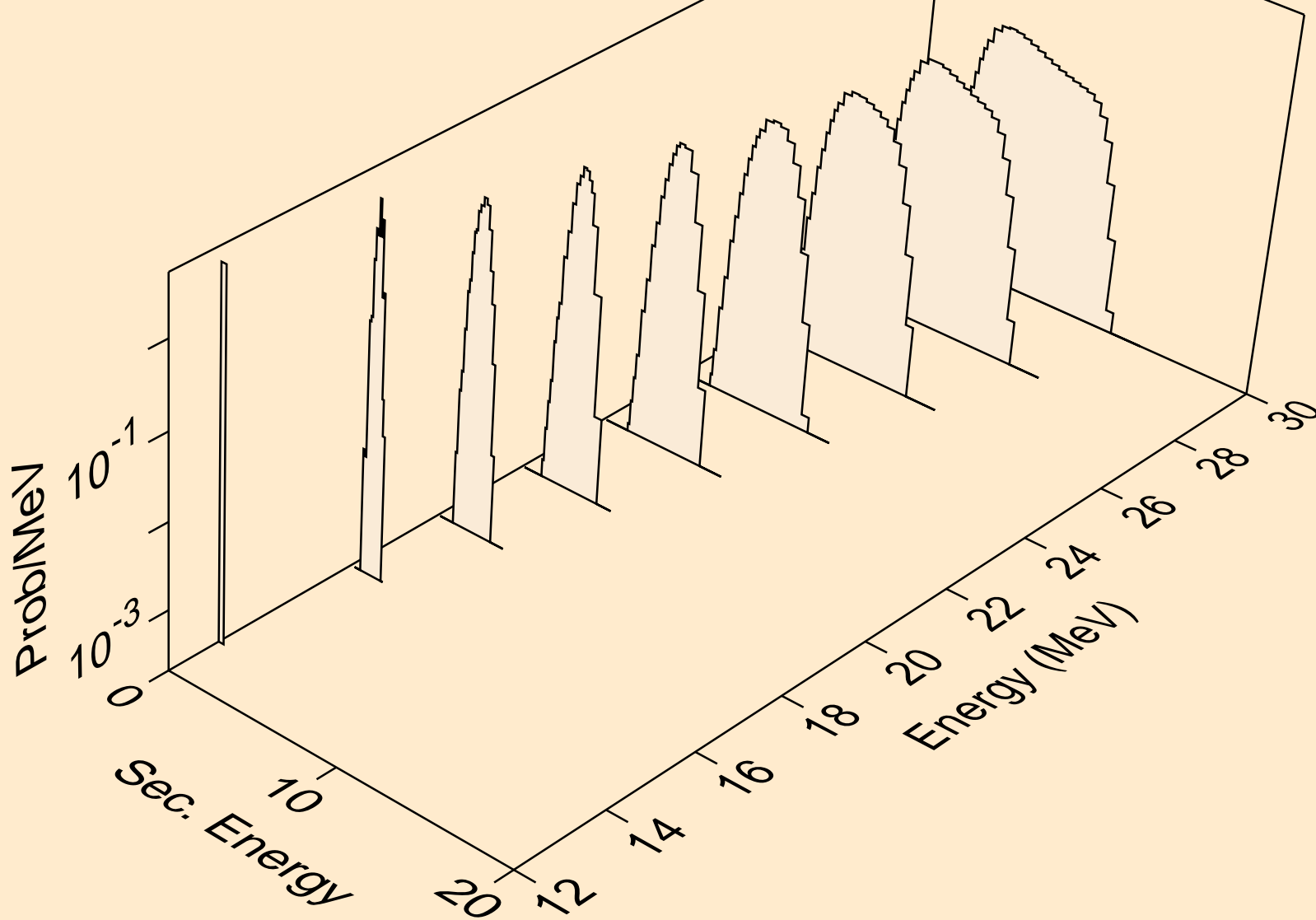

SI028 NEUTRON ACER TENDL-2019 LIBRARY; T=293.16K
alphas from (n,3a)

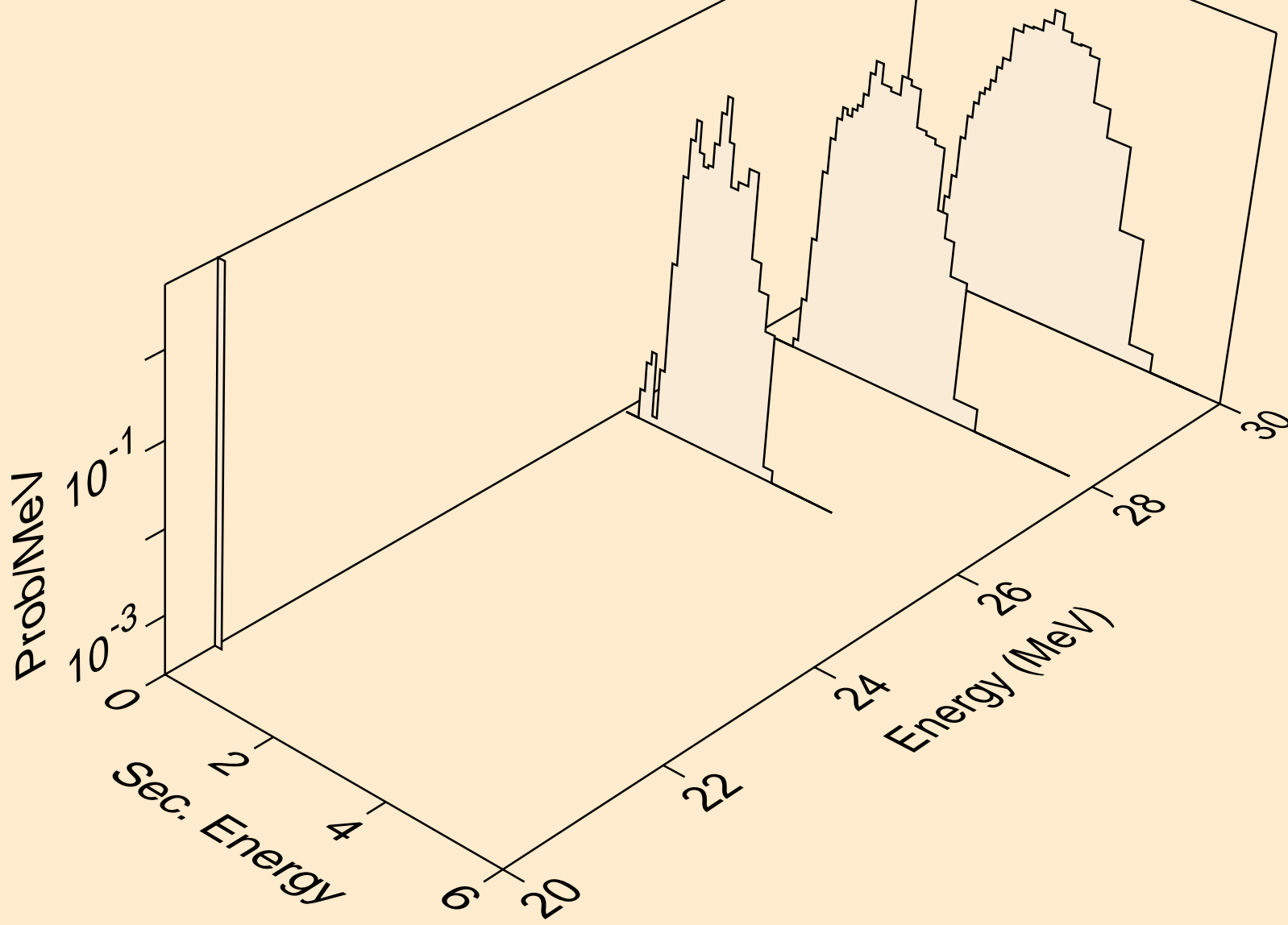

SI028 NEUTRON ACER TENDL-2019 LIBRARY; T=293.16K
alphas from (n,pa)

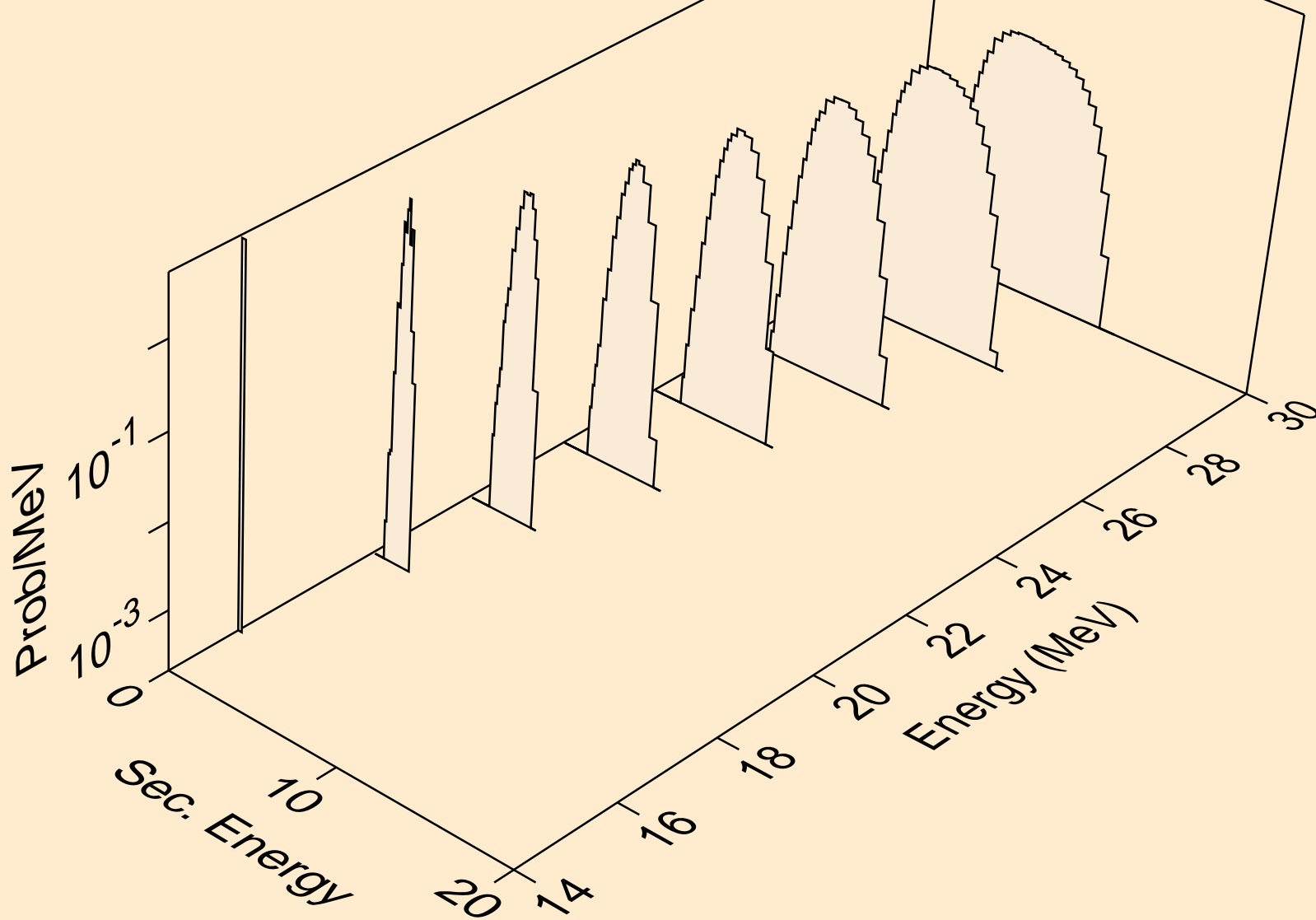

SI028 NEUTRON ACER TENDL-2019 LIBRARY; T=293.16K
alphas from (n,da)

