

SN101 NEUTRON ACER TENDL-2019 LIBRARY; T=293.16K

Principal cross sections

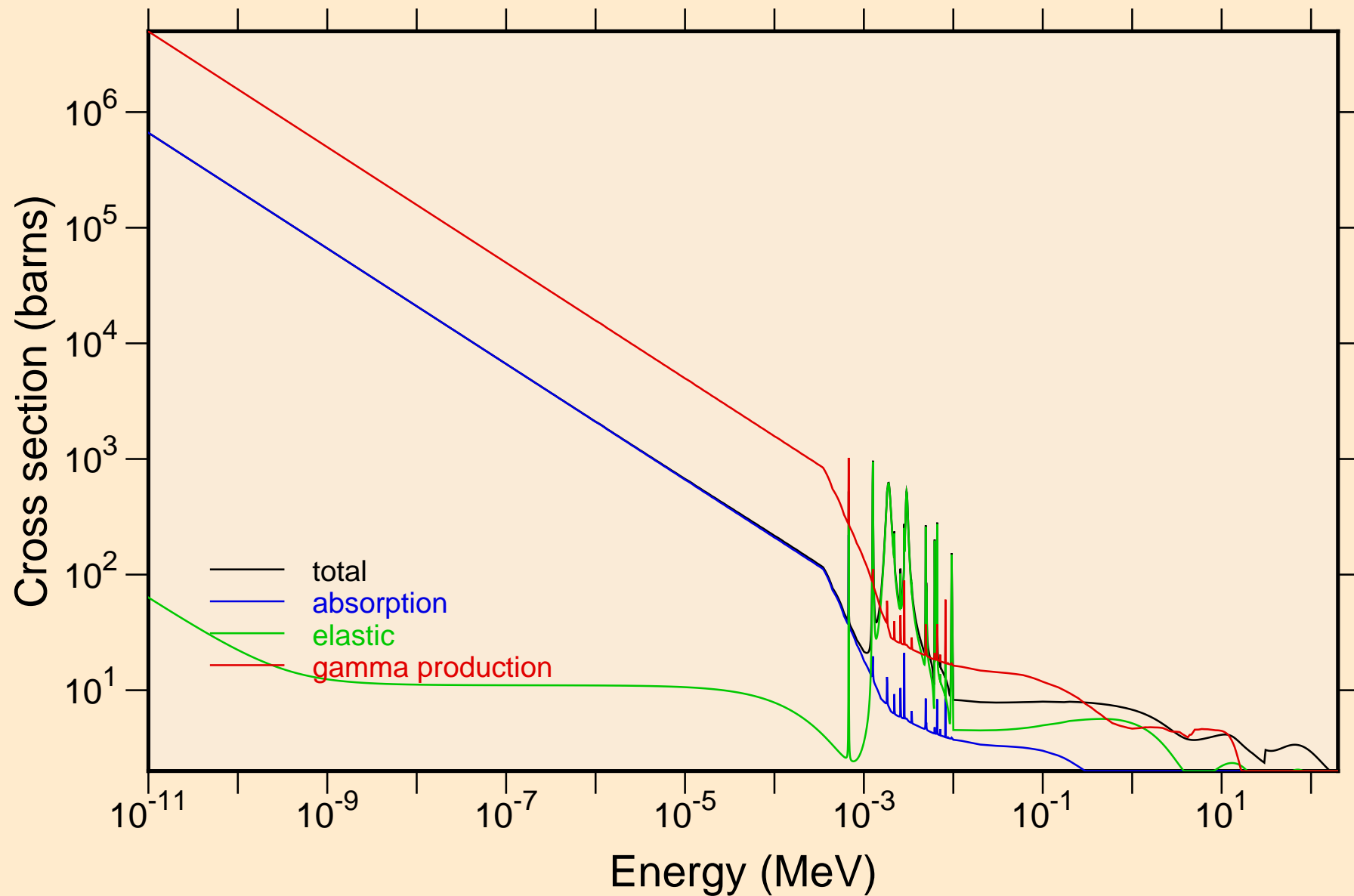

SN101 NEUTRON ACER TENDL-2019 LIBRARY; T=293.16K
resonance total cross section

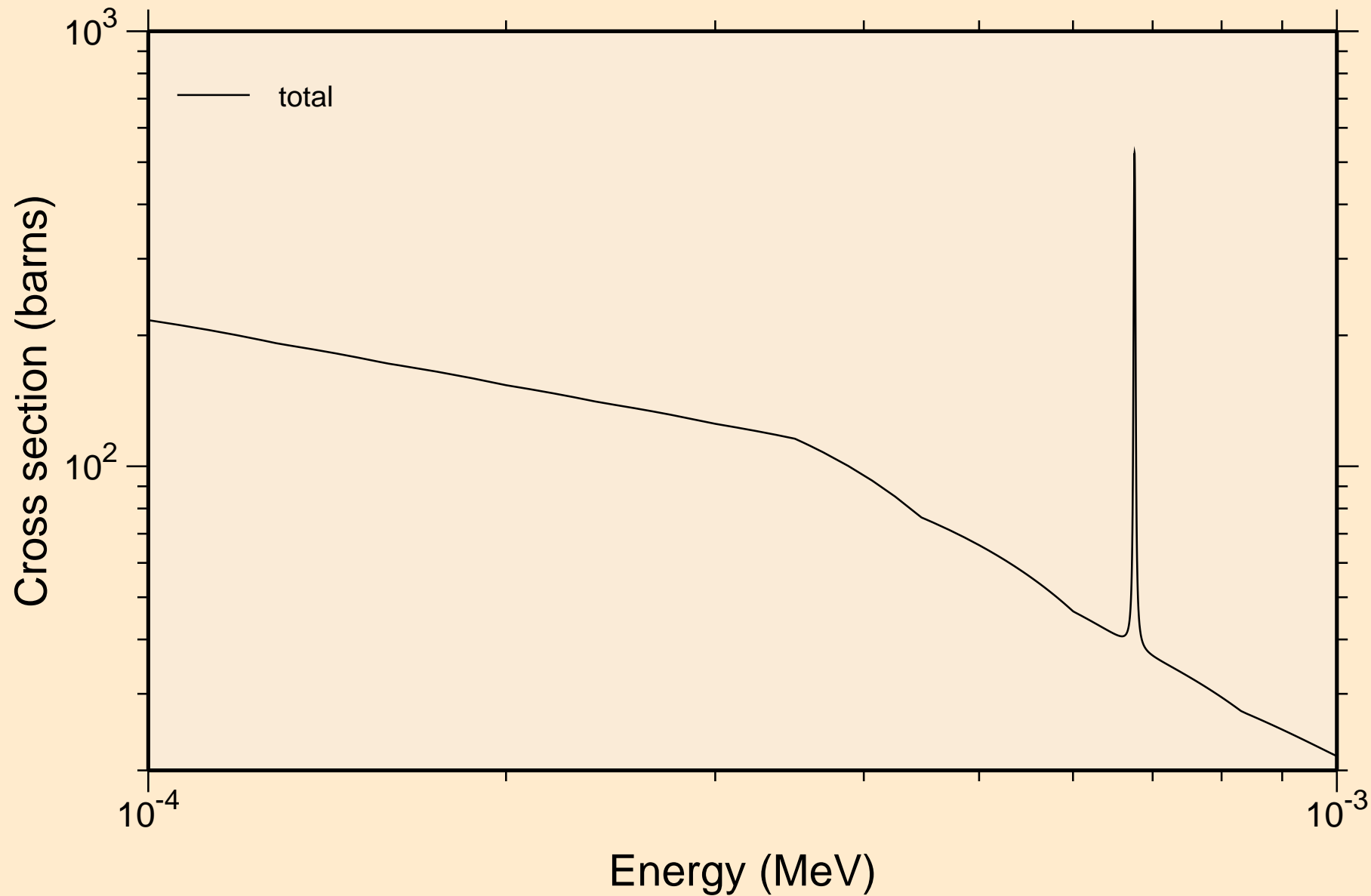

SN101 NEUTRON ACER TENDL-2019 LIBRARY; T=293.16K
resonance total cross section

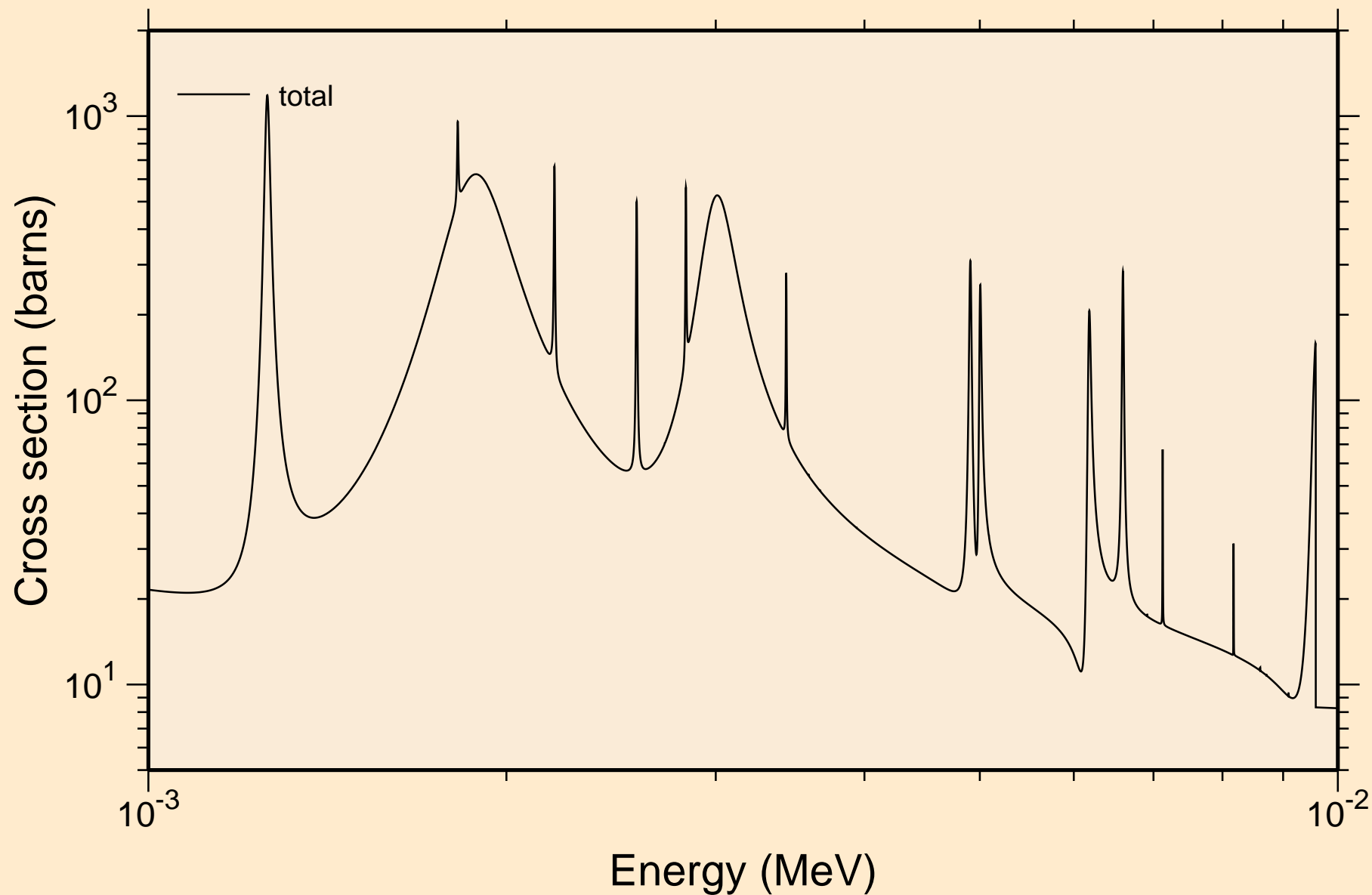

SN101 NEUTRON ACER TENDL-2019 LIBRARY; T=293.16K
resonance total cross section

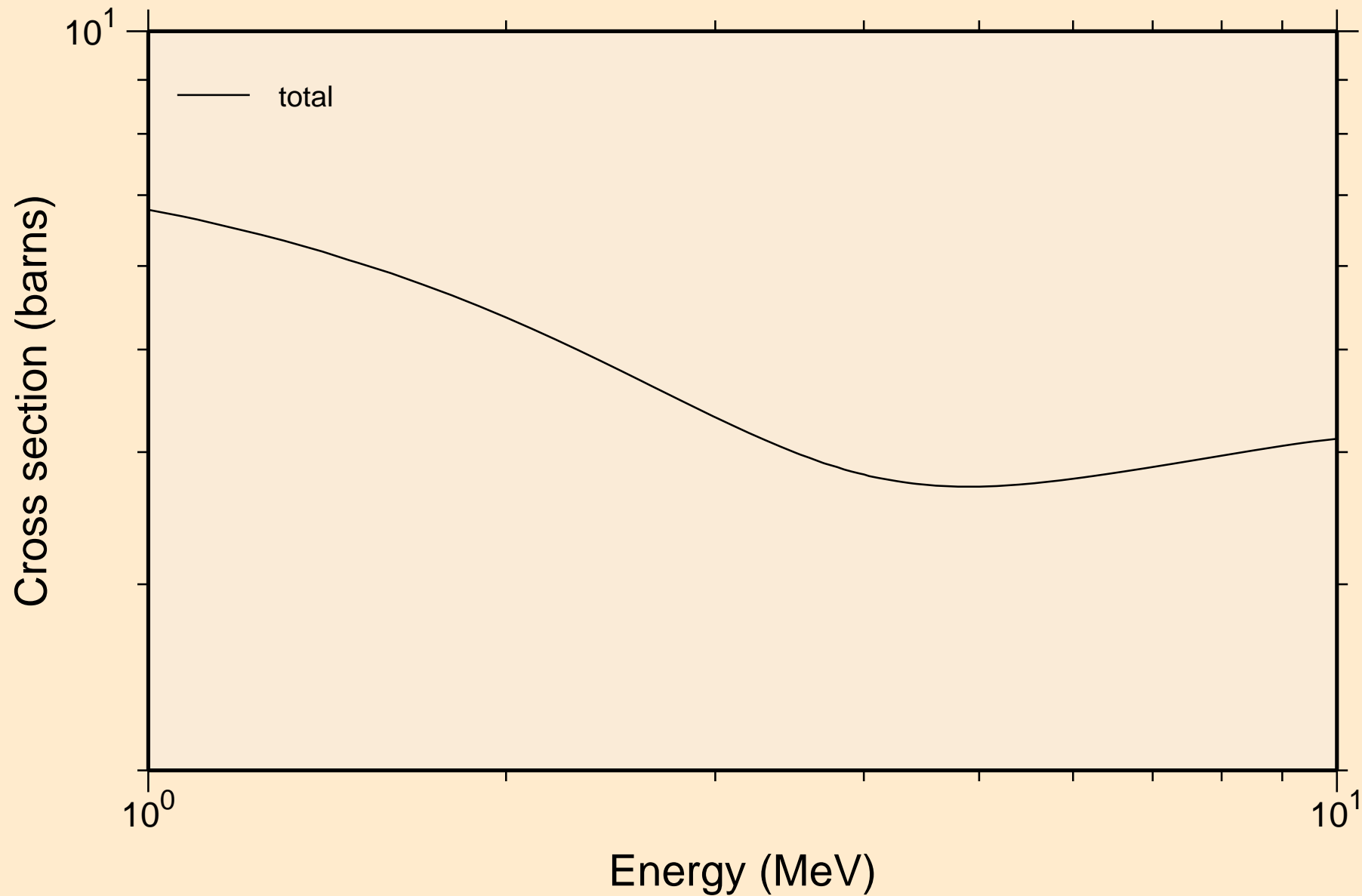

SN101 NEUTRON ACER TENDL-2019 LIBRARY; T=293.16K
resonance absorption cross sections

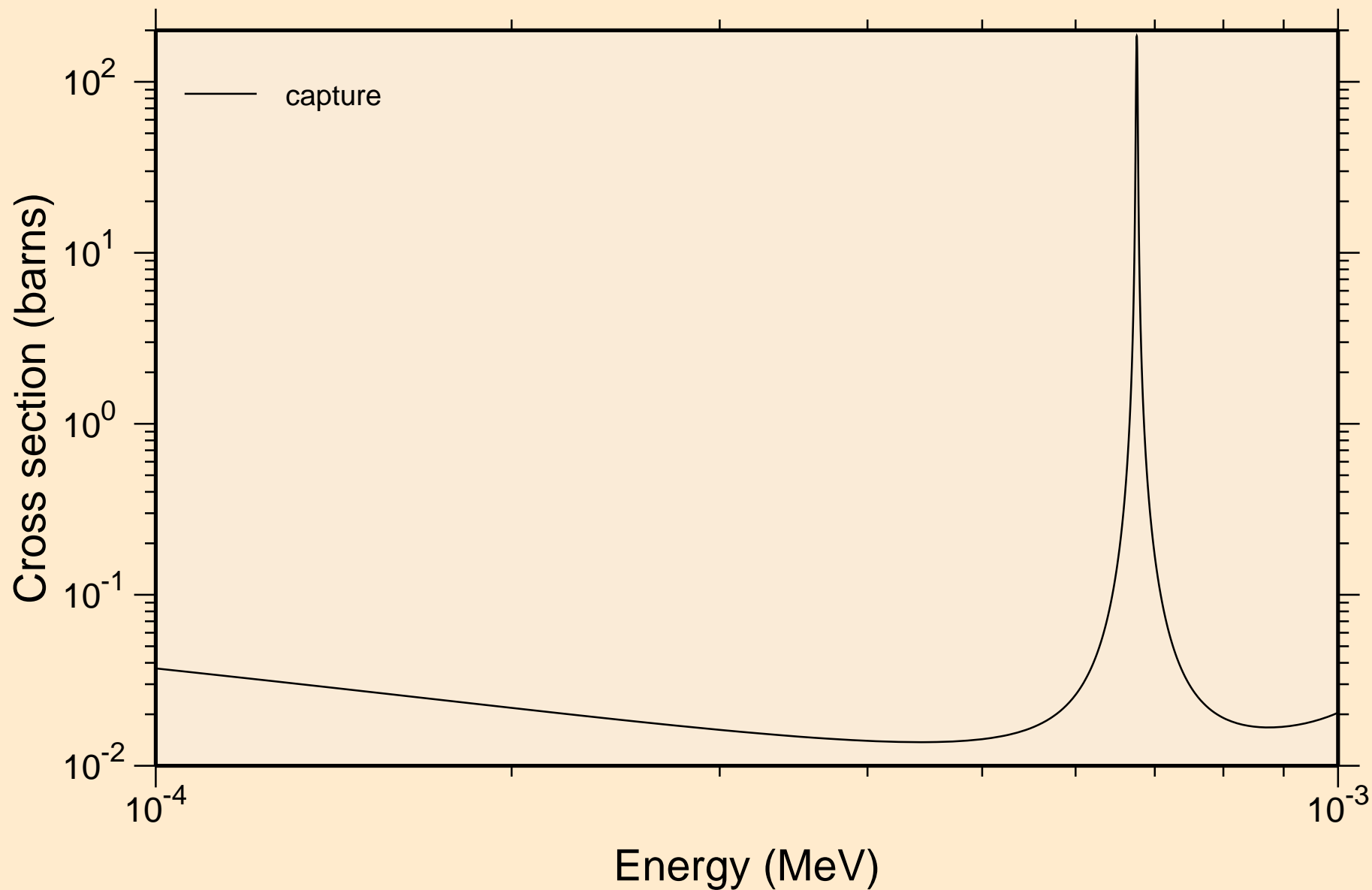

SN101 NEUTRON ACER TENDL-2019 LIBRARY; T=293.16K
resonance absorption cross sections

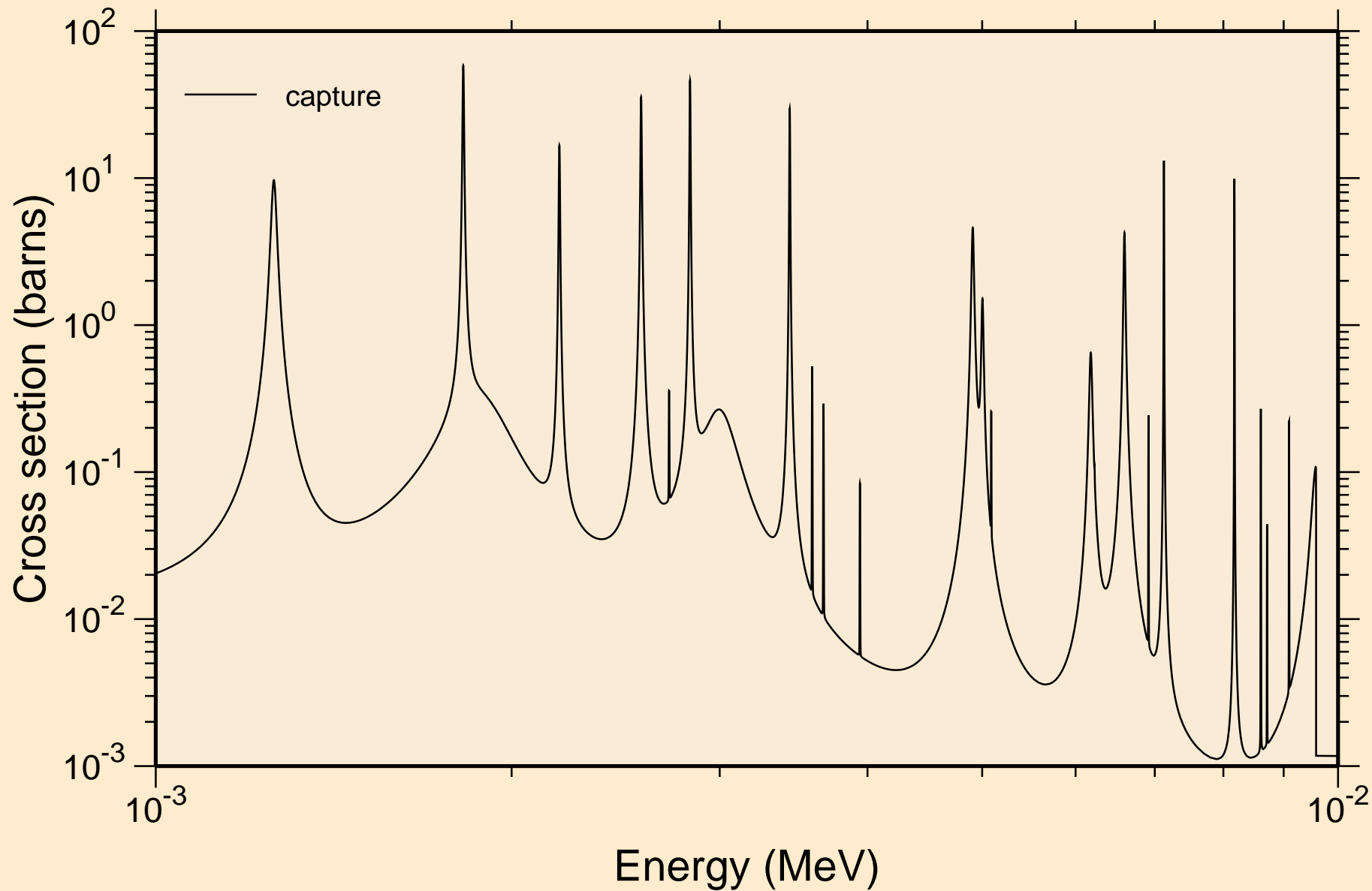

SN101 NEUTRON ACER TENDL-2019 LIBRARY; T=293.16K
resonance absorption cross sections

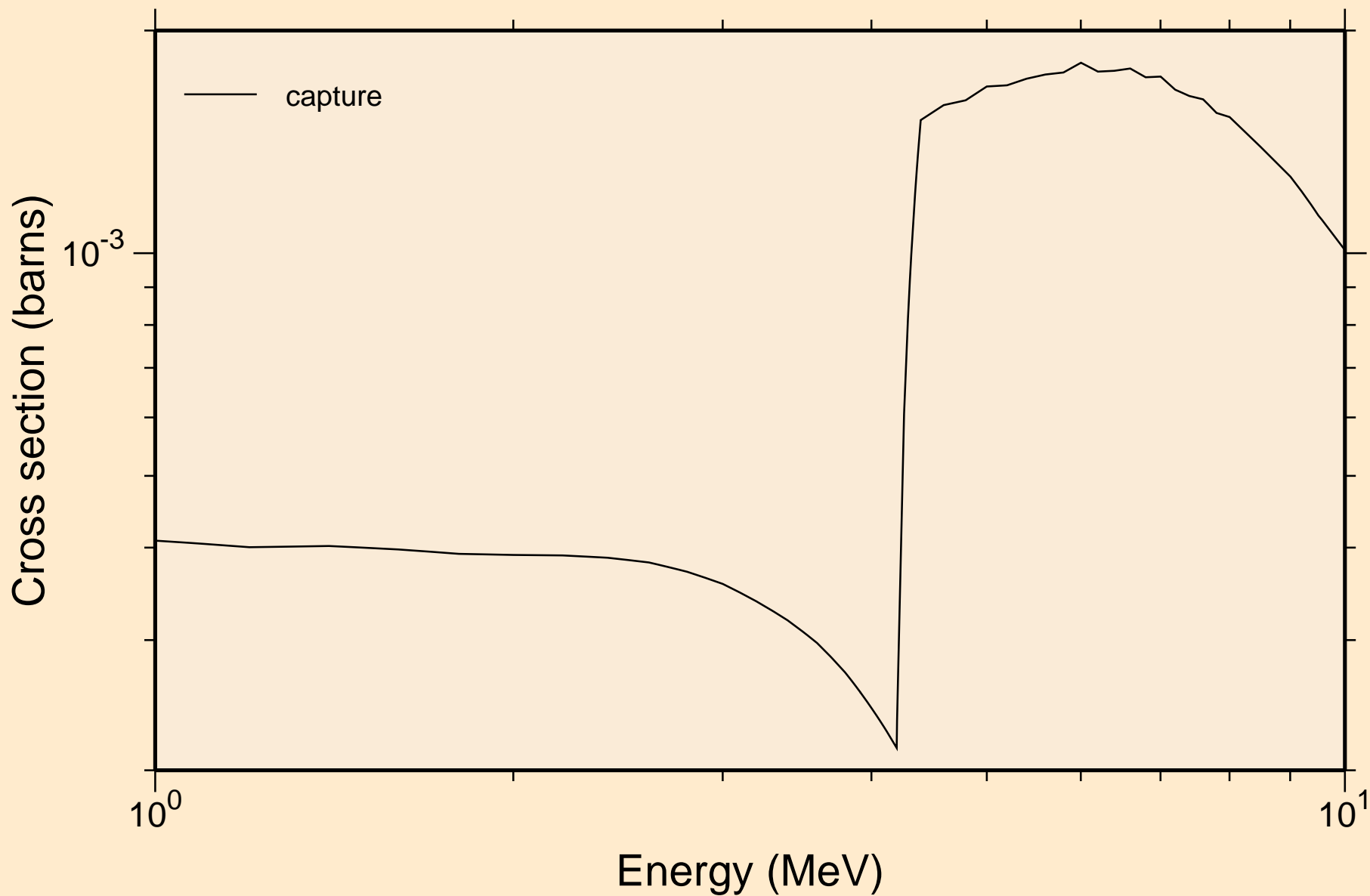

SN101 NEUTRON ACER TENDL-2019 LIBRARY; T=293.16K
Heating

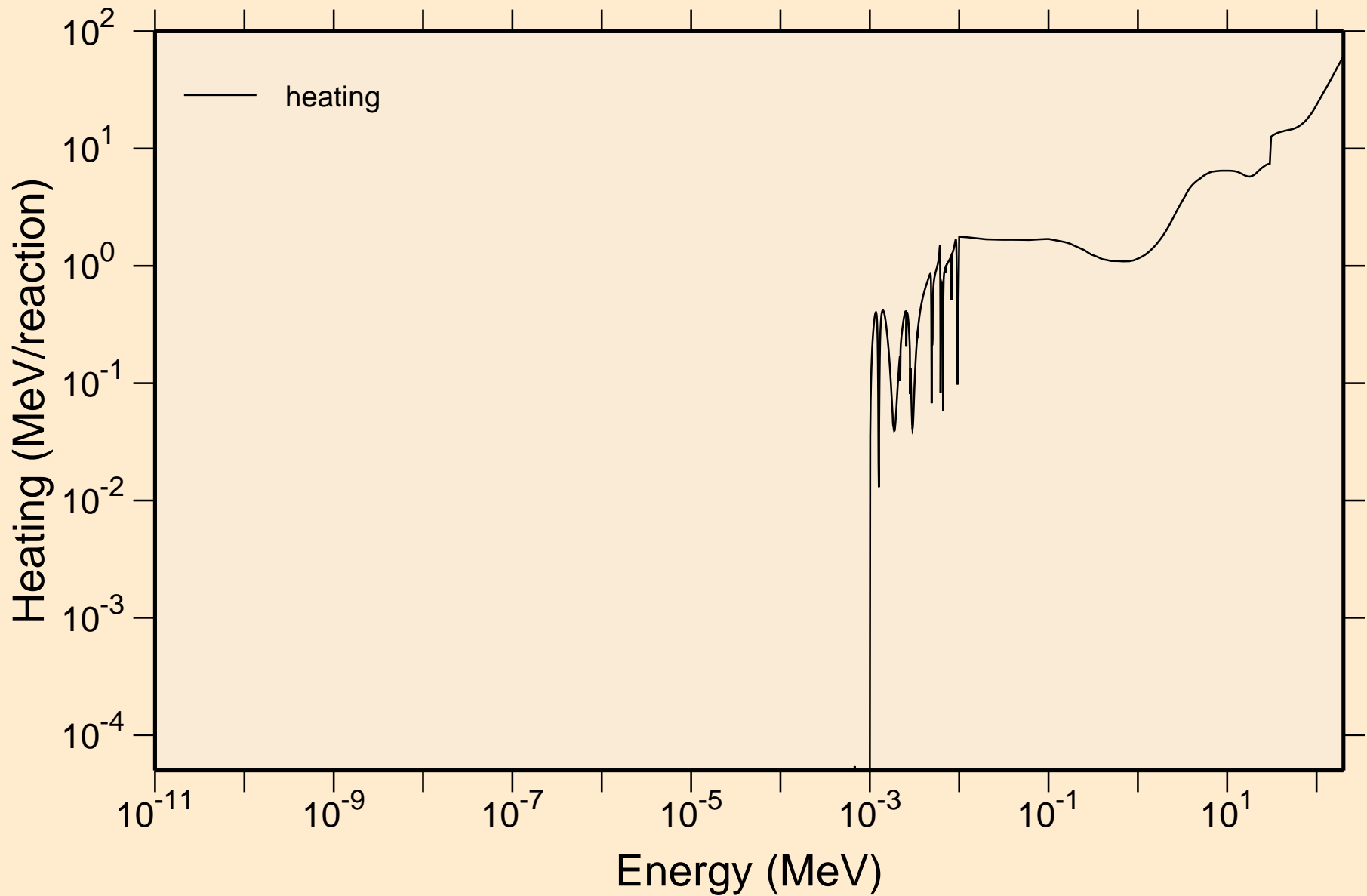

SN101 NEUTRON ACER TENDL-2019 LIBRARY; T=293.16K
Damage

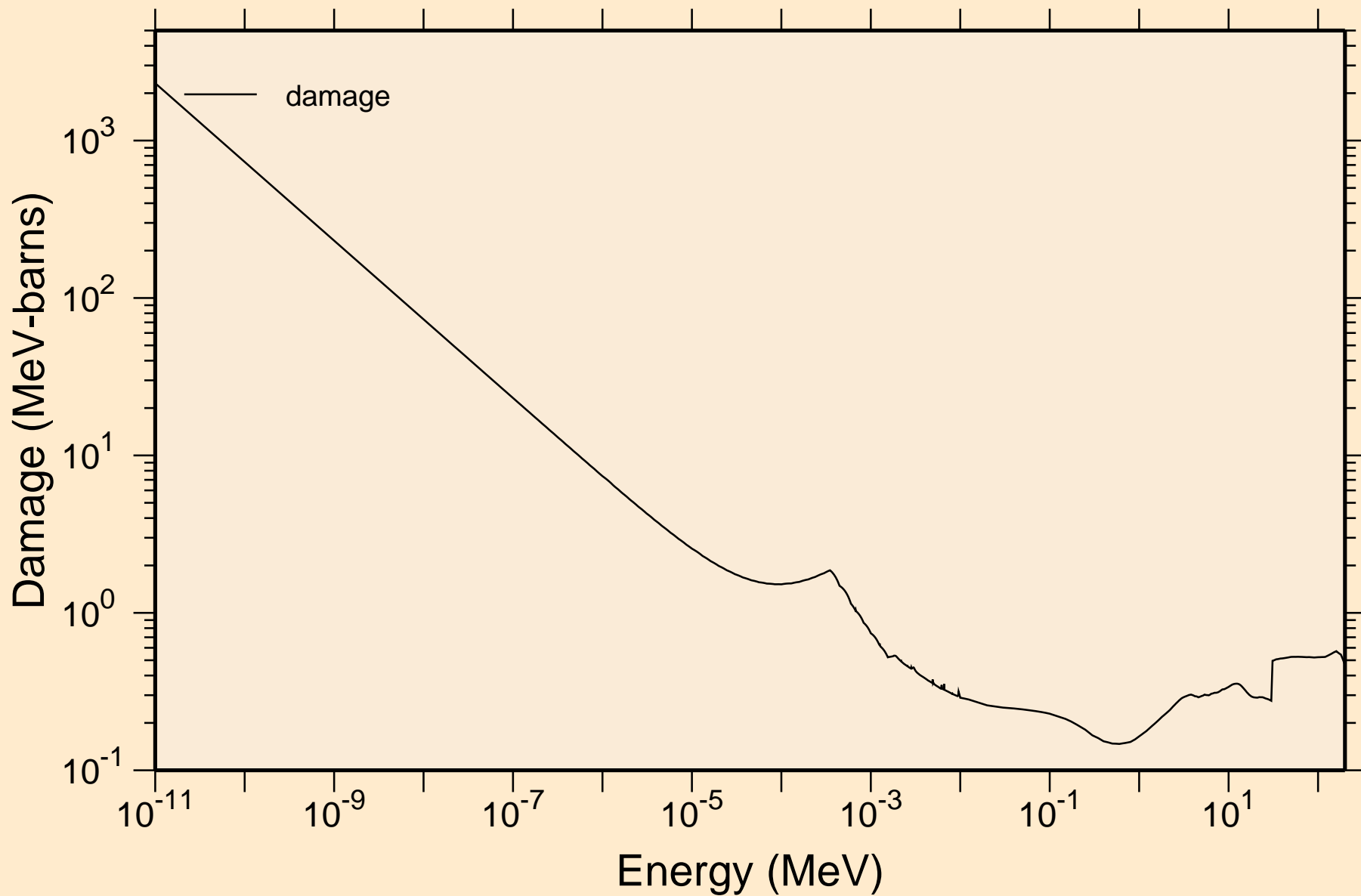

SN101 NEUTRON ACER TENDL-2019 LIBRARY; T=293.16K

Non-threshold reactions

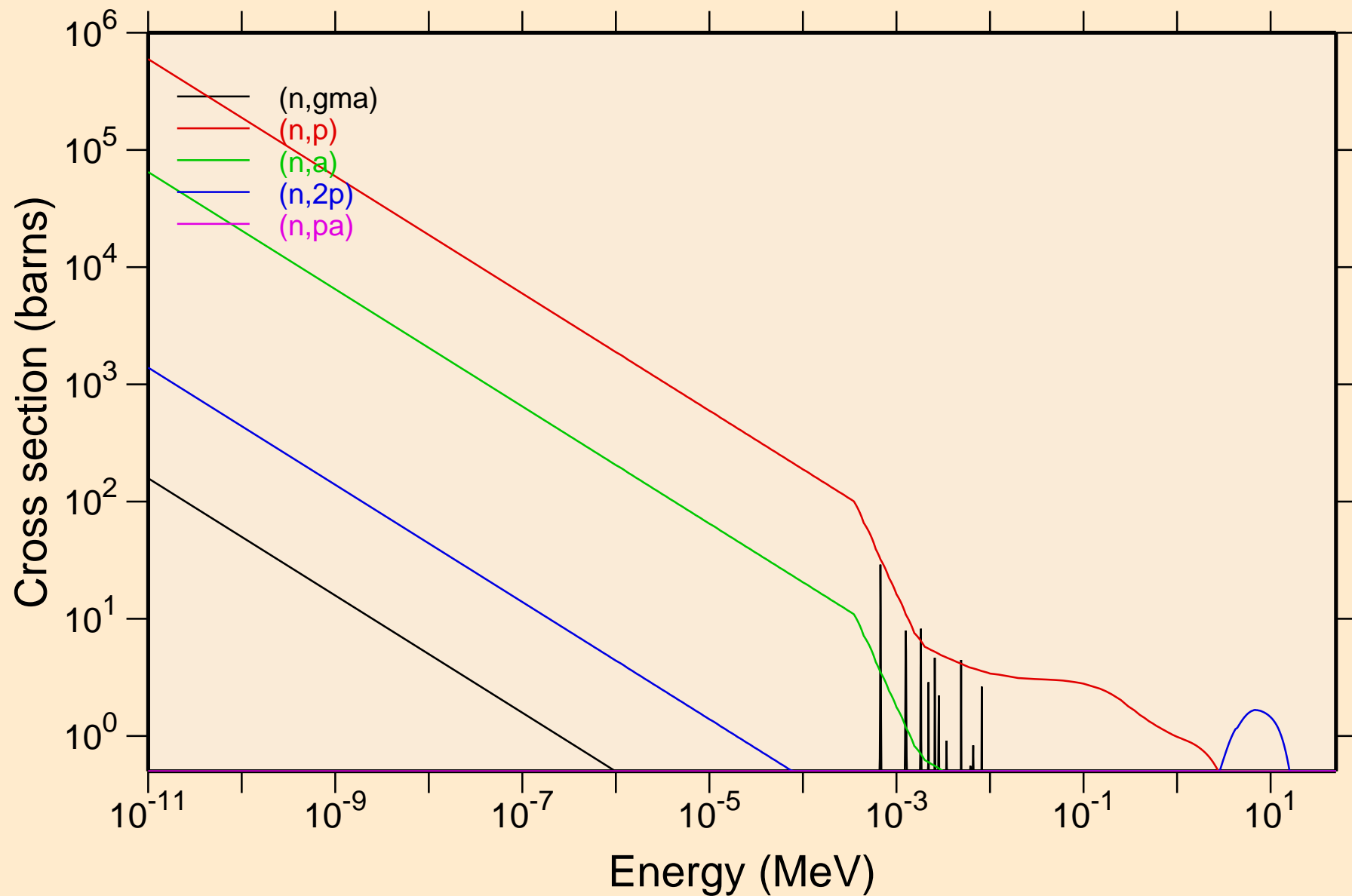

SN101 NEUTRON ACER TENDL-2019 LIBRARY; T=293.16K
Non-threshold reactions

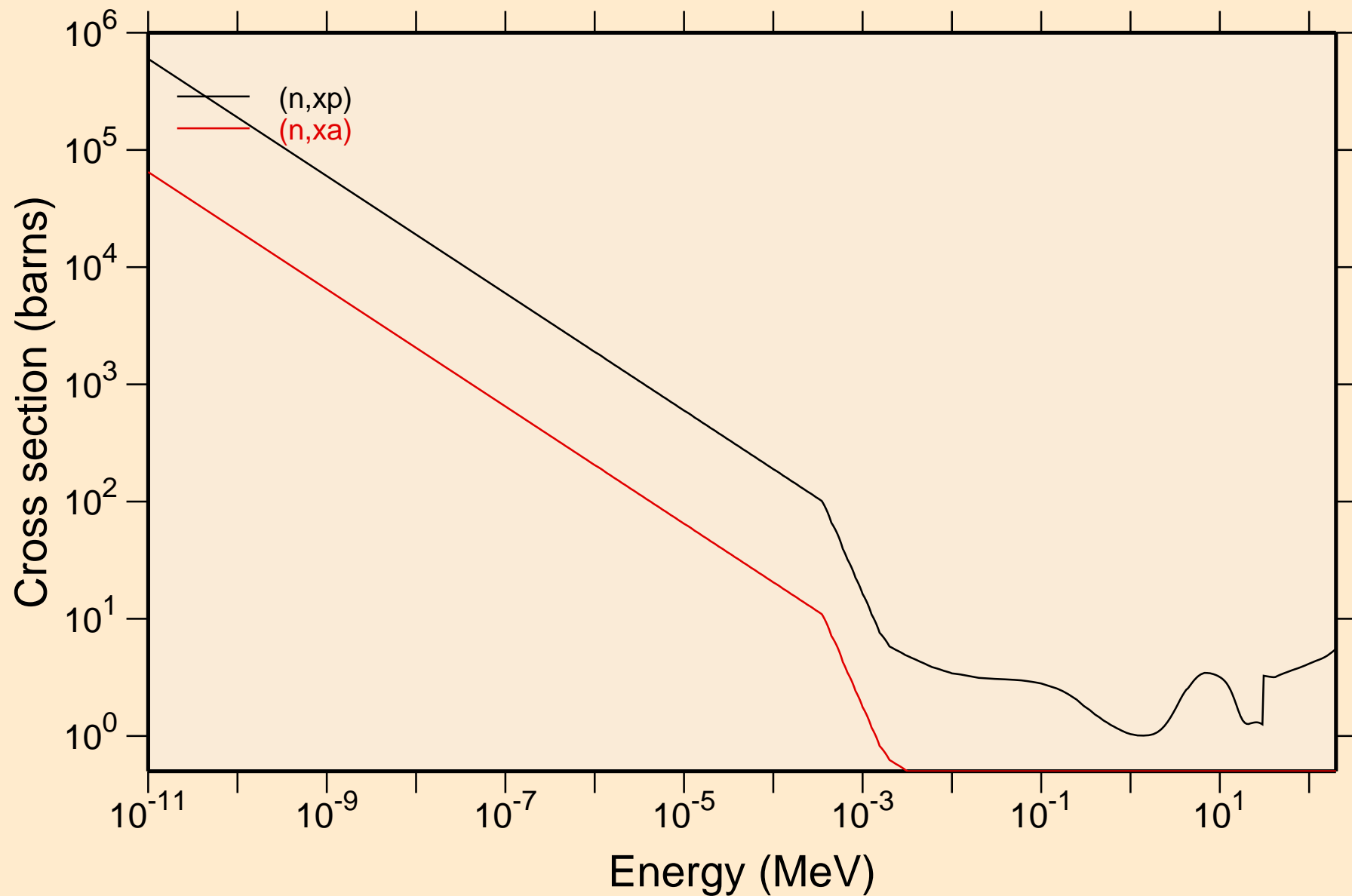

SN101 NEUTRON ACER TENDL-2019 LIBRARY; T=293.16K

Principal cross sections

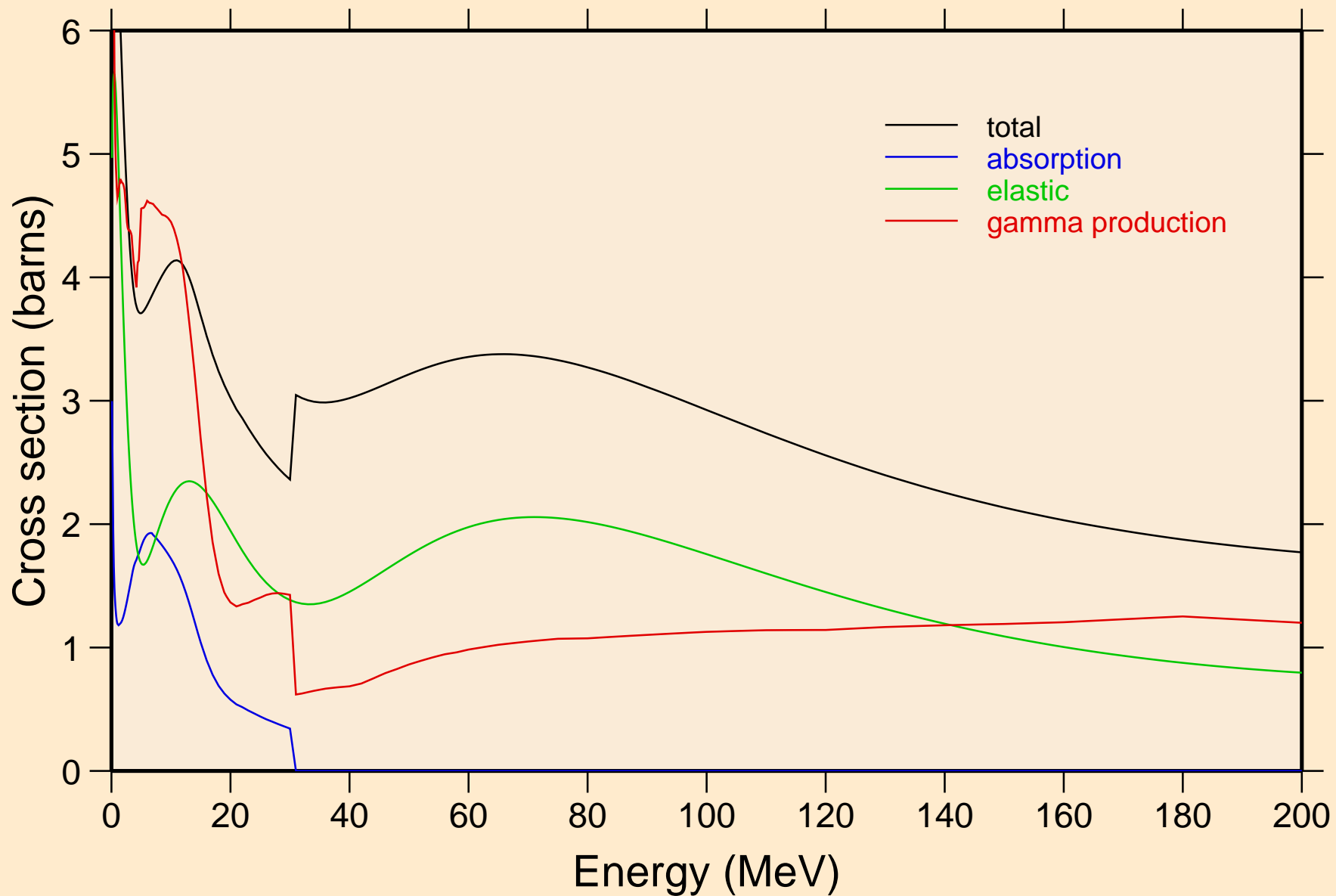

SN101 NEUTRON ACER TENDL-2019 LIBRARY; T=293.16K

Heating

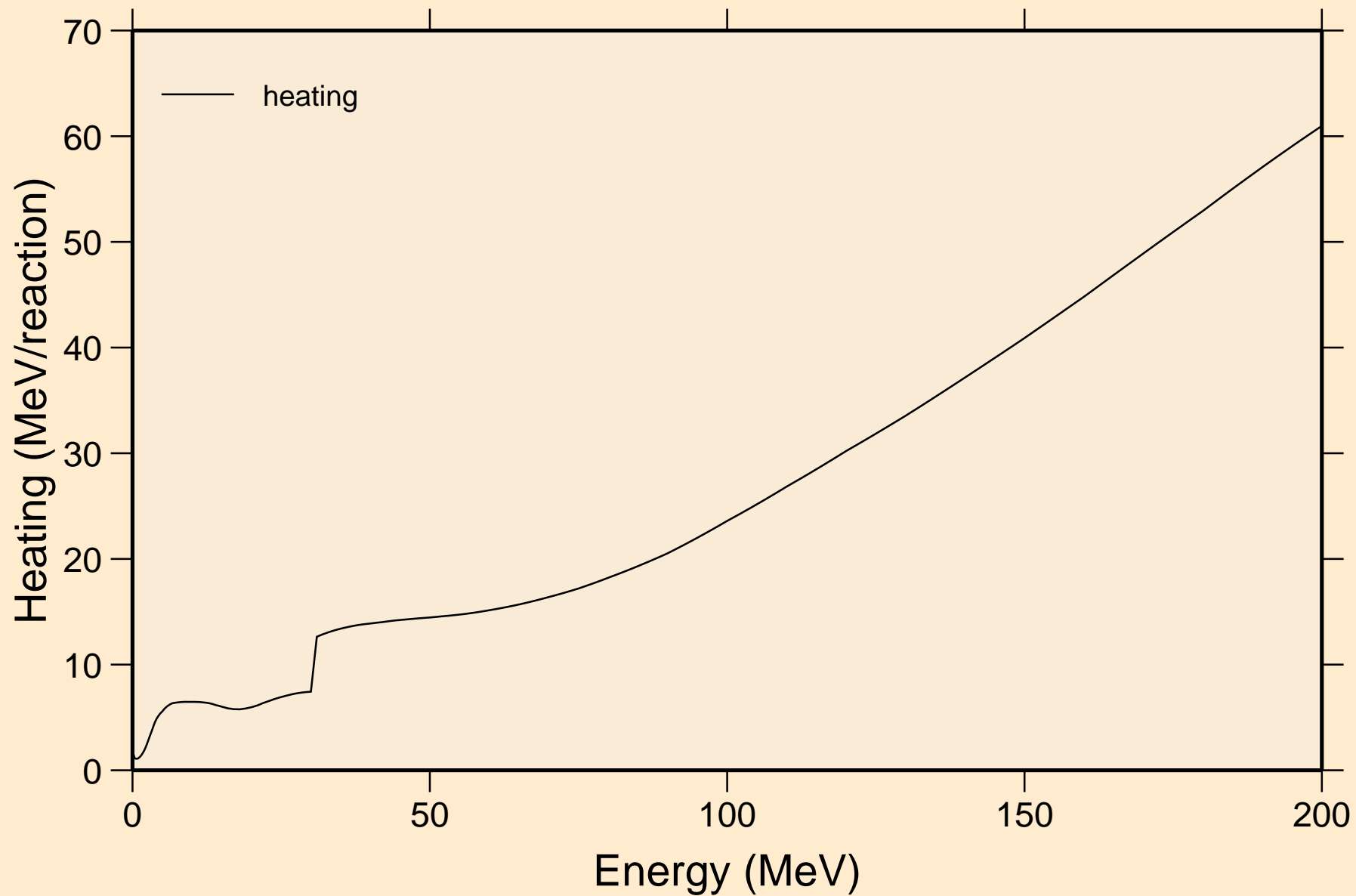

SN101 NEUTRON ACER TENDL-2019 LIBRARY; T=293.16K Damage

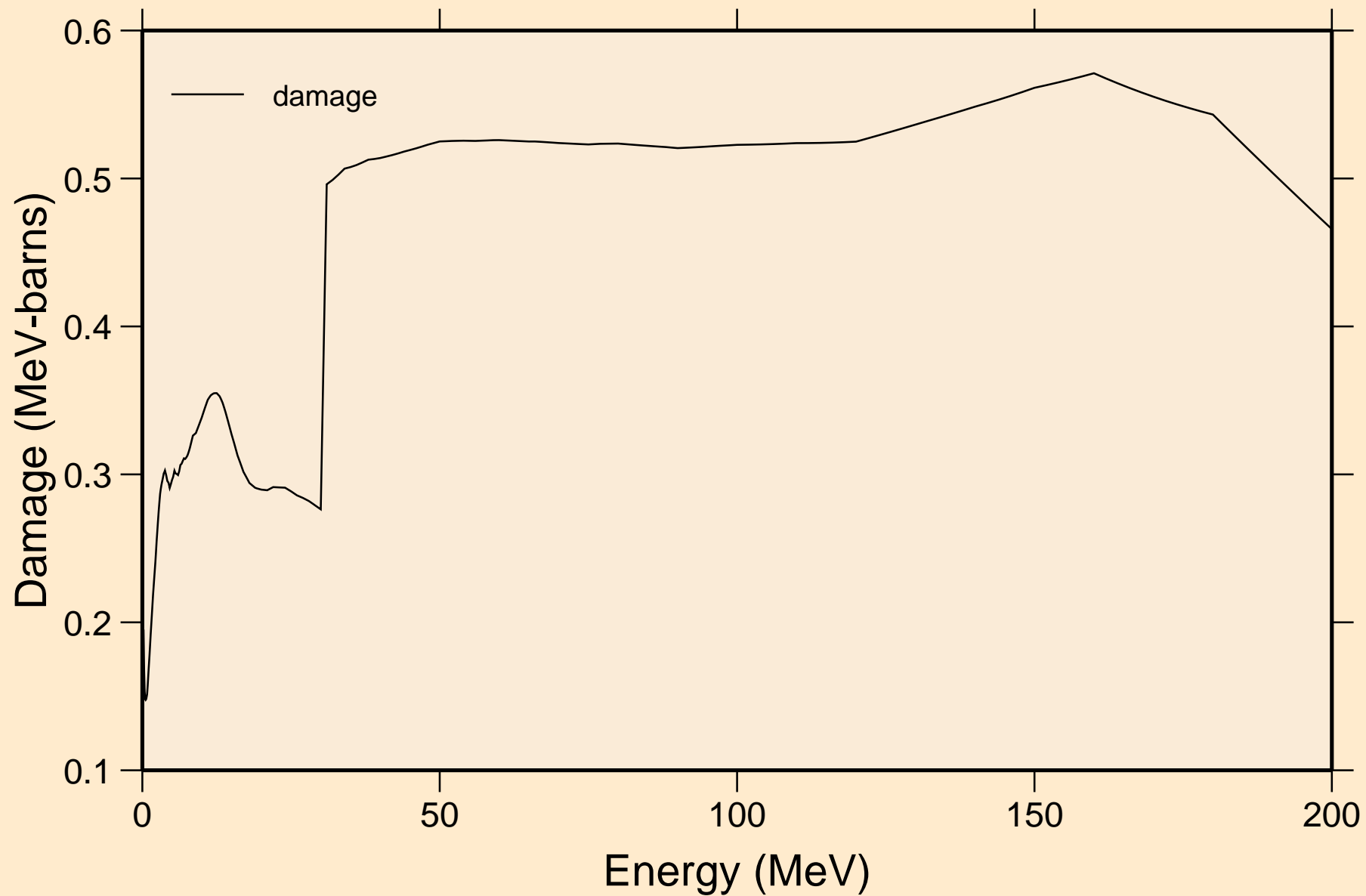

SN101 NEUTRON ACER TENDL-2019 LIBRARY; T=293.16K
Non-threshold reactions

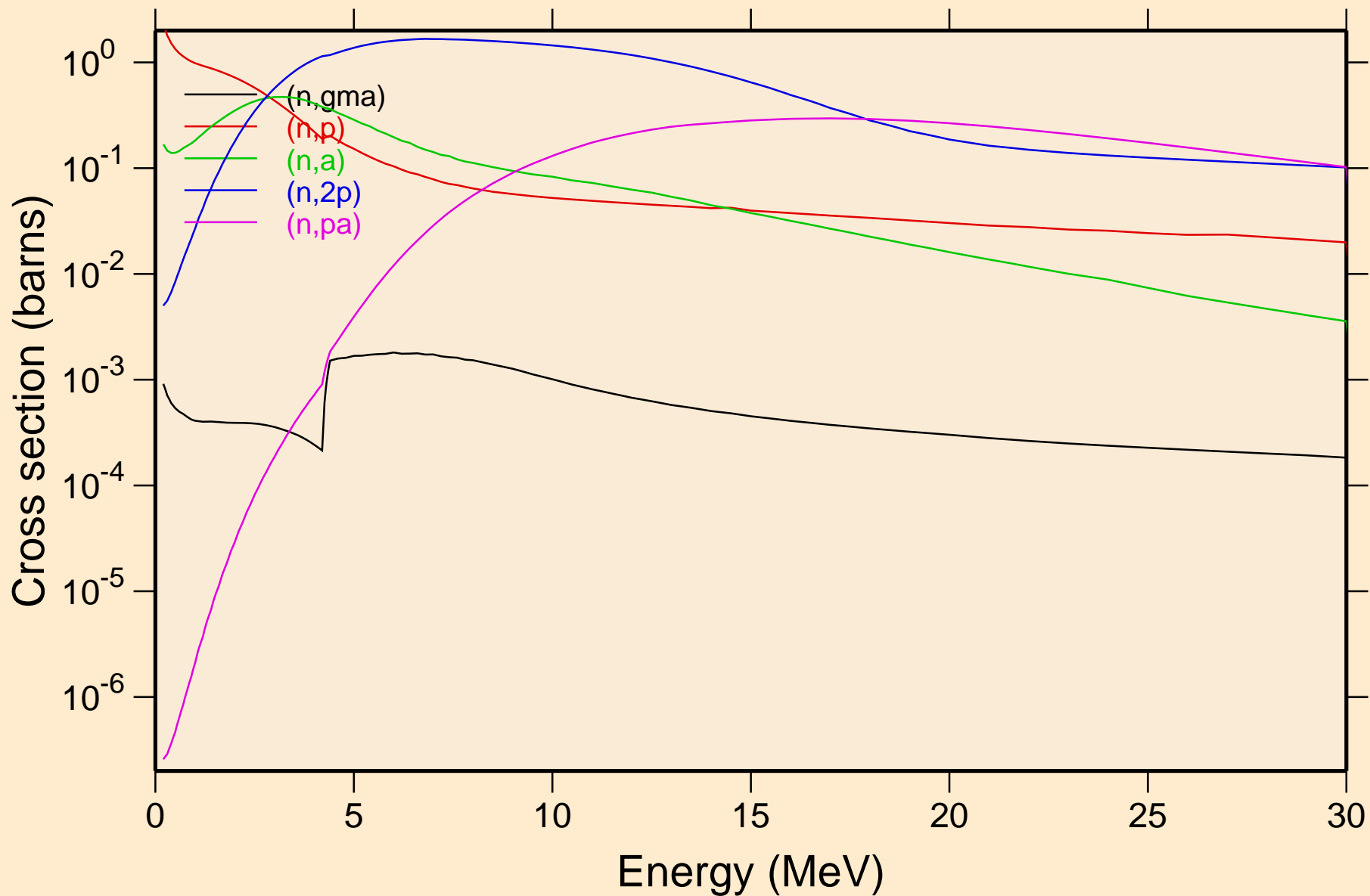

SN101 NEUTRON ACER TENDL-2019 LIBRARY; T=293.16K
Non-threshold reactions

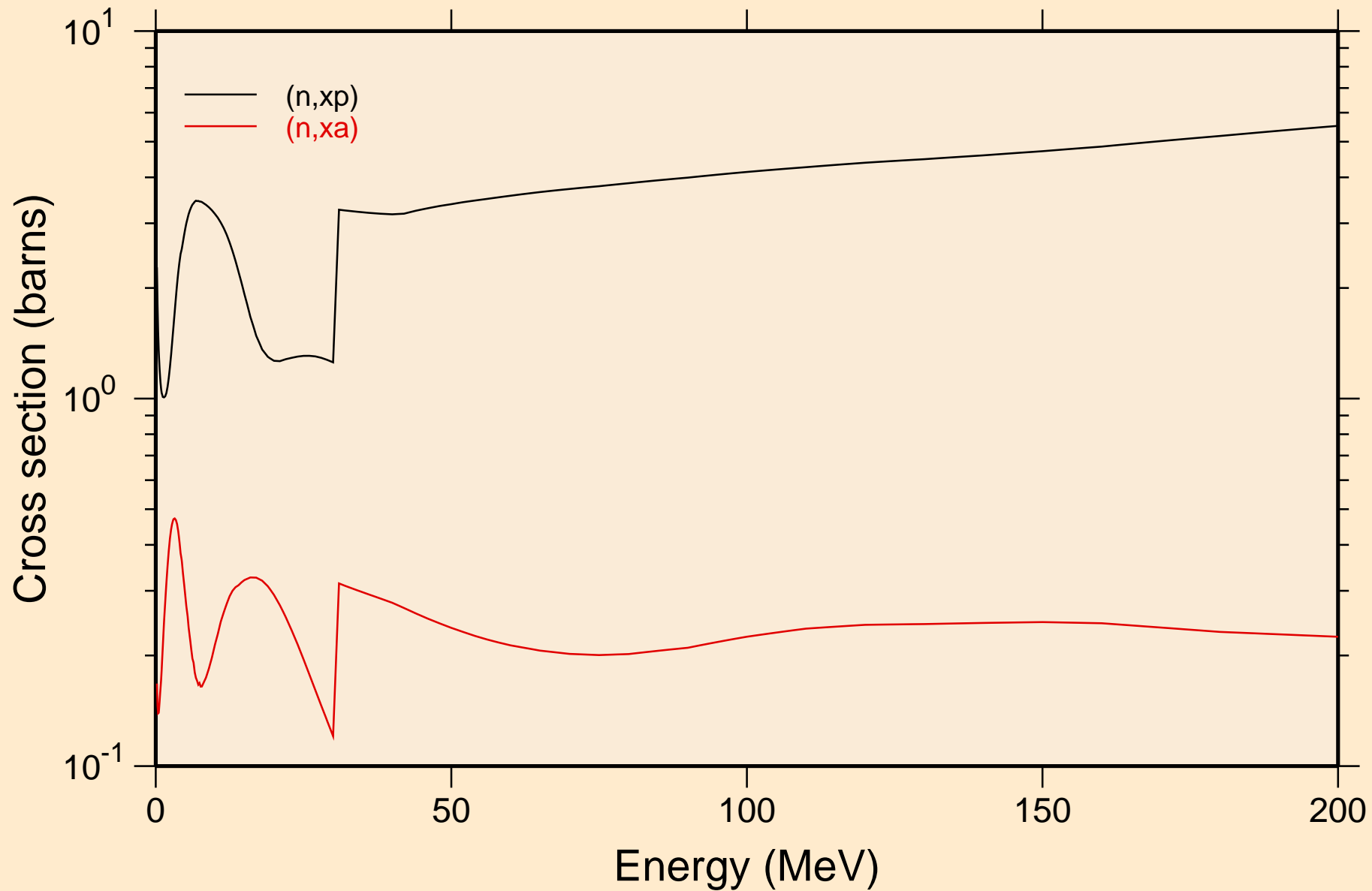

SN101 NEUTRON ACER TENDL-2019 LIBRARY; T=293.16K
Inelastic levels

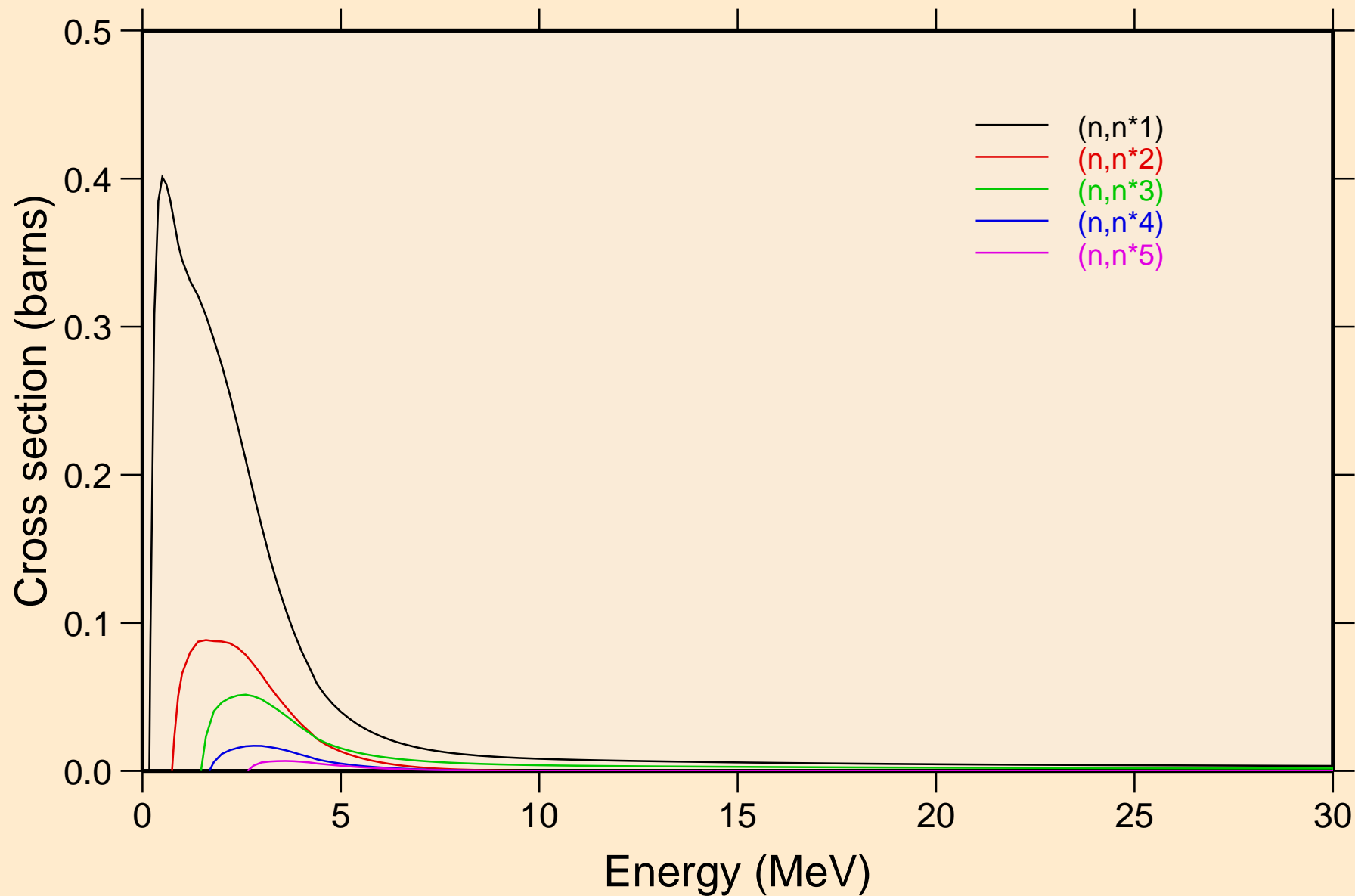

SN101 NEUTRON ACER TENDL-2019 LIBRARY; T=293.16K

Inelastic levels

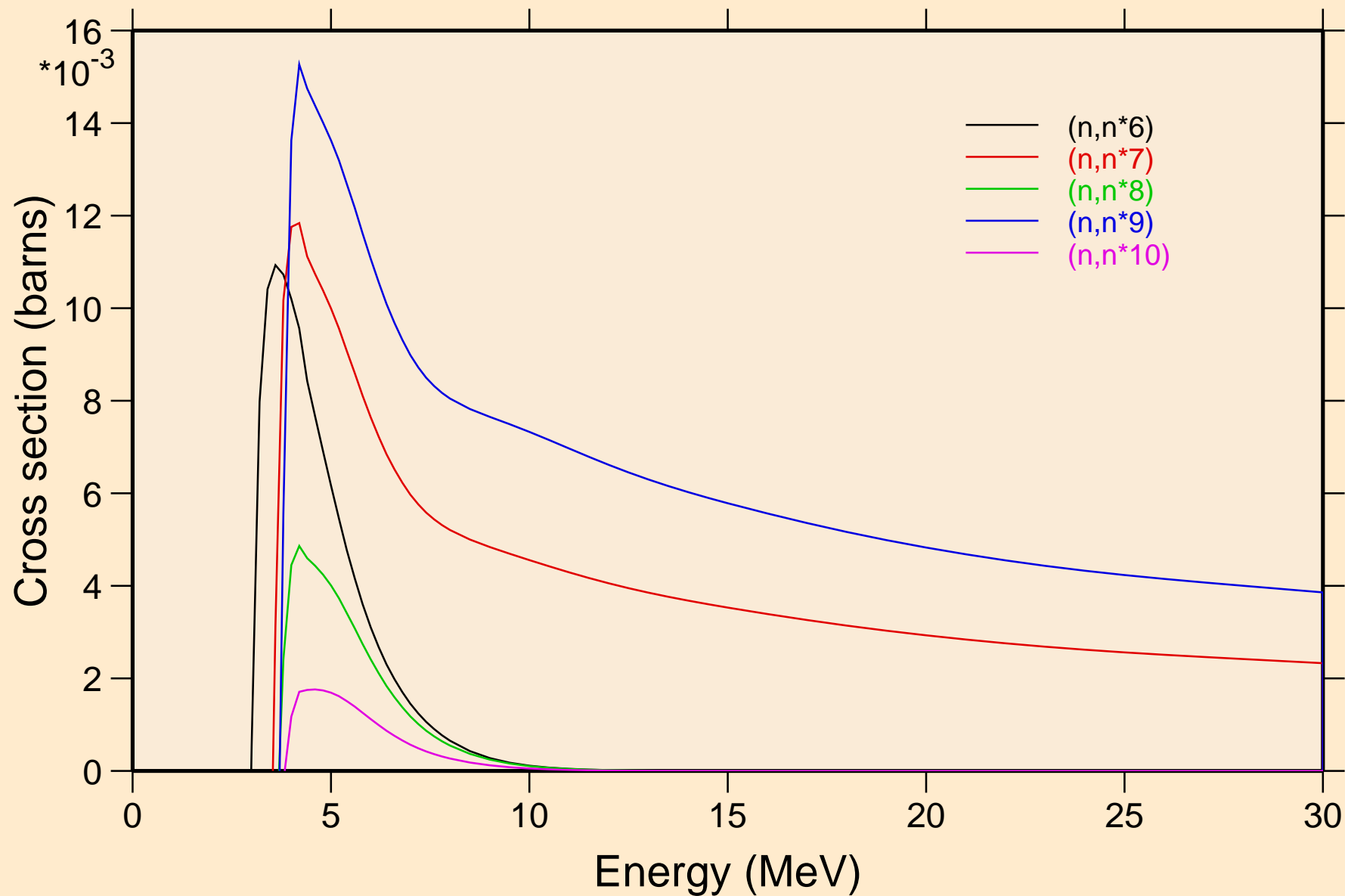

SN101 NEUTRON ACER TENDL-2019 LIBRARY; T=293.16K
Inelastic levels

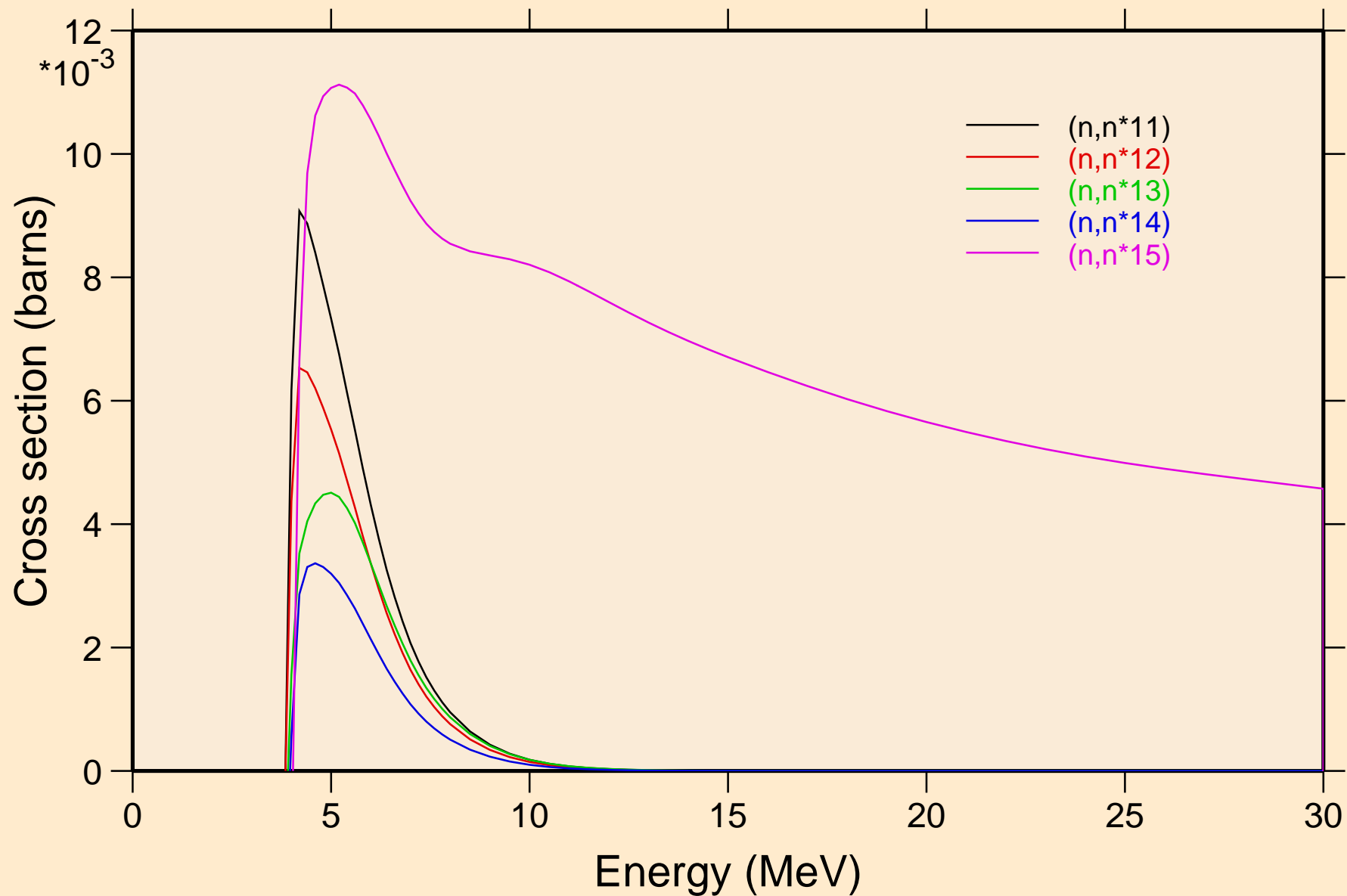

SN101 NEUTRON ACER TENDL-2019 LIBRARY; T=293.16K

Threshold reactions

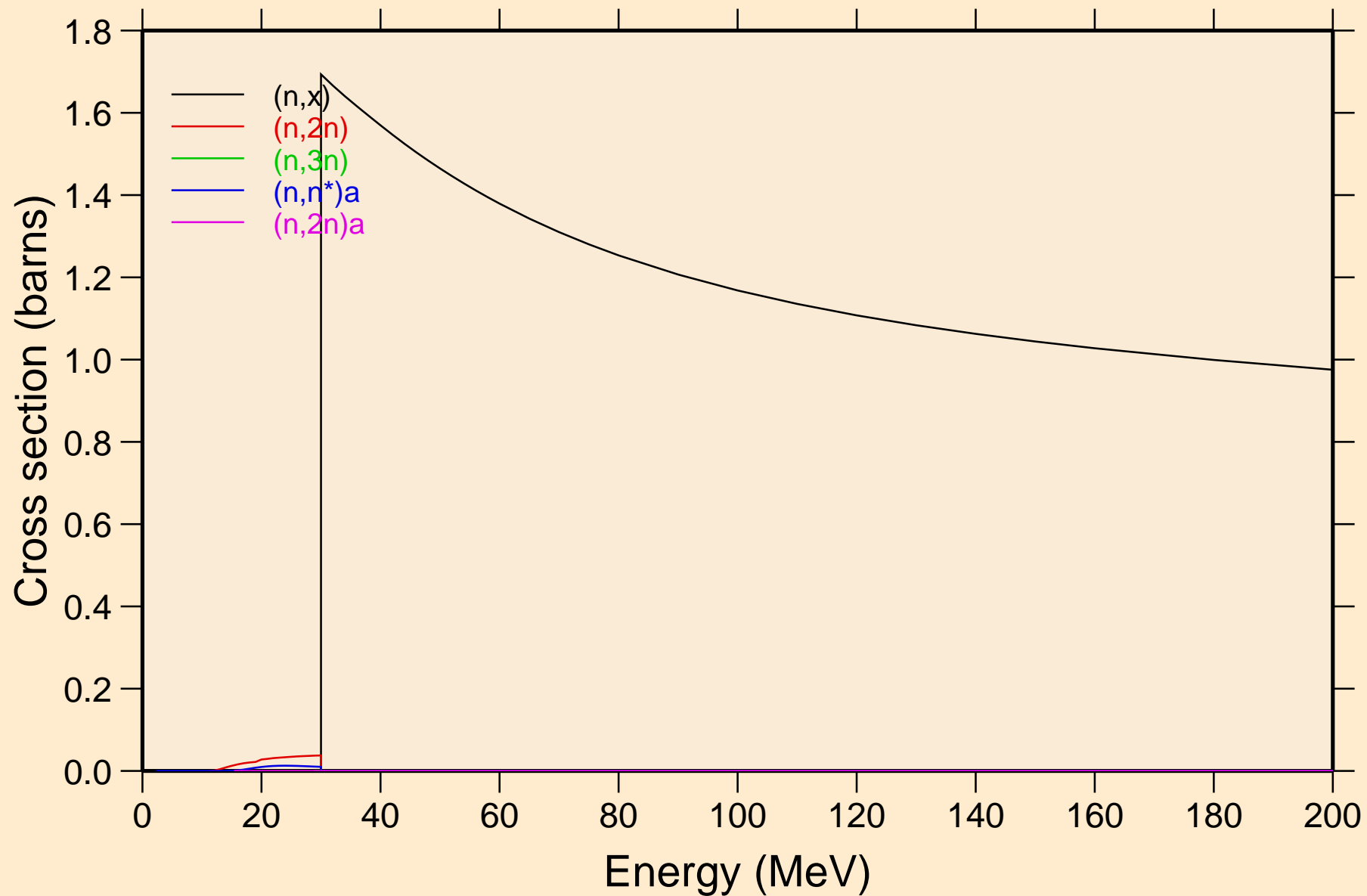

SN101 NEUTRON ACER TENDL-2019 LIBRARY; T=293.16K

Threshold reactions

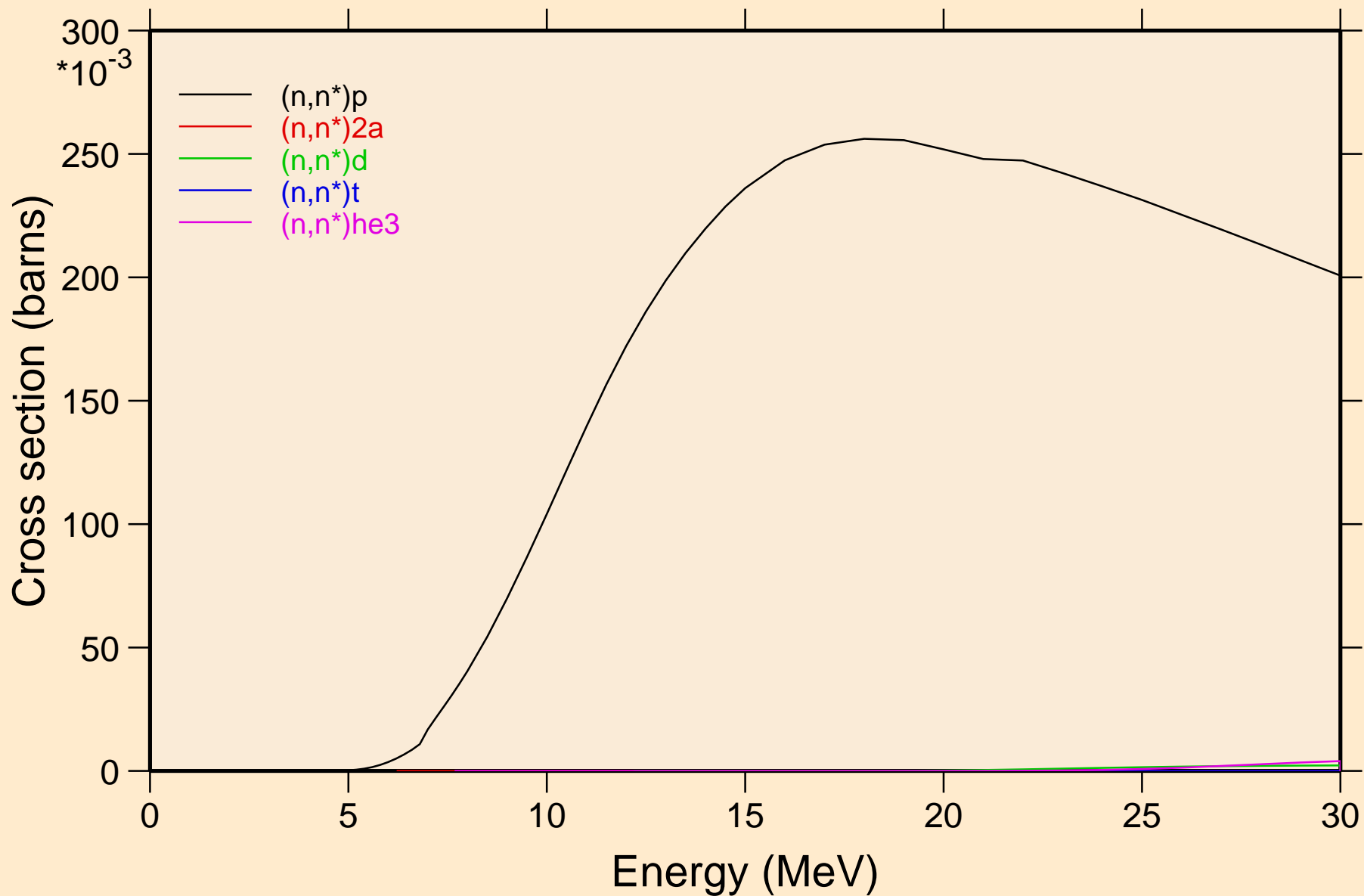

SN101 NEUTRON ACER TENDL-2019 LIBRARY; T=293.16K

Threshold reactions

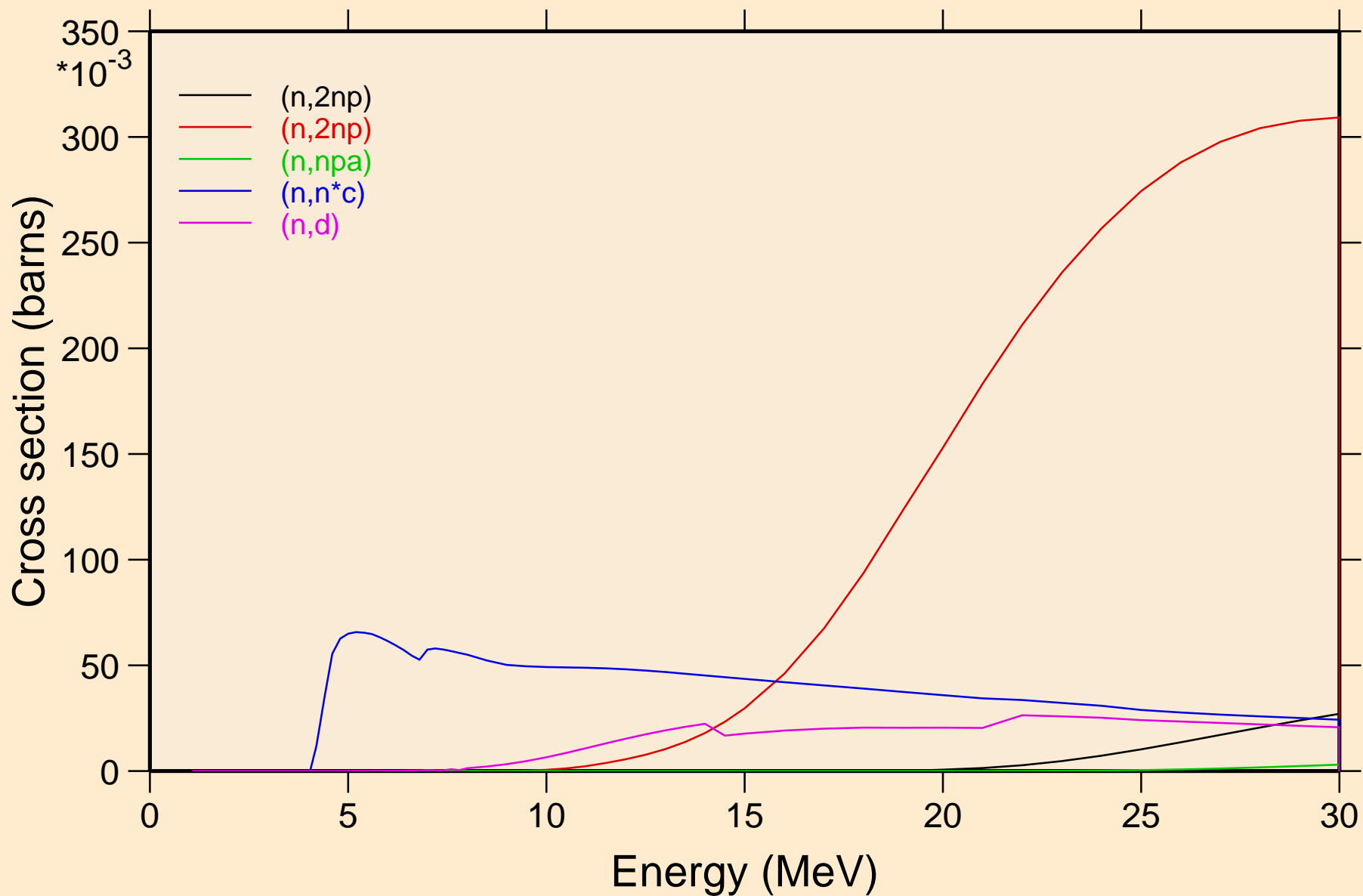

SN101 NEUTRON ACER TENDL-2019 LIBRARY; T=293.16K

Threshold reactions

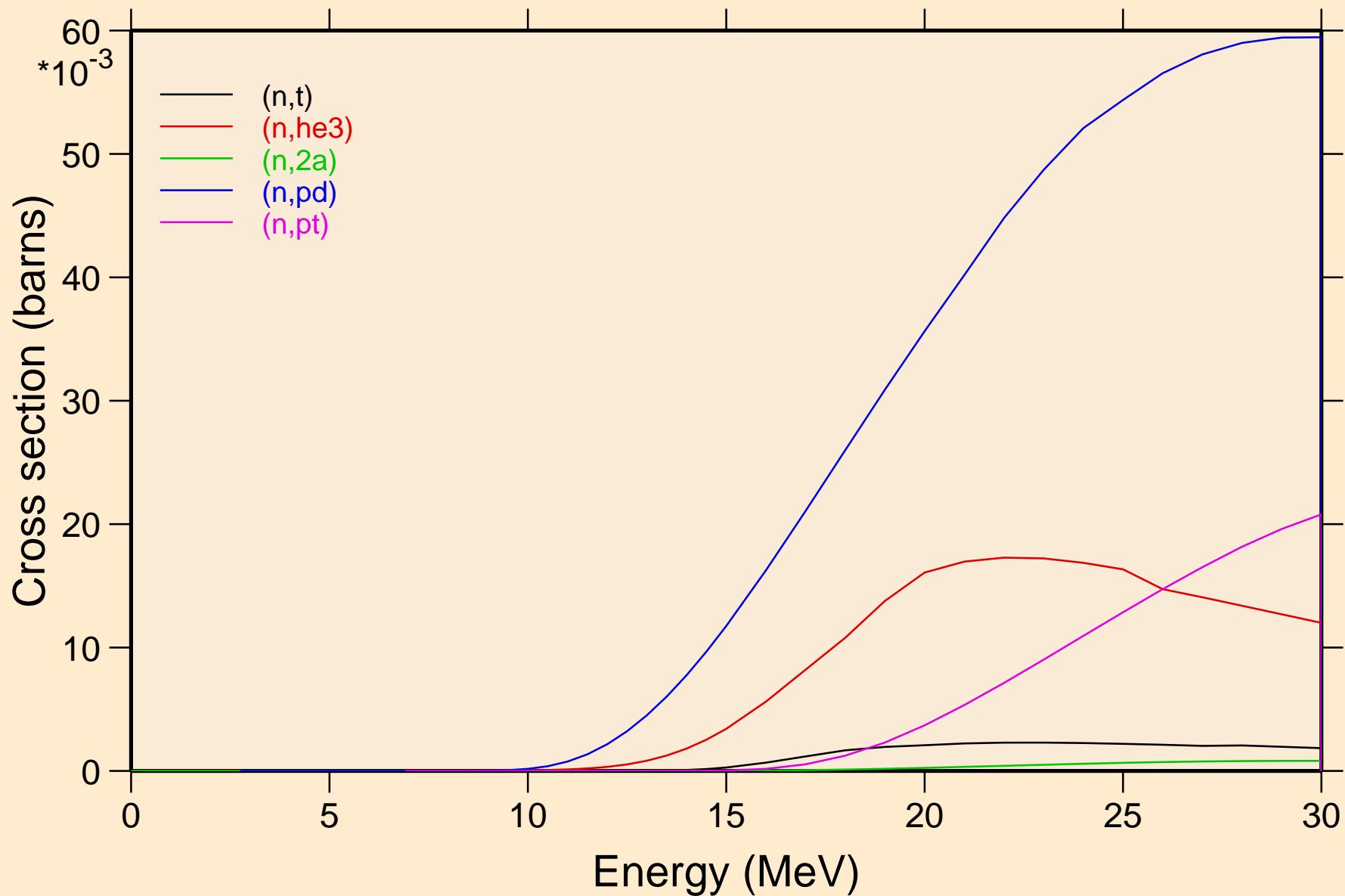

SN101 NEUTRON ACER TENDL-2019 LIBRARY; T=293.16K
Threshold reactions

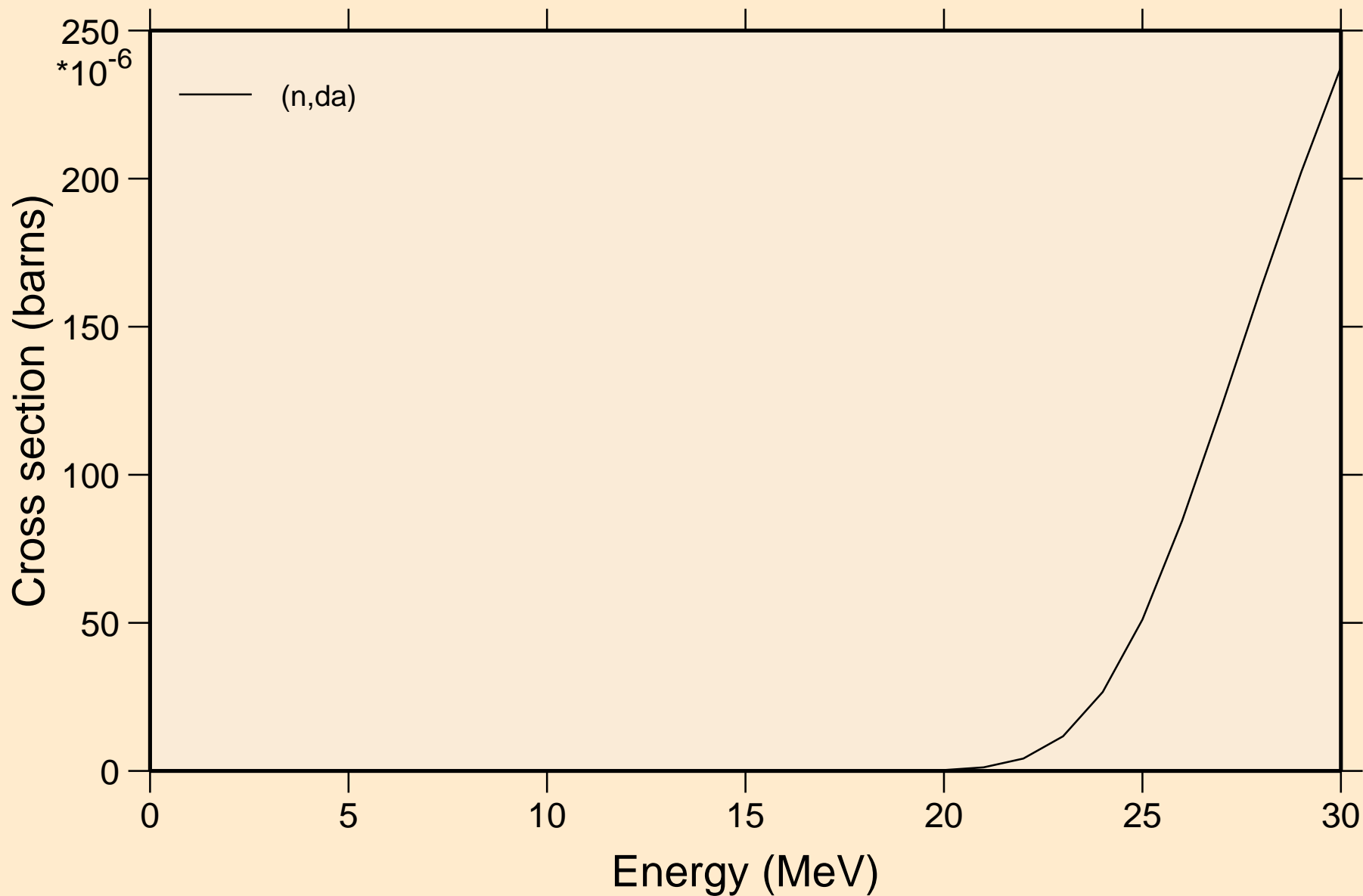

SN101 NEUTRON ACER TENDL-2019 LIBRARY; T=293.16K

Threshold reactions

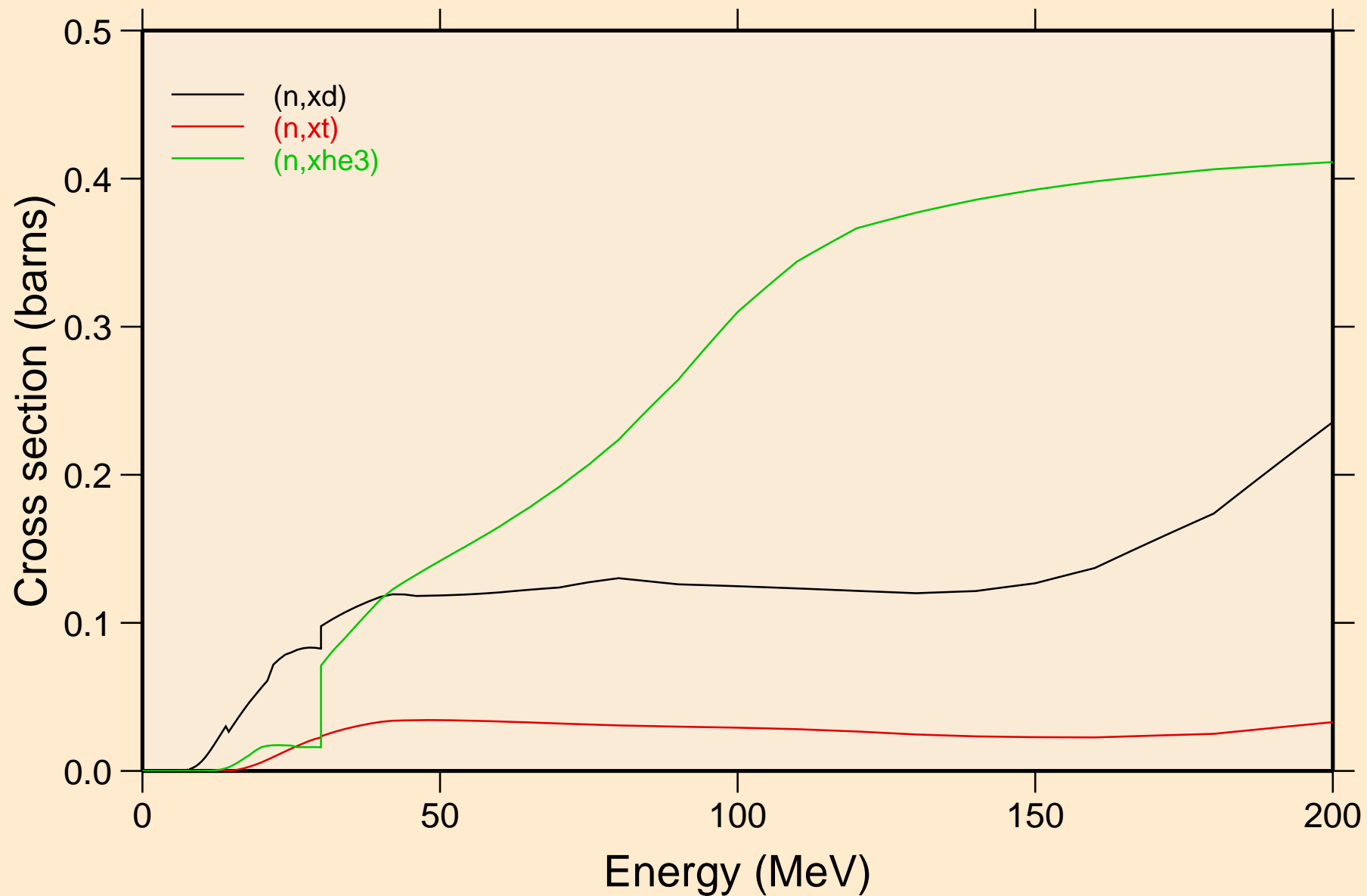

SN101 NEUTRON ACER TENDL-2019 LIBRARY; T=293.16K
angular distribution for elastic

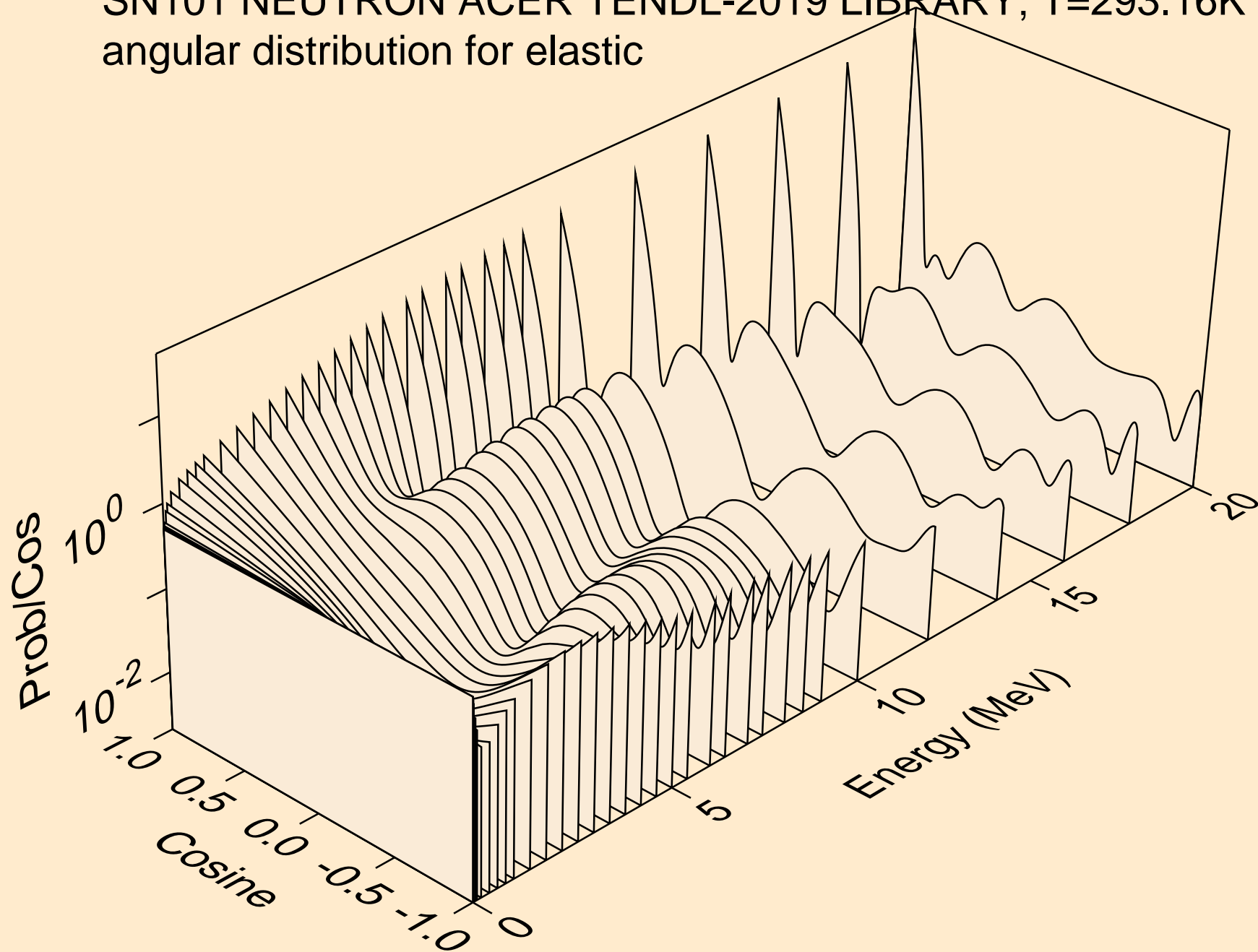

SN101 NEUTRON ACER TENDL-2019 LIBRARY; T=293.16K
angular distribution for elastic

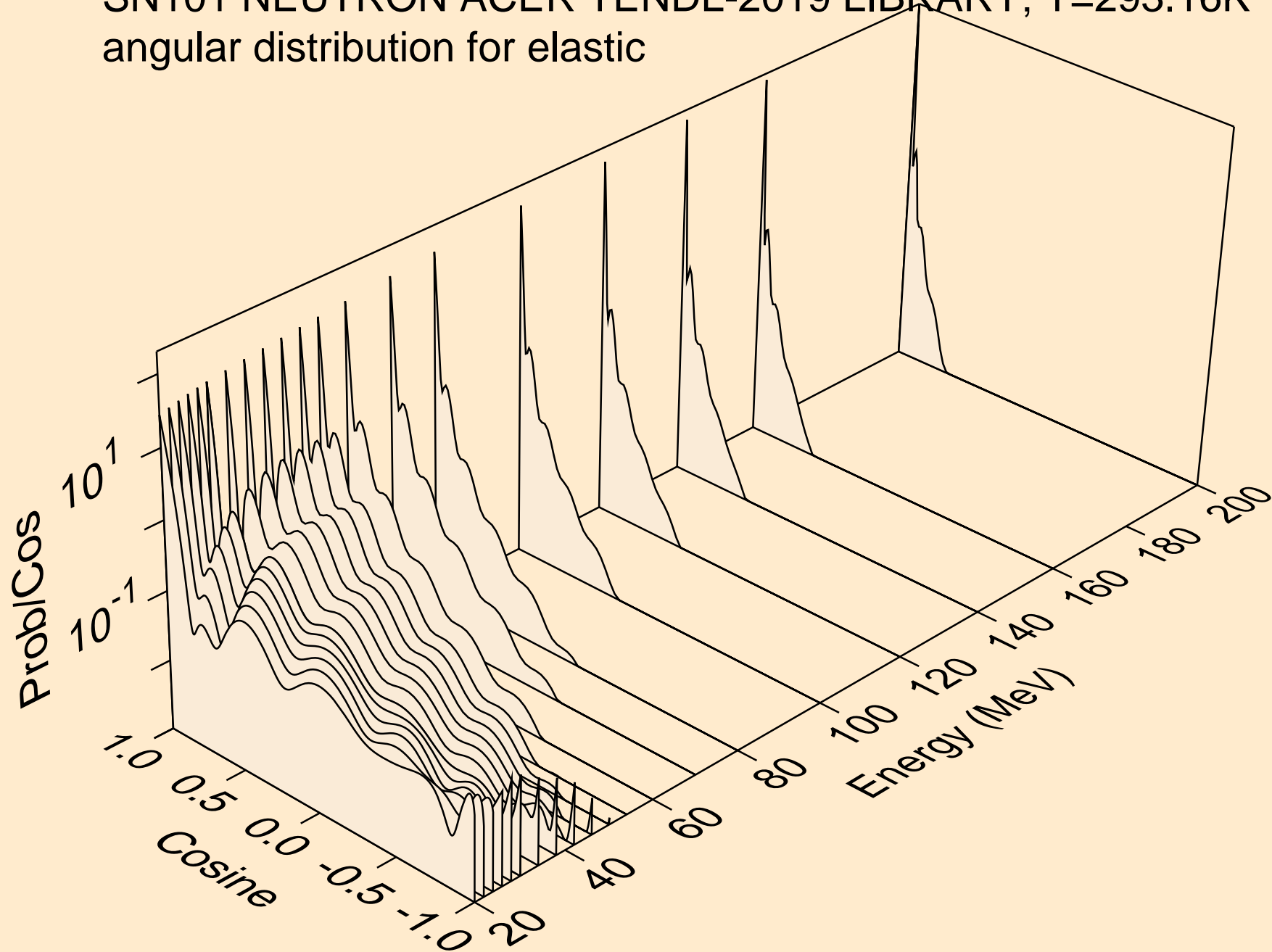

SN101 NEUTRON ACER TENDL-2019 LIBRARY; T=293.16K
angular distribution for (n,n*1)

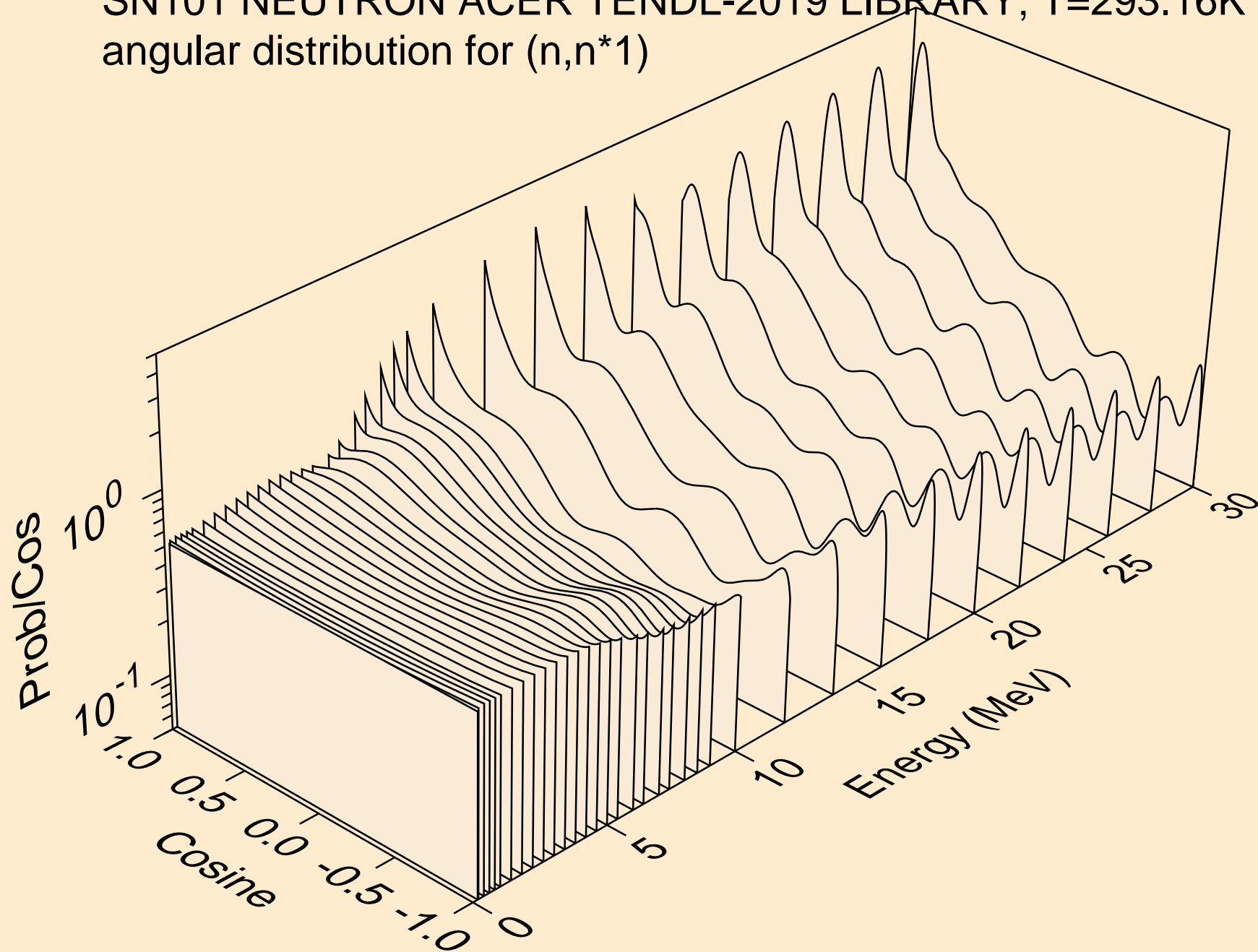

SN101 NEUTRON ACER TENDL-2019 LIBRARY; T=293.16K
angular distribution for (n,n*2)

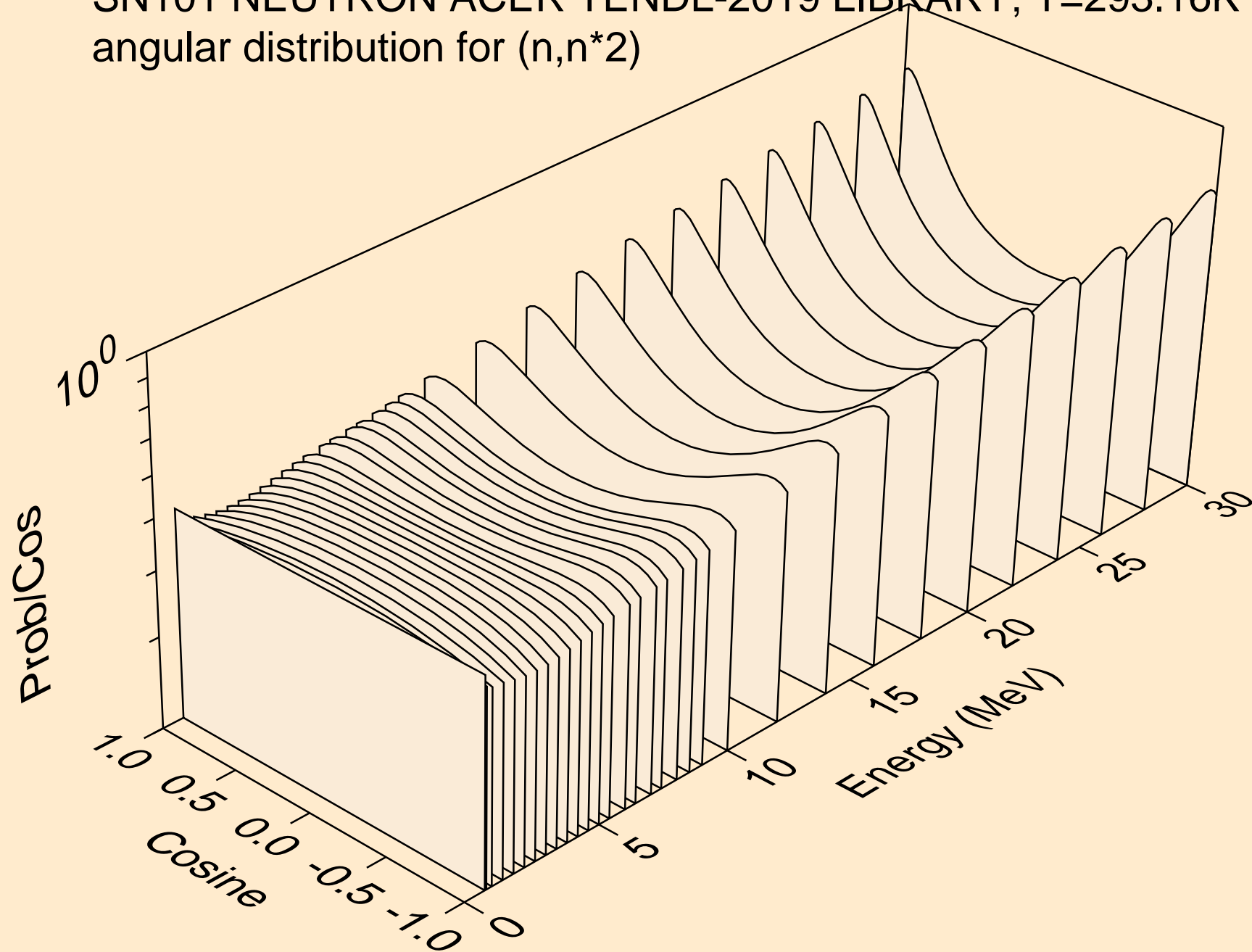

SN101 NEUTRON ACER TENDL-2019 LIBRARY; T=293.16K
angular distribution for (n,n*3)

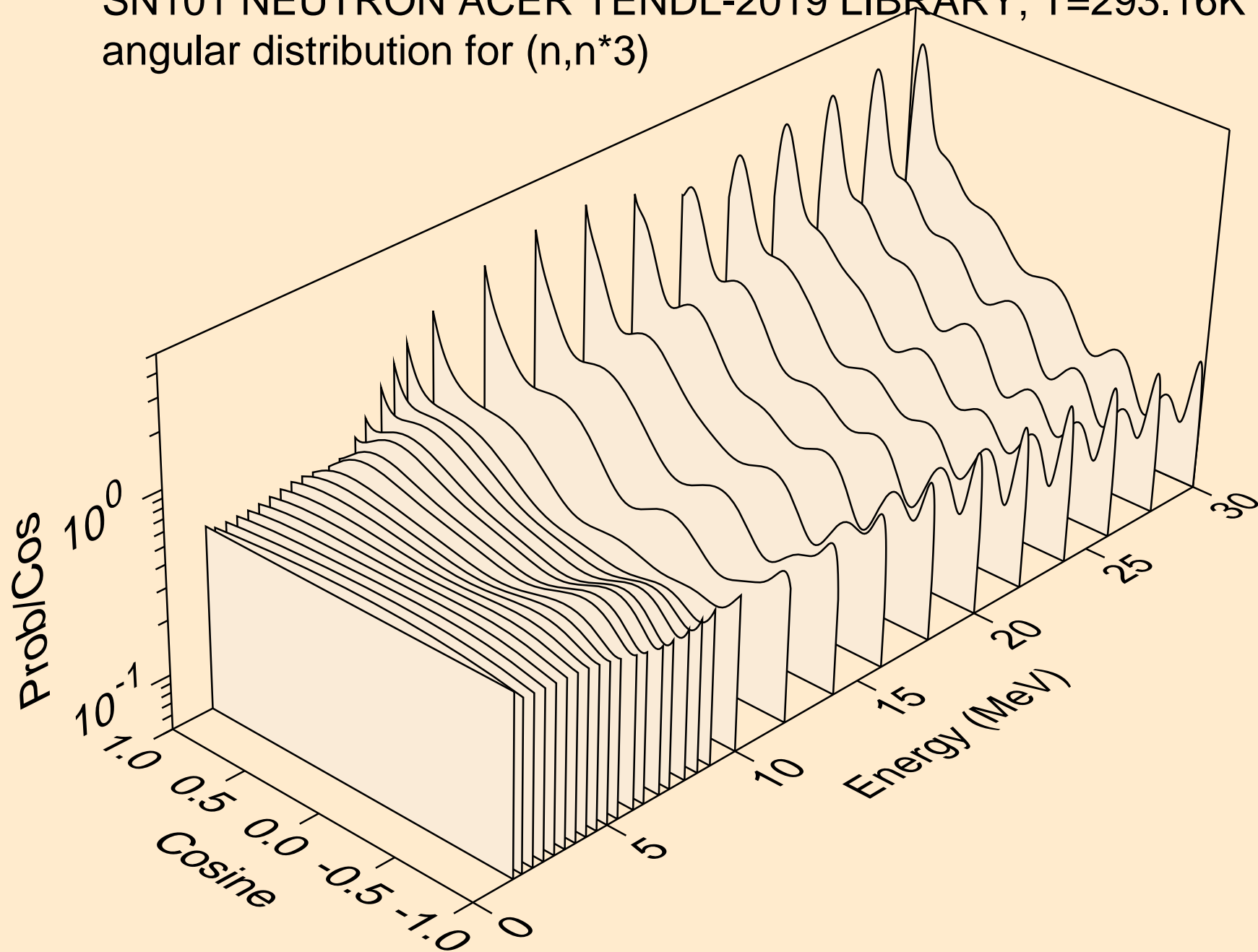

SN101 NEUTRON ACER TENDL-2019 LIBRARY; T=293.16K
angular distribution for (n,n*4)

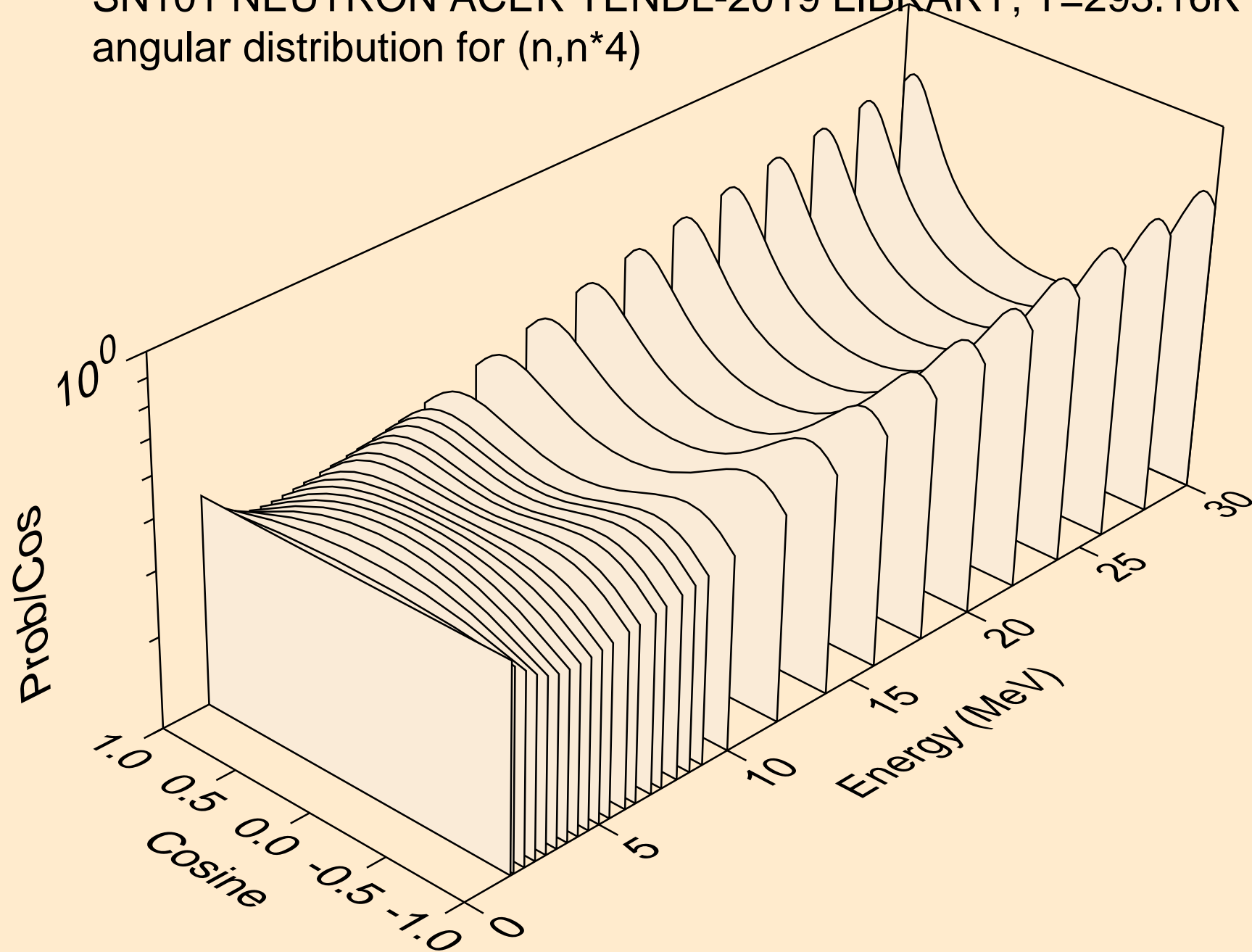

SN101 NEUTRON ACER TENDL-2019 LIBRARY; T=293.16K
angular distribution for (n,n*5)

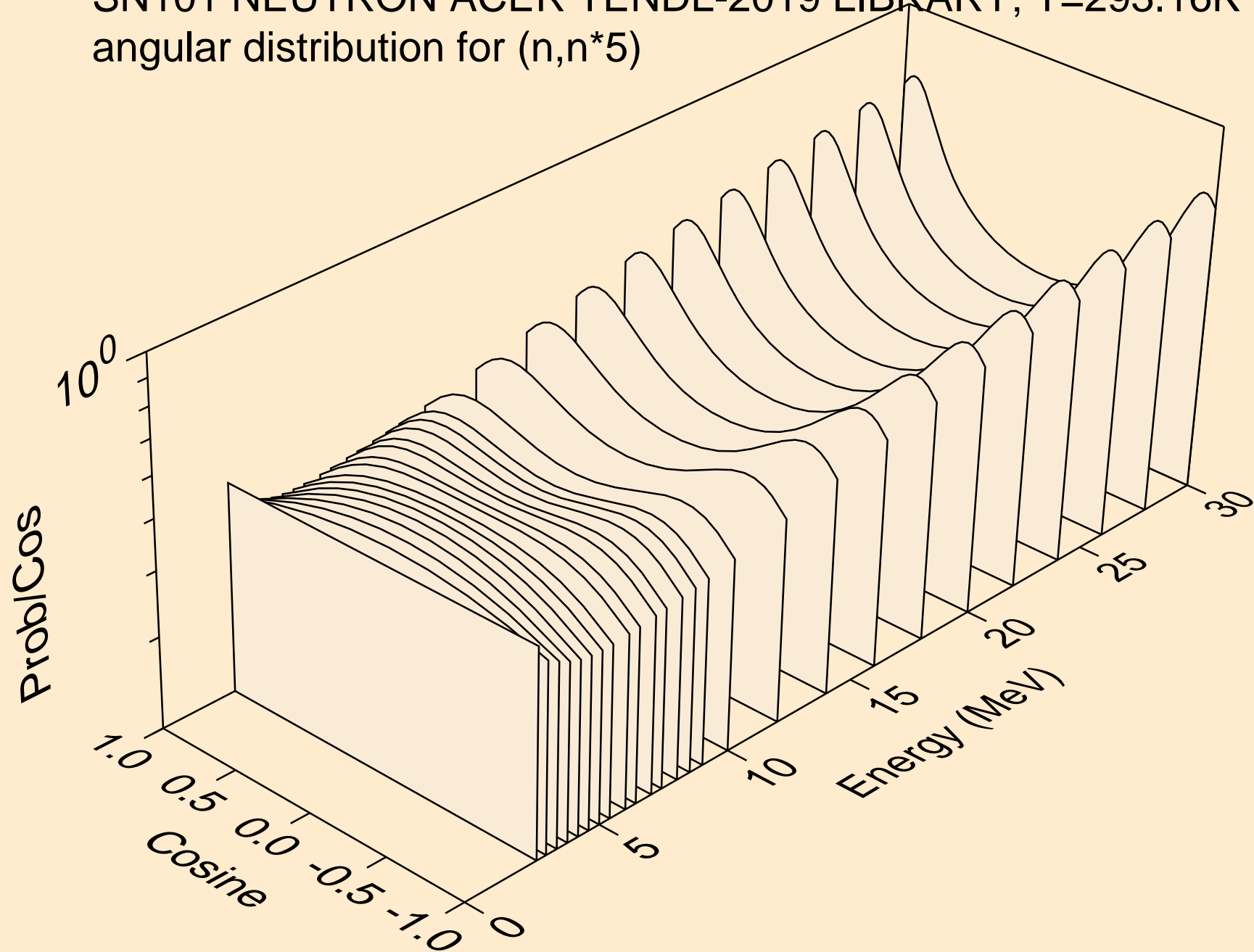

SN101 NEUTRON ACER TENDL-2019 LIBRARY; T=293.16K
angular distribution for (n,n*6)

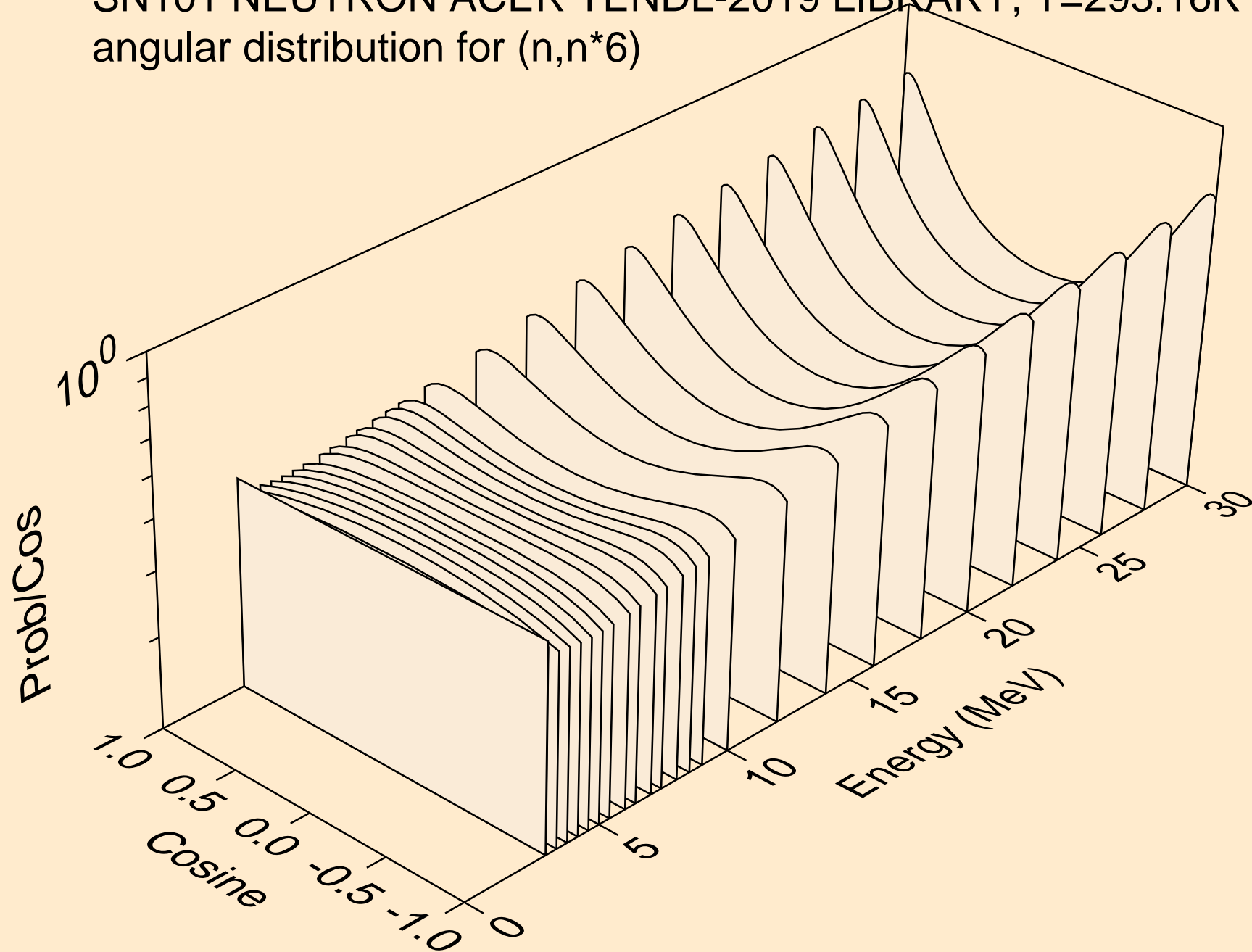

SN101 NEUTRON ACER TENDL-2019 LIBRARY; T=293.16K
angular distribution for (n,n*7)

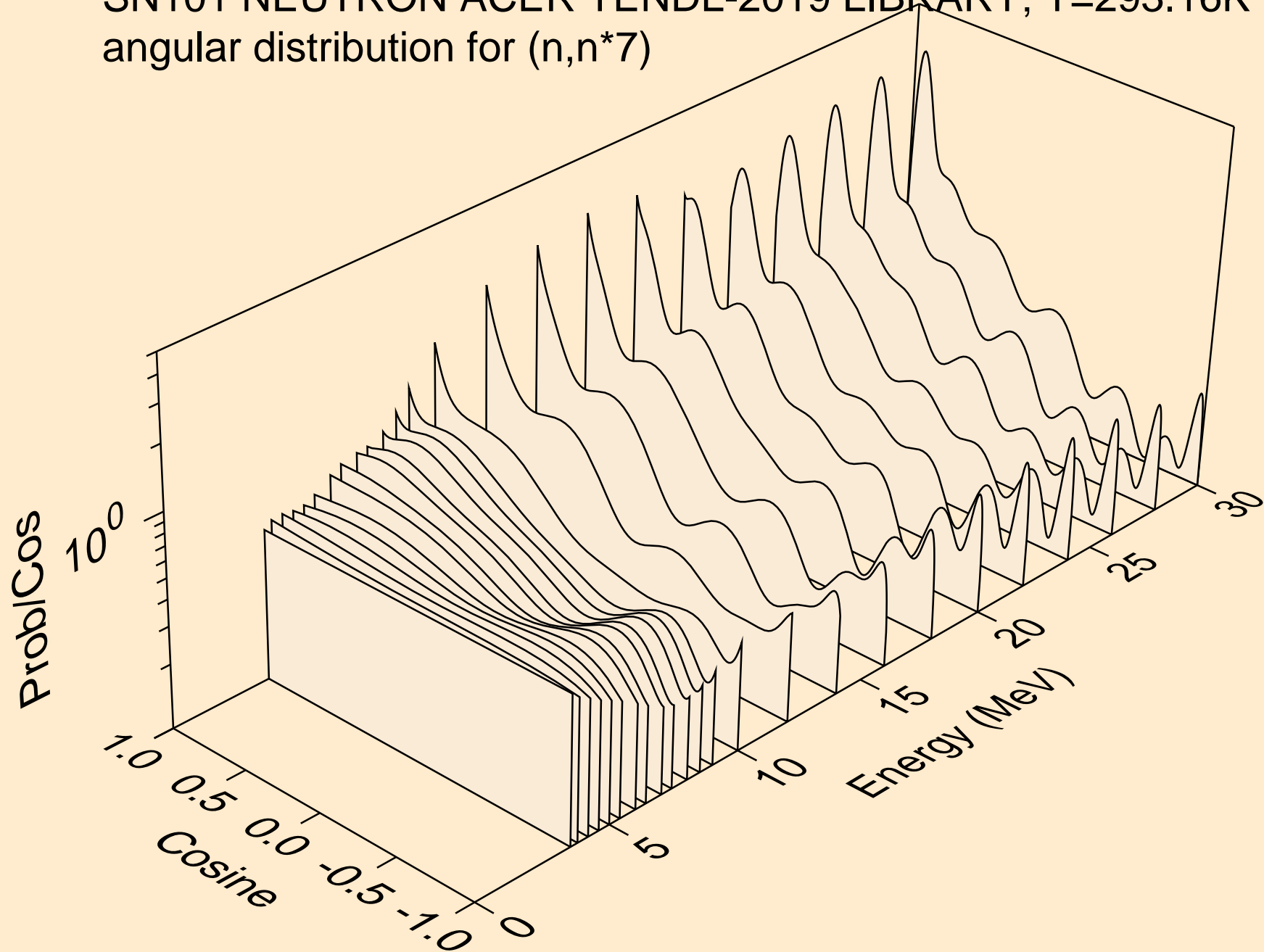

SN101 NEUTRON ACER TENDL-2019 LIBRARY; T=293.16K
angular distribution for (n,n*8)

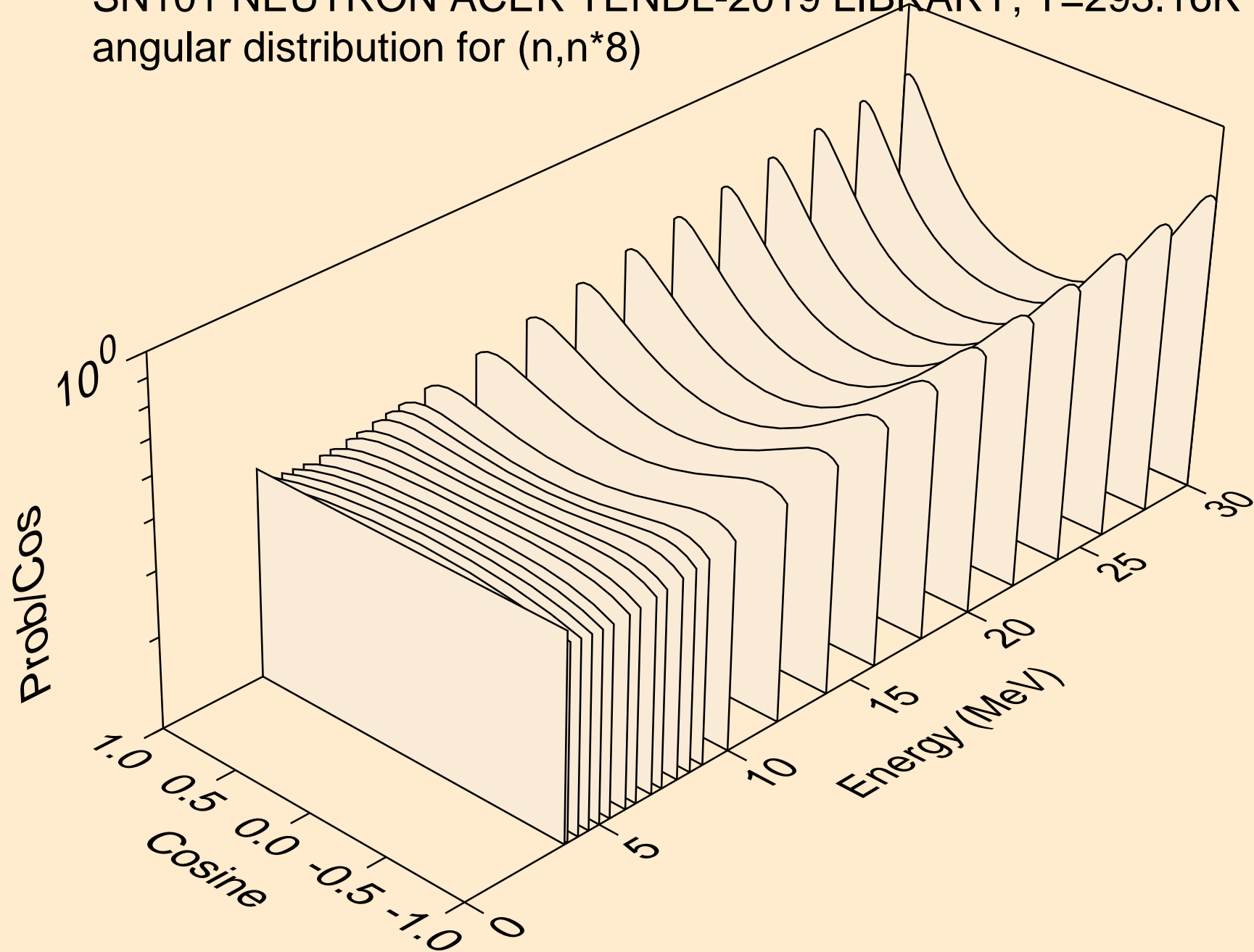

SN101 NEUTRON ACER TENDL-2019 LIBRARY; T=293.16K
angular distribution for (n,n*9)

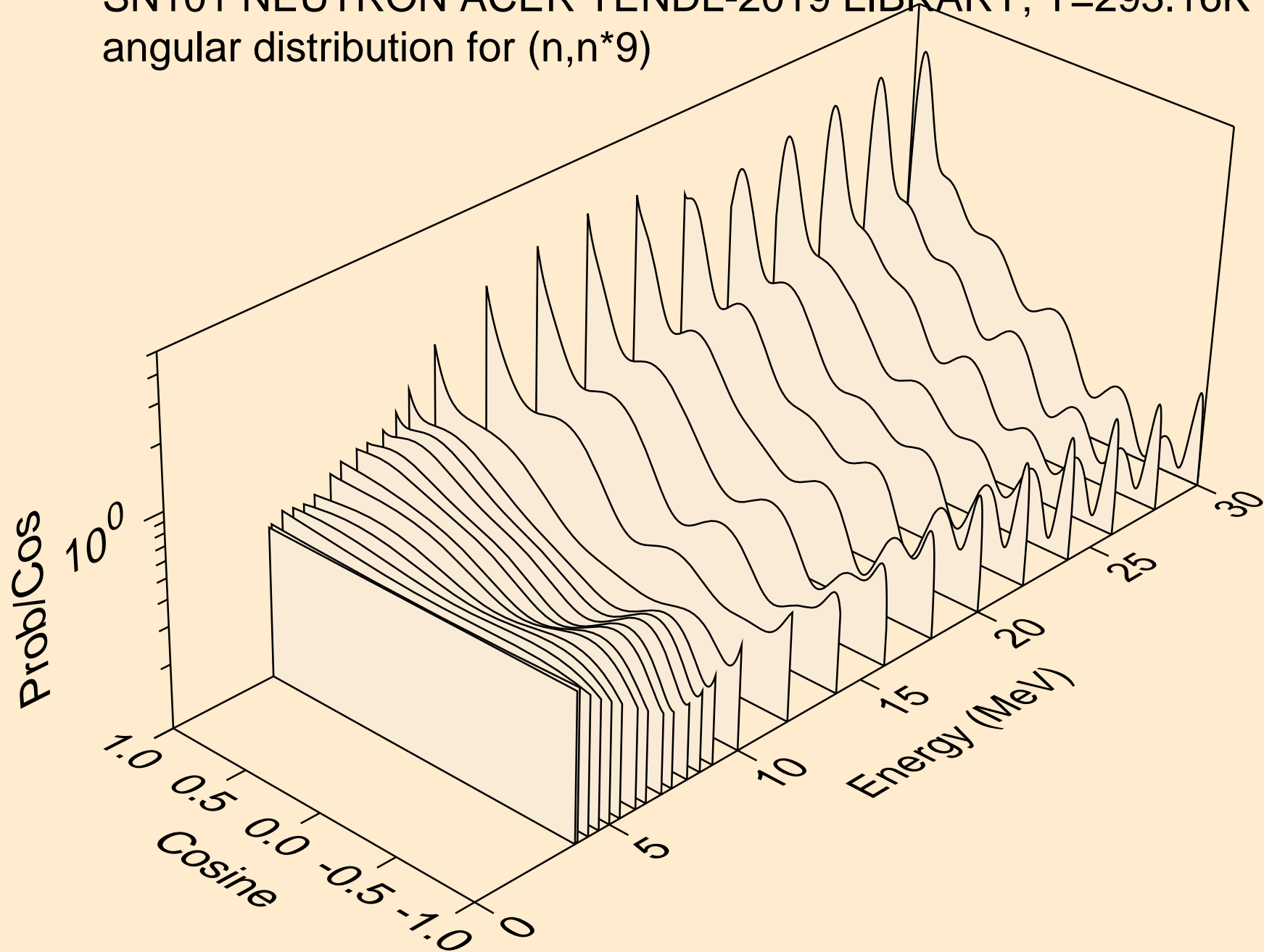

SN101 NEUTRON ACER TENDL-2019 LIBRARY; T=293.16K
angular distribution for (n,n*10)

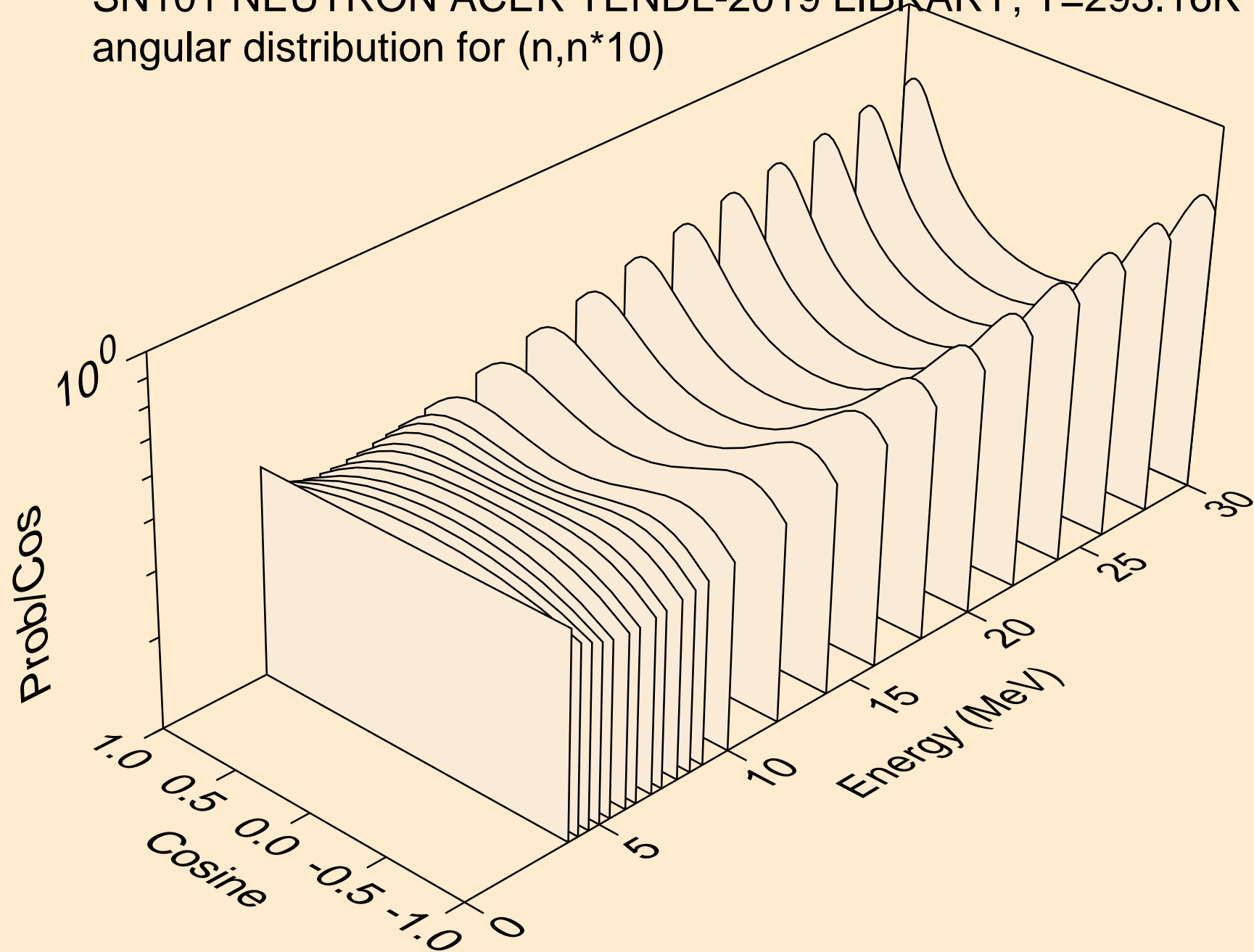

SN101 NEUTRON ACER TENDL-2019 LIBRARY; T=293.16K
angular distribution for (n,n*11)

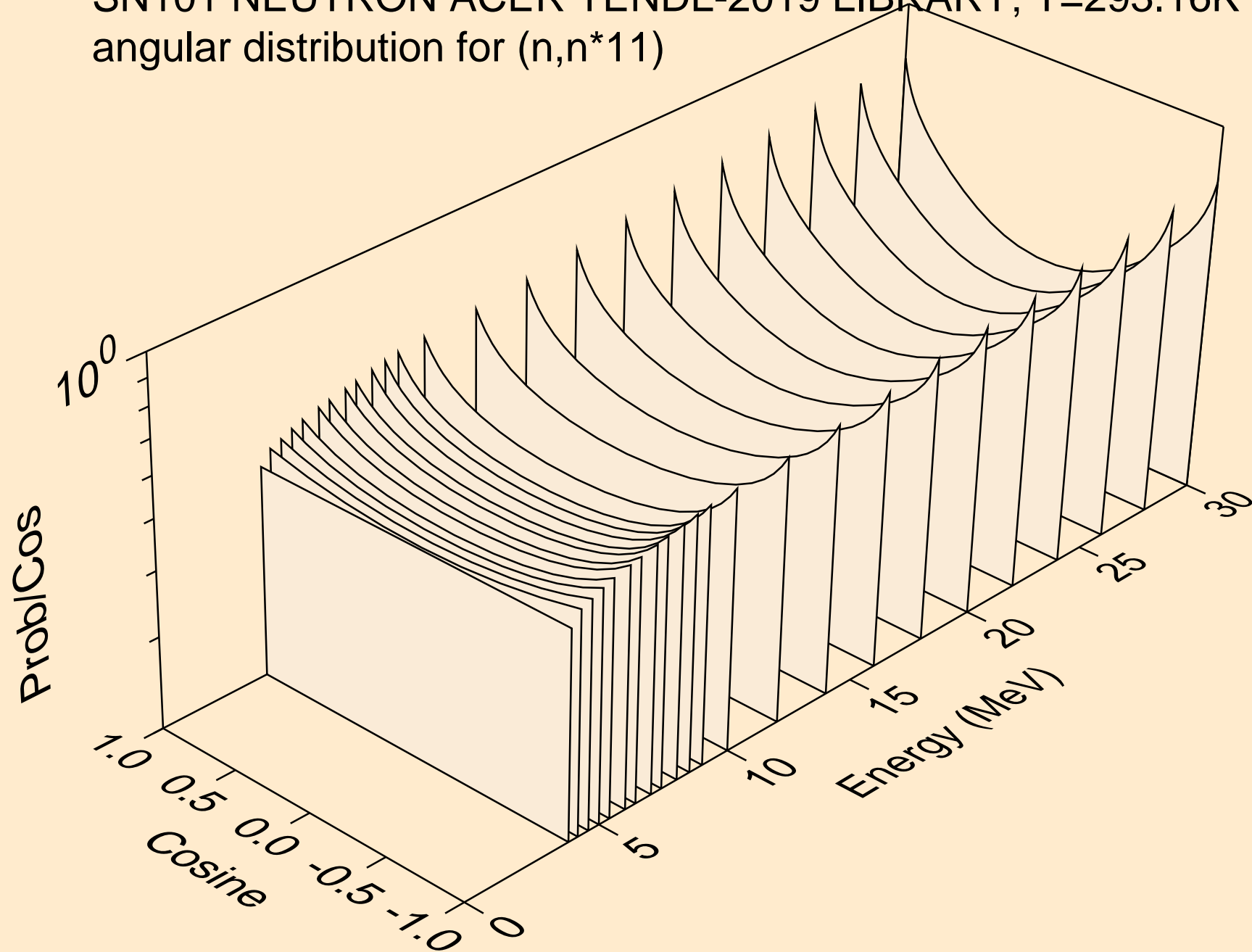

SN101 NEUTRON ACER TENDL-2019 LIBRARY; T=293.16K
angular distribution for (n,n*12)

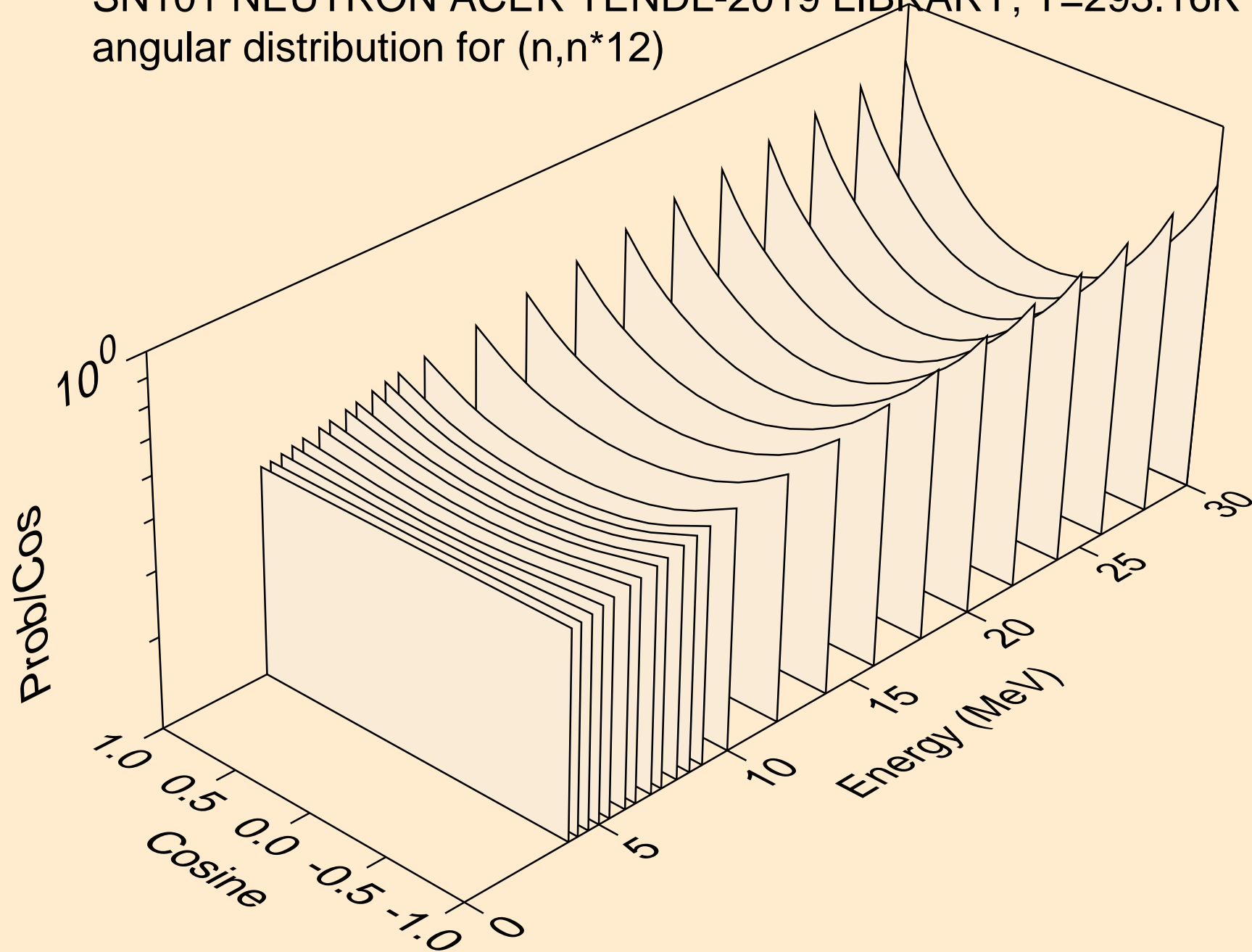

SN101 NEUTRON ACER TENDL-2019 LIBRARY; T=293.16K
angular distribution for (n,n*13)

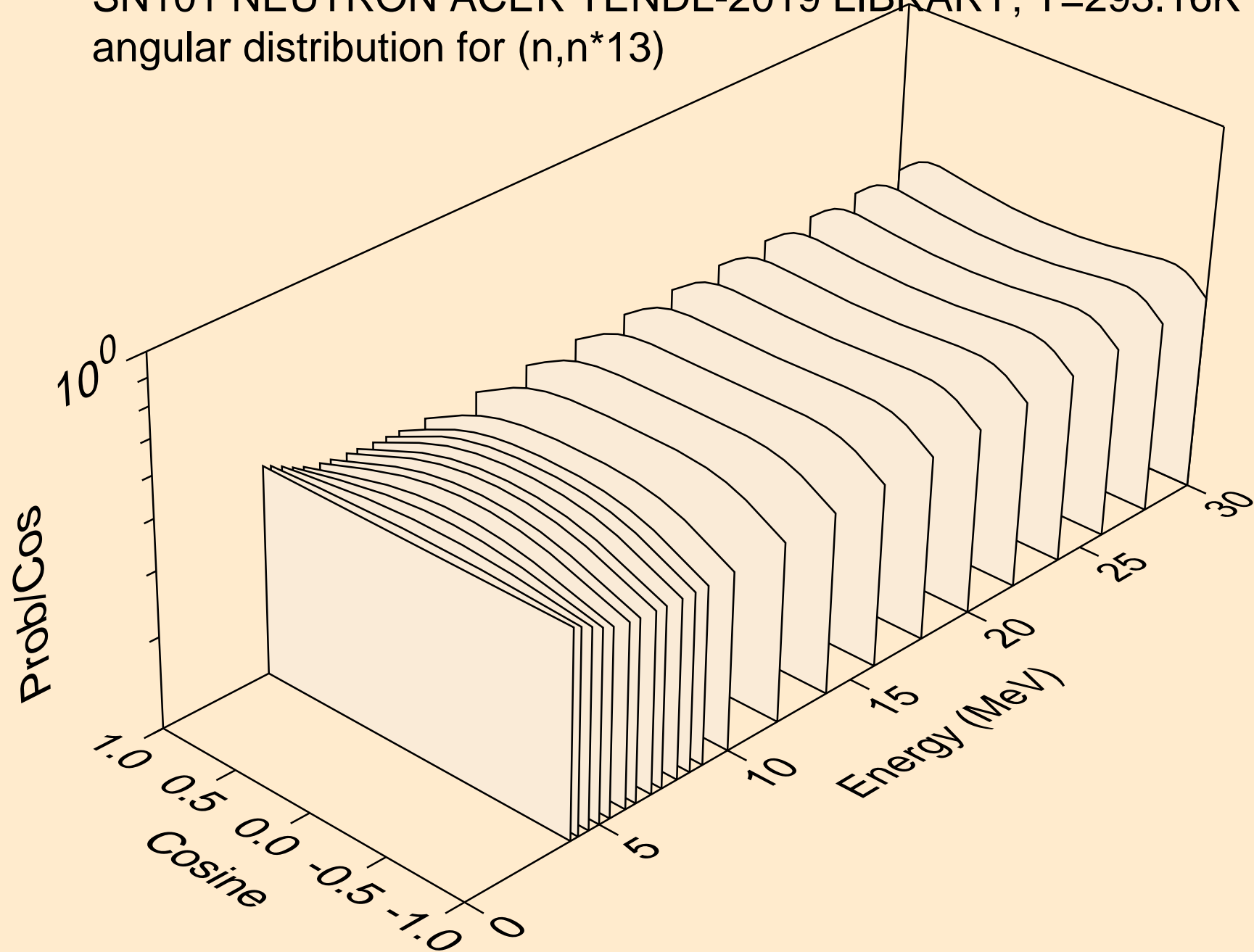

SN101 NEUTRON ACER TENDL-2019 LIBRARY; T=293.16K
angular distribution for (n,n*14)

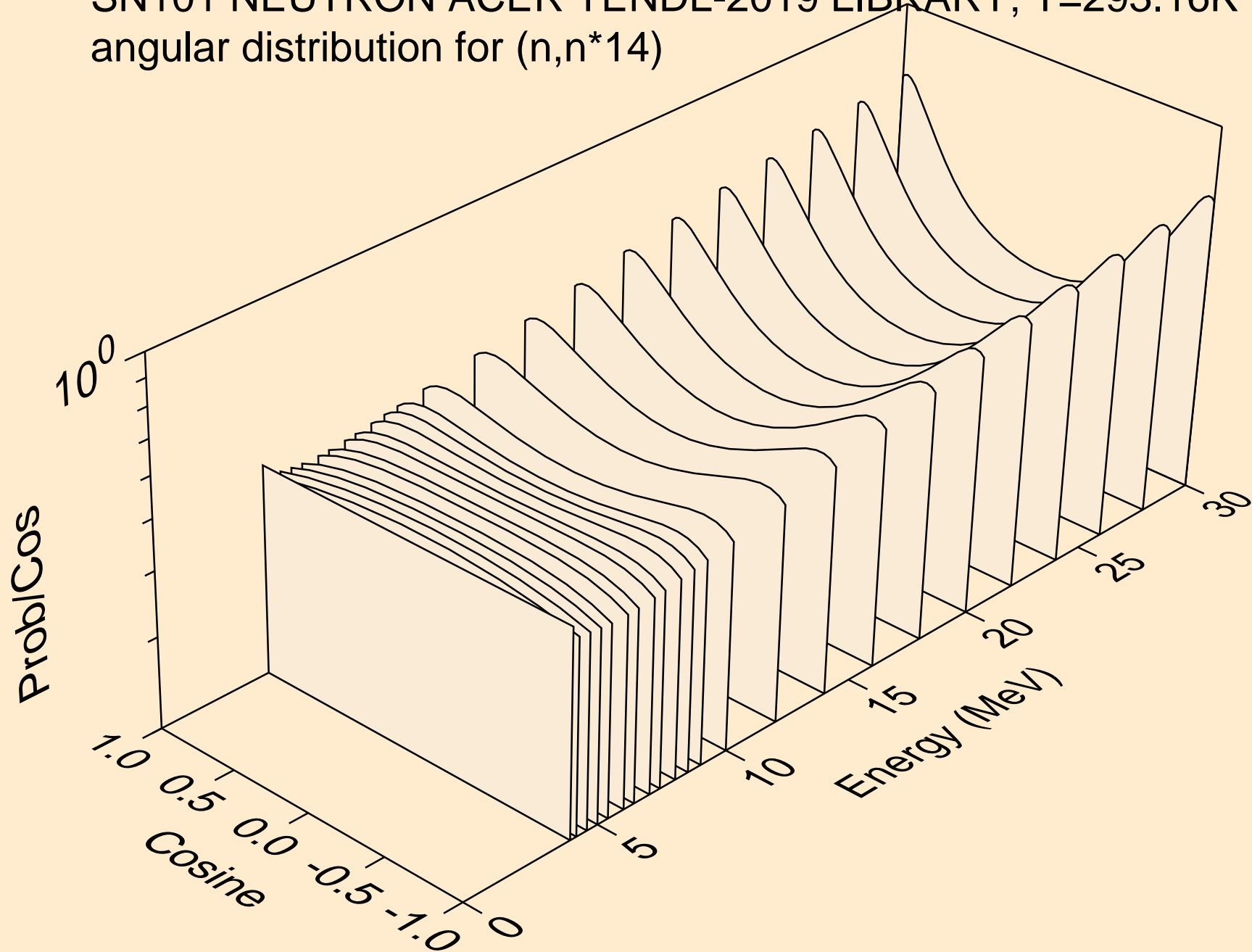

SN101 NEUTRON ACER TENDL-2019 LIBRARY; T=293.16K
angular distribution for (n,n*15)

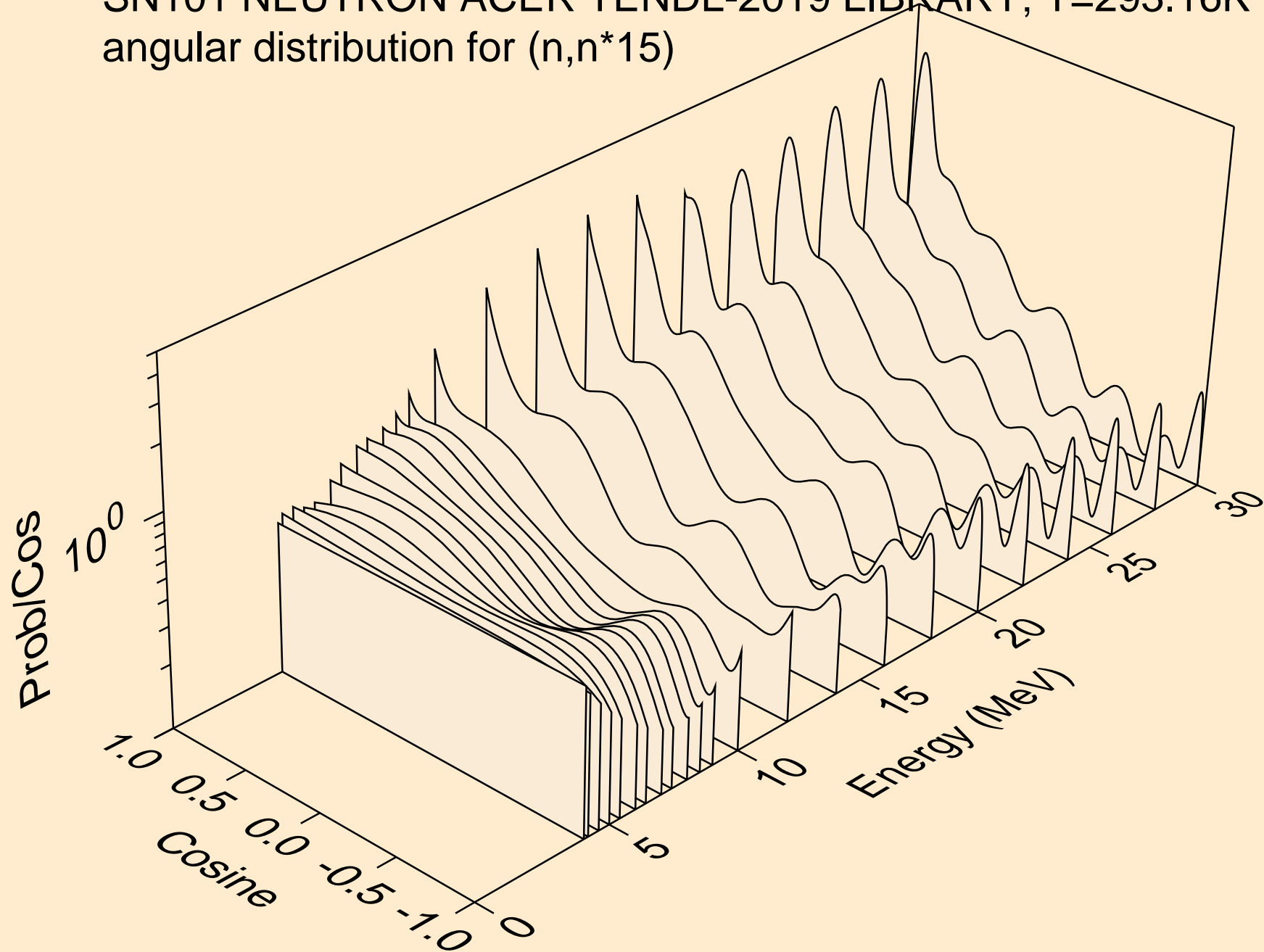

SN101 NEUTRON ACER TENDL-2019 LIBRARY; T=293.16K
Neutron emission for (n,x)

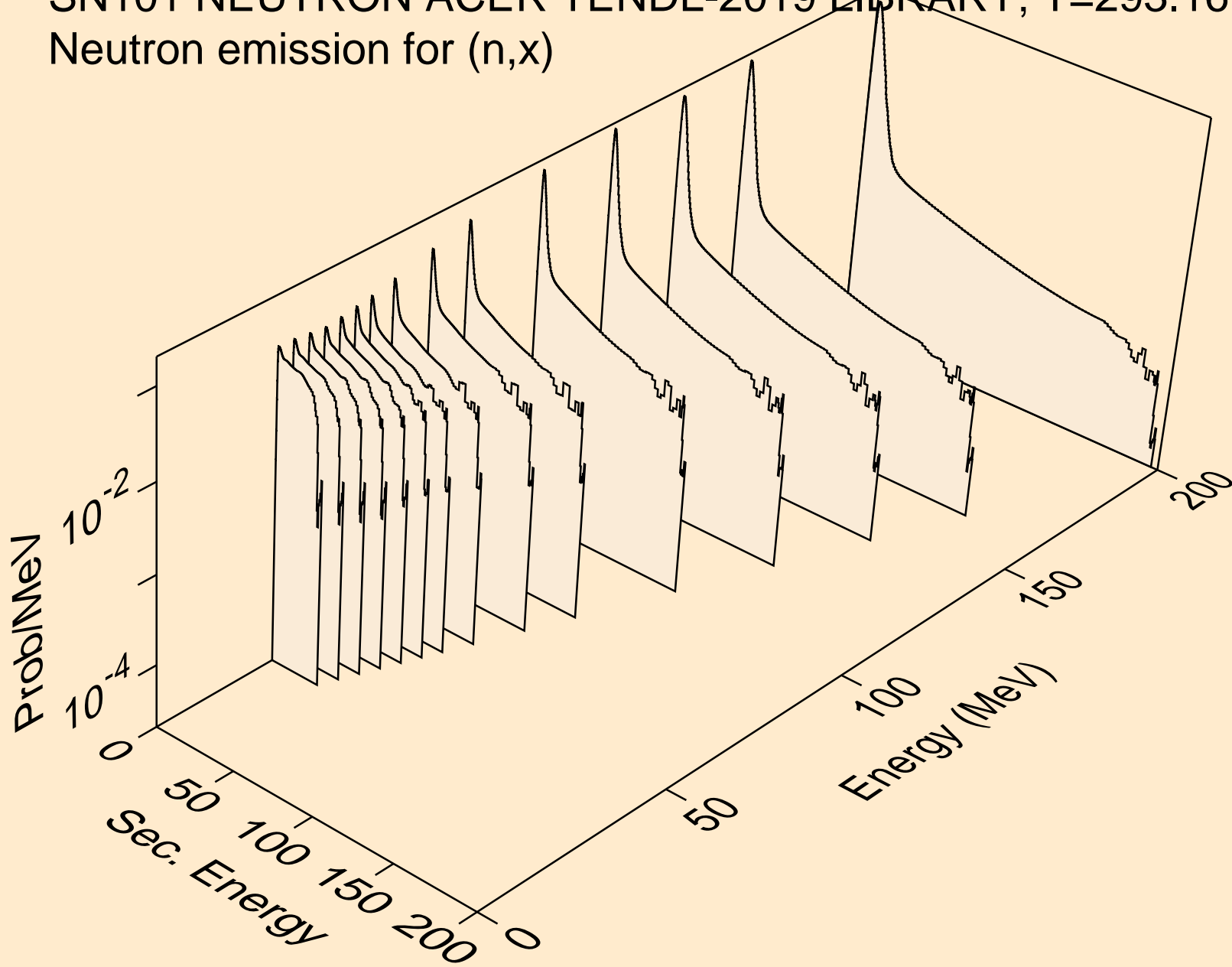

SN101 NEUTRON ACER TENDL-2019 LIBRARY; T=293.16K
Neutron emission for (n,2n)

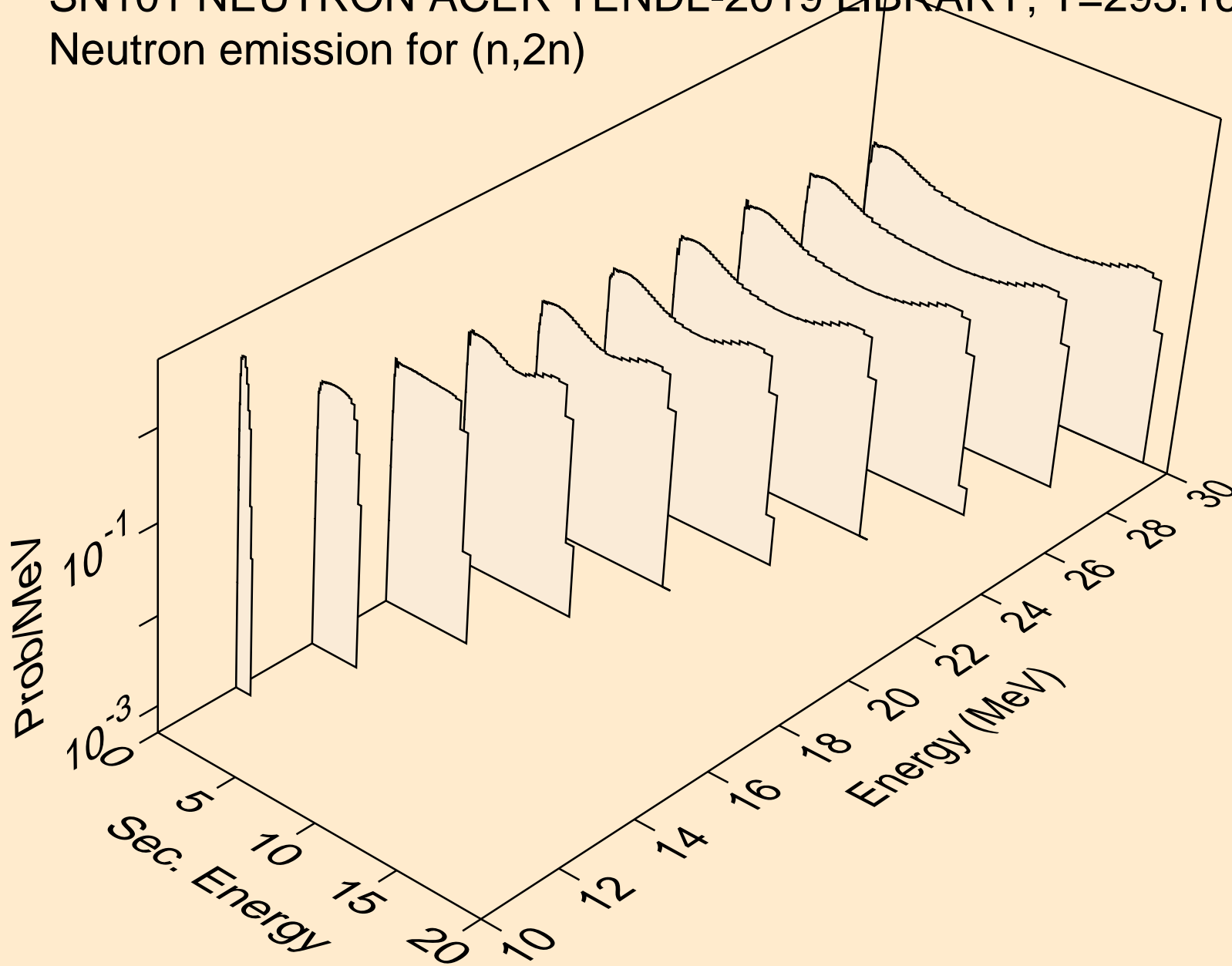

SN101 NEUTRON ACER TENDL-2019 LIBRARY; T=293.16K
Neutron emission for (n,3n)

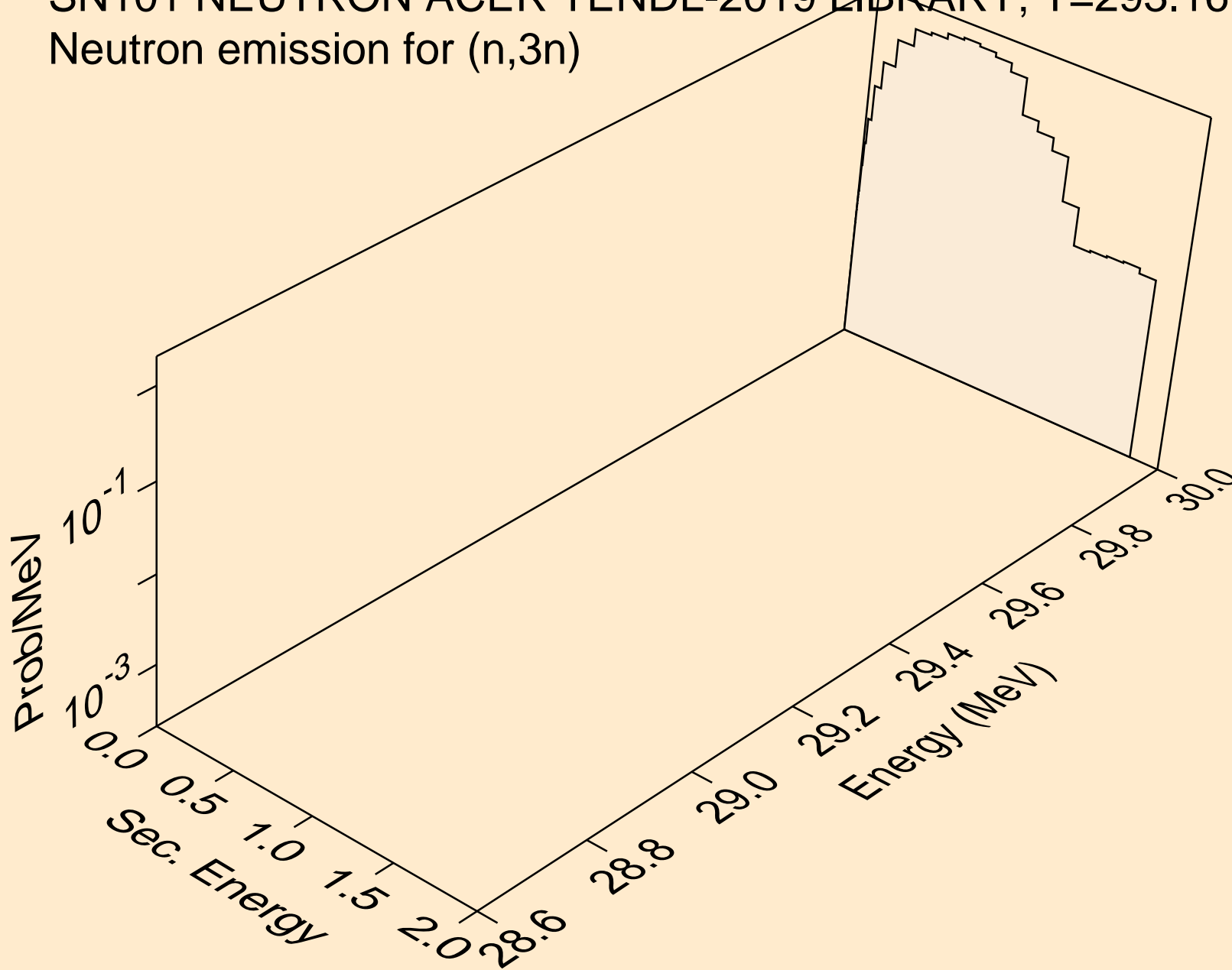

SN101 NEUTRON ACER TENDL-2019 LIBRARY; T=293.16K
Neutron emission for (n,n*)a

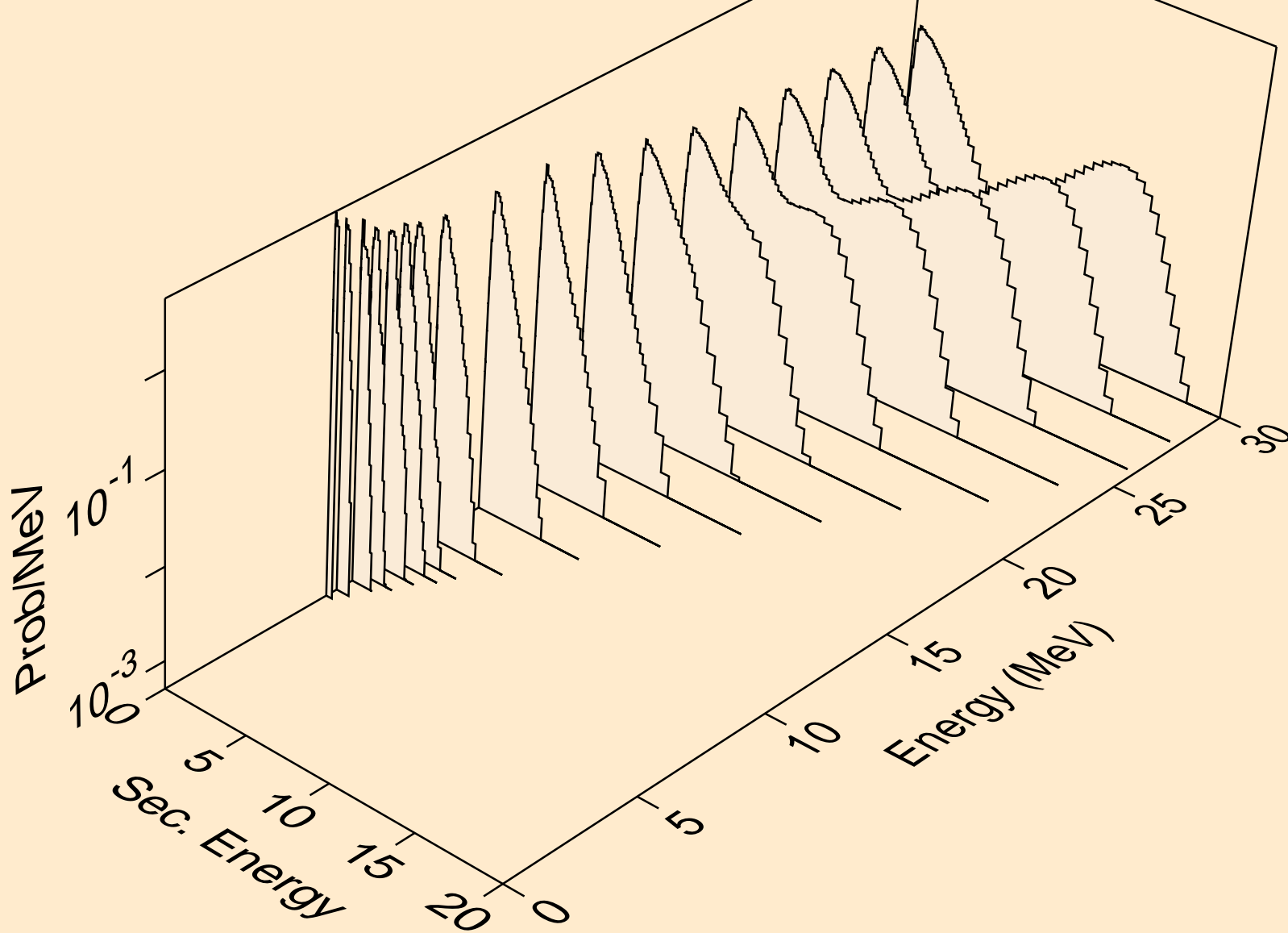

SN101 NEUTRON ACER TENDL-2019 LIBRARY; T=293.16K
Neutron emission for (n,2n)a

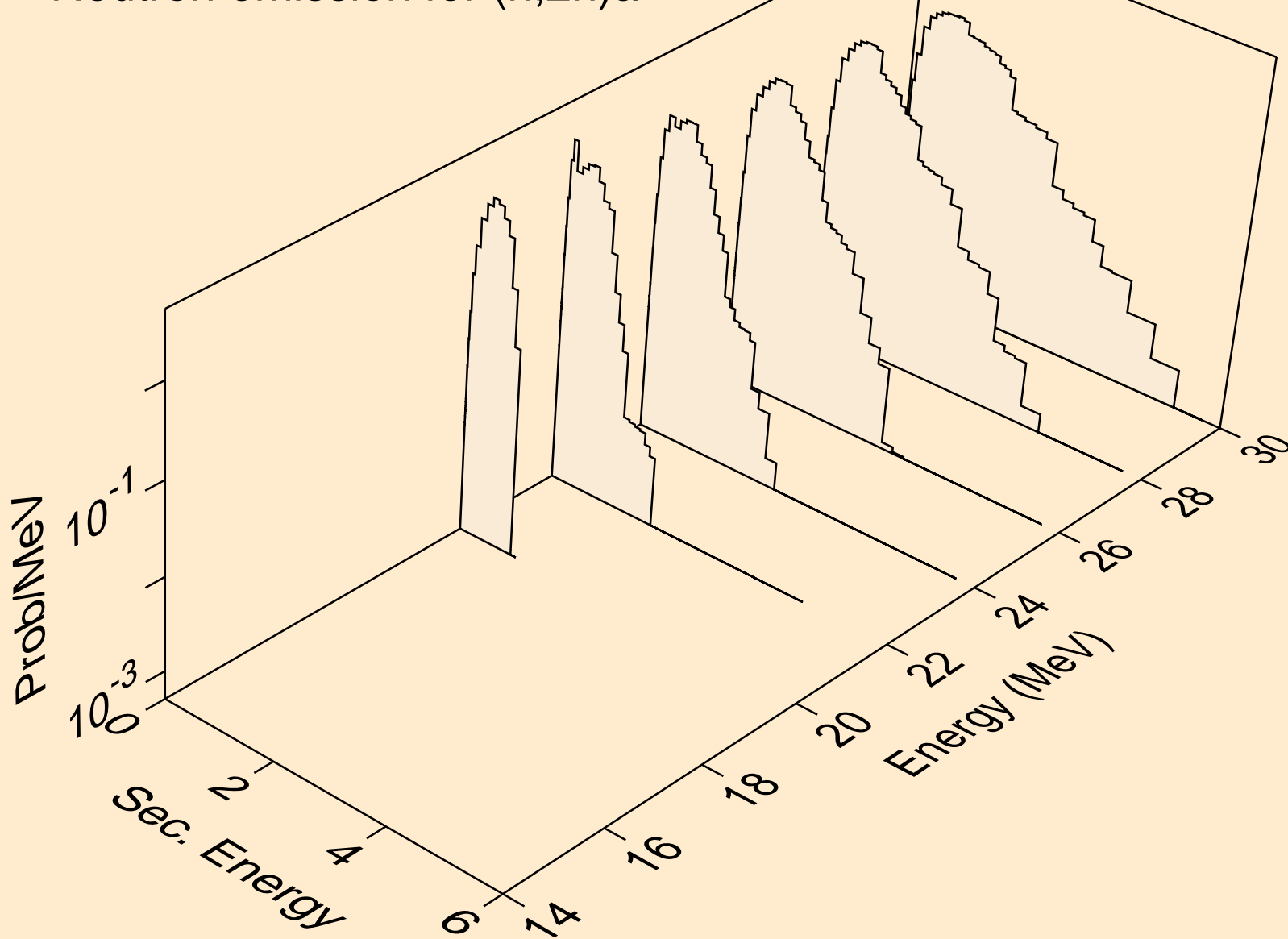

SN101 NEUTRON ACER TENDL-2019 LIBRARY; T=293.16K
Neutron emission for (n,n*)p

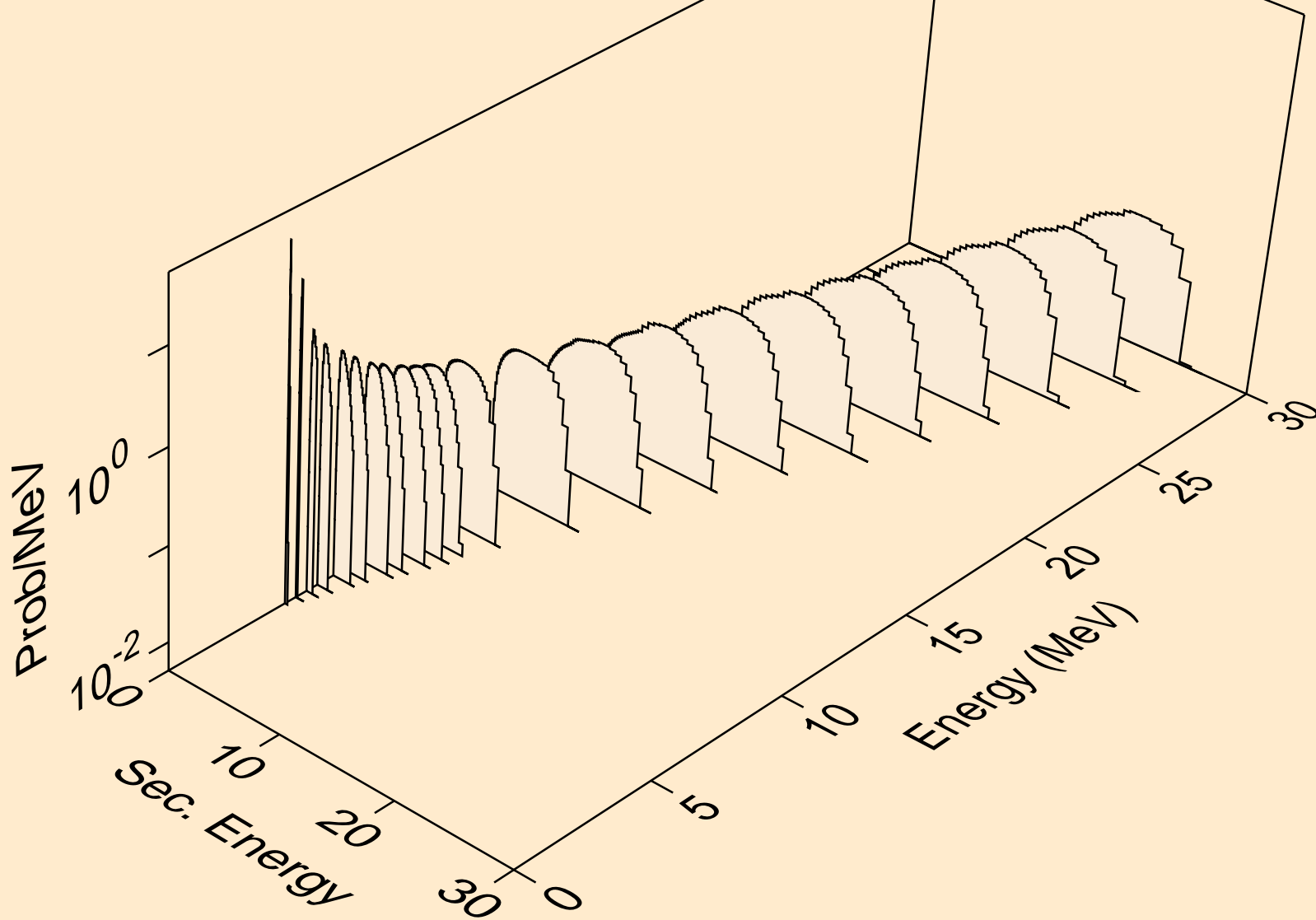

SN101 NEUTRON ACER TENDL-2019 LIBRARY; T=293.16K
Neutron emission for (n,n*)2a

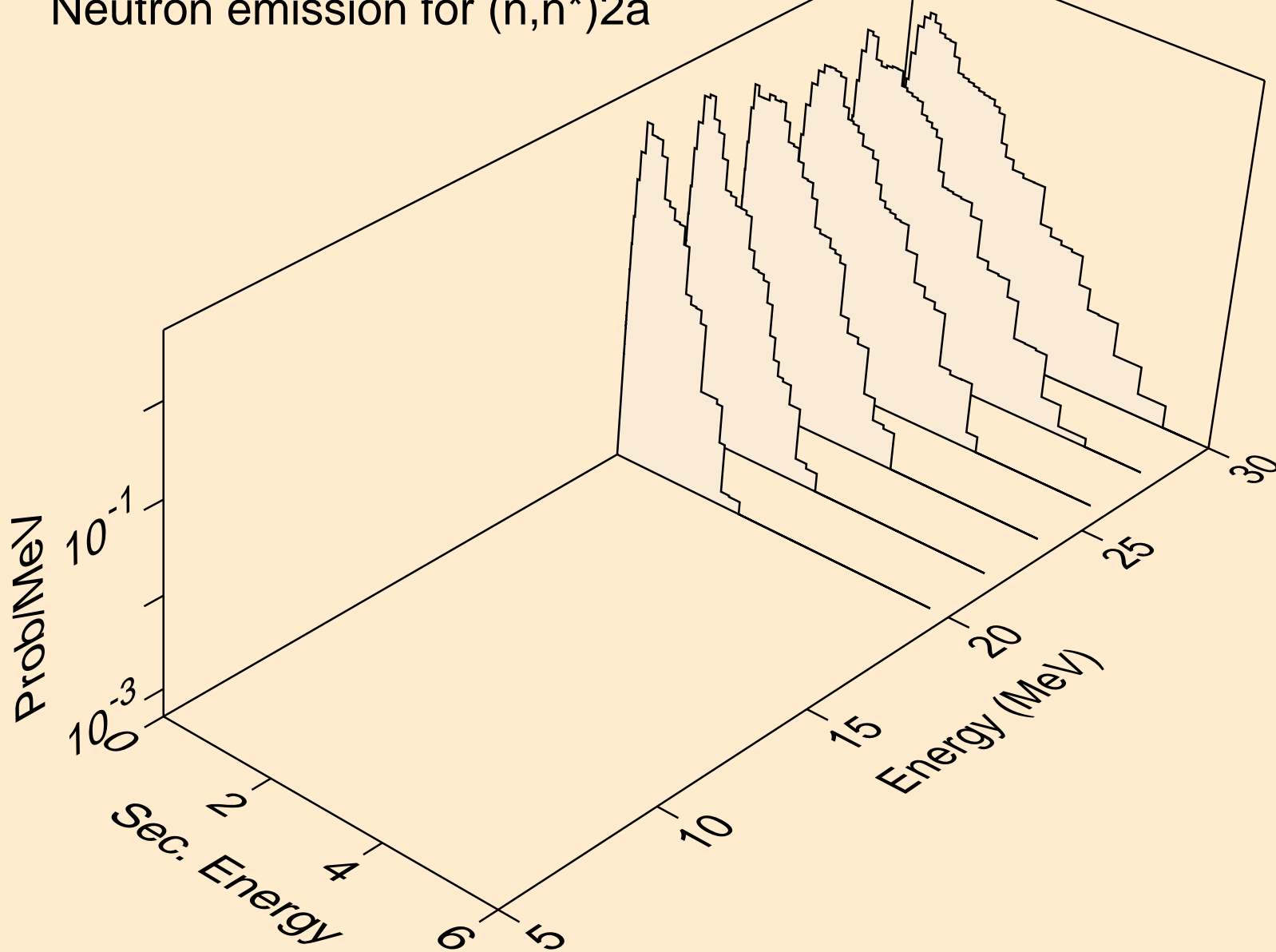

SN101 NEUTRON ACER TENDL-2019 LIBRARY; T=293.16K
Neutron emission for (n,n*)d

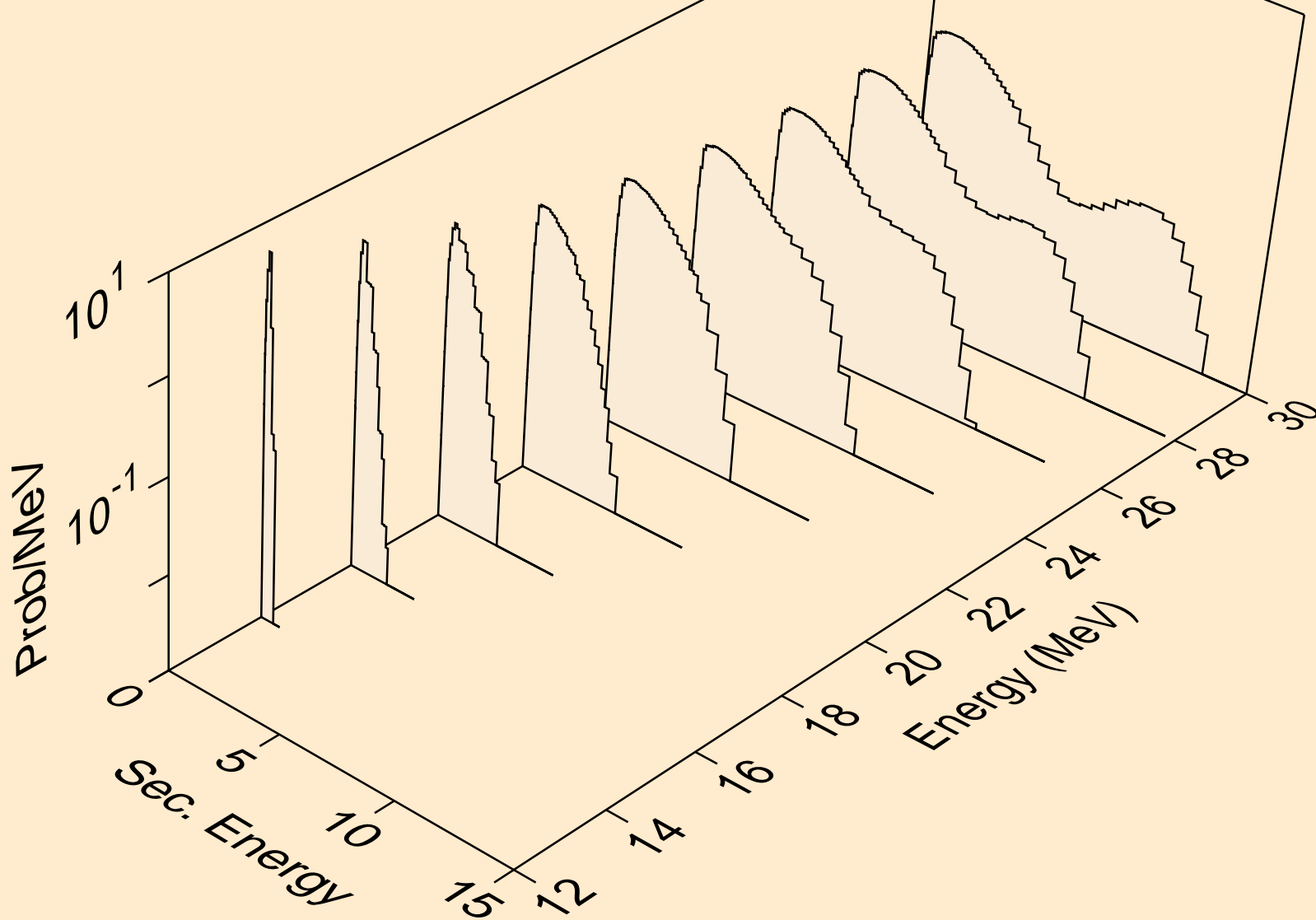

SN101 NEUTRON ACER TENDL-2019 LIBRARY; T=293.16K
Neutron emission for (n,n*)t

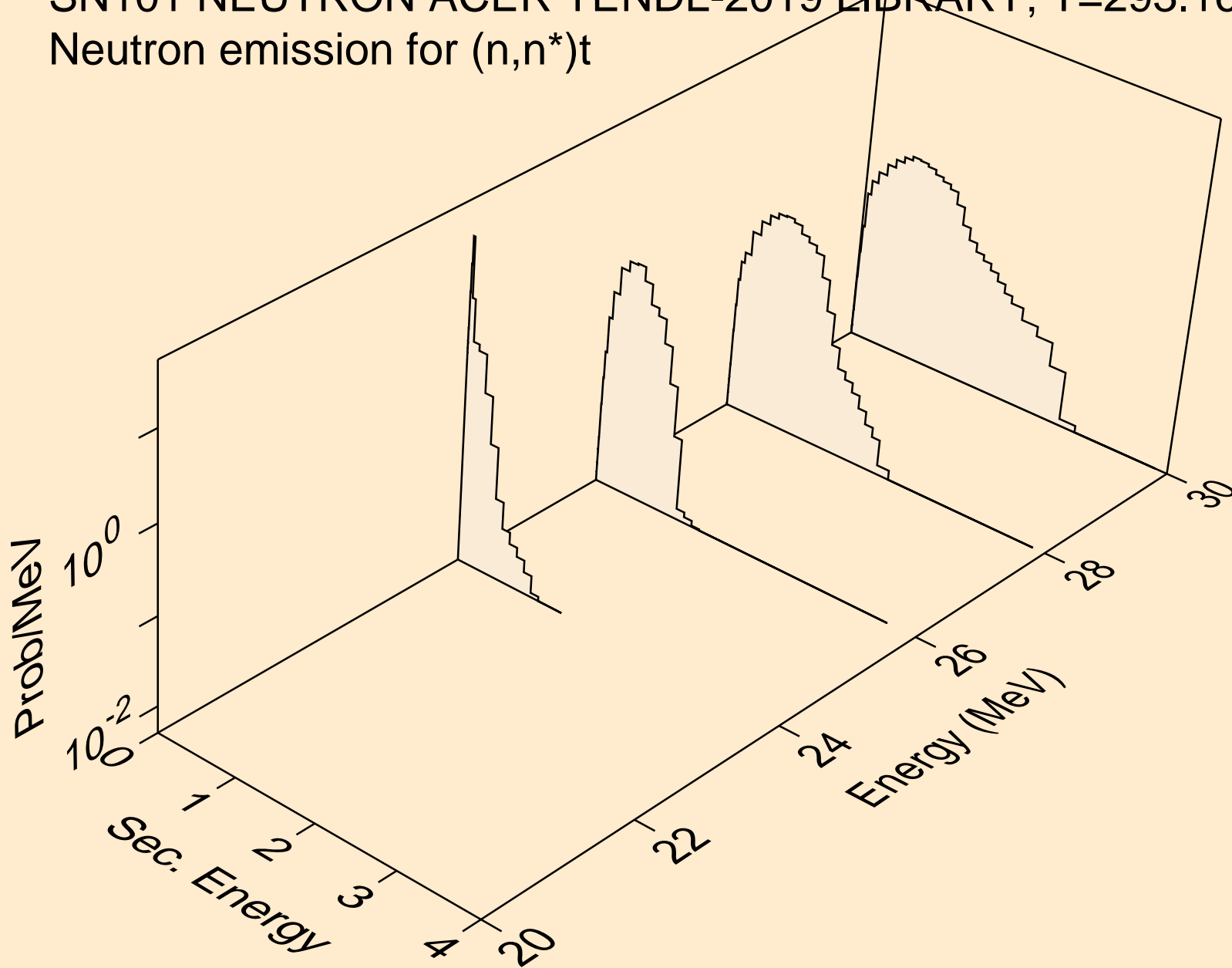

SN101 NEUTRON ACER TENDL-2019 LIBRARY; T=293.16K
Neutron emission for (n,n*)he3

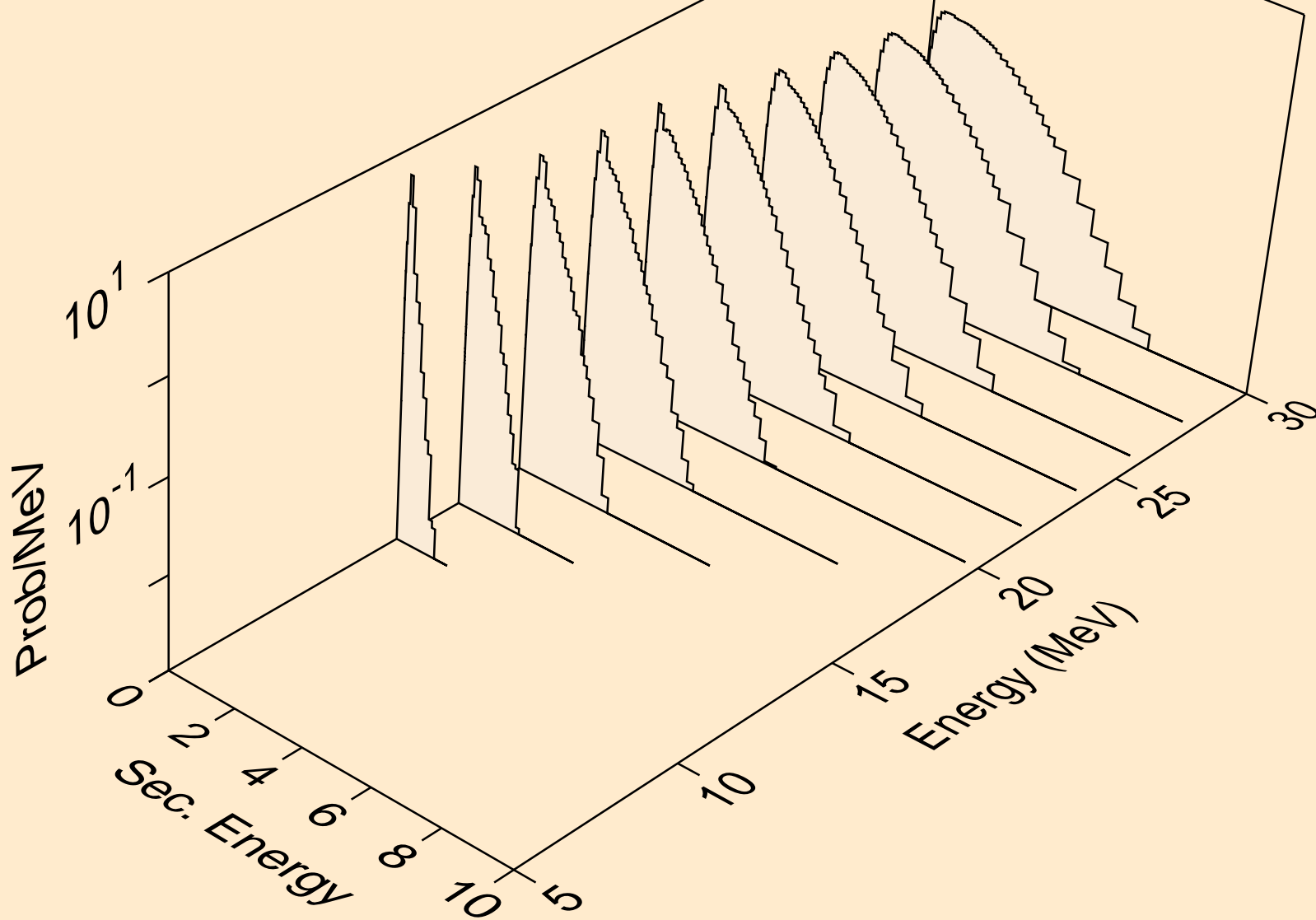

SN101 NEUTRON ACER TENDL-2019 LIBRARY; T=293.16K
Neutron emission for (n,2np)

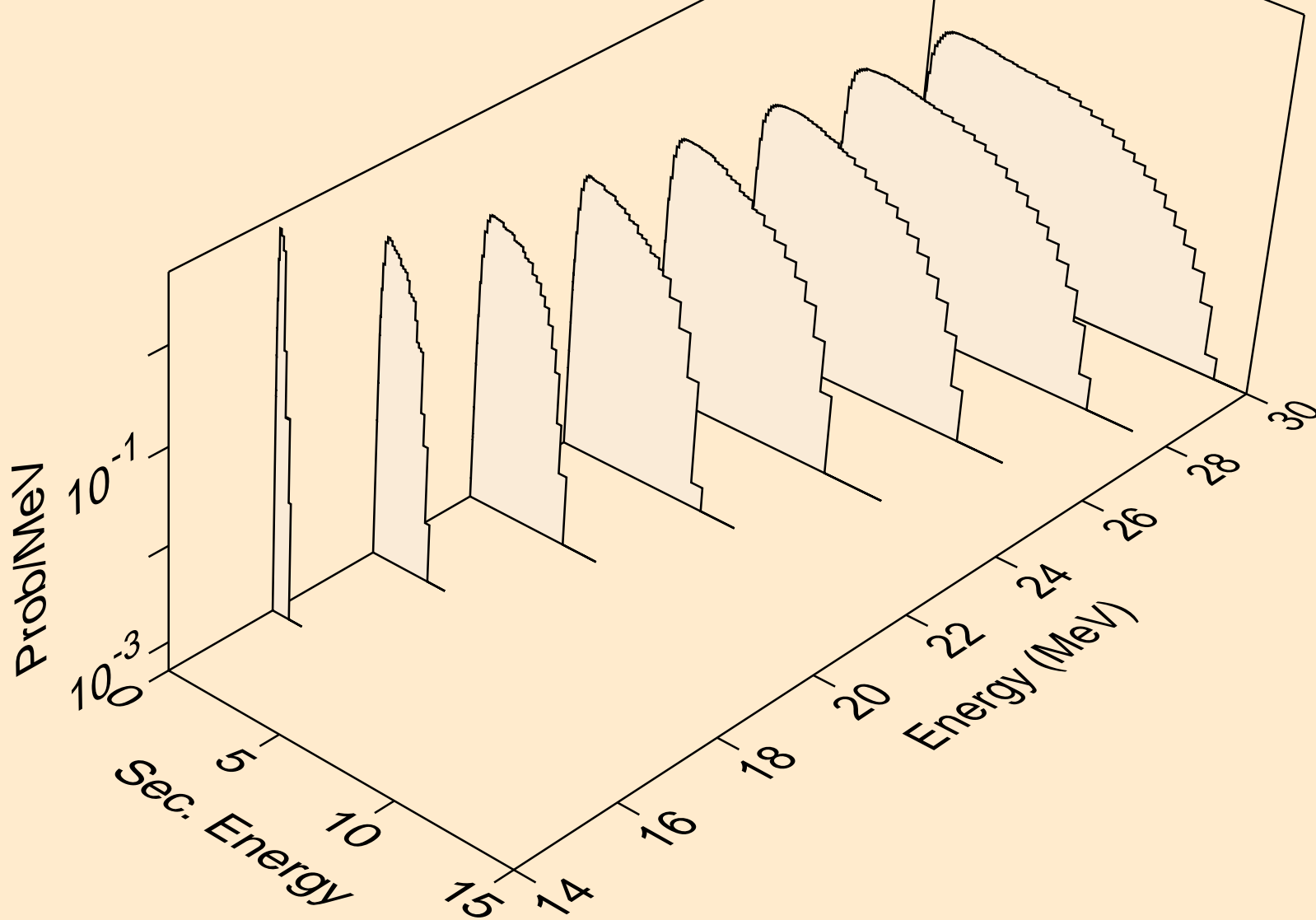

SN101 NEUTRON ACER TENDL-2019 LIBRARY; T=293.16K
Neutron emission for (n,2np)

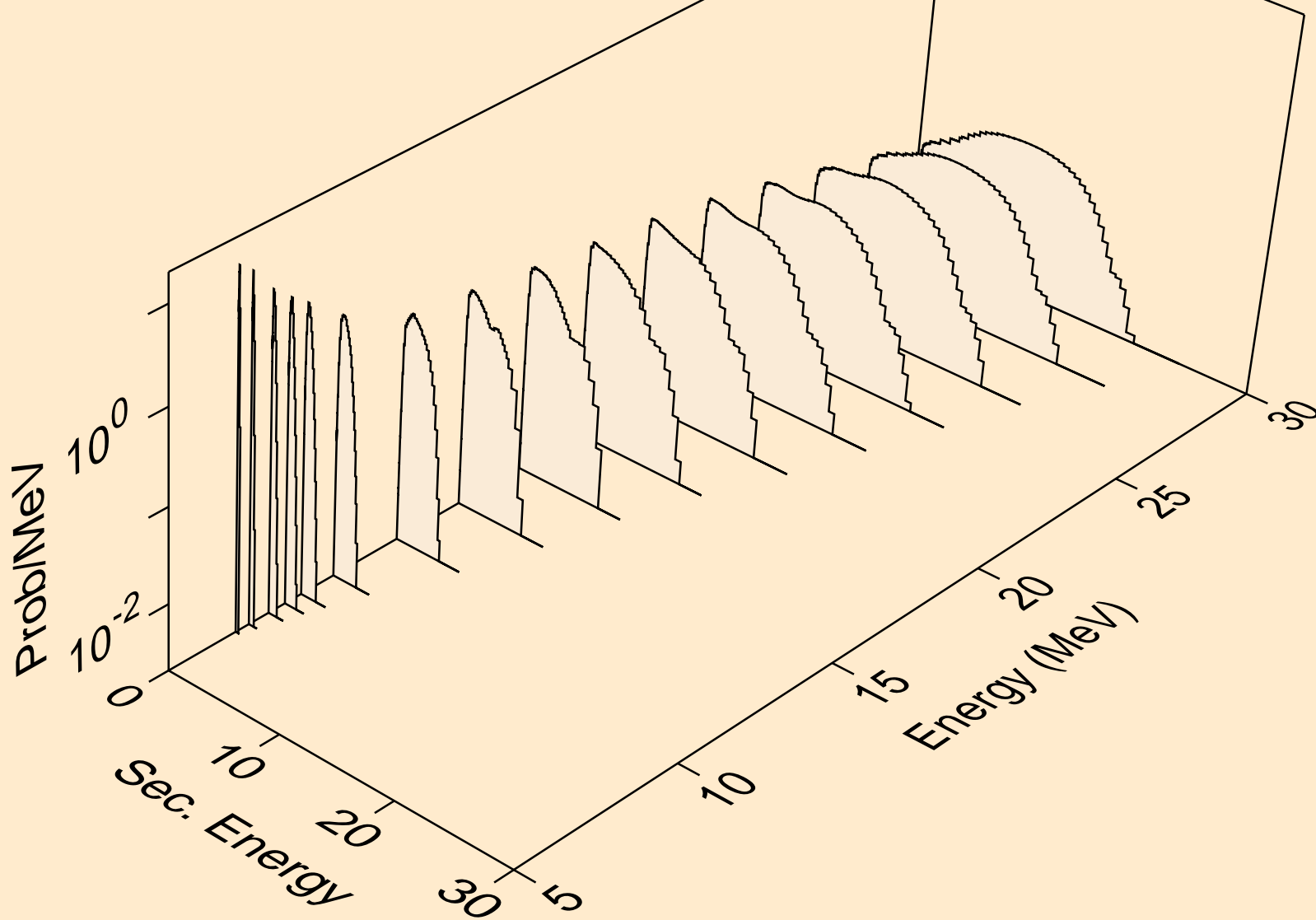

SN101 NEUTRON ACER TENDL-2019 LIBRARY; T=293.16K
Neutron emission for (n,npa)

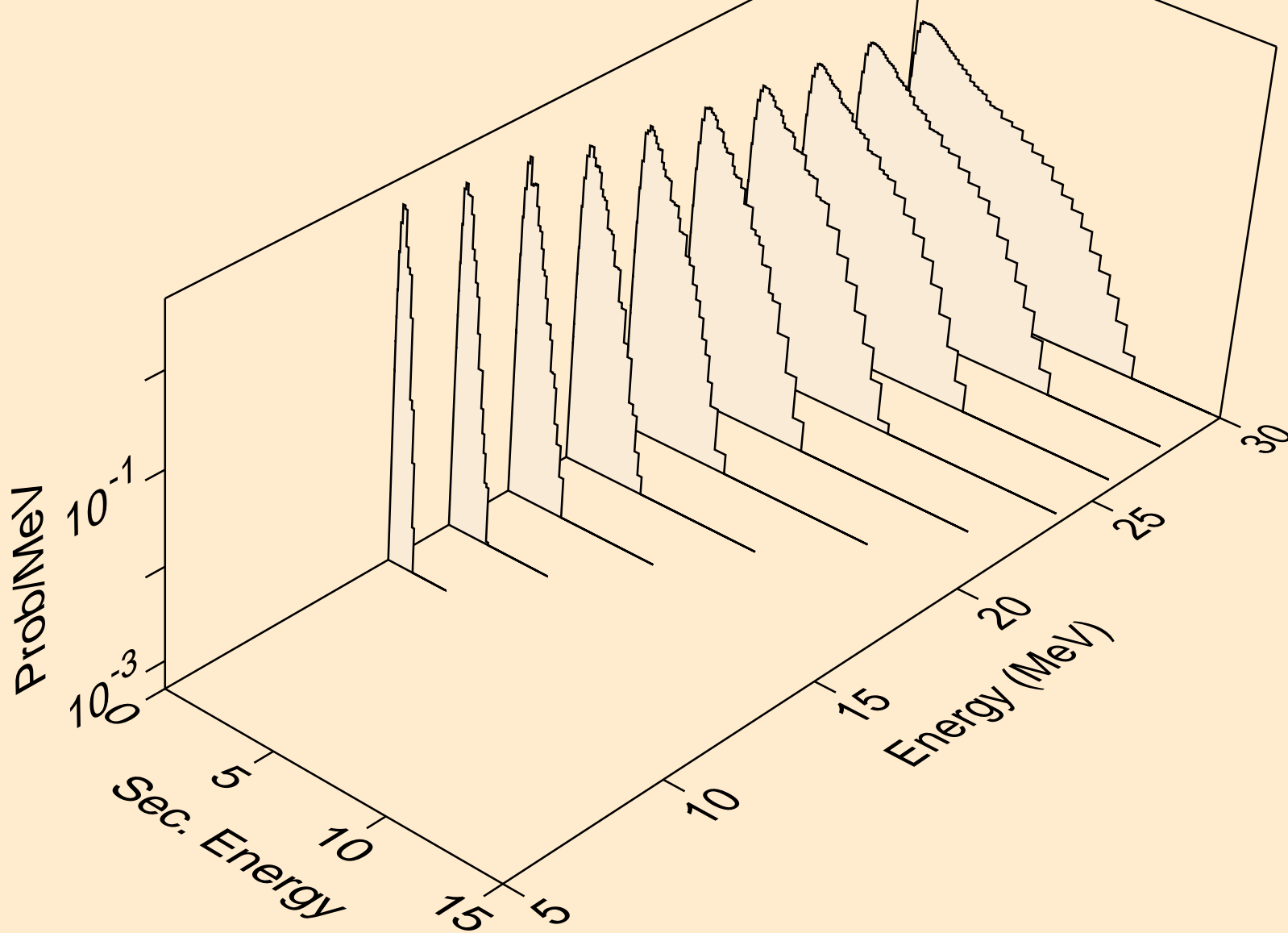

SN101 NEUTRON ACER TENDL-2019 LIBRARY; T=293.16K
Neutron emission for (n,n*c)

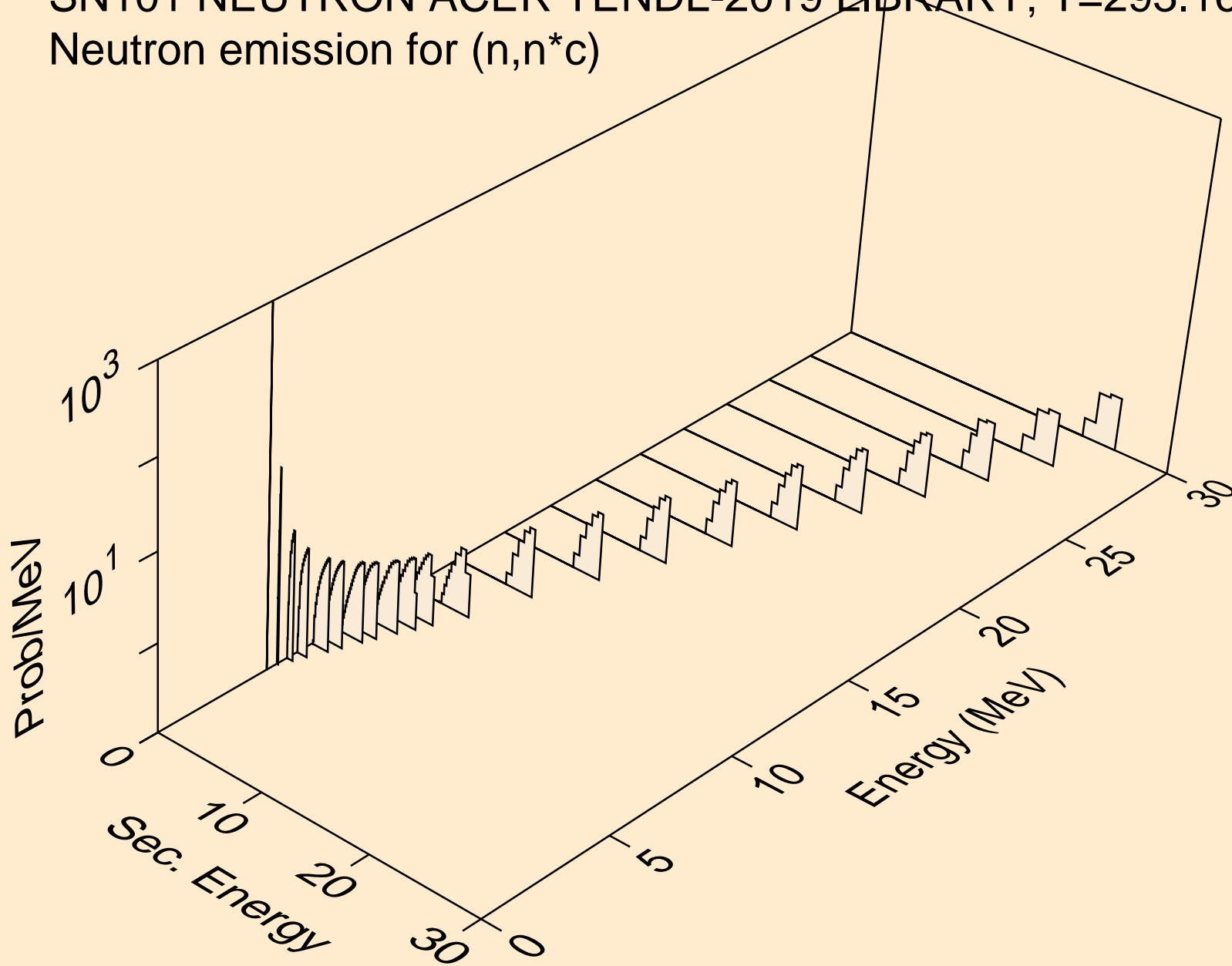

SN101 NEUTRON ACER TENDL-2019 LIBRARY; T=293.16K
Photon emission for (n,x)

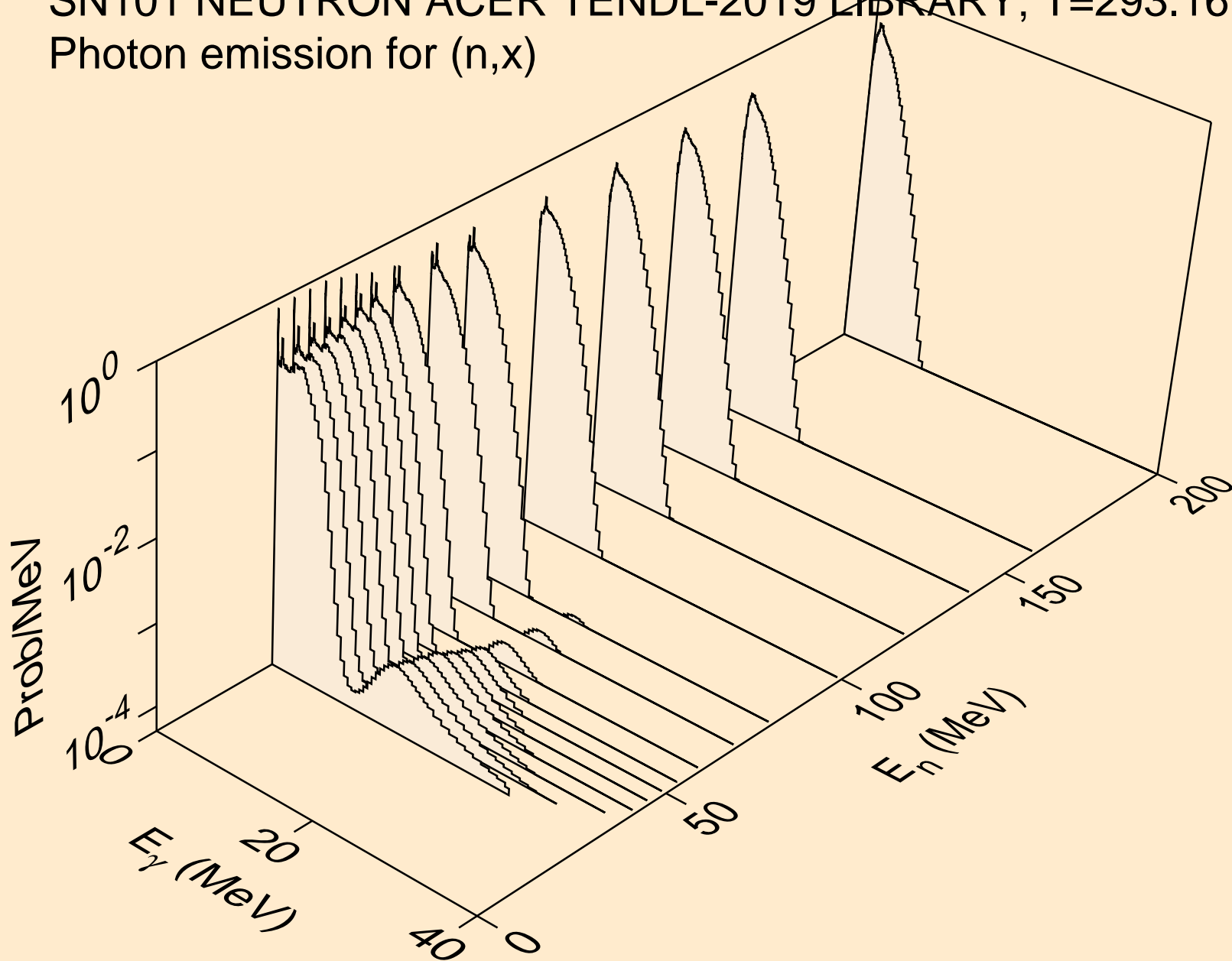

SN101 NEUTRON ACER TENDL-2019 LIBRARY; T=293.16K
Photon emission for (n,2n)

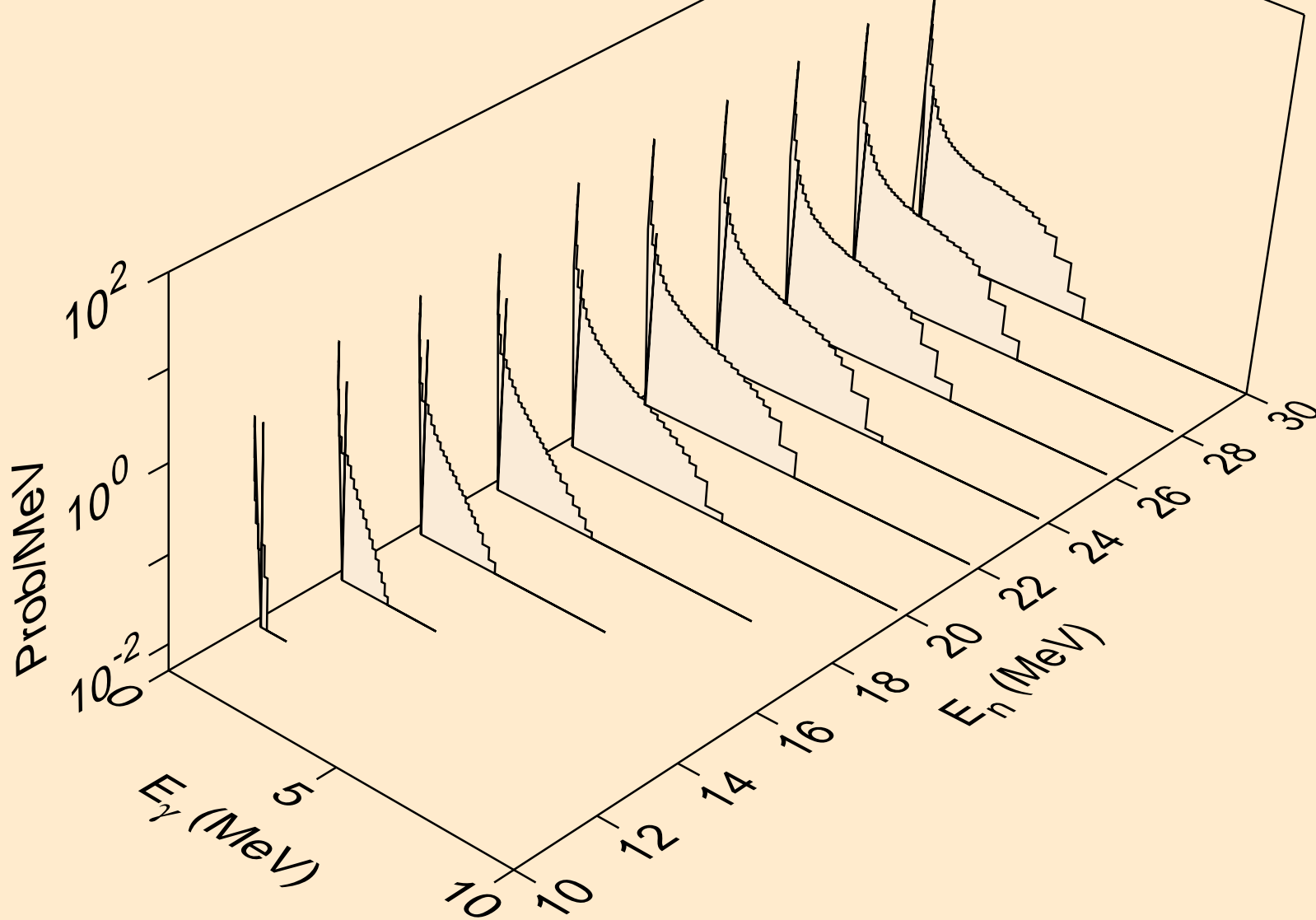

SN101 NEUTRON ACER TENDL-2019 LIBRARY; T=293.16K
Photon emission for (n,3n)

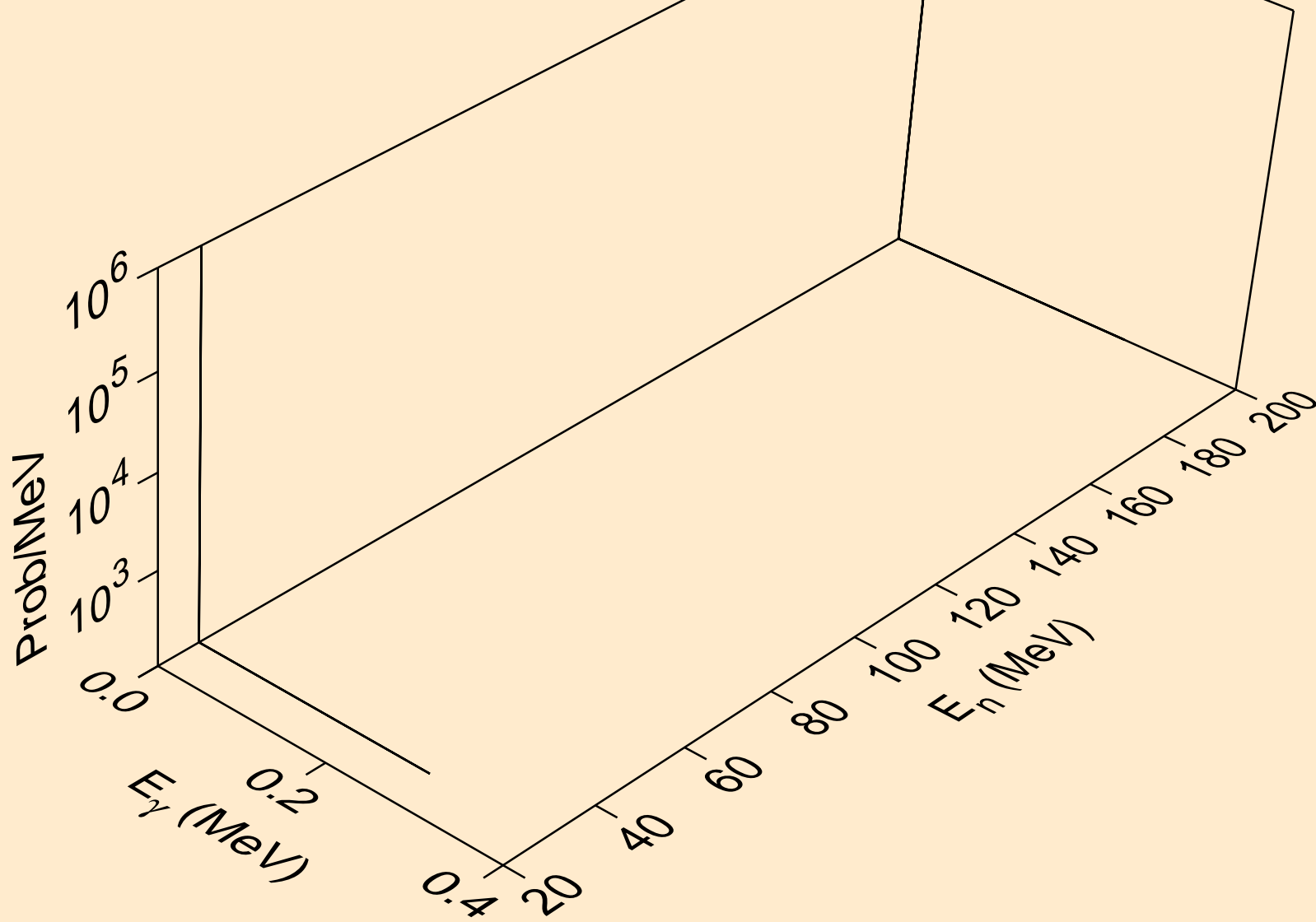

SN101 NEUTRON ACER TENDL-2019 LIBRARY; T=293.16K
Photon emission for (n,n*)a

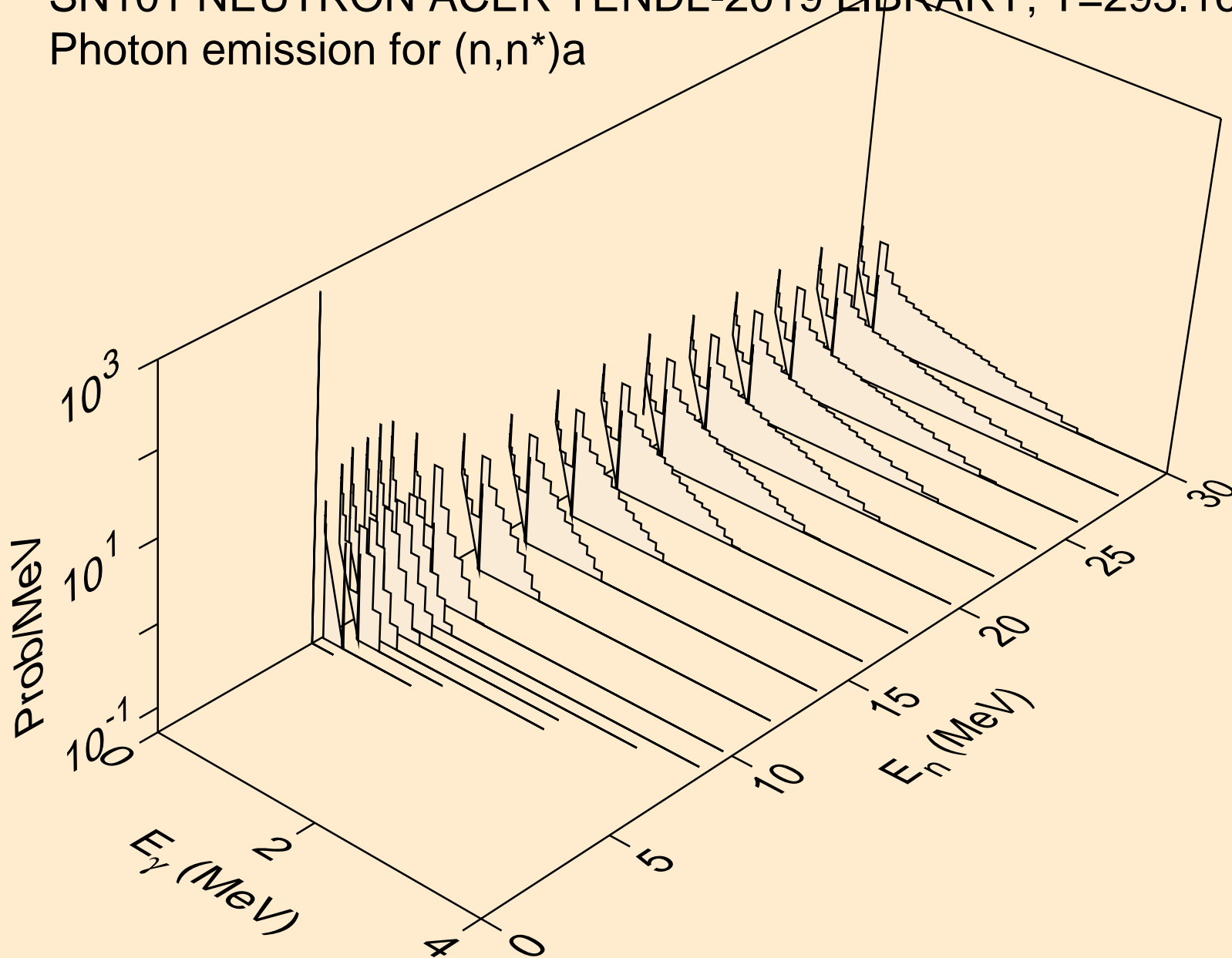

SN101 NEUTRON ACER TENDL-2019 LIBRARY; T=293.16K
Photon emission for (n,2n)a

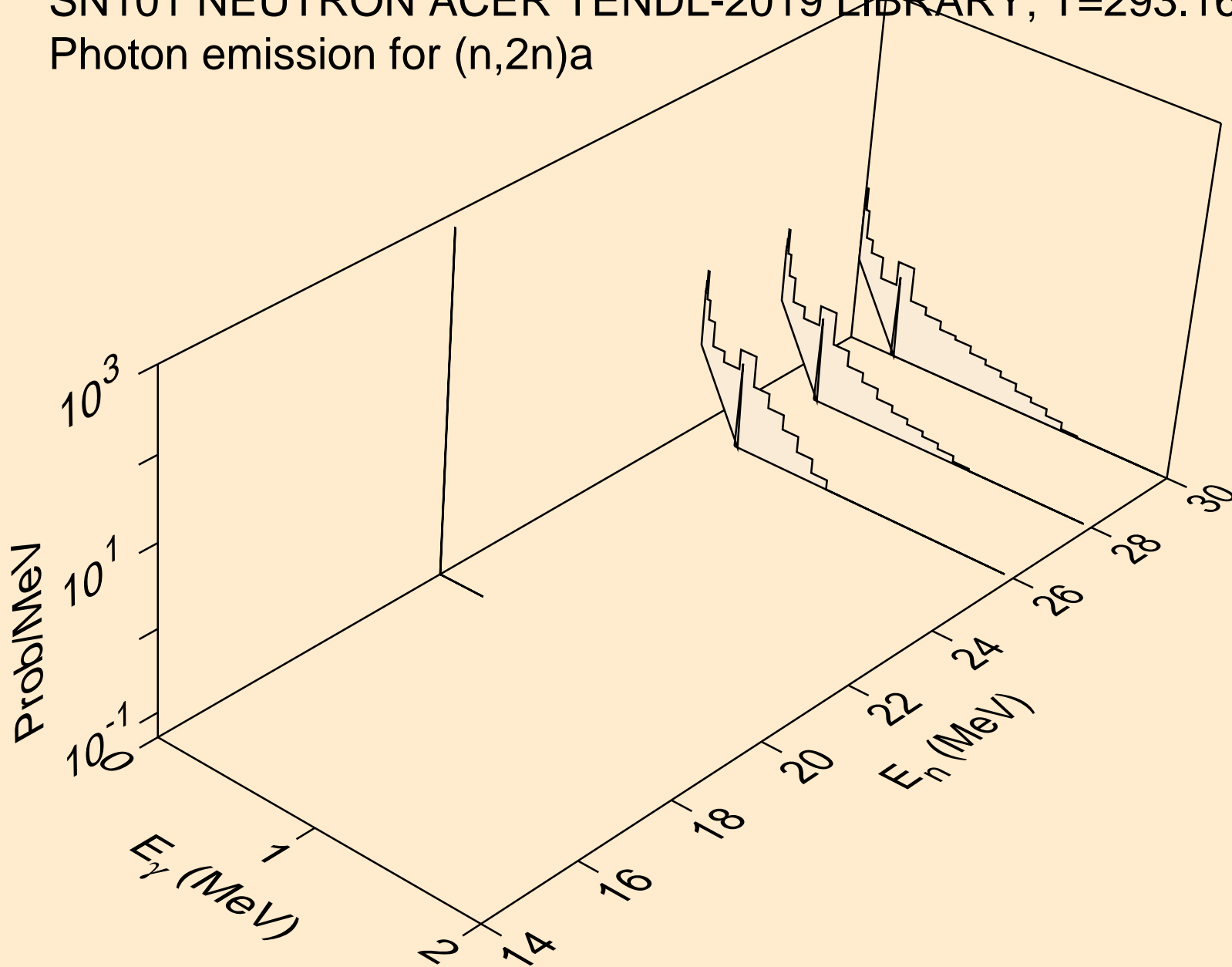

SN101 NEUTRON ACER TENDL-2019 LIBRARY; T=293.16K
Photon emission for (n,n*)p

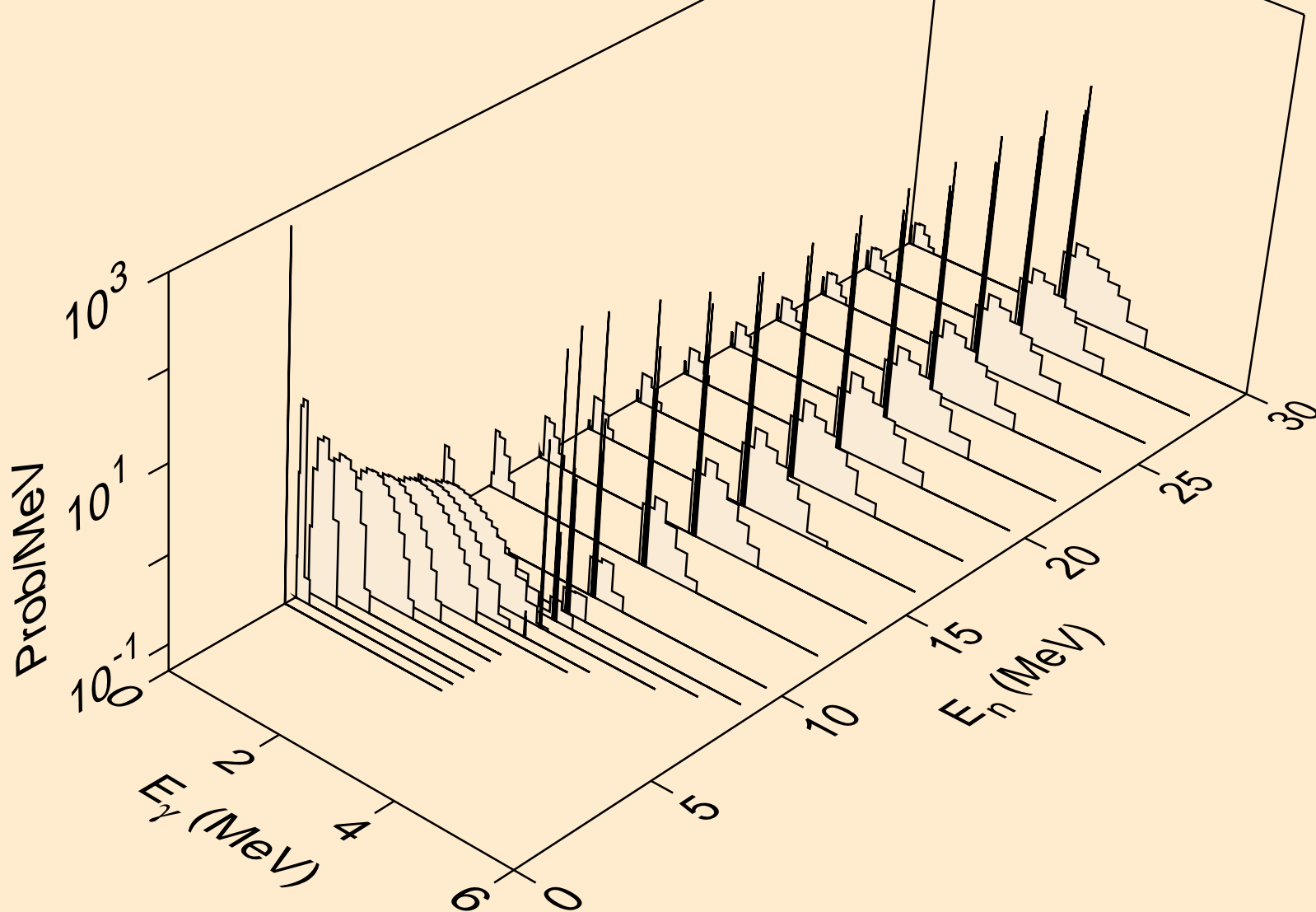

SN101 NEUTRON ACER TENDL-2019 LIBRARY; T=293.16K
Photon emission for (n,n*)2a

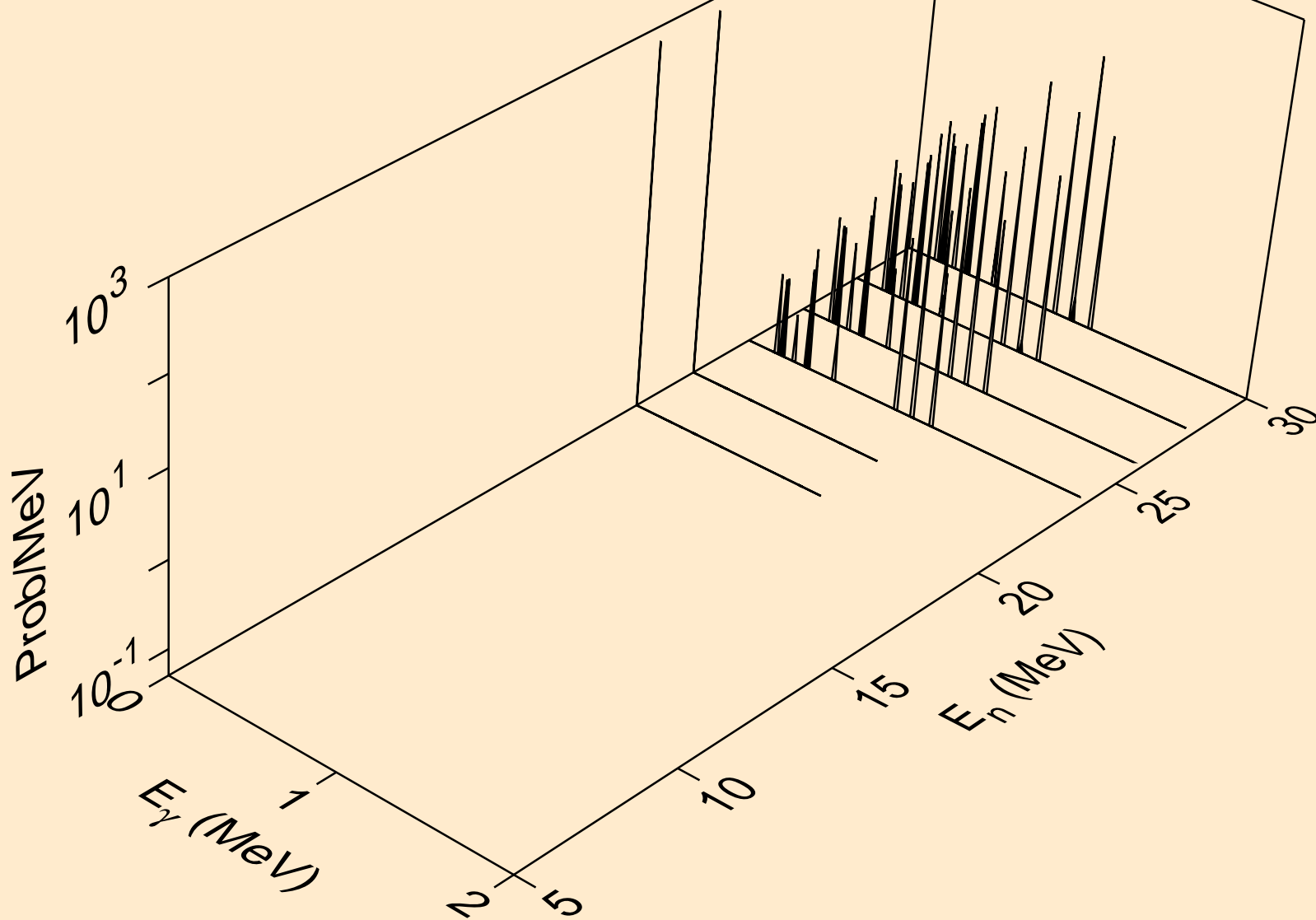

SN101 NEUTRON ACER TENDL-2019 LIBRARY; T=293.16K
Photon emission for (n,n*)d

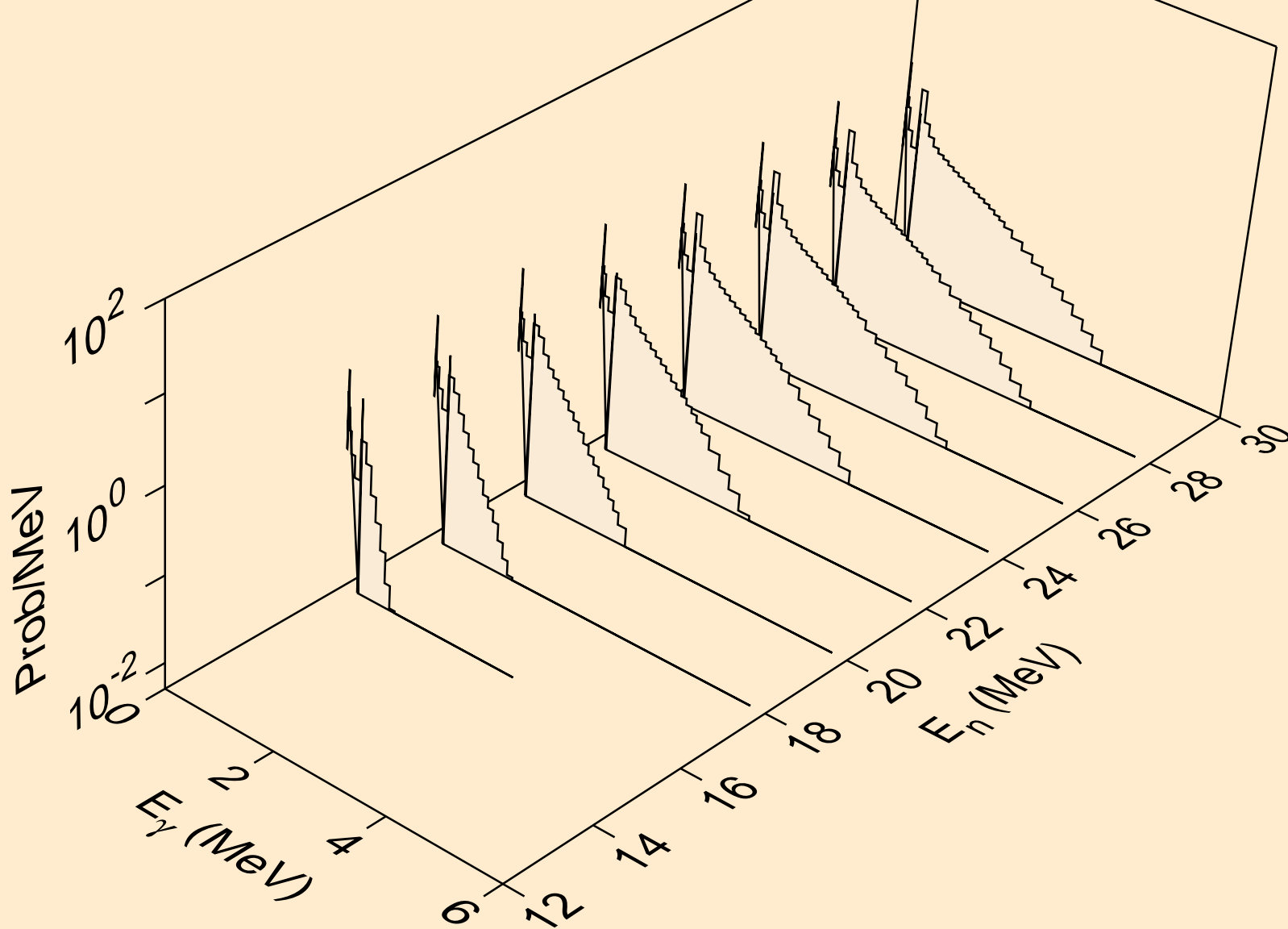

SN101 NEUTRON ACER TENDL-2019 LIBRARY; T=293.16K
Photon emission for (n,n*)t

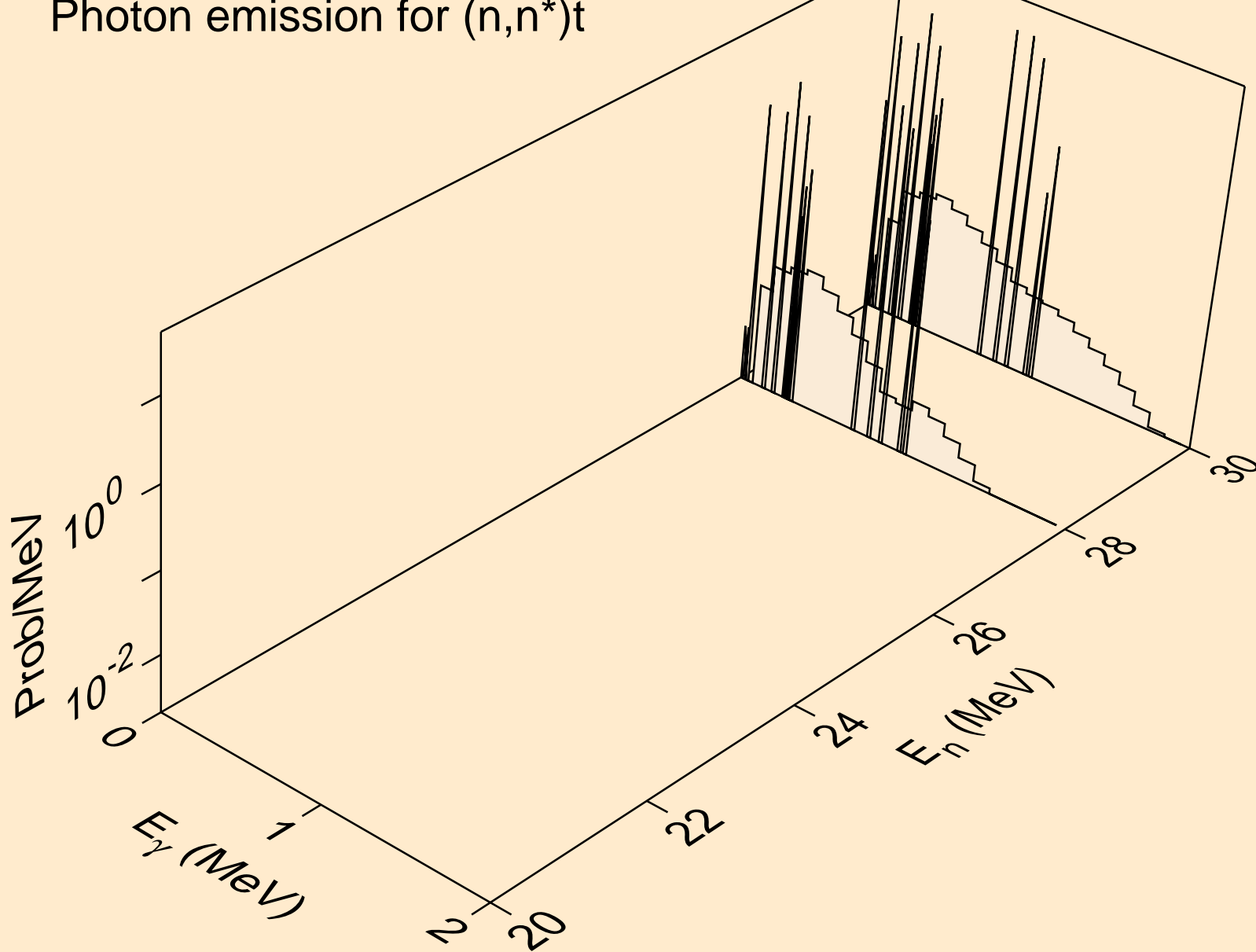

SN101 NEUTRON ACER TENDL-2019 LIBRARY; T=293.16K
Photon emission for (n,n*)he3

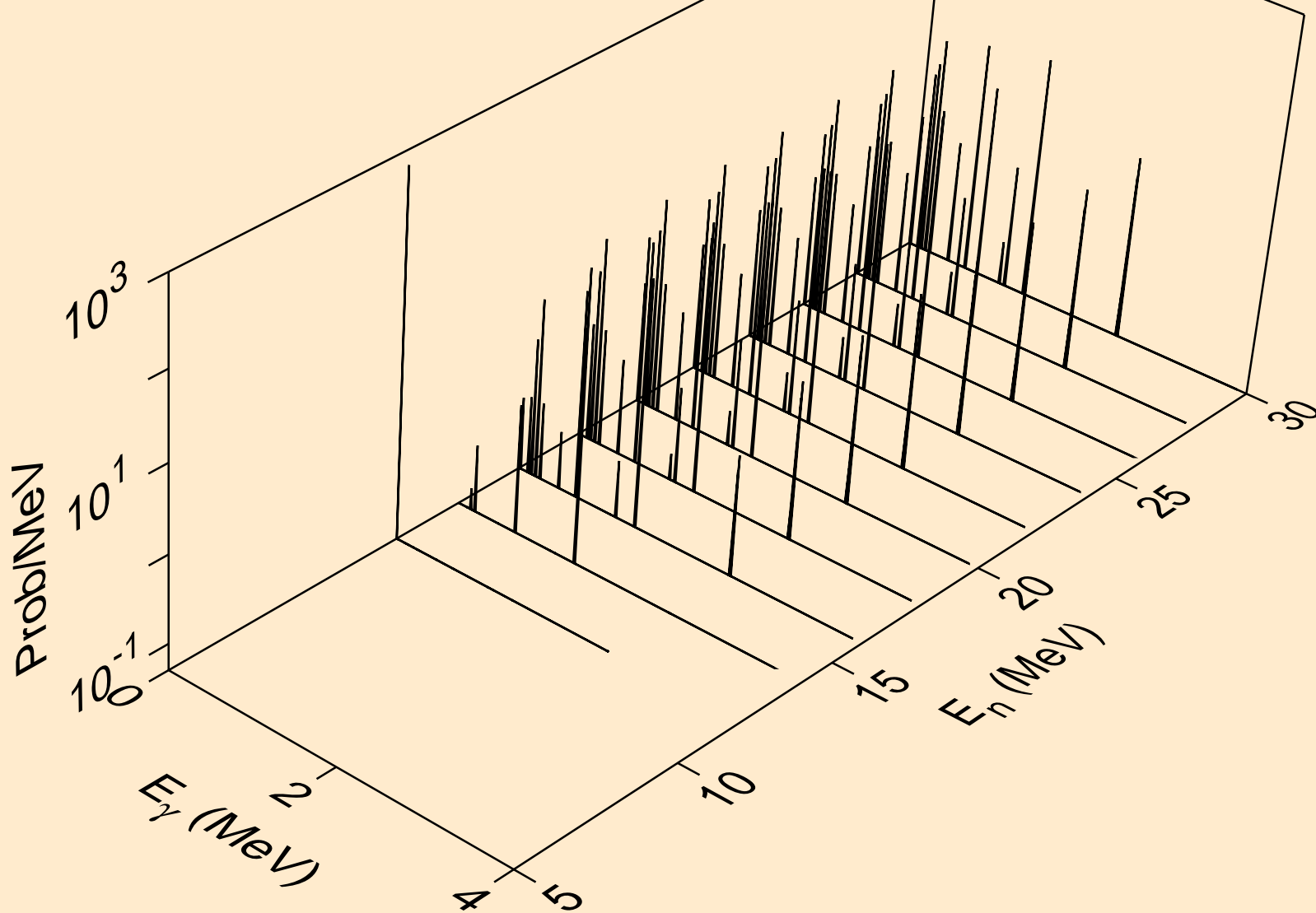

SN101 NEUTRON ACER TENDL-2019 LIBRARY; T=293.16K
Photon emission for (n,2np)

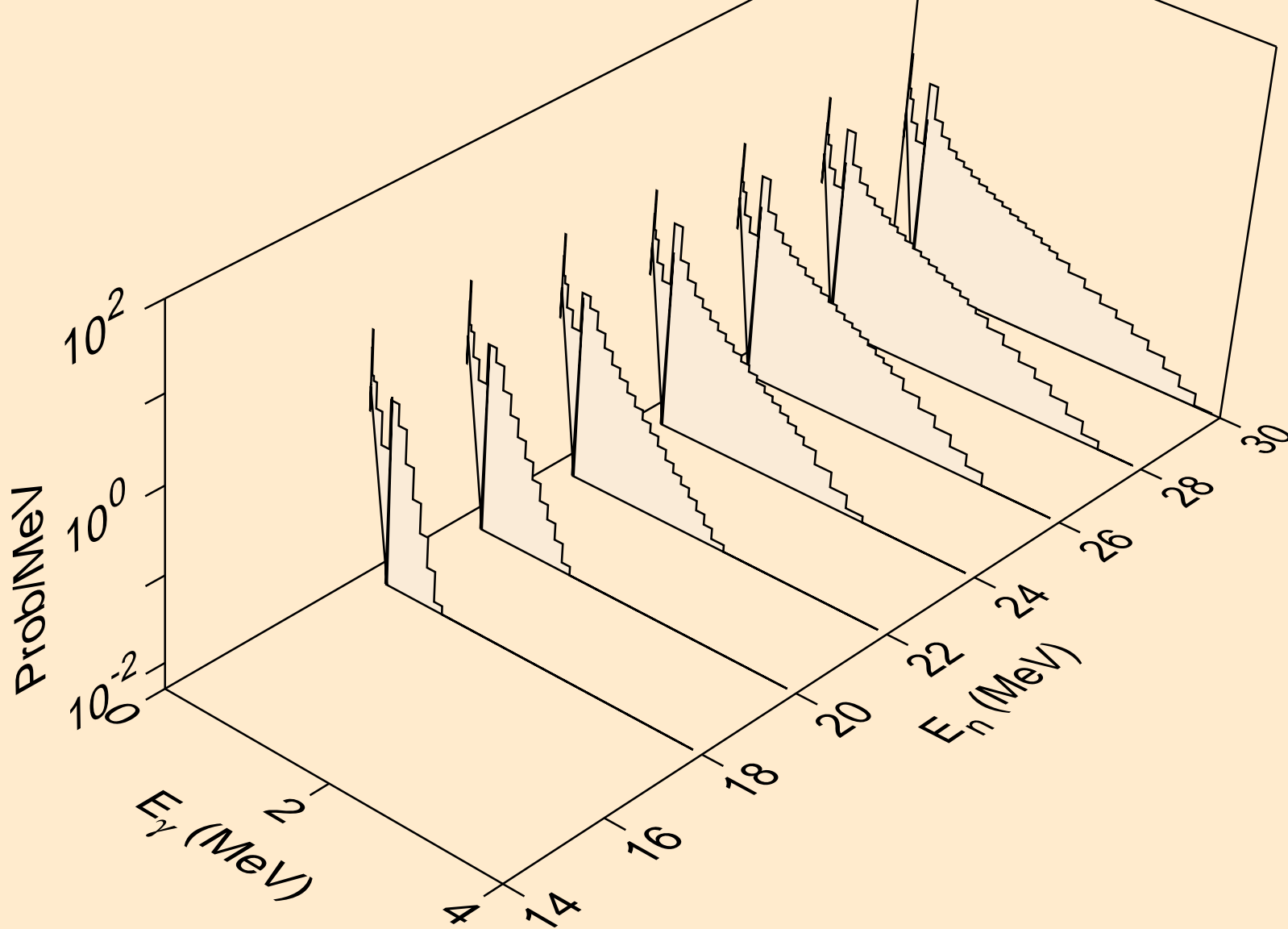

SN101 NEUTRON ACER TENDL-2019 LIBRARY; T=293.16K
Photon emission for (n,2np)

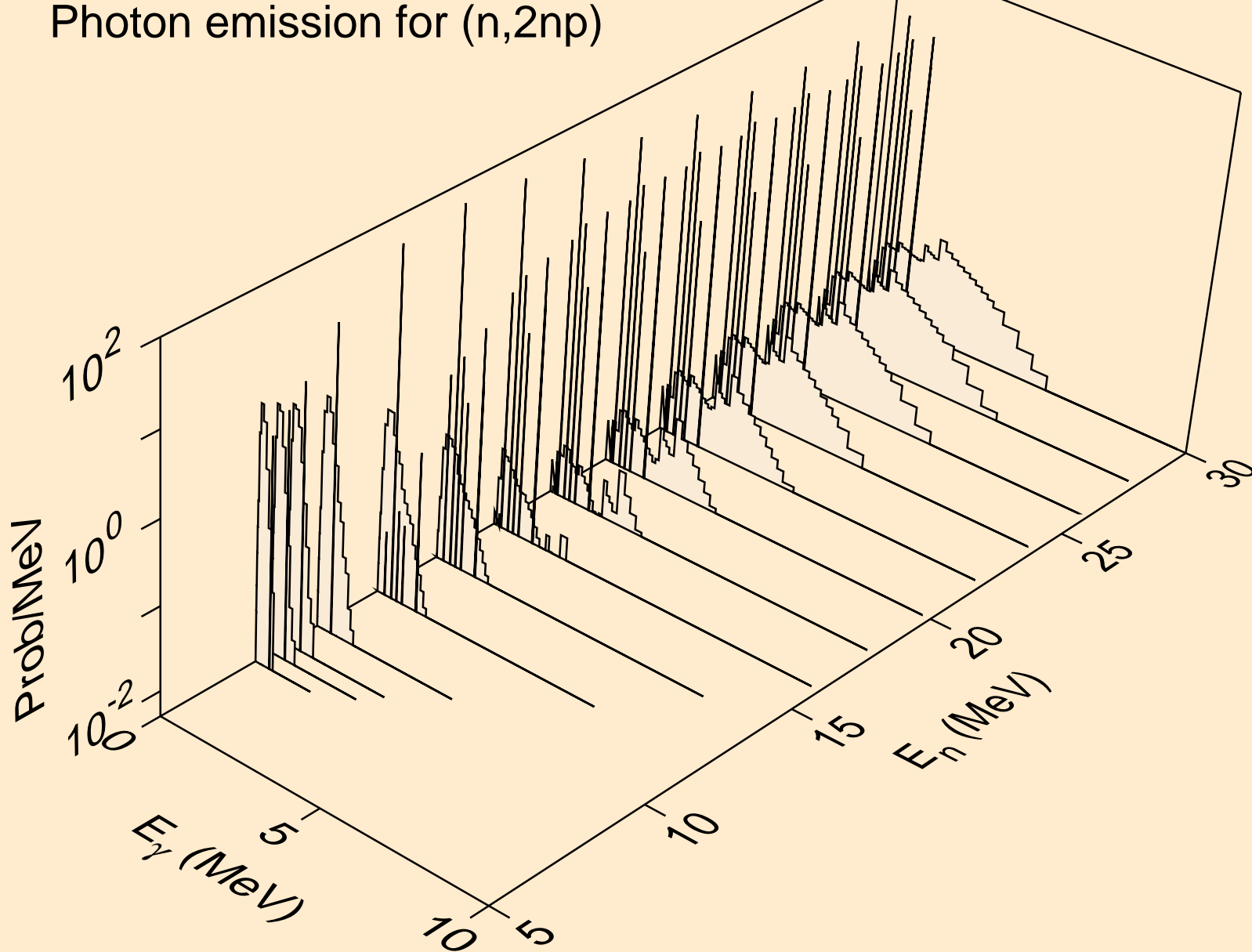

SN101 NEUTRON ACER TENDL-2019 LIBRARY; T=293.16K
Photon emission for (n,npa)

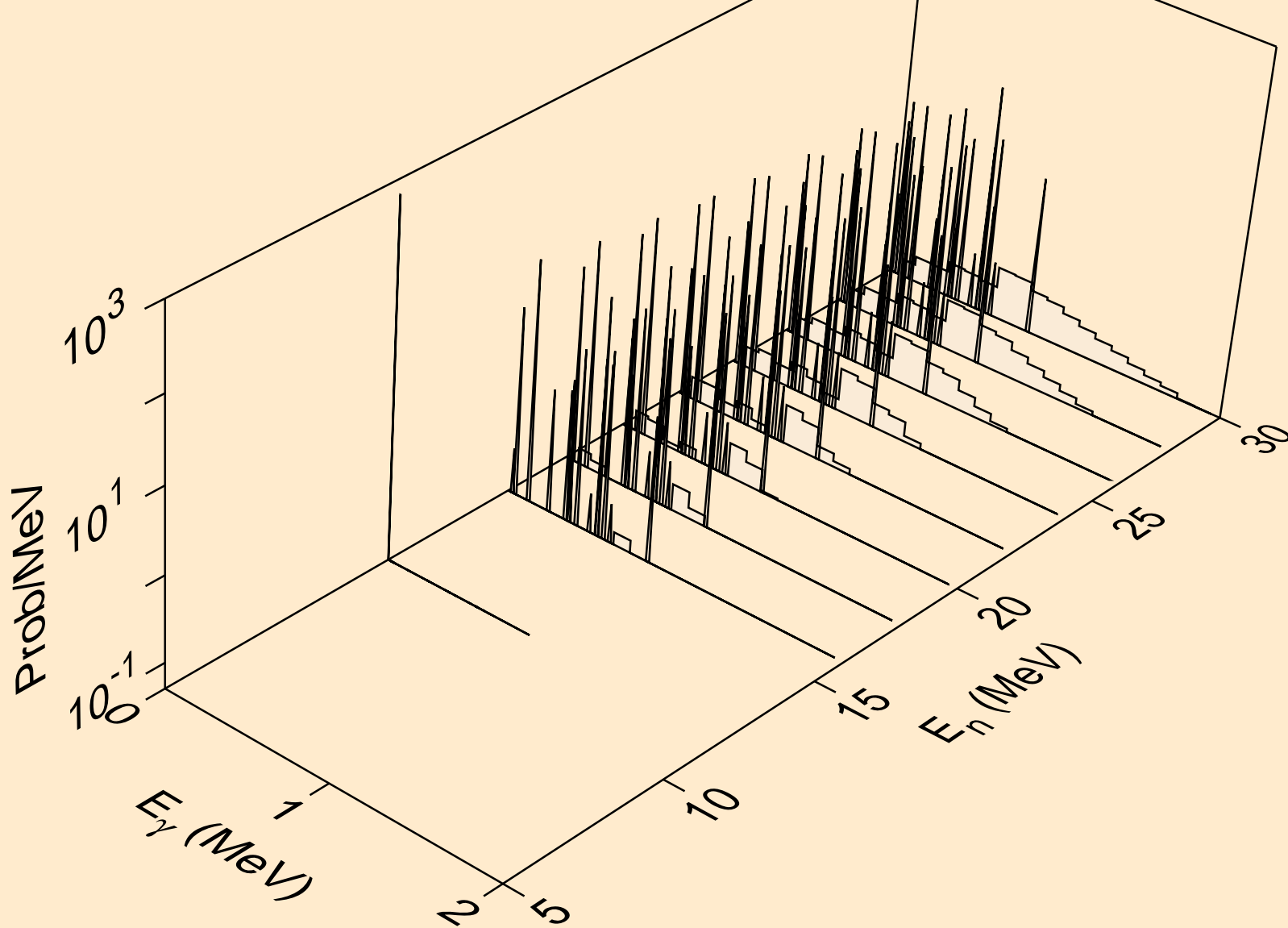

SN101 NEUTRON ACER TENDL-2019 LIBRARY; T=293.16K
Photon emission for (n,n*c)

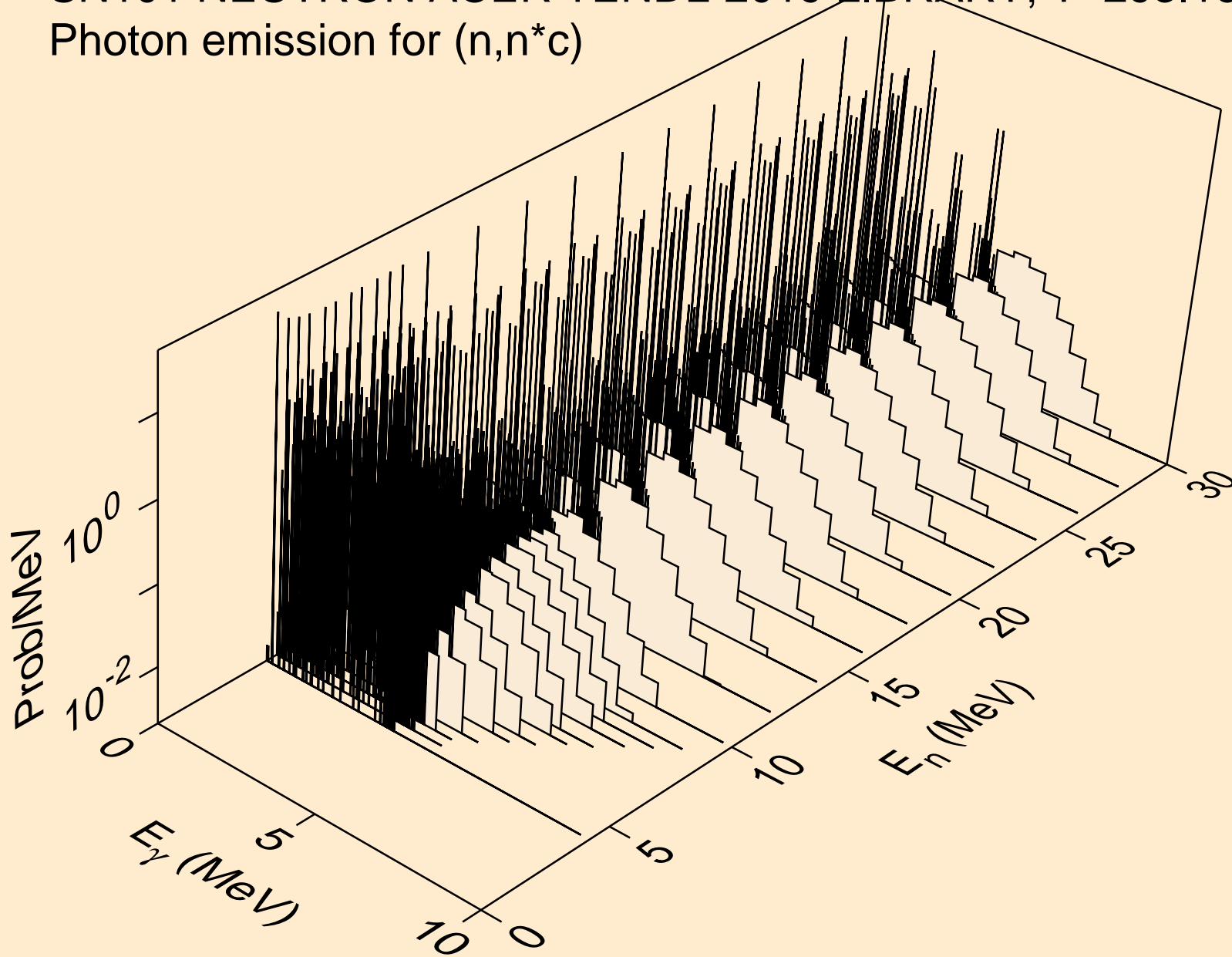

SN101 NEUTRON ACER TENDL-2019 LIBRARY; T=293.16K
Photon emission for (n,gma)

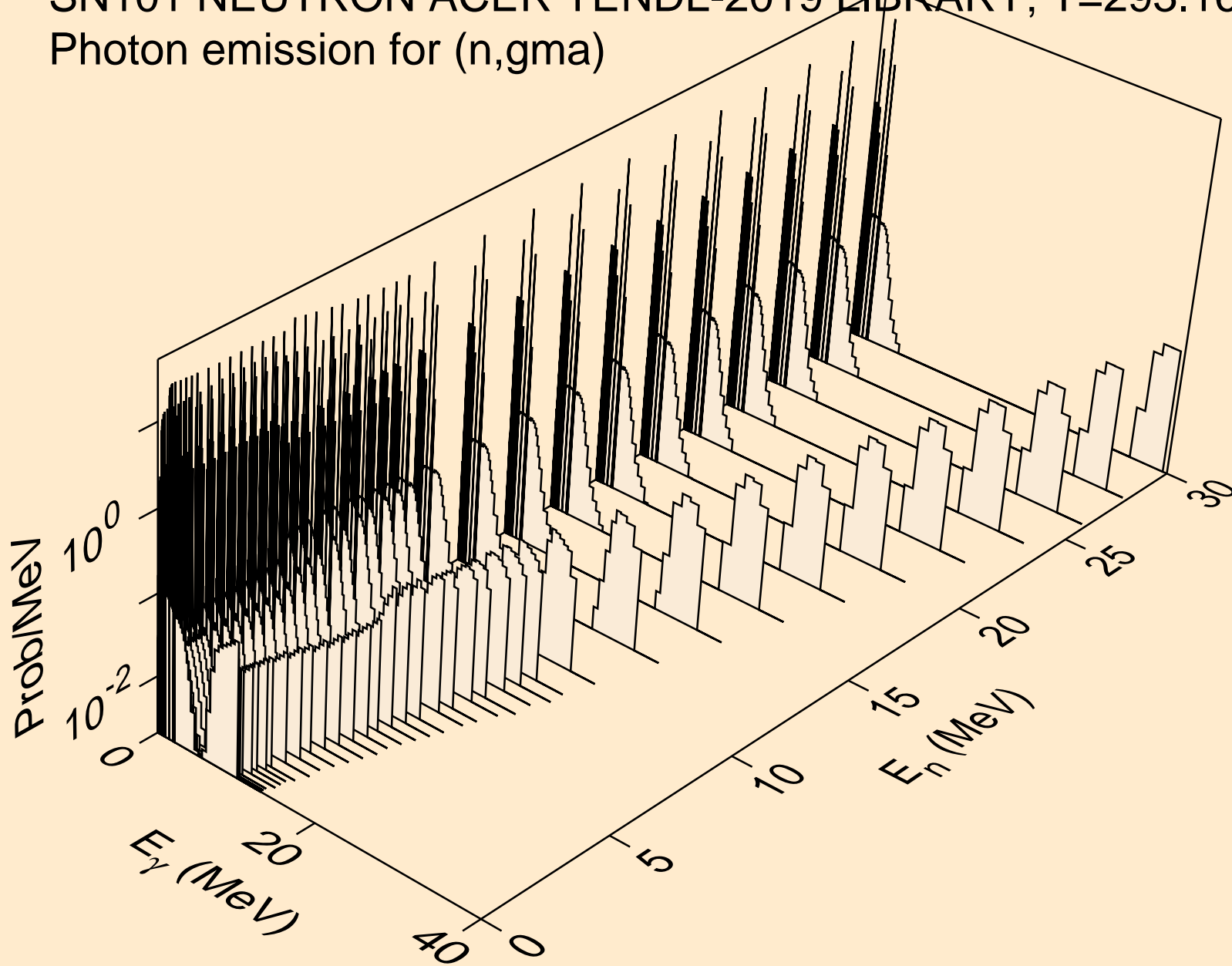

SN101 NEUTRON ACER TENDL-2019 LIBRARY; T=293.16K
Photon emission for (n,p)

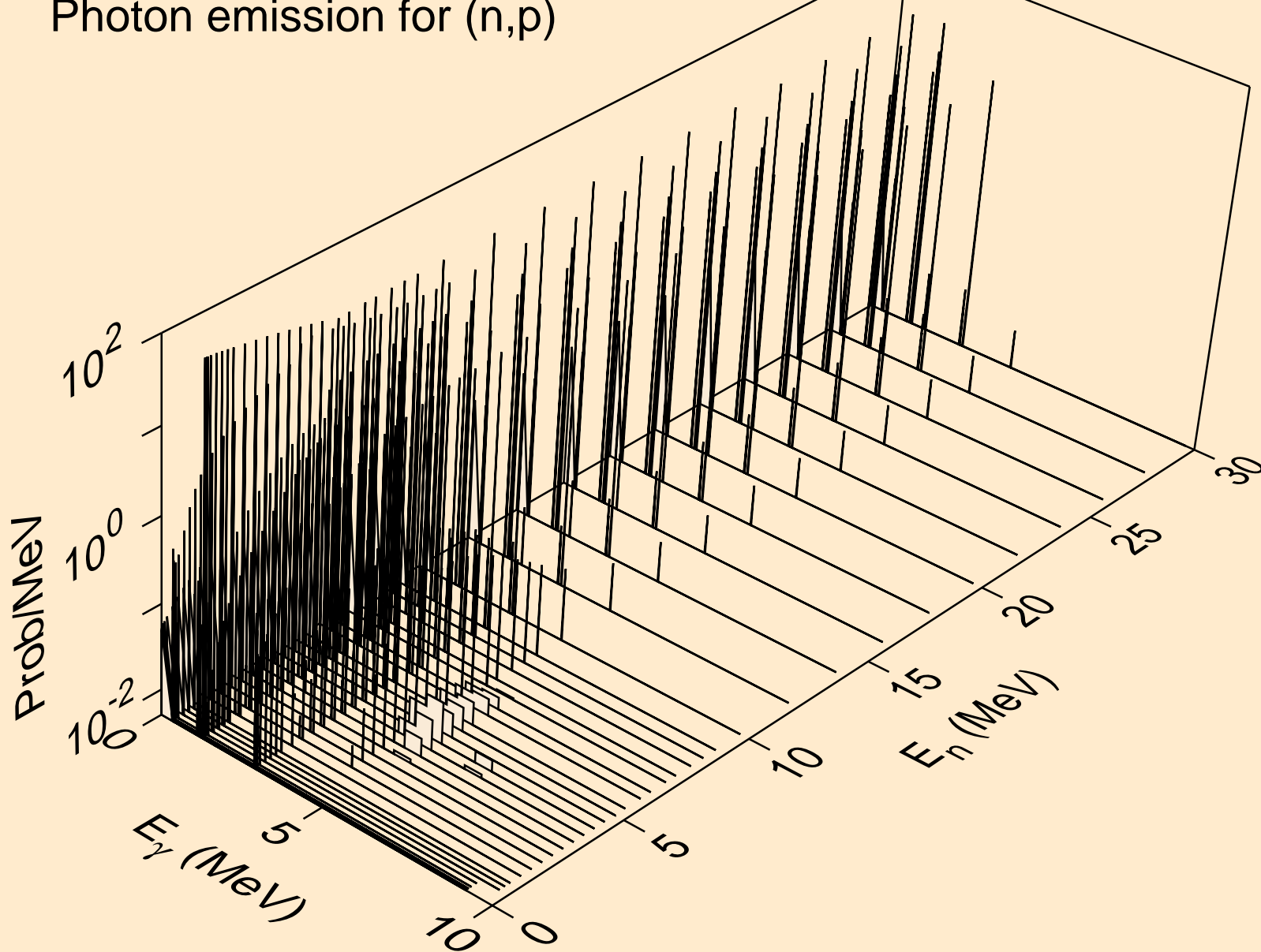

SN101 NEUTRON ACER TENDL-2019 LIBRARY; T=293.16K
Photon emission for (n,d)

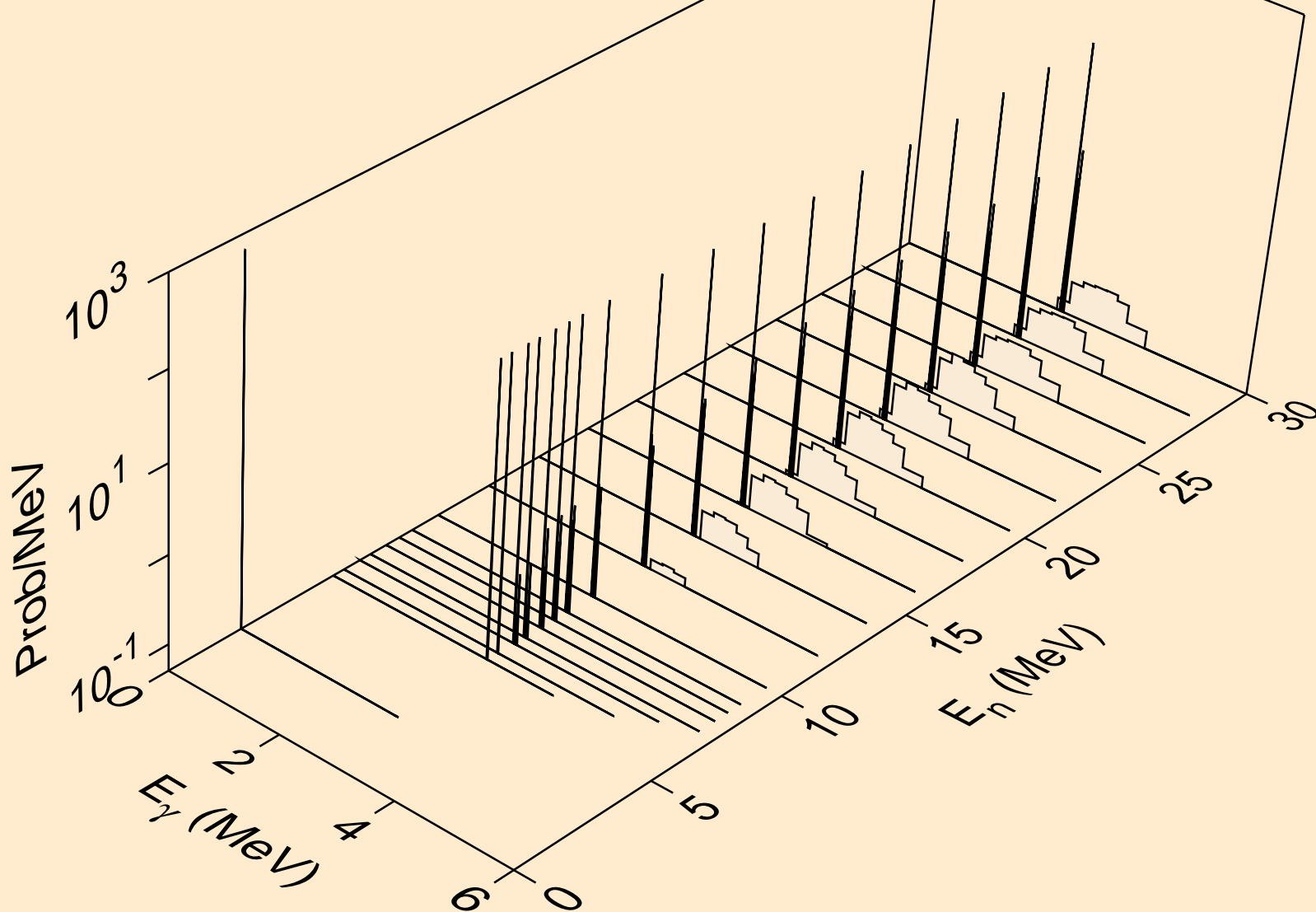

SN101 NEUTRON ACER TENDL-2019 LIBRARY; T=293.16K
Photon emission for (n,t)

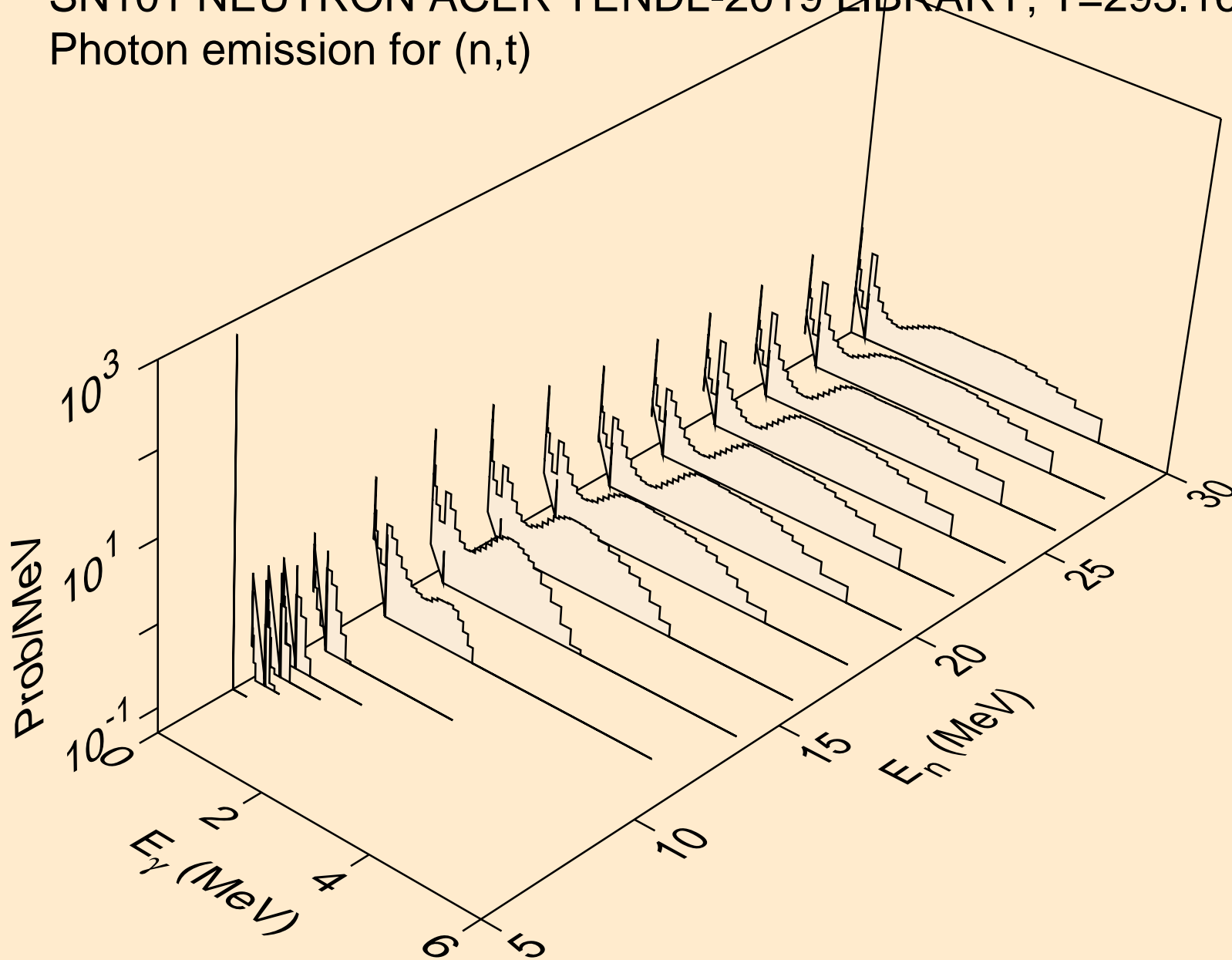

SN101 NEUTRON ACER TENDL-2019 LIBRARY; T=293.16K
Photon emission for (n,he3)

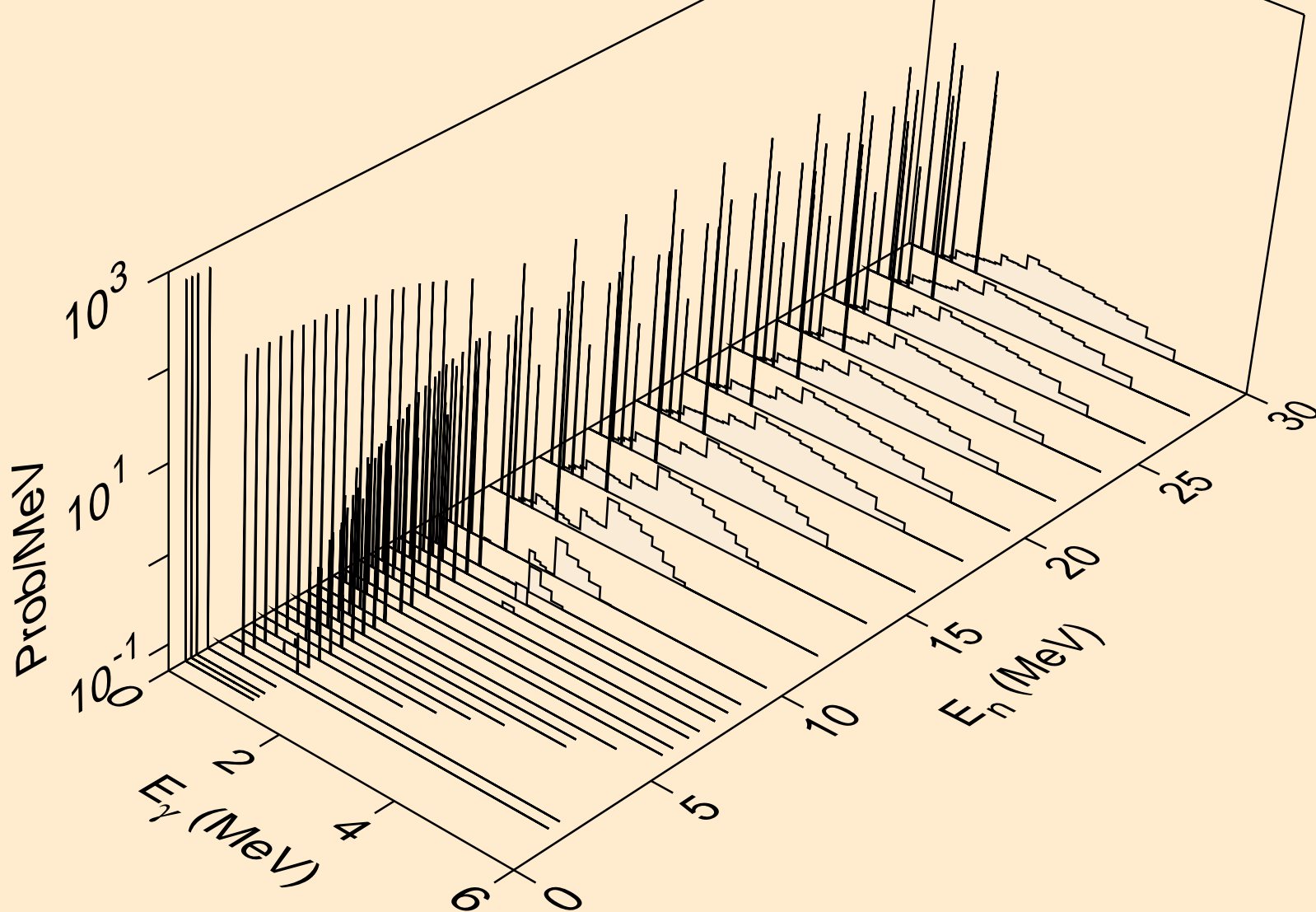

SN101 NEUTRON ACER TENDL-2019 LIBRARY; T=293.16K
Photon emission for (n,a)

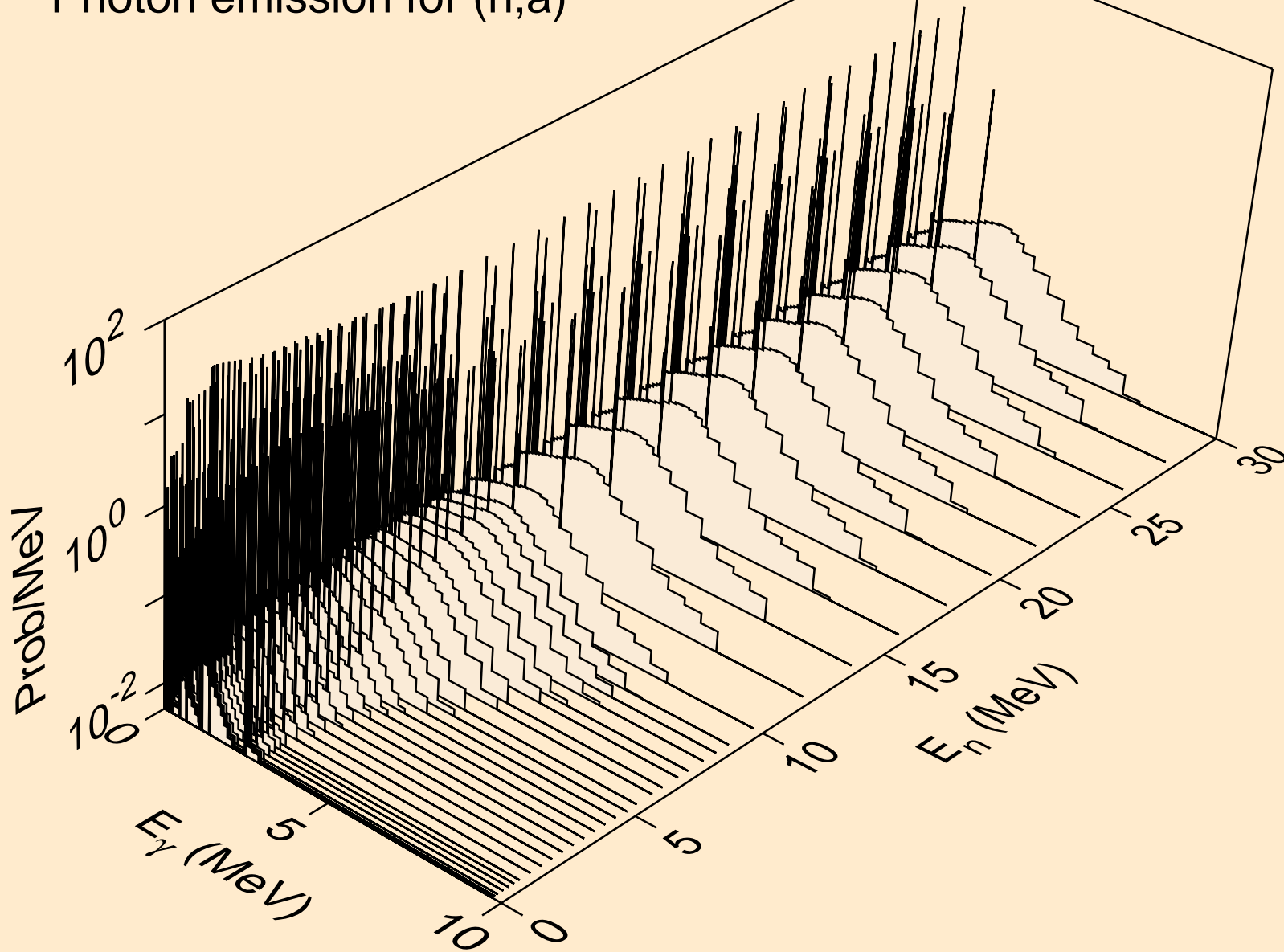

SN101 NEUTRON ACER TENDL-2019 LIBRARY; T=293.16K
Photon emission for (n,2a)

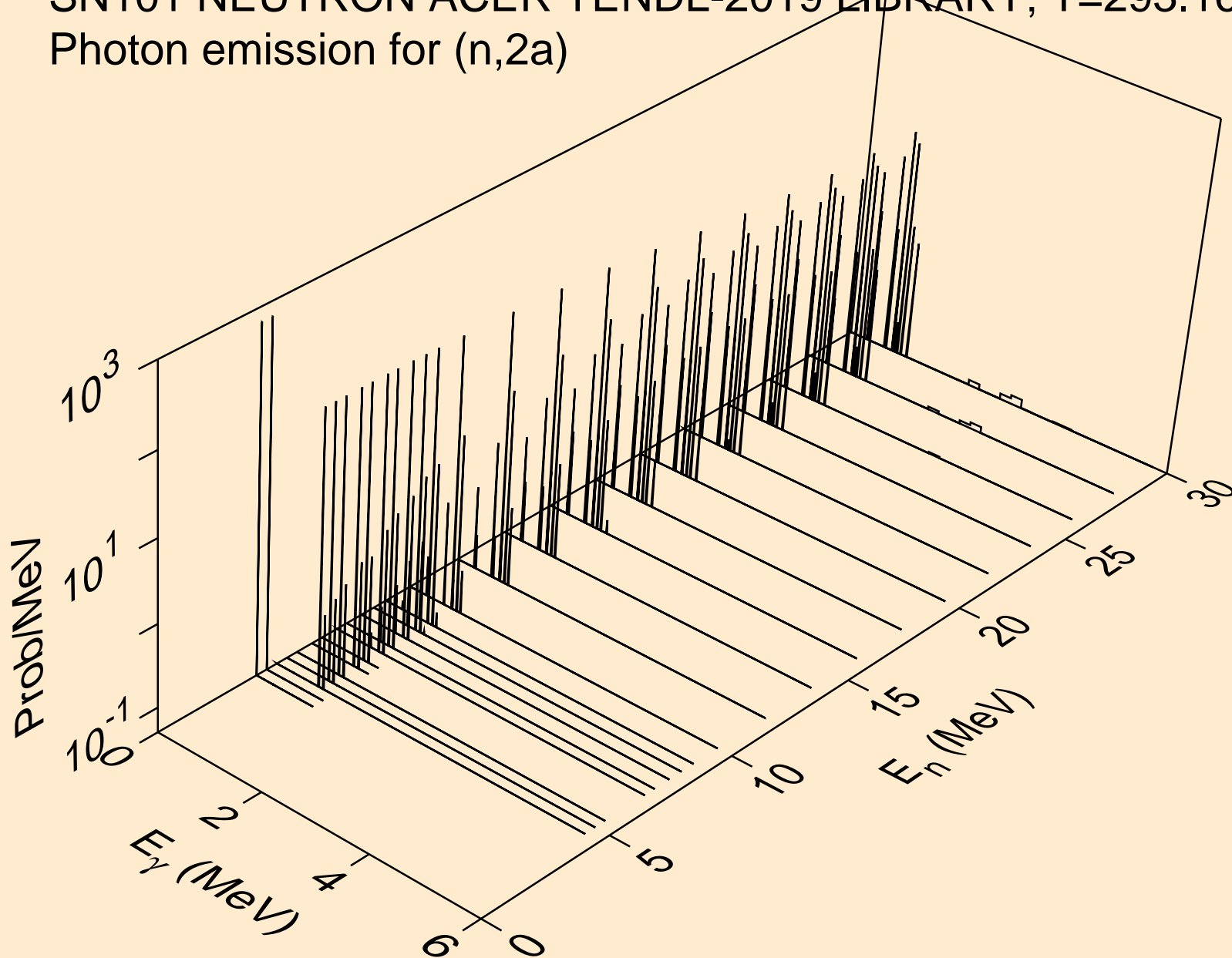

SN101 NEUTRON ACER TENDL-2019 LIBRARY; T=293.16K
Photon emission for (n,2p)

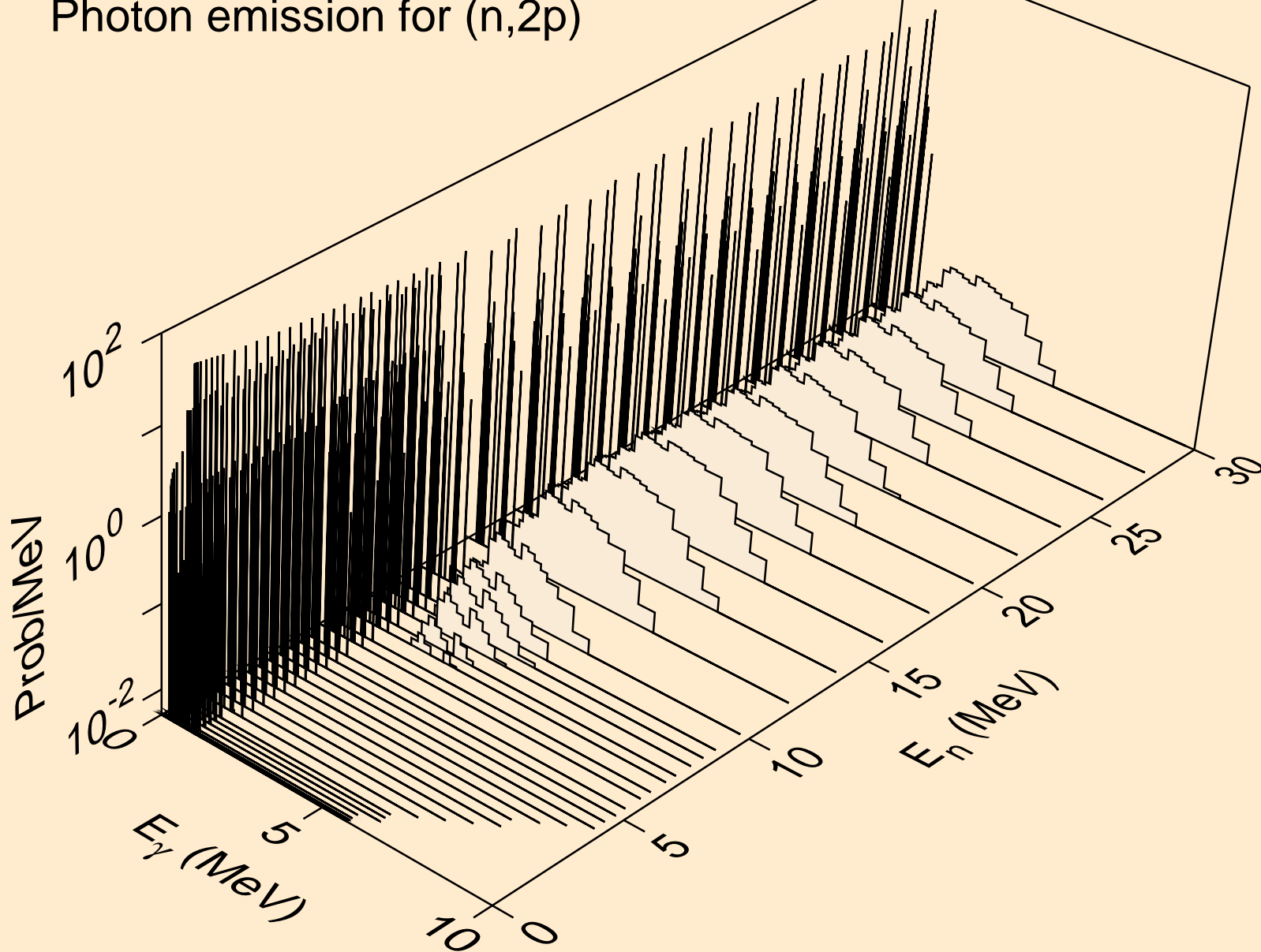

SN101 NEUTRON ACER TENDL-2019 LIBRARY; T=293.16K
Photon emission for (n,p α)

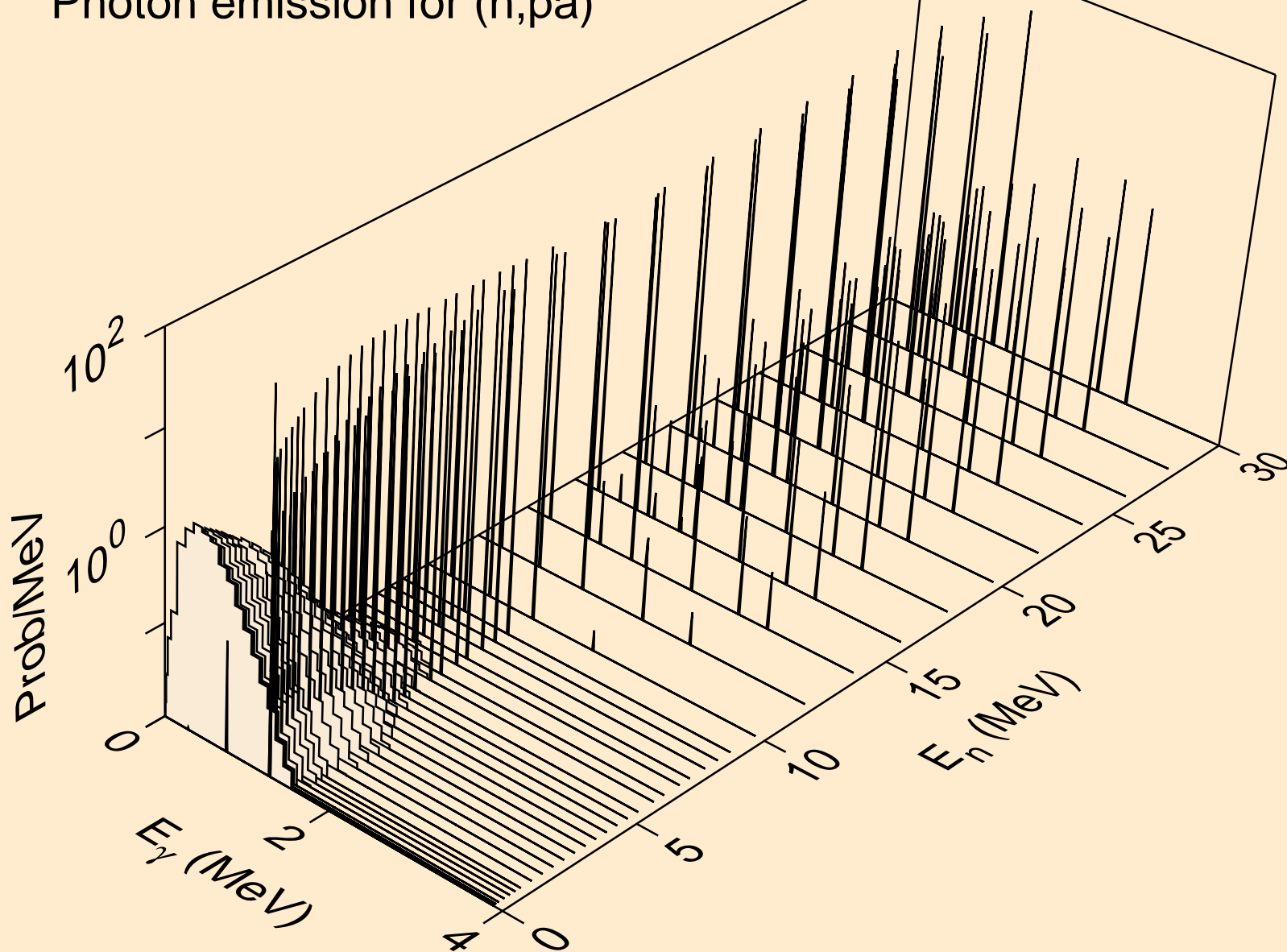

SN101 NEUTRON ACER TENDL-2019 LIBRARY; T=293.16K
Photon emission for (n,pd)

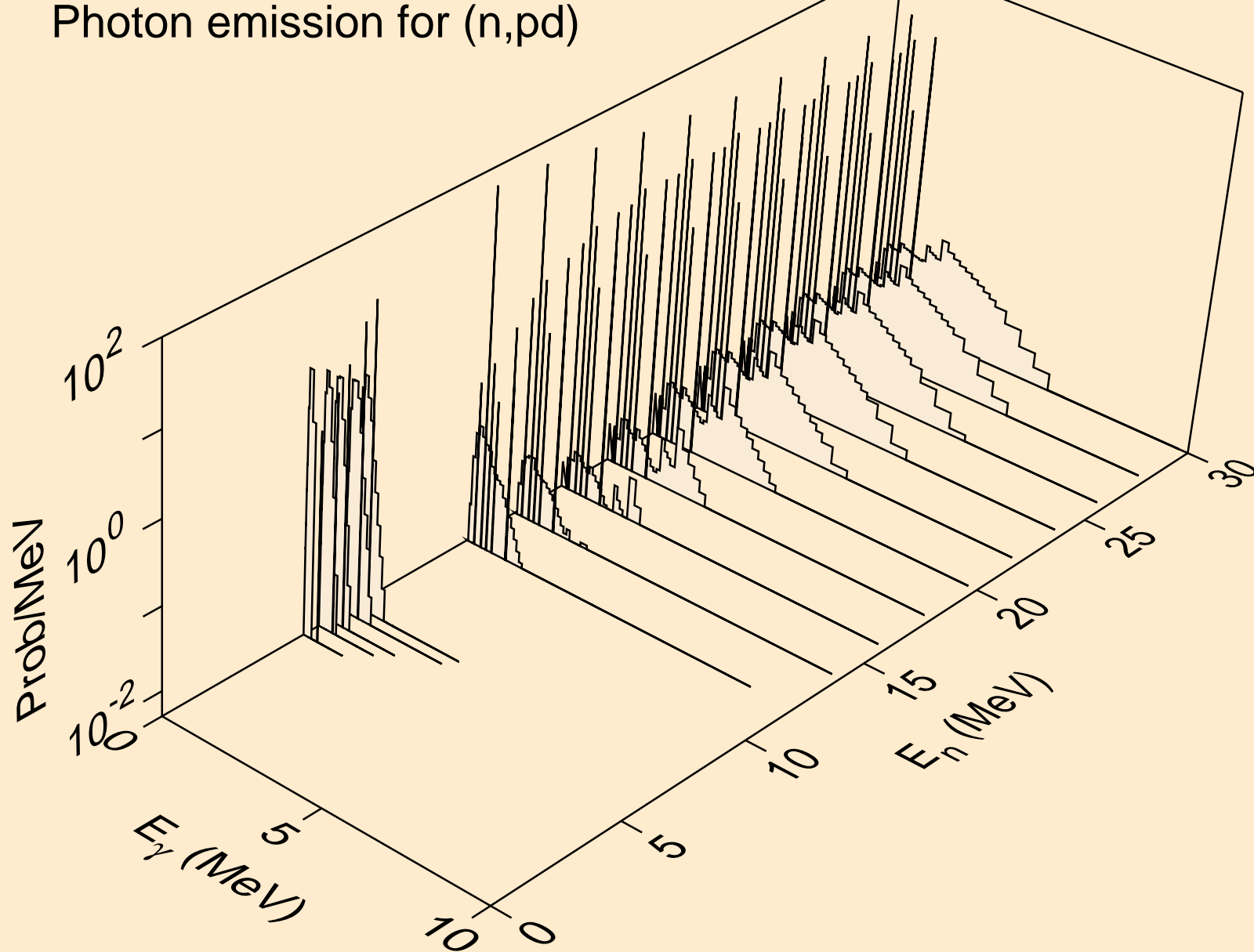

SN101 NEUTRON ACER TENDL-2019 LIBRARY; T=293.16K
Photon emission for (n,pt)

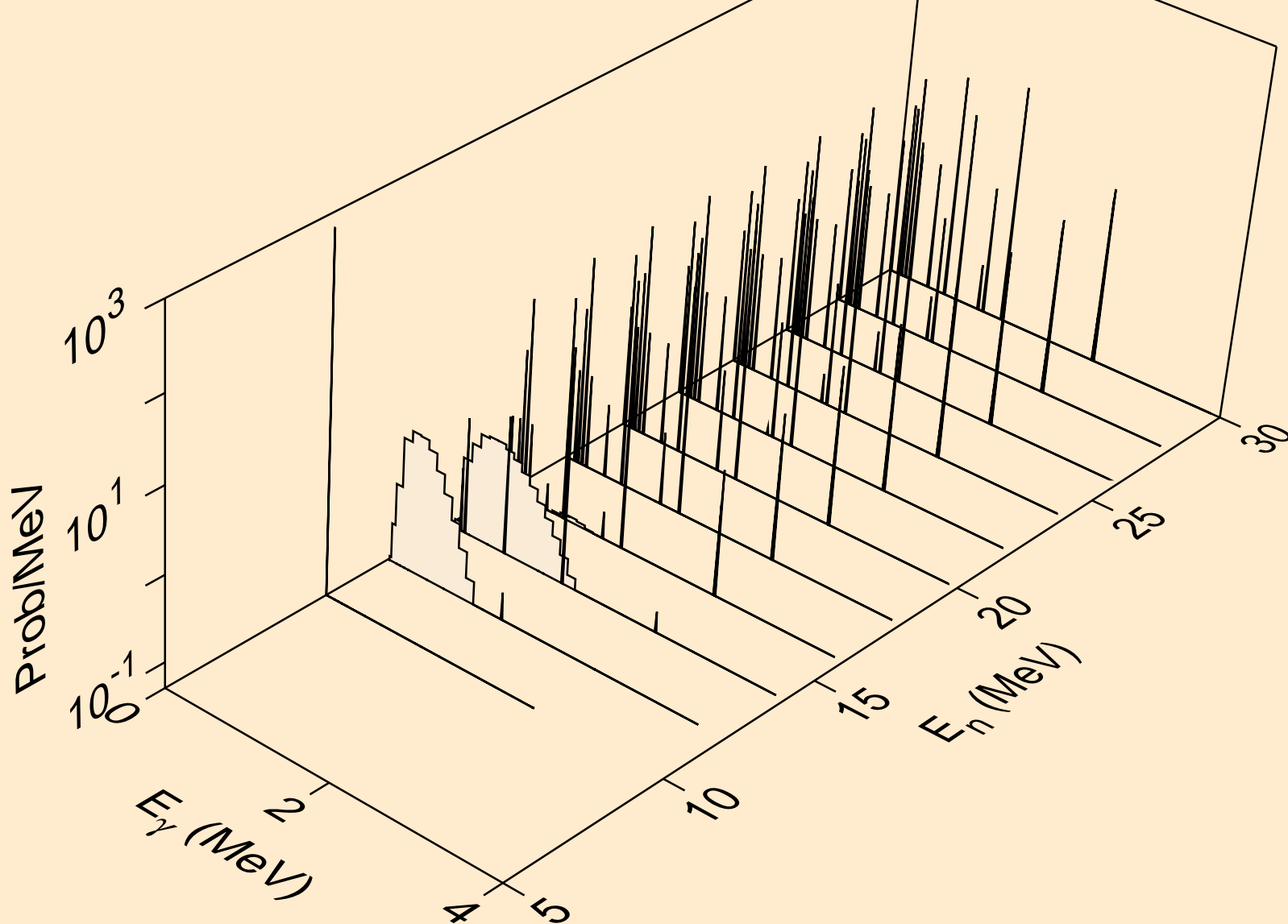

SN101 NEUTRON ACER TENDL-2019 LIBRARY; T=293.16K
Photon emission for (n,da)

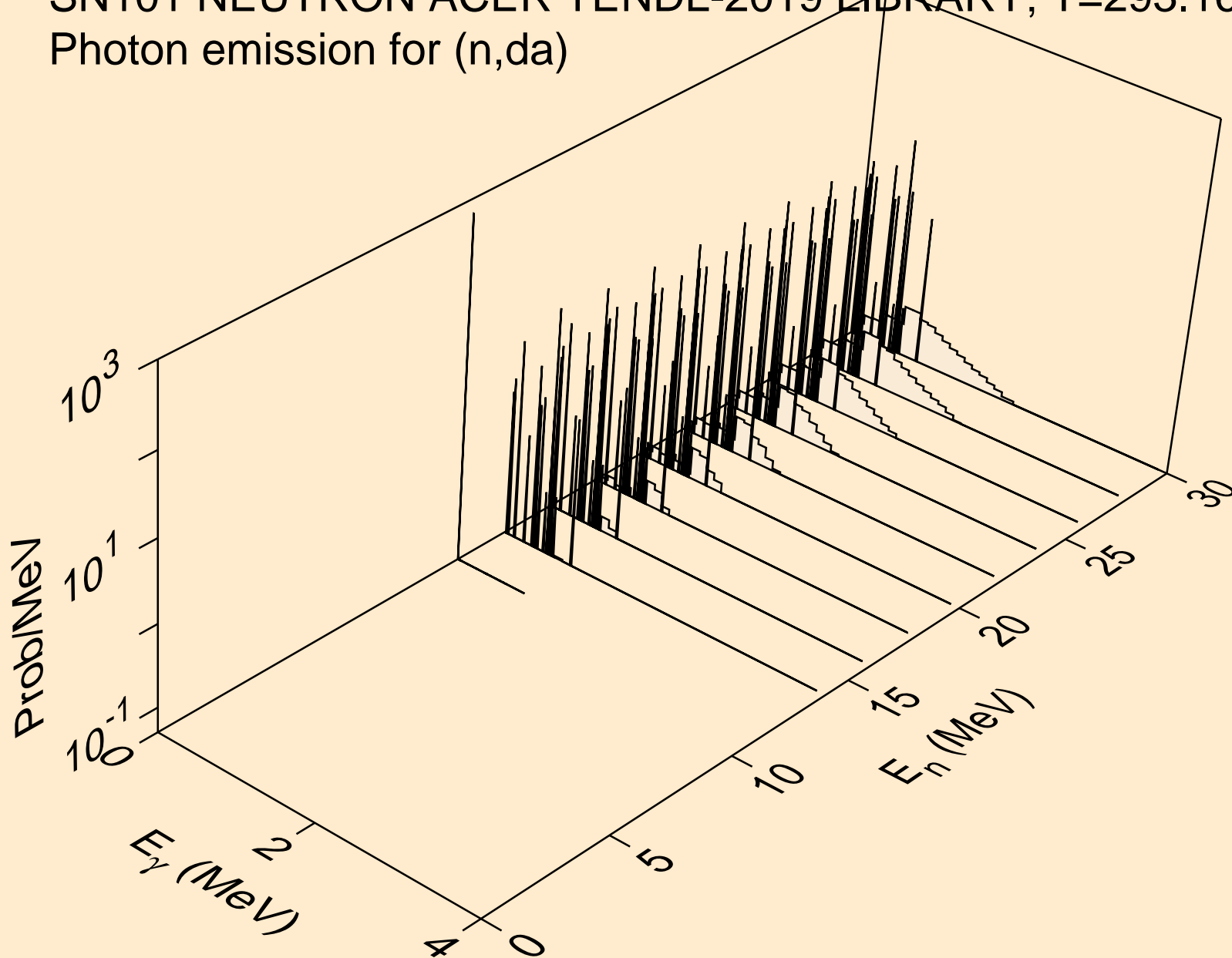

SN101 NEUTRON ACER TENDL-2019 LIBRARY; T=293.16K
14 MeV photon spectrum

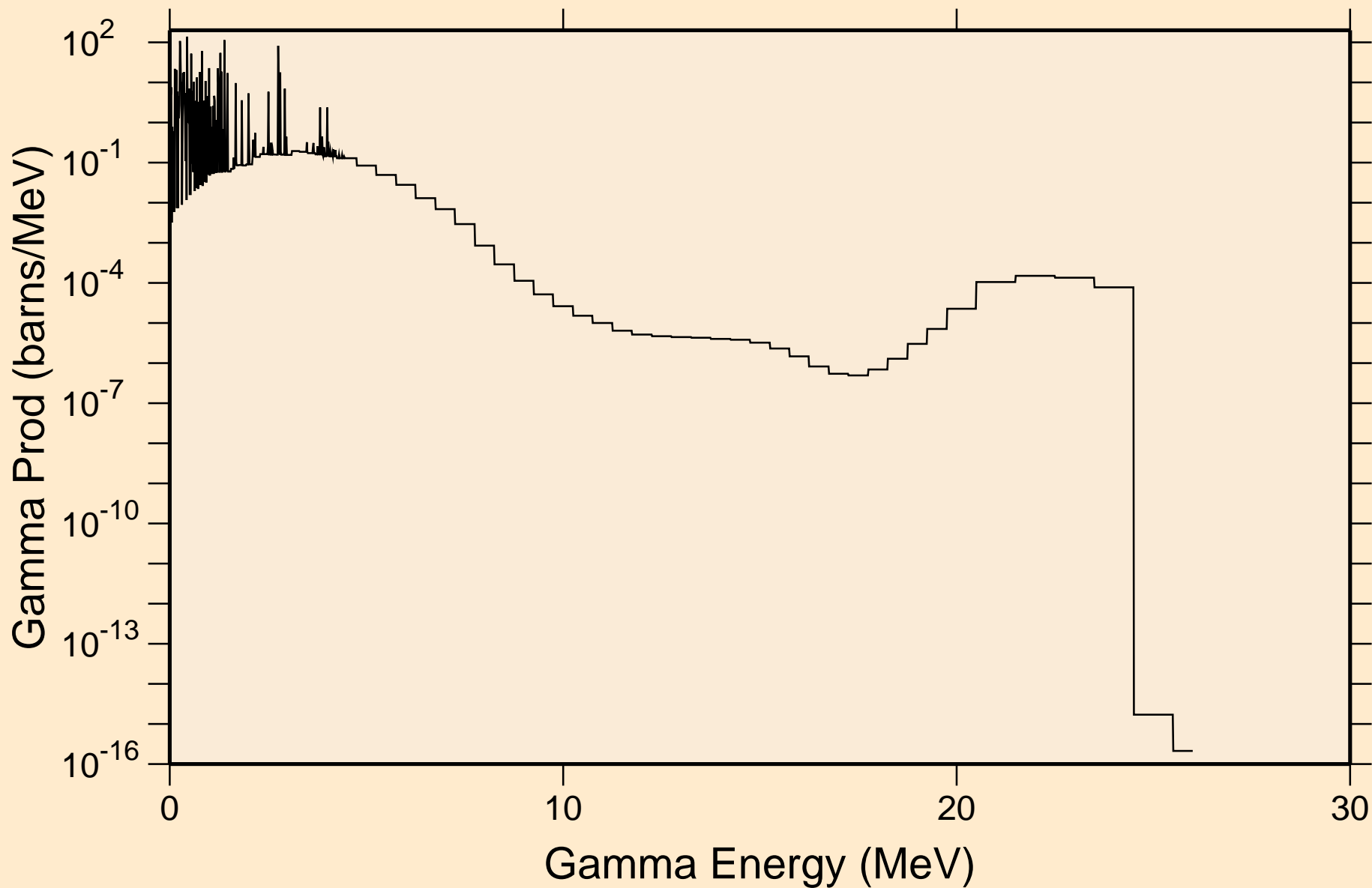

SN101 NEUTRON ACER TENDL-2019 LIBRARY; T=293.16K

Particle heating contributions

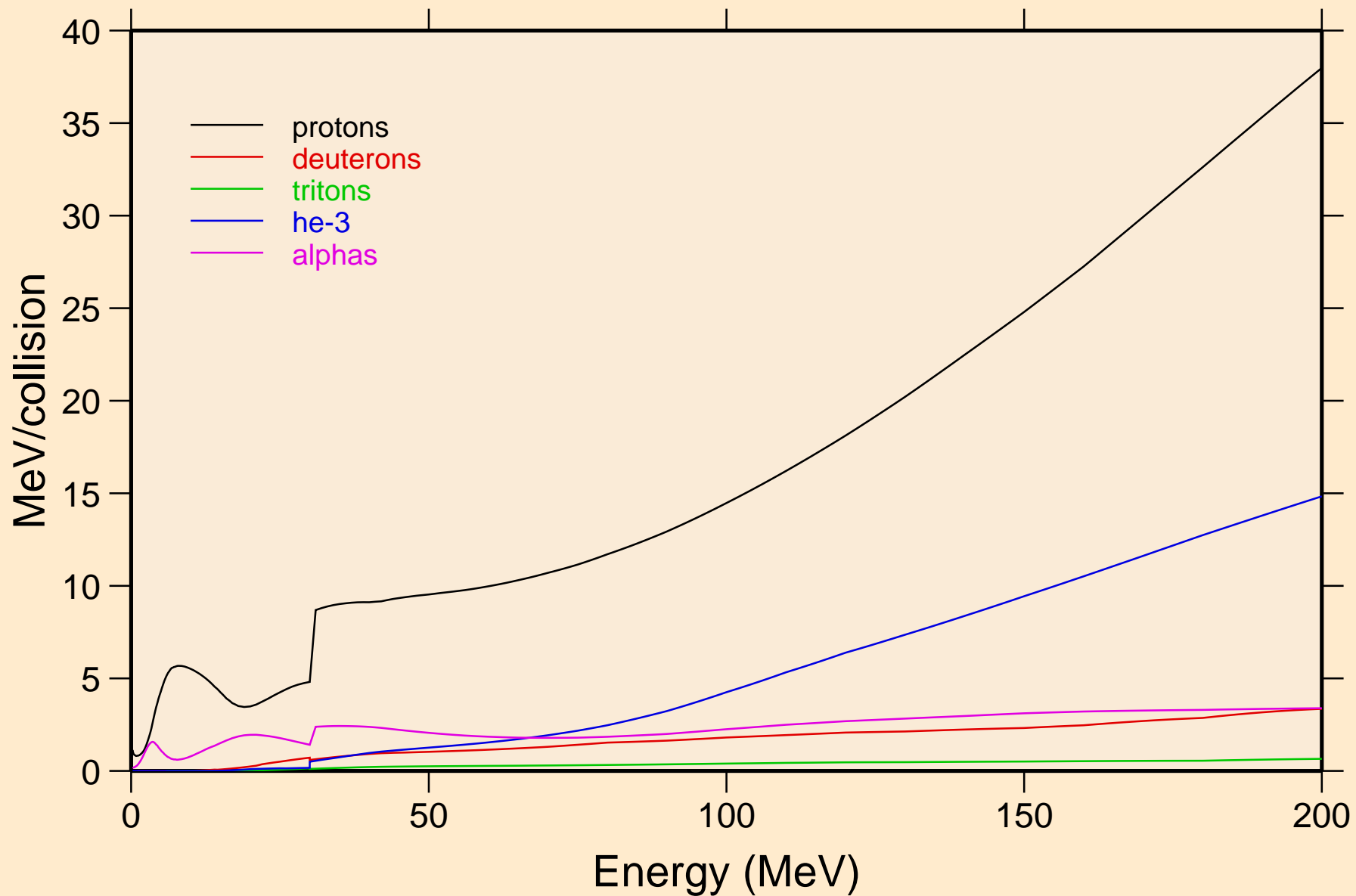

SN101 NEUTRON ACER TENDL-2019 LIBRARY; T=293.16K
Recoil Heating

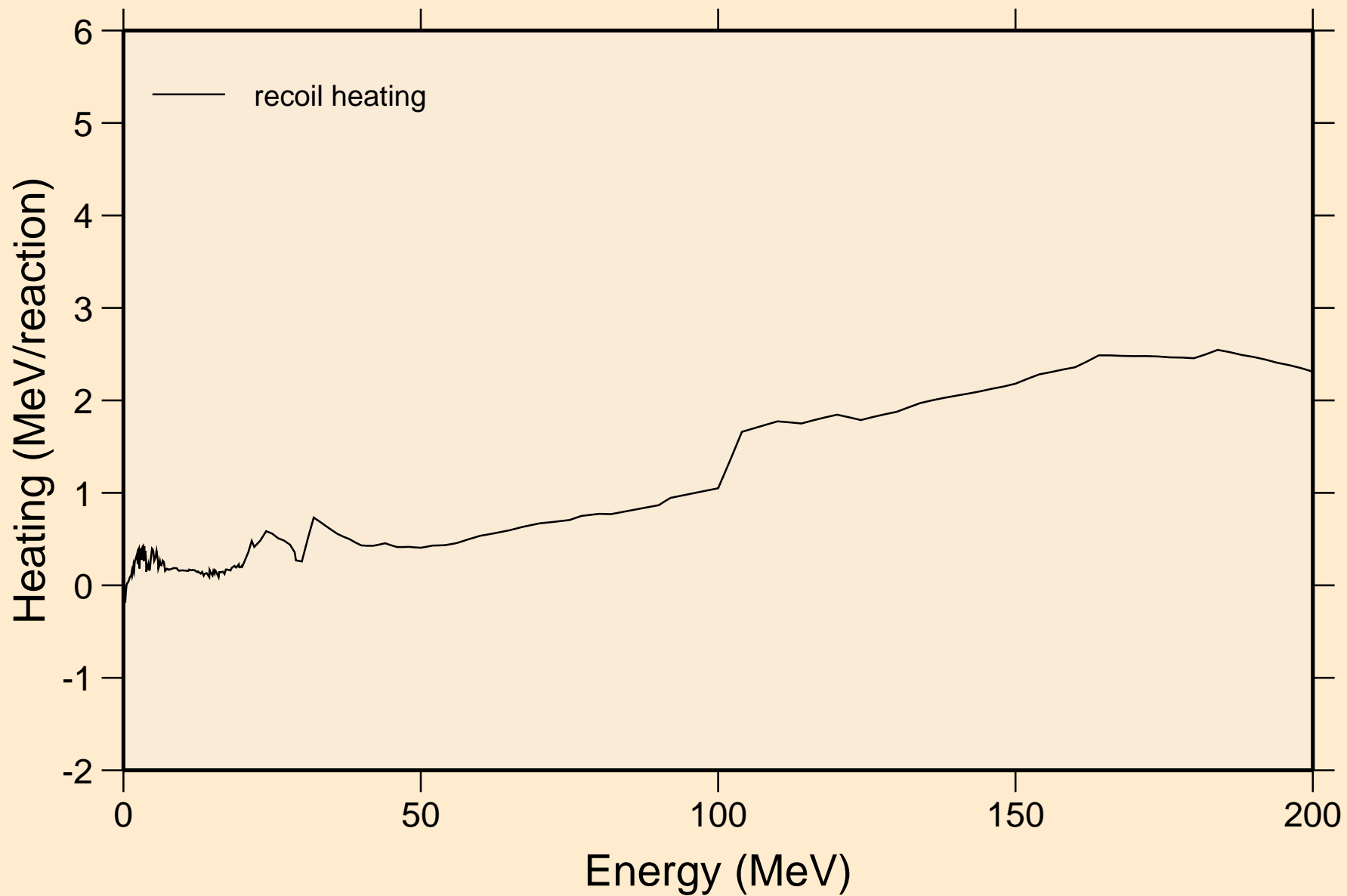

SN101 NEUTRON ACER TENDL-2019 LIBRARY; T=293.16K

Particle production cross sections

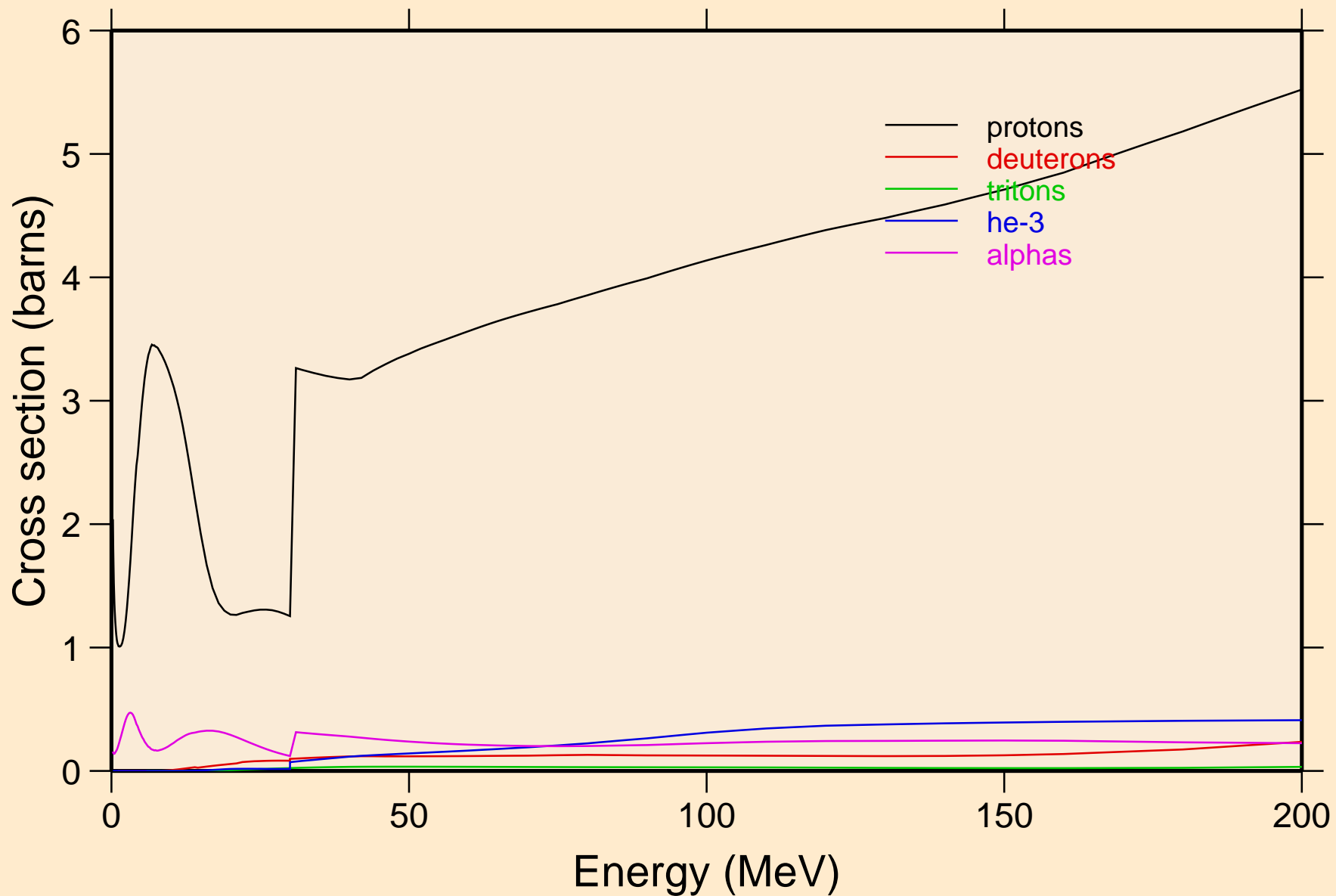

SN101 NEUTRON ACER TENDL-2019 LIBRARY; T=293.16K
protons from (n,x)

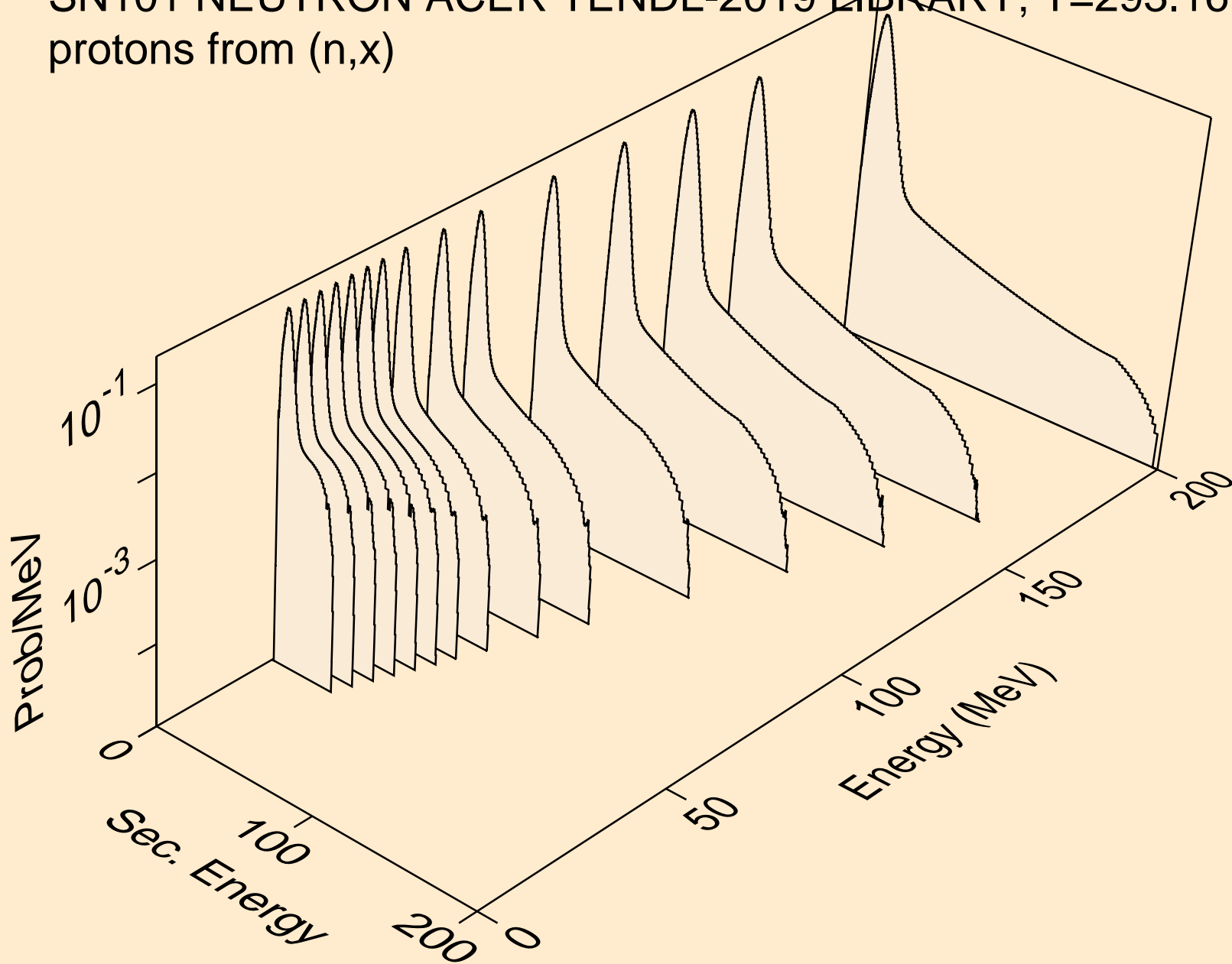

SN101 NEUTRON ACER TENDL-2019 LIBRARY; T=293.16K
protons from (n,n*)p

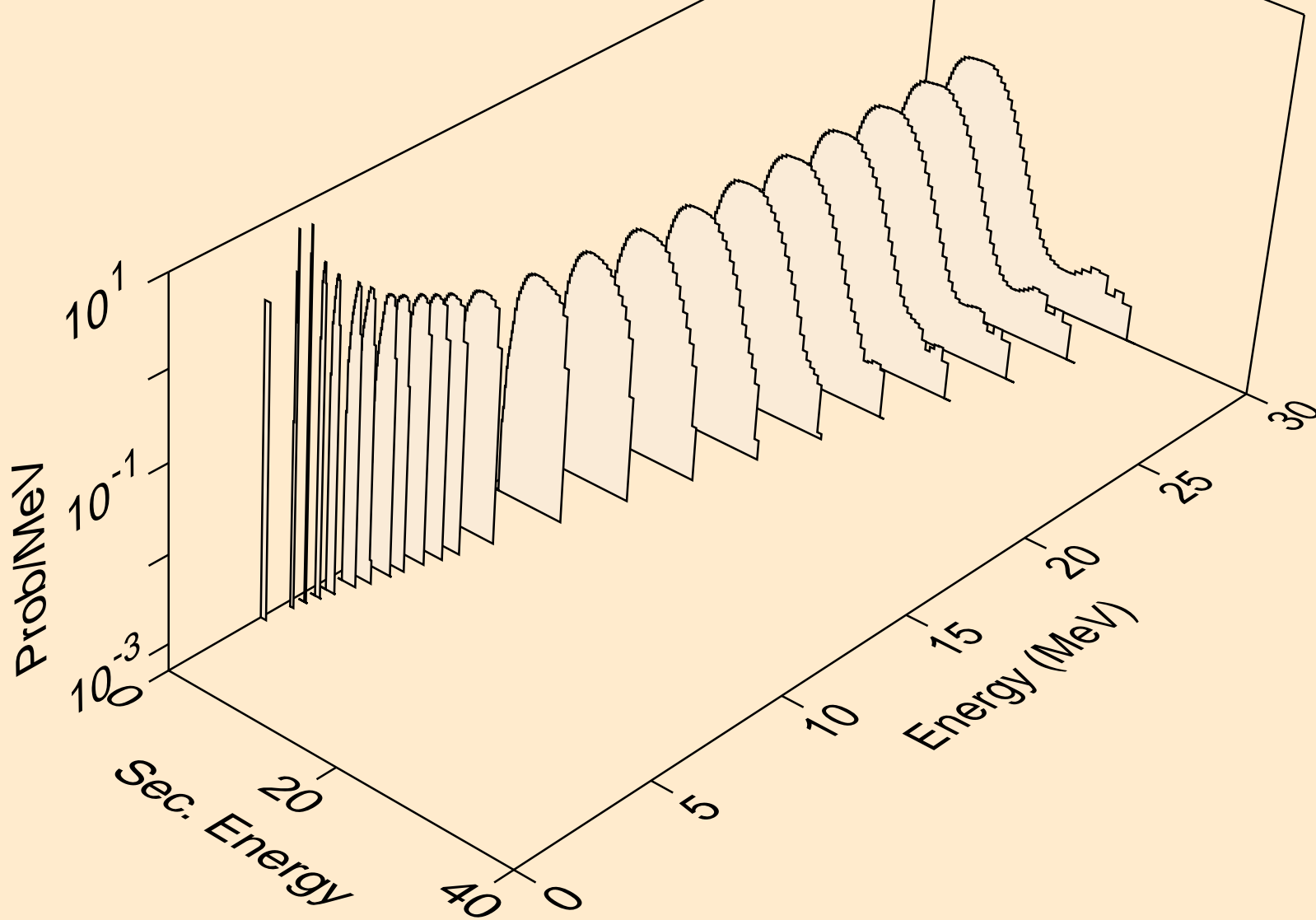

SN101 NEUTRON ACER TENDL-2019 LIBRARY; T=293.16K
protons from (n,2np)

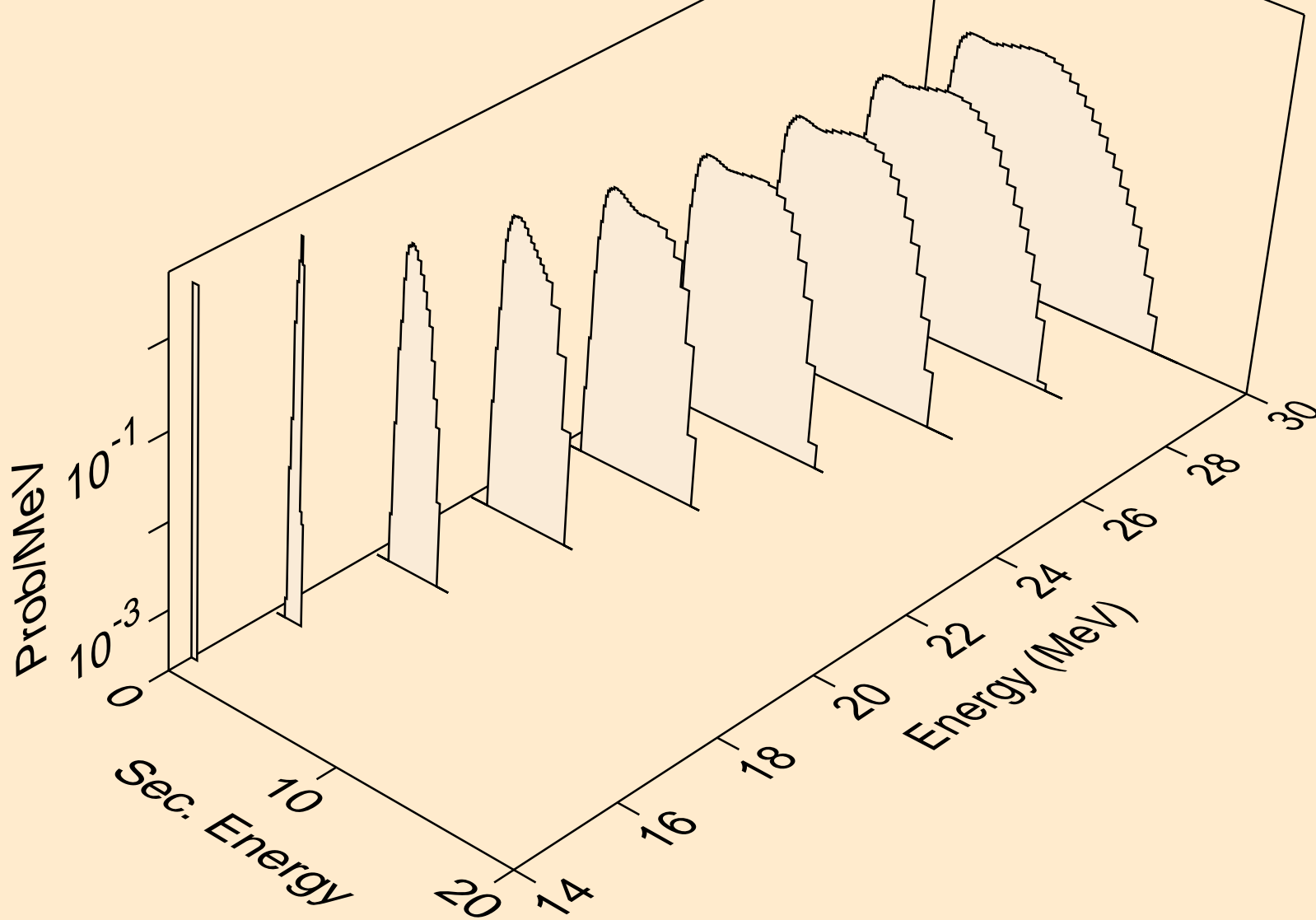

SN101 NEUTRON ACER TENDL-2019 LIBRARY; T=293.16K
protons from (n,2np)

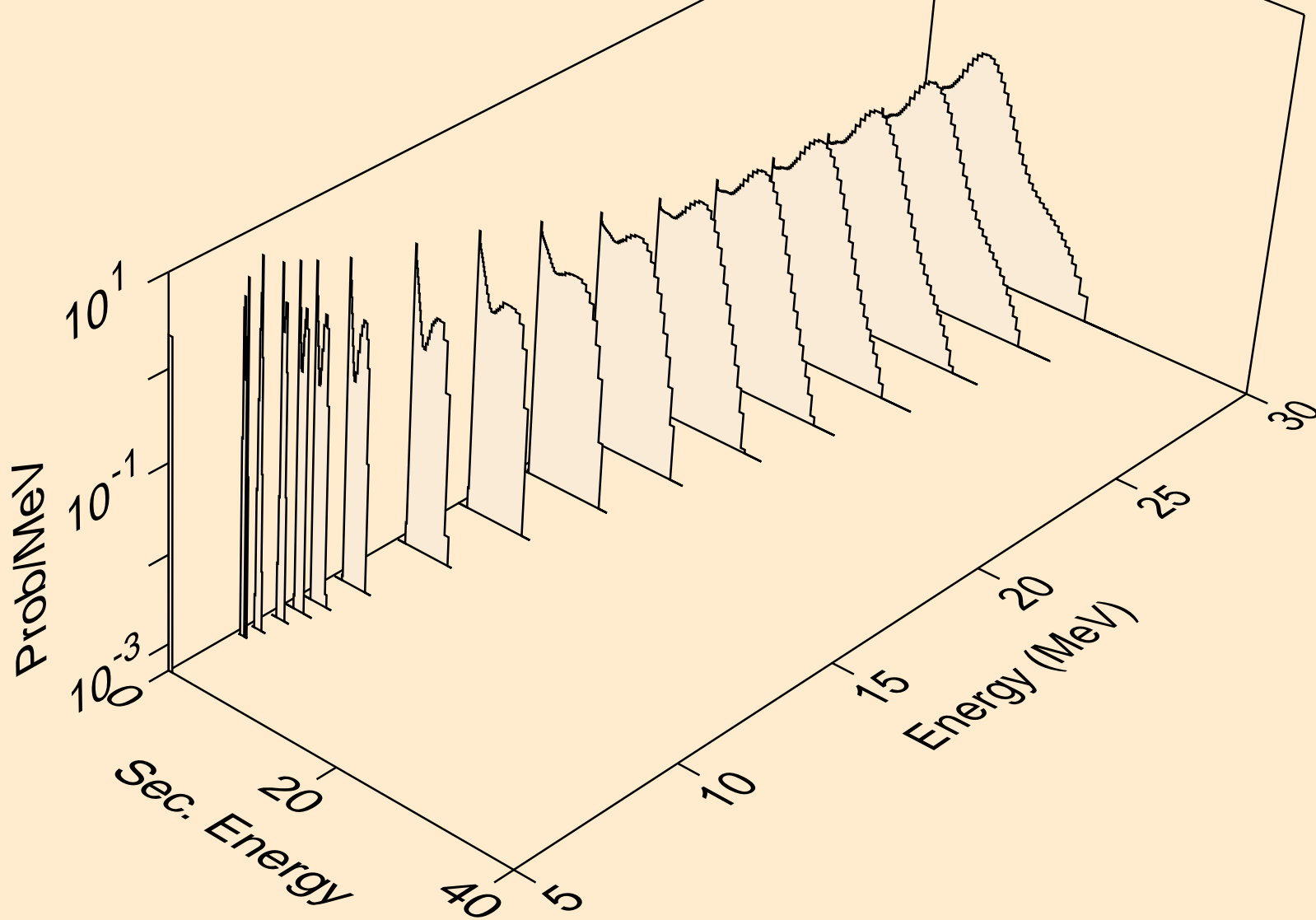

SN101 NEUTRON ACER TENDL-2019 LIBRARY; T=293.16K
protons from (n,npa)

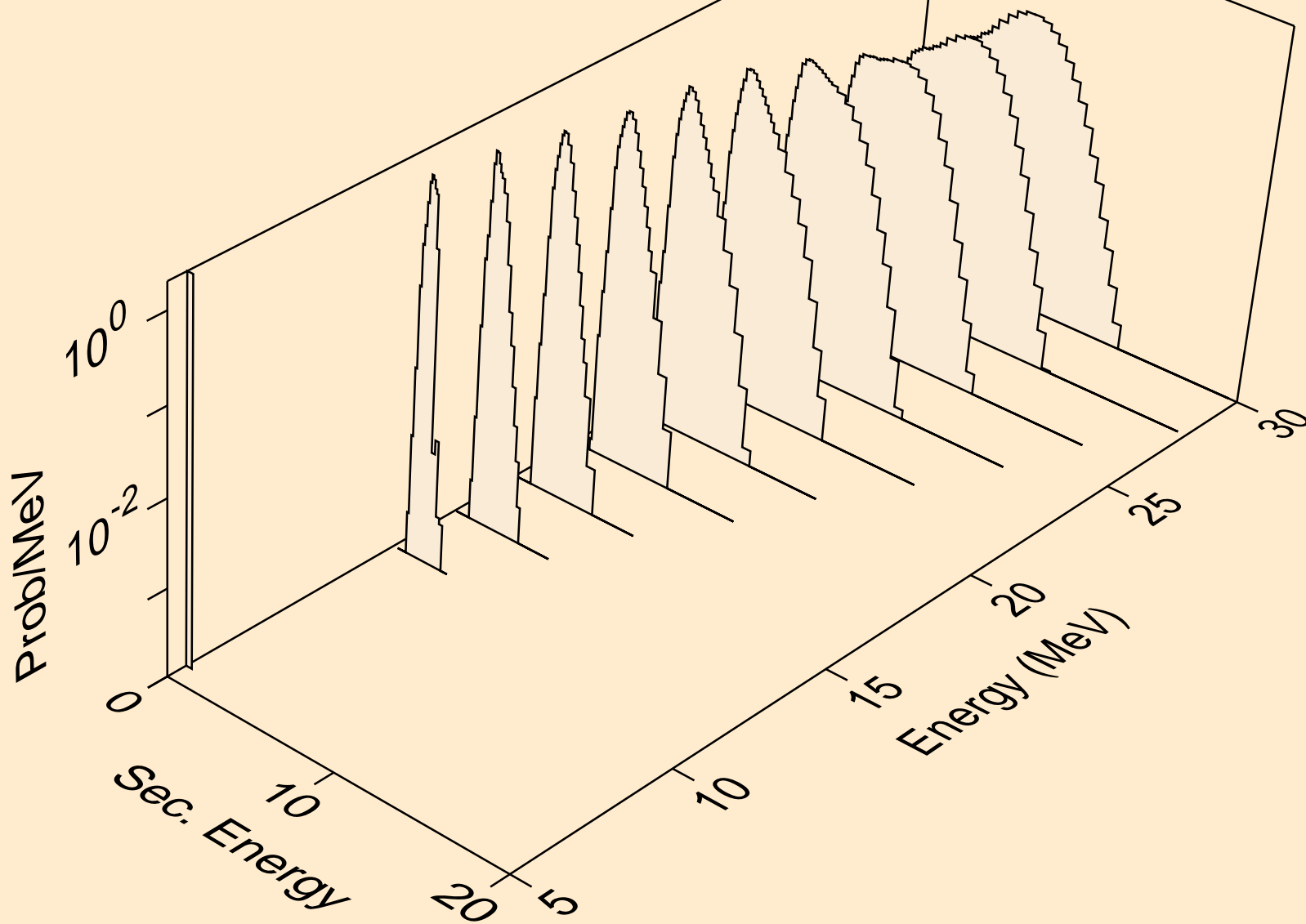

SN101 NEUTRON ACER TENDL-2019 LIBRARY; T=293.16K
protons from (n,p)

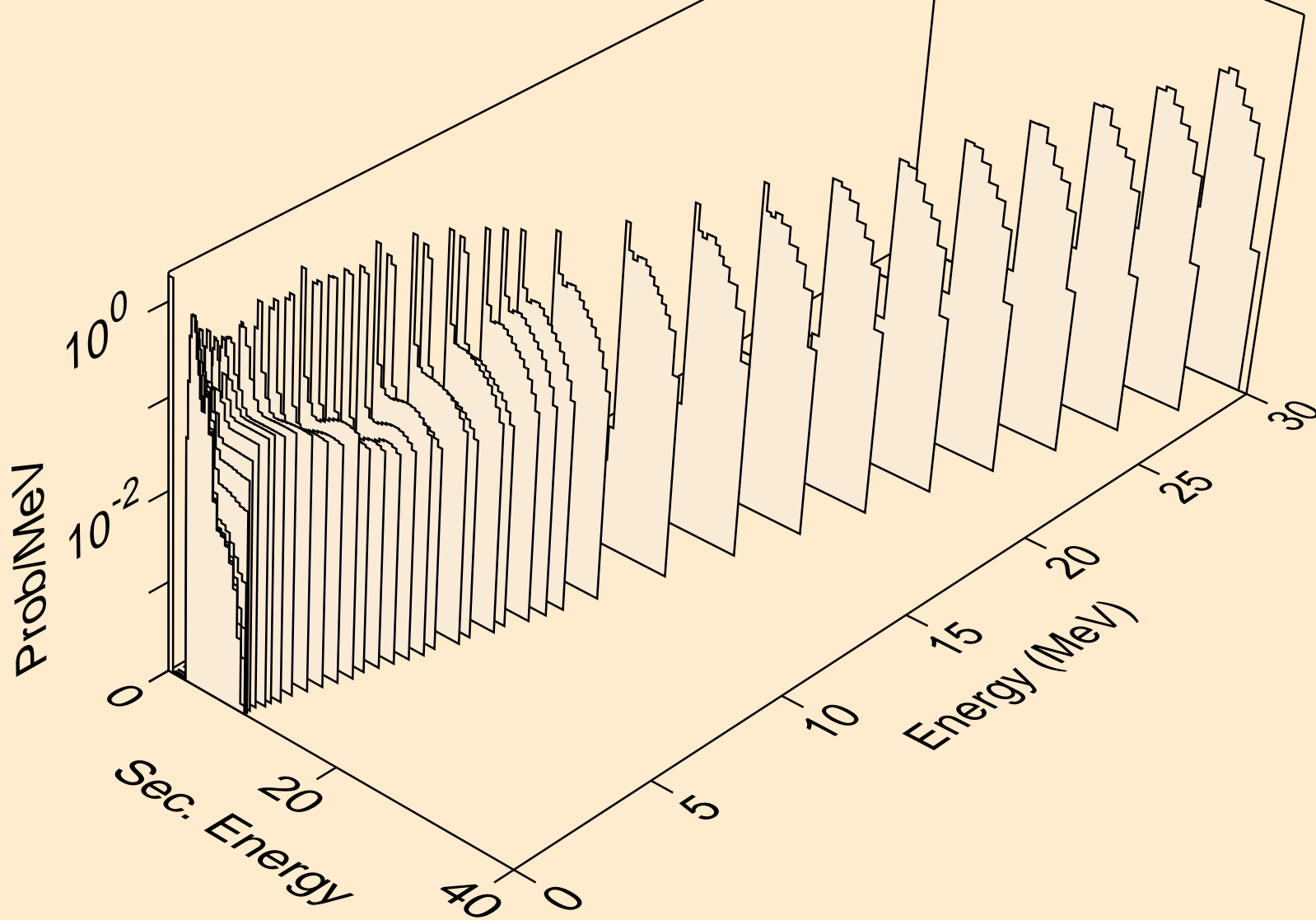

SN101 NEUTRON ACER TENDL-2019 LIBRARY; T=293.16K
protons from (n,2p)

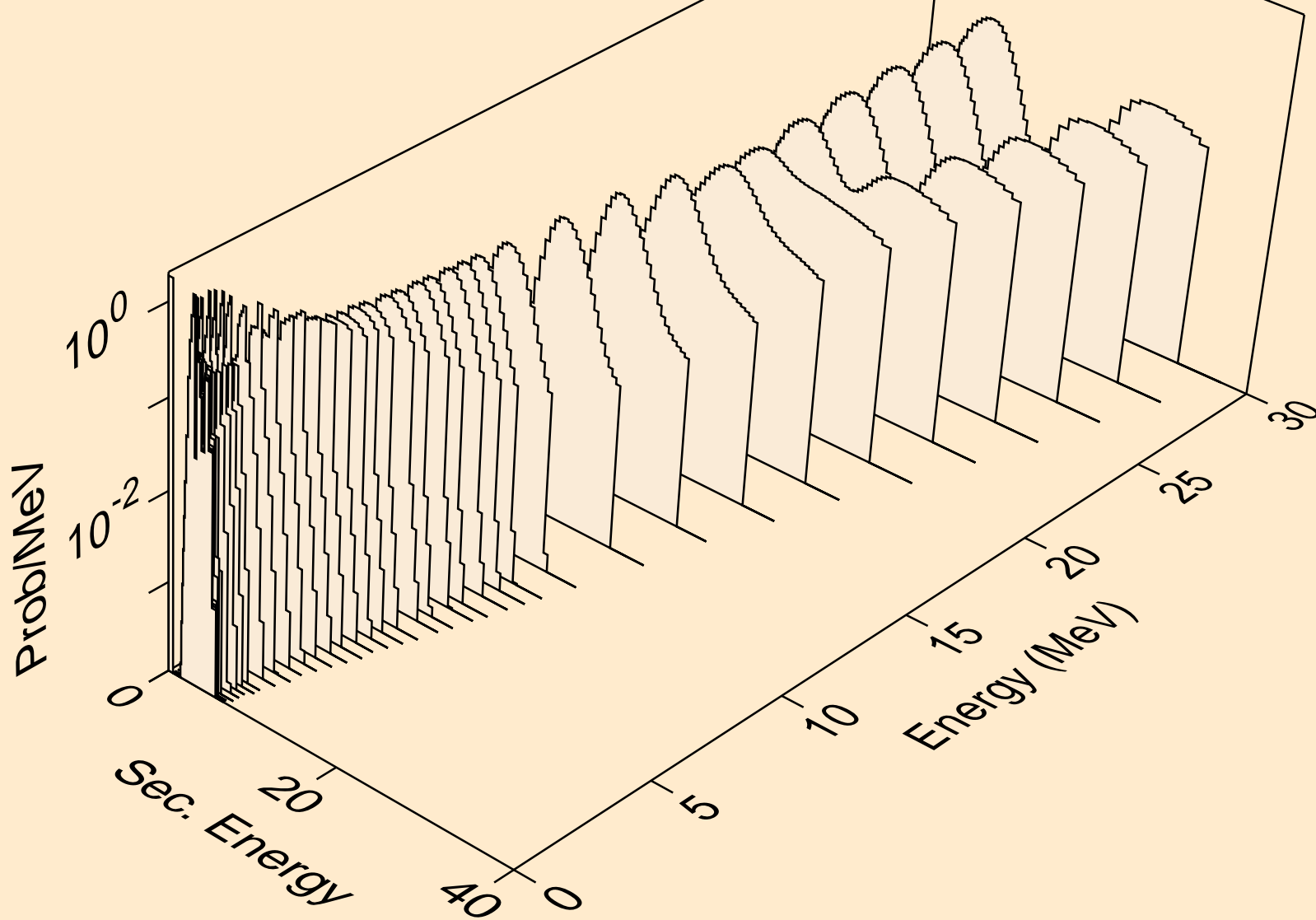

SN101 NEUTRON ACER TENDL-2019 LIBRARY; T=293.16K
protons from (n,p)

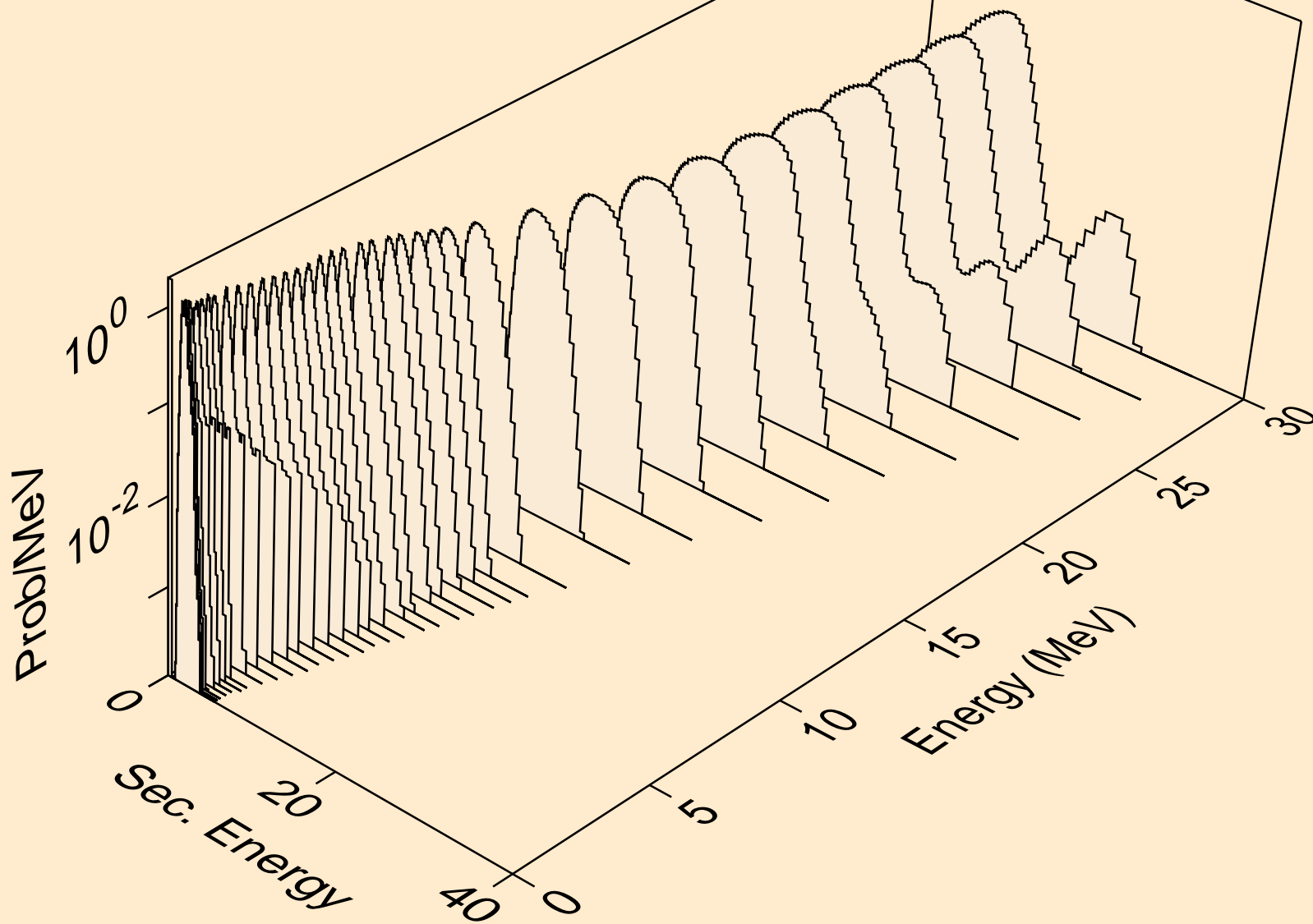

SN101 NEUTRON ACER TENDL-2019 LIBRARY; T=293.16K
protons from (n,pd)

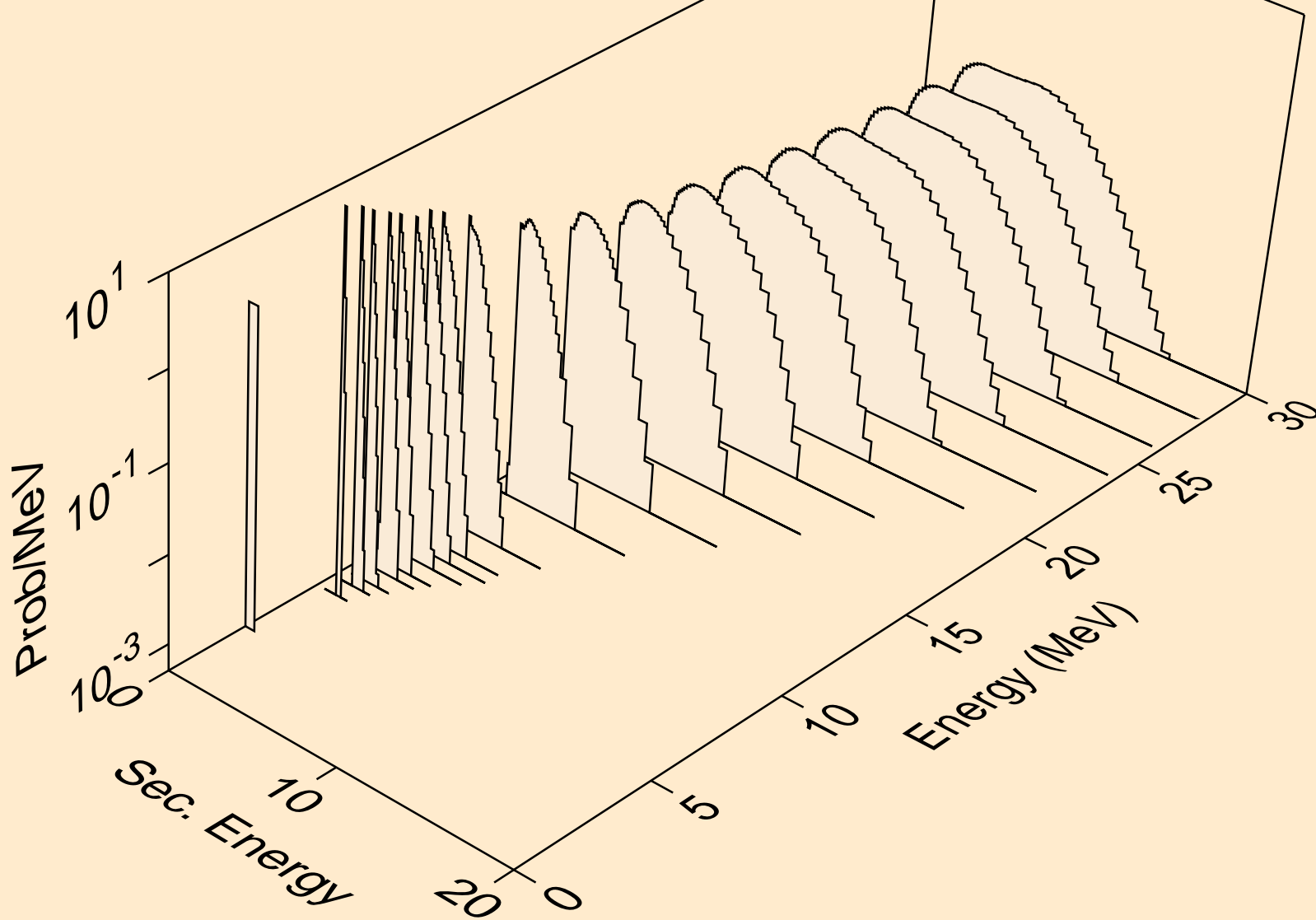

SN101 NEUTRON ACER TENDL-2019 LIBRARY; T=293.16K
protons from (n,pt)

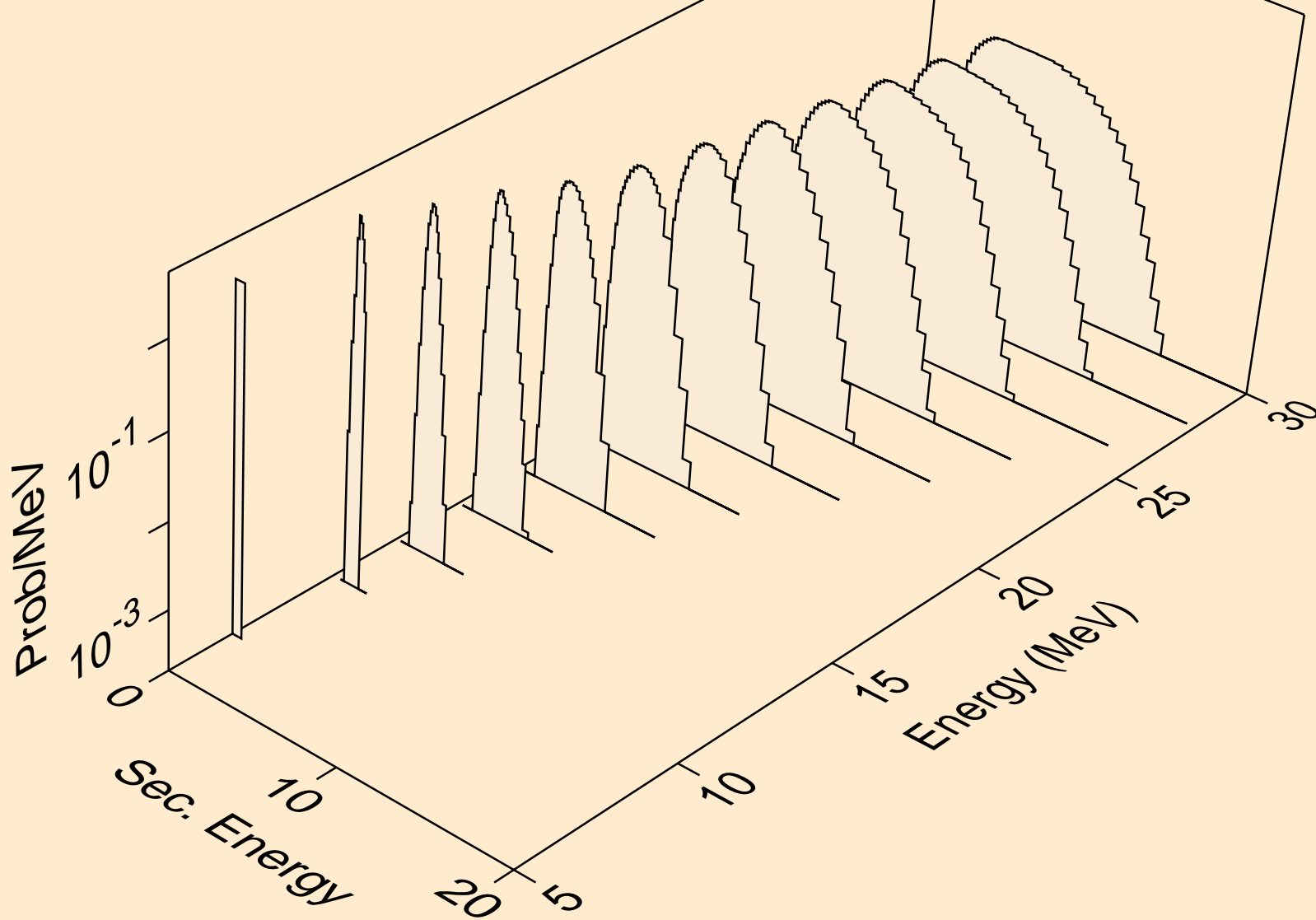

SN101 NEUTRON ACER TENDL-2019 LIBRARY; T=293.16K
deuterons from (n,x)

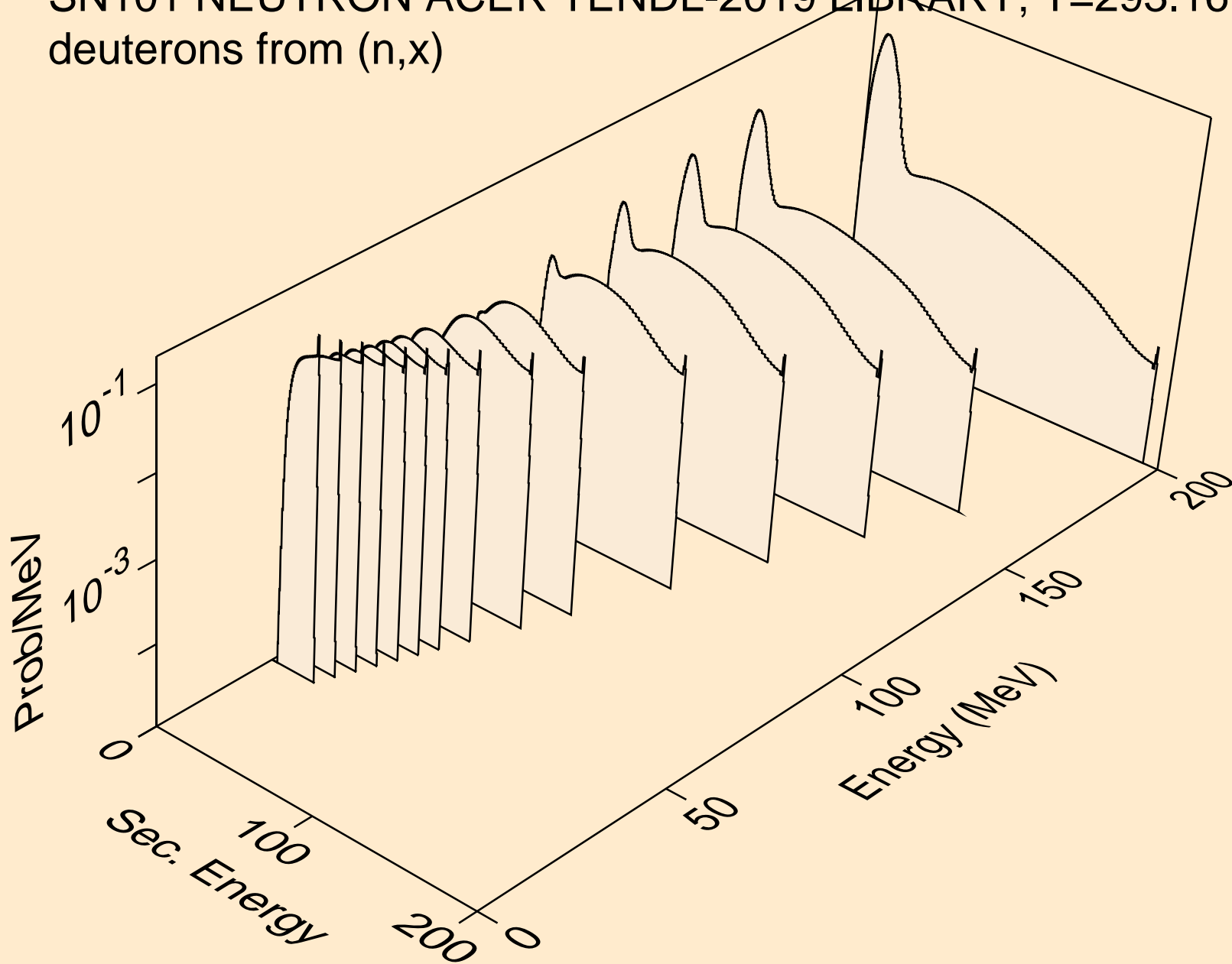

SN101 NEUTRON ACER TENDL-2019 LIBRARY; T=293.16K
deuterons from (n,n*)d

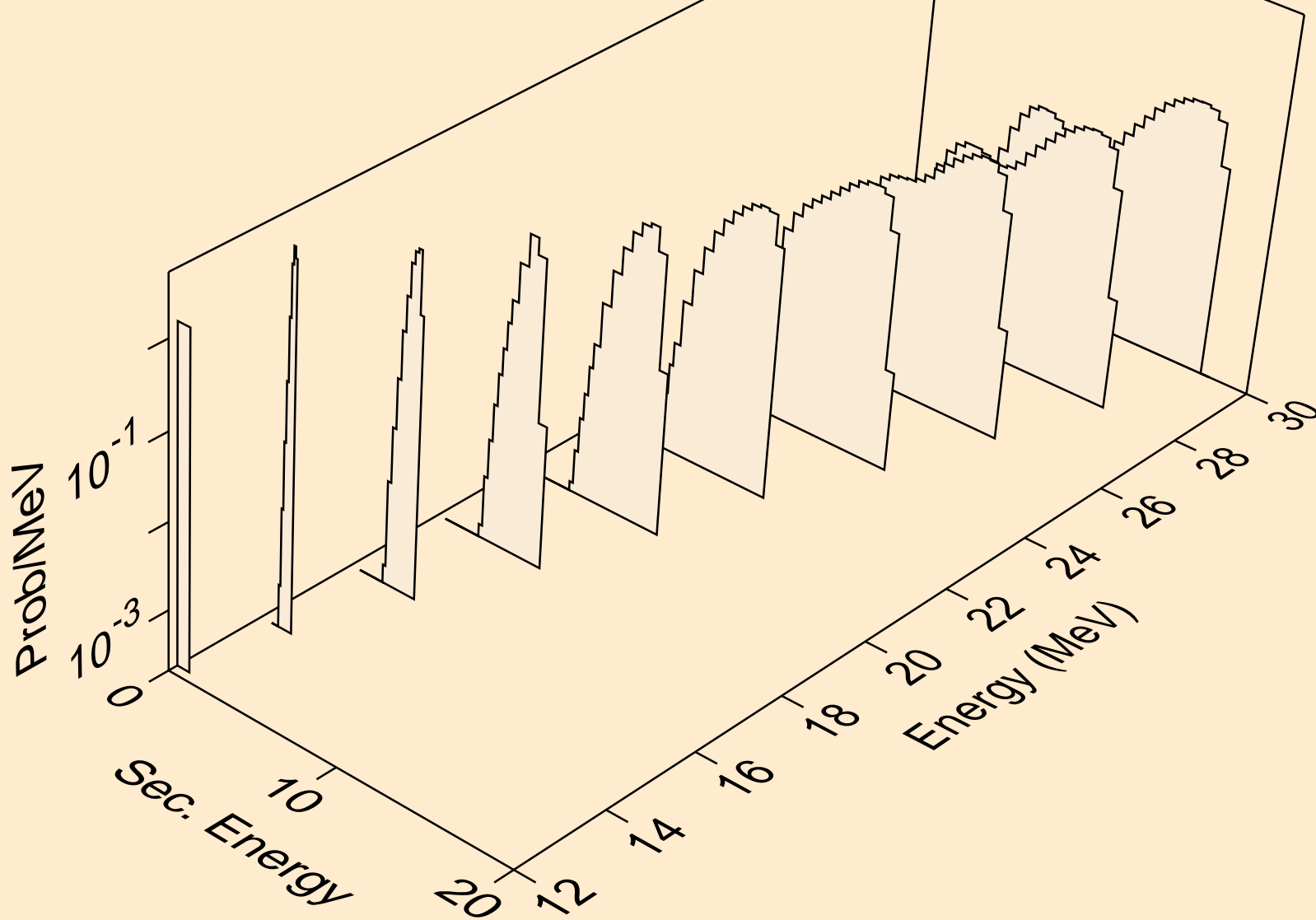

SN101 NEUTRON ACER TENDL-2019 LIBRARY; T=293.16K
deuterons from (n,d)

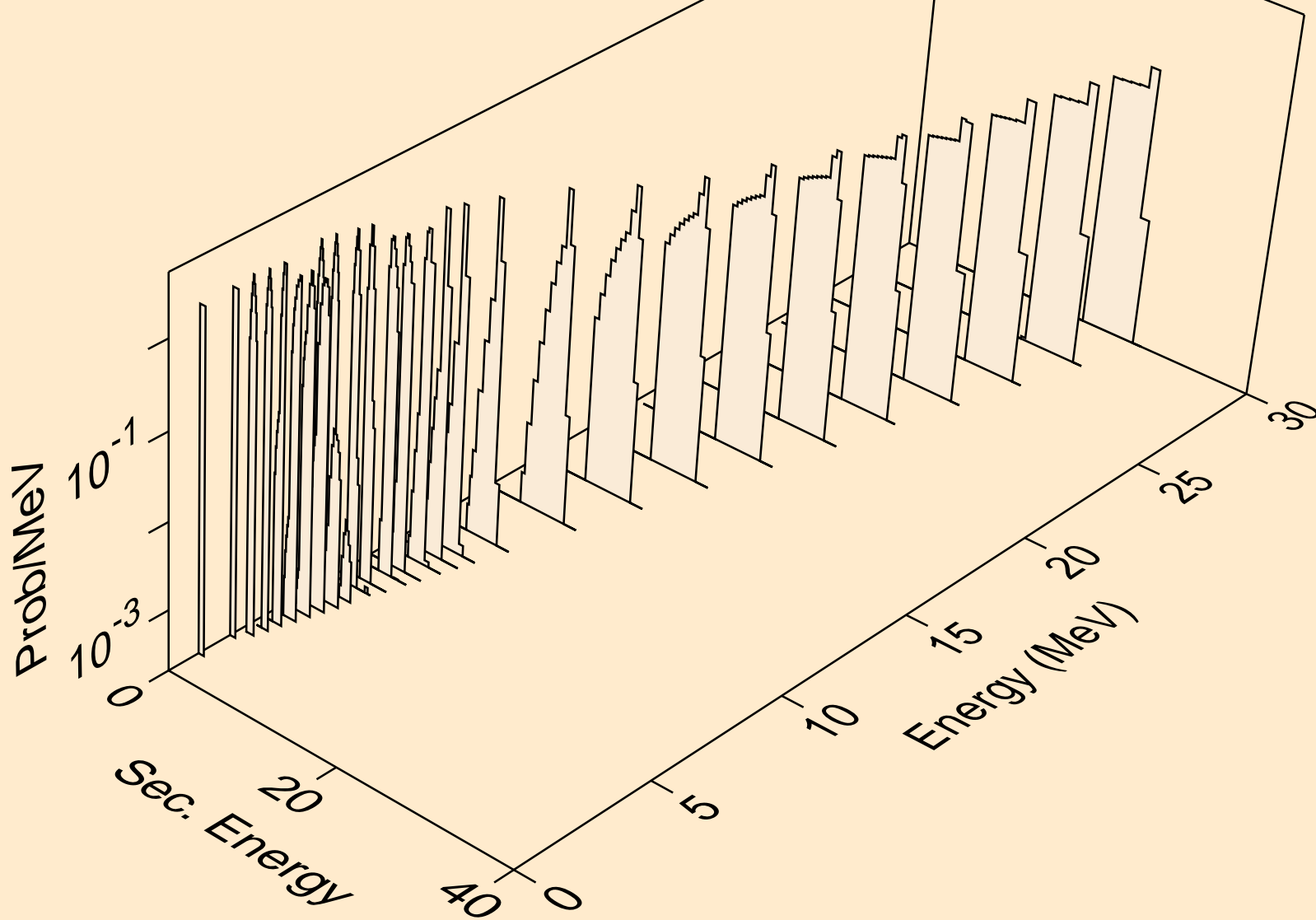

SN101 NEUTRON ACER TENDL-2019 LIBRARY; T=293.16K
deuterons from (n,pd)

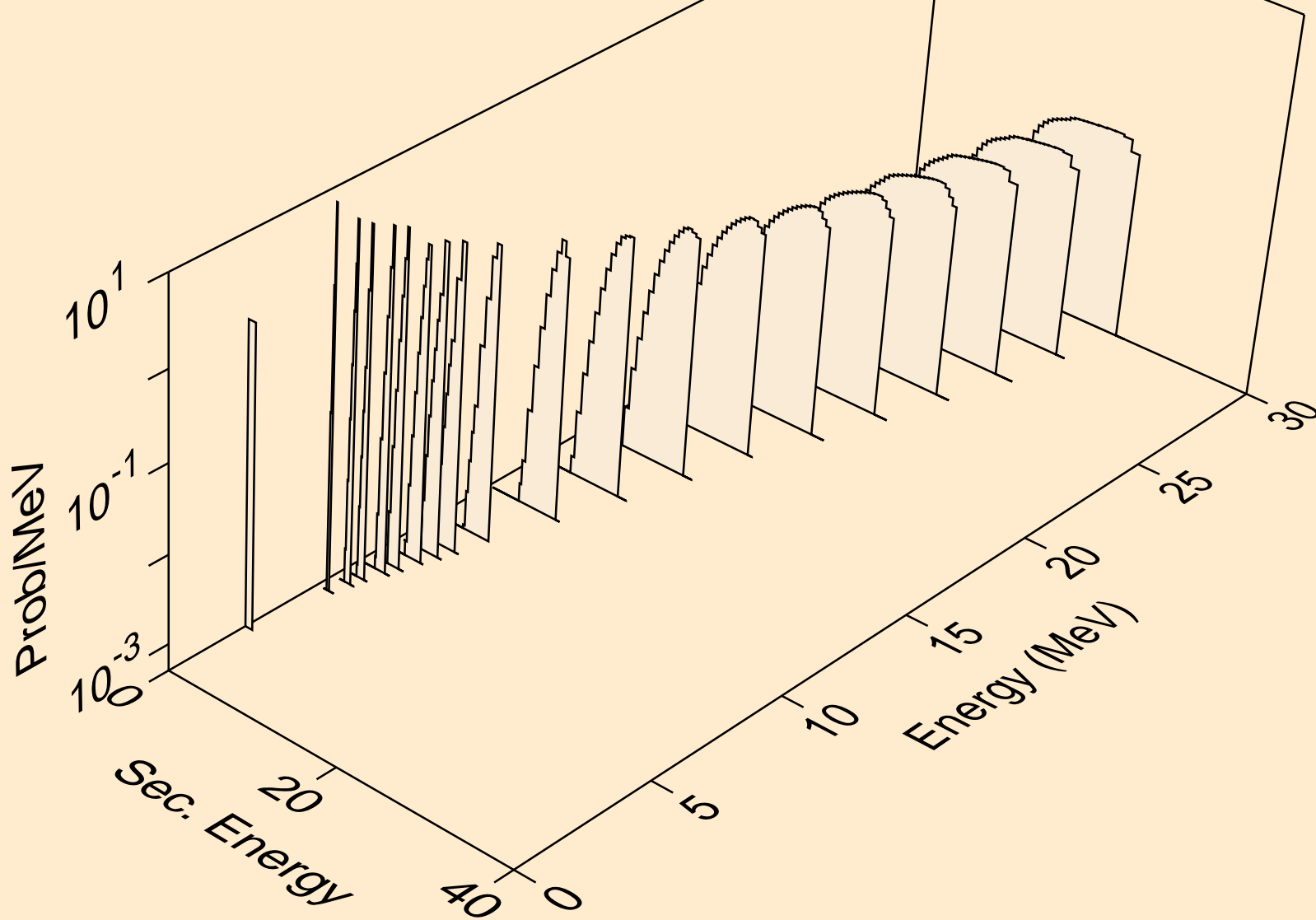

SN101 NEUTRON ACER TENDL-2019 LIBRARY; T=293.16K
deuterons from (n,da)

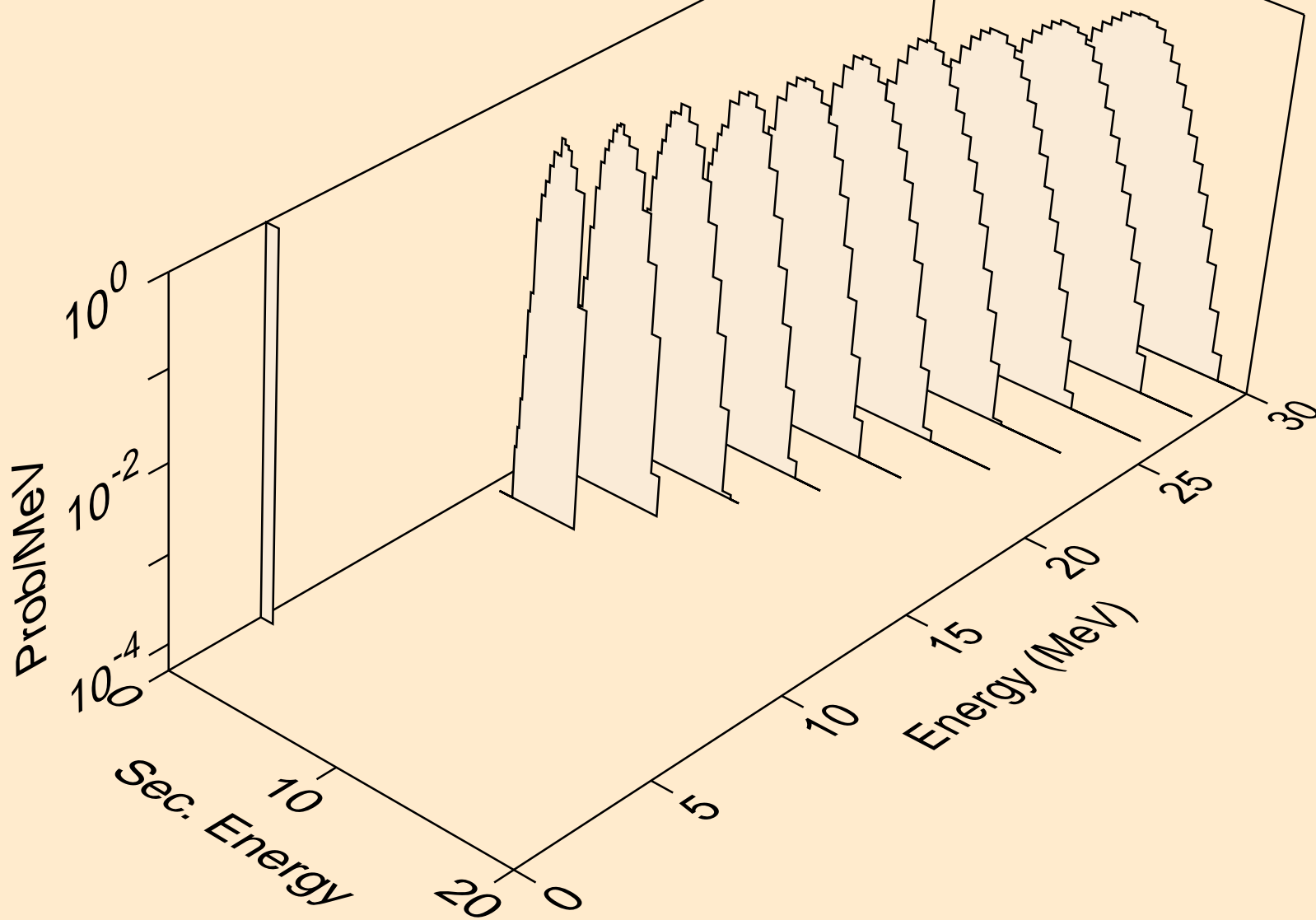

SN101 NEUTRON ACER TENDL-2019 LIBRARY; T=293.16K
tritons from (n,x)

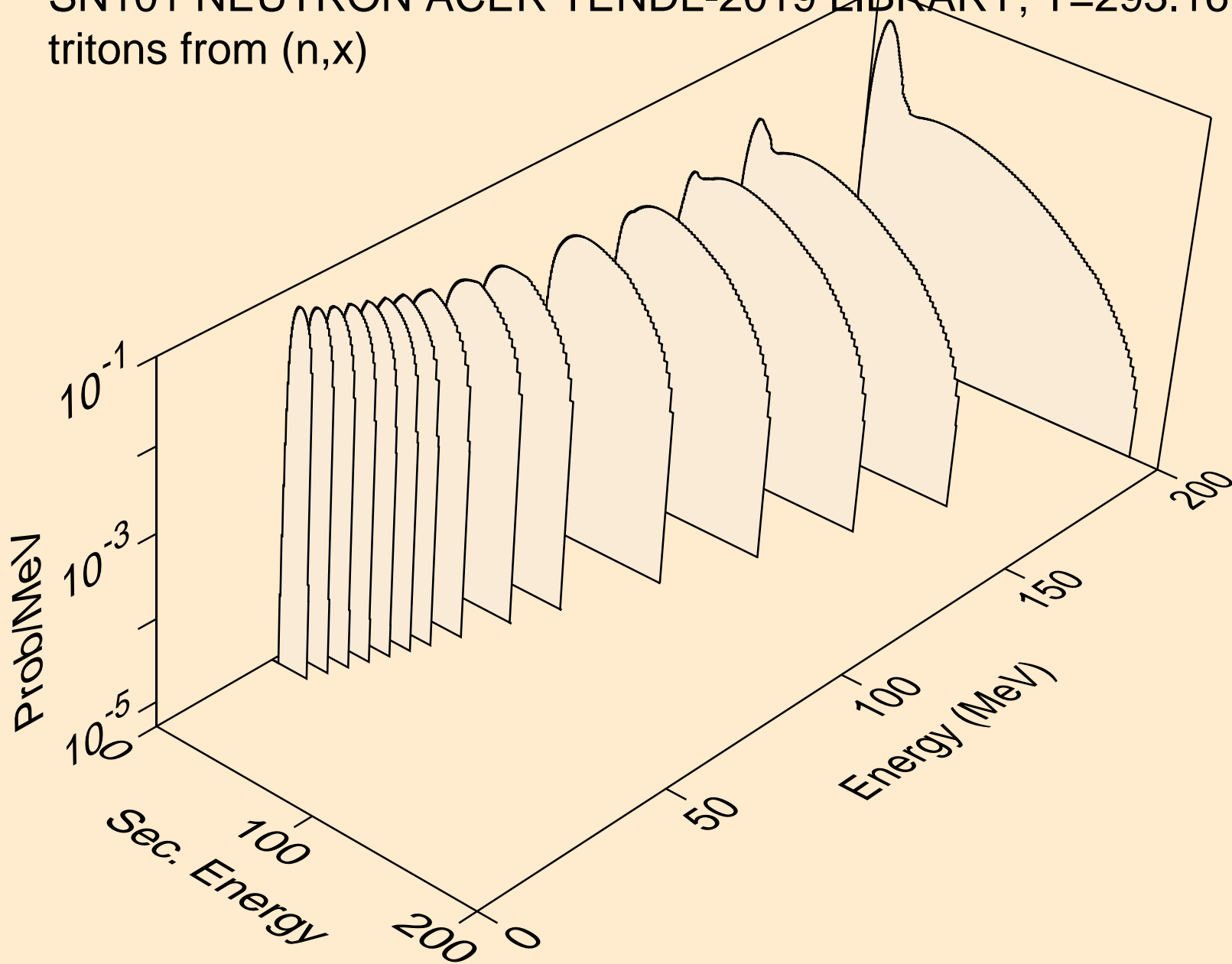

SN101 NEUTRON ACER TENDL-2019 LIBRARY; T=293.16K
tritons from (n,n*)t

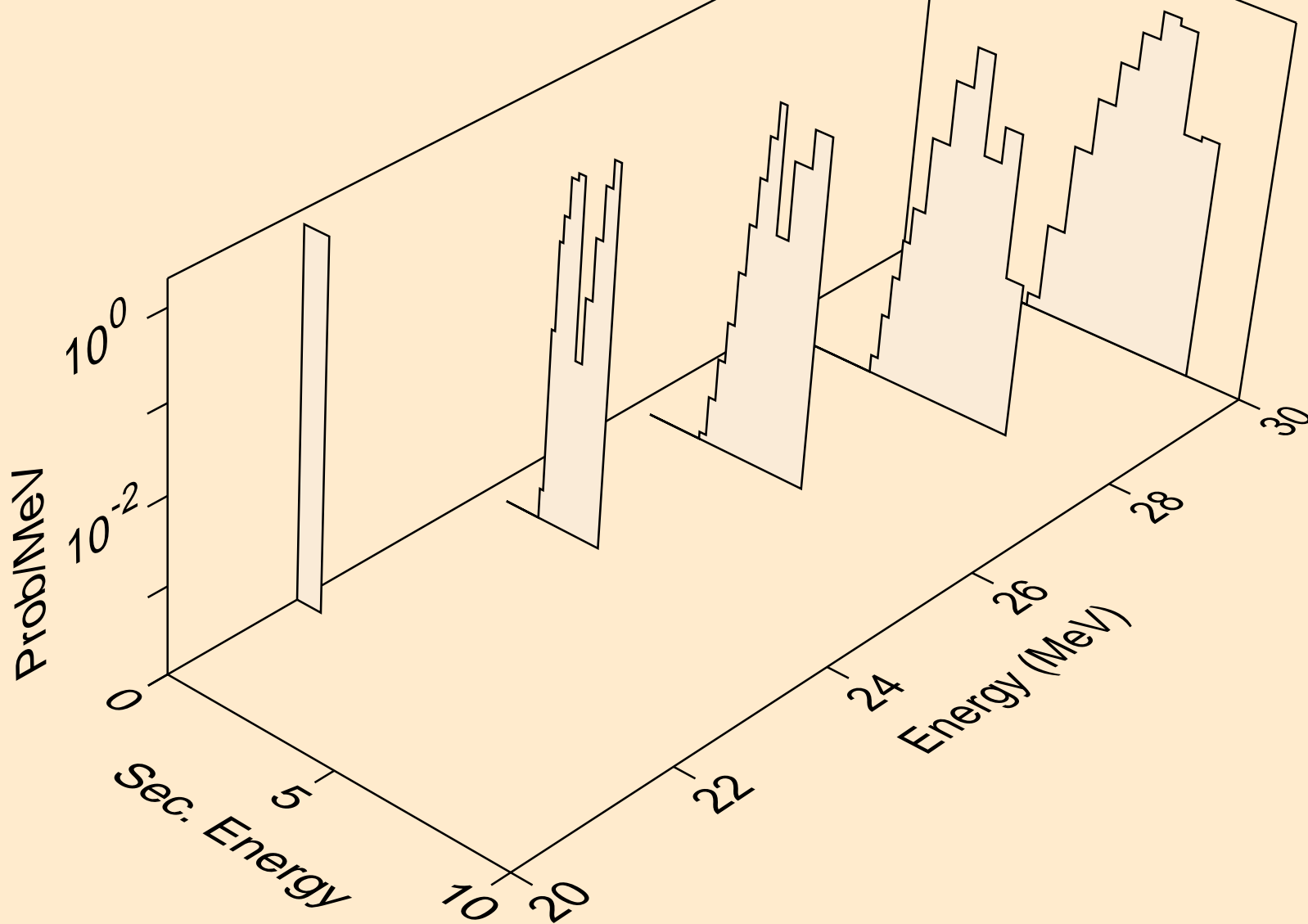

SN101 NEUTRON ACER TENDL-2019 LIBRARY; T=293.16K
tritons from (n,t)

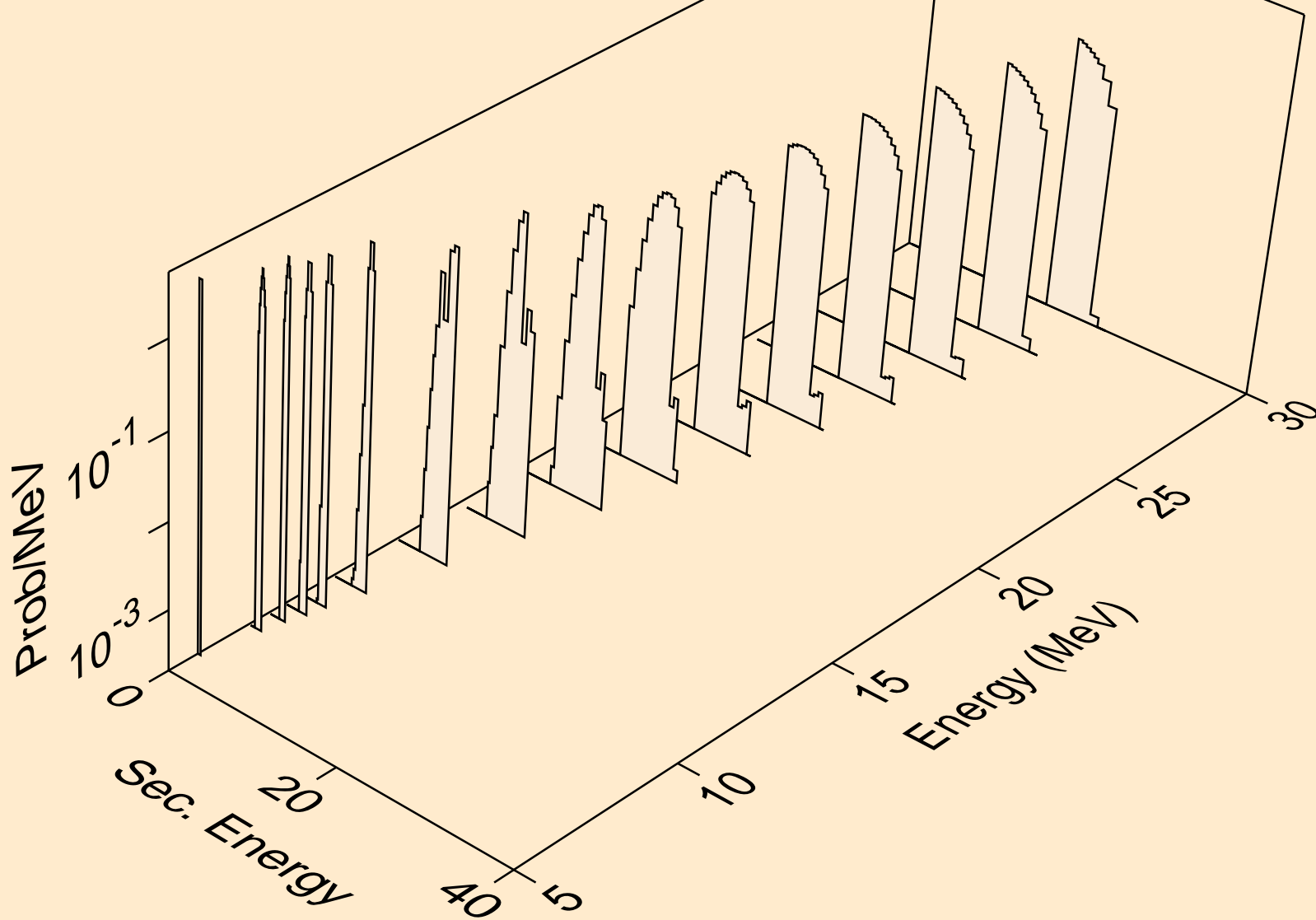

SN101 NEUTRON ACER TENDL-2019 LIBRARY; T=293.16K
tritons from (n,pt)

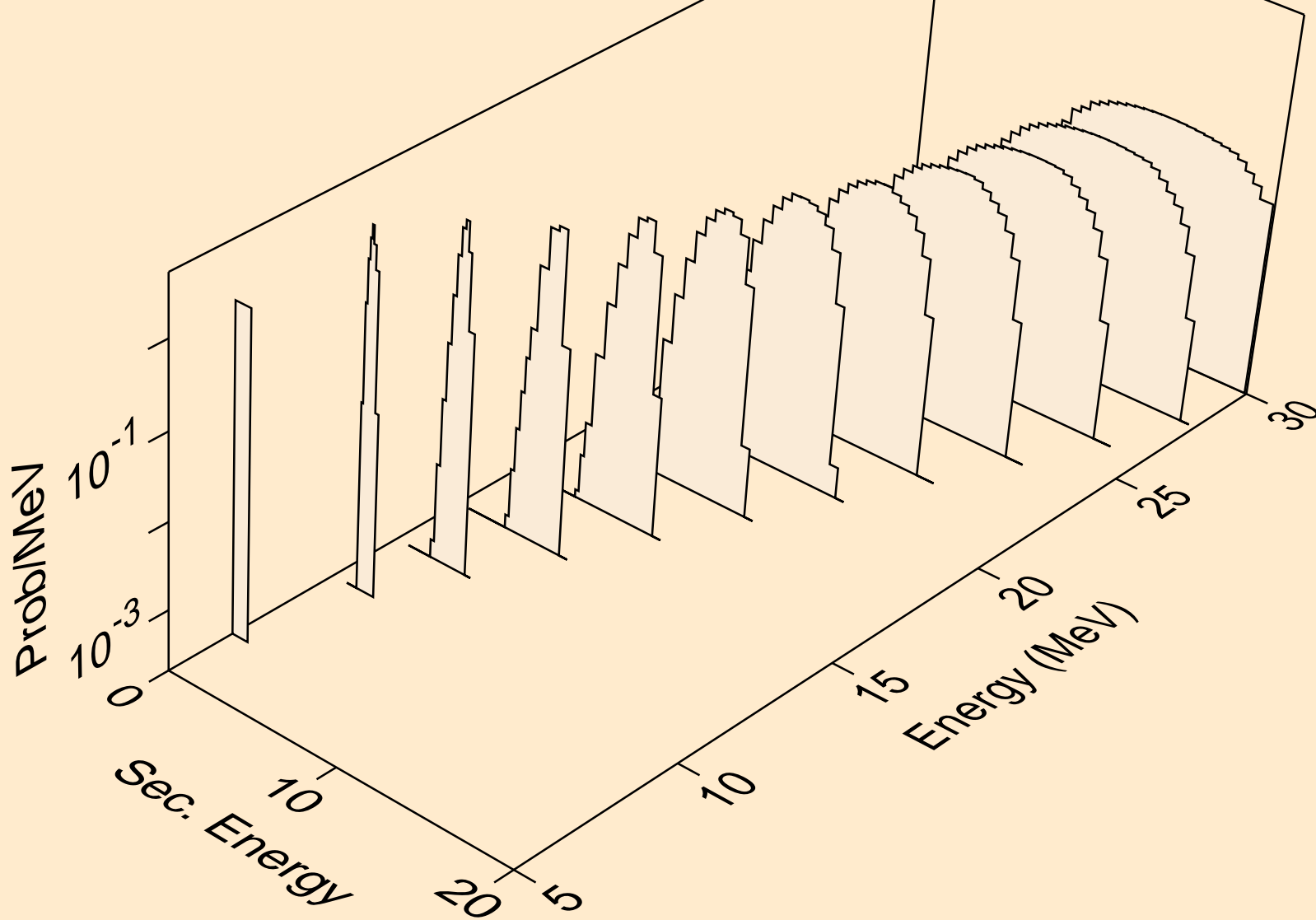

SN101 NEUTRON ACER TENDL-2019 LIBRARY; T=293.16K
he3s from (n,x)

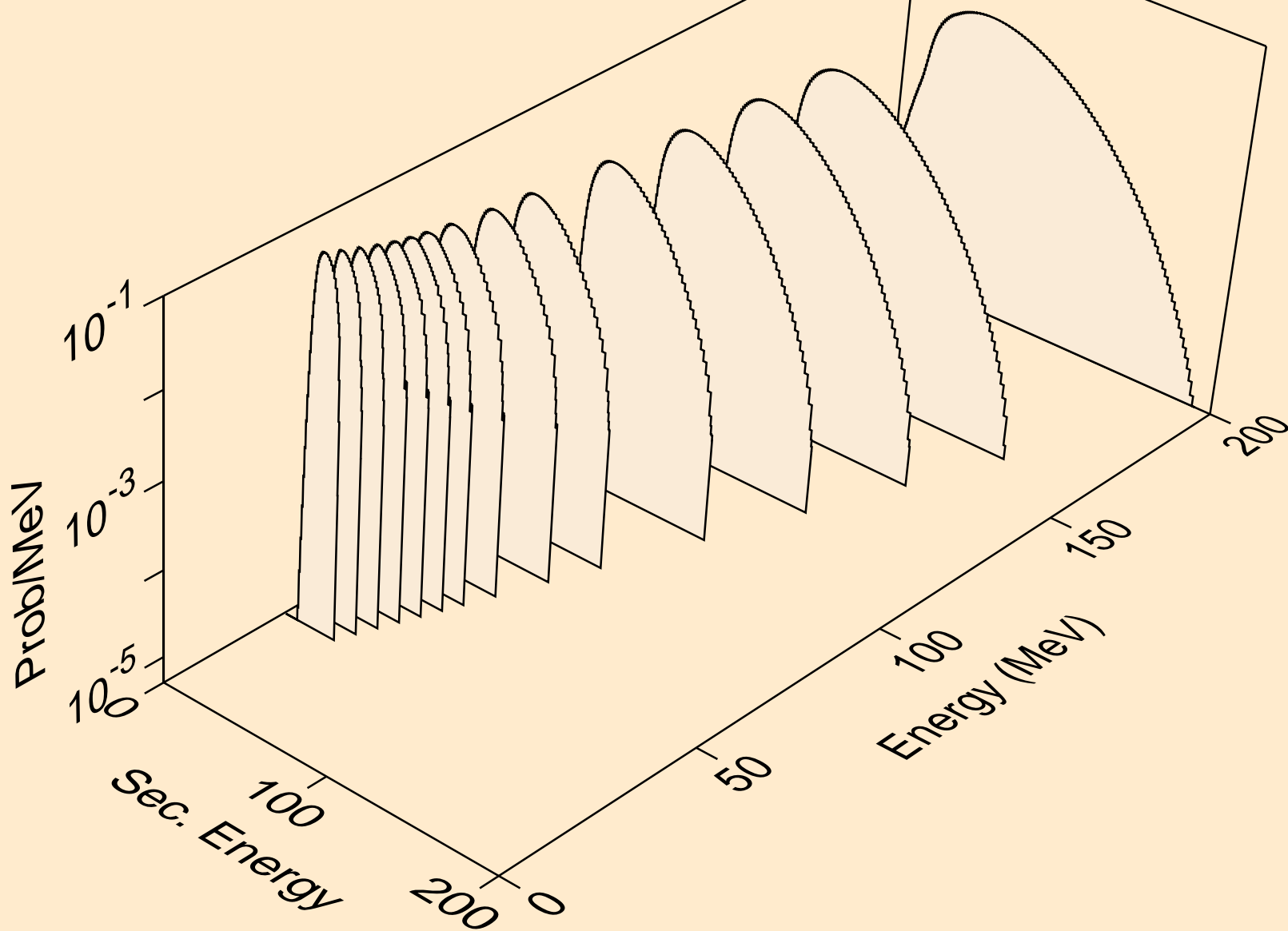

SN101 NEUTRON ACER TENDL-2019 LIBRARY; T=293.16K
he3s from (n,n*)he3

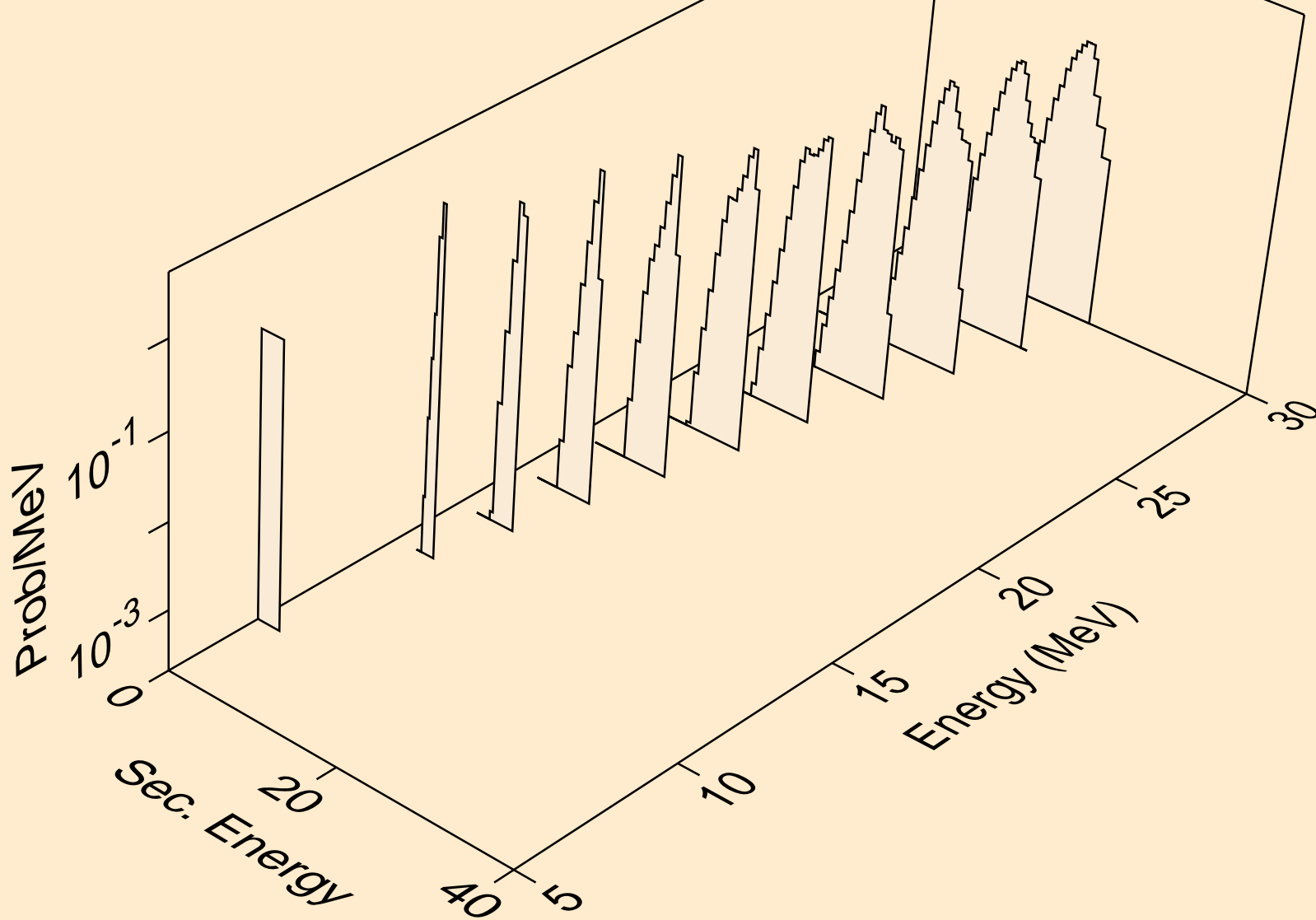

SN101 NEUTRON ACER TENDL-2019 LIBRARY; T=293.16K
he3s from (n,he3)

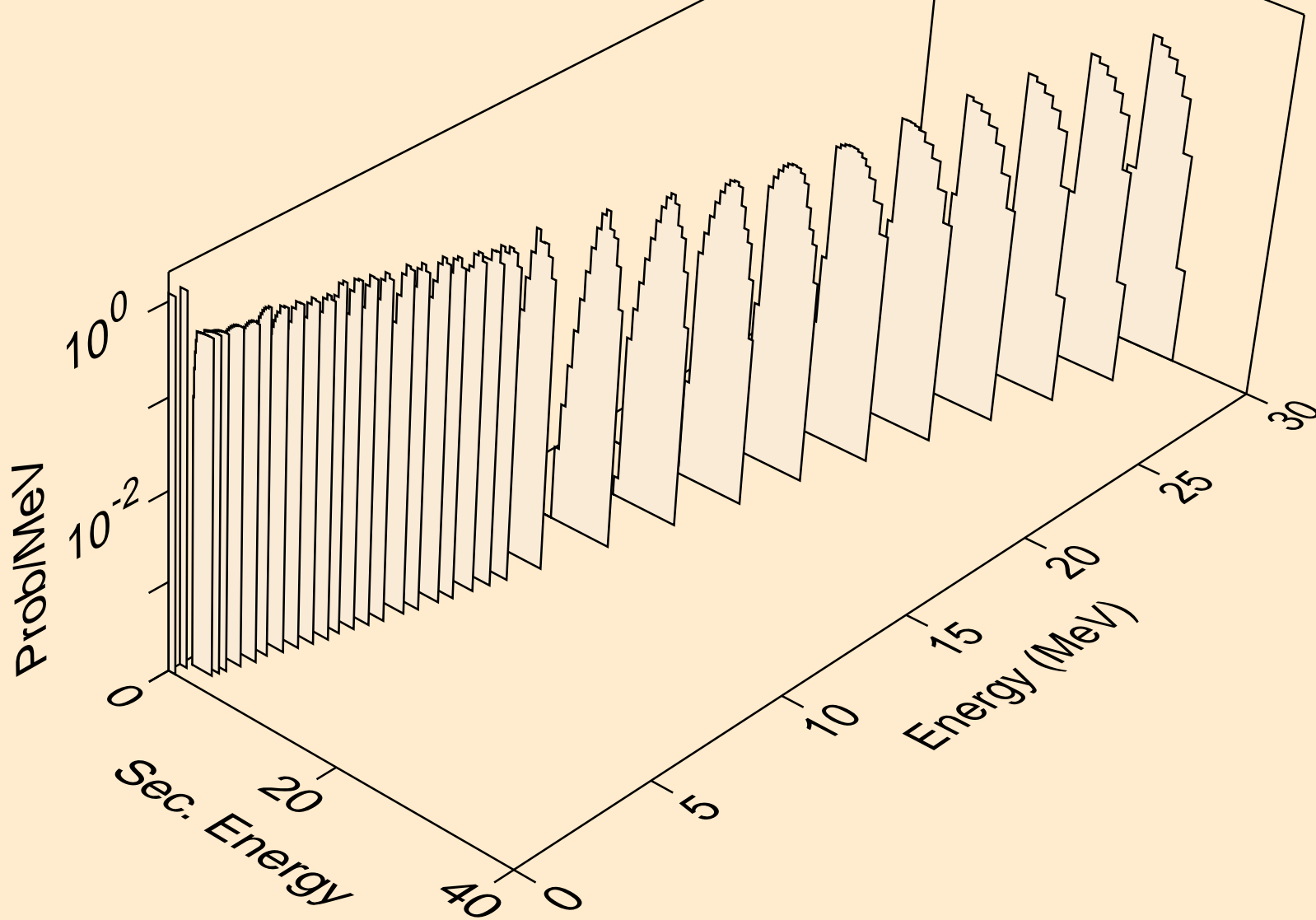

SN101 NEUTRON ACER TENDL-2019 LIBRARY; T=293.16K
alphas from (n,x)

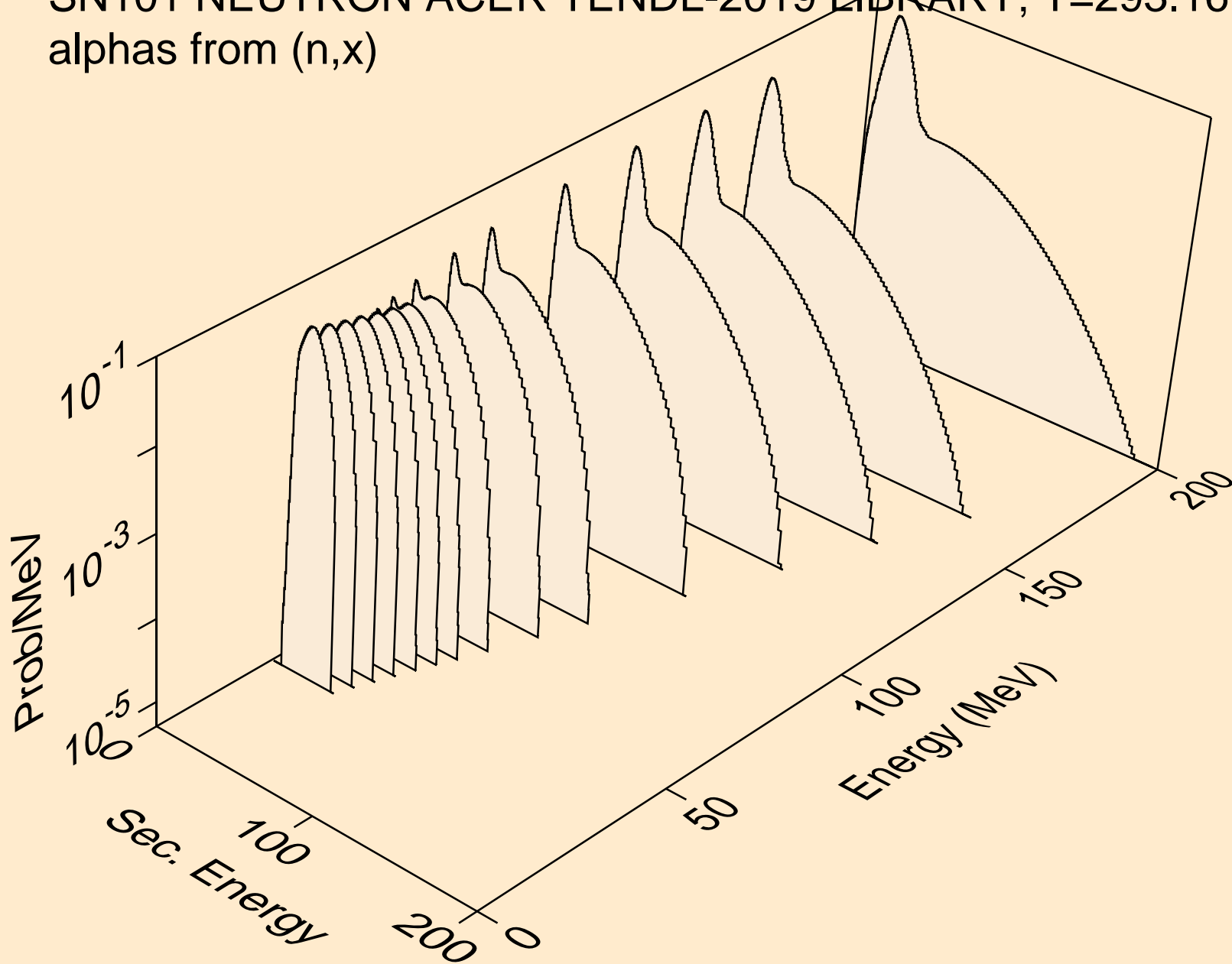

SN101 NEUTRON ACER TENDL-2019 LIBRARY; T=293.16K
alphas from (n,n*)a

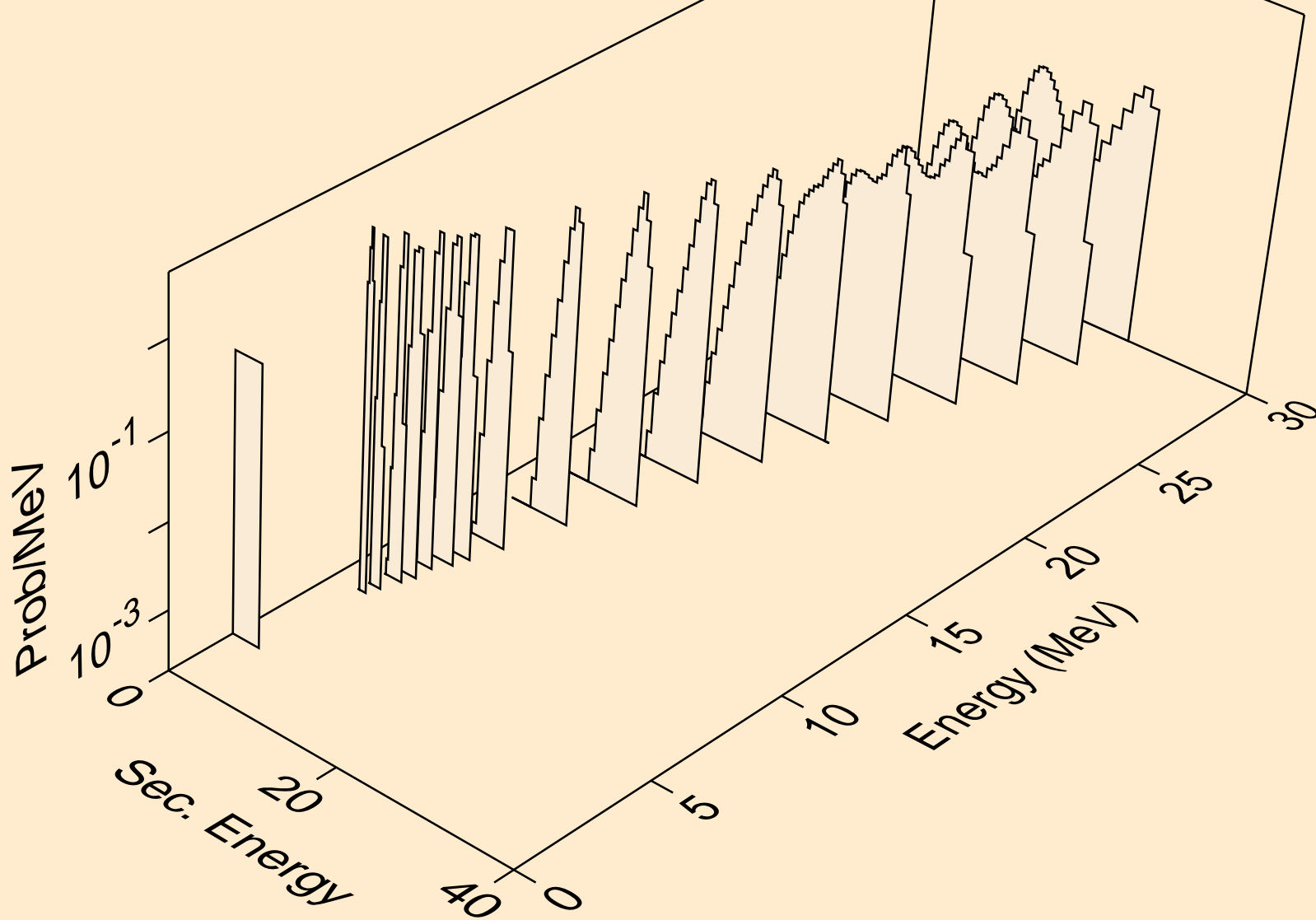

SN101 NEUTRON ACER TENDL-2019 LIBRARY; T=293.16K
alphas from (n,2n)a

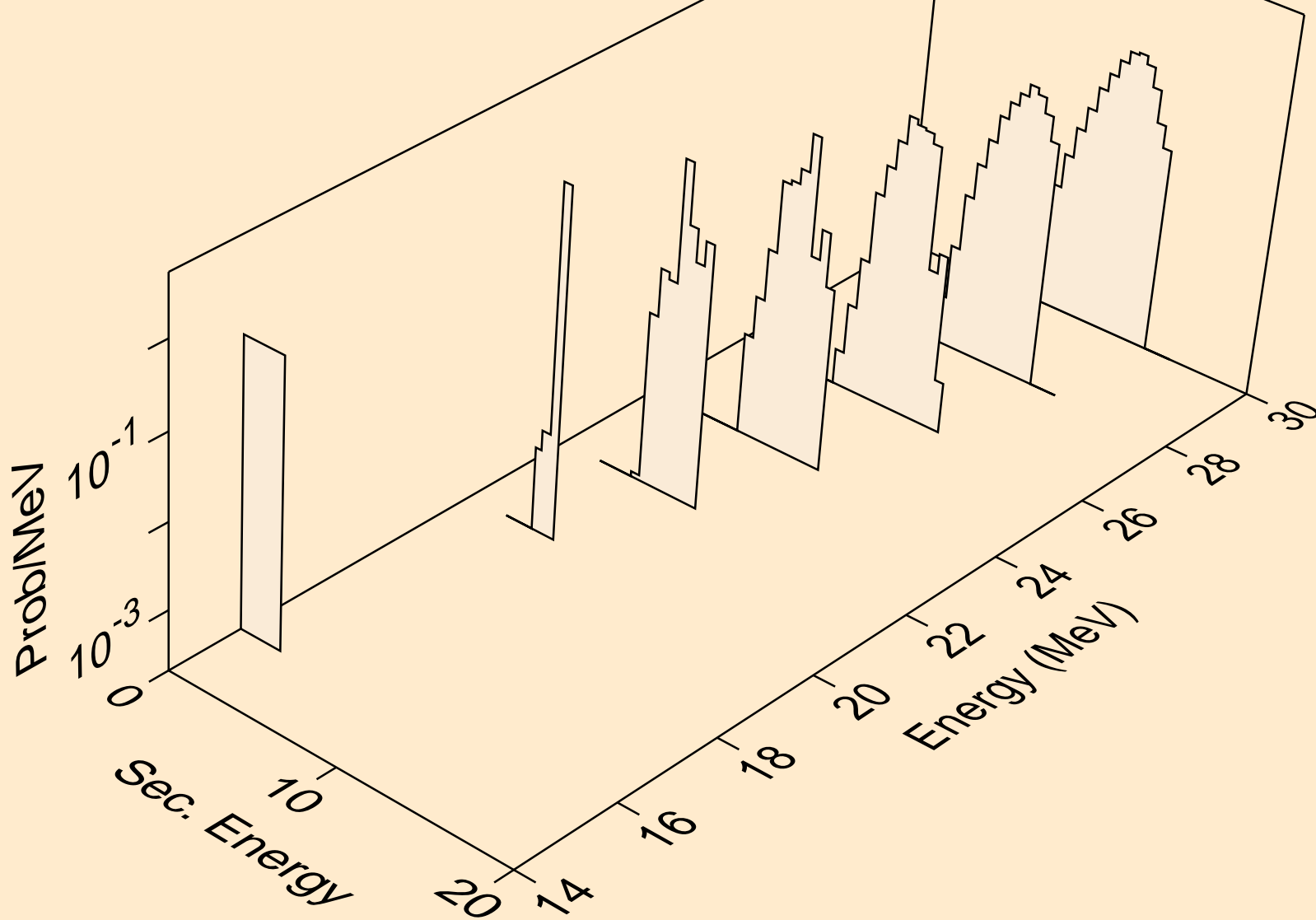

SN101 NEUTRON ACER TENDL-2019 LIBRARY; T=293.16K
alphas from (n,n*)2a

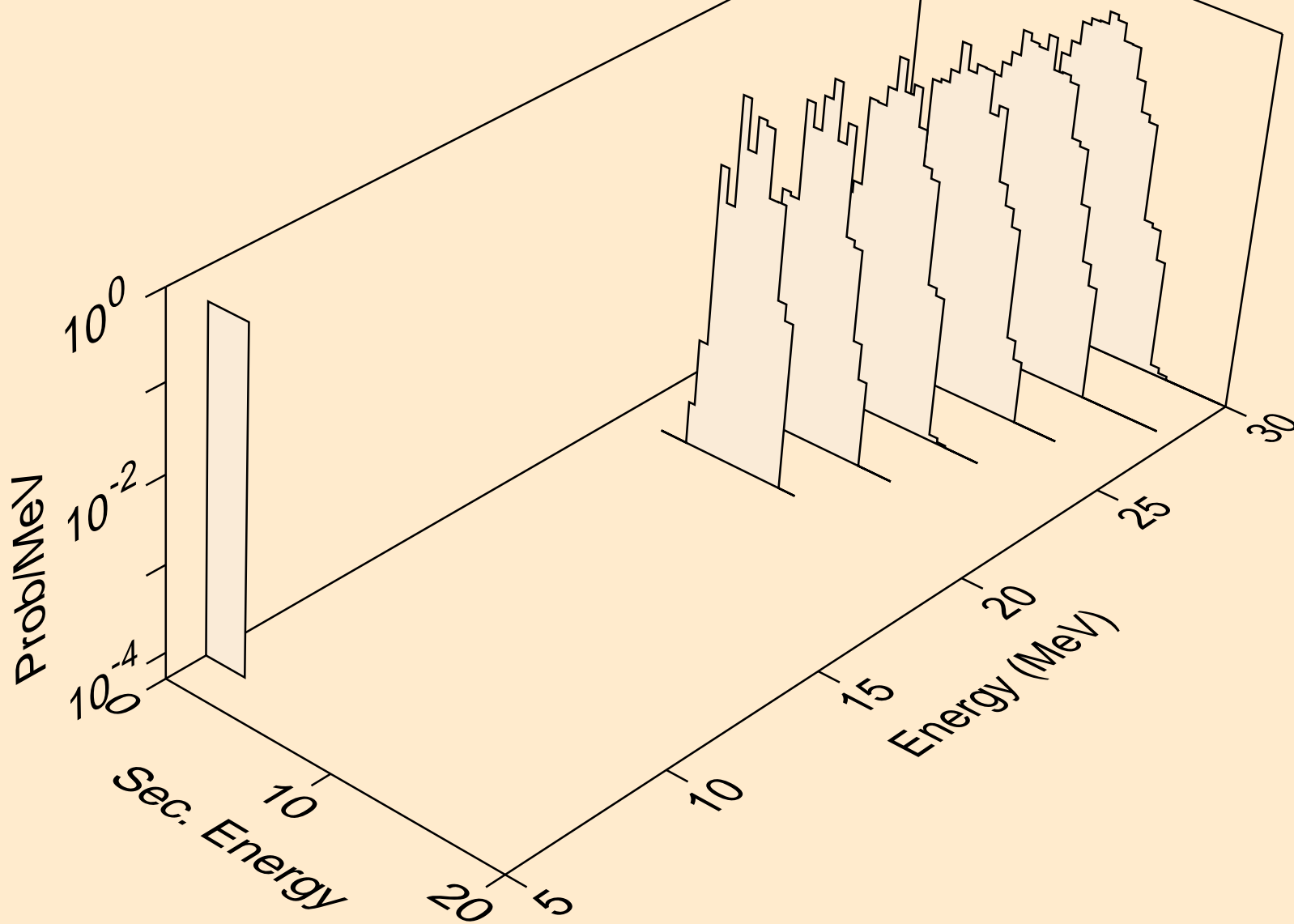

SN101 NEUTRON ACER TENDL-2019 LIBRARY; T=293.16K
alphas from (n,npa)

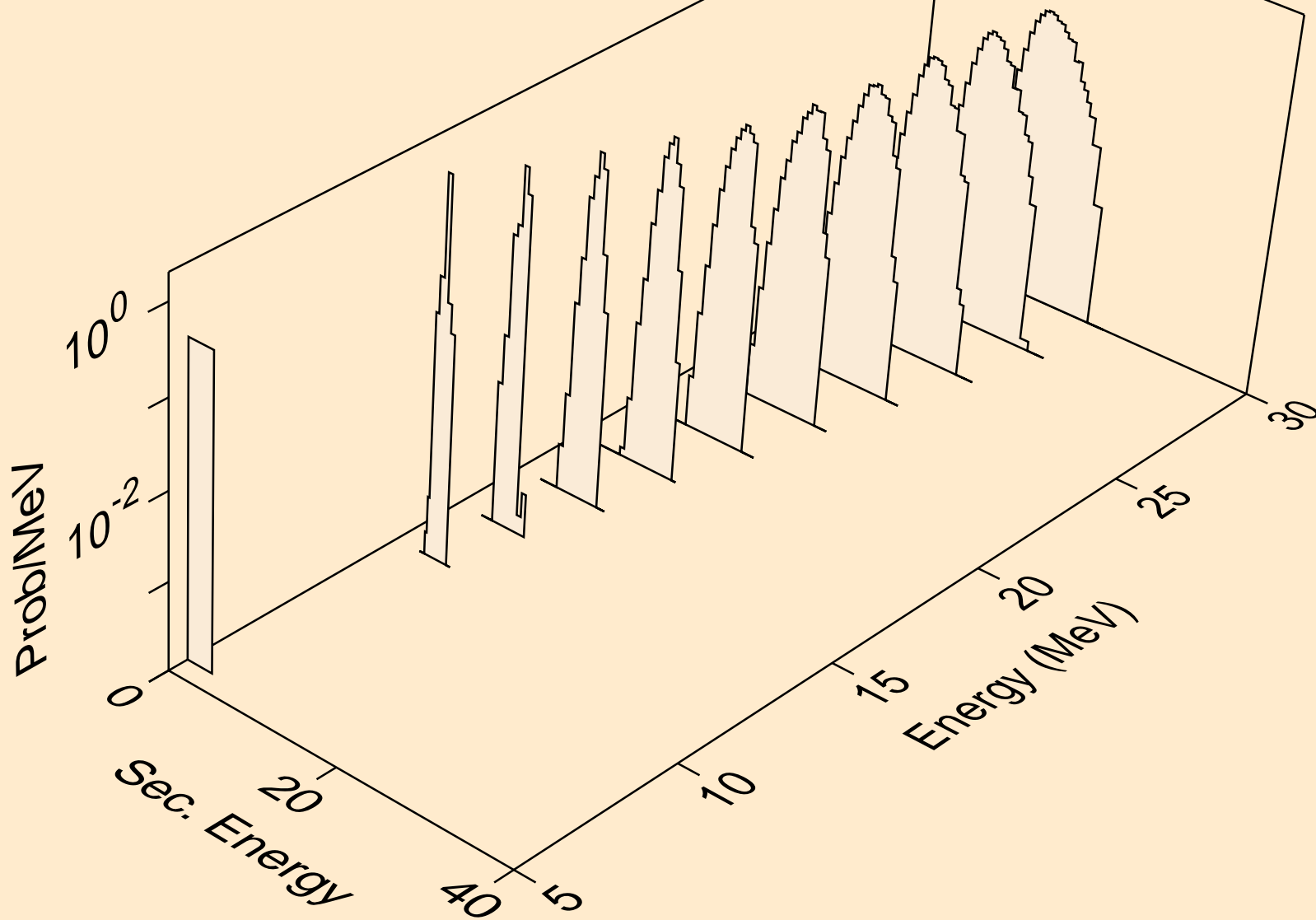

SN101 NEUTRON ACER TENDL-2019 LIBRARY; T=293.16K
alphas from (n,a)

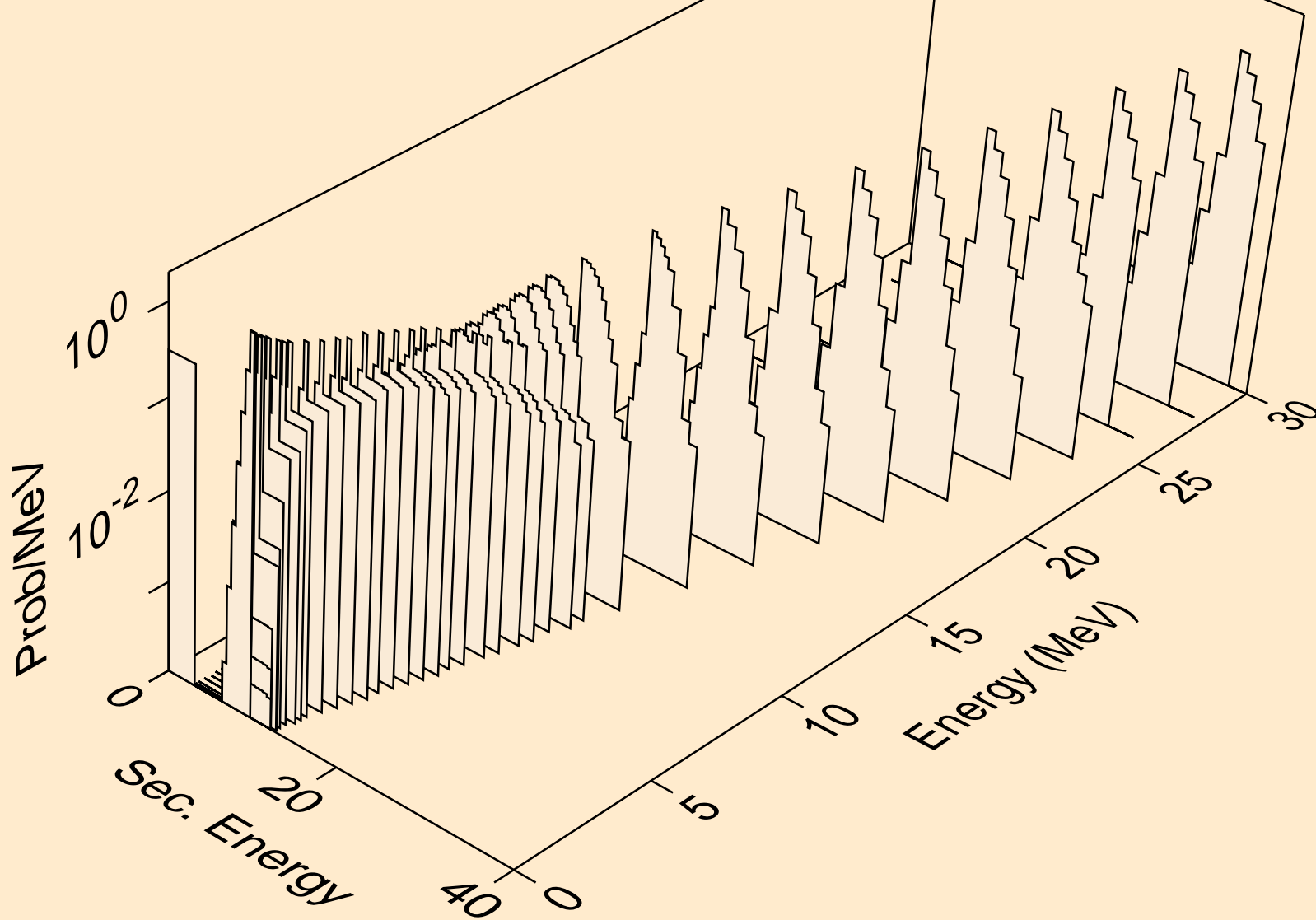

SN101 NEUTRON ACER TENDL-2019 LIBRARY; T=293.16K
alphas from (n,2a)

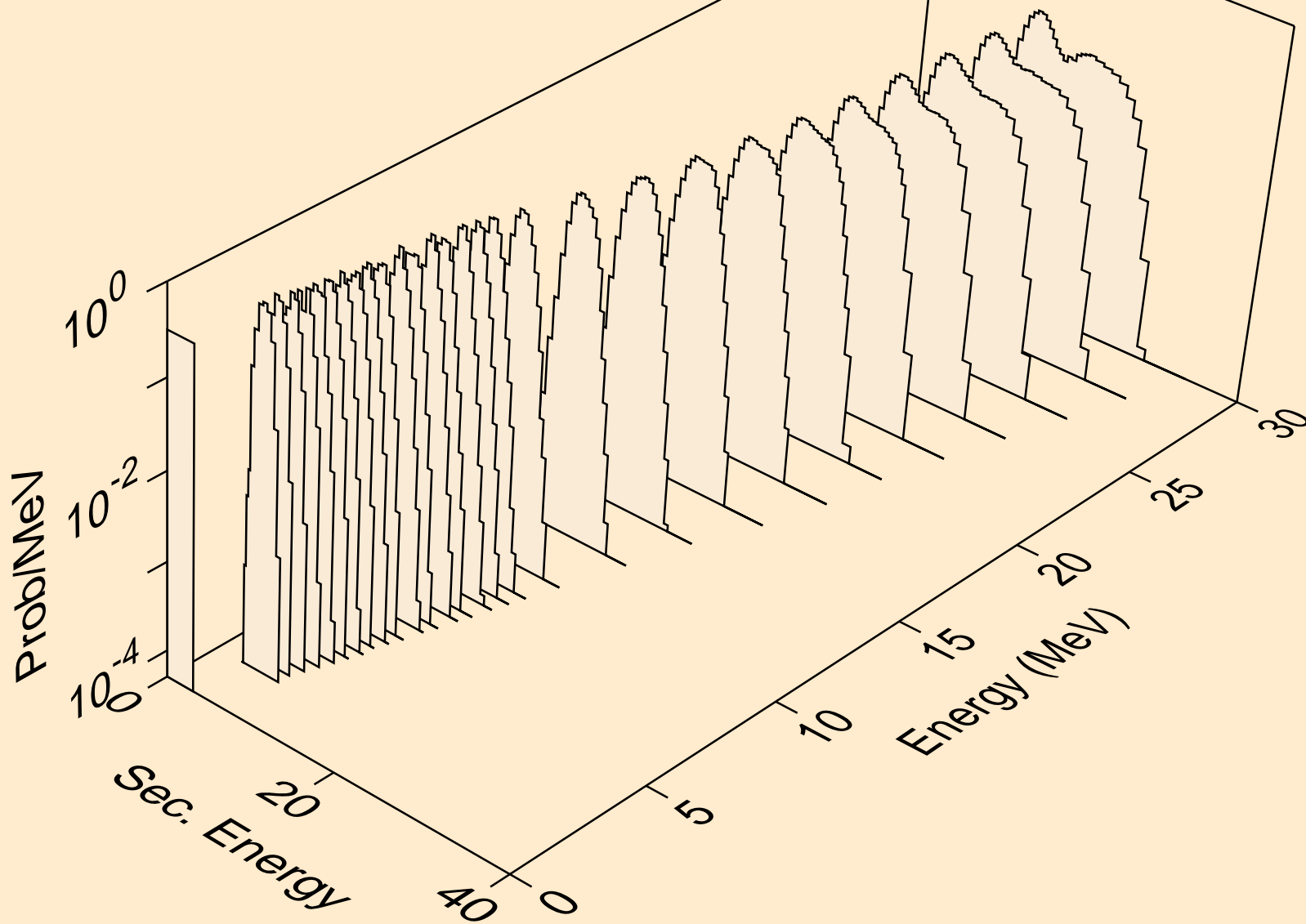

SN101 NEUTRON ACER TENDL-2019 LIBRARY; T=293.16K
alphas from (n,pa)

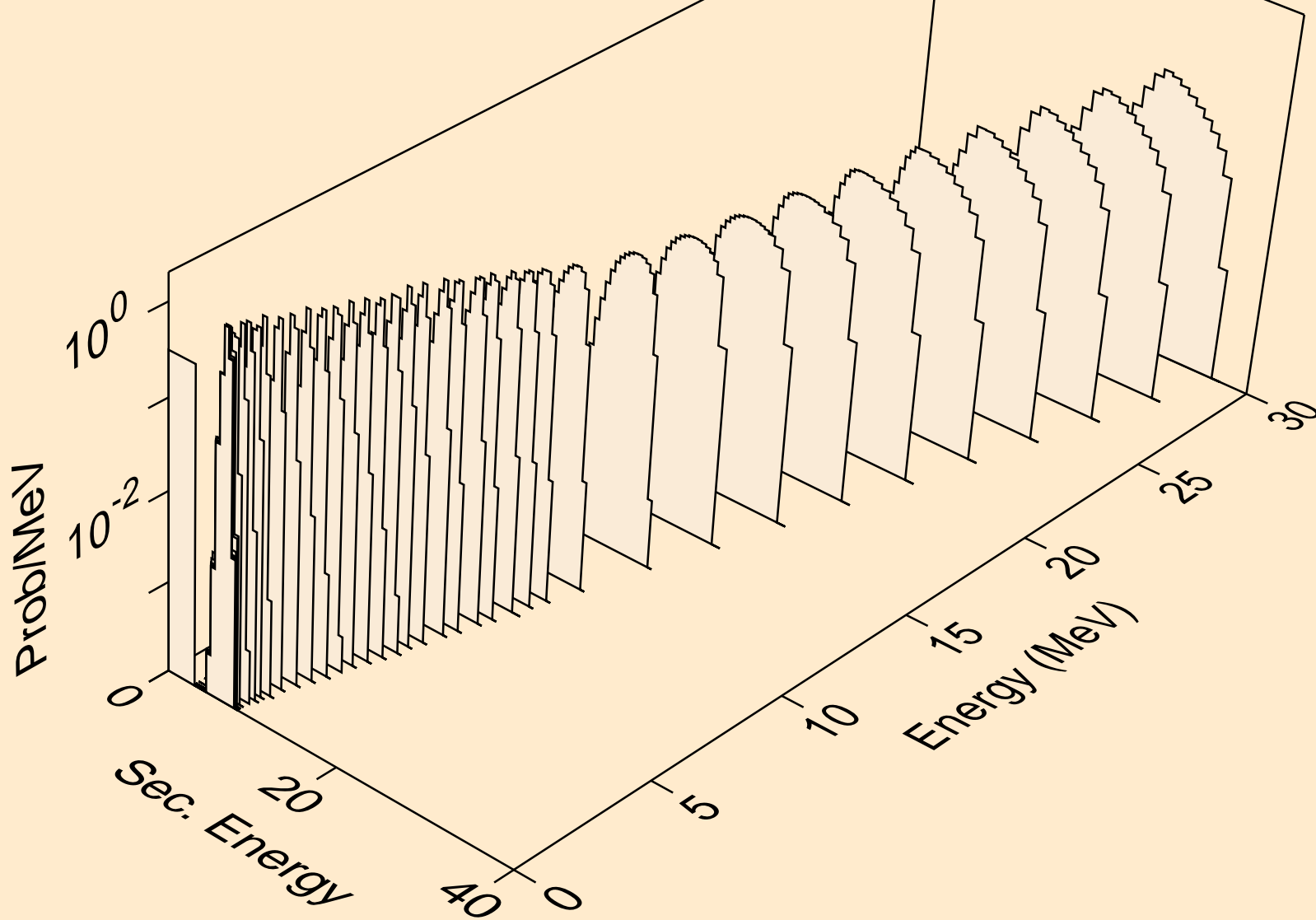

SN101 NEUTRON ACER TENDL-2019 LIBRARY; T=293.16K
alphas from (n,da)

