

# SN104 NEUTRON ACER TENDL-2019 LIBRARY; T=293.16K

## Principal cross sections

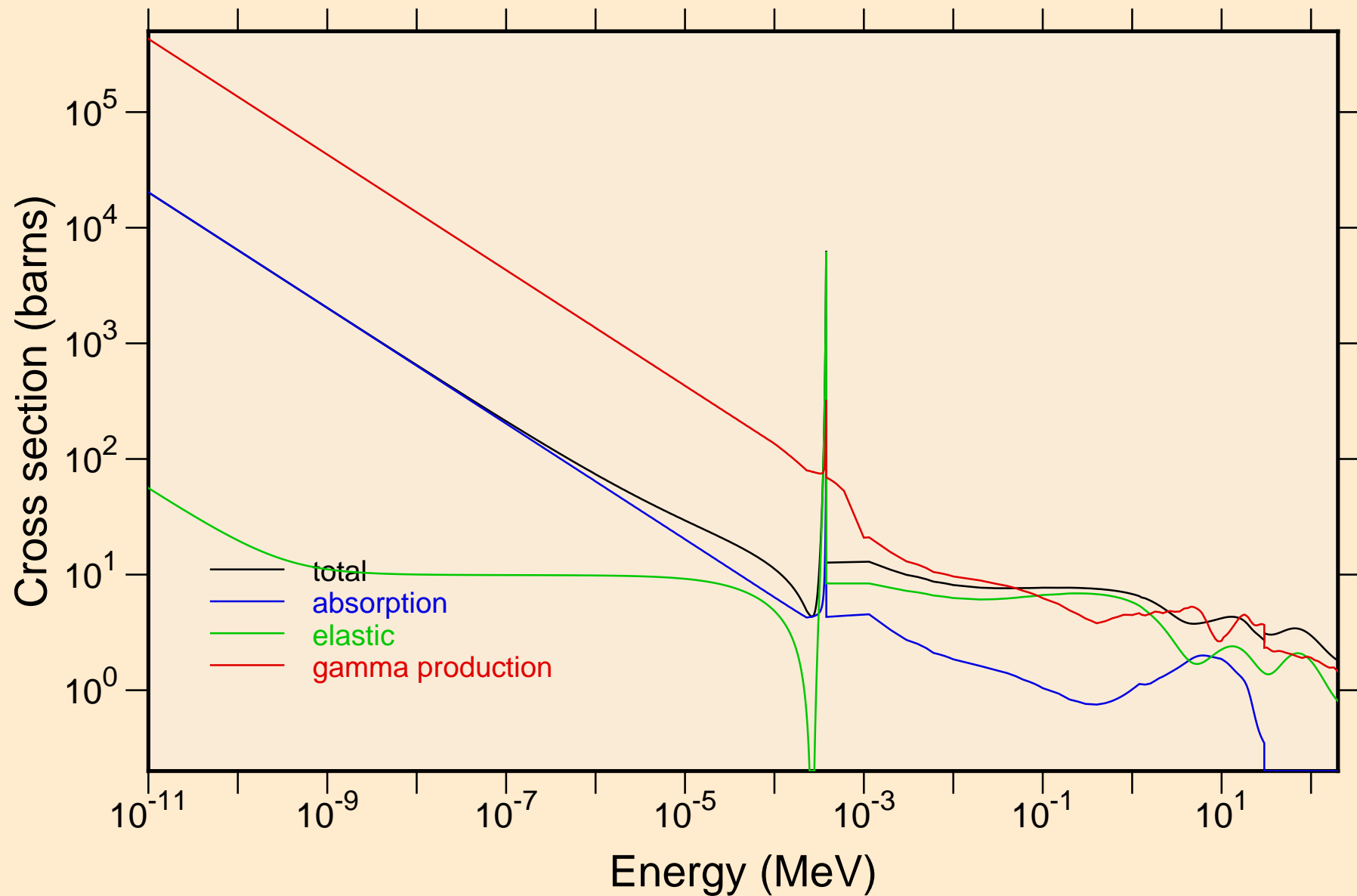

SN104 NEUTRON ACER TENDL-2019 LIBRARY; T=293.16K  
Heating

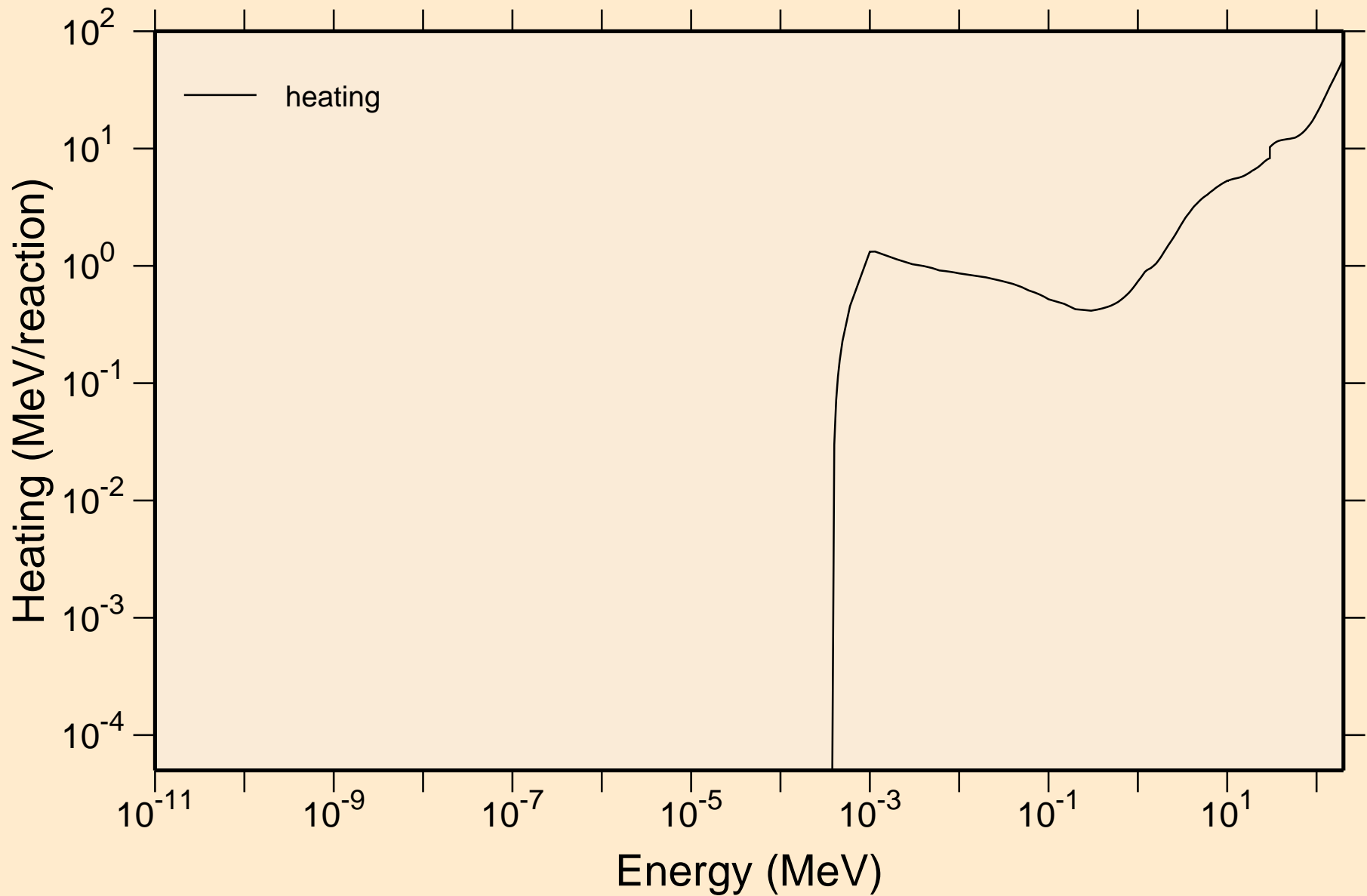

SN104 NEUTRON ACER TENDL-2019 LIBRARY; T=293.16K  
Damage

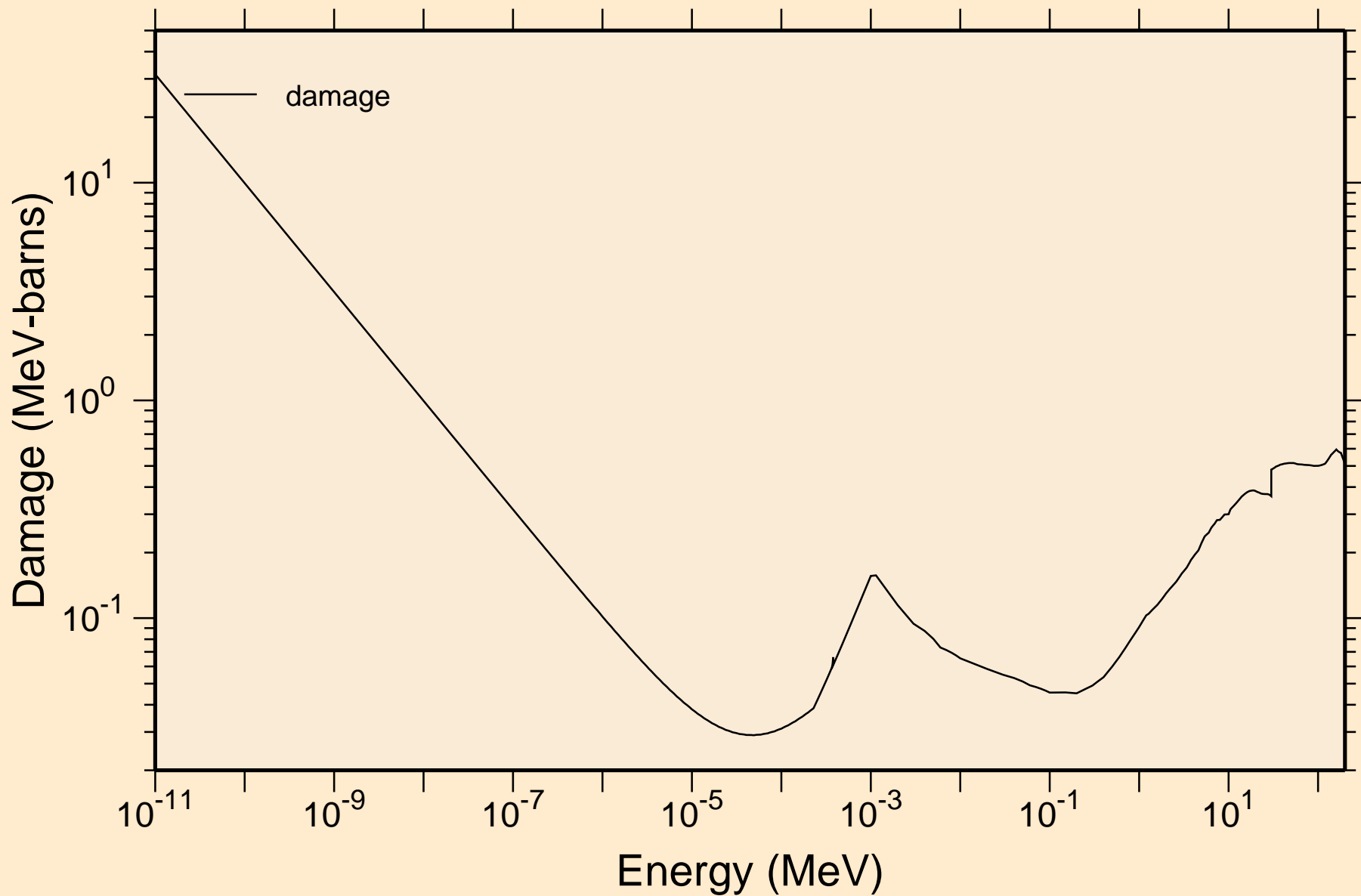

# SN104 NEUTRON ACER TENDL-2019 LIBRARY; T=293.16K

## Non-threshold reactions

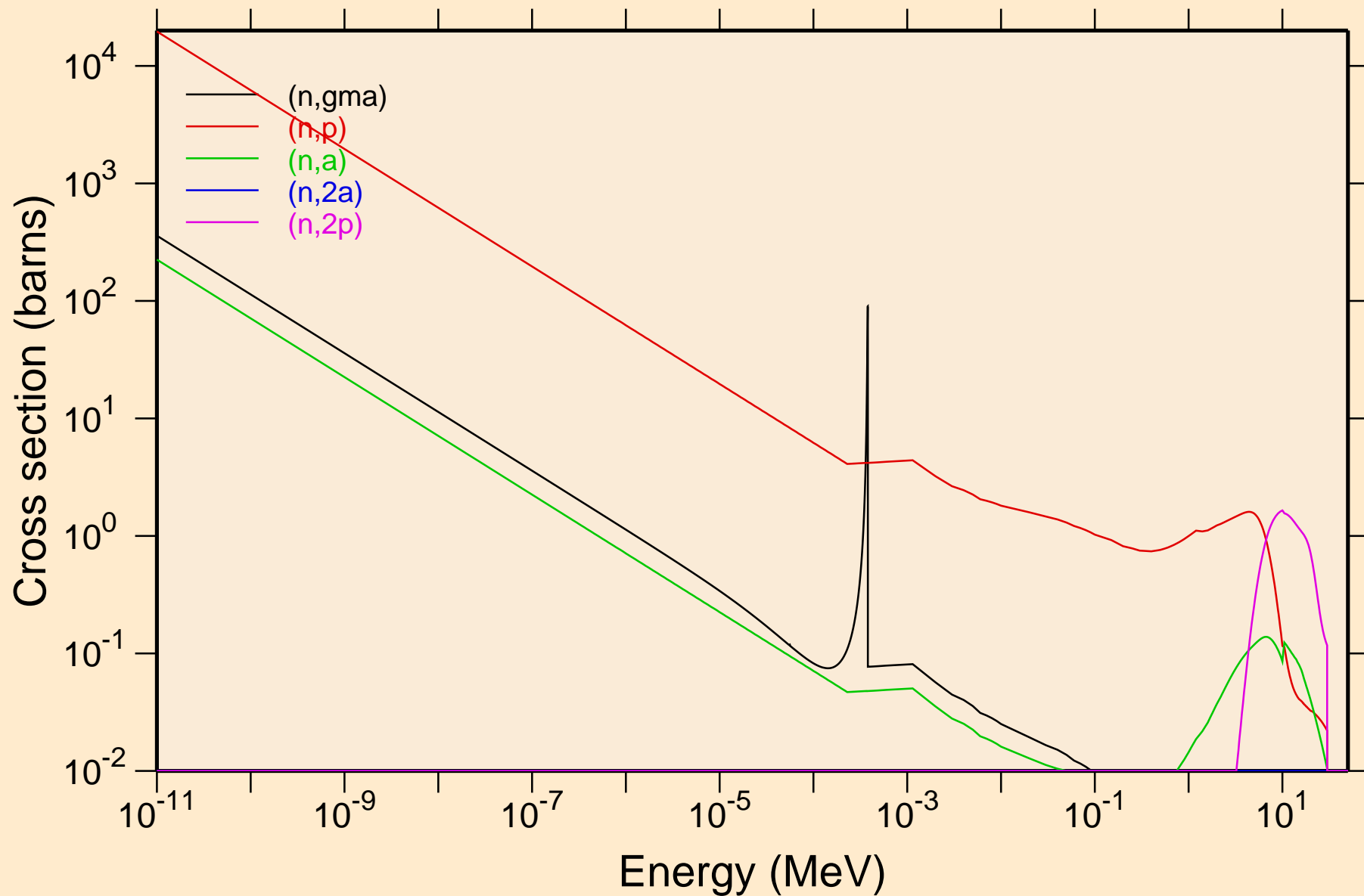

# SN104 NEUTRON ACER TENDL-2019 LIBRARY; T=293.16K

## Non-threshold reactions

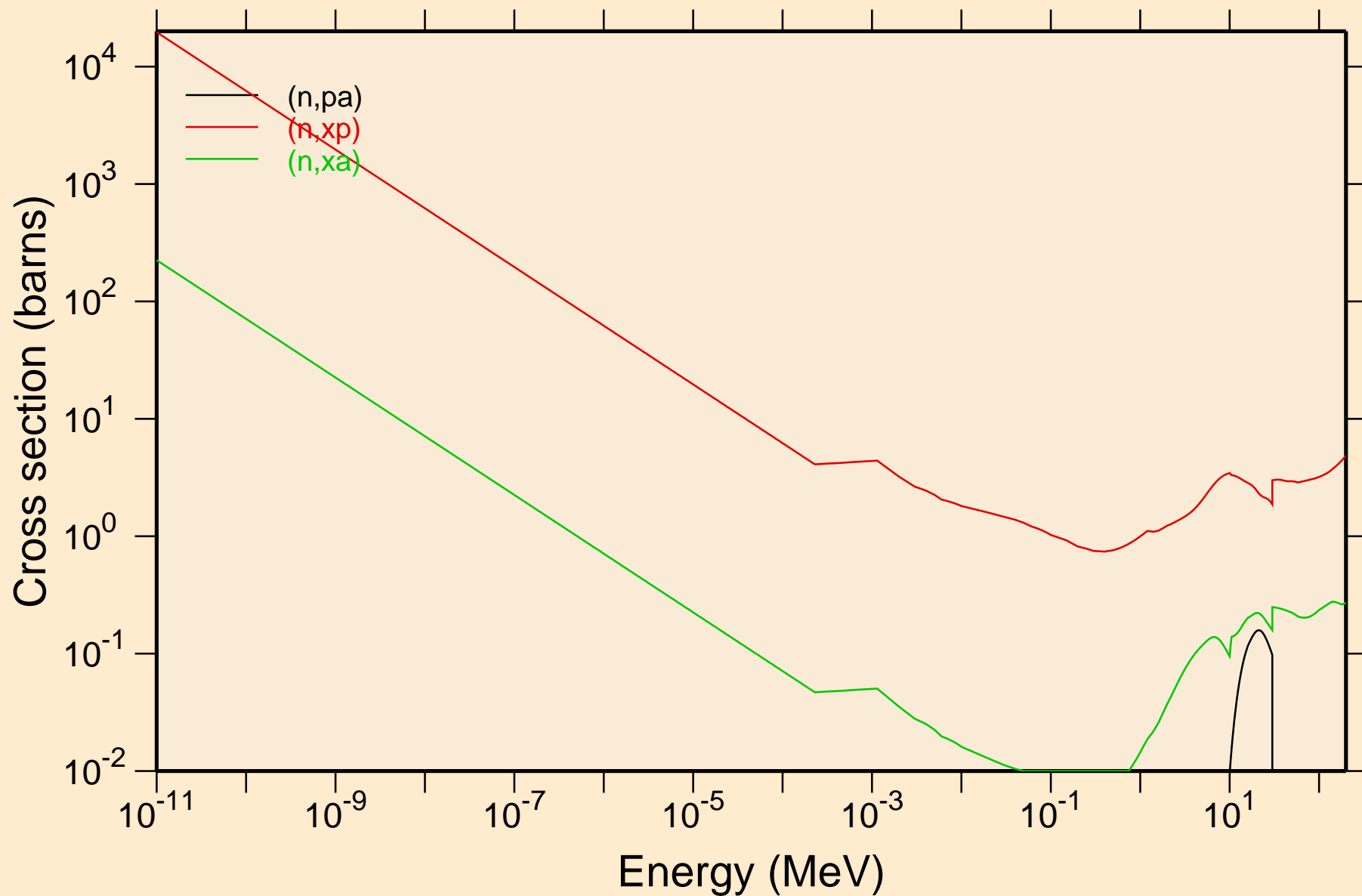

# SN104 NEUTRON ACER TENDL-2019 LIBRARY; T=293.16K

## Principal cross sections

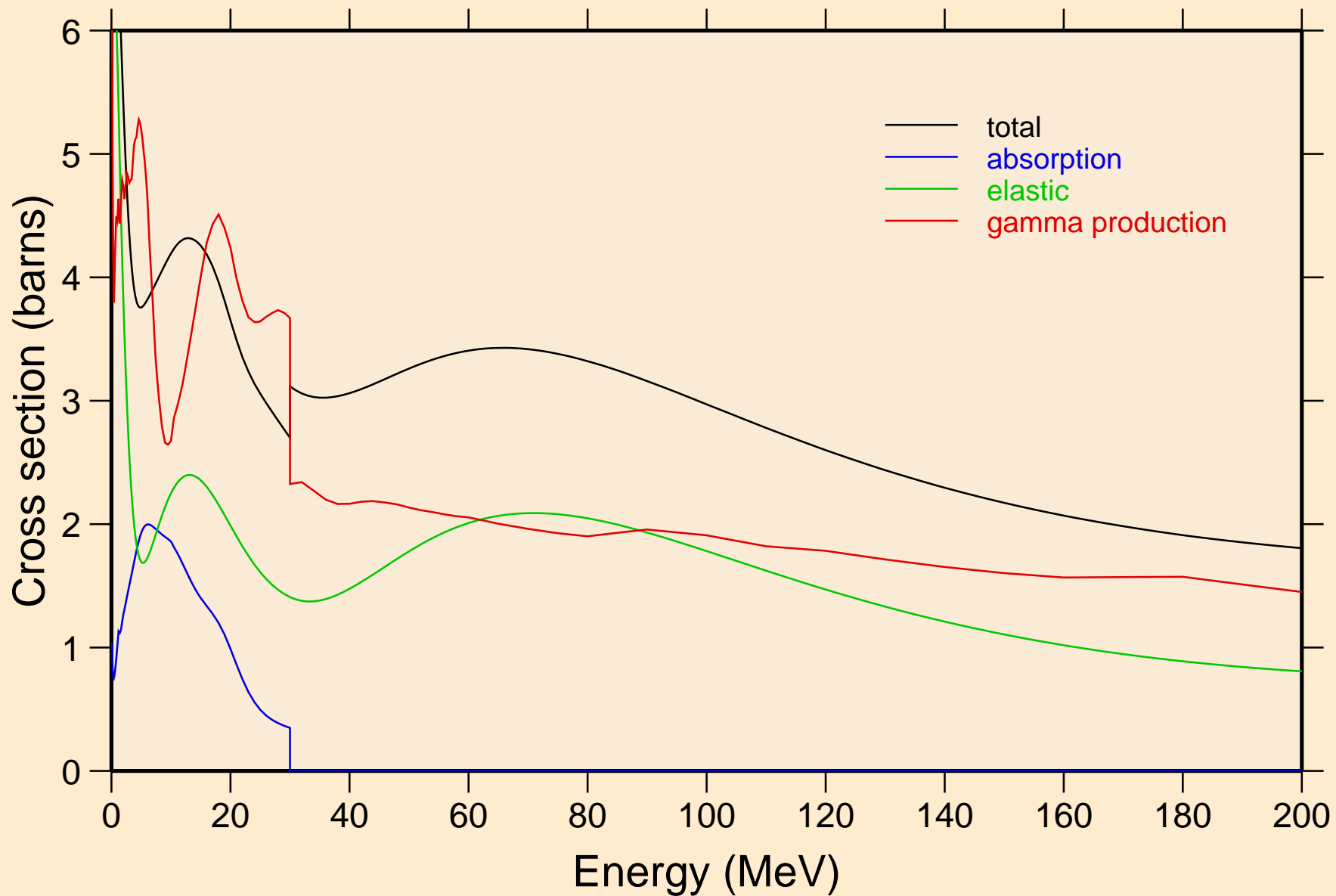

SN104 NEUTRON ACER TENDL-2019 LIBRARY; T=293.16K  
Heating

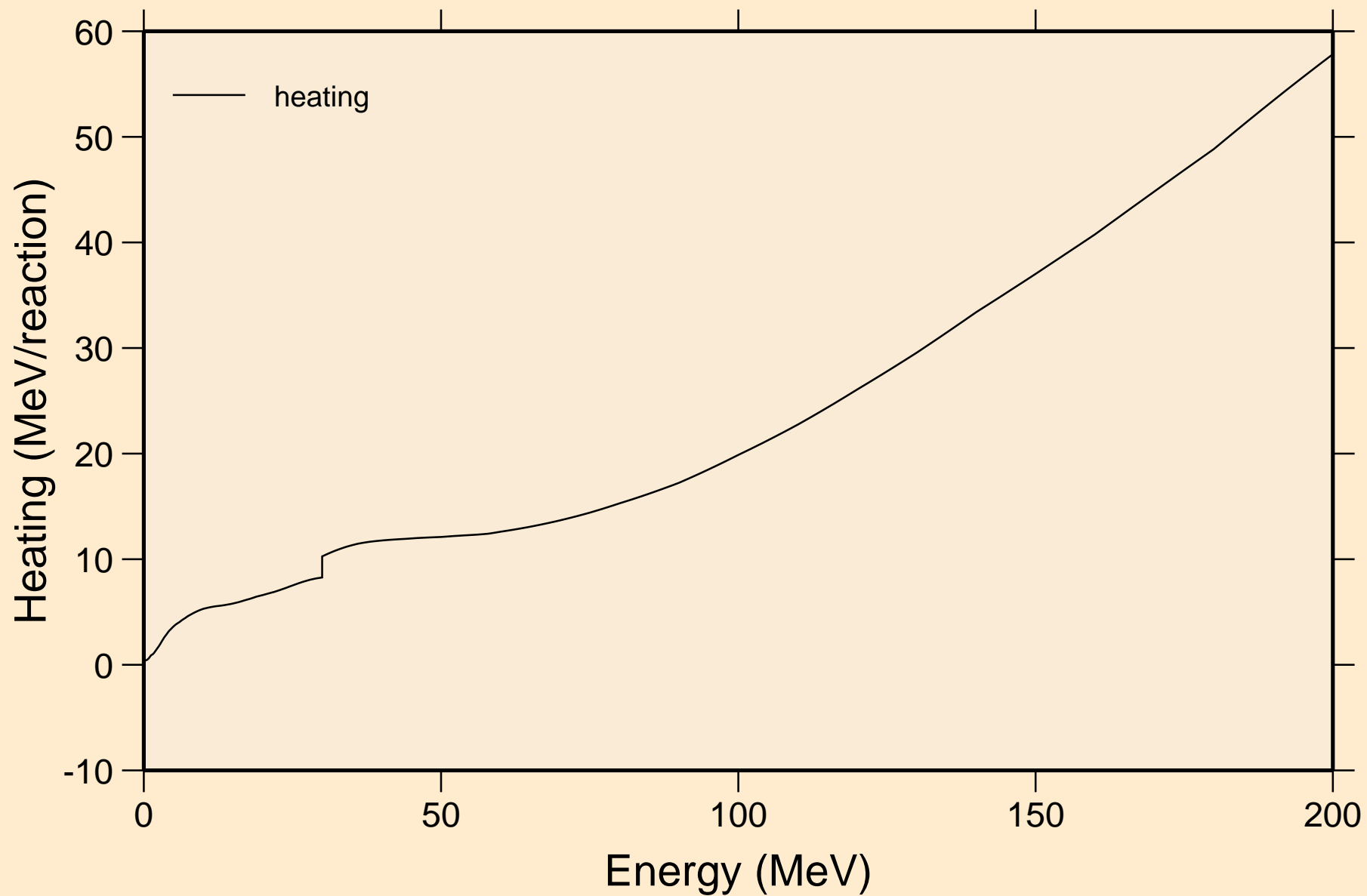

# SN104 NEUTRON ACER TENDL-2019 LIBRARY; T=293.16K Damage

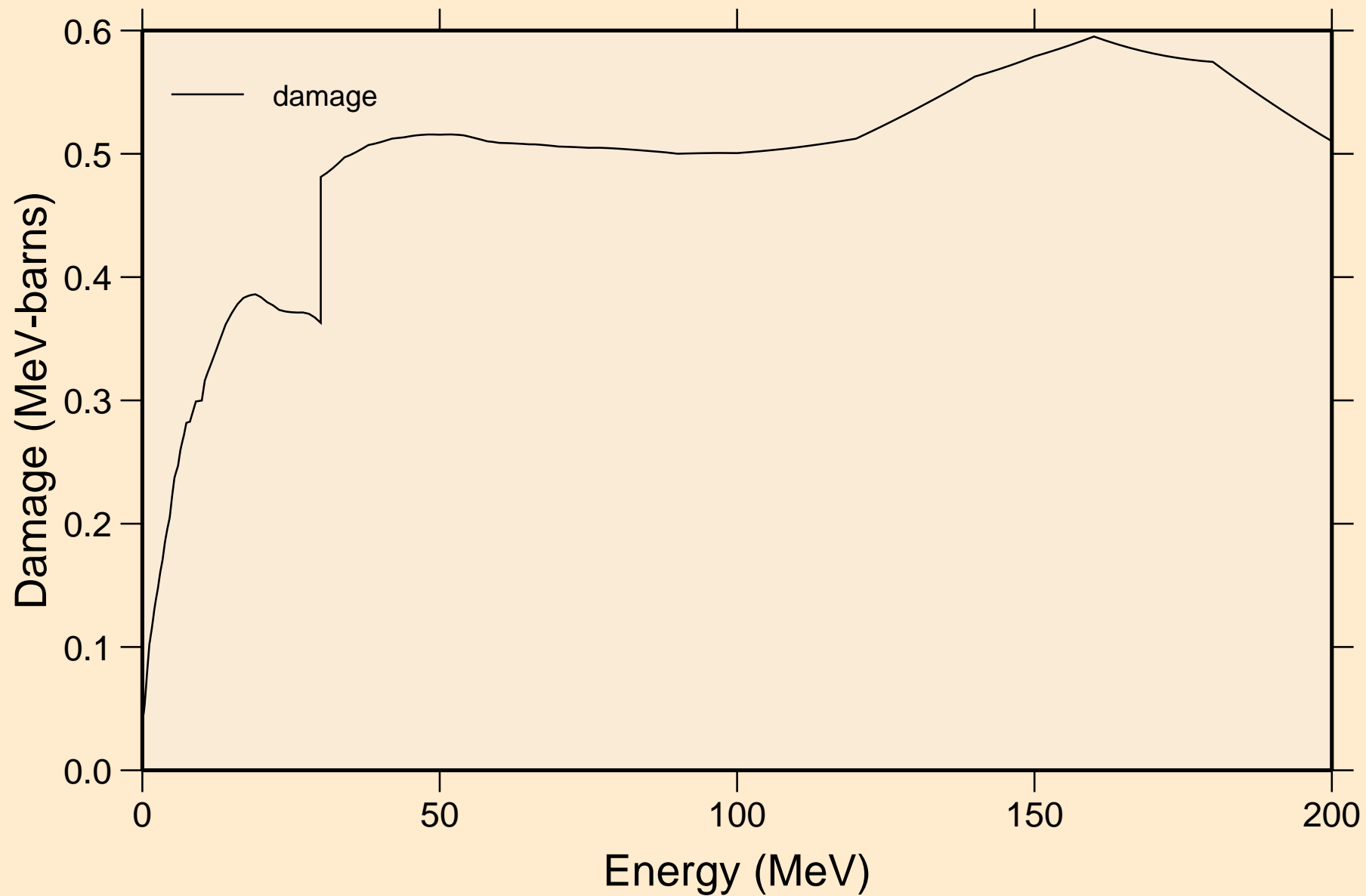



SN104 NEUTRON ACER TENDL-2019 LIBRARY; T=293.16K  
Non-threshold reactions

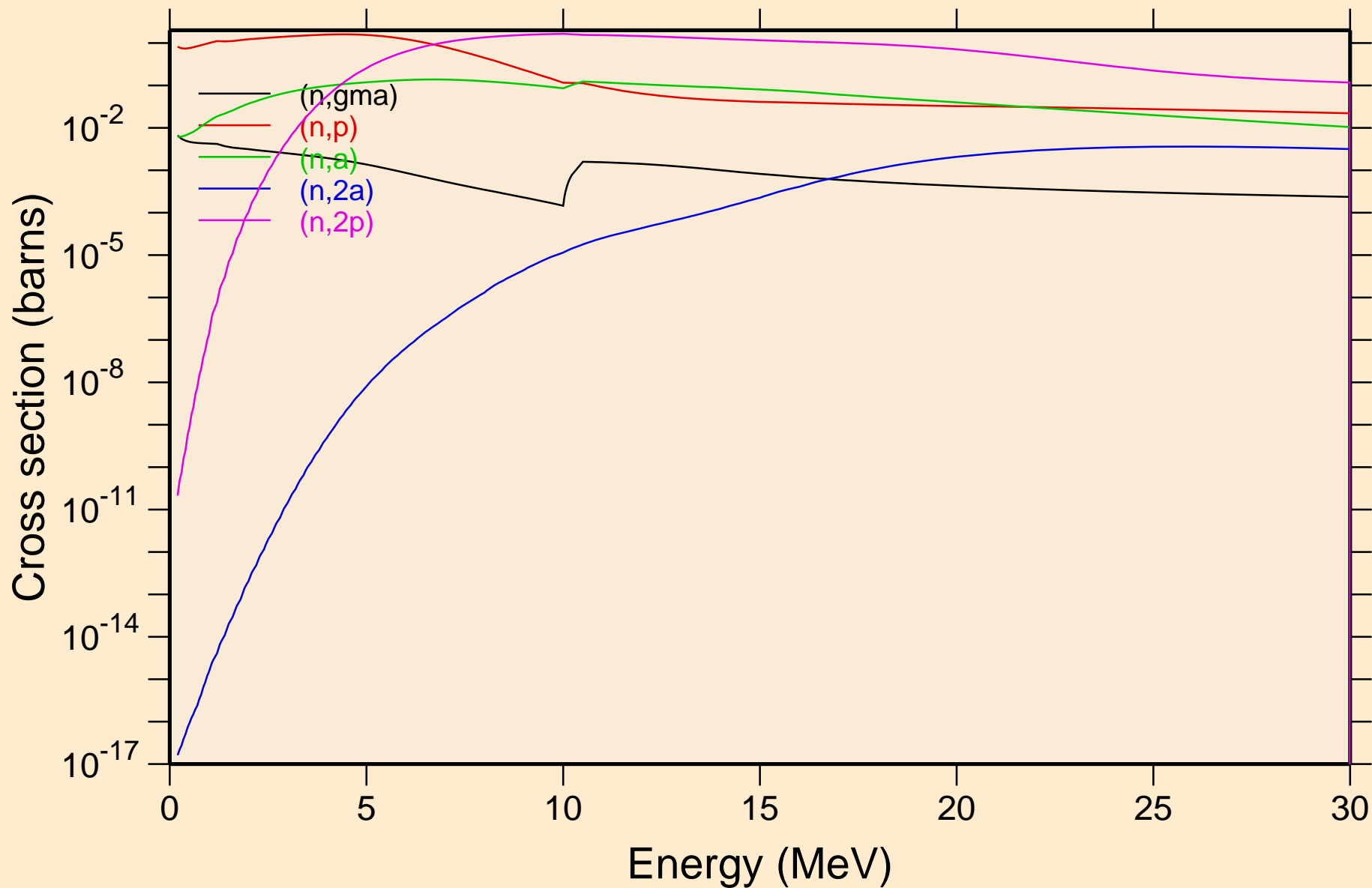

SN104 NEUTRON ACER TENDL-2019 LIBRARY; T=293.16K  
Non-threshold reactions

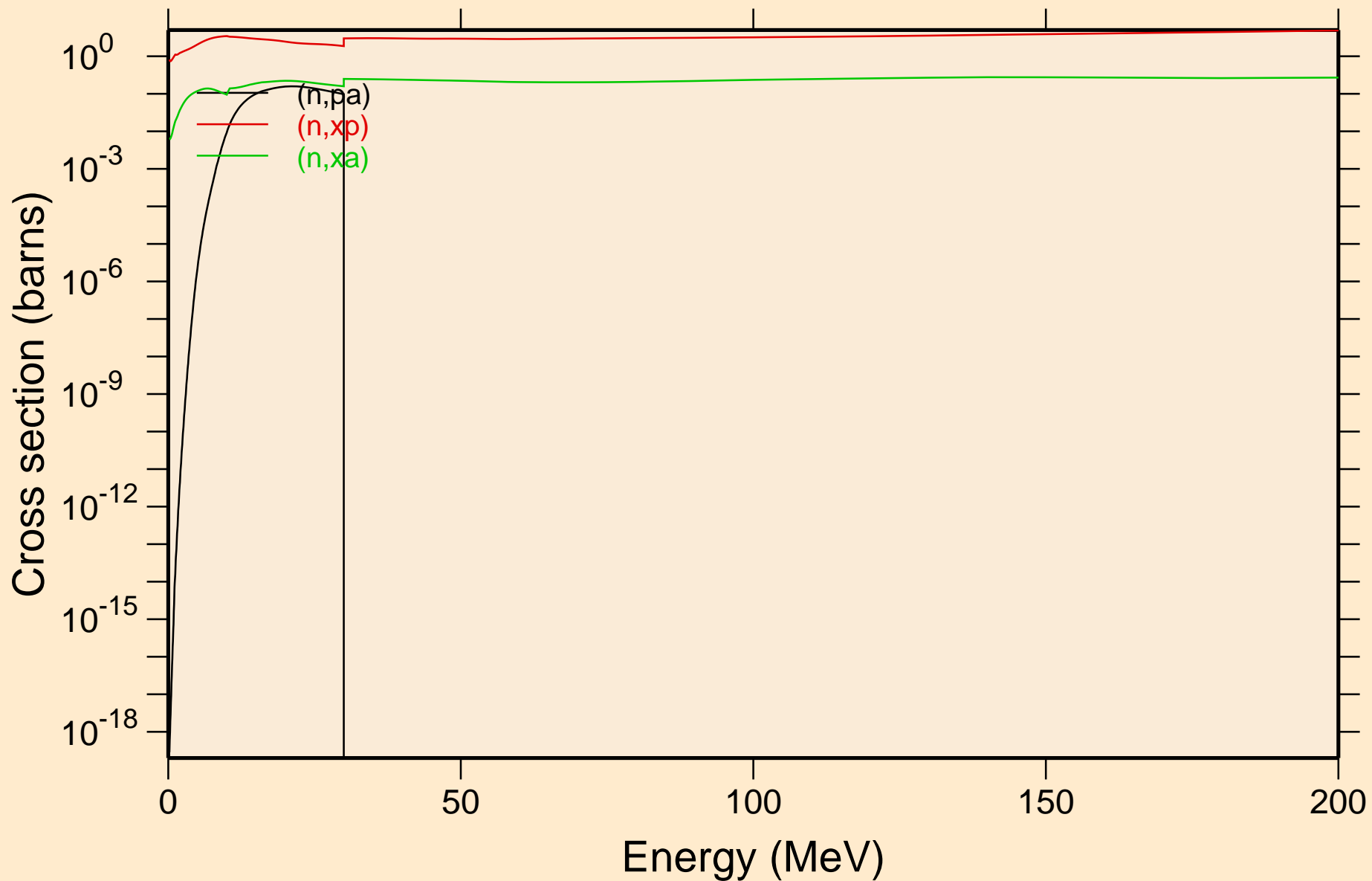

SN104 NEUTRON ACER TENDL-2019 LIBRARY; T=293.16K  
Inelastic levels

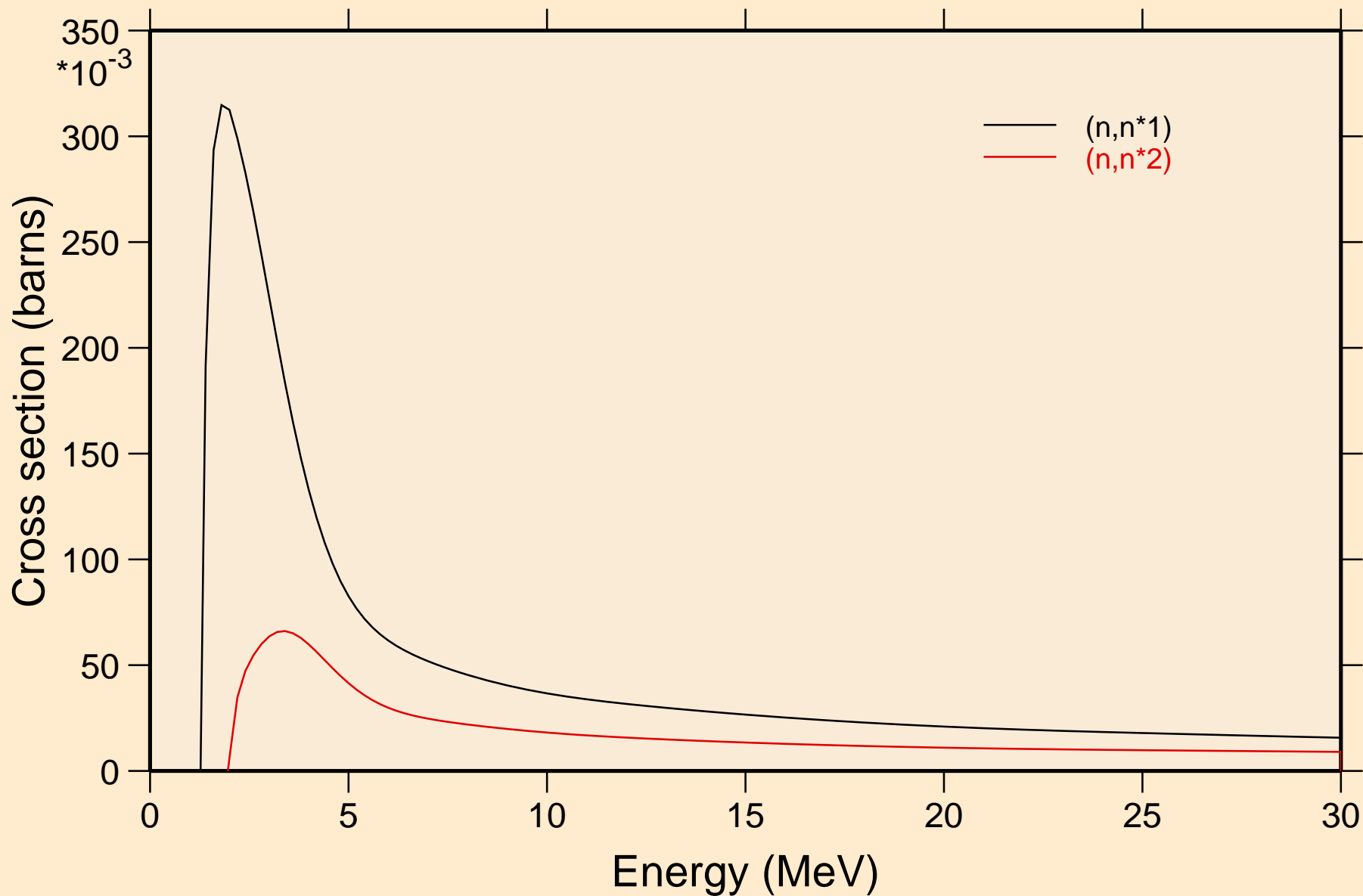

# SN104 NEUTRON ACER TENDL-2019 LIBRARY; T=293.16K

## Threshold reactions

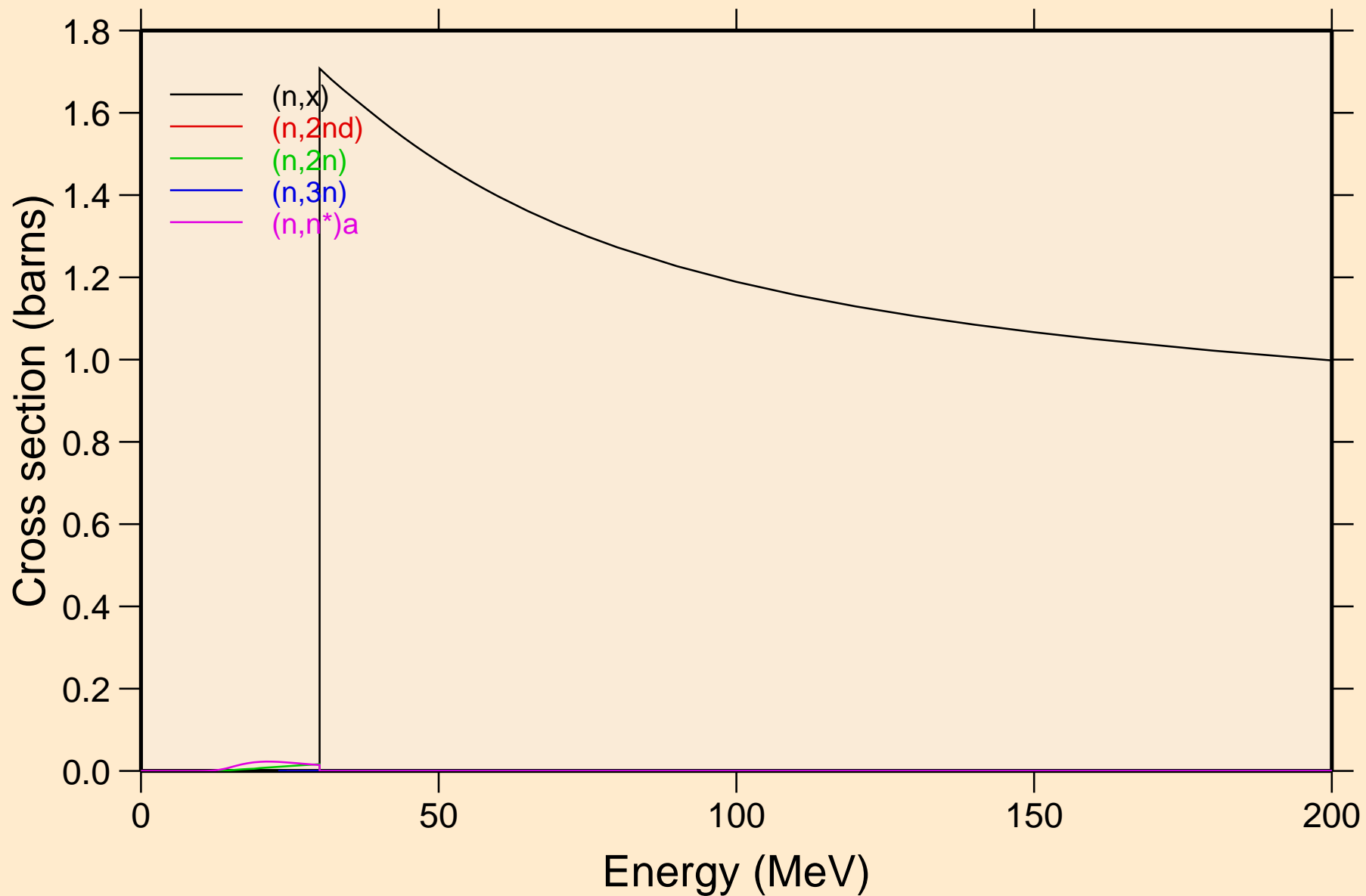

SN104 NEUTRON ACER TENDL-2019 LIBRARY; T=293.16K  
Threshold reactions

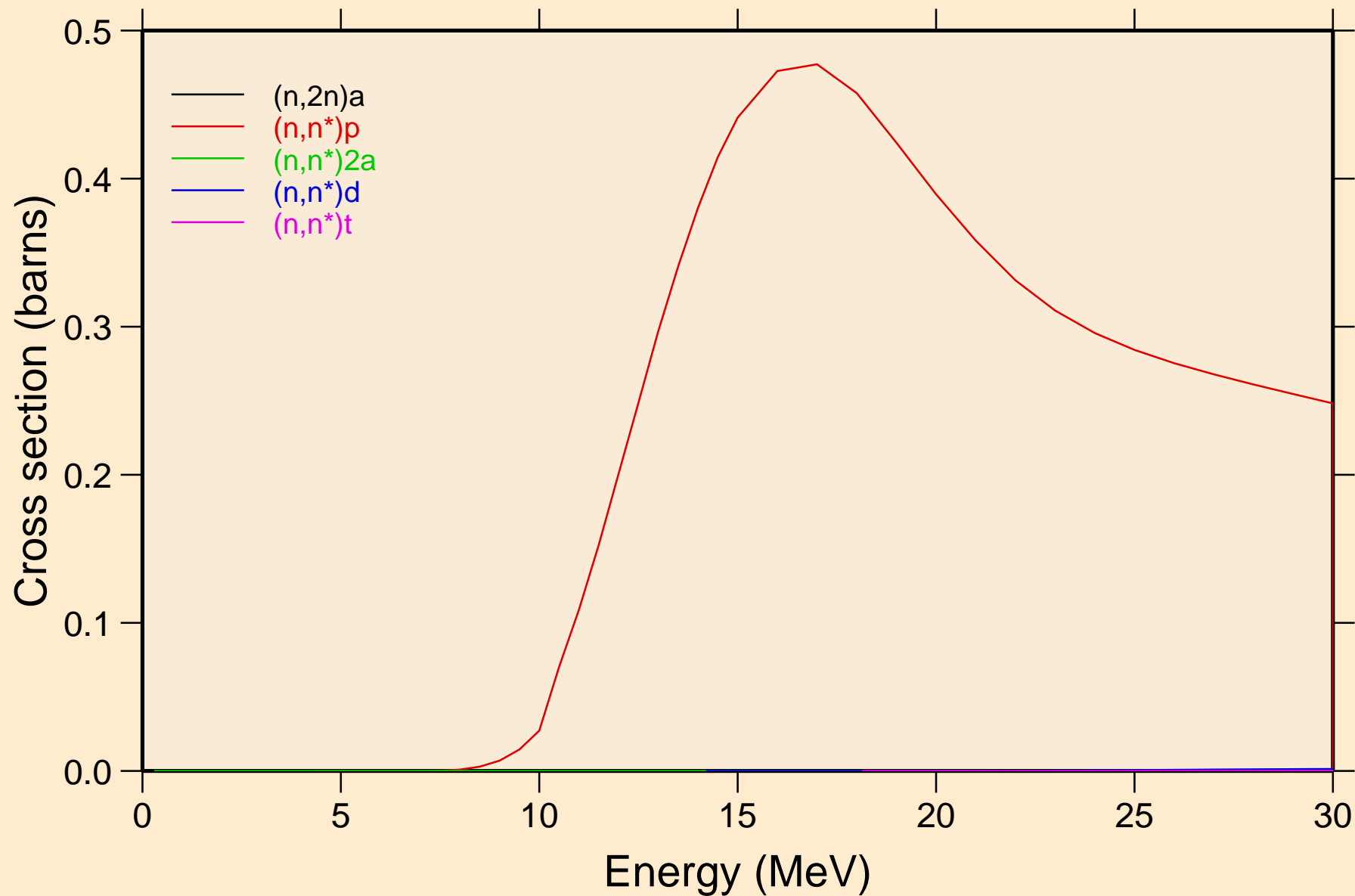

SN104 NEUTRON ACER TENDL-2019 LIBRARY; T=293.16K  
Threshold reactions

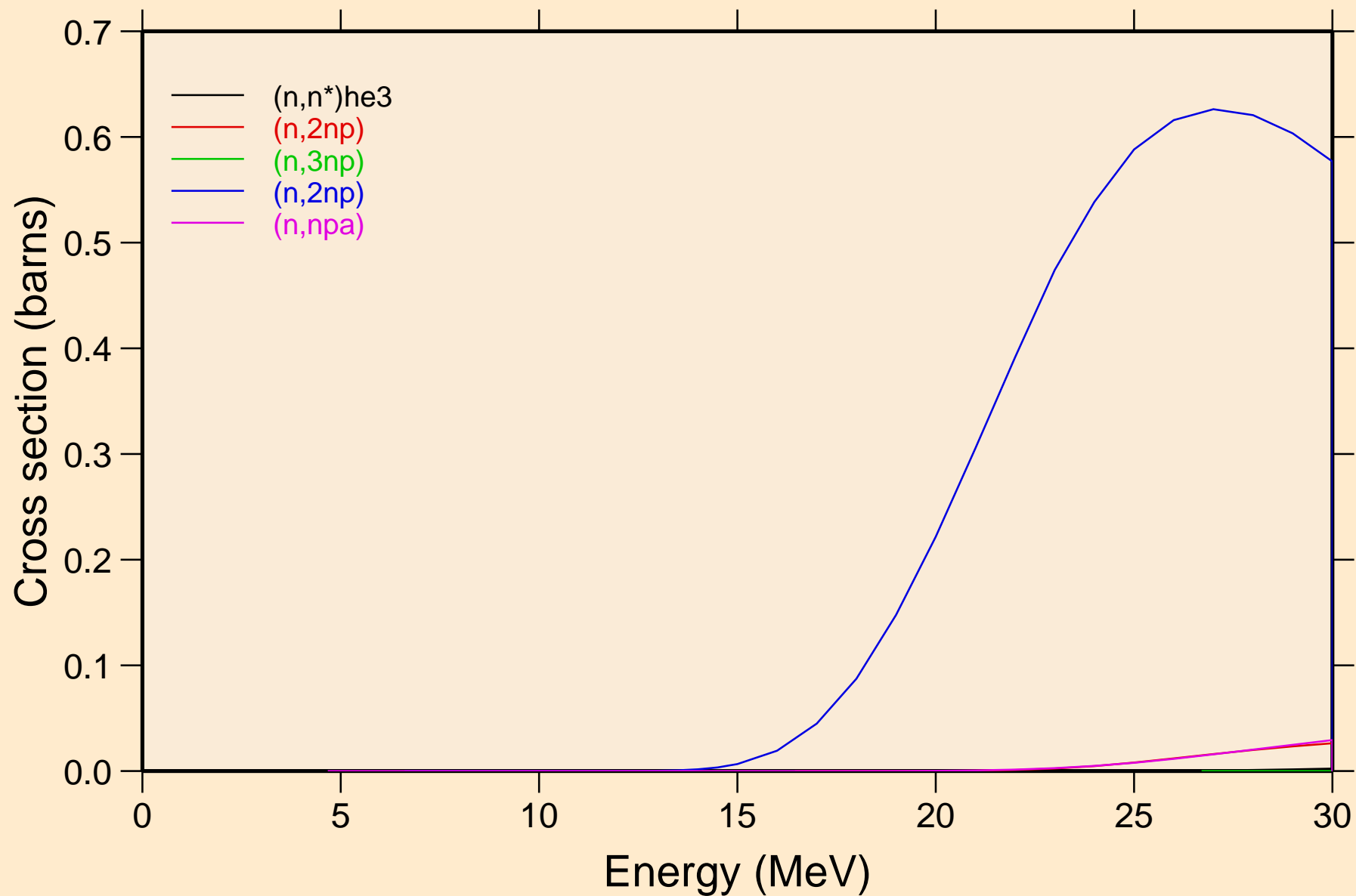

# SN104 NEUTRON ACER TENDL-2019 LIBRARY; T=293.16K

## Threshold reactions

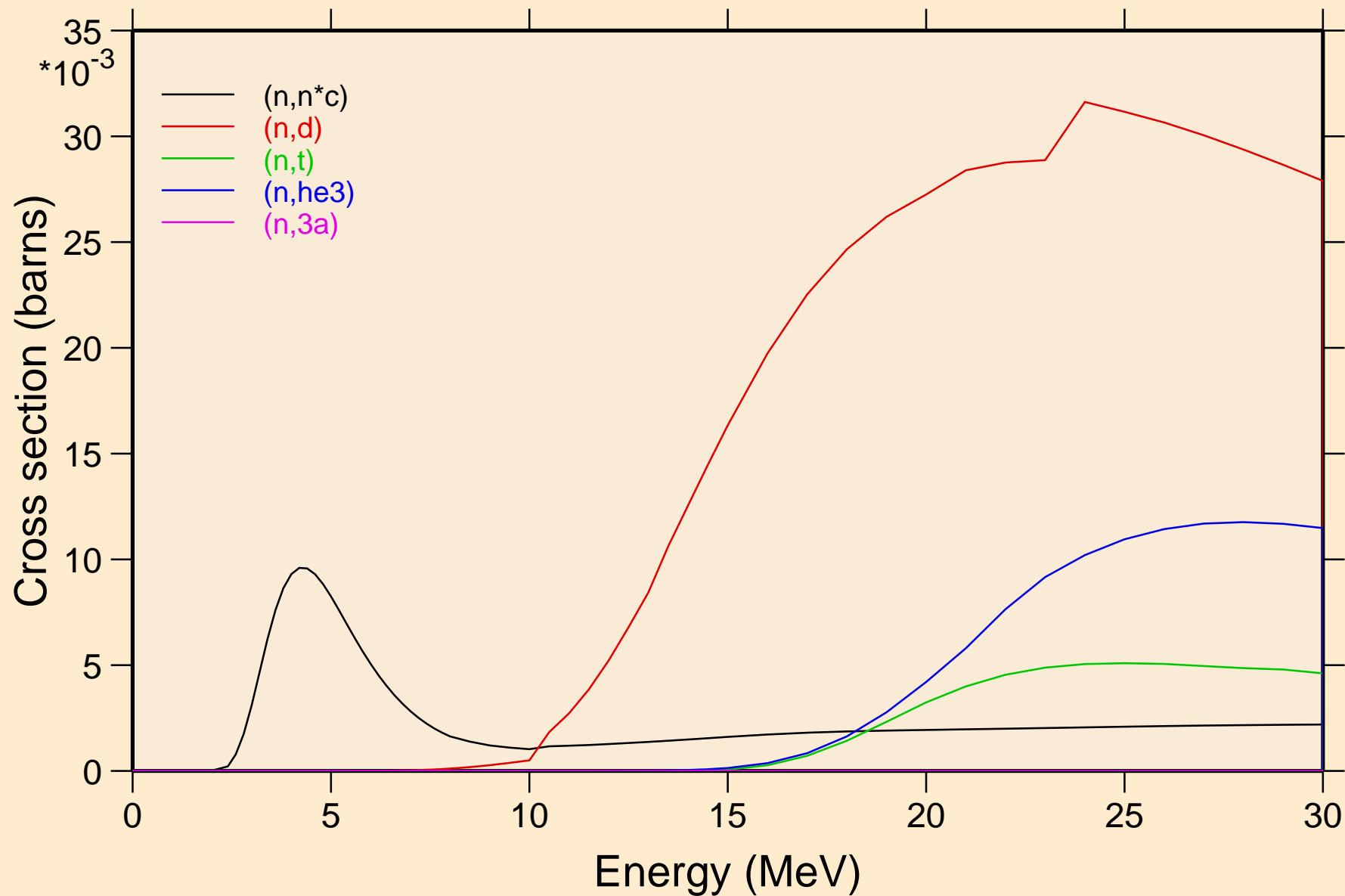

SN104 NEUTRON ACER TENDL-2019 LIBRARY; T=293.16K  
Threshold reactions

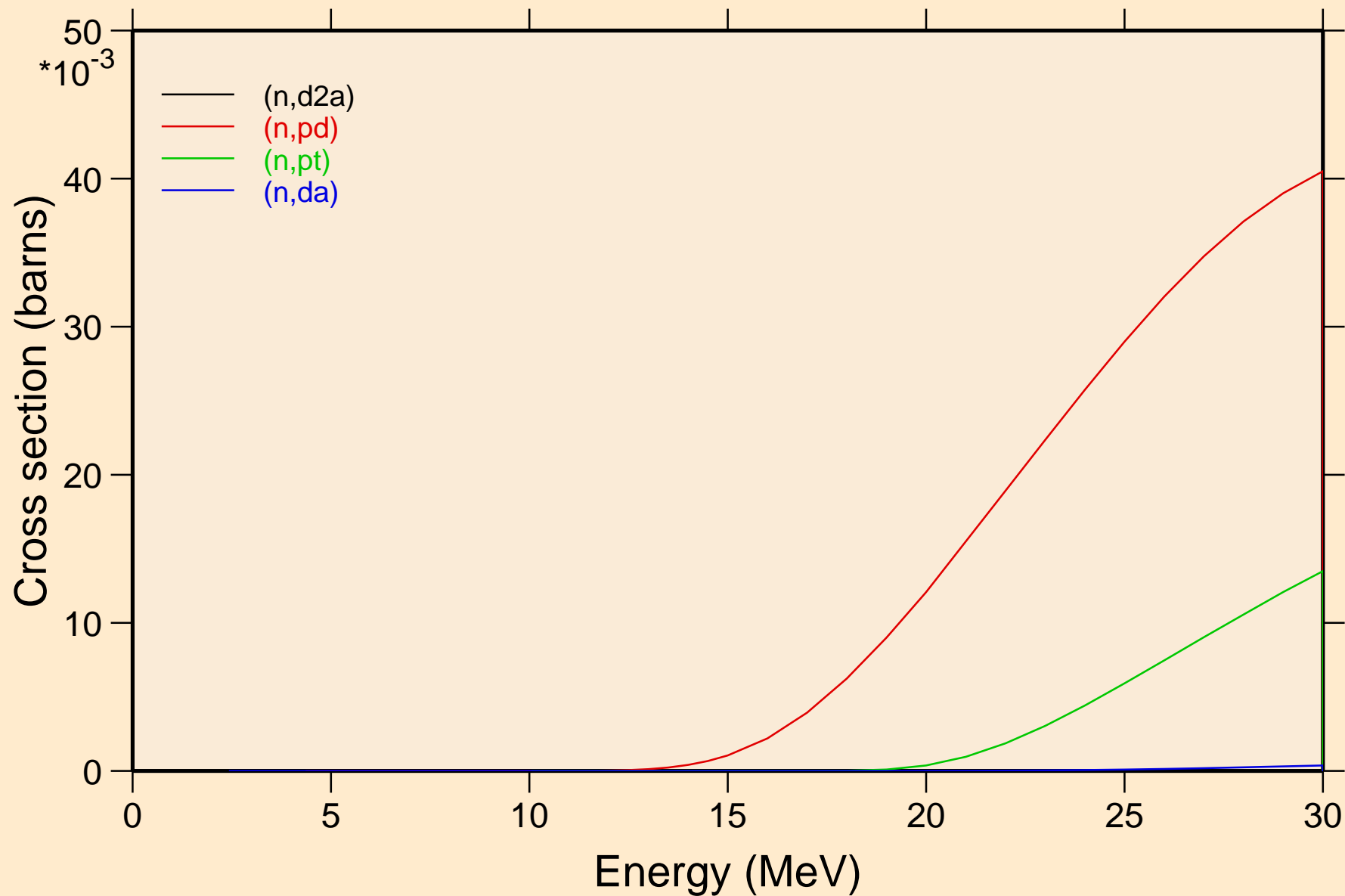



# SN104 NEUTRON ACER TENDL-2019 LIBRARY; T=293.16K

## Threshold reactions

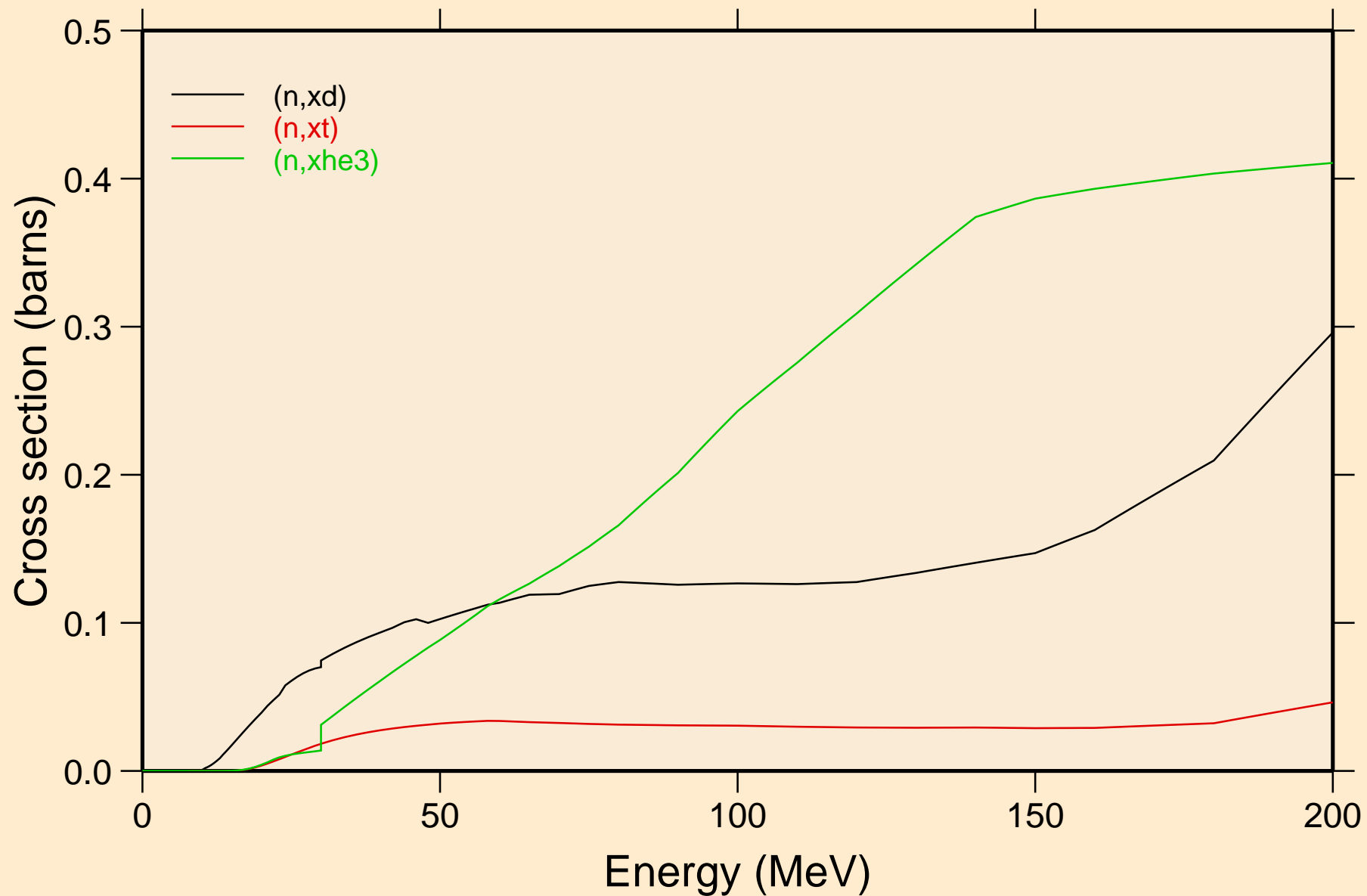

SN104 NEUTRON ACER TENDL-2019 LIBRARY; T=293.16K  
angular distribution for elastic

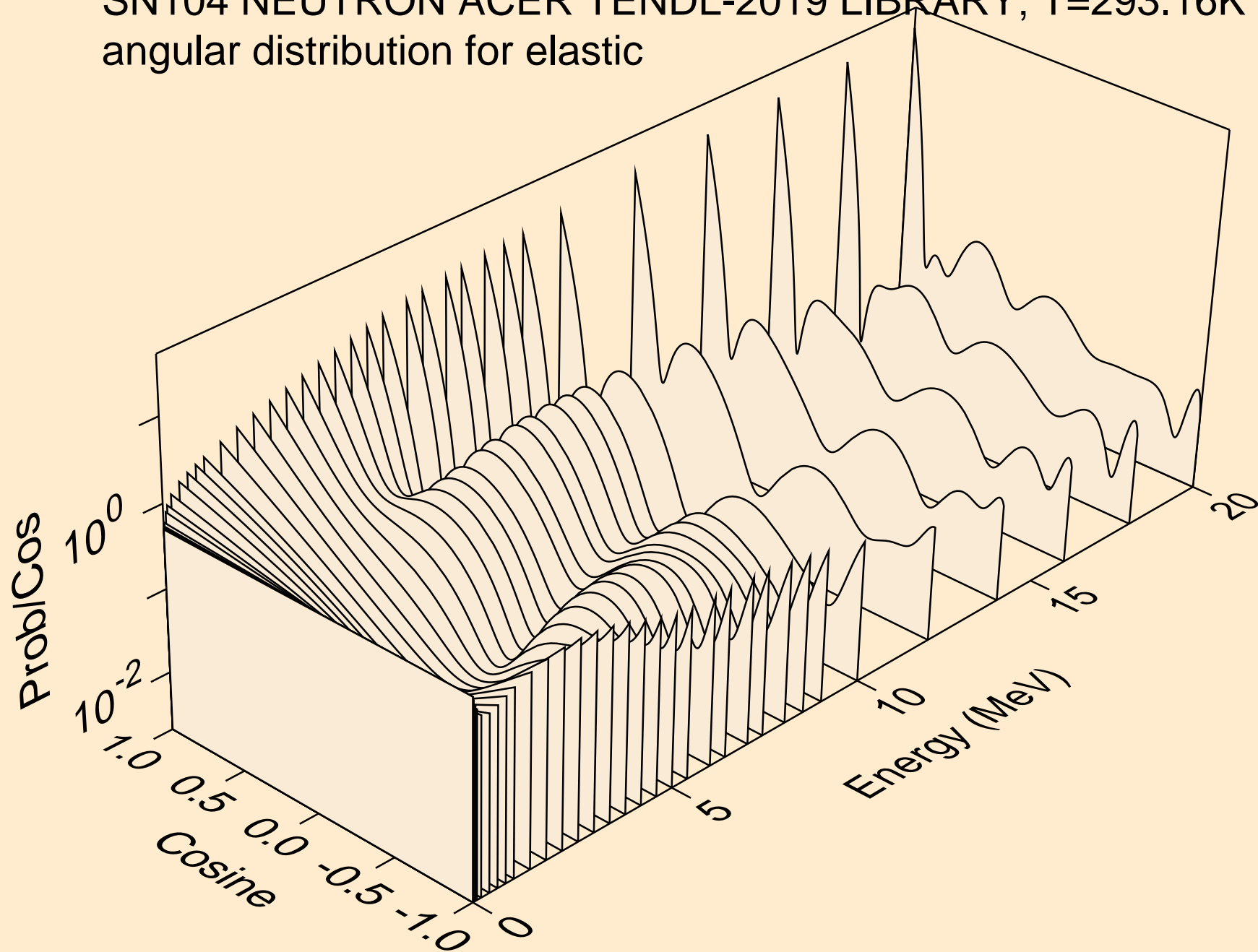

SN104 NEUTRON ACER TENDL-2019 LIBRARY; T=293.16K  
angular distribution for elastic

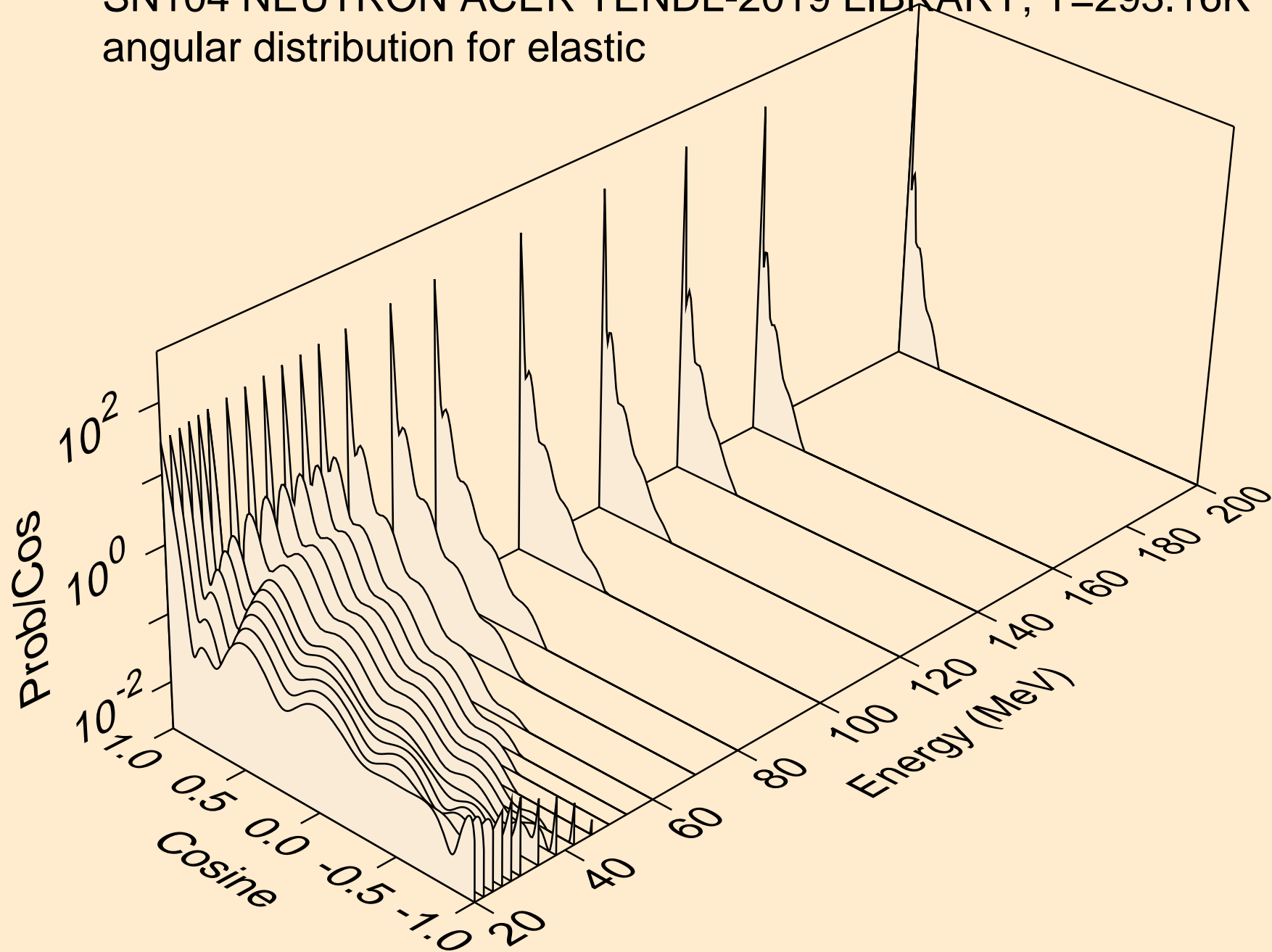

SN104 NEUTRON ACER TENDL-2019 LIBRARY; T=293.16K  
angular distribution for (n,n\*1)

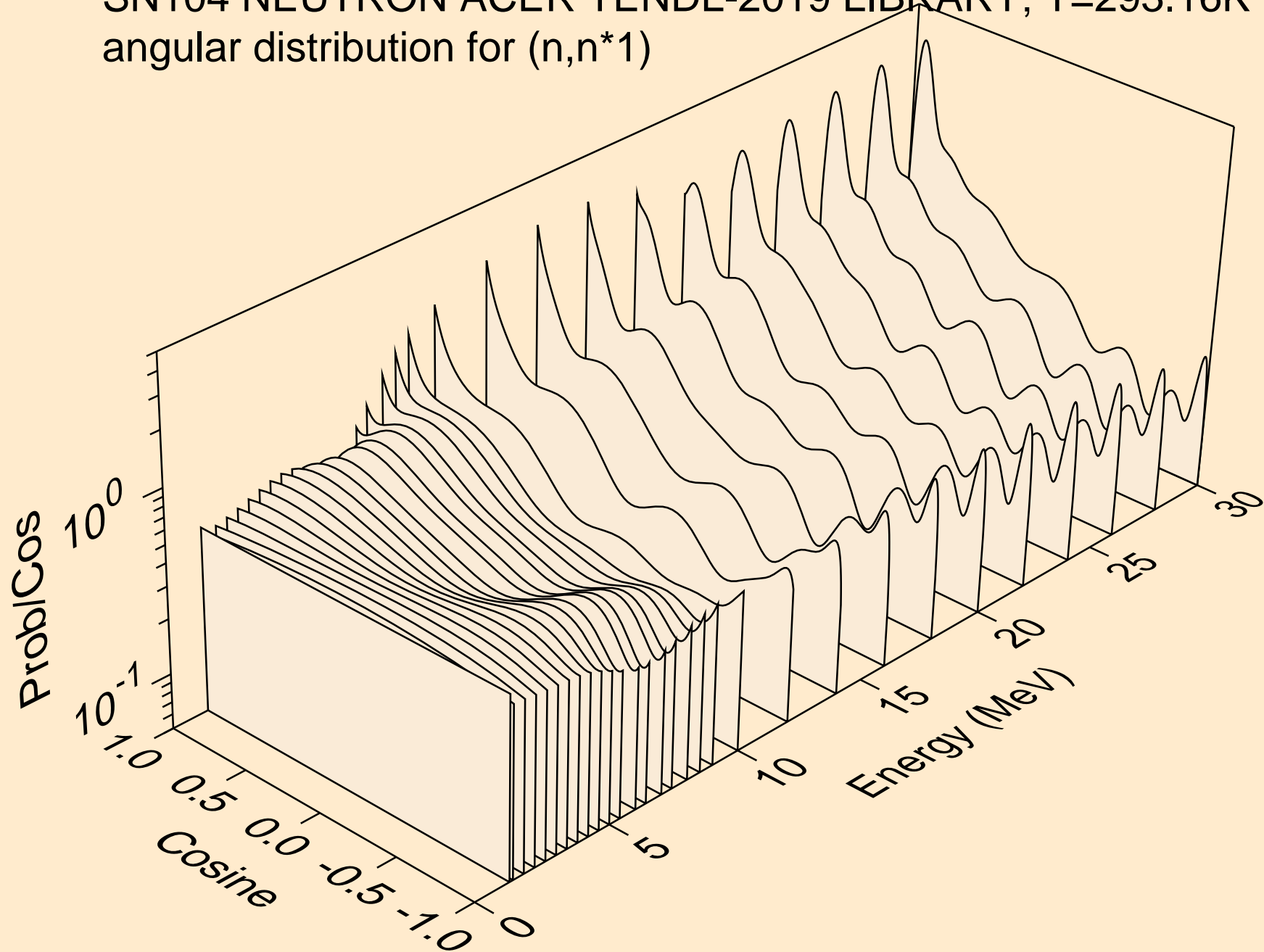

SN104 NEUTRON ACER TENDL-2019 LIBRARY; T=293.16K  
angular distribution for (n,n\*2)

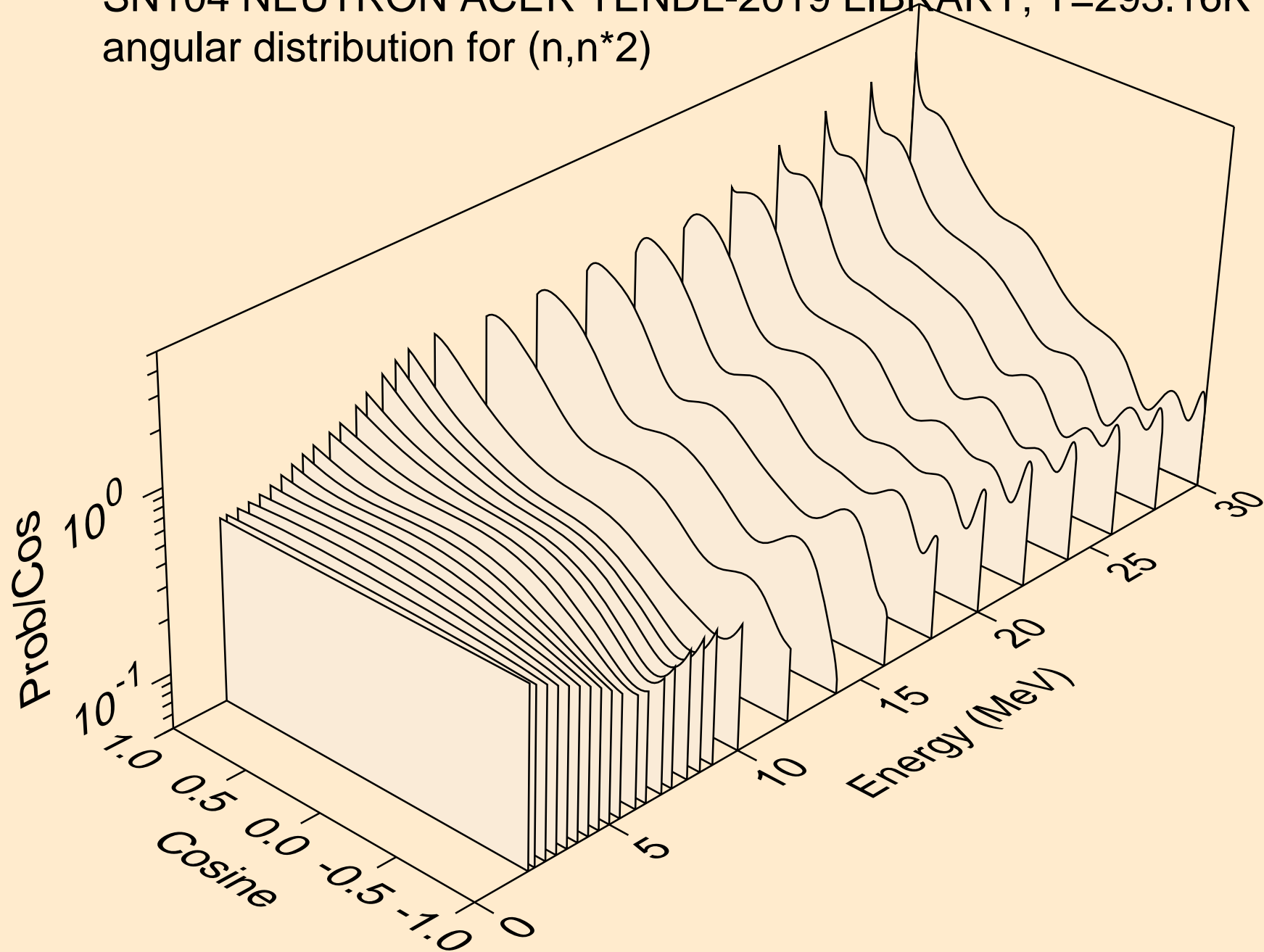

SN104 NEUTRON ACER TENDL-2019 LIBRARY; T=293.16K  
Neutron emission for (n,x)

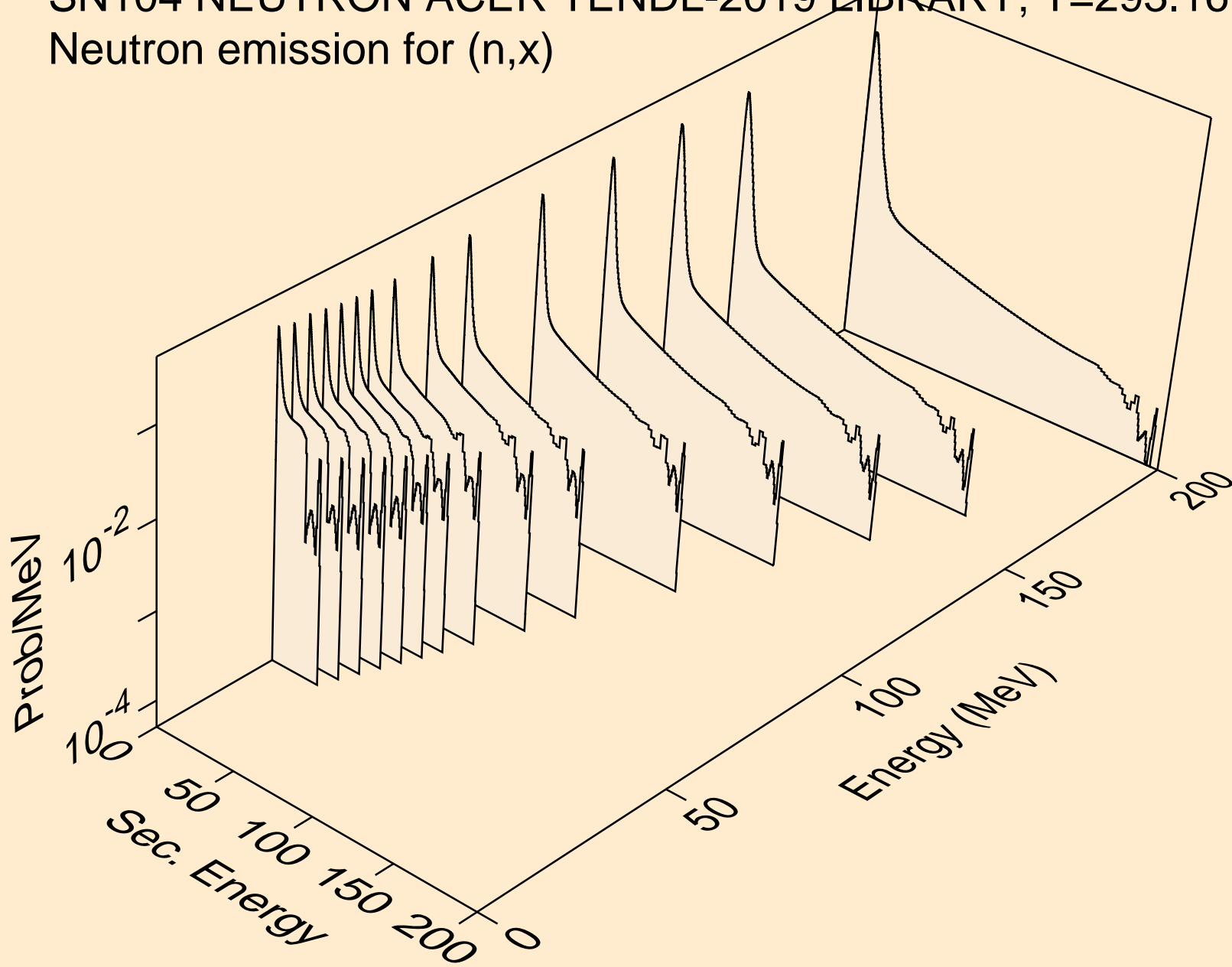

SN104 NEUTRON ACER TENDL-2019 LIBRARY; T=293.16K  
Neutron emission for (n,2nd)

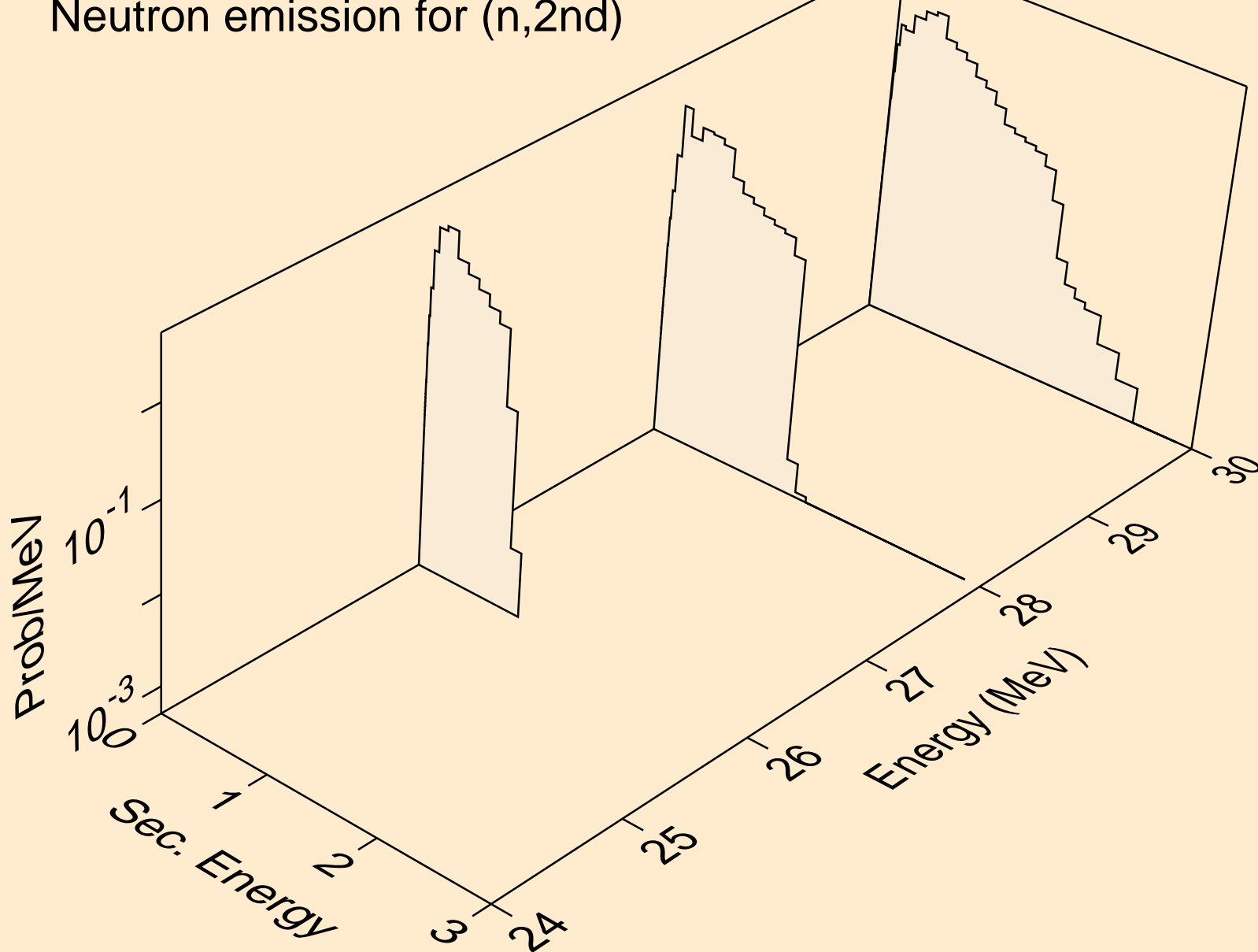

SN104 NEUTRON ACER TENDL-2019 LIBRARY; T=293.16K  
Neutron emission for (n,2n)

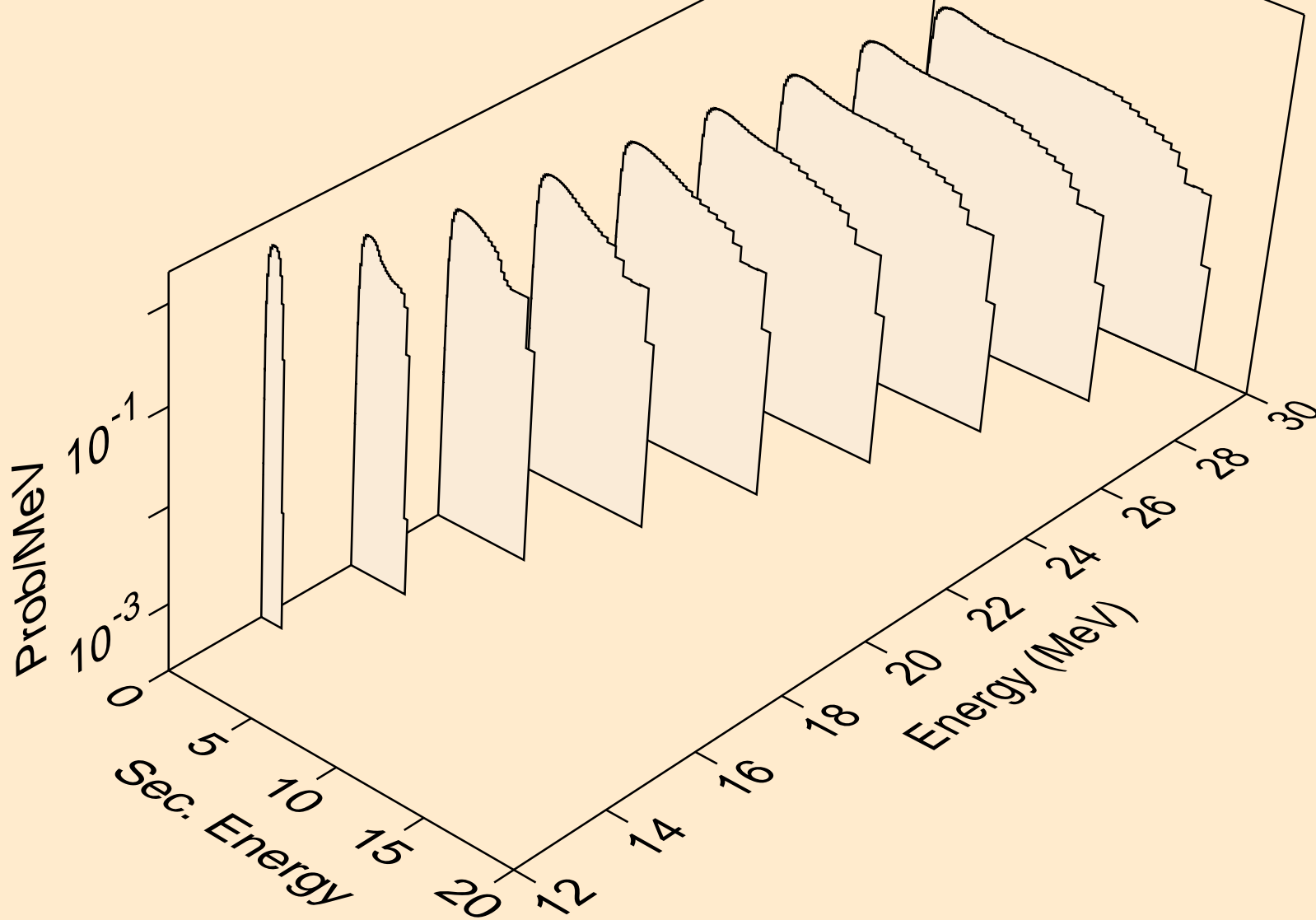



SN104 NEUTRON ACER TENDL-2019 LIBRARY; T=293.16K  
Neutron emission for (n,3n)

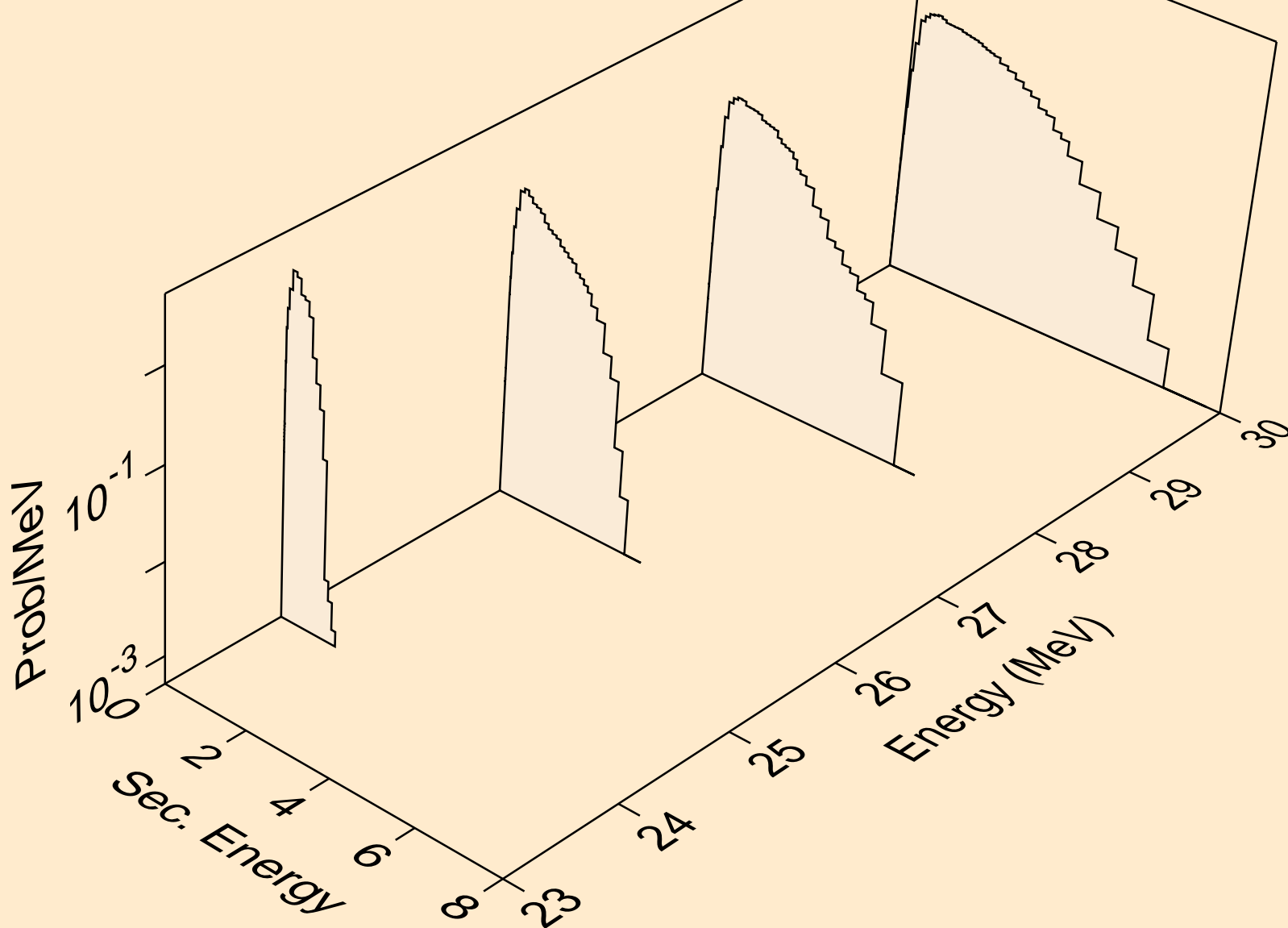

SN104 NEUTRON ACER TENDL-2019 LIBRARY; T=293.16K  
Neutron emission for (n,n\*)a

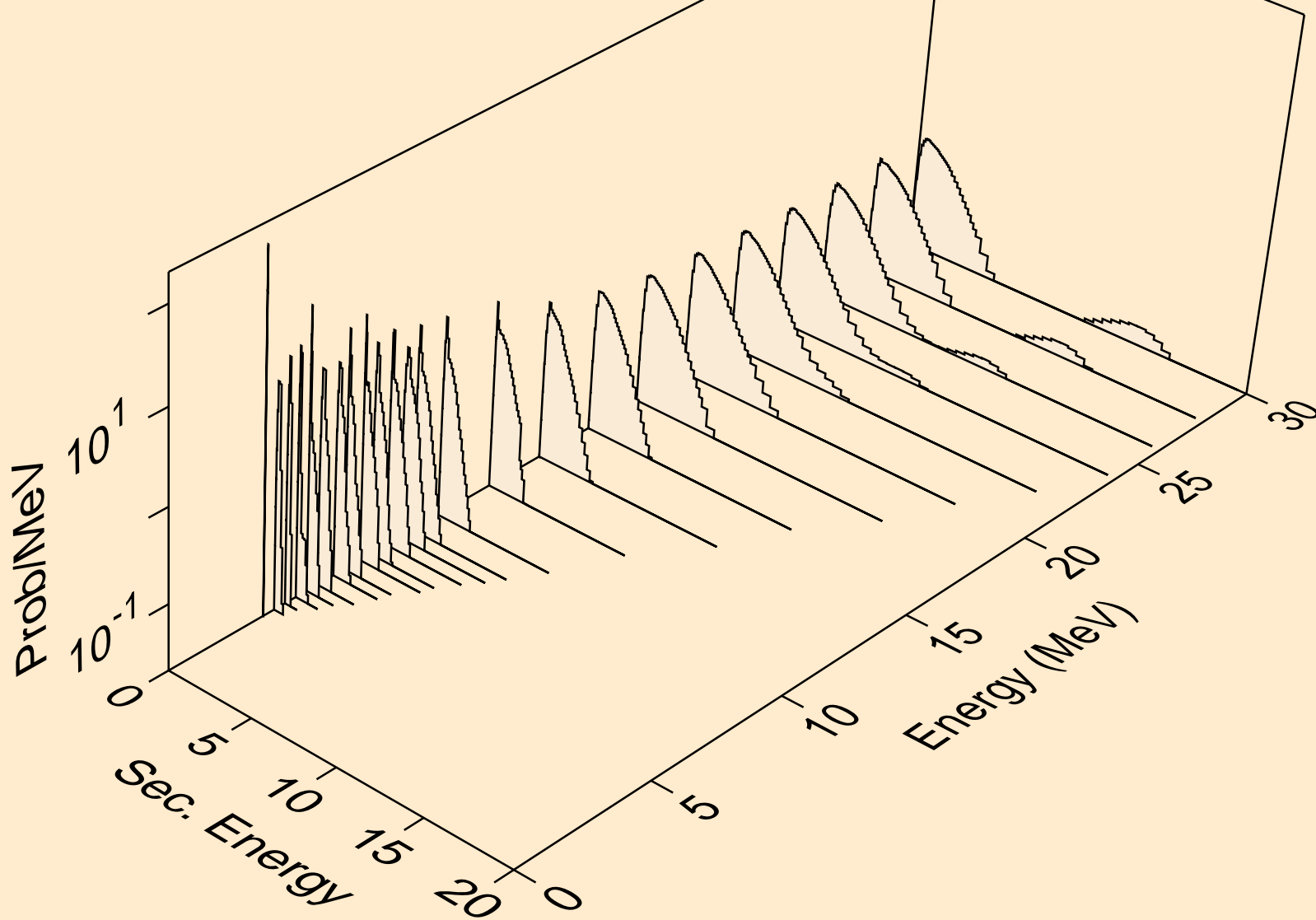

SN104 NEUTRON ACER TENDL-2019 LIBRARY; T=293.16K  
Neutron emission for (n,2n)a

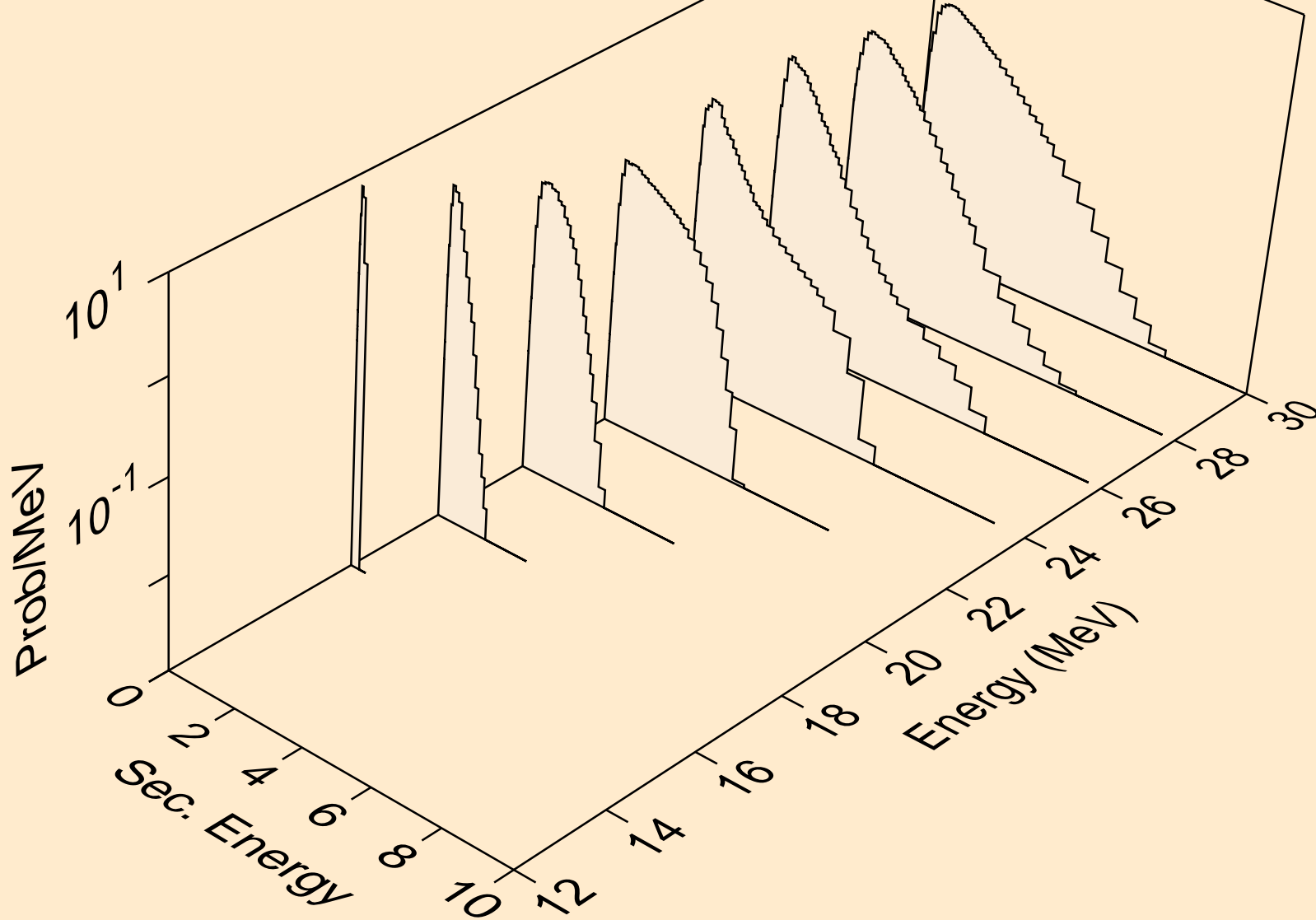

SN104 NEUTRON ACER TENDL-2019 LIBRARY; T=293.16K  
Neutron emission for (n,n\*)p

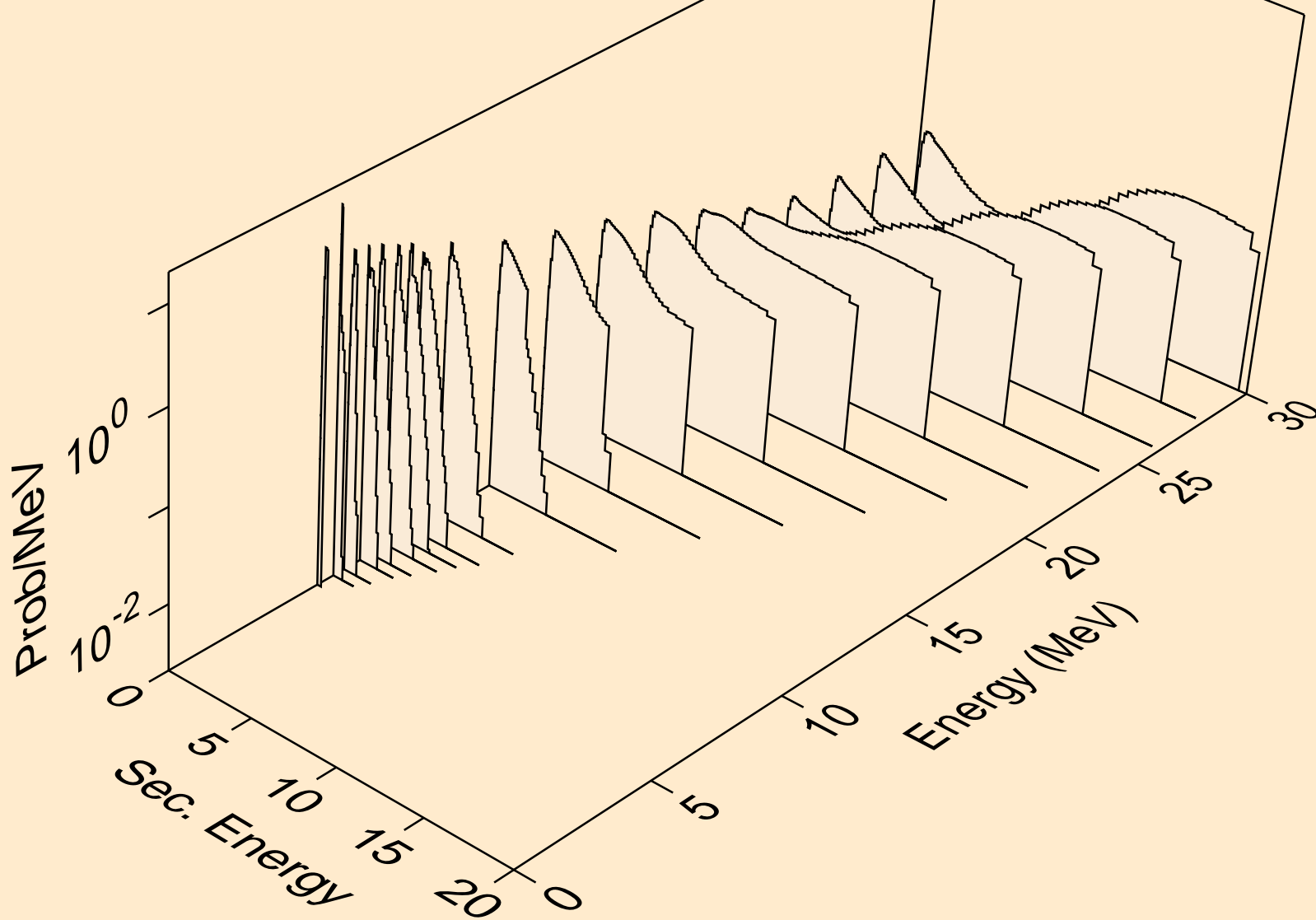

SN104 NEUTRON ACER TENDL-2019 LIBRARY; T=293.16K  
Neutron emission for (n,n\*)2a

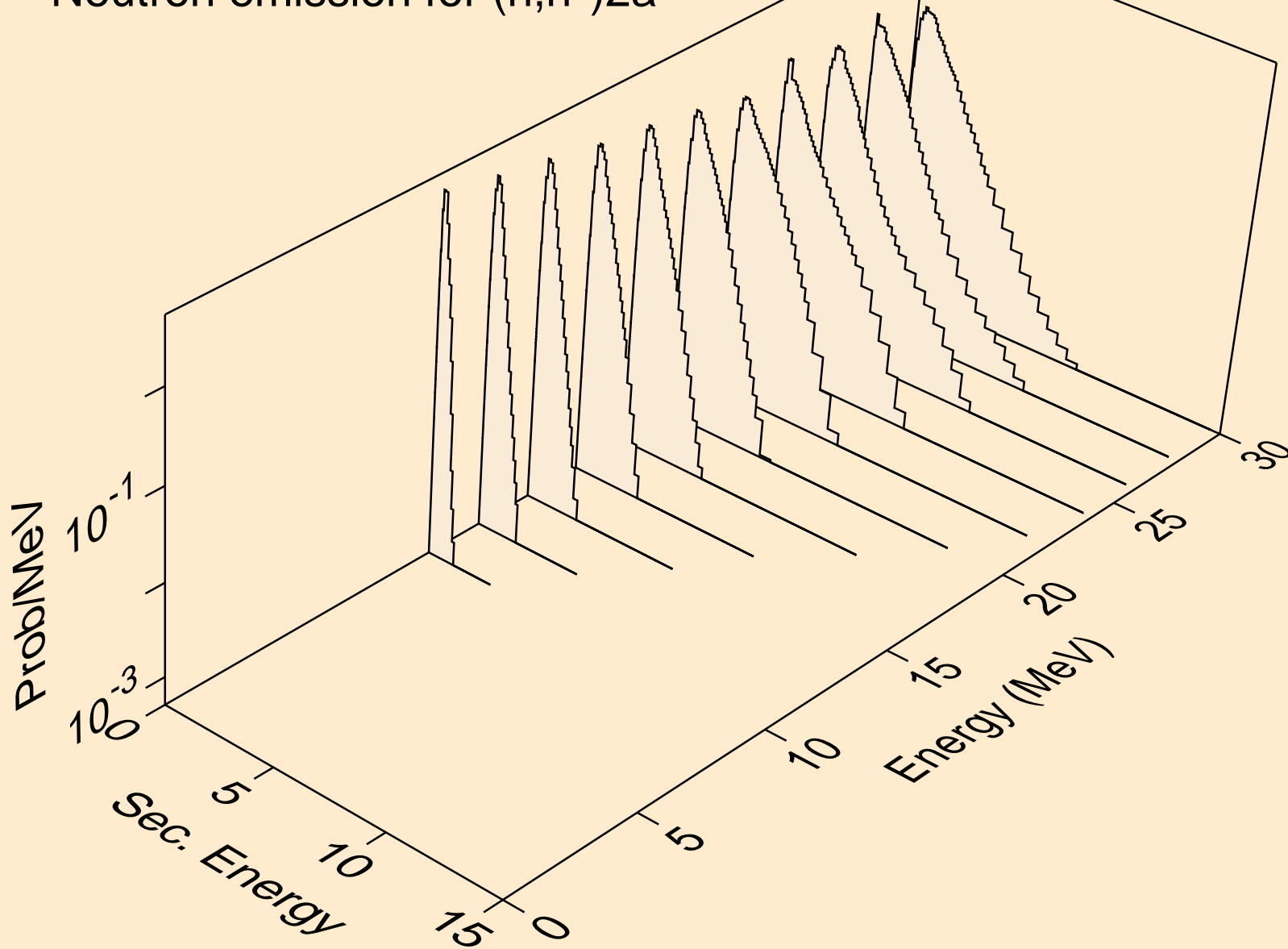

SN104 NEUTRON ACER TENDL-2019 LIBRARY; T=293.16K  
Neutron emission for (n,n\*)d

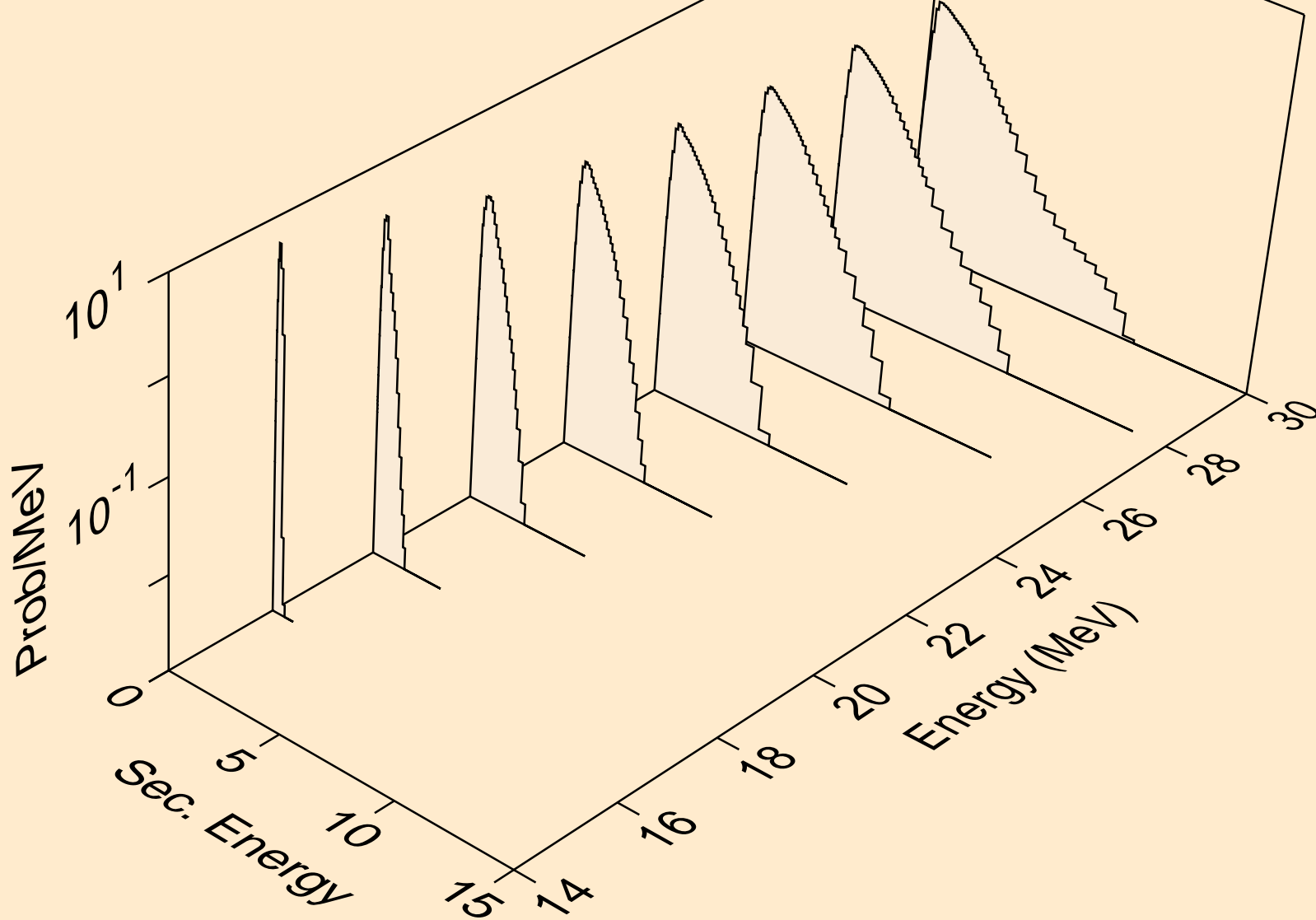

SN104 NEUTRON ACER TENDL-2019 LIBRARY; T=293.16K  
Neutron emission for (n,n\*)t

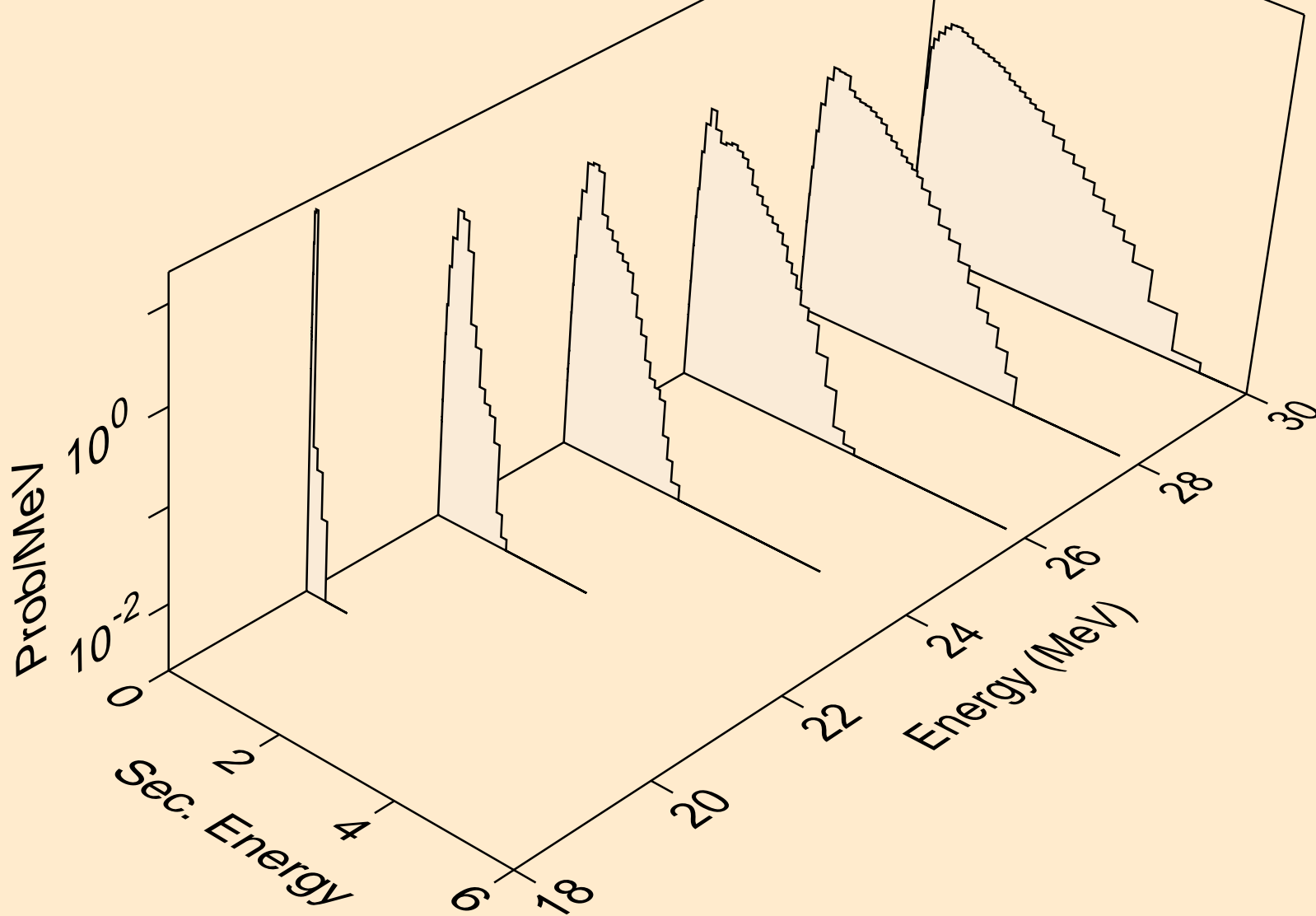

SN104 NEUTRON ACER TENDL-2019 LIBRARY; T=293.16K  
Neutron emission for (n,n\*)he3

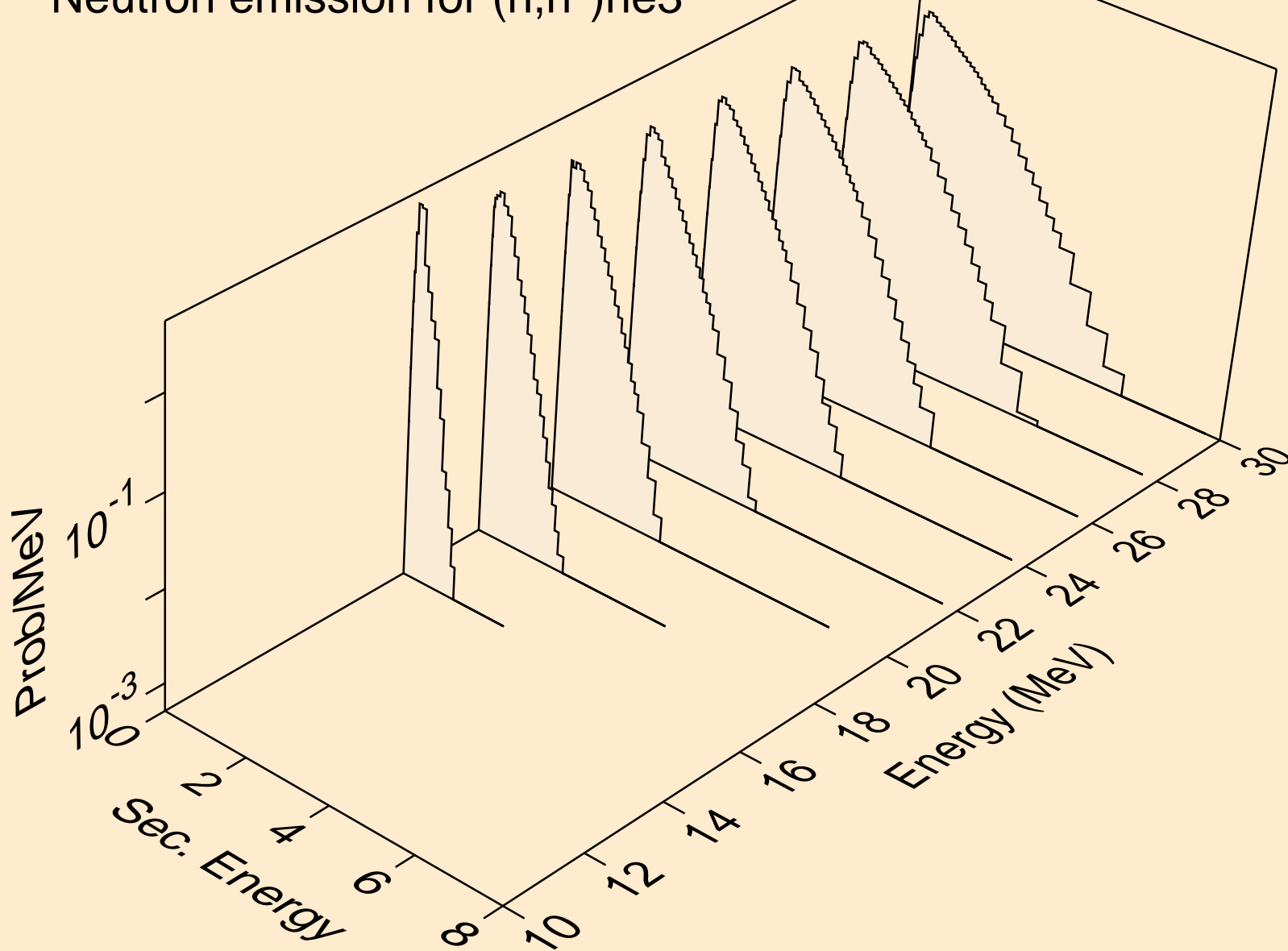



SN104 NEUTRON ACER TENDL-2019 LIBRARY; T=293.16K  
Neutron emission for (n,2np)

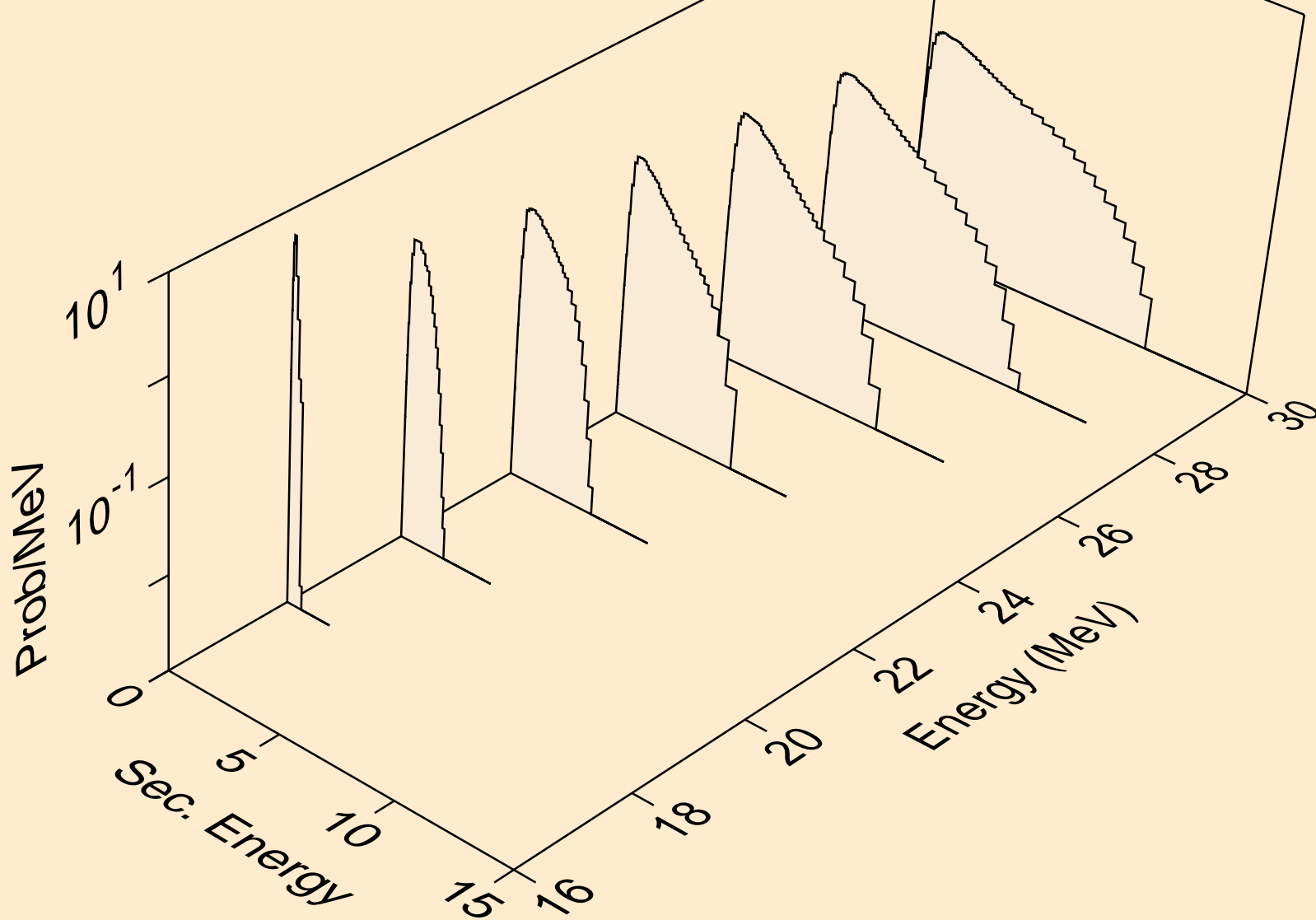



SN104 NEUTRON ACER TENDL-2019 LIBRARY; T=293.16K  
Neutron emission for (n,2np)

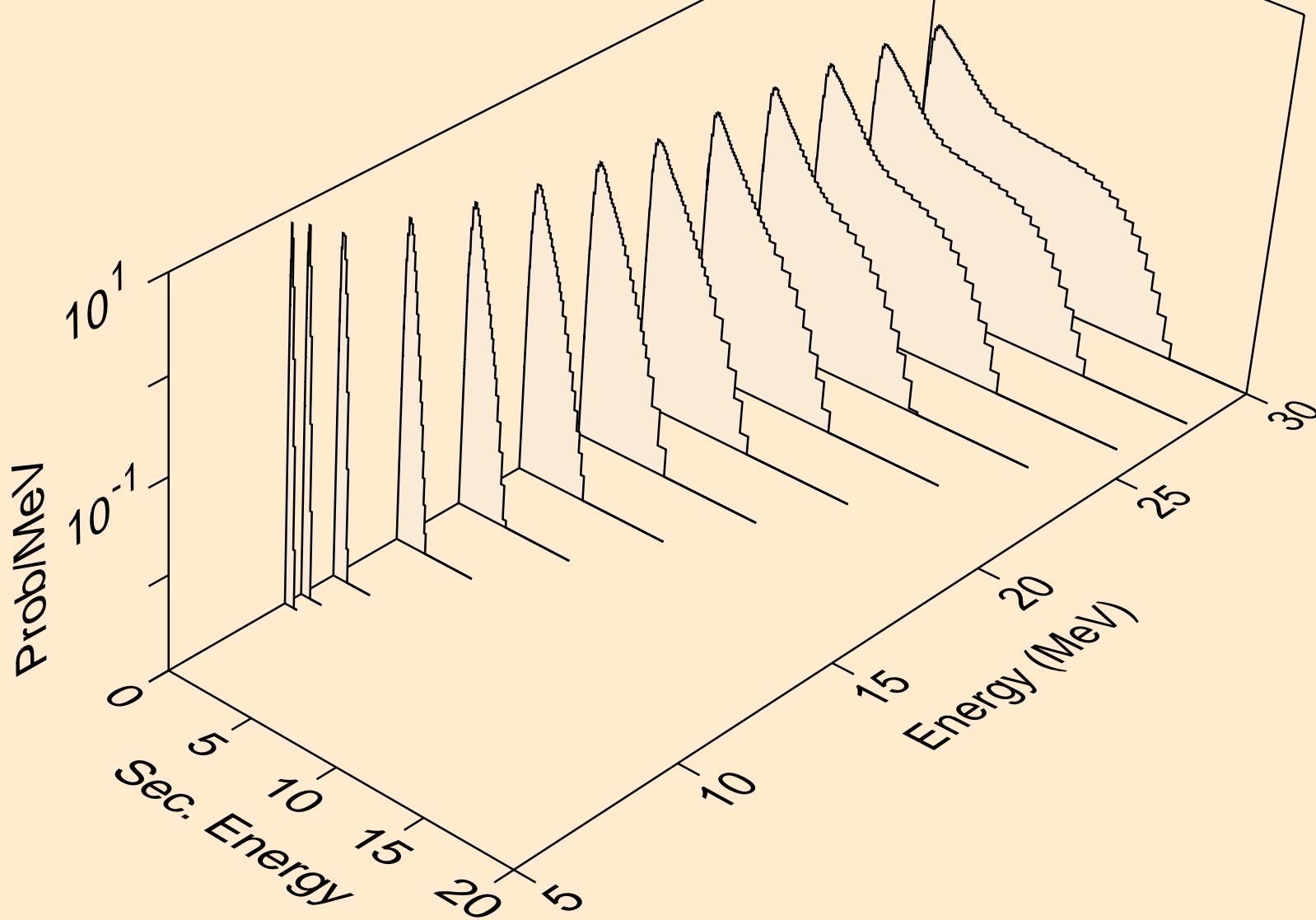

SN104 NEUTRON ACER TENDL-2019 LIBRARY; T=293.16K  
Neutron emission for (n,npa)

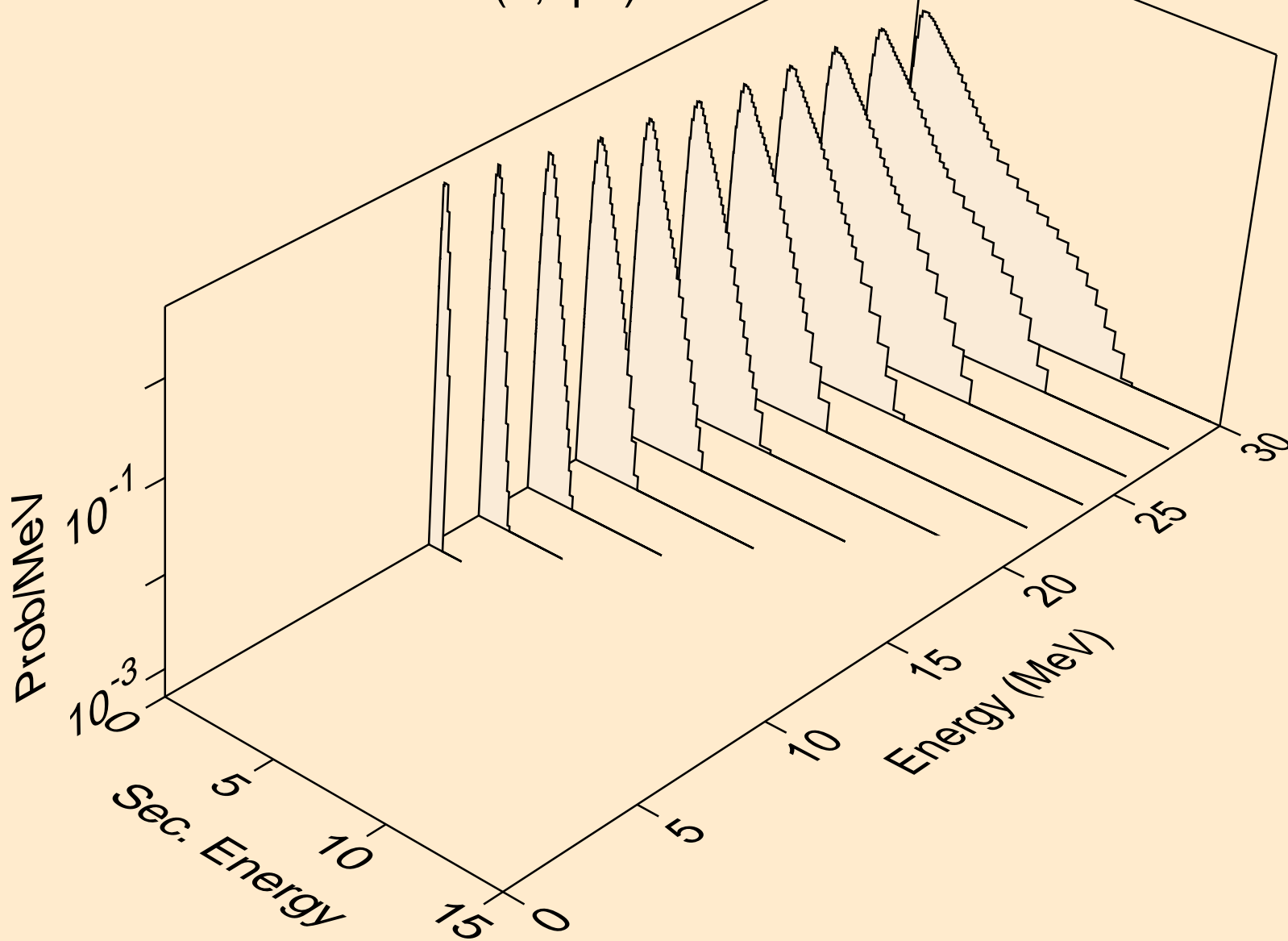

SN104 NEUTRON ACER TENDL-2019 LIBRARY; T=293.16K  
Neutron emission for (n,n\*c)

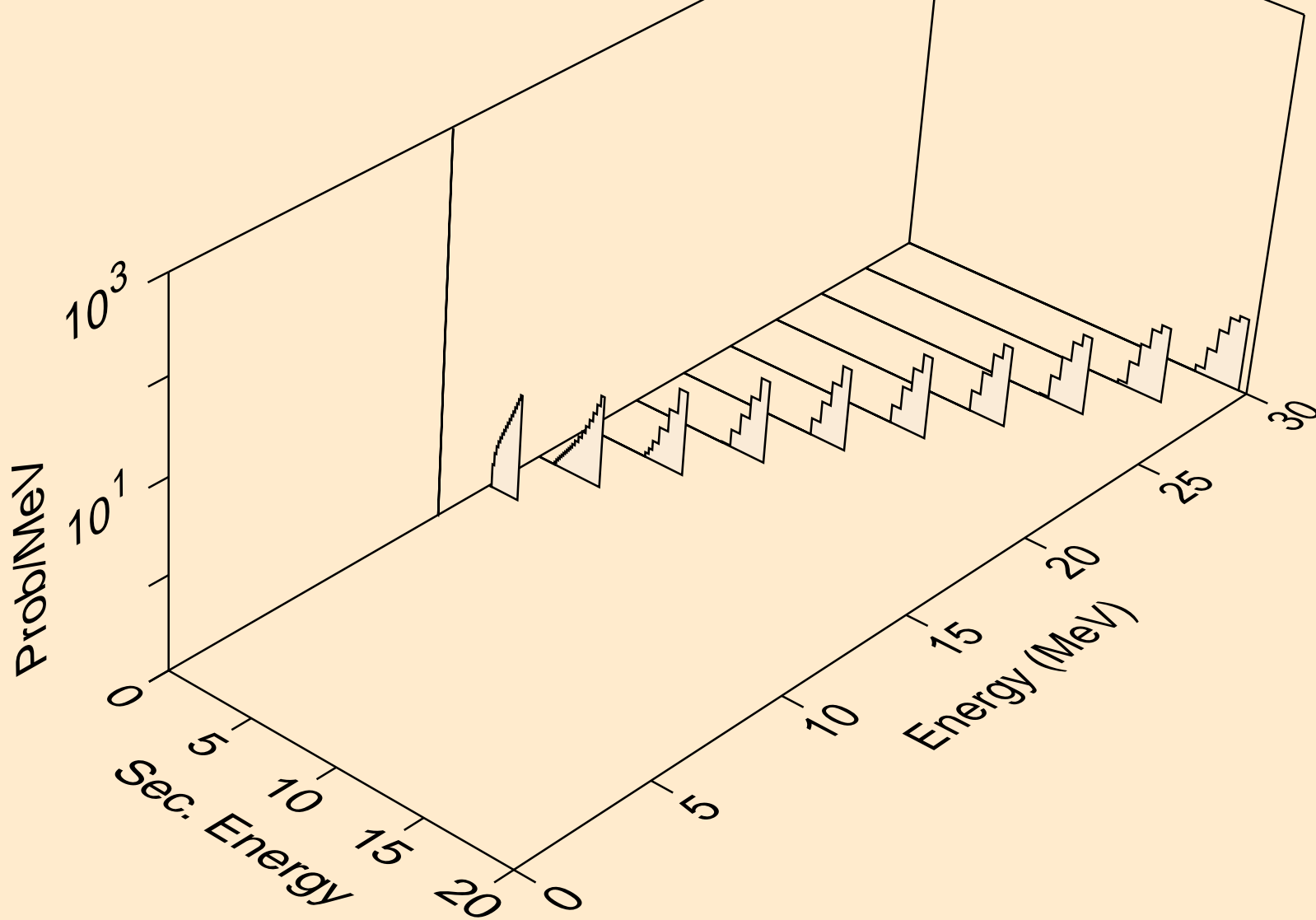

SN104 NEUTRON ACER TENDL-2019 LIBRARY; T=293.16K  
Photon emission for (n,x)

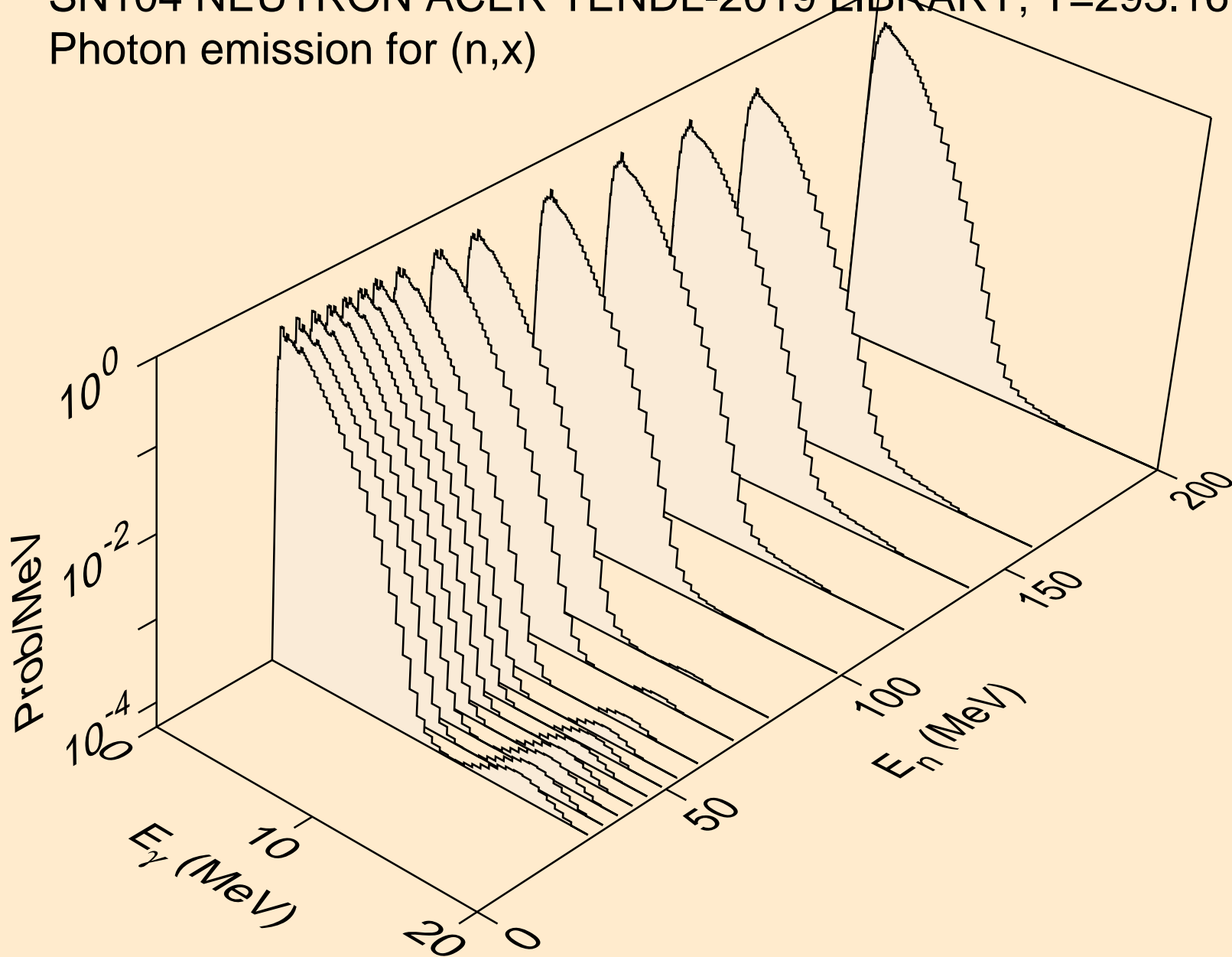

SN104 NEUTRON ACER TENDL-2019 LIBRARY; T=293.16K  
Photon emission for (n,2nd)

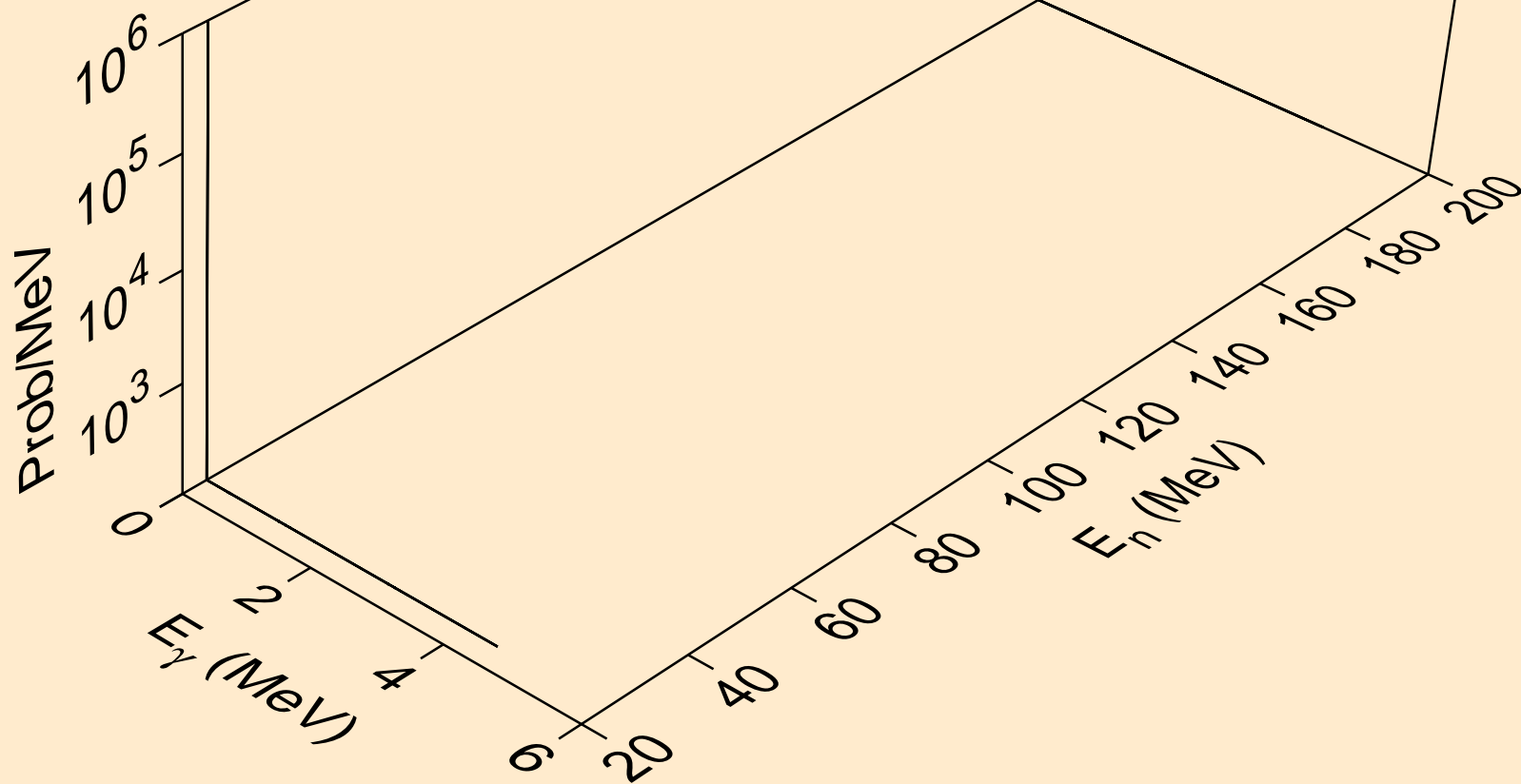

SN104 NEUTRON ACER TENDL-2019 LIBRARY; T=293.16K  
Photon emission for (n,2n)

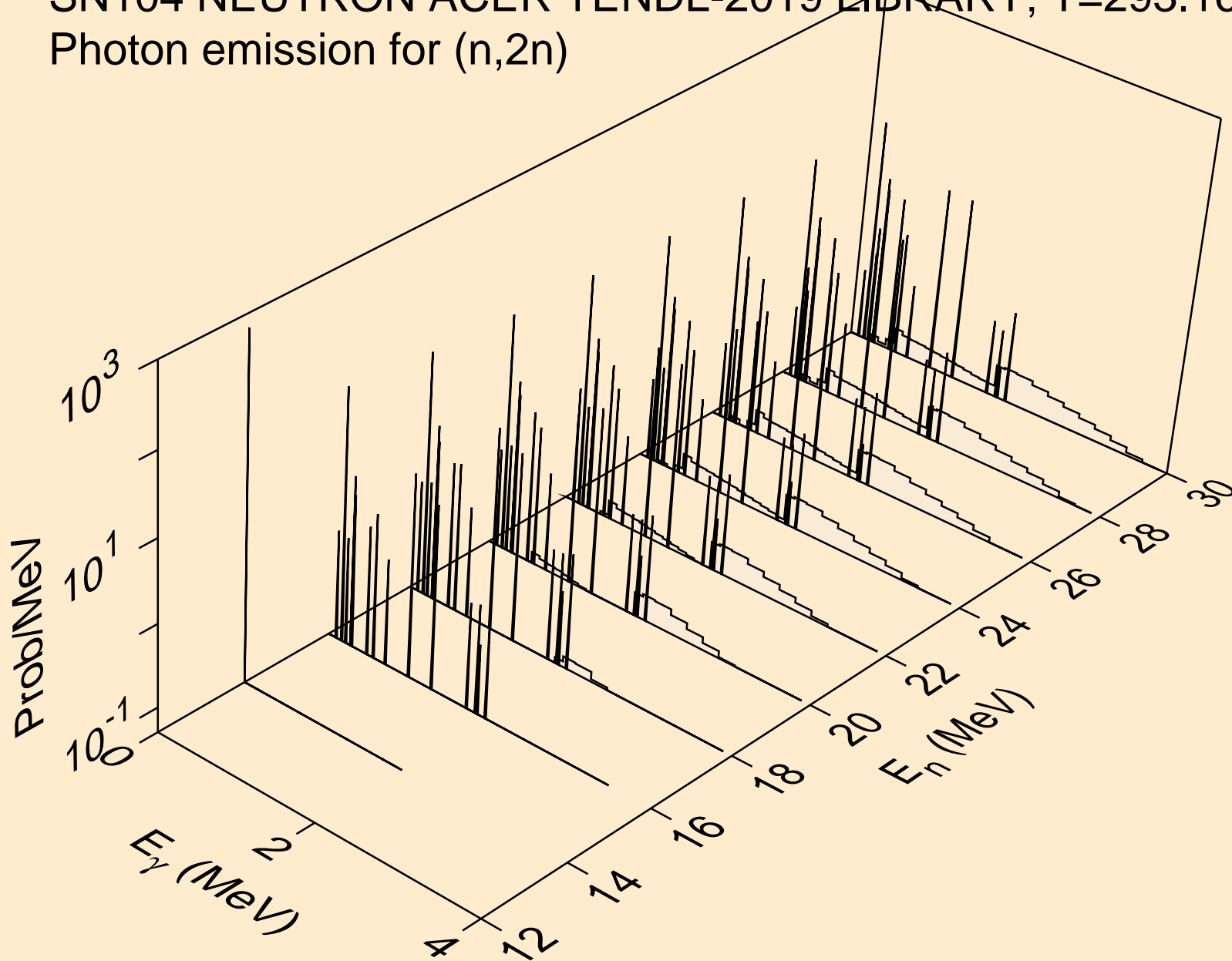



SN104 NEUTRON ACER TENDL-2019 LIBRARY; T=293.16K  
Photon emission for (n,3n)

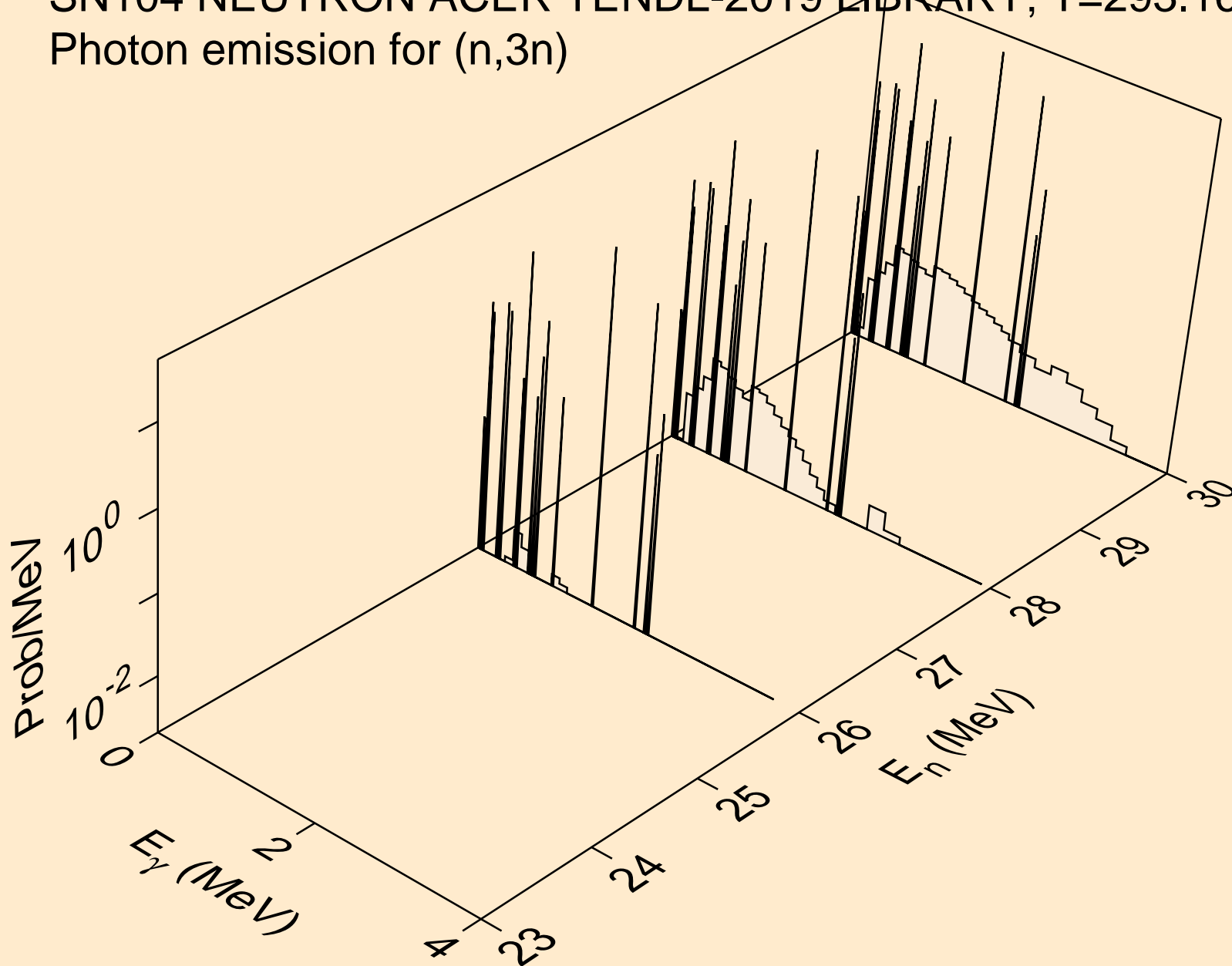

SN104 NEUTRON ACER TENDL-2019 LIBRARY; T=293.16K  
Photon emission for (n,n\*)a

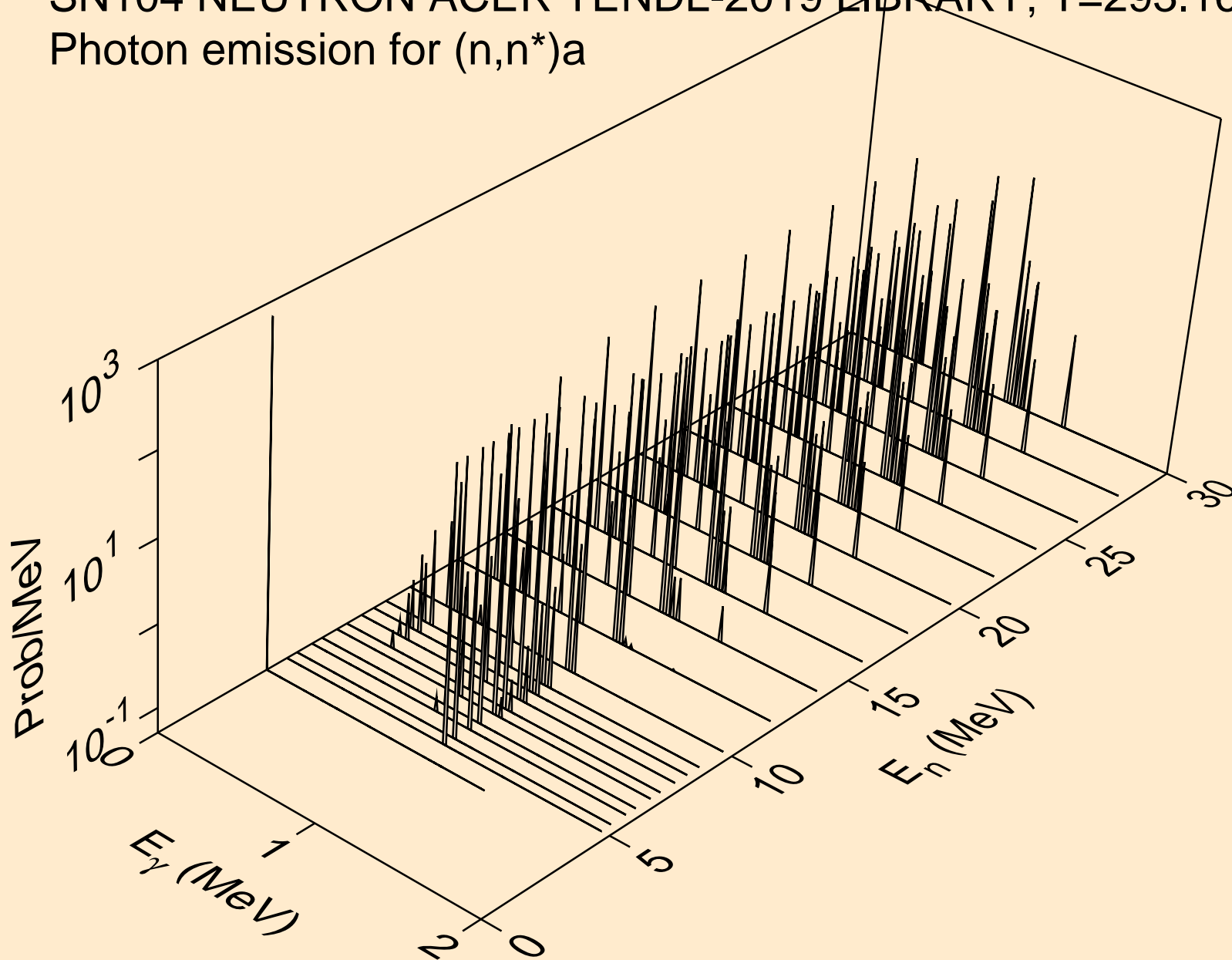

SN104 NEUTRON ACER TENDL-2019 LIBRARY; T=293.16K  
Photon emission for (n,2n)a

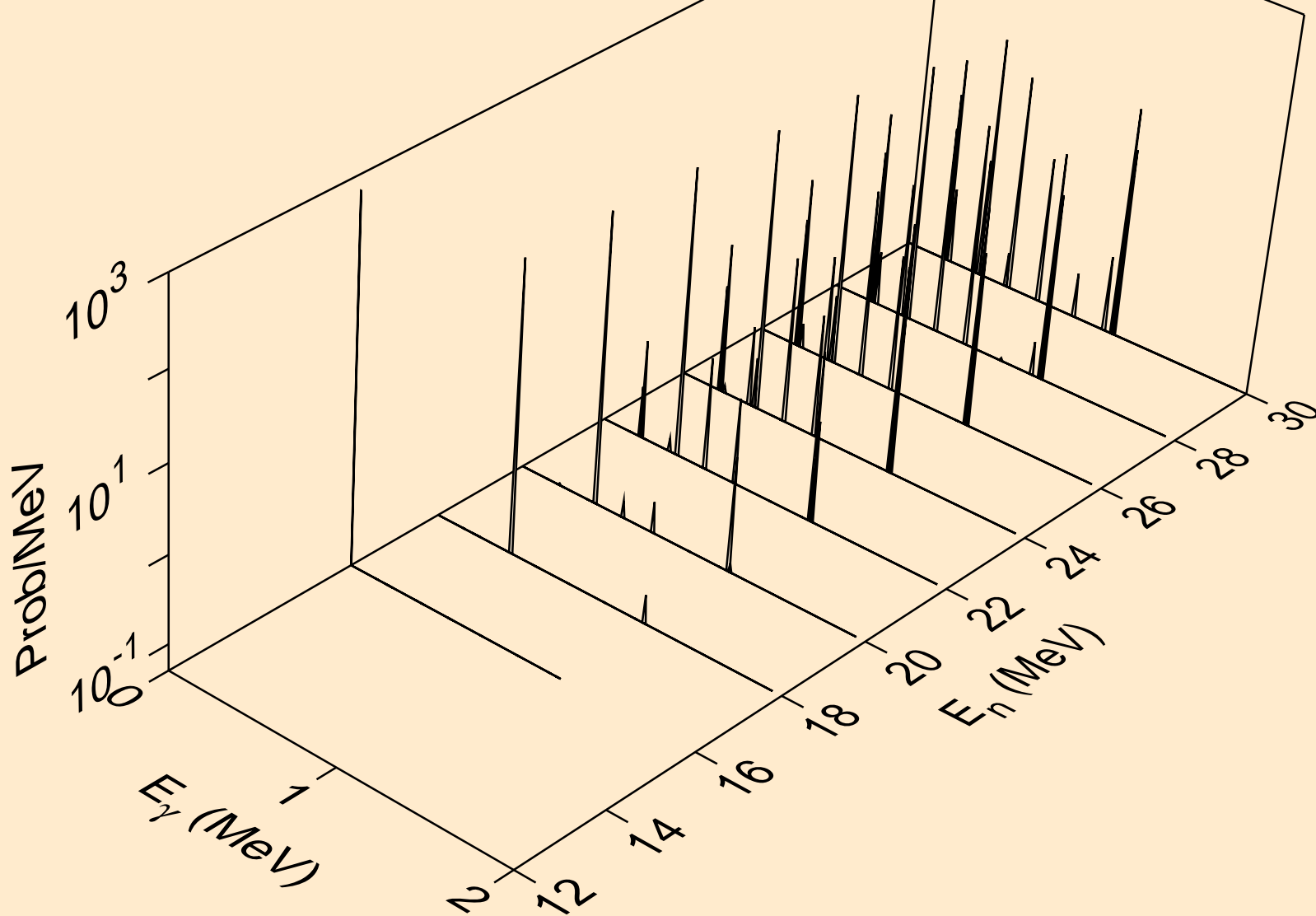

SN104 NEUTRON ACER TENDL-2019 LIBRARY; T=293.16K  
Photon emission for (n,n\*)p

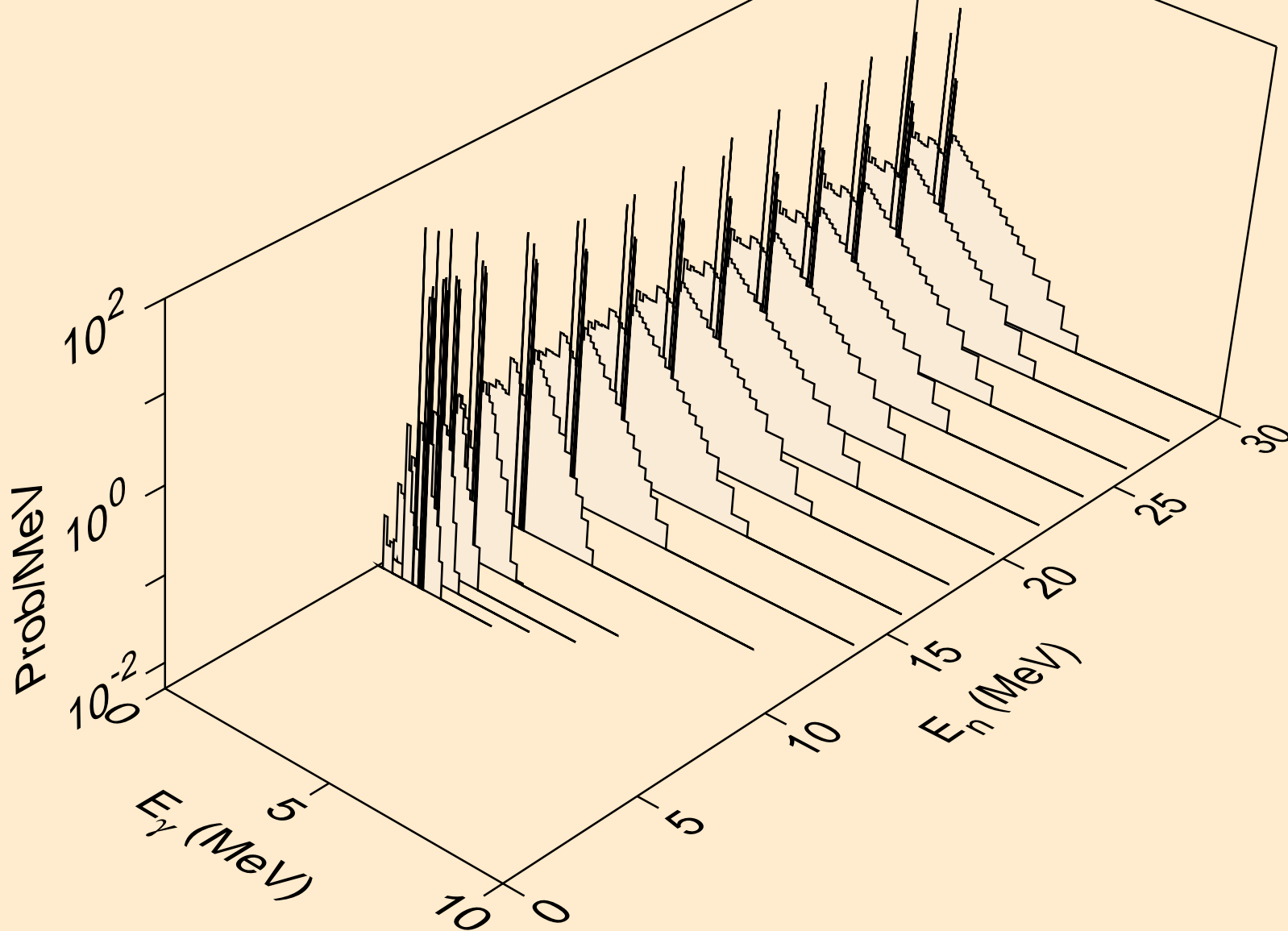

SN104 NEUTRON ACER TENDL-2019 LIBRARY; T=293.16K  
Photon emission for (n,n\*)2a

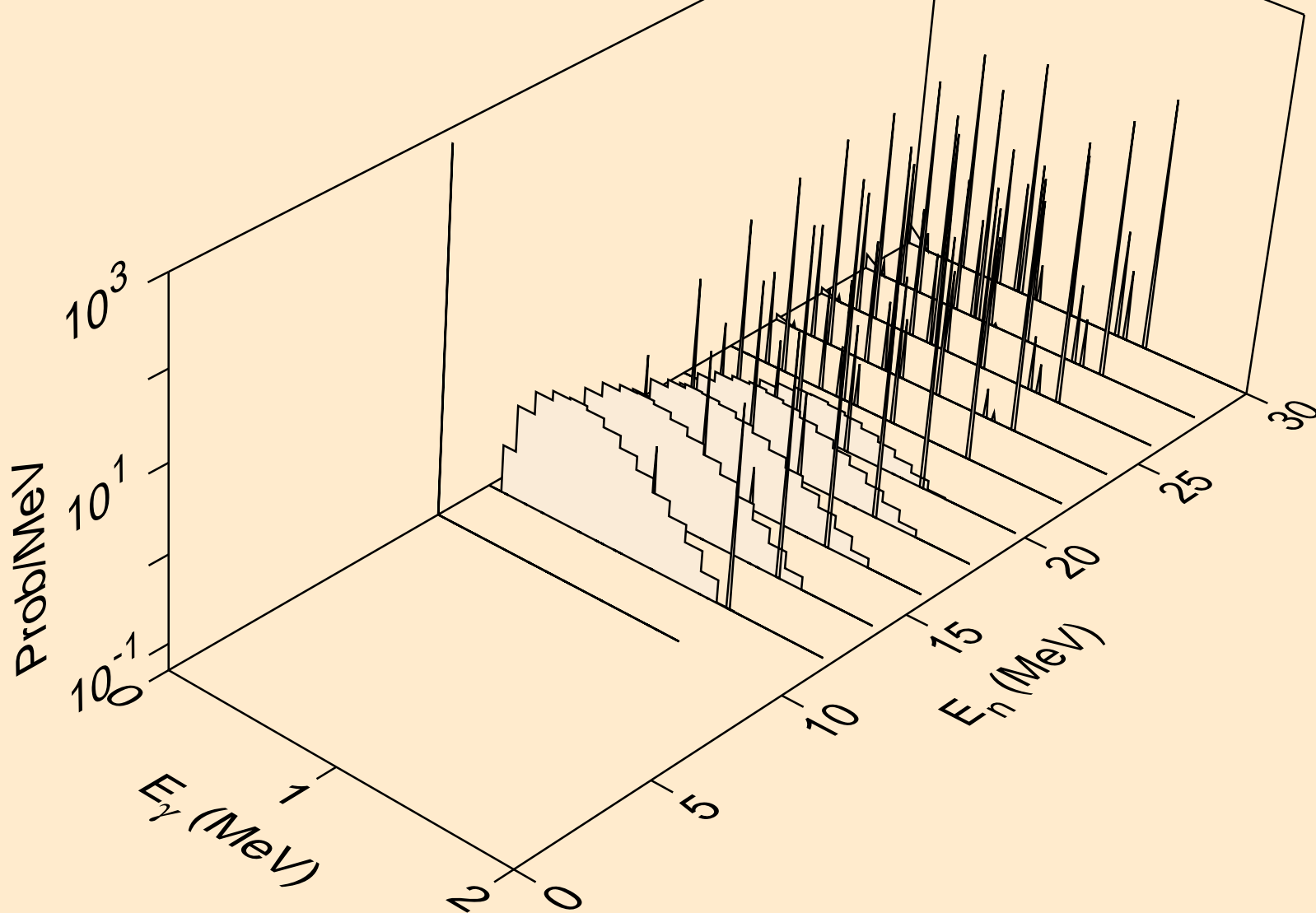

SN104 NEUTRON ACER TENDL-2019 LIBRARY; T=293.16K  
Photon emission for (n,n\*)d

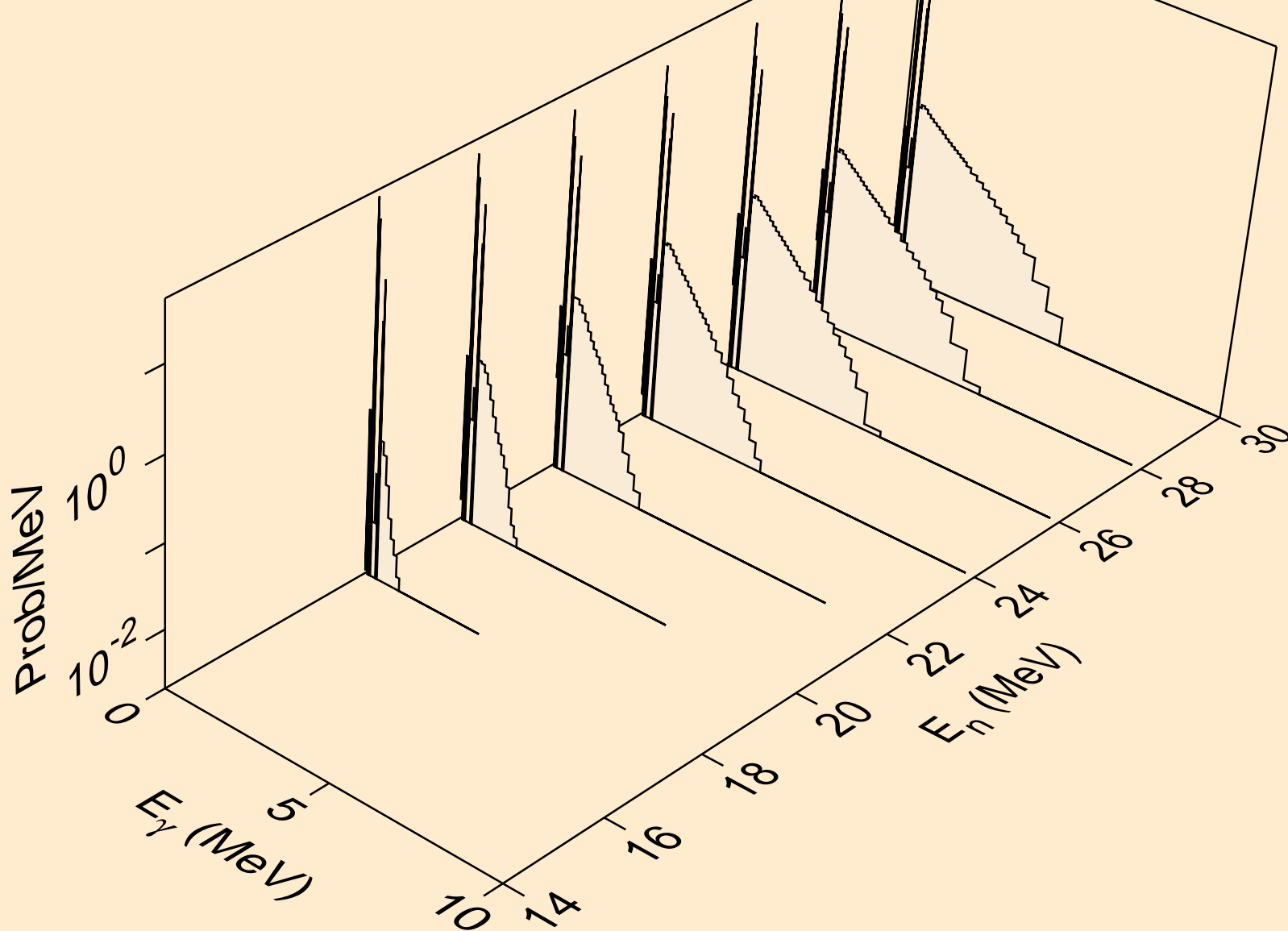

SN104 NEUTRON ACER TENDL-2019 LIBRARY; T=293.16K  
Photon emission for (n,n\*)t

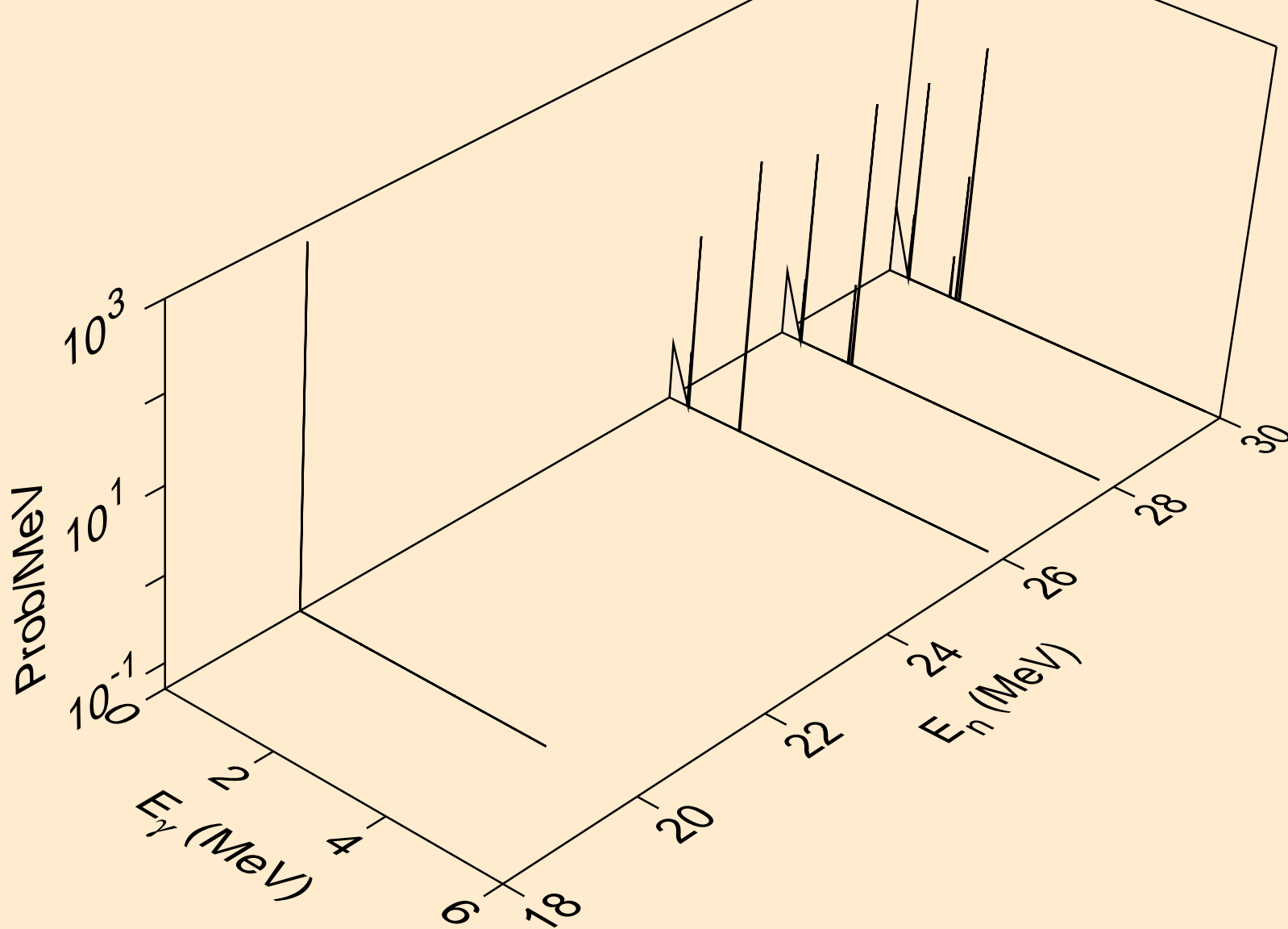

SN104 NEUTRON ACER TENDL-2019 LIBRARY; T=293.16K  
Photon emission for (n,n\*)he3

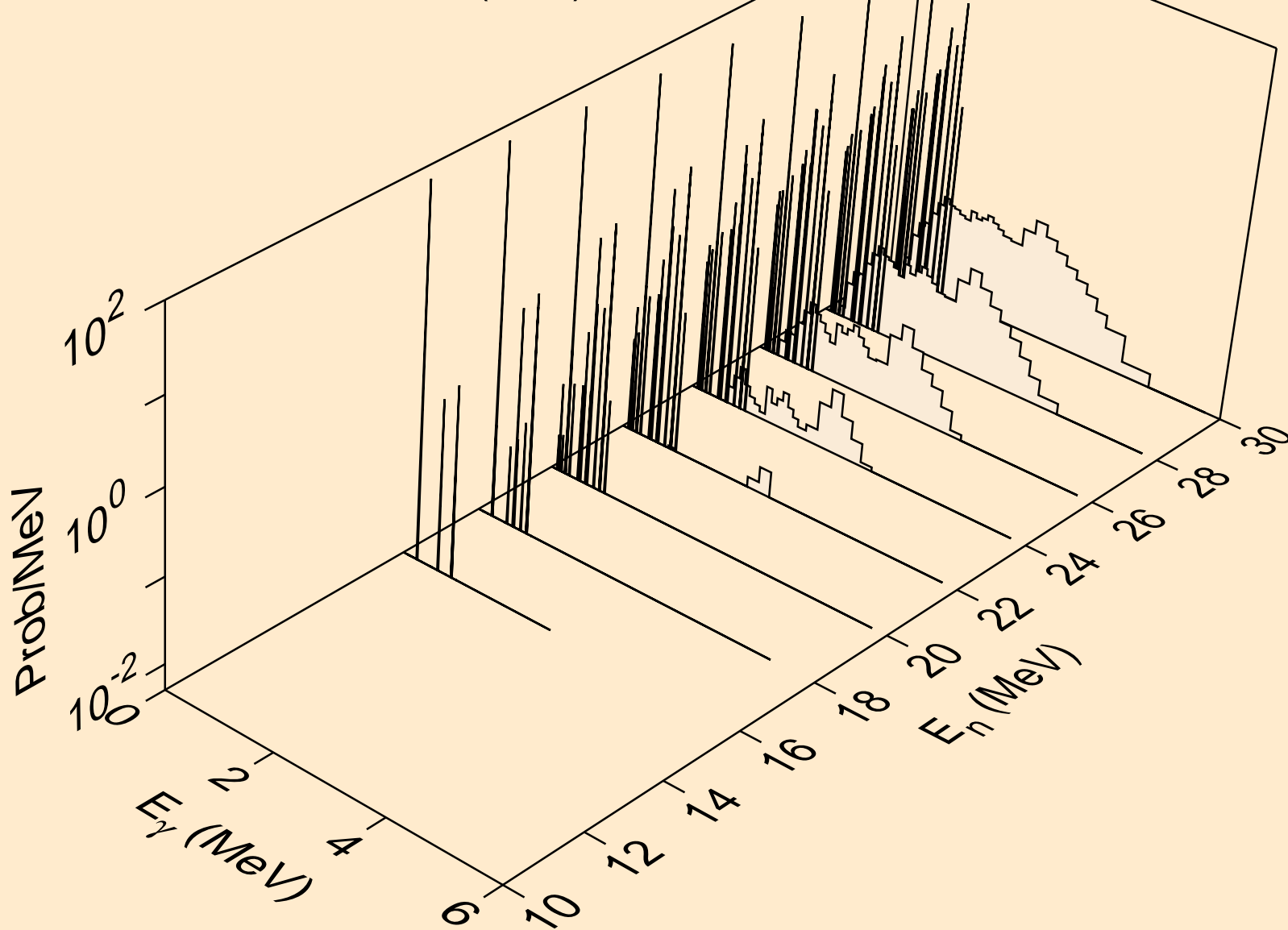



SN104 NEUTRON ACER TENDL-2019 LIBRARY; T=293.16K  
Photon emission for (n,2np)

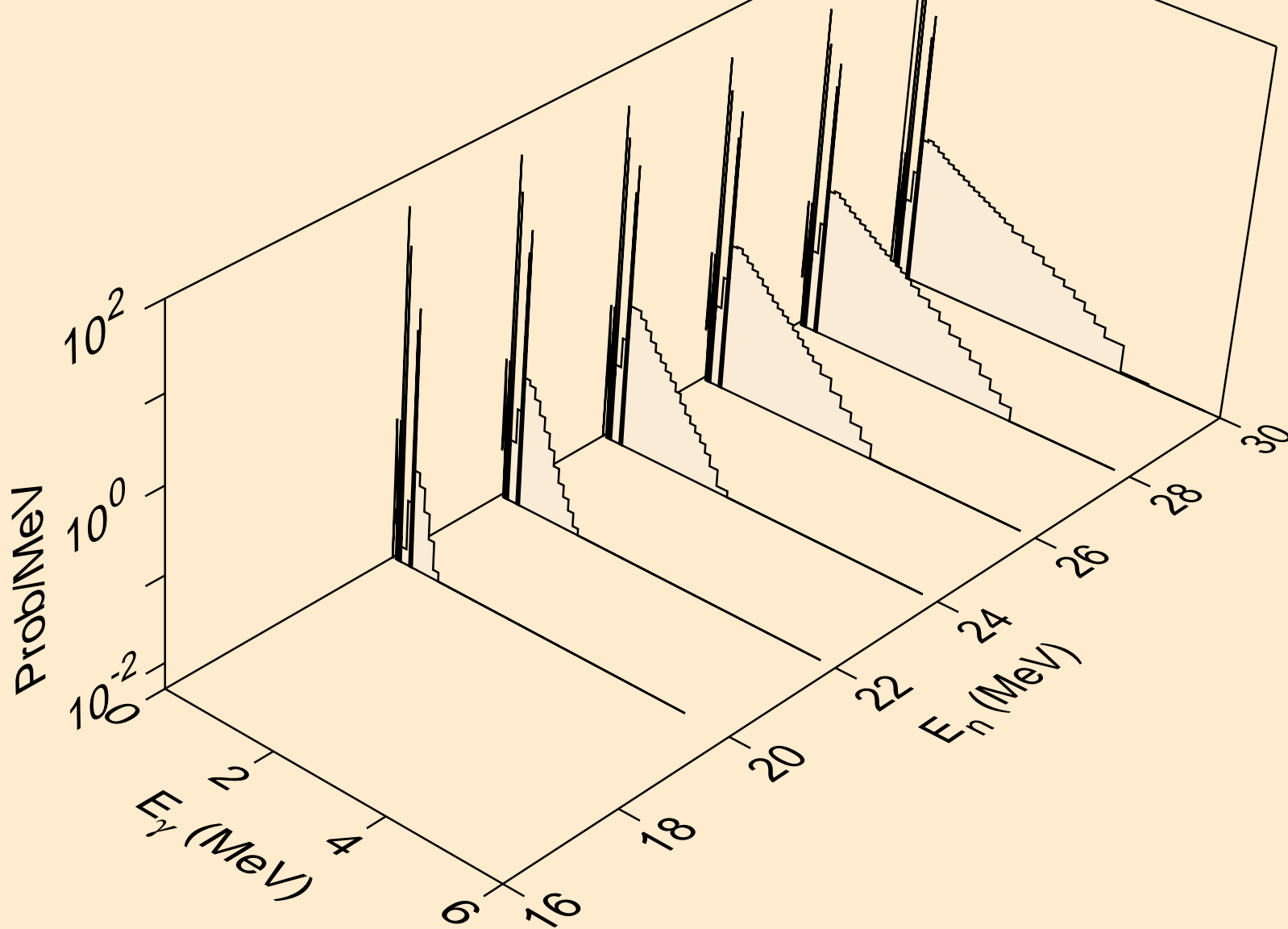

SN104 NEUTRON ACER TENDL-2019 LIBRARY; T=293.16K  
Photon emission for (n,3np)

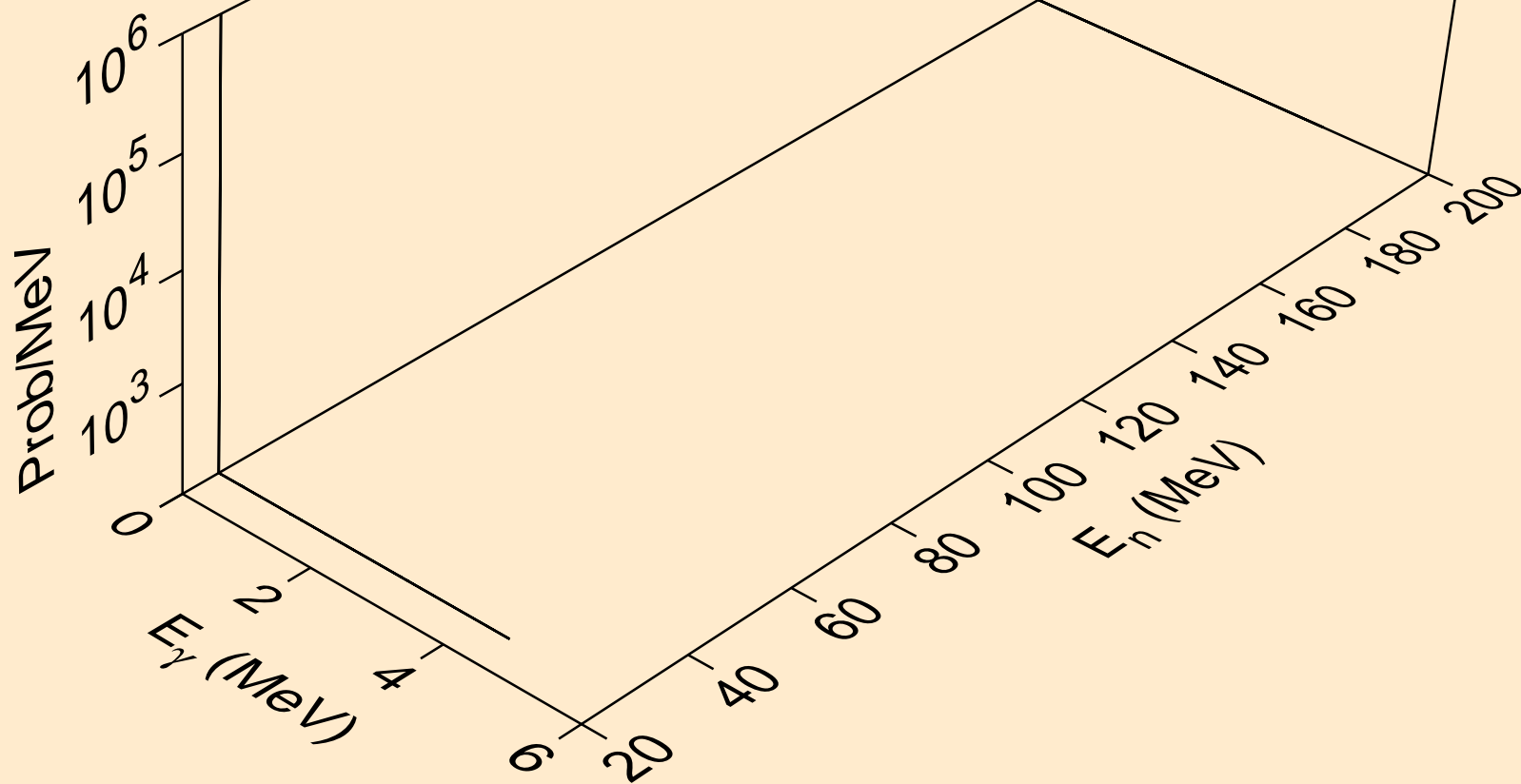

SN104 NEUTRON ACER TENDL-2019 LIBRARY; T=293.16K  
Photon emission for (n,2np)

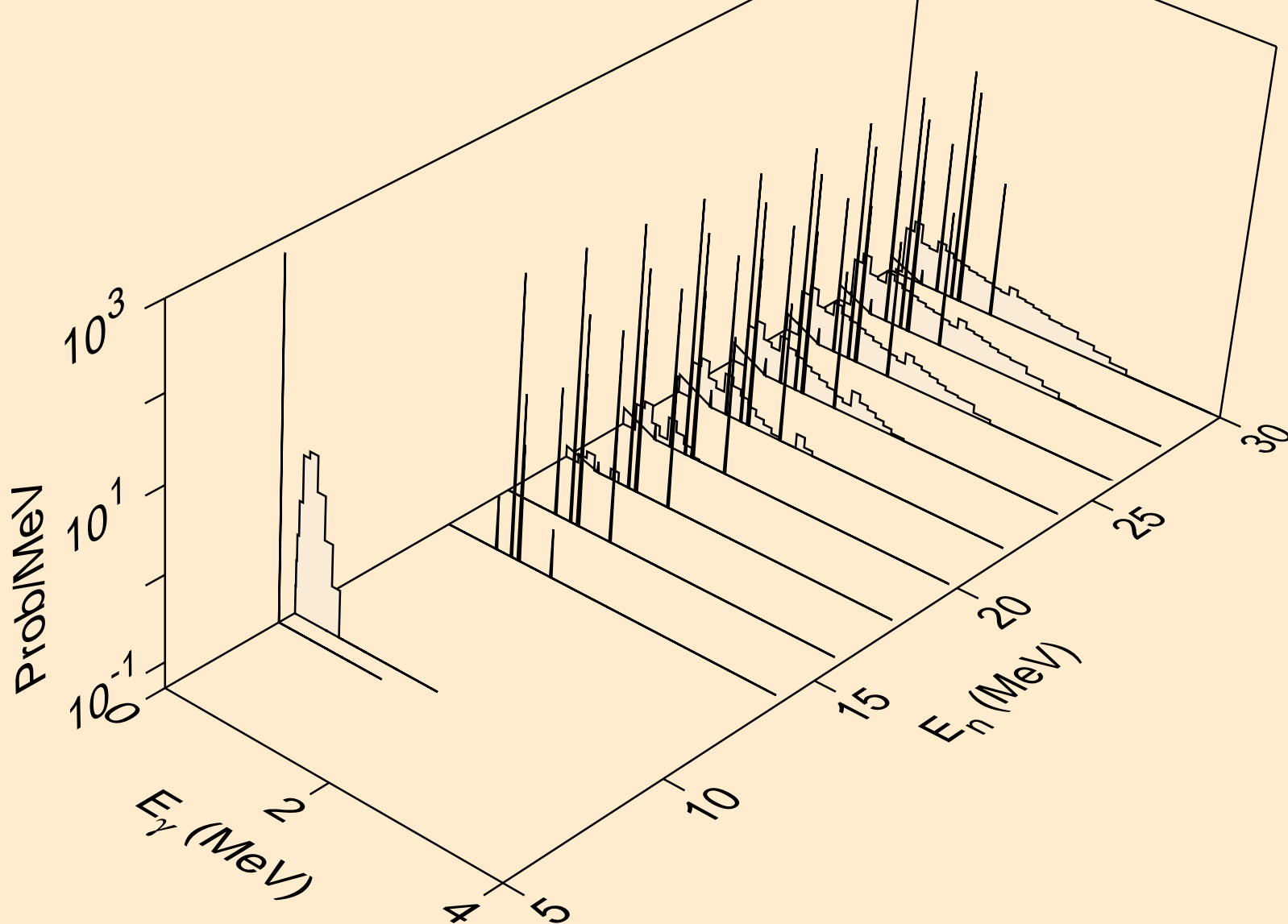

SN104 NEUTRON ACER TENDL-2019 LIBRARY; T=293.16K  
Photon emission for (n,npa)

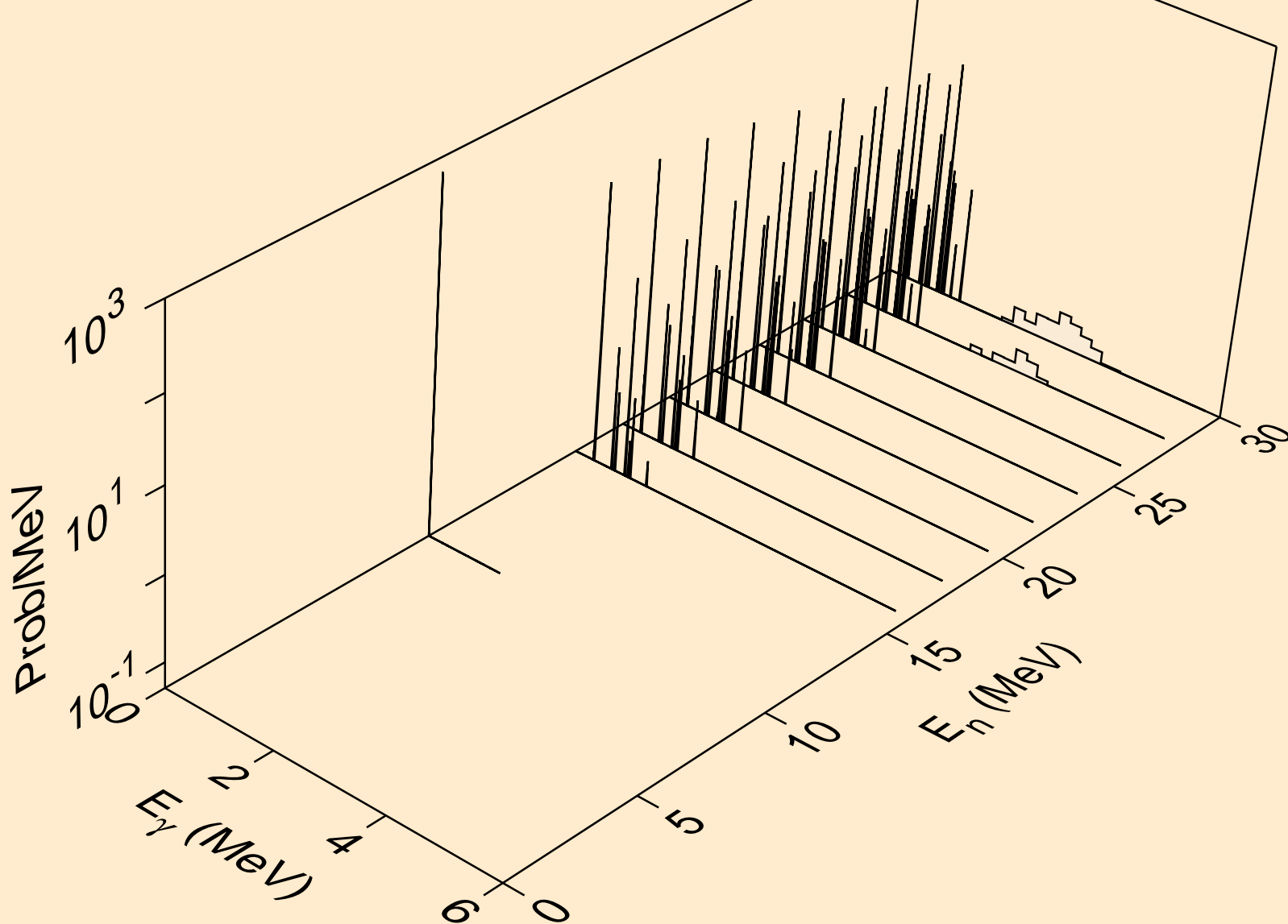

SN104 NEUTRON ACER TENDL-2019 LIBRARY; T=293.16K  
Photon emission for (n,n\*c)

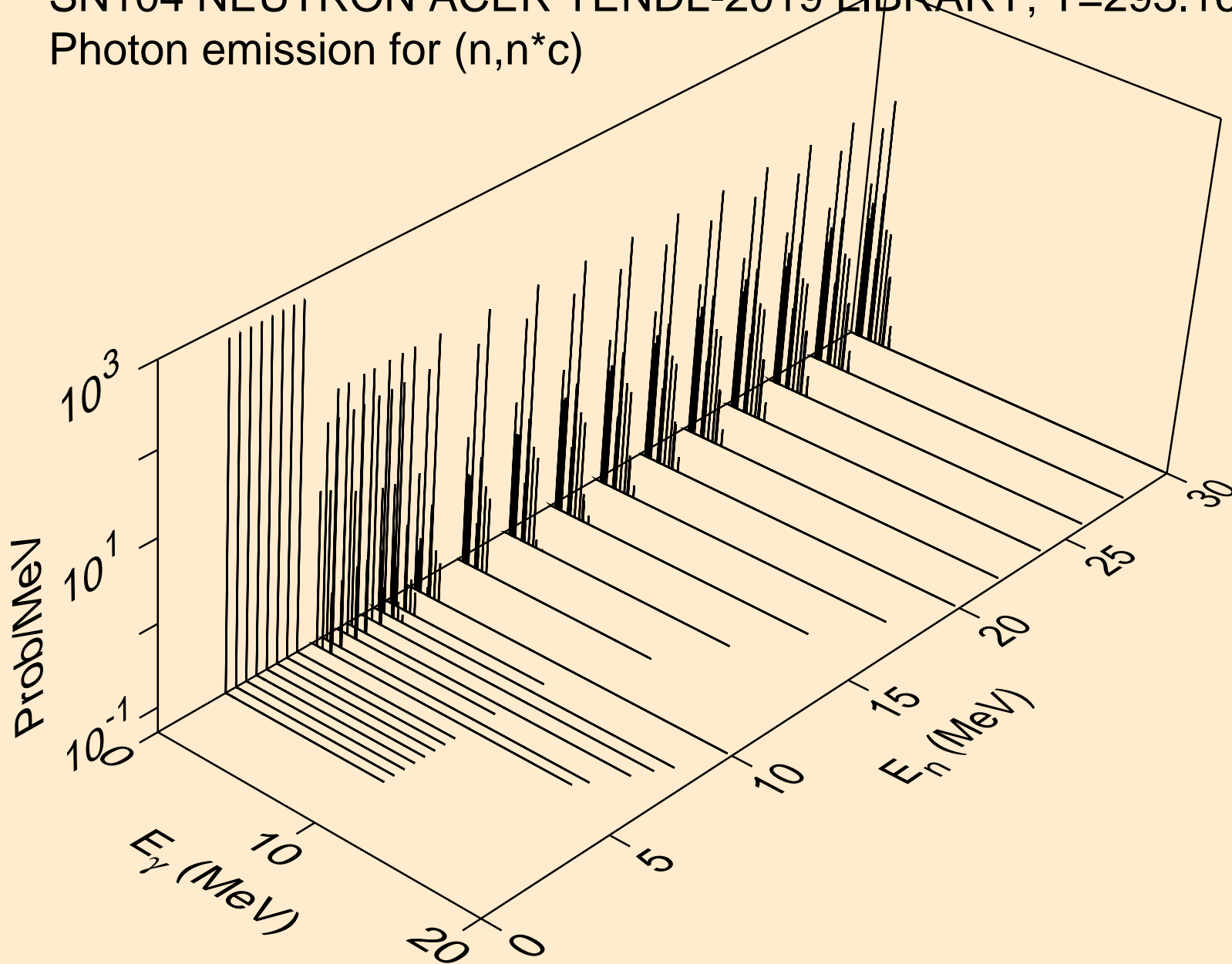

SN104 NEUTRON ACER TENDL-2019 LIBRARY; T=293.16K  
Photon emission for (n,gma)

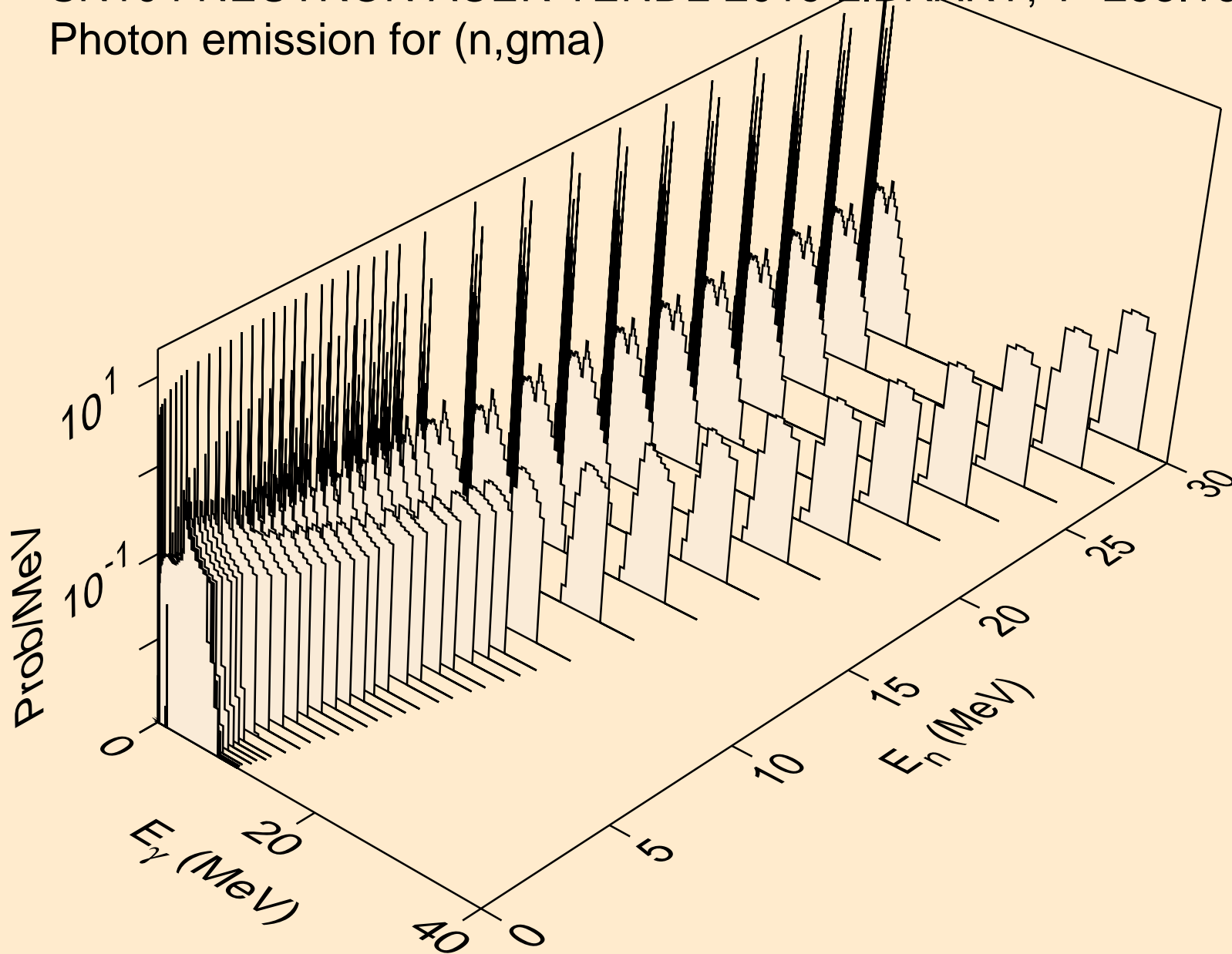

SN104 NEUTRON ACER TENDL-2019 LIBRARY; T=293.16K  
Photon emission for (n,p)

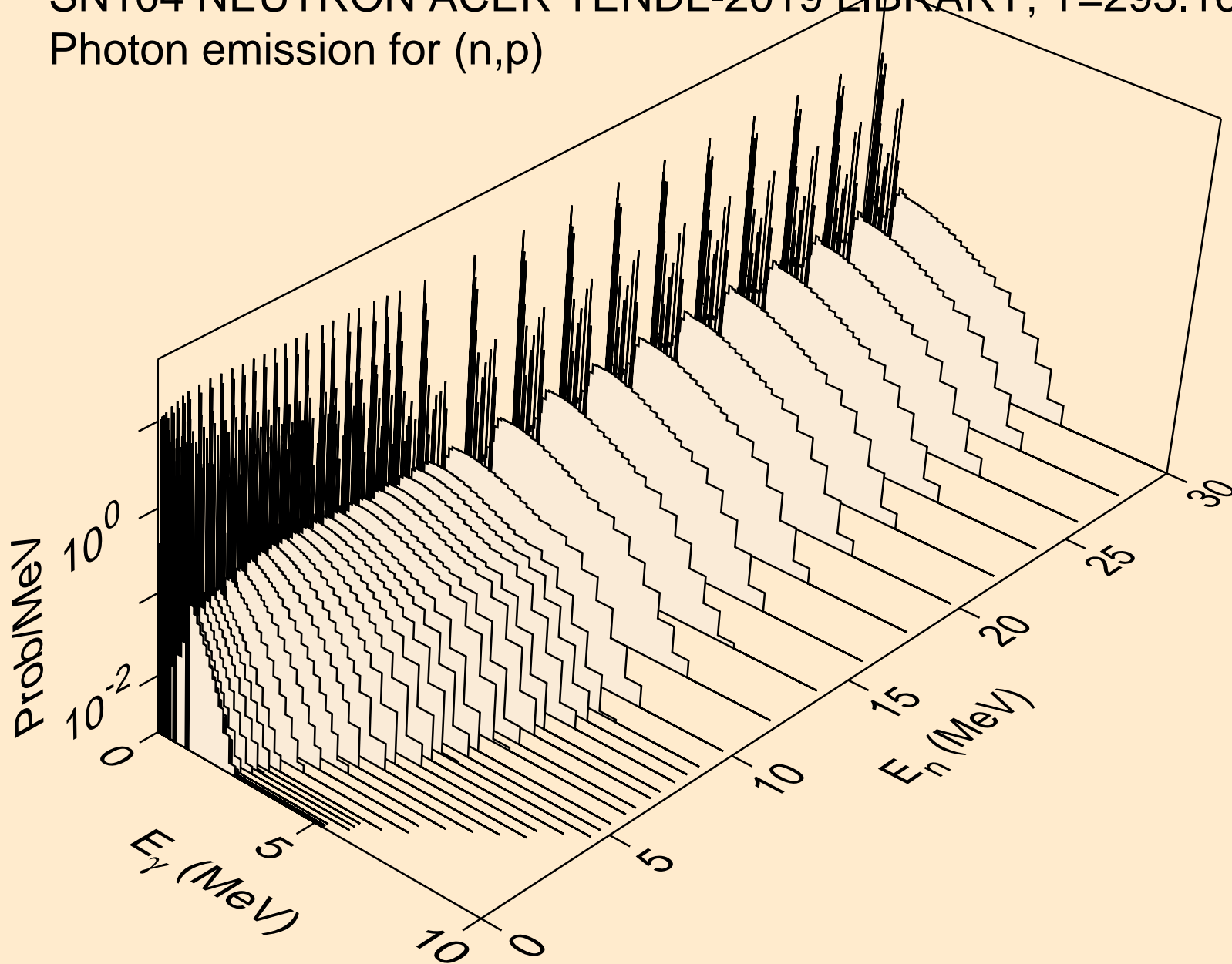

SN104 NEUTRON ACER TENDL-2019 LIBRARY; T=293.16K  
Photon emission for (n,d)

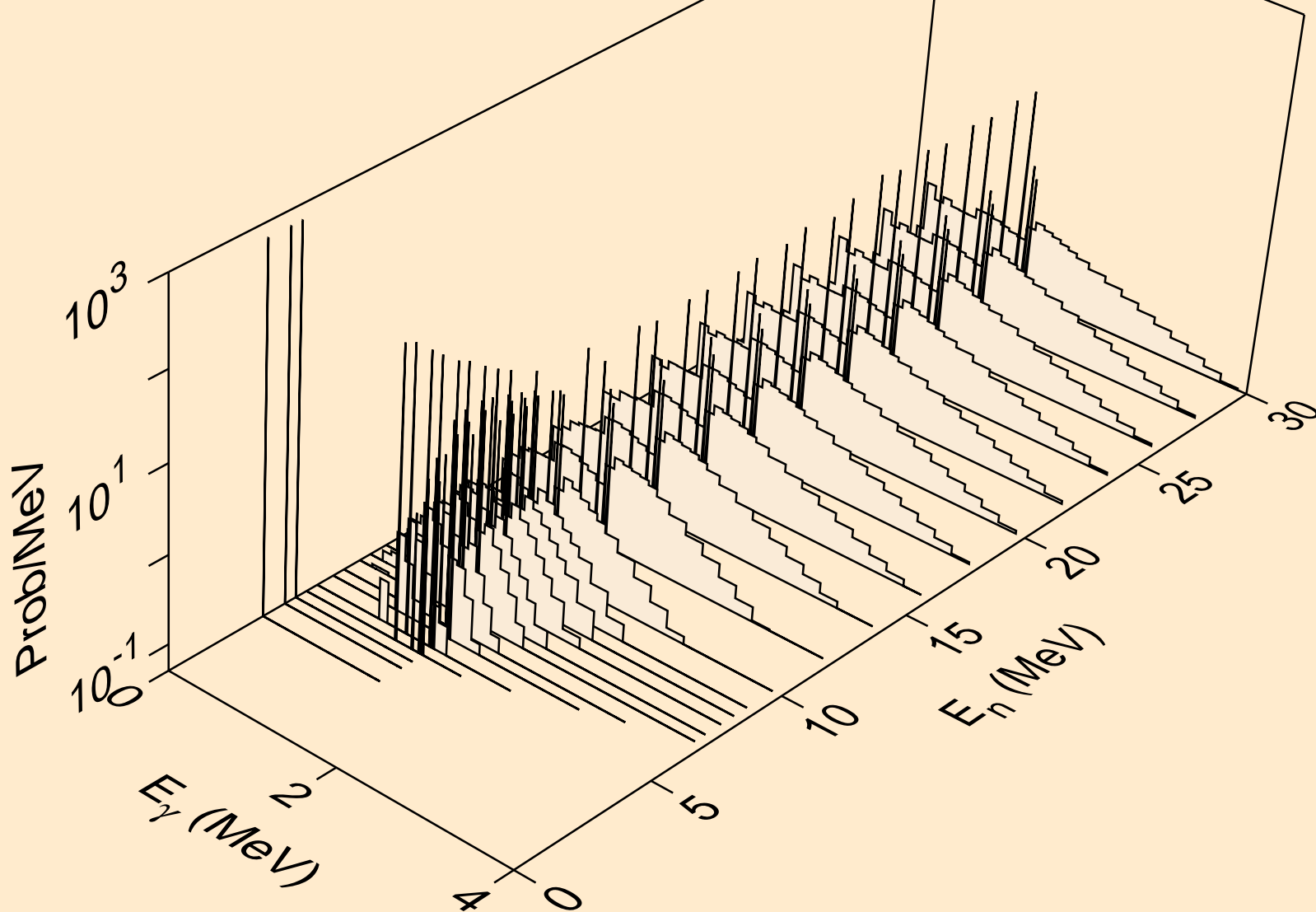



SN104 NEUTRON ACER TENDL-2019 LIBRARY; T=293.16K  
Photon emission for (n,t)

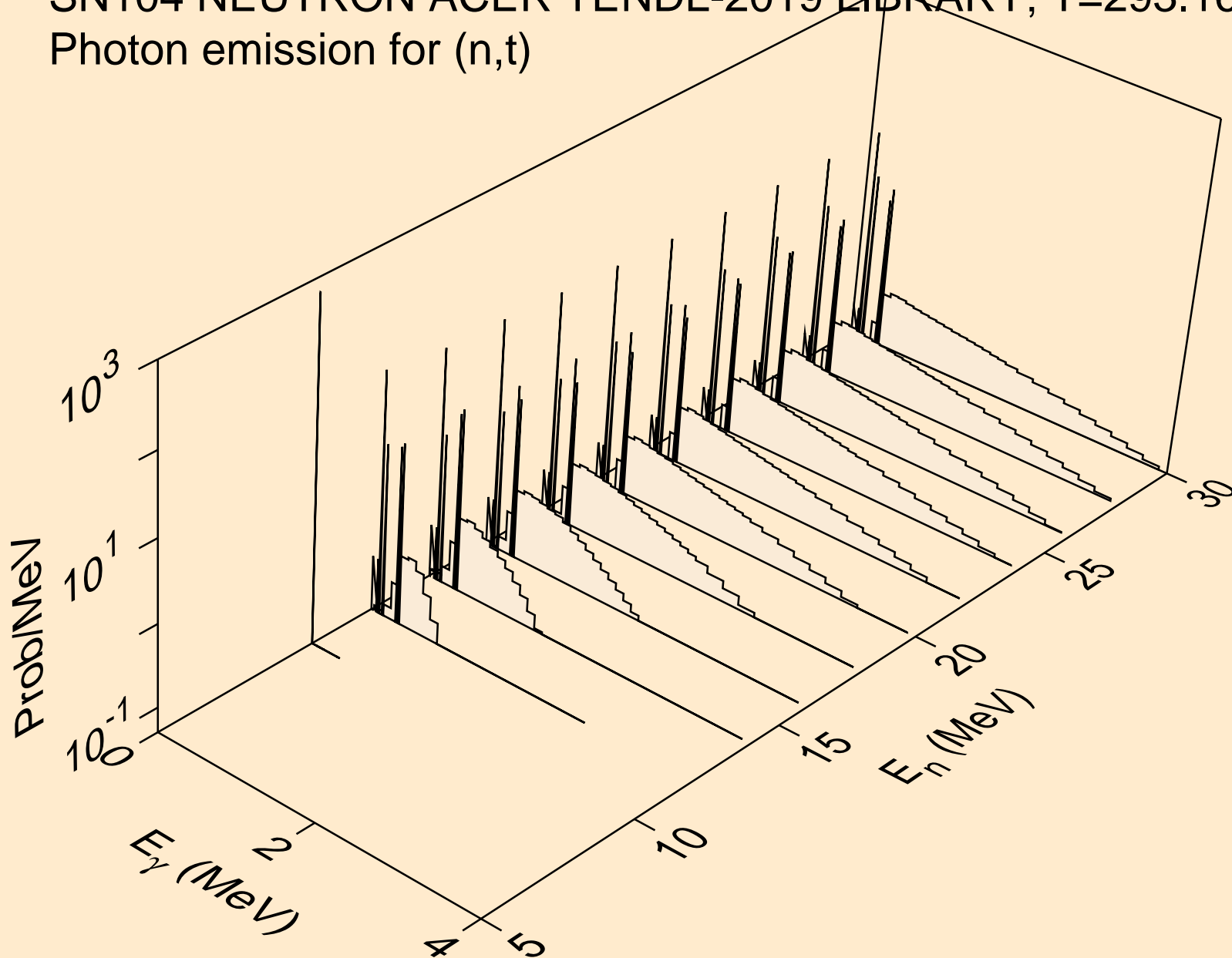

SN104 NEUTRON ACER TENDL-2019 LIBRARY; T=293.16K  
Photon emission for (n,he3)

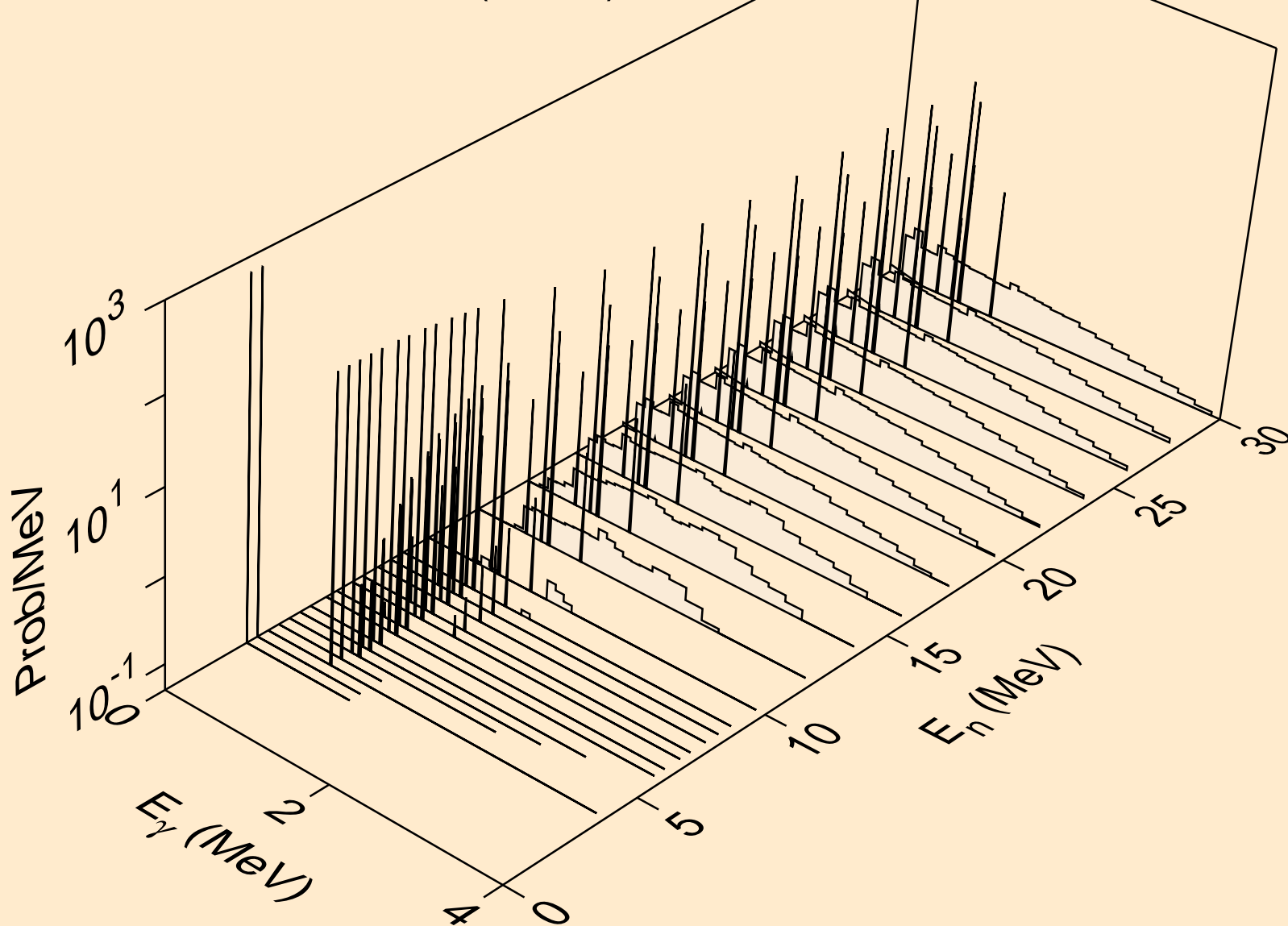

SN104 NEUTRON ACER TENDL-2019 LIBRARY; T=293.16K  
Photon emission for (n,a)

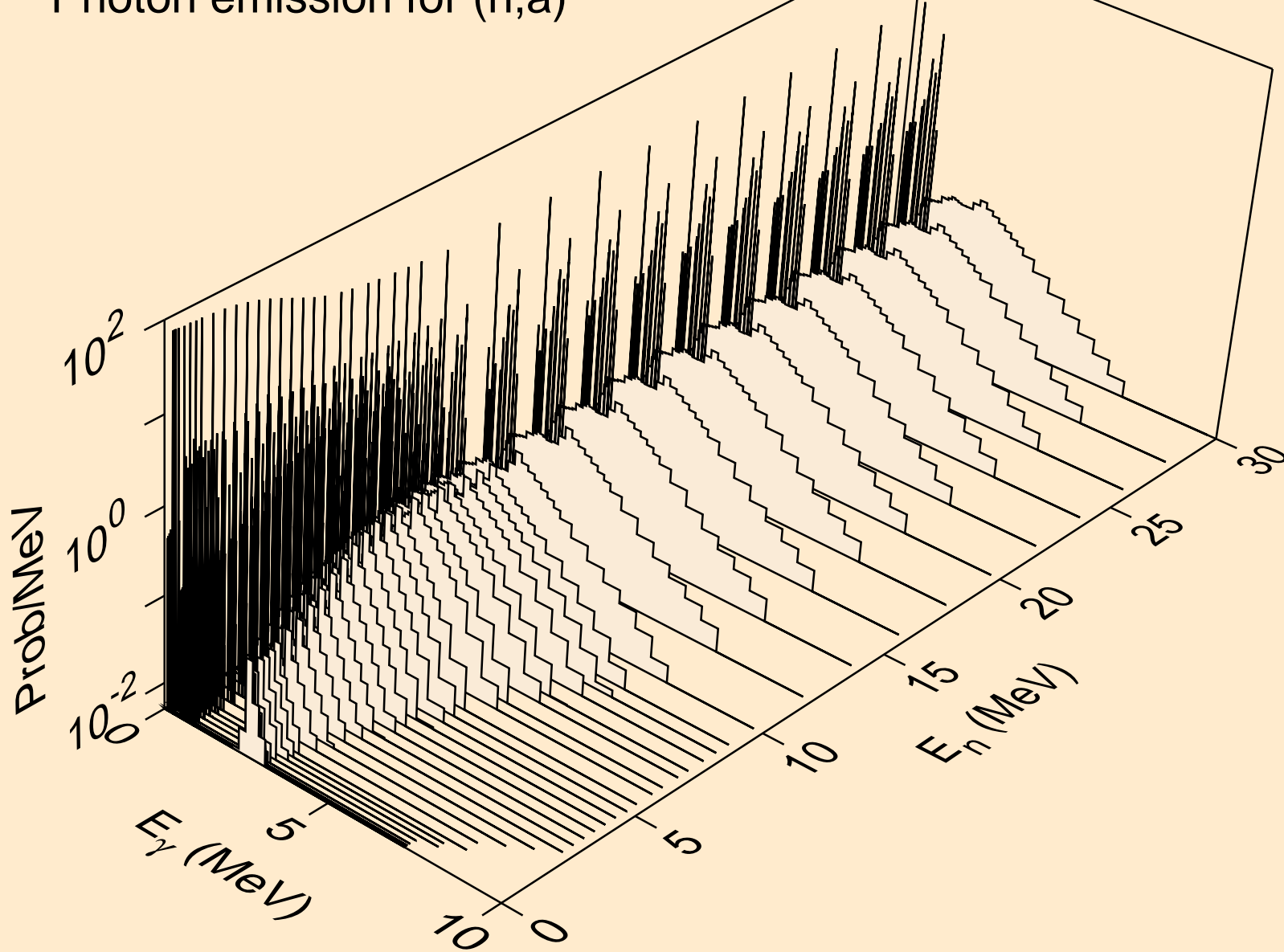

SN104 NEUTRON ACER TENDL-2019 LIBRARY; T=293.16K  
Photon emission for (n,2a)

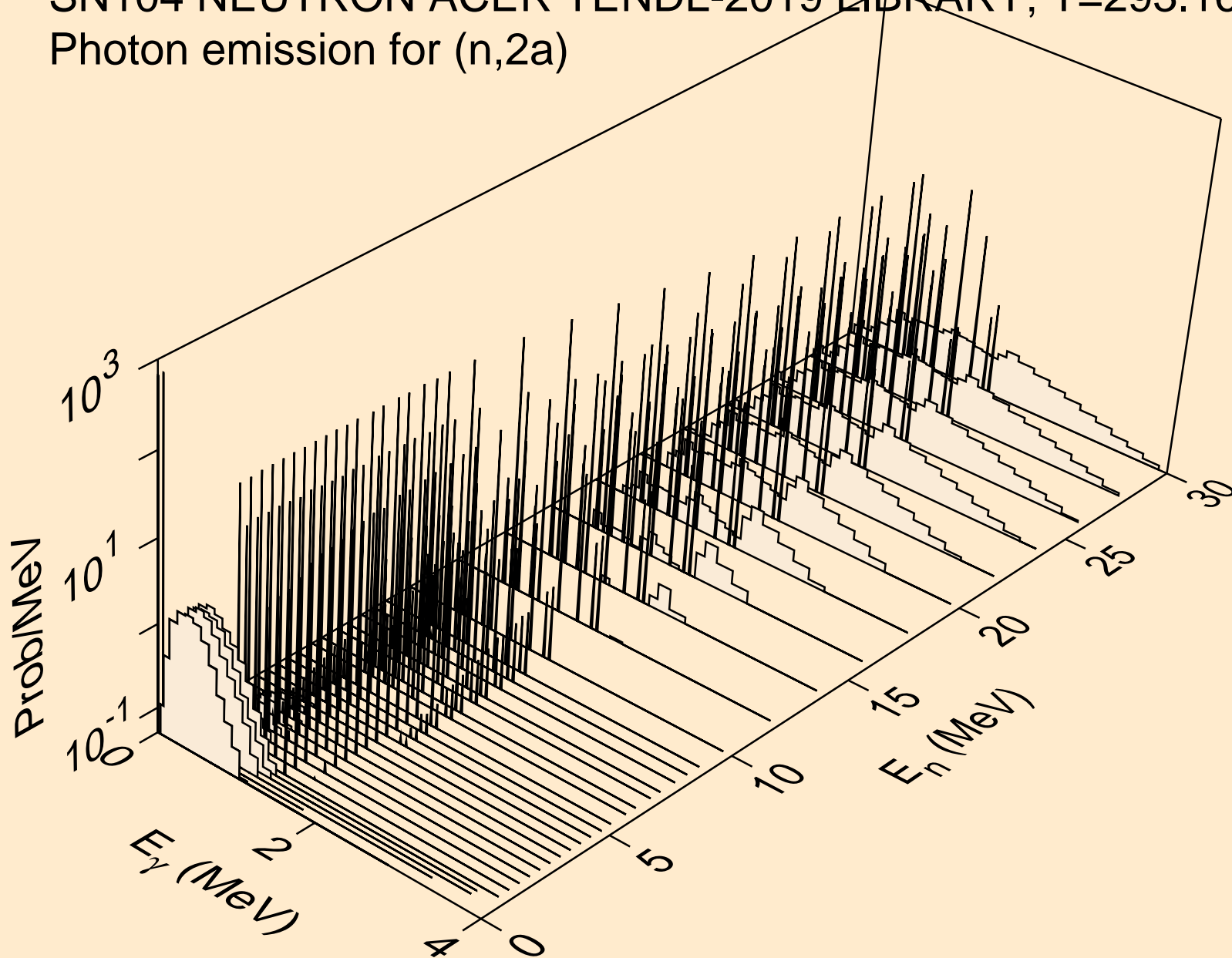

SN104 NEUTRON ACER TENDL-2019 LIBRARY; T=293.16K  
Photon emission for (n,3a)

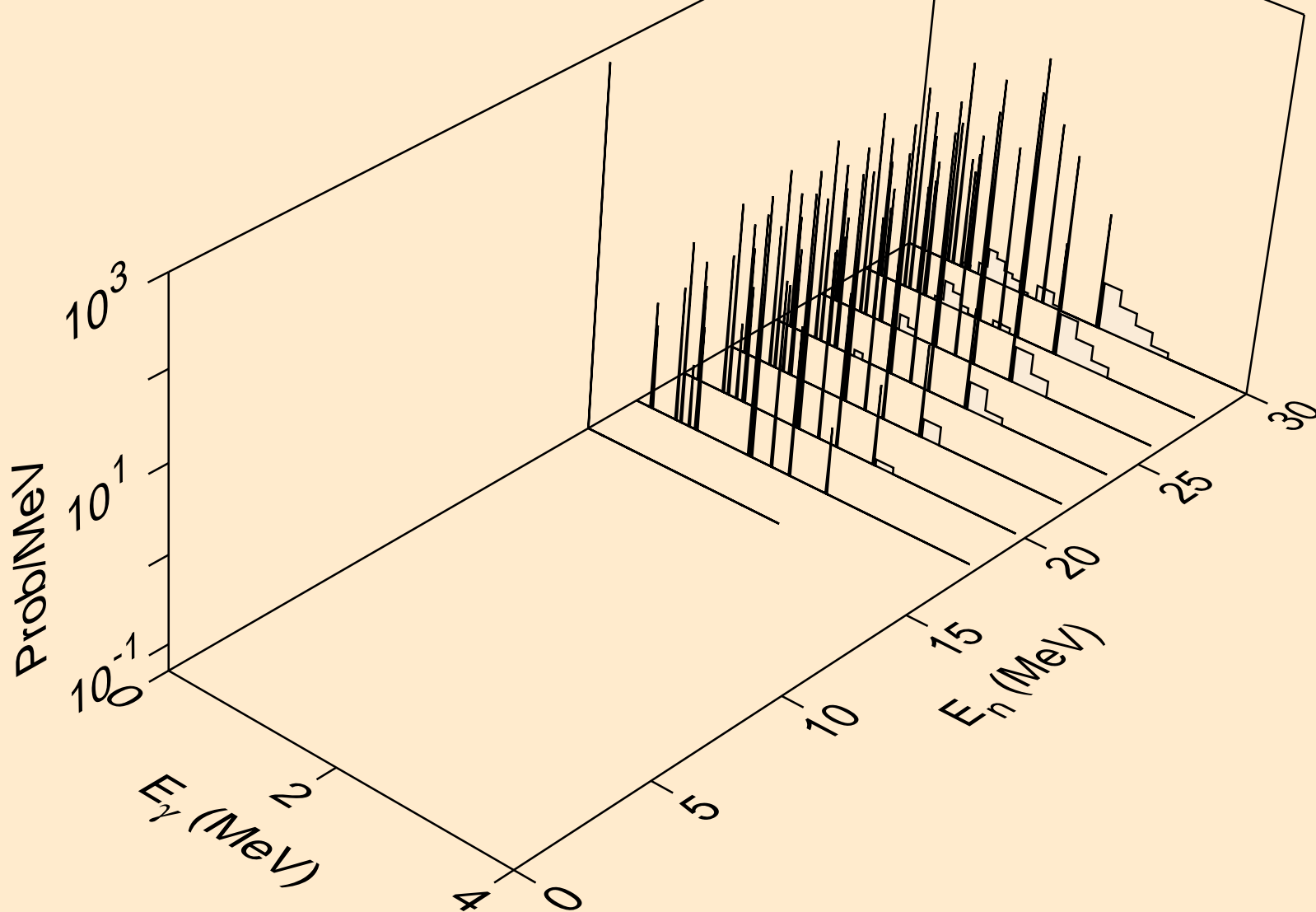

SN104 NEUTRON ACER TENDL-2019 LIBRARY; T=293.16K  
Photon emission for (n,2p)

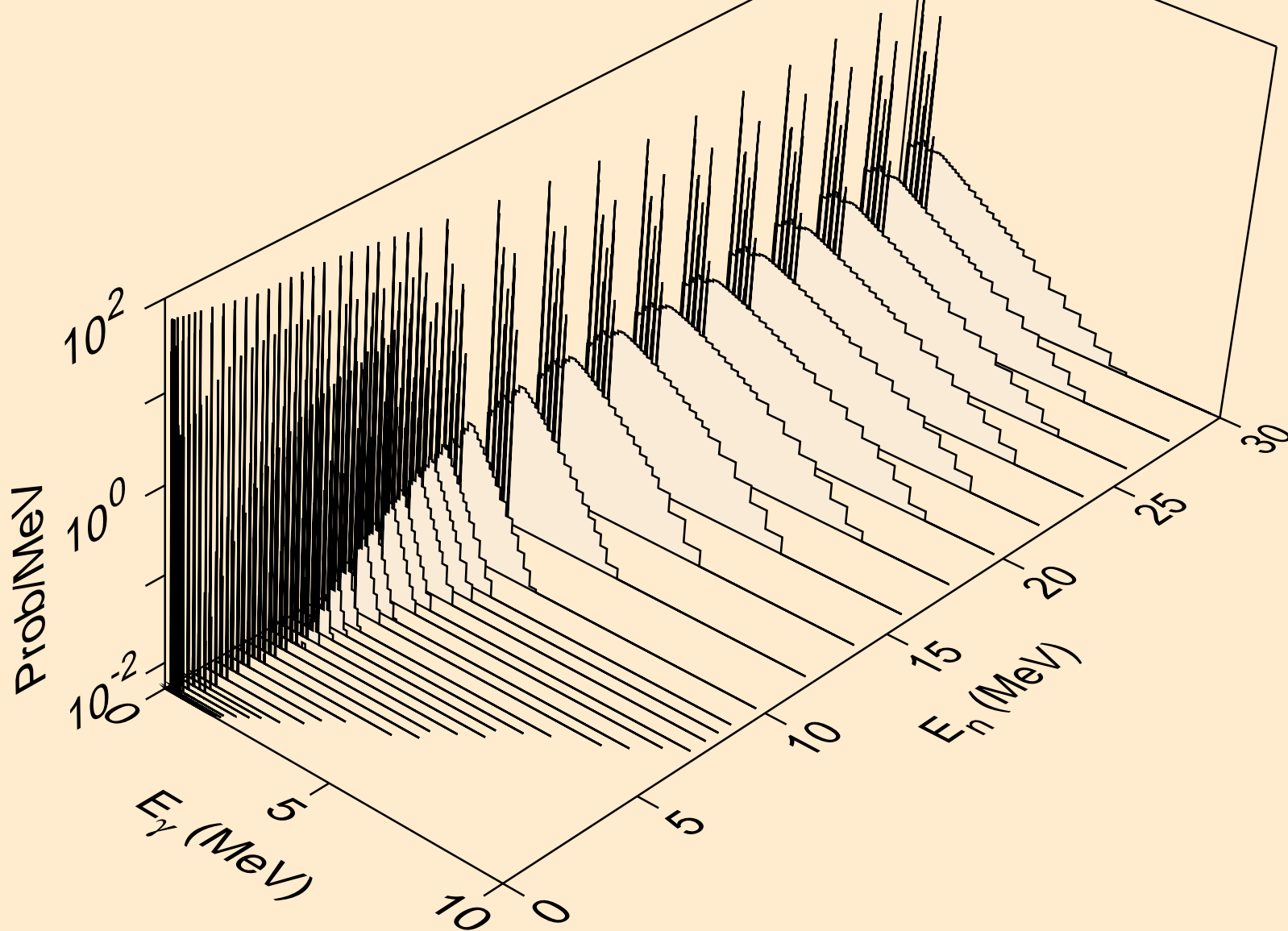

SN104 NEUTRON ACER TENDL-2019 LIBRARY; T=293.16K  
Photon emission for (n,p $\alpha$ )

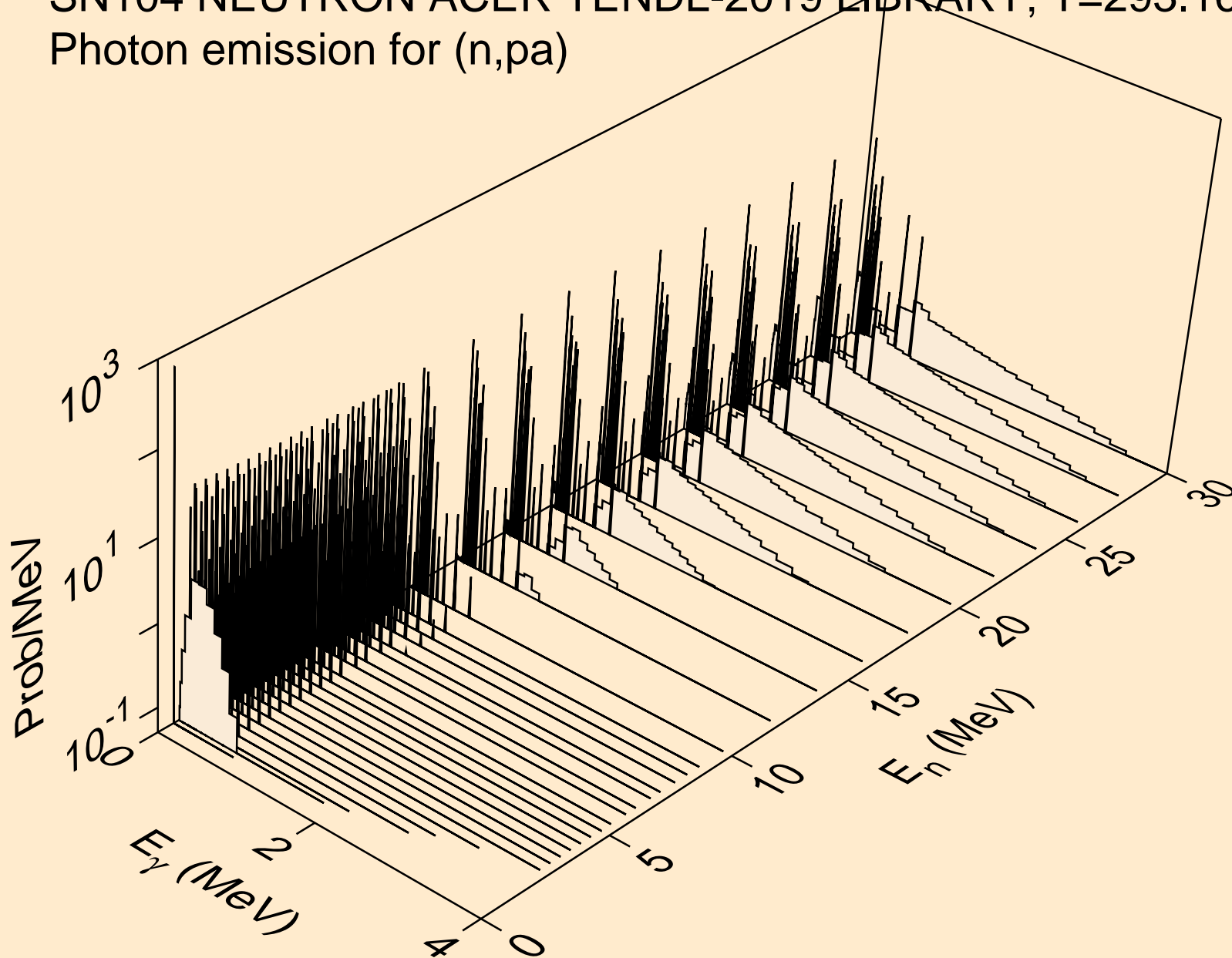

SN104 NEUTRON ACER TENDL-2019 LIBRARY; T=293.16K  
Photon emission for (n,d2a)

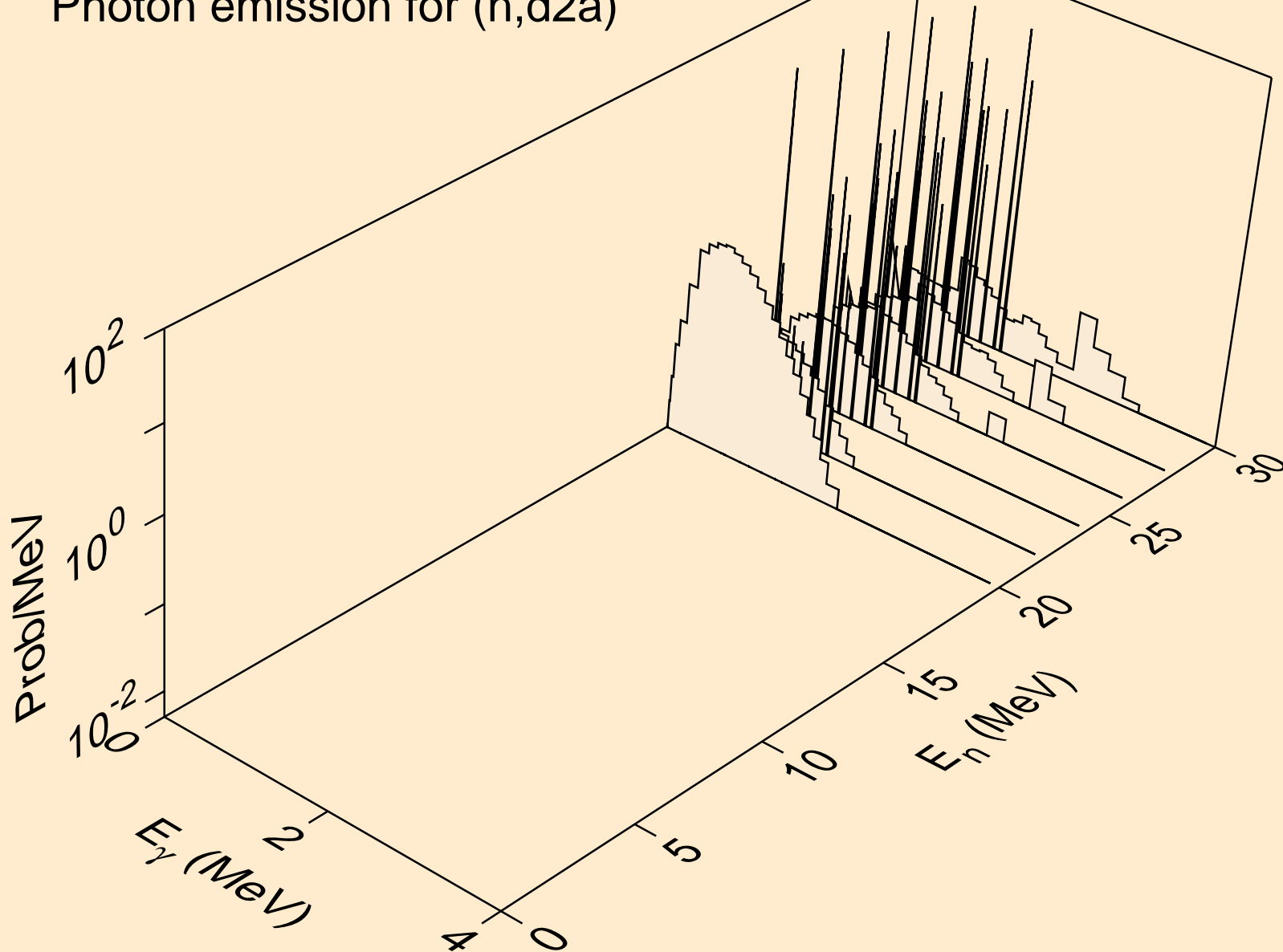



SN104 NEUTRON ACER TENDL-2019 LIBRARY; T=293.16K  
Photon emission for (n,pd)

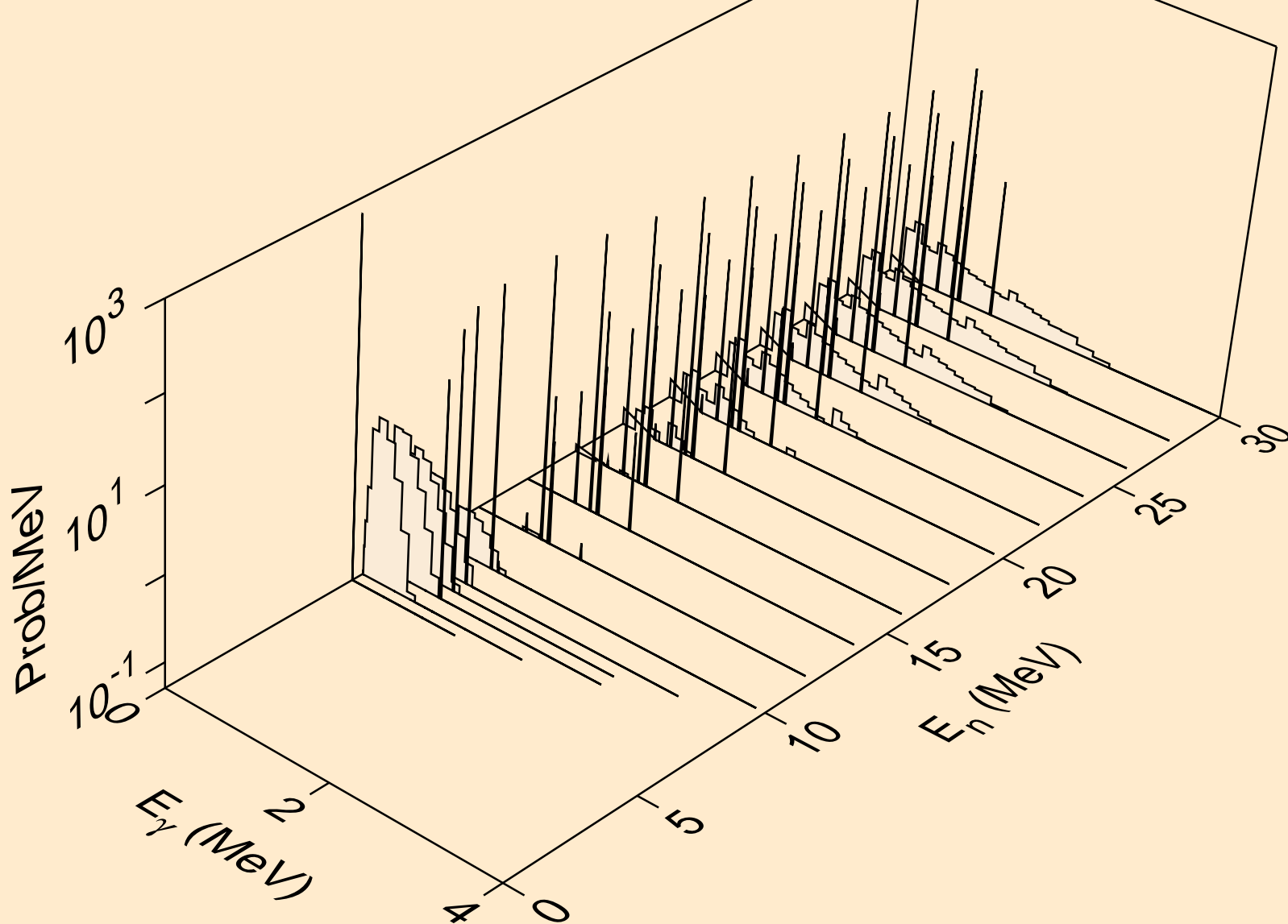

SN104 NEUTRON ACER TENDL-2019 LIBRARY; T=293.16K  
Photon emission for (n,pt)

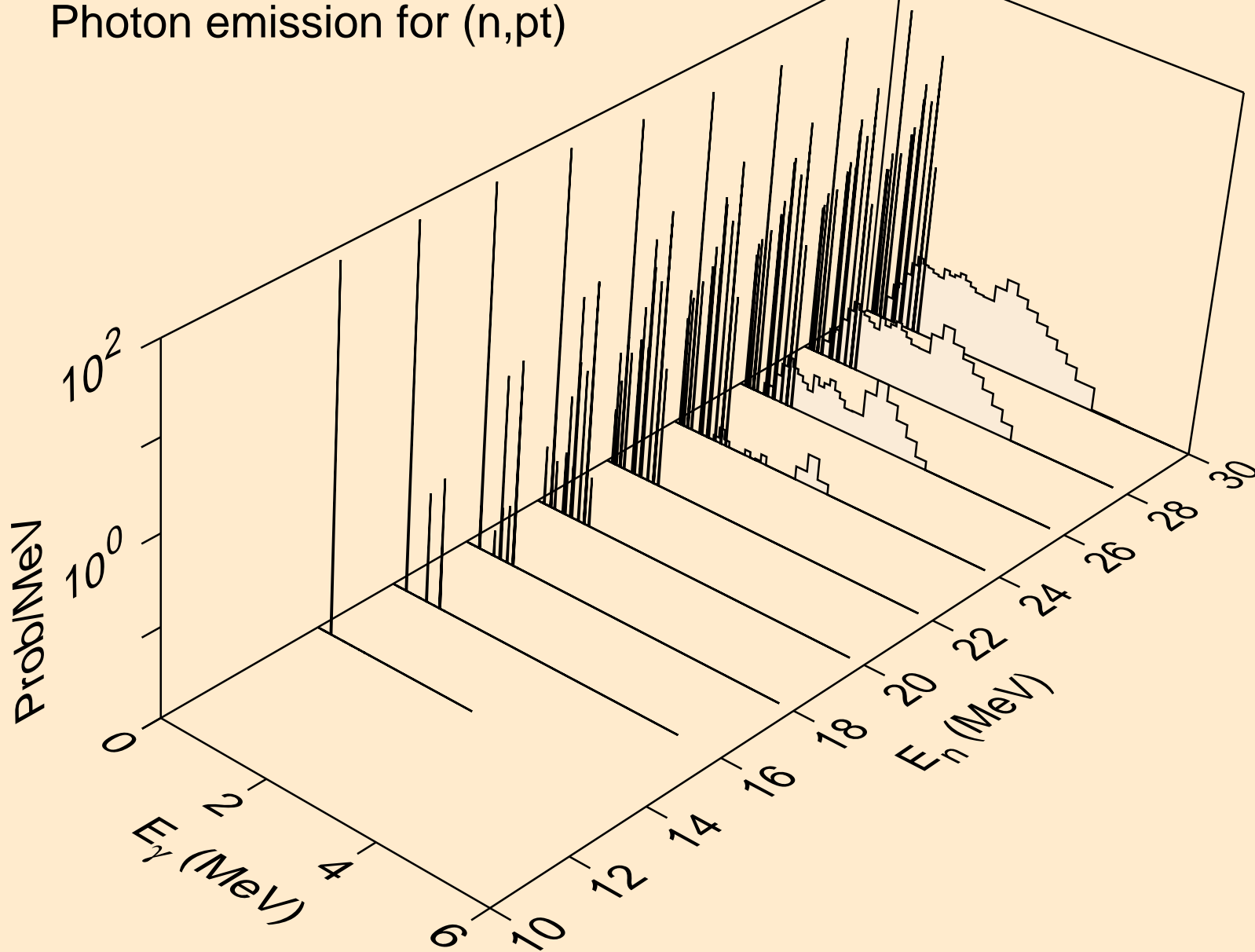

SN104 NEUTRON ACER TENDL-2019 LIBRARY; T=293.16K  
Photon emission for (n,da)

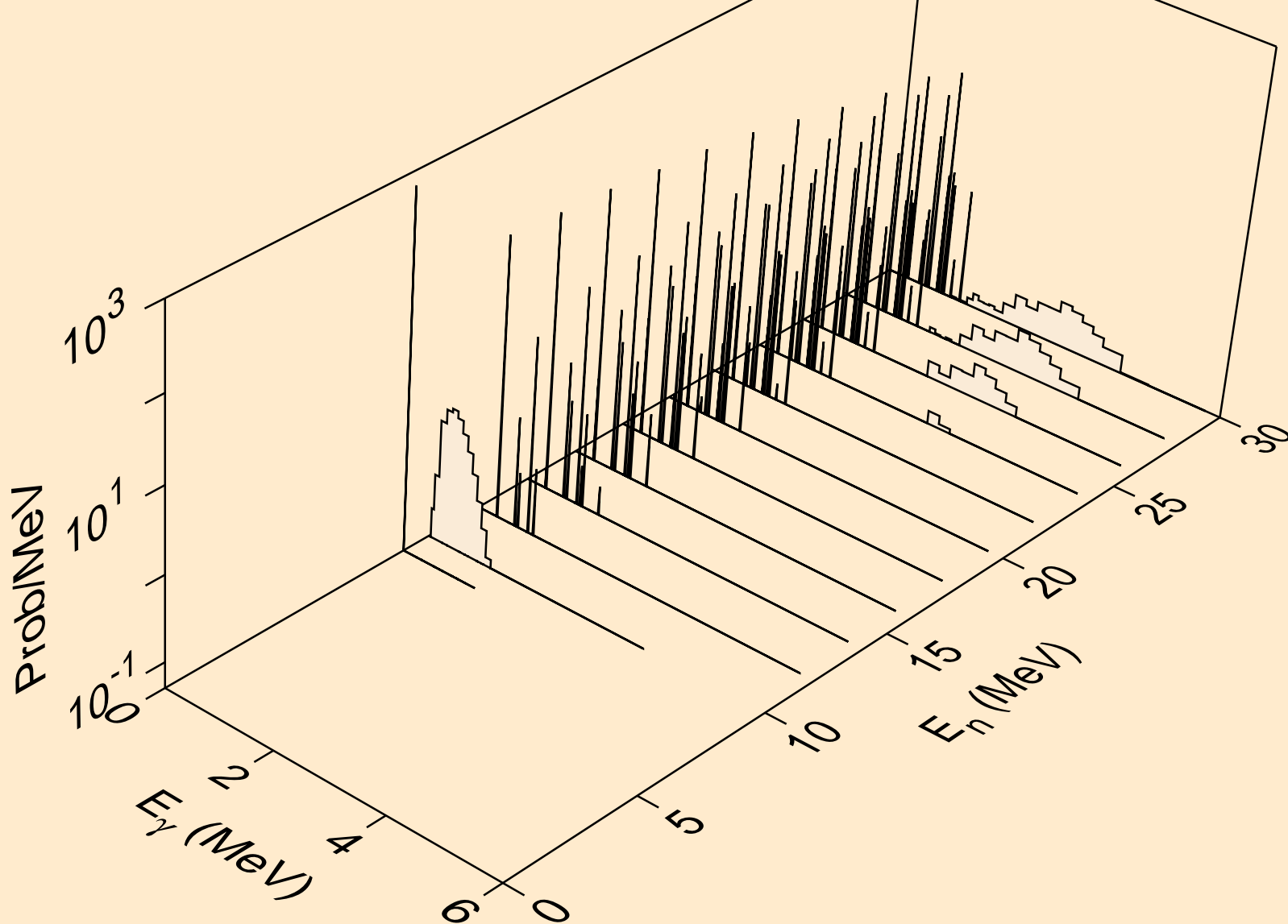

SN104 NEUTRON ACER TENDL-2019 LIBRARY; T=293.16K  
thermal capture photon spectrum

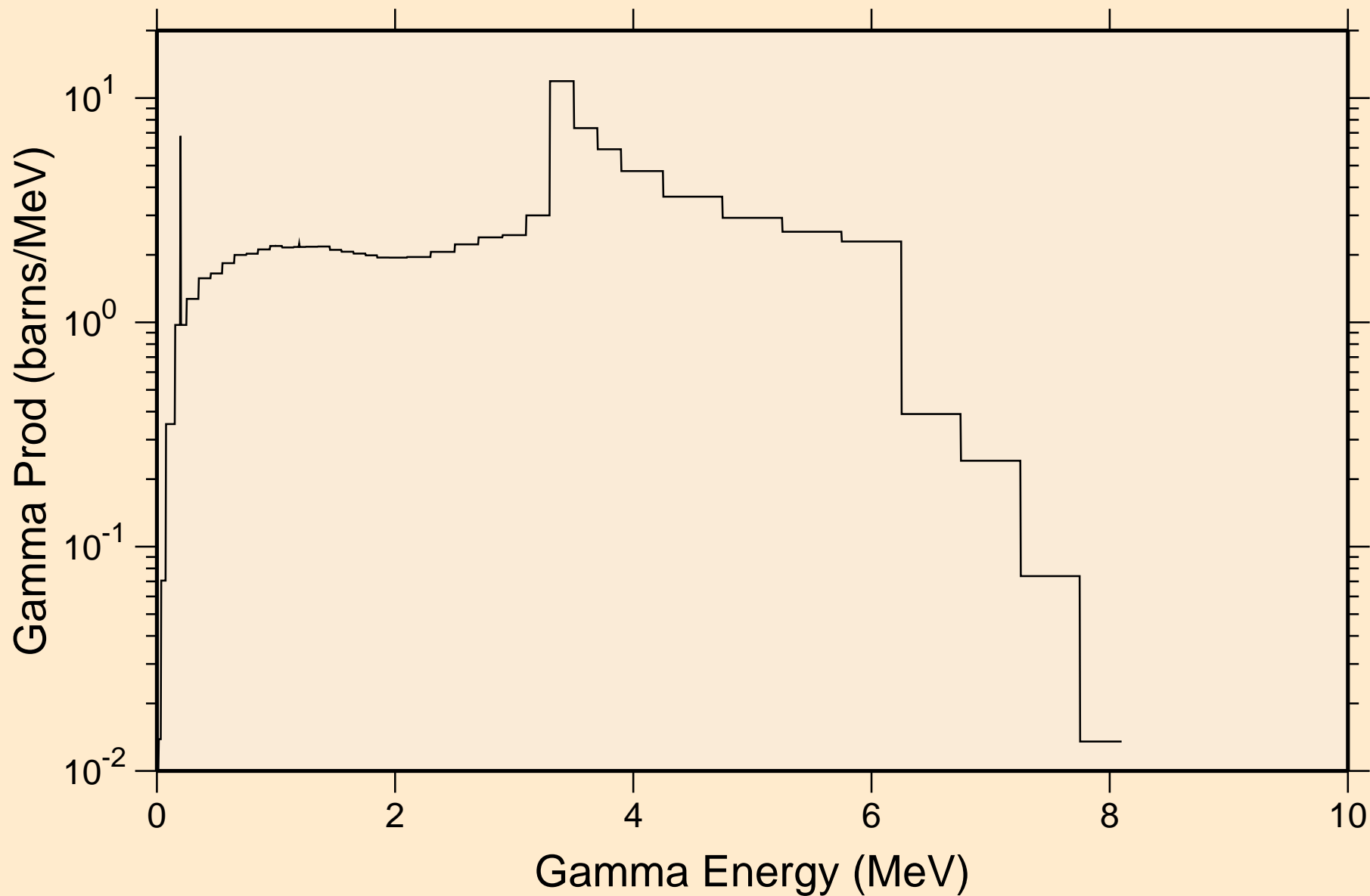

SN104 NEUTRON ACER TENDL-2019 LIBRARY; T=293.16K  
14 MeV photon spectrum

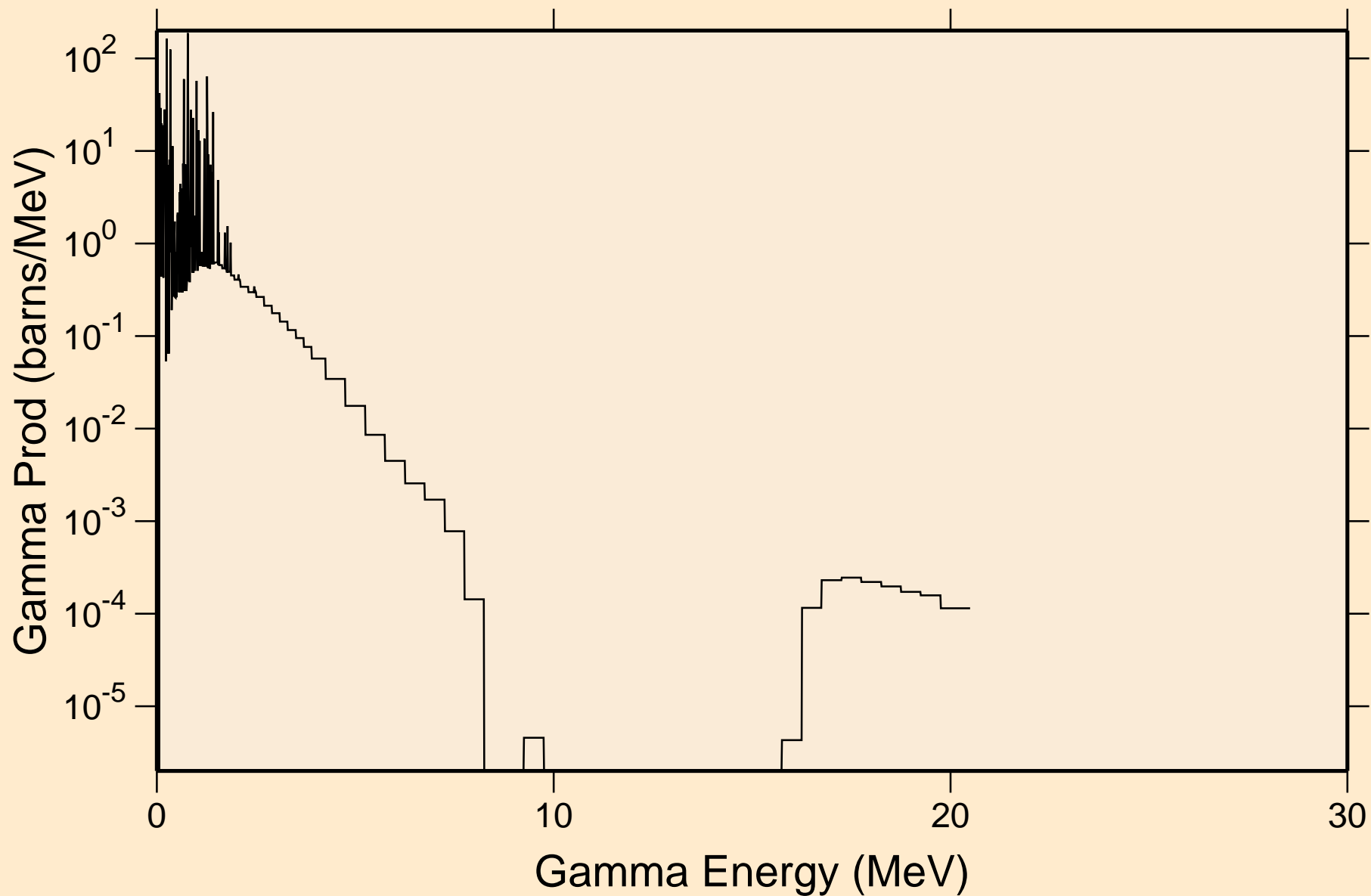

# SN104 NEUTRON ACER TENDL-2019 LIBRARY; T=293.16K

## Particle heating contributions

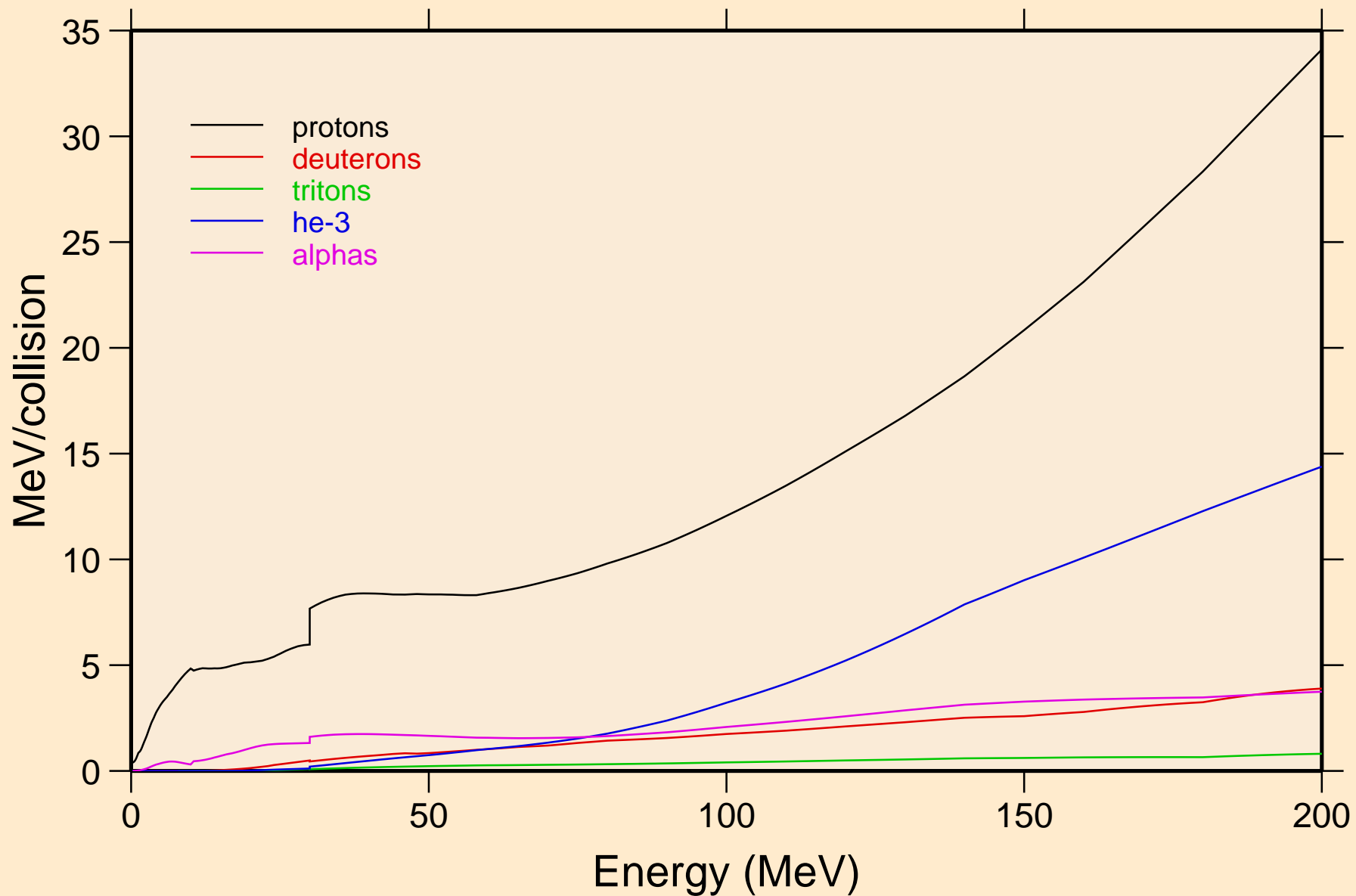

SN104 NEUTRON ACER TENDL-2019 LIBRARY; T=293.16K  
Recoil Heating

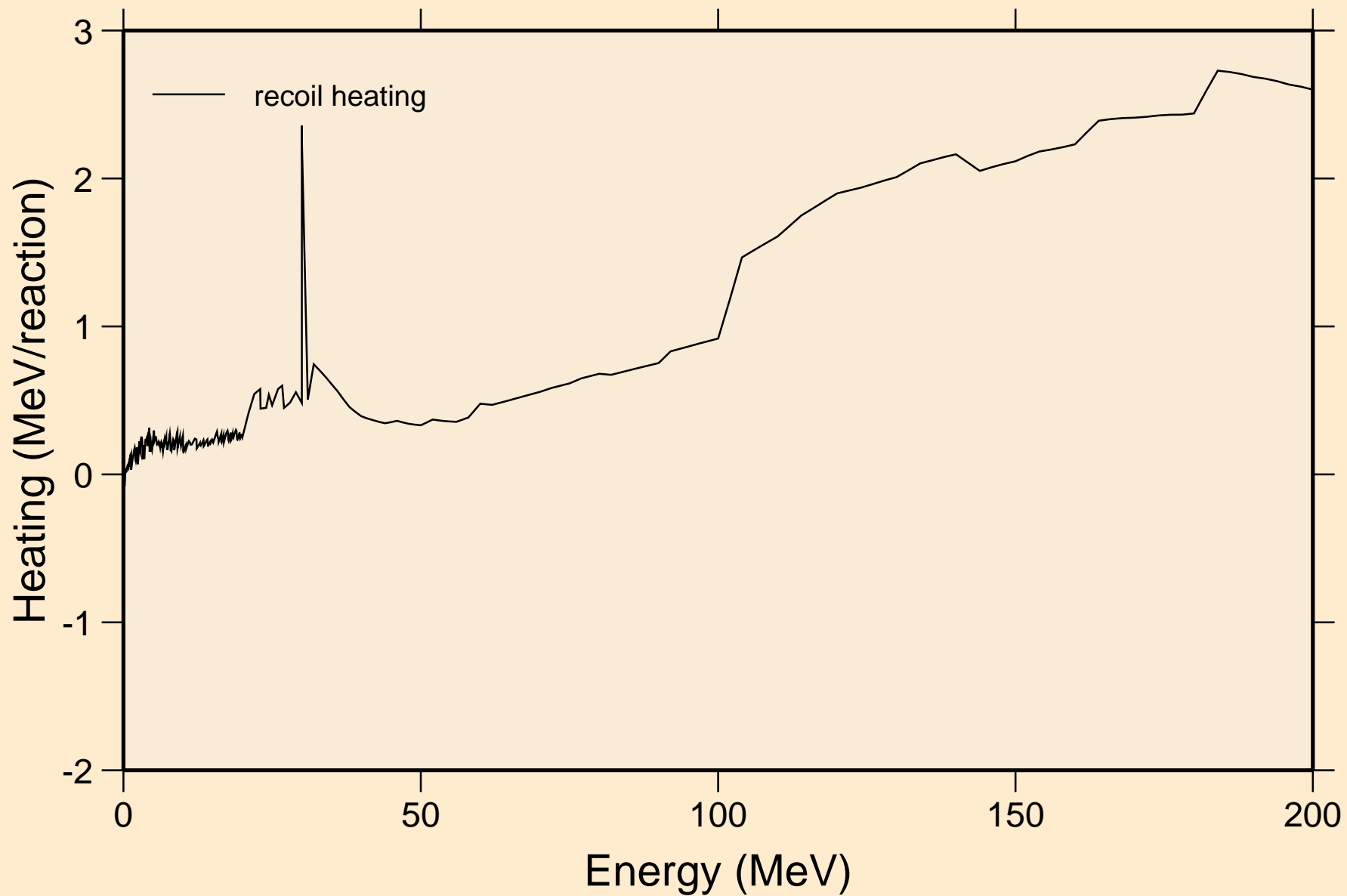

# SN104 NEUTRON ACER TENDL-2019 LIBRARY; T=293.16K

## Particle production cross sections

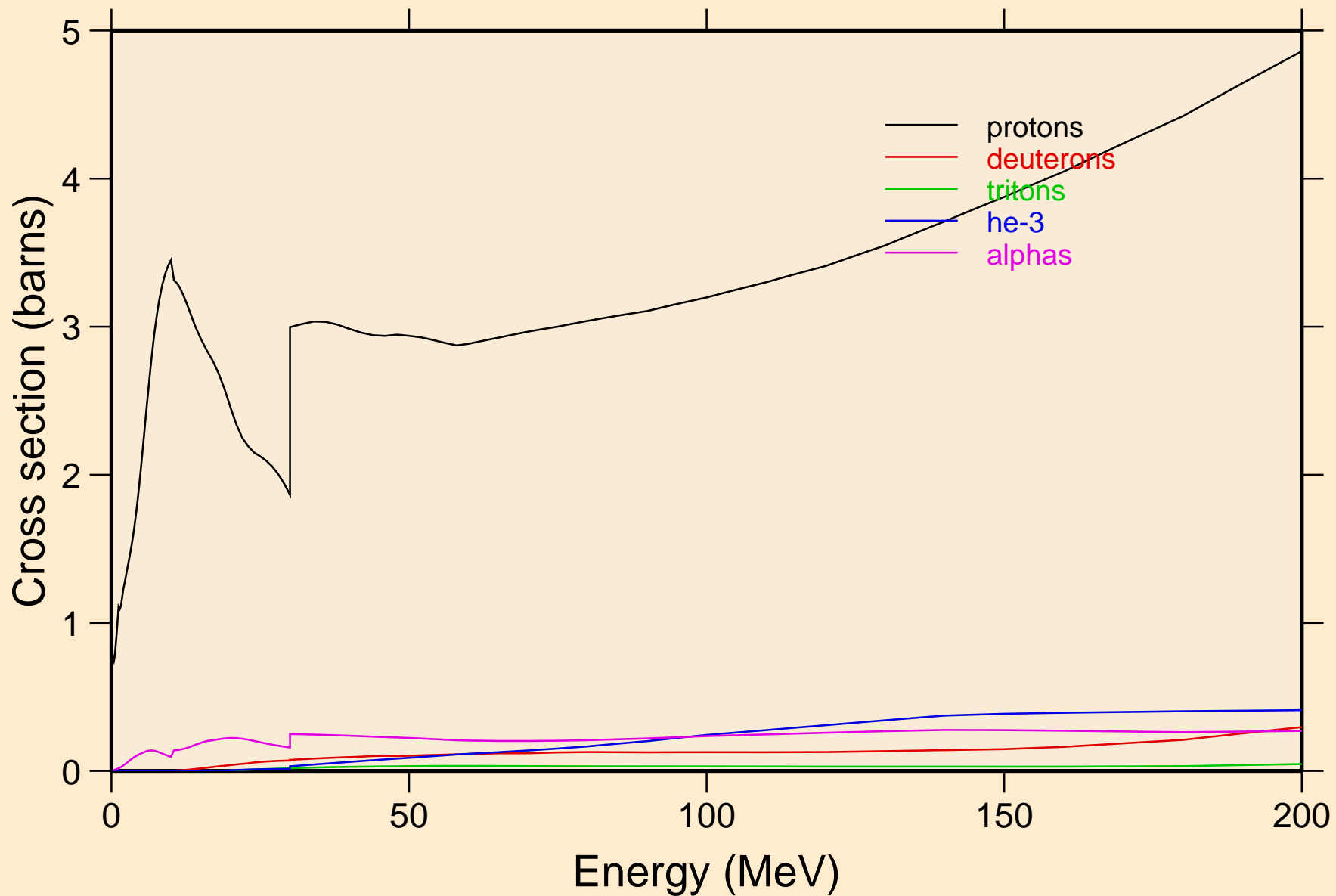



SN104 NEUTRON ACER TENDL-2019 LIBRARY; T=293.16K  
protons from (n,x)

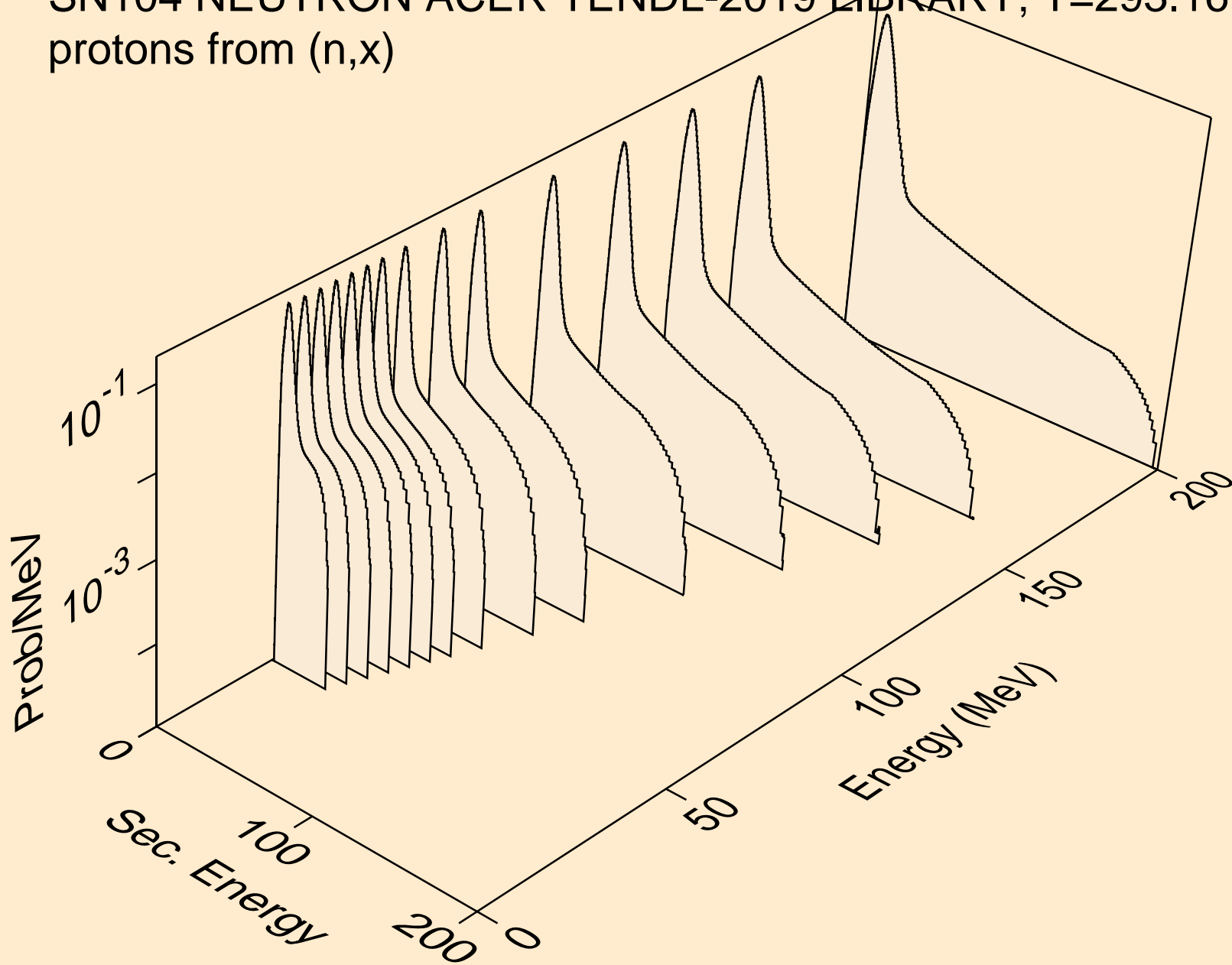

SN104 NEUTRON ACER TENDL-2019 LIBRARY; T=293.16K  
protons from (n,n\*)p

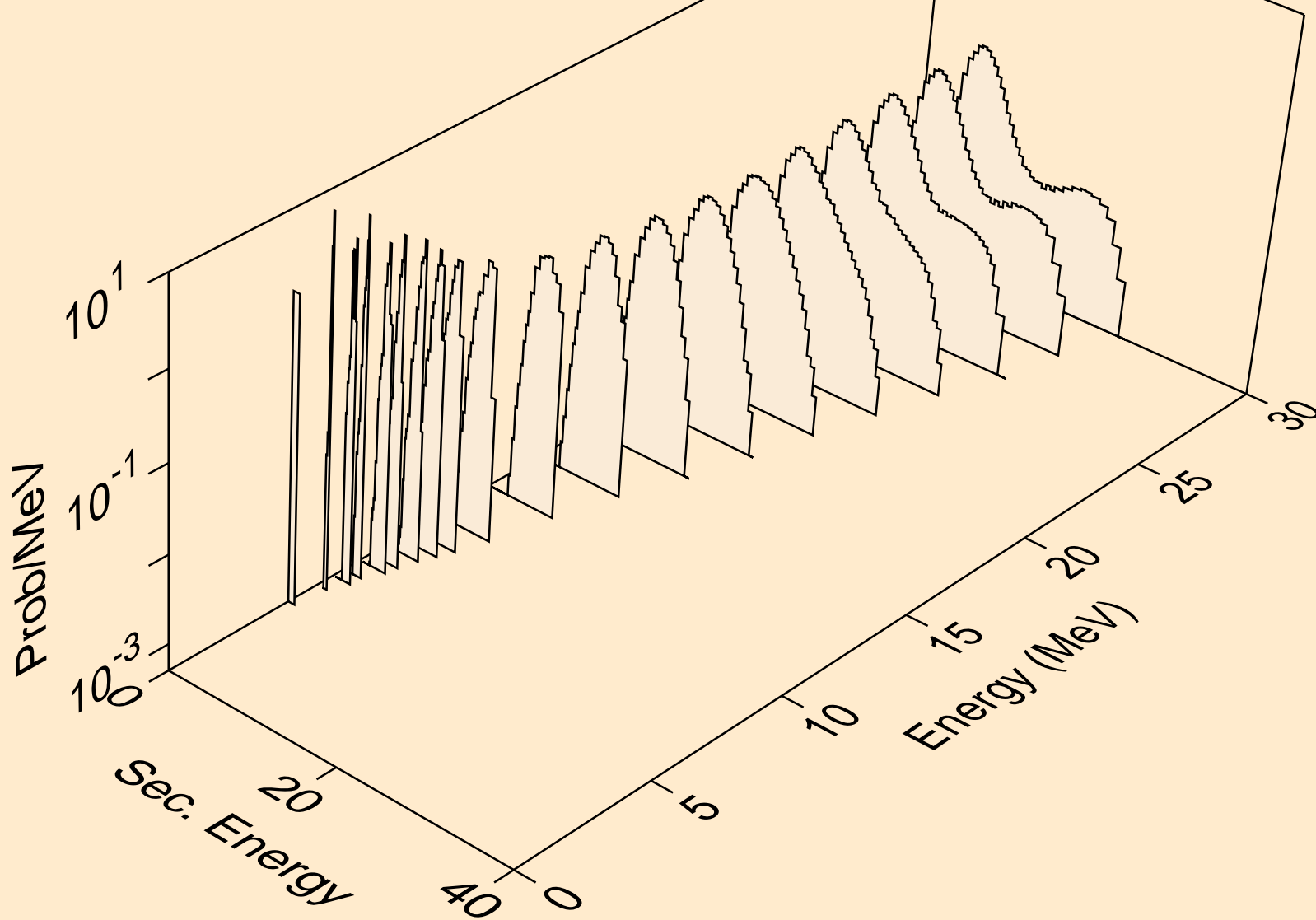

SN104 NEUTRON ACER TENDL-2019 LIBRARY; T=293.16K  
protons from (n,2np)

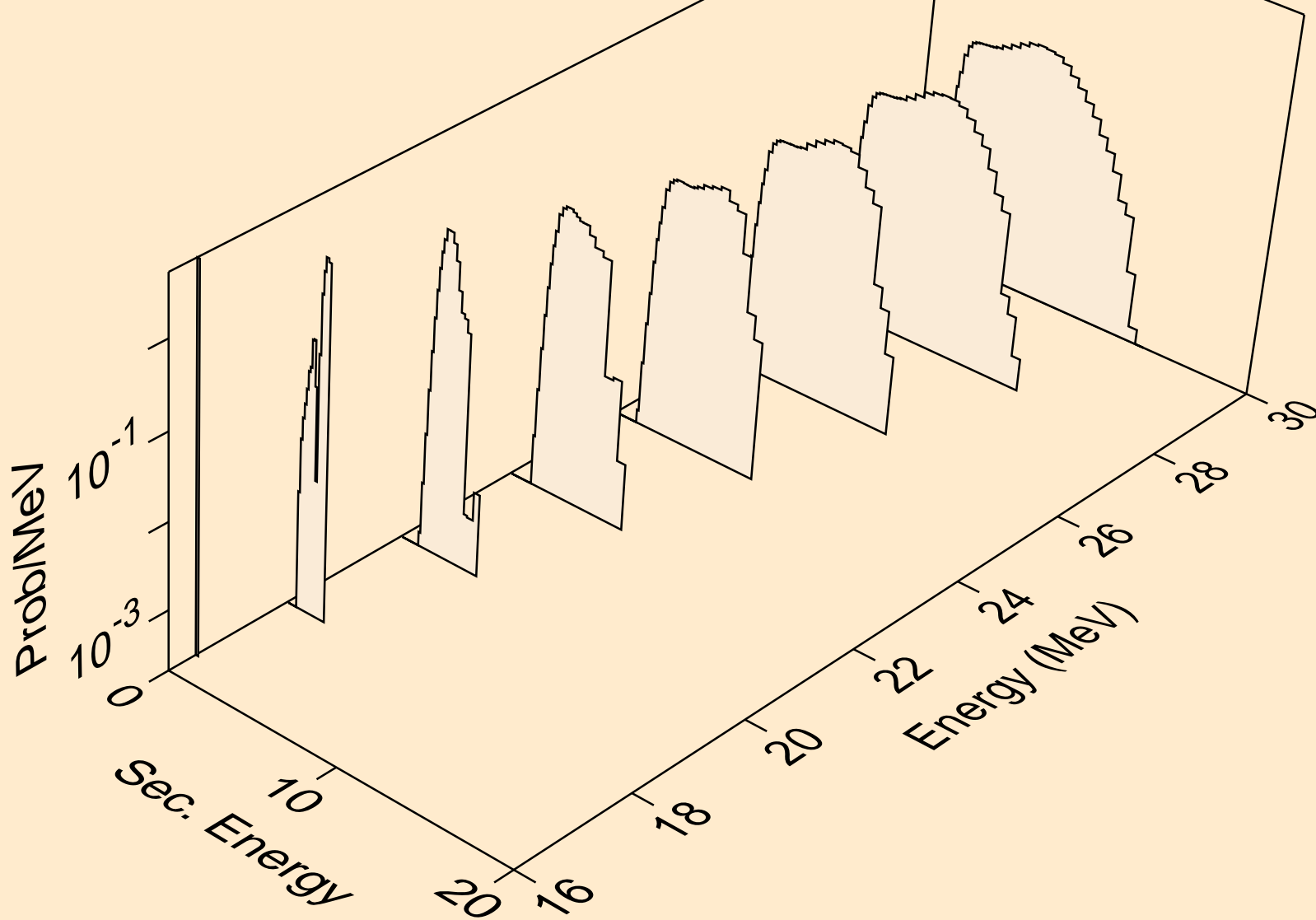

SN104 NEUTRON ACER TENDL-2019 LIBRARY; T=293.16K  
protons from (n,3np)

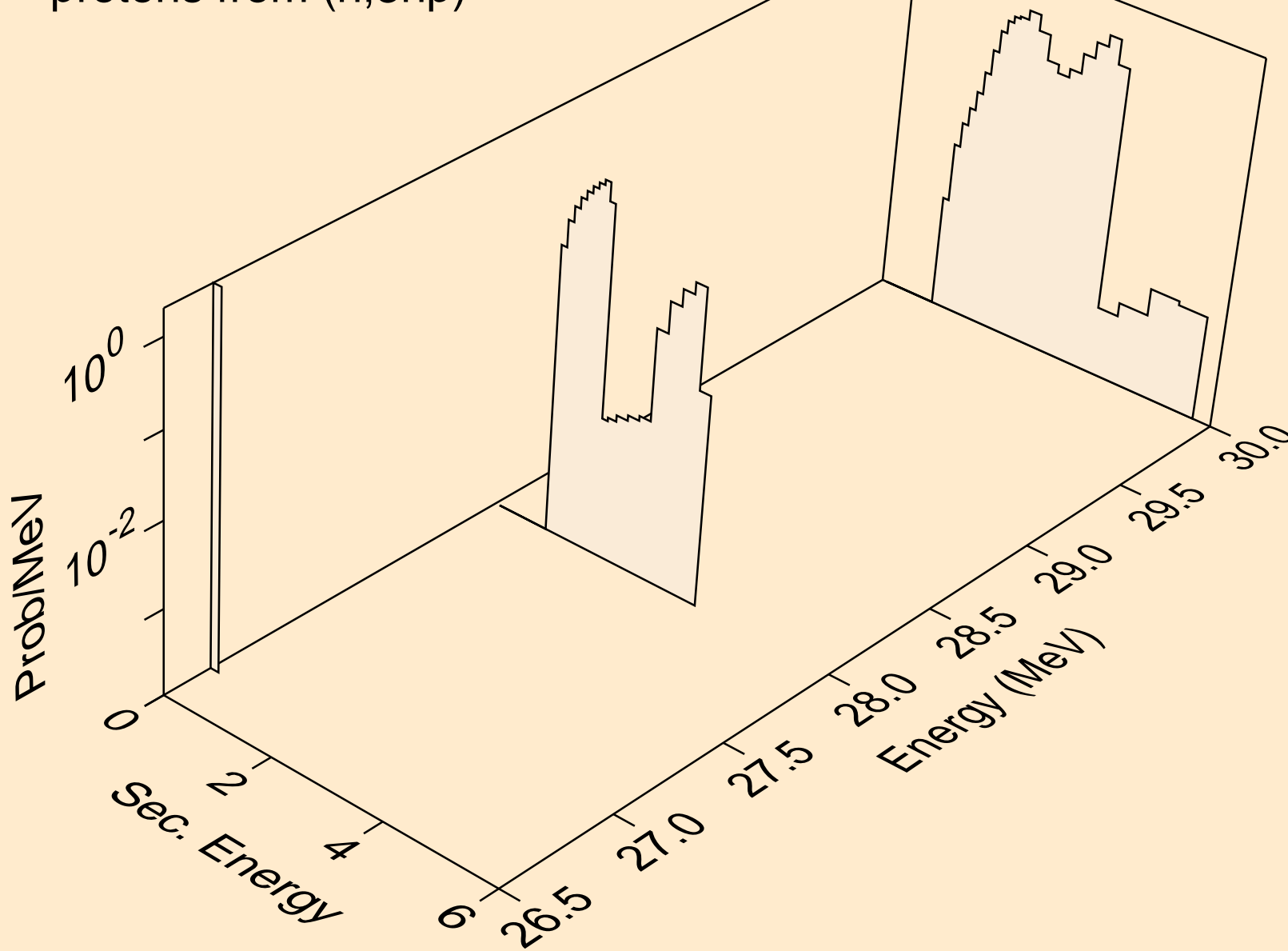

SN104 NEUTRON ACER TENDL-2019 LIBRARY; T=293.16K  
protons from (n,2np)

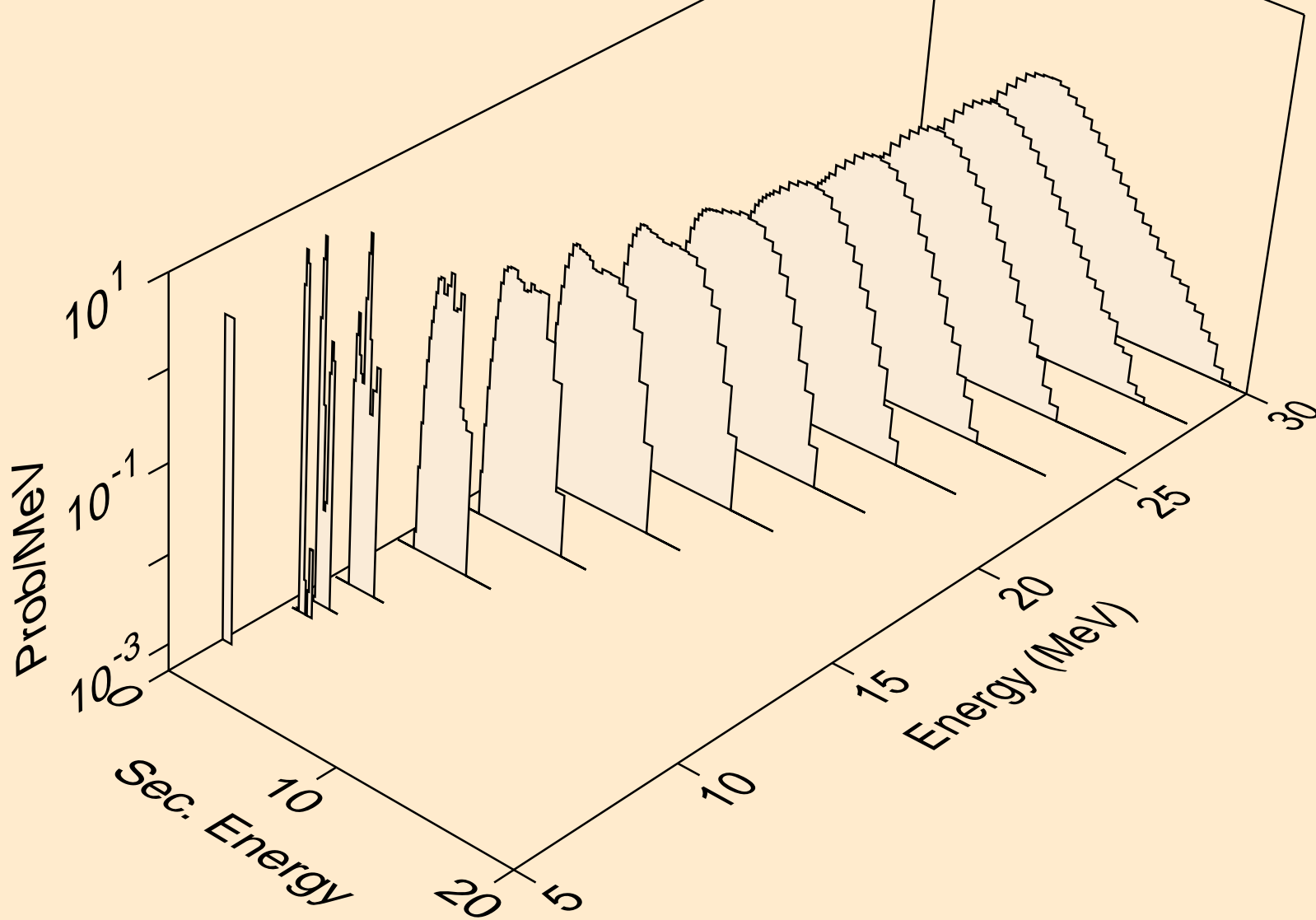

SN104 NEUTRON ACER TENDL-2019 LIBRARY; T=293.16K  
protons from (n,npa)

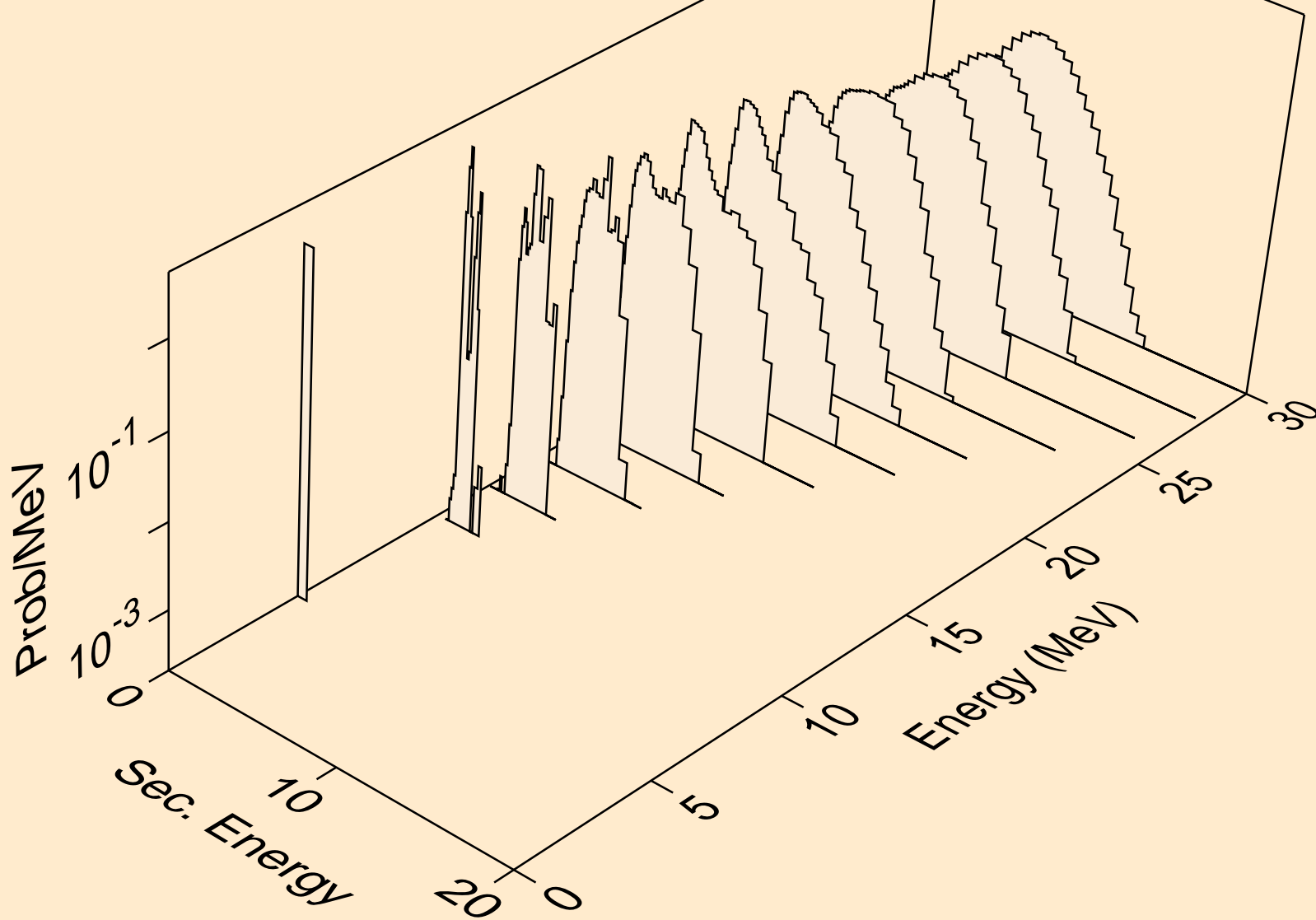

SN104 NEUTRON ACER TENDL-2019 LIBRARY; T=293.16K  
protons from (n,p)

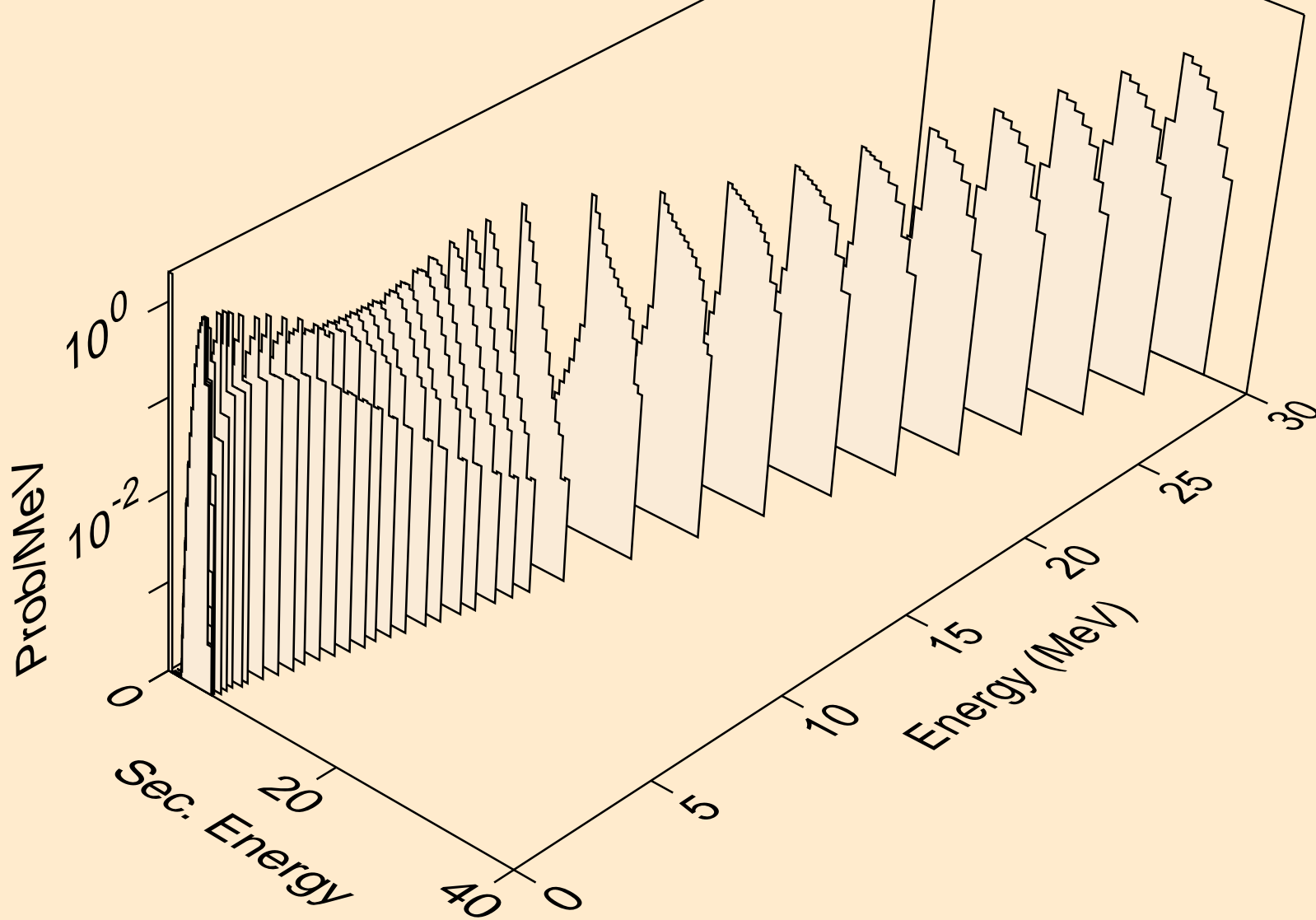

SN104 NEUTRON ACER TENDL-2019 LIBRARY; T=293.16K  
protons from (n,2p)

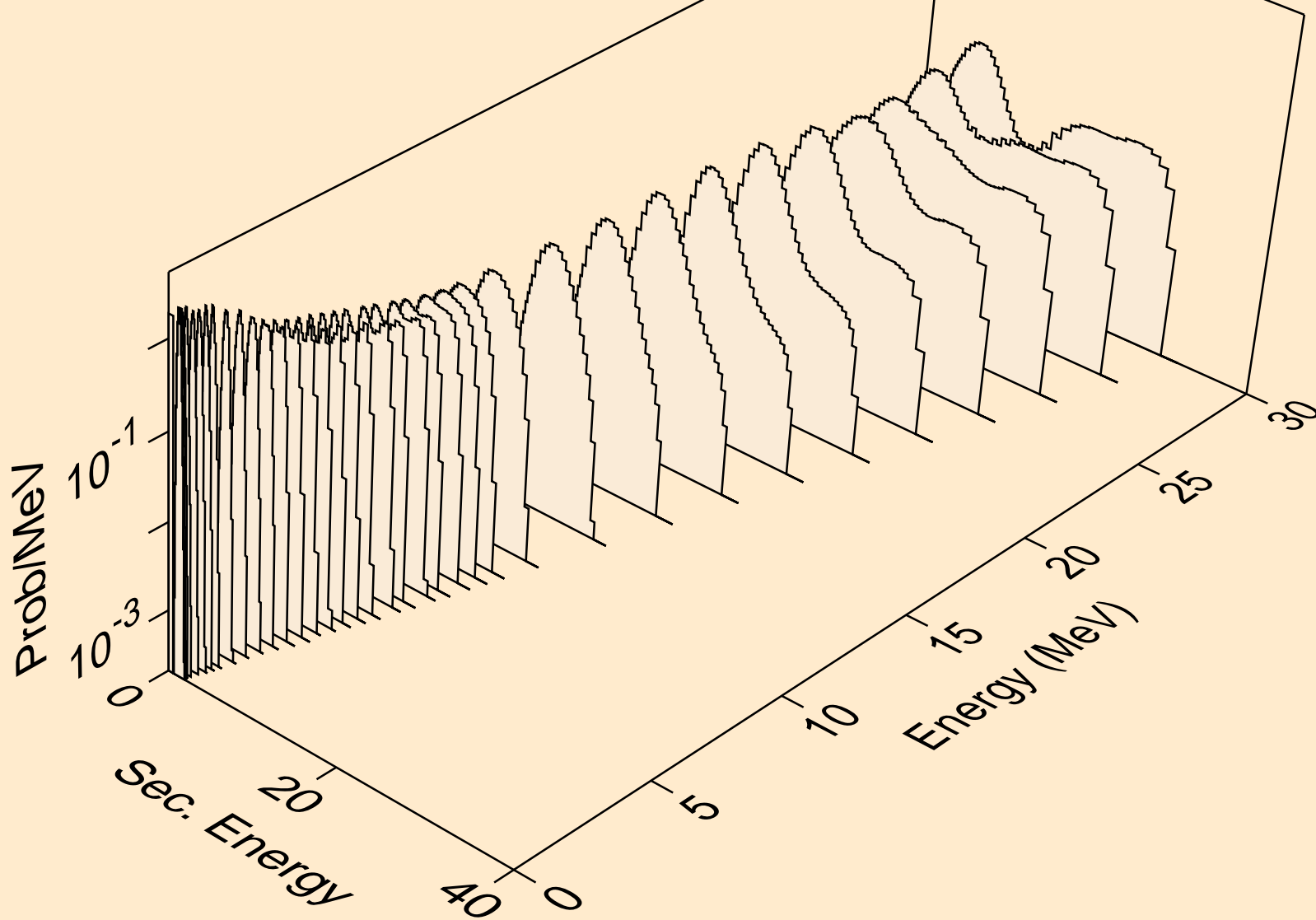



SN104 NEUTRON ACER TENDL-2019 LIBRARY; T=293.16K  
protons from (n,p)

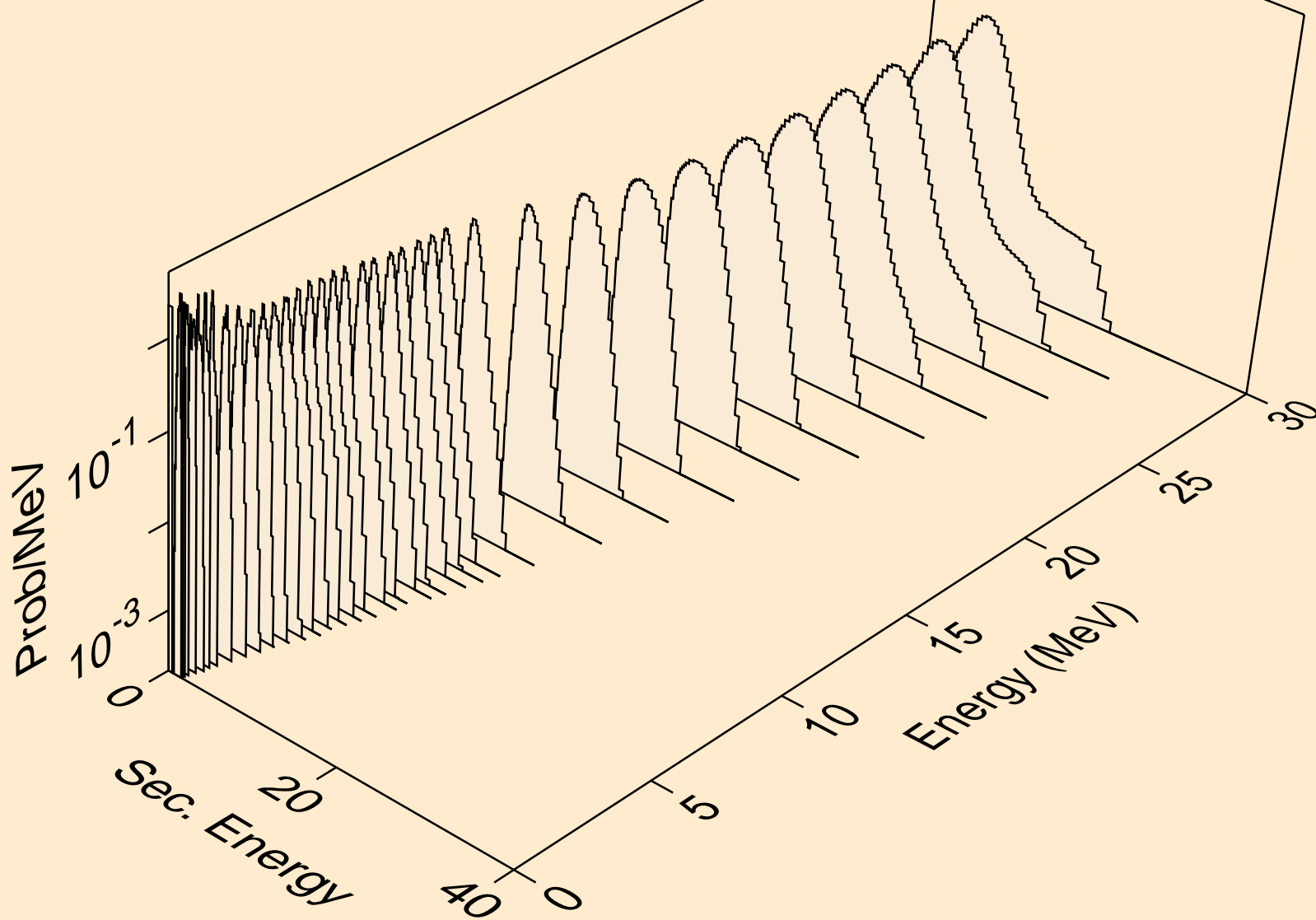

SN104 NEUTRON ACER TENDL-2019 LIBRARY; T=293.16K  
protons from (n,pd)

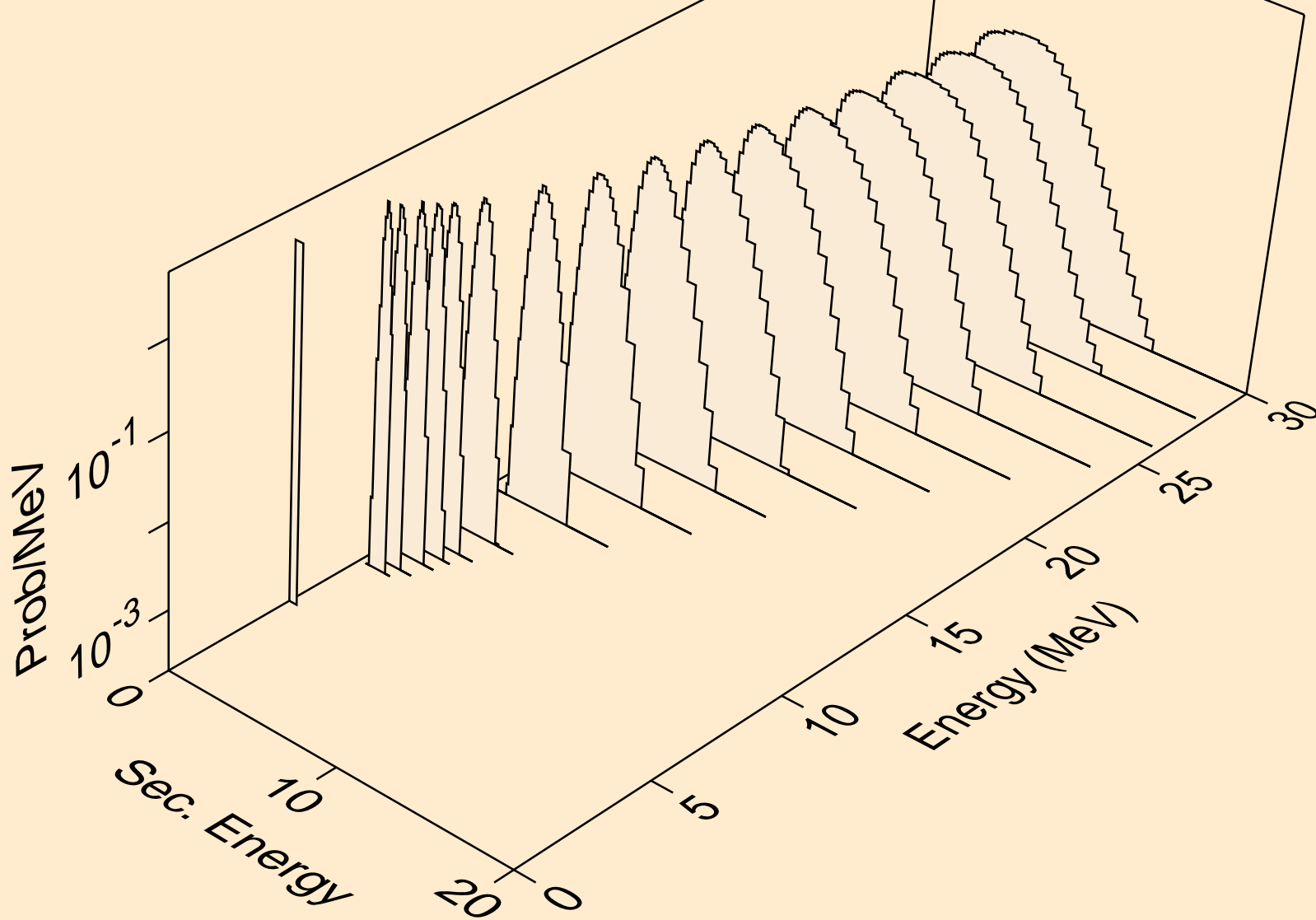

SN104 NEUTRON ACER TENDL-2019 LIBRARY; T=293.16K  
protons from (n,pt)

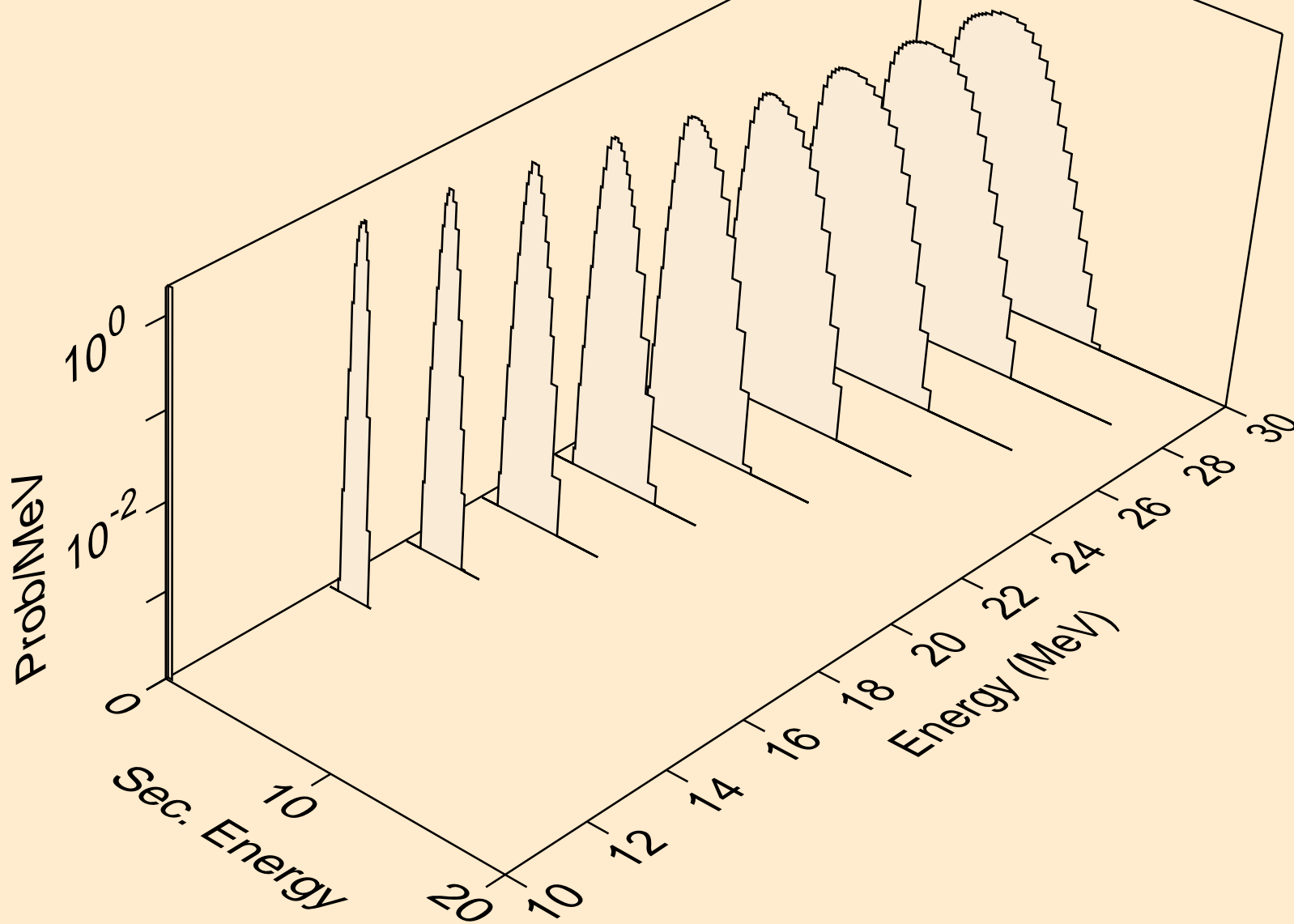

SN104 NEUTRON ACER TENDL-2019 LIBRARY; T=293.16K  
deuterons from (n,x)

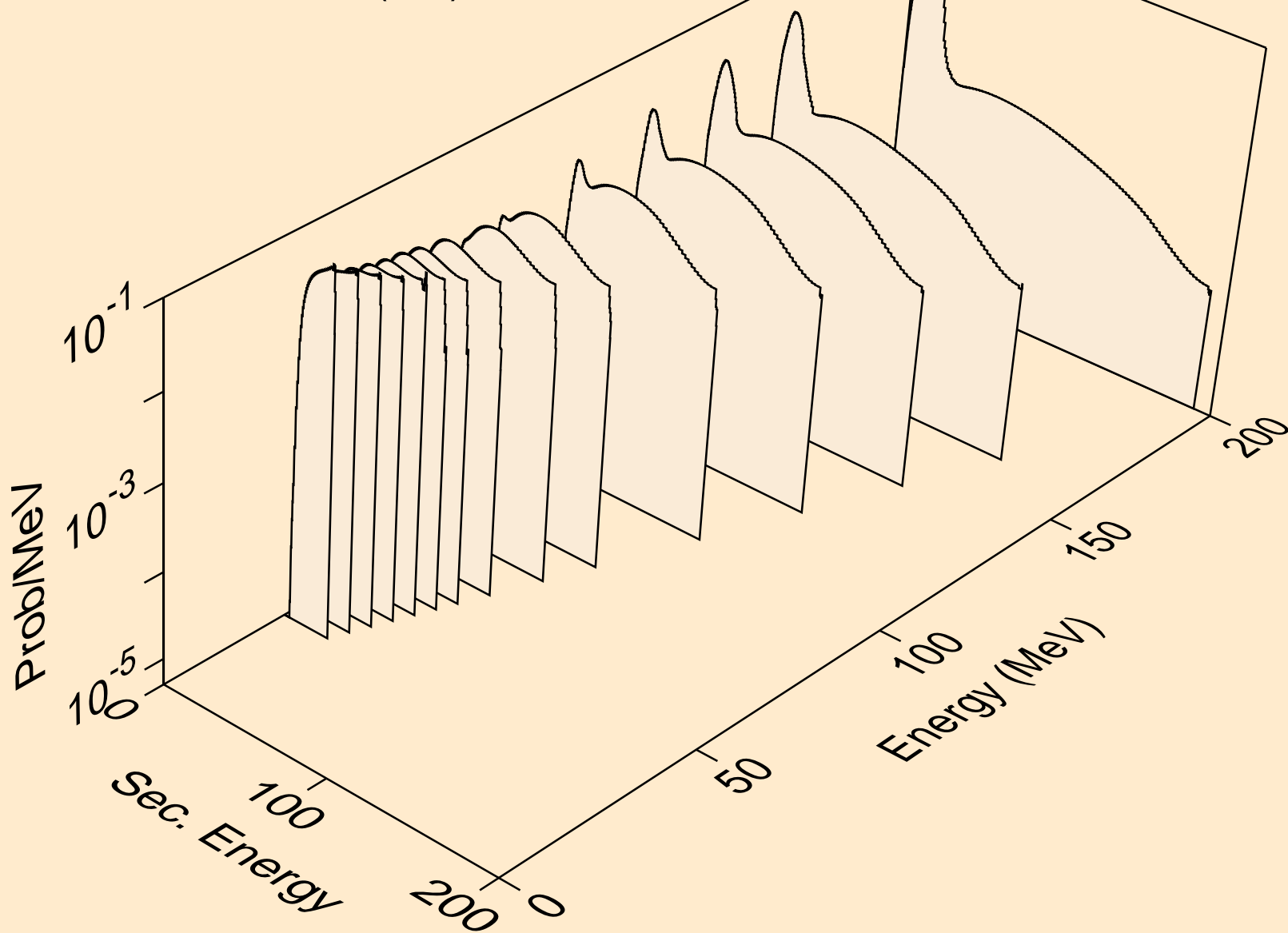

SN104 NEUTRON ACER TENDL-2019 LIBRARY; T=293.16K  
deuterons from (n,2nd)

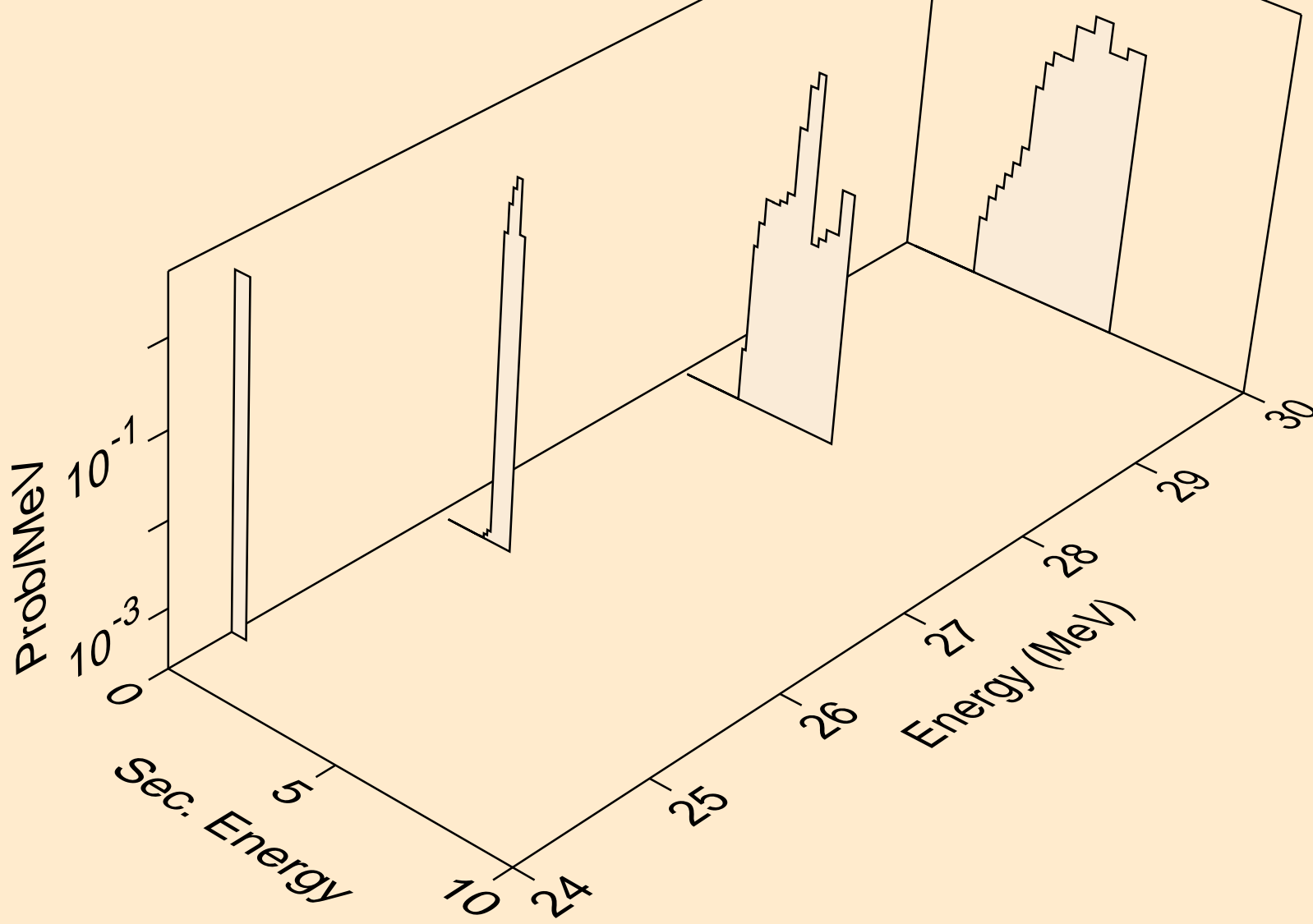

SN104 NEUTRON ACER TENDL-2019 LIBRARY; T=293.16K  
deuterons from (n,n\*)d

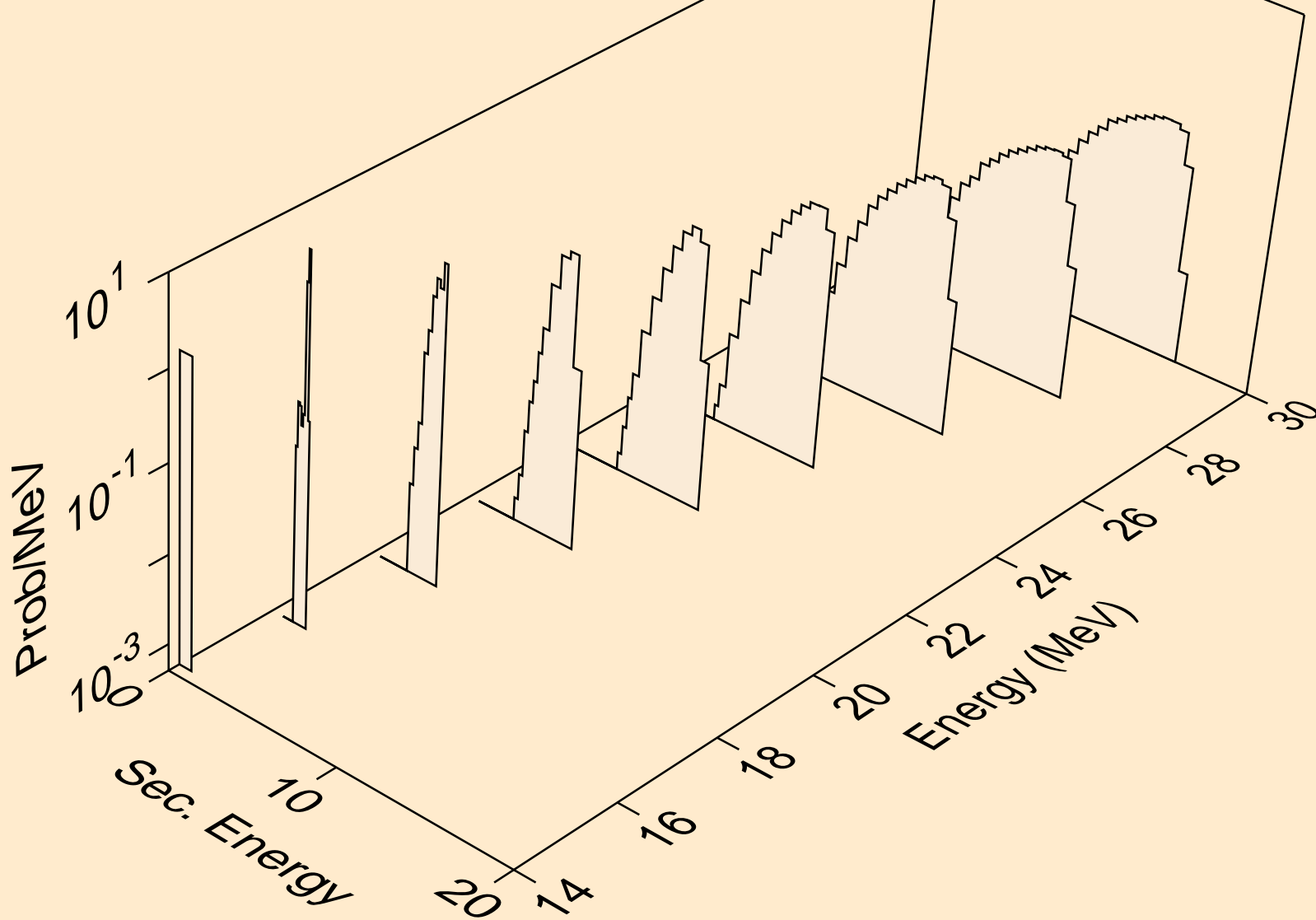

SN104 NEUTRON ACER TENDL-2019 LIBRARY; T=293.16K  
deuterons from (n,d)

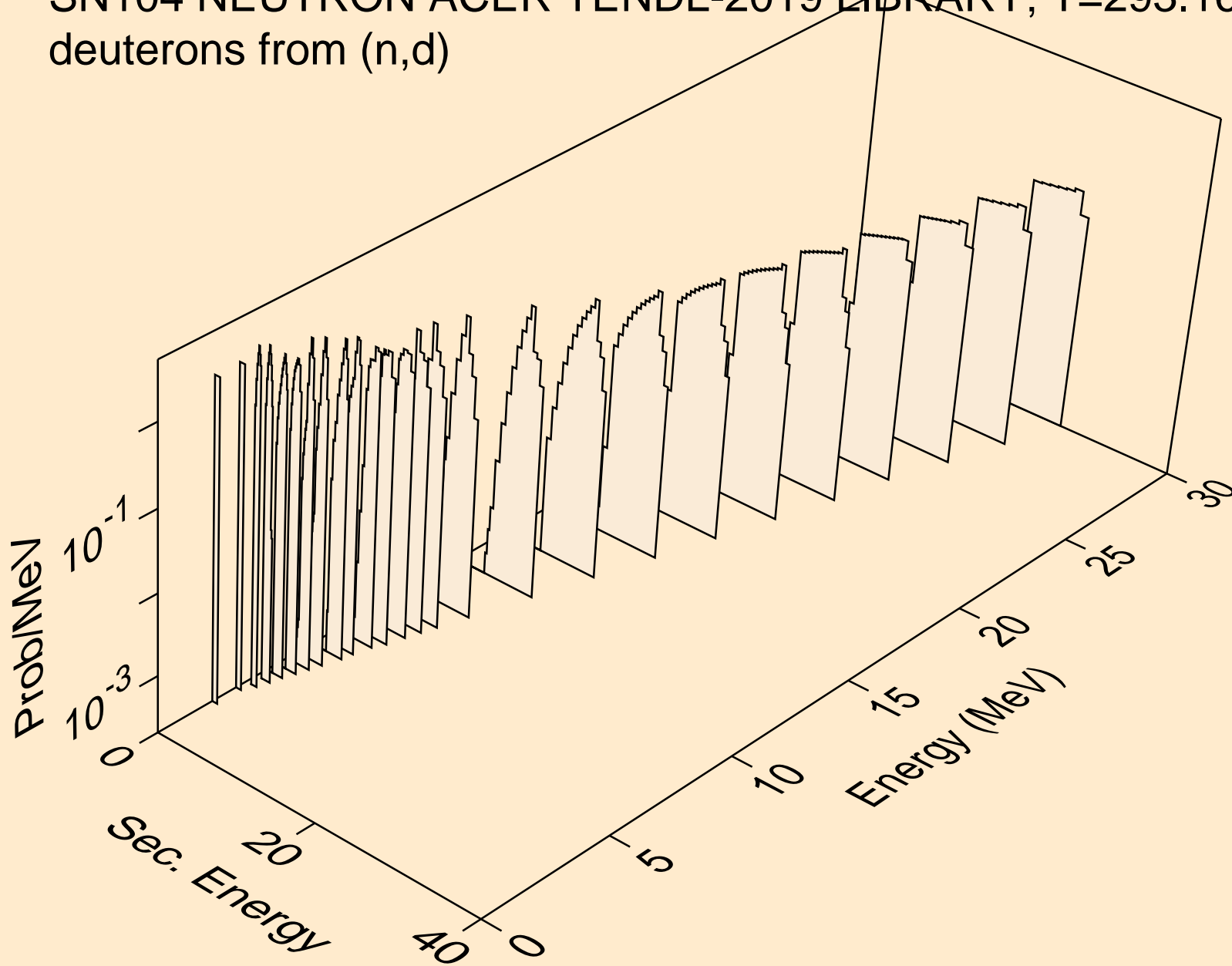

SN104 NEUTRON ACER TENDL-2019 LIBRARY; T=293.16K  
deuterons from (n,d2a)

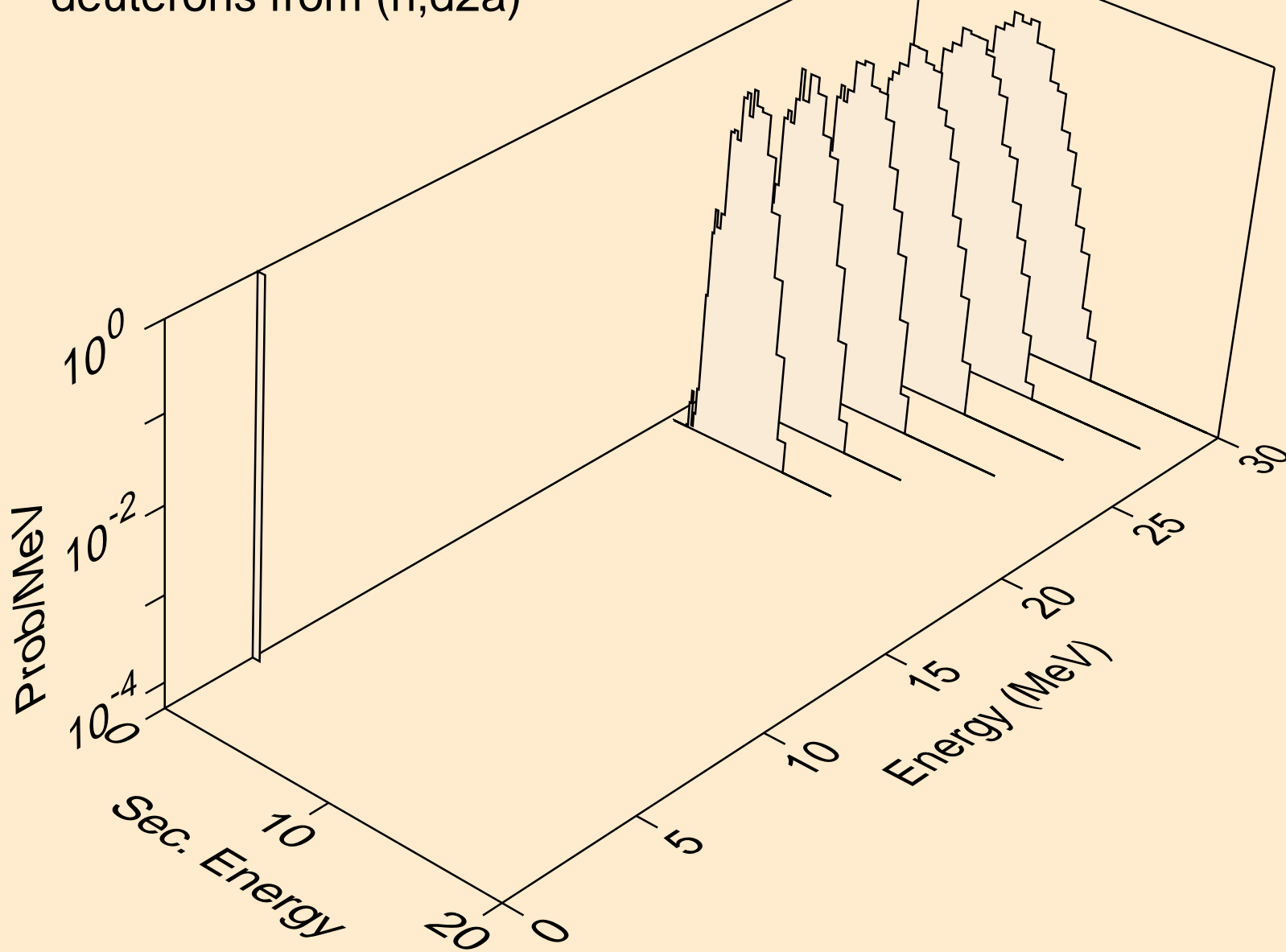



SN104 NEUTRON ACER TENDL-2019 LIBRARY; T=293.16K  
deuterons from (n,pd)

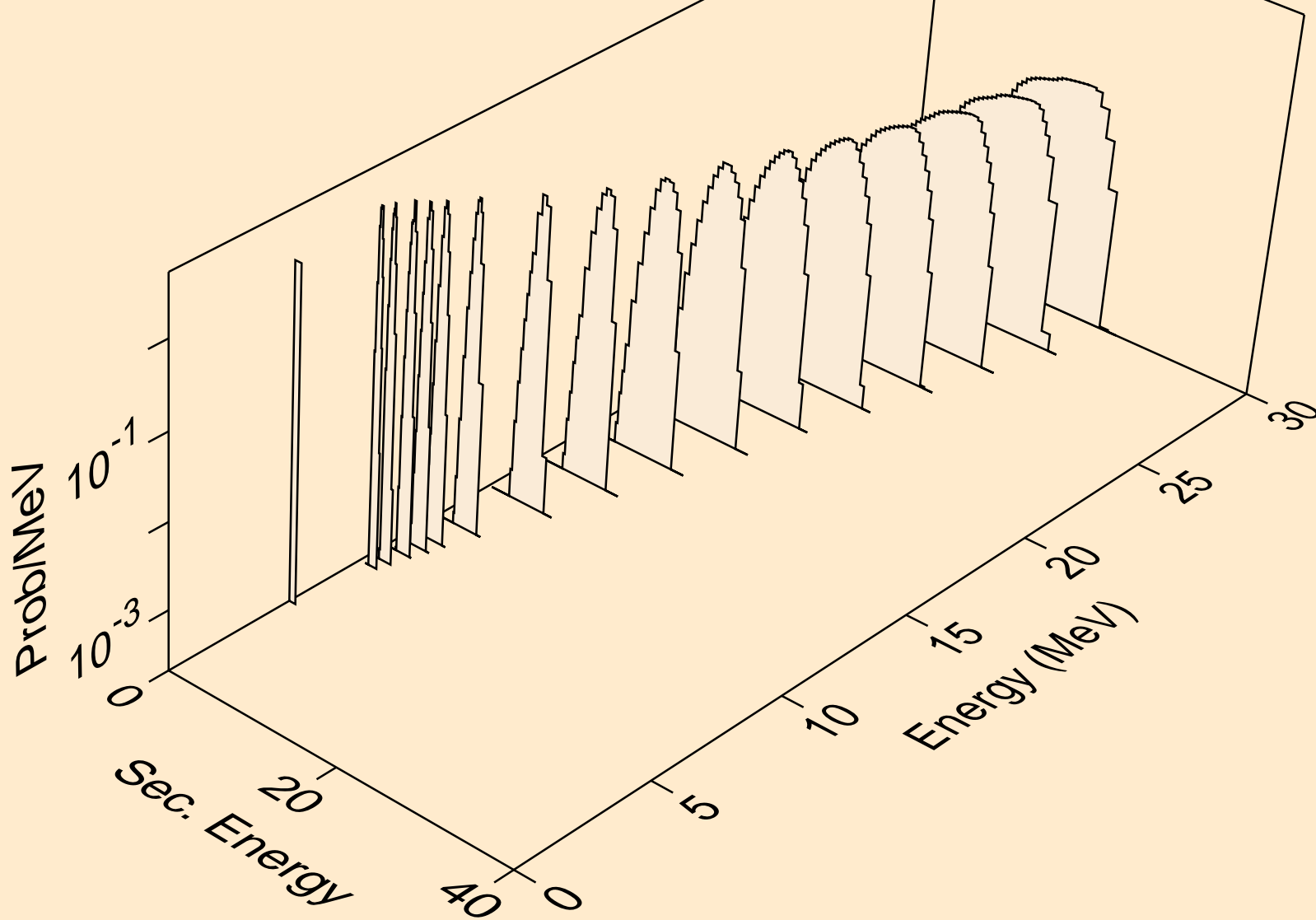

SN104 NEUTRON ACER TENDL-2019 LIBRARY; T=293.16K  
deuterons from (n,da)

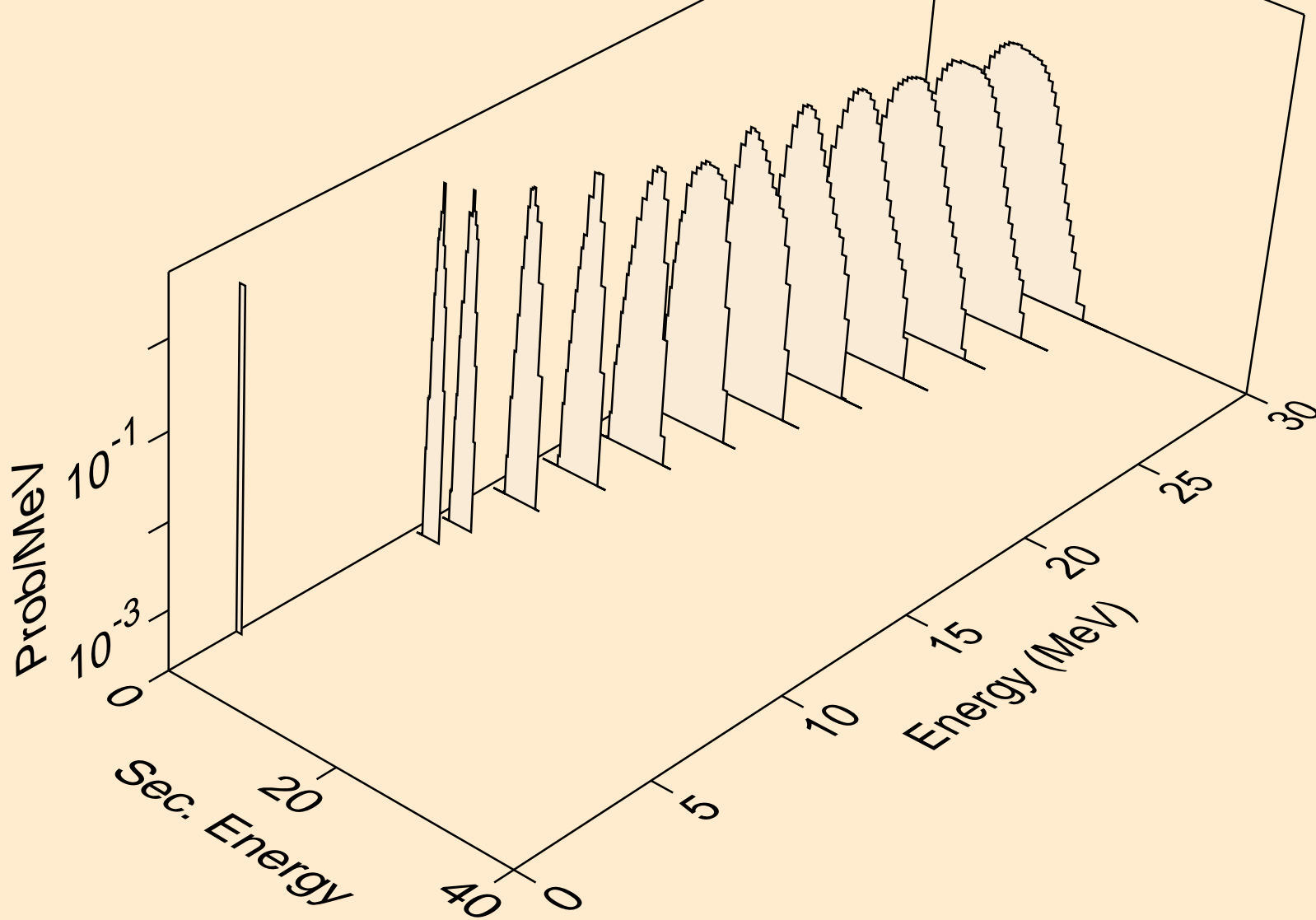

SN104 NEUTRON ACER TENDL-2019 LIBRARY; T=293.16K  
tritons from (n,x)

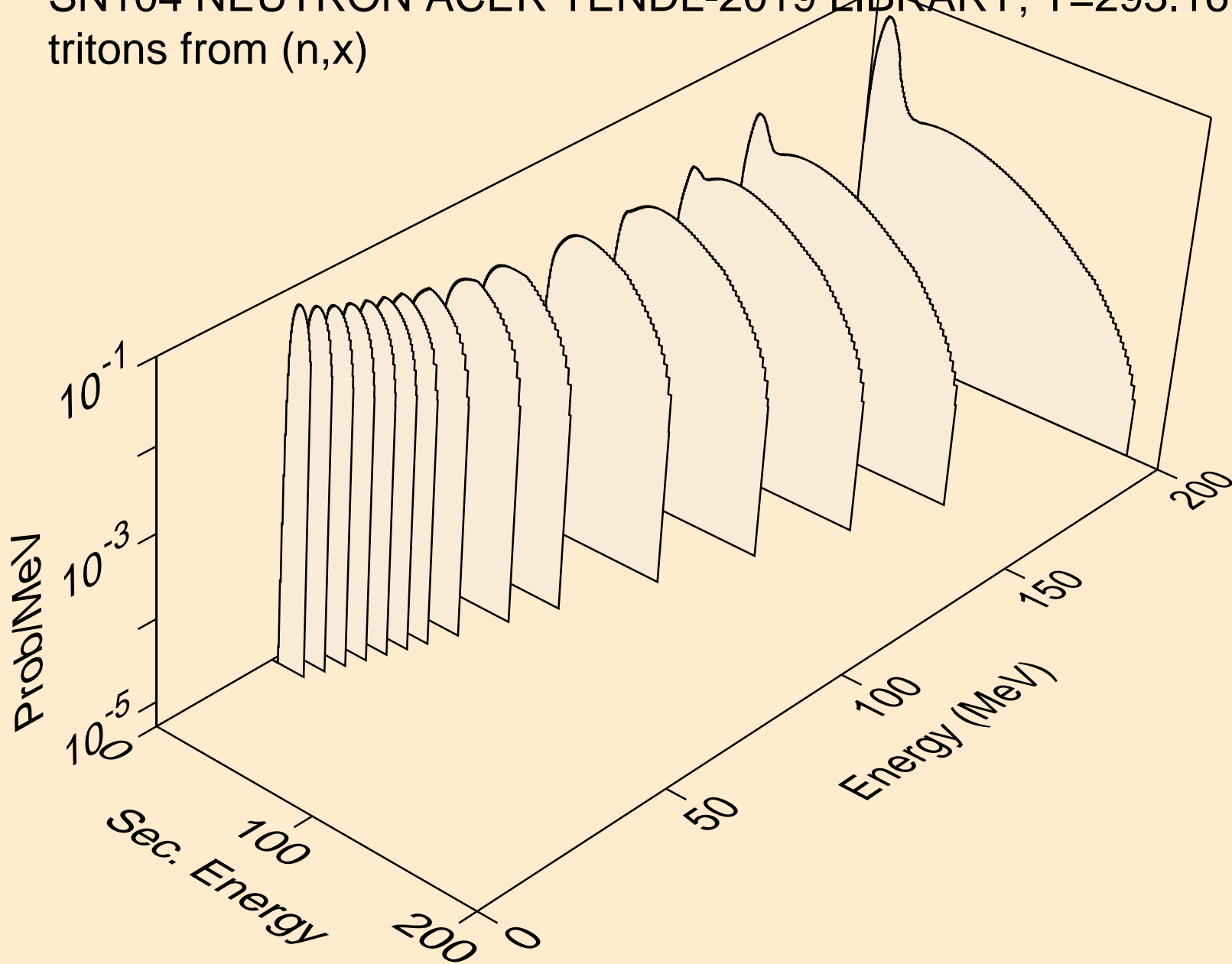

SN104 NEUTRON ACER TENDL-2019 LIBRARY; T=293.16K  
tritons from (n,n\*)t

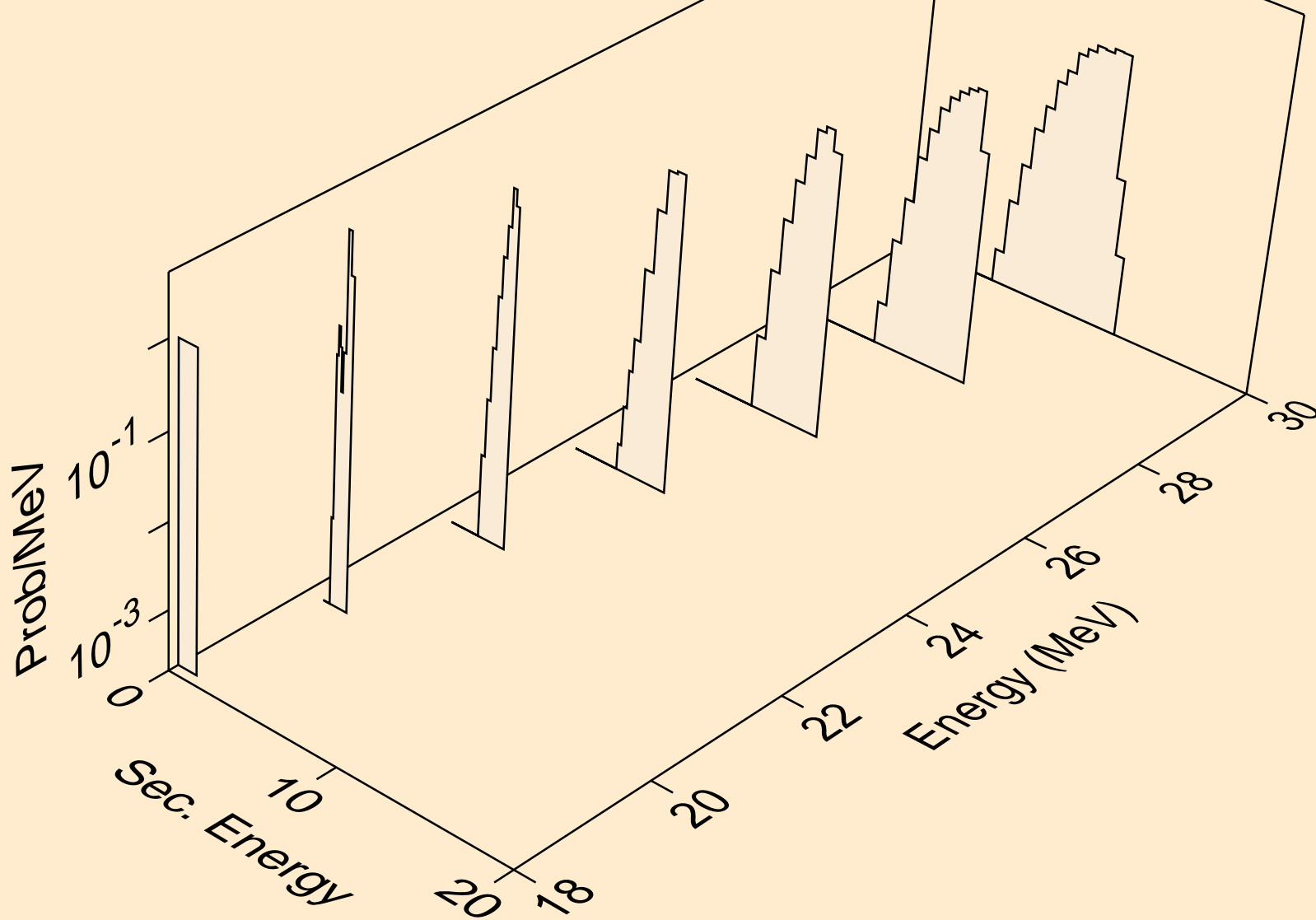

SN104 NEUTRON ACER TENDL-2019 LIBRARY; T=293.16K  
tritons from (n,t)

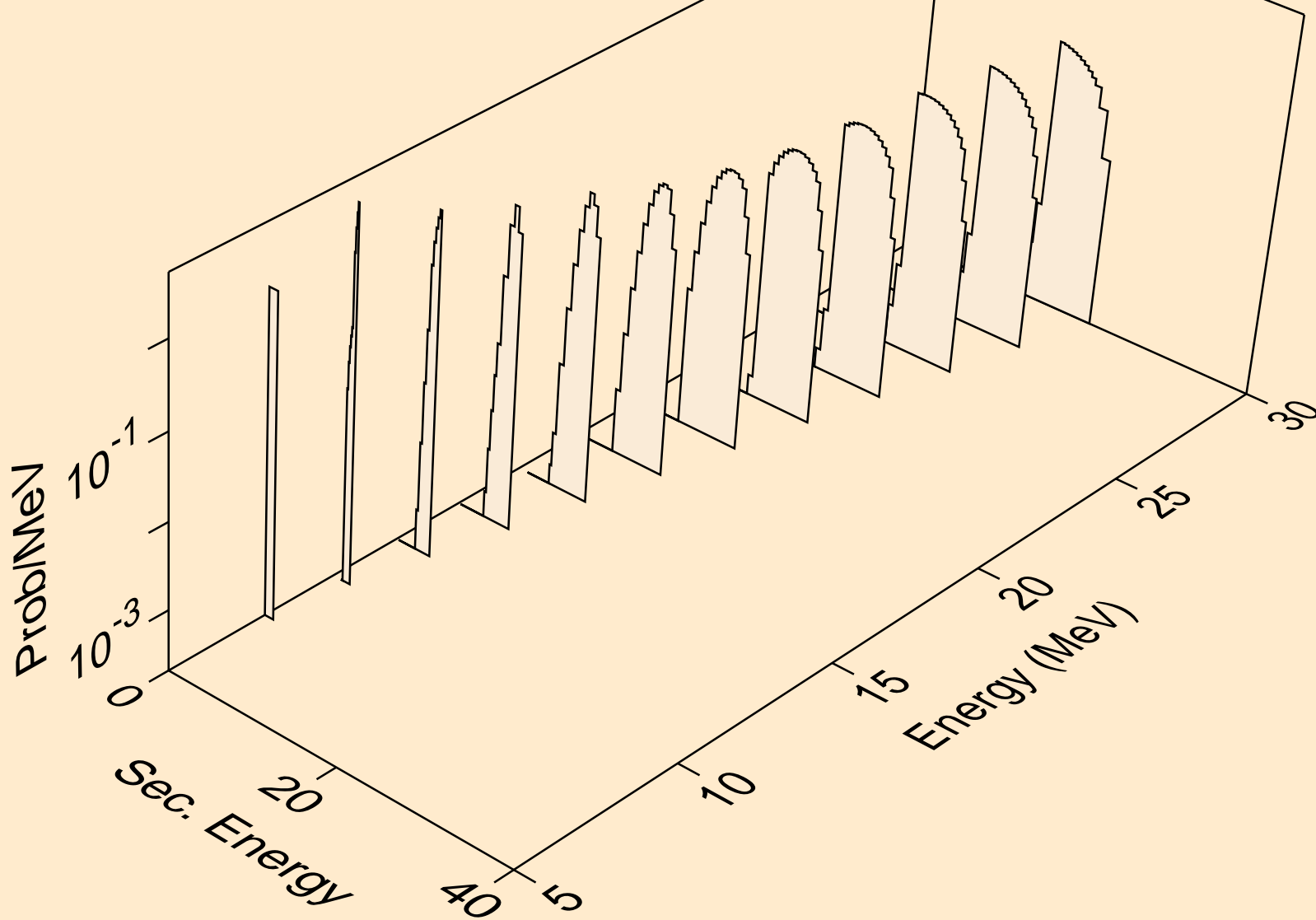

SN104 NEUTRON ACER TENDL-2019 LIBRARY; T=293.16K  
tritons from (n,pt)

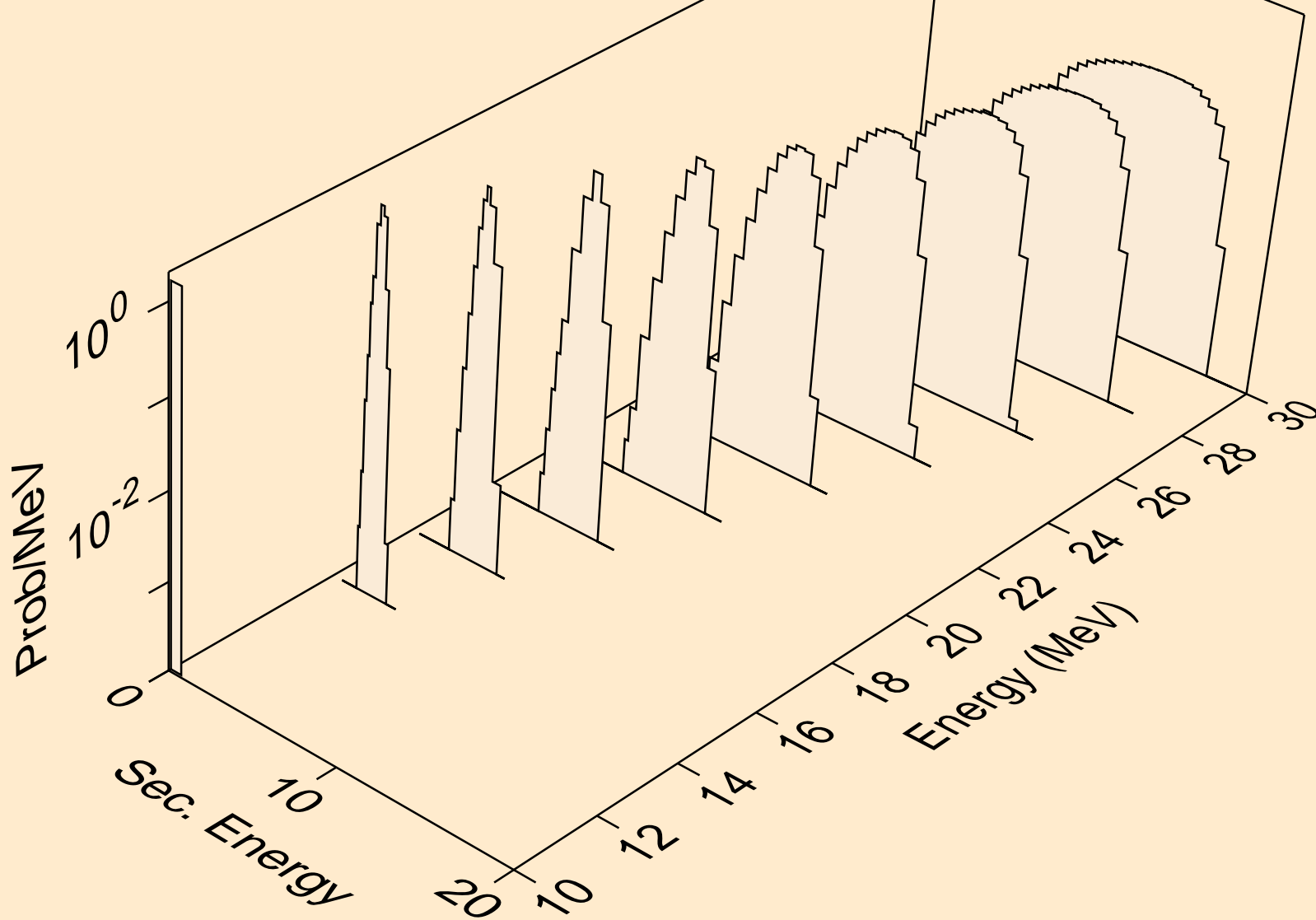

SN104 NEUTRON ACER TENDL-2019 LIBRARY; T=293.16K  
he3s from (n,x)

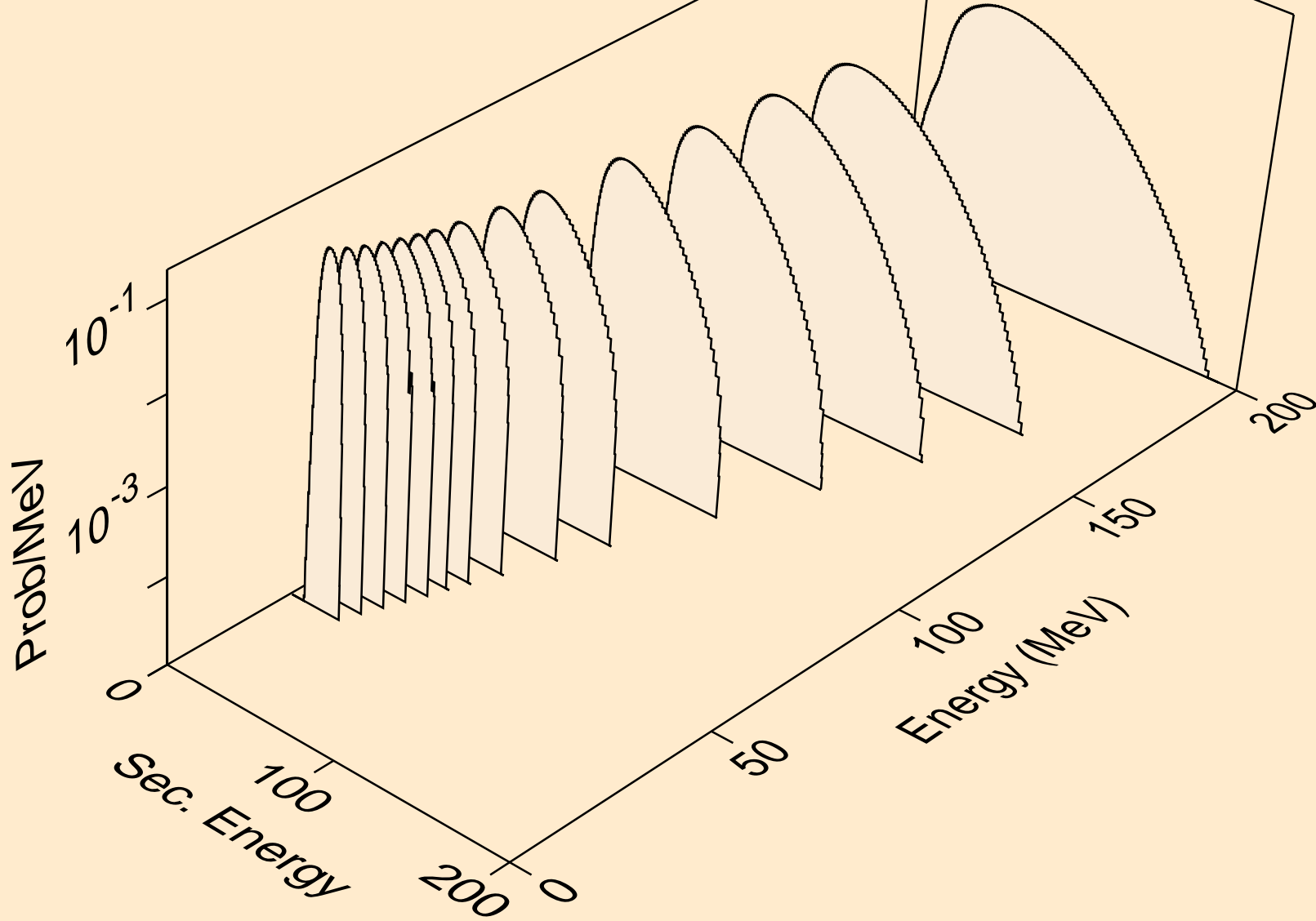

SN104 NEUTRON ACER TENDL-2019 LIBRARY; T=293.16K  
he3s from (n,n\*)he3

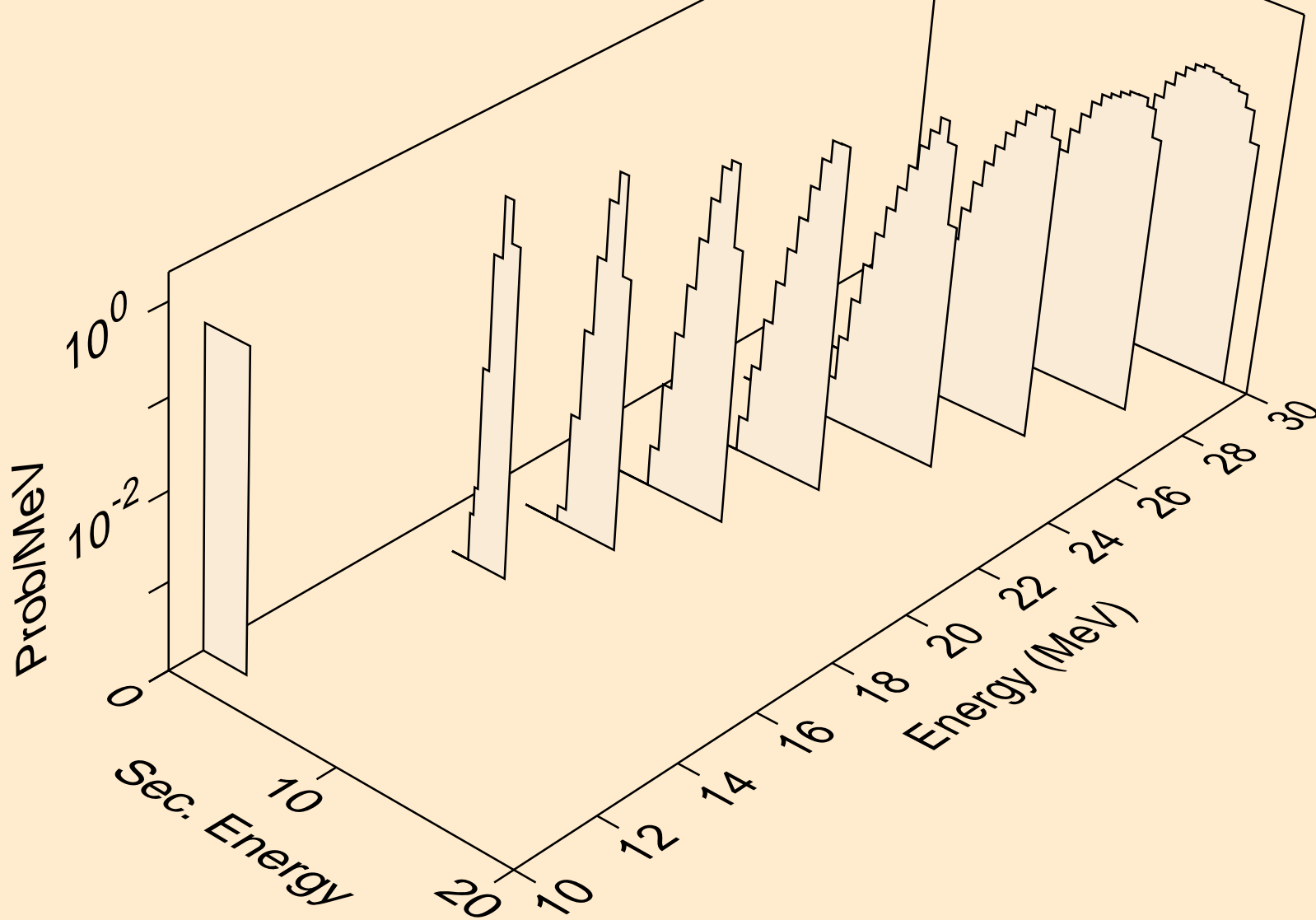



SN104 NEUTRON ACER TENDL-2019 LIBRARY; T=293.16K  
he3s from (n,he3)

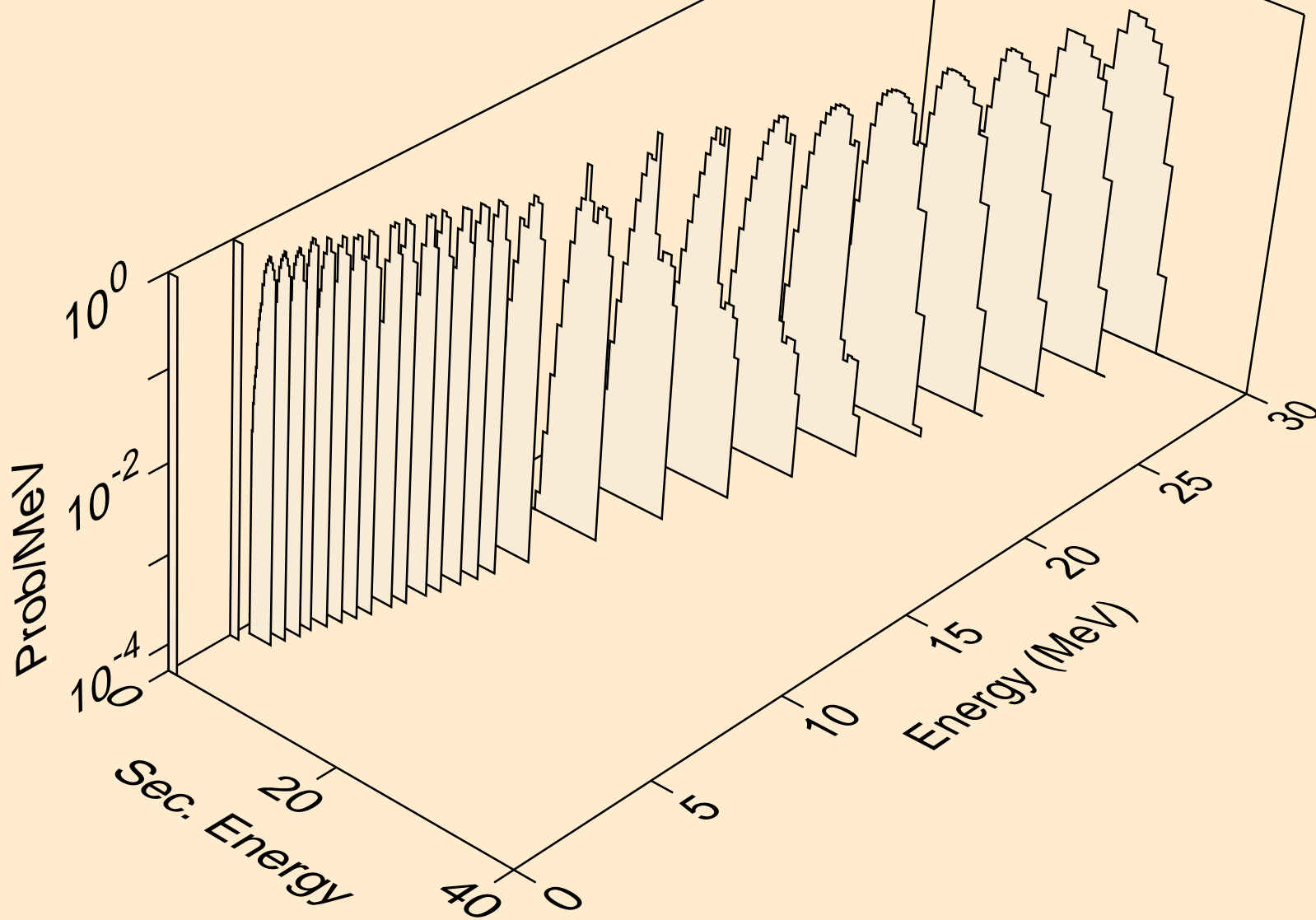

SN104 NEUTRON ACER TENDL-2019 LIBRARY; T=293.16K  
alphas from (n,x)

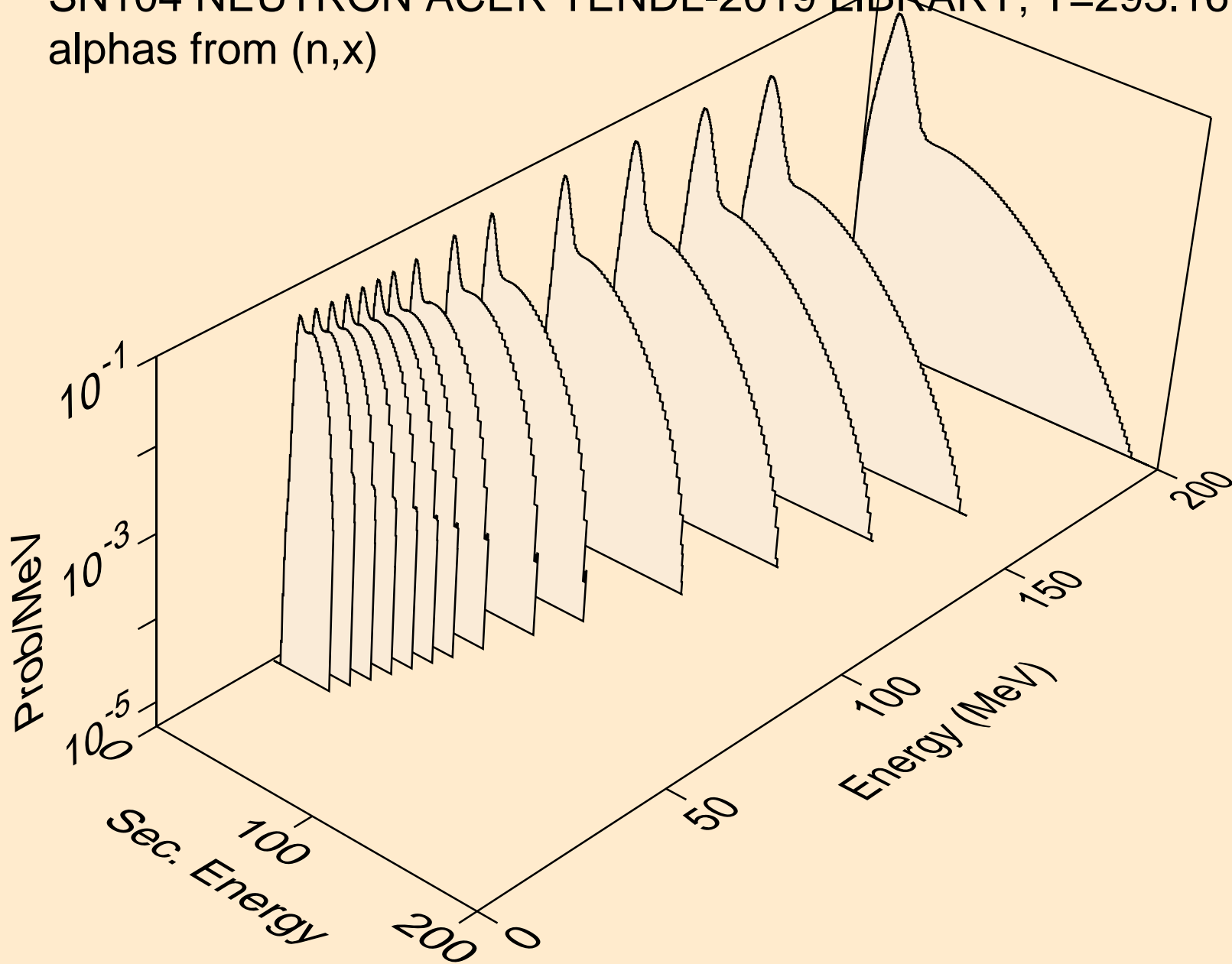

SN104 NEUTRON ACER TENDL-2019 LIBRARY; T=293.16K  
alphas from (n,n\*)a

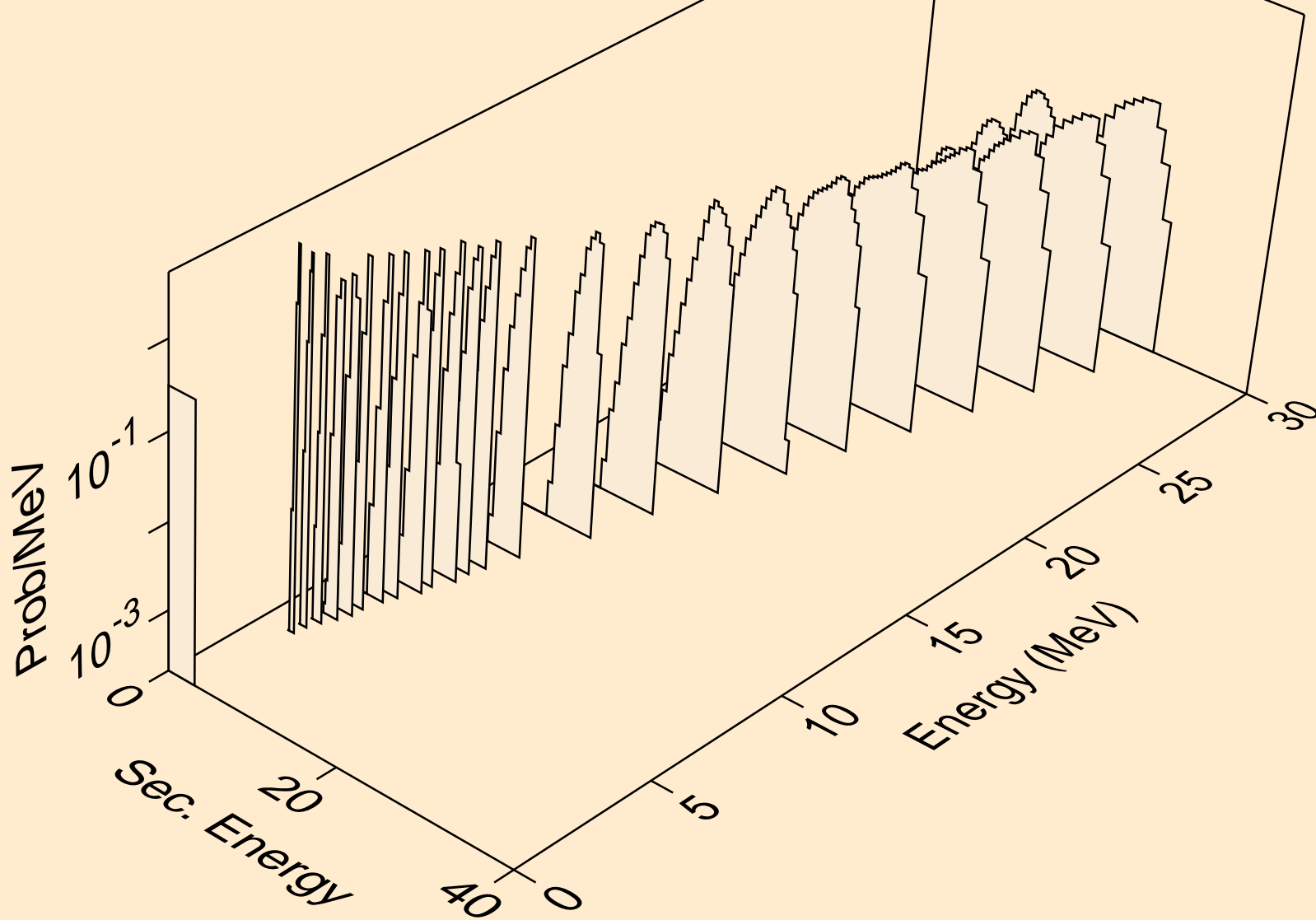

SN104 NEUTRON ACER TENDL-2019 LIBRARY; T=293.16K  
alphas from (n,2n)a

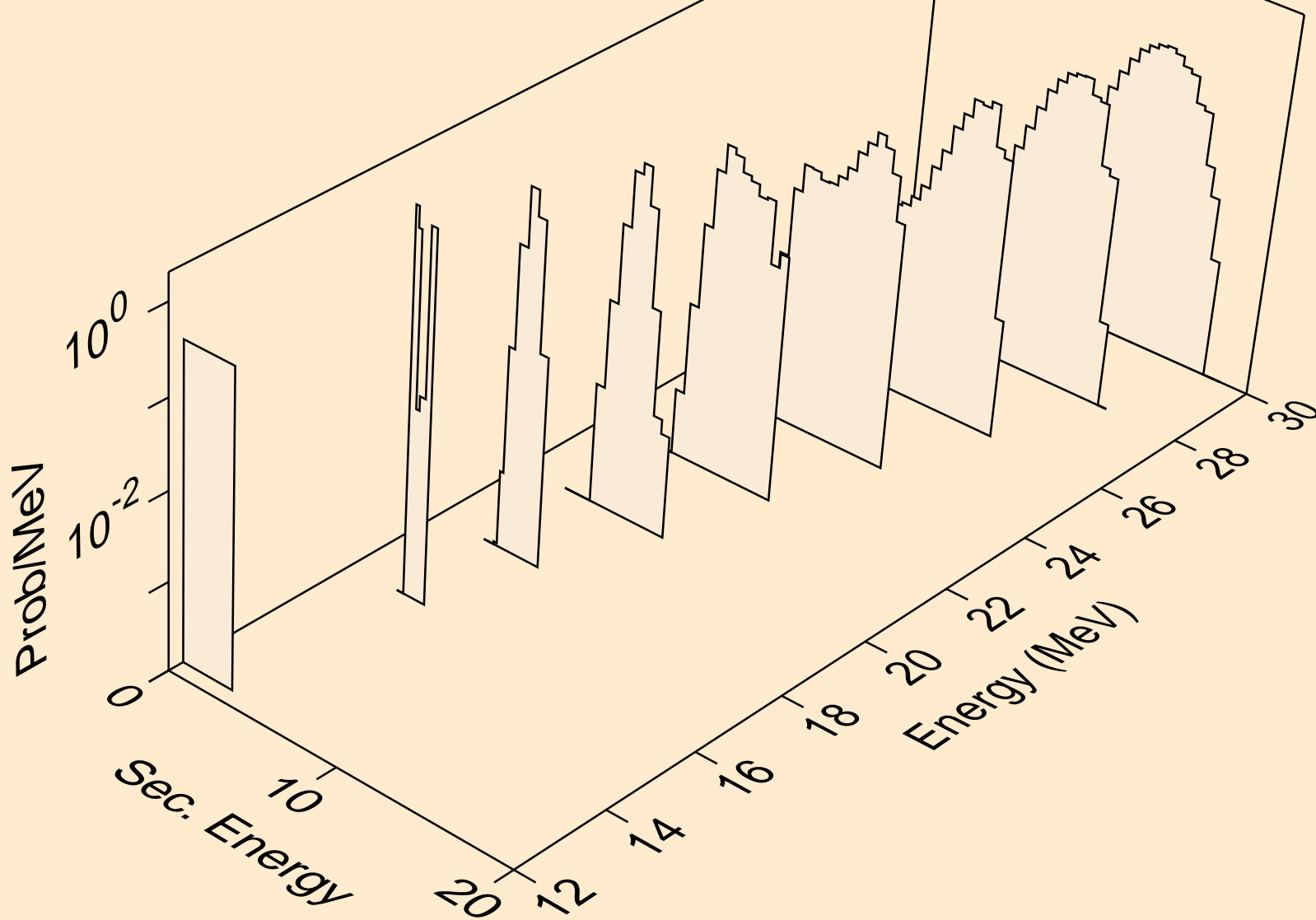

SN104 NEUTRON ACER TENDL-2019 LIBRARY; T=293.16K  
alphas from (n,n\*)2a

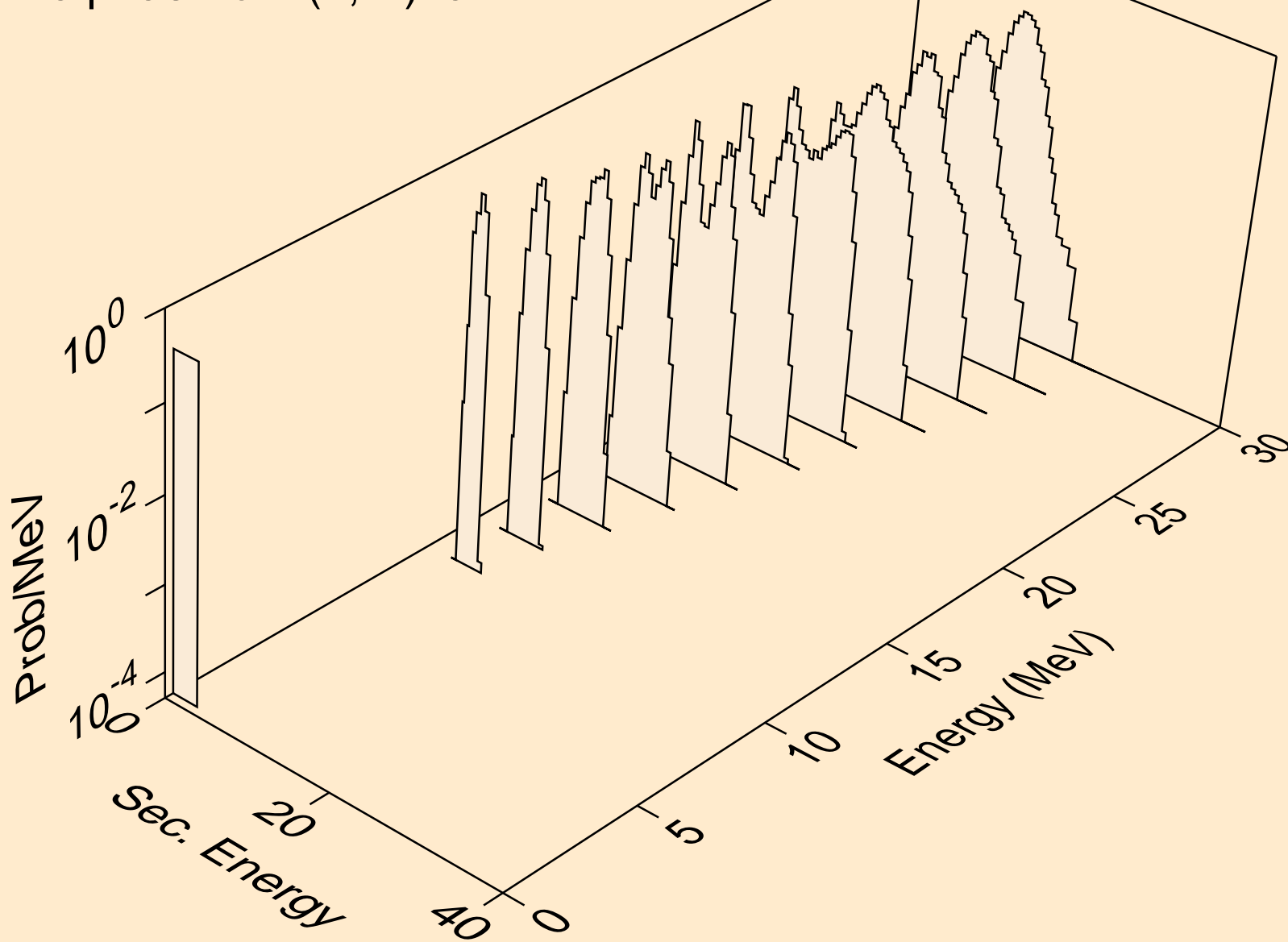

SN104 NEUTRON ACER TENDL-2019 LIBRARY; T=293.16K  
alphas from (n,npa)

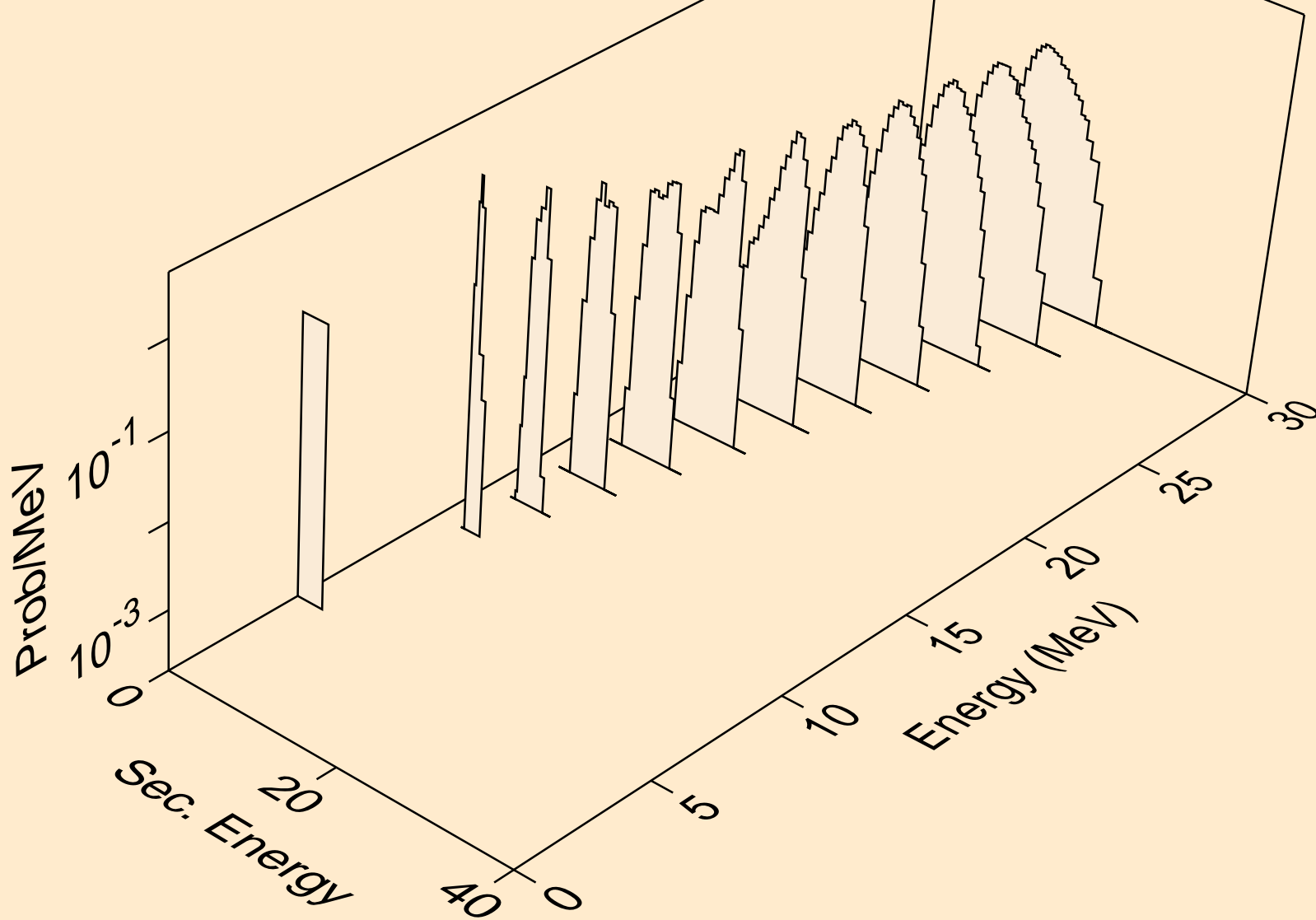

SN104 NEUTRON ACER TENDL-2019 LIBRARY; T=293.16K  
alphas from (n,a)

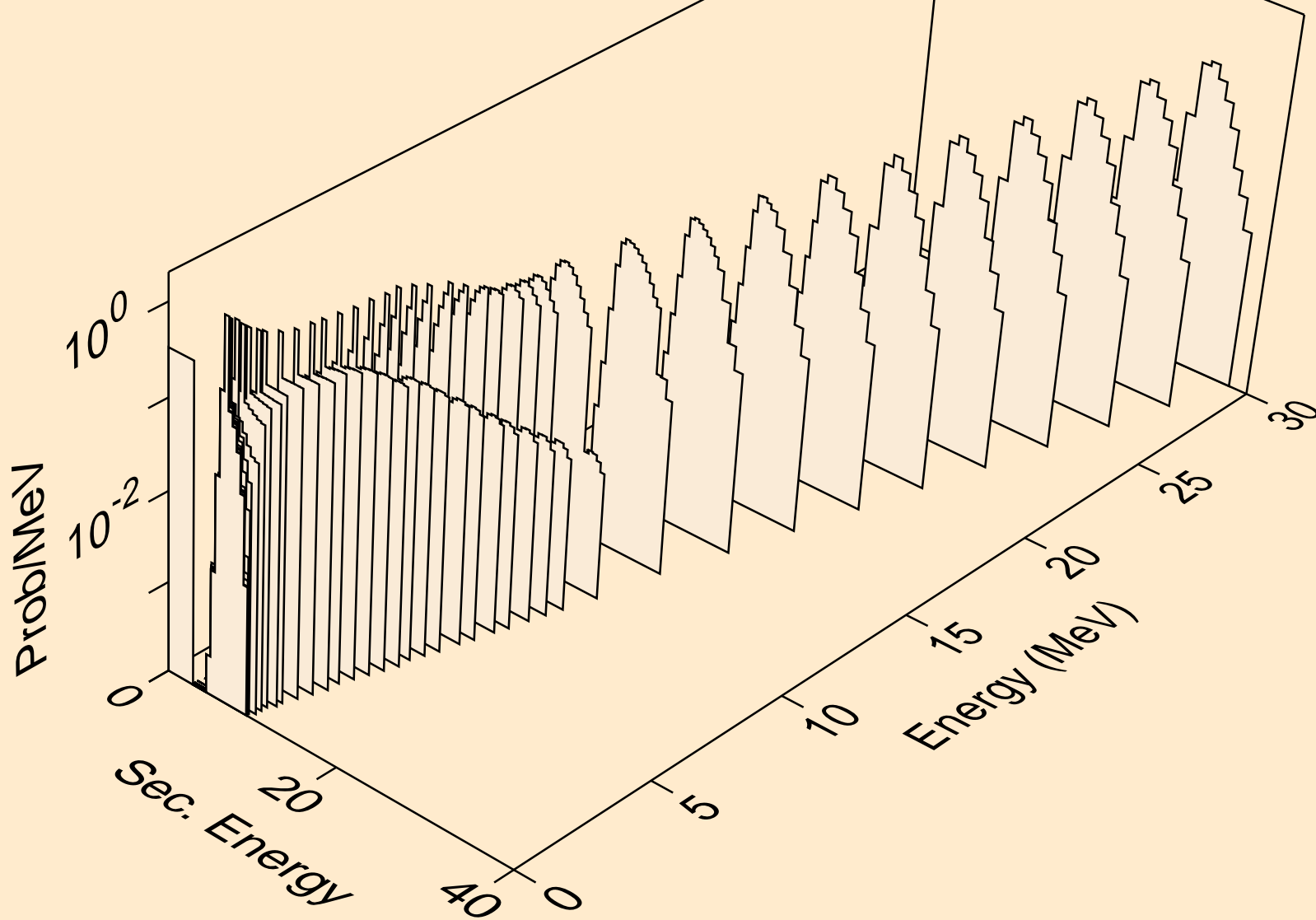

SN104 NEUTRON ACER TENDL-2019 LIBRARY; T=293.16K  
alphas from (n,2a)

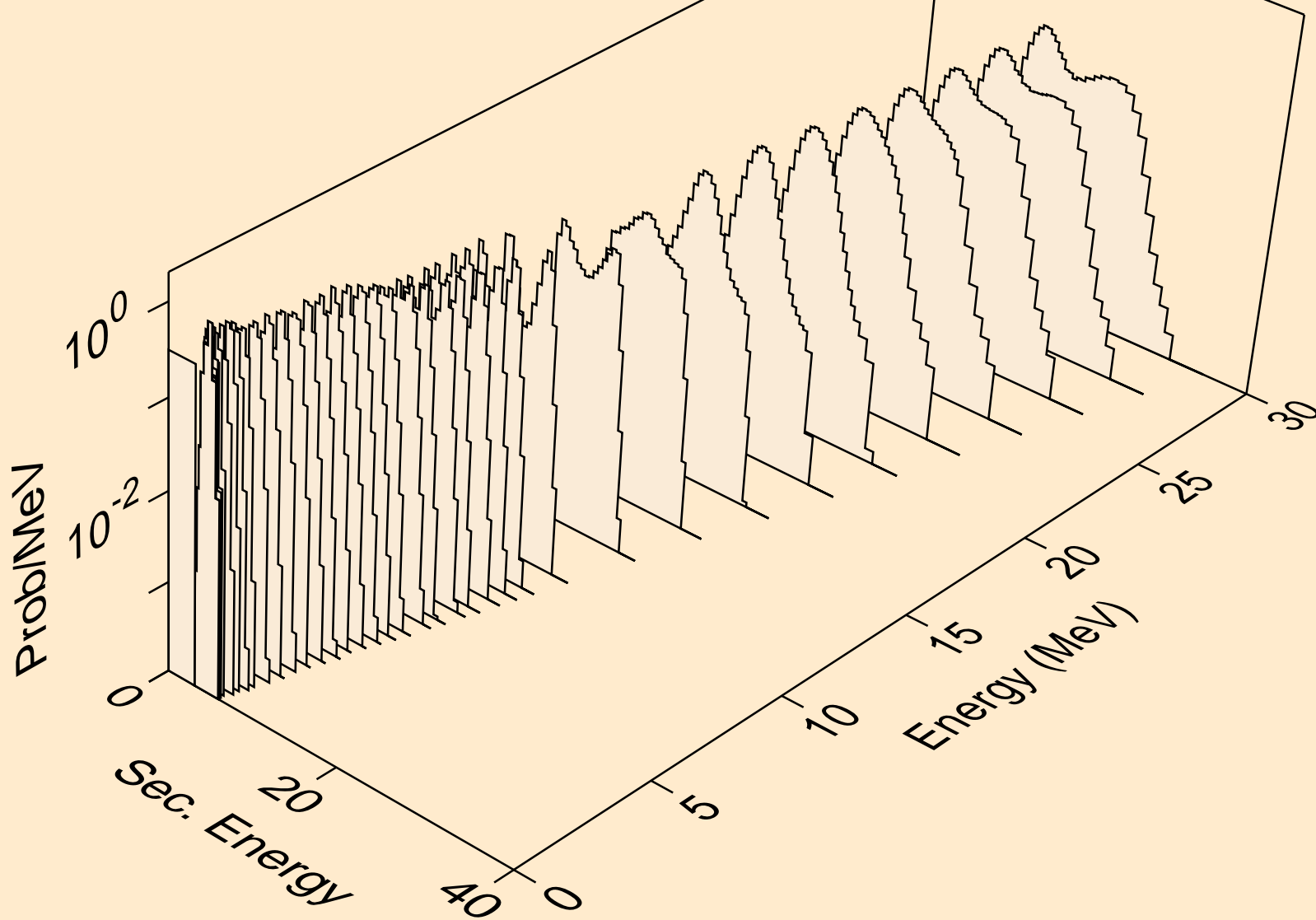



SN104 NEUTRON ACER TENDL-2019 LIBRARY; T=293.16K  
alphas from (n,3a)

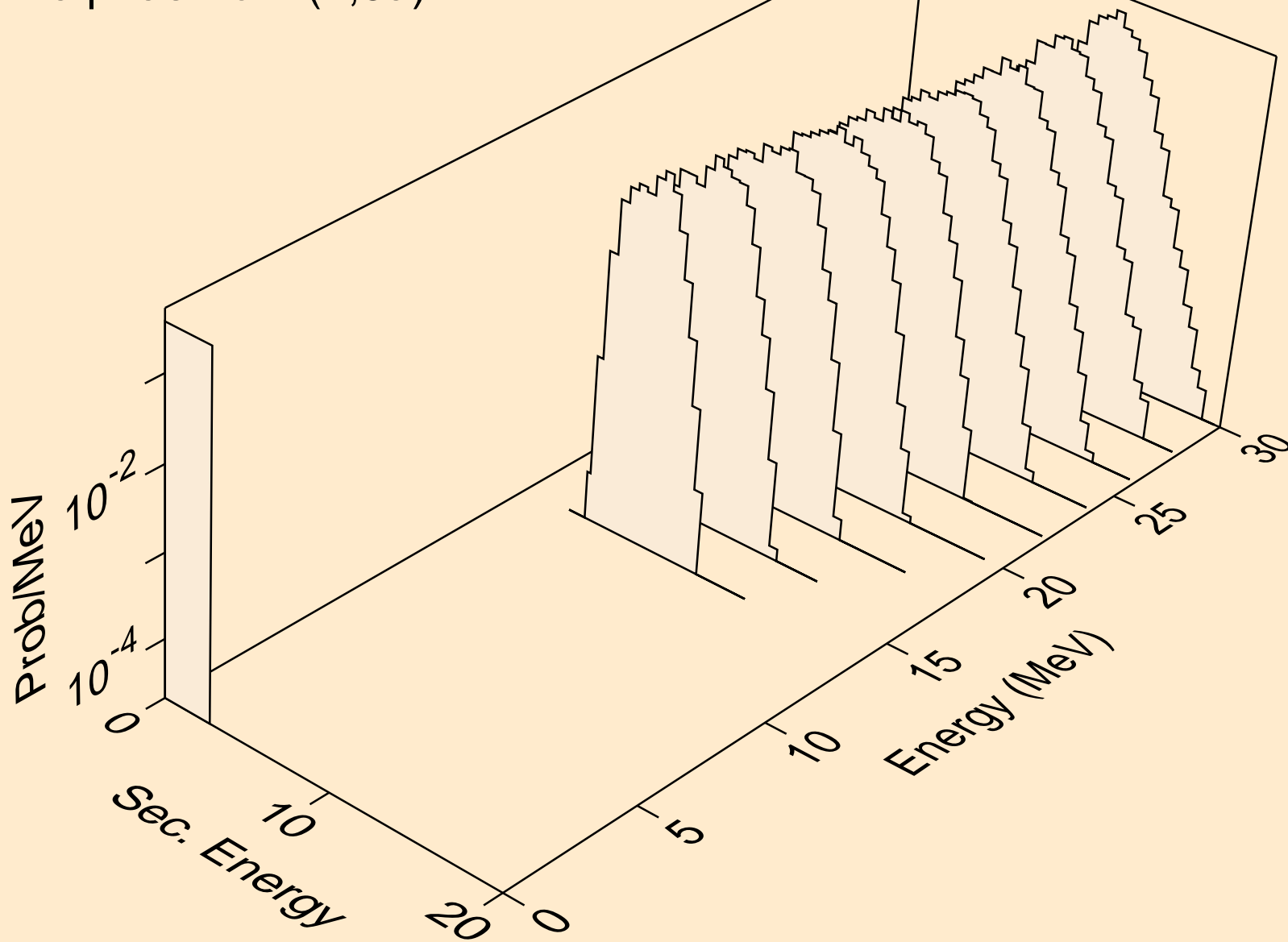

SN104 NEUTRON ACER TENDL-2019 LIBRARY; T=293.16K  
alphas from (n,pa)

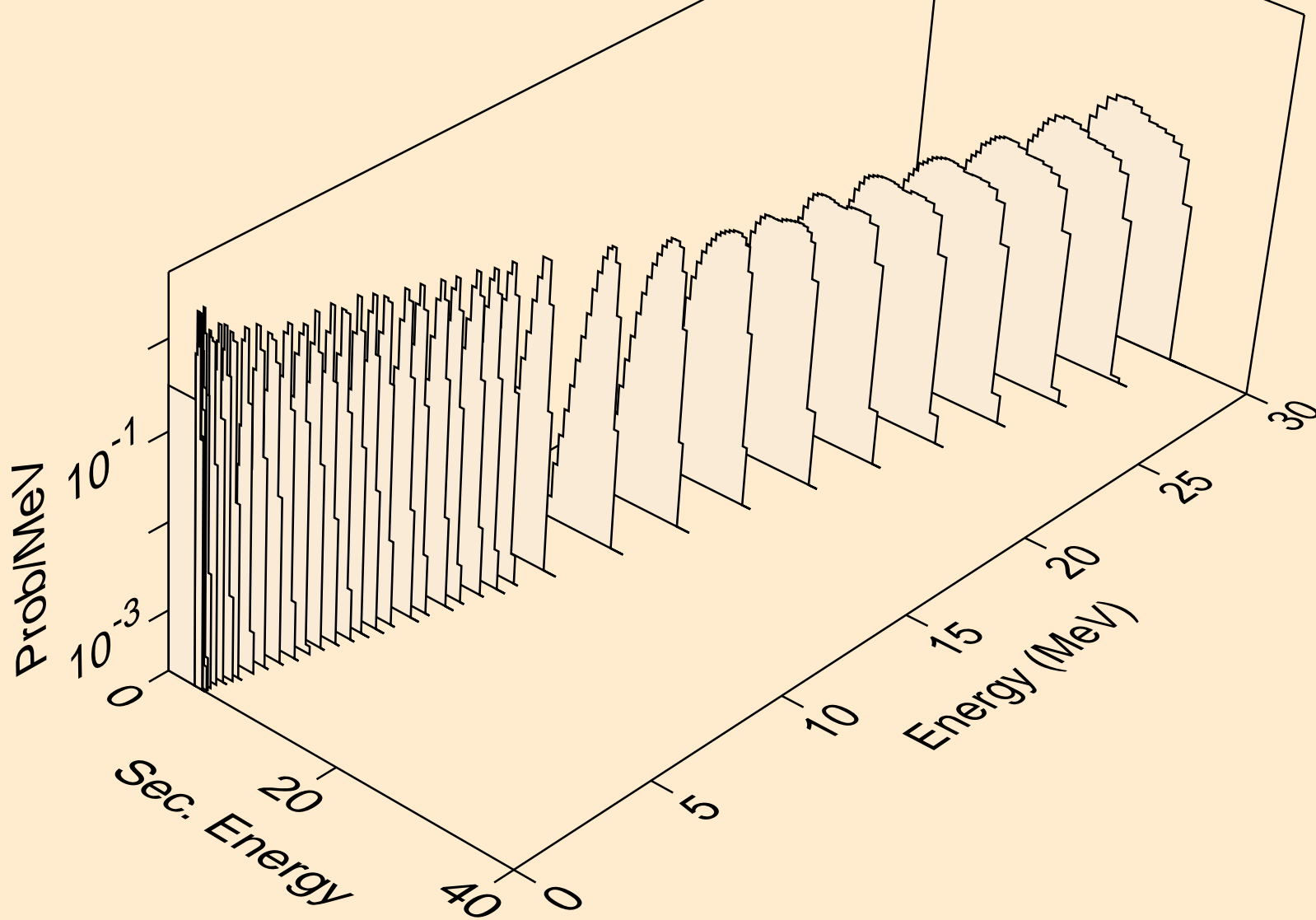

SN104 NEUTRON ACER TENDL-2019 LIBRARY; T=293.16K  
alphas from (n,d2a)

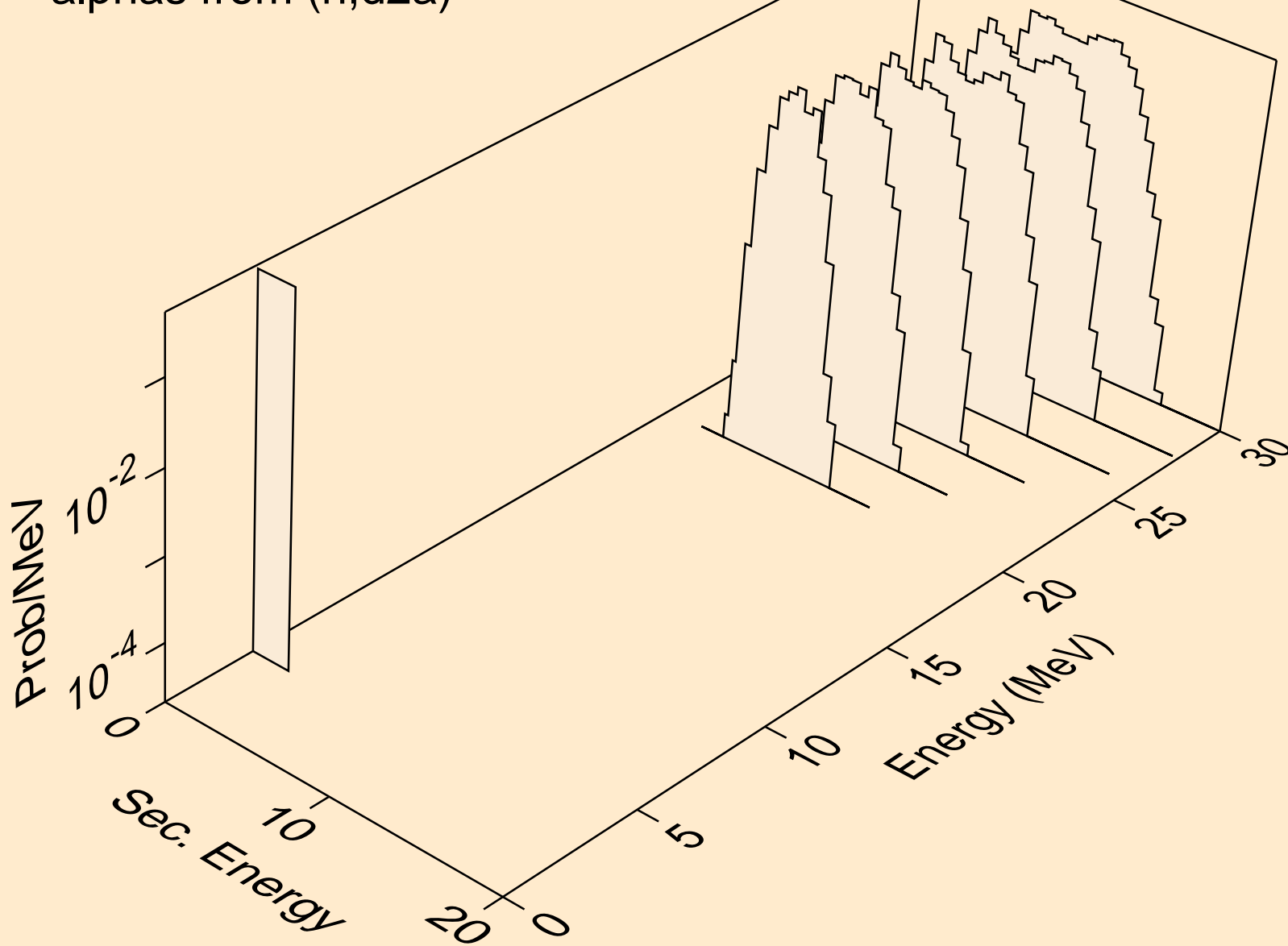

SN104 NEUTRON ACER TENDL-2019 LIBRARY; T=293.16K  
alphas from (n,da)

