

# SN114 NEUTRON ACER TENDL-2019 LIBRARY; T=293.16K

## Principal cross sections

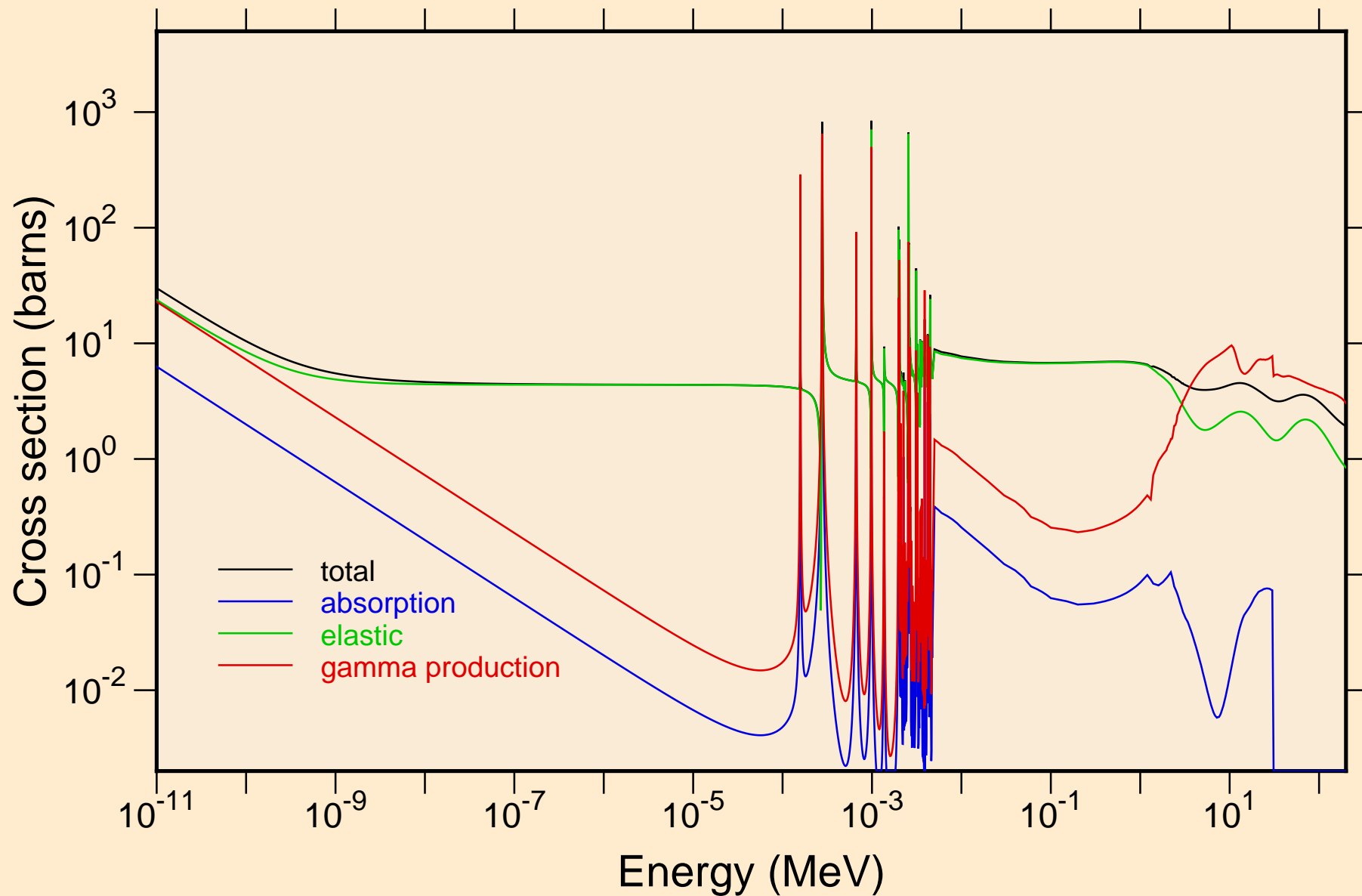

SN114 NEUTRON ACER TENDL-2019 LIBRARY; T=293.16K  
resonance total cross section

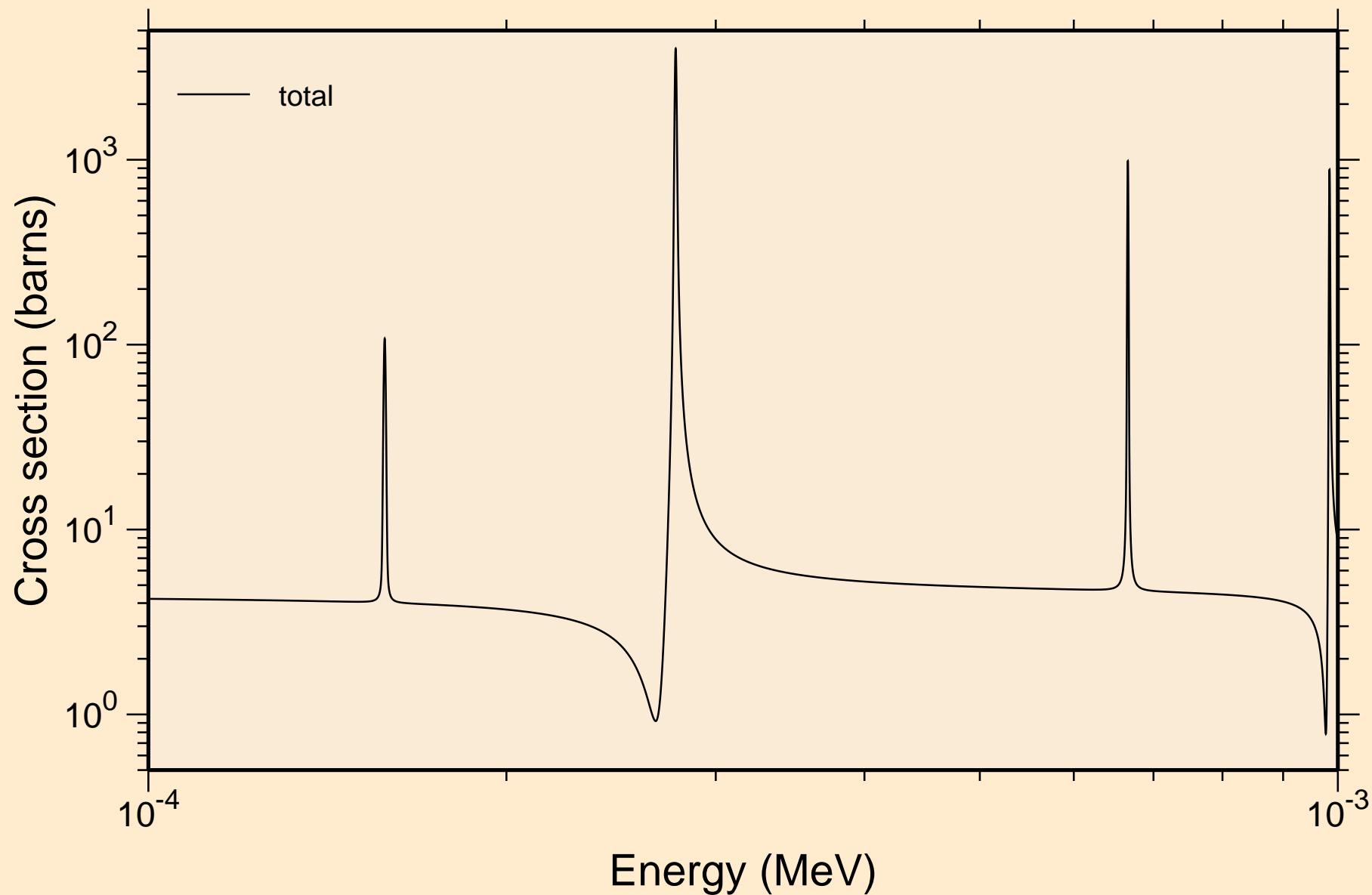

SN114 NEUTRON ACER TENDL-2019 LIBRARY; T=293.16K  
resonance total cross section

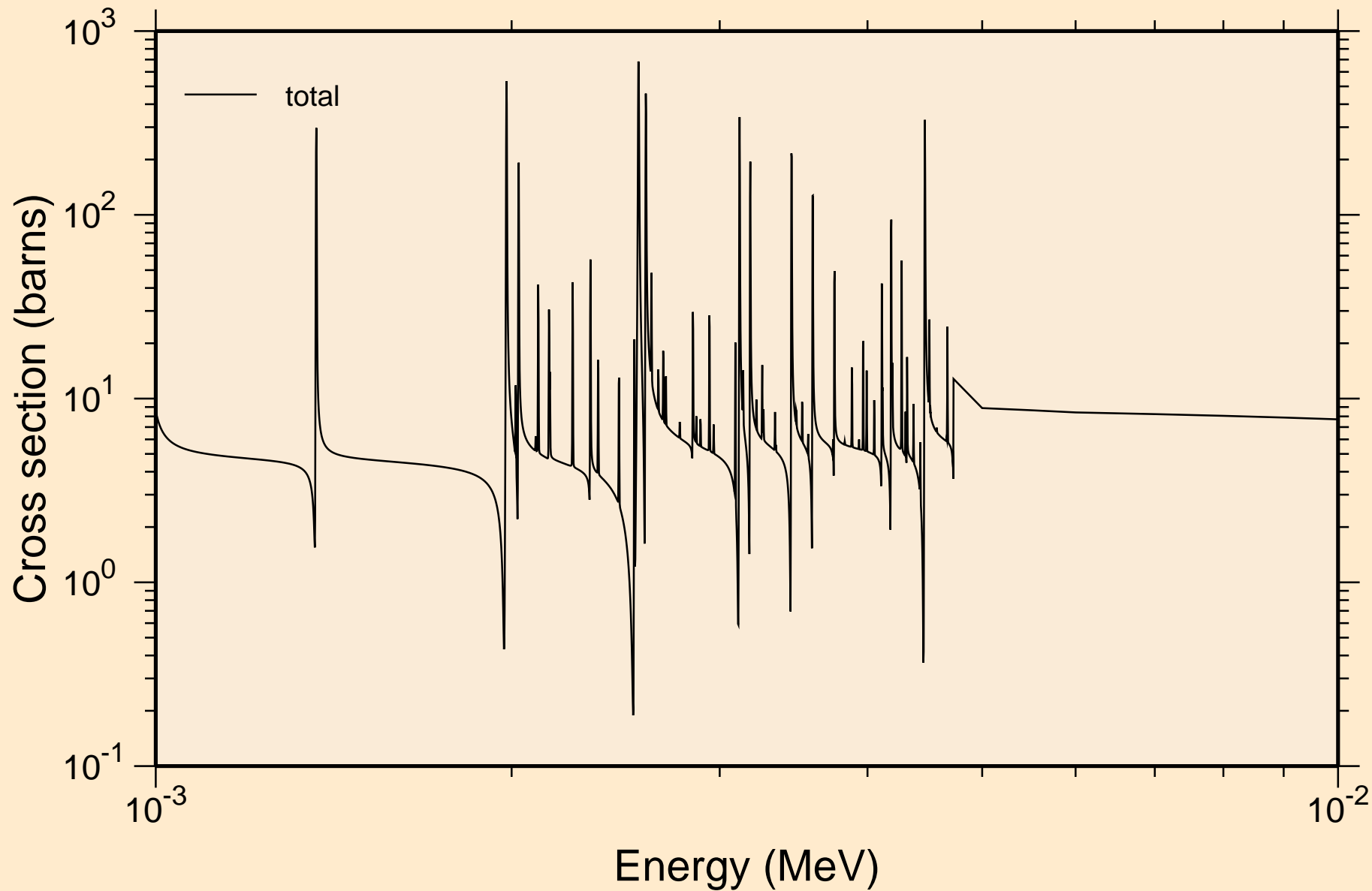

SN114 NEUTRON ACER TENDL-2019 LIBRARY; T=293.16K  
resonance total cross section

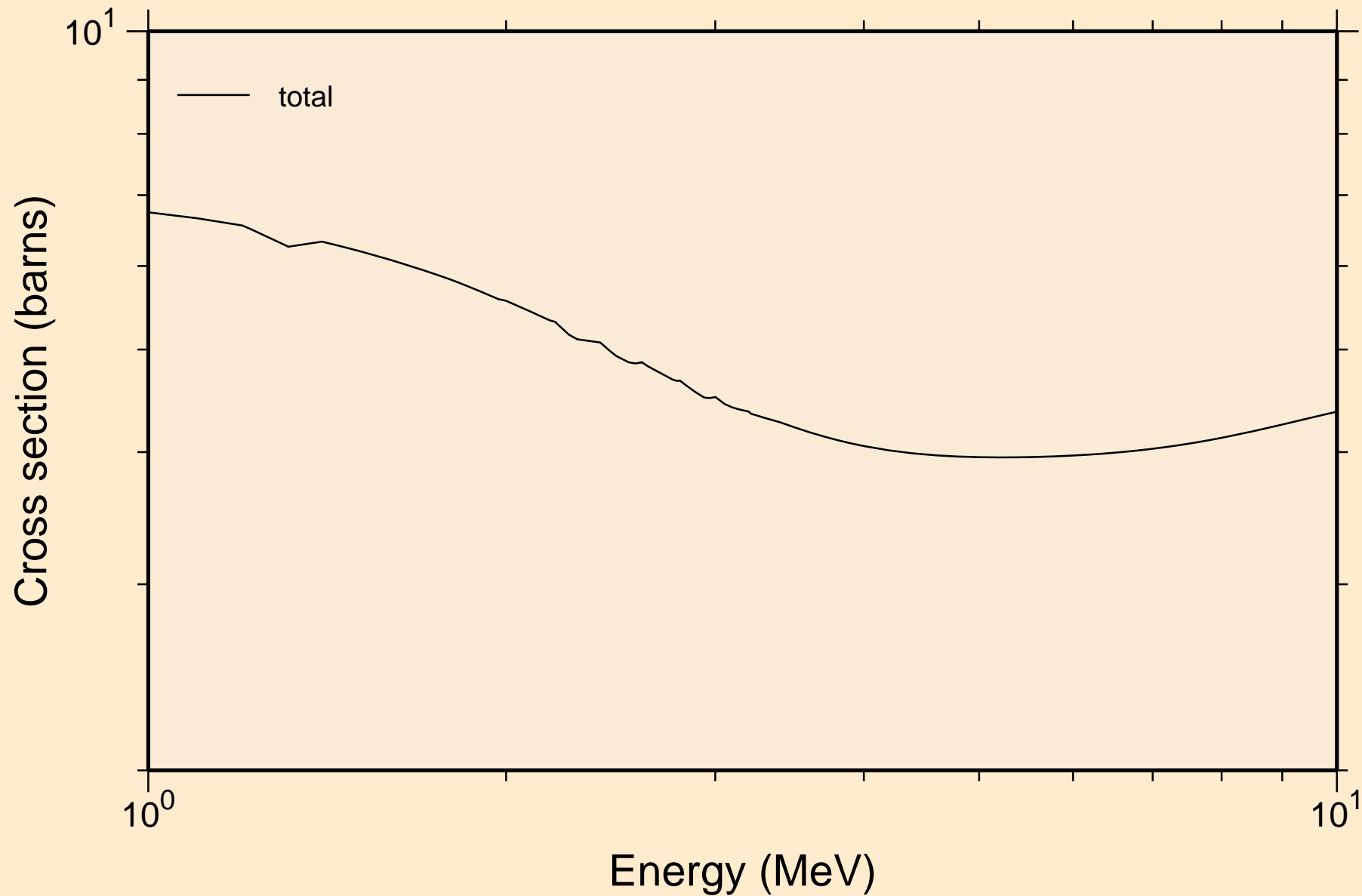

SN114 NEUTRON ACER TENDL-2019 LIBRARY; T=293.16K  
resonance absorption cross sections

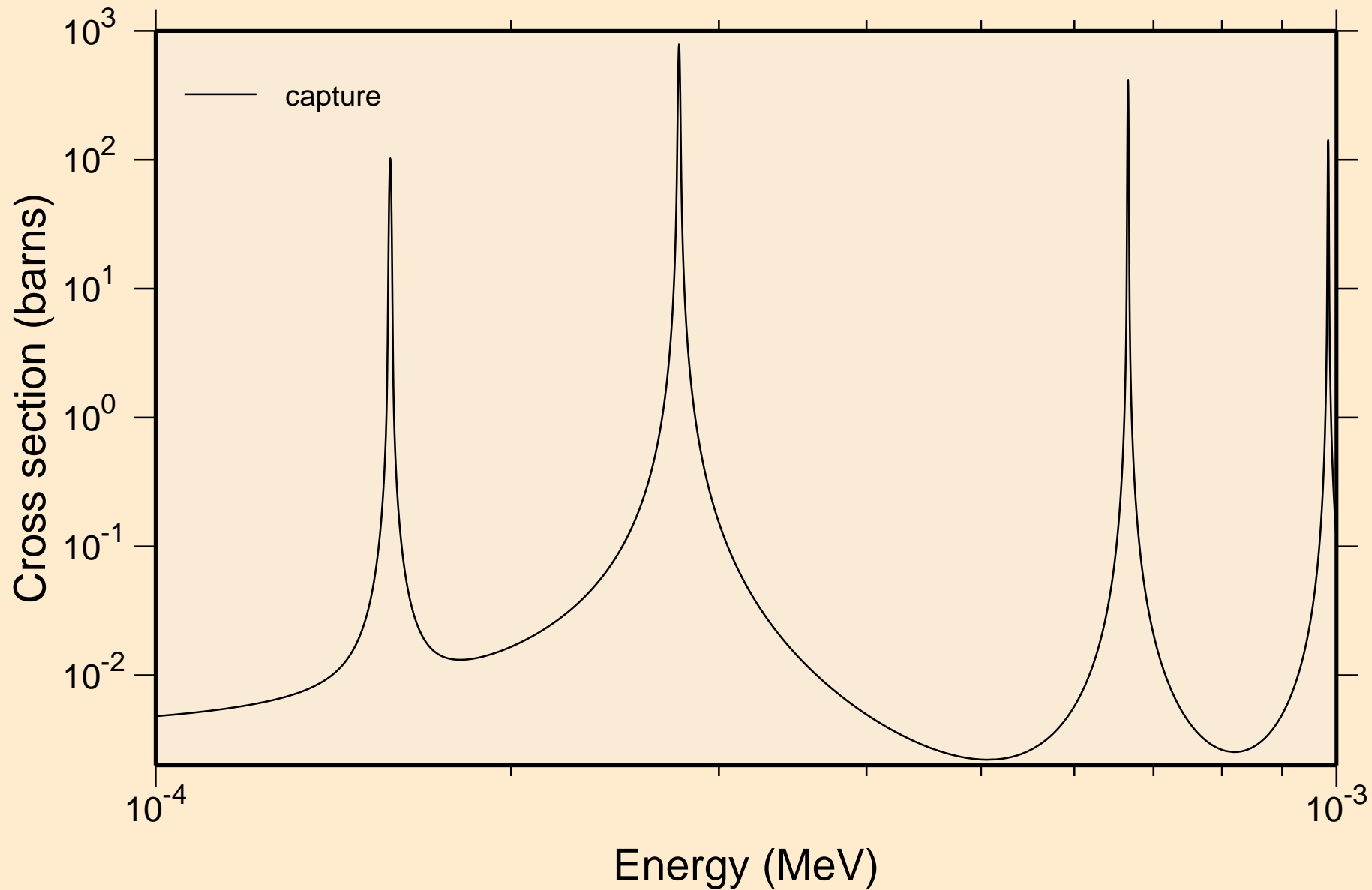

SN114 NEUTRON ACER TENDL-2019 LIBRARY; T=293.16K  
resonance absorption cross sections

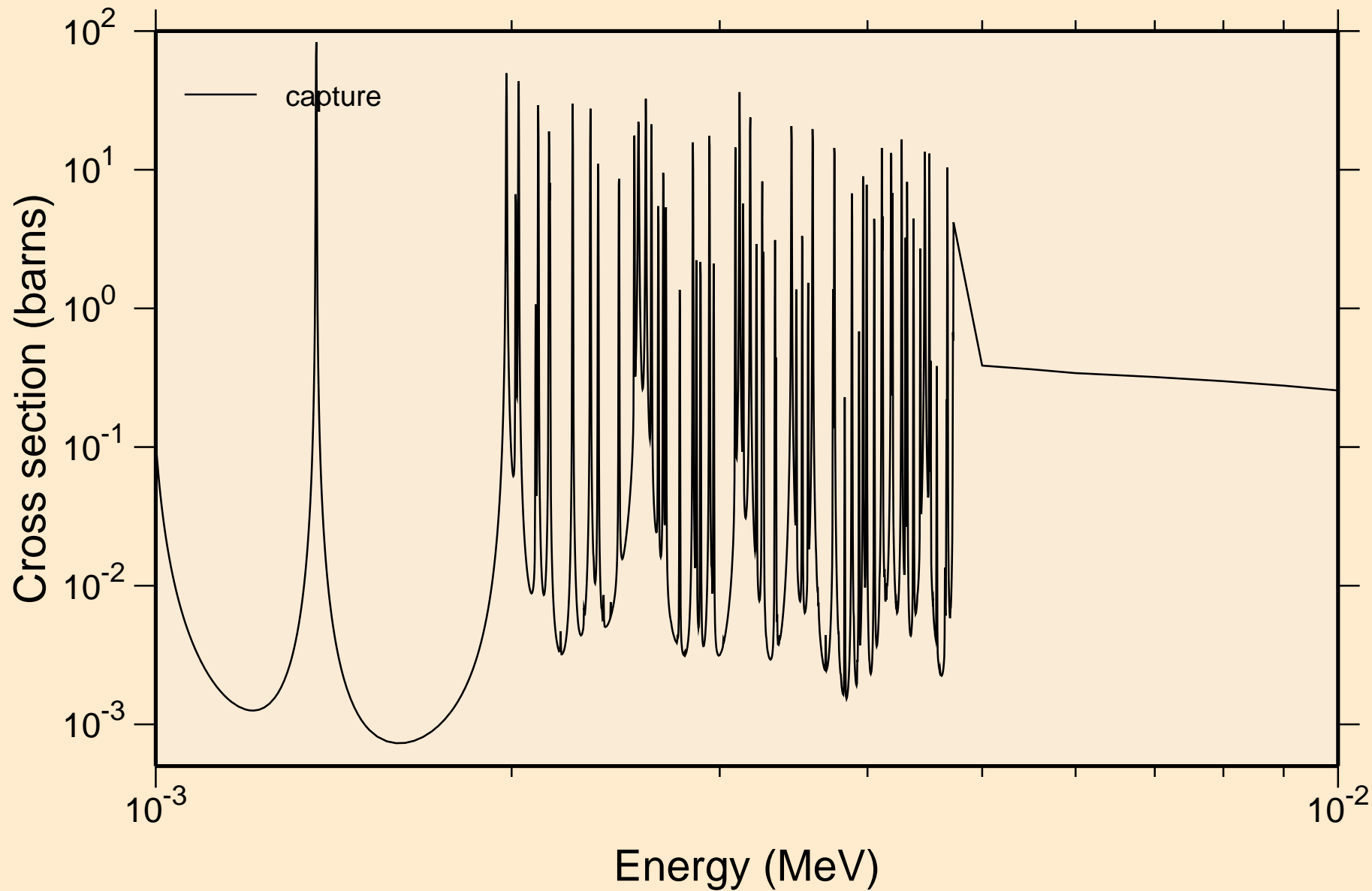

SN114 NEUTRON ACER TENDL-2019 LIBRARY; T=293.16K  
resonance absorption cross sections

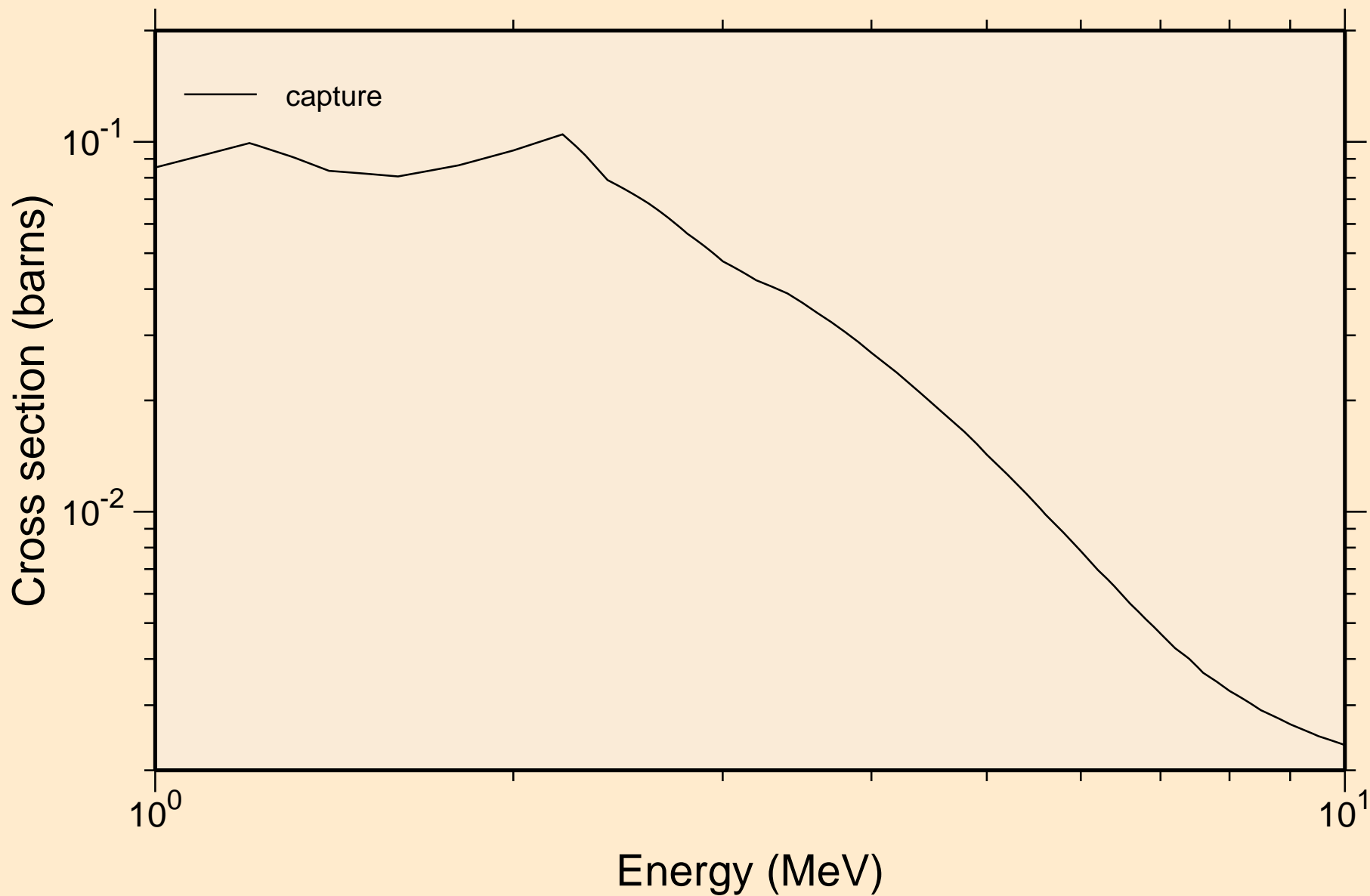

SN114 NEUTRON ACER TENDL-2019 LIBRARY; T=293.16K  
Heating

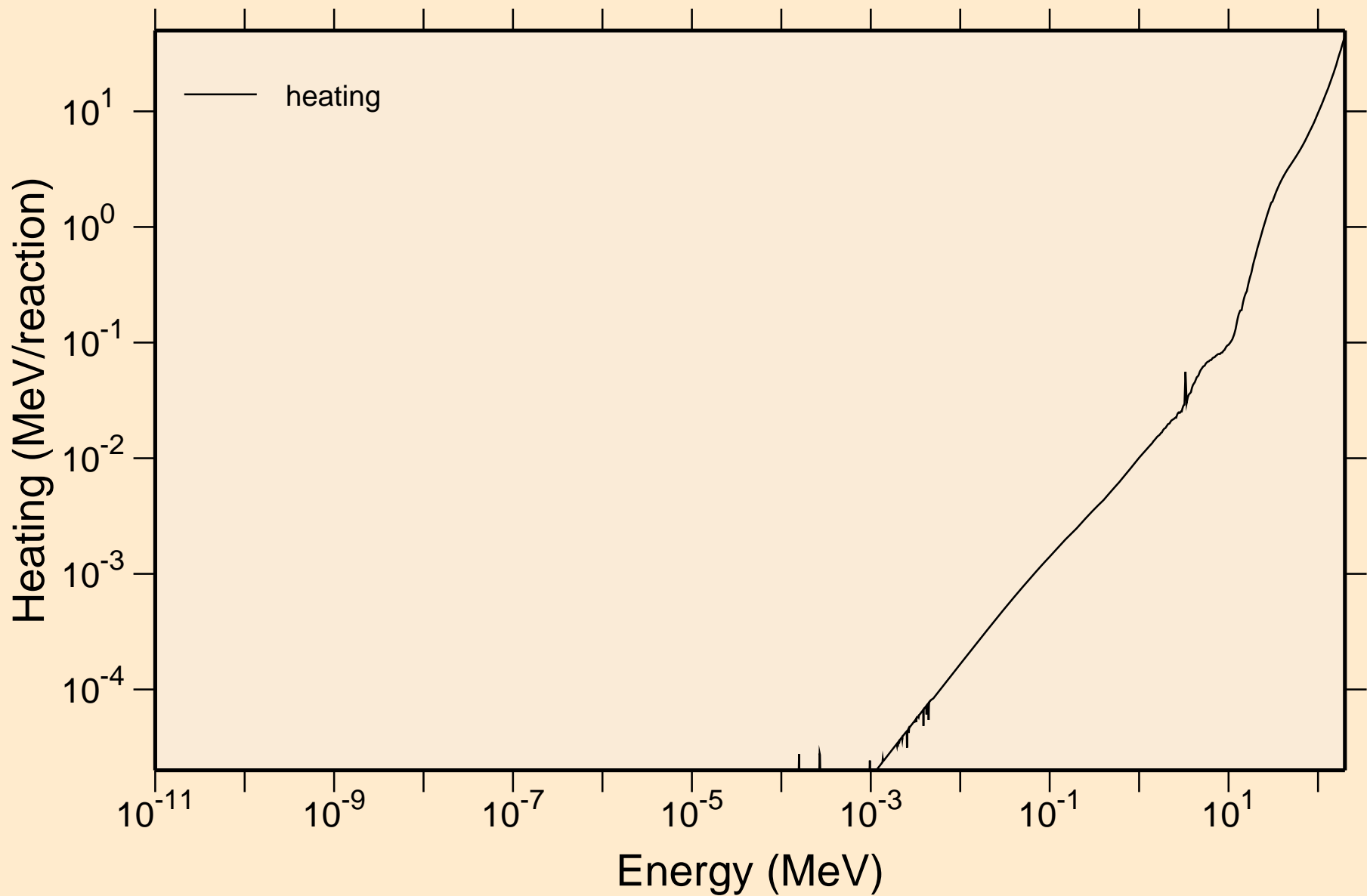



# SN114 NEUTRON ACER TENDL-2019 LIBRARY; T=293.16K

## Damage

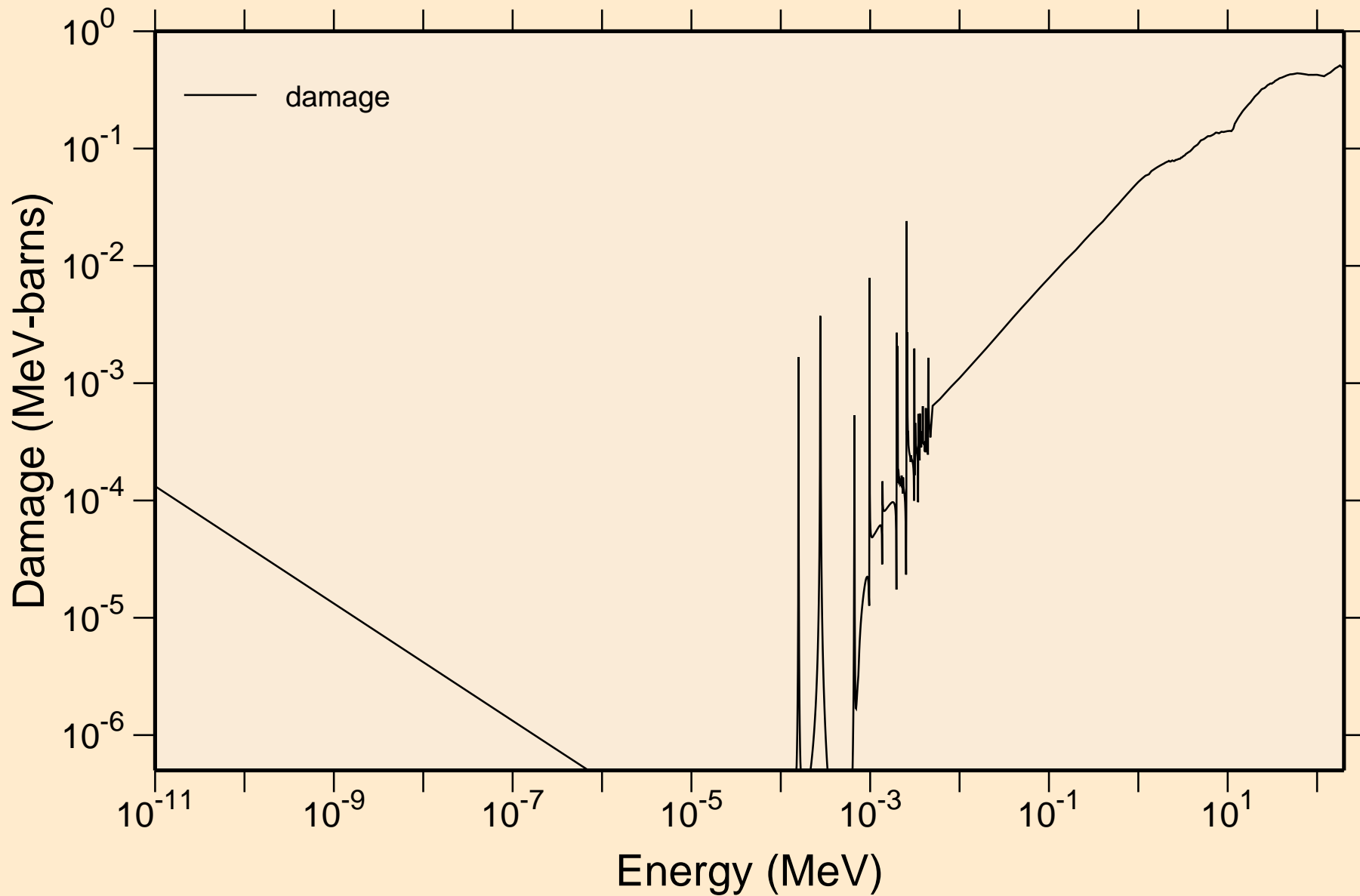

# SN114 NEUTRON ACER TENDL-2019 LIBRARY; T=293.16K

## Non-threshold reactions

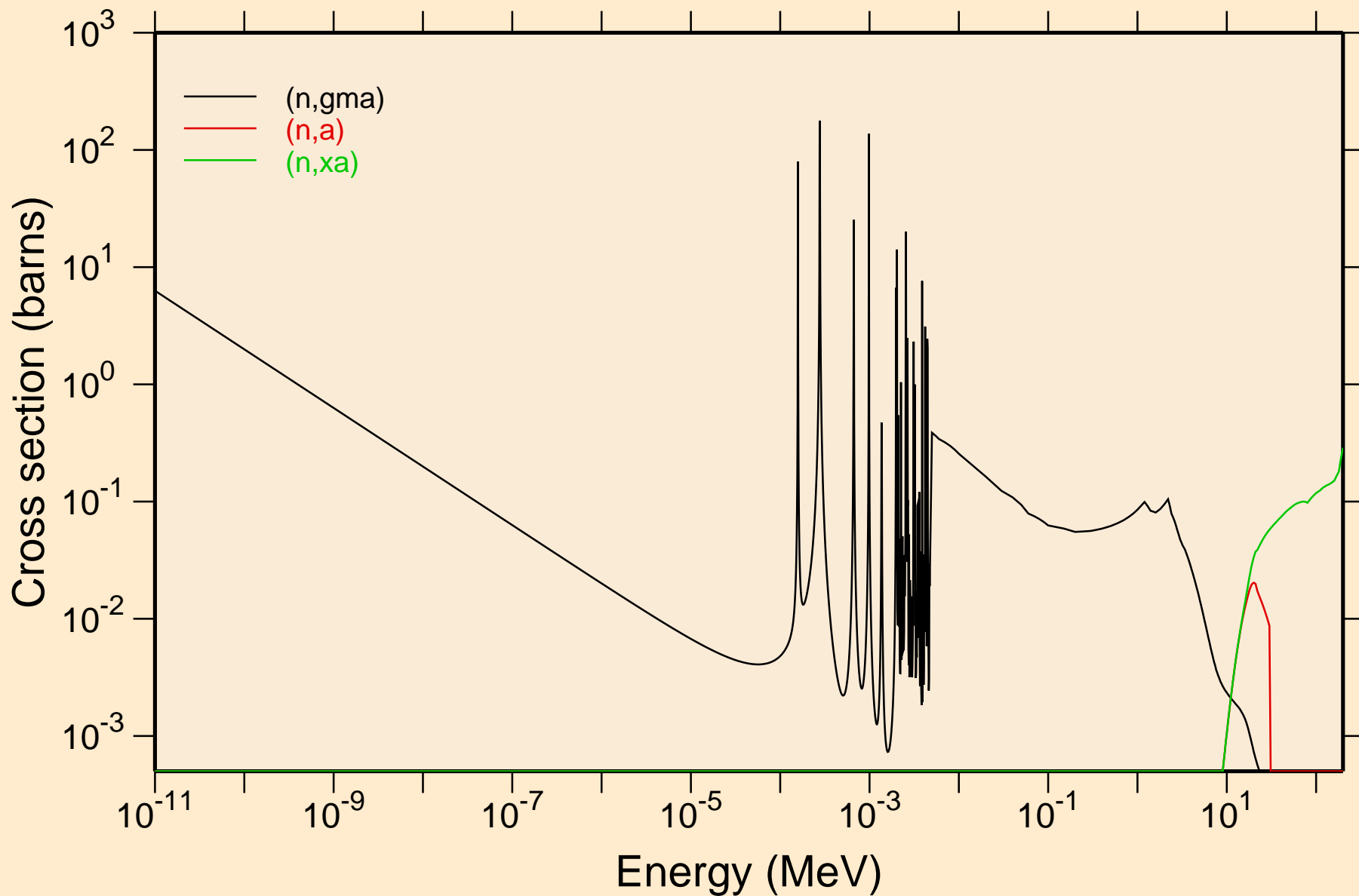

# SN114 NEUTRON ACER TENDL-2019 LIBRARY; T=293.16K

## Principal cross sections

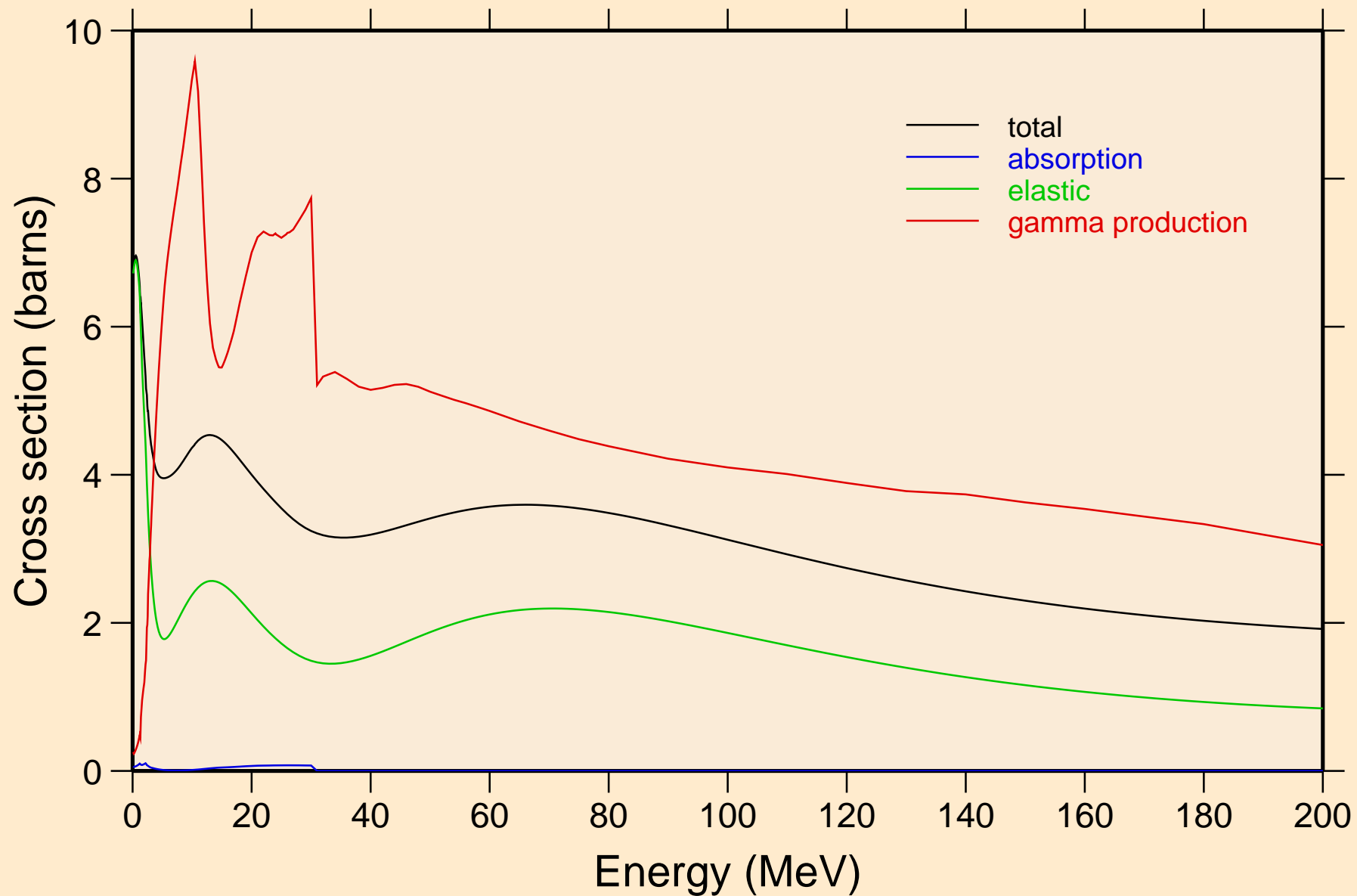

SN114 NEUTRON ACER TENDL-2019 LIBRARY; T=293.16K  
Heating

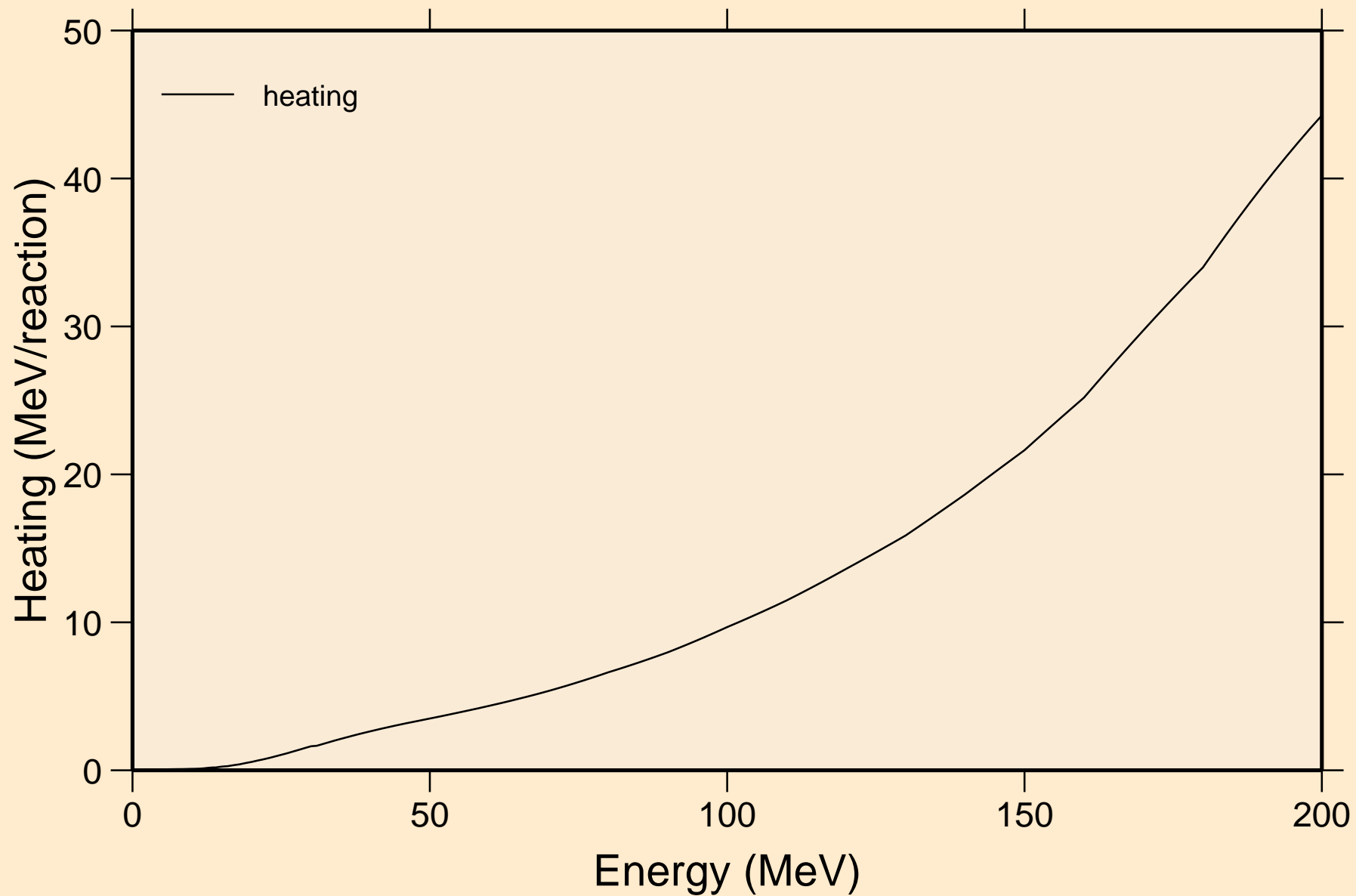

# SN114 NEUTRON ACER TENDL-2019 LIBRARY; T=293.16K Damage

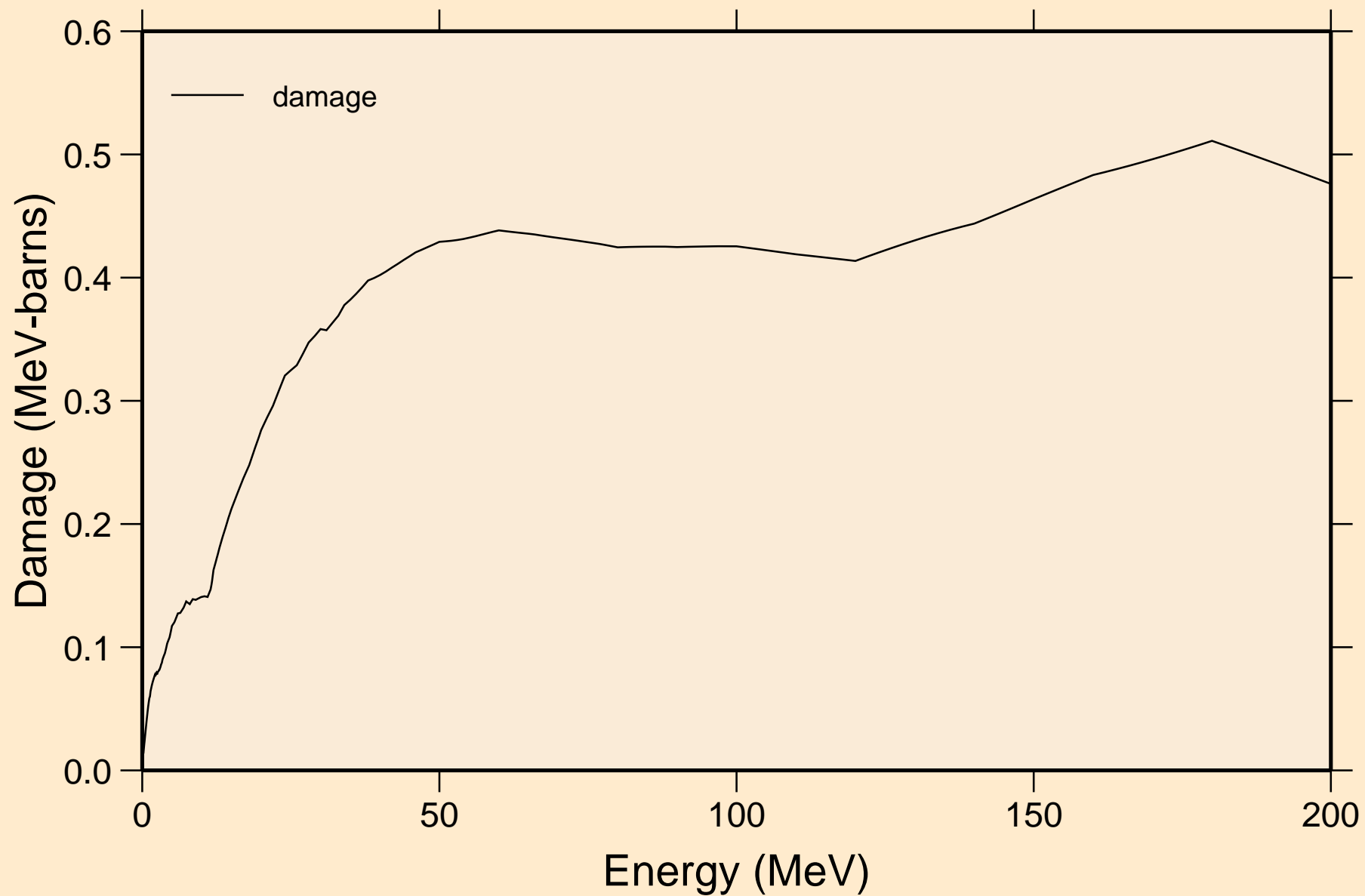

# SN114 NEUTRON ACER TENDL-2019 LIBRARY; T=293.16K

## Non-threshold reactions

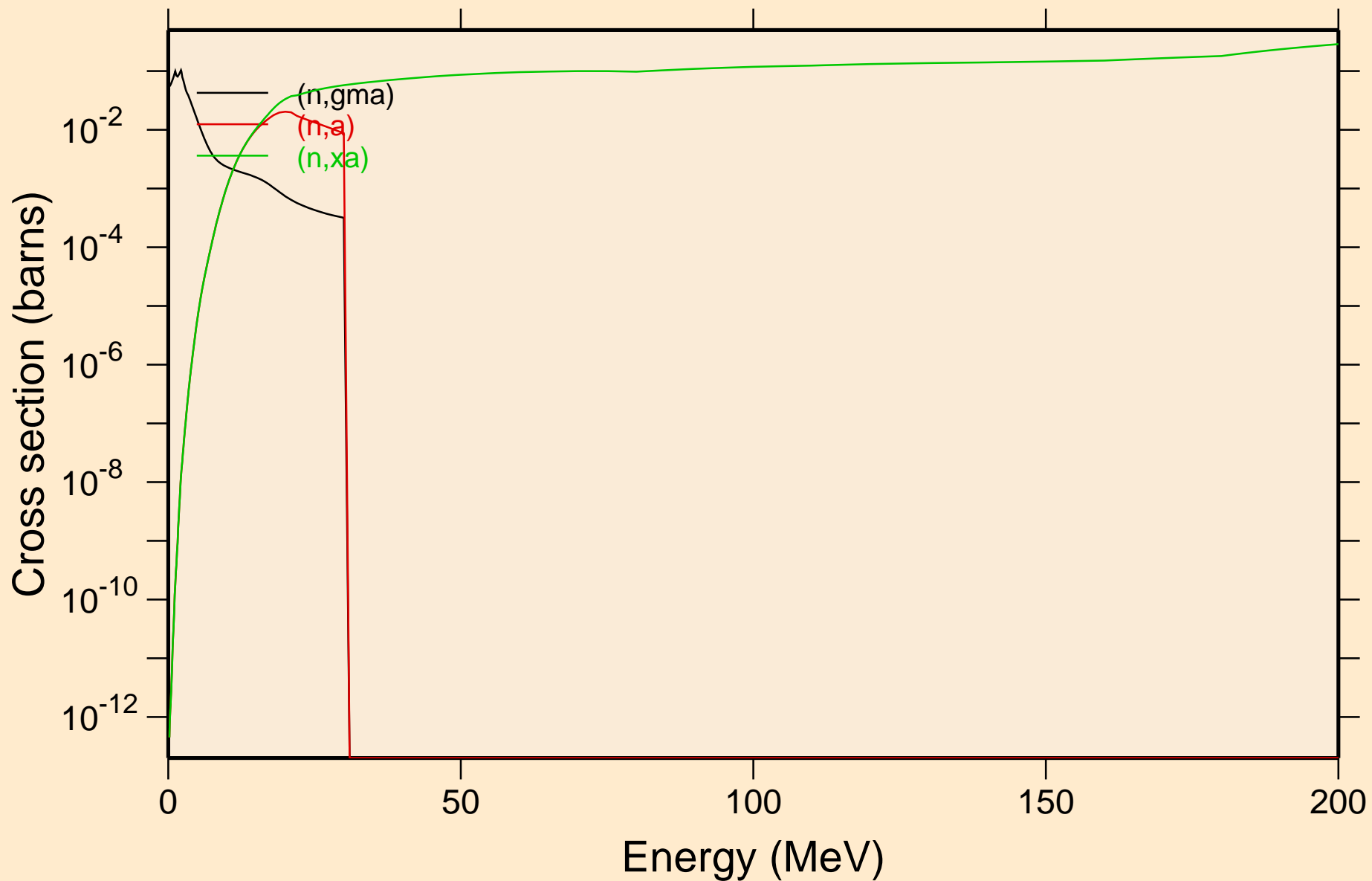

# SN114 NEUTRON ACER TENDL-2019 LIBRARY; T=293.16K

## Inelastic levels

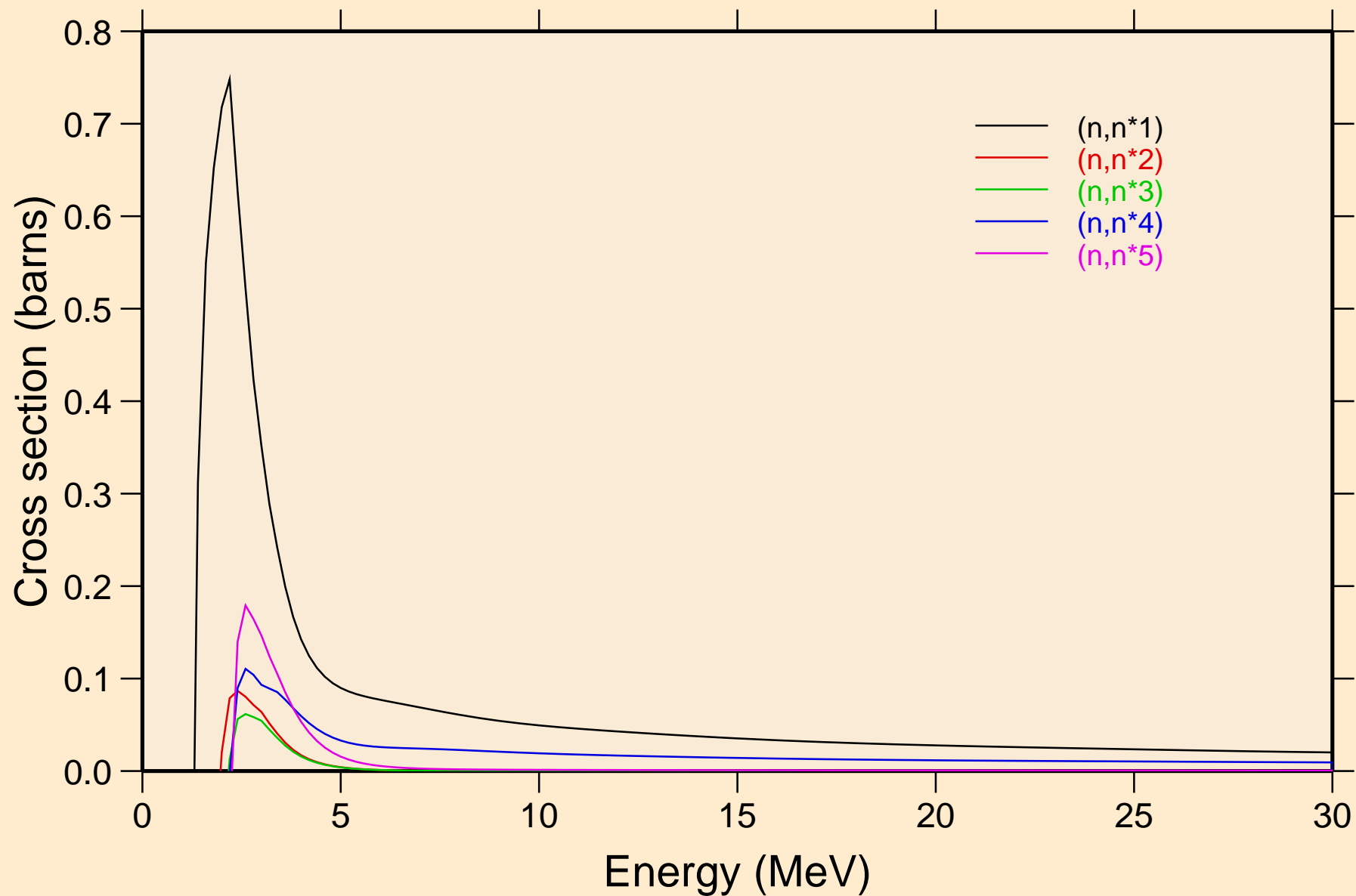

# SN114 NEUTRON ACER TENDL-2019 LIBRARY; T=293.16K

## Inelastic levels

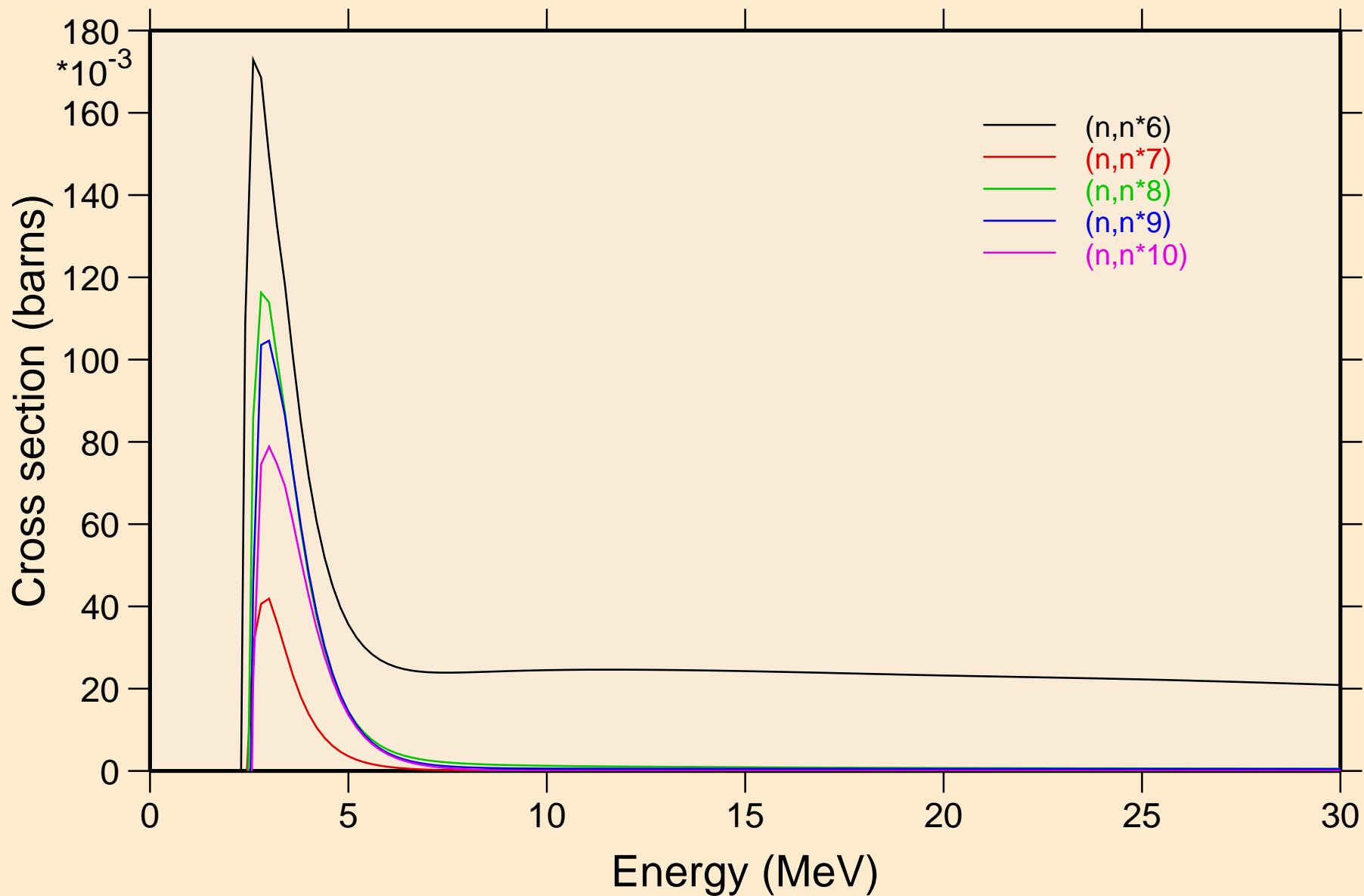



# SN114 NEUTRON ACER TENDL-2019 LIBRARY; T=293.16K

## Inelastic levels

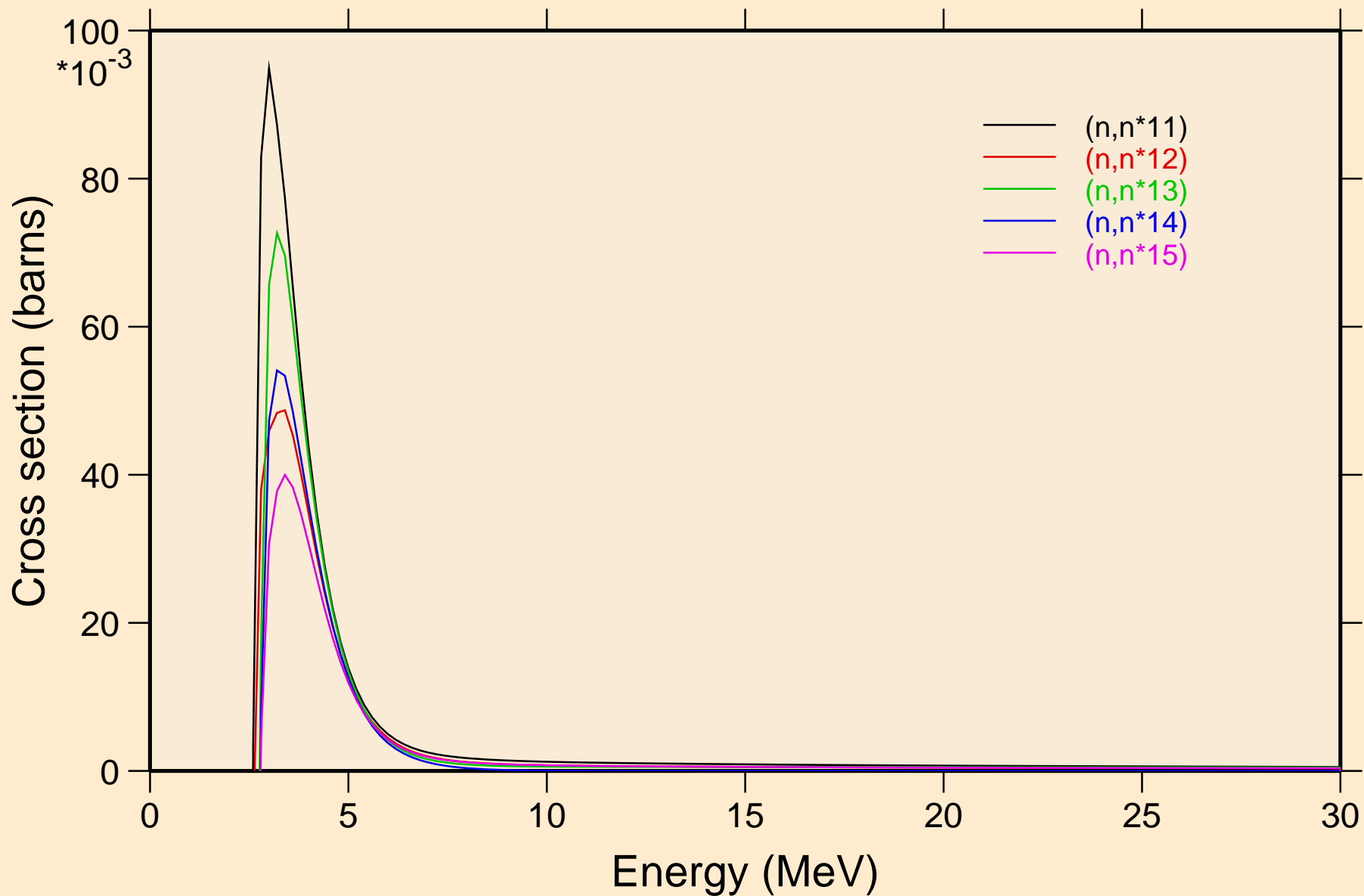

# SN114 NEUTRON ACER TENDL-2019 LIBRARY; T=293.16K

## Inelastic levels

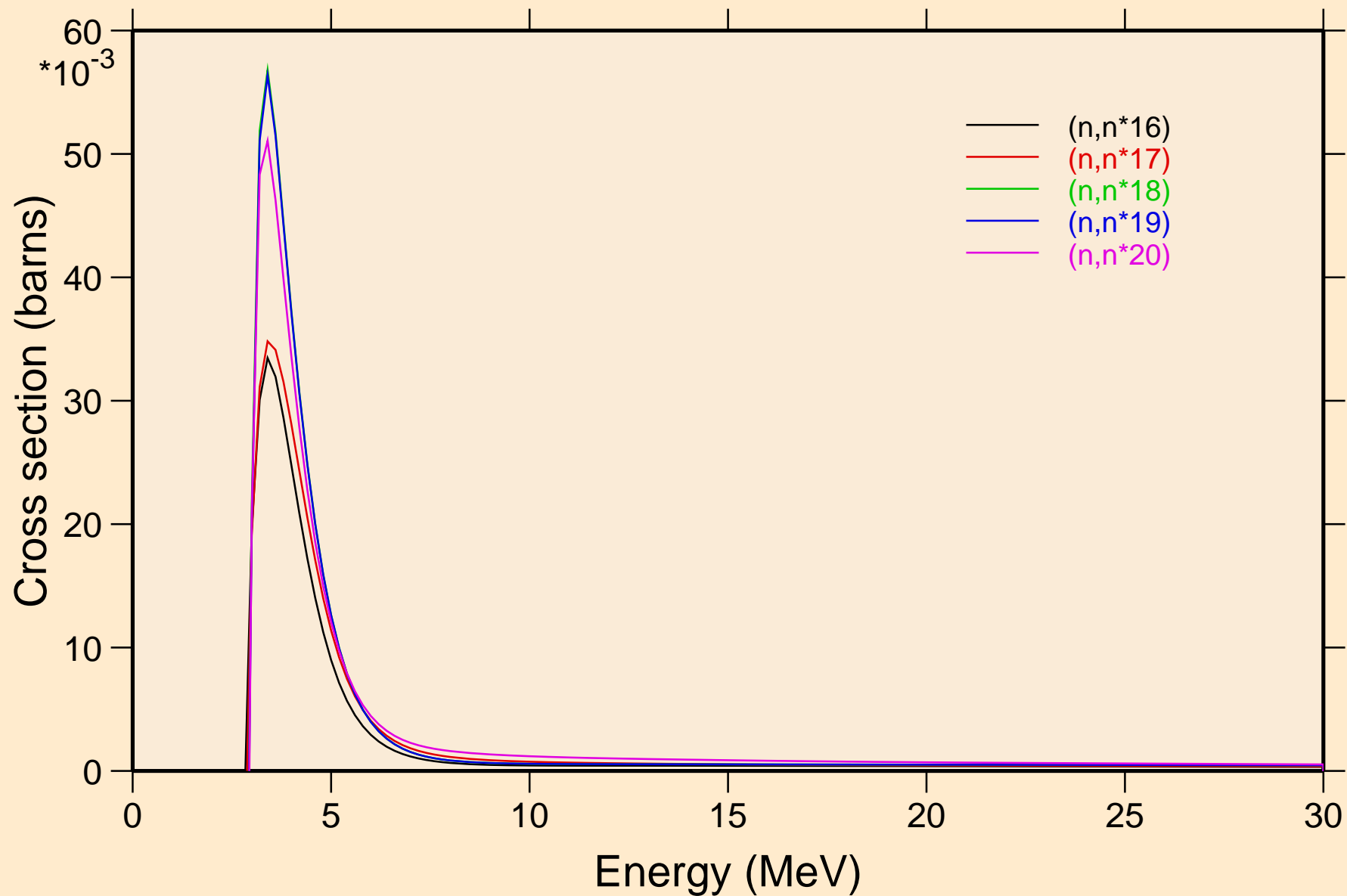

# SN114 NEUTRON ACER TENDL-2019 LIBRARY; T=293.16K

## Inelastic levels

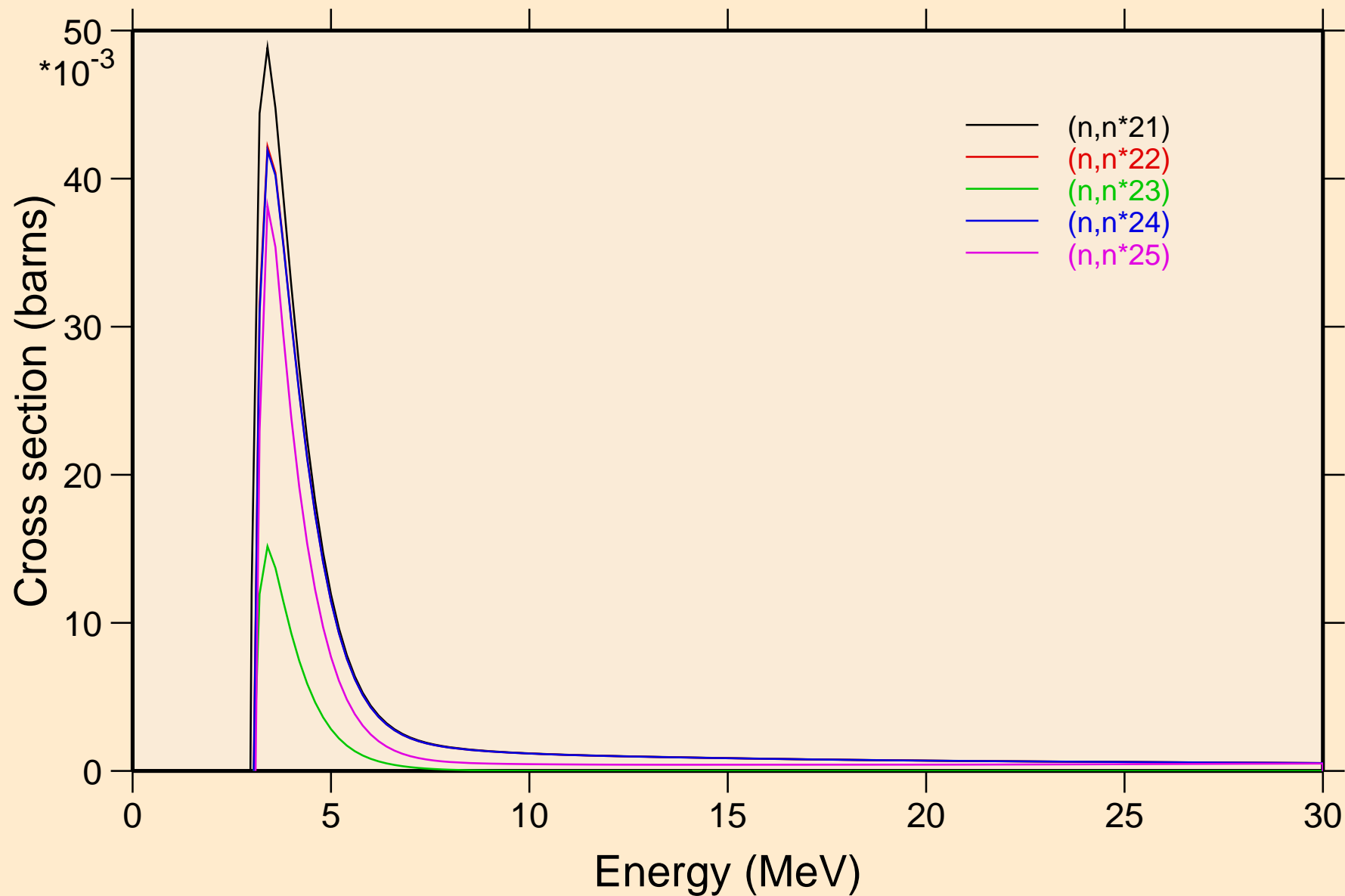

SN114 NEUTRON ACER TENDL-2019 LIBRARY; T=293.16K  
Inelastic levels

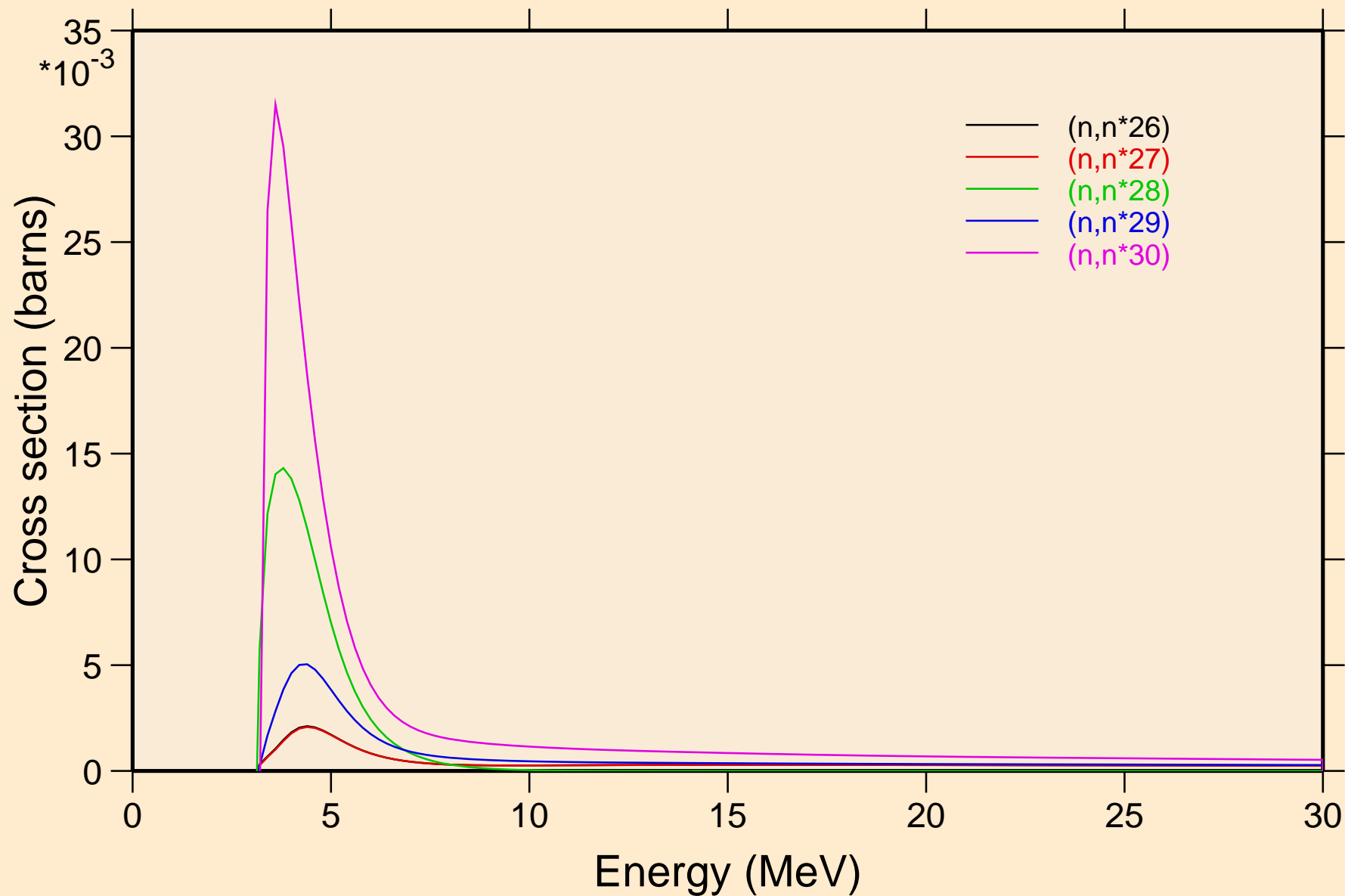

# SN114 NEUTRON ACER TENDL-2019 LIBRARY; T=293.16K

## Threshold reactions

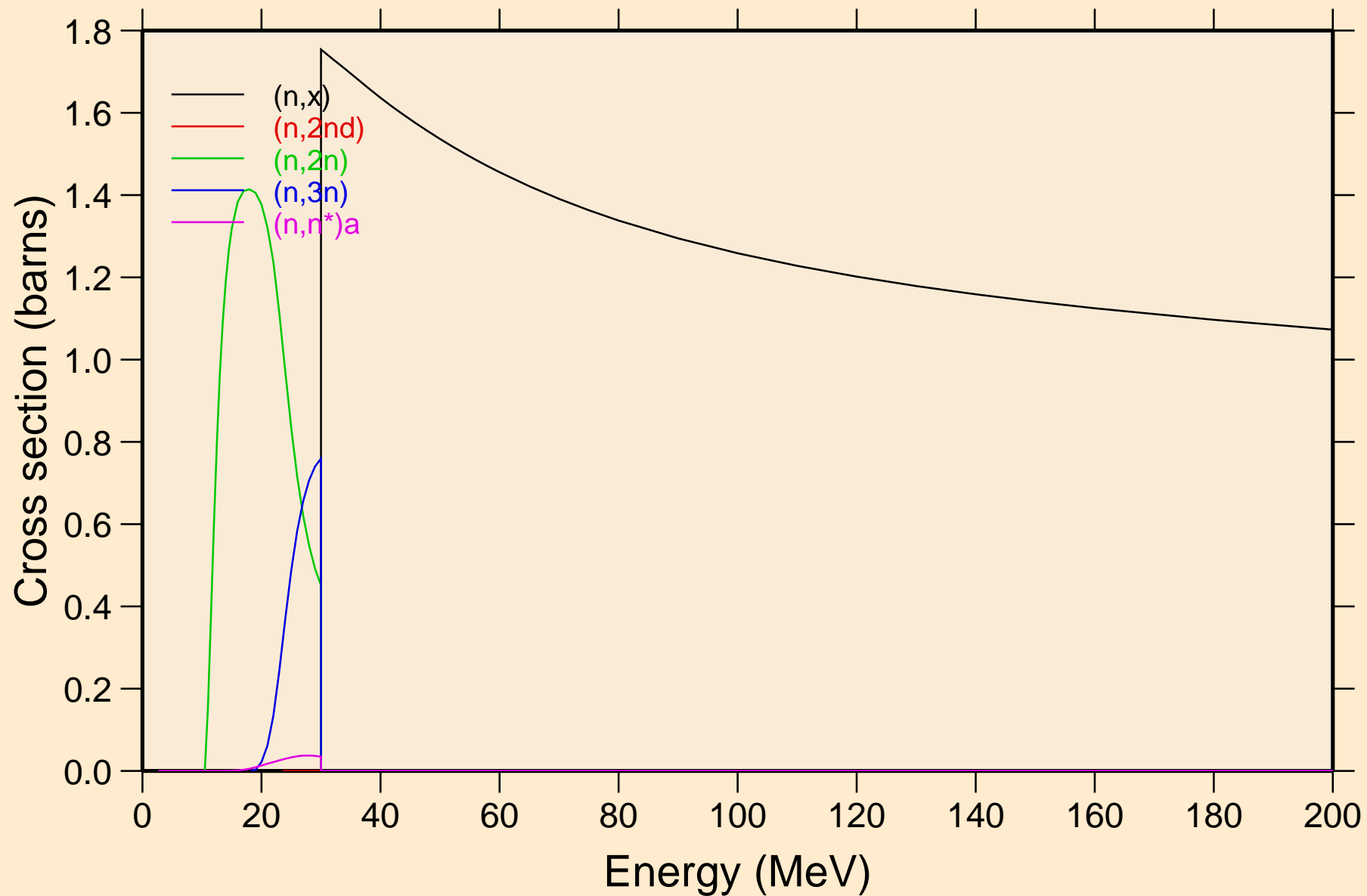

# SN114 NEUTRON ACER TENDL-2019 LIBRARY; T=293.16K

## Threshold reactions

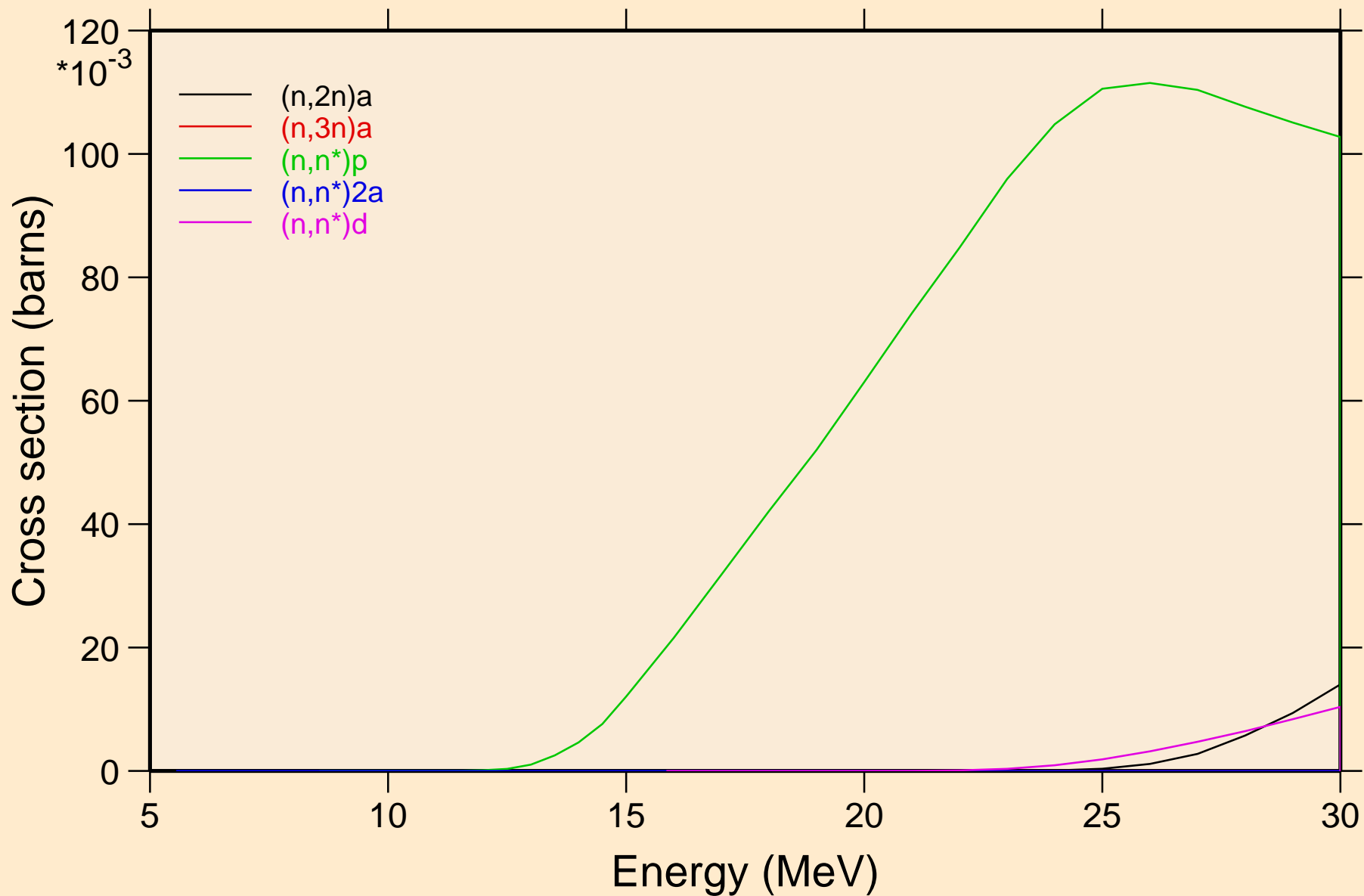

# SN114 NEUTRON ACER TENDL-2019 LIBRARY; T=293.16K

## Threshold reactions

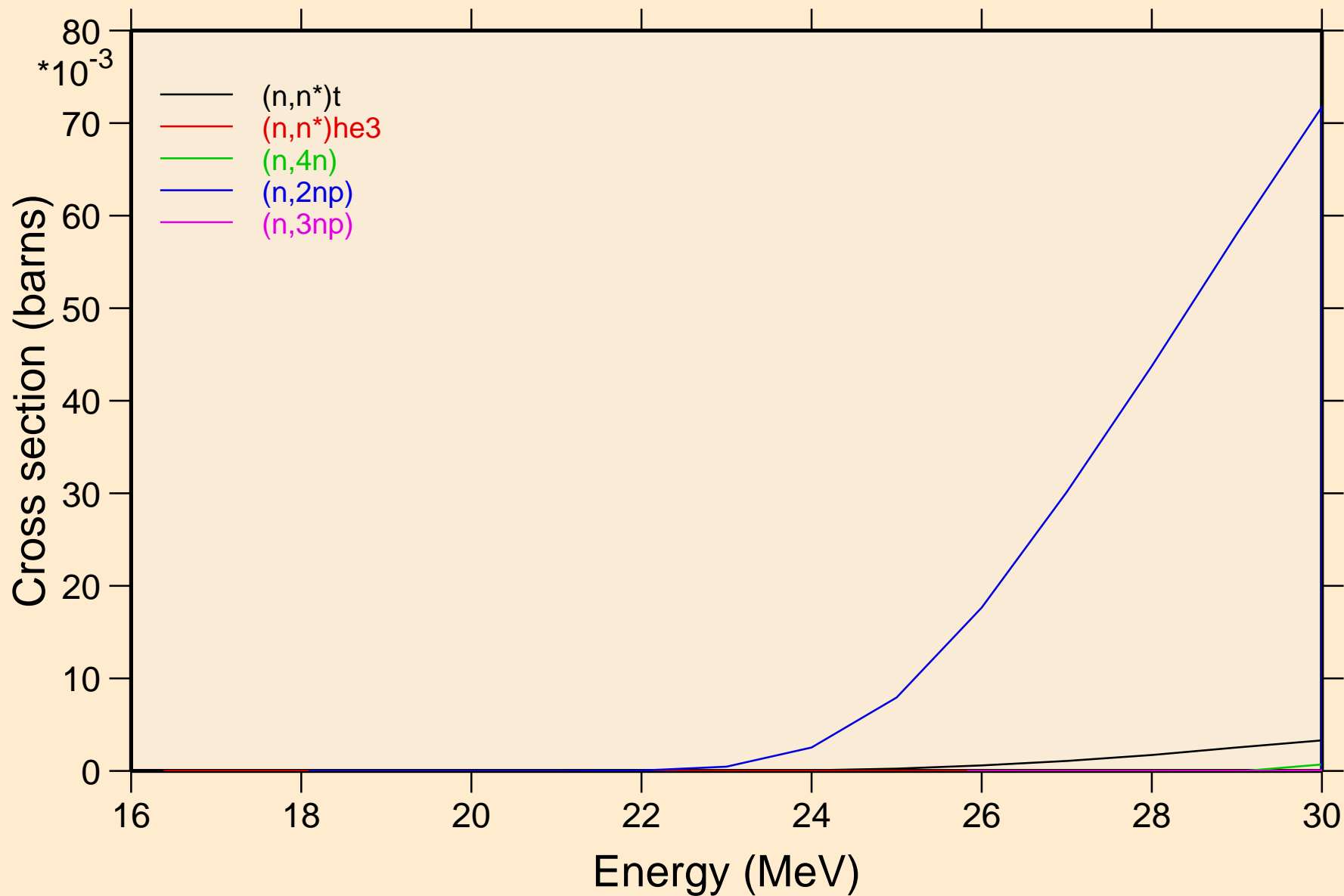

# SN114 NEUTRON ACER TENDL-2019 LIBRARY; T=293.16K

## Threshold reactions

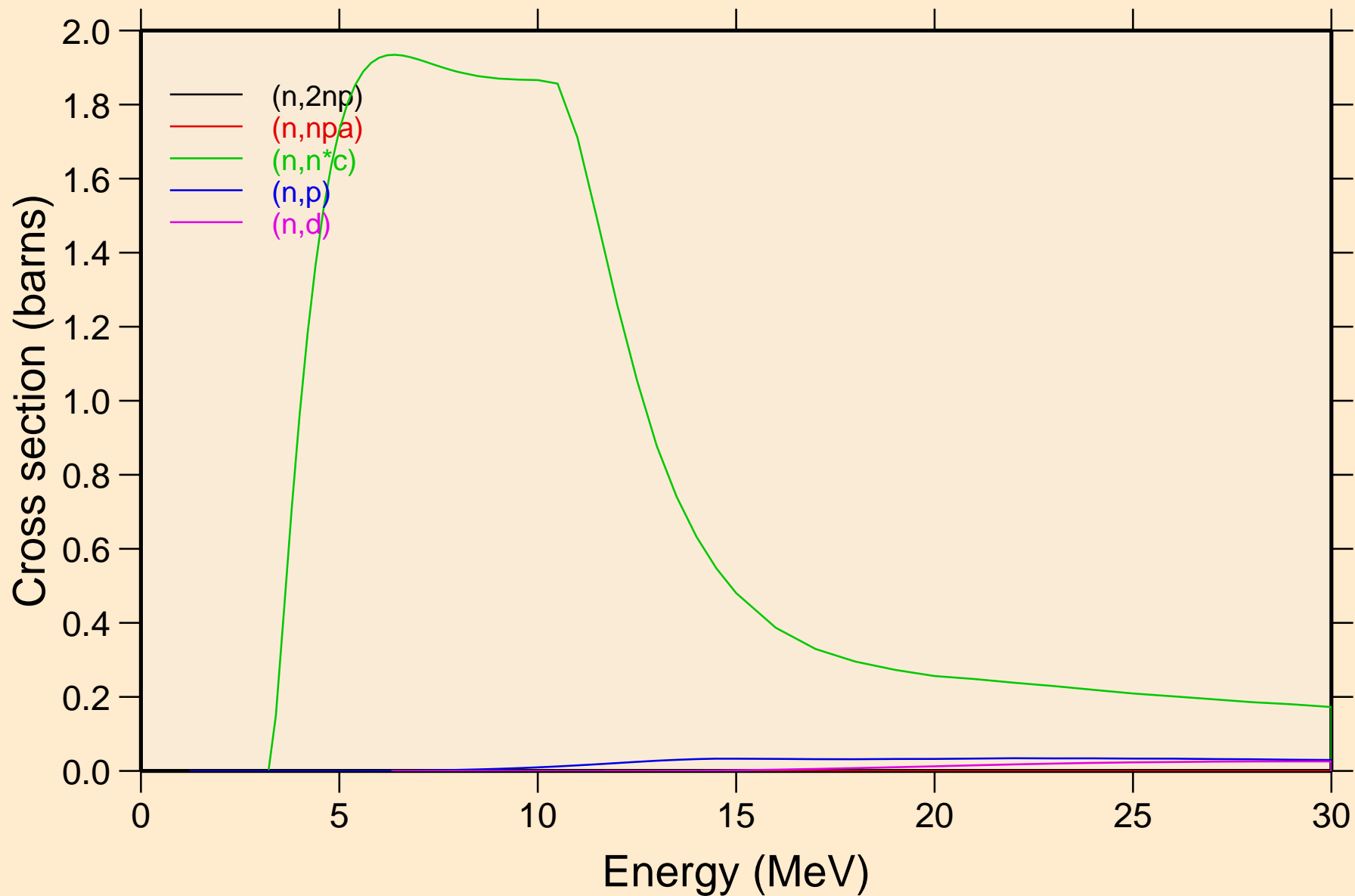



# SN114 NEUTRON ACER TENDL-2019 LIBRARY; T=293.16K

## Threshold reactions

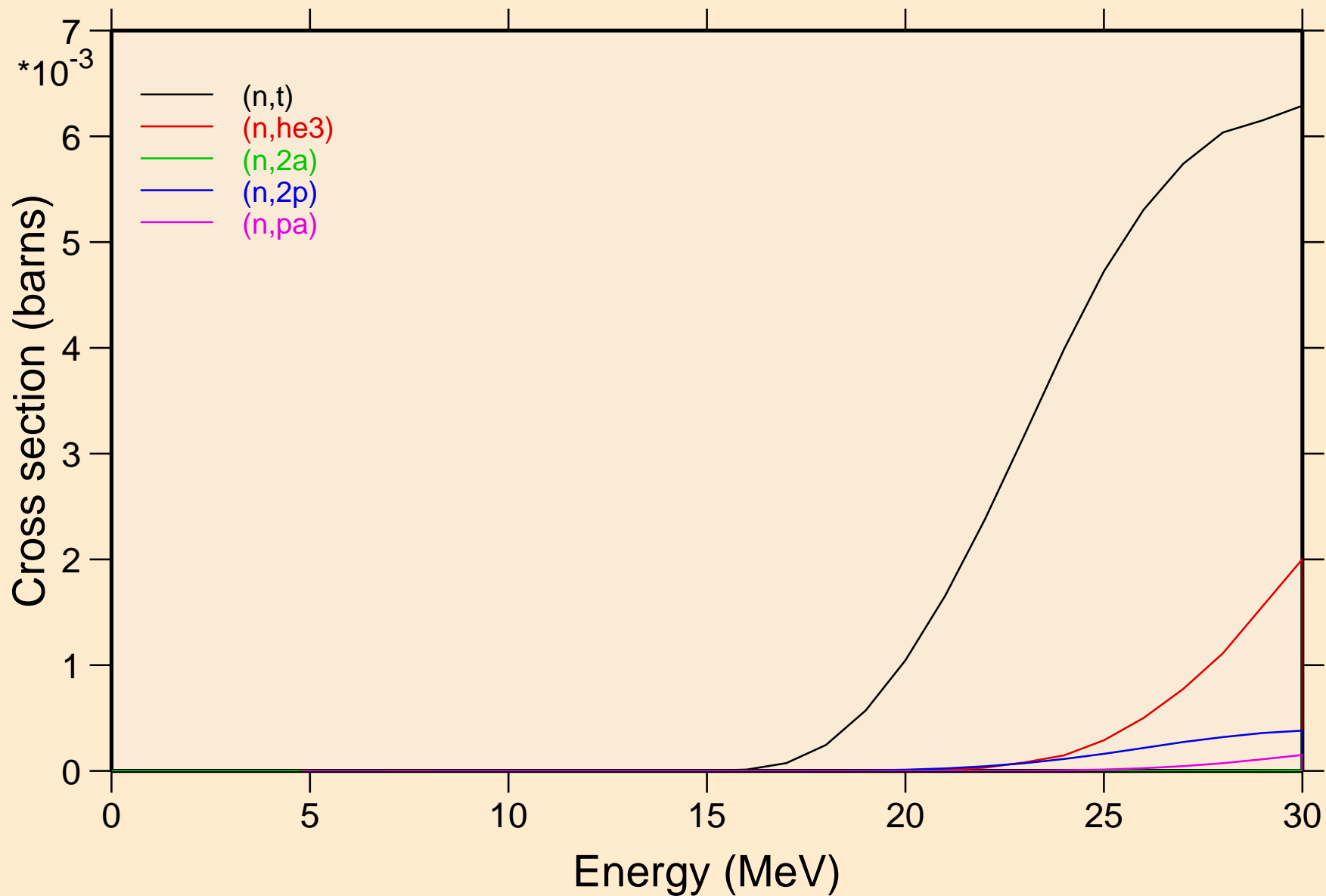

# SN114 NEUTRON ACER TENDL-2019 LIBRARY; T=293.16K

## Threshold reactions

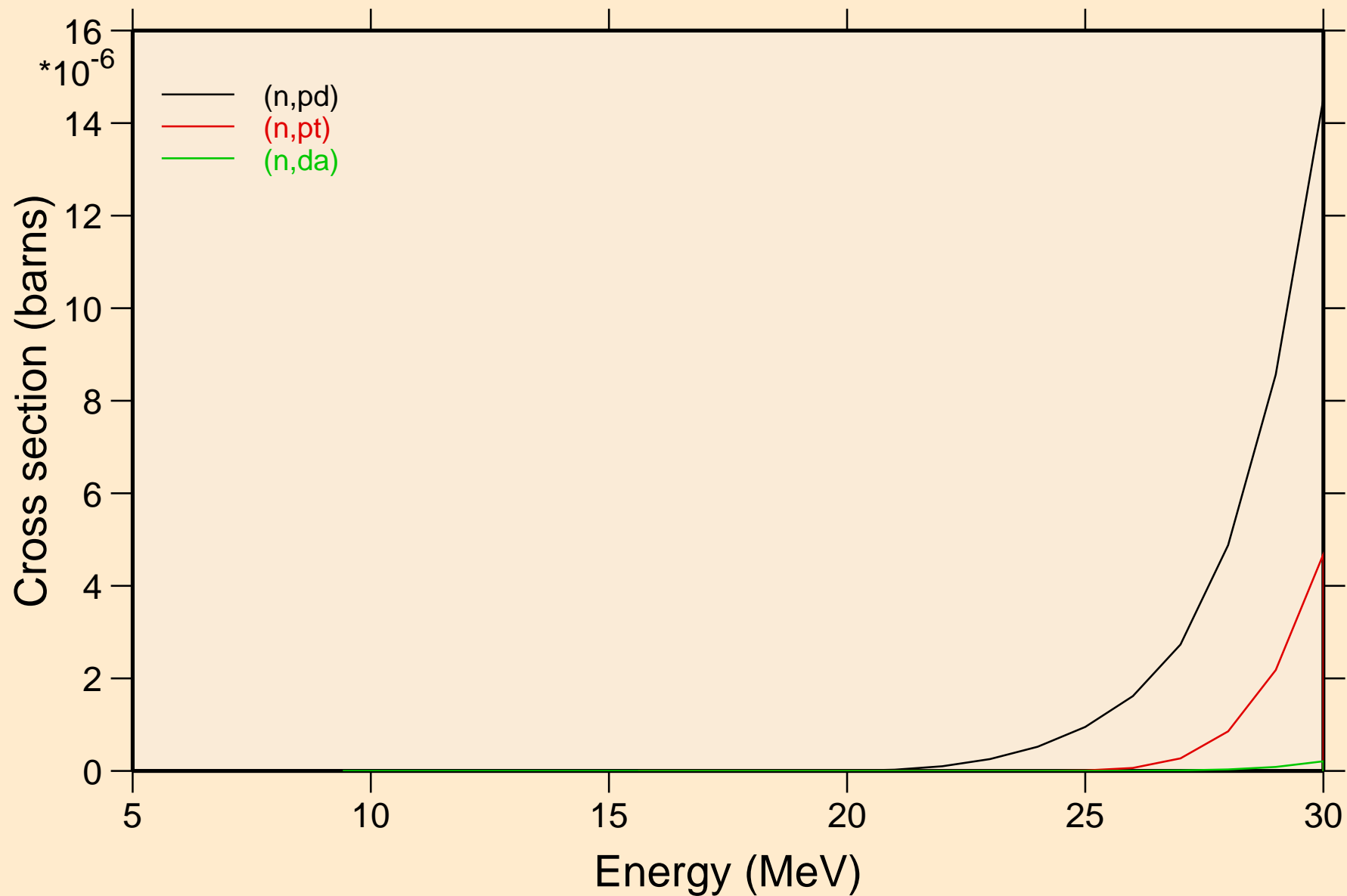

SN114 NEUTRON ACER TENDL-2019 LIBRARY; T=293.16K  
Threshold reactions

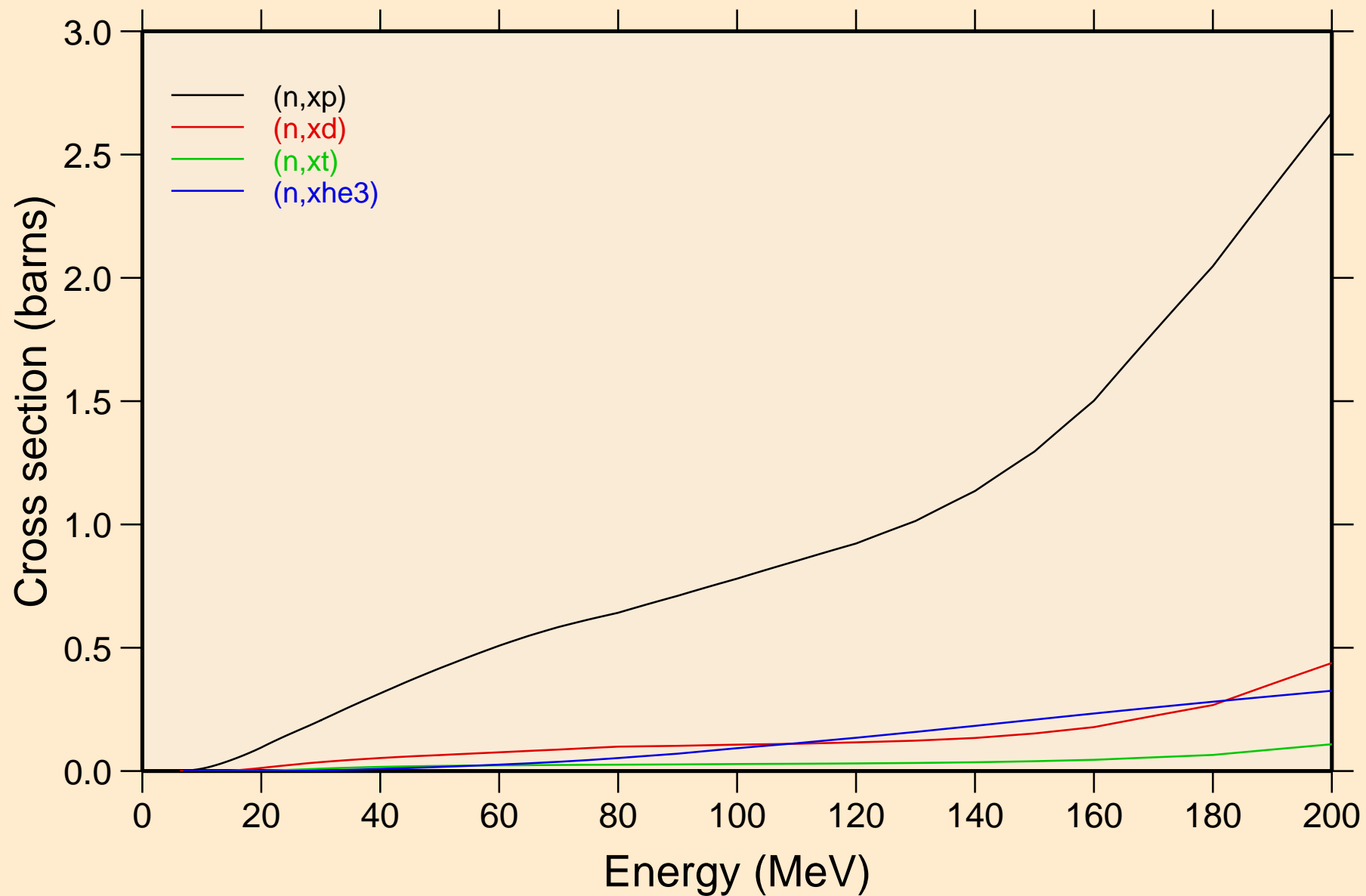

SN114 NEUTRON ACER TENDL-2019 LIBRARY; T=293.16K  
angular distribution for elastic

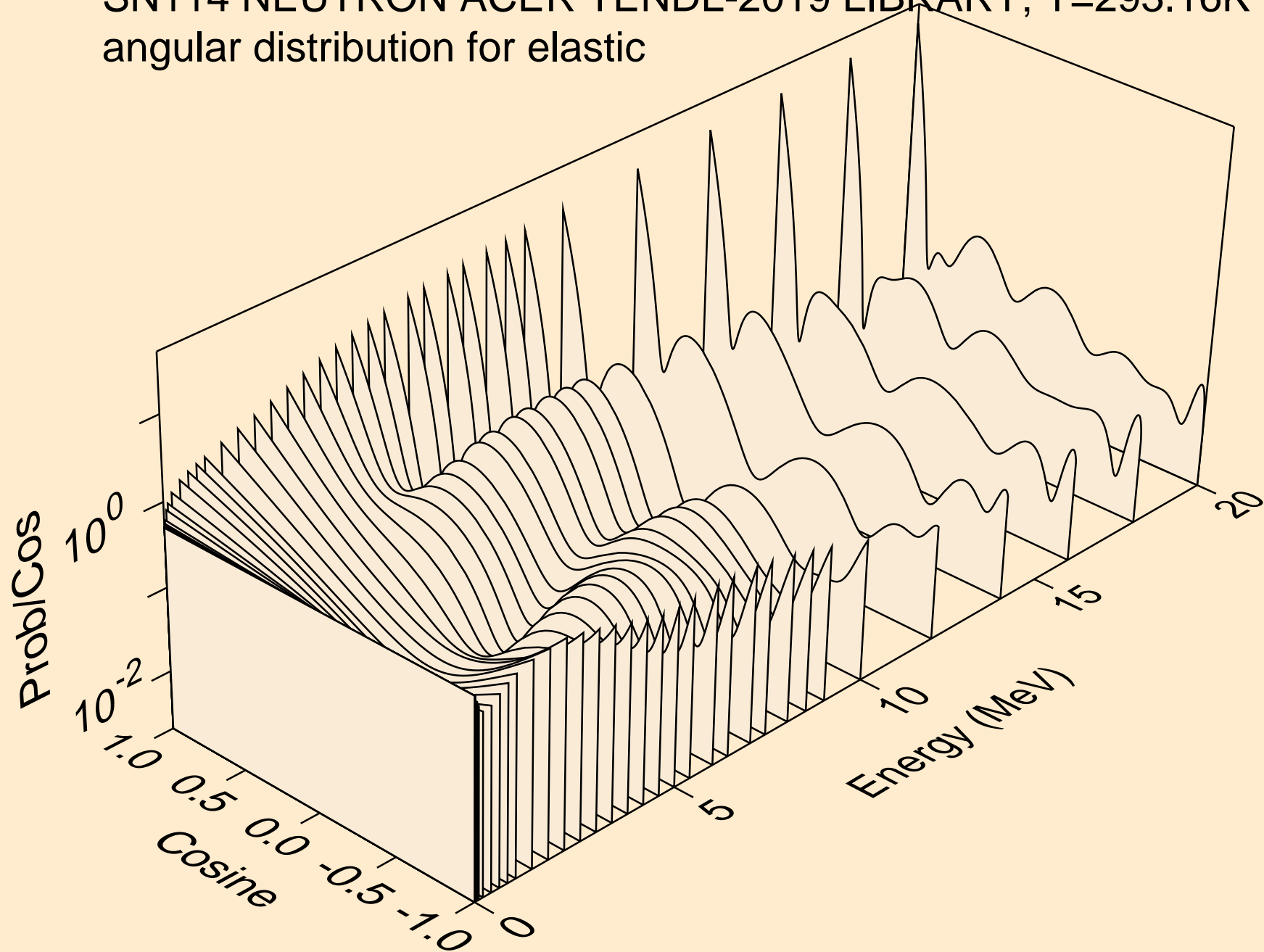

SN114 NEUTRON ACER TENDL-2019 LIBRARY; T=293.16K  
angular distribution for elastic

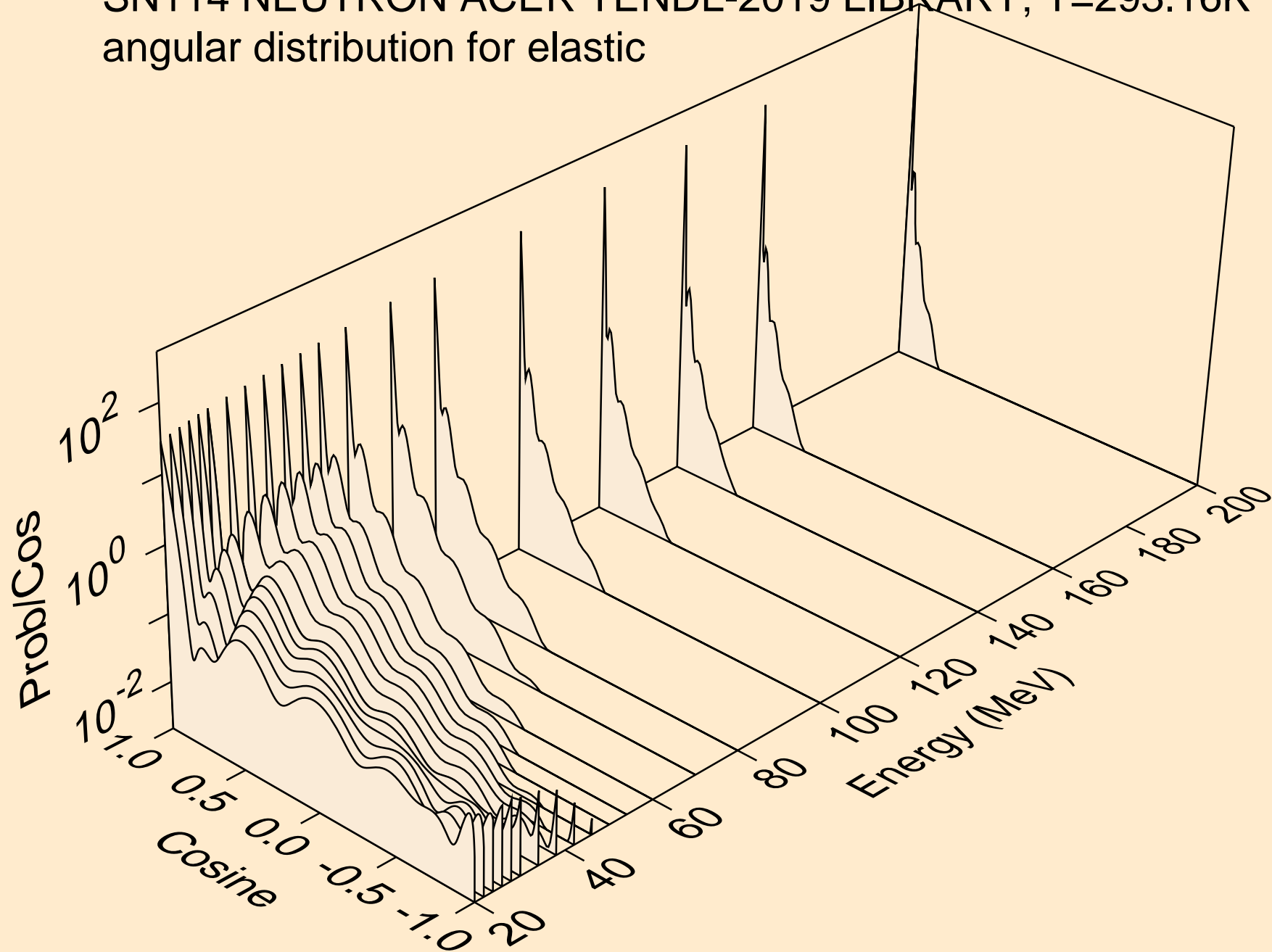

SN114 NEUTRON ACER TENDL-2019 LIBRARY; T=293.16K  
angular distribution for (n,n\*1)

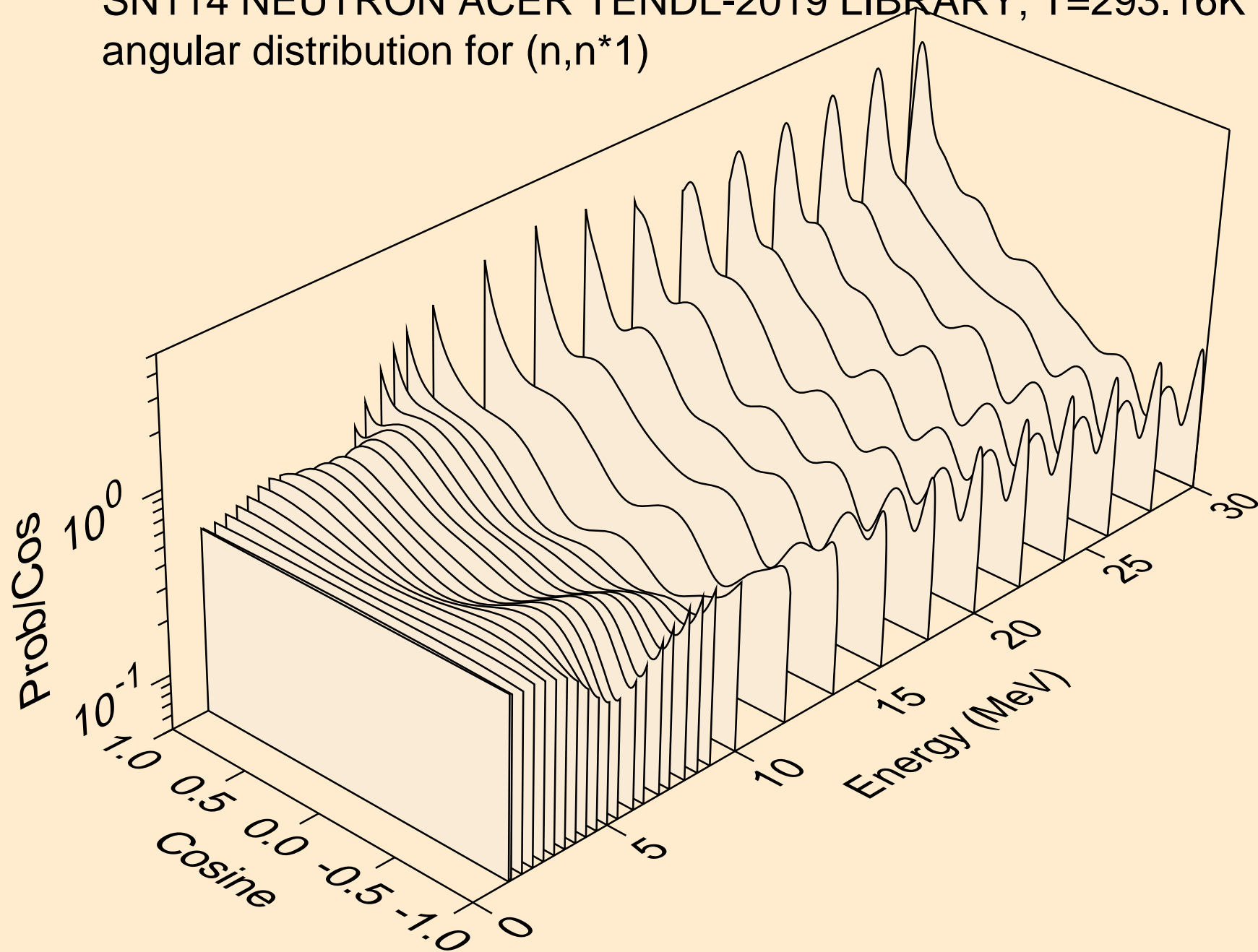

SN114 NEUTRON ACER TENDL-2019 LIBRARY; T=293.16K  
angular distribution for (n,n\*2)

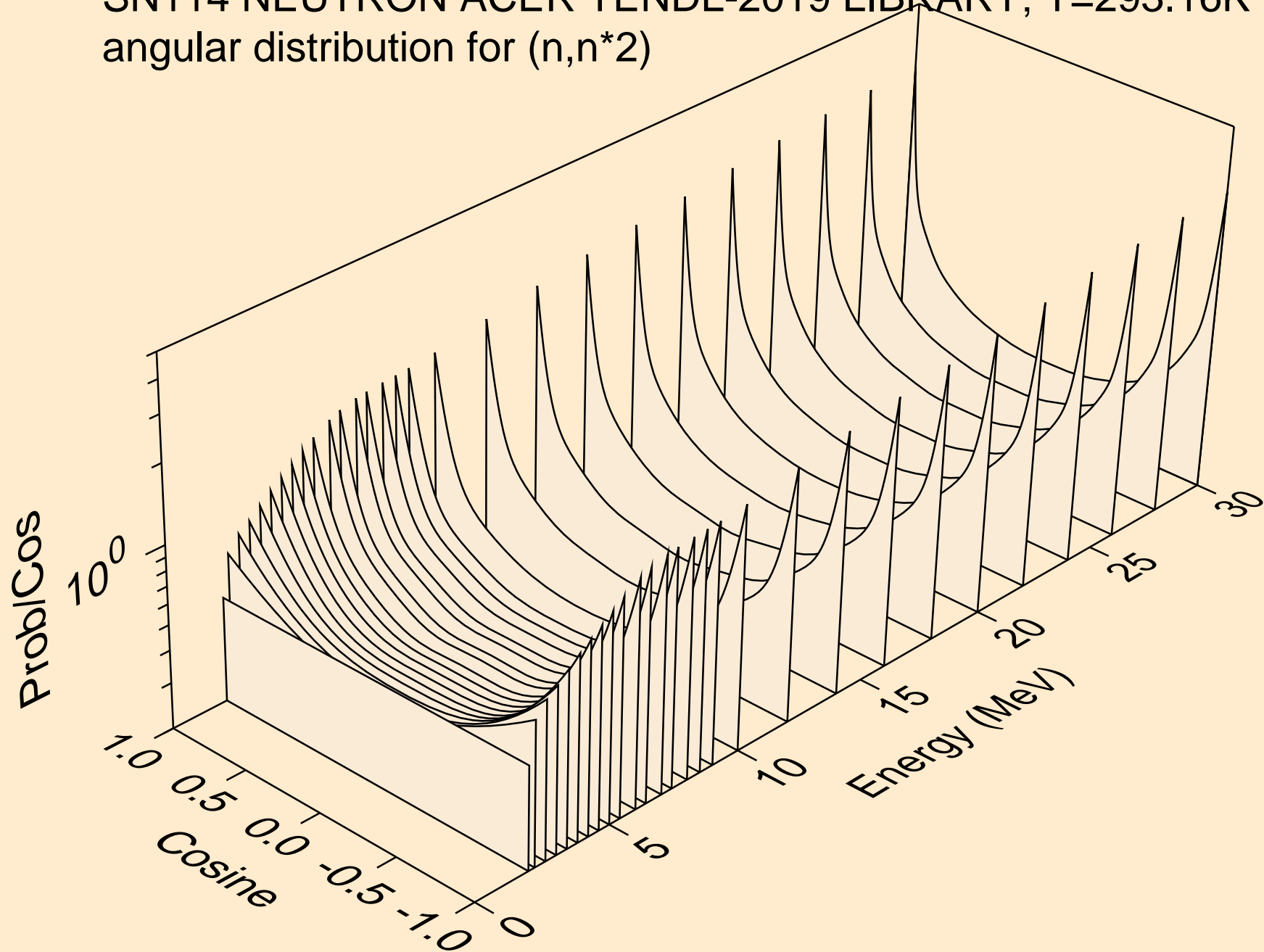

SN114 NEUTRON ACER TENDL-2019 LIBRARY; T=293.16K  
angular distribution for (n,n\*3)

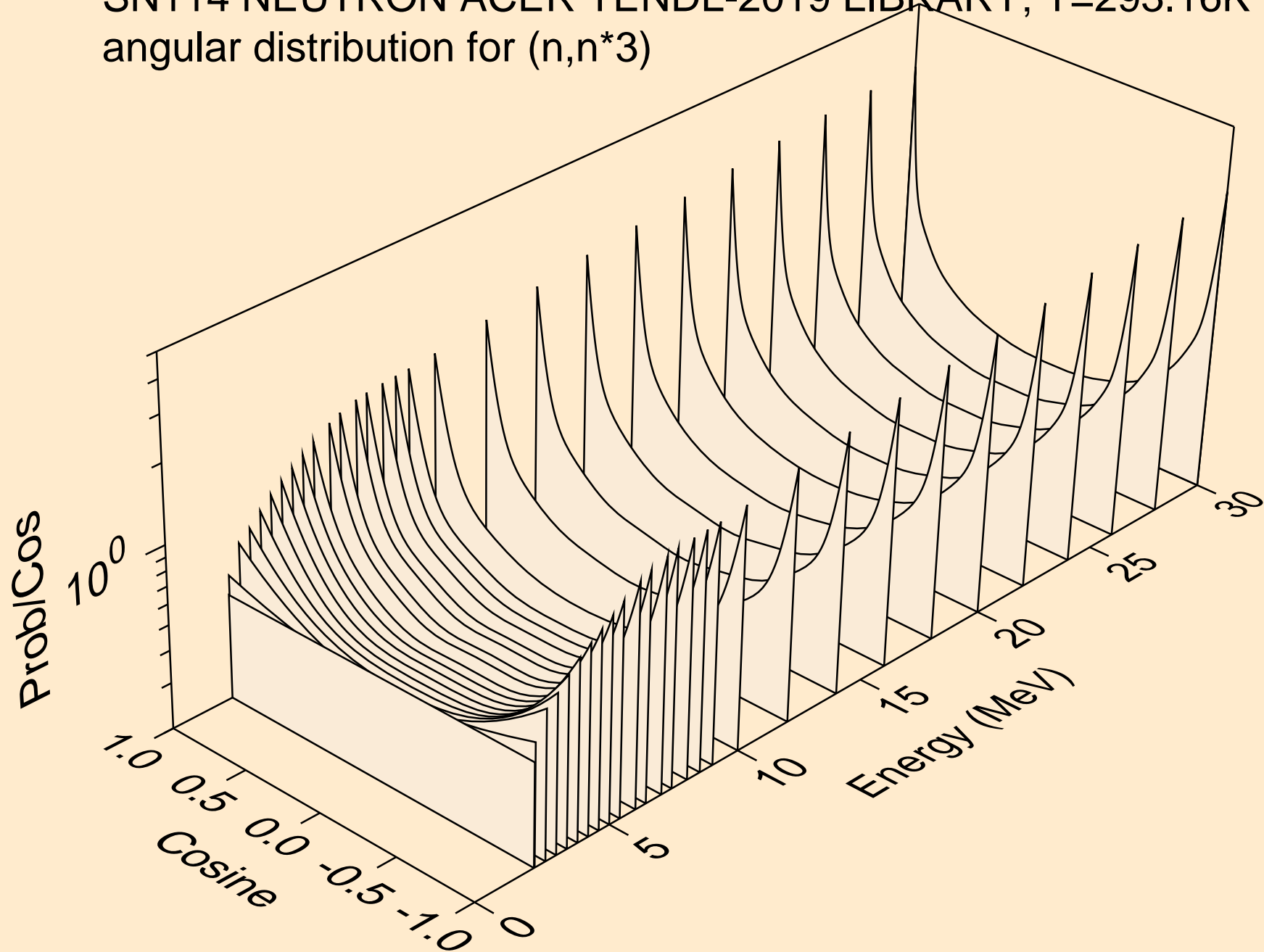



SN114 NEUTRON ACER TENDL-2019 LIBRARY; T=293.16K  
angular distribution for (n,n\*4)

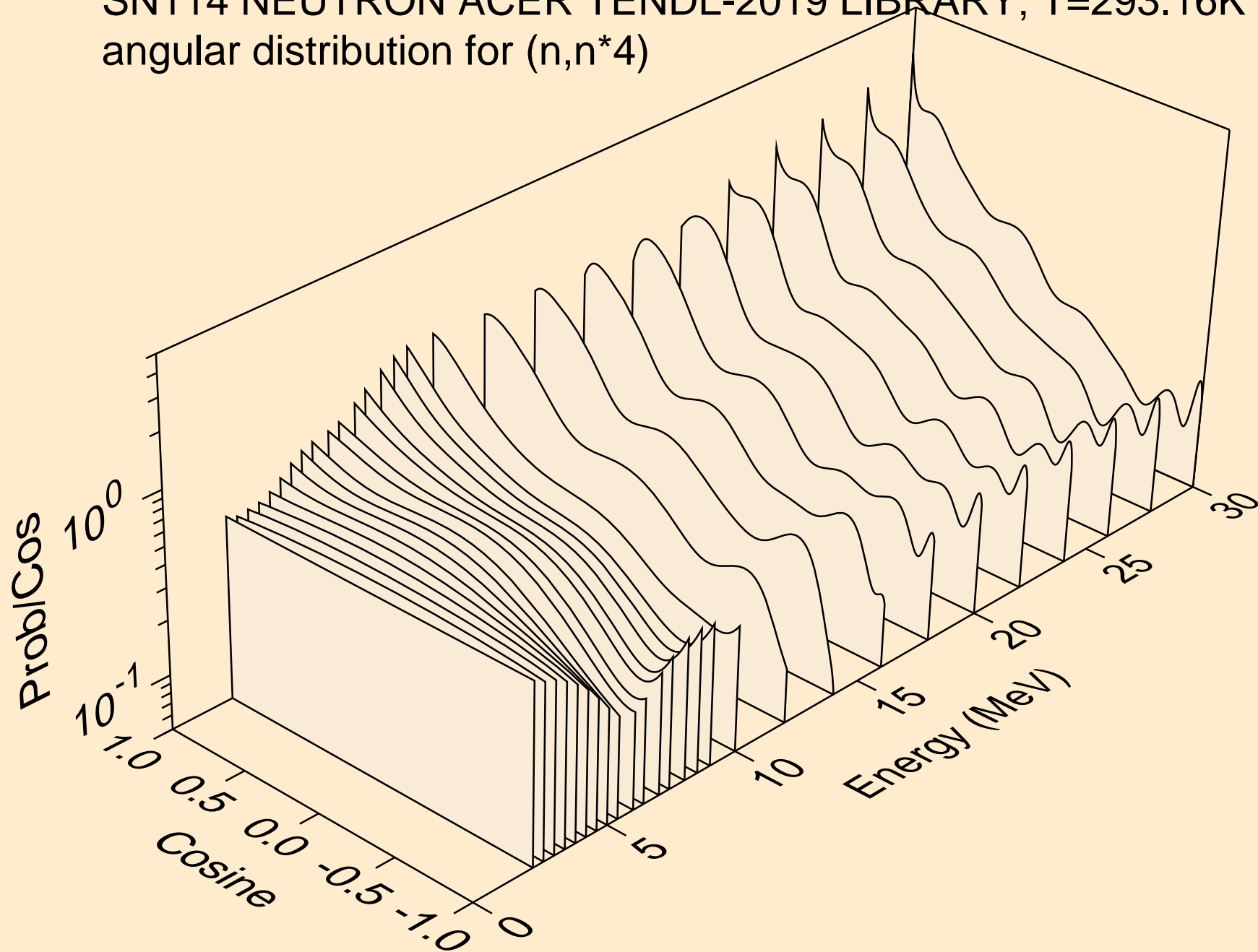

SN114 NEUTRON ACER TENDL-2019 LIBRARY; T=293.16K  
angular distribution for (n,n\*5)

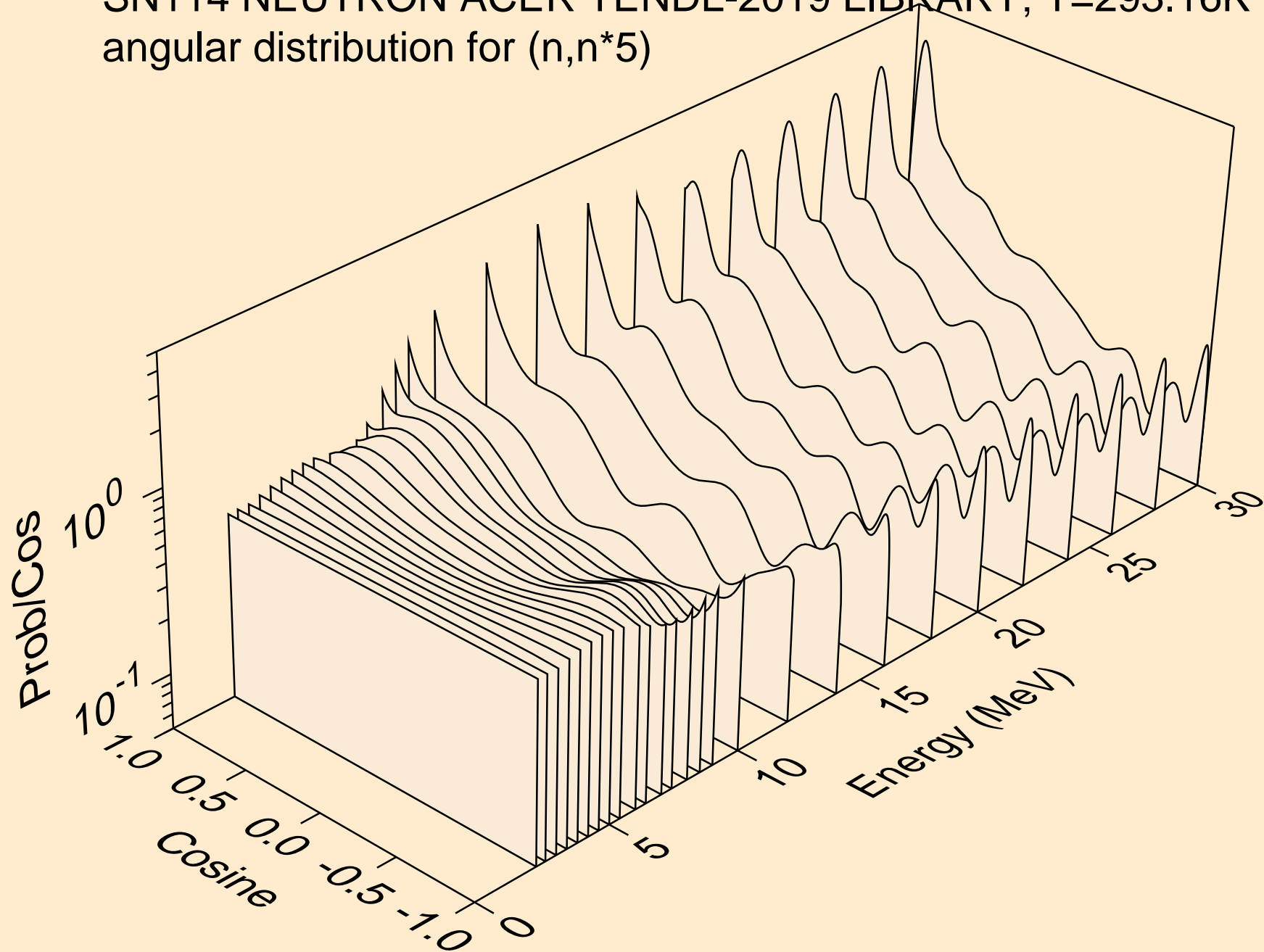

SN114 NEUTRON ACER TENDL-2019 LIBRARY; T=293.16K  
angular distribution for (n,n\*6)

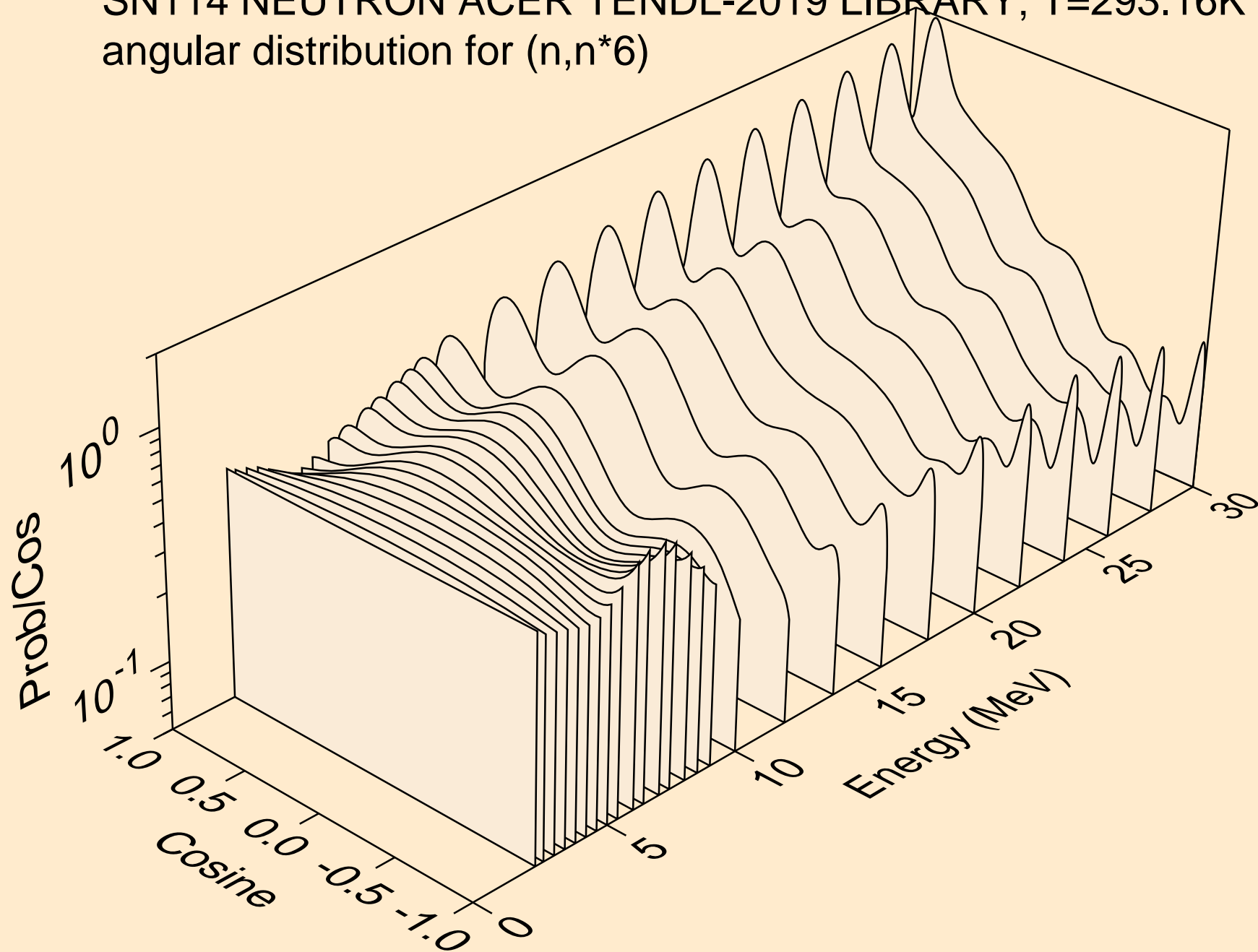

SN114 NEUTRON ACER TENDL-2019 LIBRARY; T=293.16K  
angular distribution for (n,n\*7)

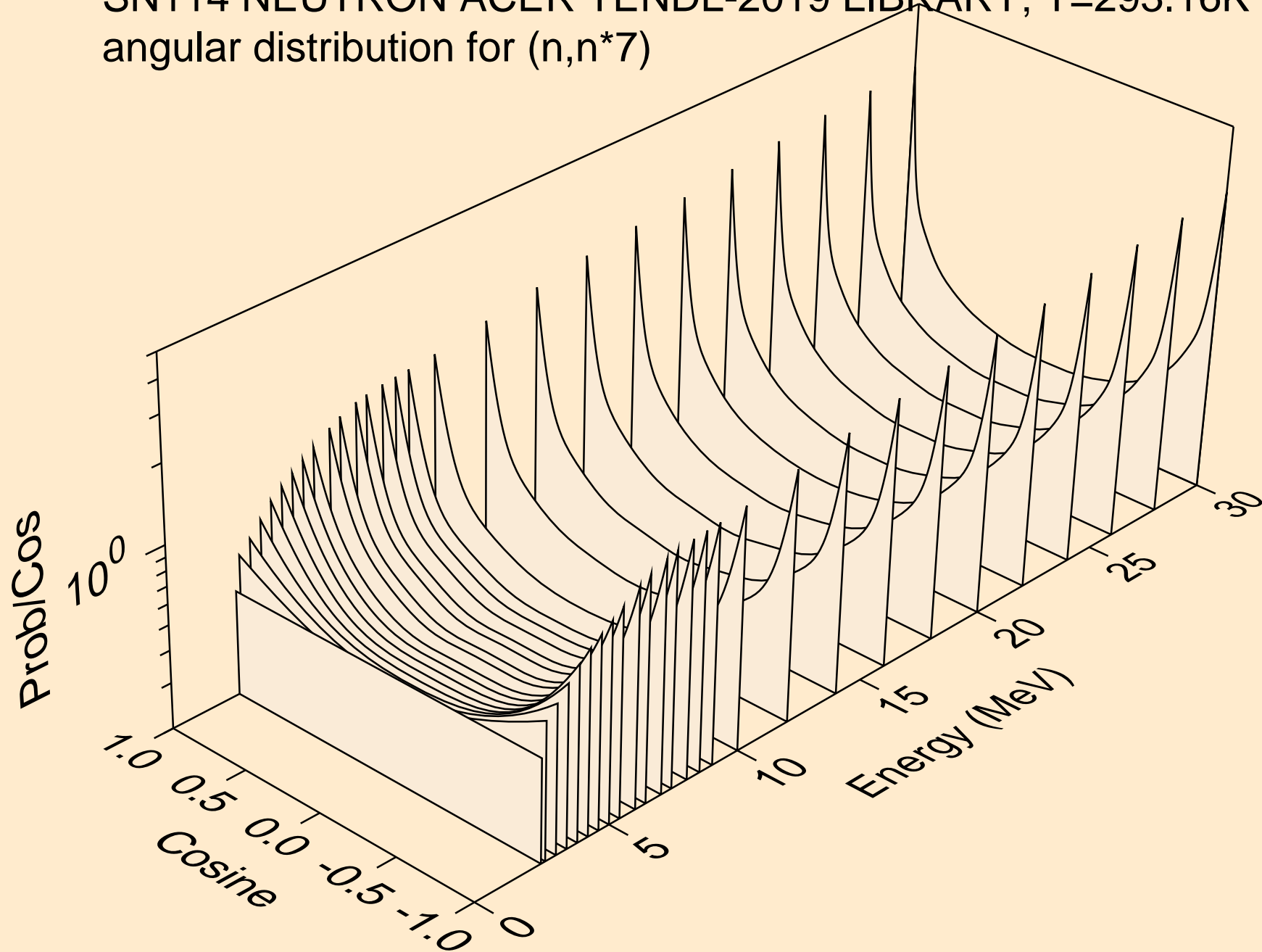

SN114 NEUTRON ACER TENDL-2019 LIBRARY; T=293.16K  
angular distribution for (n,n\*8)

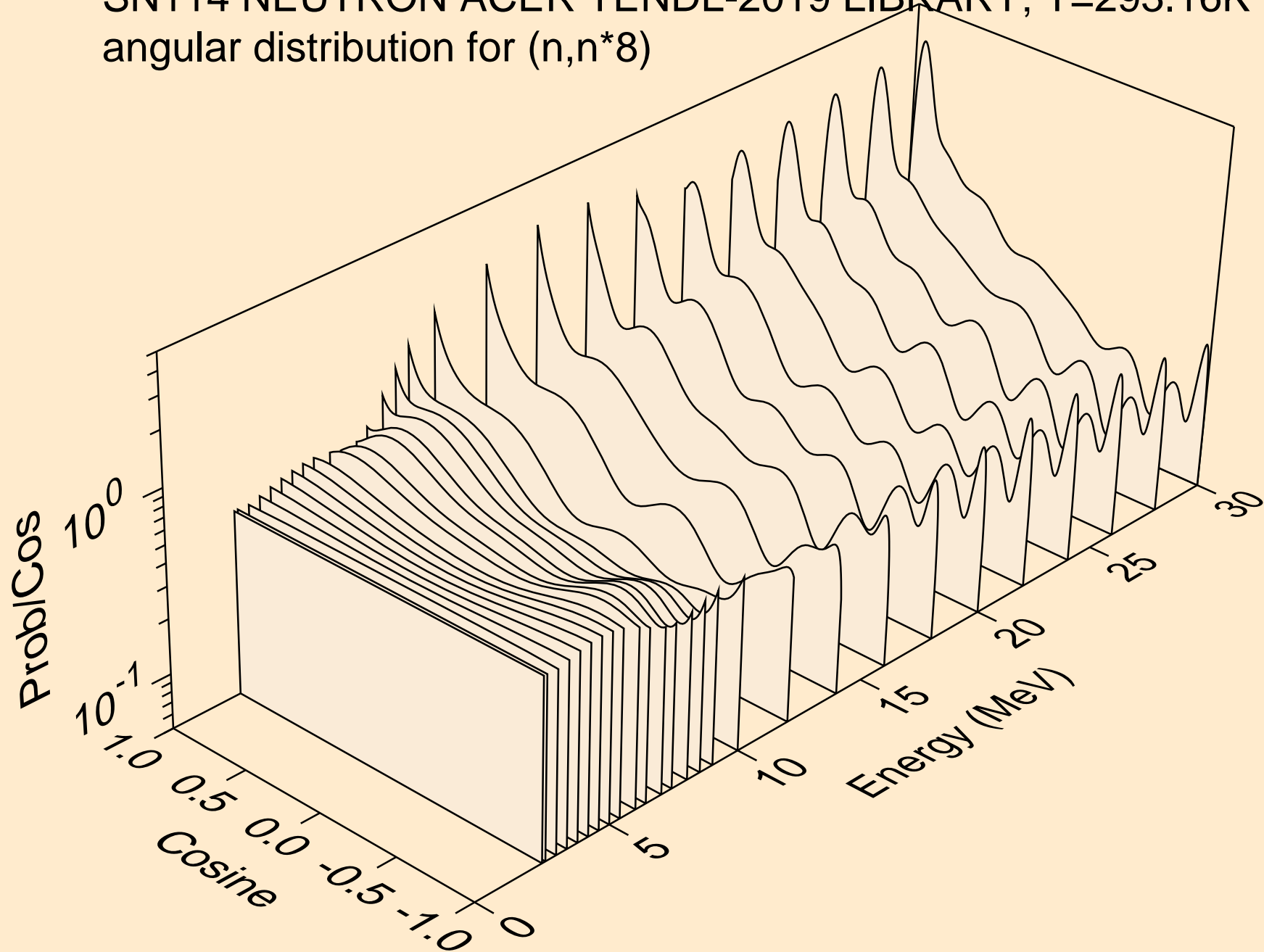

SN114 NEUTRON ACER TENDL-2019 LIBRARY; T=293.16K  
angular distribution for (n,n\*9)

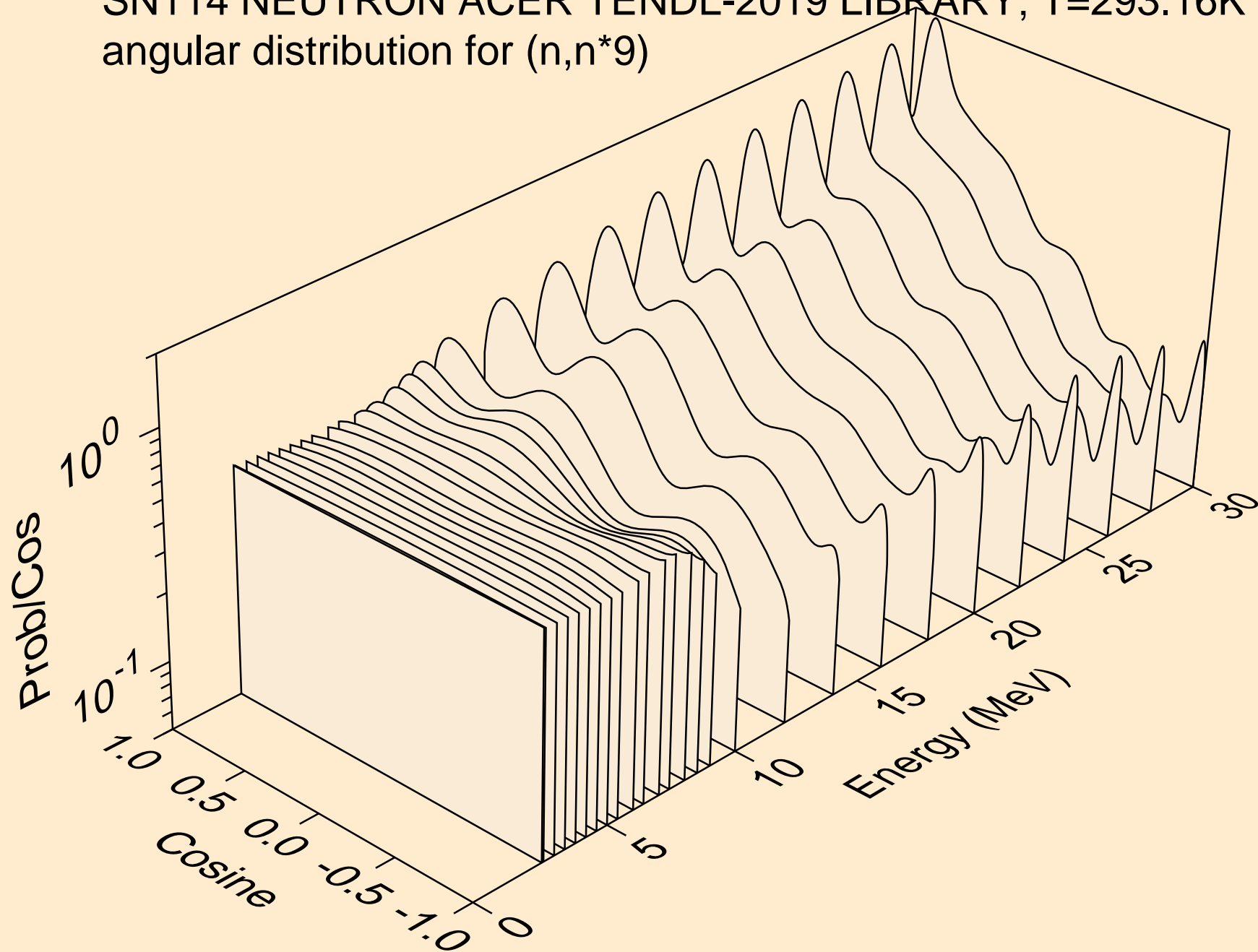

SN114 NEUTRON ACER TENDL-2019 LIBRARY; T=293.16K  
angular distribution for (n,n\*10)

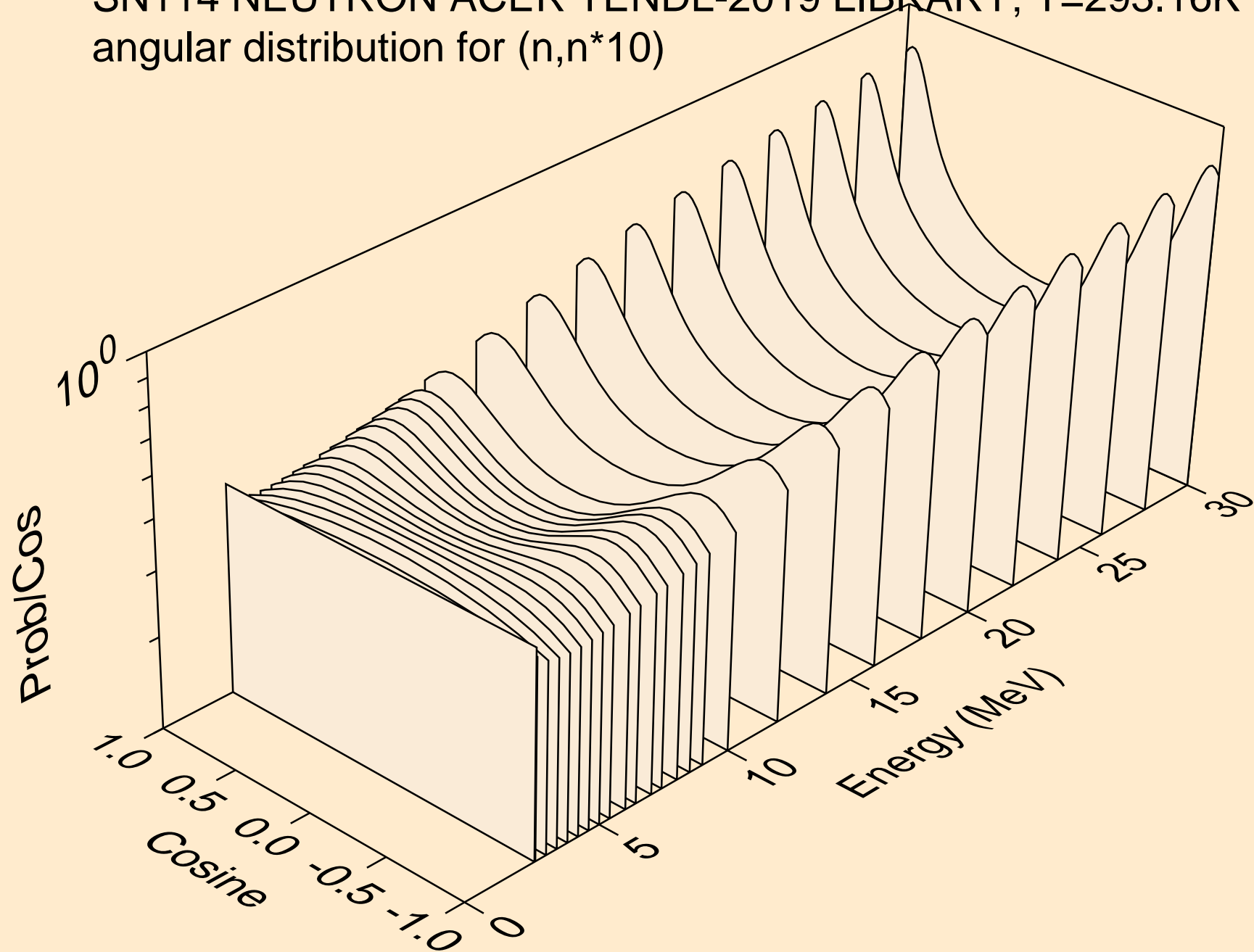

SN114 NEUTRON ACER TENDL-2019 LIBRARY; T=293.16K  
angular distribution for (n,n\*11)

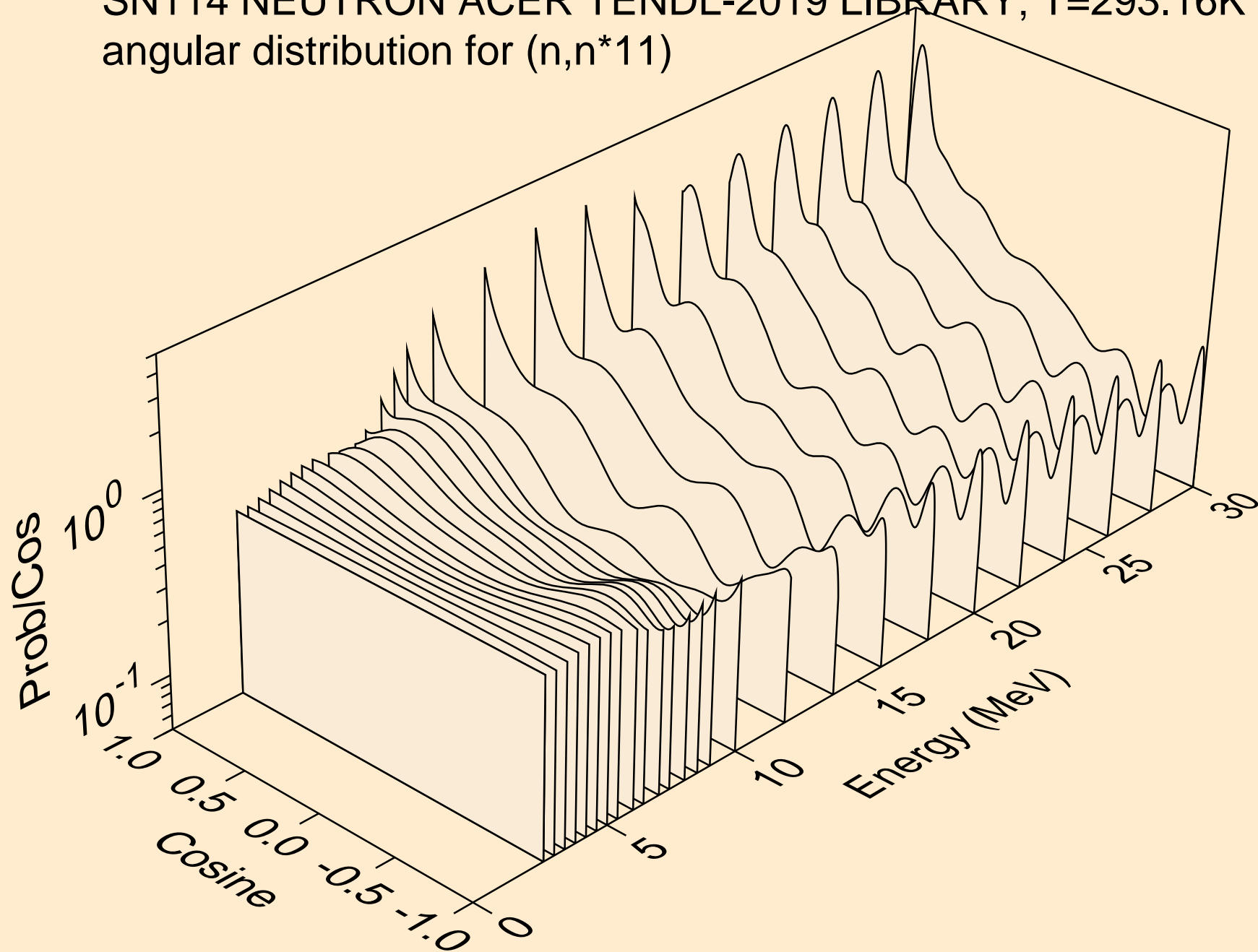



SN114 NEUTRON ACER TENDL-2019 LIBRARY; T=293.16K  
angular distribution for (n,n\*12)

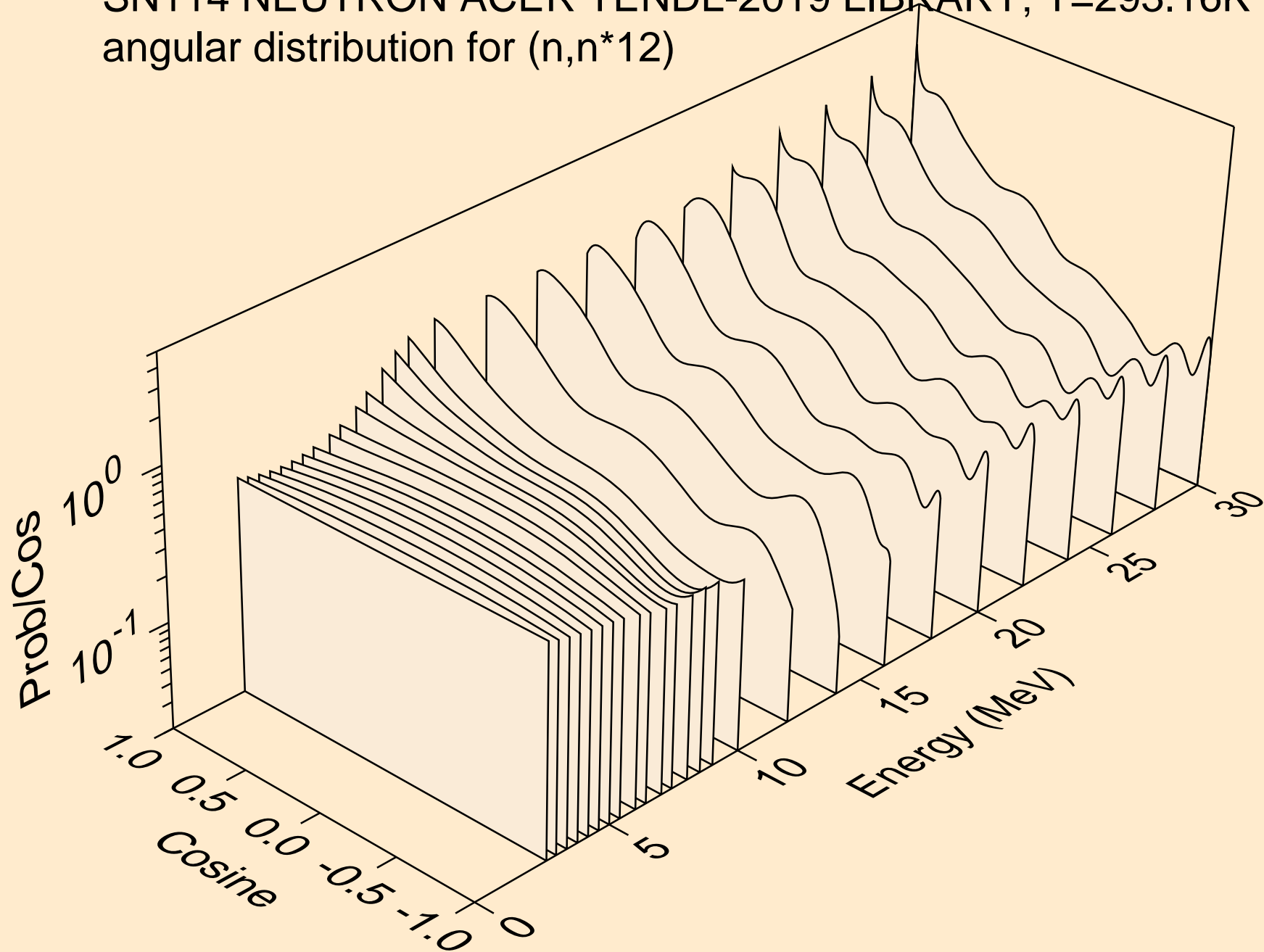

SN114 NEUTRON ACER TENDL-2019 LIBRARY; T=293.16K  
angular distribution for (n,n\*13)

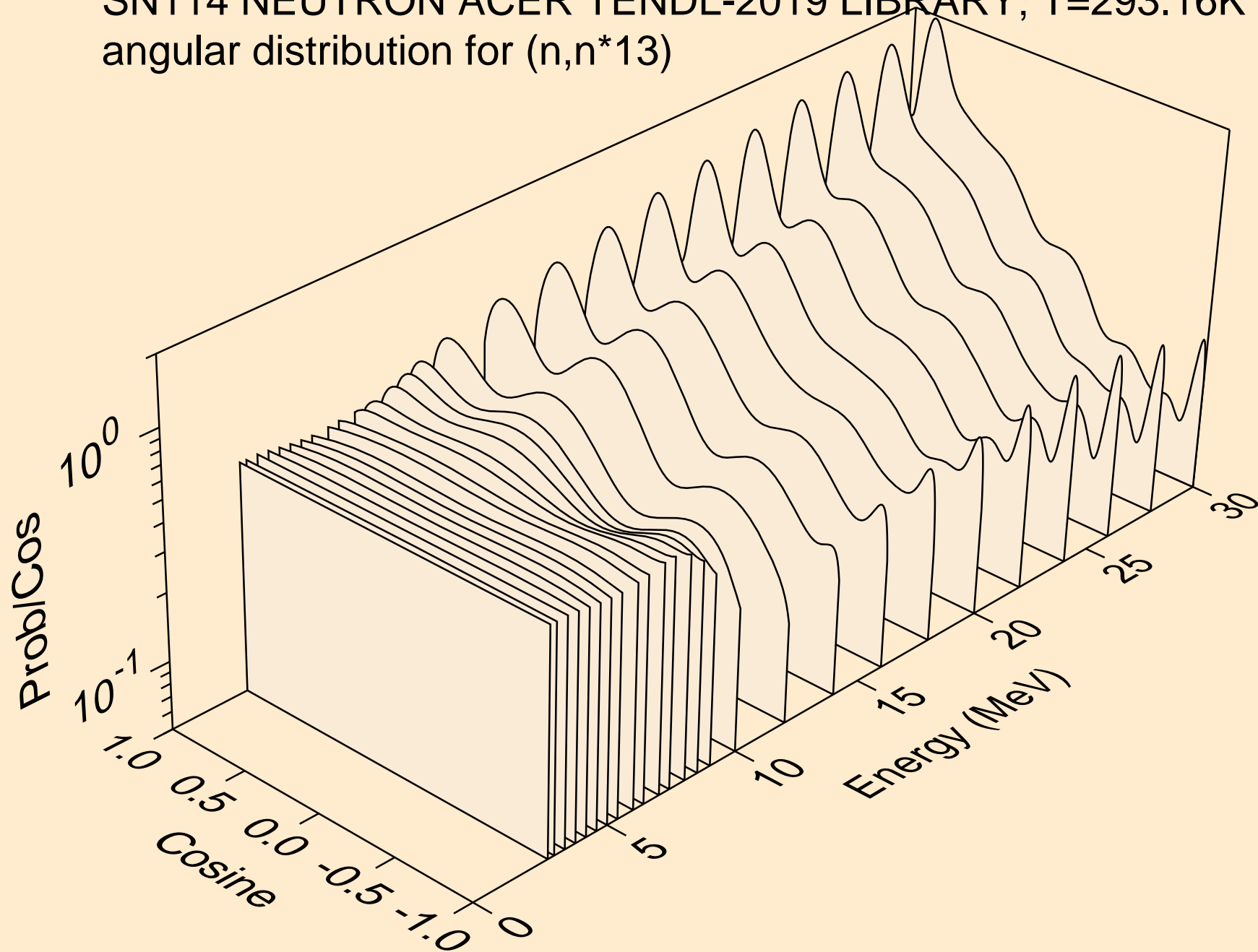

SN114 NEUTRON ACER TENDL-2019 LIBRARY; T=293.16K  
angular distribution for (n,n\*14)

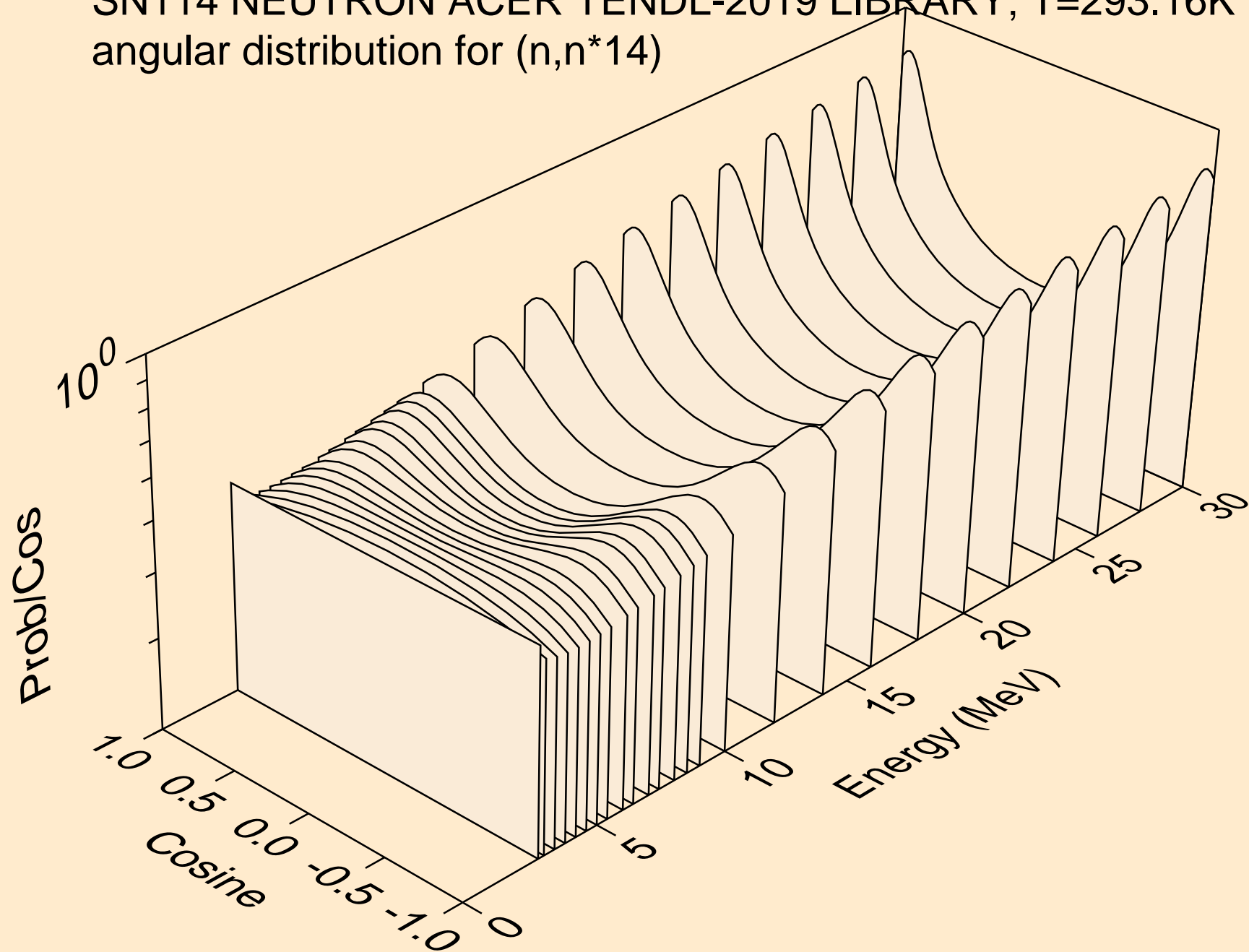

SN114 NEUTRON ACER TENDL-2019 LIBRARY; T=293.16K  
angular distribution for (n,n\*15)

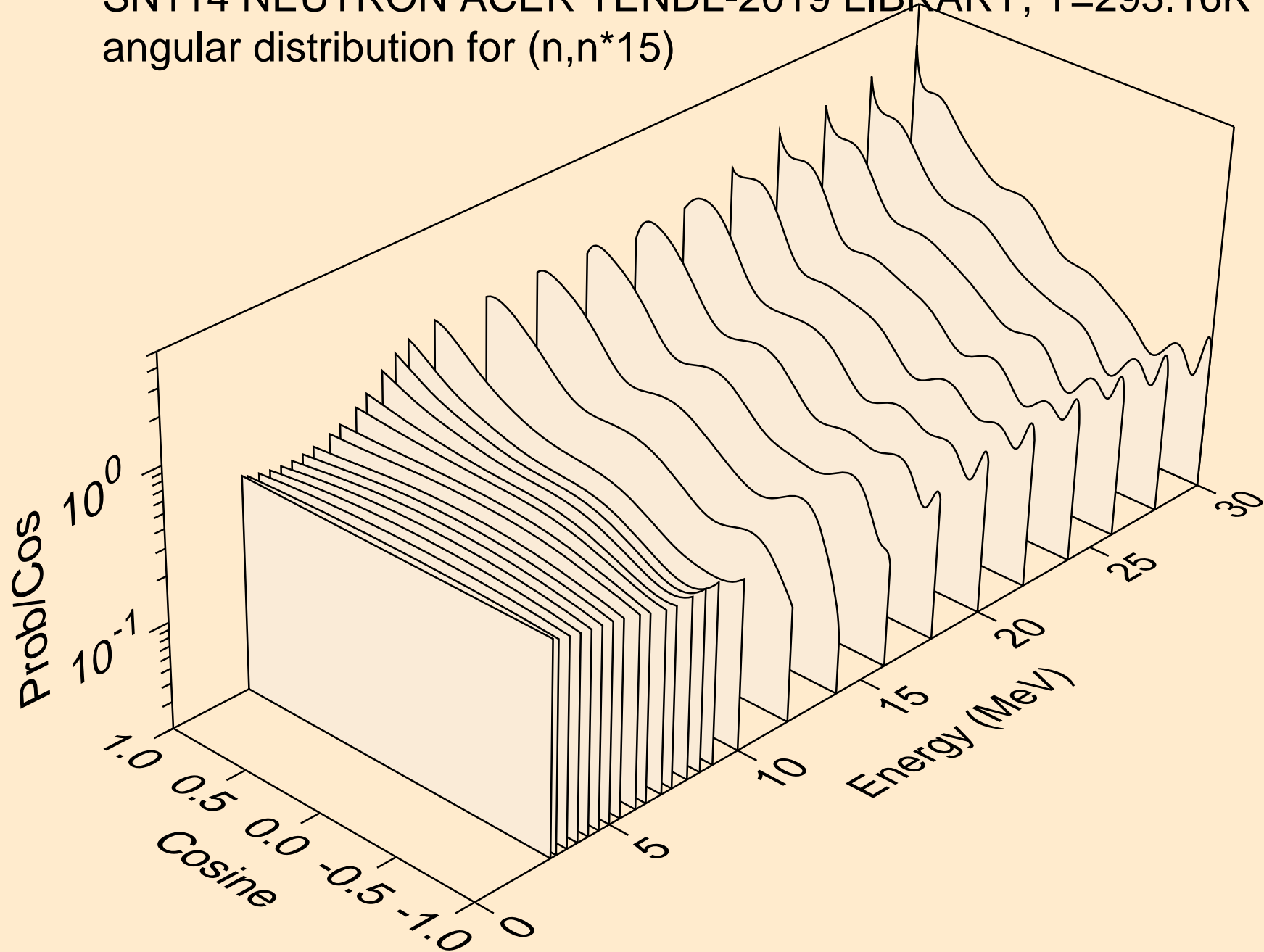

SN114 NEUTRON ACER TENDL-2019 LIBRARY; T=293.16K  
angular distribution for (n,n\*16)

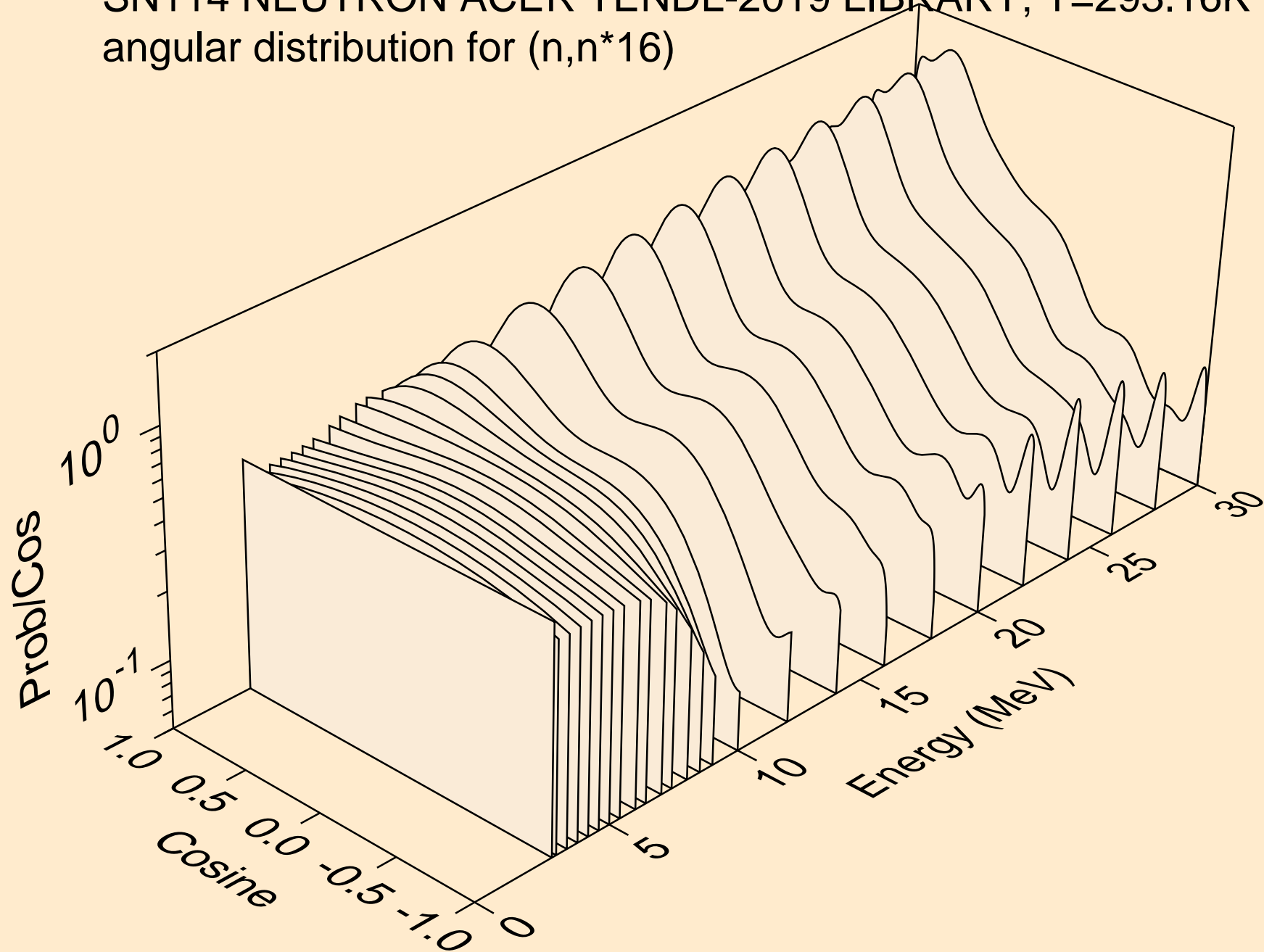

SN114 NEUTRON ACER TENDL-2019 LIBRARY; T=293.16K  
angular distribution for (n,n\*17)

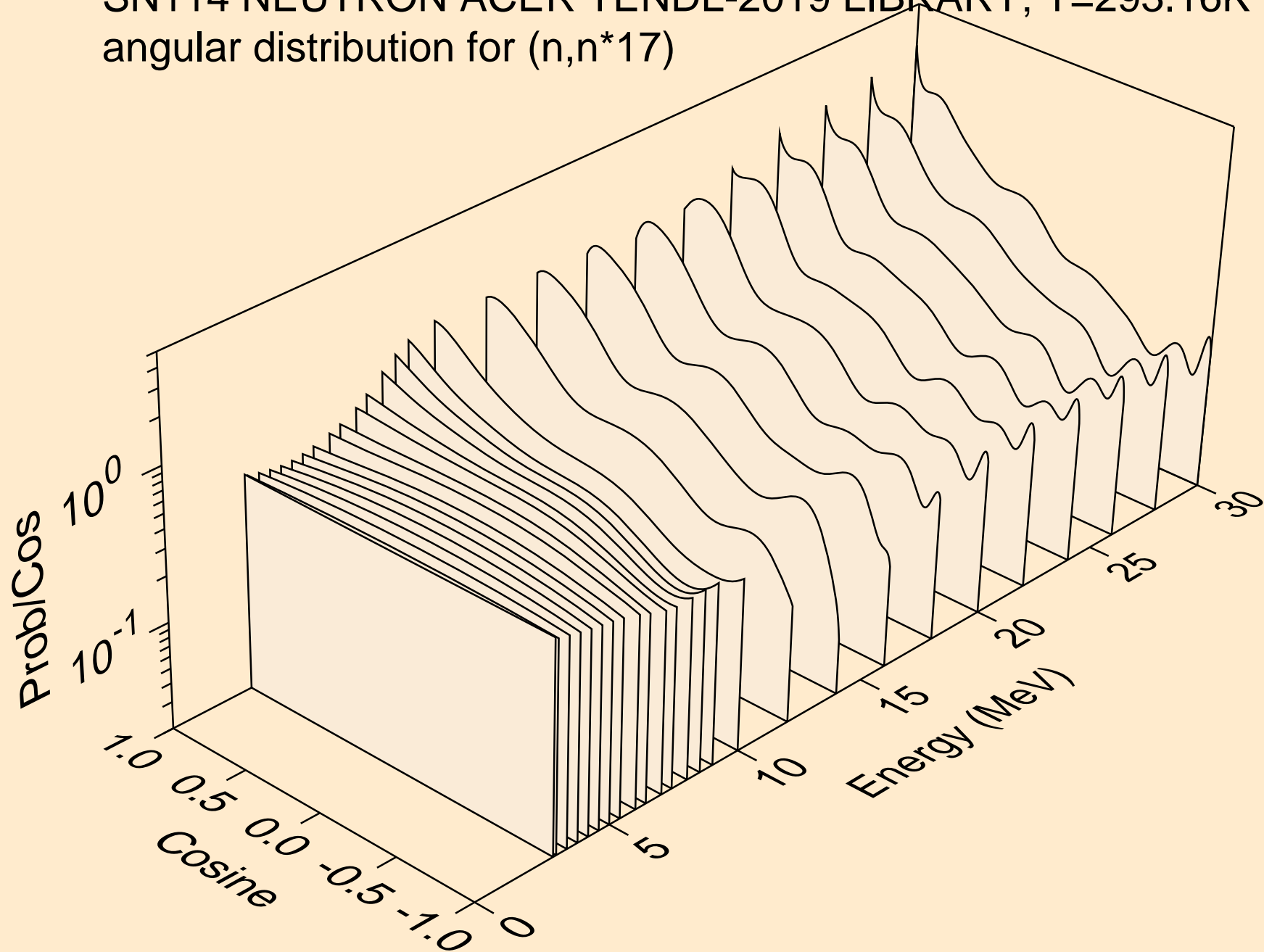

SN114 NEUTRON ACER TENDL-2019 LIBRARY; T=293.16K  
angular distribution for (n,n\*18)

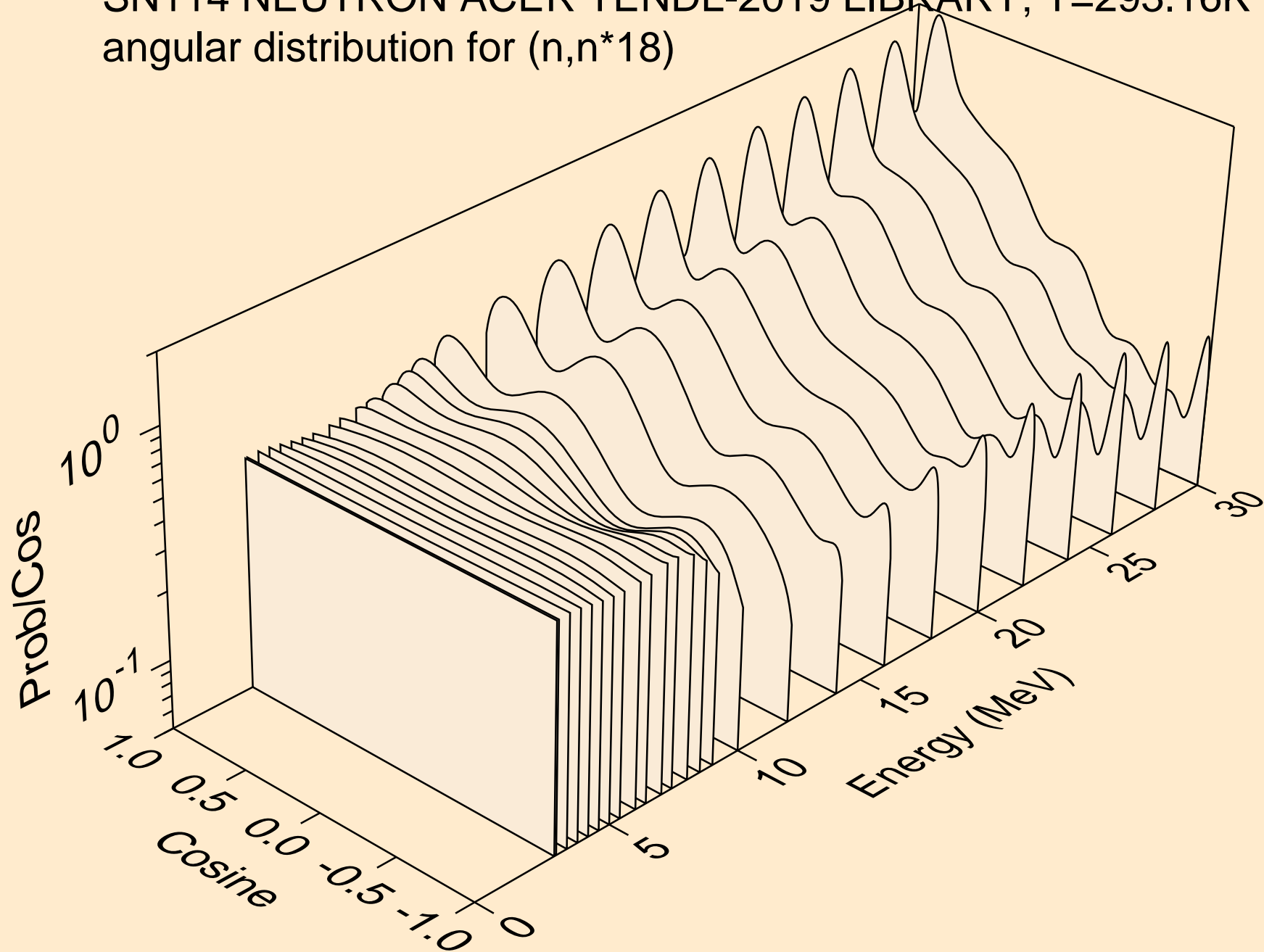

SN114 NEUTRON ACER TENDL-2019 LIBRARY; T=293.16K  
angular distribution for (n,n\*19)

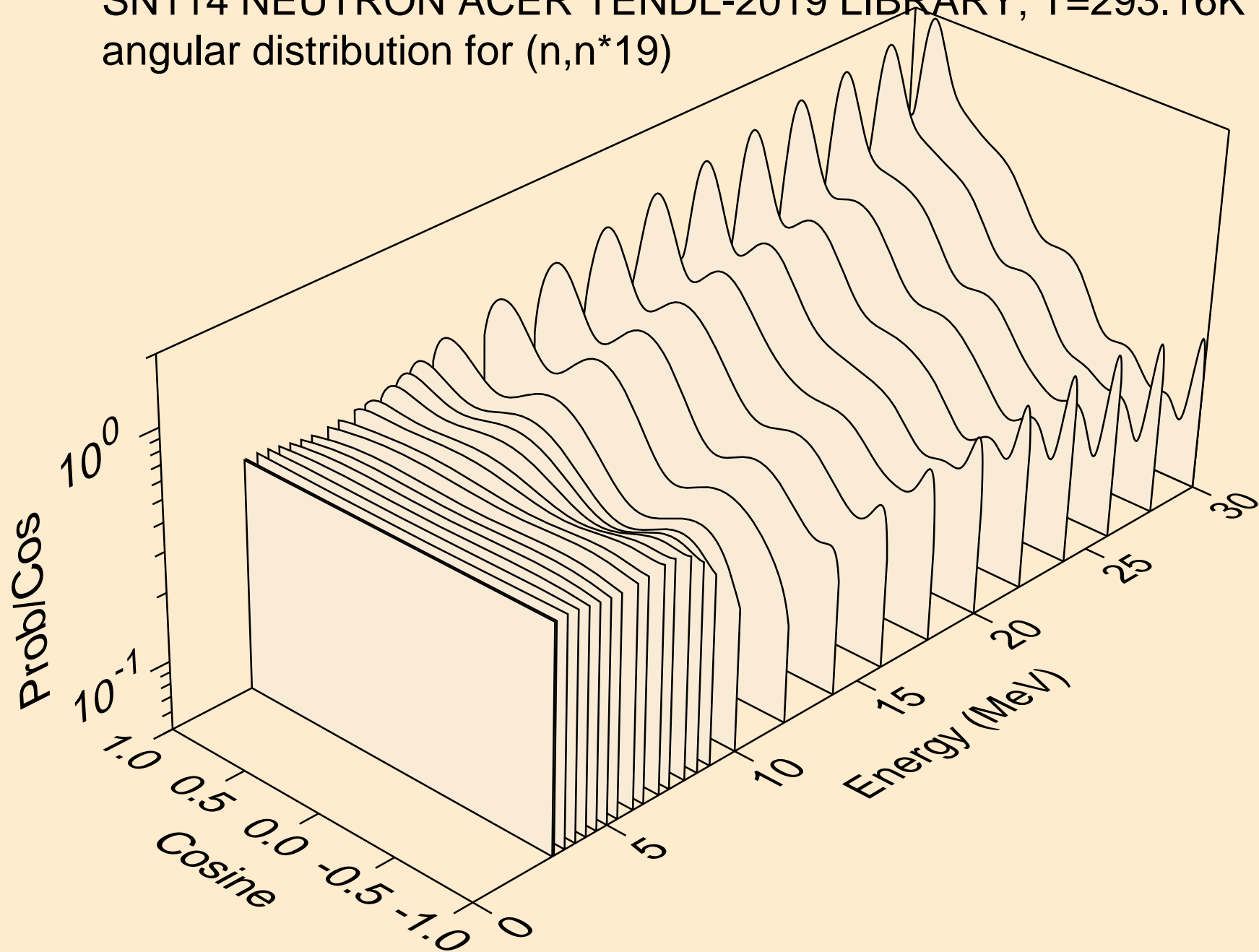



SN114 NEUTRON ACER TENDL-2019 LIBRARY; T=293.16K  
angular distribution for (n,n\*20)

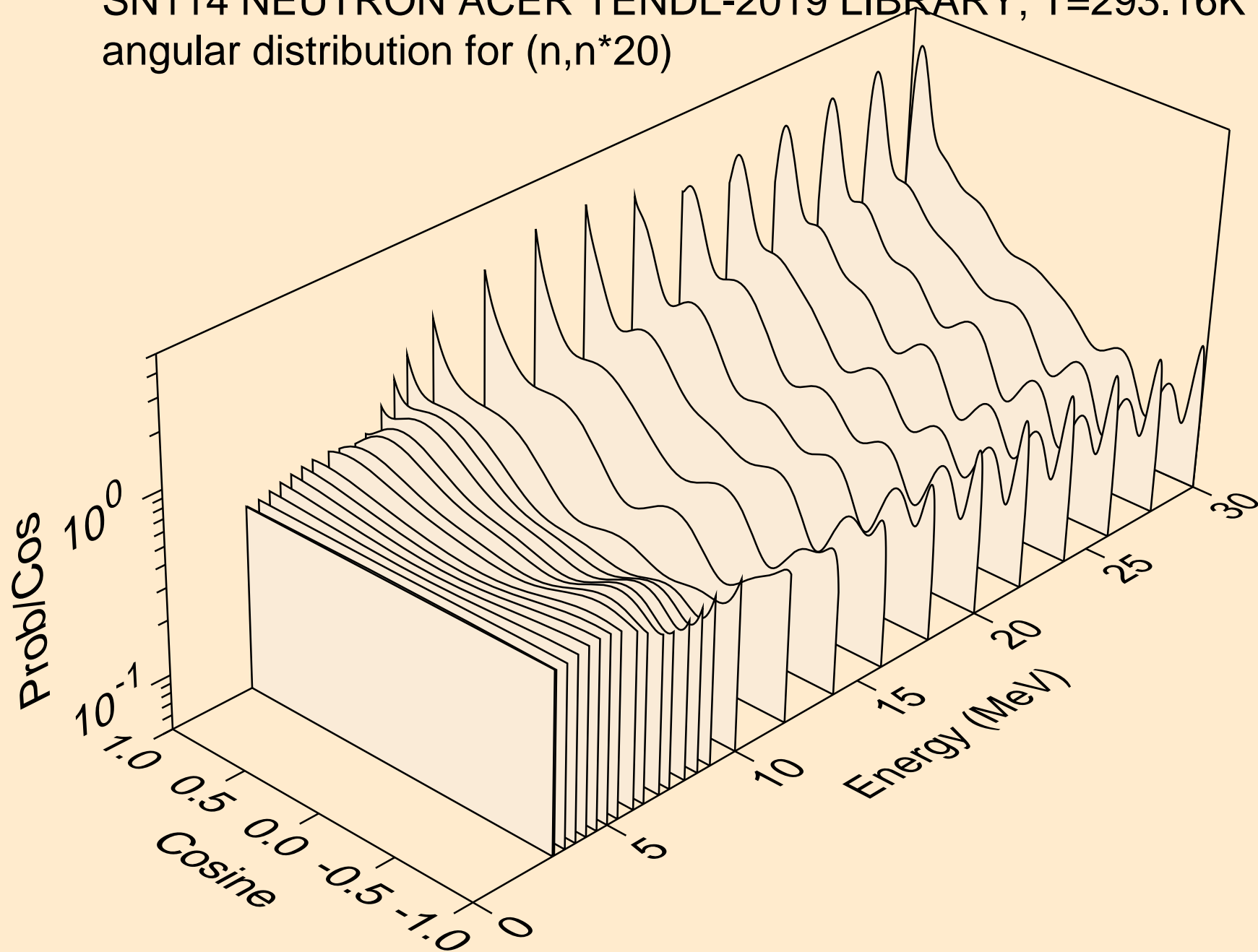

SN114 NEUTRON ACER TENDL-2019 LIBRARY; T=293.16K  
angular distribution for (n,n\*21)

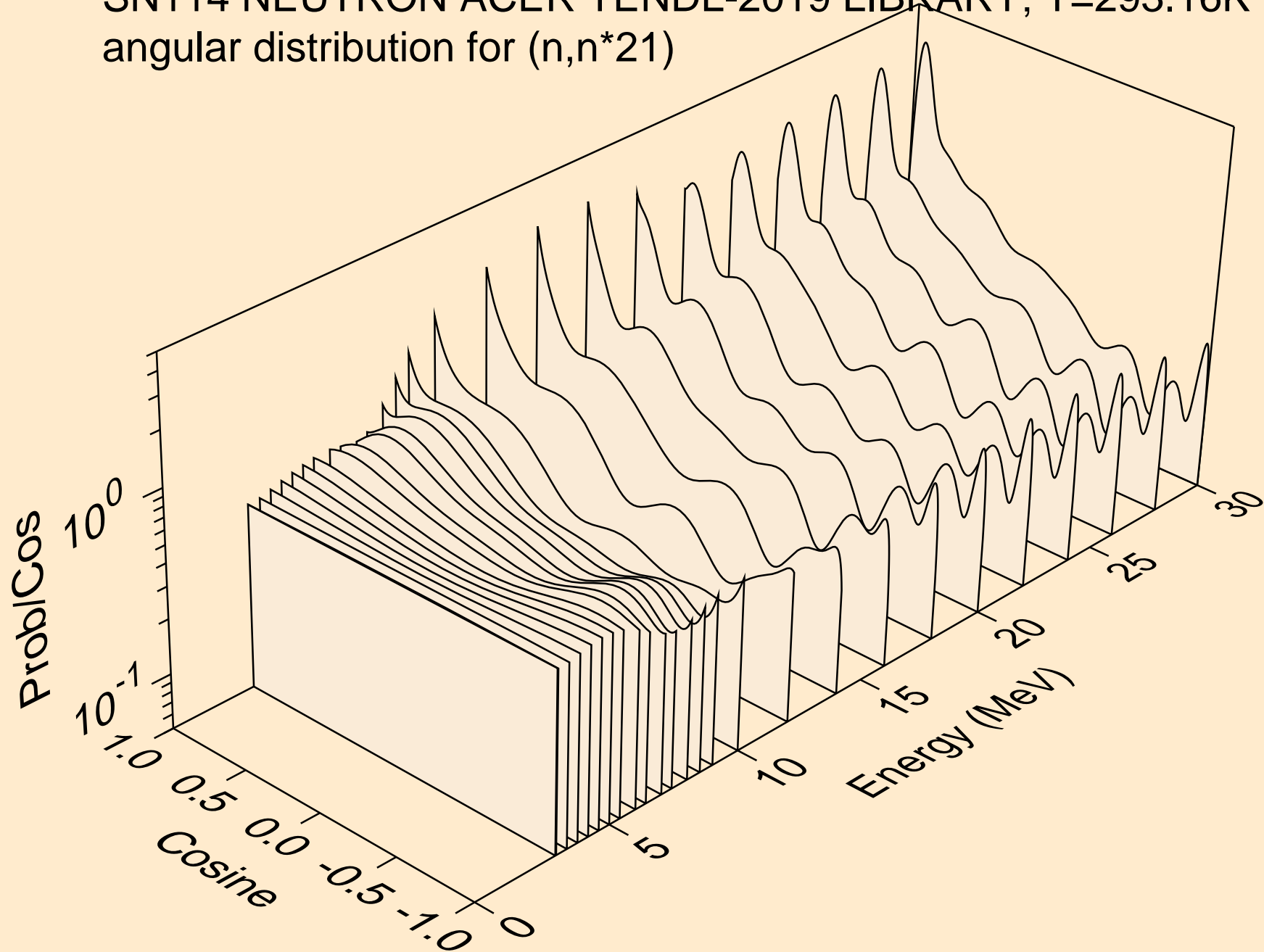

SN114 NEUTRON ACER TENDL-2019 LIBRARY; T=293.16K  
angular distribution for (n,n\*22)

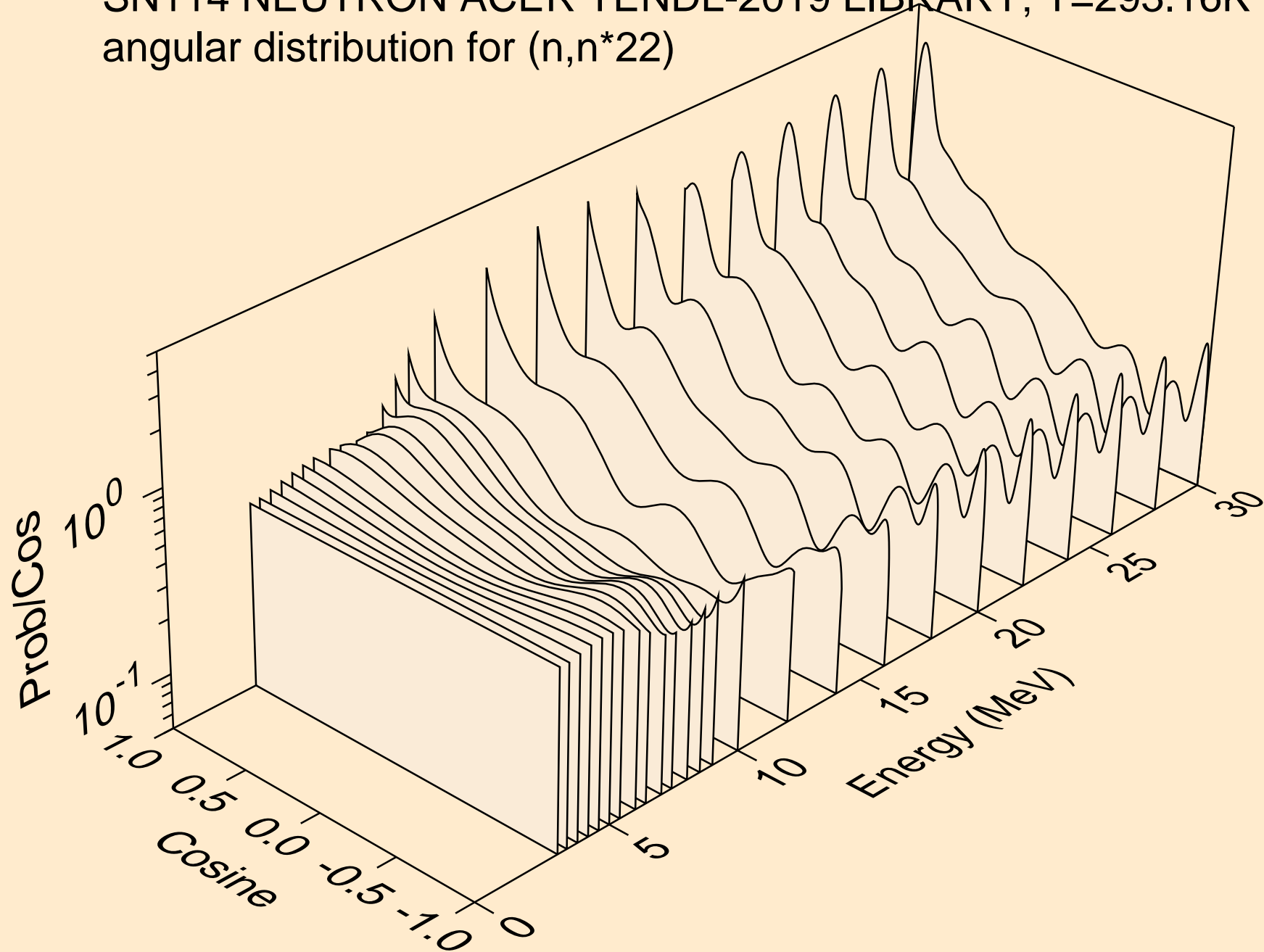

SN114 NEUTRON ACER TENDL-2019 LIBRARY; T=293.16K  
angular distribution for (n,n\*23)

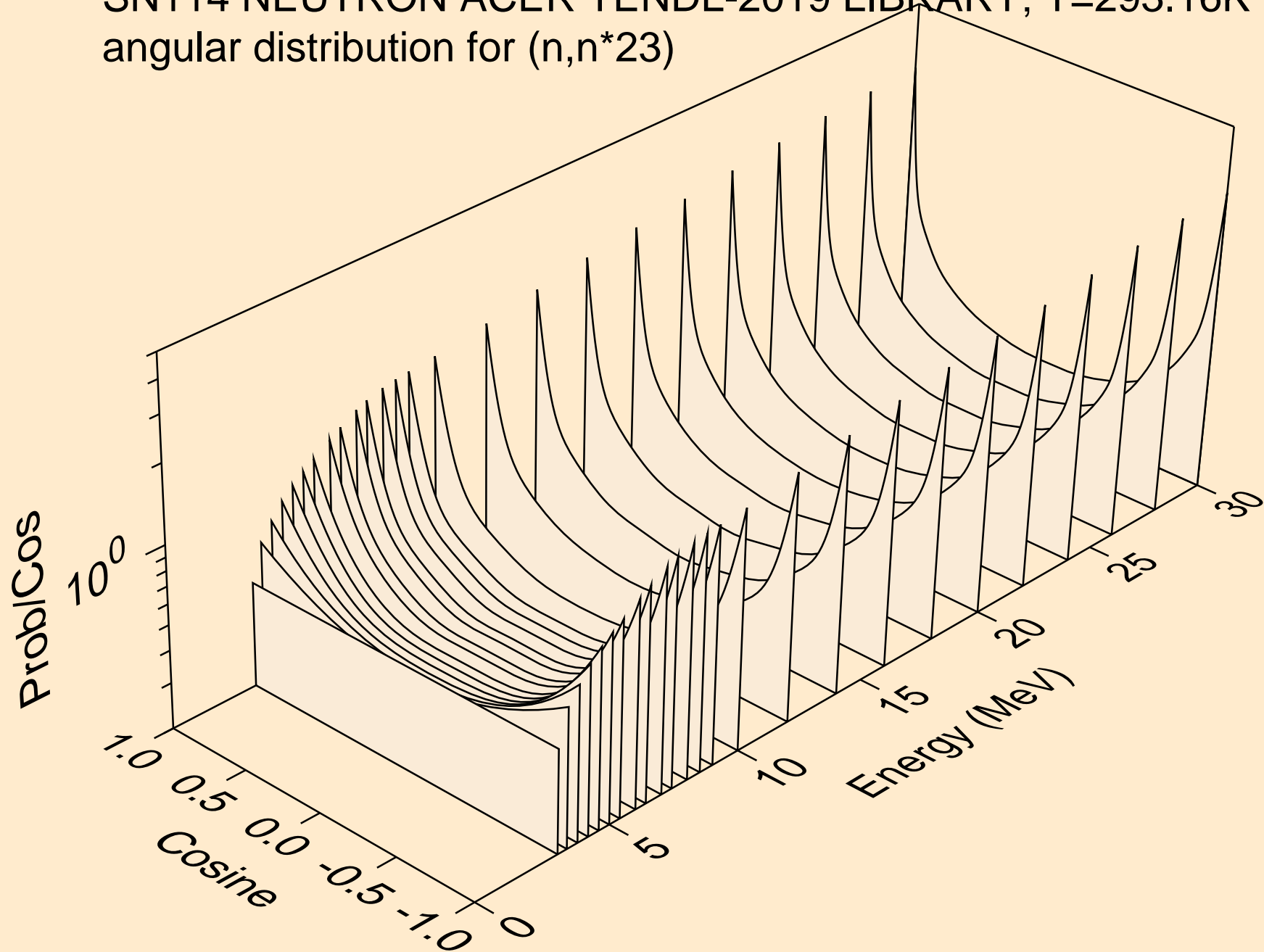

SN114 NEUTRON ACER TENDL-2019 LIBRARY; T=293.16K  
angular distribution for (n,n\*24)

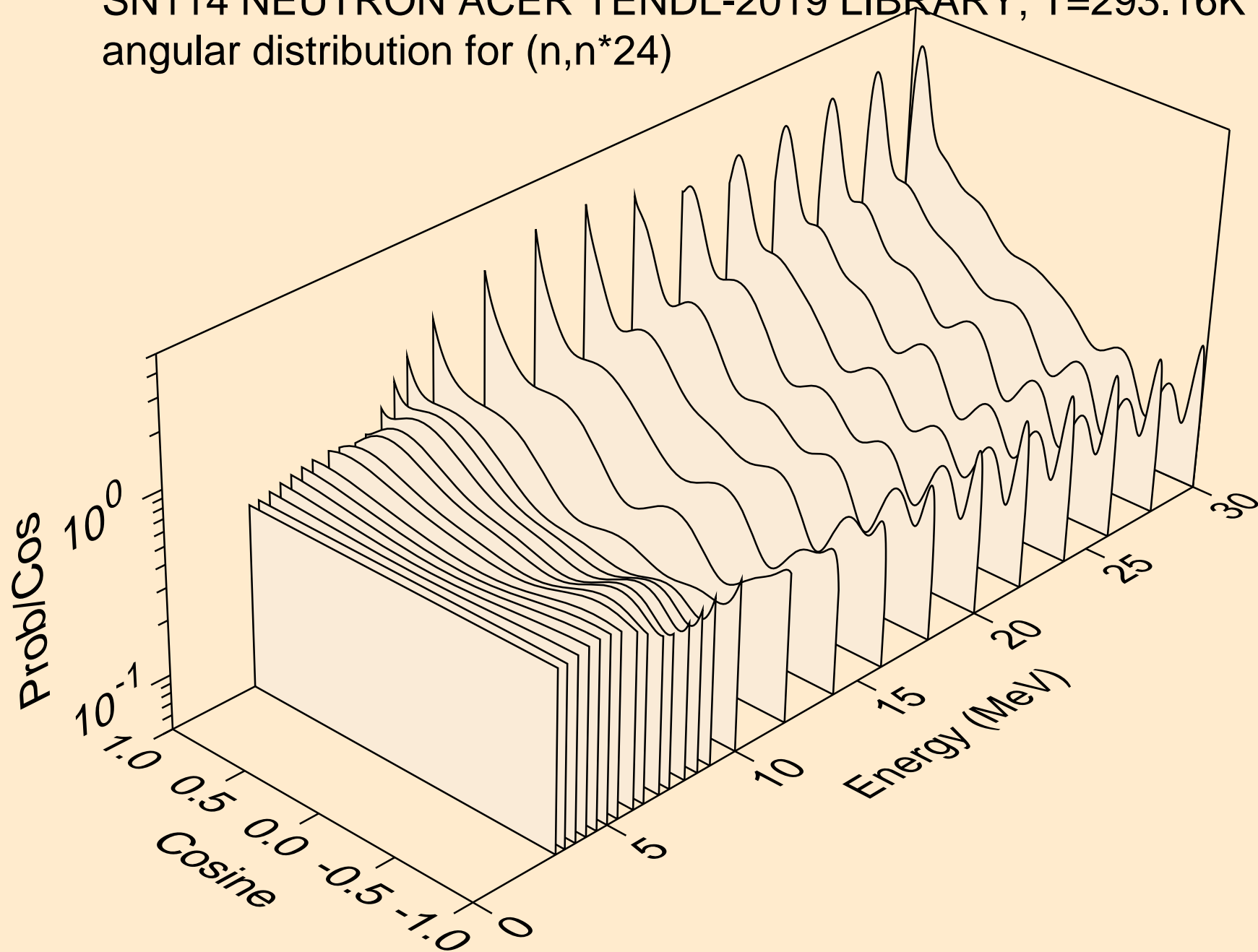

SN114 NEUTRON ACER TENDL-2019 LIBRARY; T=293.16K  
angular distribution for (n,n\*25)

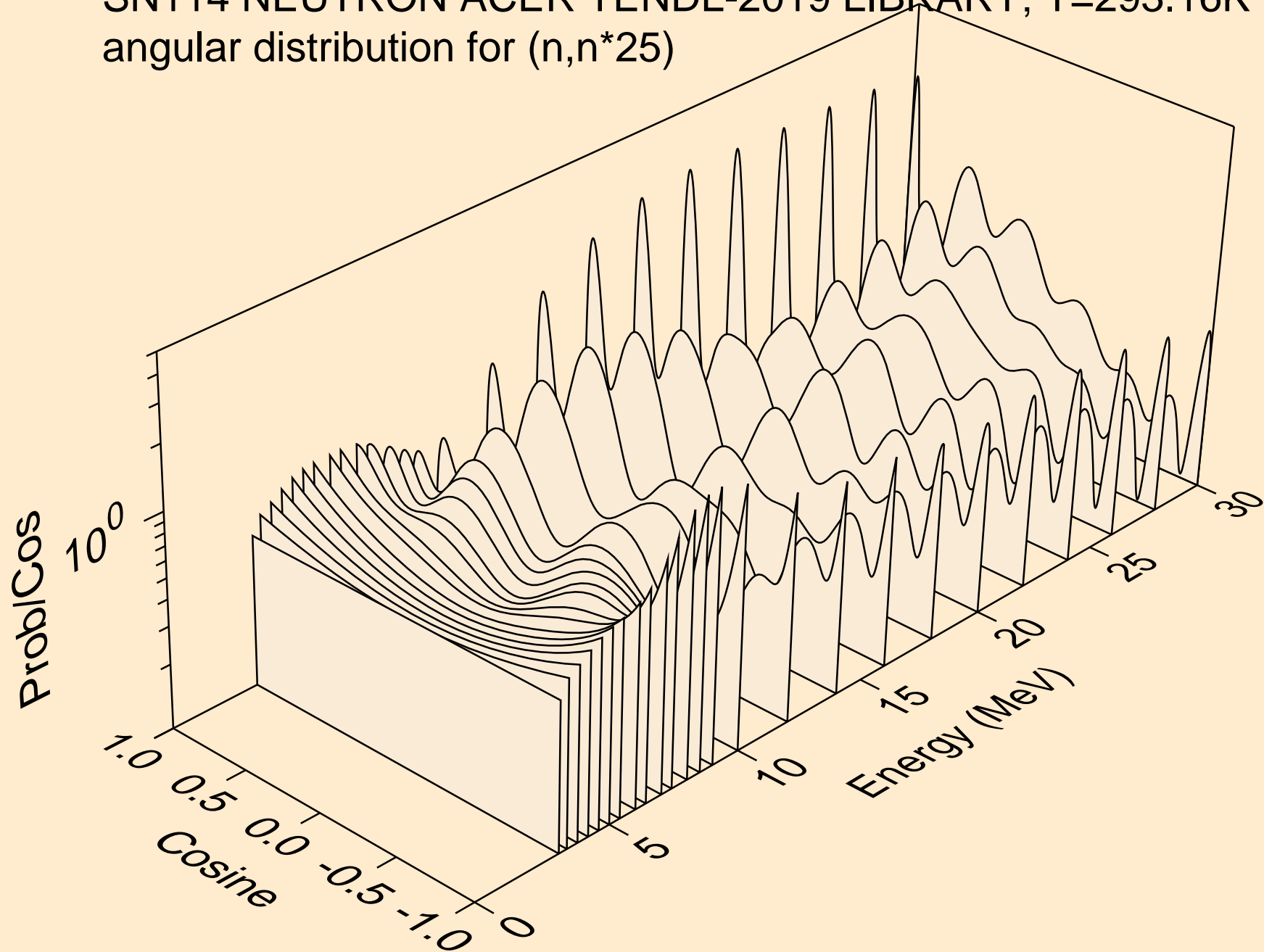

SN114 NEUTRON ACER TENDL-2019 LIBRARY; T=293.16K  
angular distribution for (n,n\*26)

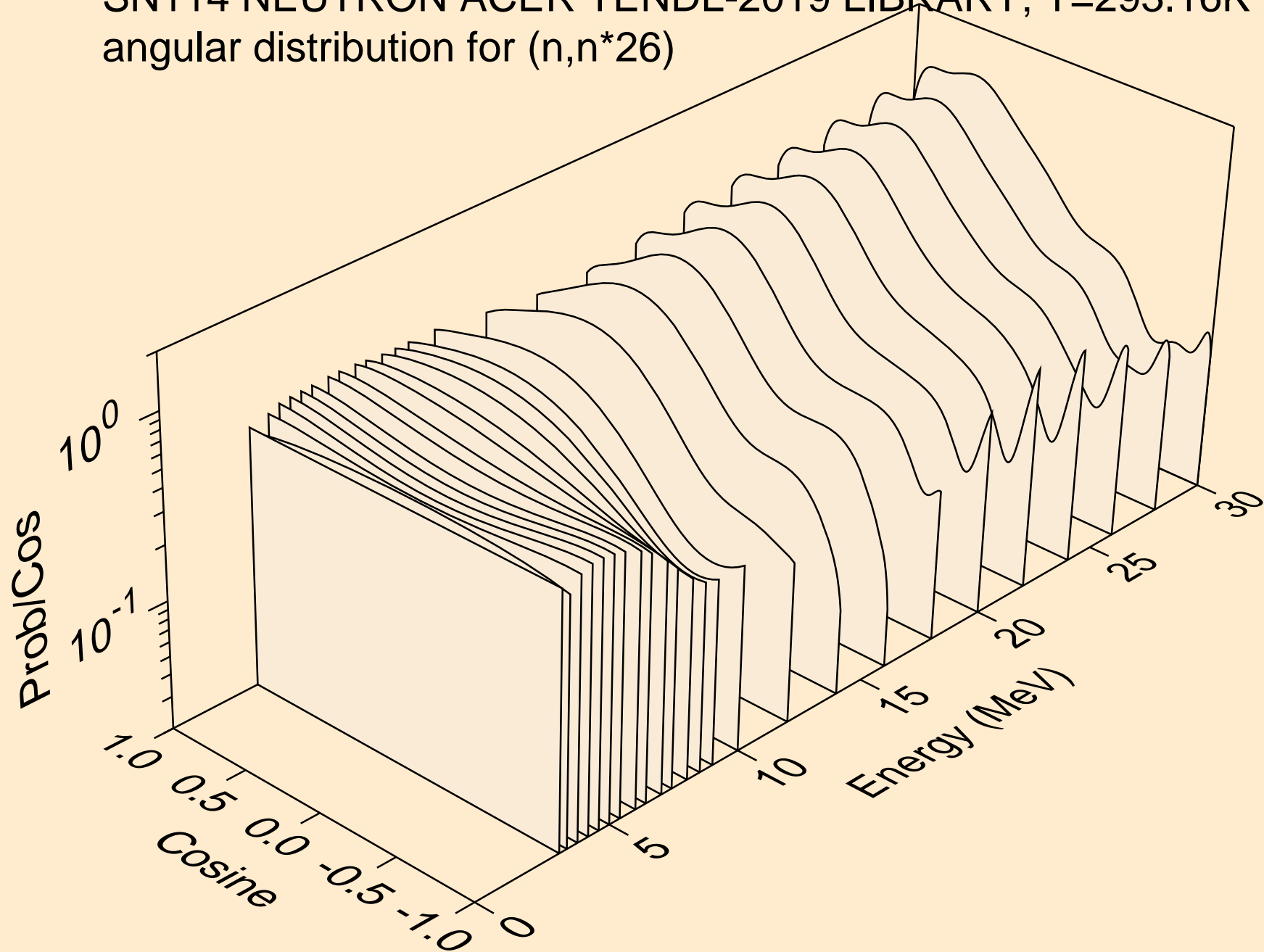

SN114 NEUTRON ACER TENDL-2019 LIBRARY; T=293.16K  
angular distribution for (n,n\*27)

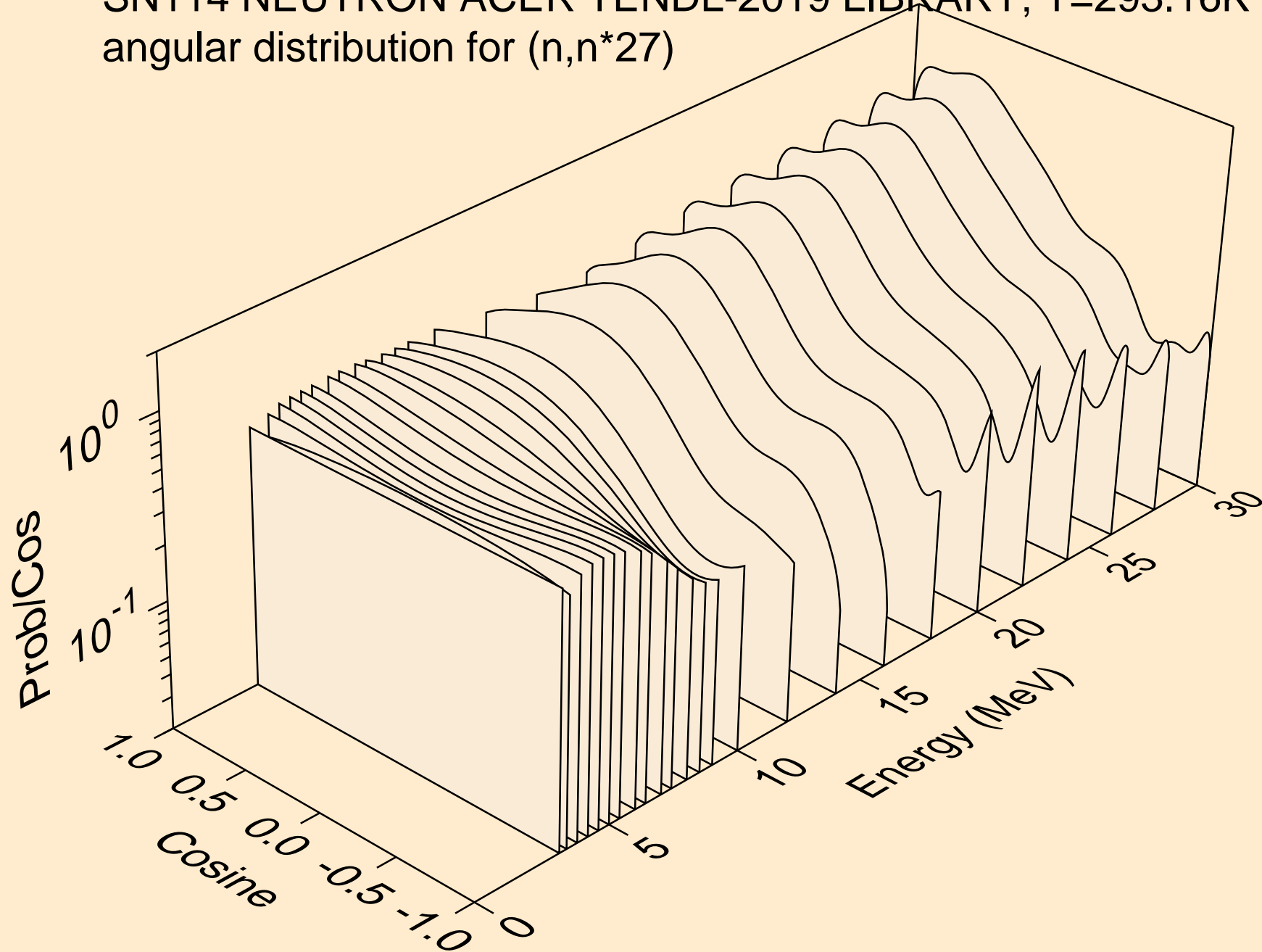



SN114 NEUTRON ACER TENDL-2019 LIBRARY; T=293.16K  
angular distribution for (n,n\*28)

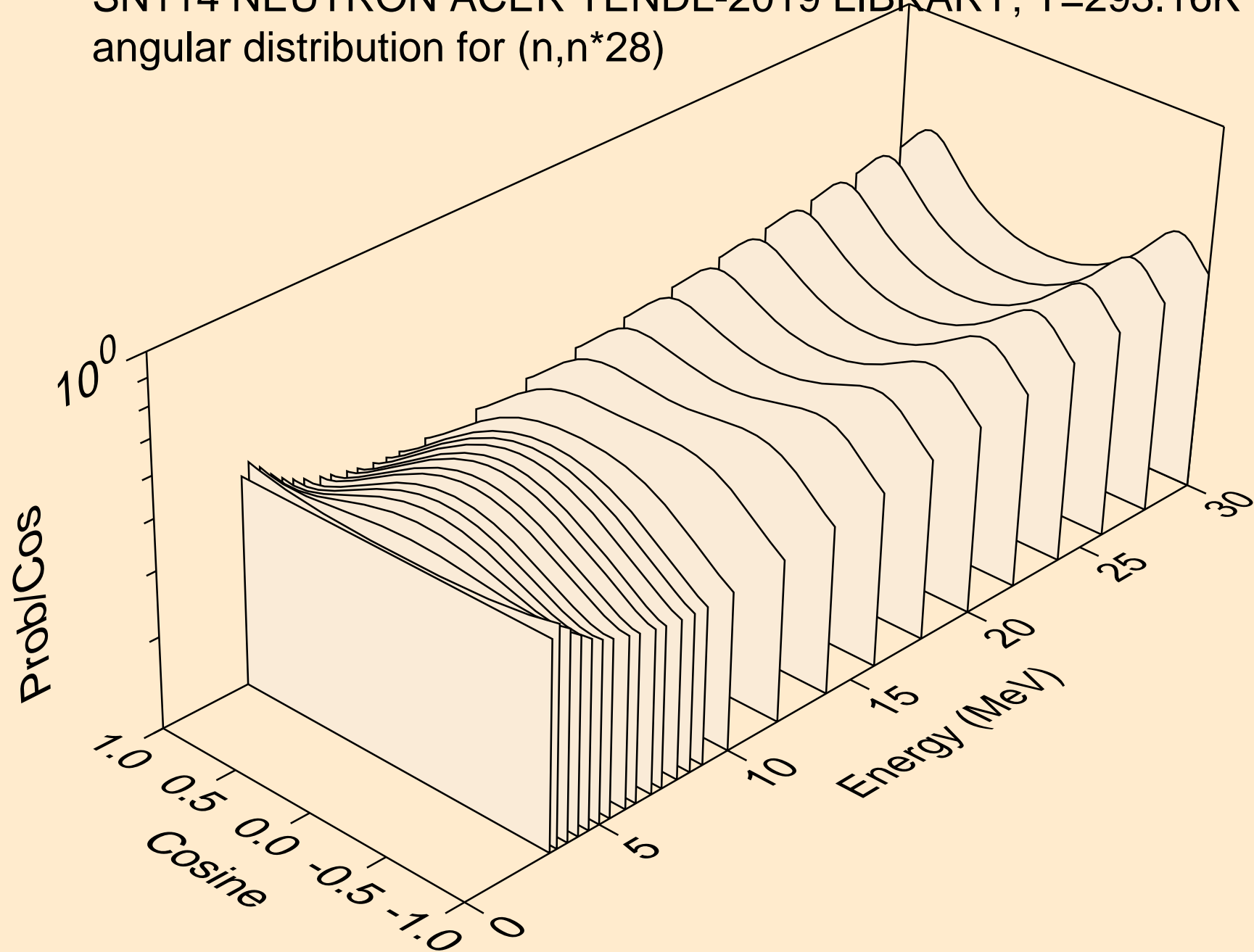

SN114 NEUTRON ACER TENDL-2019 LIBRARY; T=293.16K  
angular distribution for (n,n\*29)

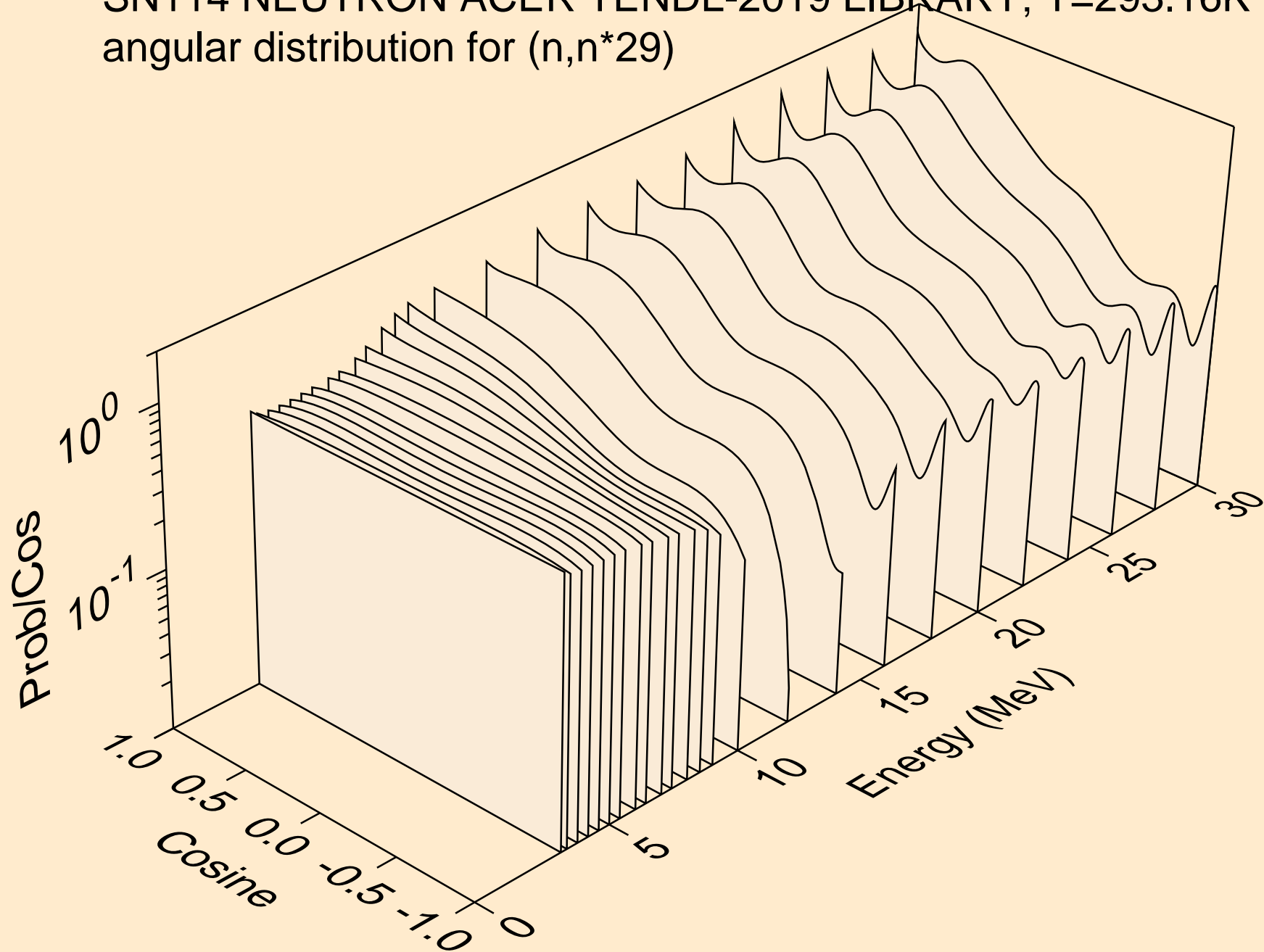

SN114 NEUTRON ACER TENDL-2019 LIBRARY; T=293.16K  
angular distribution for (n,n\*30)

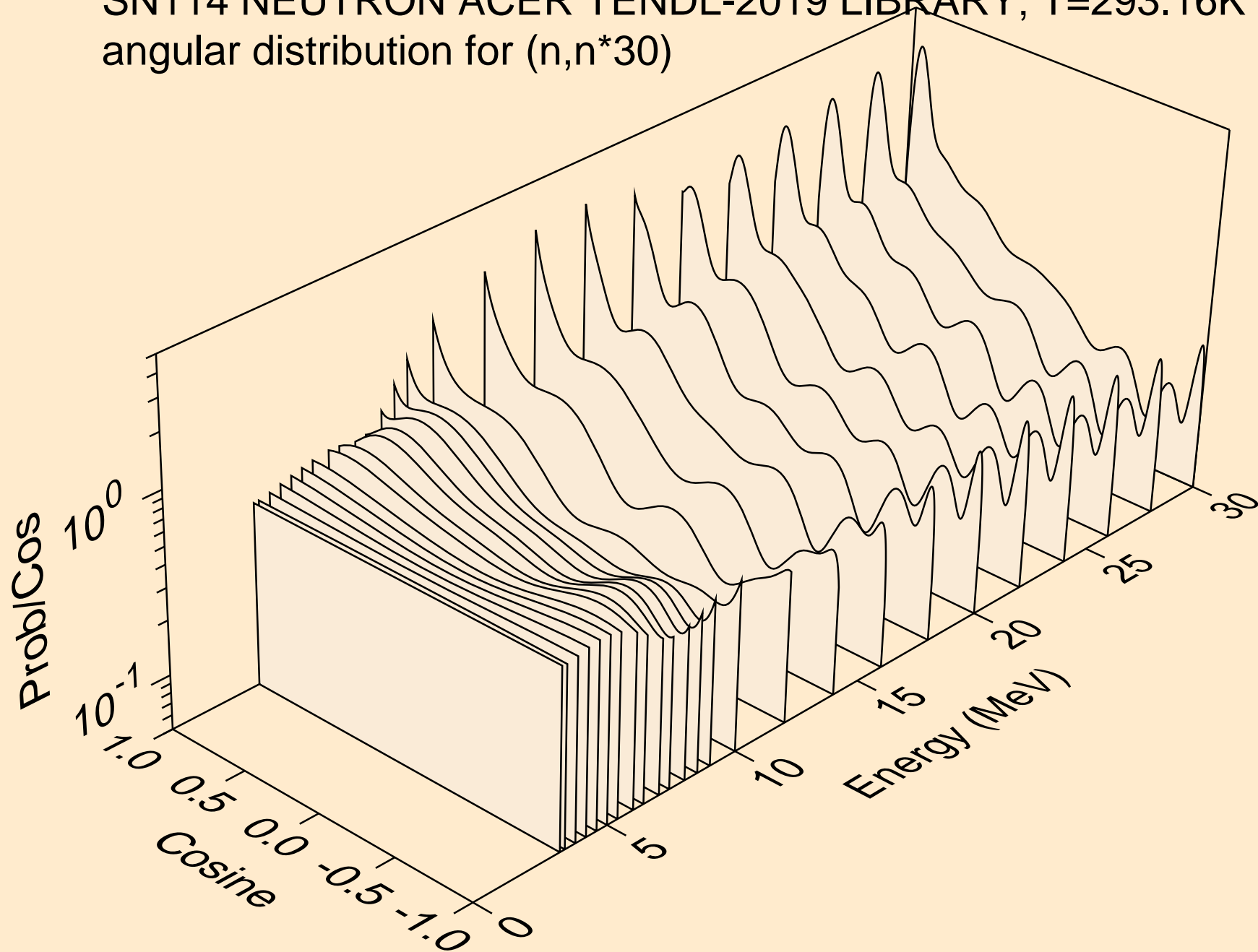

SN114 NEUTRON ACER TENDL-2019 LIBRARY; T=293.16K  
Neutron emission for (n,x)

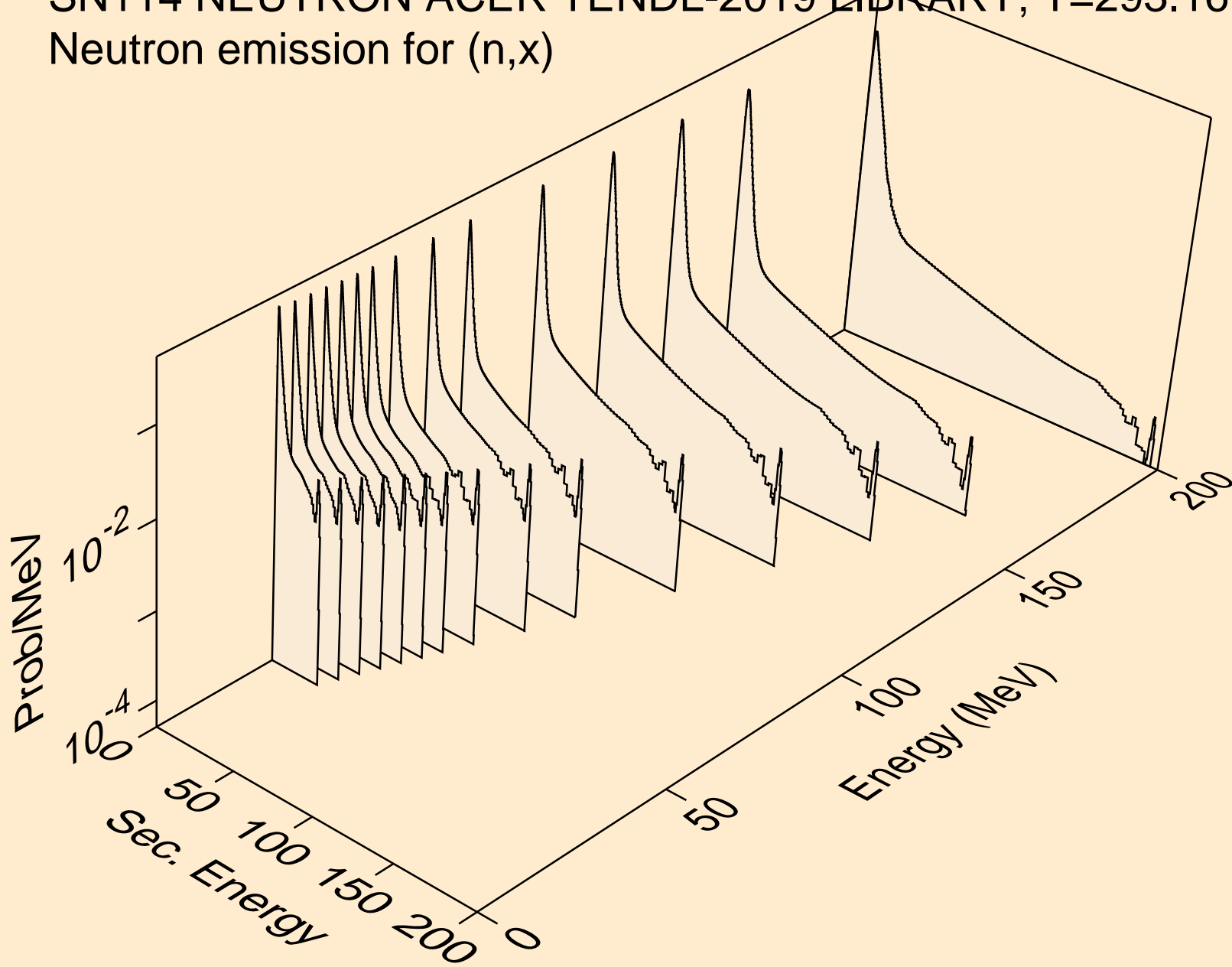

SN114 NEUTRON ACER TENDL-2019 LIBRARY; T=293.16K  
Neutron emission for (n,2nd)

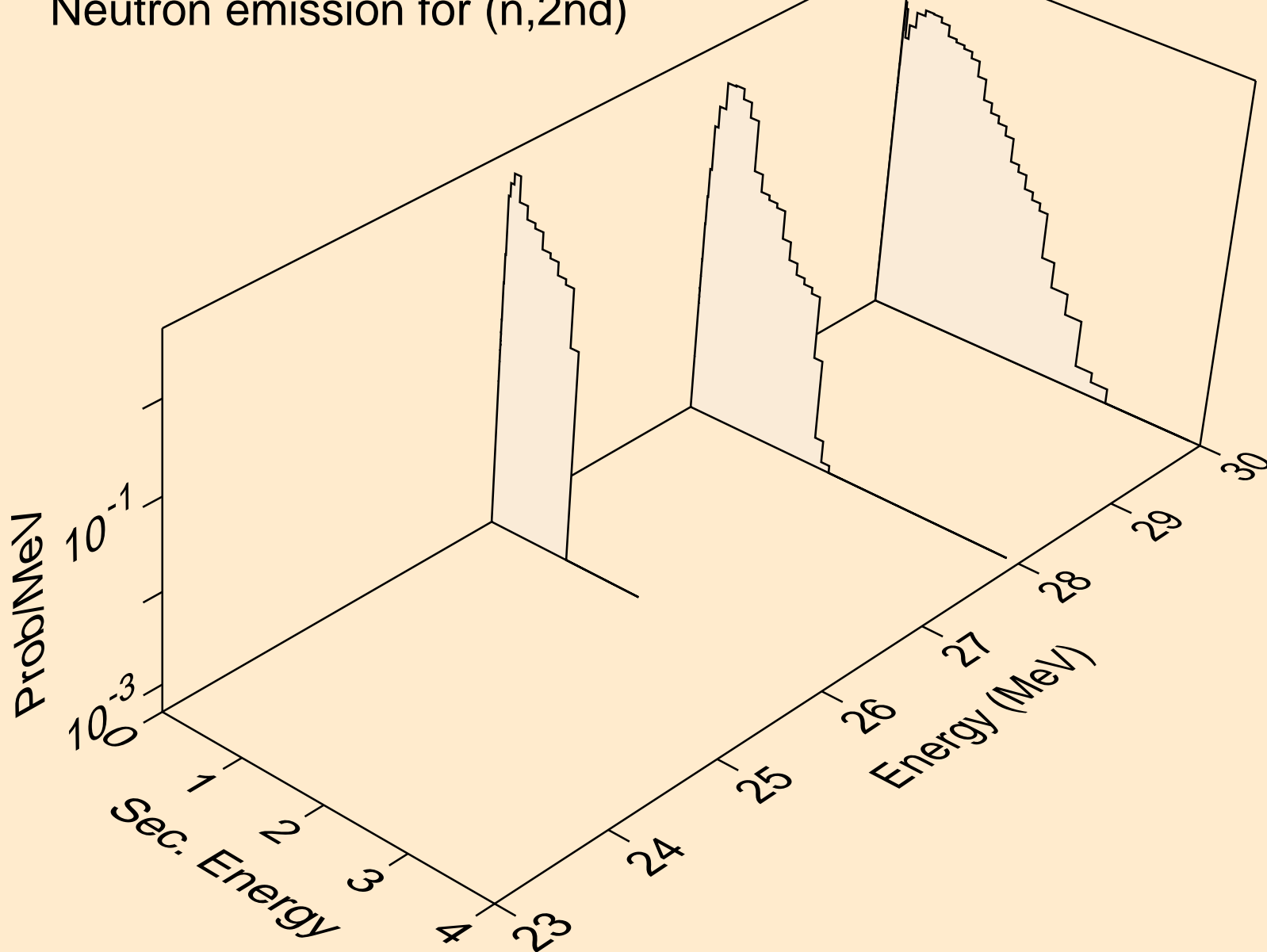

SN114 NEUTRON ACER TENDL-2019 LIBRARY; T=293.16K  
Neutron emission for (n,2n)

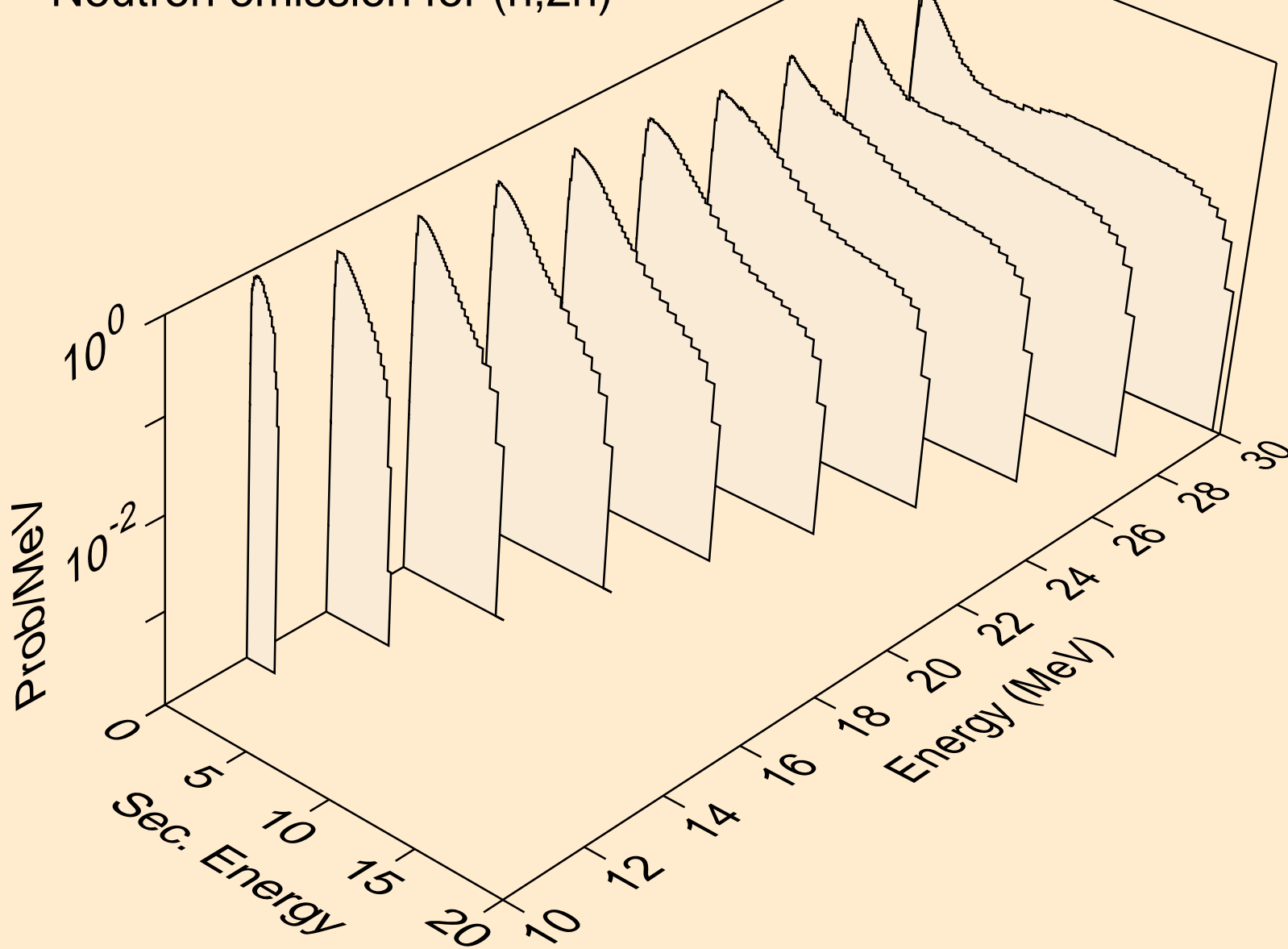

SN114 NEUTRON ACER TENDL-2019 LIBRARY; T=293.16K  
Neutron emission for (n,3n)

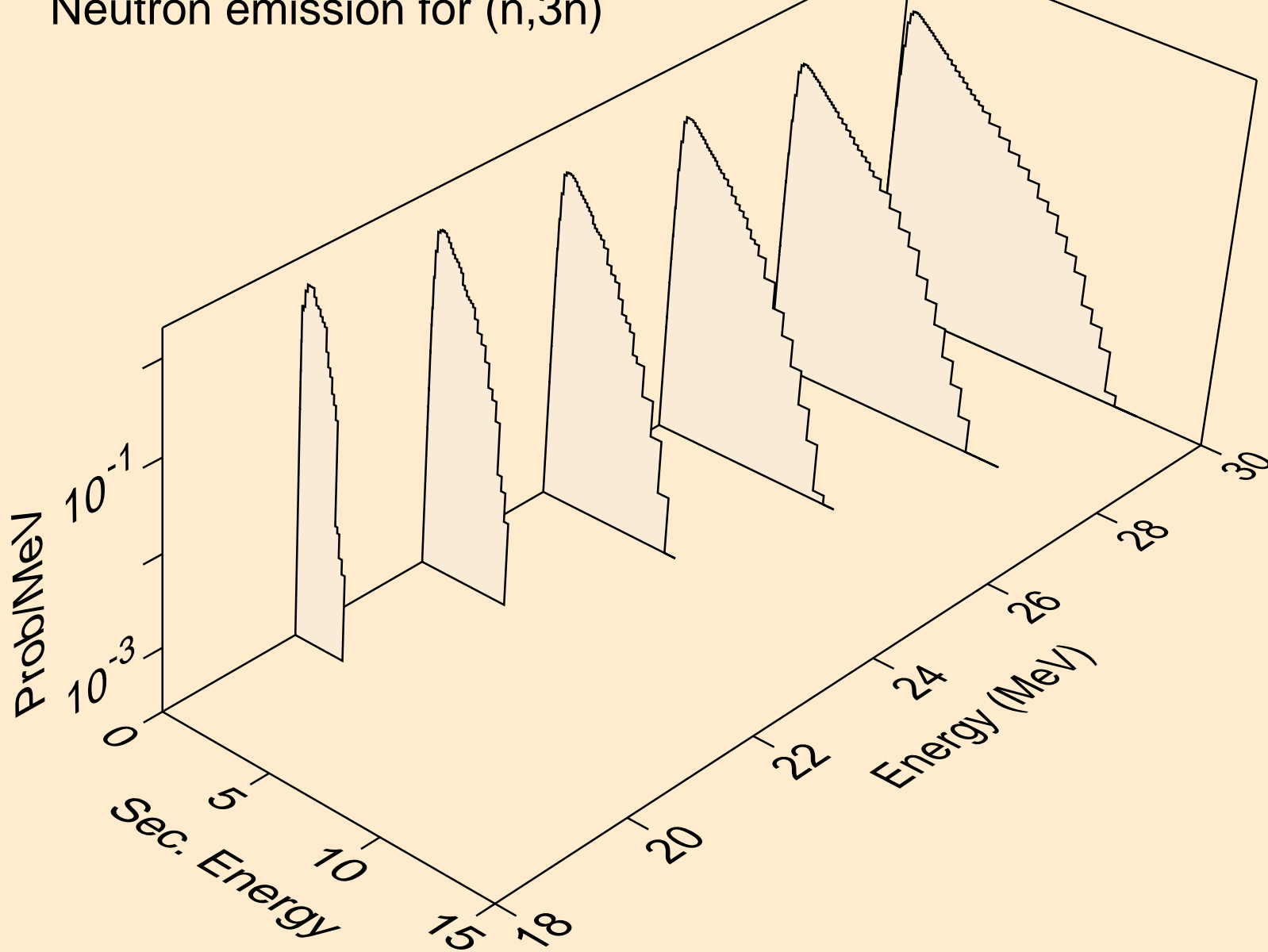

SN114 NEUTRON ACER TENDL-2019 LIBRARY; T=293.16K  
Neutron emission for (n,n\*)a

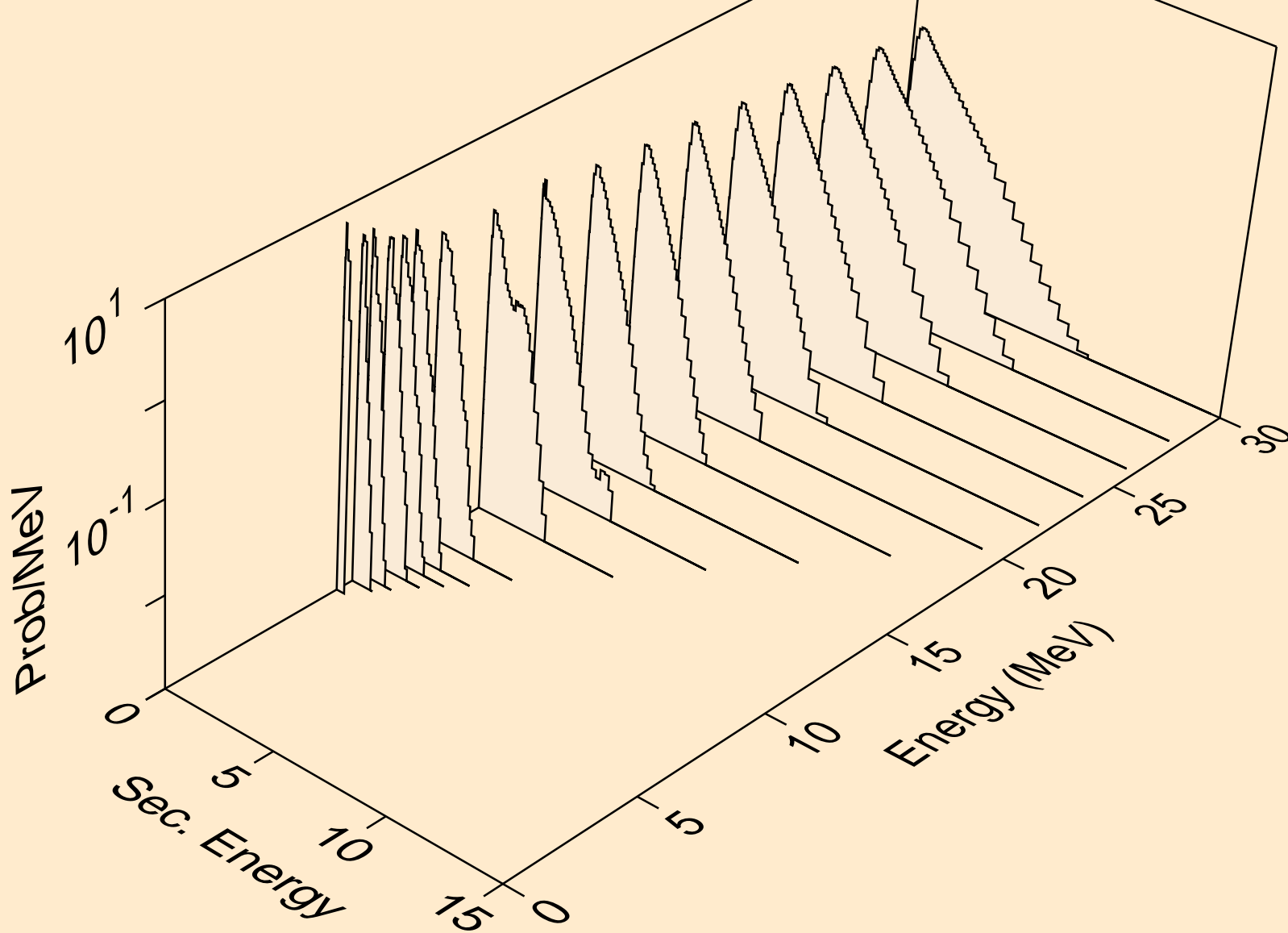



SN114 NEUTRON ACER TENDL-2019 LIBRARY; T=293.16K  
Neutron emission for (n,2n)a

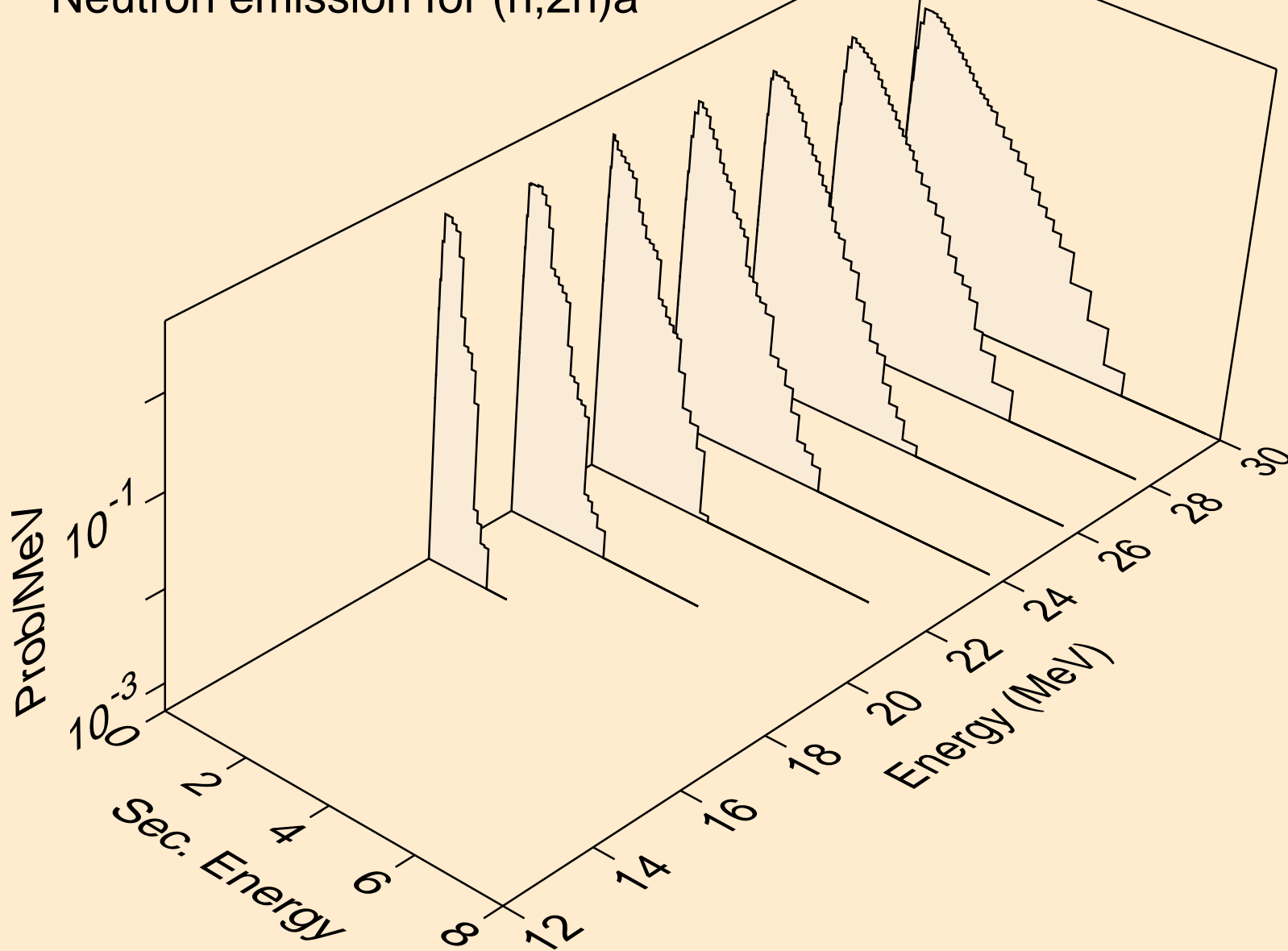

SN114 NEUTRON ACER TENDL-2019 LIBRARY; T=293.16K  
Neutron emission for (n,3n)a

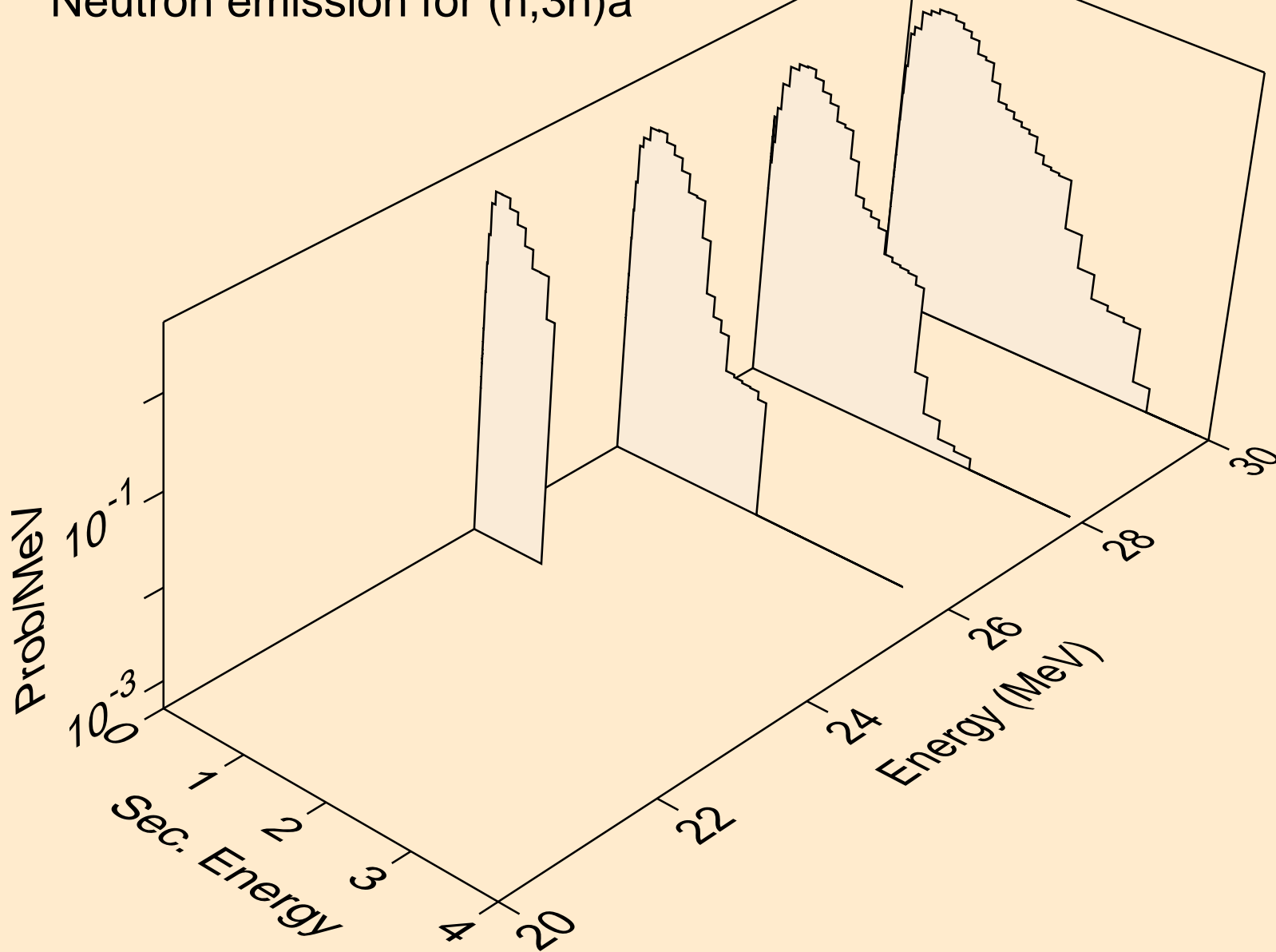

SN114 NEUTRON ACER TENDL-2019 LIBRARY; T=293.16K  
Neutron emission for (n,n\*)p

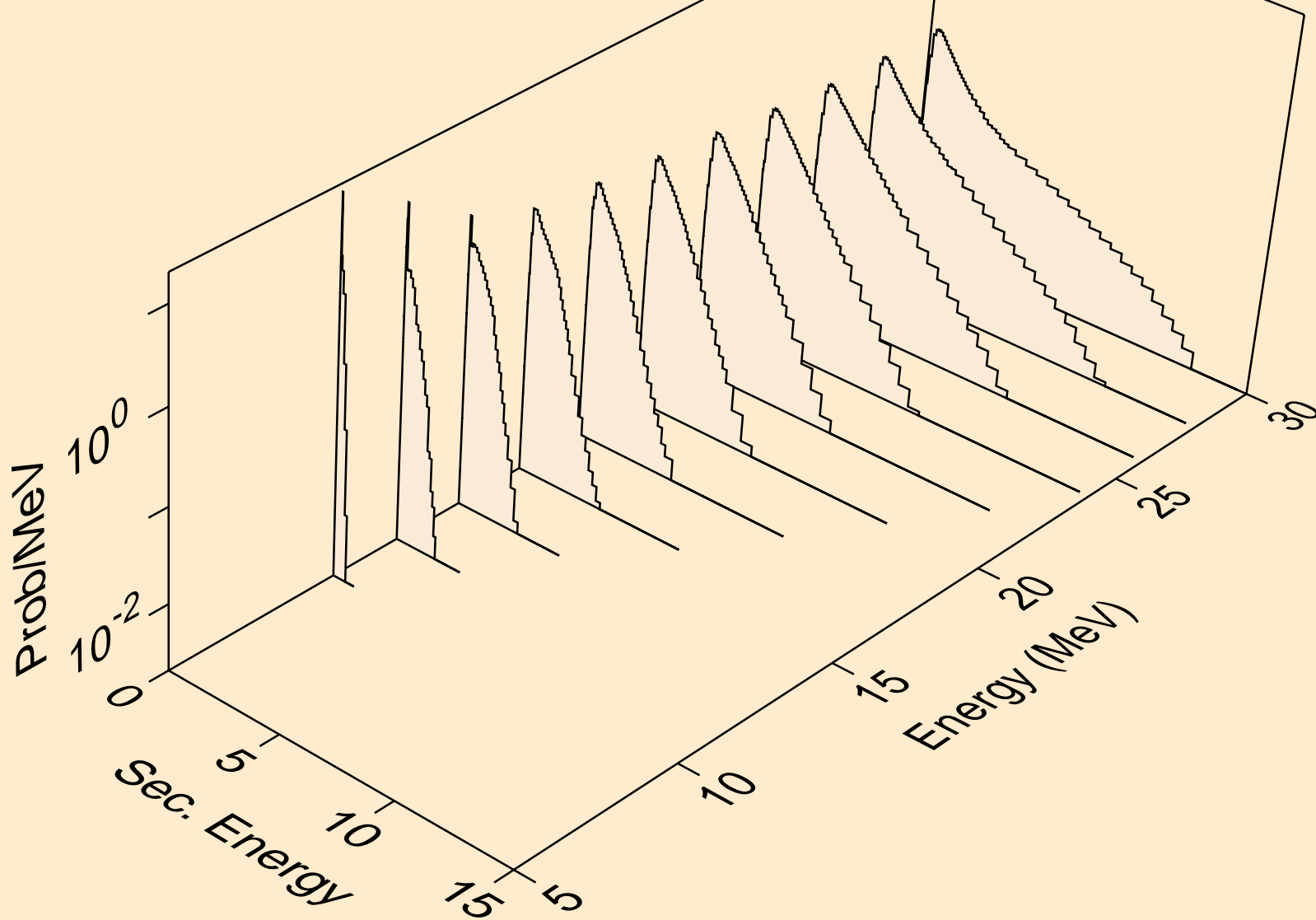

SN114 NEUTRON ACER TENDL-2019 LIBRARY; T=293.16K  
Neutron emission for (n,n\*)2a

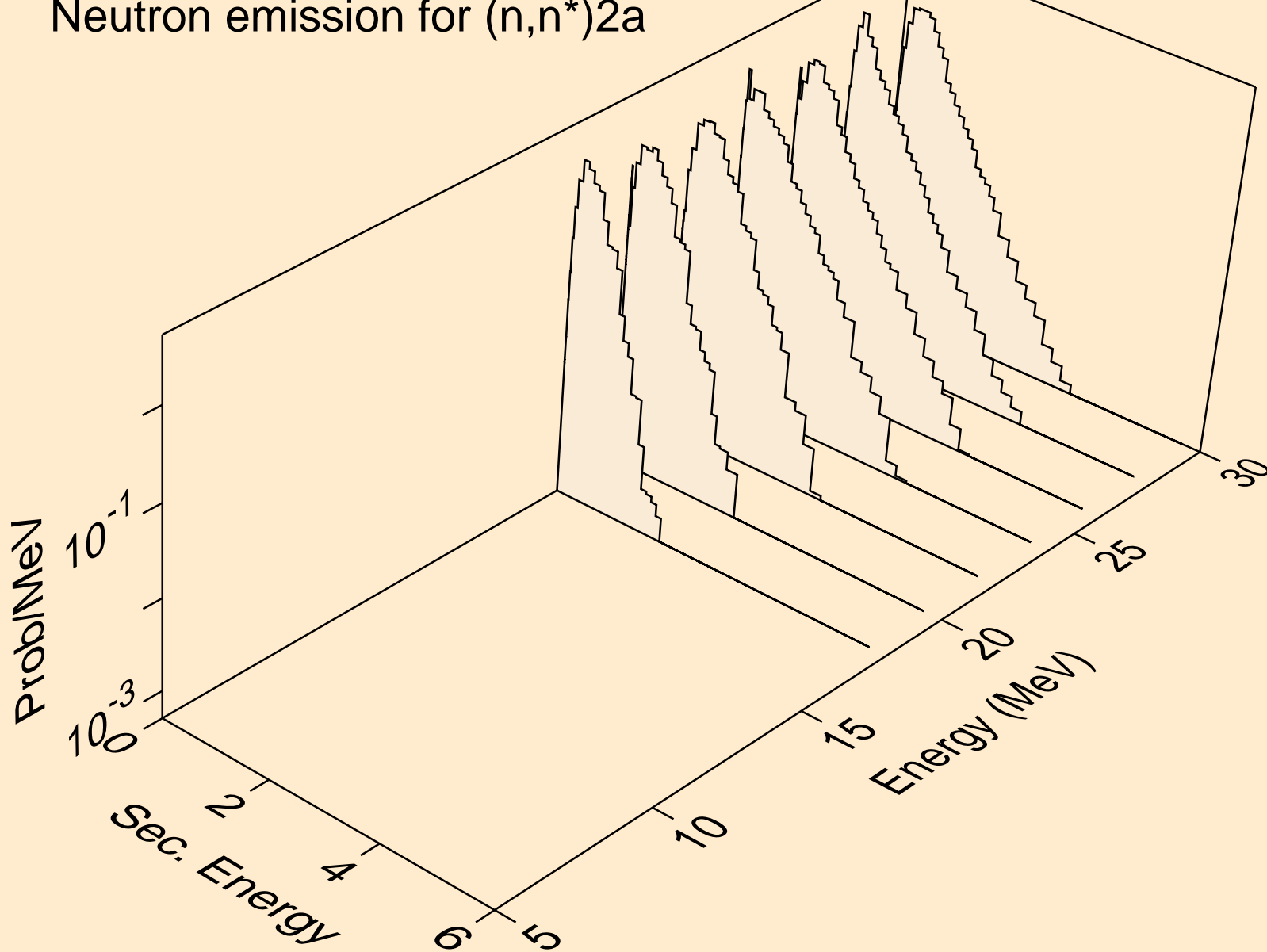

SN114 NEUTRON ACER TENDL-2019 LIBRARY; T=293.16K  
Neutron emission for (n,n\*)d

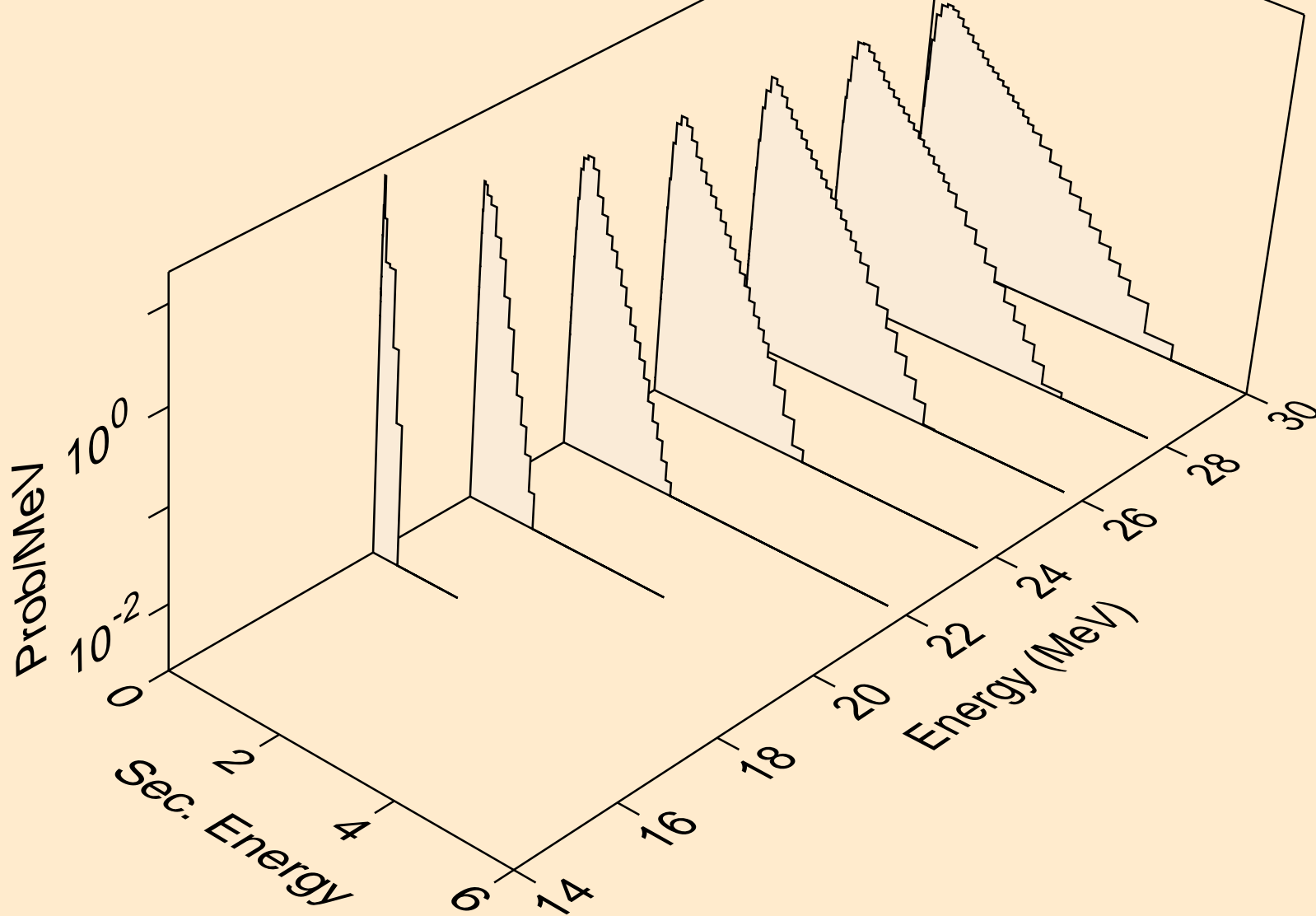

SN114 NEUTRON ACER TENDL-2019 LIBRARY; T=293.16K  
Neutron emission for (n,n\*)t

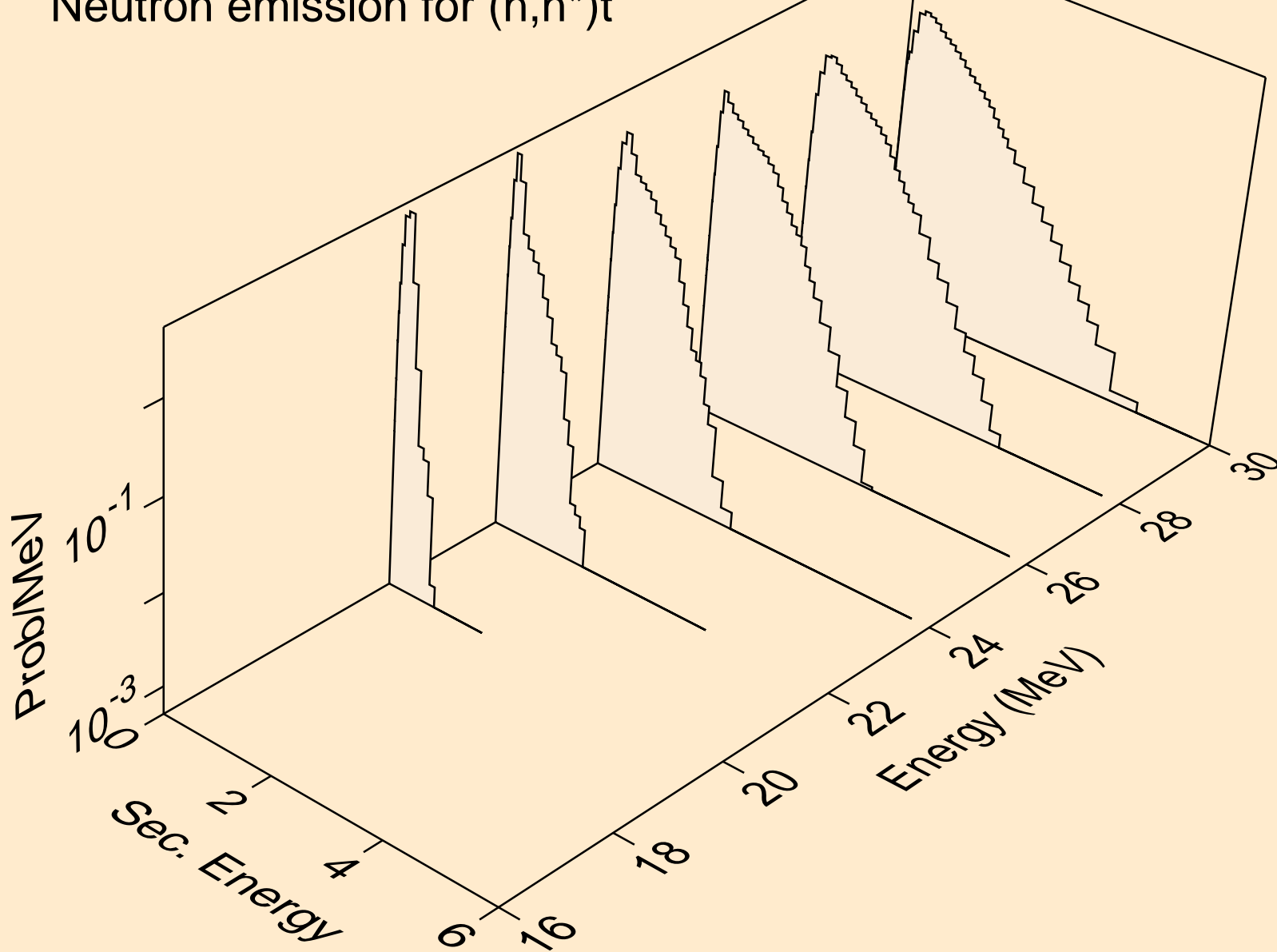

SN114 NEUTRON ACER TENDL-2019 LIBRARY; T=293.16K  
Neutron emission for (n,n\*)he3

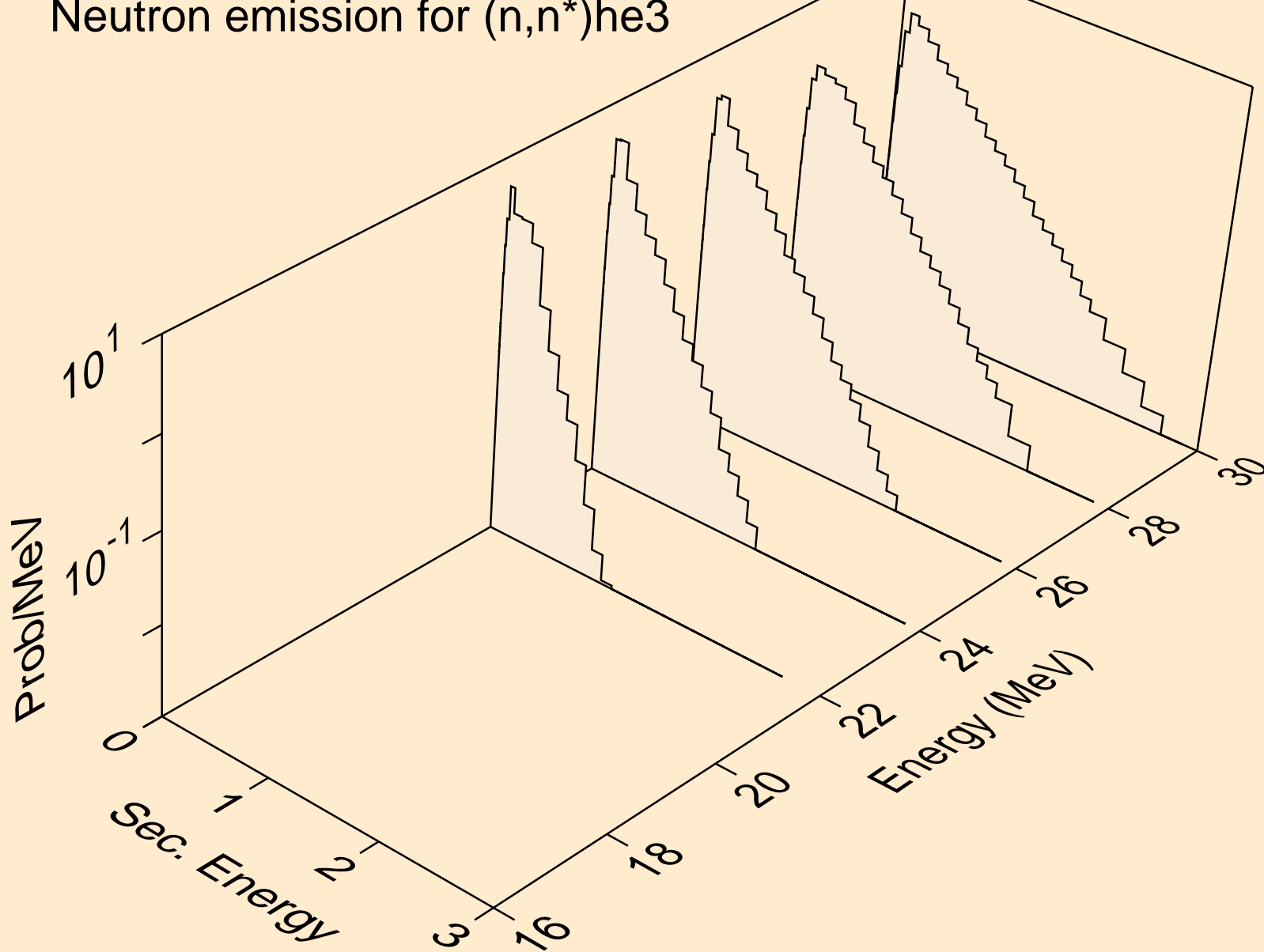

SN114 NEUTRON ACER TENDL-2019 LIBRARY; T=293.16K  
Neutron emission for (n,4n)

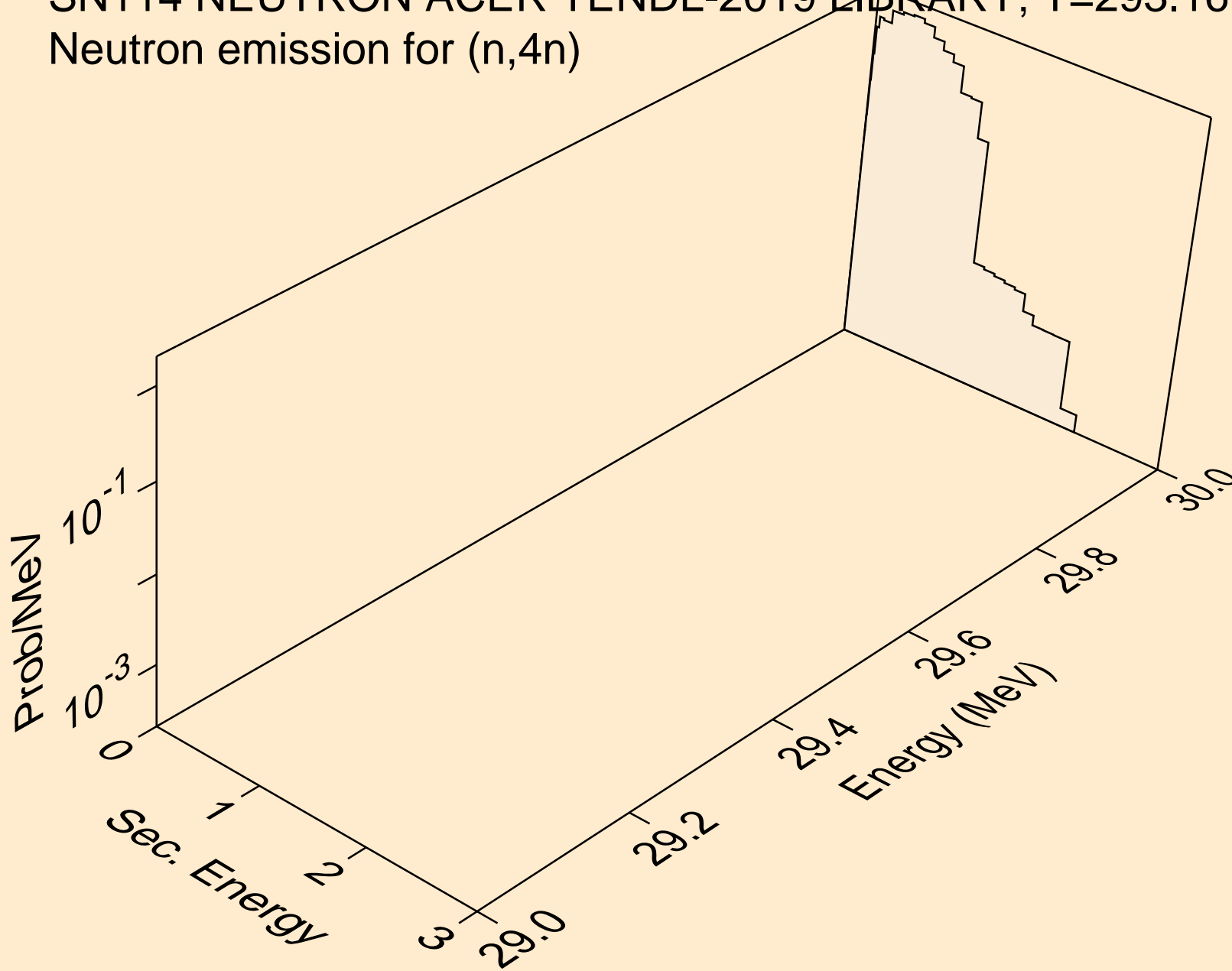



SN114 NEUTRON ACER TENDL-2019 LIBRARY; T=293.16K  
Neutron emission for (n,2np)

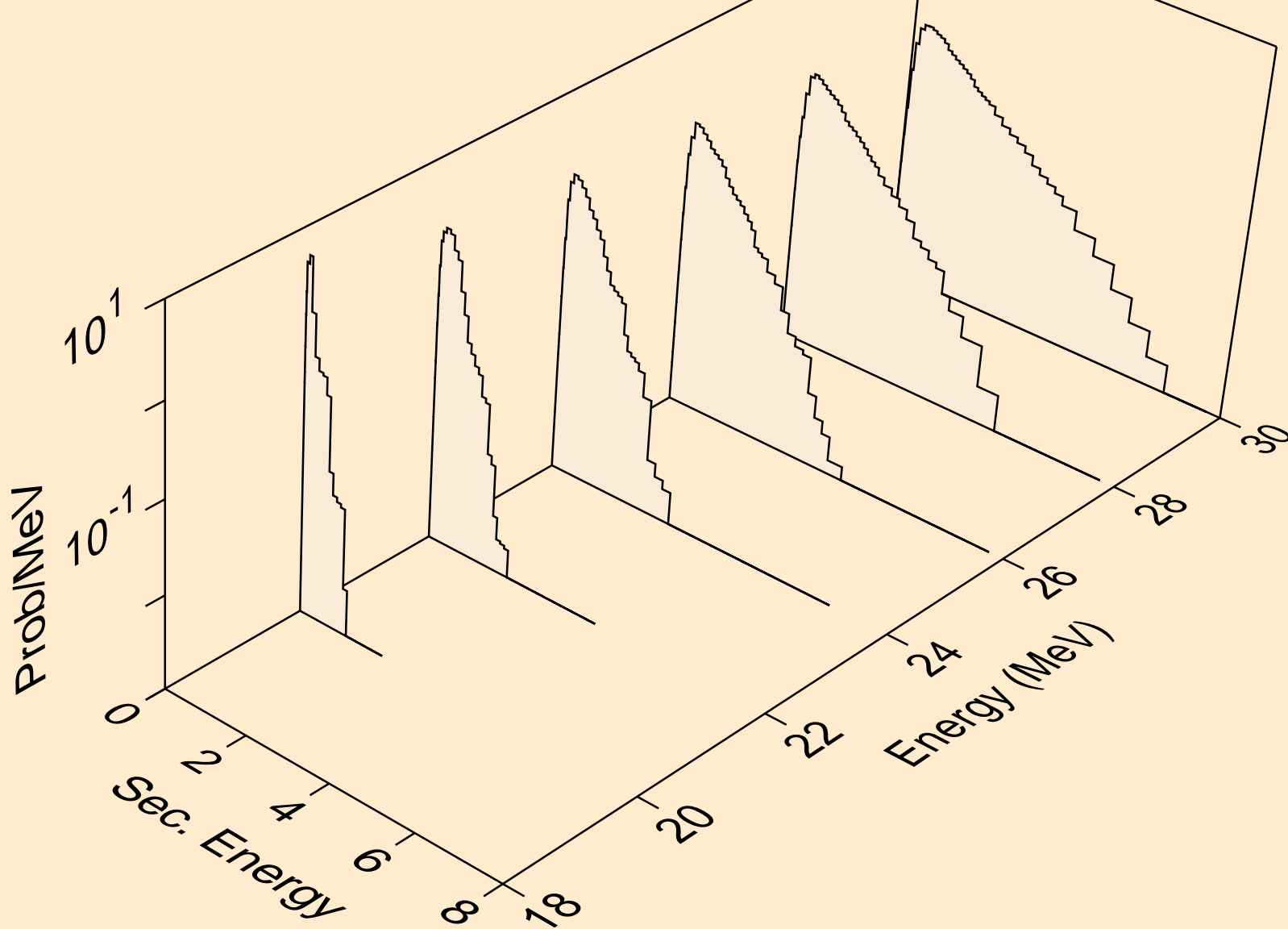

SN114 NEUTRON ACER TENDL-2019 LIBRARY; T=293.16K  
Neutron emission for (n,3np)

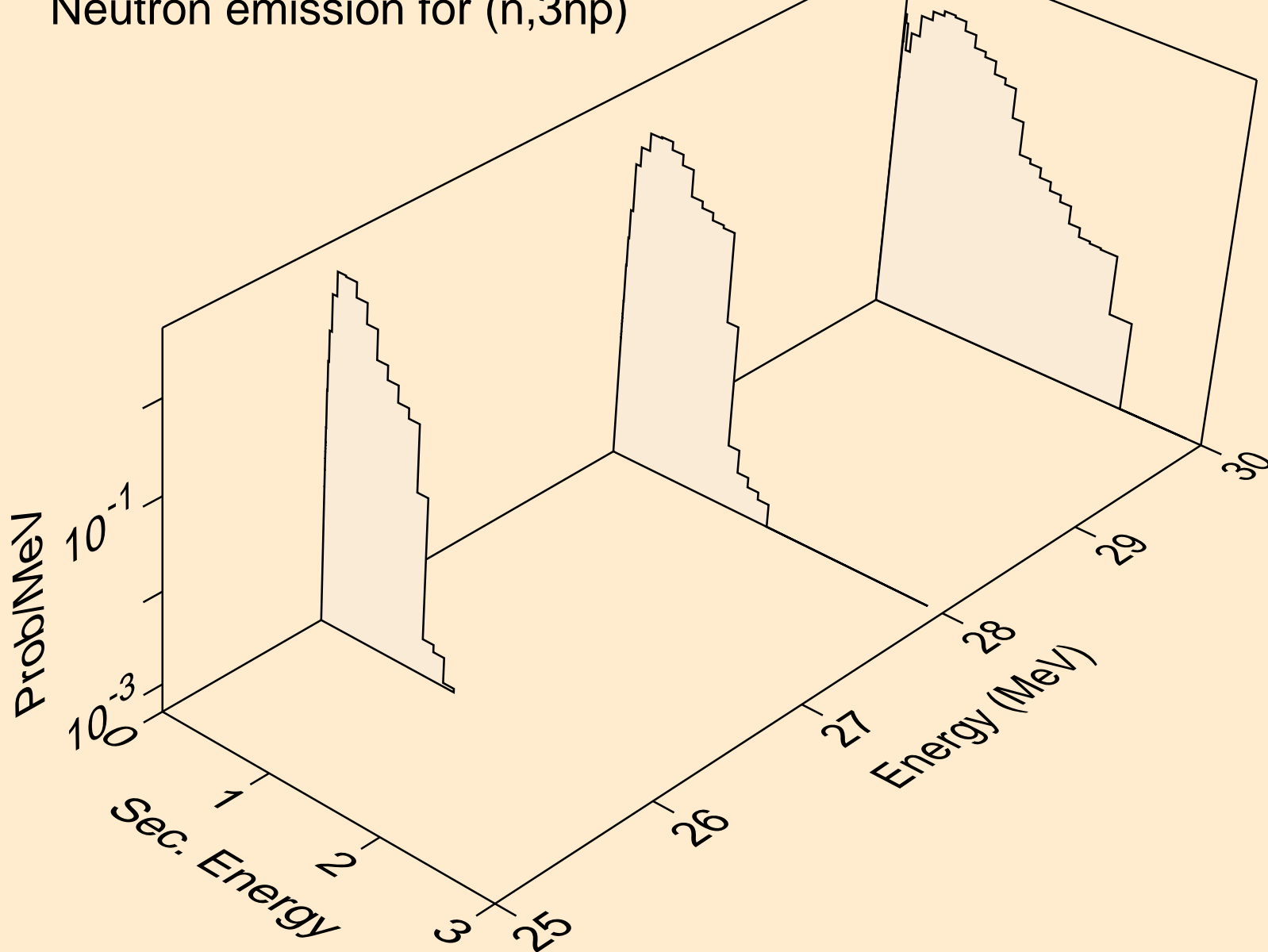

SN114 NEUTRON ACER TENDL-2019 LIBRARY; T=293.16K  
Neutron emission for (n,2np)

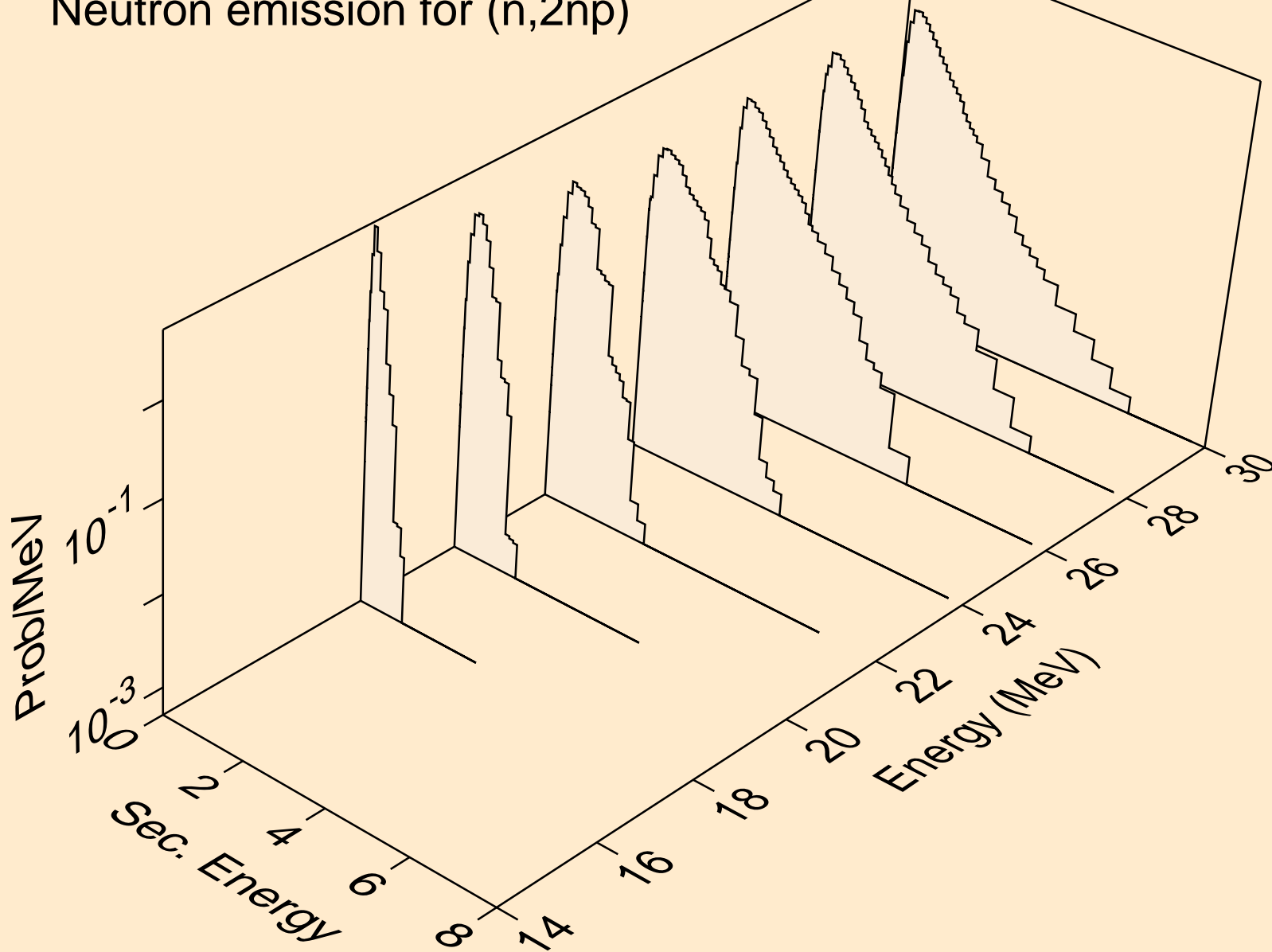

SN114 NEUTRON ACER TENDL-2019 LIBRARY; T=293.16K  
Neutron emission for (n,npa)

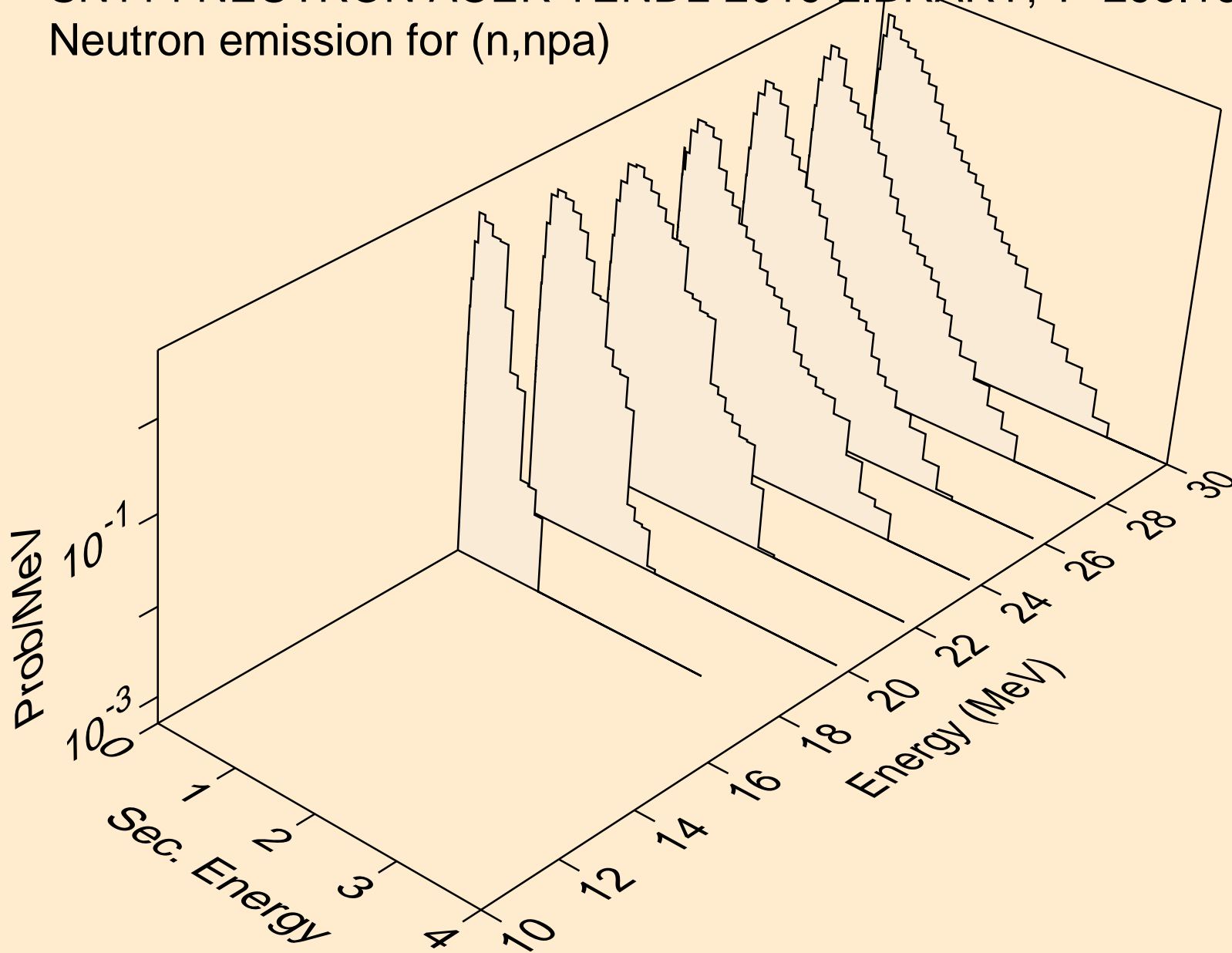

SN114 NEUTRON ACER TENDL-2019 LIBRARY; T=293.16K  
Neutron emission for (n,n\*c)

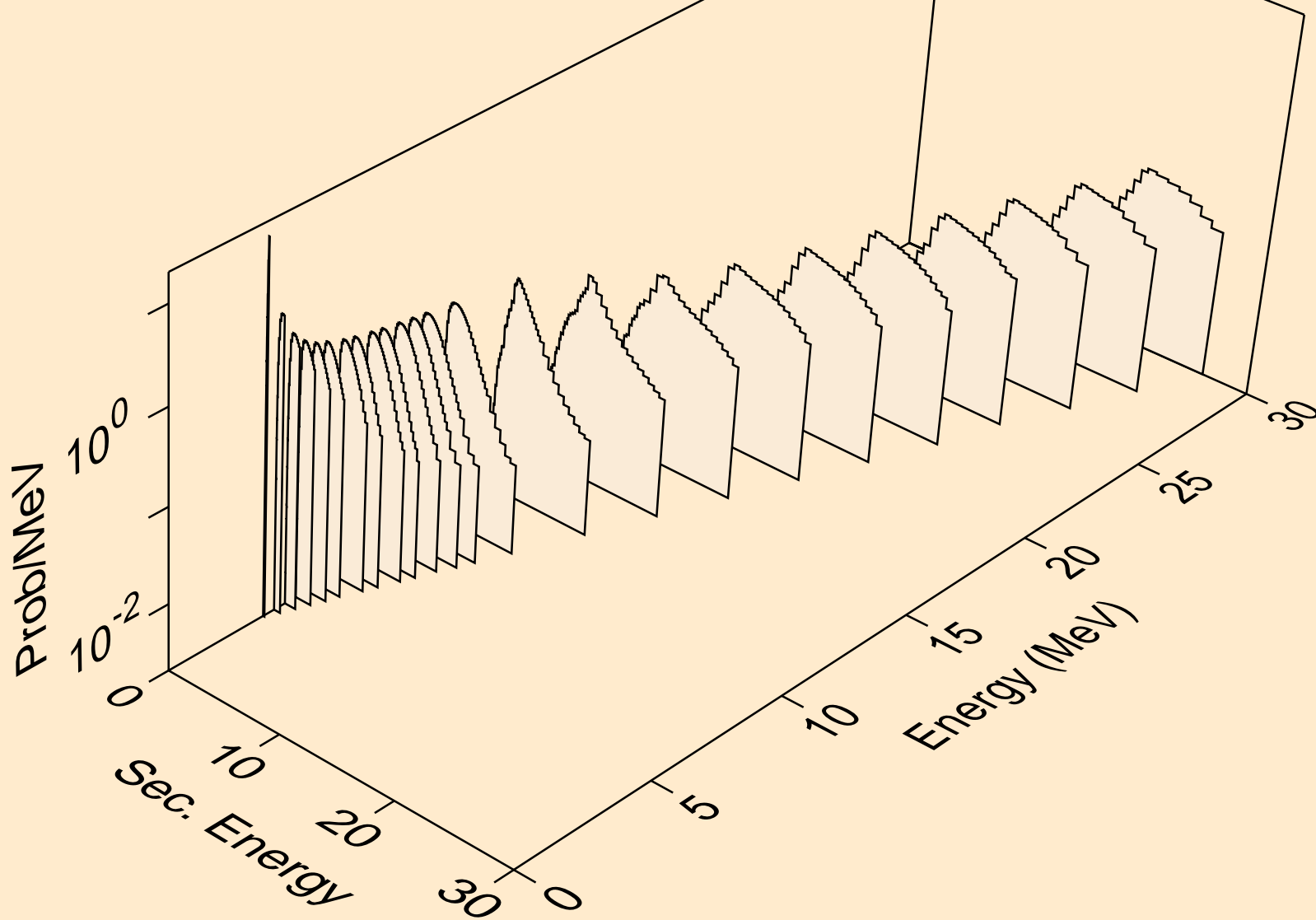

SN114 NEUTRON ACER TENDL-2019 LIBRARY; T=293.16K  
Photon emission for (n,x)

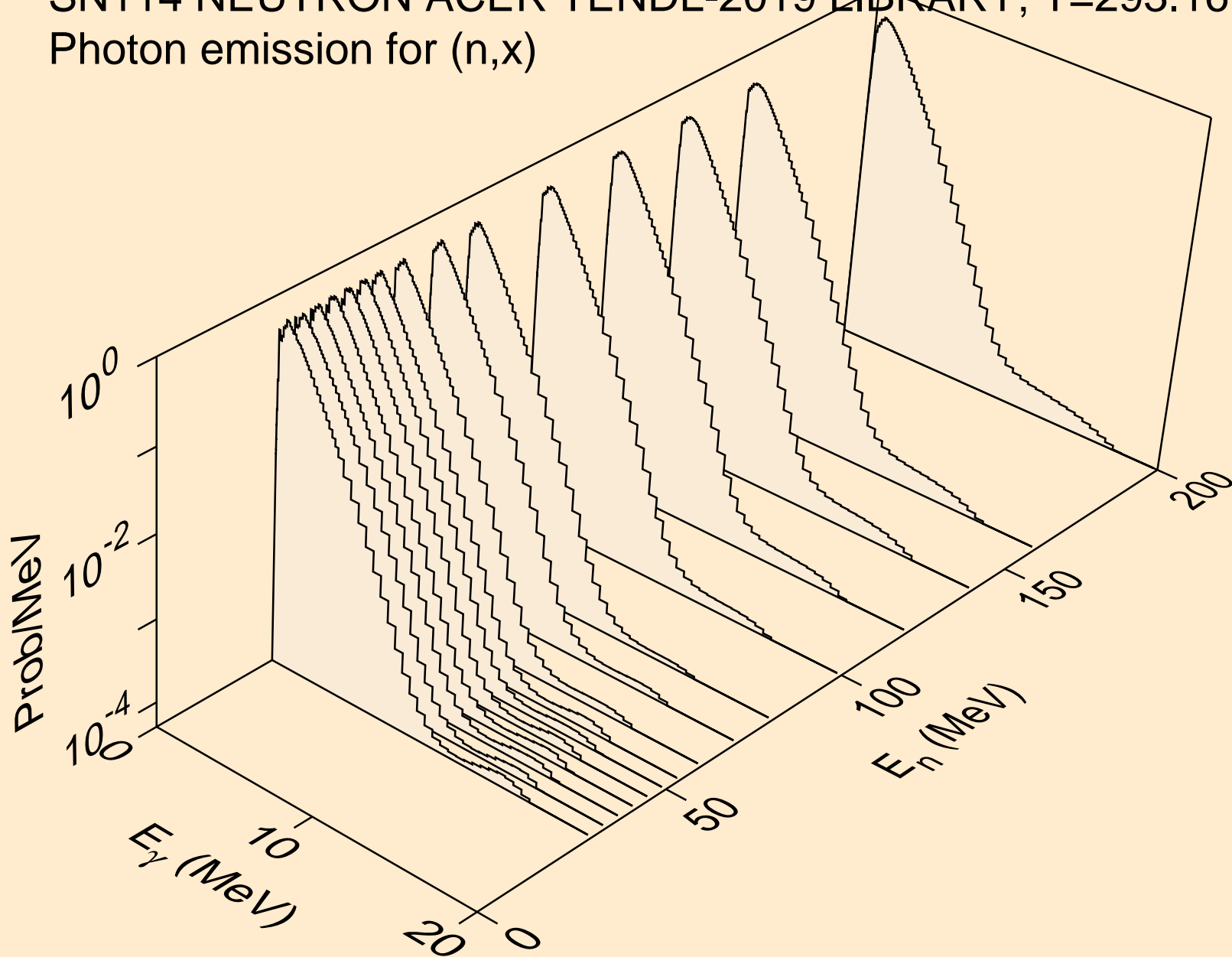

SN114 NEUTRON ACER TENDL-2019 LIBRARY; T=293.16K  
Photon emission for (n,2nd)

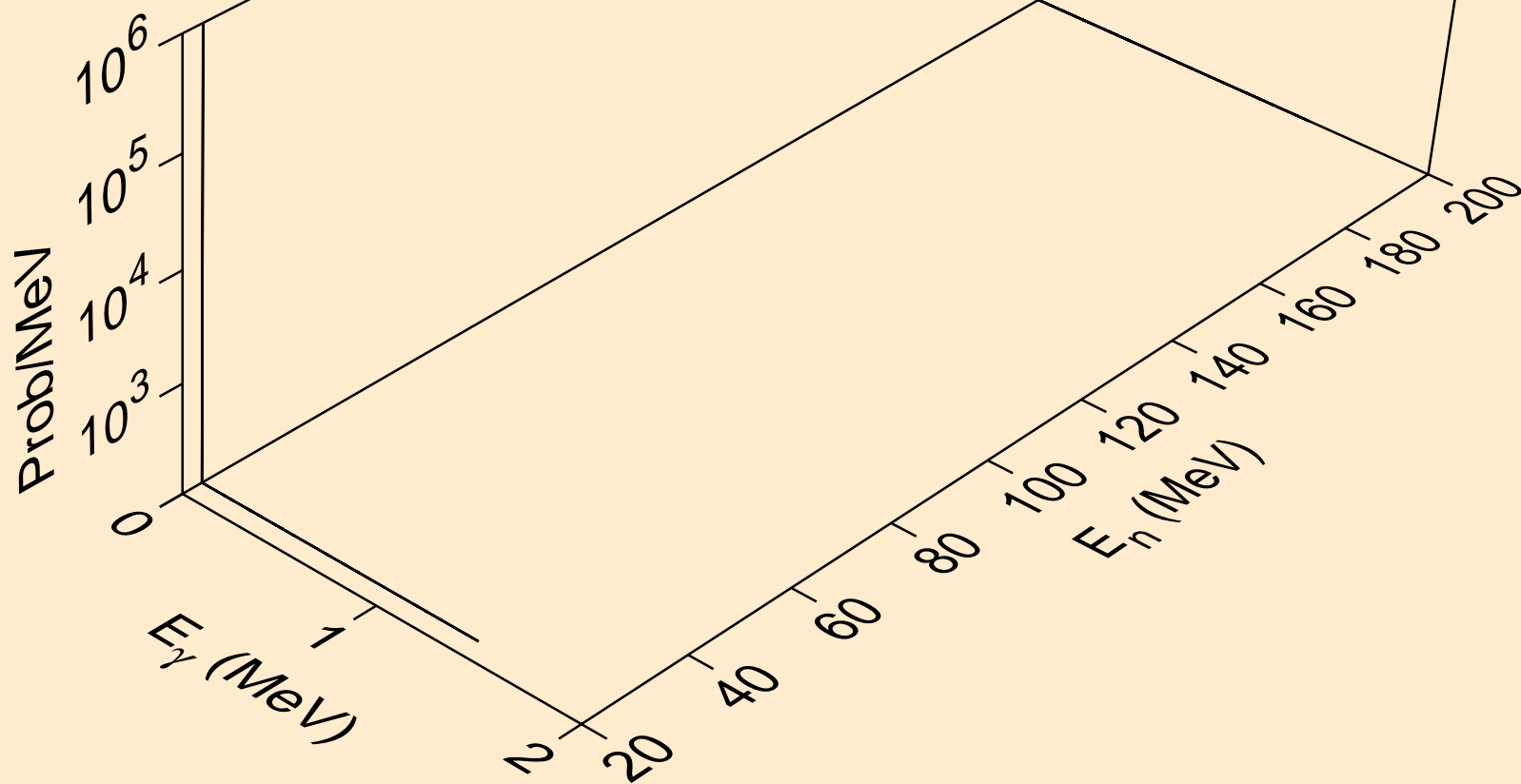

SN114 NEUTRON ACER TENDL-2019 LIBRARY; T=293.16K  
Photon emission for (n,2n)

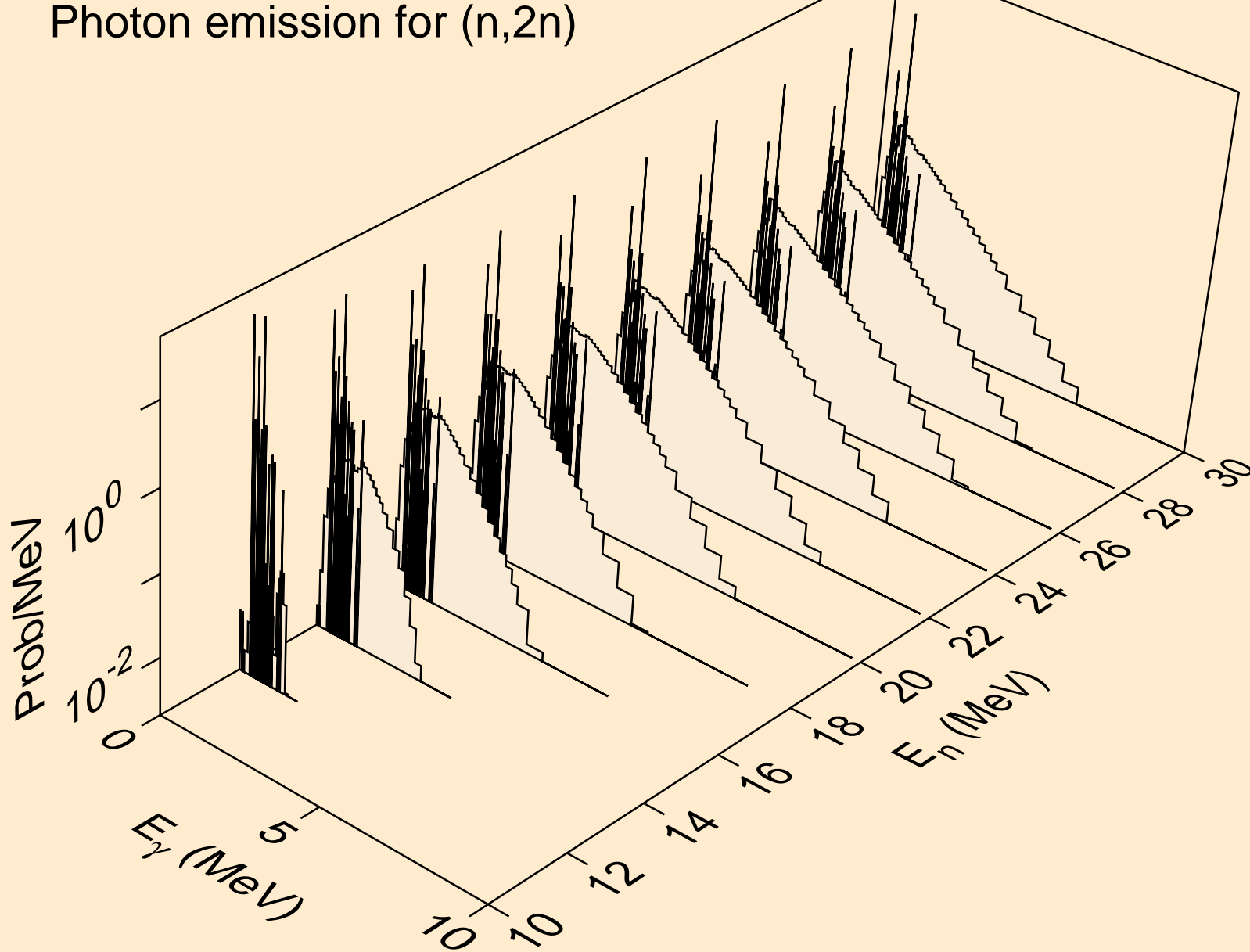



SN114 NEUTRON ACER TENDL-2019 LIBRARY; T=293.16K  
Photon emission for (n,3n)

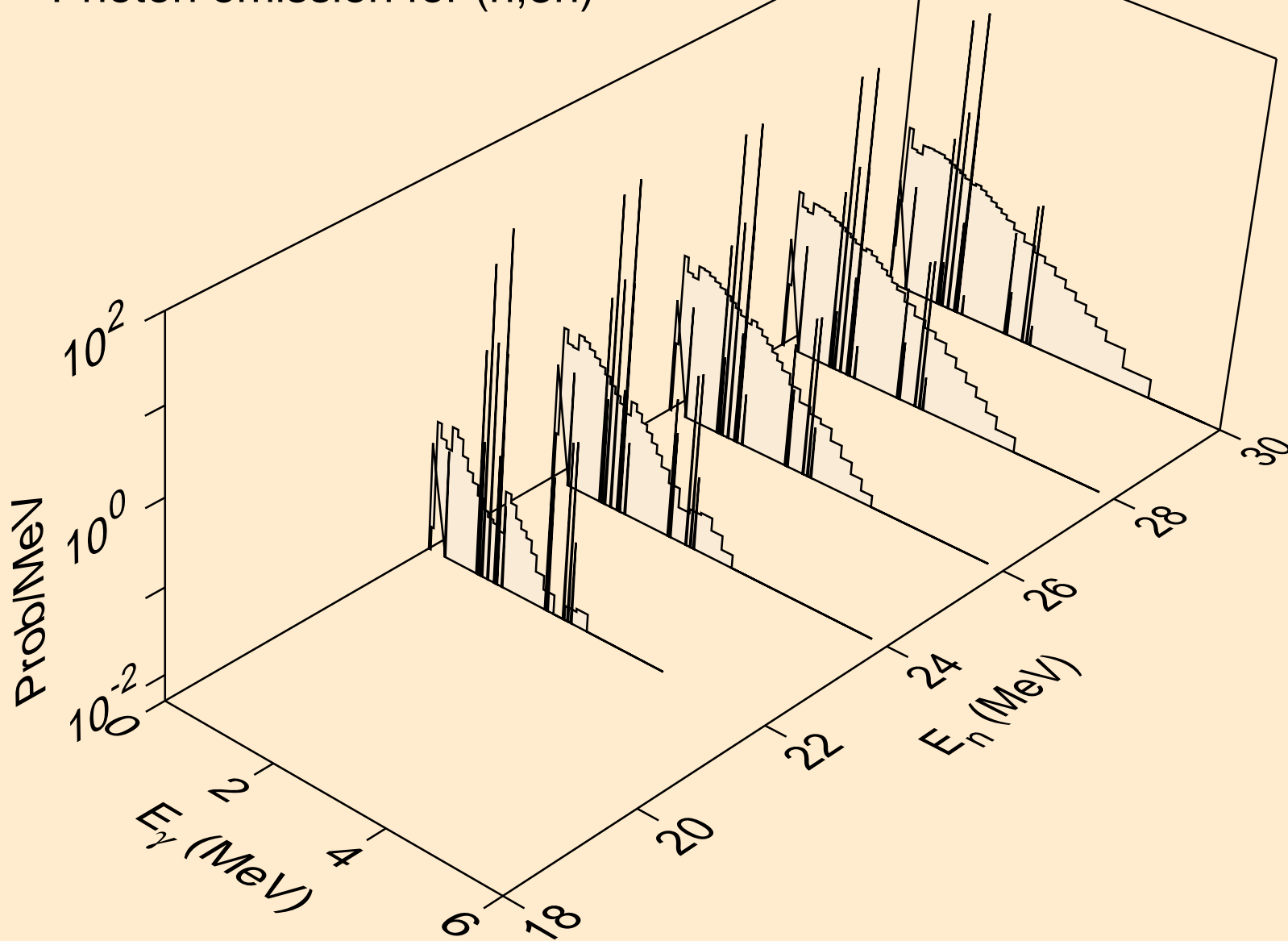

SN114 NEUTRON ACER TENDL-2019 LIBRARY; T=293.16K  
Photon emission for (n,n\*)a

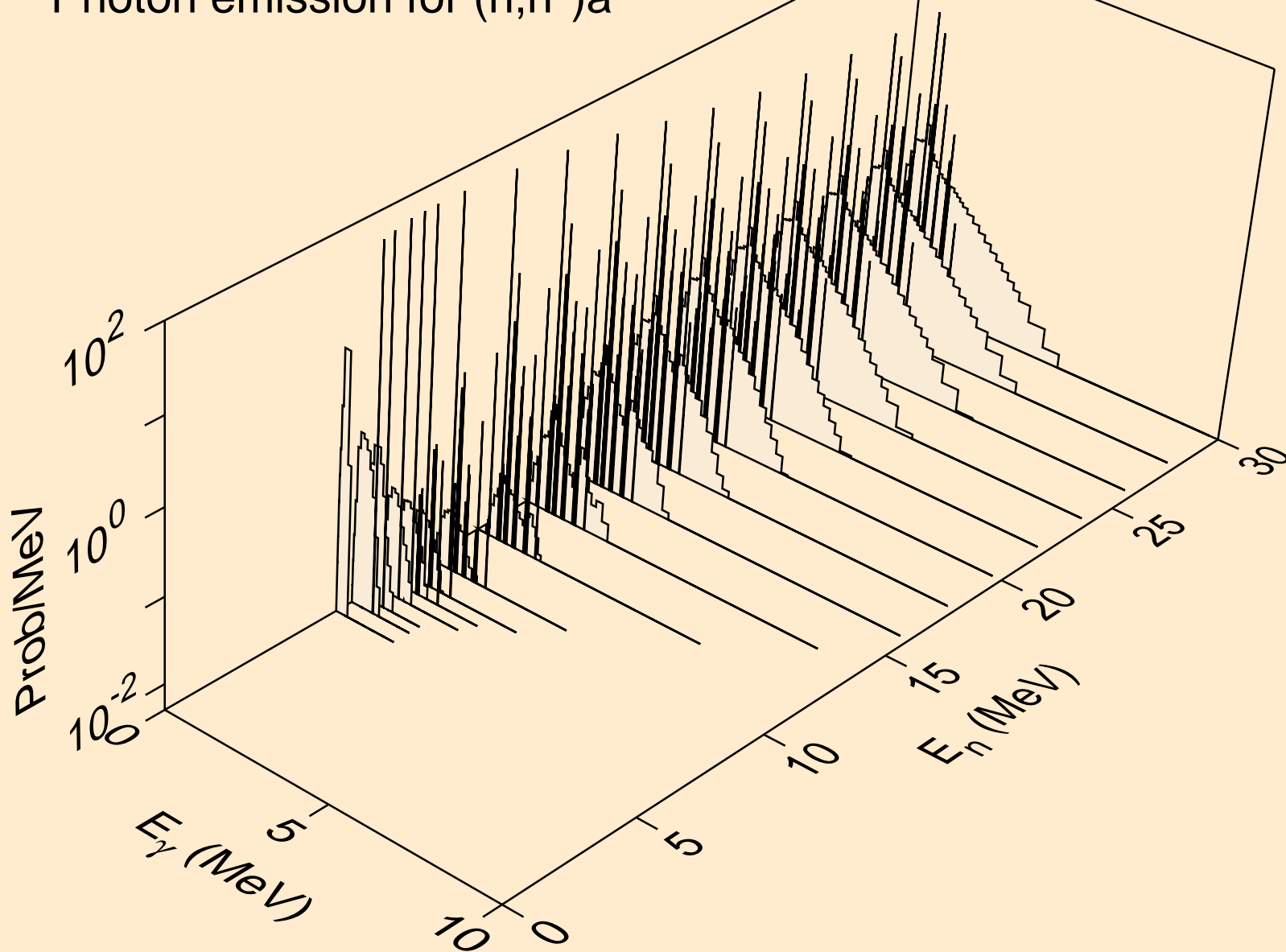

SN114 NEUTRON ACER TENDL-2019 LIBRARY; T=293.16K  
Photon emission for (n,2n)a

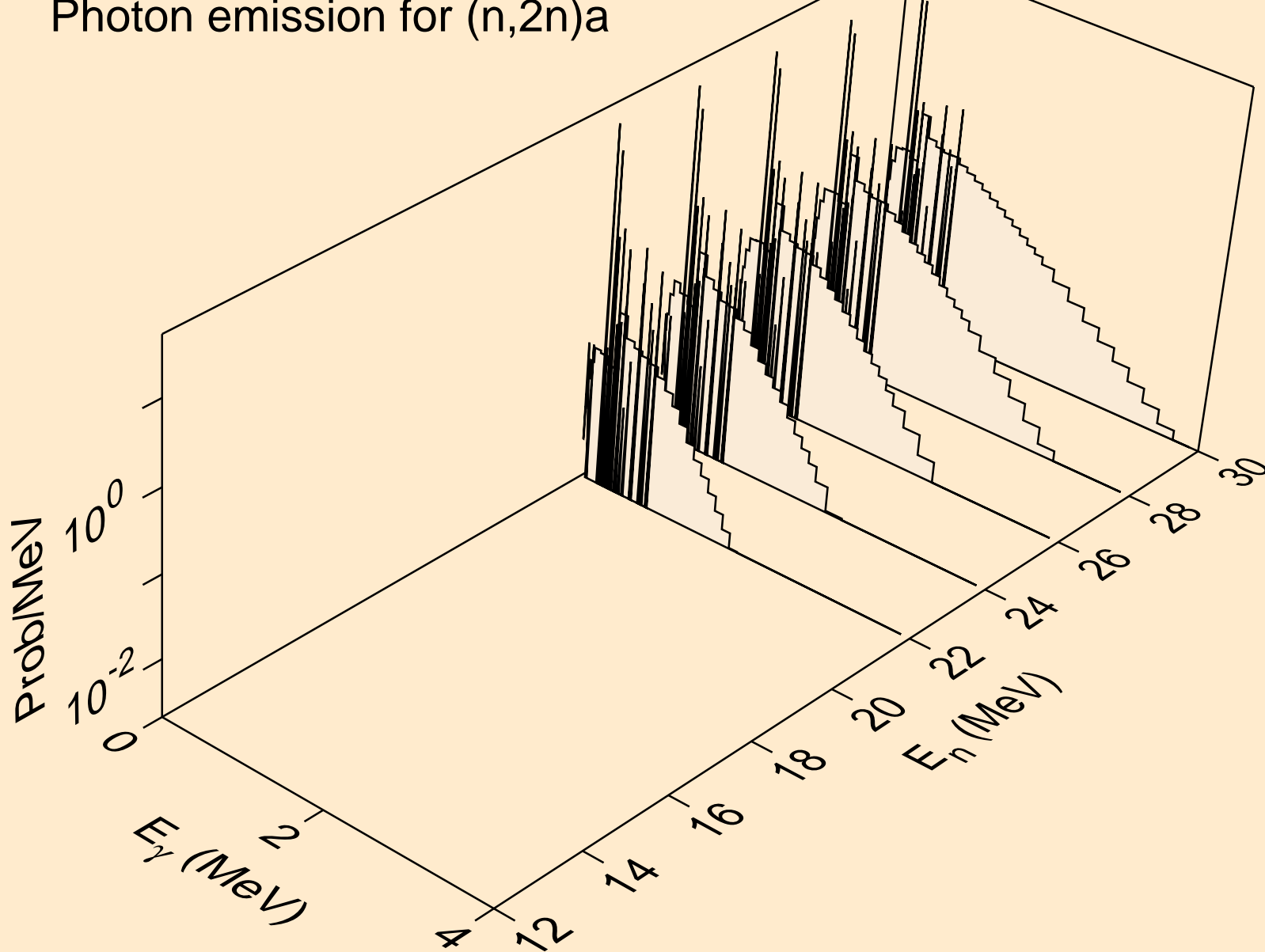

SN114 NEUTRON ACER TENDL-2019 LIBRARY; T=293.16K  
Photon emission for (n,3n)a

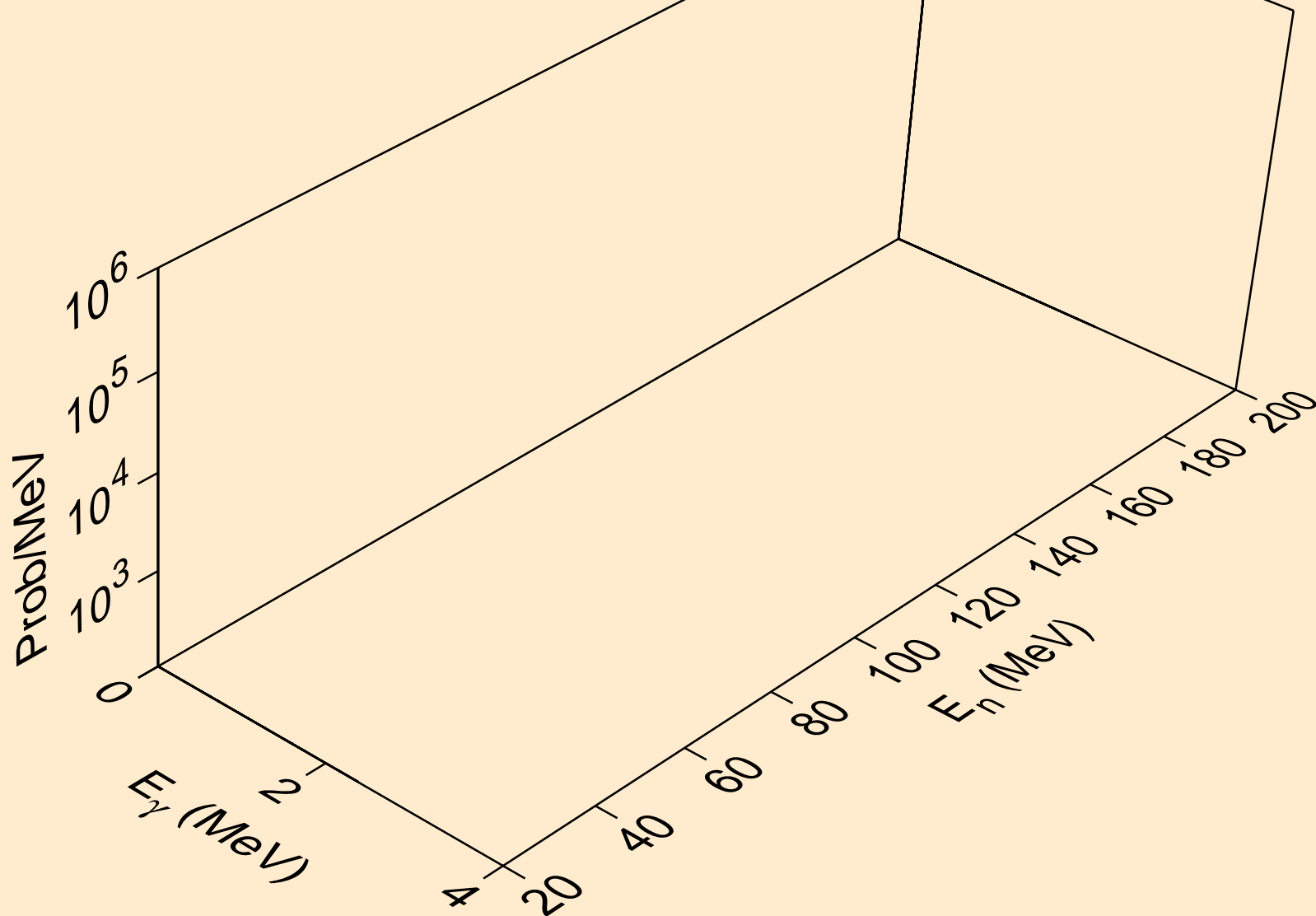

SN114 NEUTRON ACER TENDL-2019 LIBRARY; T=293.16K  
Photon emission for (n,n\*)p

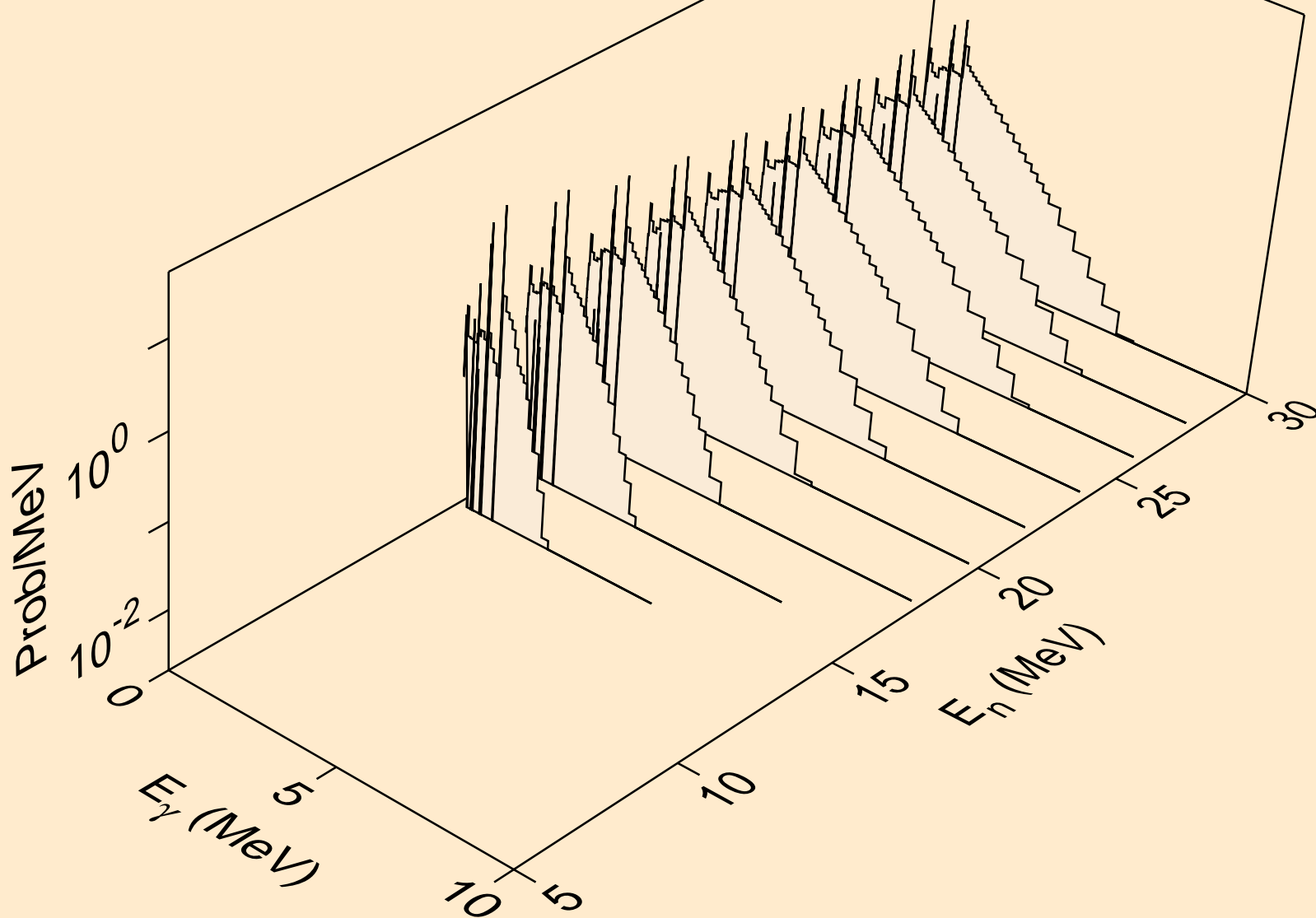

SN114 NEUTRON ACER TENDL-2019 LIBRARY; T=293.16K  
Photon emission for (n,n\*)2a

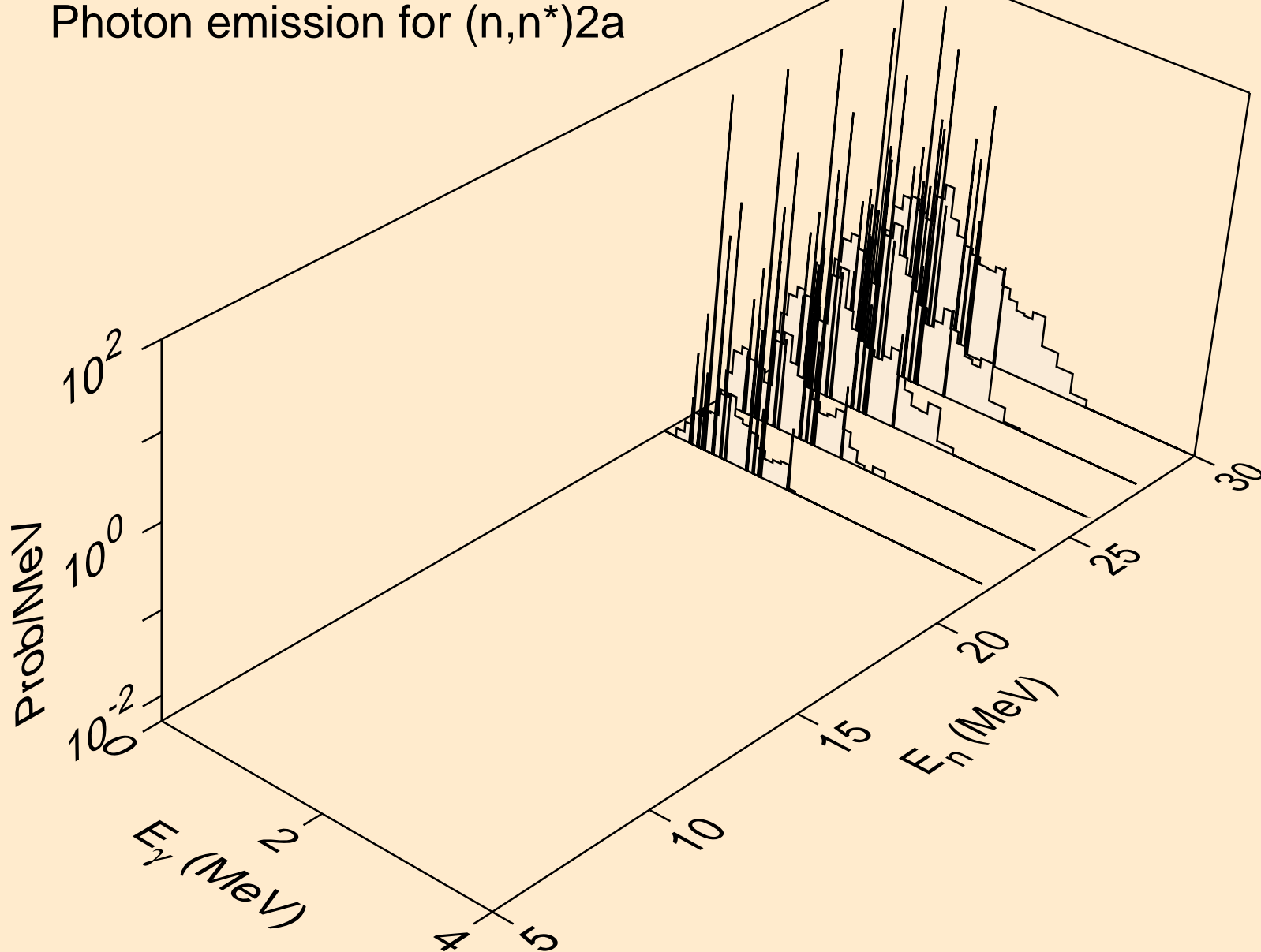

SN114 NEUTRON ACER TENDL-2019 LIBRARY; T=293.16K  
Photon emission for (n,n\*)d

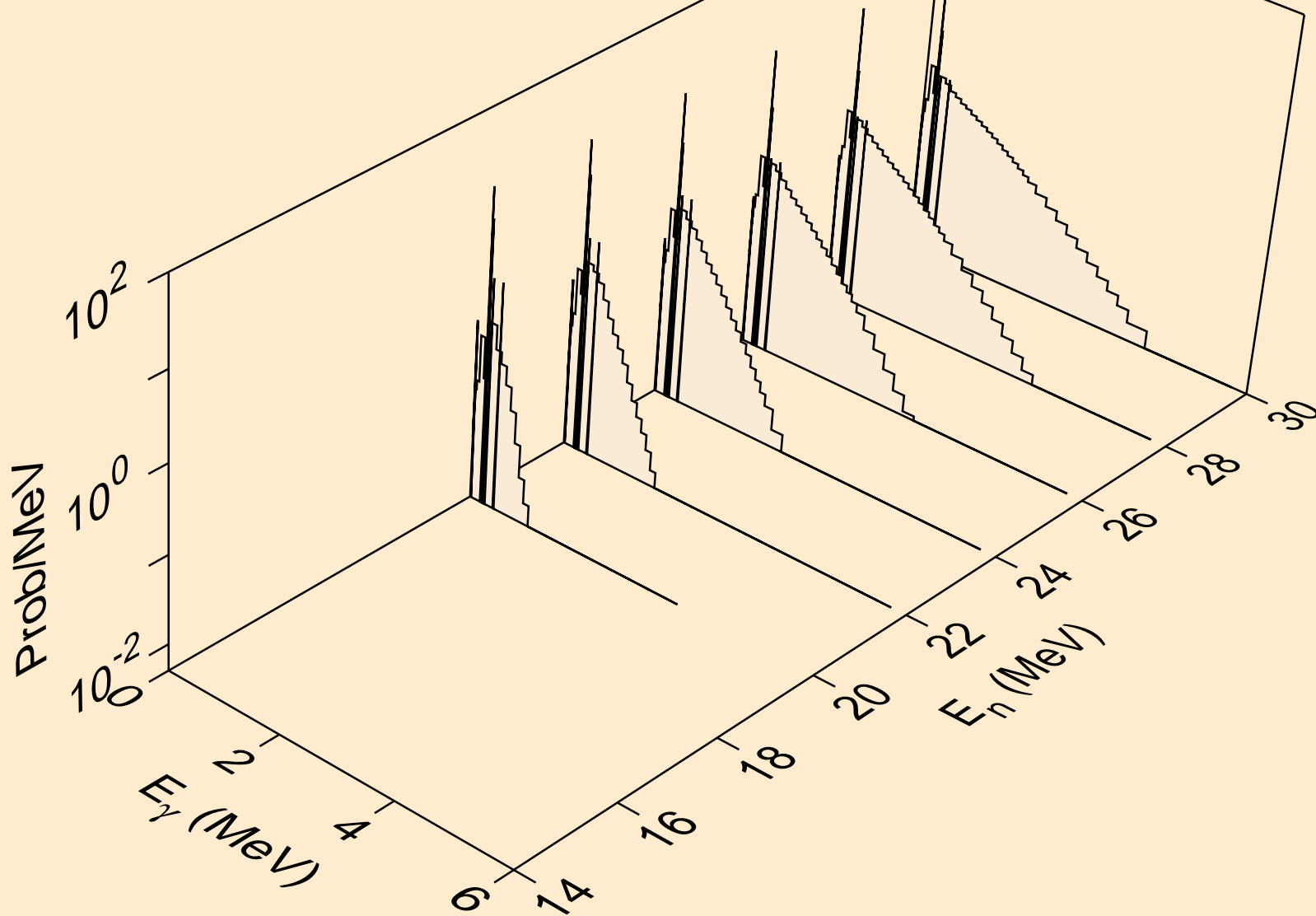

SN114 NEUTRON ACER TENDL-2019 LIBRARY; T=293.16K  
Photon emission for (n,n\*)t

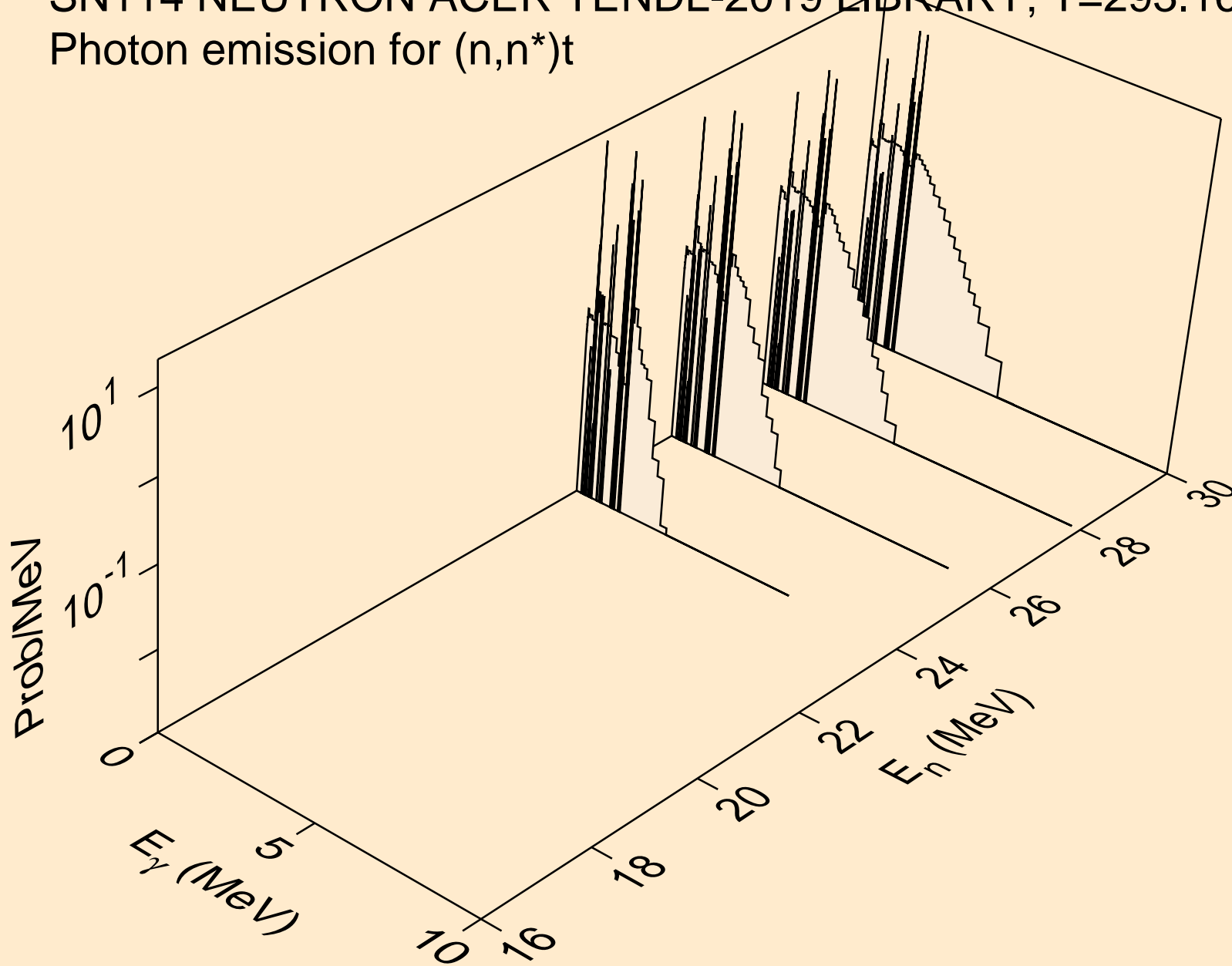



SN114 NEUTRON ACER TENDL-2019 LIBRARY; T=293.16K  
Photon emission for (n,n\*)he3

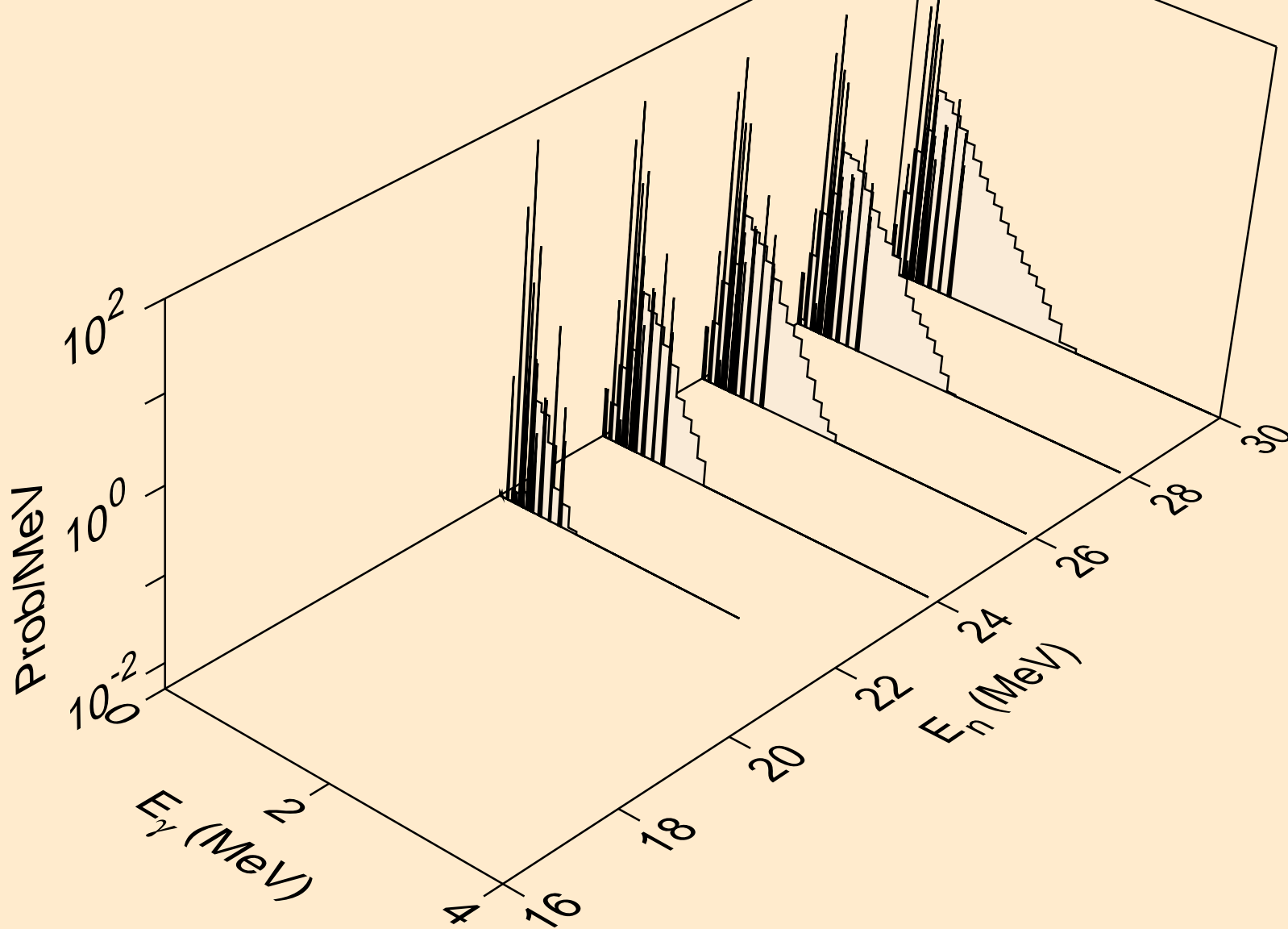

SN114 NEUTRON ACER TENDL-2019 LIBRARY; T=293.16K  
Photon emission for (n,4n)

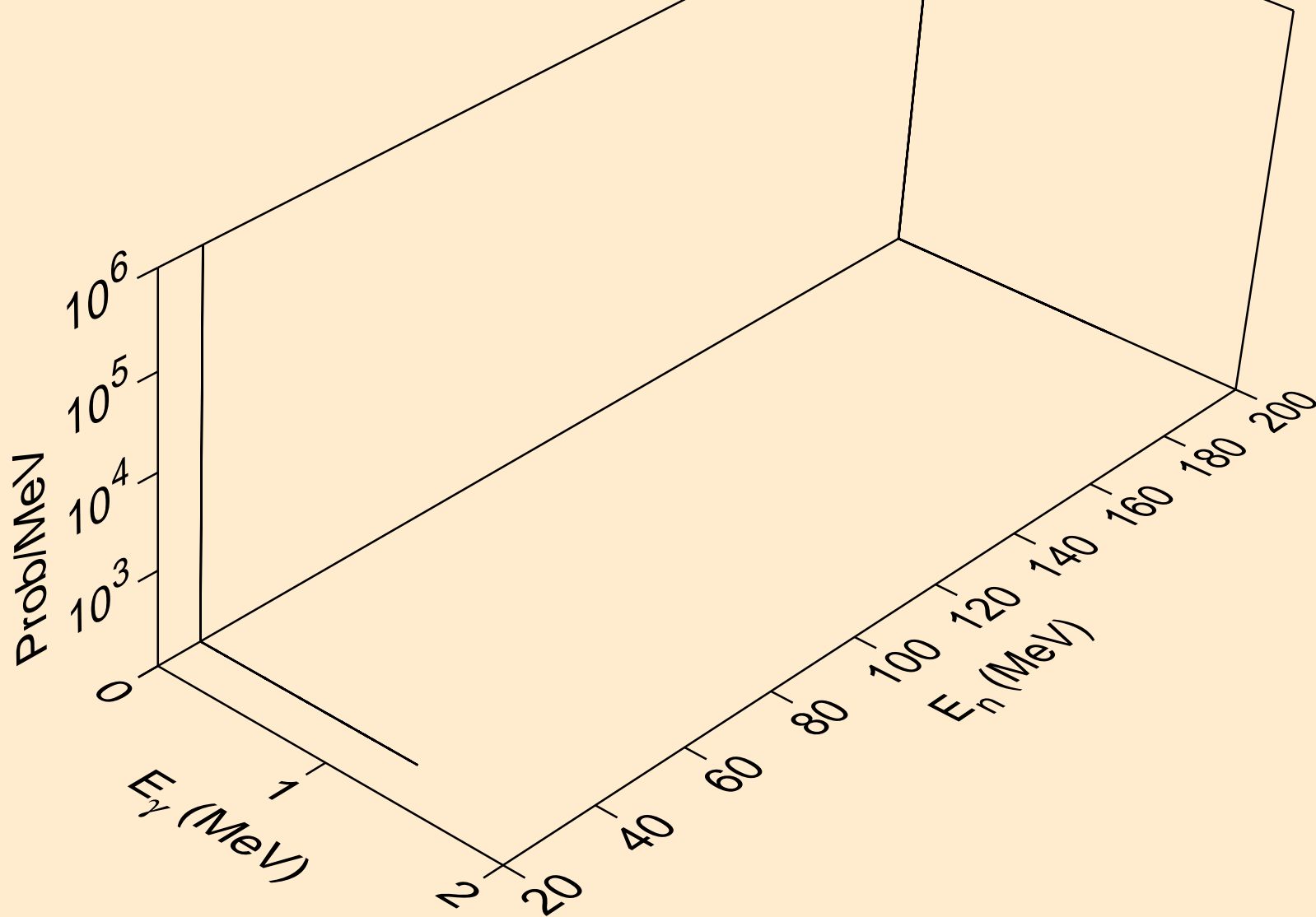

SN114 NEUTRON ACER TENDL-2019 LIBRARY; T=293.16K  
Photon emission for (n,2np)

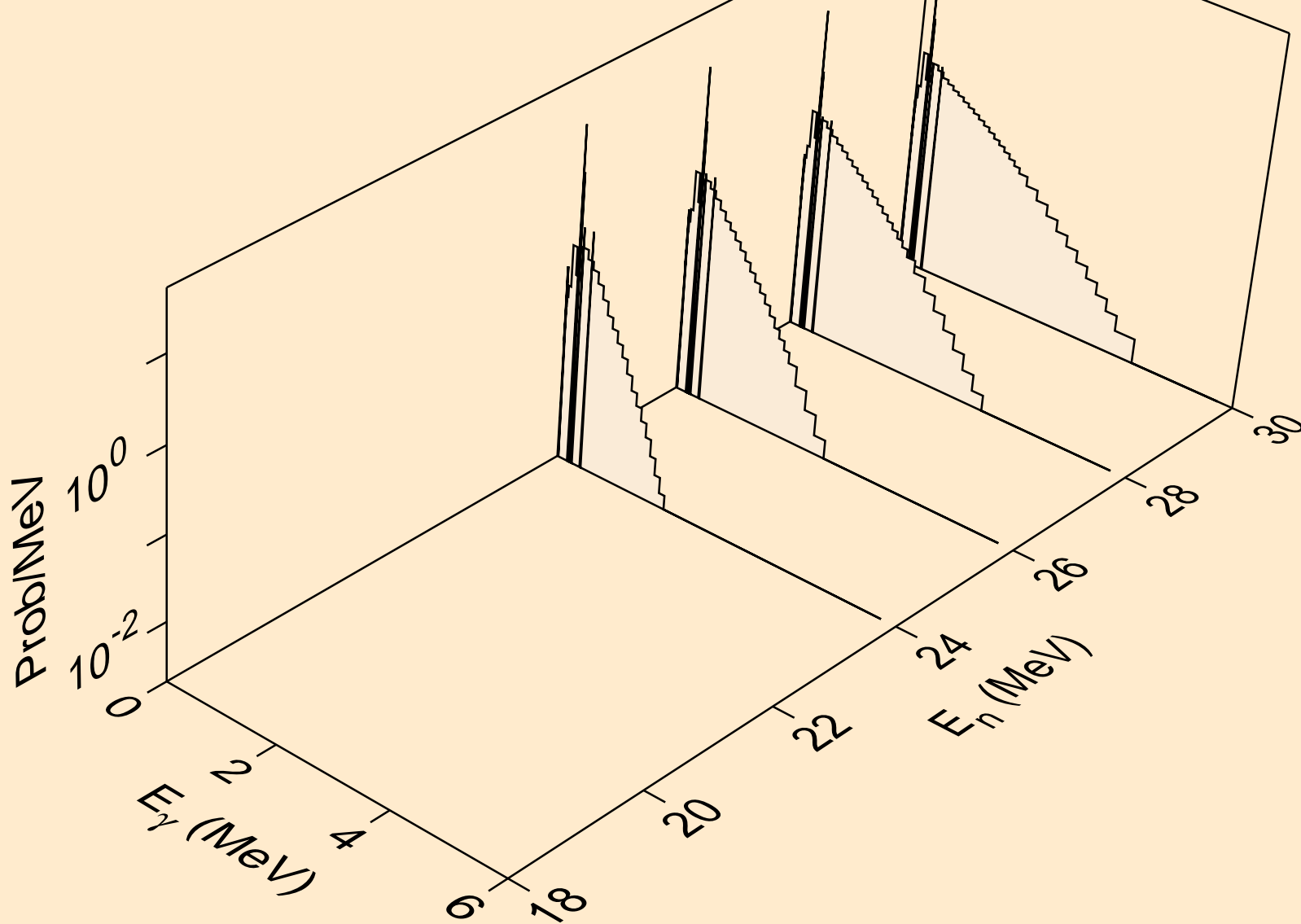

SN114 NEUTRON ACER TENDL-2019 LIBRARY; T=293.16K  
Photon emission for (n,3np)

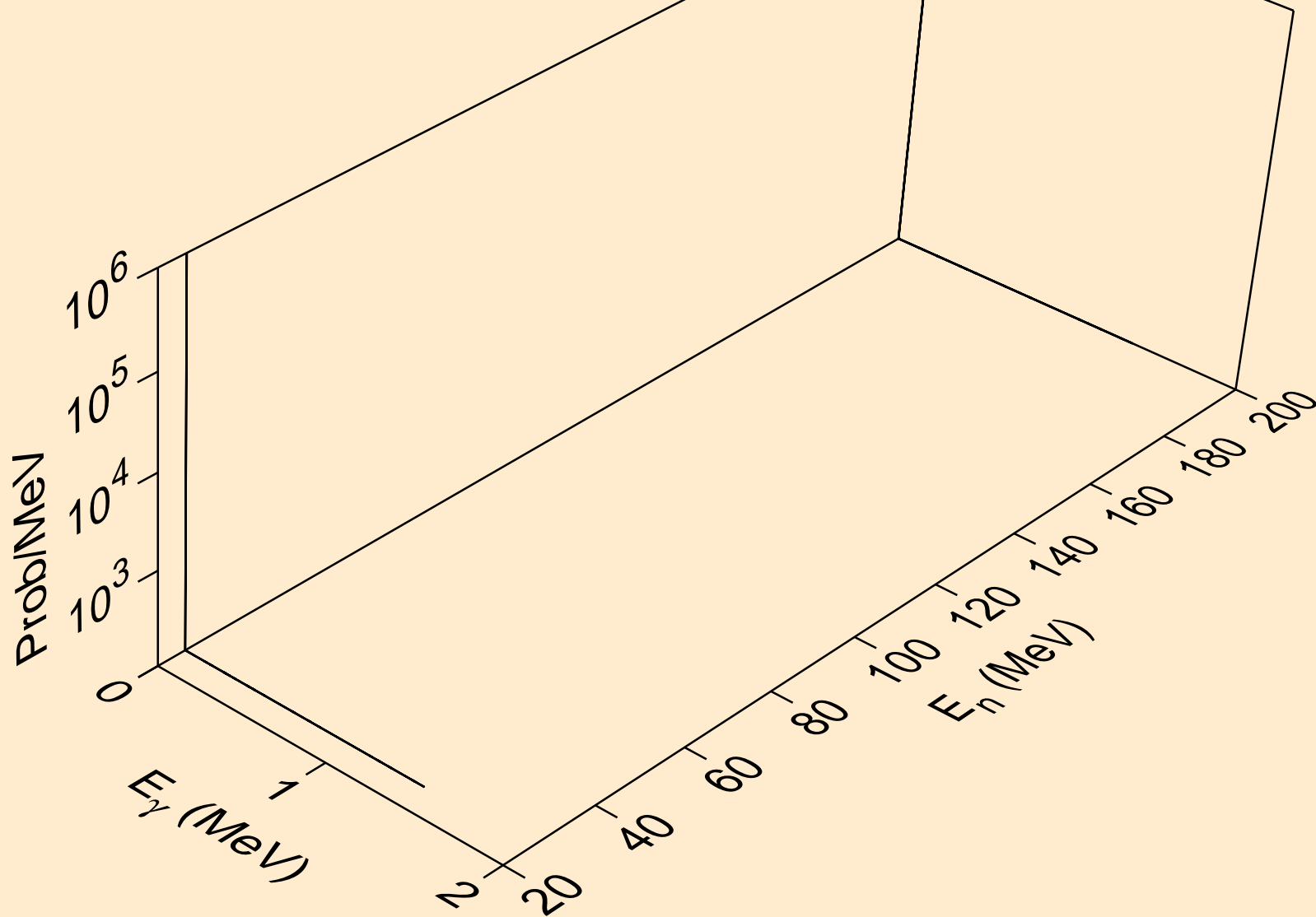

SN114 NEUTRON ACER TENDL-2019 LIBRARY; T=293.16K  
Photon emission for (n,2np)

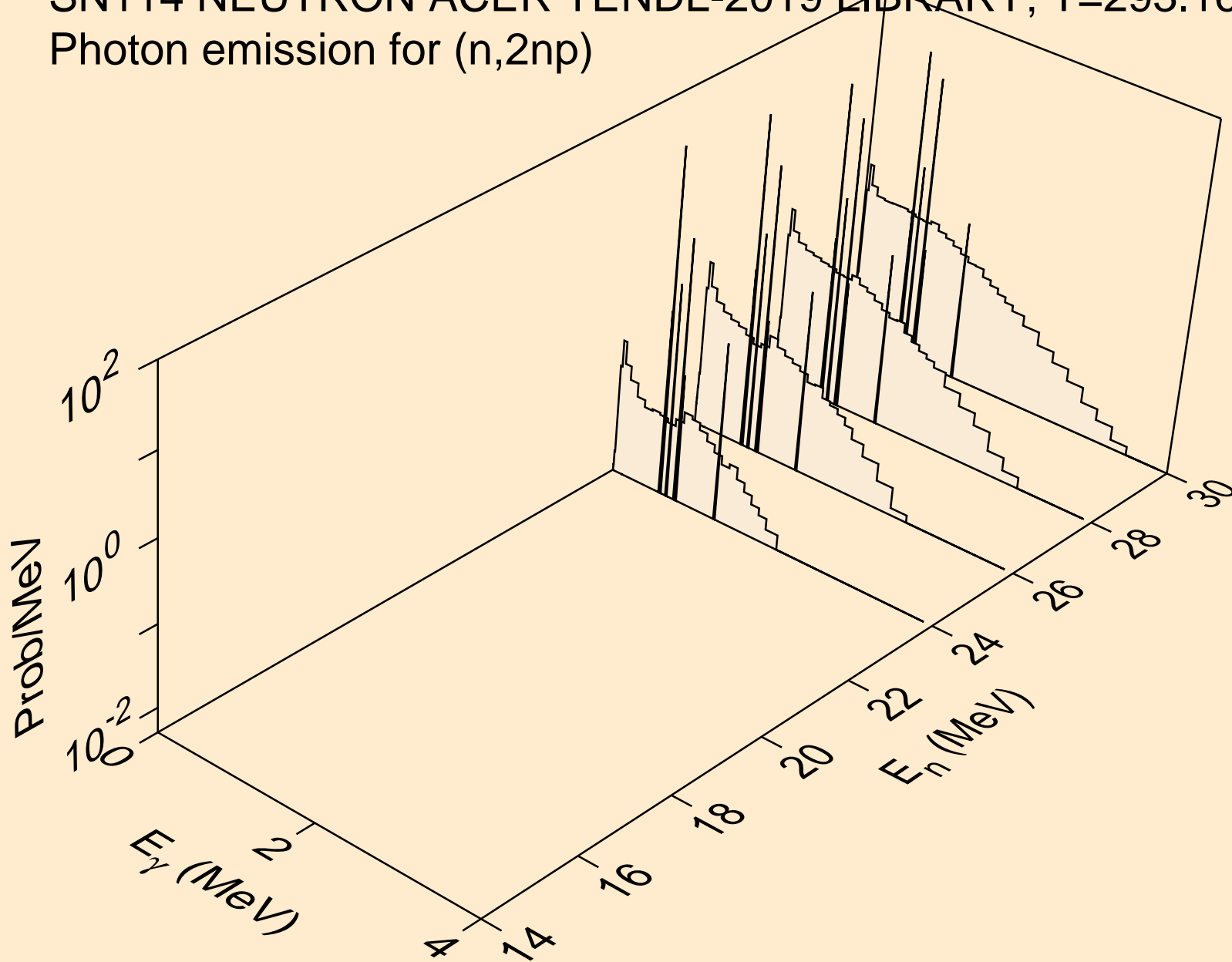

SN114 NEUTRON ACER TENDL-2019 LIBRARY; T=293.16K  
Photon emission for (n,npa)

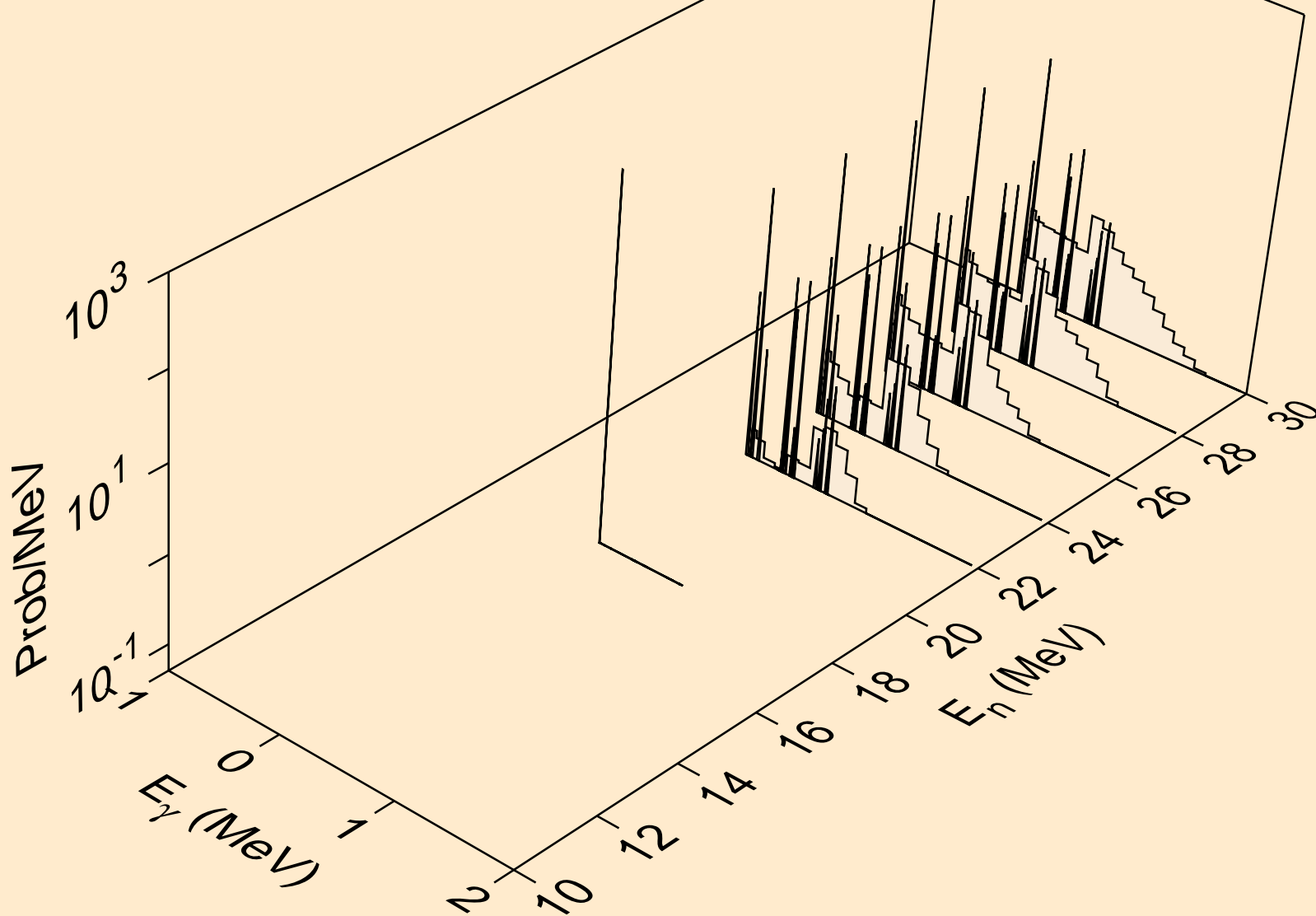

SN114 NEUTRON ACER TENDL-2019 LIBRARY; T=293.16K  
Photon emission for (n,n\*c)

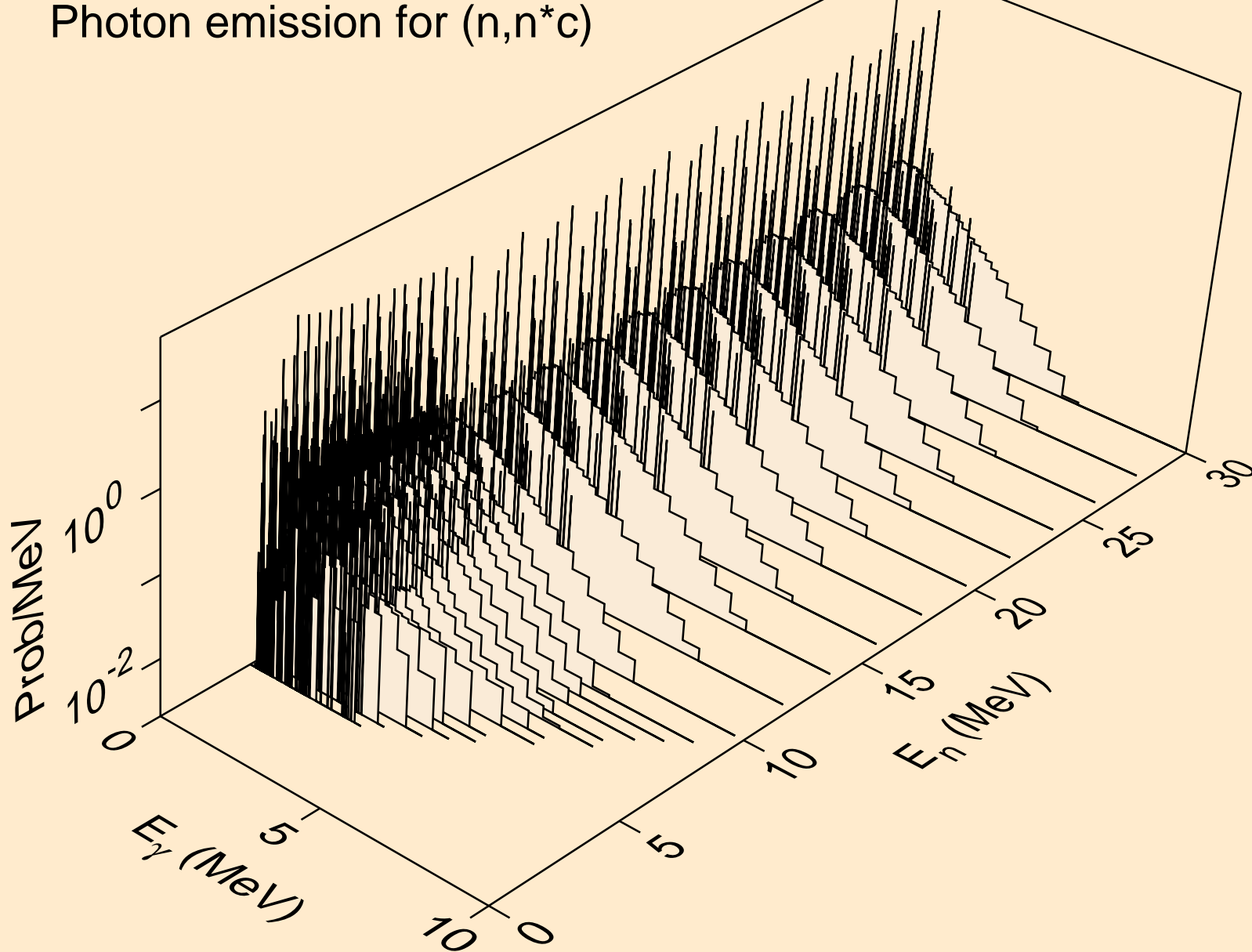

SN114 NEUTRON ACER TENDL-2019 LIBRARY; T=293.16K  
Photon emission for (n,gma)

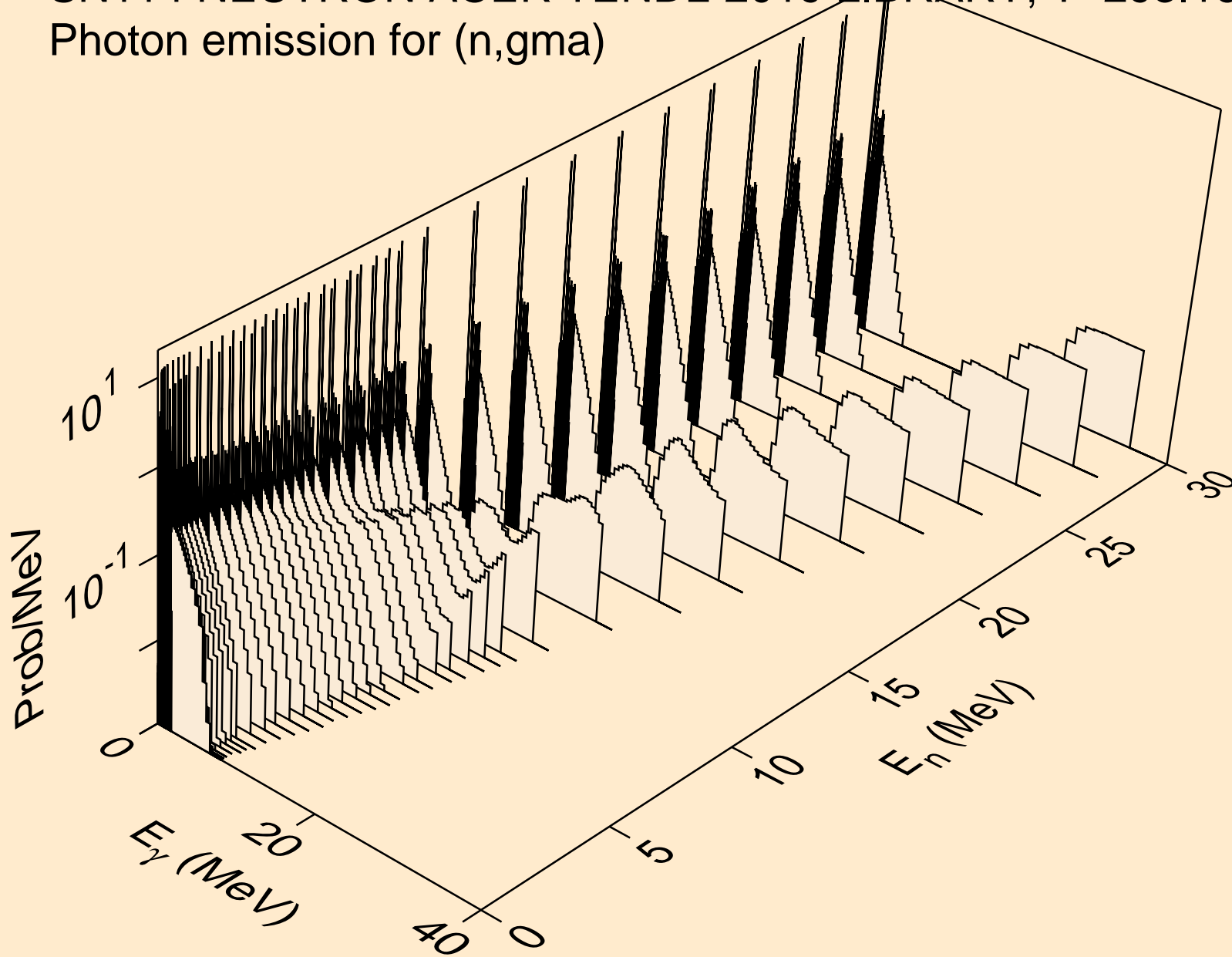



SN114 NEUTRON ACER TENDL-2019 LIBRARY; T=293.16K  
Photon emission for (n,p)

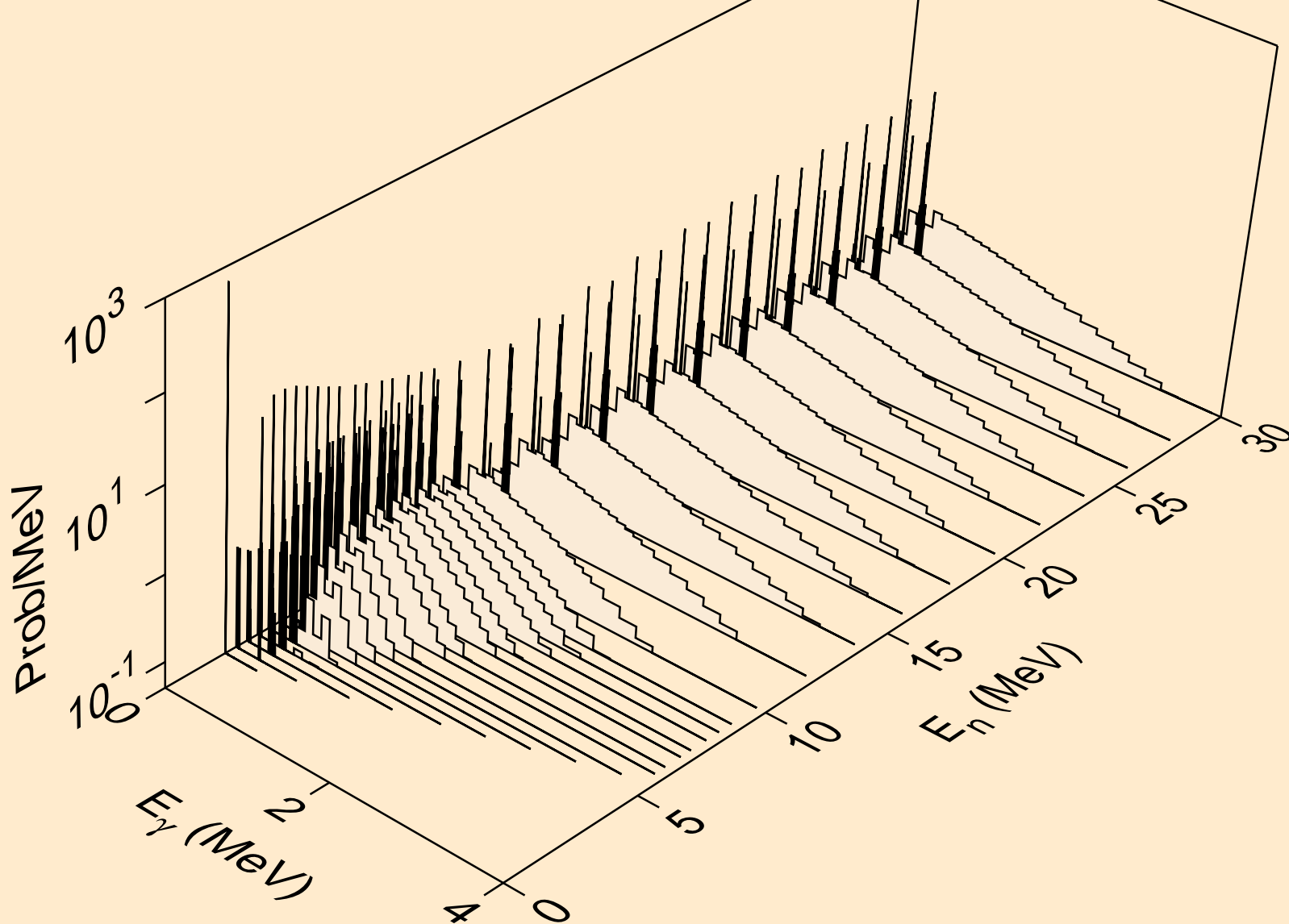

SN114 NEUTRON ACER TENDL-2019 LIBRARY; T=293.16K  
Photon emission for (n,d)

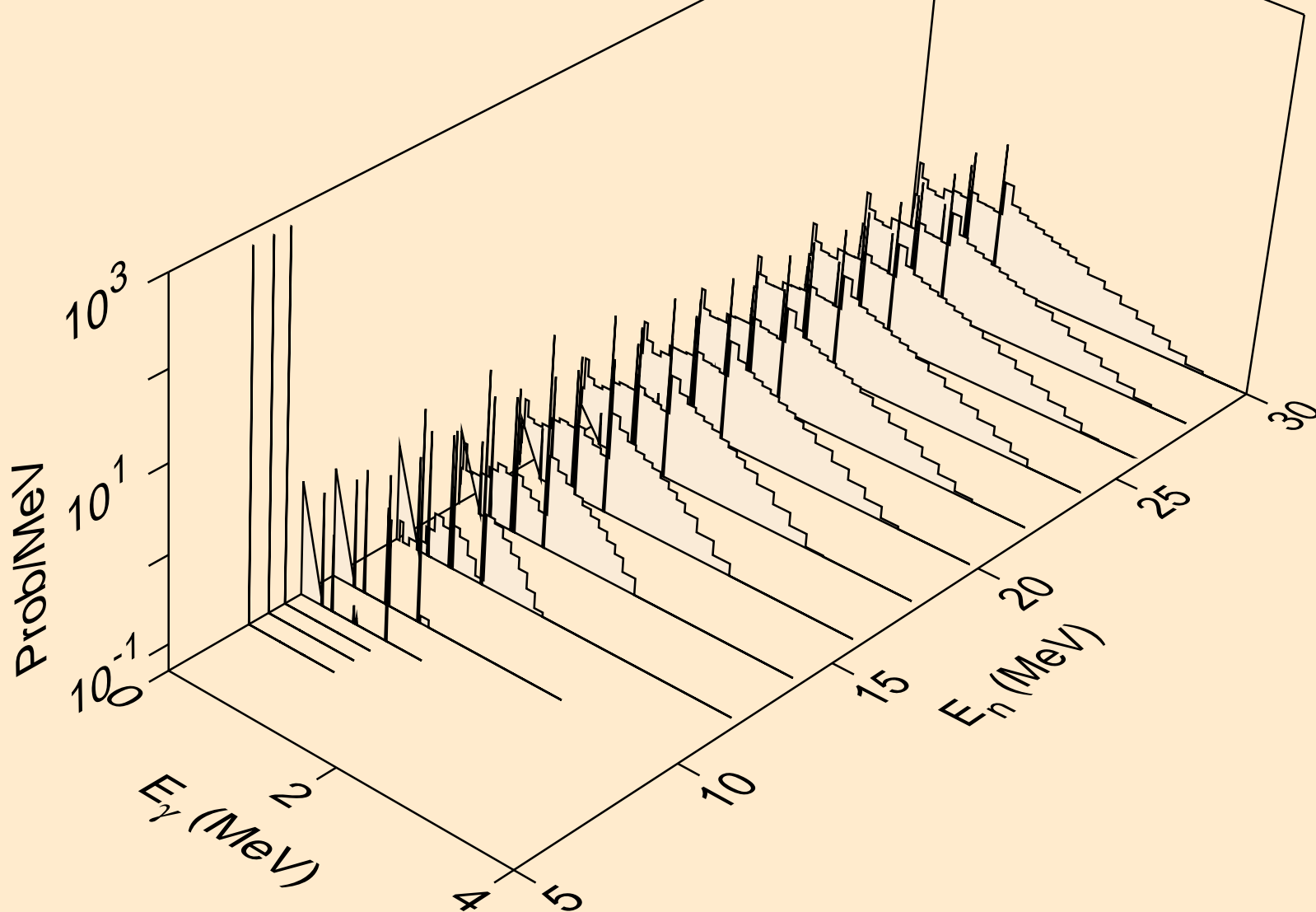

SN114 NEUTRON ACER TENDL-2019 LIBRARY; T=293.16K  
Photon emission for (n,t)

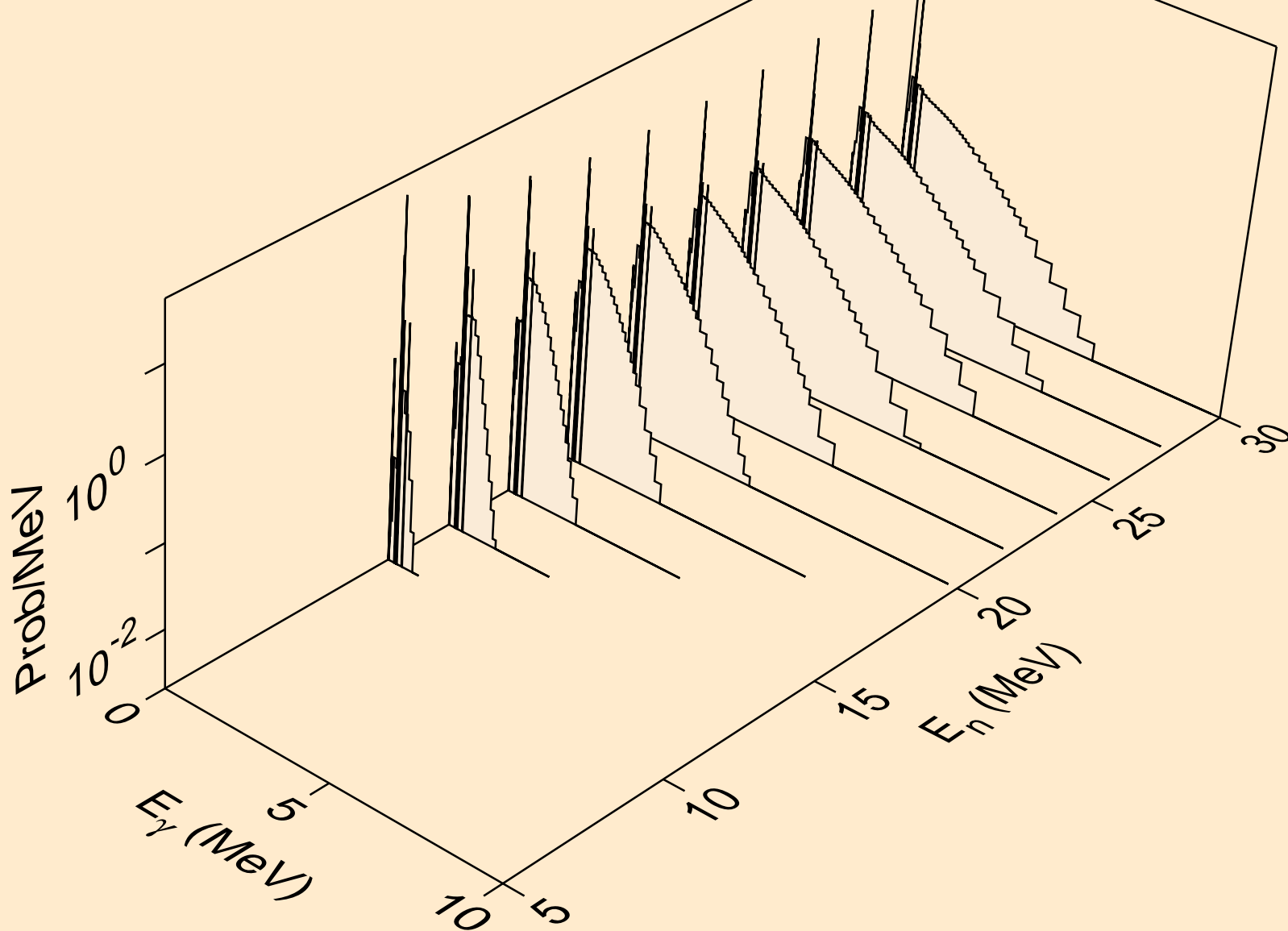

SN114 NEUTRON ACER TENDL-2019 LIBRARY; T=293.16K  
Photon emission for (n,he3)

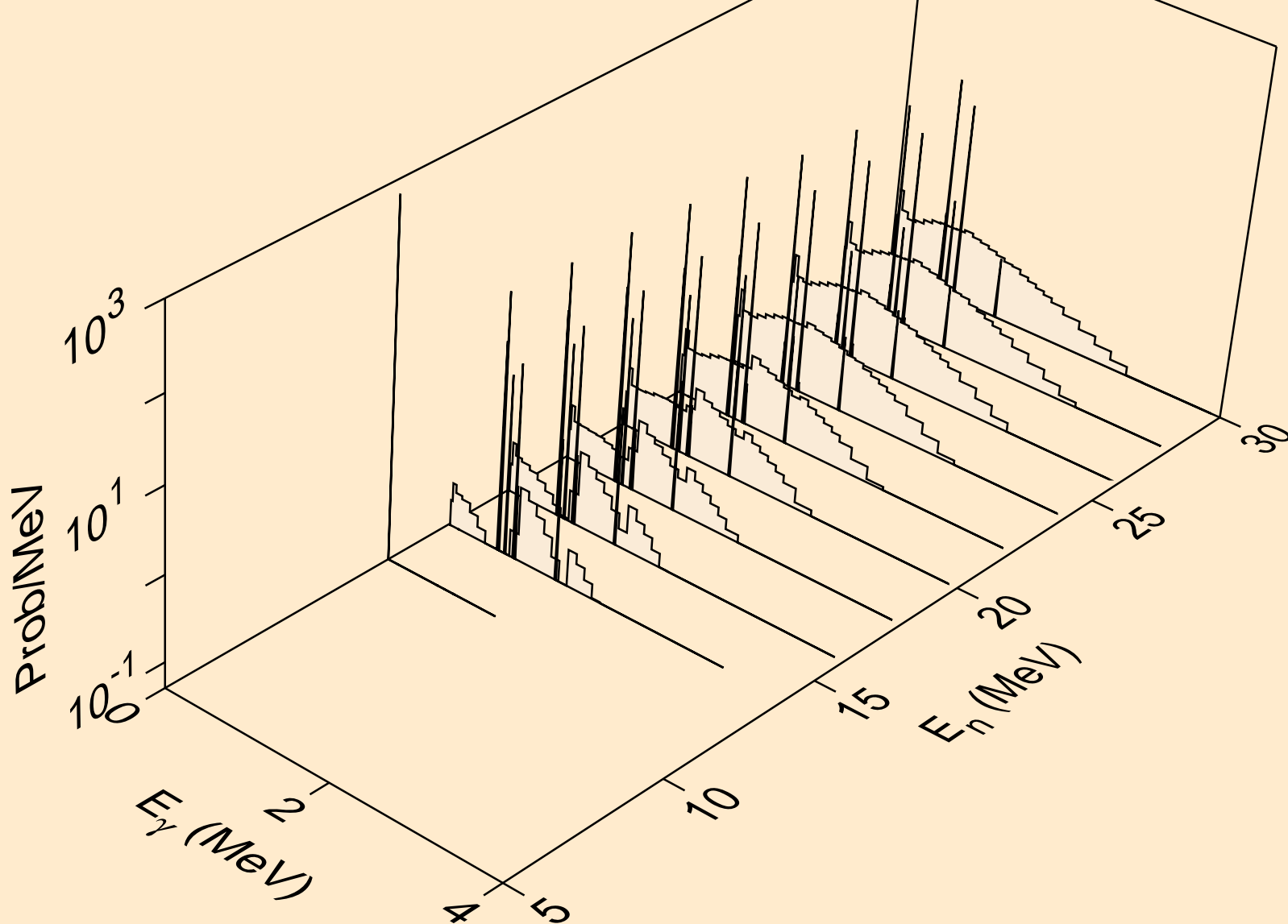

SN114 NEUTRON ACER TENDL-2019 LIBRARY; T=293.16K  
Photon emission for (n,a)

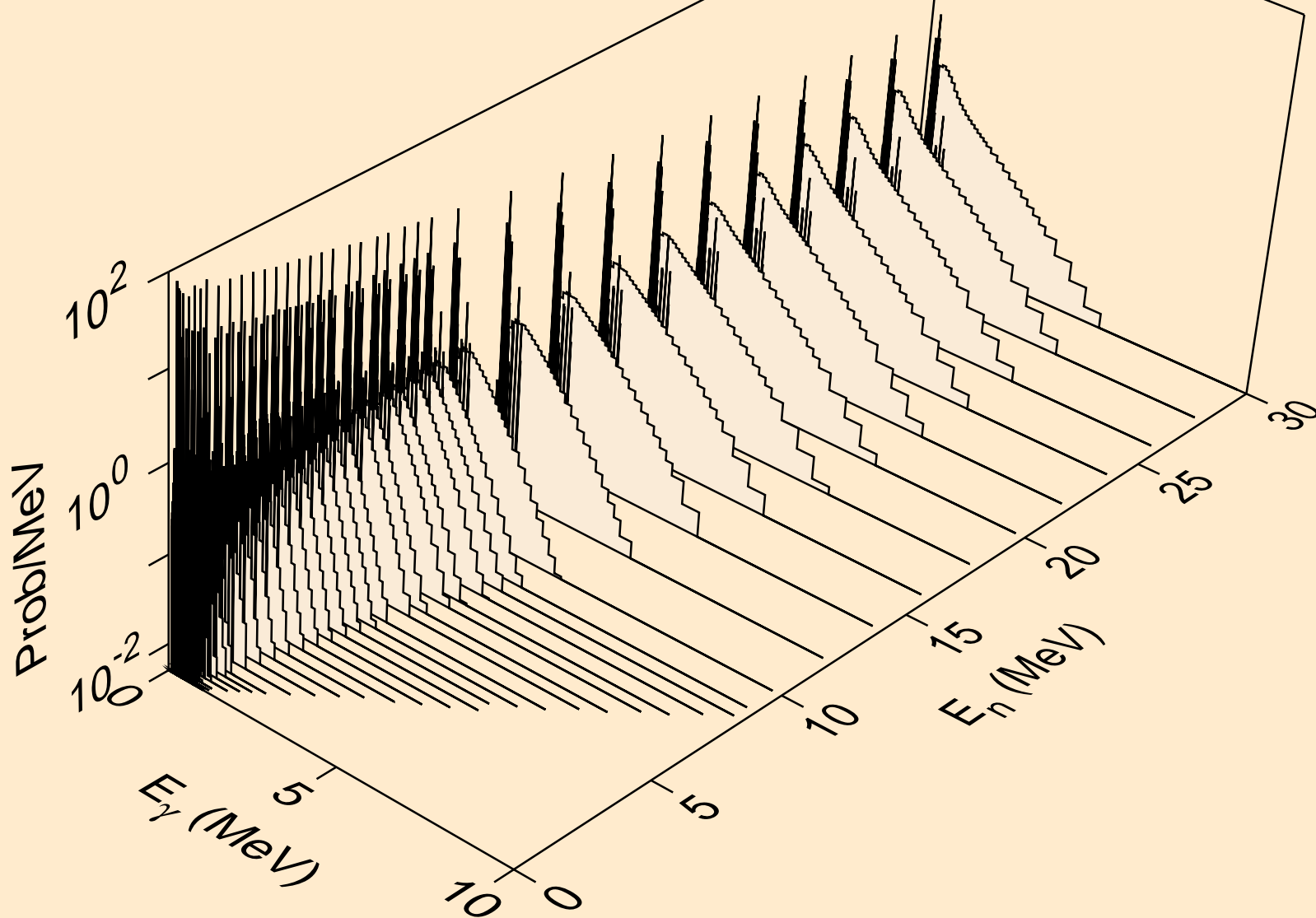

SN114 NEUTRON ACER TENDL-2019 LIBRARY; T=293.16K  
Photon emission for (n,2a)

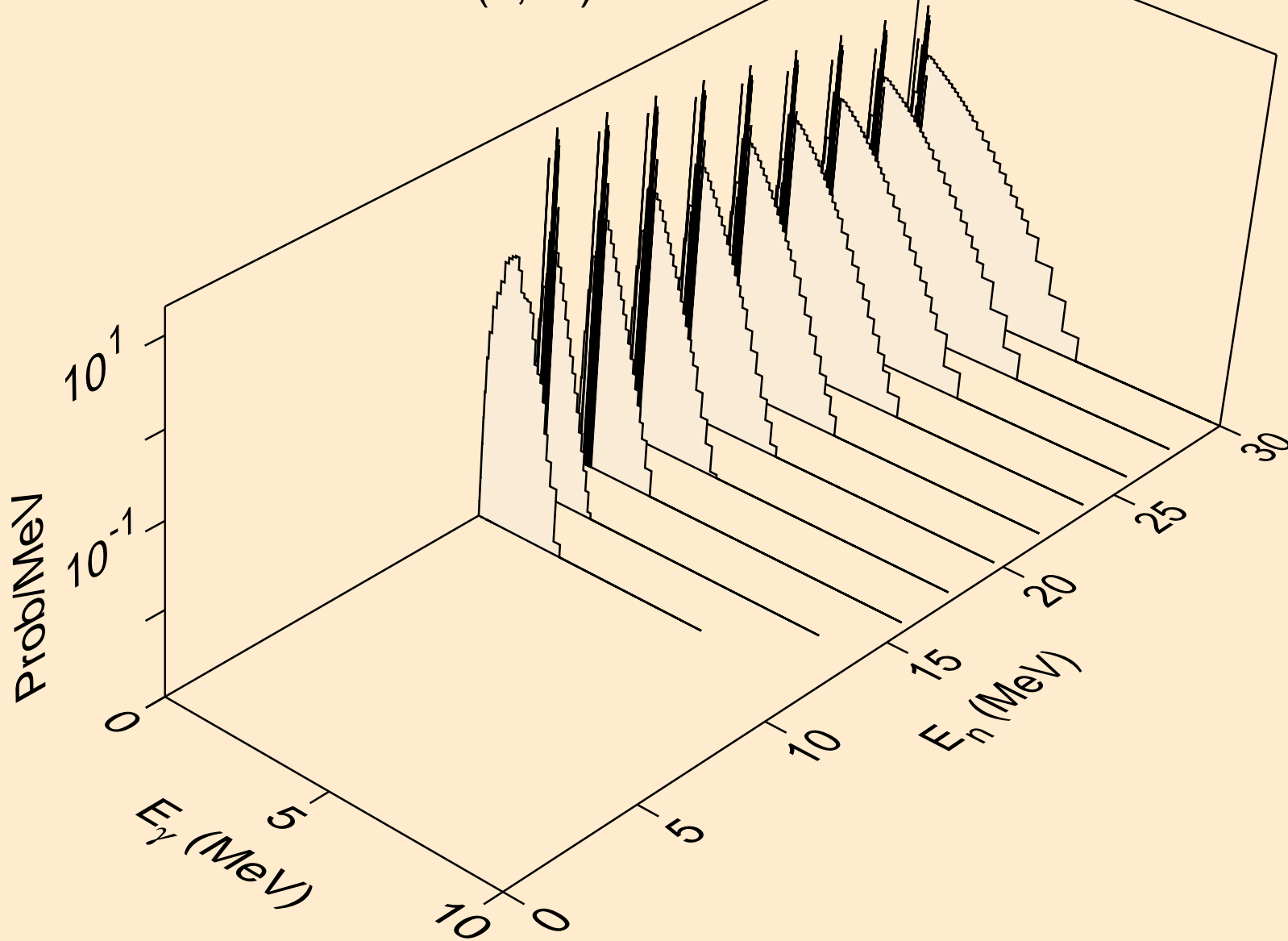

SN114 NEUTRON ACER TENDL-2019 LIBRARY; T=293.16K  
Photon emission for (n,2p)

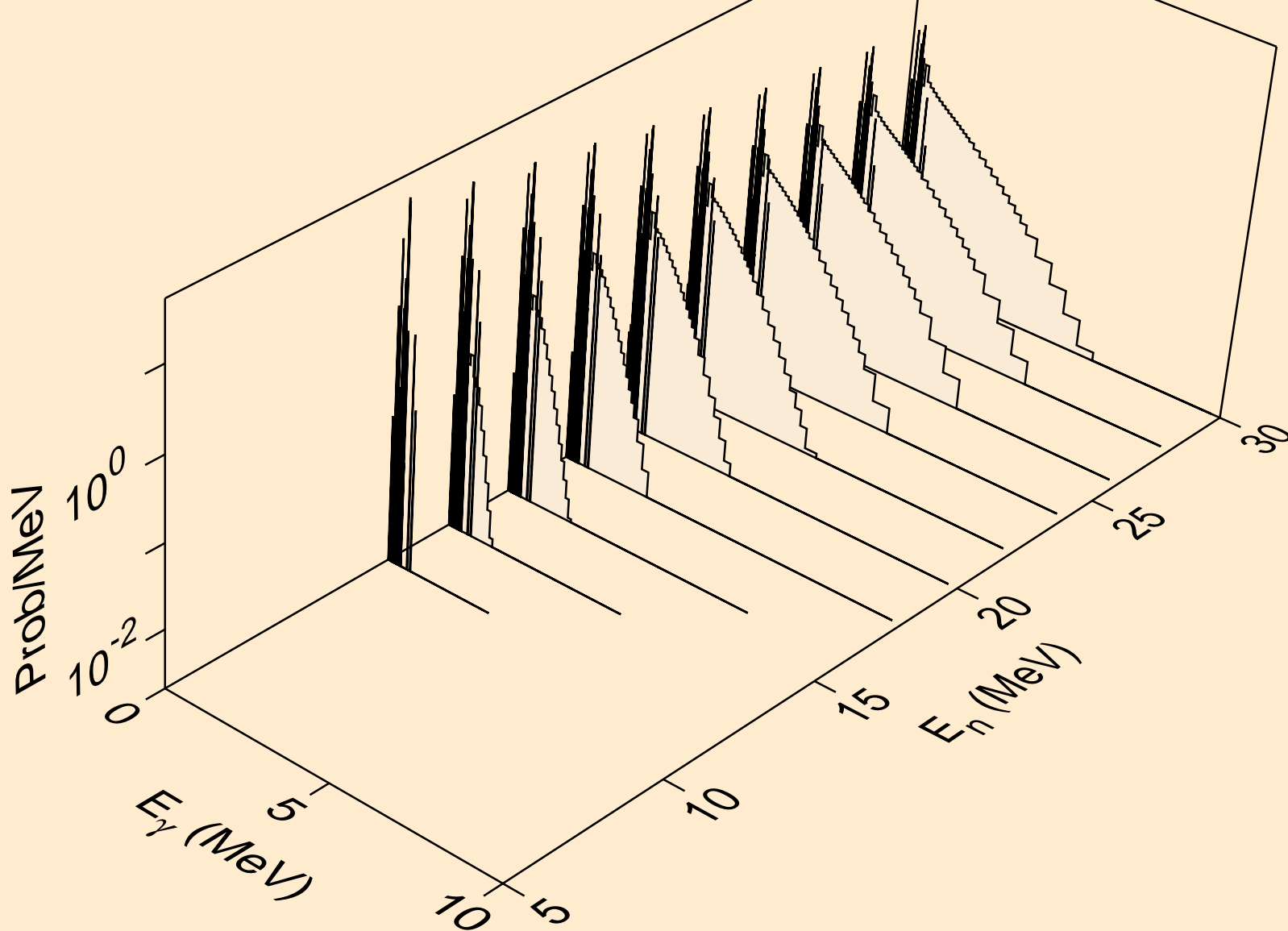

SN114 NEUTRON ACER TENDL-2019 LIBRARY; T=293.16K  
Photon emission for (n,p)

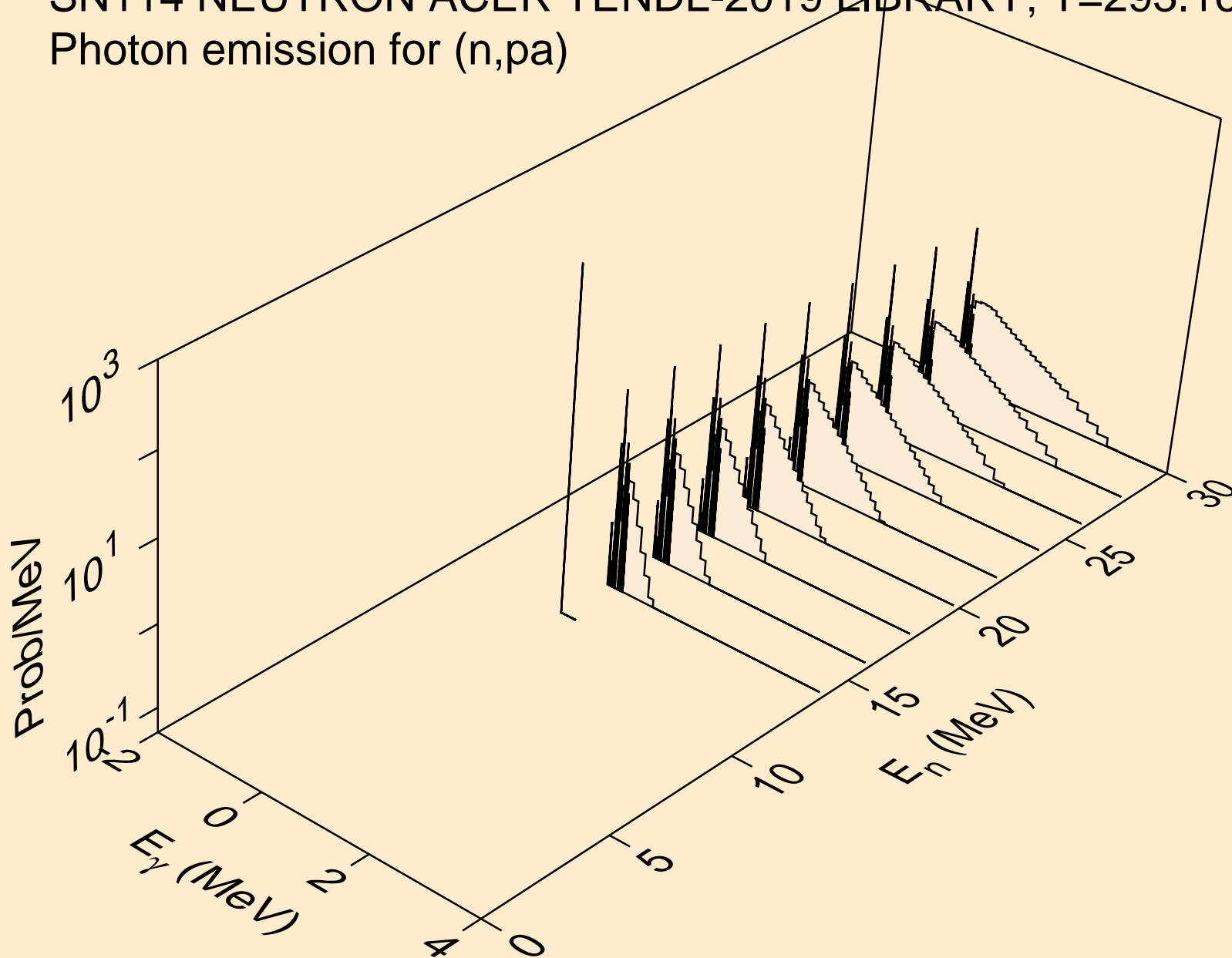



SN114 NEUTRON ACER TENDL-2019 LIBRARY; T=293.16K  
Photon emission for (n,pd)

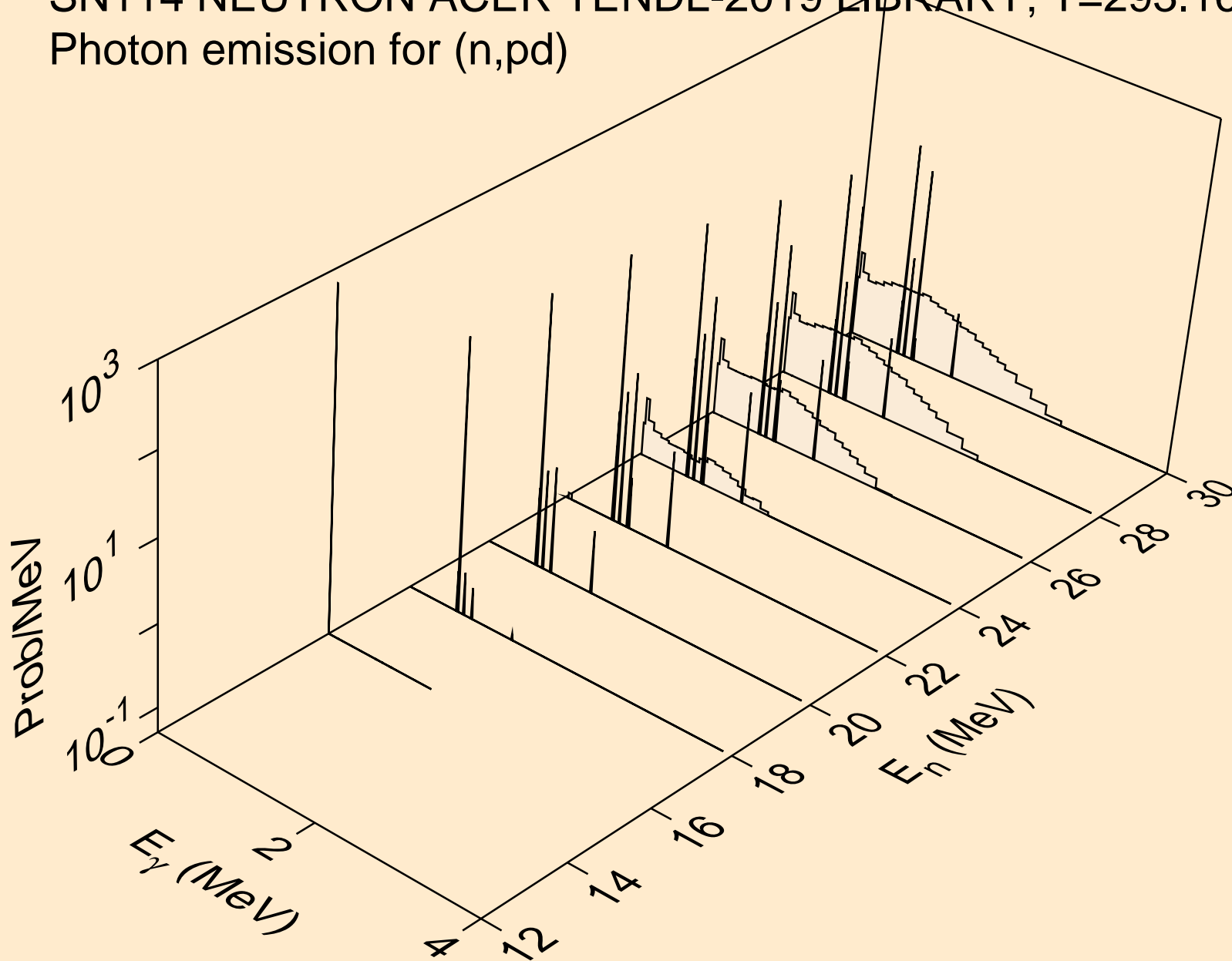

SN114 NEUTRON ACER TENDL-2019 LIBRARY; T=293.16K  
Photon emission for (n,pt)

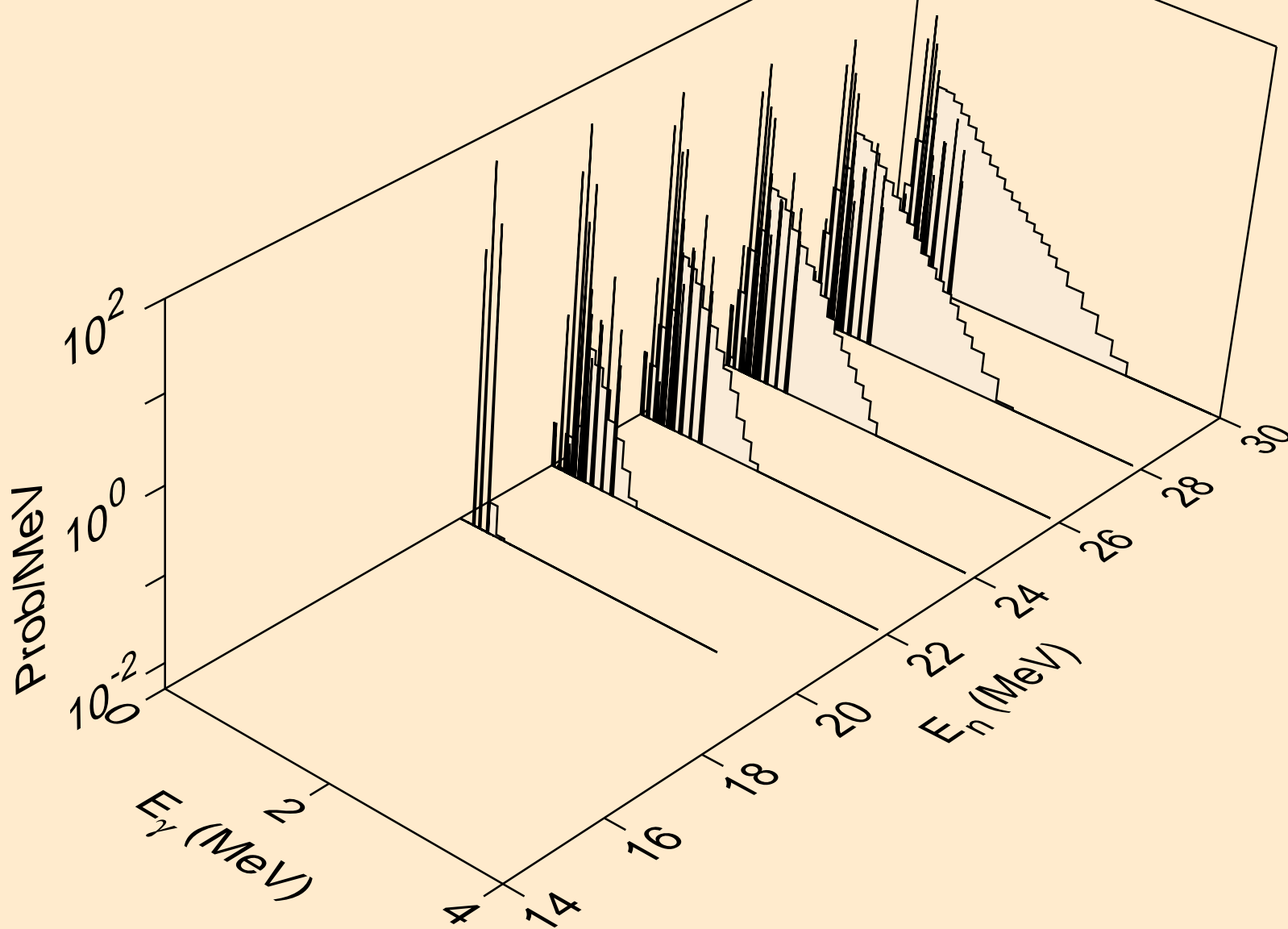

SN114 NEUTRON ACER TENDL-2019 LIBRARY; T=293.16K  
Photon emission for (n,da)

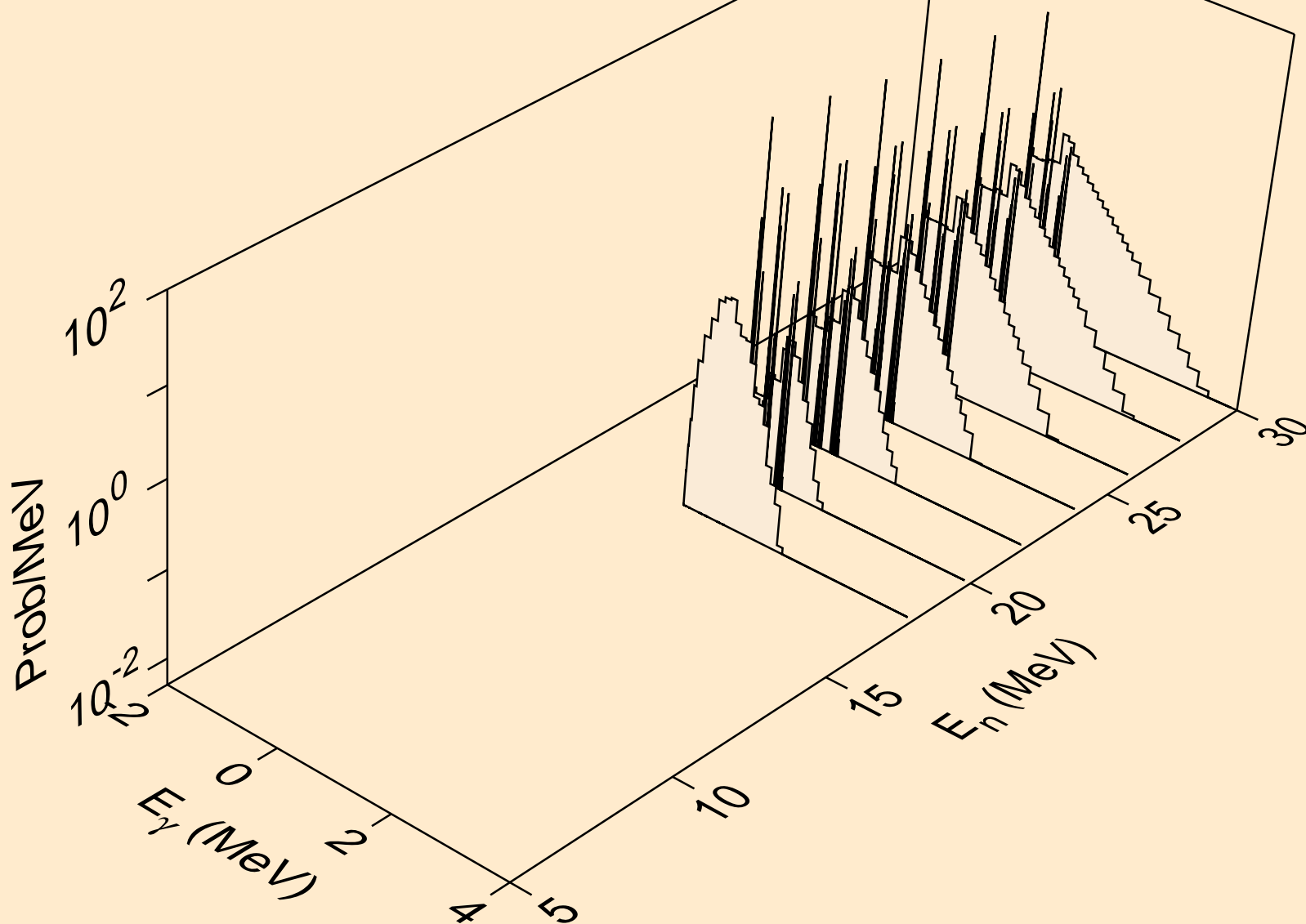

SN114 NEUTRON ACER TENDL-2019 LIBRARY; T=293.16K  
thermal capture photon spectrum

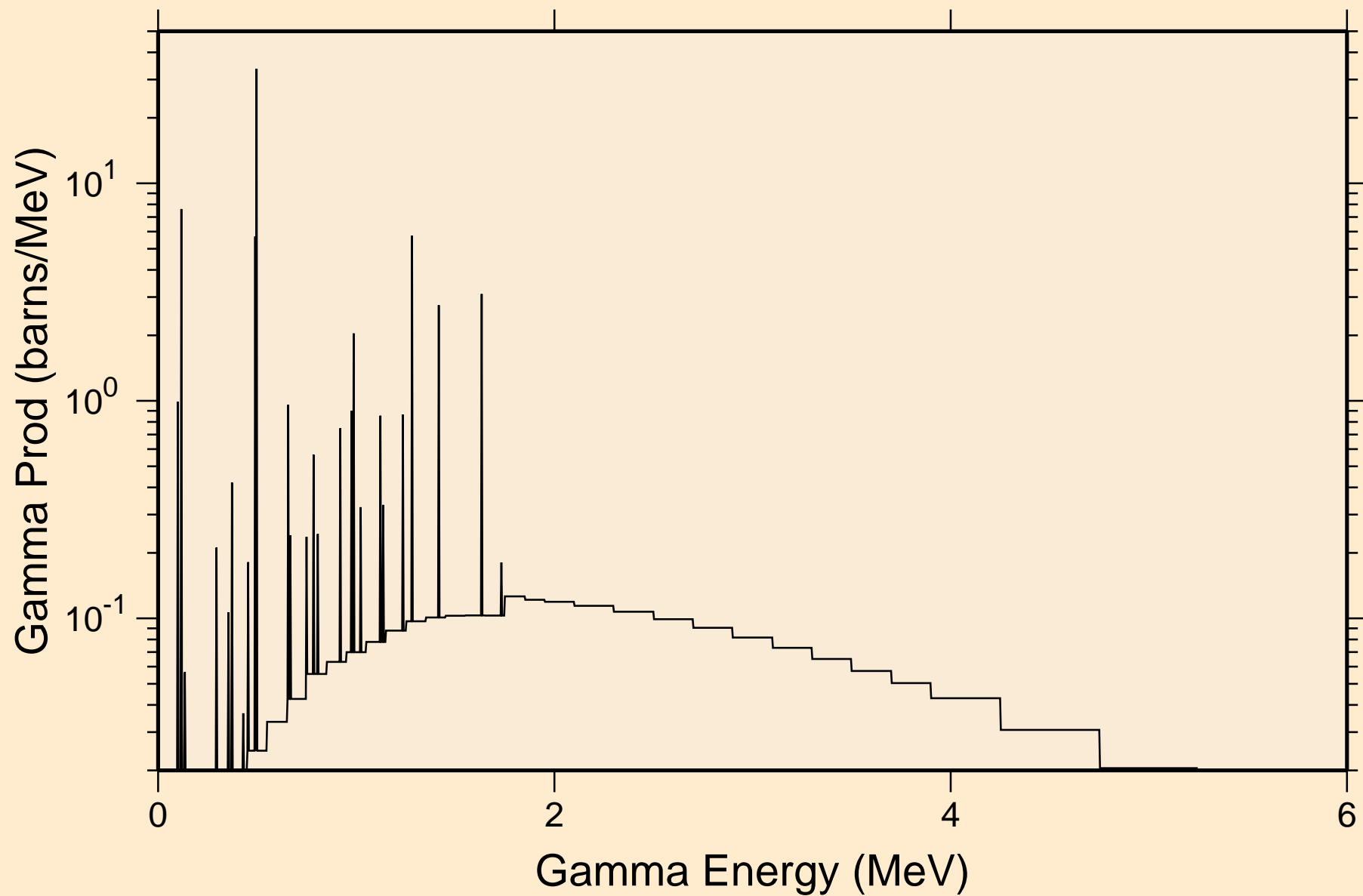

SN114 NEUTRON ACER TENDL-2019 LIBRARY; T=293.16K  
14 MeV photon spectrum

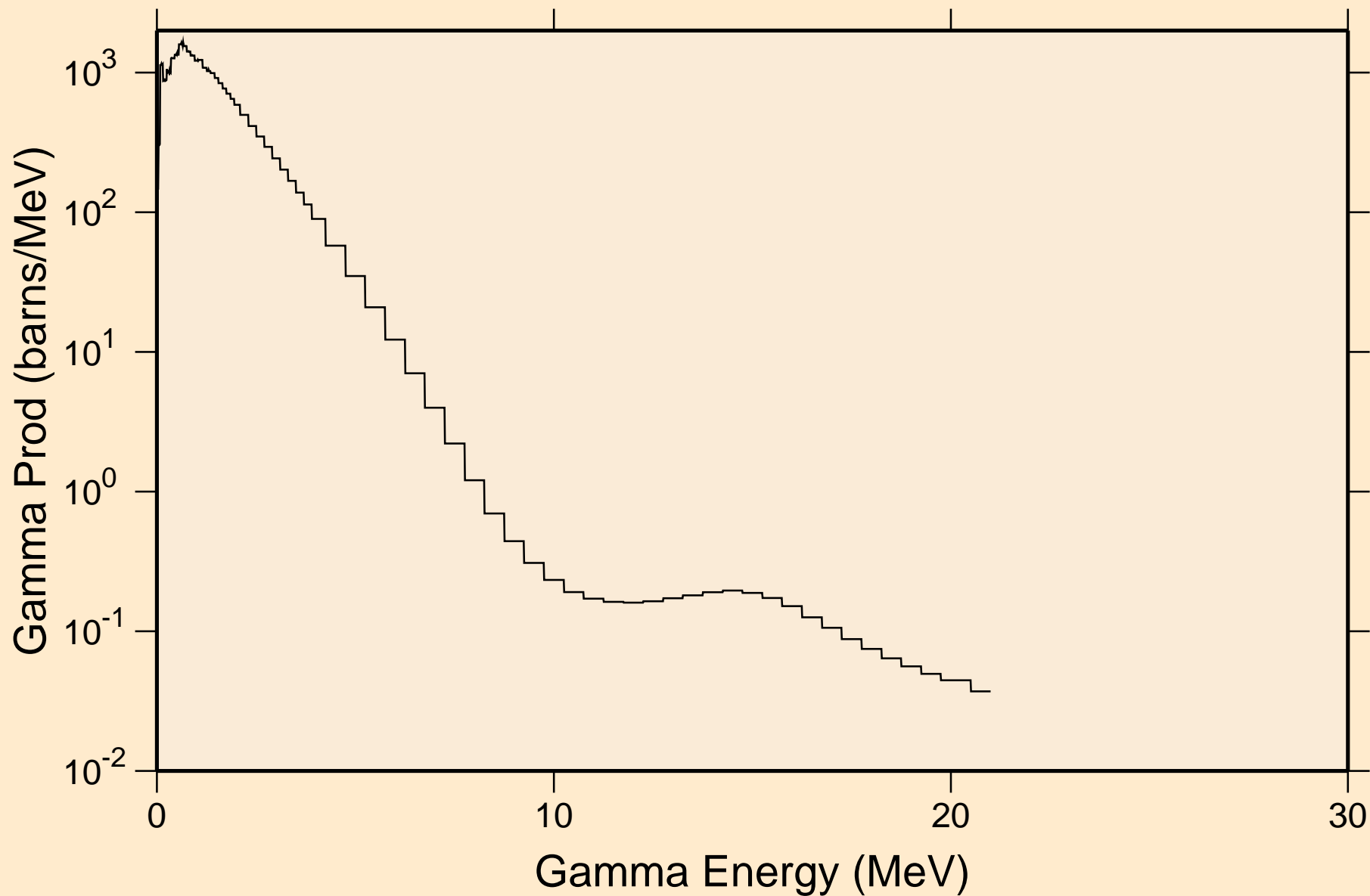

# SN114 NEUTRON ACER TENDL-2019 LIBRARY; T=293.16K

## Particle heating contributions

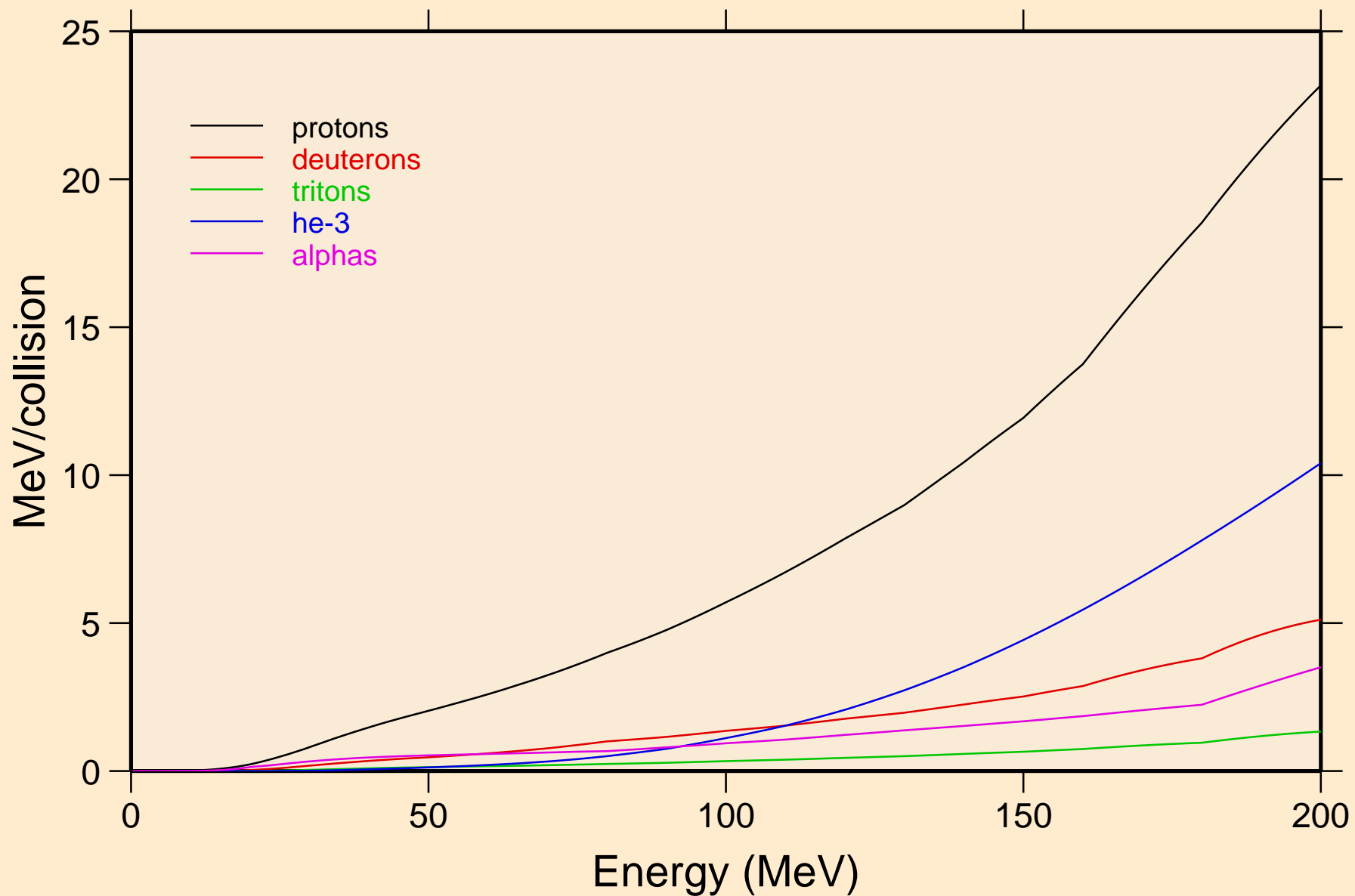

# SN114 NEUTRON ACER TENDL-2019 LIBRARY; T=293.16K

## Recoil Heating

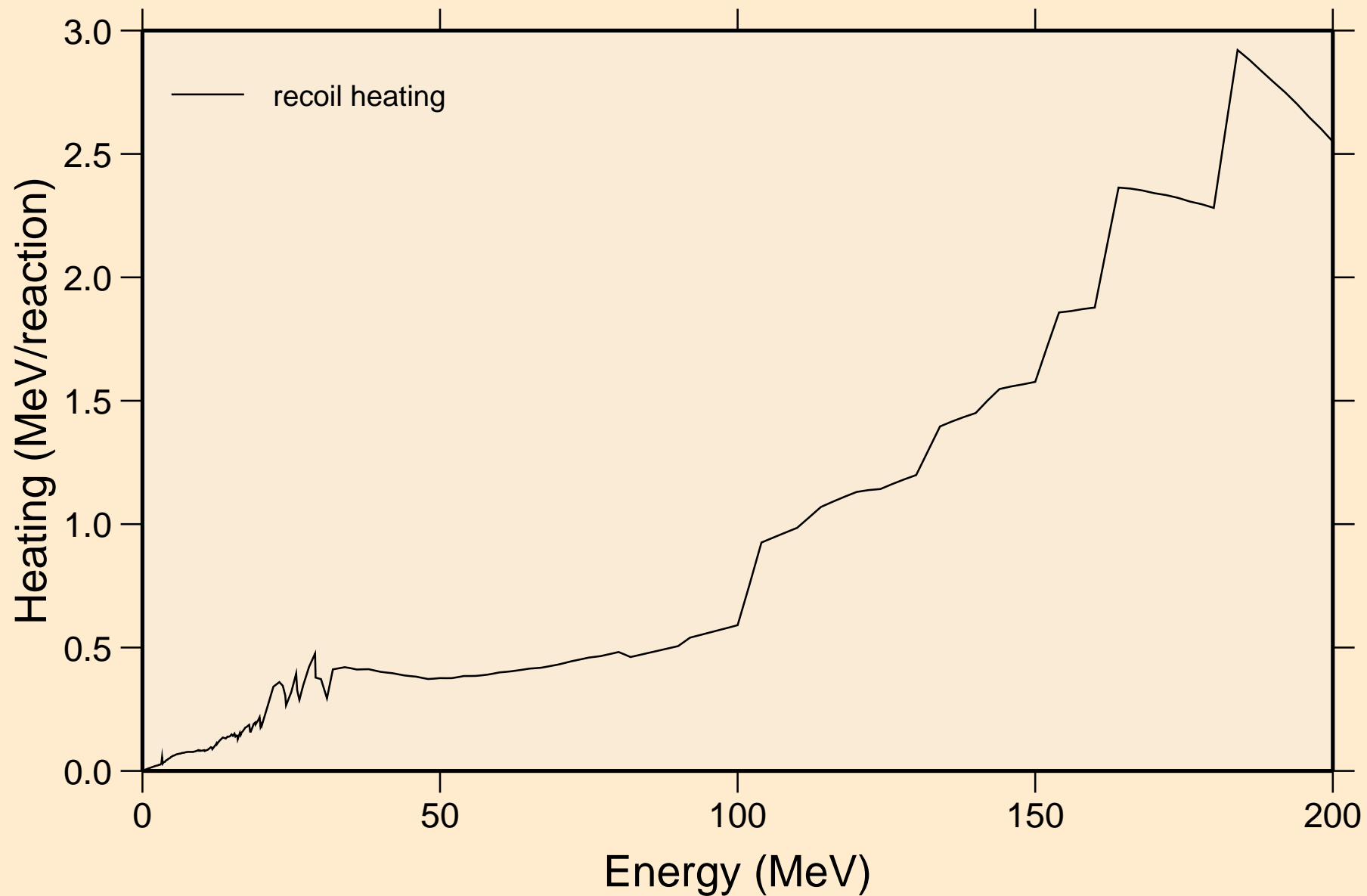

# SN114 NEUTRON ACER TENDL-2019 LIBRARY; T=293.16K

## Particle production cross sections

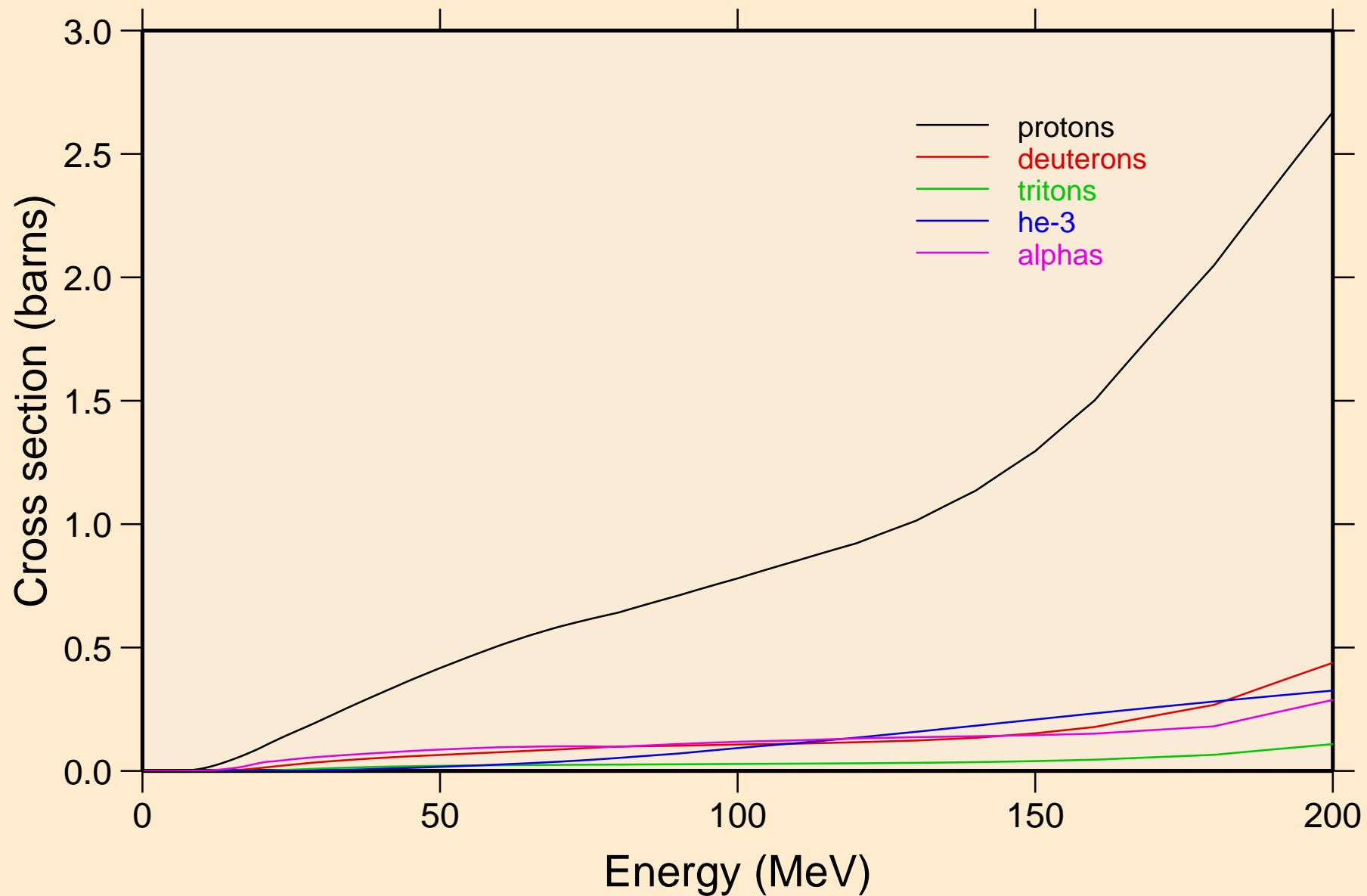



SN114 NEUTRON ACER TENDL-2019 LIBRARY; T=293.16K  
protons from (n,x)

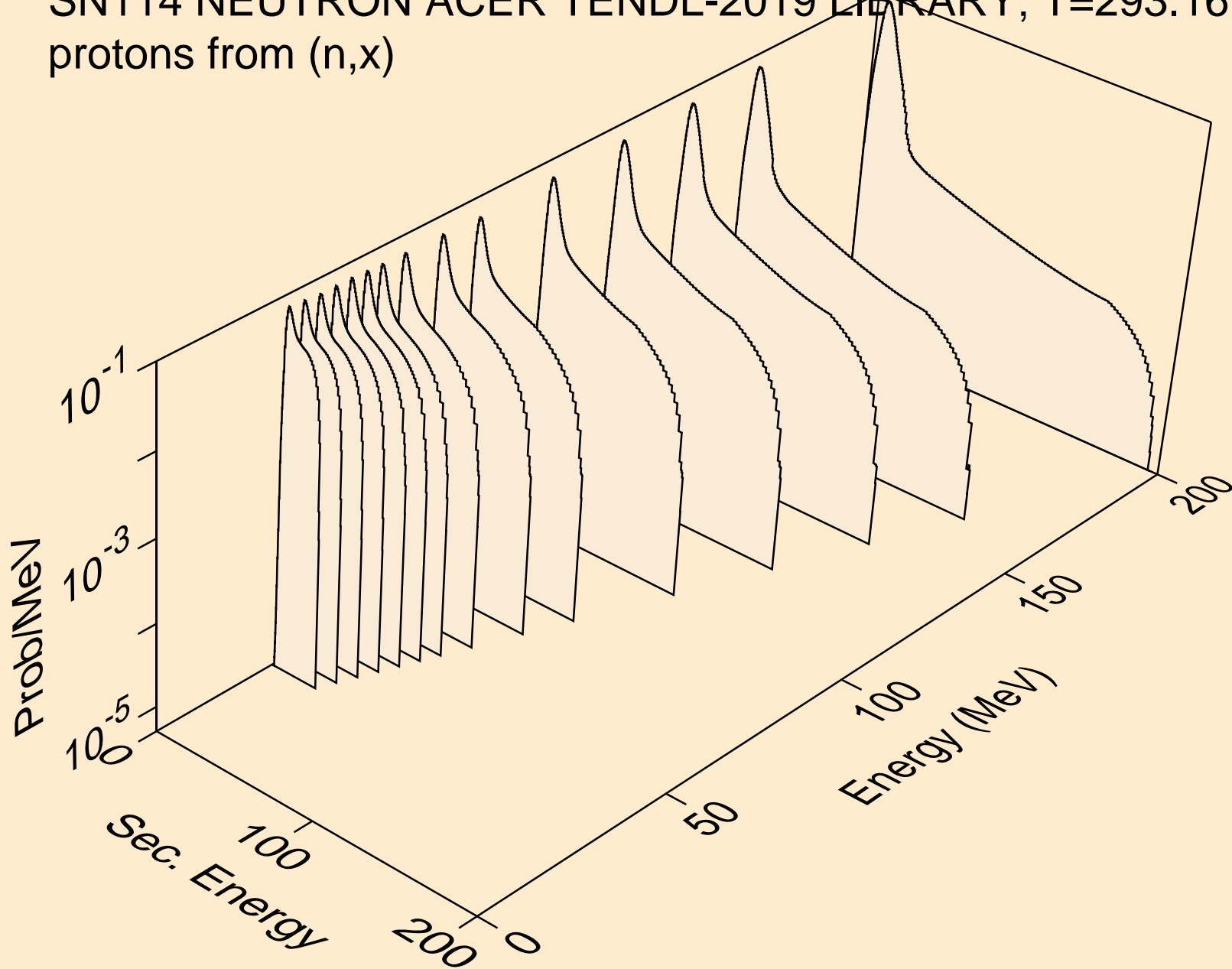

SN114 NEUTRON ACER TENDL-2019 LIBRARY; T=293.16K  
protons from (n,n\*)p

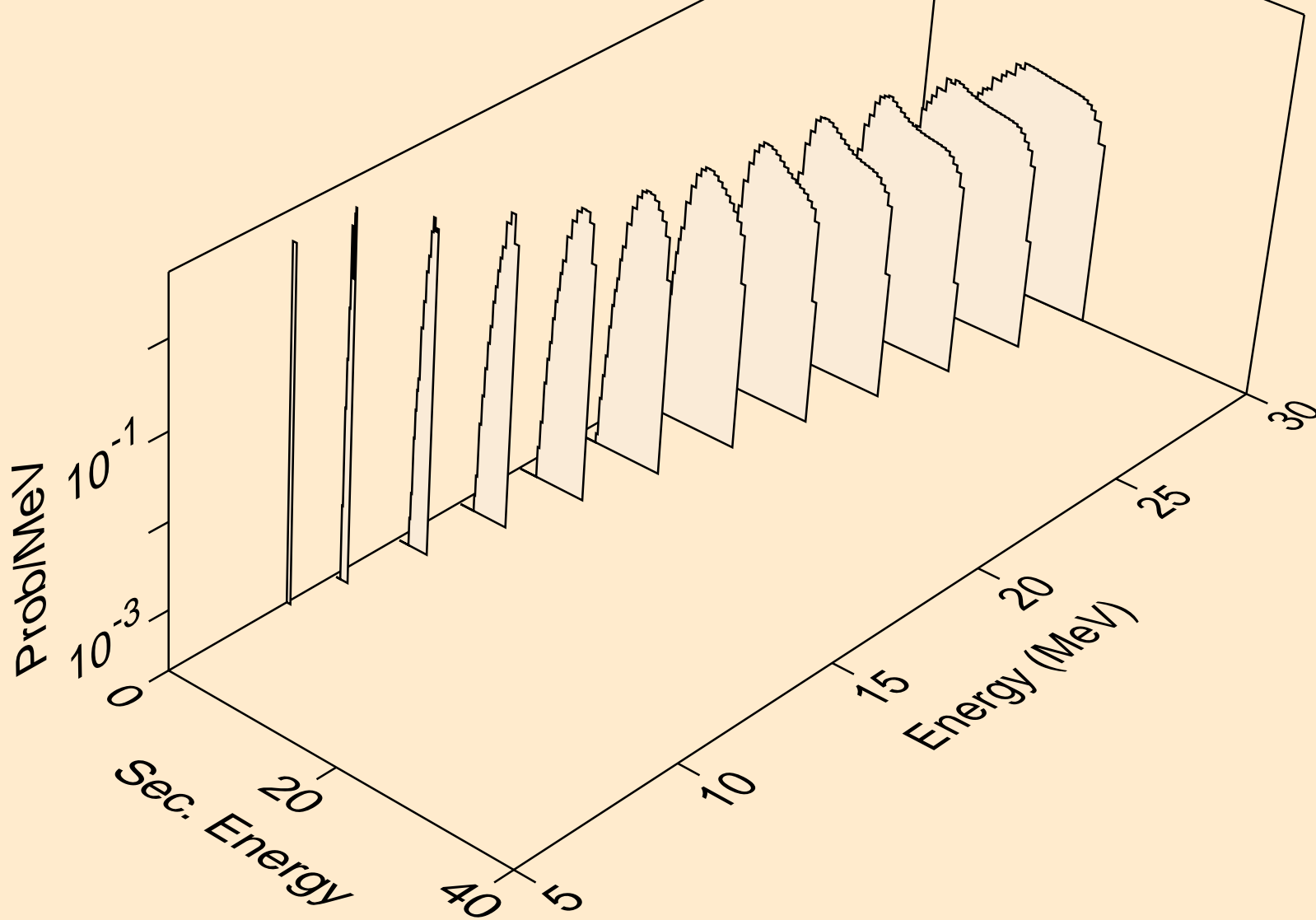

SN114 NEUTRON ACER TENDL-2019 LIBRARY; T=293.16K  
protons from (n,2np)

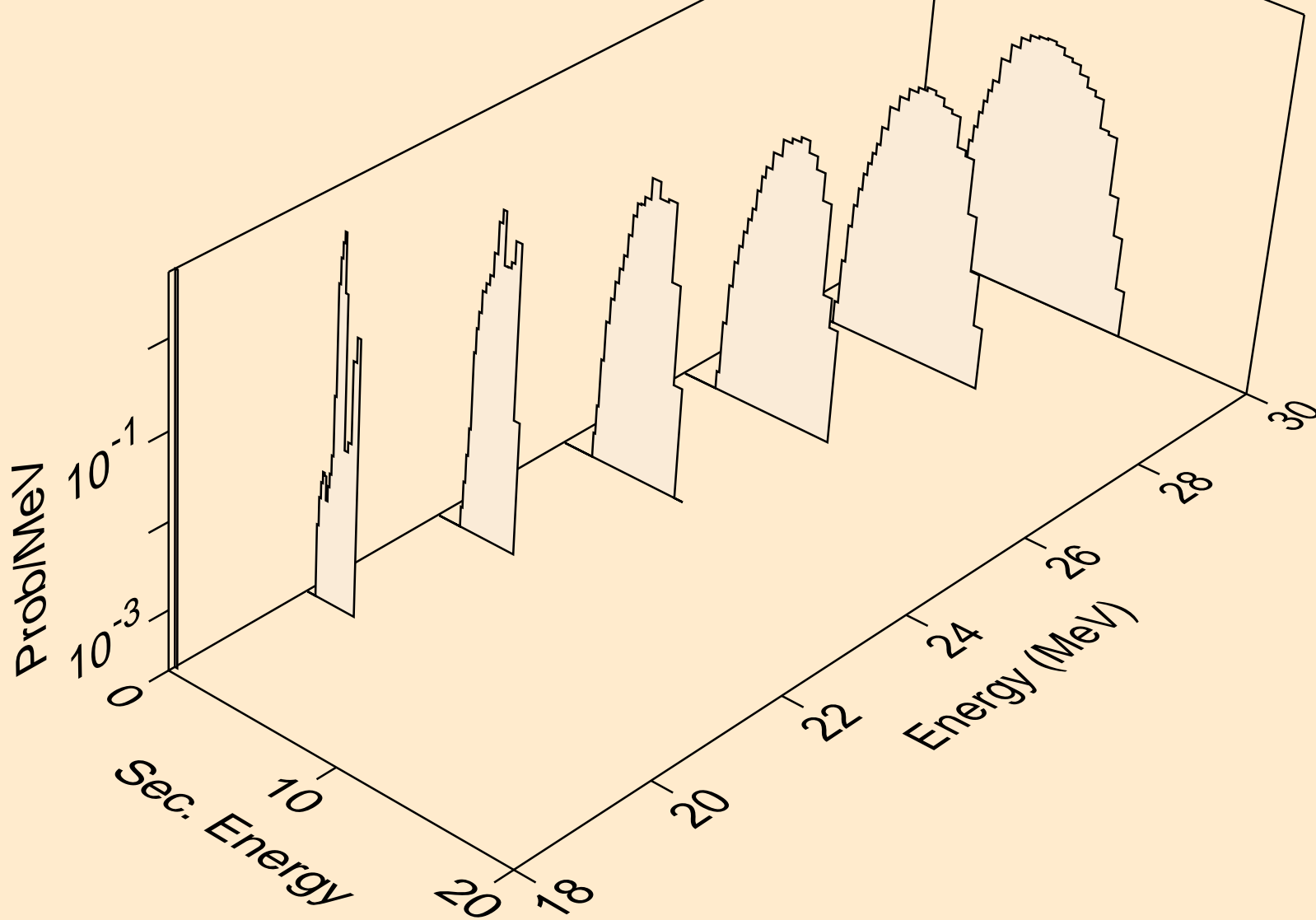

SN114 NEUTRON ACER TENDL-2019 LIBRARY; T=293.16K  
protons from (n,3np)

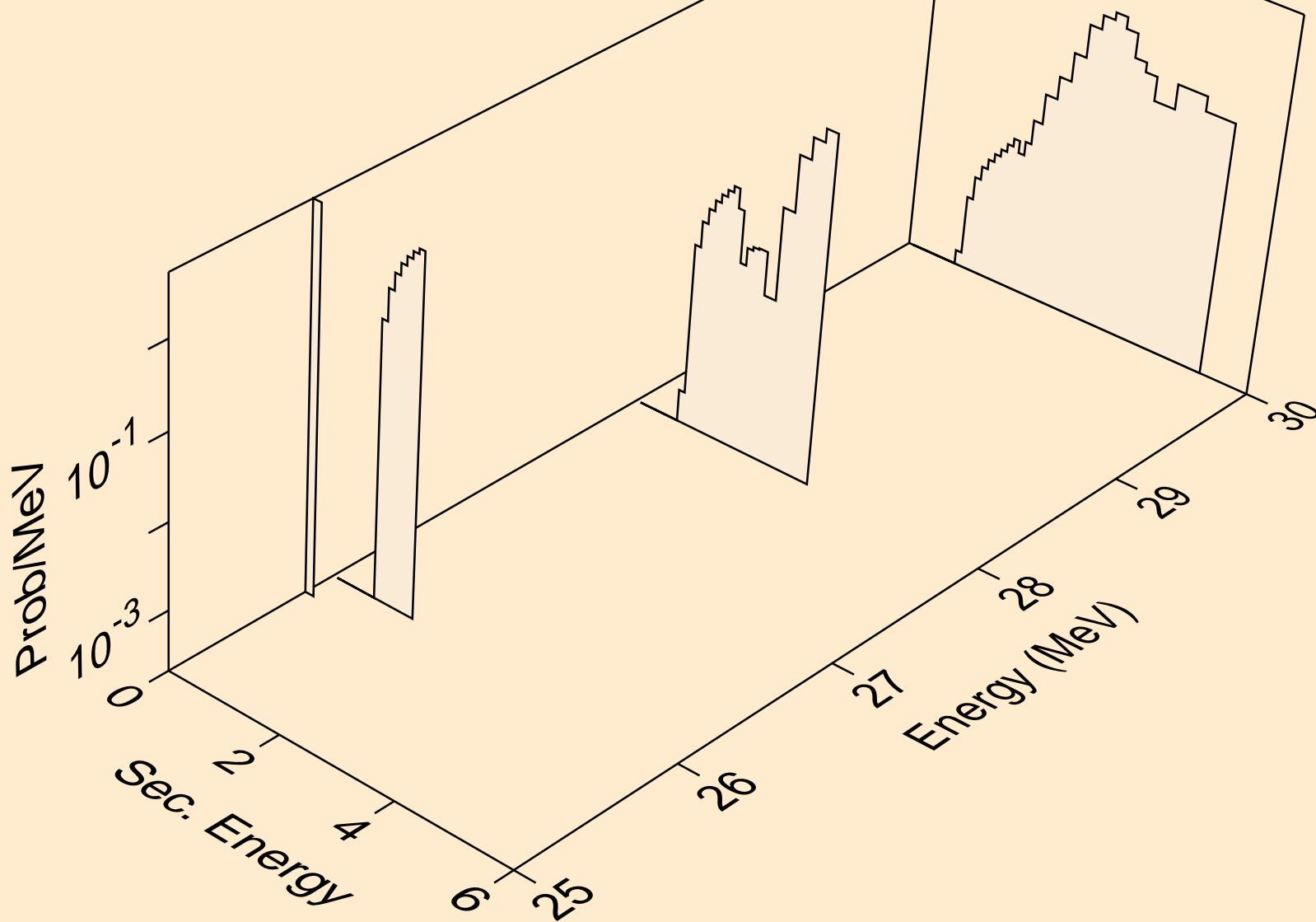

SN114 NEUTRON ACER TENDL-2019 LIBRARY; T=293.16K  
protons from (n,2np)

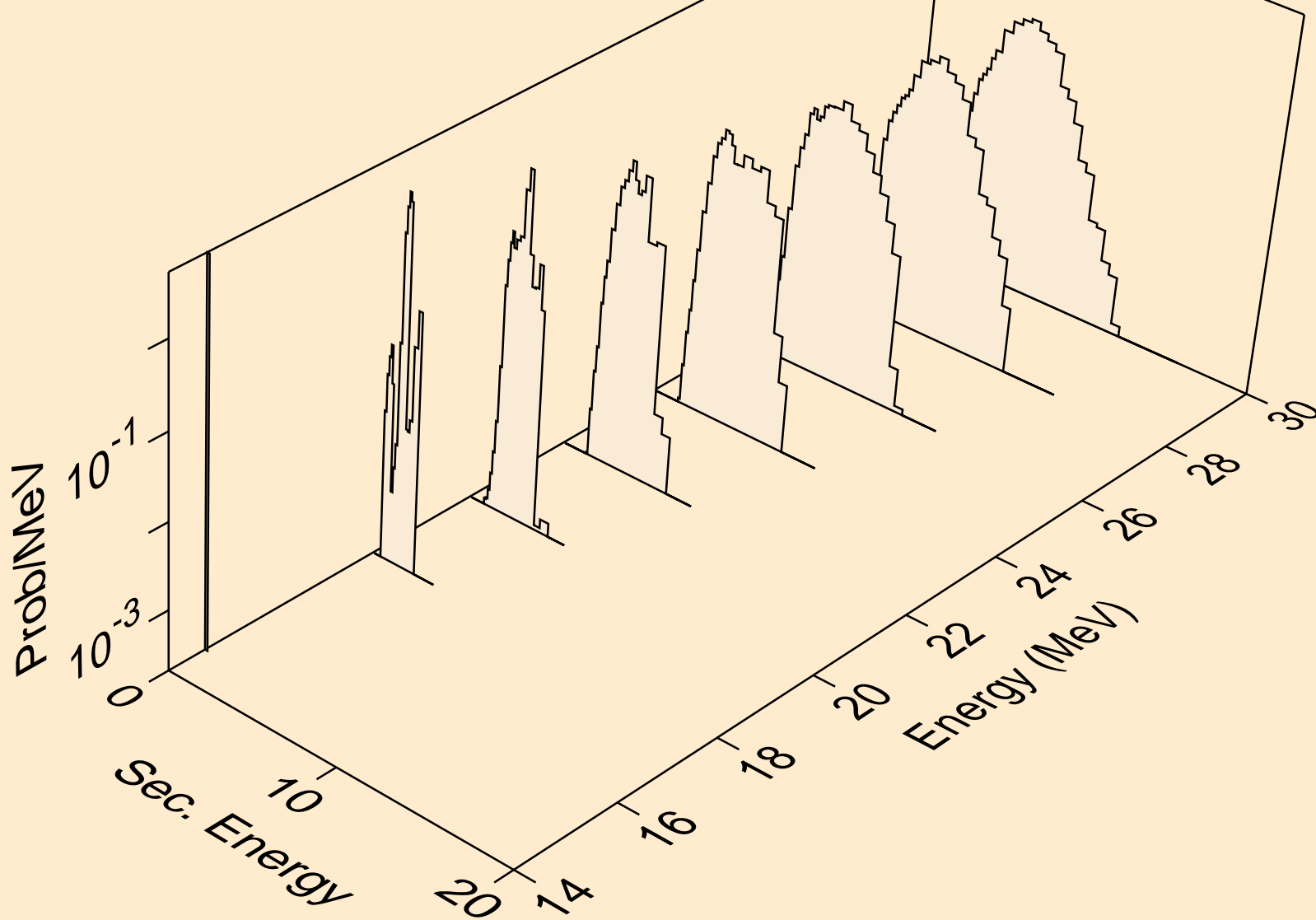

SN114 NEUTRON ACER TENDL-2019 LIBRARY; T=293.16K  
protons from (n,npa)

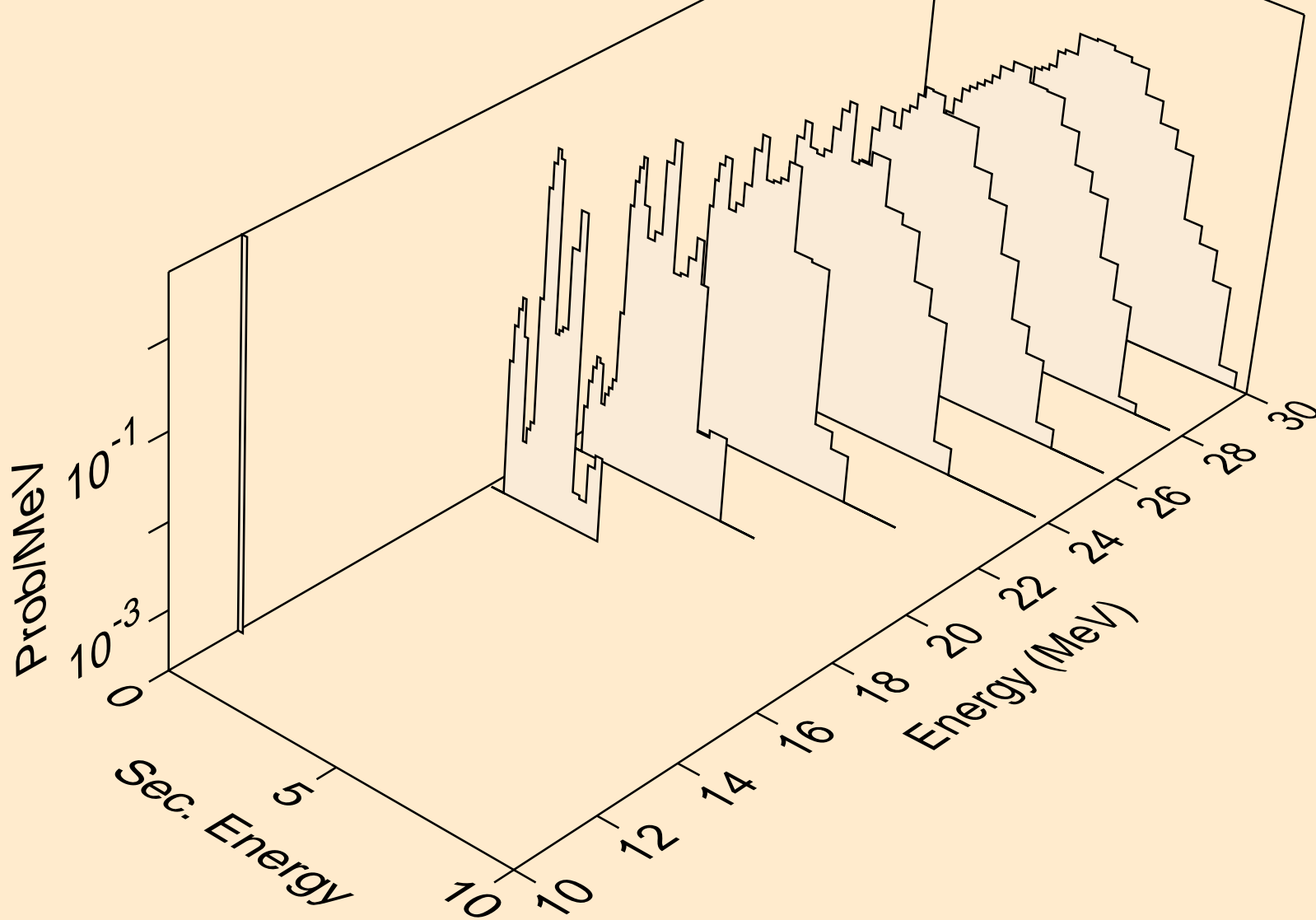

SN114 NEUTRON ACER TENDL-2019 LIBRARY; T=293.16K  
protons from (n,p)

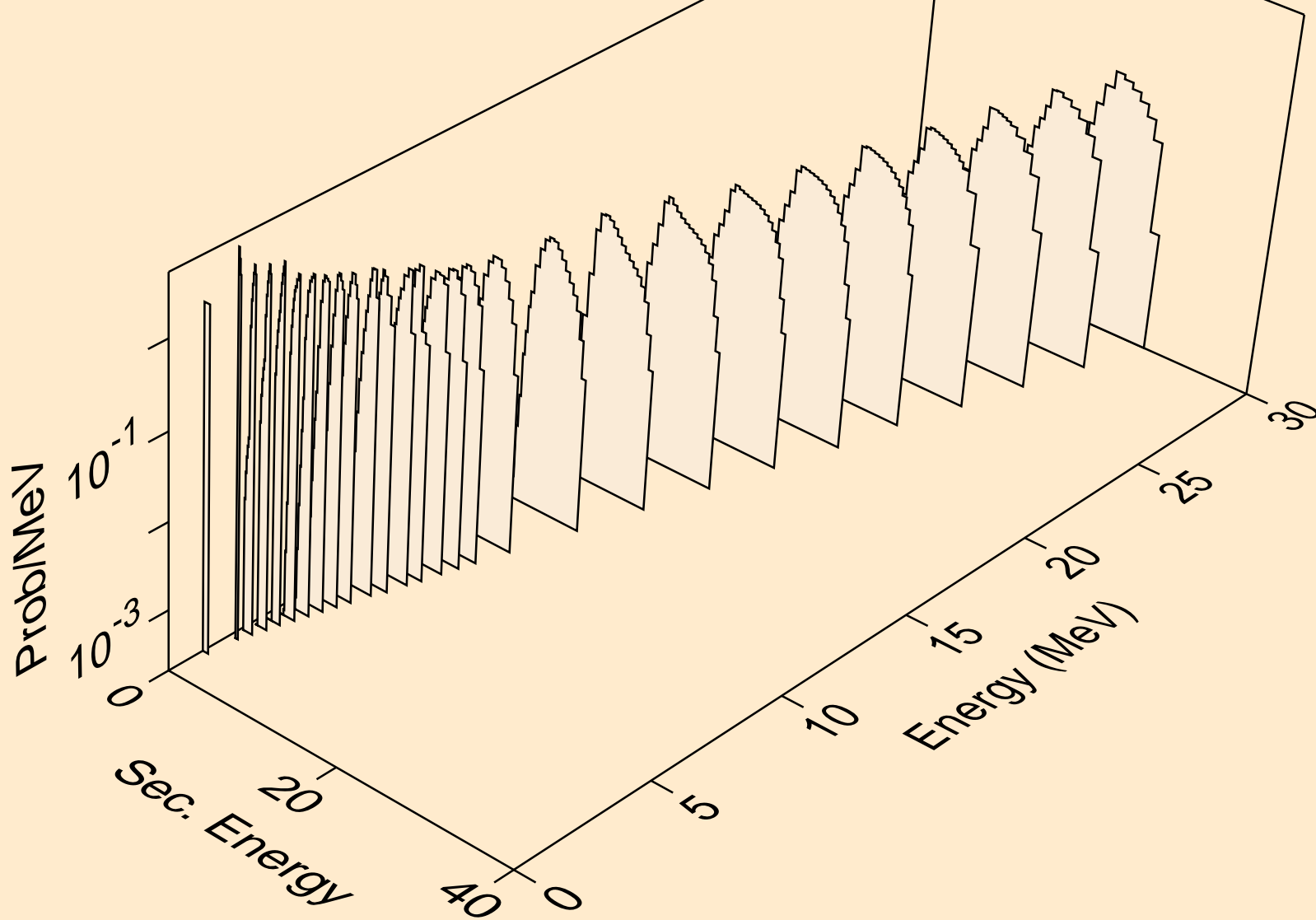

SN114 NEUTRON ACER TENDL-2019 LIBRARY; T=293.16K  
protons from (n,2p)

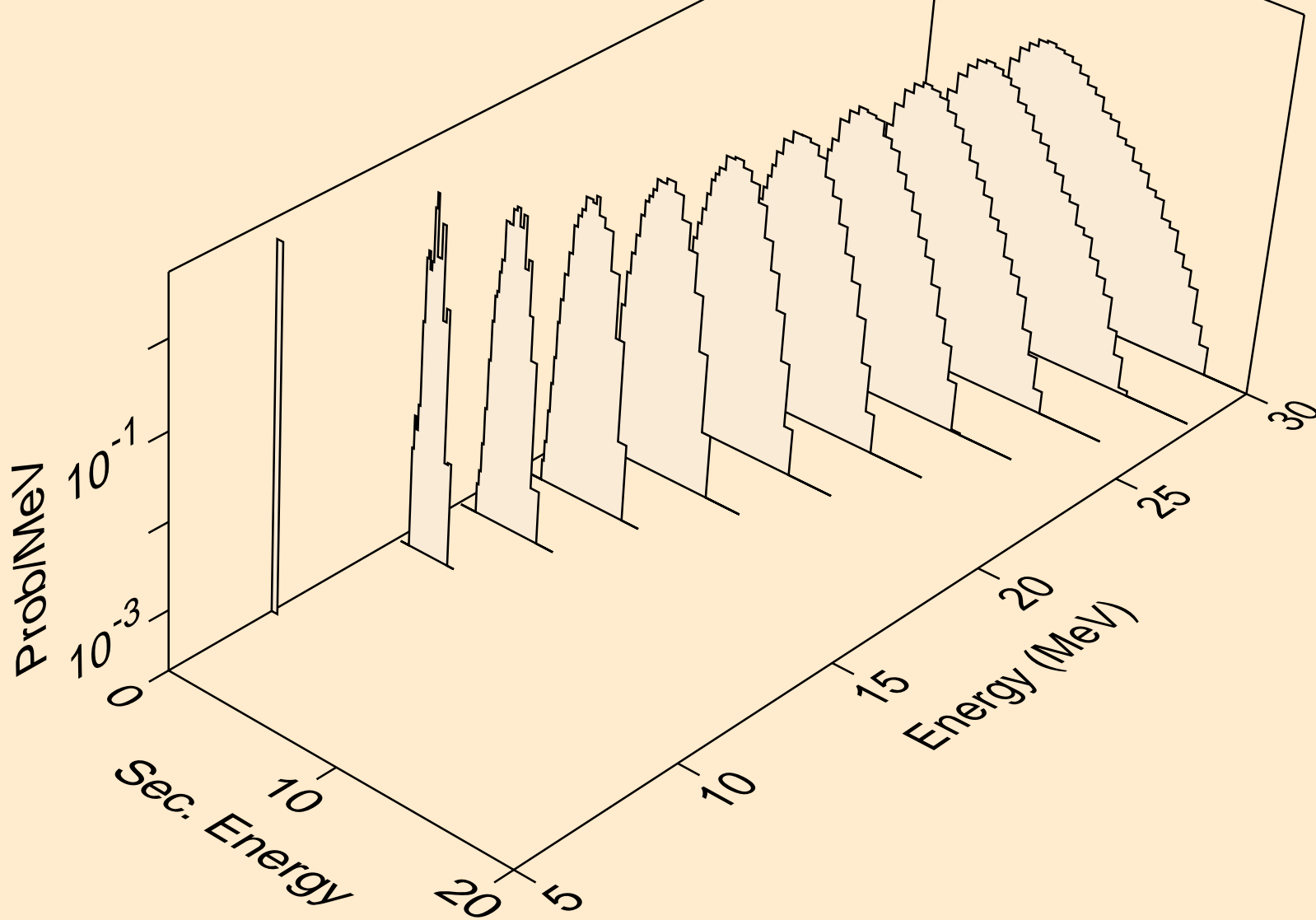



SN114 NEUTRON ACER TENDL-2019 LIBRARY; T=293.16K  
protons from (n,p)

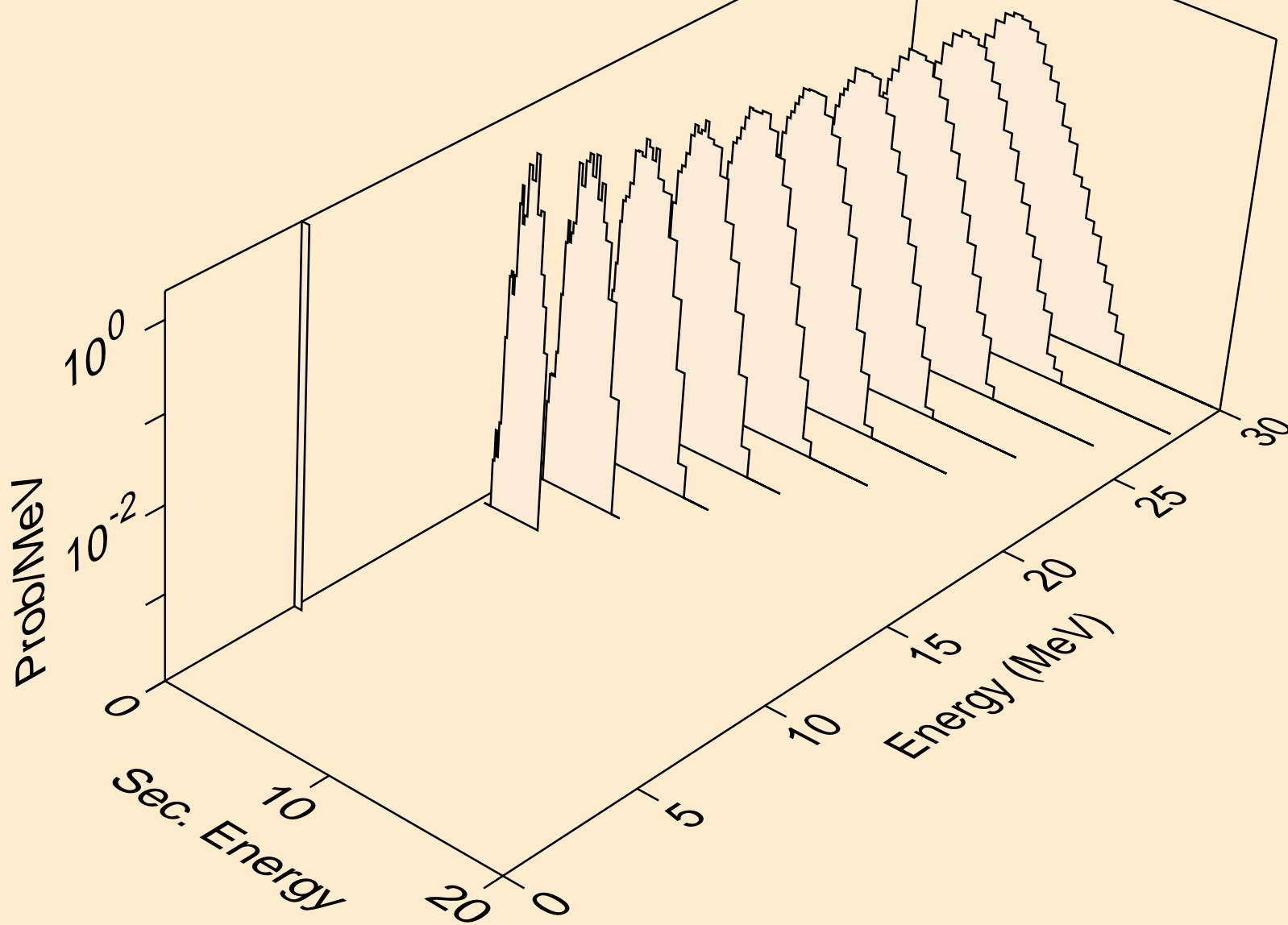

SN114 NEUTRON ACER TENDL-2019 LIBRARY; T=293.16K  
protons from (n,pd)

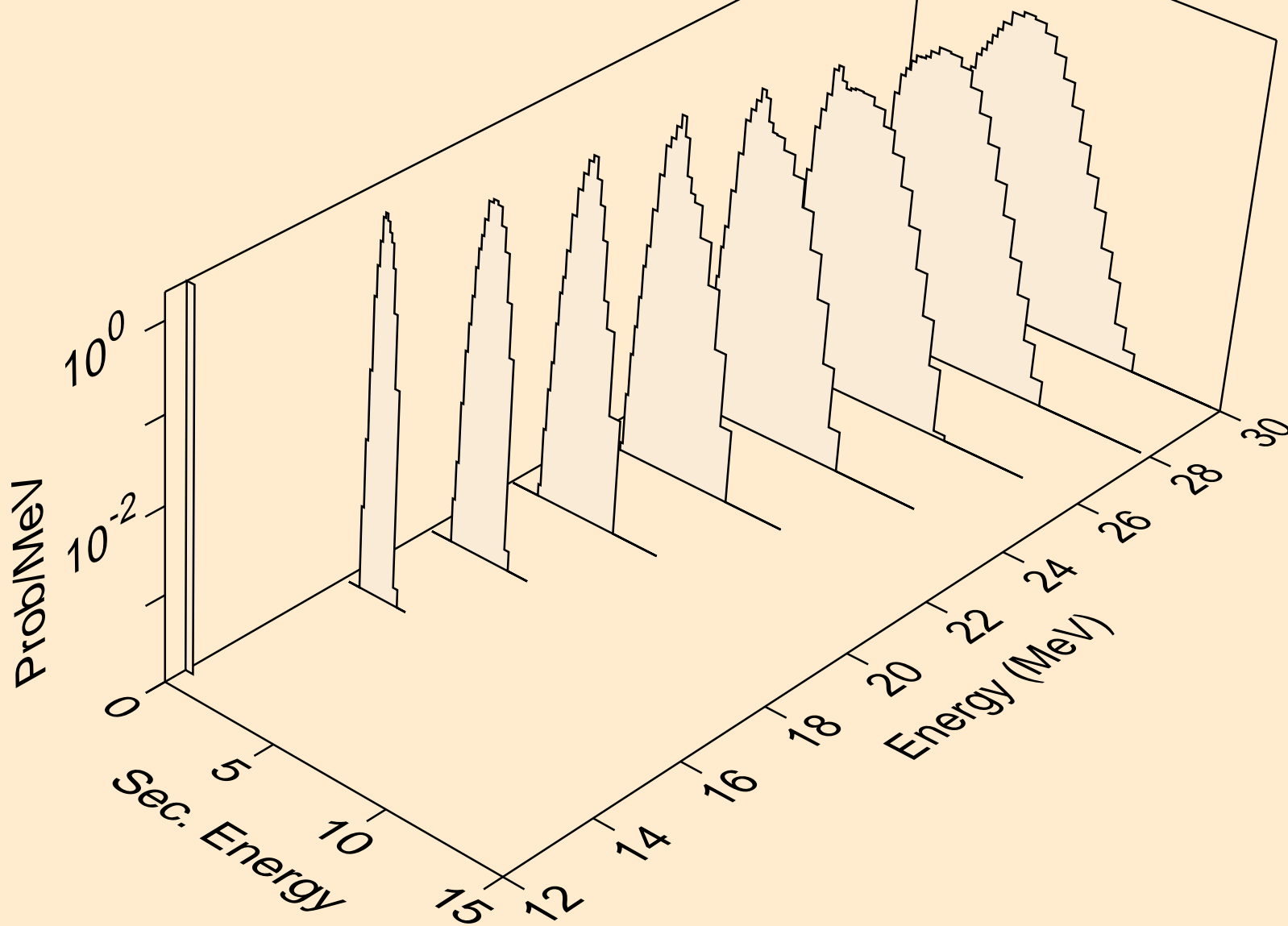

SN114 NEUTRON ACER TENDL-2019 LIBRARY; T=293.16K  
protons from (n,pt)

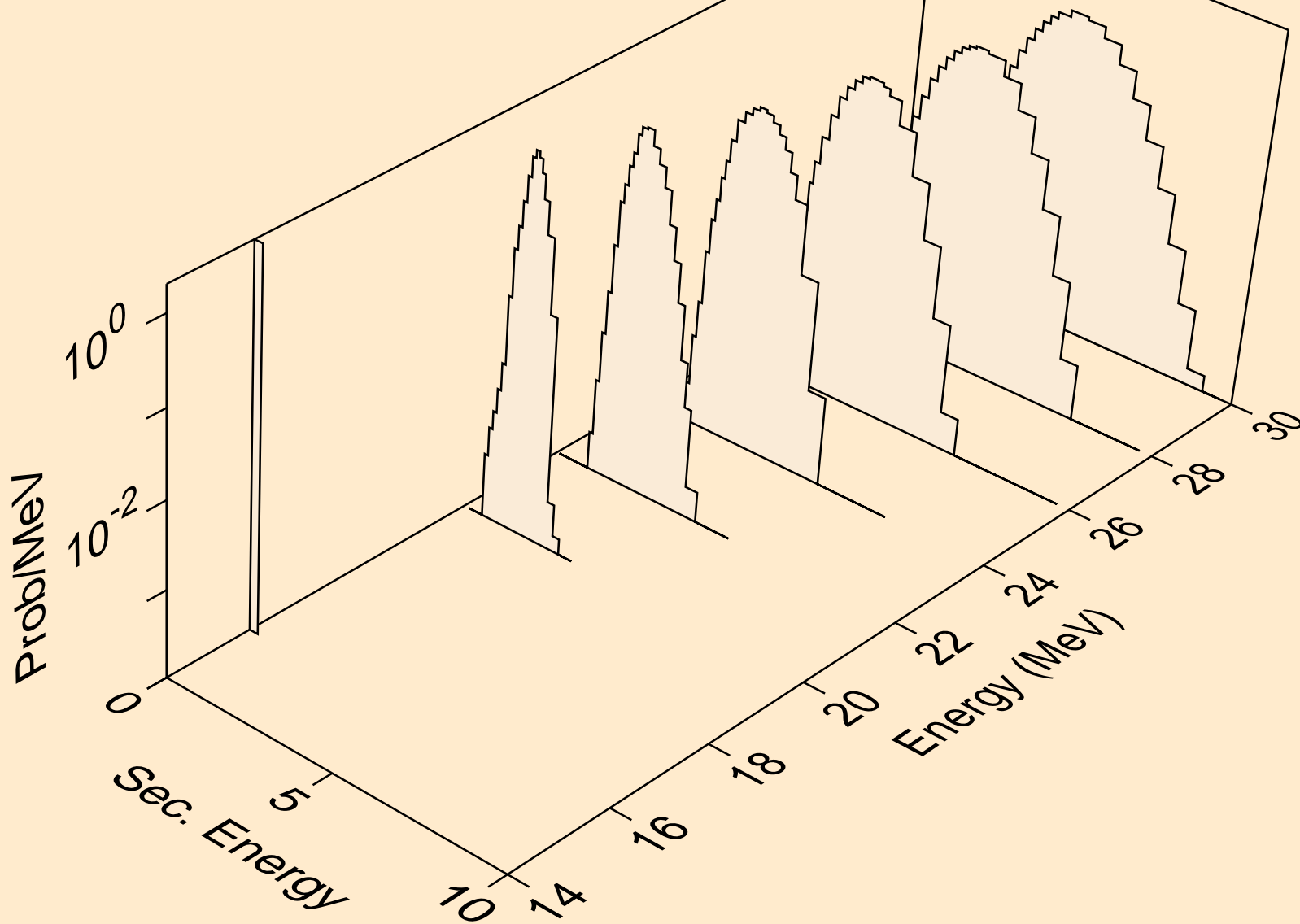

SN114 NEUTRON ACER TENDL-2019 LIBRARY; T=293.16K  
deuterons from (n,x)

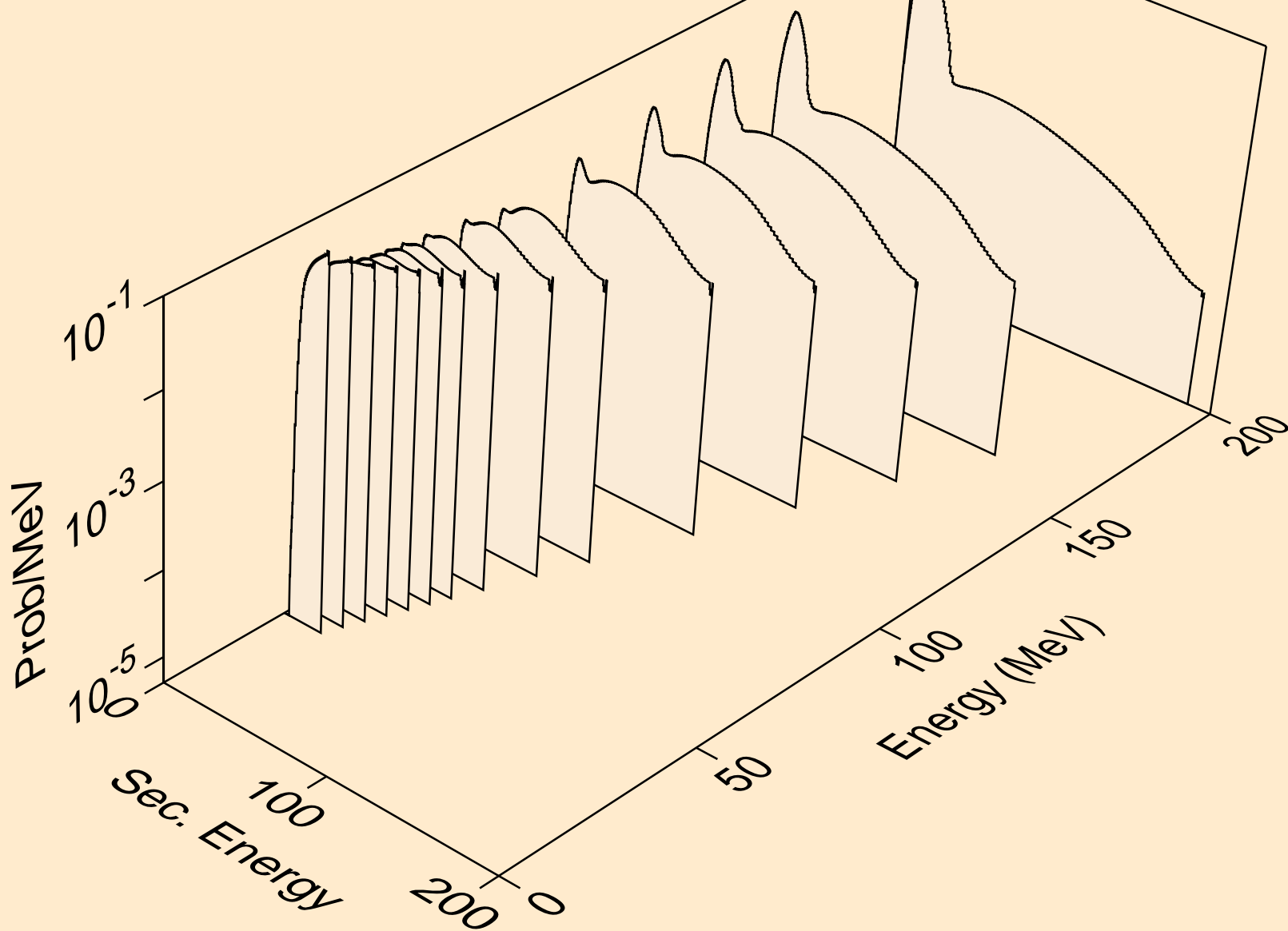

SN114 NEUTRON ACER TENDL-2019 LIBRARY; T=293.16K  
deuterons from (n,2nd)

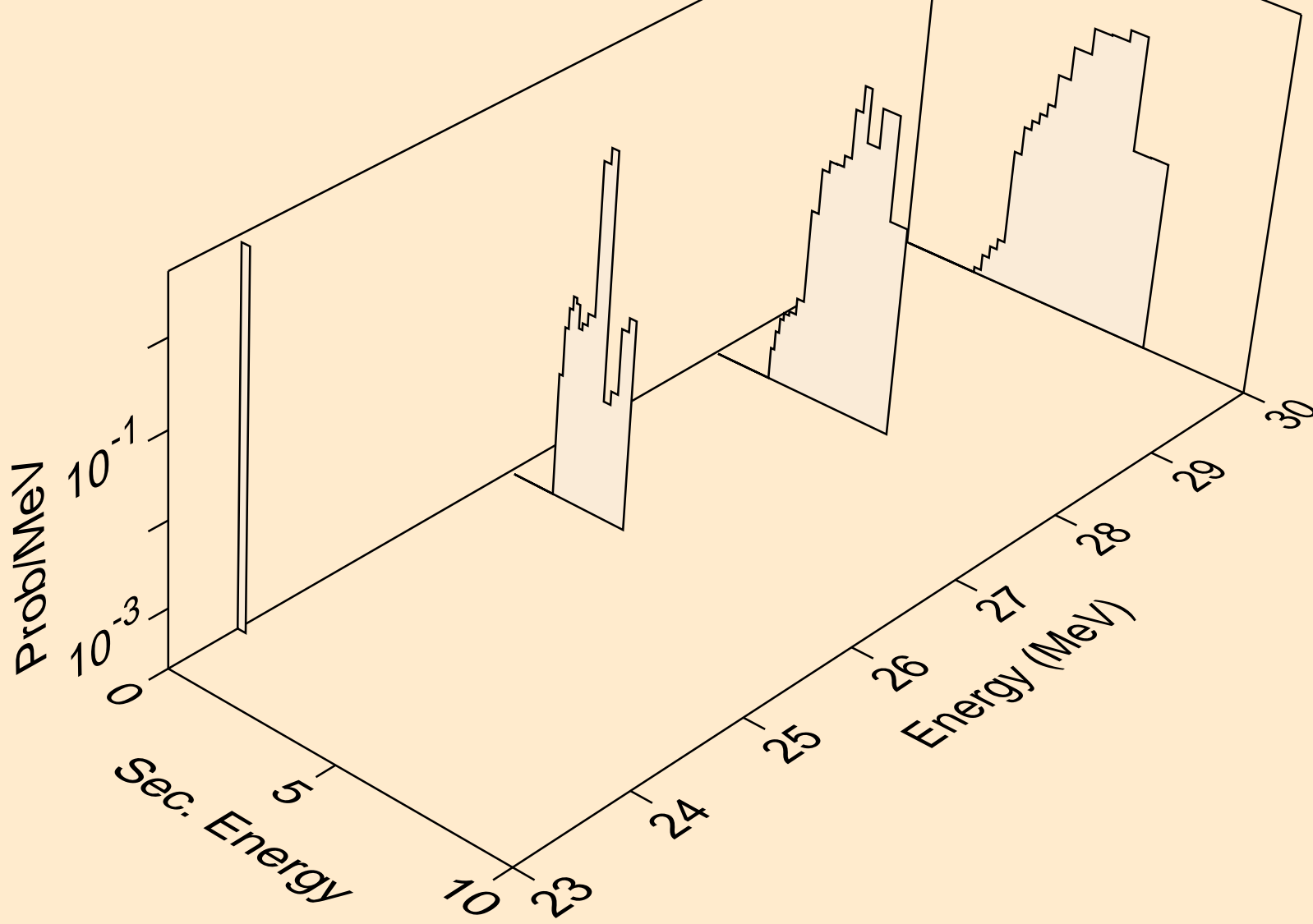

SN114 NEUTRON ACER TENDL-2019 LIBRARY; T=293.16K  
deuterons from (n,n\*)d

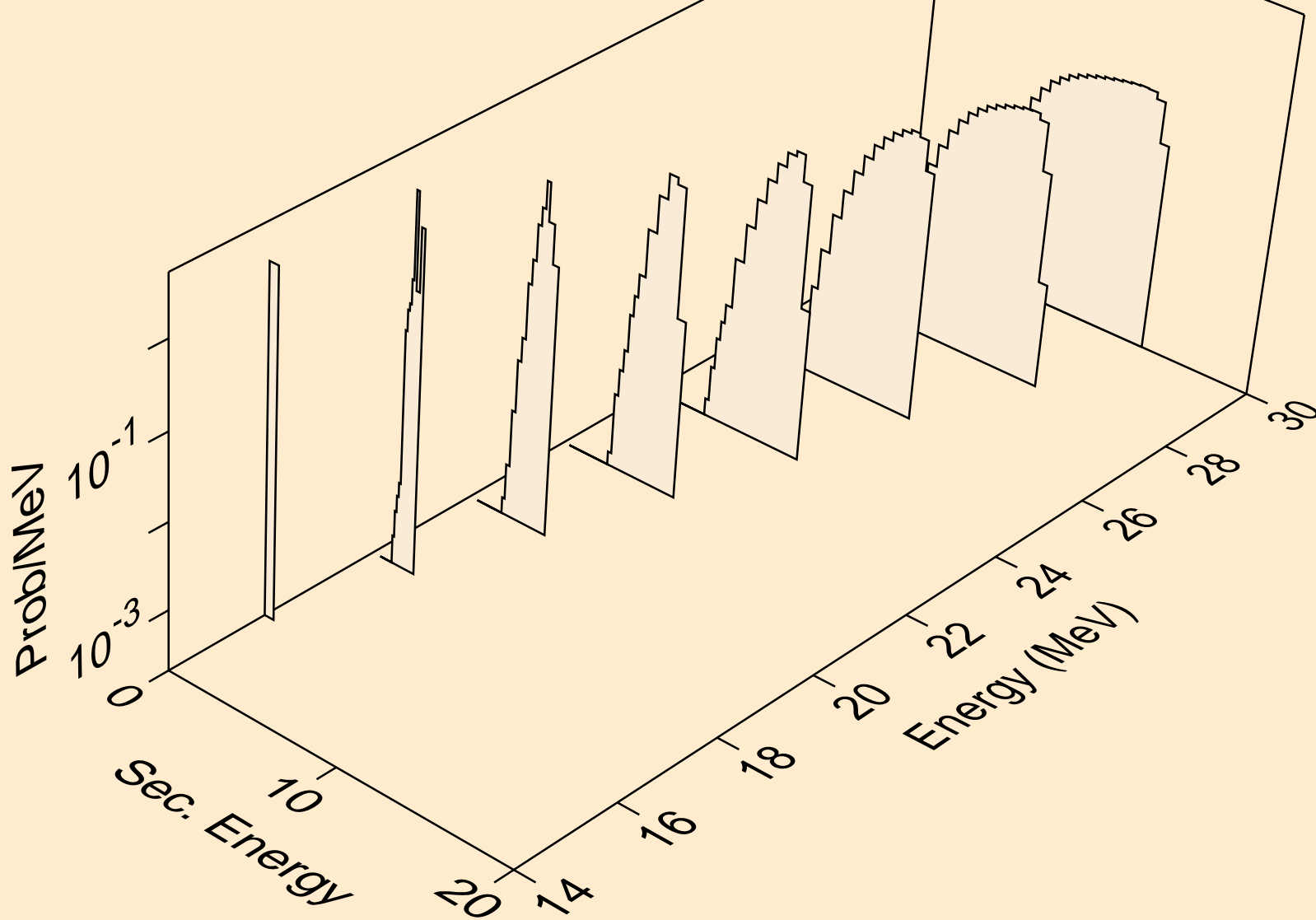

SN114 NEUTRON ACER TENDL-2019 LIBRARY; T=293.16K  
deuterons from (n,d)

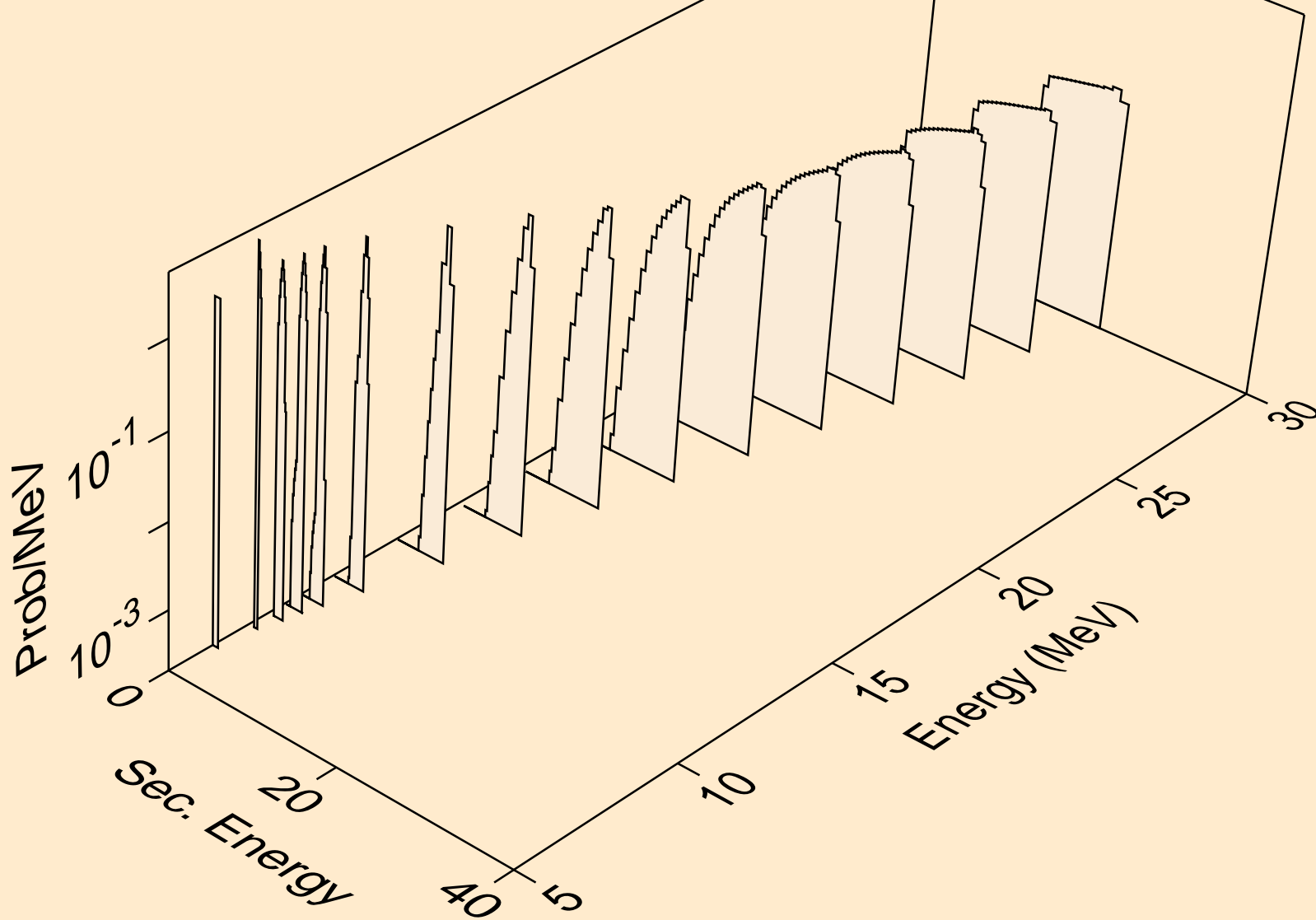

SN114 NEUTRON ACER TENDL-2019 LIBRARY; T=293.16K  
deuterons from (n,pd)

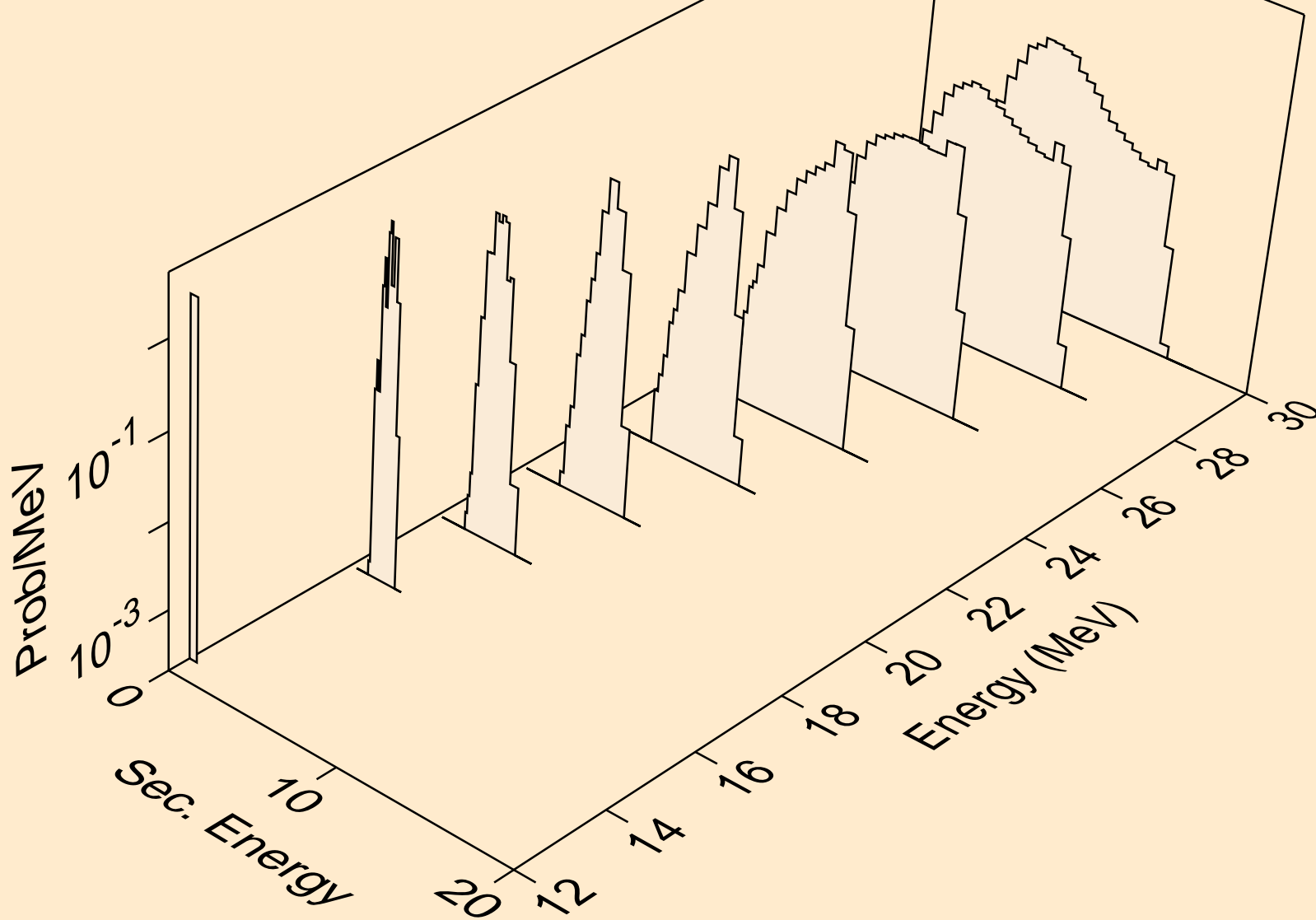



SN114 NEUTRON ACER TENDL-2019 LIBRARY; T=293.16K  
deuterons from (n,da)

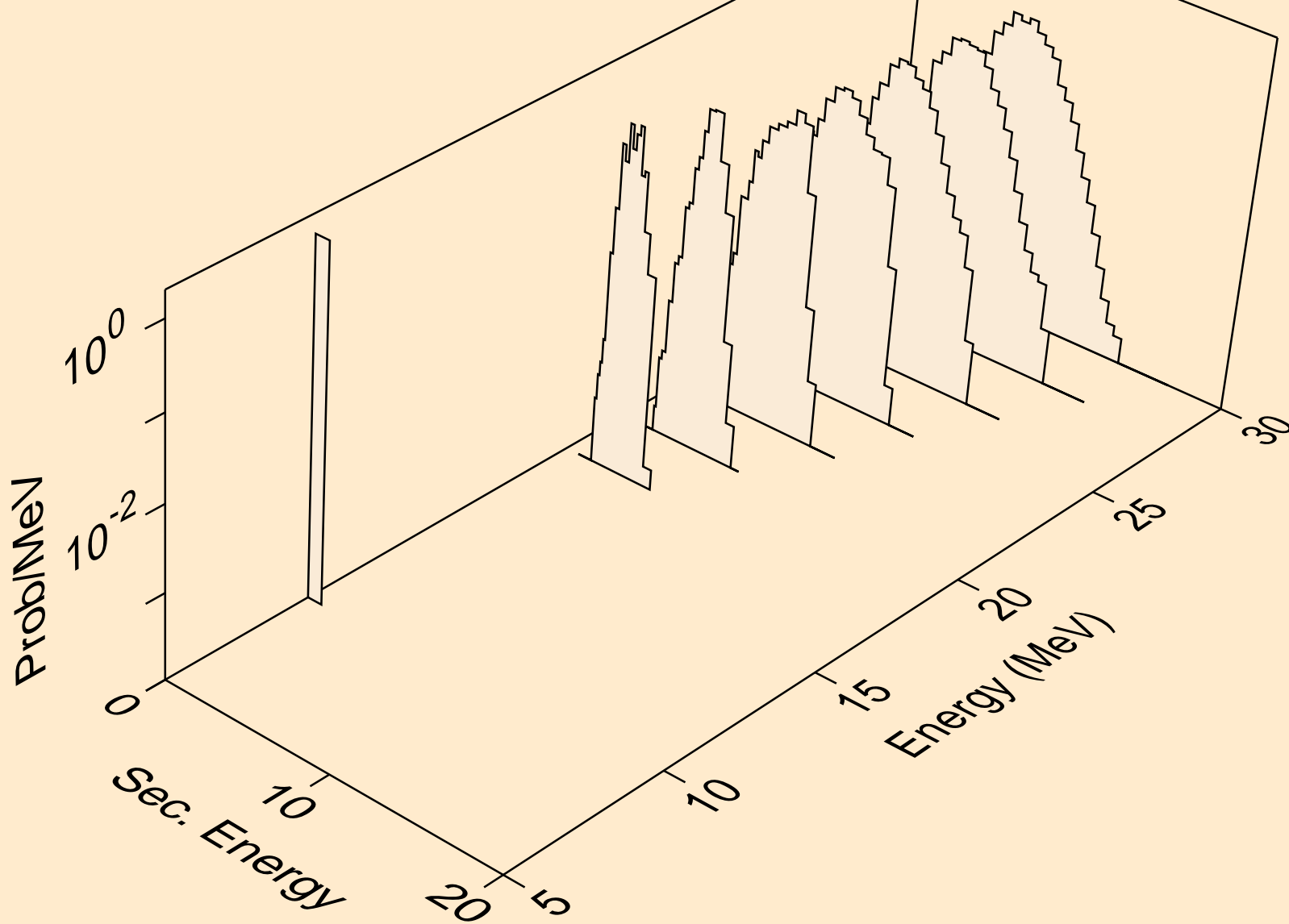

SN114 NEUTRON ACER TENDL-2019 LIBRARY; T=293.16K  
tritons from (n,x)

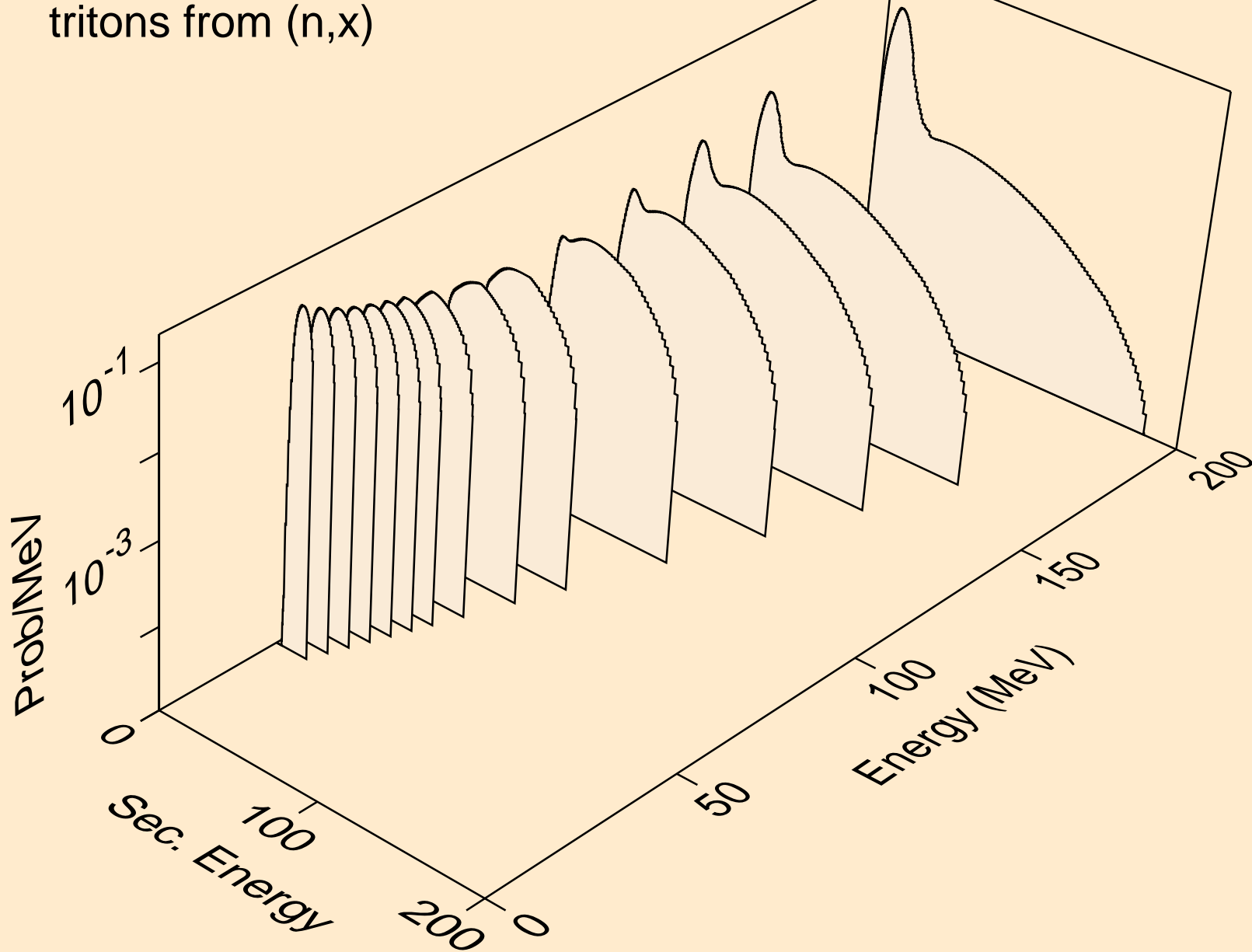

SN114 NEUTRON ACER TENDL-2019 LIBRARY; T=293.16K  
tritons from (n,n\*)t

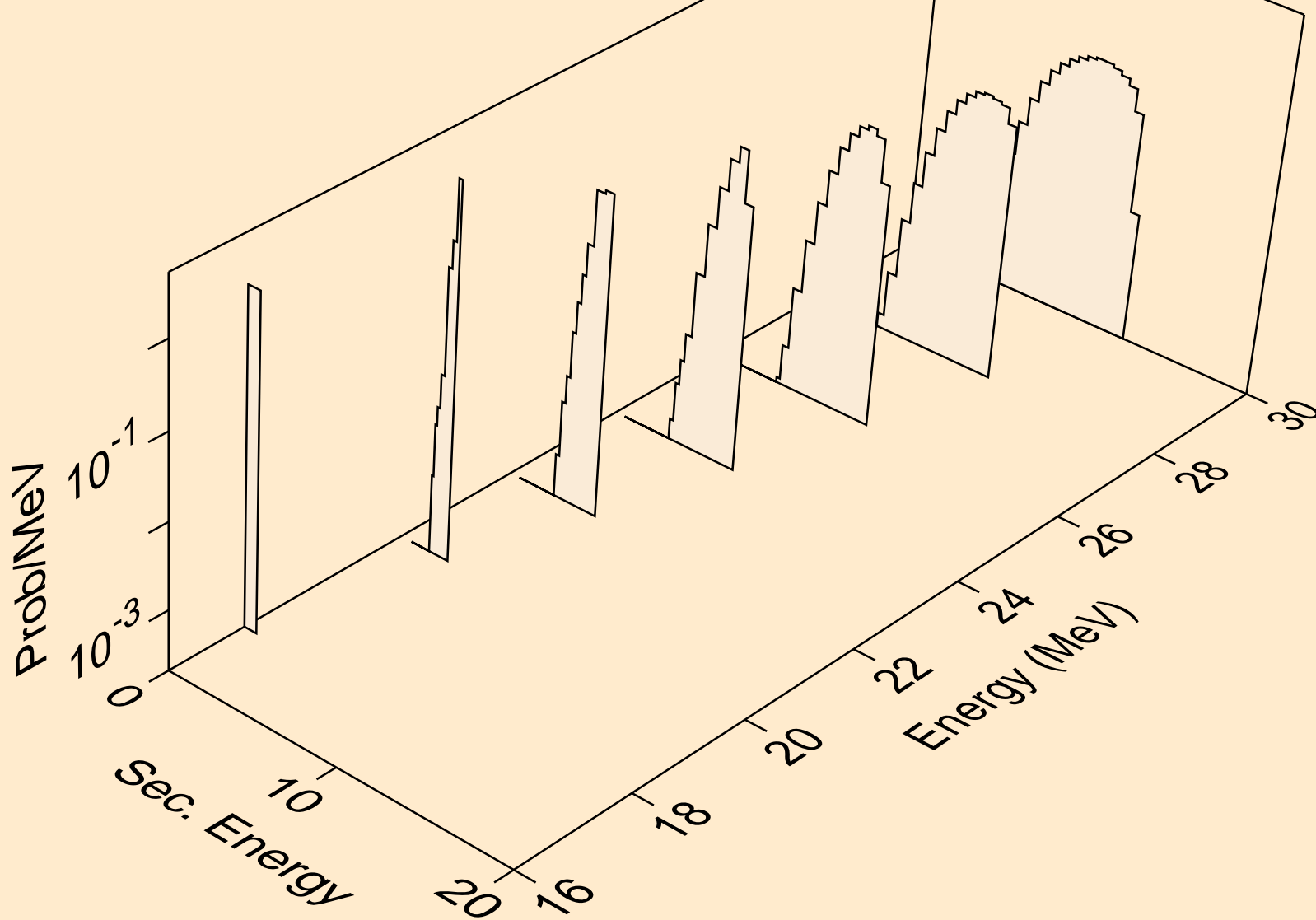

SN114 NEUTRON ACER TENDL-2019 LIBRARY; T=293.16K  
tritons from (n,t)

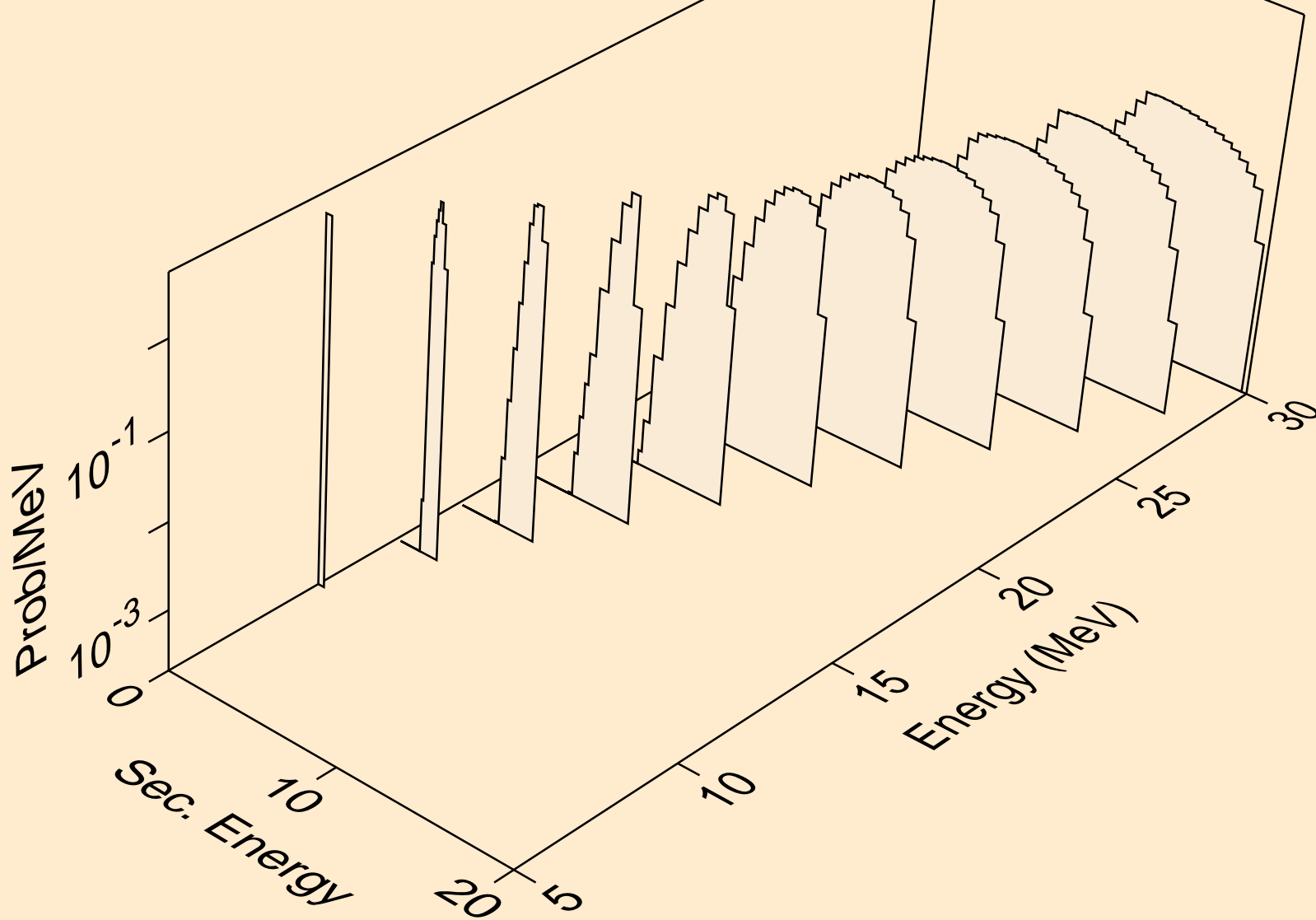

SN114 NEUTRON ACER TENDL-2019 LIBRARY; T=293.16K  
tritons from (n,pt)

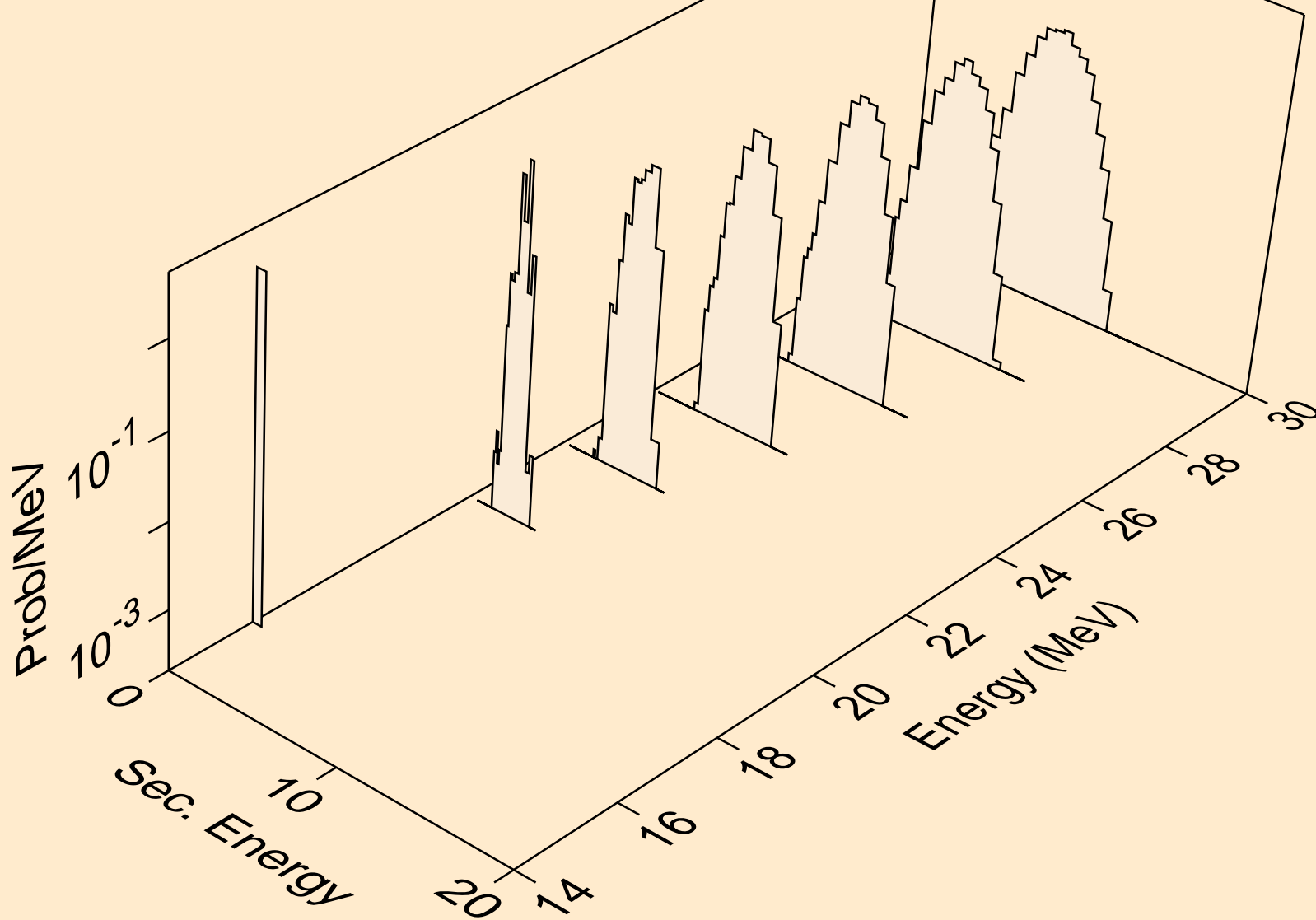

SN114 NEUTRON ACER TENDL-2019 LIBRARY; T=293.16K  
he3s from (n,x)

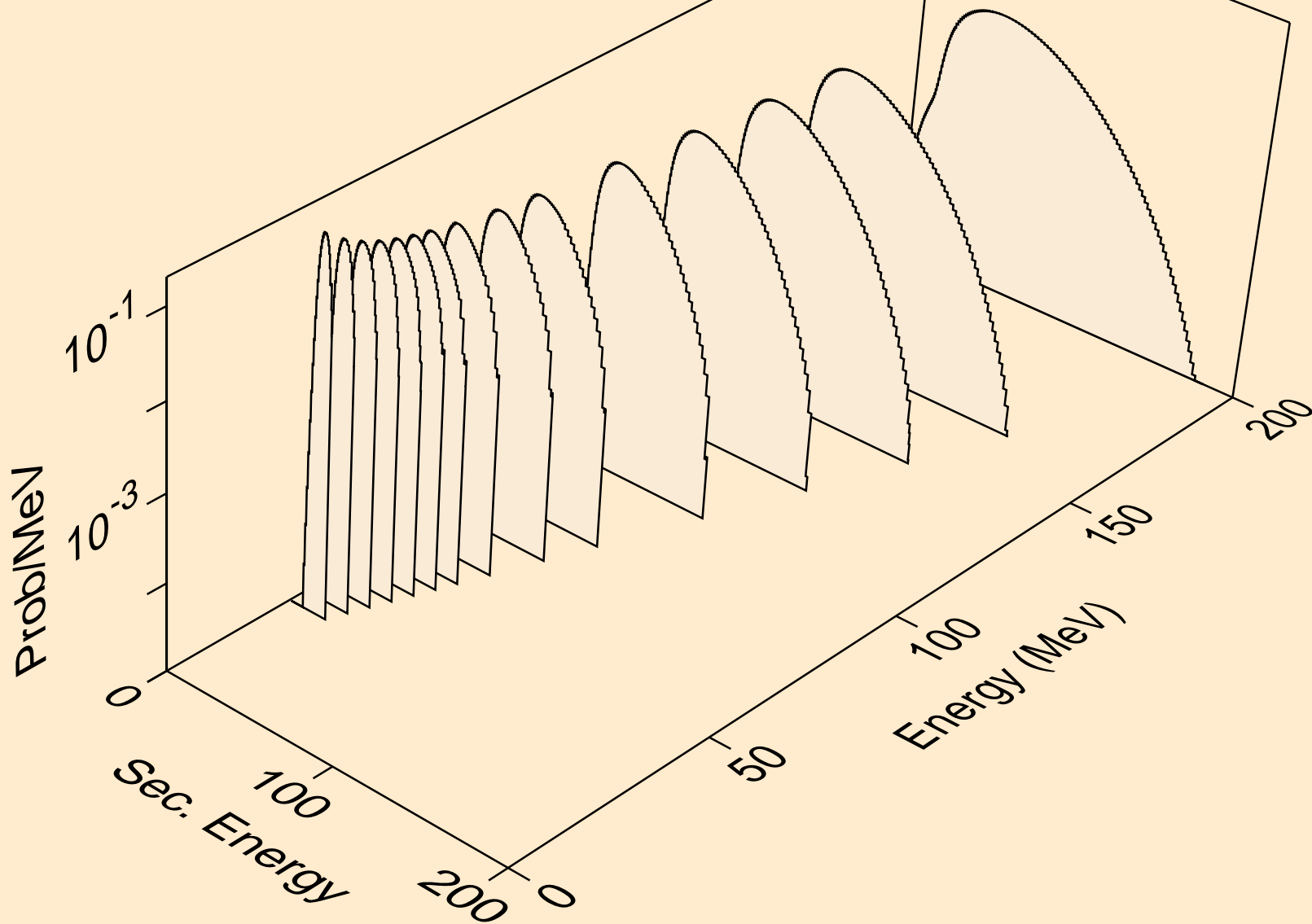

SN114 NEUTRON ACER TENDL-2019 LIBRARY; T=293.16K  
he3s from (n,n\*)he3

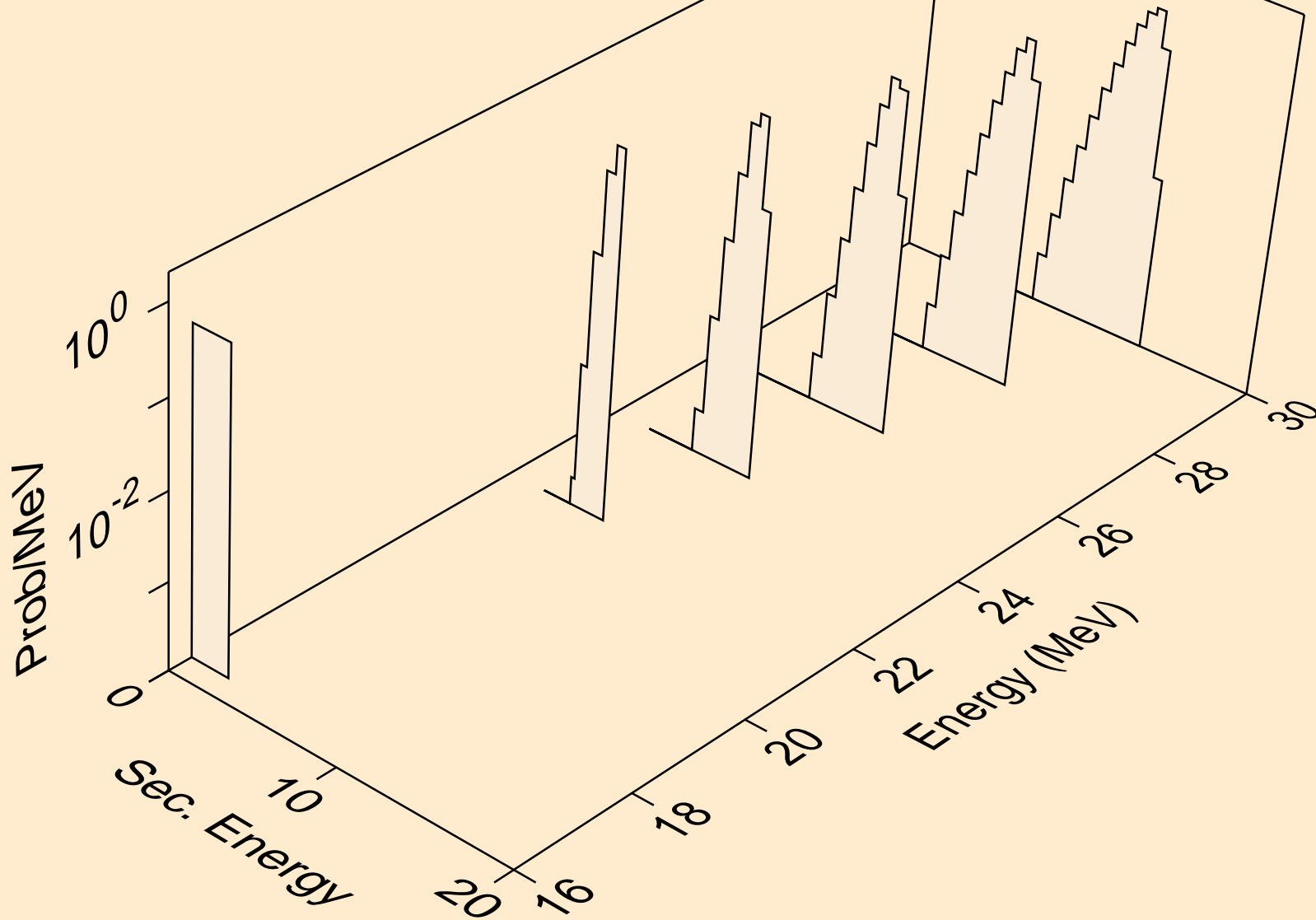

SN114 NEUTRON ACER TENDL-2019 LIBRARY; T=293.16K  
he3s from (n,he3)

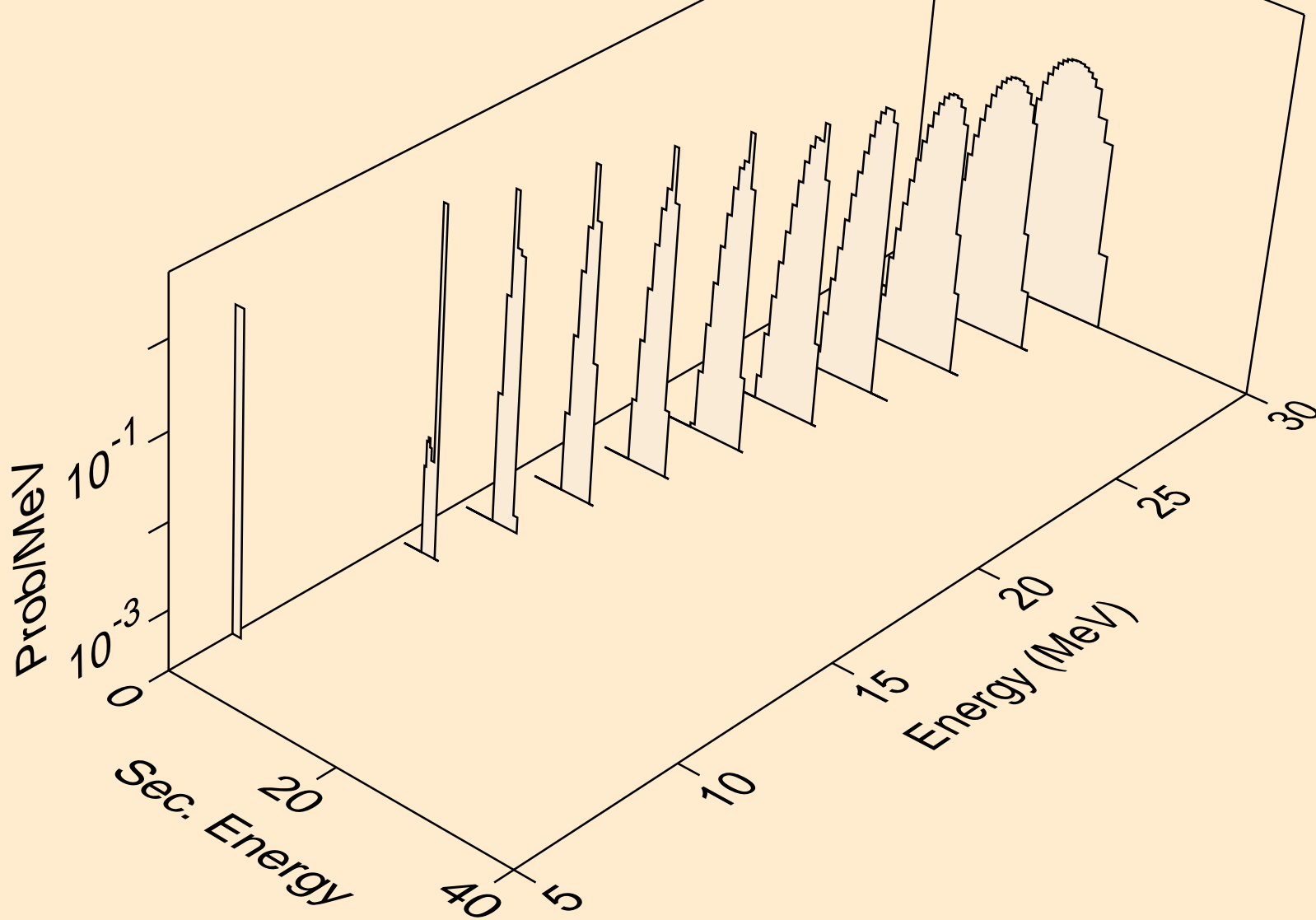



SN114 NEUTRON ACER TENDL-2019 LIBRARY; T=293.16K  
alphas from (n,x)

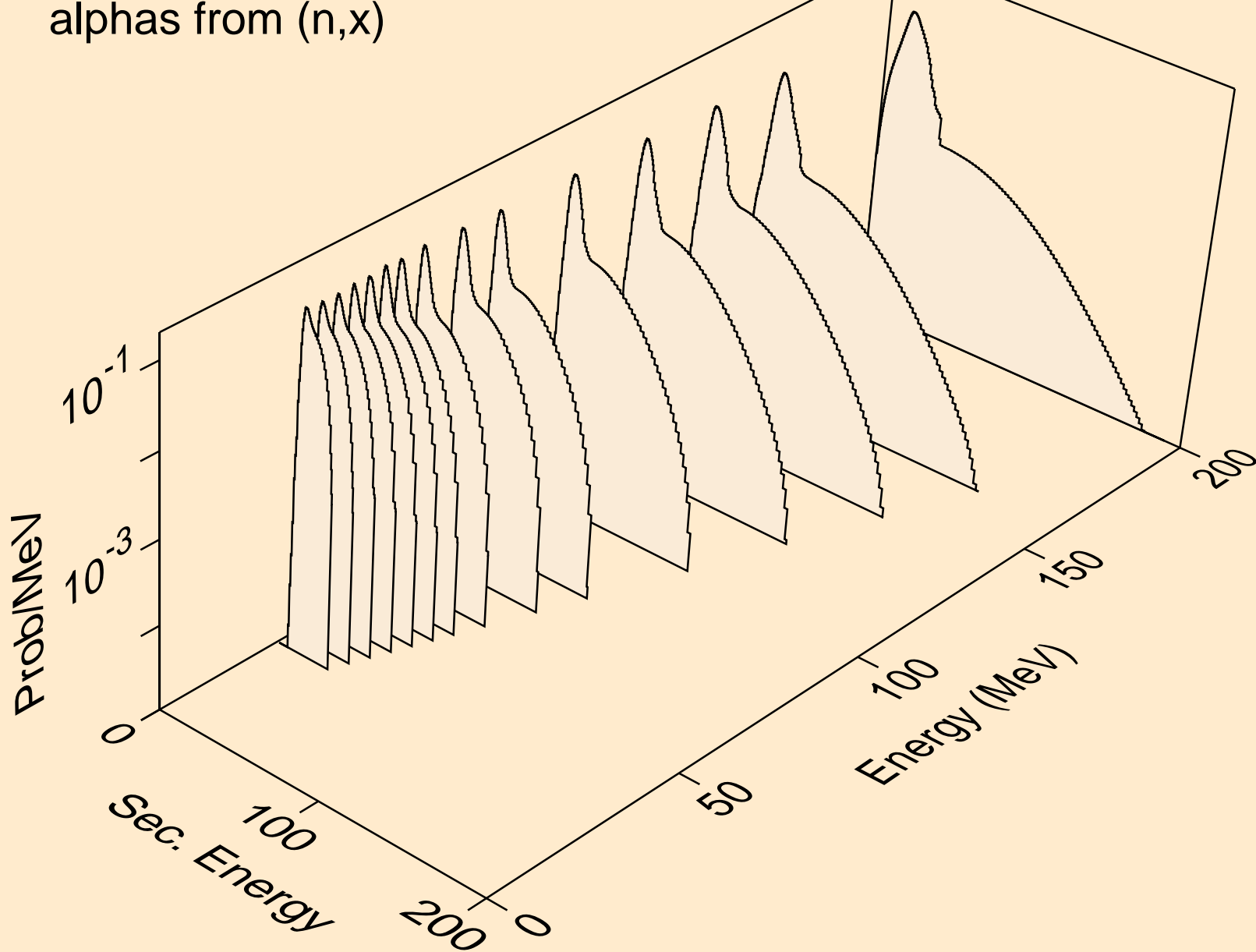

SN114 NEUTRON ACER TENDL-2019 LIBRARY; T=293.16K  
alphas from (n,n\*)a

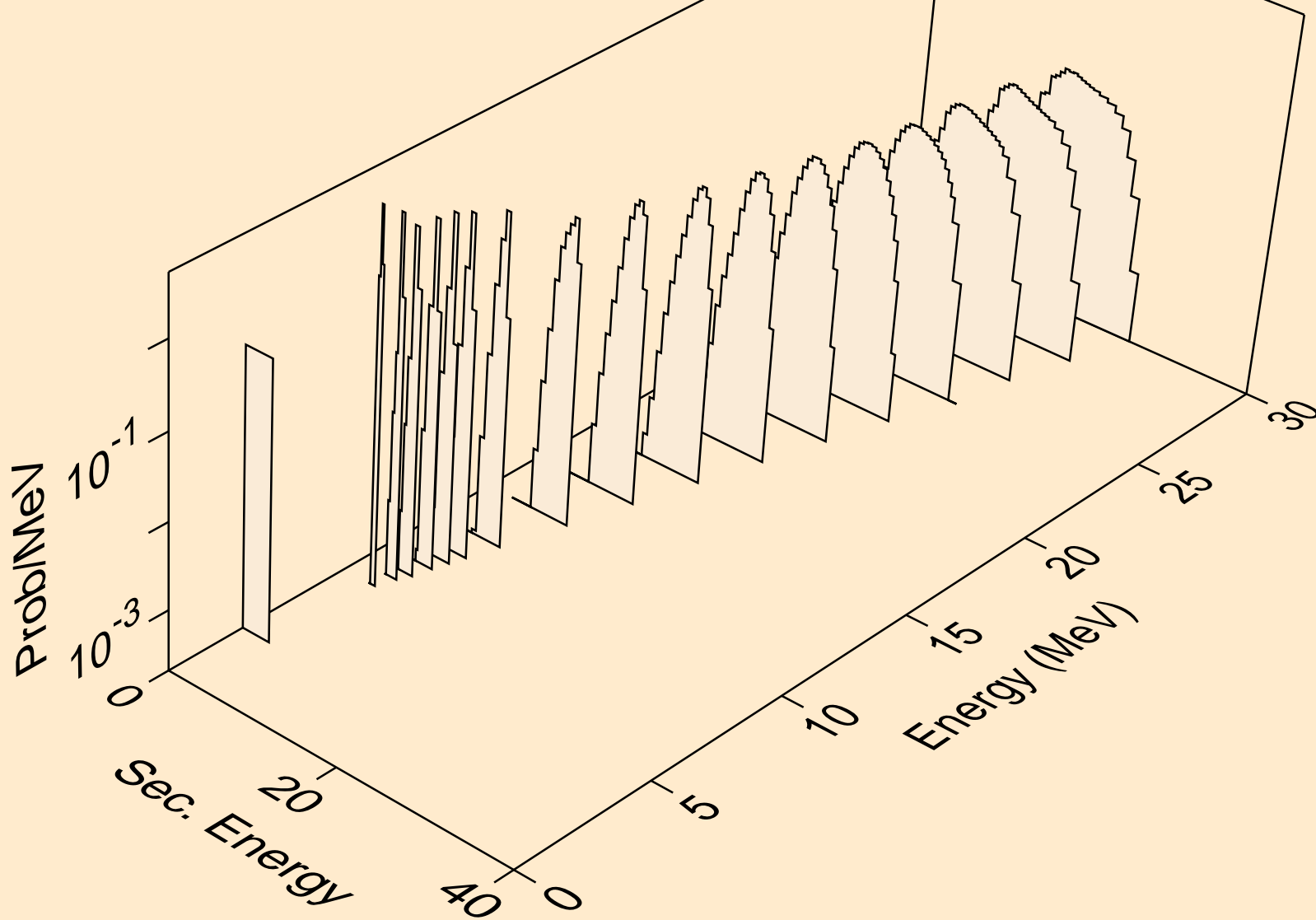

SN114 NEUTRON ACER TENDL-2019 LIBRARY; T=293.16K  
alphas from (n,2n)a

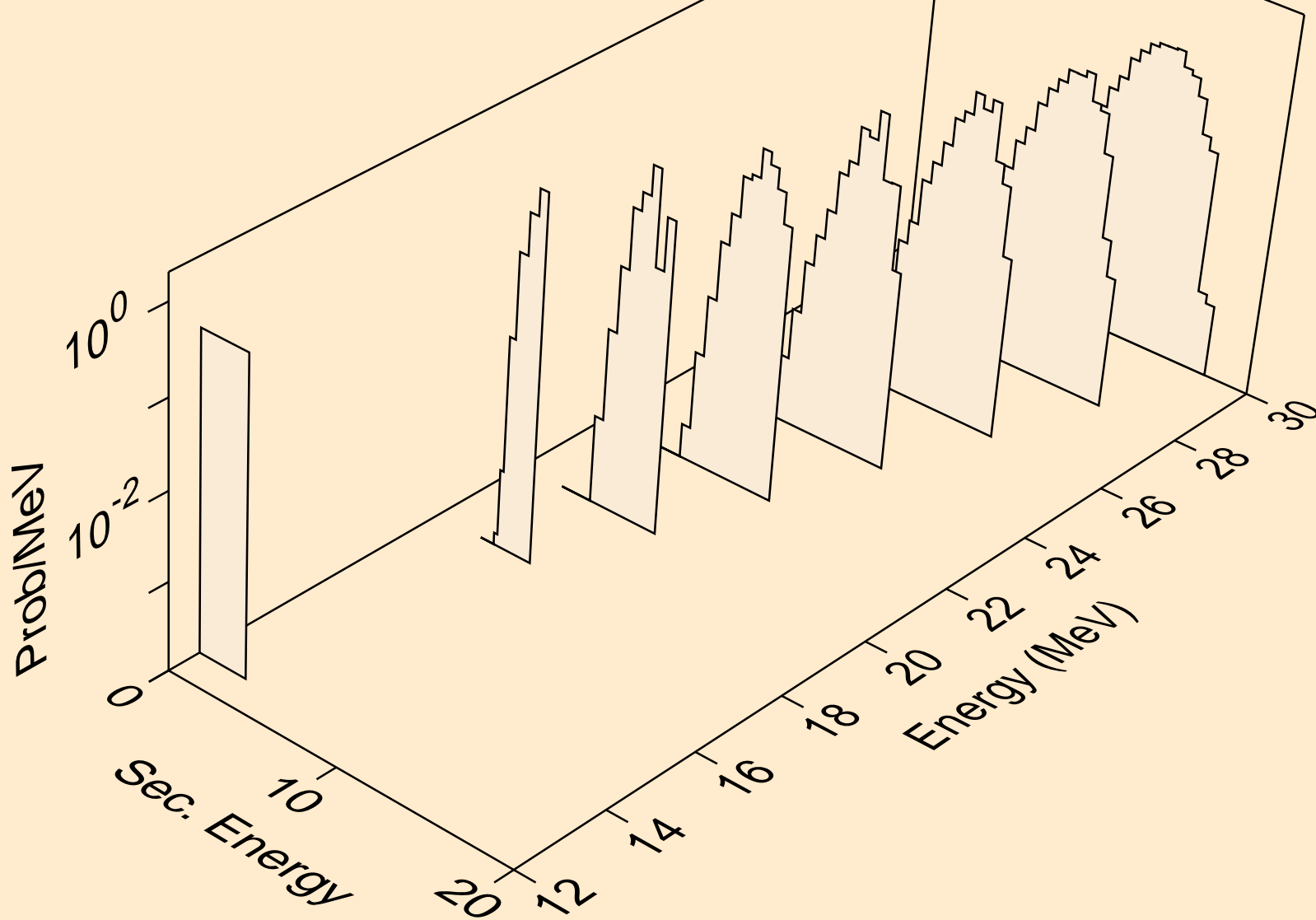

SN114 NEUTRON ACER TENDL-2019 LIBRARY; T=293.16K  
alphas from (n,3n)a

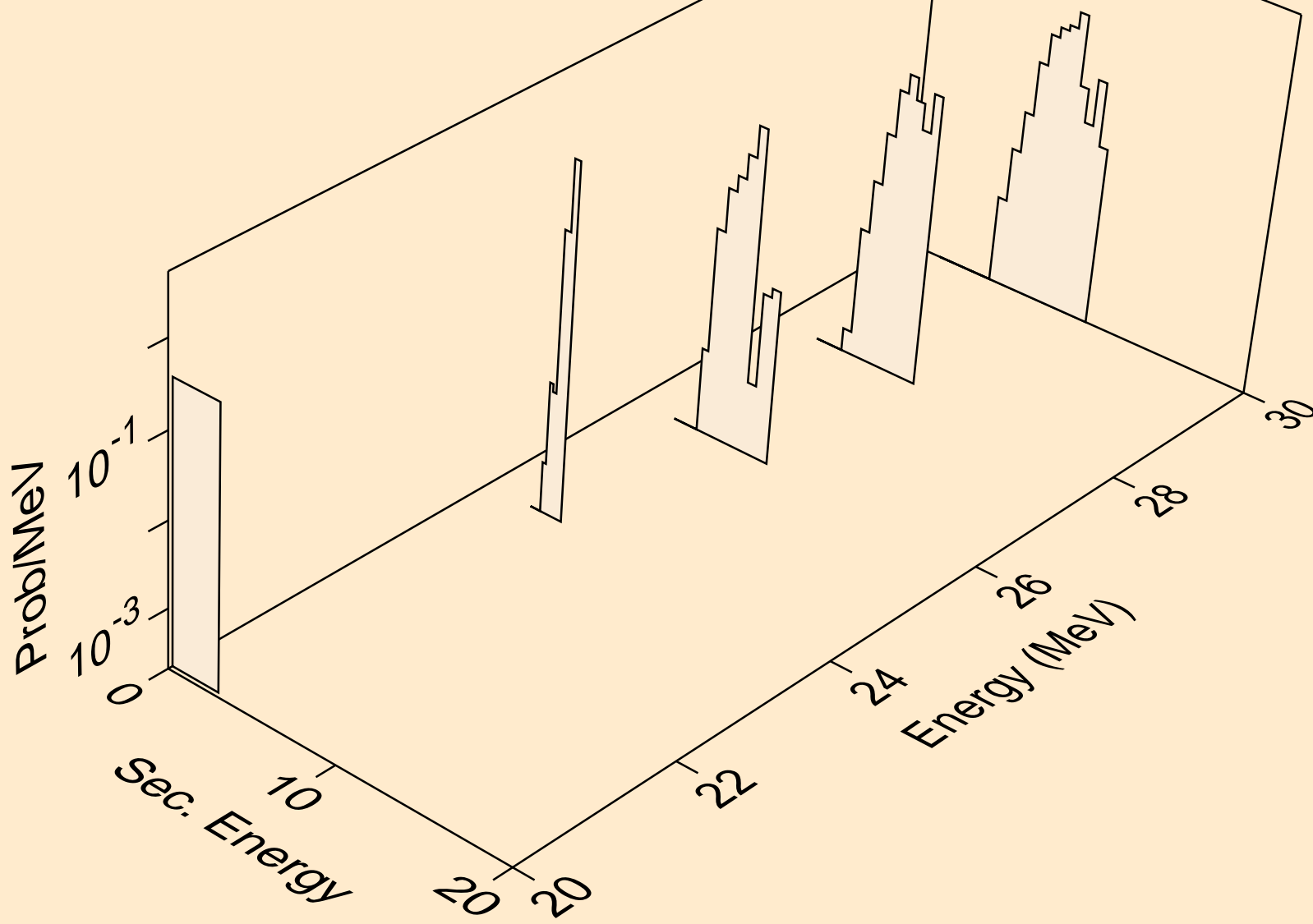

SN114 NEUTRON ACER TENDL-2019 LIBRARY; T=293.16K  
alphas from (n,n\*)2a

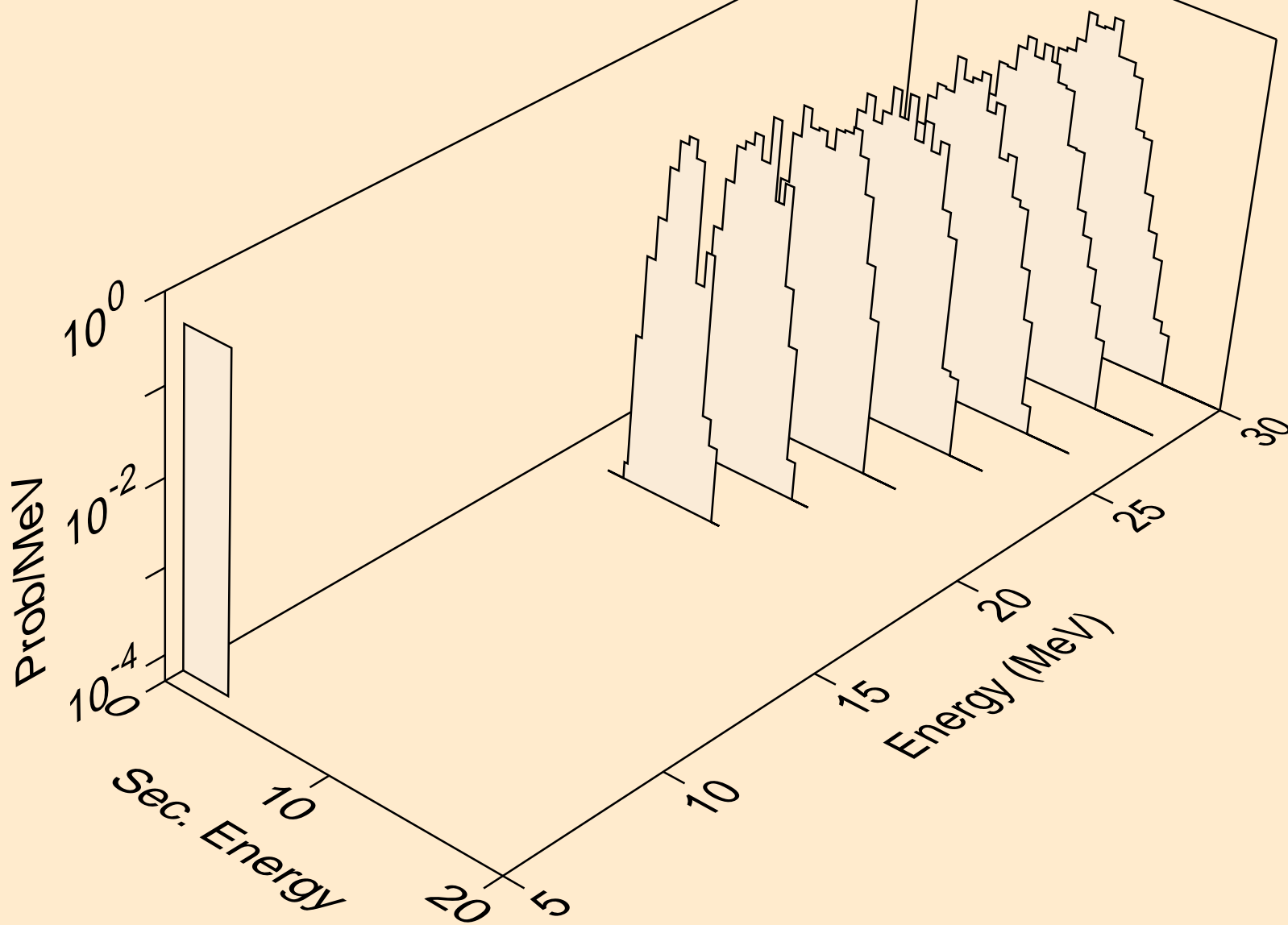

SN114 NEUTRON ACER TENDL-2019 LIBRARY; T=293.16K  
alphas from (n,npa)

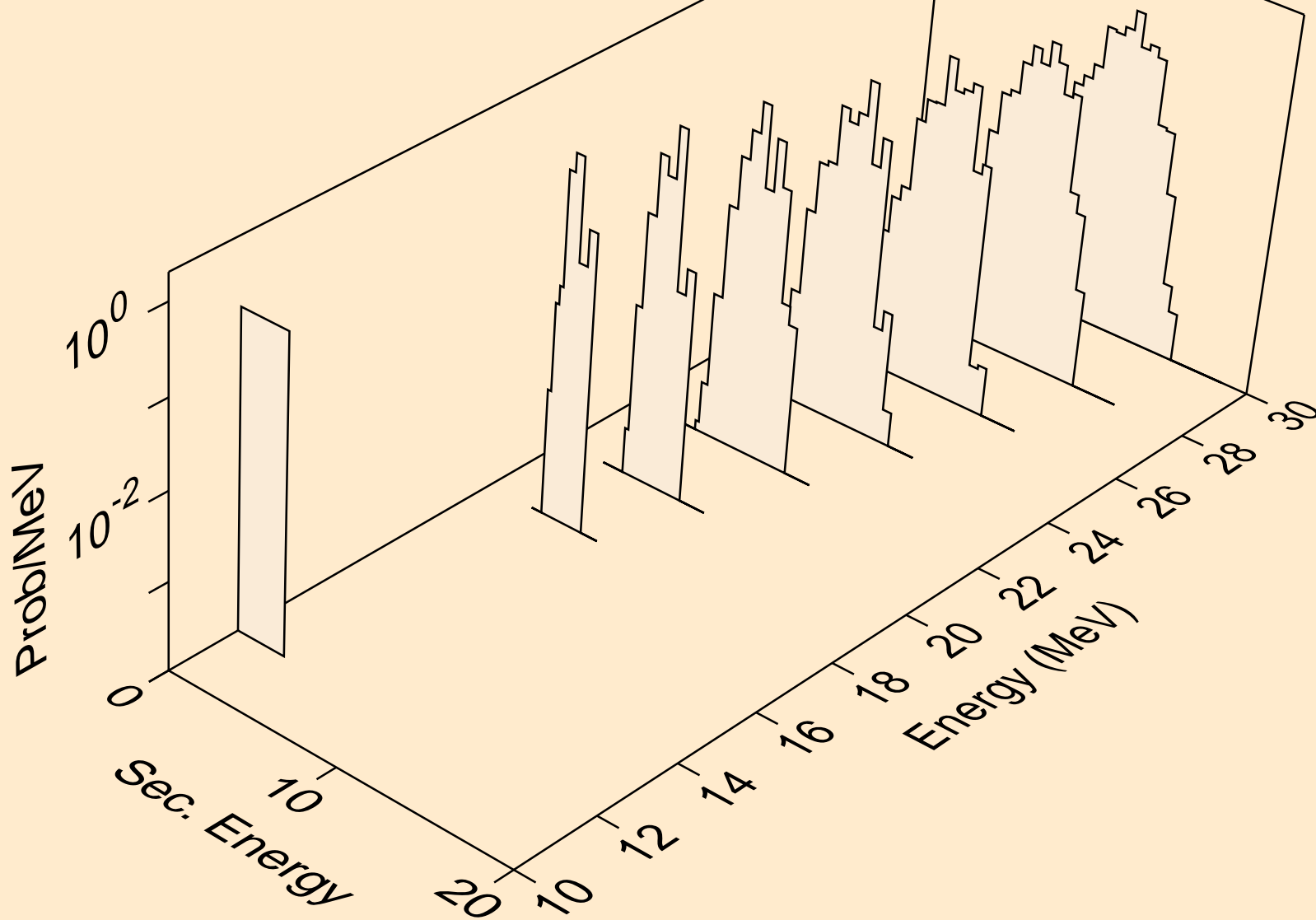

SN114 NEUTRON ACER TENDL-2019 LIBRARY; T=293.16K  
alphas from (n,a)

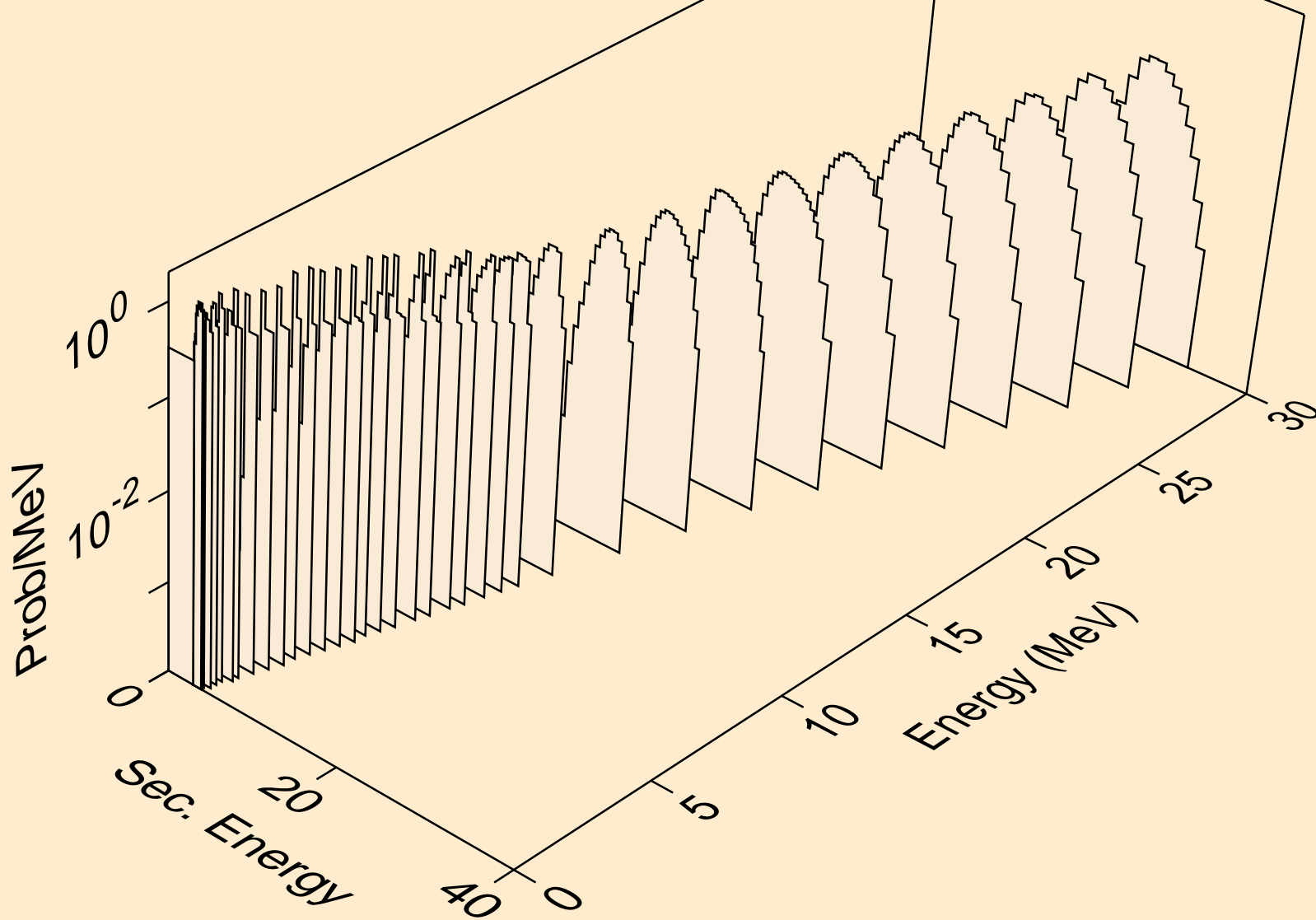

SN114 NEUTRON ACER TENDL-2019 LIBRARY; T=293.16K  
alphas from (n,2a)

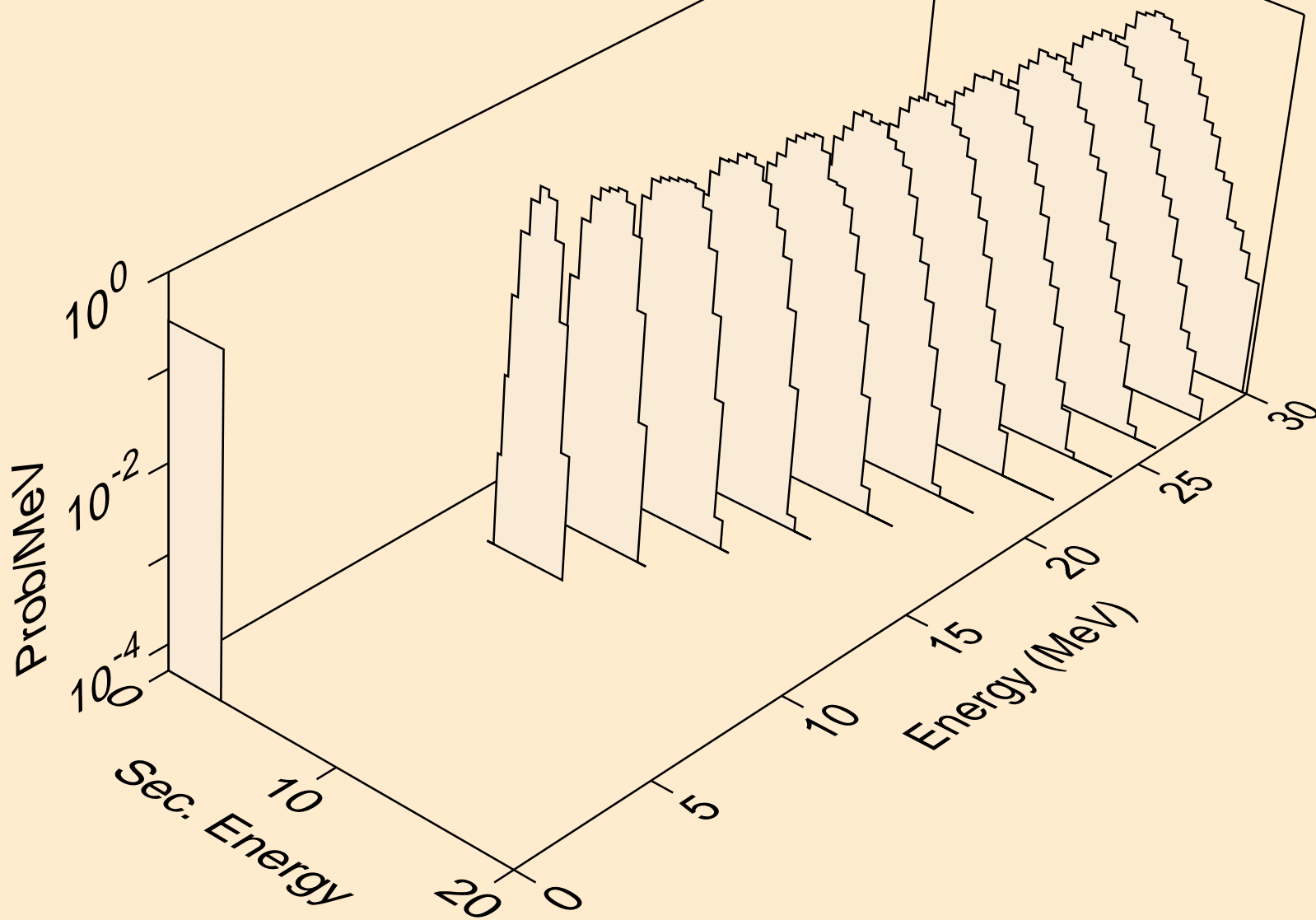



SN114 NEUTRON ACER TENDL-2019 LIBRARY; T=293.16K  
alphas from (n,pa)

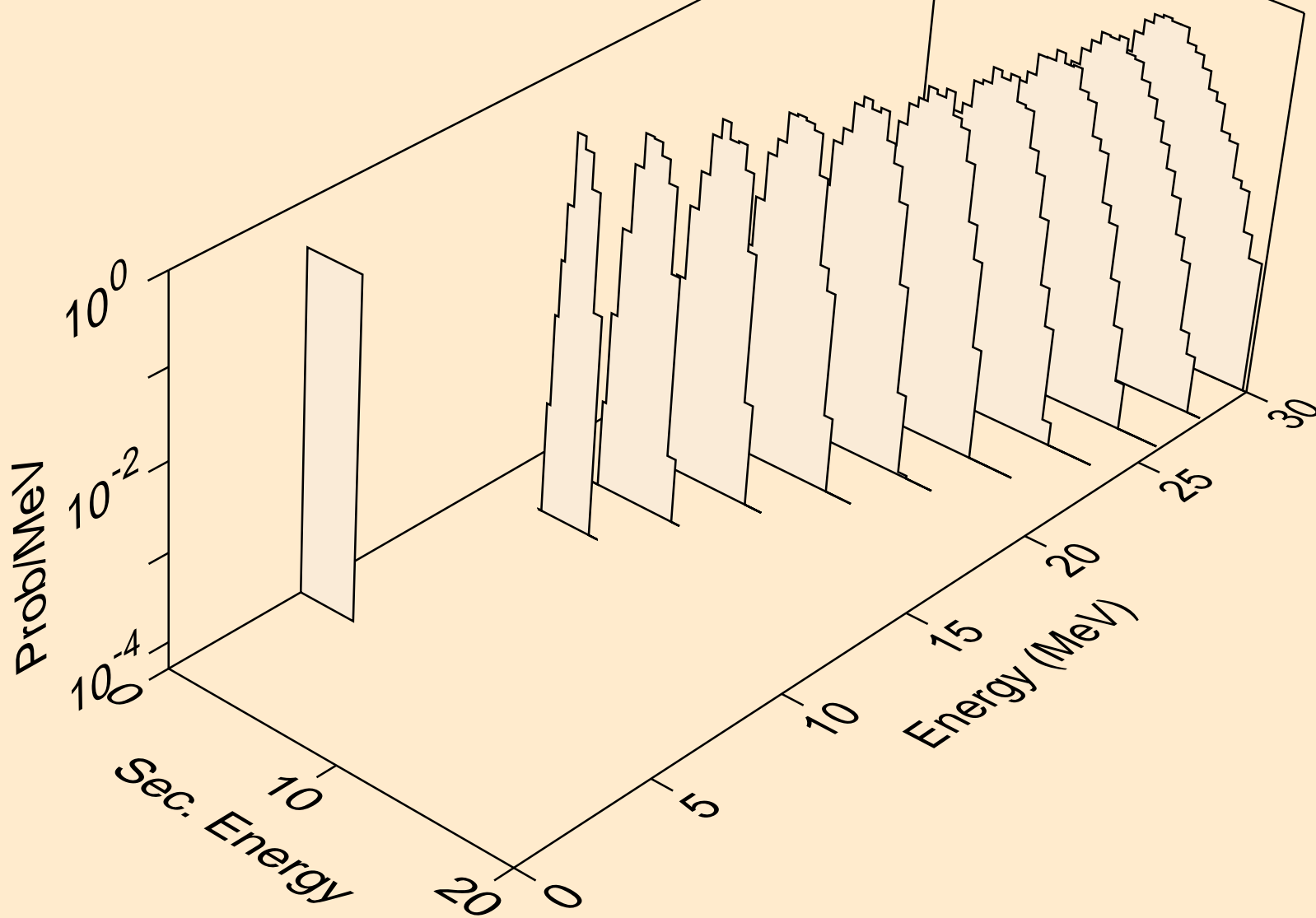

SN114 NEUTRON ACER TENDL-2019 LIBRARY; T=293.16K  
alphas from (n,da)

