

SN117 NEUTRON ACER TENDL-2019 LIBRARY; T=293.16K

Principal cross sections

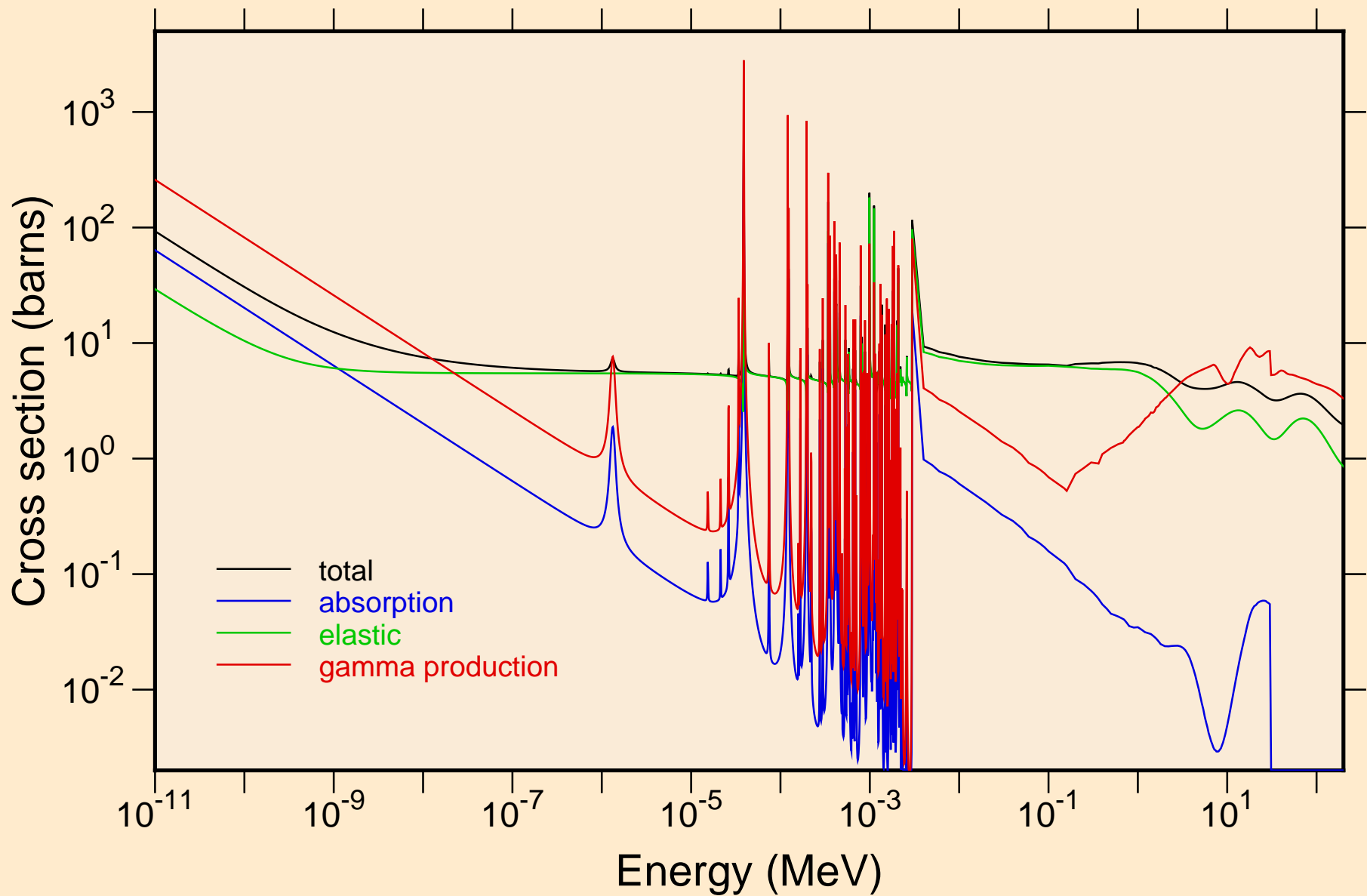

SN117 NEUTRON ACER TENDL-2019 LIBRARY; T=293.16K
resonance total cross section

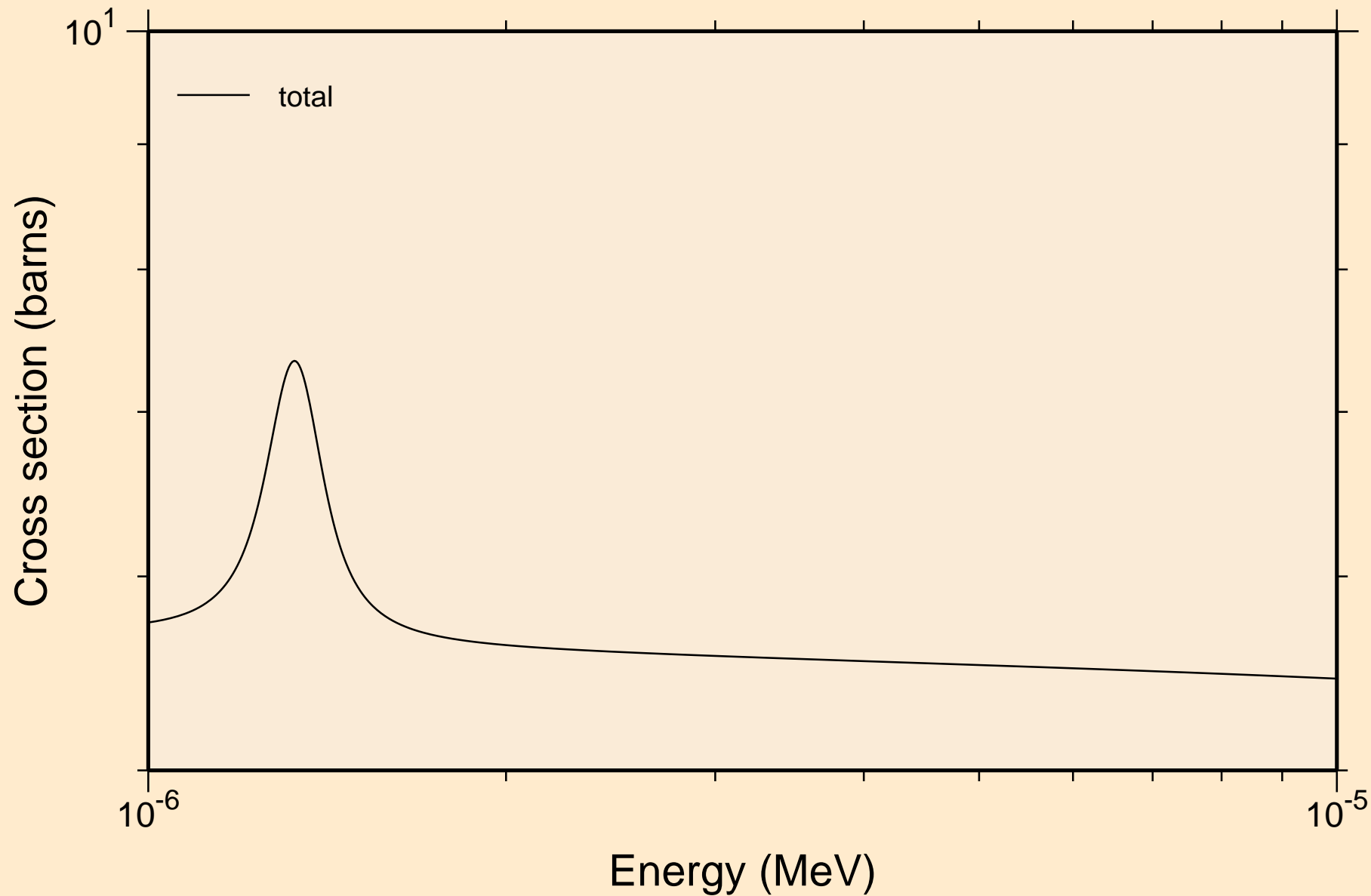

SN117 NEUTRON ACER TENDL-2019 LIBRARY; T=293.16K
resonance total cross section

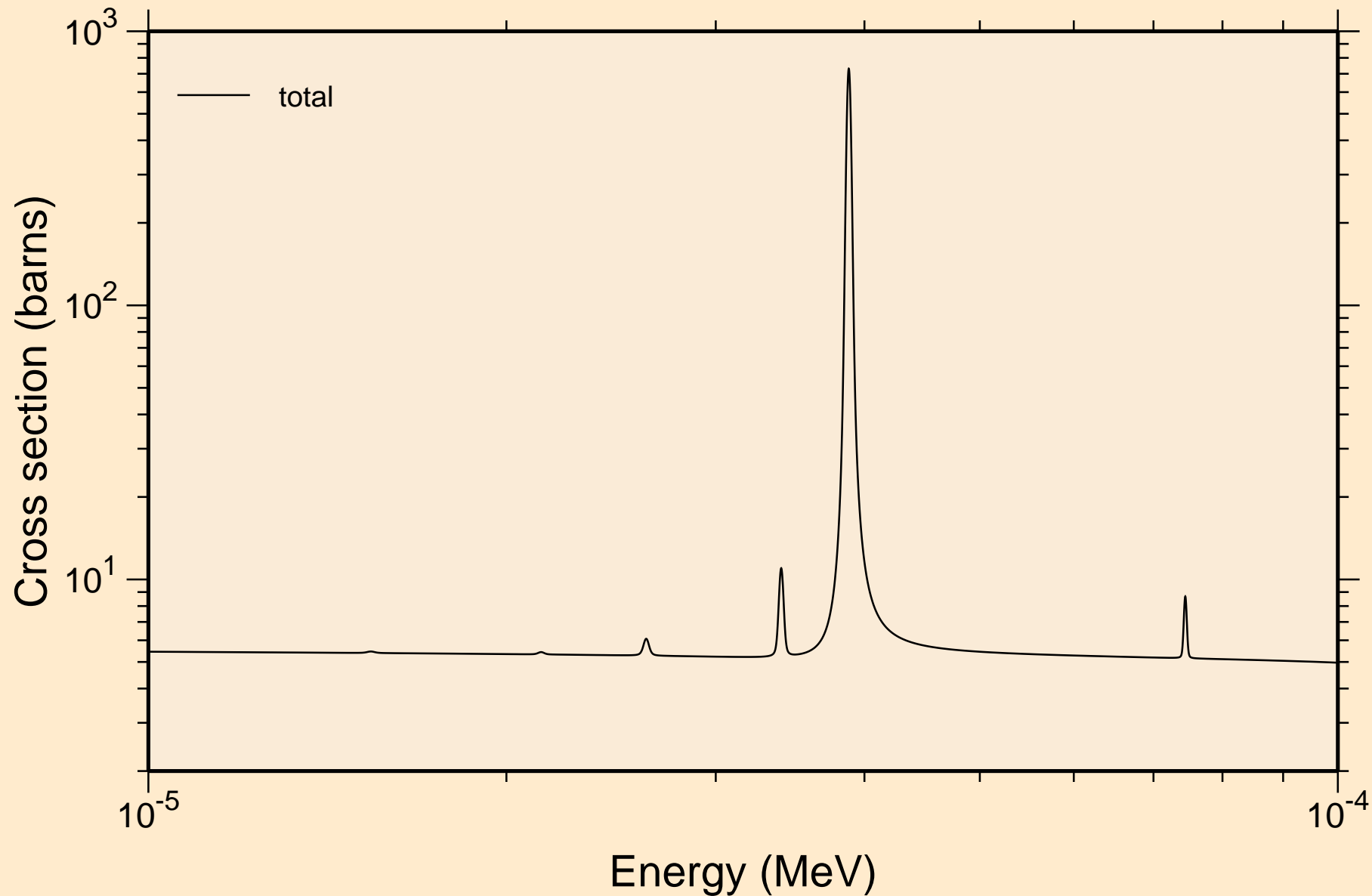

SN117 NEUTRON ACER TENDL-2019 LIBRARY; T=293.16K
resonance total cross section

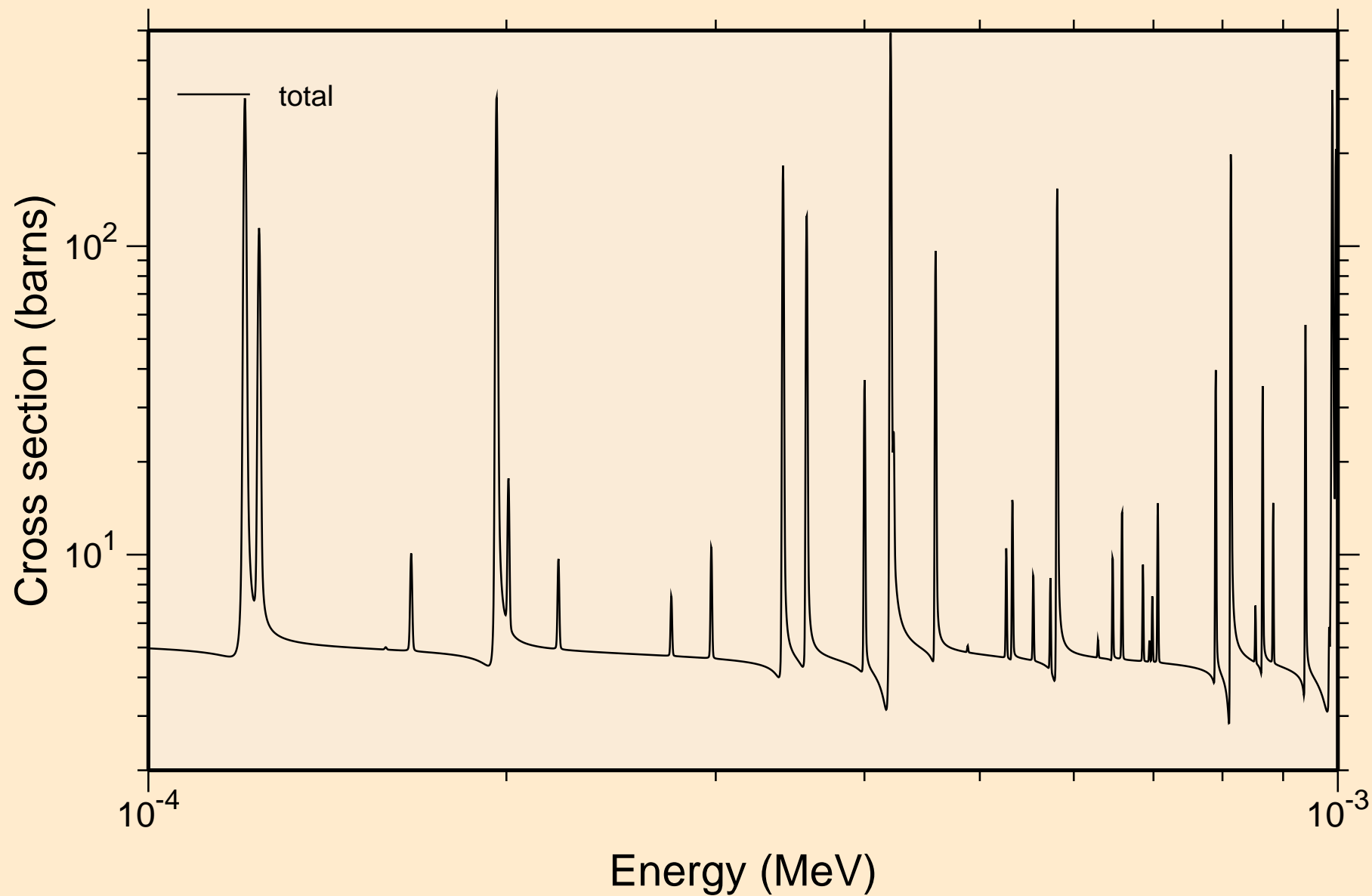

SN117 NEUTRON ACER TENDL-2019 LIBRARY; T=293.16K
resonance total cross section

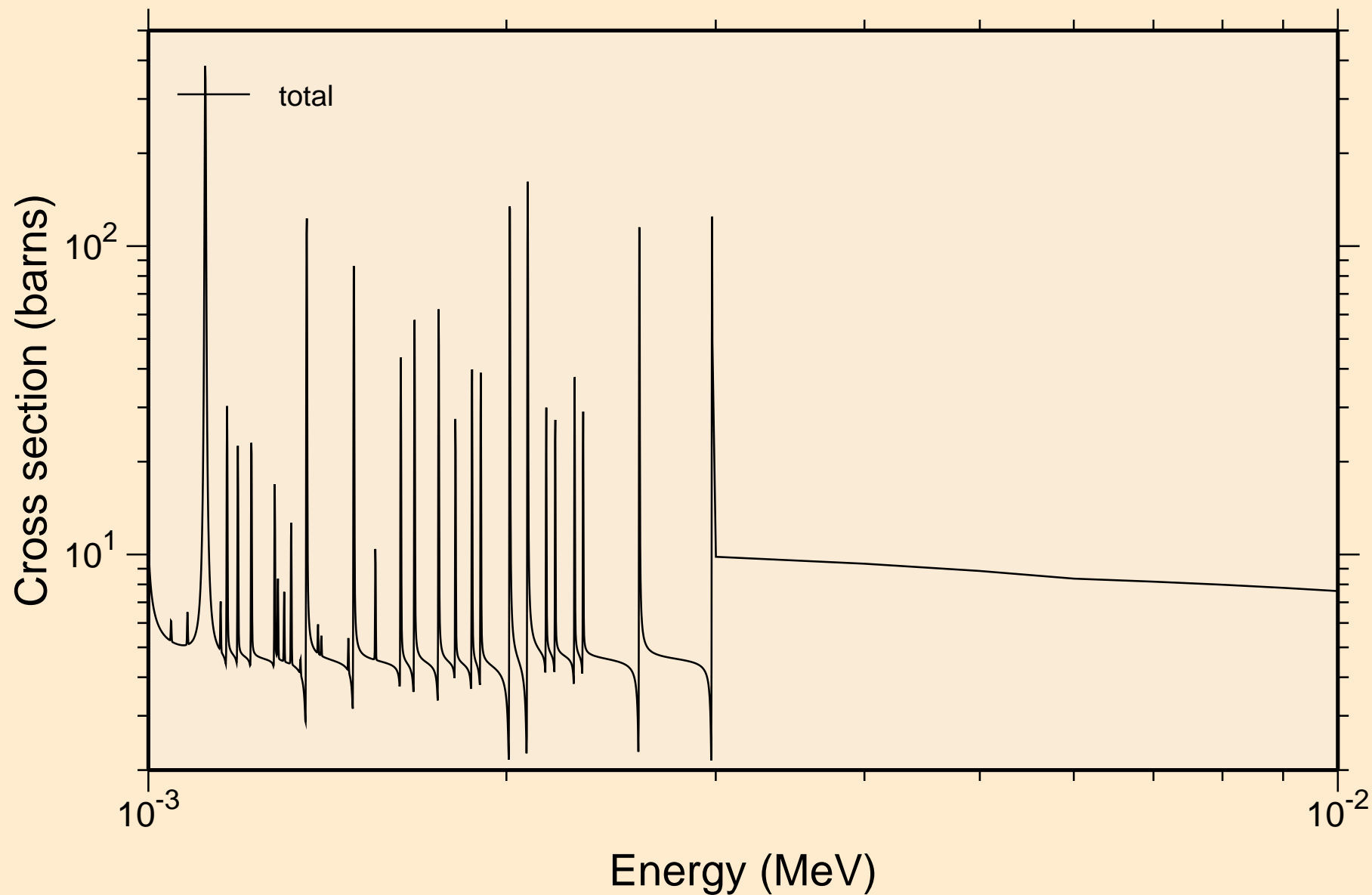

SN117 NEUTRON ACER TENDL-2019 LIBRARY; T=293.16K
resonance total cross section

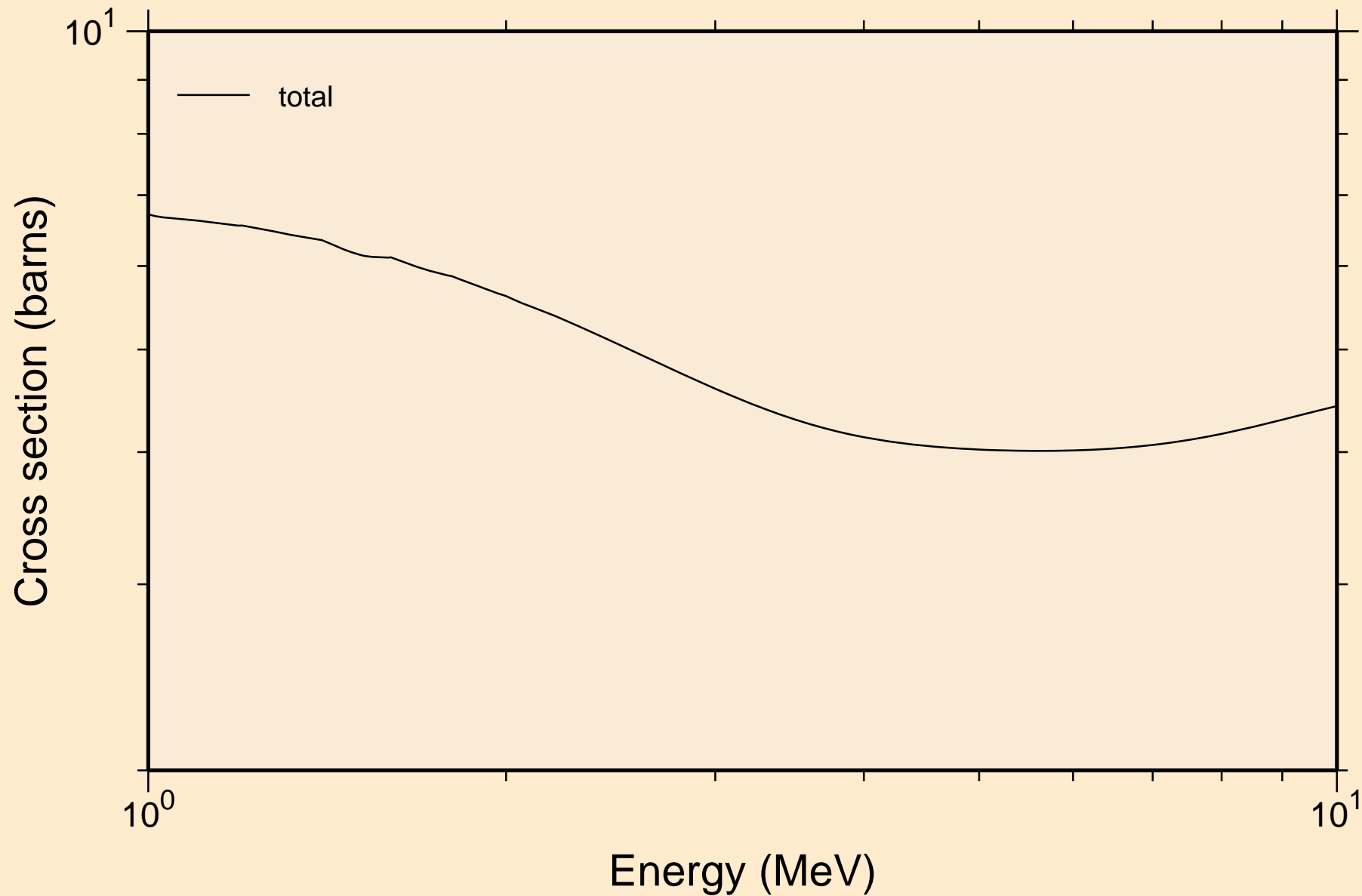

SN117 NEUTRON ACER TENDL-2019 LIBRARY; T=293.16K
resonance absorption cross sections

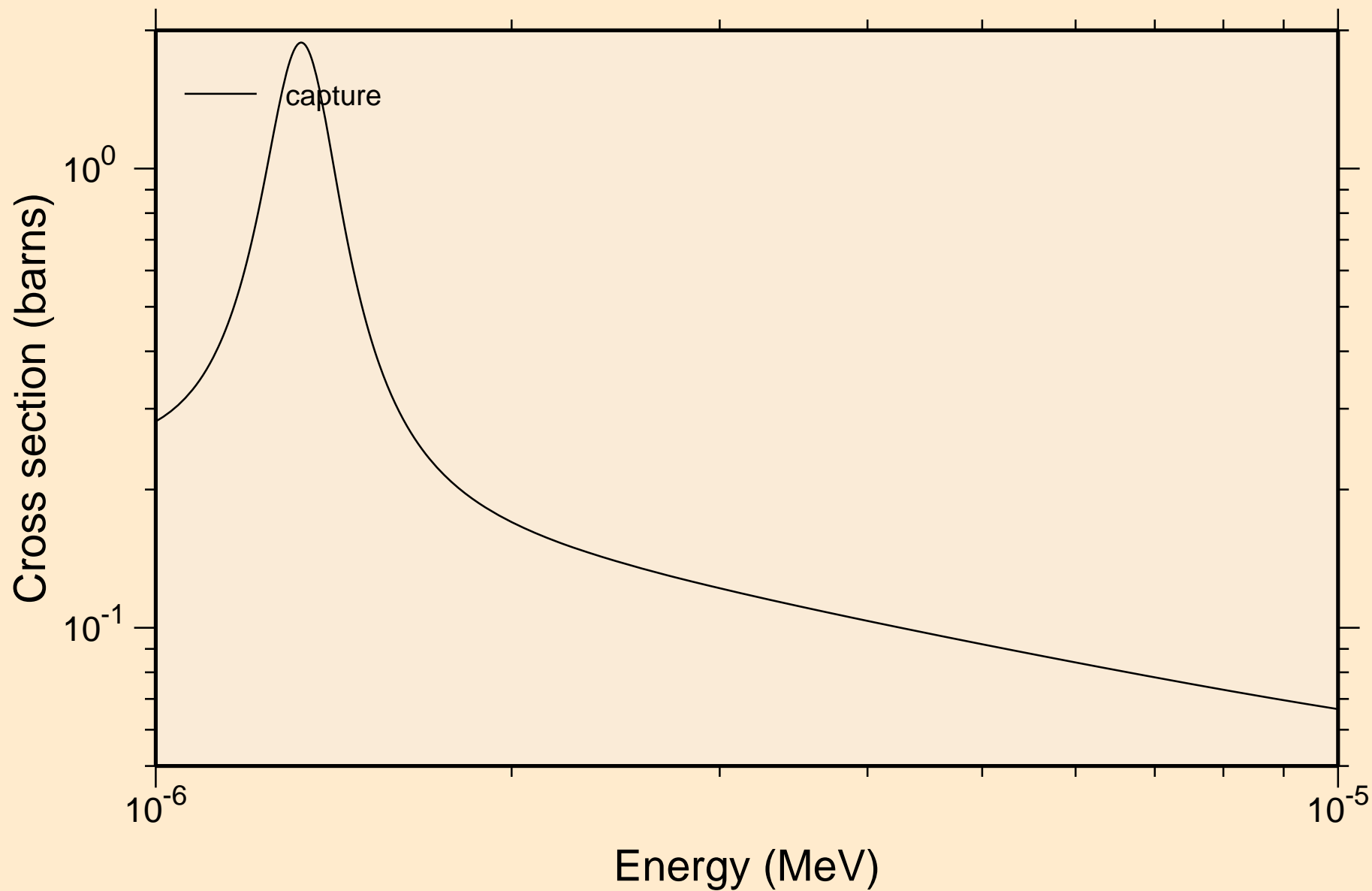

SN117 NEUTRON ACER TENDL-2019 LIBRARY; T=293.16K
resonance absorption cross sections

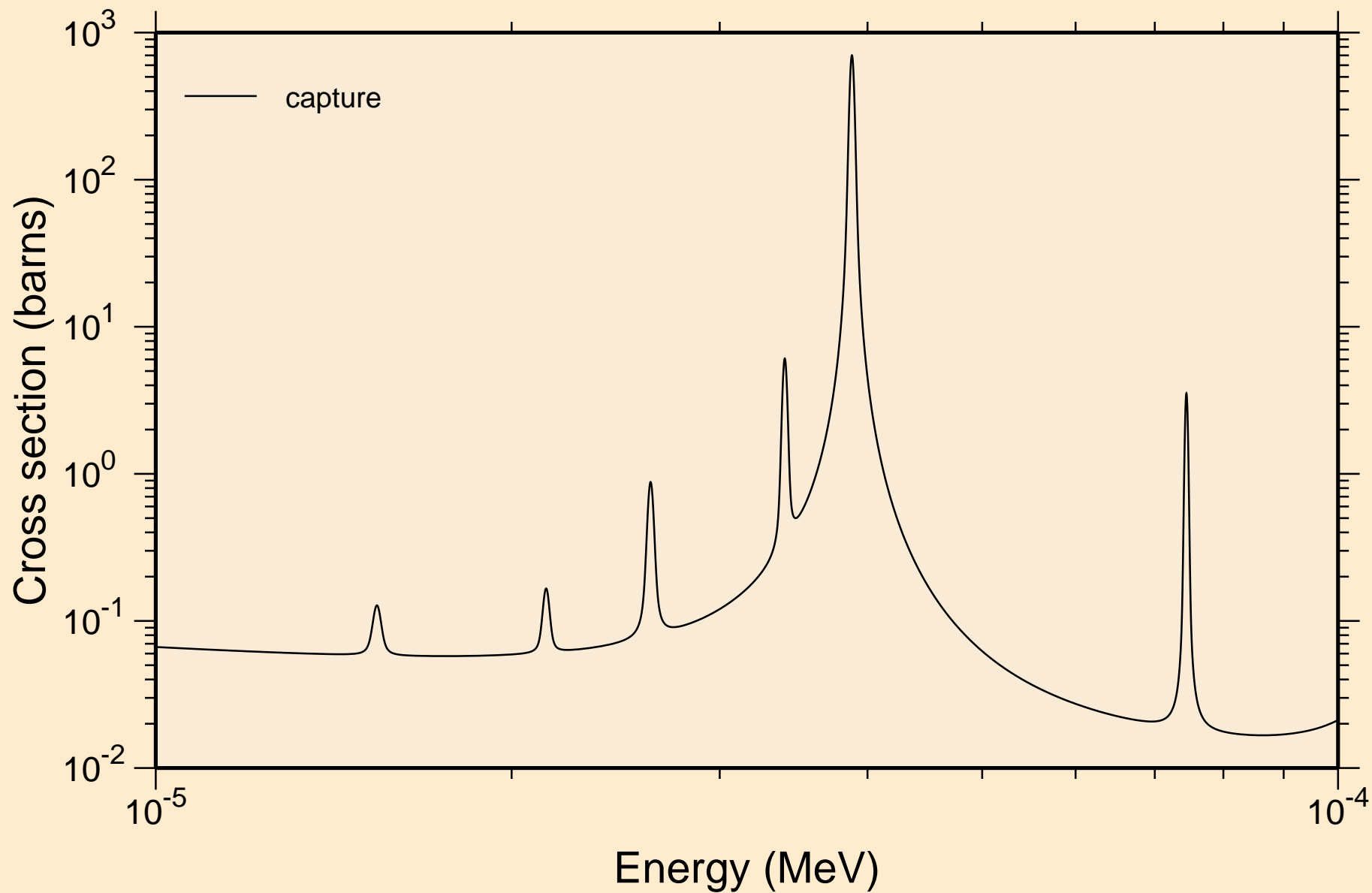

SN117 NEUTRON ACER TENDL-2019 LIBRARY; T=293.16K
resonance absorption cross sections

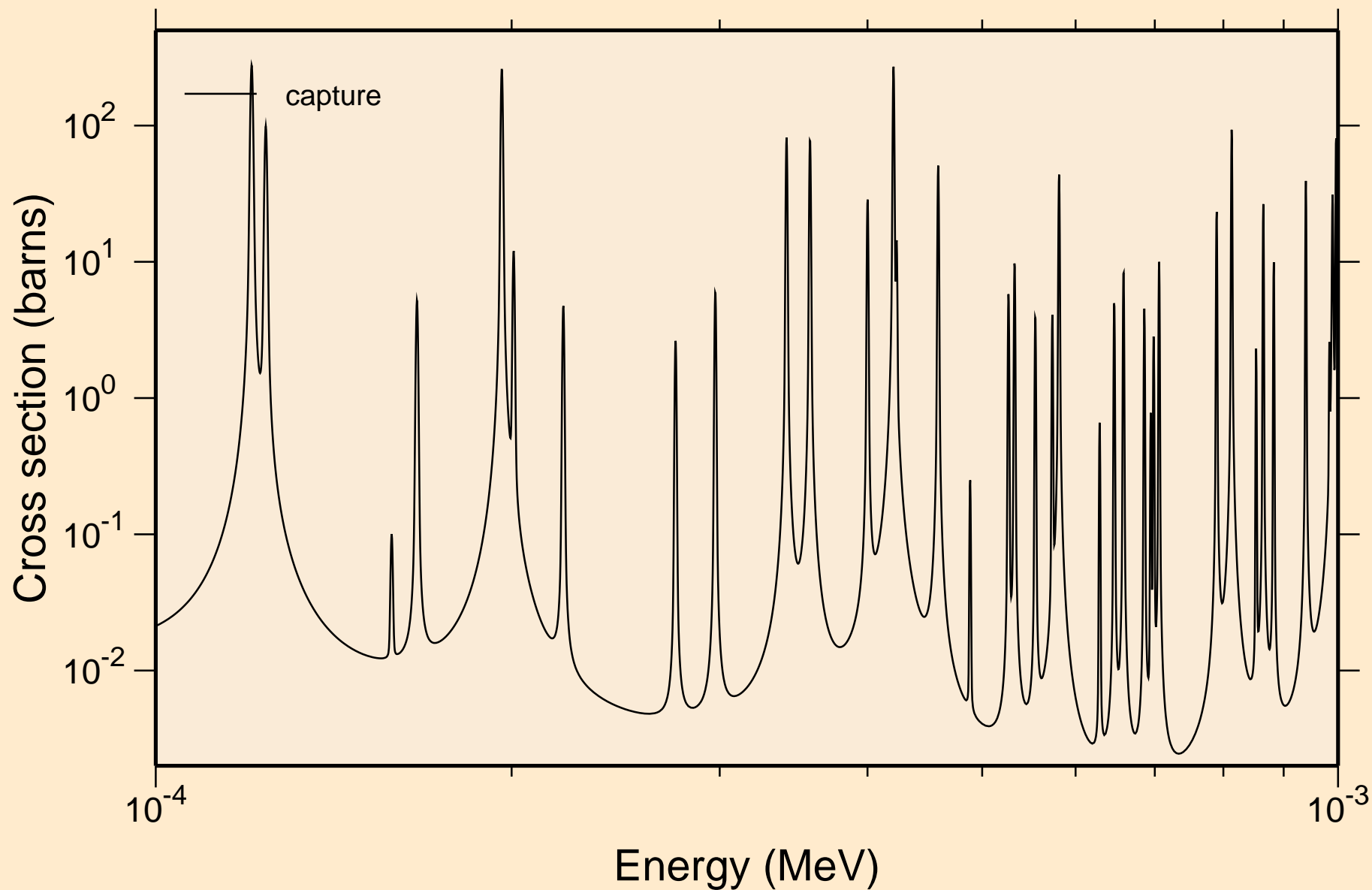

SN117 NEUTRON ACER TENDL-2019 LIBRARY; T=293.16K
resonance absorption cross sections

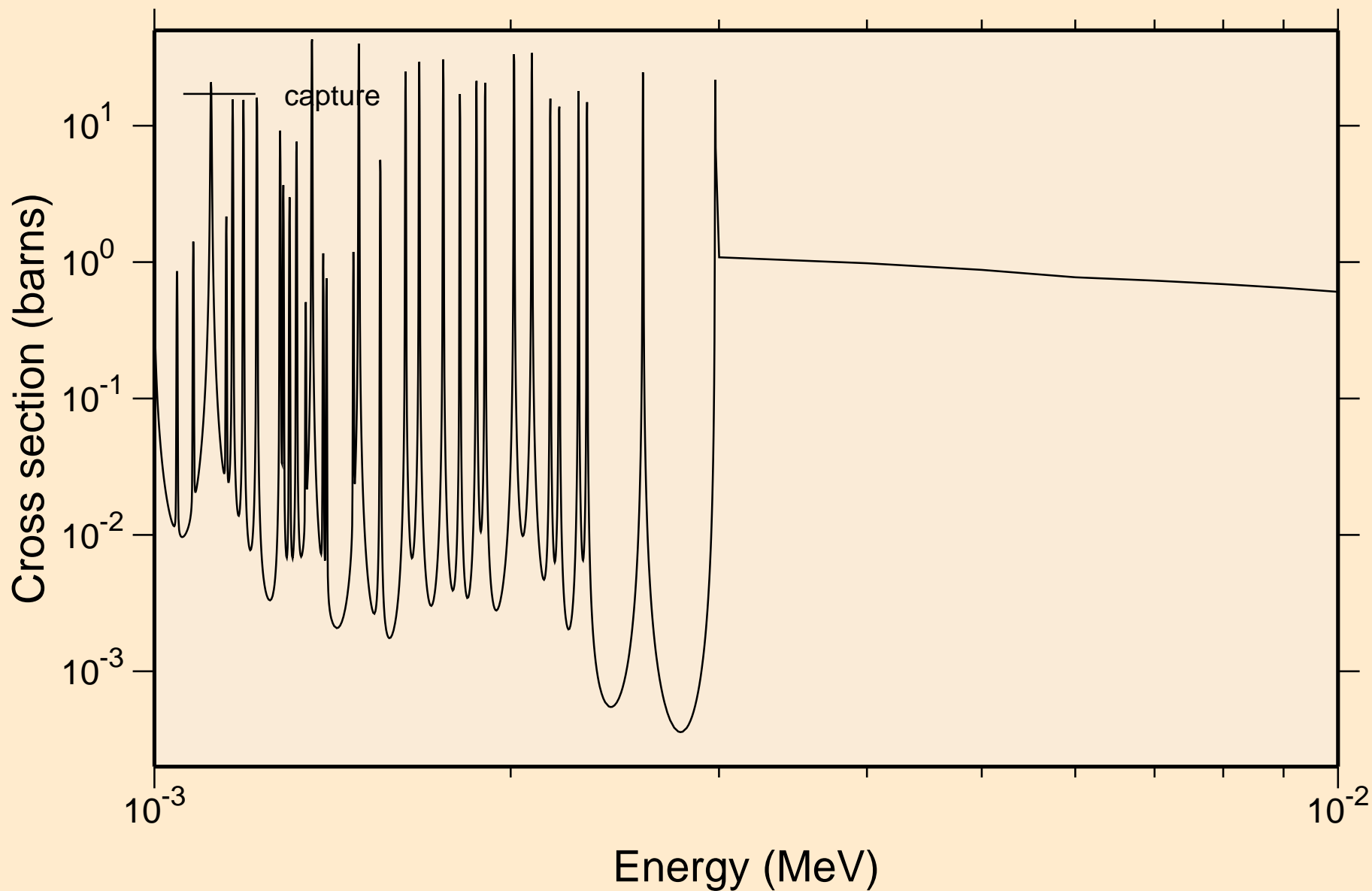

SN117 NEUTRON ACER TENDL-2019 LIBRARY; T=293.16K
resonance absorption cross sections

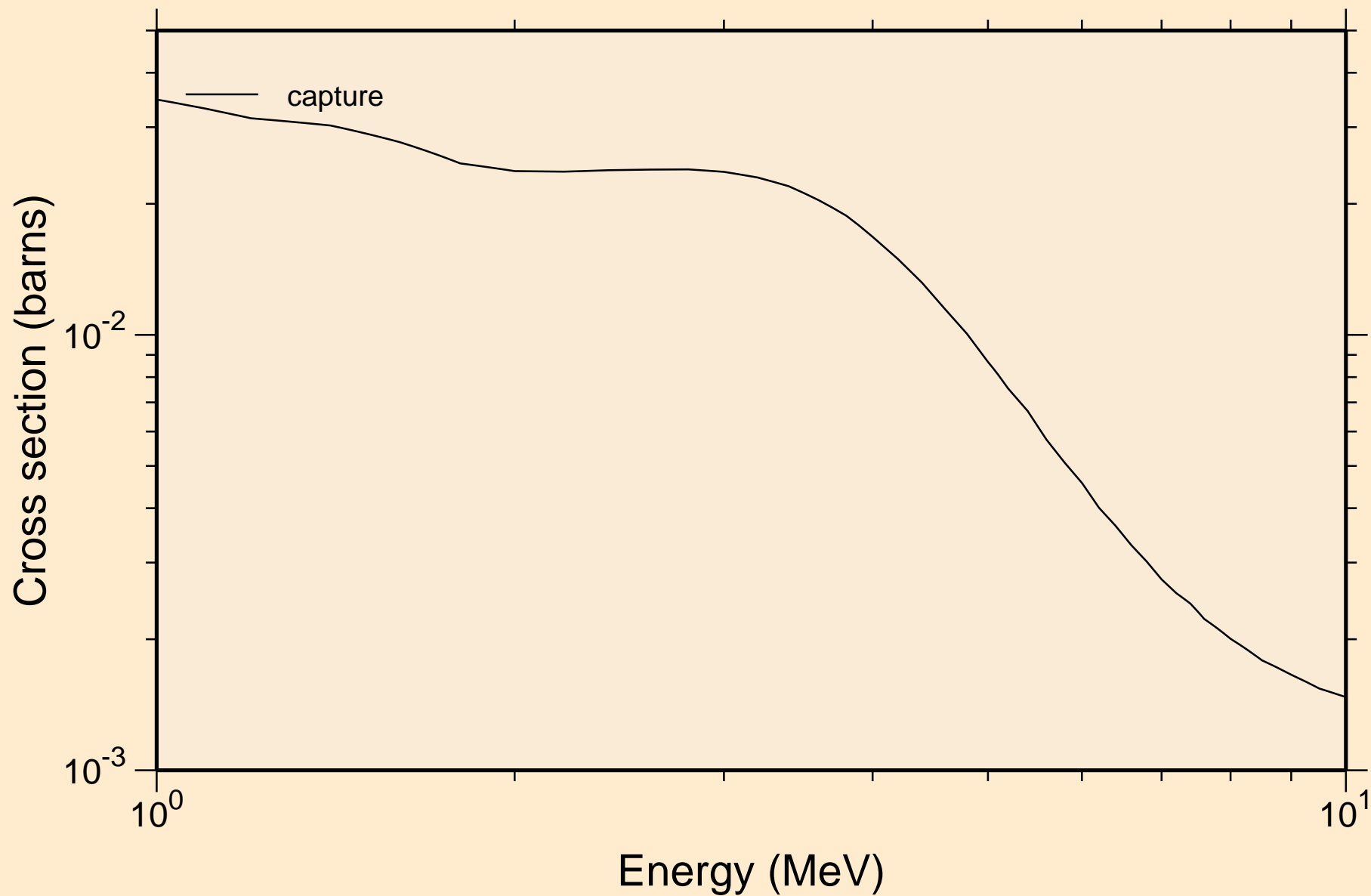

SN117 NEUTRON ACER TENDL-2019 LIBRARY; T=293.16K
Heating

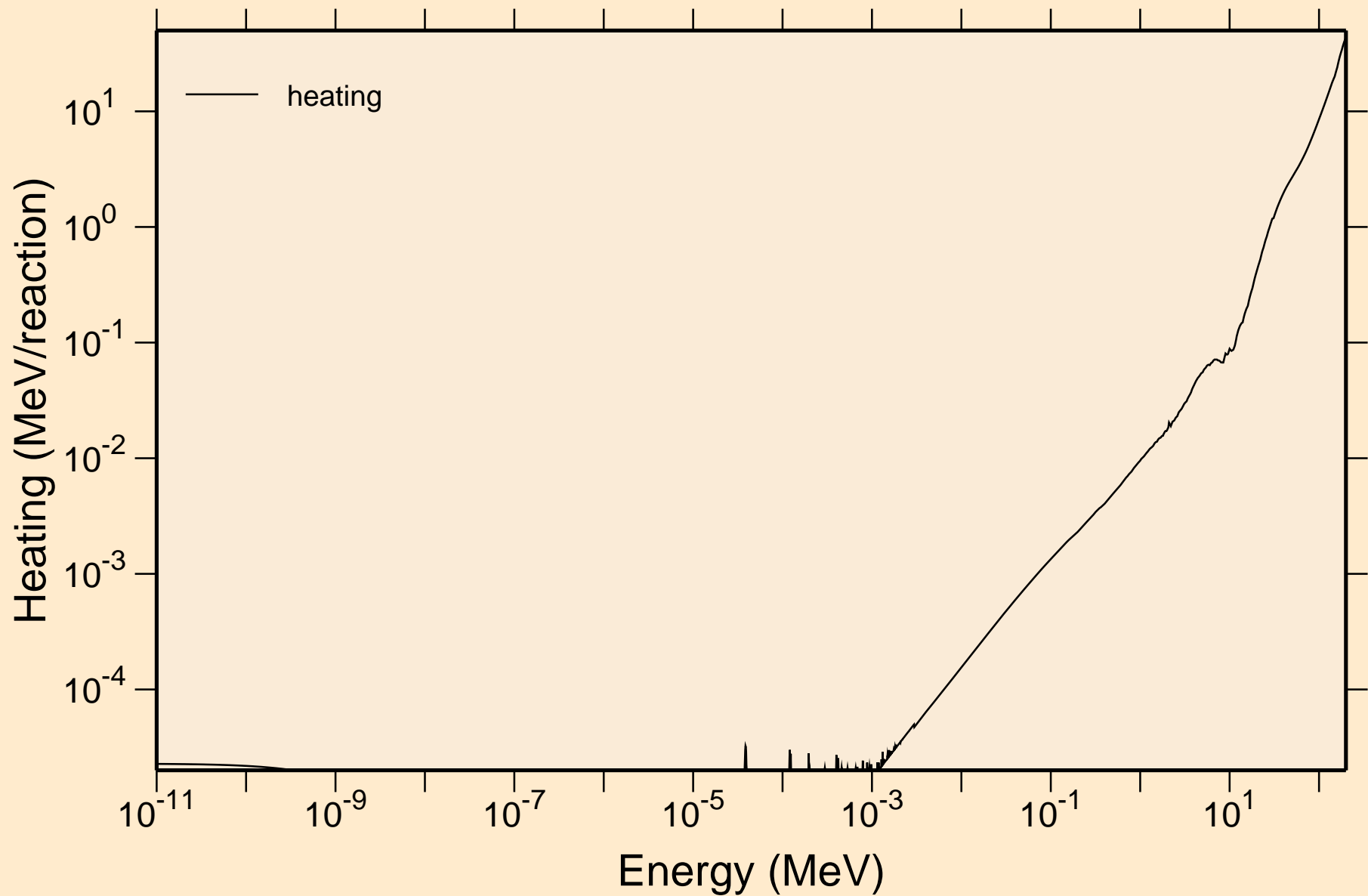

SN117 NEUTRON ACER TENDL-2019 LIBRARY; T=293.16K Damage

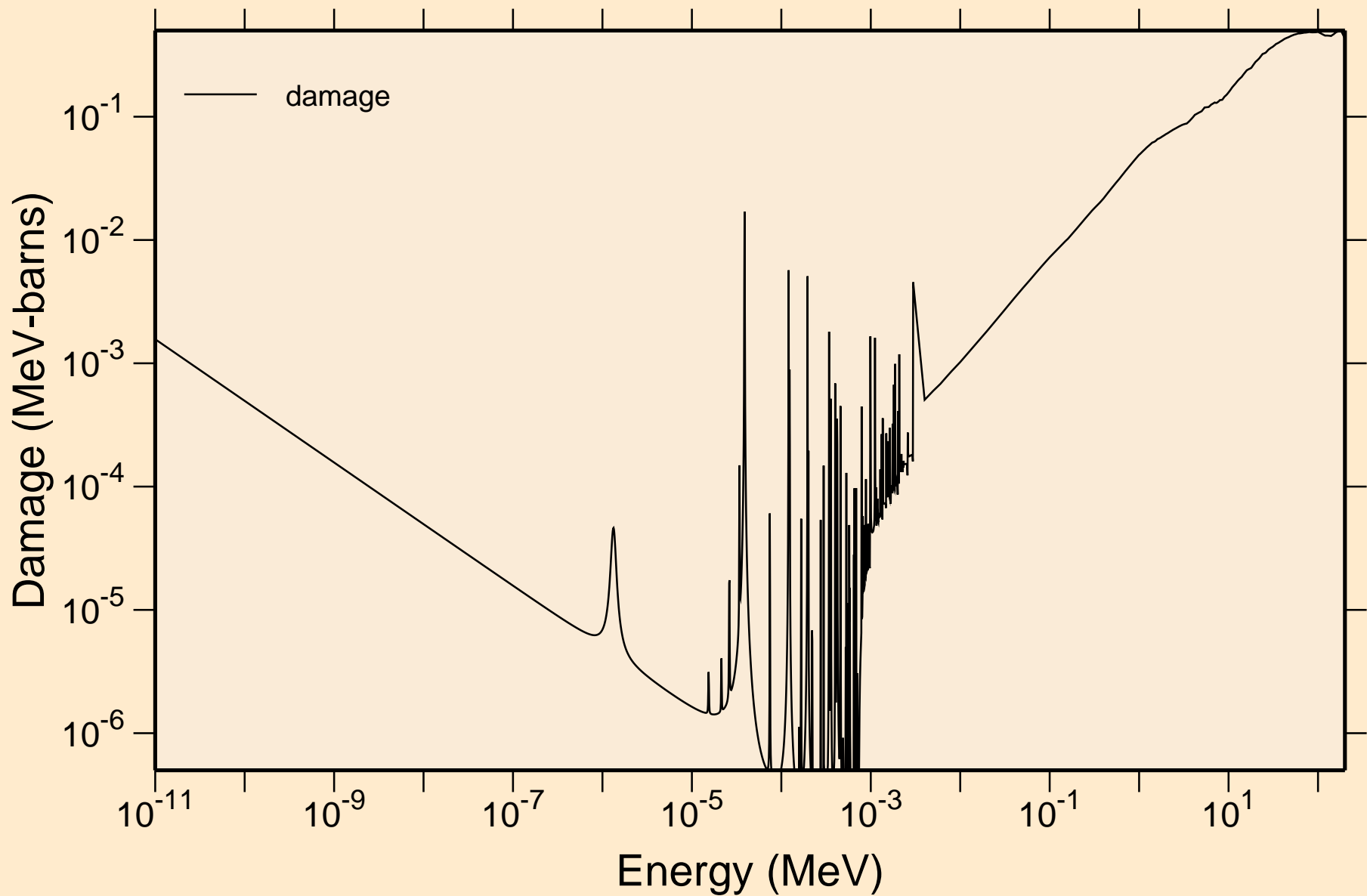

SN117 NEUTRON ACER TENDL-2019 LIBRARY; T=293.16K
Non-threshold reactions

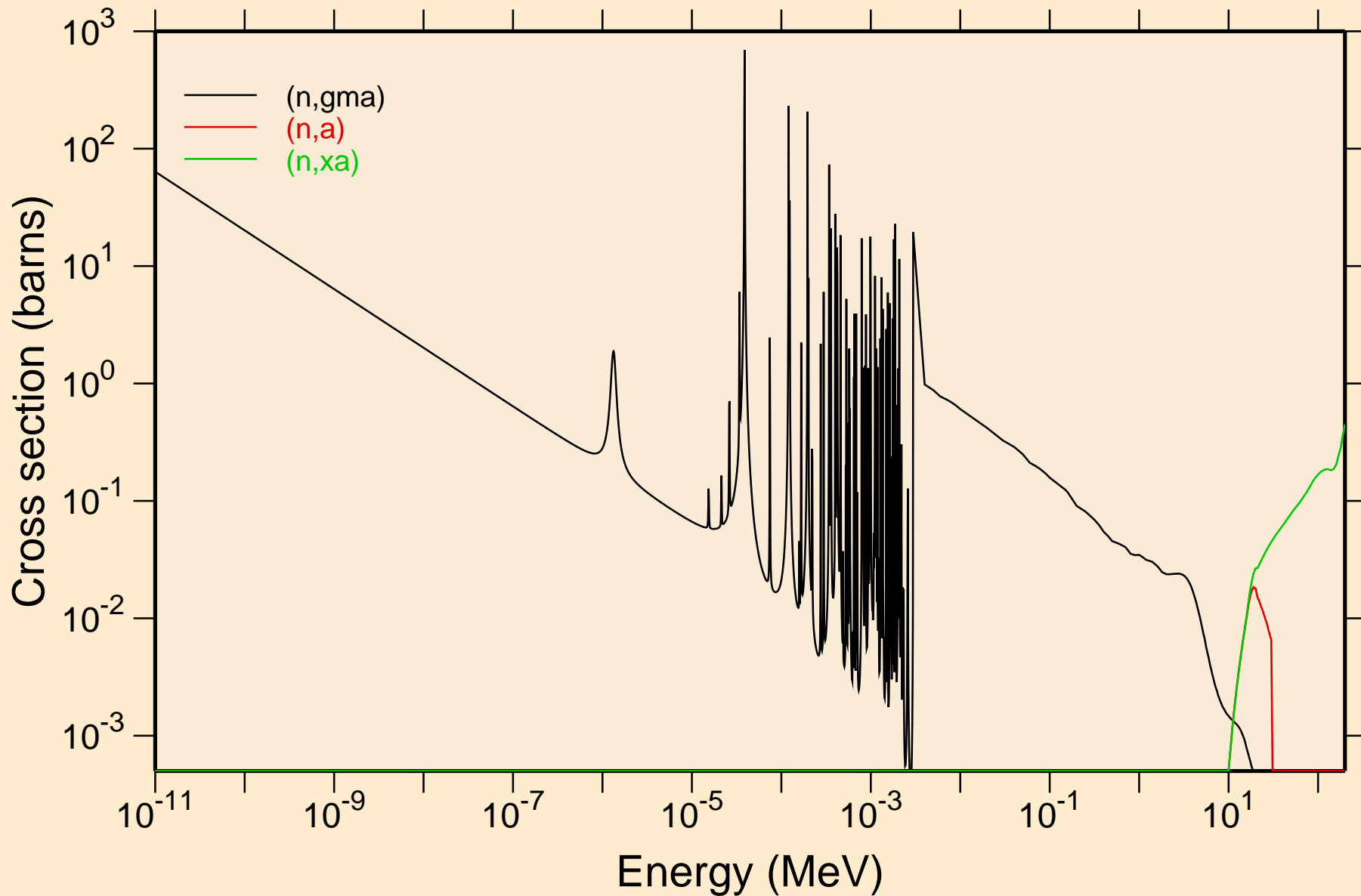

SN117 NEUTRON ACER TENDL-2019 LIBRARY; T=293.16K

Principal cross sections

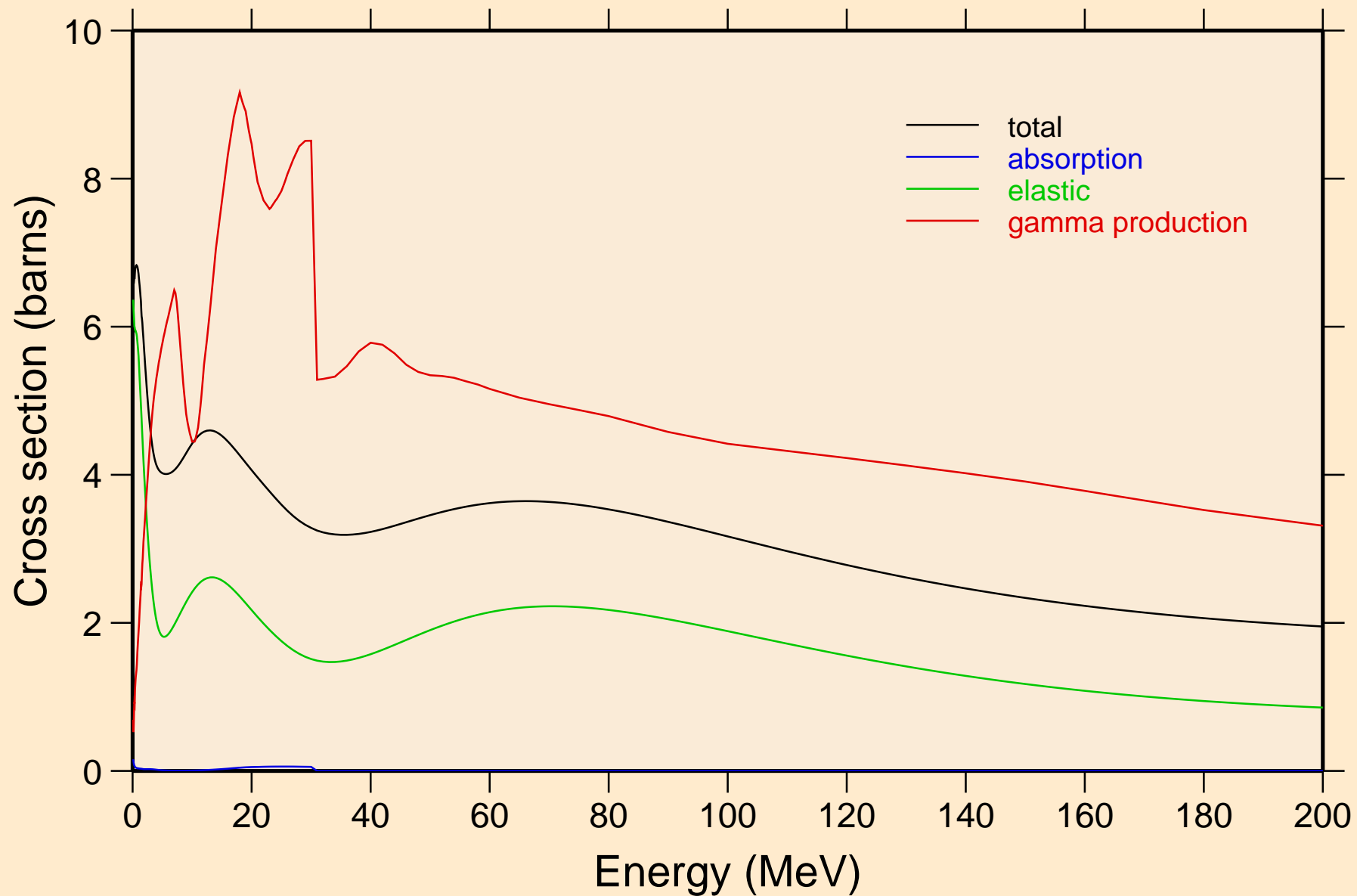

SN117 NEUTRON ACER TENDL-2019 LIBRARY; T=293.16K
Heating

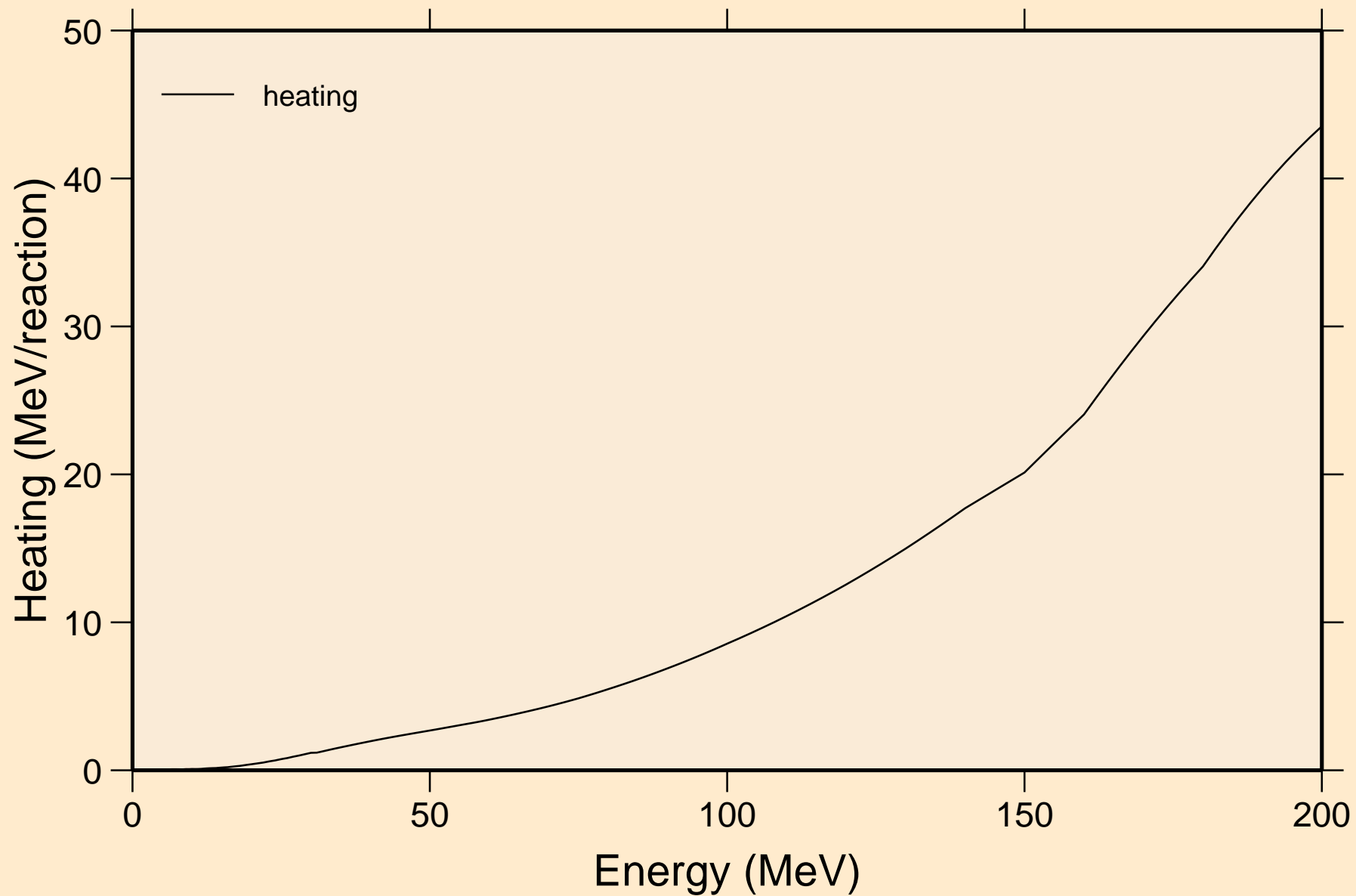

SN117 NEUTRON ACER TENDL-2019 LIBRARY; T=293.16K Damage

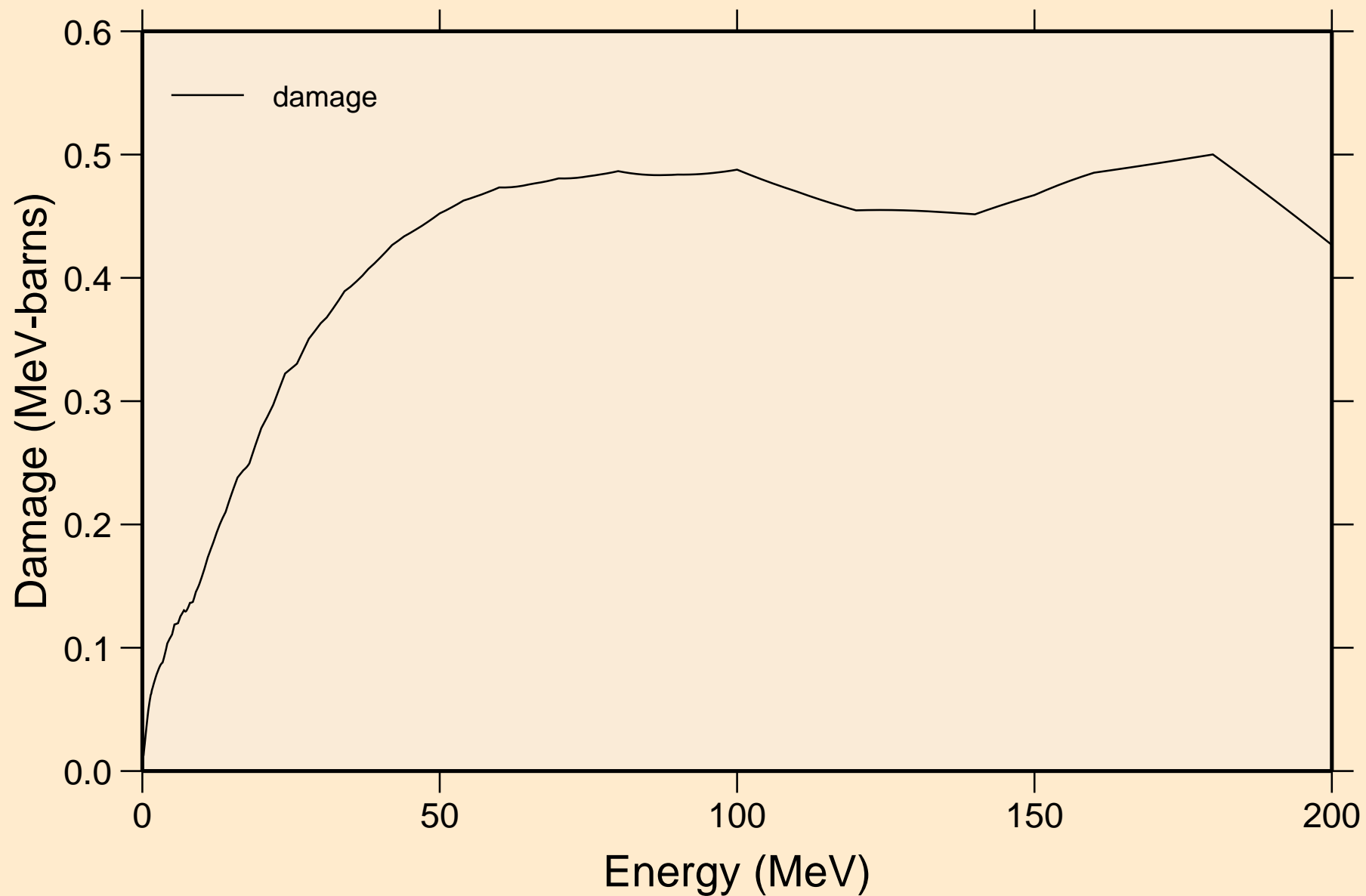

SN117 NEUTRON ACER TENDL-2019 LIBRARY; T=293.16K

Non-threshold reactions

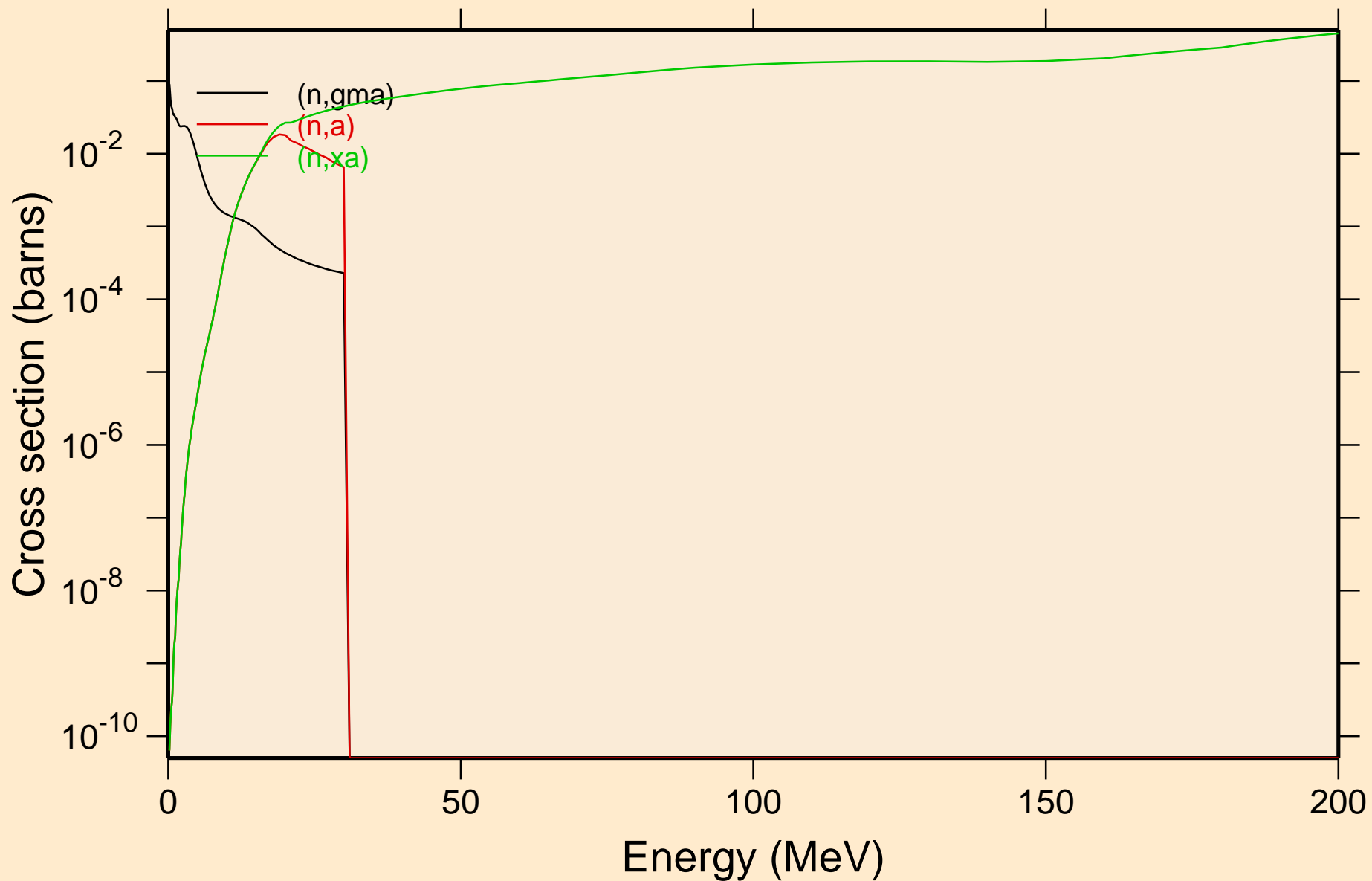

SN117 NEUTRON ACER TENDL-2019 LIBRARY; T=293.16K

Inelastic levels

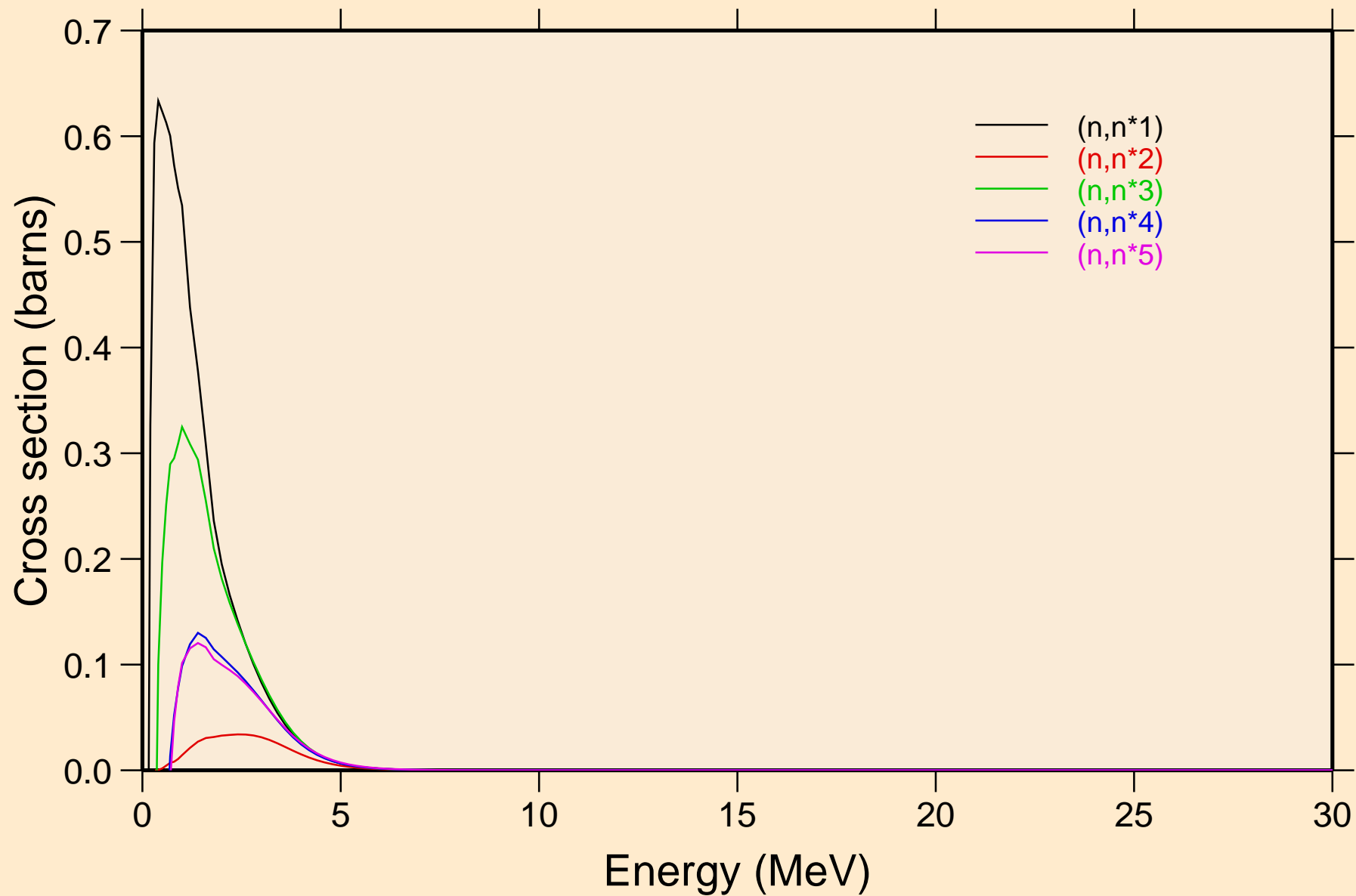

SN117 NEUTRON ACER TENDL-2019 LIBRARY; T=293.16K

Inelastic levels

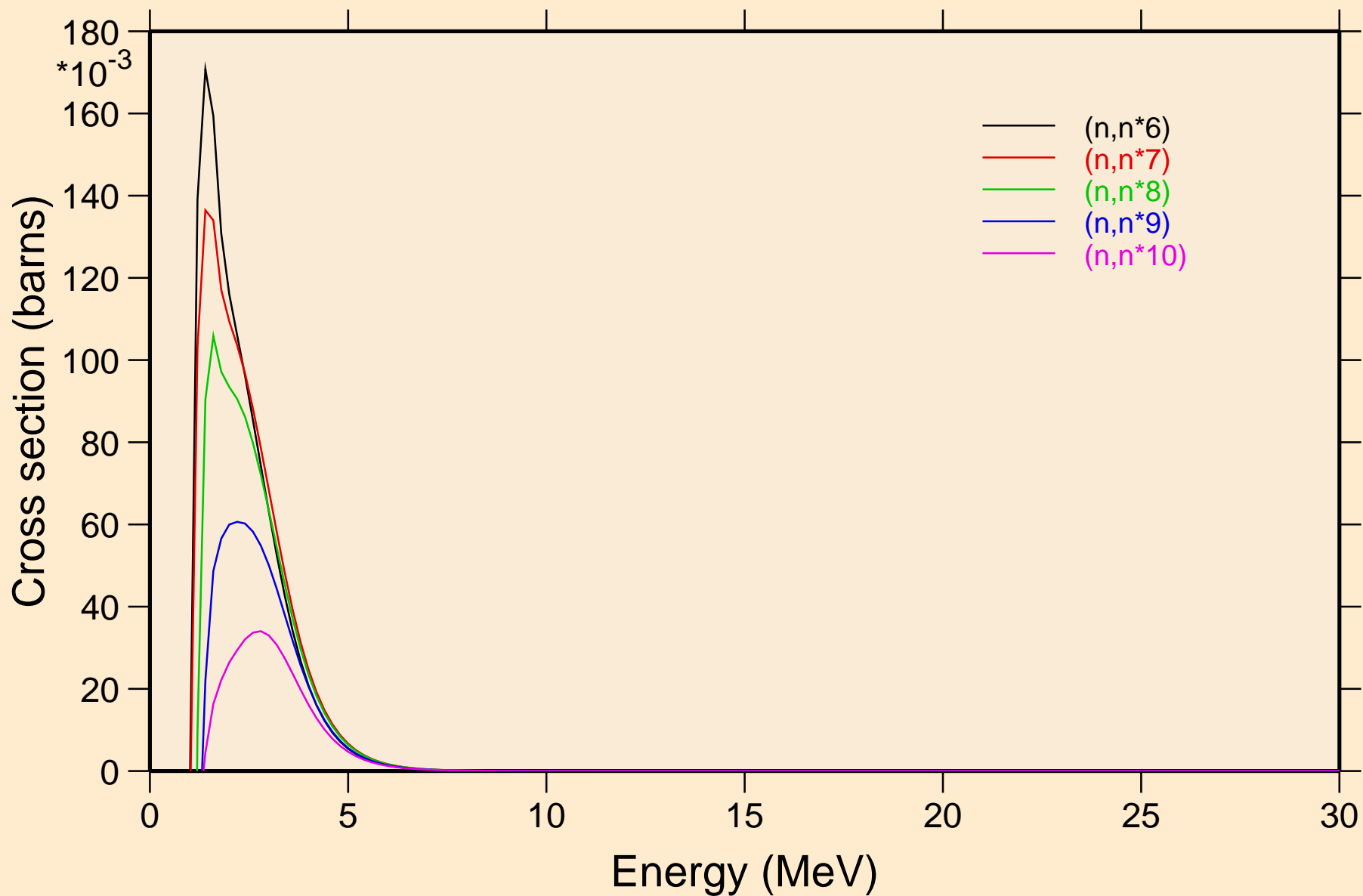

SN117 NEUTRON ACER TENDL-2019 LIBRARY; T=293.16K

Inelastic levels

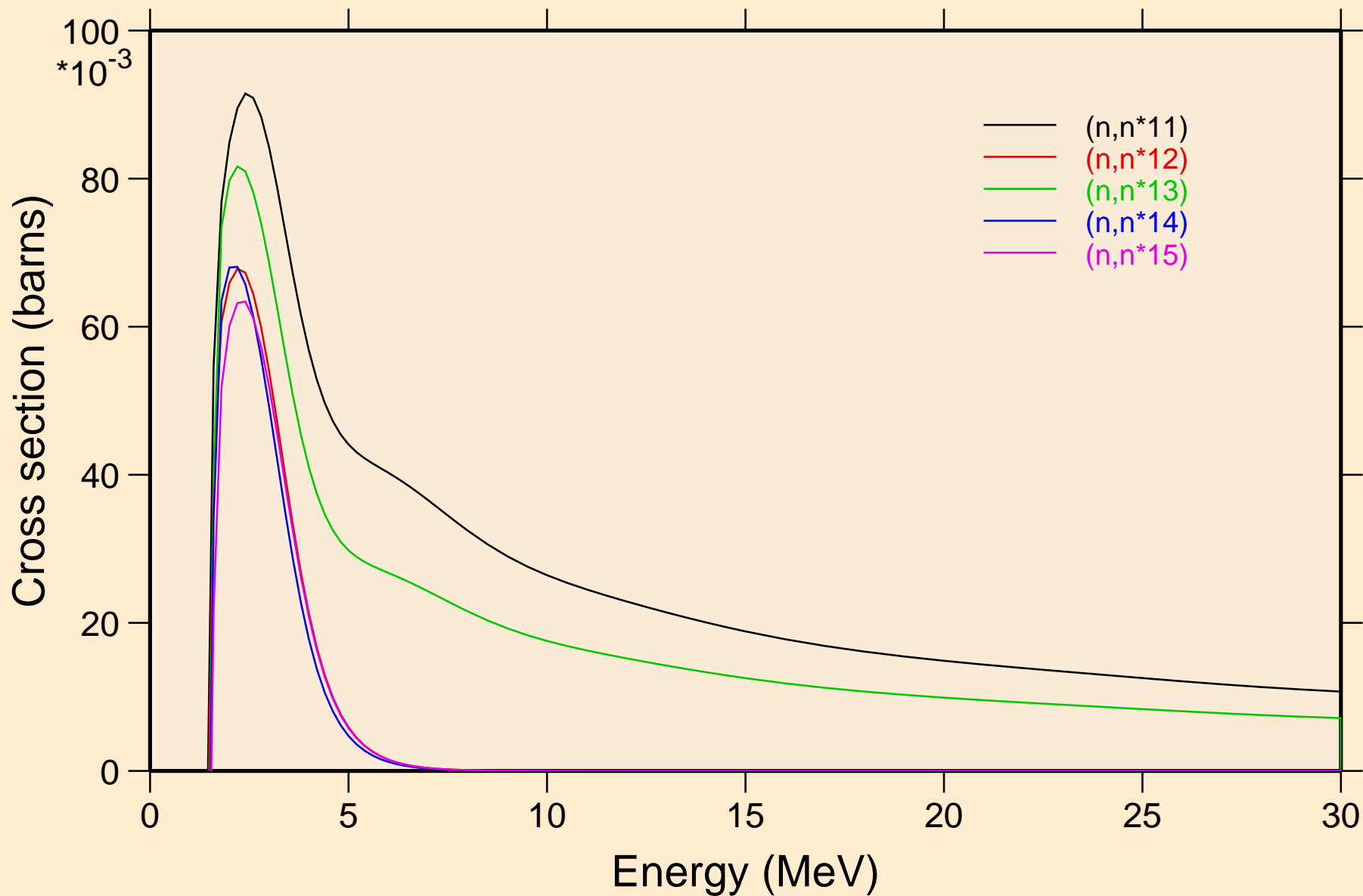

SN117 NEUTRON ACER TENDL-2019 LIBRARY; T=293.16K

Inelastic levels

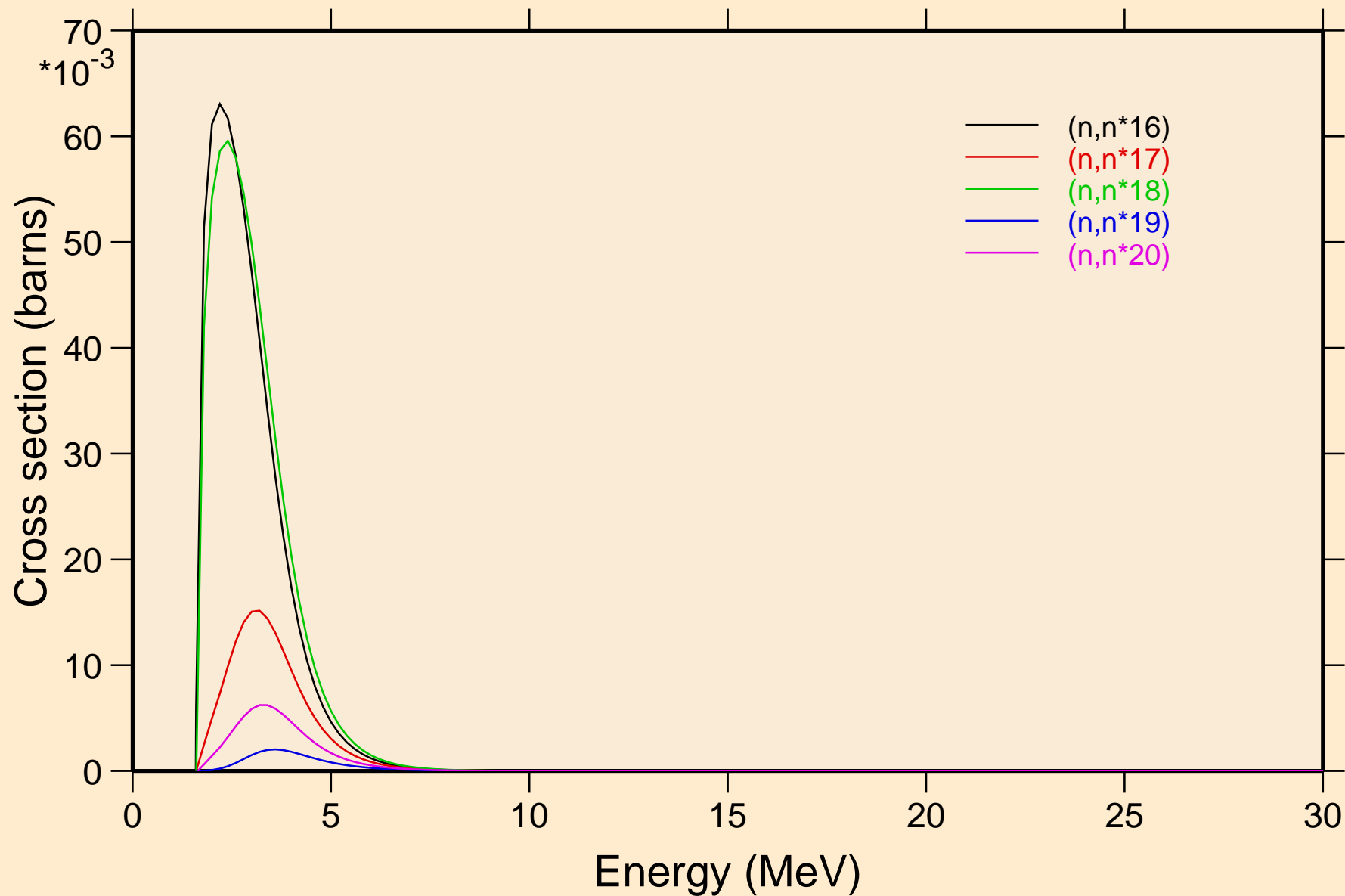

SN117 NEUTRON ACER TENDL-2019 LIBRARY; T=293.16K

Inelastic levels

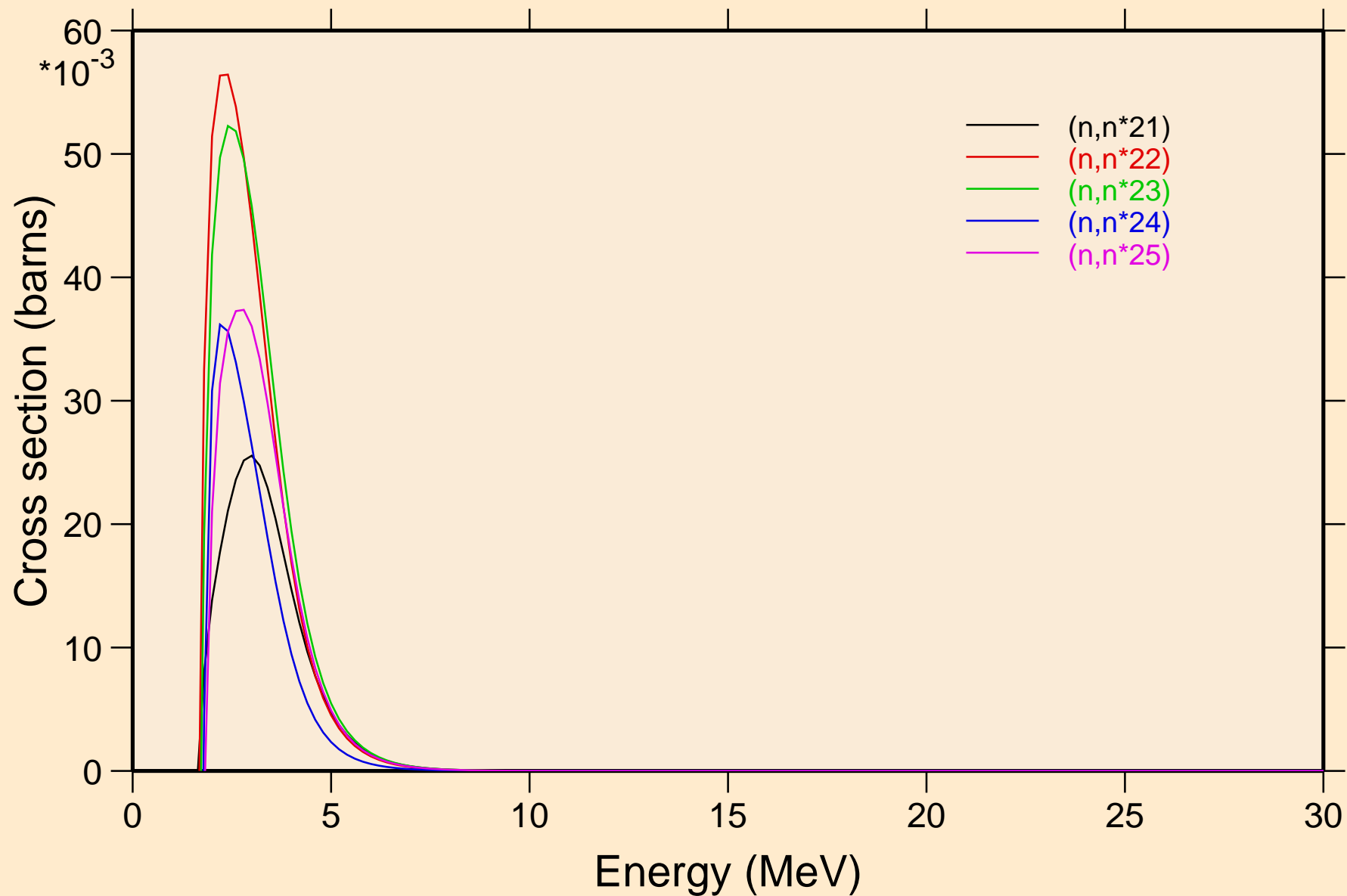

SN117 NEUTRON ACER TENDL-2019 LIBRARY; T=293.16K

Inelastic levels

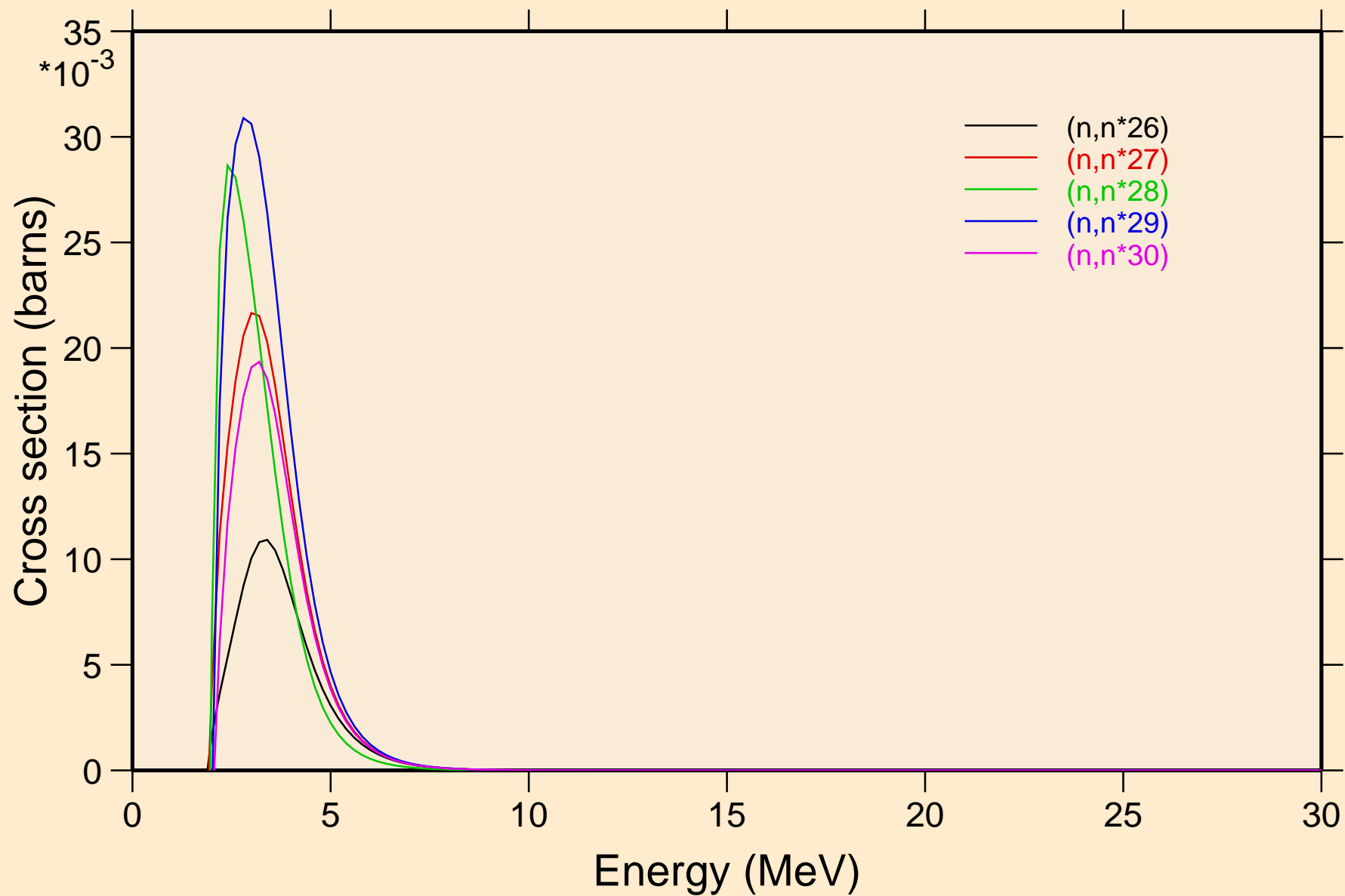

SN117 NEUTRON ACER TENDL-2019 LIBRARY; T=293.16K

Threshold reactions

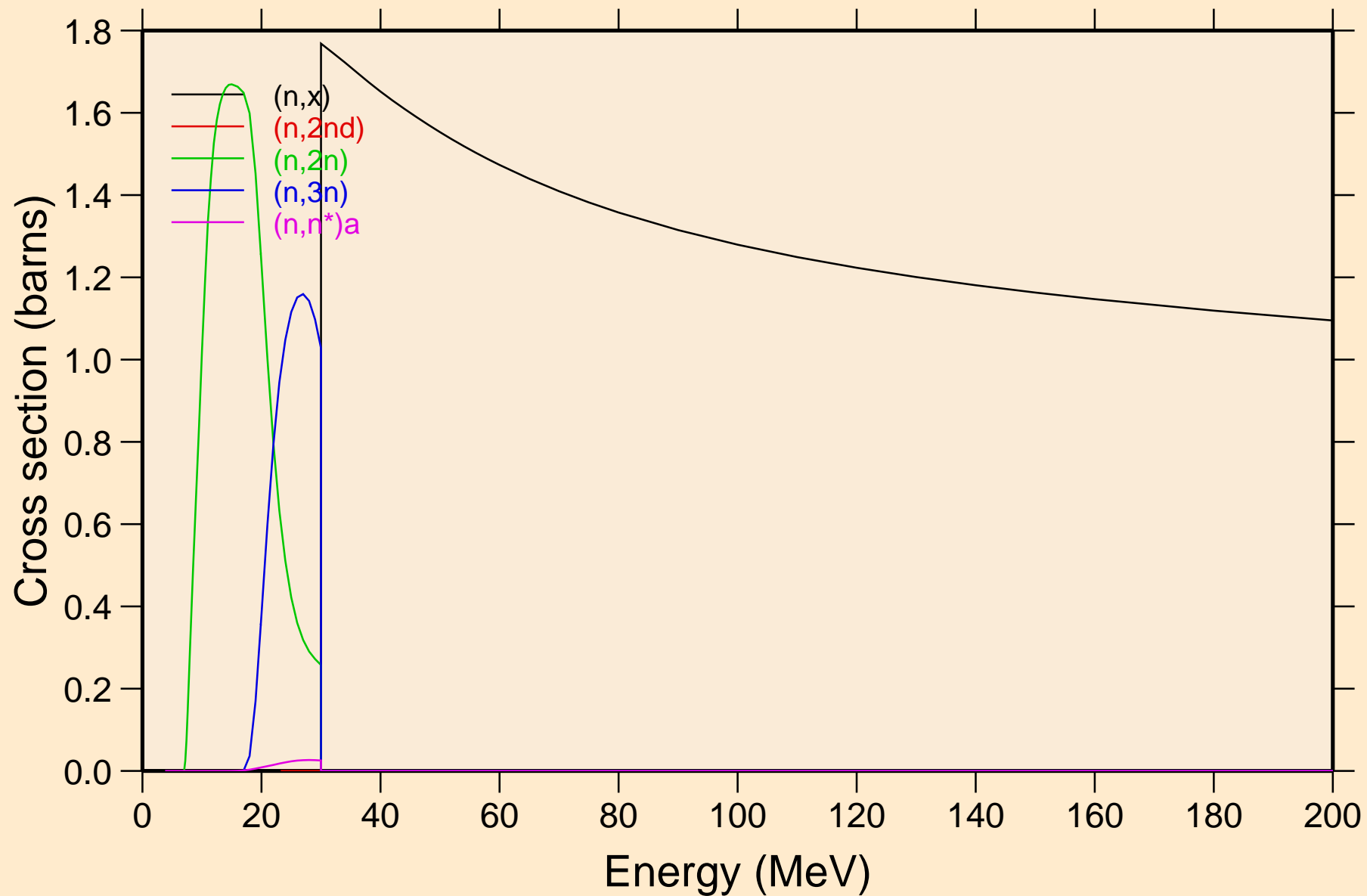

SN117 NEUTRON ACER TENDL-2019 LIBRARY; T=293.16K

Threshold reactions

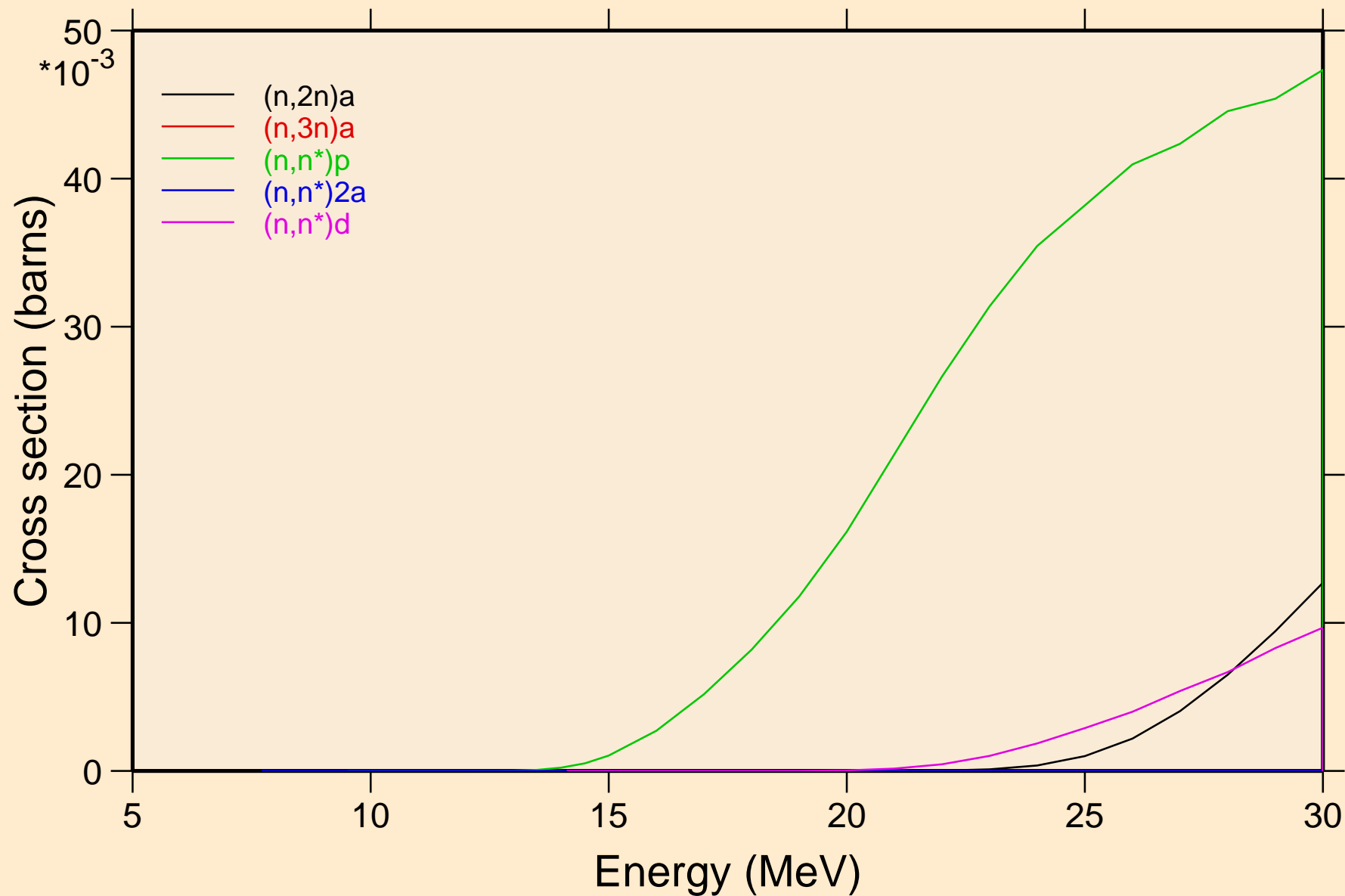

SN117 NEUTRON ACER TENDL-2019 LIBRARY; T=293.16K

Threshold reactions

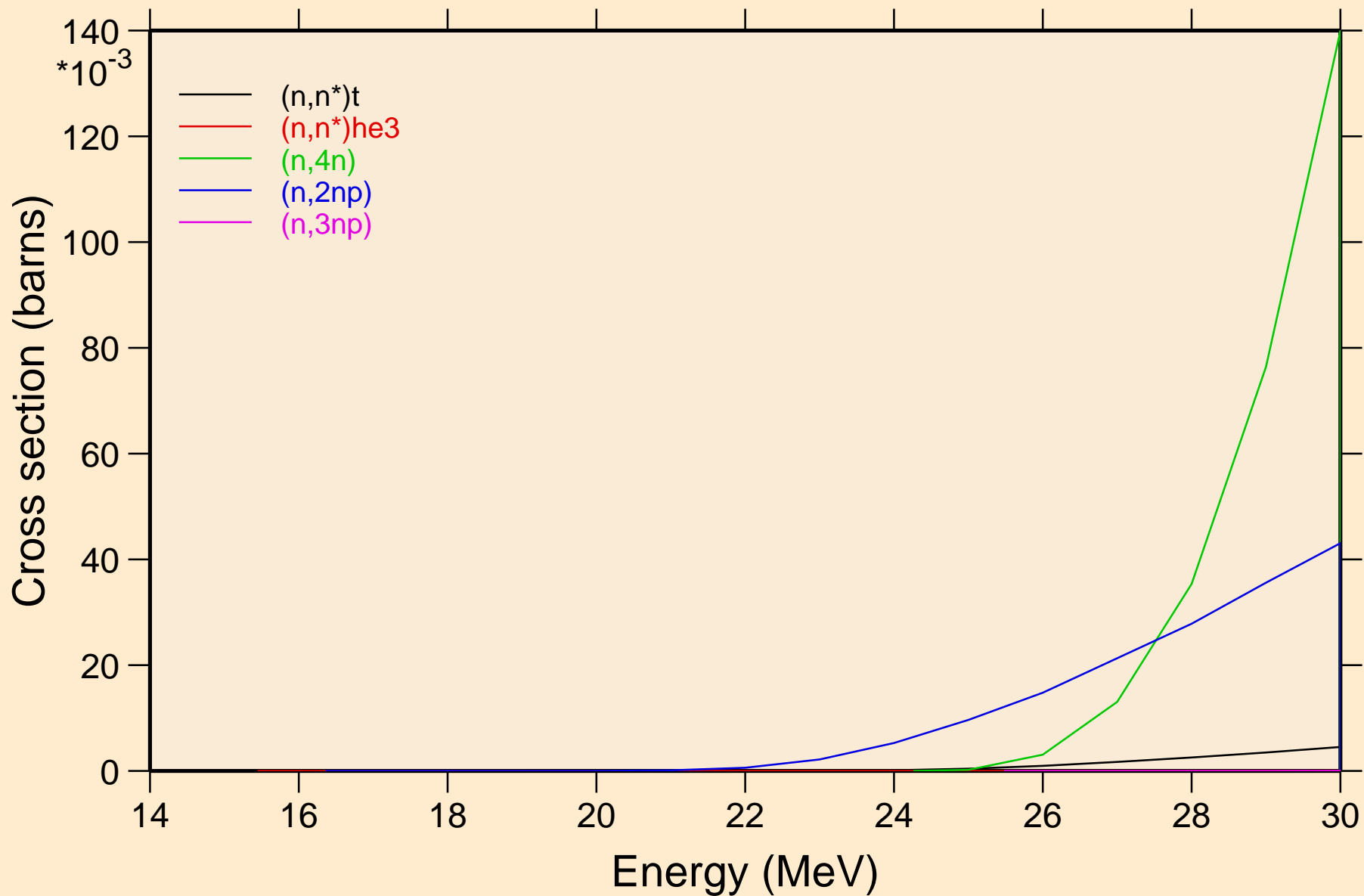

SN117 NEUTRON ACER TENDL-2019 LIBRARY; T=293.16K

Threshold reactions

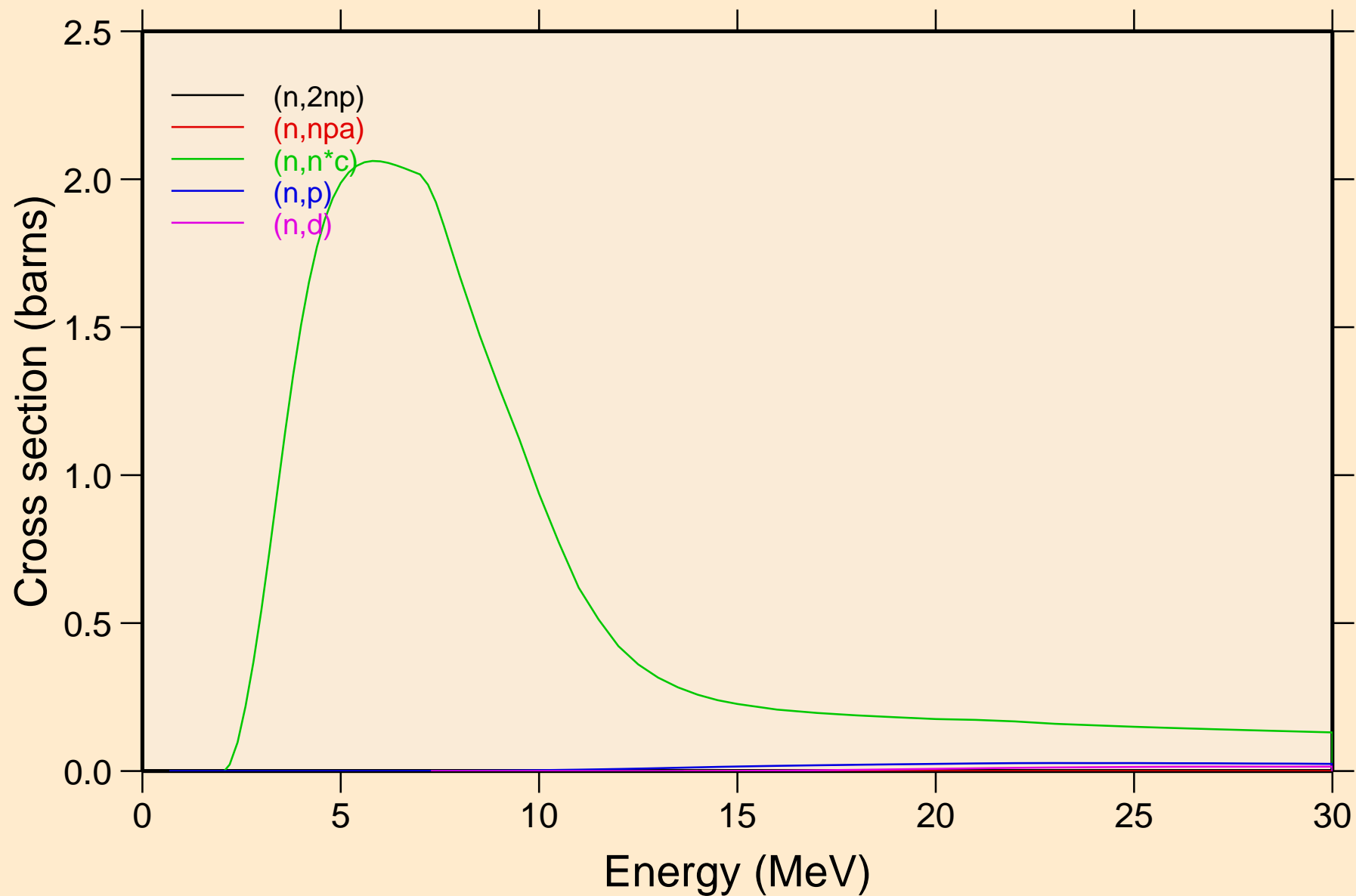

SN117 NEUTRON ACER TENDL-2019 LIBRARY; T=293.16K

Threshold reactions

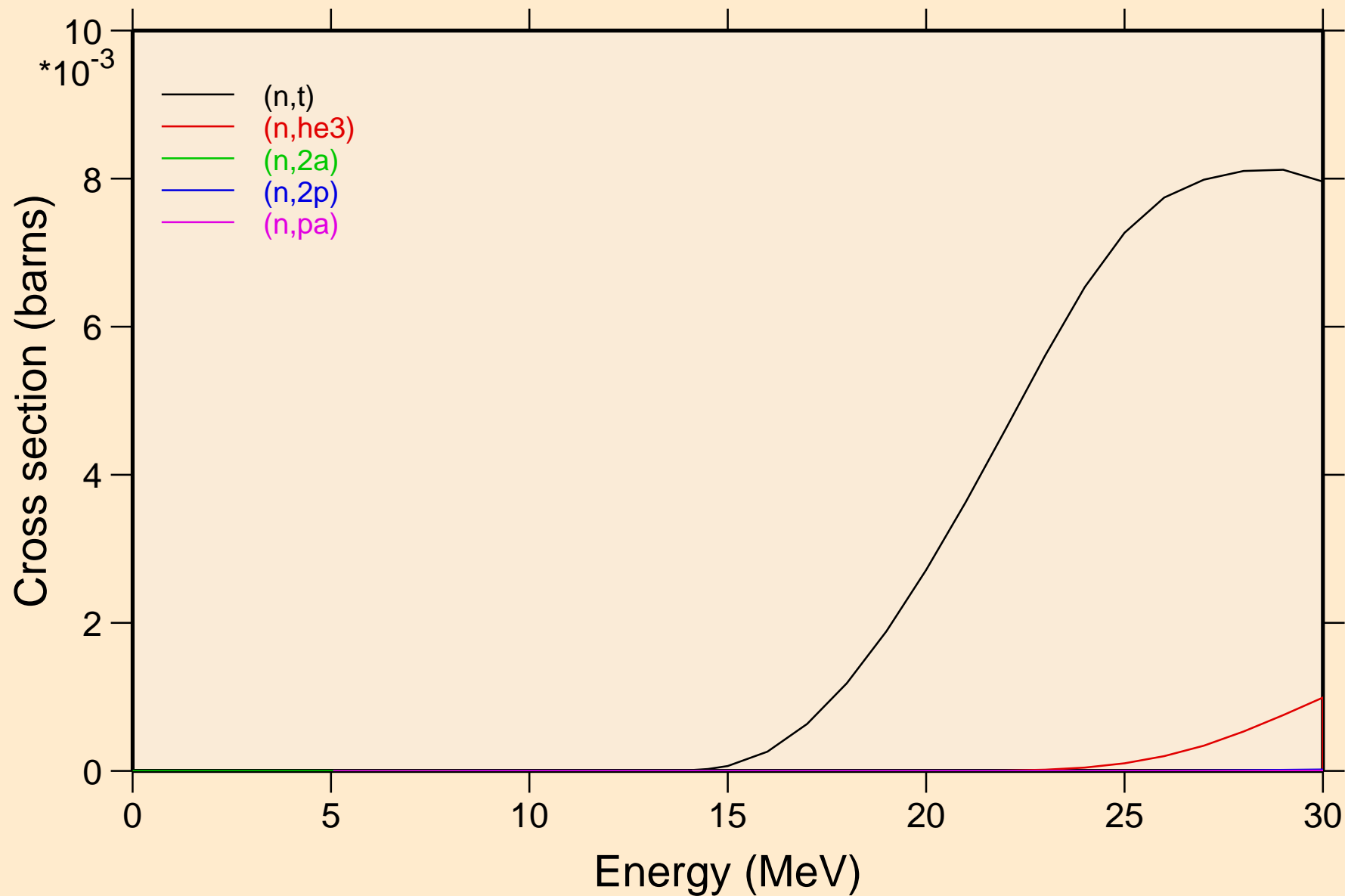

SN117 NEUTRON ACER TENDL-2019 LIBRARY; T=293.16K

Threshold reactions

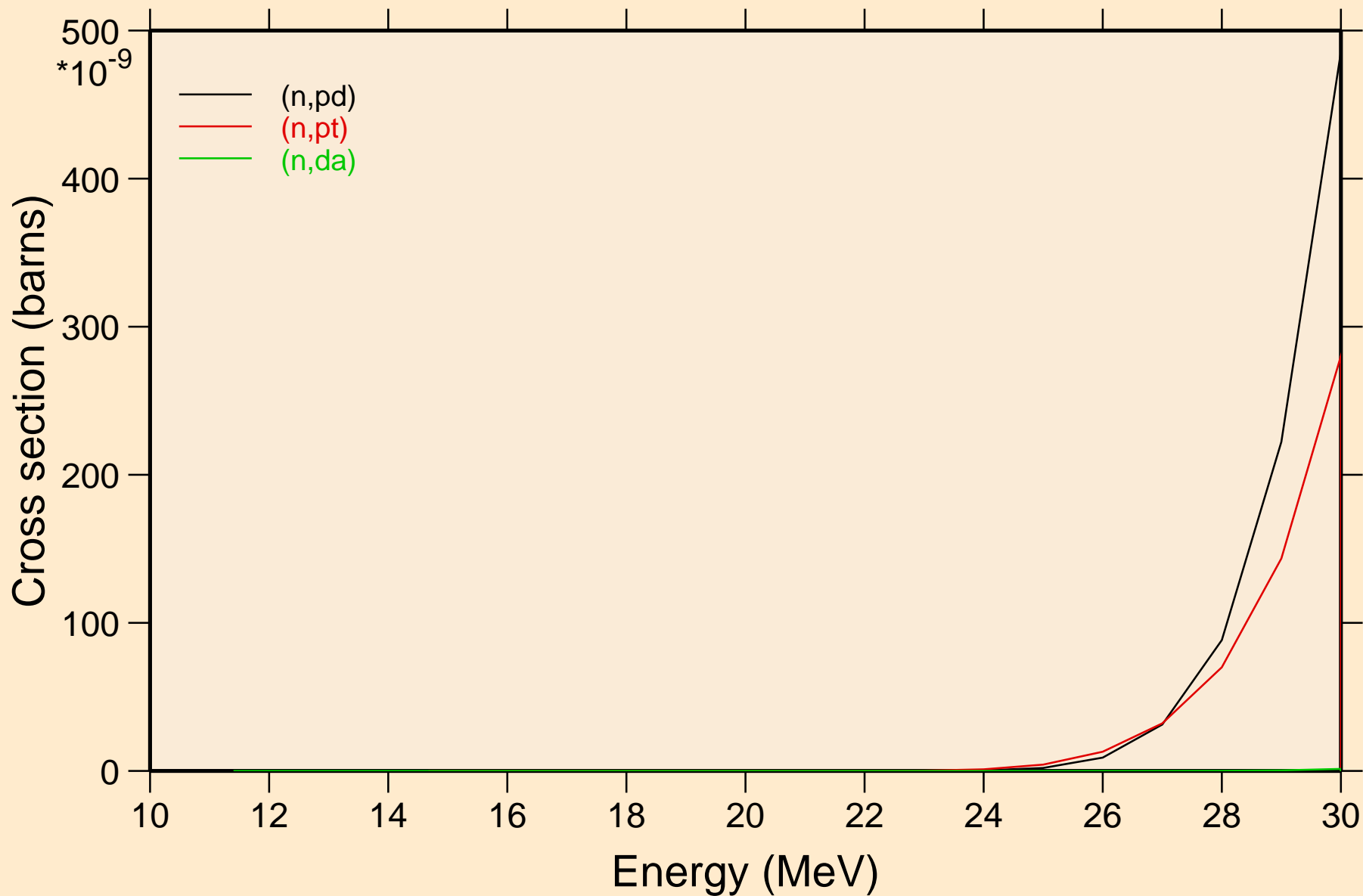

SN117 NEUTRON ACER TENDL-2019 LIBRARY; T=293.16K

Threshold reactions

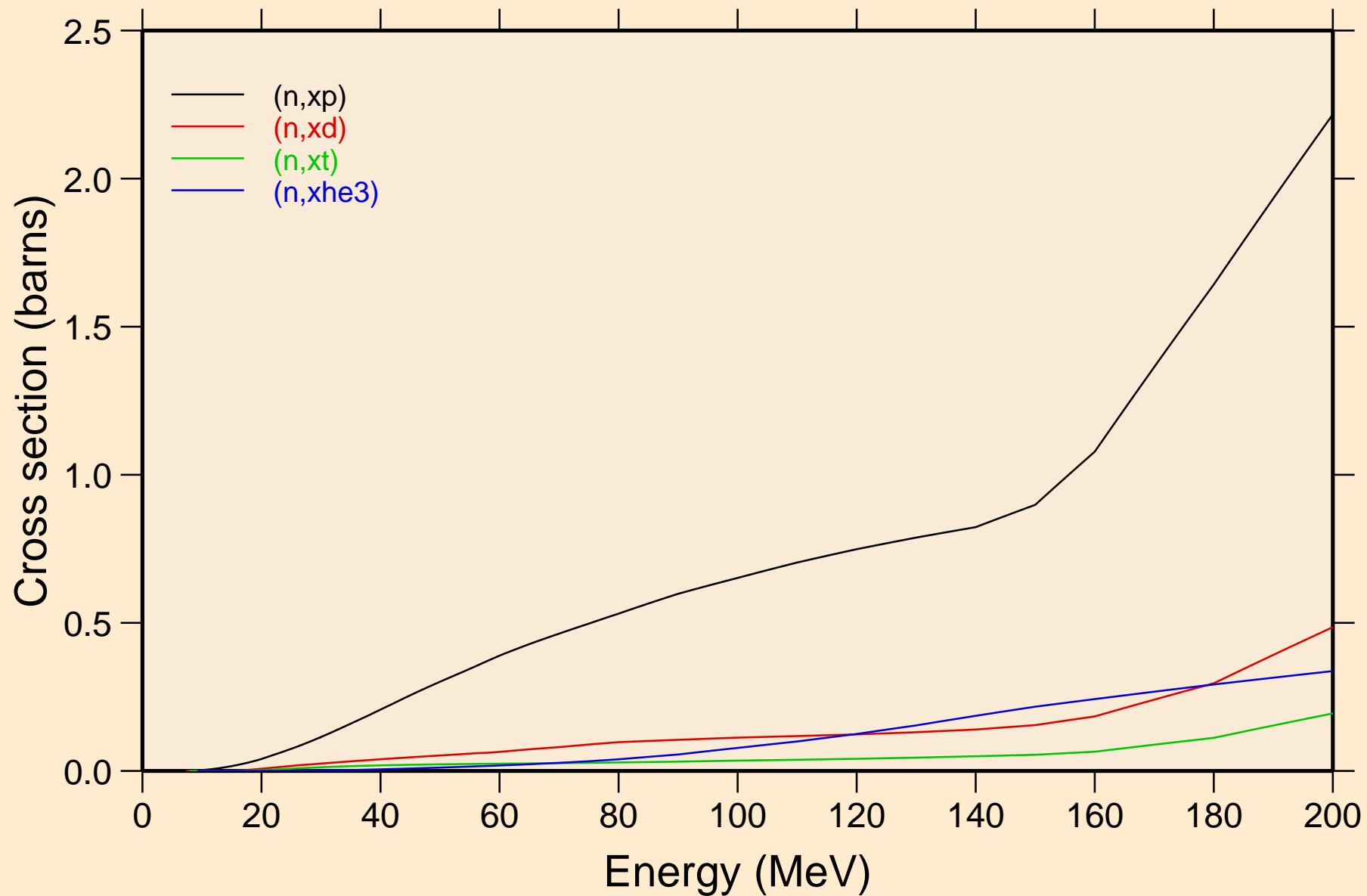

SN117 NEUTRON ACER TENDL-2019 LIBRARY; T=293.16K
angular distribution for elastic

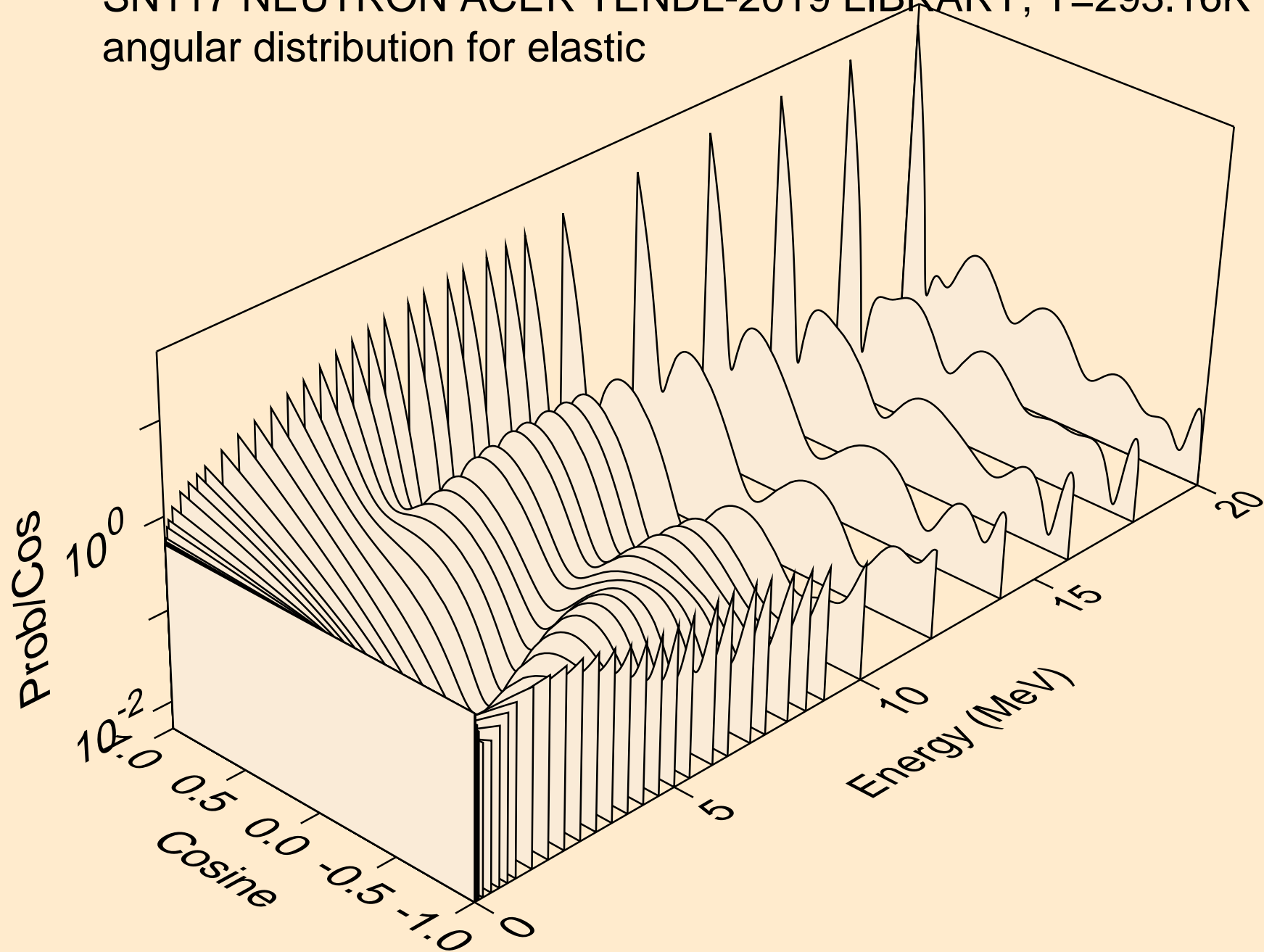

SN117 NEUTRON ACER TENDL-2019 LIBRARY; T=293.16K
angular distribution for elastic

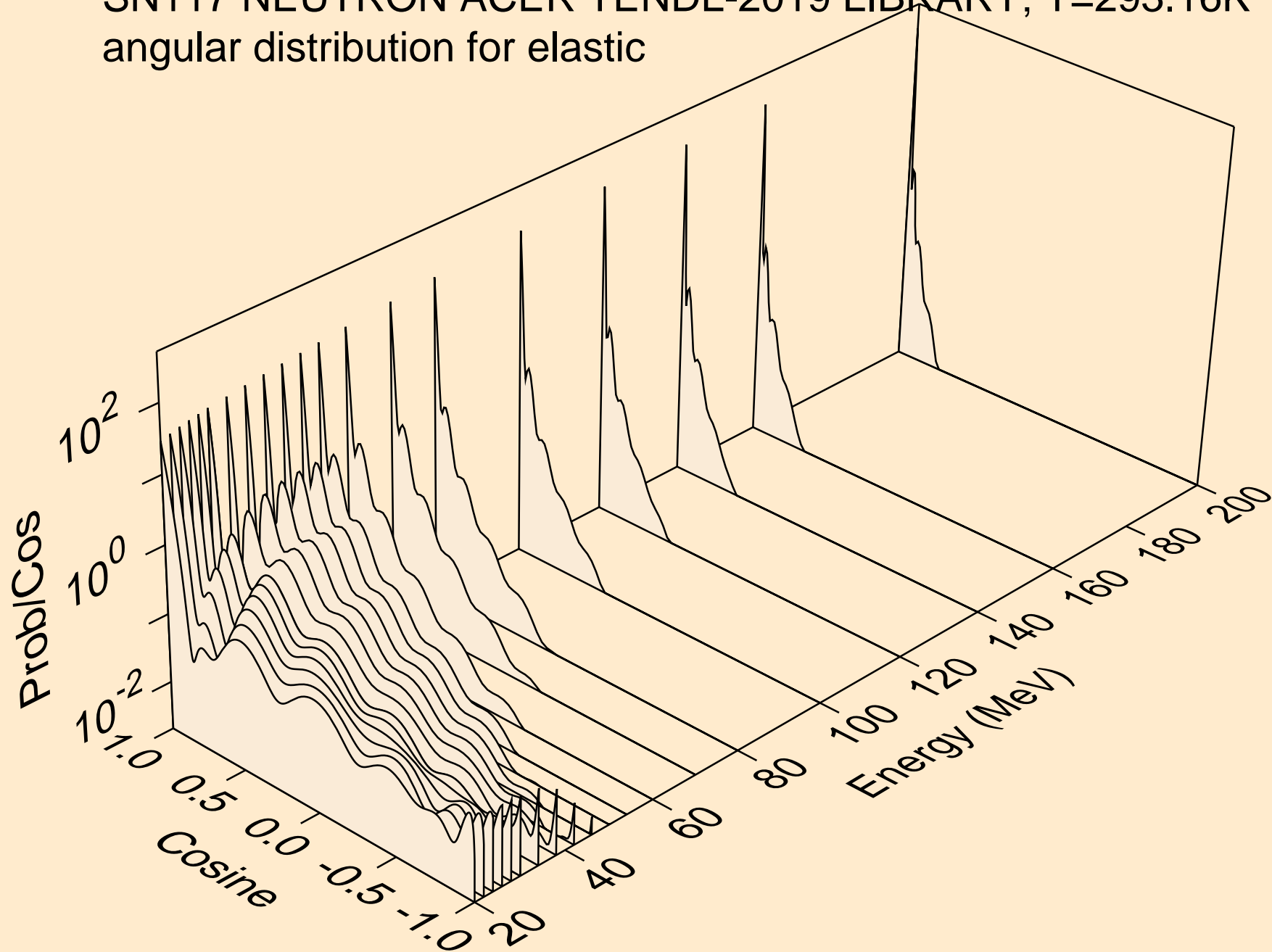

SN117 NEUTRON ACER TENDL-2019 LIBRARY; T=293.16K
angular distribution for (n,n*1)

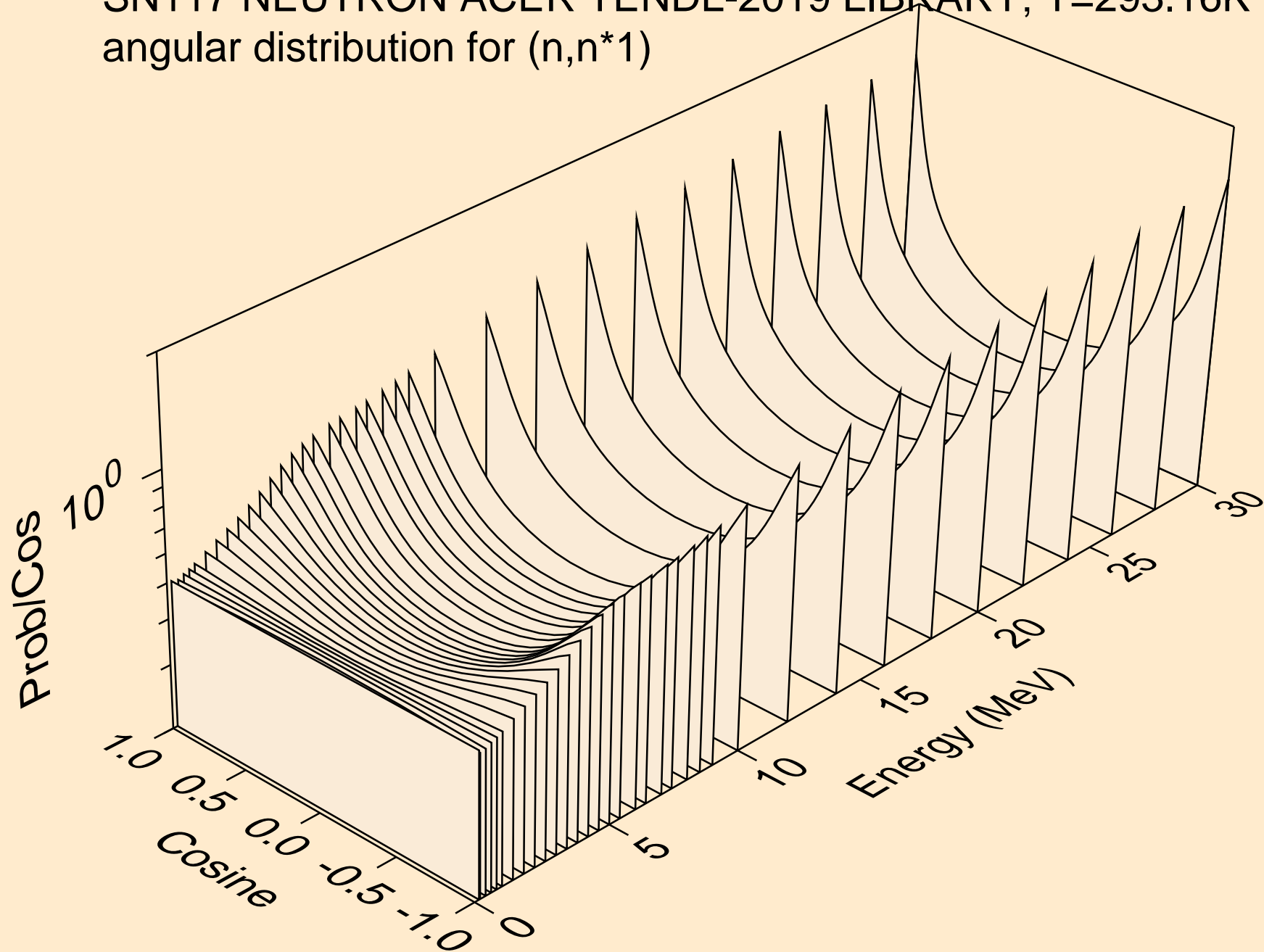

SN117 NEUTRON ACER TENDL-2019 LIBRARY; T=293.16K
angular distribution for (n,n*2)

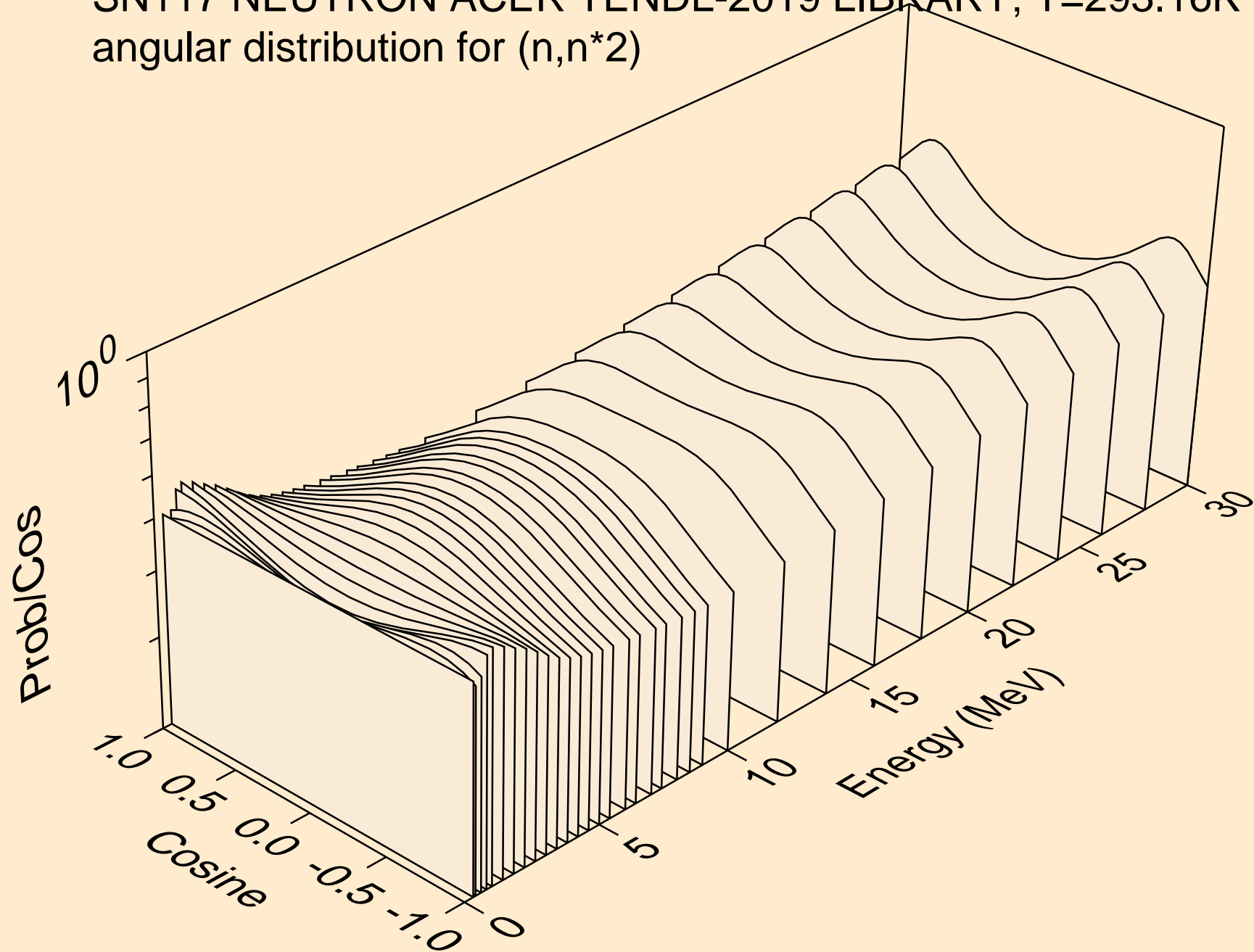

SN117 NEUTRON ACER TENDL-2019 LIBRARY; T=293.16K
angular distribution for (n,n*3)

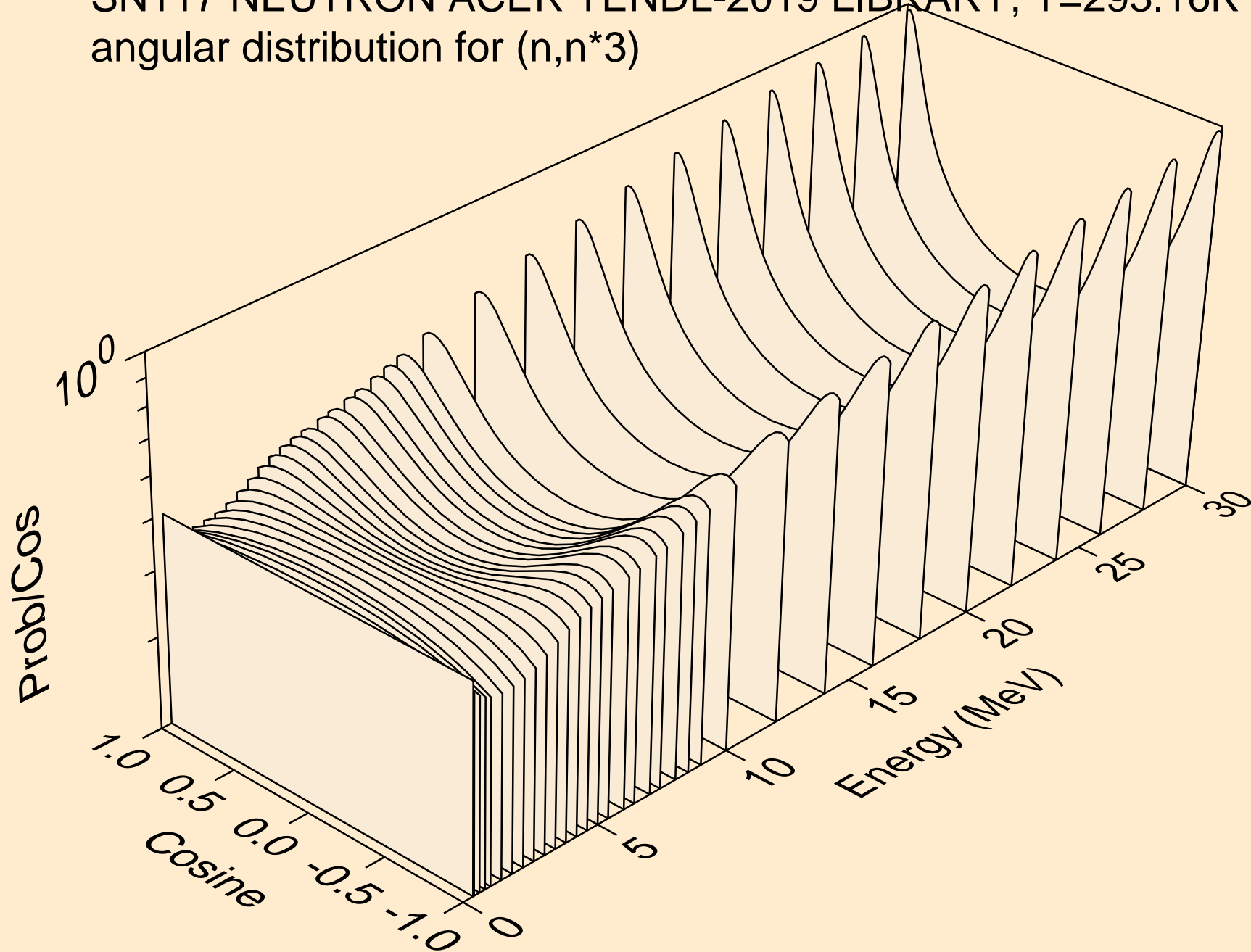

SN117 NEUTRON ACER TENDL-2019 LIBRARY; T=293.16K
angular distribution for (n,n*4)

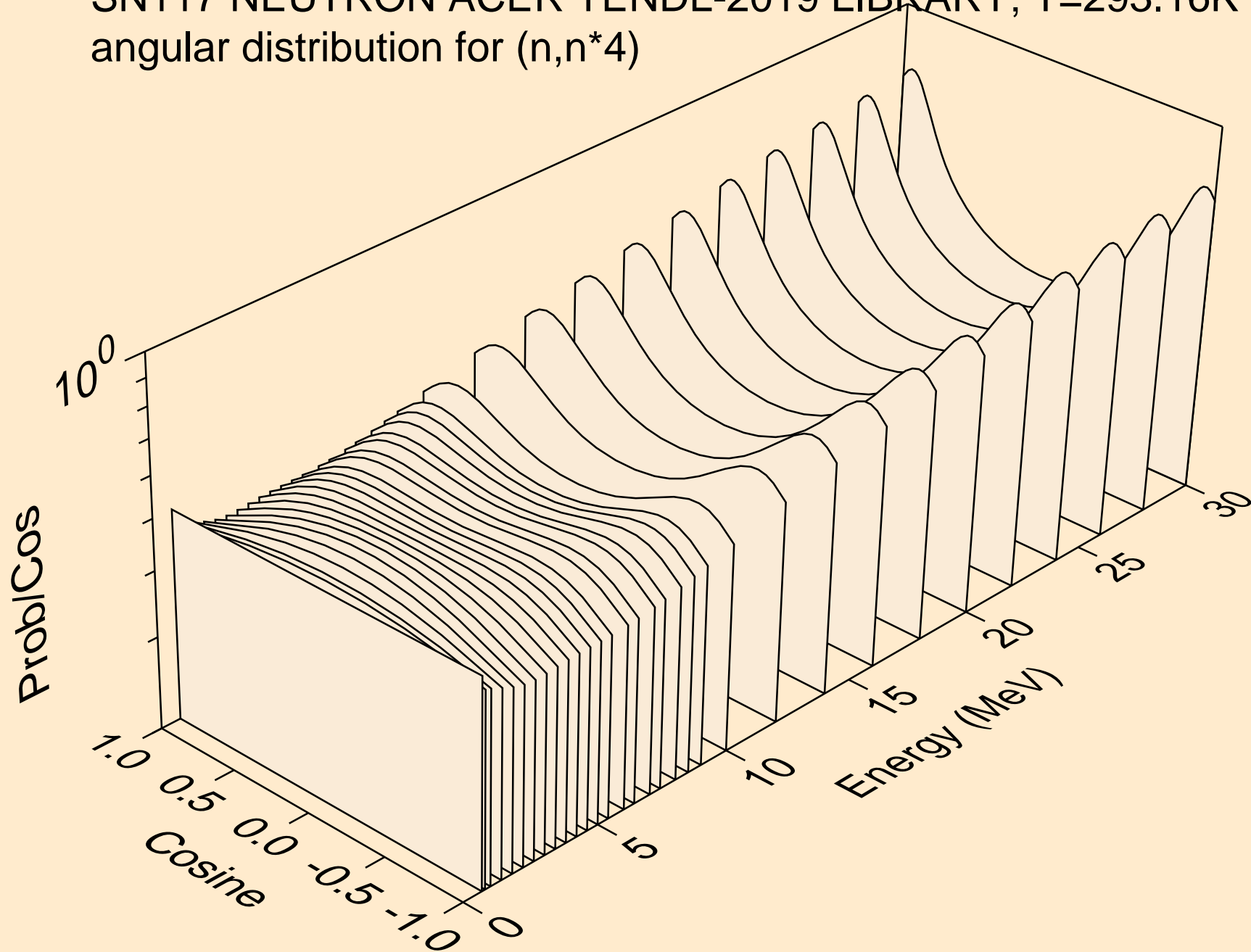

SN117 NEUTRON ACER TENDL-2019 LIBRARY; T=293.16K
angular distribution for (n,n*5)

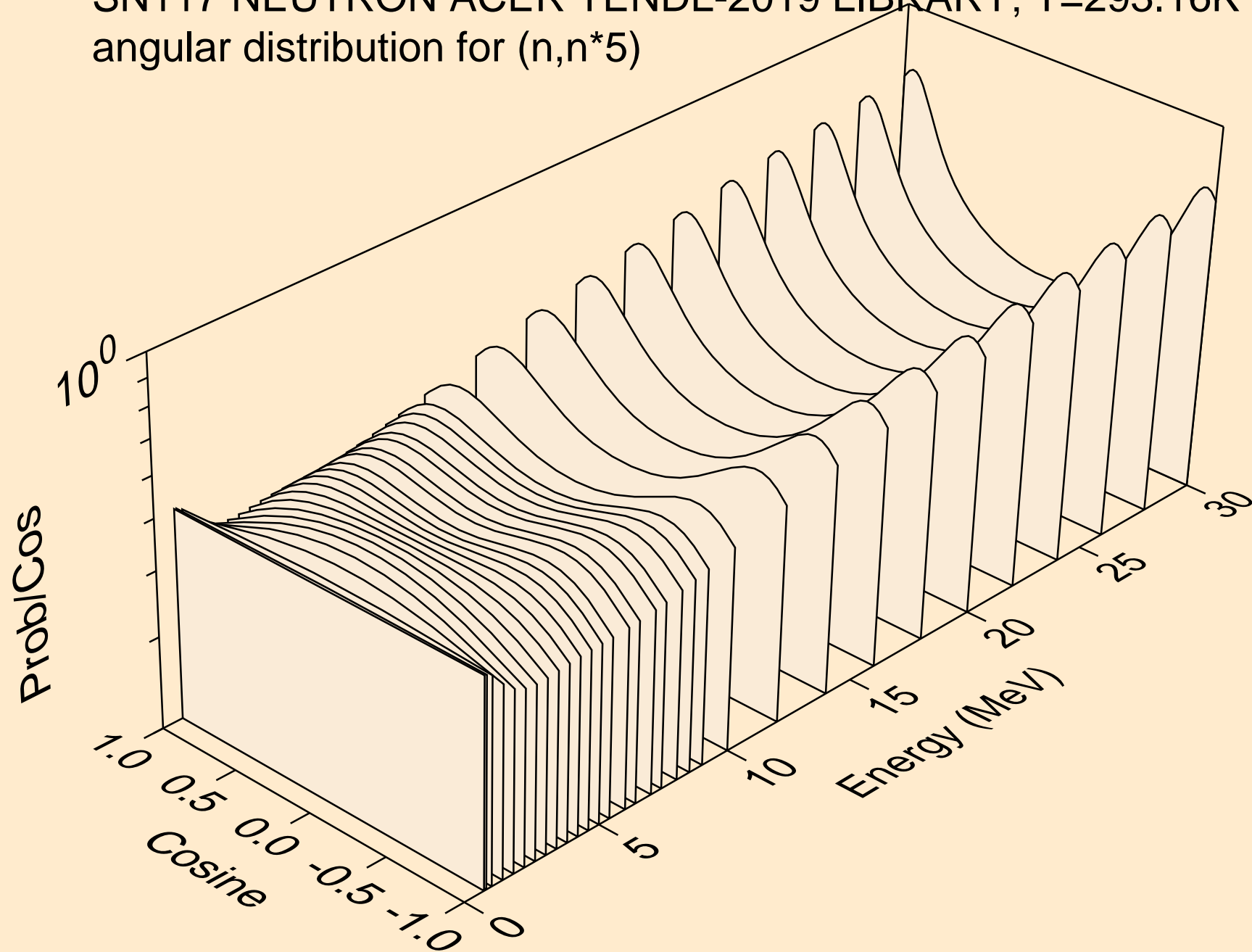

SN117 NEUTRON ACER TENDL-2019 LIBRARY; T=293.16K
angular distribution for (n,n*6)

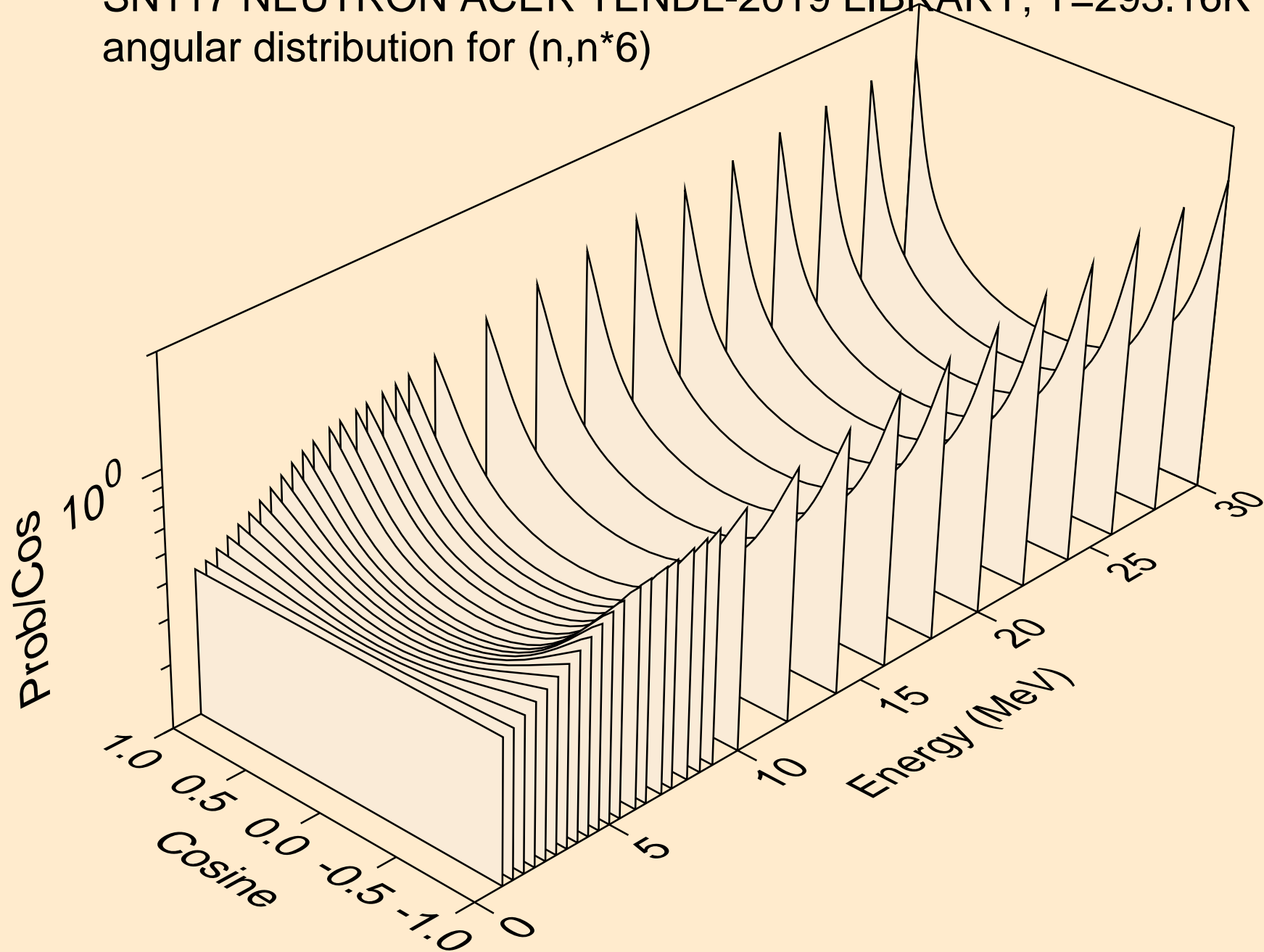

SN117 NEUTRON ACER TENDL-2019 LIBRARY; T=293.16K
angular distribution for (n,n*7)

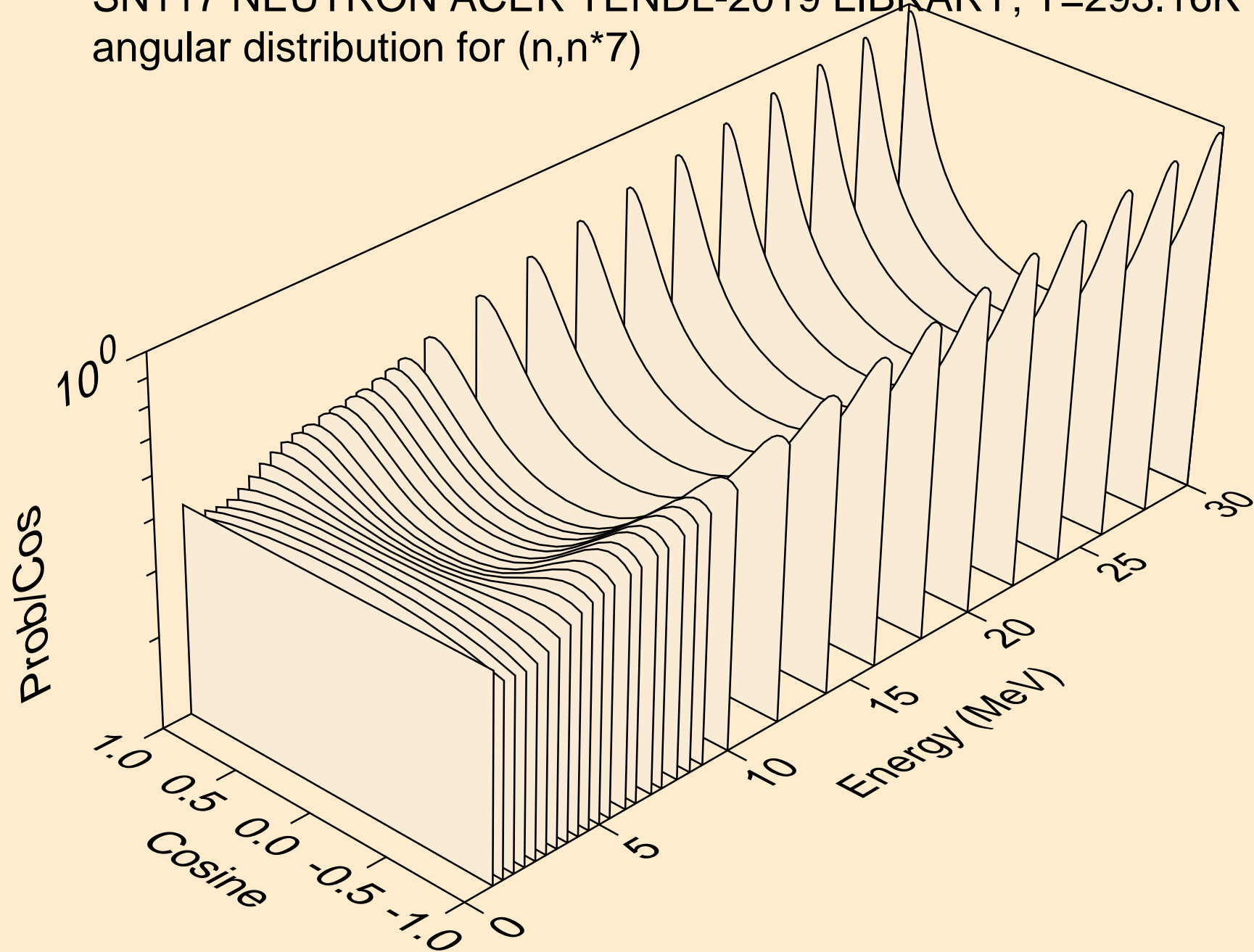

SN117 NEUTRON ACER TENDL-2019 LIBRARY; T=293.16K
angular distribution for (n,n*8)

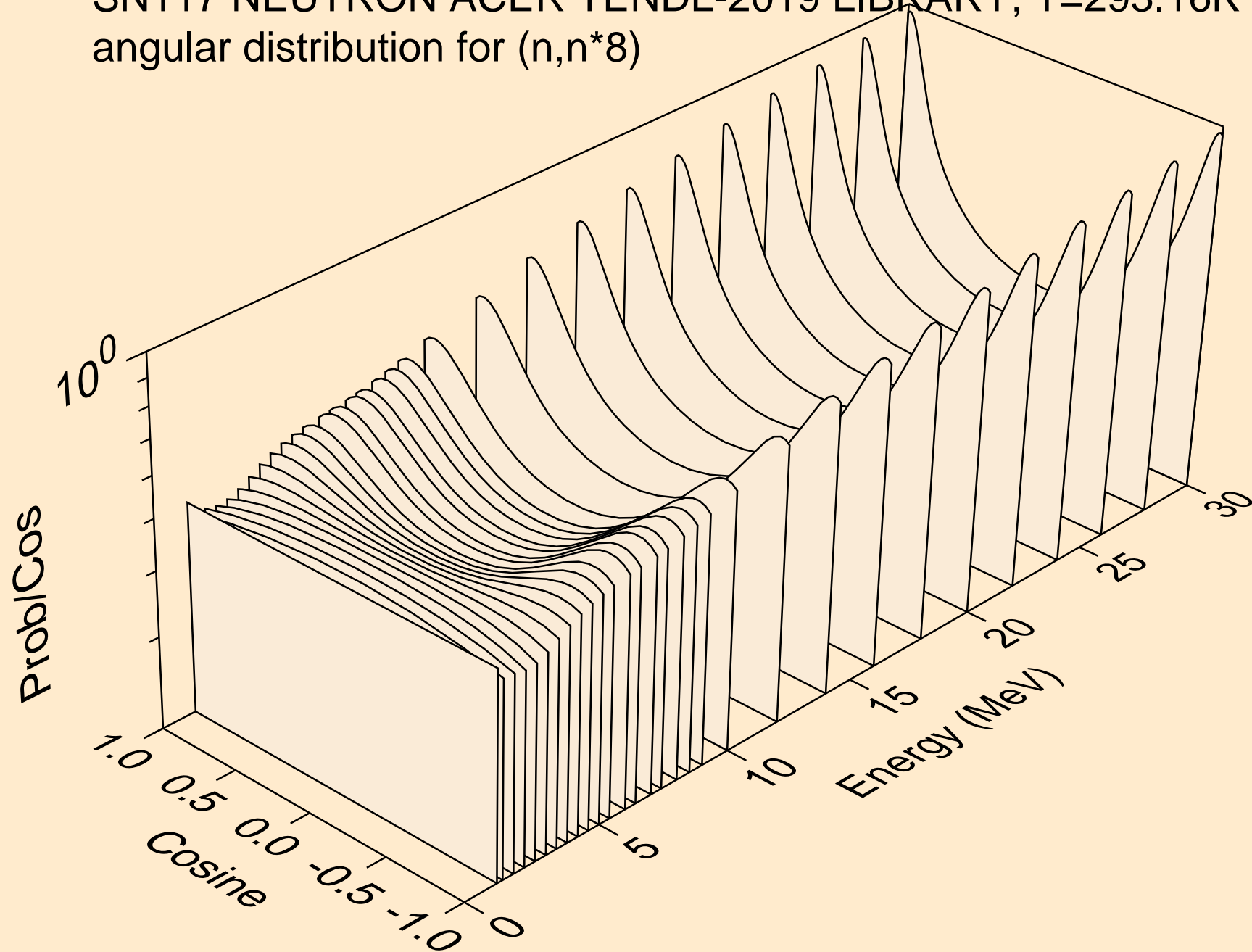

SN117 NEUTRON ACER TENDL-2019 LIBRARY; T=293.16K
angular distribution for (n,n*9)

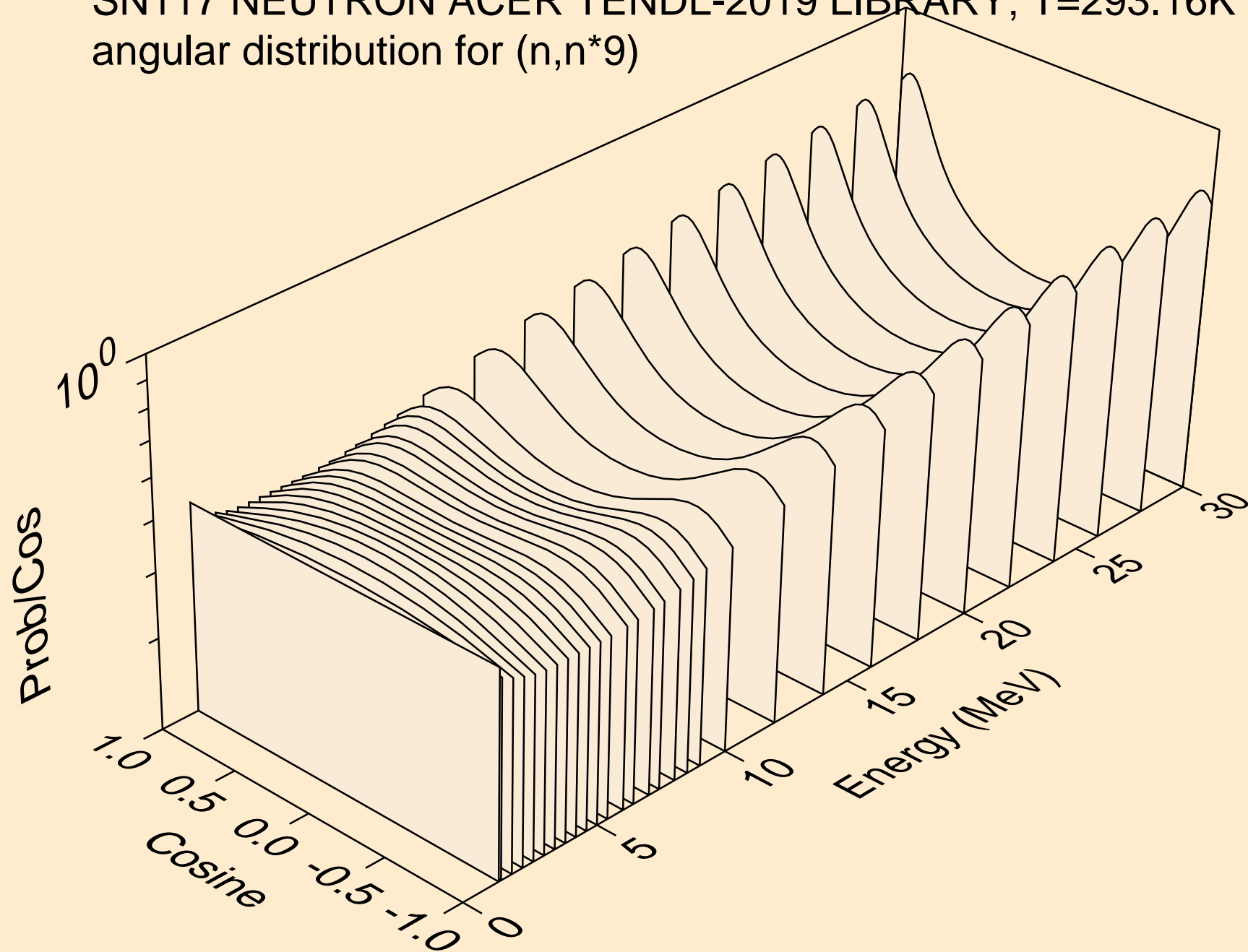

SN117 NEUTRON ACER TENDL-2019 LIBRARY; T=293.16K
angular distribution for (n,n*10)

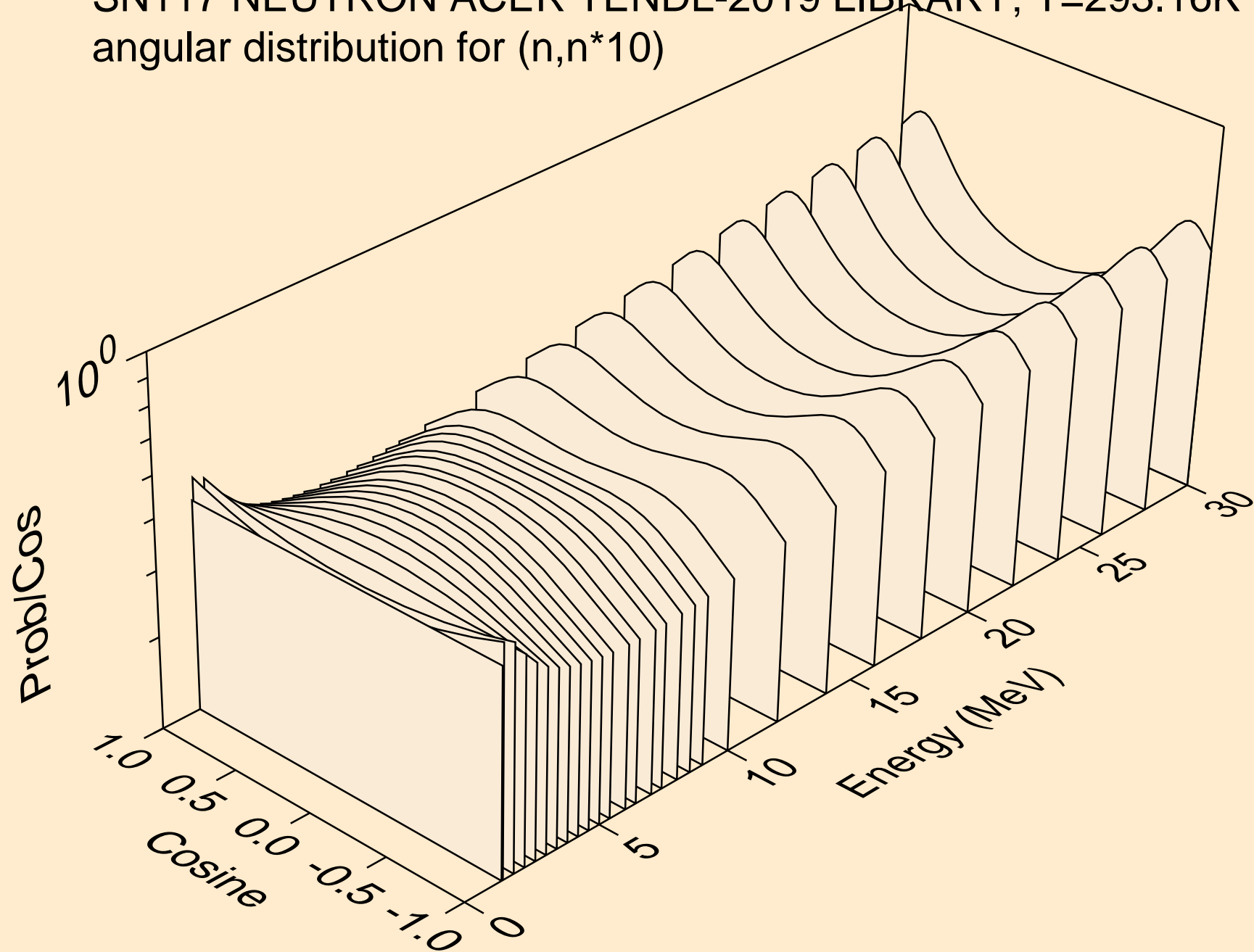

SN117 NEUTRON ACER TENDL-2019 LIBRARY; T=293.16K
angular distribution for (n,n*11)

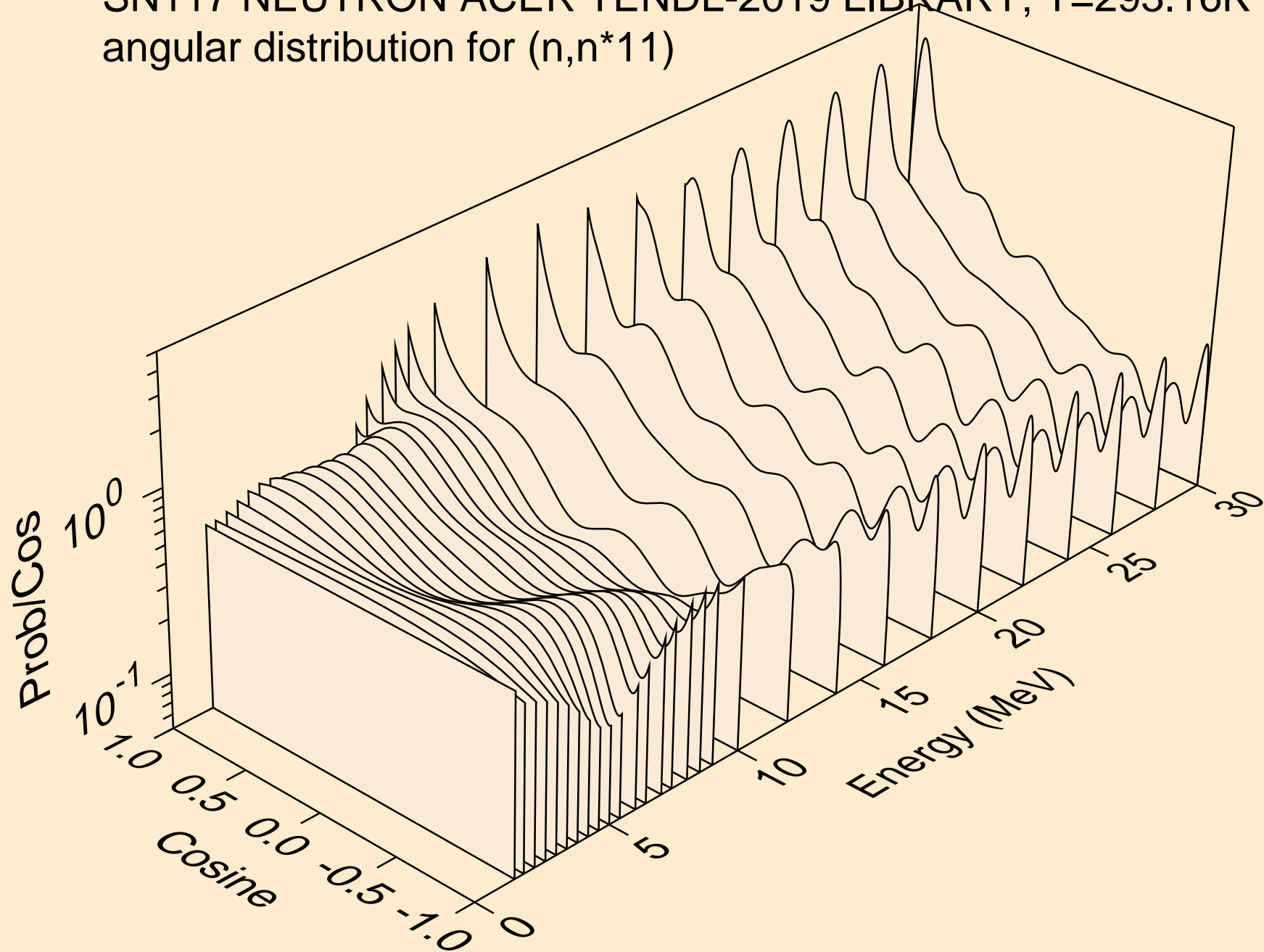

SN117 NEUTRON ACER TENDL-2019 LIBRARY; T=293.16K
angular distribution for (n,n*12)

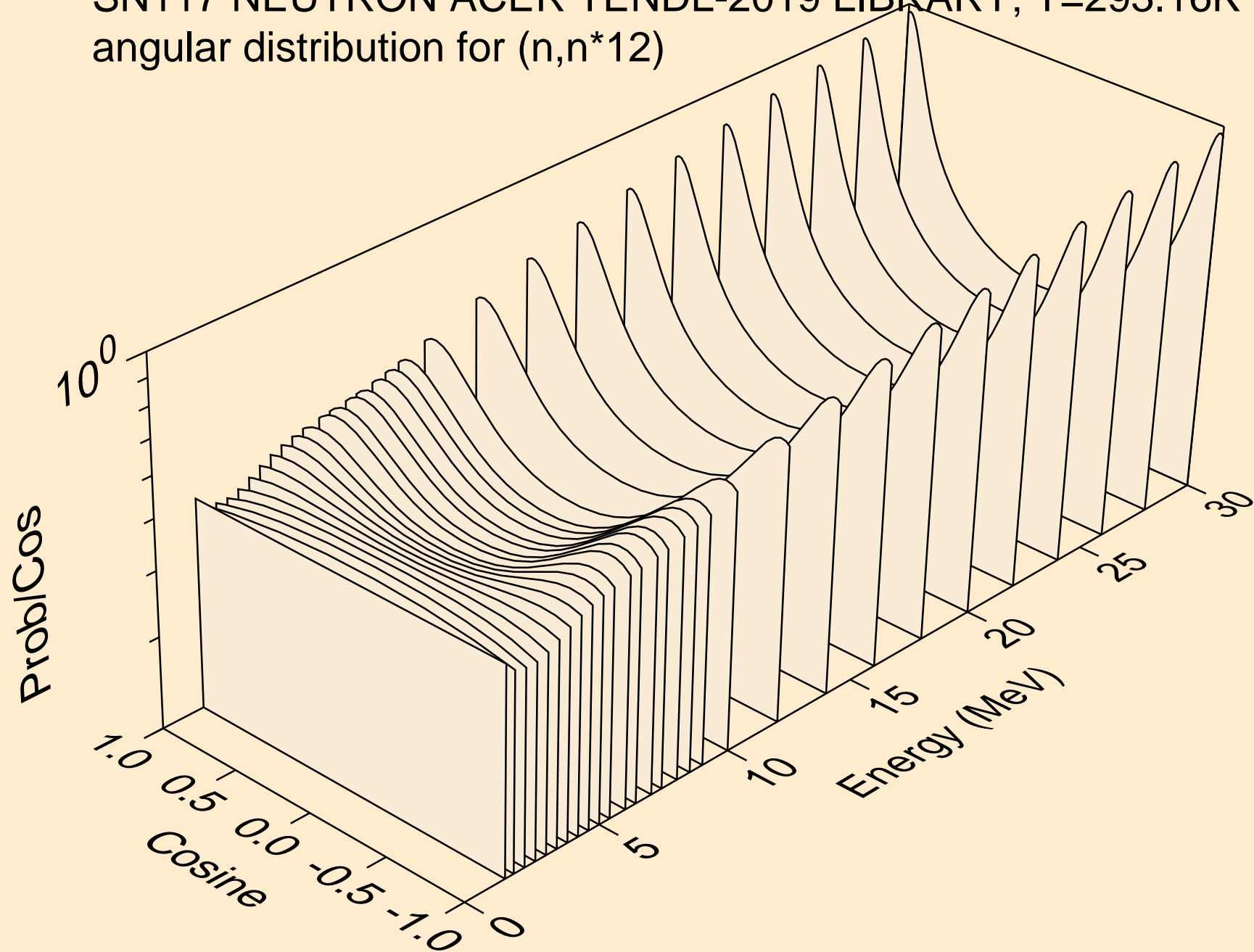

SN117 NEUTRON ACER TENDL-2019 LIBRARY; T=293.16K
angular distribution for (n,n*13)

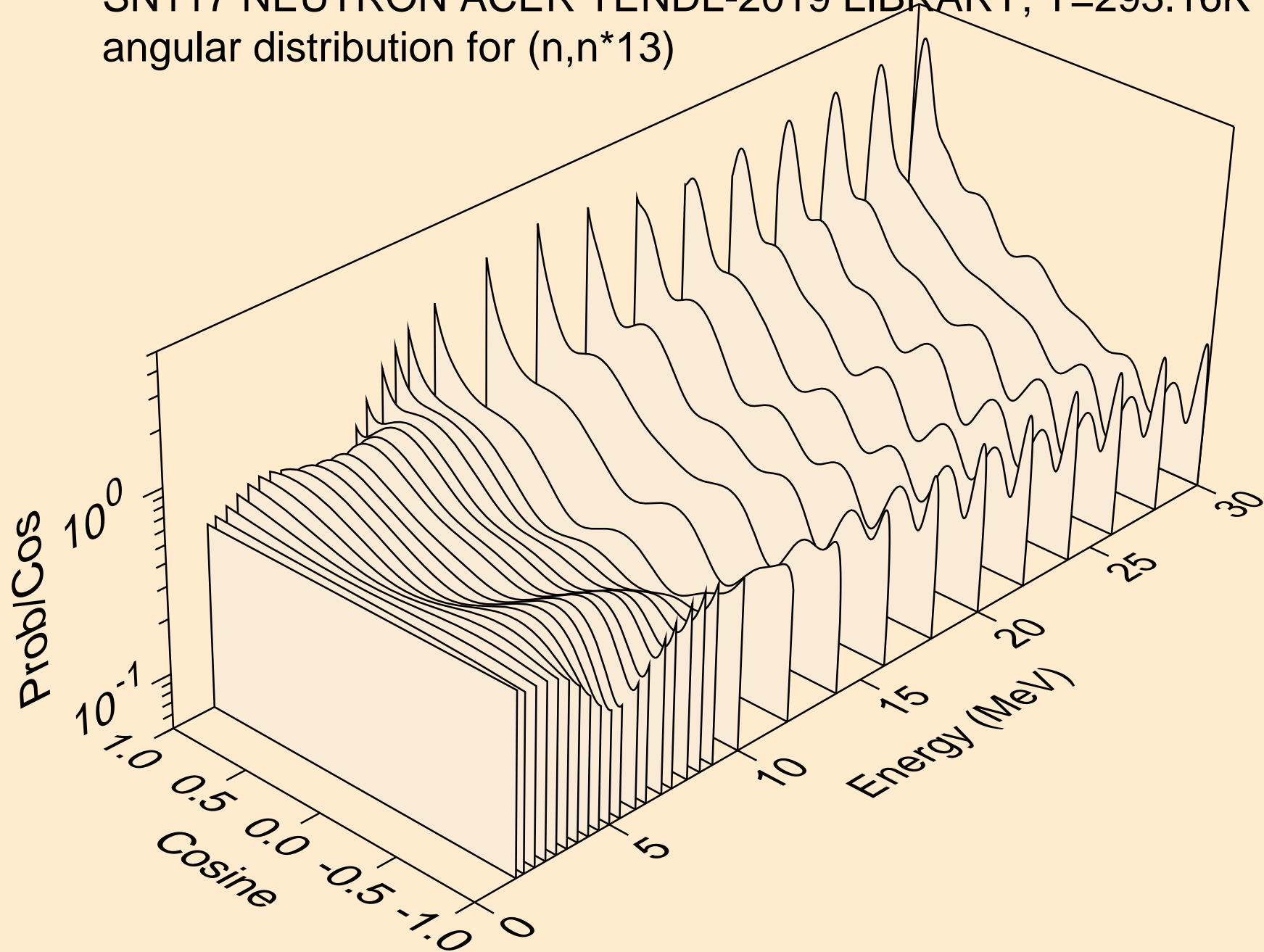

SN117 NEUTRON ACER TENDL-2019 LIBRARY; T=293.16K
angular distribution for (n,n*14)

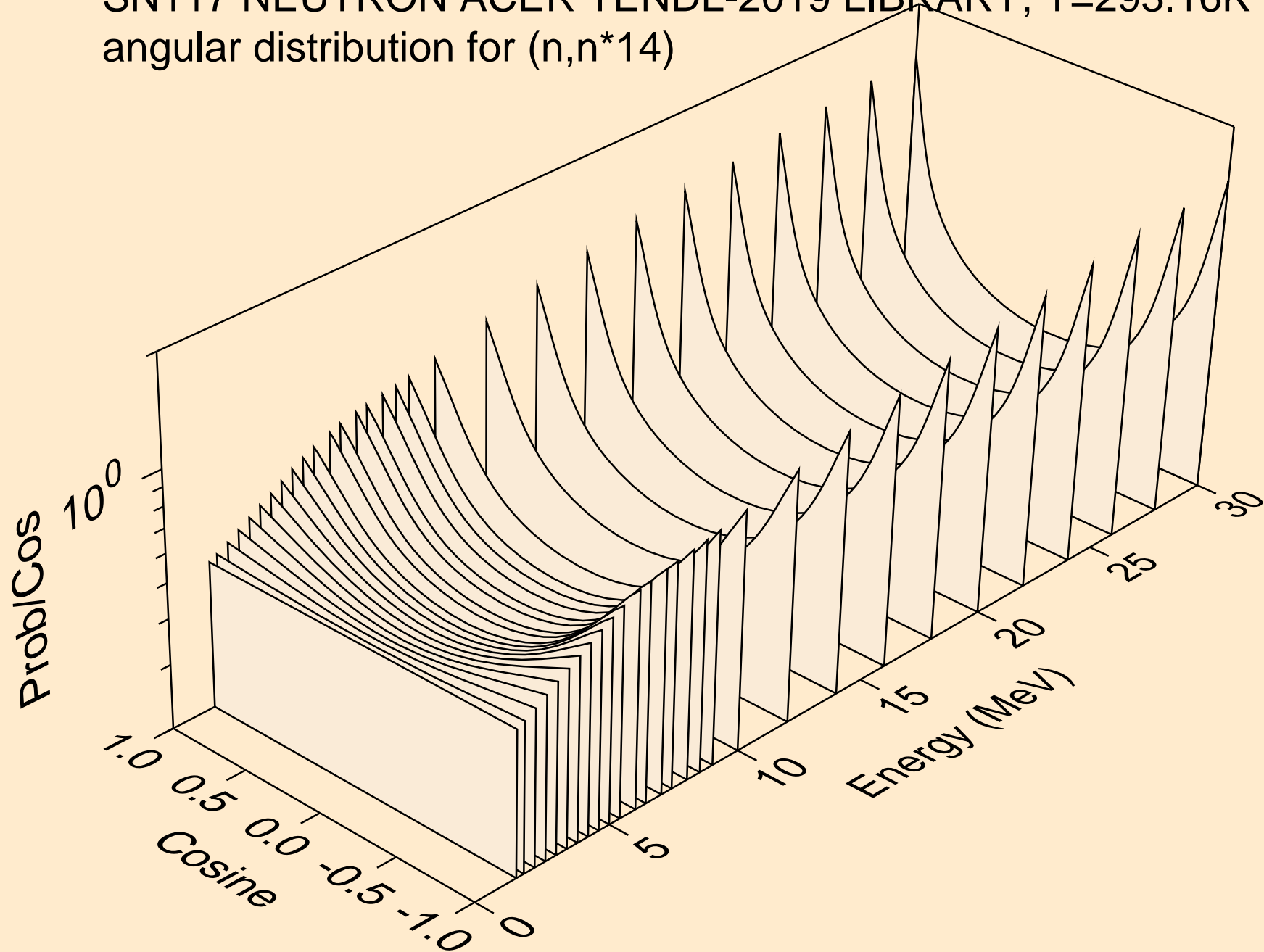

SN117 NEUTRON ACER TENDL-2019 LIBRARY; T=293.16K
angular distribution for (n,n*15)

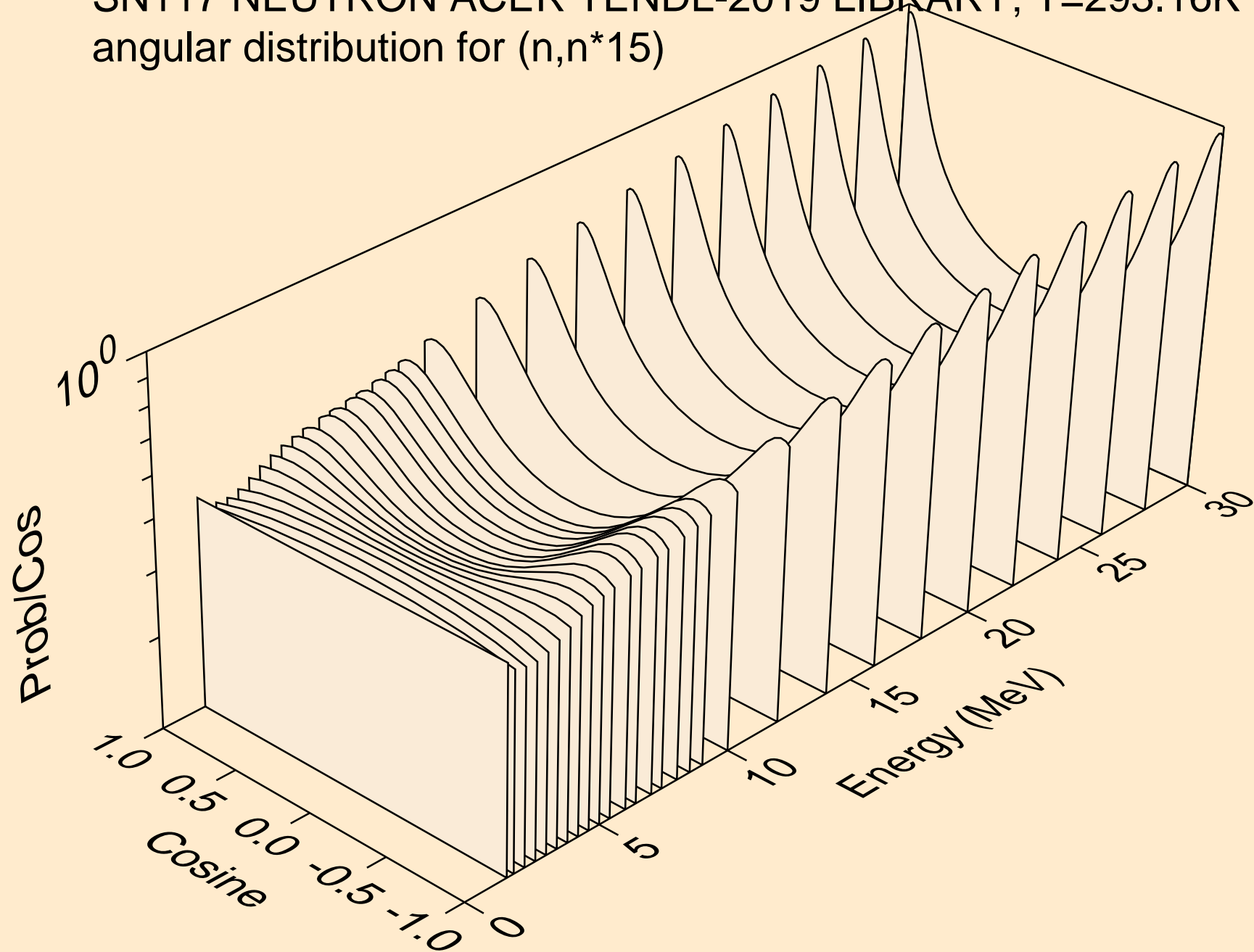

SN117 NEUTRON ACER TENDL-2019 LIBRARY; T=293.16K
angular distribution for (n,n*16)

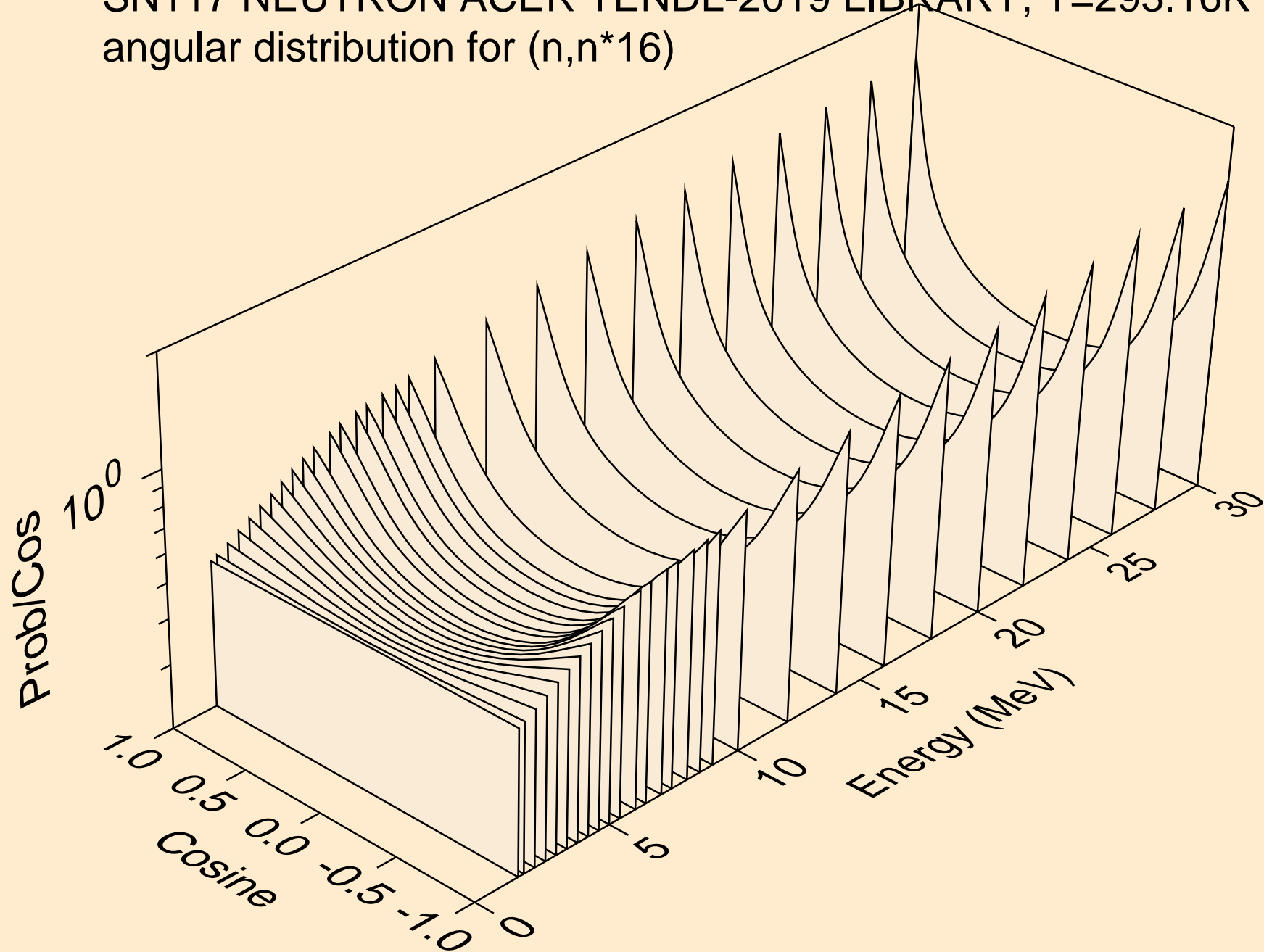

SN117 NEUTRON ACER TENDL-2019 LIBRARY; T=293.16K
angular distribution for (n,n*17)

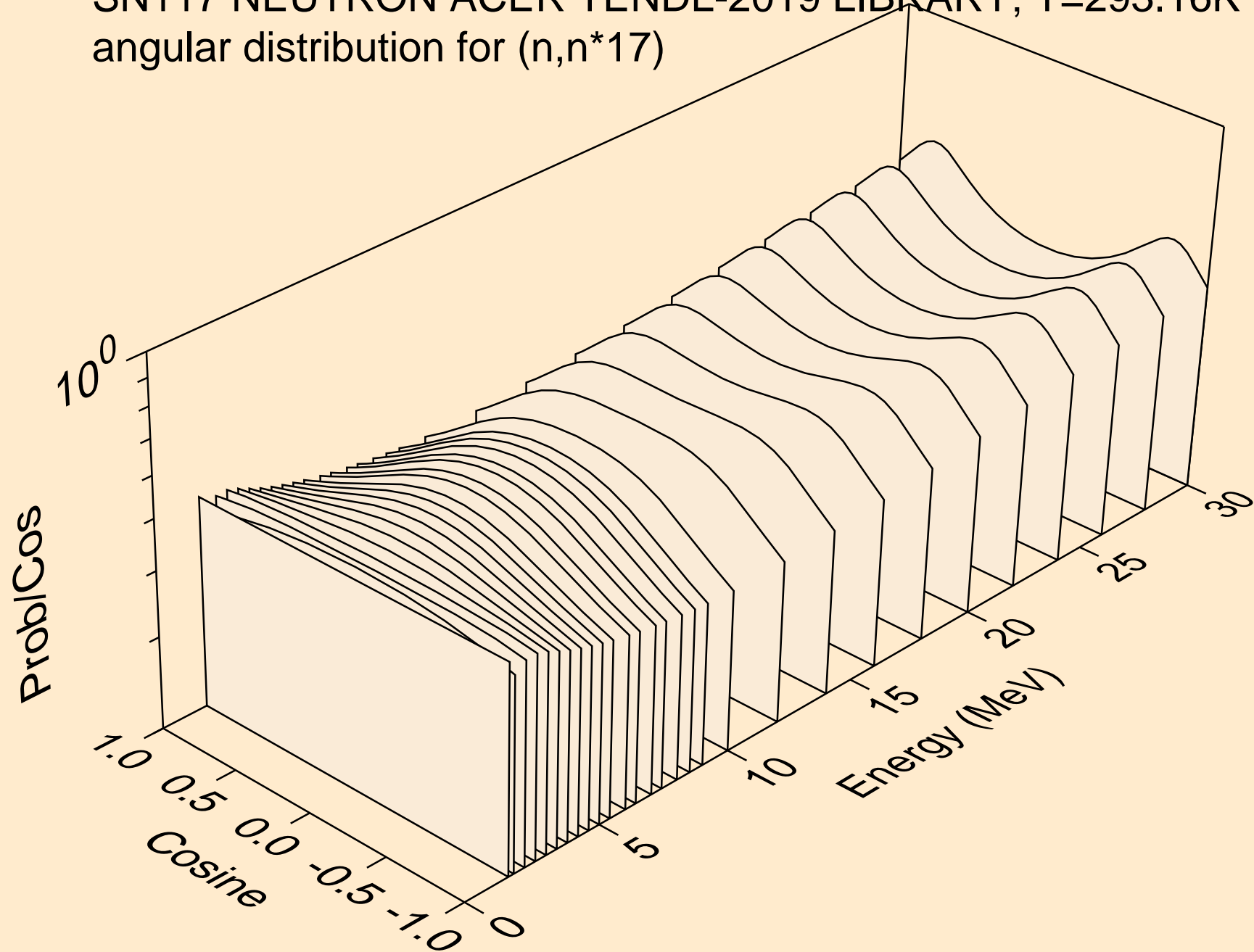

SN117 NEUTRON ACER TENDL-2019 LIBRARY; T=293.16K
angular distribution for (n,n*18)

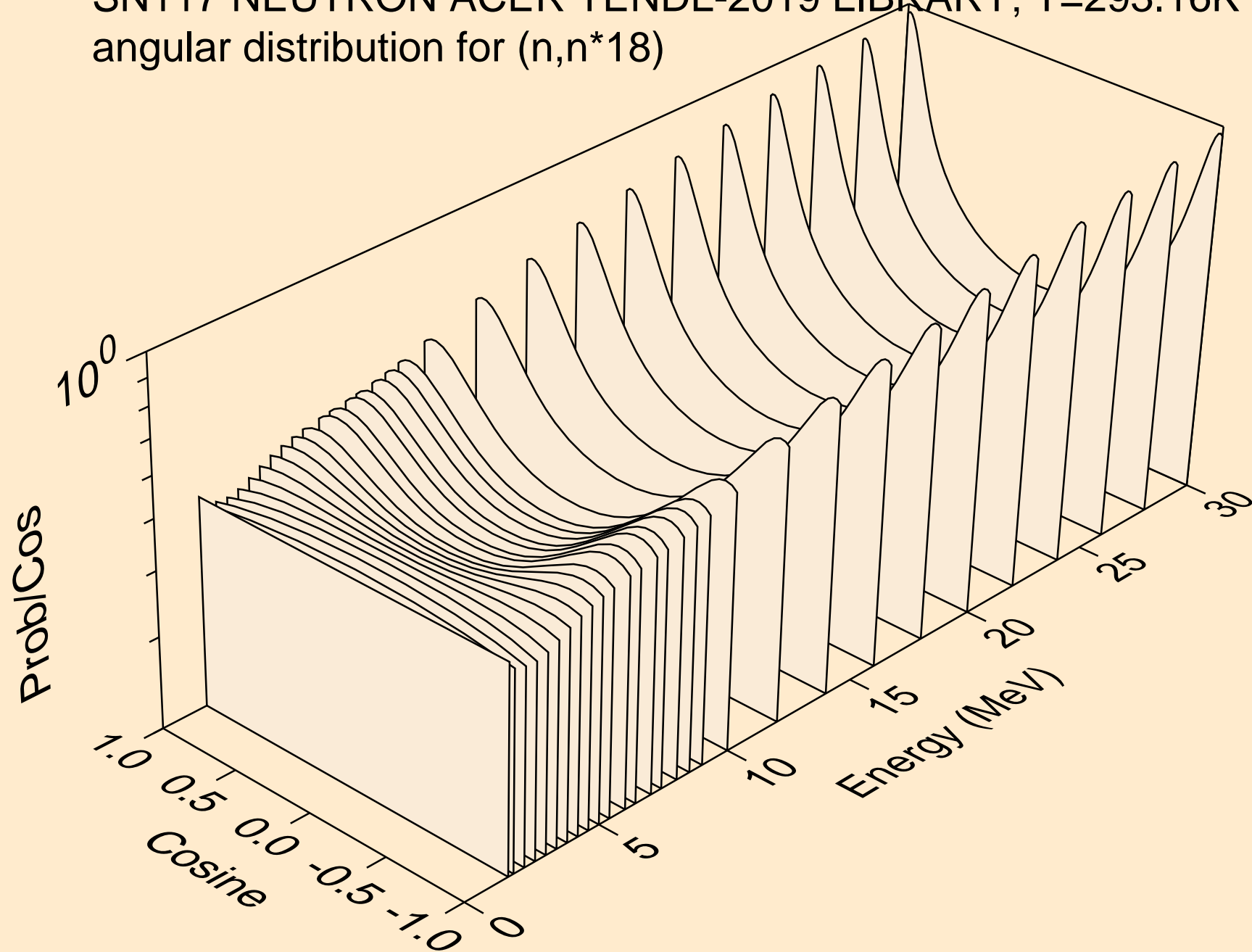

SN117 NEUTRON ACER TENDL-2019 LIBRARY; T=293.16K
angular distribution for (n,n*19)

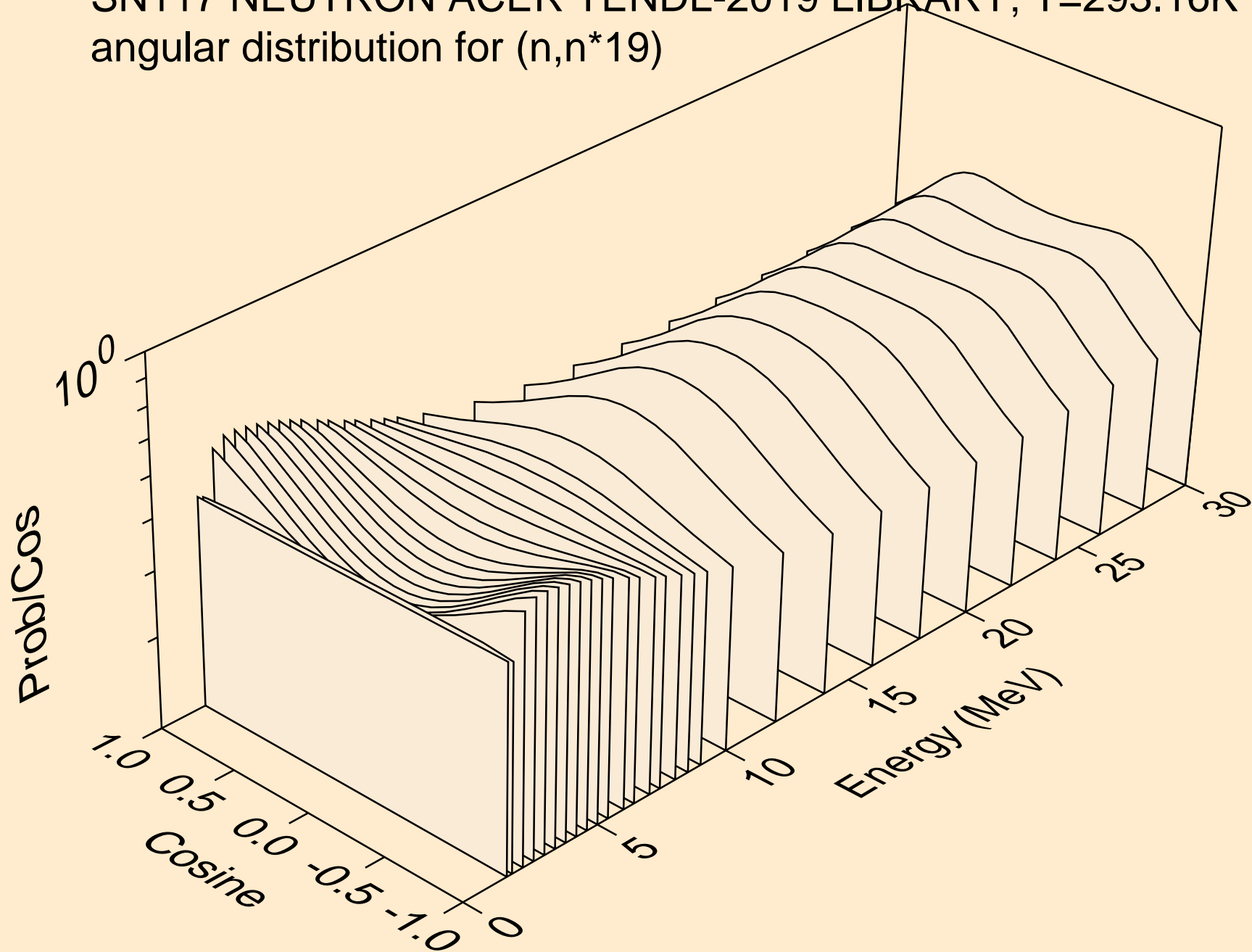

SN117 NEUTRON ACER TENDL-2019 LIBRARY; T=293.16K
angular distribution for (n,n*20)

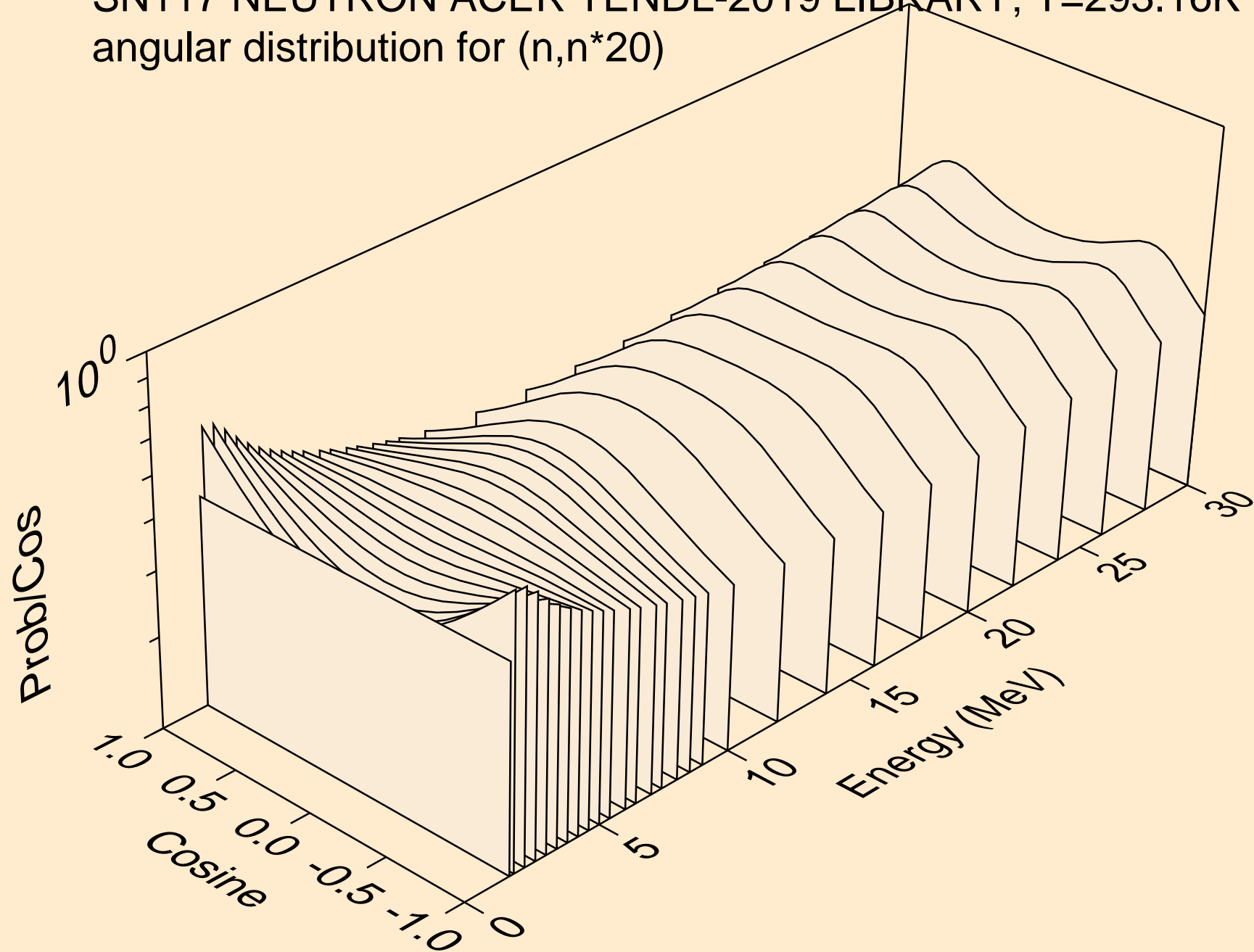

SN117 NEUTRON ACER TENDL-2019 LIBRARY; T=293.16K
angular distribution for (n,n*21)

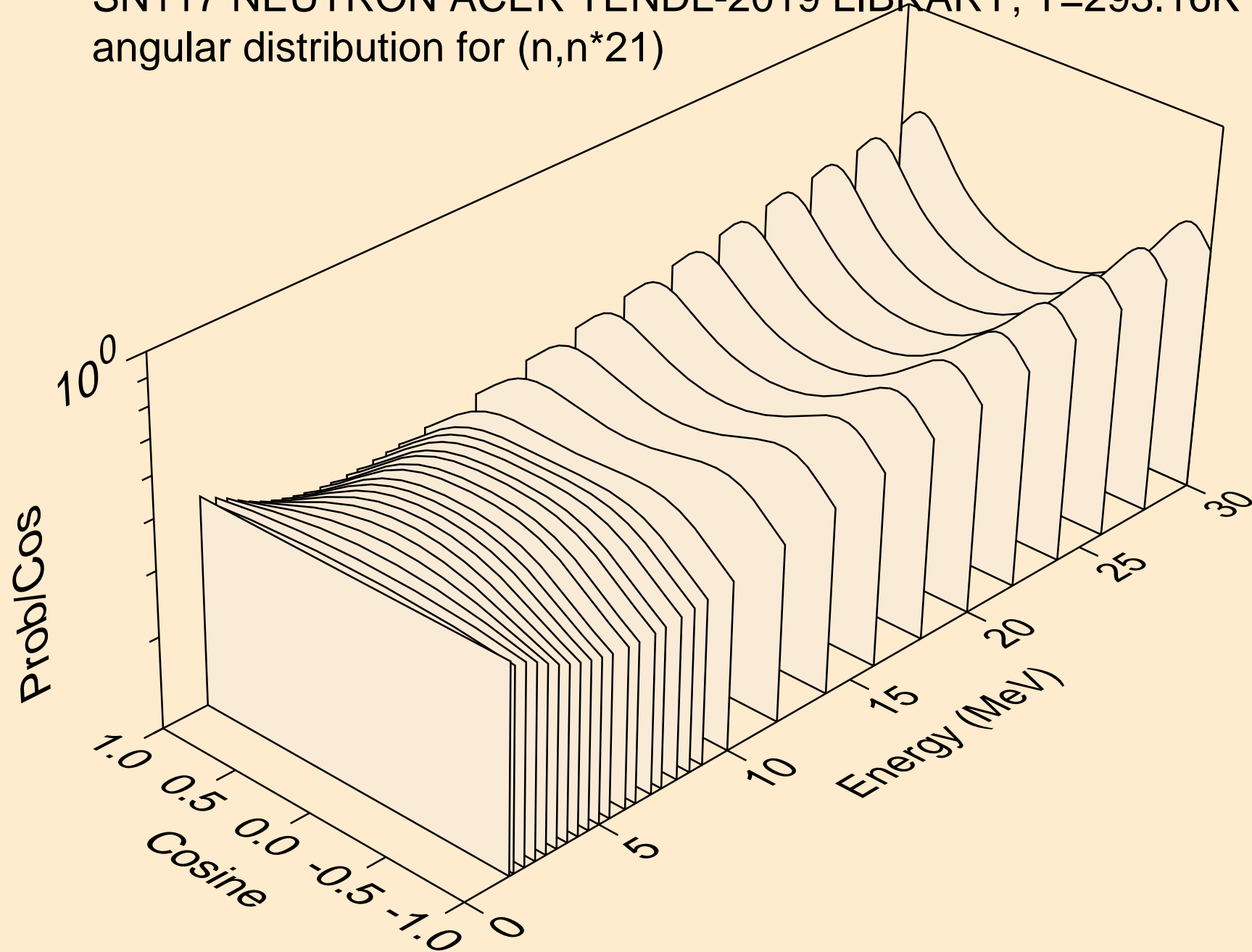

SN117 NEUTRON ACER TENDL-2019 LIBRARY; T=293.16K
angular distribution for (n,n*22)

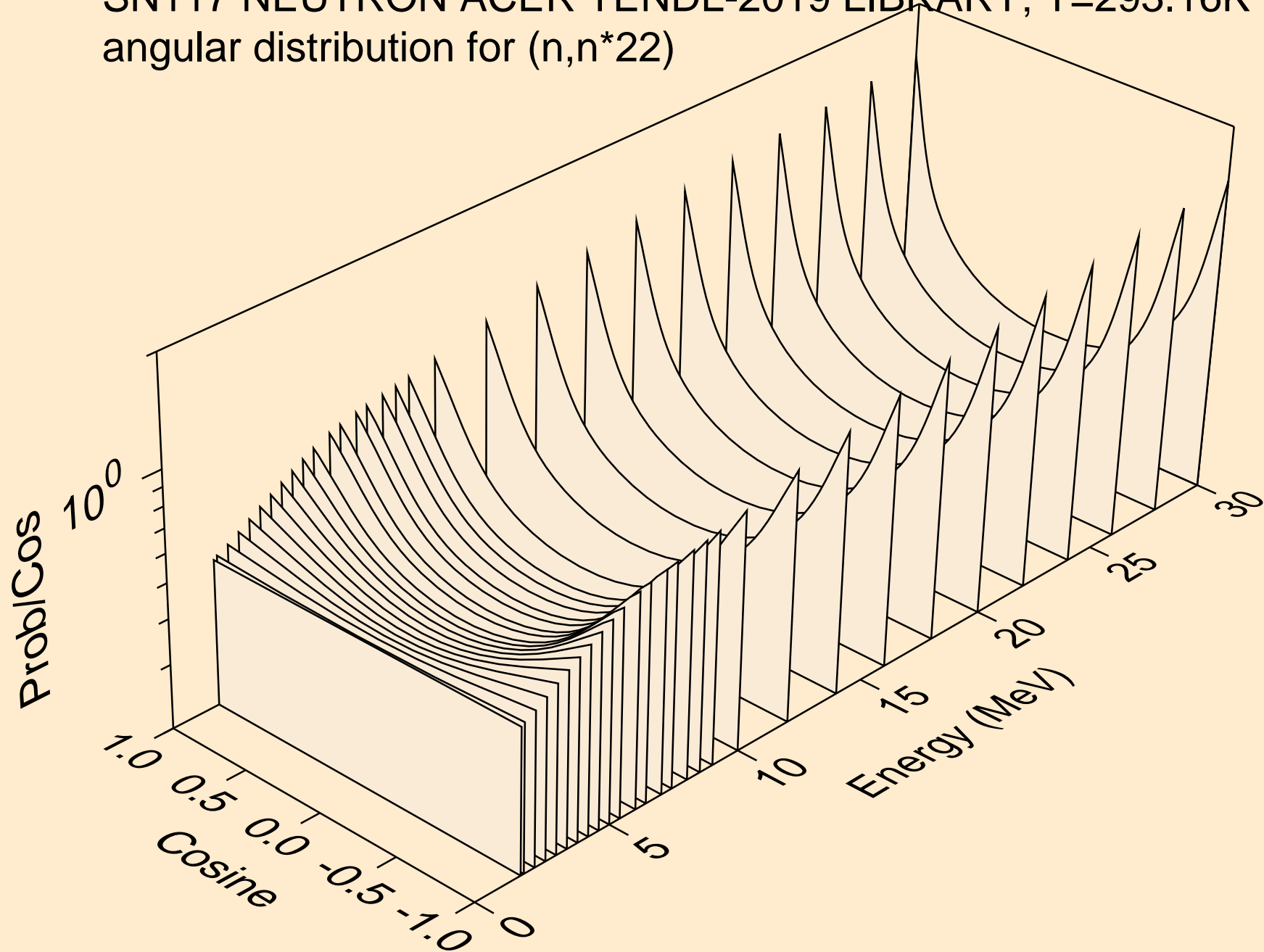

SN117 NEUTRON ACER TENDL-2019 LIBRARY; T=293.16K
angular distribution for (n,n*23)

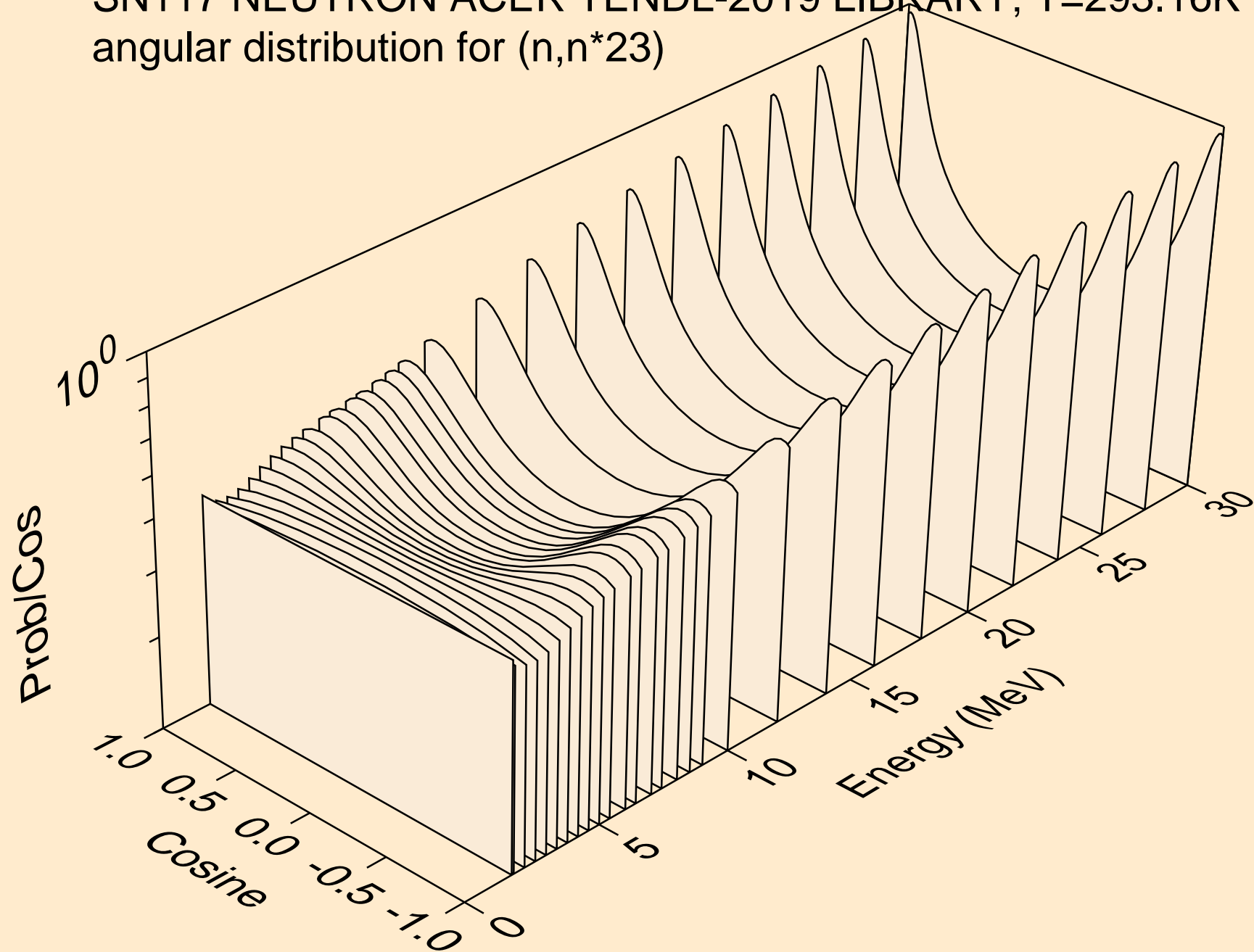

SN117 NEUTRON ACER TENDL-2019 LIBRARY; T=293.16K
angular distribution for (n,n*24)

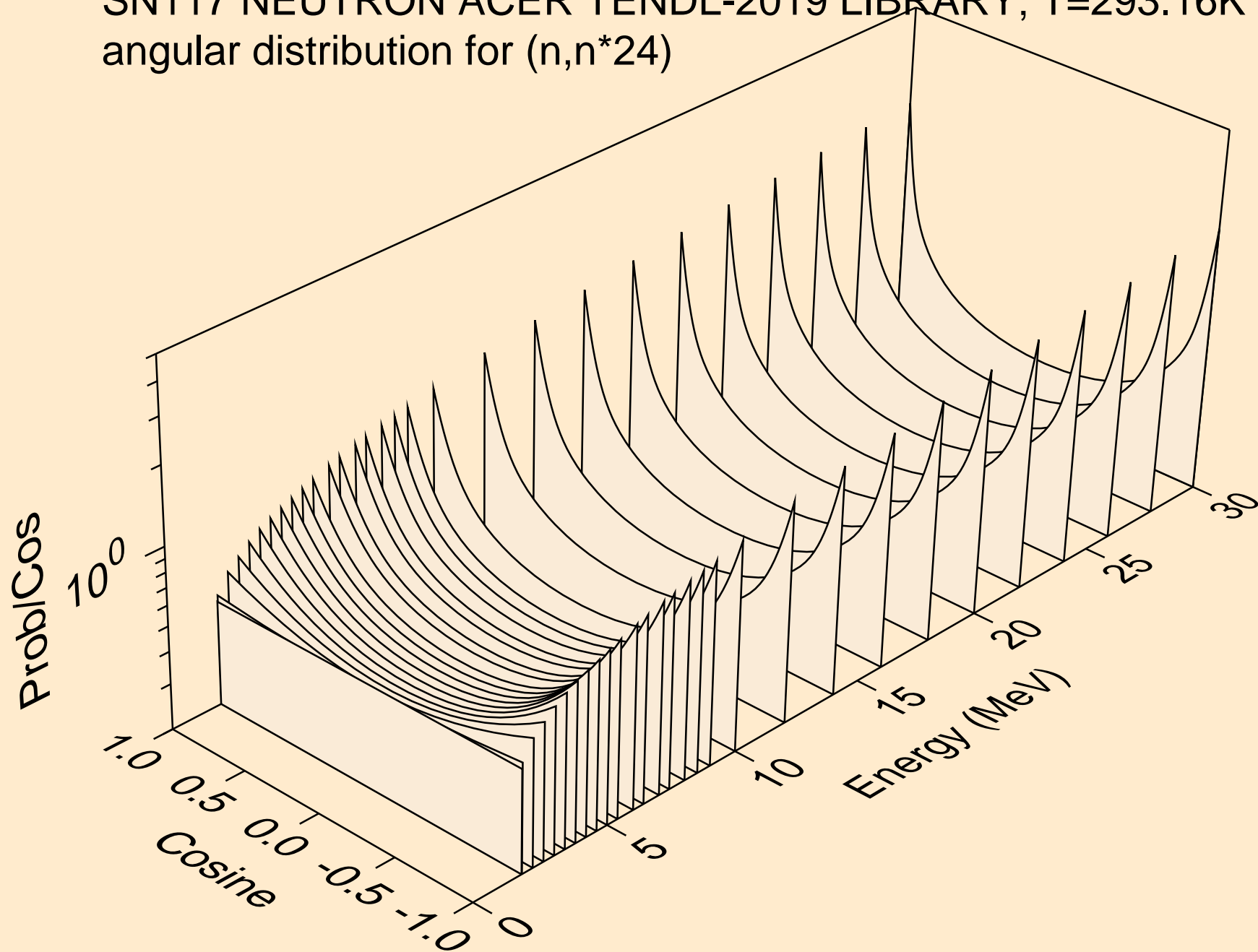

SN117 NEUTRON ACER TENDL-2019 LIBRARY; T=293.16K
angular distribution for (n,n*25)

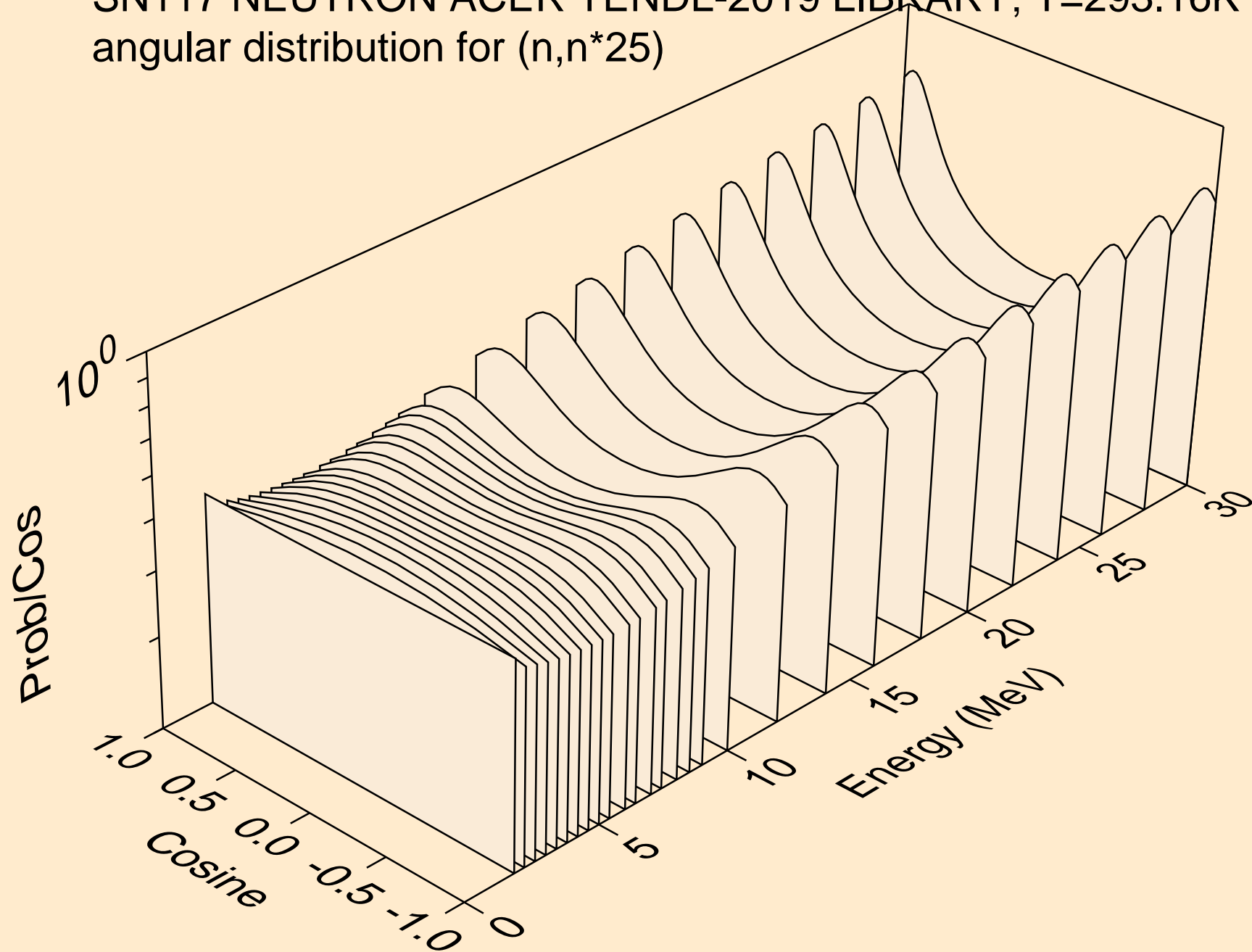

SN117 NEUTRON ACER TENDL-2019 LIBRARY; T=293.16K
angular distribution for (n,n*26)

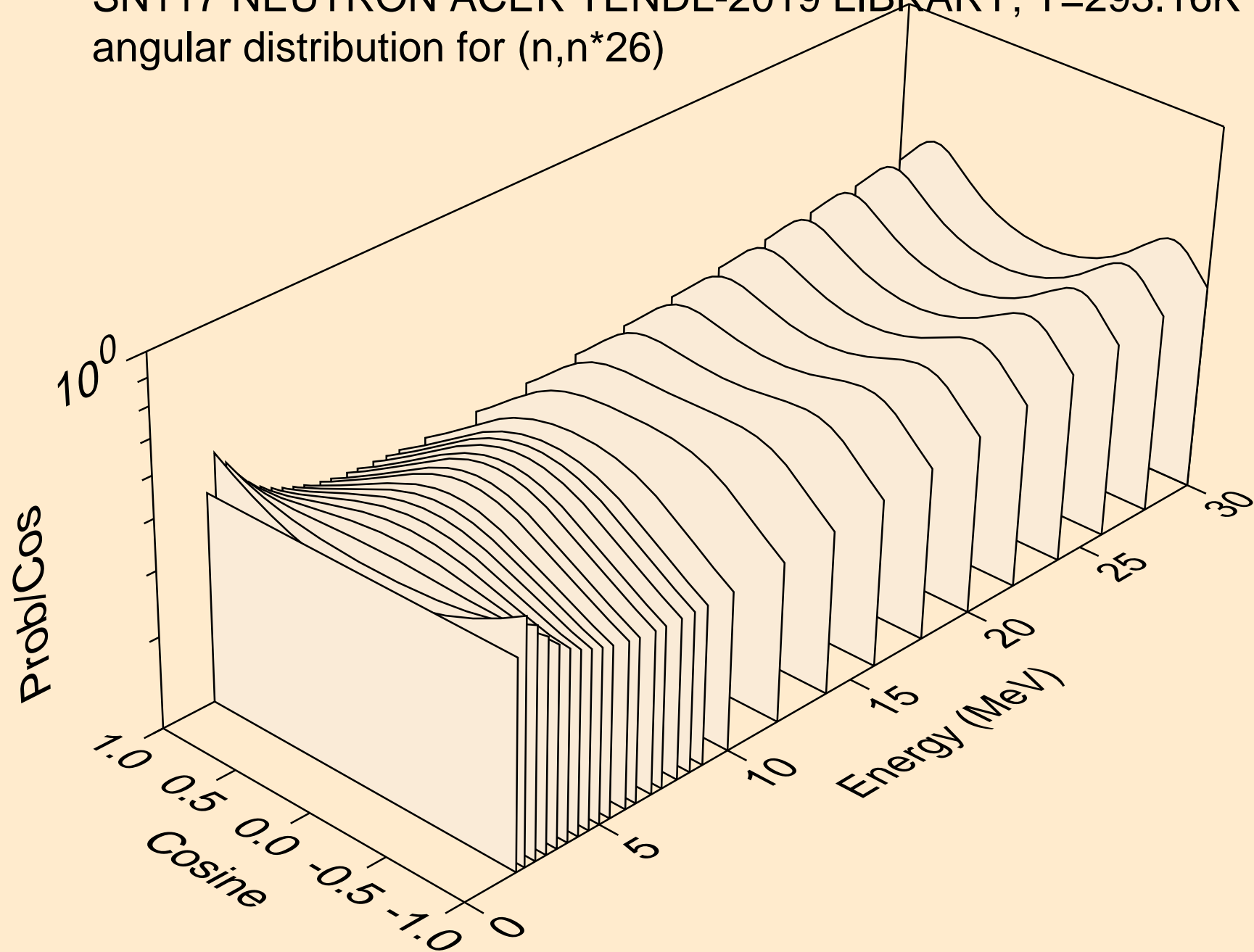

SN117 NEUTRON ACER TENDL-2019 LIBRARY; T=293.16K
angular distribution for (n,n*27)

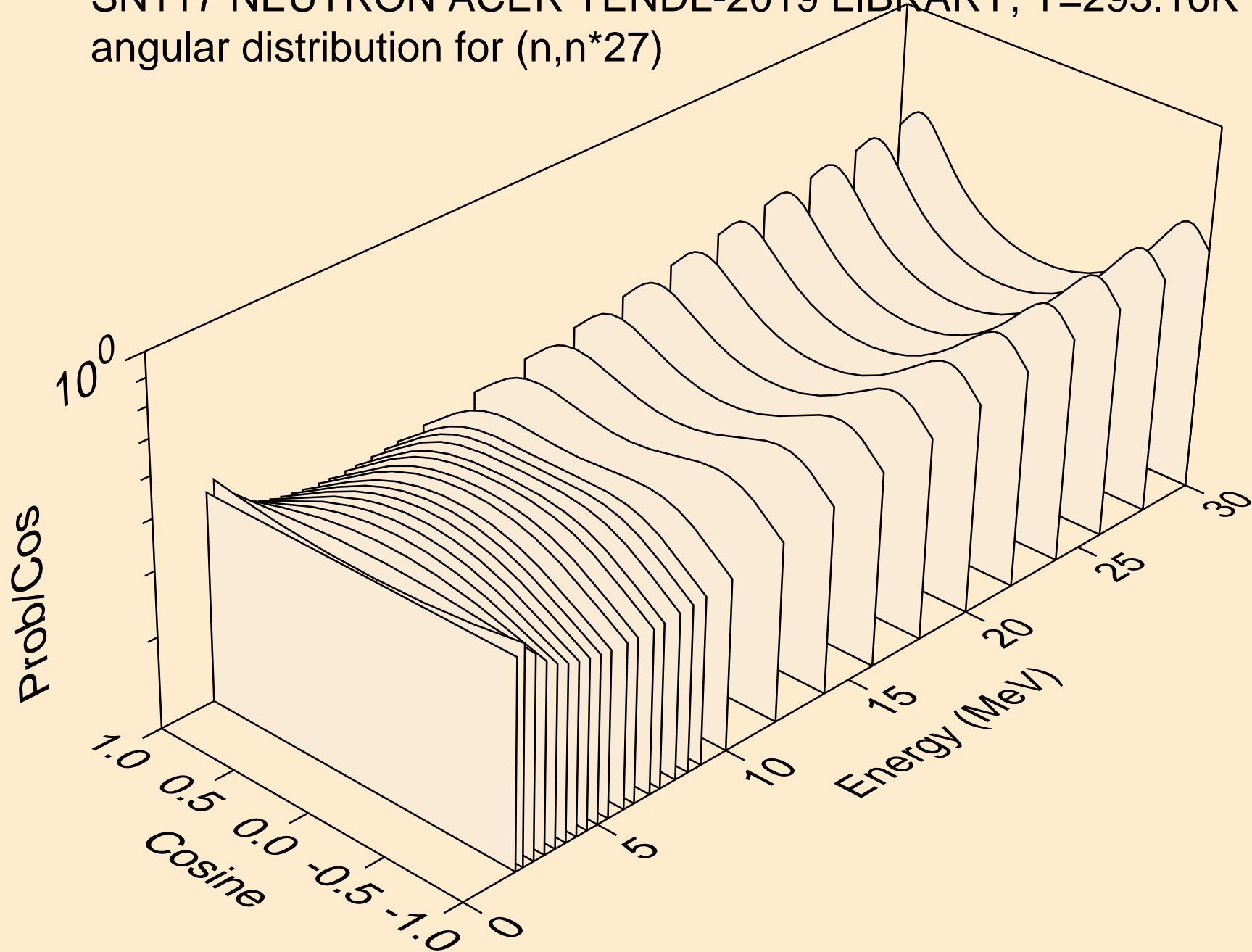

SN117 NEUTRON ACER TENDL-2019 LIBRARY; T=293.16K
angular distribution for (n,n*28)

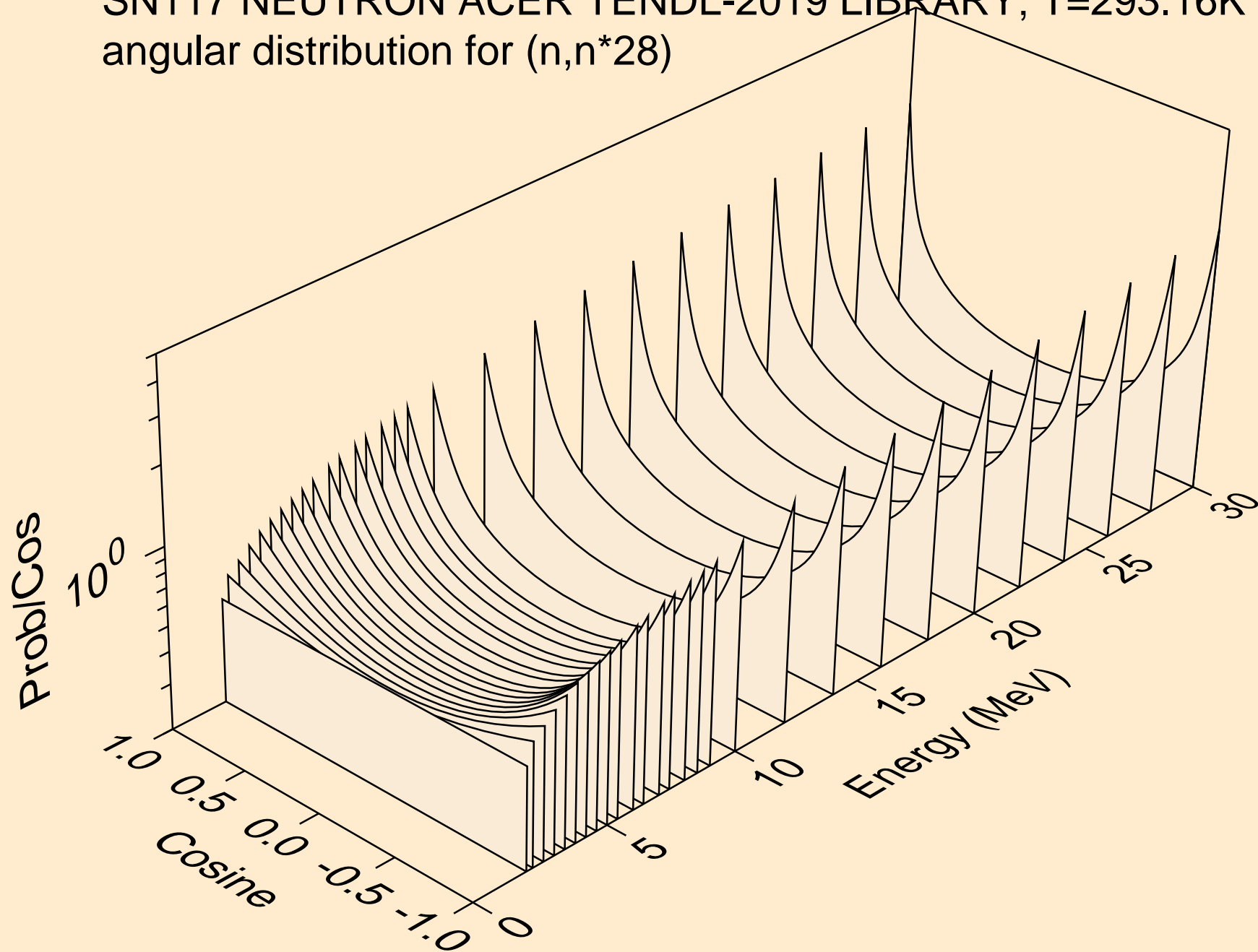

SN117 NEUTRON ACER TENDL-2019 LIBRARY; T=293.16K
angular distribution for (n,n*29)

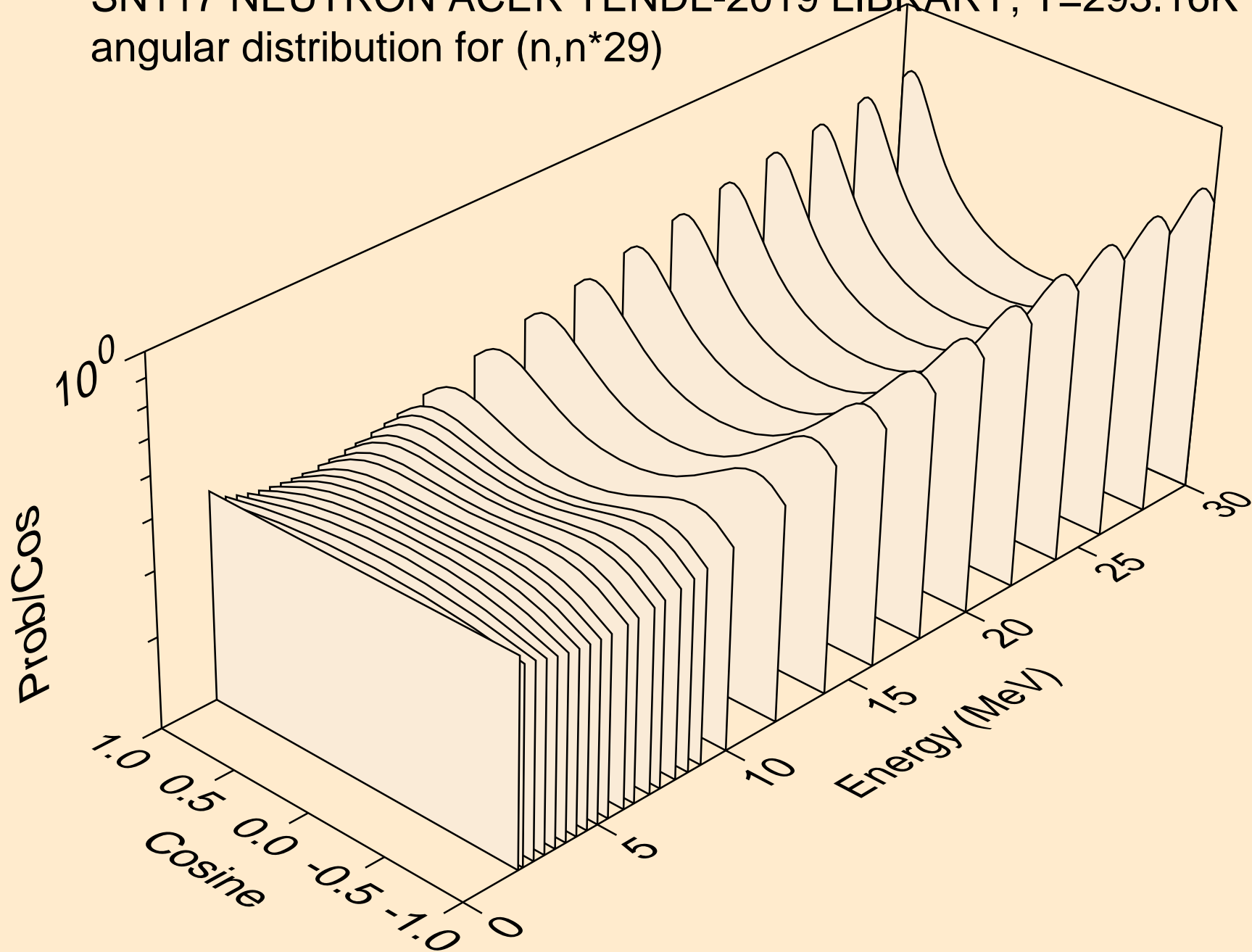

SN117 NEUTRON ACER TENDL-2019 LIBRARY; T=293.16K
angular distribution for (n,n*30)

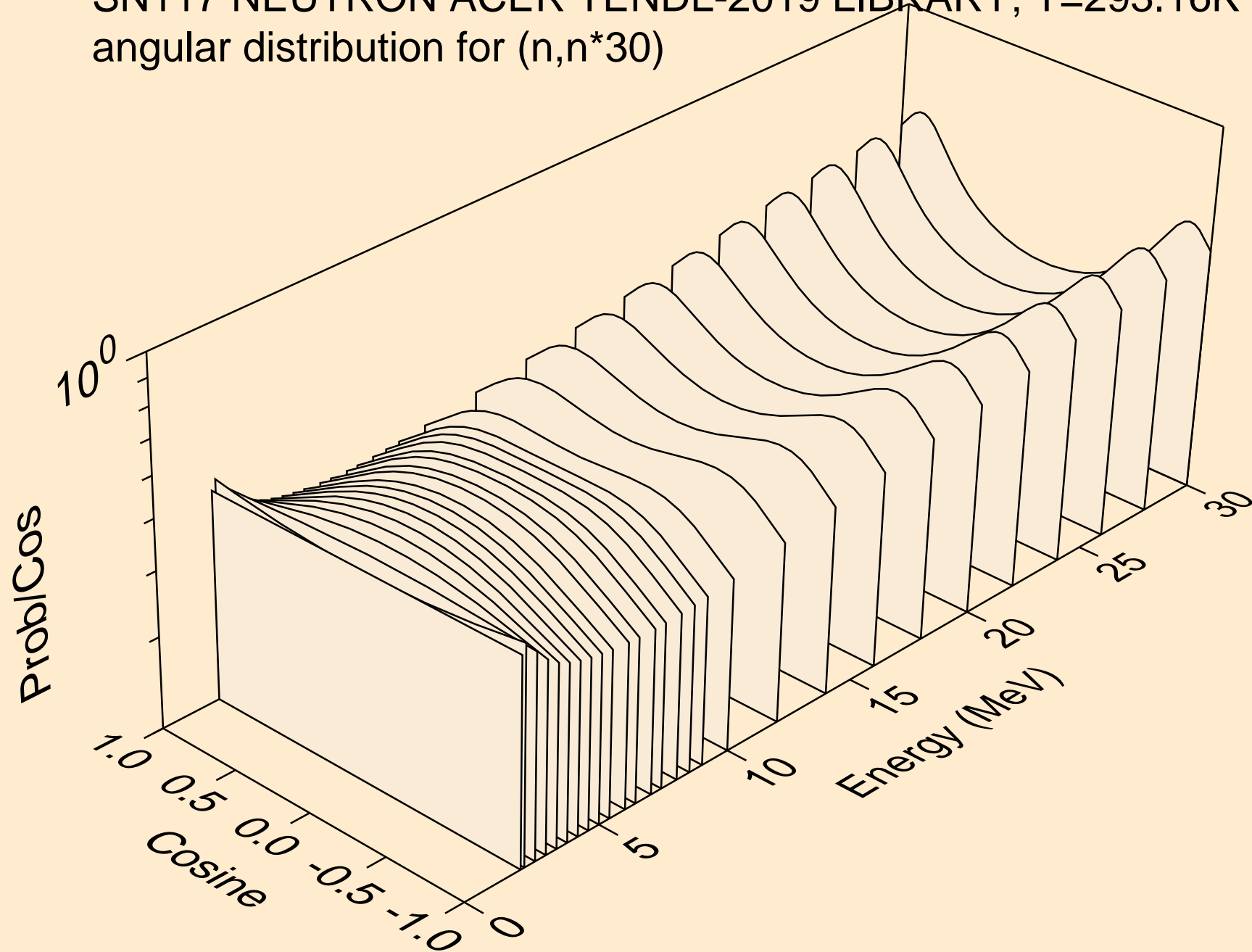

SN117 NEUTRON ACER TENDL-2019 LIBRARY; T=293.16K
Neutron emission for (n,x)

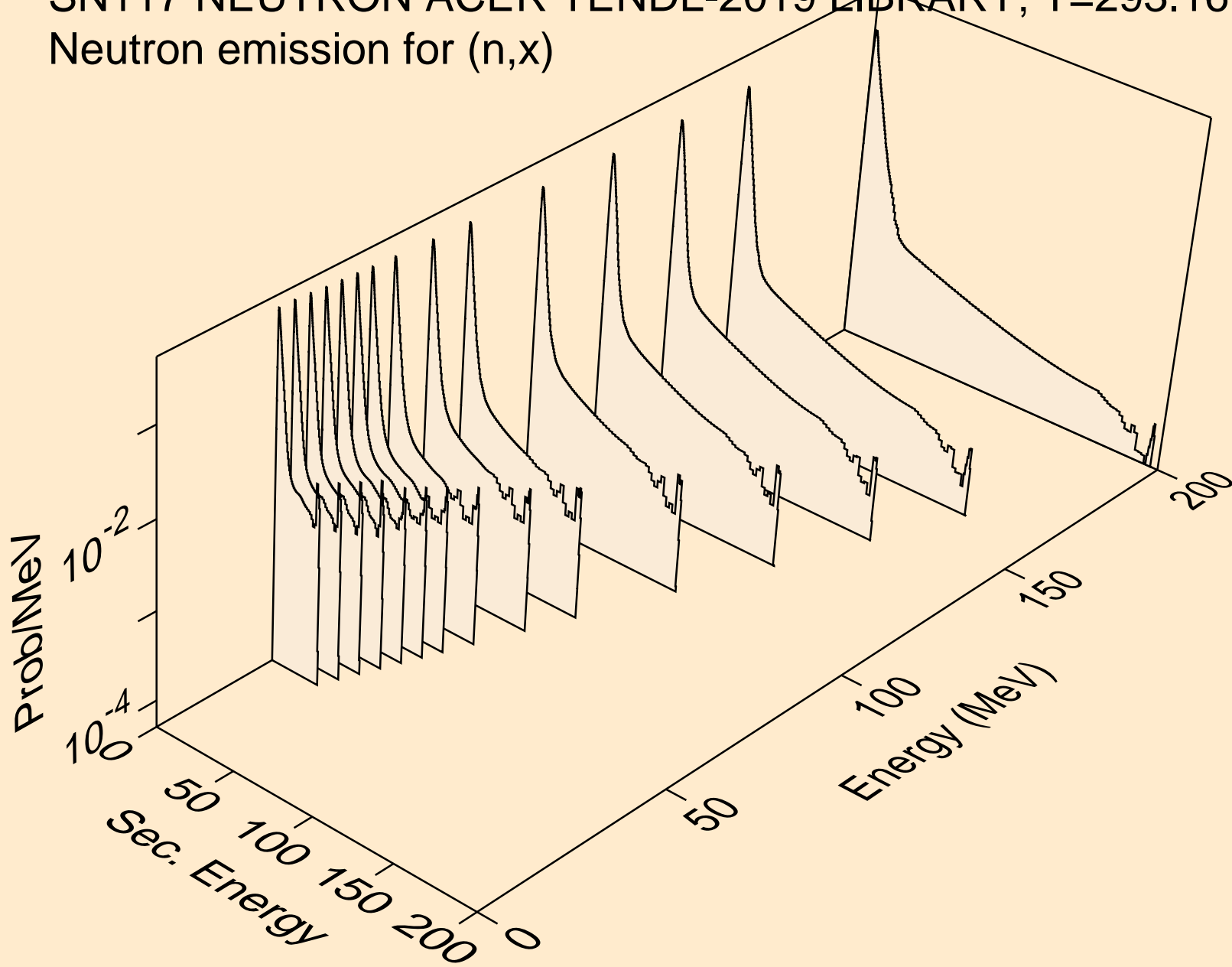

SN117 NEUTRON ACER TENDL-2019 LIBRARY; T=293.16K
Neutron emission for (n,2nd)

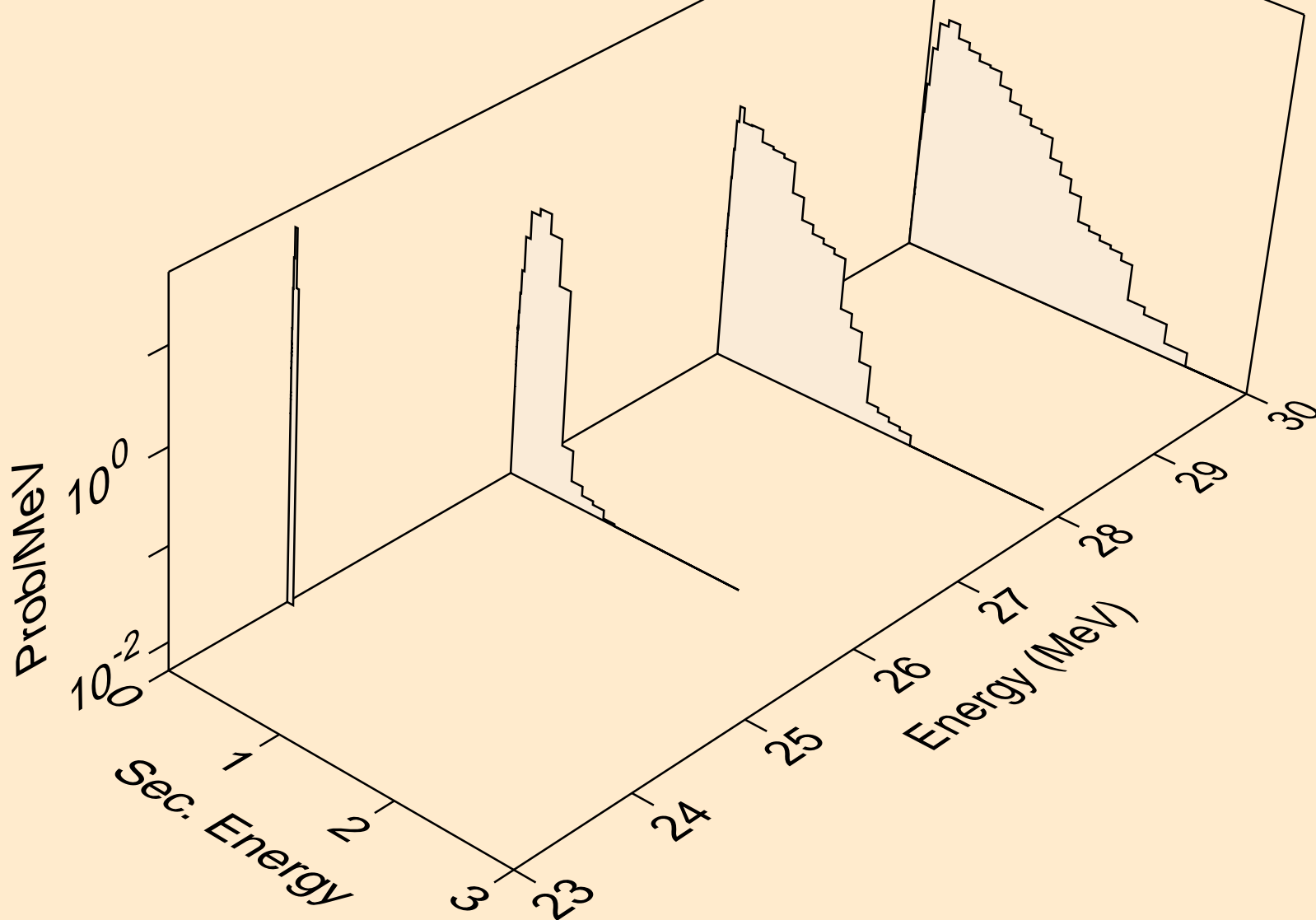

SN117 NEUTRON ACER TENDL-2019 LIBRARY; T=293.16K
Neutron emission for (n,2n)

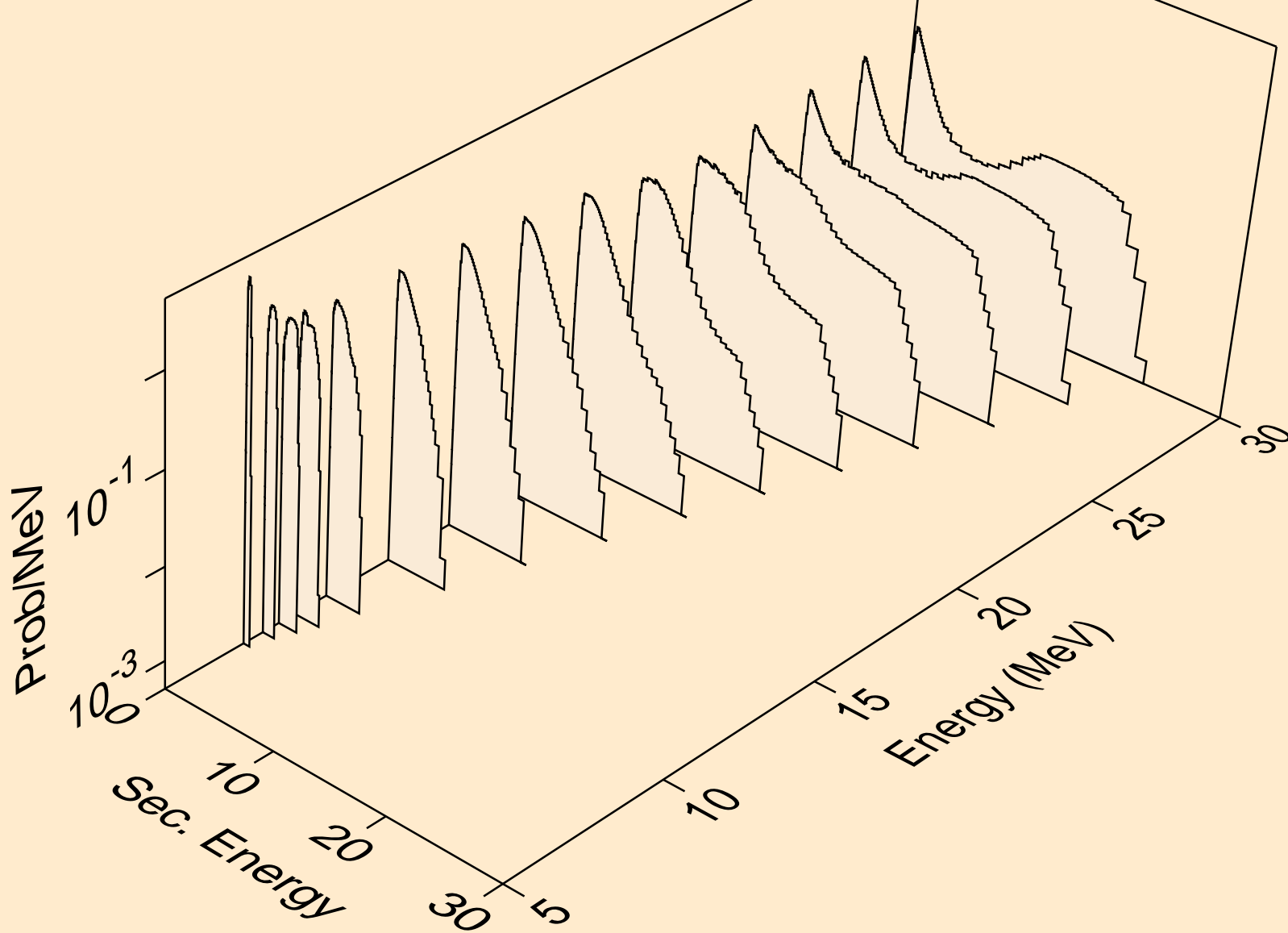

SN117 NEUTRON ACER TENDL-2019 LIBRARY; T=293.16K
Neutron emission for (n,3n)

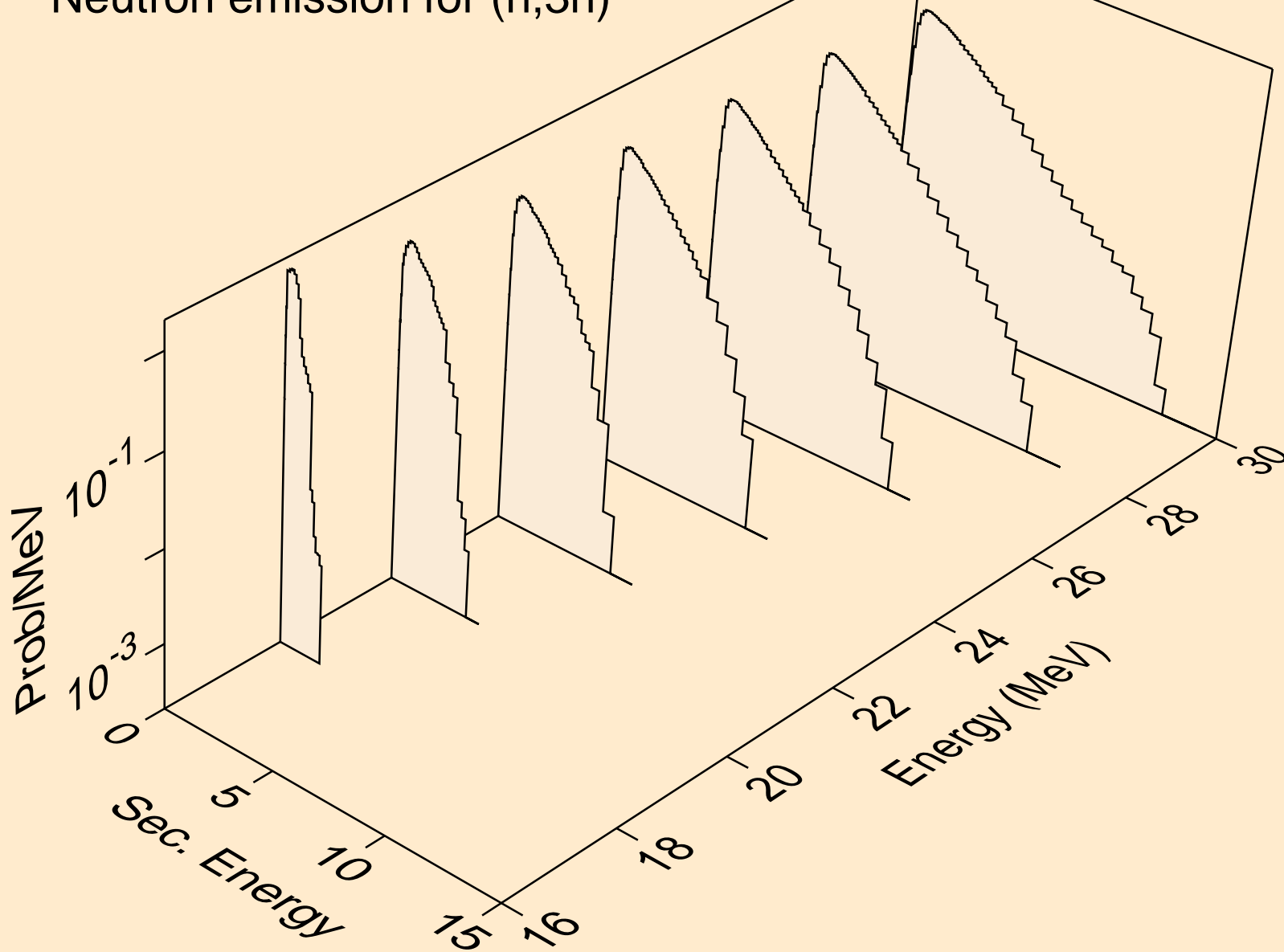

SN117 NEUTRON ACER TENDL-2019 LIBRARY; T=293.16K
Neutron emission for (n,n*)a

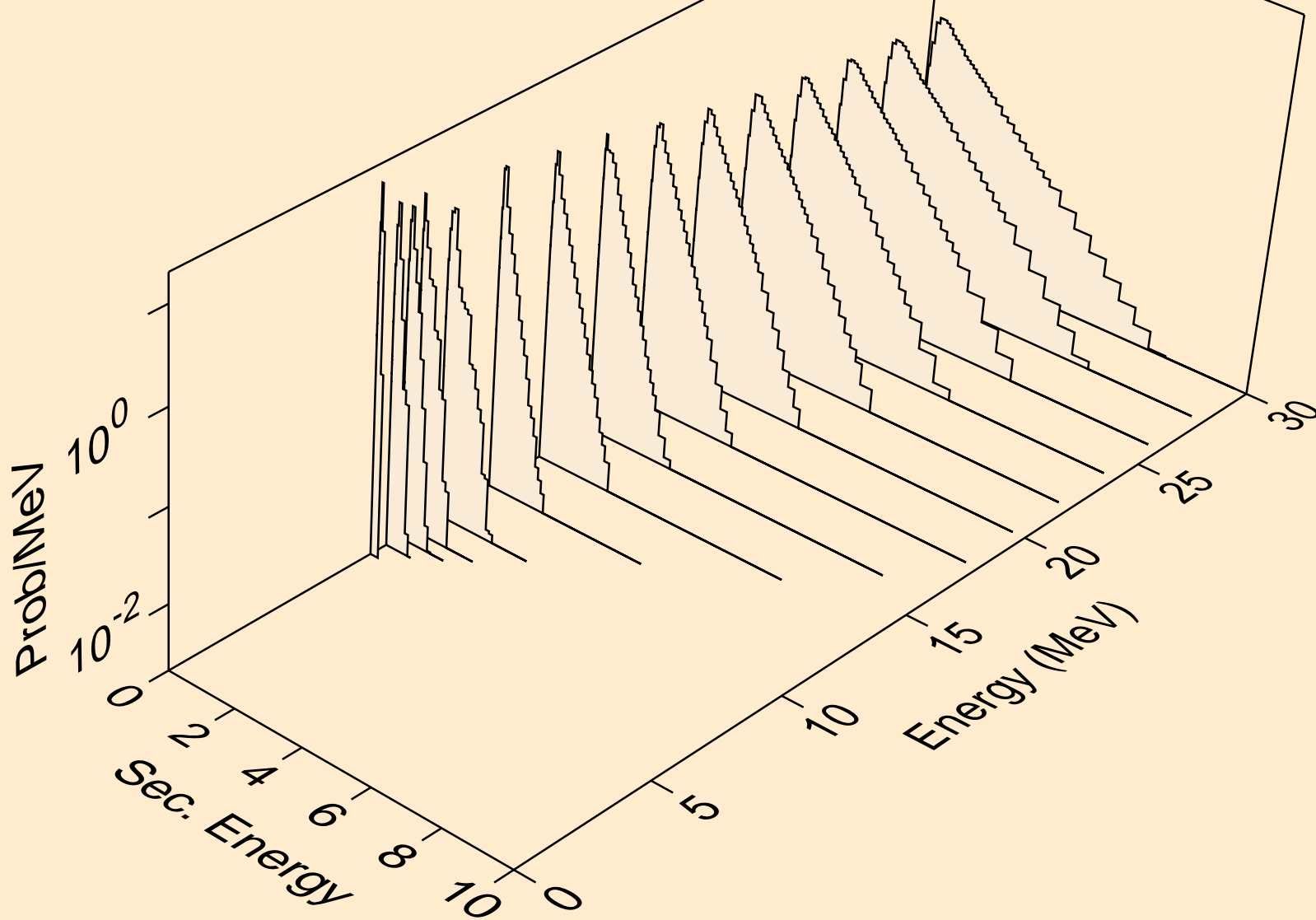

SN117 NEUTRON ACER TENDL-2019 LIBRARY; T=293.16K
Neutron emission for (n,2n)a

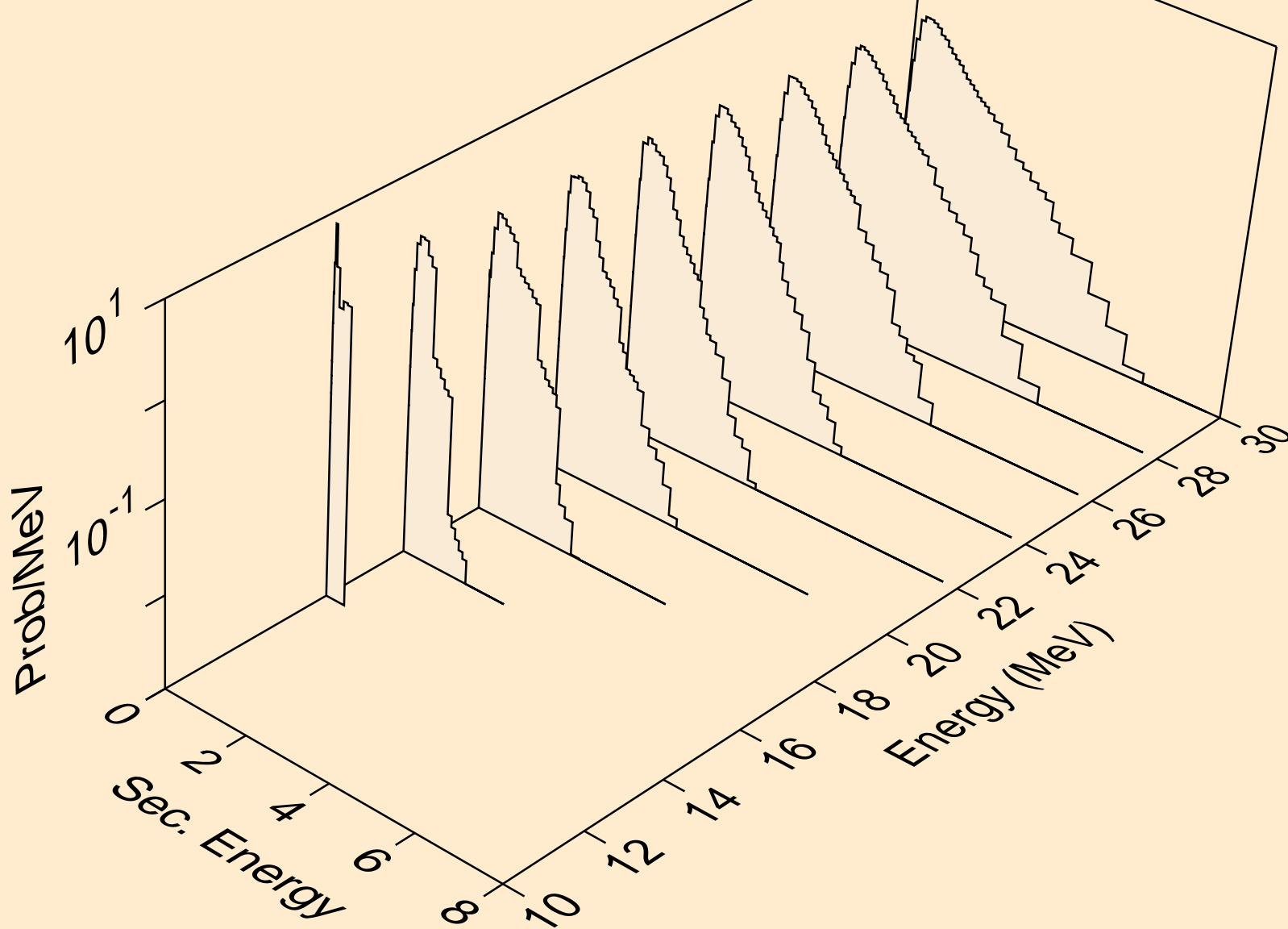

SN117 NEUTRON ACER TENDL-2019 LIBRARY; T=293.16K
Neutron emission for (n,3n)a

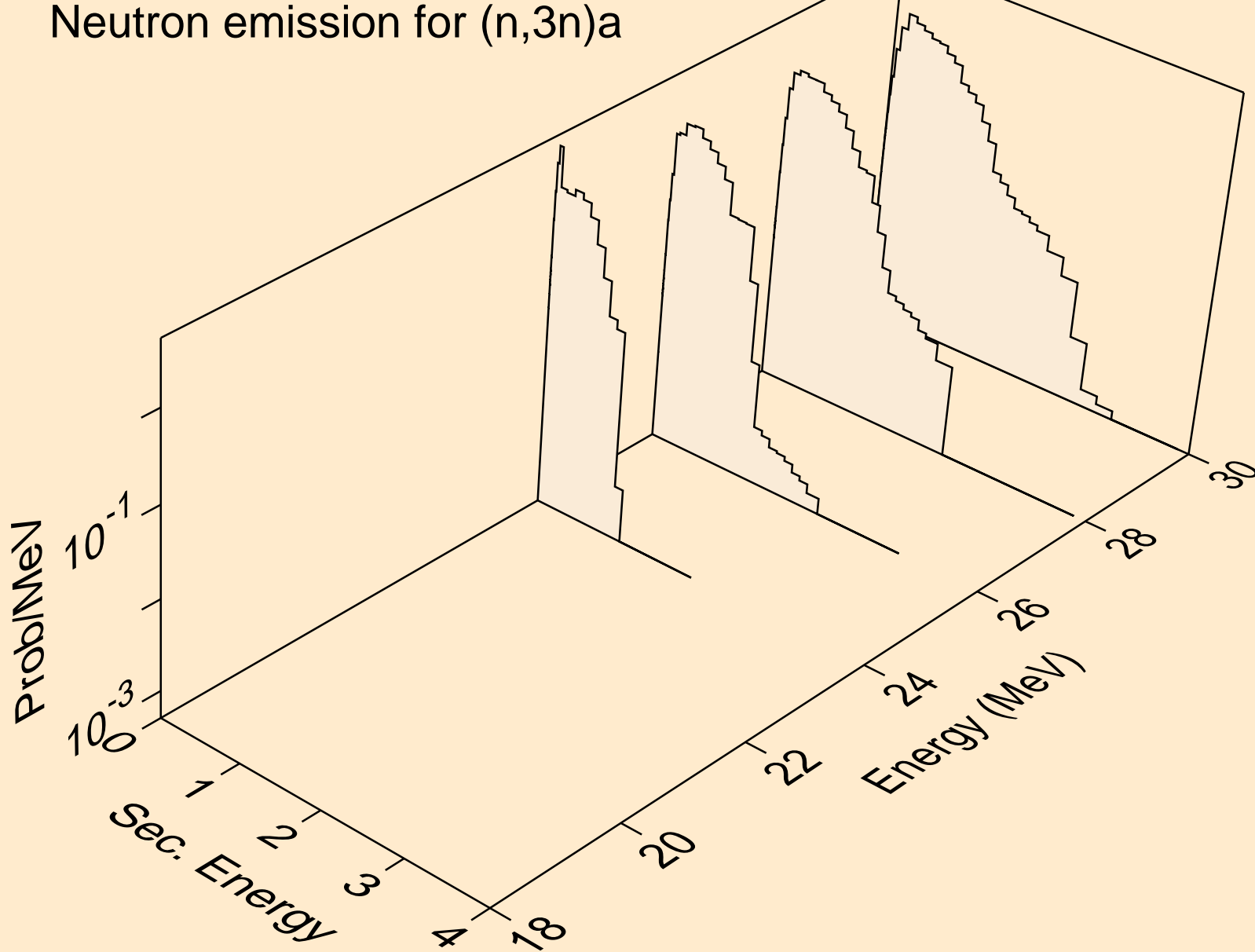

SN117 NEUTRON ACER TENDL-2019 LIBRARY; T=293.16K
Neutron emission for (n,n*)p

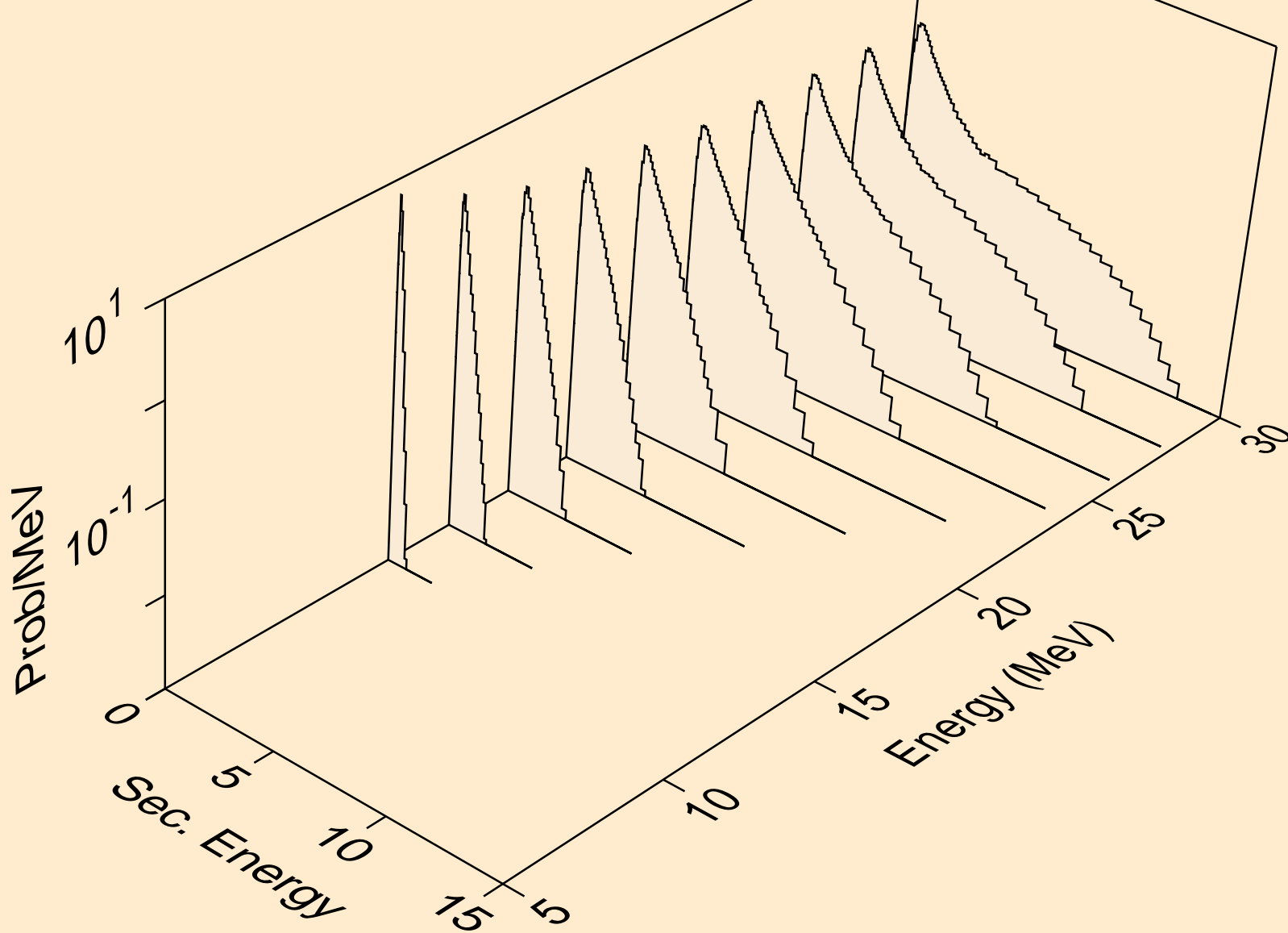

SN117 NEUTRON ACER TENDL-2019 LIBRARY; T=293.16K
Neutron emission for (n,n*)2a

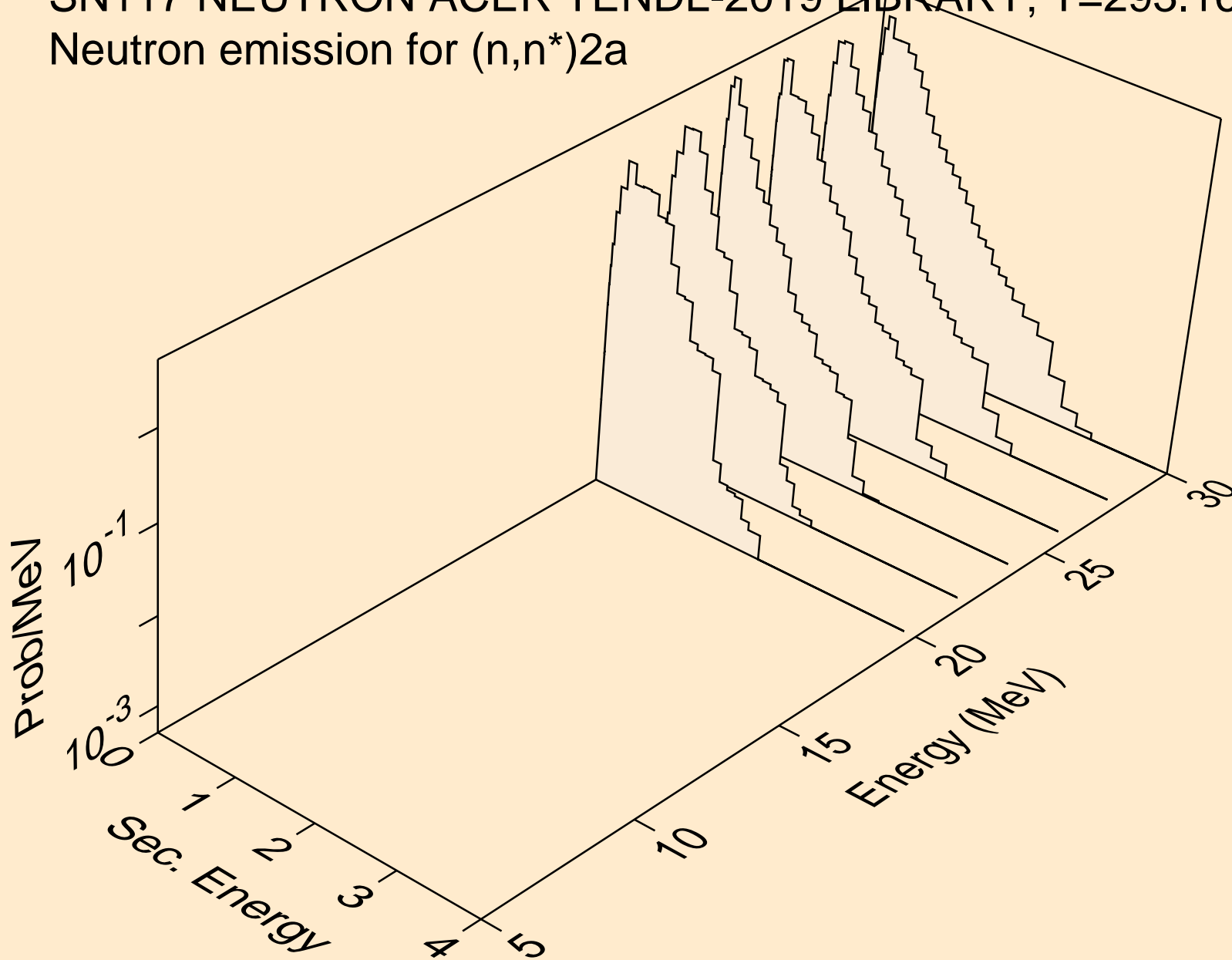

SN117 NEUTRON ACER TENDL-2019 LIBRARY; T=293.16K
Neutron emission for (n,n*)d

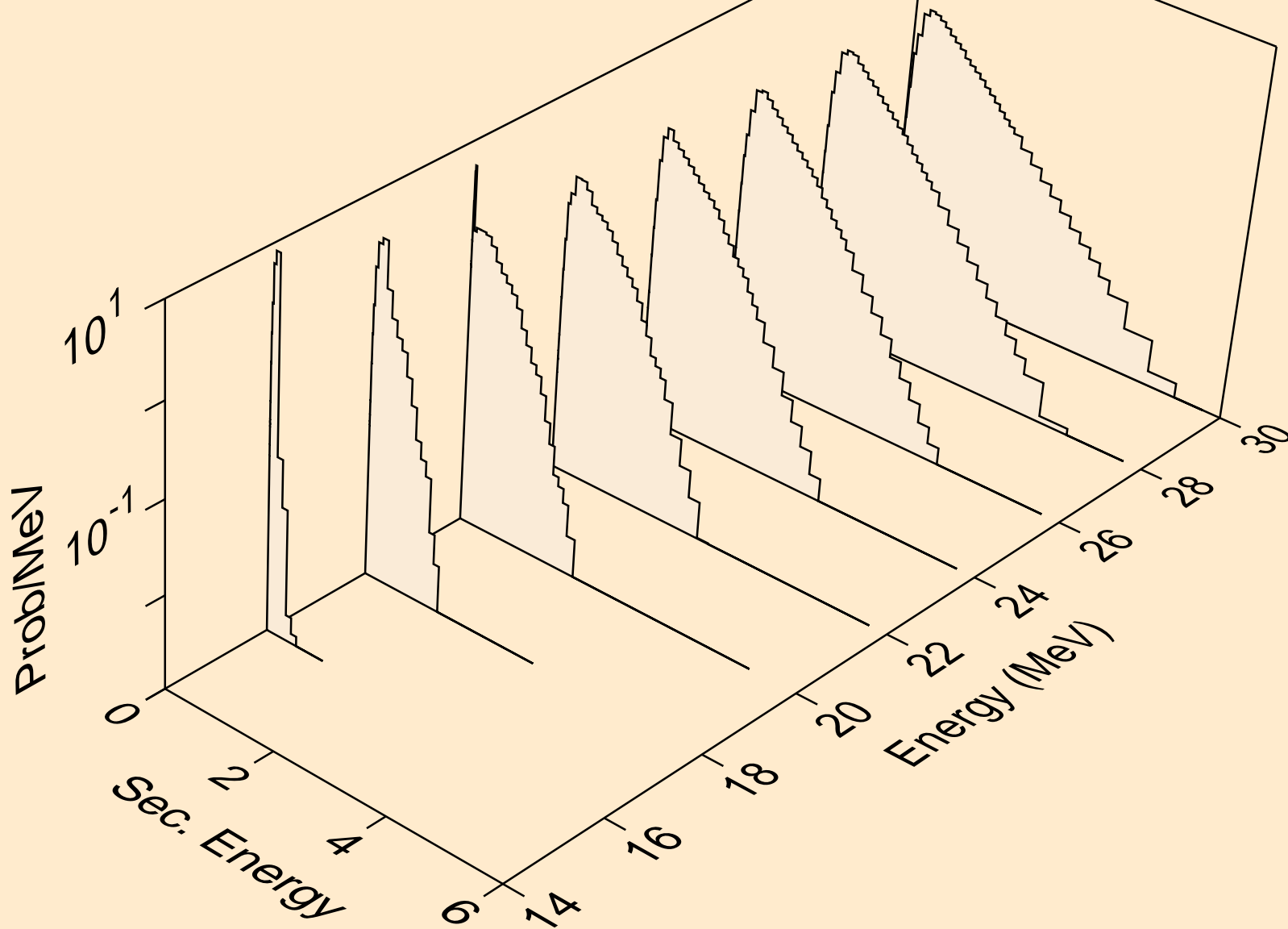

SN117 NEUTRON ACER TENDL-2019 LIBRARY; T=293.16K
Neutron emission for (n,n*)t

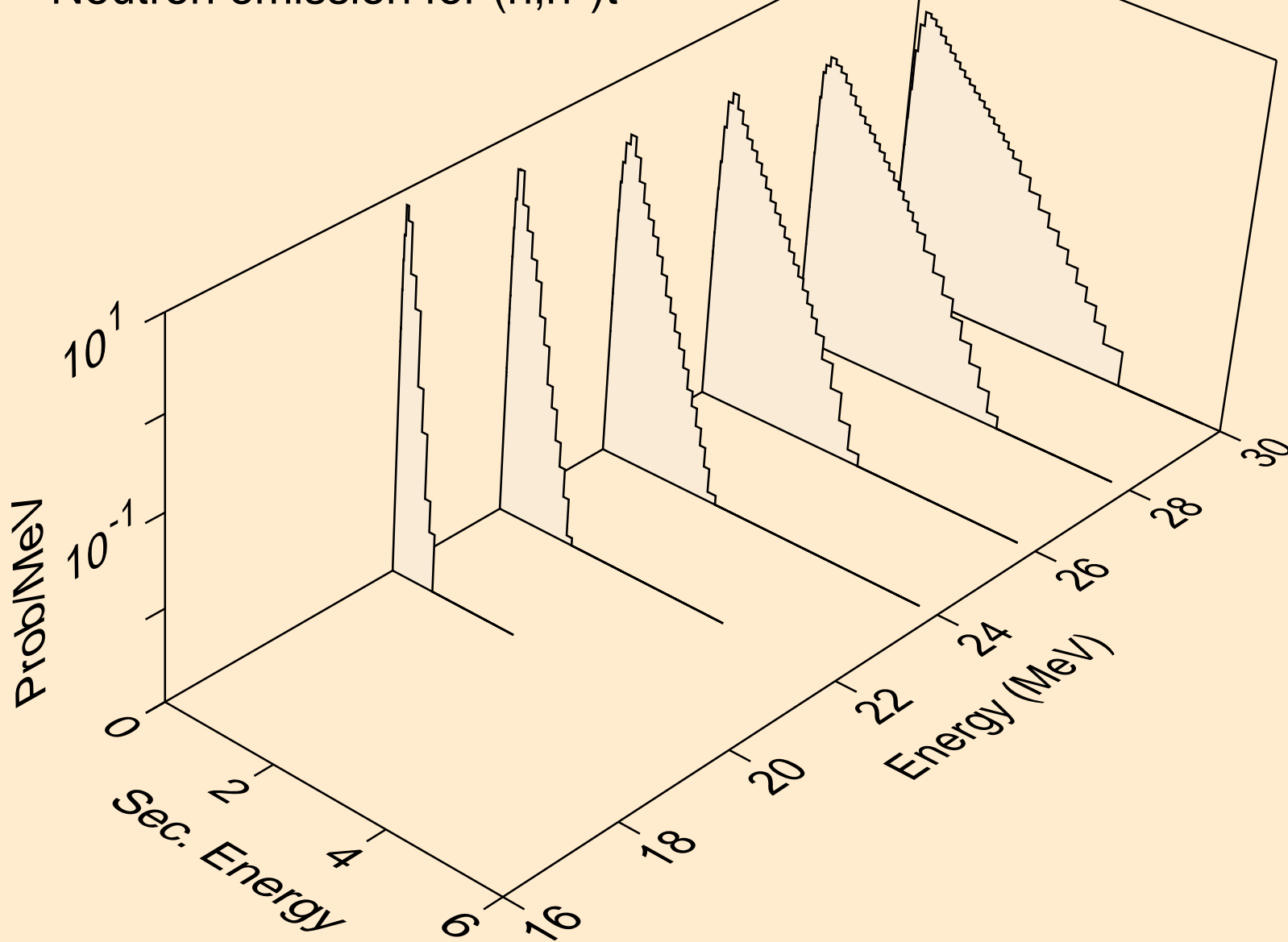

SN117 NEUTRON ACER TENDL-2019 LIBRARY; T=293.16K
Neutron emission for (n,n*)he3

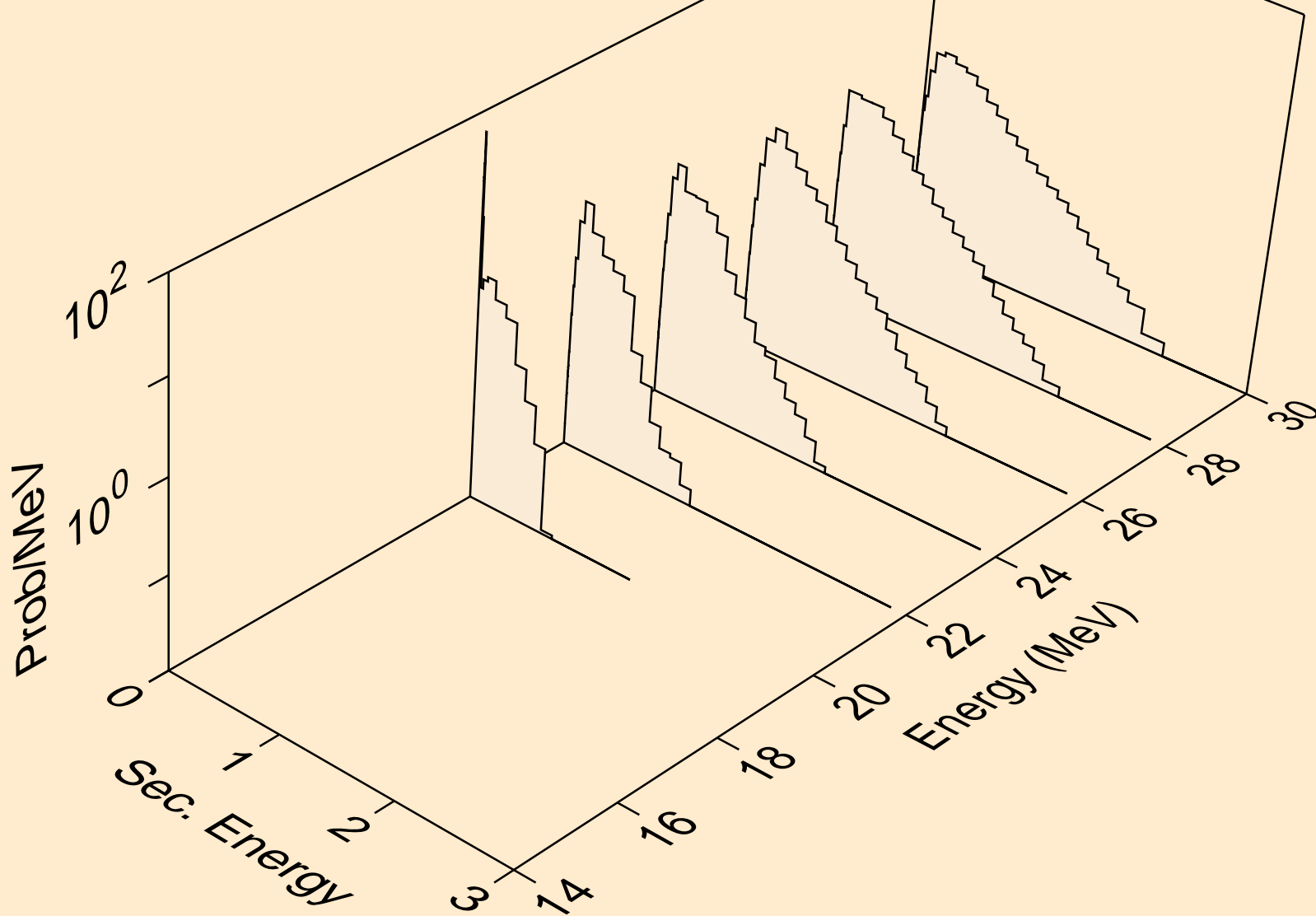

SN117 NEUTRON ACER TENDL-2019 LIBRARY; T=293.16K
Neutron emission for (n,4n)

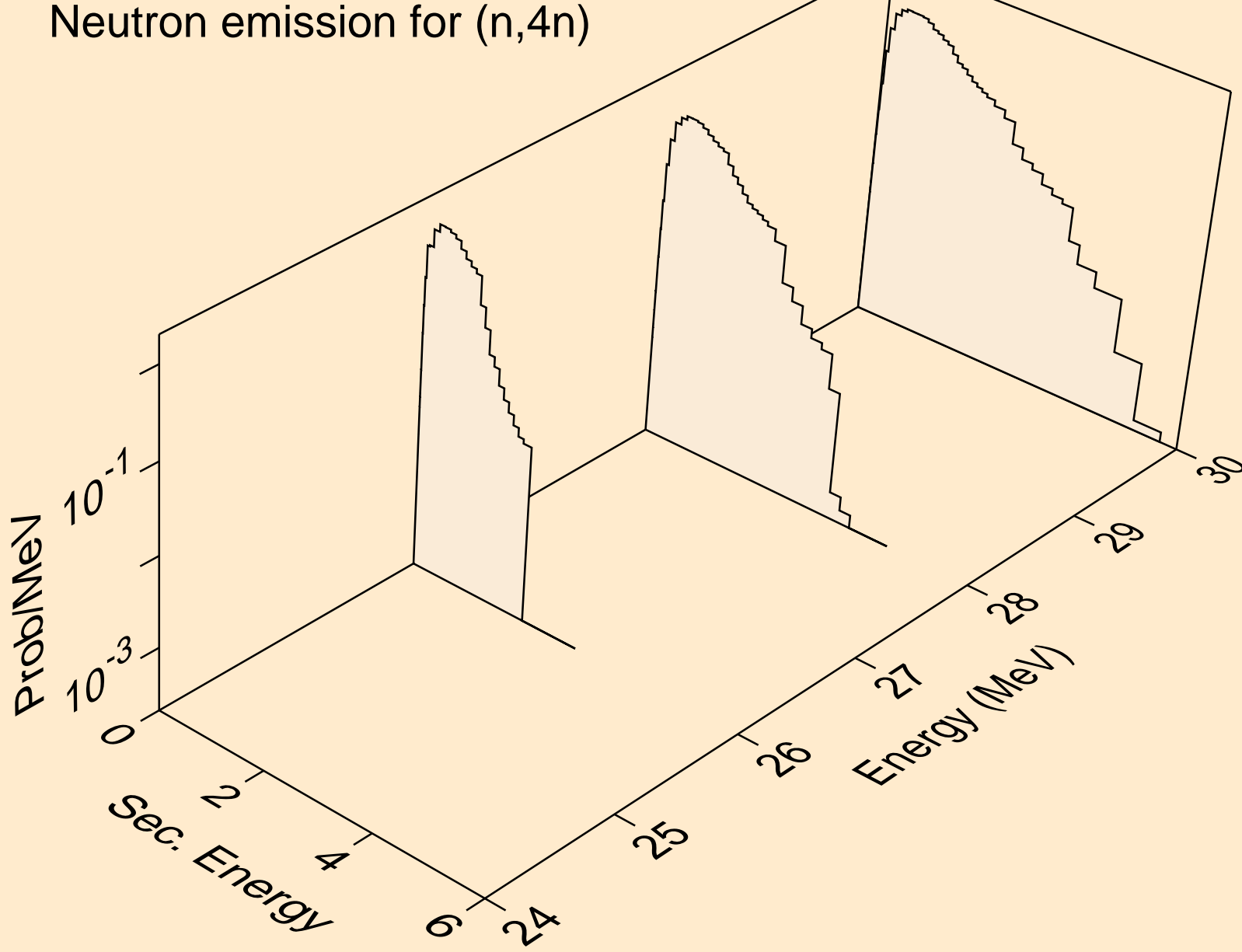

SN117 NEUTRON ACER TENDL-2019 LIBRARY; T=293.16K
Neutron emission for (n,2np)

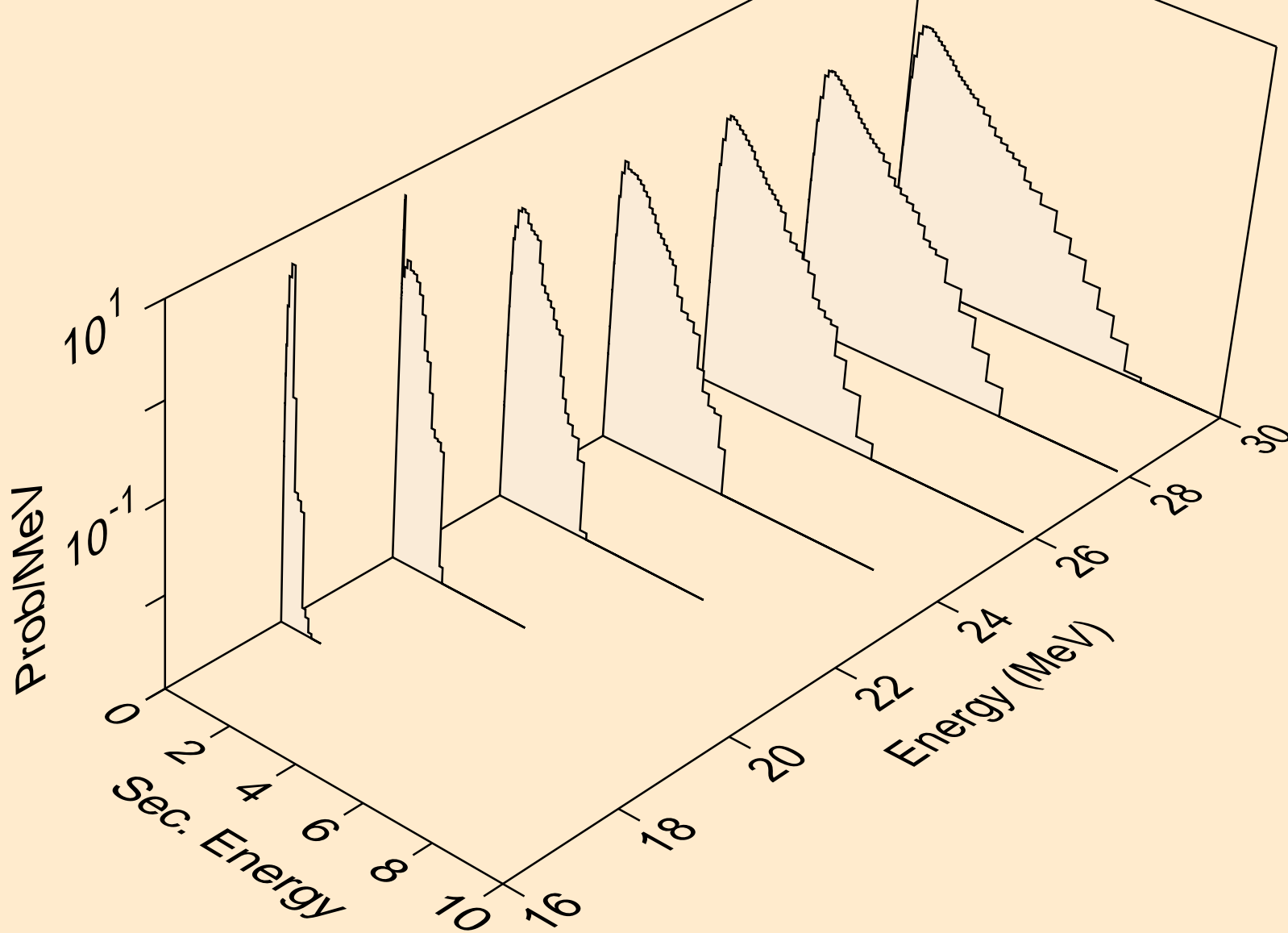

SN117 NEUTRON ACER TENDL-2019 LIBRARY; T=293.16K
Neutron emission for (n,3np)

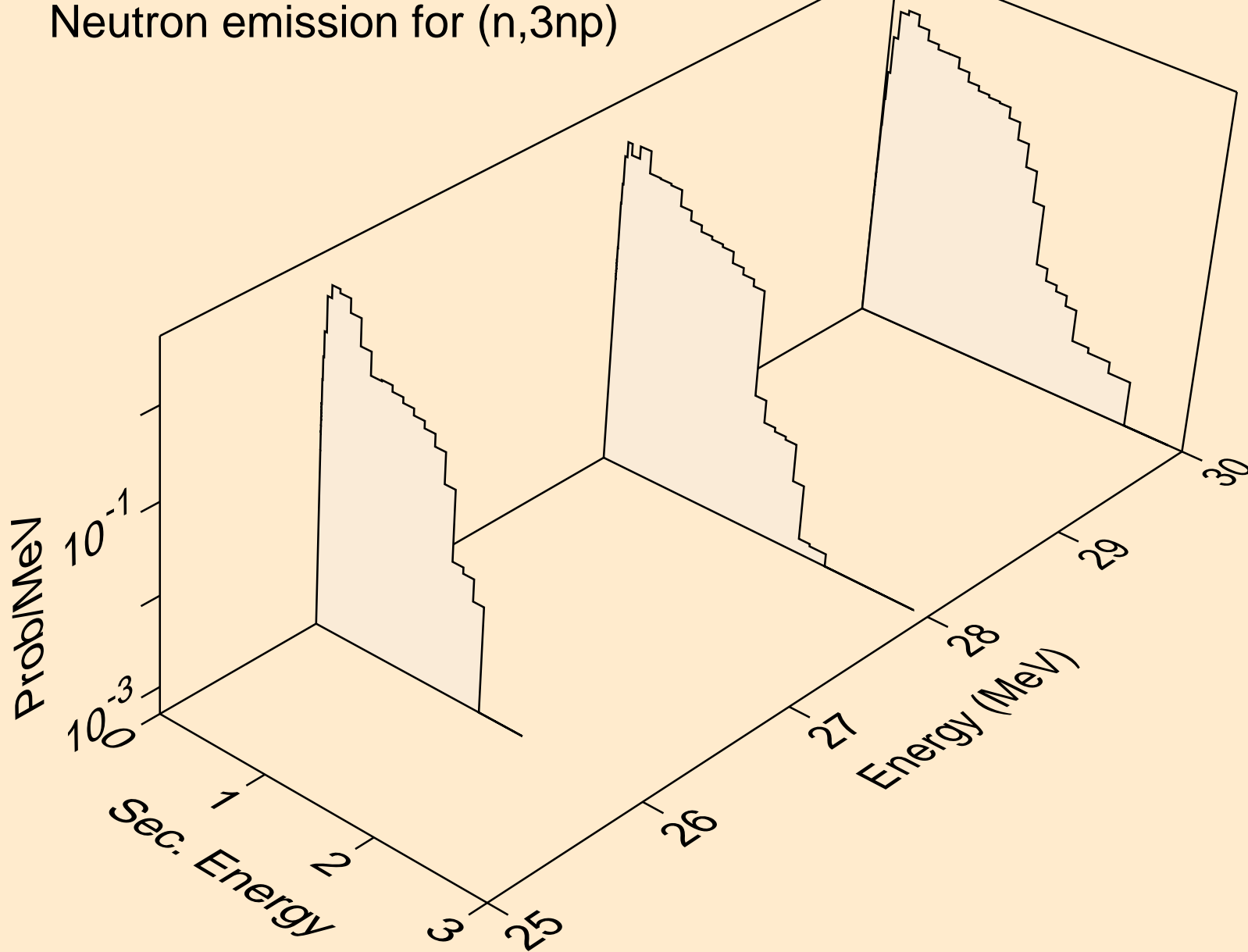

SN117 NEUTRON ACER TENDL-2019 LIBRARY; T=293.16K
Neutron emission for (n,2np)

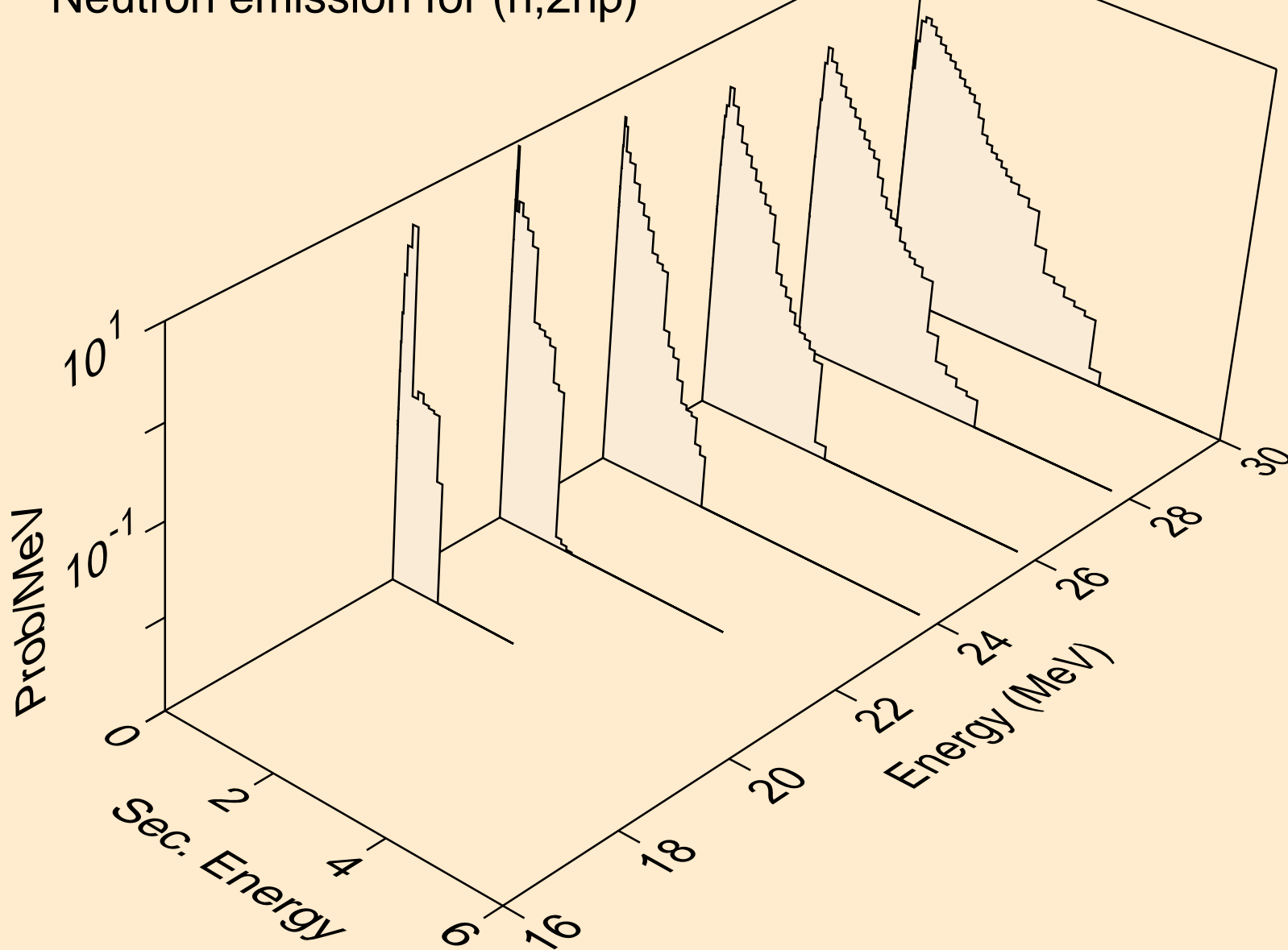

SN117 NEUTRON ACER TENDL-2019 LIBRARY; T=293.16K
Neutron emission for (n,npa)

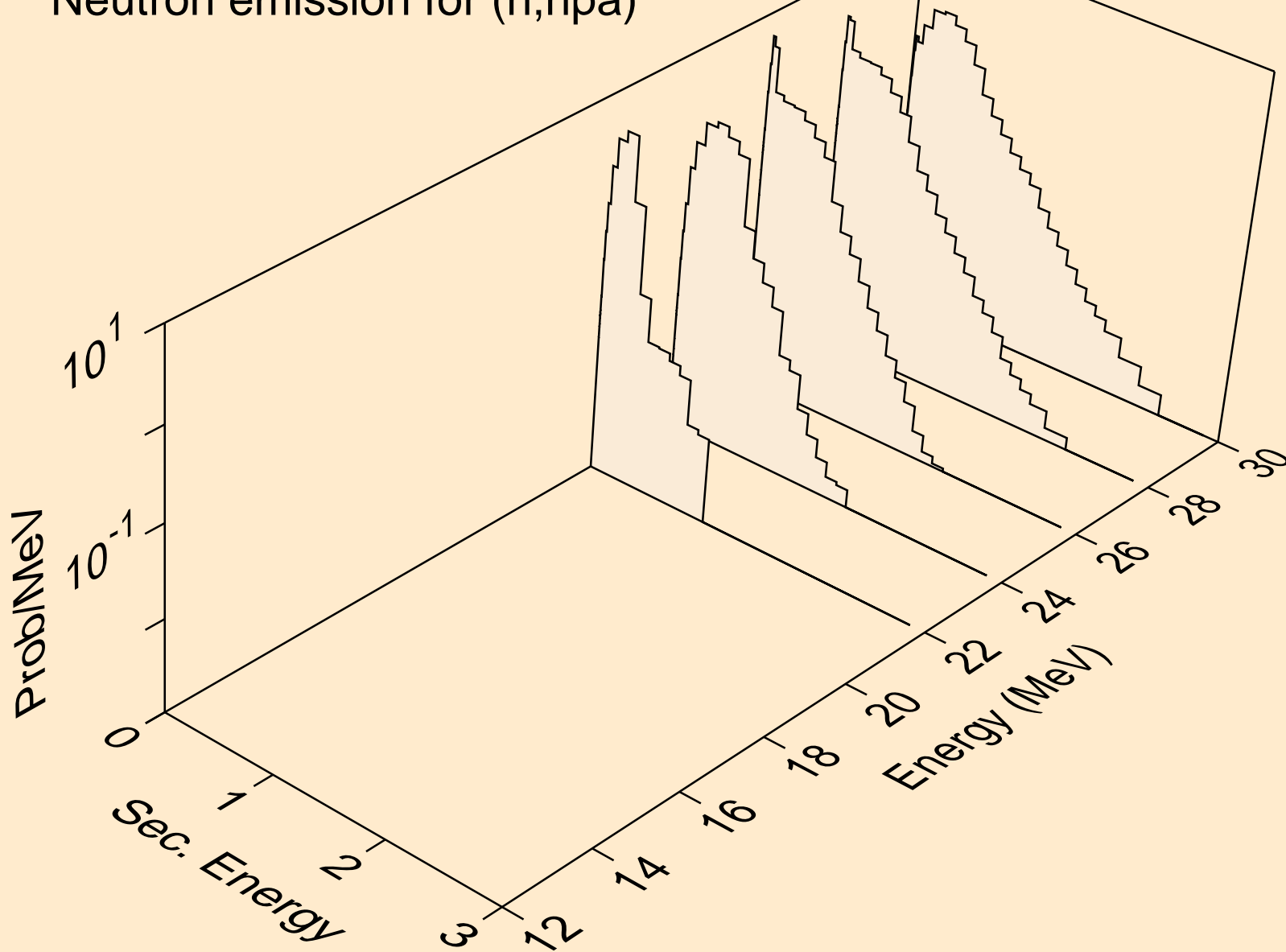

SN117 NEUTRON ACER TENDL-2019 LIBRARY; T=293.16K
Neutron emission for (n,n*c)

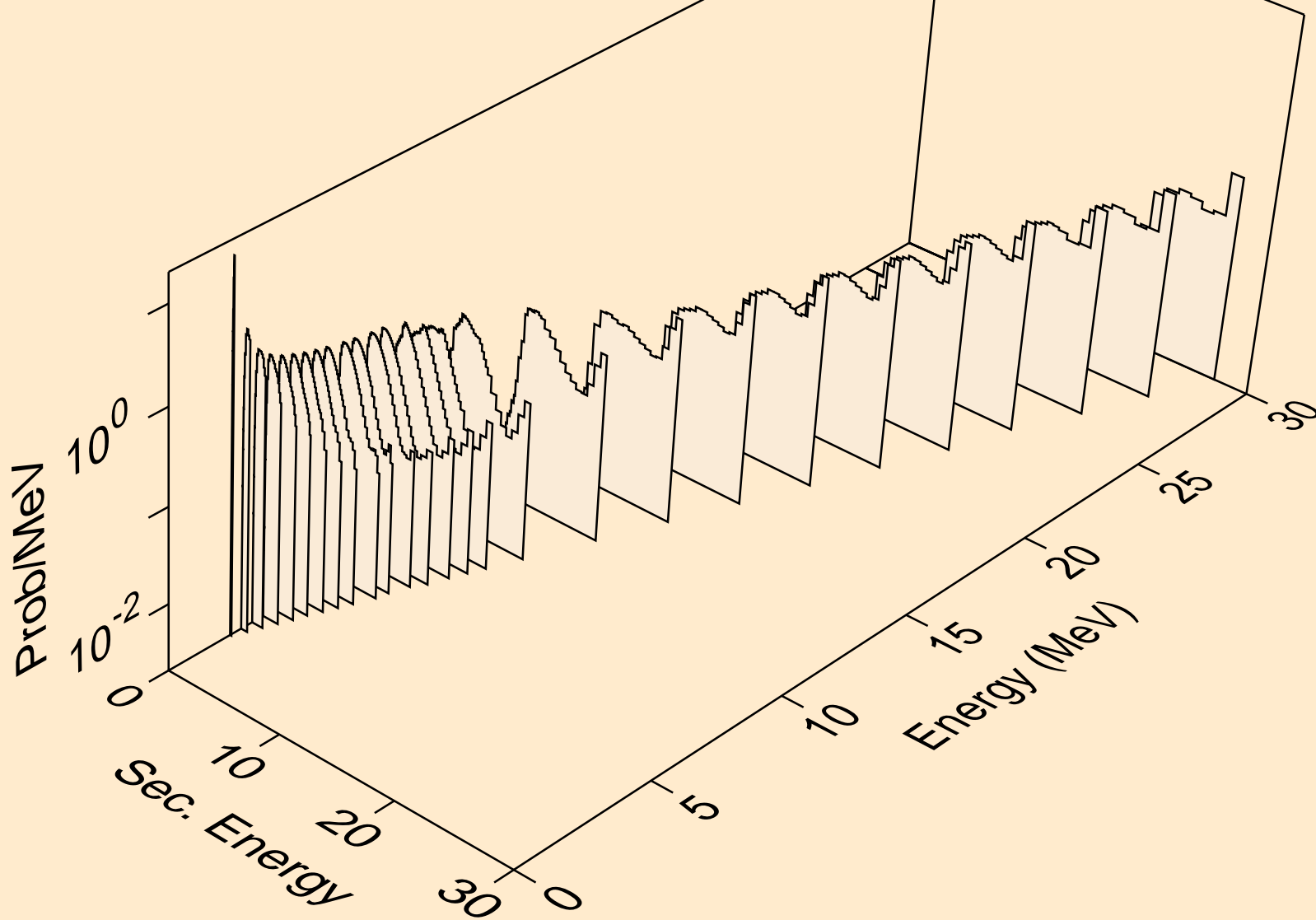

SN117 NEUTRON ACER TENDL-2019 LIBRARY; T=293.16K
Photon emission for (n,x)

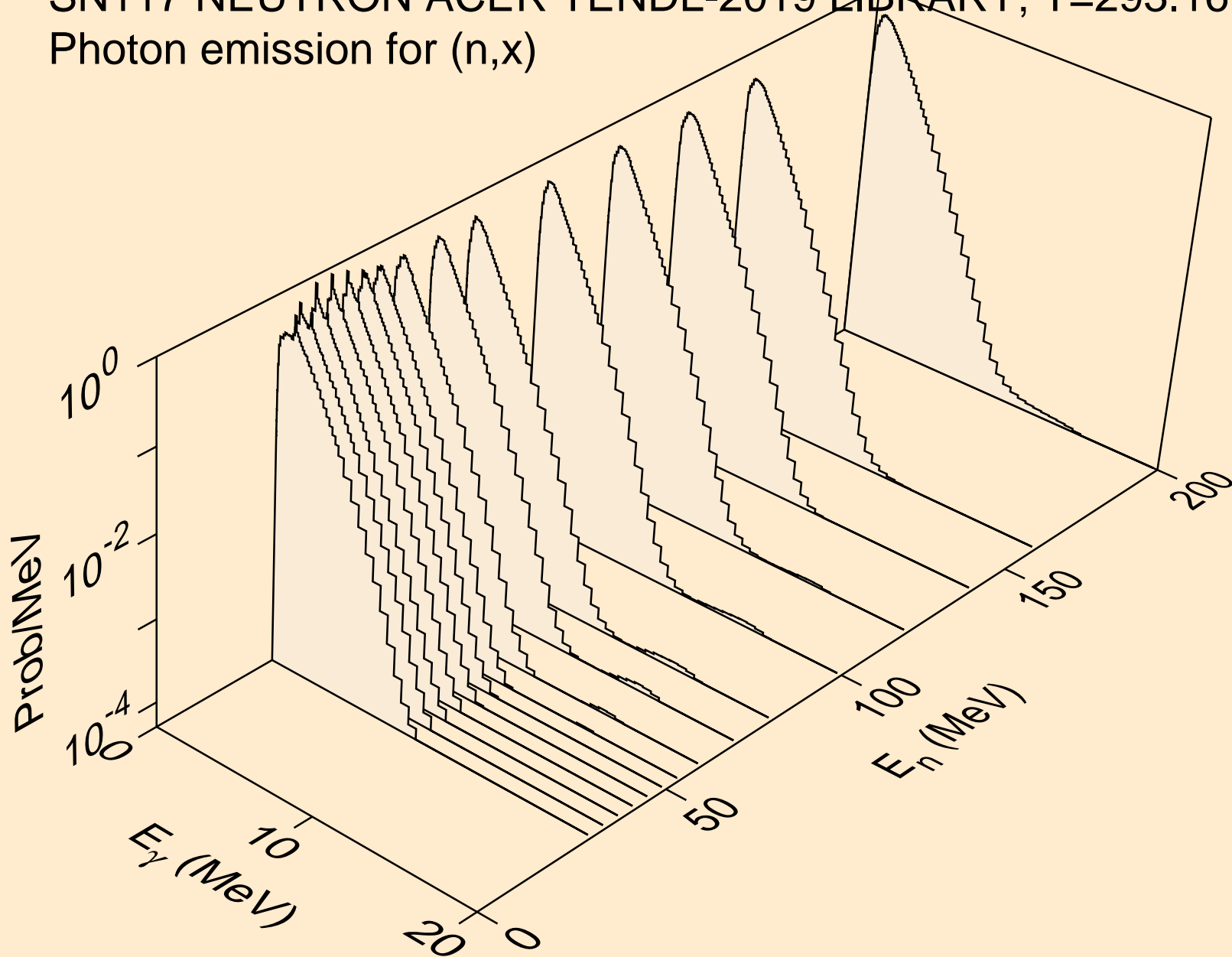

SN117 NEUTRON ACER TENDL-2019 LIBRARY; T=293.16K
Photon emission for (n,2nd)

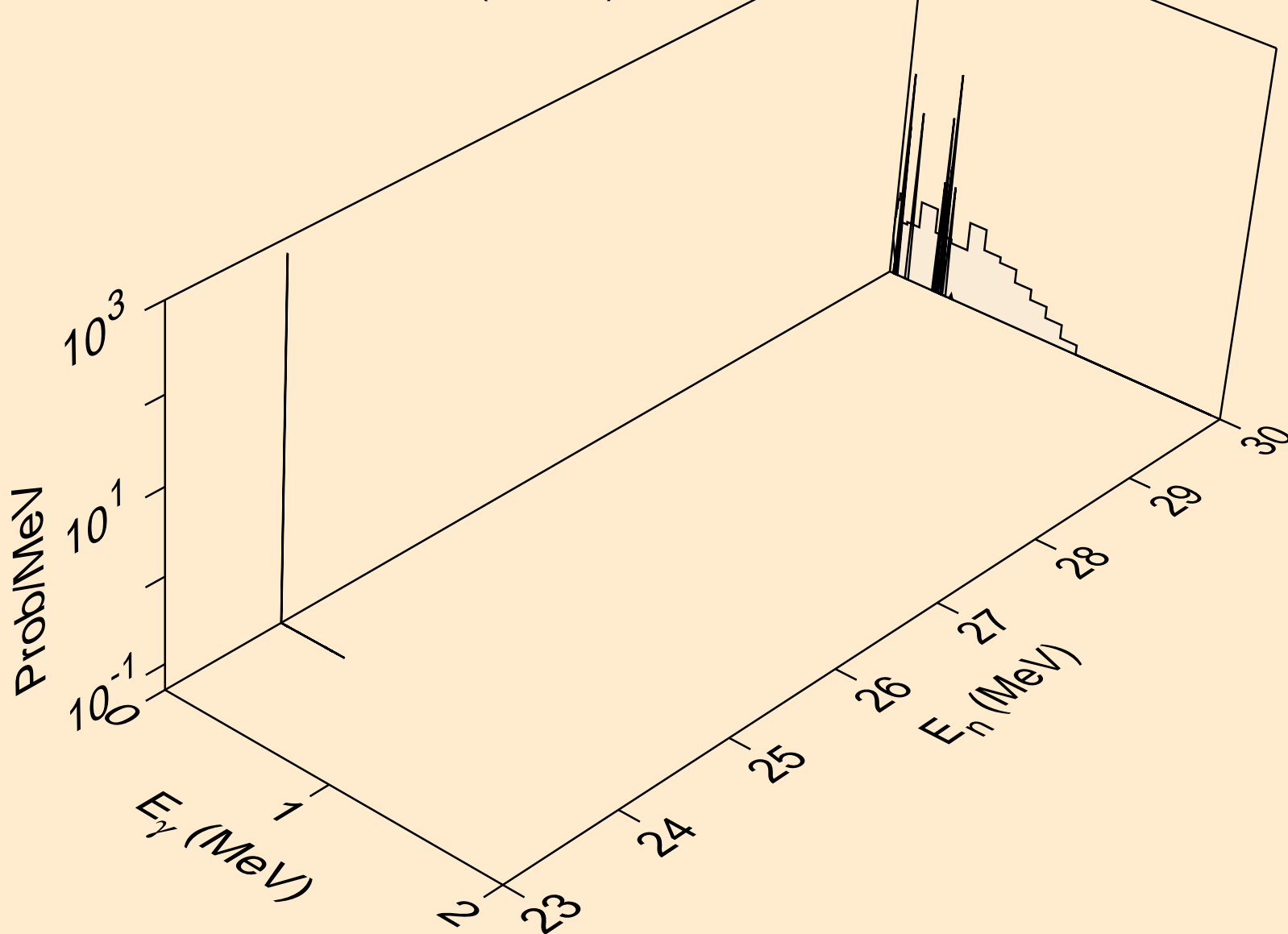

SN117 NEUTRON ACER TENDL-2019 LIBRARY; T=293.16K
Photon emission for (n,2n)

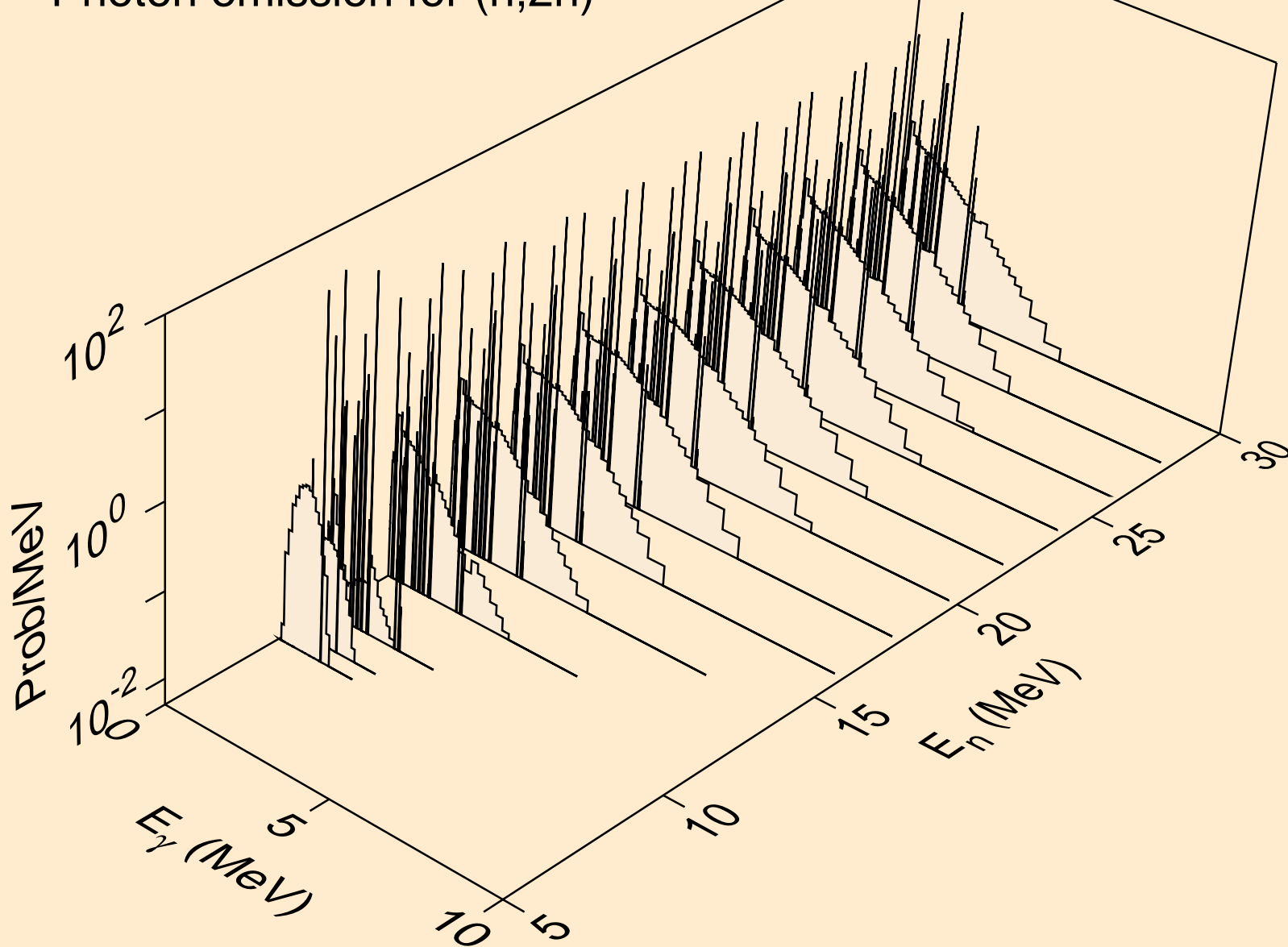

SN117 NEUTRON ACER TENDL-2019 LIBRARY; T=293.16K
Photon emission for (n,3n)

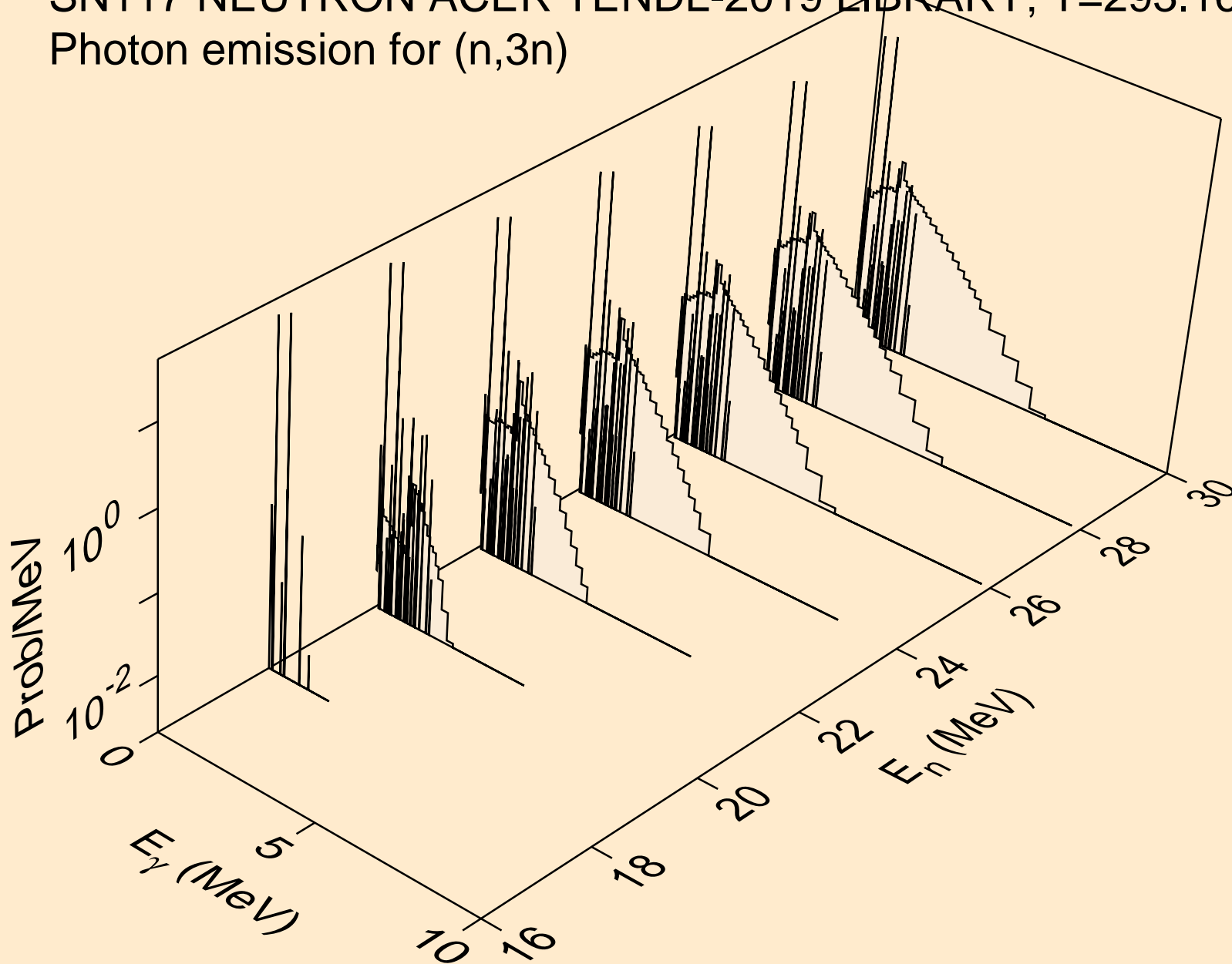

SN117 NEUTRON ACER TENDL-2019 LIBRARY; T=293.16K
Photon emission for (n,n*)a

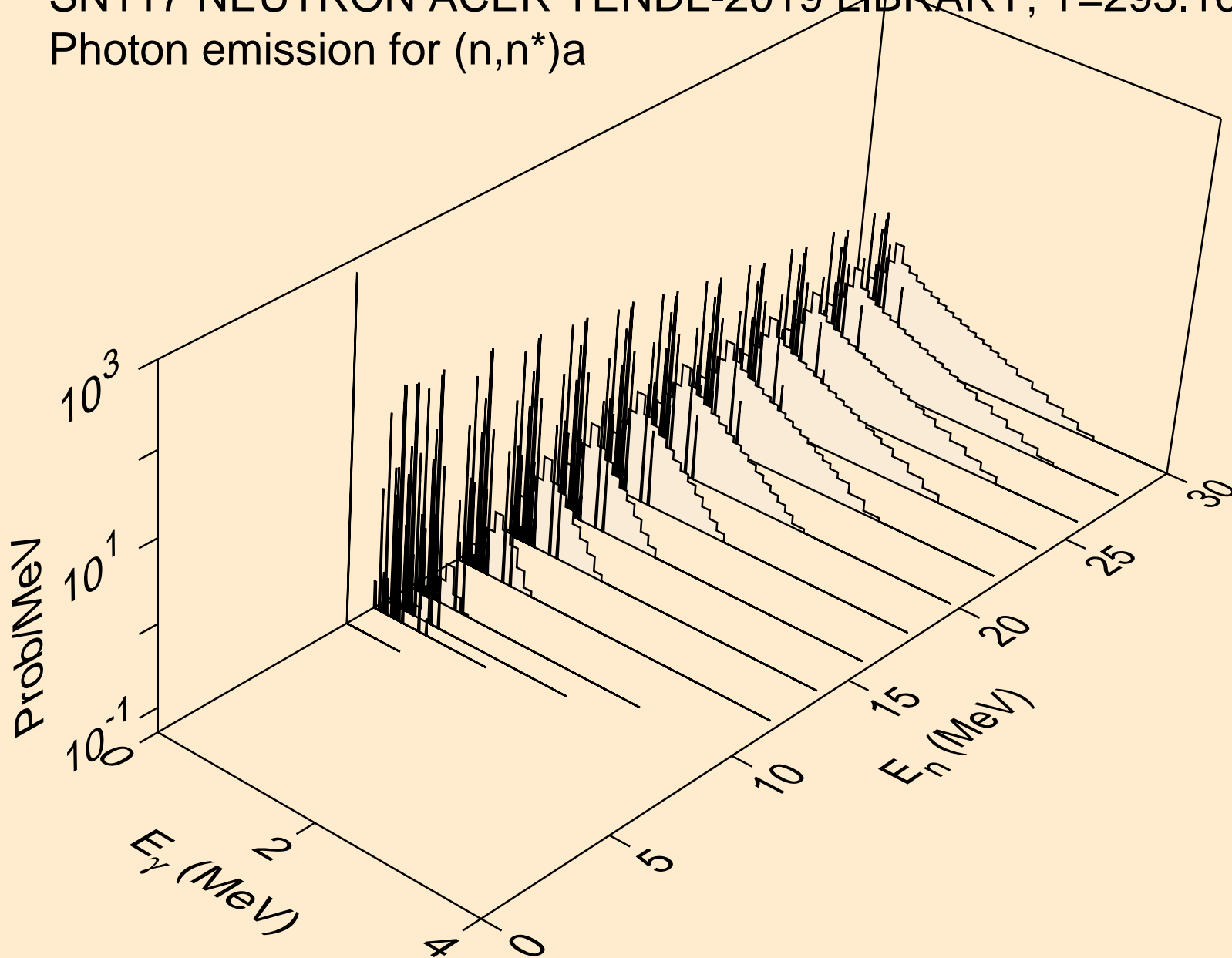

SN117 NEUTRON ACER TENDL-2019 LIBRARY; T=293.16K
Photon emission for (n,2n)a

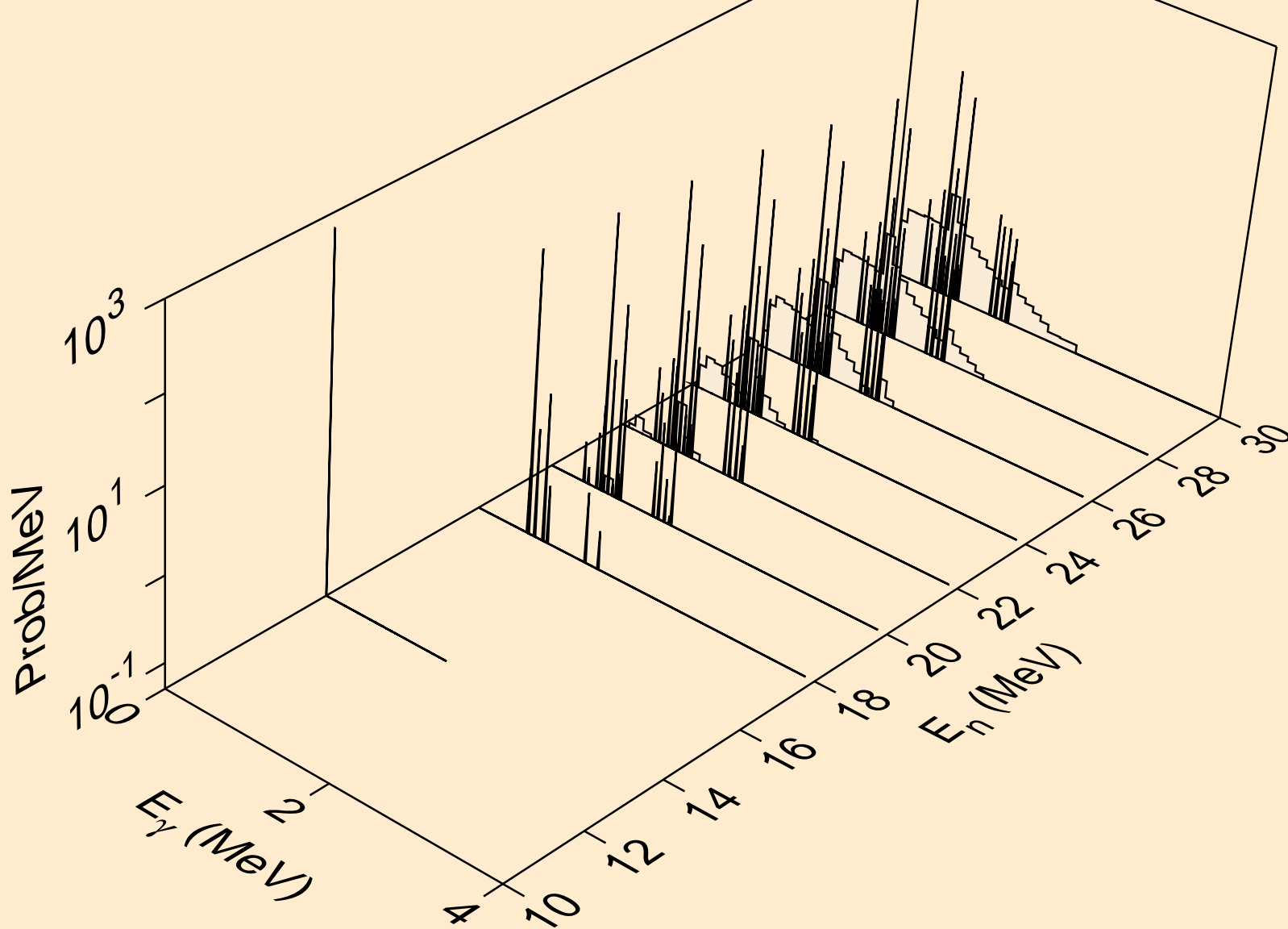

SN117 NEUTRON ACER TENDL-2019 LIBRARY; T=293.16K
Photon emission for (n,3n)a

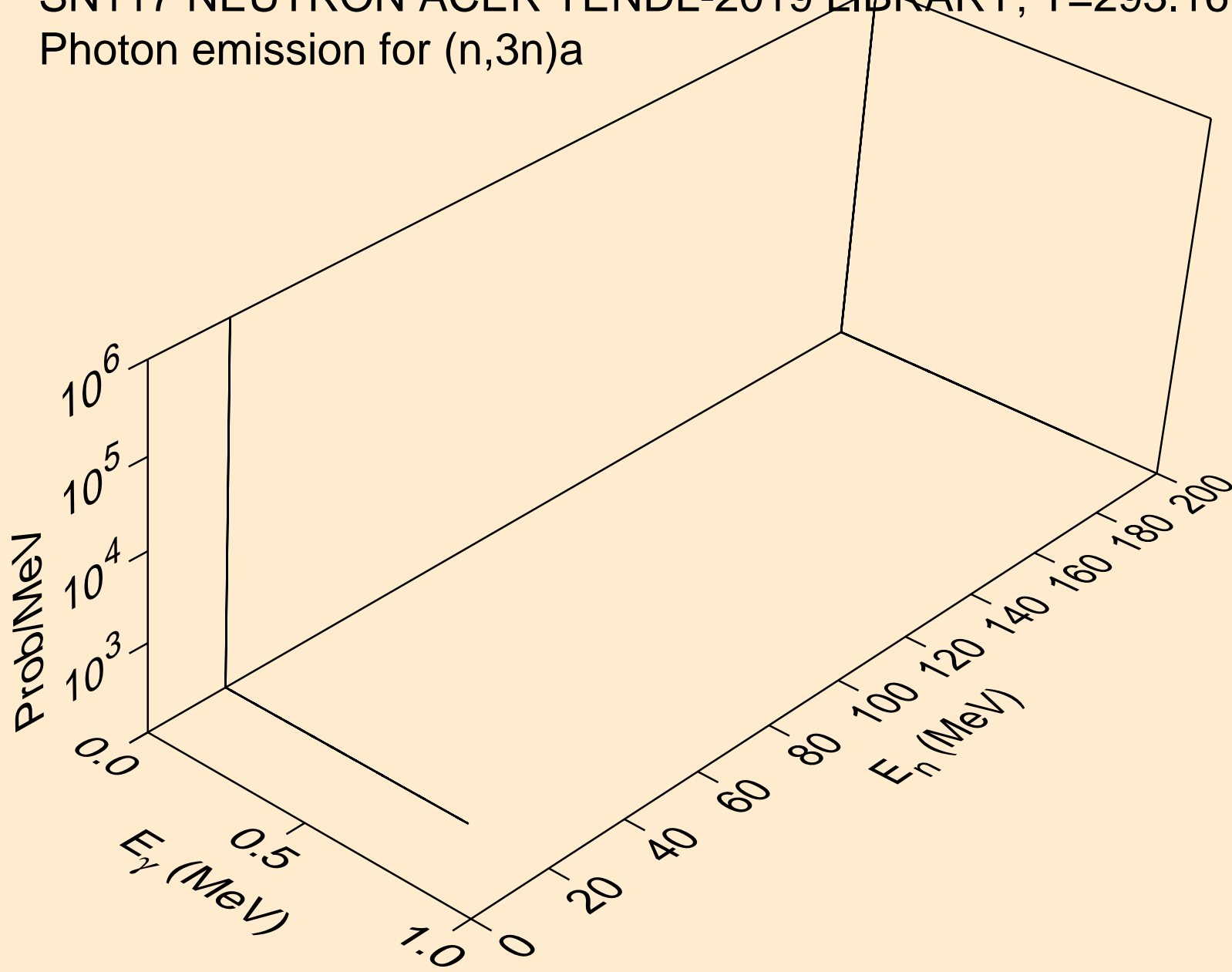

SN117 NEUTRON ACER TENDL-2019 LIBRARY; T=293.16K
Photon emission for (n,n*)p

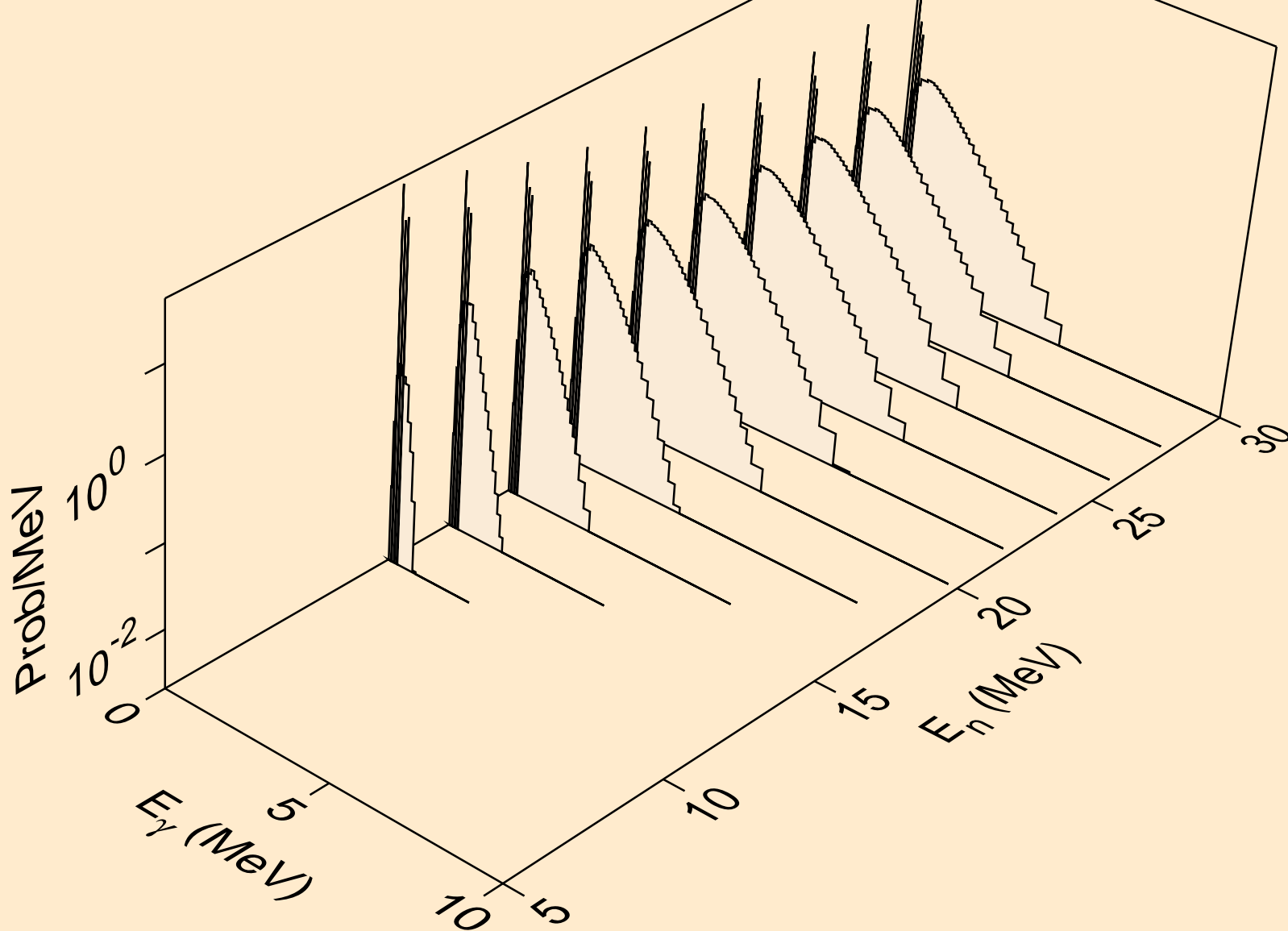

SN117 NEUTRON ACER TENDL-2019 LIBRARY; T=293.16K
Photon emission for (n,n*)2a

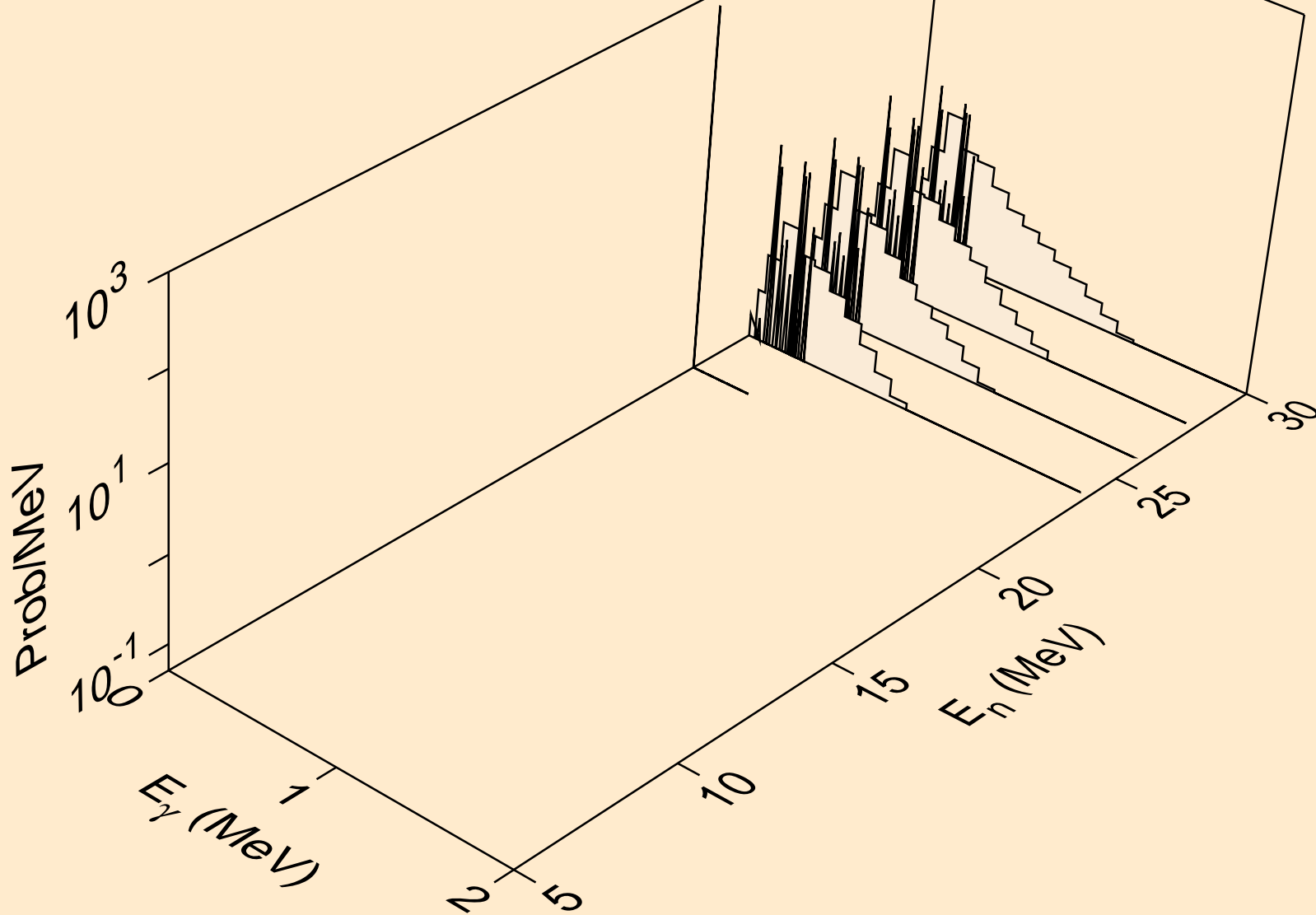

SN117 NEUTRON ACER TENDL-2019 LIBRARY; T=293.16K
Photon emission for (n,n*)d

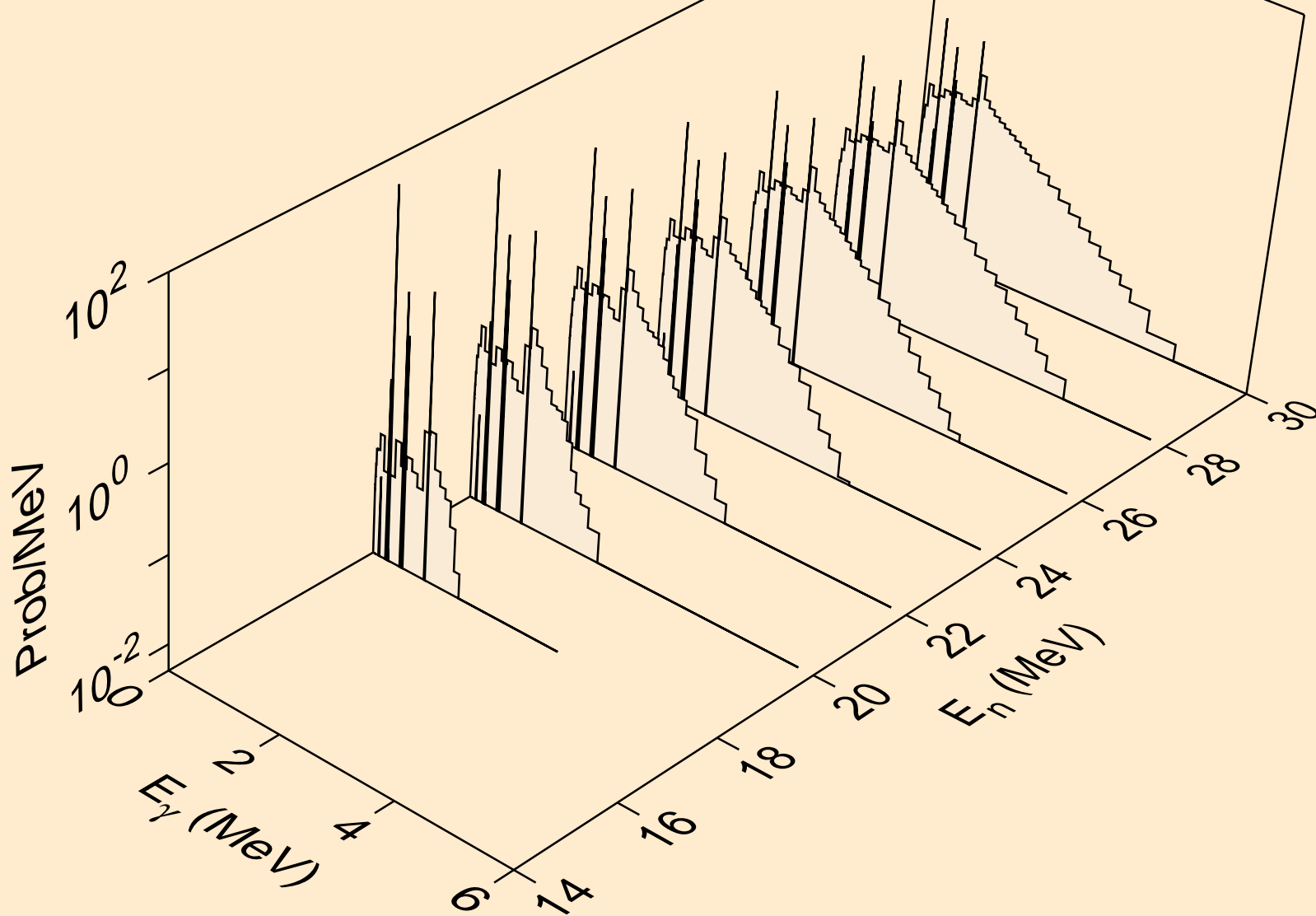

SN117 NEUTRON ACER TENDL-2019 LIBRARY; T=293.16K
Photon emission for (n,n*)t

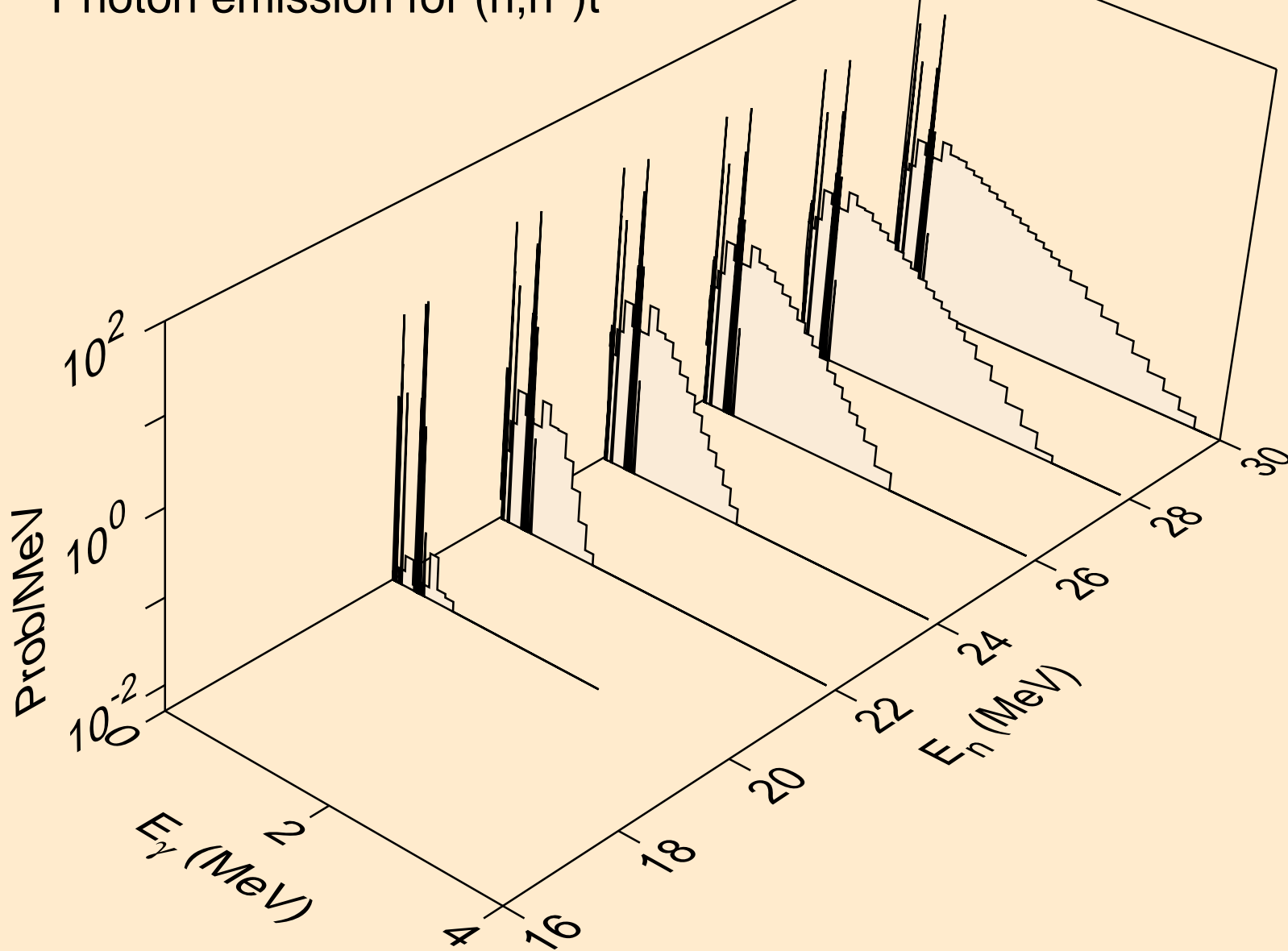

SN117 NEUTRON ACER TENDL-2019 LIBRARY; T=293.16K
Photon emission for (n,n*)he3

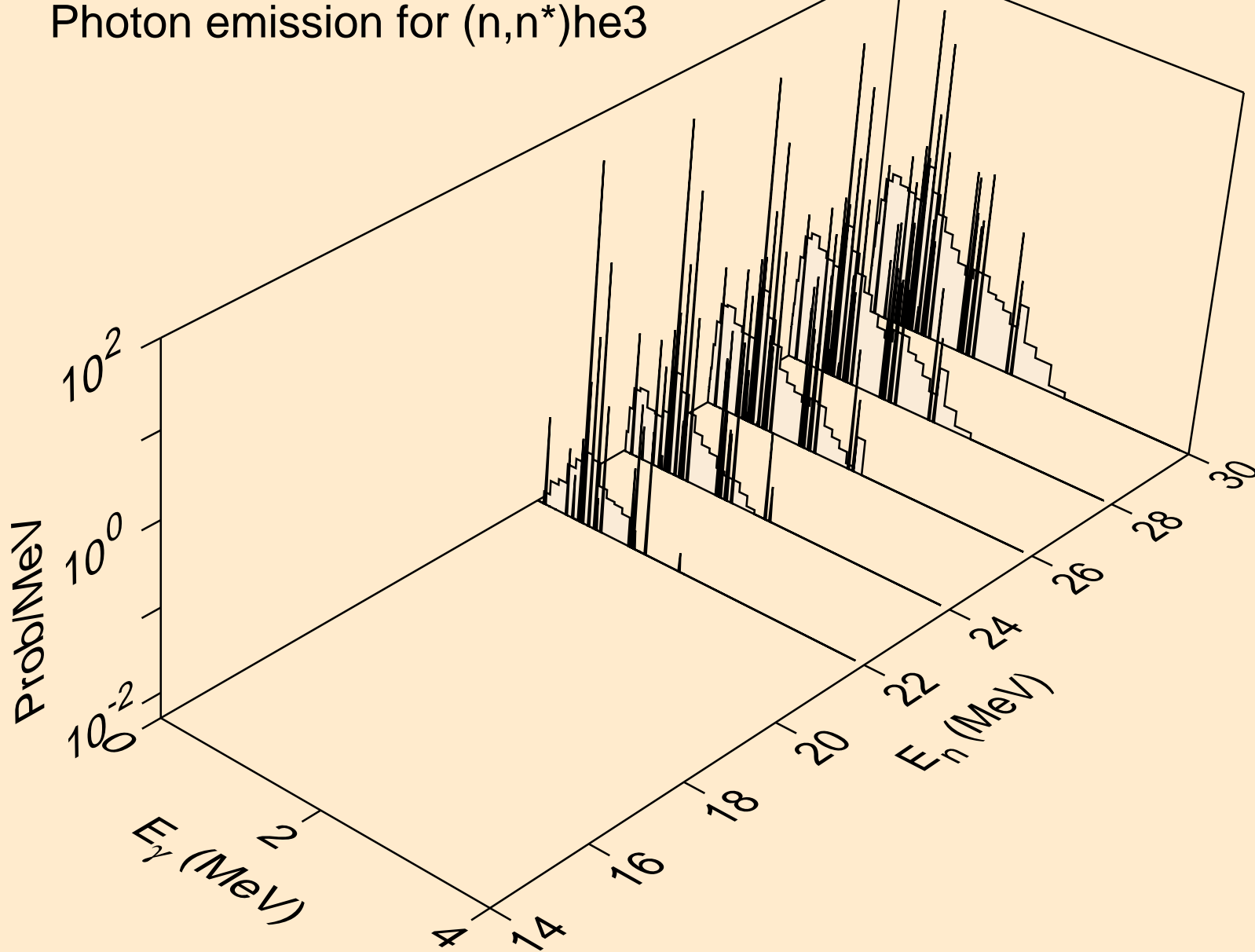

SN117 NEUTRON ACER TENDL-2019 LIBRARY; T=293.16K
Photon emission for (n,4n)

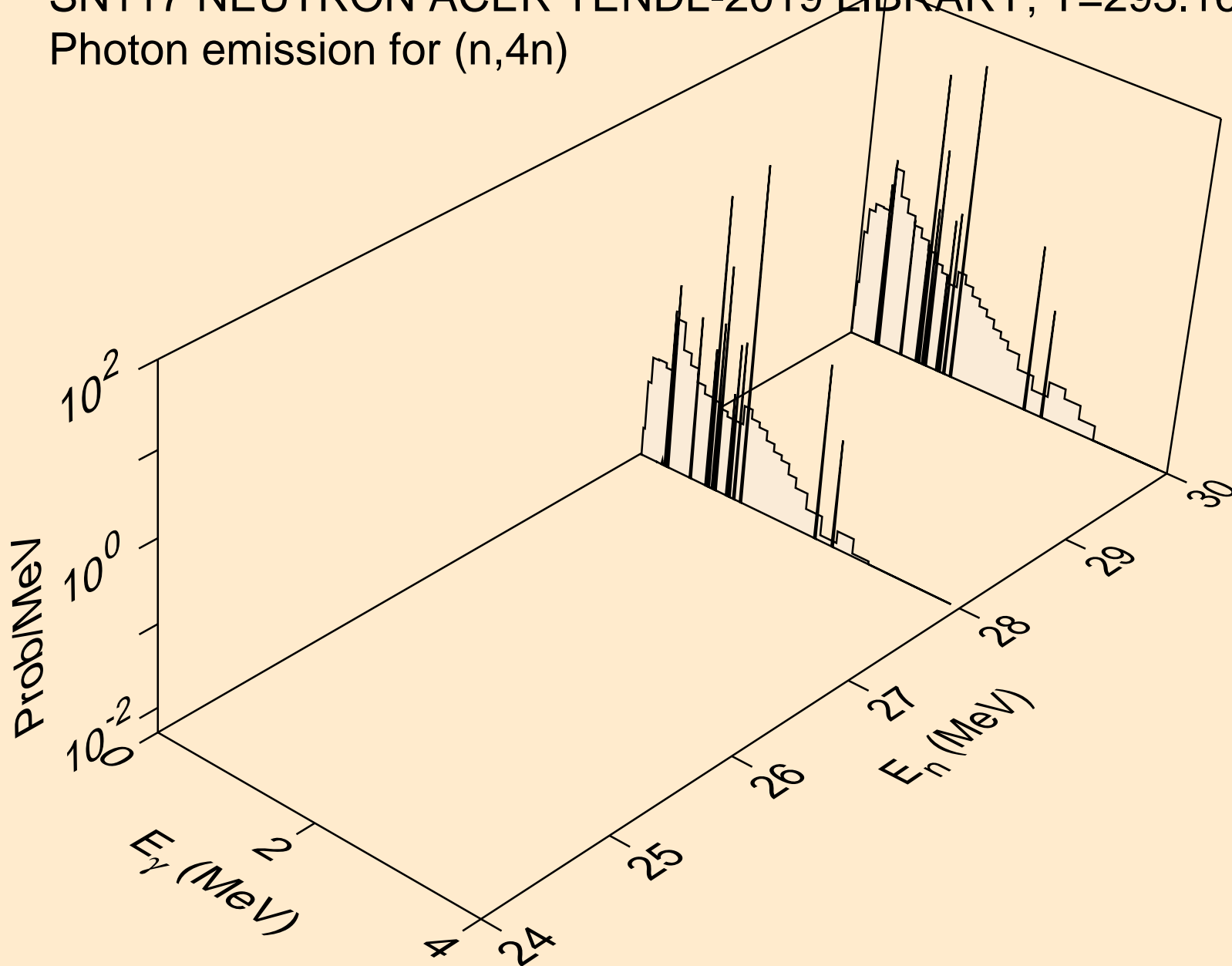

SN117 NEUTRON ACER TENDL-2019 LIBRARY; T=293.16K
Photon emission for (n,2np)

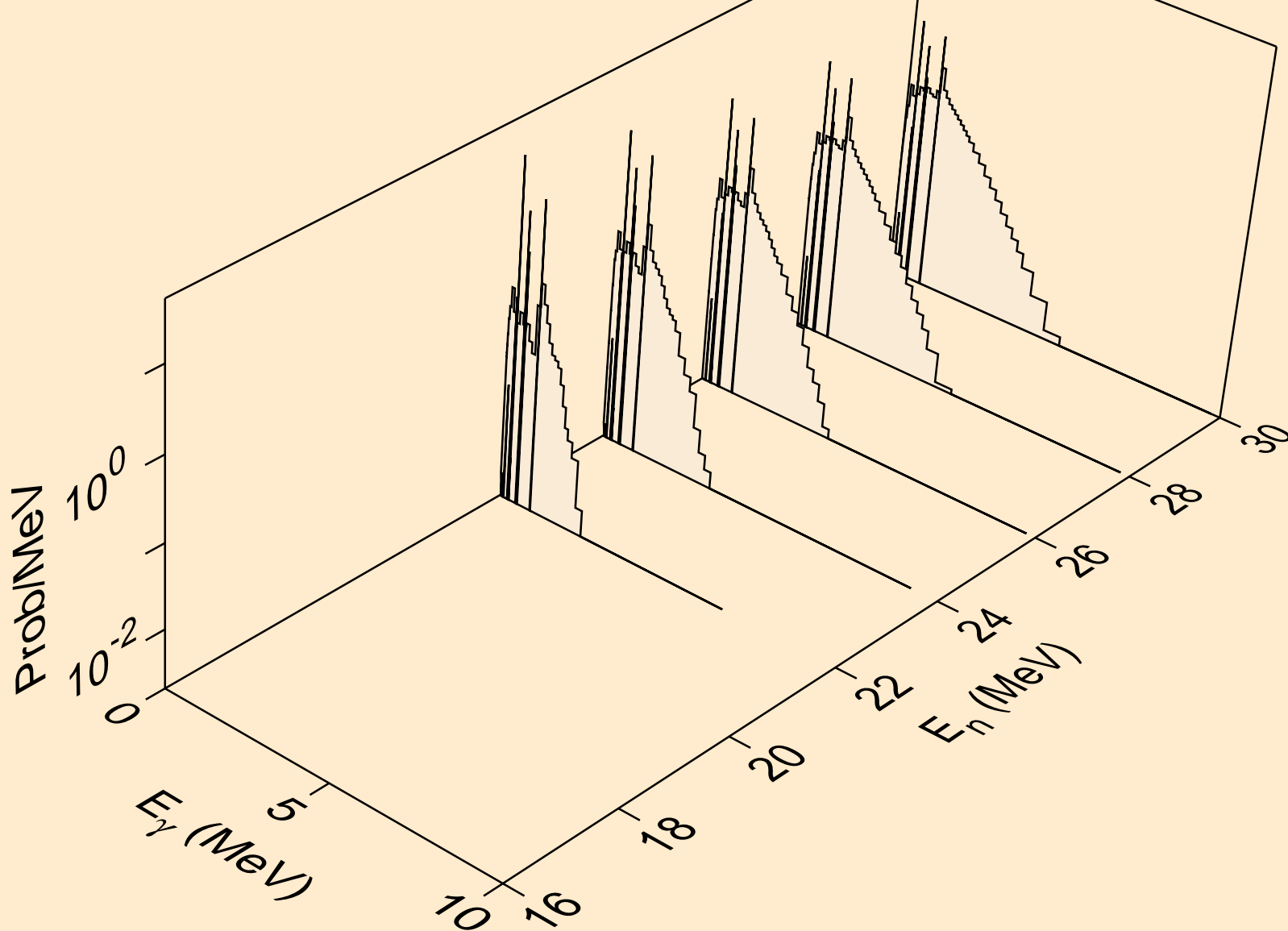

SN117 NEUTRON ACER TENDL-2019 LIBRARY; T=293.16K
Photon emission for (n,3np)

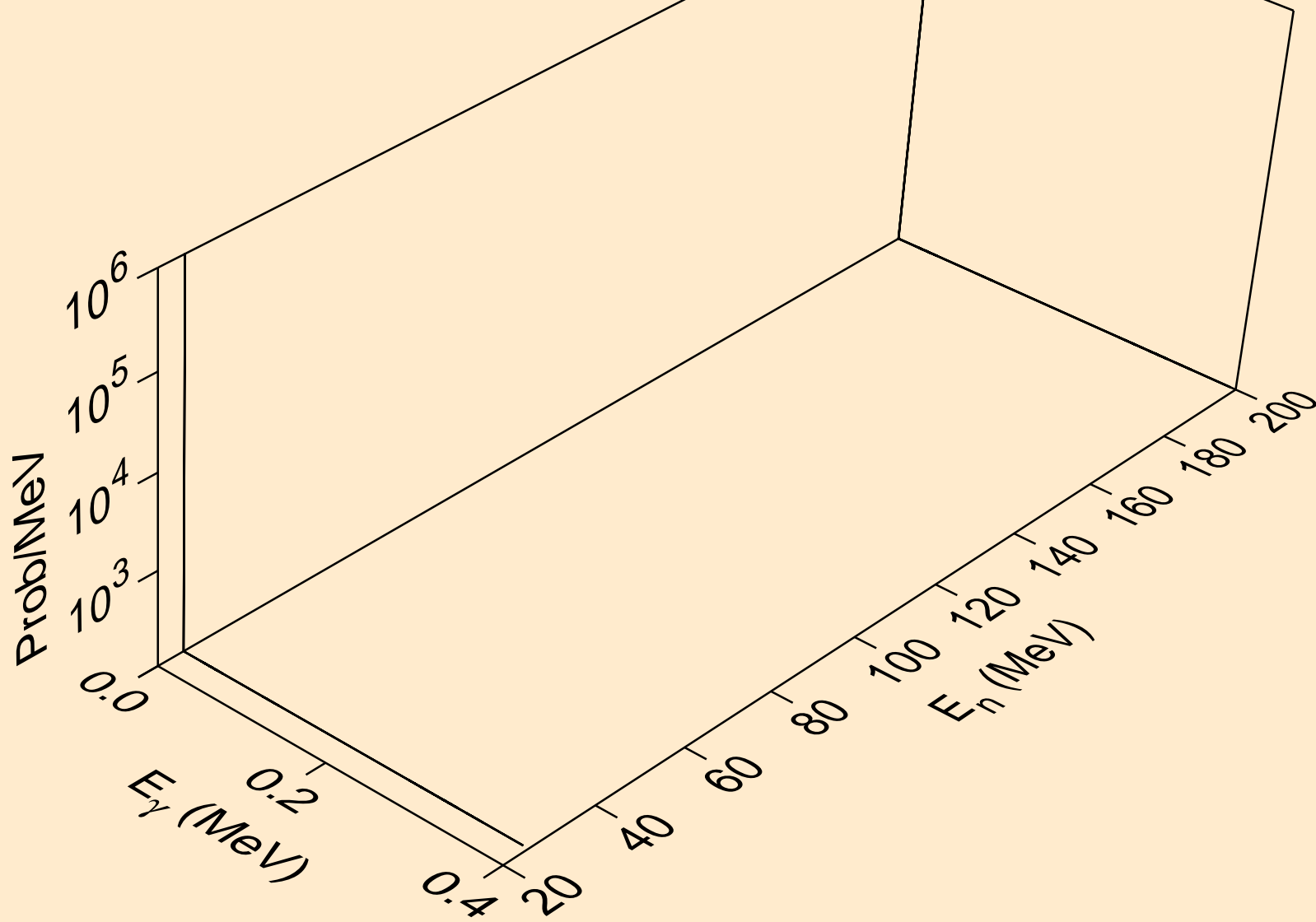

SN117 NEUTRON ACER TENDL-2019 LIBRARY; T=293.16K
Photon emission for (n,2np)

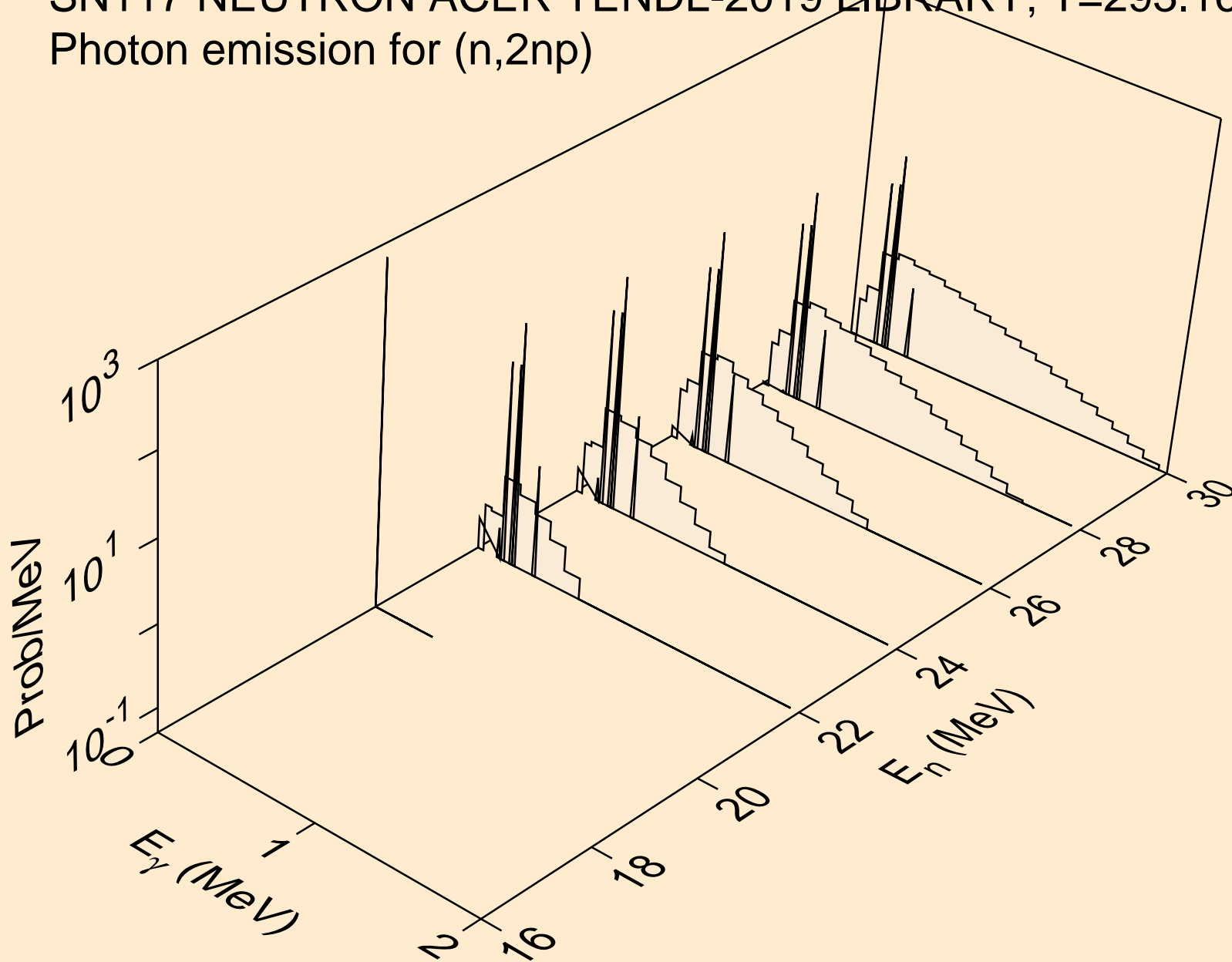

SN117 NEUTRON ACER TENDL-2019 LIBRARY; T=293.16K
Photon emission for (n,npa)

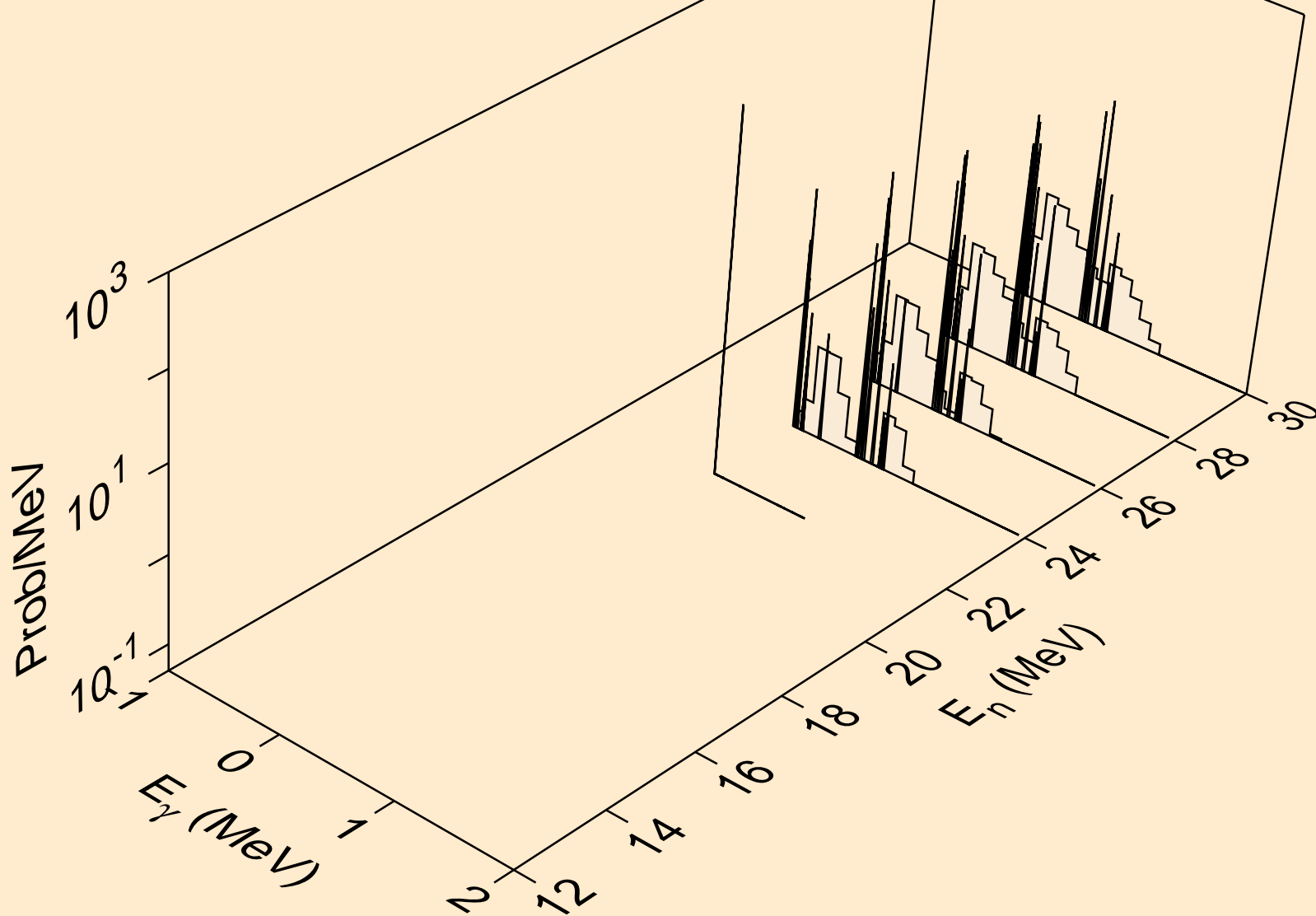

SN117 NEUTRON ACER TENDL-2019 LIBRARY; T=293.16K
Photon emission for (n,n*c)

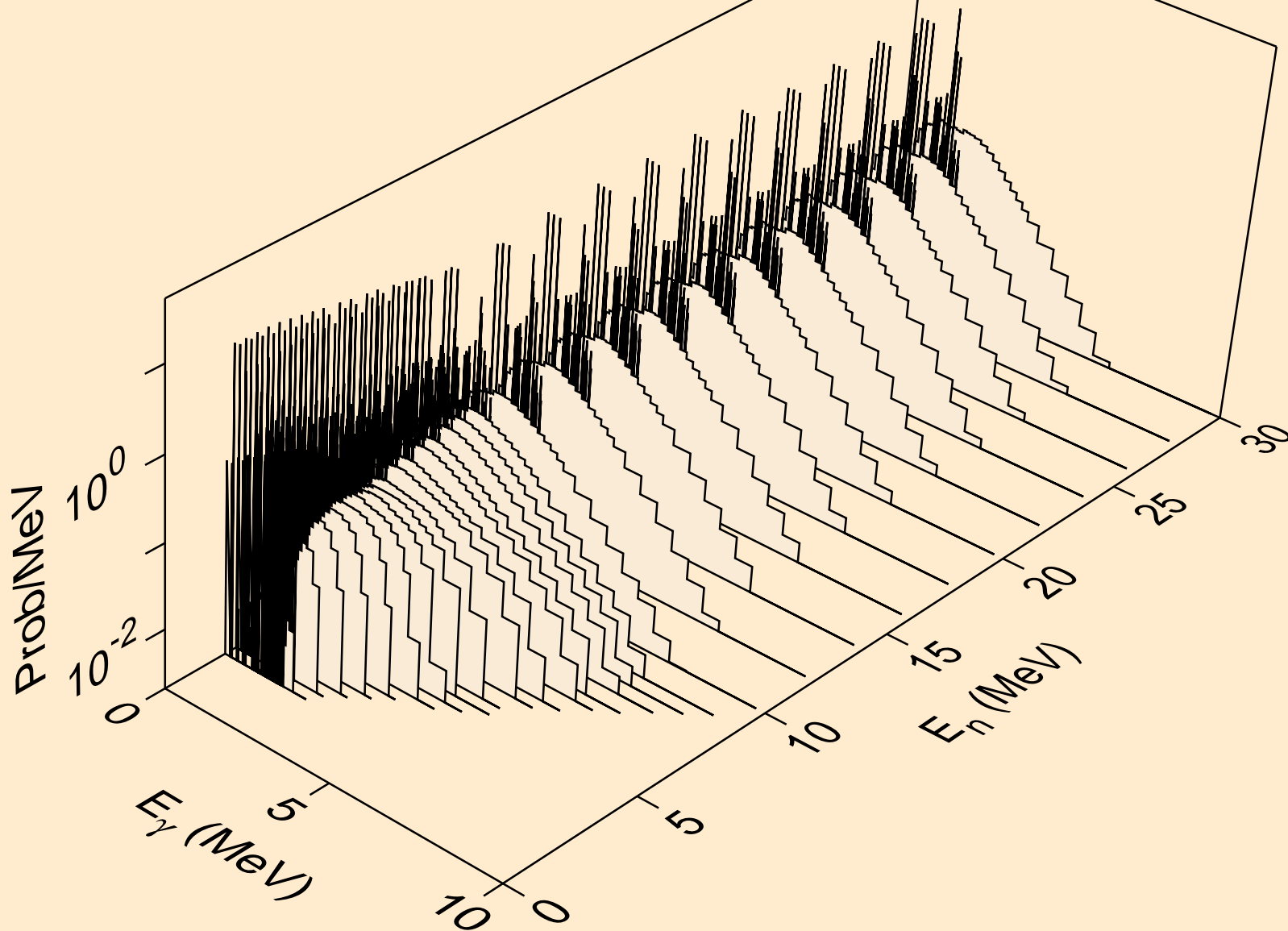

SN117 NEUTRON ACER TENDL-2019 LIBRARY; T=293.16K
Photon emission for (n,gma)

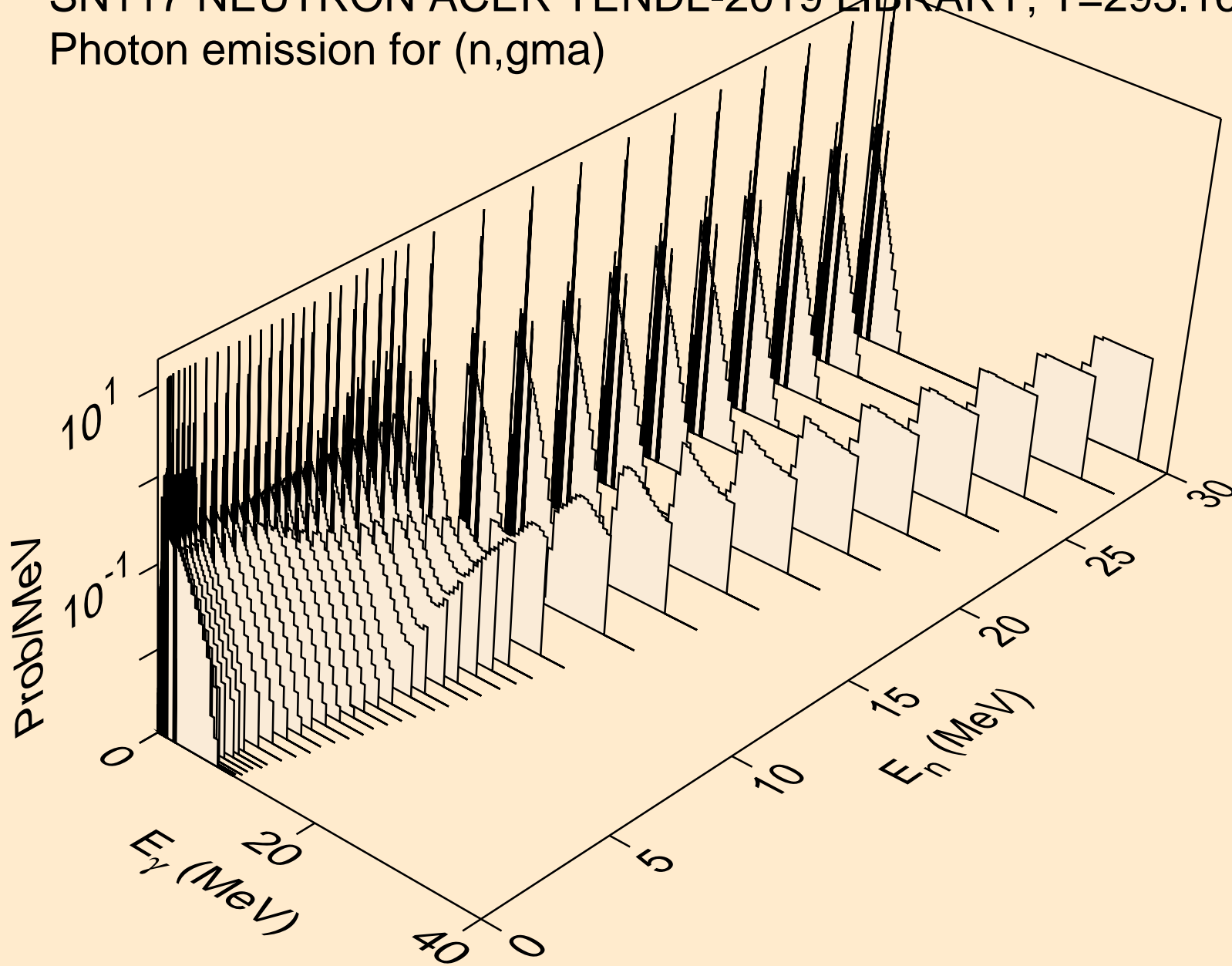

SN117 NEUTRON ACER TENDL-2019 LIBRARY; T=293.16K
Photon emission for (n,p)

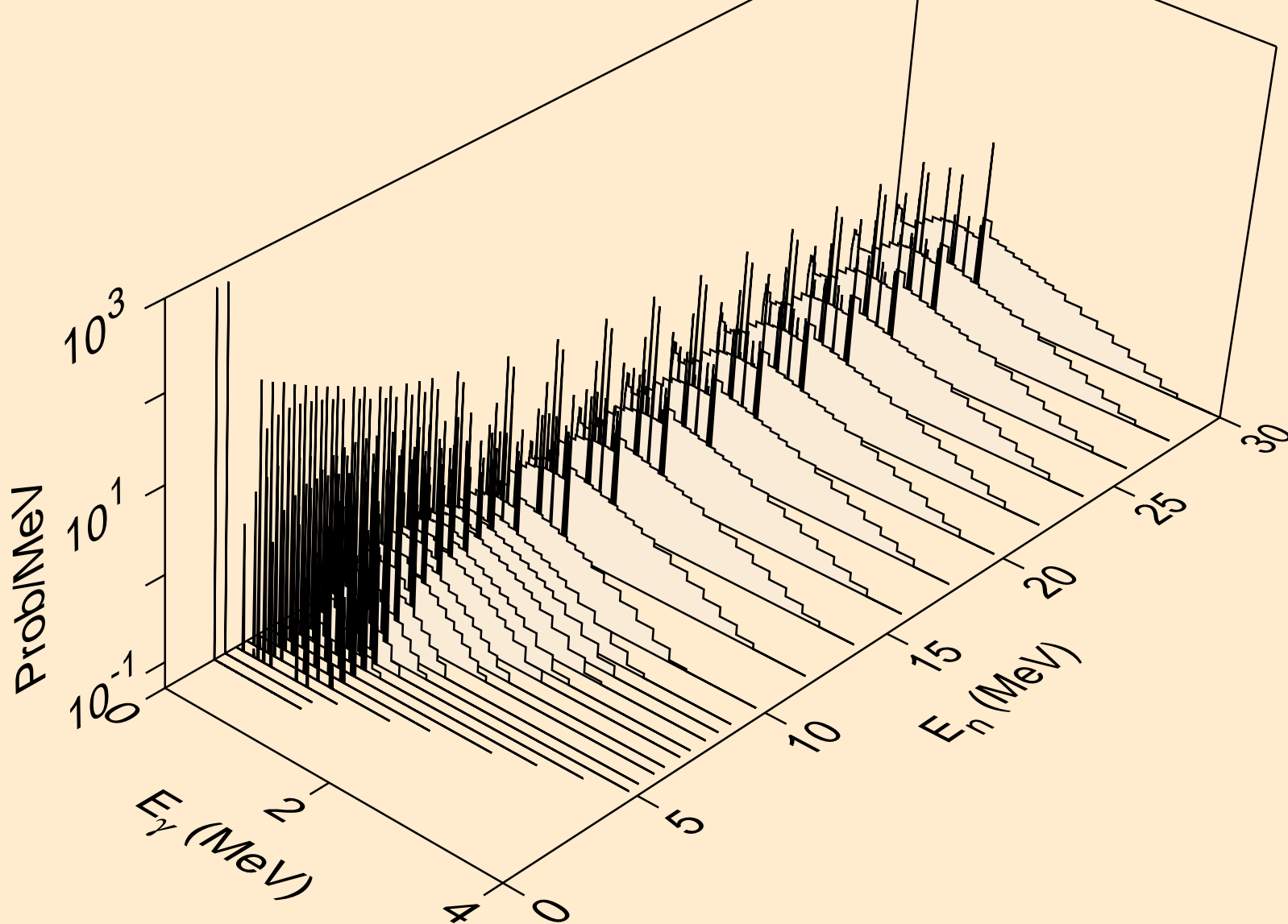

SN117 NEUTRON ACER TENDL-2019 LIBRARY; T=293.16K
Photon emission for (n,d)

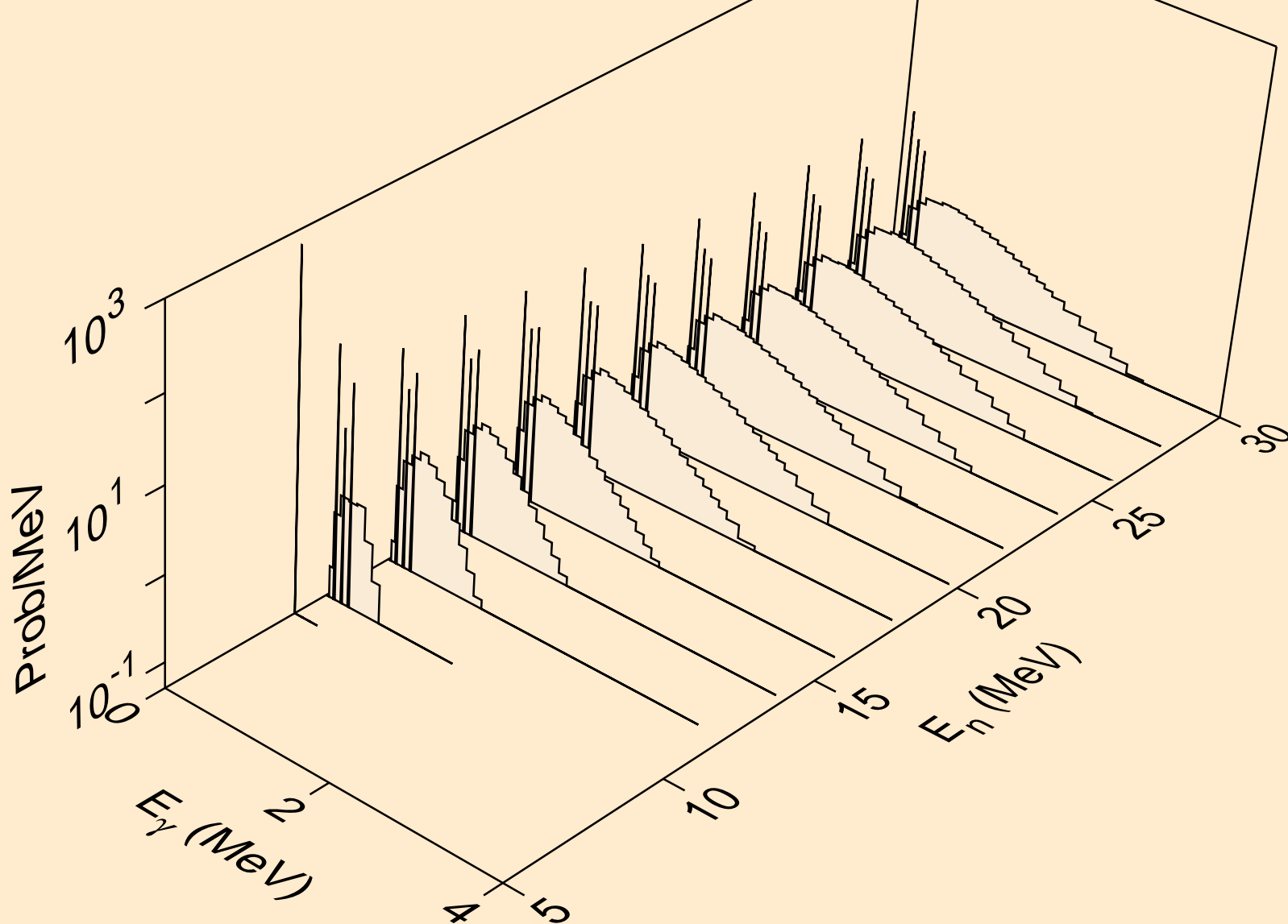

SN117 NEUTRON ACER TENDL-2019 LIBRARY; T=293.16K
Photon emission for (n,t)

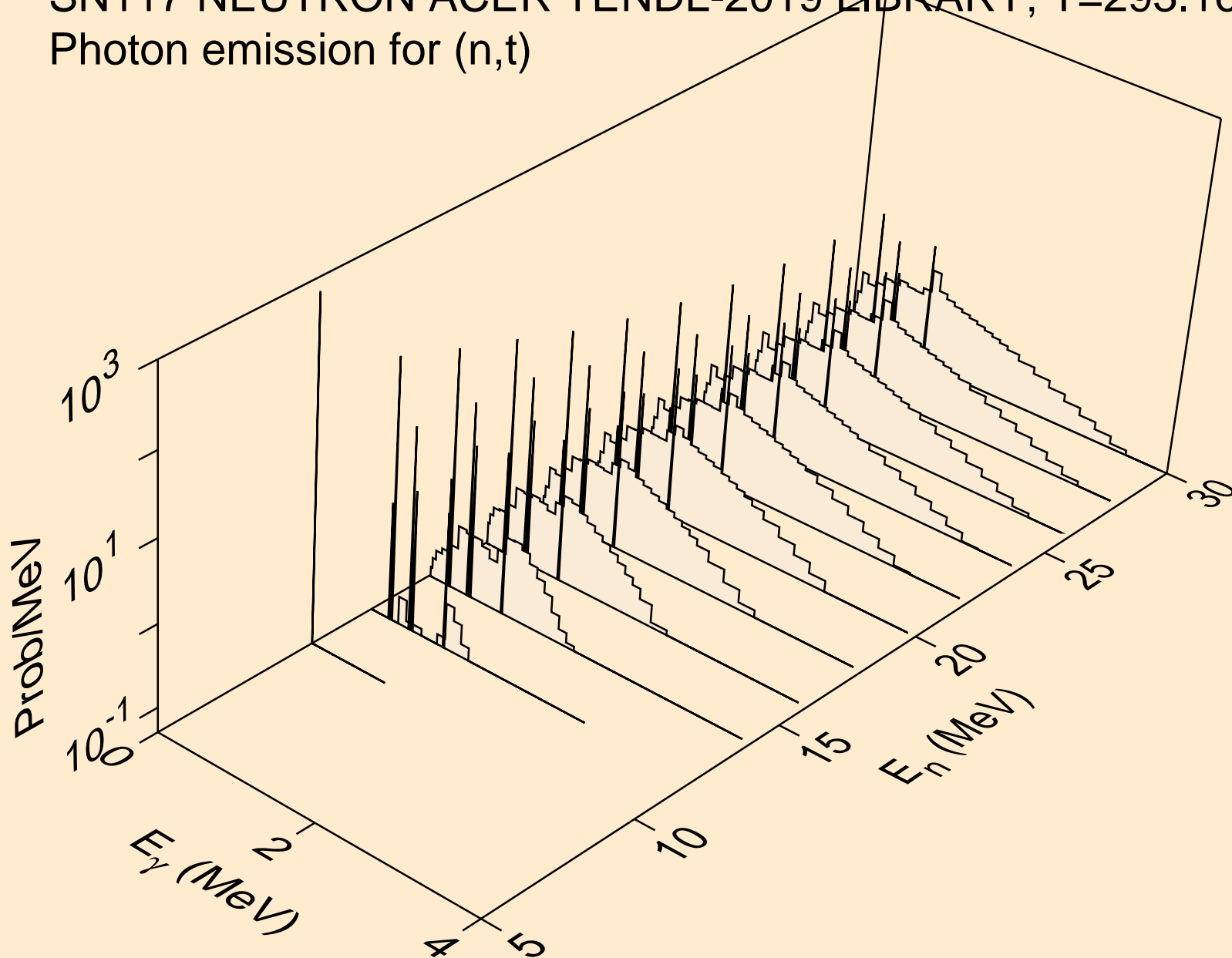

SN117 NEUTRON ACER TENDL-2019 LIBRARY; T=293.16K
Photon emission for (n,he3)

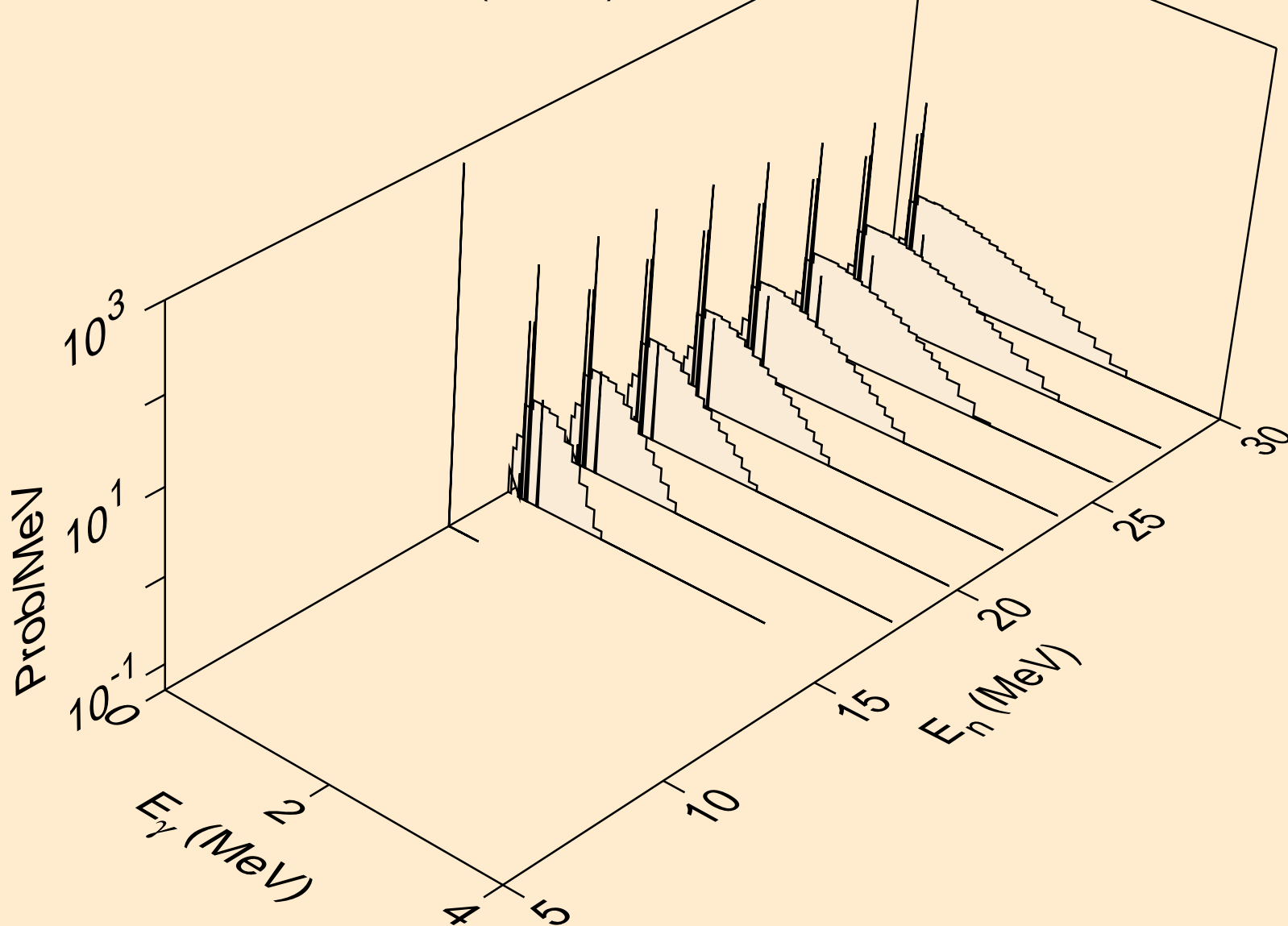

SN117 NEUTRON ACER TENDL-2019 LIBRARY; T=293.16K
Photon emission for (n,a)

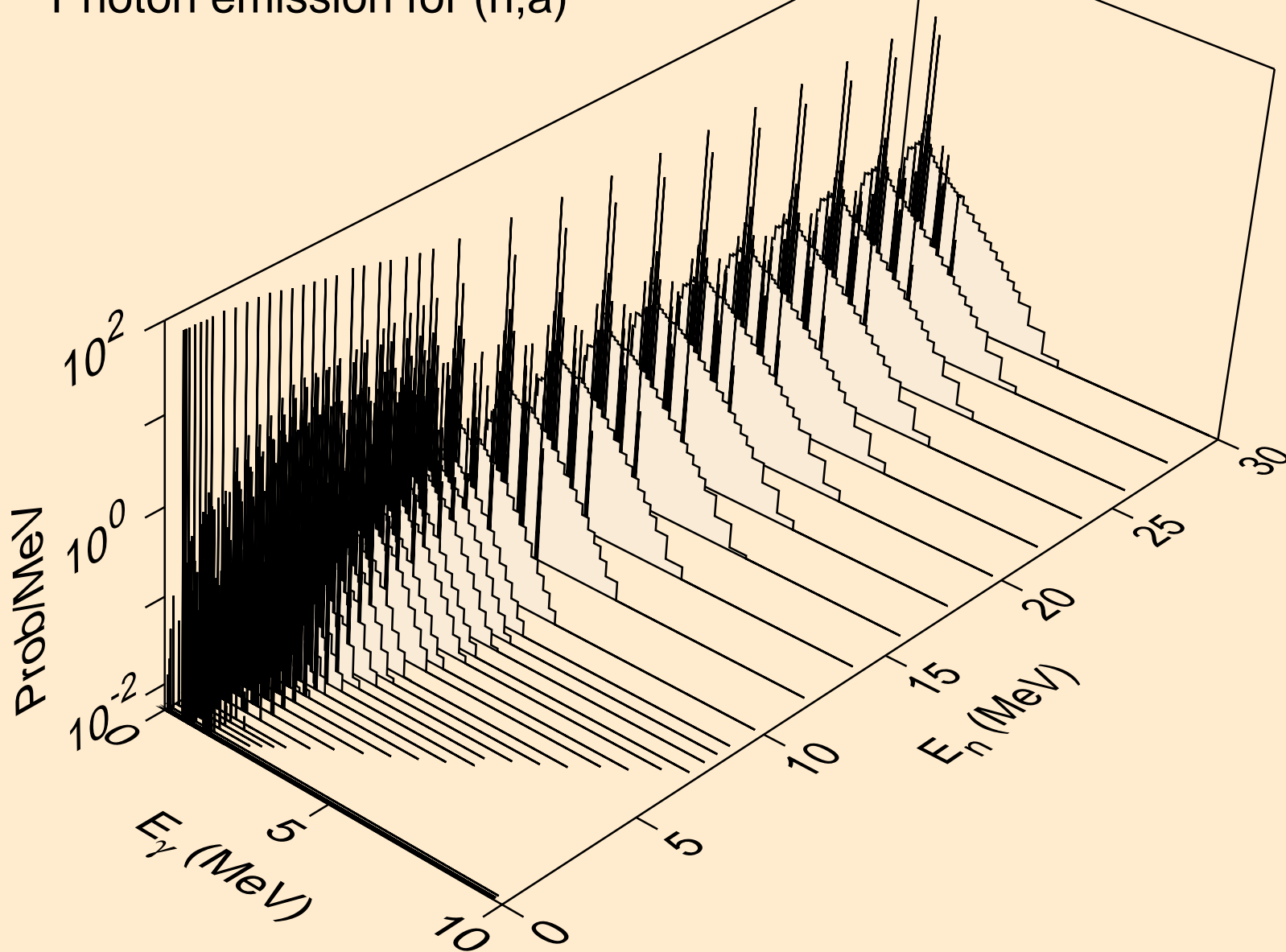

SN117 NEUTRON ACER TENDL-2019 LIBRARY; T=293.16K
Photon emission for (n,2a)

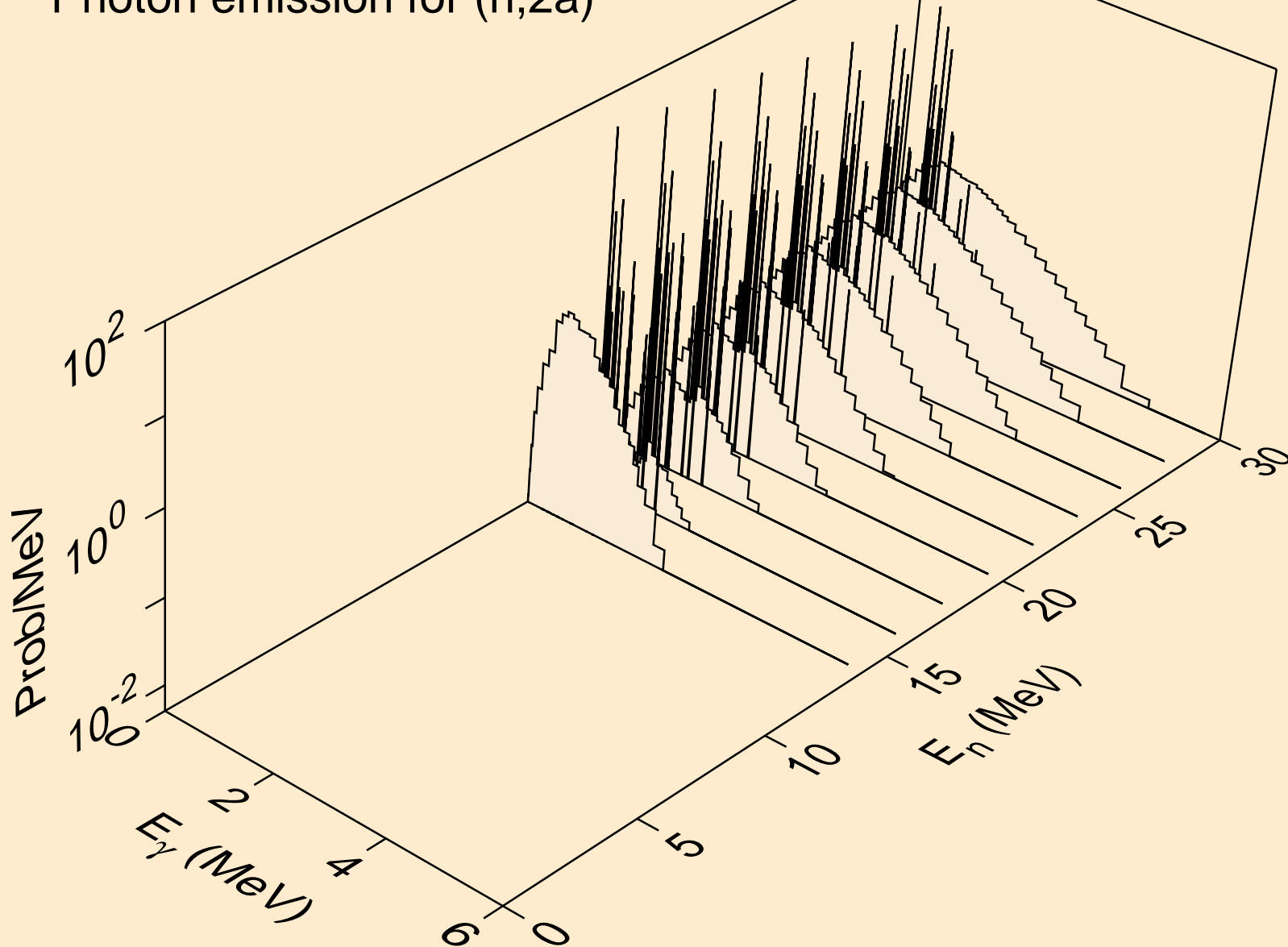

SN117 NEUTRON ACER TENDL-2019 LIBRARY; T=293.16K
Photon emission for (n,2p)

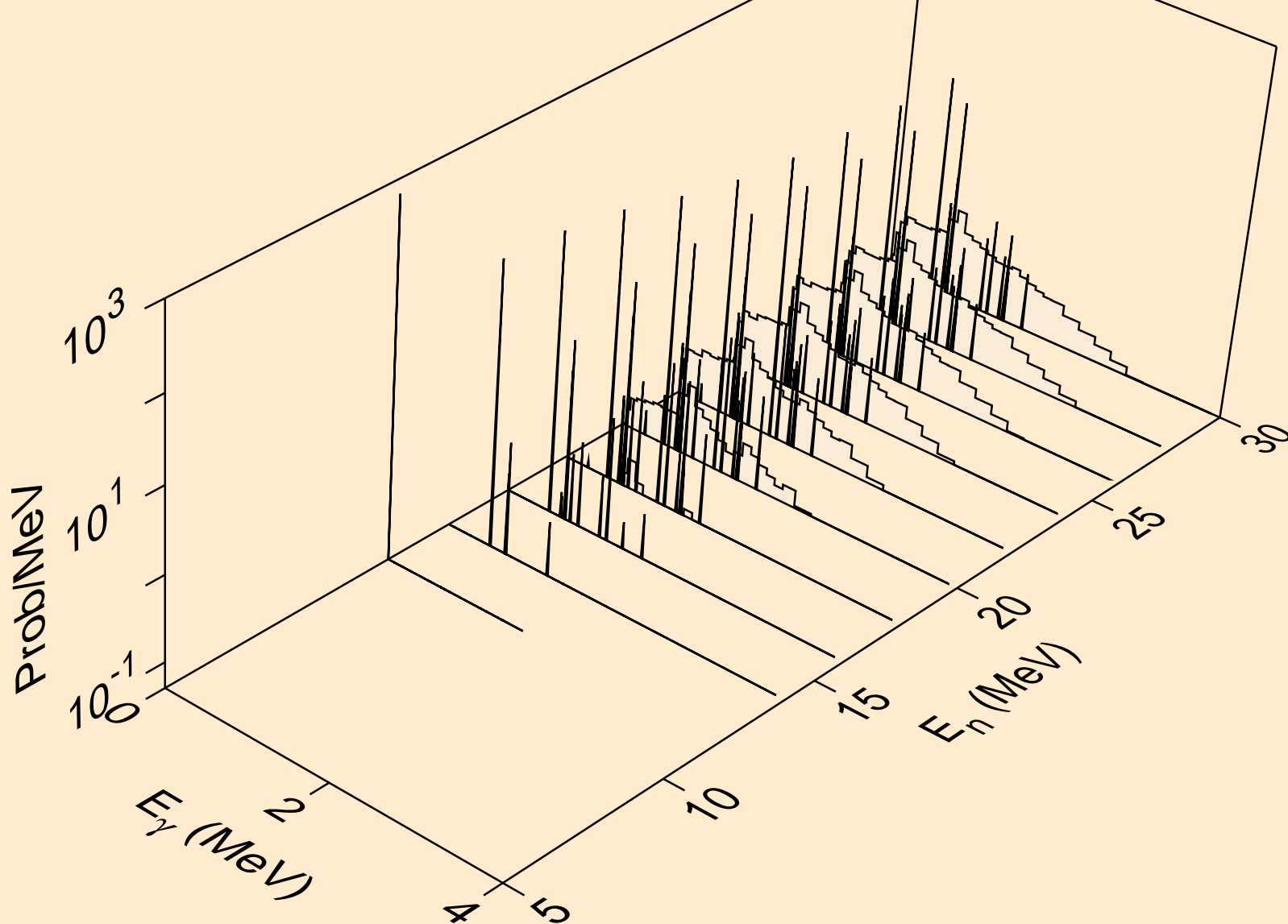

SN117 NEUTRON ACER TENDL-2019 LIBRARY; T=293.16K
Photon emission for (n,p)

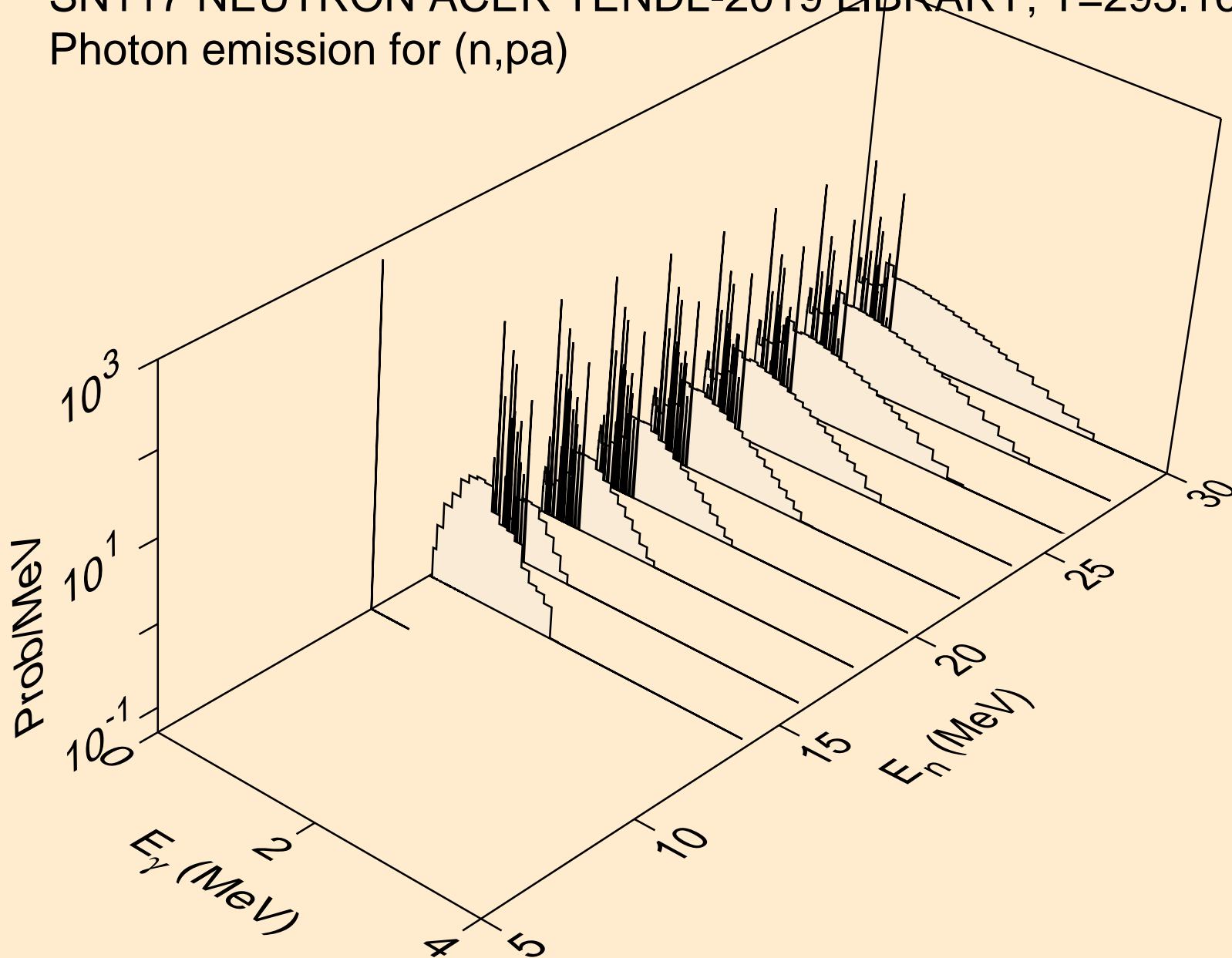

SN117 NEUTRON ACER TENDL-2019 LIBRARY; T=293.16K
Photon emission for (n,pd)

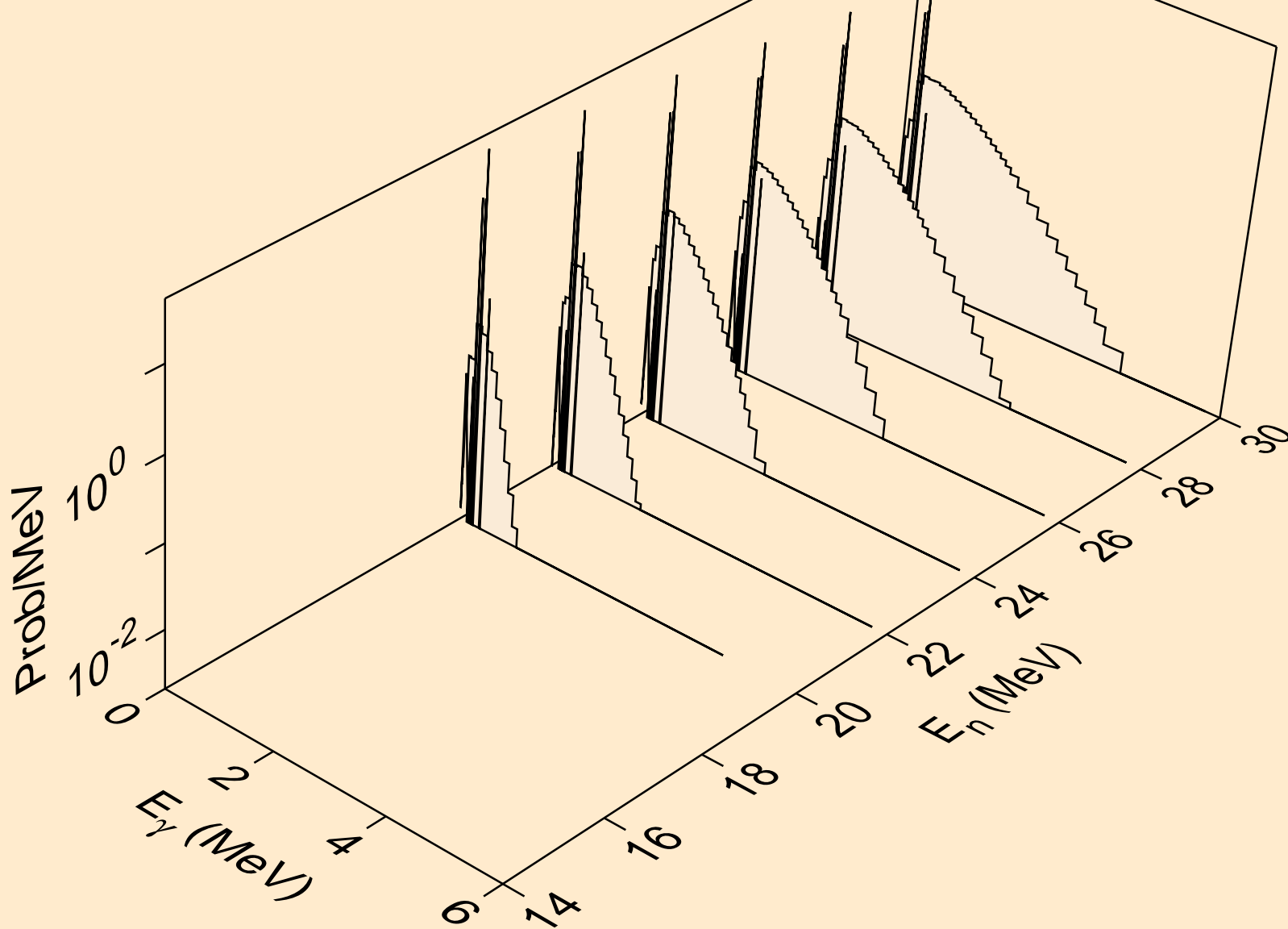

SN117 NEUTRON ACER TENDL-2019 LIBRARY; T=293.16K
Photon emission for (n,pt)

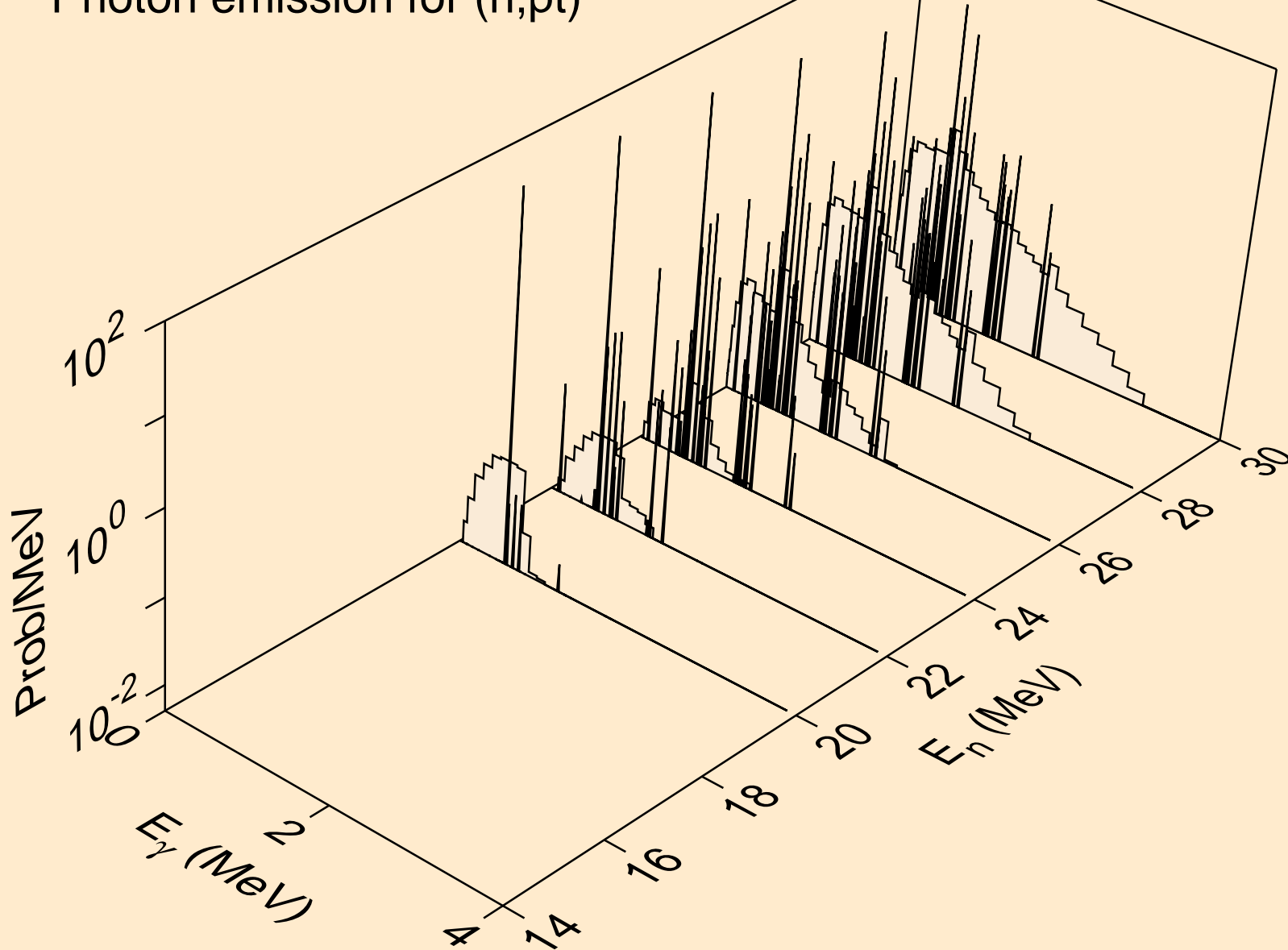

SN117 NEUTRON ACER TENDL-2019 LIBRARY; T=293.16K
Photon emission for (n,da)

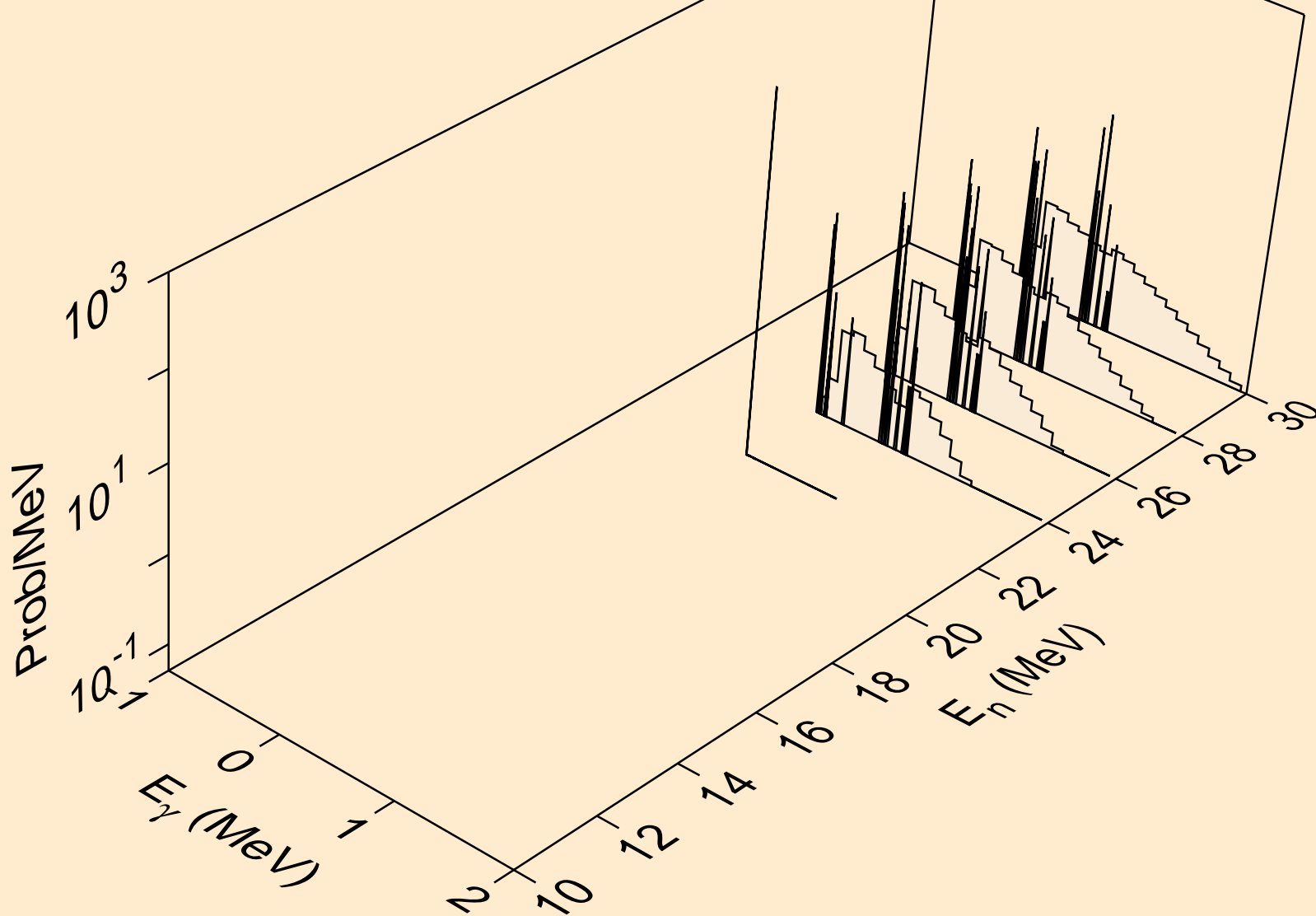

SN117 NEUTRON ACER TENDL-2019 LIBRARY; T=293.16K
thermal capture photon spectrum

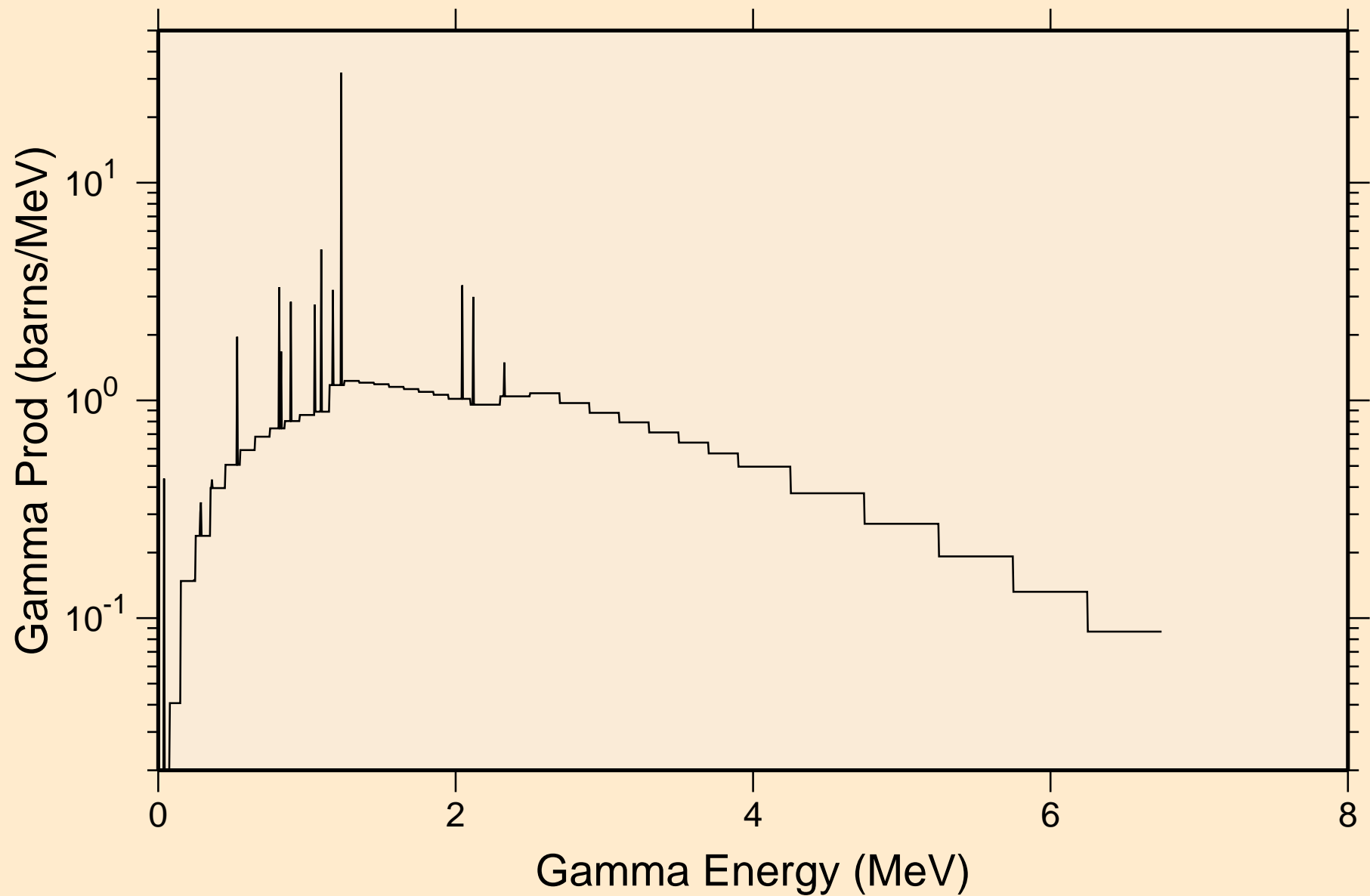

SN117 NEUTRON ACER TENDL-2019 LIBRARY; T=293.16K
14 MeV photon spectrum

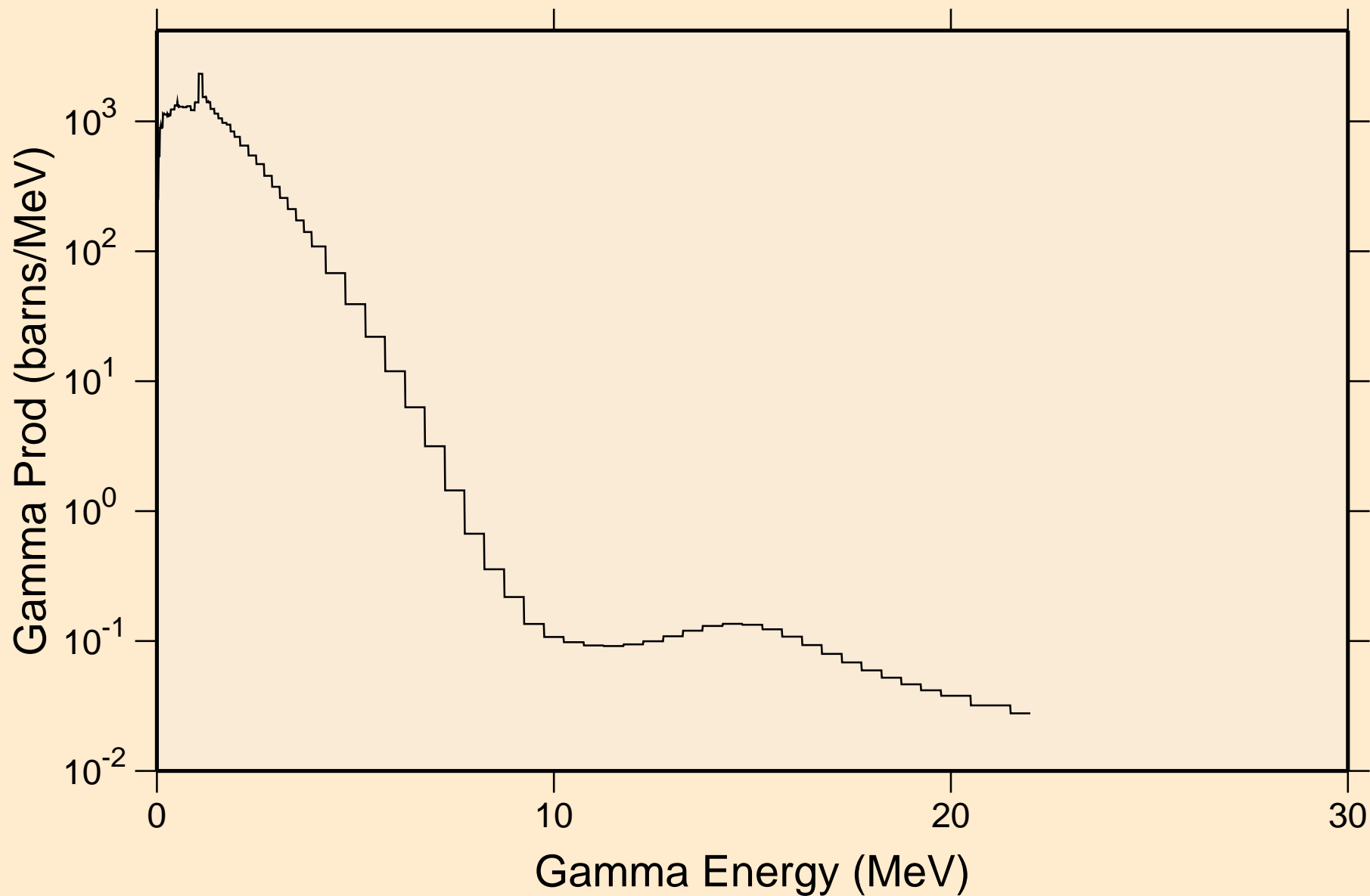

SN117 NEUTRON ACER TENDL-2019 LIBRARY; T=293.16K

Particle heating contributions

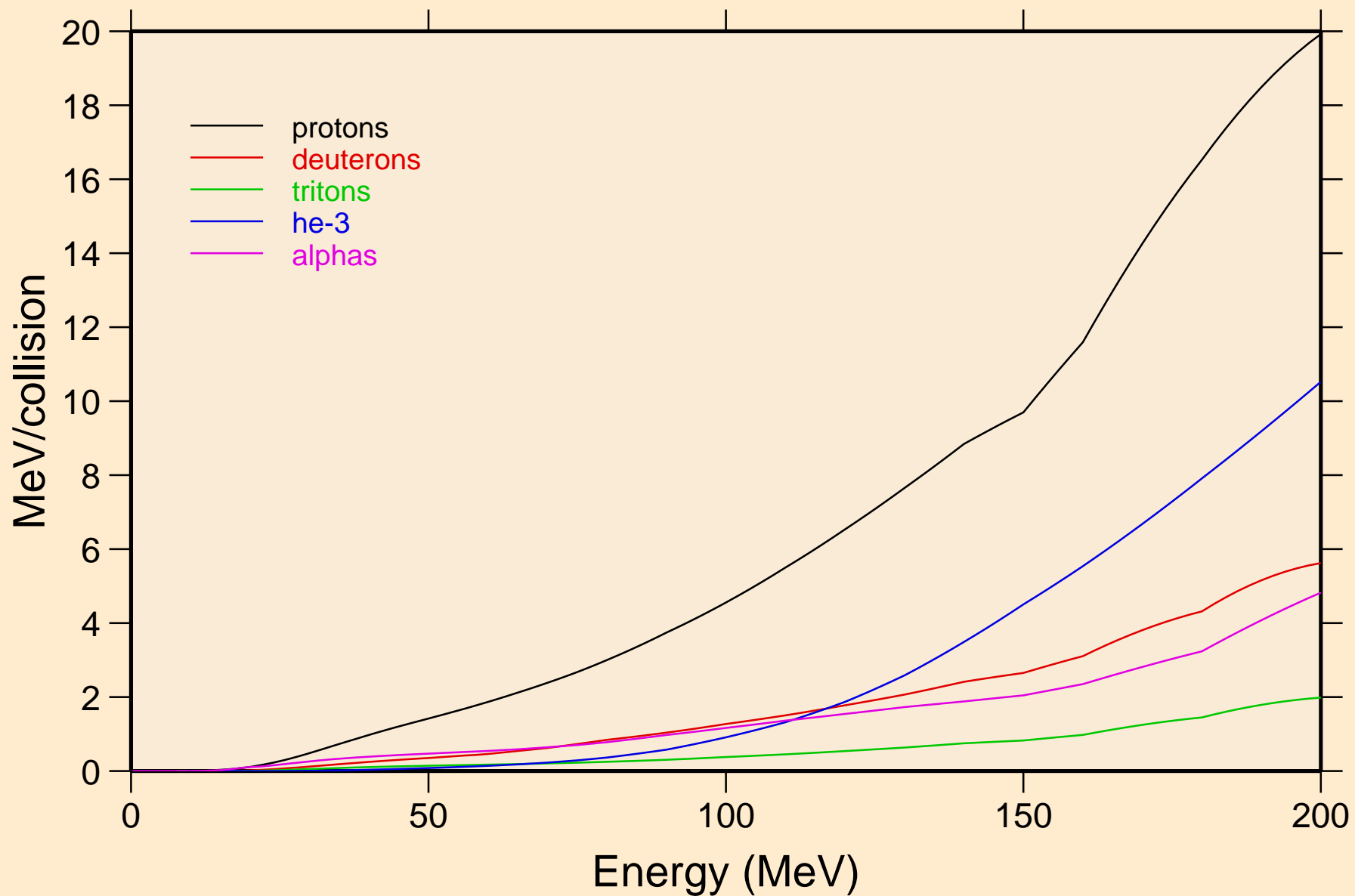

SN117 NEUTRON ACER TENDL-2019 LIBRARY; T=293.16K

Recoil Heating

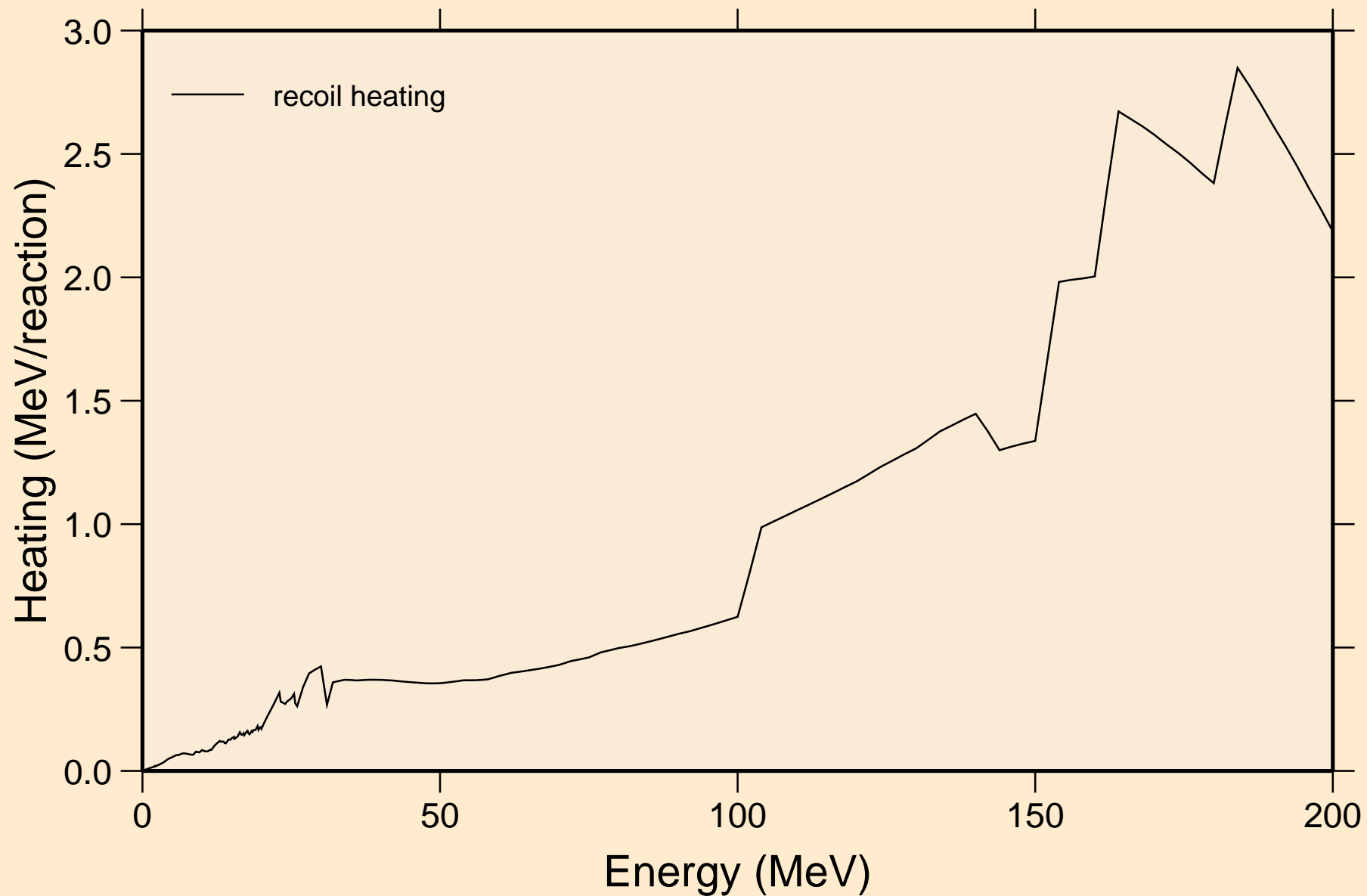

SN117 NEUTRON ACER TENDL-2019 LIBRARY; T=293.16K

Particle production cross sections

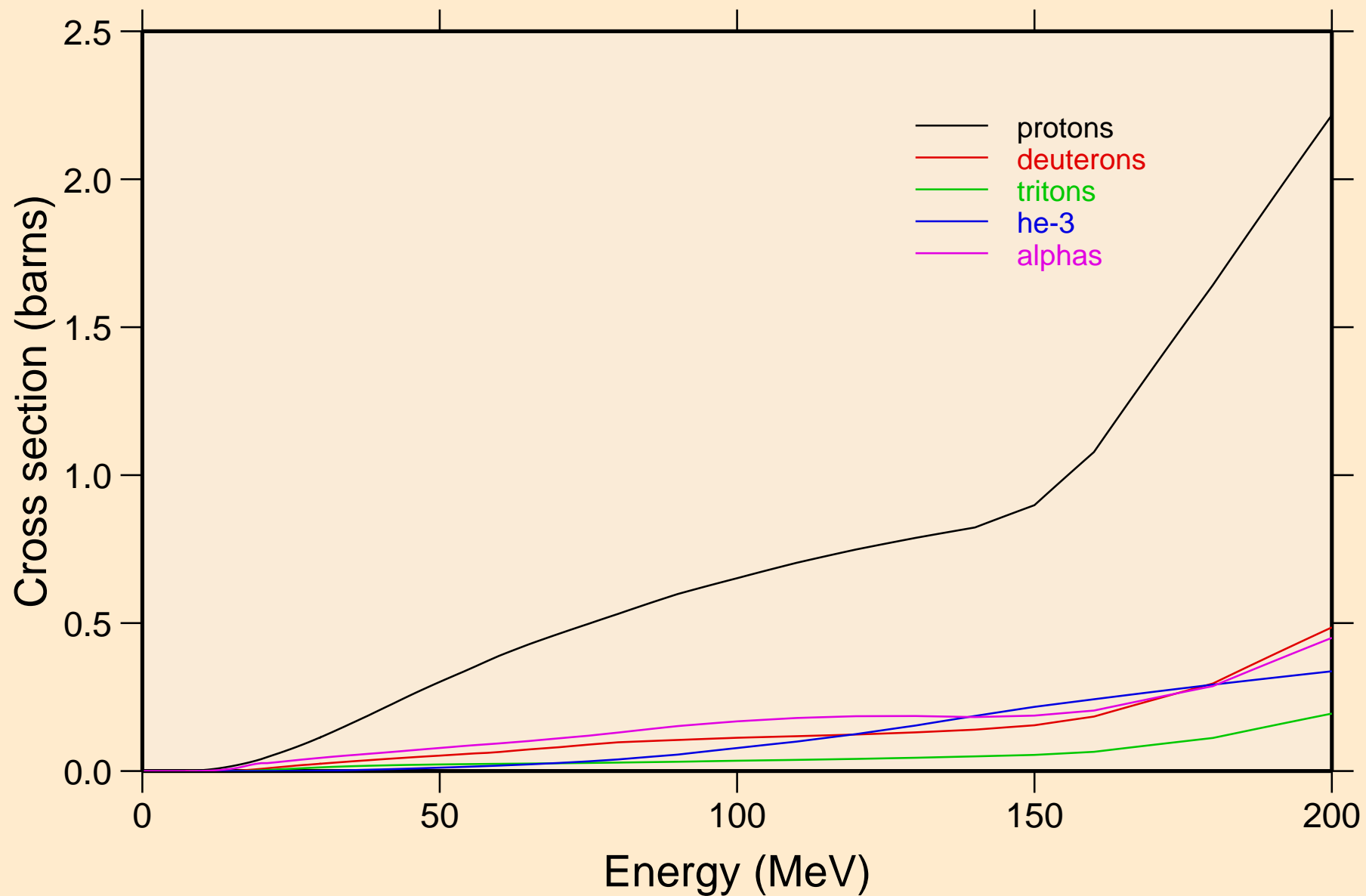

SN117 NEUTRON ACER TENDL-2019 LIBRARY; T=293.16K
protons from (n,x)

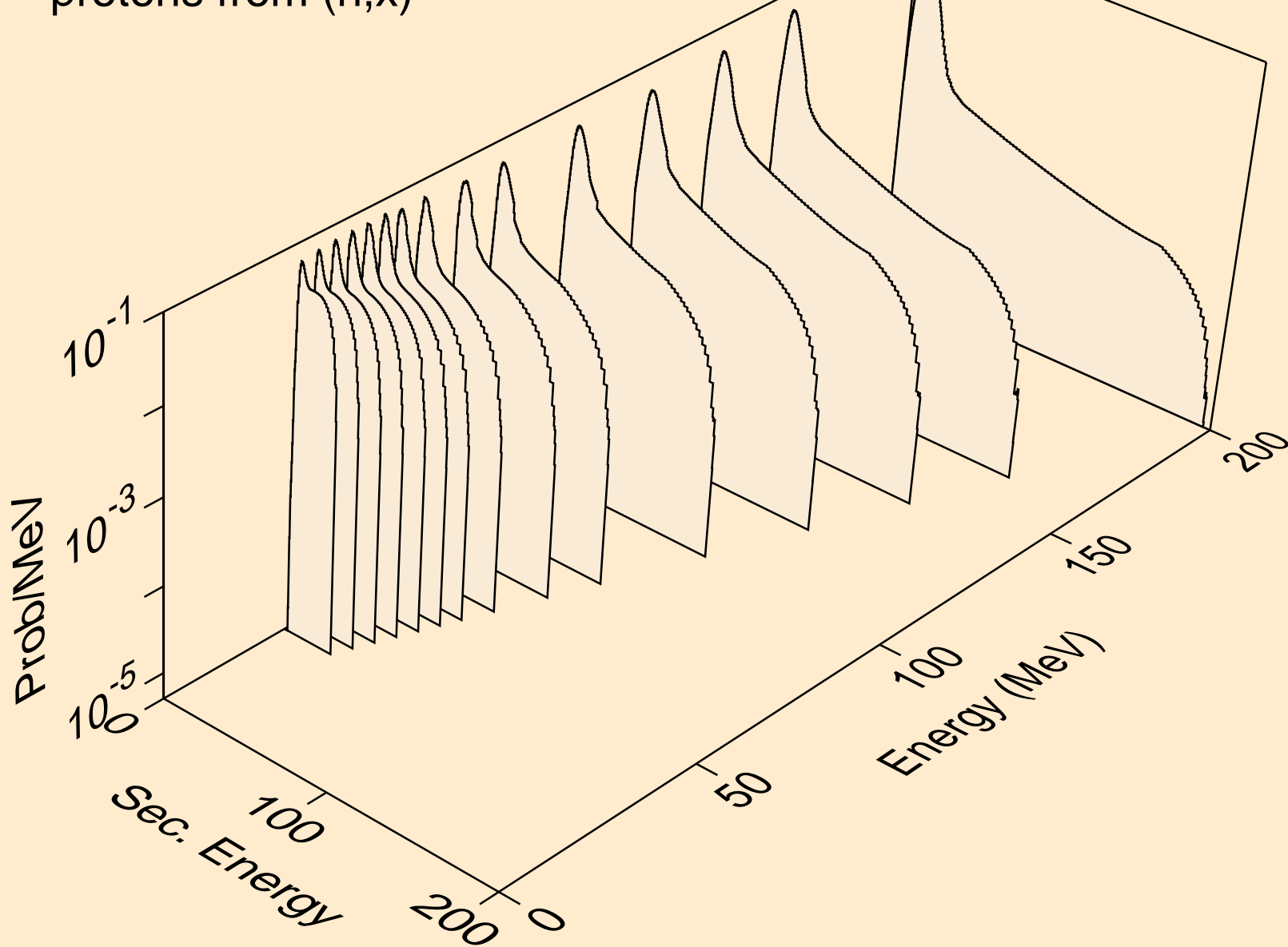

SN117 NEUTRON ACER TENDL-2019 LIBRARY; T=293.16K
protons from (n,n*)p

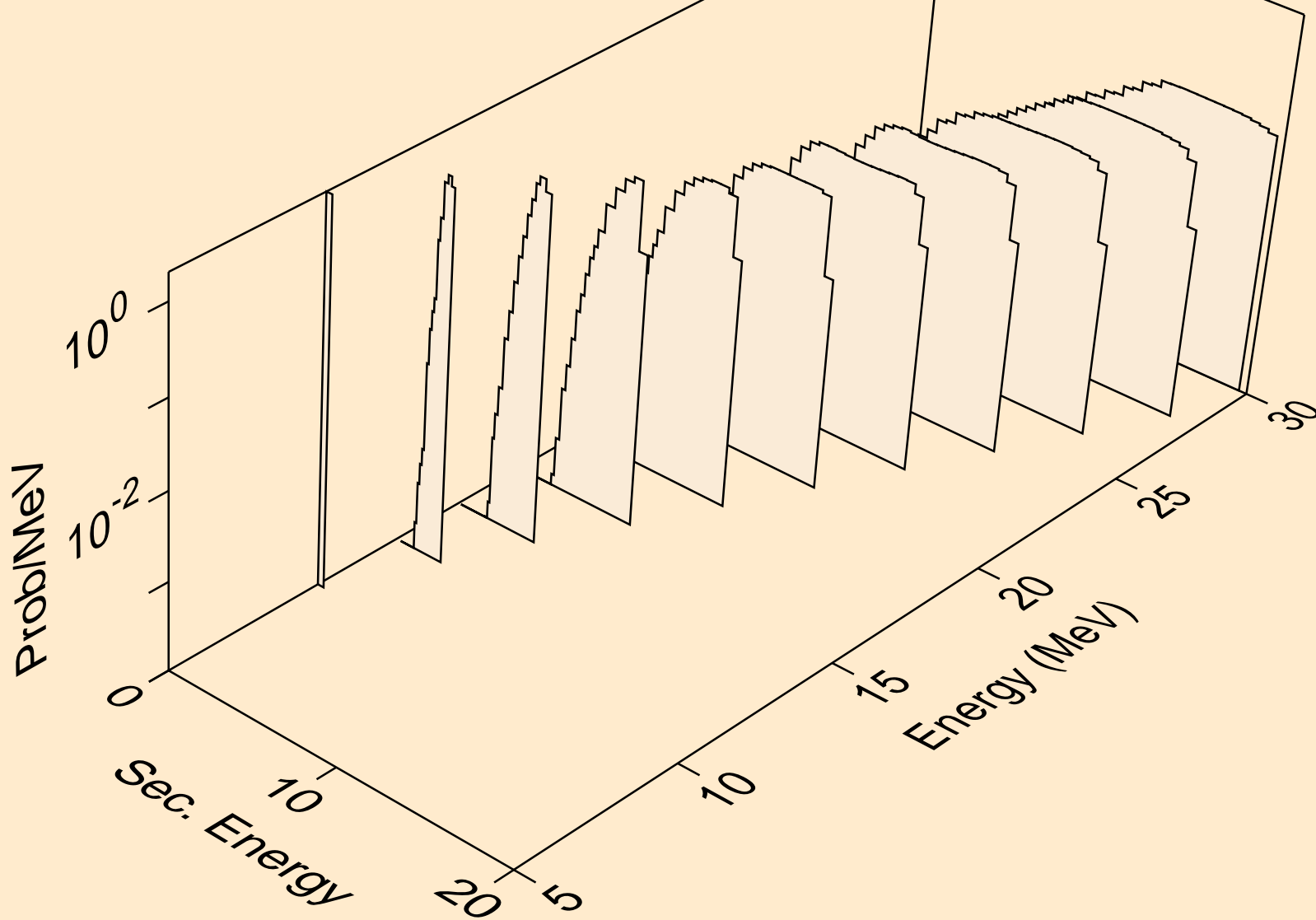

SN117 NEUTRON ACER TENDL-2019 LIBRARY; T=293.16K
protons from (n,2np)

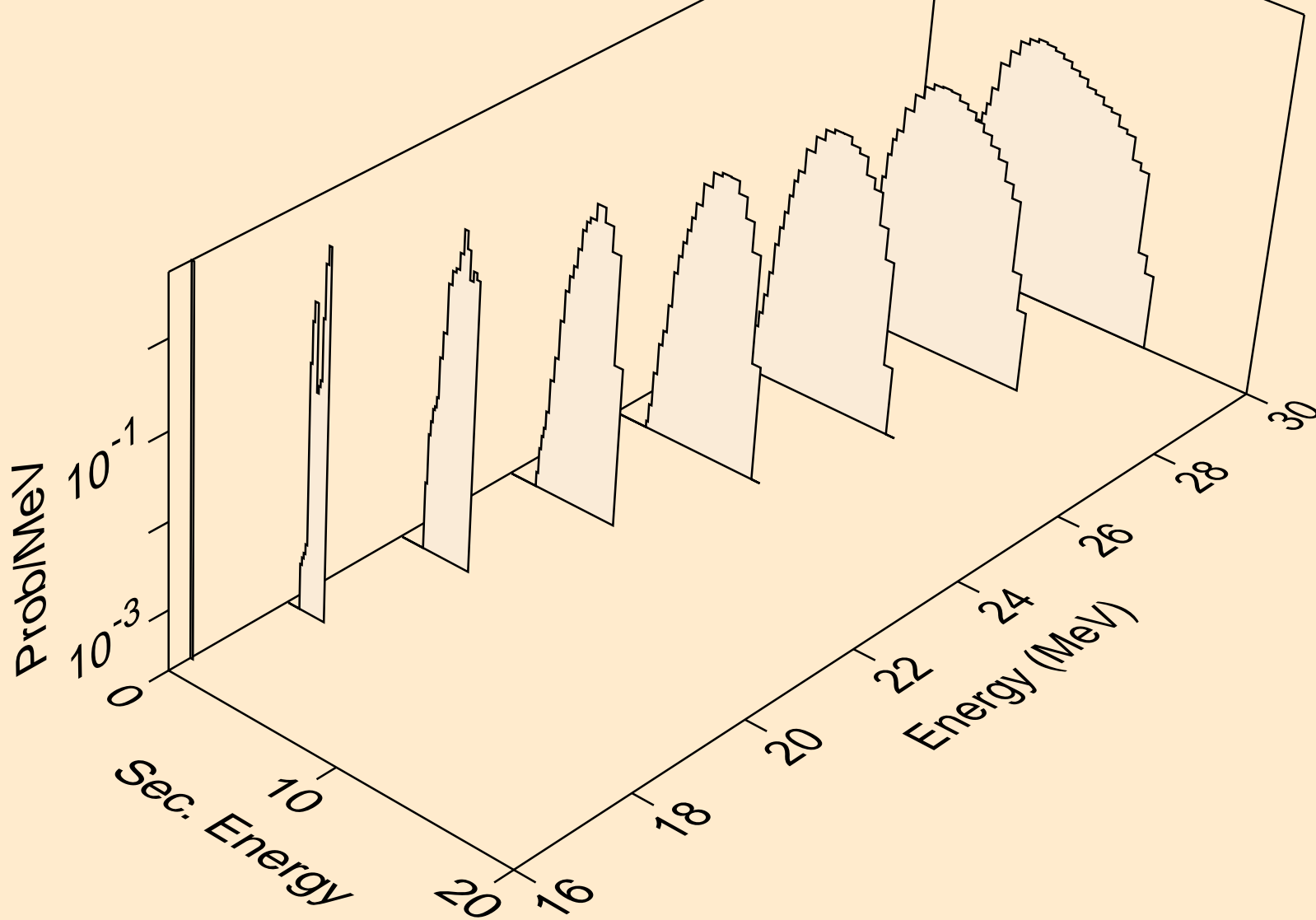

SN117 NEUTRON ACER TENDL-2019 LIBRARY; T=293.16K
protons from (n,3np)

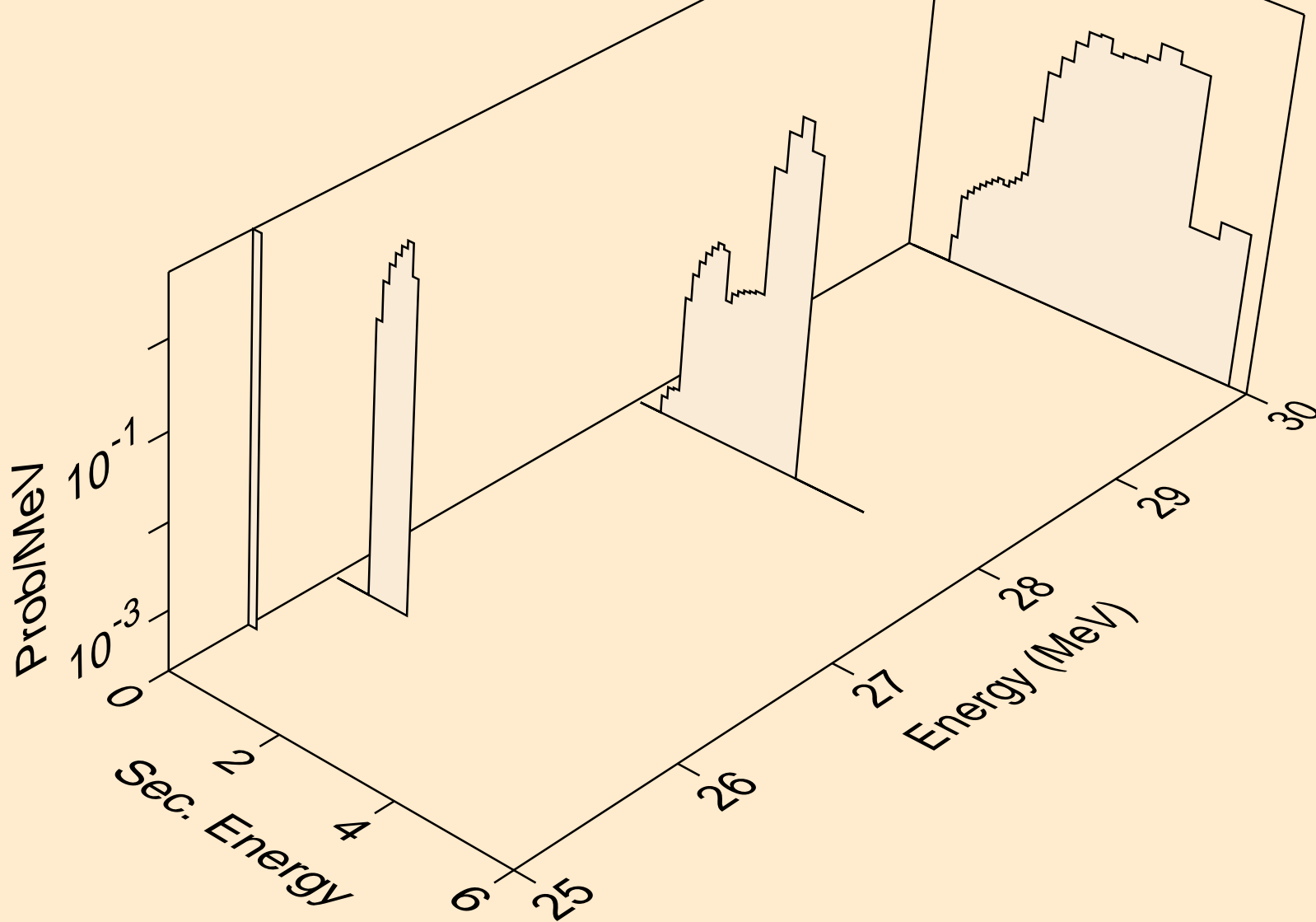

SN117 NEUTRON ACER TENDL-2019 LIBRARY; T=293.16K
protons from (n,2np)

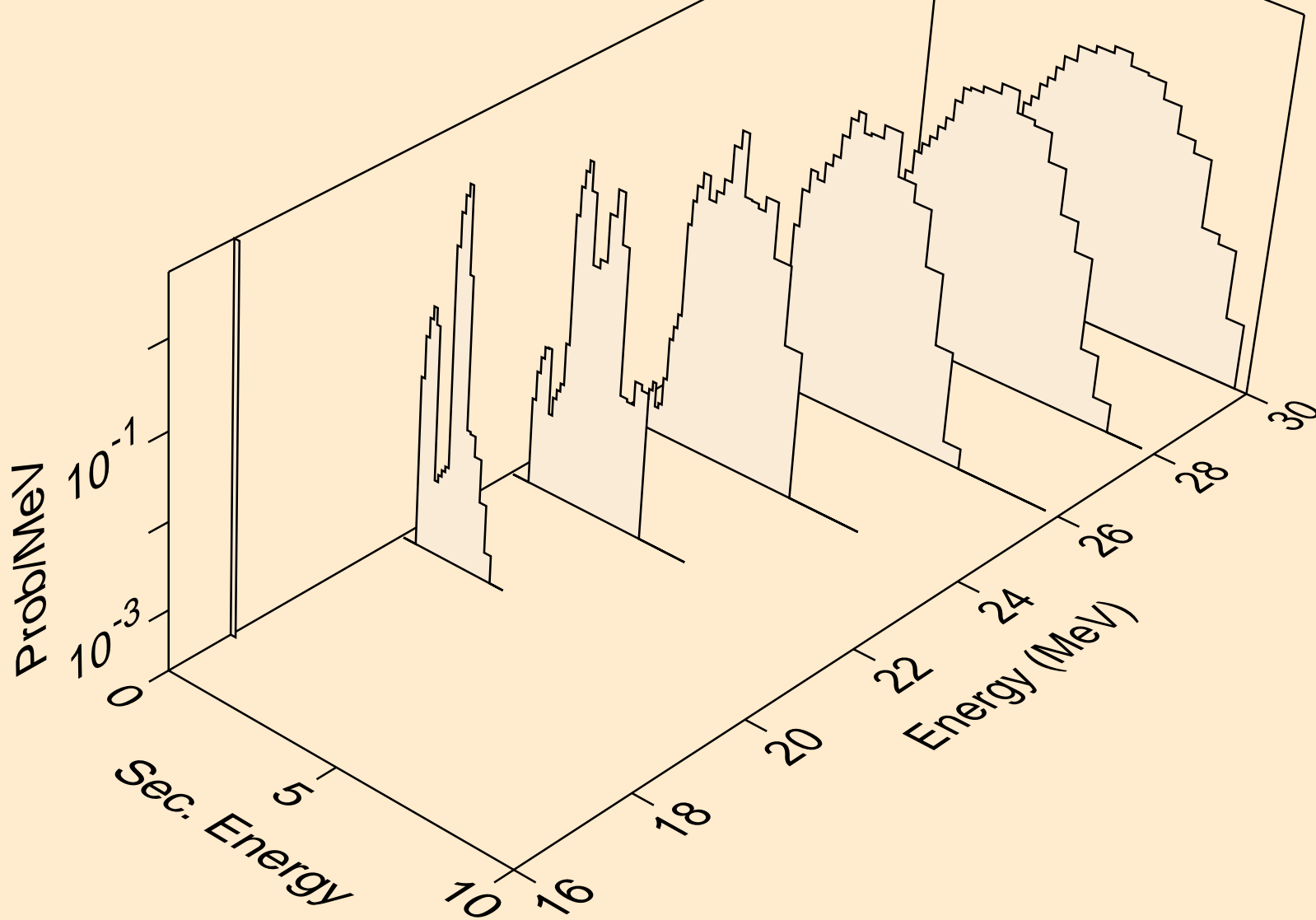

SN117 NEUTRON ACER TENDL-2019 LIBRARY; T=293.16K
protons from (n,npa)

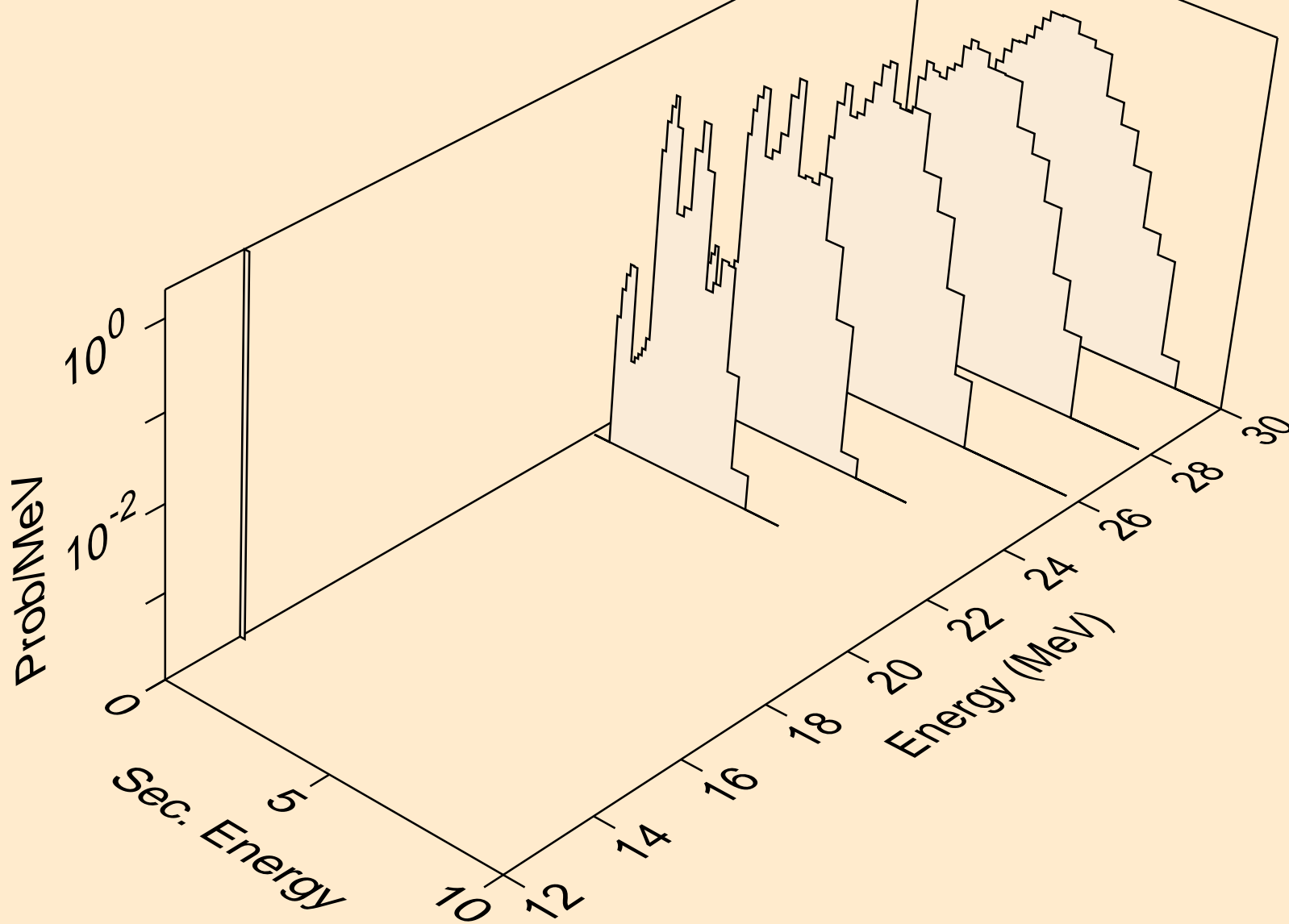

SN117 NEUTRON ACER TENDL-2019 LIBRARY; T=293.16K
protons from (n,p)

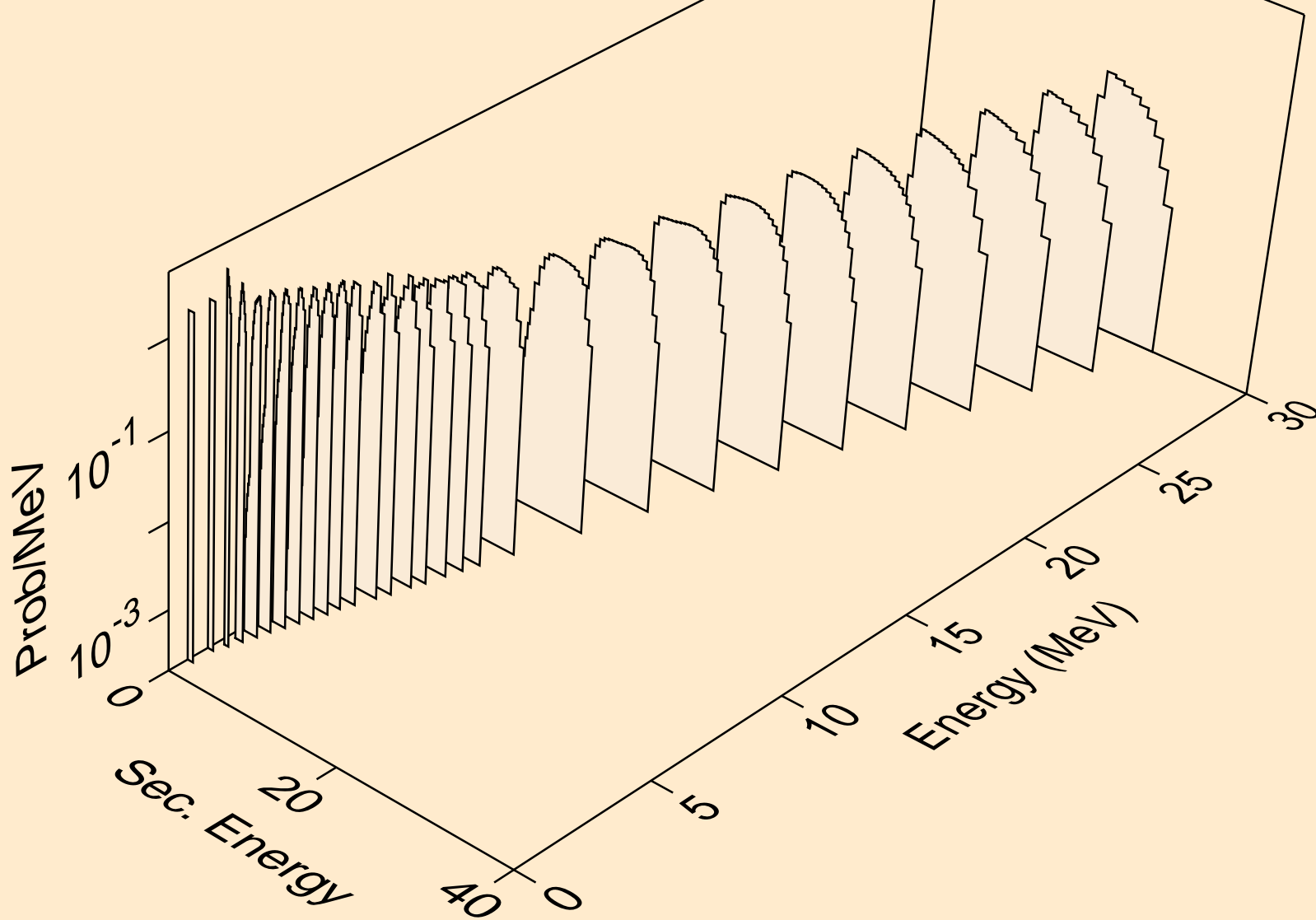

SN117 NEUTRON ACER TENDL-2019 LIBRARY; T=293.16K
protons from (n,2p)

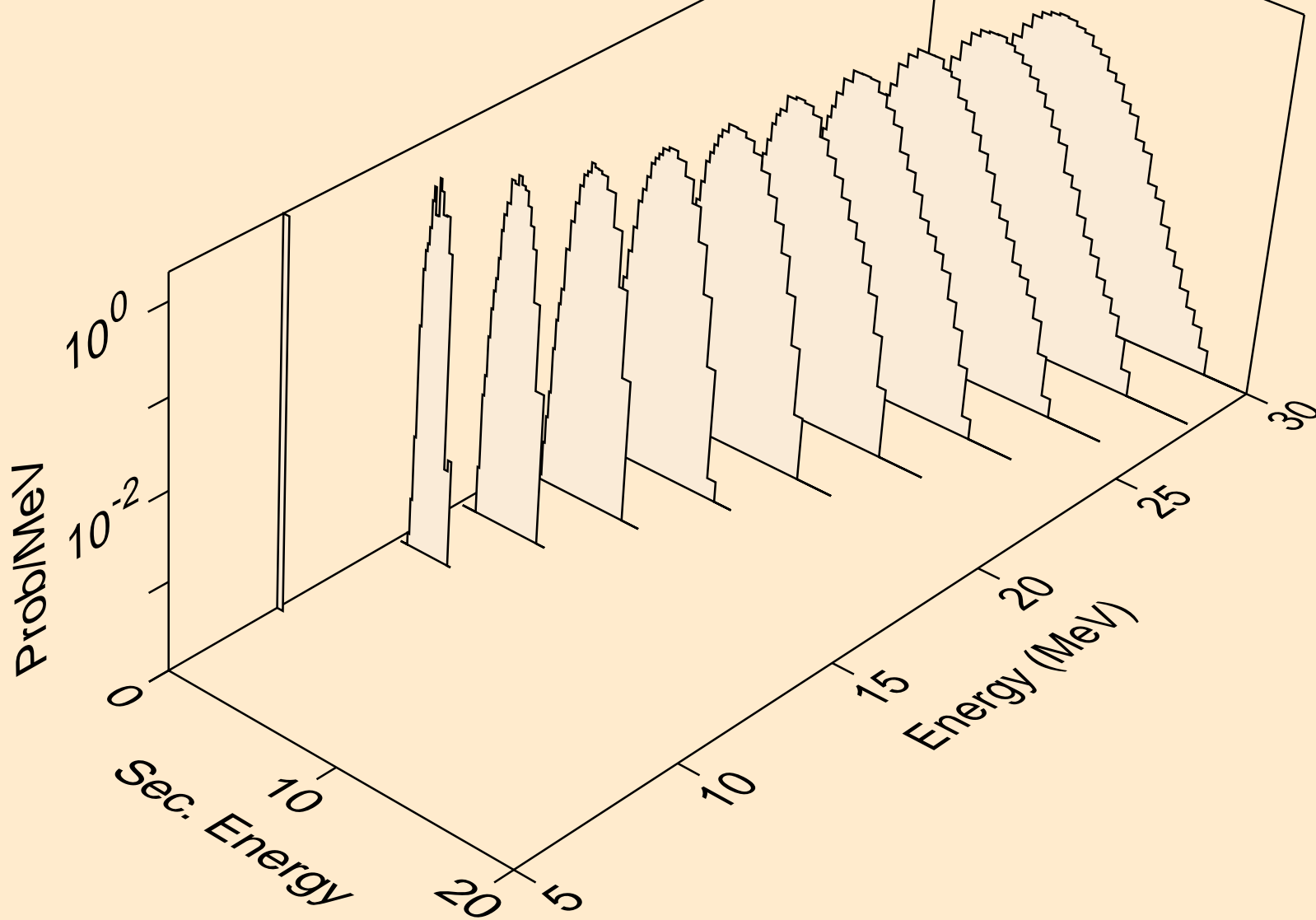

SN117 NEUTRON ACER TENDL-2019 LIBRARY; T=293.16K
protons from (n,p)

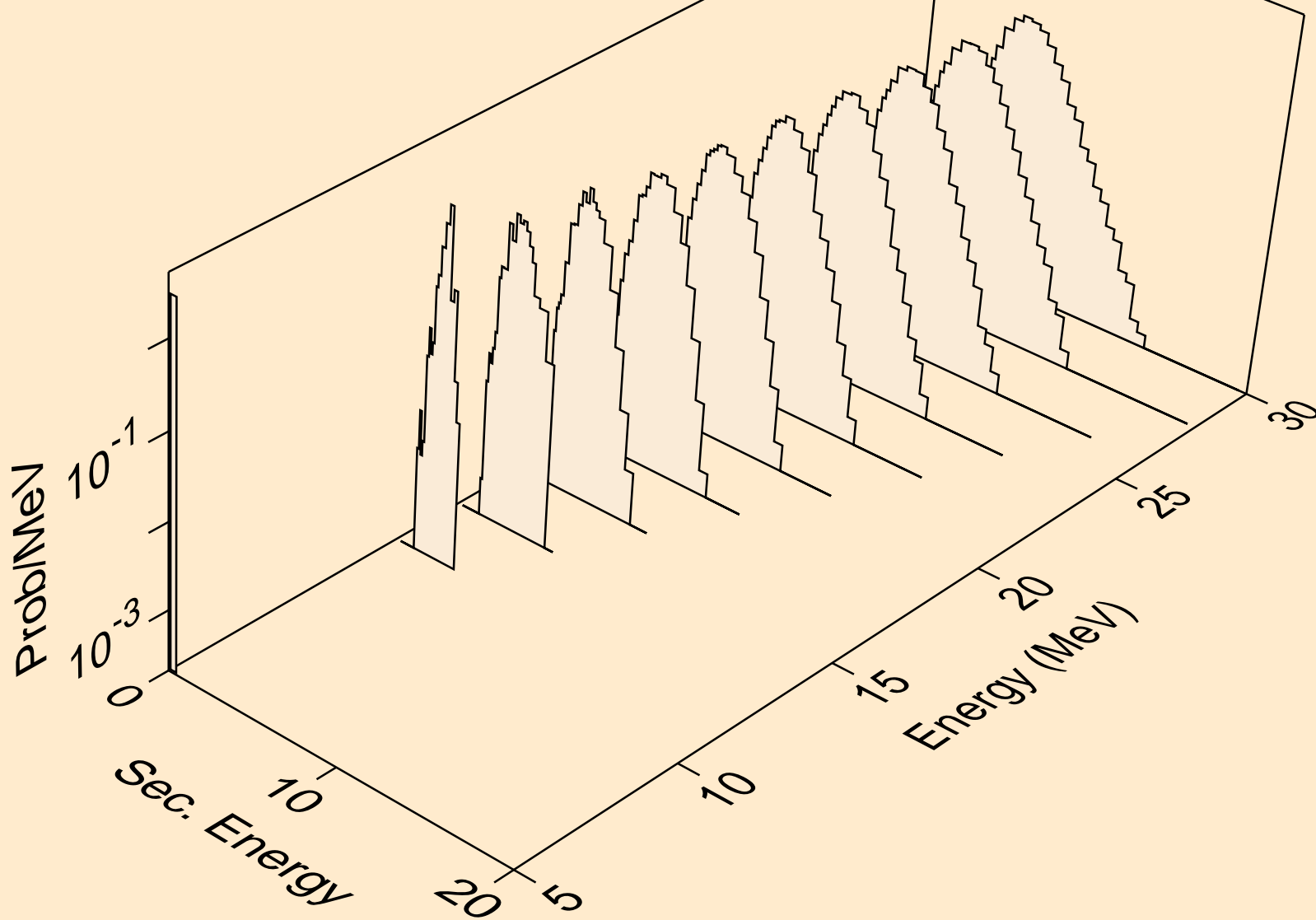

SN117 NEUTRON ACER TENDL-2019 LIBRARY; T=293.16K
protons from (n,pd)

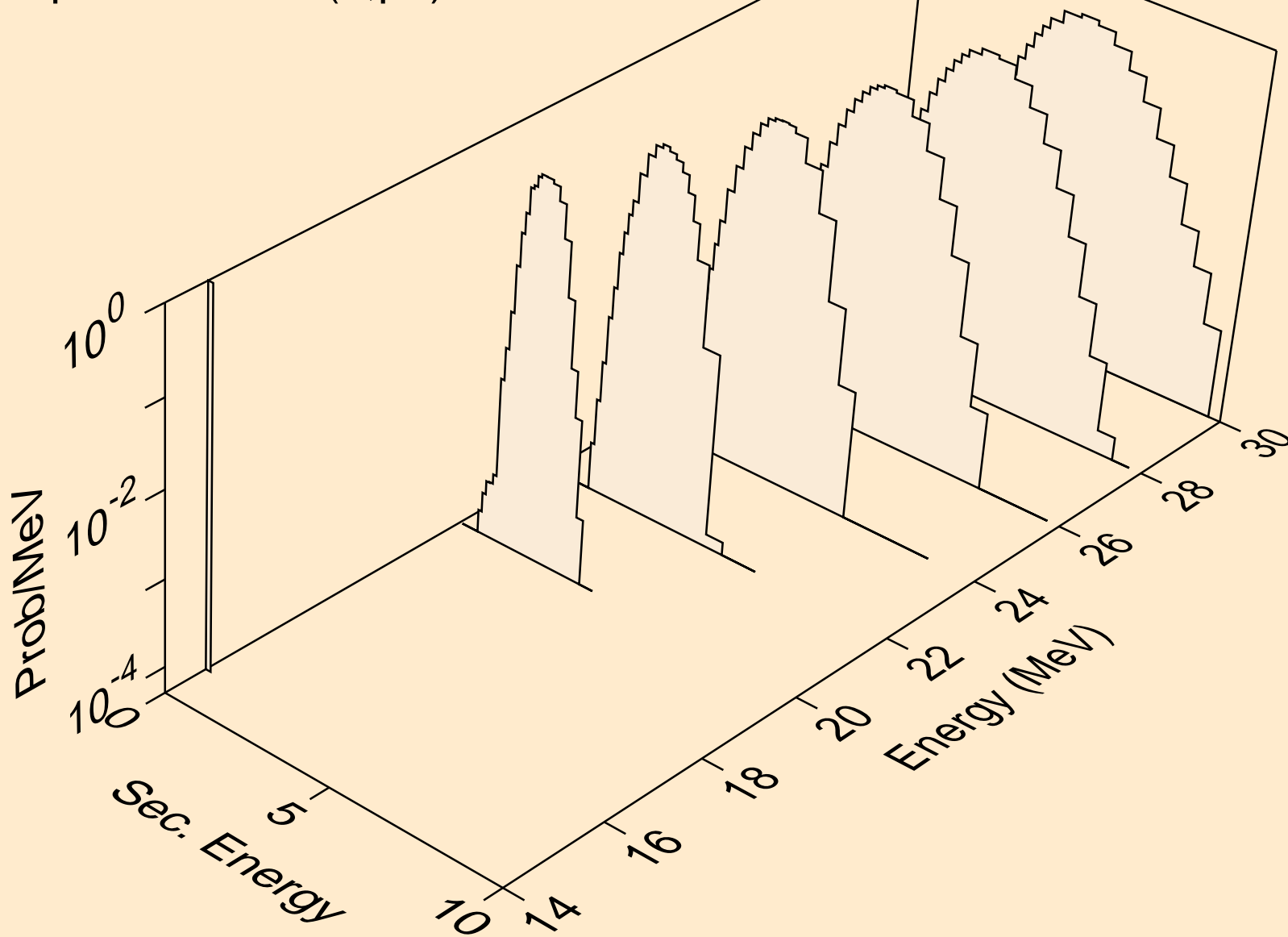

SN117 NEUTRON ACER TENDL-2019 LIBRARY; T=293.16K
protons from (n,pt)

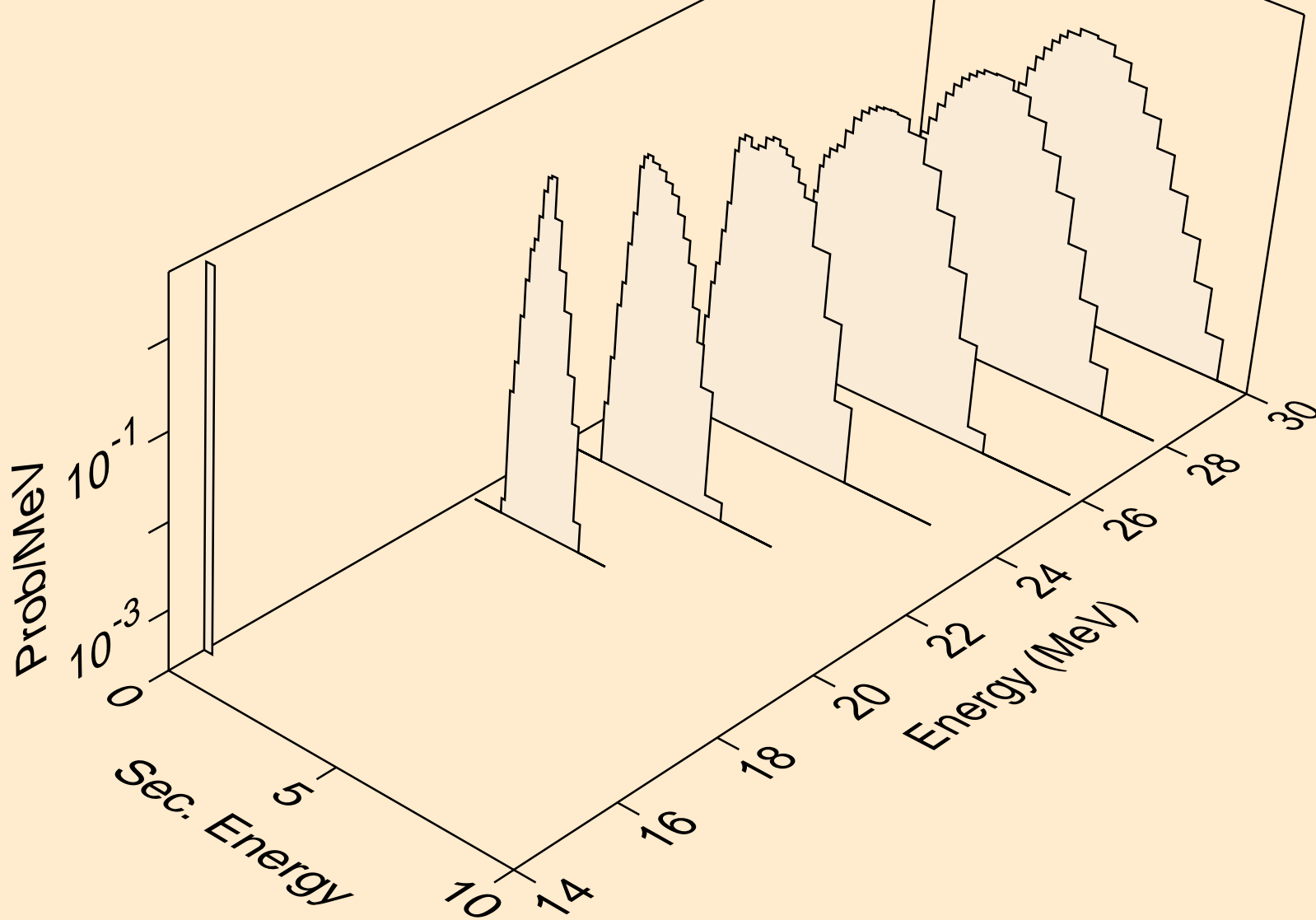

SN117 NEUTRON ACER TENDL-2019 LIBRARY; T=293.16K
deuterons from (n,x)

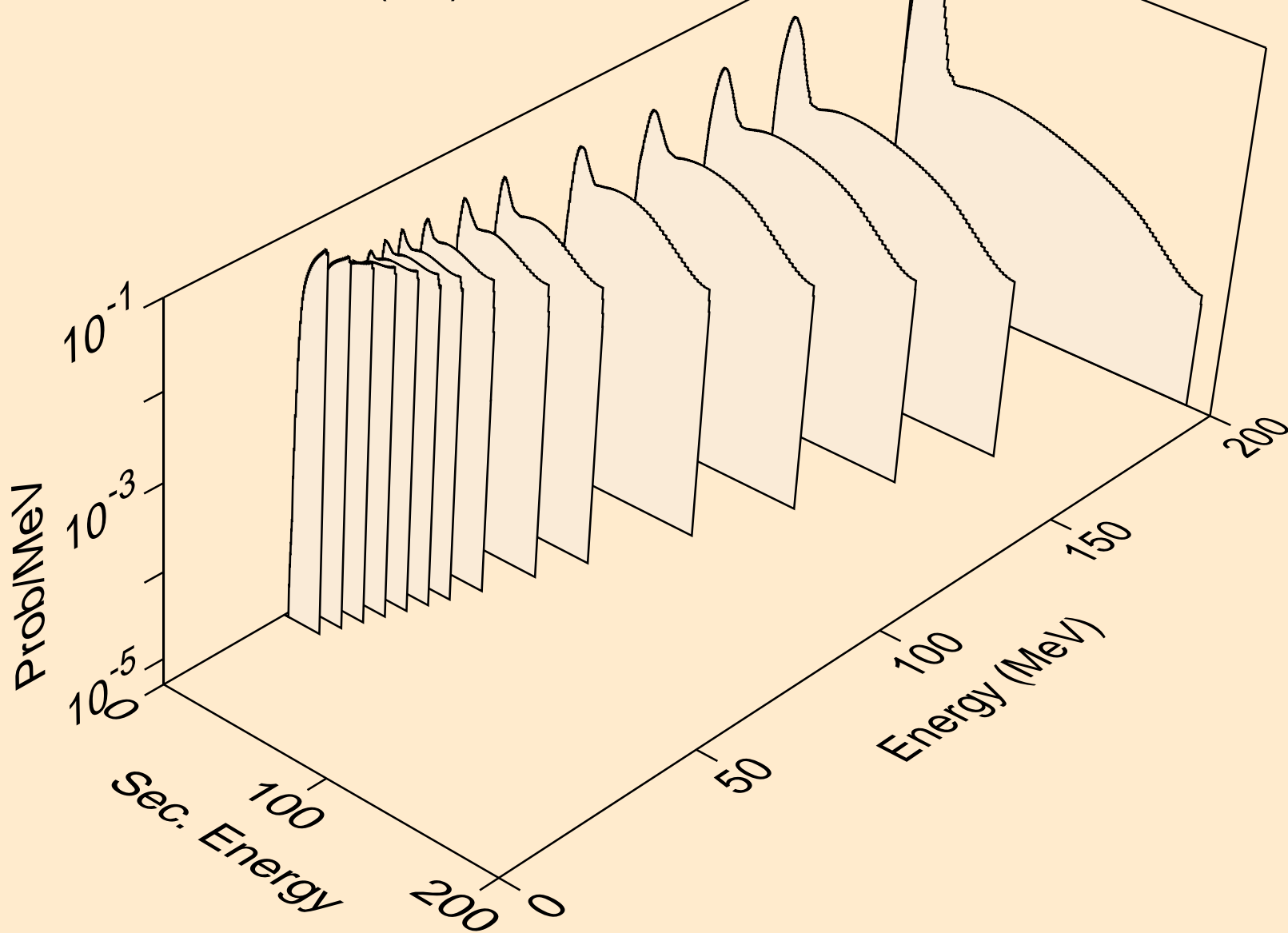

SN117 NEUTRON ACER TENDL-2019 LIBRARY; T=293.16K
deuterons from (n,2nd)

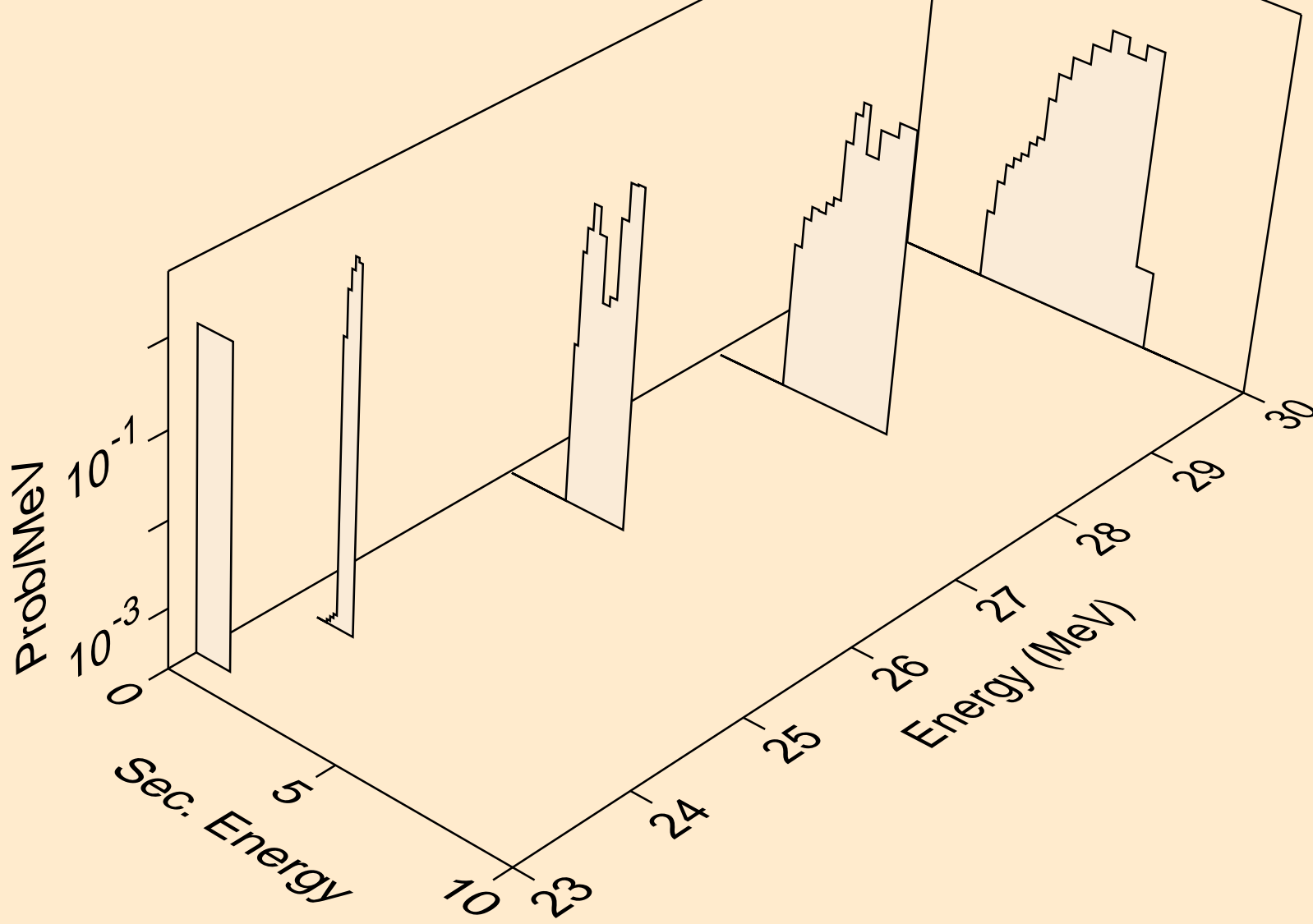

SN117 NEUTRON ACER TENDL-2019 LIBRARY; T=293.16K
deuterons from (n,n*)d

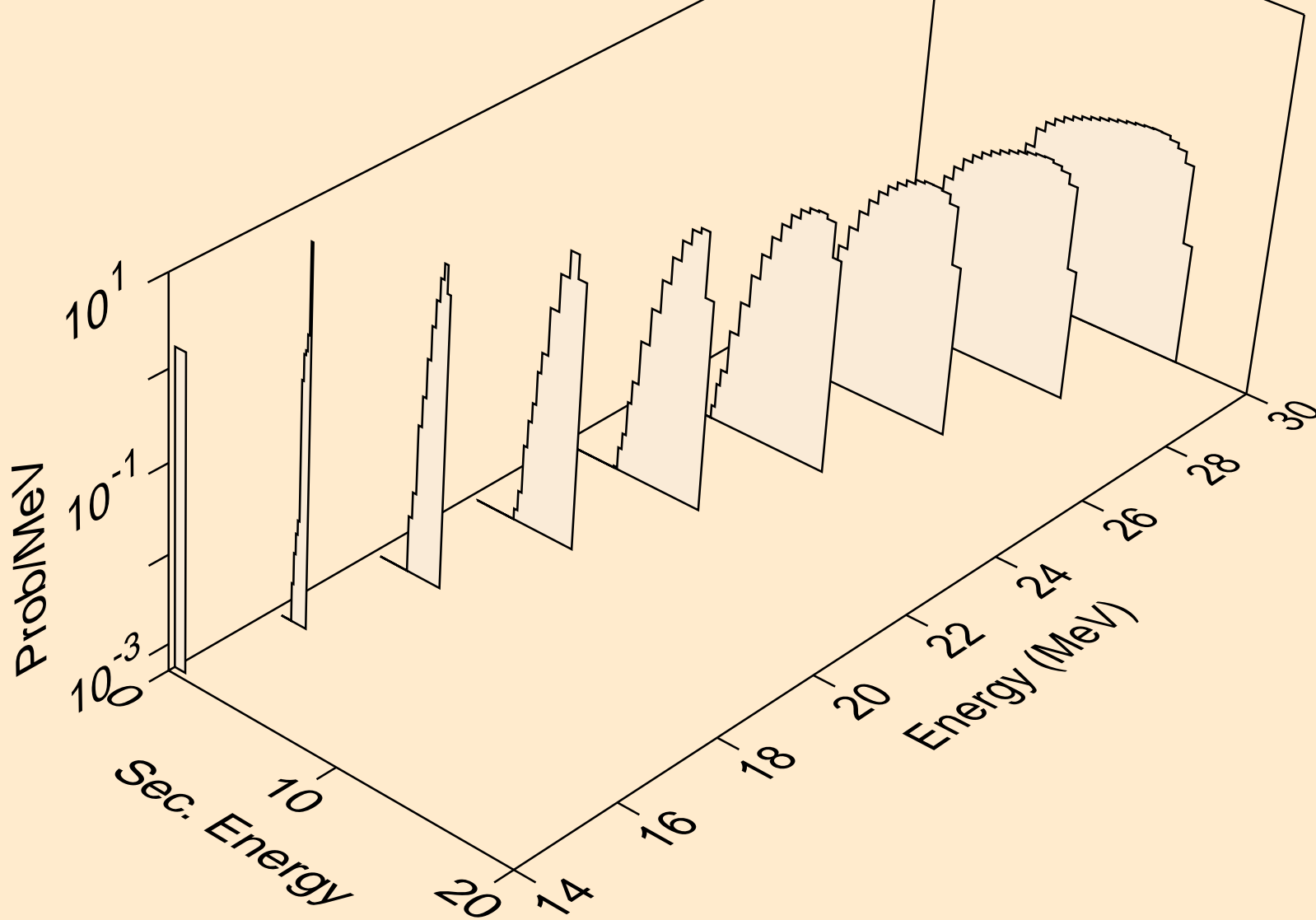

SN117 NEUTRON ACER TENDL-2019 LIBRARY; T=293.16K
deuterons from (n,d)

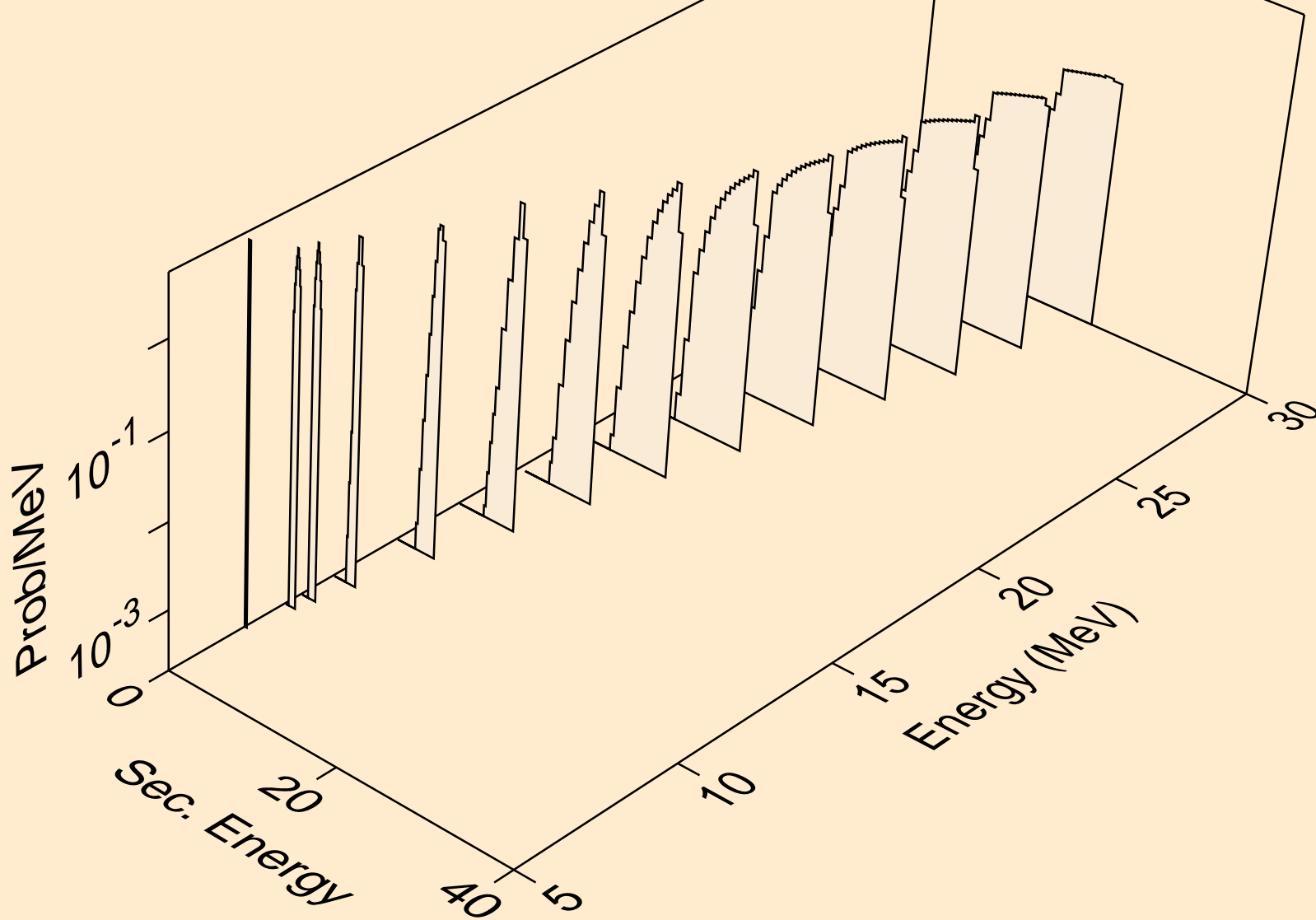

SN117 NEUTRON ACER TENDL-2019 LIBRARY; T=293.16K
deuterons from (n,pd)

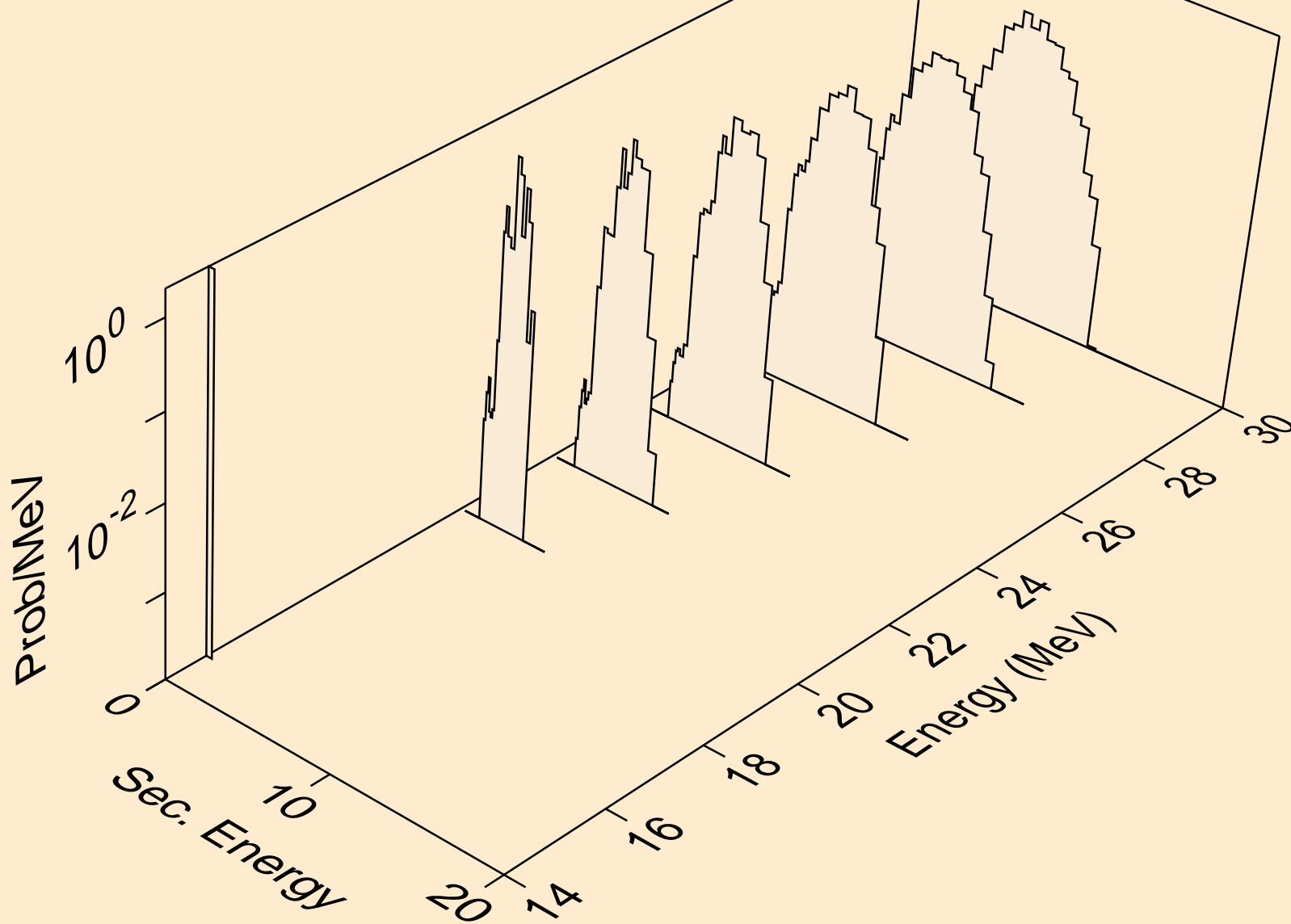

SN117 NEUTRON ACER TENDL-2019 LIBRARY; T=293.16K
deuterons from (n,da)

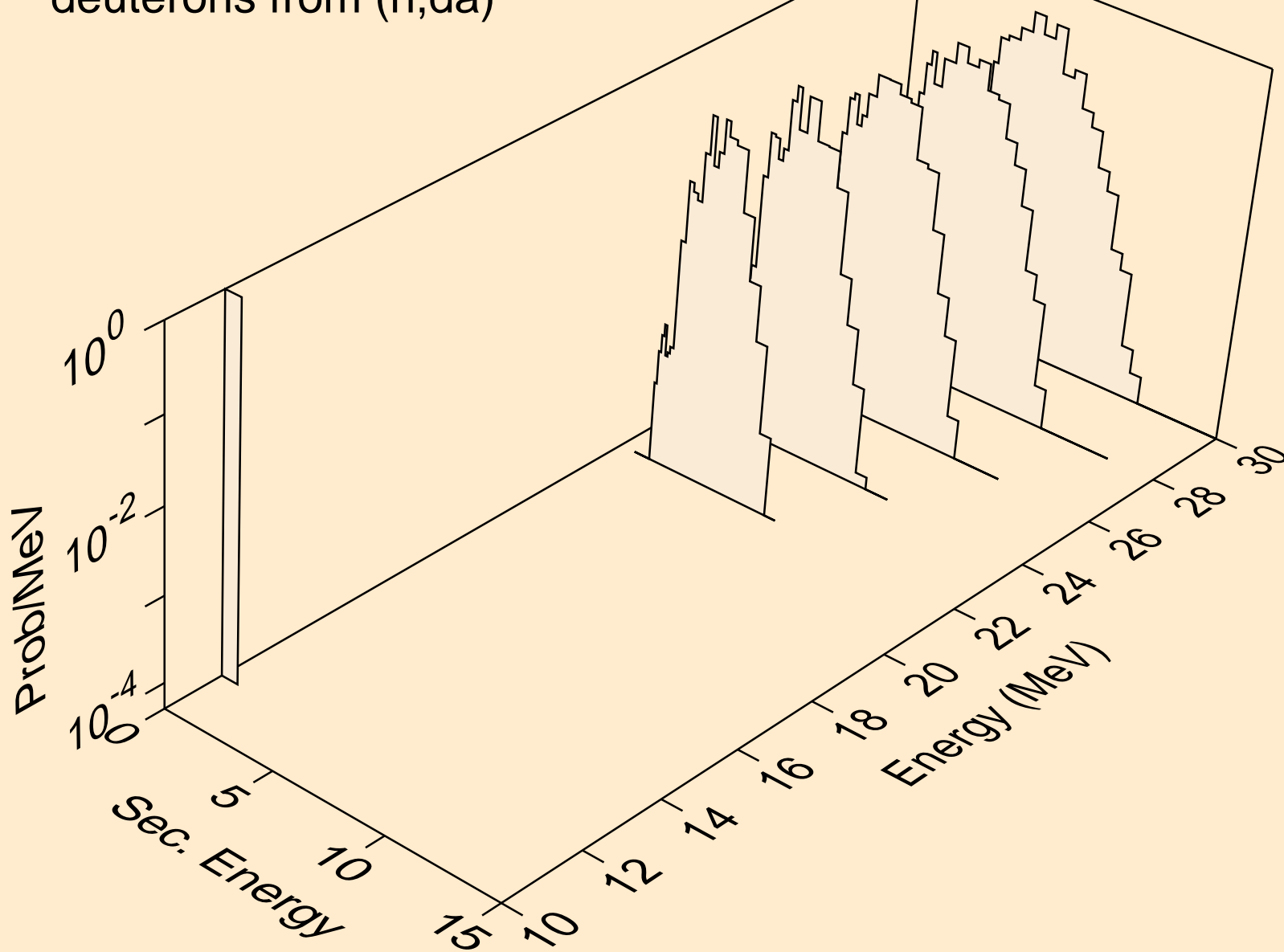

SN117 NEUTRON ACER TENDL-2019 LIBRARY; T=293.16K
tritons from (n,x)

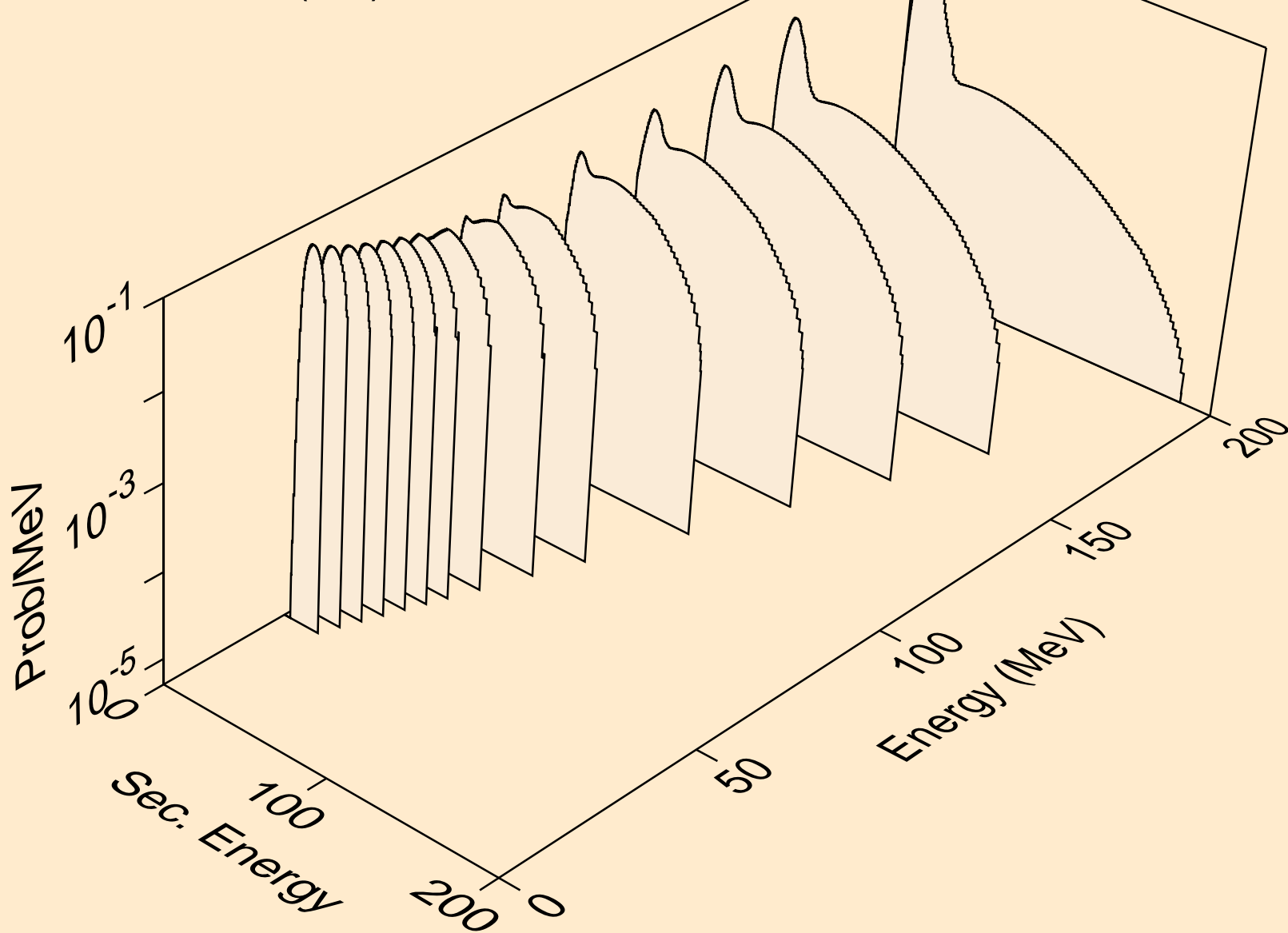

SN117 NEUTRON ACER TENDL-2019 LIBRARY; T=293.16K
tritons from (n,n*)t

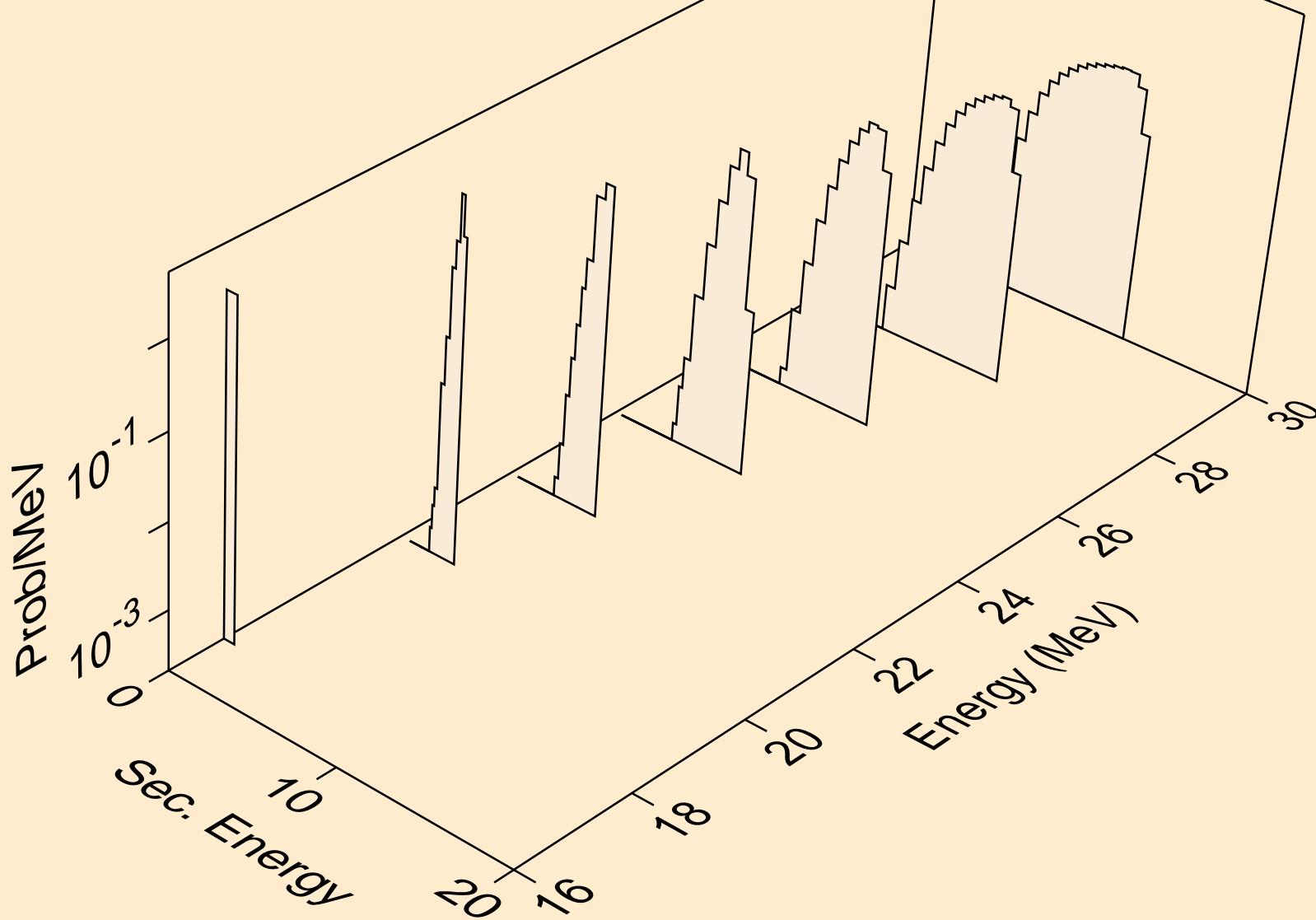

SN117 NEUTRON ACER TENDL-2019 LIBRARY; T=293.16K
tritons from (n,t)

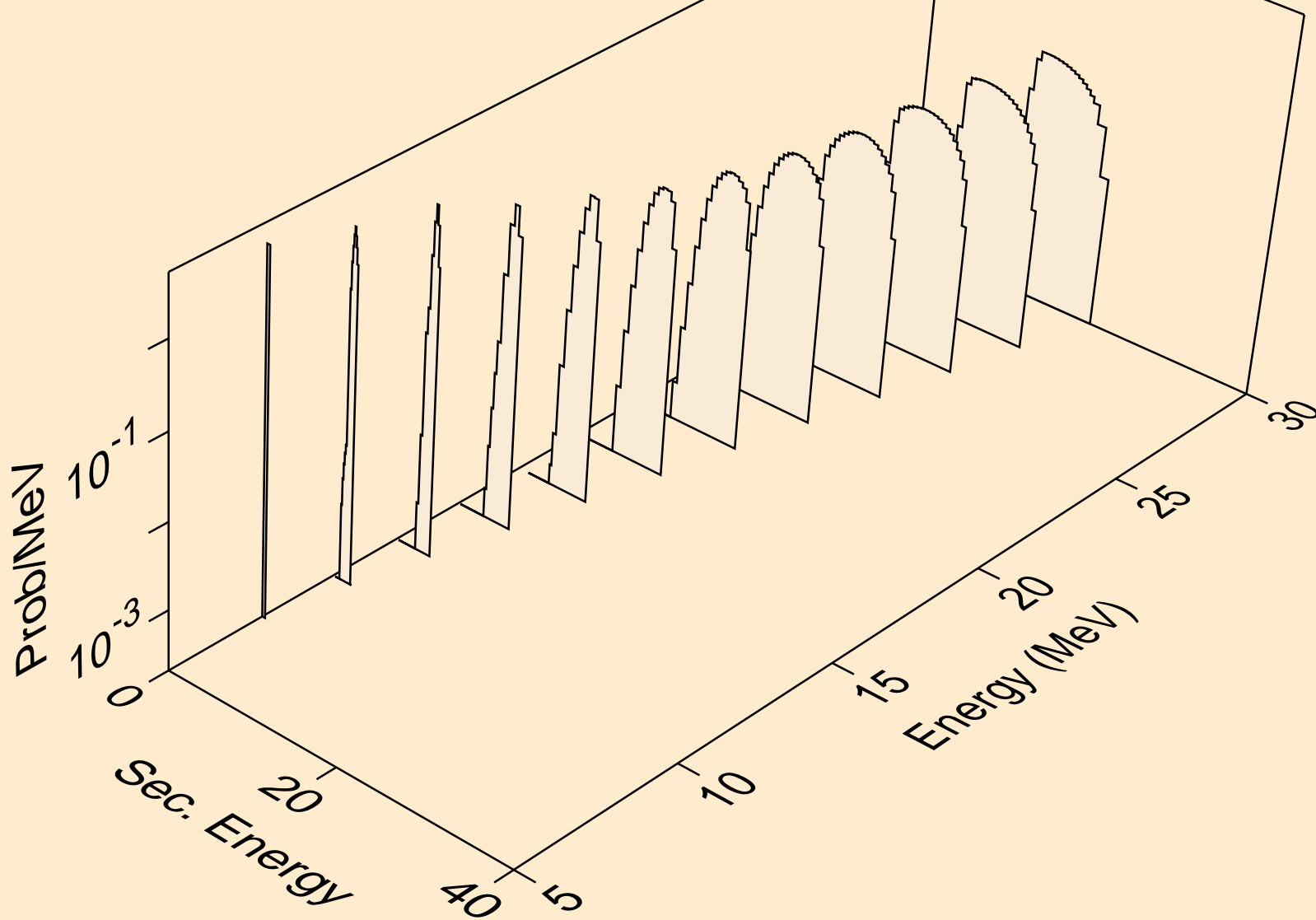

SN117 NEUTRON ACER TENDL-2019 LIBRARY; T=293.16K
tritons from (n,pt)

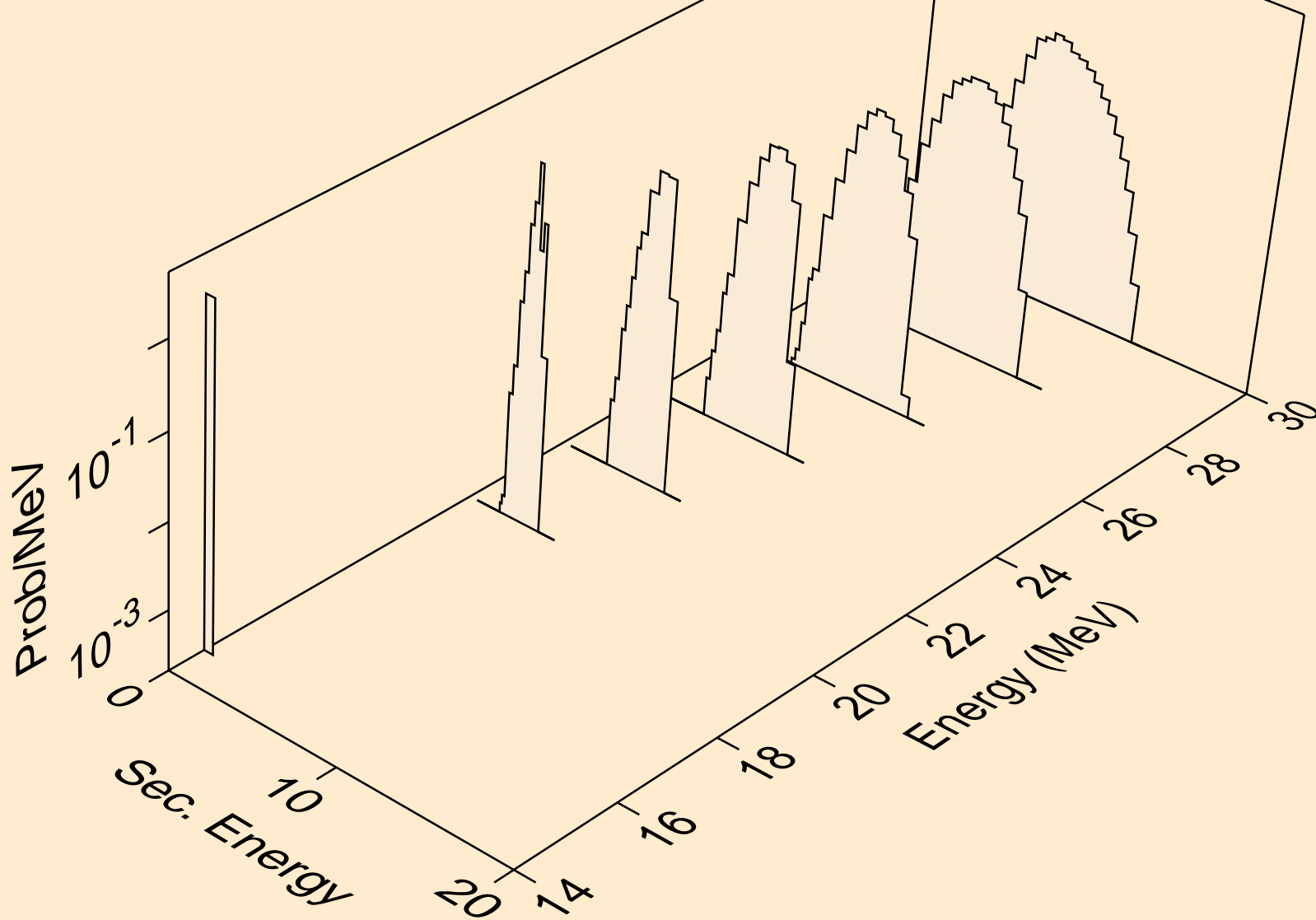

SN117 NEUTRON ACER TENDL-2019 LIBRARY; T=293.16K
he3s from (n,x)

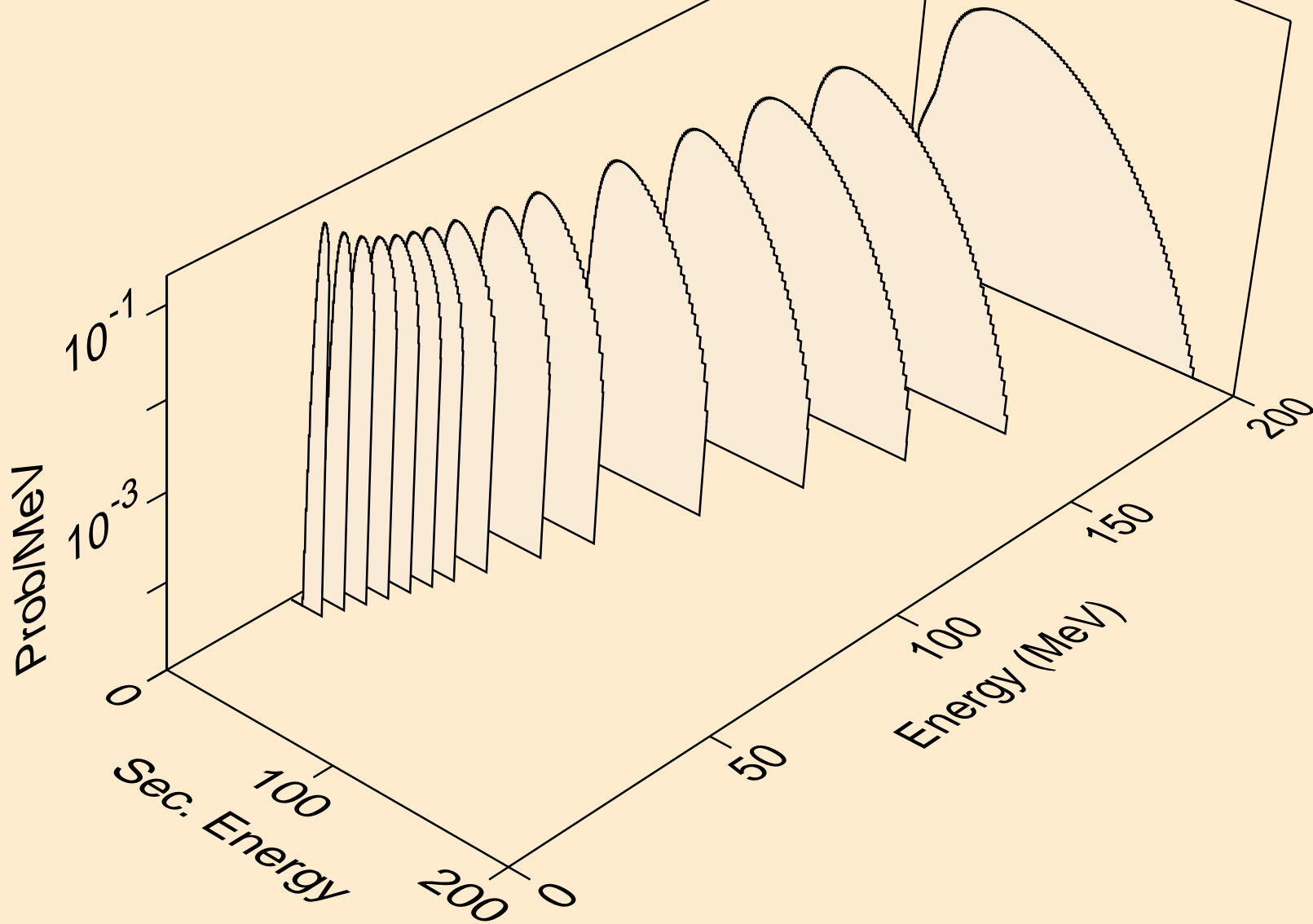

SN117 NEUTRON ACER TENDL-2019 LIBRARY; T=293.16K
he3s from (n,n*)he3

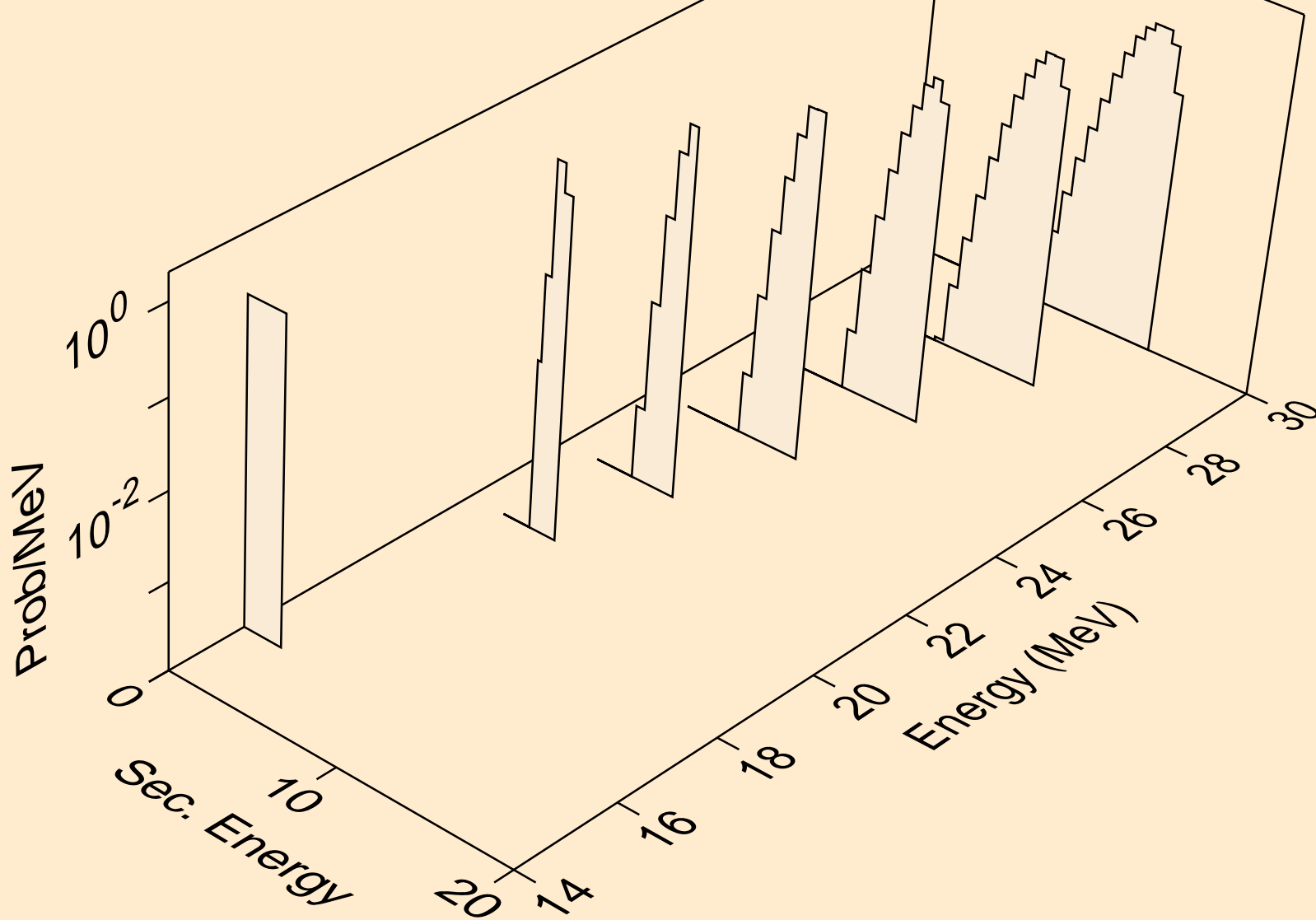

SN117 NEUTRON ACER TENDL-2019 LIBRARY; T=293.16K
he3s from (n,he3)

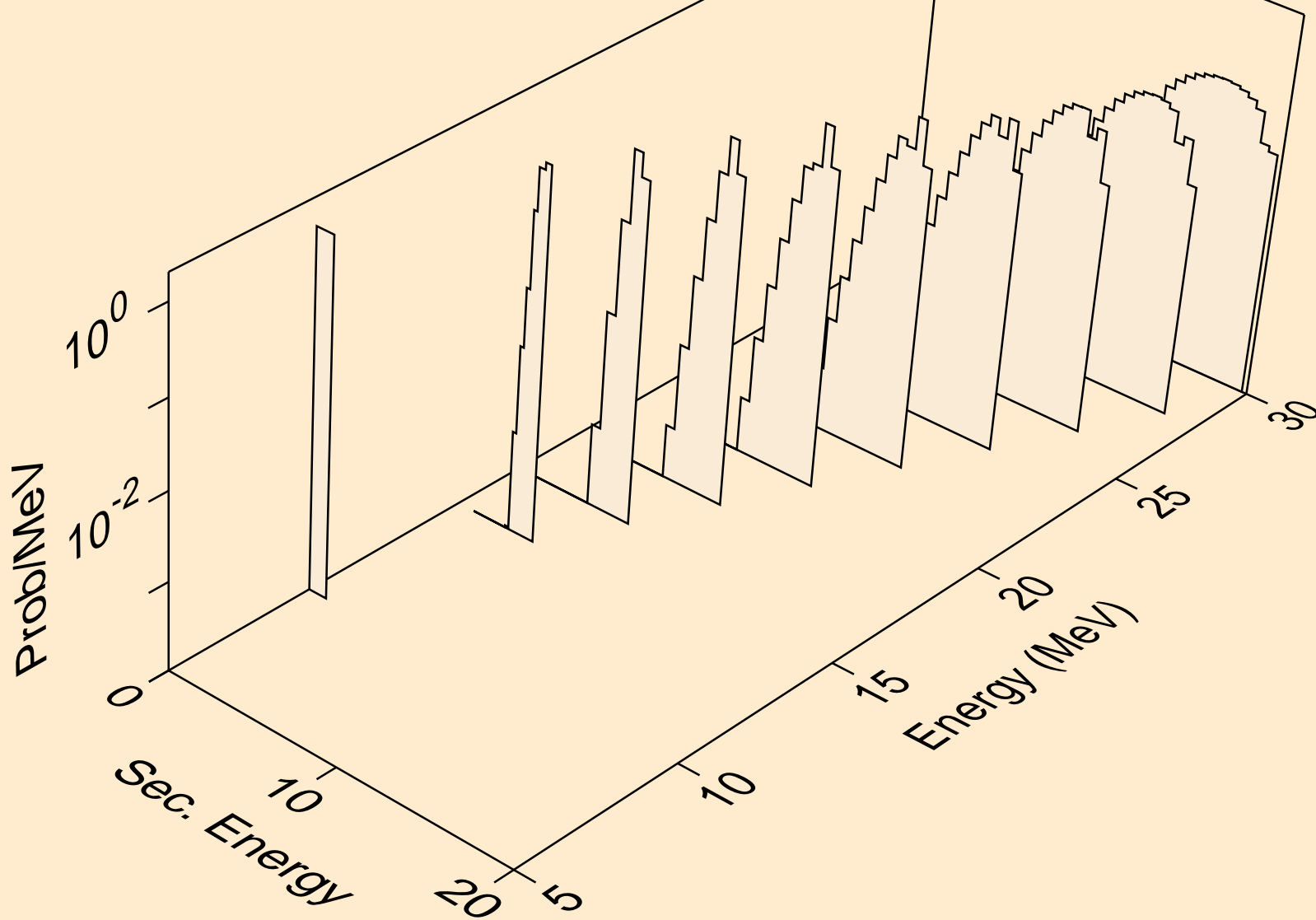

SN117 NEUTRON ACER TENDL-2019 LIBRARY; T=293.16K
alphas from (n,x)

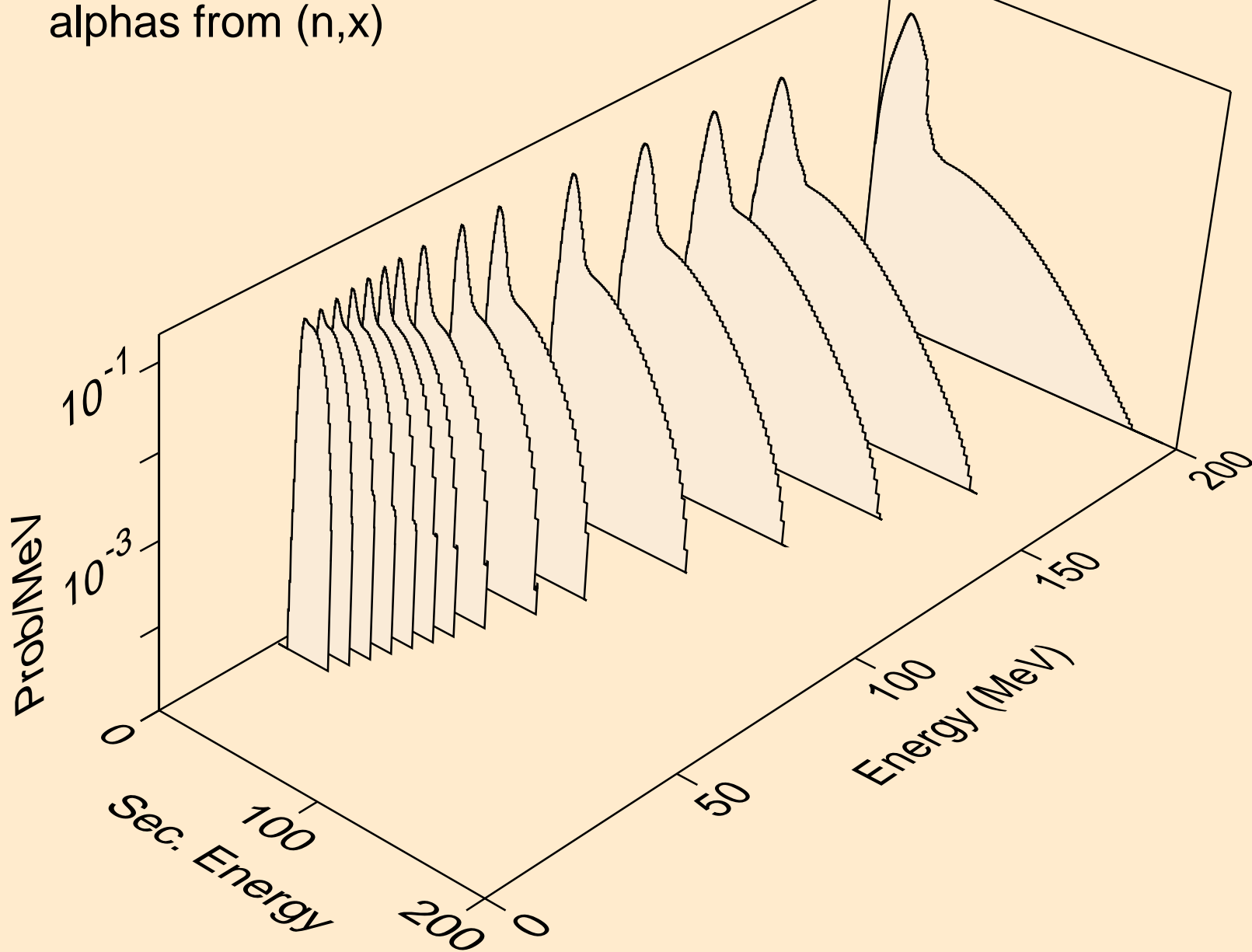

SN117 NEUTRON ACER TENDL-2019 LIBRARY; T=293.16K
alphas from (n,n*)a

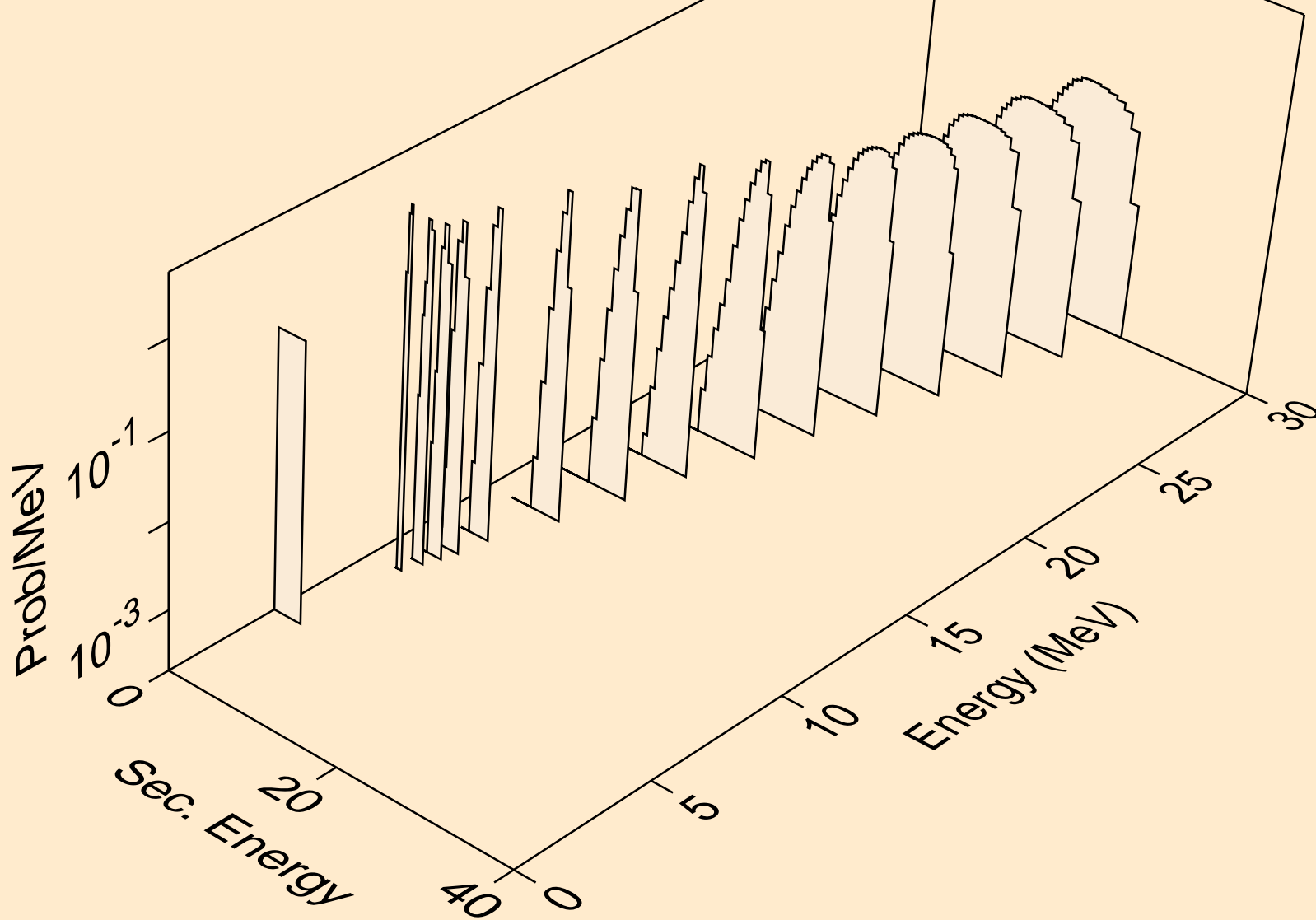

SN117 NEUTRON ACER TENDL-2019 LIBRARY; T=293.16K
alphas from (n,2n)a

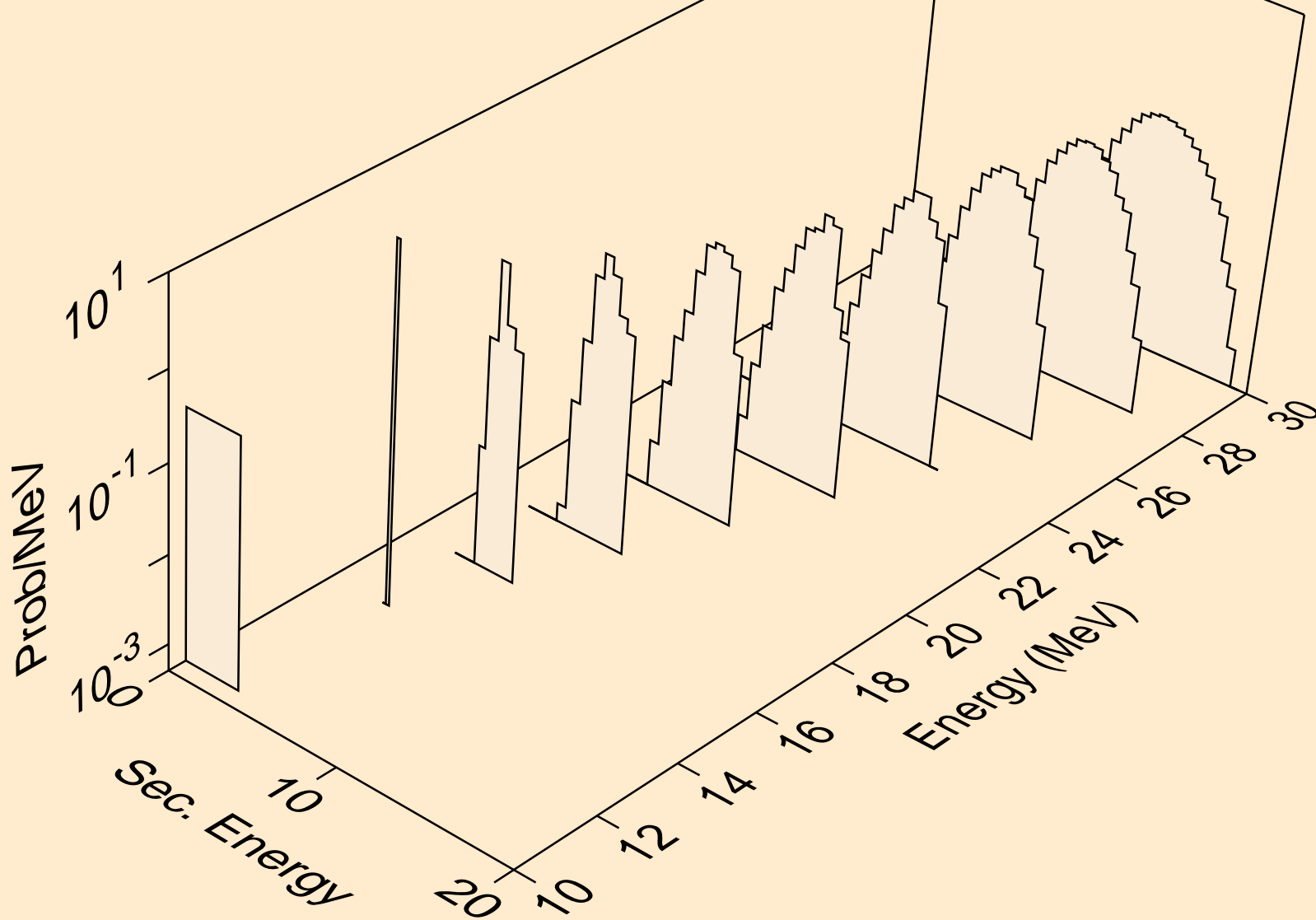

SN117 NEUTRON ACER TENDL-2019 LIBRARY; T=293.16K
alphas from (n,3n)a

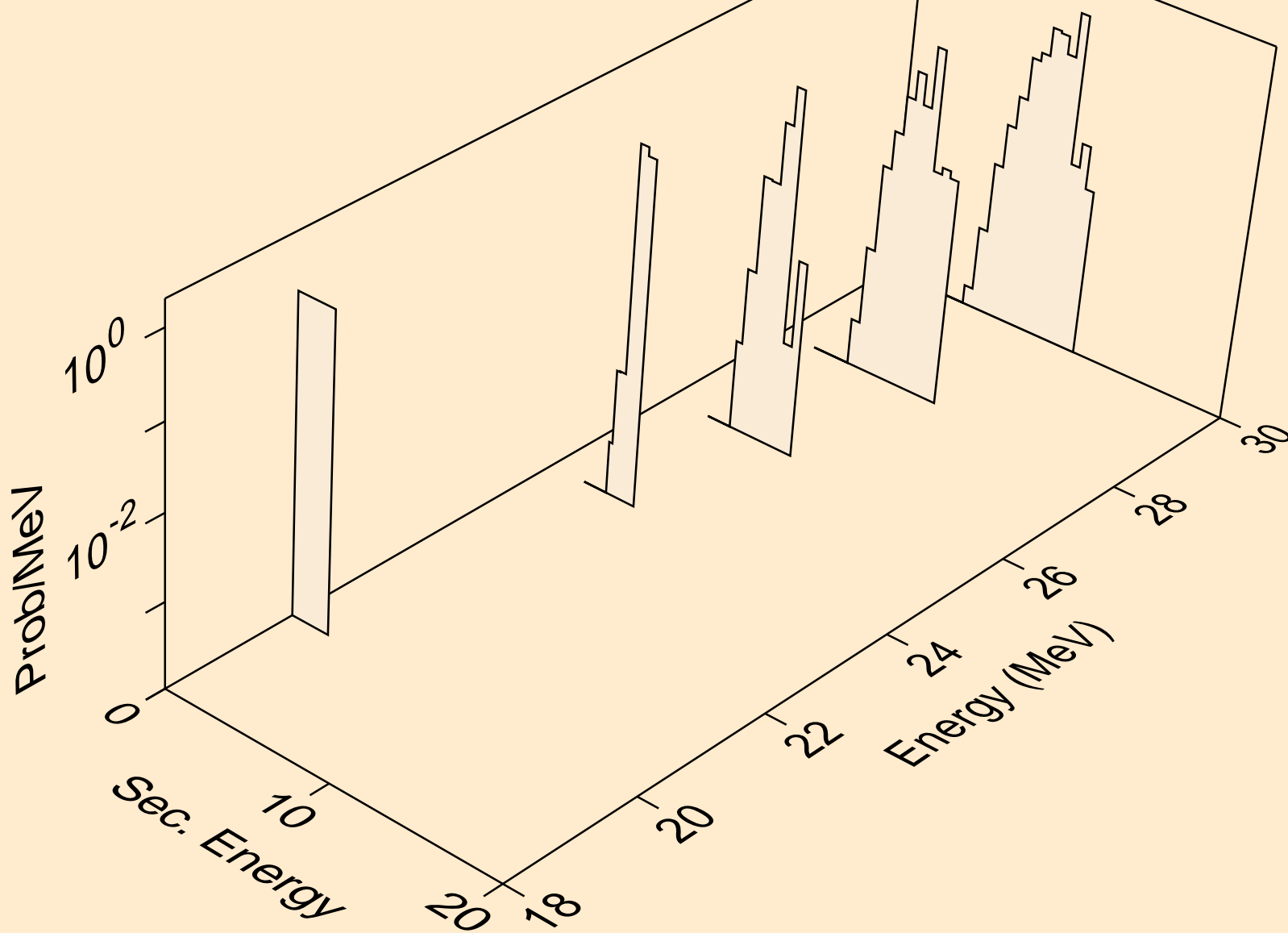

SN117 NEUTRON ACER TENDL-2019 LIBRARY; T=293.16K
alphas from (n,n*)2a

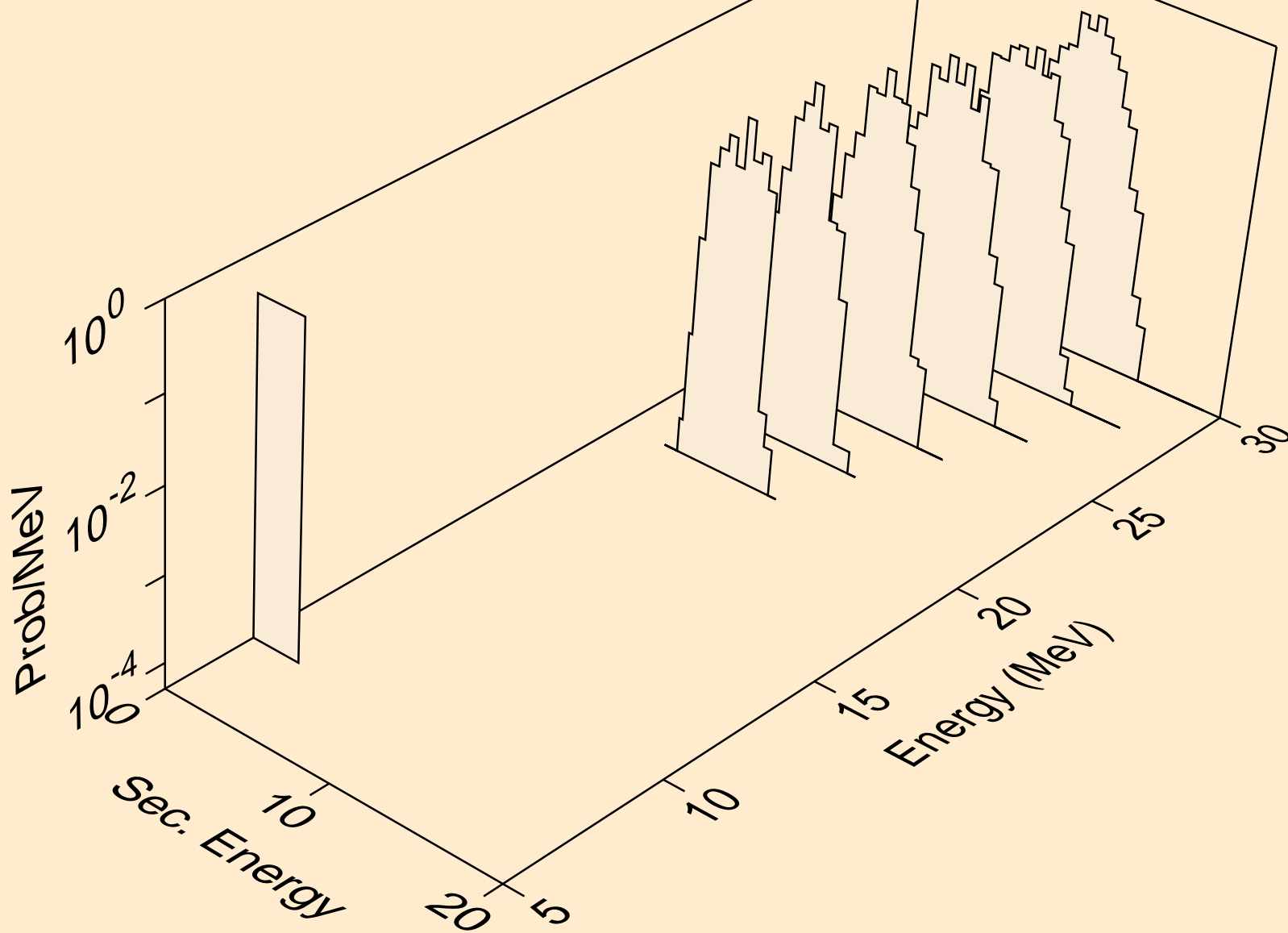

SN117 NEUTRON ACER TENDL-2019 LIBRARY; T=293.16K
alphas from (n,npa)

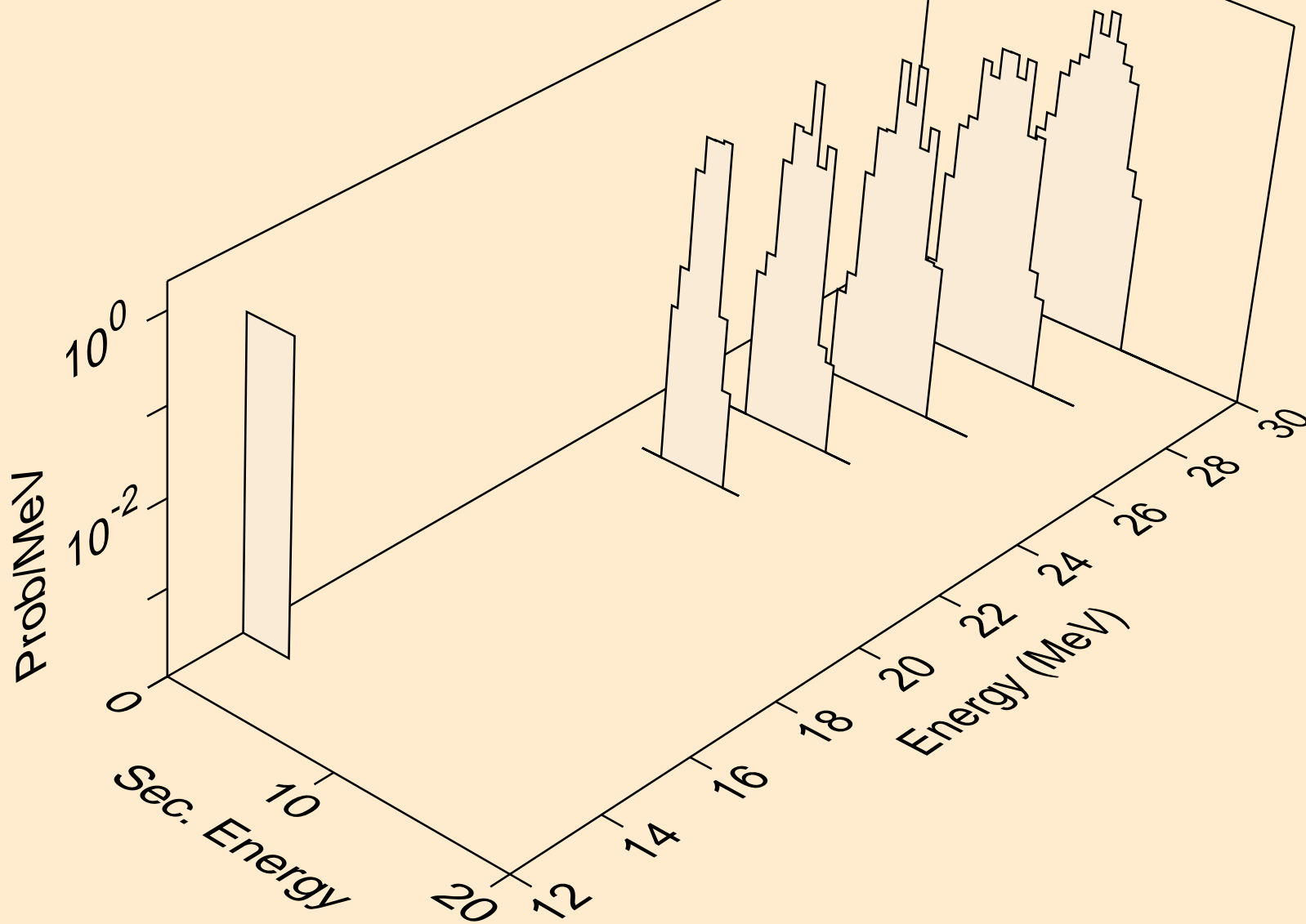

SN117 NEUTRON ACER TENDL-2019 LIBRARY; T=293.16K
alphas from (n,a)

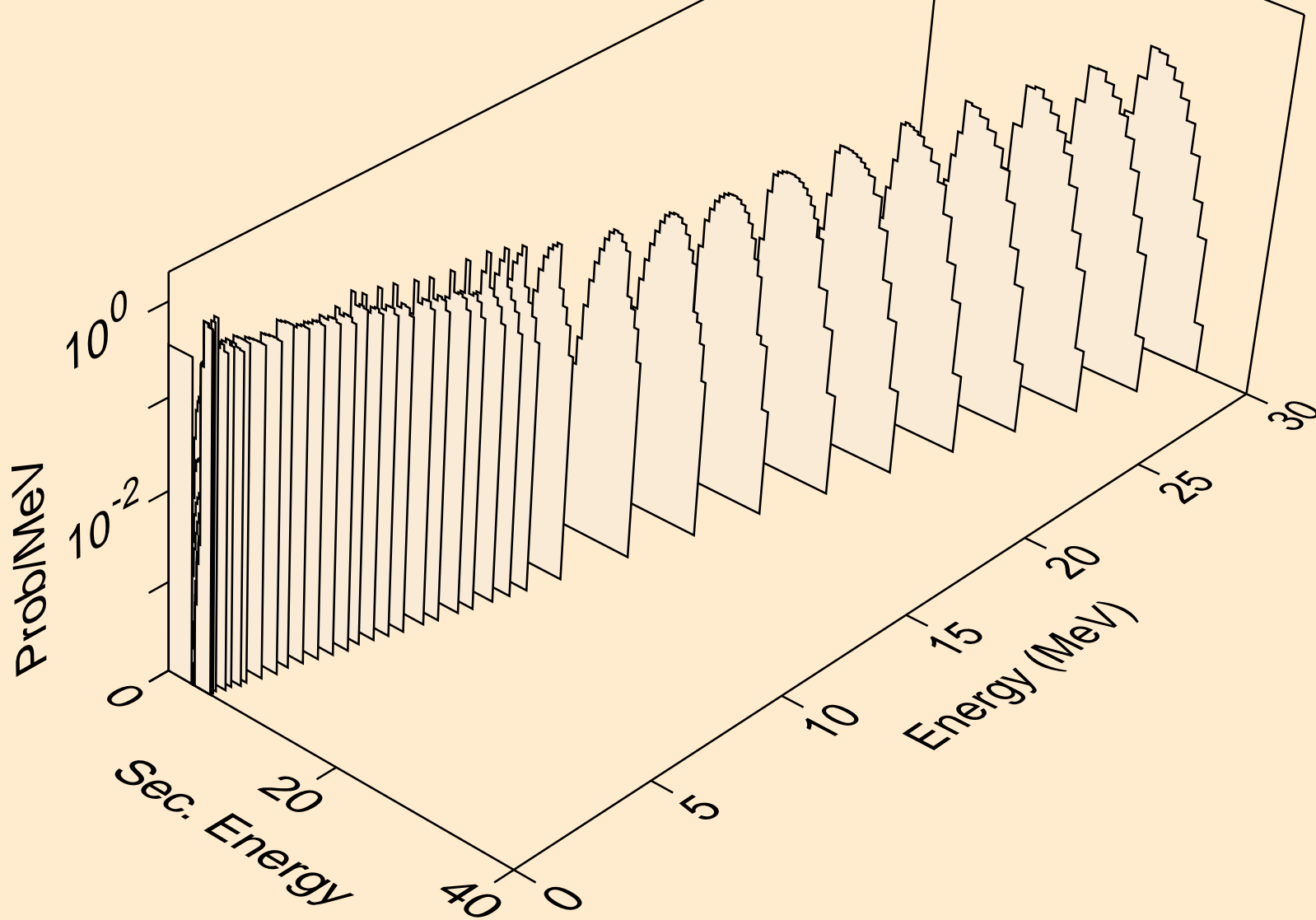

SN117 NEUTRON ACER TENDL-2019 LIBRARY; T=293.16K
alphas from (n,2a)

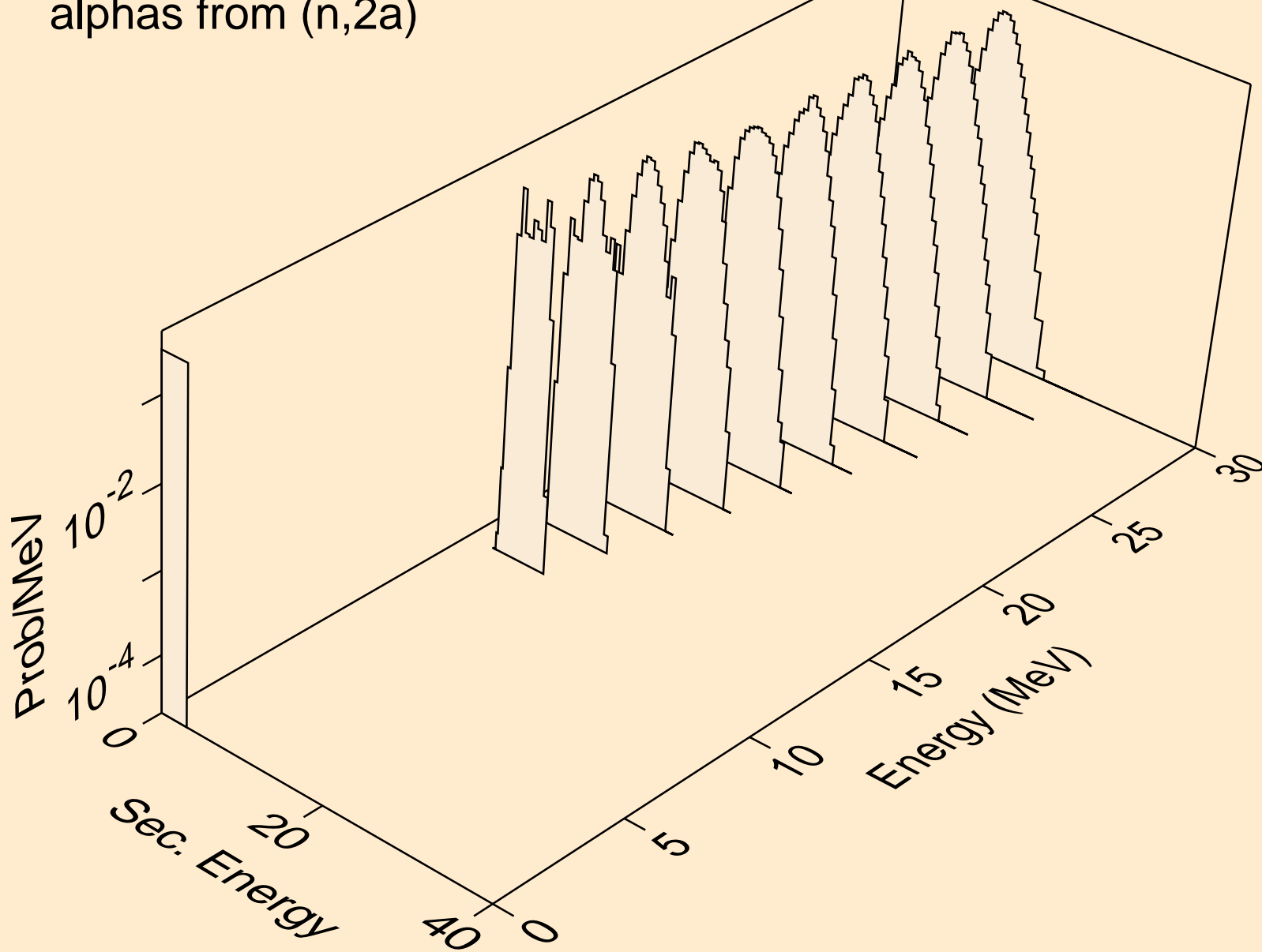

SN117 NEUTRON ACER TENDL-2019 LIBRARY; T=293.16K
alphas from (n,pa)

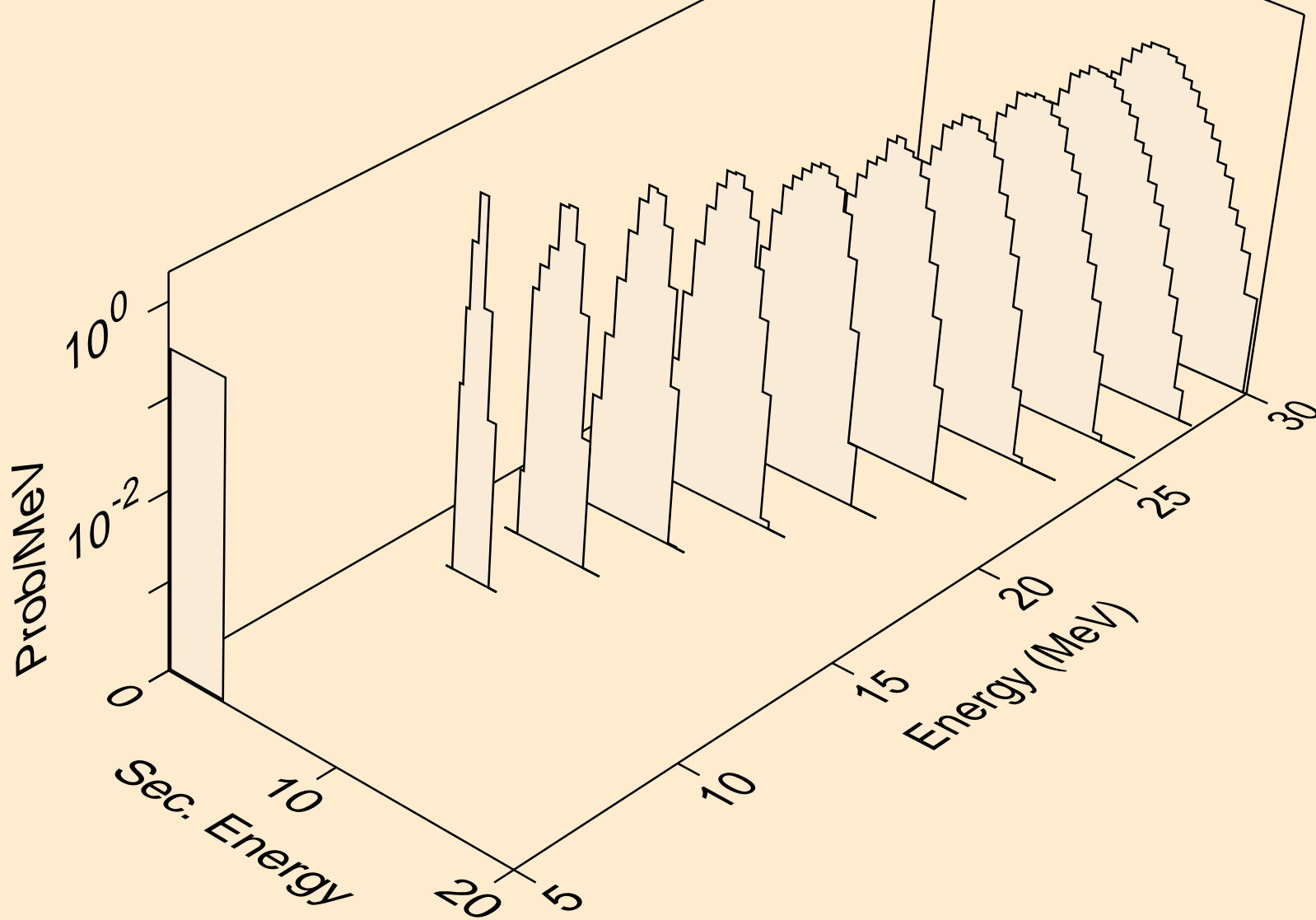

SN117 NEUTRON ACER TENDL-2019 LIBRARY; T=293.16K
alphas from (n,da)

