

# SN117M NEUTRON ACER TENDL-2019 LIBRARY; T=293.16K

## Principal cross sections

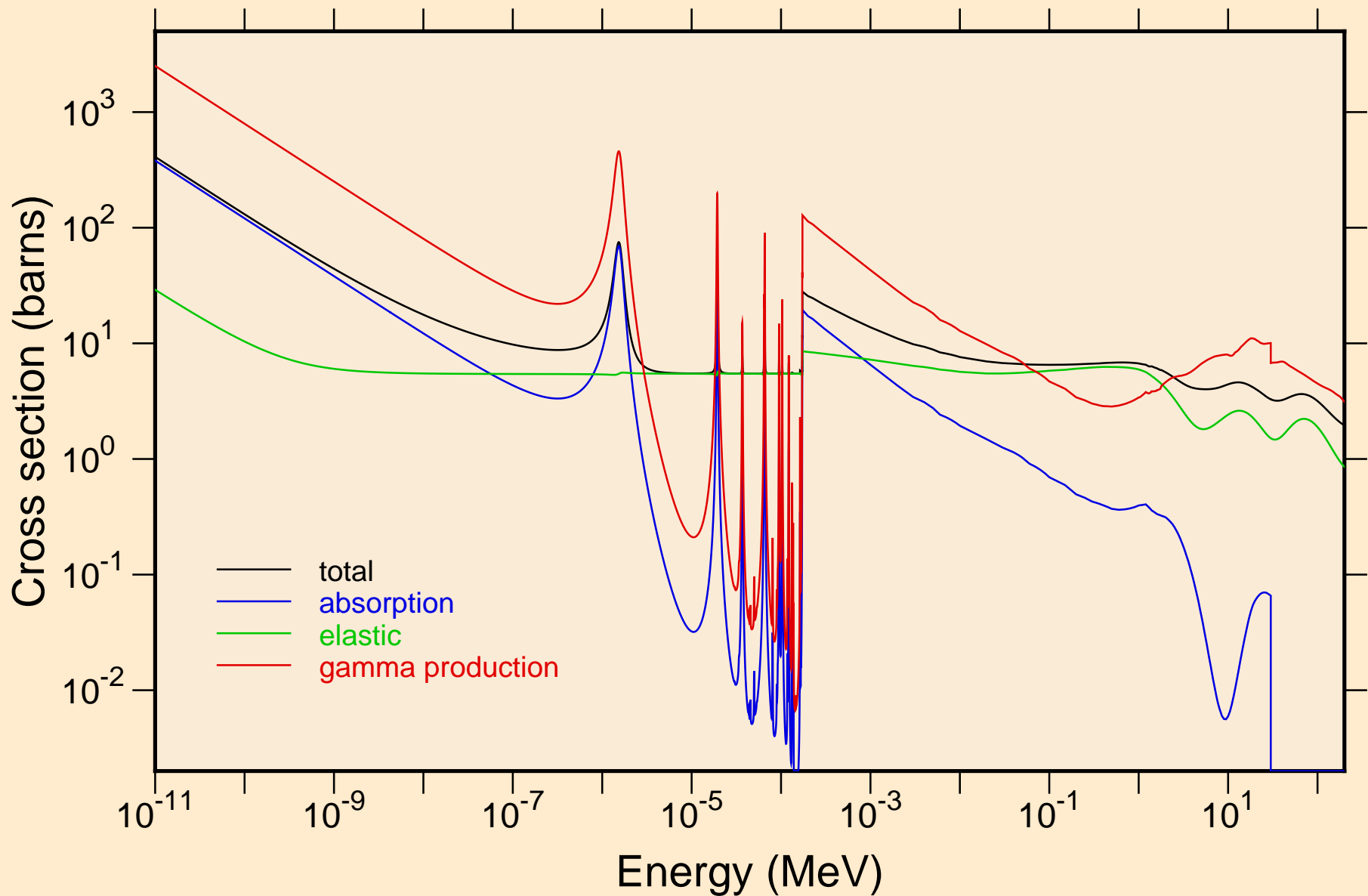

SN117M NEUTRON ACER TENDL-2019 LIBRARY; T=293.16K  
resonance total cross section

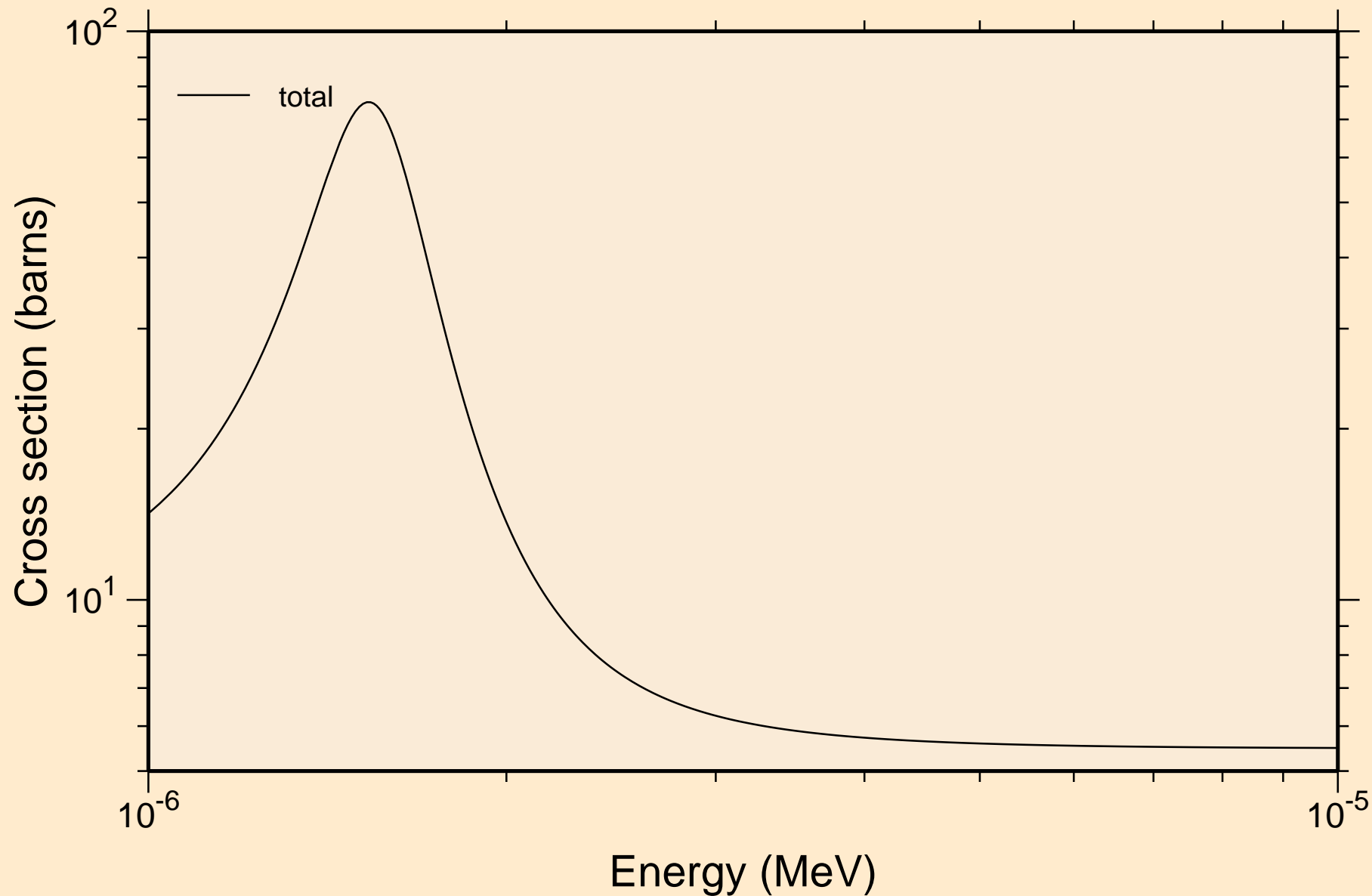

SN117M NEUTRON ACER TENDL-2019 LIBRARY; T=293.16K  
resonance total cross section

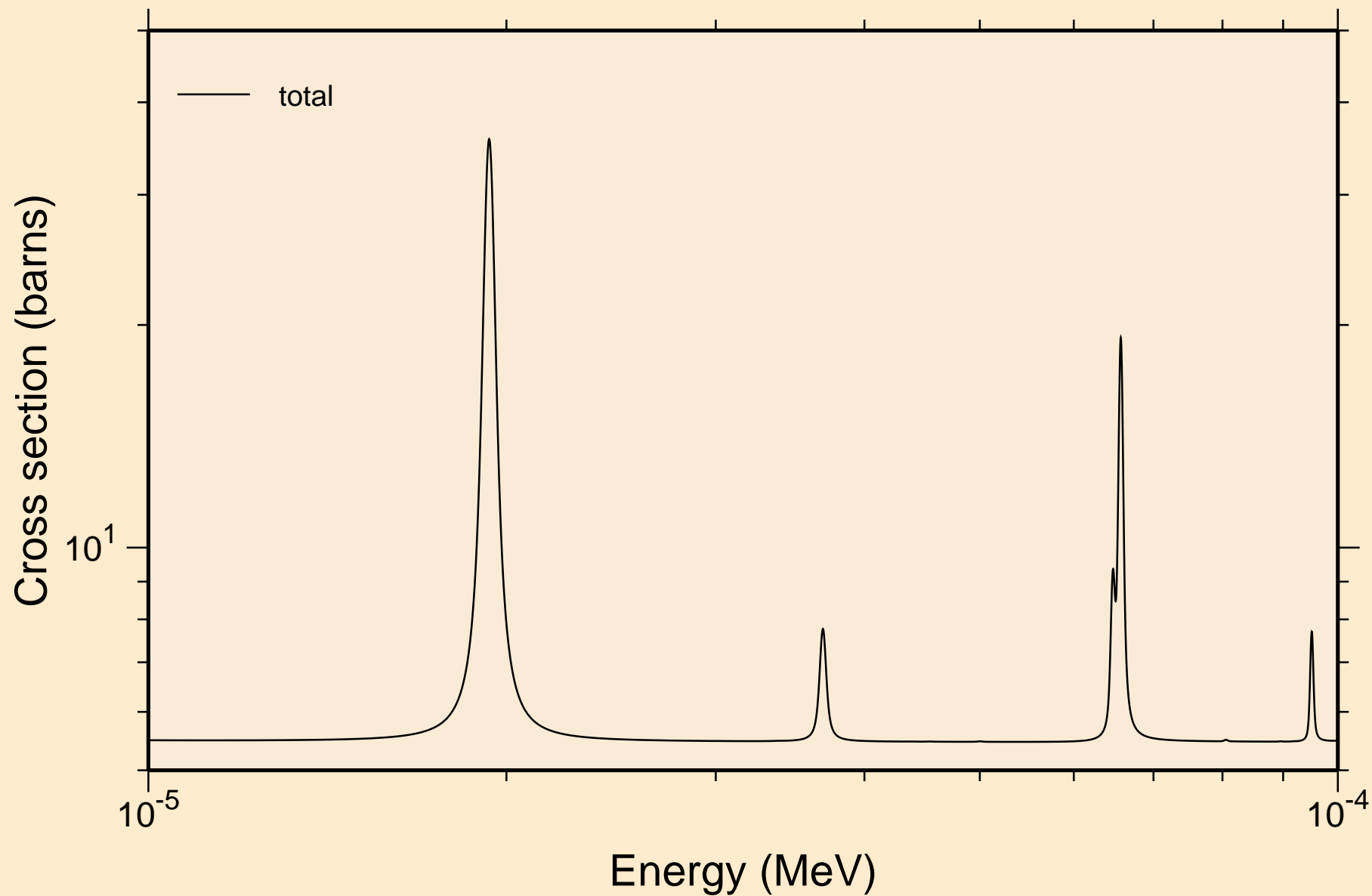

SN117M NEUTRON ACER TENDL-2019 LIBRARY; T=293.16K  
resonance total cross section

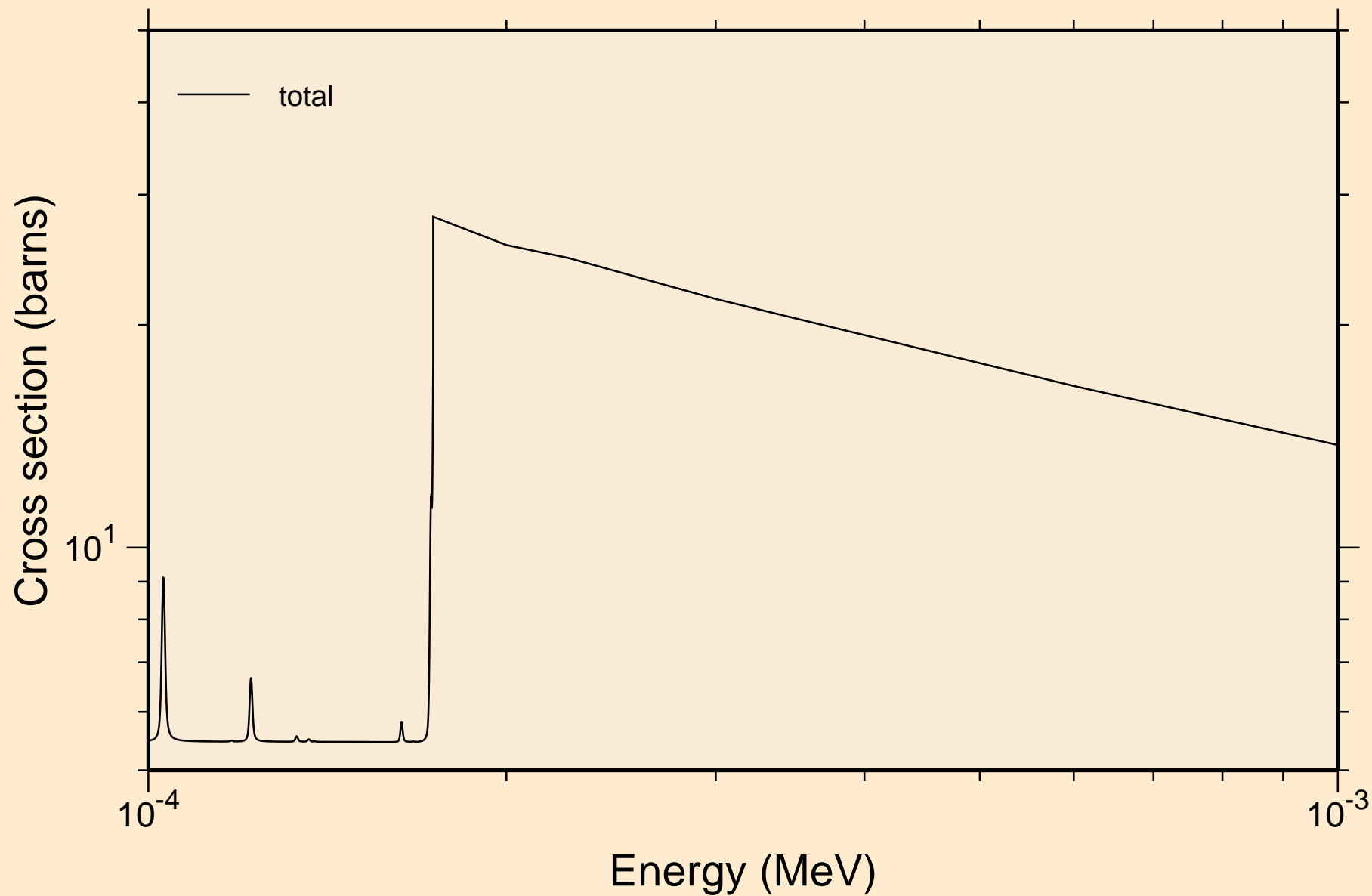

SN117M NEUTRON ACER TENDL-2019 LIBRARY; T=293.16K  
resonance total cross section

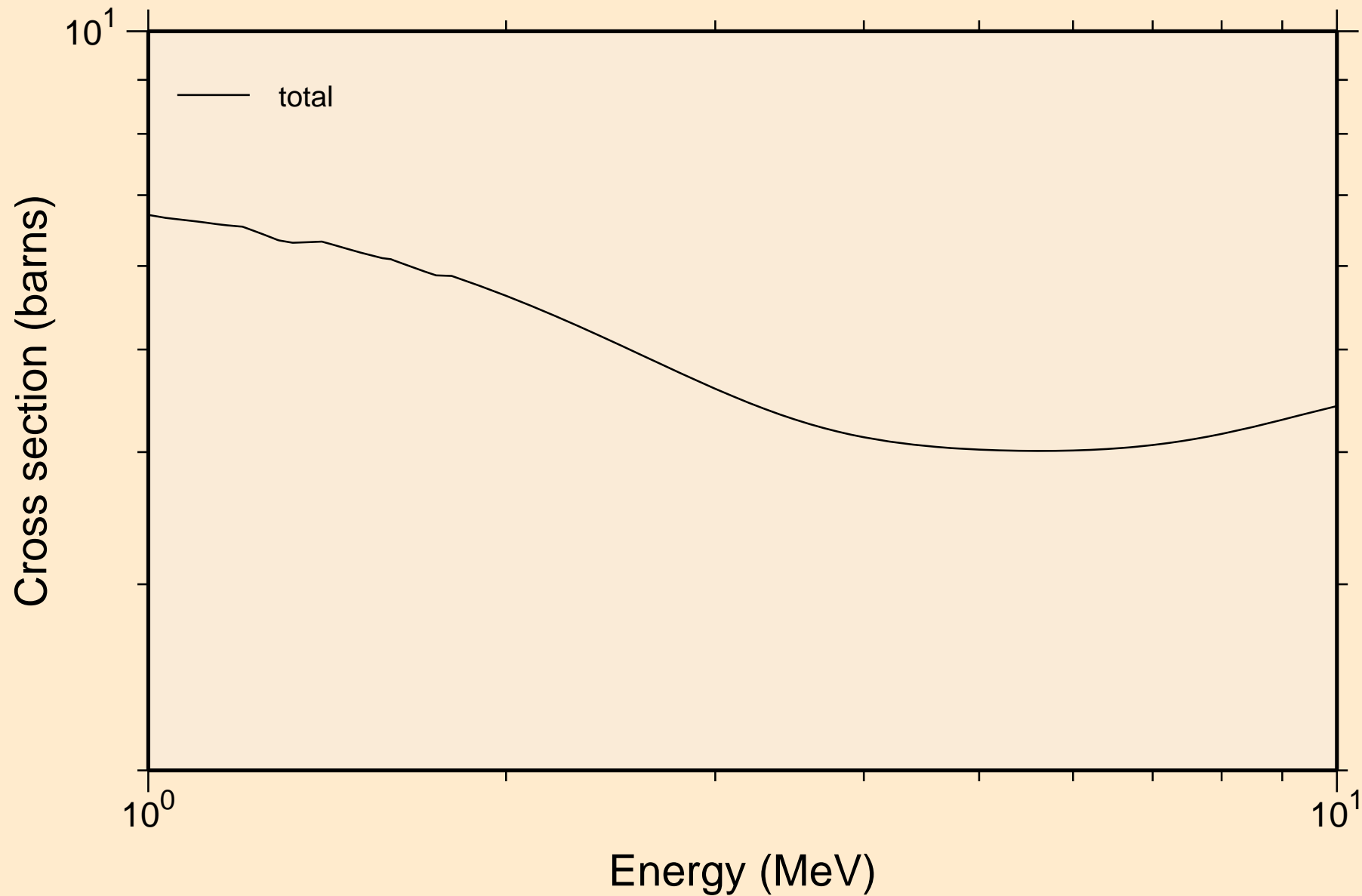

SN117M NEUTRON ACER TENDL-2019 LIBRARY; T=293.16K  
resonance absorption cross sections

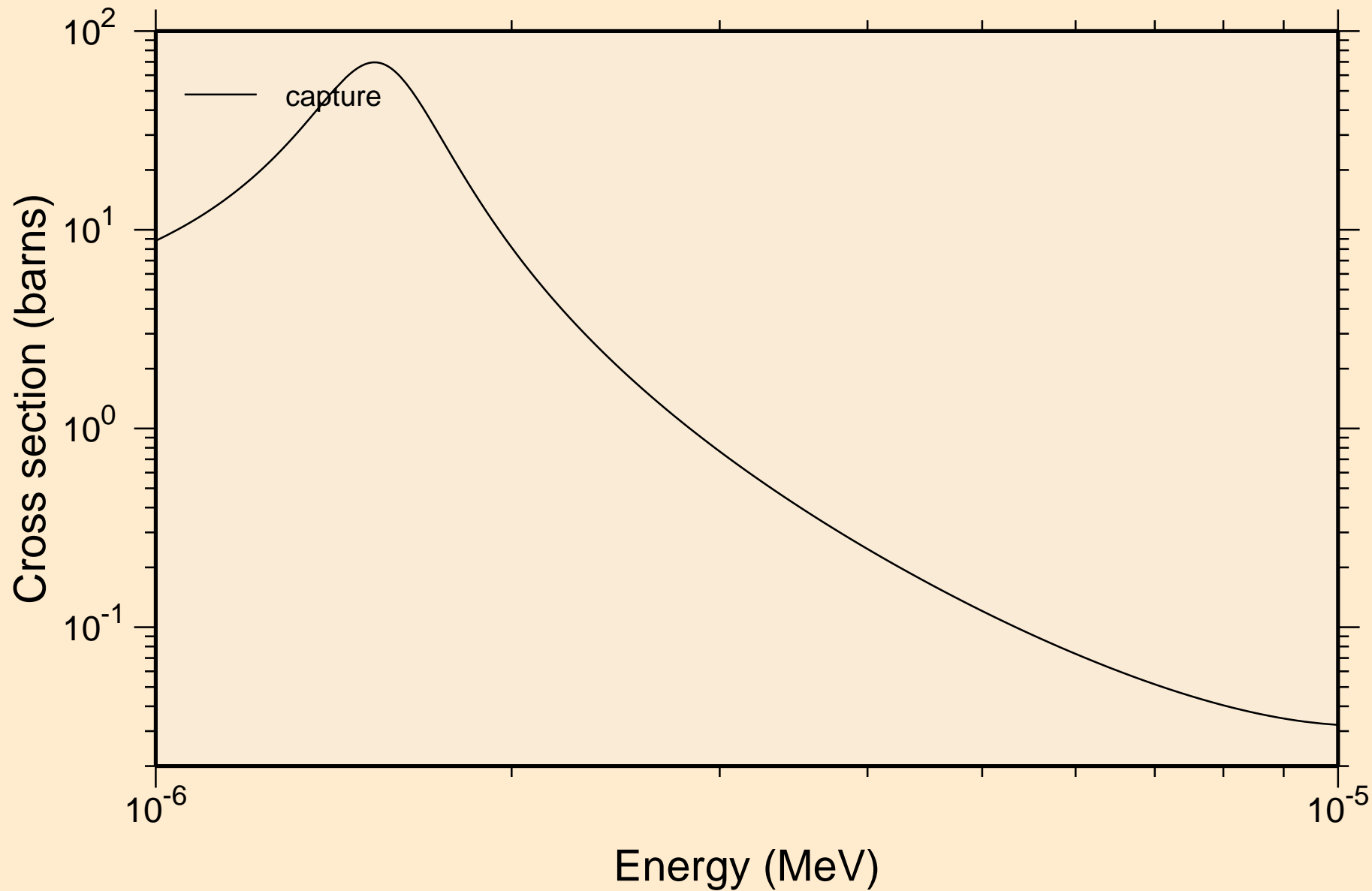

SN117M NEUTRON ACER TENDL-2019 LIBRARY; T=293.16K  
resonance absorption cross sections

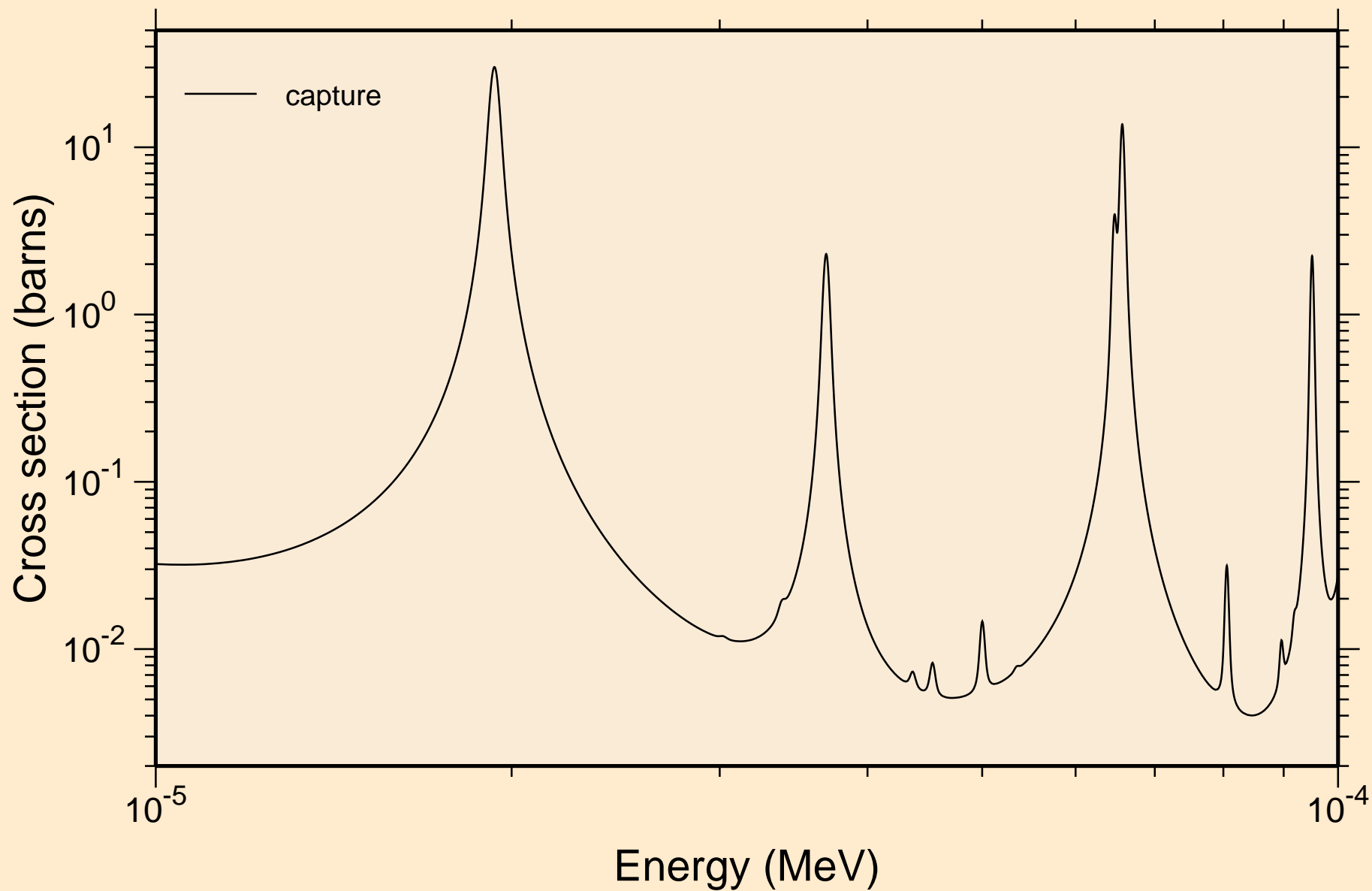

SN117M NEUTRON ACER TENDL-2019 LIBRARY; T=293.16K  
resonance absorption cross sections

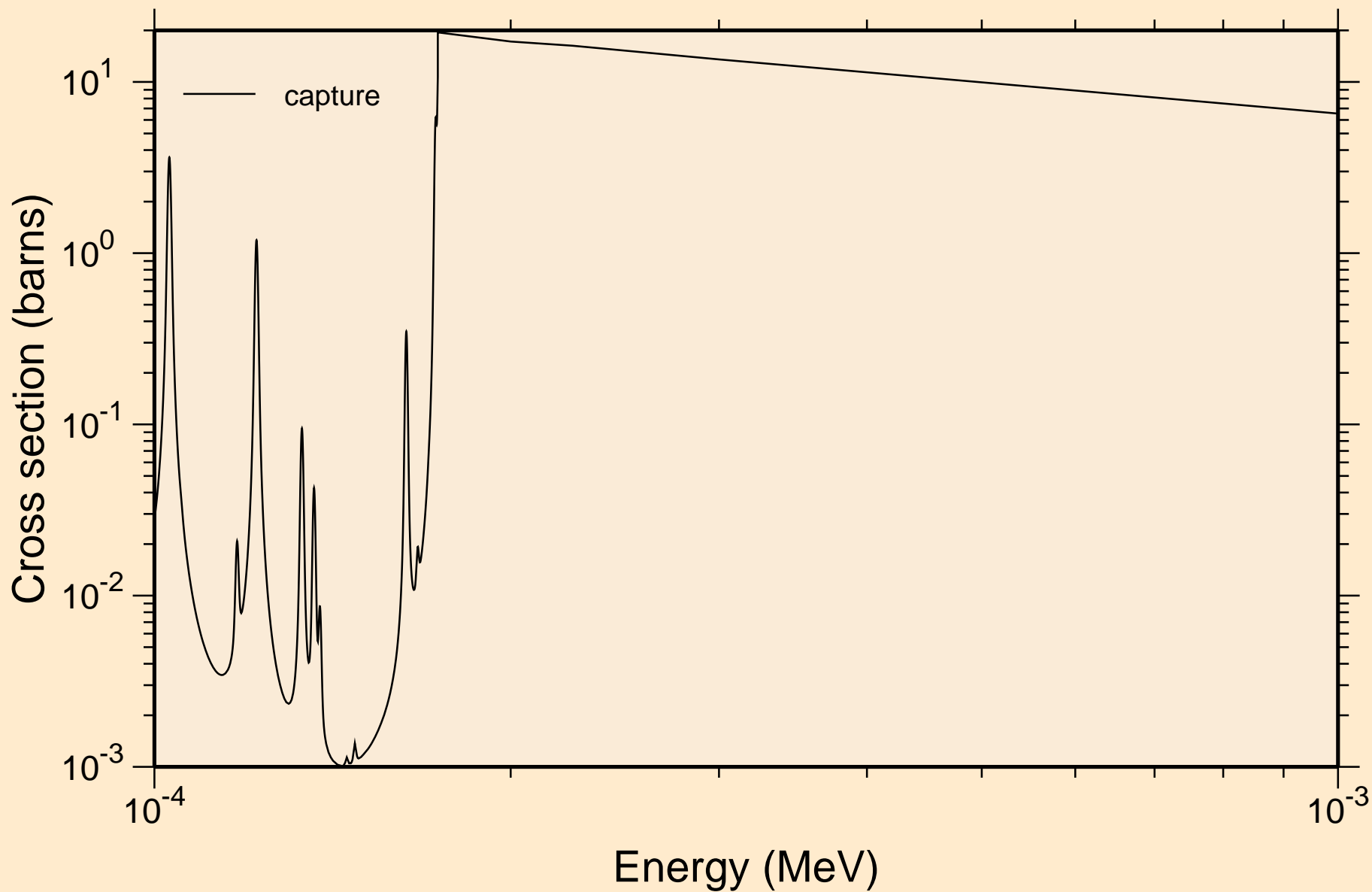



SN117M NEUTRON ACER TENDL-2019 LIBRARY; T=293.16K  
resonance absorption cross sections

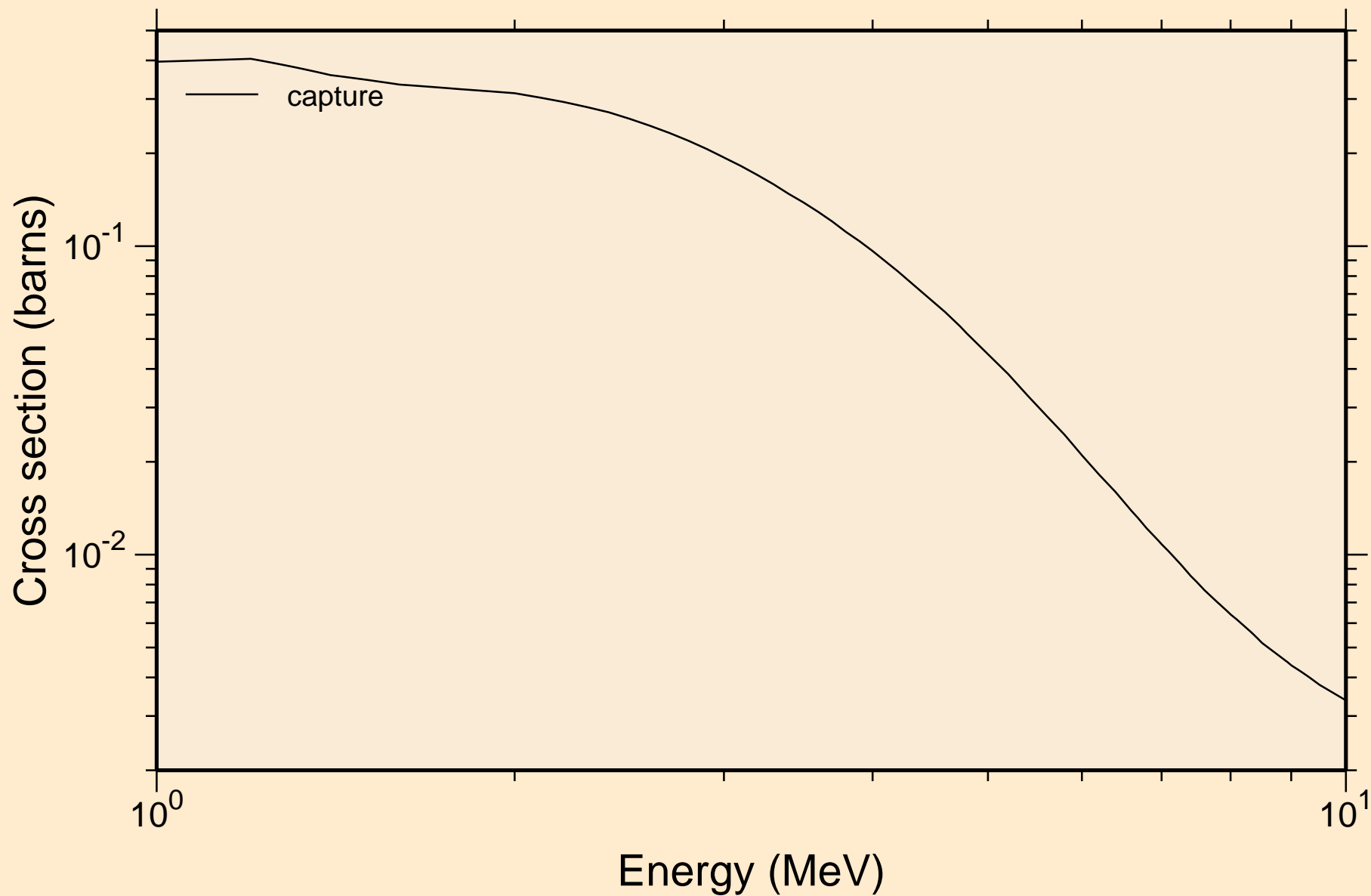

SN117M NEUTRON ACER TENDL-2019 LIBRARY; T=293.16K  
Heating

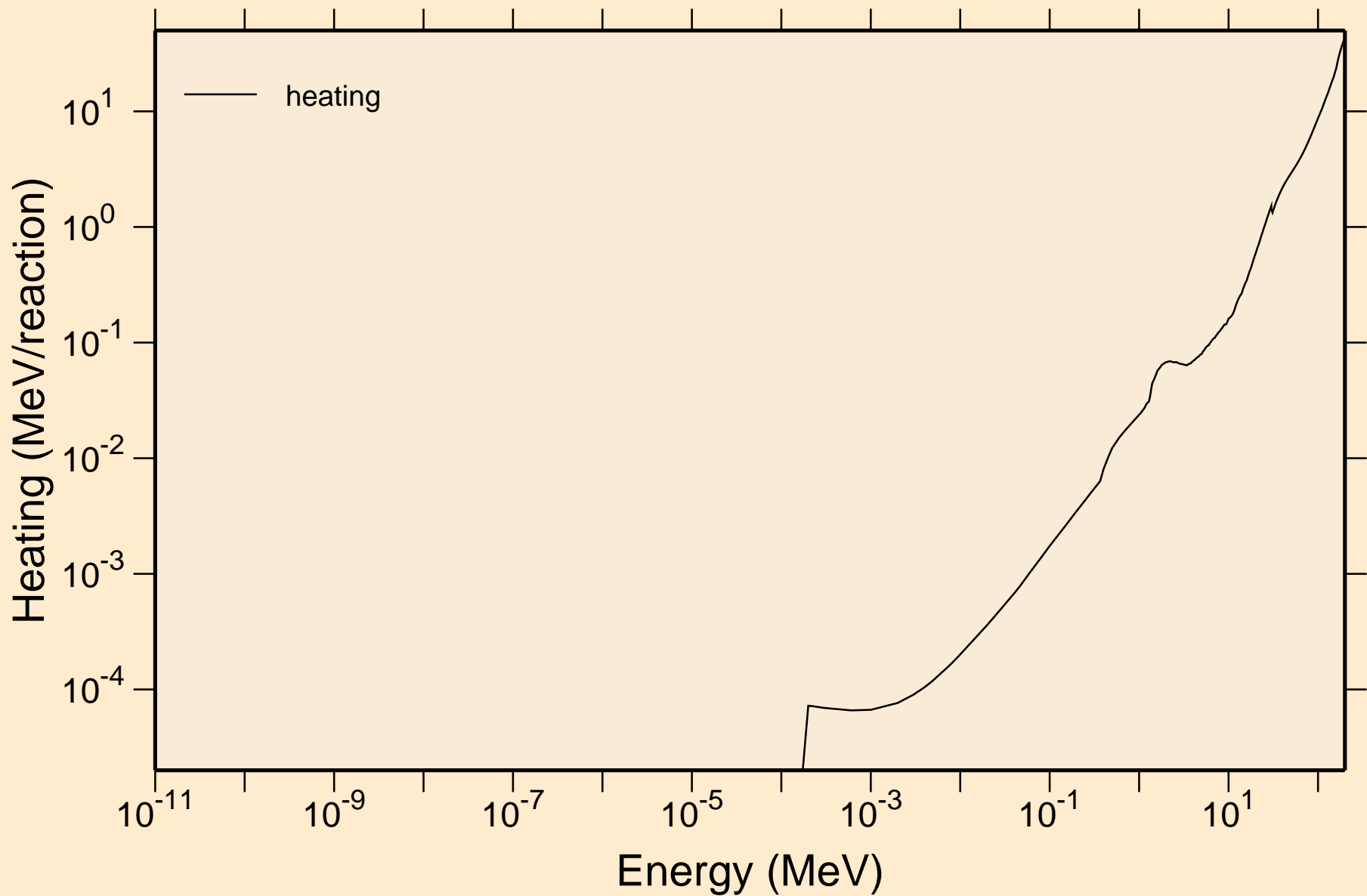

# SN117M NEUTRON ACER TENDL-2019 LIBRARY; T=293.16K Damage

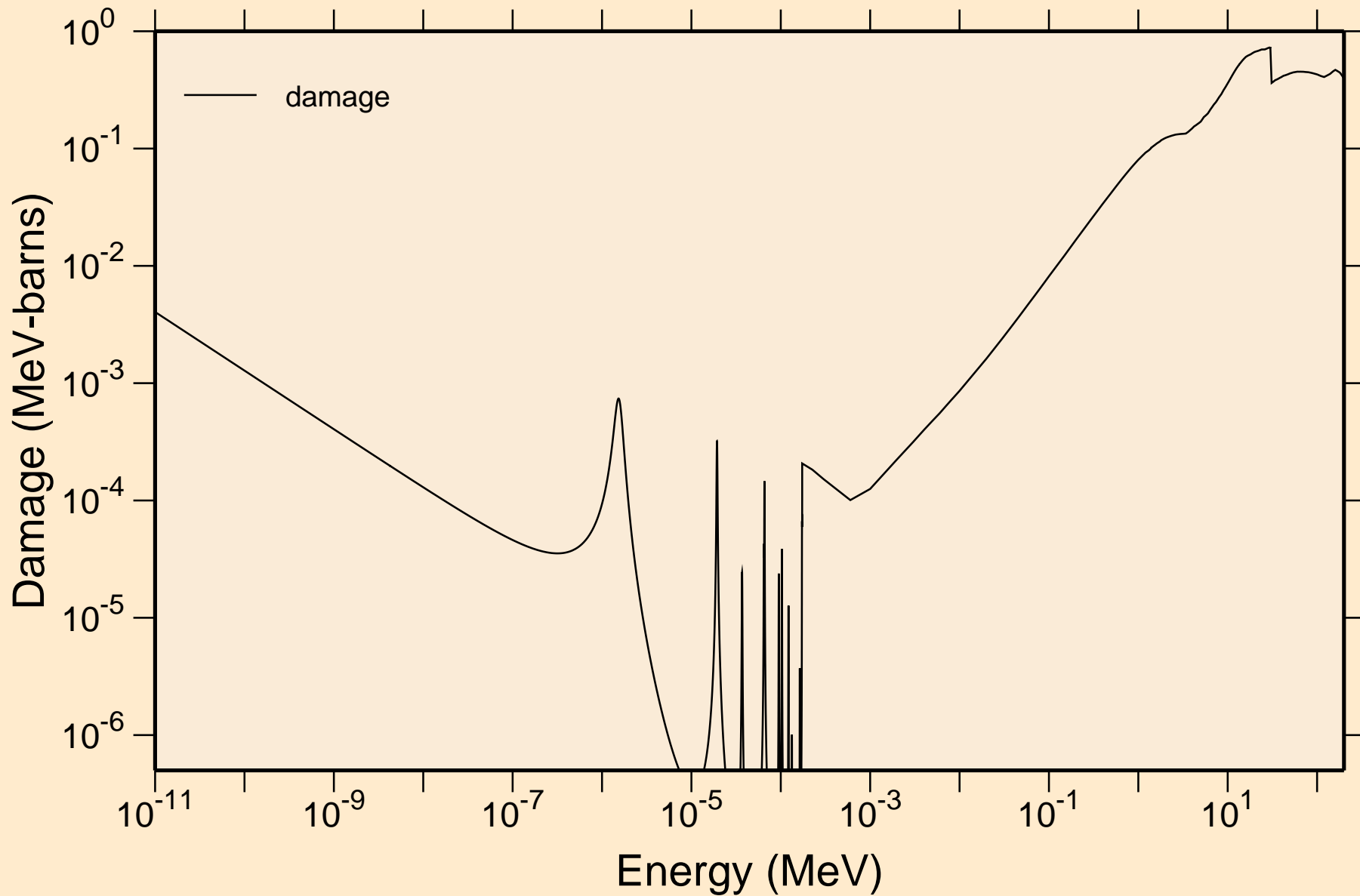

SN117M NEUTRON ACER TENDL-2019 LIBRARY; T=293.16K  
Non-threshold reactions

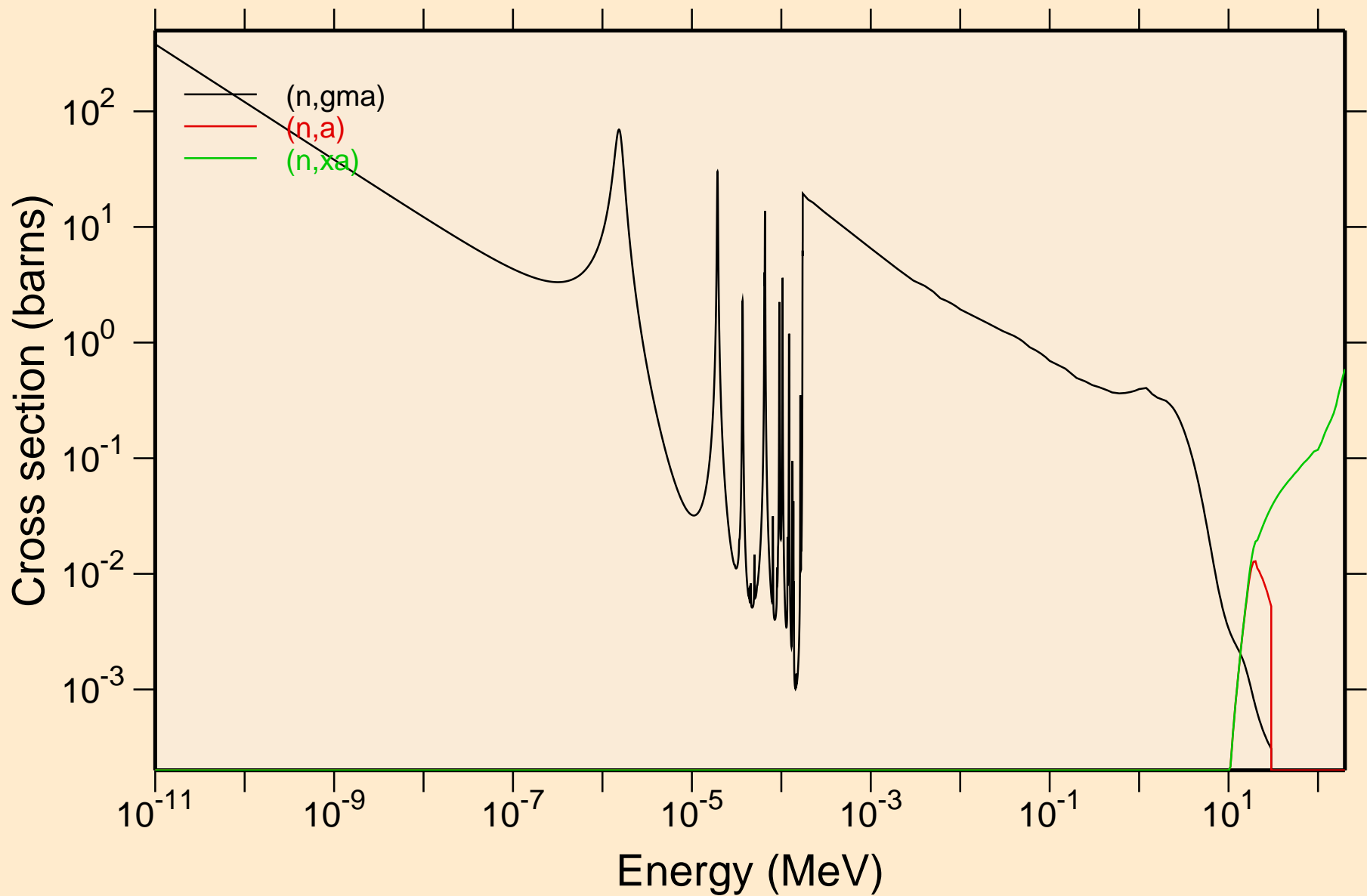

SN117M NEUTRON ACER TENDL-2019 LIBRARY; T=293.16K  
Principal cross sections

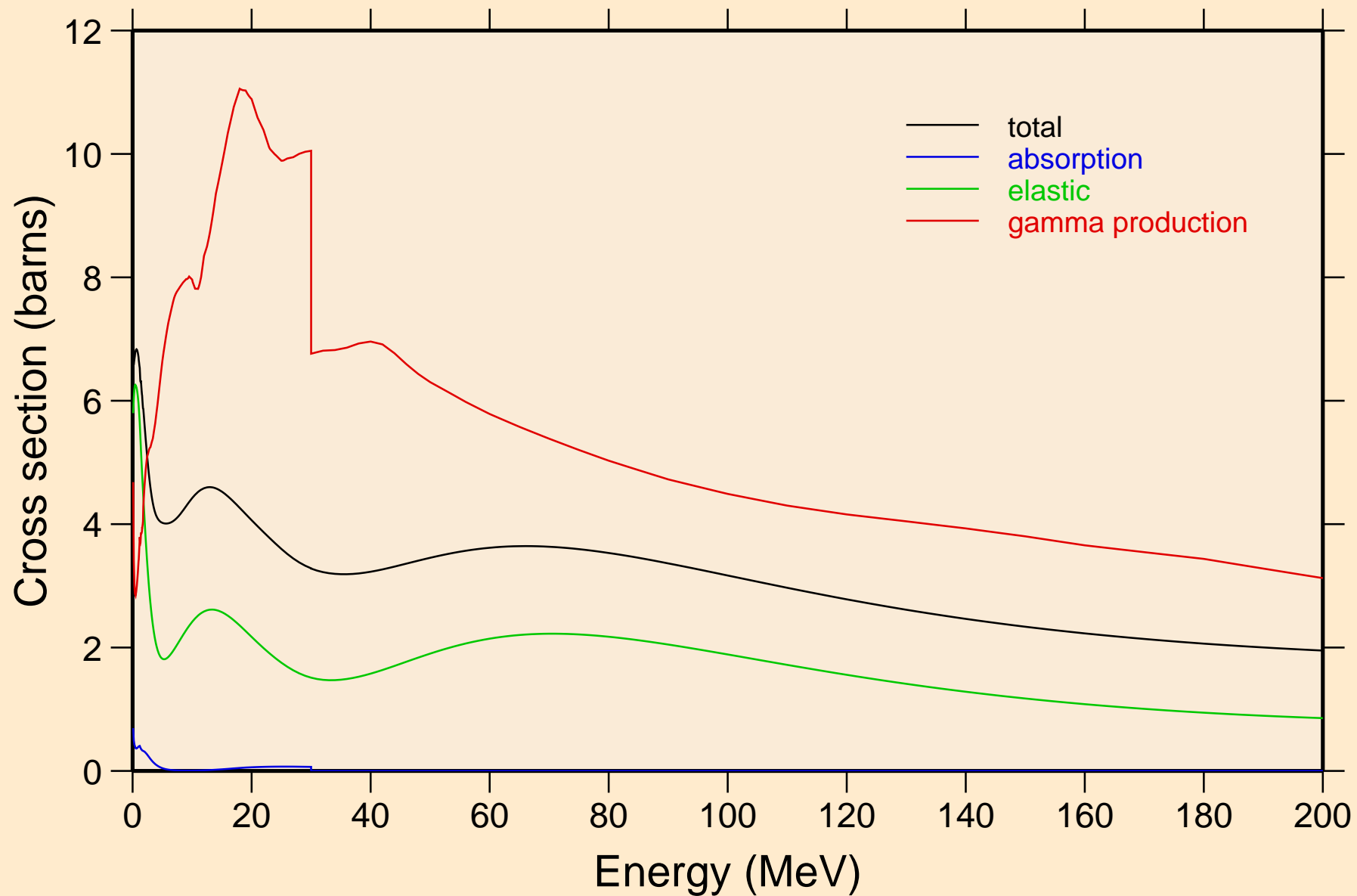

SN117M NEUTRON ACER TENDL-2019 LIBRARY; T=293.16K  
Heating

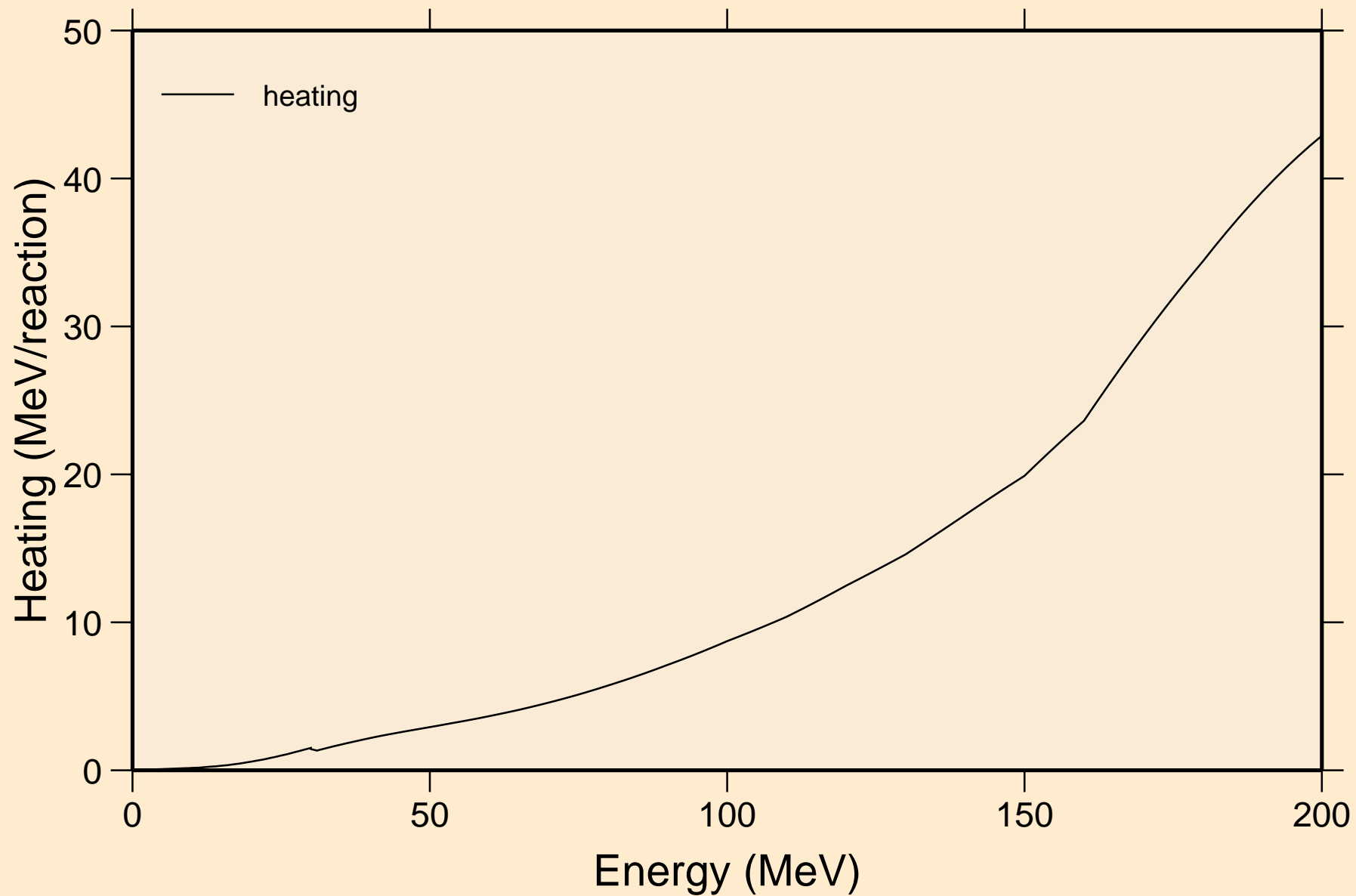

# SN117M NEUTRON ACER TENDL-2019 LIBRARY; T=293.16K Damage

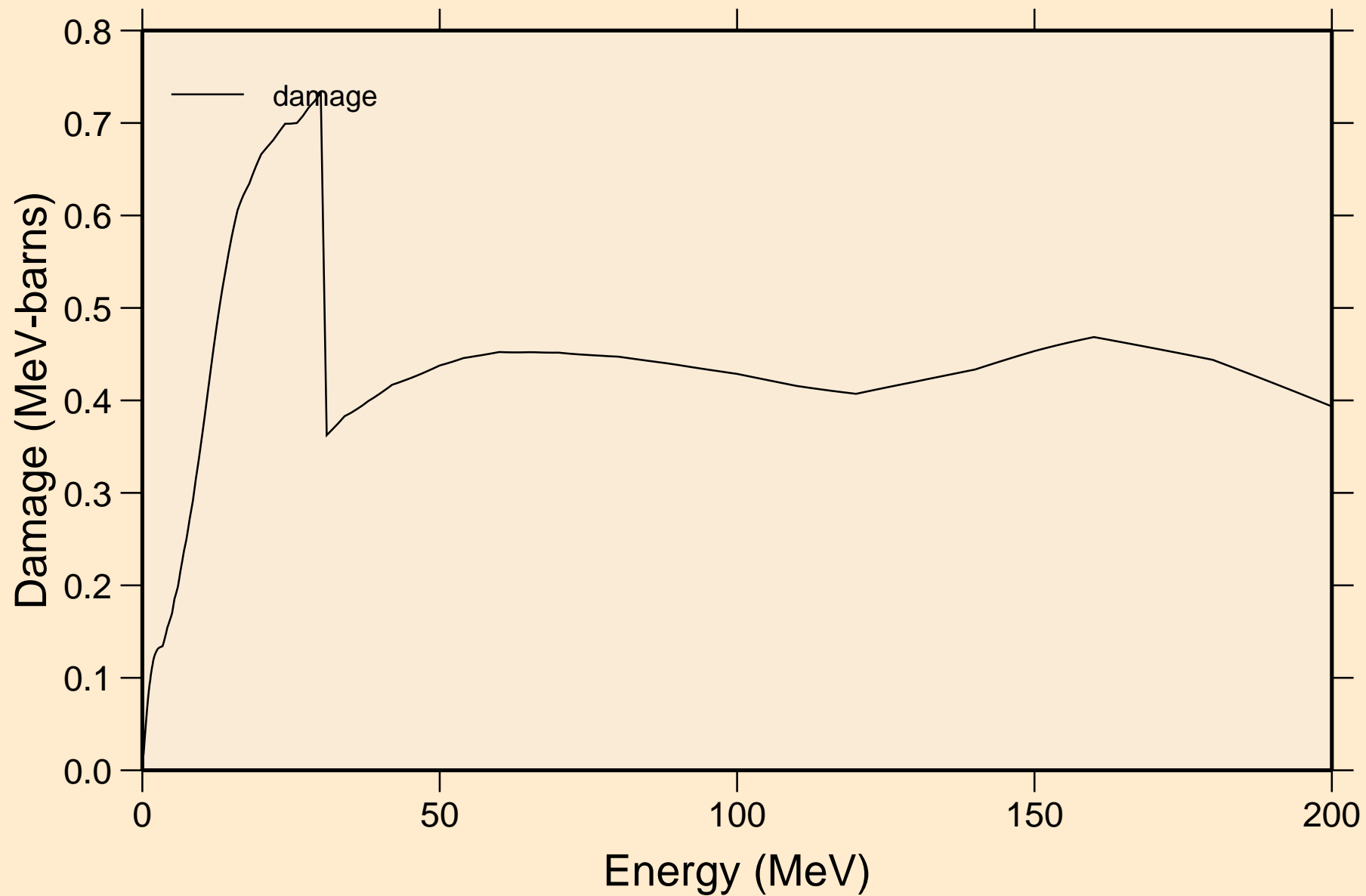

SN117M NEUTRON ACER TENDL-2019 LIBRARY; T=293.16K  
Non-threshold reactions

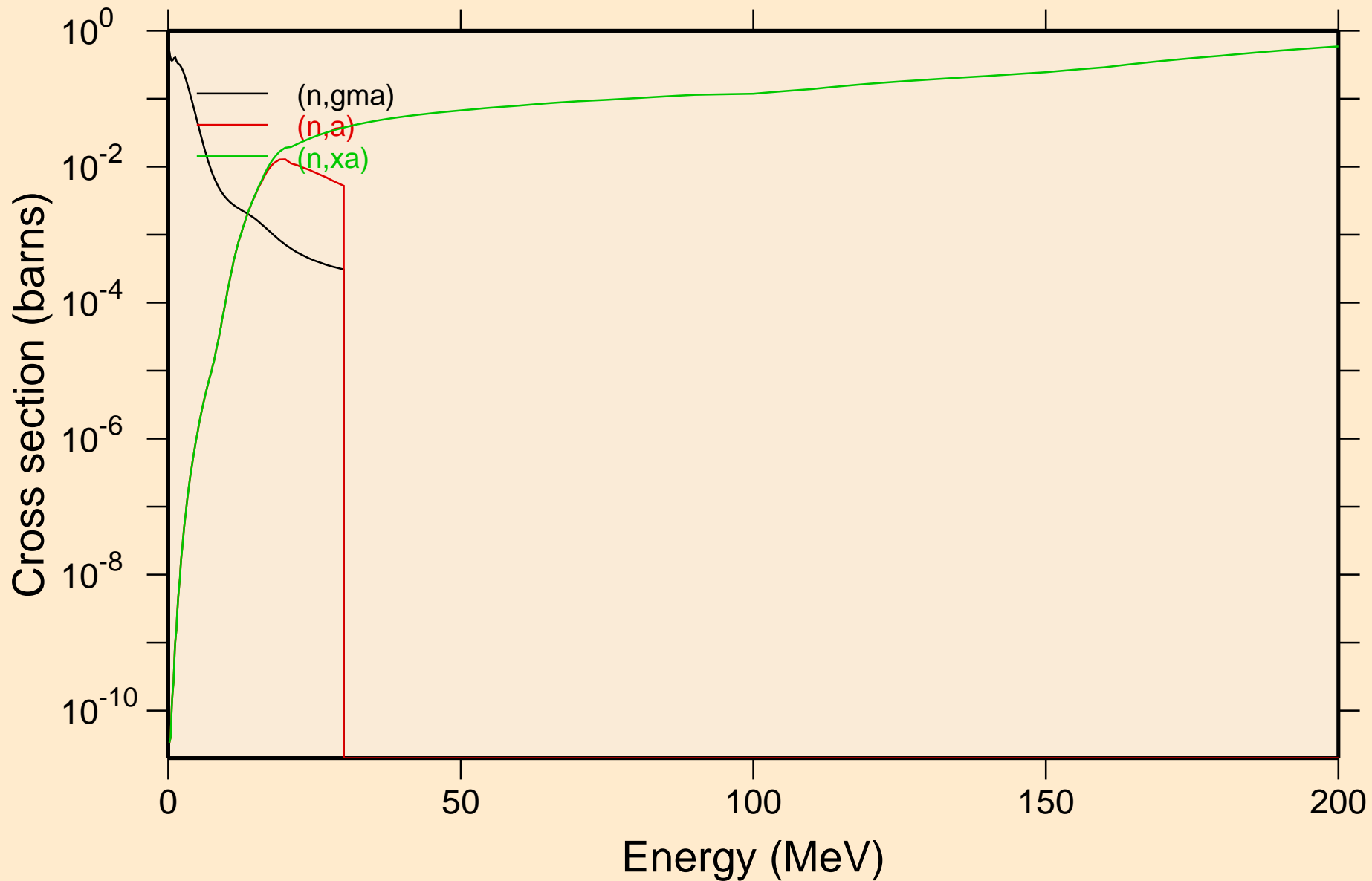



SN117M NEUTRON ACER TENDL-2019 LIBRARY; T=293.16K  
Inelastic levels

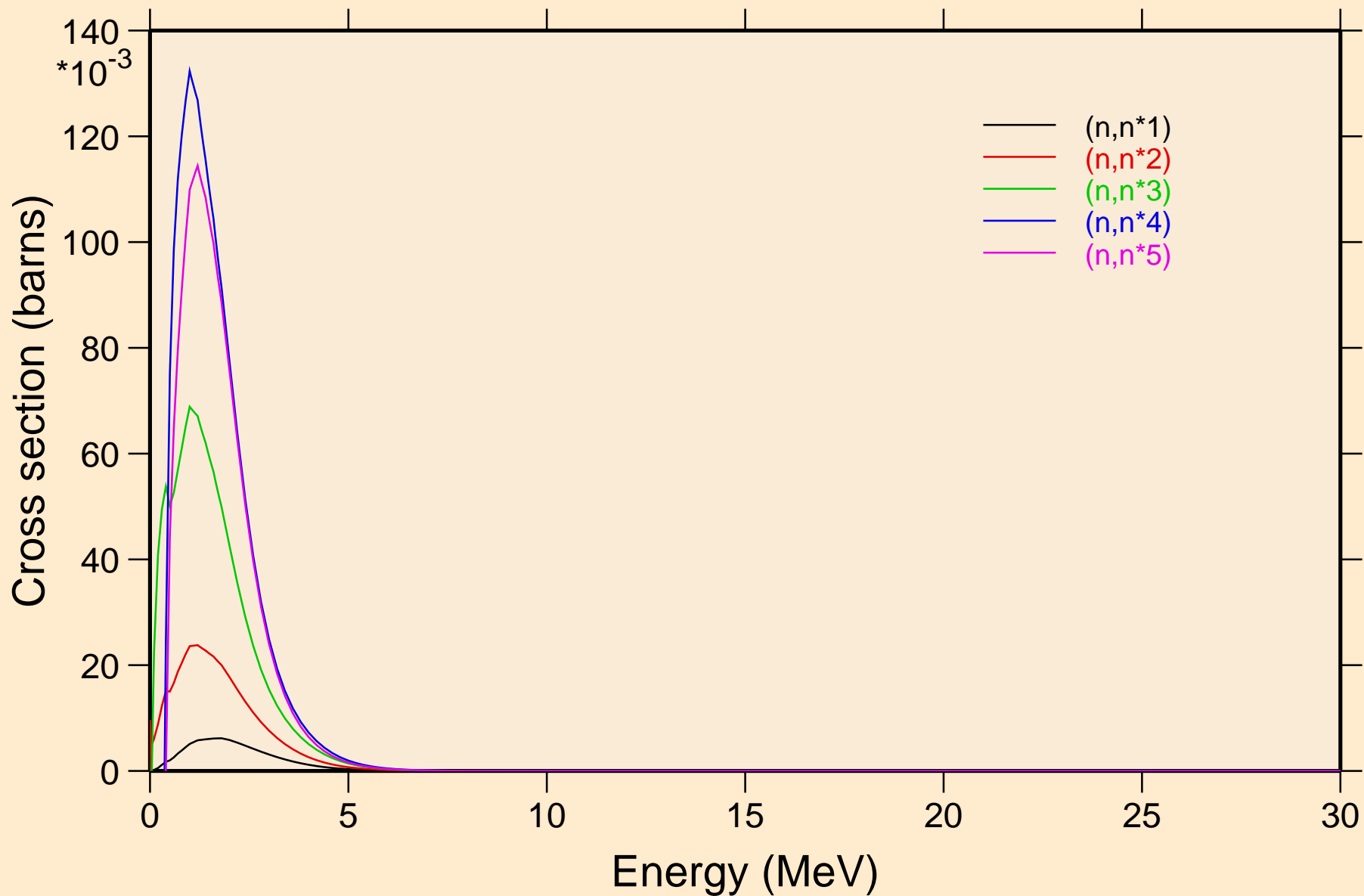

SN117M NEUTRON ACER TENDL-2019 LIBRARY; T=293.16K  
Inelastic levels

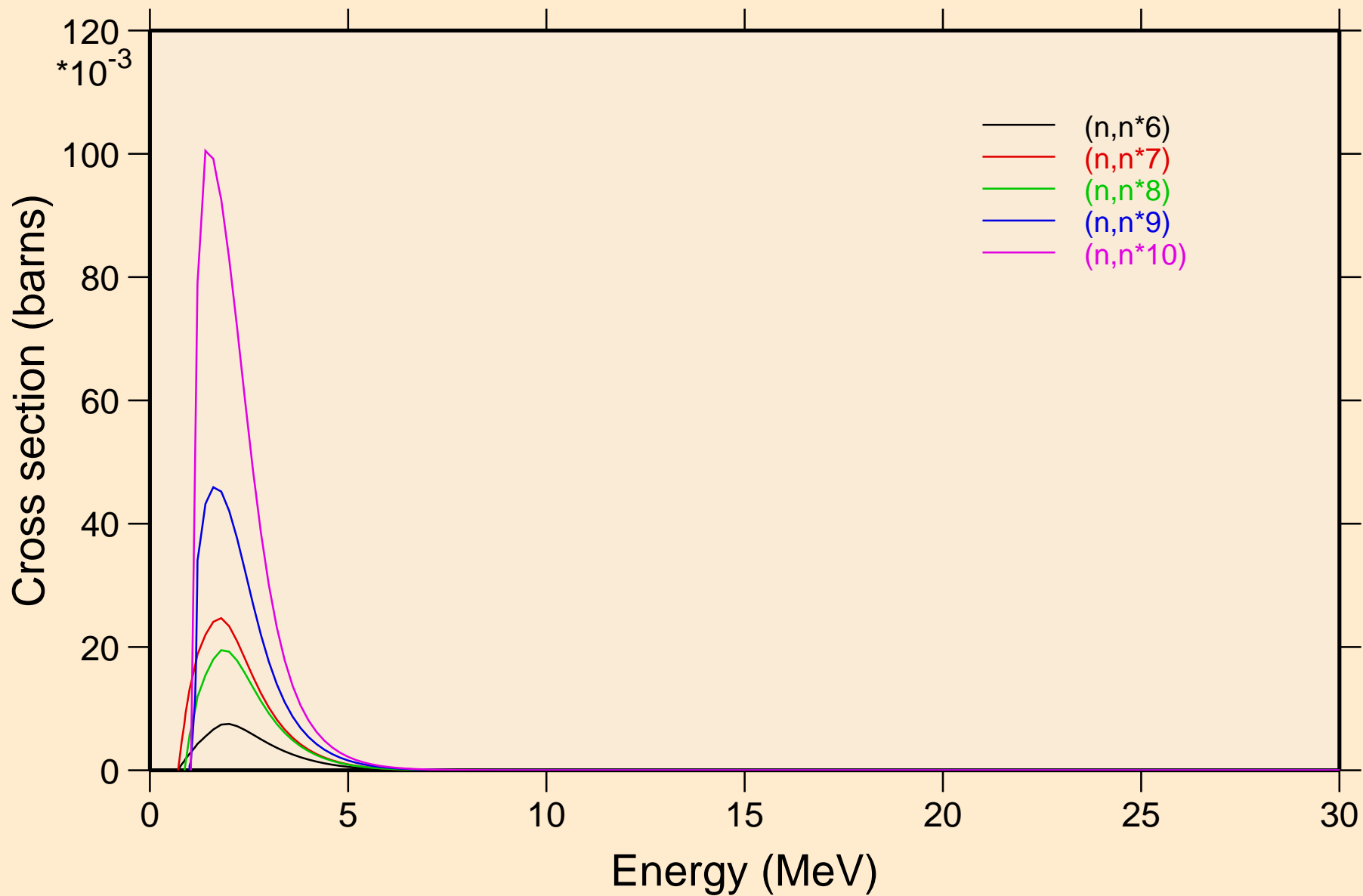

SN117M NEUTRON ACER TENDL-2019 LIBRARY; T=293.16K  
Inelastic levels

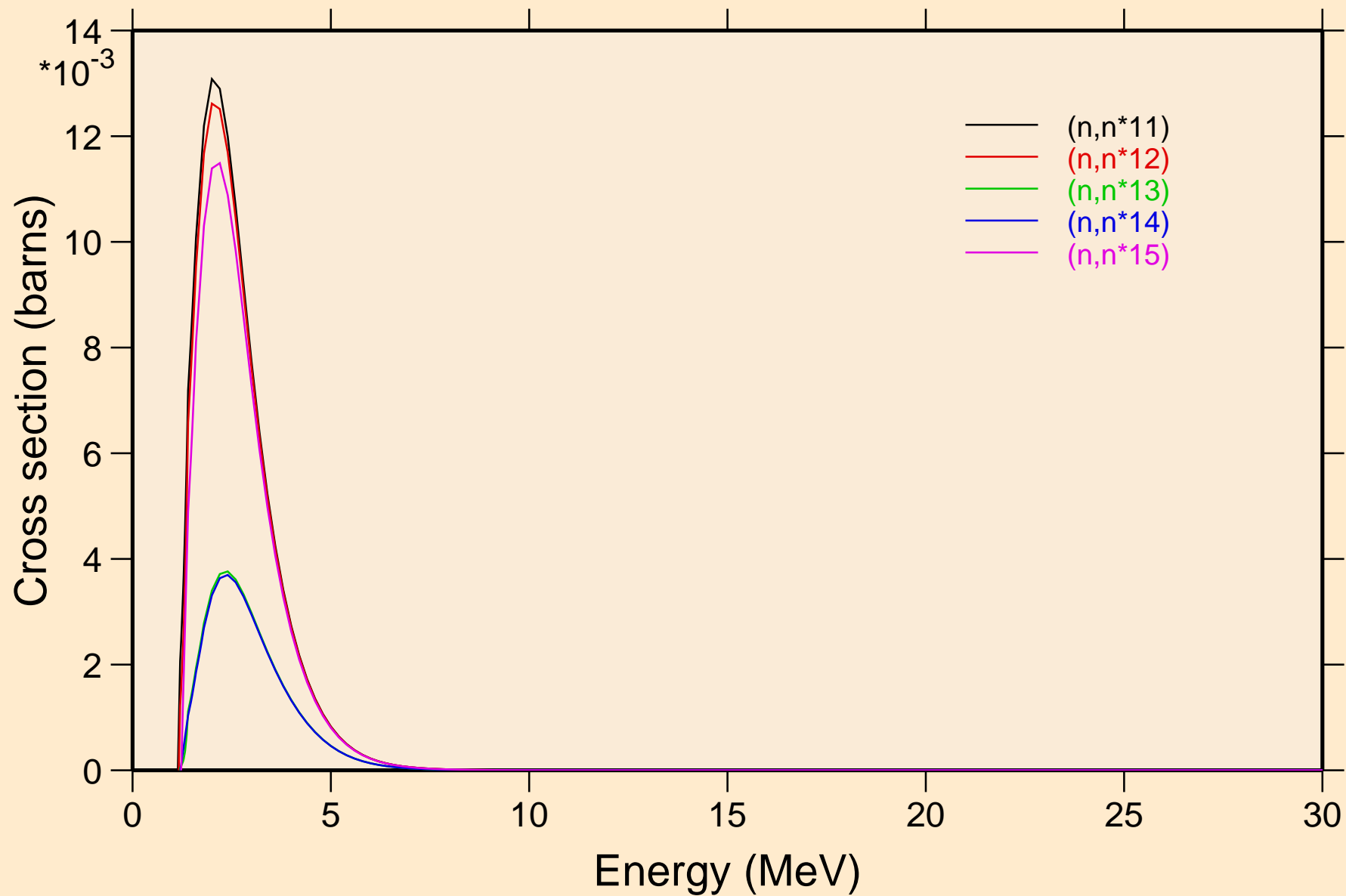

# SN117M NEUTRON ACER TENDL-2019 LIBRARY; T=293.16K

## Inelastic levels

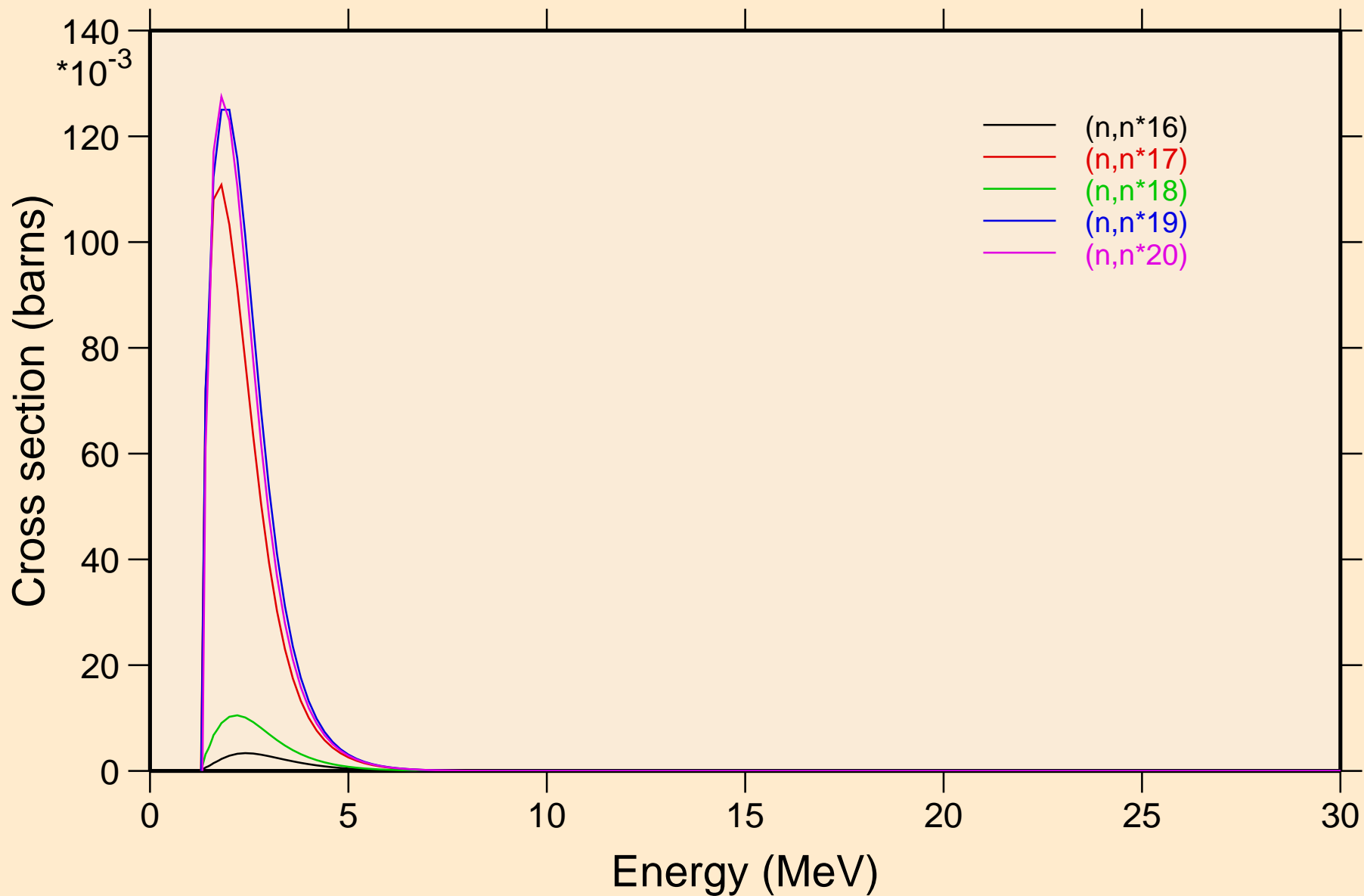

SN117M NEUTRON ACER TENDL-2019 LIBRARY; T=293.16K  
Inelastic levels

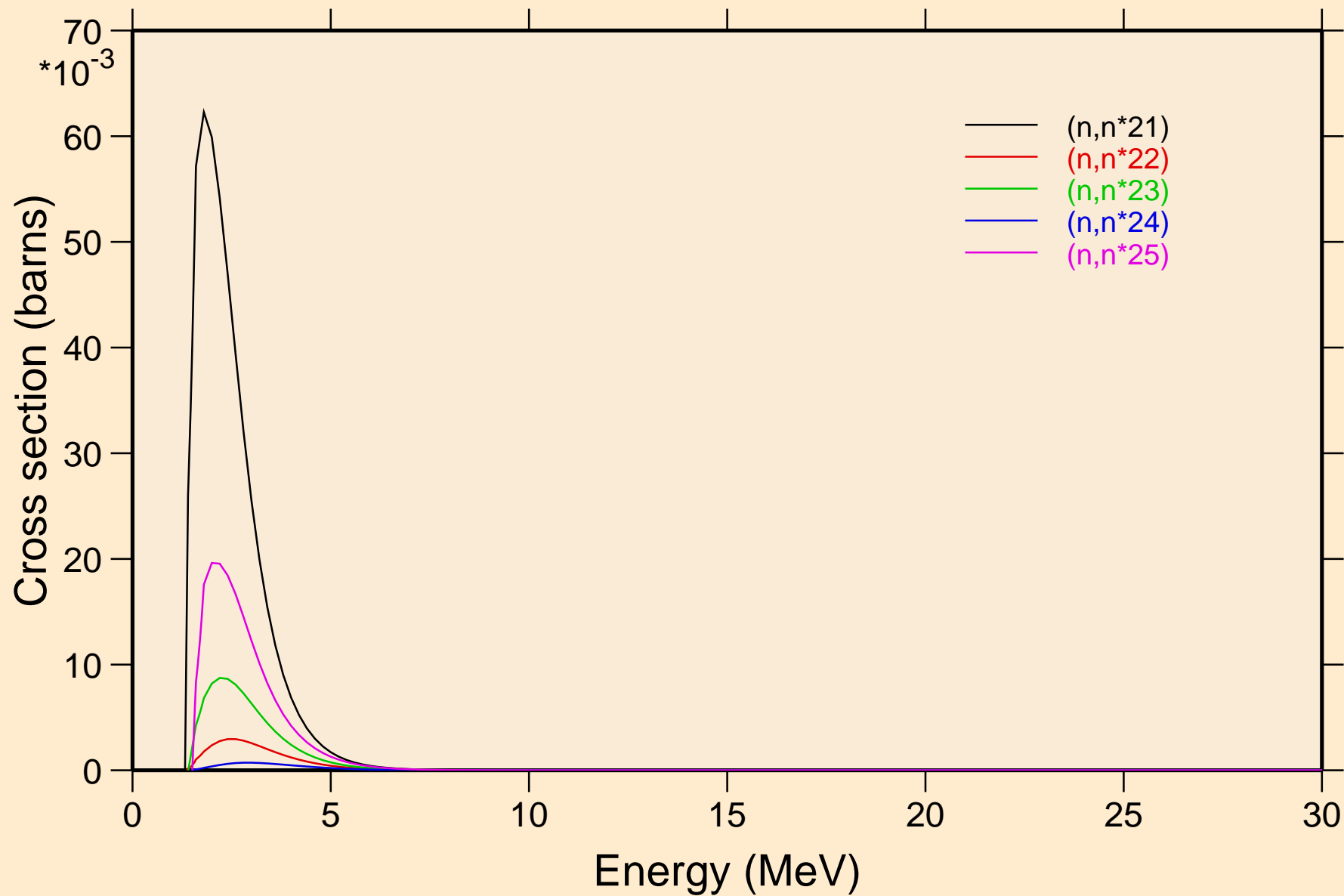

# SN117M NEUTRON ACER TENDL-2019 LIBRARY; T=293.16K

## Inelastic levels

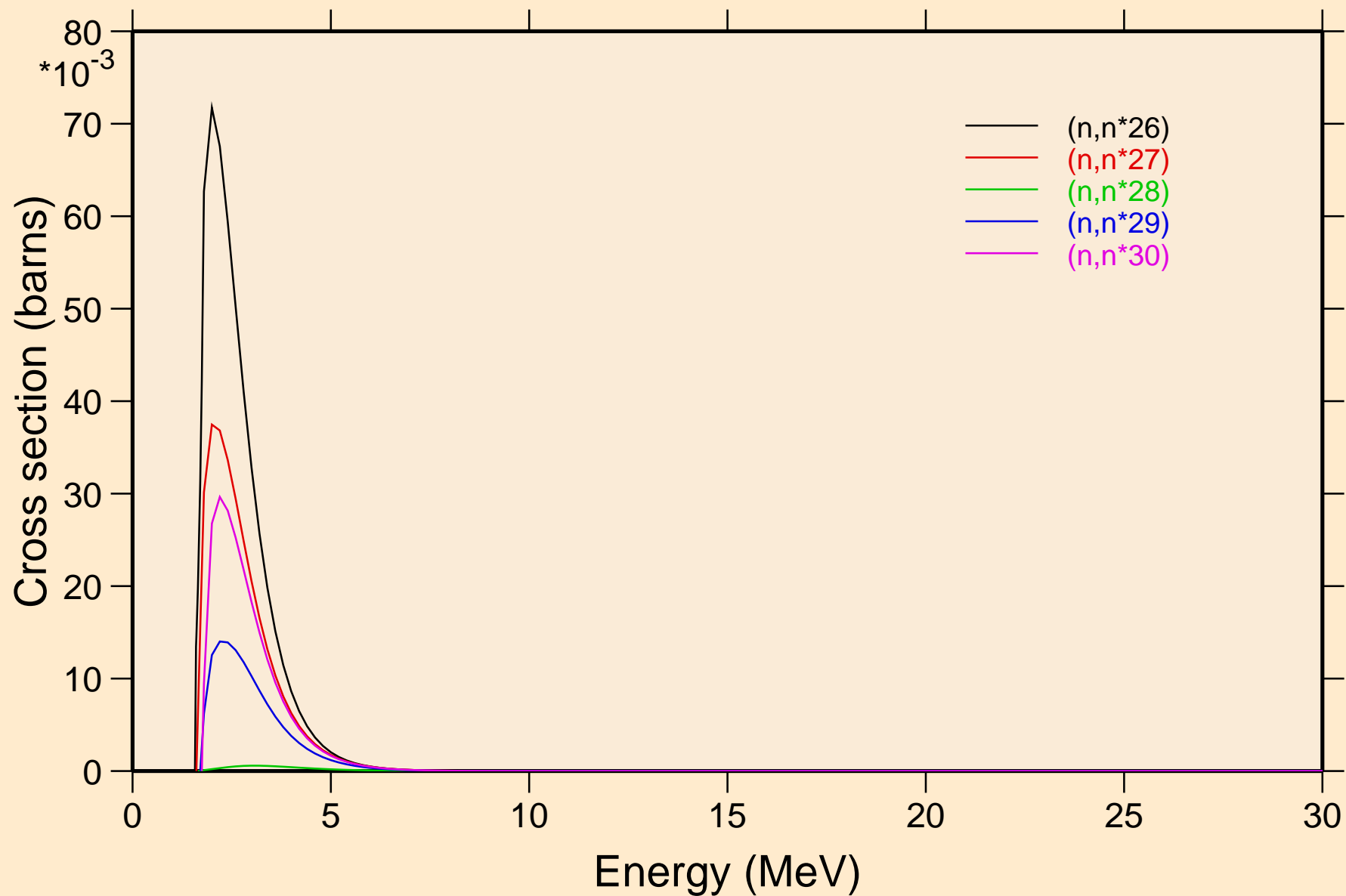

# SN117M NEUTRON ACER TENDL-2019 LIBRARY; T=293.16K

## Threshold reactions

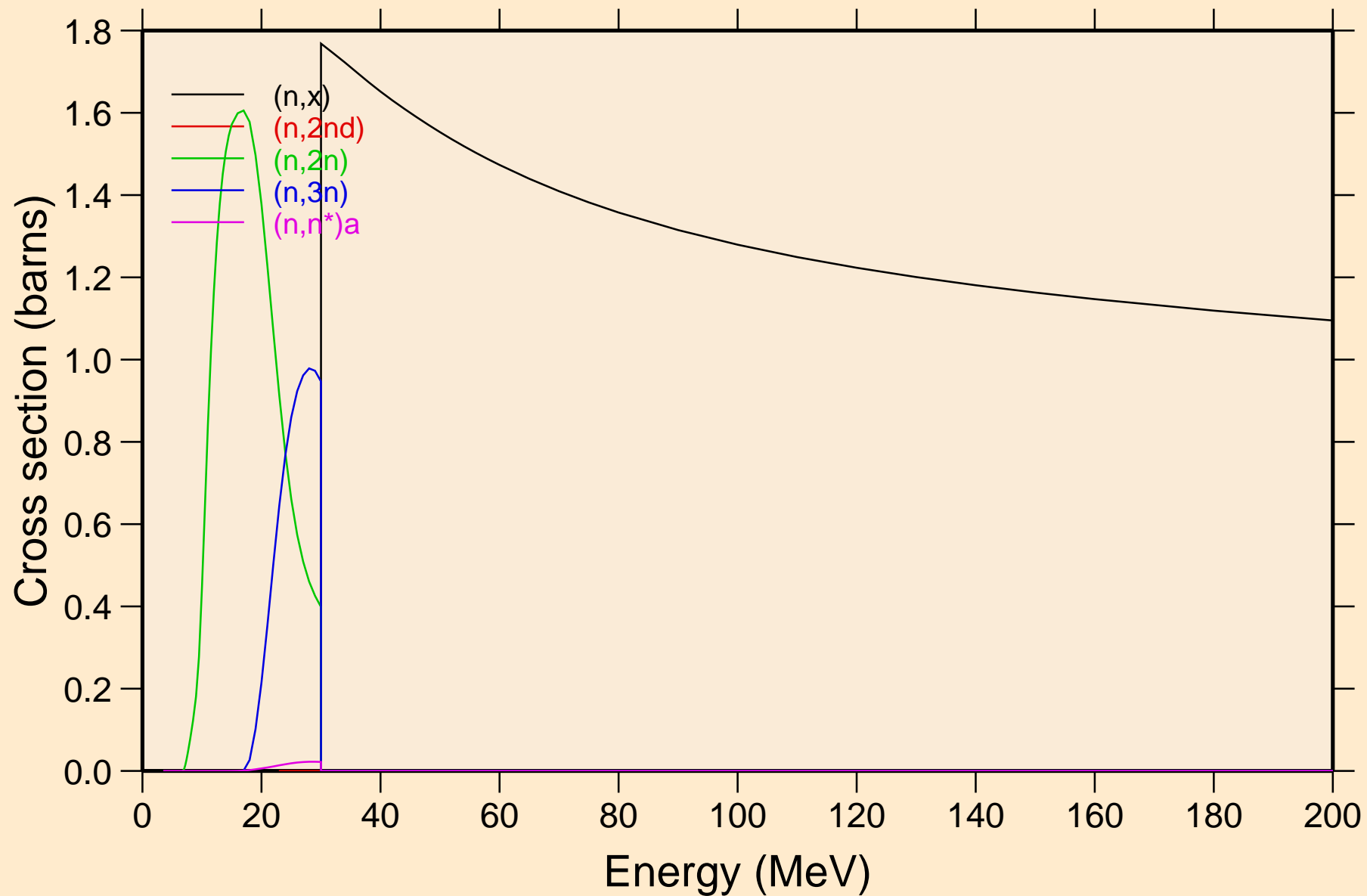

# SN117M NEUTRON ACER TENDL-2019 LIBRARY; T=293.16K

## Threshold reactions

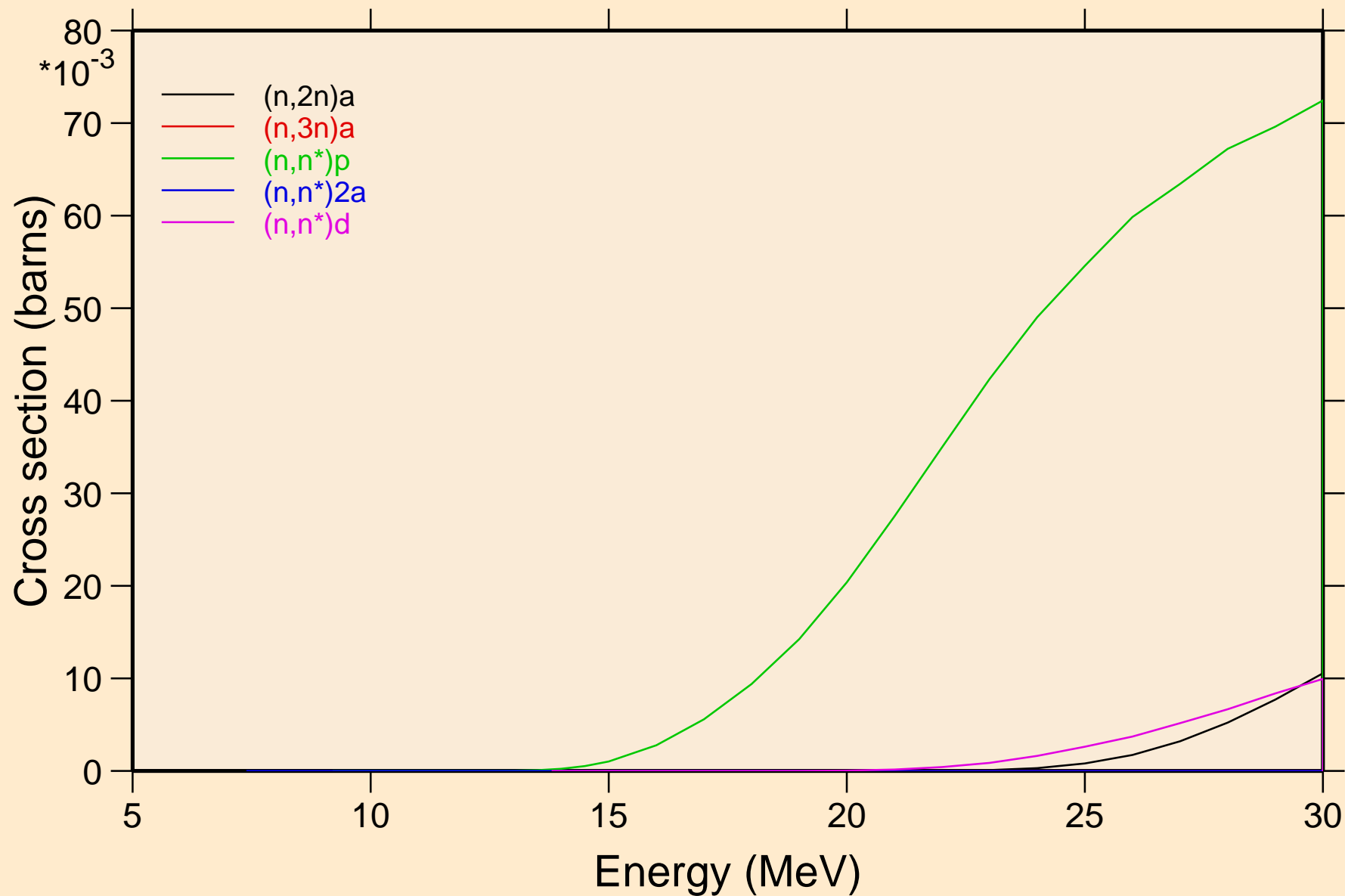



# SN117M NEUTRON ACER TENDL-2019 LIBRARY; T=293.16K

## Threshold reactions

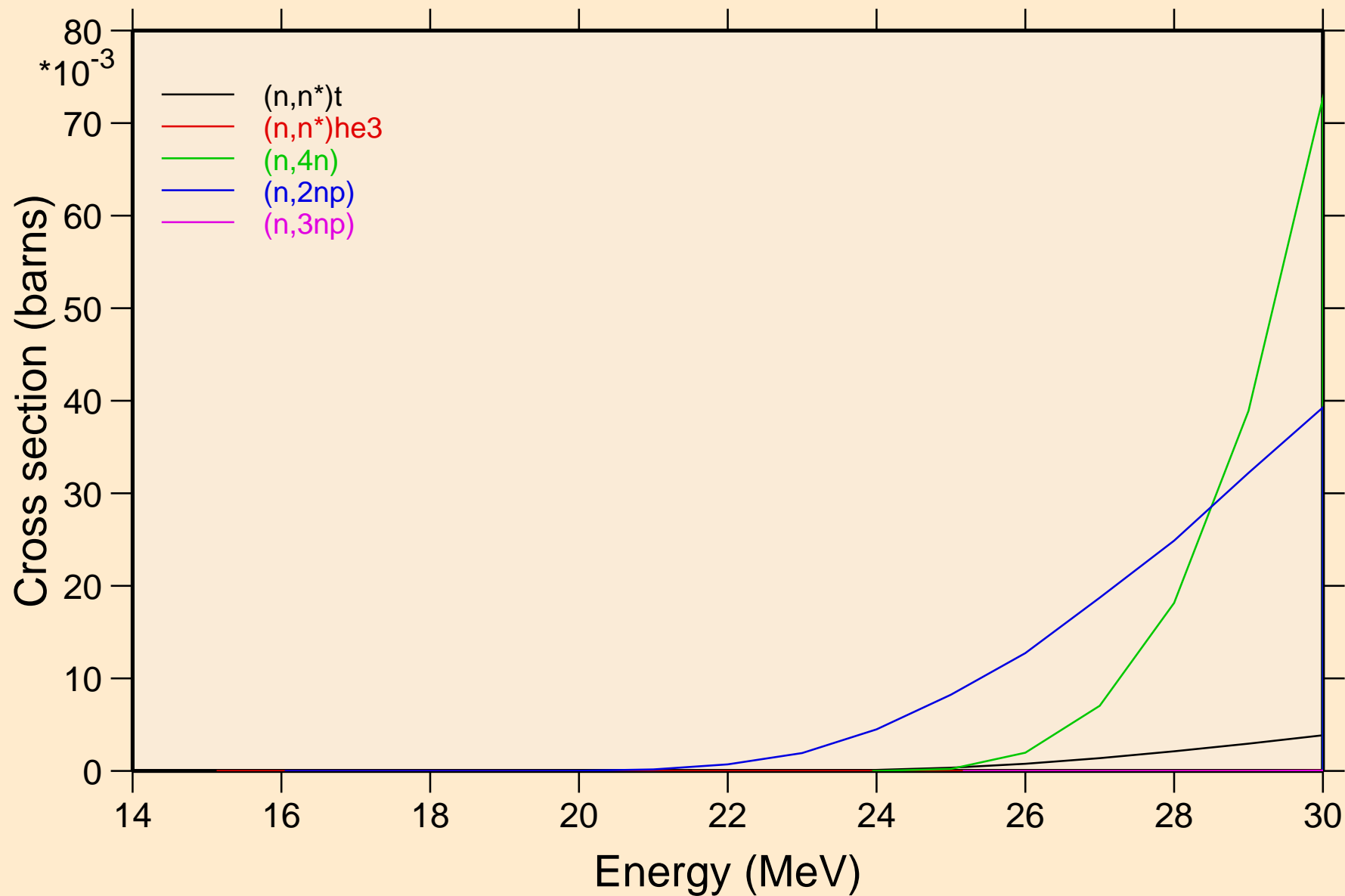

SN117M NEUTRON ACER TENDL-2019 LIBRARY; T=293.16K  
Threshold reactions

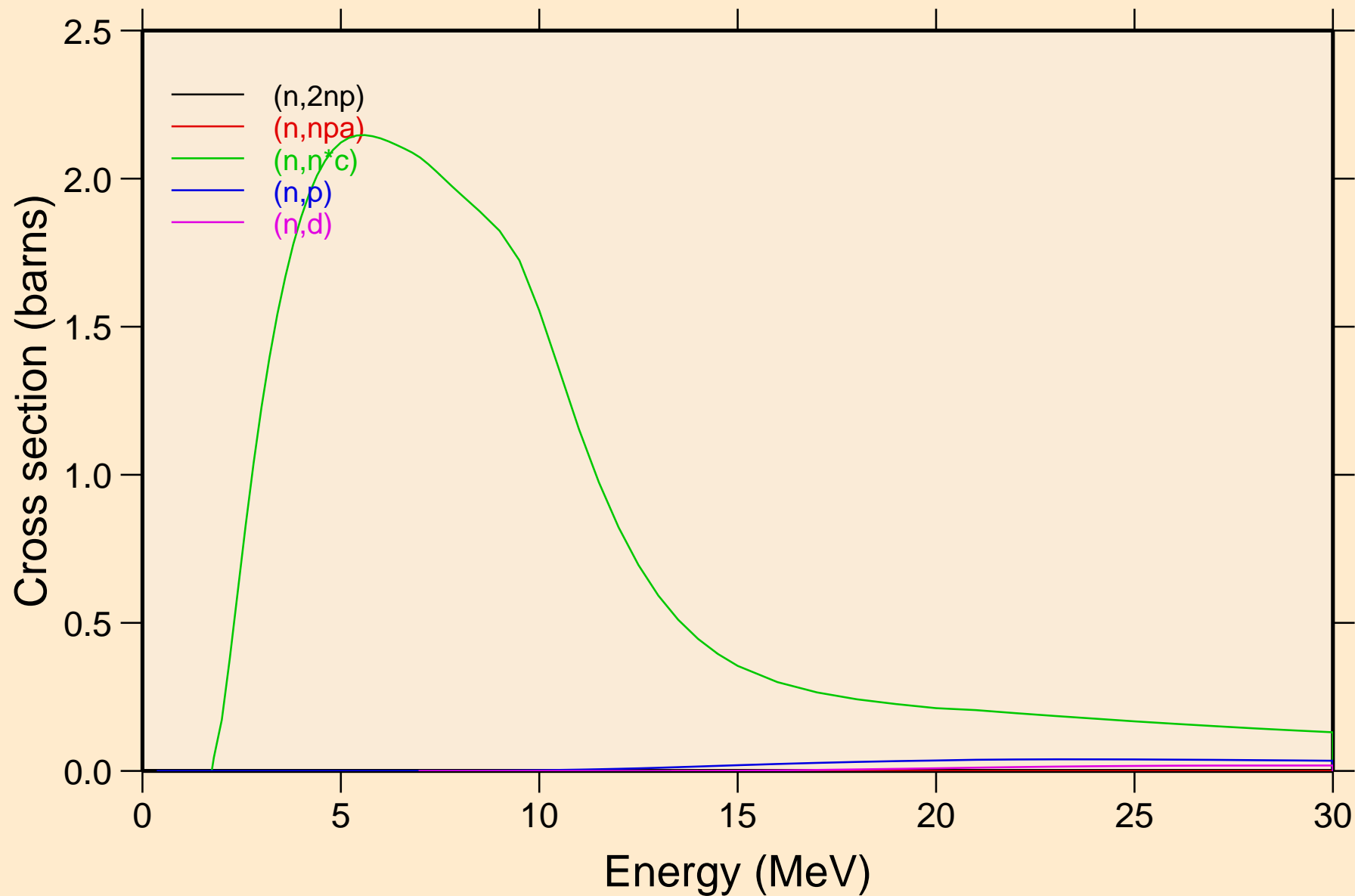

# SN117M NEUTRON ACER TENDL-2019 LIBRARY; T=293.16K

## Threshold reactions

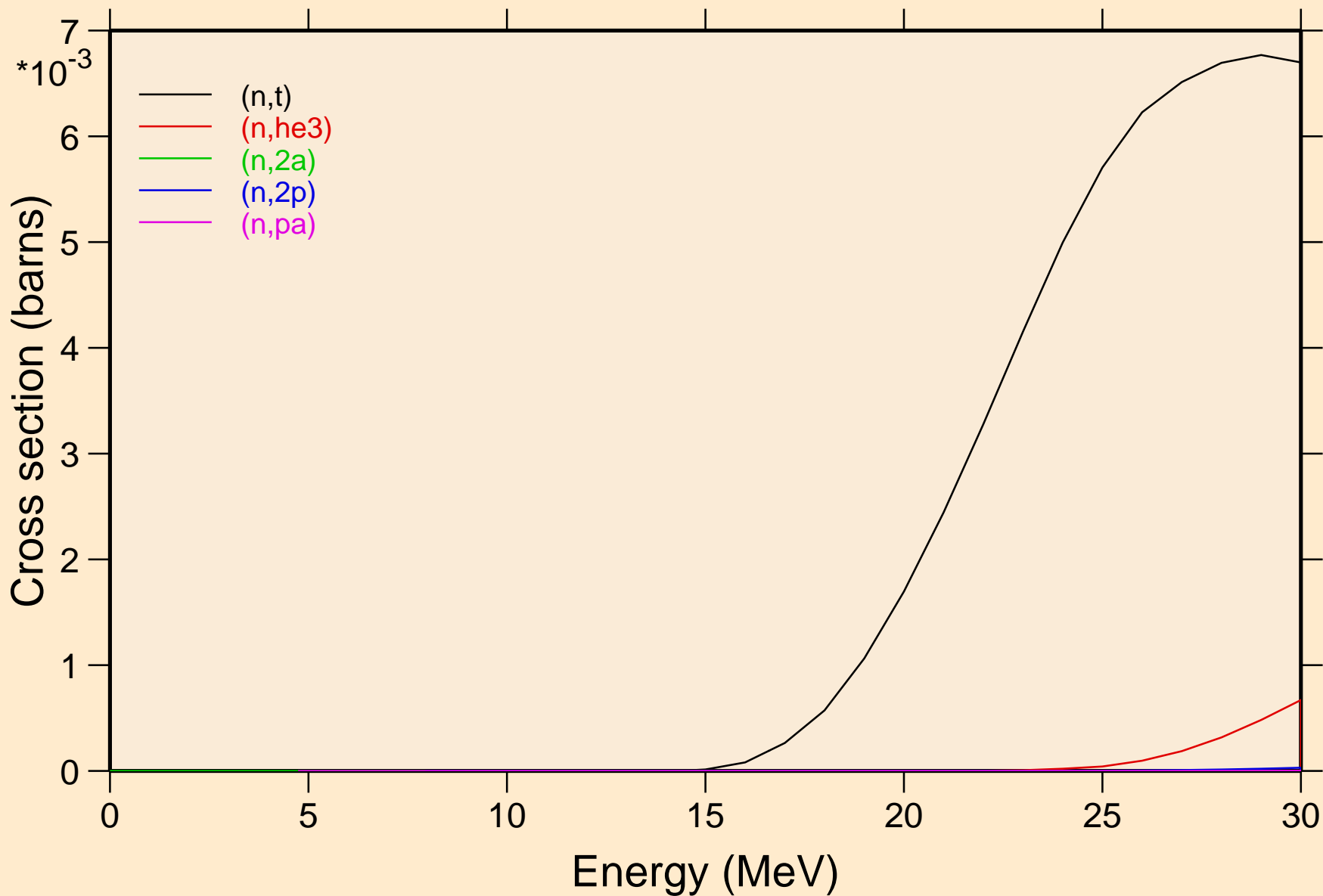

SN117M NEUTRON ACER TENDL-2019 LIBRARY; T=293.16K  
Threshold reactions

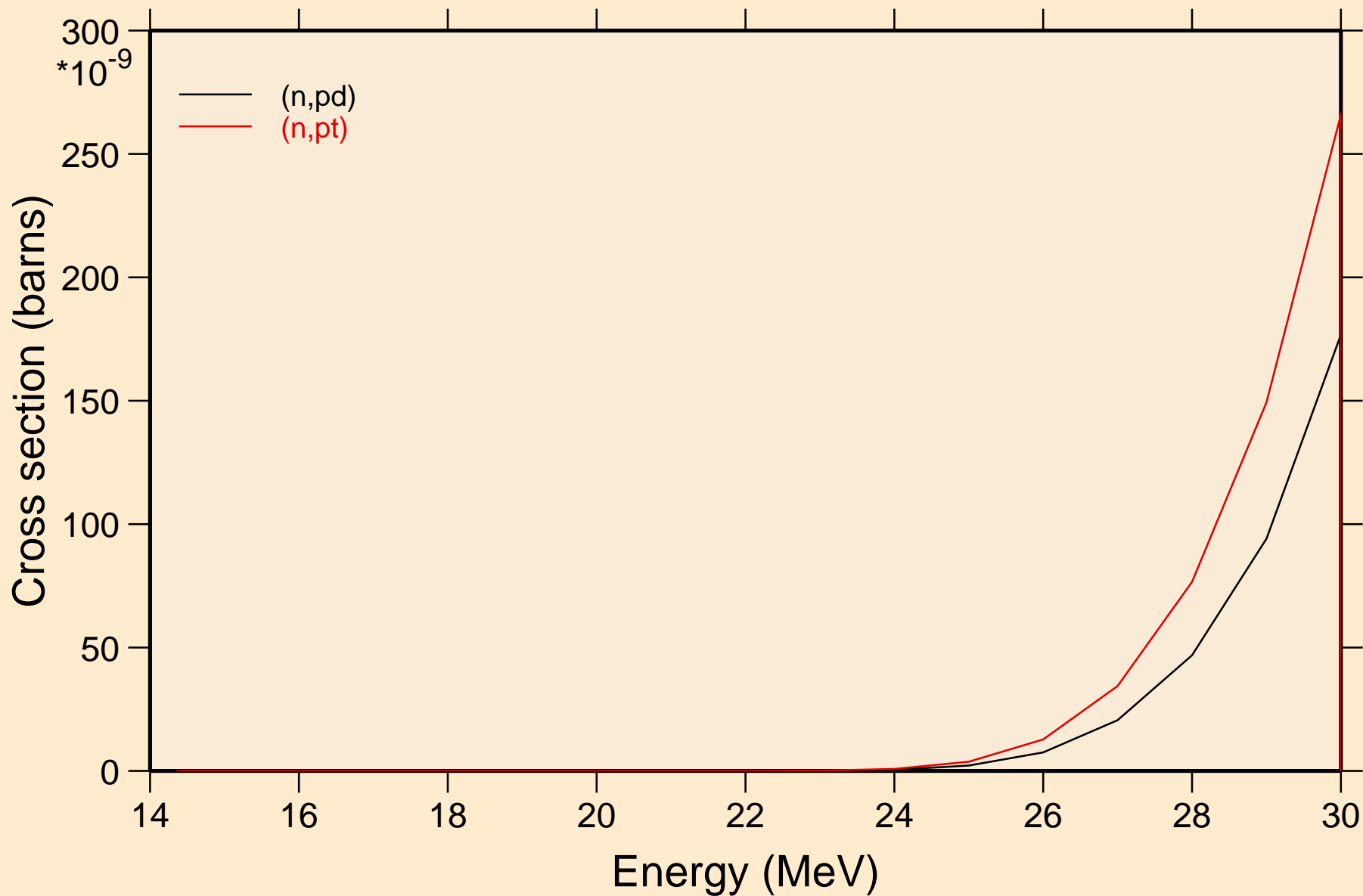

# SN117M NEUTRON ACER TENDL-2019 LIBRARY; T=293.16K

## Threshold reactions

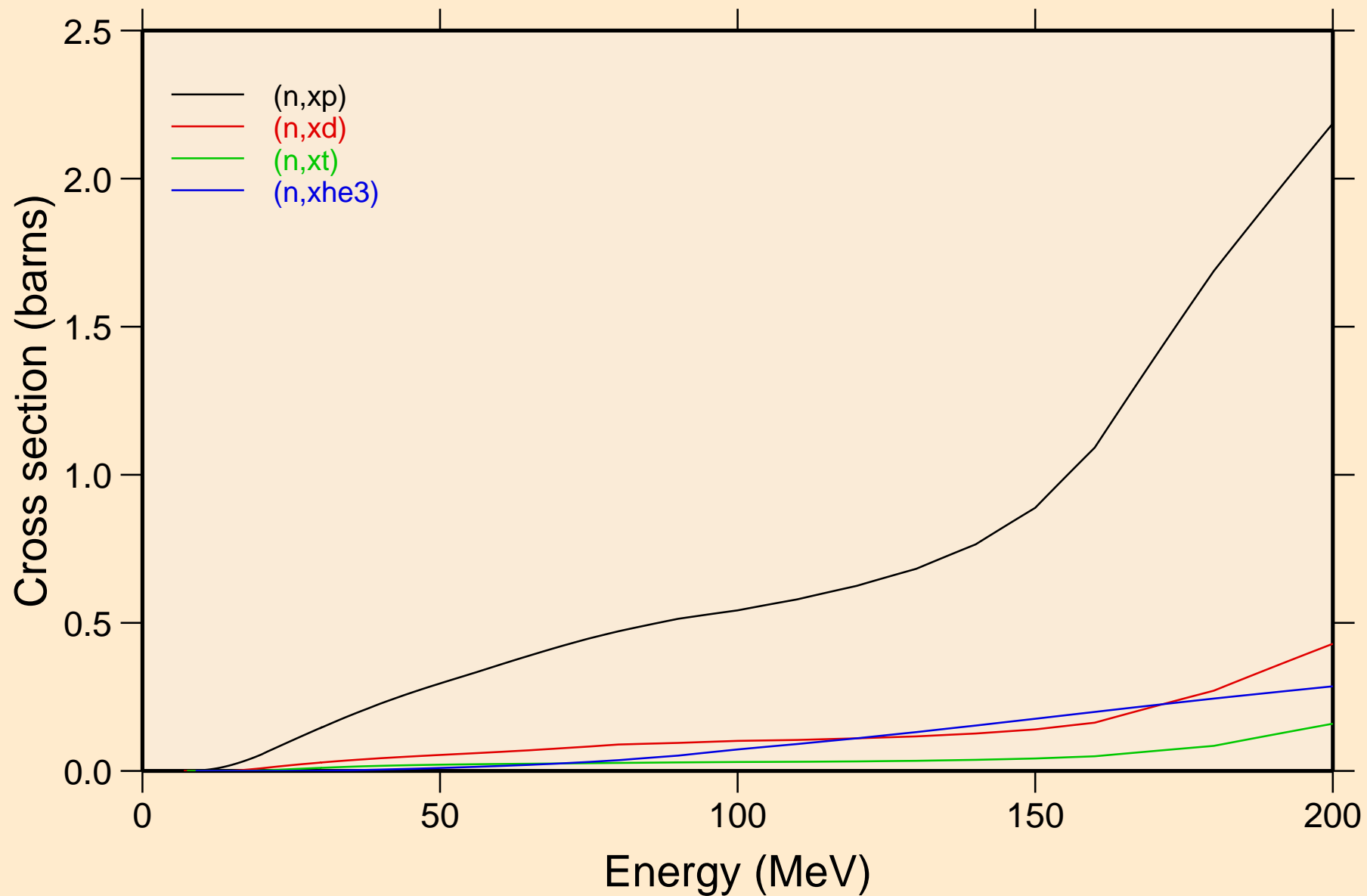

SN117M NEUTRON ACER TENDL-2019 LIBRARY; T=293.16K  
angular distribution for elastic

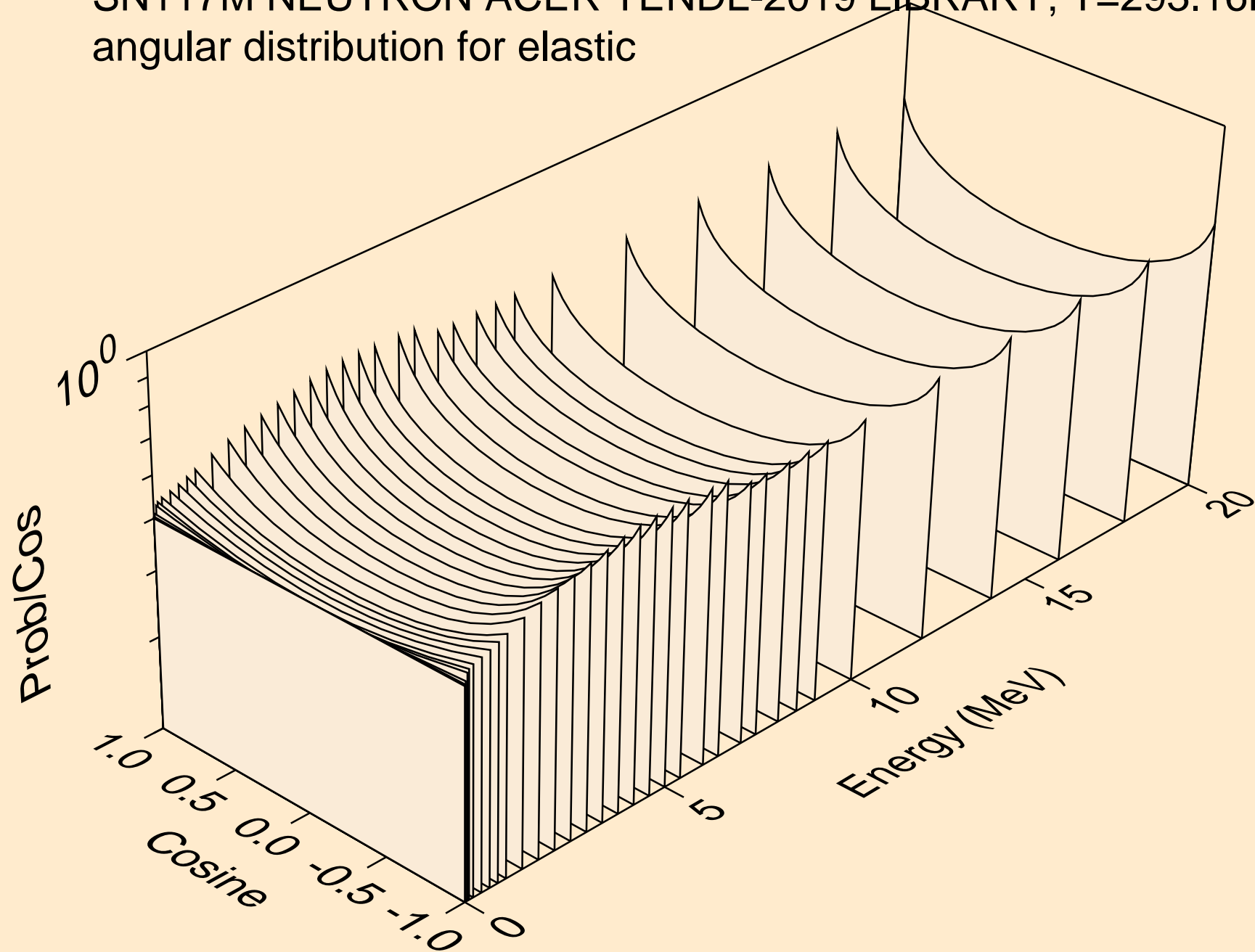

SN117M NEUTRON ACER TENDL-2019 LIBRARY; T=293.16K  
angular distribution for elastic

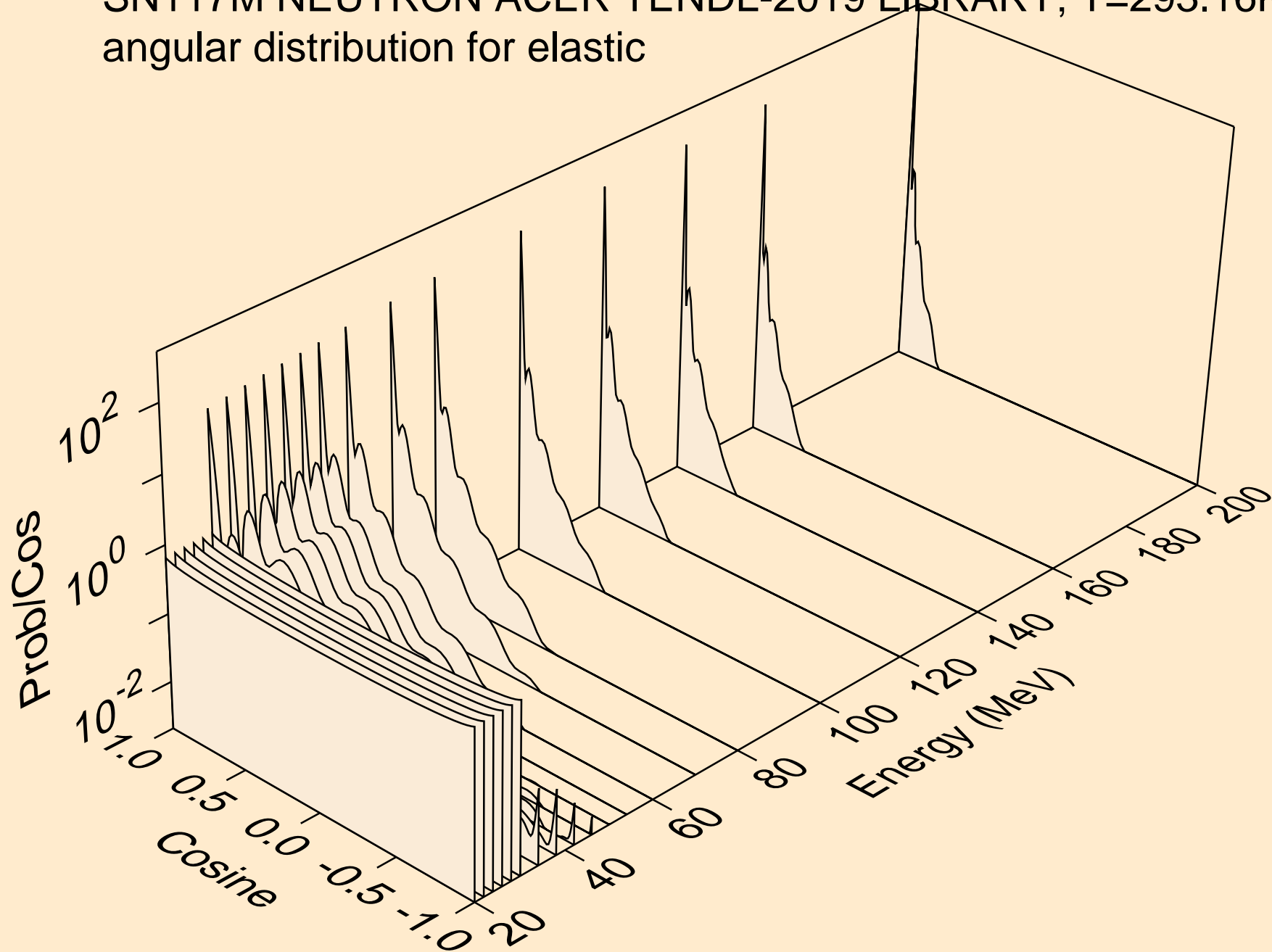

SN117M NEUTRON ACER TENDL-2019 LIBRARY; T=293.16K  
angular distribution for (n,n\*1)

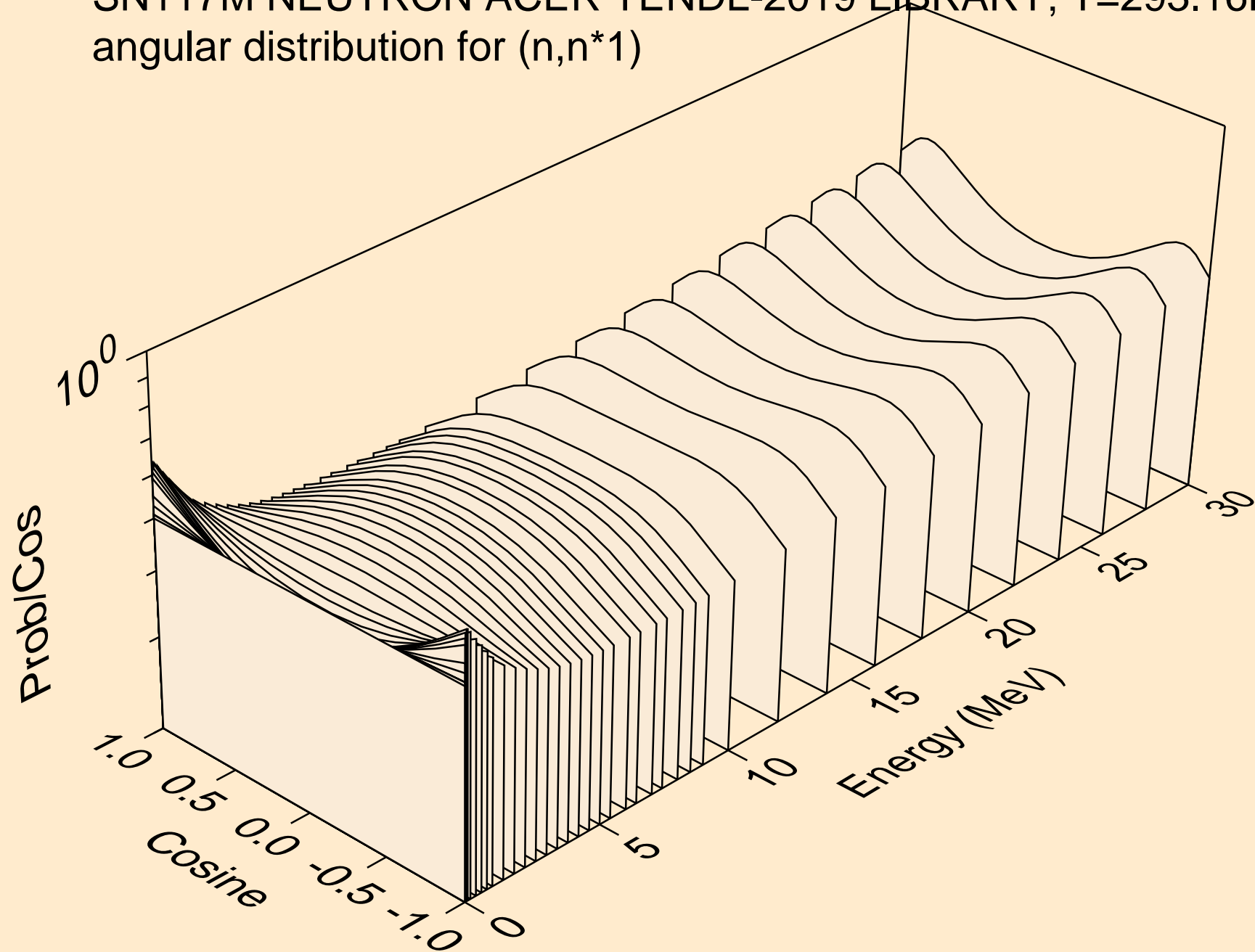



SN117M NEUTRON ACER TENDL-2019 LIBRARY; T=293.16K  
angular distribution for (n,n\*2)

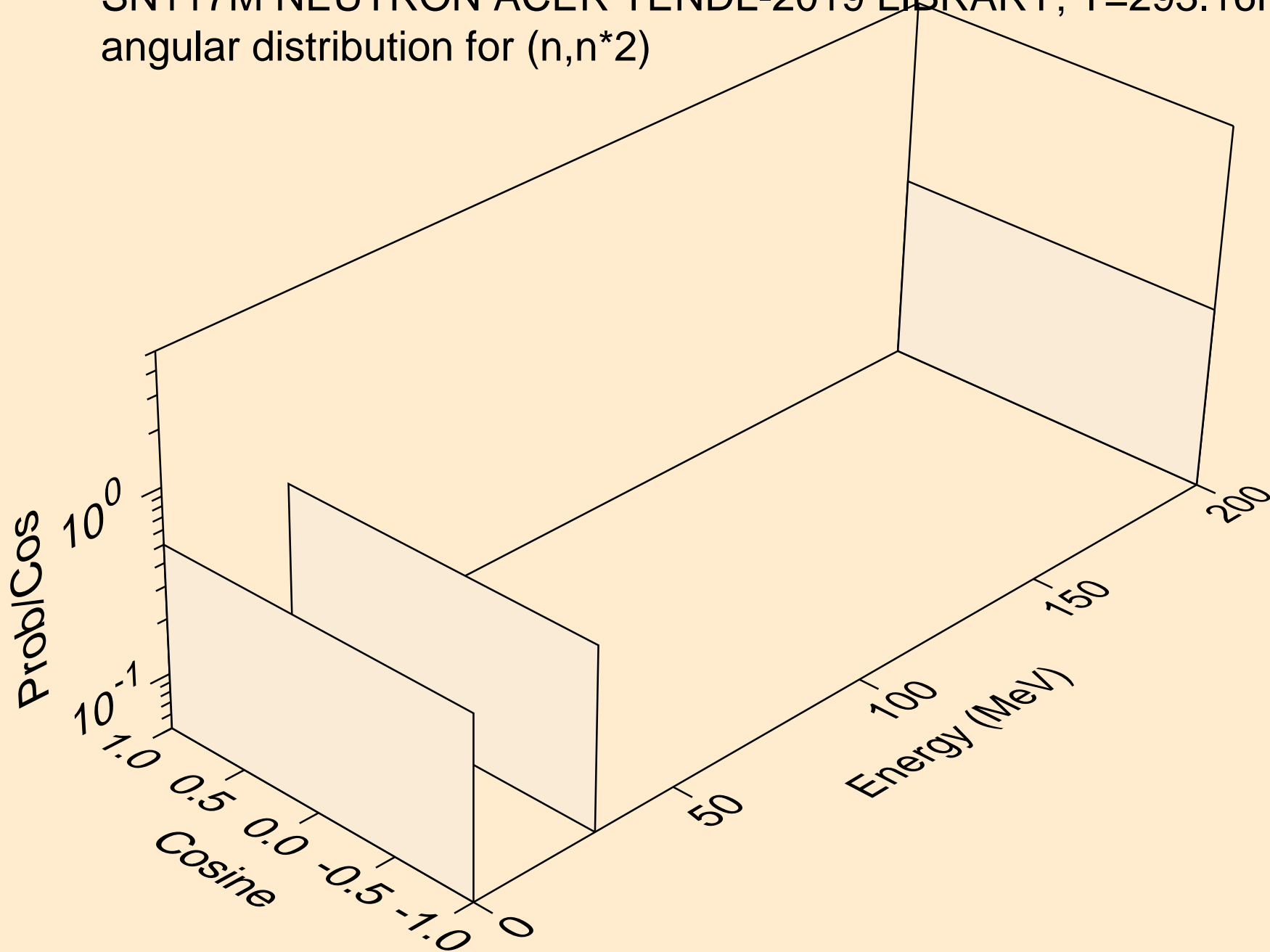

SN117M NEUTRON ACER TENDL-2019 LIBRARY; T=293.16K  
angular distribution for (n,n\*3)

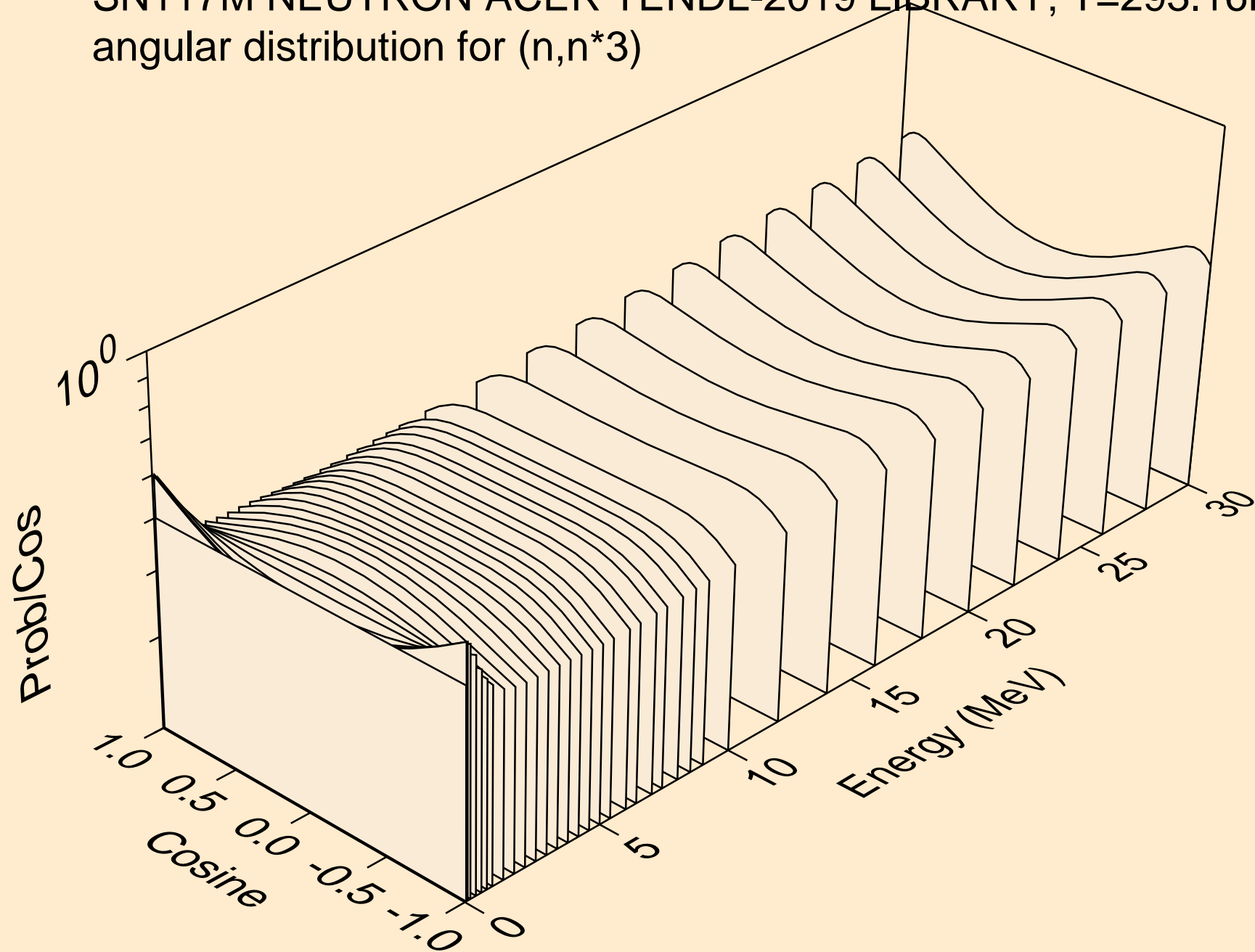

SN117M NEUTRON ACER TENDL-2019 LIBRARY; T=293.16K  
angular distribution for (n,n\*4)

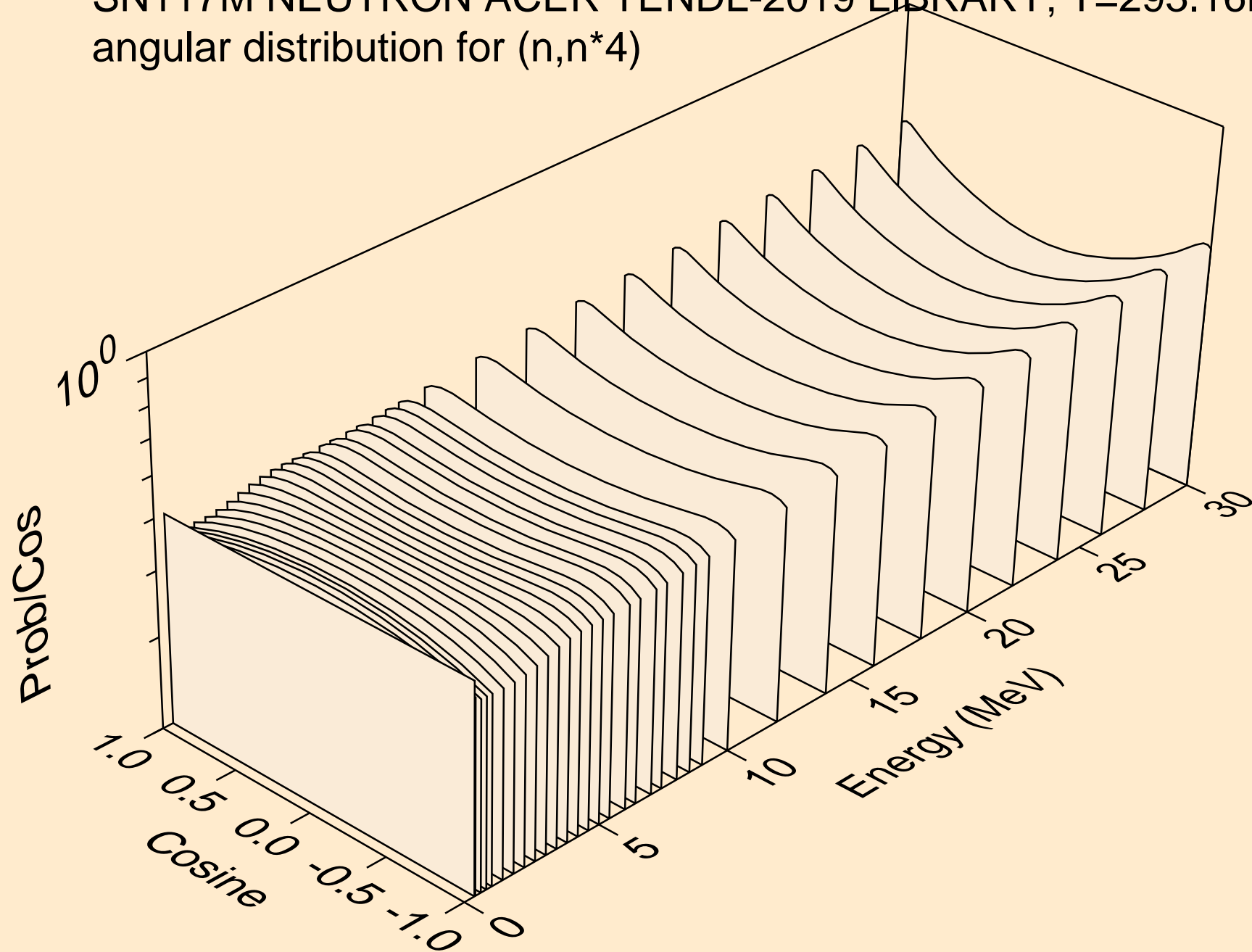

SN117M NEUTRON ACER TENDL-2019 LIBRARY; T=293.16K  
angular distribution for (n,n\*5)

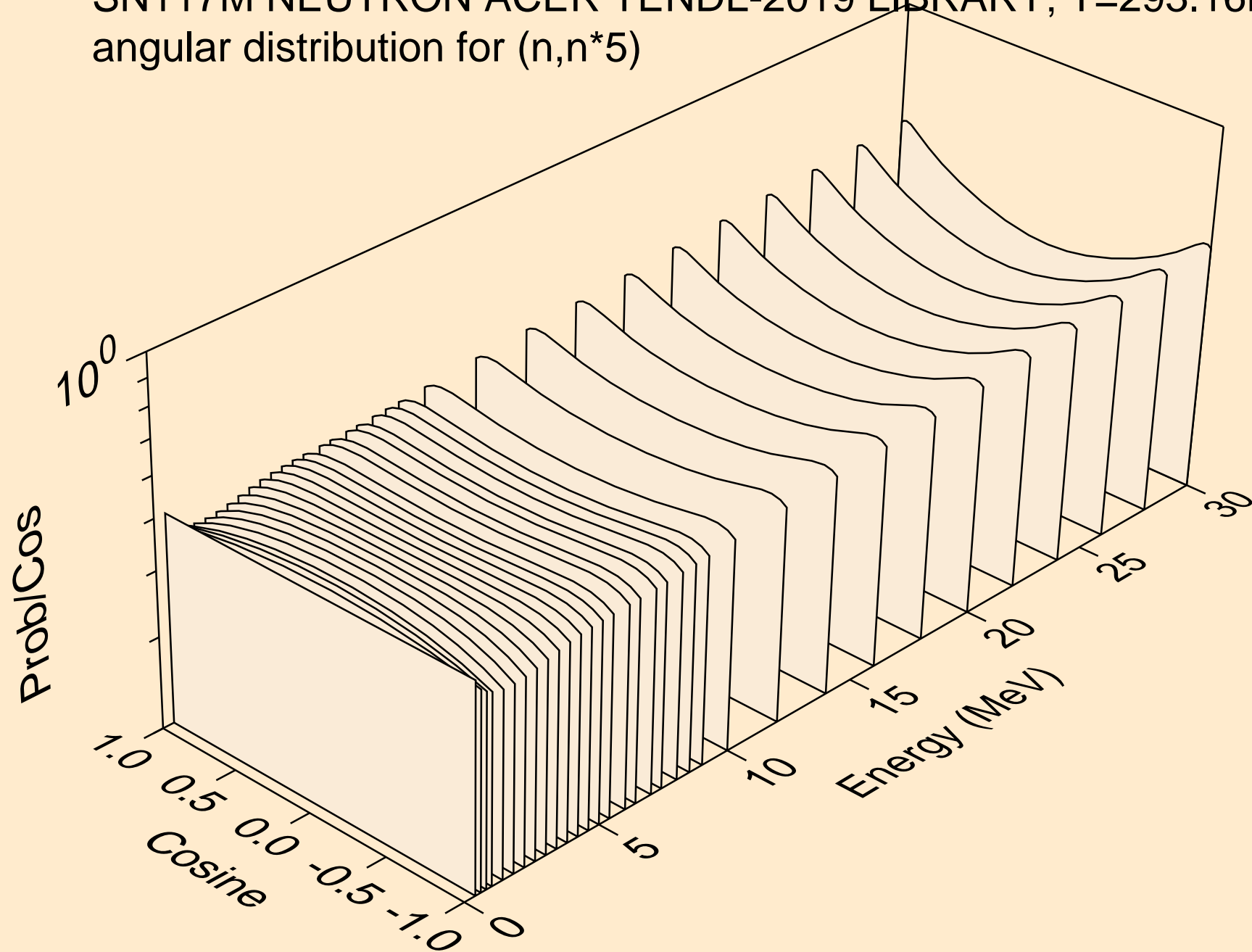

SN117M NEUTRON ACER TENDL-2019 LIBRARY; T=293.16K  
angular distribution for (n,n\*6)

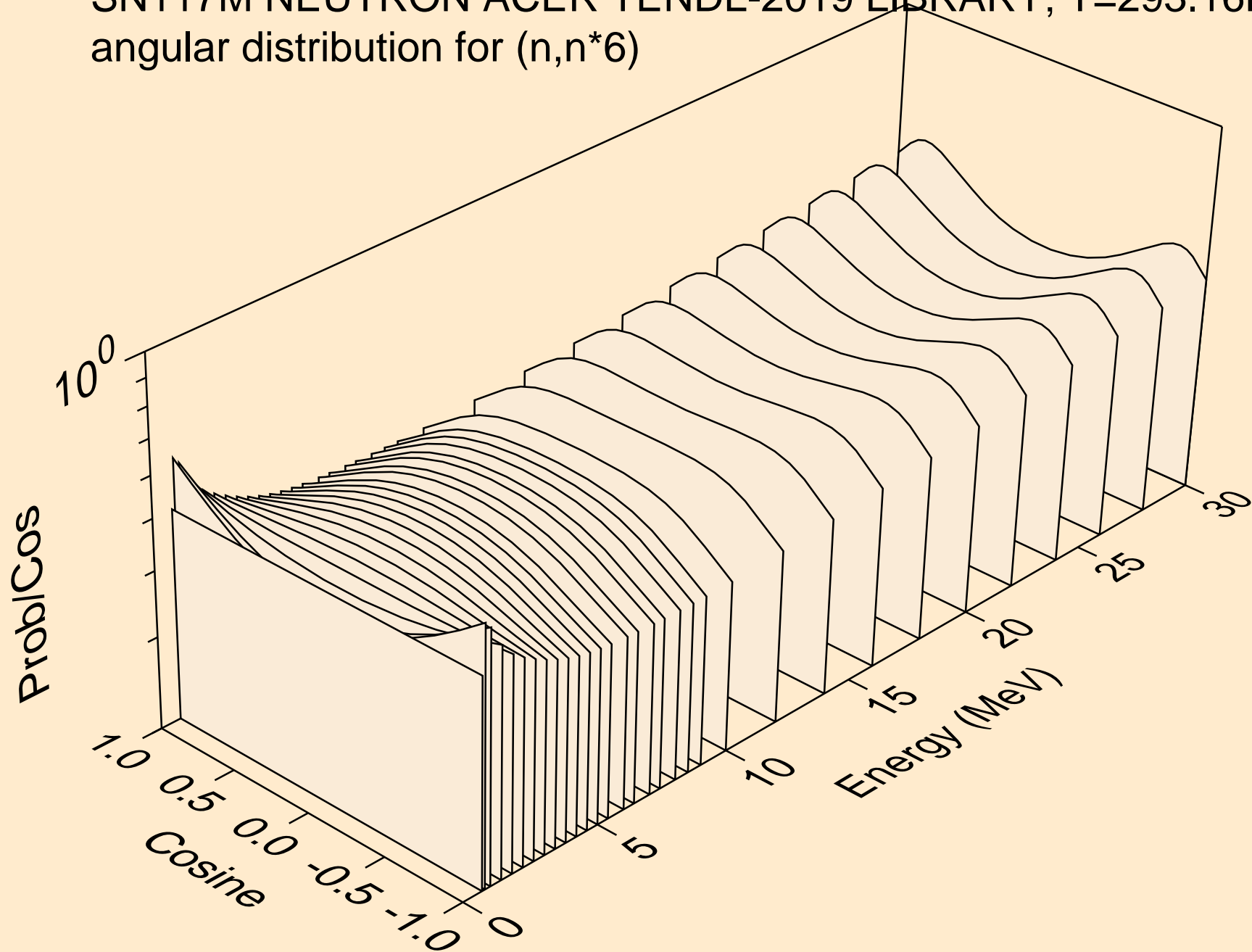

SN117M NEUTRON ACER TENDL-2019 LIBRARY; T=293.16K  
angular distribution for (n,n\*7)

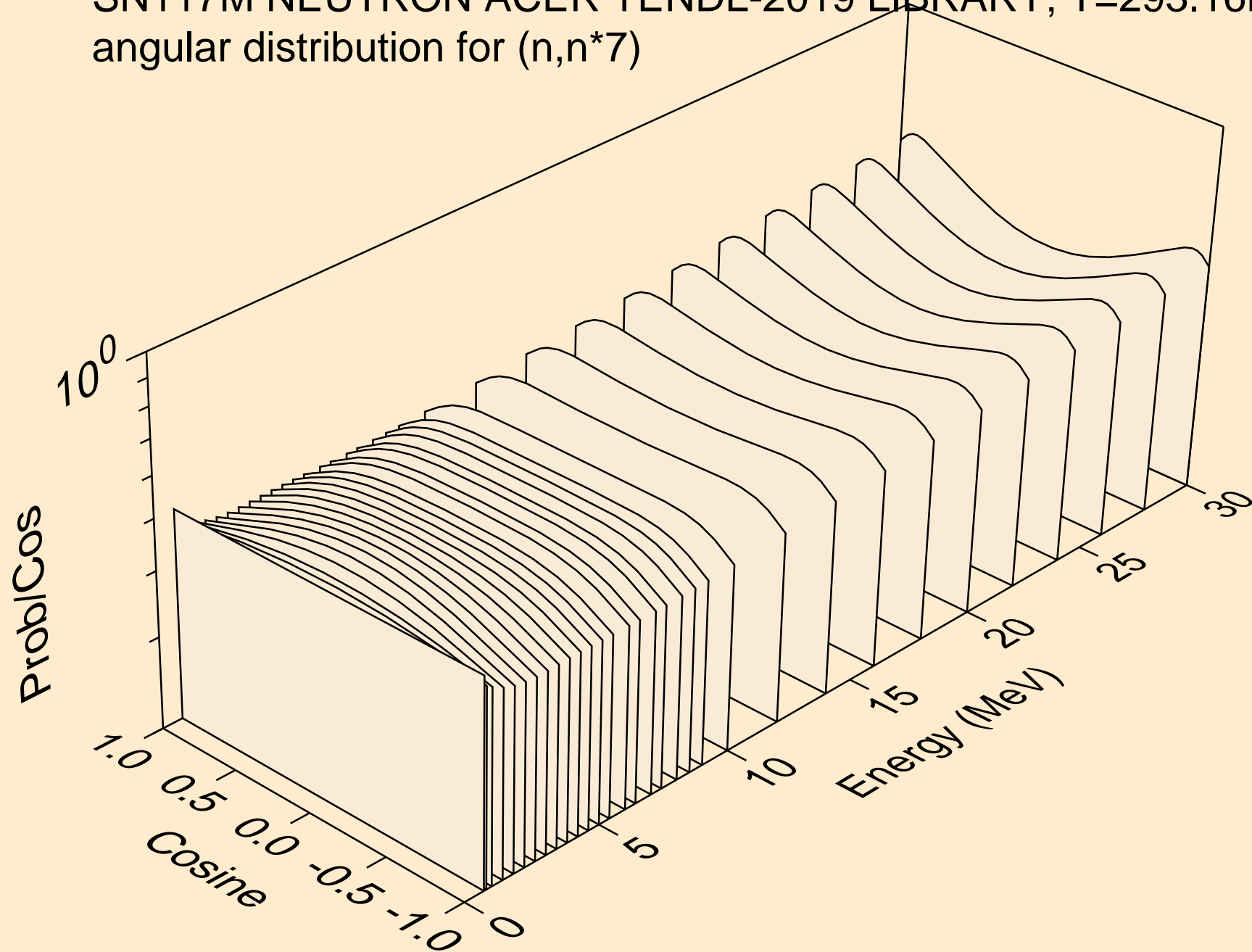

SN117M NEUTRON ACER TENDL-2019 LIBRARY; T=293.16K  
angular distribution for (n,n\*8)

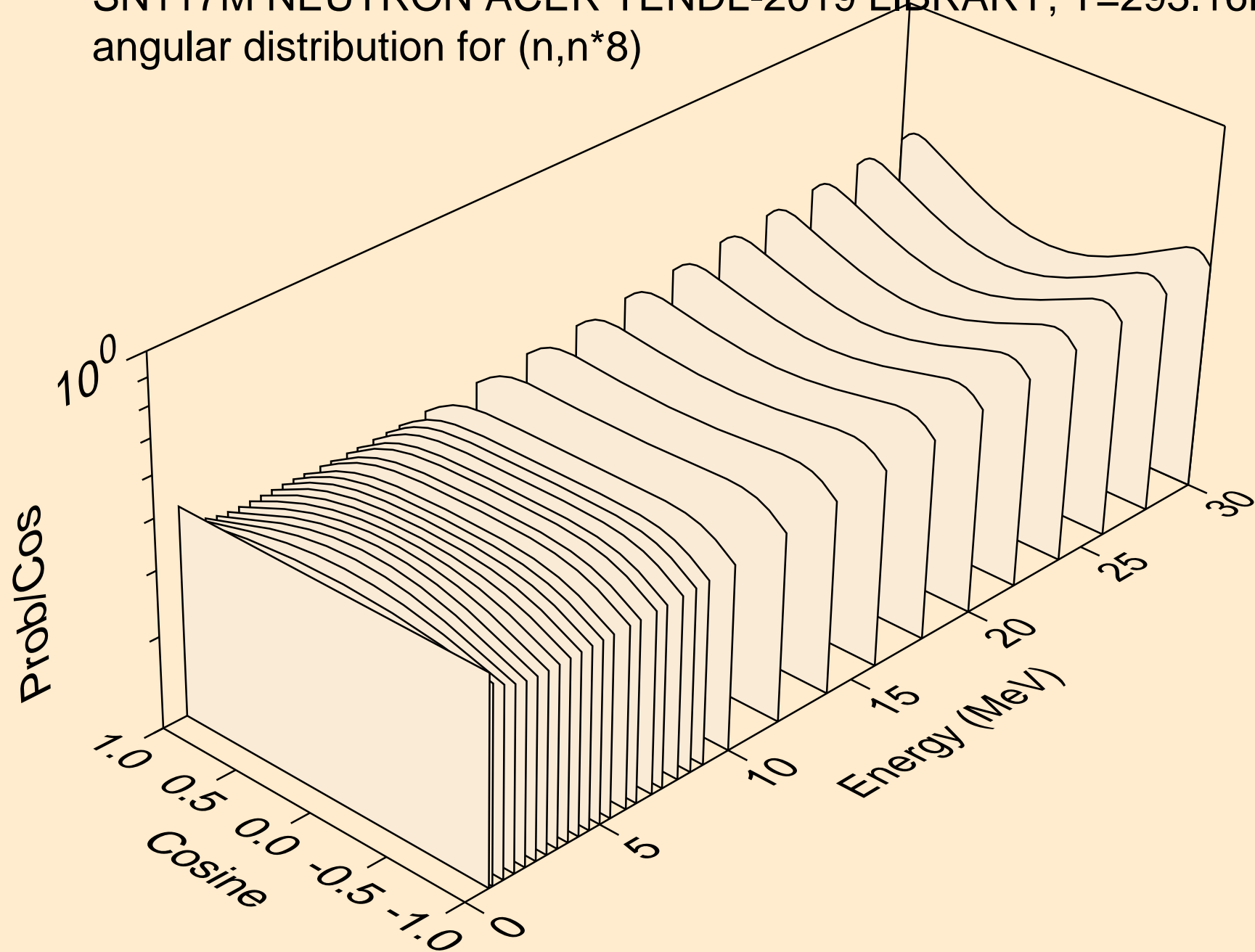

SN117M NEUTRON ACER TENDL-2019 LIBRARY; T=293.16K  
angular distribution for (n,n\*9)

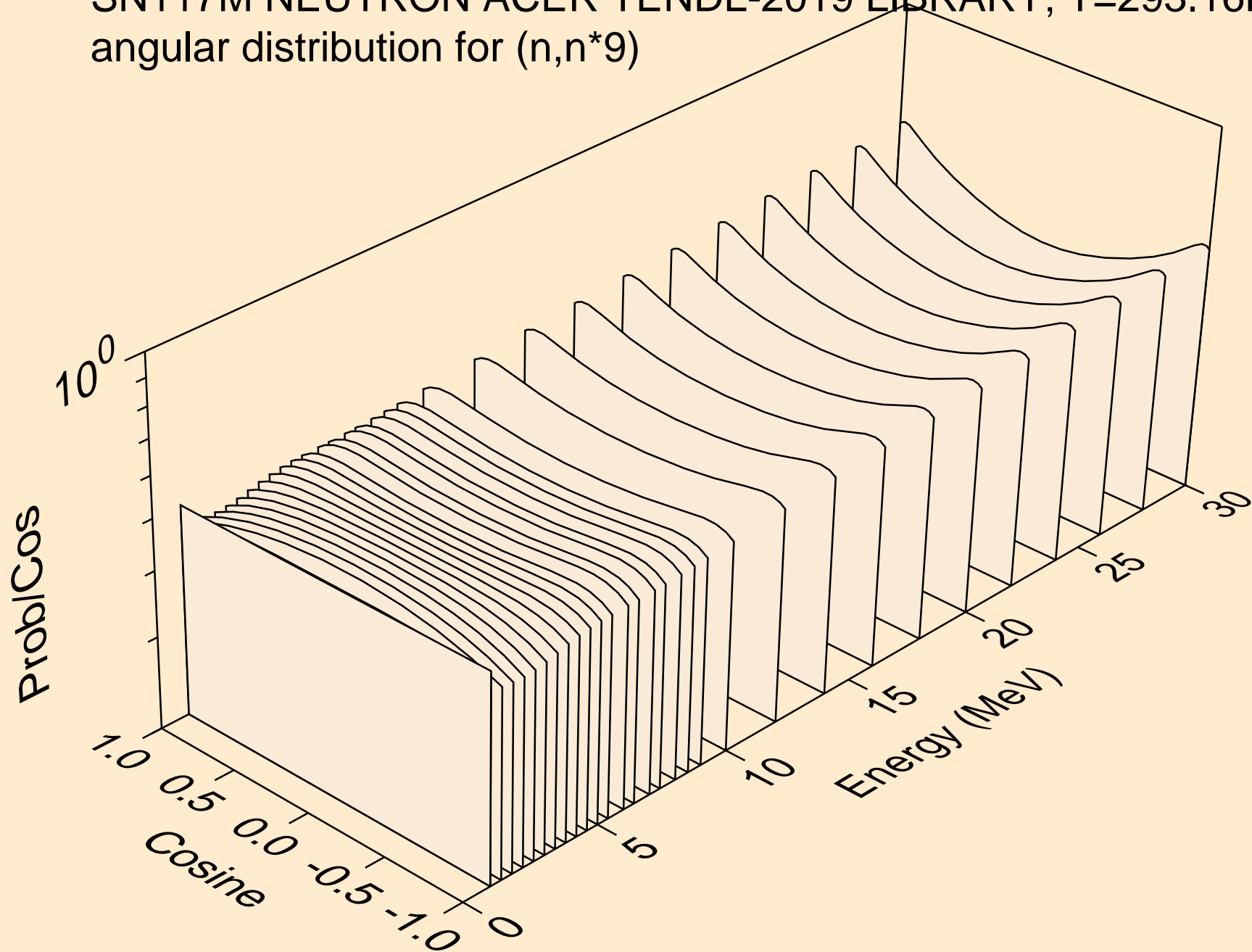



SN117M NEUTRON ACER TENDL-2019 LIBRARY; T=293.16K  
angular distribution for (n,n\*10)

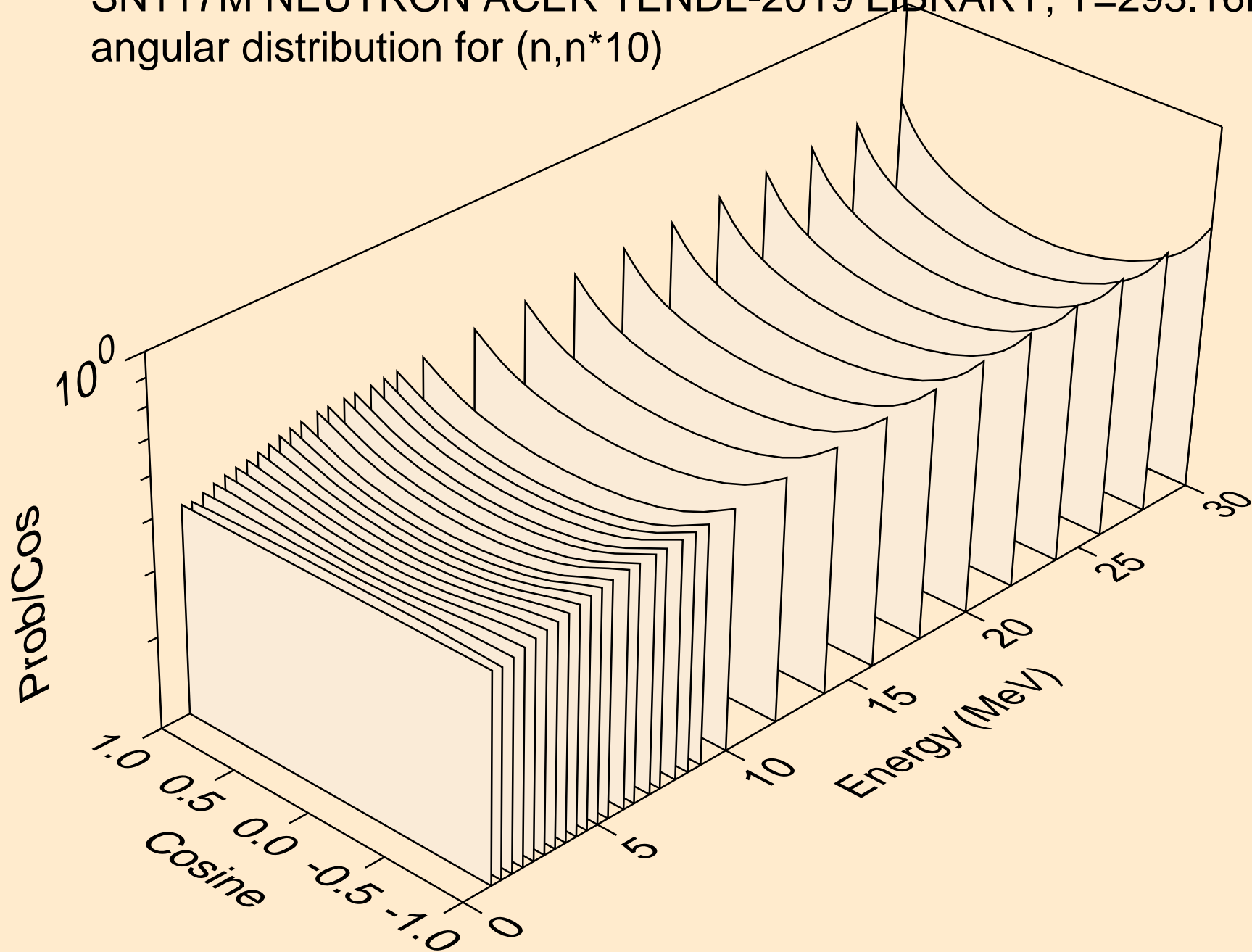

SN117M NEUTRON ACER TENDL-2019 LIBRARY; T=293.16K  
angular distribution for (n,n\*11)

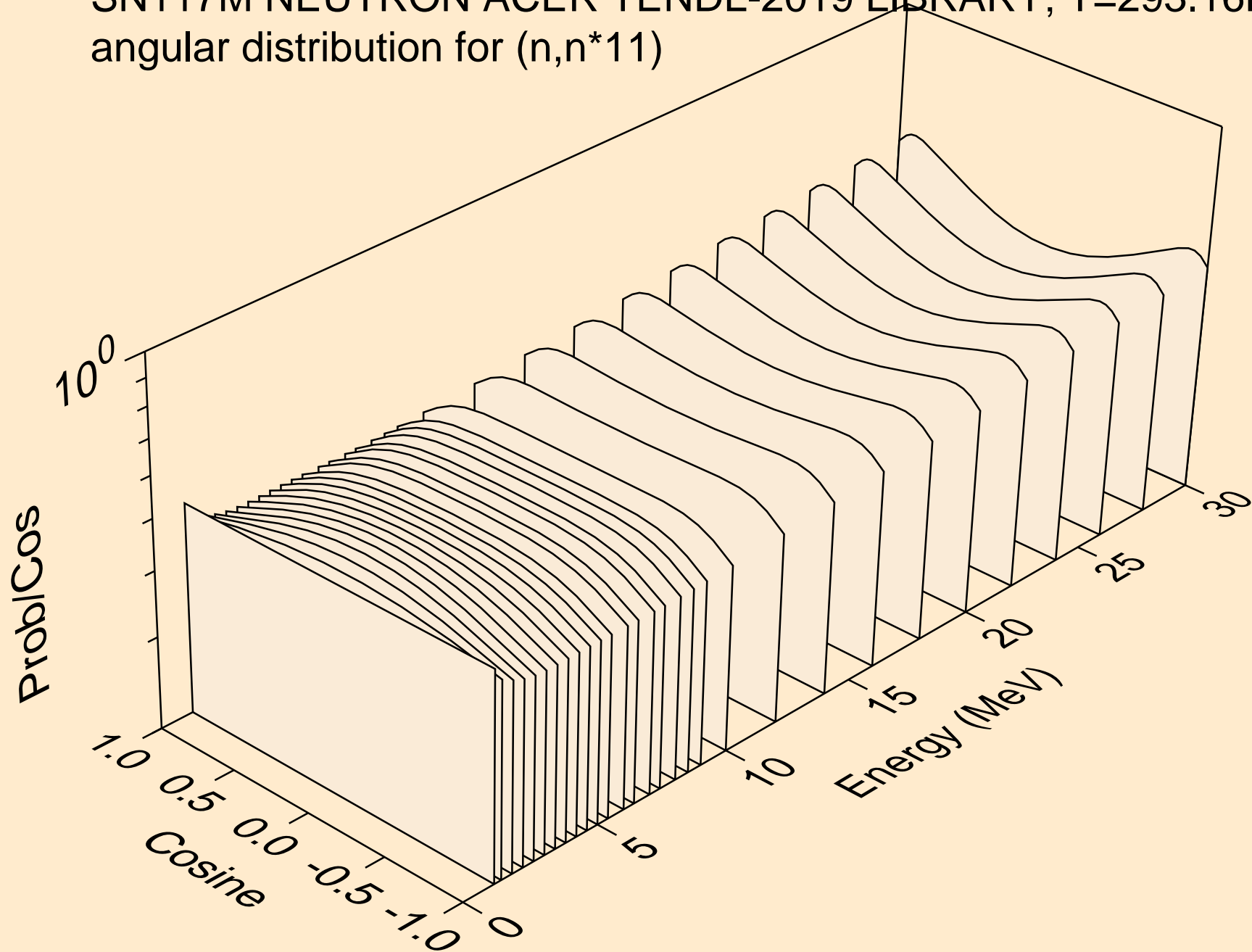

SN117M NEUTRON ACER TENDL-2019 LIBRARY; T=293.16K  
angular distribution for (n,n\*12)

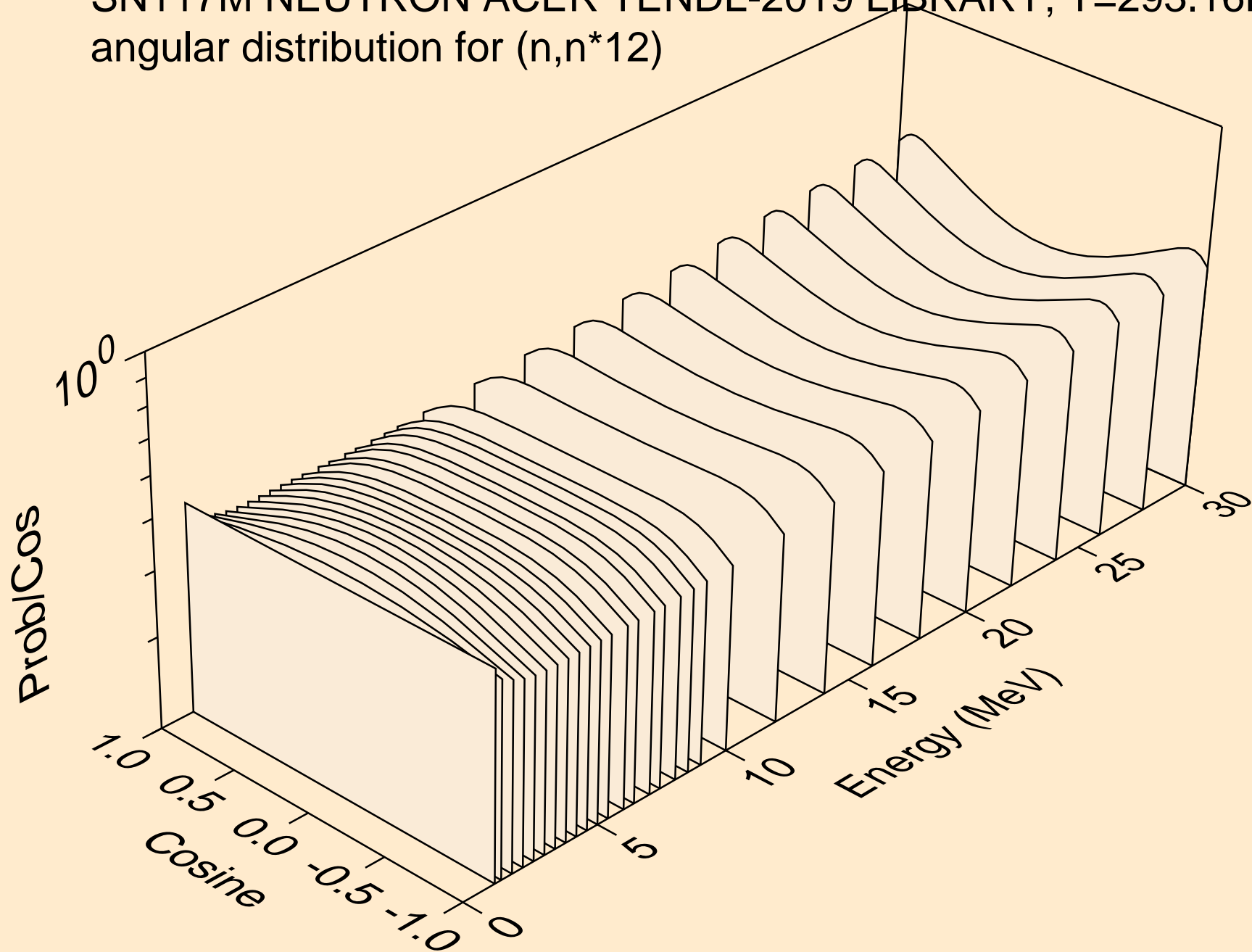

SN117M NEUTRON ACER TENDL-2019 LIBRARY; T=293.16K  
angular distribution for (n,n\*13)

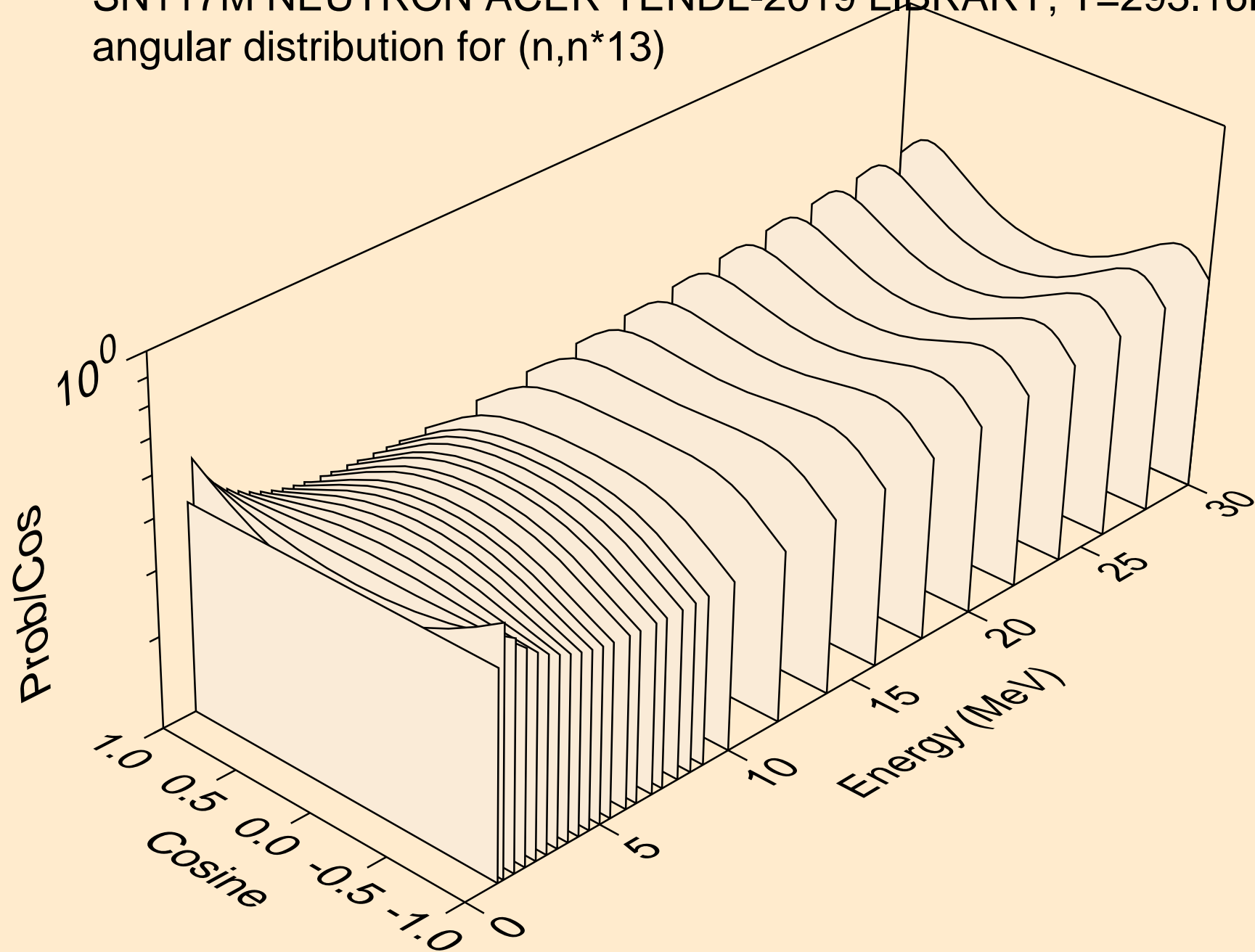

SN117M NEUTRON ACER TENDL-2019 LIBRARY; T=293.16K  
angular distribution for (n,n\*14)

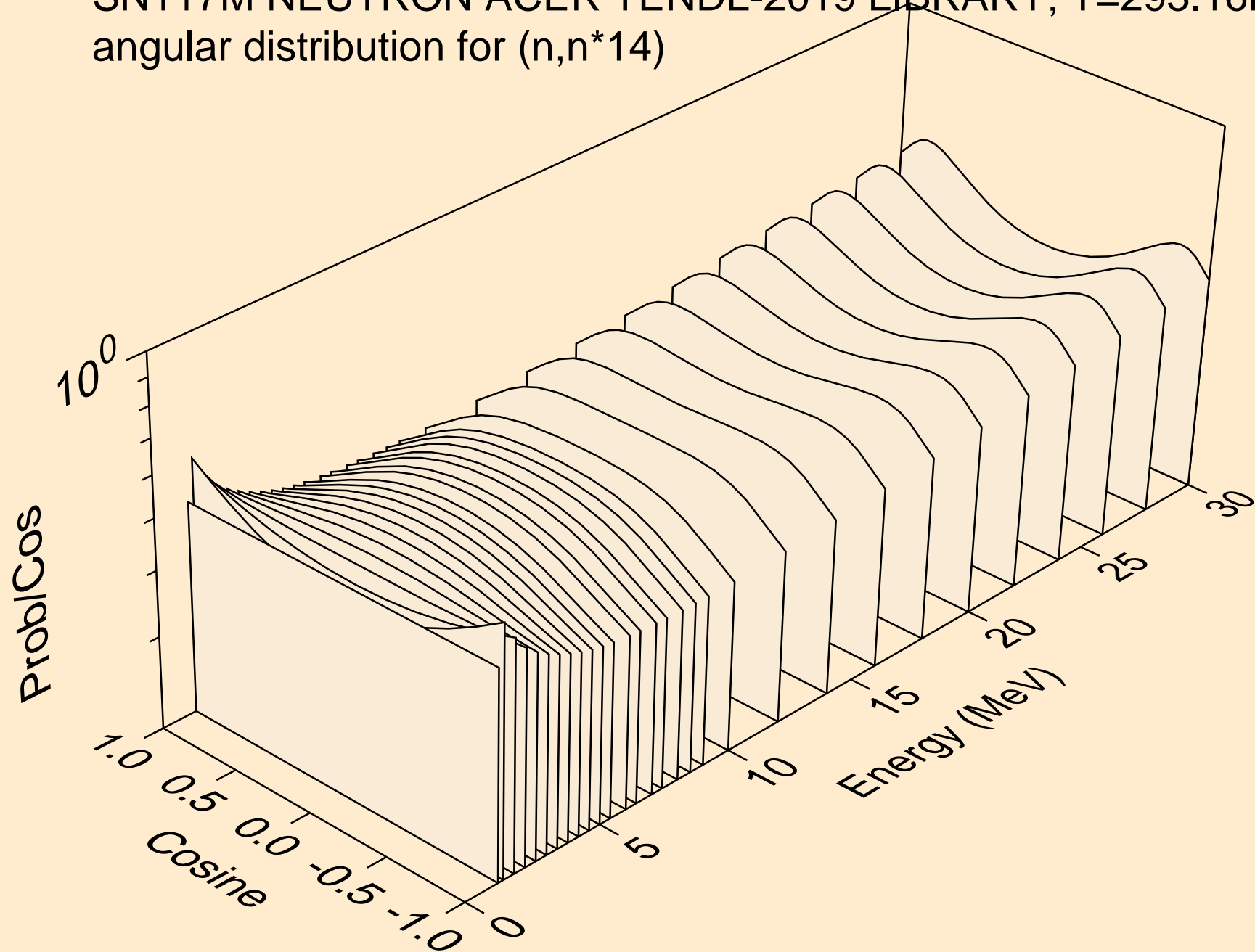

SN117M NEUTRON ACER TENDL-2019 LIBRARY; T=293.16K  
angular distribution for (n,n\*15)

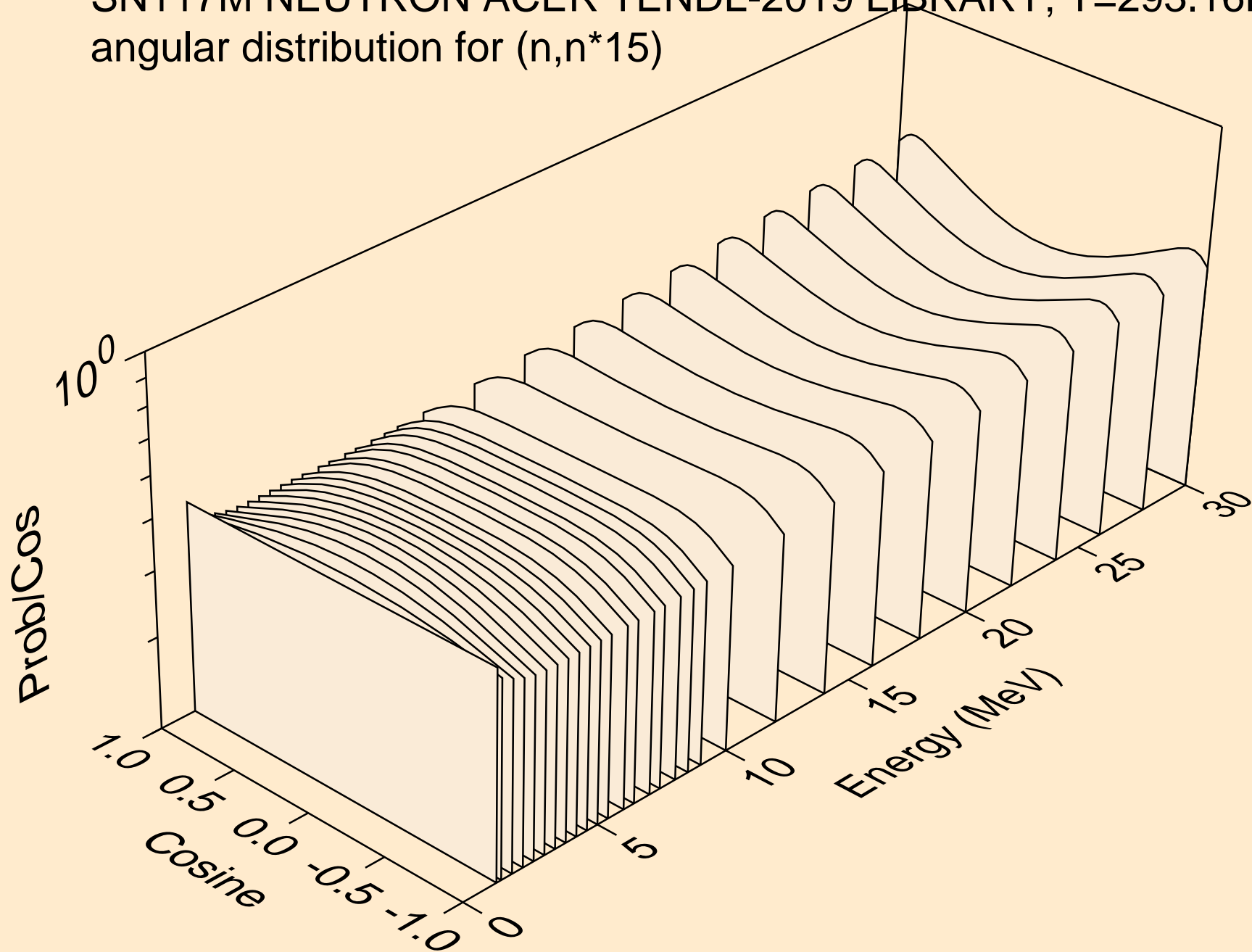

SN117M NEUTRON ACER TENDL-2019 LIBRARY; T=293.16K  
angular distribution for (n,n\*16)

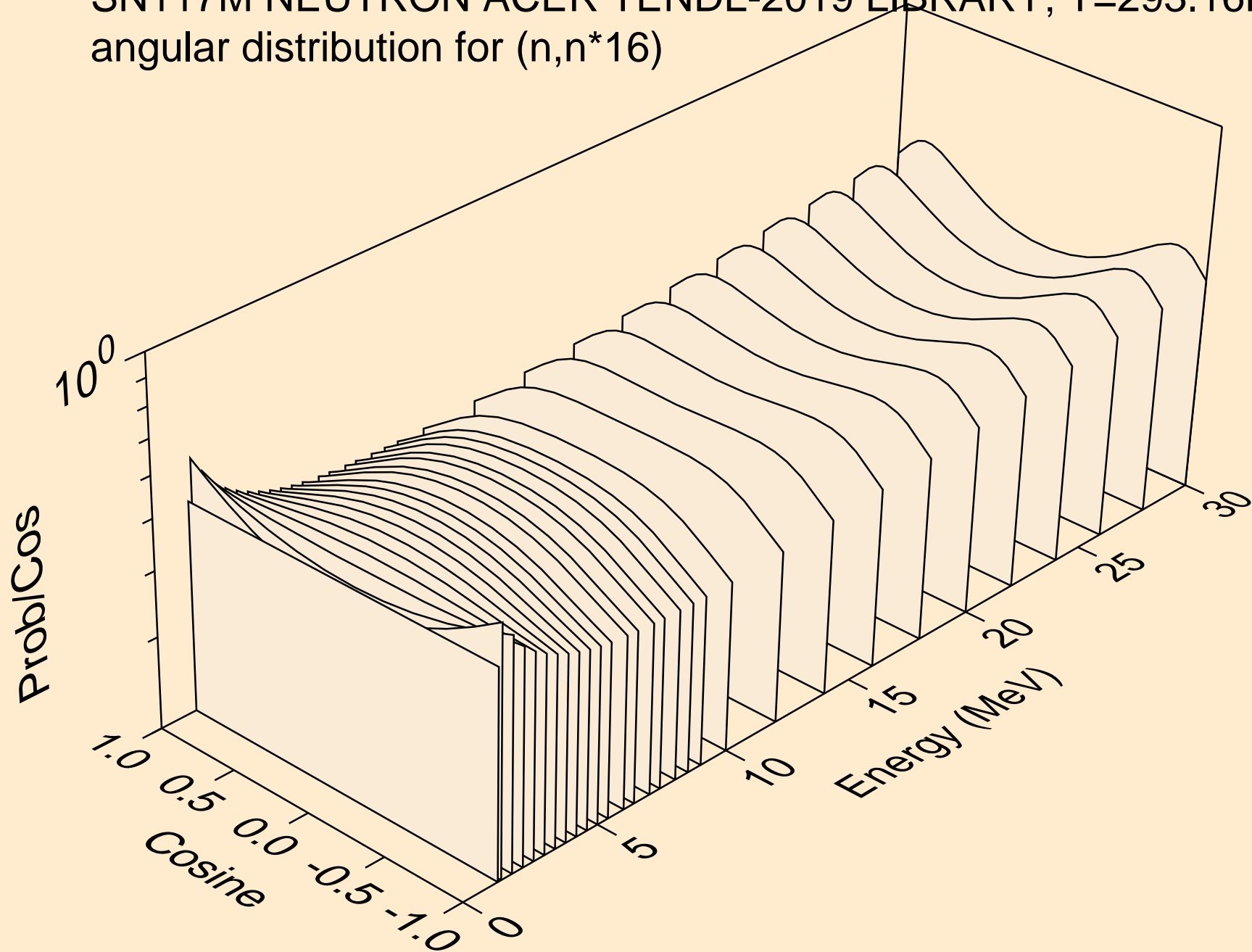

SN117M NEUTRON ACER TENDL-2019 LIBRARY; T=293.16K  
angular distribution for (n,n\*17)

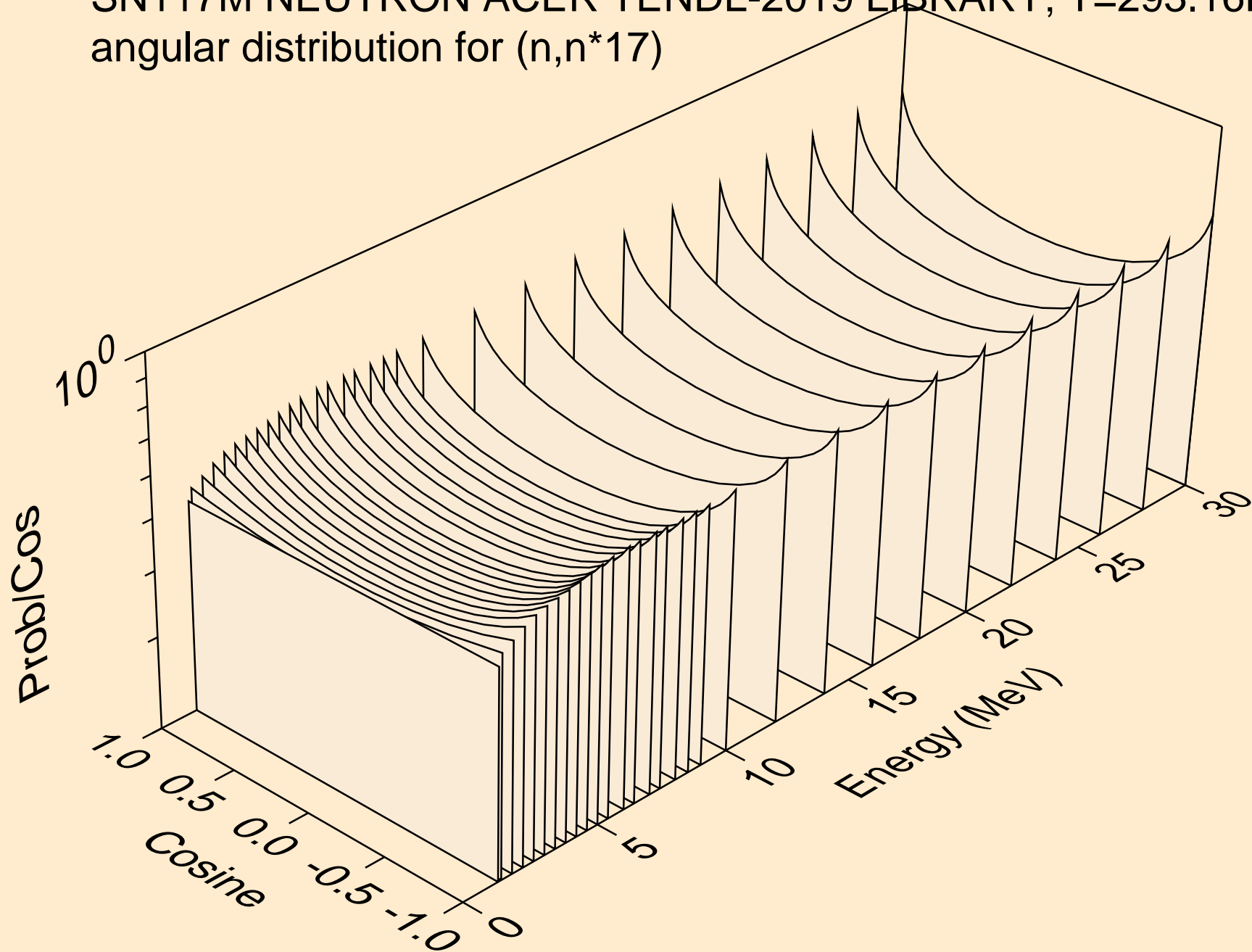



SN117M NEUTRON ACER TENDL-2019 LIBRARY; T=293.16K  
angular distribution for (n,n\*18)

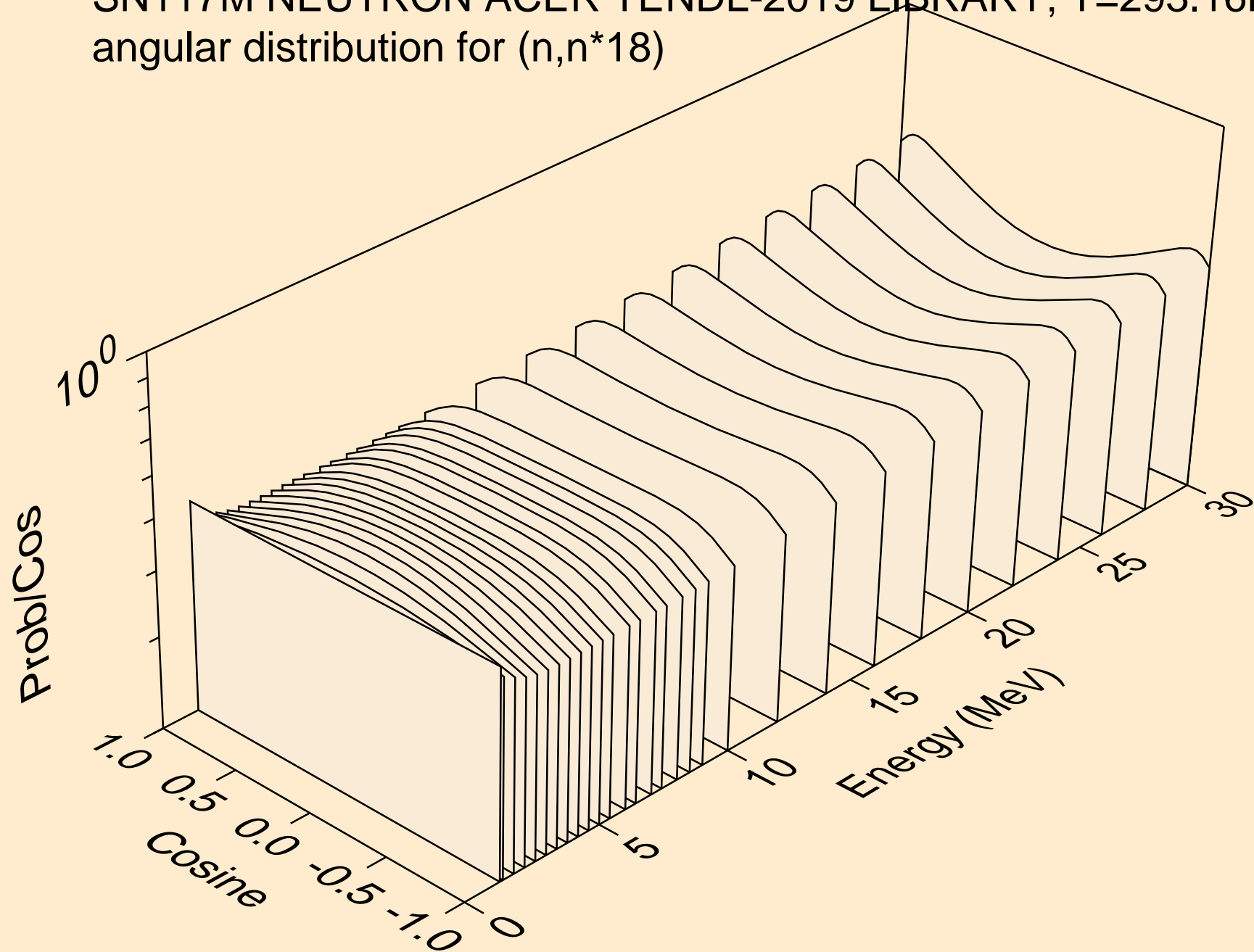

SN117M NEUTRON ACER TENDL-2019 LIBRARY; T=293.16K  
angular distribution for (n,n\*19)

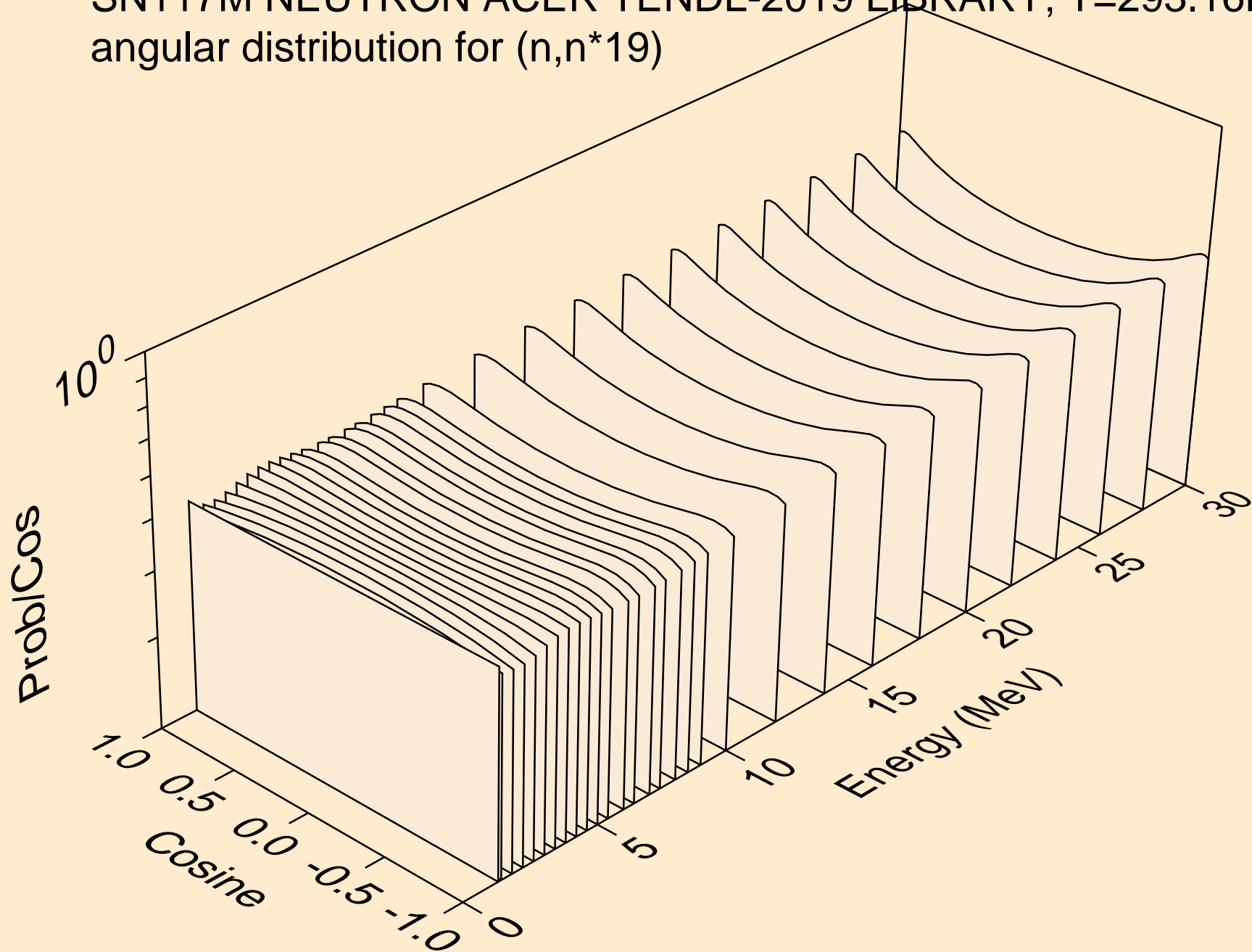

SN117M NEUTRON ACER TENDL-2019 LIBRARY; T=293.16K  
angular distribution for (n,n\*20)

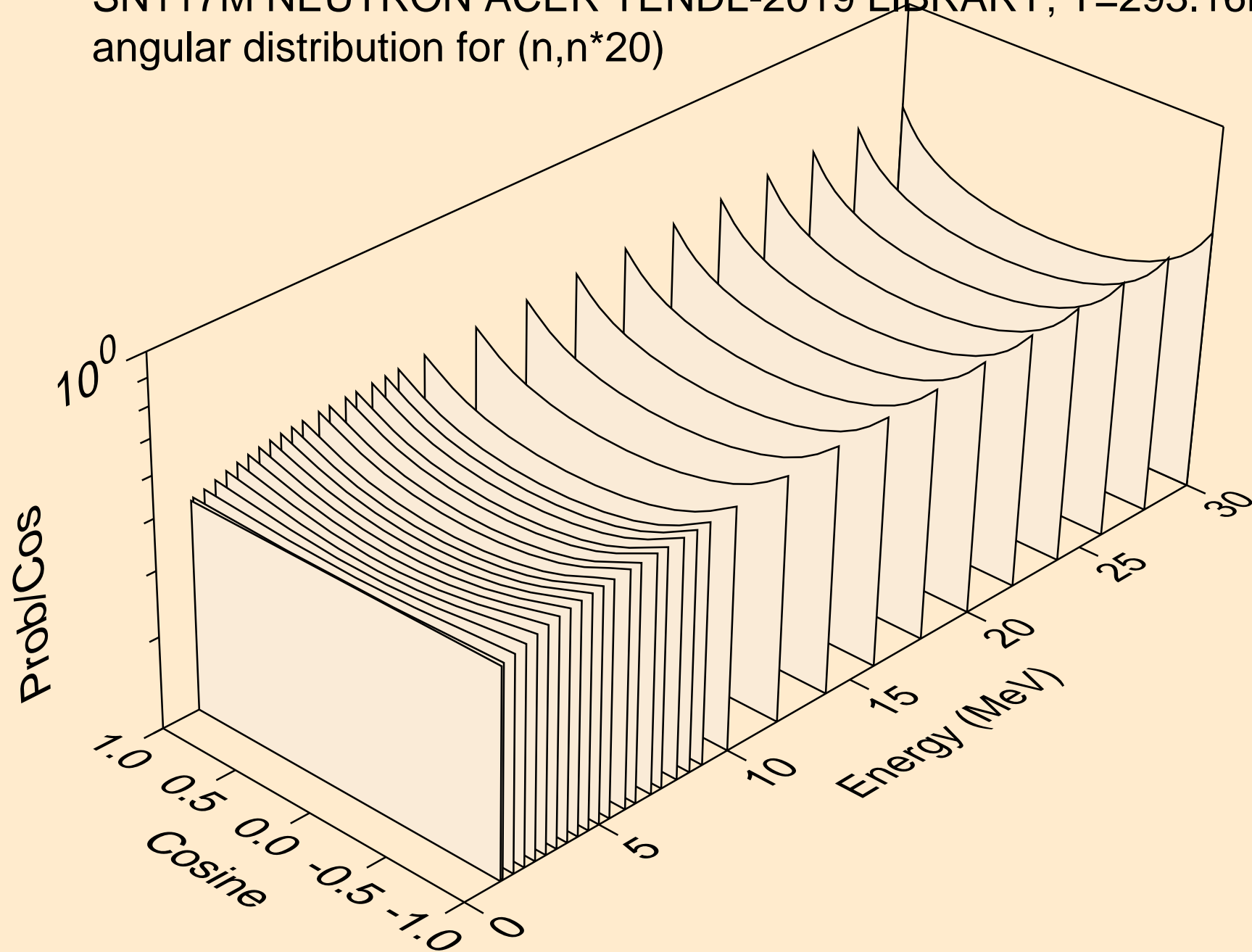

SN117M NEUTRON ACER TENDL-2019 LIBRARY; T=293.16K  
angular distribution for (n,n\*21)

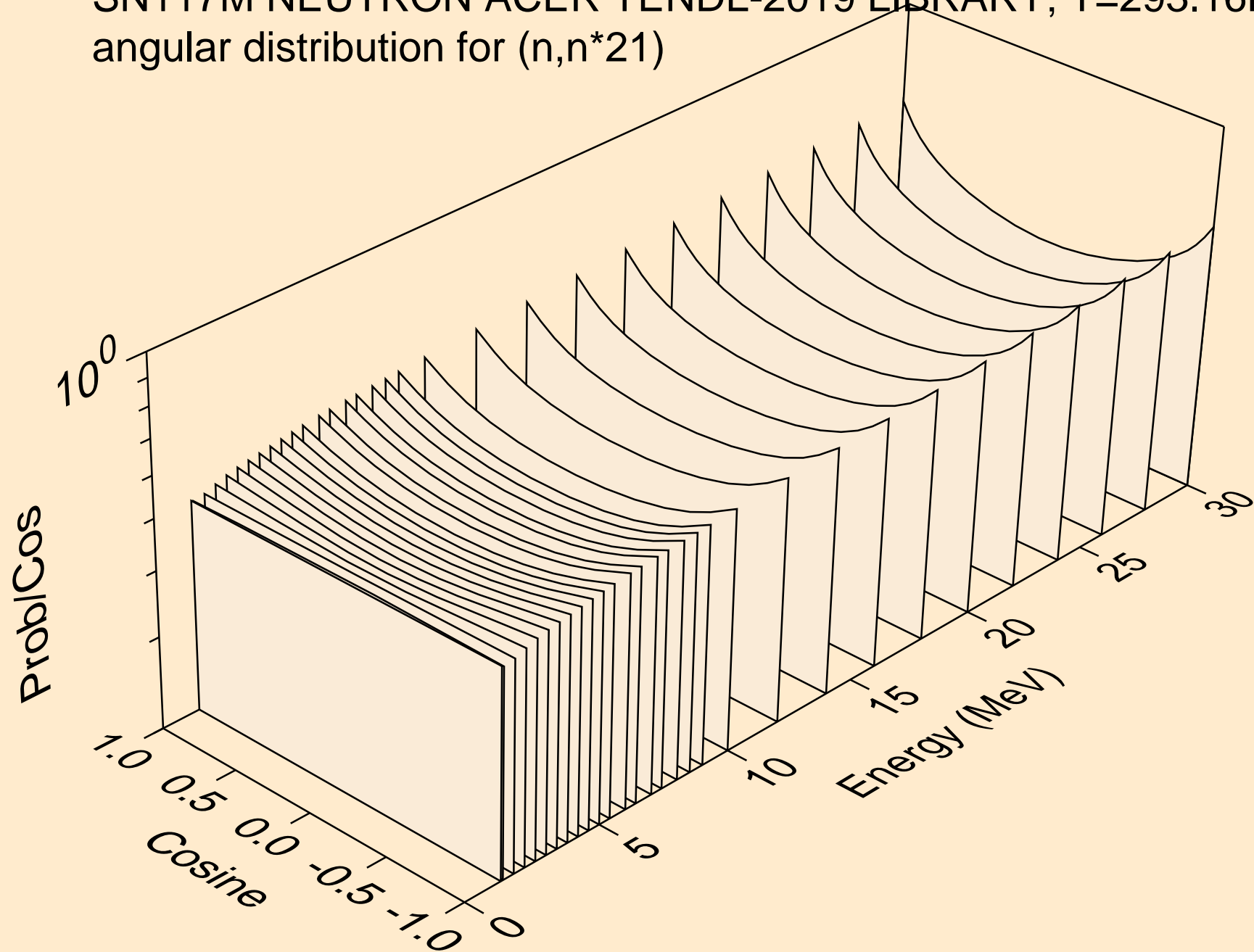

SN117M NEUTRON ACER TENDL-2019 LIBRARY; T=293.16K  
angular distribution for (n,n\*22)

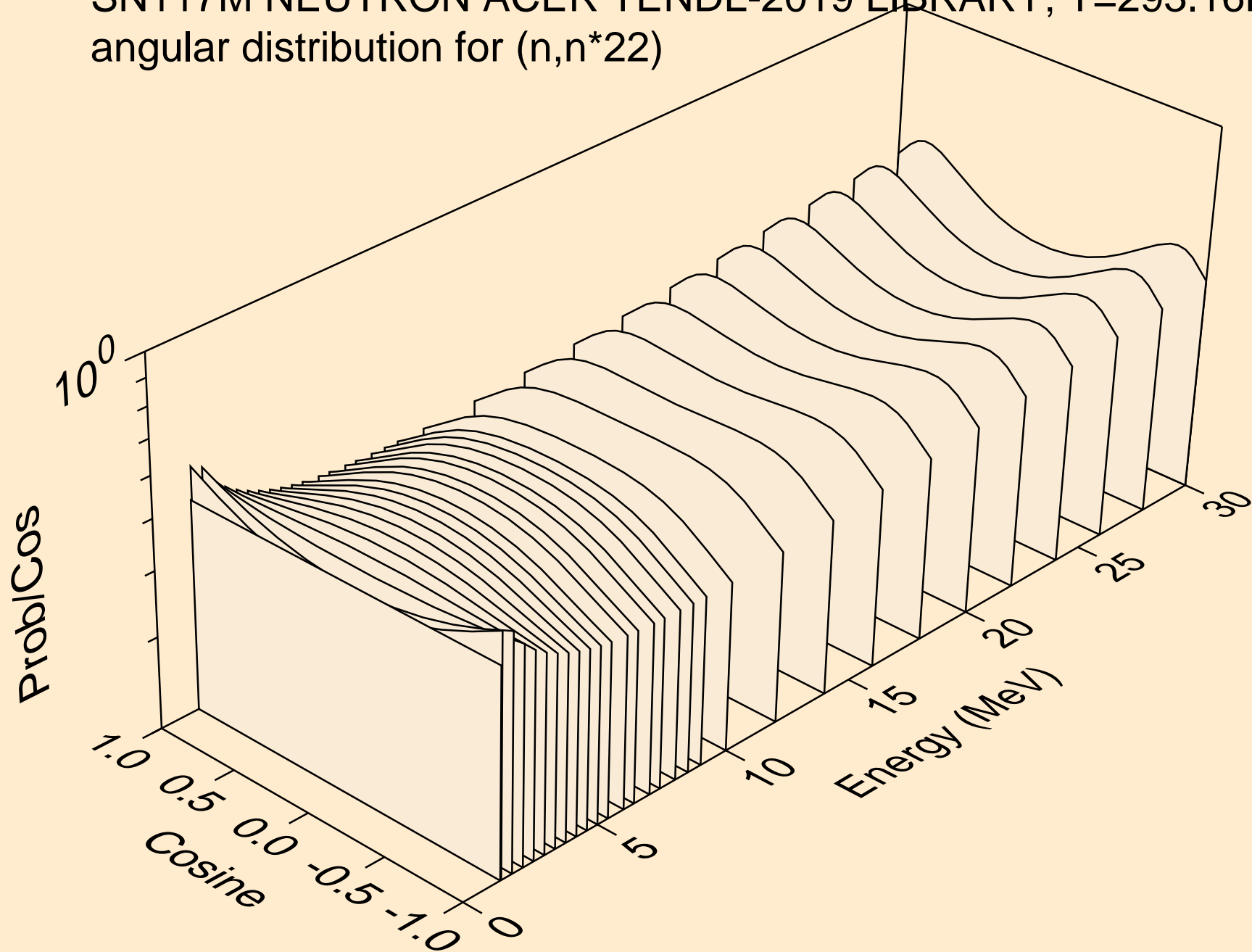

SN117M NEUTRON ACER TENDL-2019 LIBRARY; T=293.16K  
angular distribution for (n,n\*23)

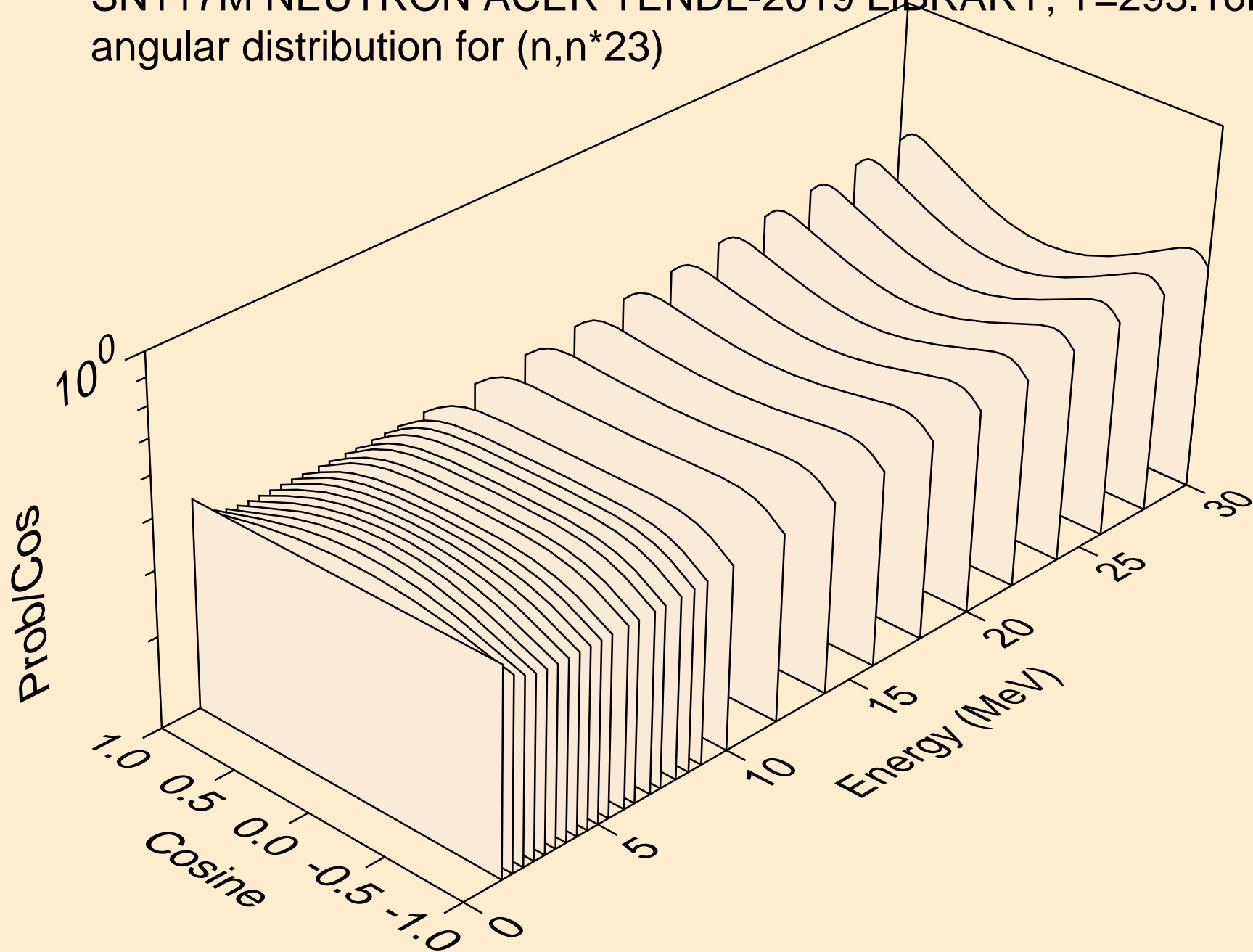

SN117M NEUTRON ACER TENDL-2019 LIBRARY; T=293.16K  
angular distribution for (n,n\*24)

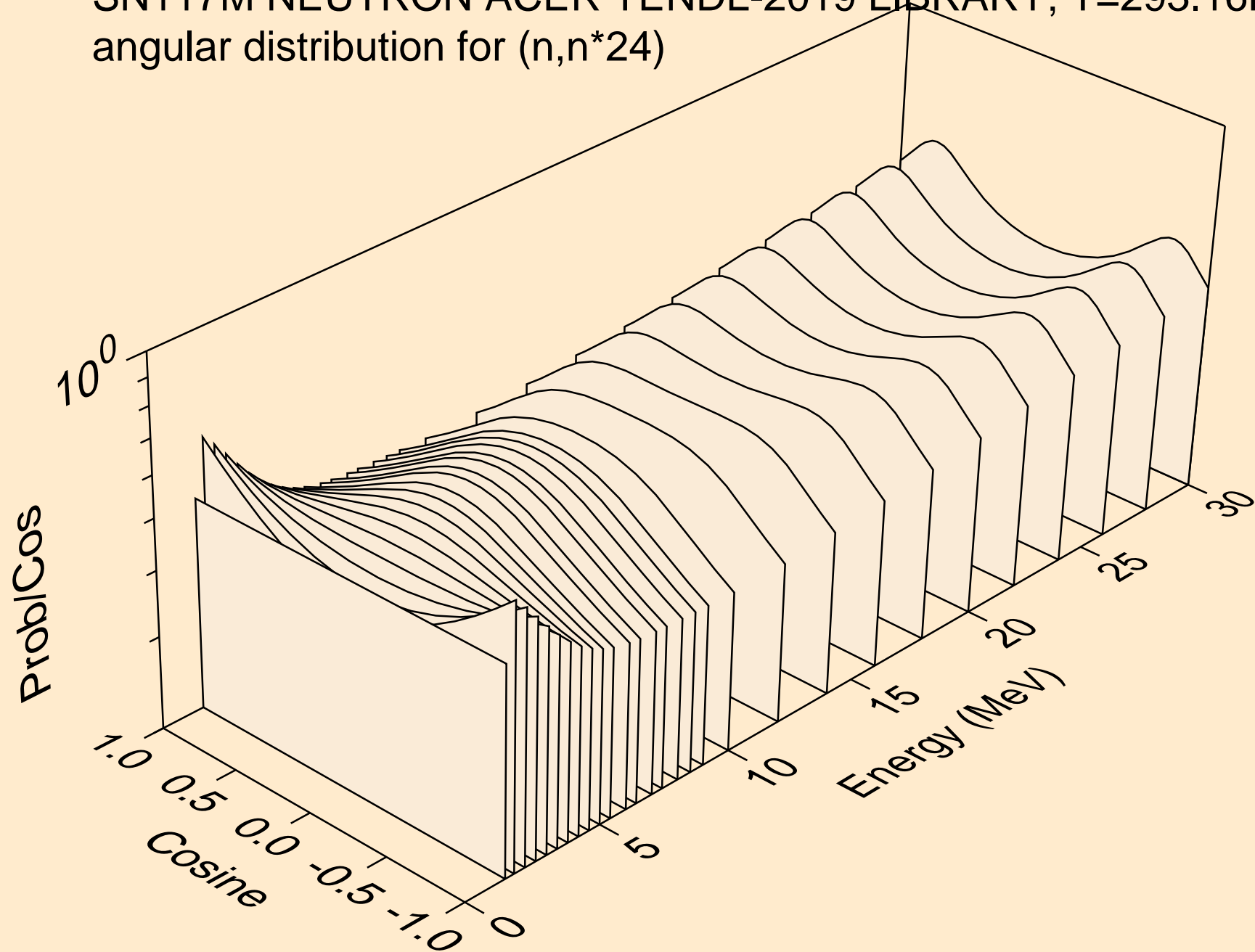

SN117M NEUTRON ACER TENDL-2019 LIBRARY; T=293.16K  
angular distribution for (n,n\*25)

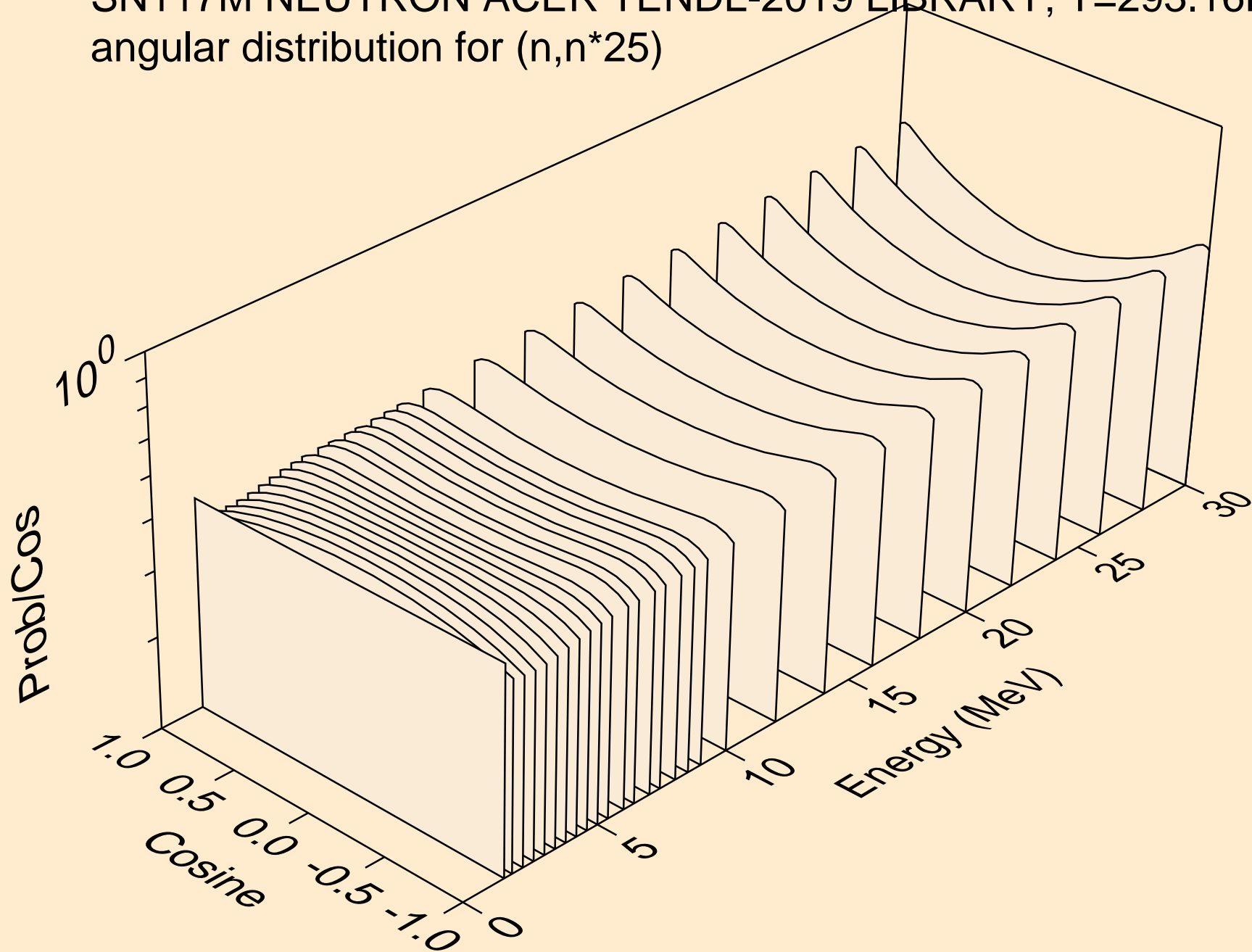



SN117M NEUTRON ACER TENDL-2019 LIBRARY; T=293.16K  
angular distribution for (n,n\*26)

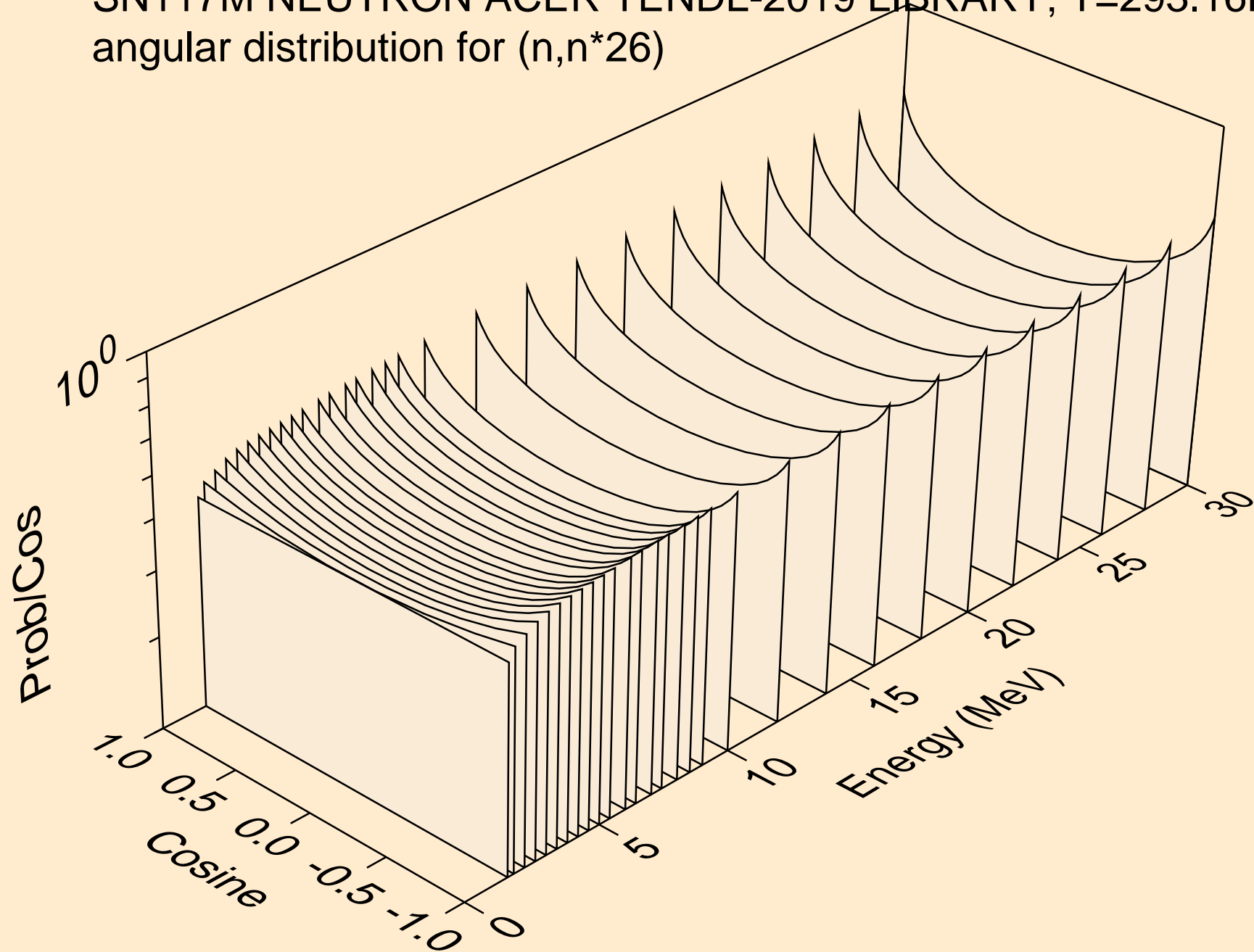

SN117M NEUTRON ACER TENDL-2019 LIBRARY; T=293.16K  
angular distribution for (n,n\*27)

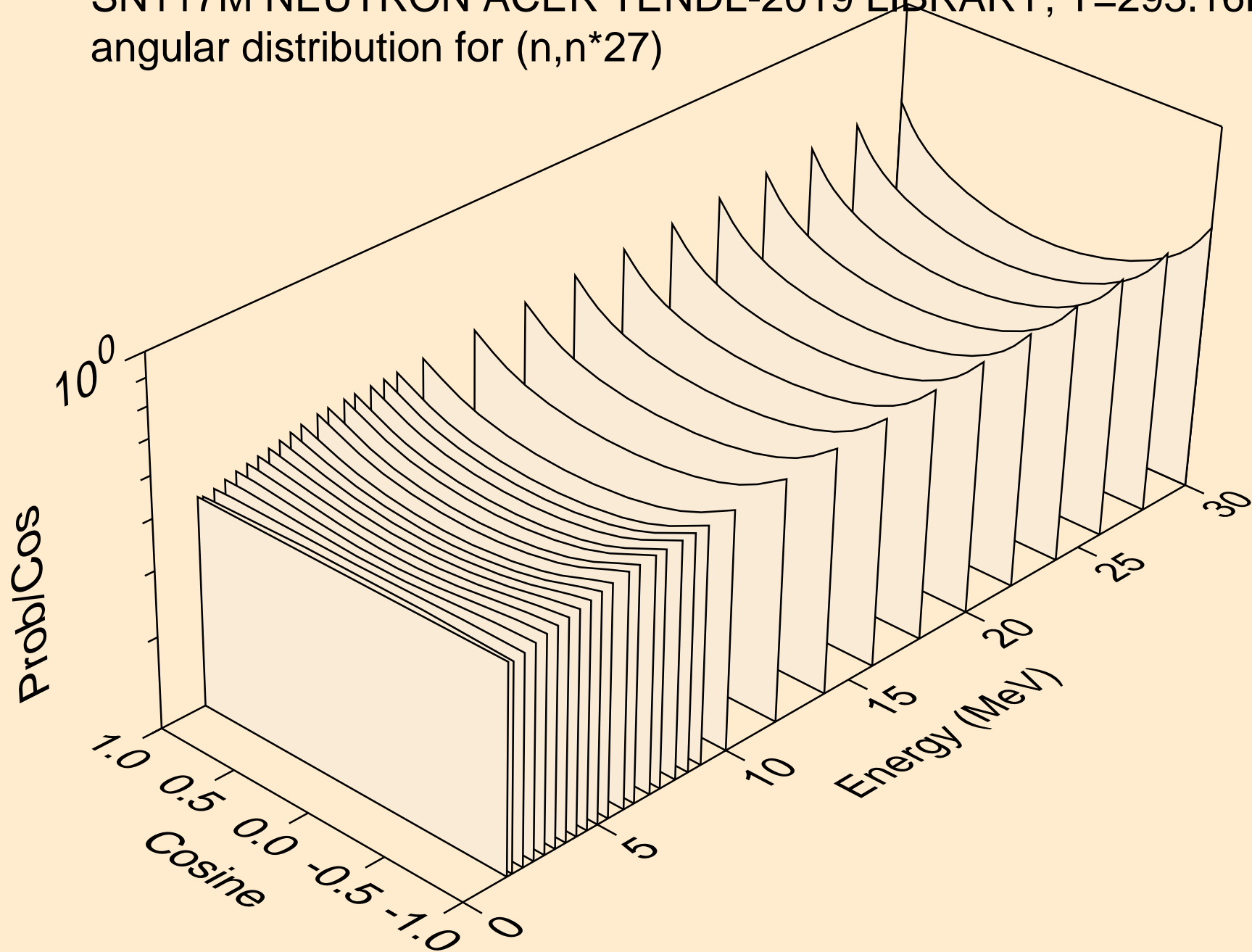

SN117M NEUTRON ACER TENDL-2019 LIBRARY; T=293.16K  
angular distribution for (n,n\*28)

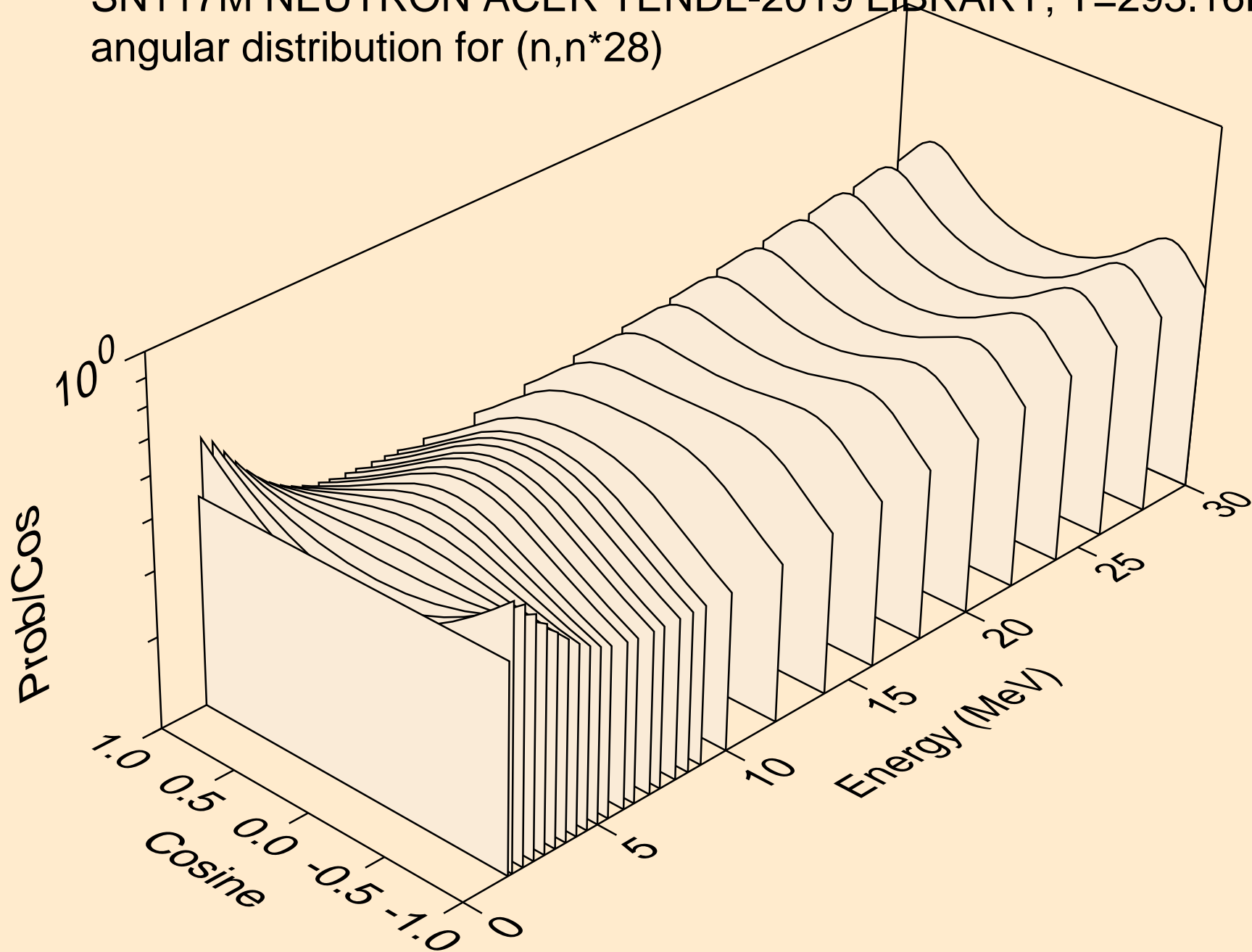

SN117M NEUTRON ACER TENDL-2019 LIBRARY; T=293.16K  
angular distribution for (n,n\*29)

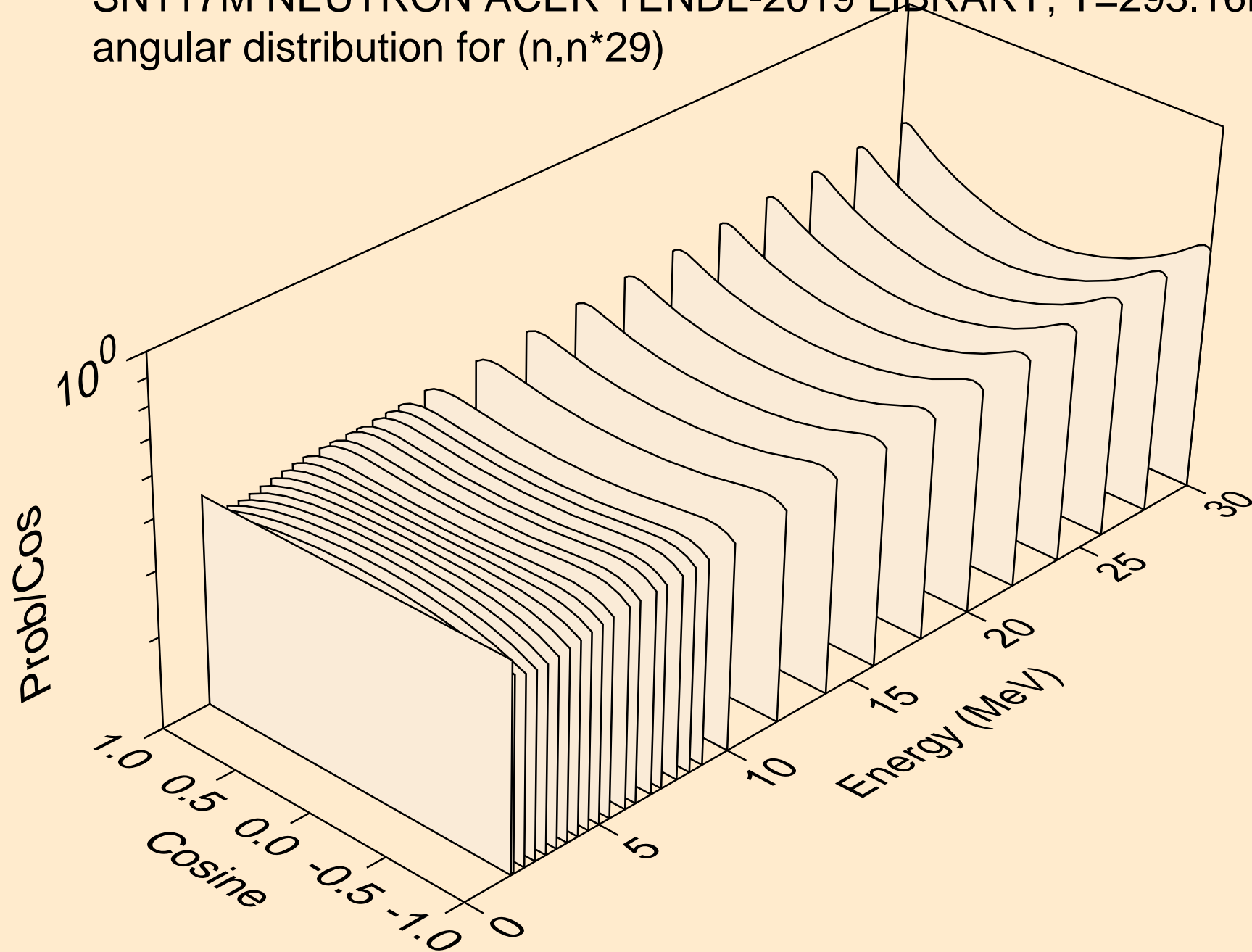

SN117M NEUTRON ACER TENDL-2019 LIBRARY; T=293.16K  
angular distribution for (n,n\*30)

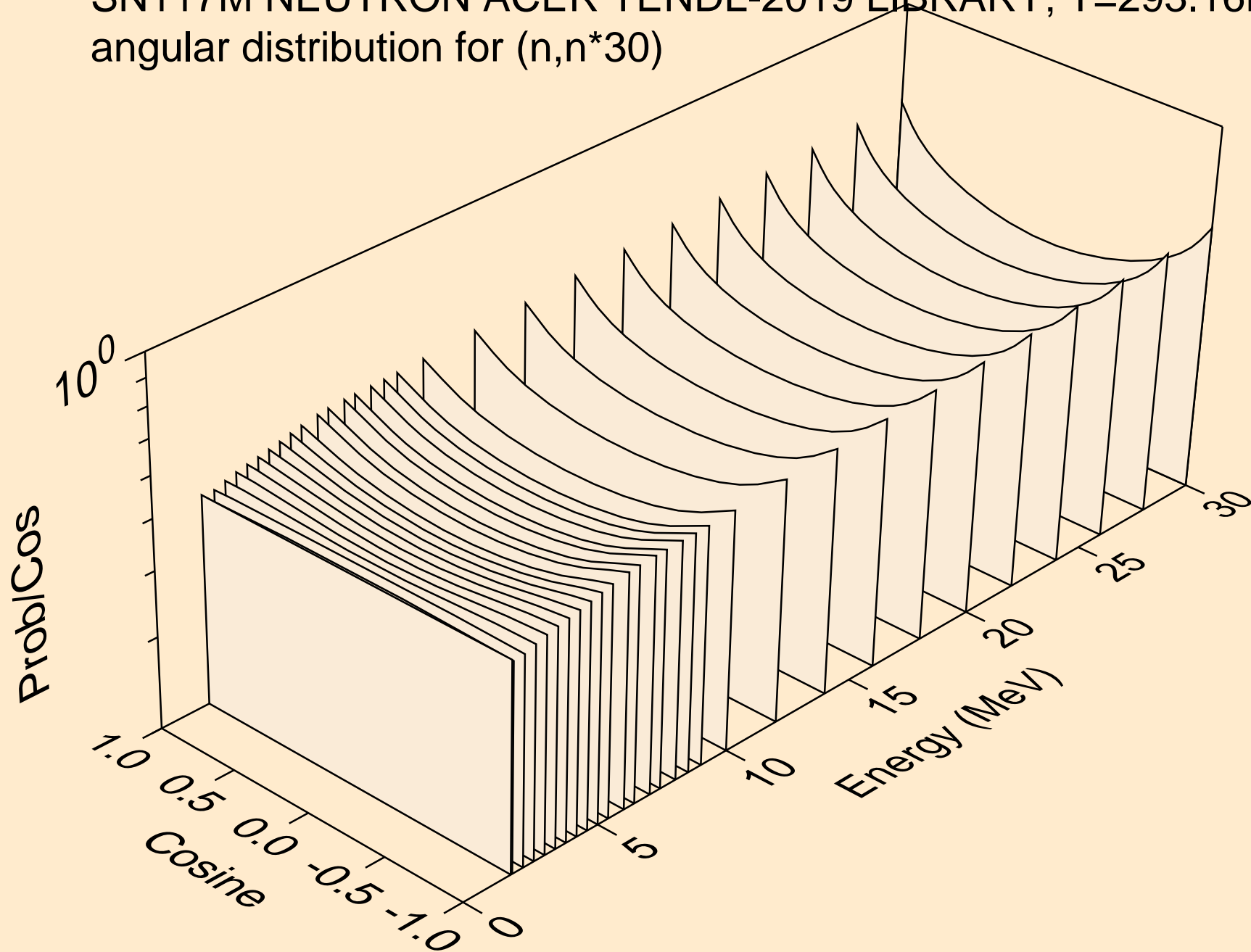

SN117M NEUTRON ACER TENDL-2019 LIBRARY; T=293.16K  
Neutron emission for (n,x)

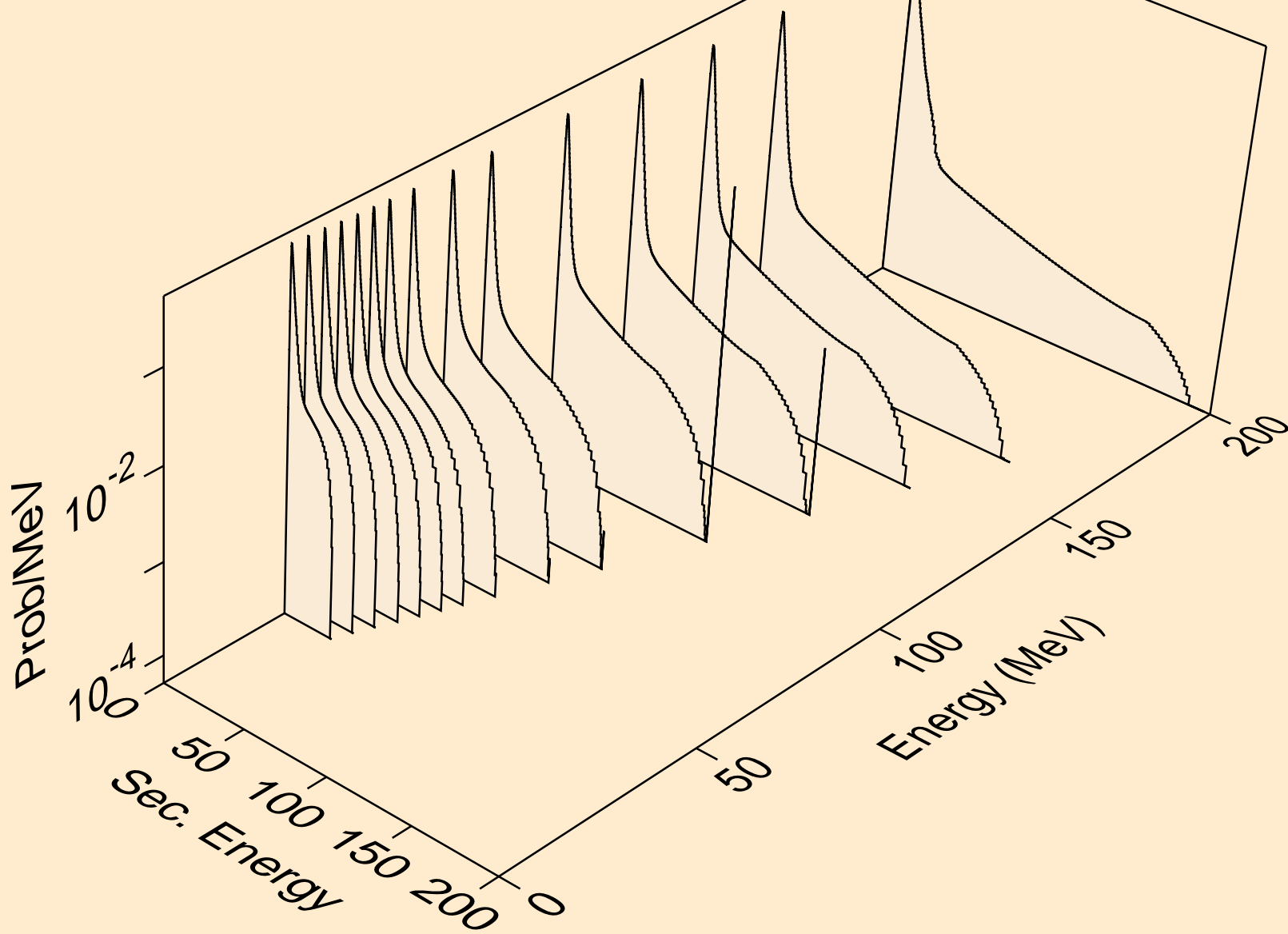

SN117M NEUTRON ACER TENDL-2019 LIBRARY; T=293.16K  
Neutron emission for (n,2nd)

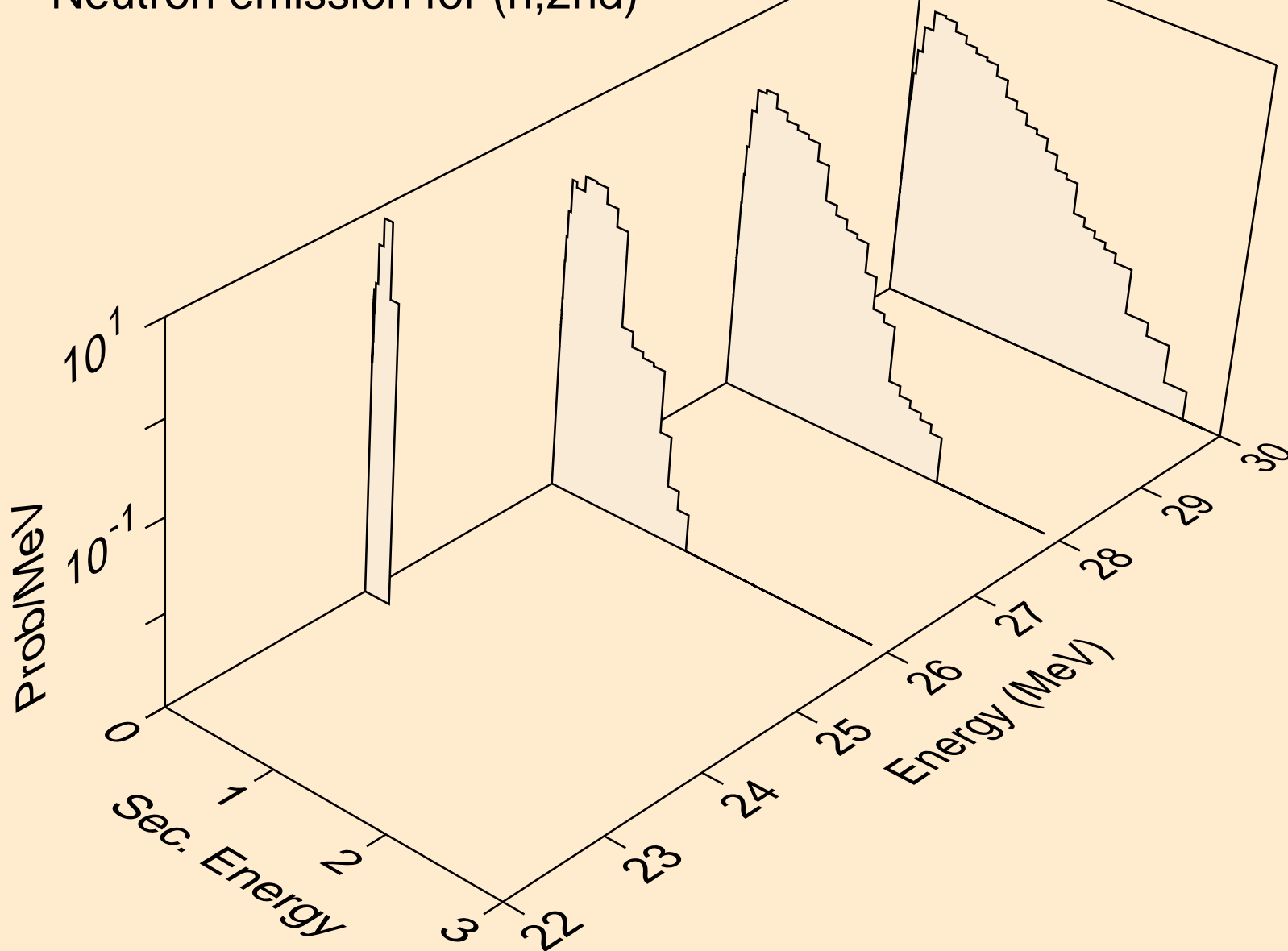

SN117M NEUTRON ACER TENDL-2019 LIBRARY; T=293.16K  
Neutron emission for (n,2n)

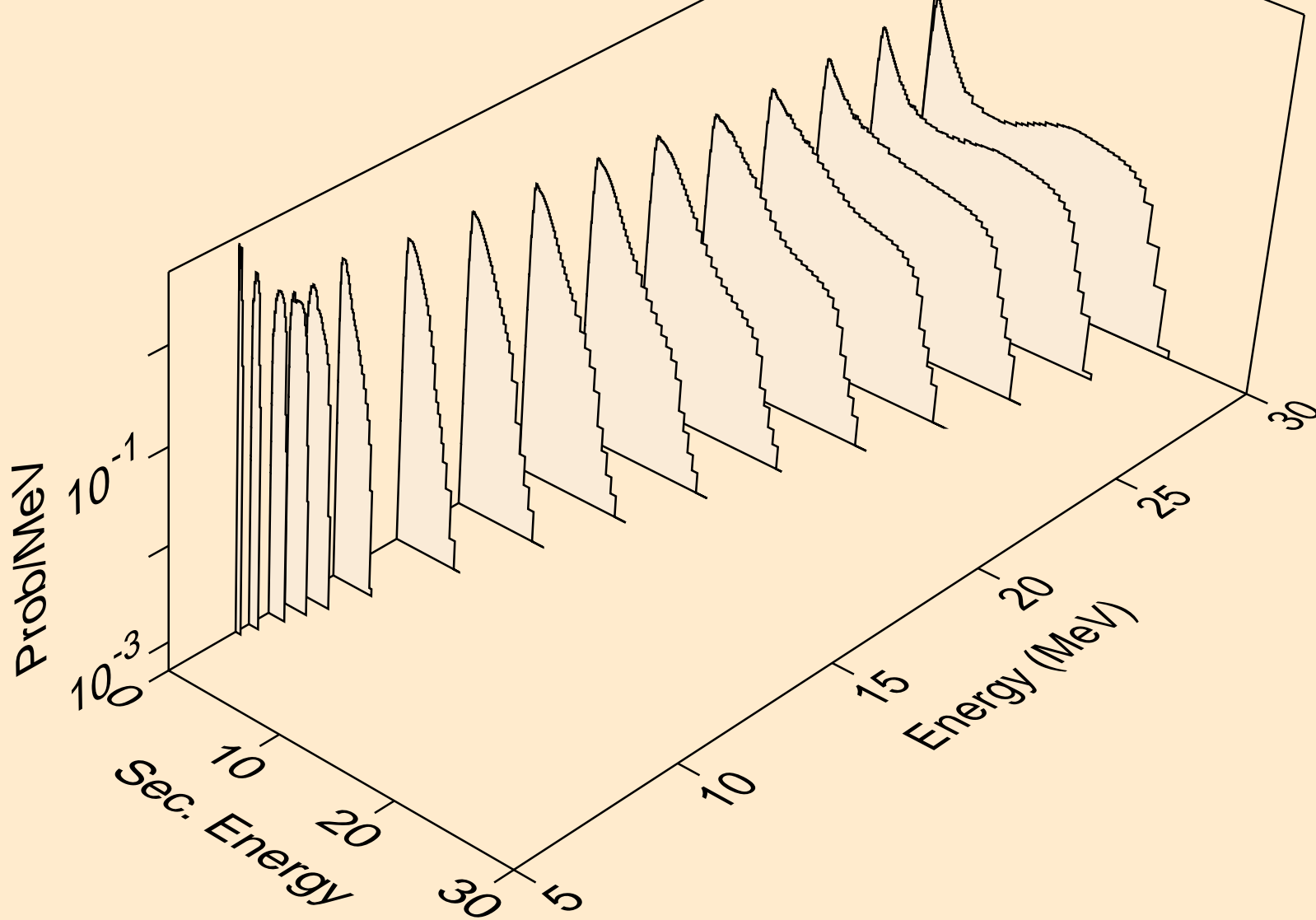



SN117M NEUTRON ACER TENDL-2019 LIBRARY; T=293.16K  
Neutron emission for (n,3n)

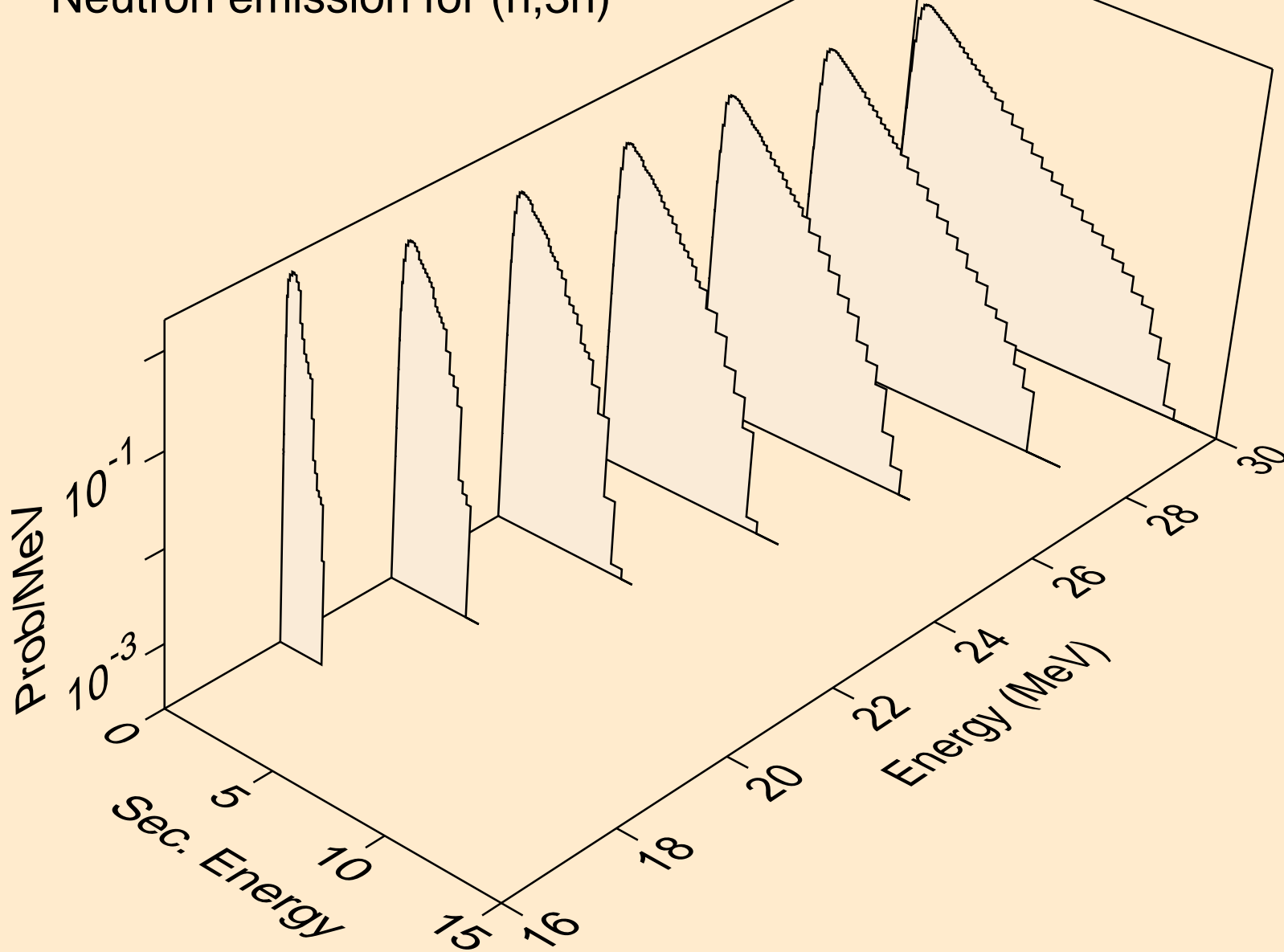

SN117M NEUTRON ACER TENDL-2019 LIBRARY; T=293.16K  
Neutron emission for (n,n\*)a

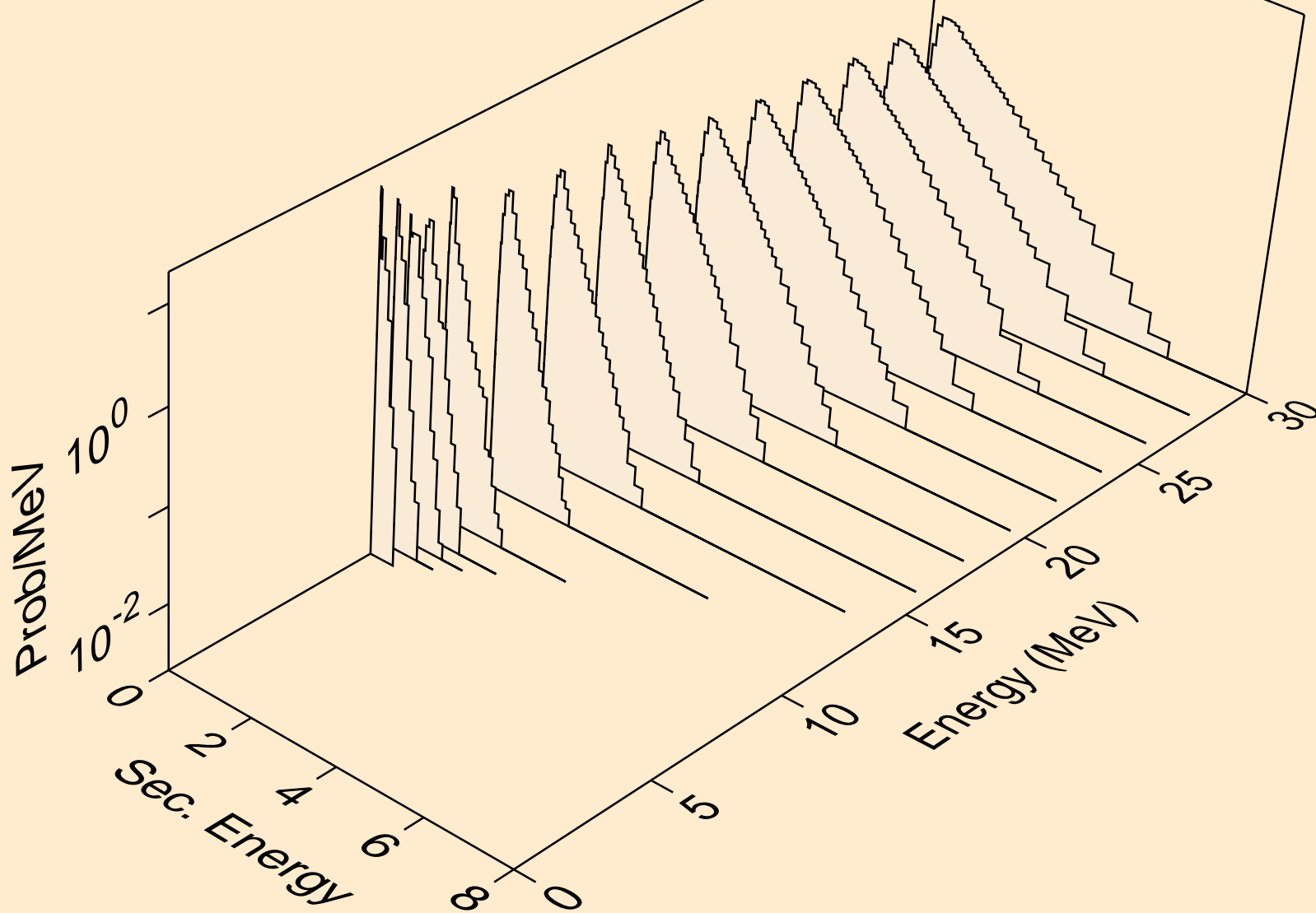

SN117M NEUTRON ACER TENDL-2019 LIBRARY; T=293.16K  
Neutron emission for (n,2n)a

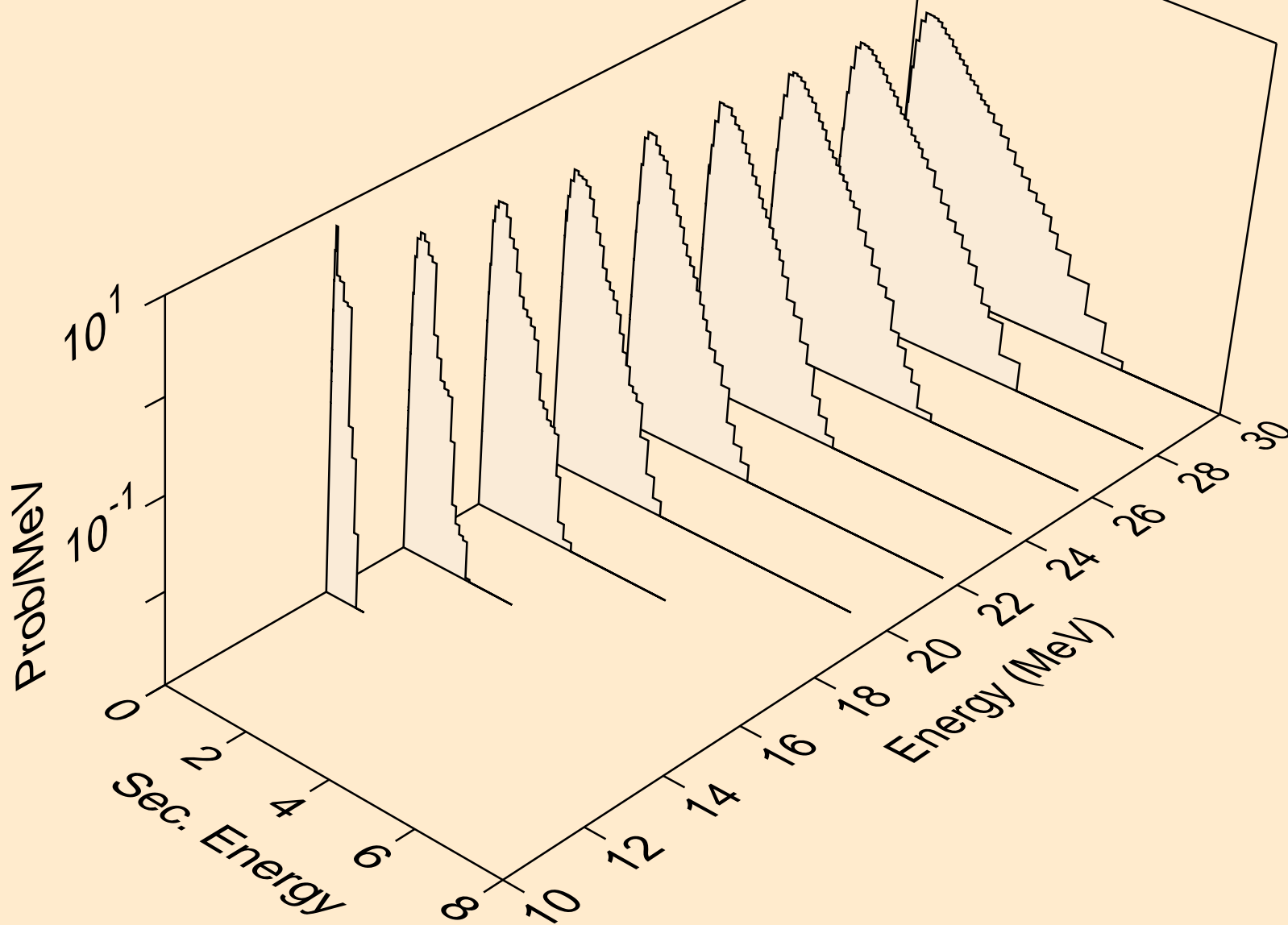

SN117M NEUTRON ACER TENDL-2019 LIBRARY; T=293.16K  
Neutron emission for (n,3n)a

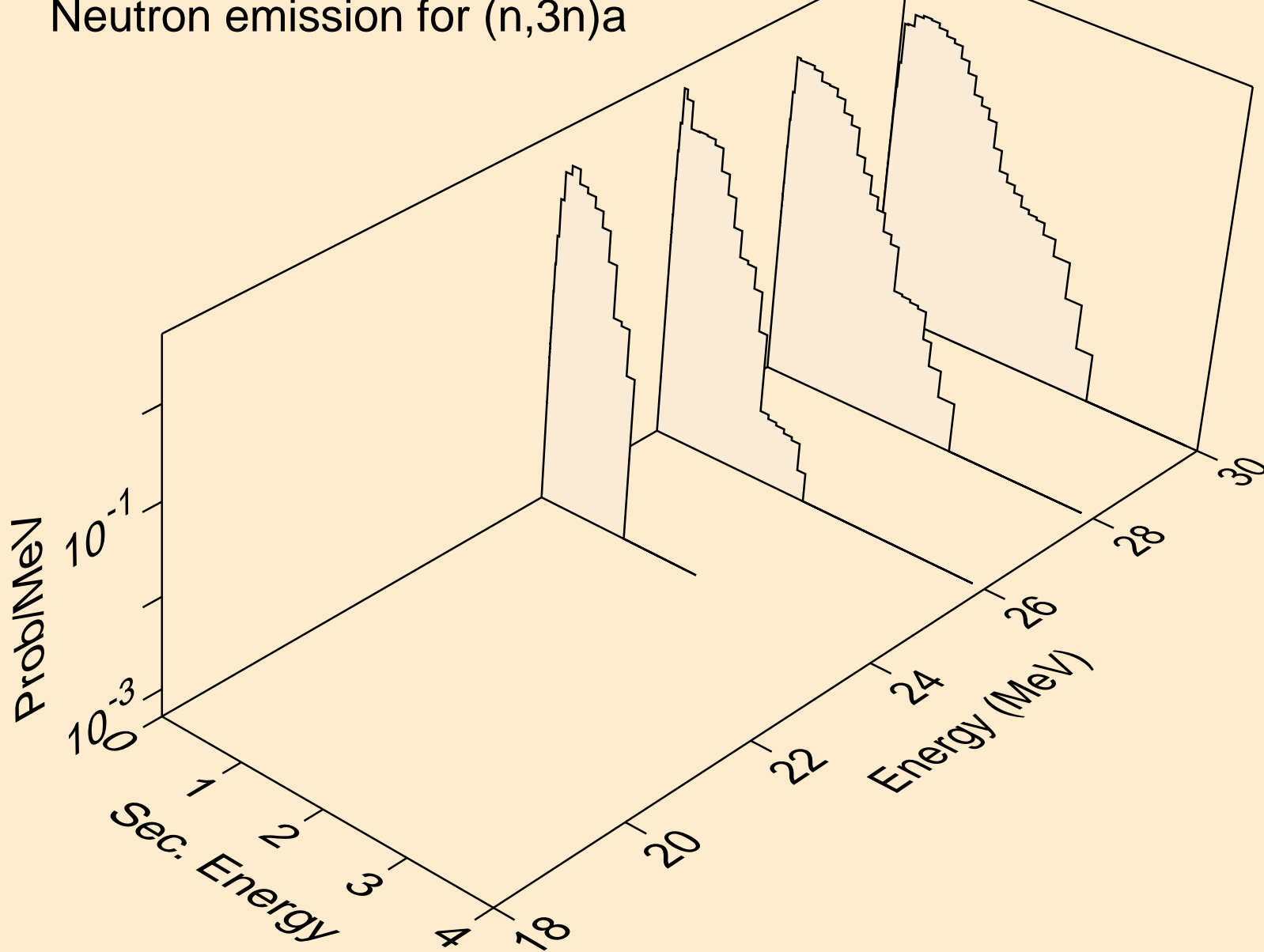

SN117M NEUTRON ACER TENDL-2019 LIBRARY; T=293.16K  
Neutron emission for (n,n\*)p

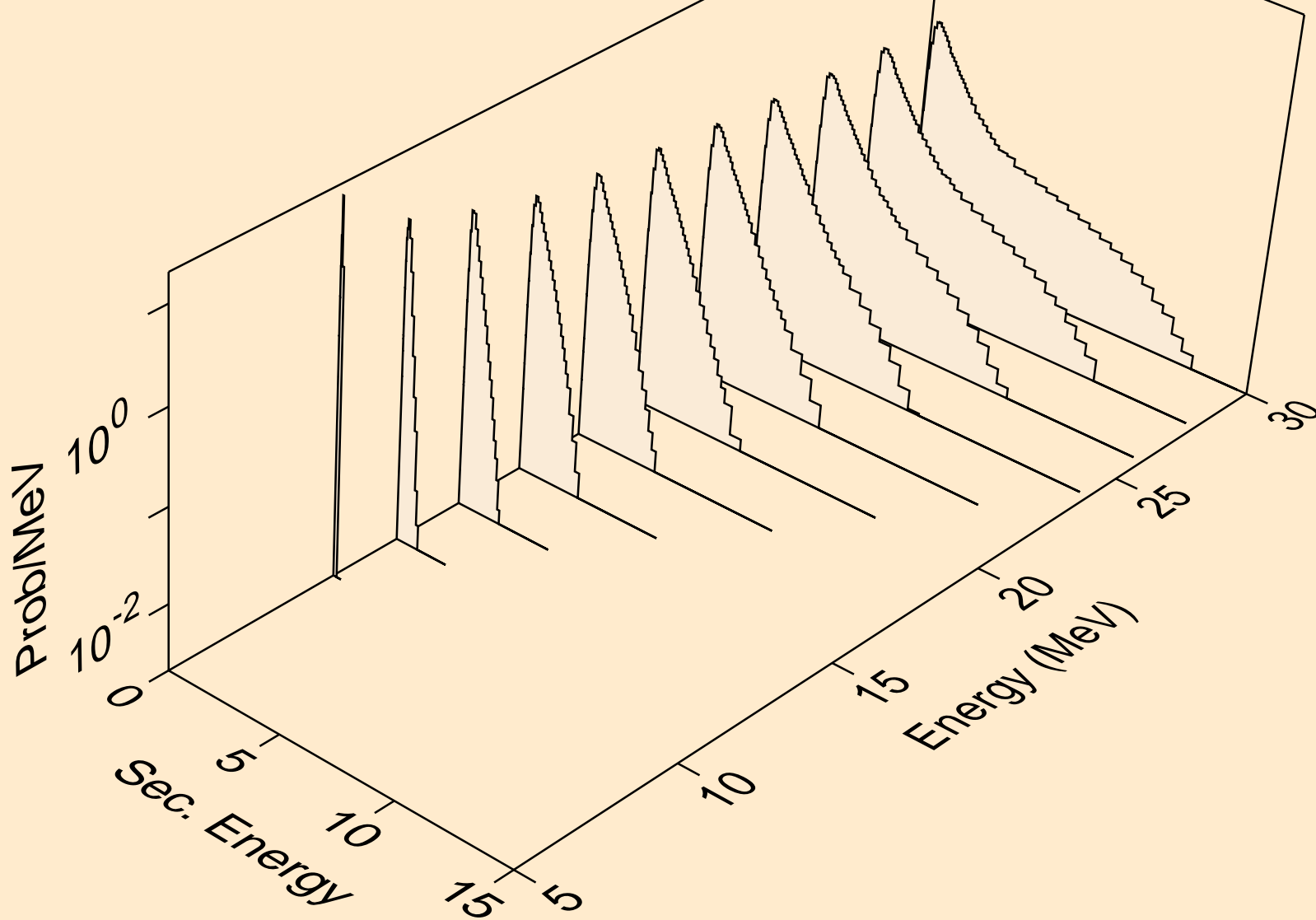

SN117M NEUTRON ACER TENDL-2019 LIBRARY; T=293.16K  
Neutron emission for (n,n\*)2a

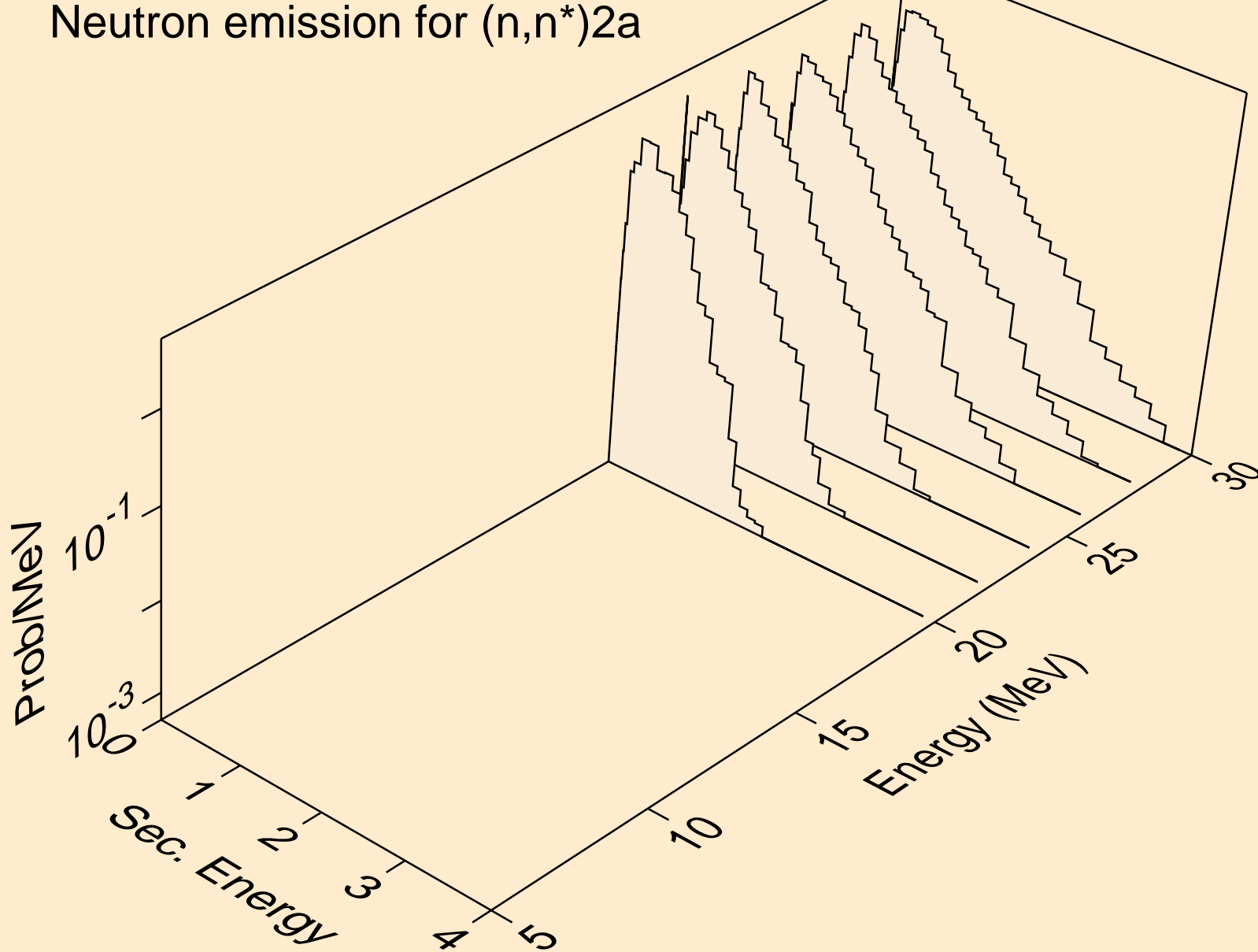

SN117M NEUTRON ACER TENDL-2019 LIBRARY; T=293.16K  
Neutron emission for (n,n\*)d

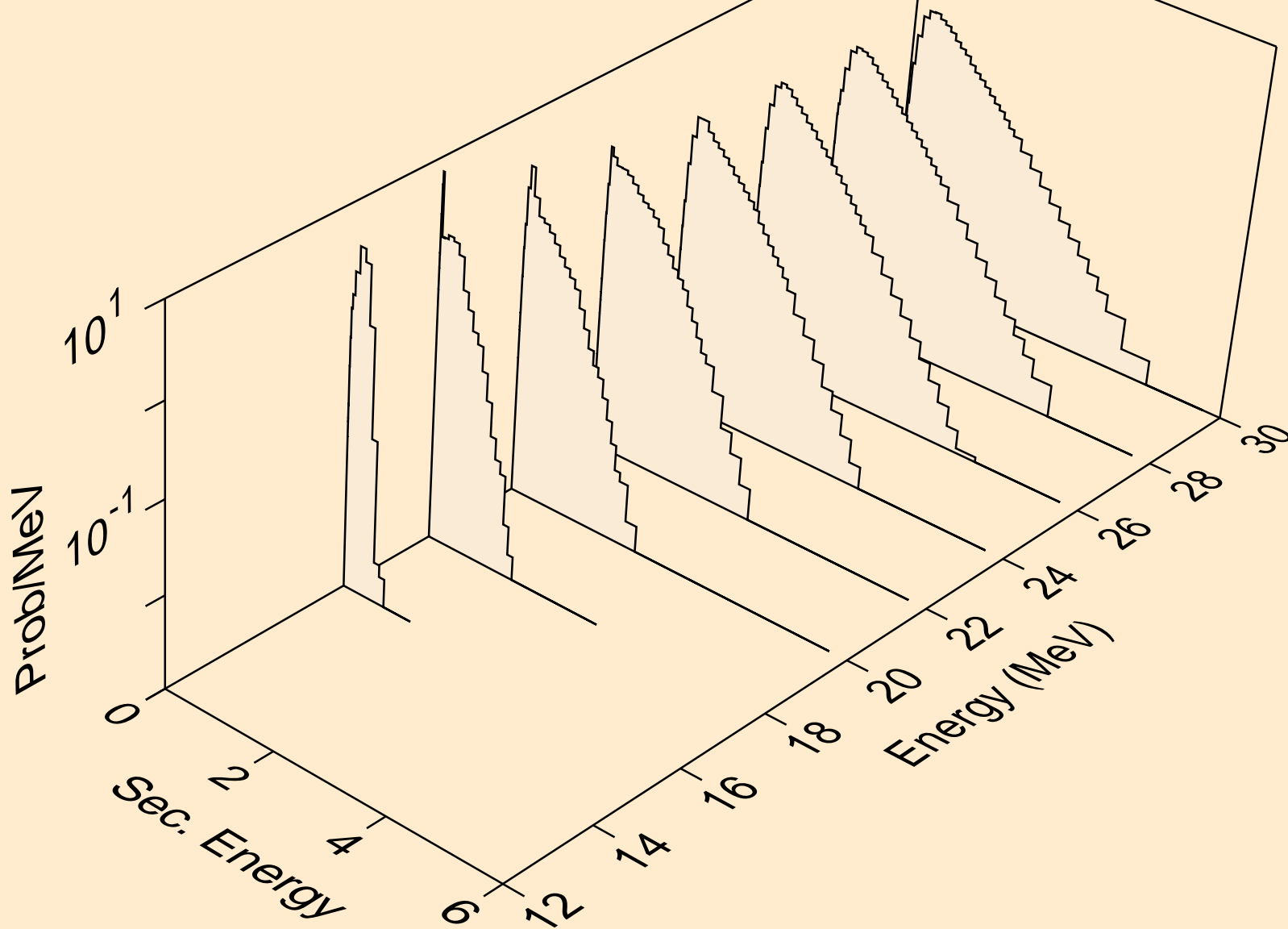

SN117M NEUTRON ACER TENDL-2019 LIBRARY; T=293.16K  
Neutron emission for (n,n\*)t

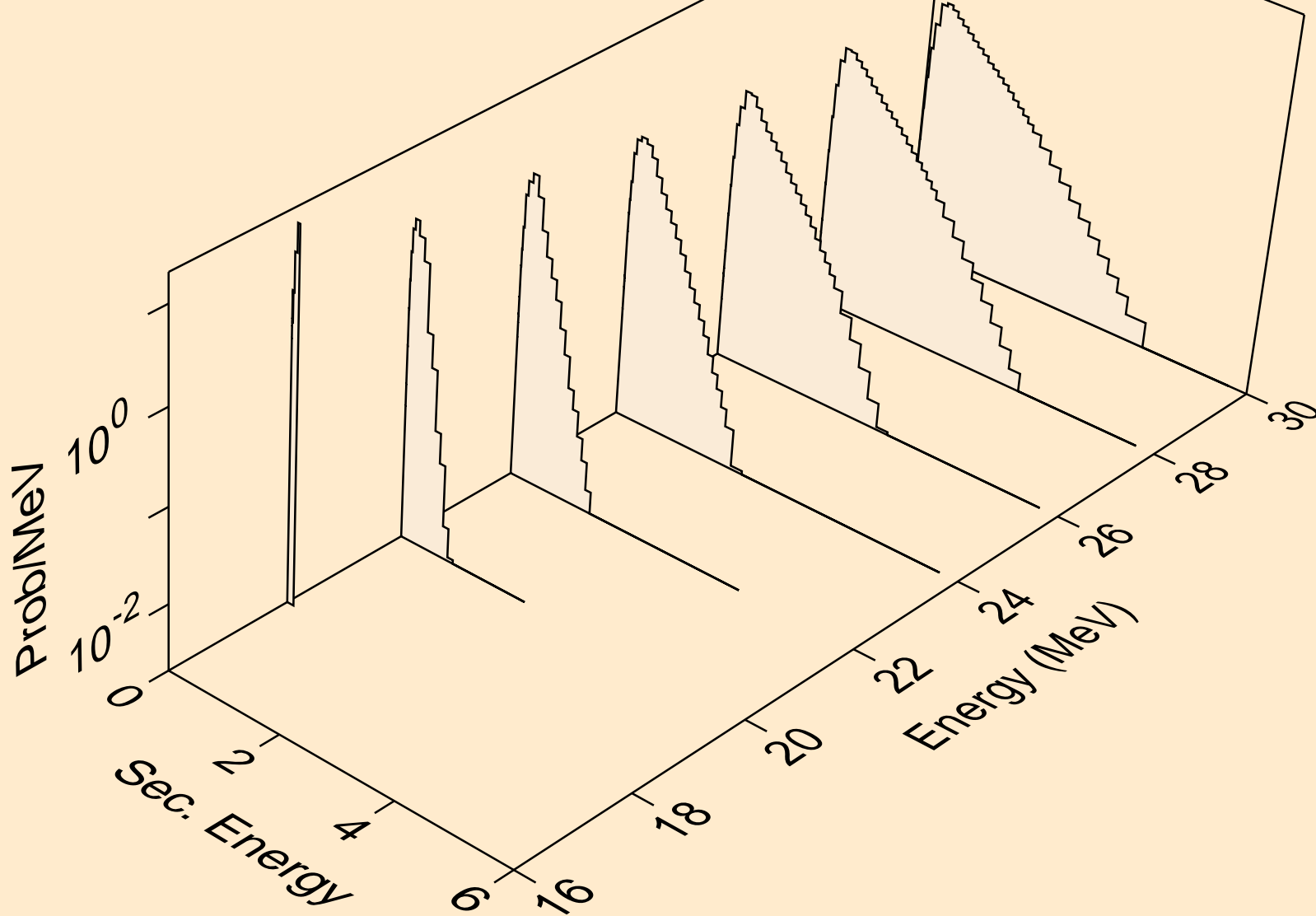



SN117M NEUTRON ACER TENDL-2019 LIBRARY; T=293.16K  
Neutron emission for (n,n\*)he3

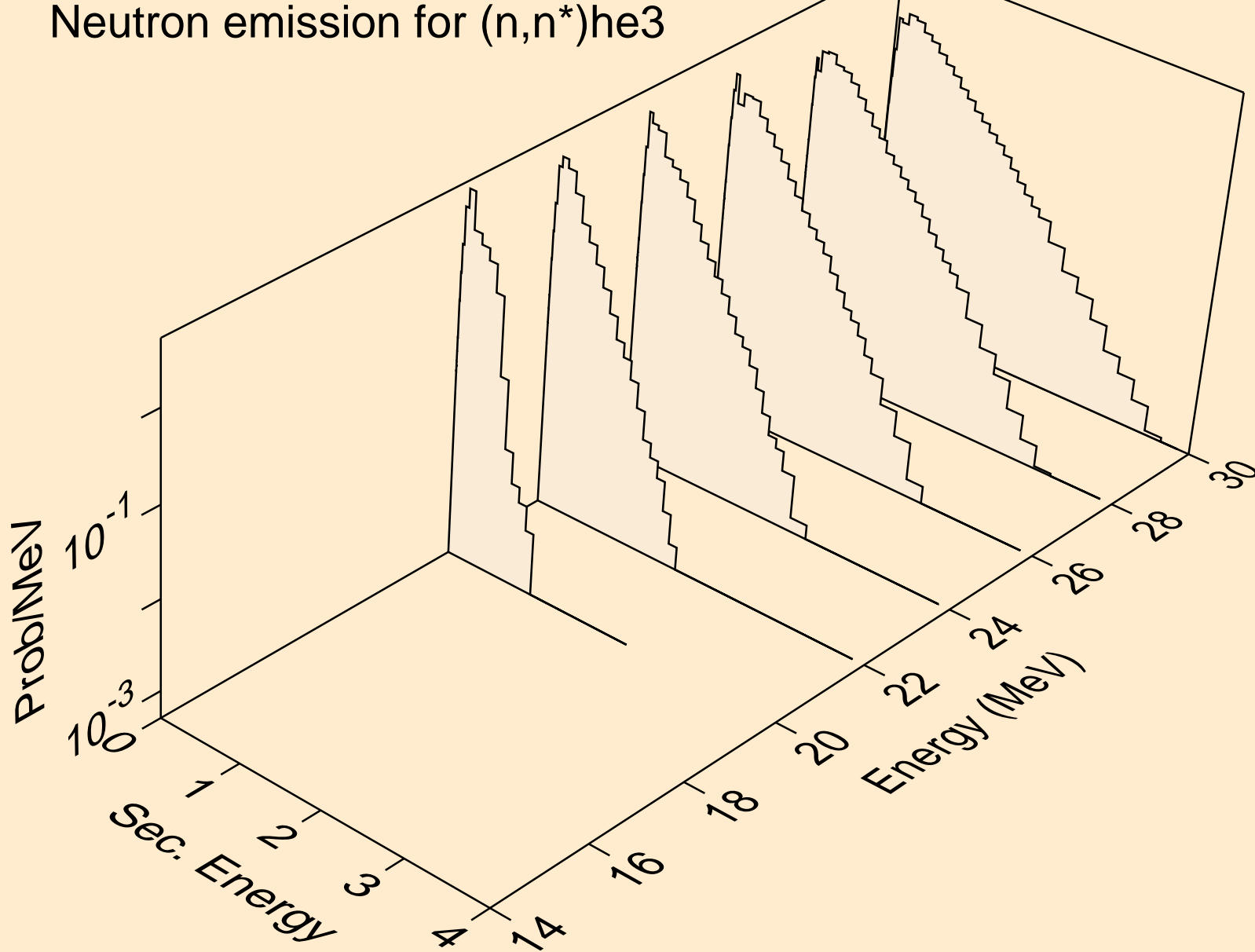

SN117M NEUTRON ACER TENDL-2019 LIBRARY; T=293.16K  
Neutron emission for (n,4n)

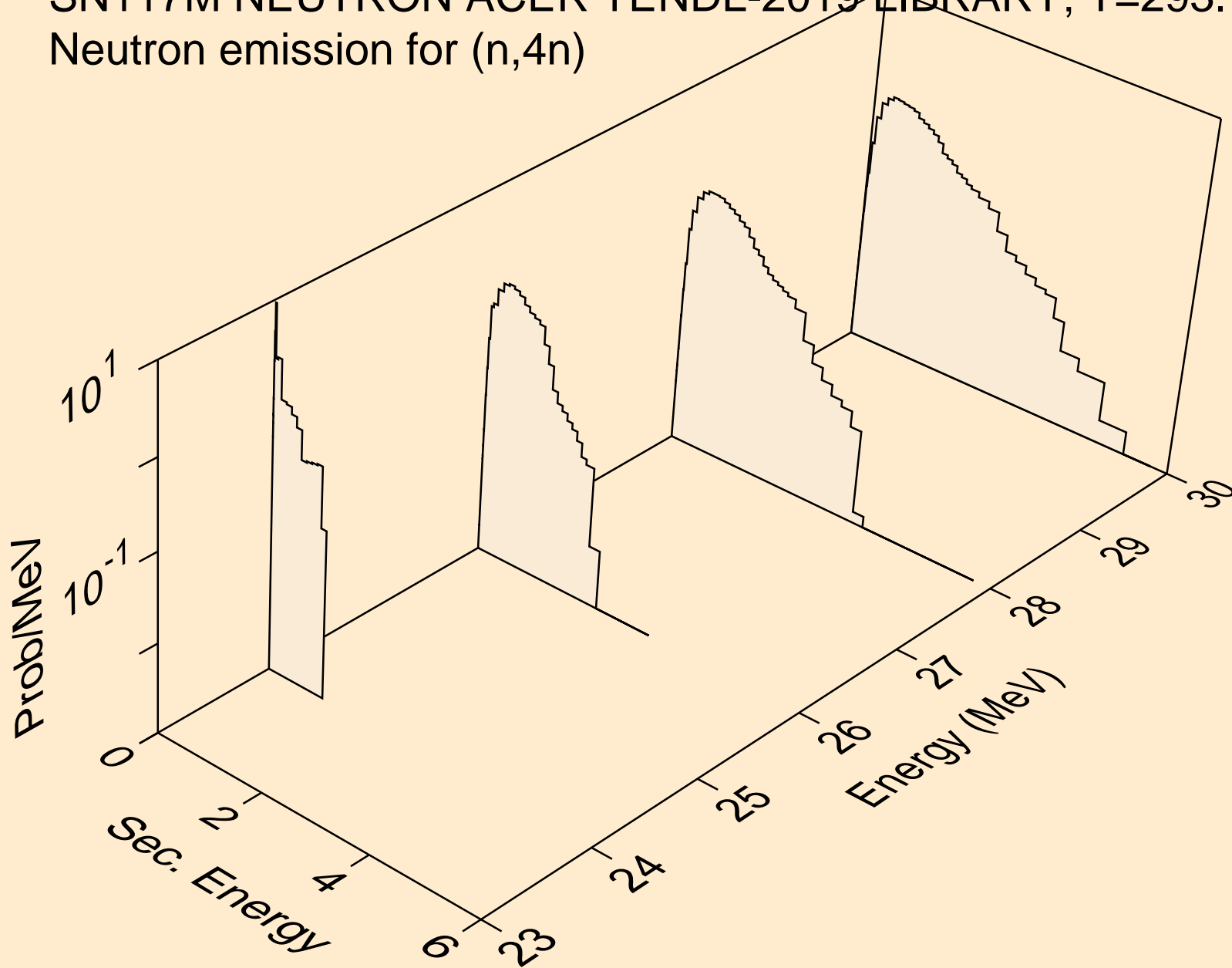

SN117M NEUTRON ACER TENDL-2019 LIBRARY; T=293.16K  
Neutron emission for (n,2np)

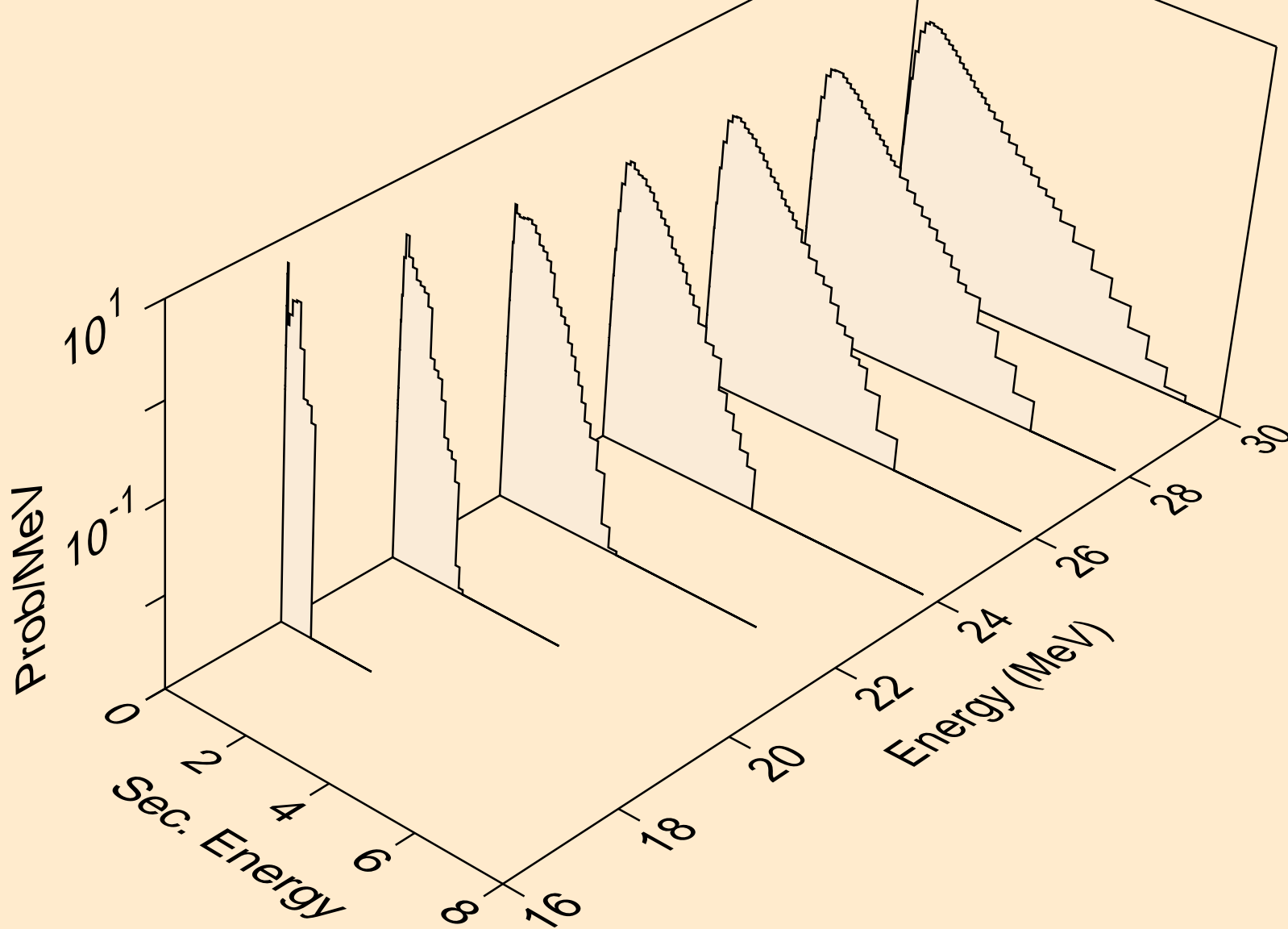

SN117M NEUTRON ACER TENDL-2019 LIBRARY; T=293.16K  
Neutron emission for (n,3np)

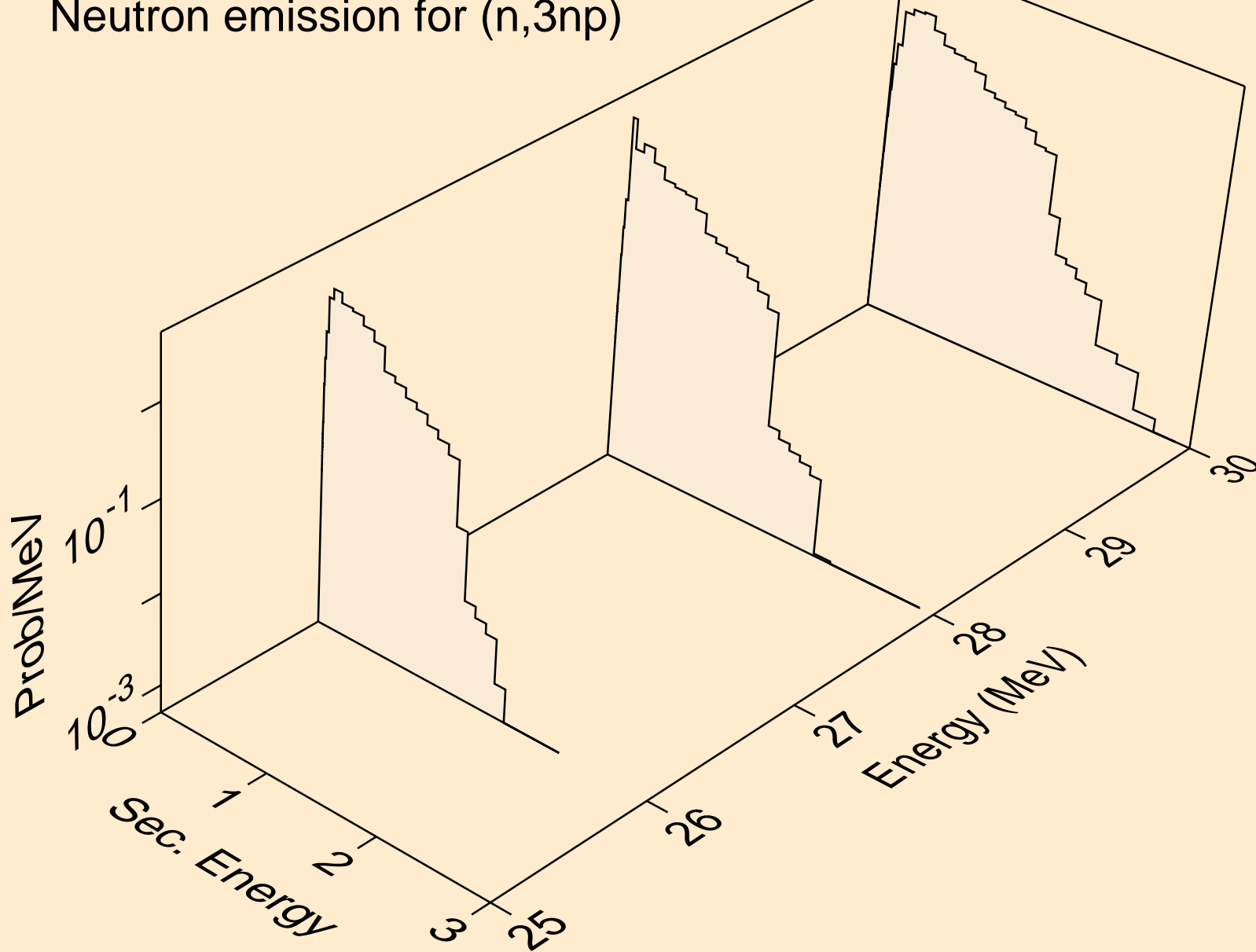

SN117M NEUTRON ACER TENDL-2019 LIBRARY; T=293.16K  
Neutron emission for (n,2np)

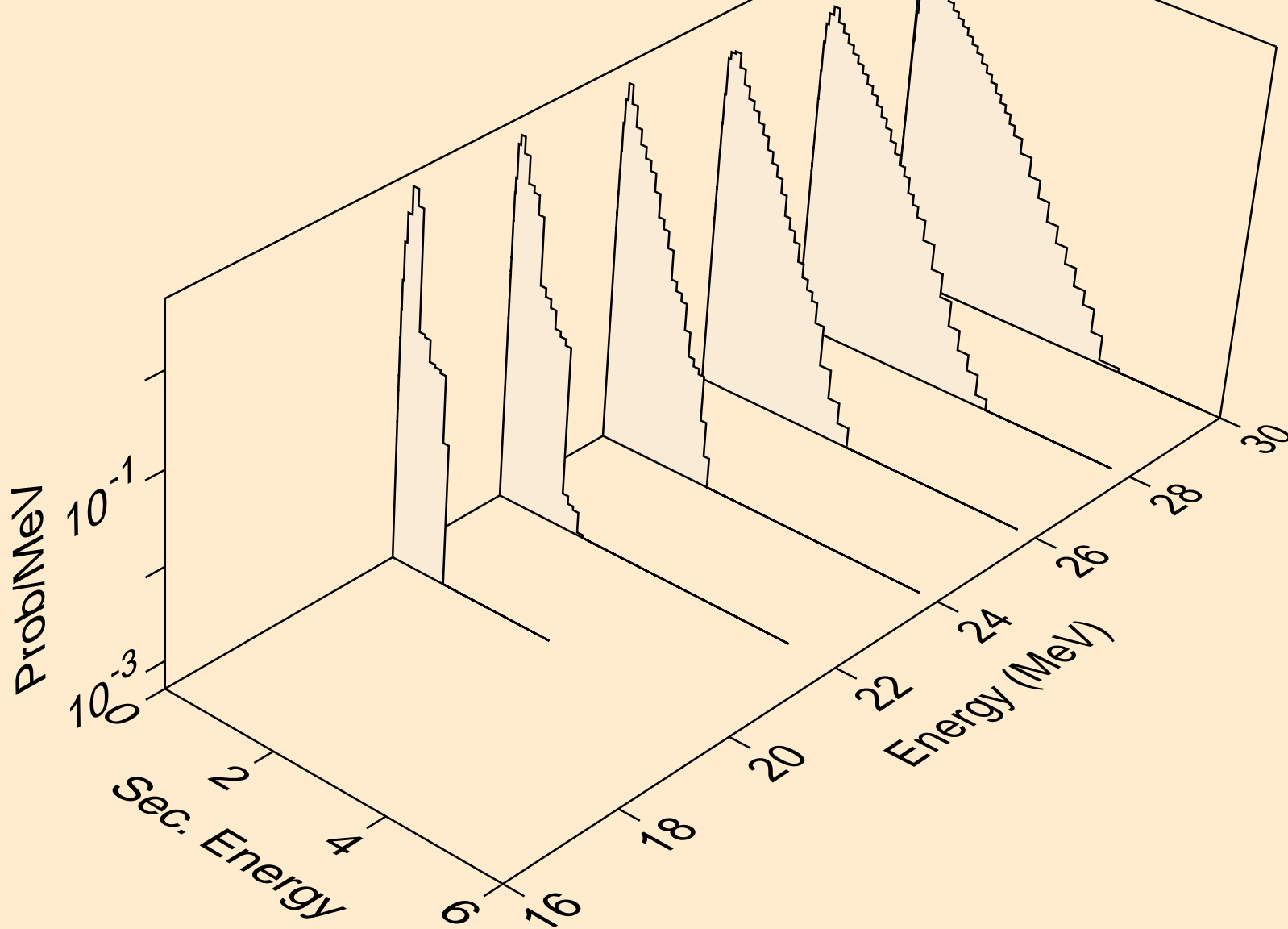

SN117M NEUTRON ACER TENDL-2019 LIBRARY; T=293.16K  
Neutron emission for (n,npa)

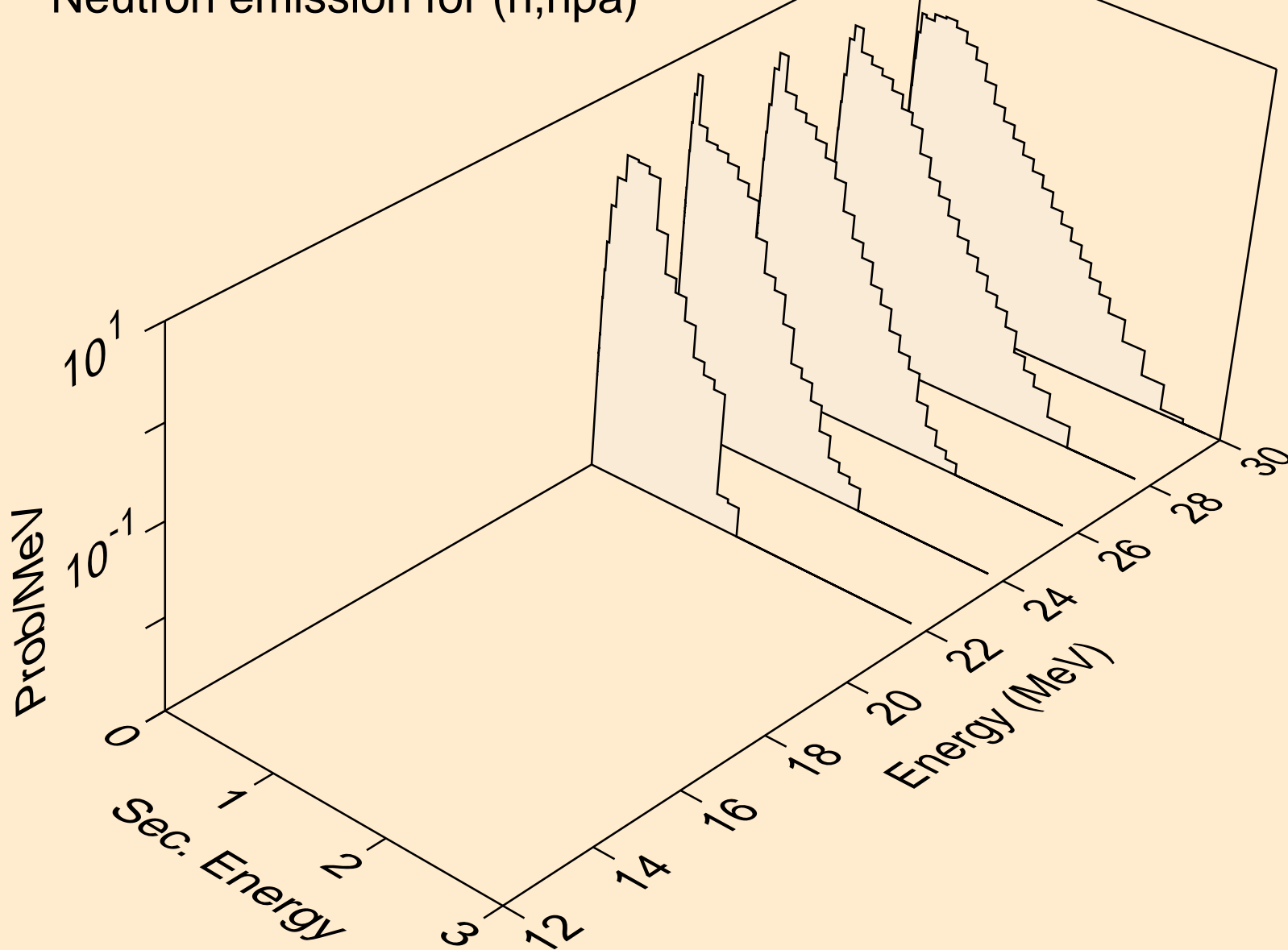

SN117M NEUTRON ACER TENDL-2019 LIBRARY; T=293.16K  
Neutron emission for (n,n\*c)

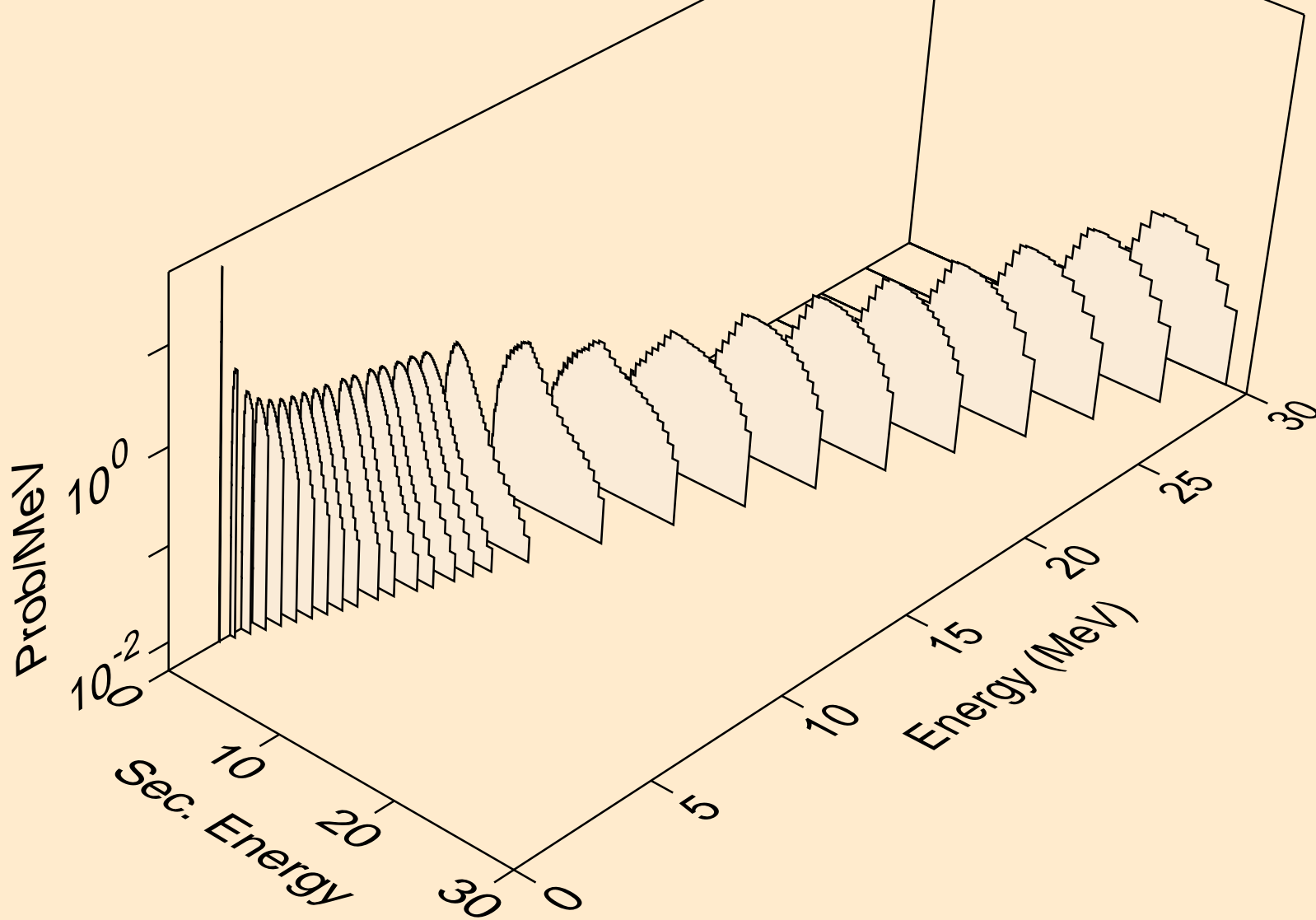

SN117M NEUTRON ACER TENDL-2019 LIBRARY; T=293.16K  
Photon emission for (n,x)

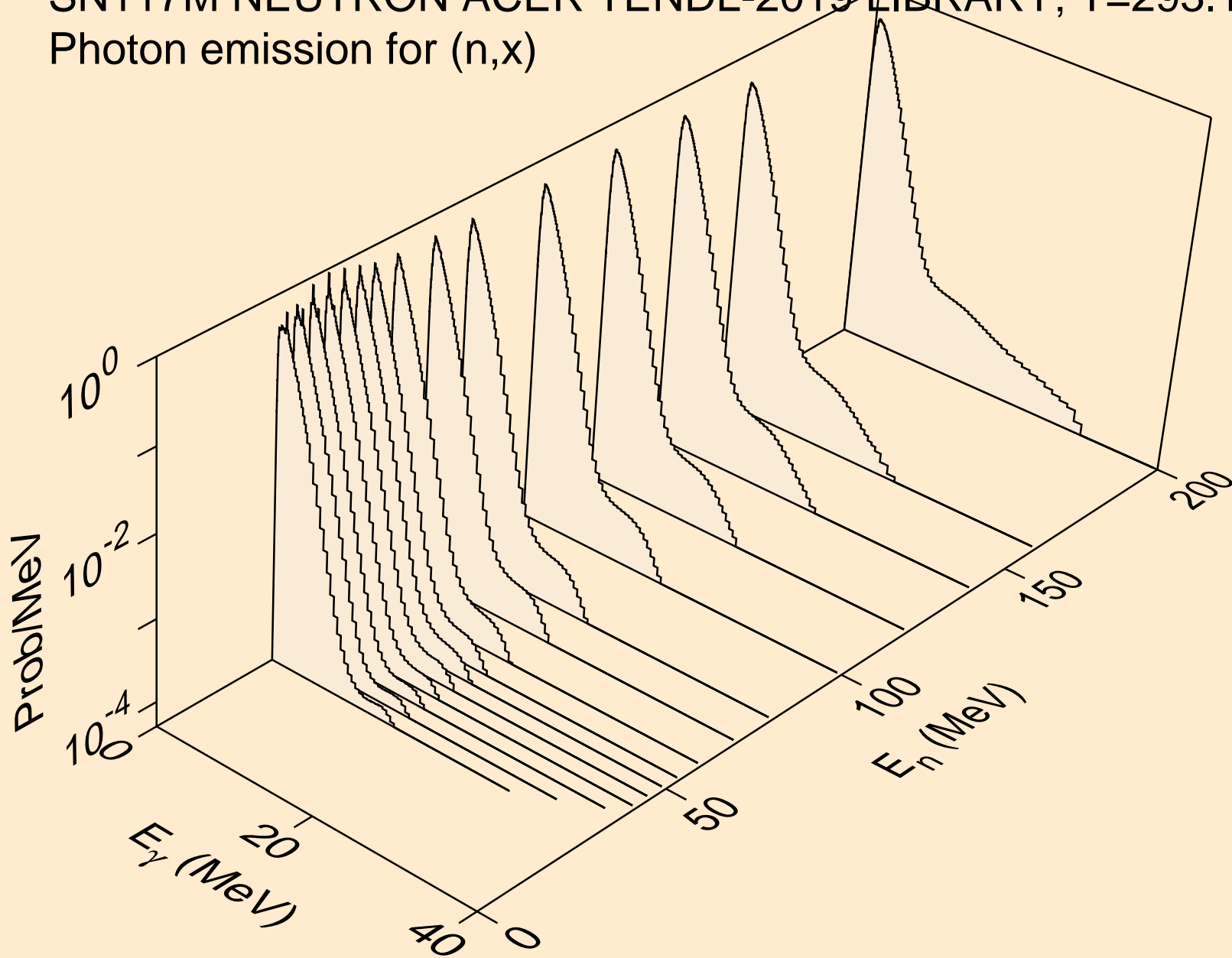



SN117M NEUTRON ACER TENDL-2019 LIBRARY; T=293.16K  
Photon emission for (n,2nd)

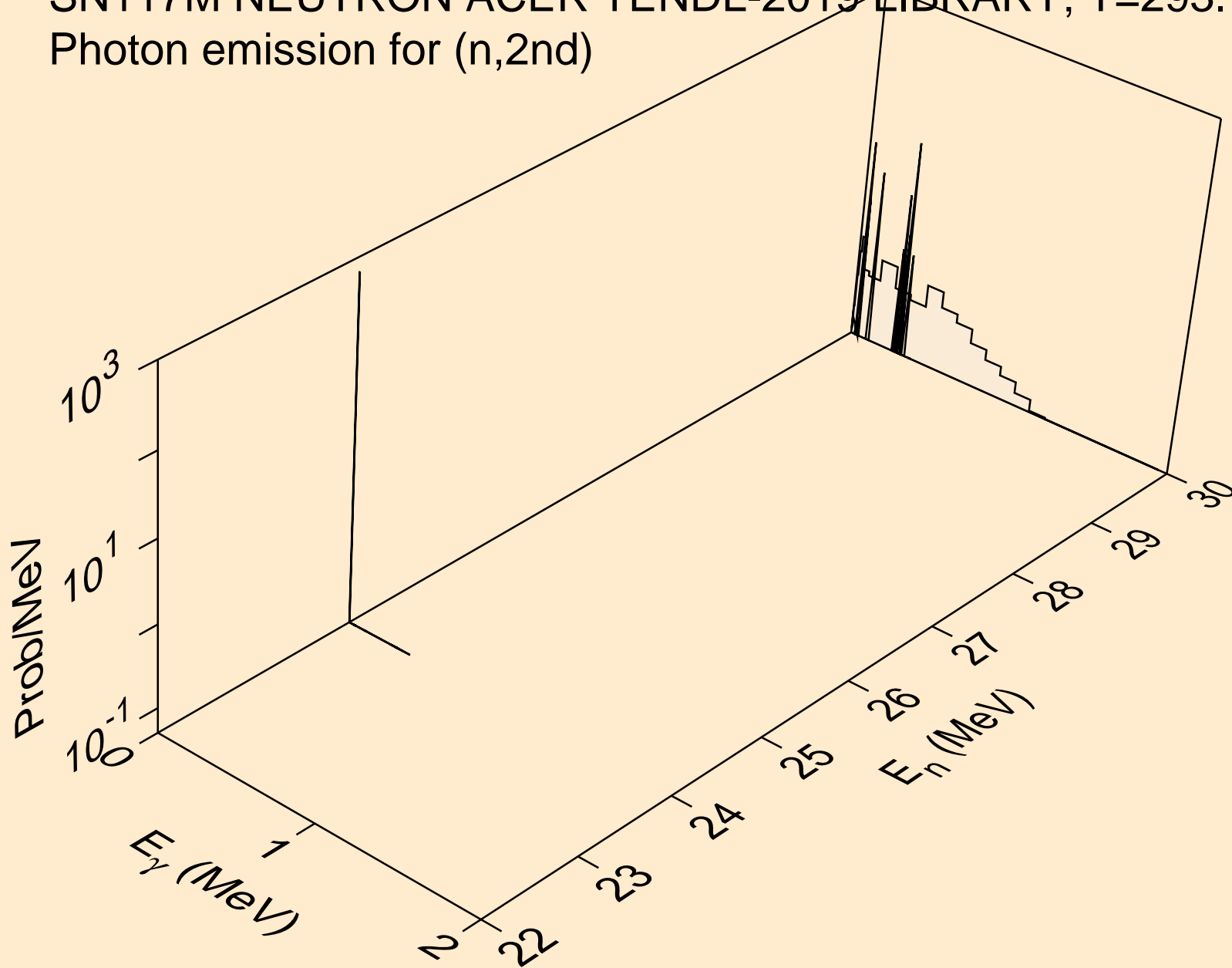

SN117M NEUTRON ACER TENDL-2019 LIBRARY; T=293.16K  
Photon emission for (n,2n)

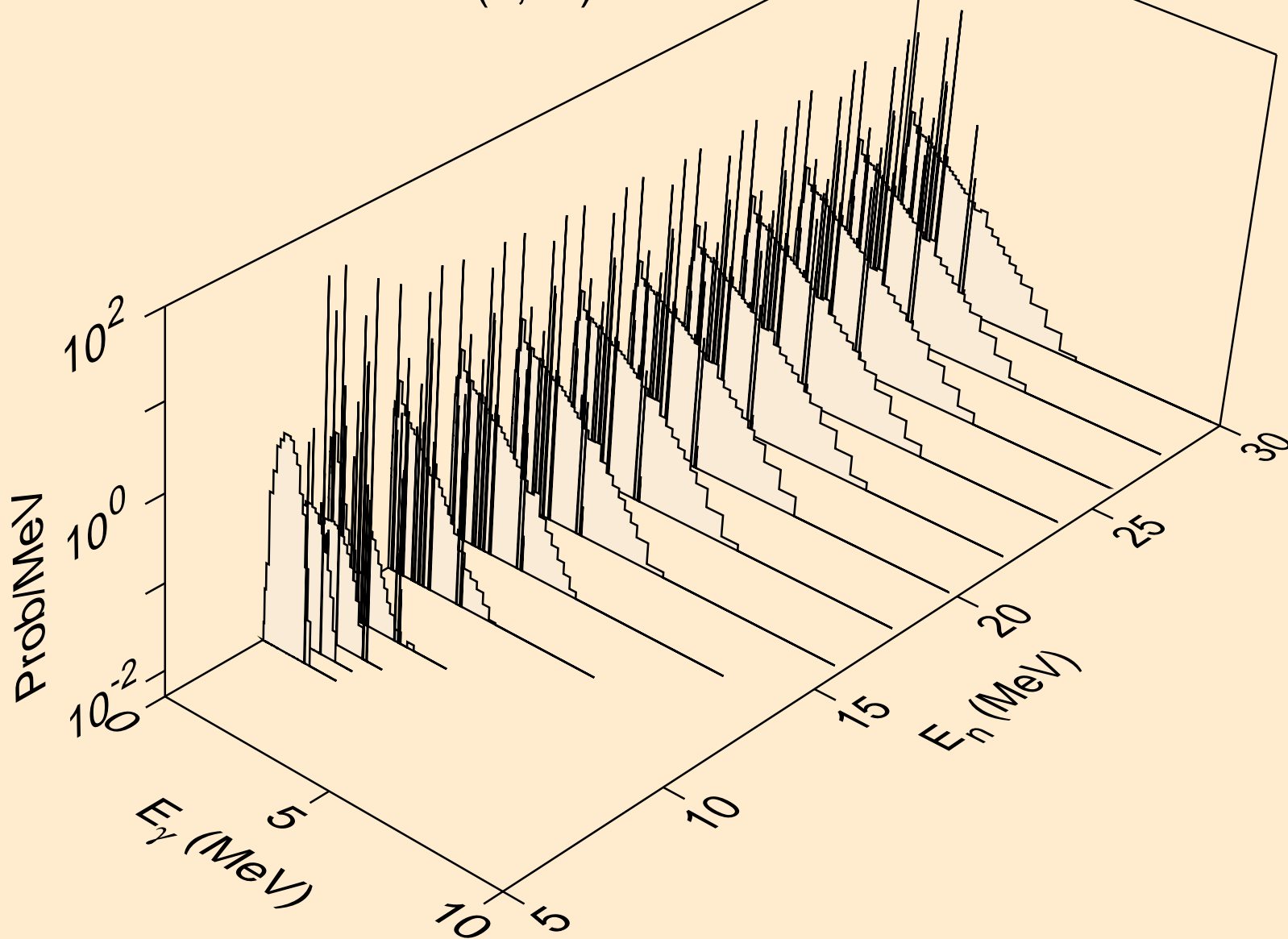

SN117M NEUTRON ACER TENDL-2019 LIBRARY; T=293.16K  
Photon emission for (n,3n)

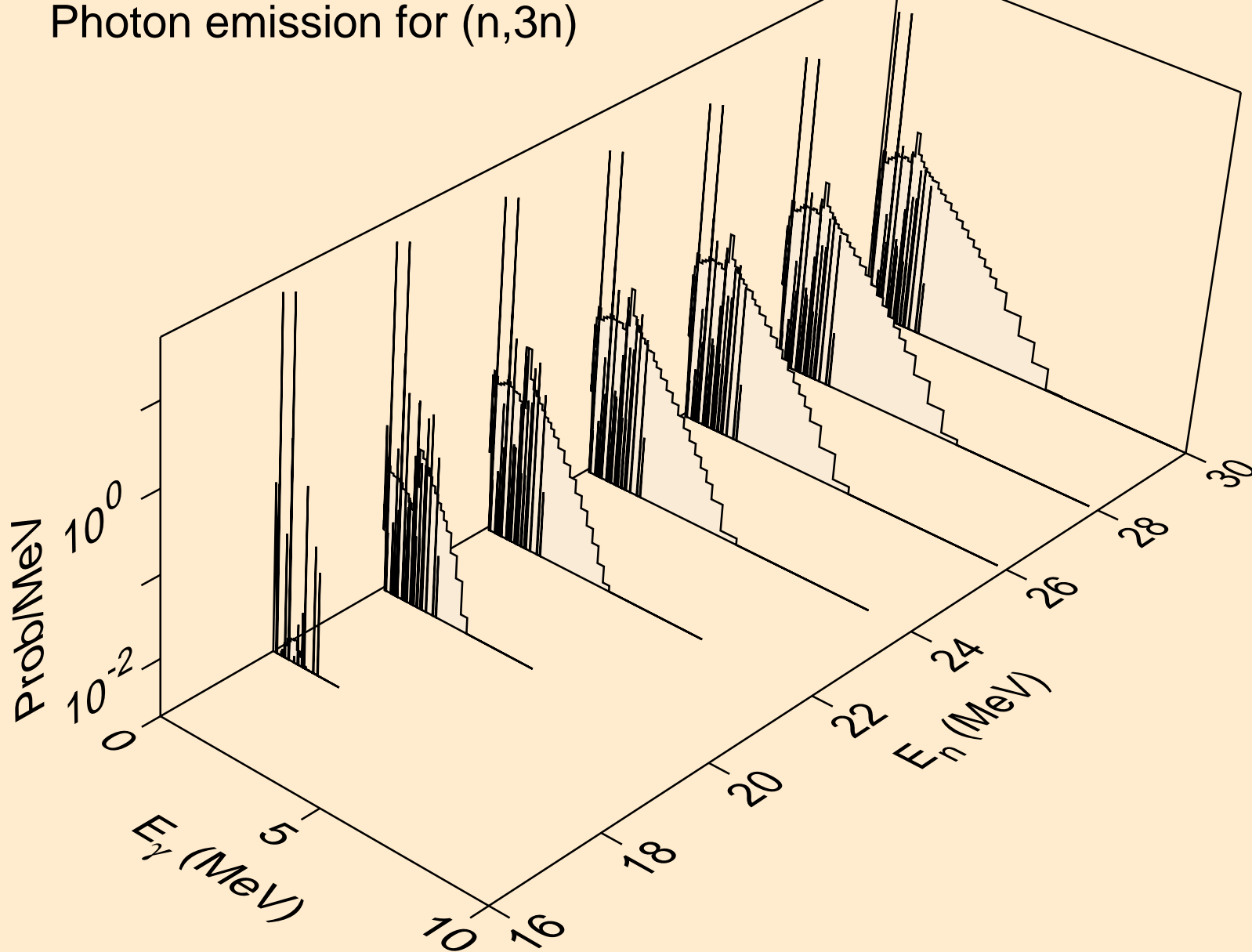

SN117M NEUTRON ACER TENDL-2019 LIBRARY; T=293.16K  
Photon emission for (n,n\*)a

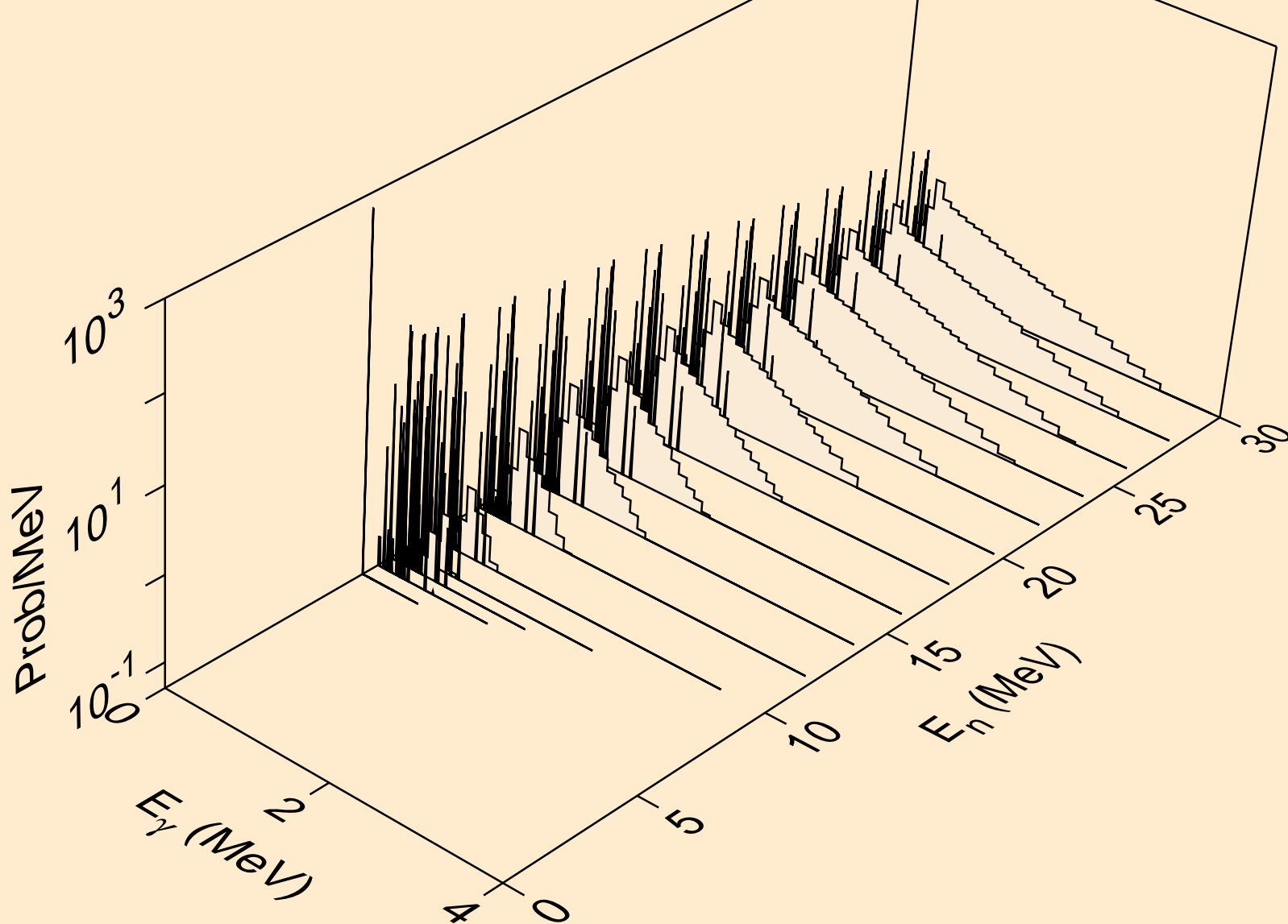

SN117M NEUTRON ACER TENDL-2019 LIBRARY; T=293.16K  
Photon emission for (n,2n)a

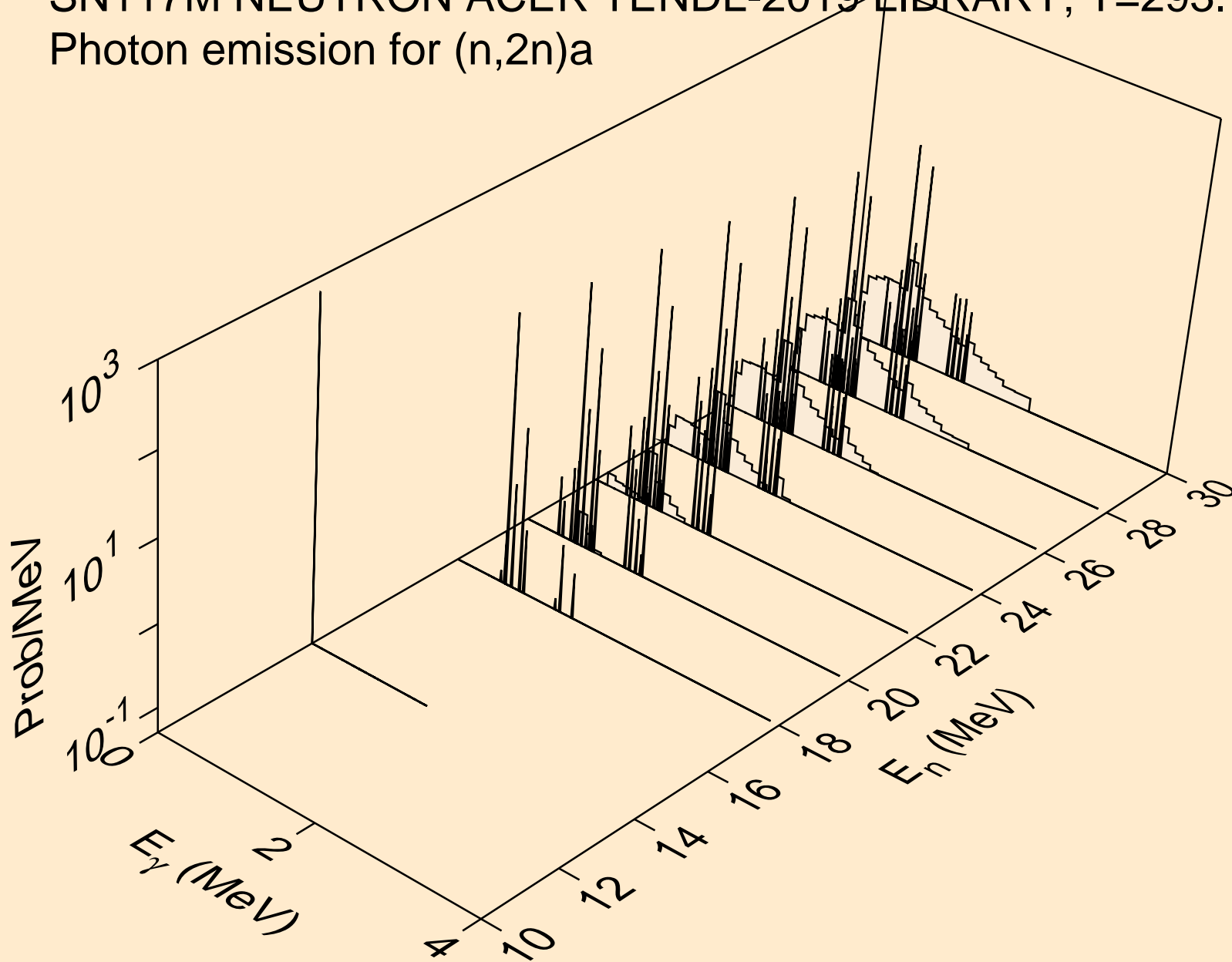

SN117M NEUTRON ACER TENDL-2019 LIBRARY; T=293.16K  
Photon emission for (n,3n)a

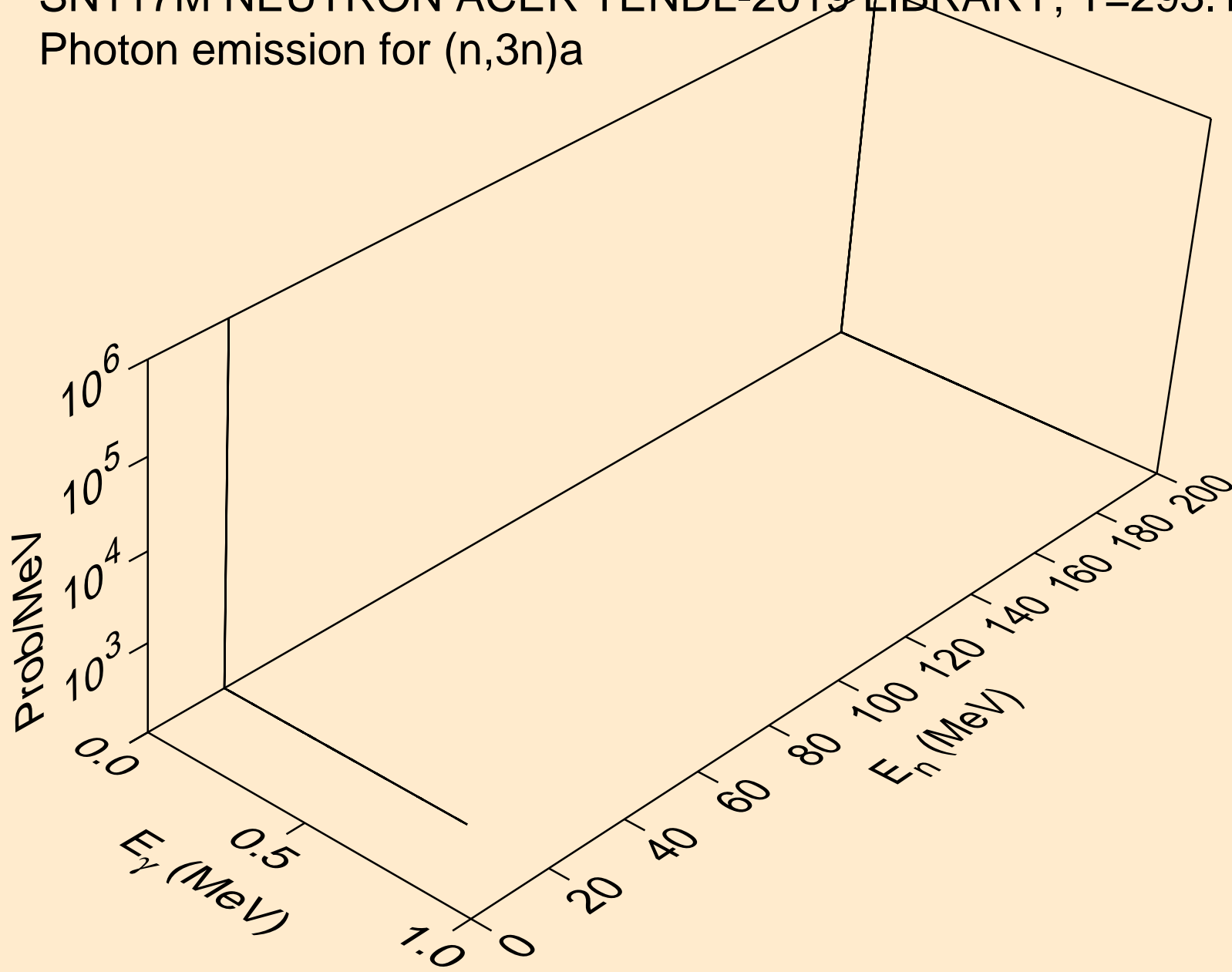

SN117M NEUTRON ACER TENDL-2019 LIBRARY; T=293.16K  
Photon emission for (n,n\*)p

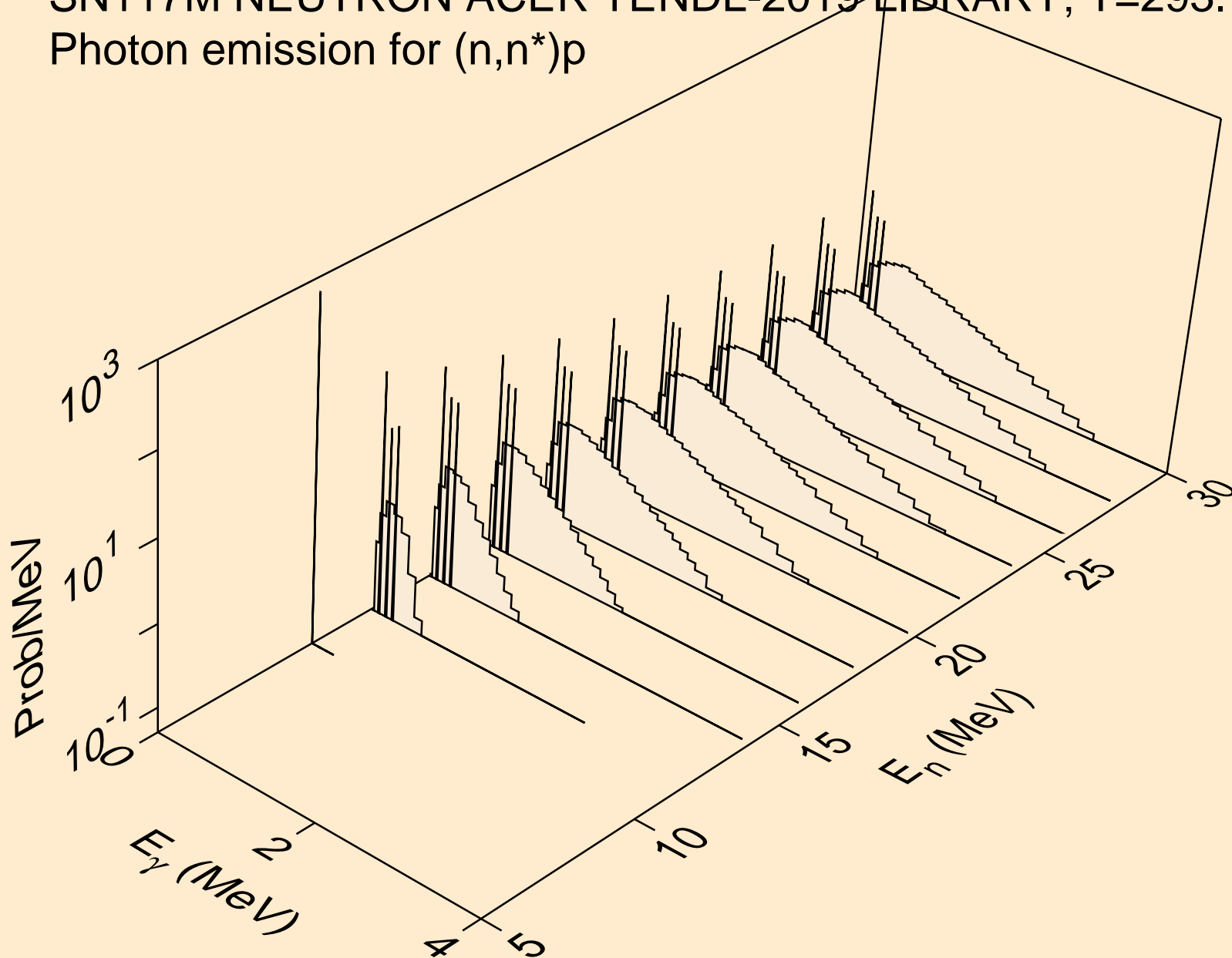

SN117M NEUTRON ACER TENDL-2019 LIBRARY; T=293.16K  
Photon emission for (n,n\*)2a

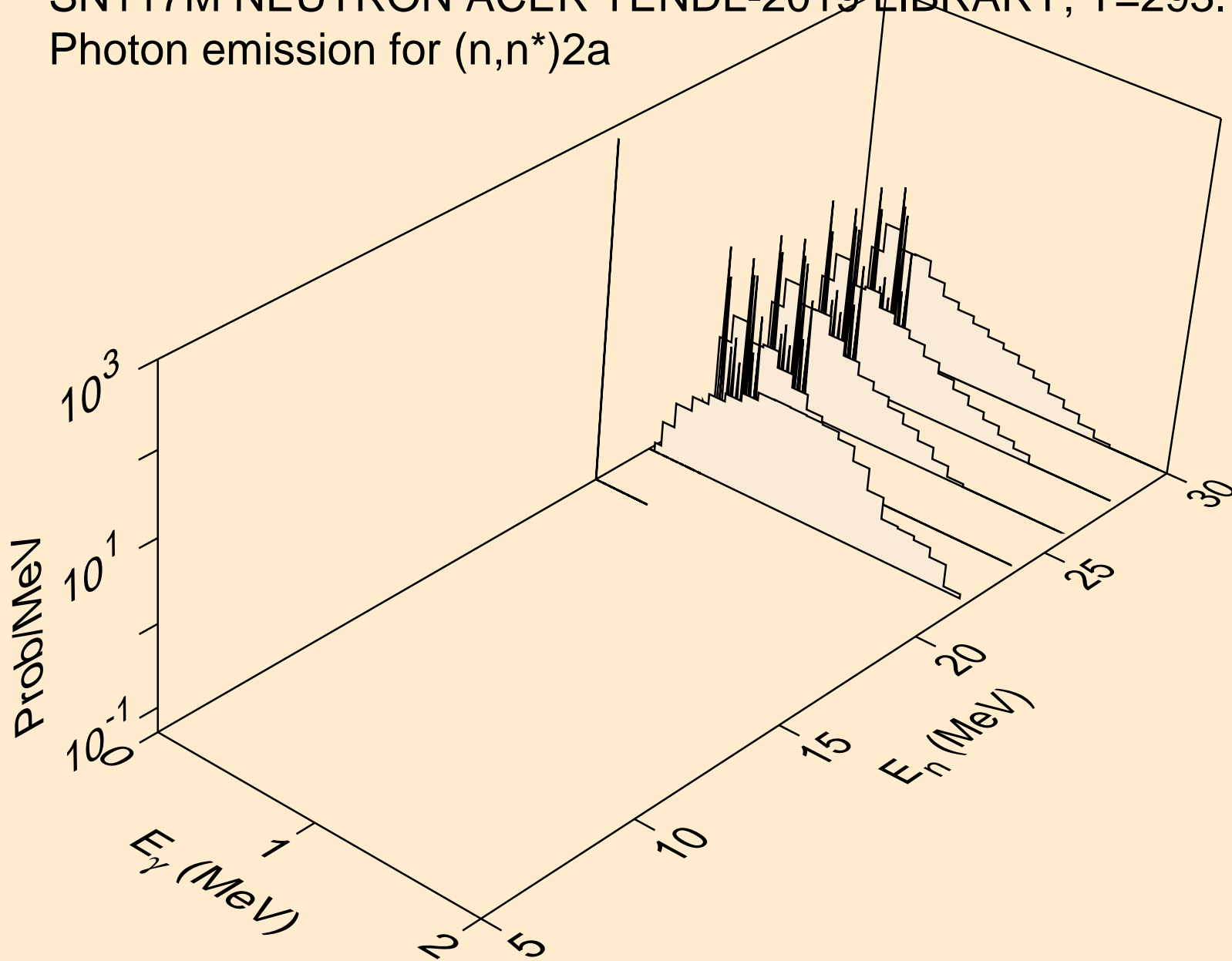



SN117M NEUTRON ACER TENDL-2019 LIBRARY; T=293.16K  
Photon emission for (n,n\*)d

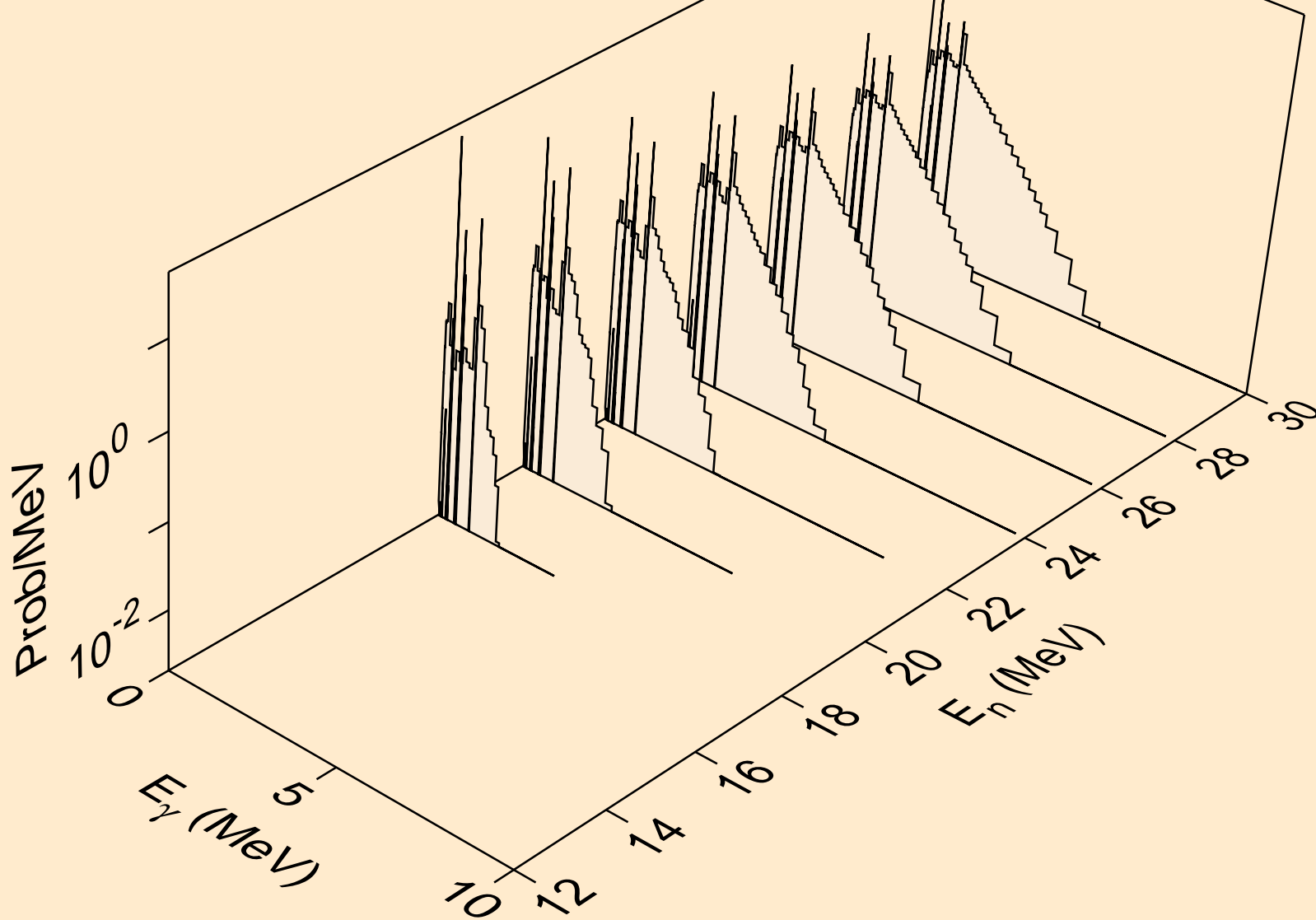

SN117M NEUTRON ACER TENDL-2019 LIBRARY; T=293.16K  
Photon emission for (n,n\*)t

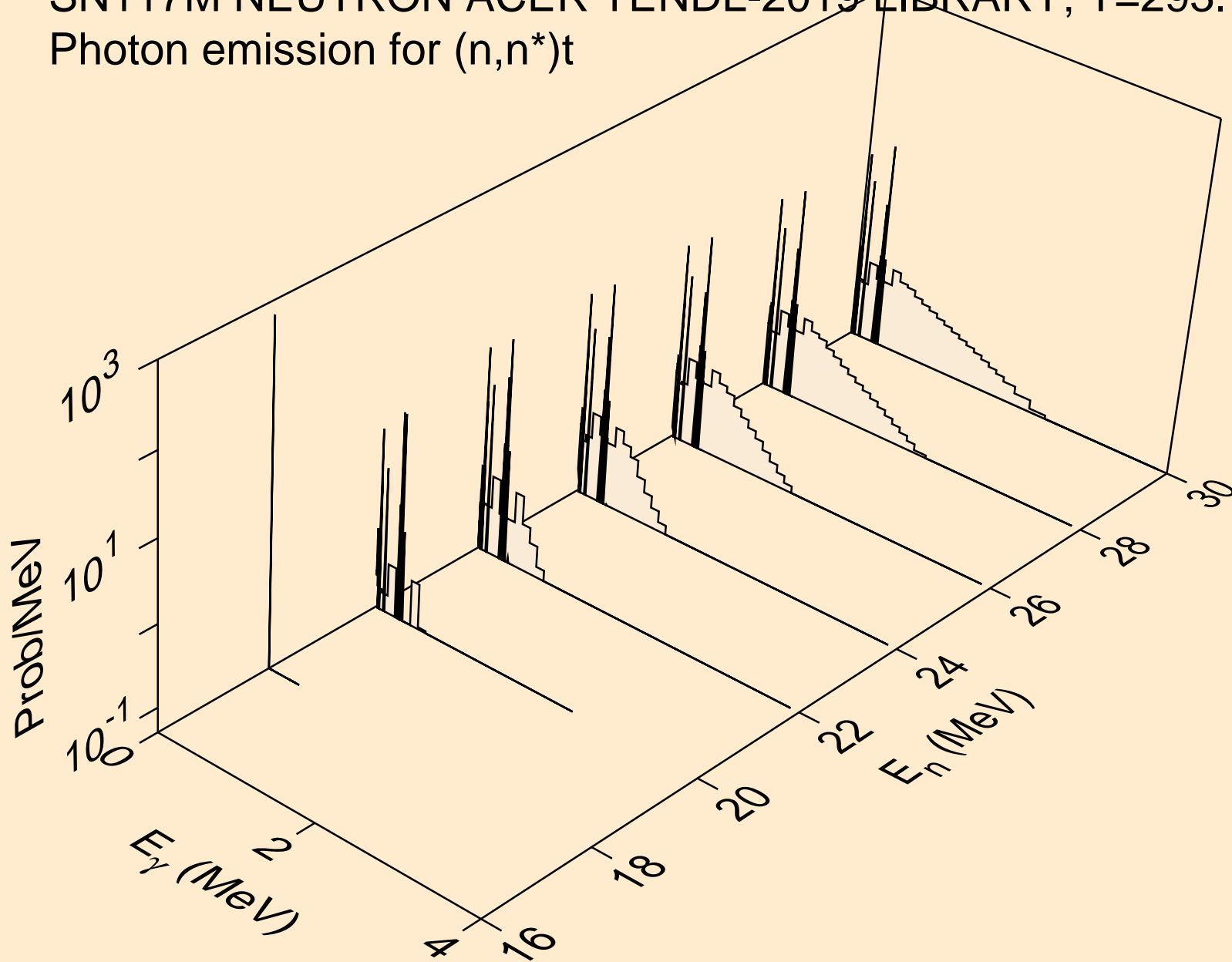

SN117M NEUTRON ACER TENDL-2019 LIBRARY; T=293.16K  
Photon emission for (n,n\*)he3

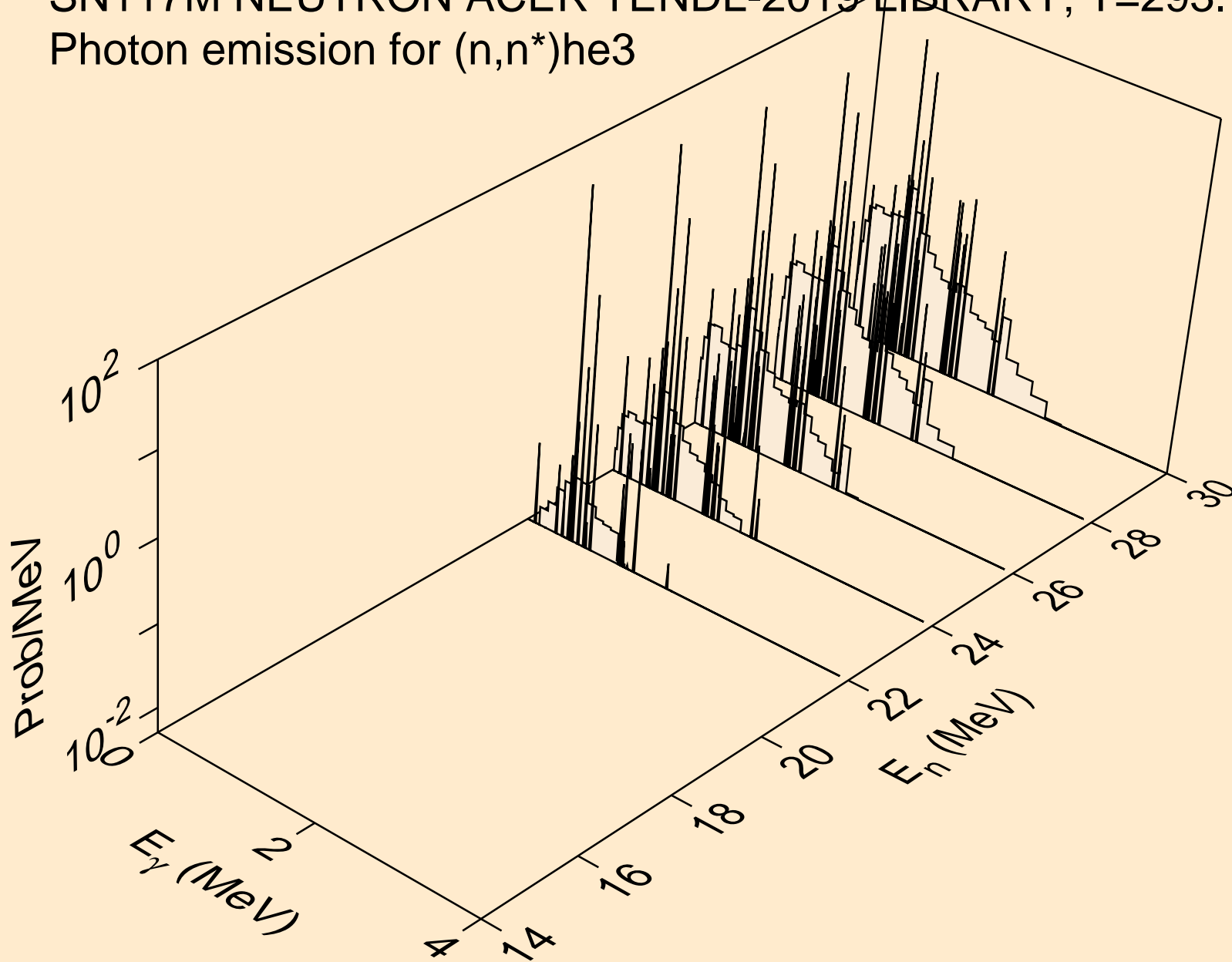

SN117M NEUTRON ACER TENDL-2019 LIBRARY; T=293.16K  
Photon emission for (n,4n)

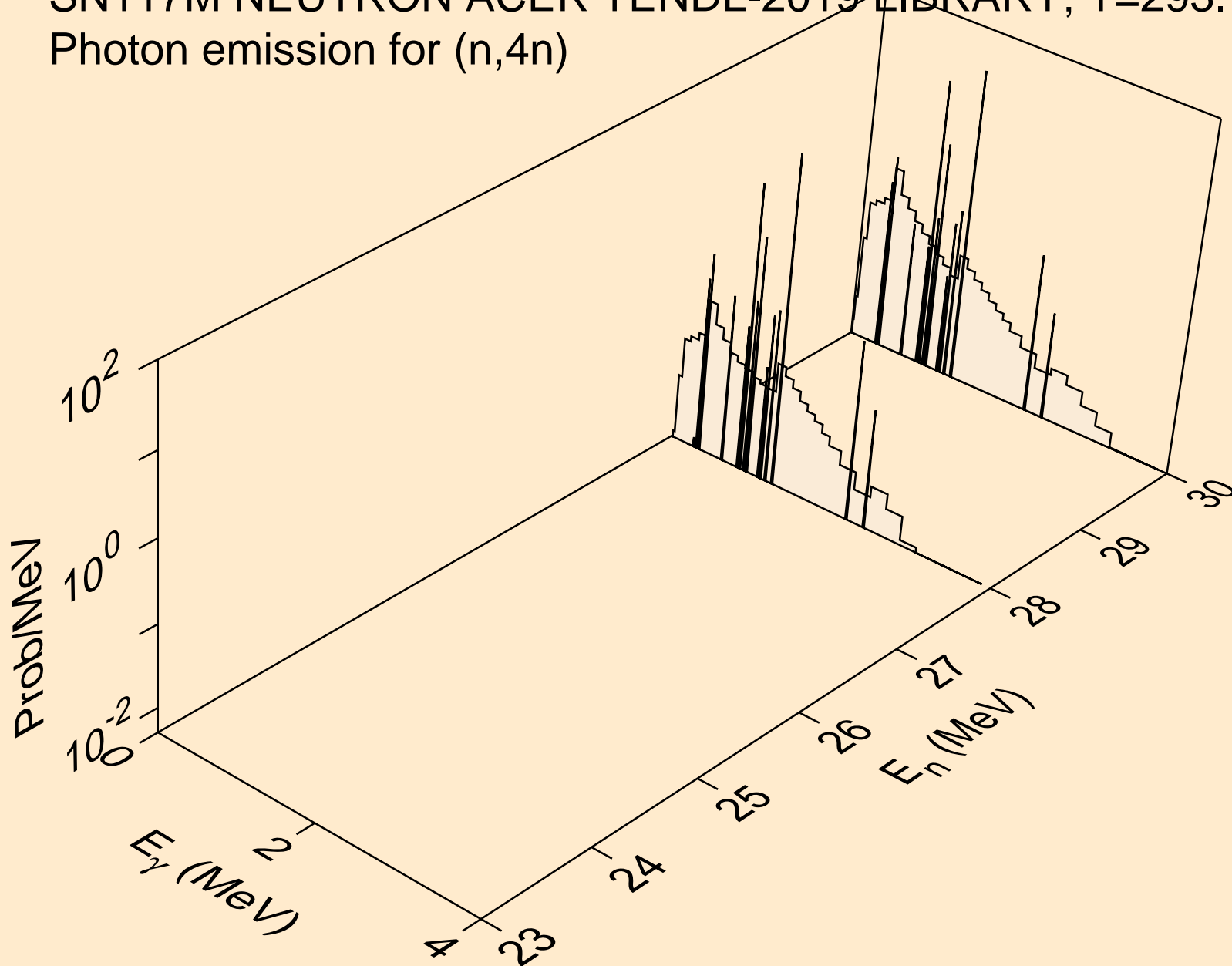

SN117M NEUTRON ACER TENDL-2019 LIBRARY; T=293.16K  
Photon emission for (n,2np)

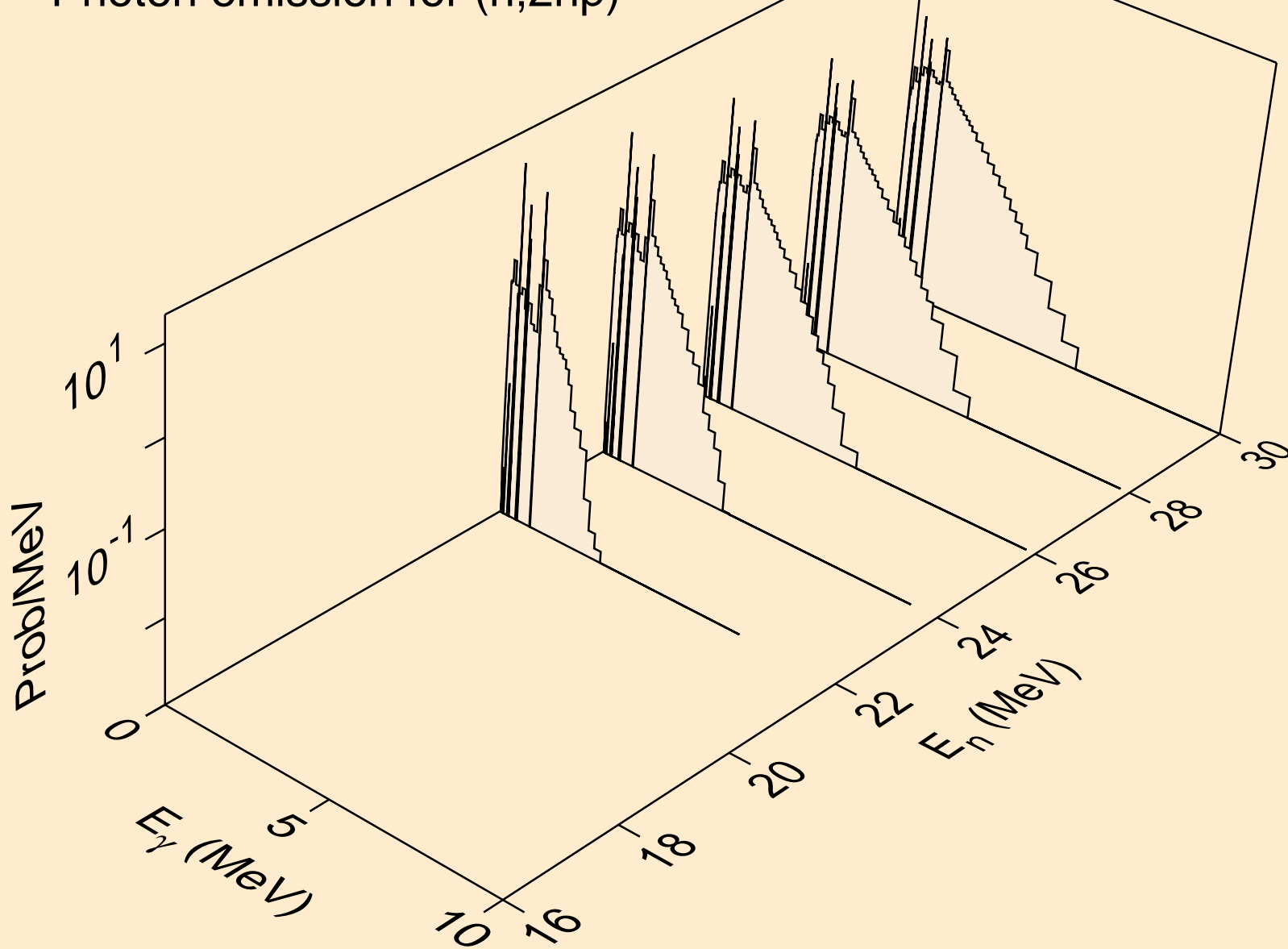

SN117M NEUTRON ACER TENDL-2019 LIBRARY; T=293.16K  
Photon emission for (n,3np)

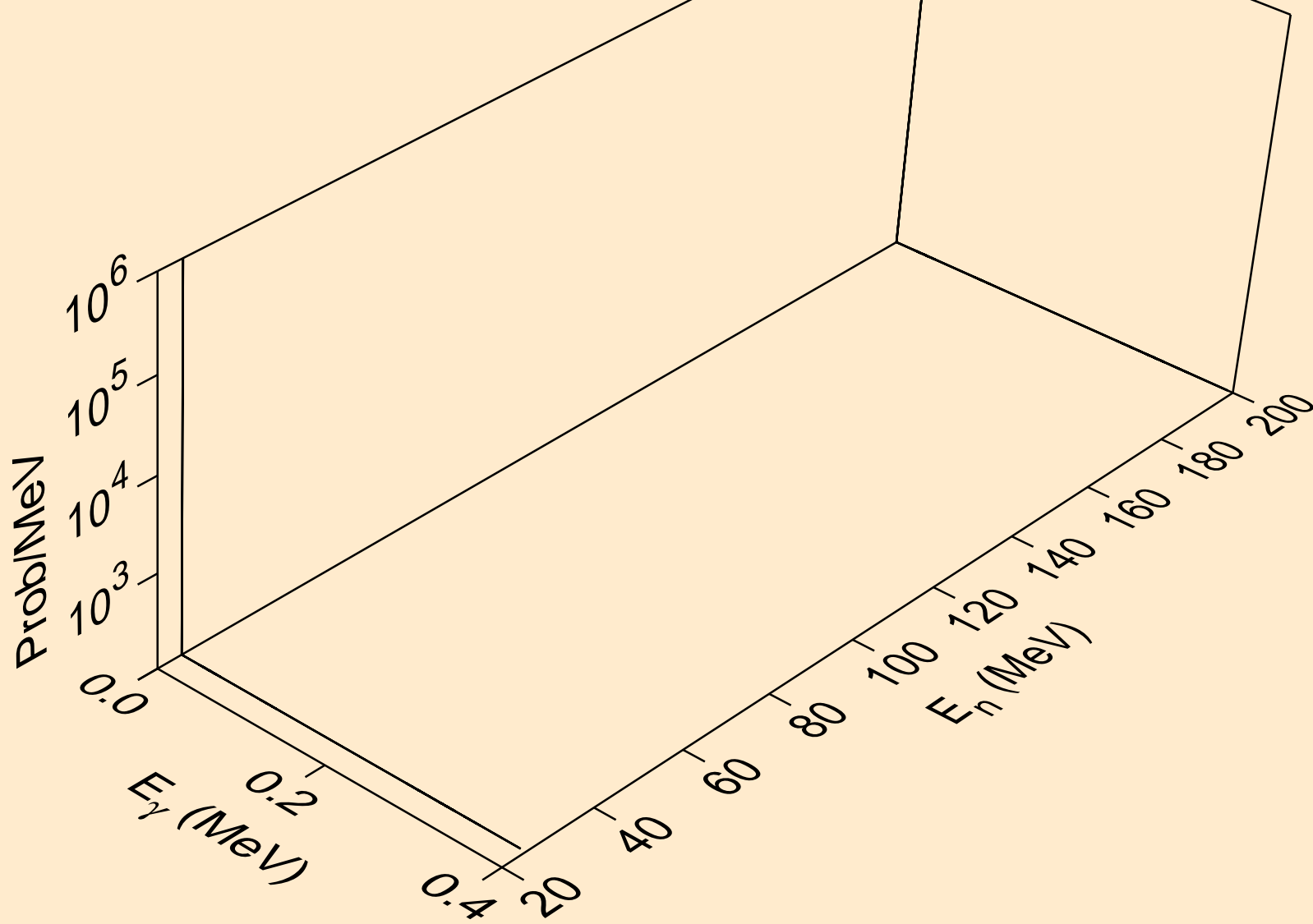

SN117M NEUTRON ACER TENDL-2019 LIBRARY; T=293.16K  
Photon emission for (n,2np)

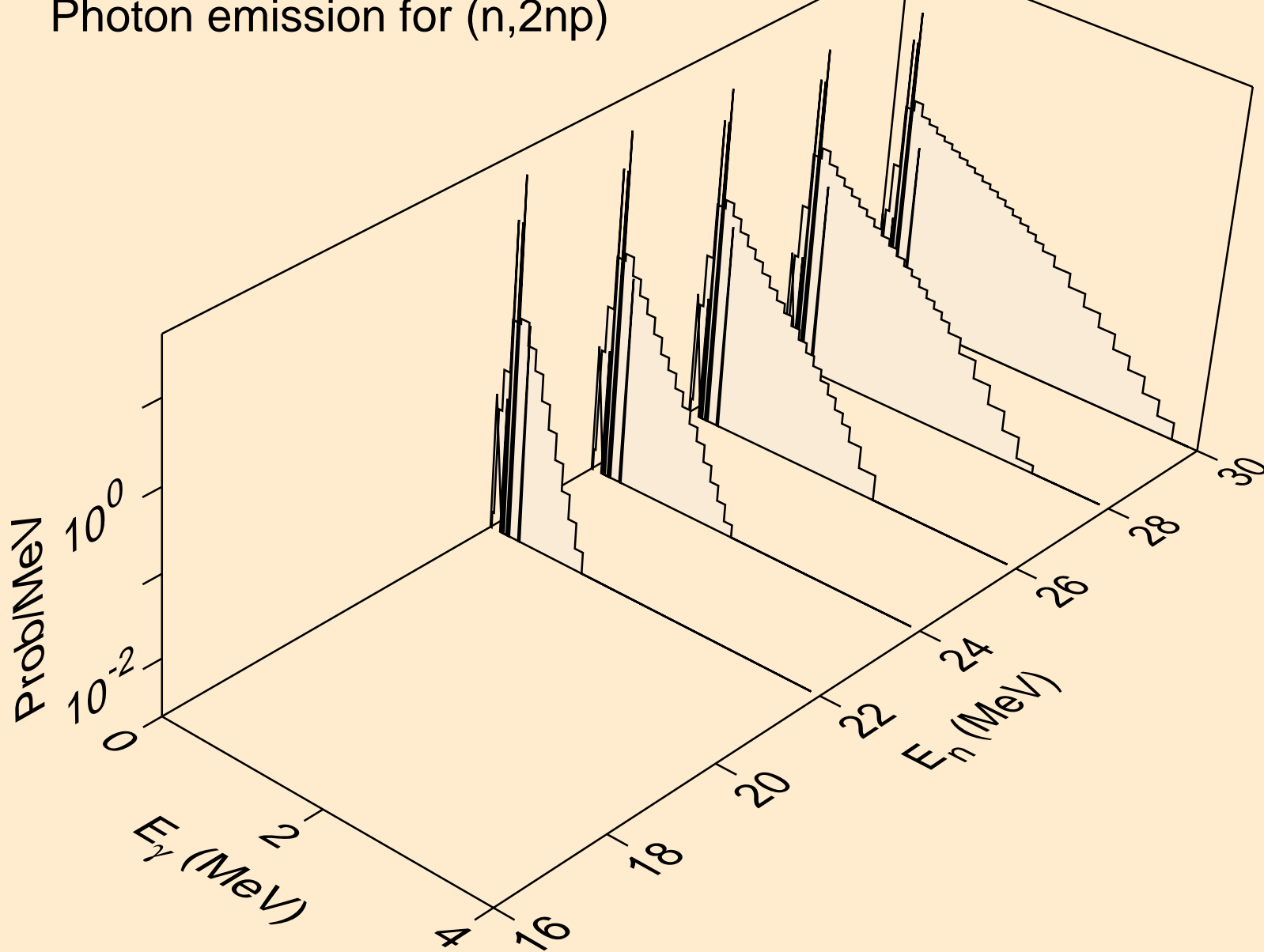

SN117M NEUTRON ACER TENDL-2019 LIBRARY; T=293.16K  
Photon emission for (n,npa)

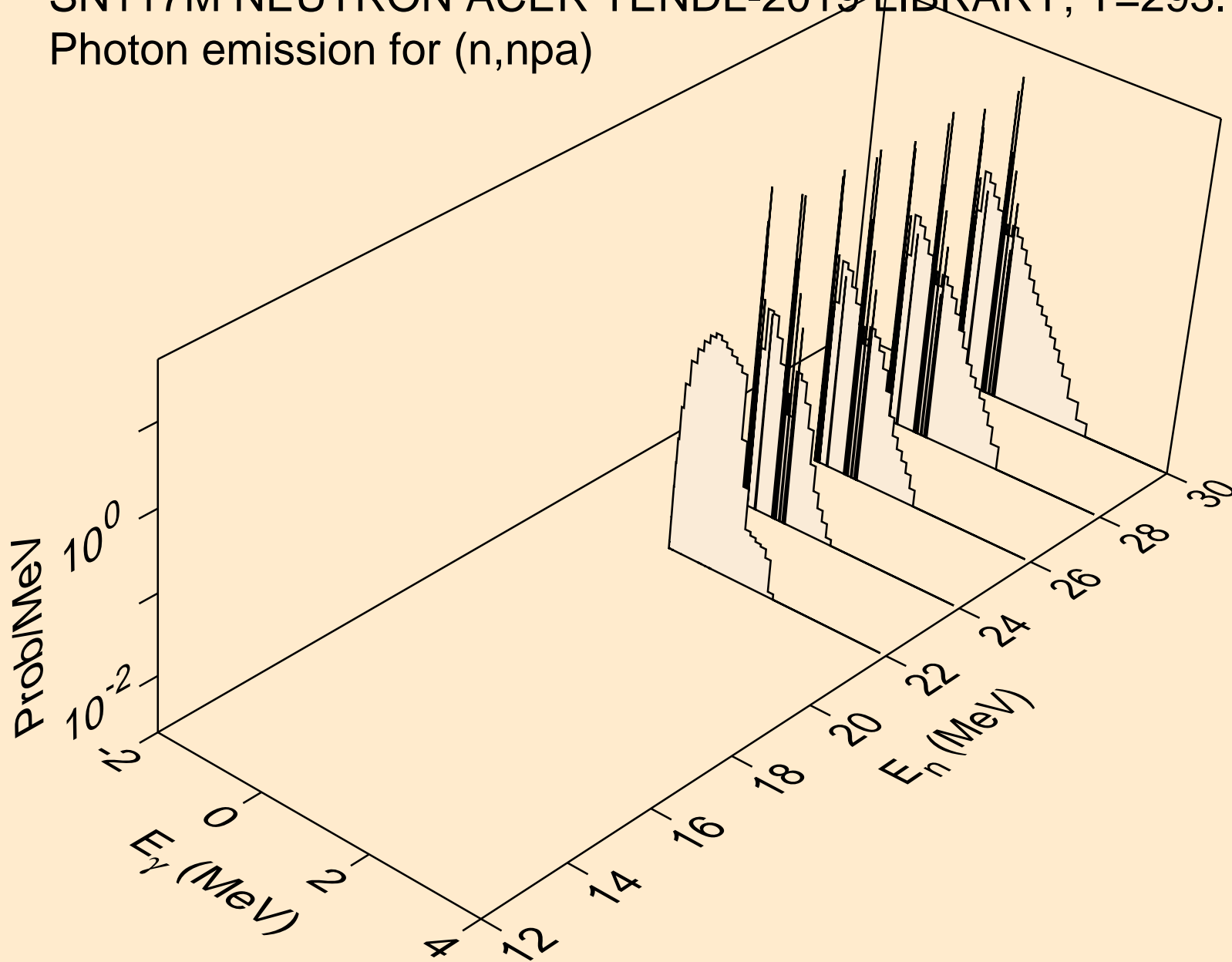



SN117M NEUTRON ACER TENDL-2019 LIBRARY; T=293.16K  
Photon emission for (n,n\*1)

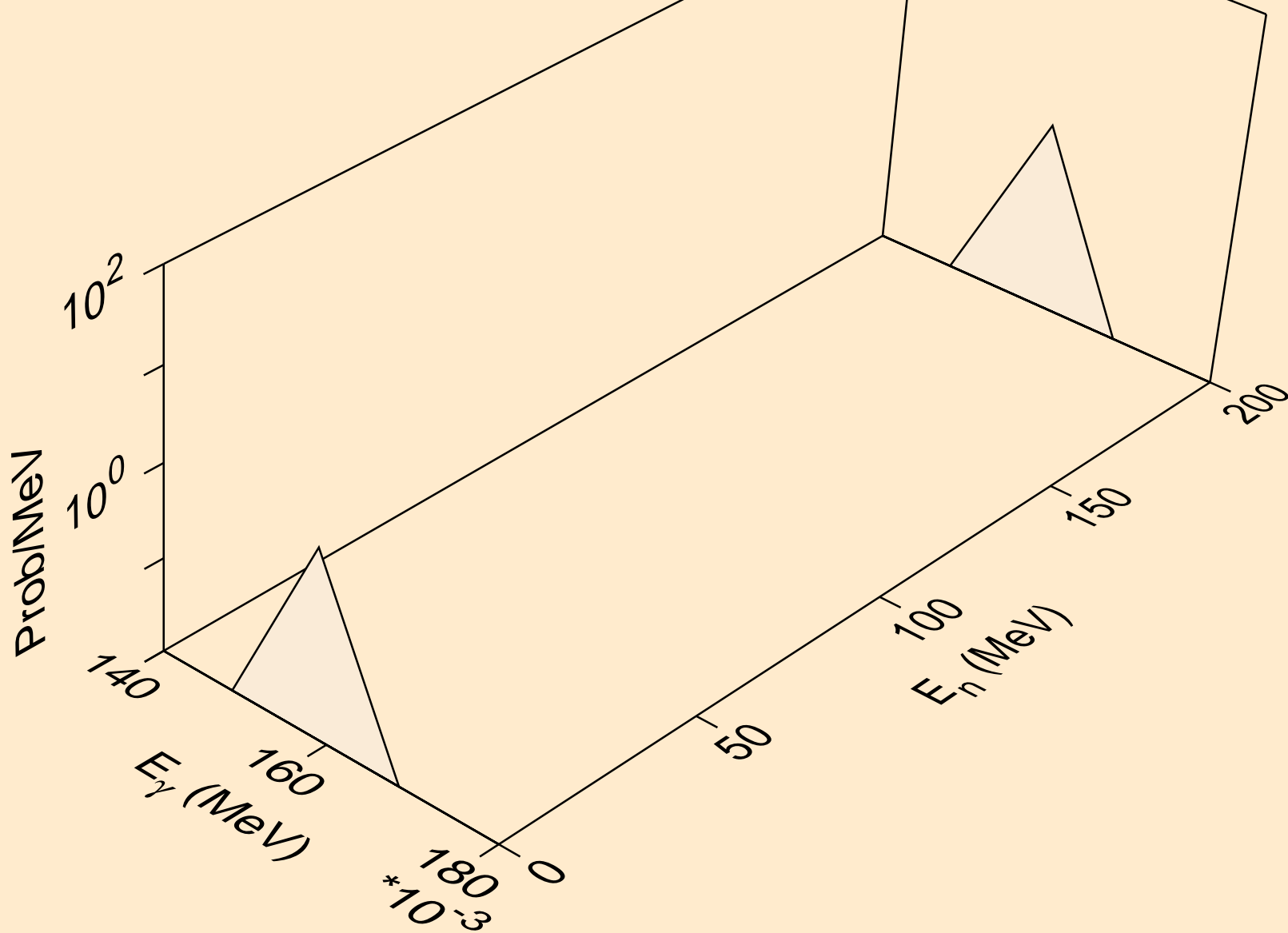

SN117M NEUTRON ACER TENDL-2019 LIBRARY; T=293.16K  
Photon emission for (n,n\*3)

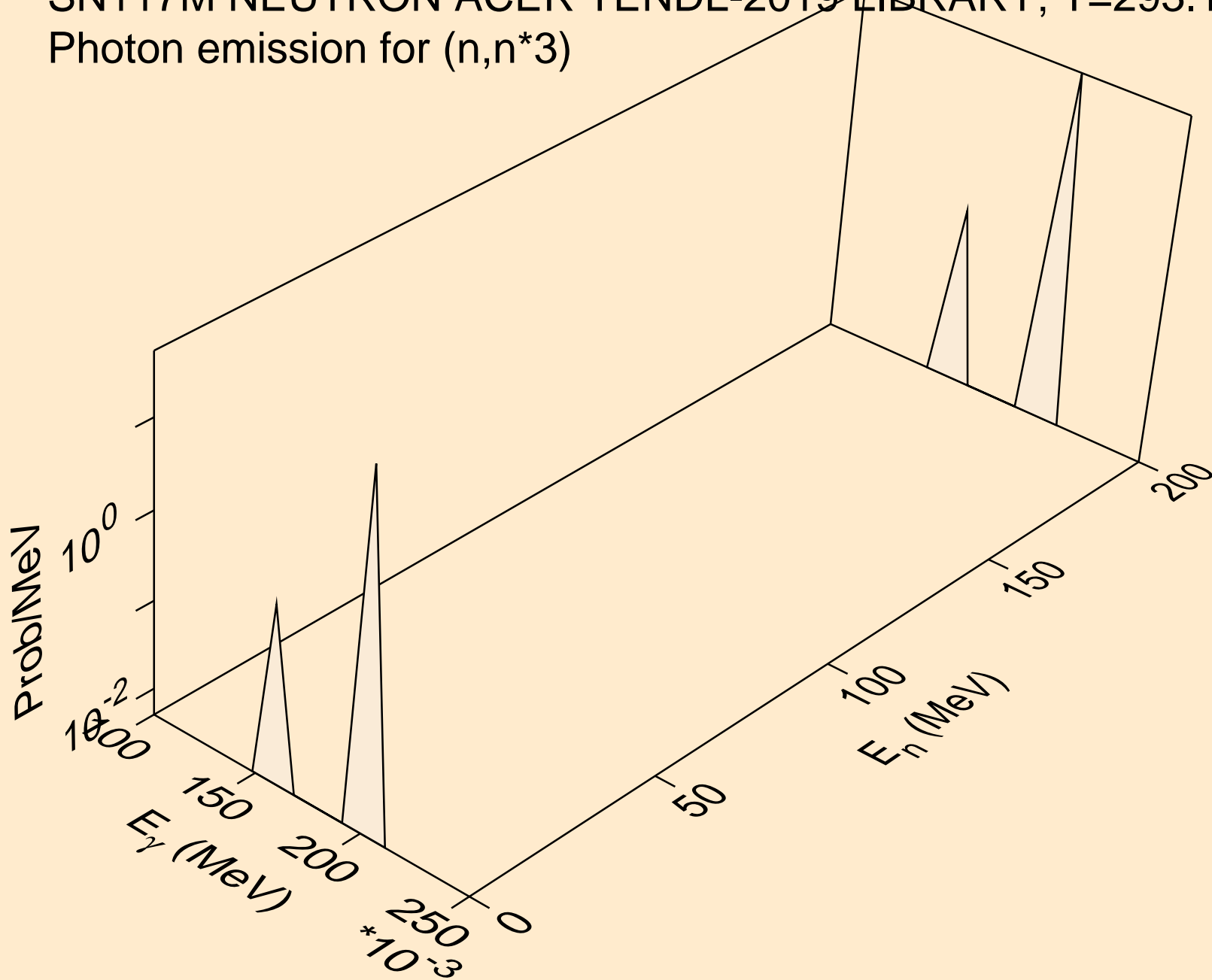

SN117M NEUTRON ACER TENDL-2019 LIBRARY; T=293.16K  
Photon emission for (n,n\*4)

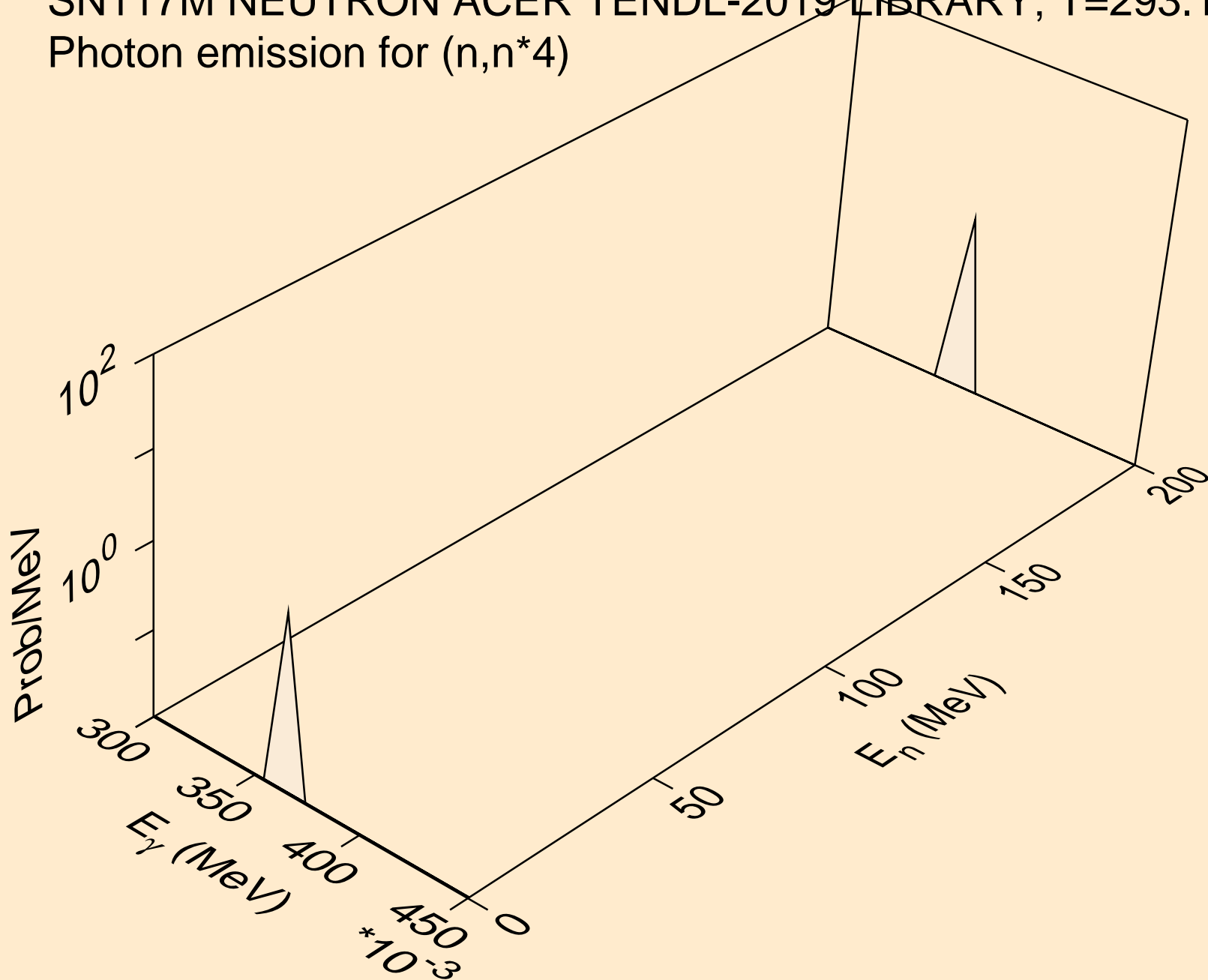

SN117M NEUTRON ACER TENDL-2019 LIBRARY; T=293.16K  
Photon emission for (n,n\*5)

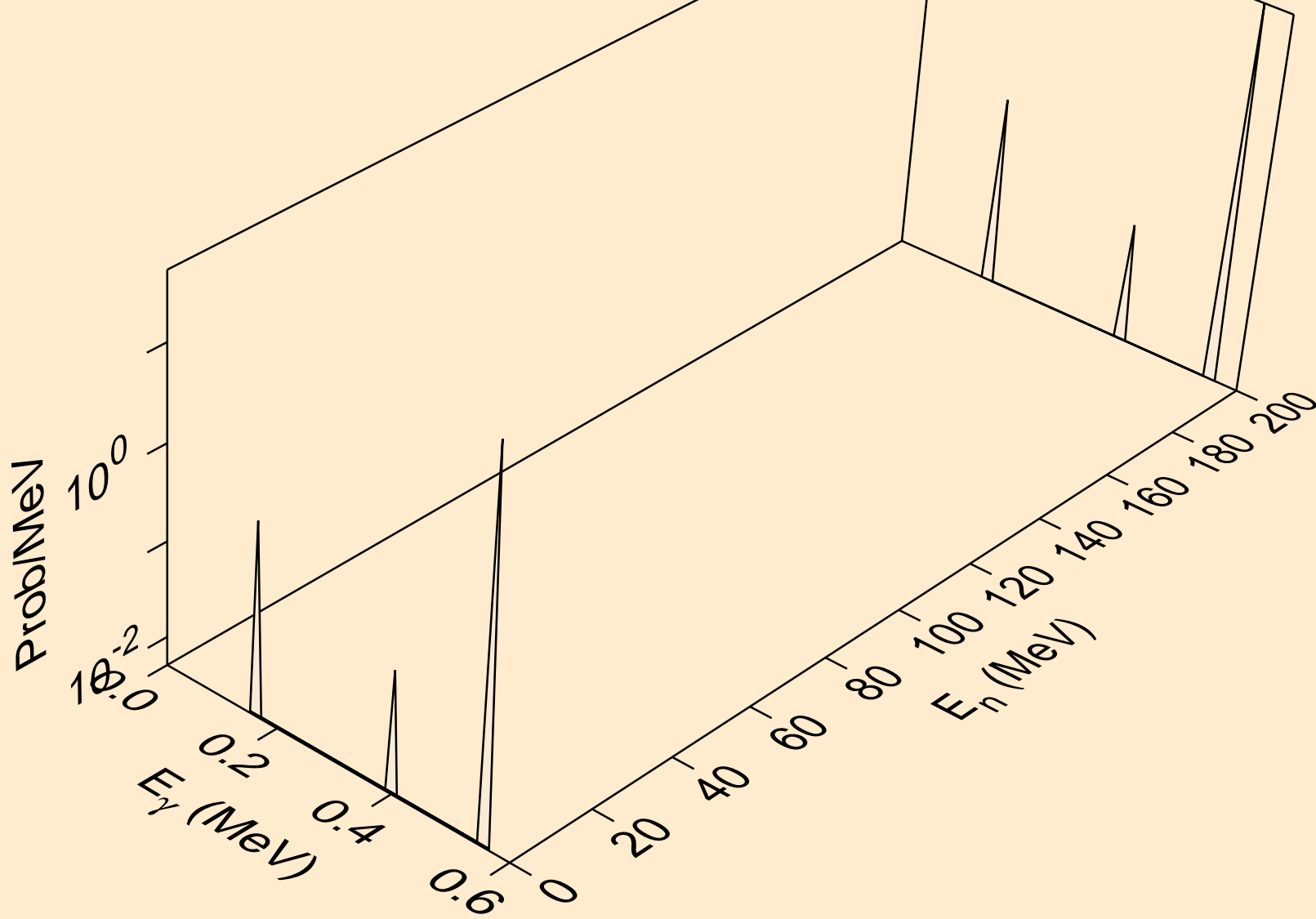

SN117M NEUTRON ACER TENDL-2019 LIBRARY; T=293.16K  
Photon emission for (n,n\*6)

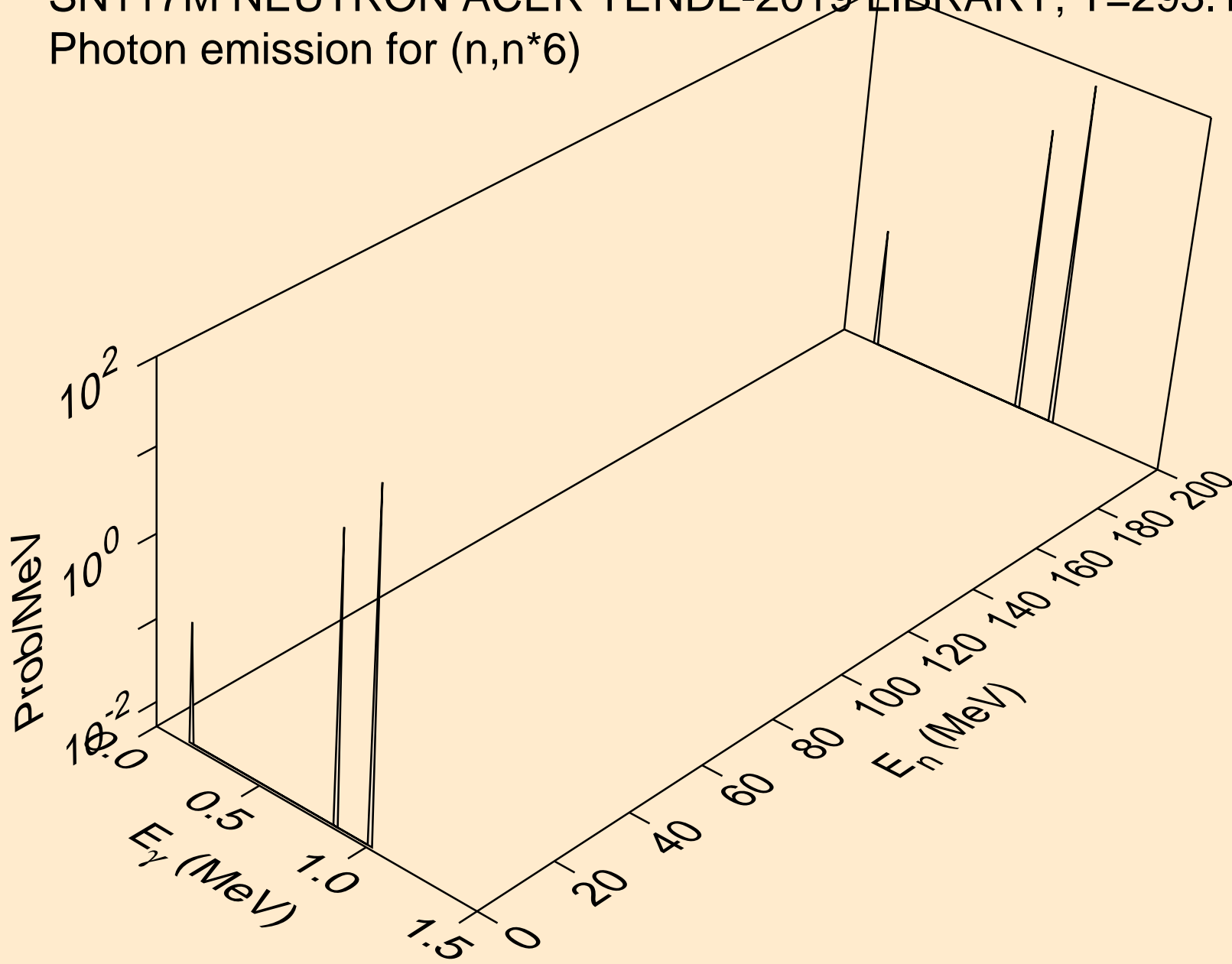

SN117M NEUTRON ACER TENDL-2019 LIBRARY; T=293.16K  
Photon emission for (n,n\*7)

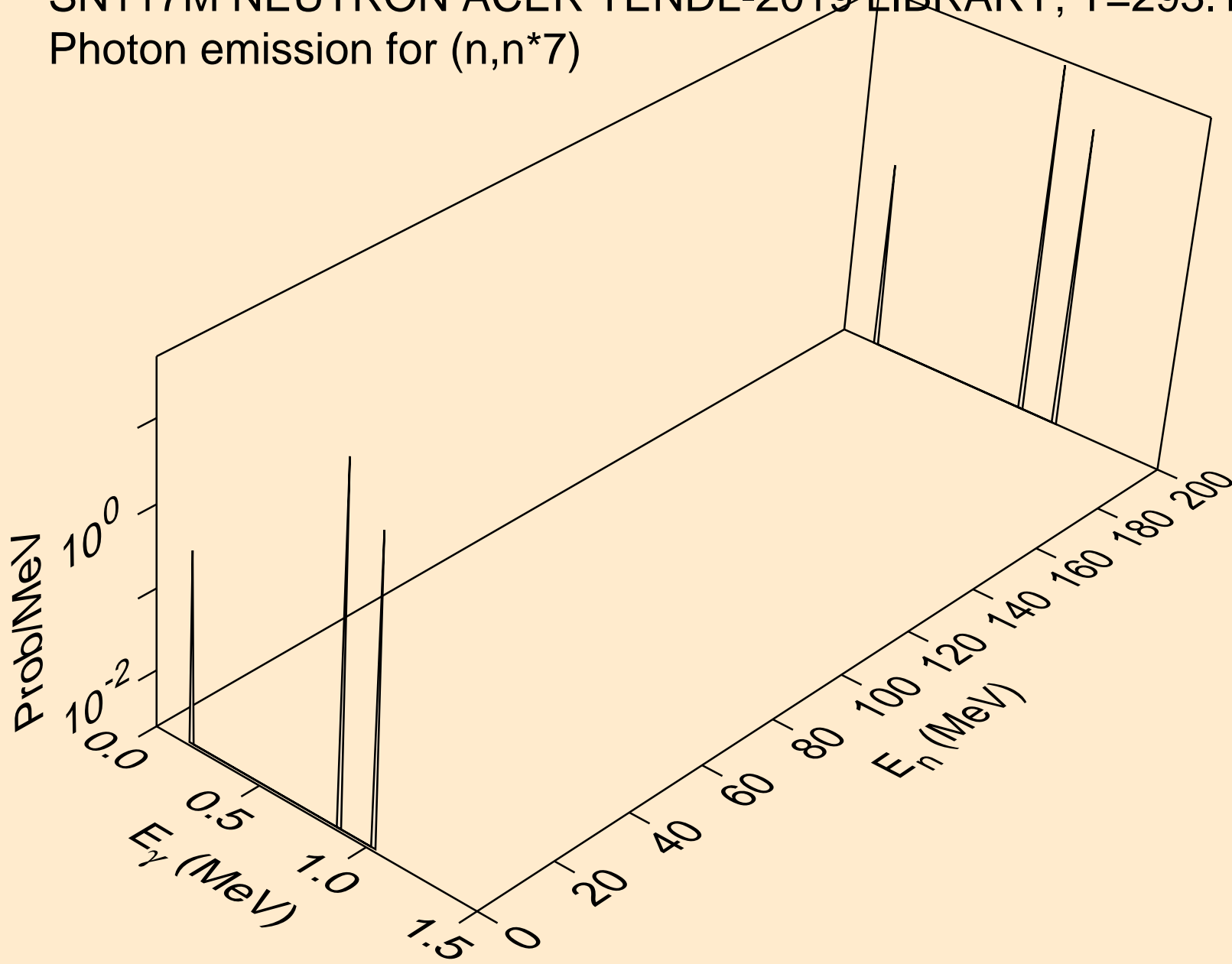

SN117M NEUTRON ACER TENDL-2019 LIBRARY; T=293.16K  
Photon emission for (n,n\*8)

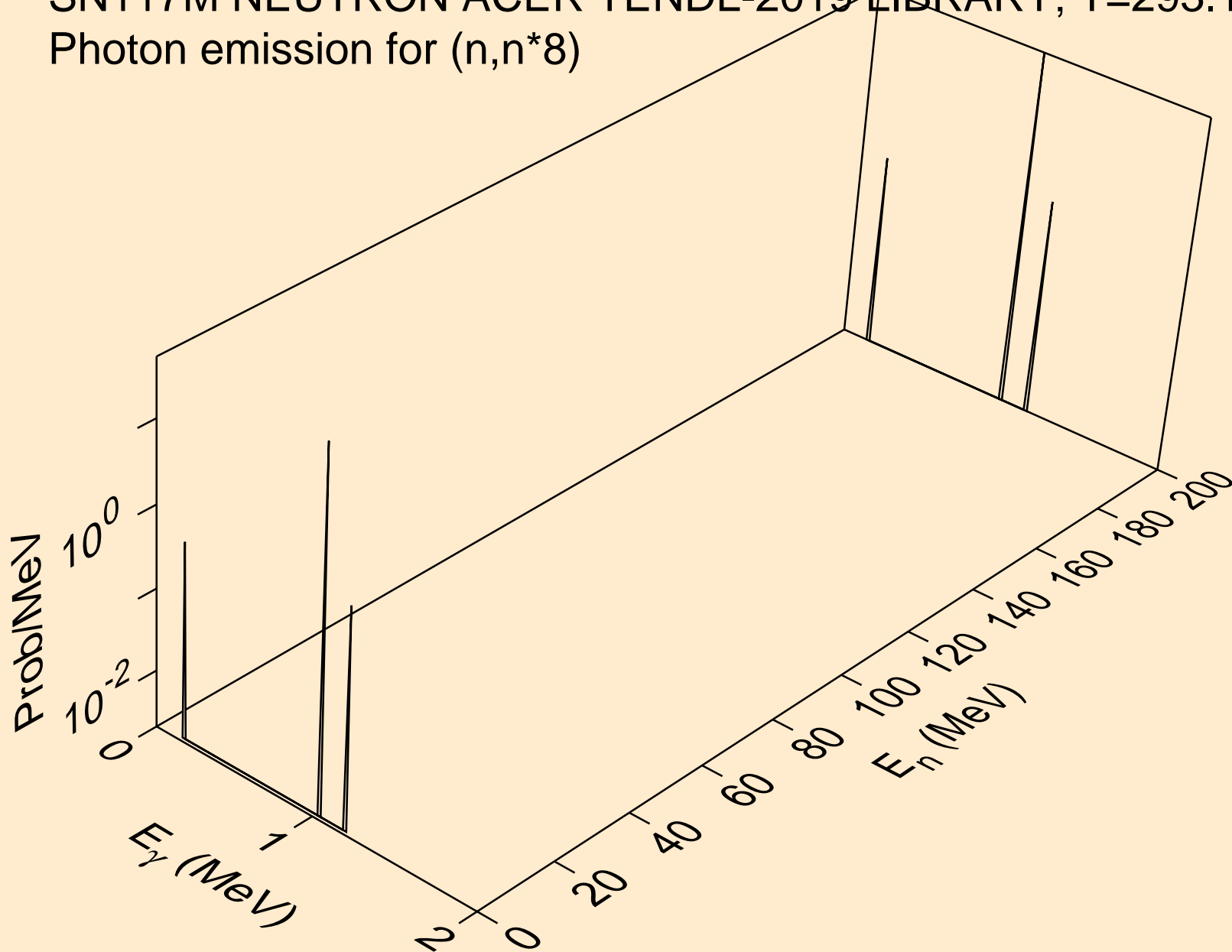

SN117M NEUTRON ACER TENDL-2019 LIBRARY; T=293.16K  
Photon emission for (n,n\*9)

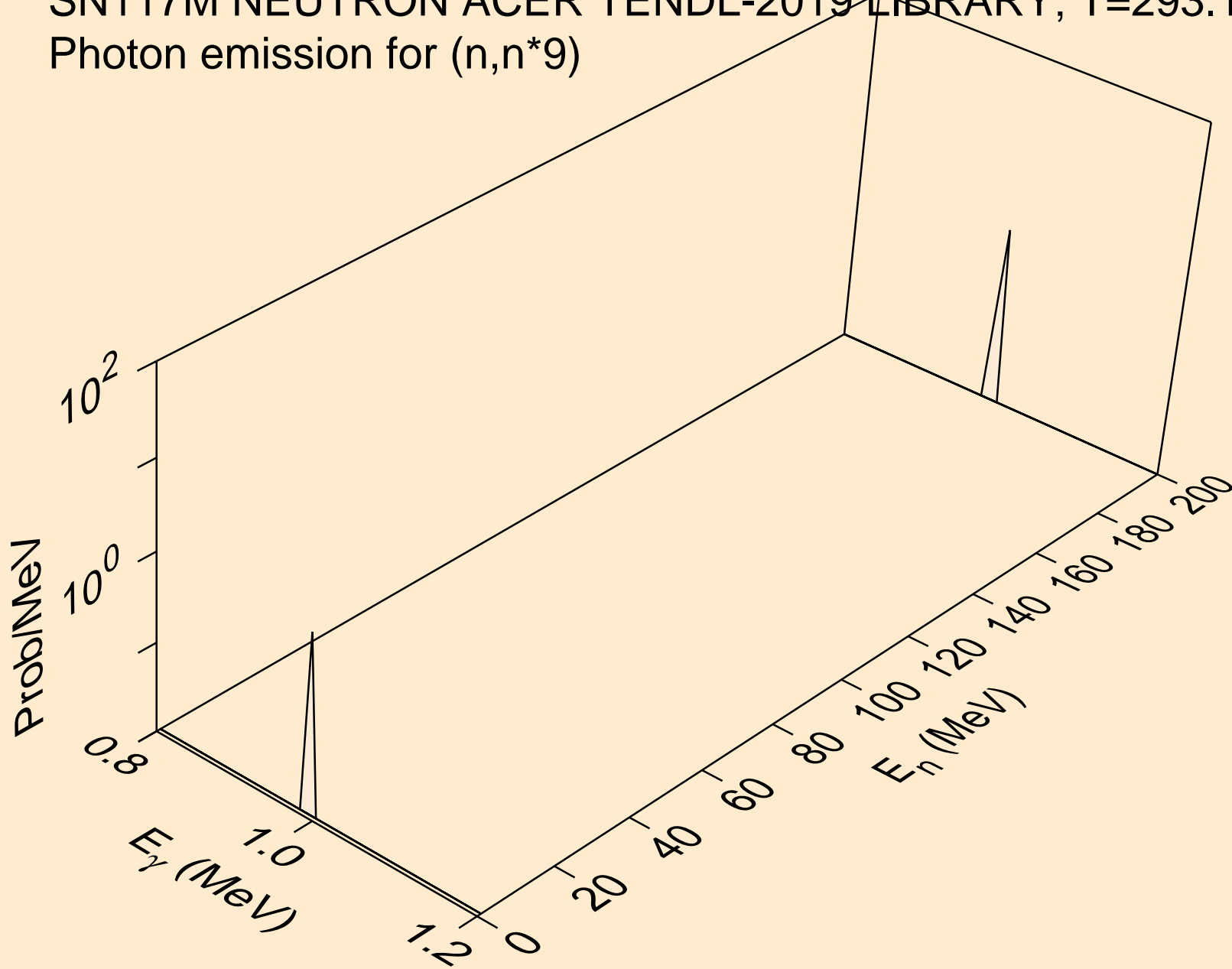



SN117M NEUTRON ACER TENDL-2019 LIBRARY; T=293.16K  
Photon emission for (n,n\*10)

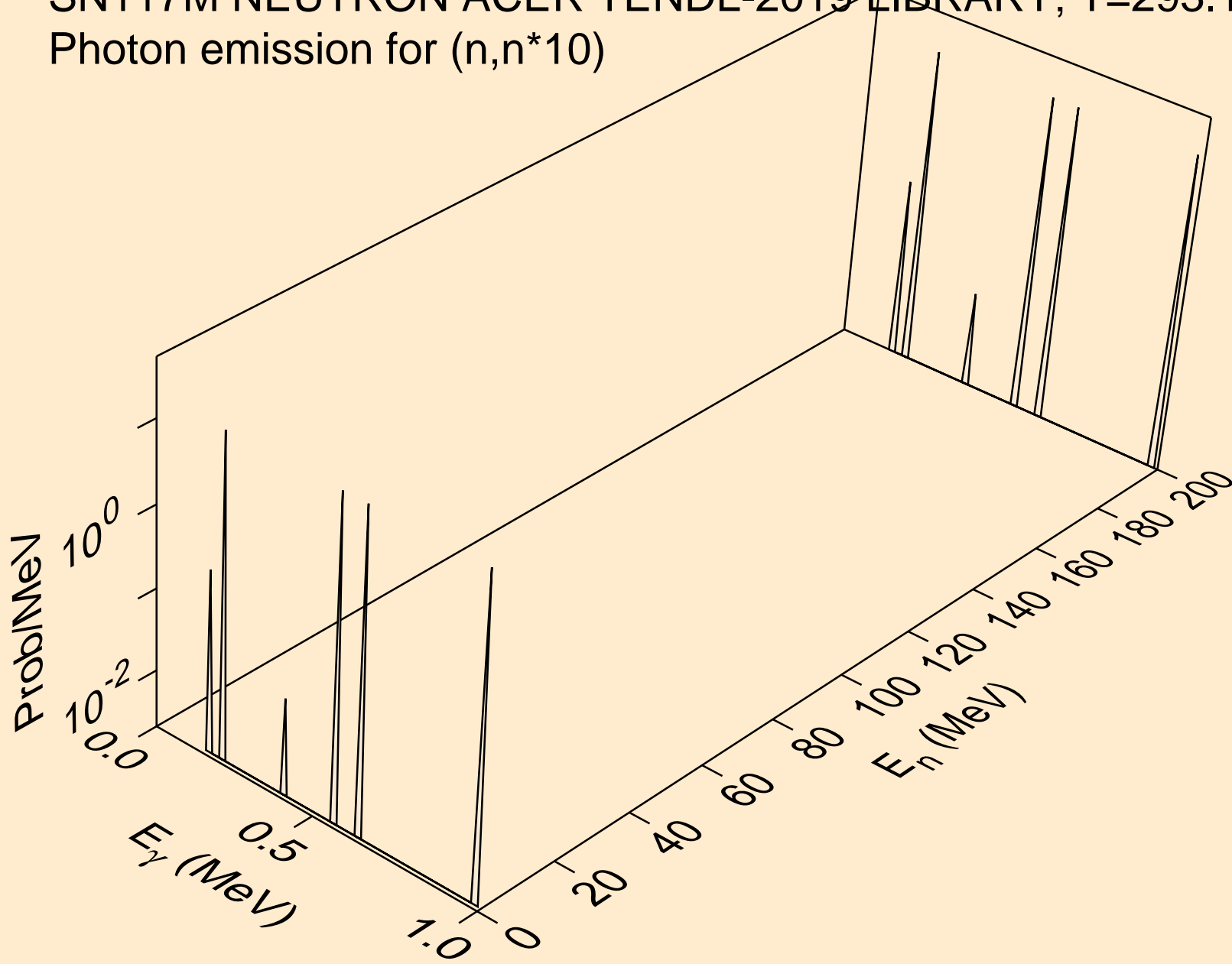

SN117M NEUTRON ACER TENDL-2019 LIBRARY; T=293.16K  
Photon emission for (n,n\*11)

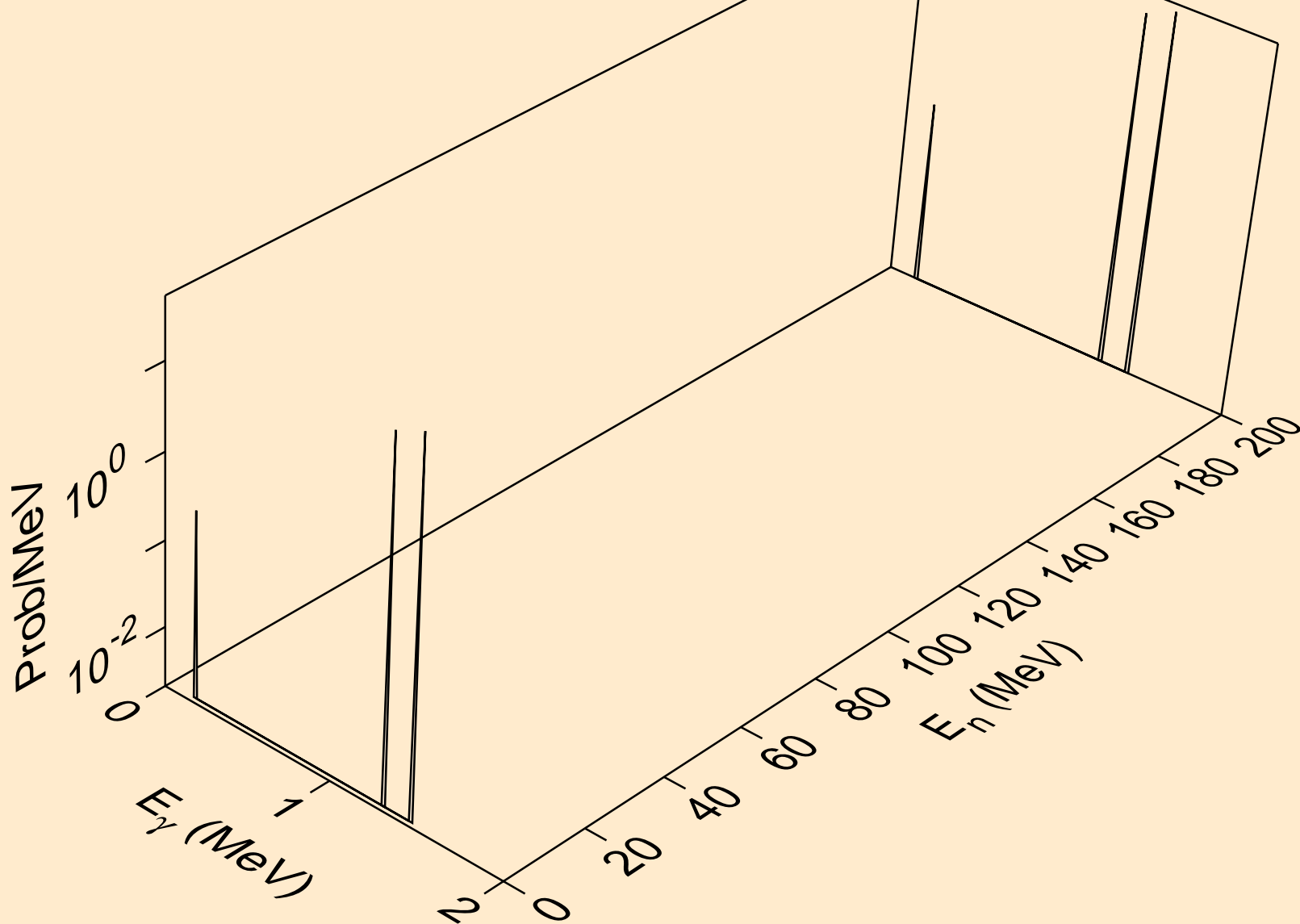

SN117M NEUTRON ACER TENDL-2019 LIBRARY; T=293.16K  
Photon emission for (n,n\*12)

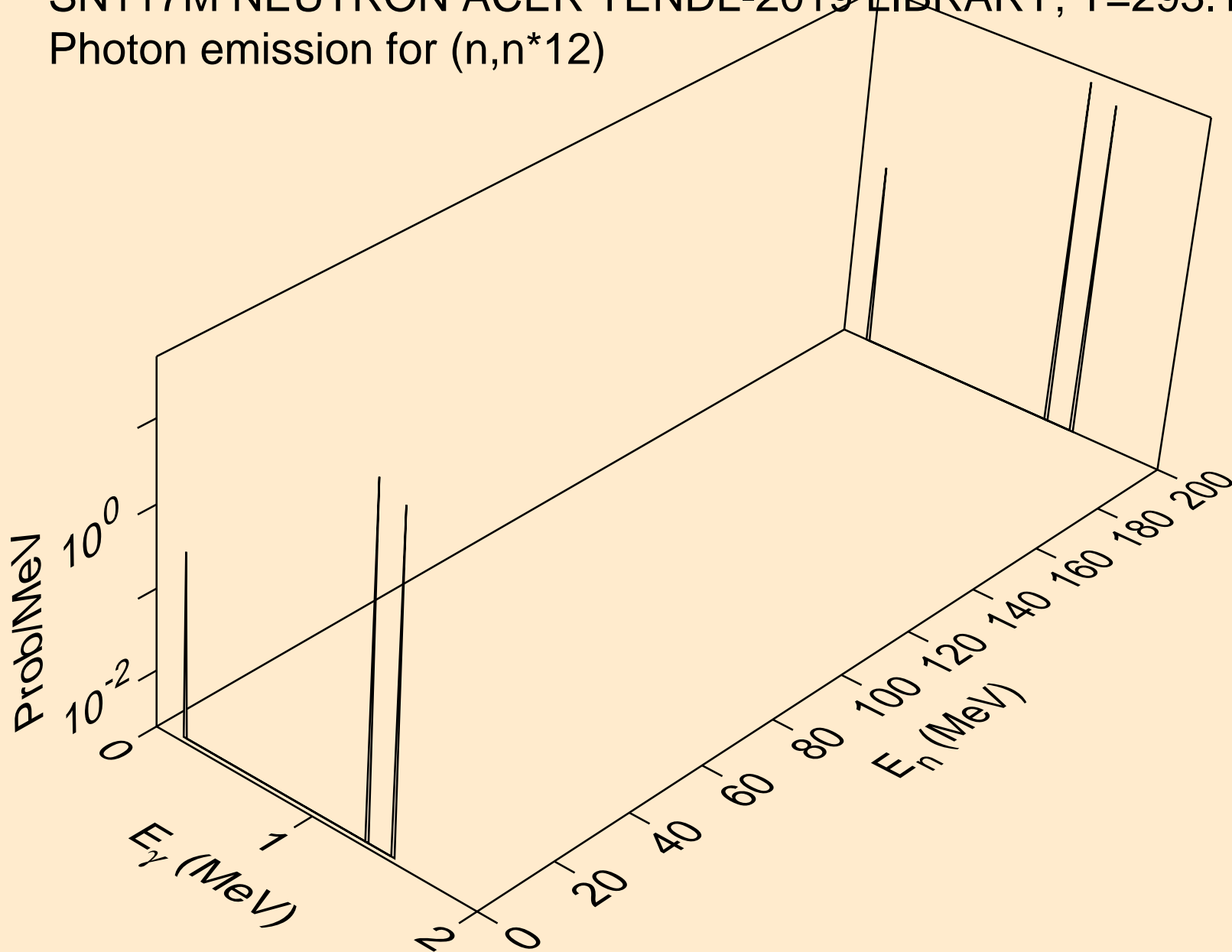

SN117M NEUTRON ACER TENDL-2019 LIBRARY; T=293.16K  
Photon emission for (n,n\*13)

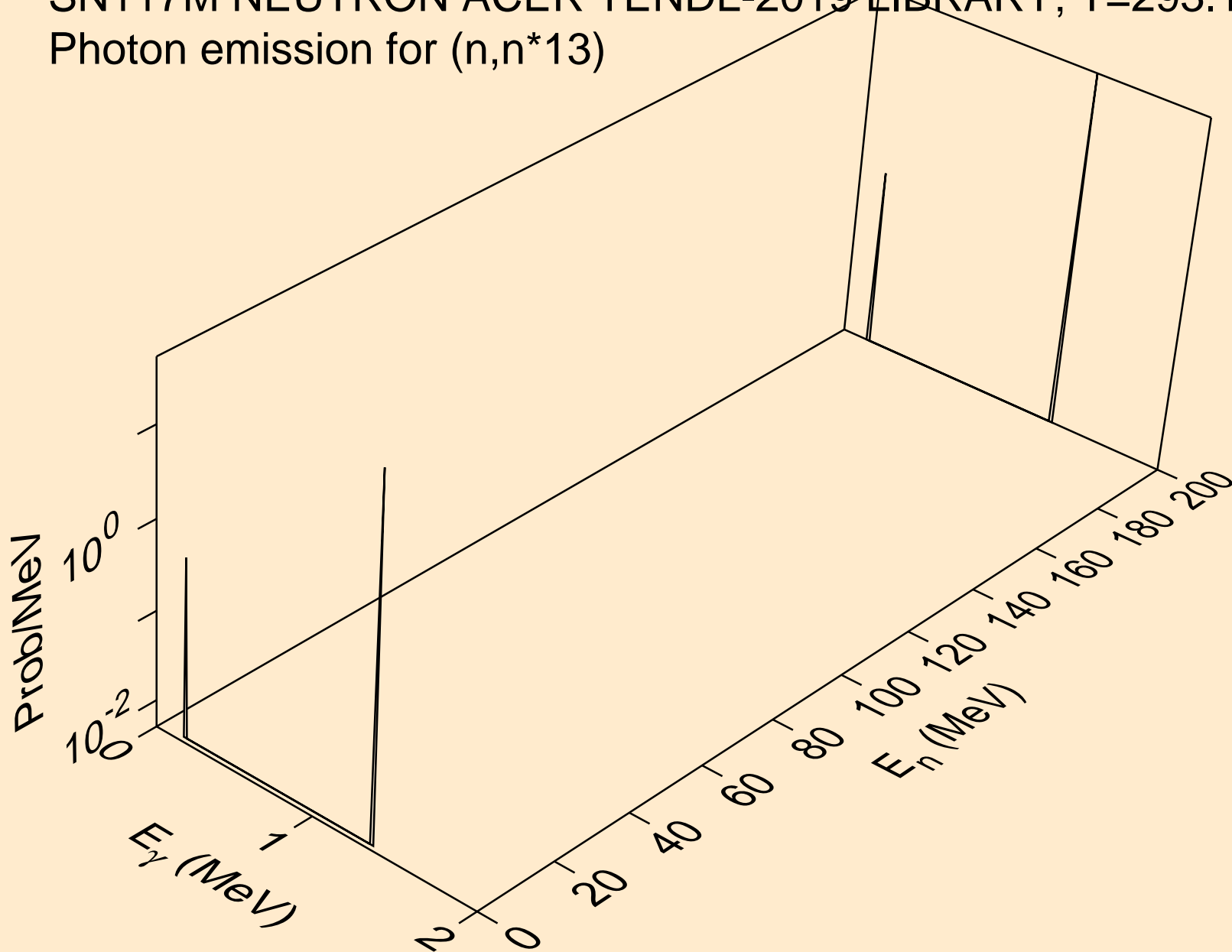

SN117M NEUTRON ACER TENDL-2019 LIBRARY; T=293.16K  
Photon emission for (n,n\*14)

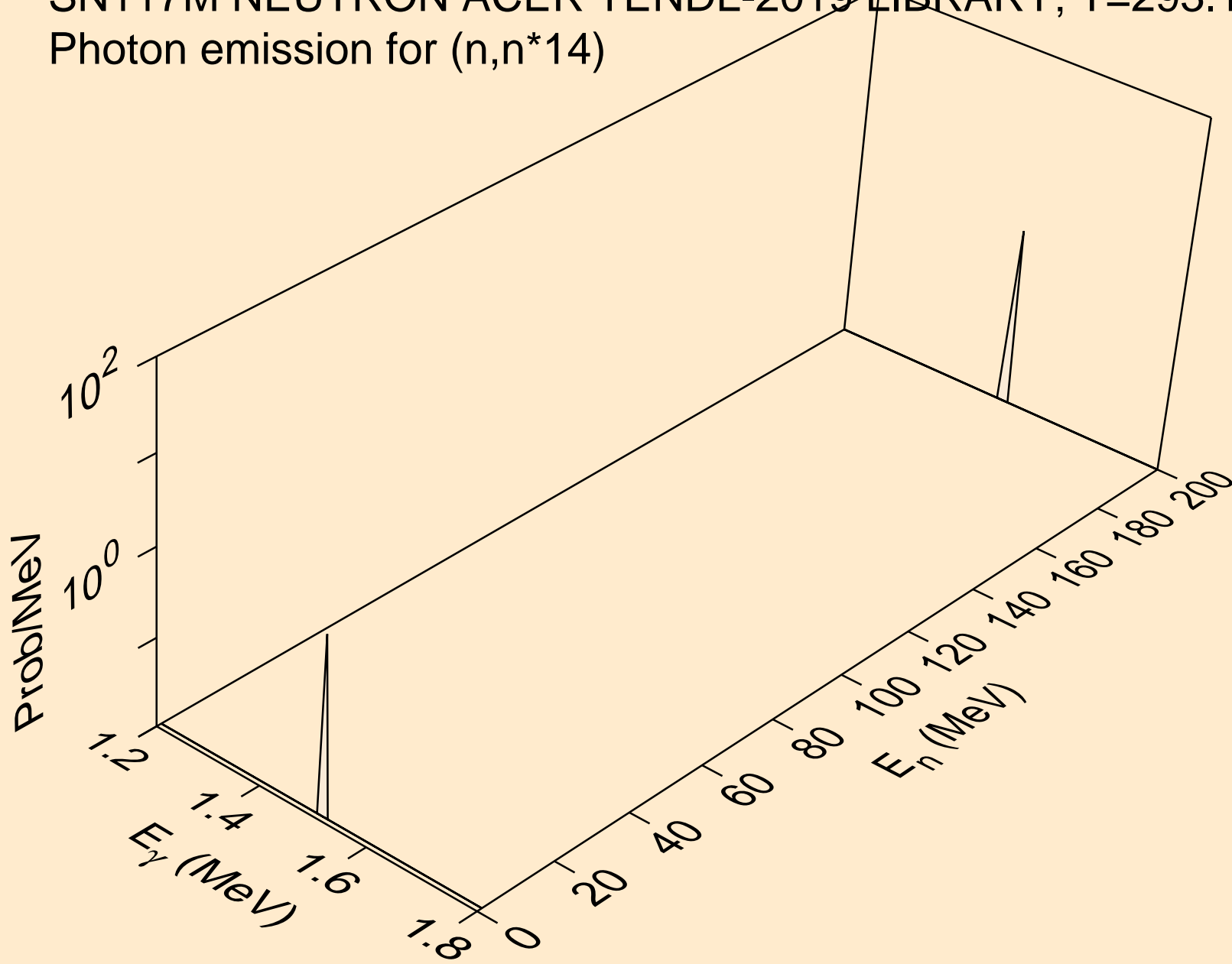

SN117M NEUTRON ACER TENDL-2019 LIBRARY; T=293.16K  
Photon emission for (n,n\*15)

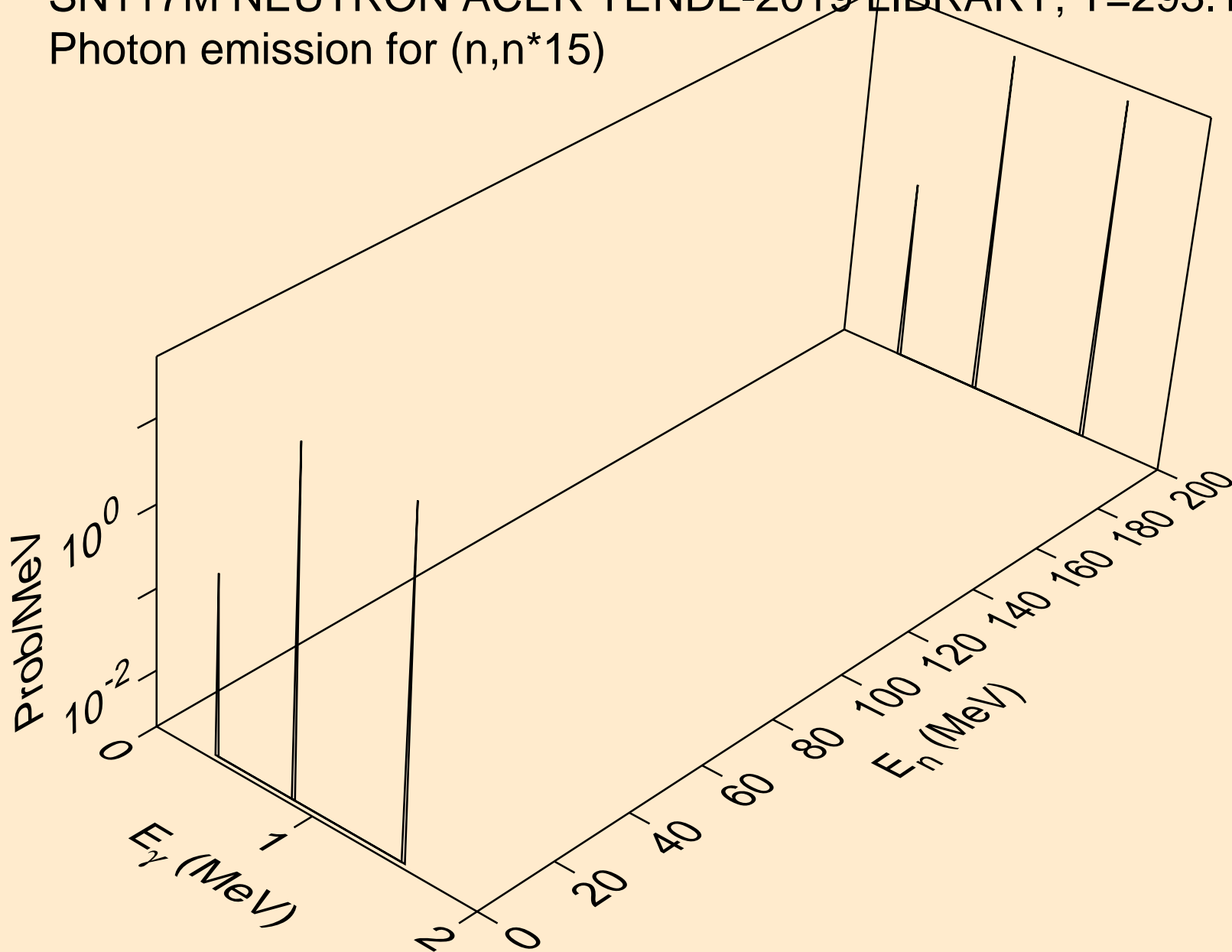

SN117M NEUTRON ACER TENDL-2019 LIBRARY; T=293.16K  
Photon emission for (n,n\*16)

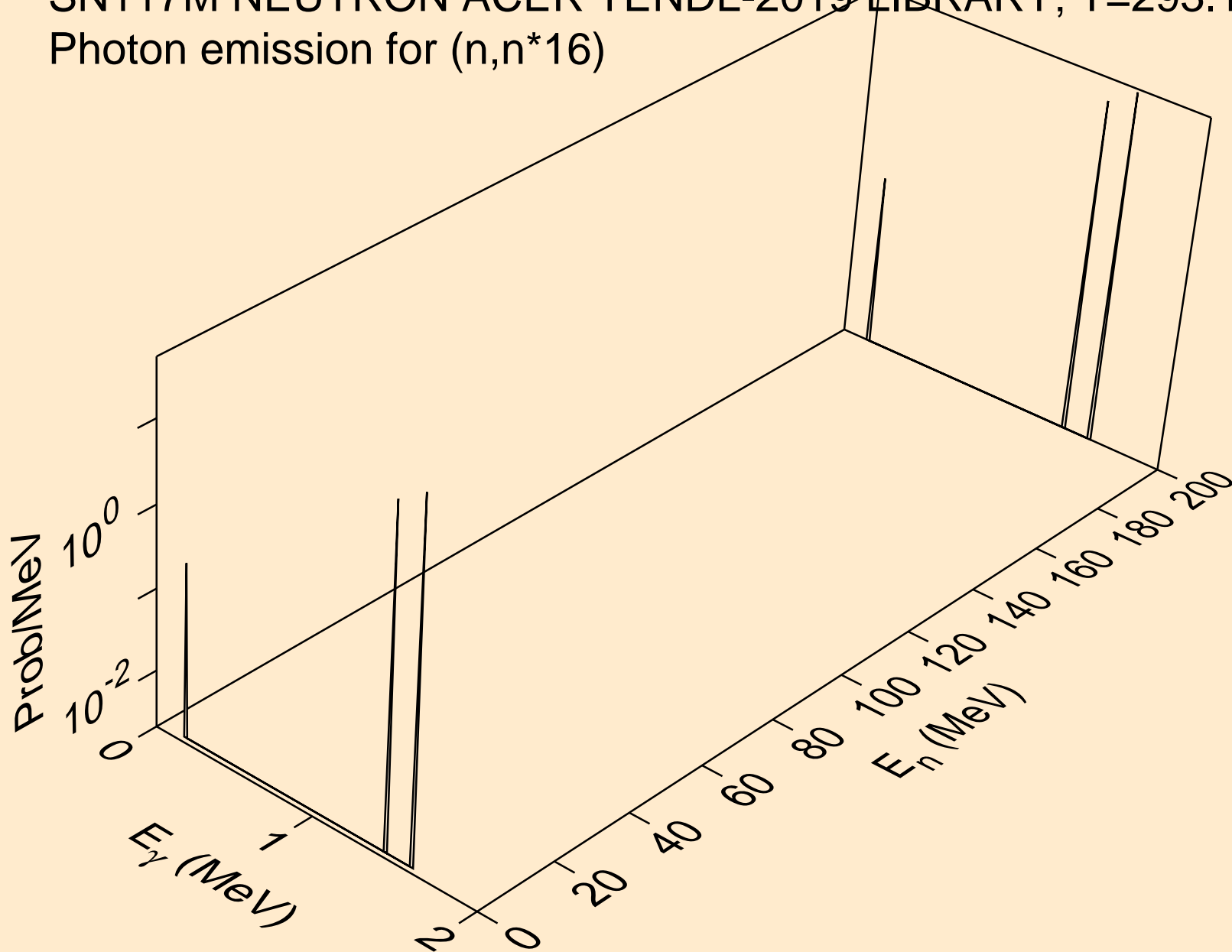

SN117M NEUTRON ACER TENDL-2019 LIBRARY; T=293.16K  
Photon emission for (n,n\*17)

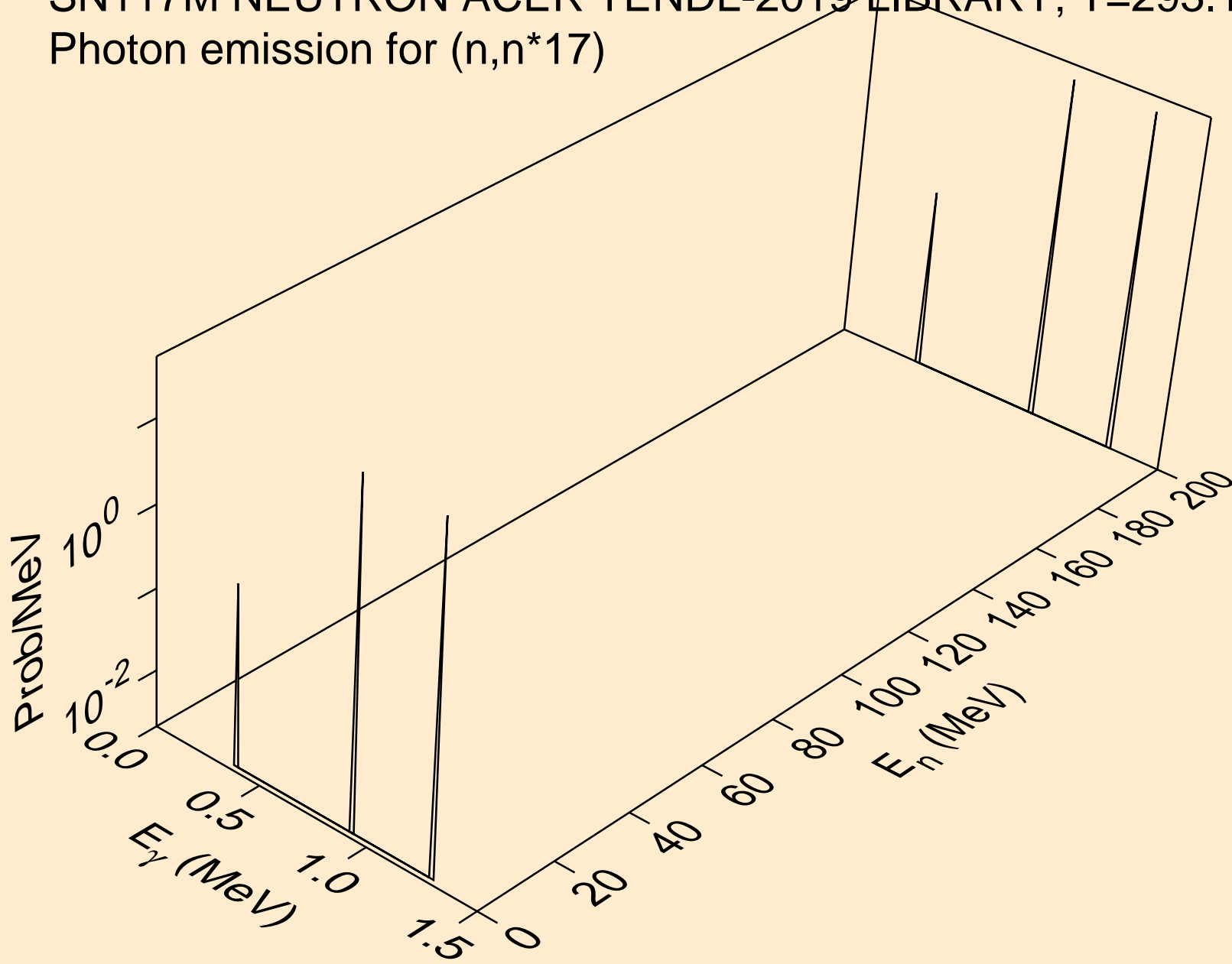



SN117M NEUTRON ACER TENDL-2019 LIBRARY; T=293.16K  
Photon emission for (n,n\*18)

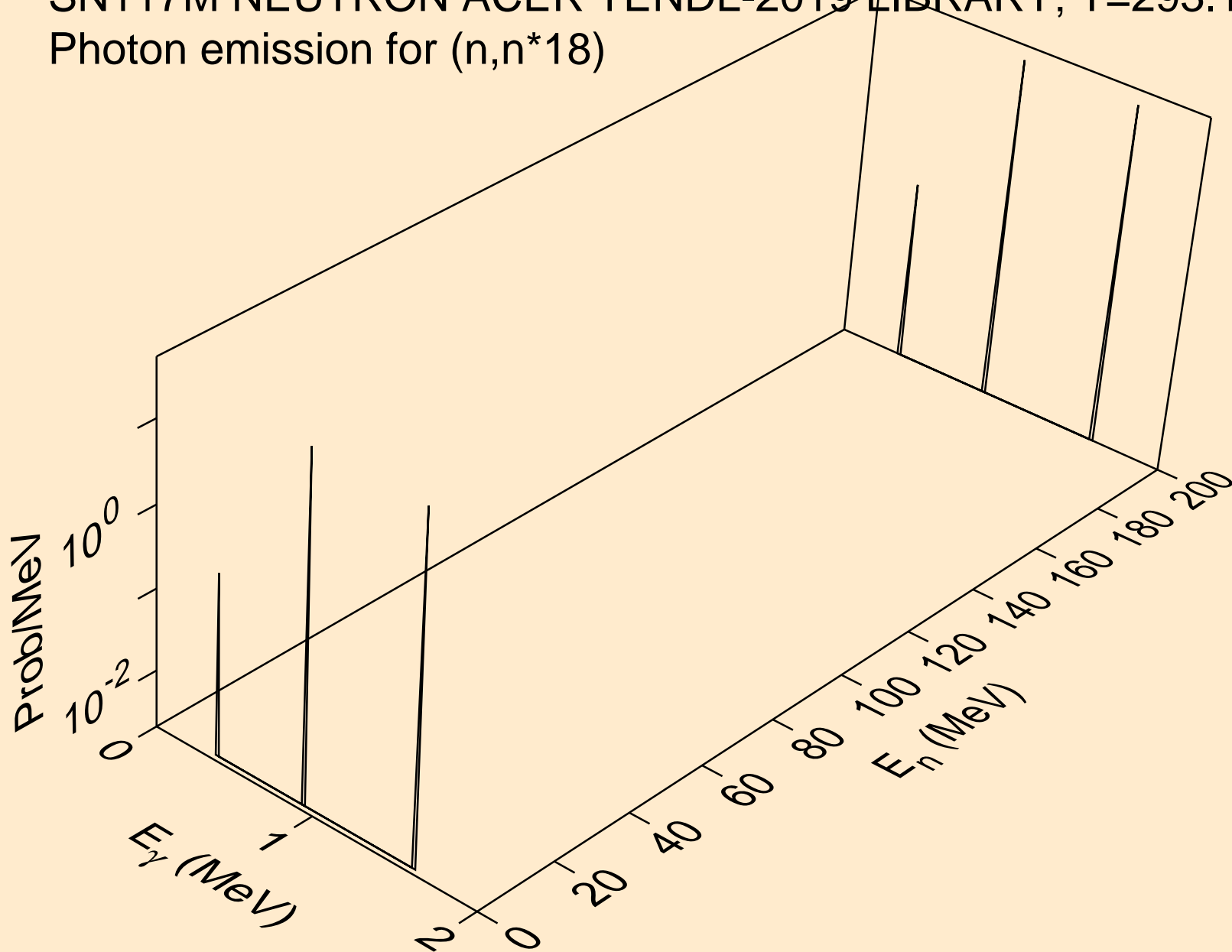

SN117M NEUTRON ACER TENDL-2019 LIBRARY; T=293.16K  
Photon emission for (n,n\*19)

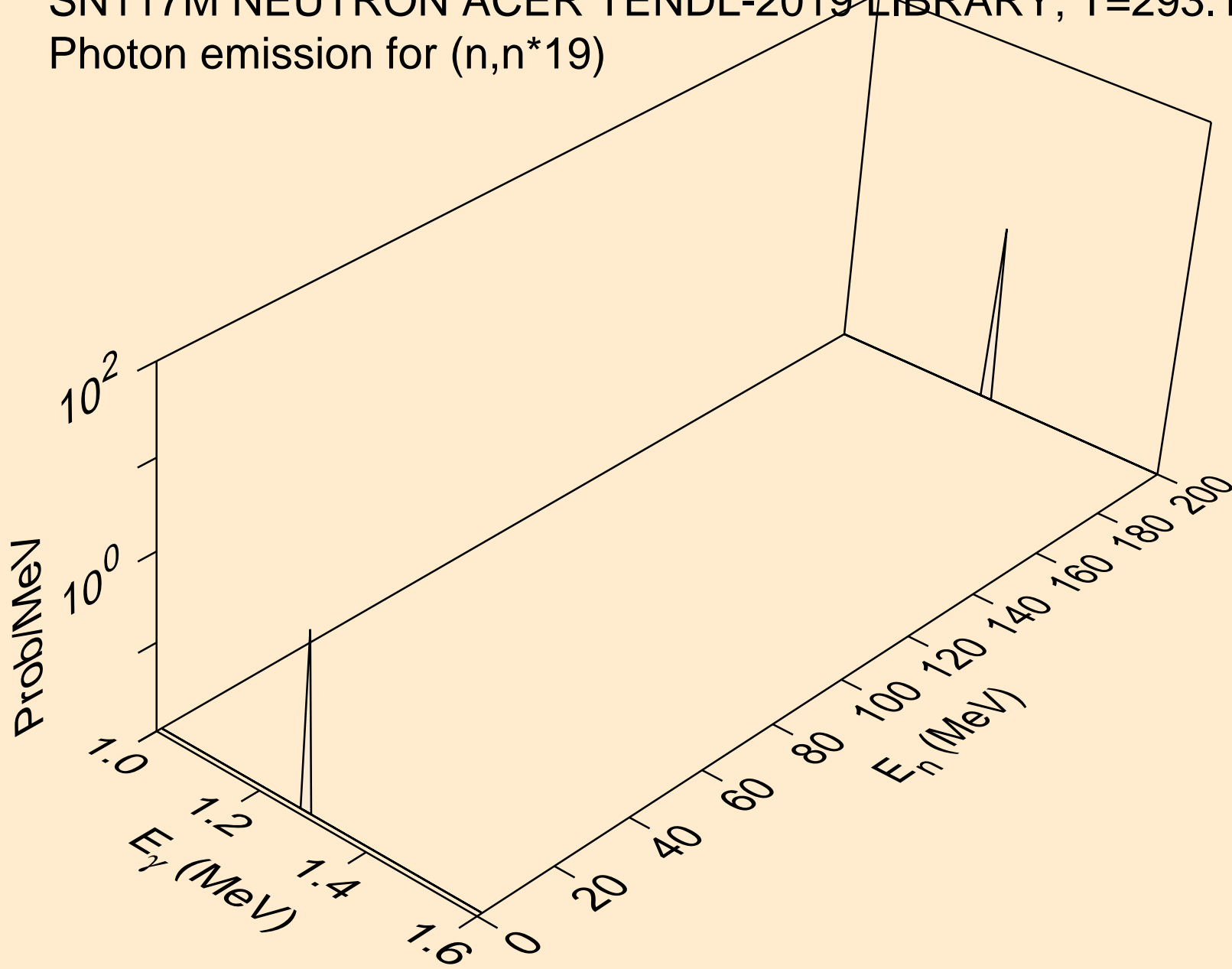

SN117M NEUTRON ACER TENDL-2019 LIBRARY; T=293.16K  
Photon emission for (n,n\*20)

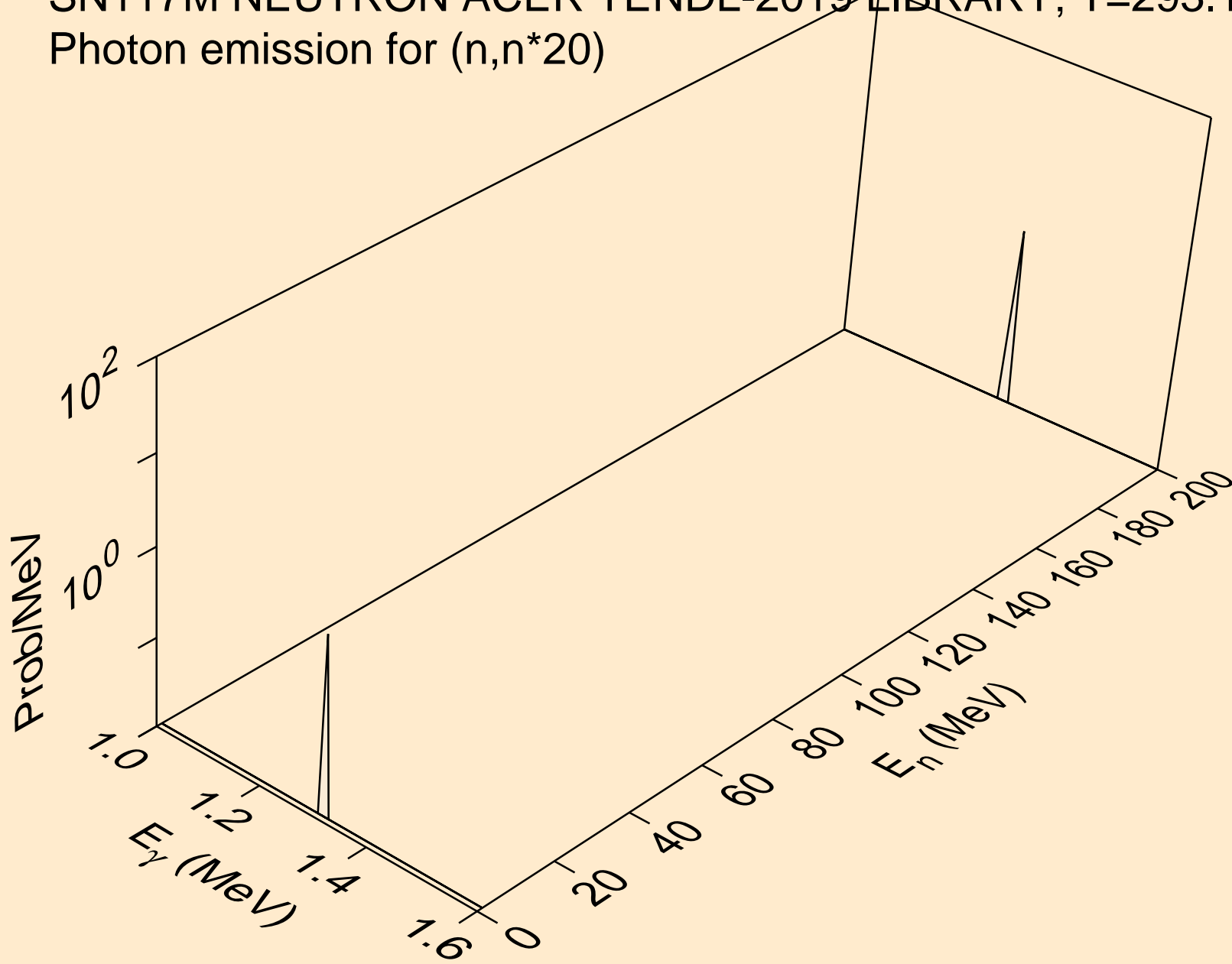

SN117M NEUTRON ACER TENDL-2019 LIBRARY; T=293.16K  
Photon emission for (n,n\*21)

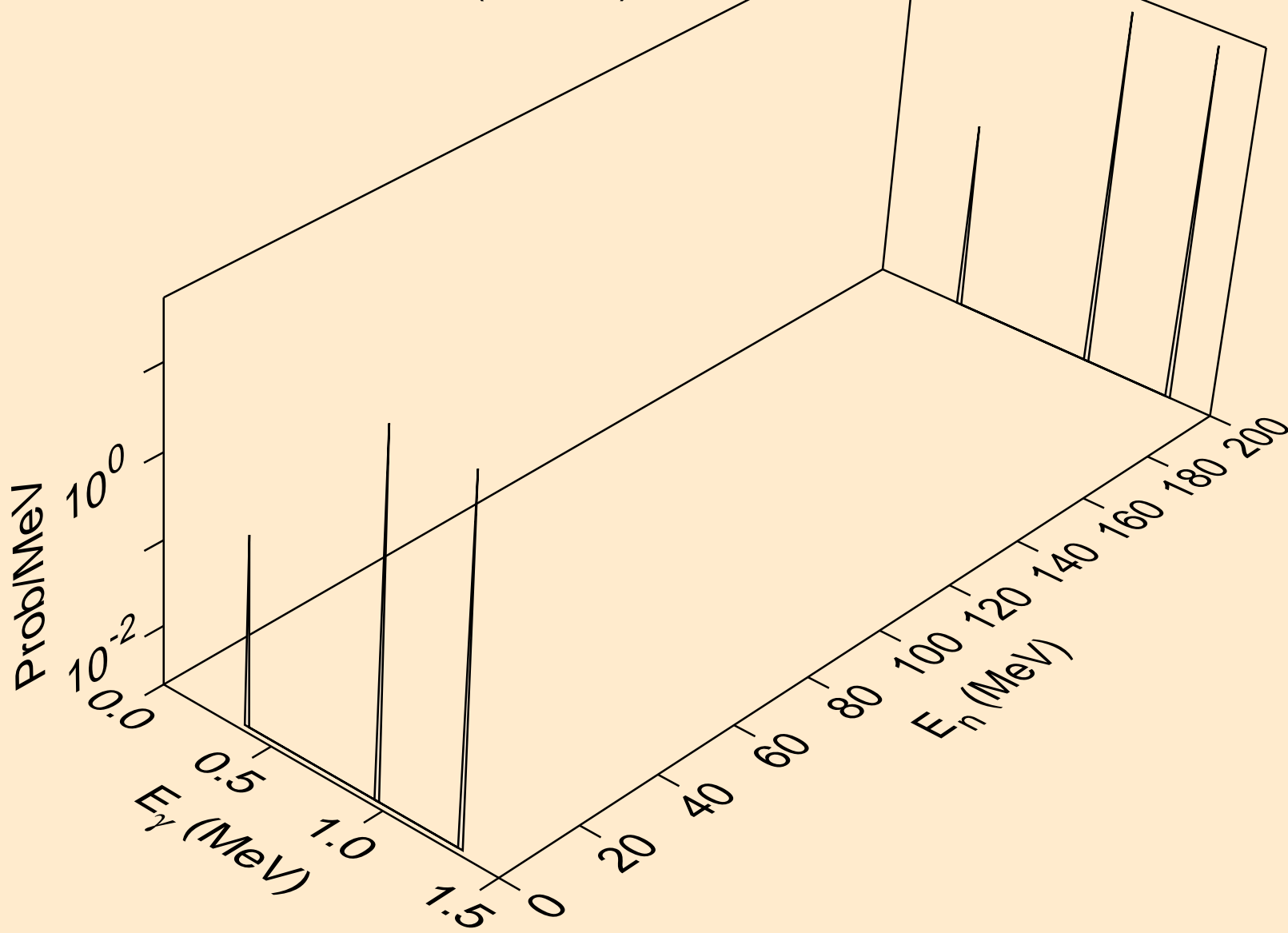

SN117M NEUTRON ACER TENDL-2019 LIBRARY; T=293.16K  
Photon emission for (n,n\*22)

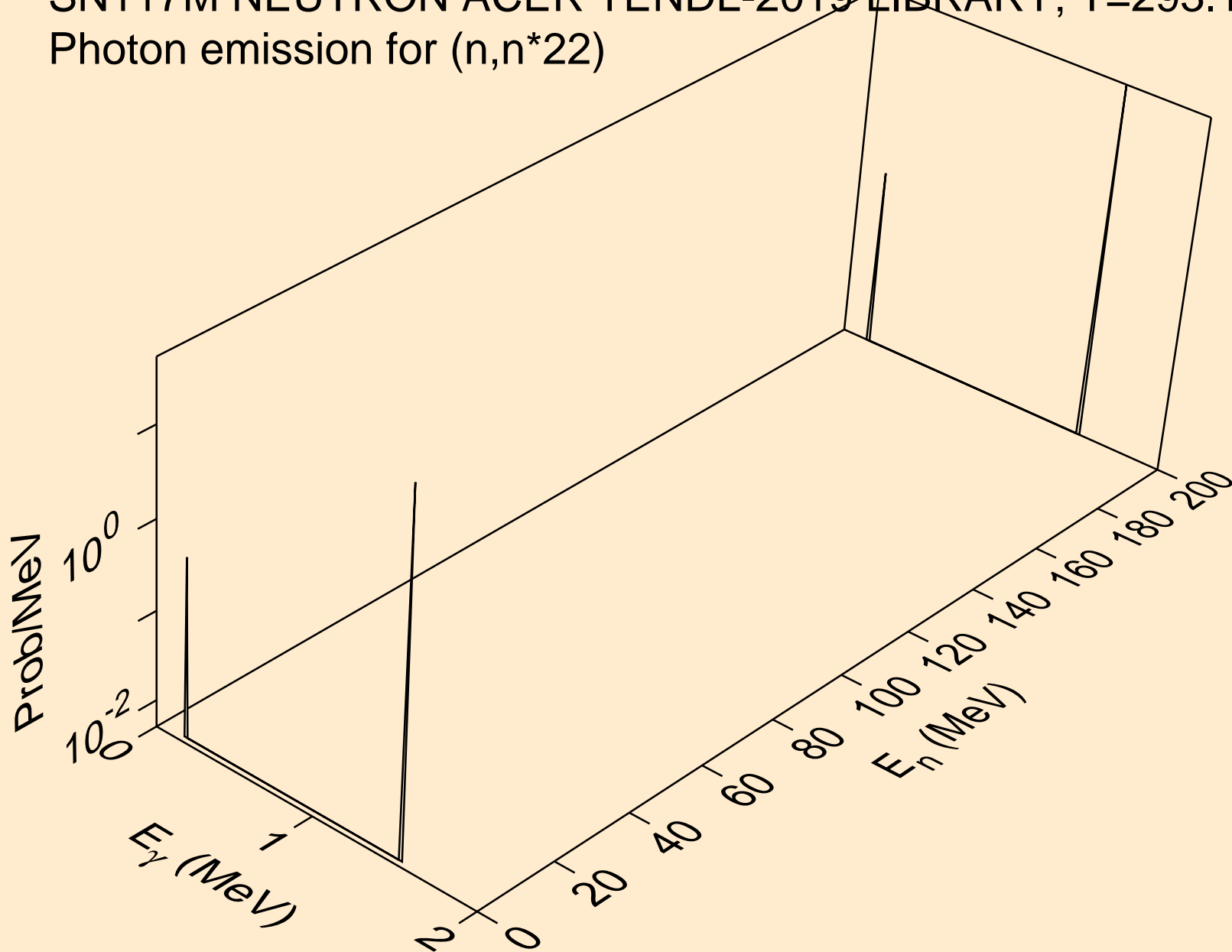

SN117M NEUTRON ACER TENDL-2019 LIBRARY; T=293.16K  
Photon emission for (n,n\*23)

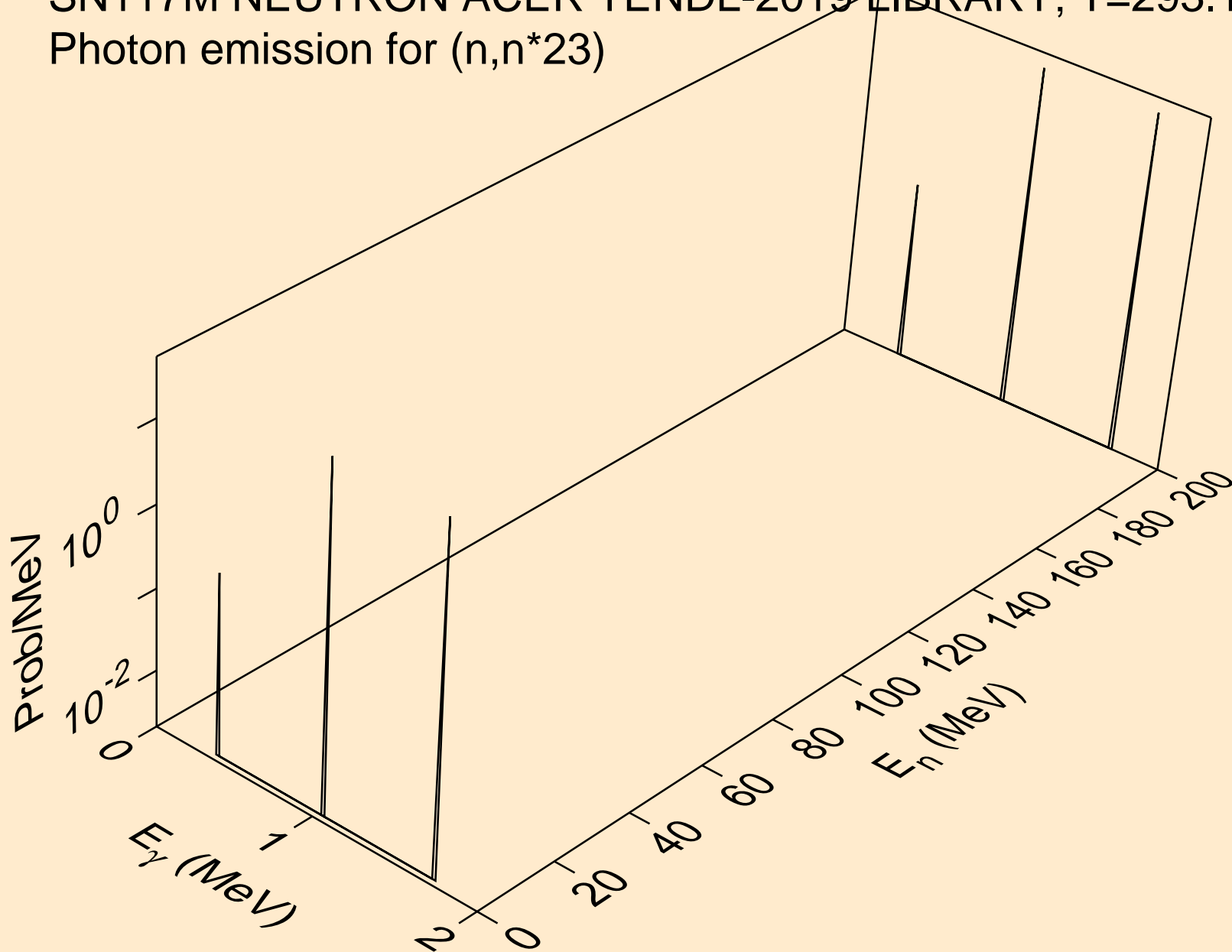

SN117M NEUTRON ACER TENDL-2019 LIBRARY; T=293.16K  
Photon emission for (n,n\*24)

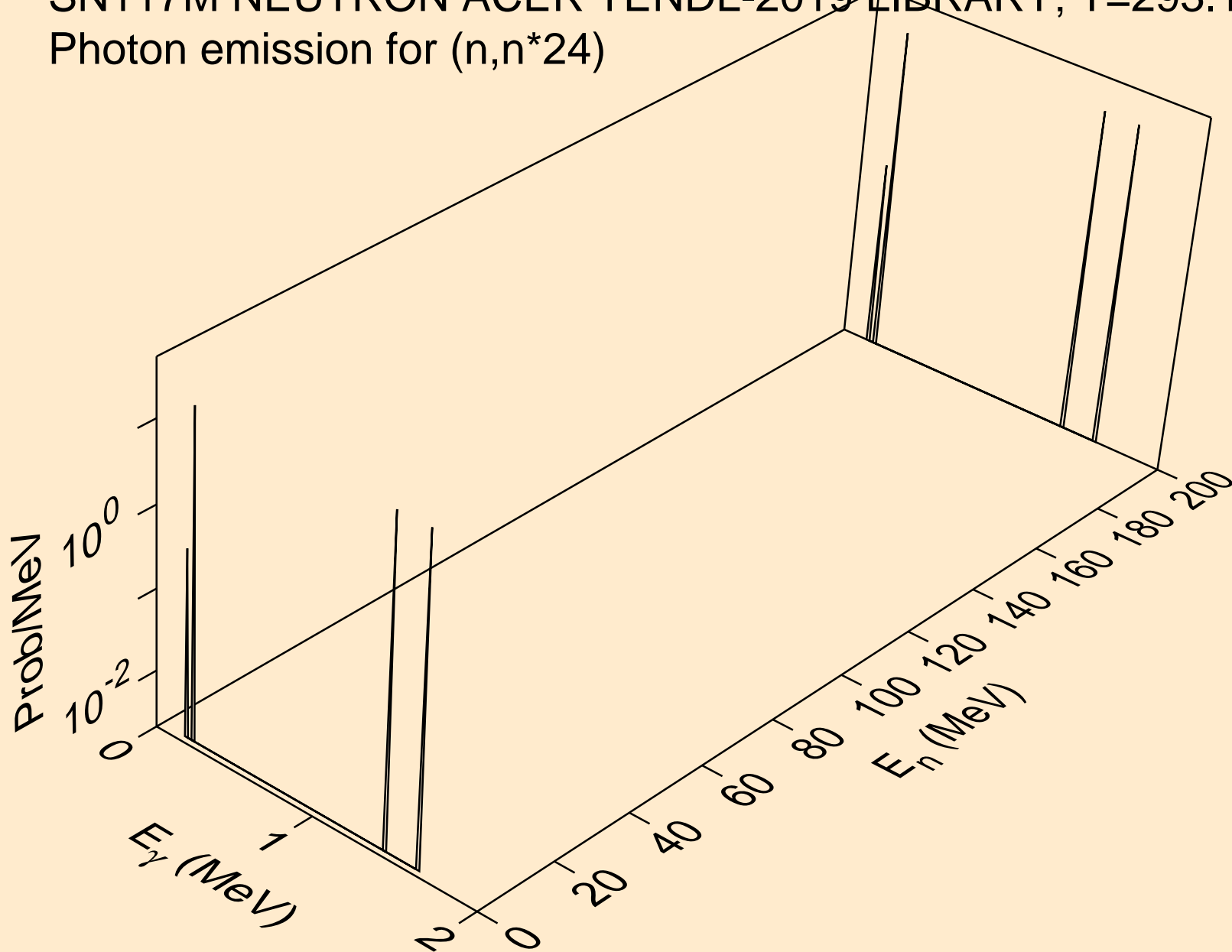

SN117M NEUTRON ACER TENDL-2019 LIBRARY; T=293.16K  
Photon emission for (n,n\*25)

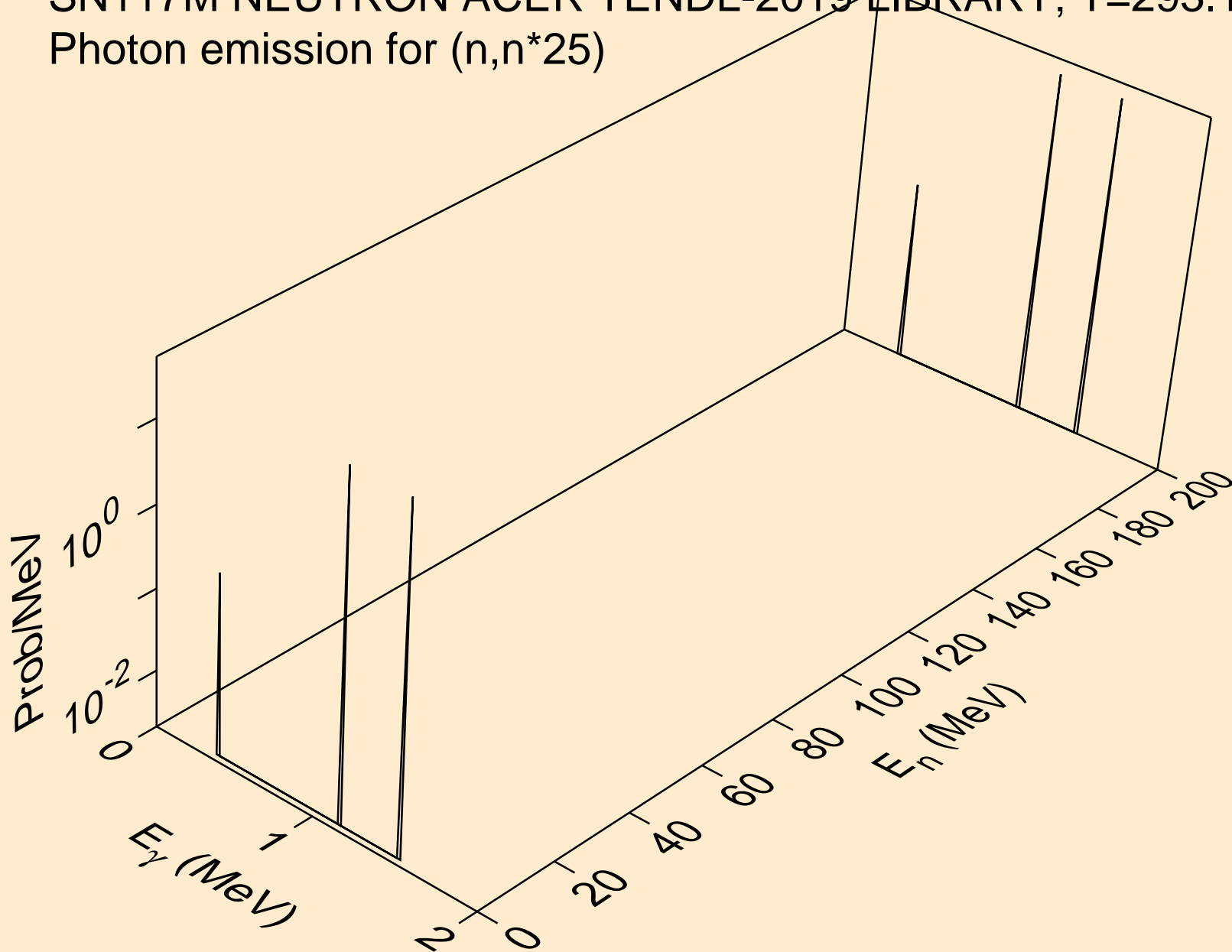



SN117M NEUTRON ACER TENDL-2019 LIBRARY; T=293.16K  
Photon emission for (n,n\*26)

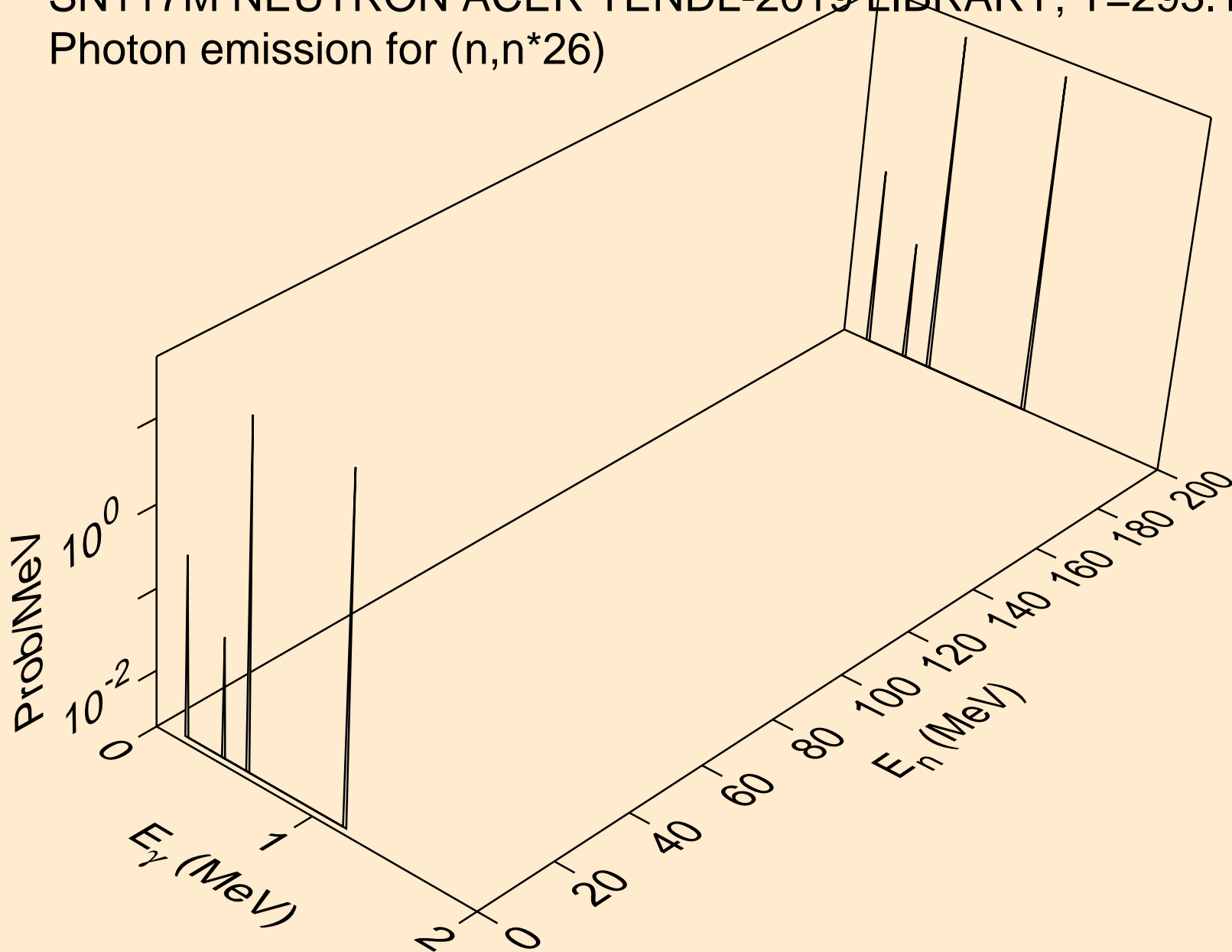

SN117M NEUTRON ACER TENDL-2019 LIBRARY; T=293.16K  
Photon emission for (n,n\*27)

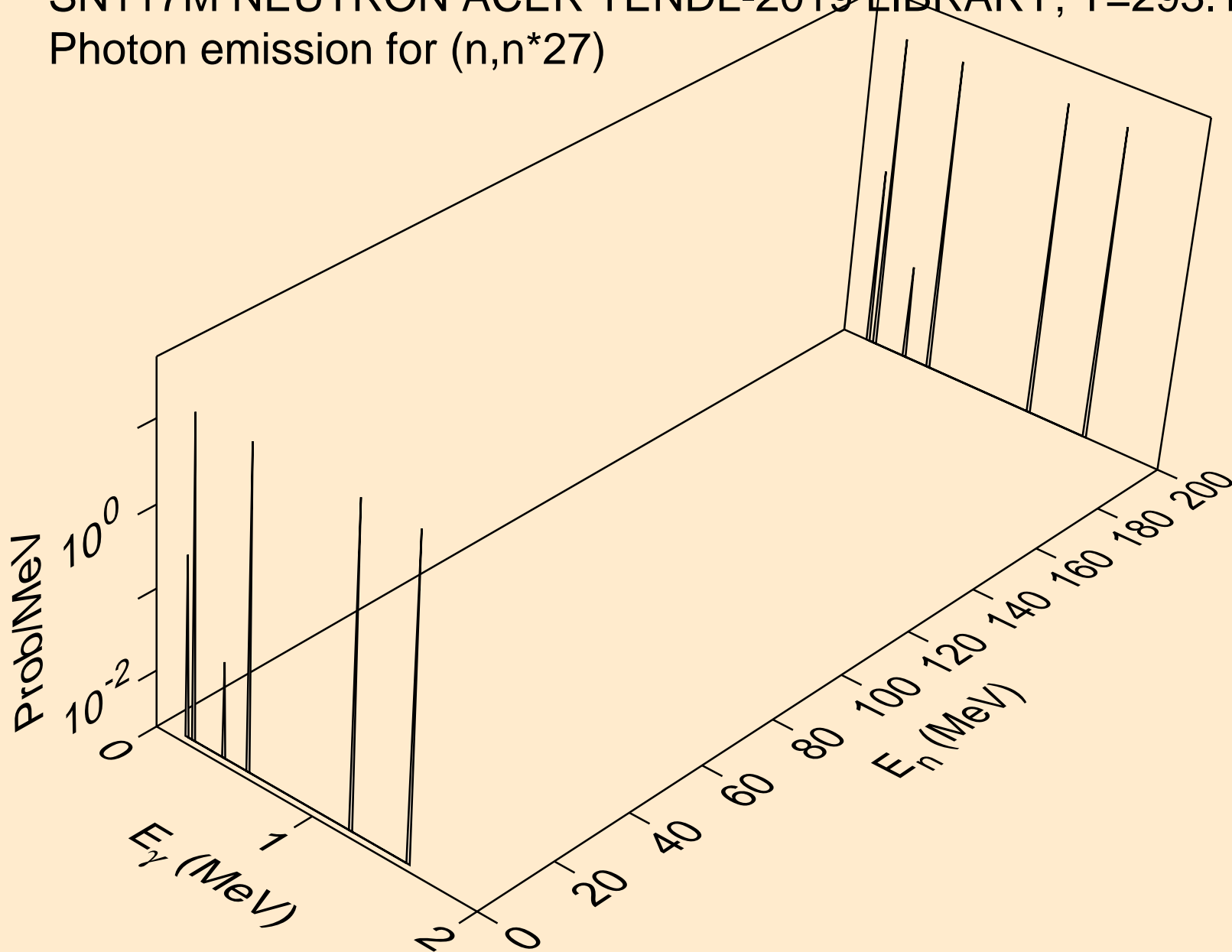

SN117M NEUTRON ACER TENDL-2019 LIBRARY; T=293.16K  
Photon emission for (n,n\*28)

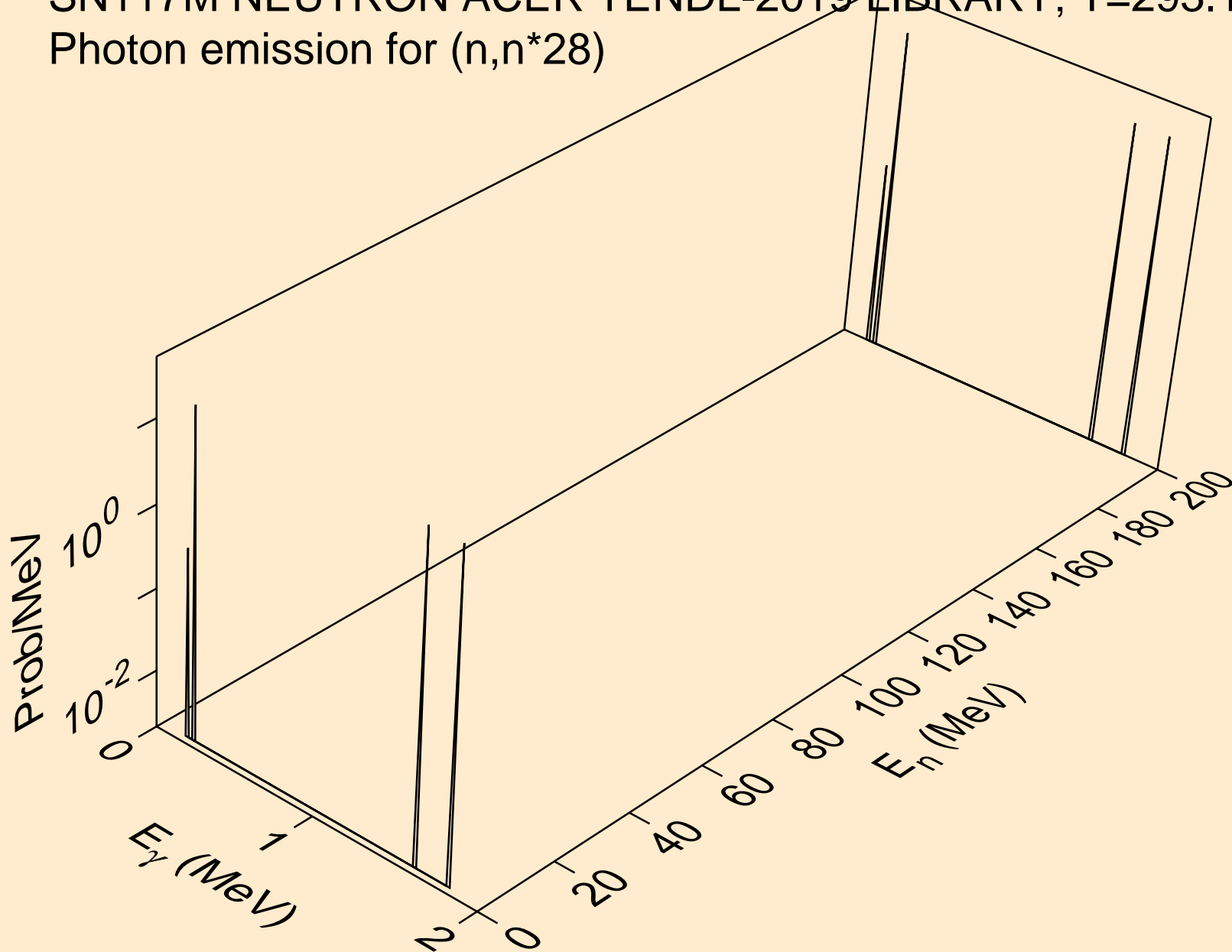

SN117M NEUTRON ACER TENDL-2019 LIBRARY; T=293.16K  
Photon emission for (n,n\*29)

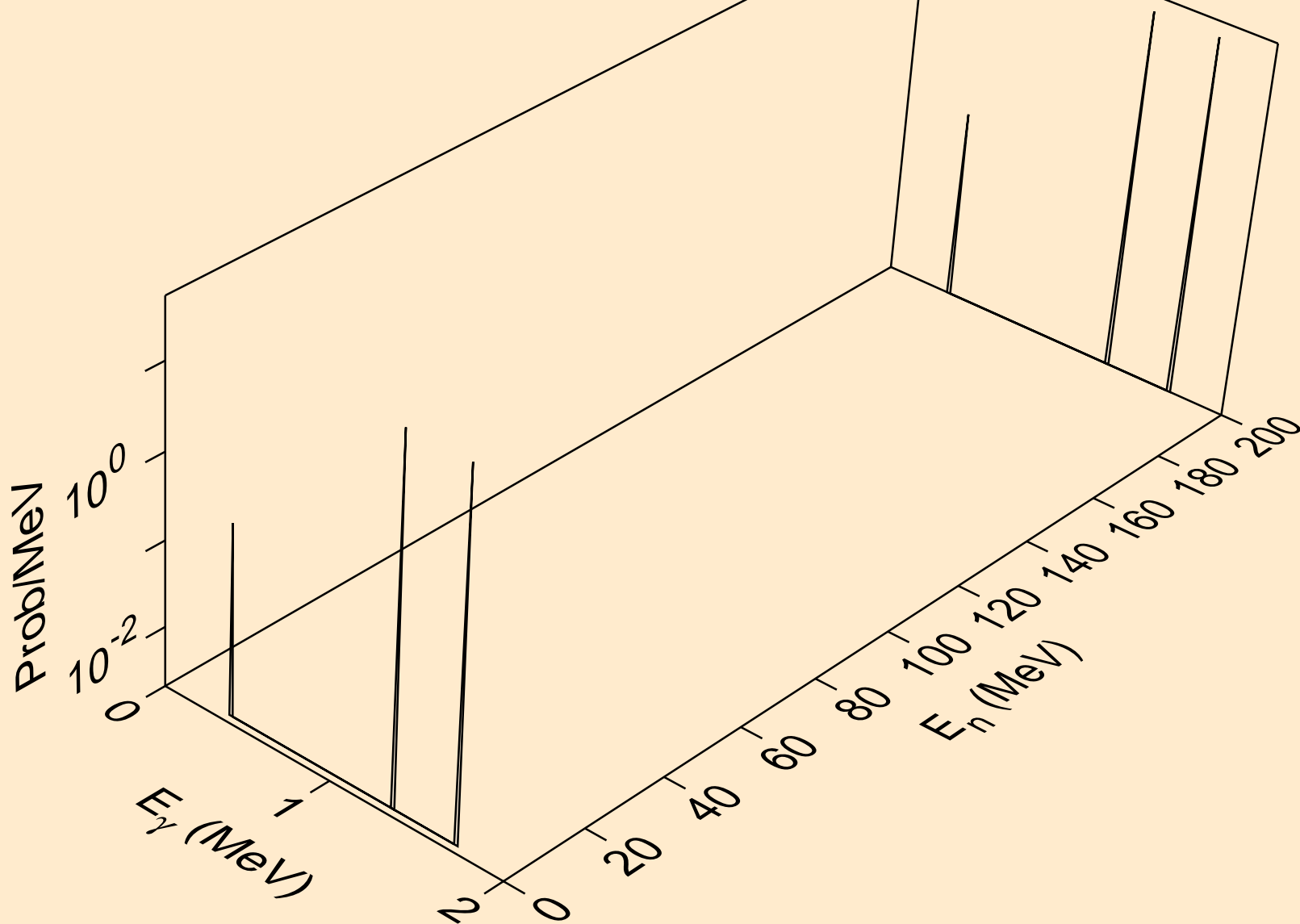

SN117M NEUTRON ACER TENDL-2019 LIBRARY; T=293.16K  
Photon emission for (n,n\*30)

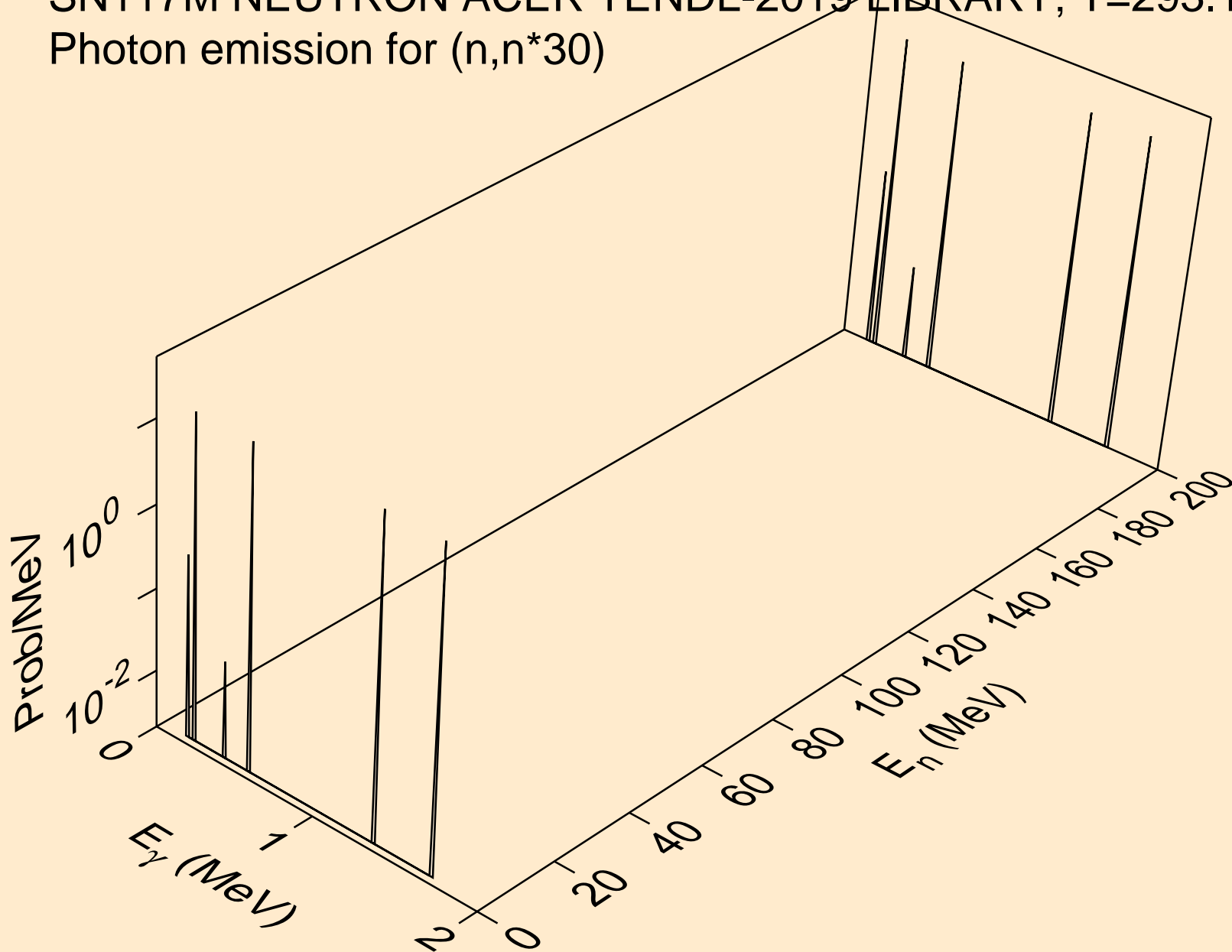

SN117M NEUTRON ACER TENDL-2019 LIBRARY; T=293.16K  
Photon emission for (n,n\*c)

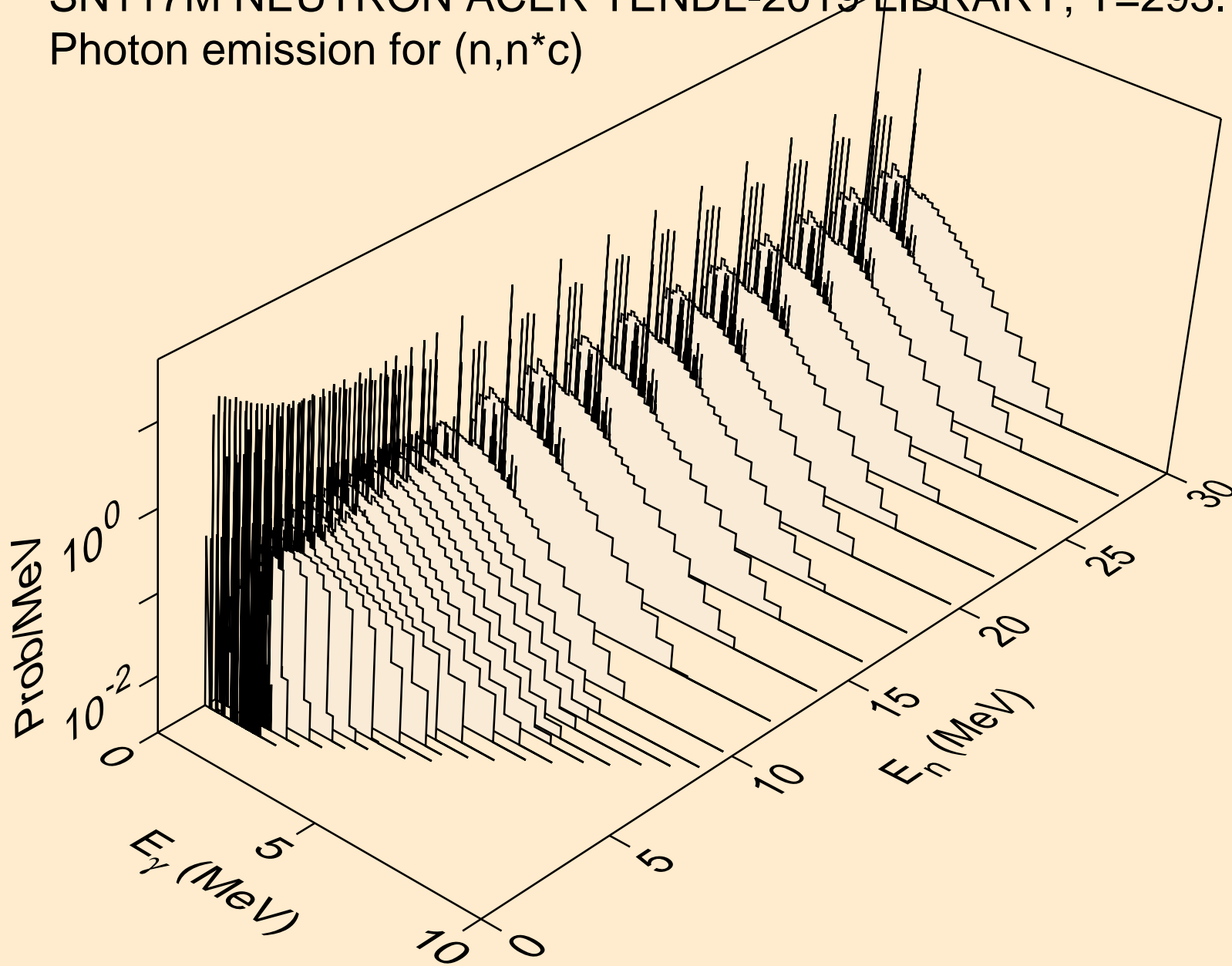

SN117M NEUTRON ACER TENDL-2019 LIBRARY; T=293.16K  
Photon emission for (n,gma)

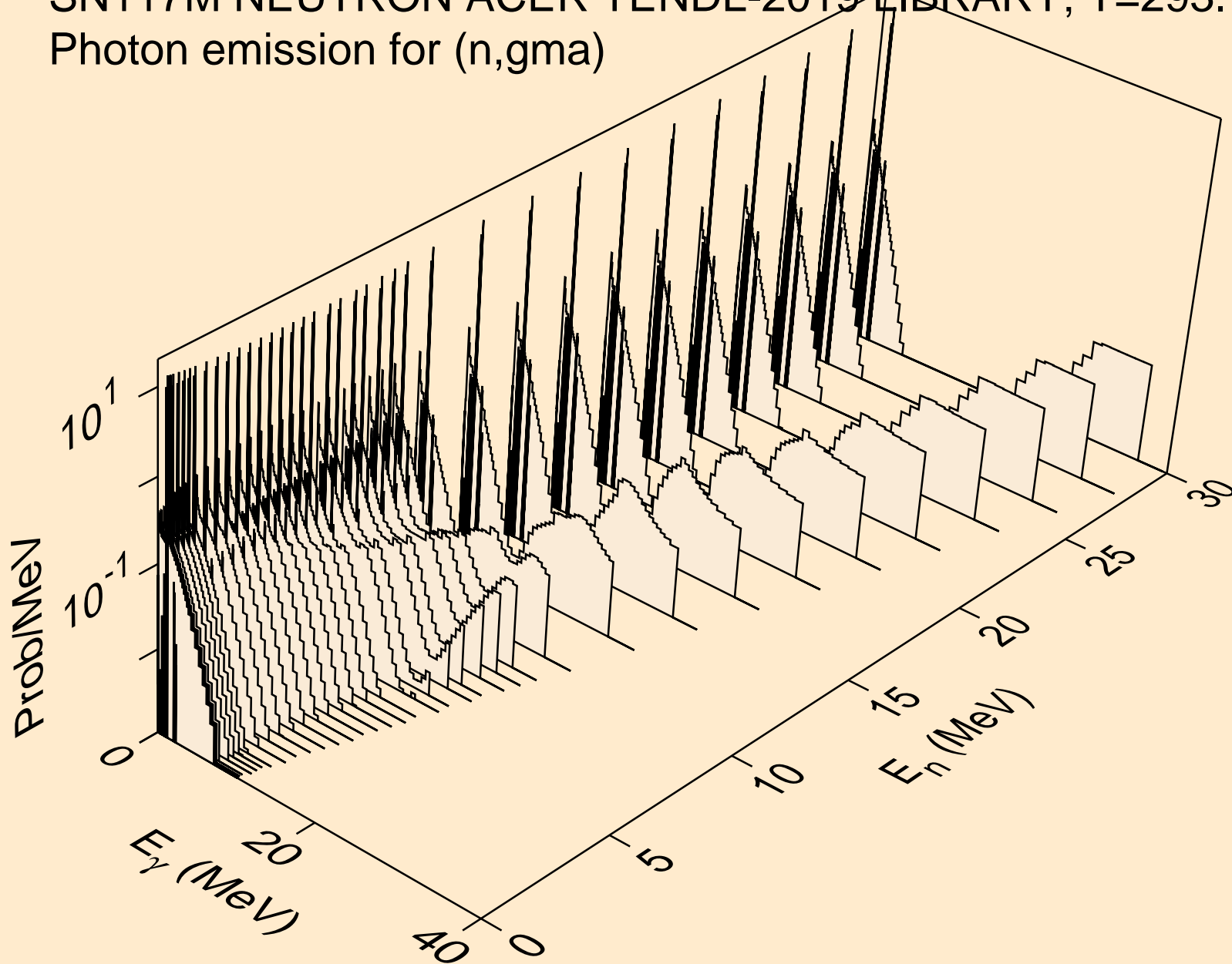

SN117M NEUTRON ACER TENDL-2019 LIBRARY; T=293.16K  
Photon emission for (n,p)

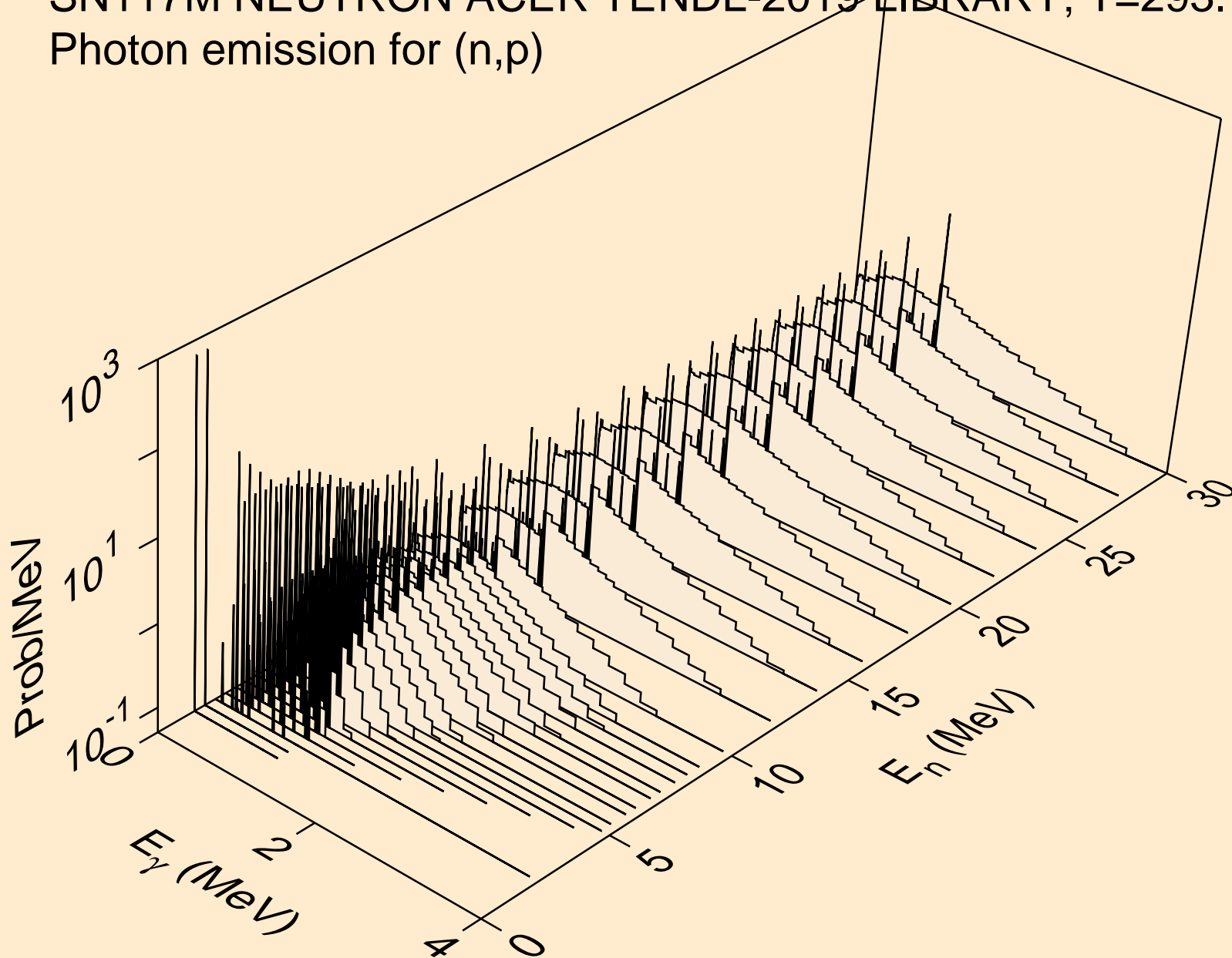



SN117M NEUTRON ACER TENDL-2019 LIBRARY; T=293.16K  
Photon emission for (n,d)

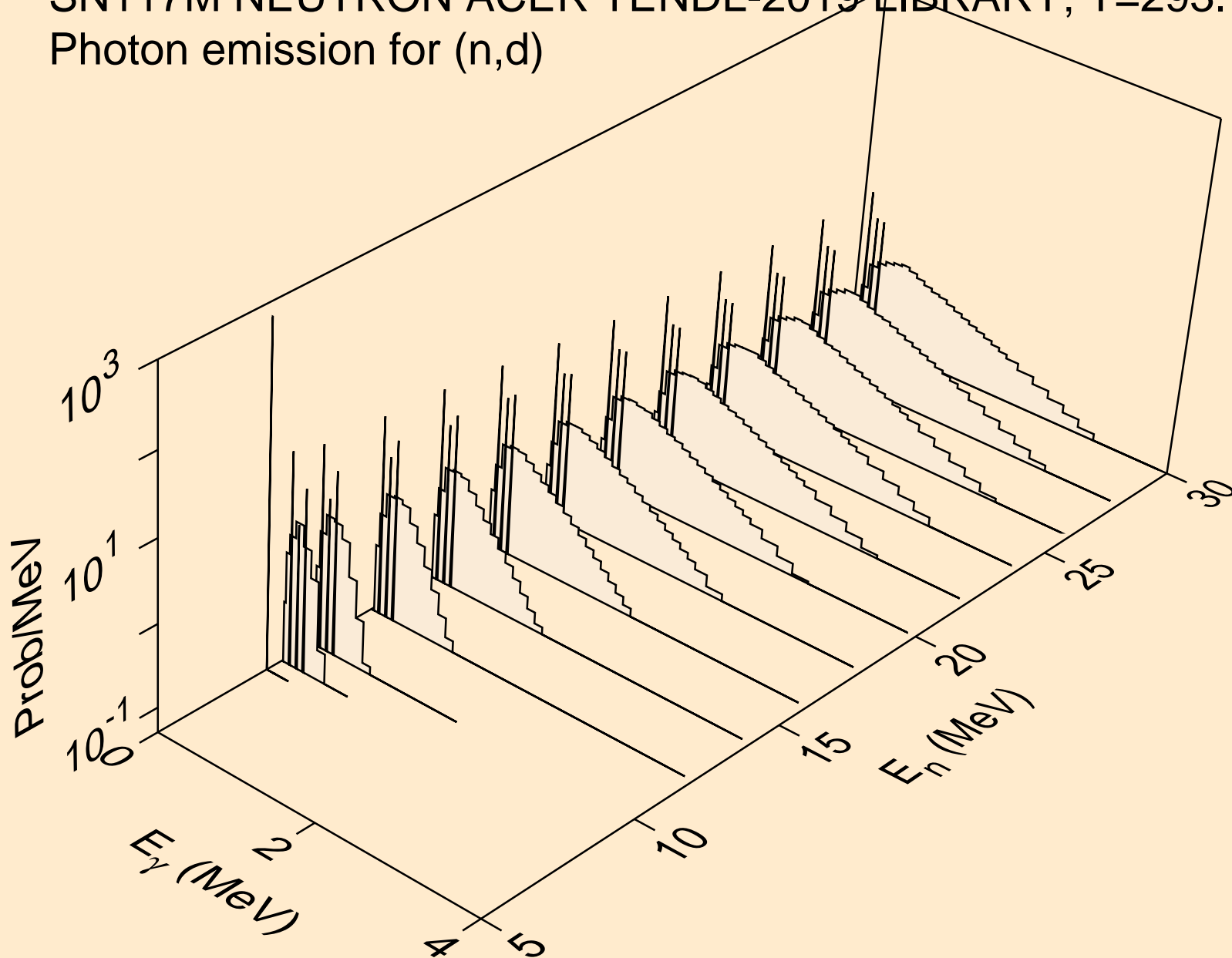

SN117M NEUTRON ACER TENDL-2019 LIBRARY; T=293.16K  
Photon emission for (n,t)

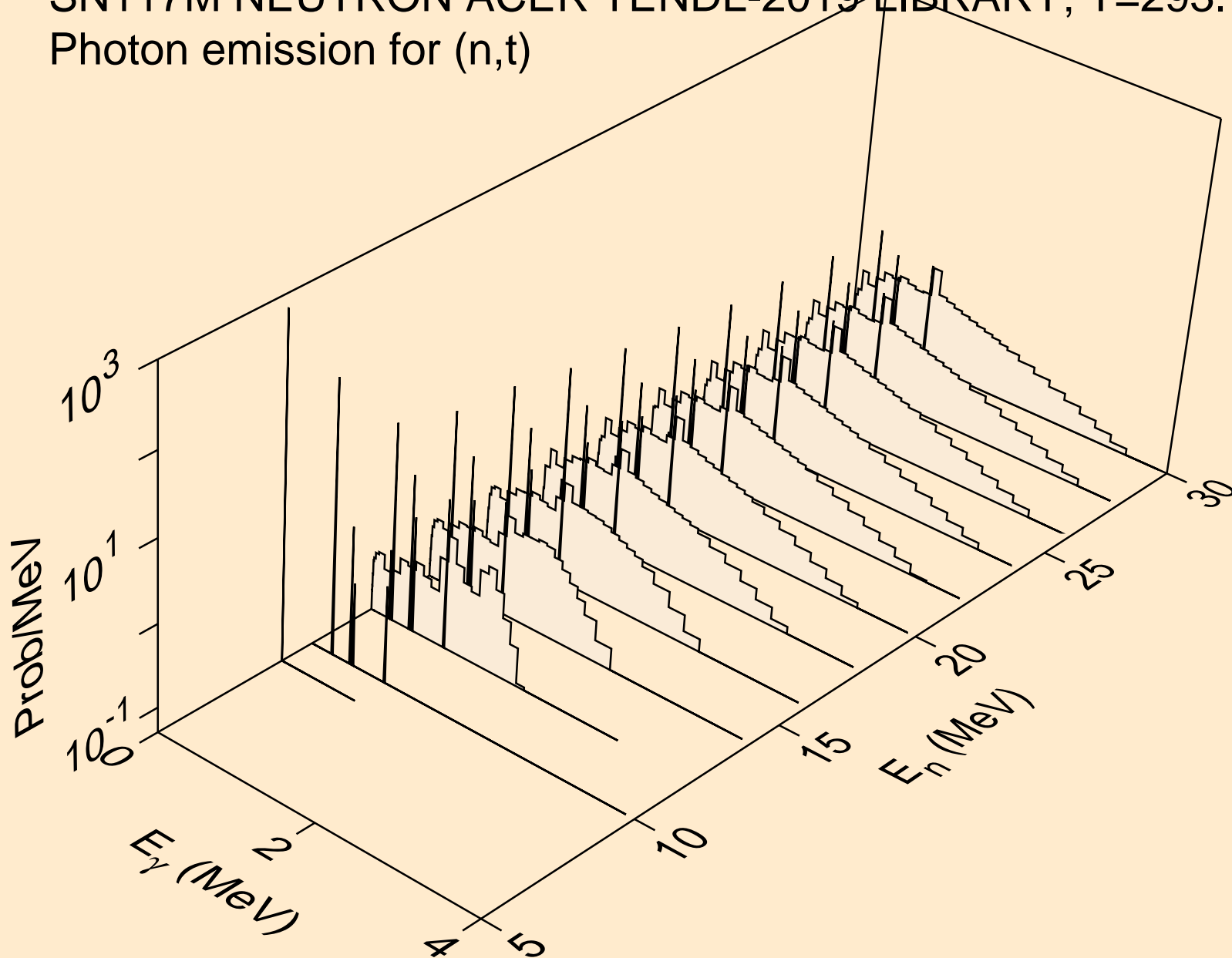

SN117M NEUTRON ACER TENDL-2019 LIBRARY; T=293.16K  
Photon emission for (n,he3)

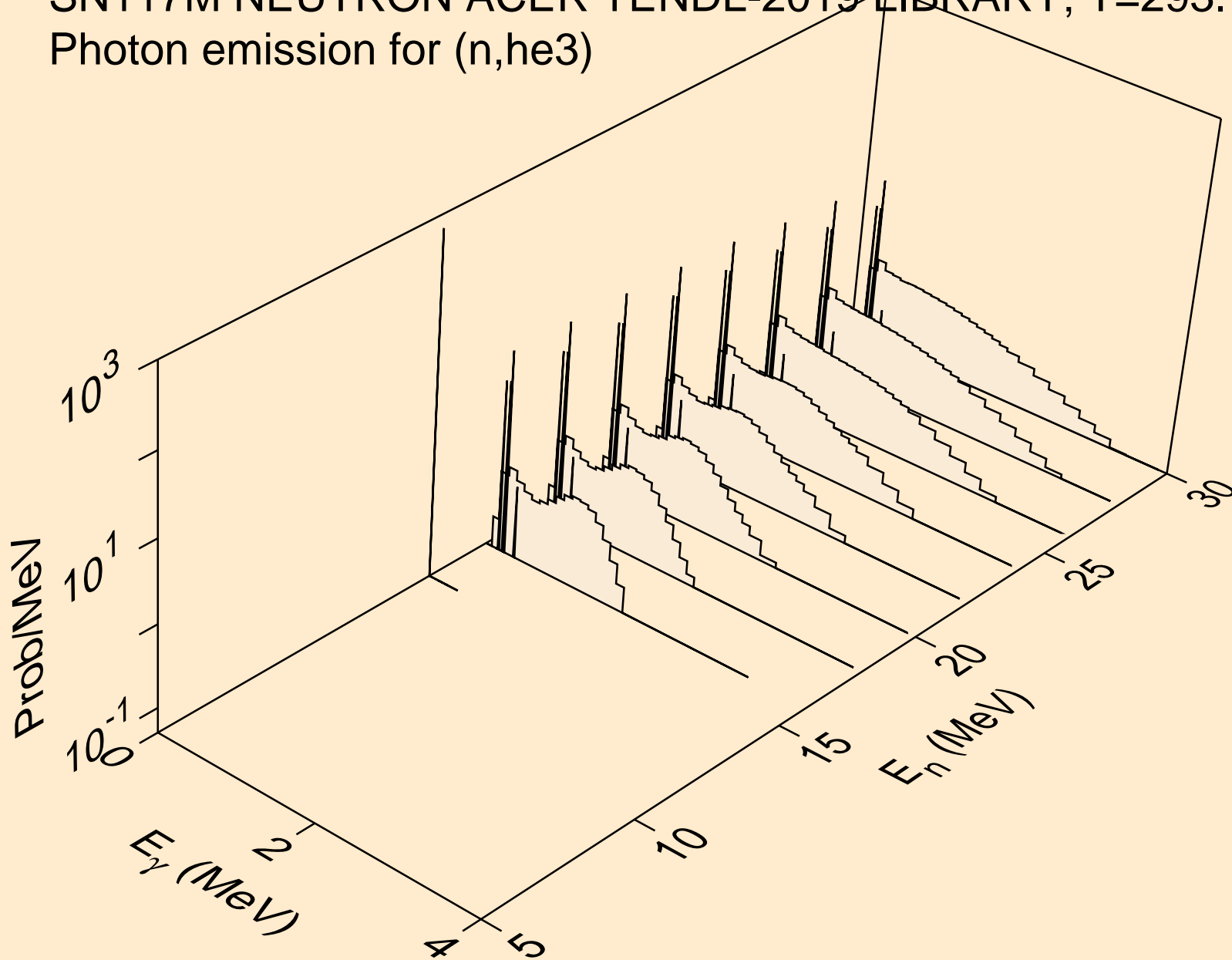

SN117M NEUTRON ACER TENDL-2019 LIBRARY; T=293.16K  
Photon emission for (n,a)

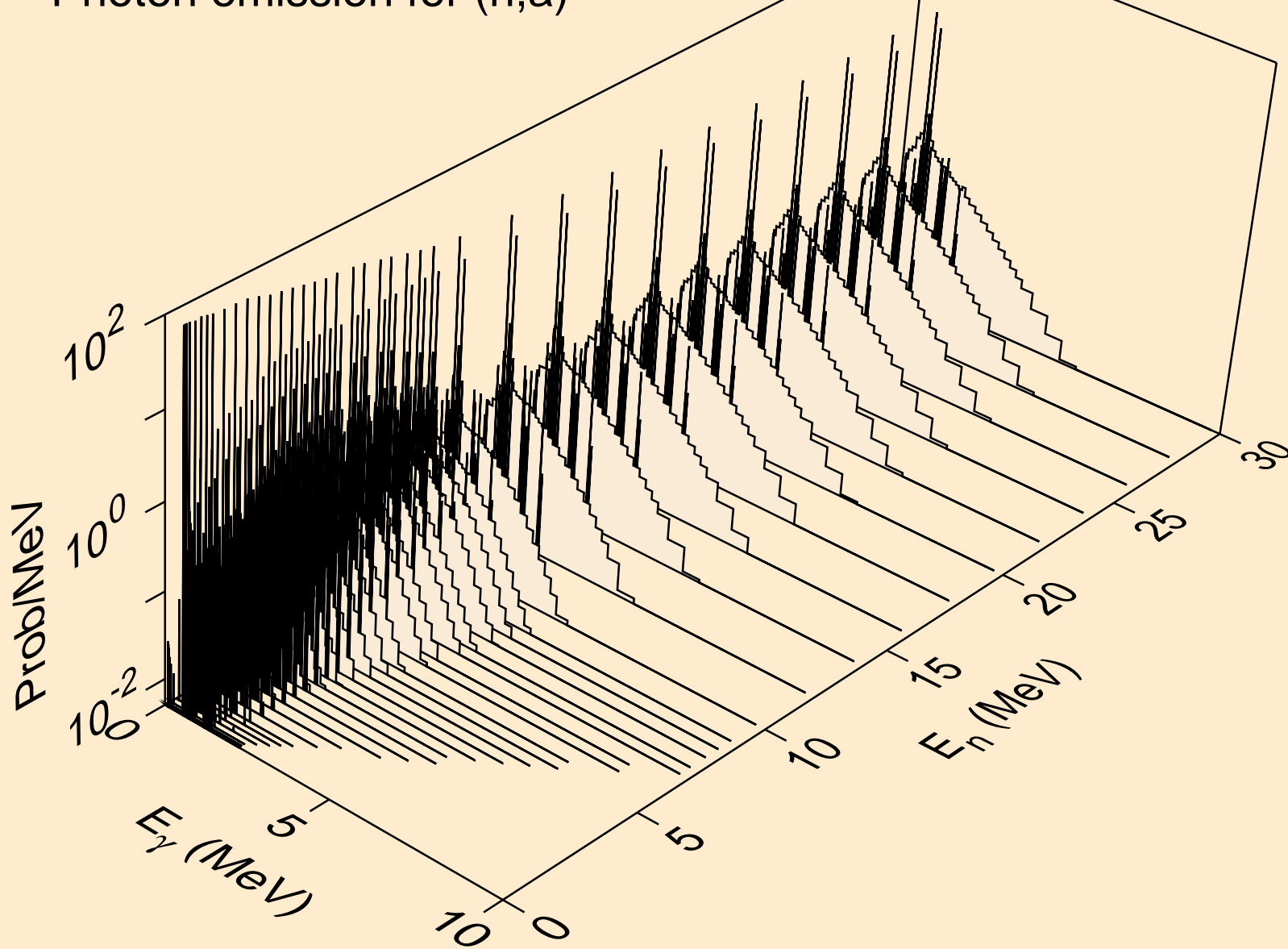

SN117M NEUTRON ACER TENDL-2019 LIBRARY; T=293.16K  
Photon emission for (n,2a)

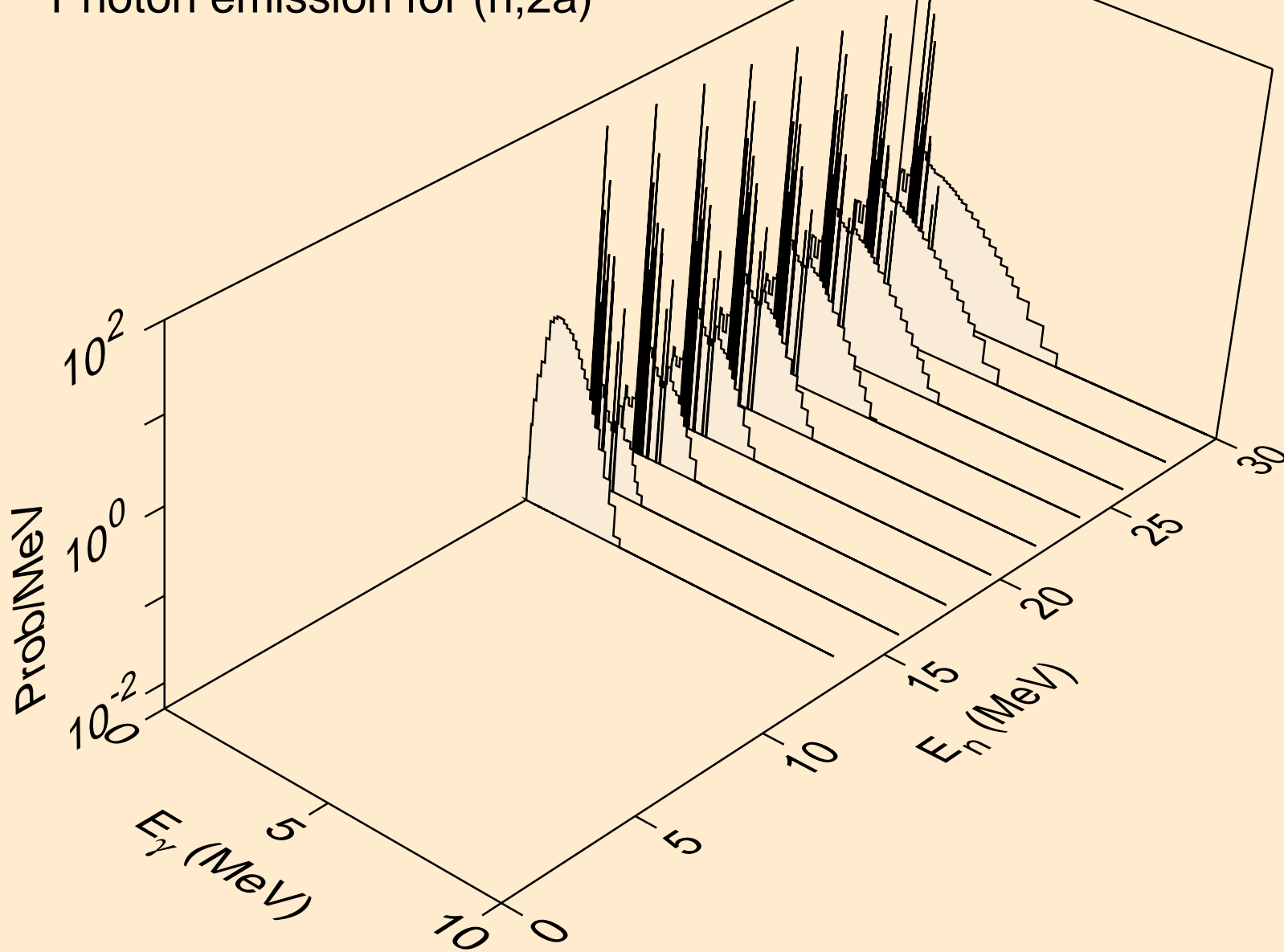

SN117M NEUTRON ACER TENDL-2019 LIBRARY; T=293.16K  
Photon emission for (n,2p)

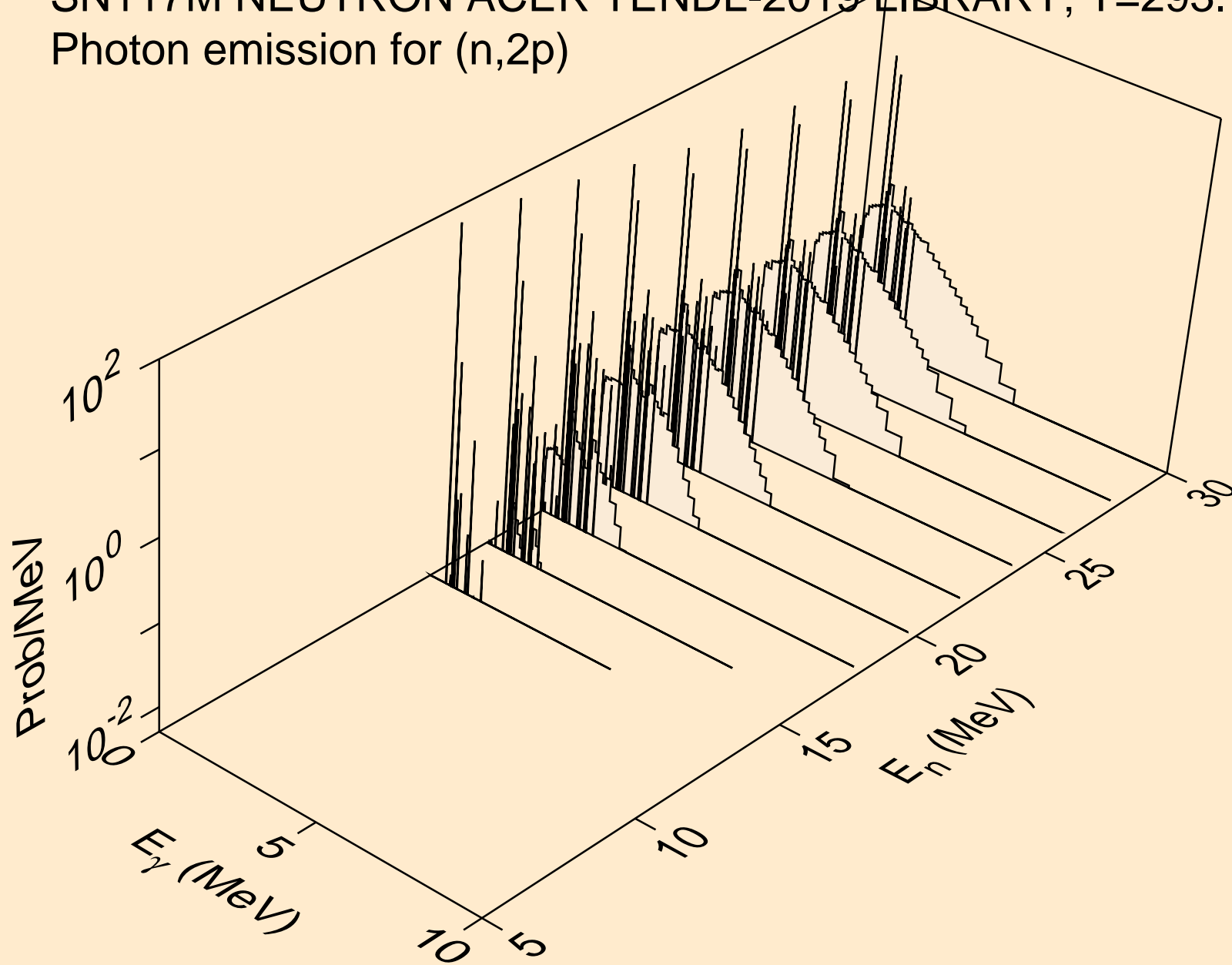

SN117M NEUTRON ACER TENDL-2019 LIBRARY; T=293.16K  
Photon emission for (n,p $\alpha$ )

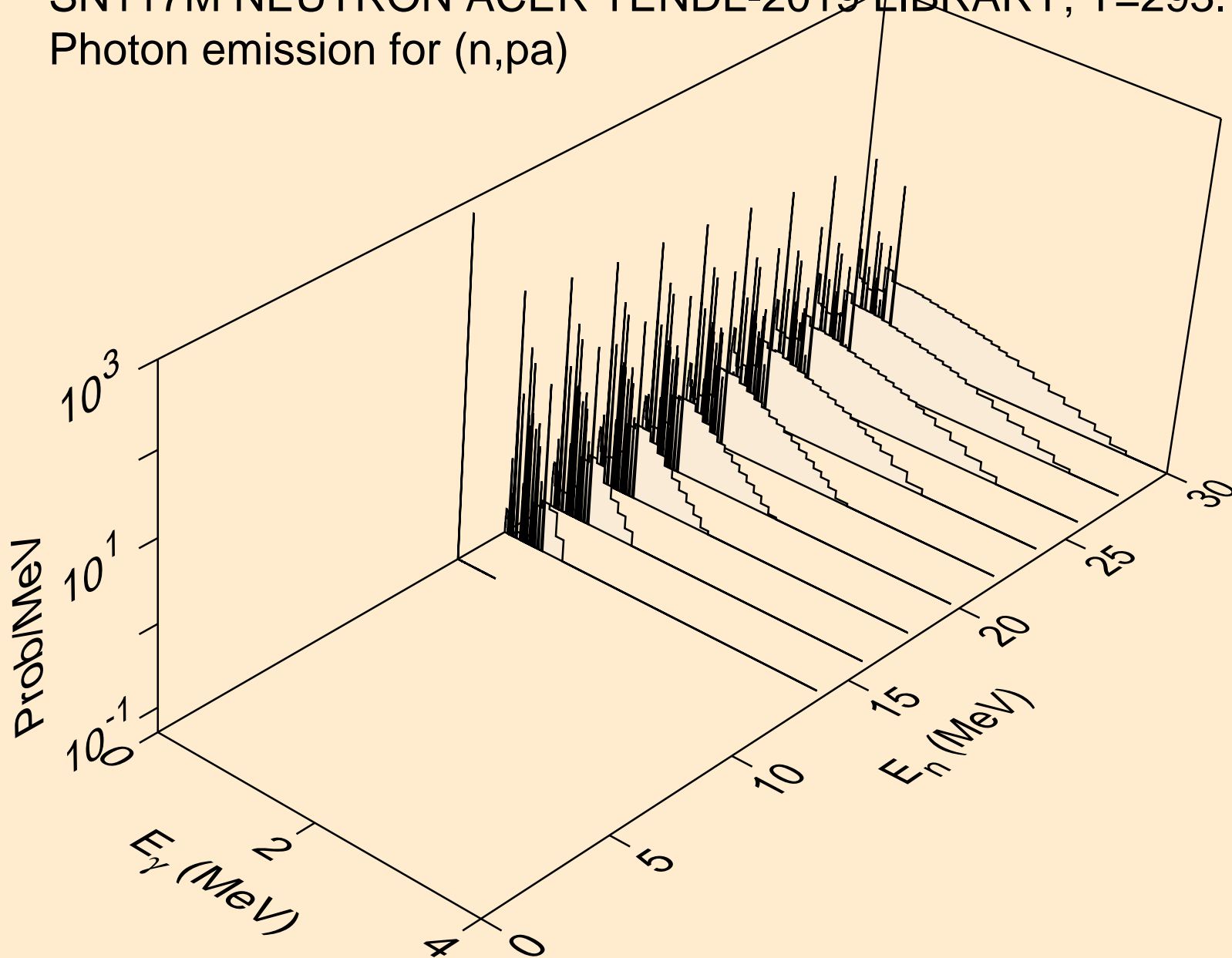

SN117M NEUTRON ACER TENDL-2019 LIBRARY; T=293.16K  
Photon emission for (n,pd)

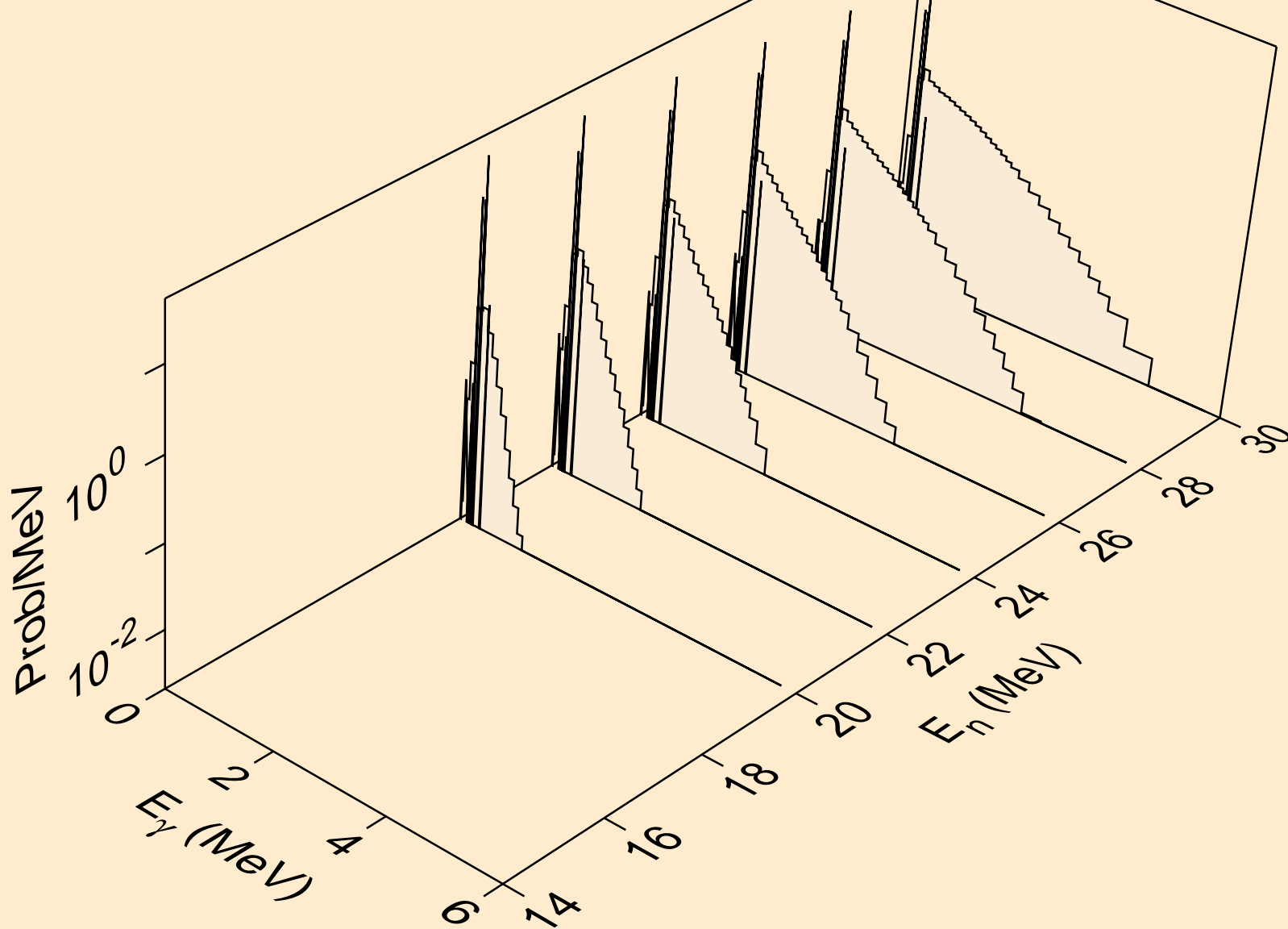



SN117M NEUTRON ACER TENDL-2019 LIBRARY; T=293.16K  
Photon emission for (n,pt)

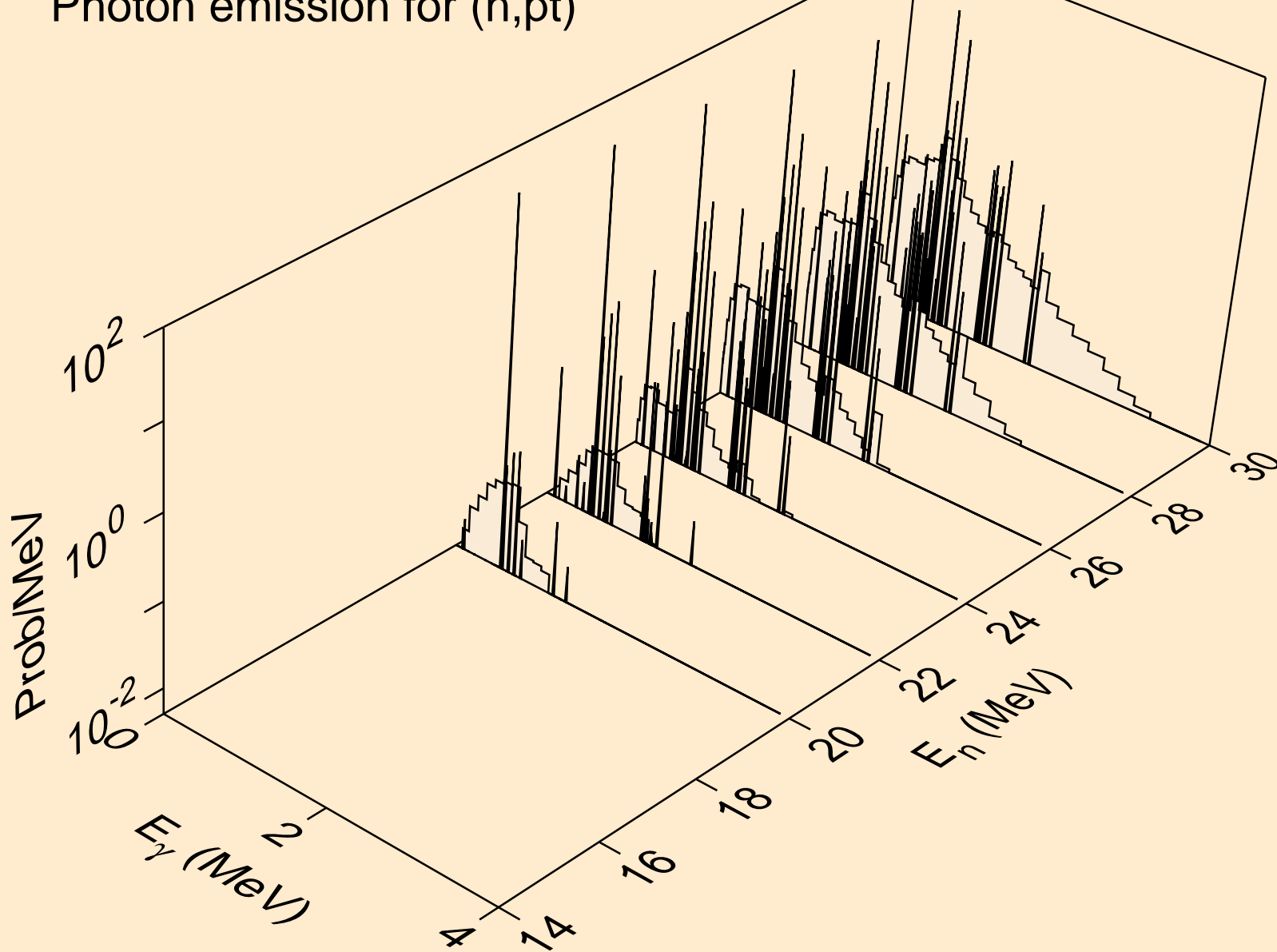

SN117M NEUTRON ACER TENDL-2019 LIBRARY; T=293.16K  
thermal capture photon spectrum

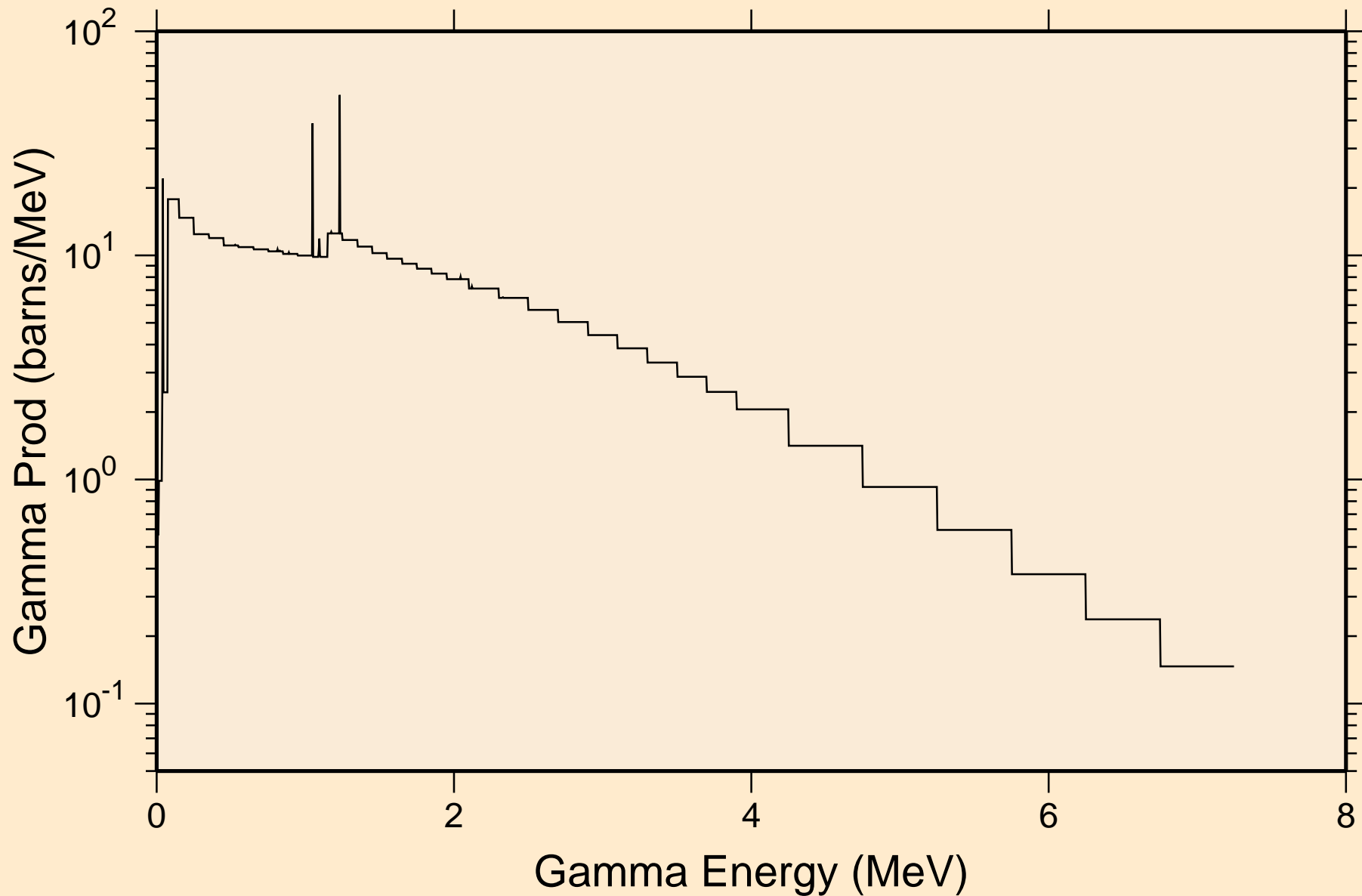

SN117M NEUTRON ACER TENDL-2019 LIBRARY; T=293.16K  
14 MeV photon spectrum

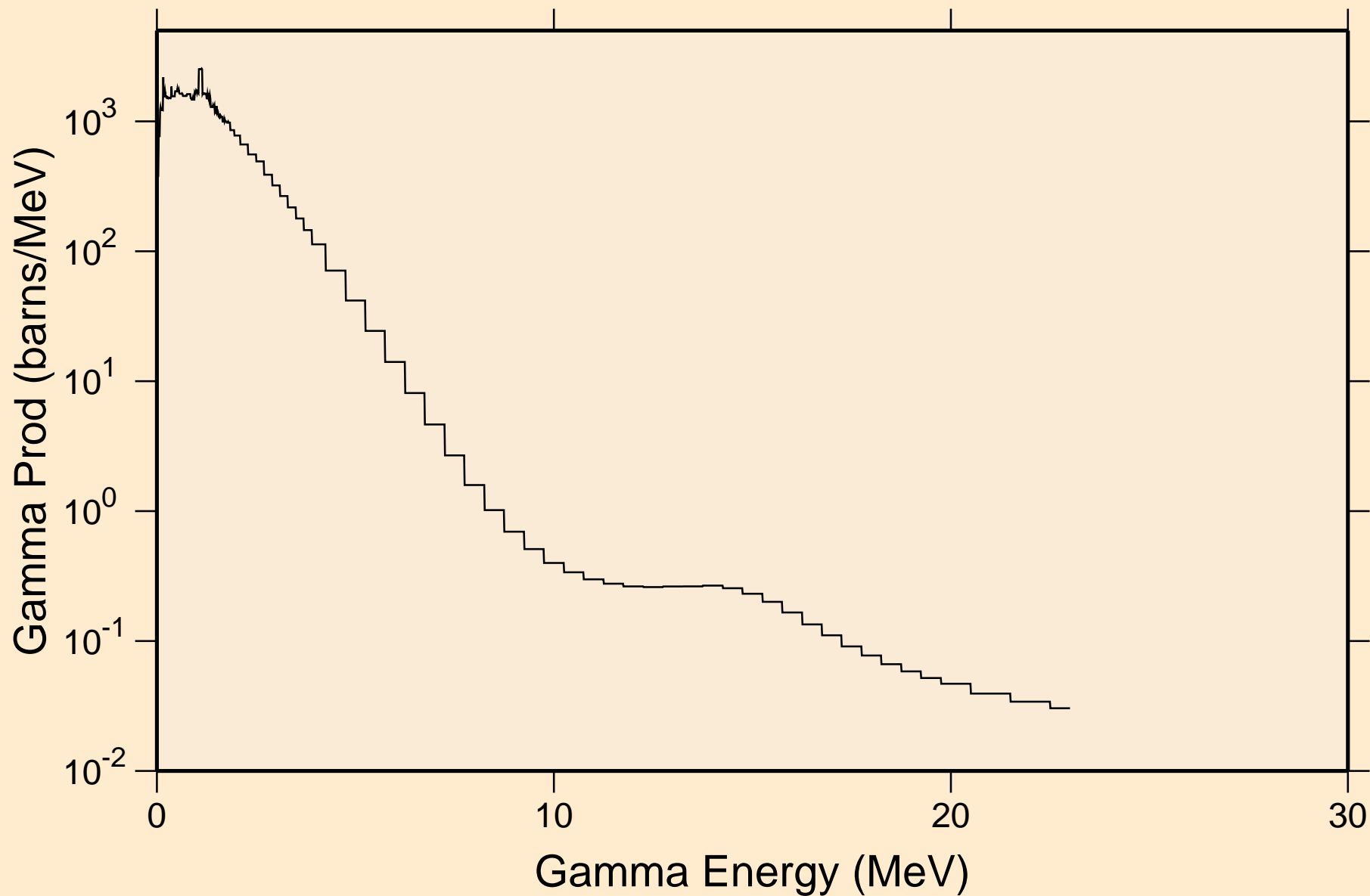

# SN117M NEUTRON ACER TENDL-2019 LIBRARY; T=293.16K

## Particle heating contributions

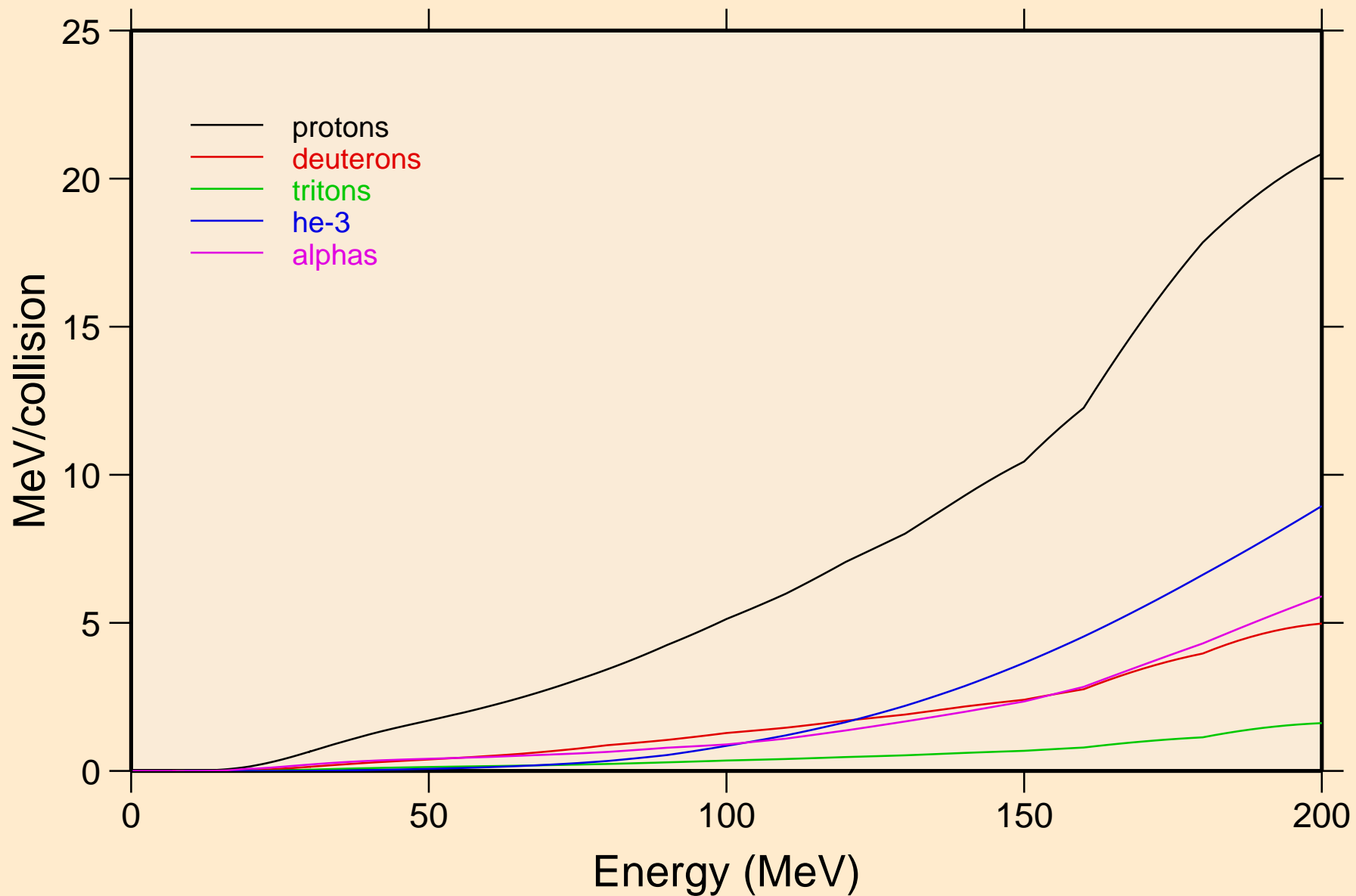

SN117M NEUTRON ACER TENDL-2019 LIBRARY; T=293.16K  
Recoil Heating

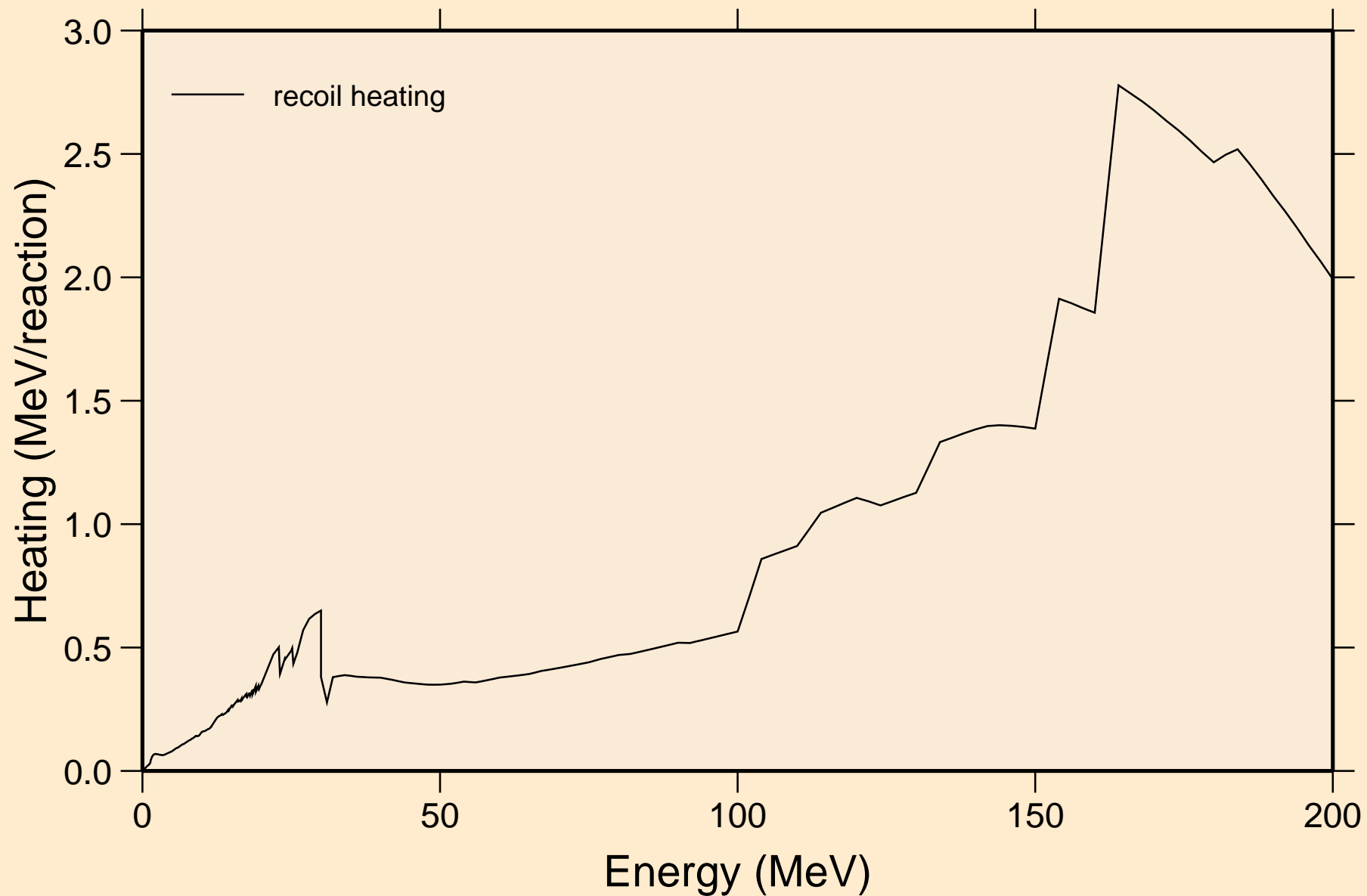

# SN117M NEUTRON ACER TENDL-2019 LIBRARY; T=293.16K

## Particle production cross sections

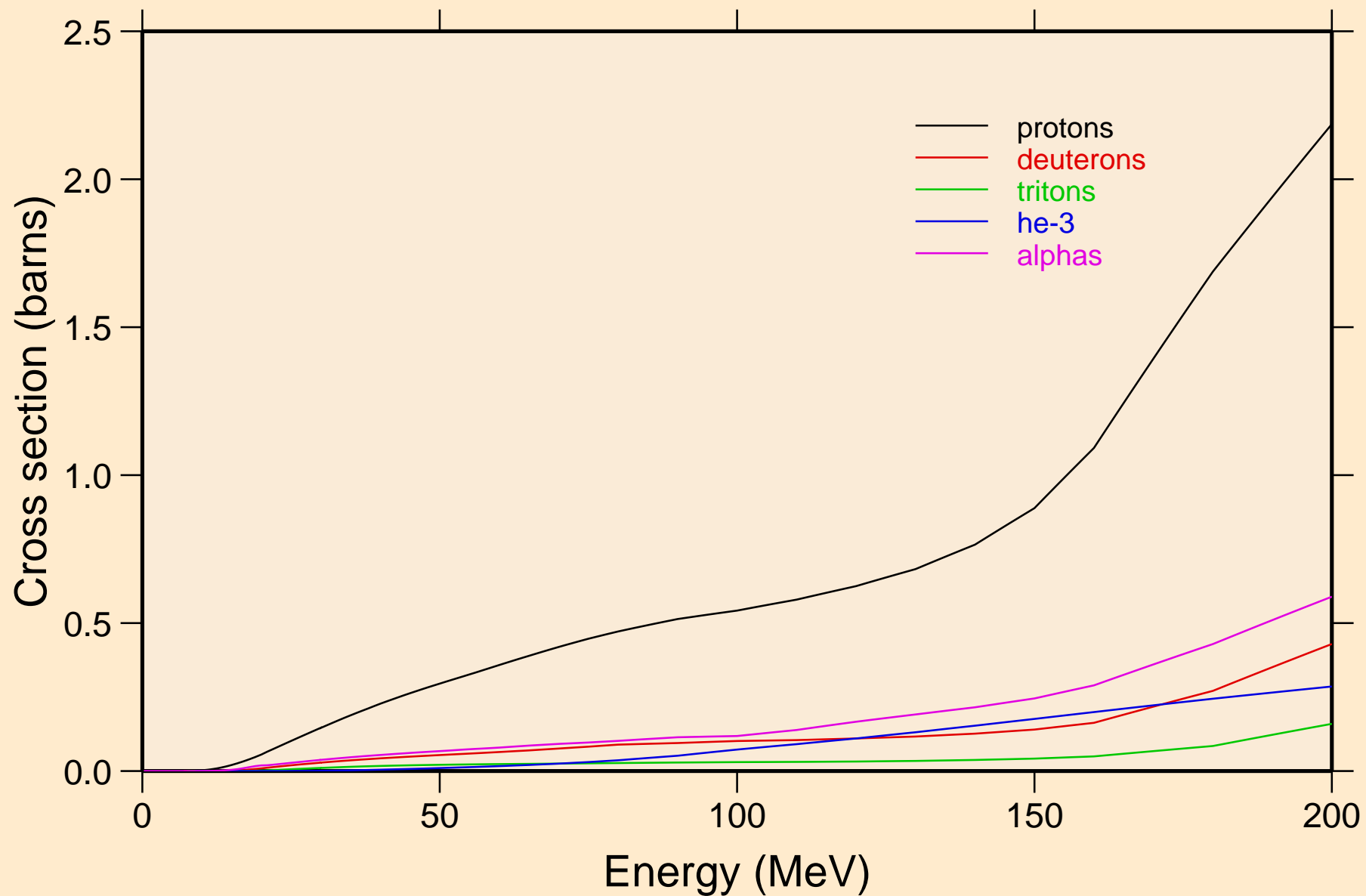

SN117M NEUTRON ACER TENDL-2019 LIBRARY; T=293.16K  
protons from (n,x)

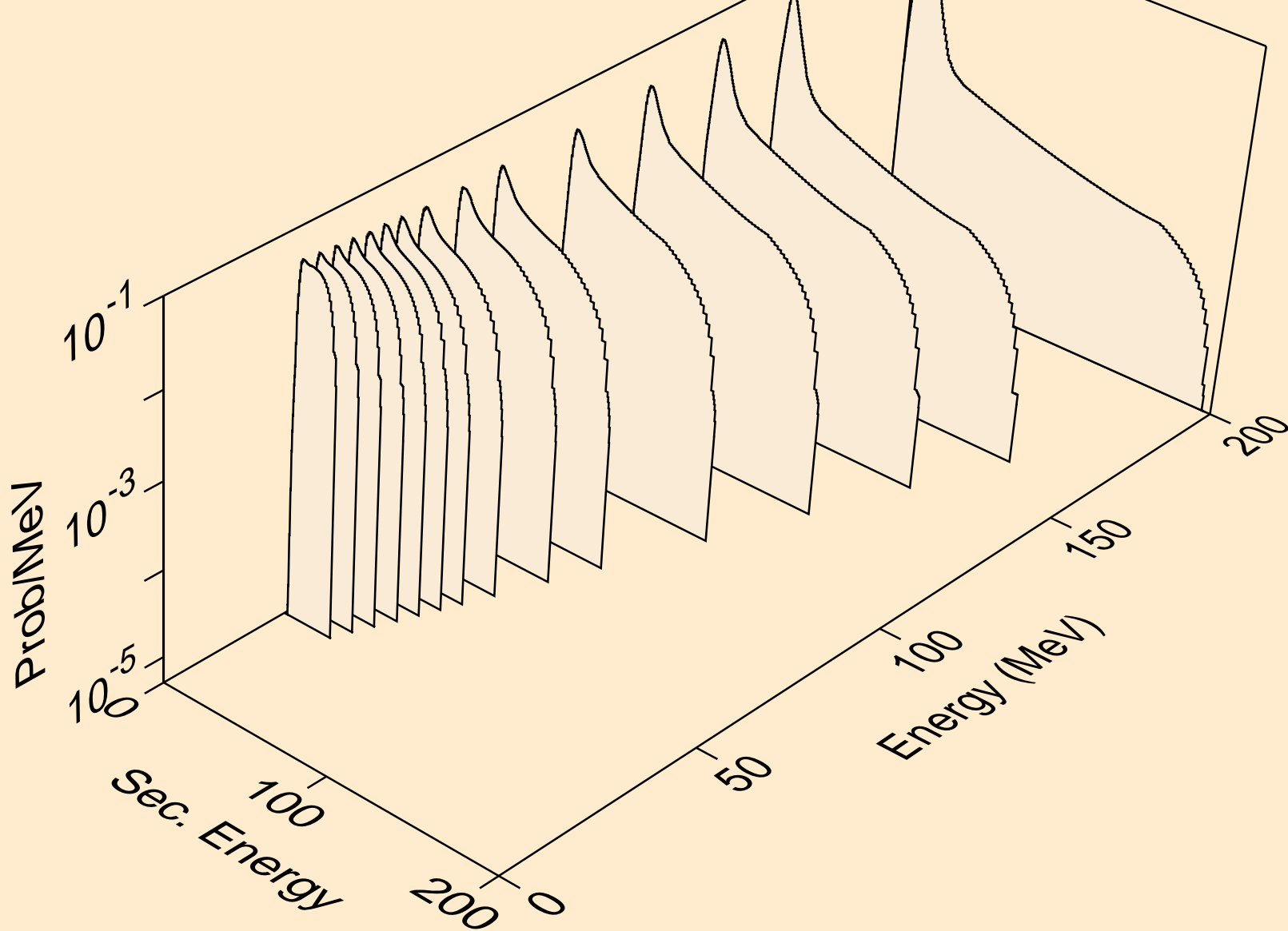

SN117M NEUTRON ACER TENDL-2019 LIBRARY; T=293.16K  
protons from (n,n\*)p

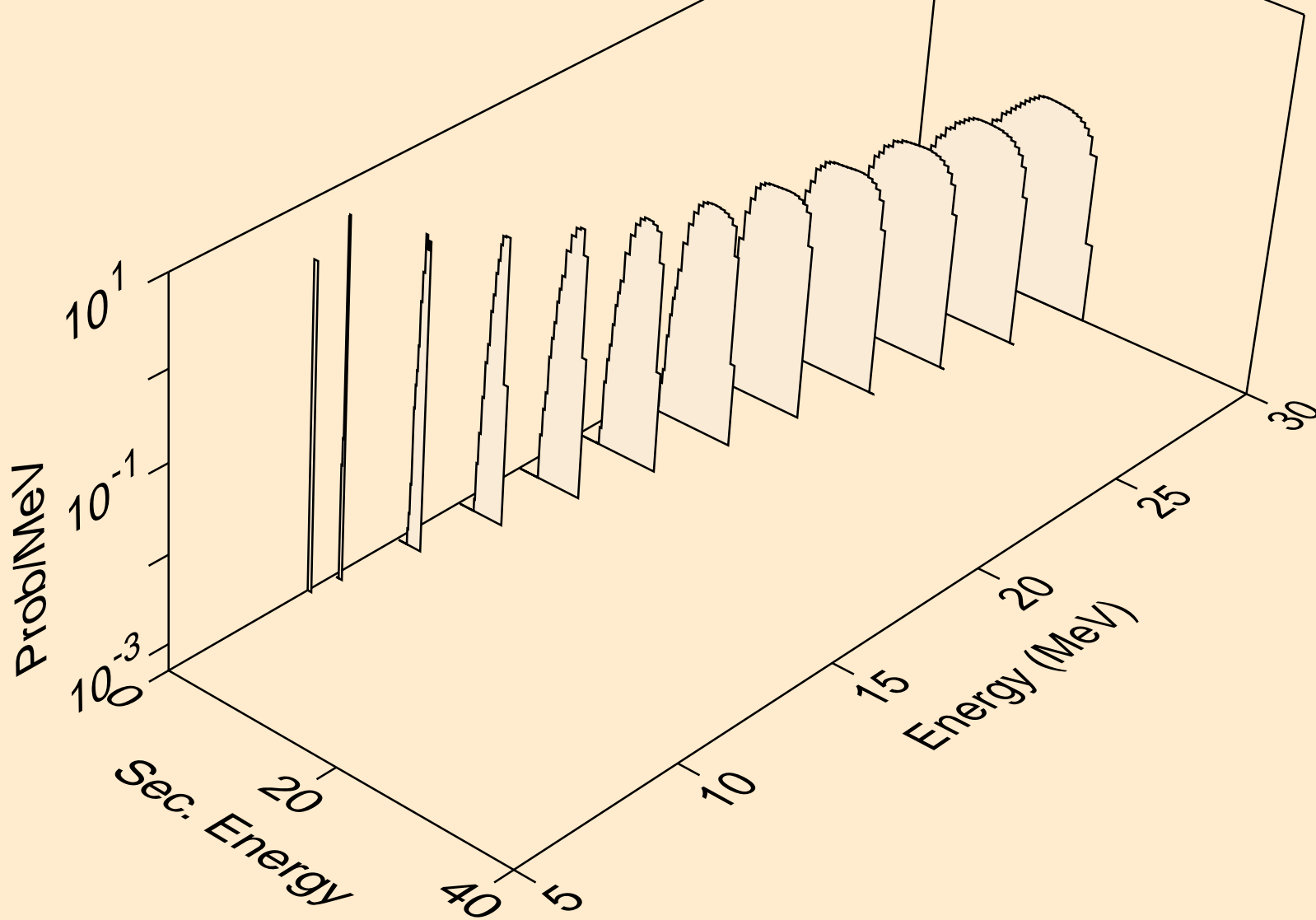



SN117M NEUTRON ACER TENDL-2019 LIBRARY; T=293.16K  
protons from (n,2np)

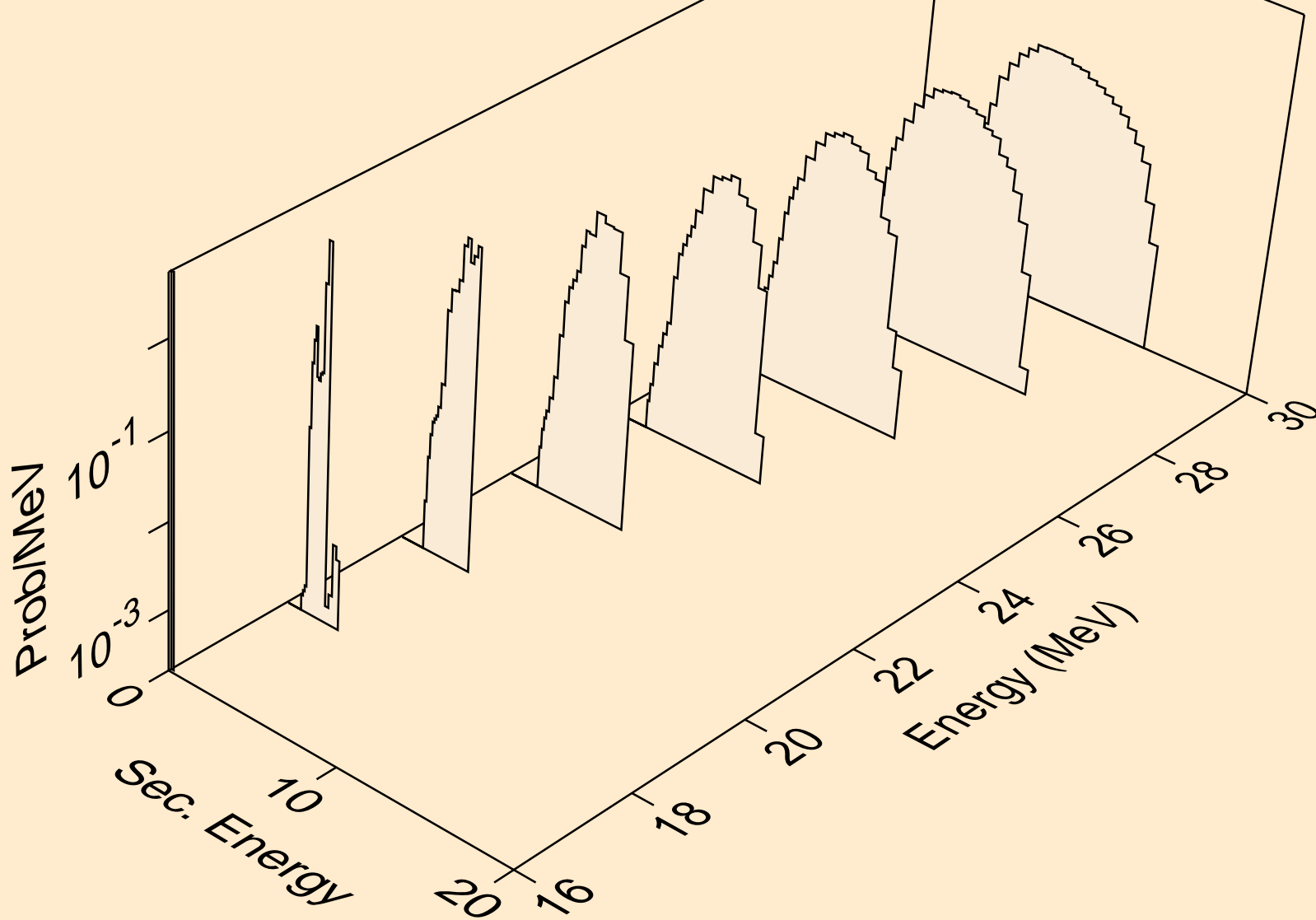

SN117M NEUTRON ACER TENDL-2019 LIBRARY; T=293.16K  
protons from (n,3np)

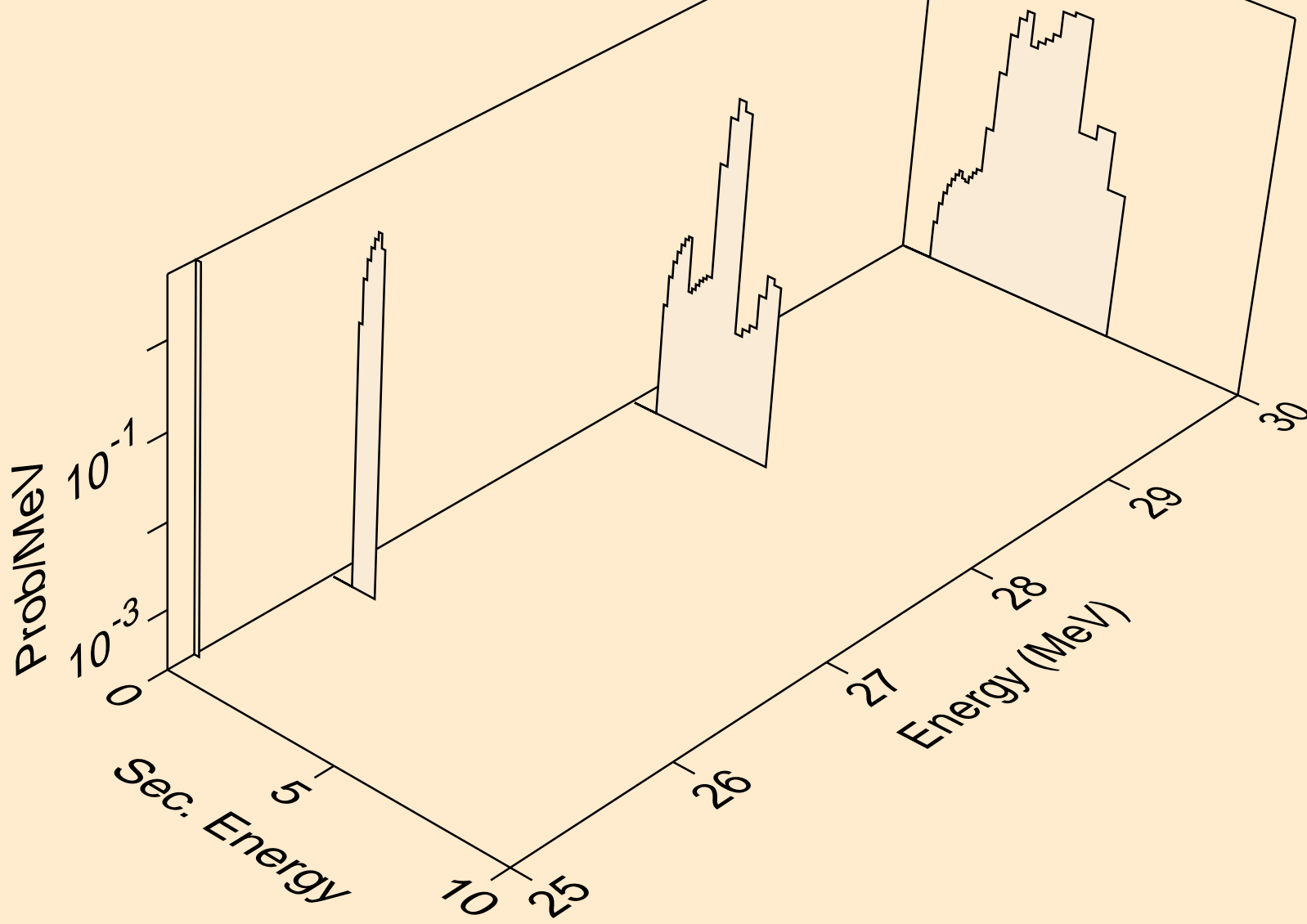

SN117M NEUTRON ACER TENDL-2019 LIBRARY; T=293.16K  
protons from (n,2np)

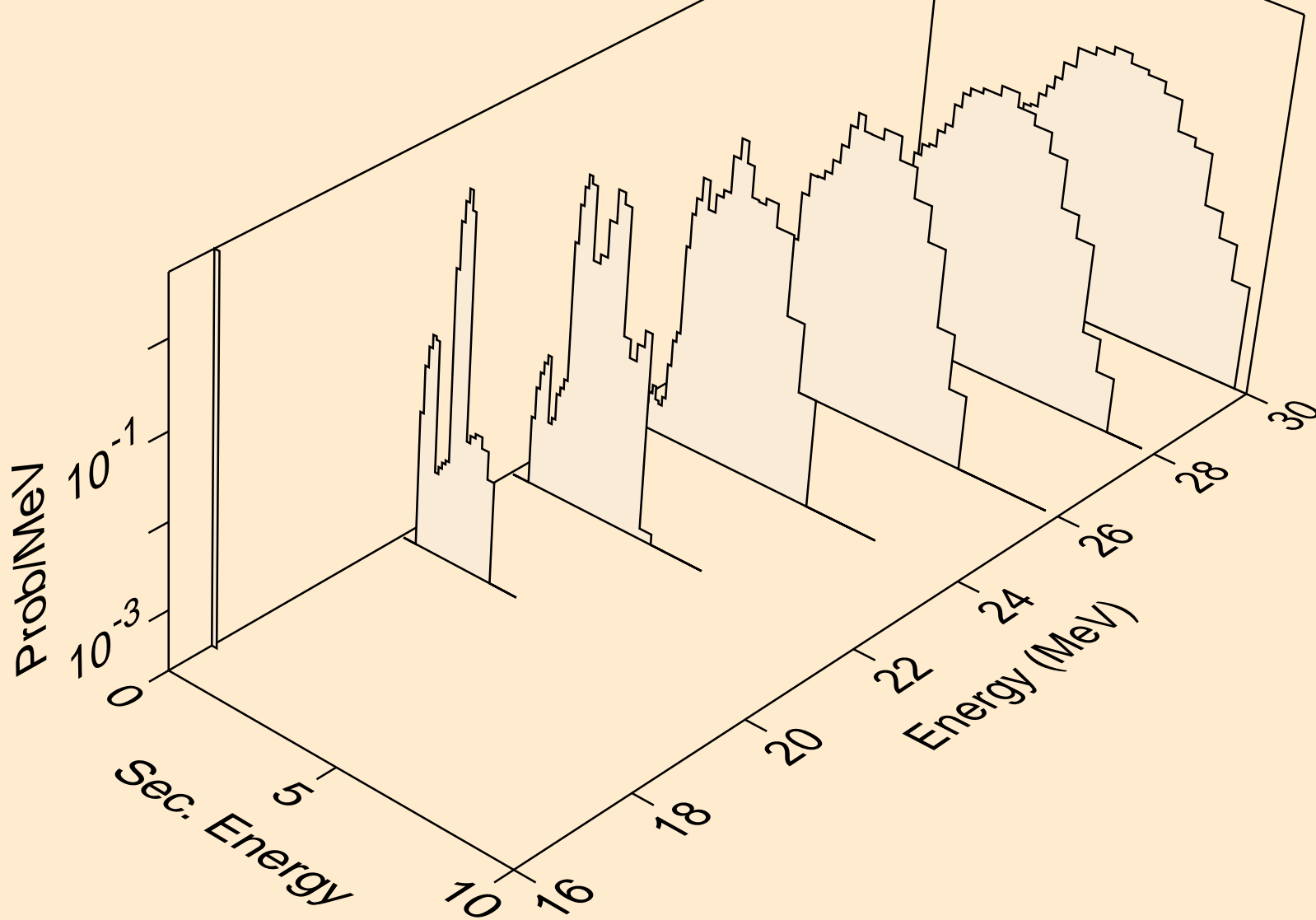

SN117M NEUTRON ACER TENDL-2019 LIBRARY; T=293.16K  
protons from (n,npa)

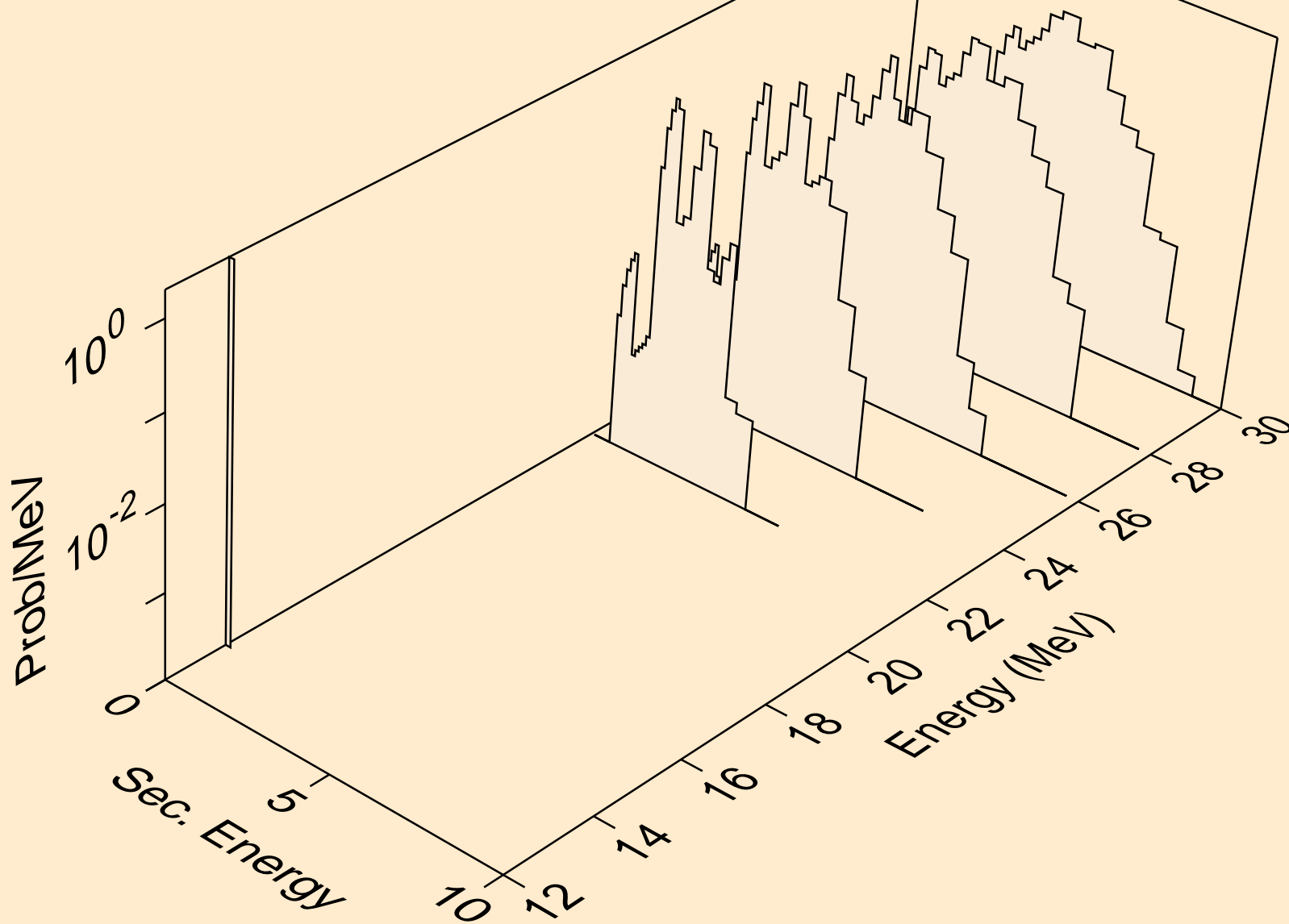

SN117M NEUTRON ACER TENDL-2019 LIBRARY; T=293.16K  
protons from (n,p)

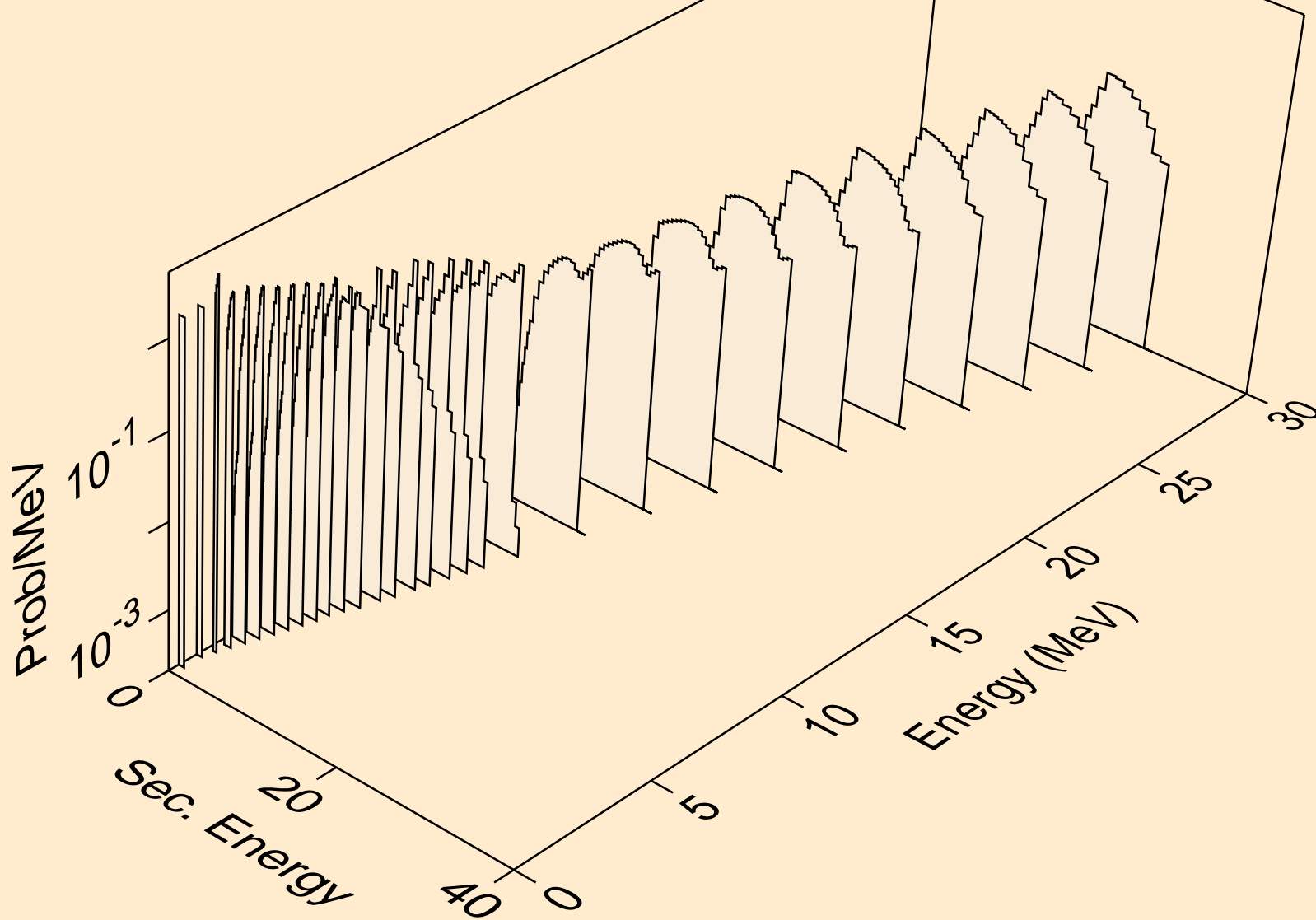

SN117M NEUTRON ACER TENDL-2019 LIBRARY; T=293.16K  
protons from (n,2p)

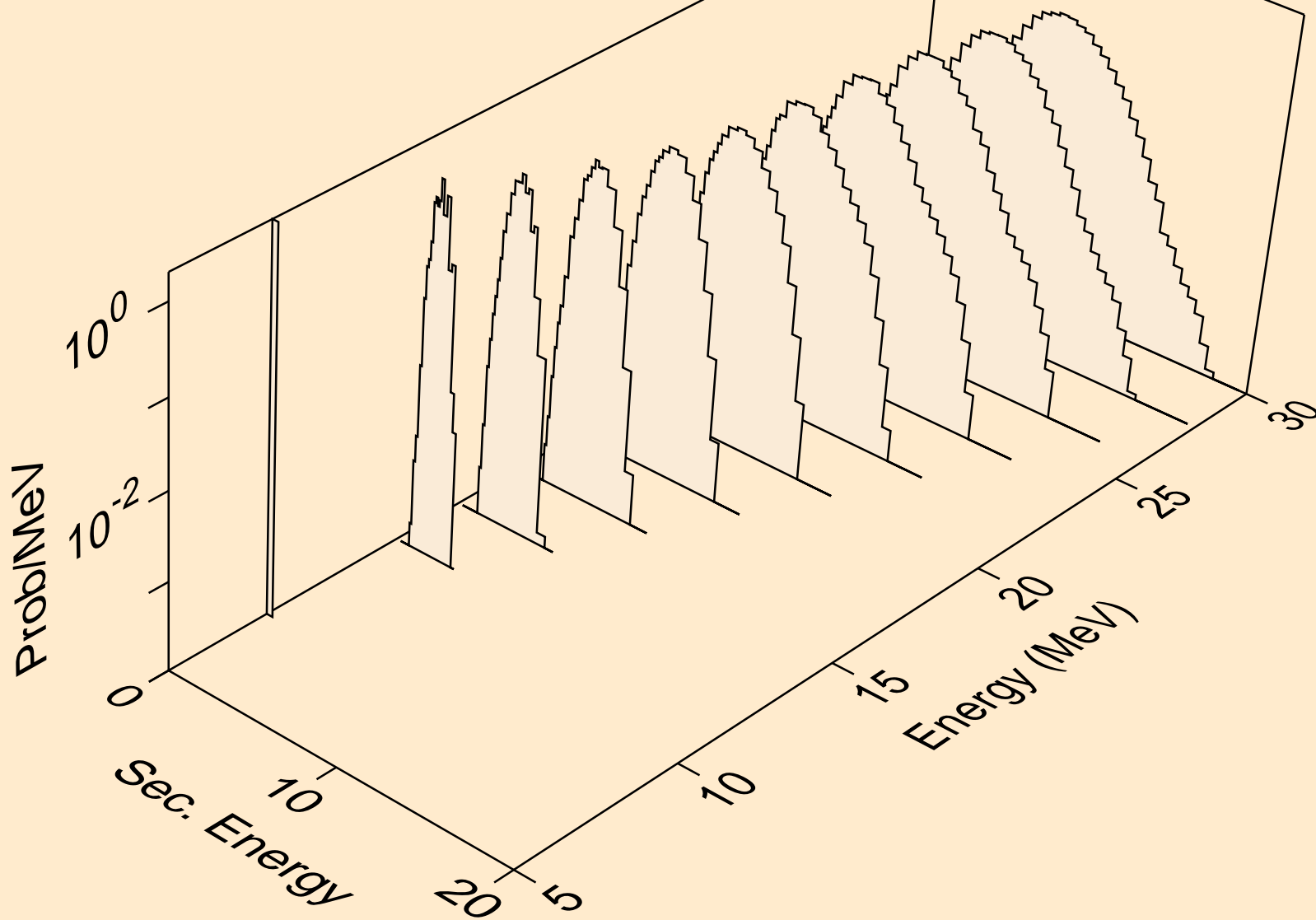

SN117M NEUTRON ACER TENDL-2019 LIBRARY; T=293.16K  
protons from (n,p)

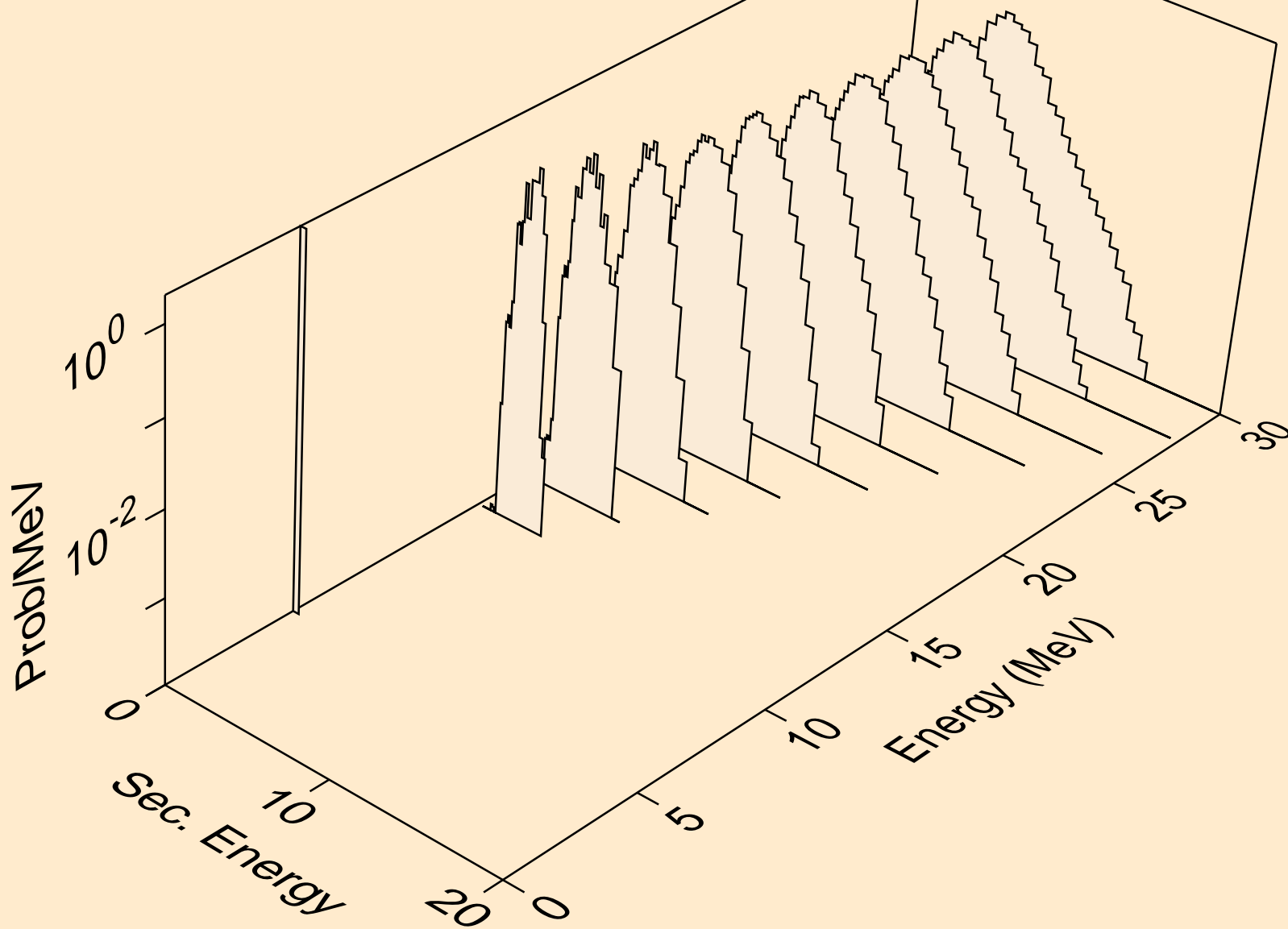

SN117M NEUTRON ACER TENDL-2019 LIBRARY; T=293.16K  
protons from (n,pd)

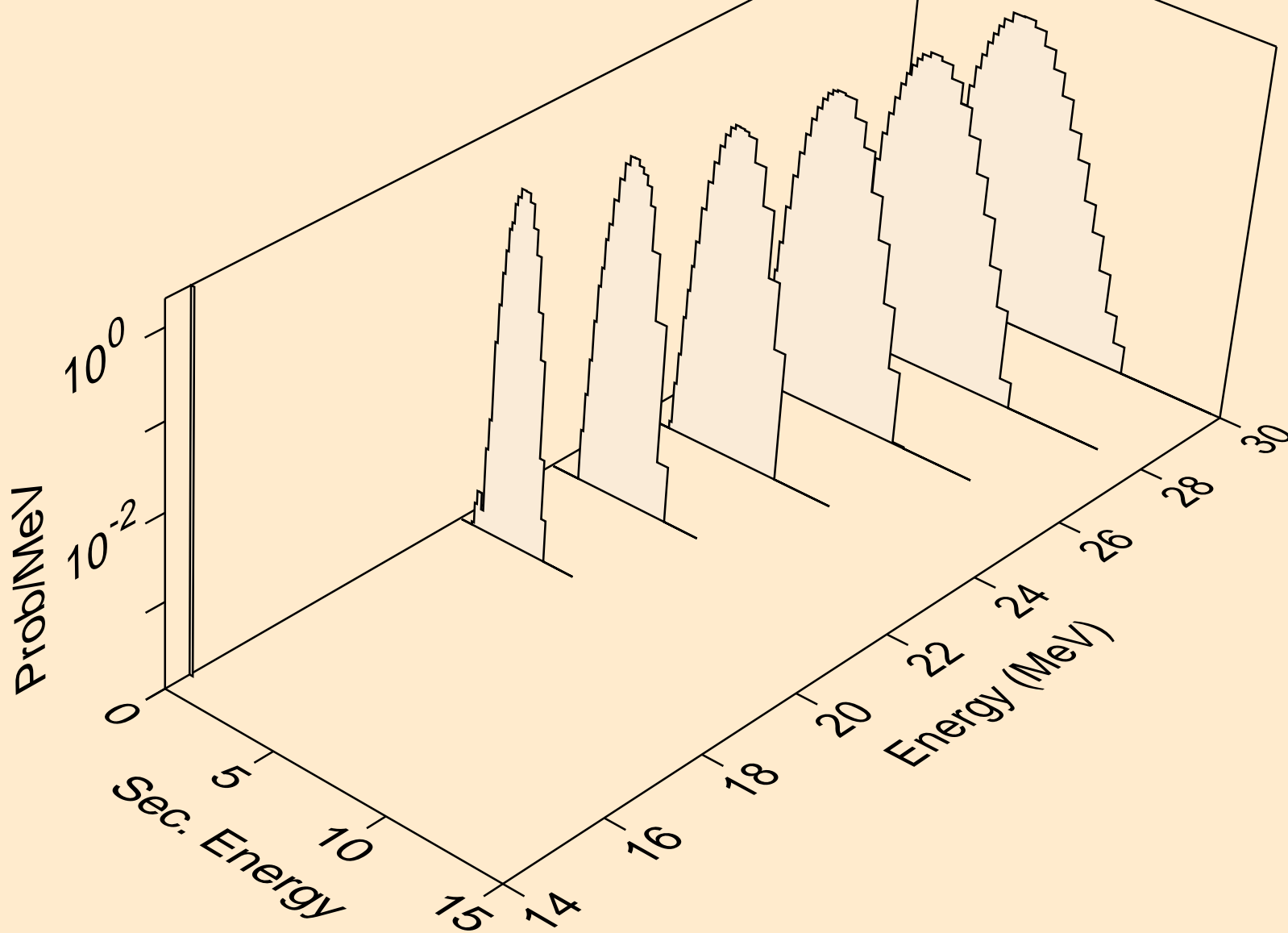



SN117M NEUTRON ACER TENDL-2019 LIBRARY; T=293.16K  
protons from (n,pt)

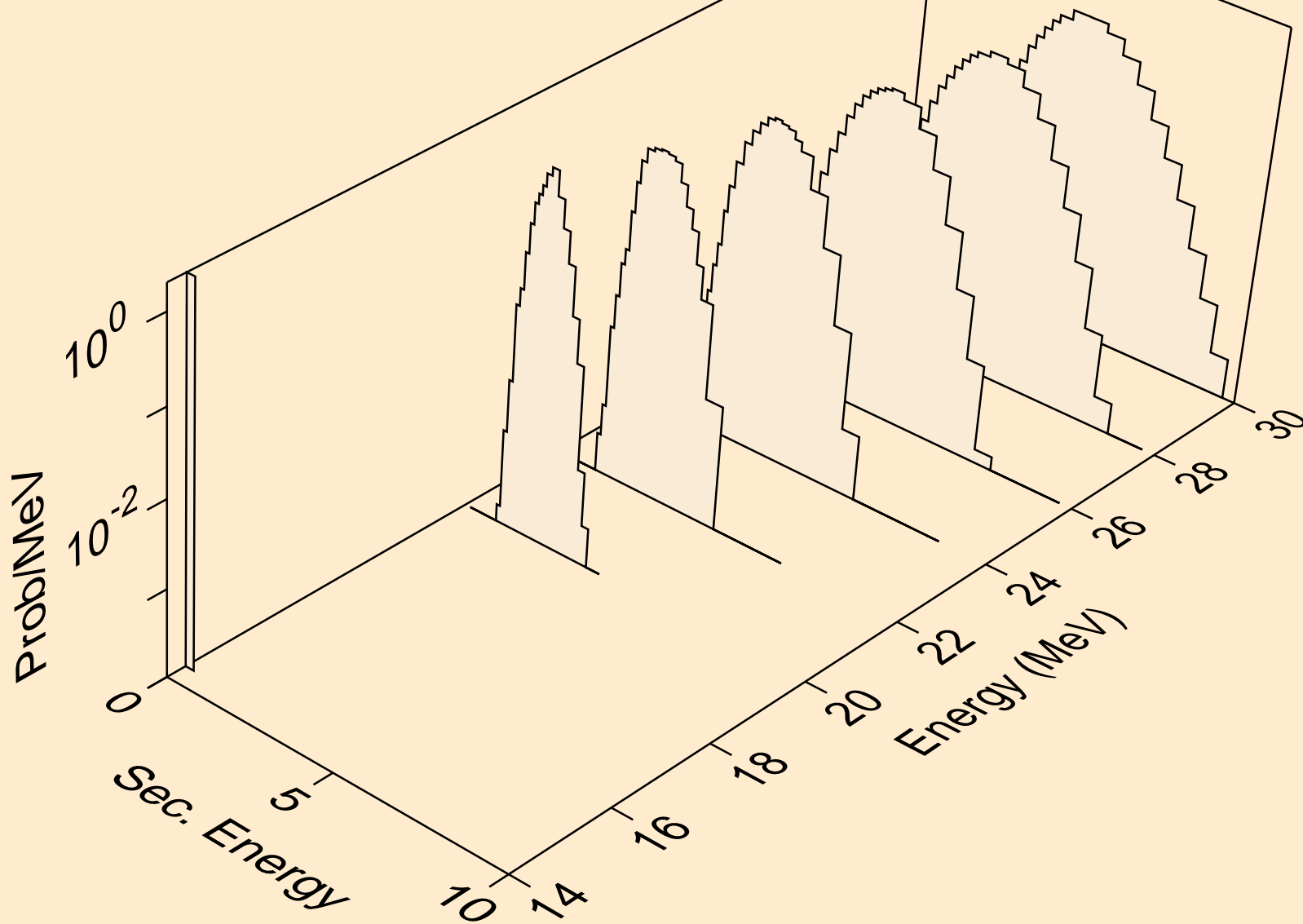

SN117M NEUTRON ACER TENDL-2019 LIBRARY; T=293.16K  
deuterons from (n,x)

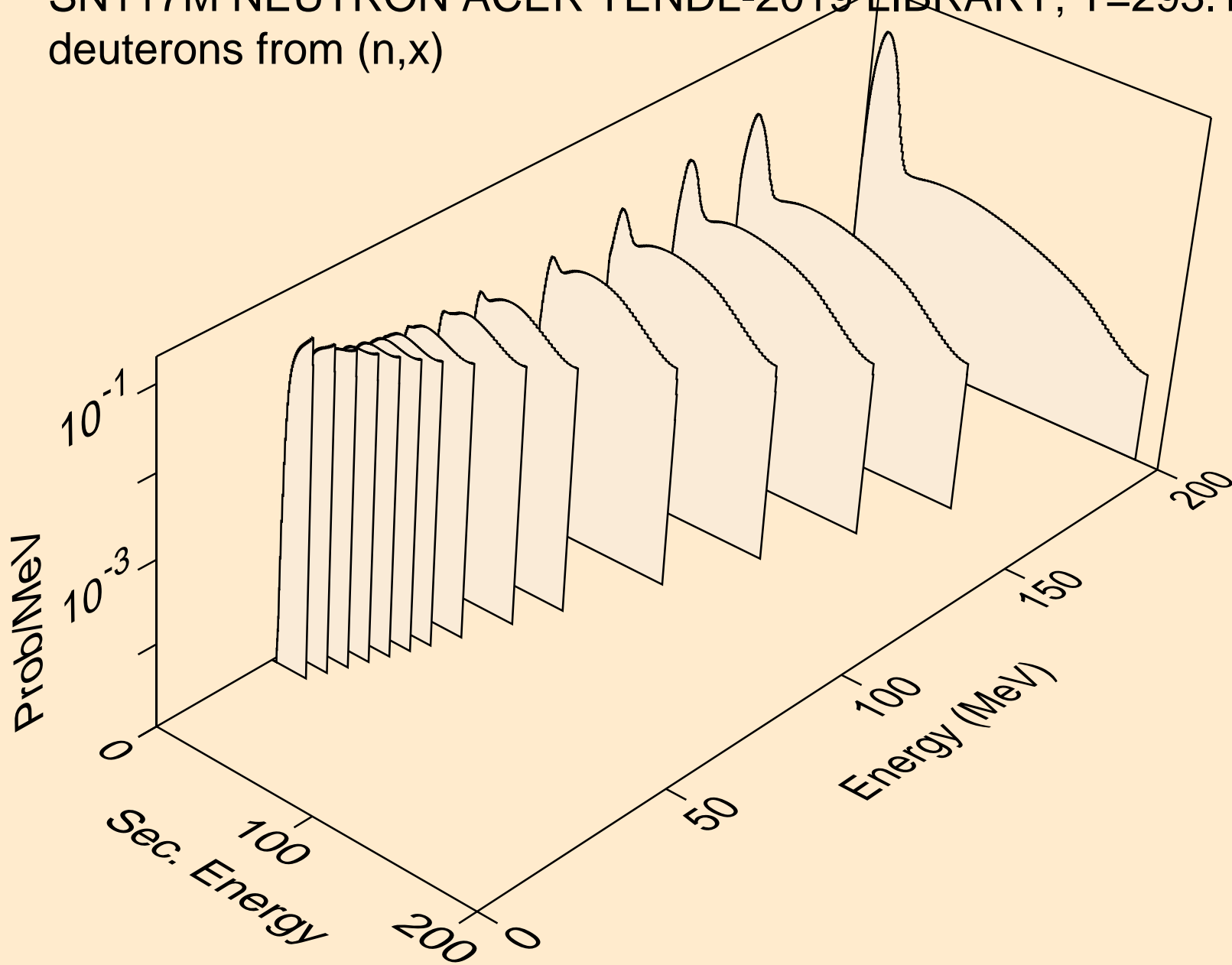

SN117M NEUTRON ACER TENDL-2019 LIBRARY; T=293.16K  
deuterons from (n,2nd)

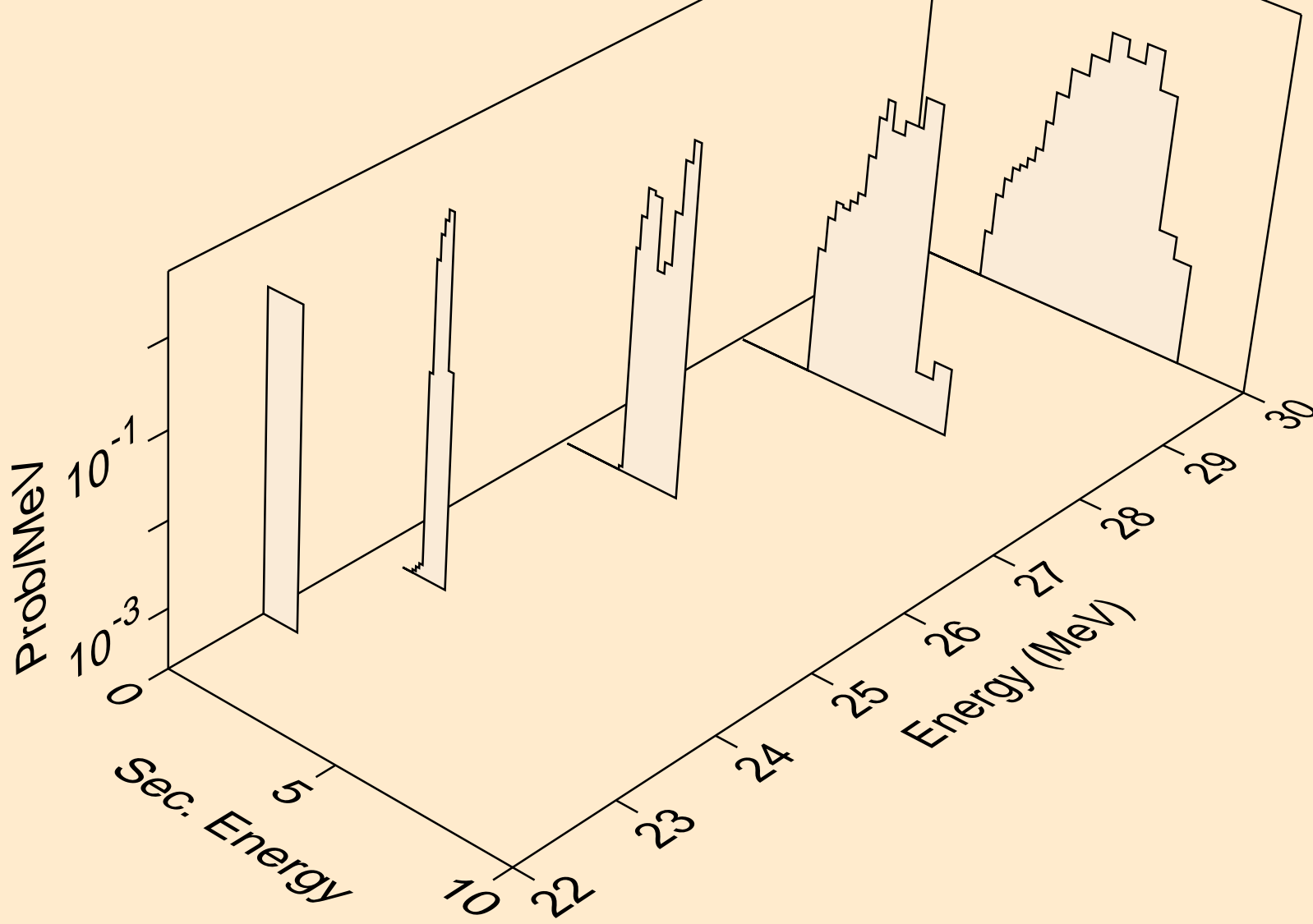

SN117M NEUTRON ACER TENDL-2019 LIBRARY; T=293.16K  
deuterons from (n,n\*)d

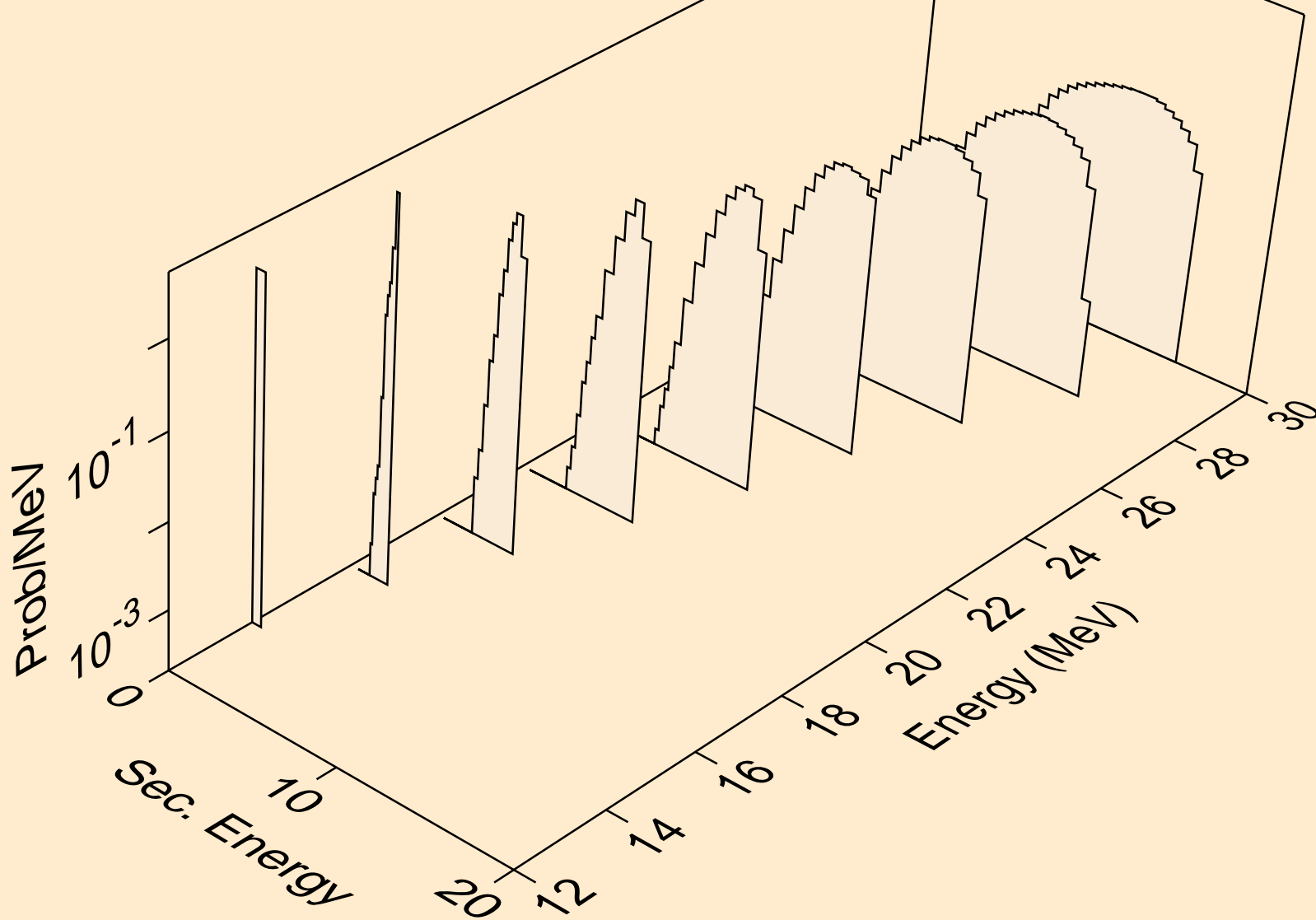

SN117M NEUTRON ACER TENDL-2019 LIBRARY; T=293.16K  
deuterons from (n,d)

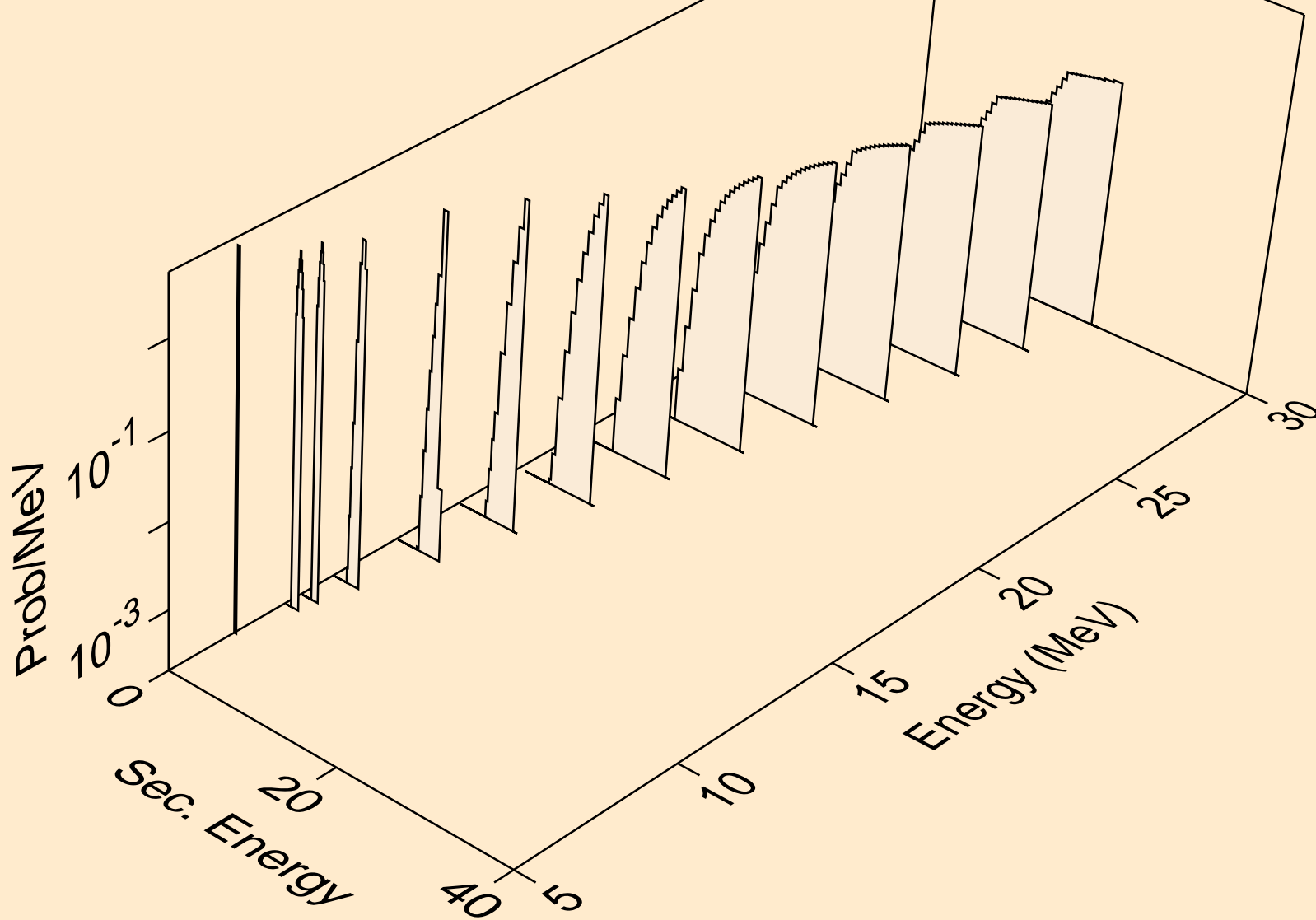

SN117M NEUTRON ACER TENDL-2019 LIBRARY; T=293.16K  
deuterons from (n,pd)

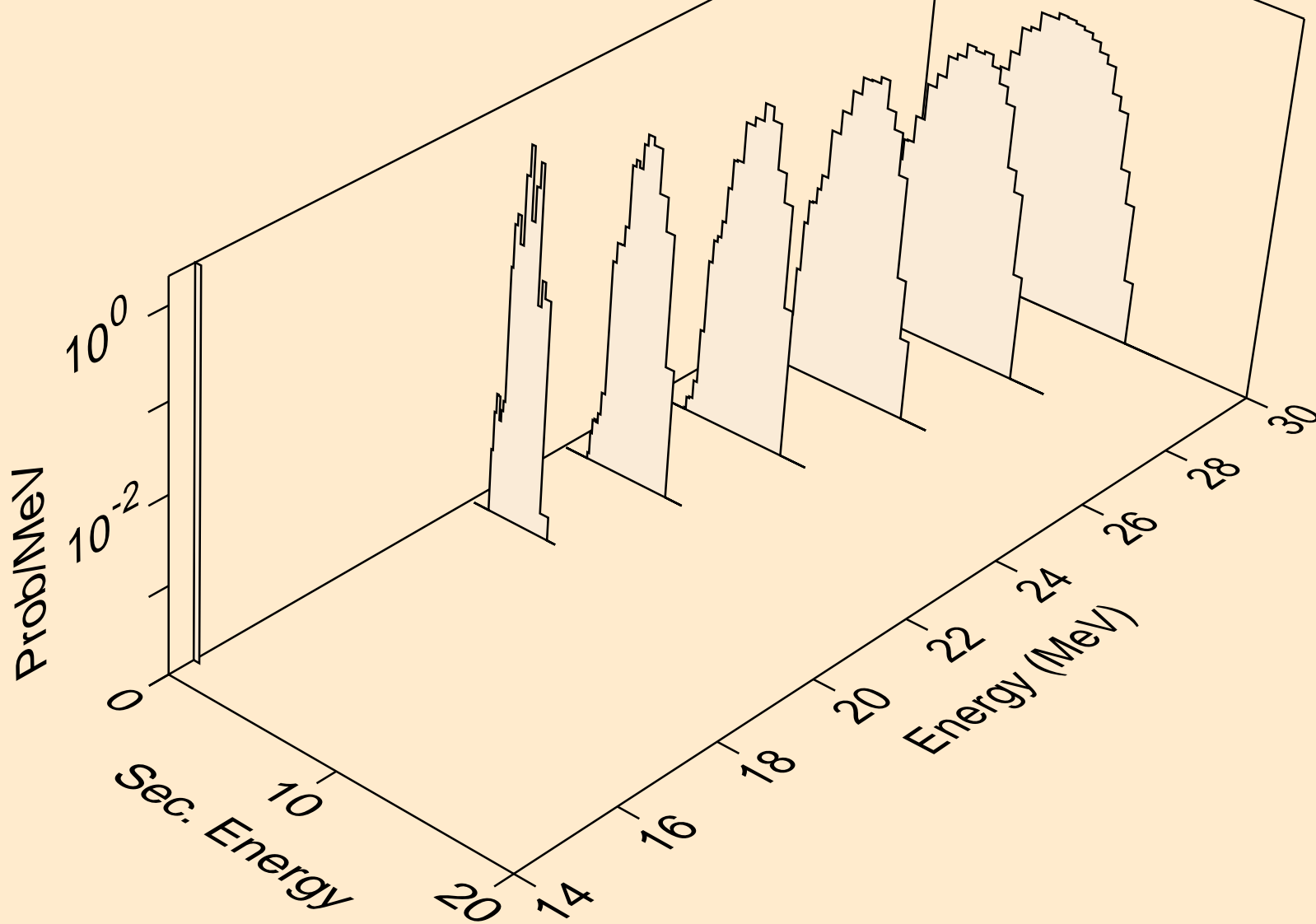

SN117M NEUTRON ACER TENDL-2019 LIBRARY; T=293.16K  
tritons from (n,x)

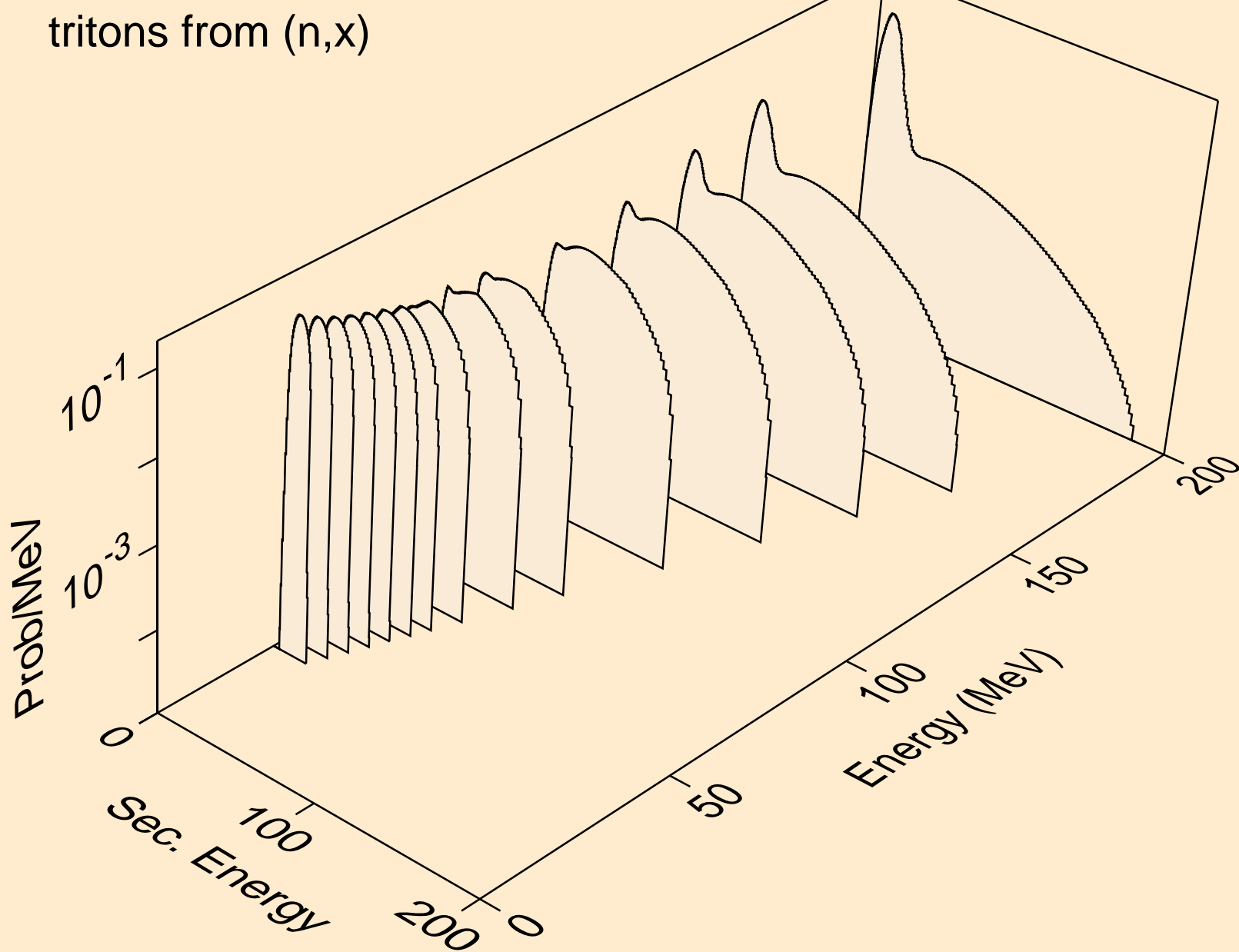

SN117M NEUTRON ACER TENDL-2019 LIBRARY; T=293.16K  
tritons from (n,n\*)t

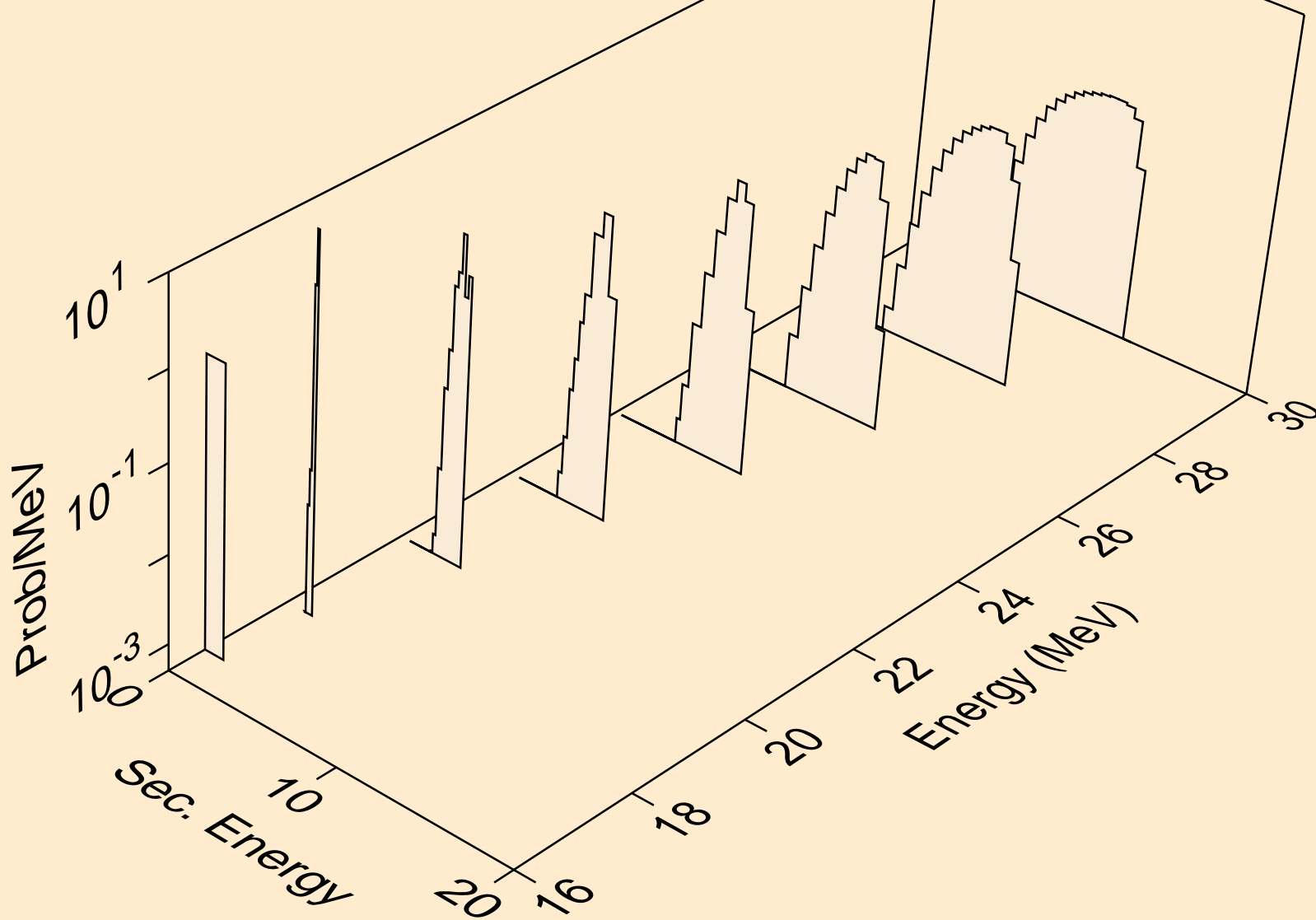



SN117M NEUTRON ACER TENDL-2019 LIBRARY; T=293.16K  
tritons from (n,t)

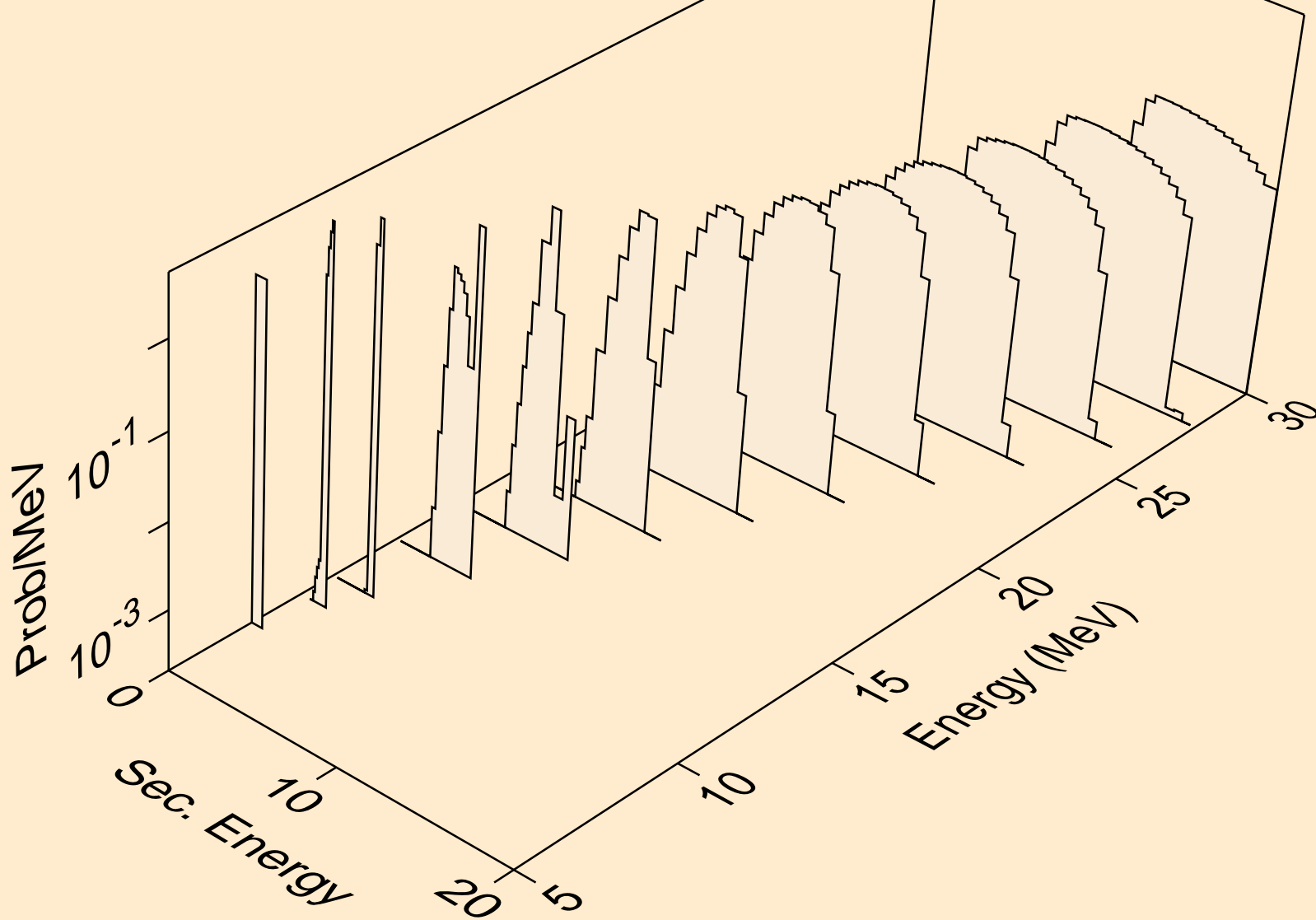

SN117M NEUTRON ACER TENDL-2019 LIBRARY; T=293.16K  
tritons from (n,pt)

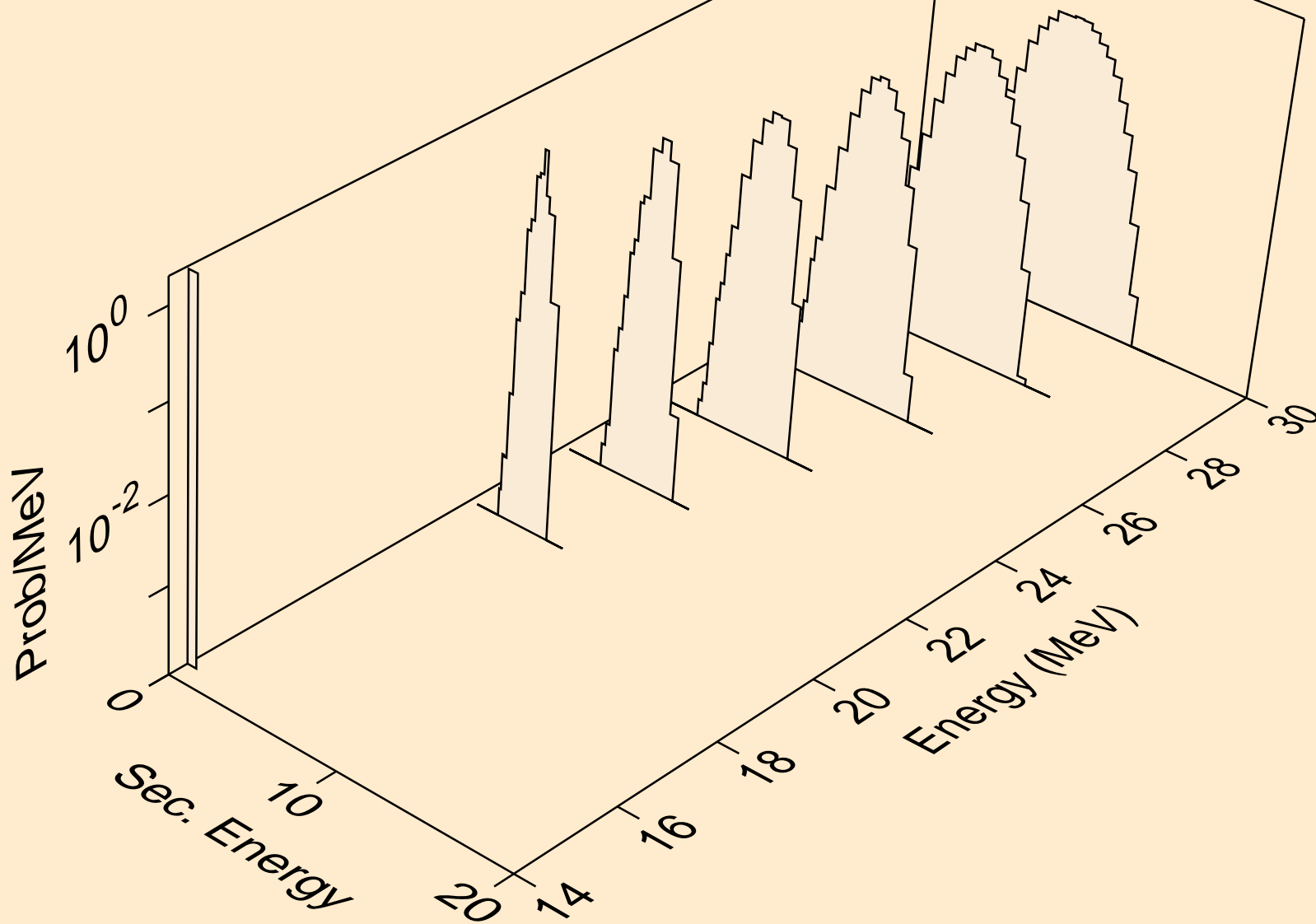

SN117M NEUTRON ACER TENDL-2019 LIBRARY; T=293.16K  
he3s from (n,x)

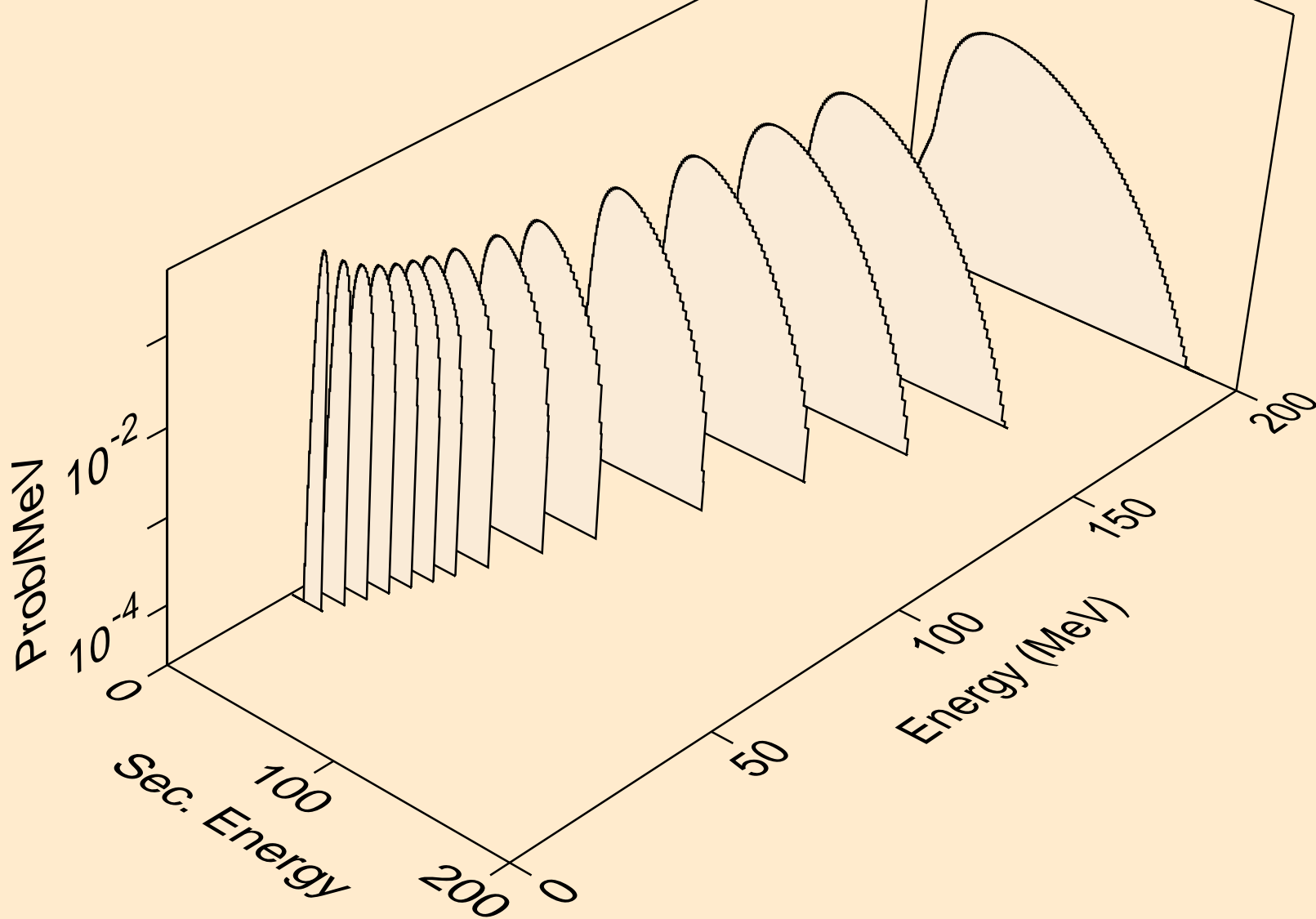

SN117M NEUTRON ACER TENDL-2019 LIBRARY; T=293.16K  
he3s from (n,n\*)he3

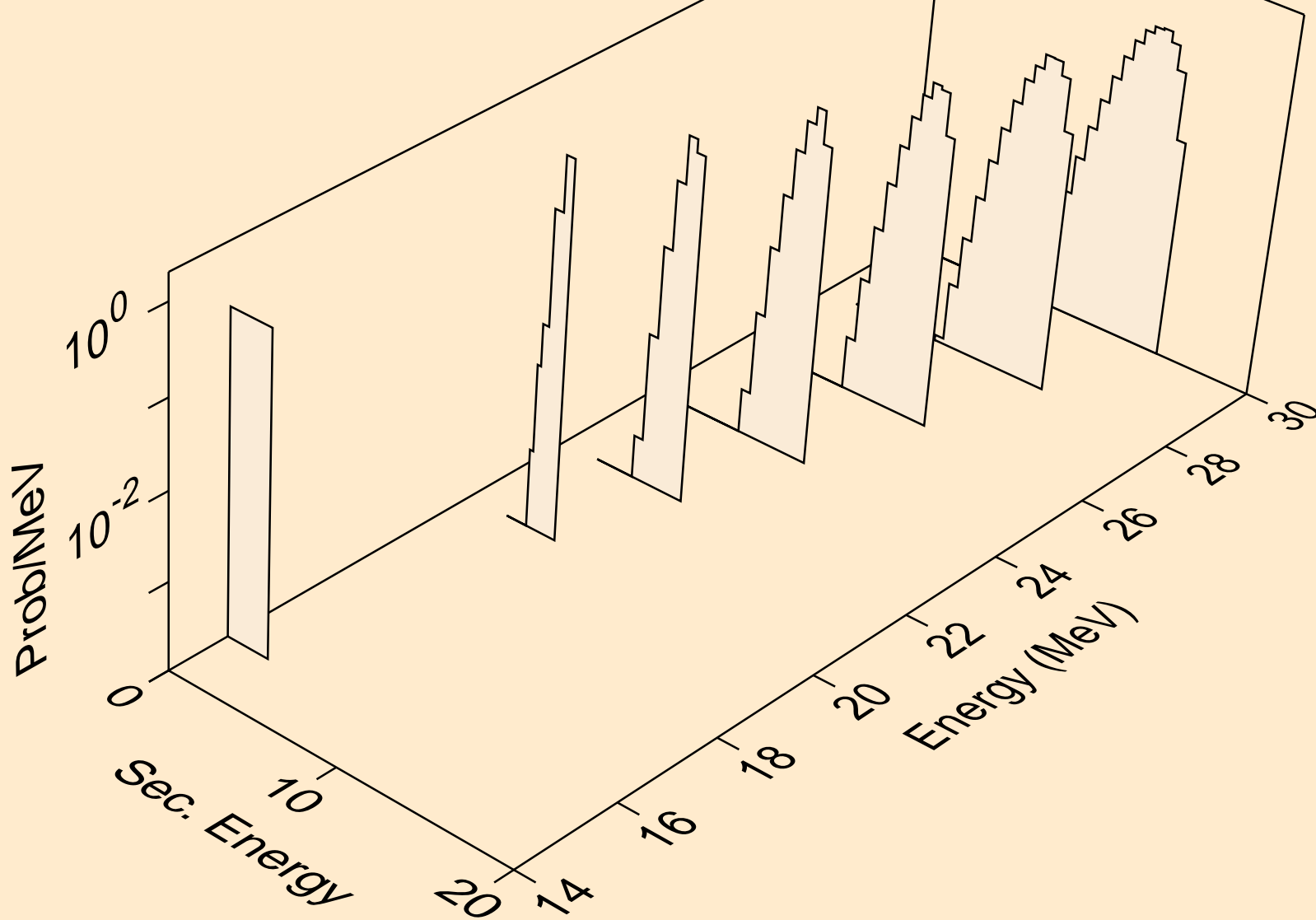

SN117M NEUTRON ACER TENDL-2019 LIBRARY; T=293.16K  
he3s from (n,he3)

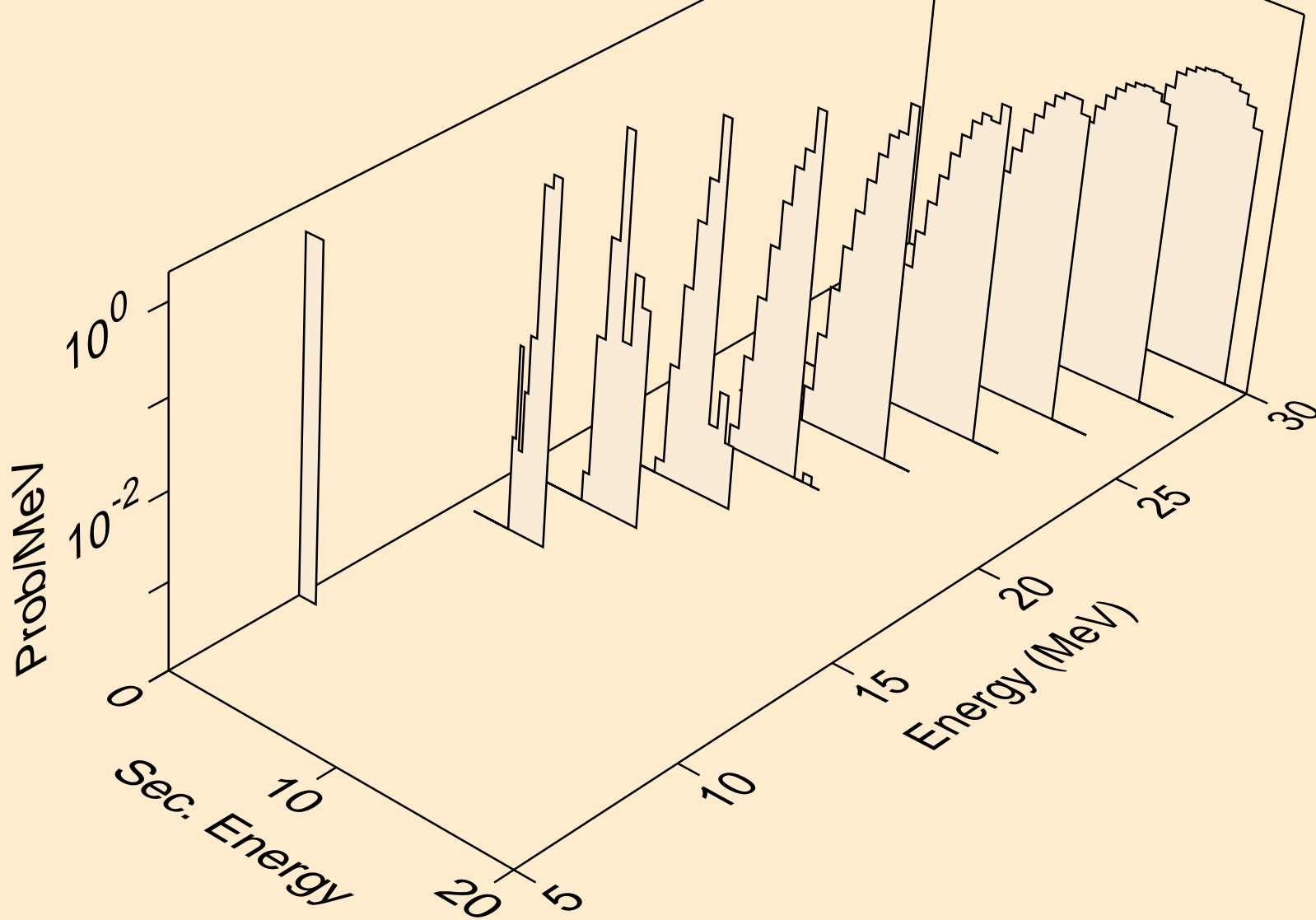

SN117M NEUTRON ACER TENDL-2019 LIBRARY; T=293.16K  
alphas from (n,x)

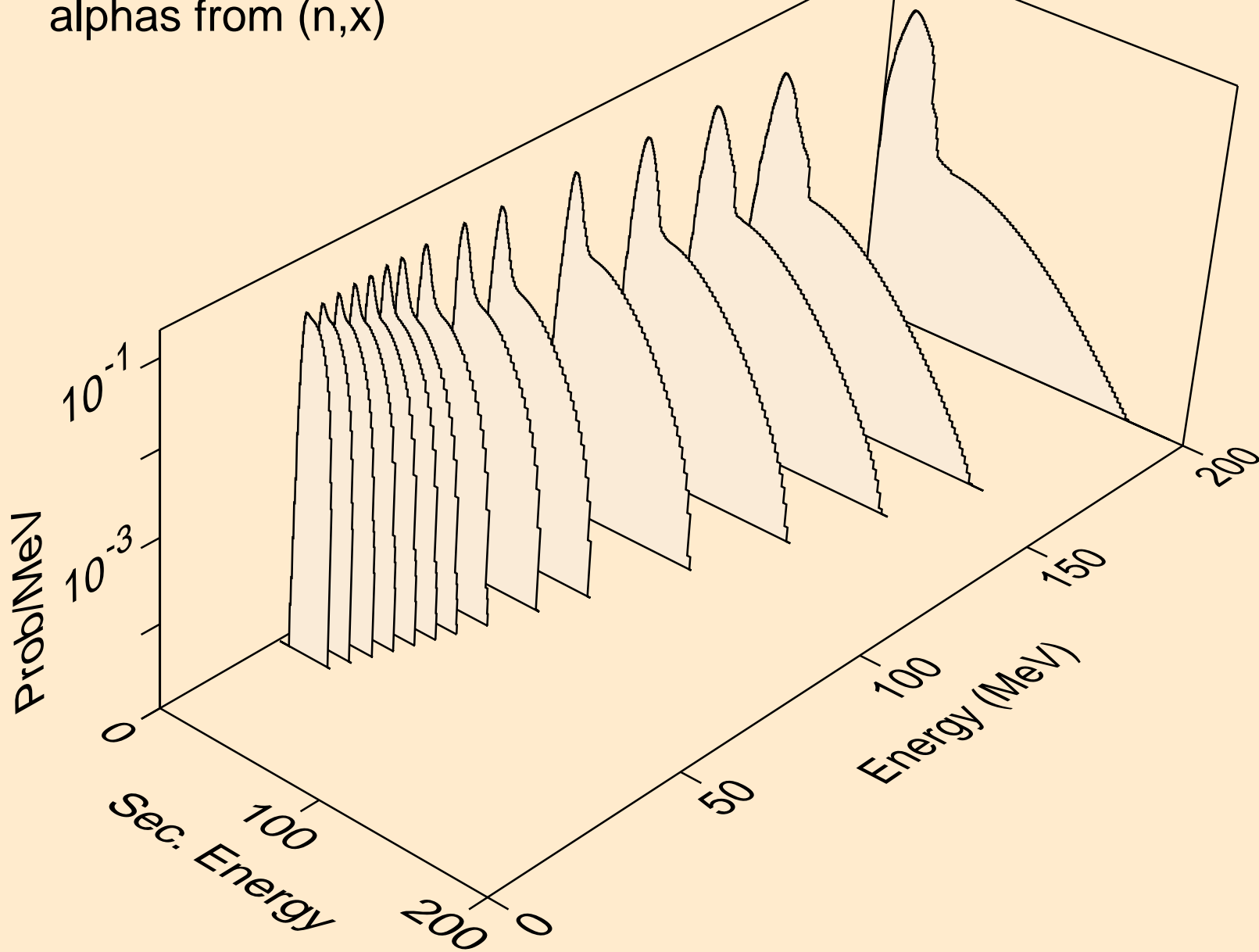

SN117M NEUTRON ACER TENDL-2019 LIBRARY; T=293.16K  
alphas from (n,n\*)a

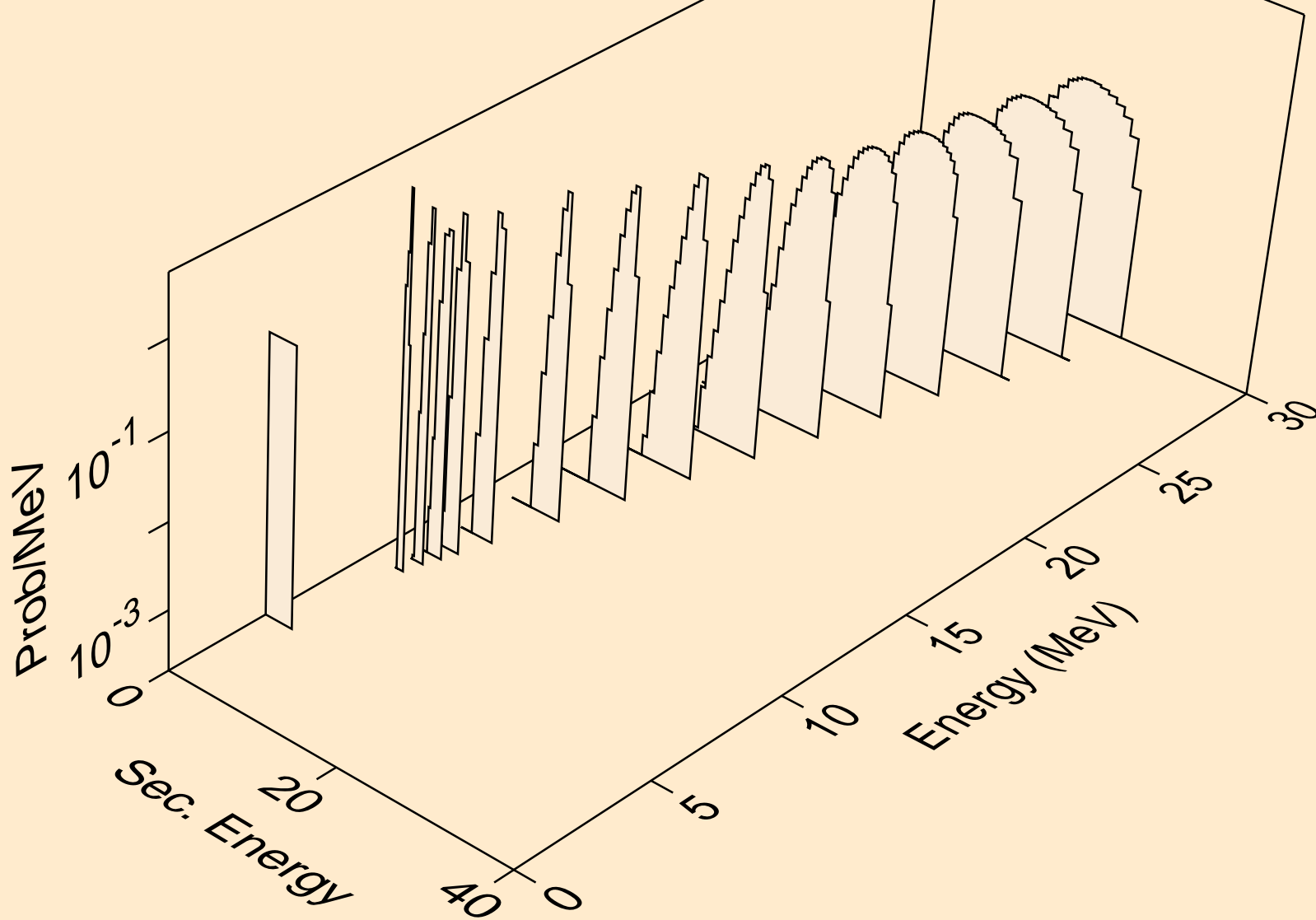

SN117M NEUTRON ACER TENDL-2019 LIBRARY; T=293.16K  
alphas from (n,2n)a

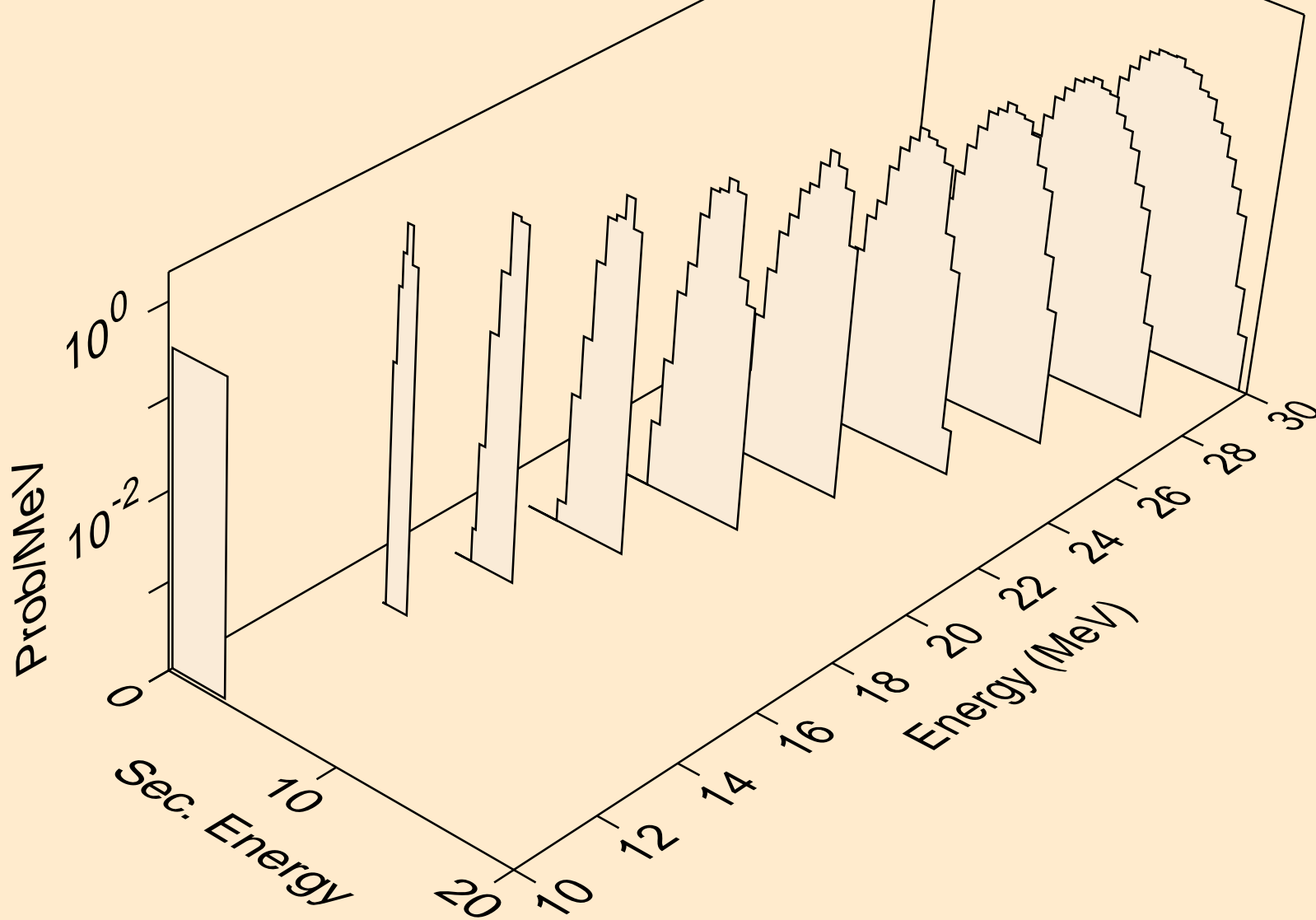



SN117M NEUTRON ACER TENDL-2019 LIBRARY; T=293.16K  
alphas from (n,3n)a

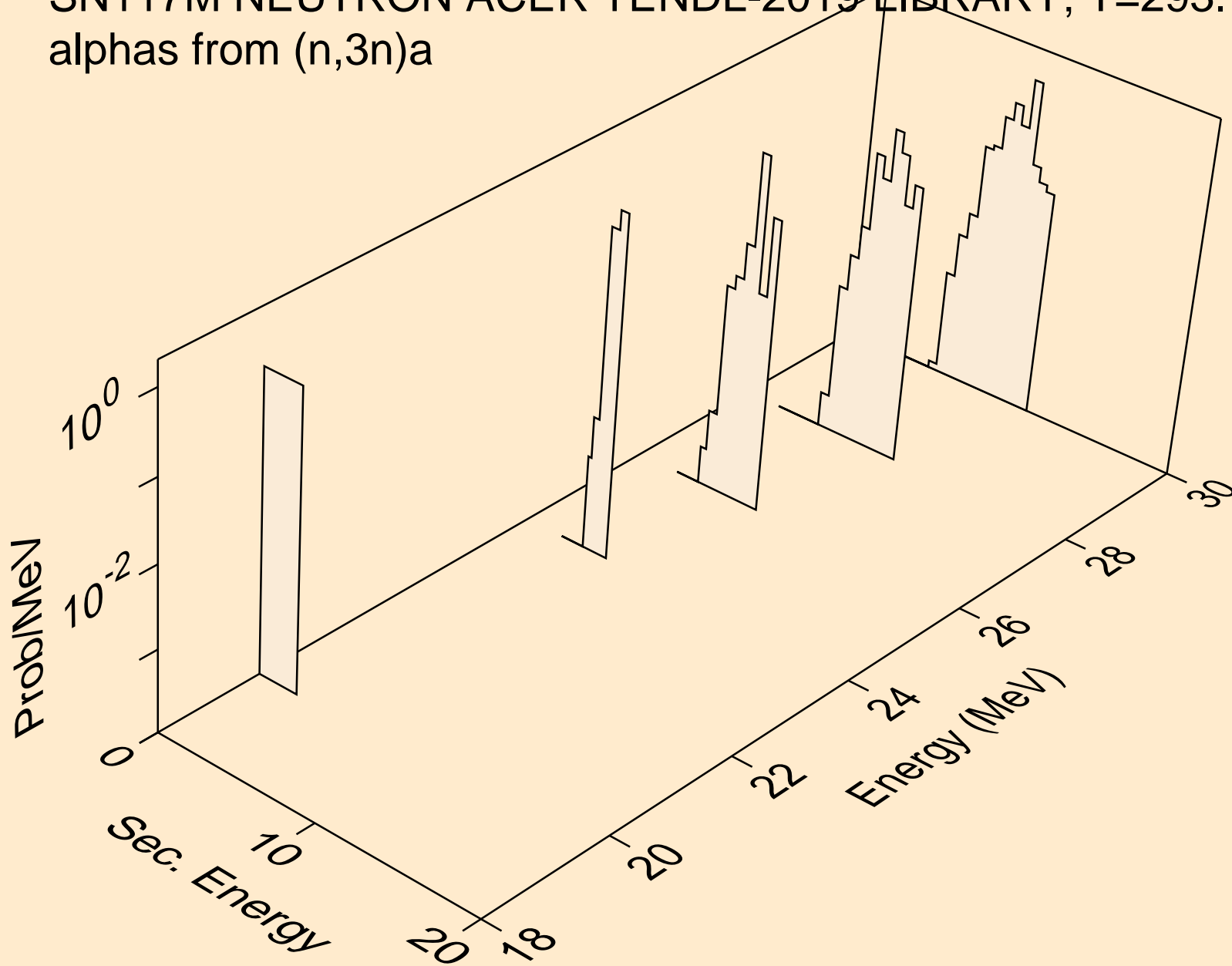

SN117M NEUTRON ACER TENDL-2019 LIBRARY; T=293.16K  
alphas from (n,n\*)2a

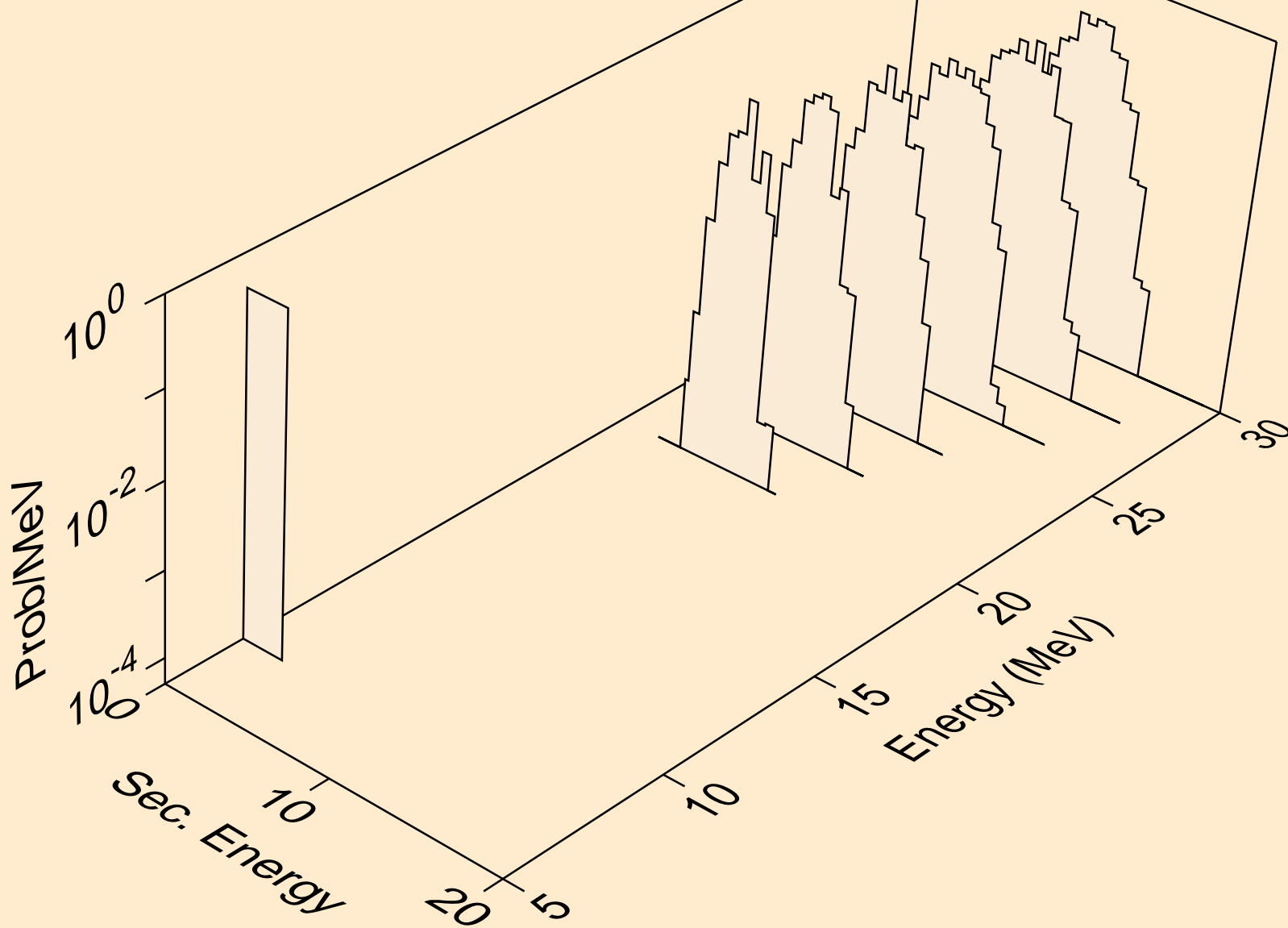

SN117M NEUTRON ACER TENDL-2019 LIBRARY; T=293.16K  
alphas from (n,npa)

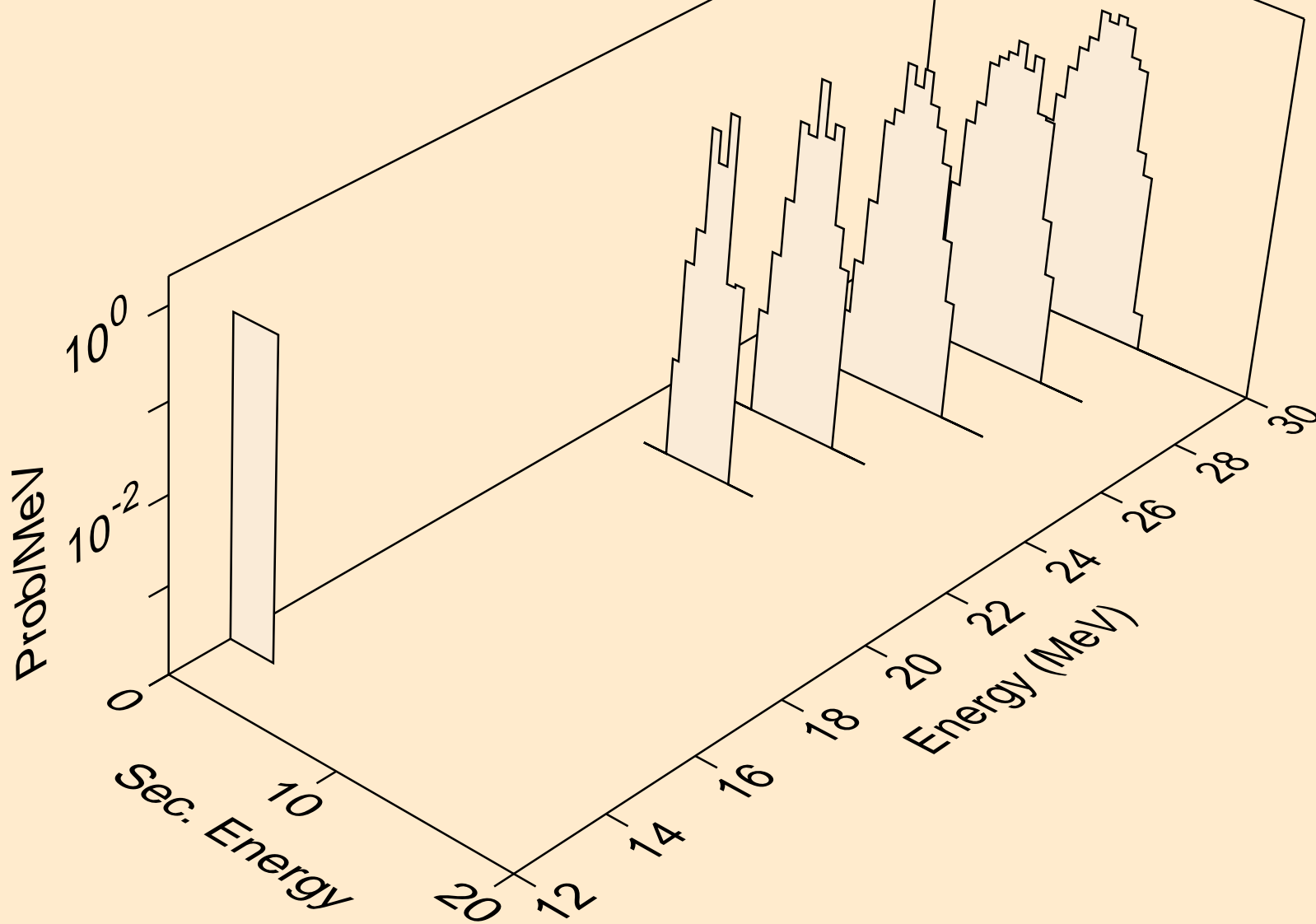

SN117M NEUTRON ACER TENDL-2019 LIBRARY; T=293.16K  
alphas from (n,a)

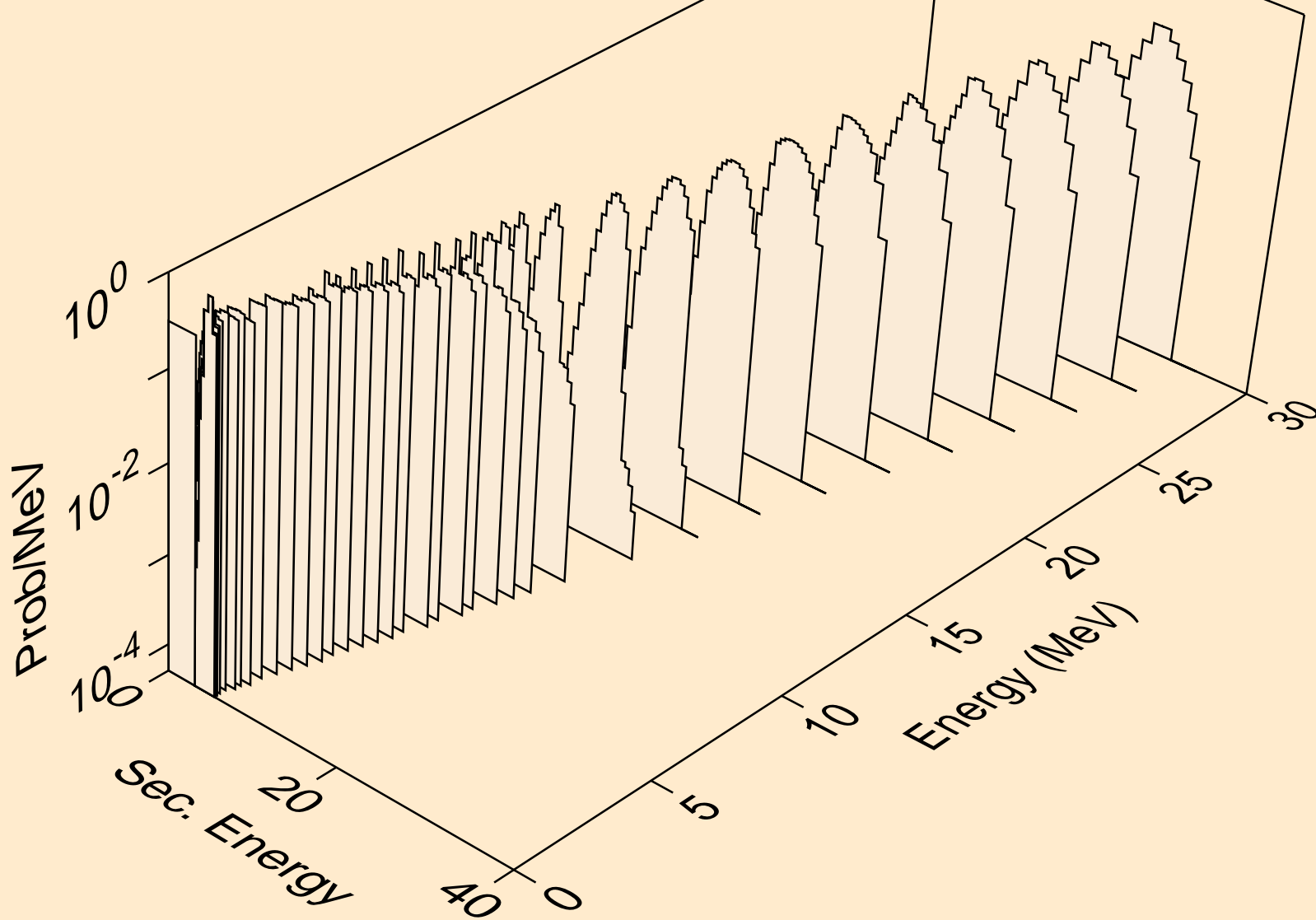

SN117M NEUTRON ACER TENDL-2019 LIBRARY; T=293.16K  
alphas from (n,2a)

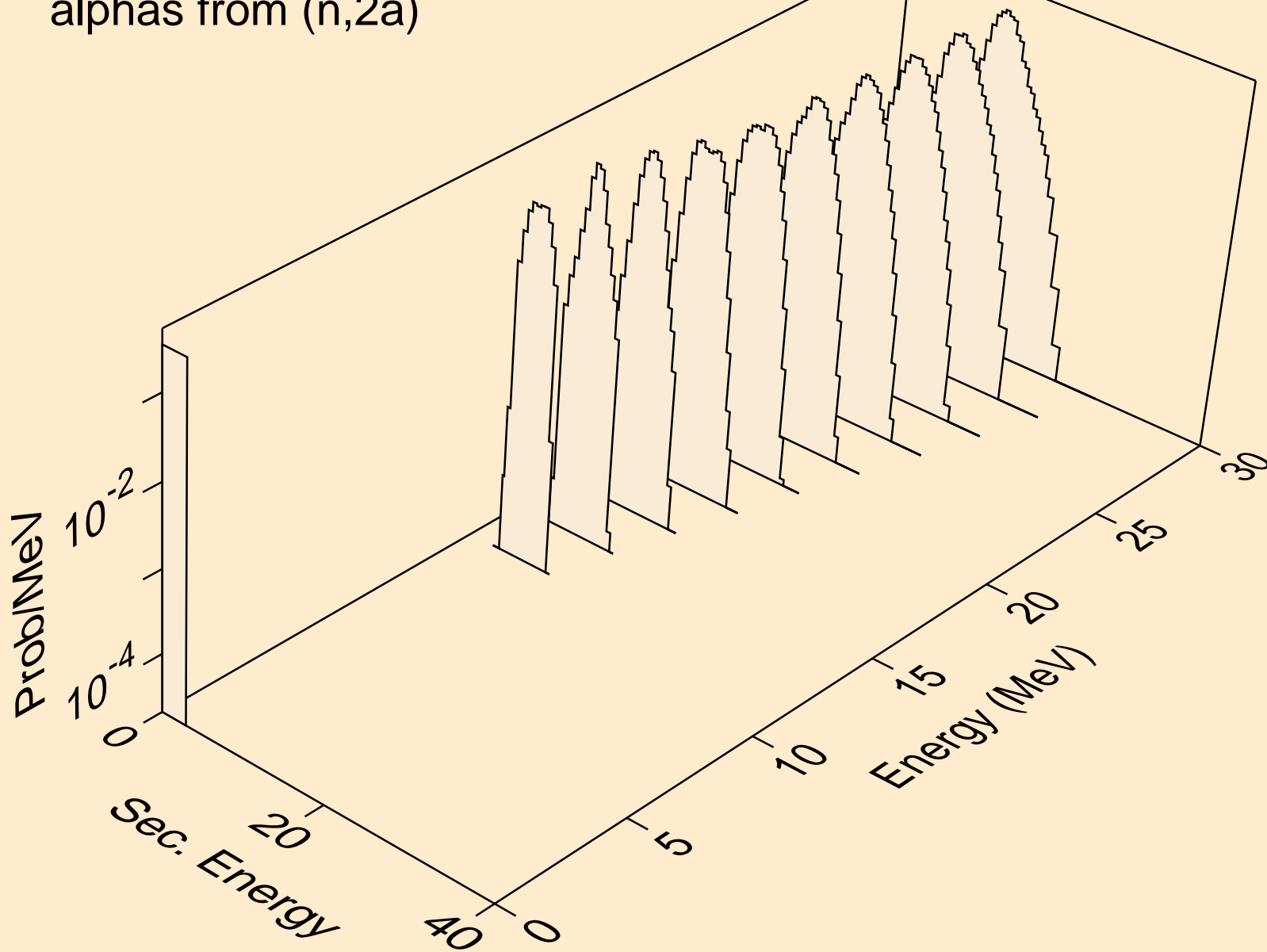

SN117M NEUTRON ACER TENDL-2019 LIBRARY; T=293.16K  
alphas from (n,pa)

