

# SN121 NEUTRON ACER TENDL-2019 LIBRARY; T=293.16K

## Principal cross sections

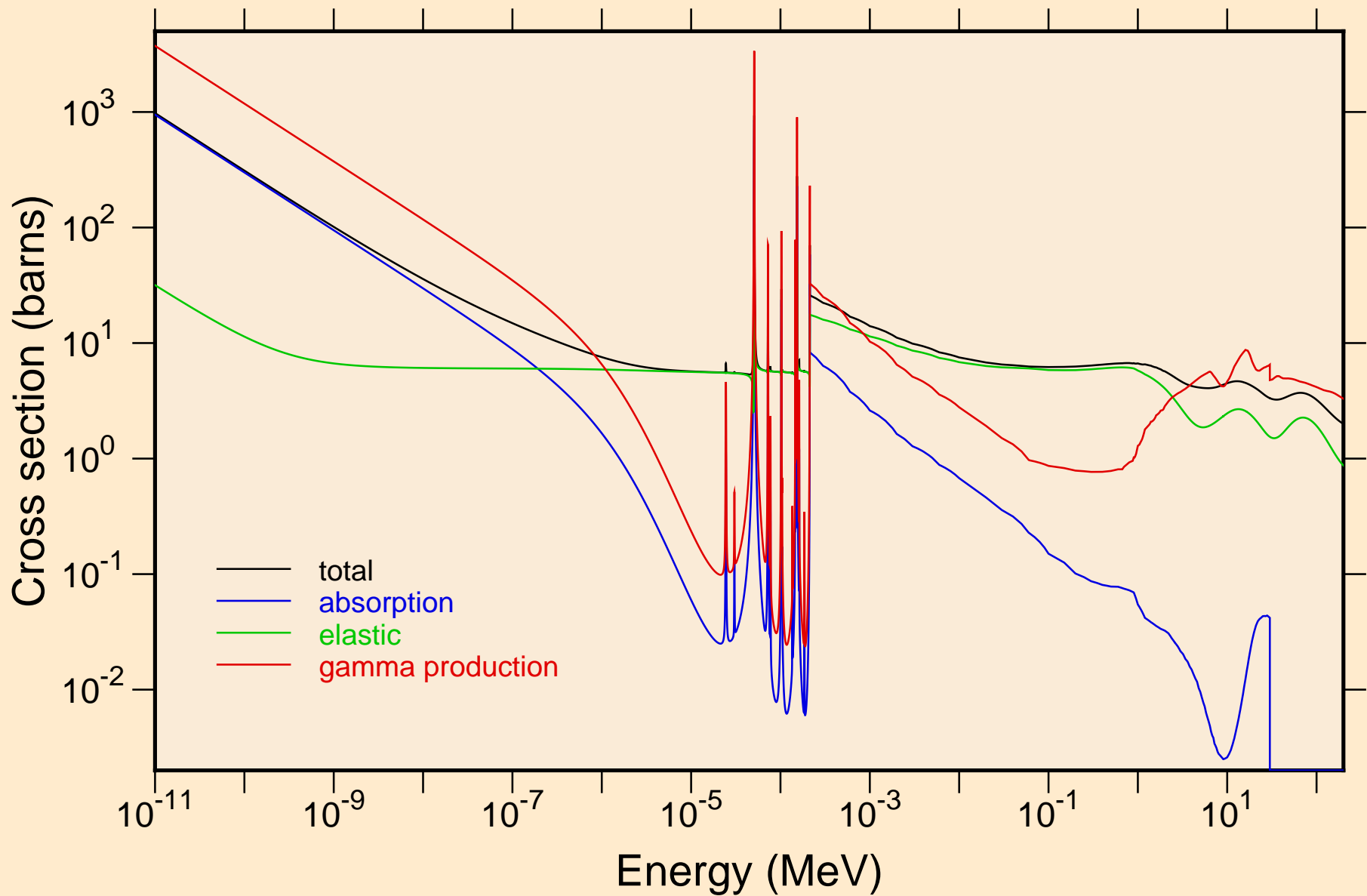

SN121 NEUTRON ACER TENDL-2019 LIBRARY; T=293.16K  
resonance total cross section

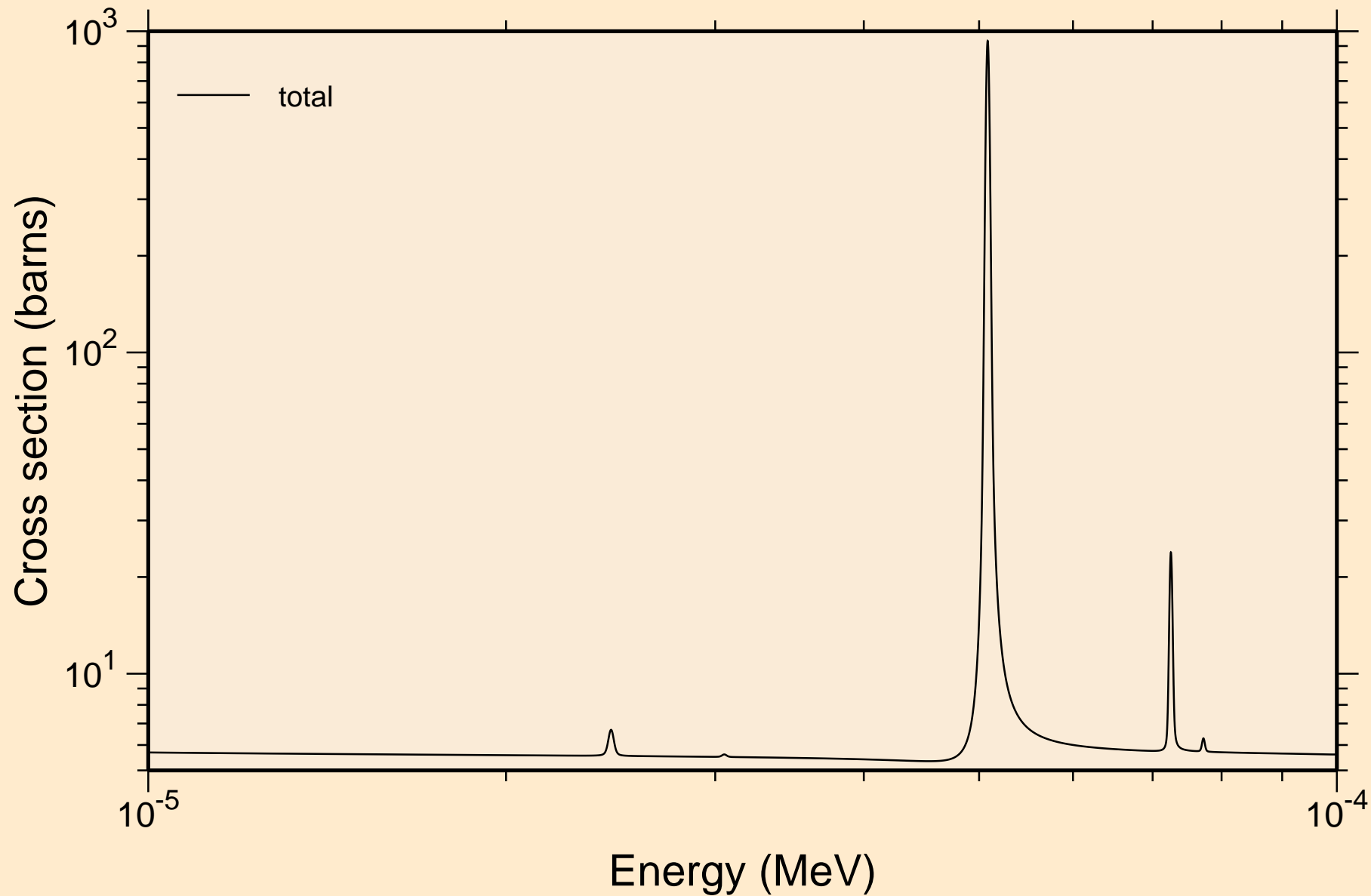

SN121 NEUTRON ACER TENDL-2019 LIBRARY; T=293.16K  
resonance total cross section

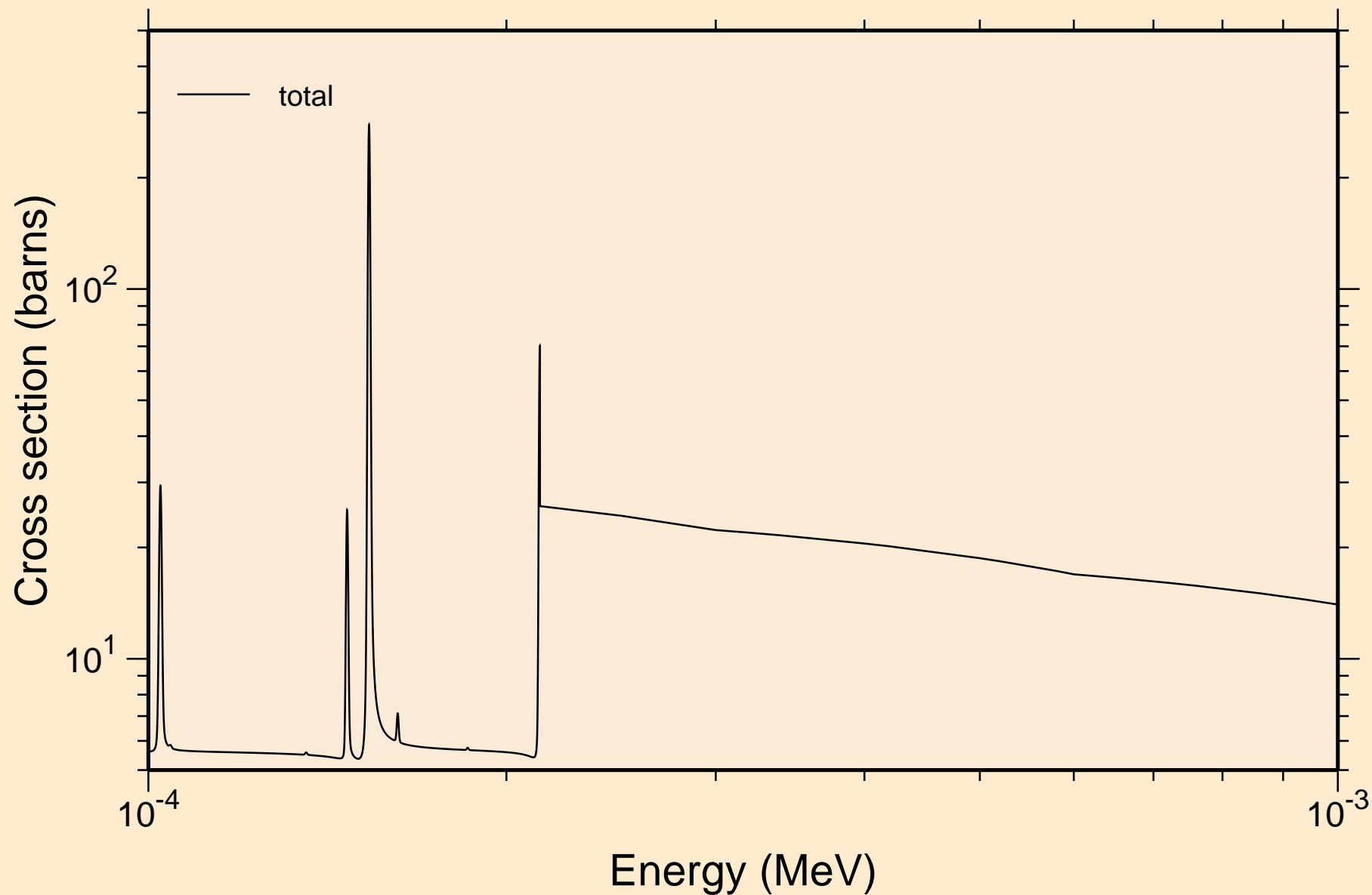

SN121 NEUTRON ACER TENDL-2019 LIBRARY; T=293.16K  
resonance total cross section

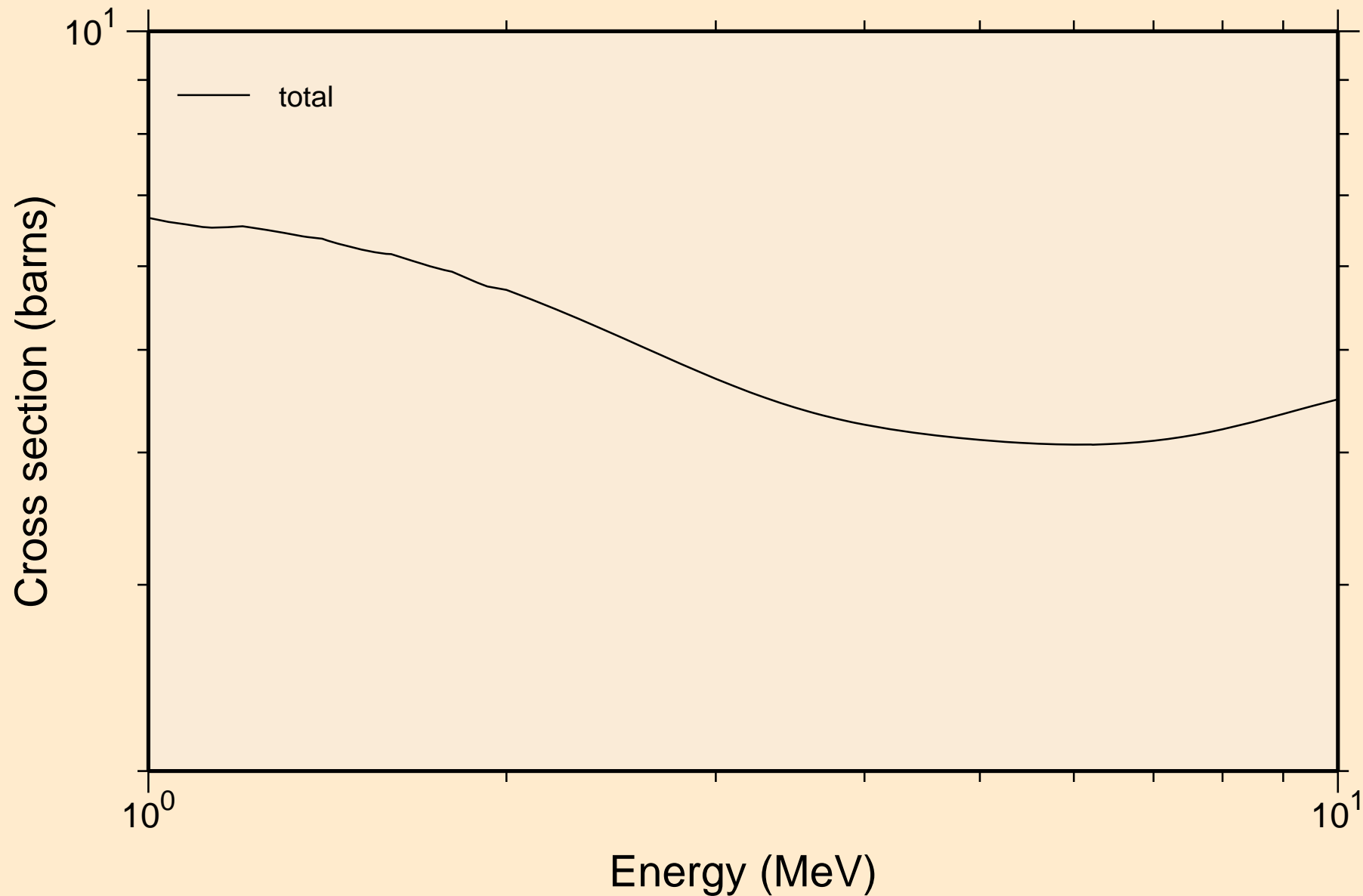

SN121 NEUTRON ACER TENDL-2019 LIBRARY; T=293.16K  
resonance absorption cross sections

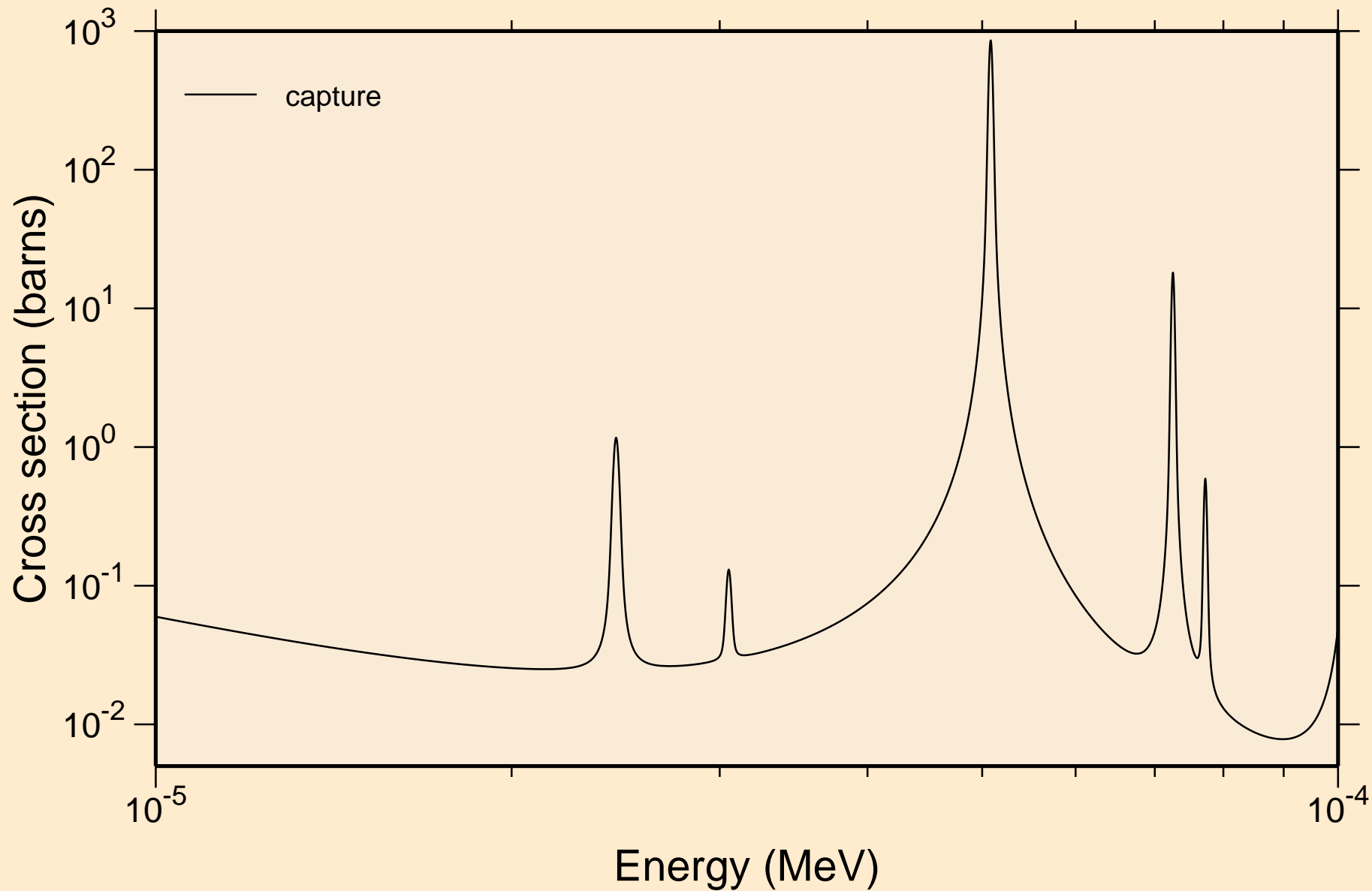

SN121 NEUTRON ACER TENDL-2019 LIBRARY; T=293.16K  
resonance absorption cross sections

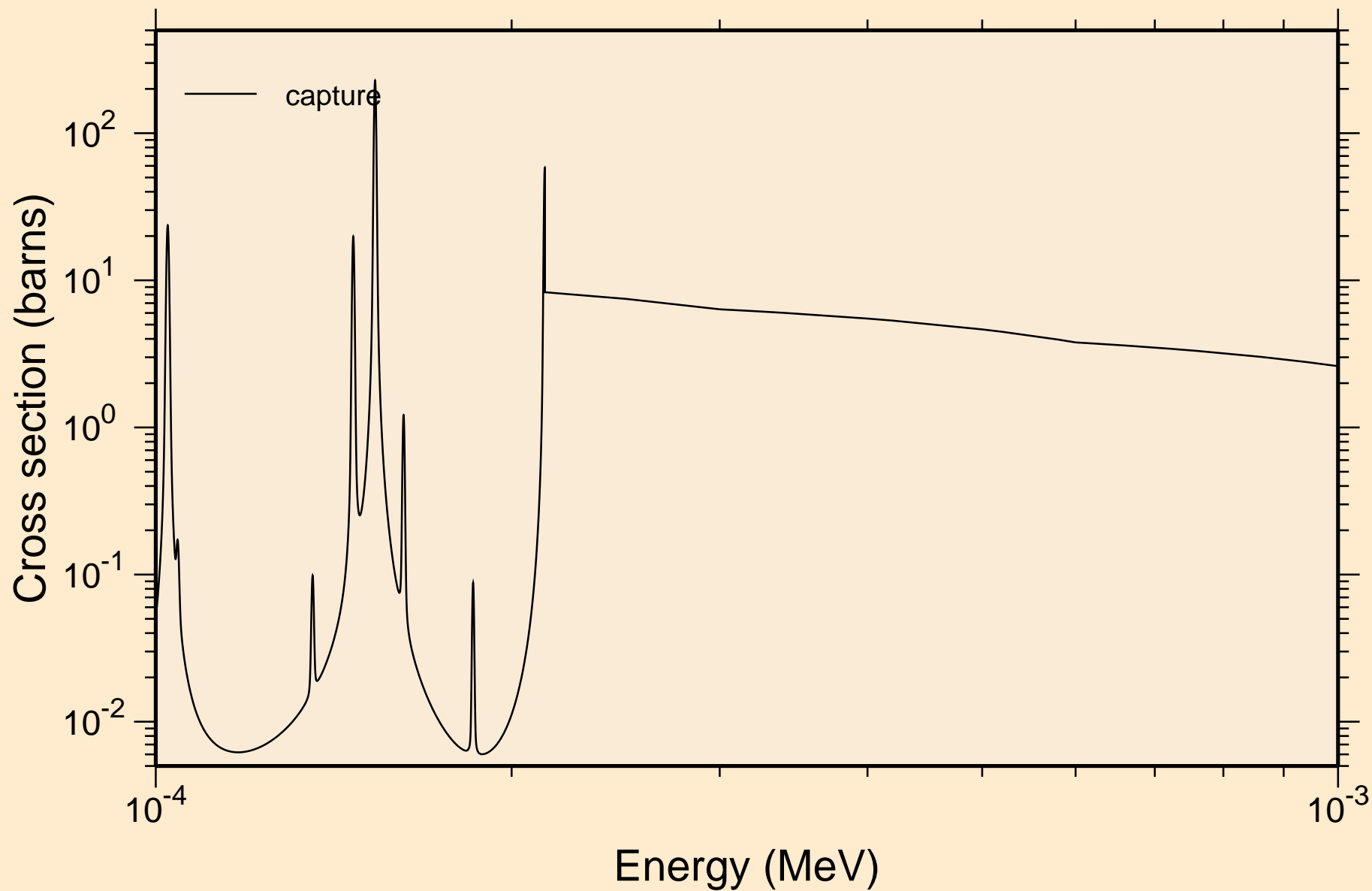

SN121 NEUTRON ACER TENDL-2019 LIBRARY; T=293.16K  
resonance absorption cross sections

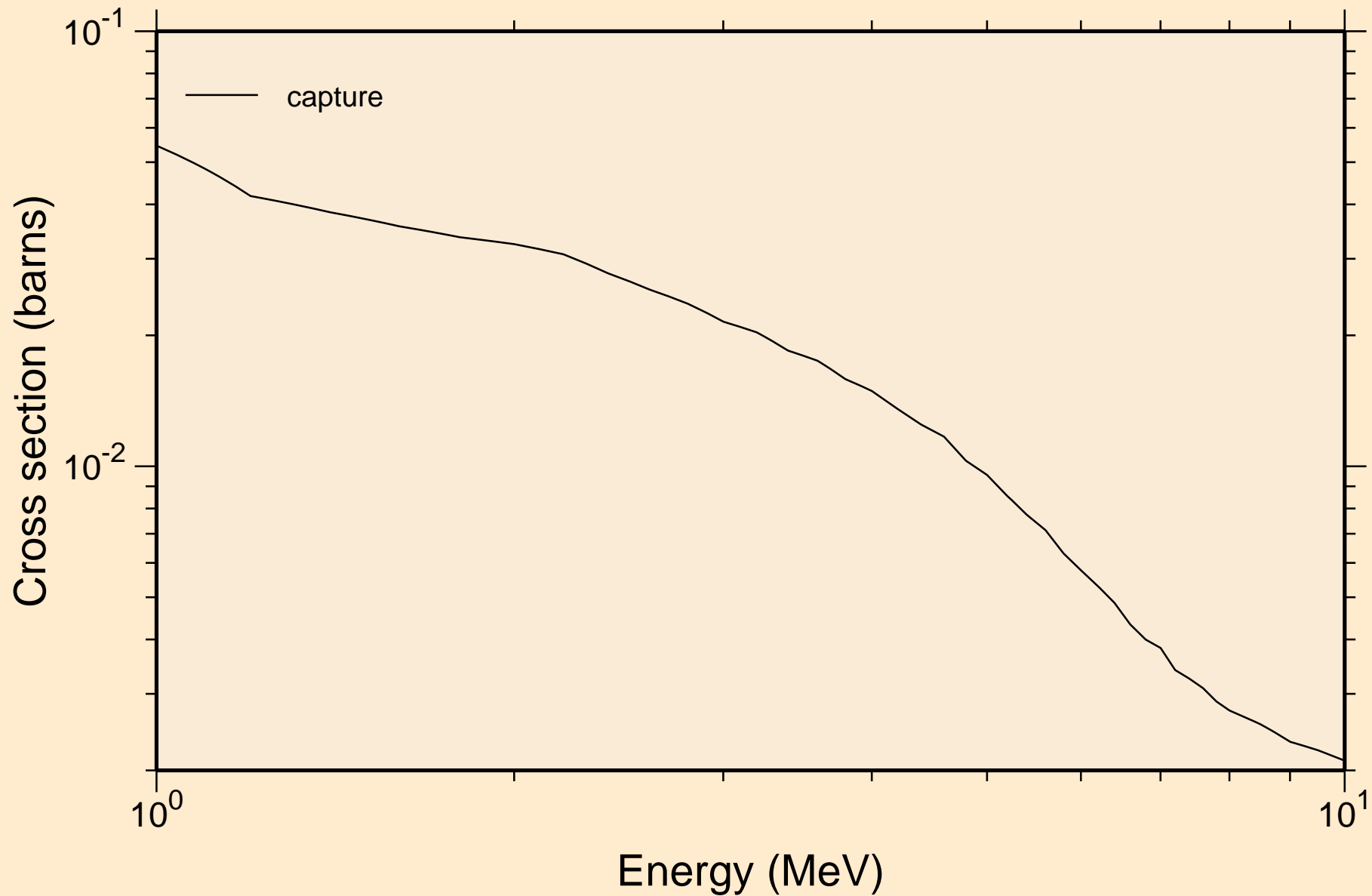

SN121 NEUTRON ACER TENDL-2019 LIBRARY; T=293.16K  
Heating

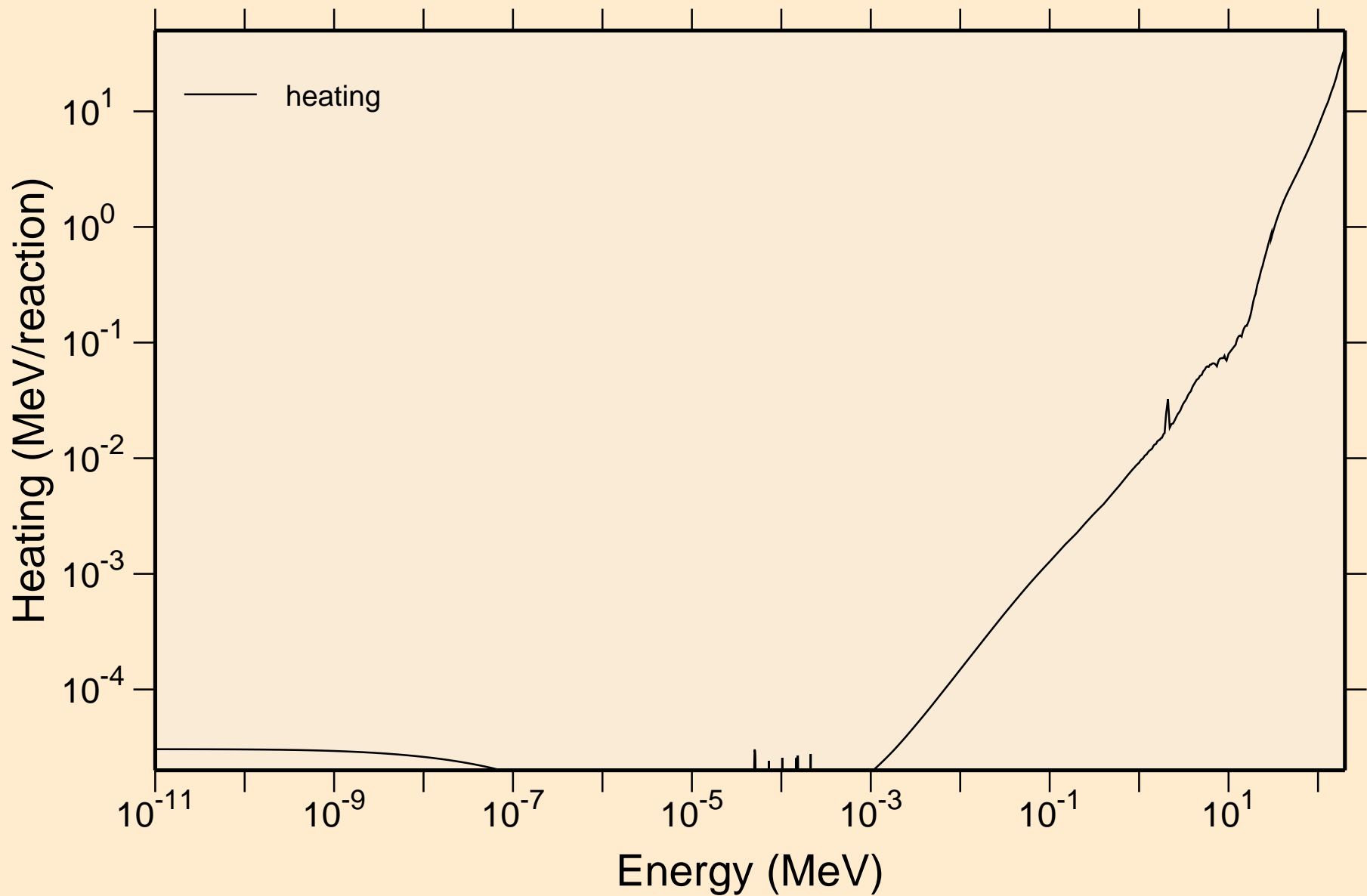



# SN121 NEUTRON ACER TENDL-2019 LIBRARY; T=293.16K Damage

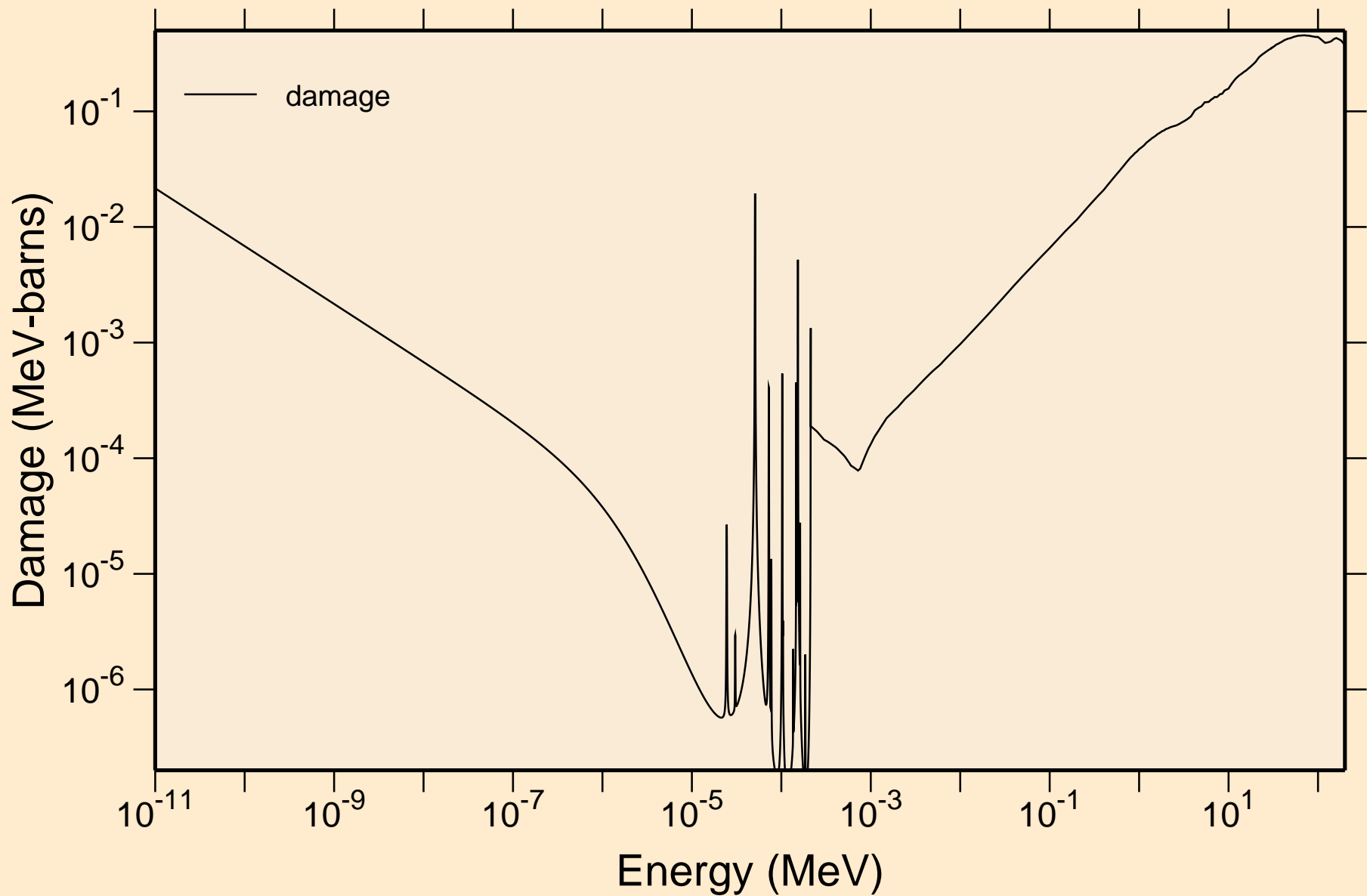

SN121 NEUTRON ACER TENDL-2019 LIBRARY; T=293.16K  
Non-threshold reactions

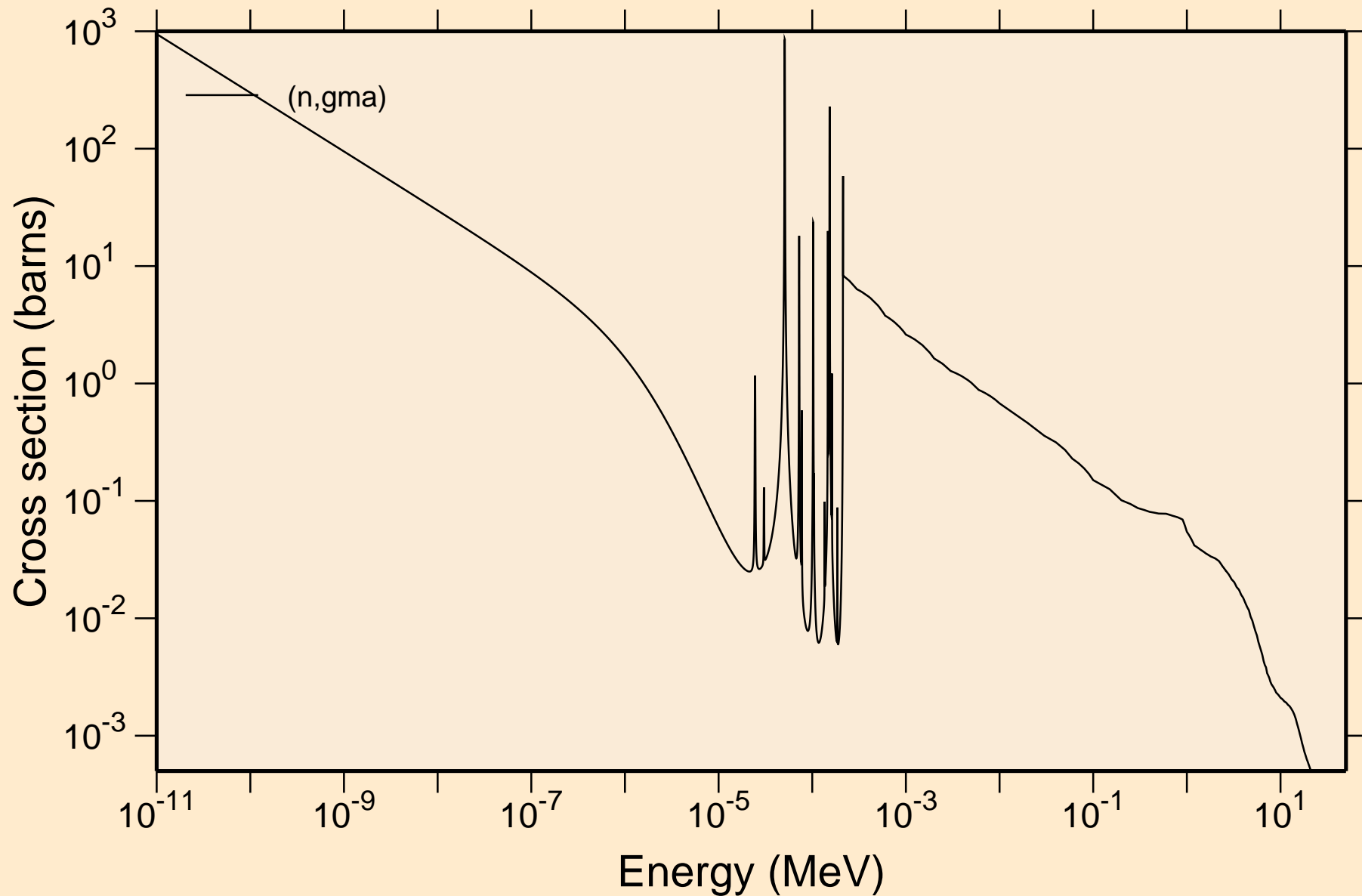

# SN121 NEUTRON ACER TENDL-2019 LIBRARY; T=293.16K

## Principal cross sections

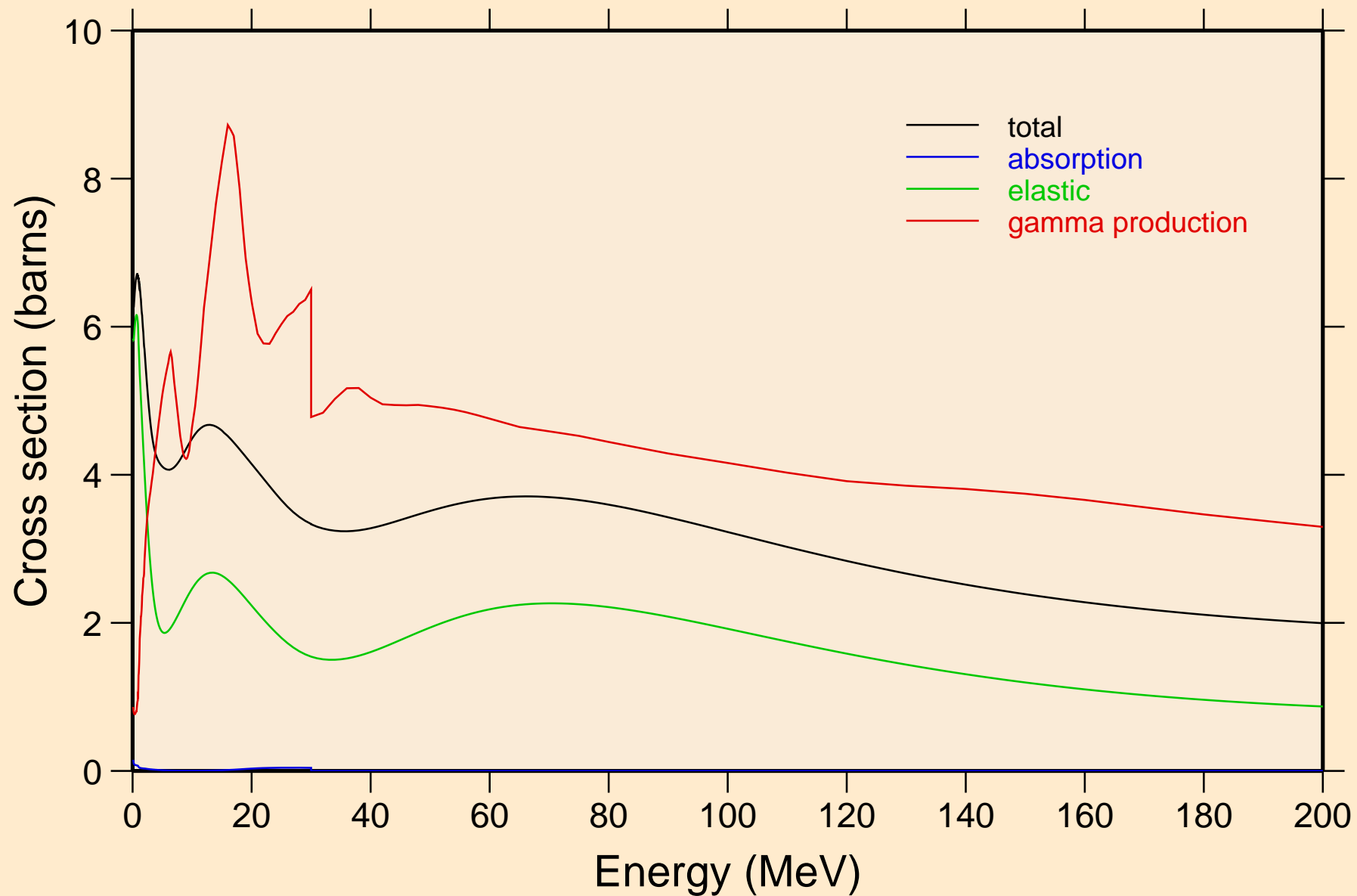

SN121 NEUTRON ACER TENDL-2019 LIBRARY; T=293.16K  
Heating

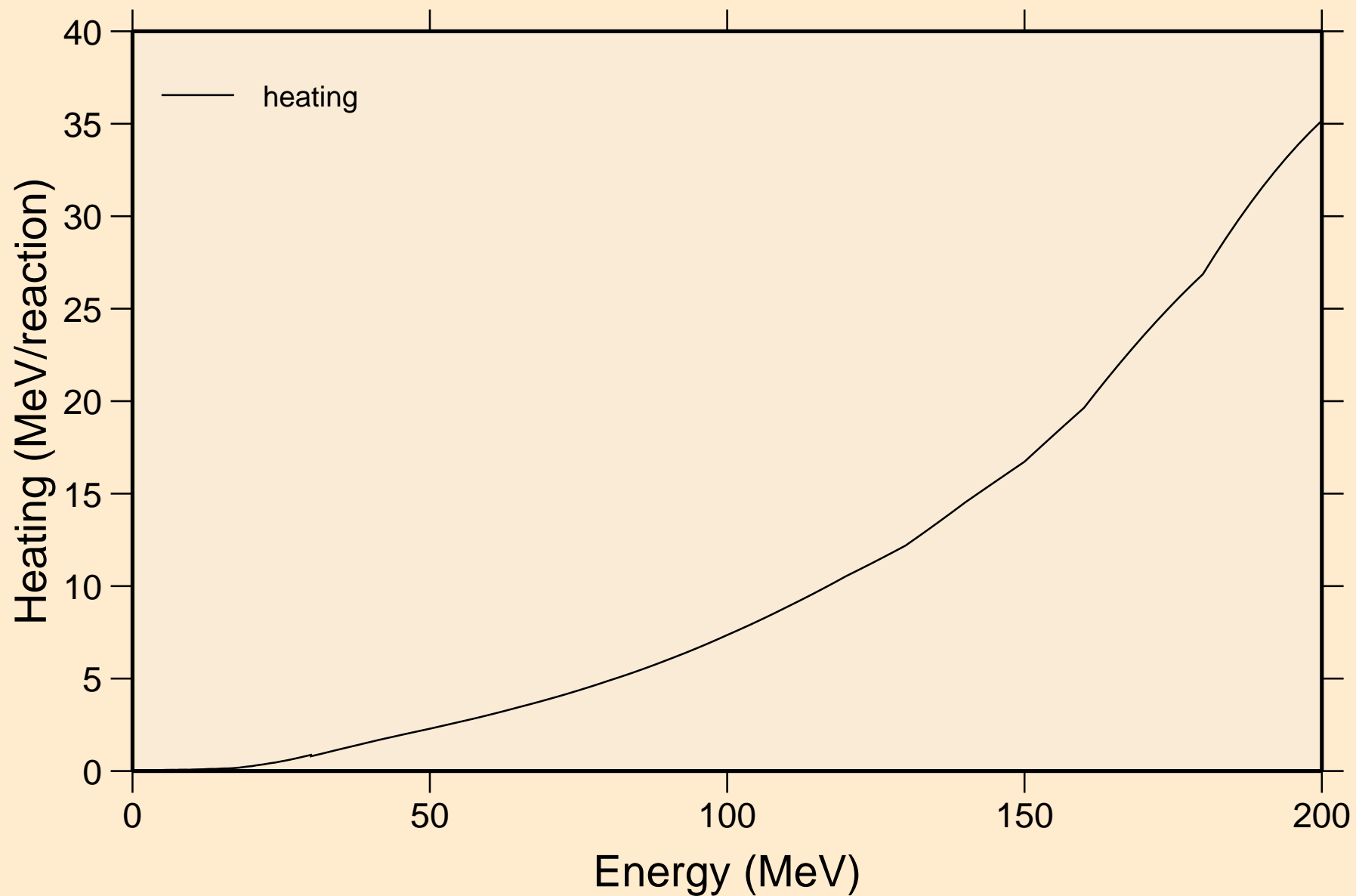

# SN121 NEUTRON ACER TENDL-2019 LIBRARY; T=293.16K Damage

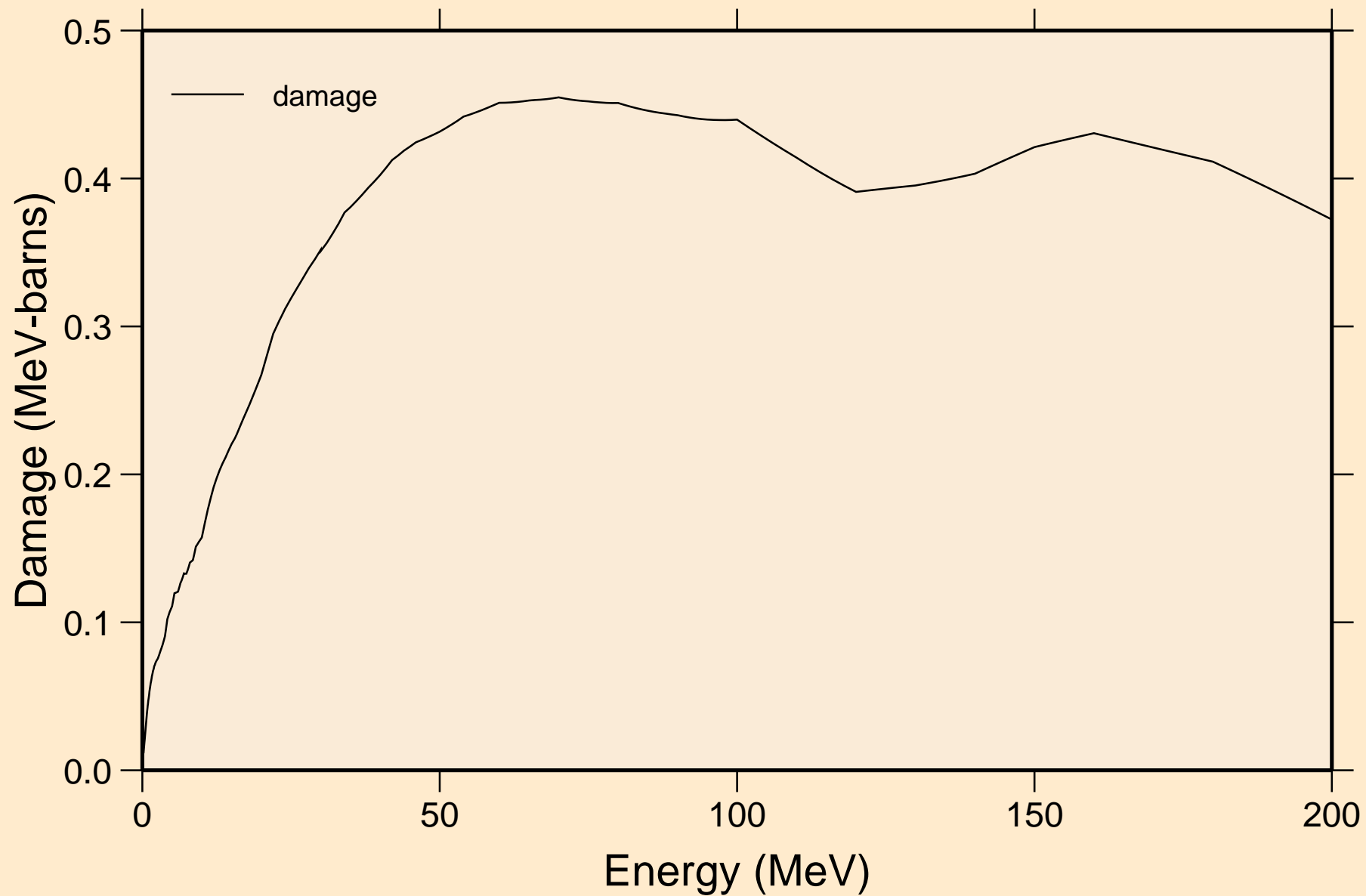

SN121 NEUTRON ACER TENDL-2019 LIBRARY; T=293.16K  
Non-threshold reactions

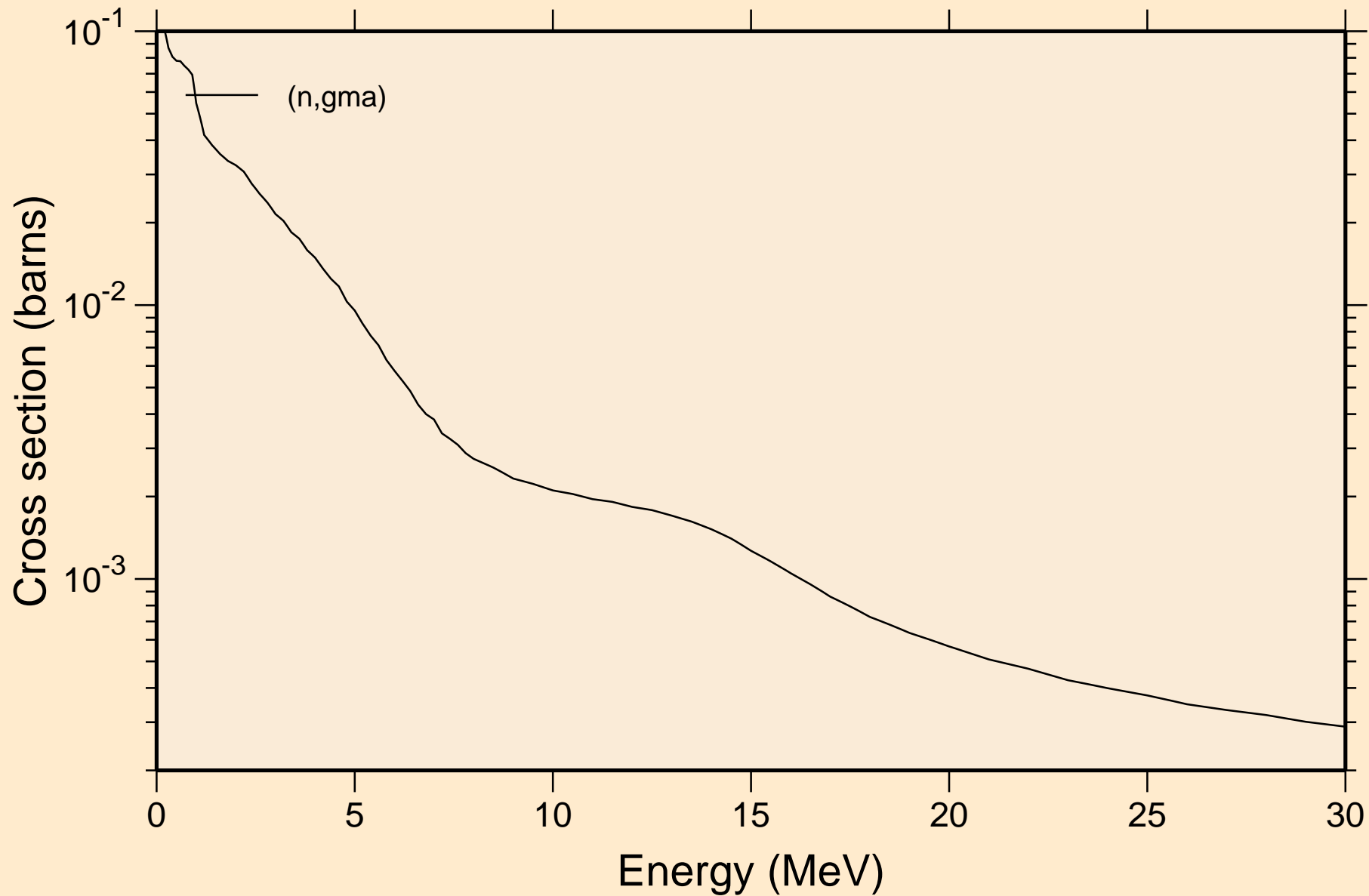

SN121 NEUTRON ACER TENDL-2019 LIBRARY; T=293.16K  
Inelastic levels

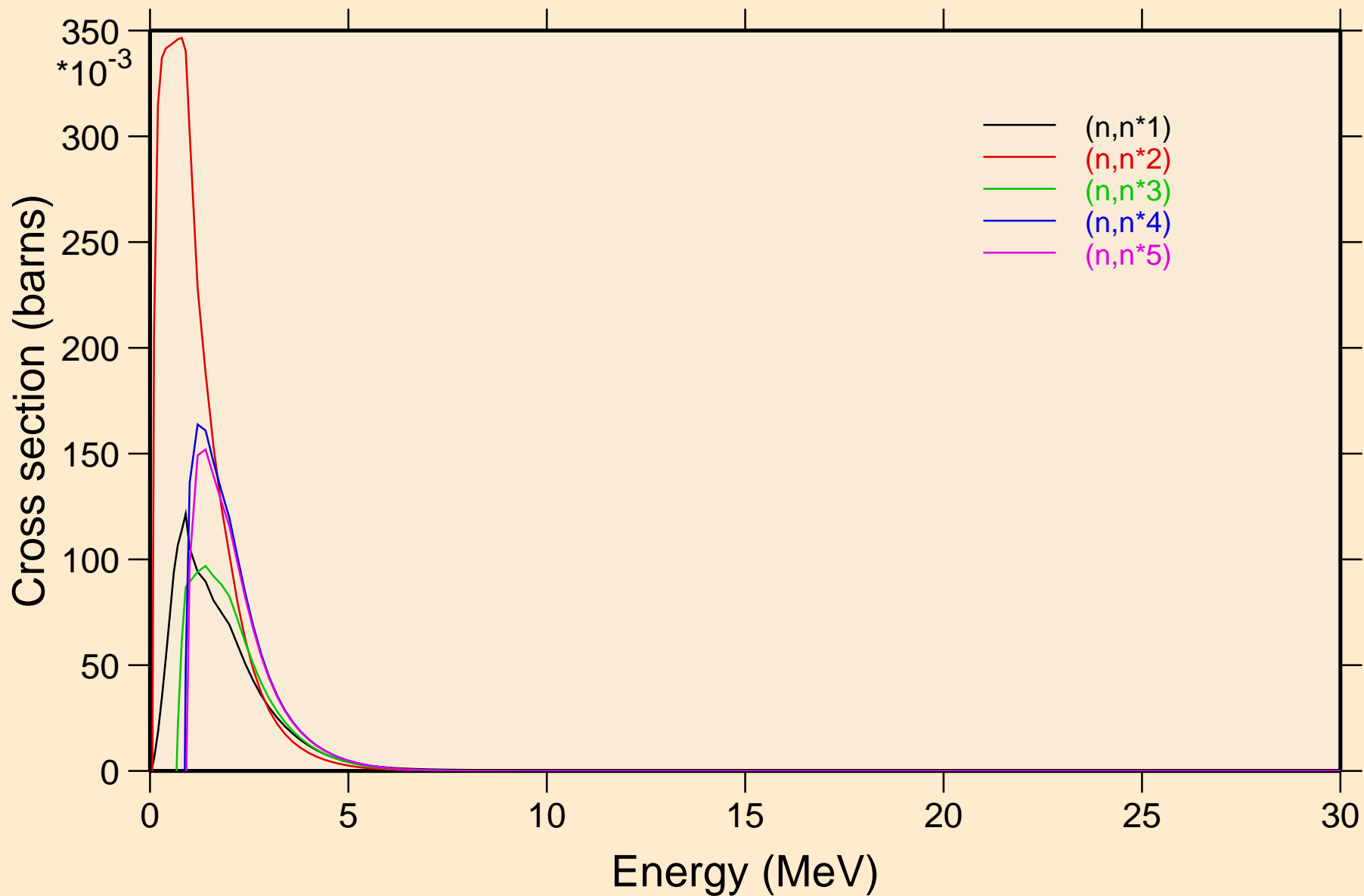

SN121 NEUTRON ACER TENDL-2019 LIBRARY; T=293.16K  
Inelastic levels

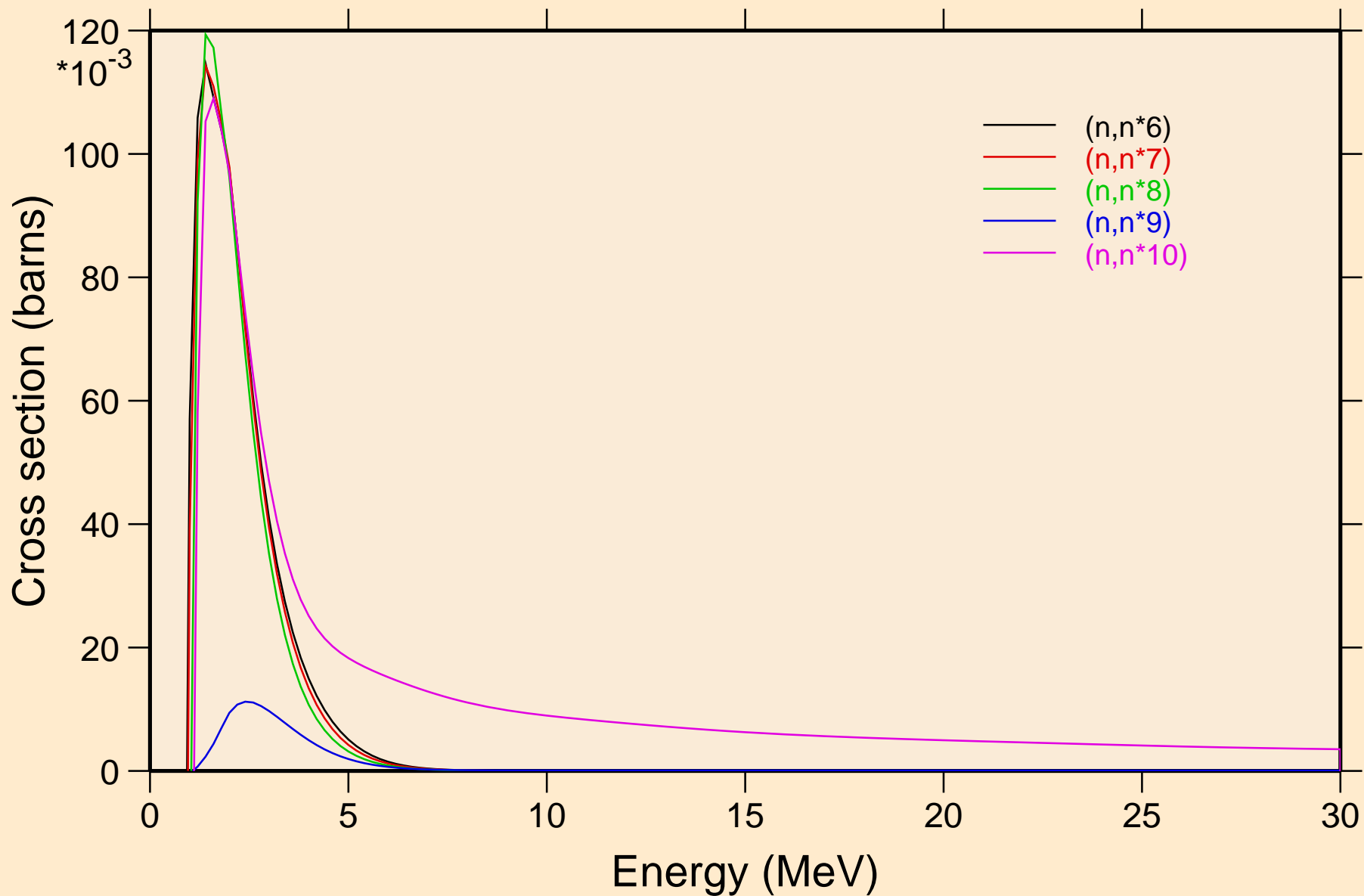



SN121 NEUTRON ACER TENDL-2019 LIBRARY; T=293.16K  
Inelastic levels

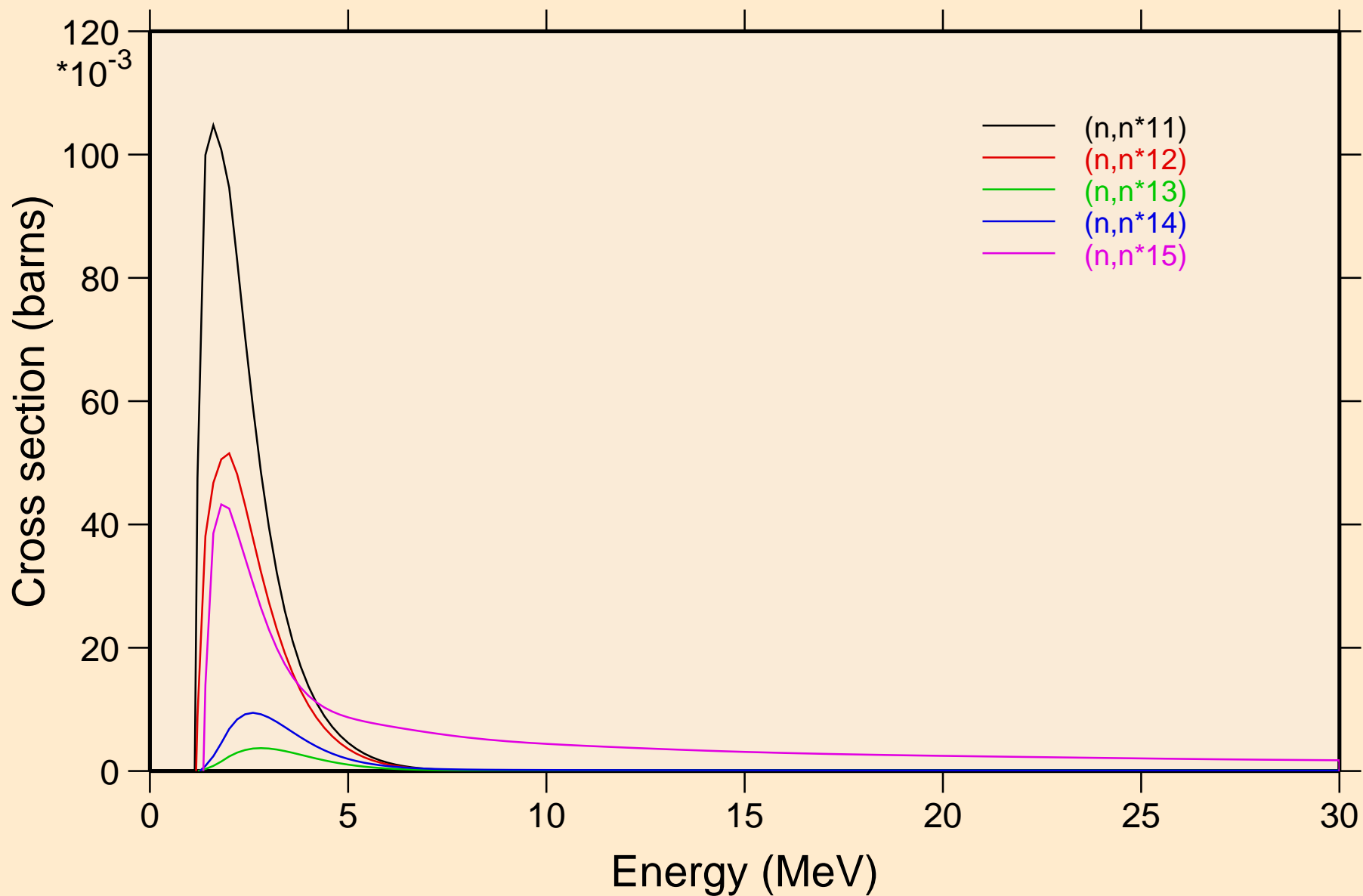

SN121 NEUTRON ACER TENDL-2019 LIBRARY; T=293.16K  
Inelastic levels

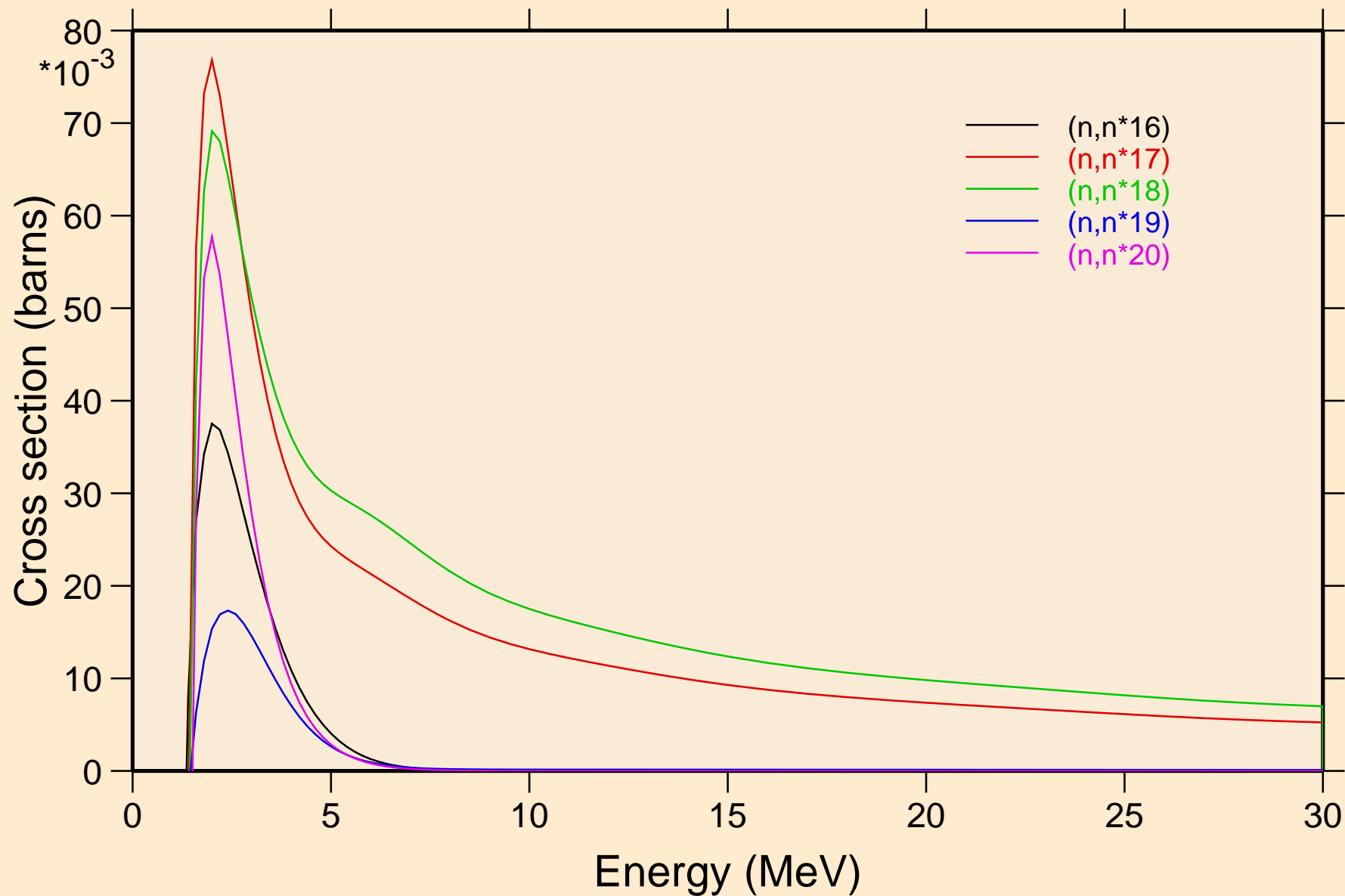

# SN121 NEUTRON ACER TENDL-2019 LIBRARY; T=293.16K

## Inelastic levels

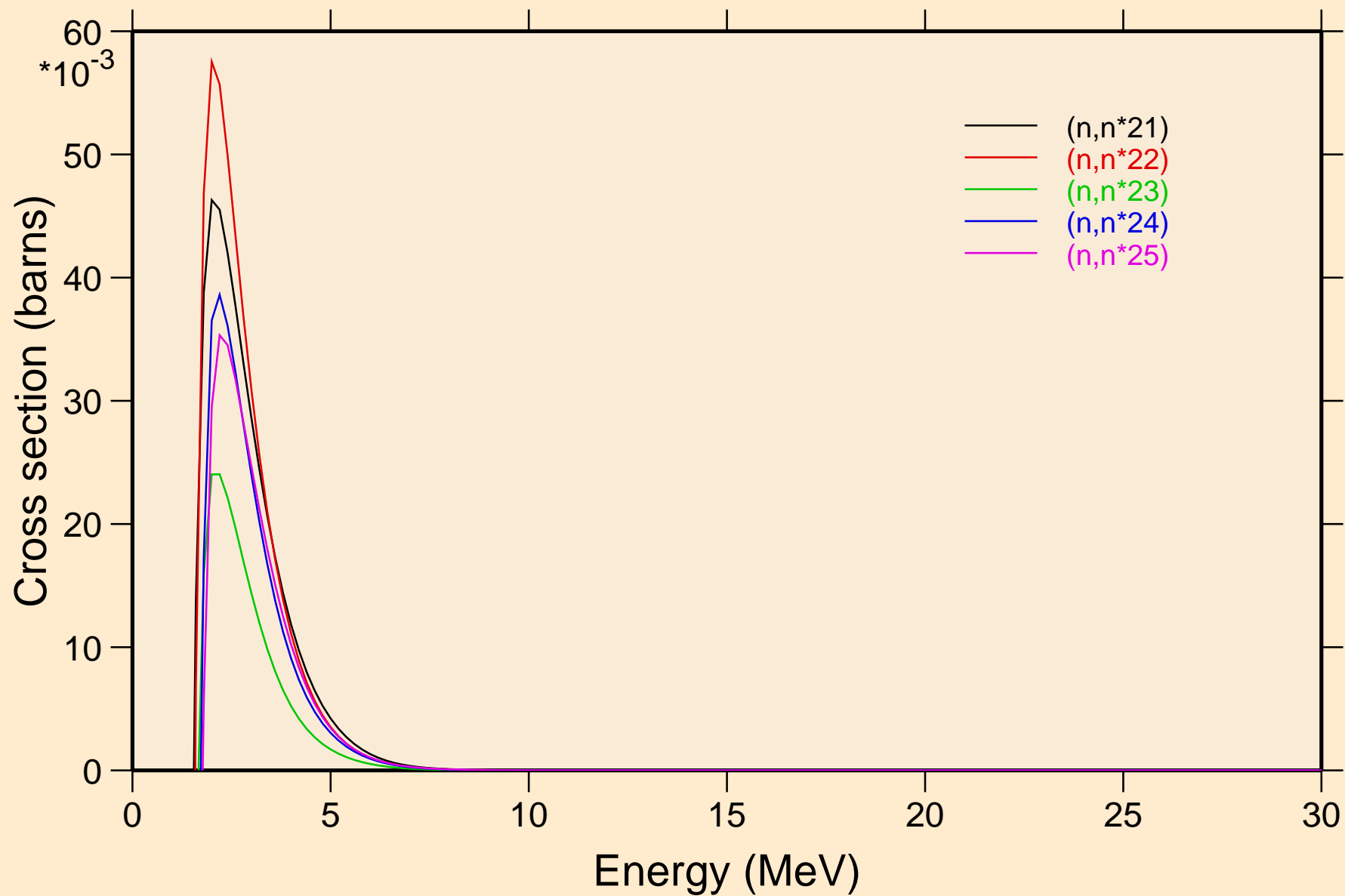

# SN121 NEUTRON ACER TENDL-2019 LIBRARY; T=293.16K

## Inelastic levels

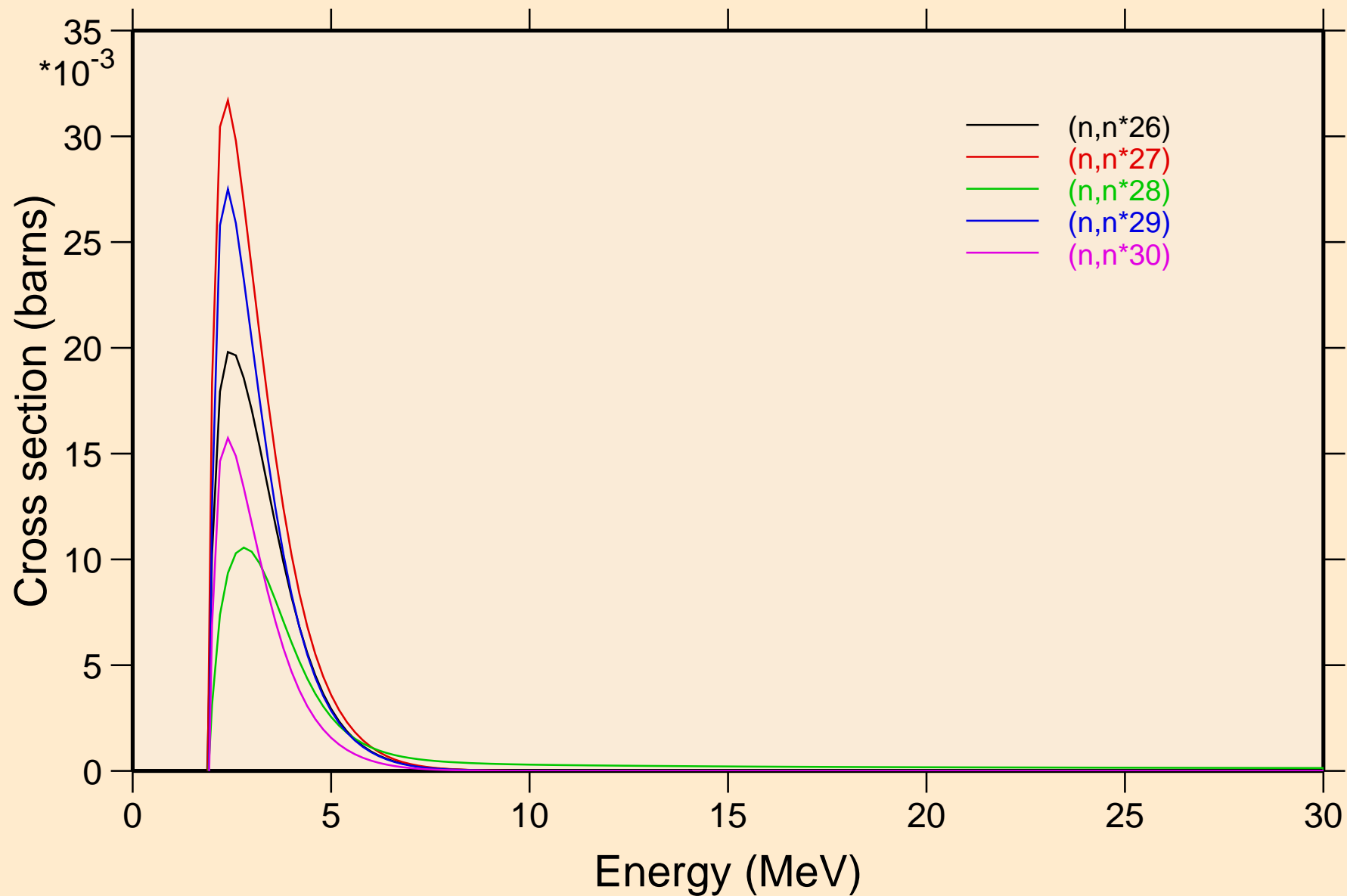

SN121 NEUTRON ACER TENDL-2019 LIBRARY; T=293.16K  
Threshold reactions

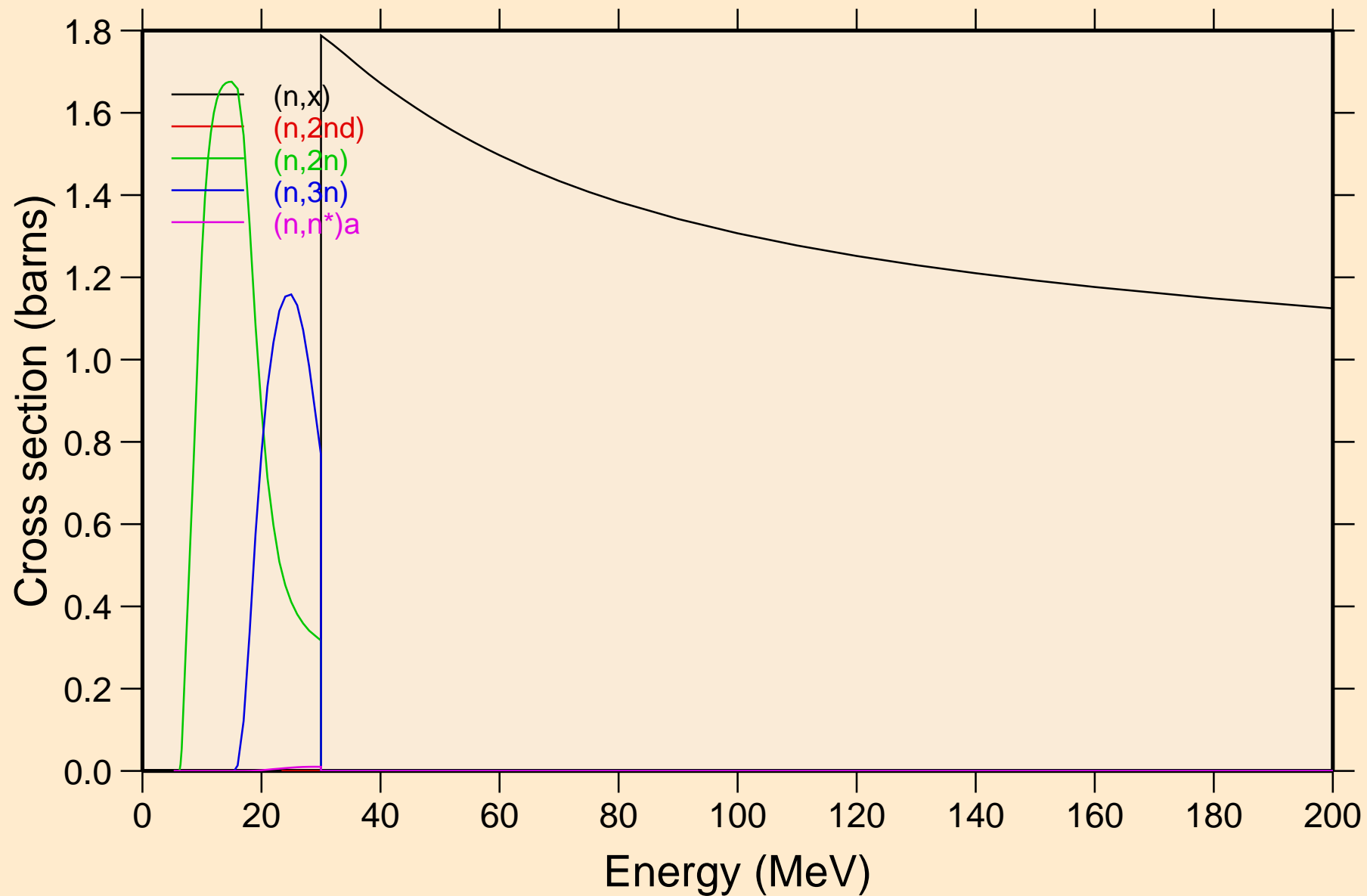

# SN121 NEUTRON ACER TENDL-2019 LIBRARY; T=293.16K

## Threshold reactions

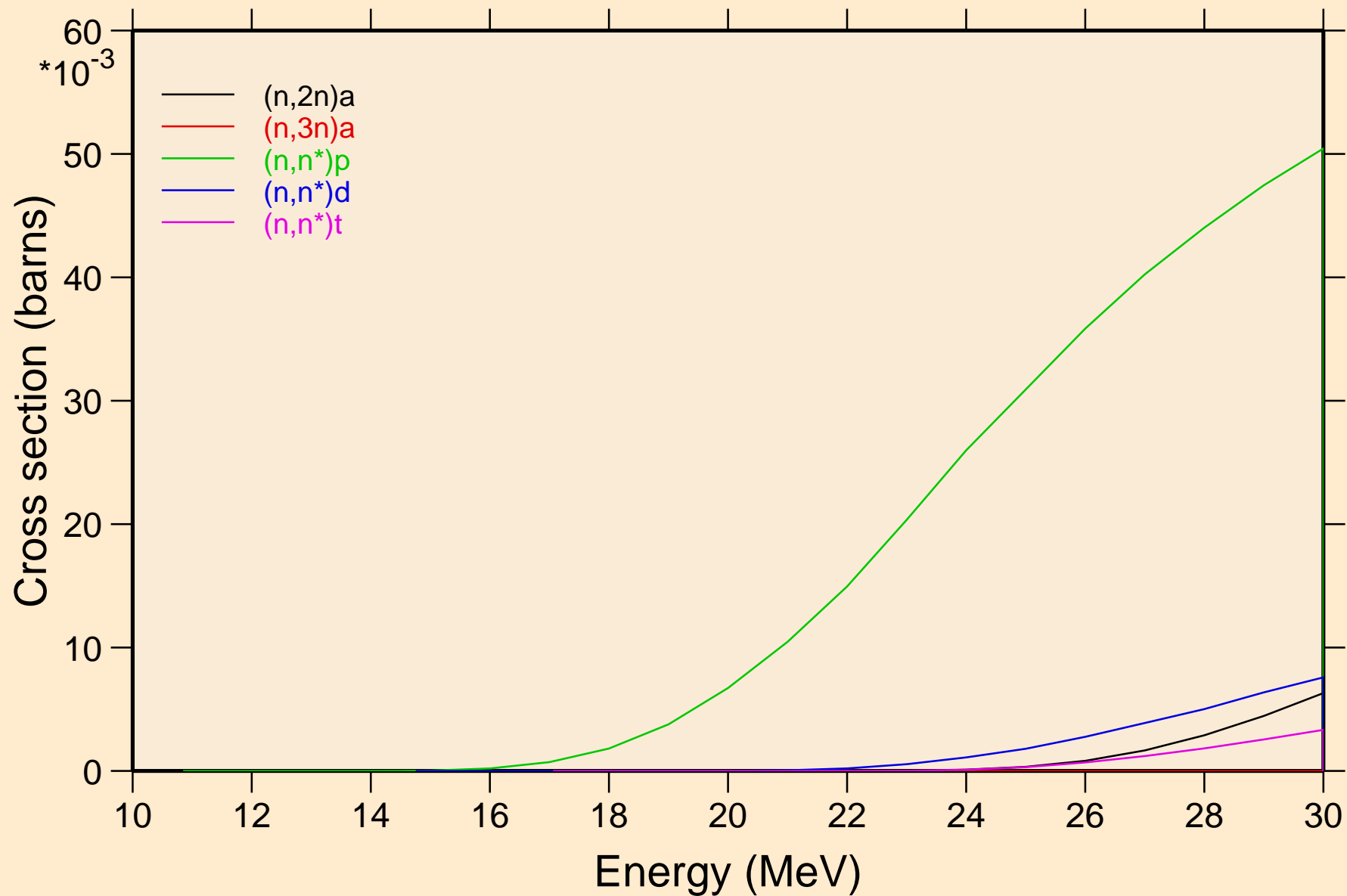

# SN121 NEUTRON ACER TENDL-2019 LIBRARY; T=293.16K

## Threshold reactions

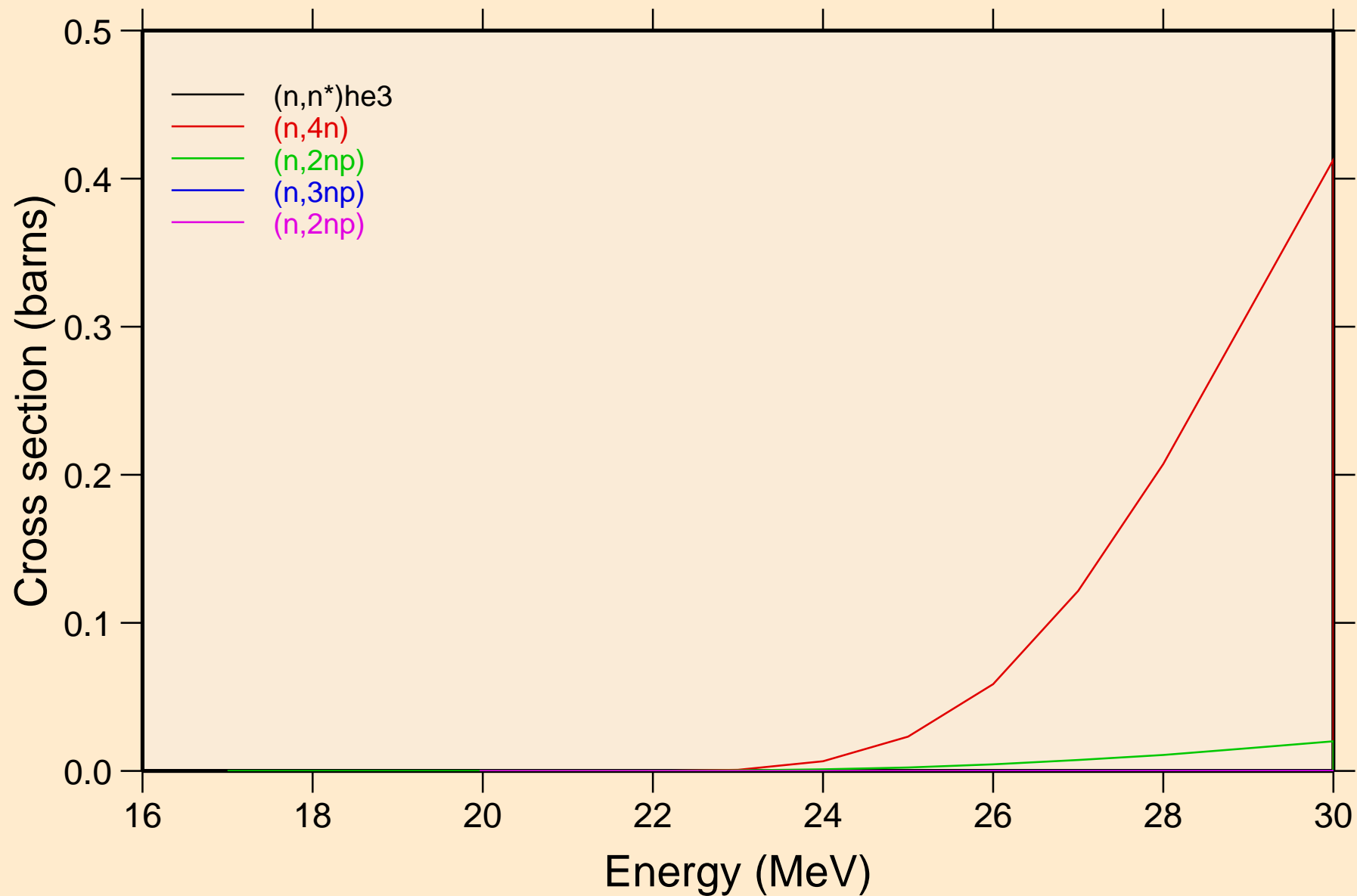

# SN121 NEUTRON ACER TENDL-2019 LIBRARY; T=293.16K

## Threshold reactions

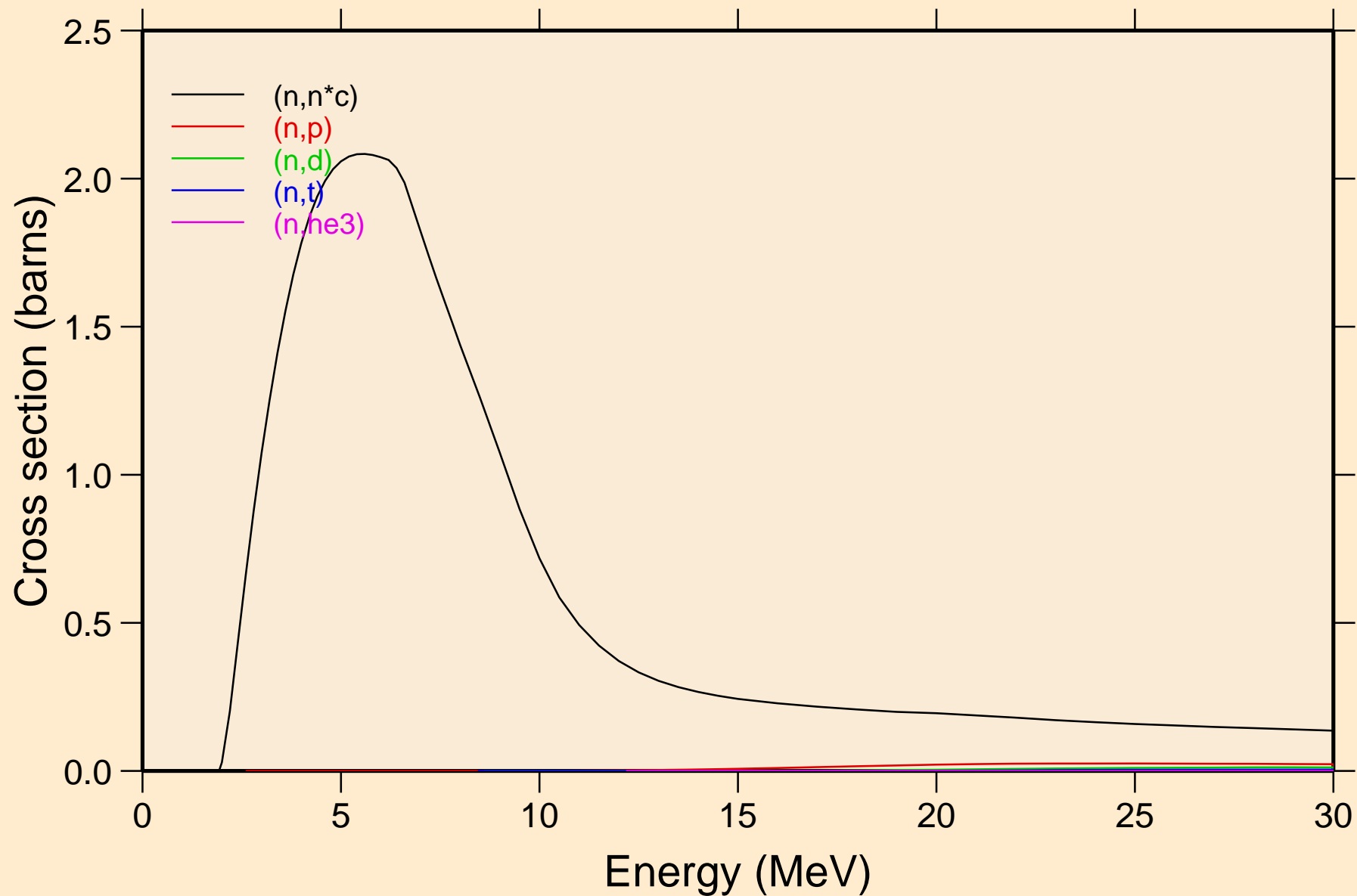



SN121 NEUTRON ACER TENDL-2019 LIBRARY; T=293.16K  
Threshold reactions

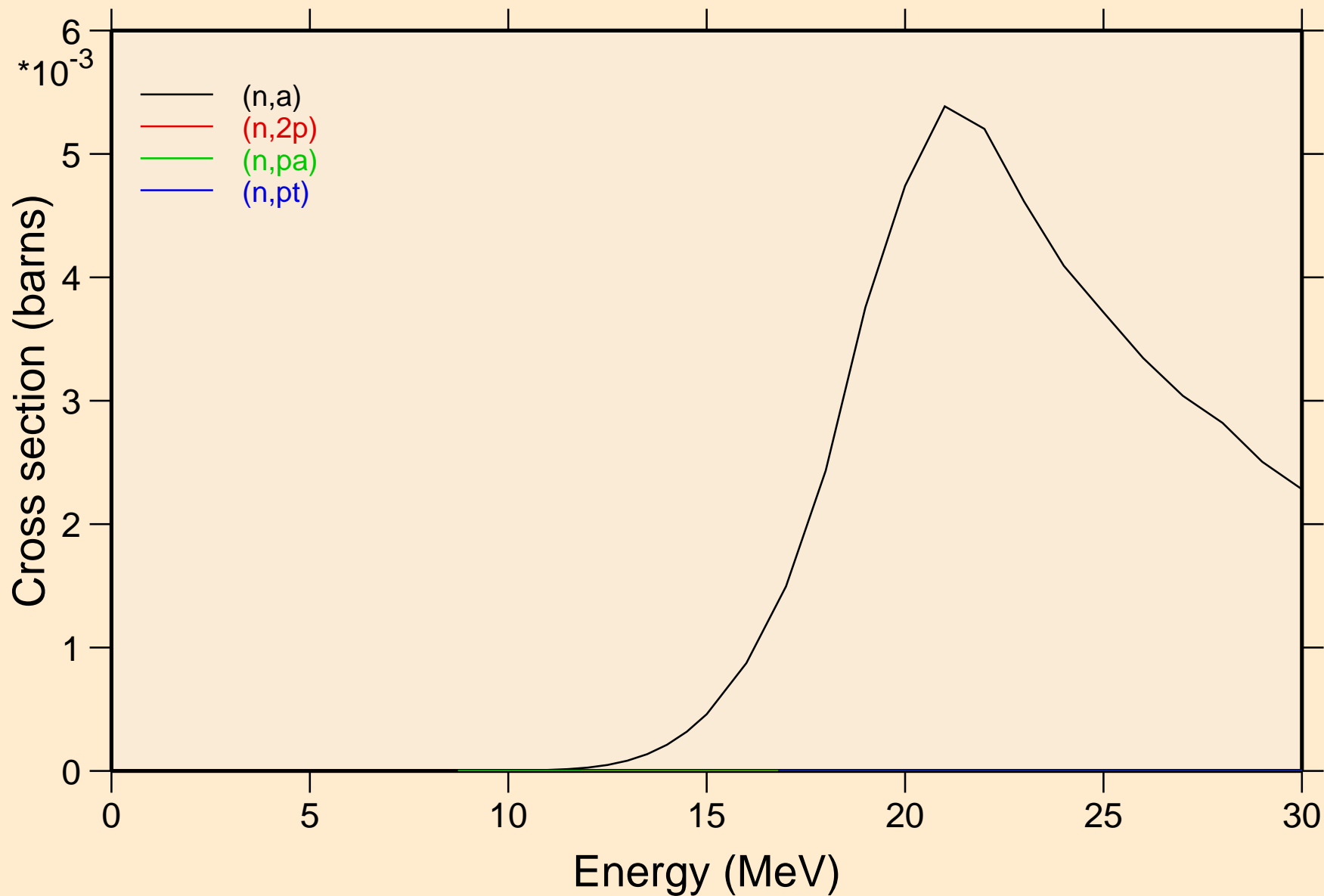

# SN121 NEUTRON ACER TENDL-2019 LIBRARY; T=293.16K

## Threshold reactions

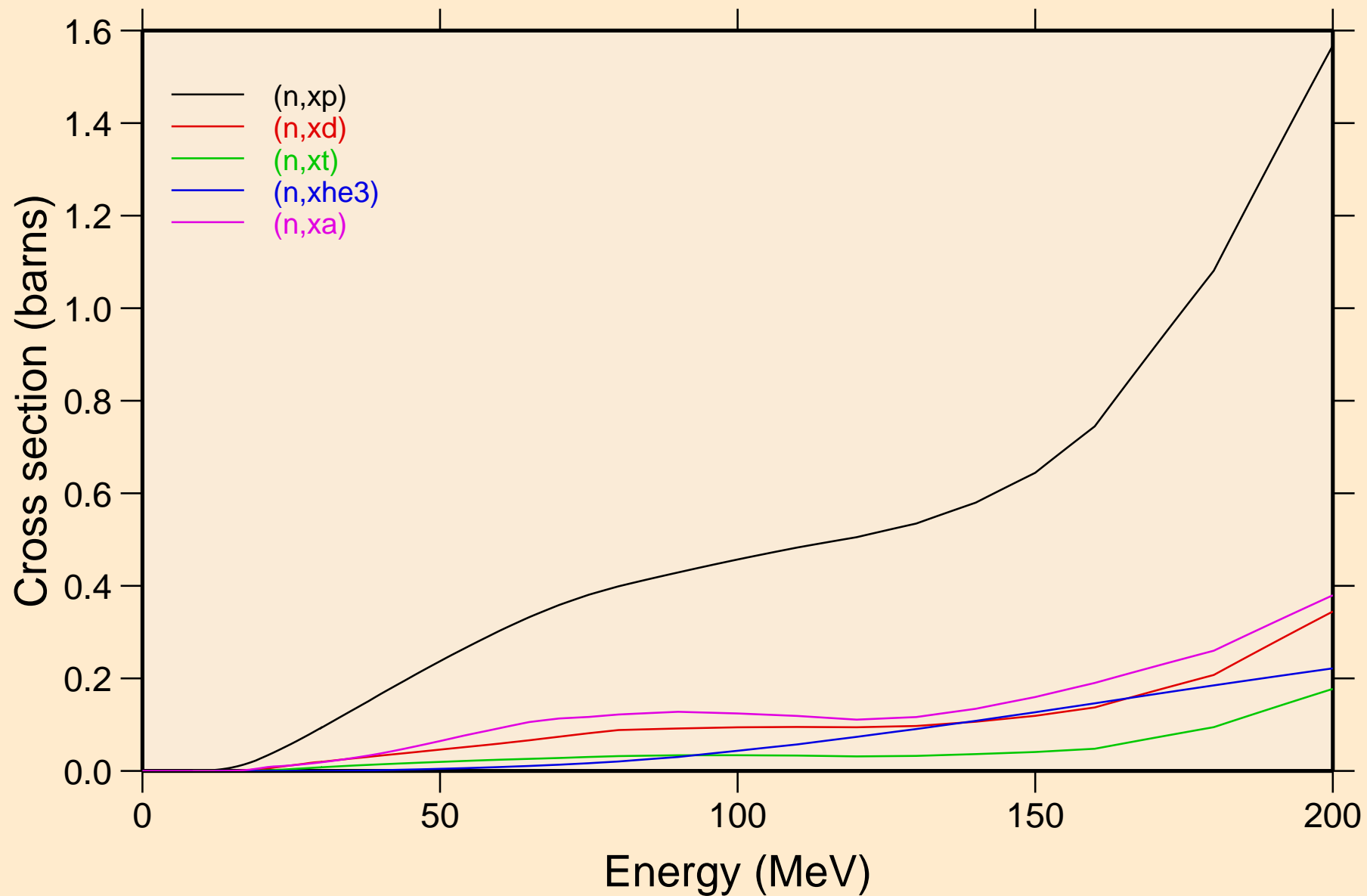

SN121 NEUTRON ACER TENDL-2019 LIBRARY; T=293.16K  
angular distribution for elastic

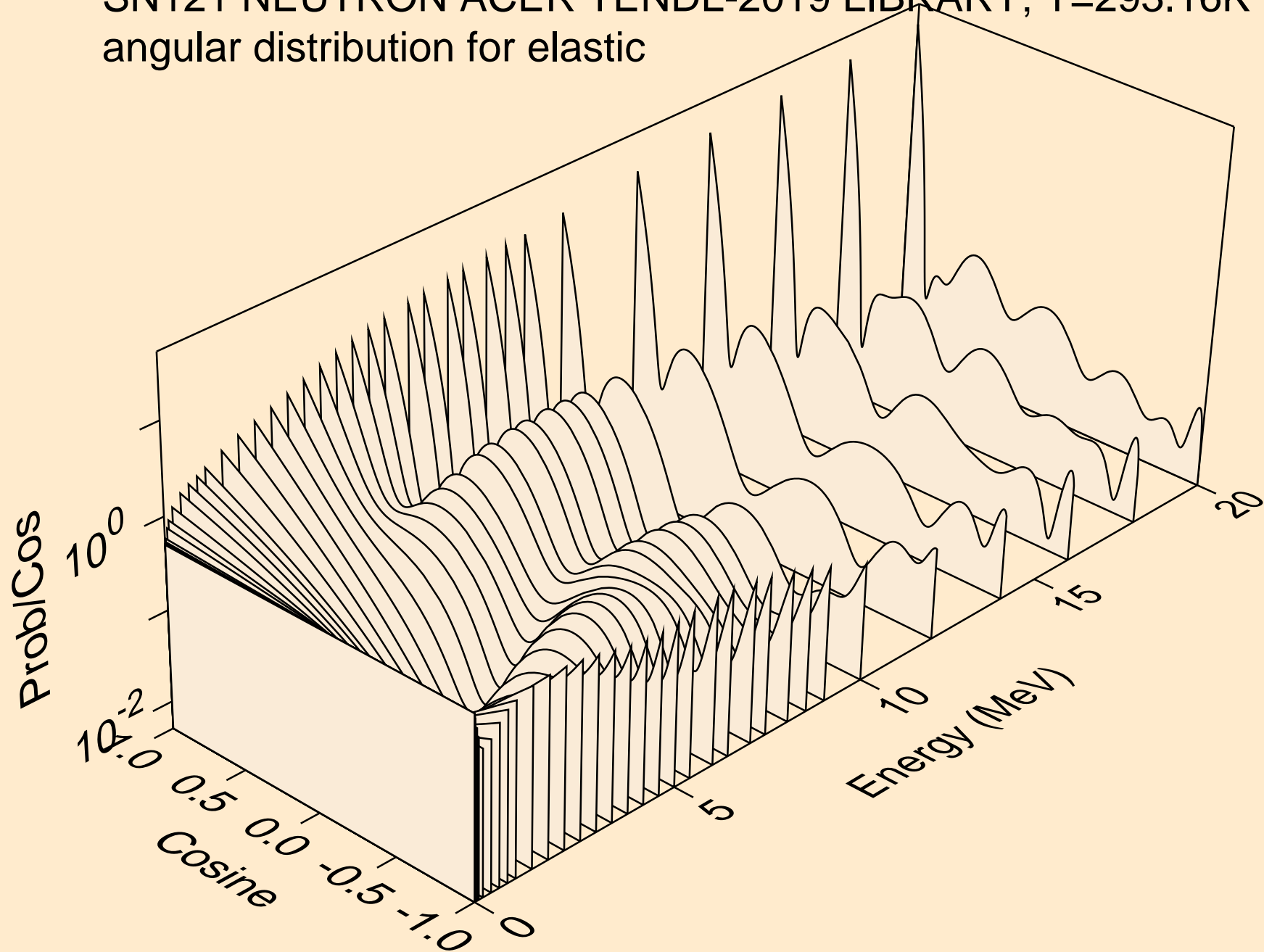

SN121 NEUTRON ACER TENDL-2019 LIBRARY; T=293.16K  
angular distribution for elastic

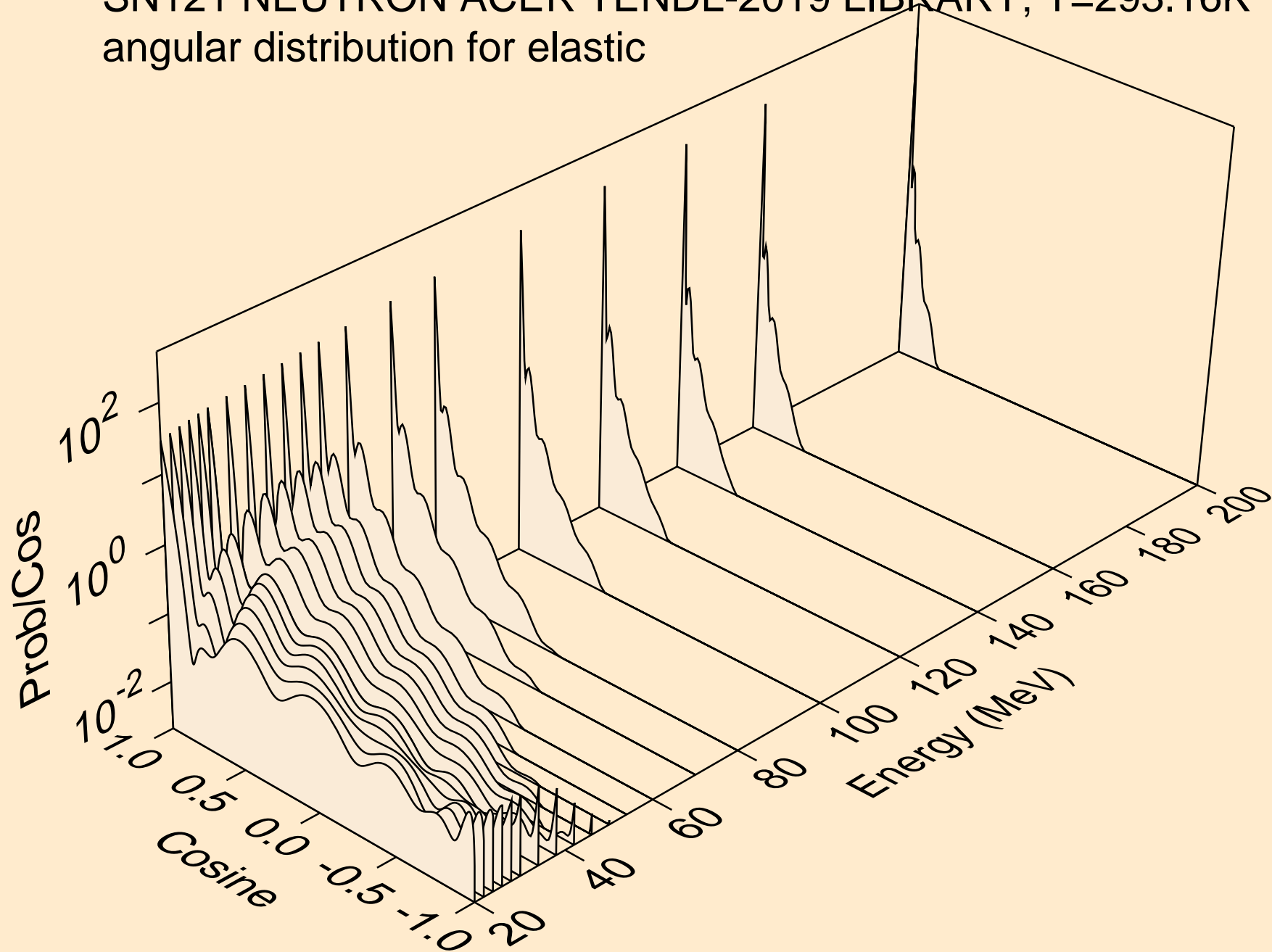

SN121 NEUTRON ACER TENDL-2019 LIBRARY; T=293.16K  
angular distribution for (n,n\*1)

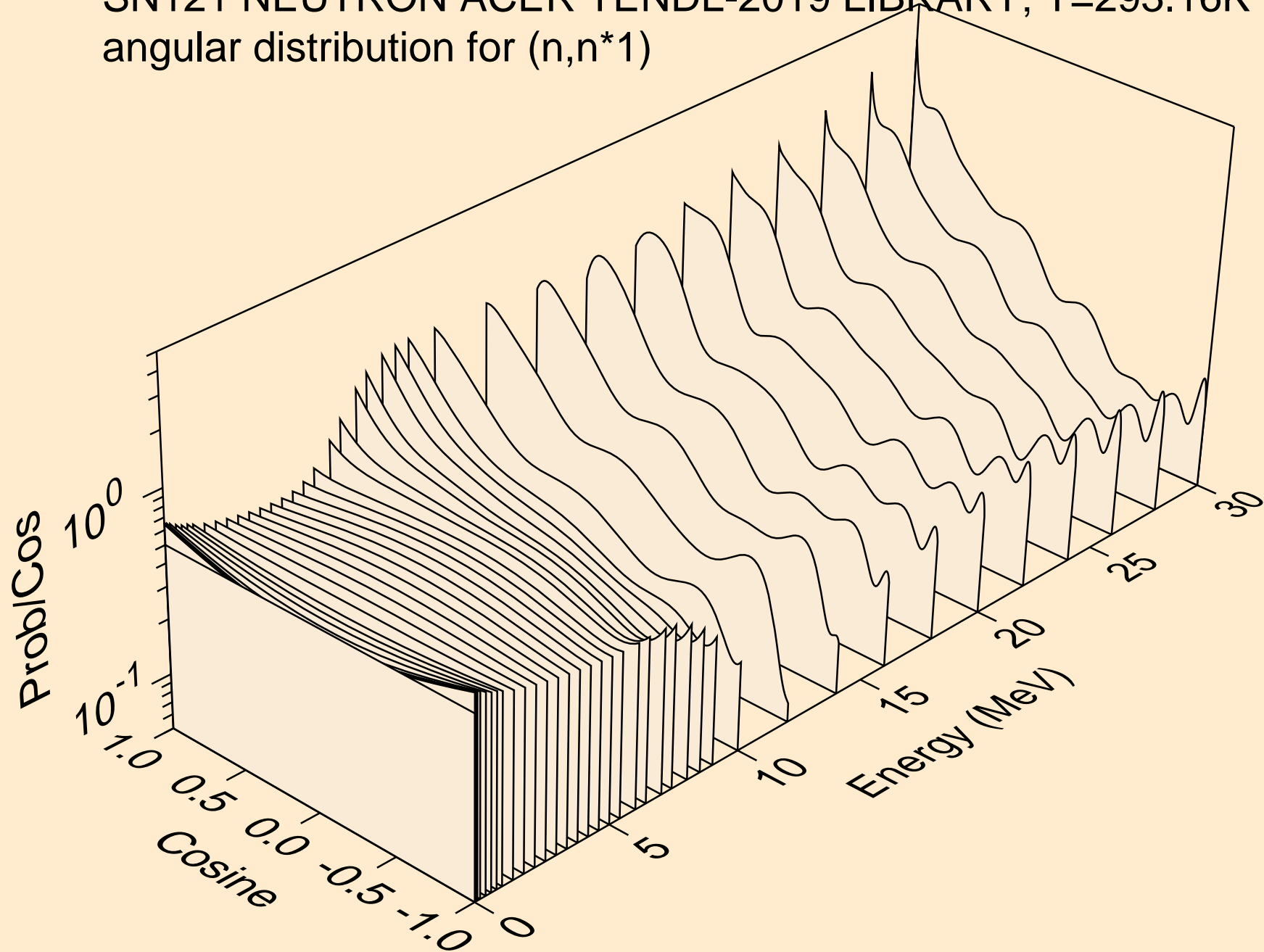

SN121 NEUTRON ACER TENDL-2019 LIBRARY; T=293.16K  
angular distribution for (n,n\*2)

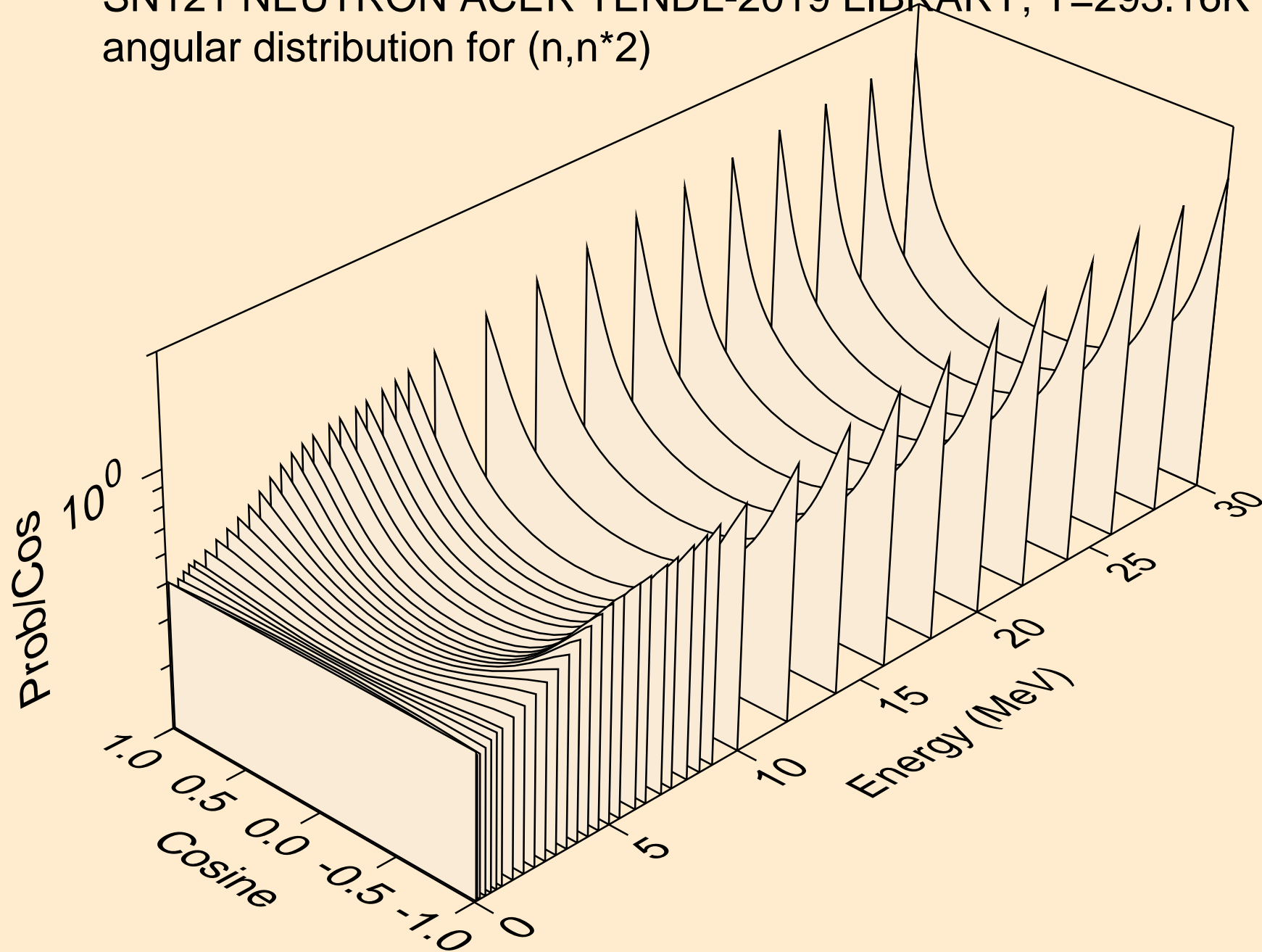

SN121 NEUTRON ACER TENDL-2019 LIBRARY; T=293.16K  
angular distribution for (n,n\*3)

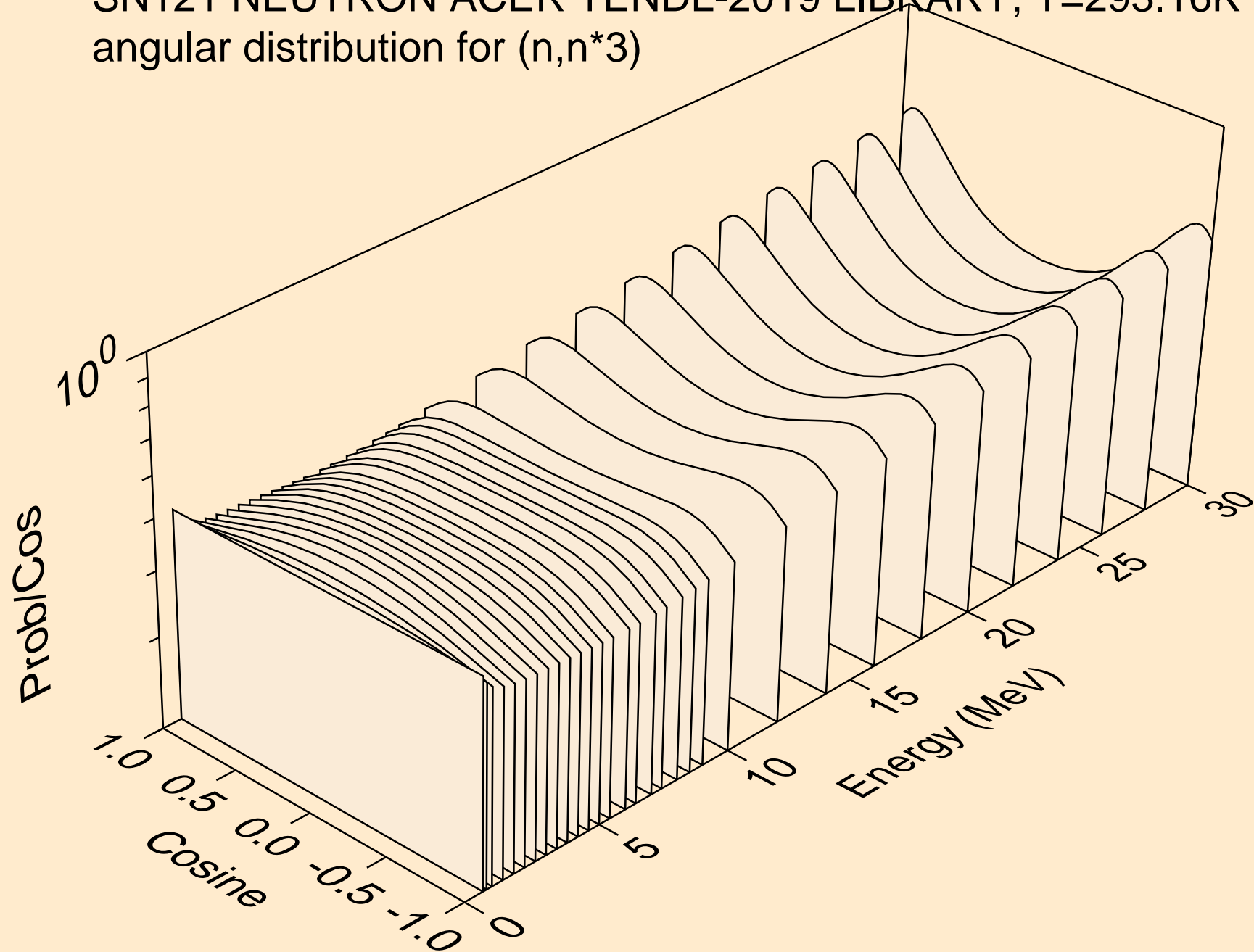

SN121 NEUTRON ACER TENDL-2019 LIBRARY; T=293.16K  
angular distribution for (n,n\*4)

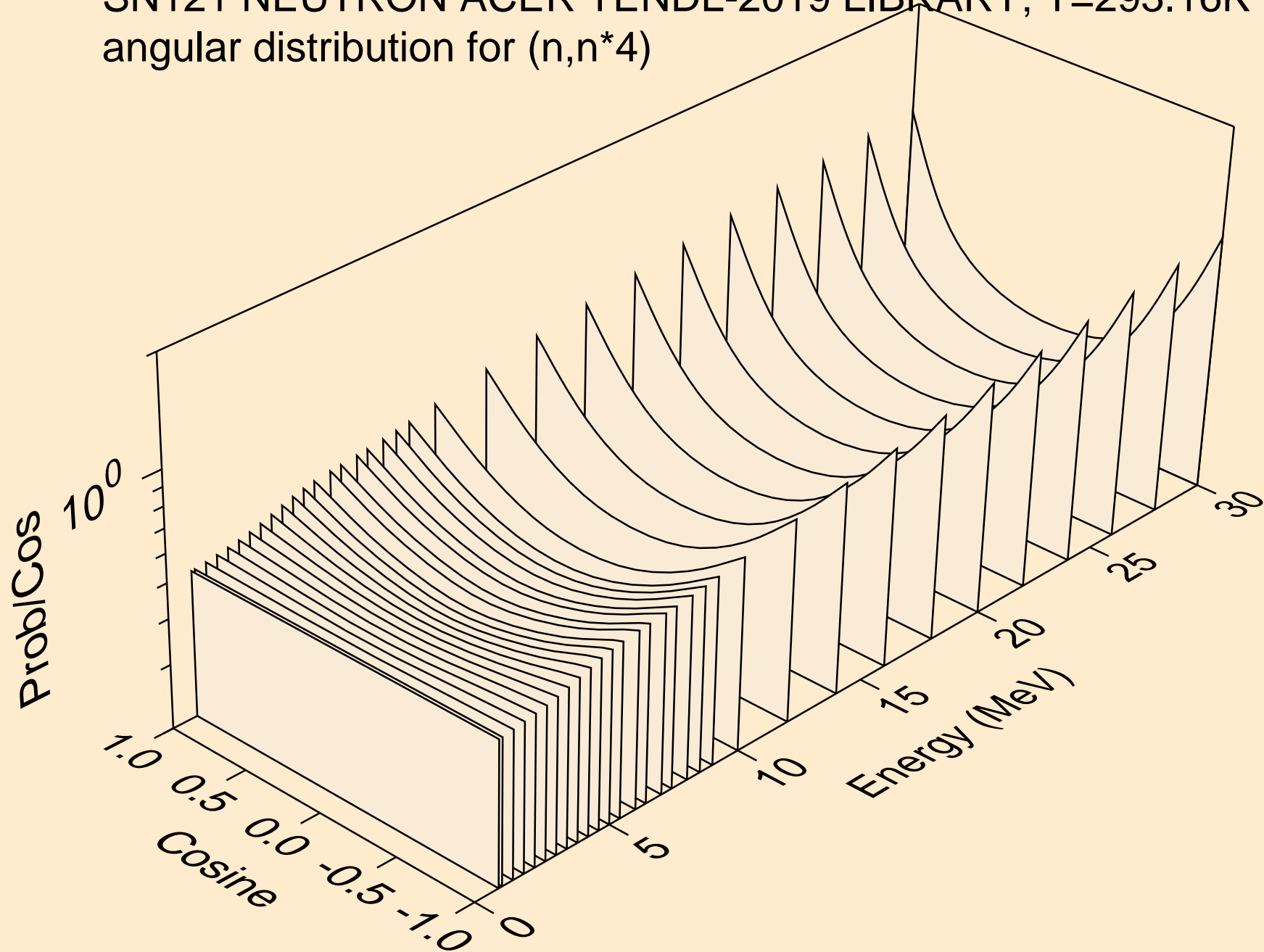



SN121 NEUTRON ACER TENDL-2019 LIBRARY; T=293.16K  
angular distribution for (n,n\*5)

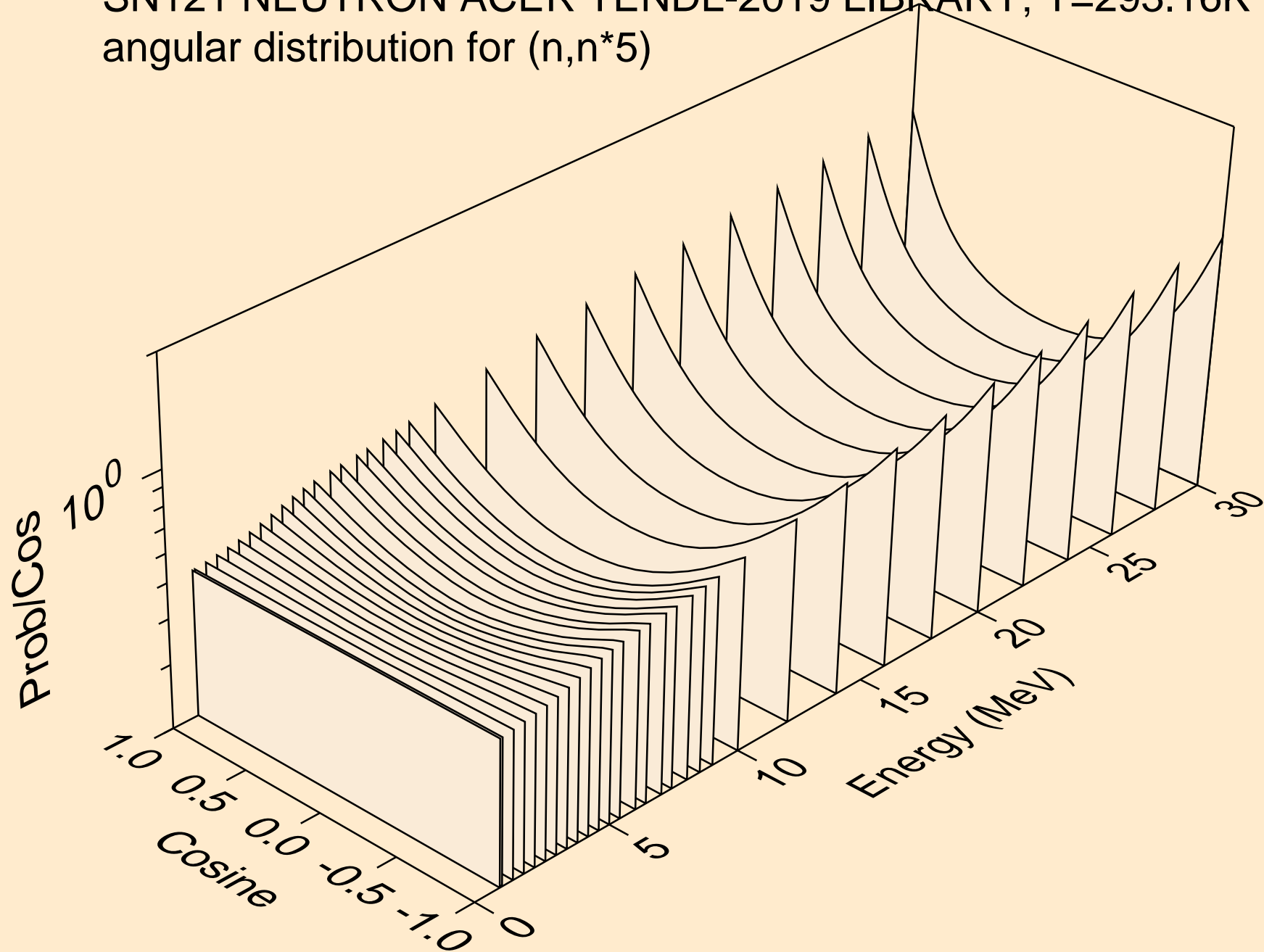

SN121 NEUTRON ACER TENDL-2019 LIBRARY; T=293.16K  
angular distribution for (n,n\*6)

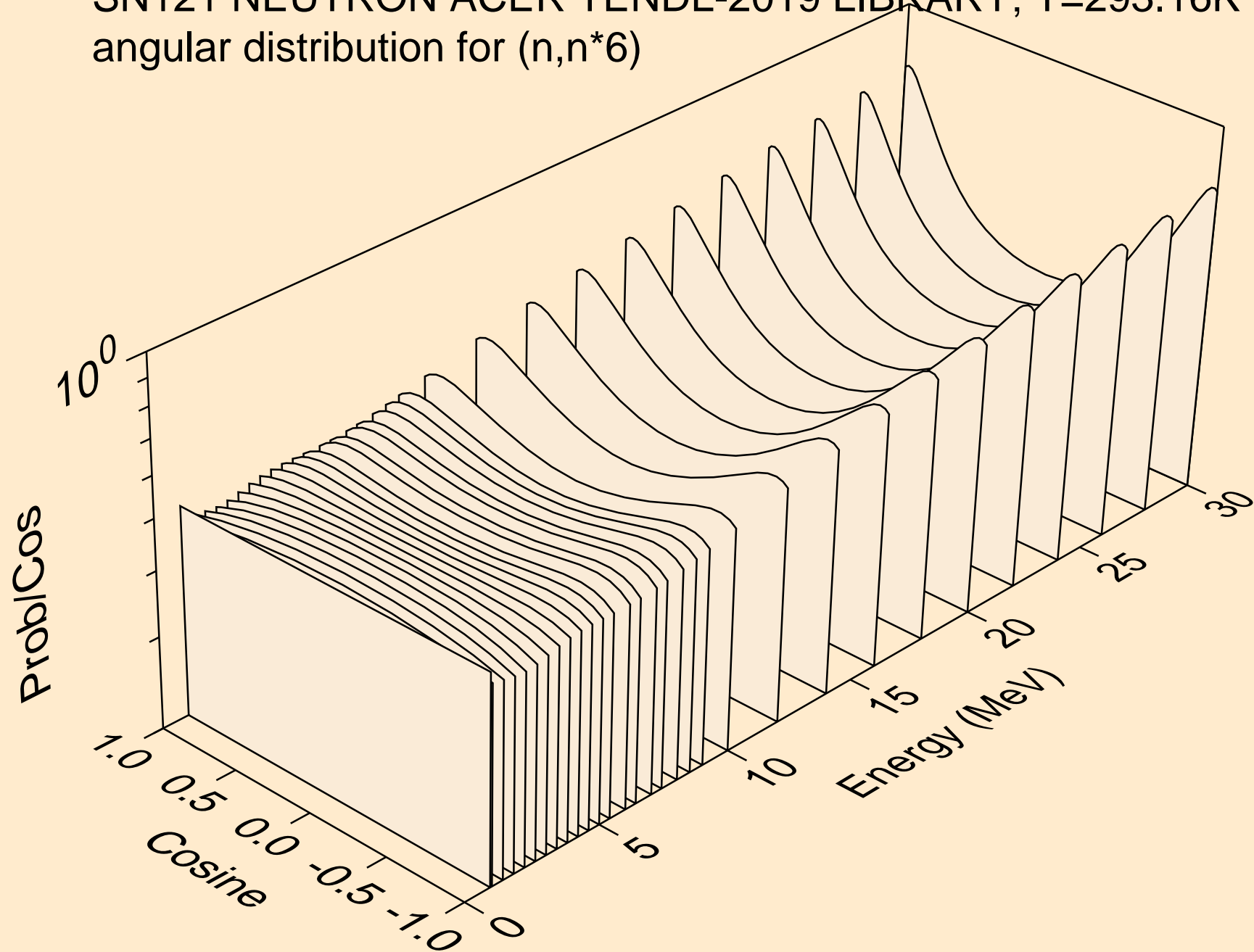

SN121 NEUTRON ACER TENDL-2019 LIBRARY; T=293.16K  
angular distribution for (n,n\*7)

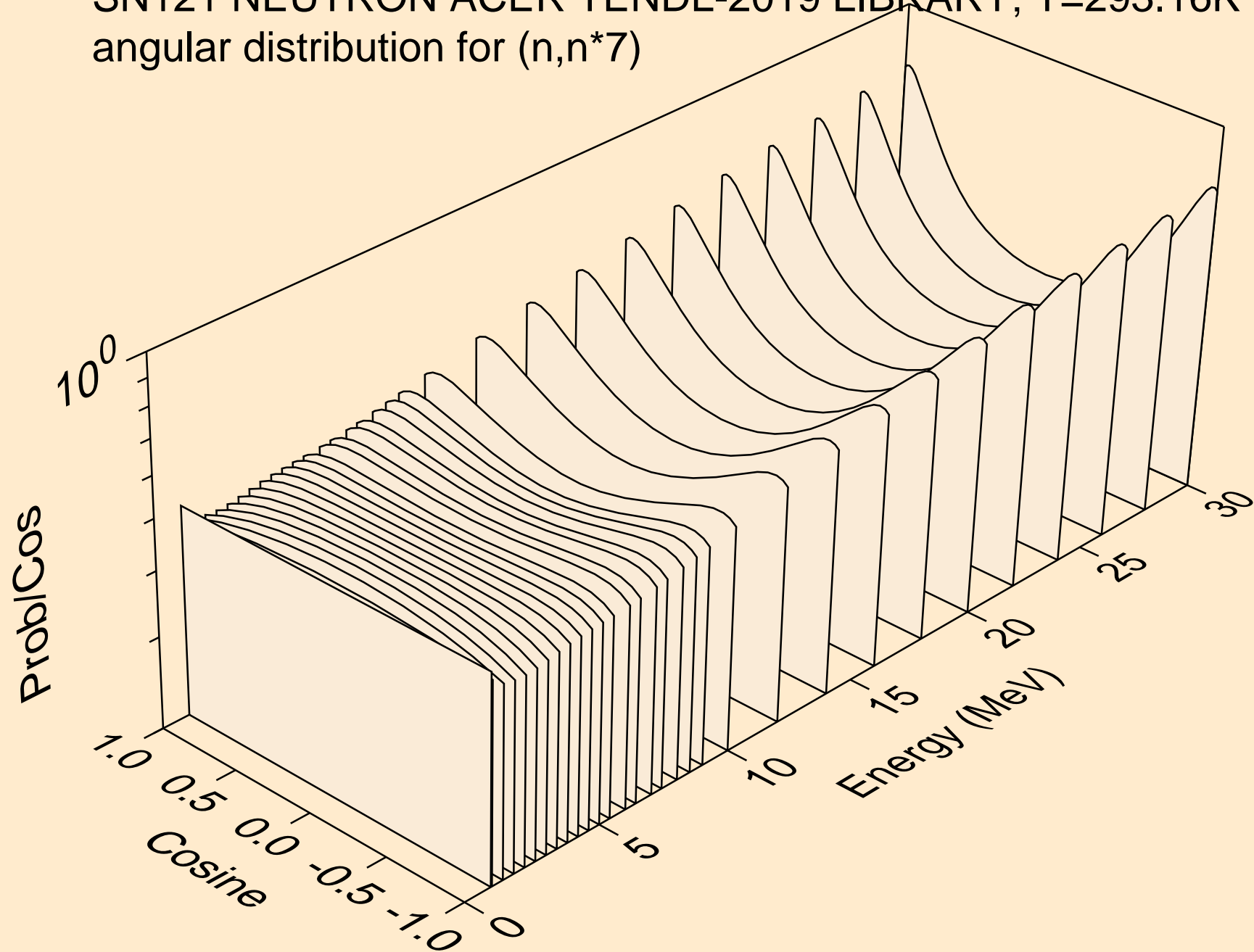

SN121 NEUTRON ACER TENDL-2019 LIBRARY; T=293.16K  
angular distribution for (n,n\*8)

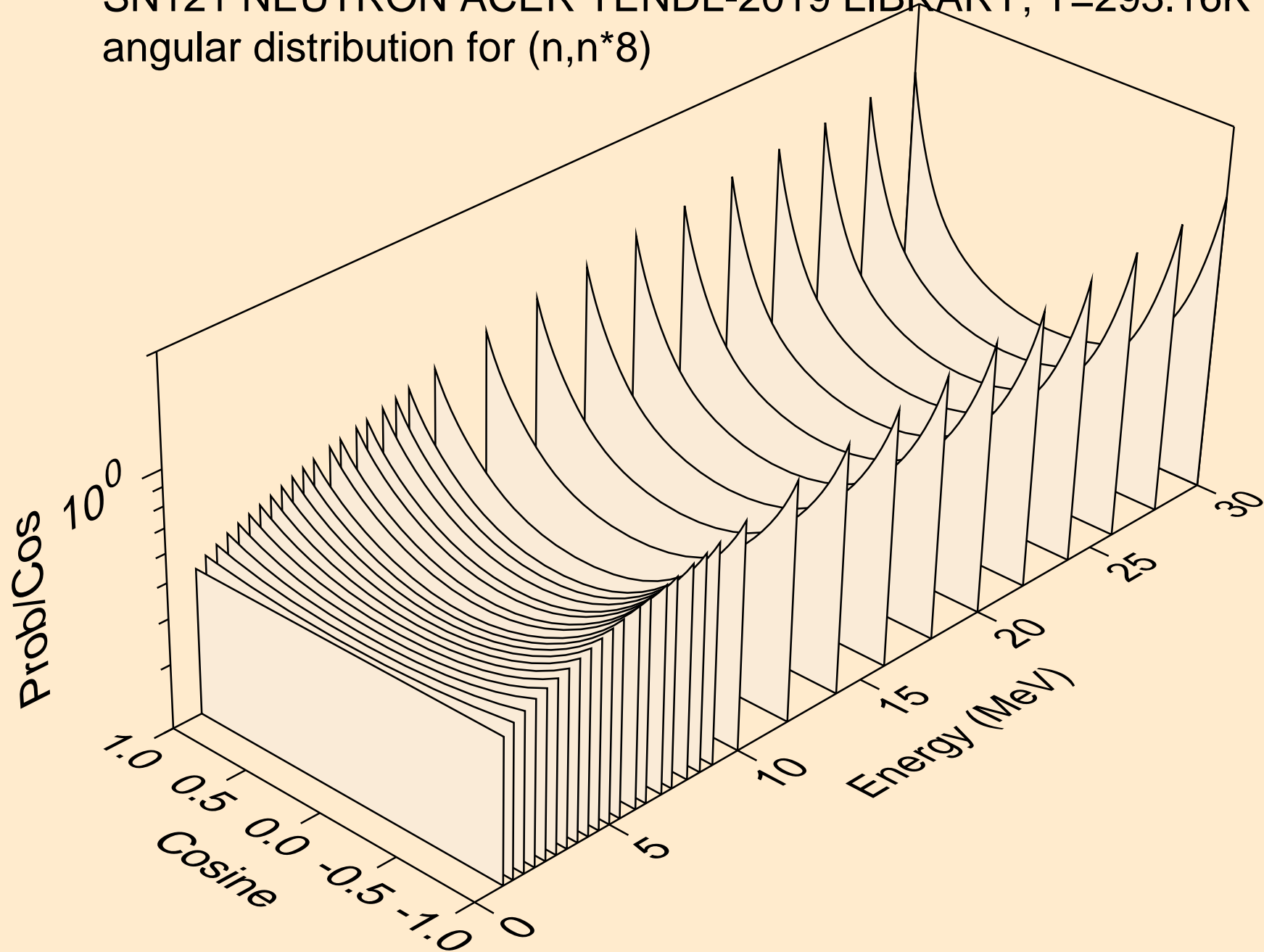

SN121 NEUTRON ACER TENDL-2019 LIBRARY; T=293.16K  
angular distribution for (n,n\*9)

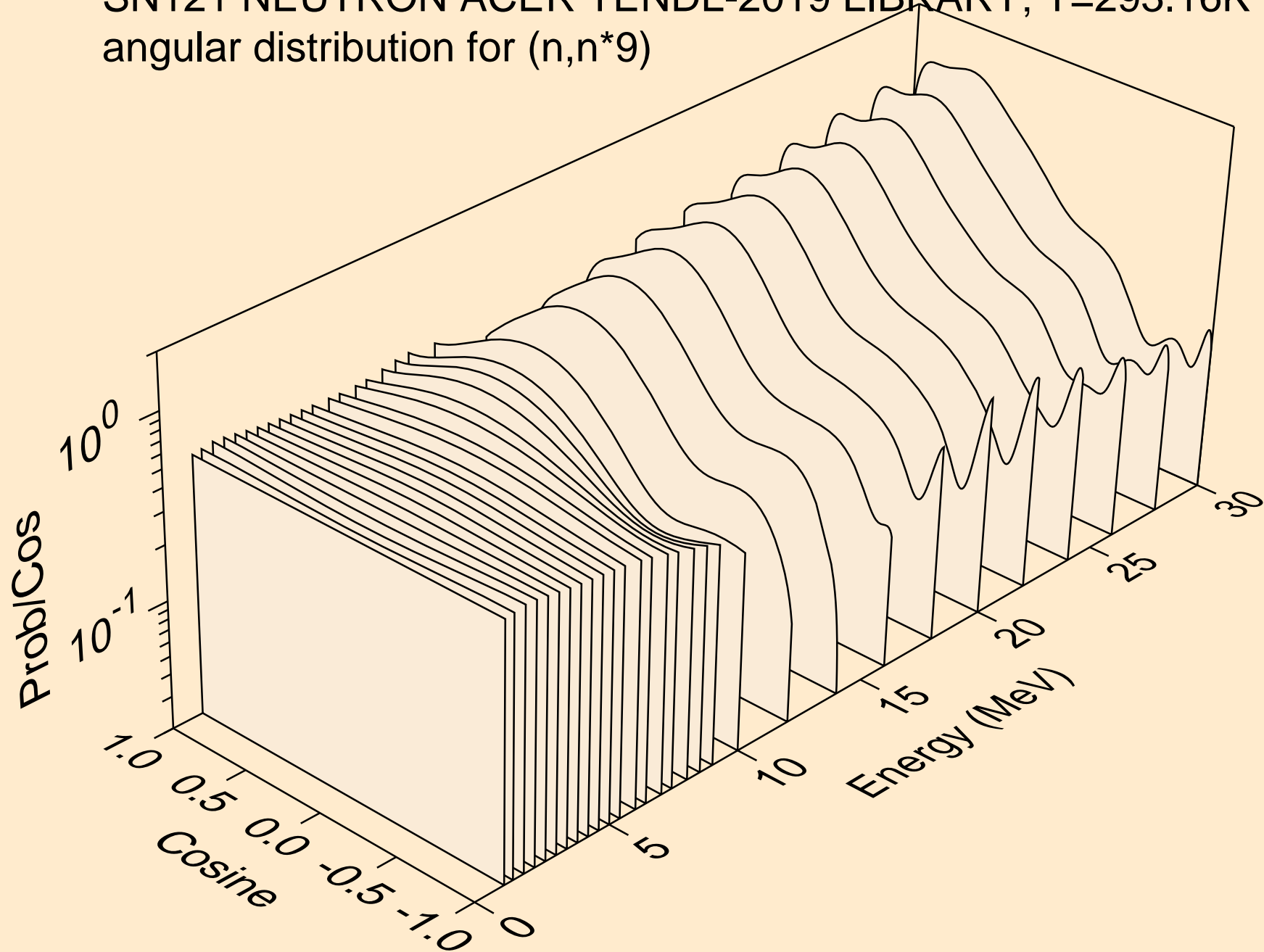

SN121 NEUTRON ACER TENDL-2019 LIBRARY; T=293.16K  
angular distribution for (n,n\*10)

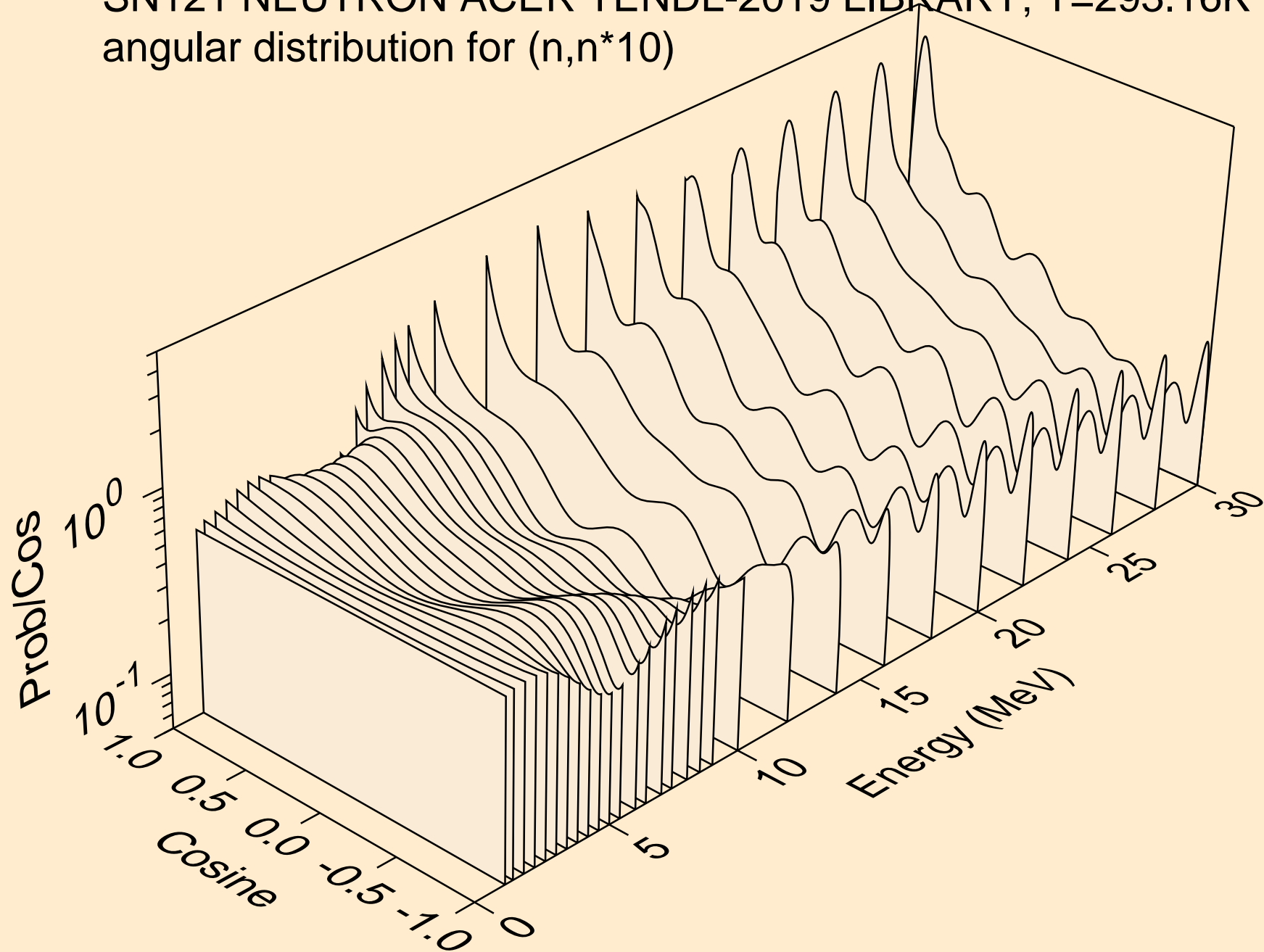

SN121 NEUTRON ACER TENDL-2019 LIBRARY; T=293.16K  
angular distribution for (n,n\*11)

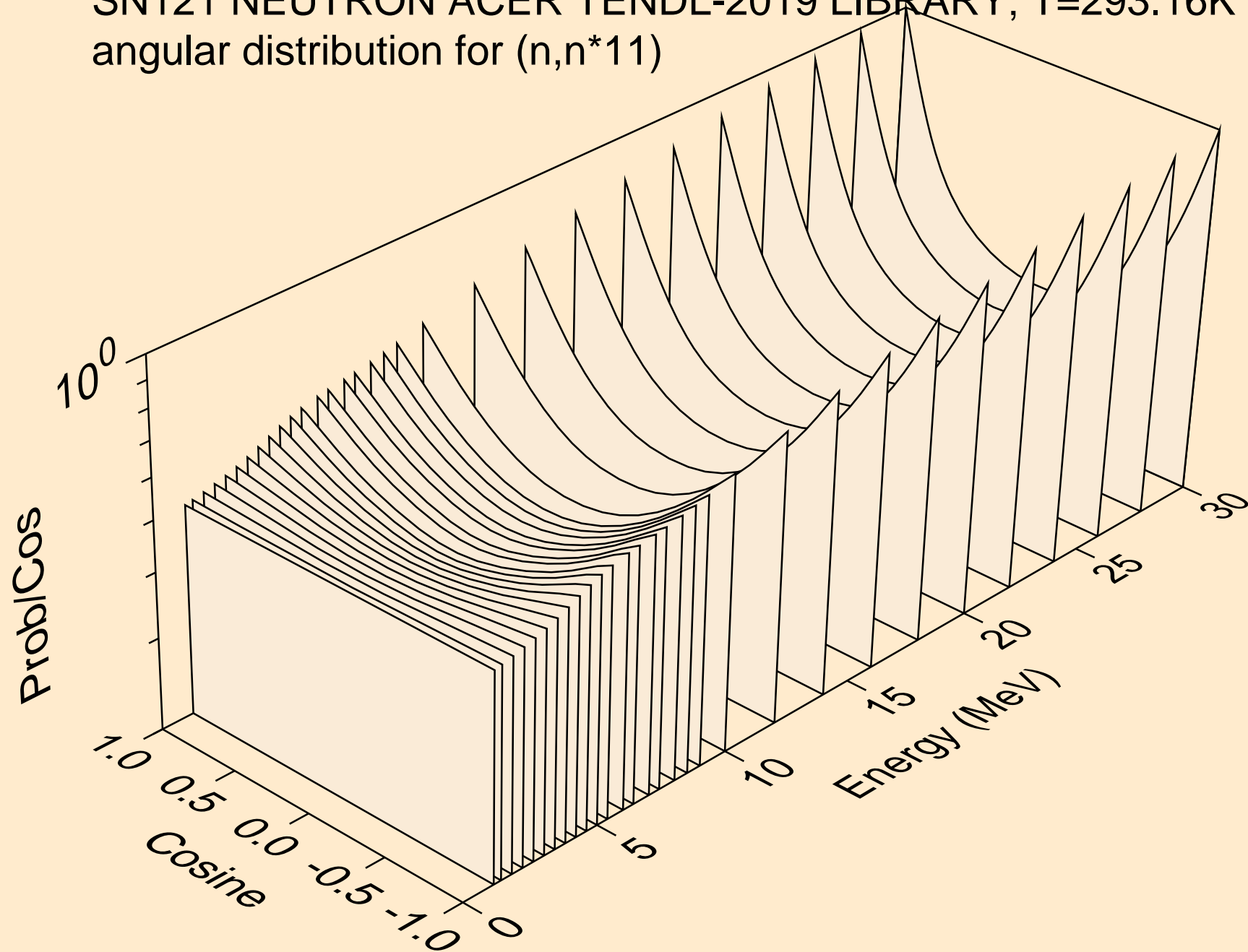

SN121 NEUTRON ACER TENDL-2019 LIBRARY; T=293.16K  
angular distribution for (n,n\*12)

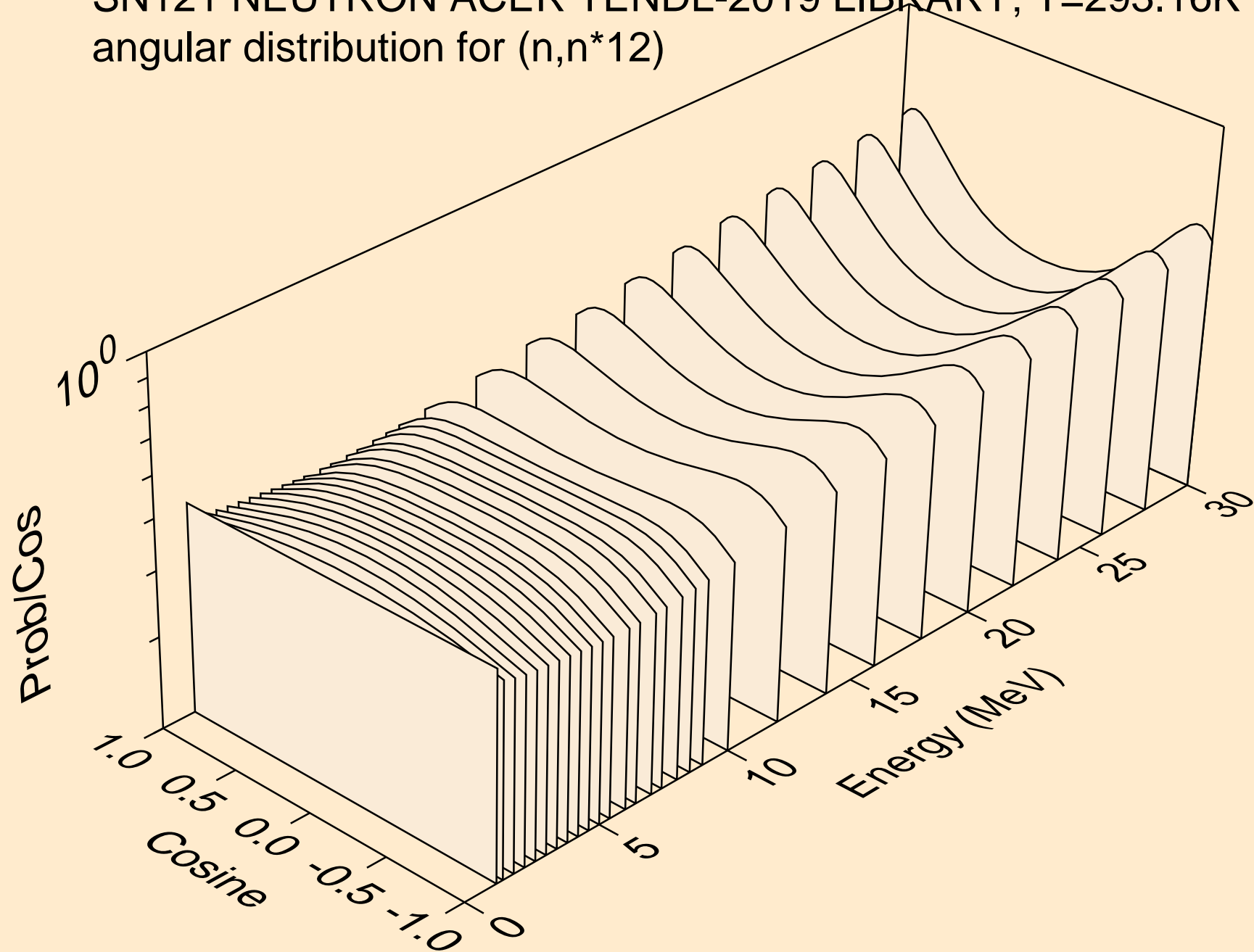



SN121 NEUTRON ACER TENDL-2019 LIBRARY; T=293.16K  
angular distribution for (n,n\*13)

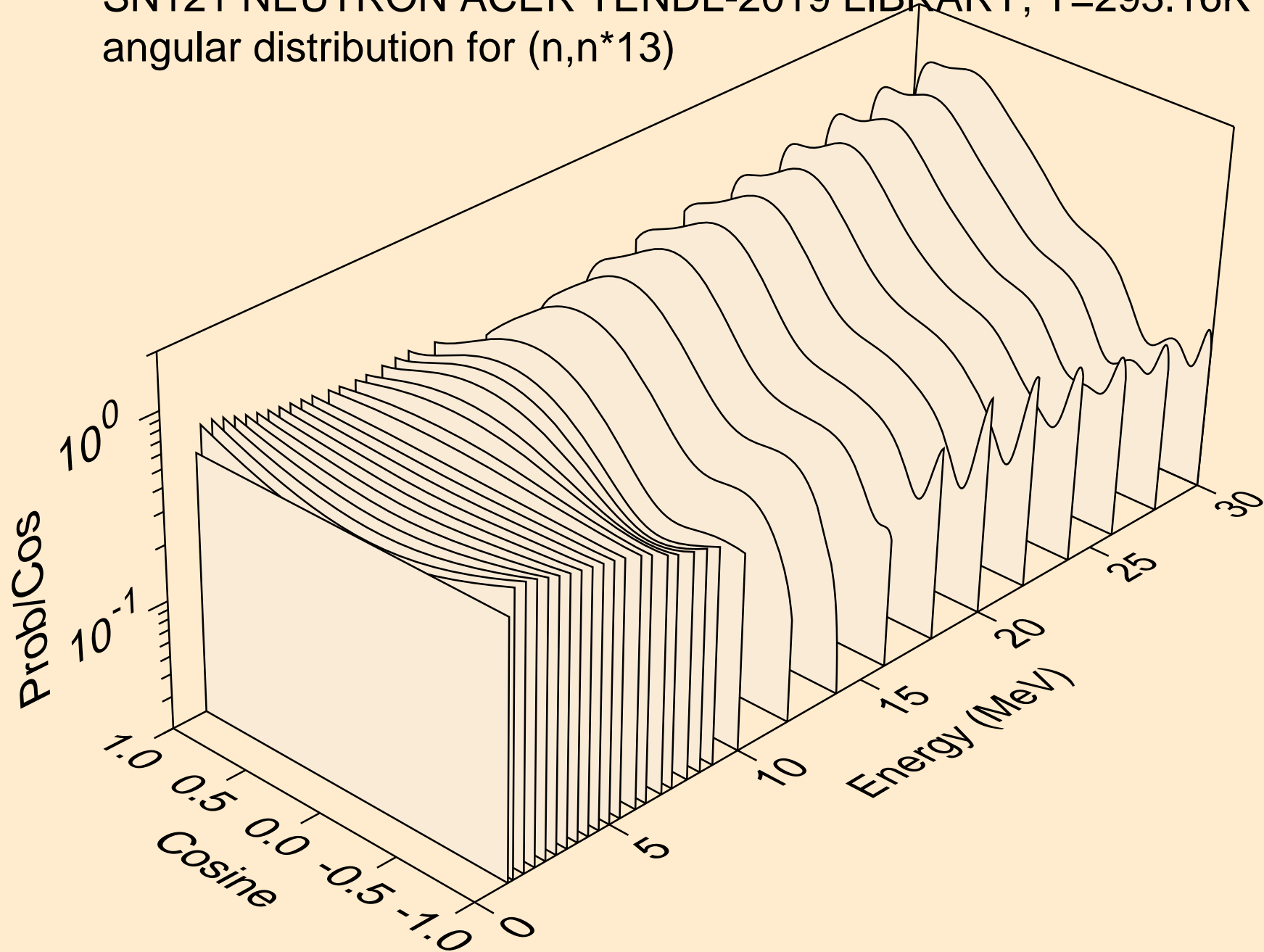

SN121 NEUTRON ACER TENDL-2019 LIBRARY; T=293.16K  
angular distribution for (n,n\*14)

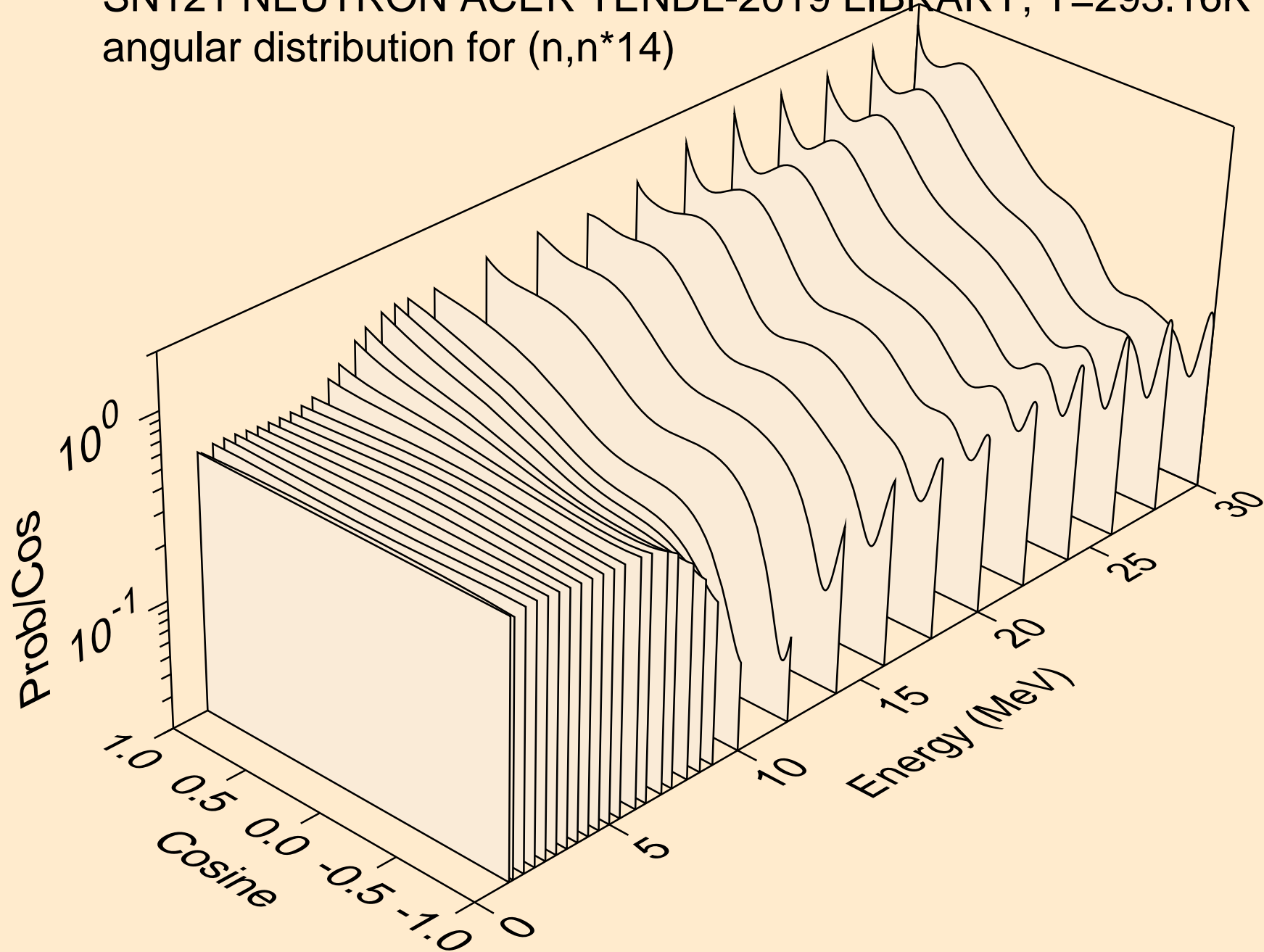

SN121 NEUTRON ACER TENDL-2019 LIBRARY; T=293.16K  
angular distribution for (n,n\*15)

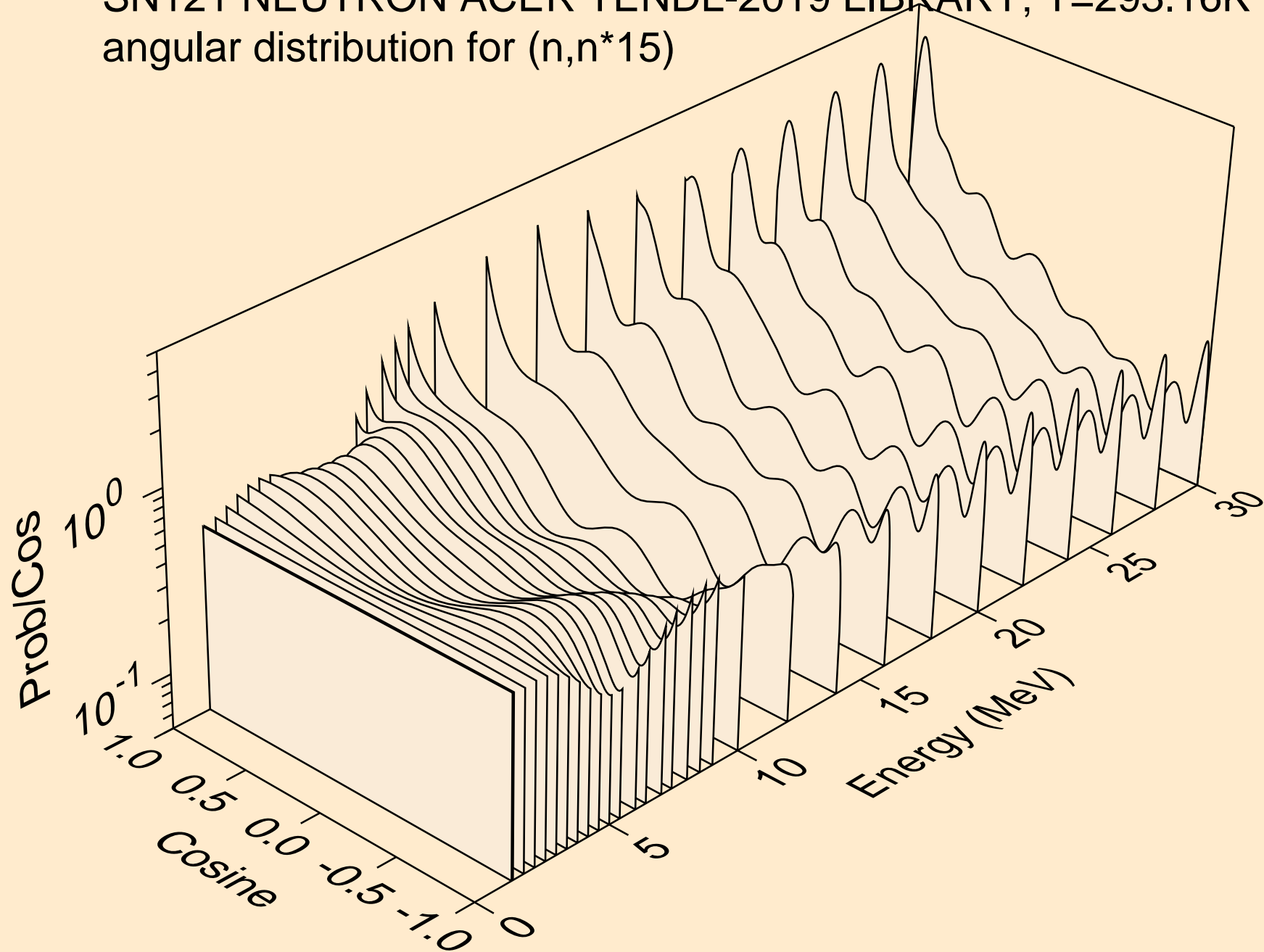

SN121 NEUTRON ACER TENDL-2019 LIBRARY; T=293.16K  
angular distribution for (n,n\*16)

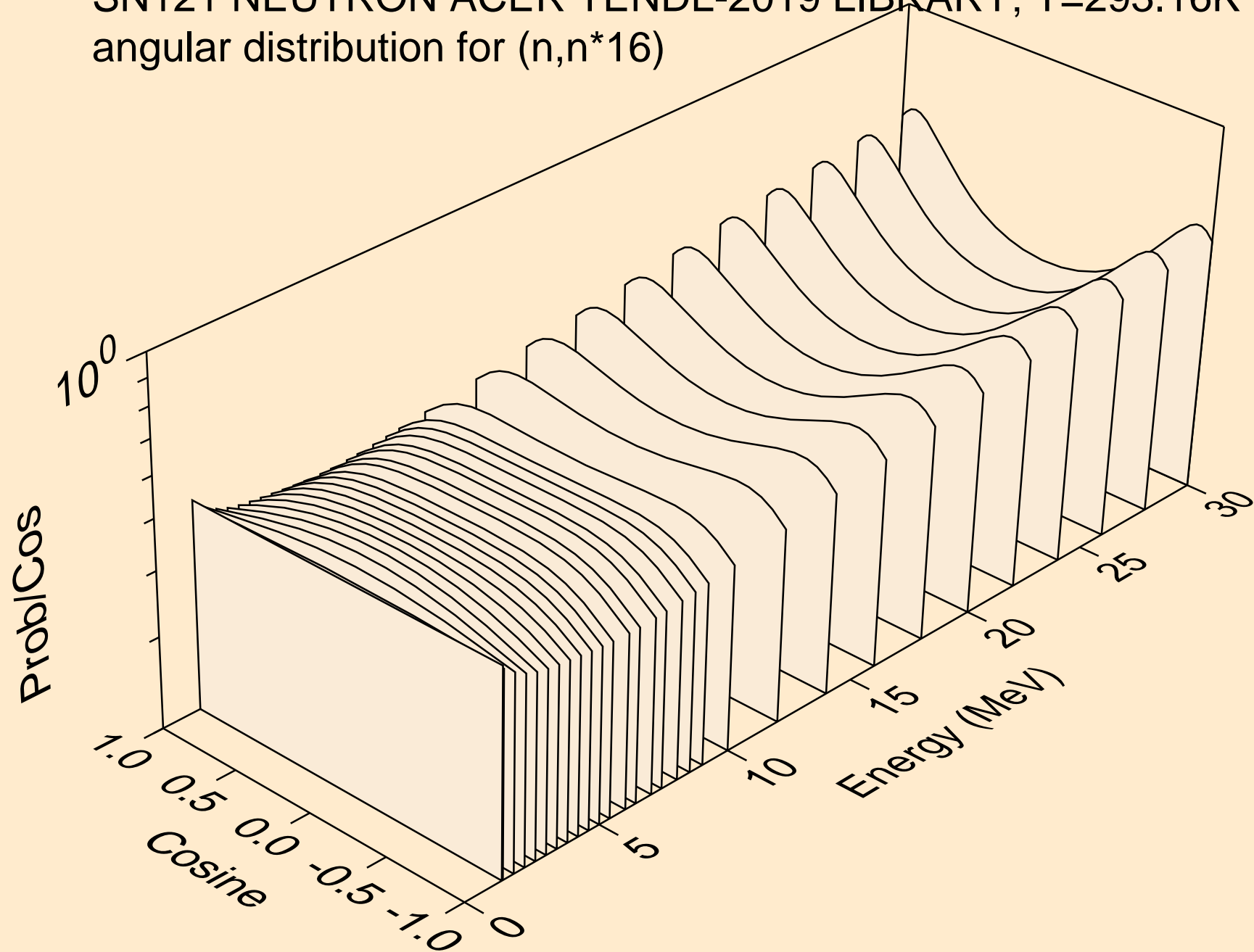

SN121 NEUTRON ACER TENDL-2019 LIBRARY; T=293.16K  
angular distribution for (n,n\*17)

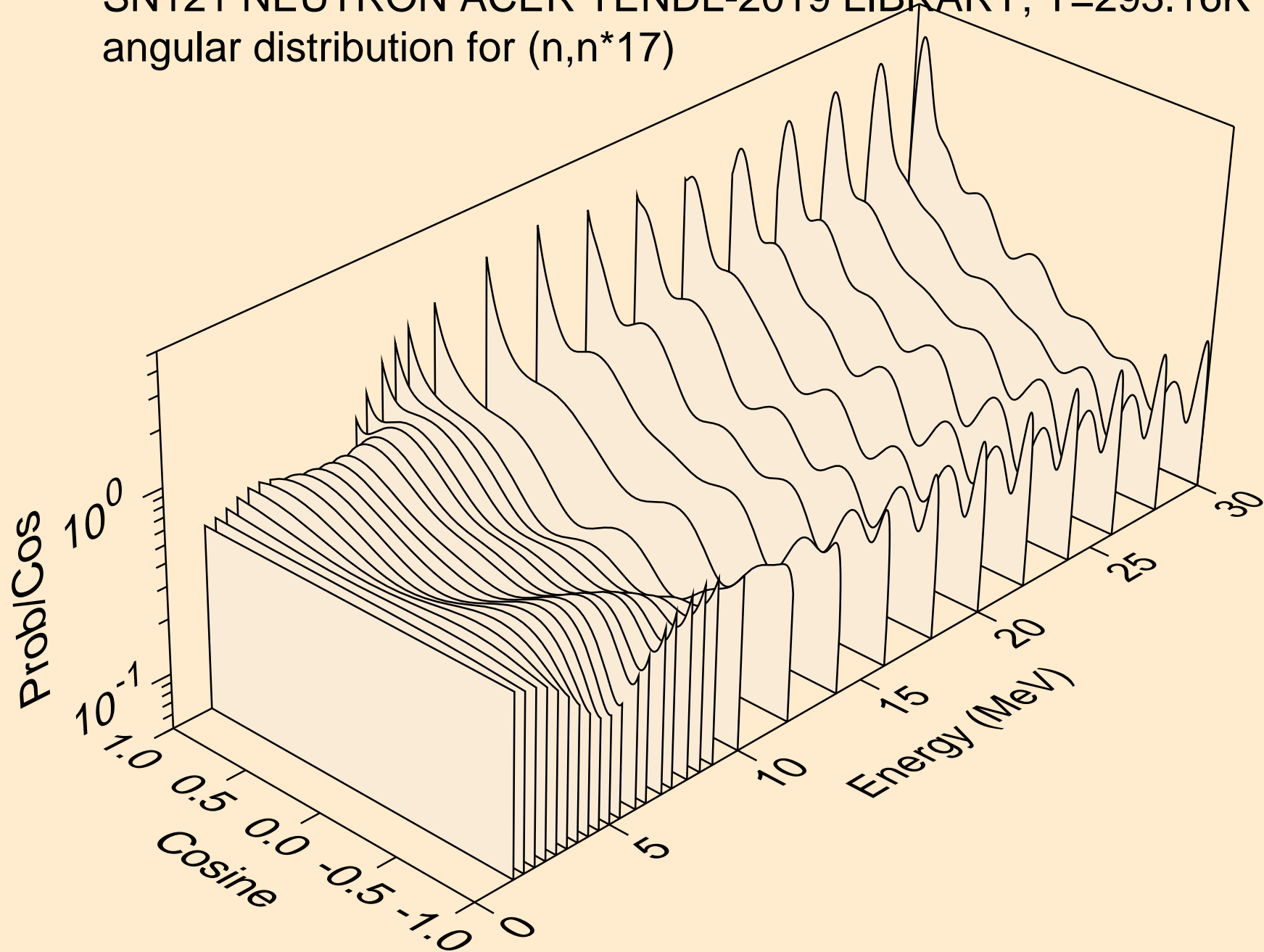

SN121 NEUTRON ACER TENDL-2019 LIBRARY; T=293.16K  
angular distribution for (n,n\*18)

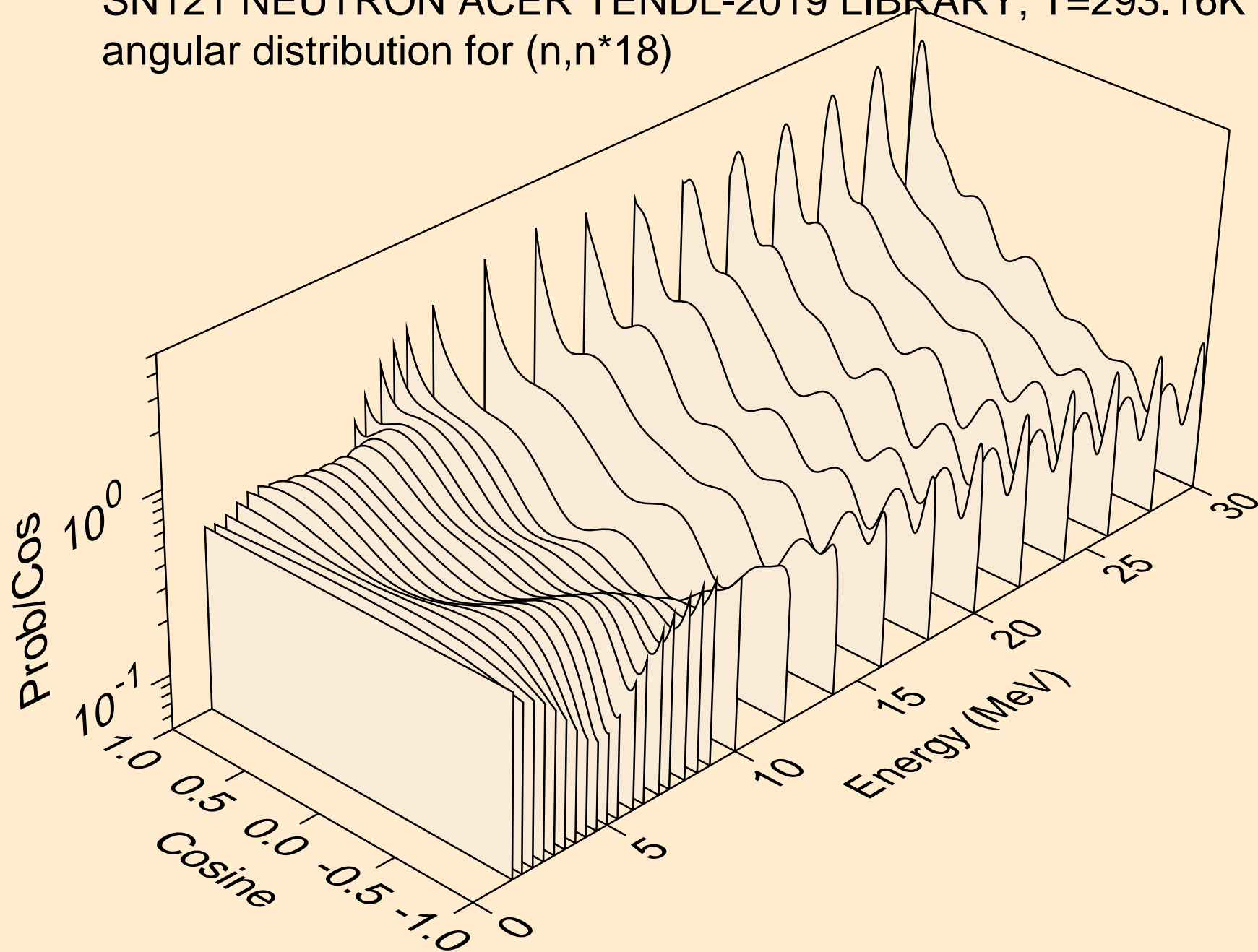

SN121 NEUTRON ACER TENDL-2019 LIBRARY; T=293.16K  
angular distribution for (n,n\*19)

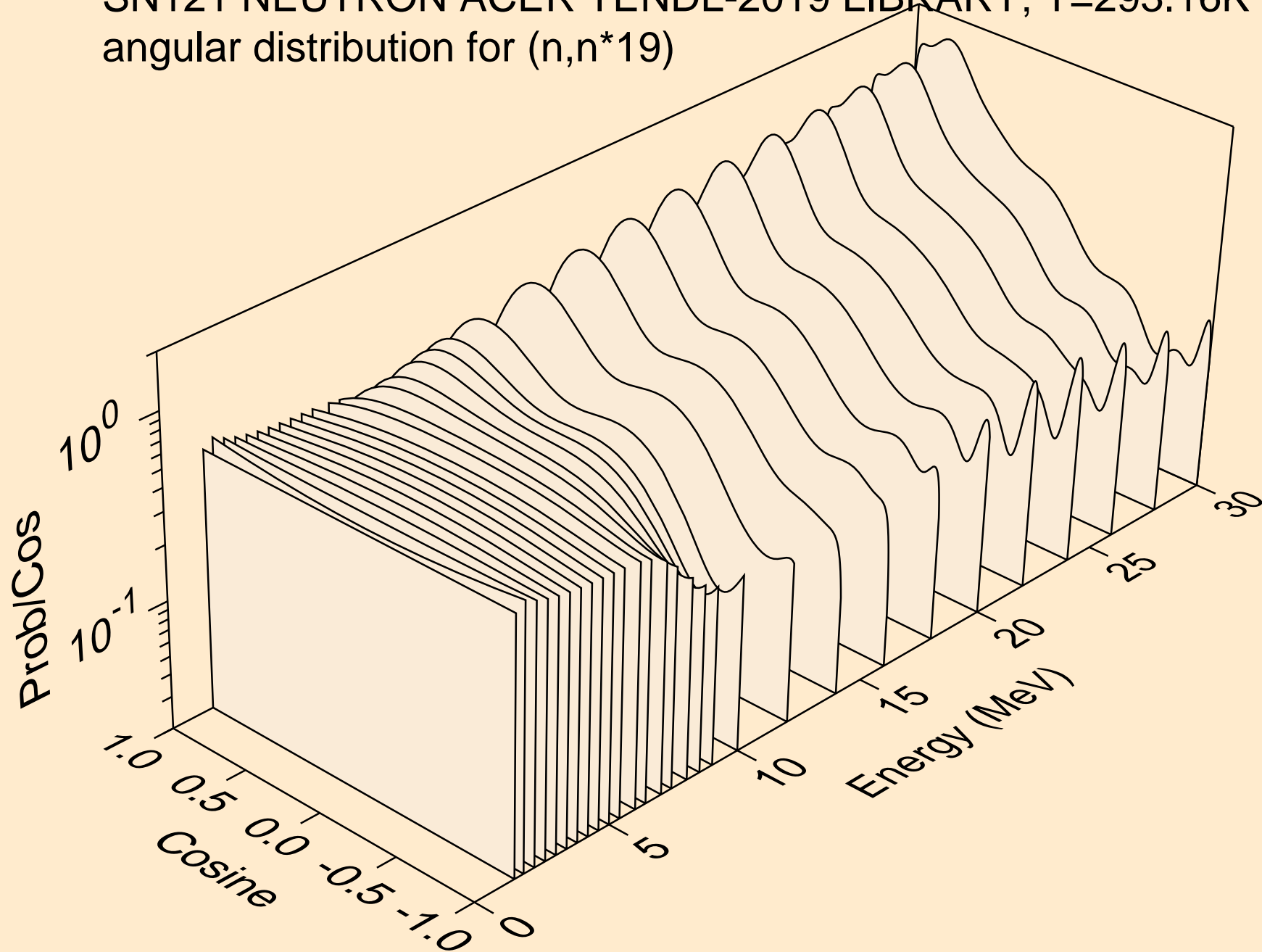

SN121 NEUTRON ACER TENDL-2019 LIBRARY; T=293.16K  
angular distribution for (n,n\*20)

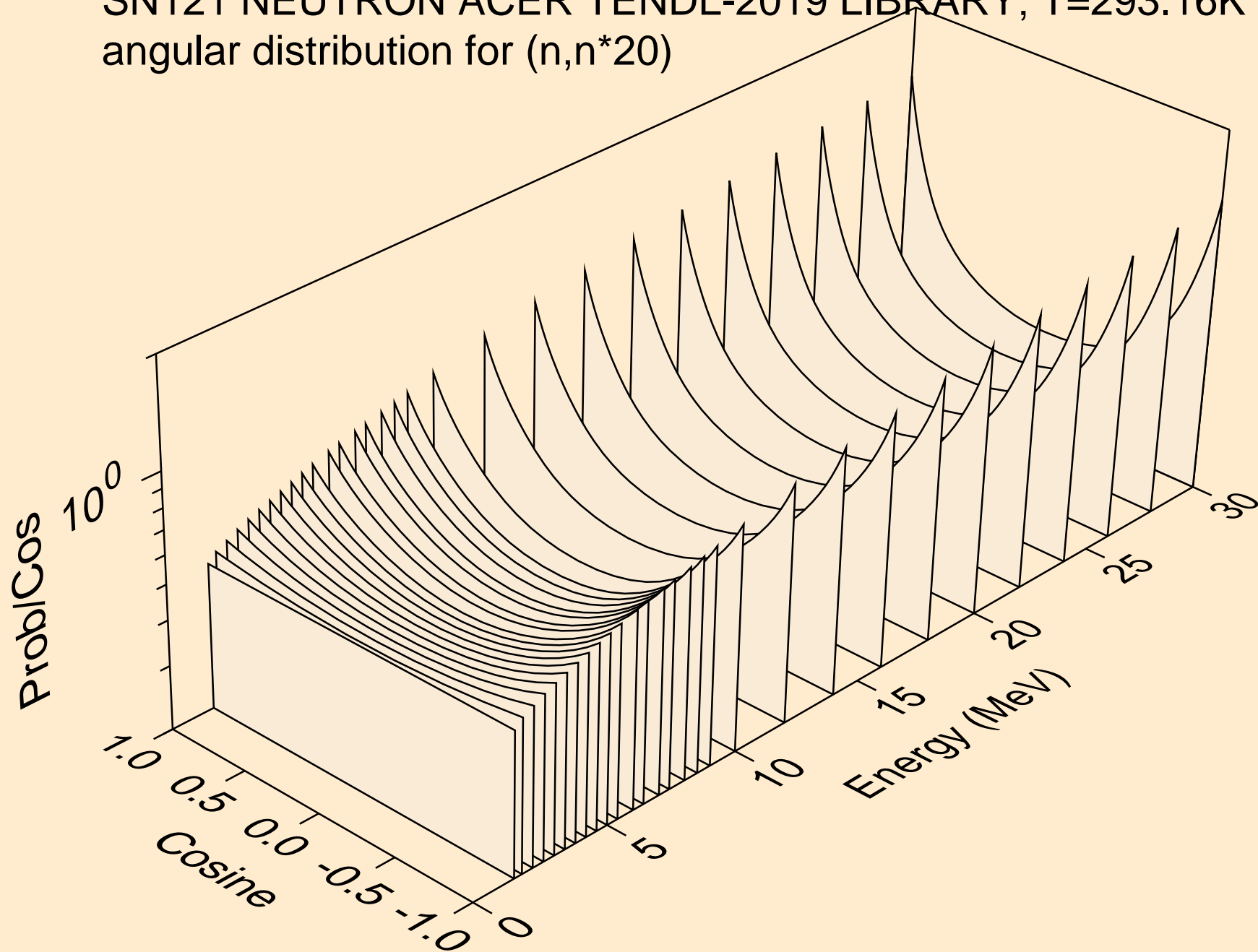



SN121 NEUTRON ACER TENDL-2019 LIBRARY; T=293.16K  
angular distribution for (n,n\*21)

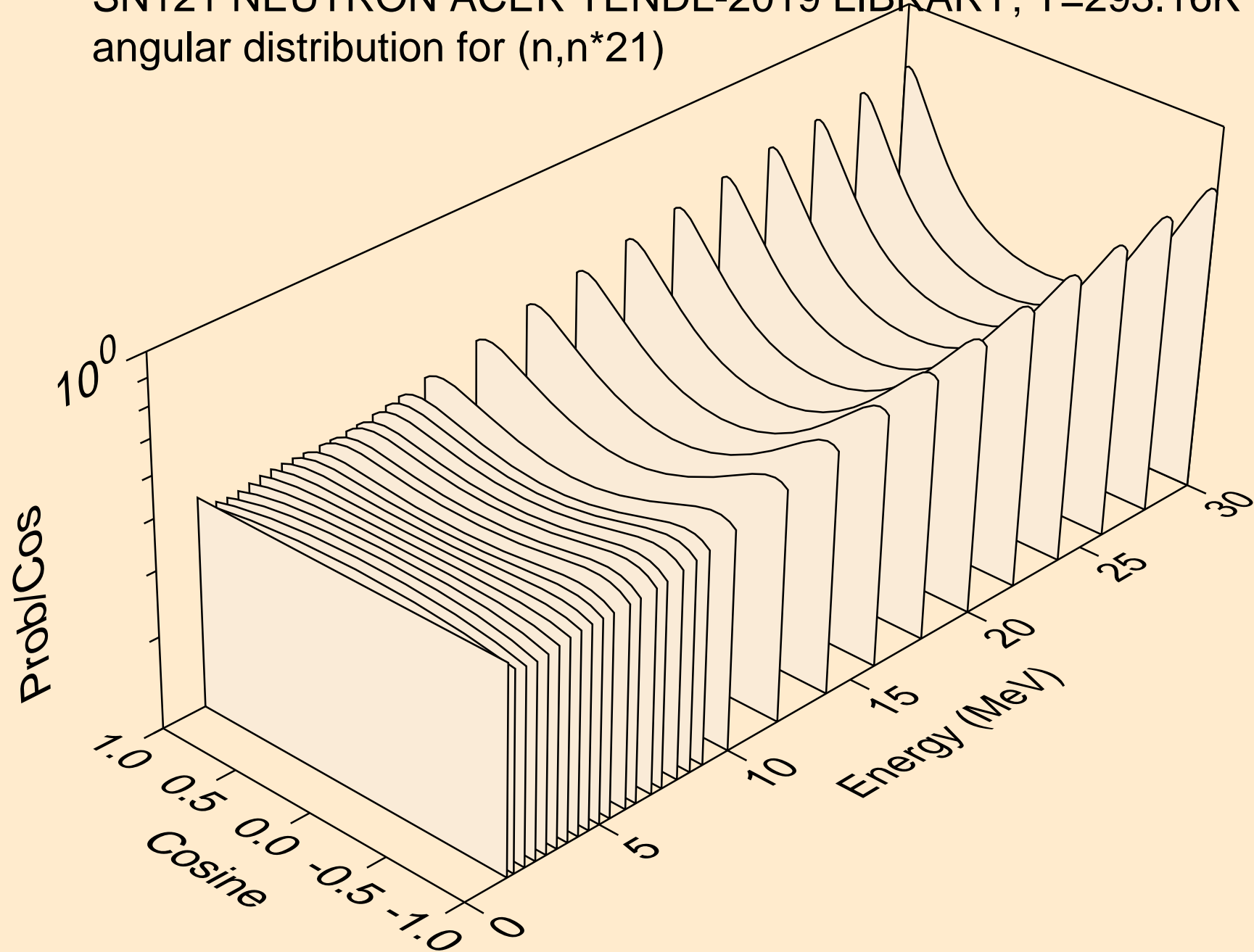

SN121 NEUTRON ACER TENDL-2019 LIBRARY; T=293.16K  
angular distribution for (n,n\*22)

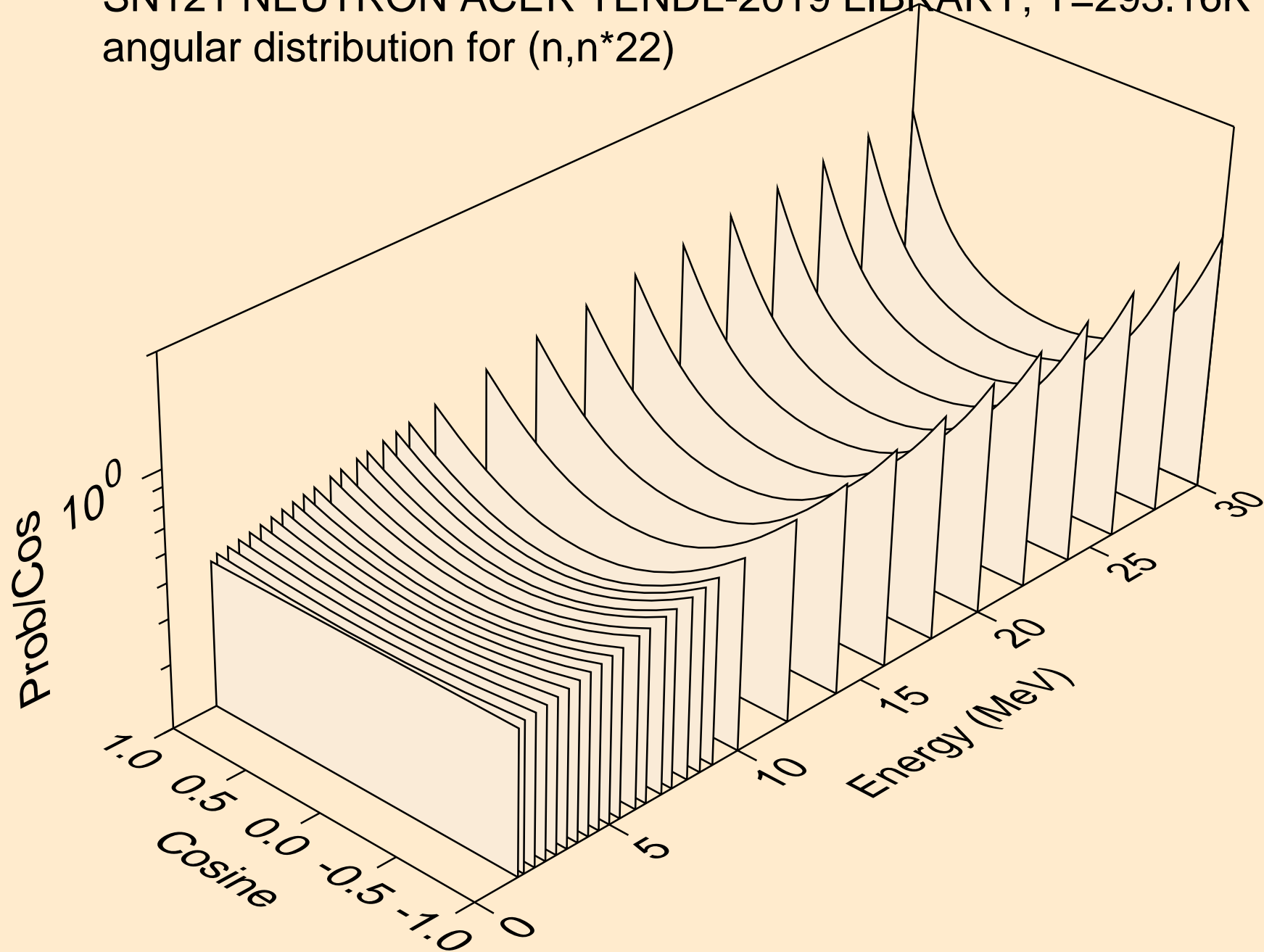

SN121 NEUTRON ACER TENDL-2019 LIBRARY; T=293.16K  
angular distribution for (n,n\*23)

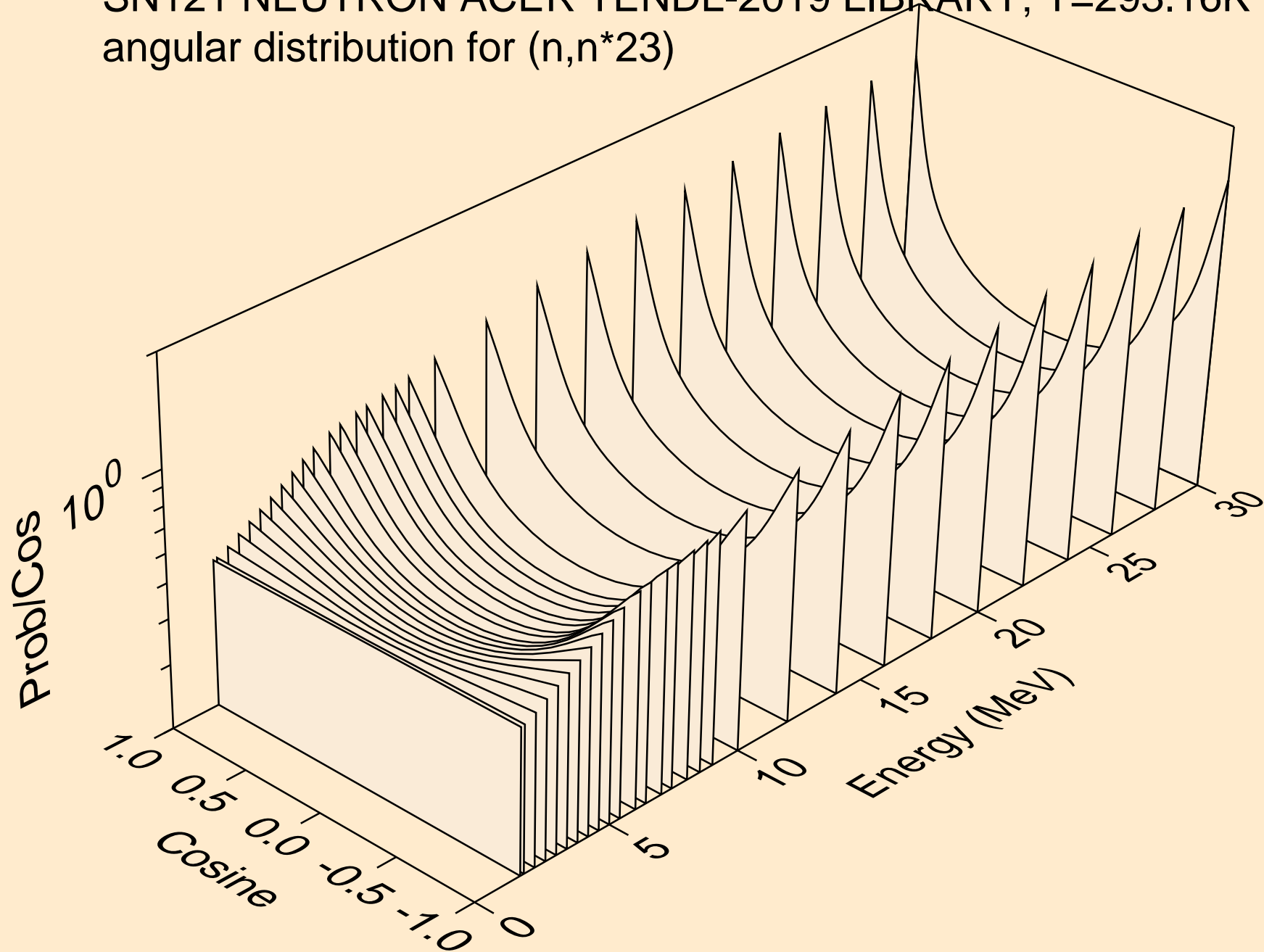

SN121 NEUTRON ACER TENDL-2019 LIBRARY; T=293.16K  
angular distribution for (n,n\*24)

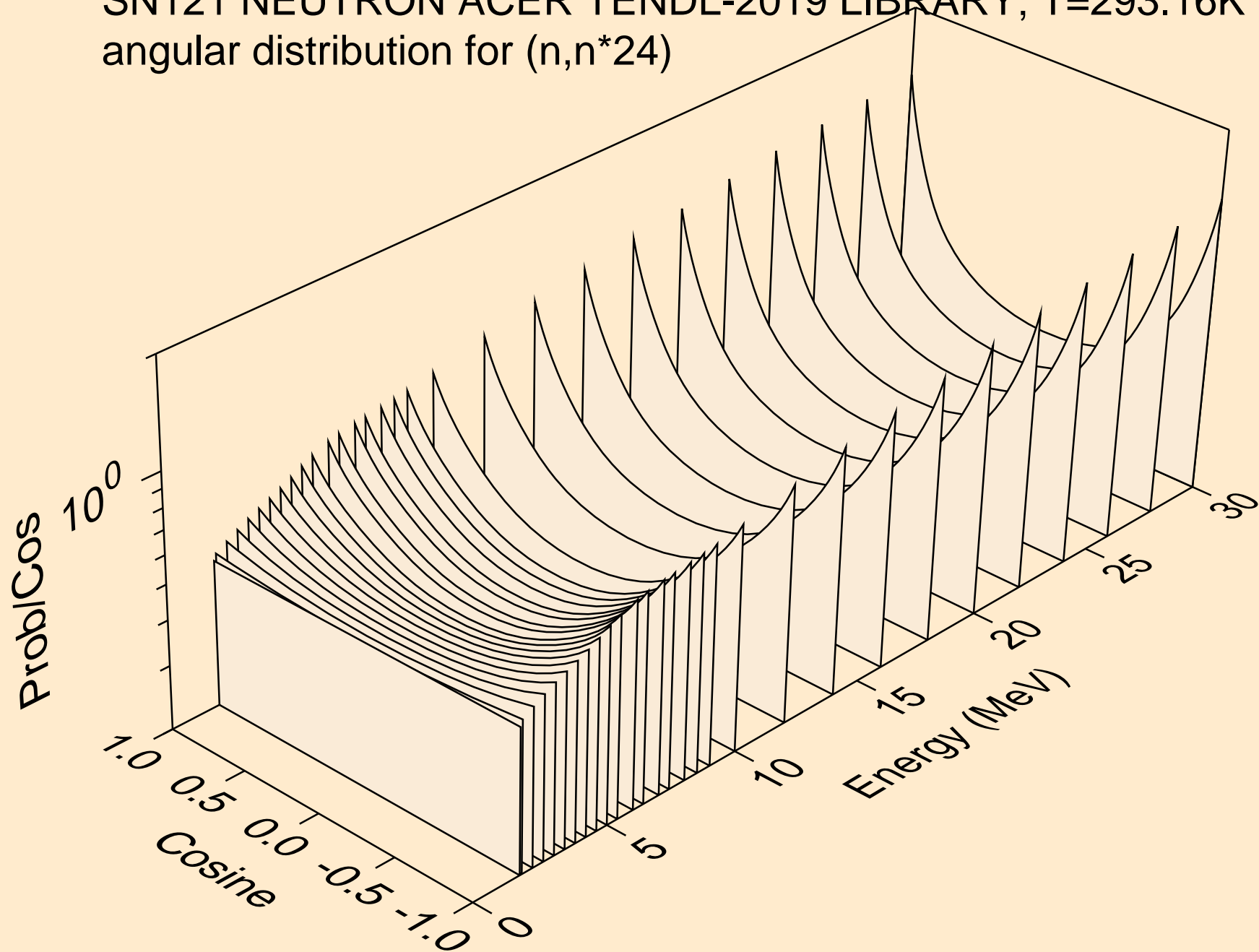

SN121 NEUTRON ACER TENDL-2019 LIBRARY; T=293.16K  
angular distribution for (n,n\*25)

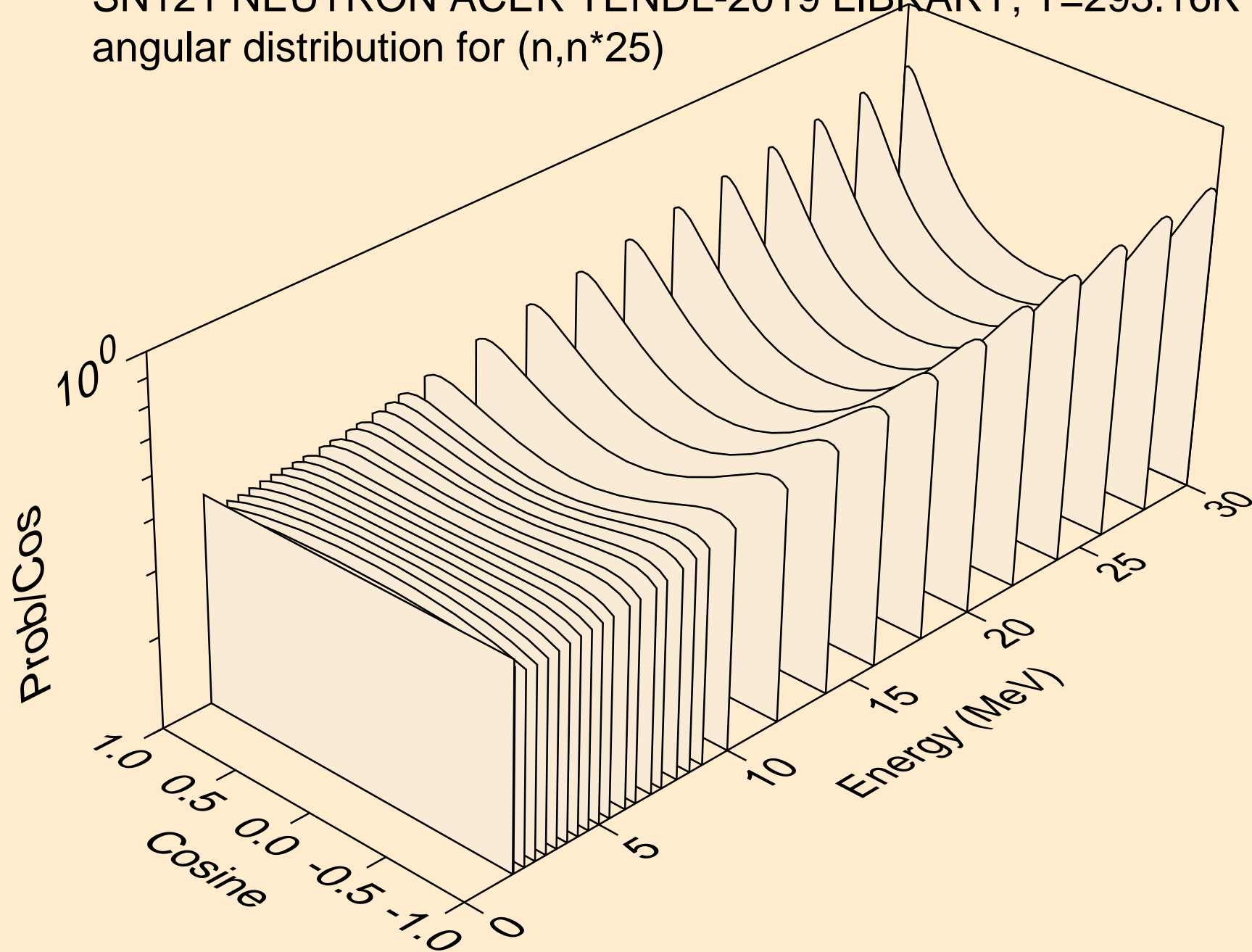

SN121 NEUTRON ACER TENDL-2019 LIBRARY; T=293.16K  
angular distribution for (n,n\*26)

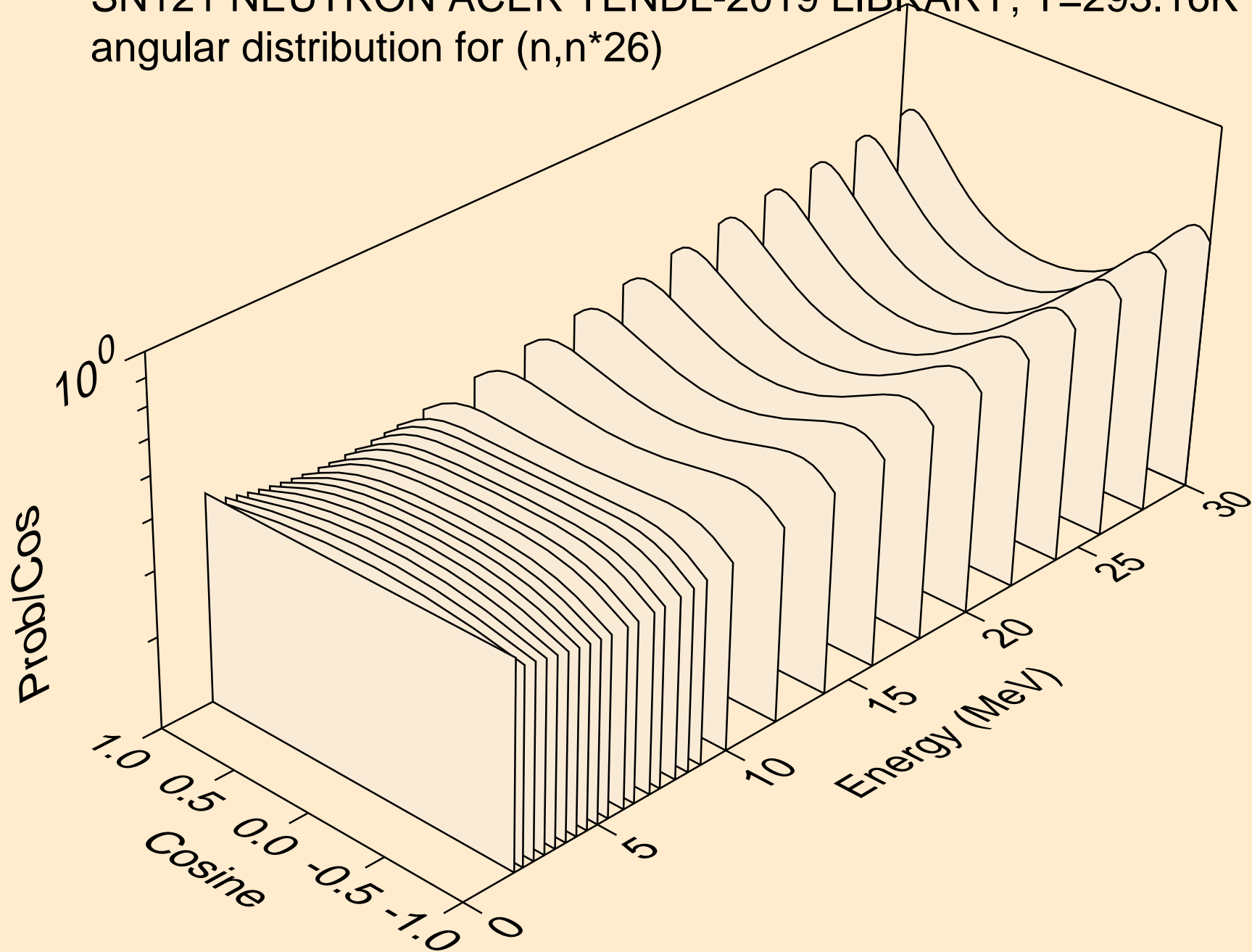

SN121 NEUTRON ACER TENDL-2019 LIBRARY; T=293.16K  
angular distribution for (n,n\*27)

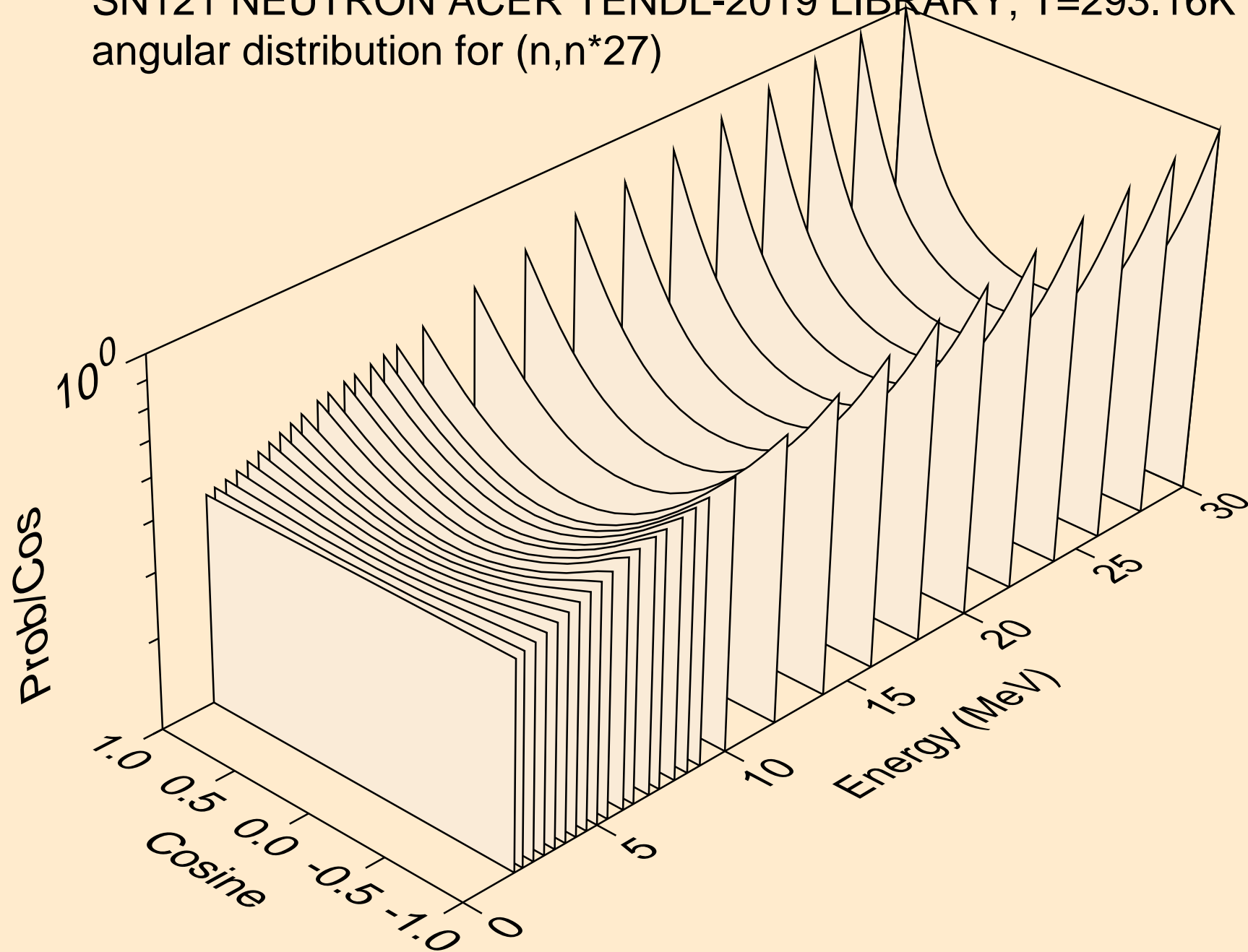

SN121 NEUTRON ACER TENDL-2019 LIBRARY; T=293.16K  
angular distribution for (n,n\*28)

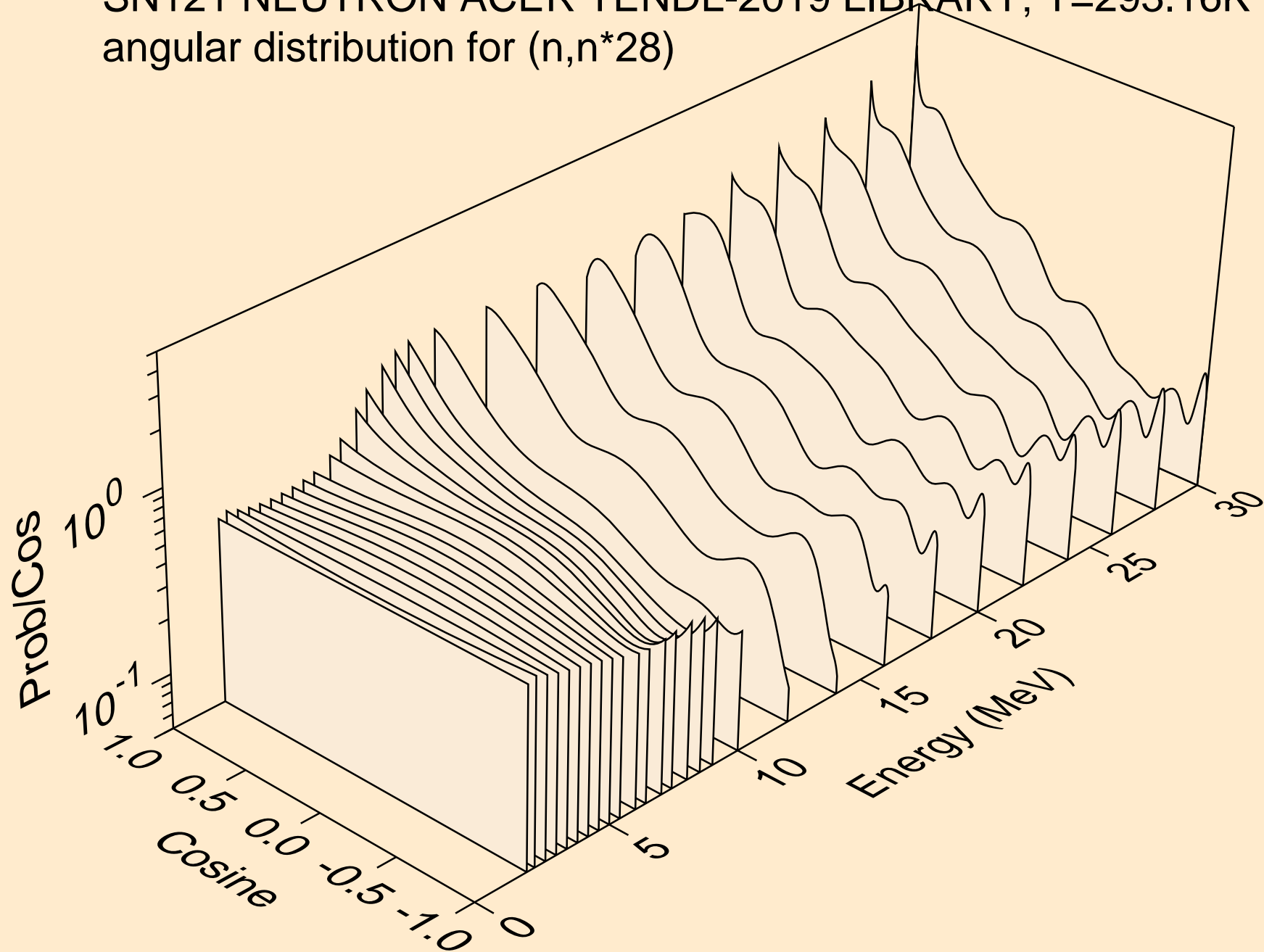



SN121 NEUTRON ACER TENDL-2019 LIBRARY; T=293.16K  
angular distribution for (n,n\*29)

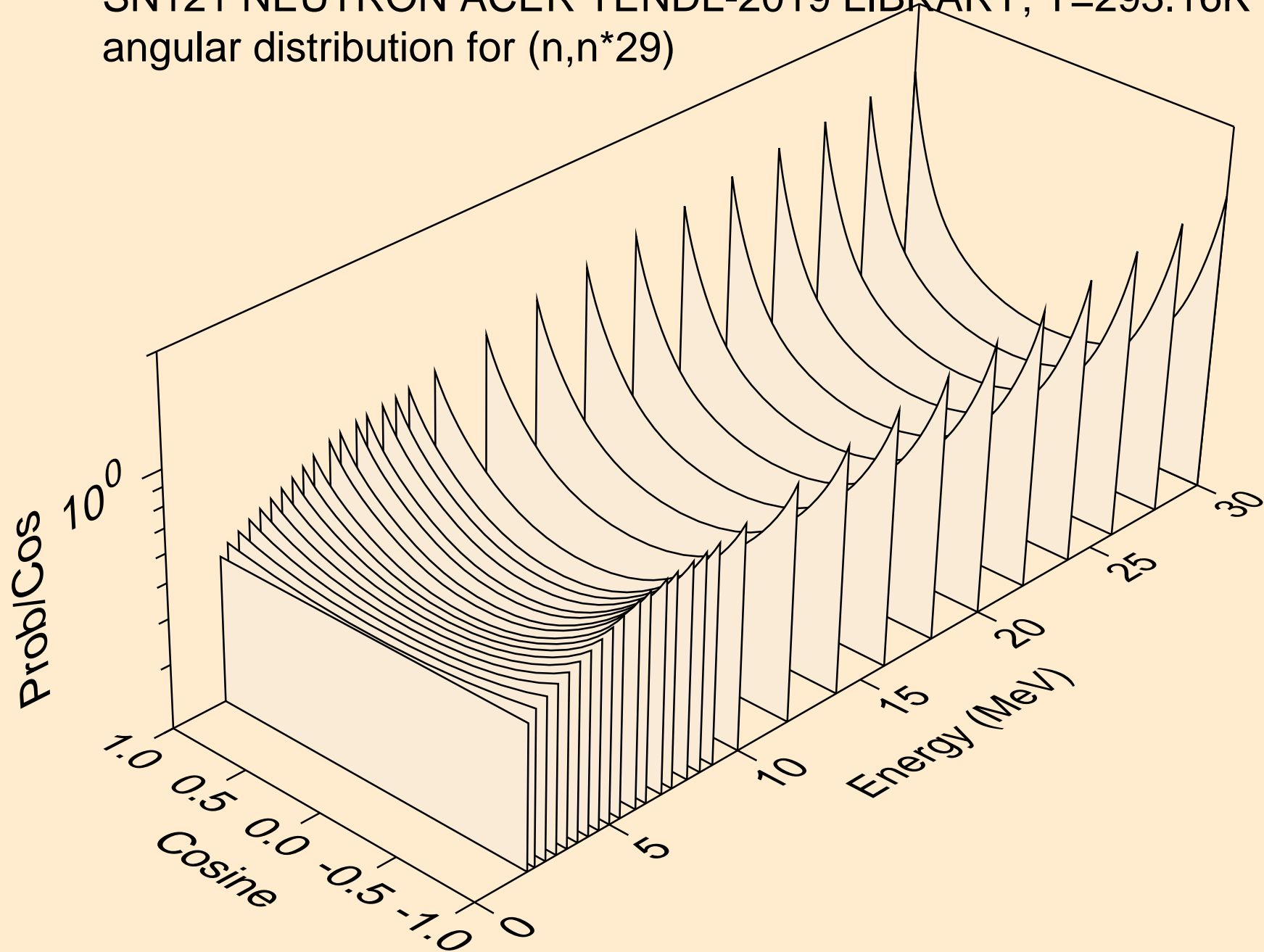

SN121 NEUTRON ACER TENDL-2019 LIBRARY; T=293.16K  
angular distribution for (n,n\*30)

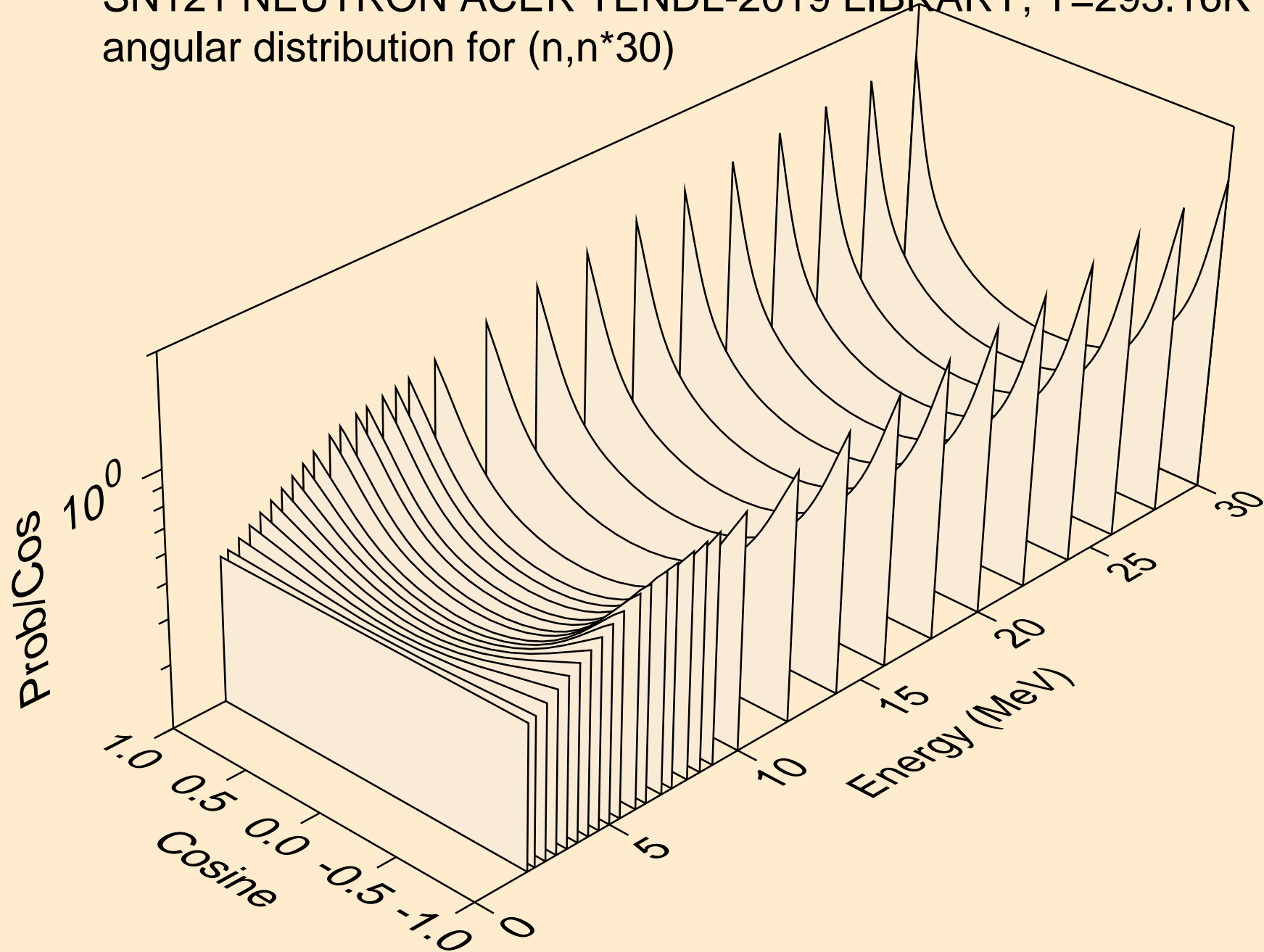

SN121 NEUTRON ACER TENDL-2019 LIBRARY; T=293.16K  
Neutron emission for (n,x)

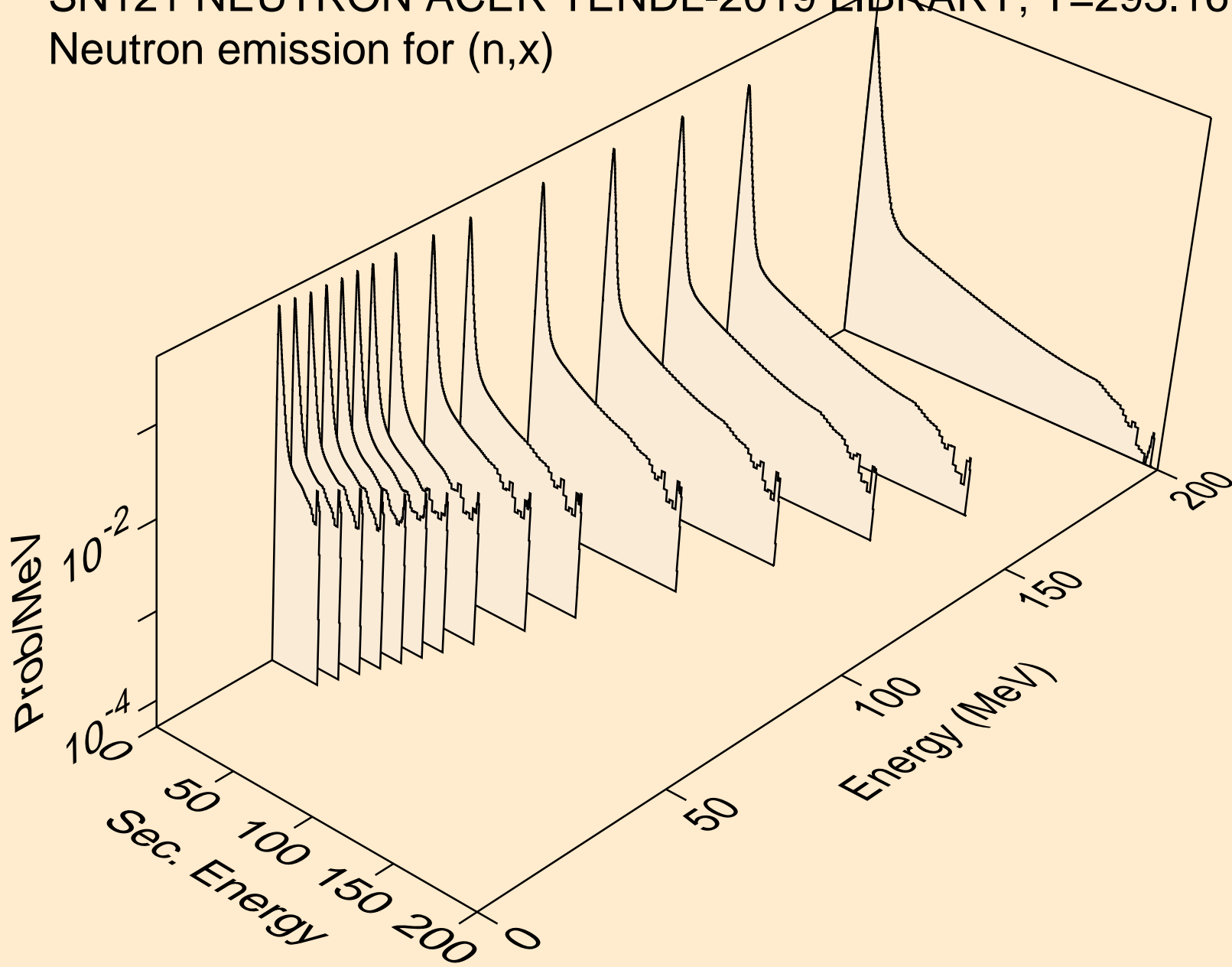

SN121 NEUTRON ACER TENDL-2019 LIBRARY; T=293.16K  
Neutron emission for (n,2nd)

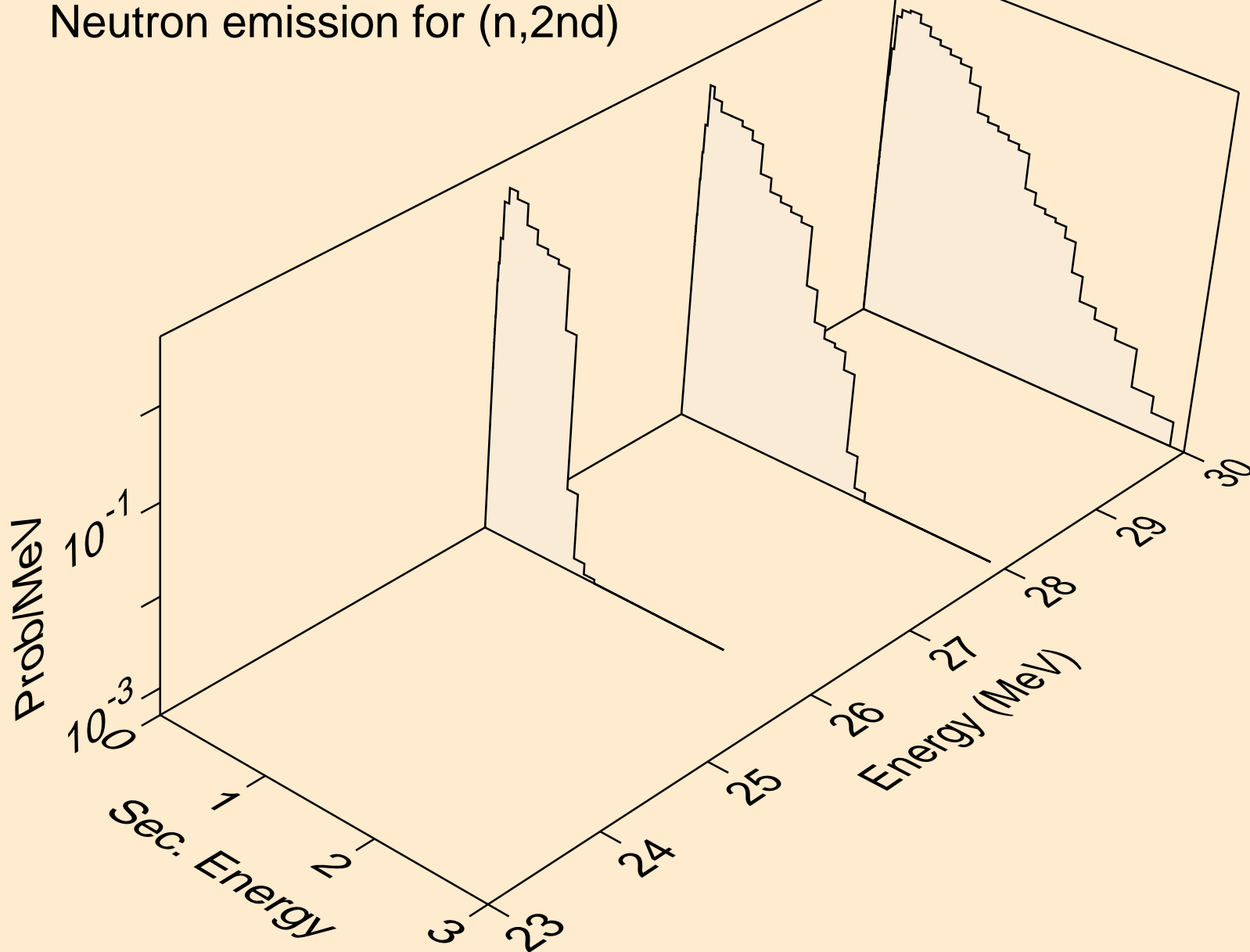

SN121 NEUTRON ACER TENDL-2019 LIBRARY; T=293.16K  
Neutron emission for (n,2n)

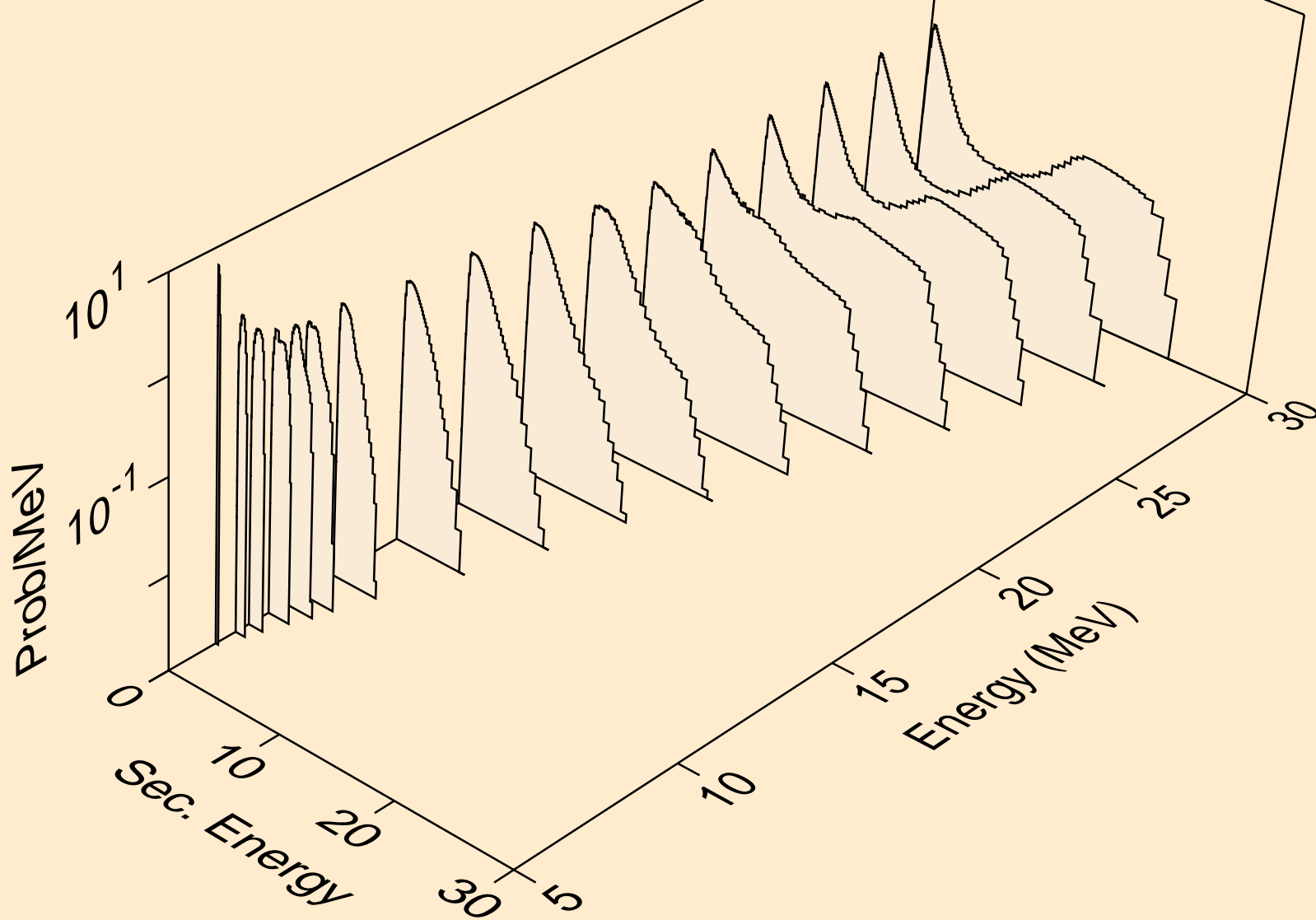

SN121 NEUTRON ACER TENDL-2019 LIBRARY; T=293.16K  
Neutron emission for (n,3n)

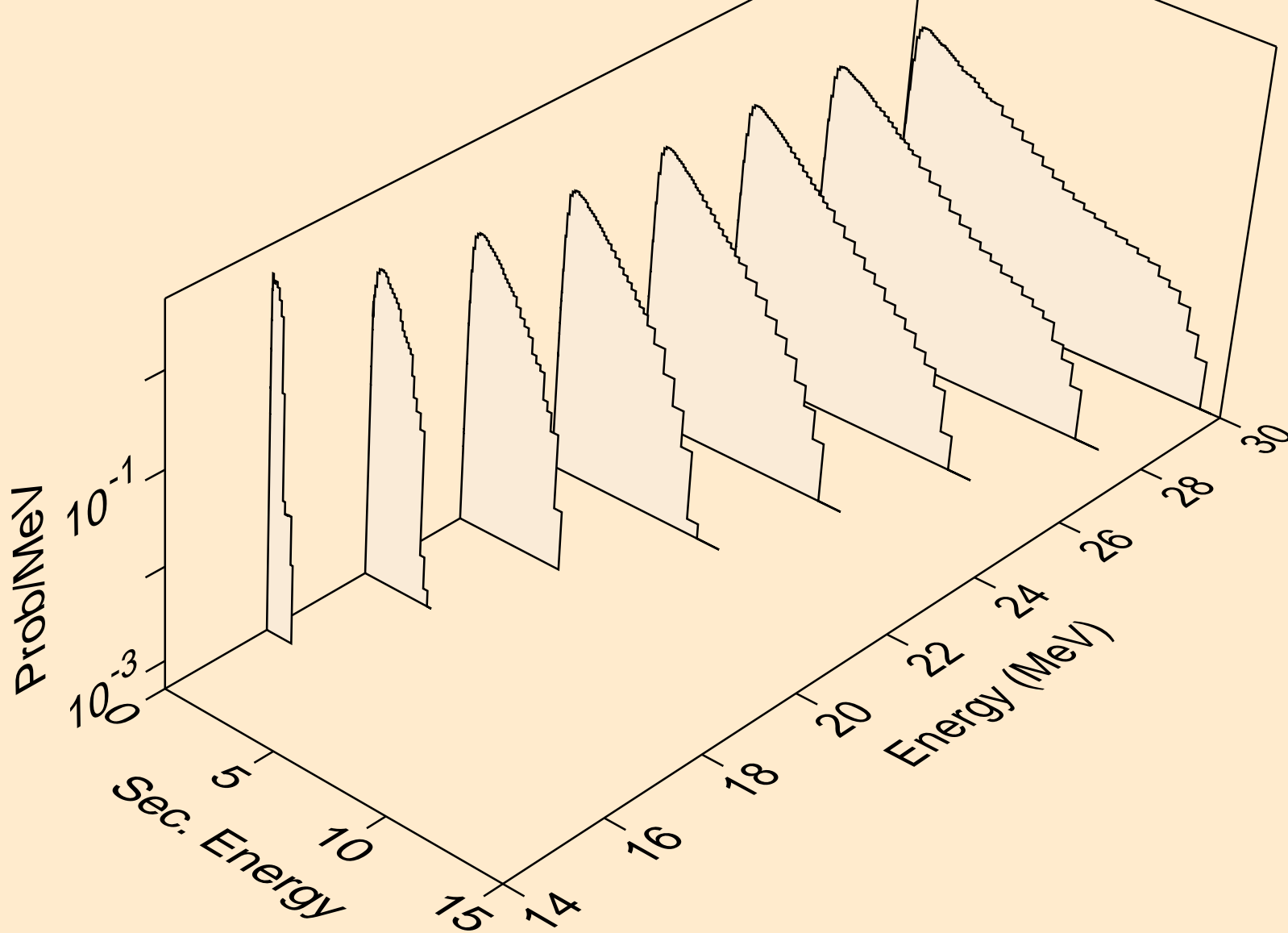

SN121 NEUTRON ACER TENDL-2019 LIBRARY; T=293.16K  
Neutron emission for (n,n\*)a

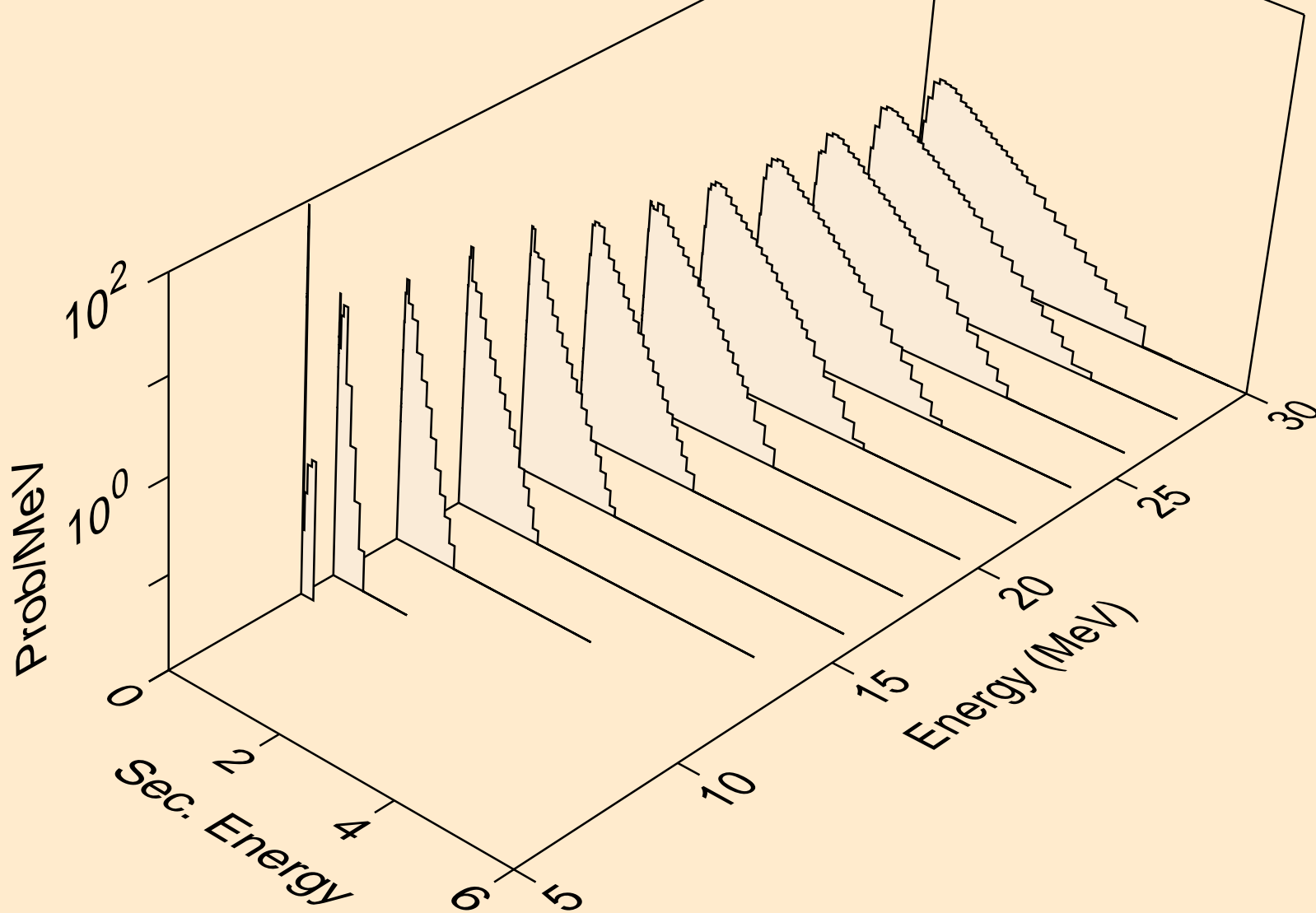

SN121 NEUTRON ACER TENDL-2019 LIBRARY; T=293.16K  
Neutron emission for (n,2n)a

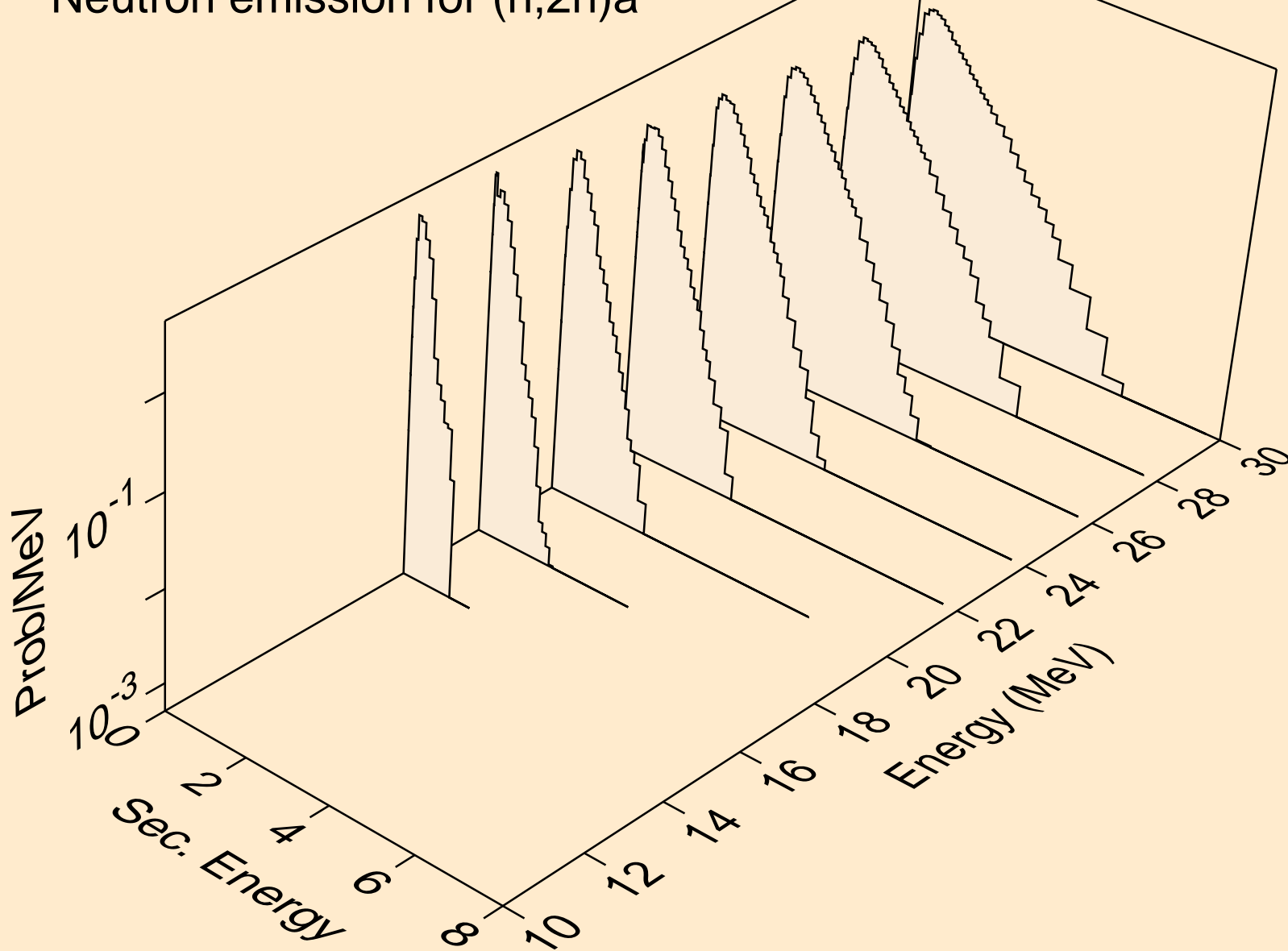



SN121 NEUTRON ACER TENDL-2019 LIBRARY; T=293.16K  
Neutron emission for (n,3n)a

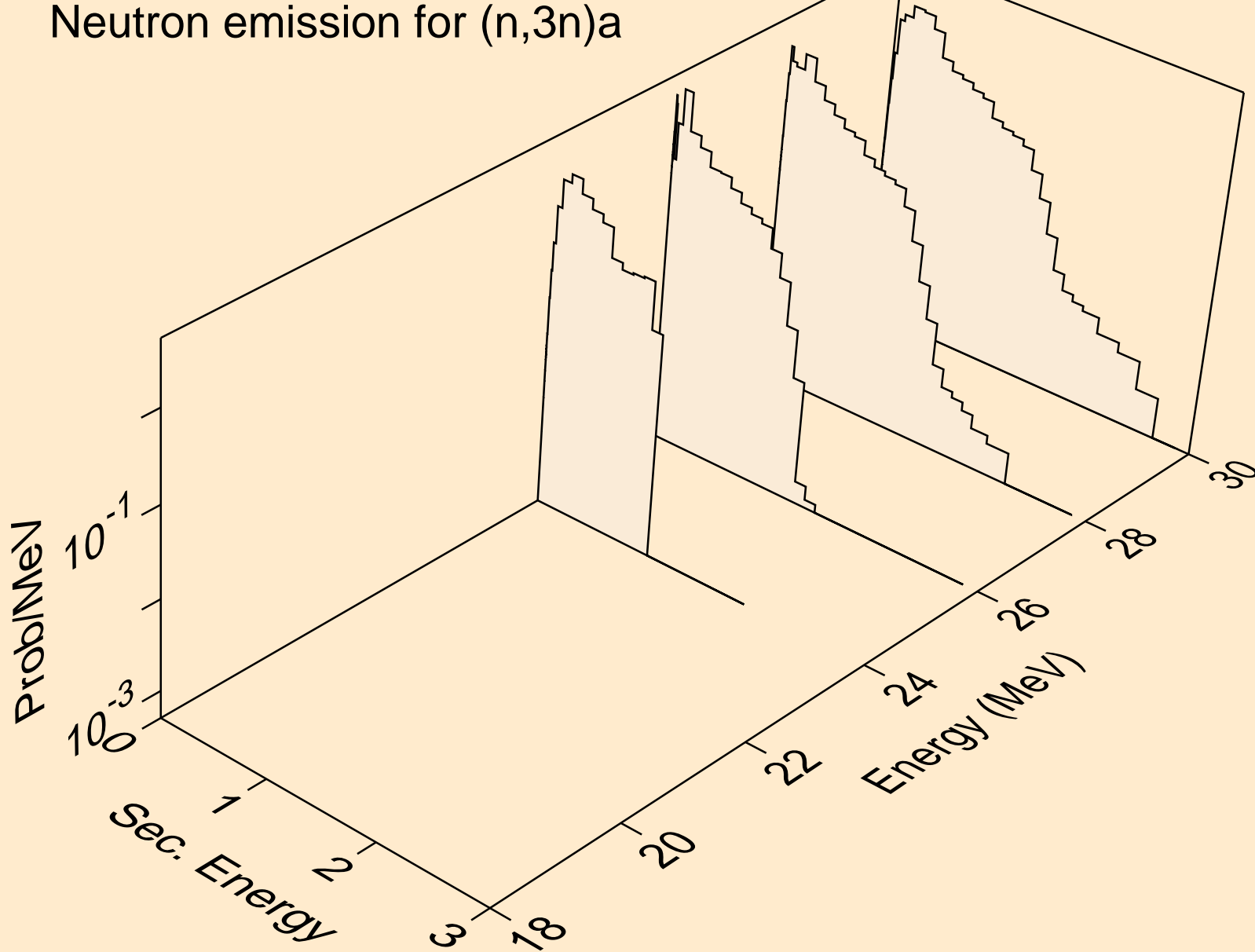

SN121 NEUTRON ACER TENDL-2019 LIBRARY; T=293.16K  
Neutron emission for (n,n\*)p

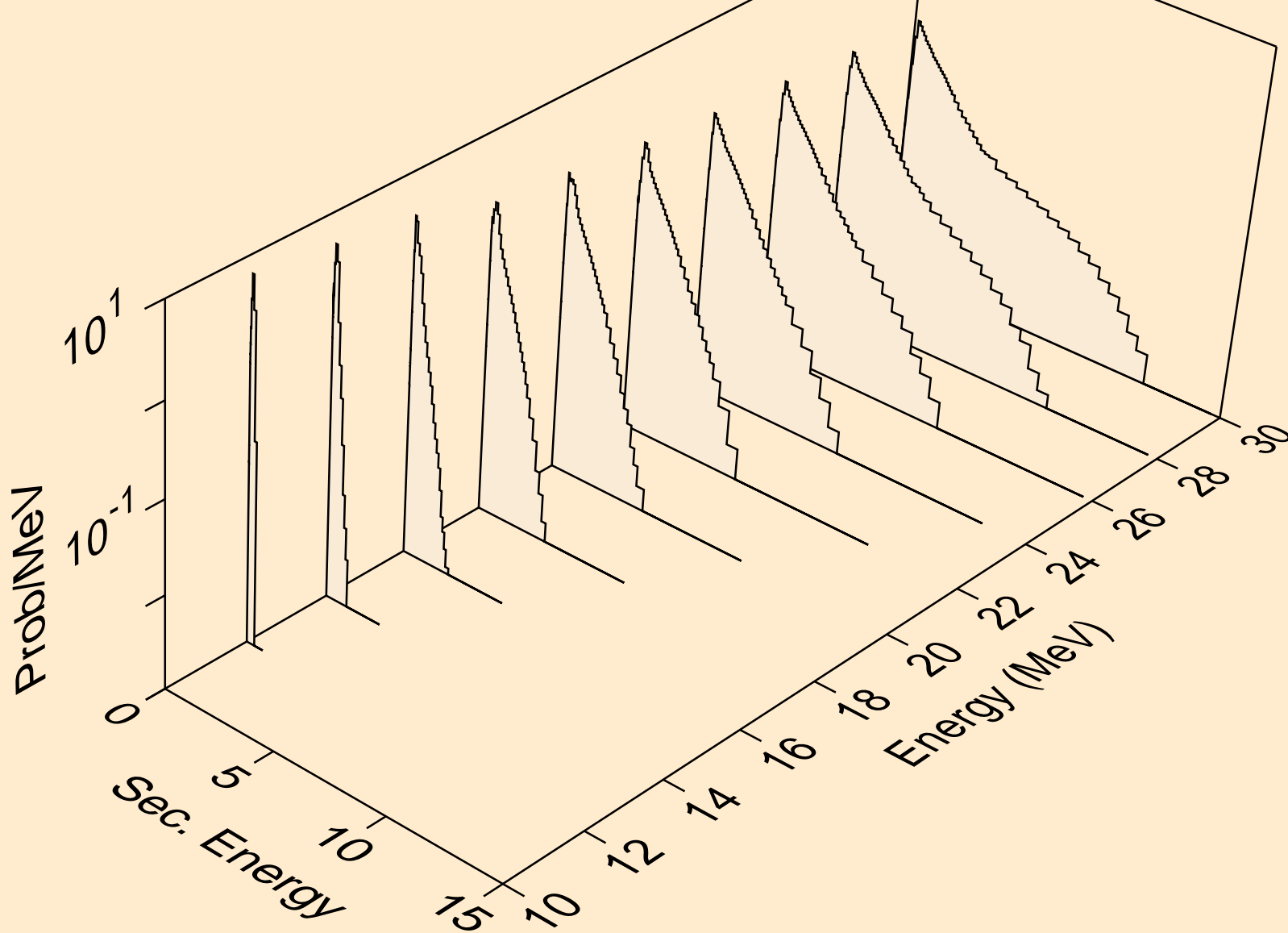

SN121 NEUTRON ACER TENDL-2019 LIBRARY; T=293.16K  
Neutron emission for (n,n\*)d

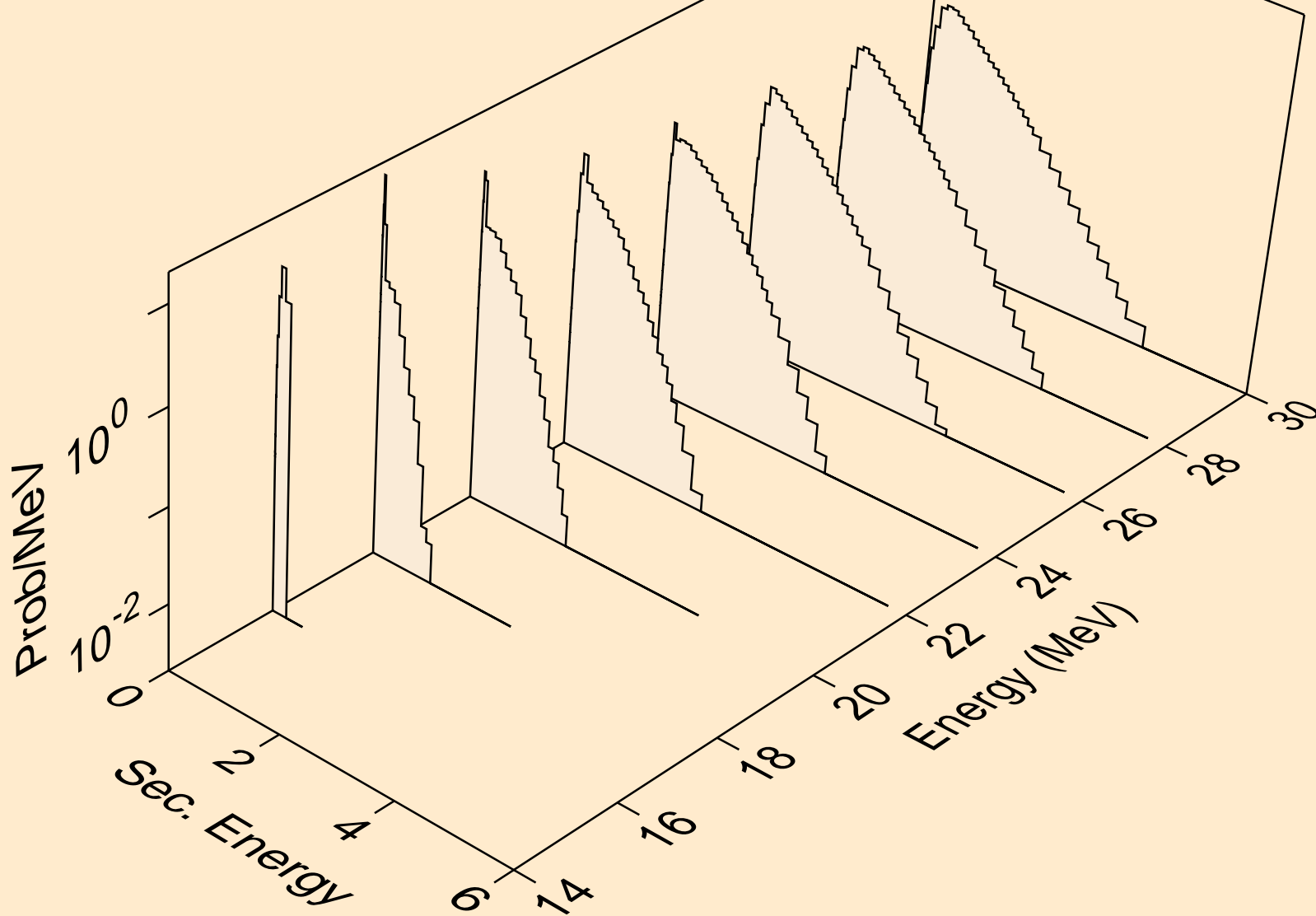

SN121 NEUTRON ACER TENDL-2019 LIBRARY; T=293.16K  
Neutron emission for (n,n\*)t

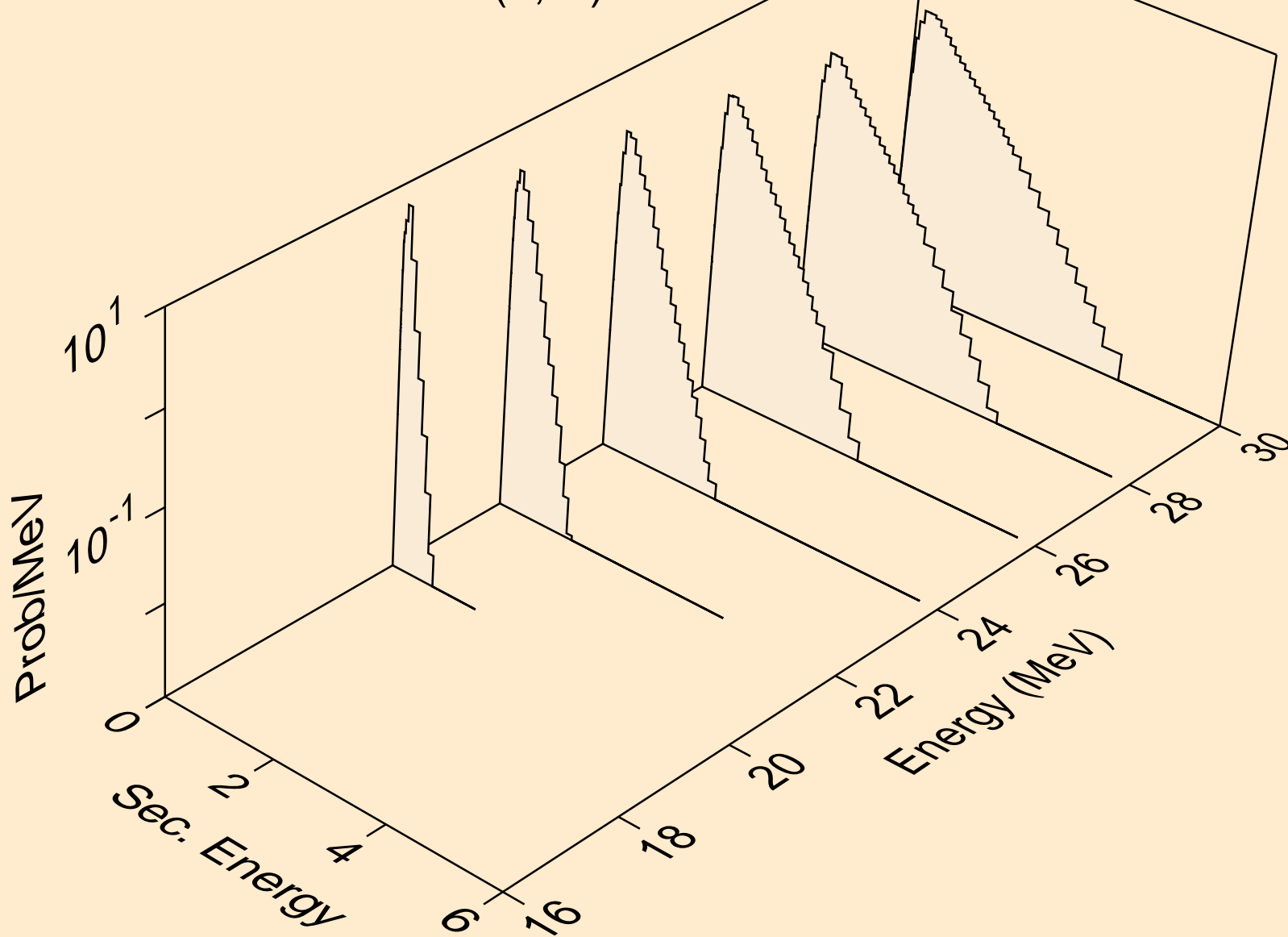

SN121 NEUTRON ACER TENDL-2019 LIBRARY; T=293.16K  
Neutron emission for (n,n\*)he3

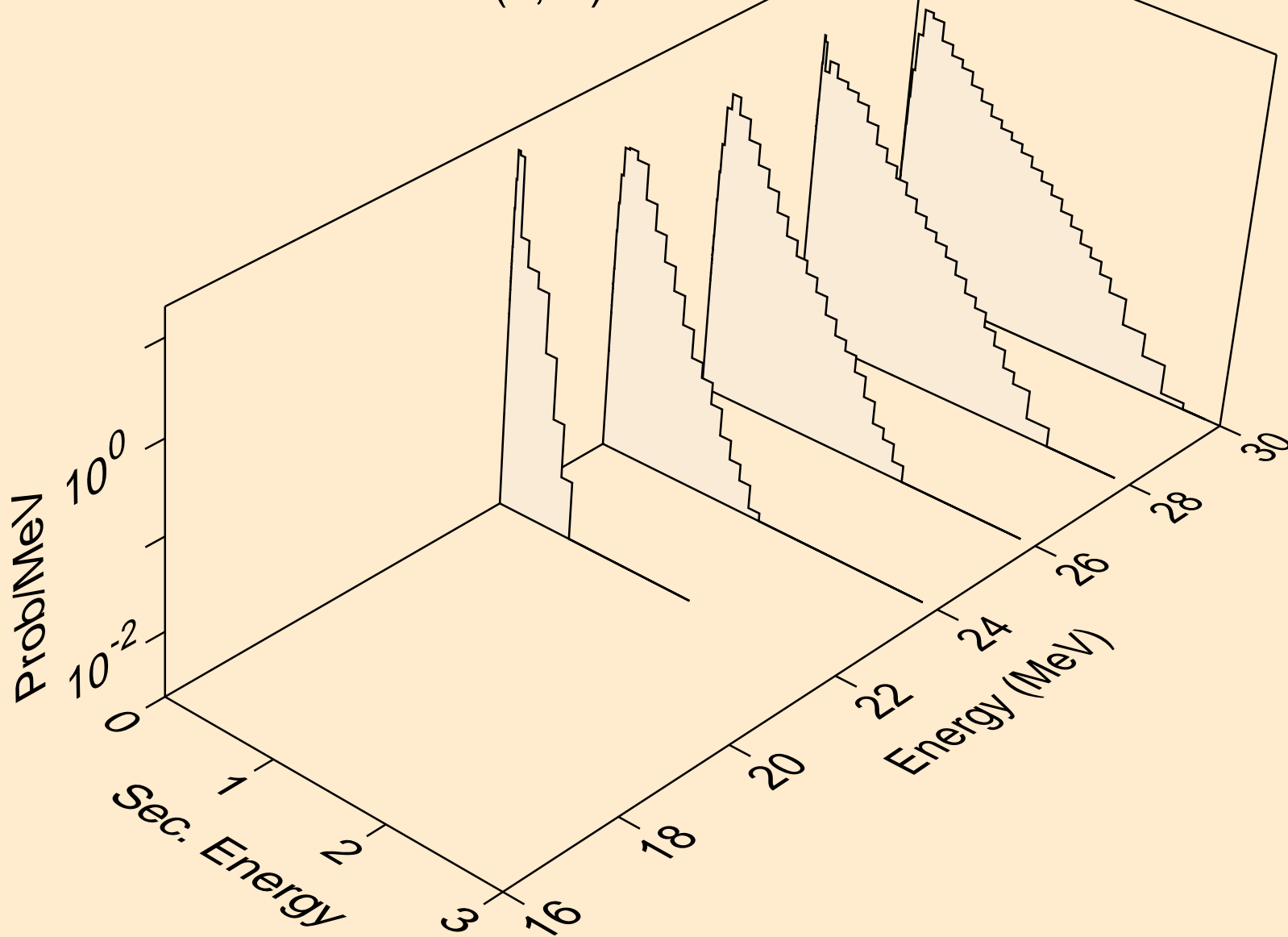

SN121 NEUTRON ACER TENDL-2019 LIBRARY; T=293.16K  
Neutron emission for (n,4n)

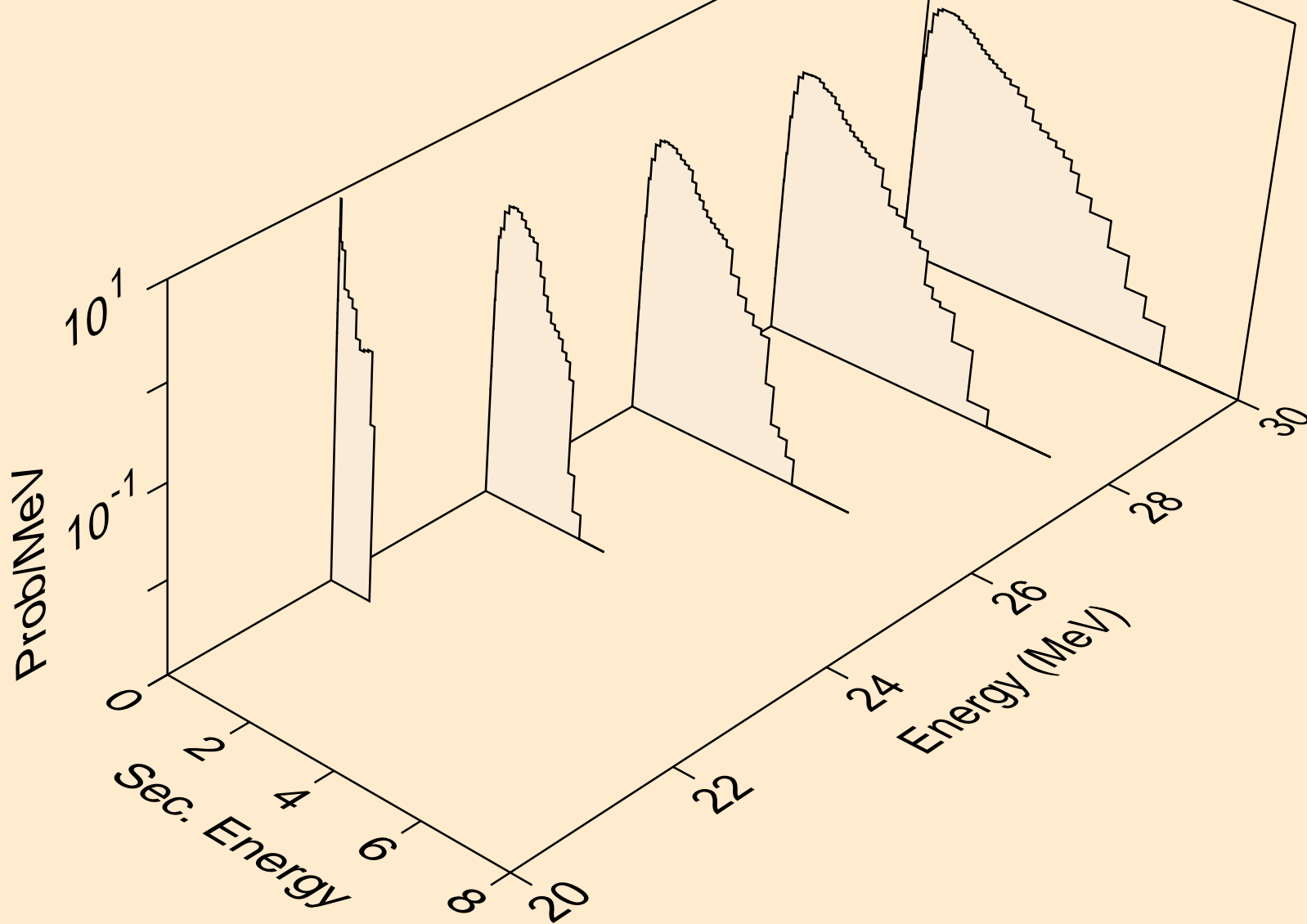

SN121 NEUTRON ACER TENDL-2019 LIBRARY; T=293.16K  
Neutron emission for (n,2np)

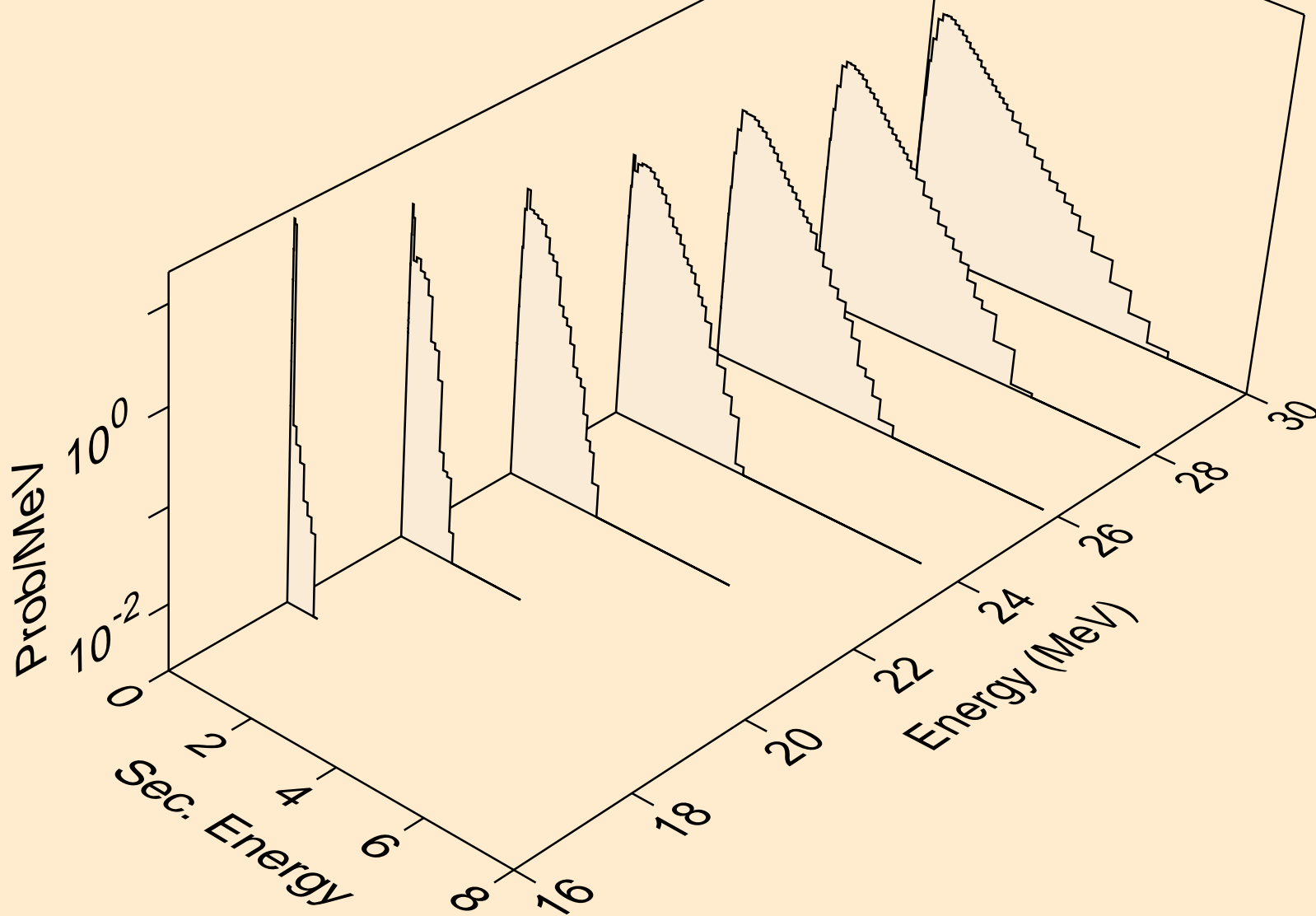

SN121 NEUTRON ACER TENDL-2019 LIBRARY; T=293.16K  
Neutron emission for (n,3np)

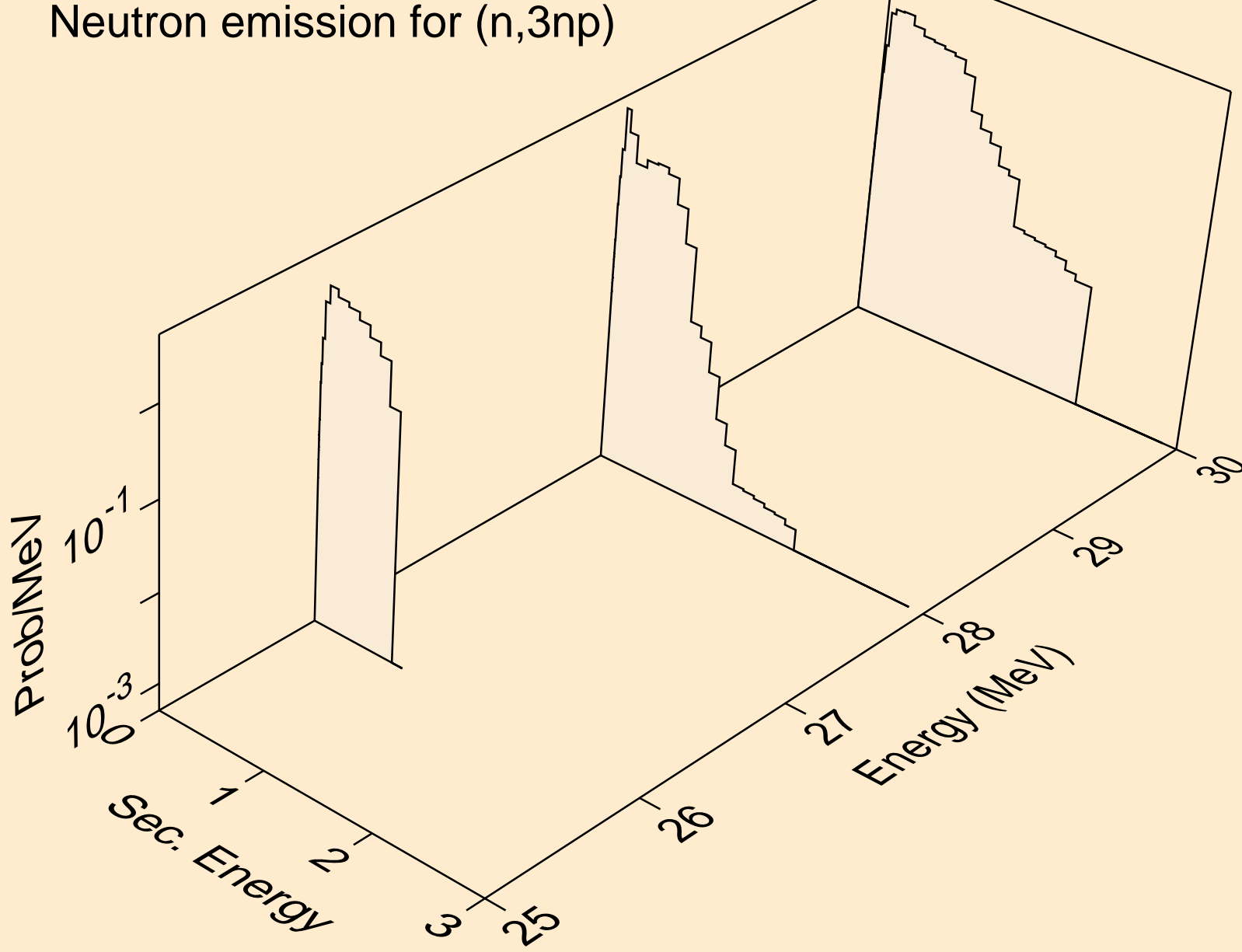



SN121 NEUTRON ACER TENDL-2019 LIBRARY; T=293.16K  
Neutron emission for (n,2np)

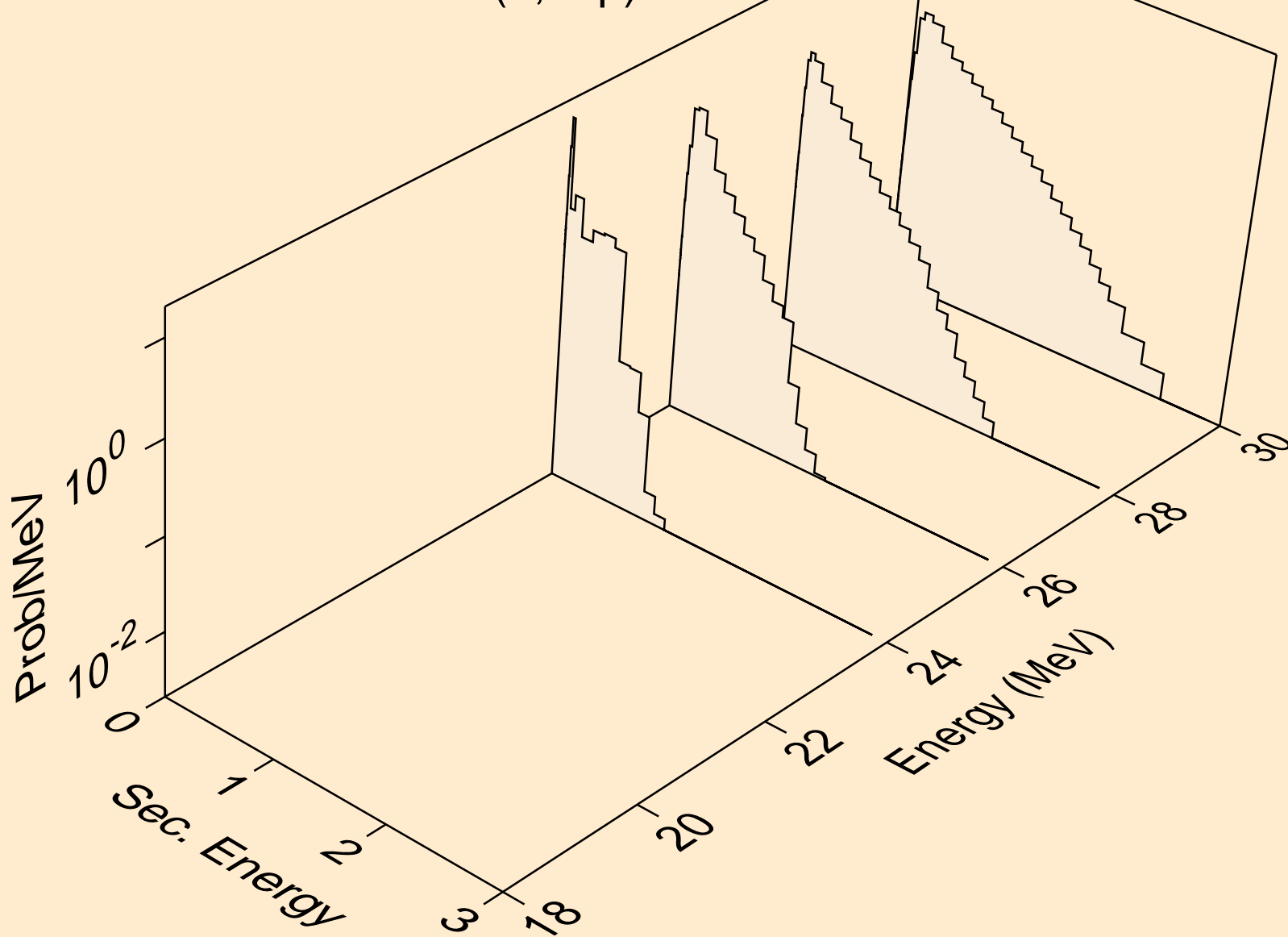

SN121 NEUTRON ACER TENDL-2019 LIBRARY; T=293.16K  
Neutron emission for (n,n\*c)

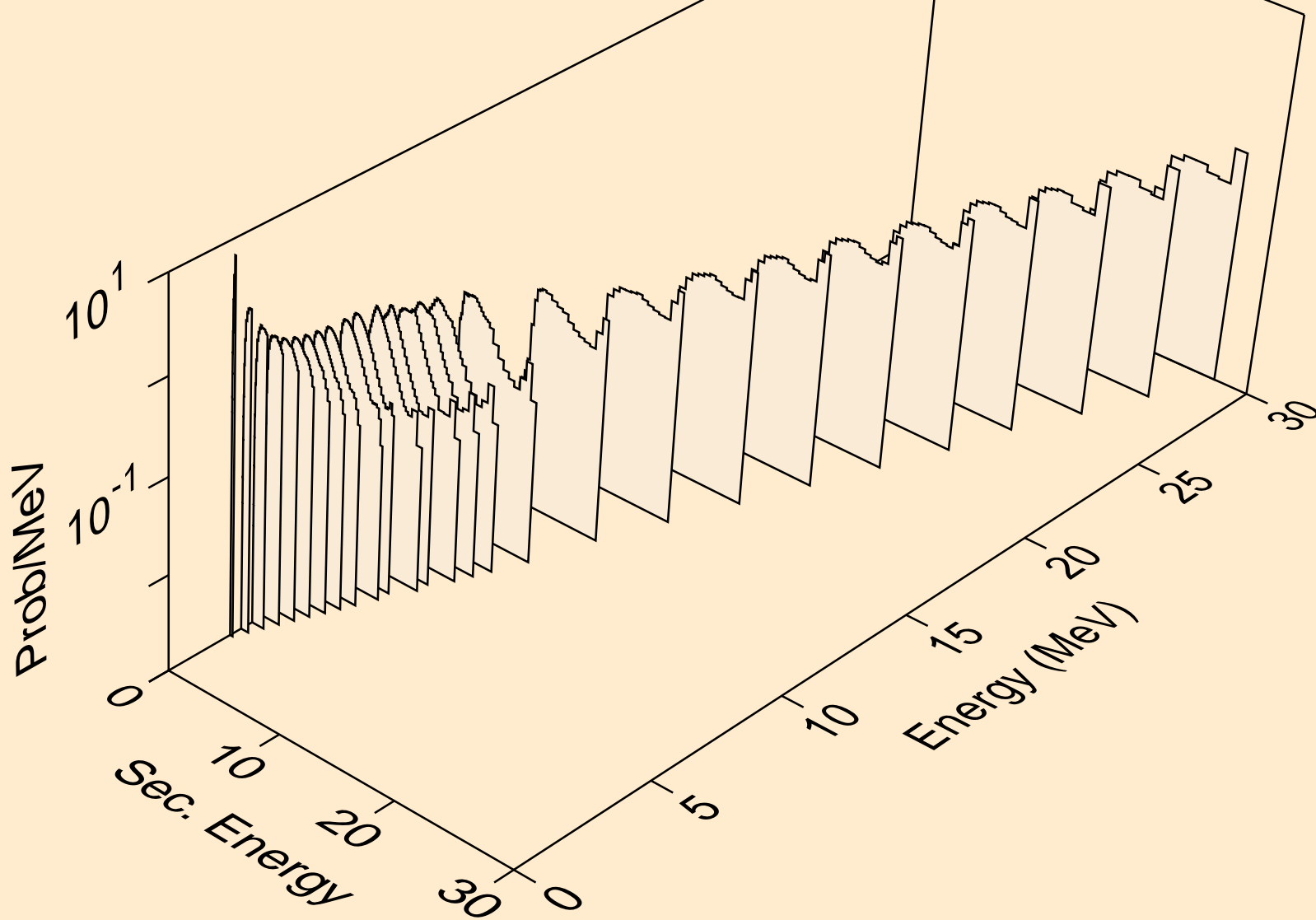

SN121 NEUTRON ACER TENDL-2019 LIBRARY; T=293.16K  
Photon emission for (n,x)

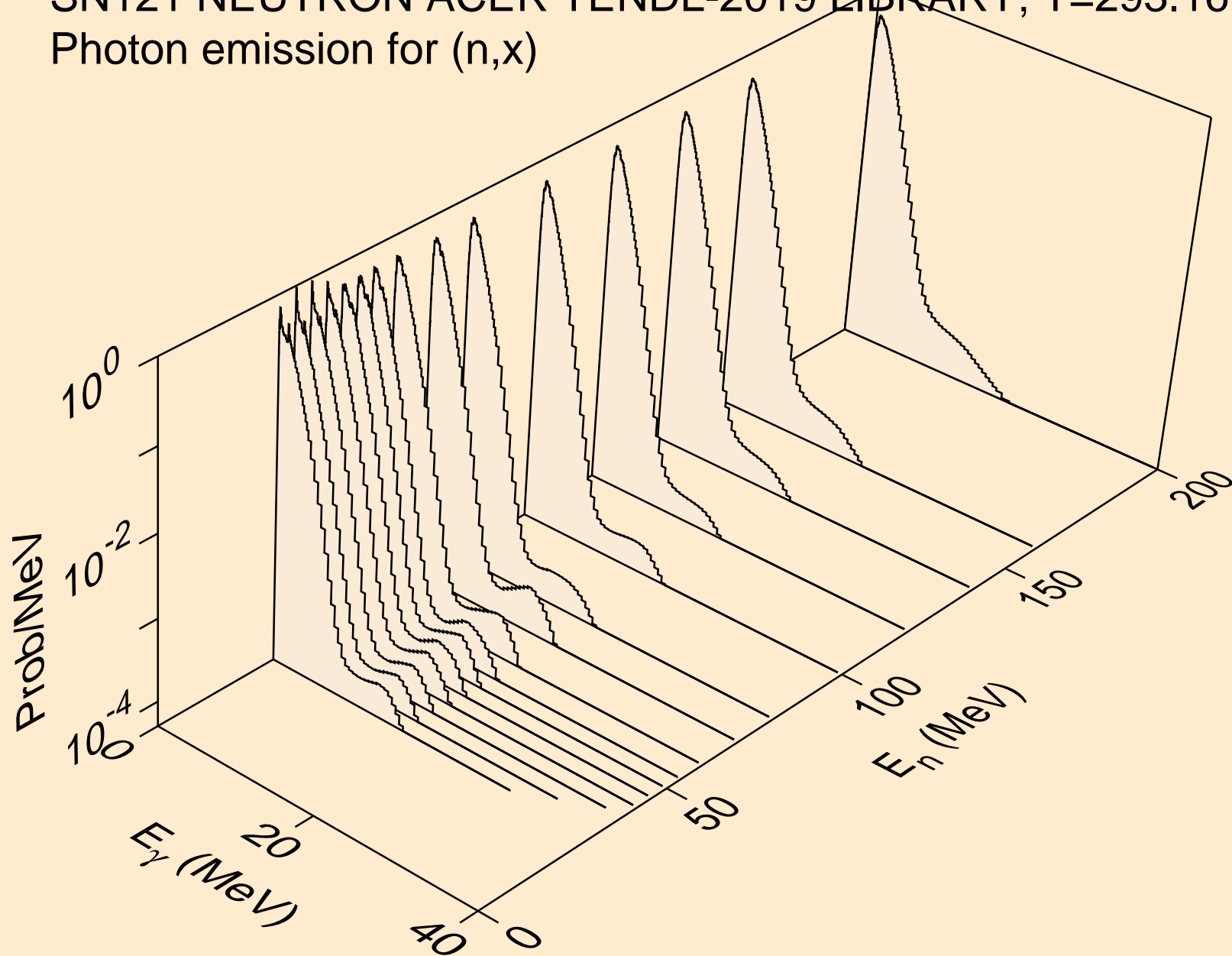

SN121 NEUTRON ACER TENDL-2019 LIBRARY; T=293.16K  
Photon emission for (n,2nd)

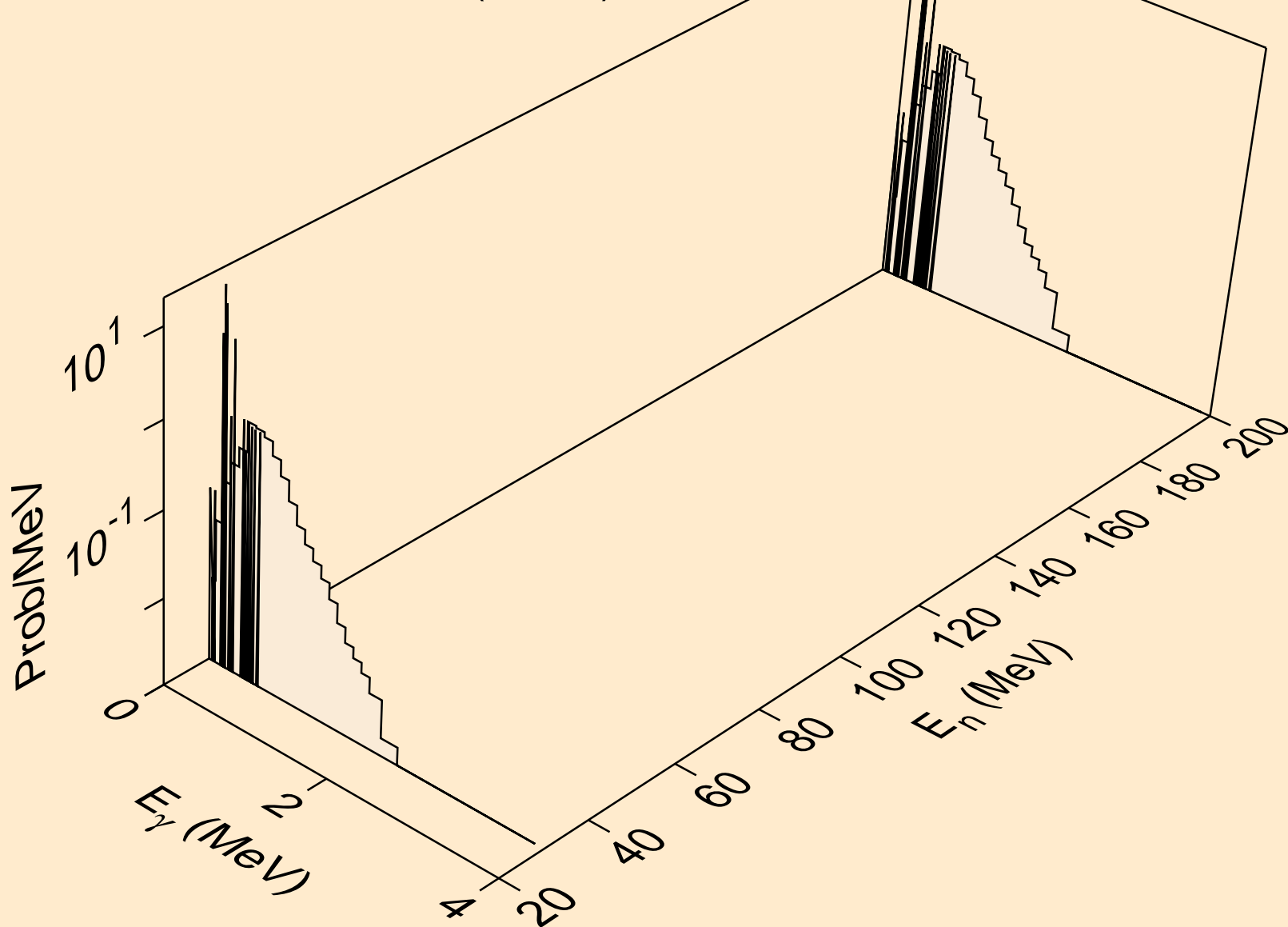

SN121 NEUTRON ACER TENDL-2019 LIBRARY; T=293.16K  
Photon emission for (n,2n)

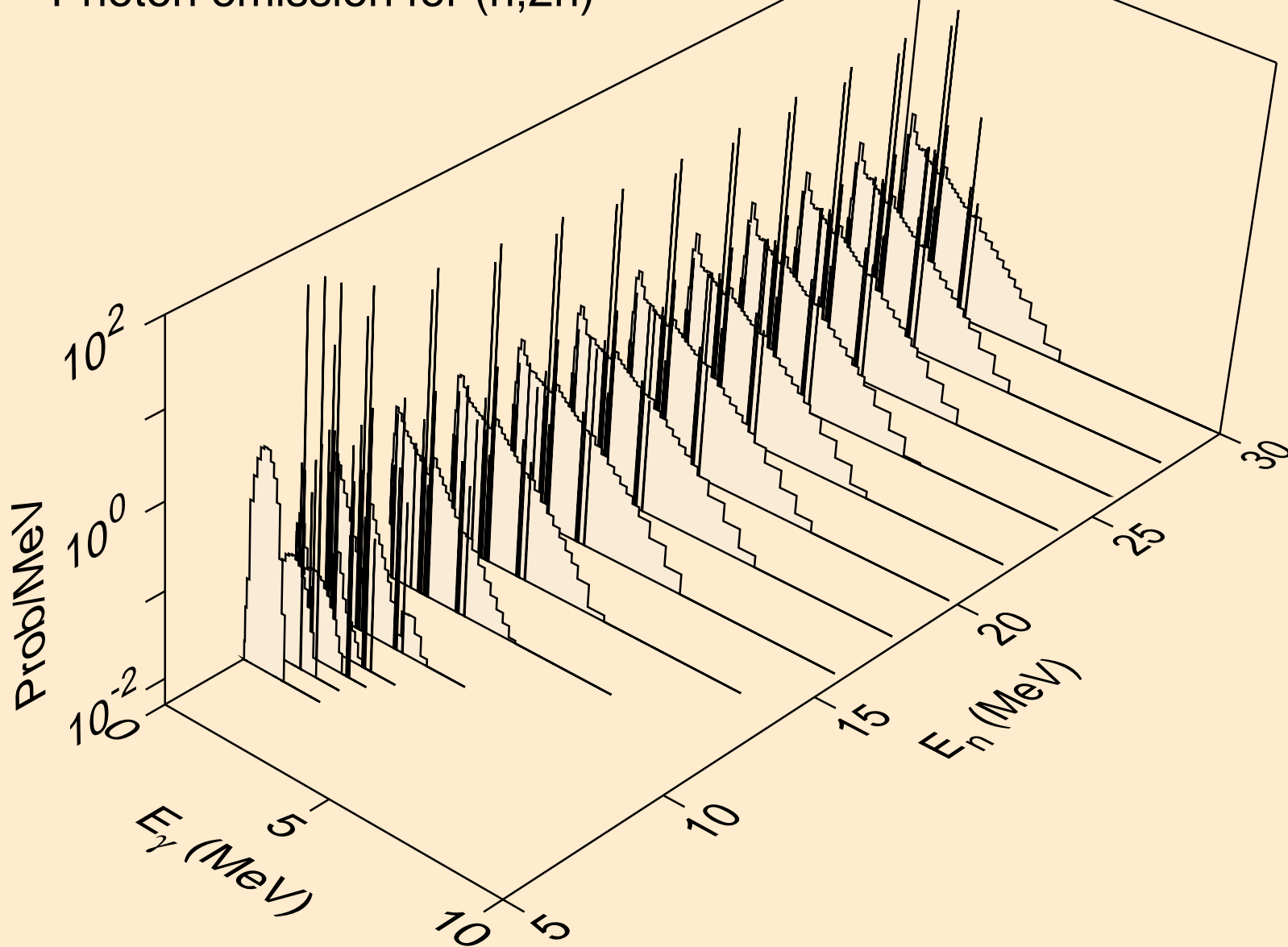

SN121 NEUTRON ACER TENDL-2019 LIBRARY; T=293.16K  
Photon emission for (n,3n)

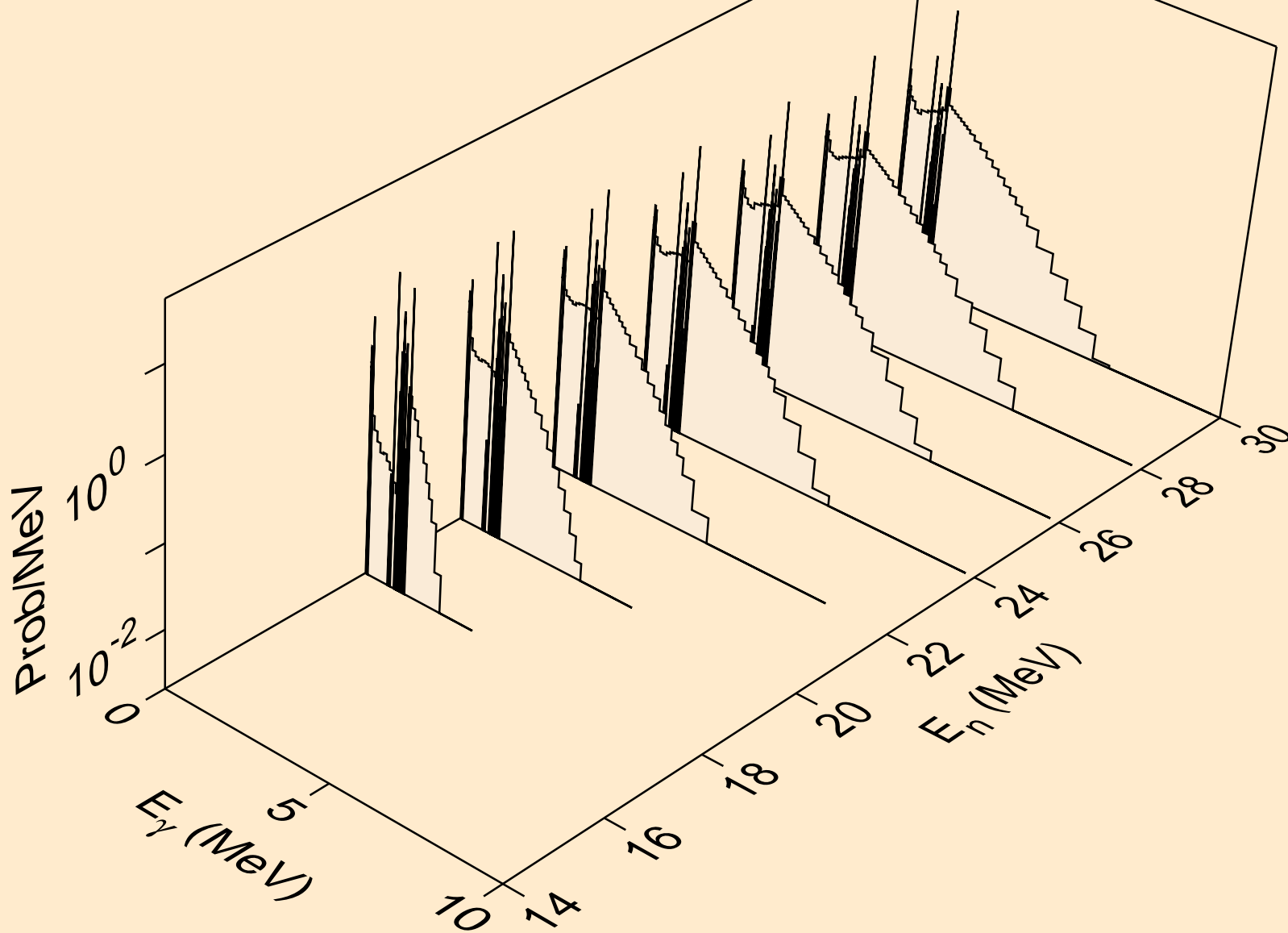

SN121 NEUTRON ACER TENDL-2019 LIBRARY; T=293.16K  
Photon emission for (n,n\*)a

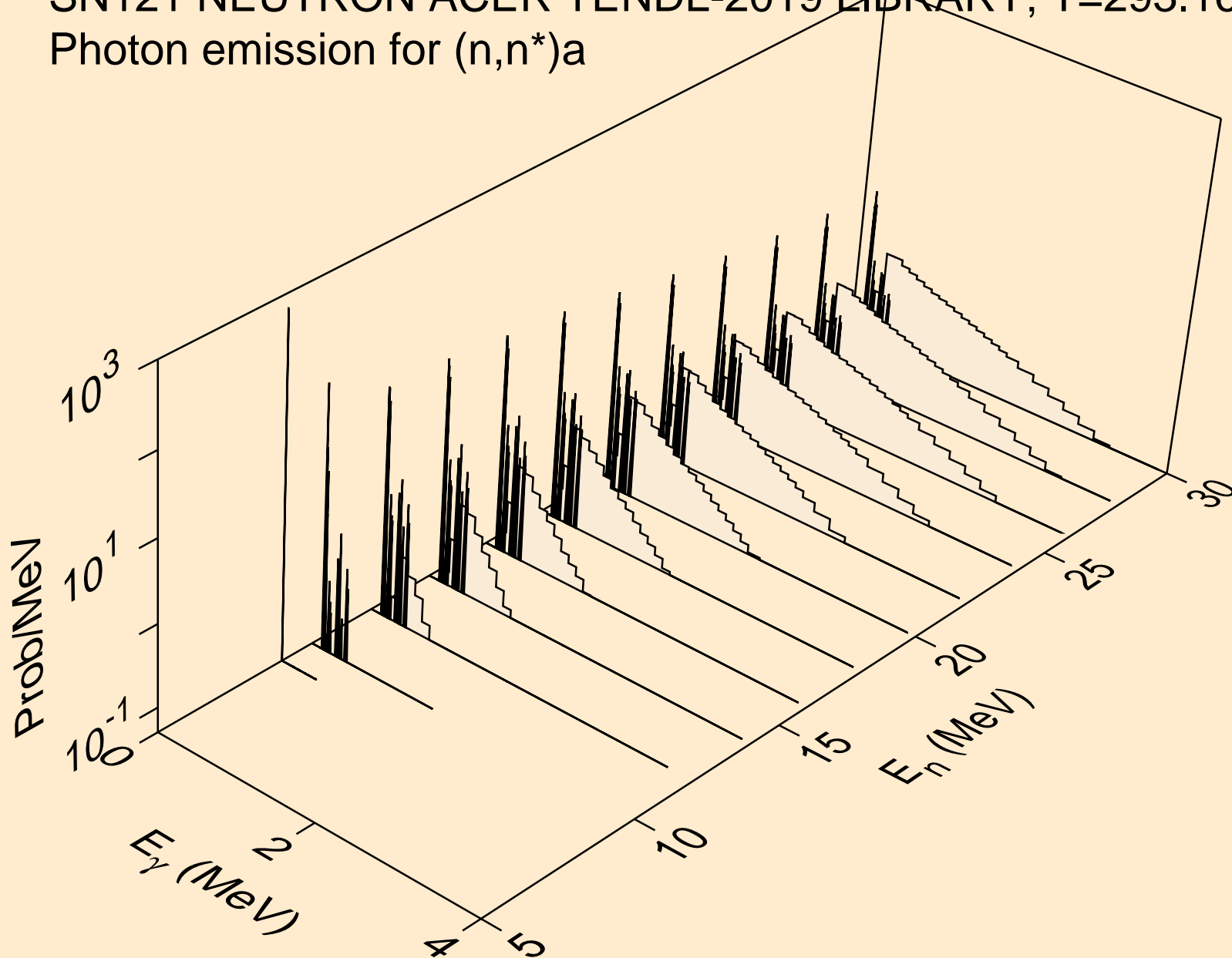

SN121 NEUTRON ACER TENDL-2019 LIBRARY; T=293.16K  
Photon emission for (n,2n)a

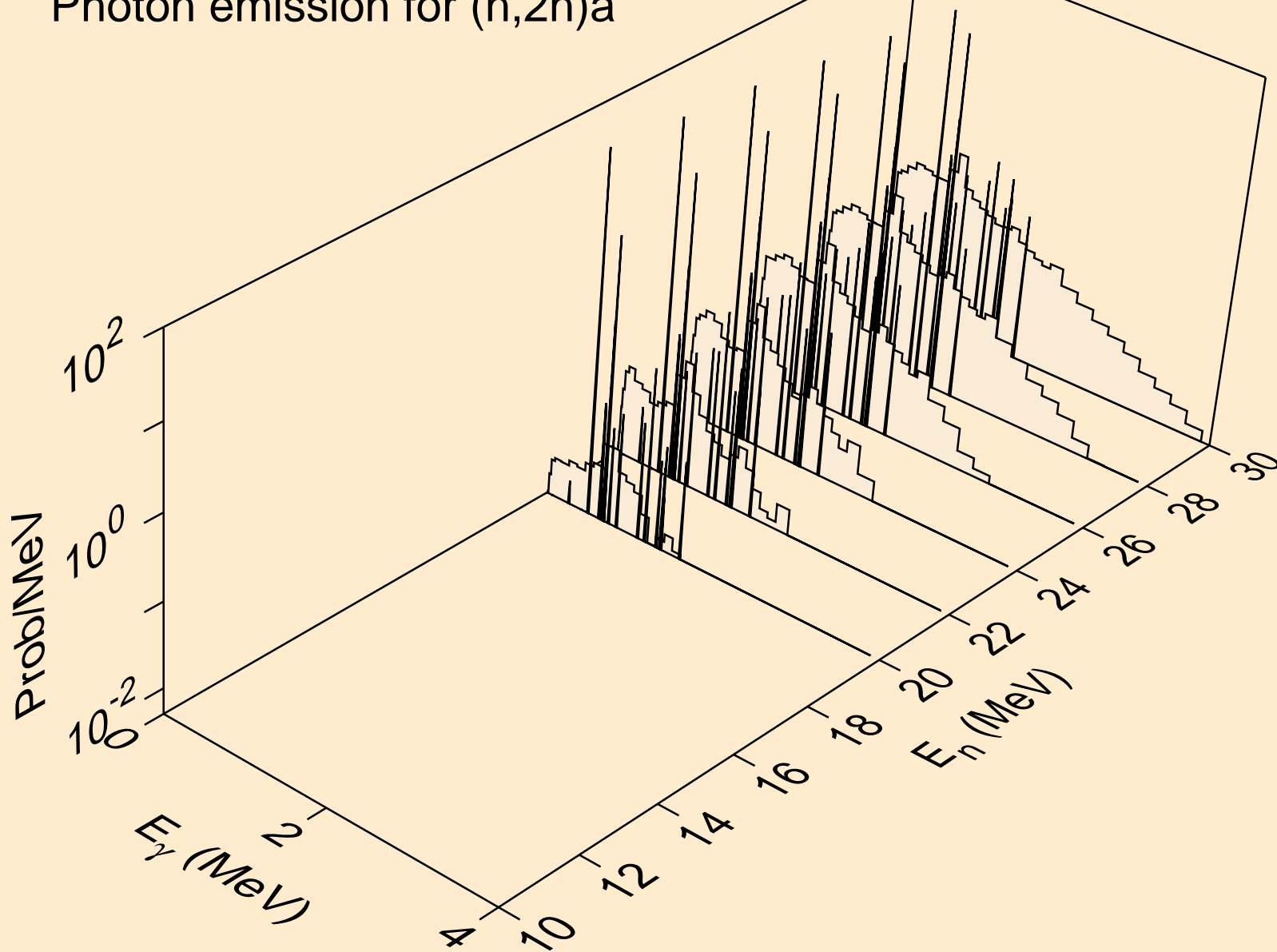



SN121 NEUTRON ACER TENDL-2019 LIBRARY; T=293.16K  
Photon emission for (n,3n)a

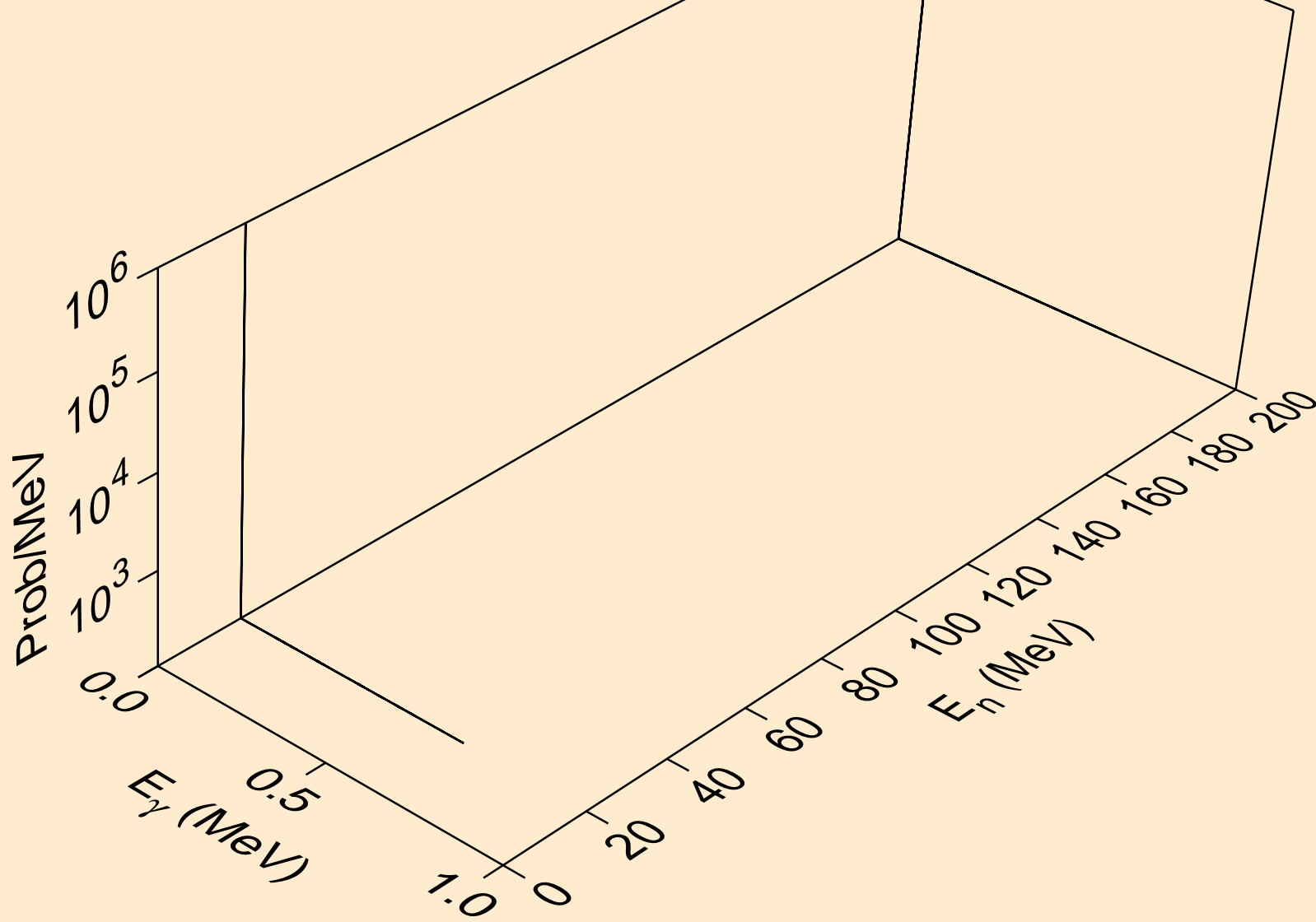

SN121 NEUTRON ACER TENDL-2019 LIBRARY; T=293.16K  
Photon emission for (n,n\*)p

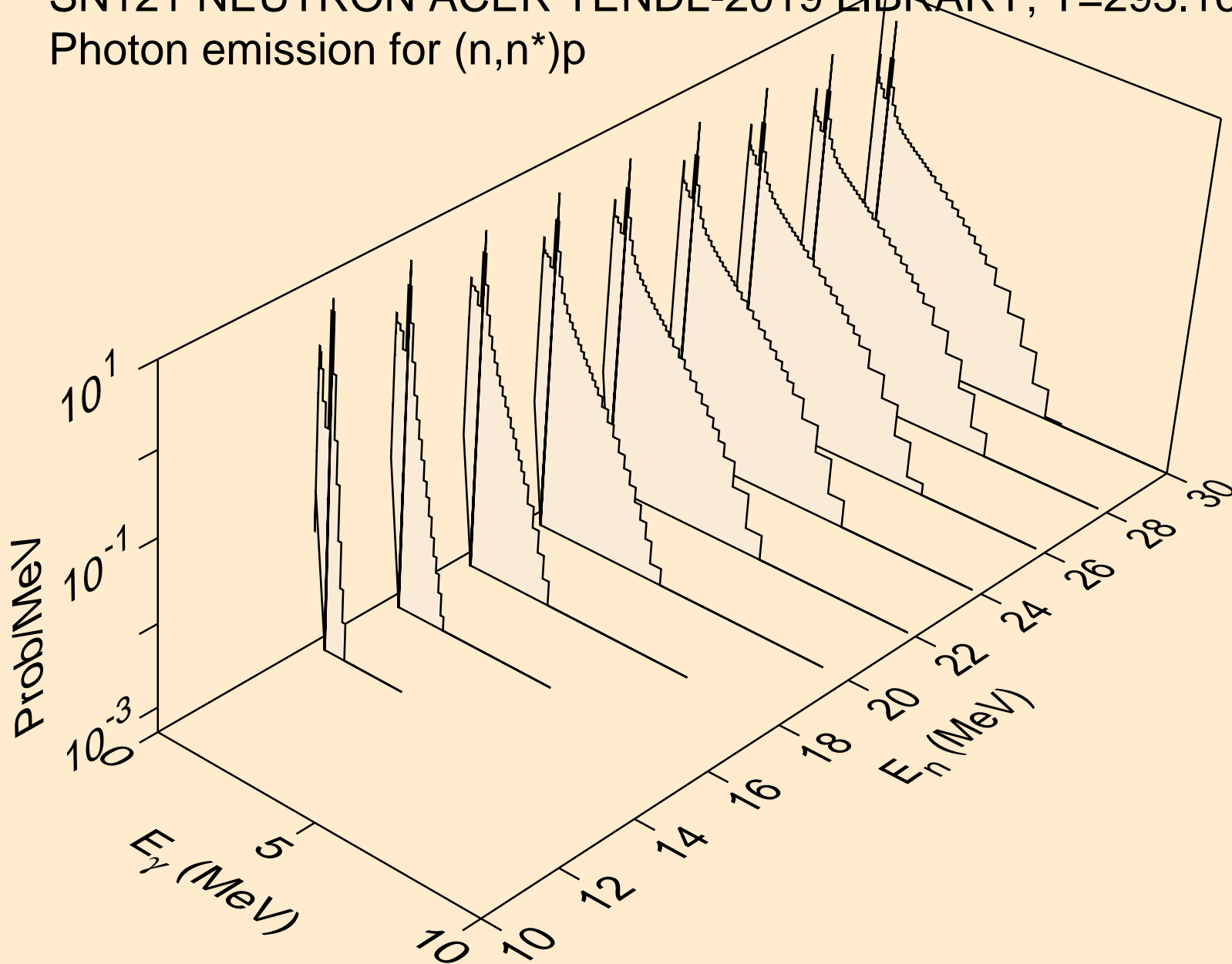

SN121 NEUTRON ACER TENDL-2019 LIBRARY; T=293.16K  
Photon emission for (n,n\*)d

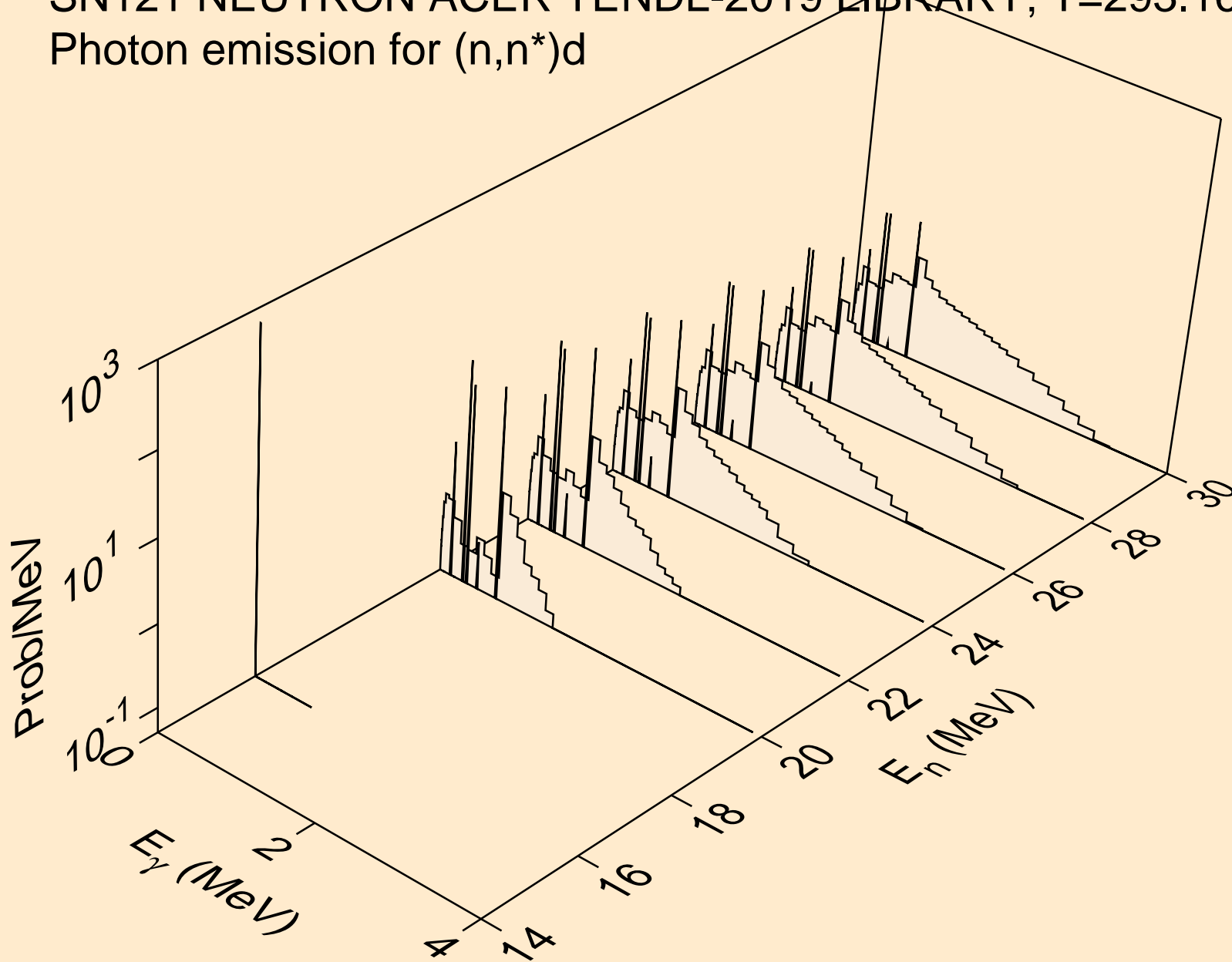

SN121 NEUTRON ACER TENDL-2019 LIBRARY; T=293.16K  
Photon emission for (n,n\*)t

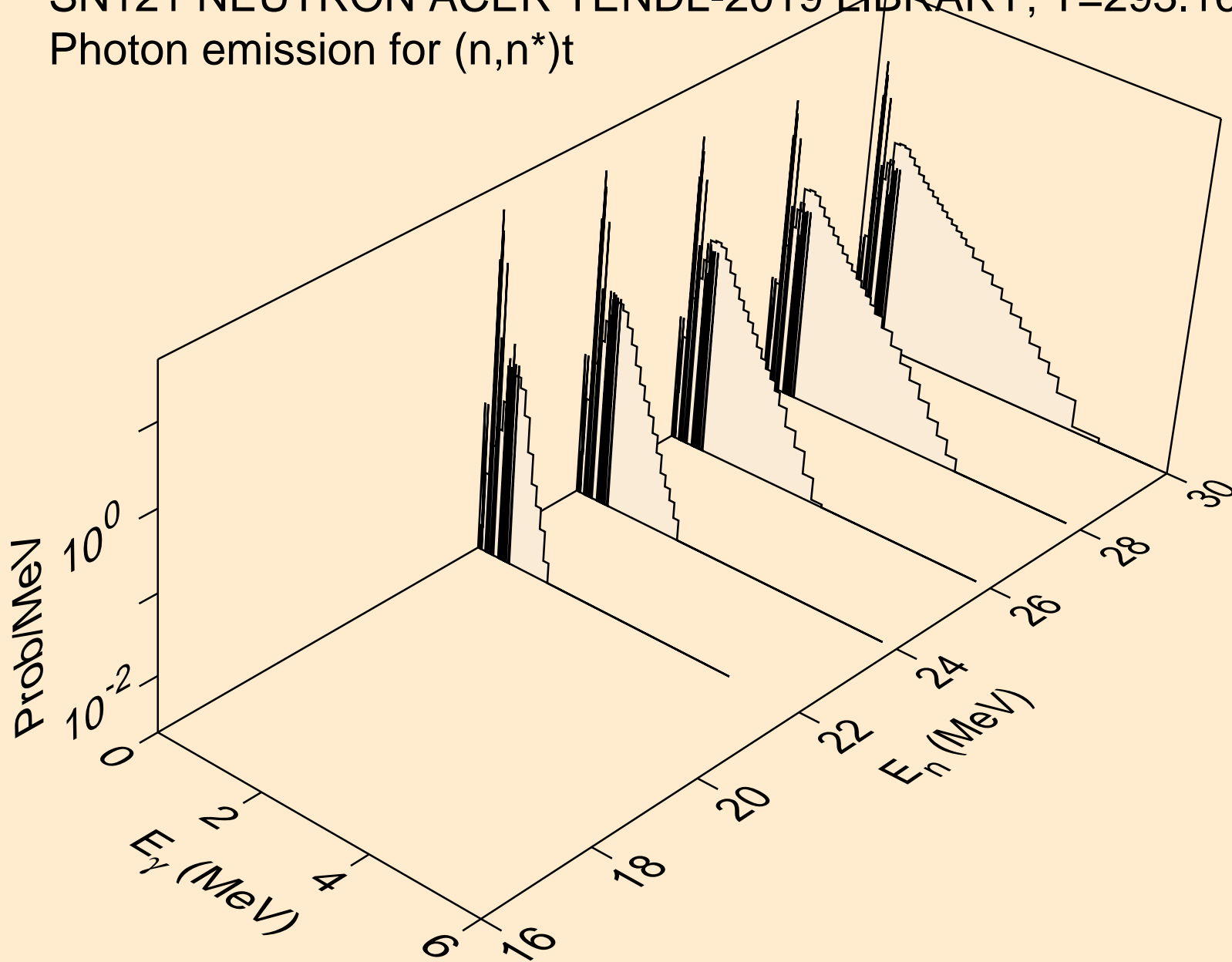

SN121 NEUTRON ACER TENDL-2019 LIBRARY; T=293.16K  
Photon emission for (n,n\*)he3

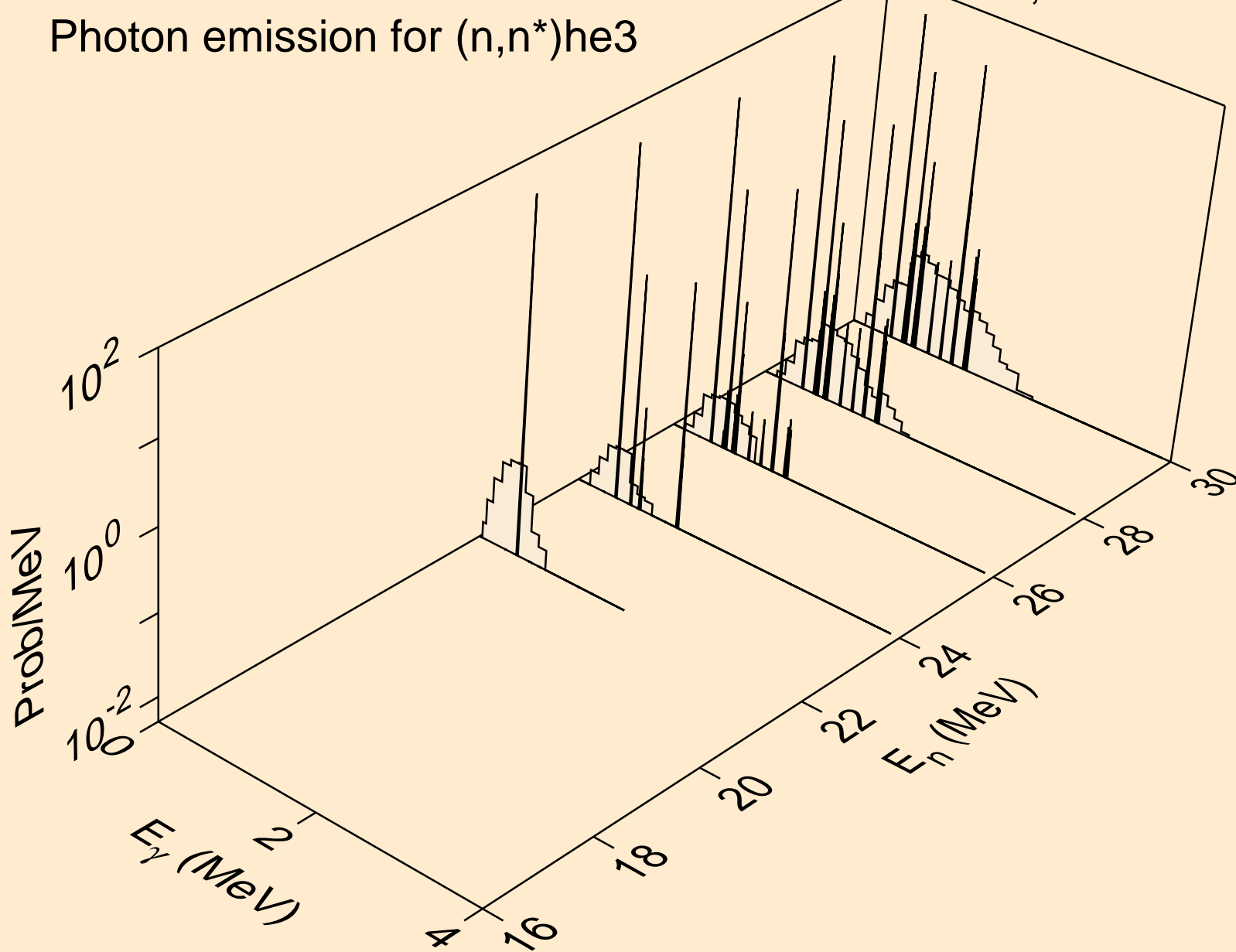

SN121 NEUTRON ACER TENDL-2019 LIBRARY; T=293.16K  
Photon emission for (n,4n)

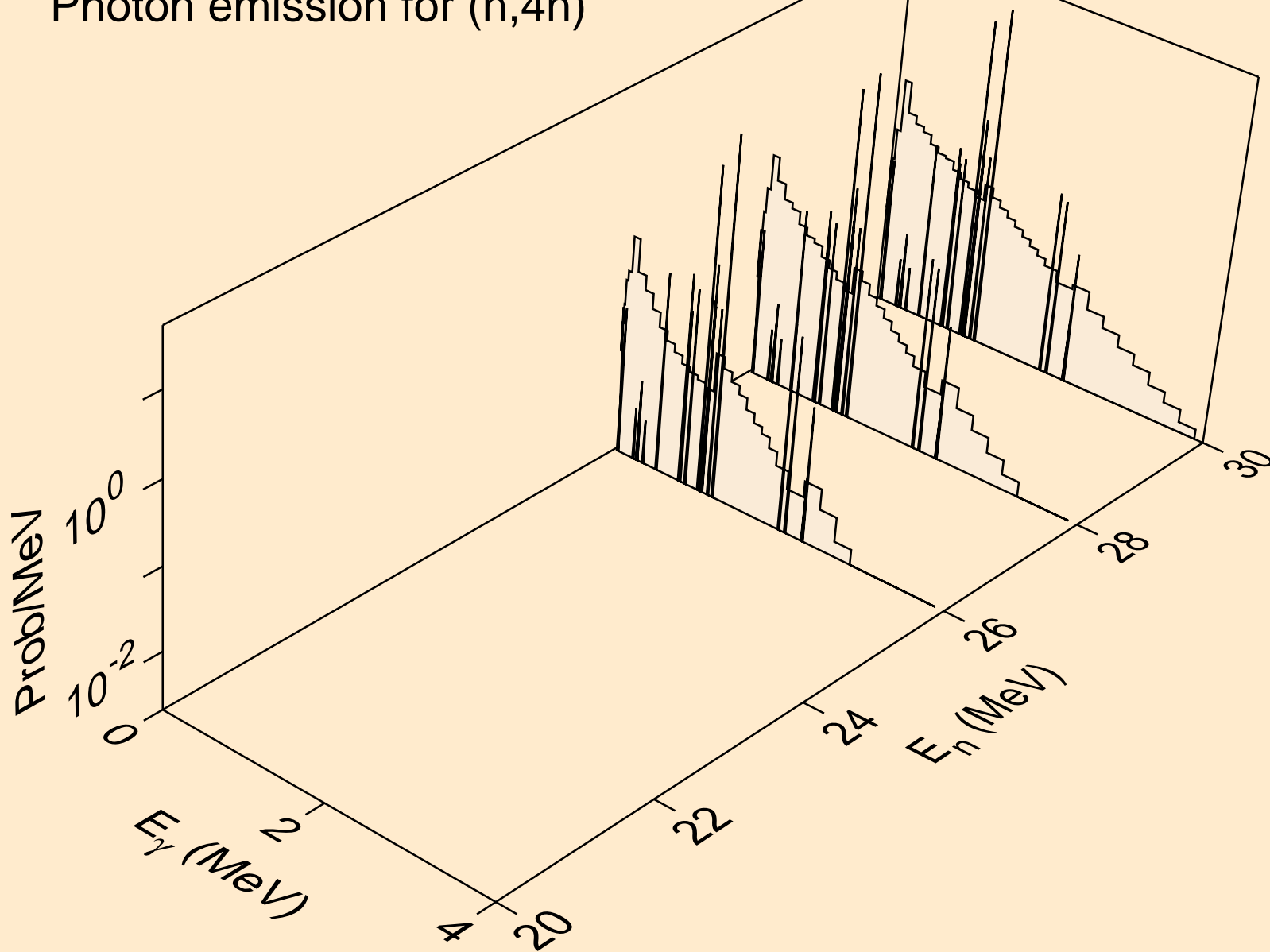

SN121 NEUTRON ACER TENDL-2019 LIBRARY; T=293.16K  
Photon emission for (n,2np)

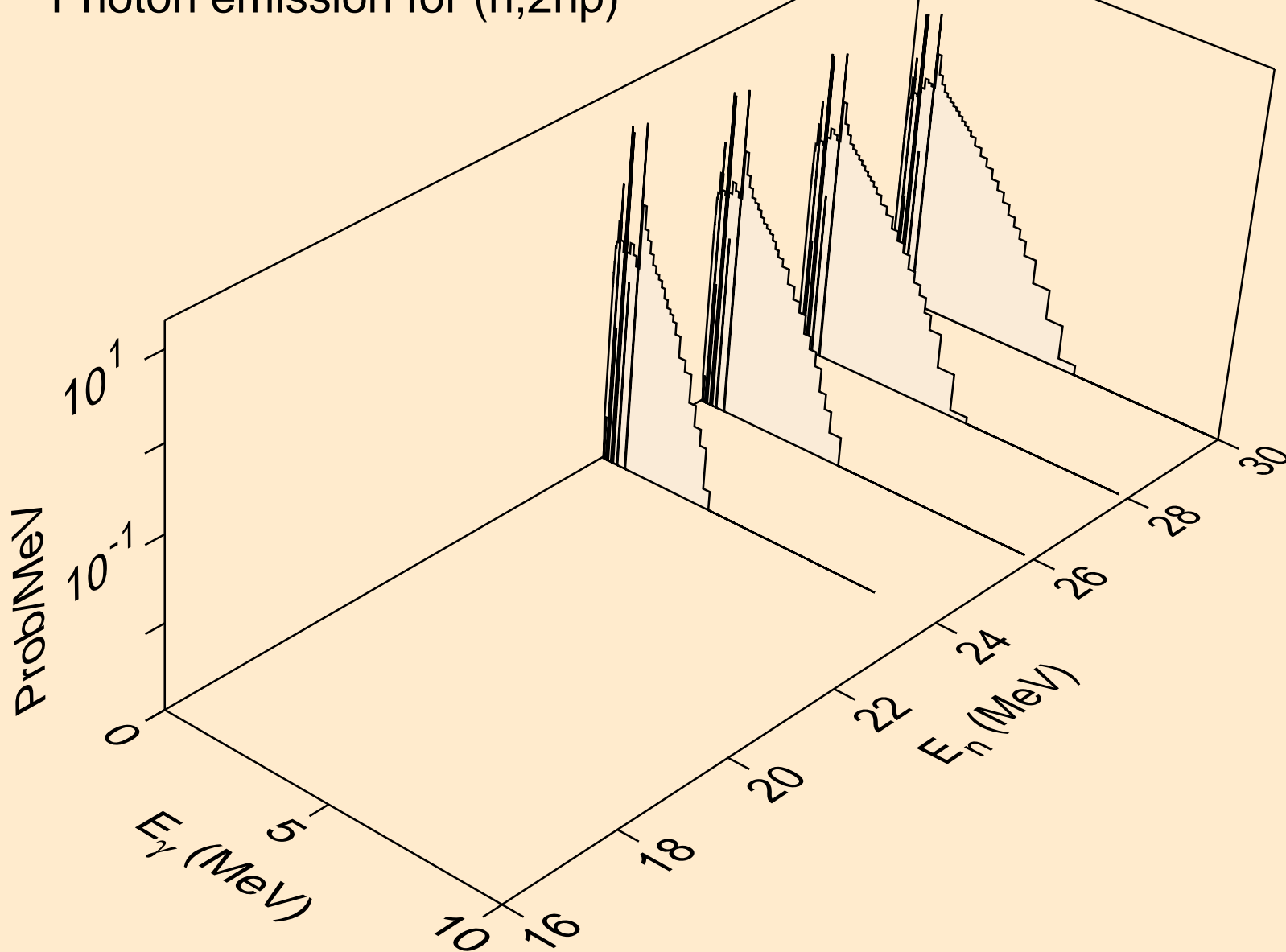

SN121 NEUTRON ACER TENDL-2019 LIBRARY; T=293.16K  
Photon emission for (n,3np)

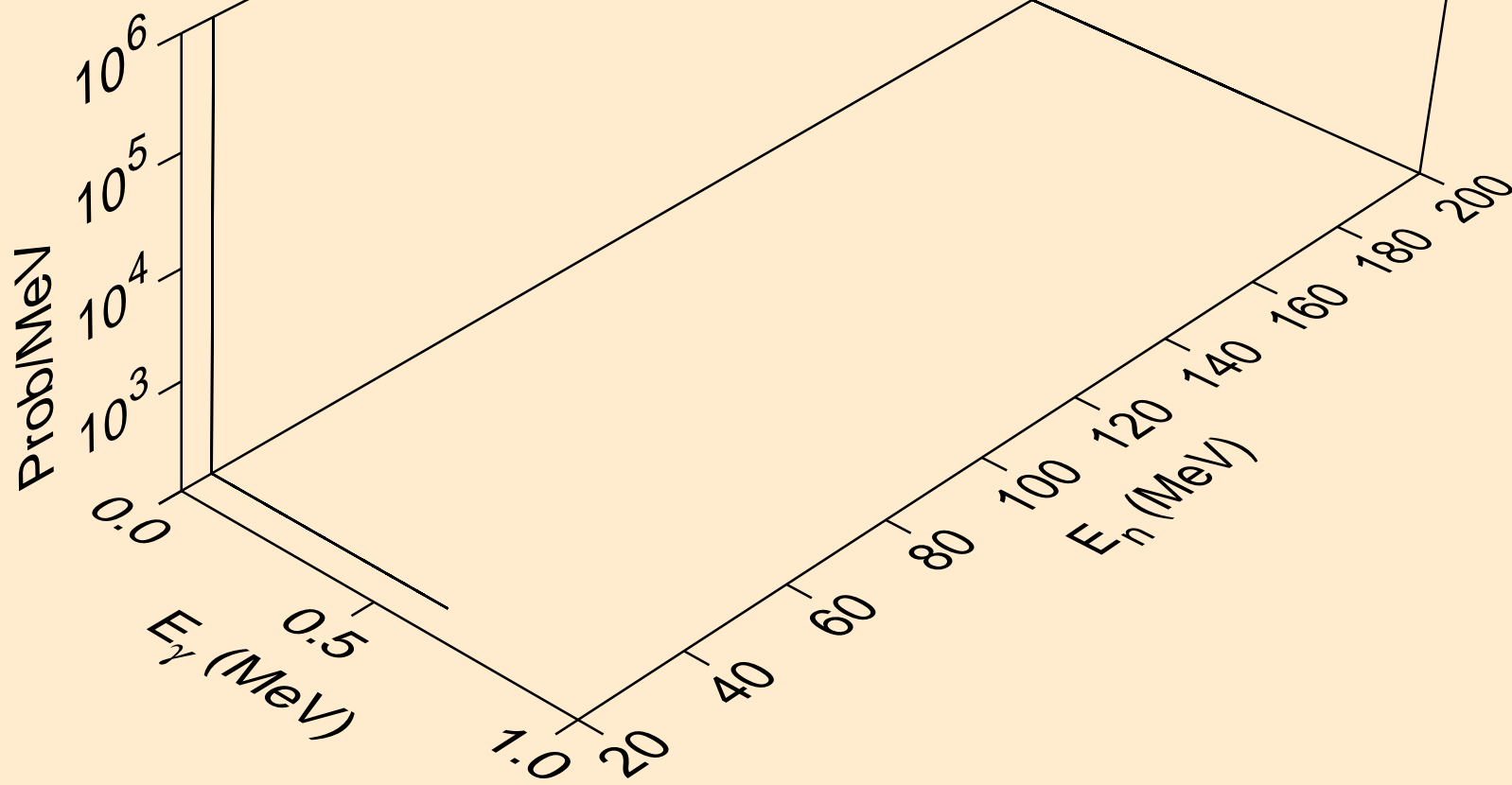



SN121 NEUTRON ACER TENDL-2019 LIBRARY; T=293.16K  
Photon emission for (n,2np)

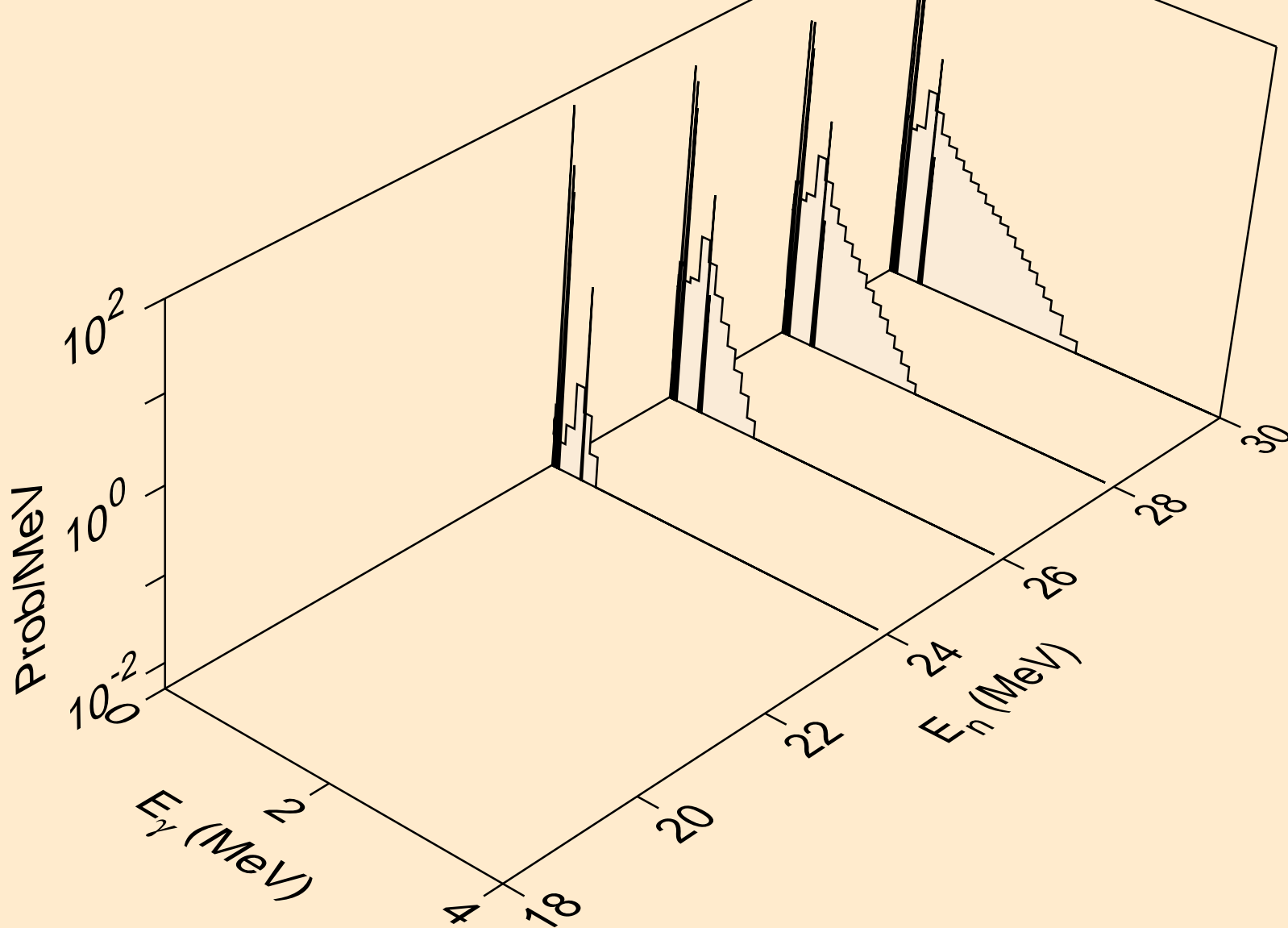

SN121 NEUTRON ACER TENDL-2019 LIBRARY; T=293.16K  
Photon emission for (n,n\*c)

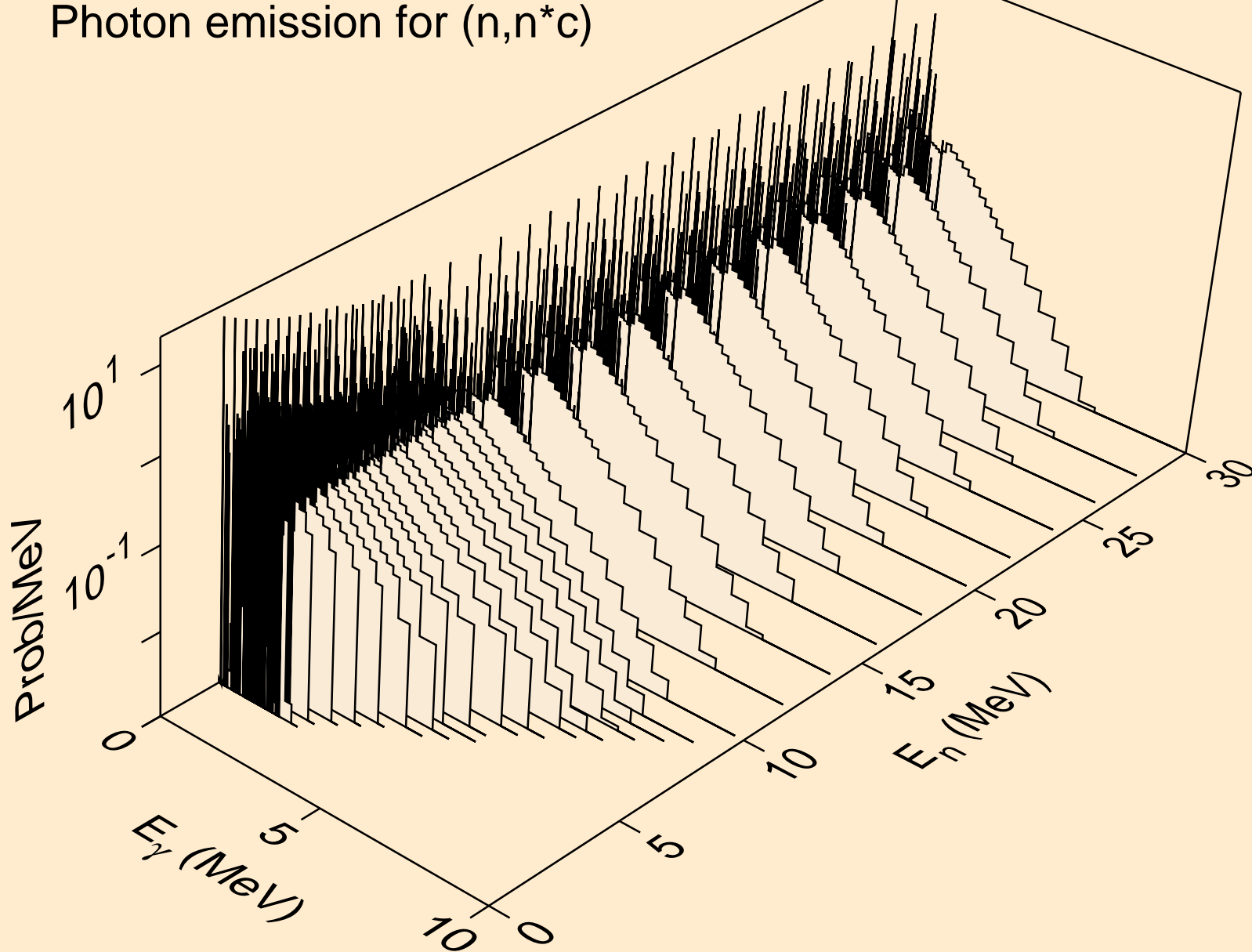

SN121 NEUTRON ACER TENDL-2019 LIBRARY; T=293.16K  
Photon emission for (n,gma)

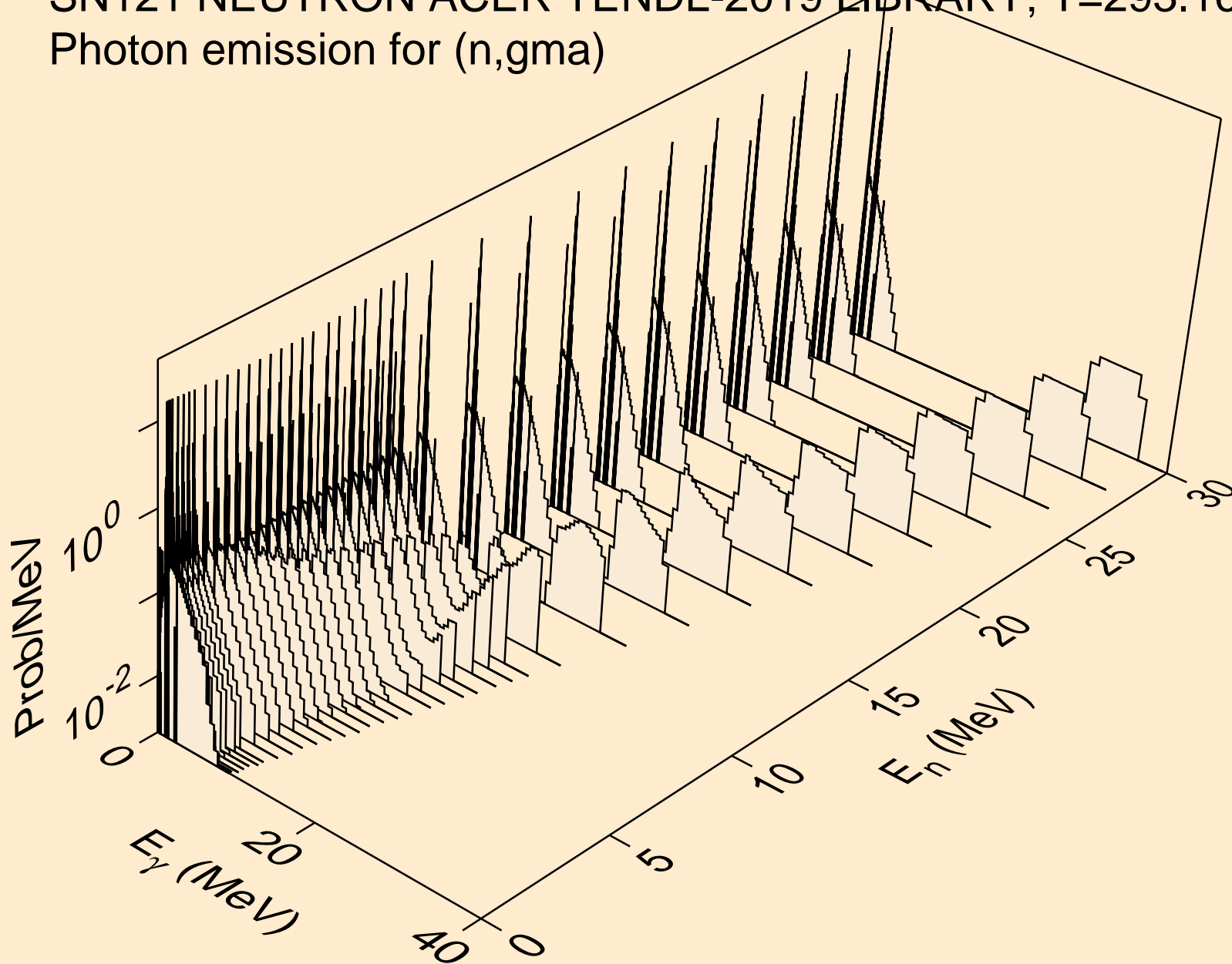

SN121 NEUTRON ACER TENDL-2019 LIBRARY; T=293.16K  
Photon emission for (n,p)

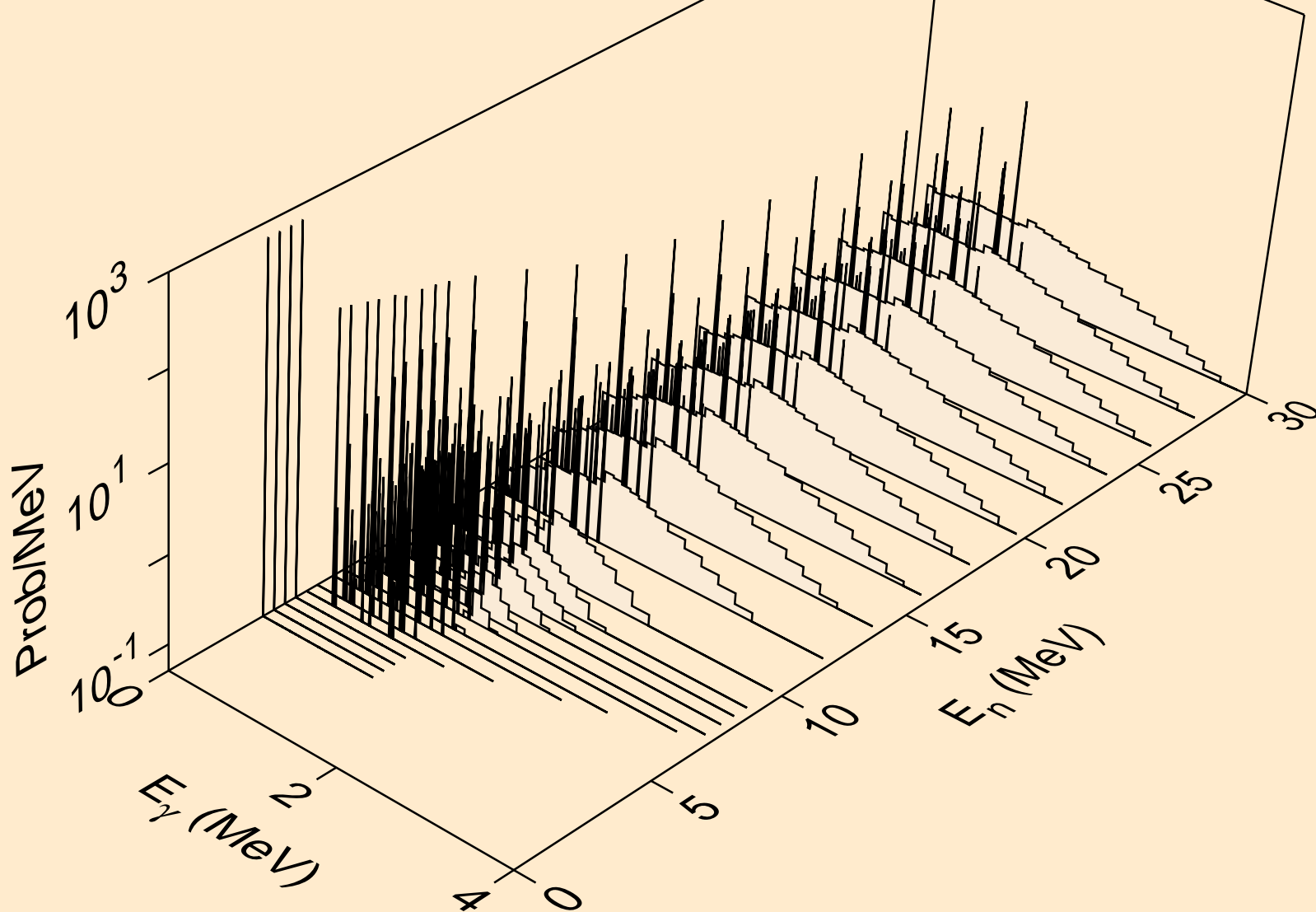

SN121 NEUTRON ACER TENDL-2019 LIBRARY; T=293.16K  
Photon emission for (n,d)

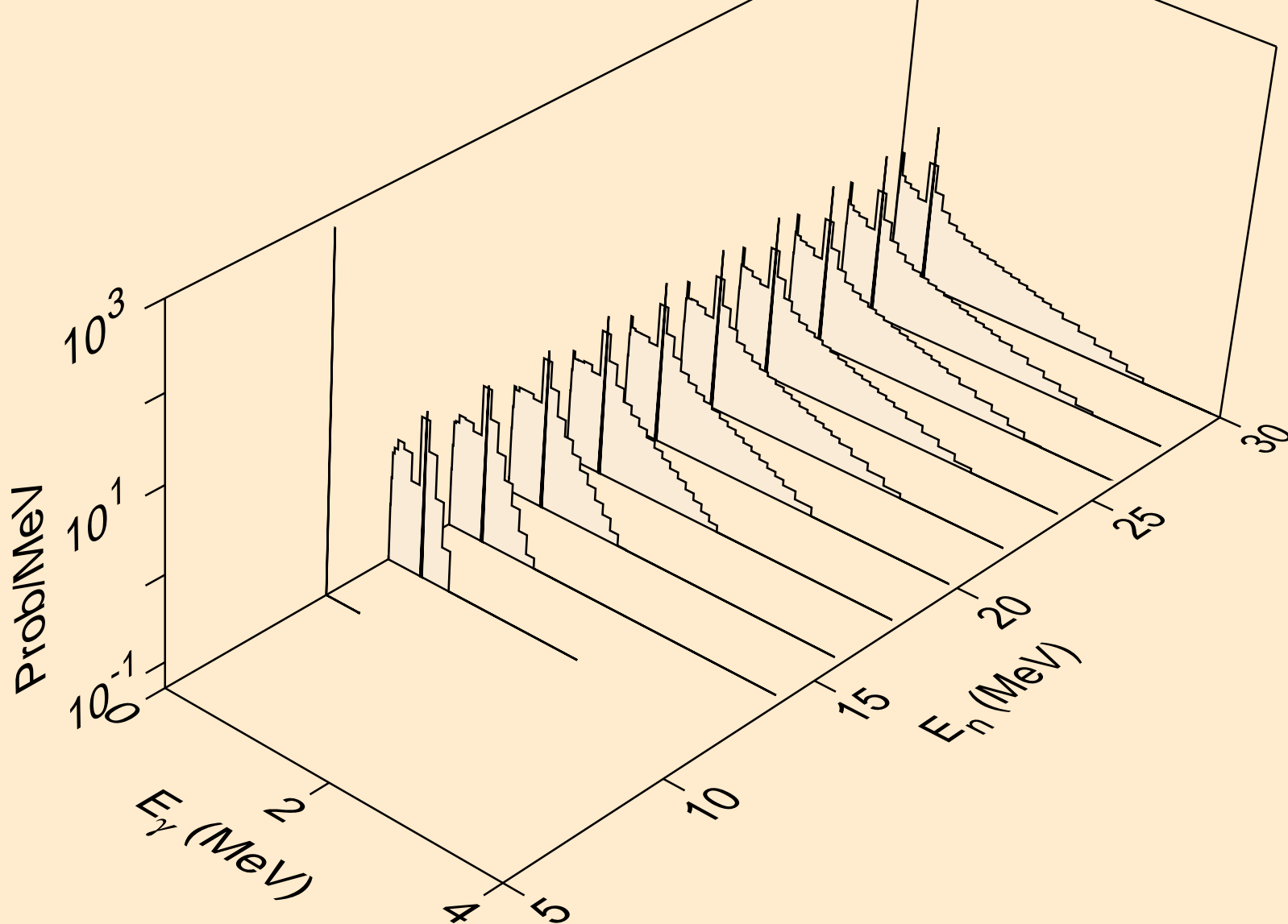

SN121 NEUTRON ACER TENDL-2019 LIBRARY; T=293.16K  
Photon emission for (n,t)

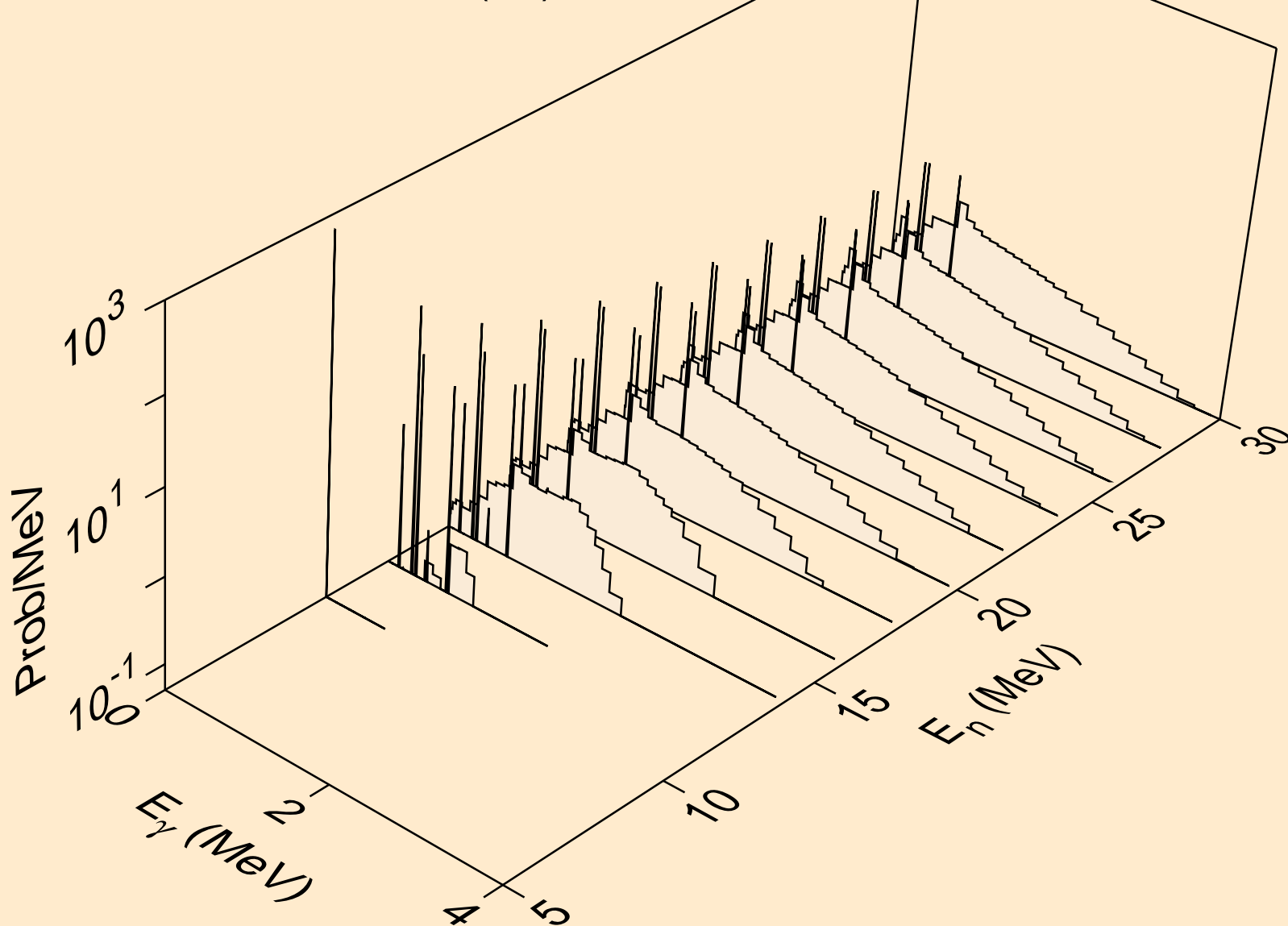

SN121 NEUTRON ACER TENDL-2019 LIBRARY; T=293.16K  
Photon emission for (n,he3)

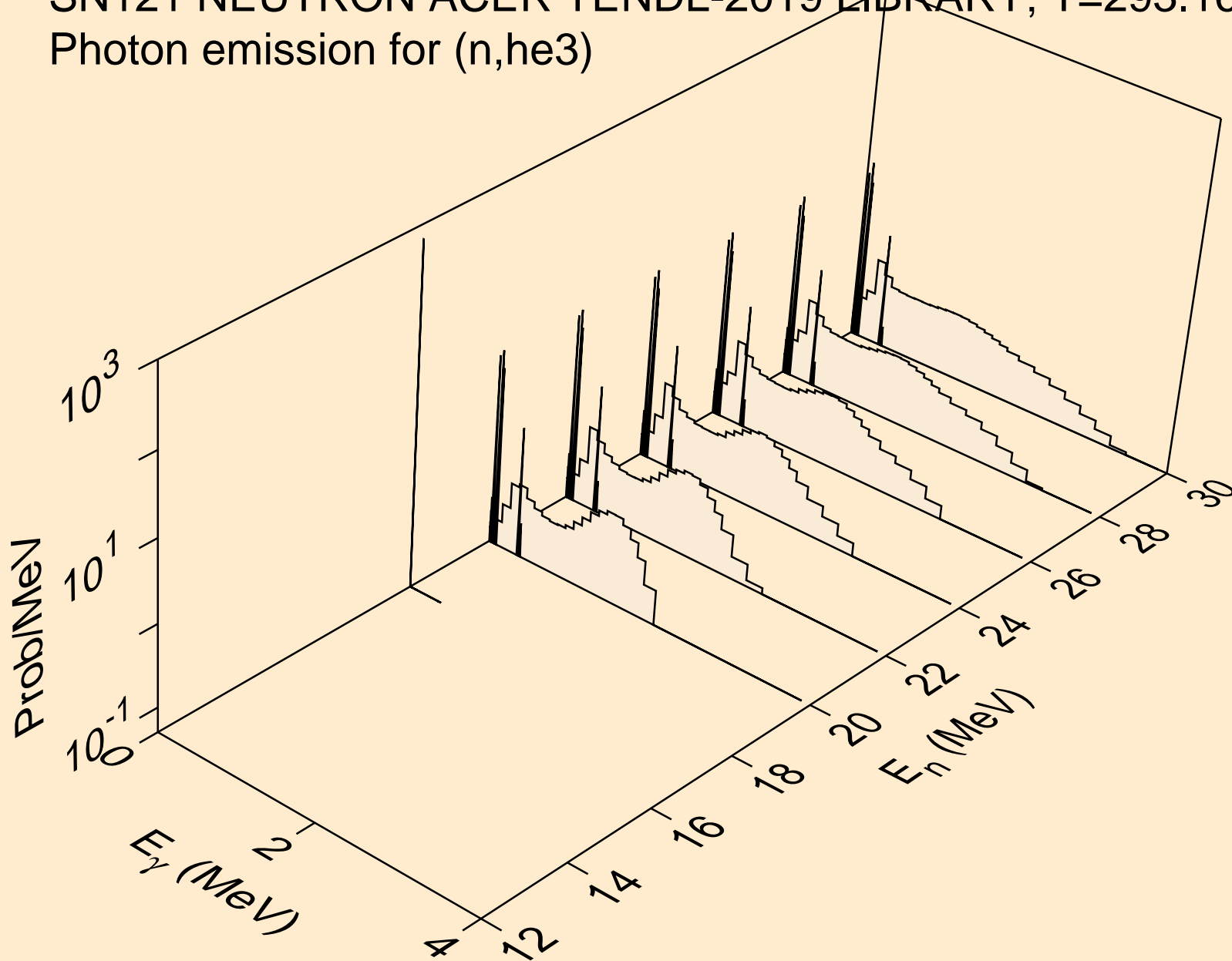

SN121 NEUTRON ACER TENDL-2019 LIBRARY; T=293.16K  
Photon emission for (n,a)

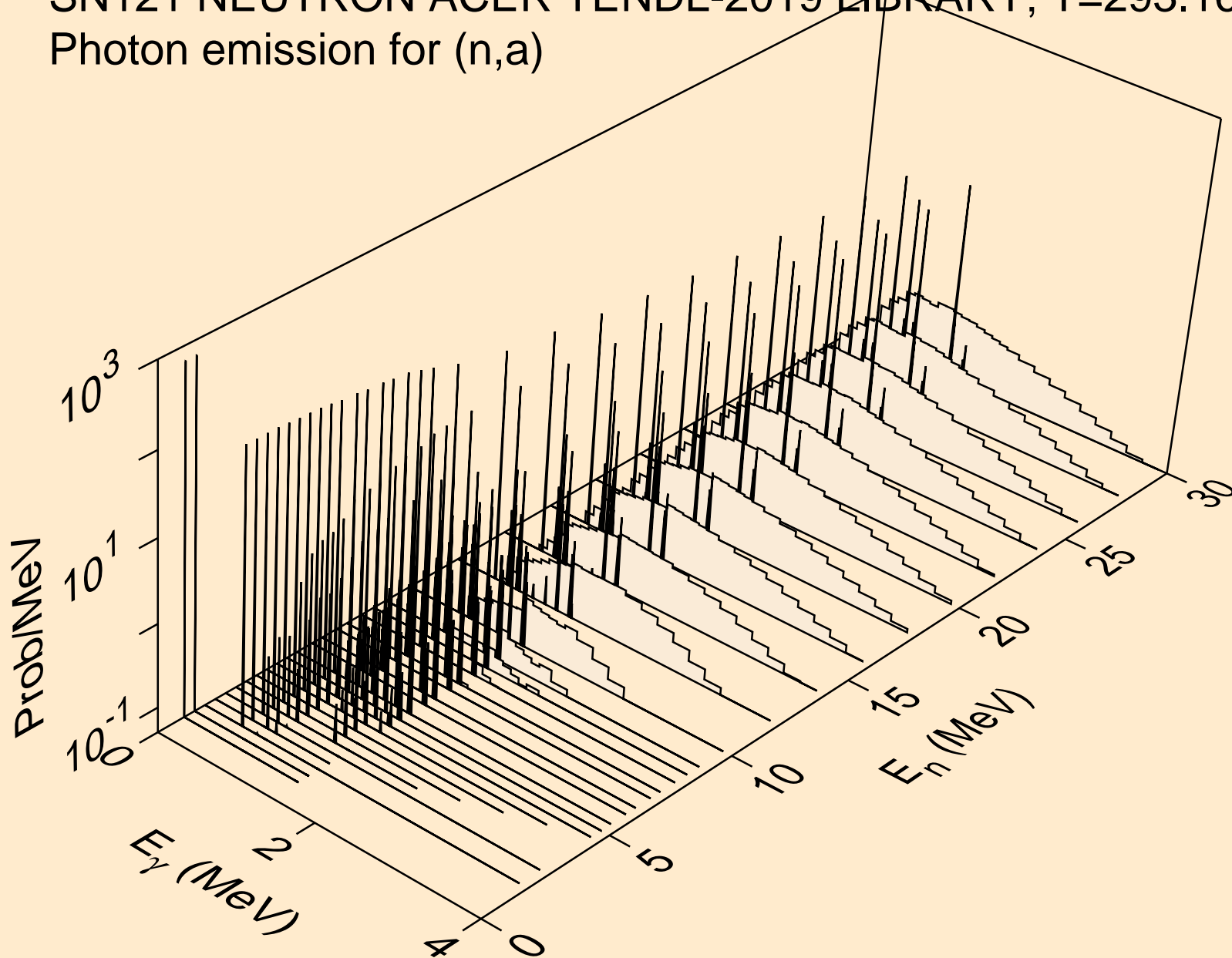



SN121 NEUTRON ACER TENDL-2019 LIBRARY; T=293.16K  
Photon emission for (n,2p)

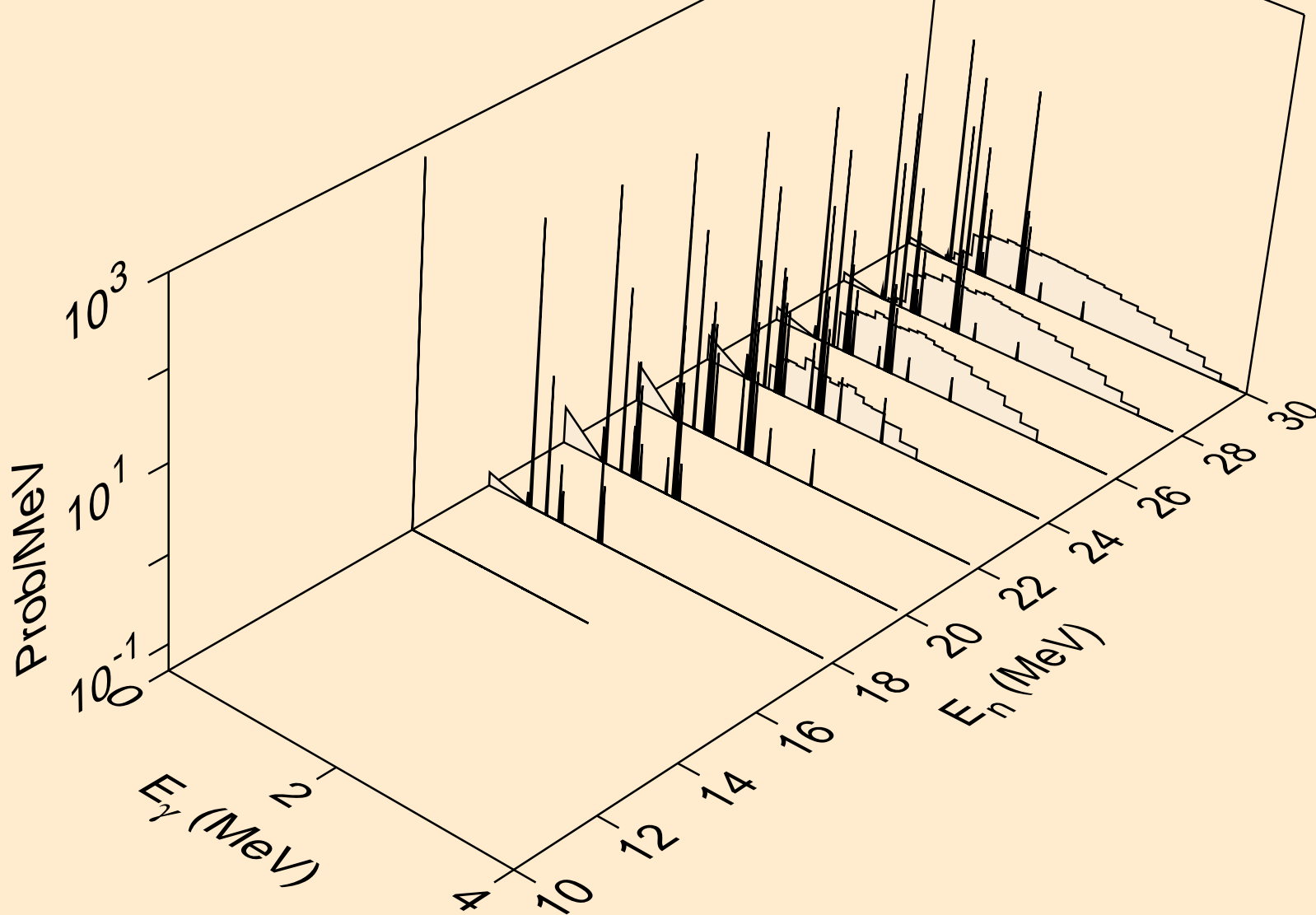

SN121 NEUTRON ACER TENDL-2019 LIBRARY; T=293.16K  
Photon emission for (n,p)

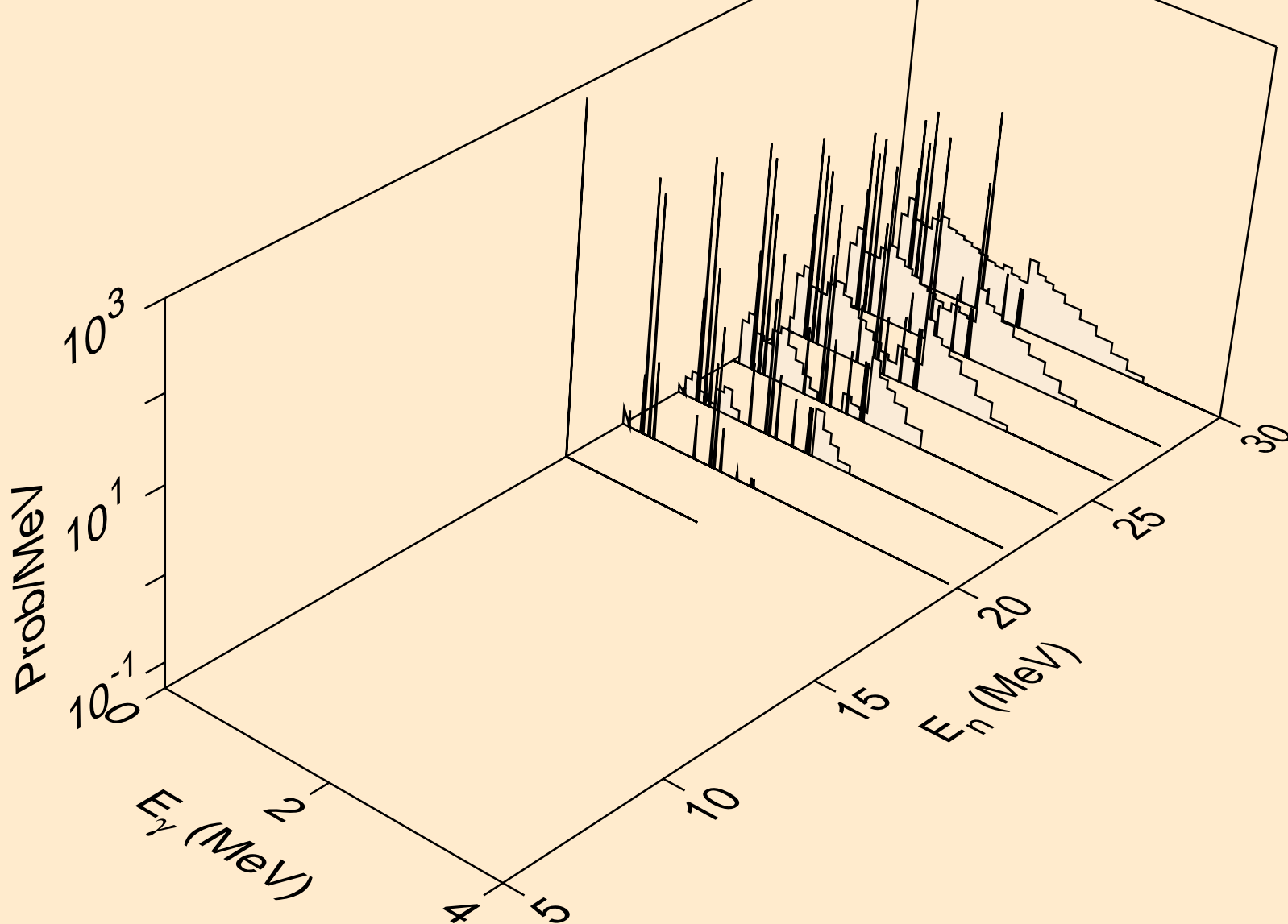

SN121 NEUTRON ACER TENDL-2019 LIBRARY; T=293.16K  
Photon emission for (n,pt)

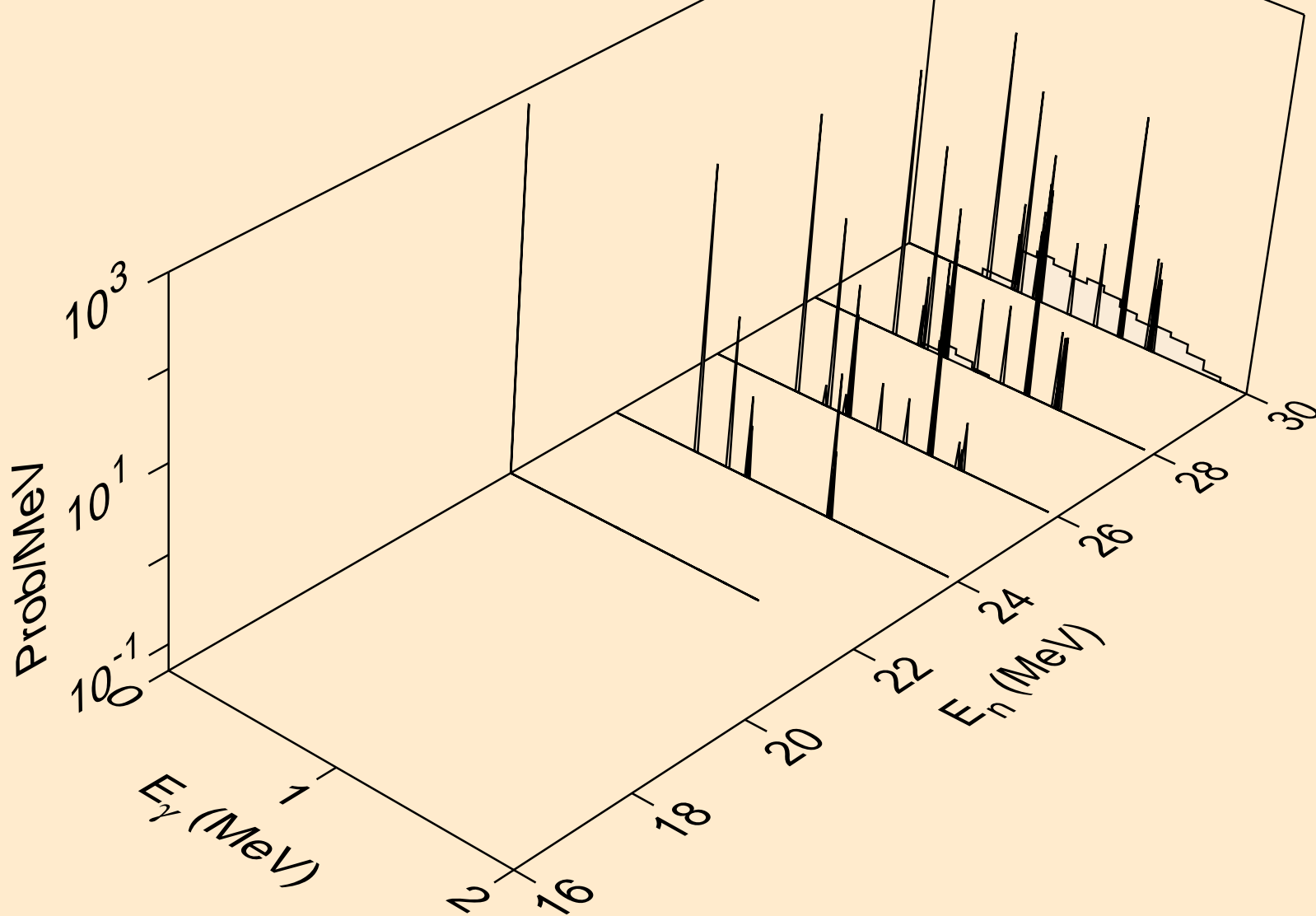

SN121 NEUTRON ACER TENDL-2019 LIBRARY; T=293.16K  
thermal capture photon spectrum

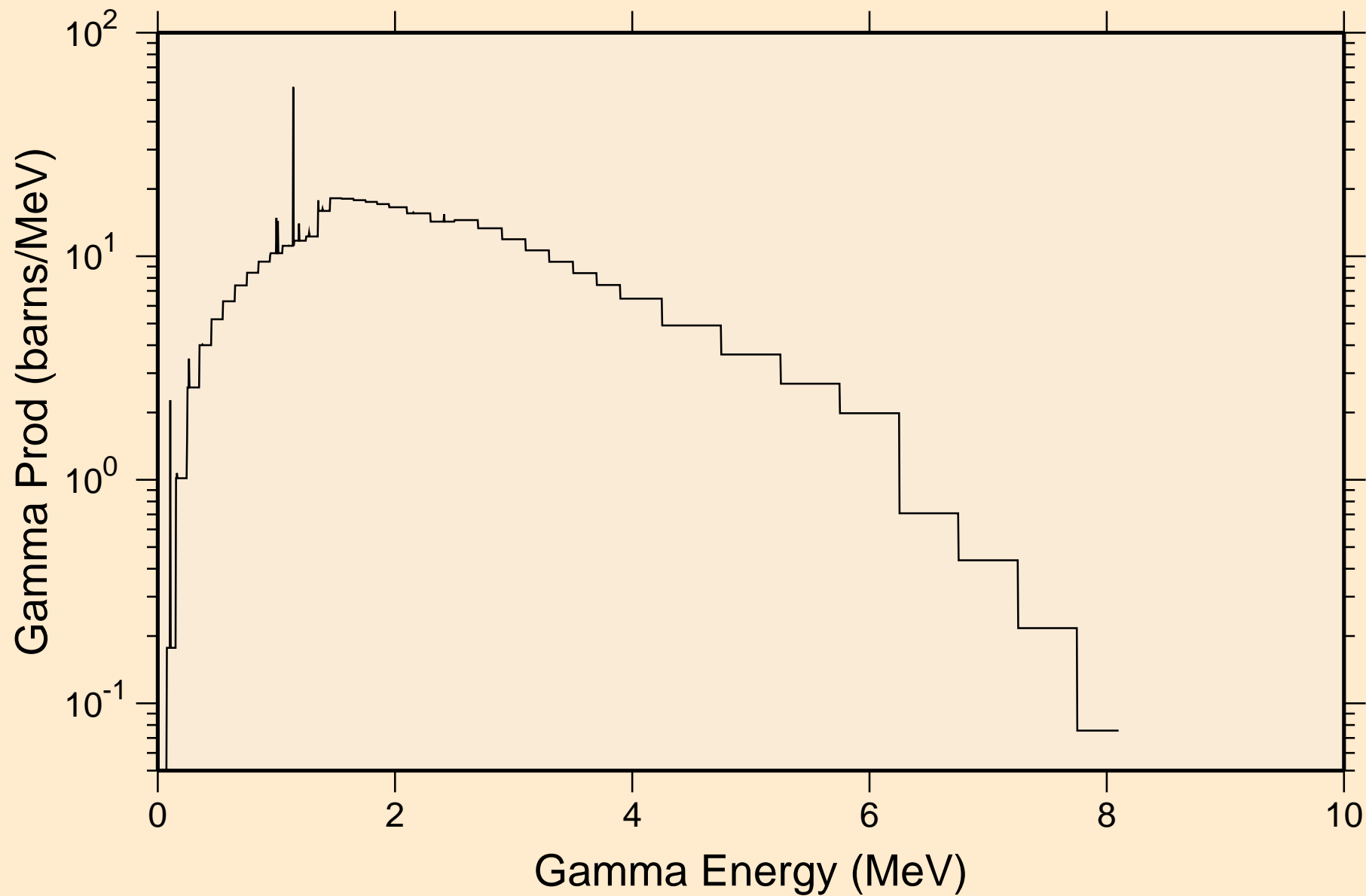

SN121 NEUTRON ACER TENDL-2019 LIBRARY; T=293.16K  
14 MeV photon spectrum

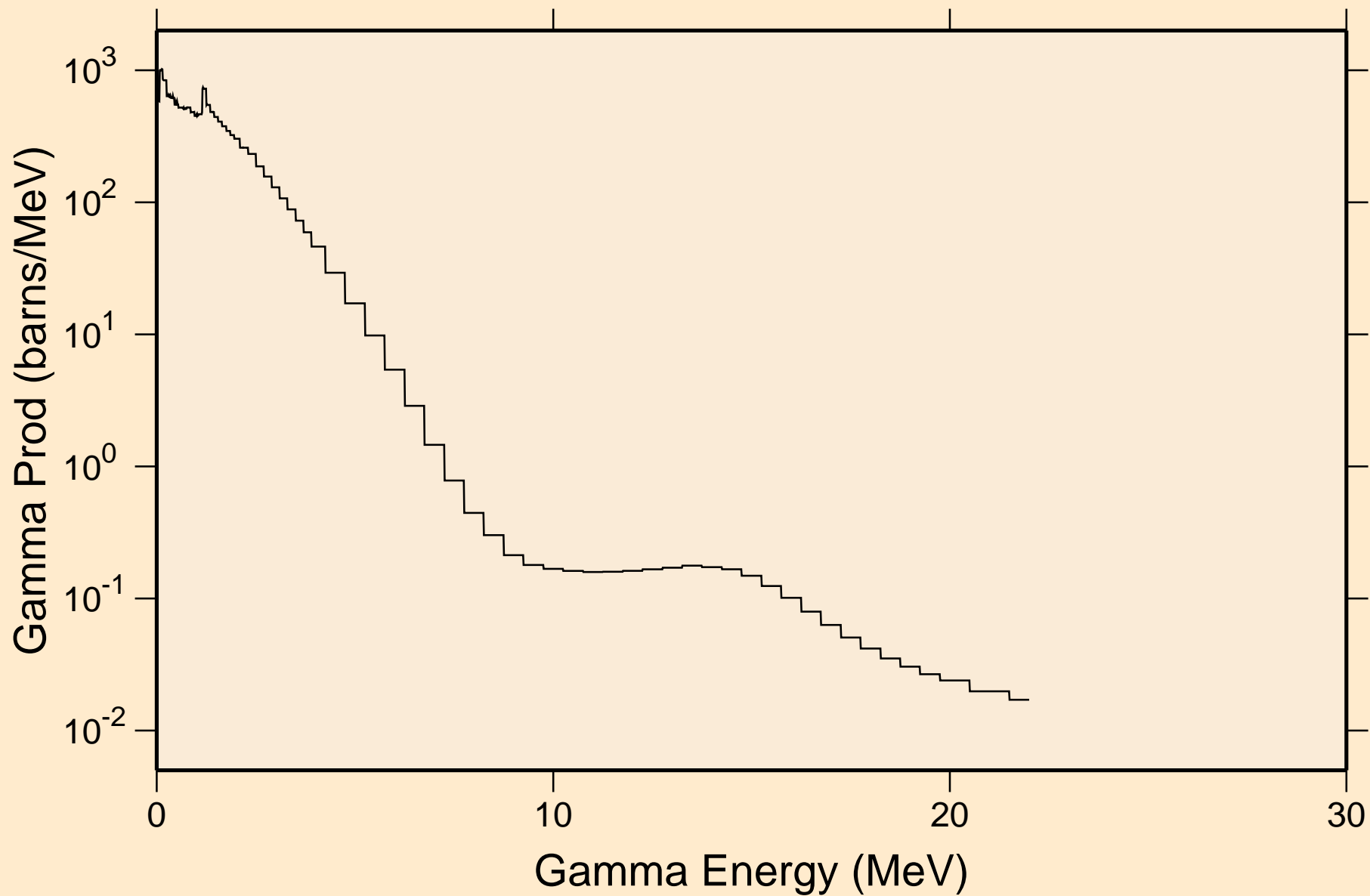

# SN121 NEUTRON ACER TENDL-2019 LIBRARY; T=293.16K

## Particle heating contributions

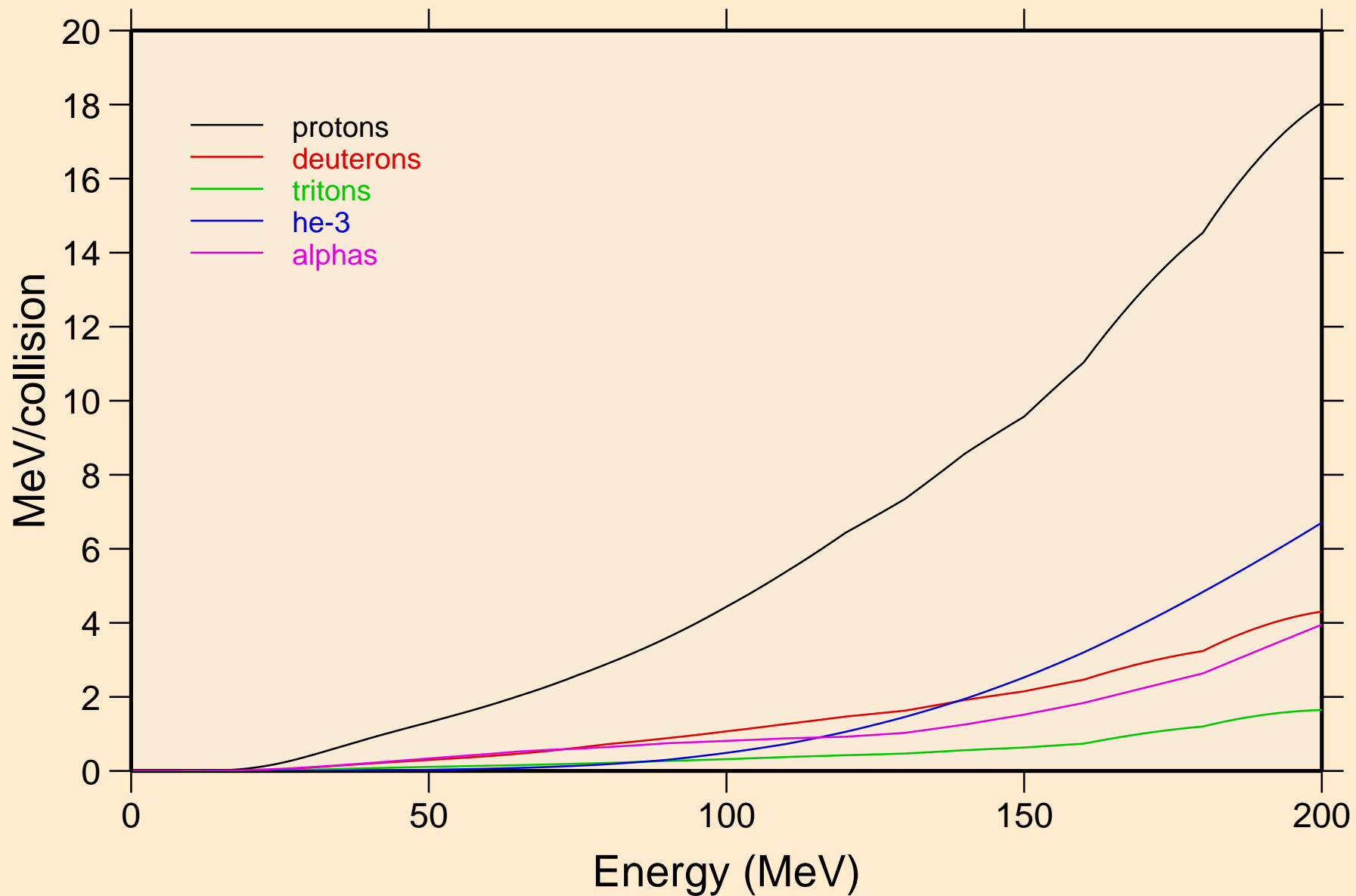

# SN121 NEUTRON ACER TENDL-2019 LIBRARY; T=293.16K

## Recoil Heating

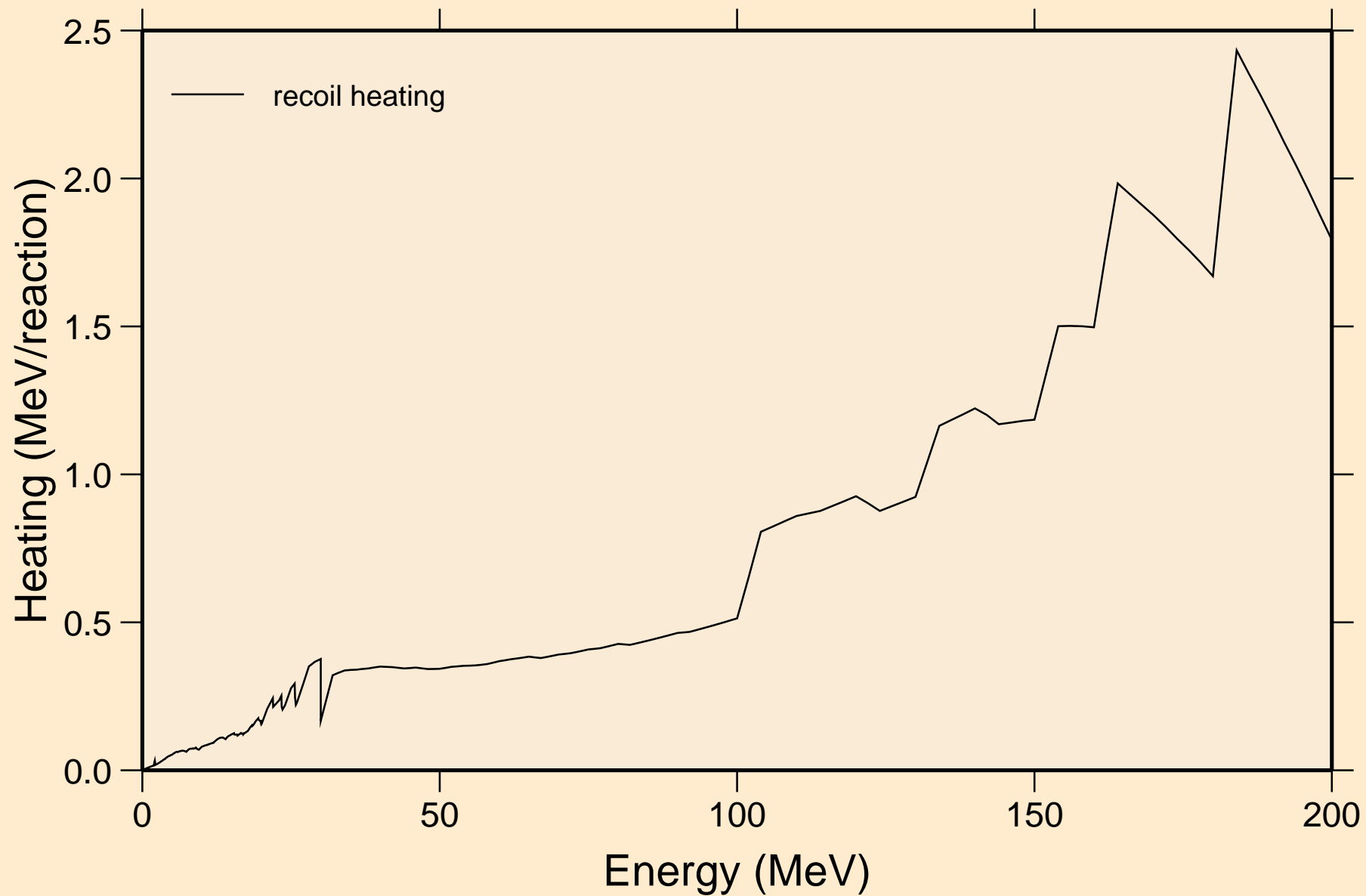

# SN121 NEUTRON ACER TENDL-2019 LIBRARY; T=293.16K

## Particle production cross sections

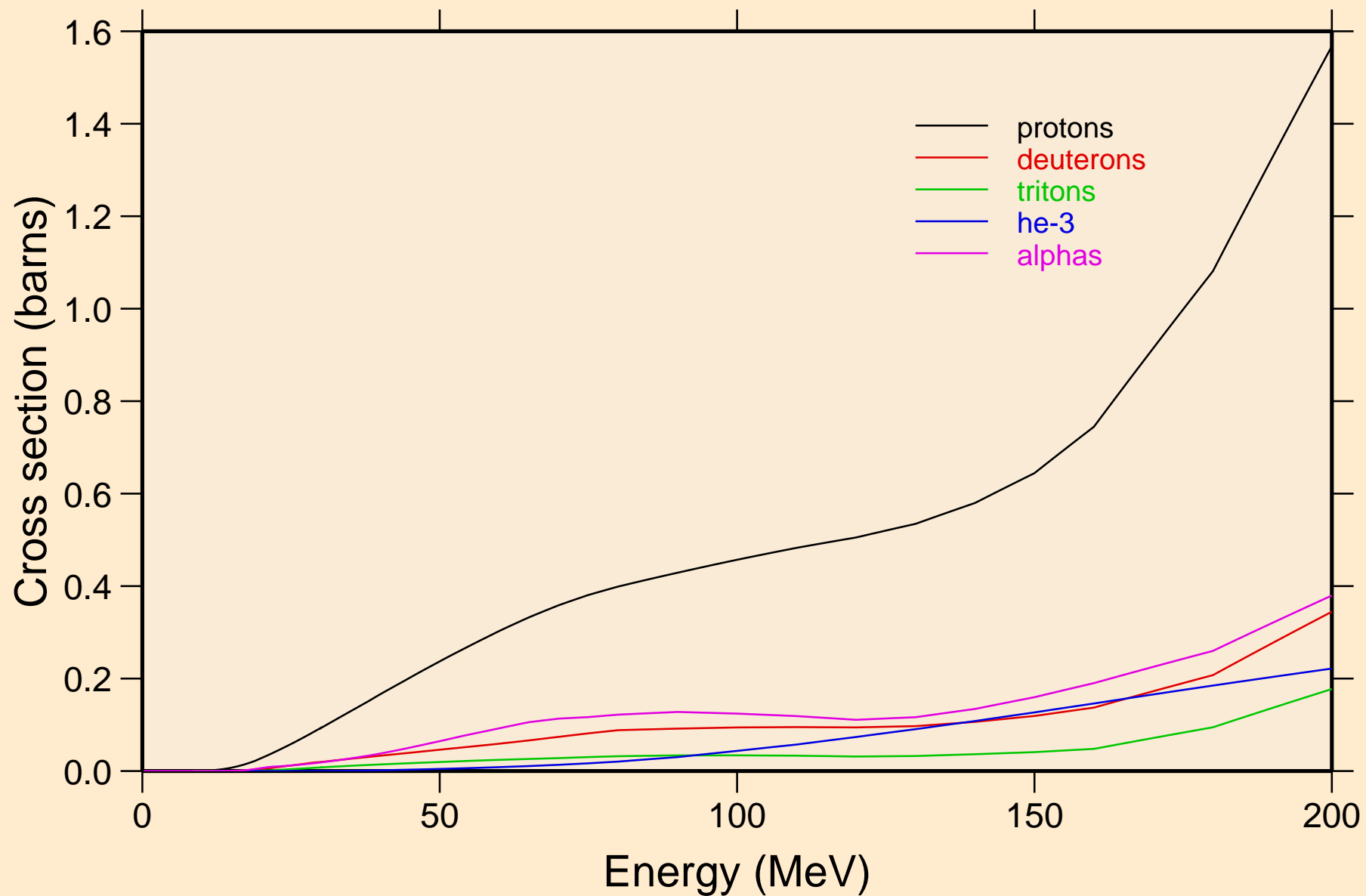



SN121 NEUTRON ACER TENDL-2019 LIBRARY; T=293.16K  
protons from (n,x)

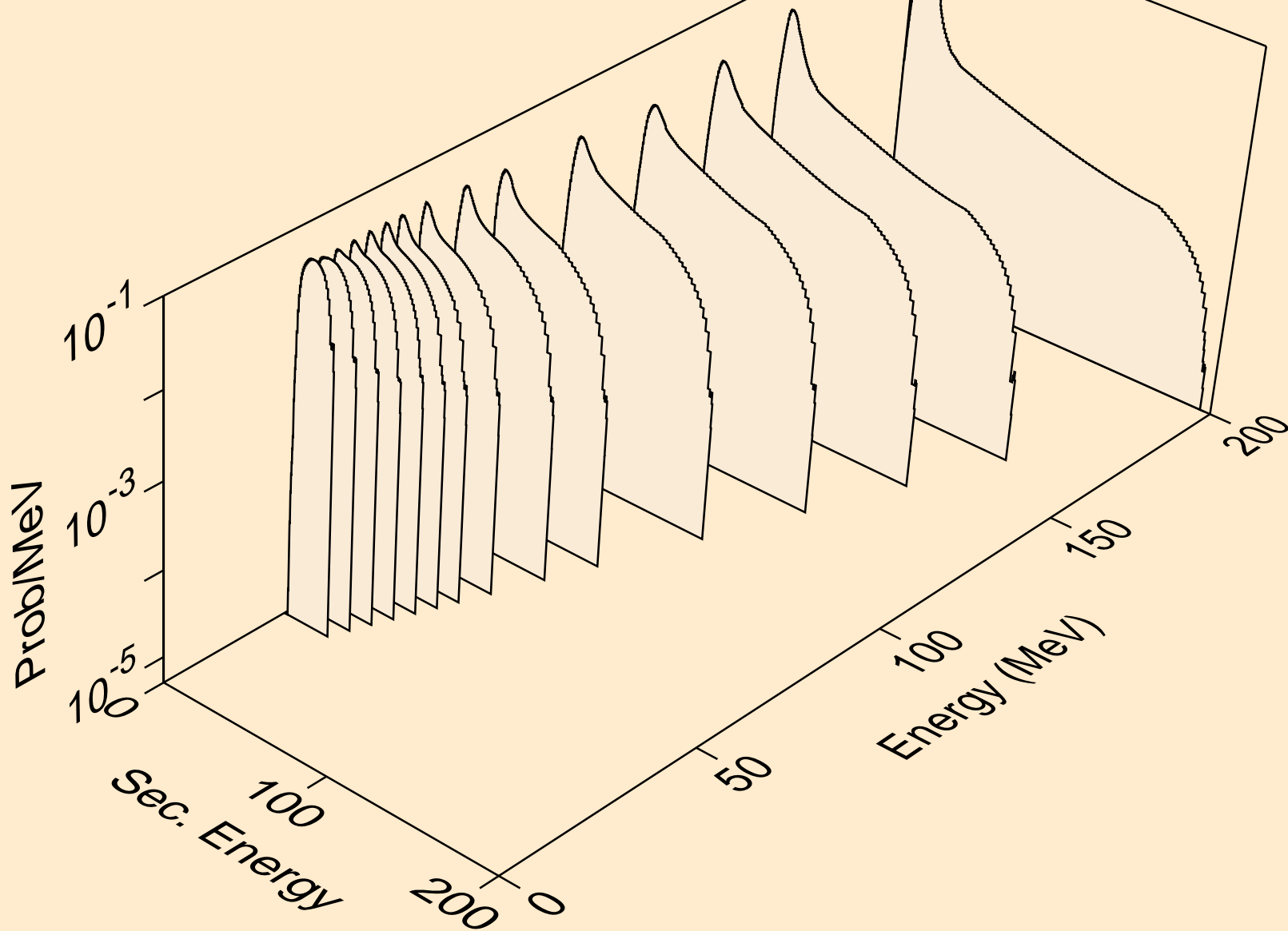

SN121 NEUTRON ACER TENDL-2019 LIBRARY; T=293.16K  
protons from (n,n\*)p

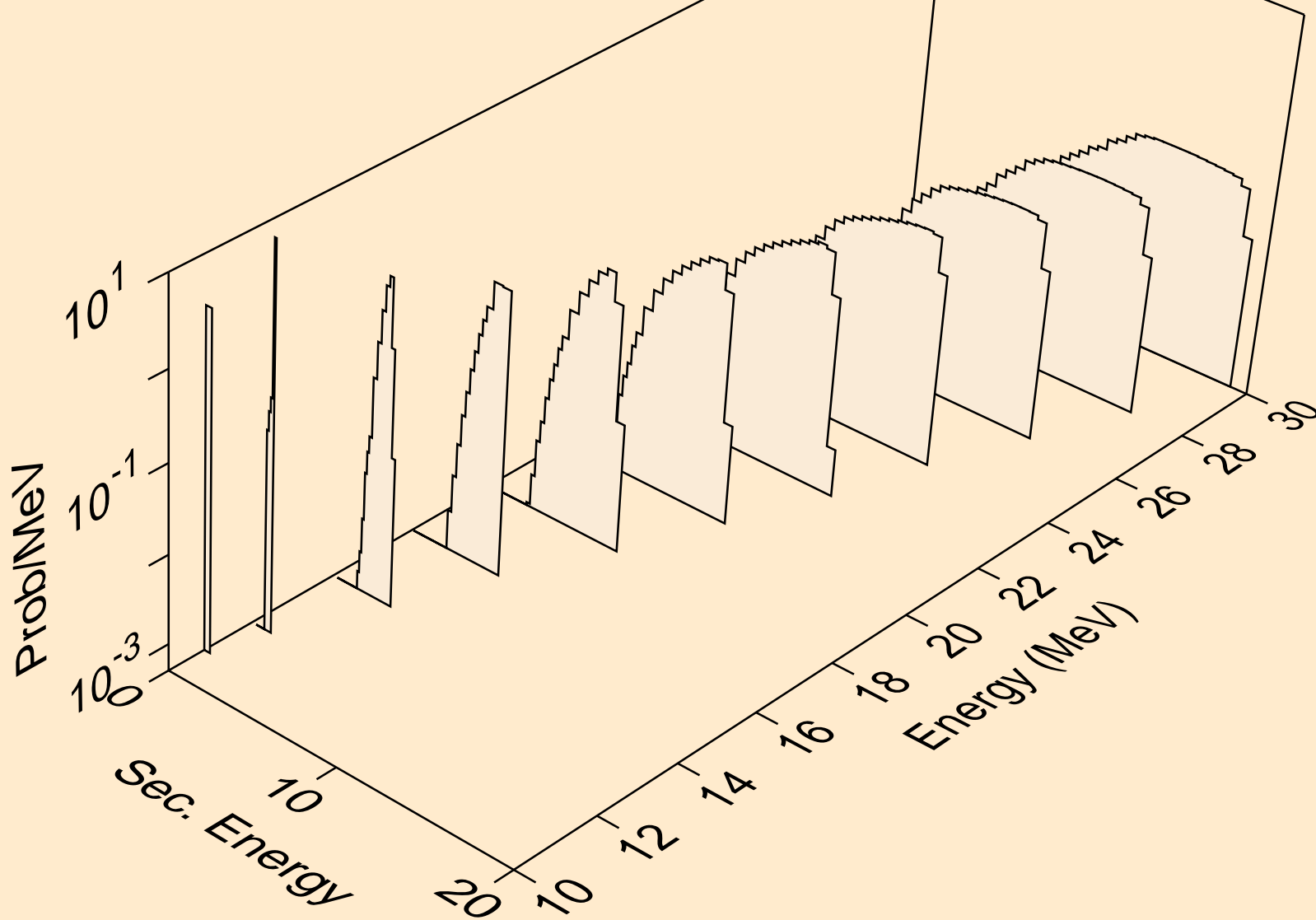

SN121 NEUTRON ACER TENDL-2019 LIBRARY; T=293.16K  
protons from (n,2np)

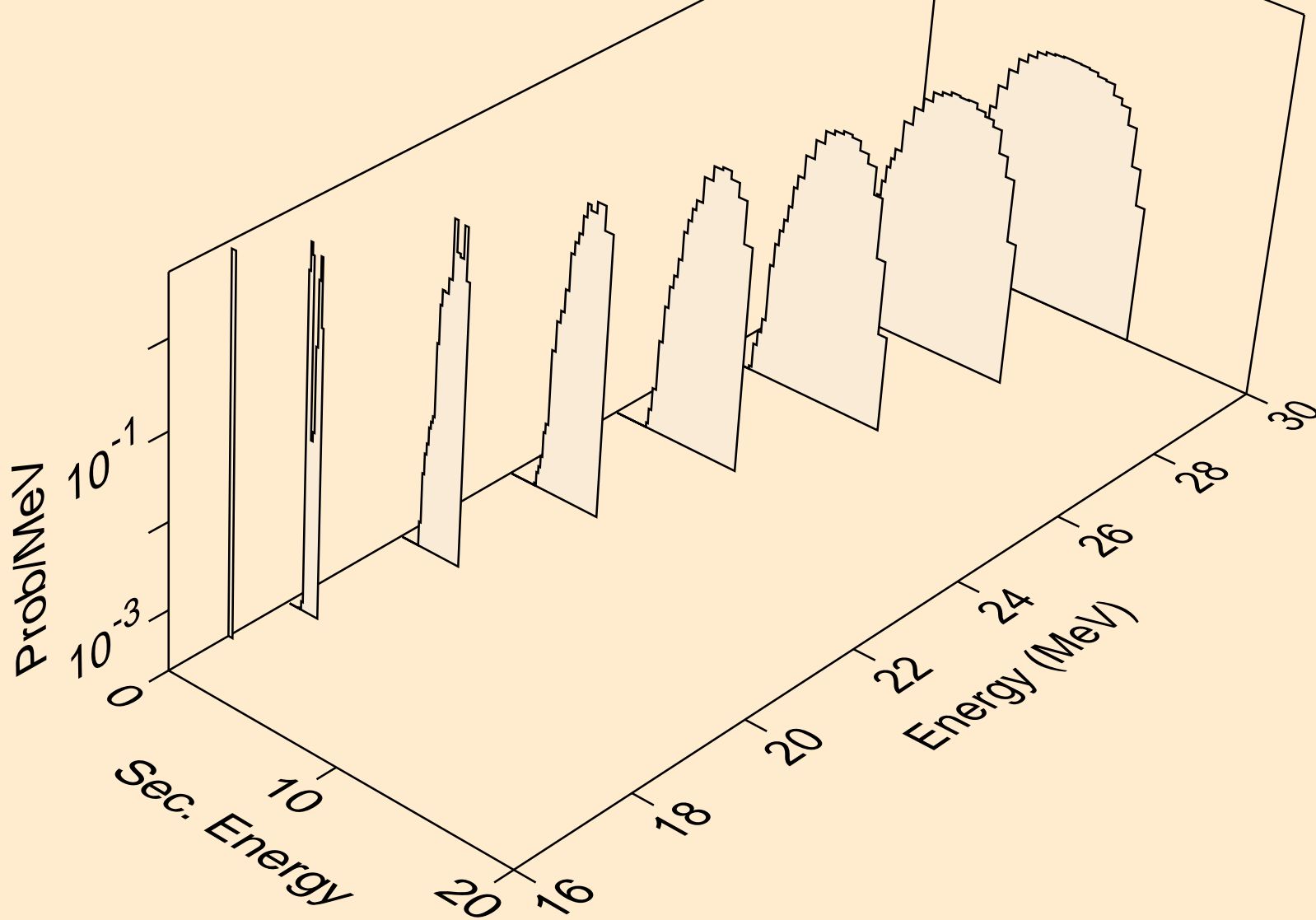

SN121 NEUTRON ACER TENDL-2019 LIBRARY; T=293.16K  
protons from (n,3np)

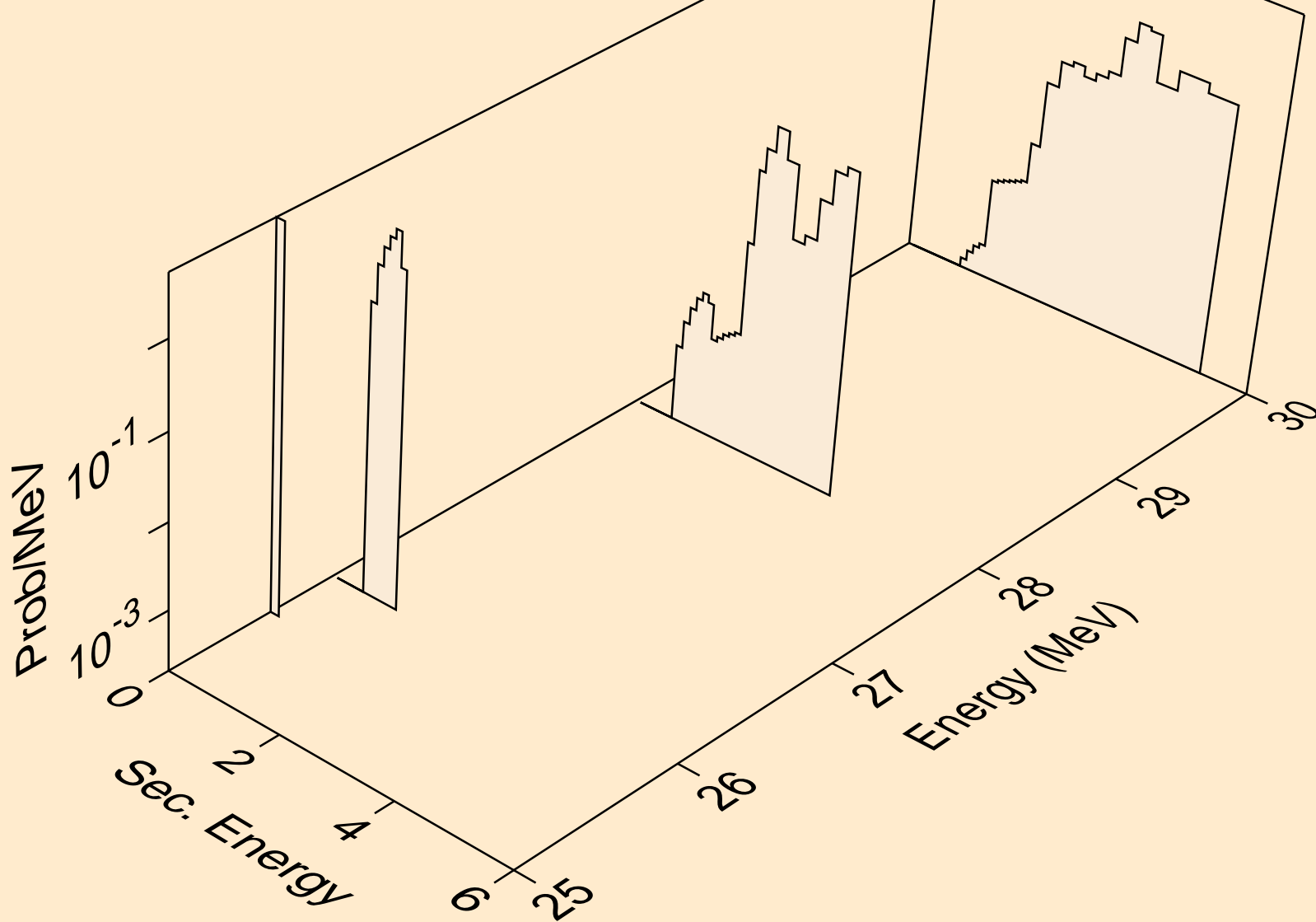

SN121 NEUTRON ACER TENDL-2019 LIBRARY; T=293.16K  
protons from (n,2np)

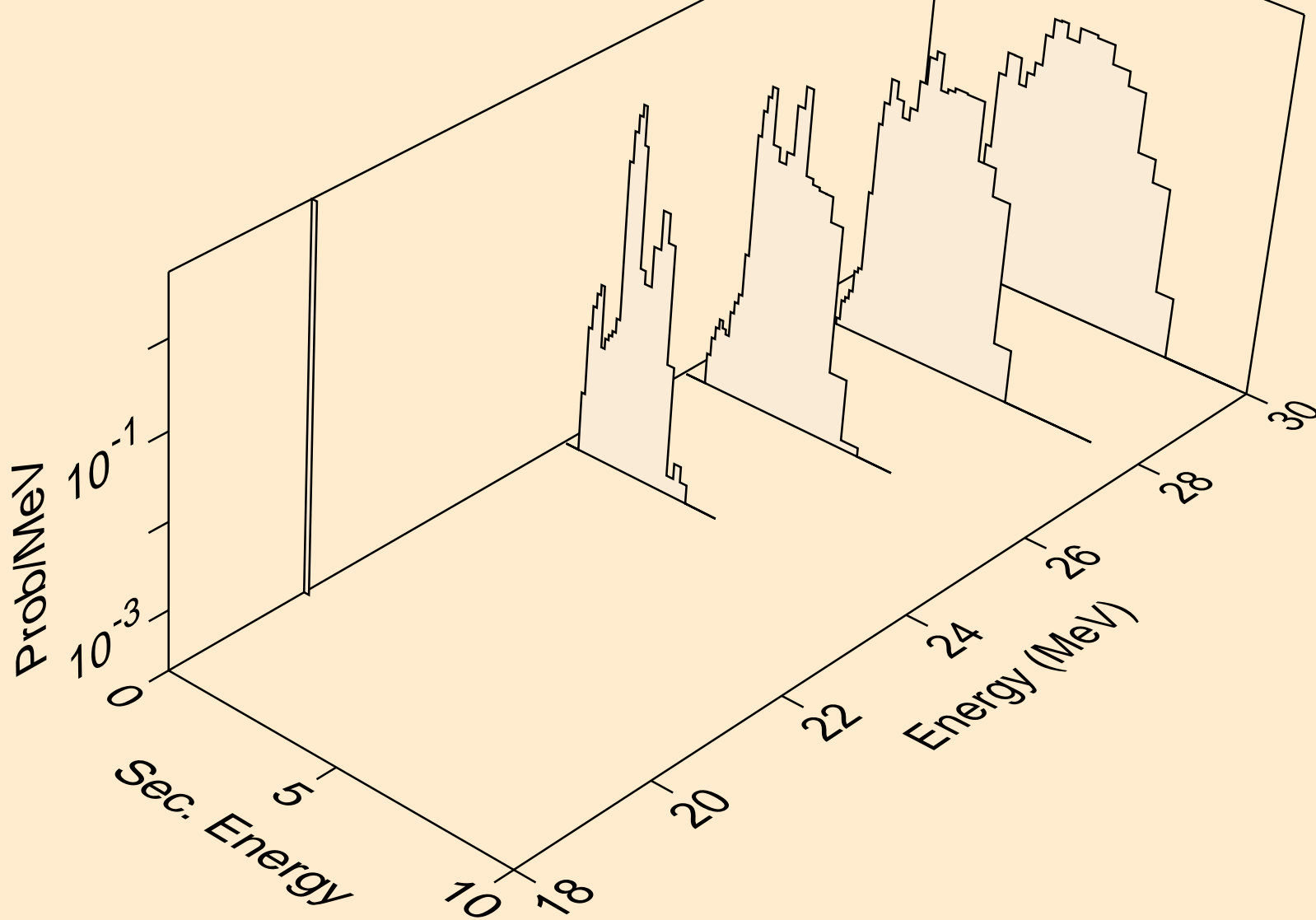

SN121 NEUTRON ACER TENDL-2019 LIBRARY; T=293.16K  
protons from (n,p)

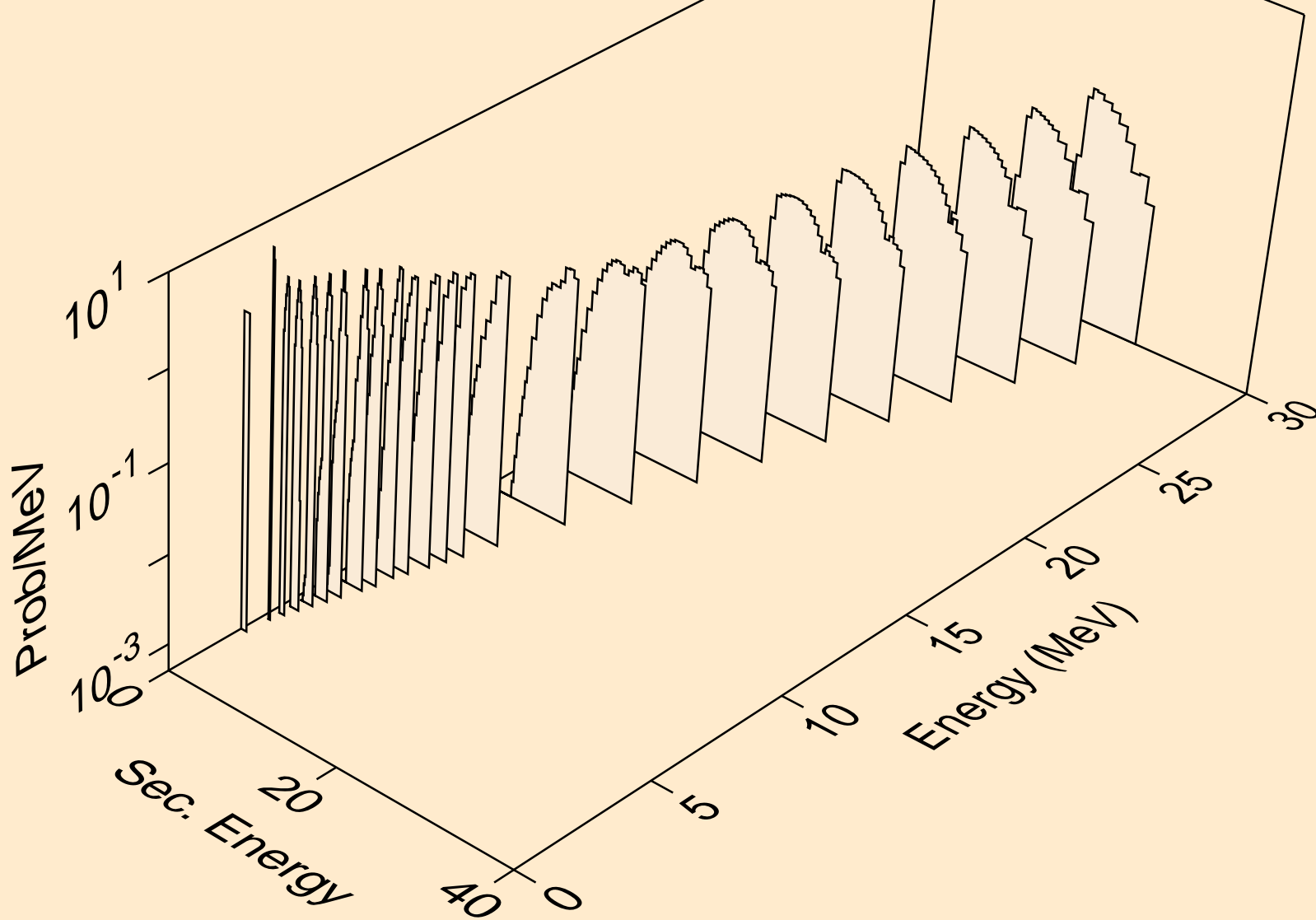

SN121 NEUTRON ACER TENDL-2019 LIBRARY; T=293.16K  
protons from (n,2p)

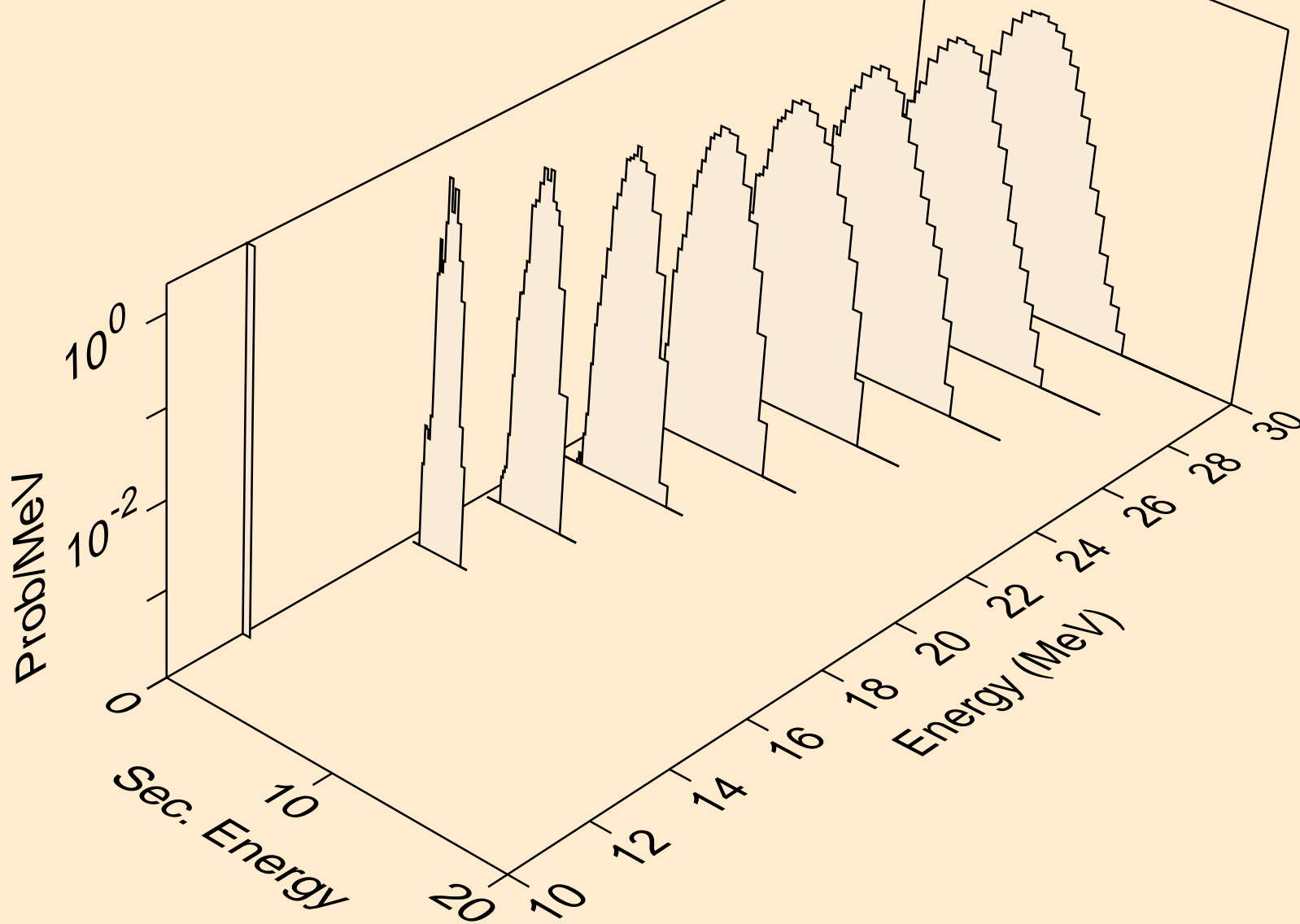

SN121 NEUTRON ACER TENDL-2019 LIBRARY; T=293.16K  
protons from (n,pa)

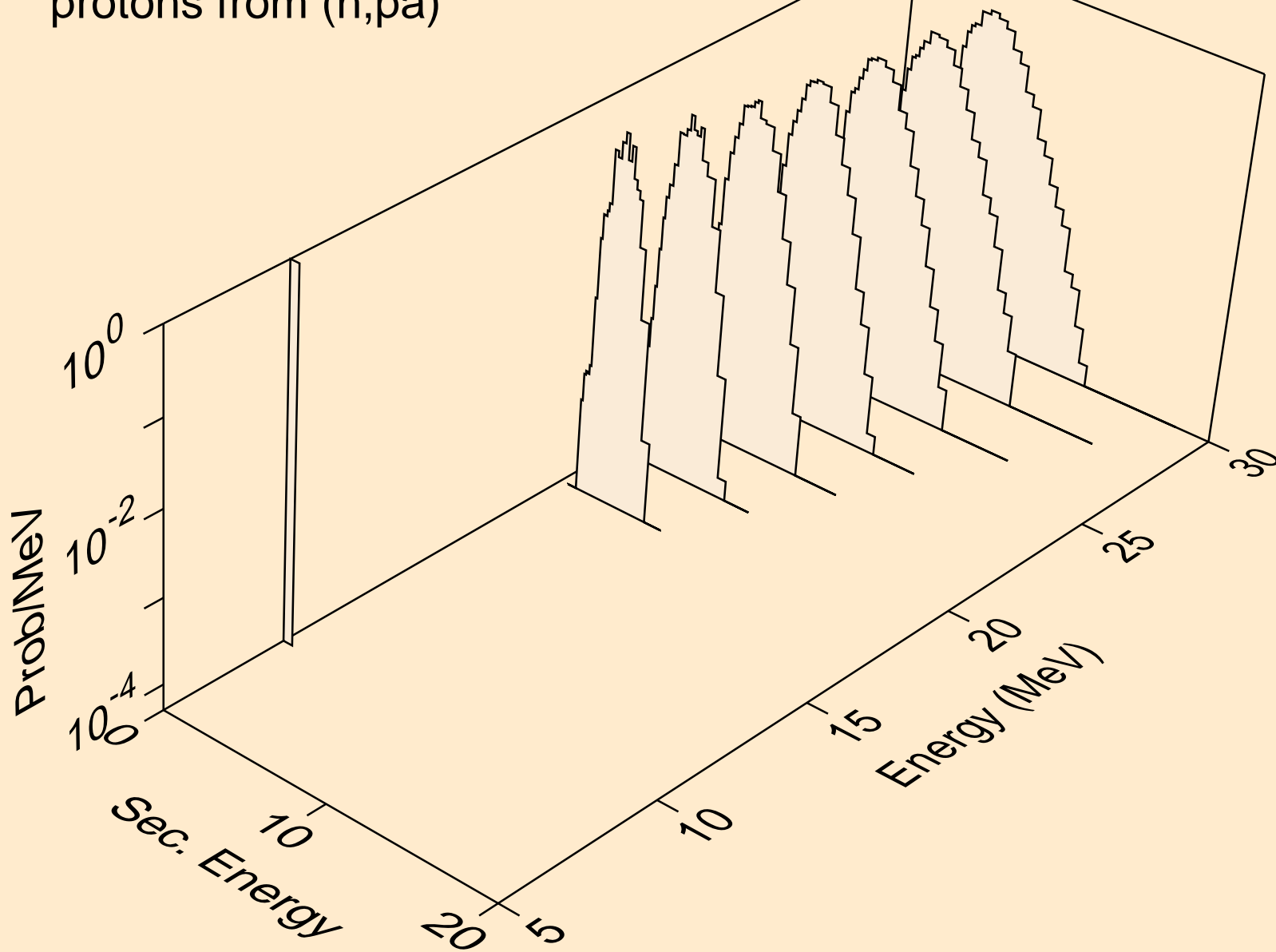



SN121 NEUTRON ACER TENDL-2019 LIBRARY; T=293.16K  
protons from (n,pt)

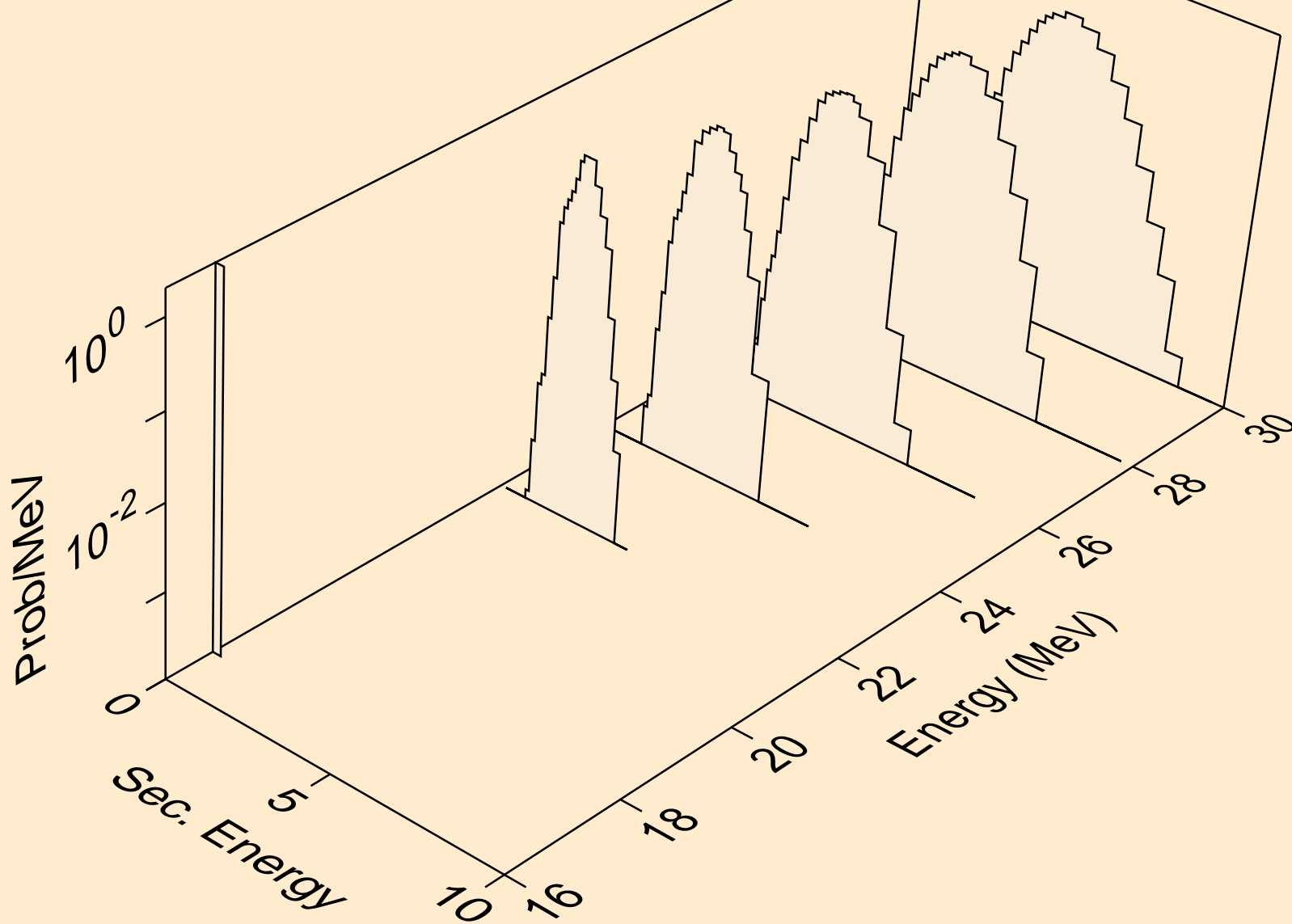

SN121 NEUTRON ACER TENDL-2019 LIBRARY; T=293.16K  
deuterons from (n,x)

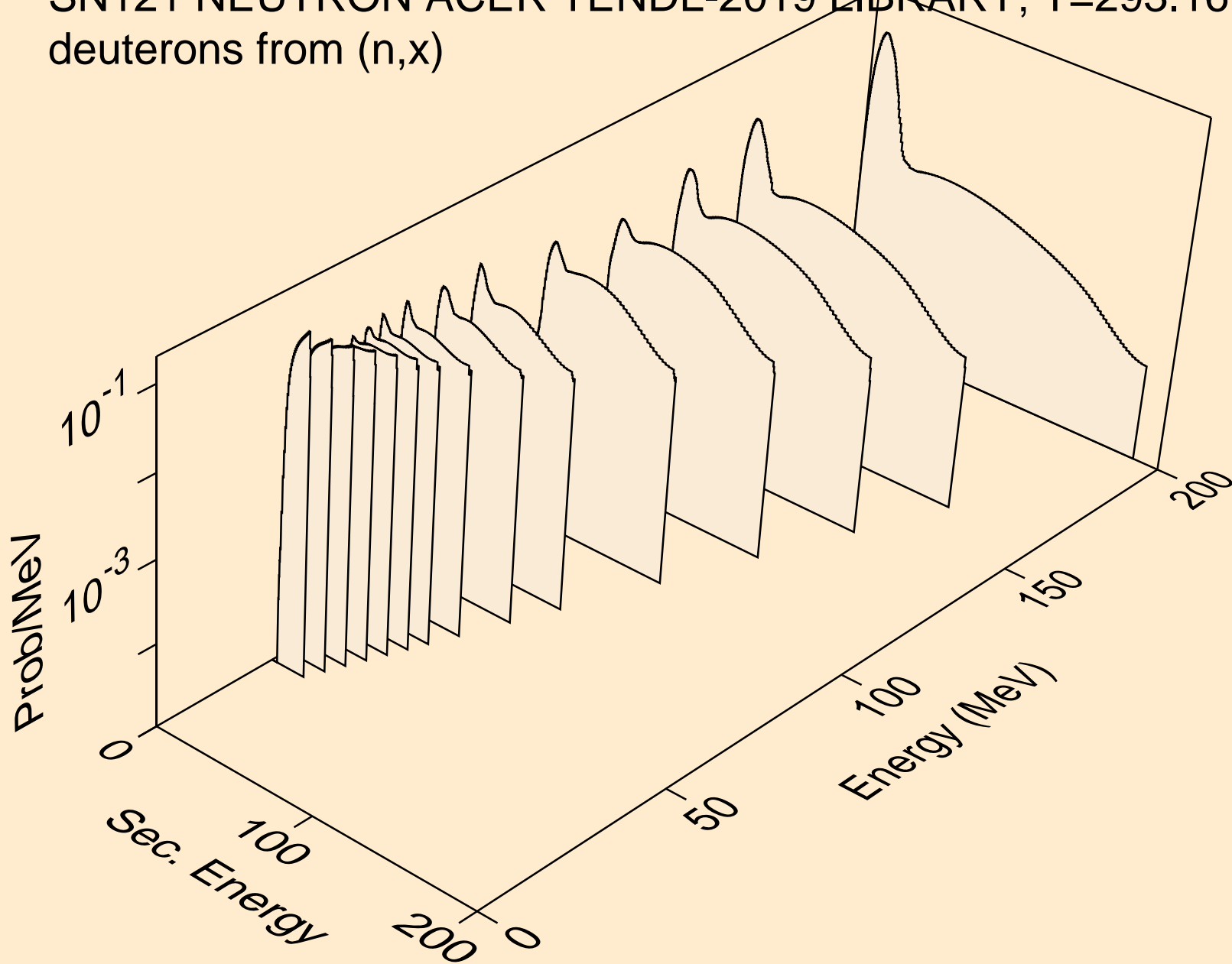

SN121 NEUTRON ACER TENDL-2019 LIBRARY; T=293.16K  
deuterons from (n,2nd)

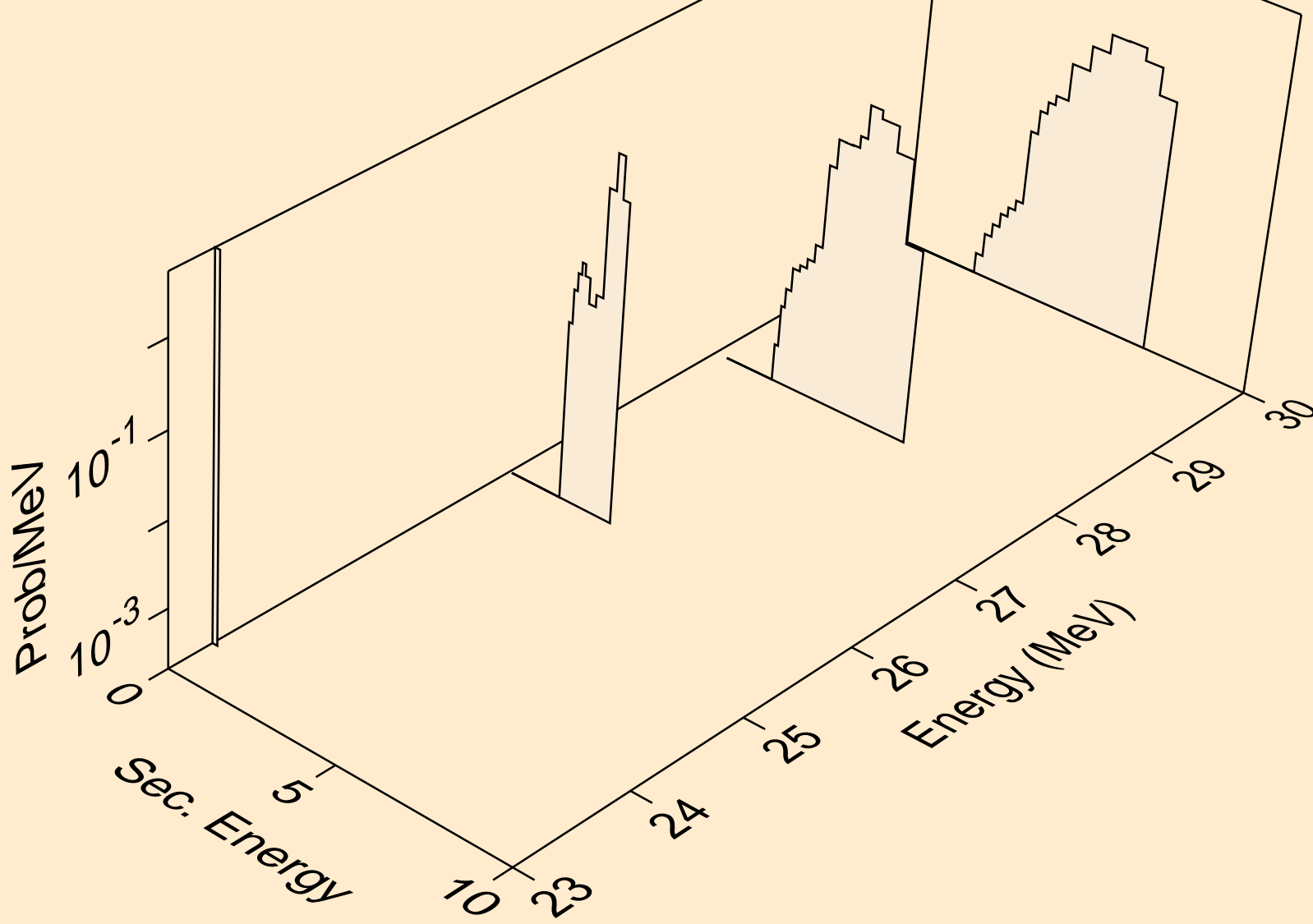

SN121 NEUTRON ACER TENDL-2019 LIBRARY; T=293.16K  
deuterons from (n,n\*)d

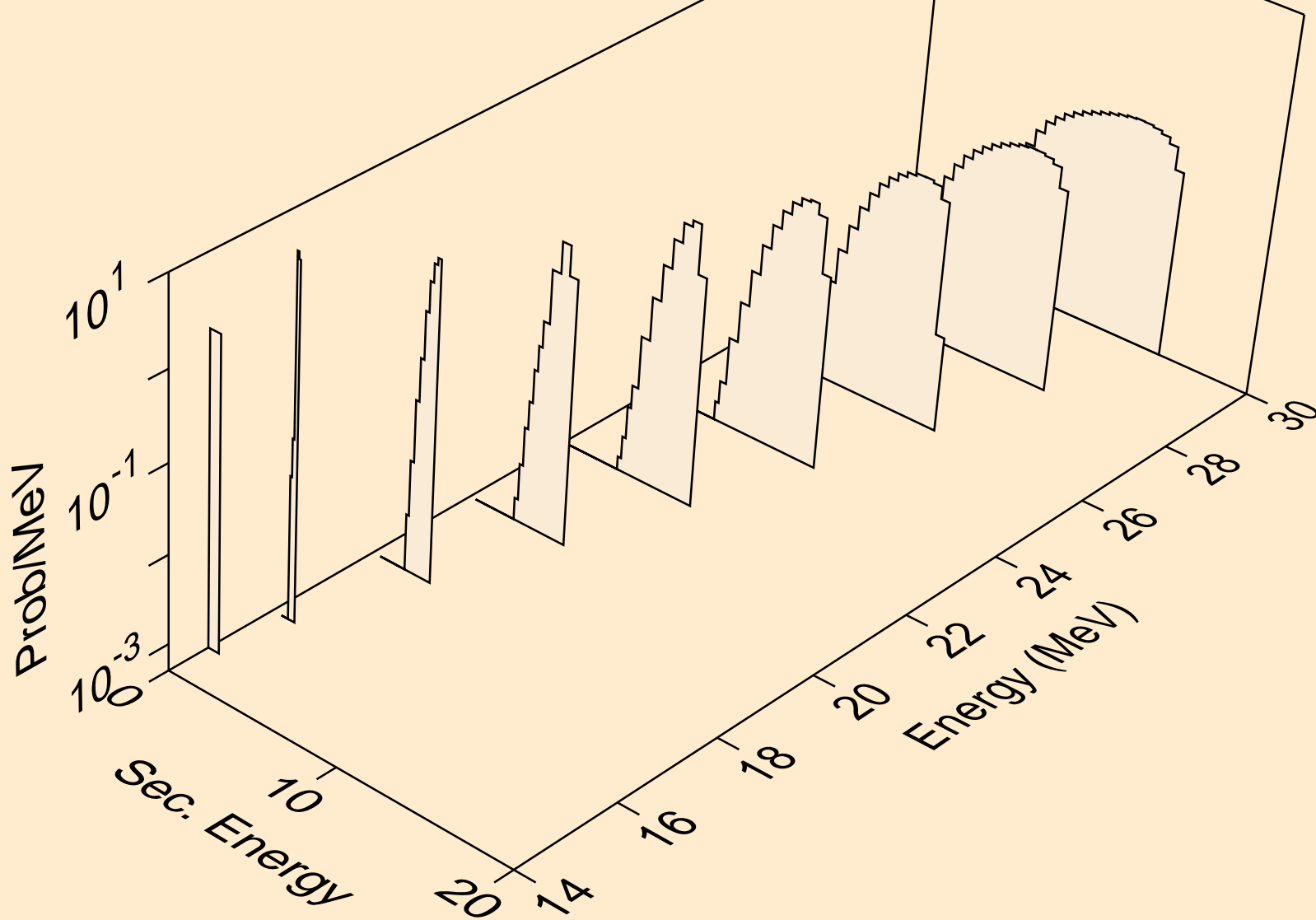

SN121 NEUTRON ACER TENDL-2019 LIBRARY; T=293.16K  
deuterons from (n,d)

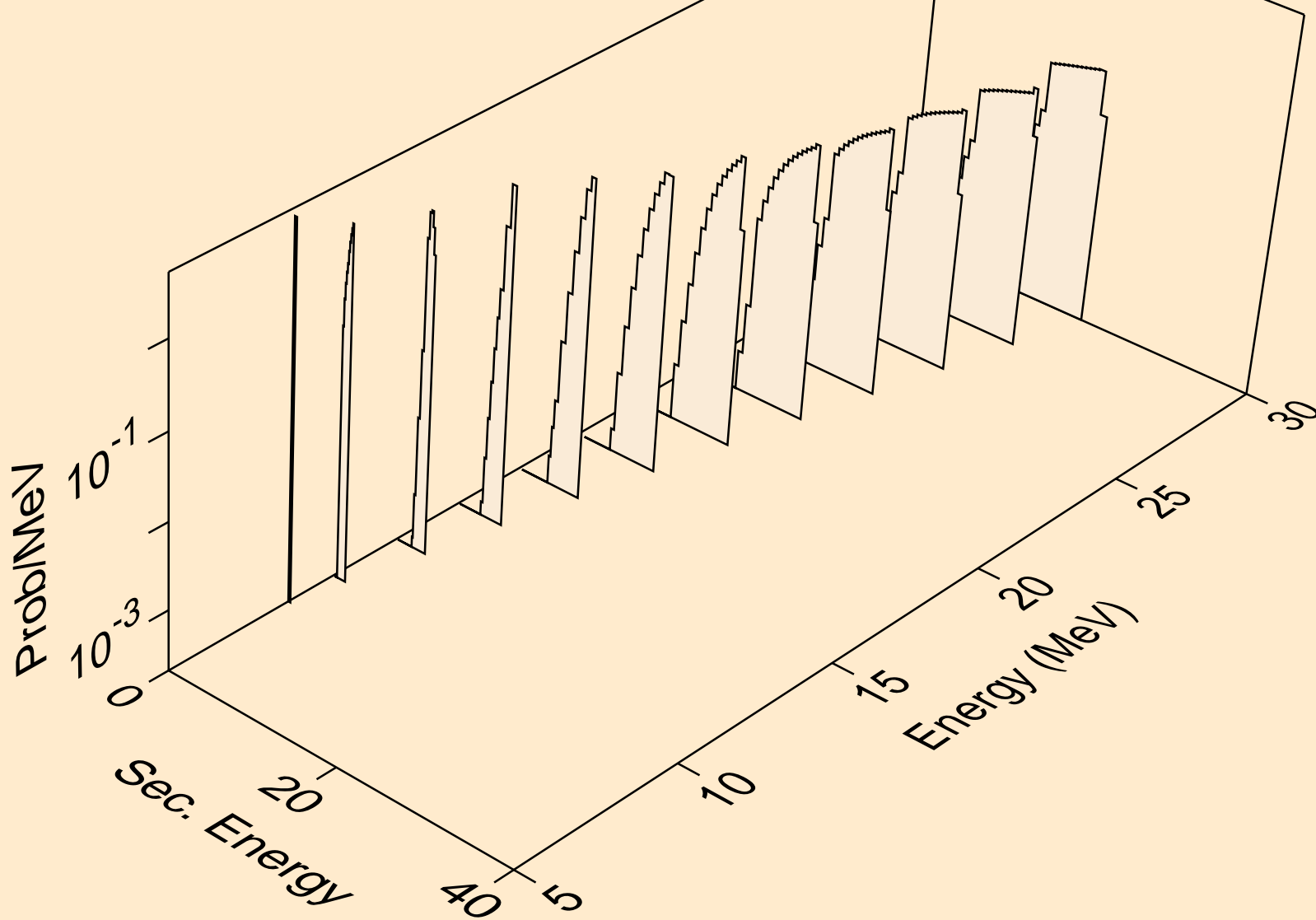

SN121 NEUTRON ACER TENDL-2019 LIBRARY; T=293.16K  
tritons from (n,x)

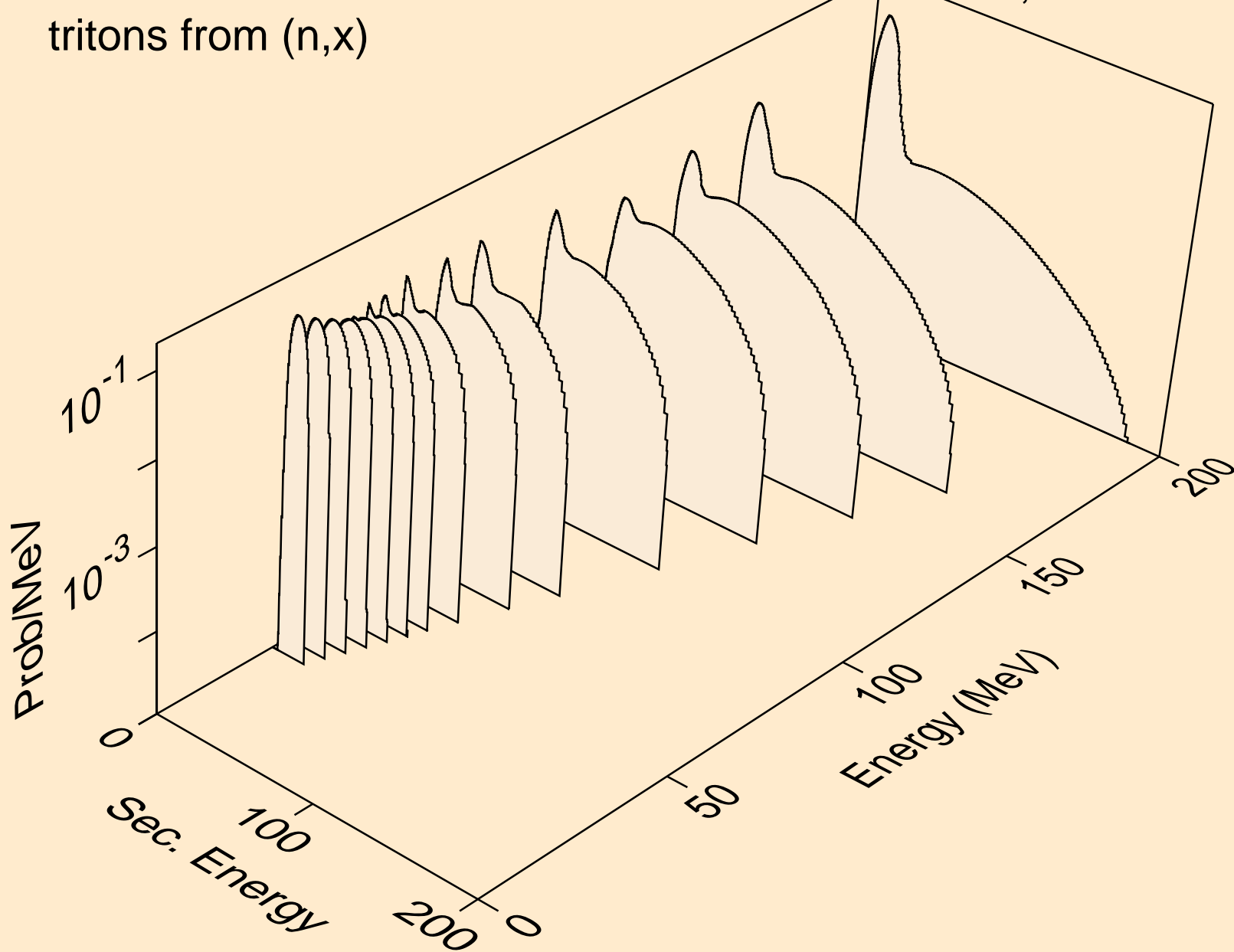

SN121 NEUTRON ACER TENDL-2019 LIBRARY; T=293.16K  
tritons from (n,n\*)t

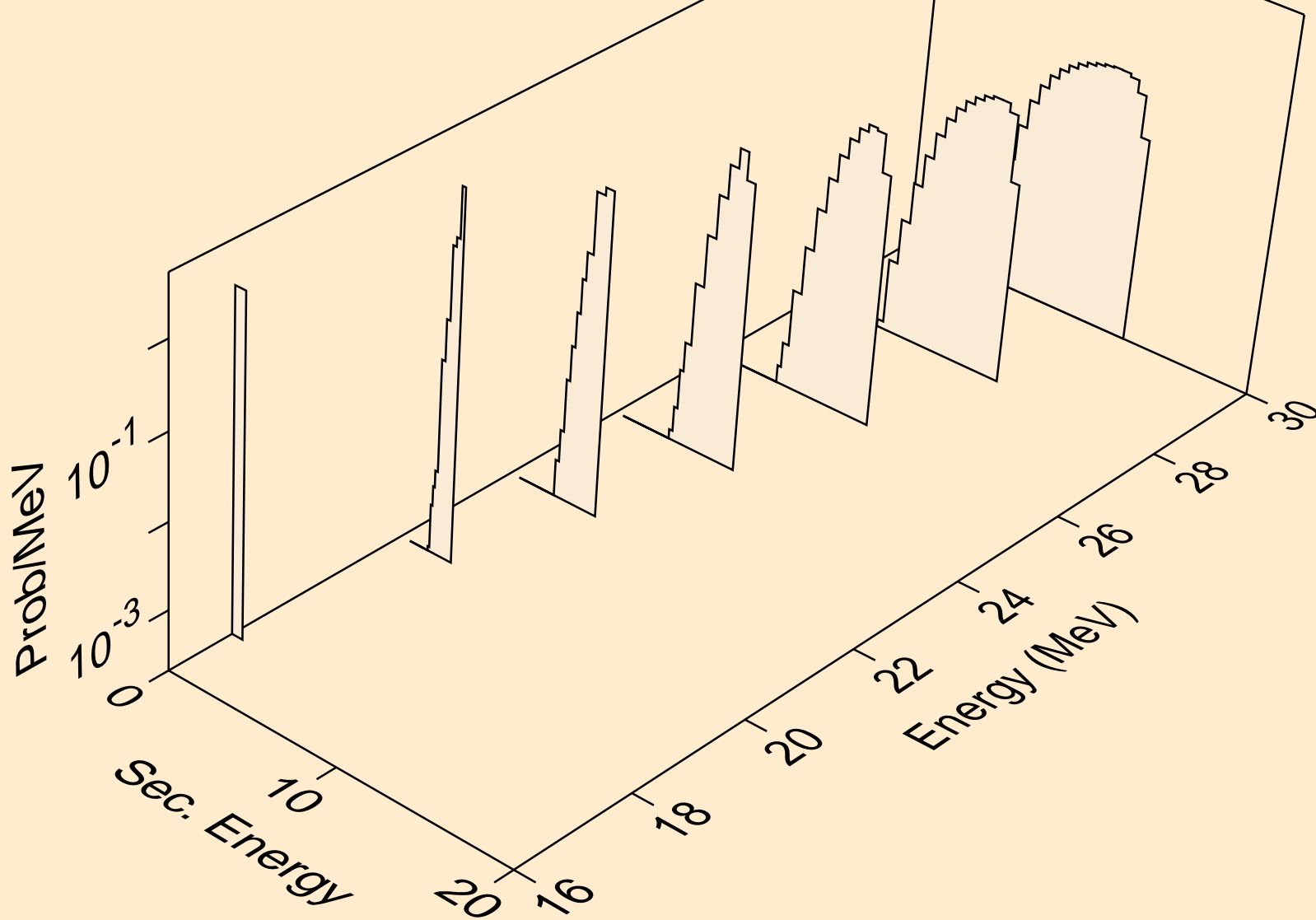

SN121 NEUTRON ACER TENDL-2019 LIBRARY; T=293.16K  
tritons from (n,t)

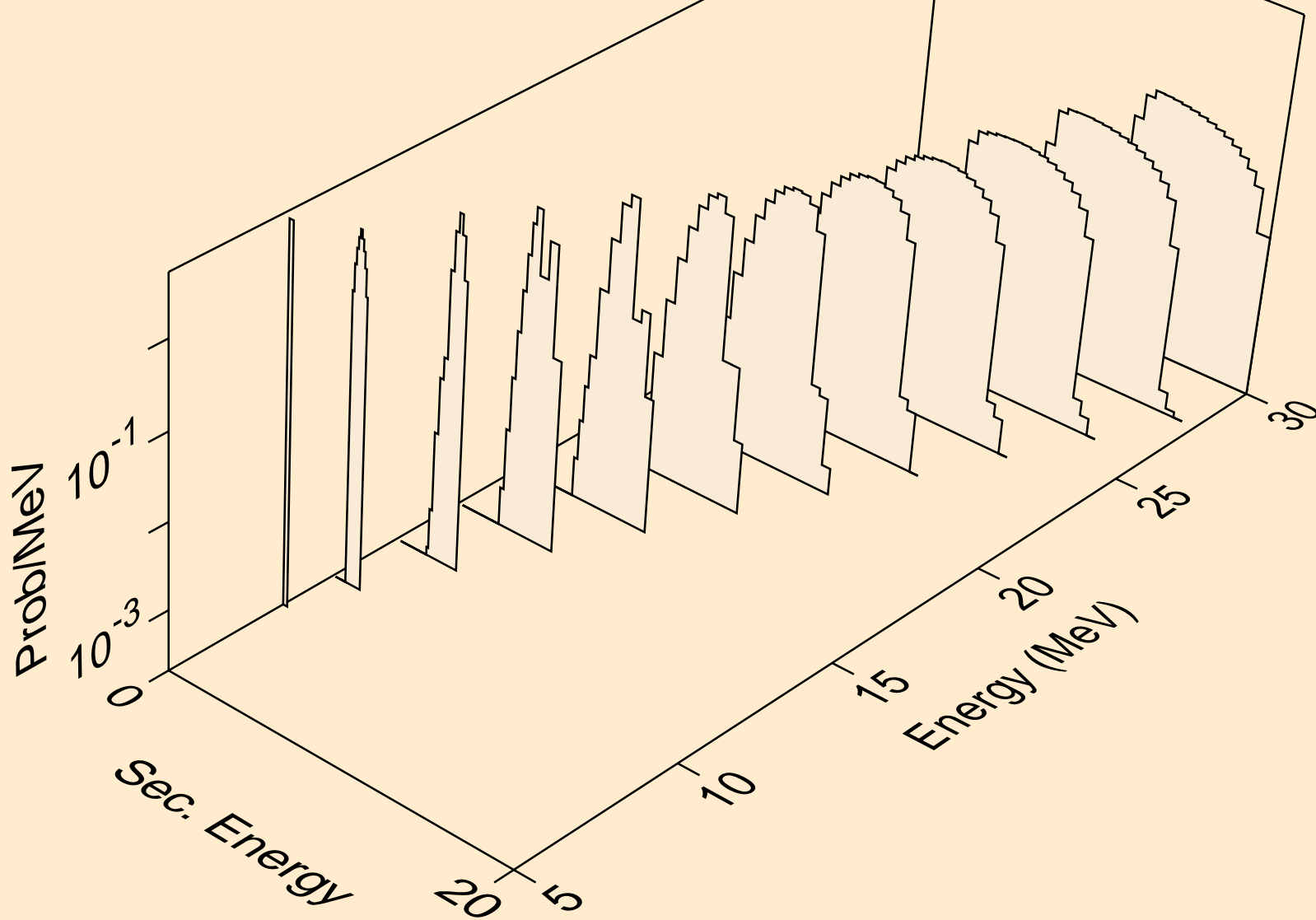



SN121 NEUTRON ACER TENDL-2019 LIBRARY; T=293.16K  
tritons from (n,pt)

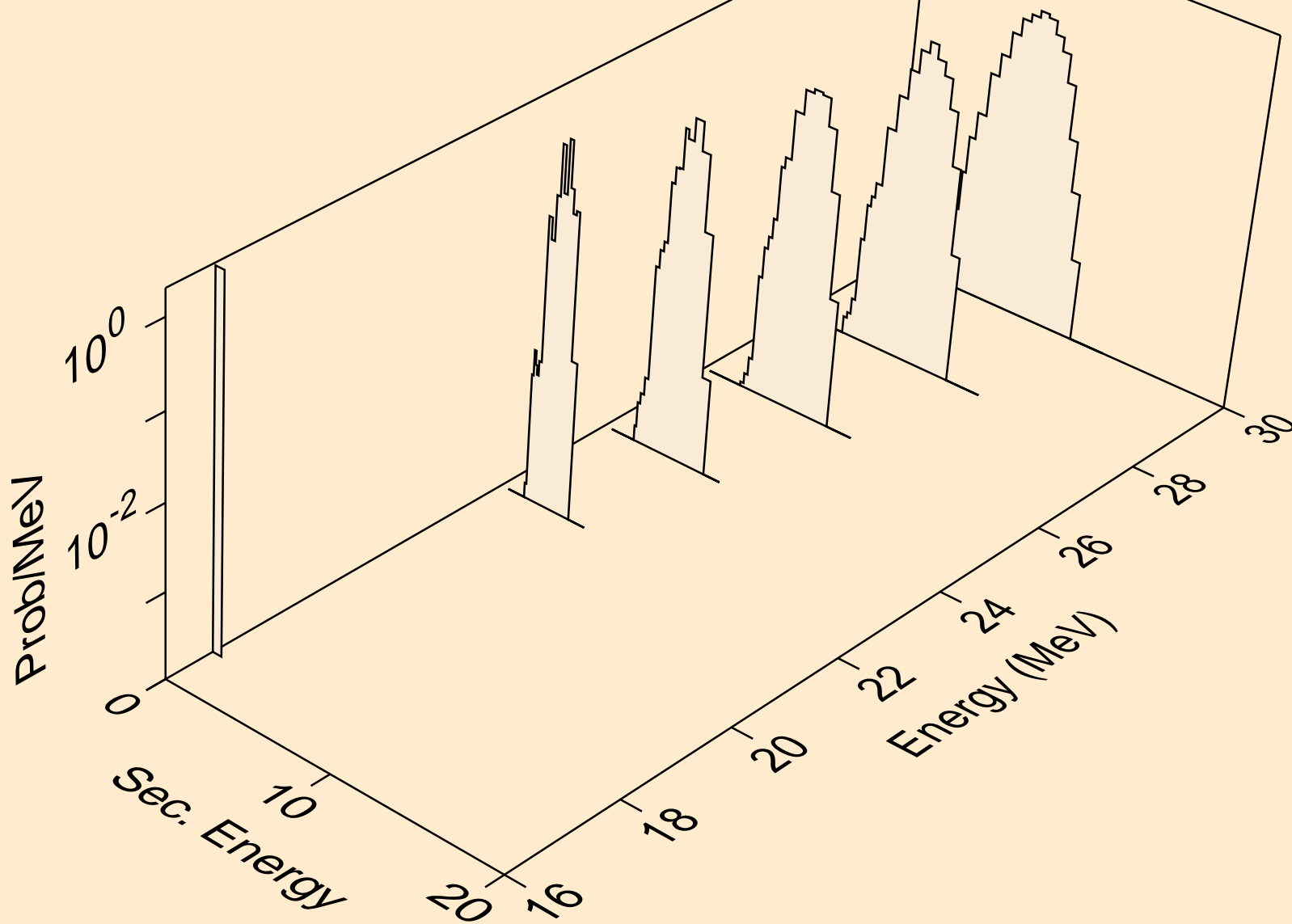

SN121 NEUTRON ACER TENDL-2019 LIBRARY; T=293.16K  
he3s from (n,x)

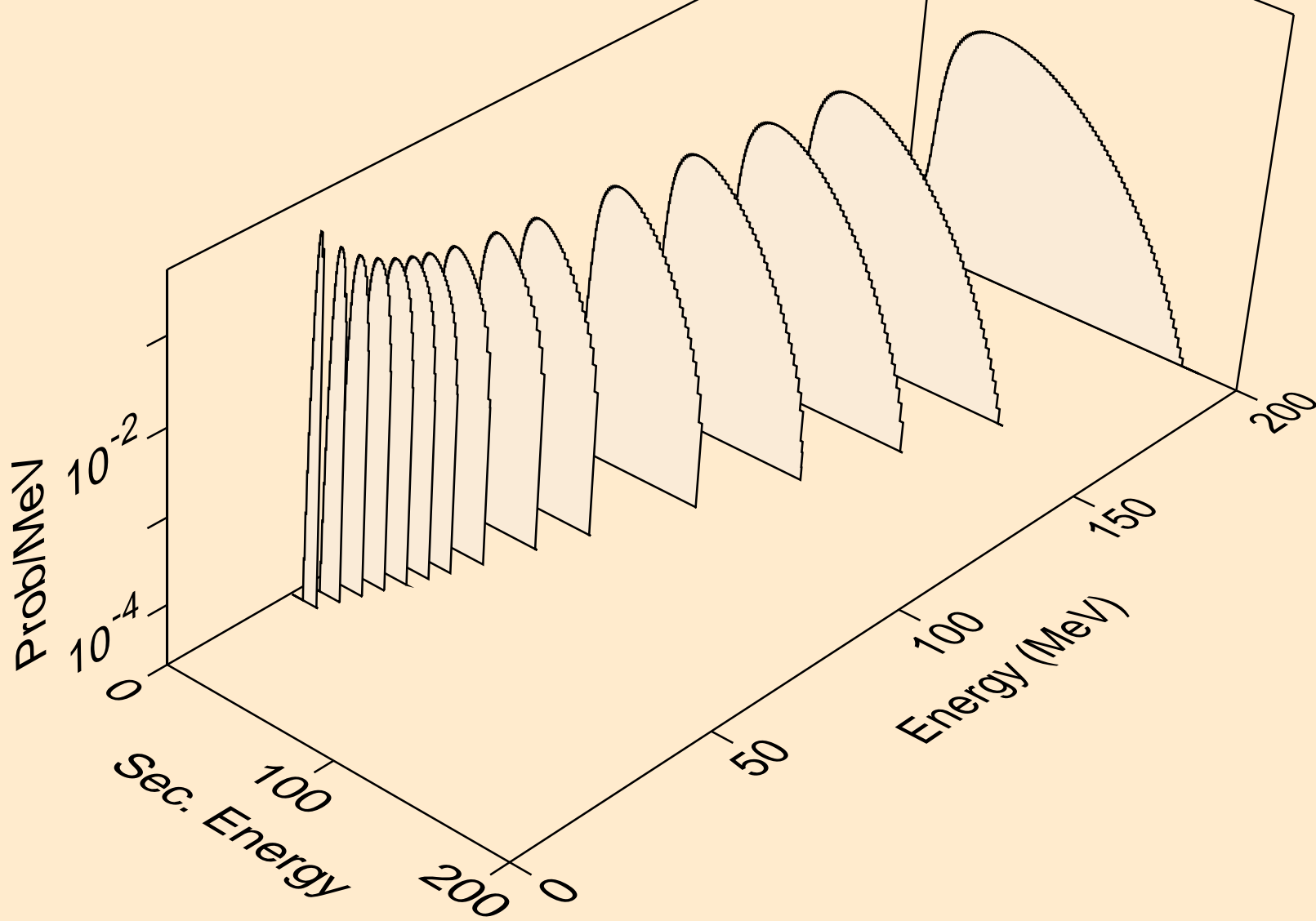

SN121 NEUTRON ACER TENDL-2019 LIBRARY; T=293.16K  
he3s from (n,n\*)he3

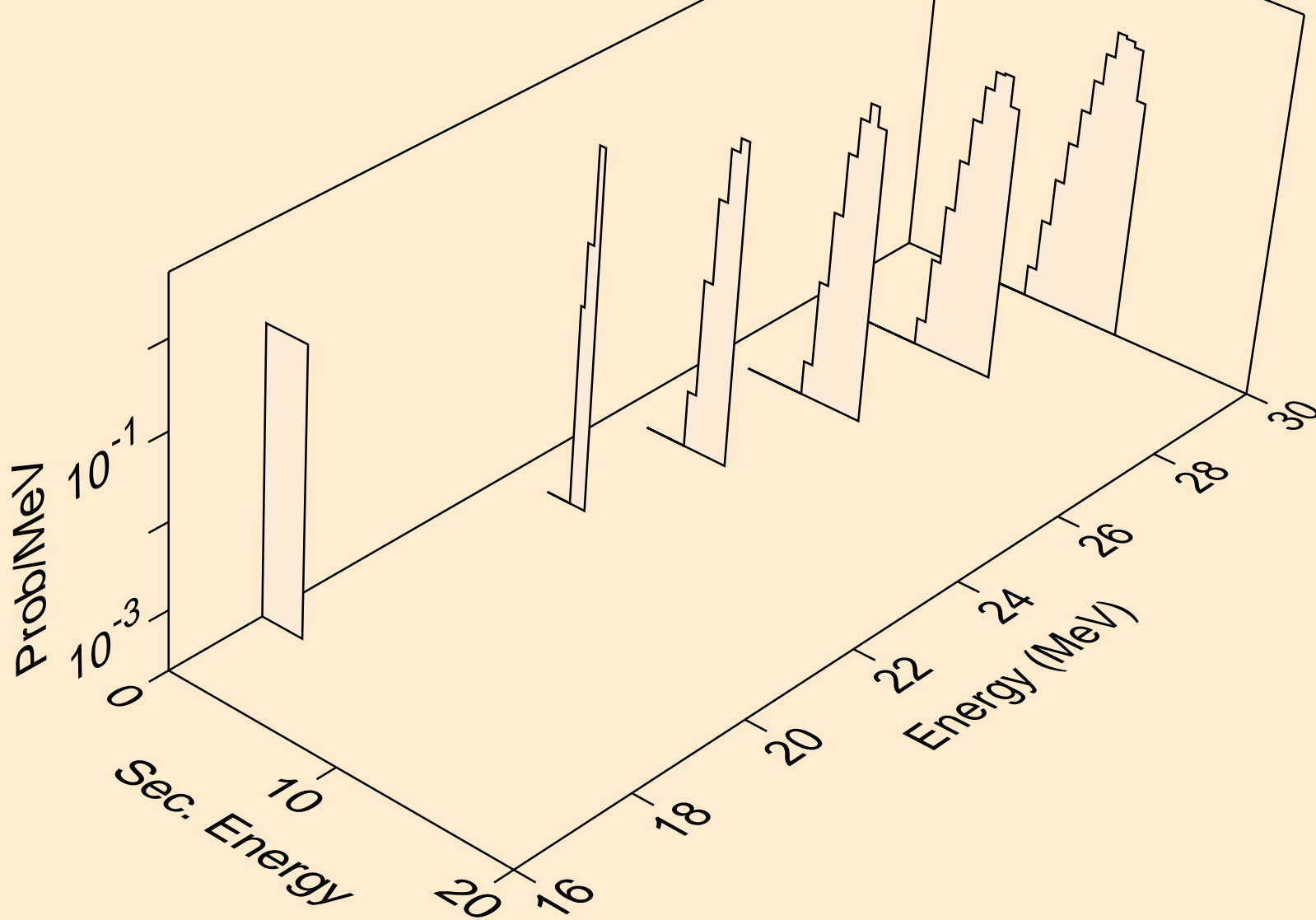

SN121 NEUTRON ACER TENDL-2019 LIBRARY; T=293.16K  
he3s from (n,he3)

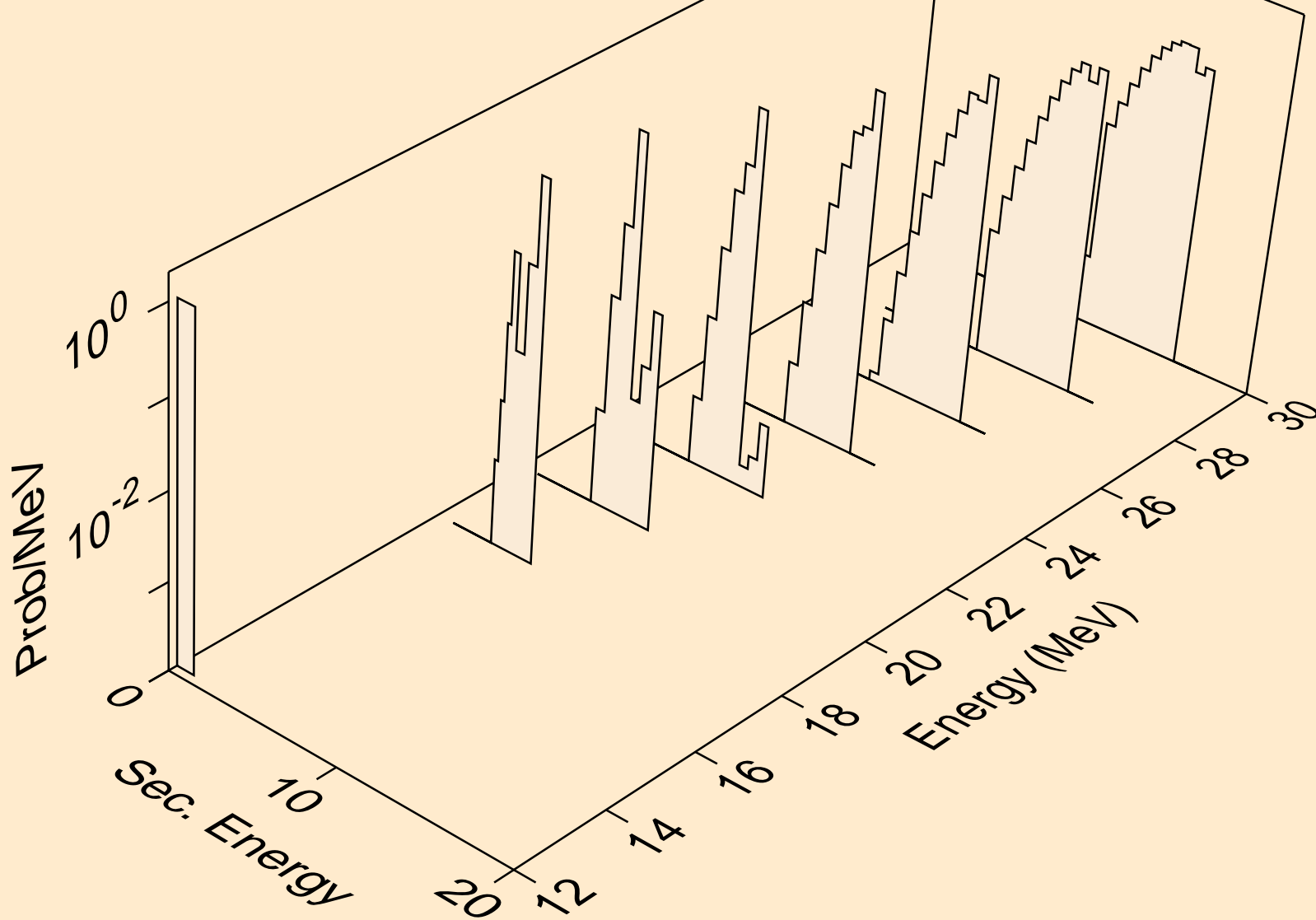

SN121 NEUTRON ACER TENDL-2019 LIBRARY; T=293.16K  
alphas from (n,x)

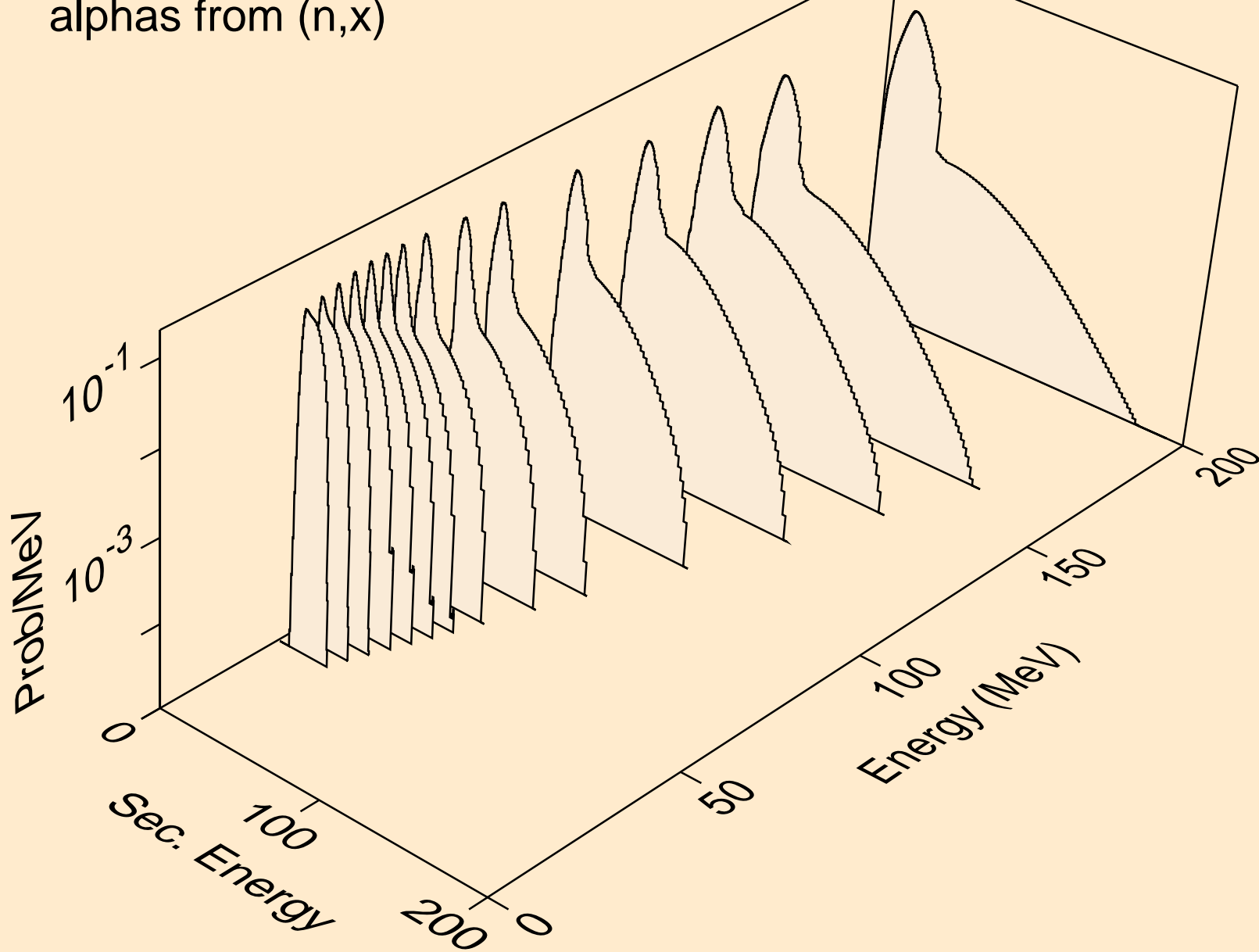

SN121 NEUTRON ACER TENDL-2019 LIBRARY; T=293.16K  
alphas from (n,n\*)a

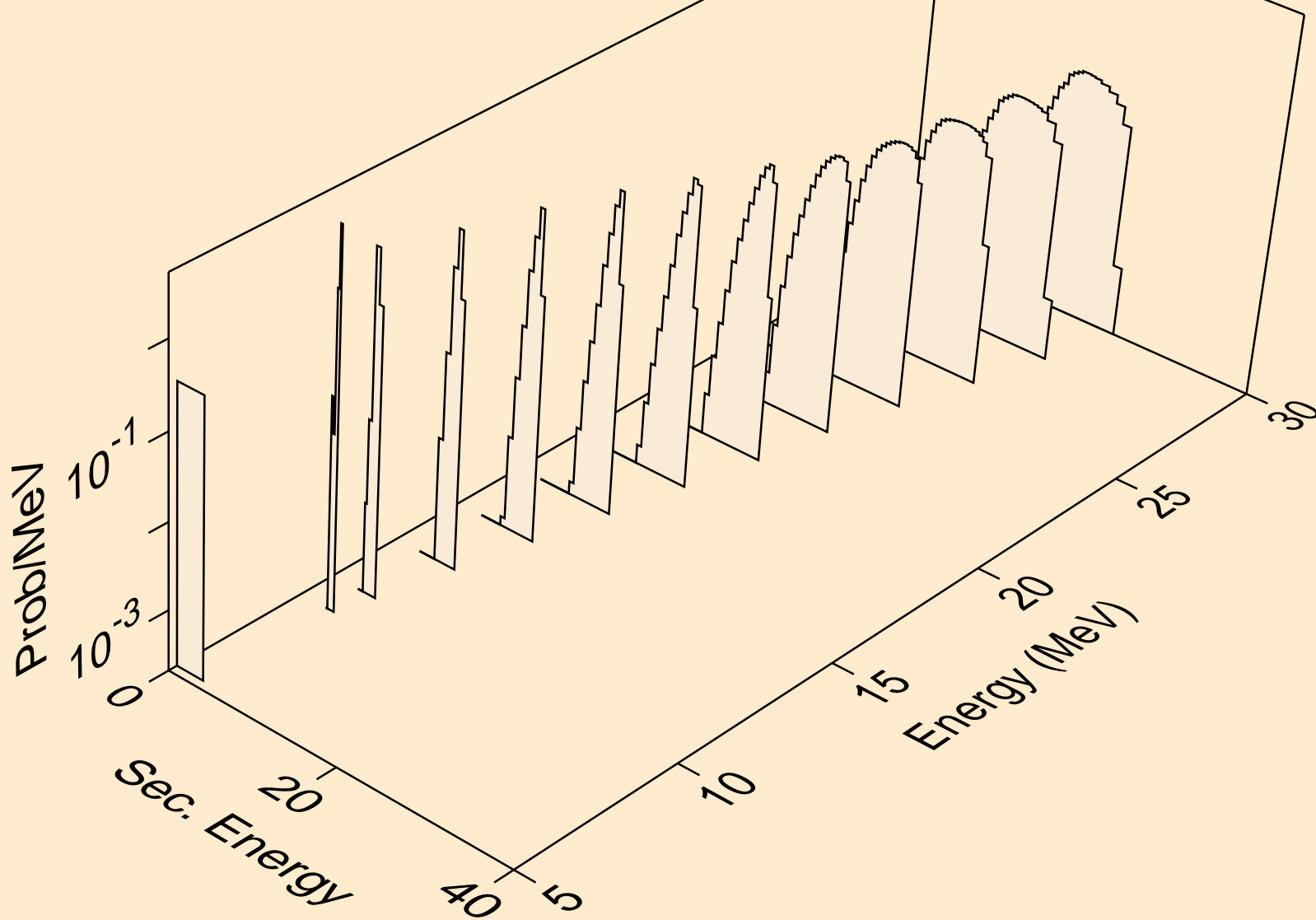

SN121 NEUTRON ACER TENDL-2019 LIBRARY; T=293.16K  
alphas from (n,2n)a

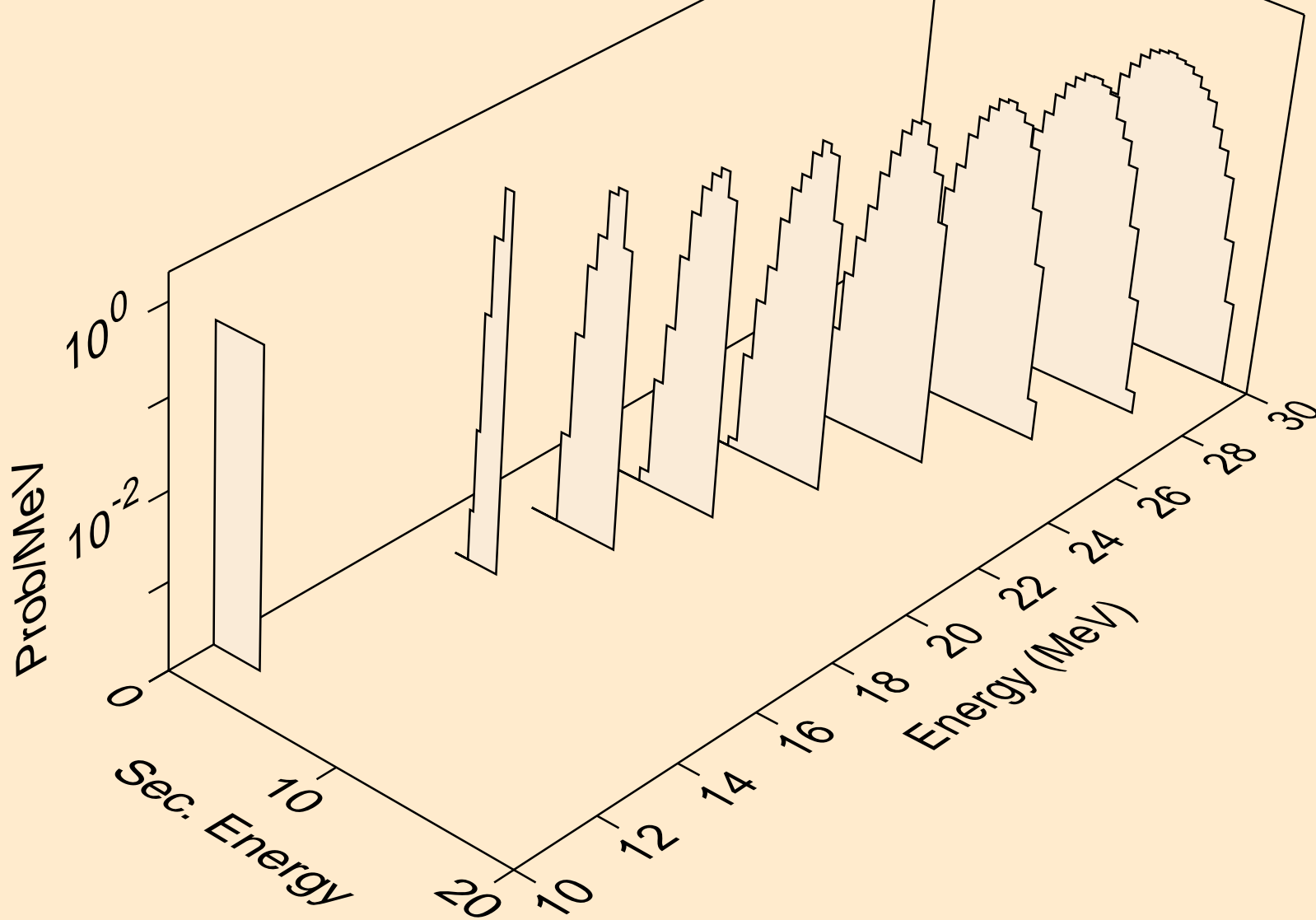

SN121 NEUTRON ACER TENDL-2019 LIBRARY; T=293.16K  
alphas from (n,3n)a

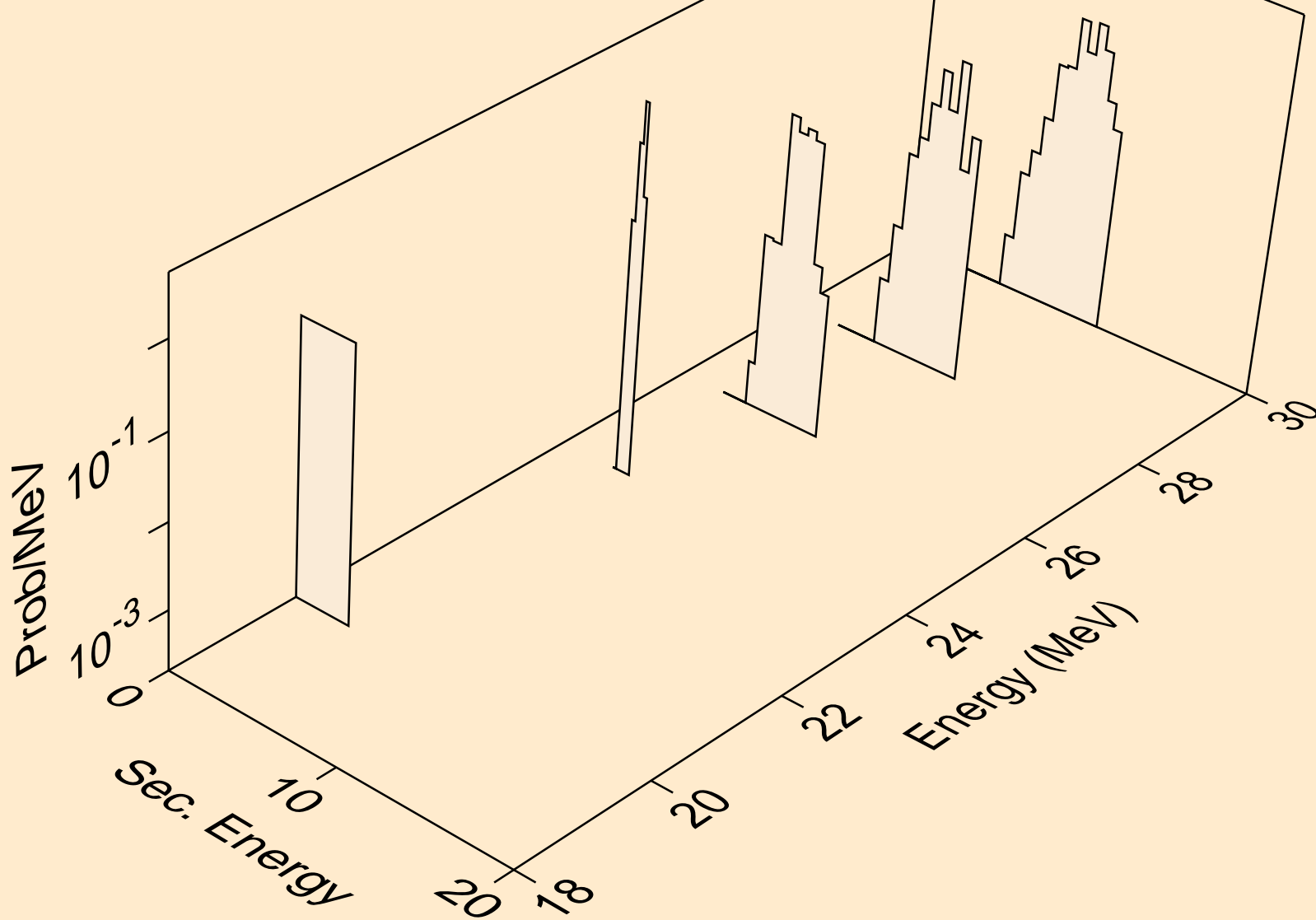



SN121 NEUTRON ACER TENDL-2019 LIBRARY; T=293.16K  
alphas from (n,a)

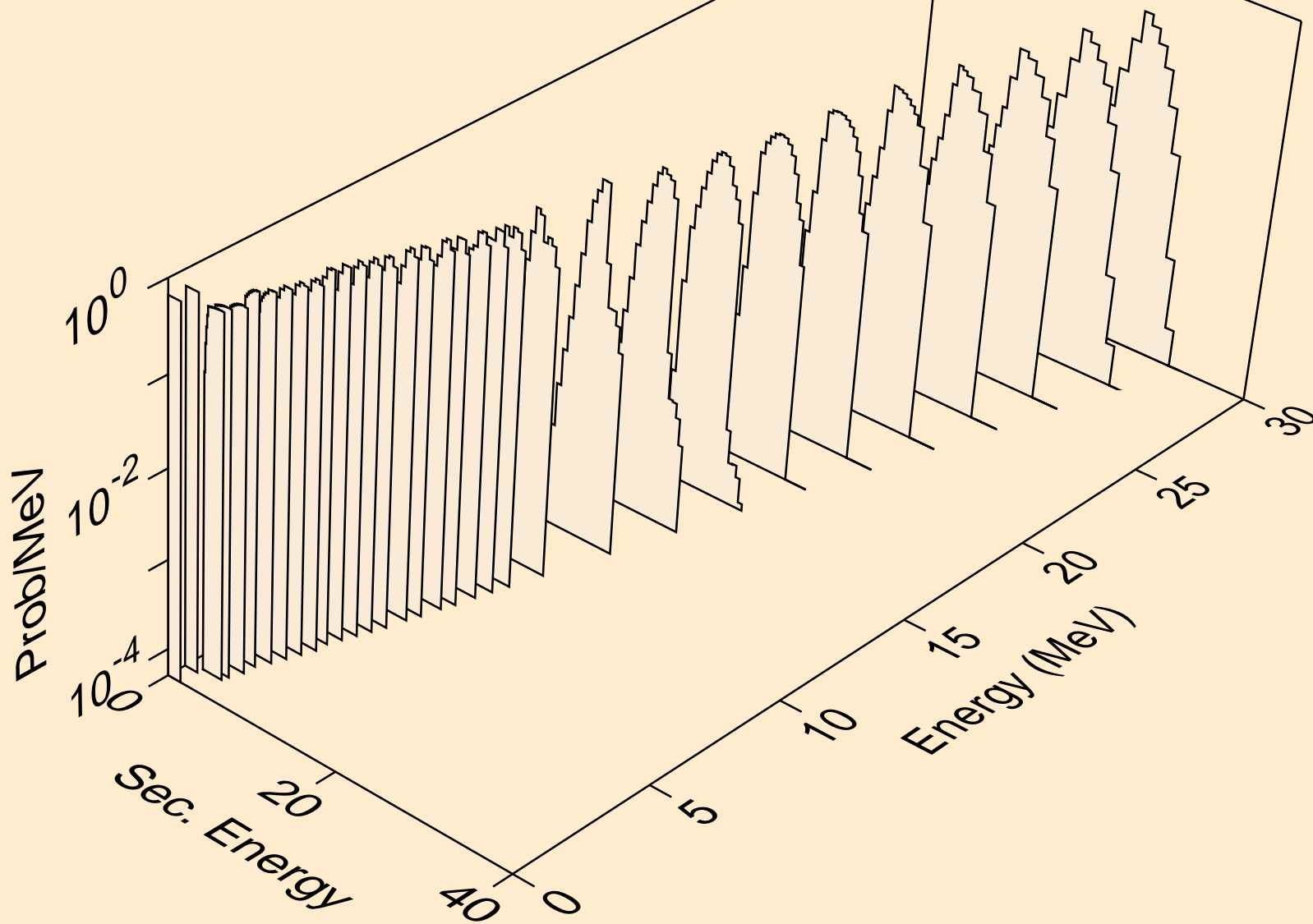

SN121 NEUTRON ACER TENDL-2019 LIBRARY; T=293.16K  
alphas from (n,pa)

