

SN132 NEUTRON ACER TENDL-2019 LIBRARY; T=293.16K

Principal cross sections

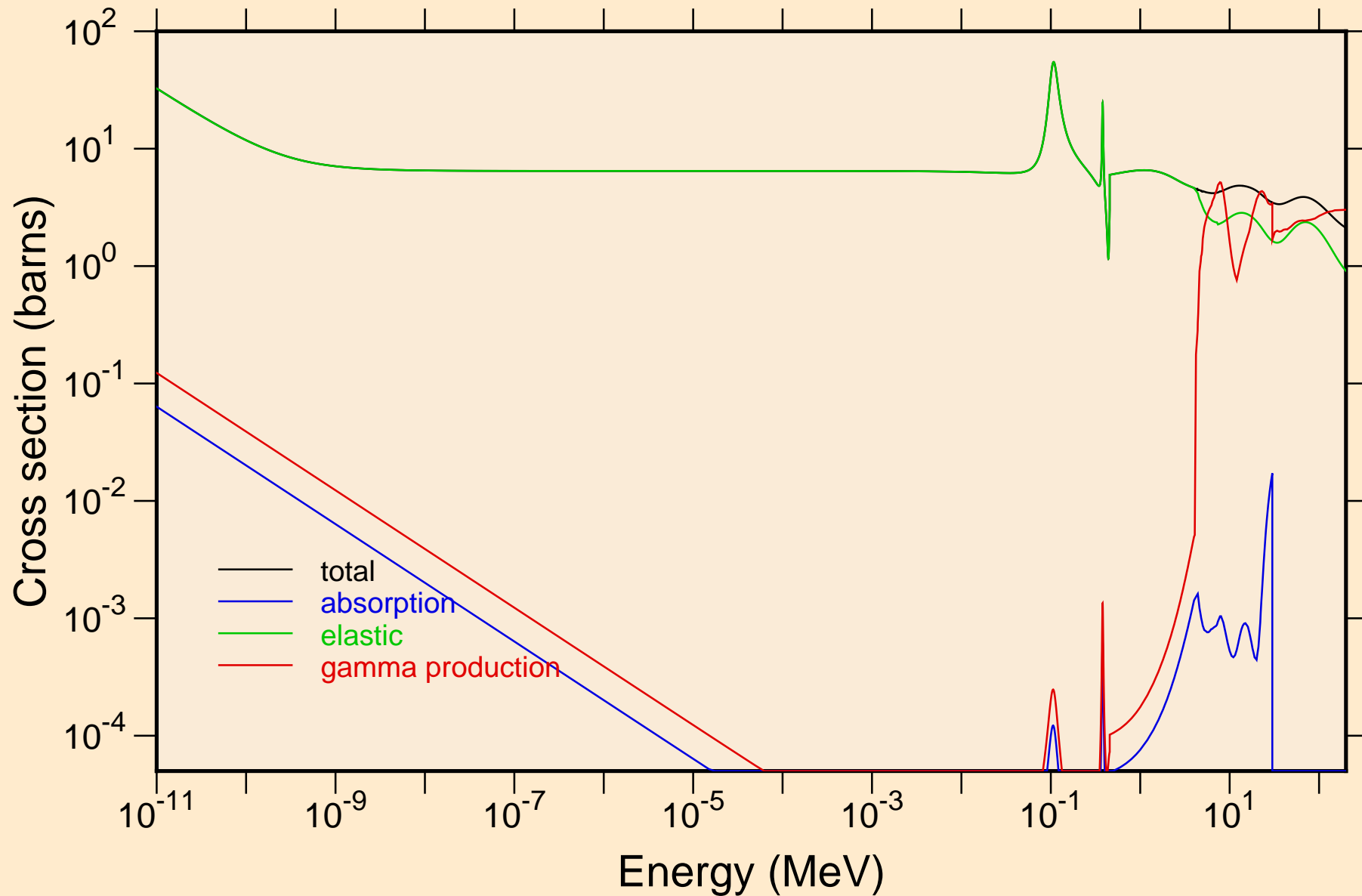

SN132 NEUTRON ACER TENDL-2019 LIBRARY; T=293.16K
Heating

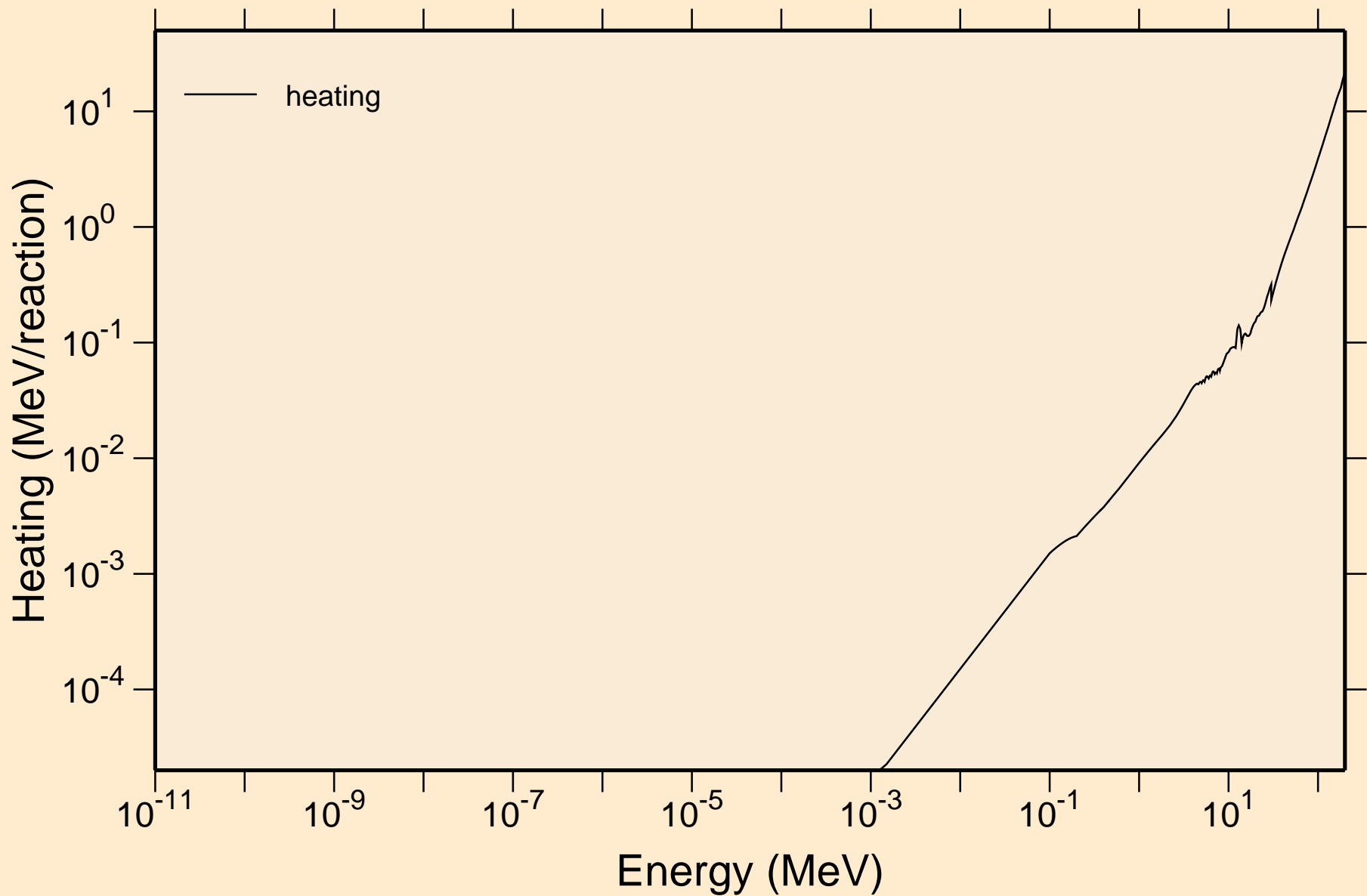

SN132 NEUTRON ACER TENDL-2019 LIBRARY; T=293.16K Damage

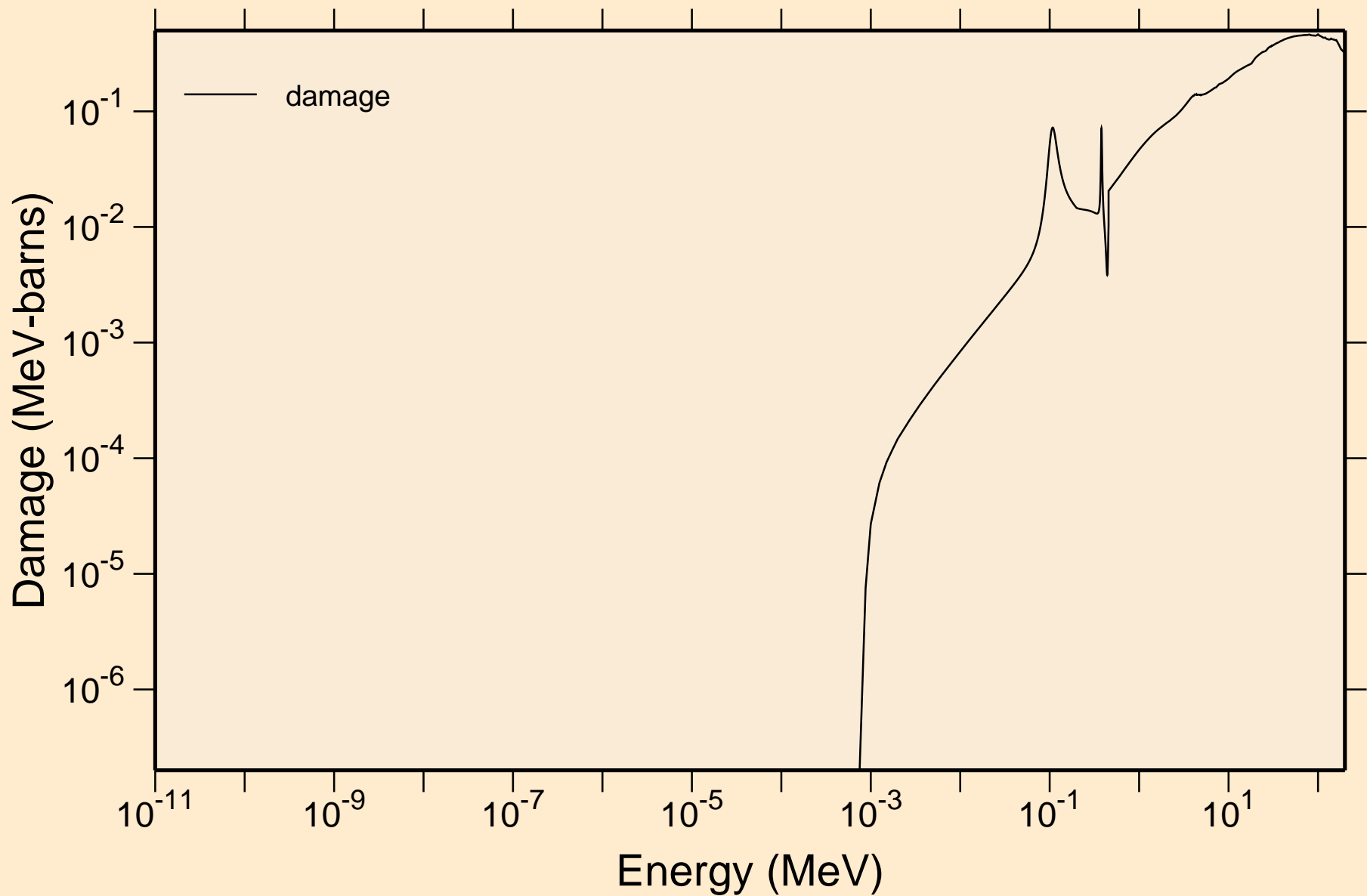

SN132 NEUTRON ACER TENDL-2019 LIBRARY; T=293.16K
Non-threshold reactions

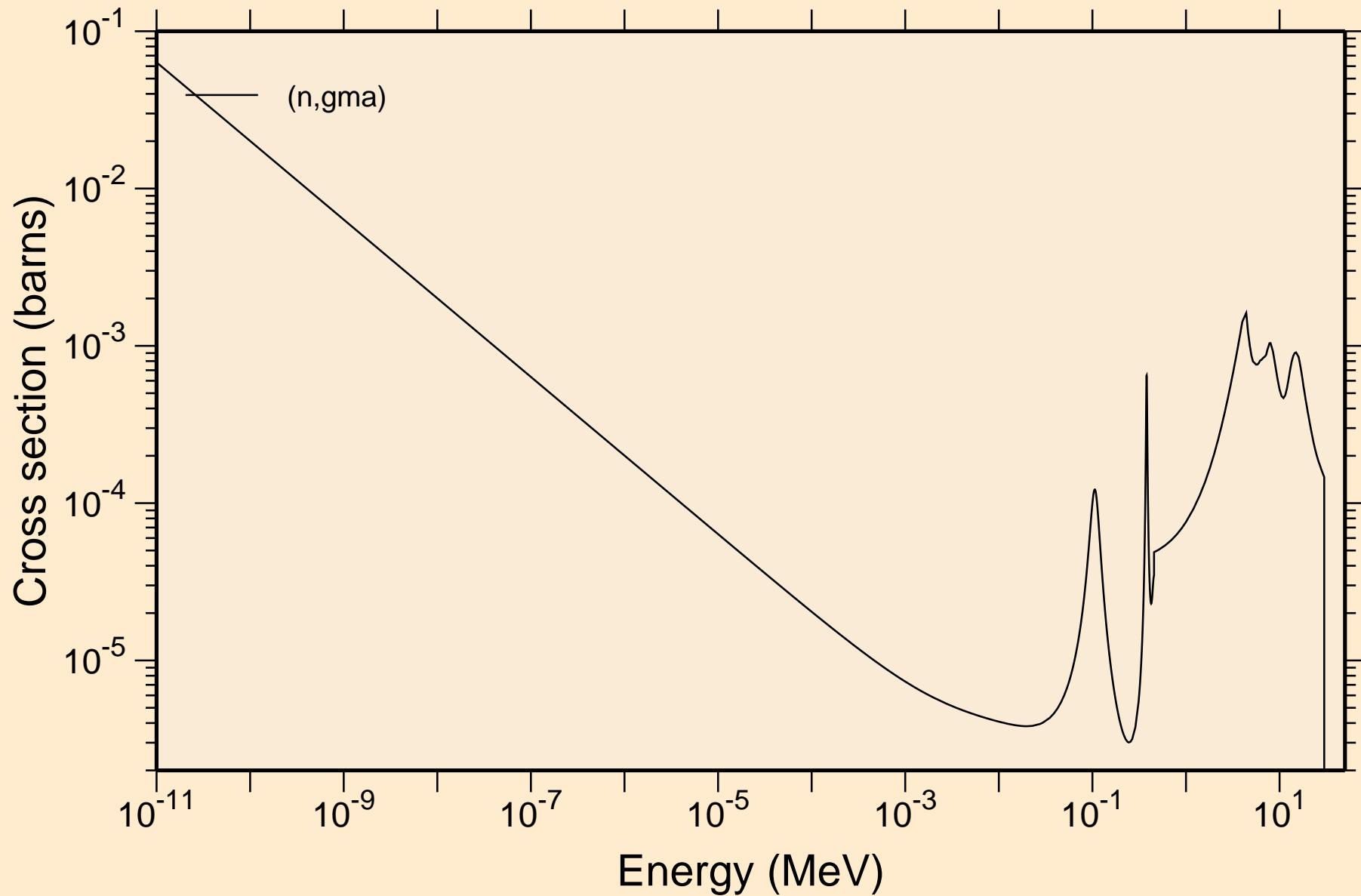

SN132 NEUTRON ACER TENDL-2019 LIBRARY; T=293.16K

Principal cross sections

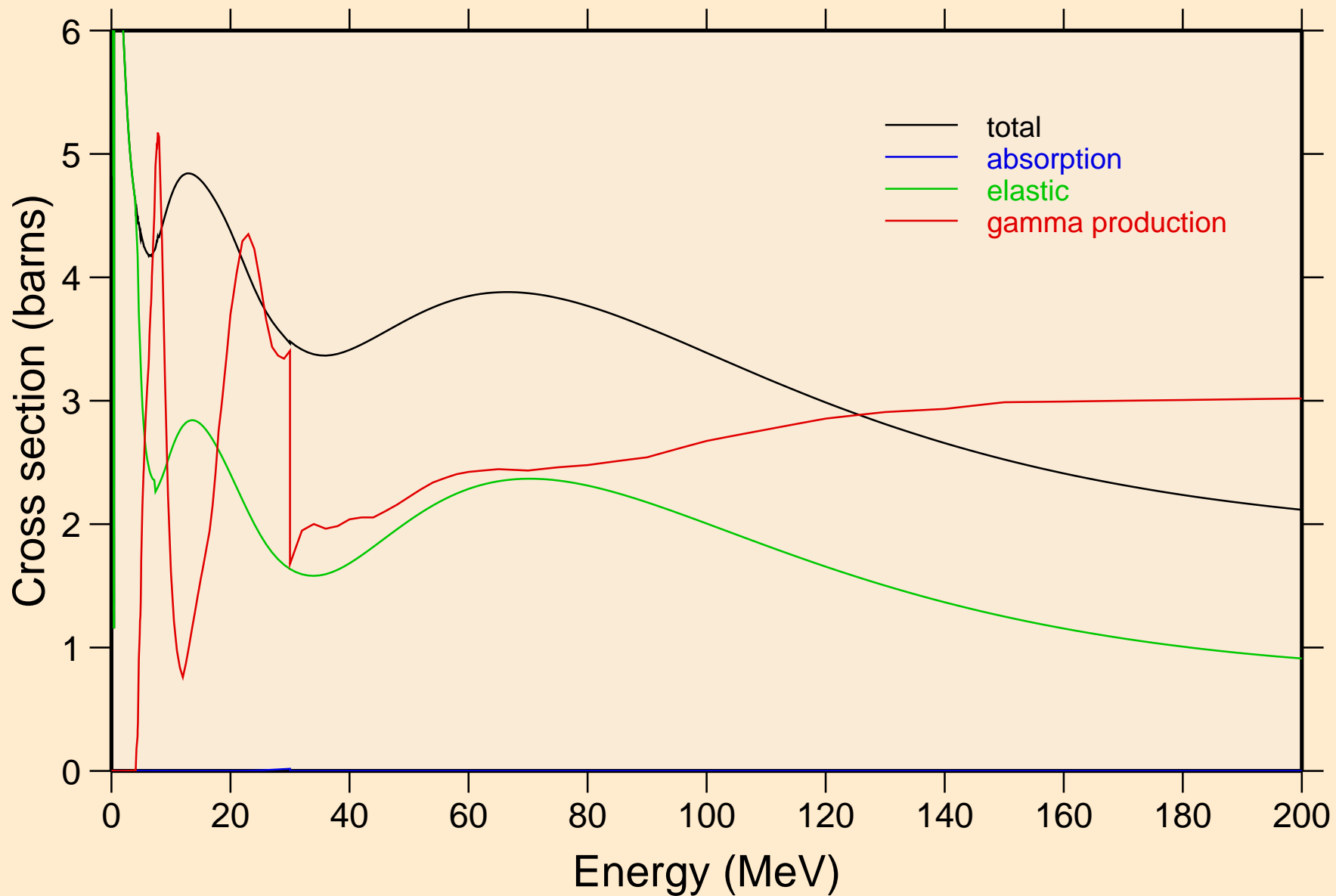

SN132 NEUTRON ACER TENDL-2019 LIBRARY; T=293.16K
Heating

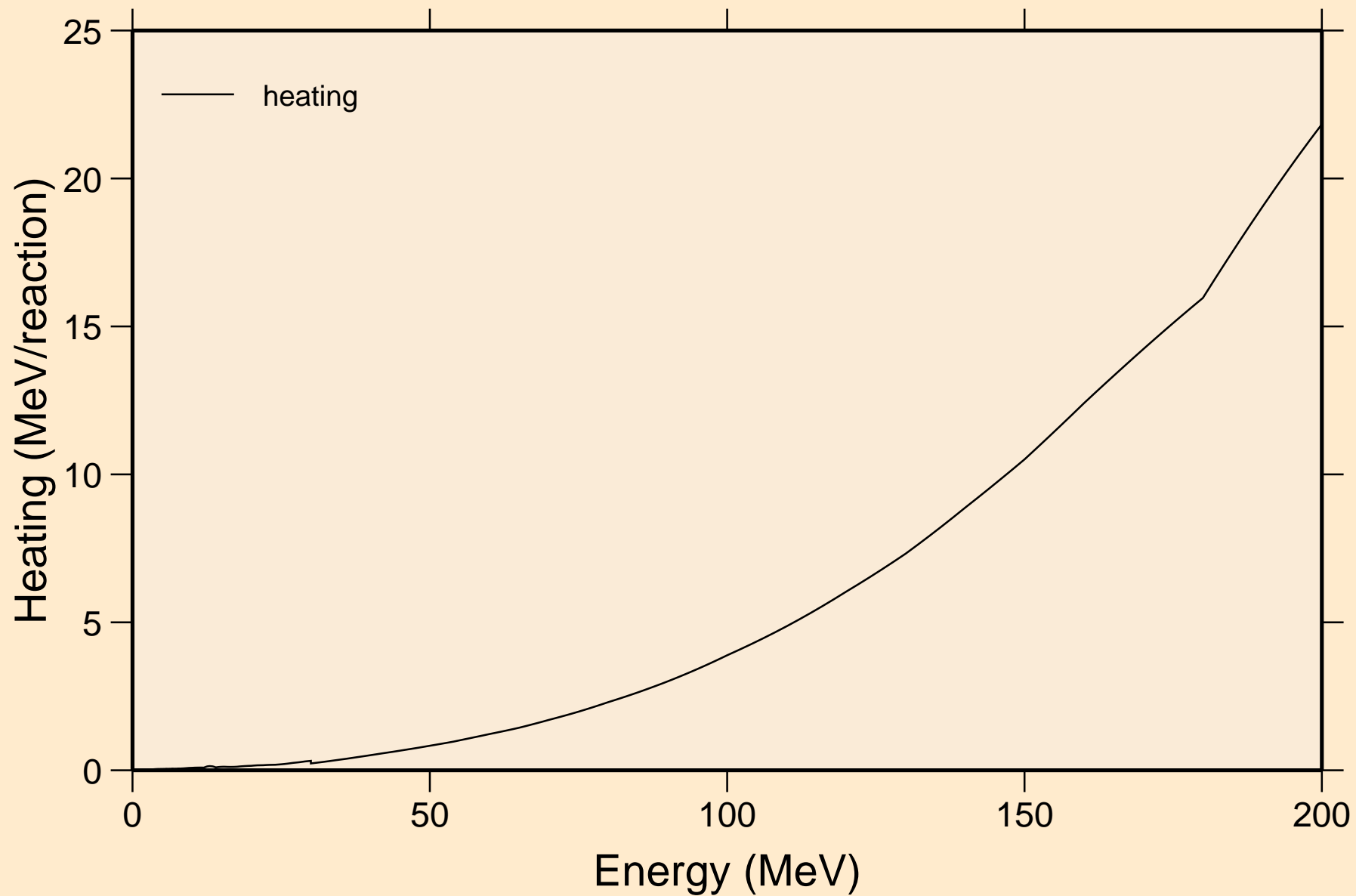

SN132 NEUTRON ACER TENDL-2019 LIBRARY; T=293.16K Damage

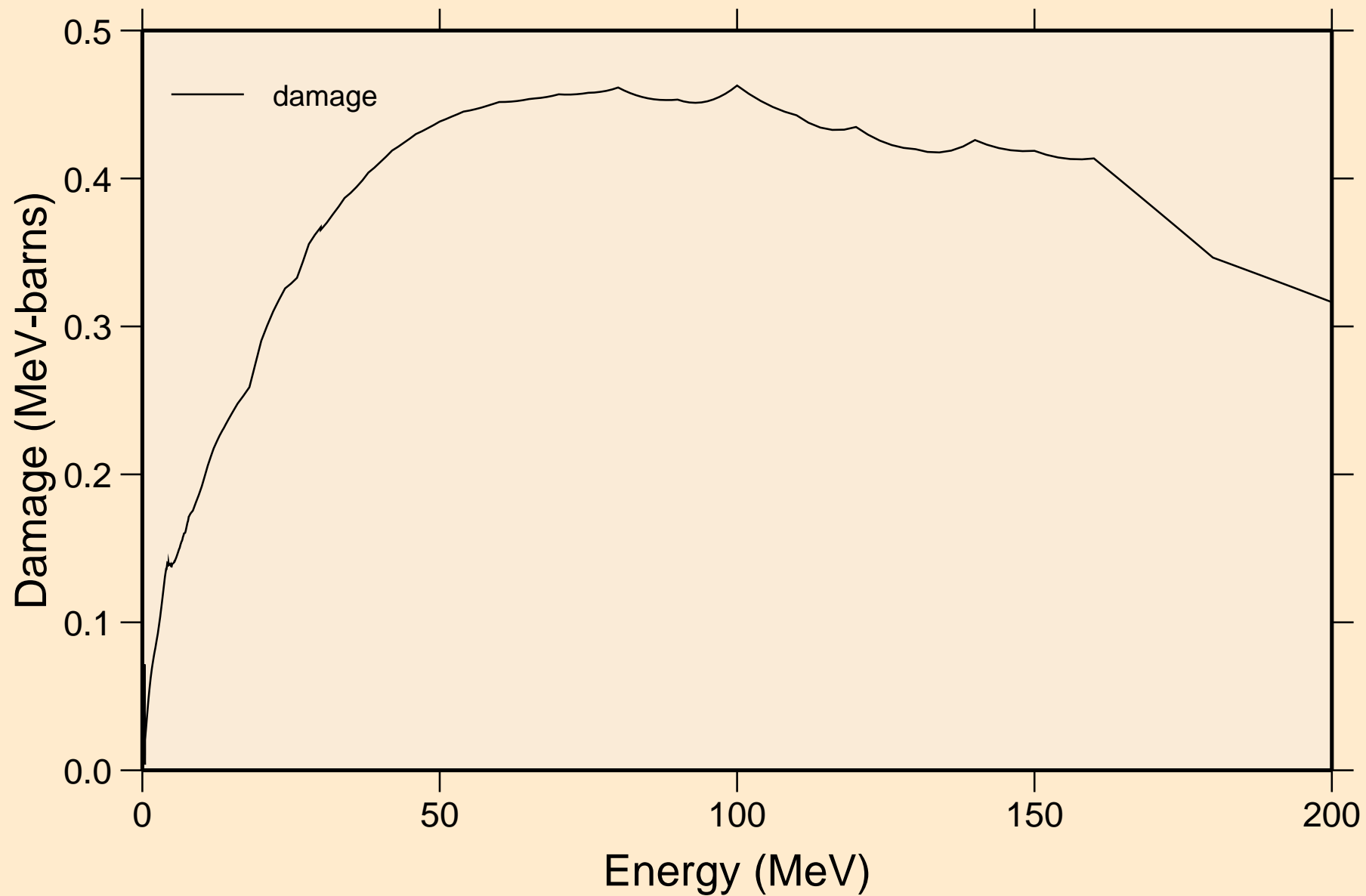

SN132 NEUTRON ACER TENDL-2019 LIBRARY; T=293.16K
Non-threshold reactions

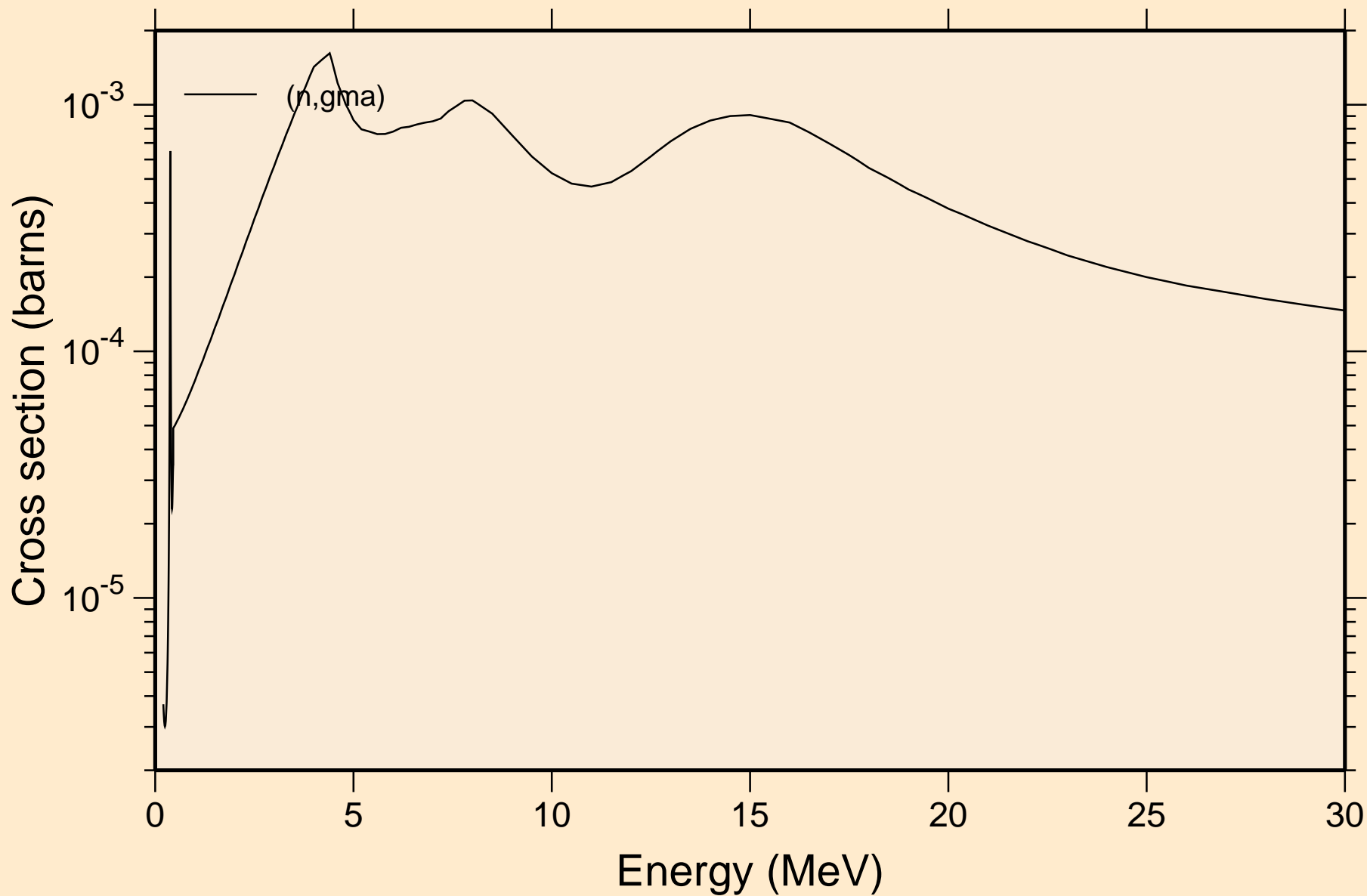

SN132 NEUTRON ACER TENDL-2019 LIBRARY; T=293.16K
Inelastic levels

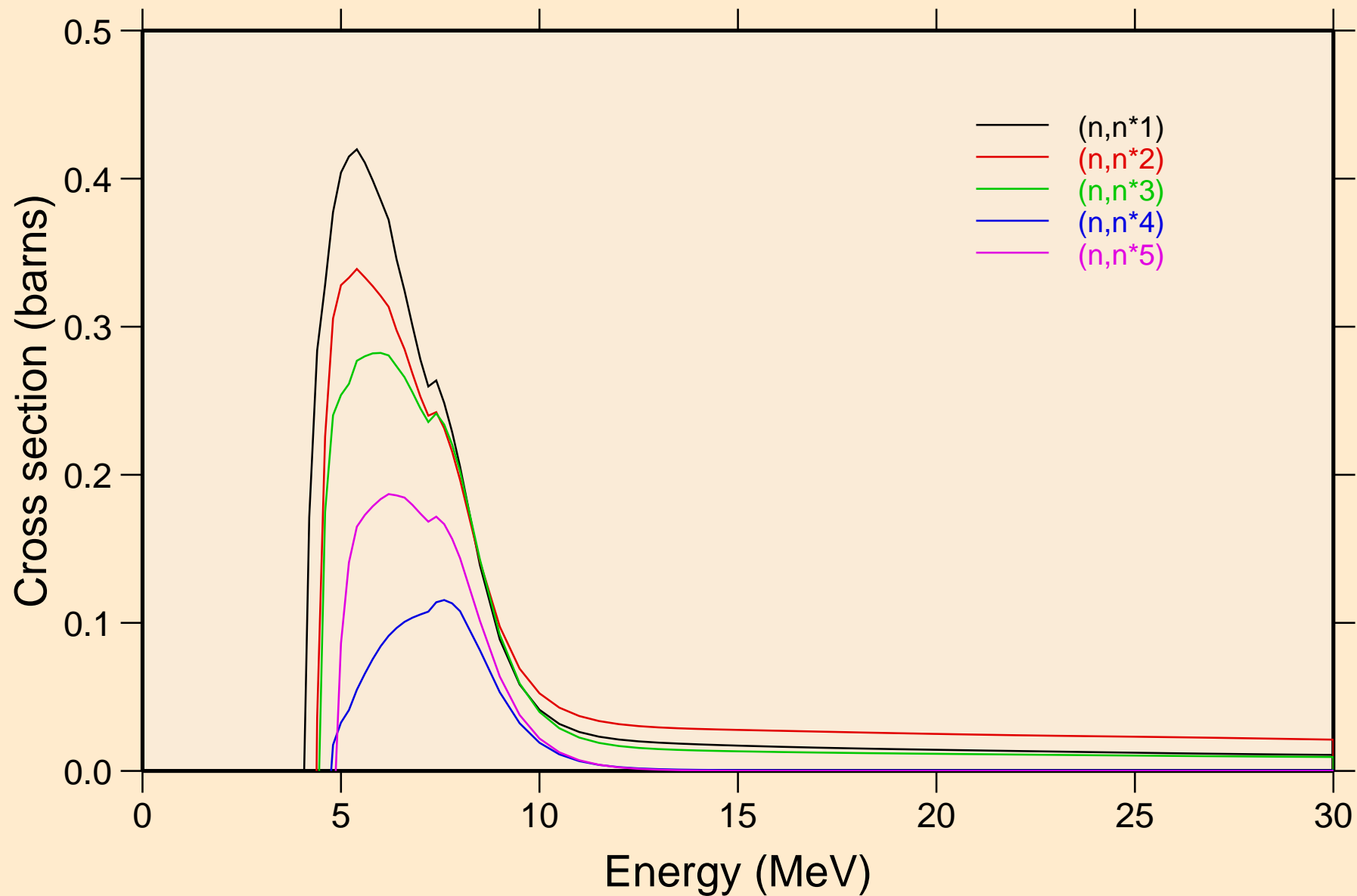

SN132 NEUTRON ACER TENDL-2019 LIBRARY; T=293.16K
Inelastic levels

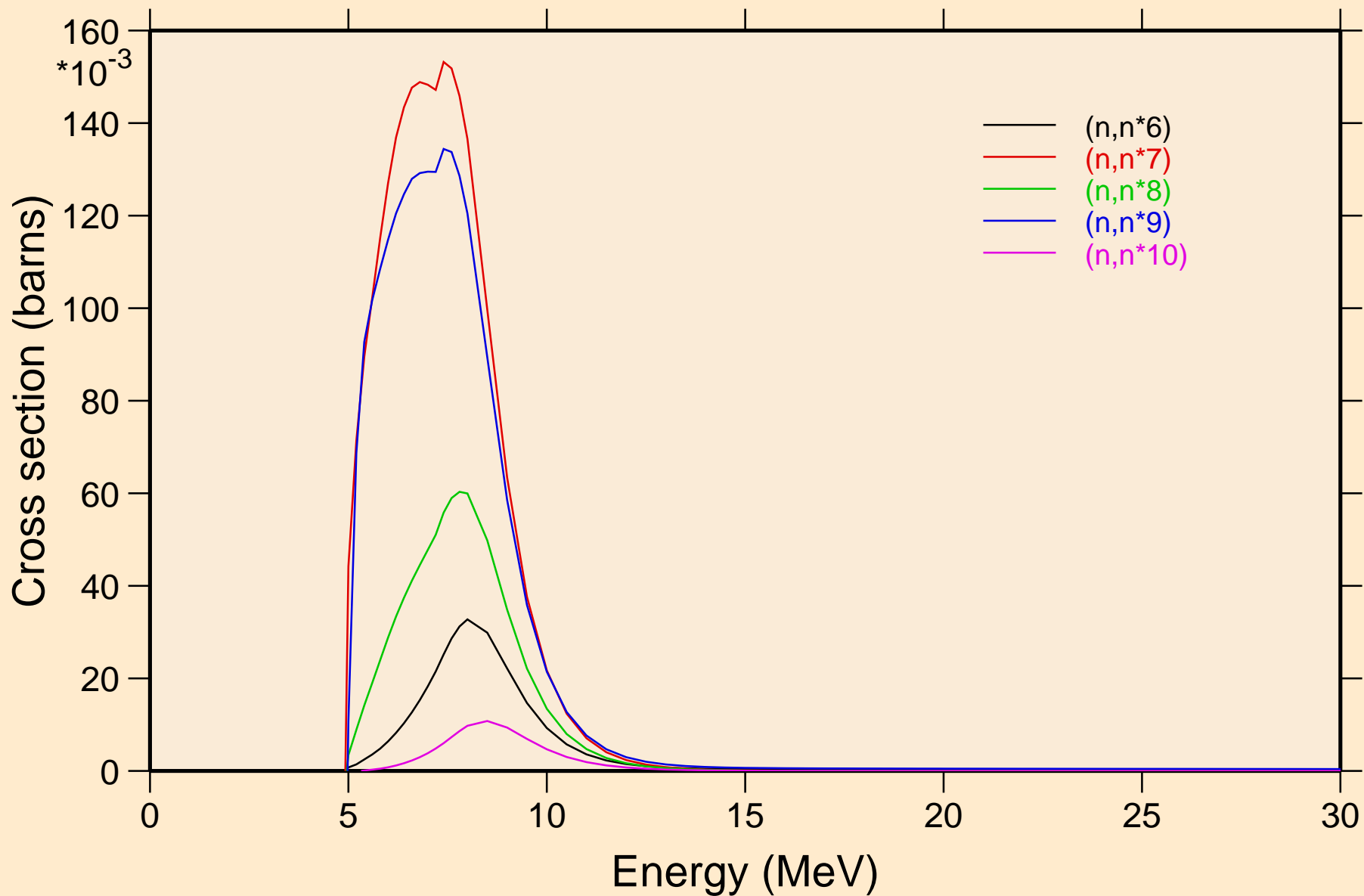

SN132 NEUTRON ACER TENDL-2019 LIBRARY; T=293.16K

Inelastic levels

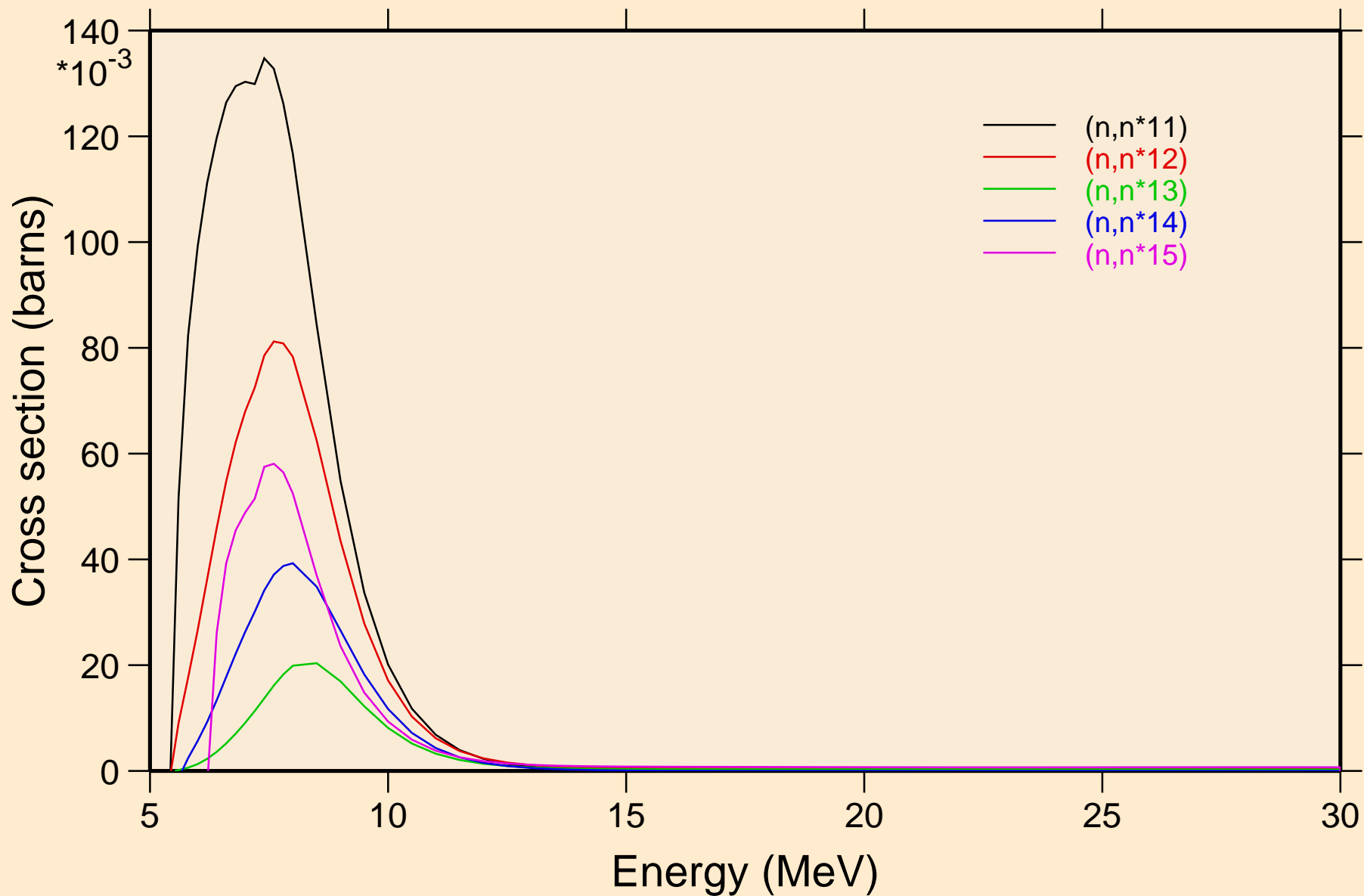

SN132 NEUTRON ACER TENDL-2019 LIBRARY; T=293.16K

Inelastic levels

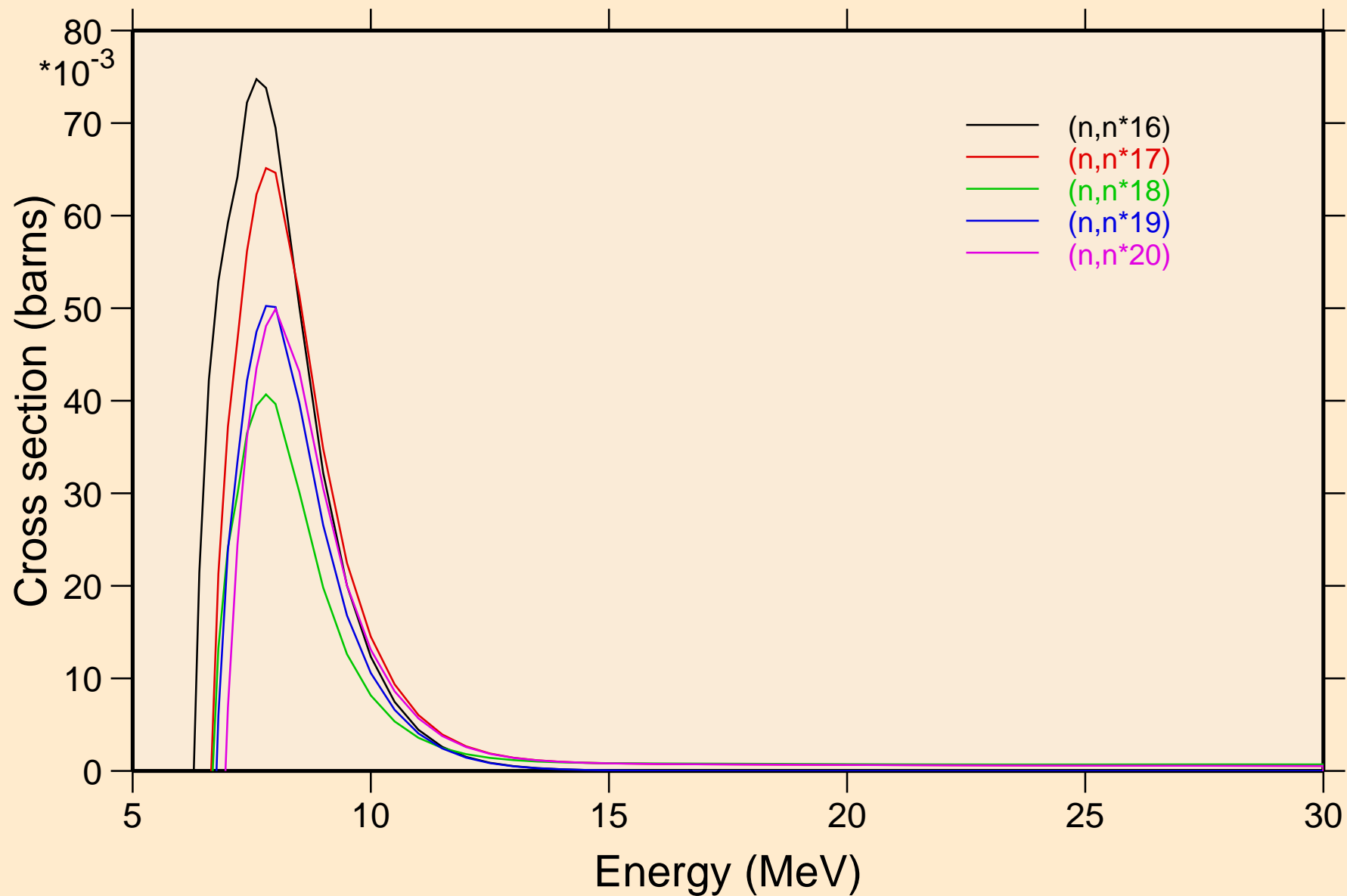

SN132 NEUTRON ACER TENDL-2019 LIBRARY; T=293.16K
Inelastic levels

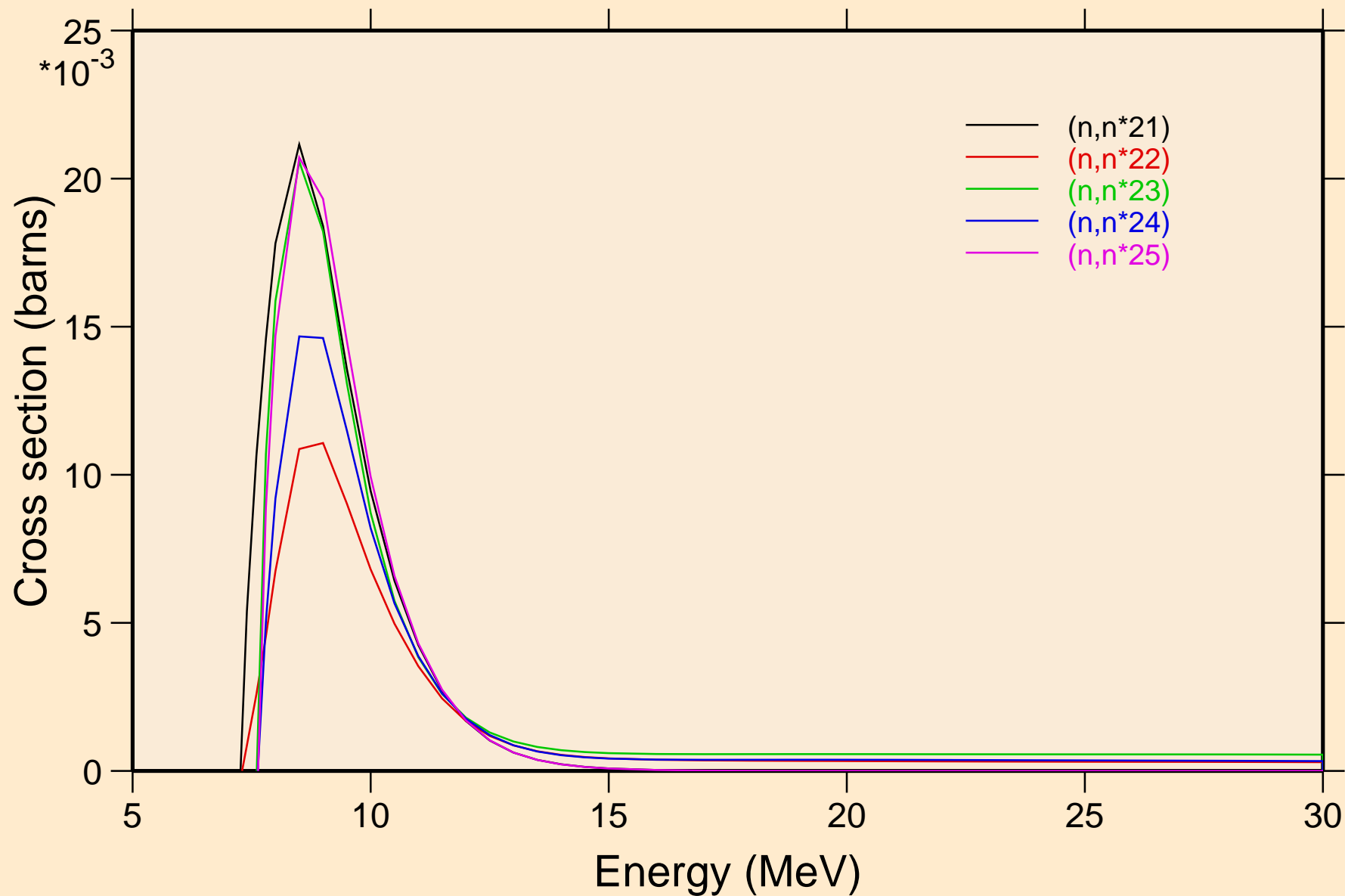

SN132 NEUTRON ACER TENDL-2019 LIBRARY; T=293.16K

Inelastic levels

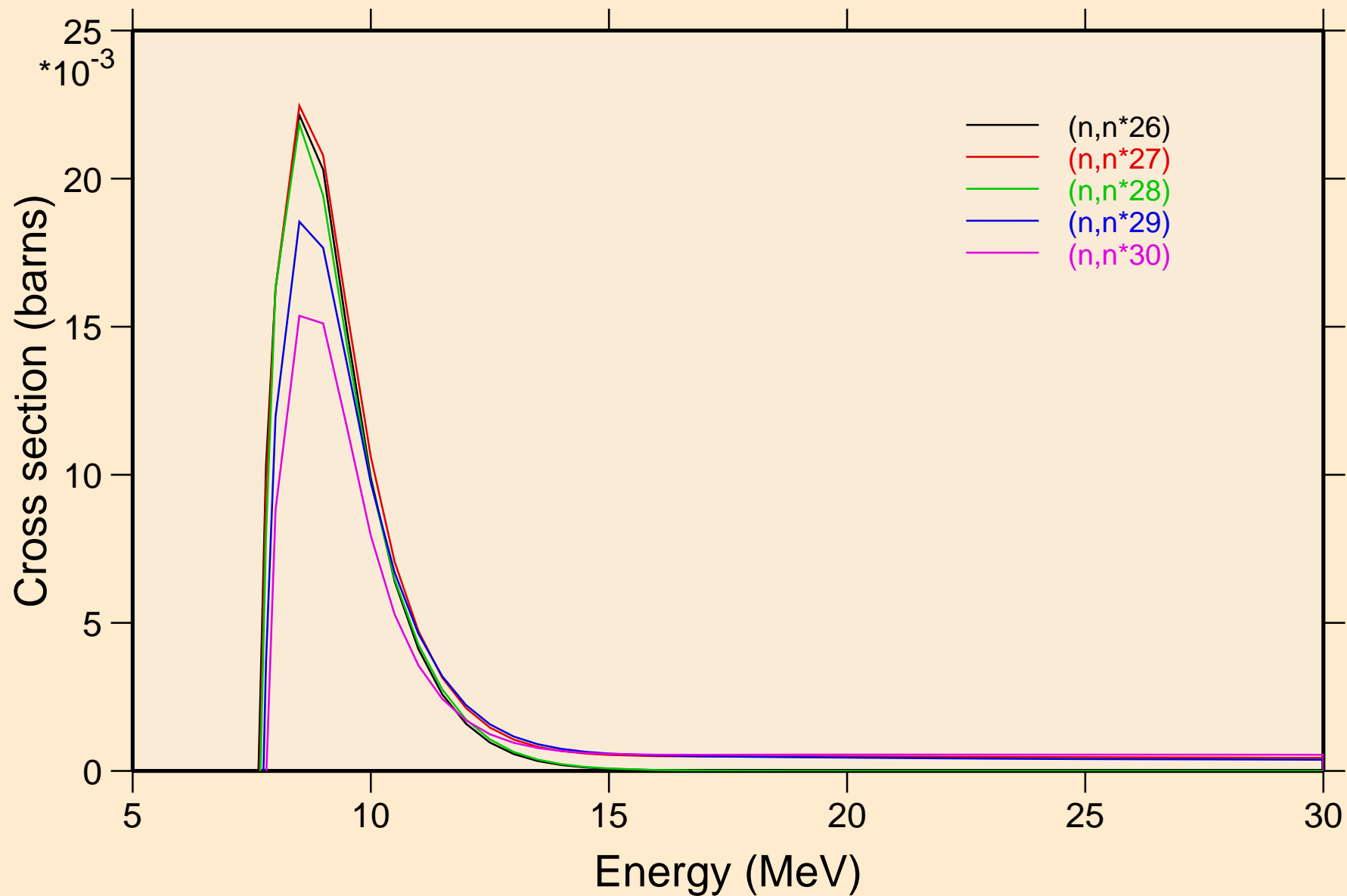

SN132 NEUTRON ACER TENDL-2019 LIBRARY; T=293.16K

Threshold reactions

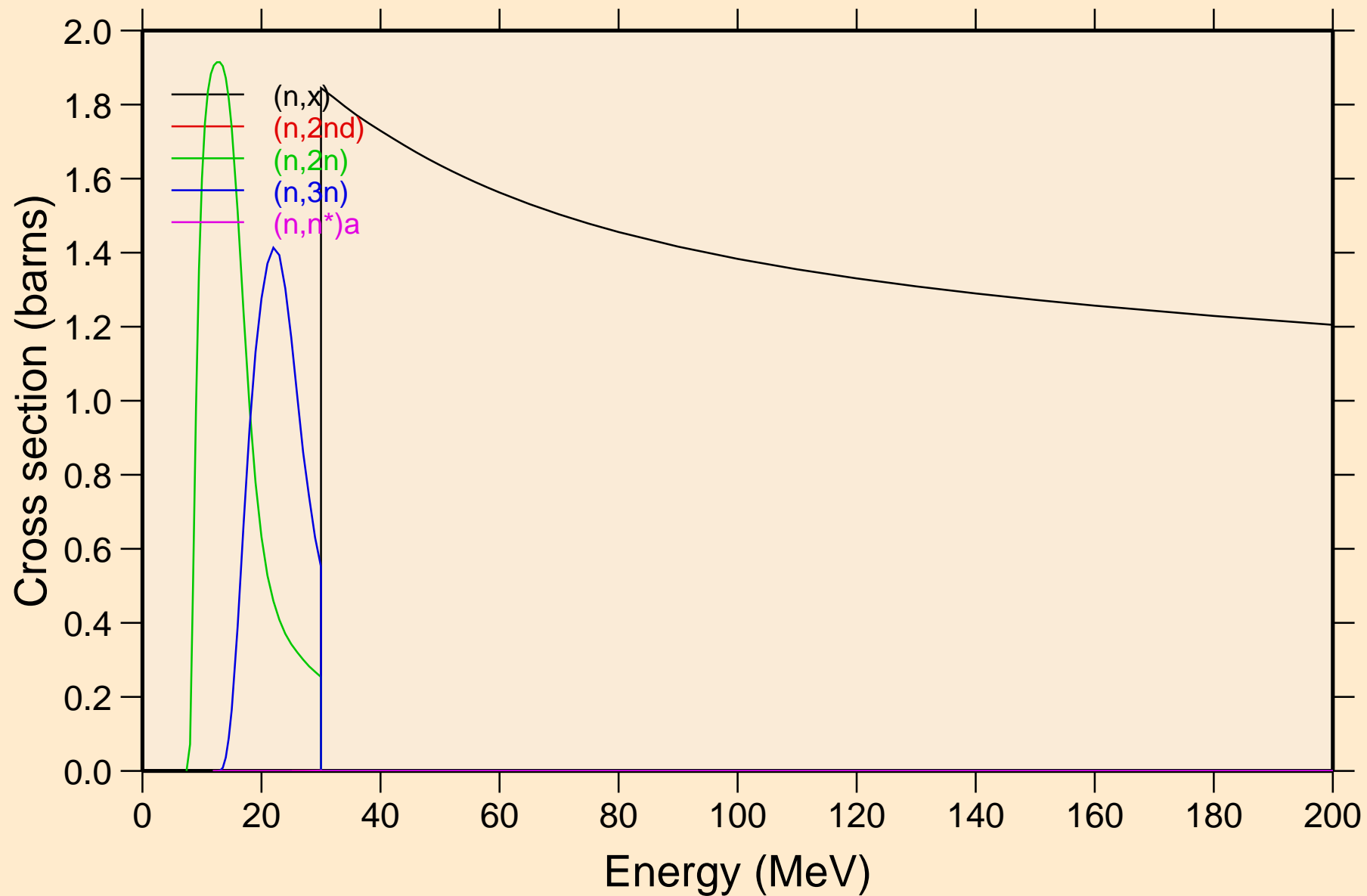

SN132 NEUTRON ACER TENDL-2019 LIBRARY; T=293.16K
Threshold reactions

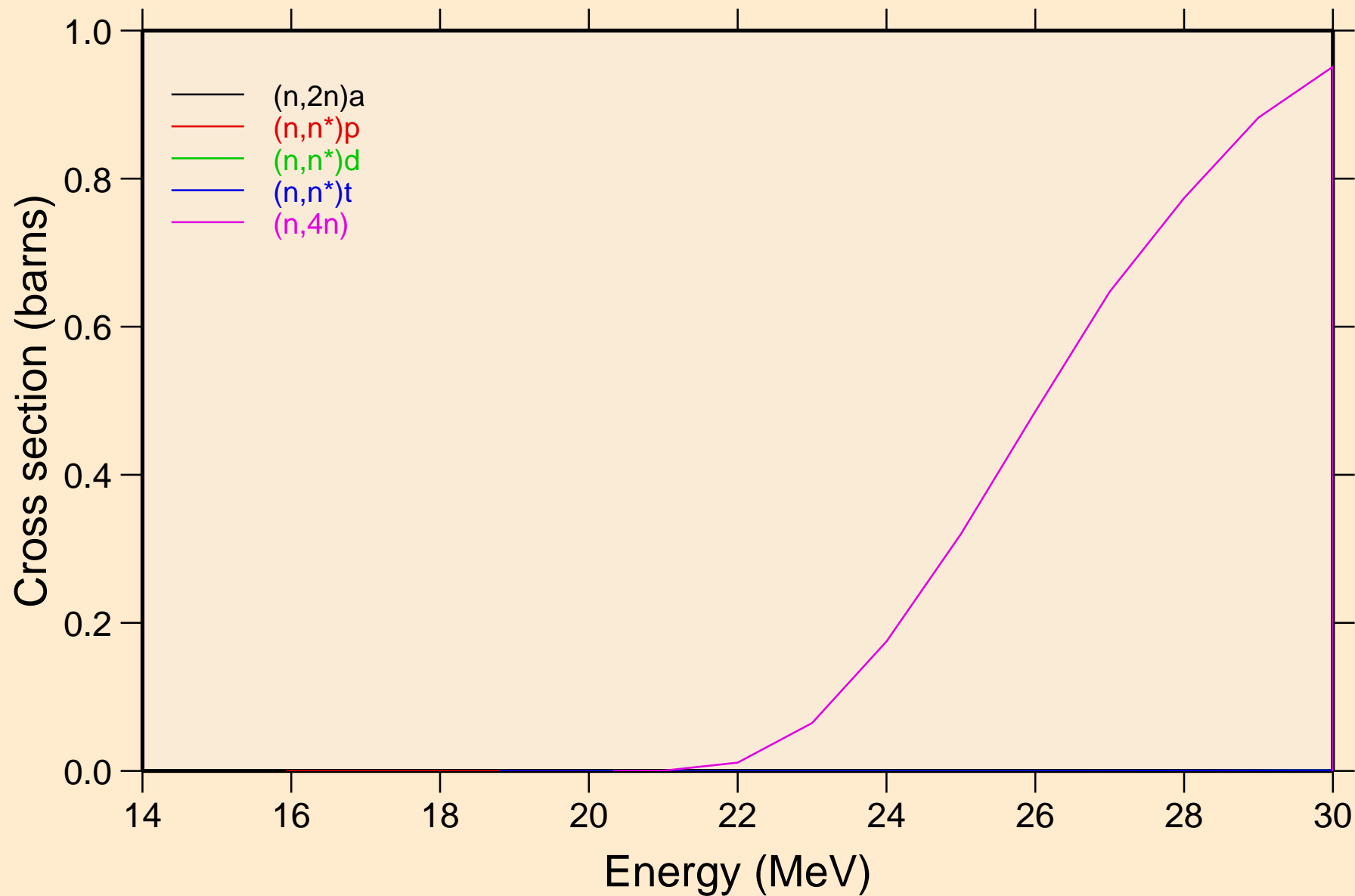

SN132 NEUTRON ACER TENDL-2019 LIBRARY; T=293.16K

Threshold reactions

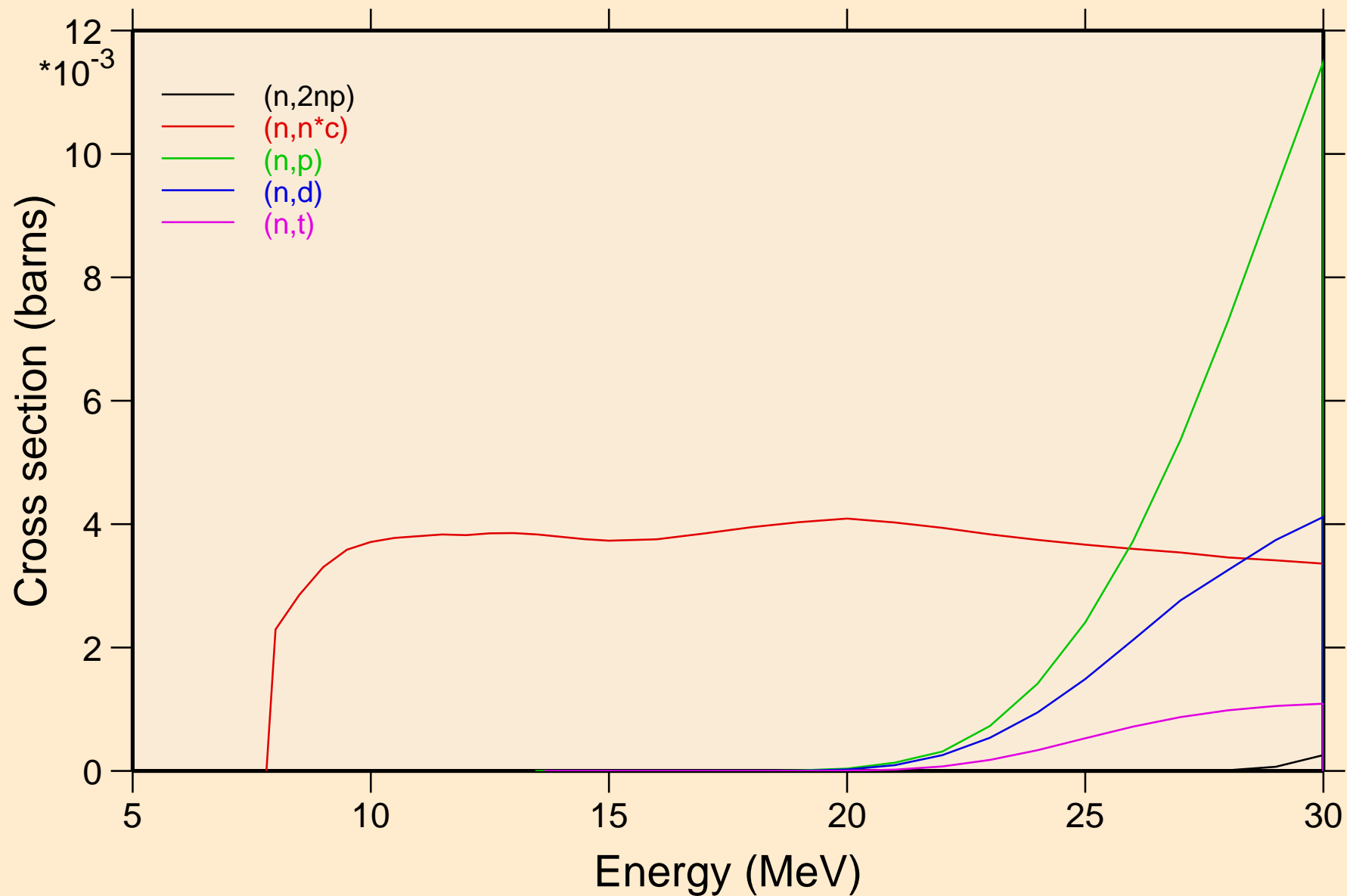

SN132 NEUTRON ACER TENDL-2019 LIBRARY; T=293.16K
Threshold reactions

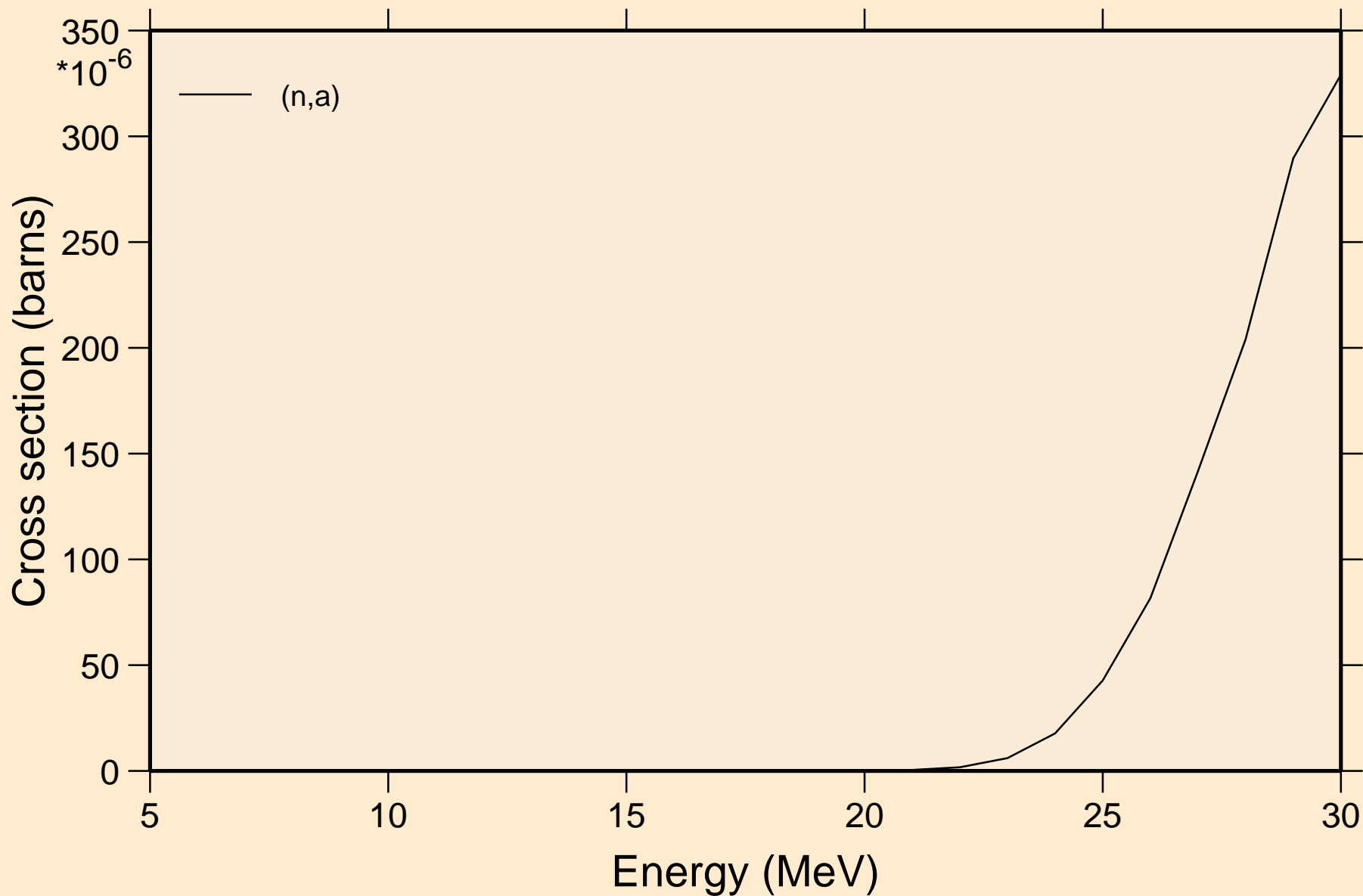

SN132 NEUTRON ACER TENDL-2019 LIBRARY; T=293.16K

Threshold reactions

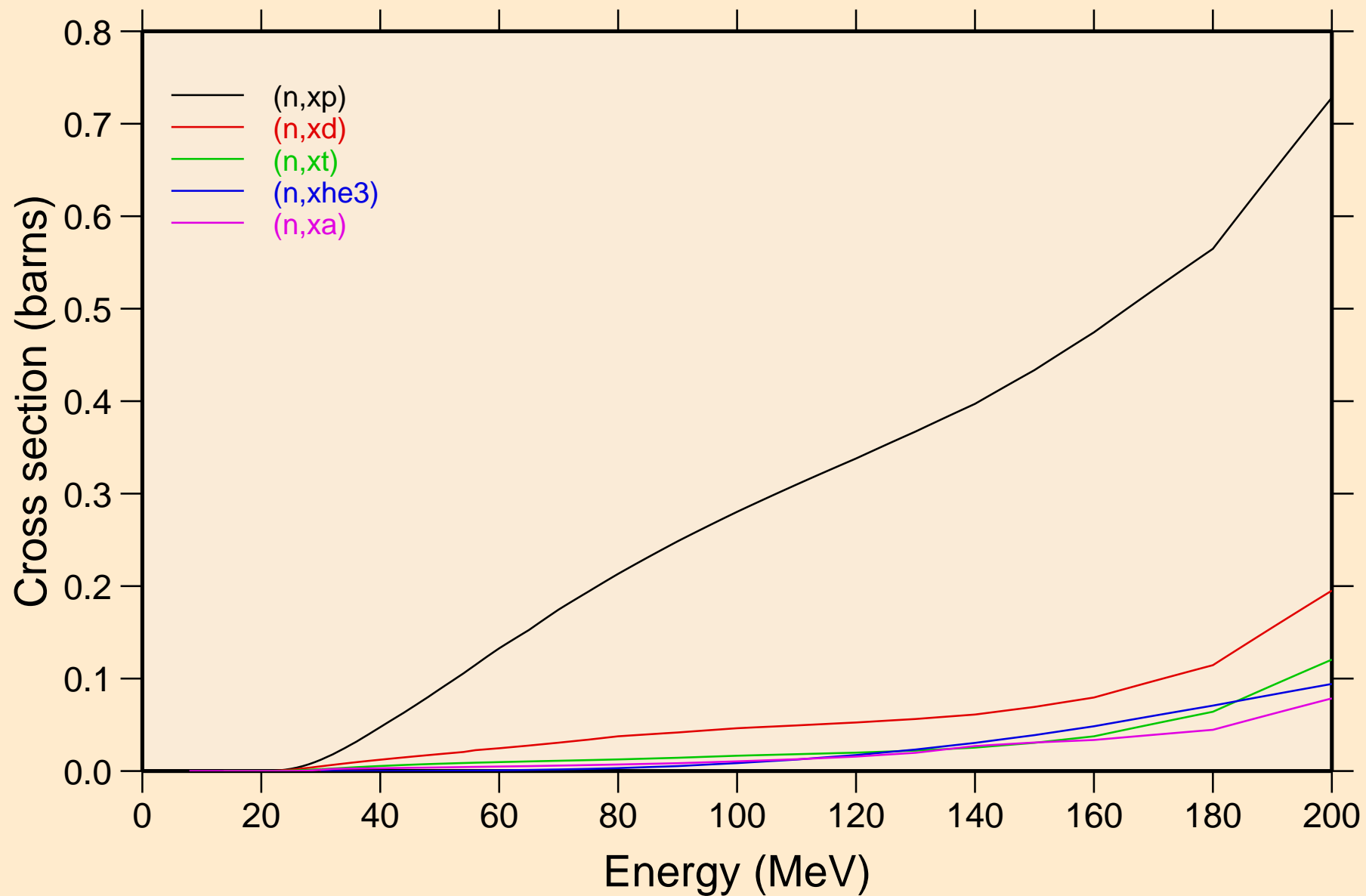

SN132 NEUTRON ACER TENDL-2019 LIBRARY; T=293.16K
angular distribution for elastic

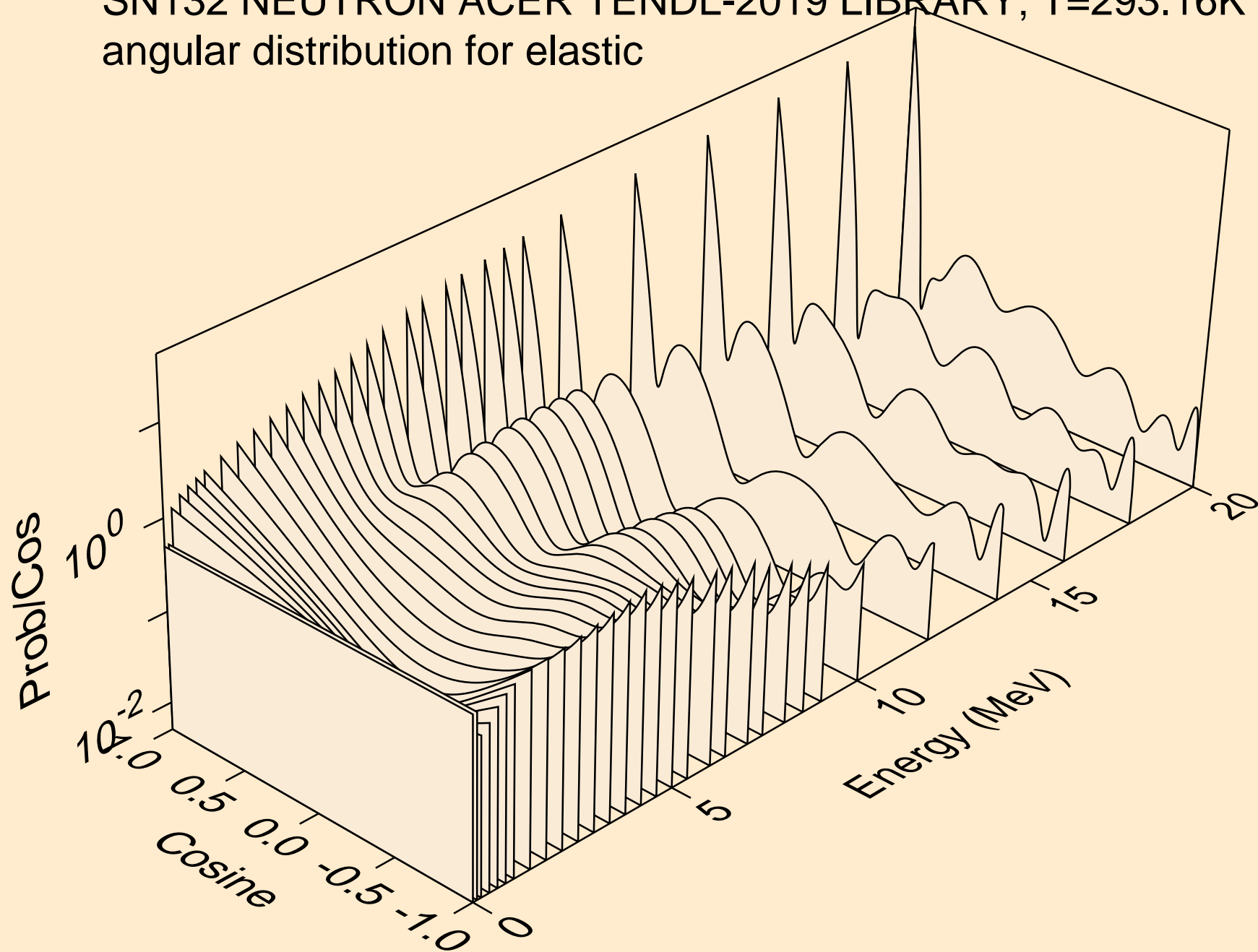

SN132 NEUTRON ACER TENDL-2019 LIBRARY; T=293.16K
angular distribution for elastic

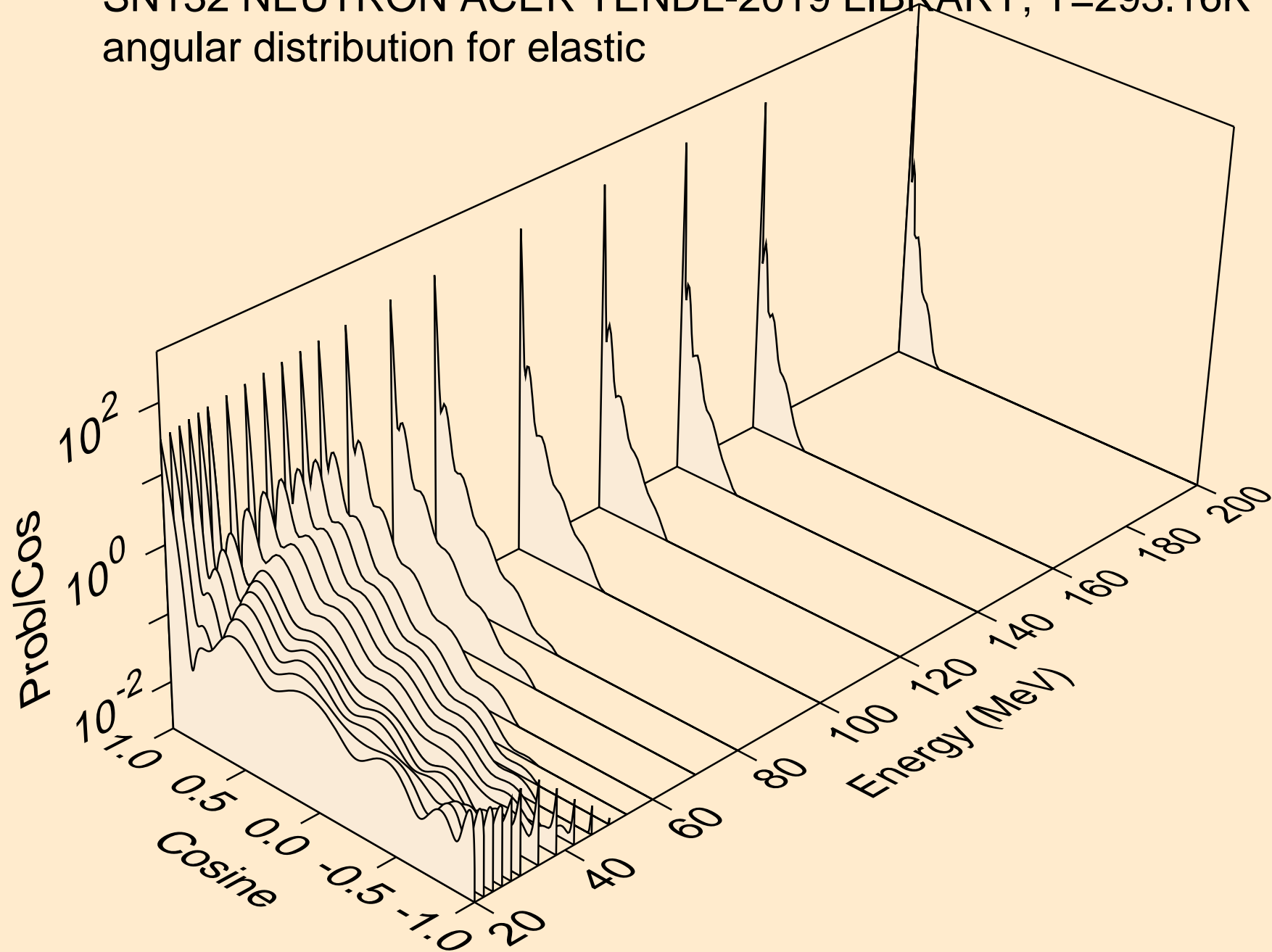

SN132 NEUTRON ACER TENDL-2019 LIBRARY; T=293.16K
angular distribution for (n,n*1)

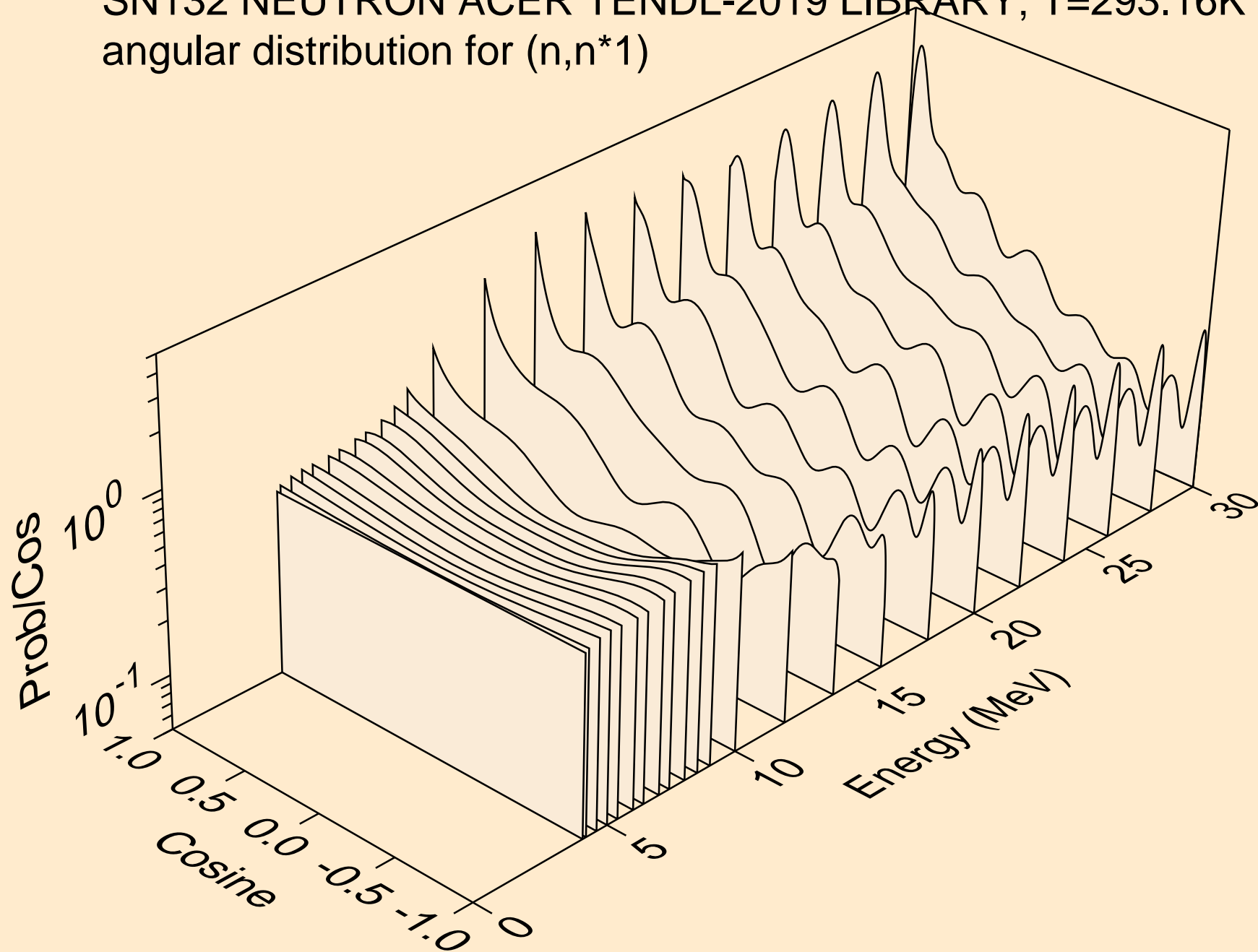

SN132 NEUTRON ACER TENDL-2019 LIBRARY; T=293.16K
angular distribution for (n,n*2)

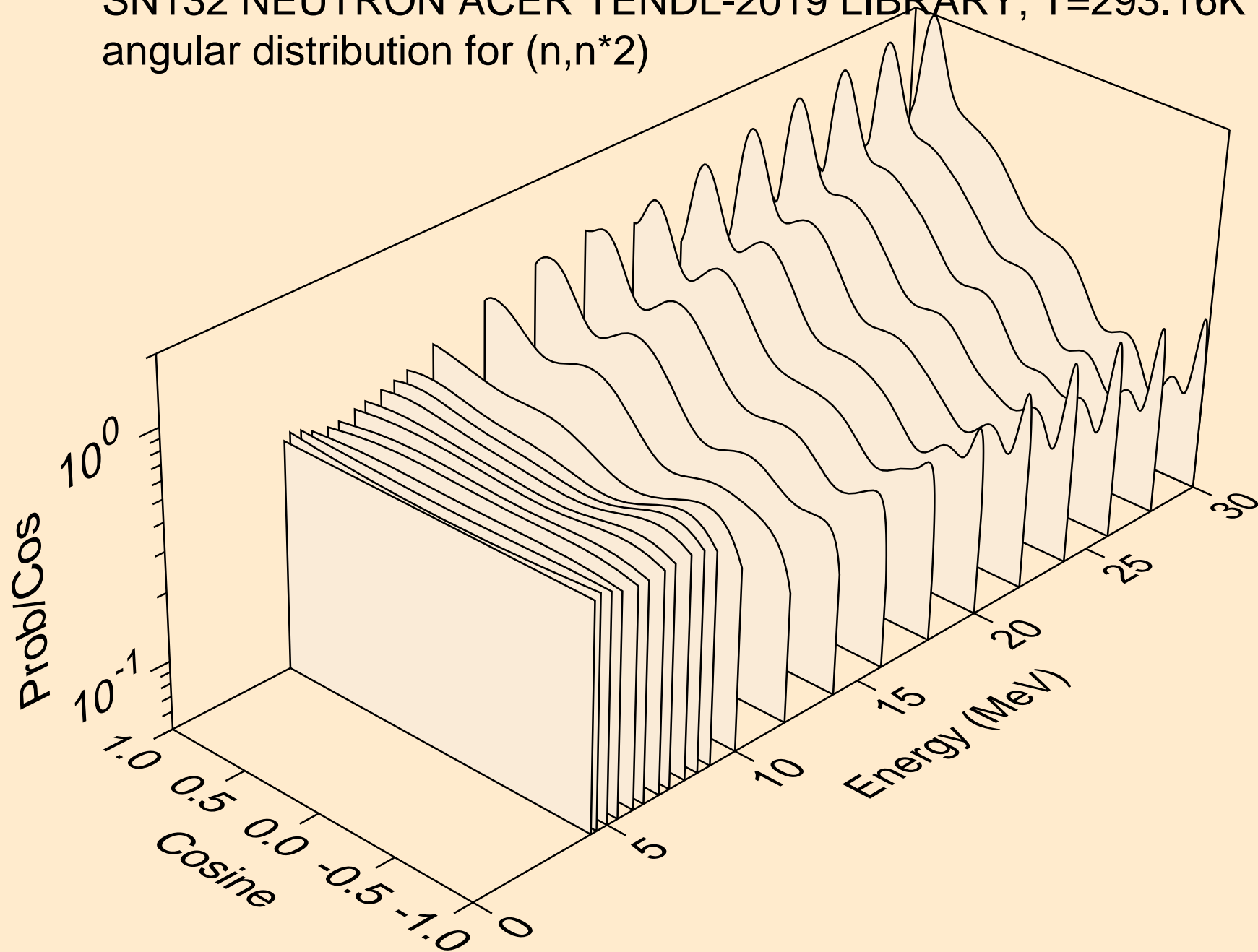

SN132 NEUTRON ACER TENDL-2019 LIBRARY; T=293.16K
angular distribution for (n,n*3)

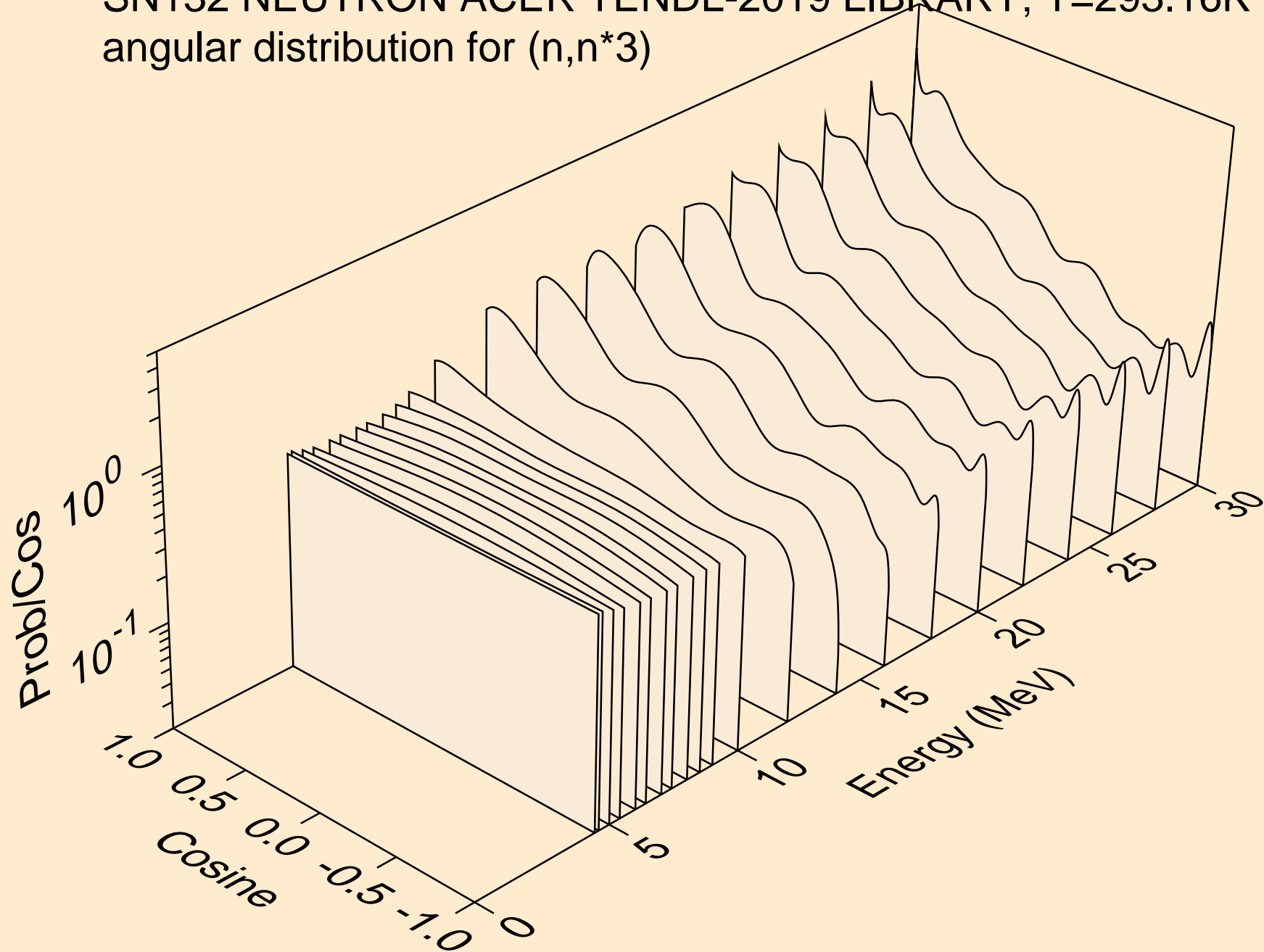

SN132 NEUTRON ACER TENDL-2019 LIBRARY; T=293.16K
angular distribution for (n,n*4)

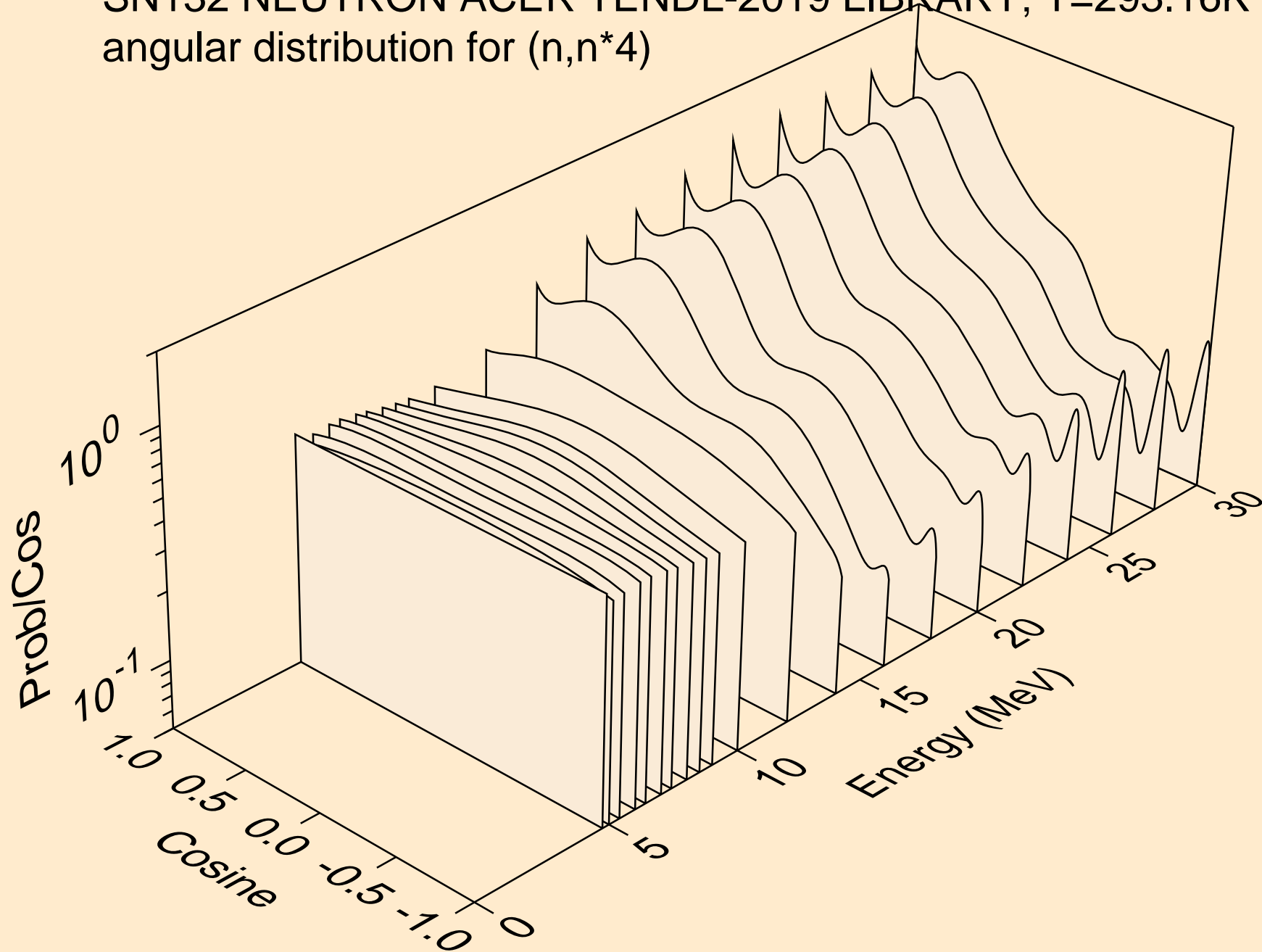

SN132 NEUTRON ACER TENDL-2019 LIBRARY; T=293.16K
angular distribution for (n,n*5)

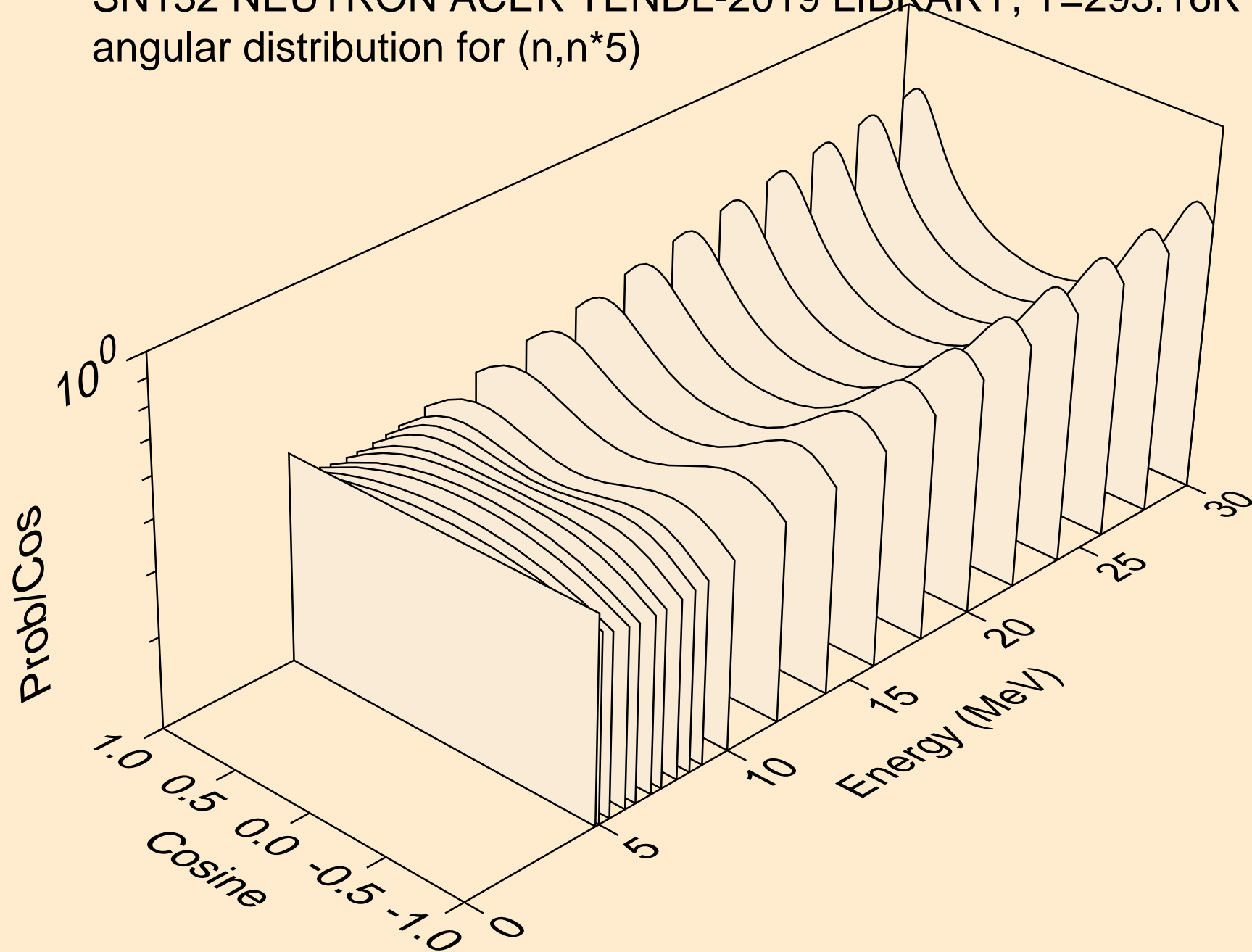

SN132 NEUTRON ACER TENDL-2019 LIBRARY; T=293.16K
angular distribution for (n,n*6)

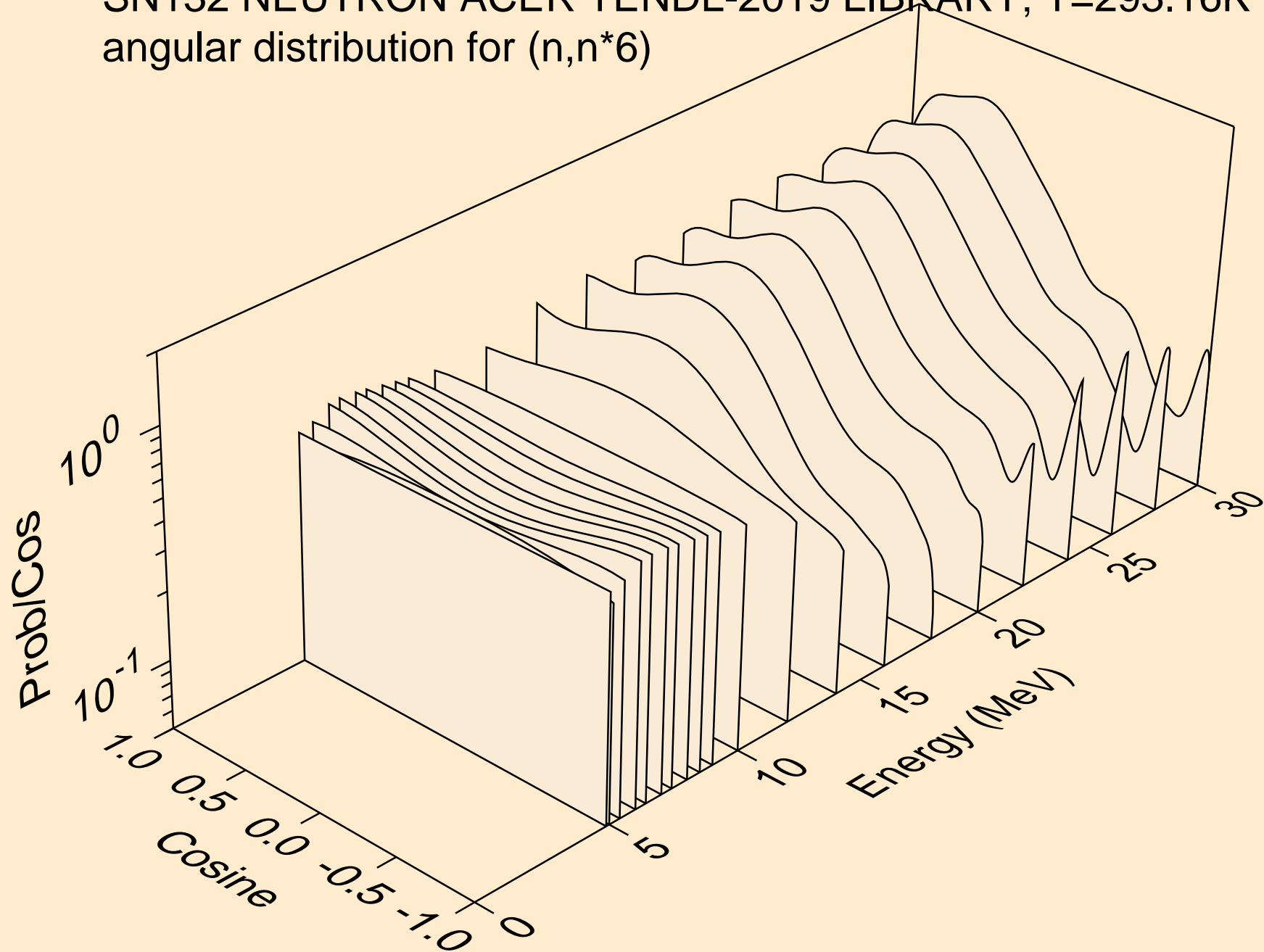

SN132 NEUTRON ACER TENDL-2019 LIBRARY; T=293.16K
angular distribution for (n,n*7)

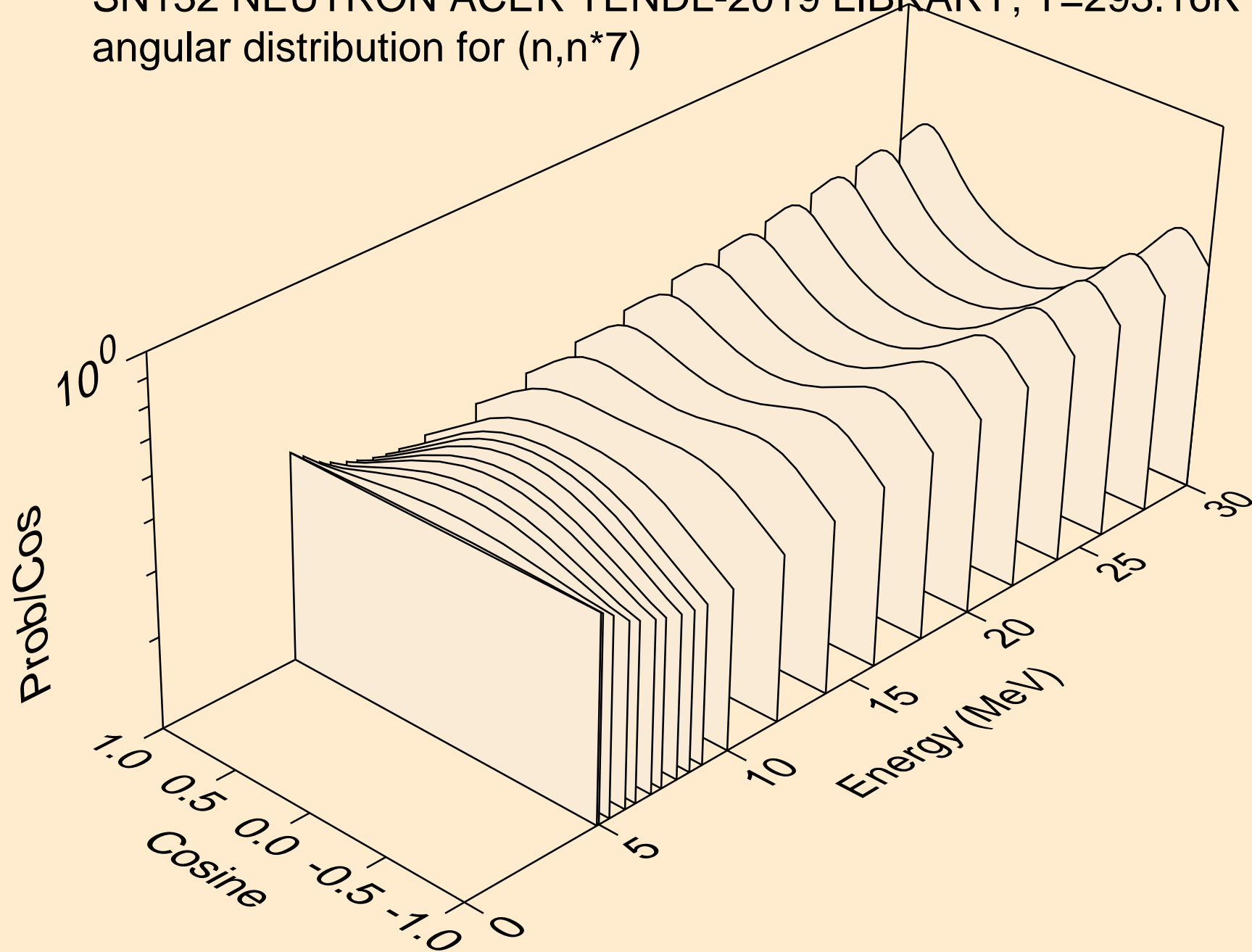

SN132 NEUTRON ACER TENDL-2019 LIBRARY; T=293.16K
angular distribution for (n,n*8)

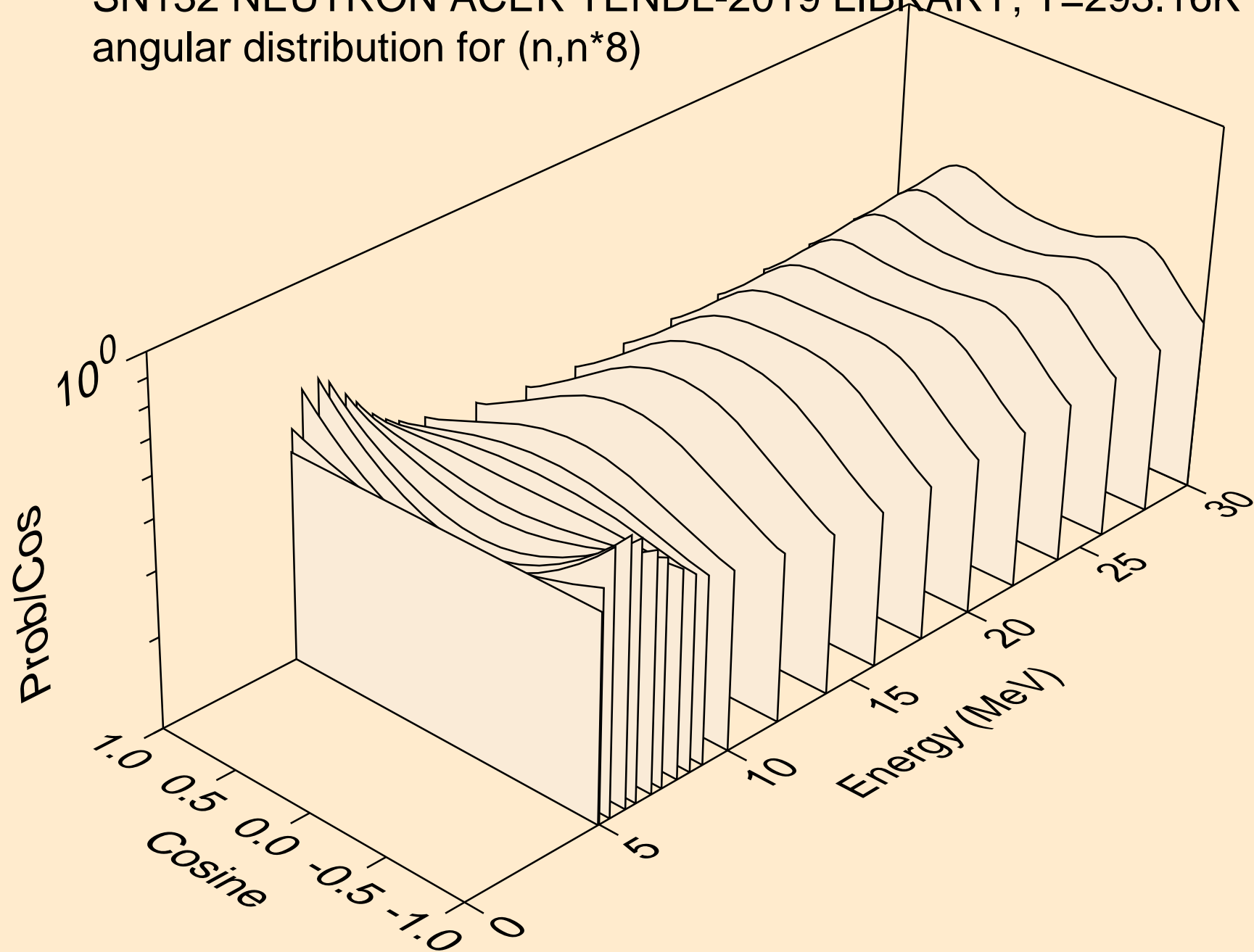

SN132 NEUTRON ACER TENDL-2019 LIBRARY; T=293.16K
angular distribution for (n,n*9)

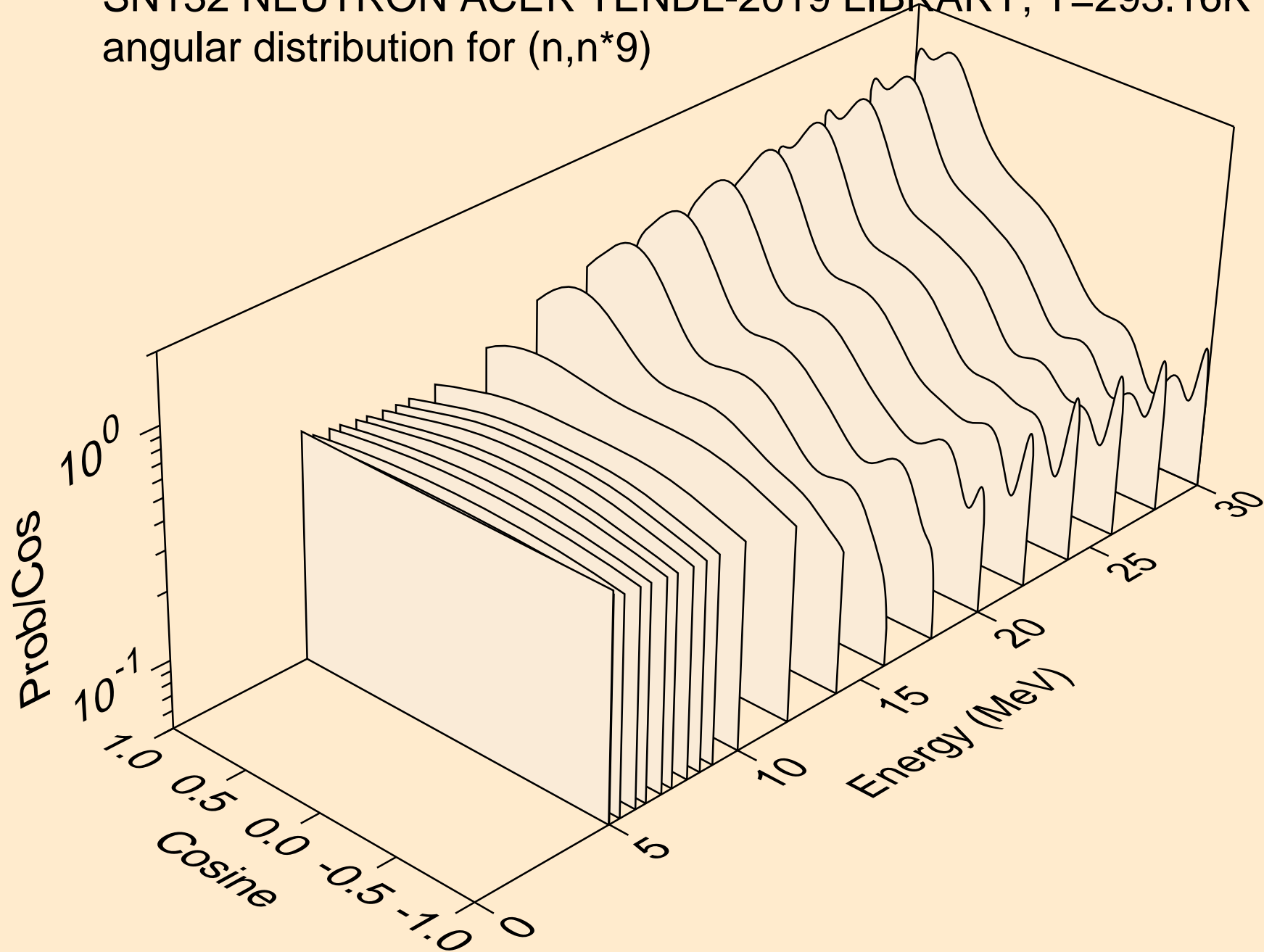

SN132 NEUTRON ACER TENDL-2019 LIBRARY; T=293.16K
angular distribution for (n,n*10)

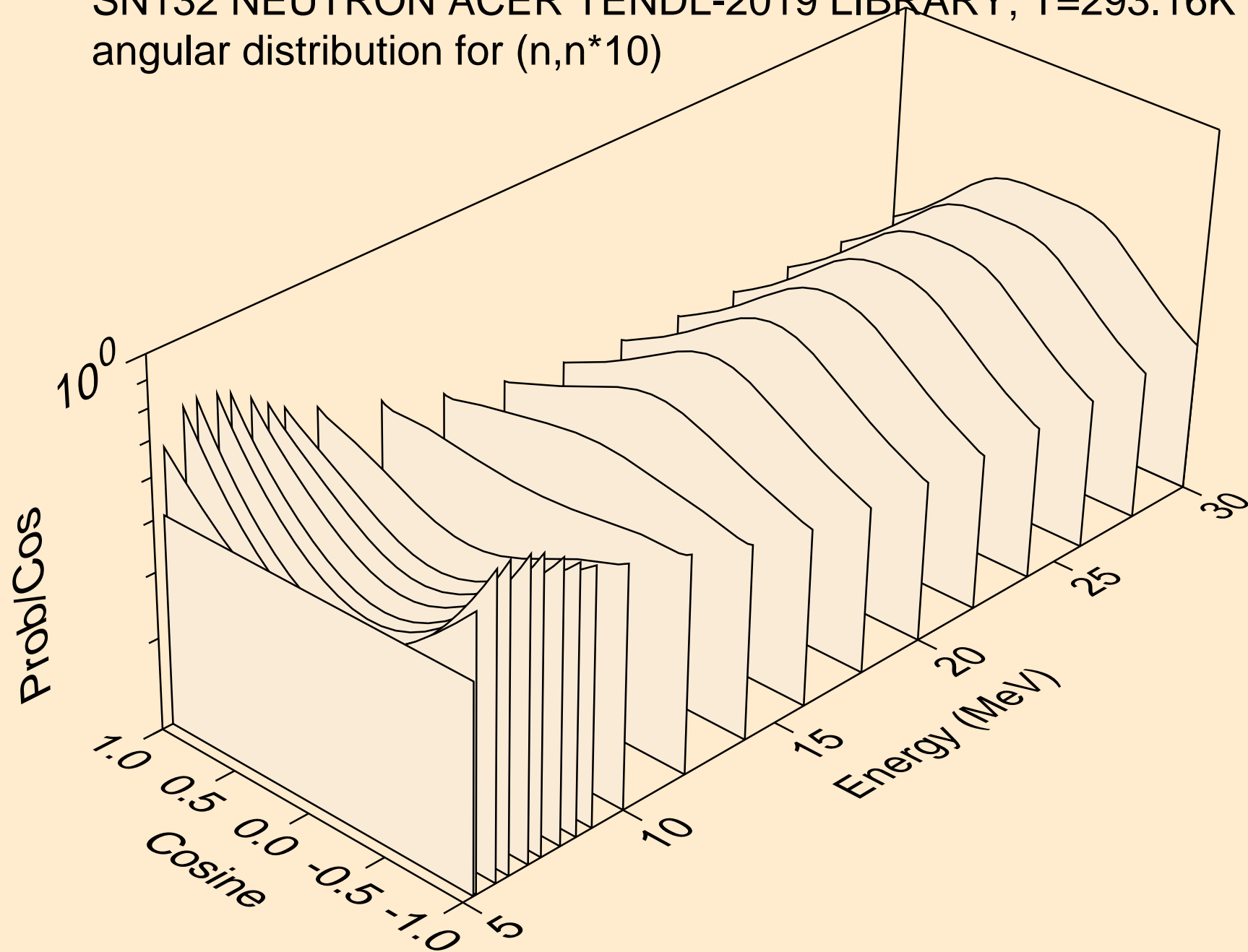

SN132 NEUTRON ACER TENDL-2019 LIBRARY; T=293.16K
angular distribution for (n,n*11)

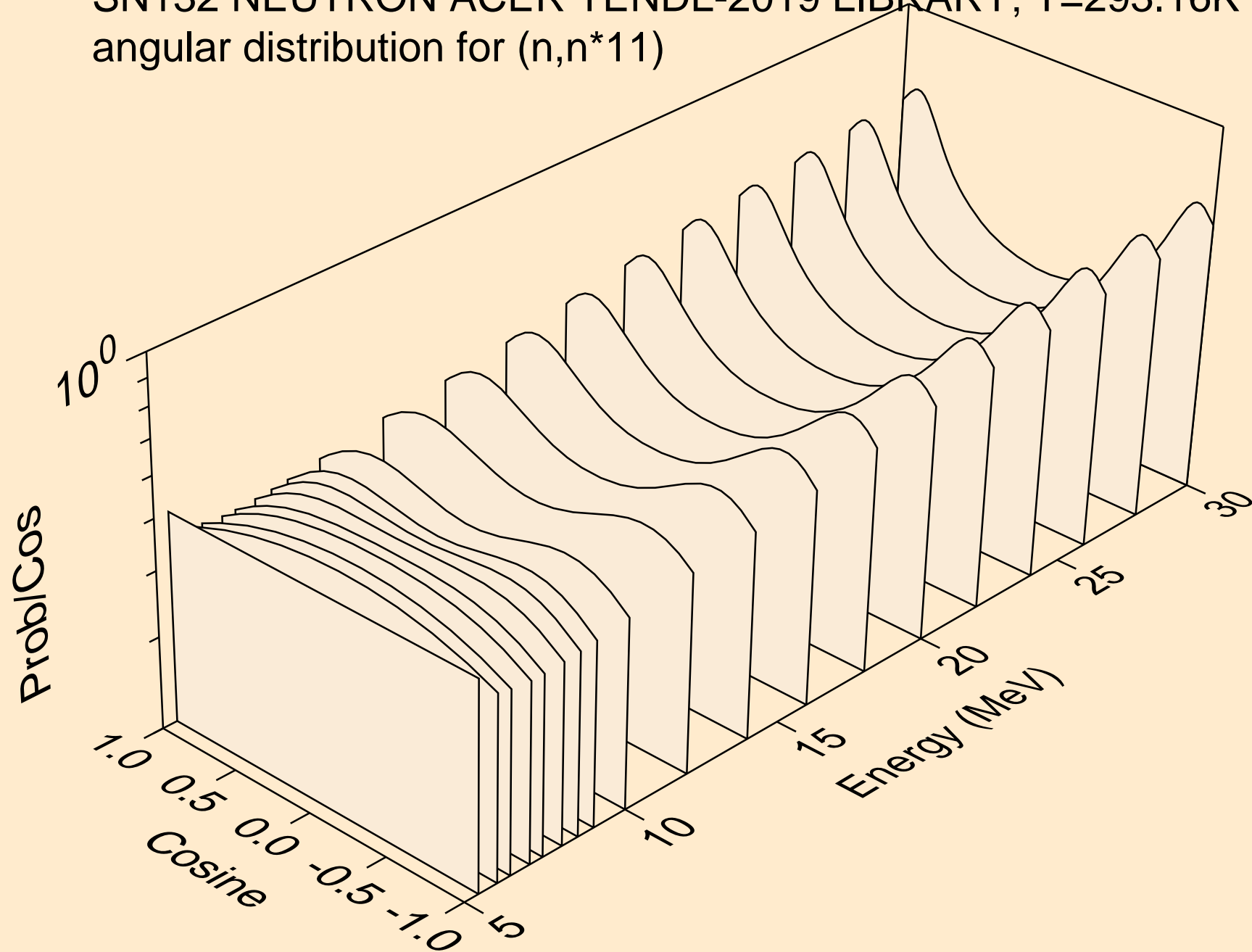

SN132 NEUTRON ACER TENDL-2019 LIBRARY; T=293.16K
angular distribution for (n,n*12)

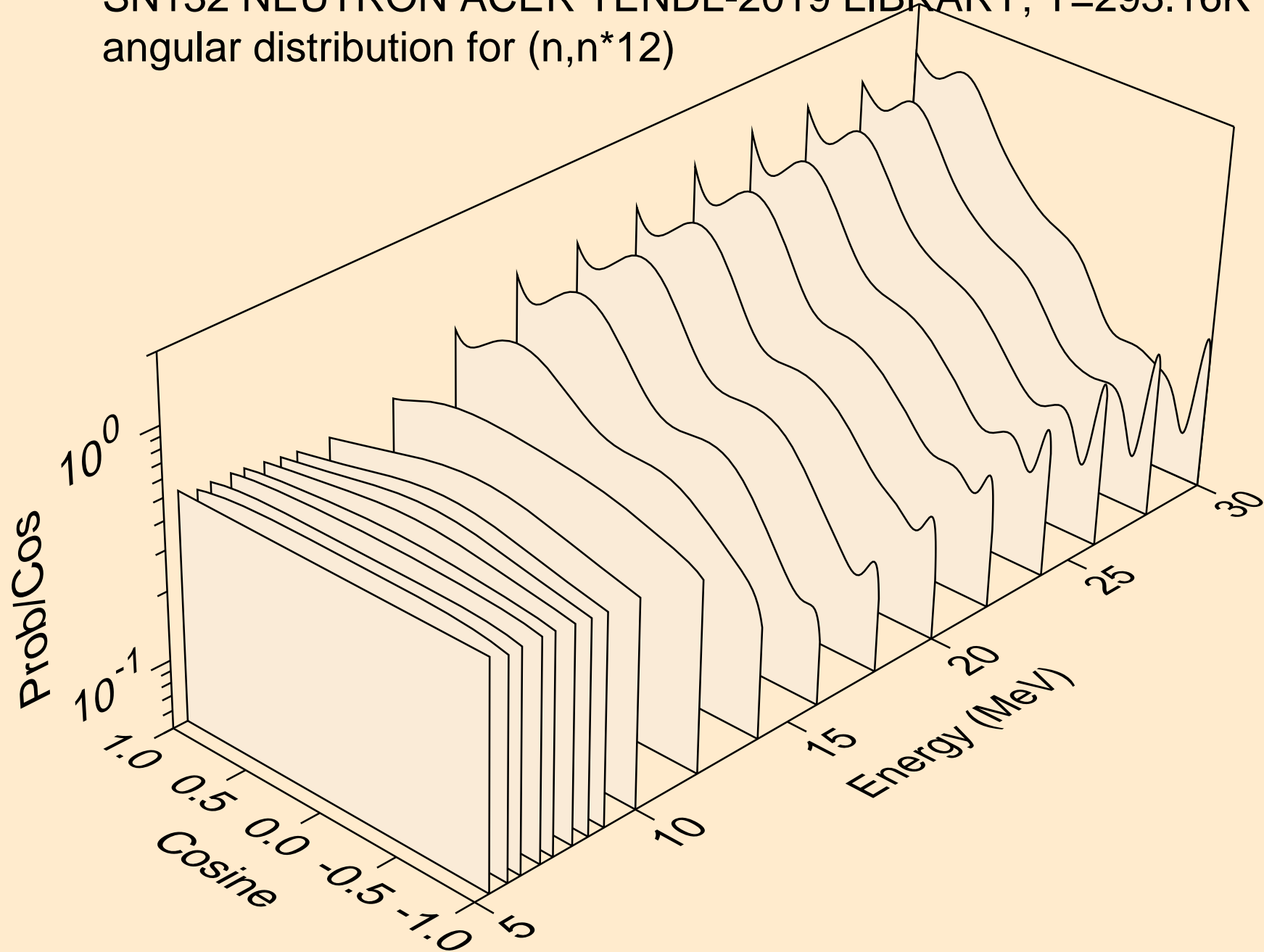

SN132 NEUTRON ACER TENDL-2019 LIBRARY; T=293.16K
angular distribution for (n,n*13)

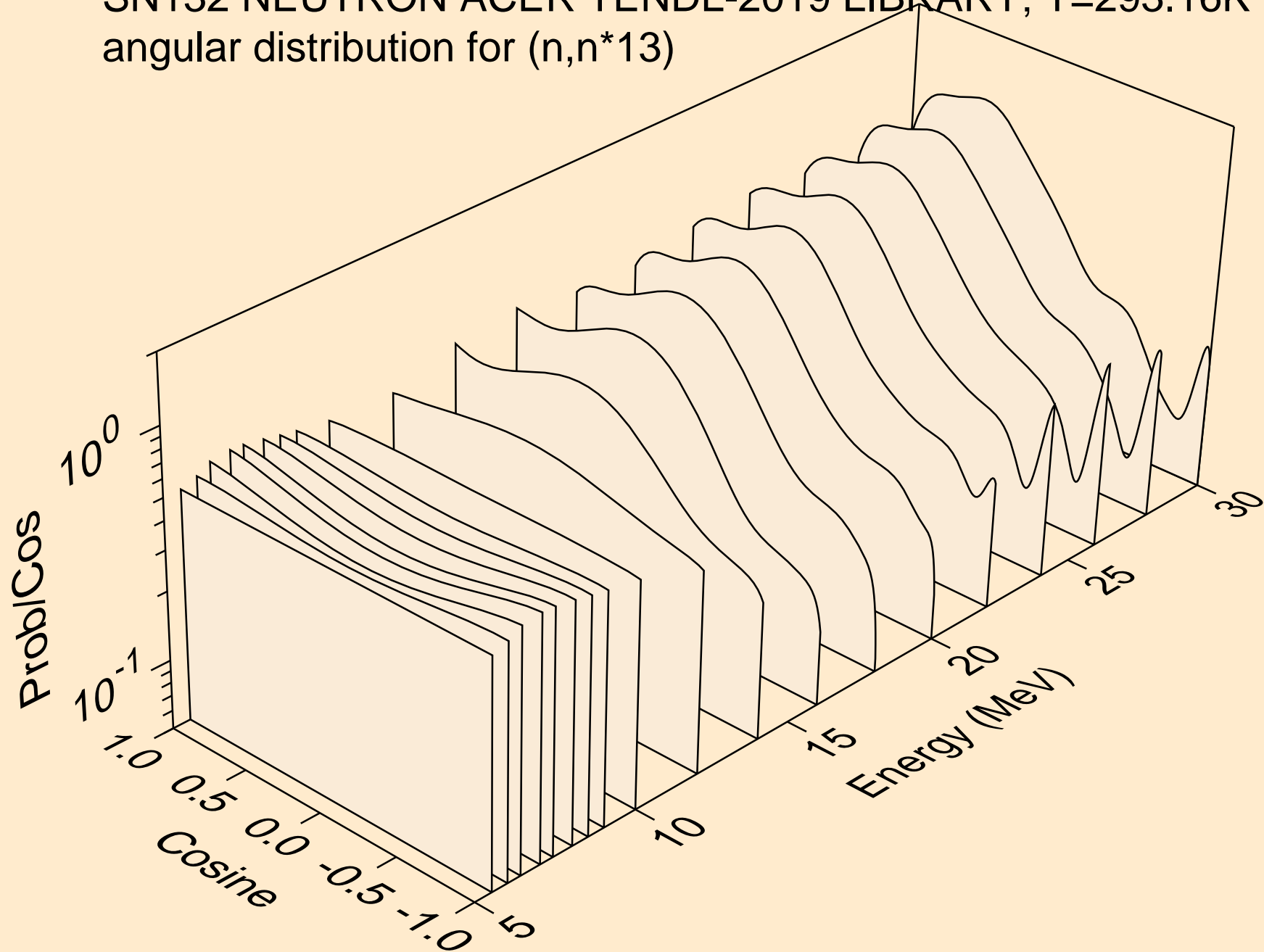

SN132 NEUTRON ACER TENDL-2019 LIBRARY; T=293.16K
angular distribution for (n,n*14)

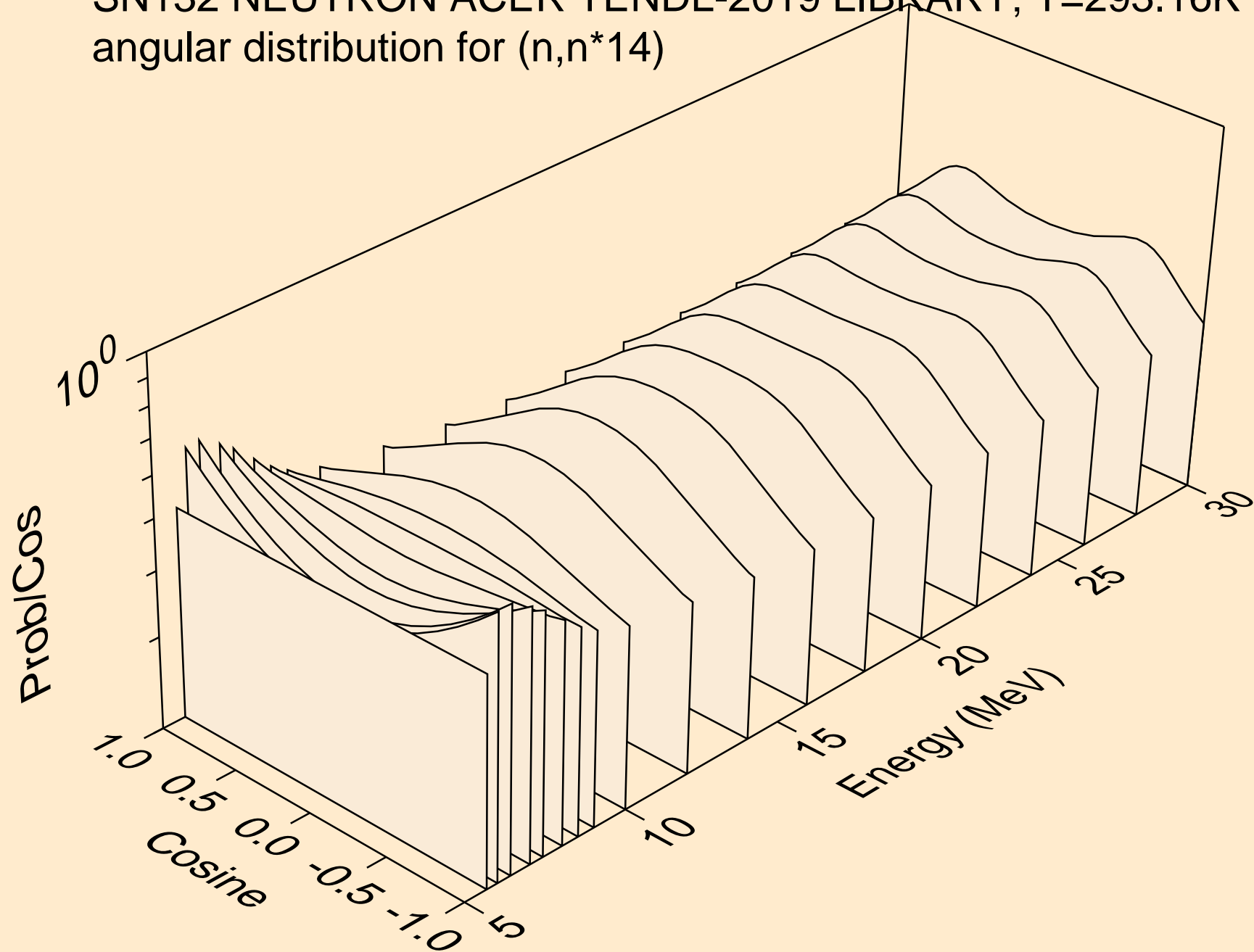

SN132 NEUTRON ACER TENDL-2019 LIBRARY; T=293.16K
angular distribution for (n,n*15)

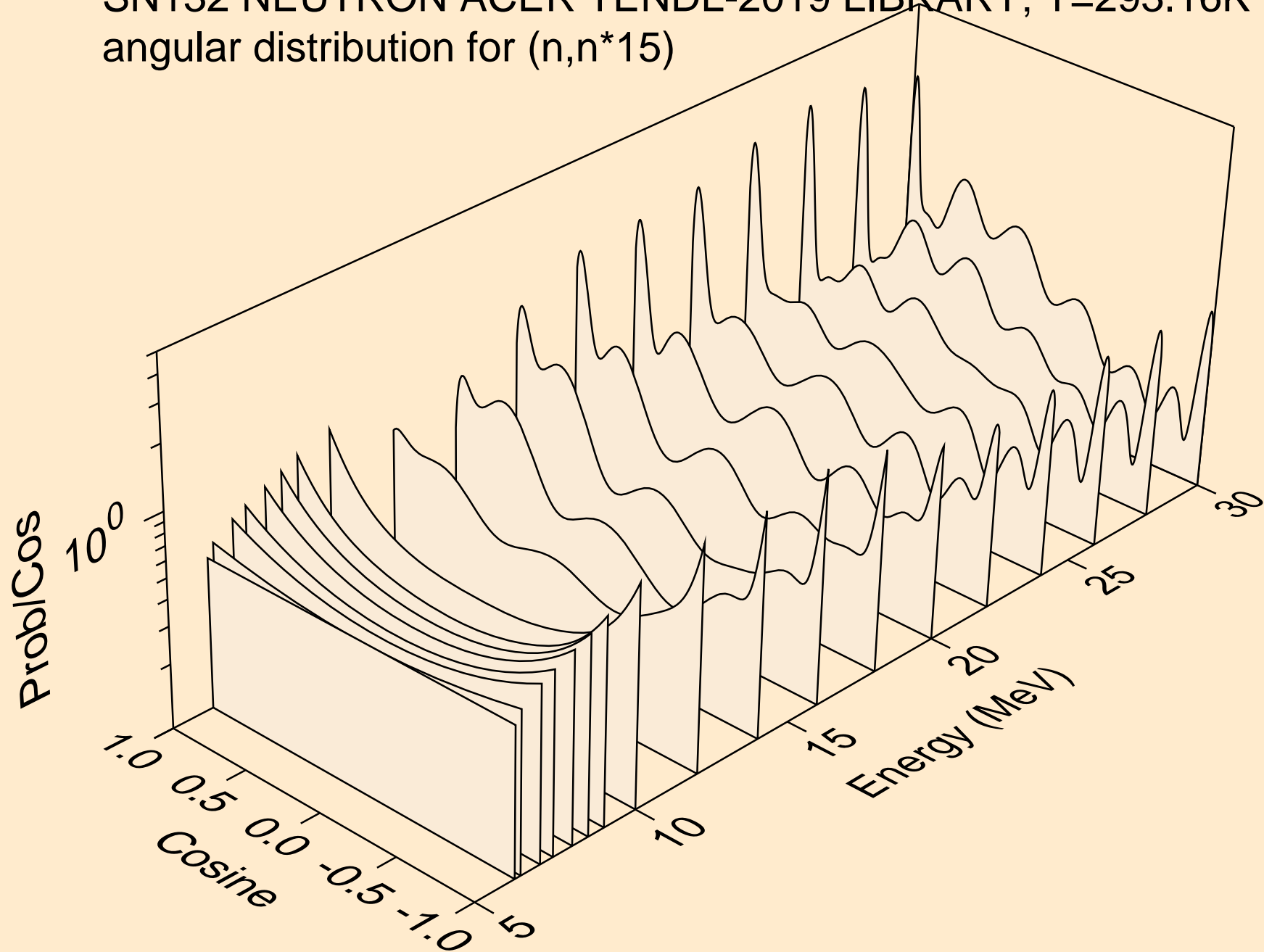

SN132 NEUTRON ACER TENDL-2019 LIBRARY; T=293.16K
angular distribution for (n,n*16)

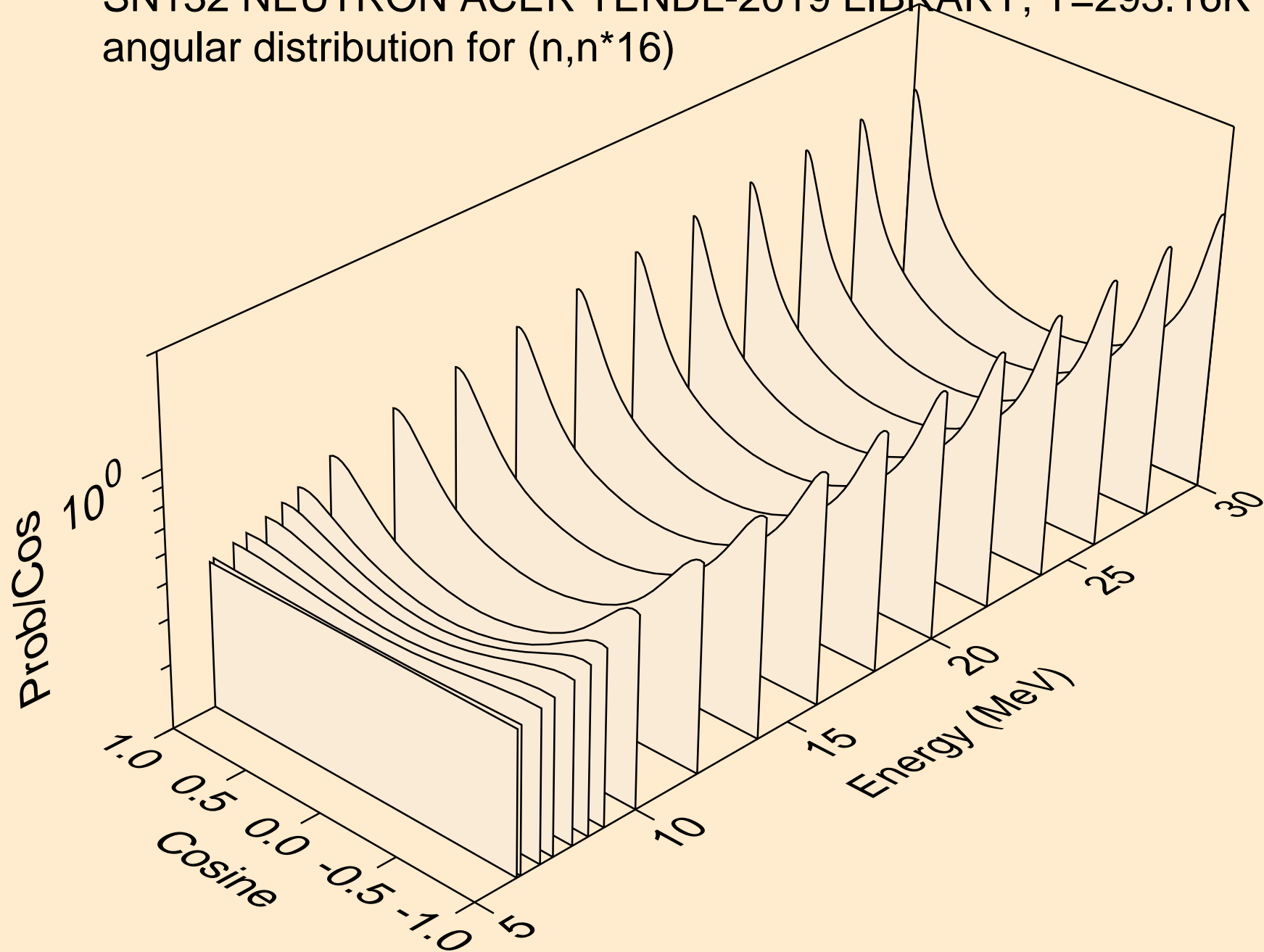

SN132 NEUTRON ACER TENDL-2019 LIBRARY; T=293.16K
angular distribution for (n,n*17)

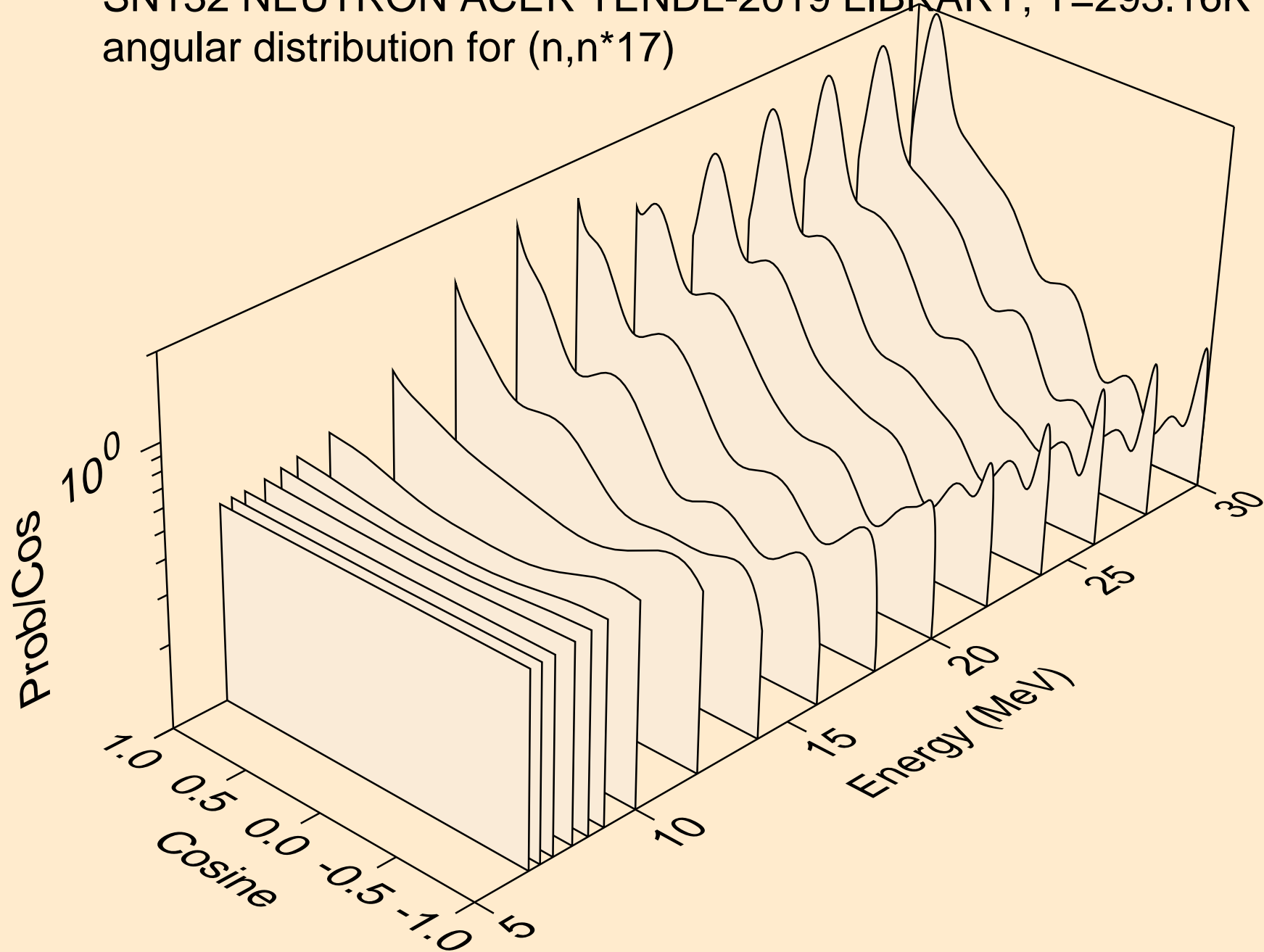

SN132 NEUTRON ACER TENDL-2019 LIBRARY; T=293.16K
angular distribution for (n,n*18)

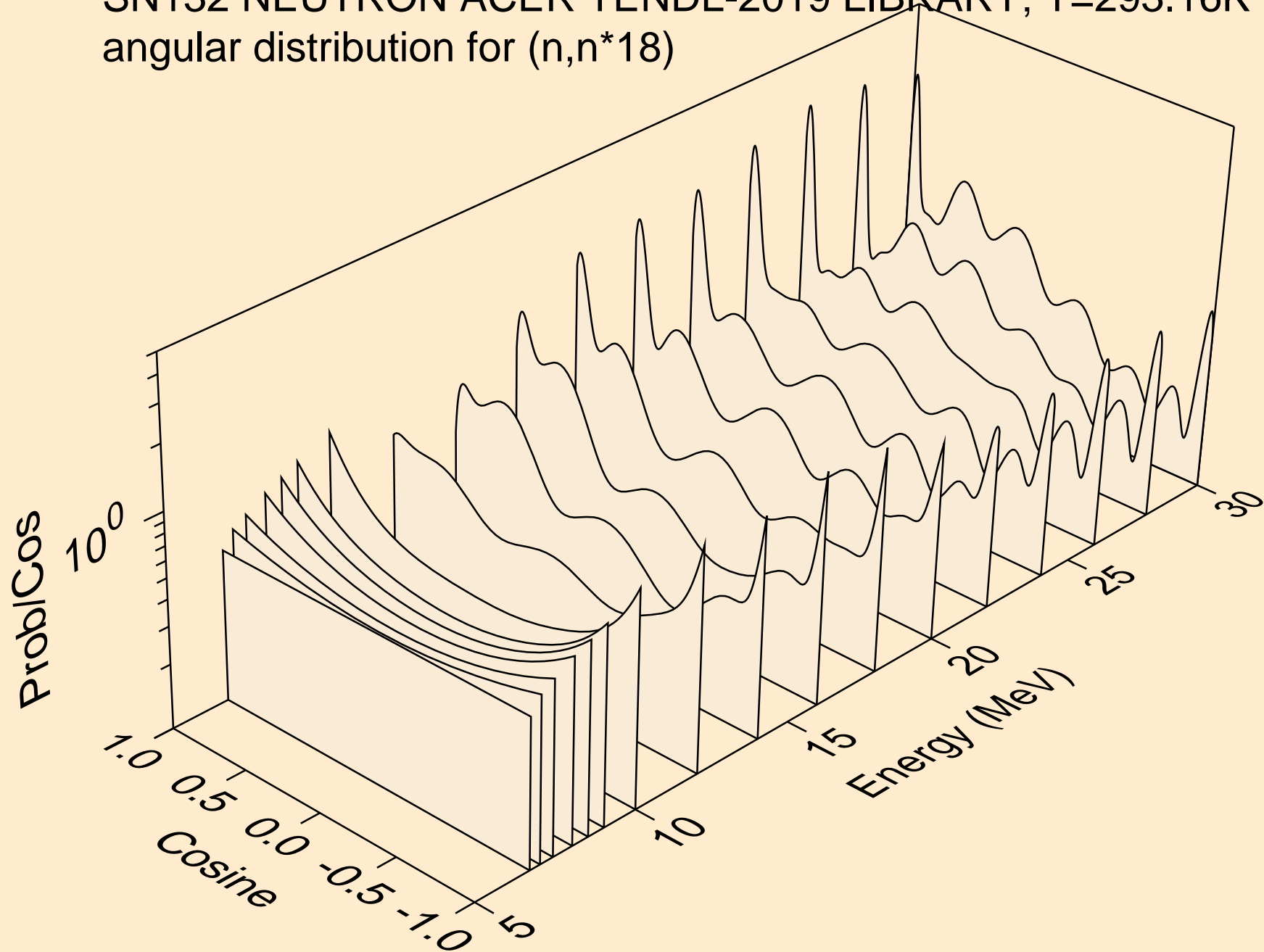

SN132 NEUTRON ACER TENDL-2019 LIBRARY; T=293.16K
angular distribution for (n,n*19)

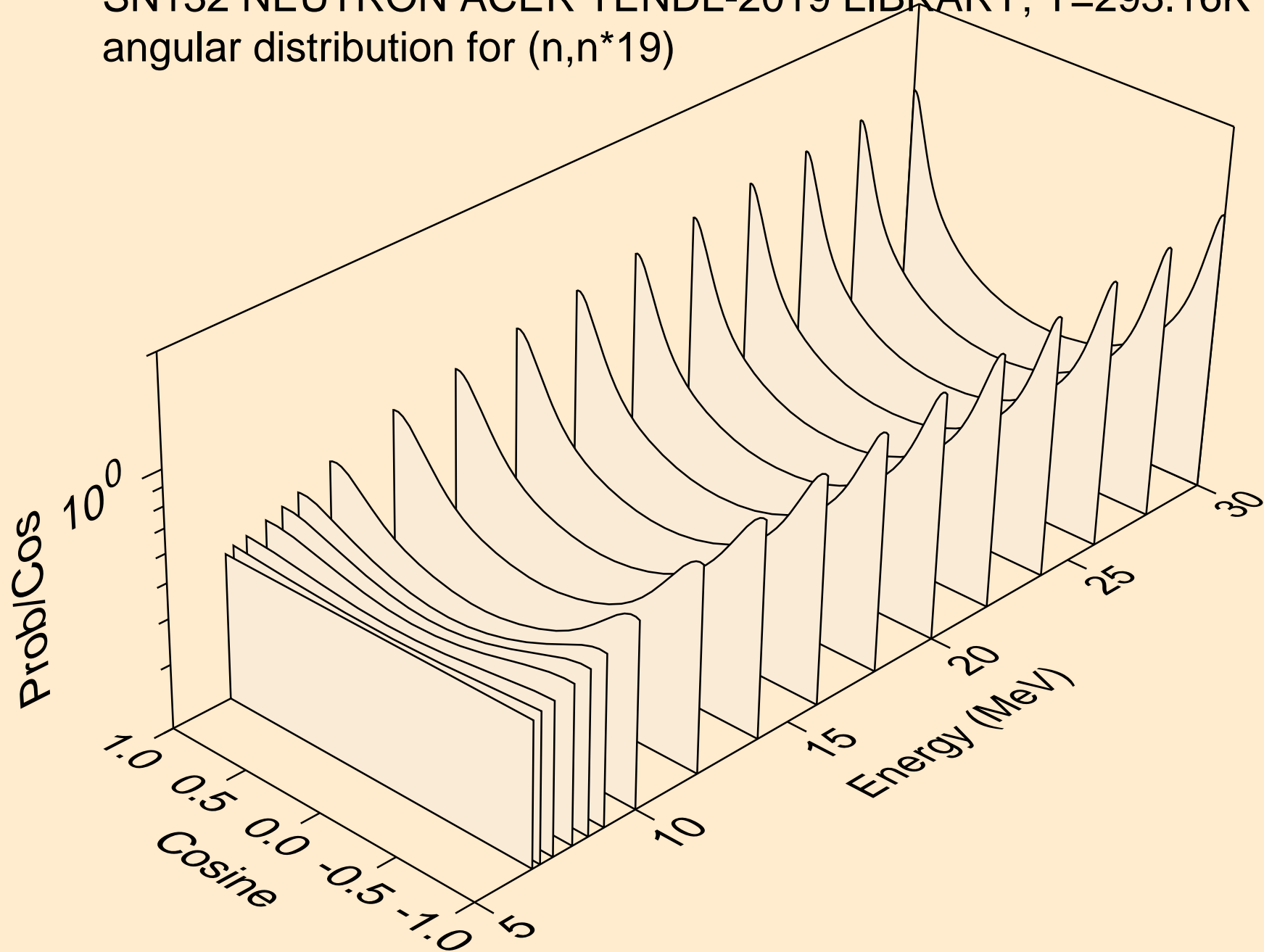

SN132 NEUTRON ACER TENDL-2019 LIBRARY; T=293.16K
angular distribution for (n,n*20)

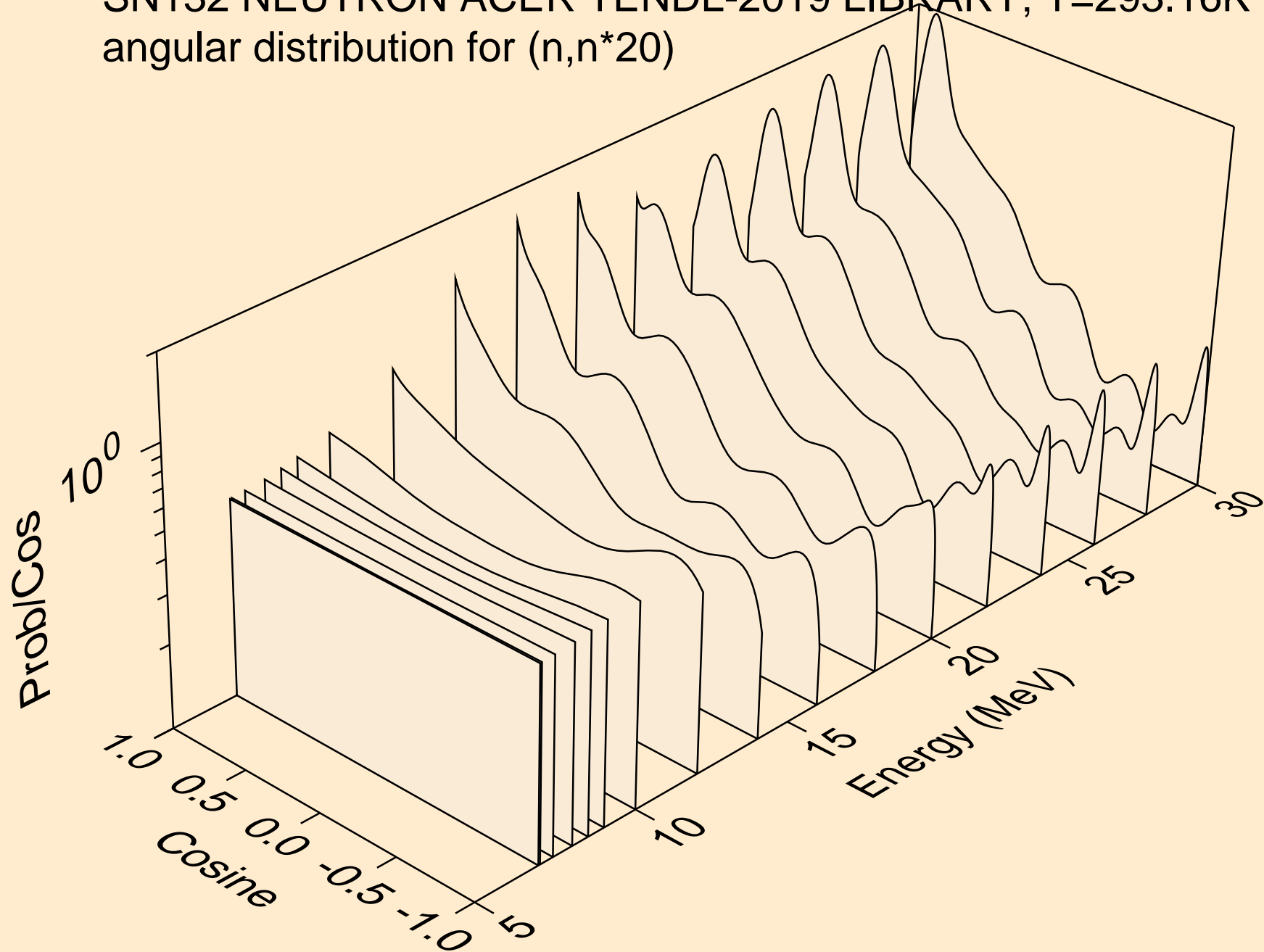

SN132 NEUTRON ACER TENDL-2019 LIBRARY; T=293.16K
angular distribution for (n,n*21)

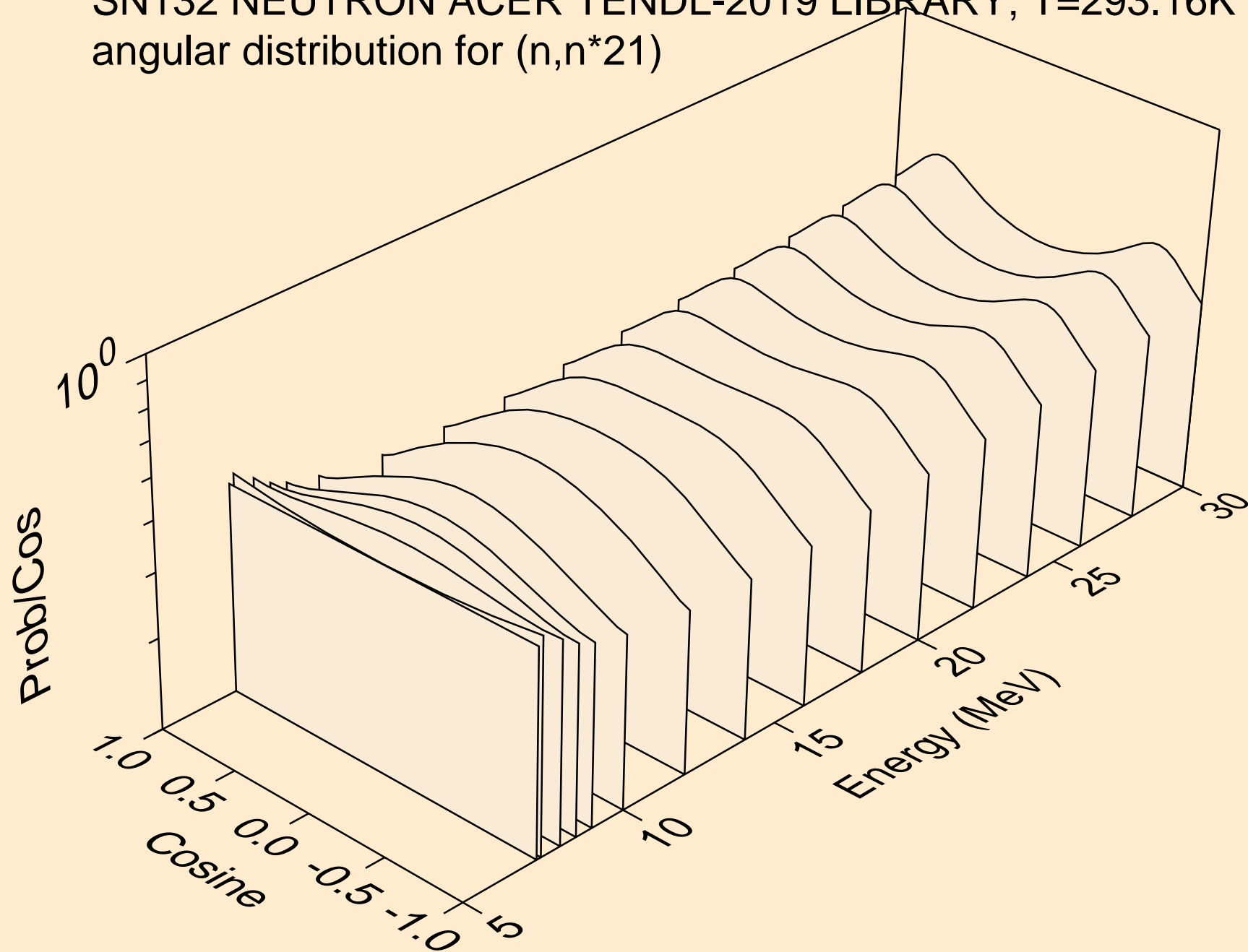

SN132 NEUTRON ACER TENDL-2019 LIBRARY; T=293.16K
angular distribution for (n,n*22)

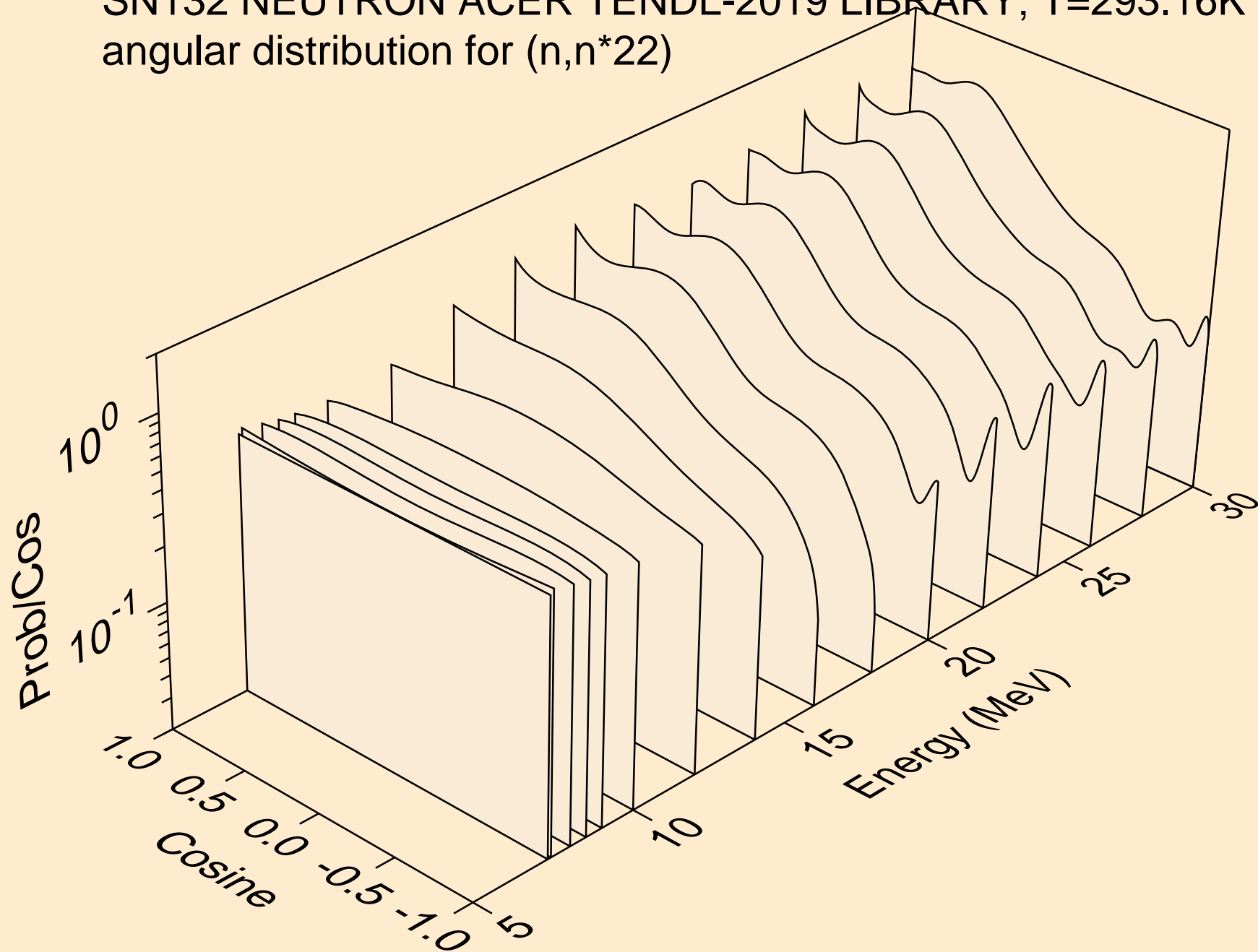

SN132 NEUTRON ACER TENDL-2019 LIBRARY; T=293.16K
angular distribution for (n,n*23)

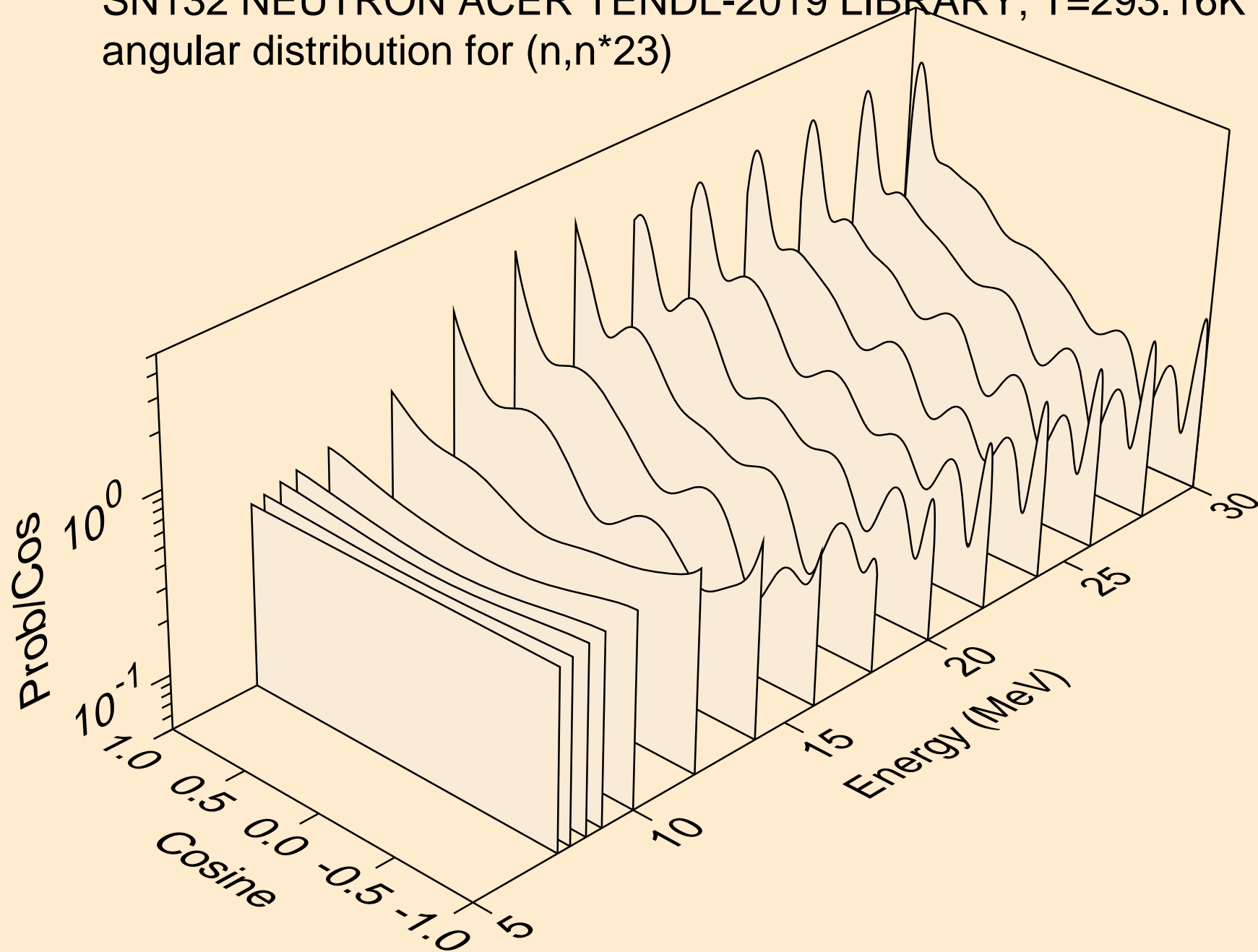

SN132 NEUTRON ACER TENDL-2019 LIBRARY; T=293.16K
angular distribution for (n,n*24)

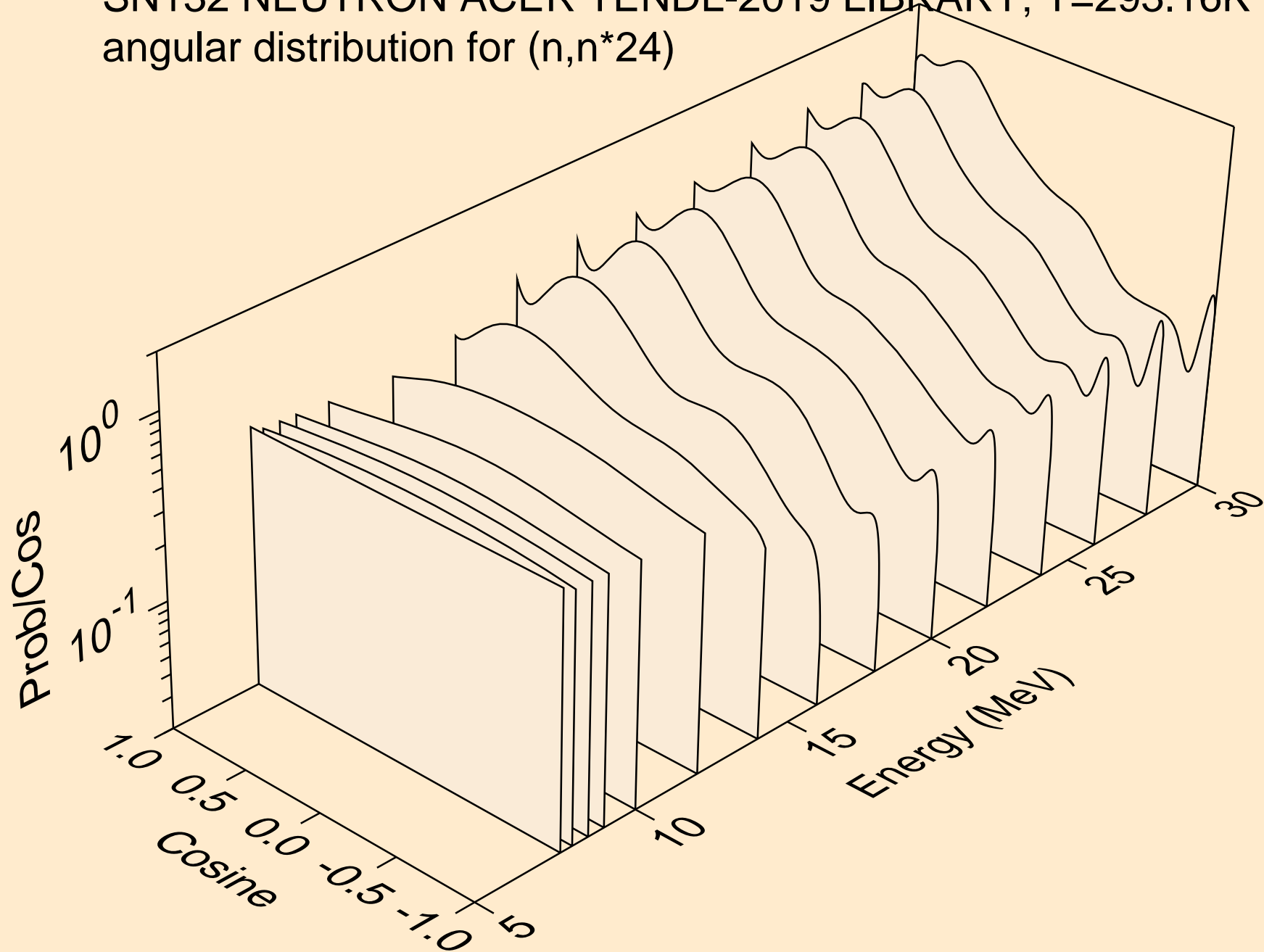

SN132 NEUTRON ACER TENDL-2019 LIBRARY; T=293.16K
angular distribution for (n,n*25)

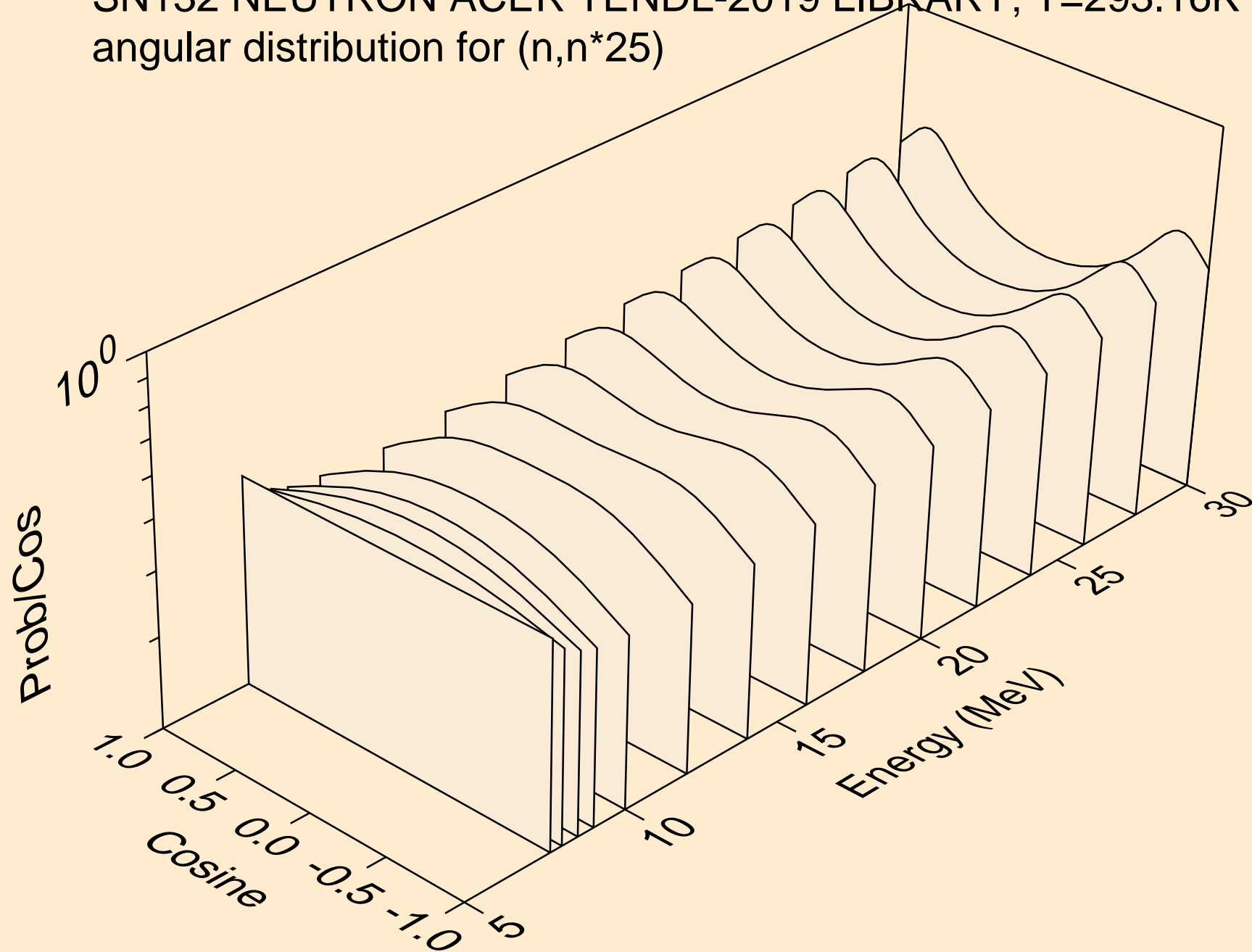

SN132 NEUTRON ACER TENDL-2019 LIBRARY; T=293.16K
angular distribution for (n,n*26)

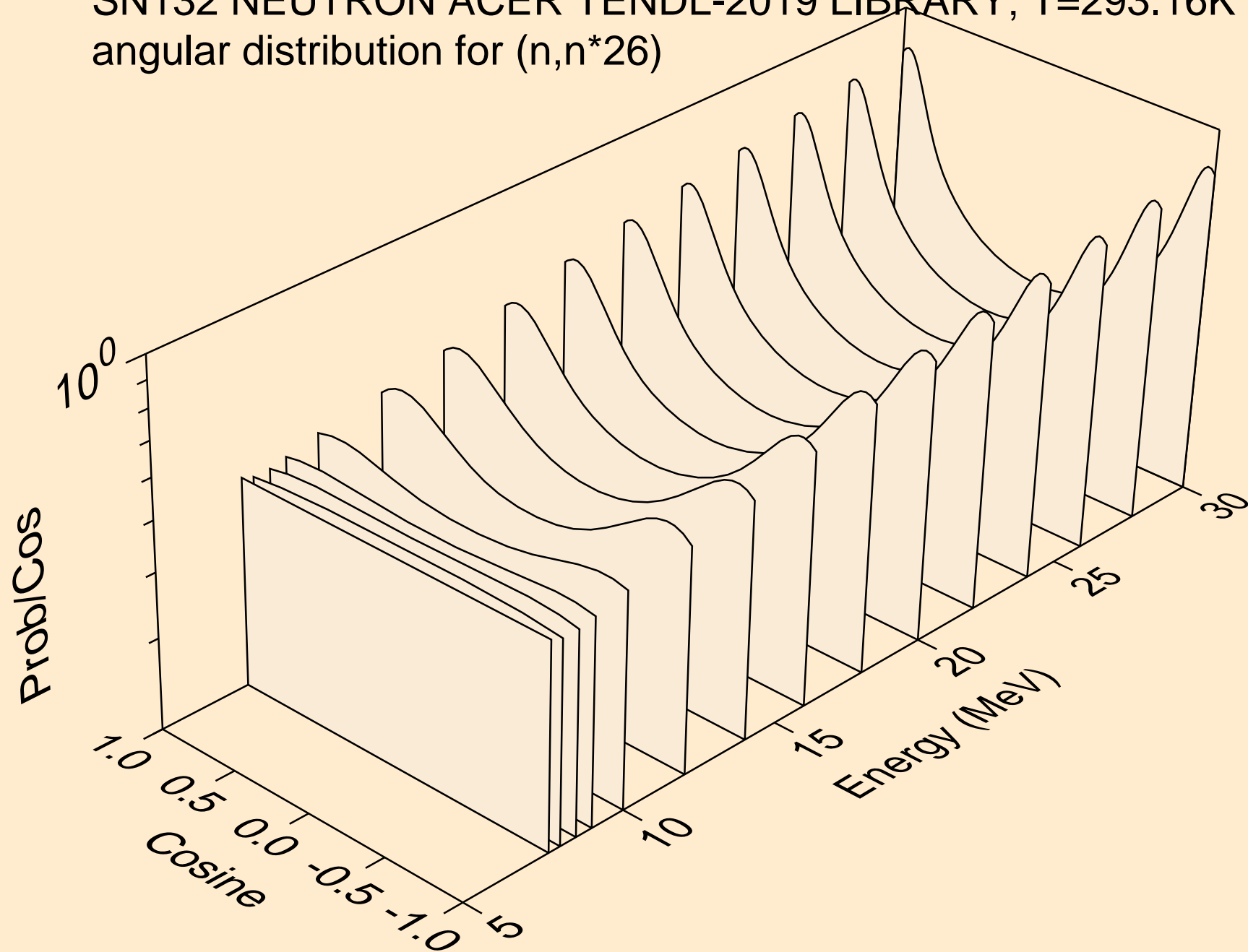

SN132 NEUTRON ACER TENDL-2019 LIBRARY; T=293.16K
angular distribution for (n,n*27)

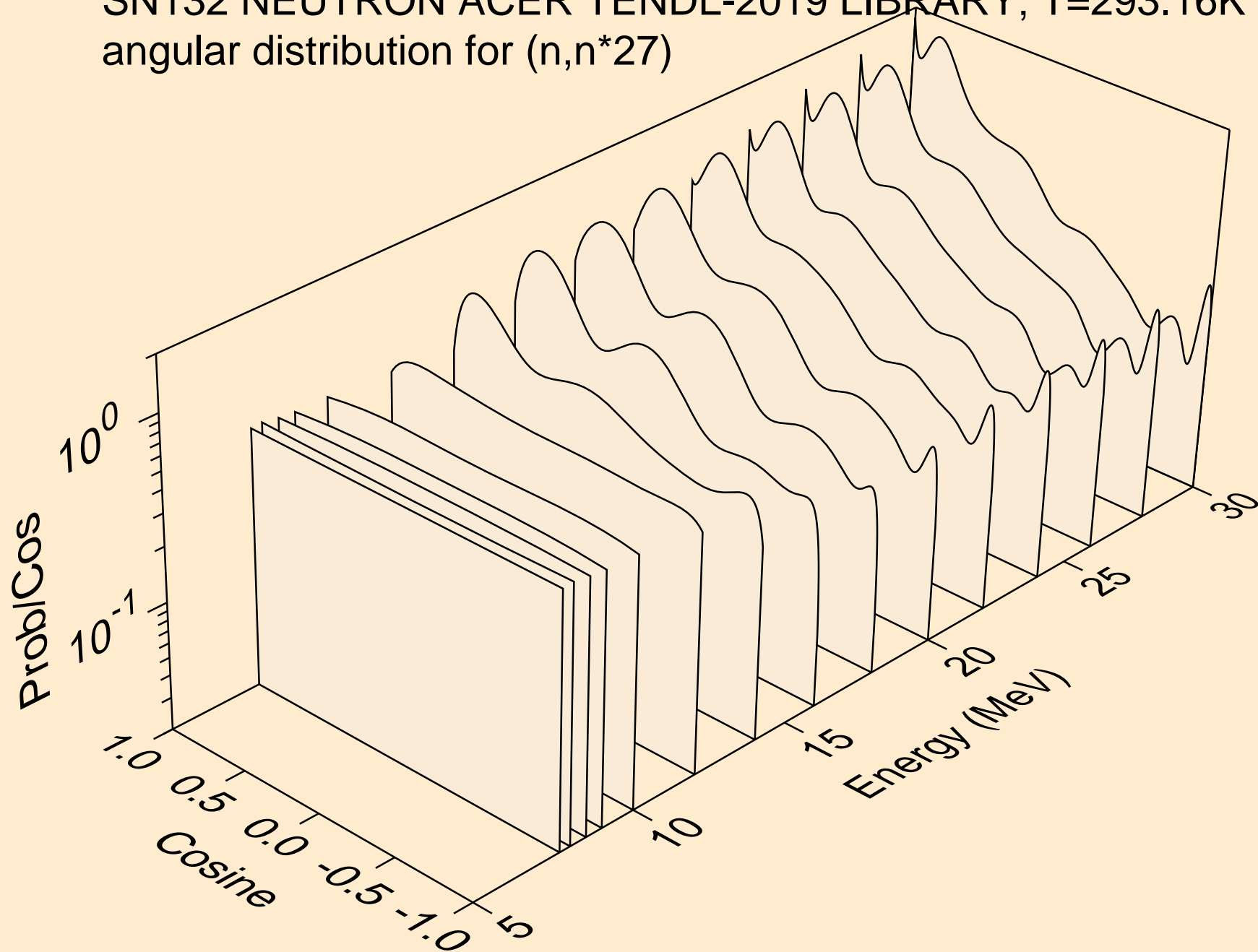

SN132 NEUTRON ACER TENDL-2019 LIBRARY; T=293.16K
angular distribution for (n,n*28)

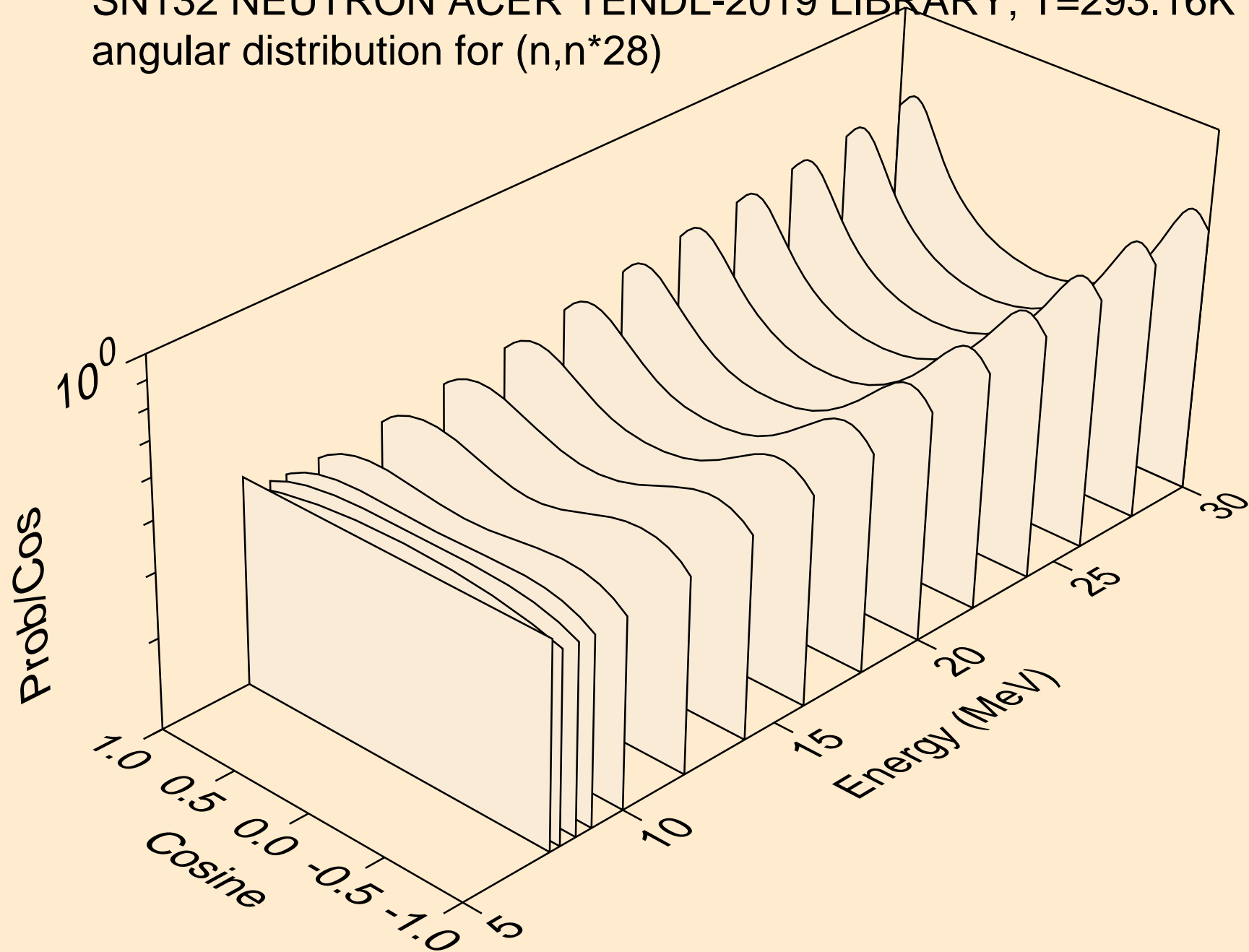

SN132 NEUTRON ACER TENDL-2019 LIBRARY; T=293.16K
angular distribution for (n,n*29)

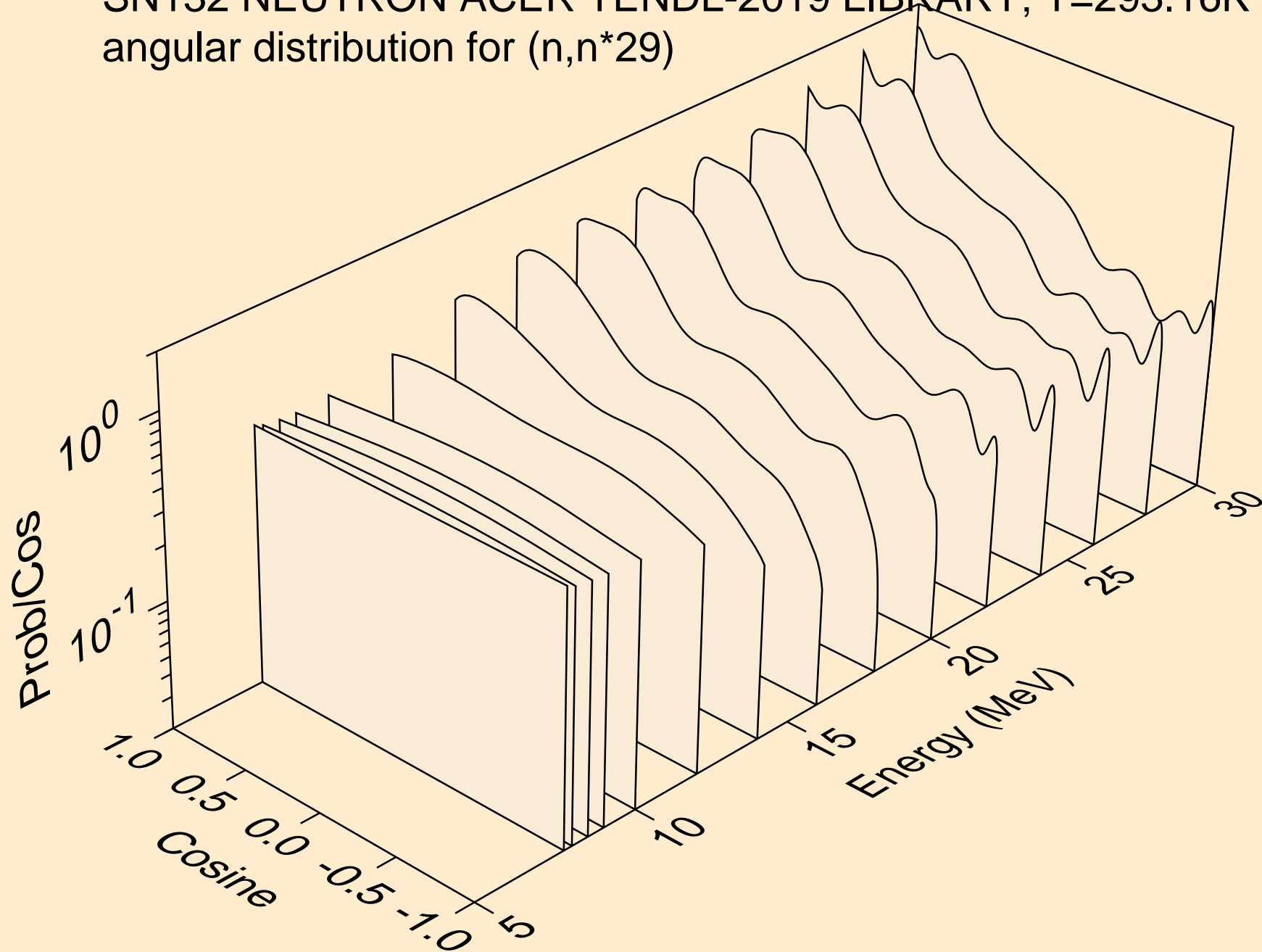

SN132 NEUTRON ACER TENDL-2019 LIBRARY; T=293.16K
angular distribution for (n,n*30)

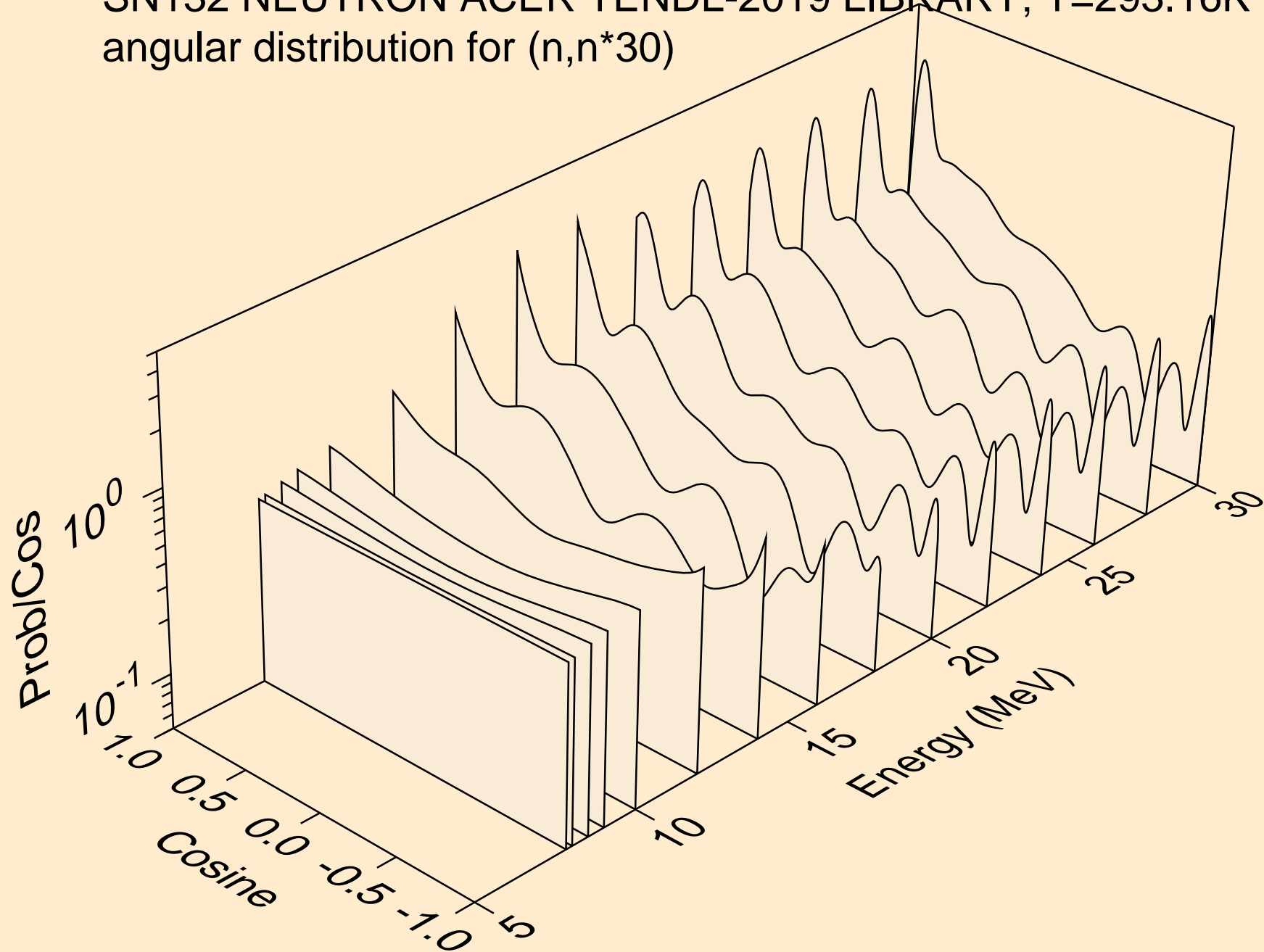

SN132 NEUTRON ACER TENDL-2019 LIBRARY; T=293.16K
Neutron emission for (n,x)

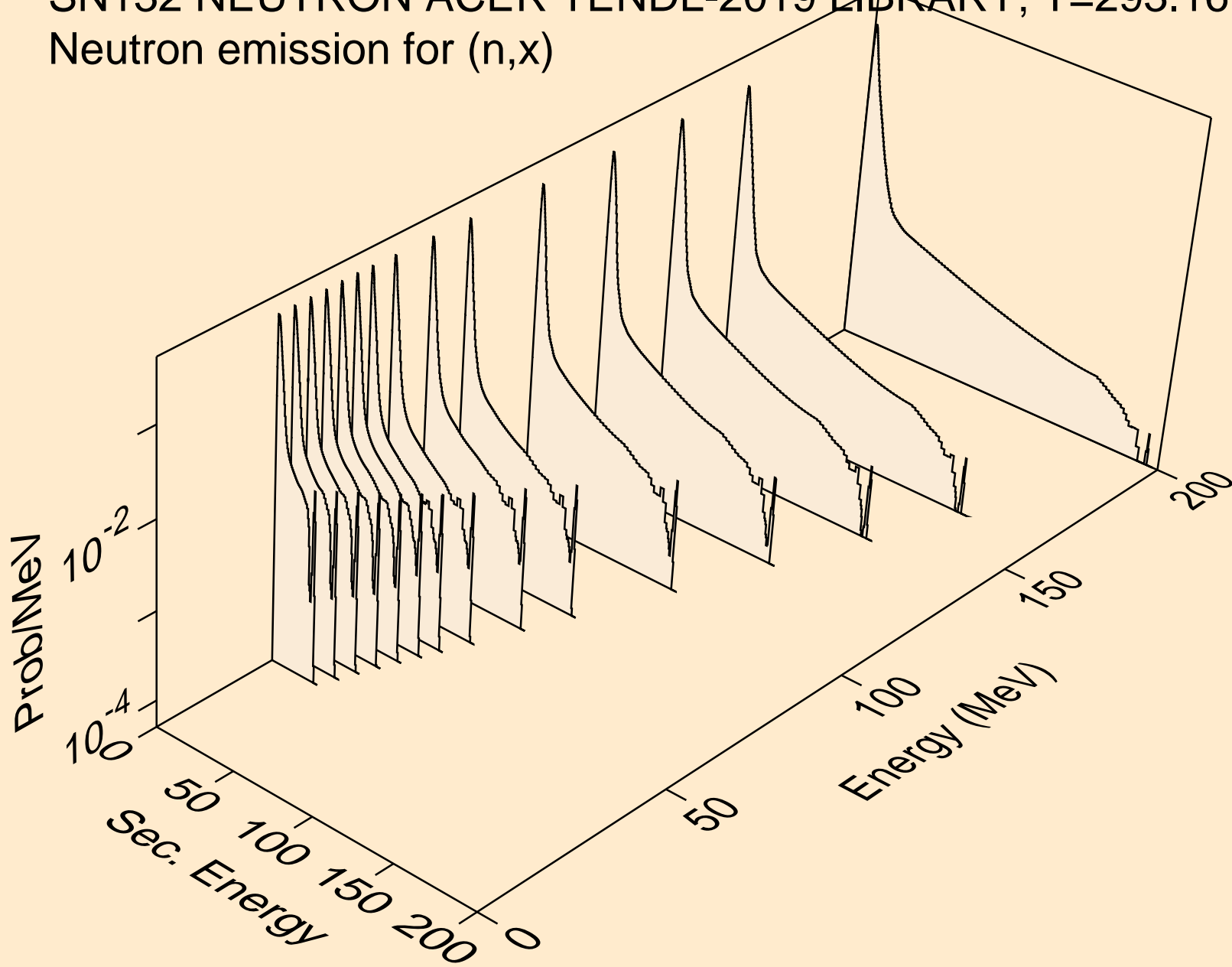

SN132 NEUTRON ACER TENDL-2019 LIBRARY; T=293.16K
Neutron emission for (n,2nd)

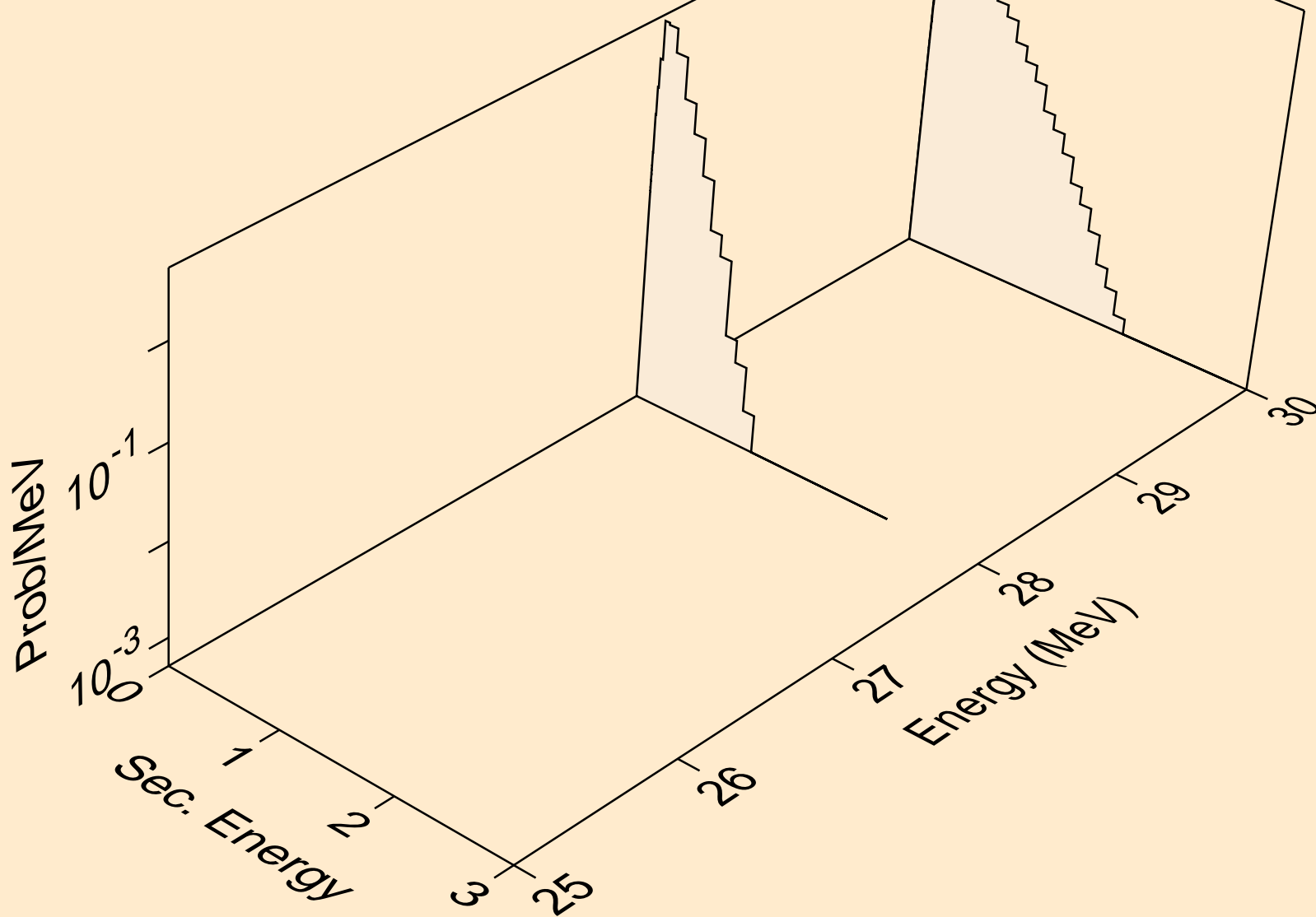

SN132 NEUTRON ACER TENDL-2019 LIBRARY; T=293.16K
Neutron emission for (n,2n)

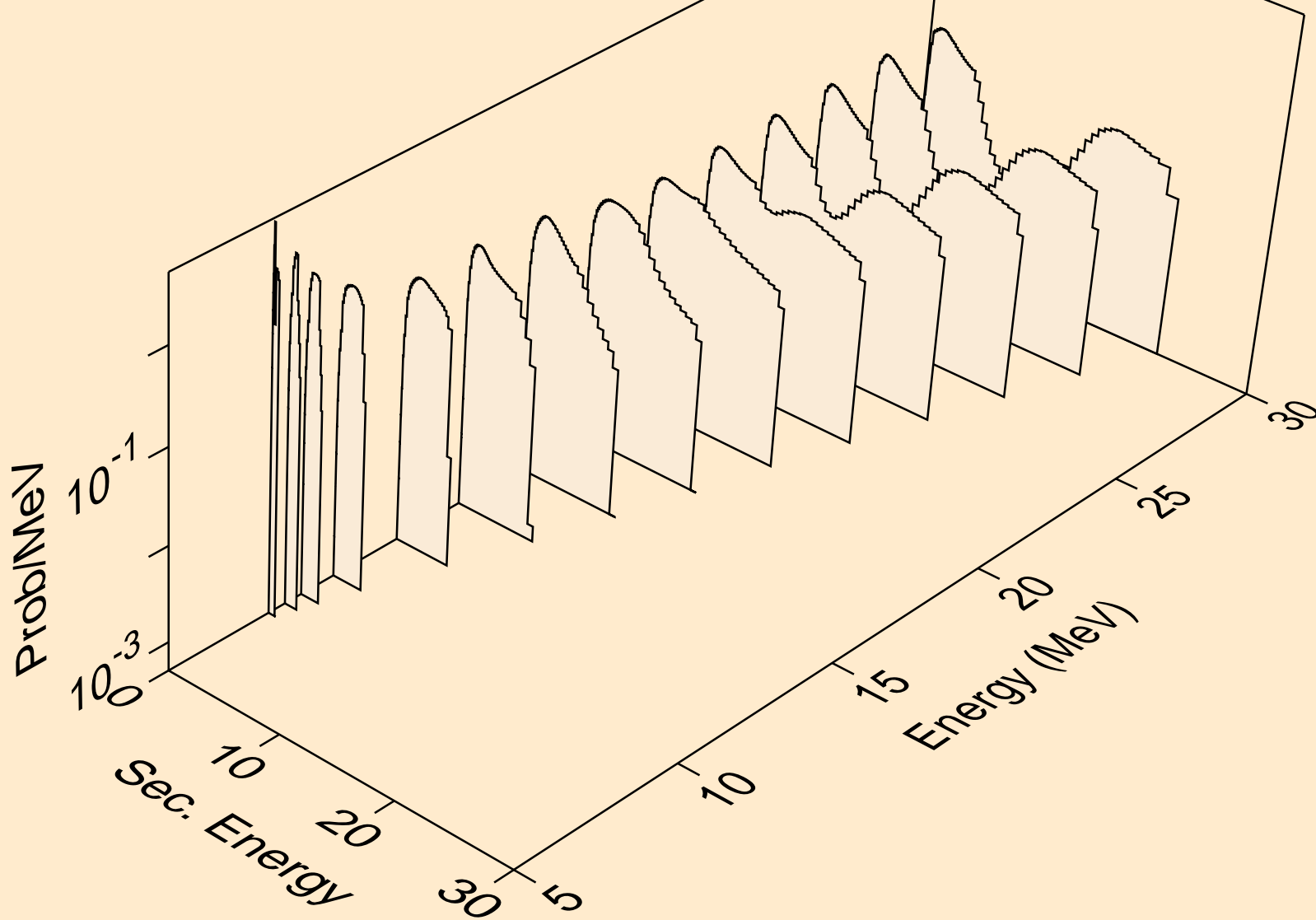

SN132 NEUTRON ACER TENDL-2019 LIBRARY; T=293.16K
Neutron emission for (n,3n)

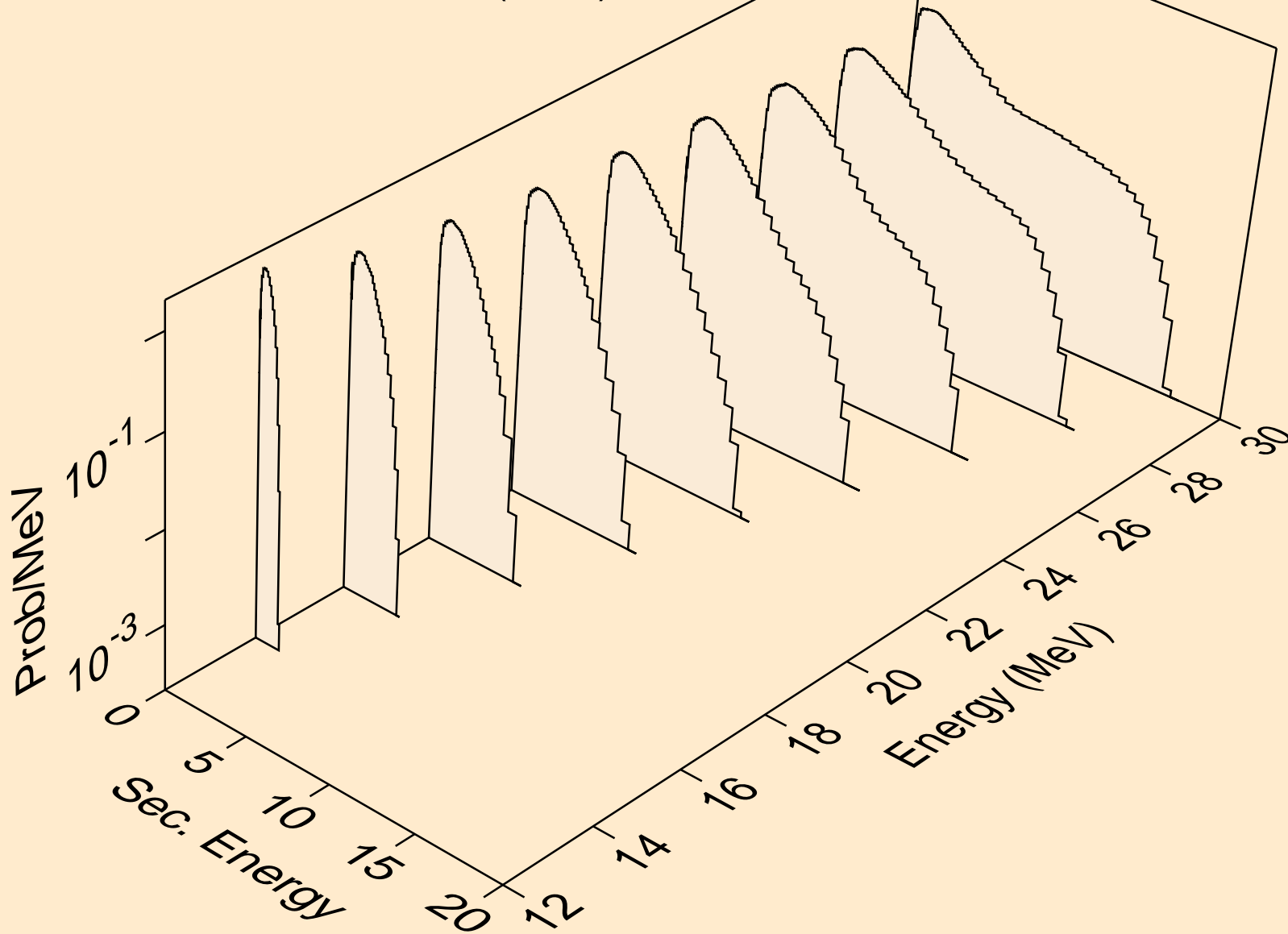

SN132 NEUTRON ACER TENDL-2019 LIBRARY; T=293.16K
Neutron emission for (n,n*)a

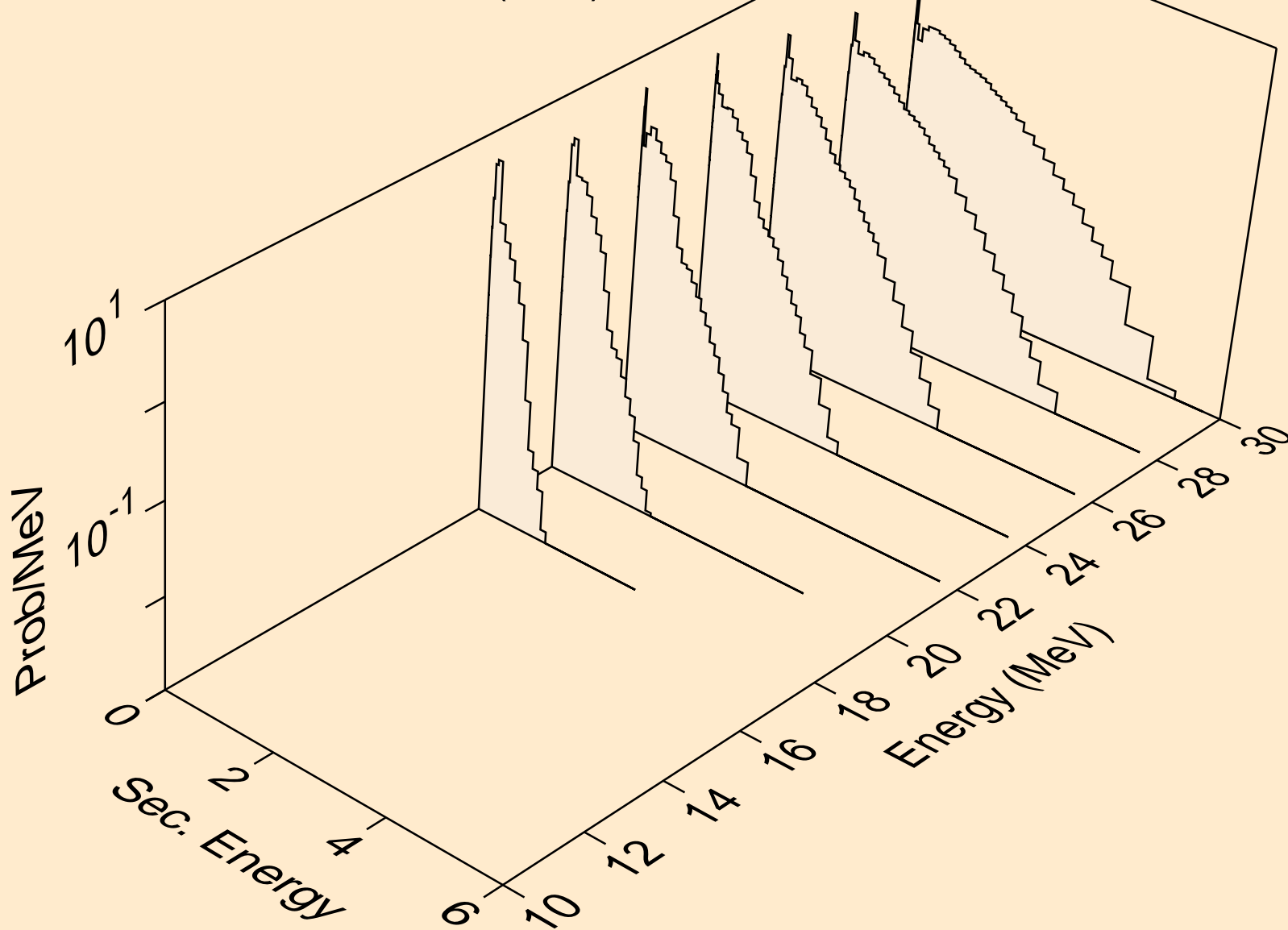

SN132 NEUTRON ACER TENDL-2019 LIBRARY; T=293.16K
Neutron emission for (n,2n)a

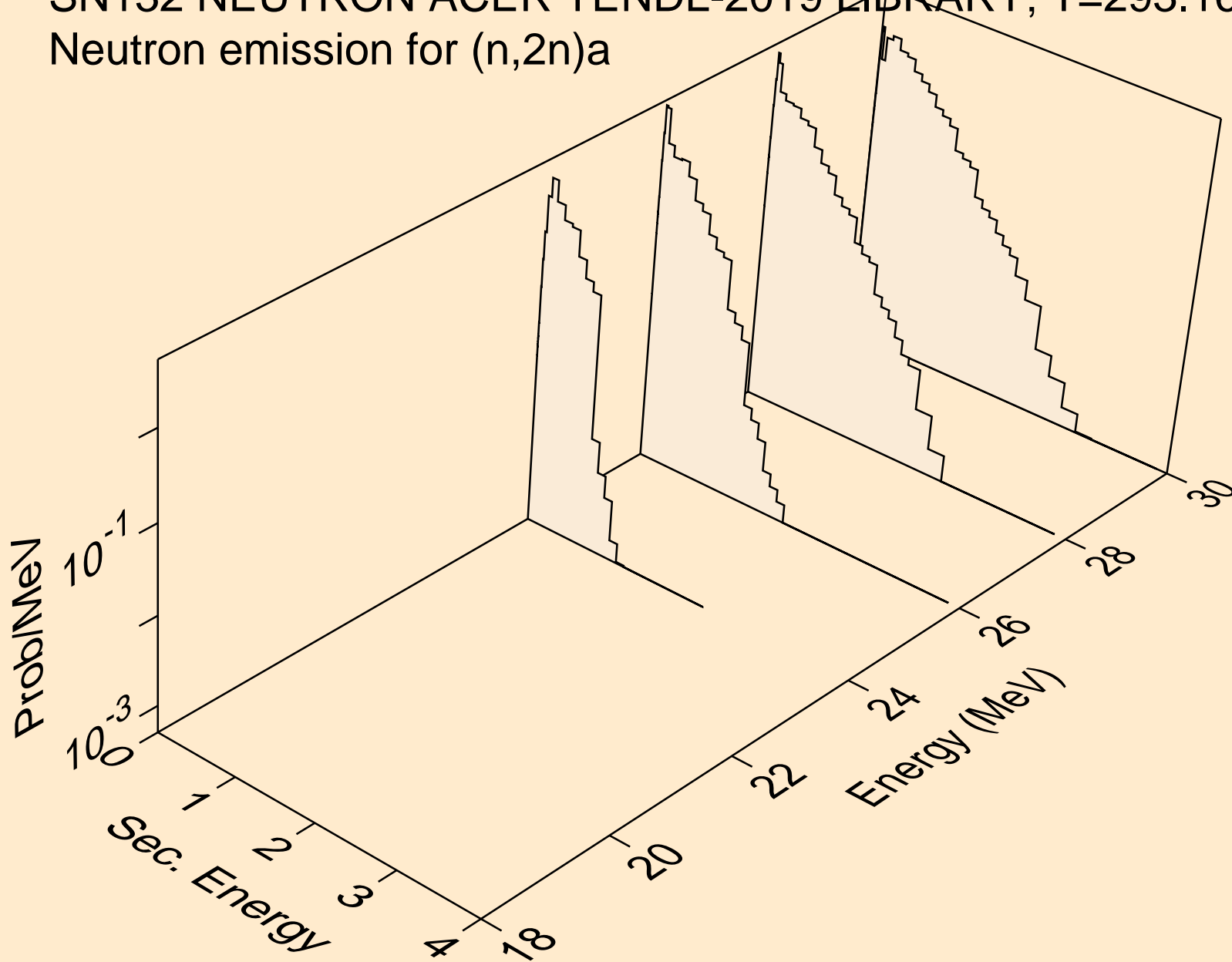

SN132 NEUTRON ACER TENDL-2019 LIBRARY; T=293.16K
Neutron emission for (n,n*)p

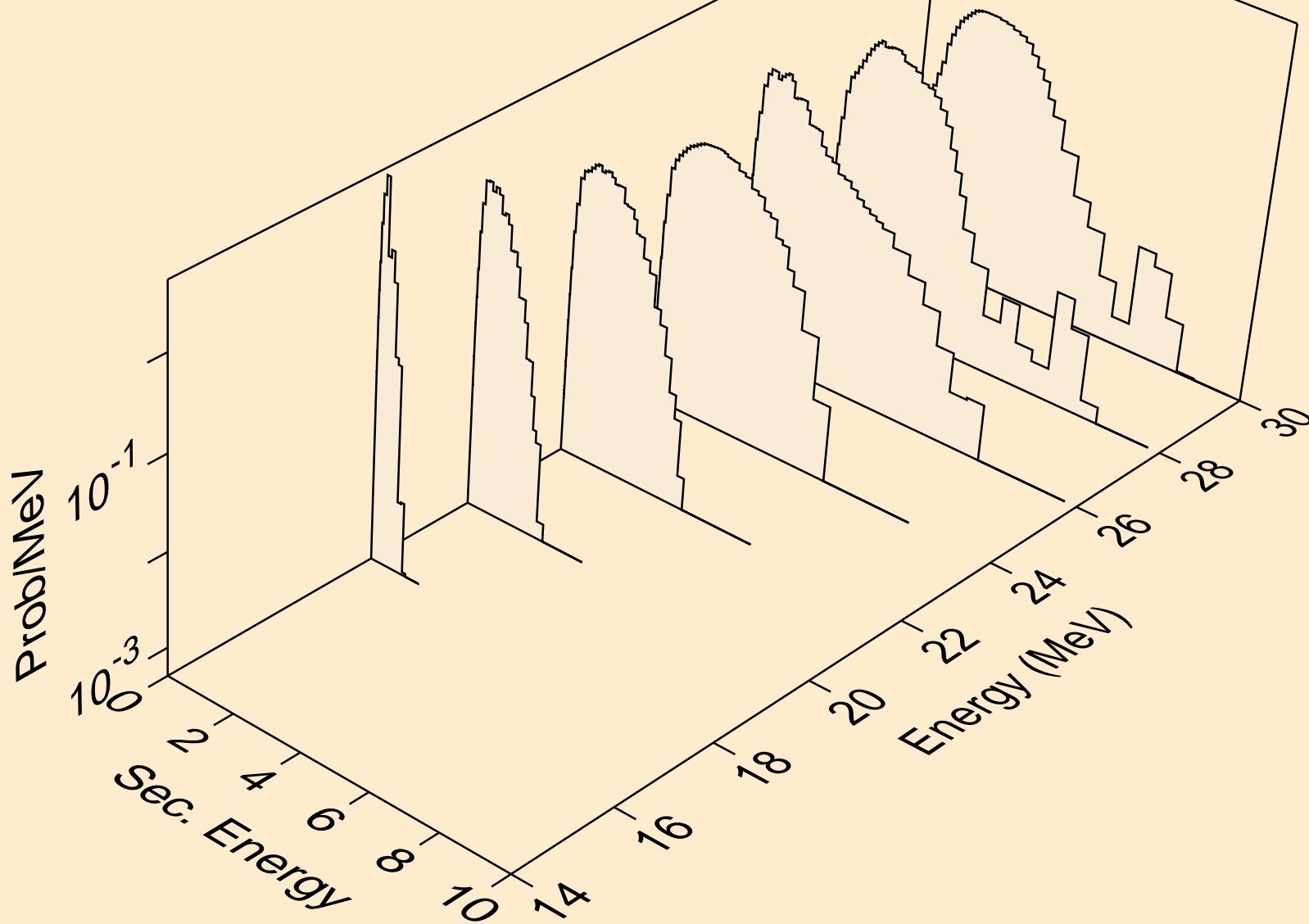

SN132 NEUTRON ACER TENDL-2019 LIBRARY; T=293.16K
Neutron emission for (n,n*)d

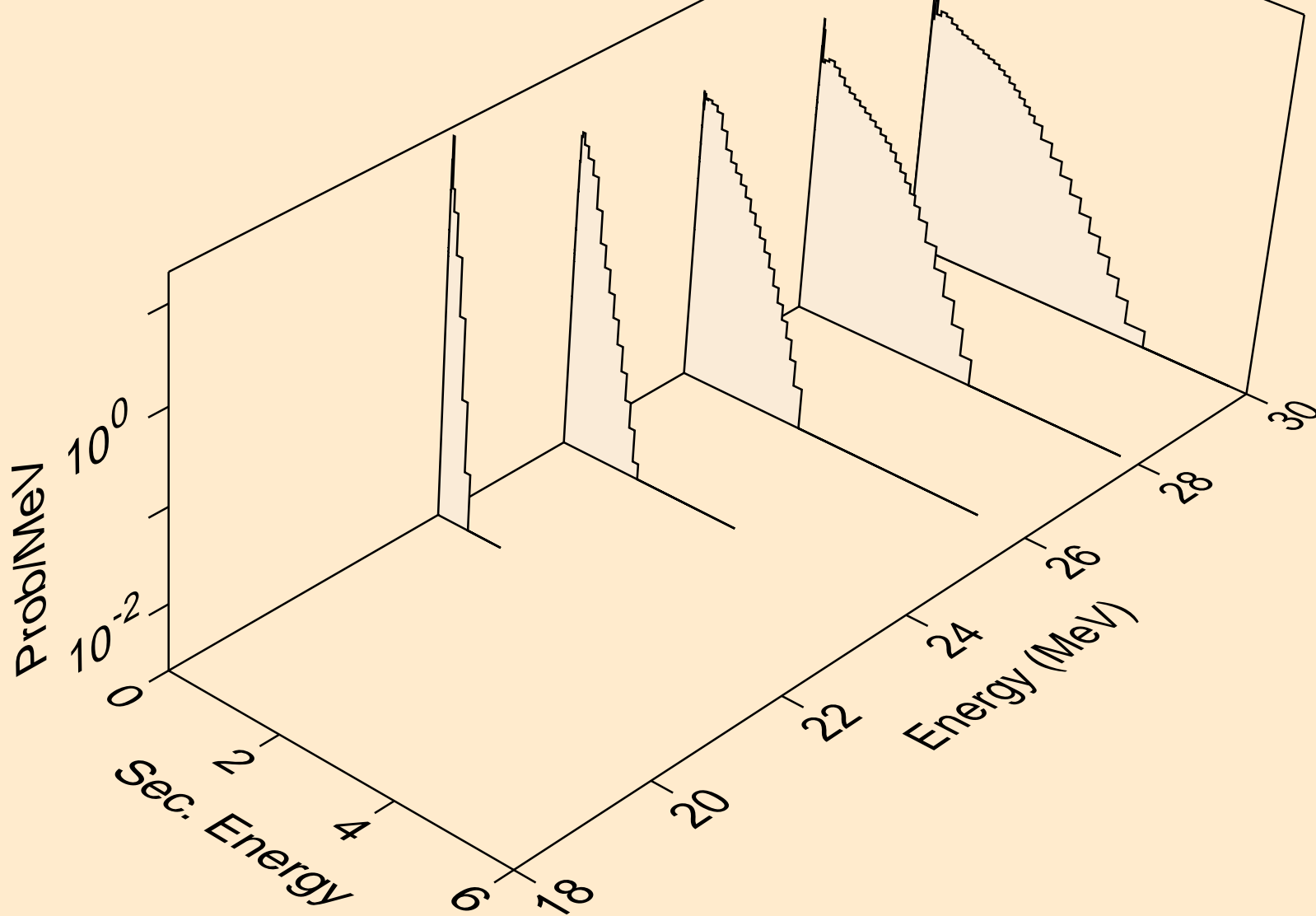

SN132 NEUTRON ACER TENDL-2019 LIBRARY; T=293.16K
Neutron emission for (n,n*)t

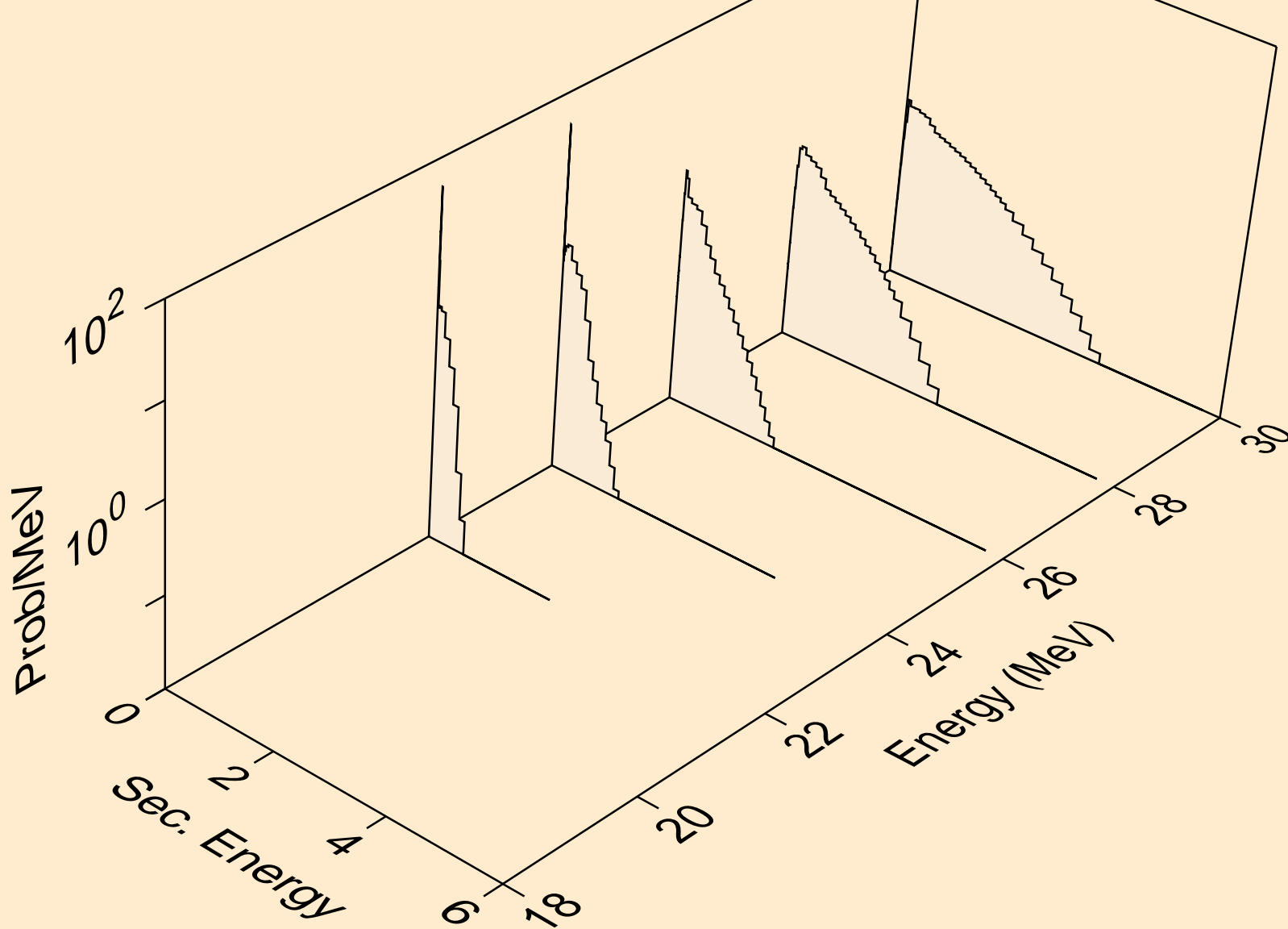

SN132 NEUTRON ACER TENDL-2019 LIBRARY; T=293.16K
Neutron emission for (n,4n)

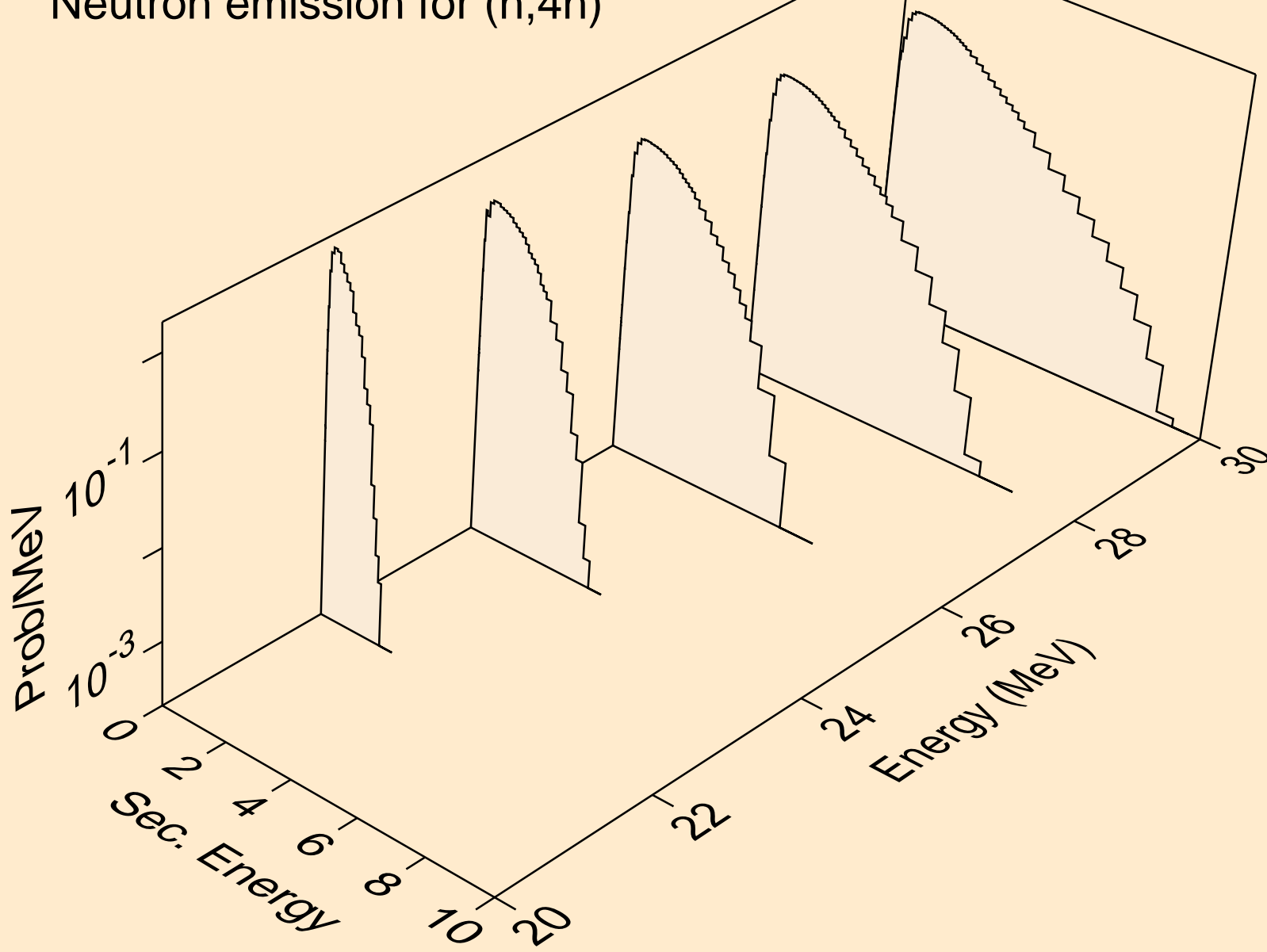

SN132 NEUTRON ACER TENDL-2019 LIBRARY; T=293.16K
Neutron emission for (n,2np)

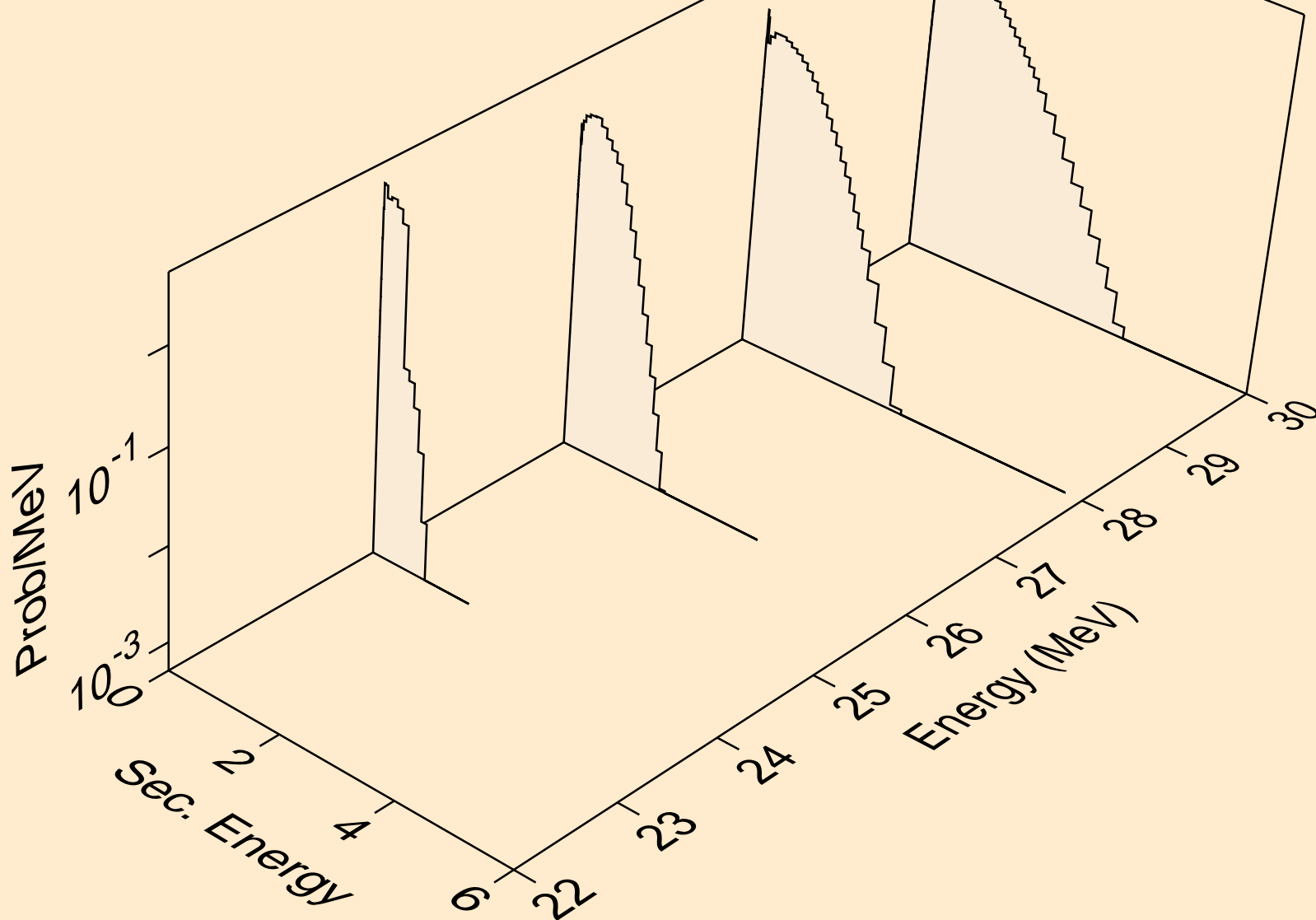

SN132 NEUTRON ACER TENDL-2019 LIBRARY; T=293.16K
Neutron emission for (n,n*c)

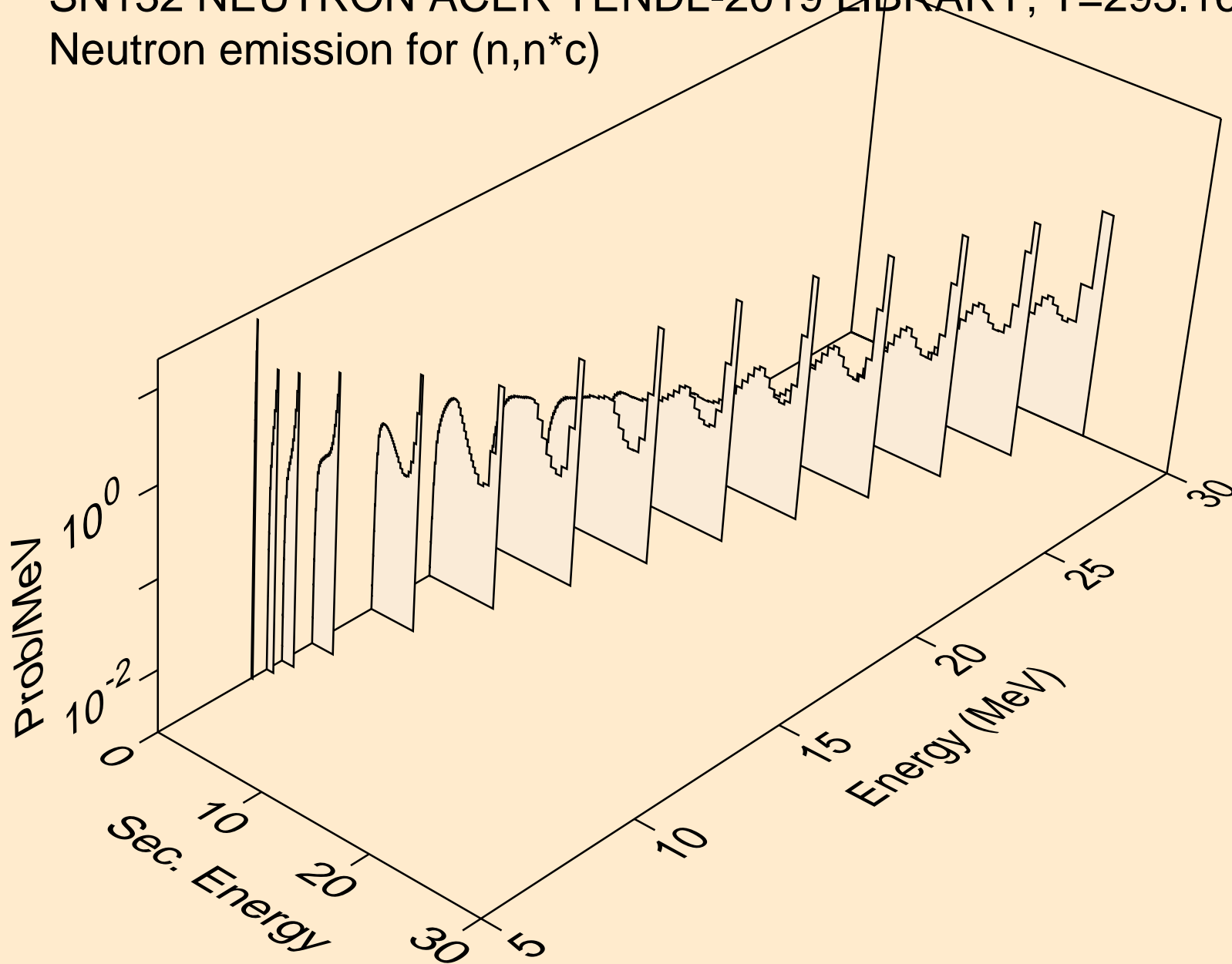

SN132 NEUTRON ACER TENDL-2019 LIBRARY; T=293.16K
Photon emission for (n,x)

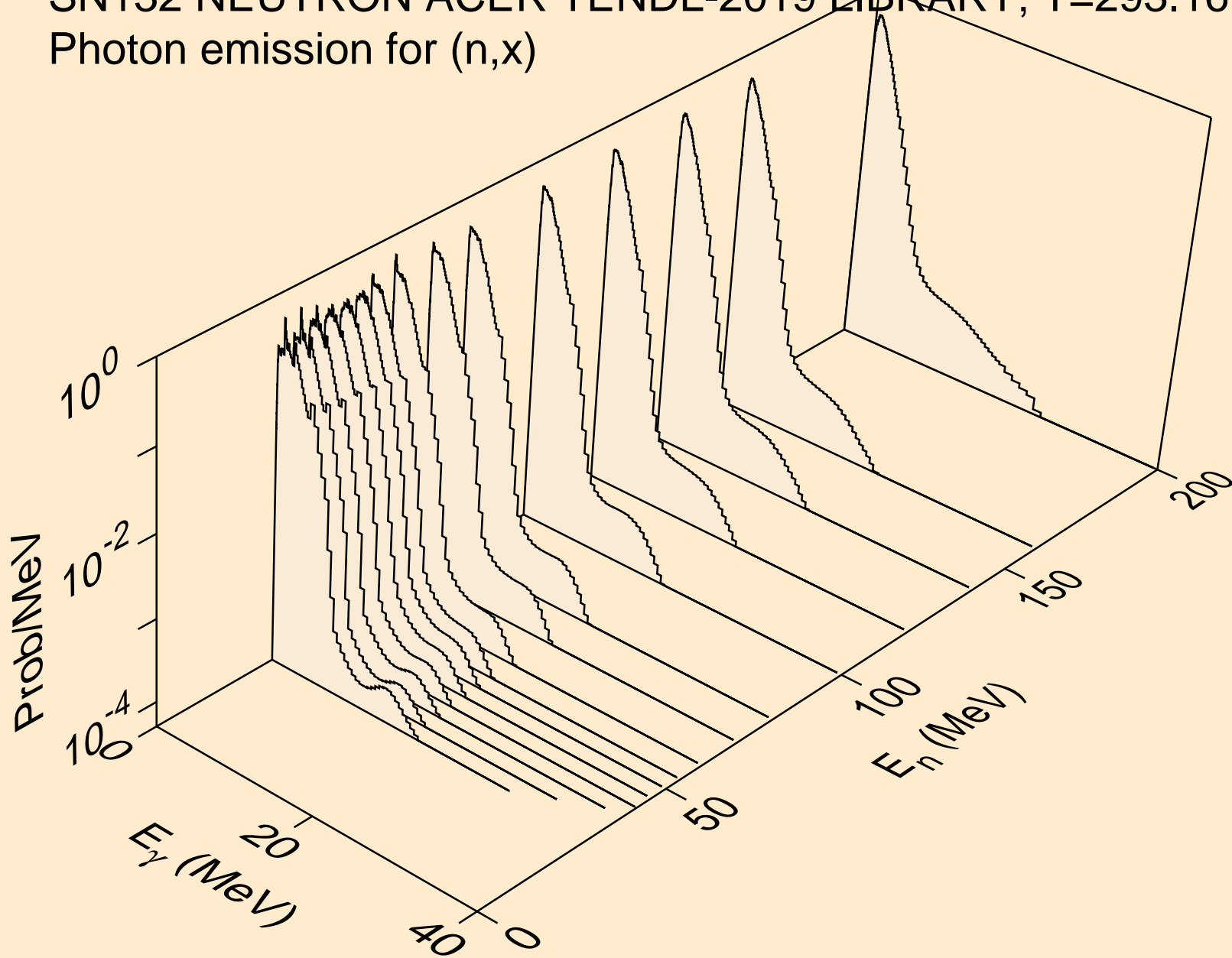

SN132 NEUTRON ACER TENDL-2019 LIBRARY; T=293.16K
Photon emission for (n,2nd)

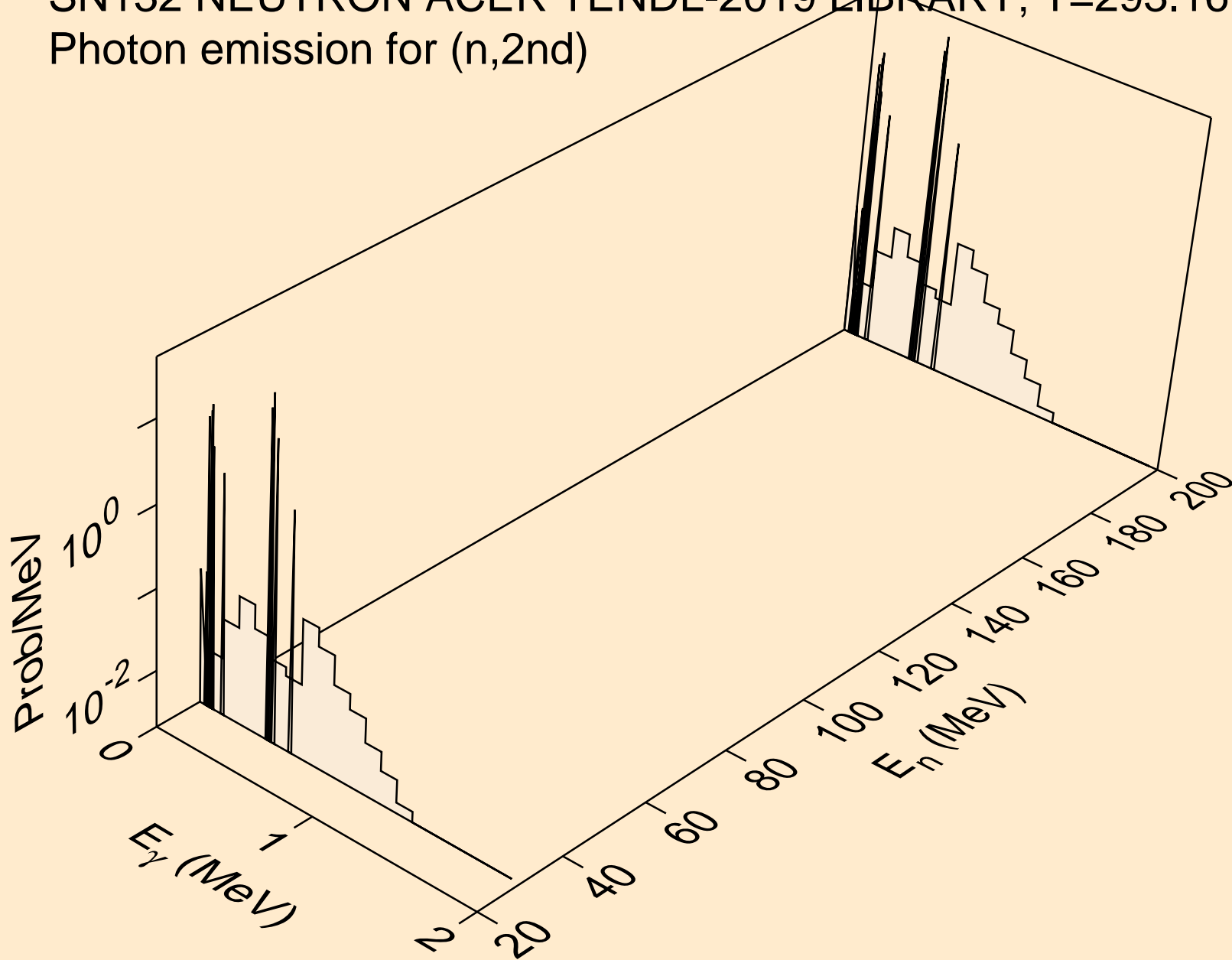

SN132 NEUTRON ACER TENDL-2019 LIBRARY; T=293.16K
Photon emission for (n,2n)

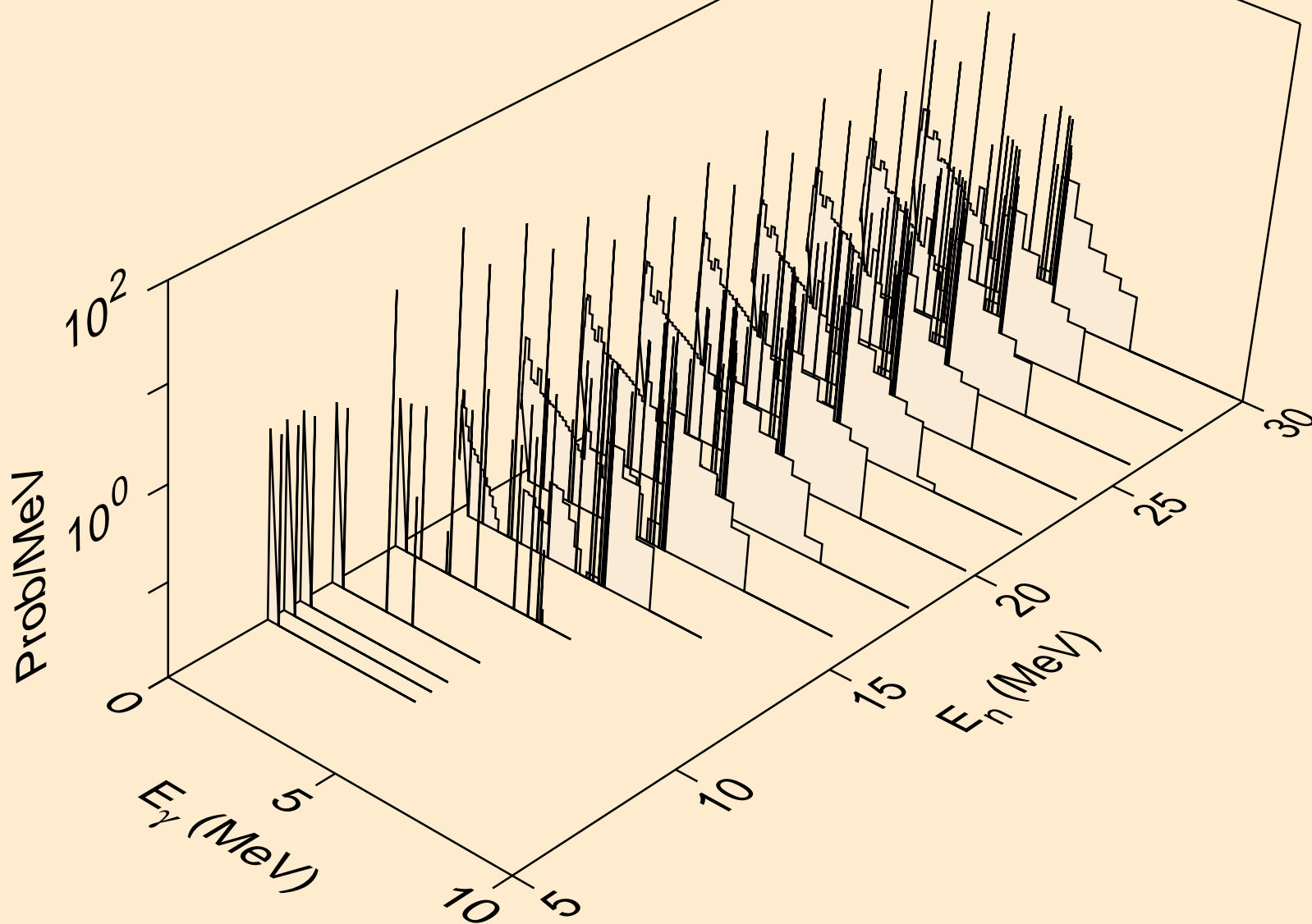

SN132 NEUTRON ACER TENDL-2019 LIBRARY; T=293.16K
Photon emission for (n,3n)

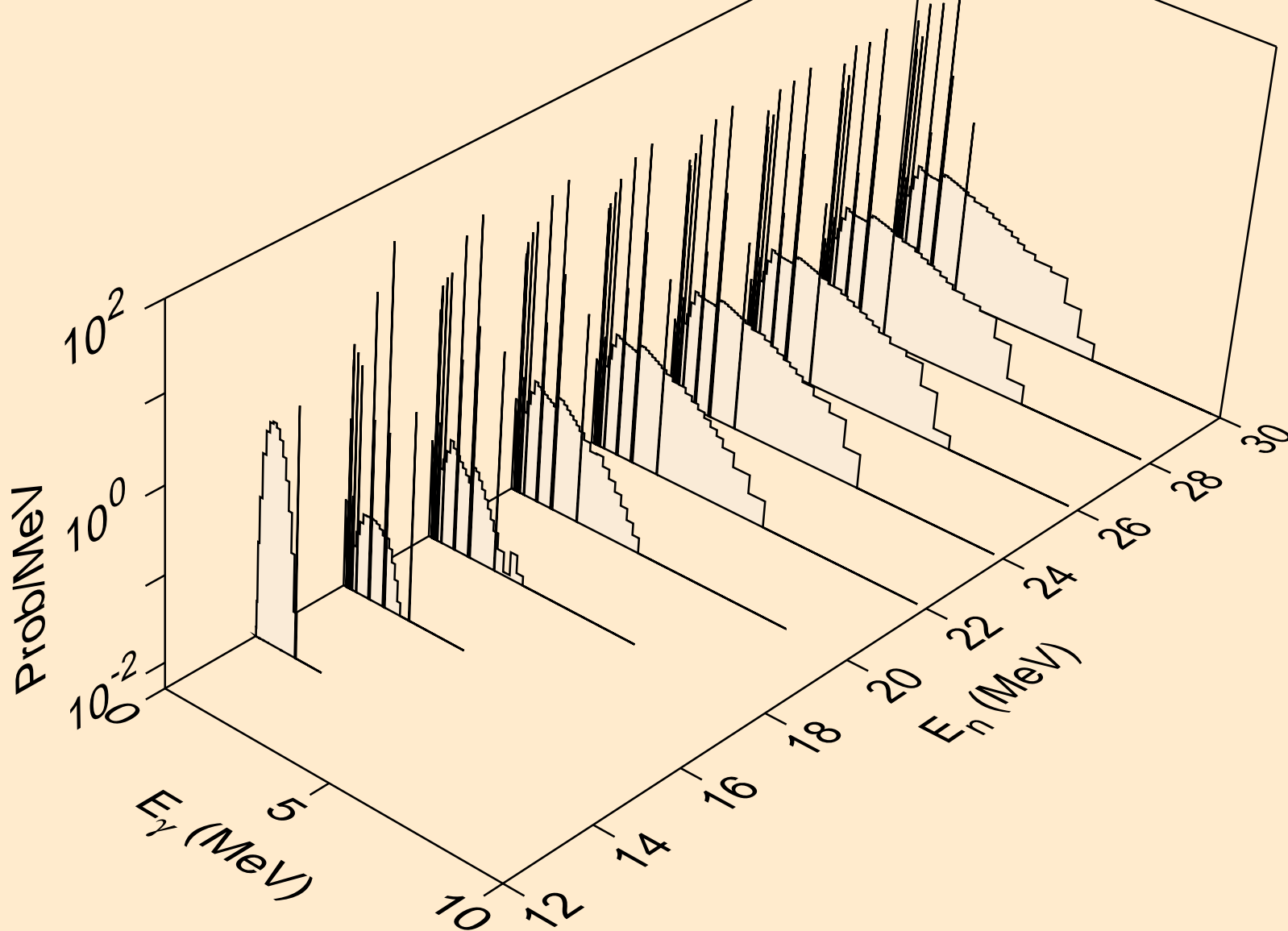

SN132 NEUTRON ACER TENDL-2019 LIBRARY; T=293.16K
Photon emission for (n,n*)a

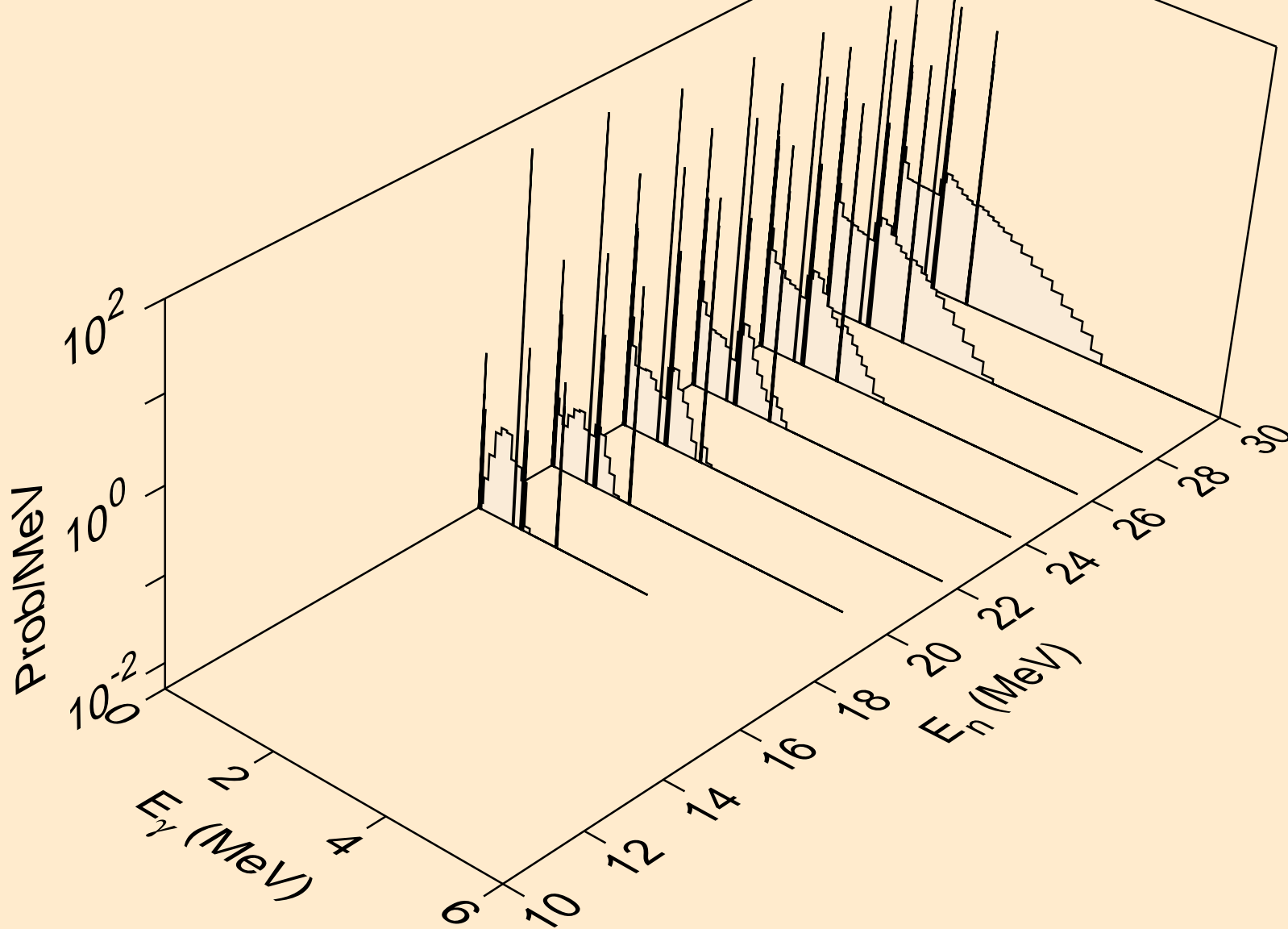

SN132 NEUTRON ACER TENDL-2019 LIBRARY; T=293.16K
Photon emission for (n,2n)a

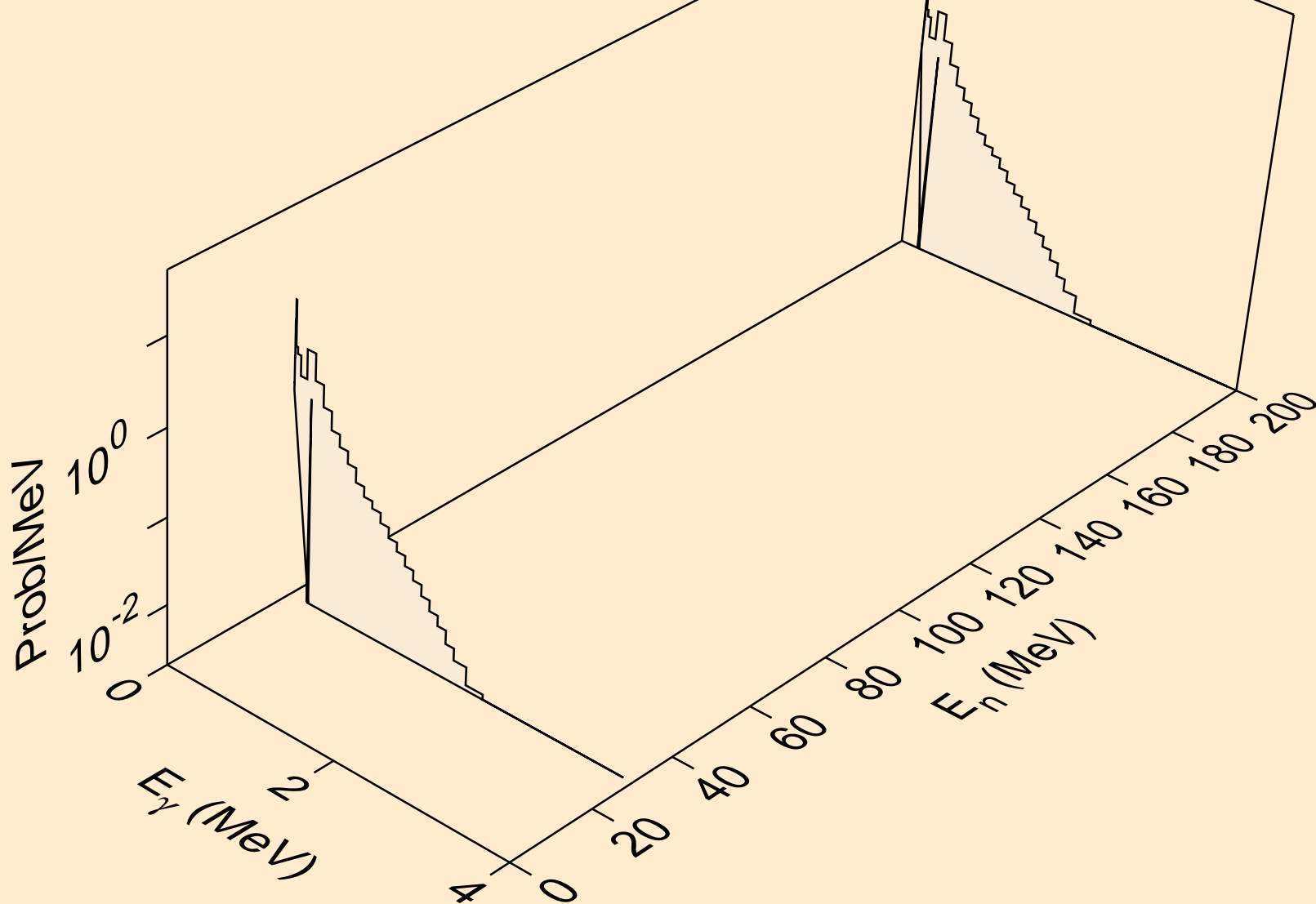

SN132 NEUTRON ACER TENDL-2019 LIBRARY; T=293.16K
Photon emission for (n,n*)p

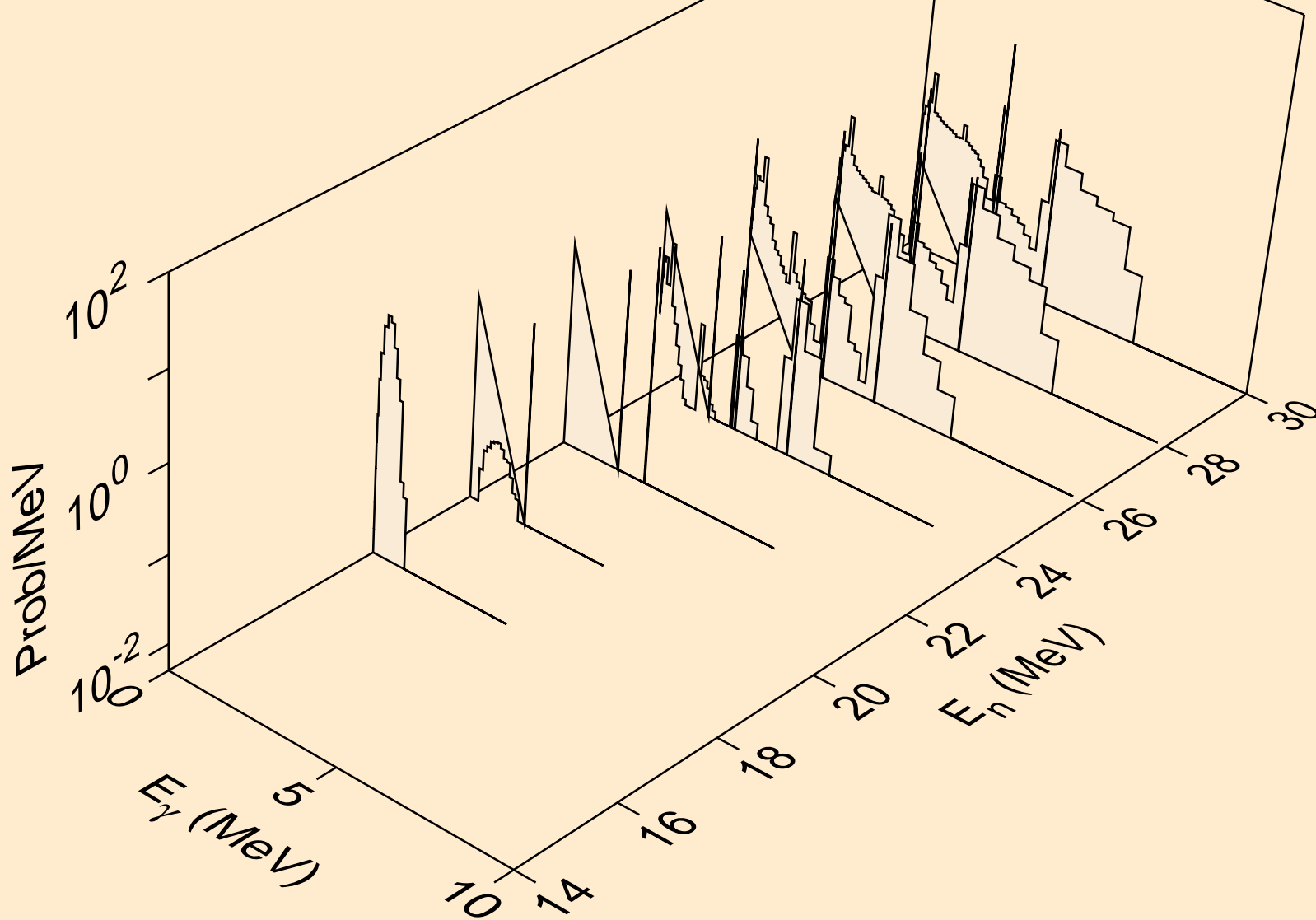

SN132 NEUTRON ACER TENDL-2019 LIBRARY; T=293.16K
Photon emission for (n,n*)d

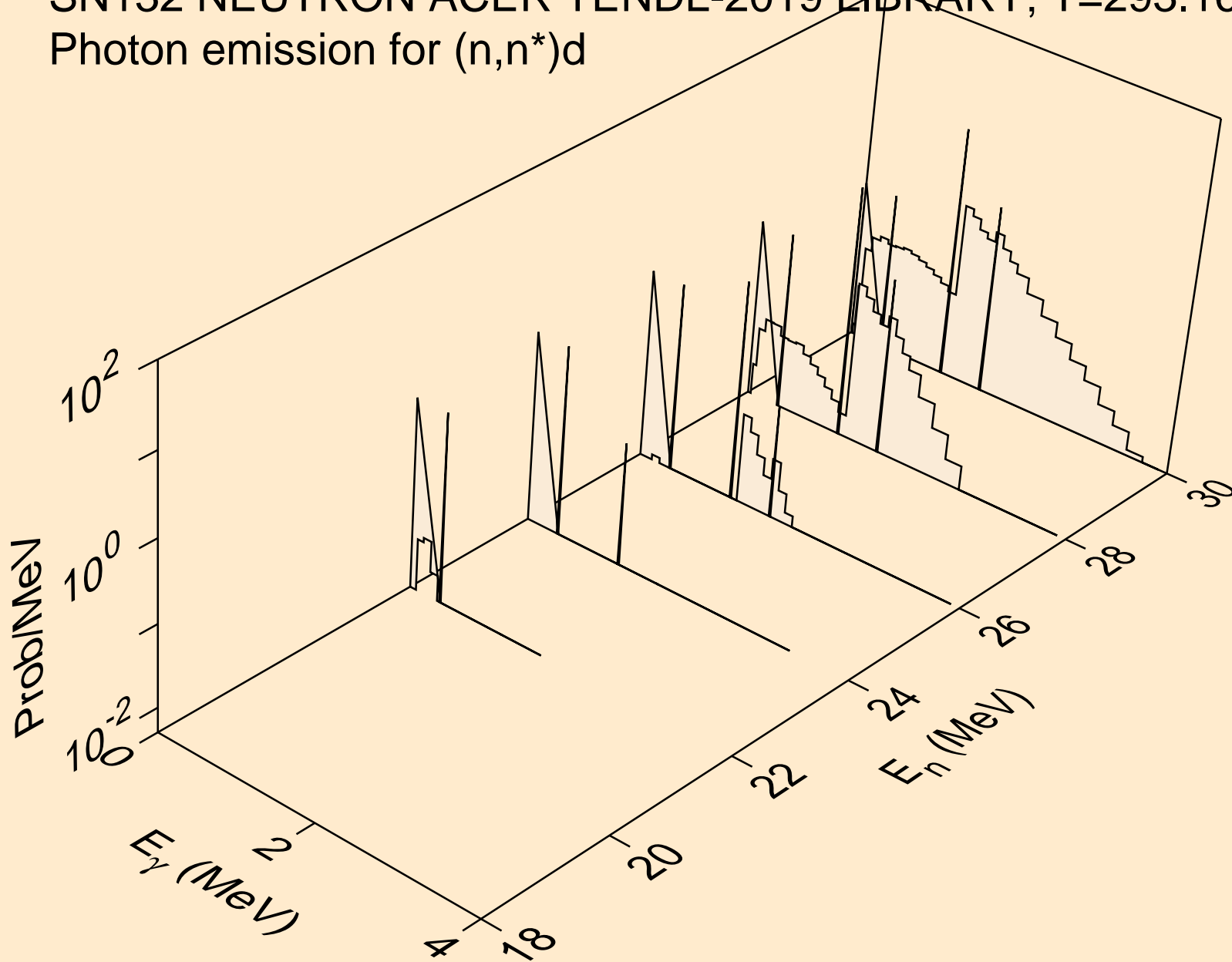

SN132 NEUTRON ACER TENDL-2019 LIBRARY; T=293.16K
Photon emission for (n,n*)t

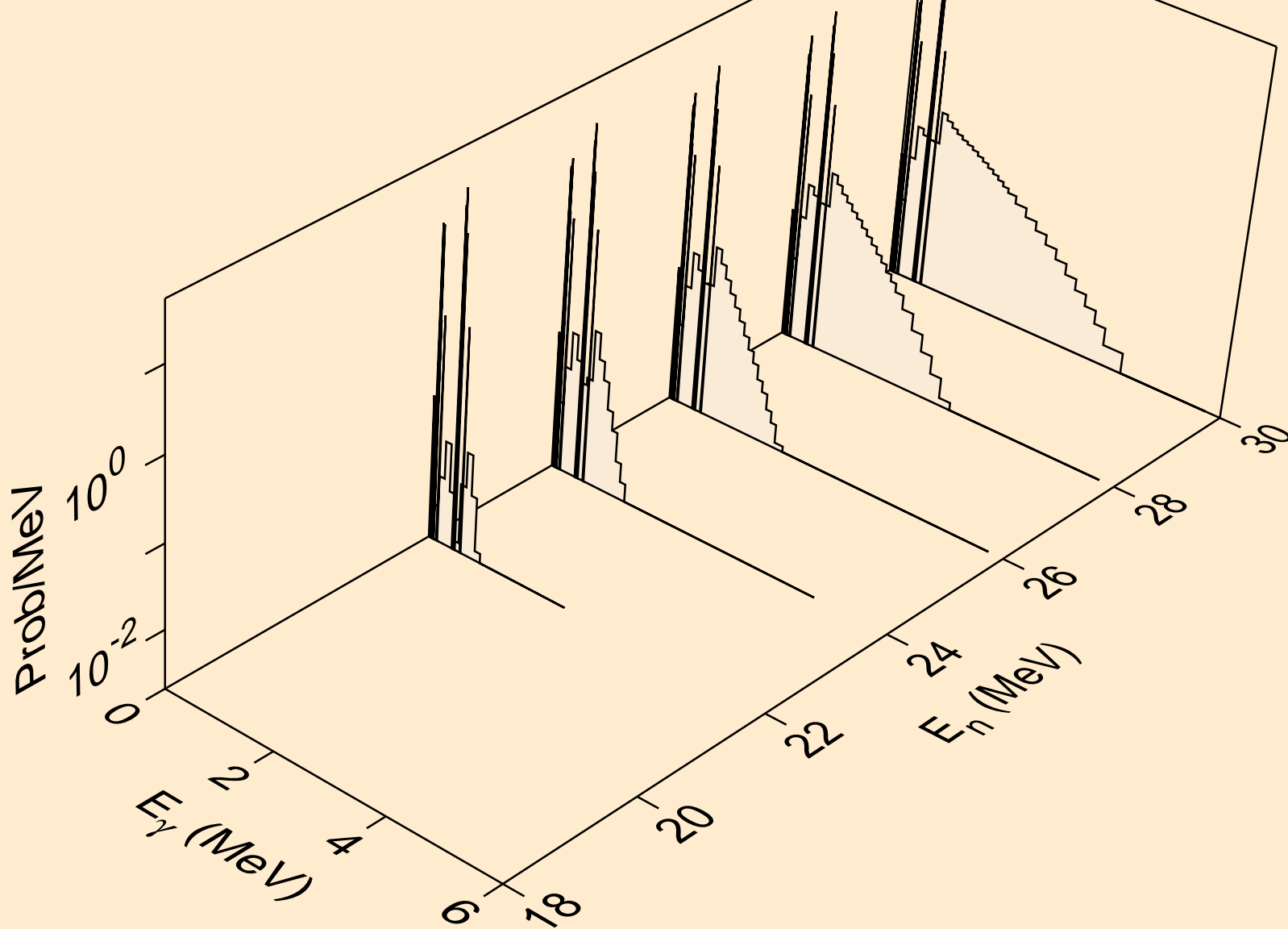

SN132 NEUTRON ACER TENDL-2019 LIBRARY; T=293.16K
Photon emission for (n,4n)

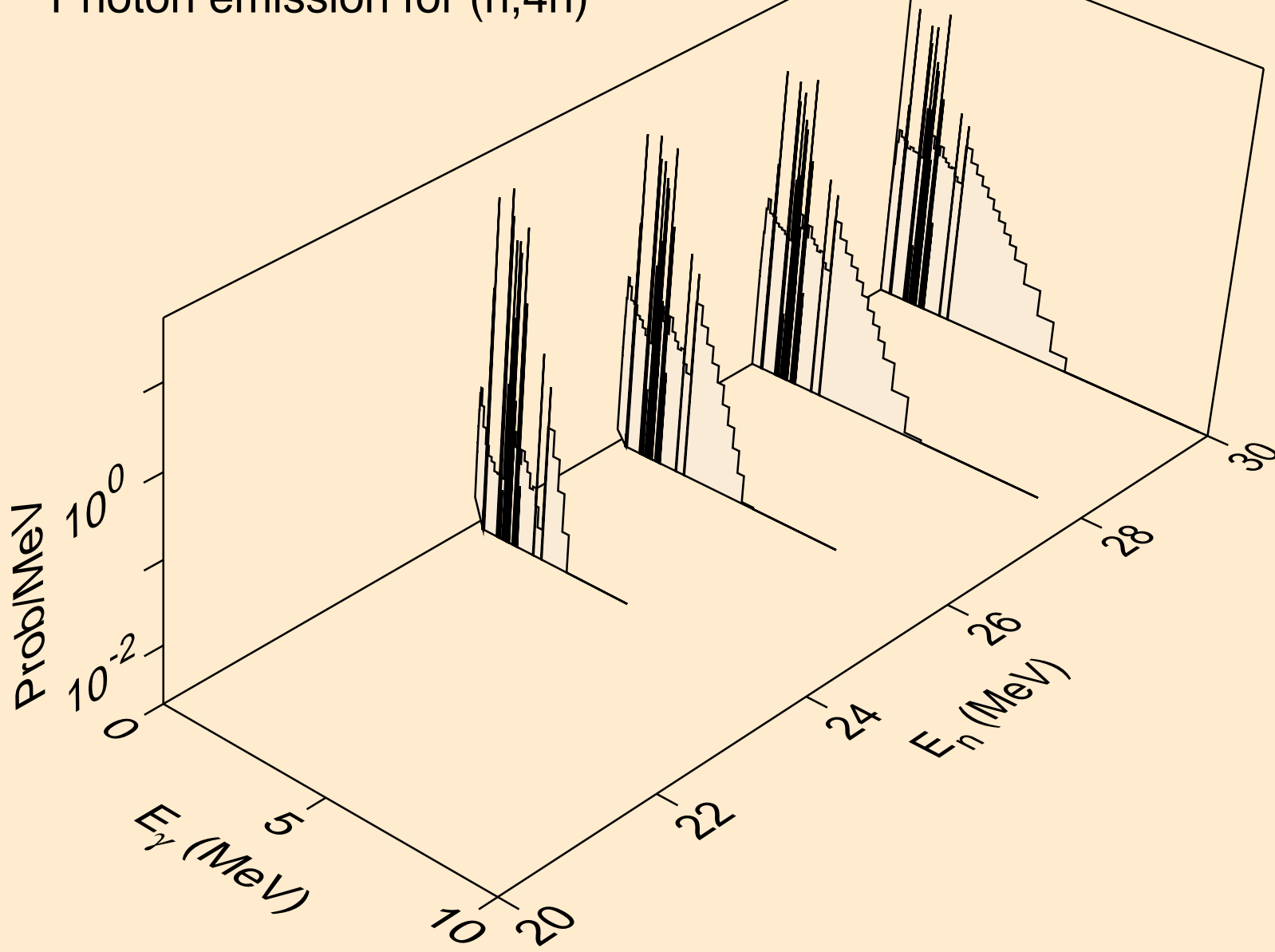

SN132 NEUTRON ACER TENDL-2019 LIBRARY; T=293.16K
Photon emission for (n,2np)

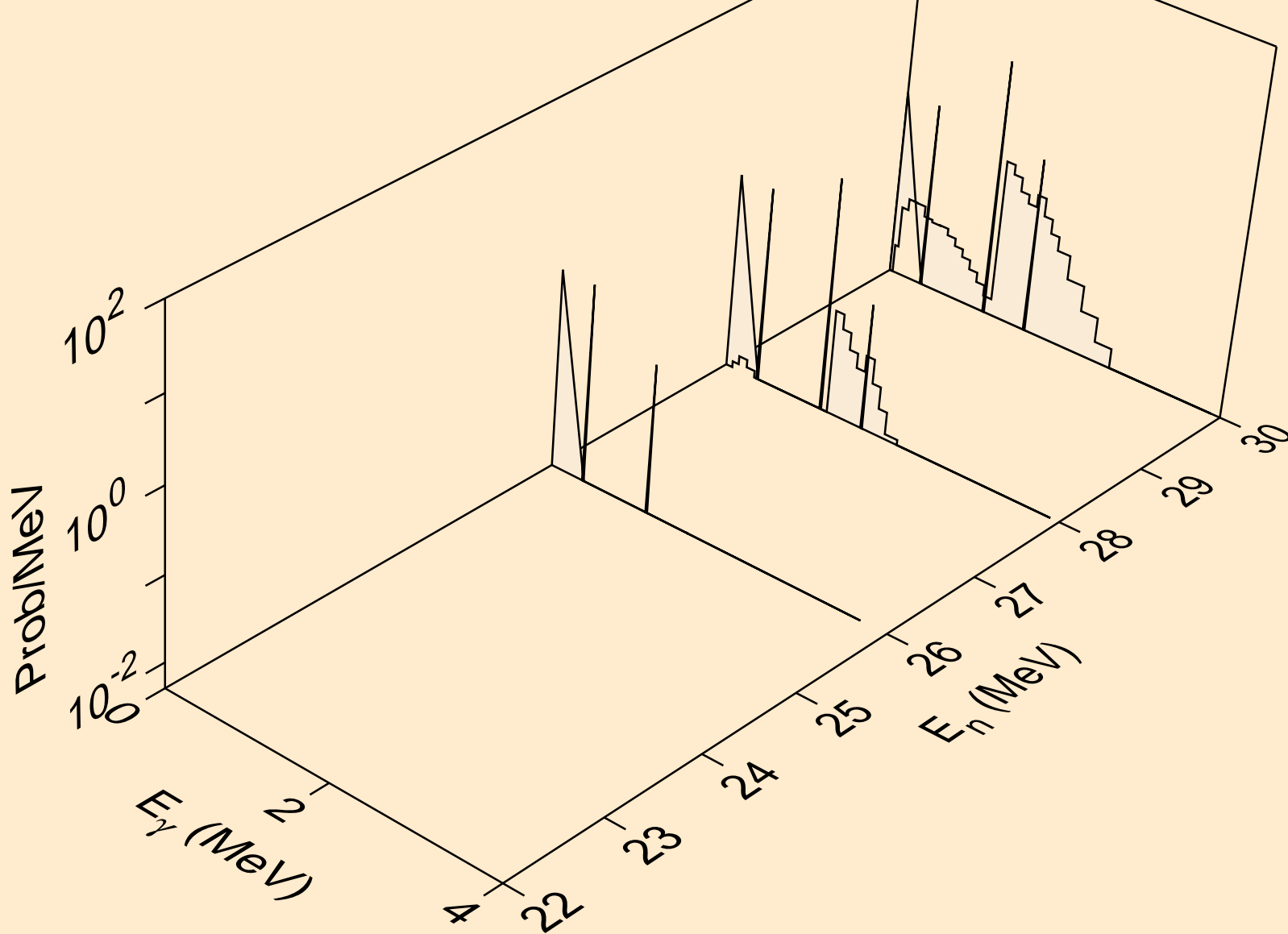

SN132 NEUTRON ACER TENDL-2019 LIBRARY; T=293.16K
Photon emission for (n,n*c)

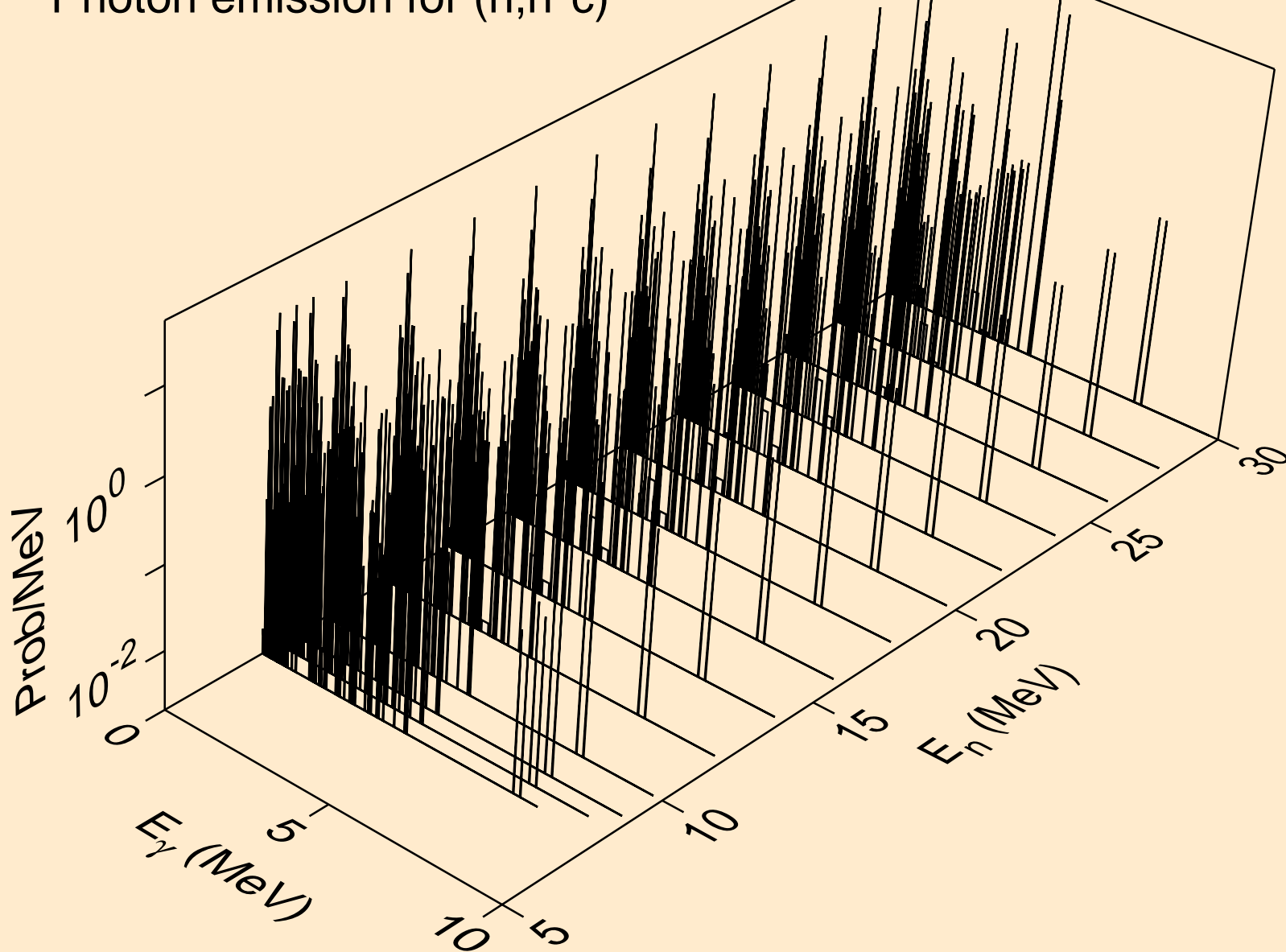

SN132 NEUTRON ACER TENDL-2019 LIBRARY; T=293.16K
Photon emission for (n,gma)

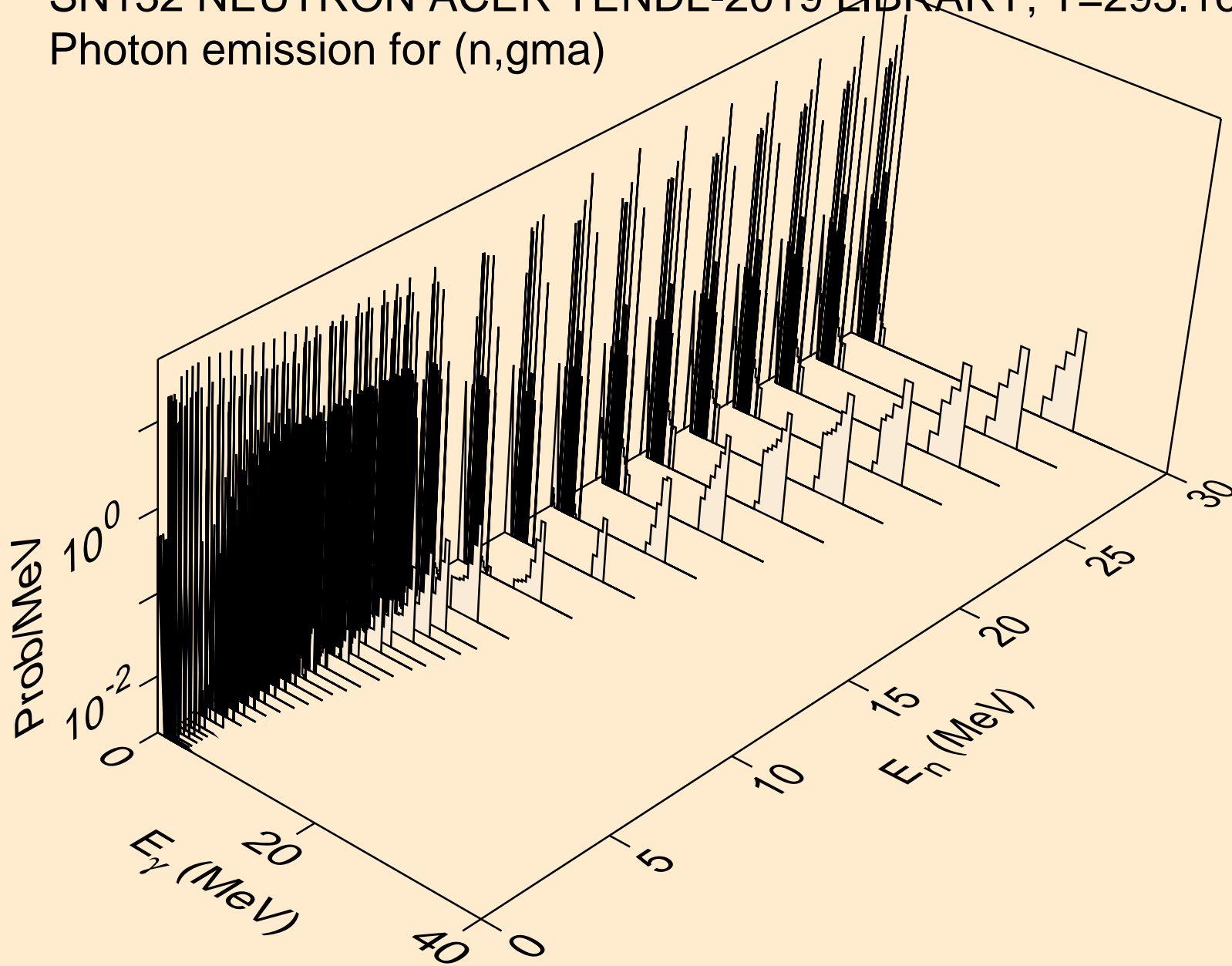

SN132 NEUTRON ACER TENDL-2019 LIBRARY; T=293.16K
Photon emission for (n,p)

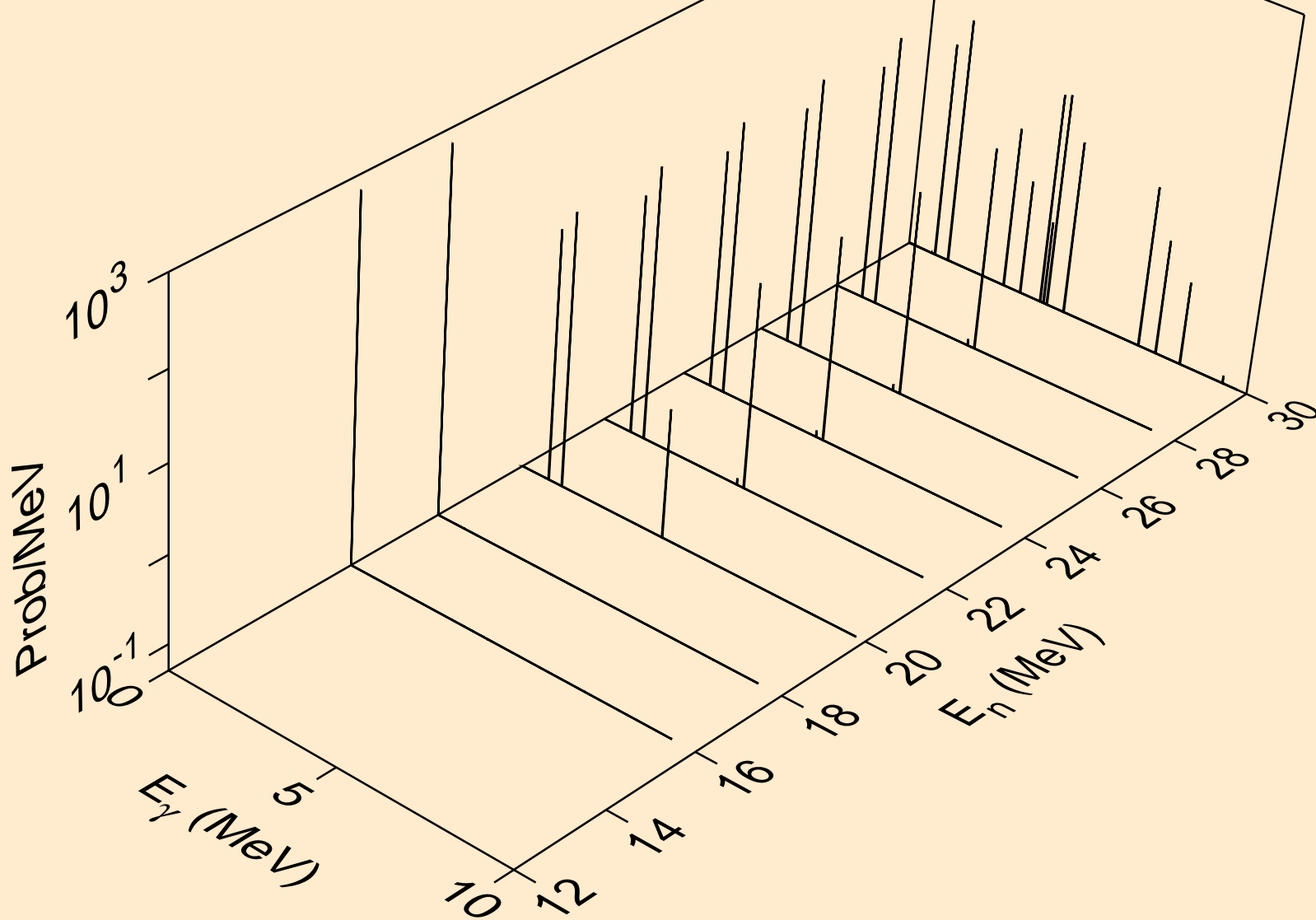

SN132 NEUTRON ACER TENDL-2019 LIBRARY; T=293.16K
Photon emission for (n,d)

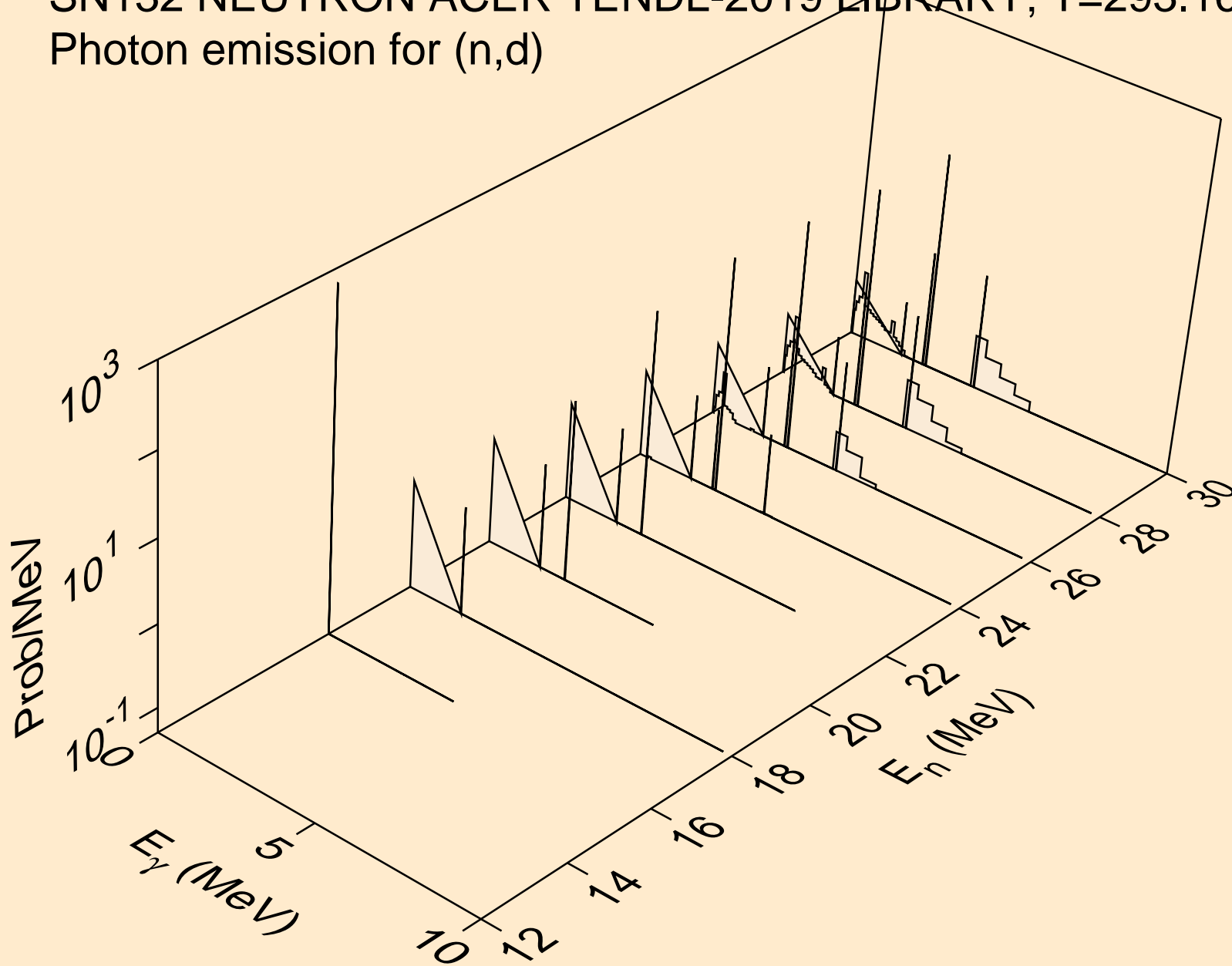

SN132 NEUTRON ACER TENDL-2019 LIBRARY; T=293.16K
Photon emission for (n,t)

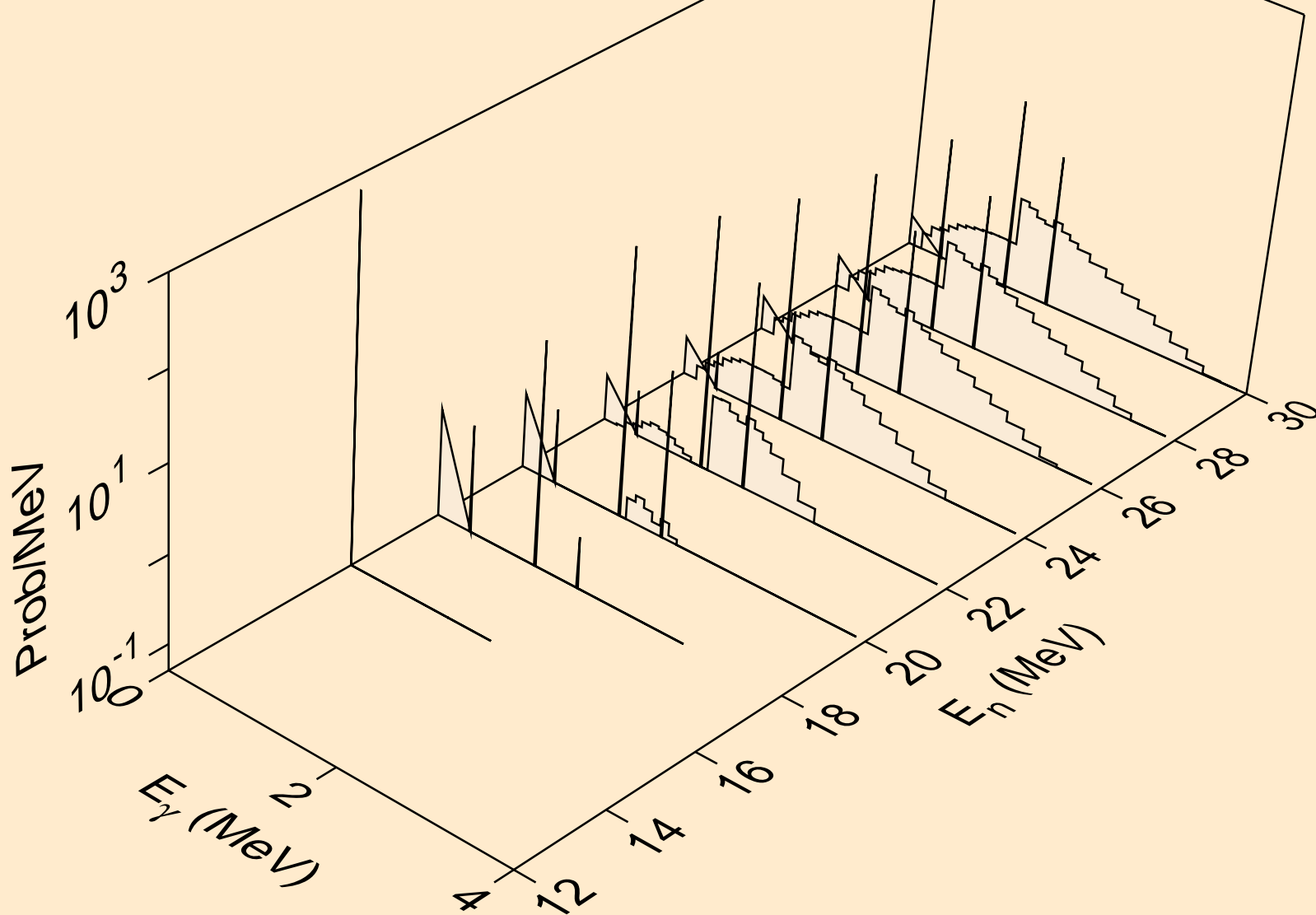

SN132 NEUTRON ACER TENDL-2019 LIBRARY; T=293.16K
Photon emission for (n,a)

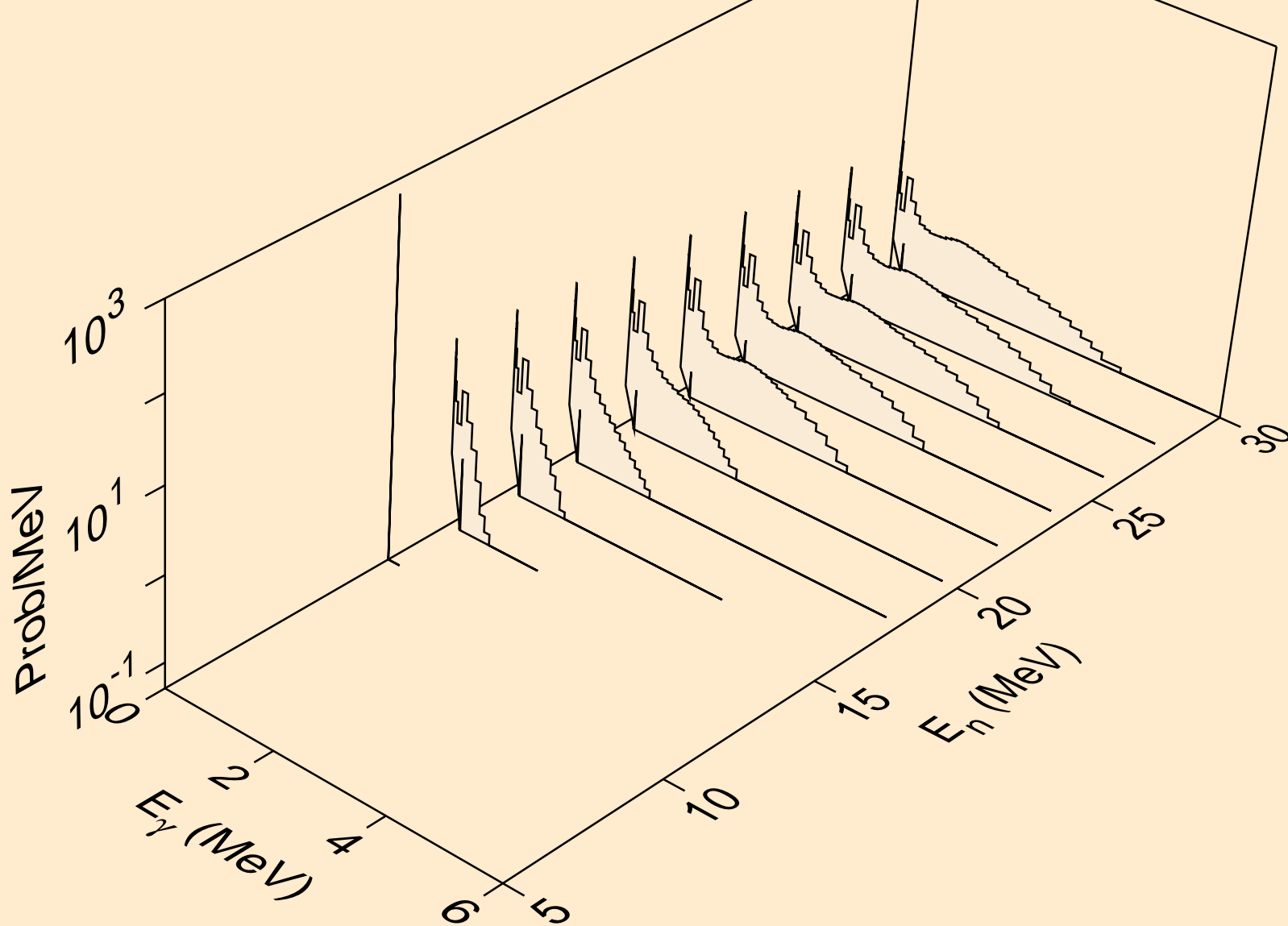

SN132 NEUTRON ACER TENDL-2019 LIBRARY; T=293.16K
thermal capture photon spectrum

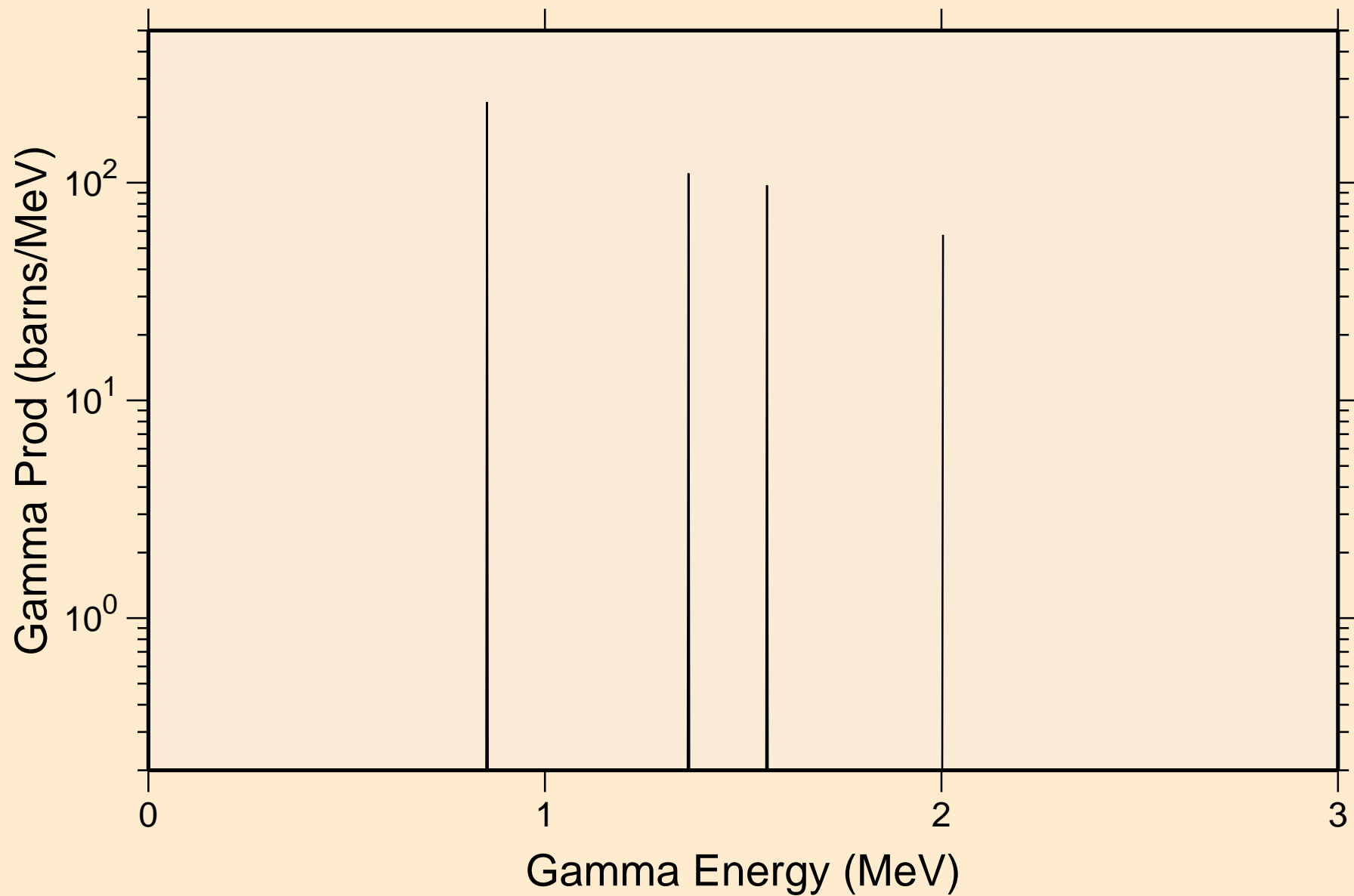

SN132 NEUTRON ACER TENDL-2019 LIBRARY; T=293.16K
14 MeV photon spectrum

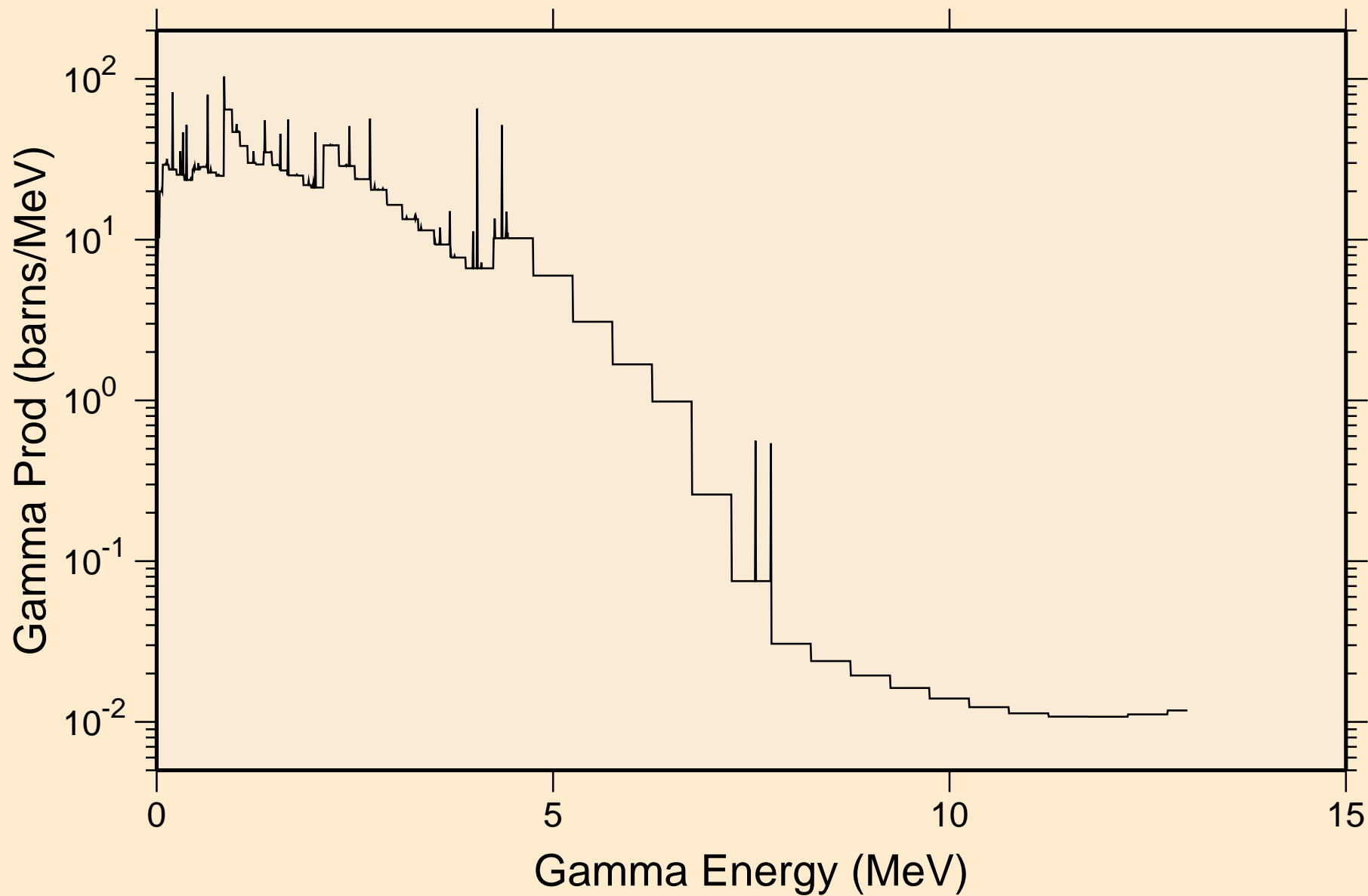

SN132 NEUTRON ACER TENDL-2019 LIBRARY; T=293.16K

Particle heating contributions

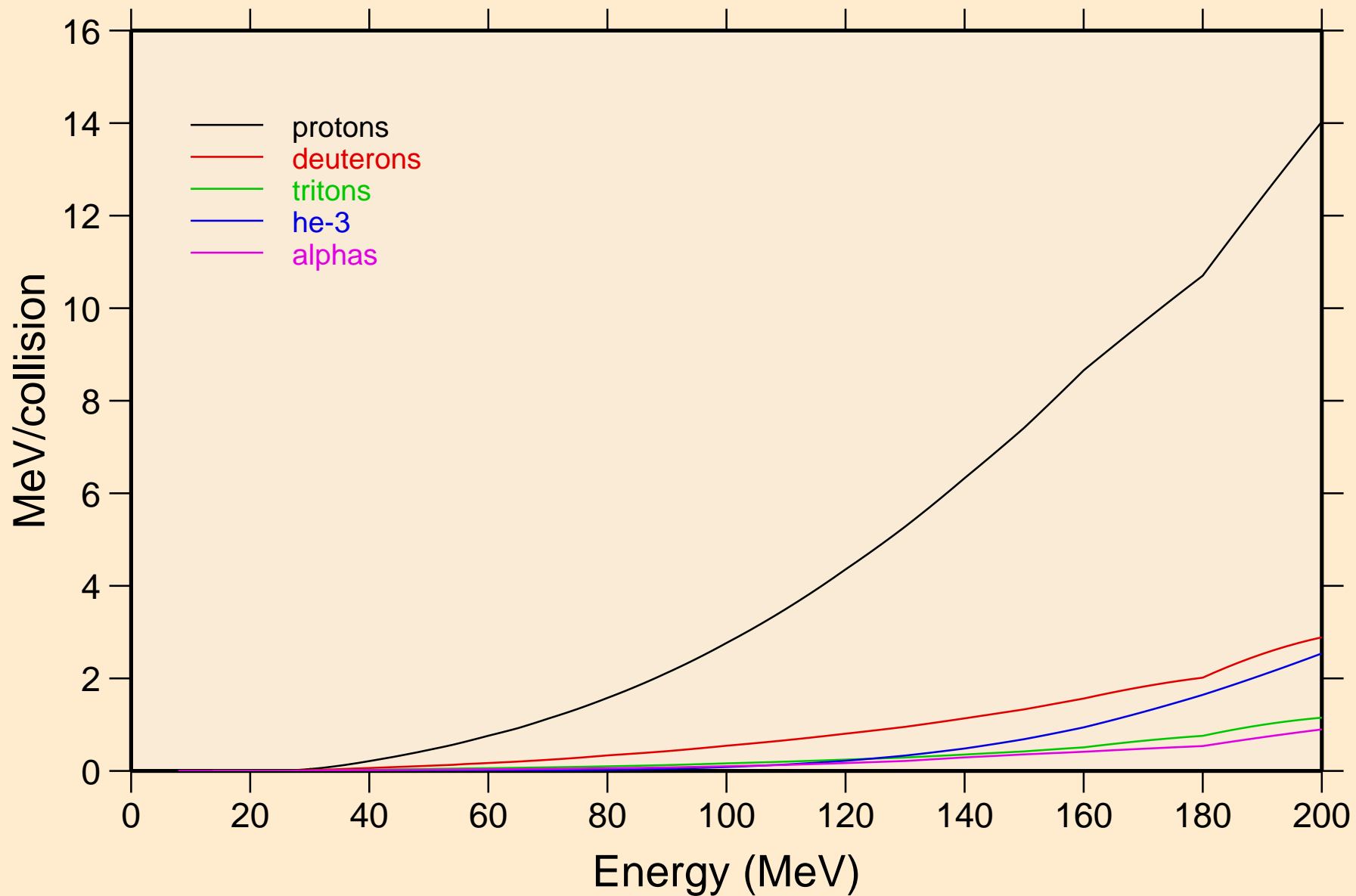

SN132 NEUTRON ACER TENDL-2019 LIBRARY; T=293.16K
Recoil Heating

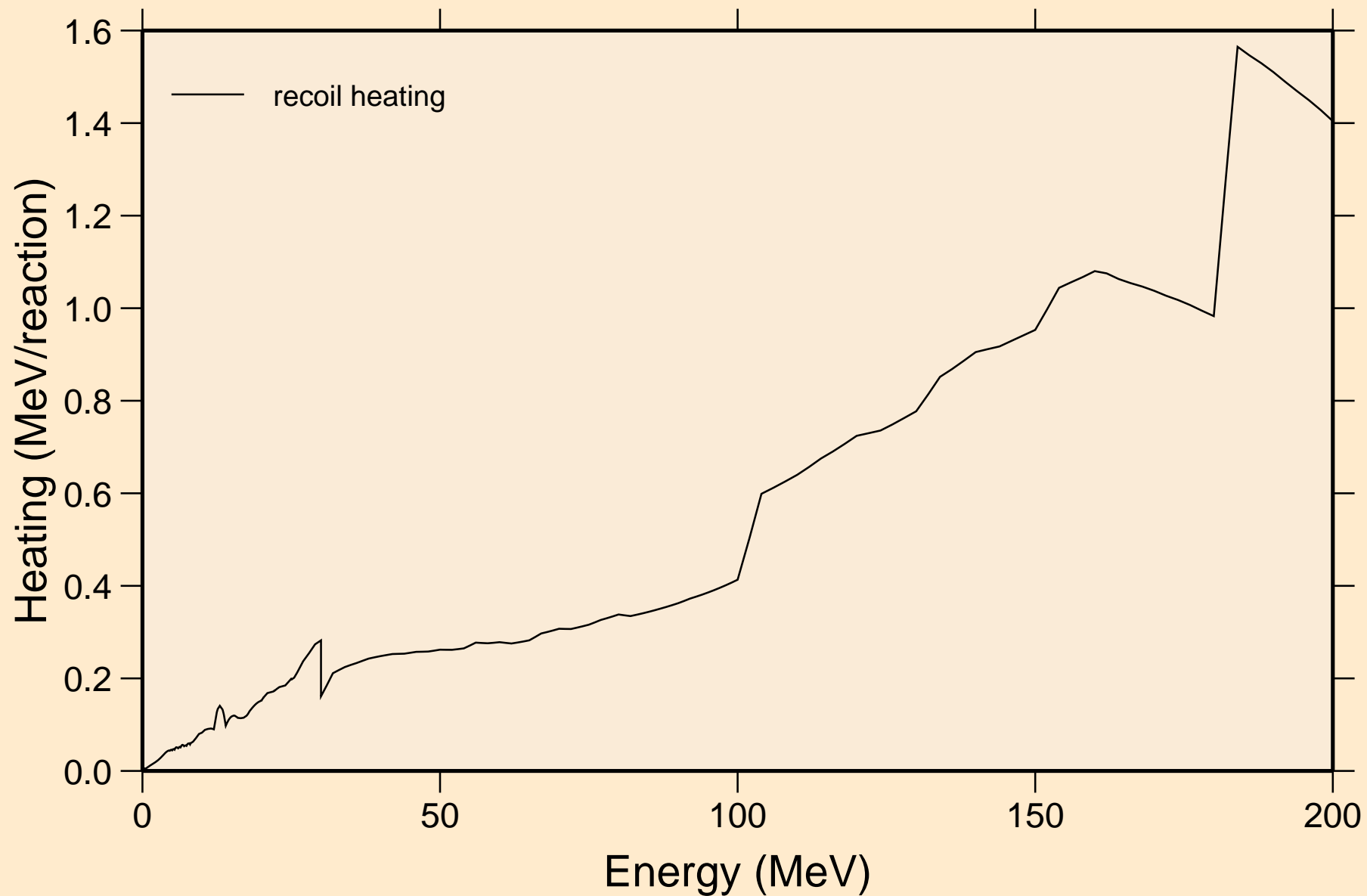

SN132 NEUTRON ACER TENDL-2019 LIBRARY; T=293.16K

Particle production cross sections

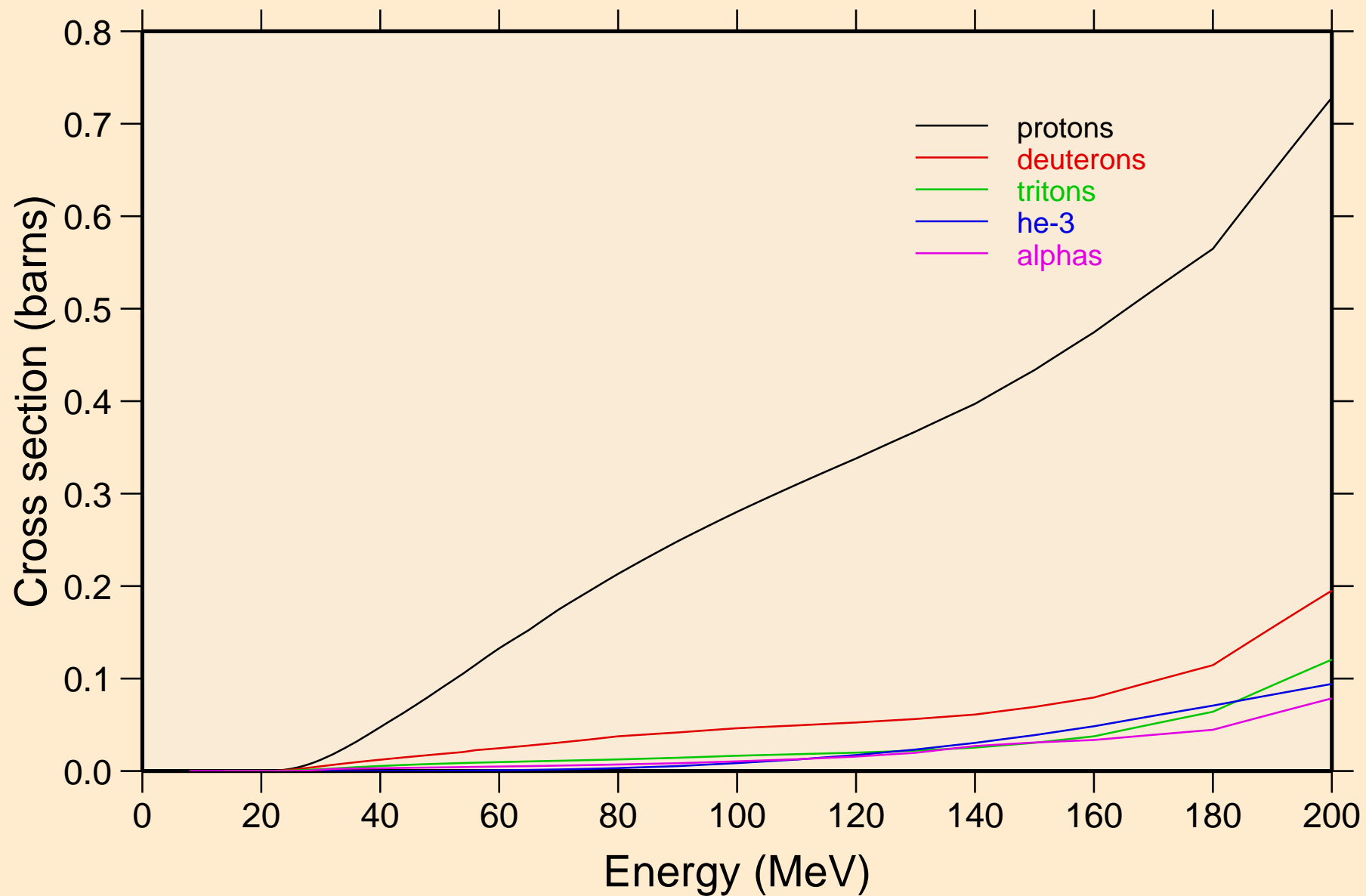

SN132 NEUTRON ACER TENDL-2019 LIBRARY; T=293.16K
protons from (n,x)

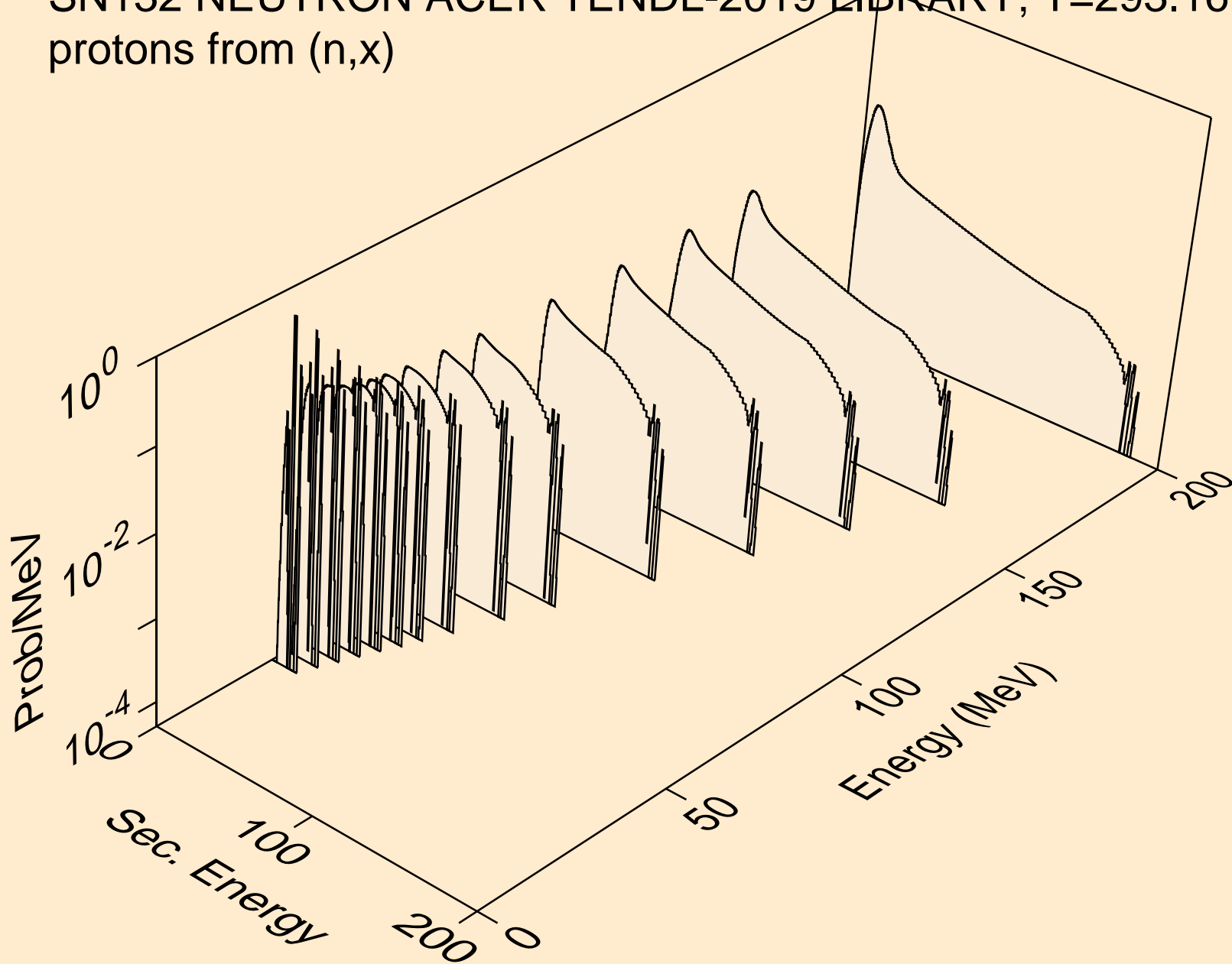

SN132 NEUTRON ACER TENDL-2019 LIBRARY; T=293.16K
protons from (n,n*)p

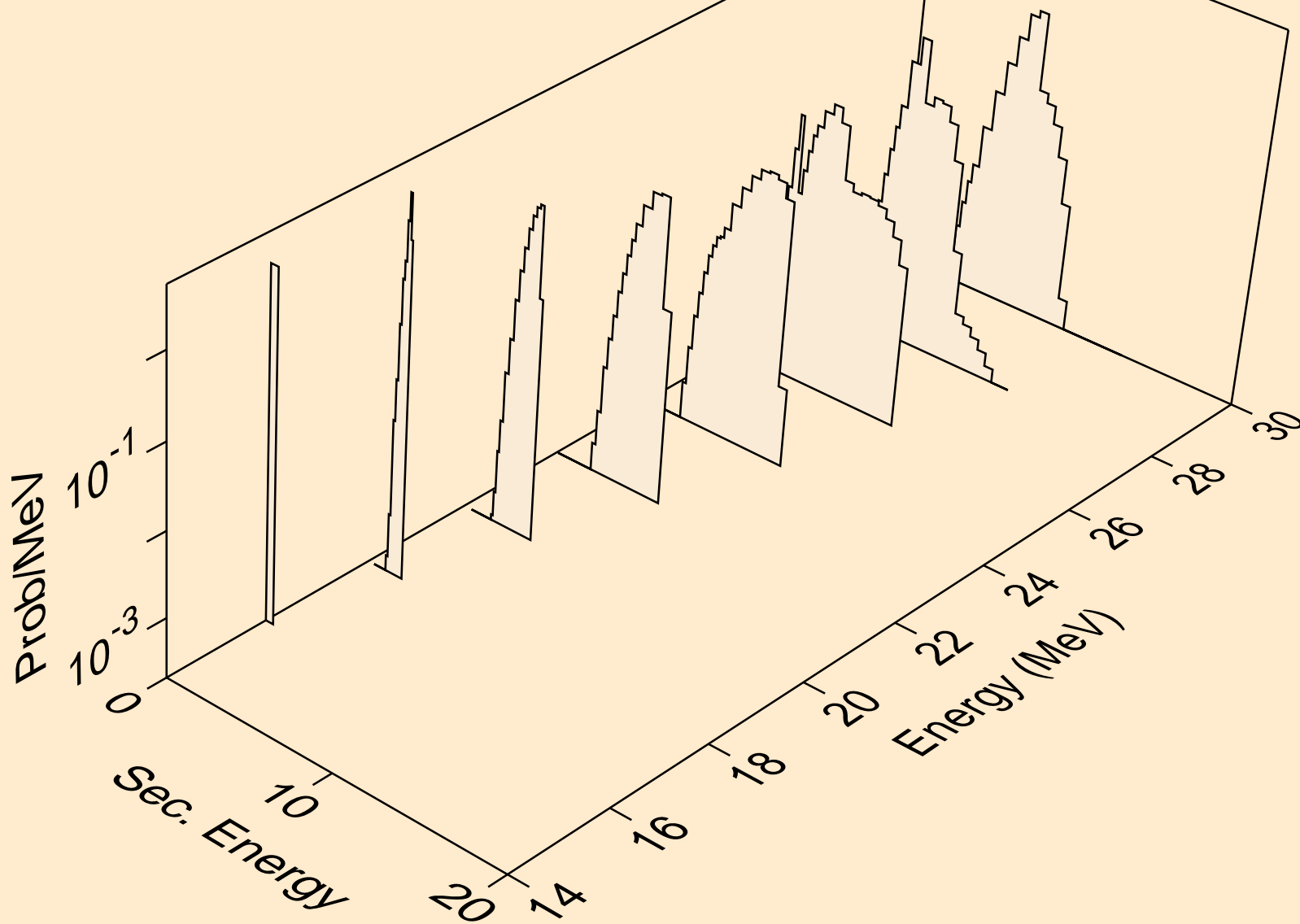

SN132 NEUTRON ACER TENDL-2019 LIBRARY; T=293.16K
protons from (n,2np)

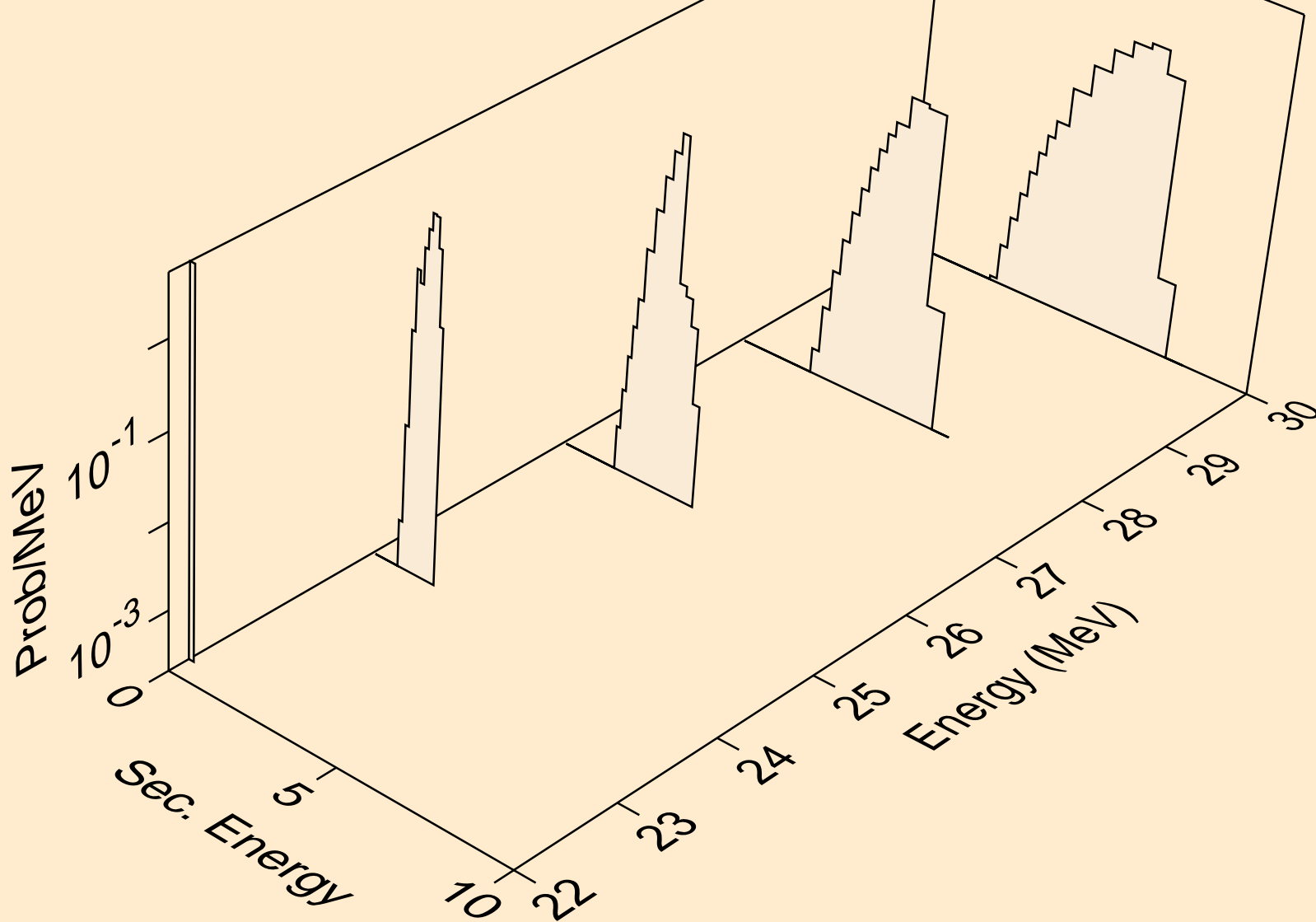

SN132 NEUTRON ACER TENDL-2019 LIBRARY; T=293.16K
protons from (n,p)

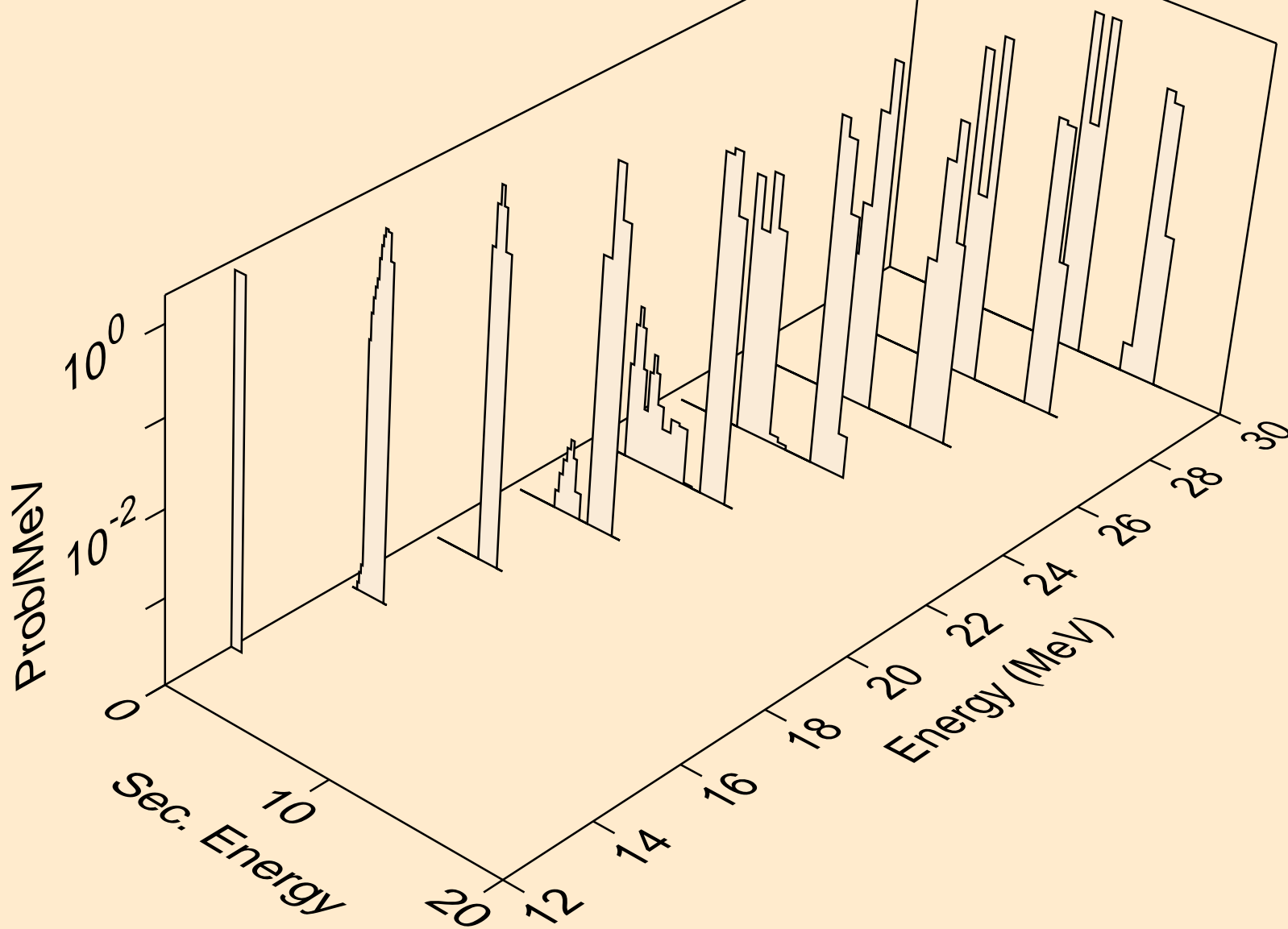

SN132 NEUTRON ACER TENDL-2019 LIBRARY; T=293.16K
deuterons from (n,x)

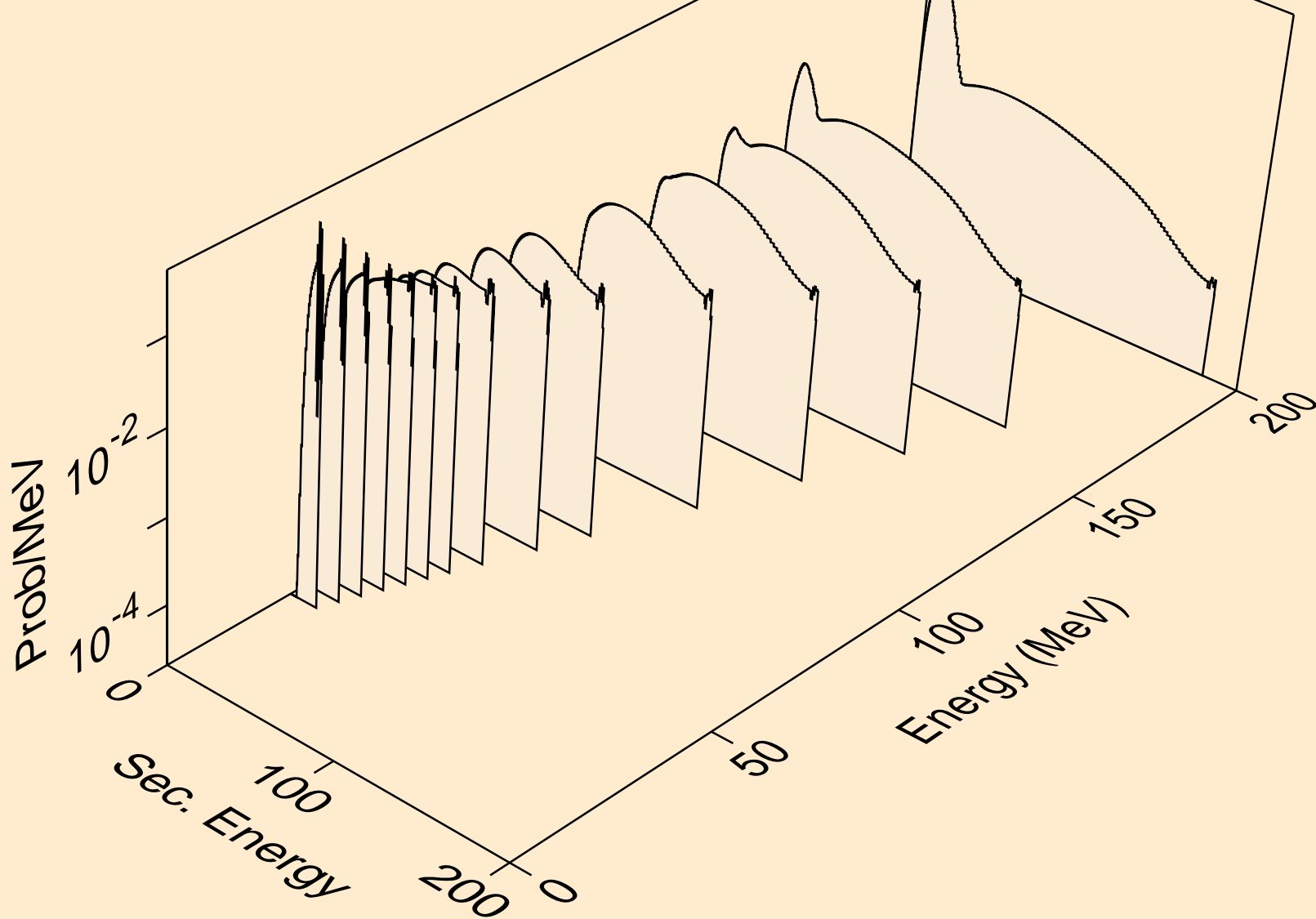

SN132 NEUTRON ACER TENDL-2019 LIBRARY; T=293.16K
deuterons from (n,2nd)

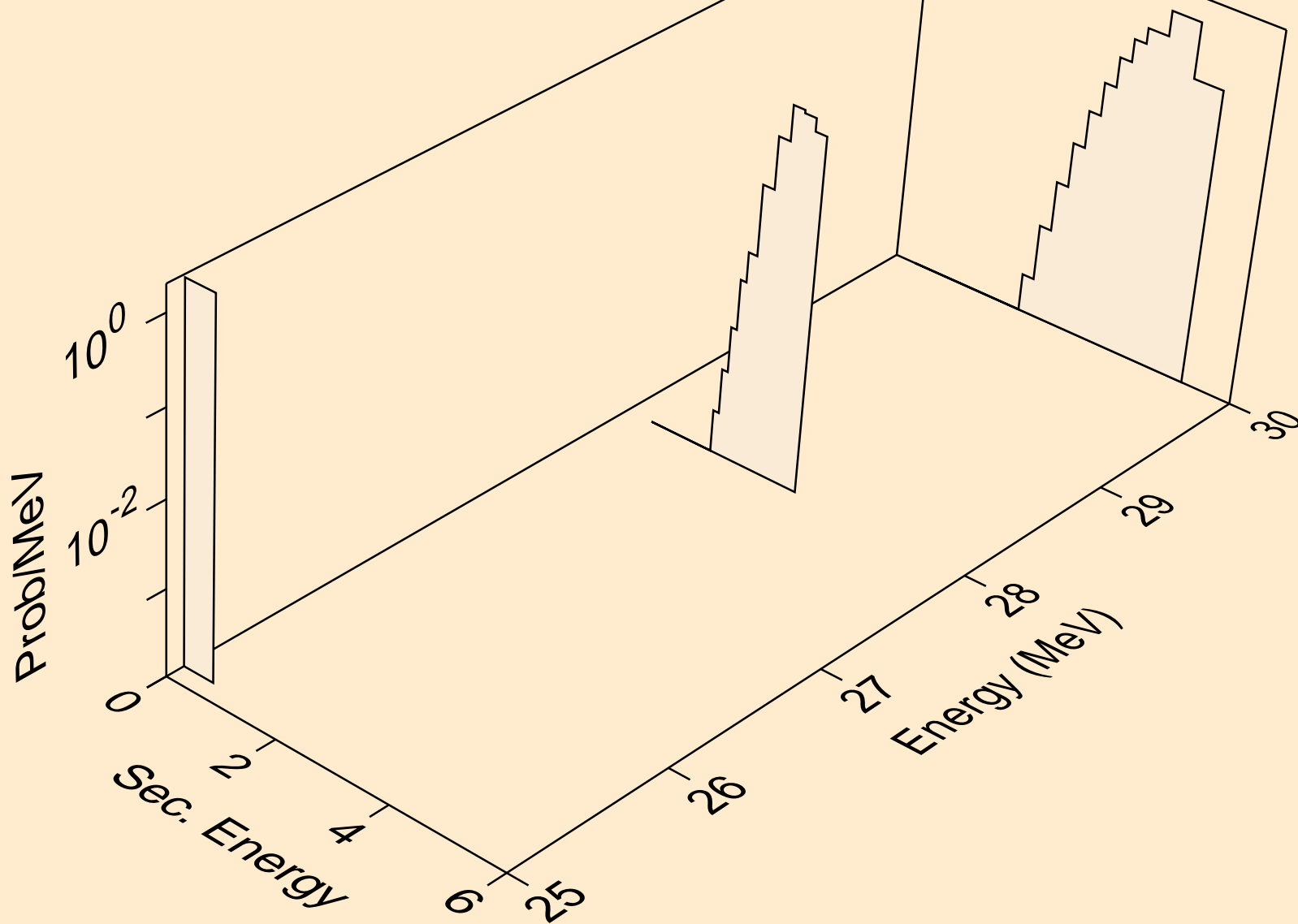

SN132 NEUTRON ACER TENDL-2019 LIBRARY; T=293.16K
deuterons from (n,n*)d

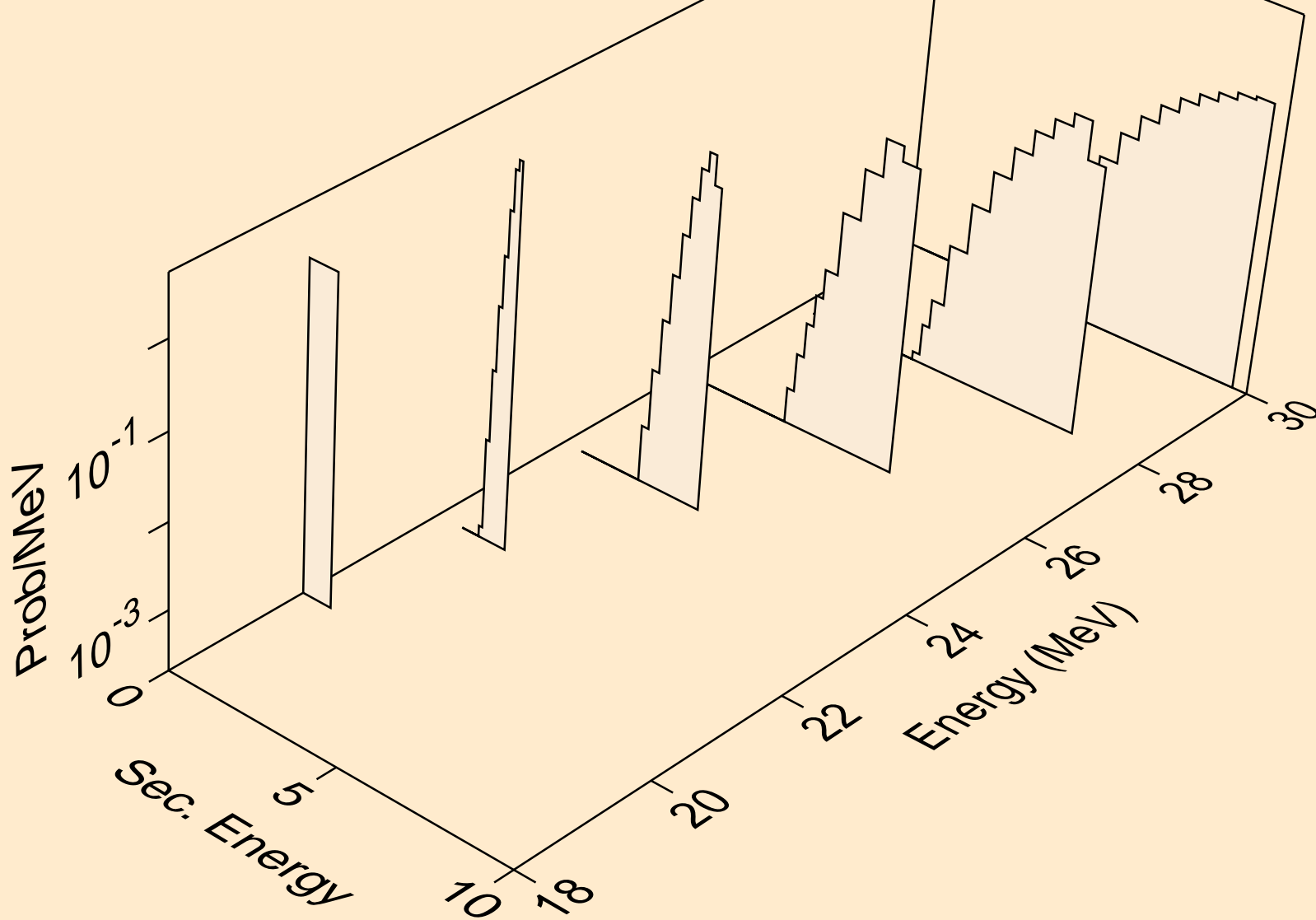

SN132 NEUTRON ACER TENDL-2019 LIBRARY; T=293.16K
deuterons from (n,d)

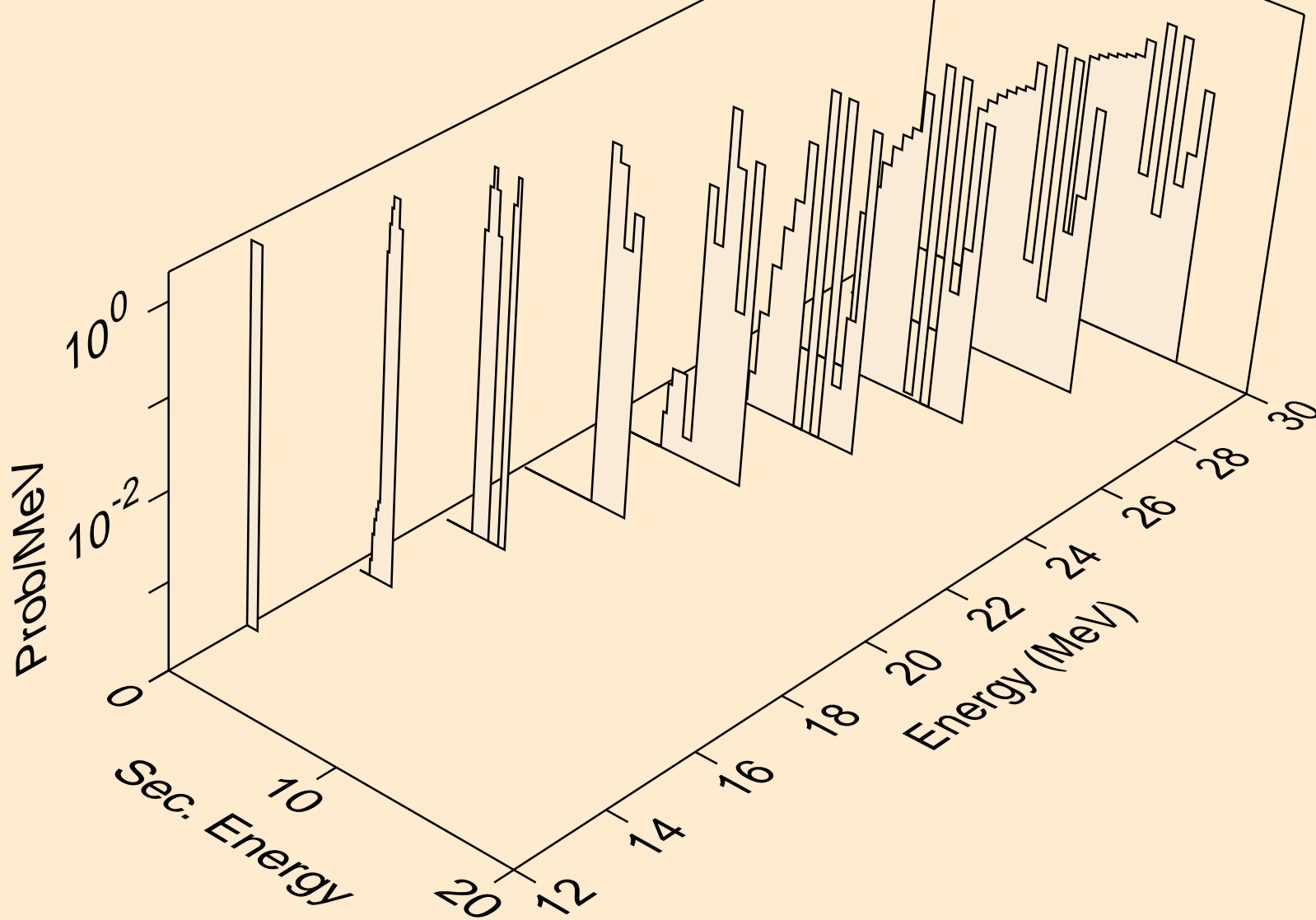

SN132 NEUTRON ACER TENDL-2019 LIBRARY; T=293.16K
tritons from (n,x)

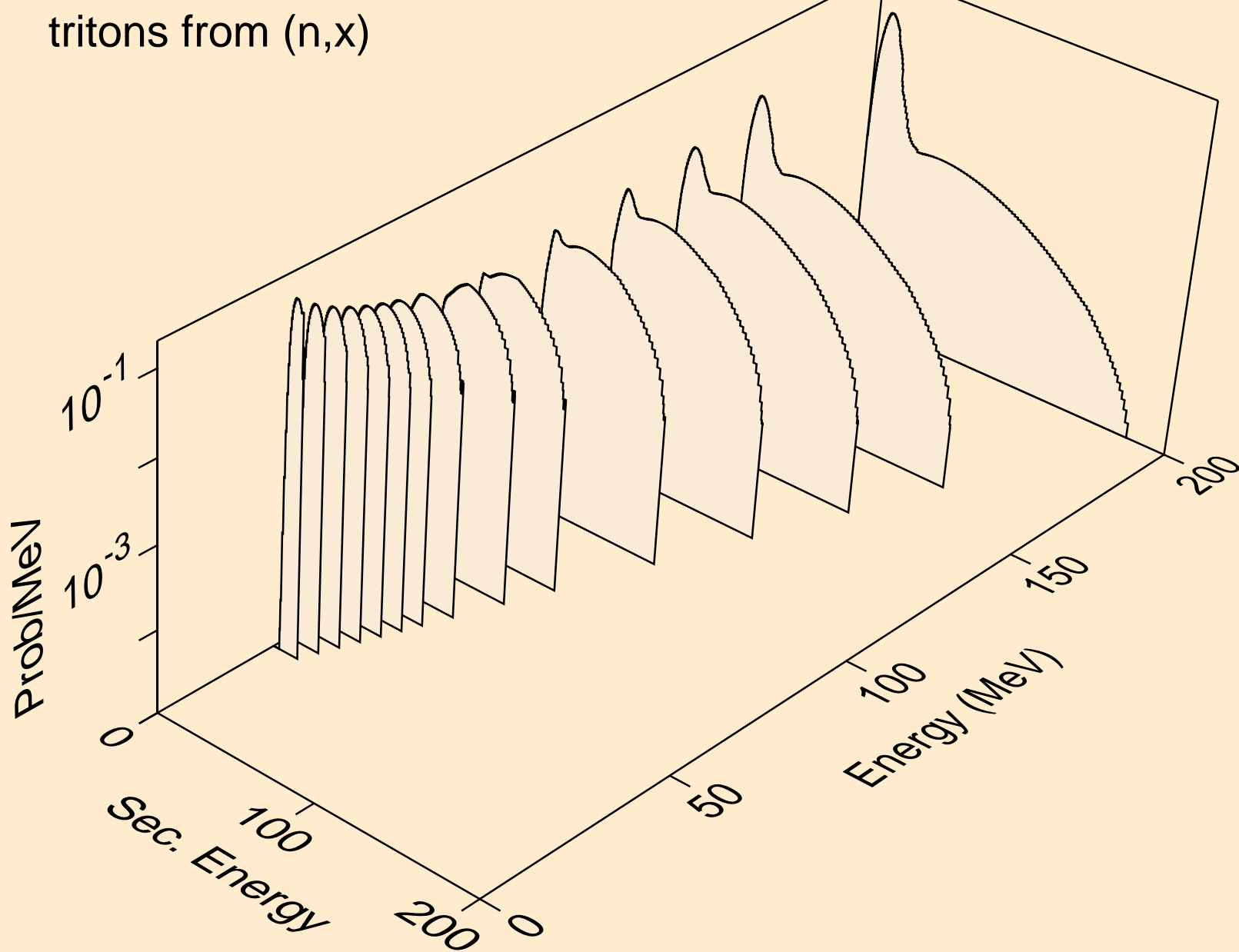

SN132 NEUTRON ACER TENDL-2019 LIBRARY; T=293.16K
tritons from (n,n*)t

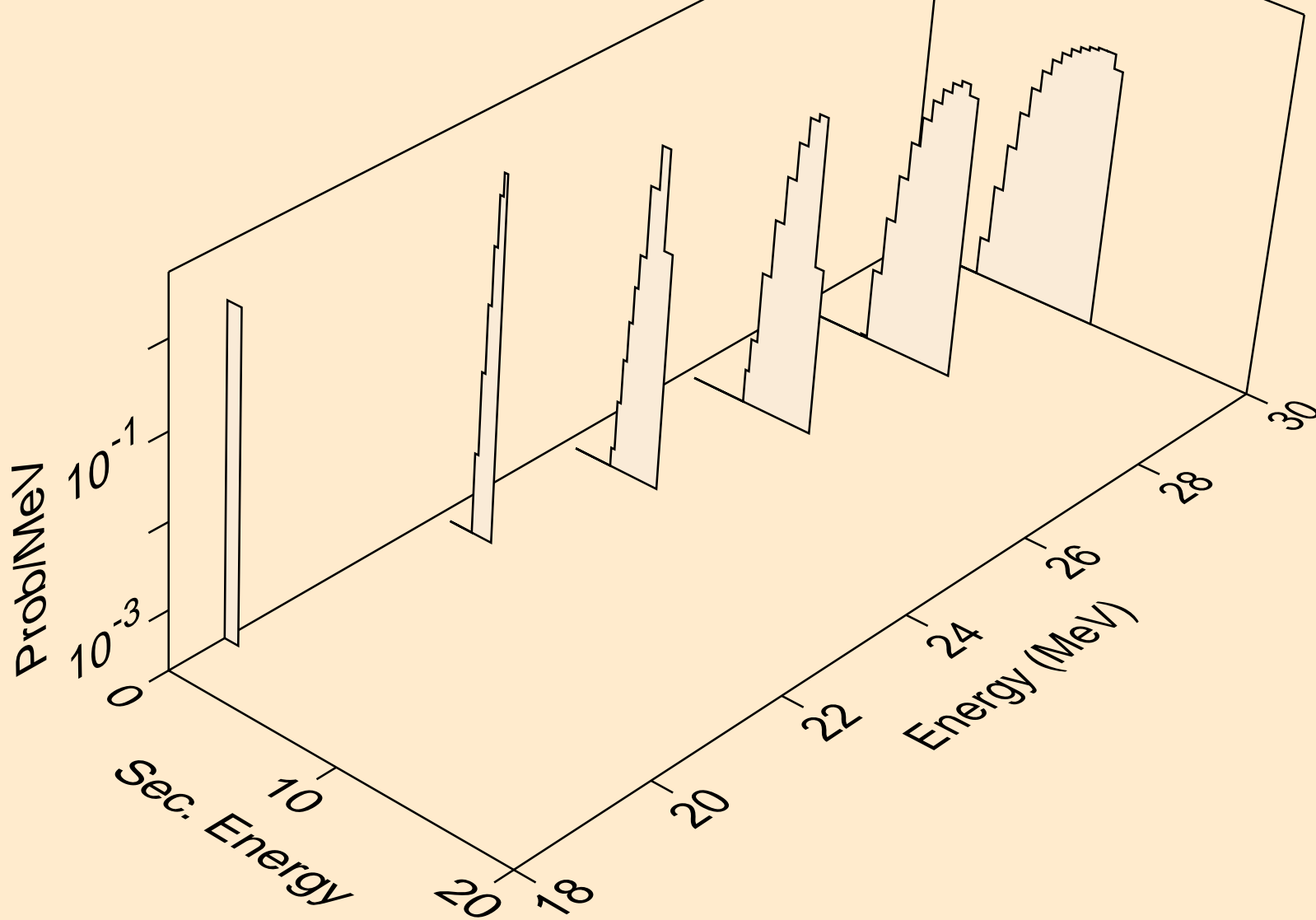

SN132 NEUTRON ACER TENDL-2019 LIBRARY; T=293.16K
tritons from (n,t)

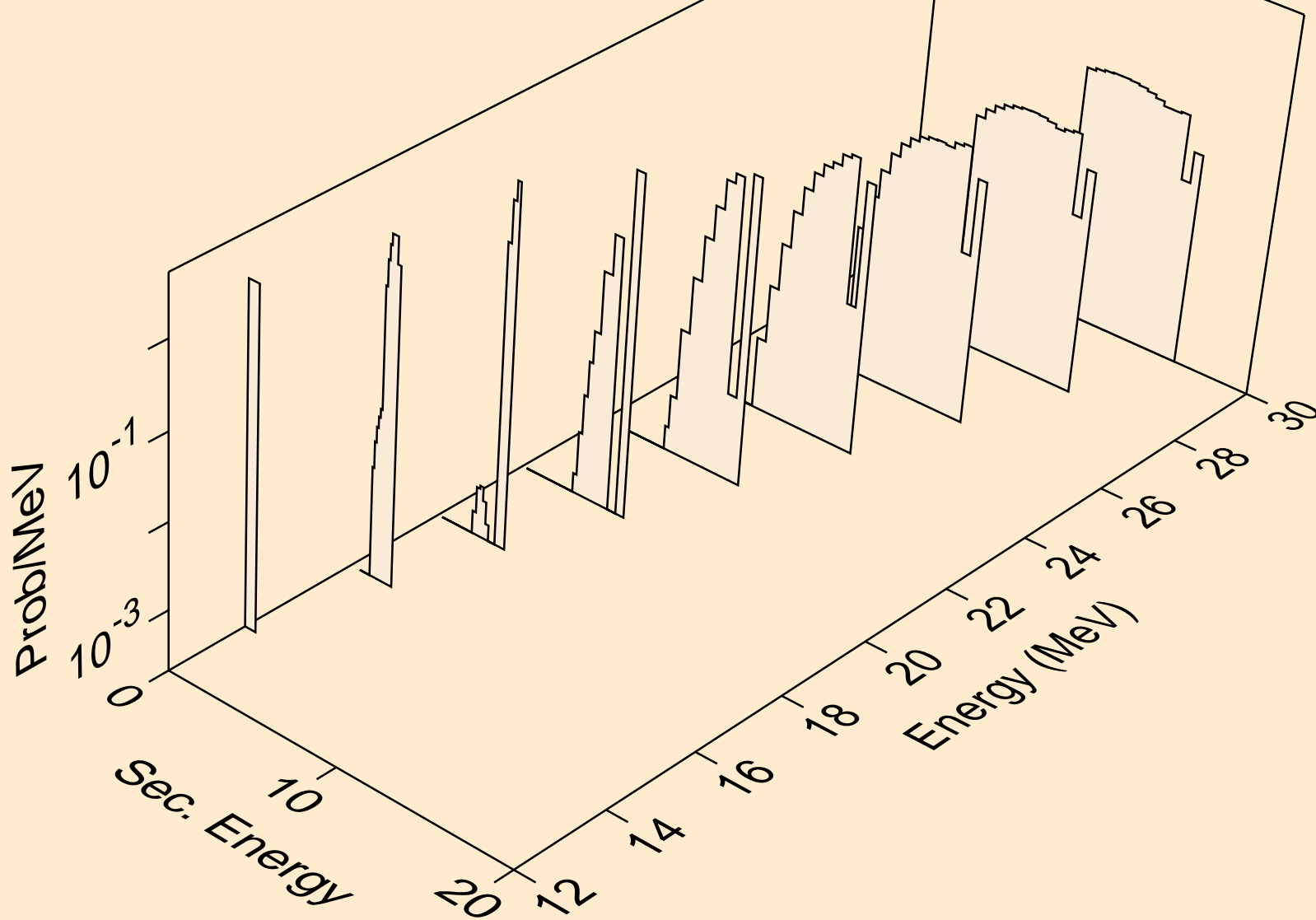

SN132 NEUTRON ACER TENDL-2019 LIBRARY; T=293.16K
he3s from (n,x)

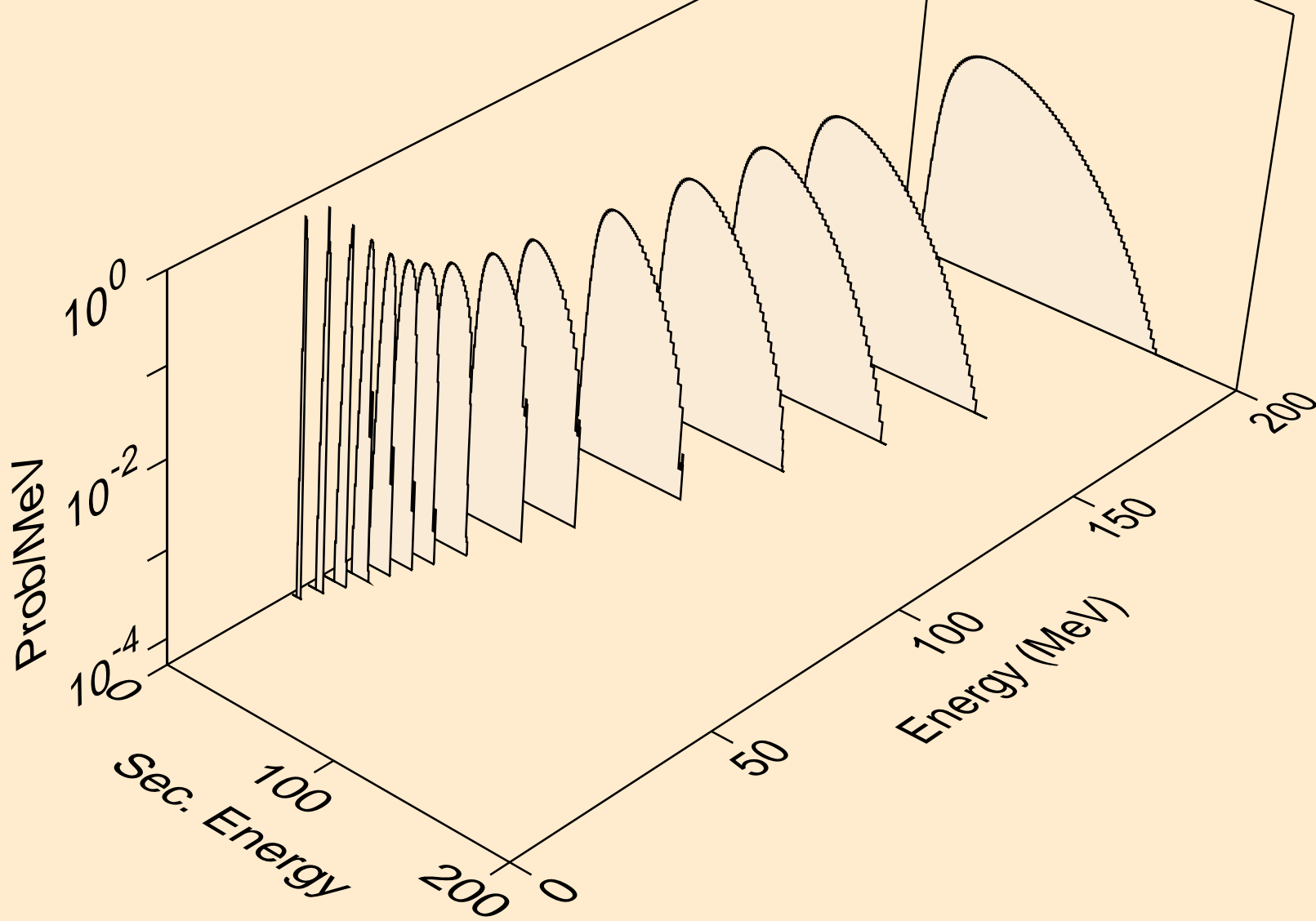

SN132 NEUTRON ACER TENDL-2019 LIBRARY; T=293.16K
alphas from (n,x)

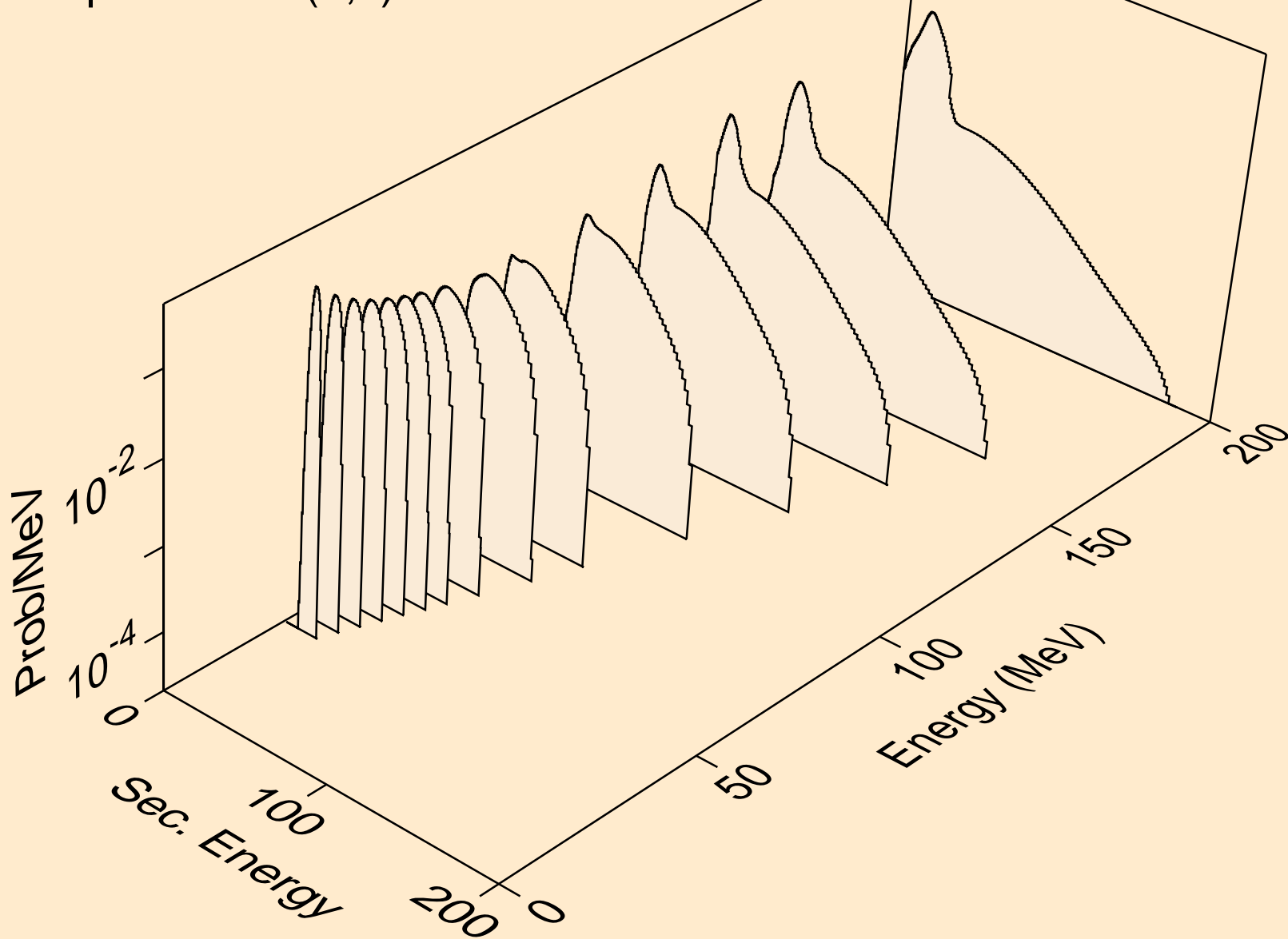

SN132 NEUTRON ACER TENDL-2019 LIBRARY; T=293.16K
alphas from (n,n*)a

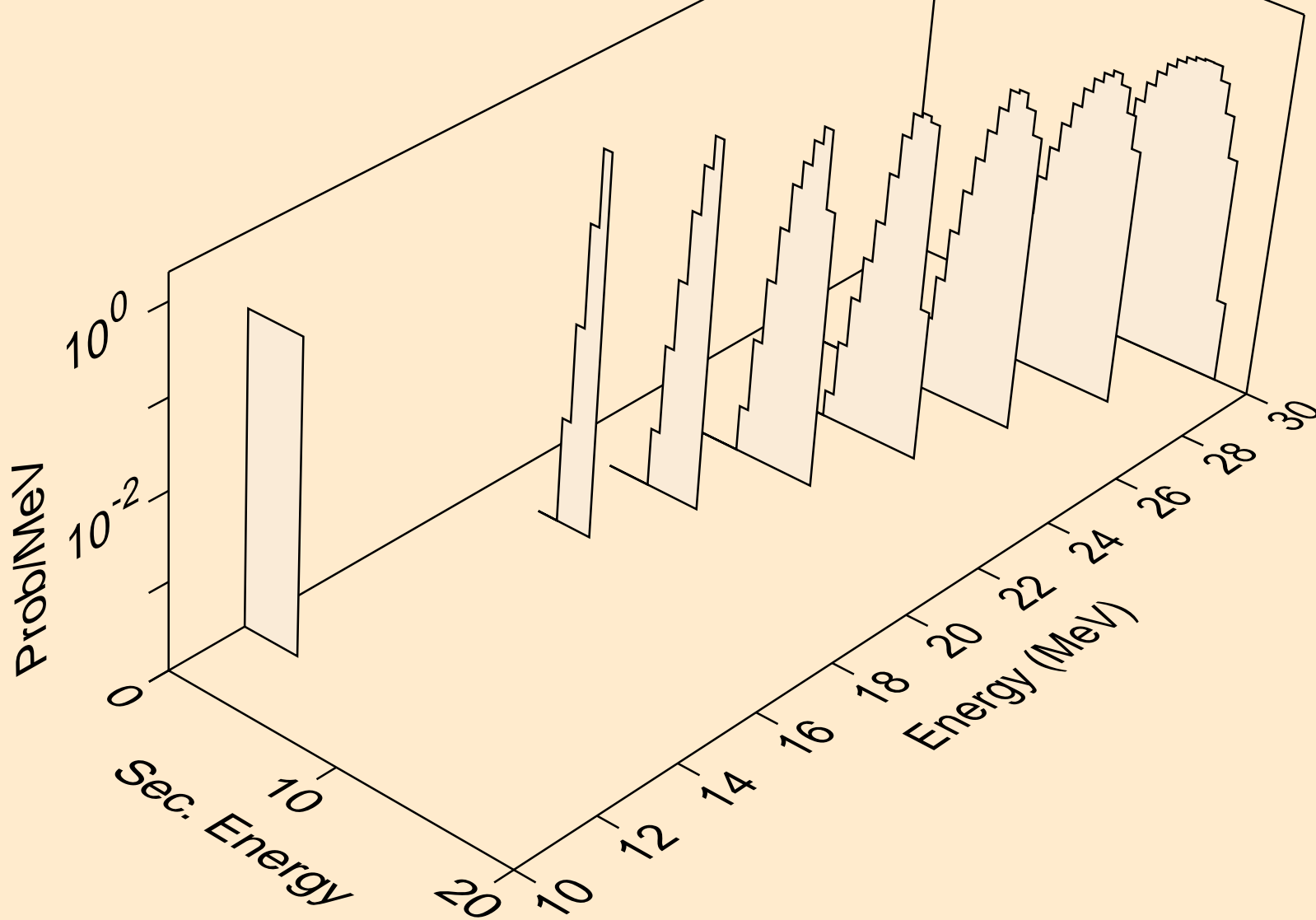

SN132 NEUTRON ACER TENDL-2019 LIBRARY; T=293.16K
alphas from (n,2n)a

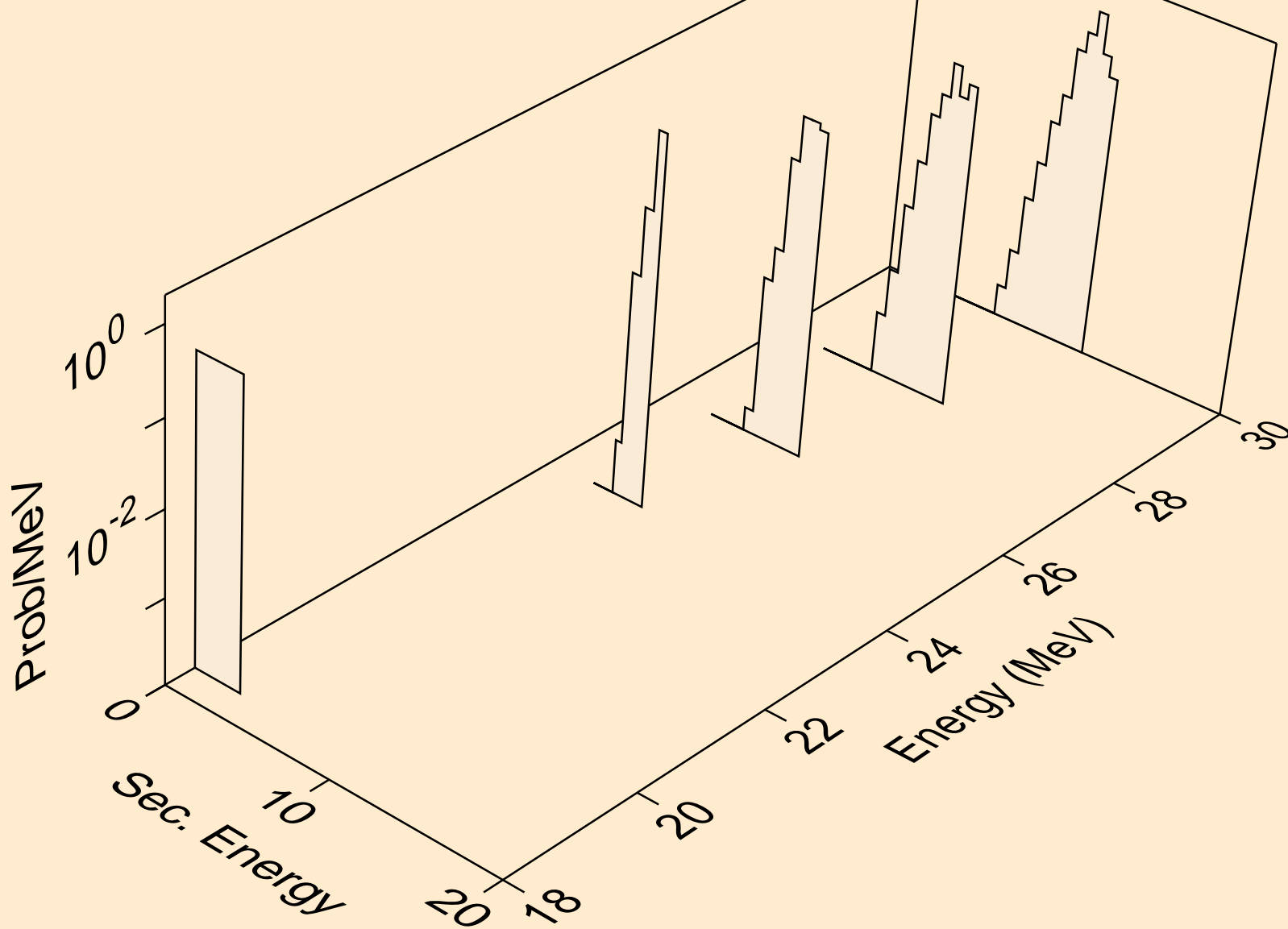

SN132 NEUTRON ACER TENDL-2019 LIBRARY; T=293.16K
alphas from (n,a)

