

TA160M NEUTRON ACER TENDL-2019 LIBRARY; T=293.16K
Principal cross sections

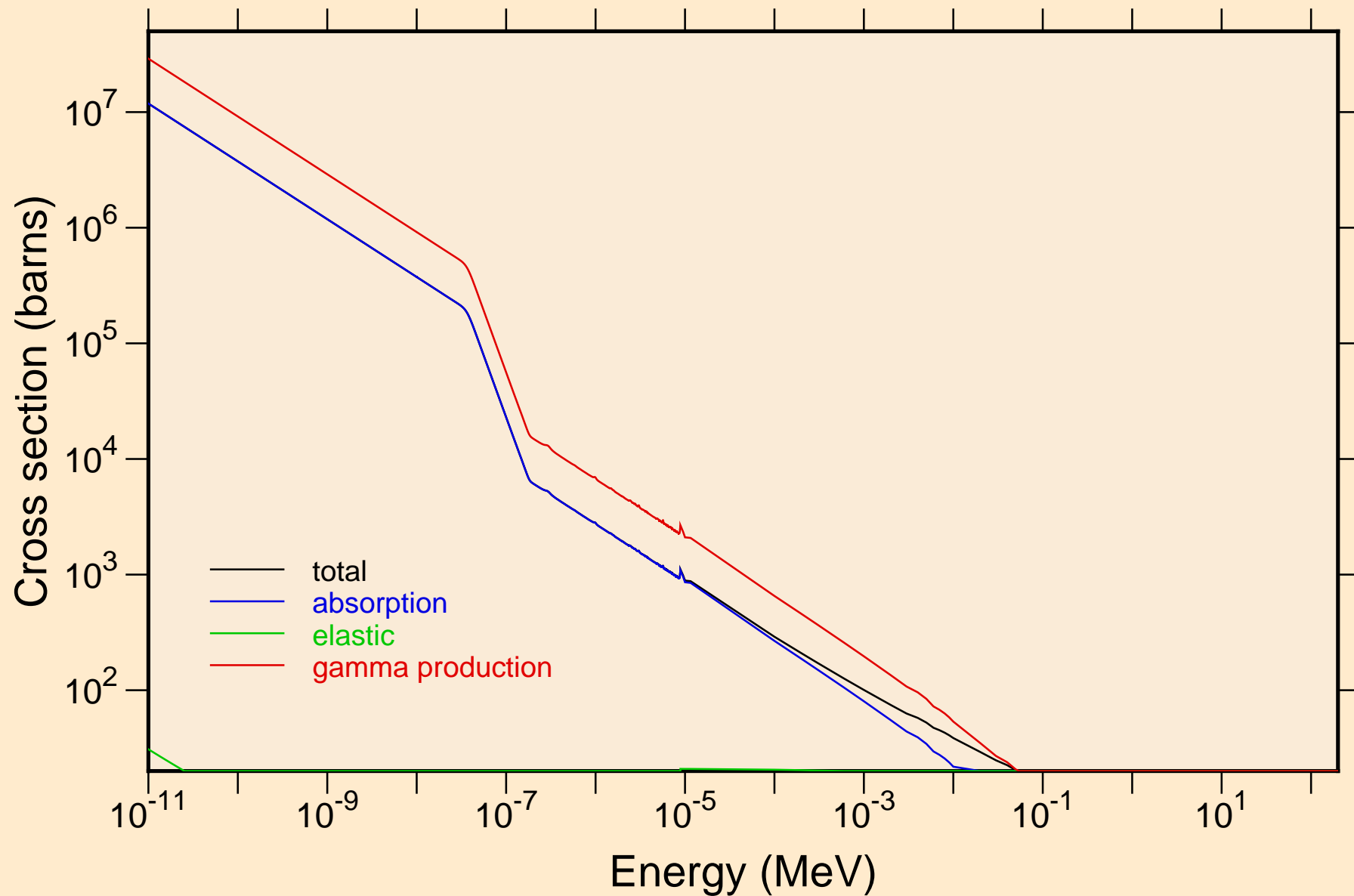

TA160M NEUTRON ACER TENDL-2019 LIBRARY; T=293.16K
resonance total cross section

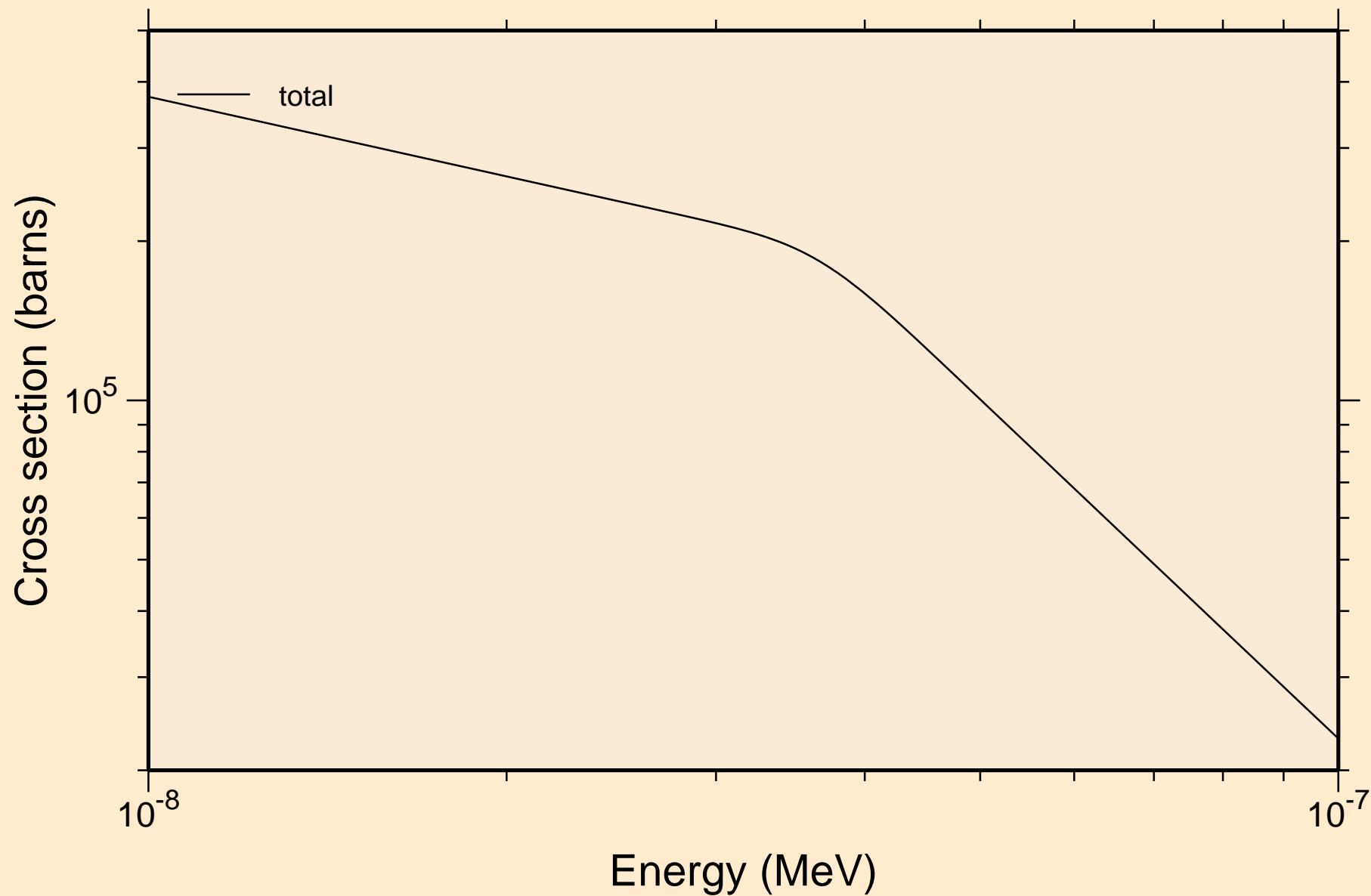

TA160M NEUTRON ACER TENDL-2019 LIBRARY; T=293.16K
resonance total cross section

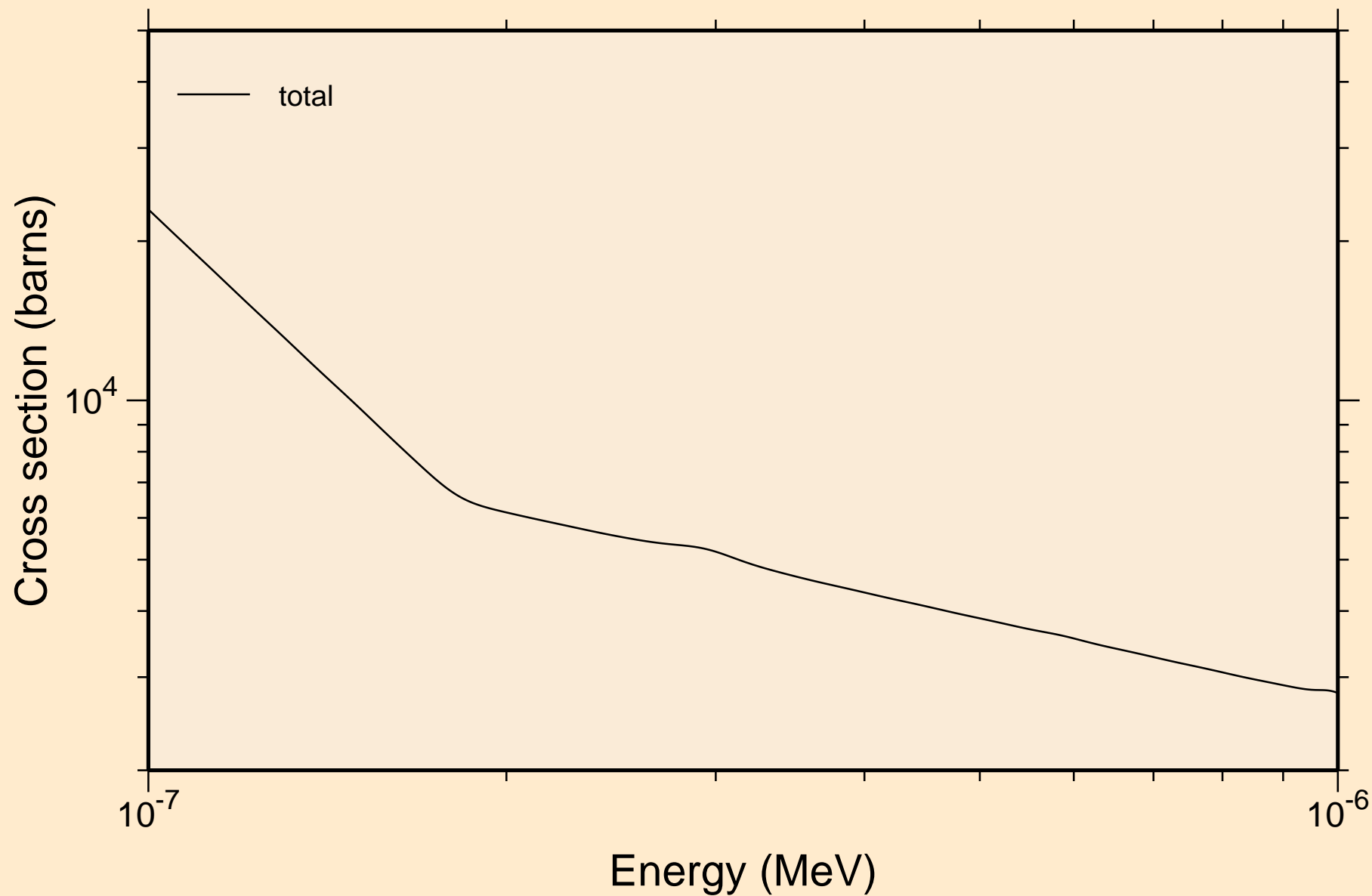

TA160M NEUTRON ACER TENDL-2019 LIBRARY; T=293.16K
resonance total cross section

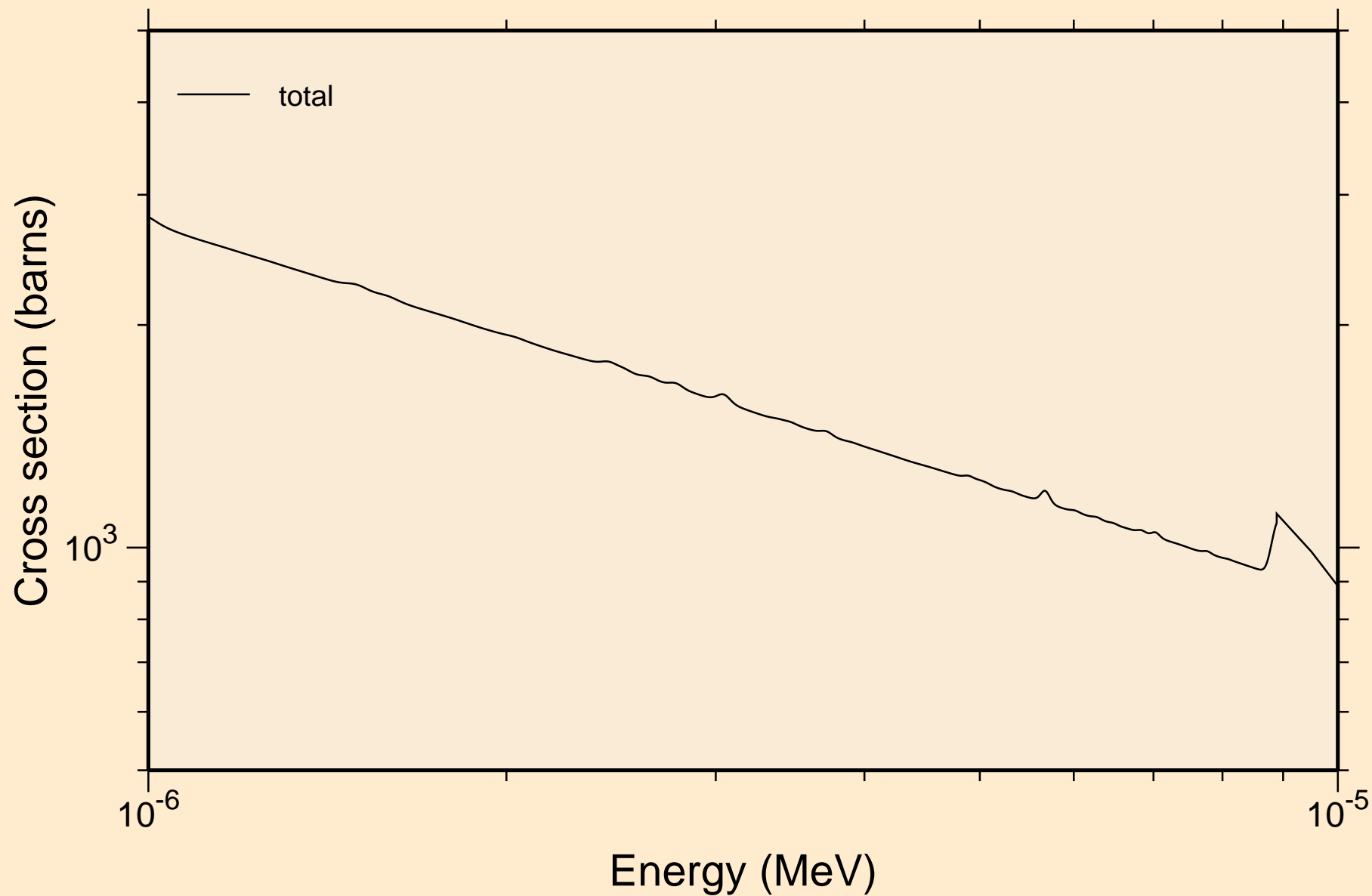

TÅ160M NEUTRON ACER TENDL-2019 LIBRARY; T=293.16K
resonance total cross section

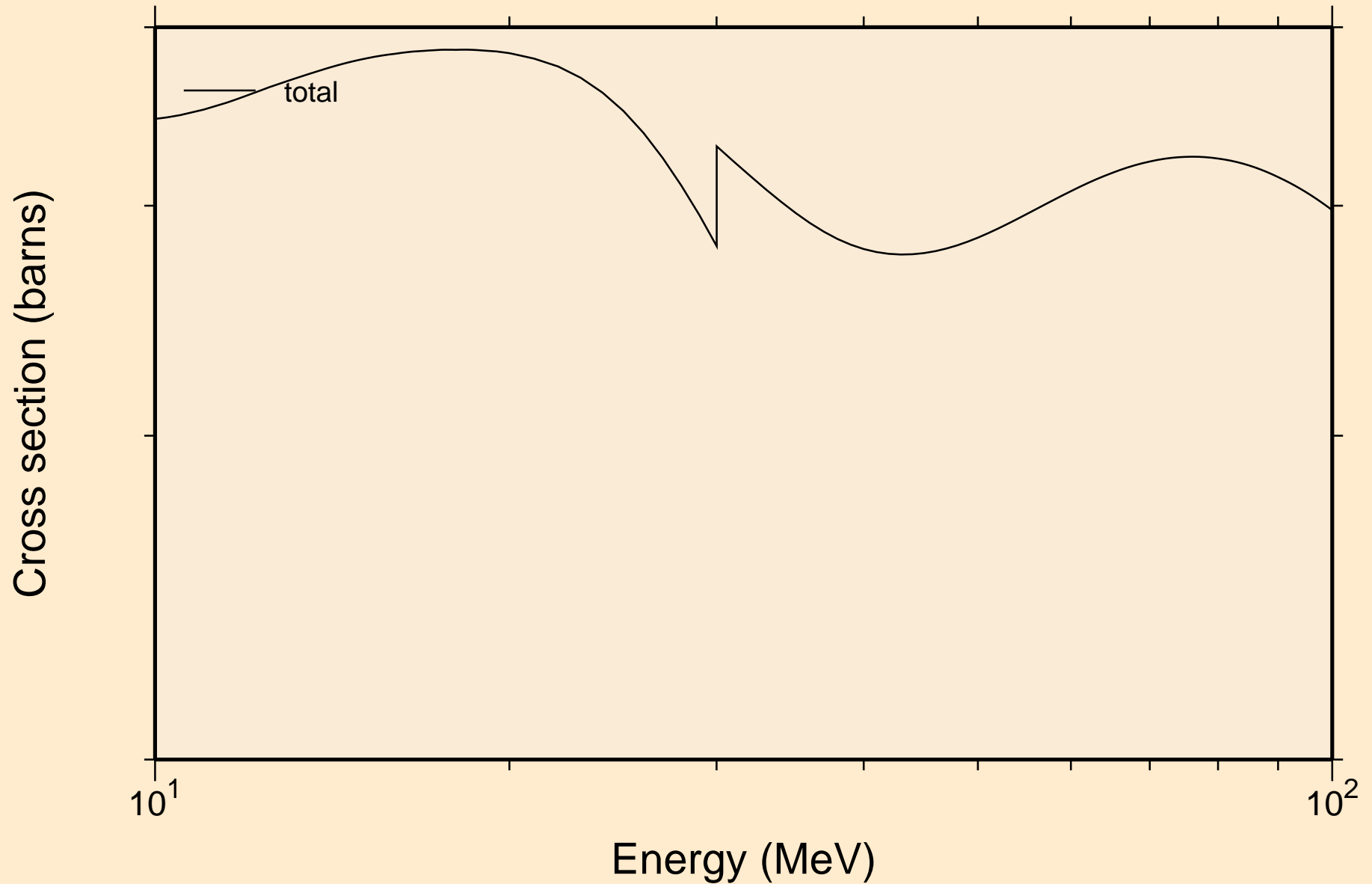

TA160M NEUTRON ACER TENDL-2019 LIBRARY; T=293.16K
resonance absorption cross sections

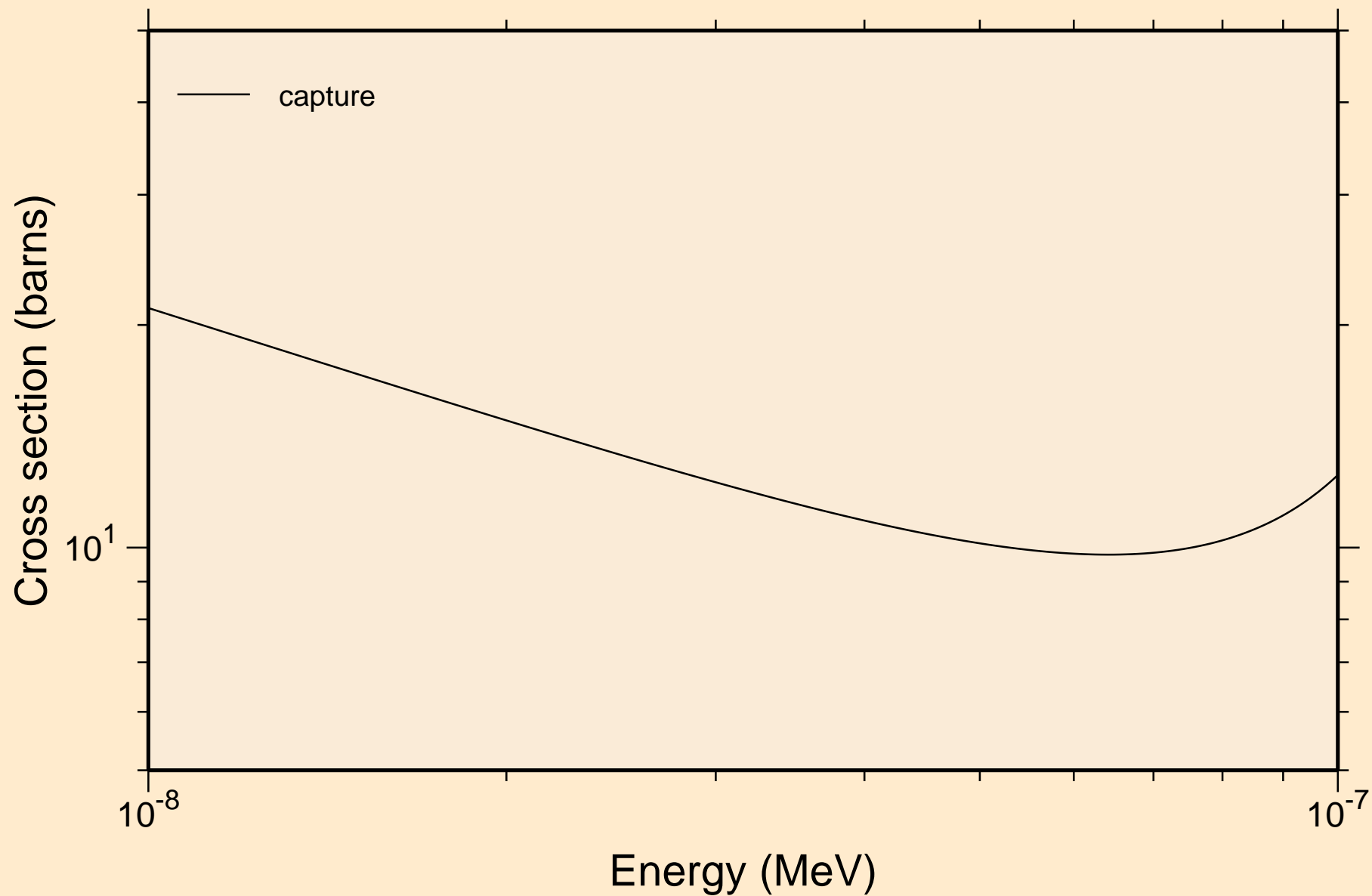

TA160M NEUTRON ACER TENDL-2019 LIBRARY; T=293.16K
resonance absorption cross sections

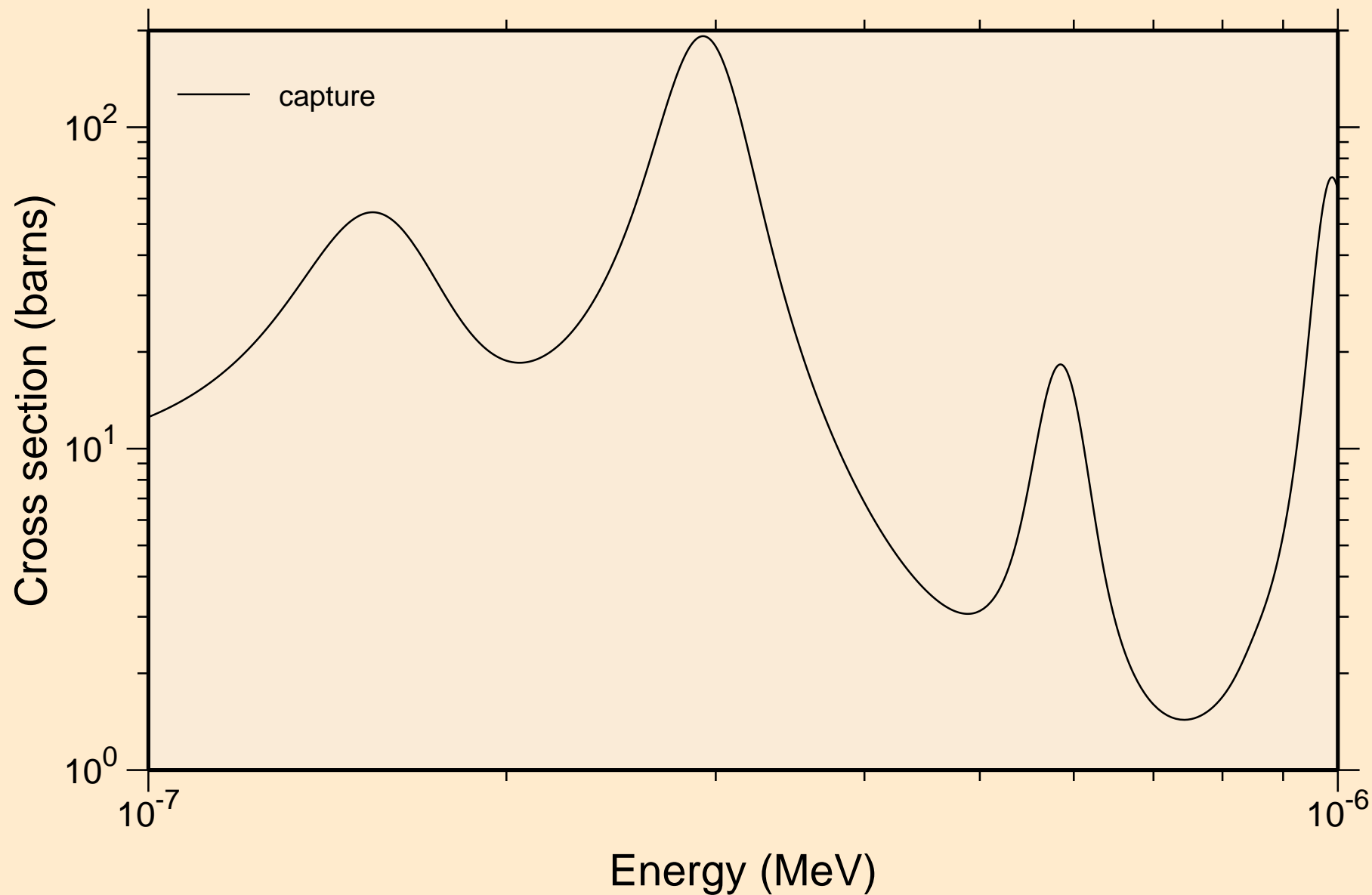

TA160M NEUTRON ACER TENDL-2019 LIBRARY; T=293.16K
resonance absorption cross sections

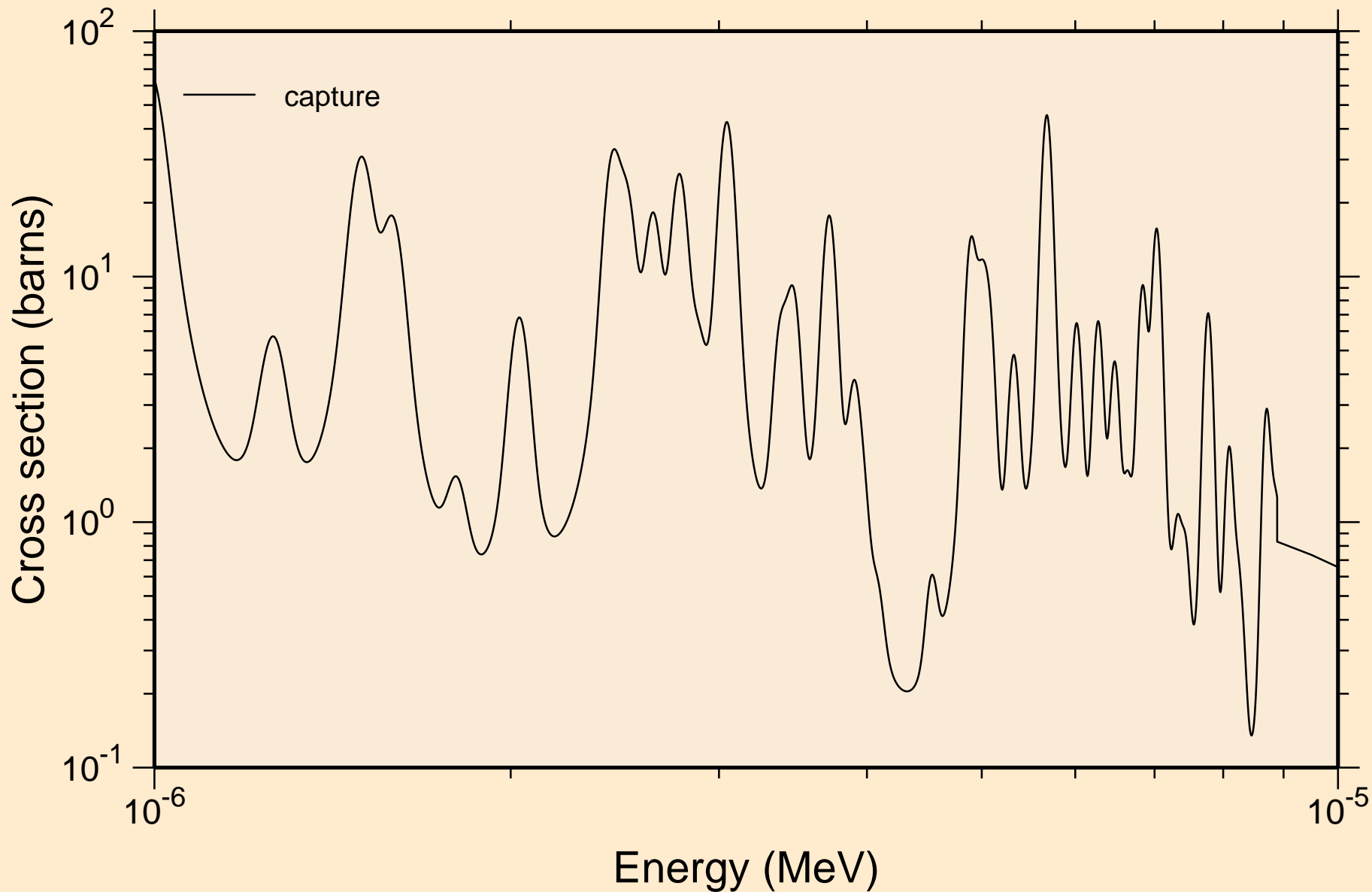

TA160M NEUTRON ACER TENDL-2019 LIBRARY; T=293.16K
resonance absorption cross sections

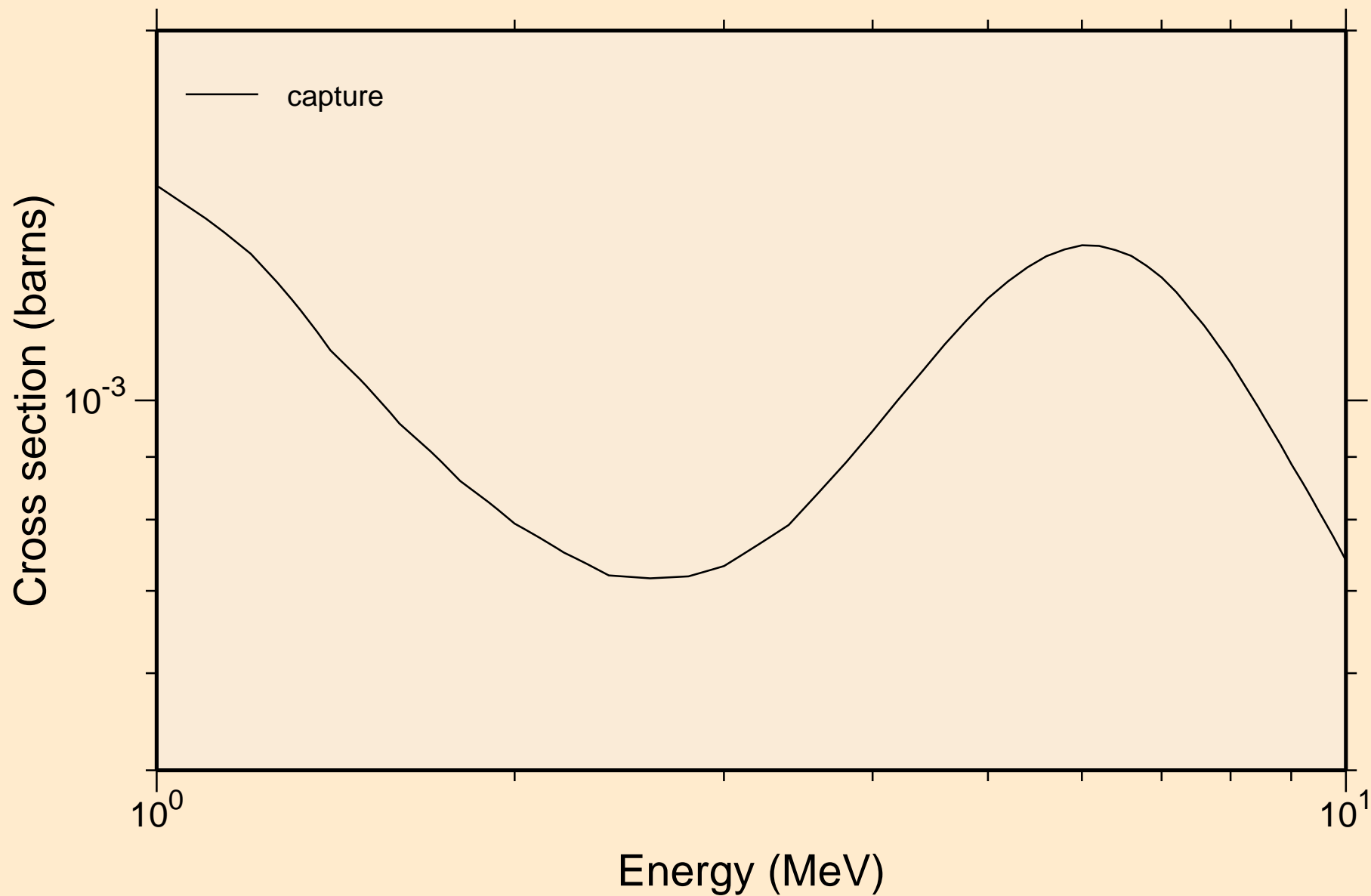

TA160M NEUTRON ACER TENDL-2019 LIBRARY; T=293.16K
Heating

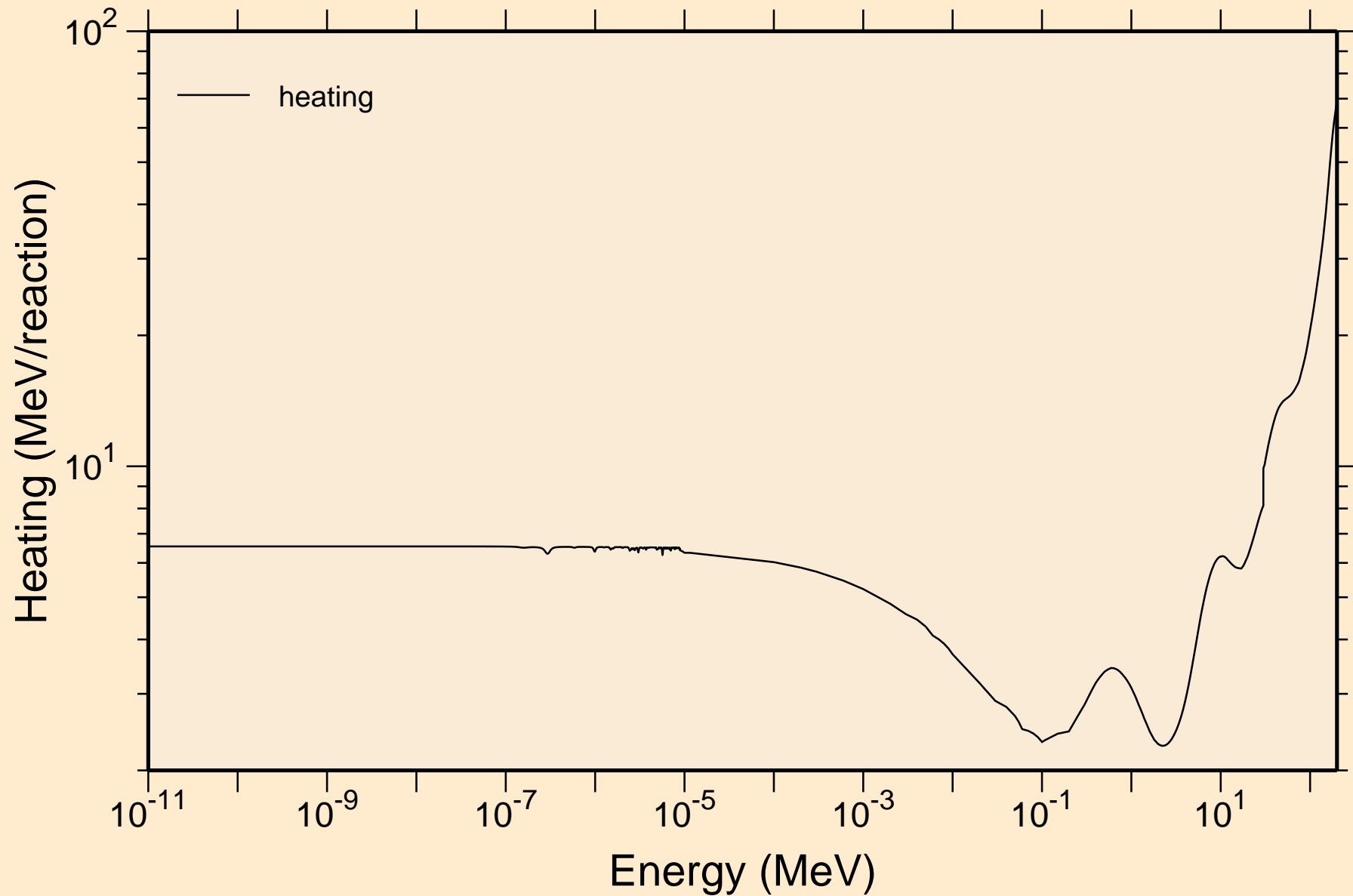

TA160M NEUTRON ACER TENDL-2019 LIBRARY; T=293.16K
Damage

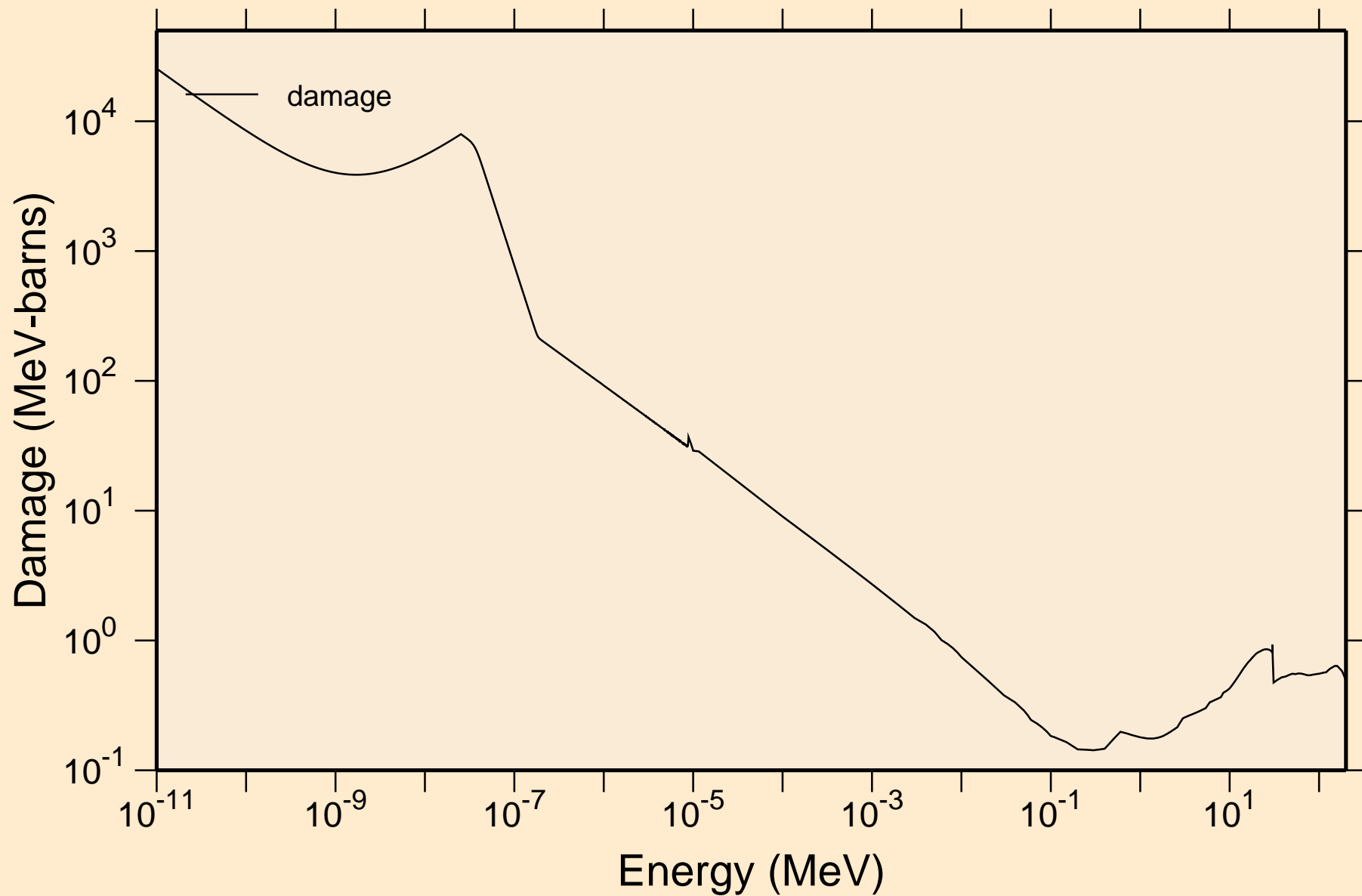

TA160M NEUTRON ACER TENDL-2019 LIBRARY; T=293.16K
Non-threshold reactions

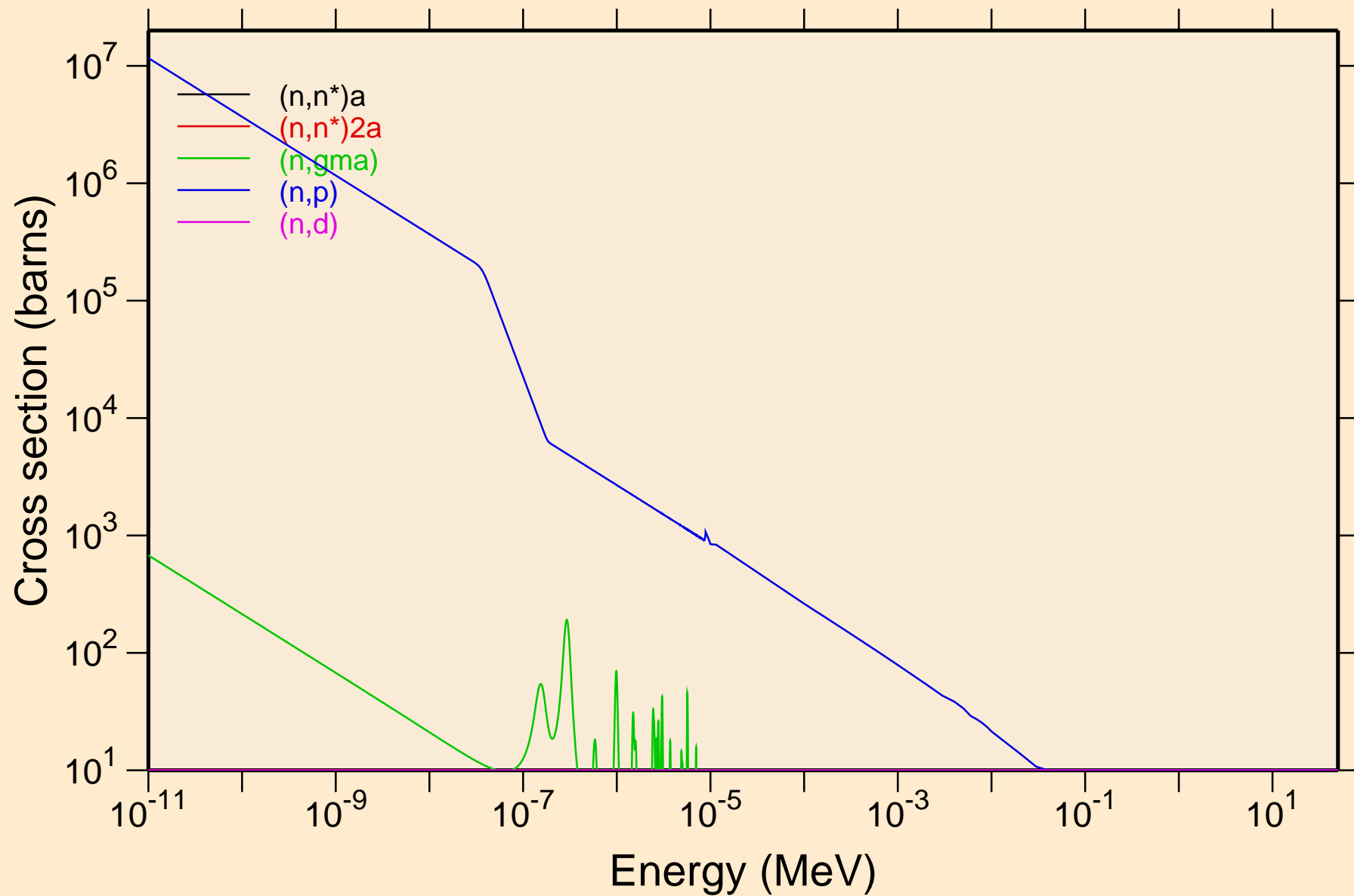

TA160M NEUTRON ACER TENDL-2019 LIBRARY; T=293.16K
Non-threshold reactions

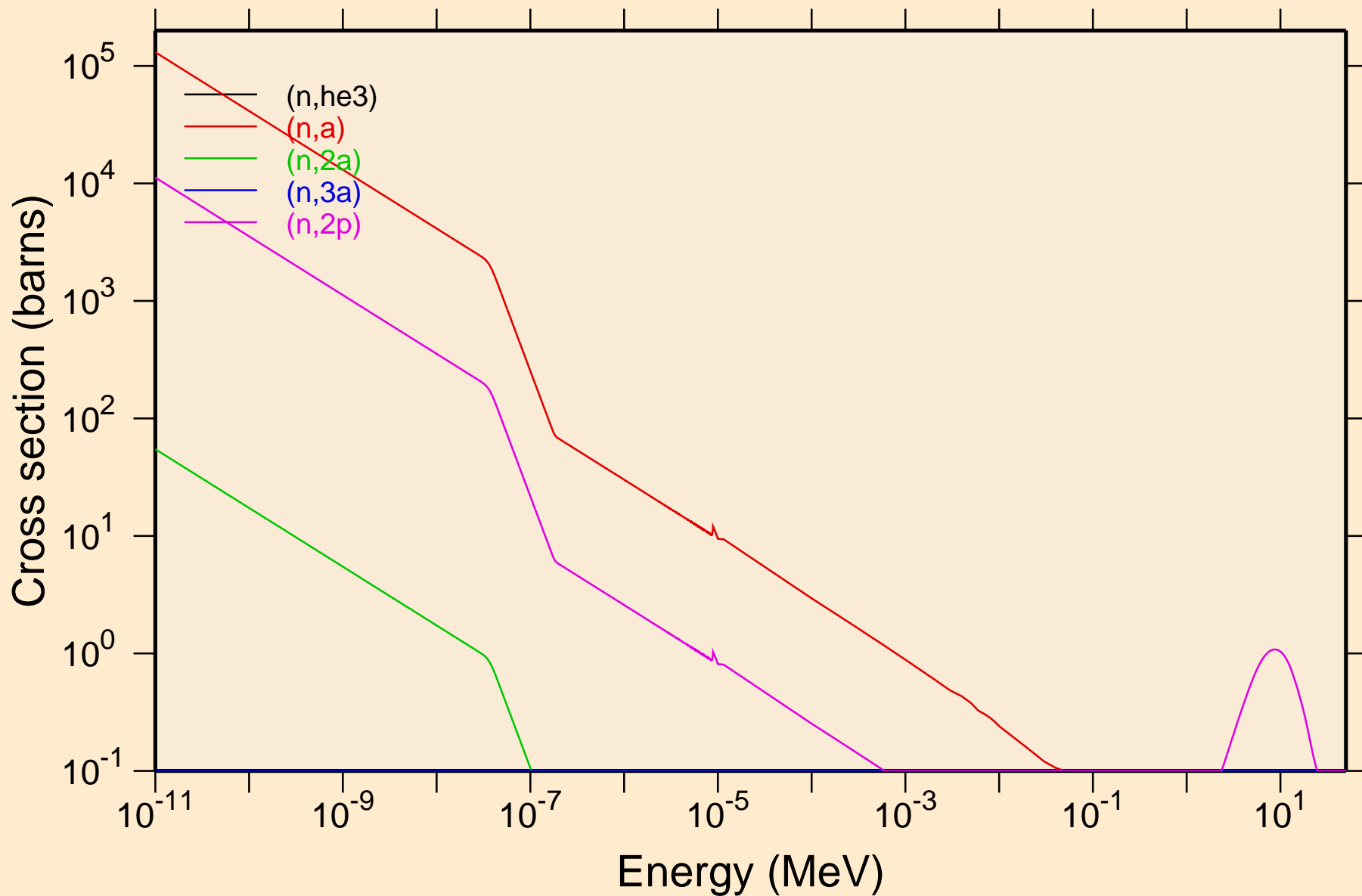

TA160M NEUTRON ACER TENDL-2019 LIBRARY; T=293.16K
Non-threshold reactions

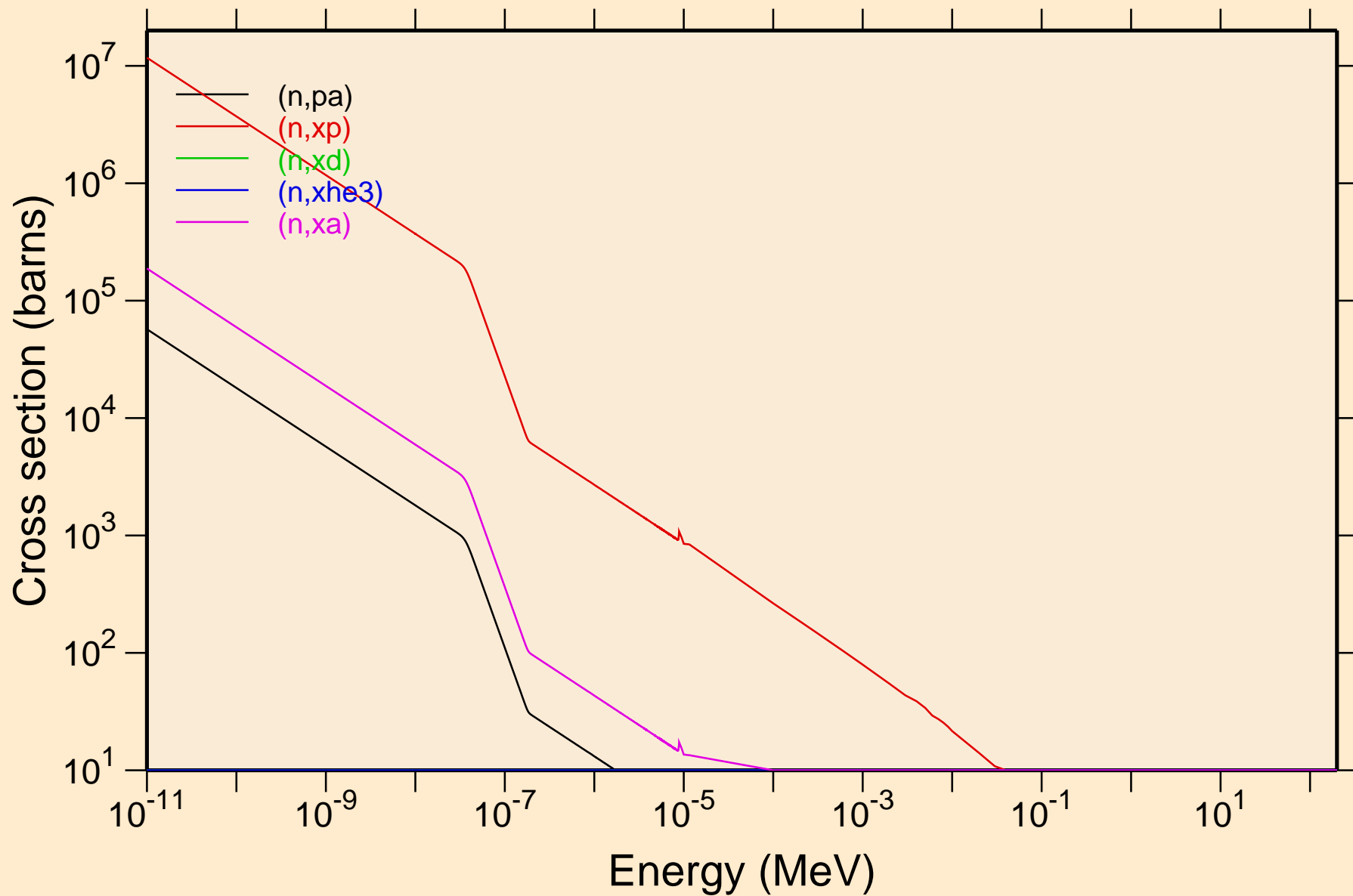

TA160M NEUTRON ACER TENDL-2019 LIBRARY; T=293.16K
Principal cross sections

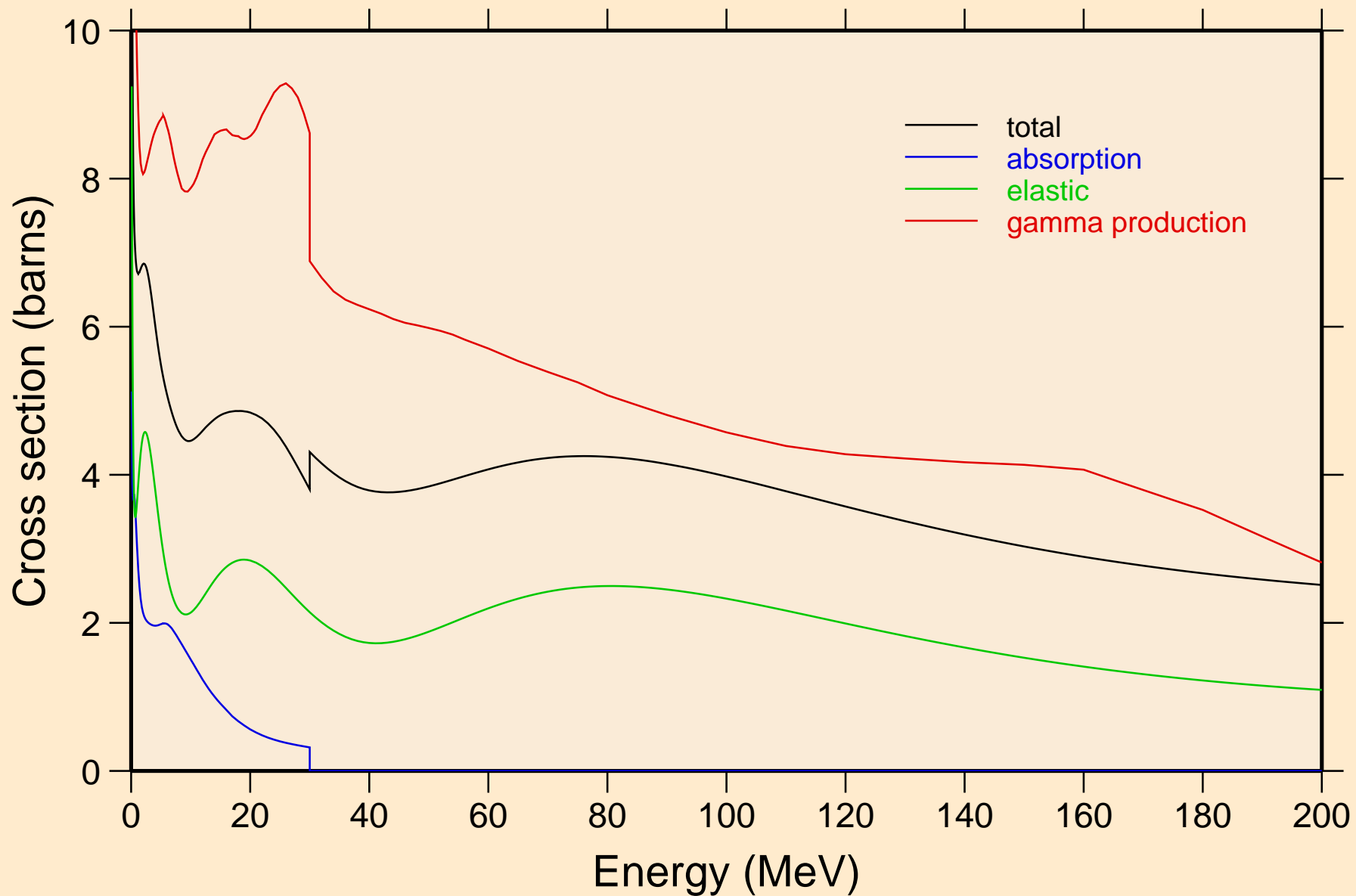

TA160M NEUTRON ACER TENDL-2019 LIBRARY; T=293.16K
Heating

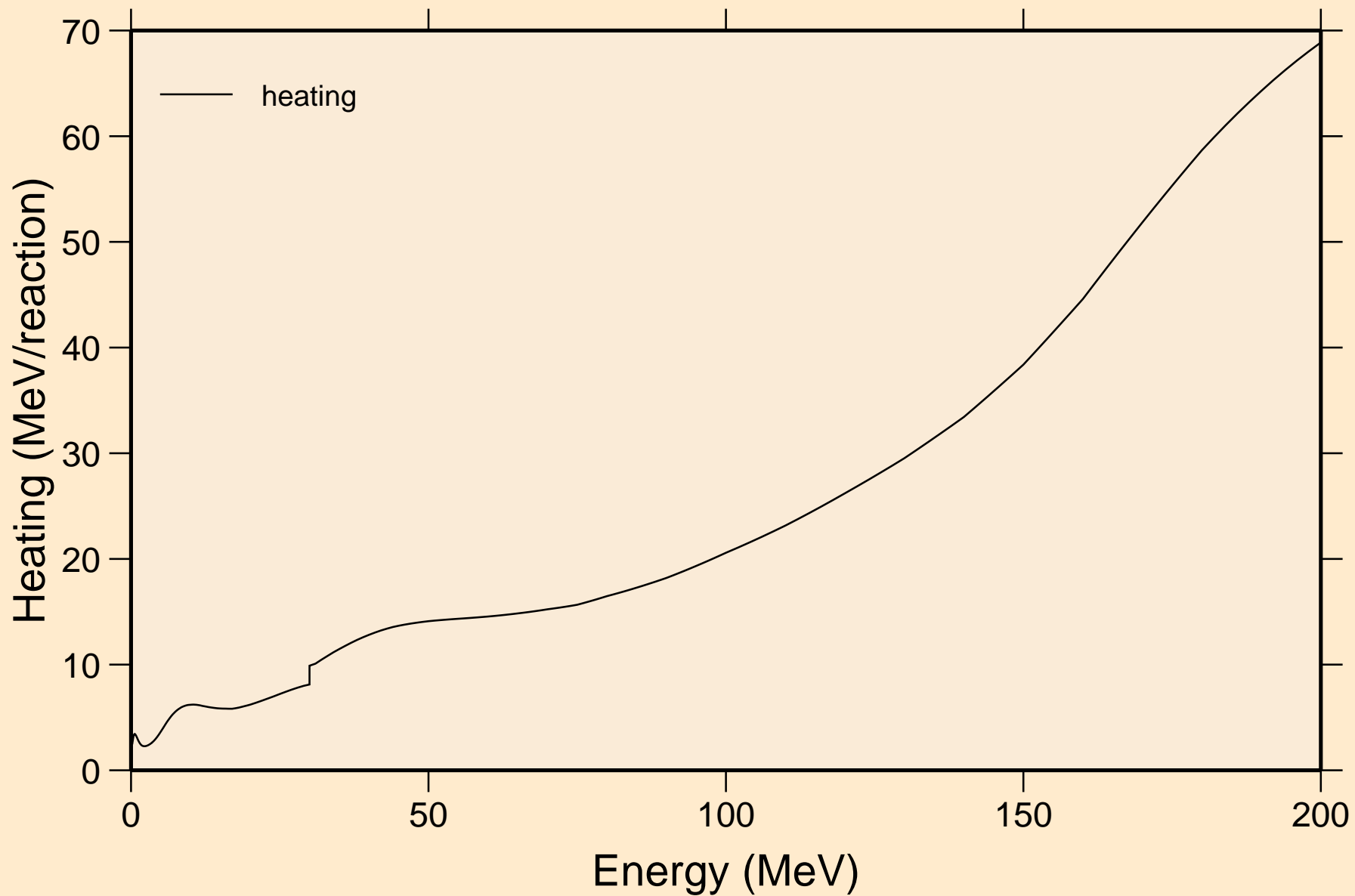

TA160M NEUTRON ACER TENDL-2019 LIBRARY; T=293.16K
Damage

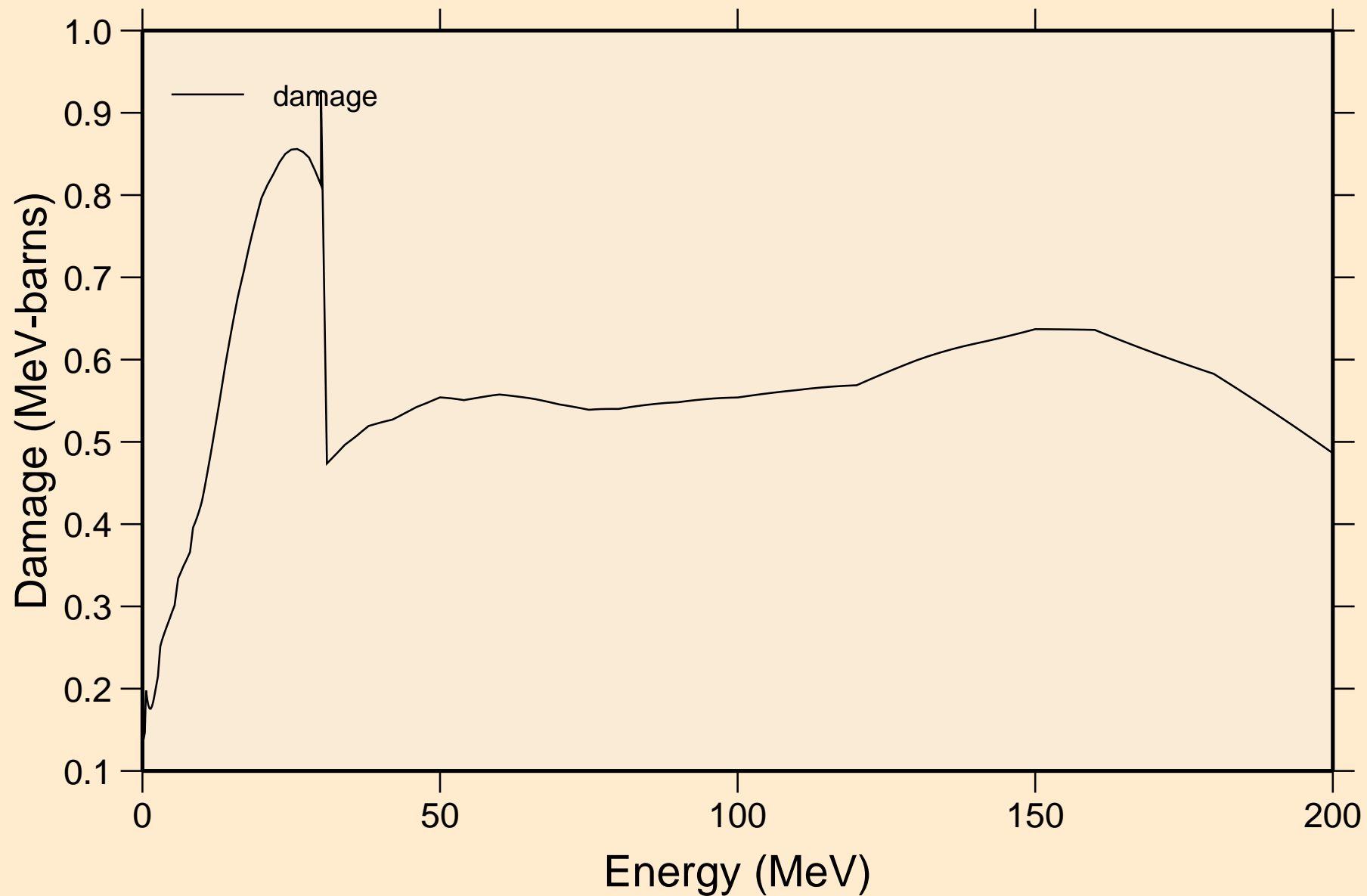

TA160M NEUTRON ACER TENDL-2019 LIBRARY; T=293.16K
Non-threshold reactions

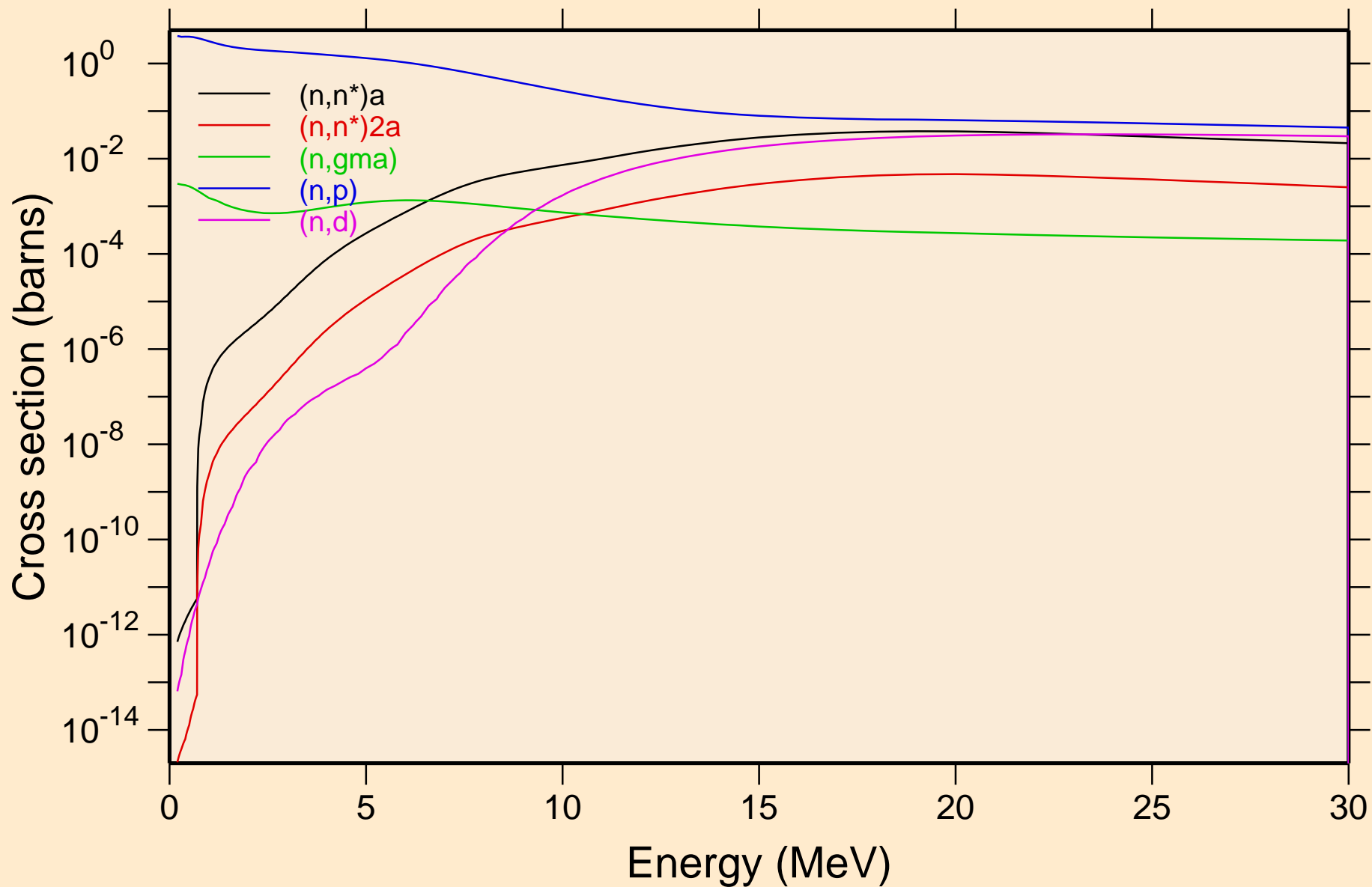

TA160M NEUTRON ACER TENDL-2019 LIBRARY; T=293.16K
Non-threshold reactions

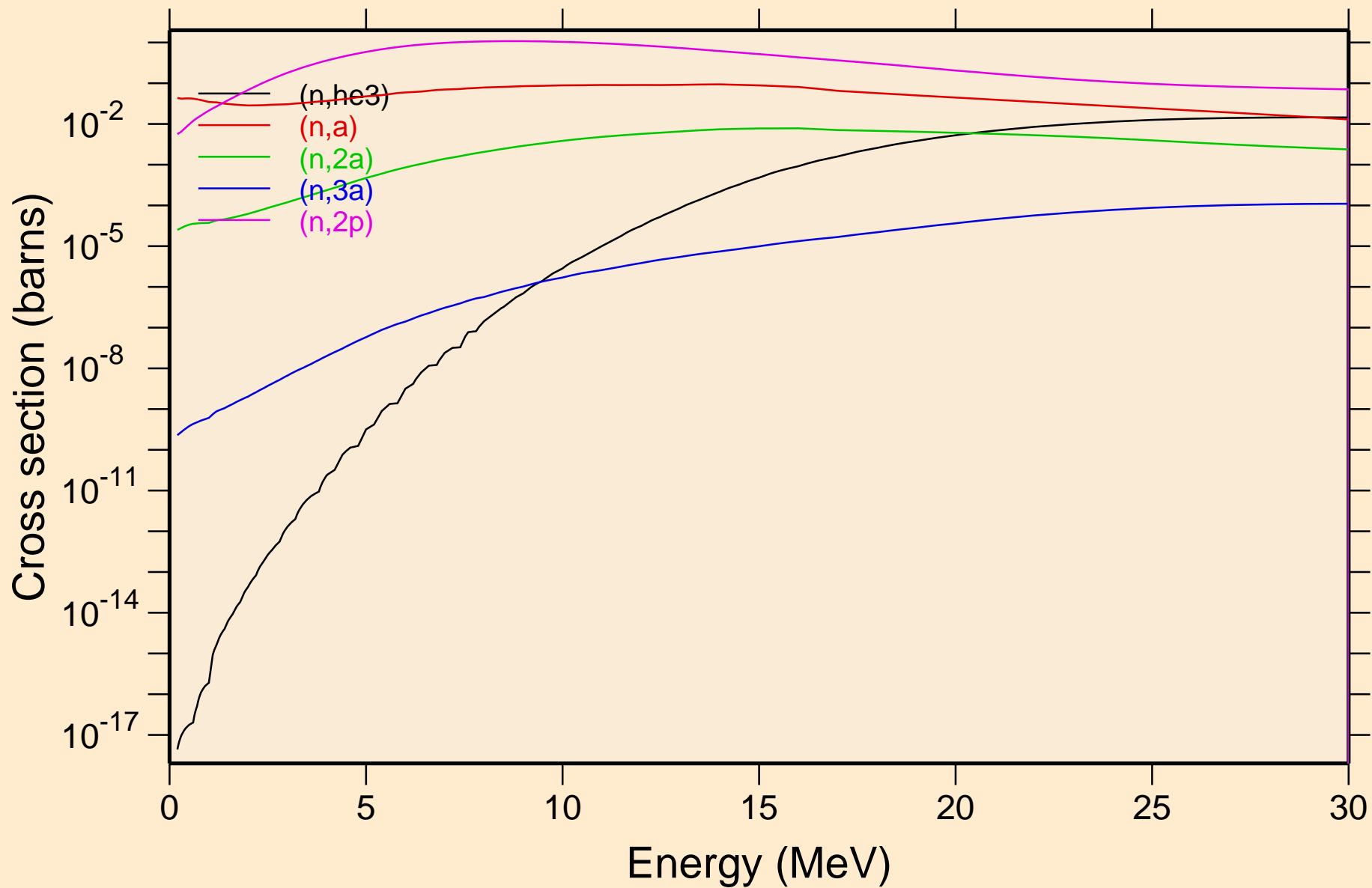

TA160M NEUTRON ACER TENDL-2019 LIBRARY; T=293.16K
Non-threshold reactions

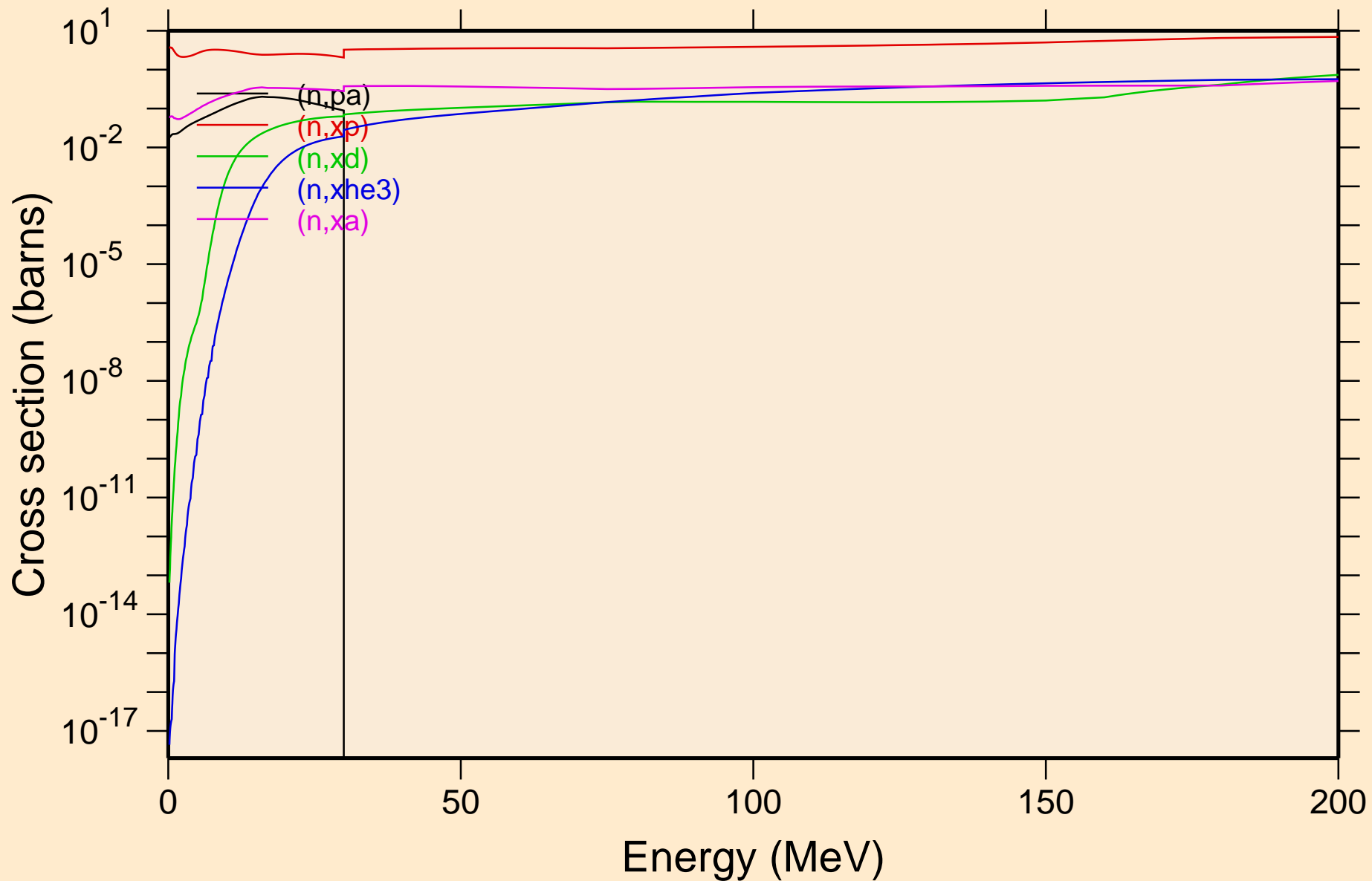

TA160M NEUTRON ACER TENDL-2019 LIBRARY; T=293.16K
Inelastic levels

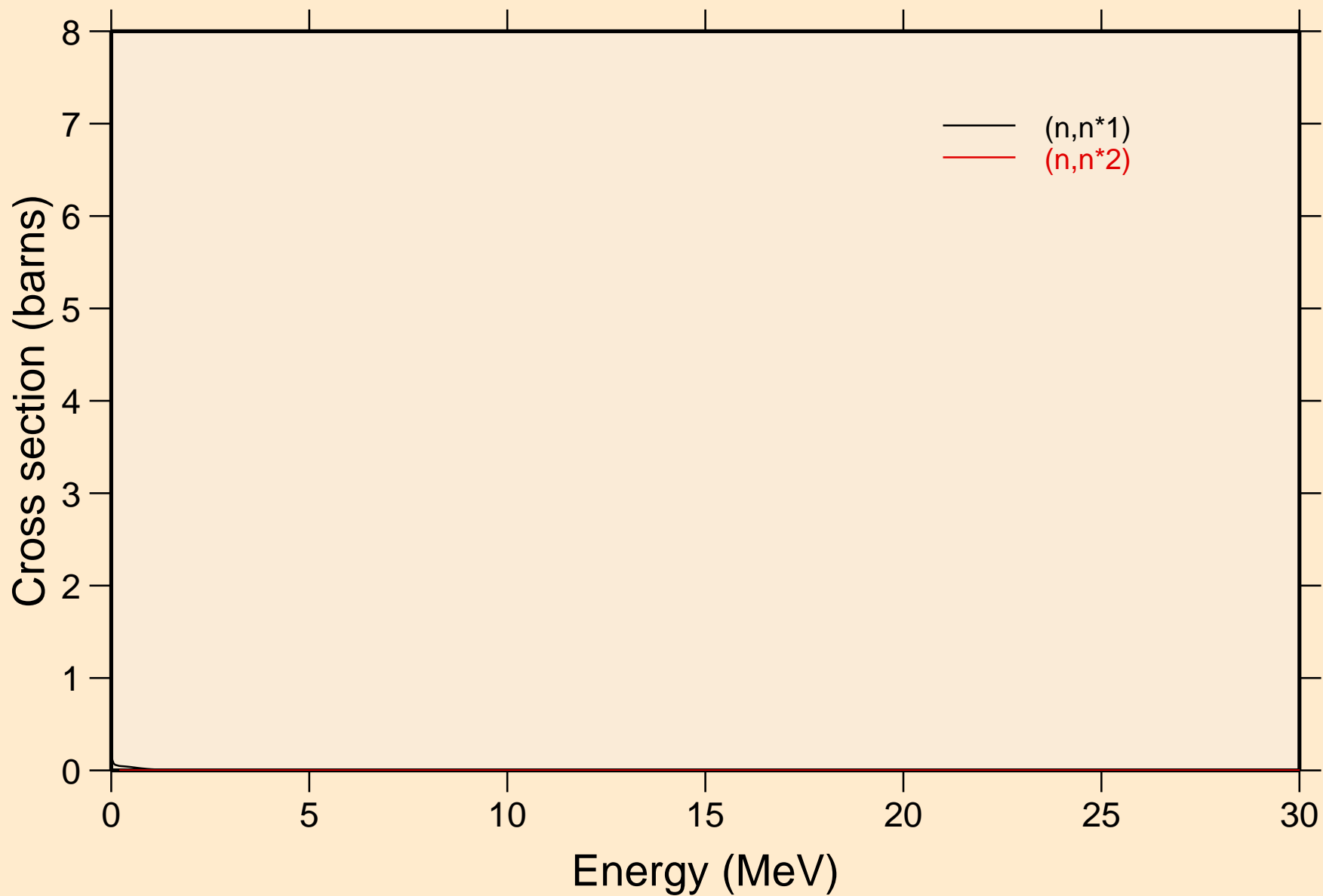

TA160M NEUTRON ACER TENDL-2019 LIBRARY; T=293.16K
Threshold reactions

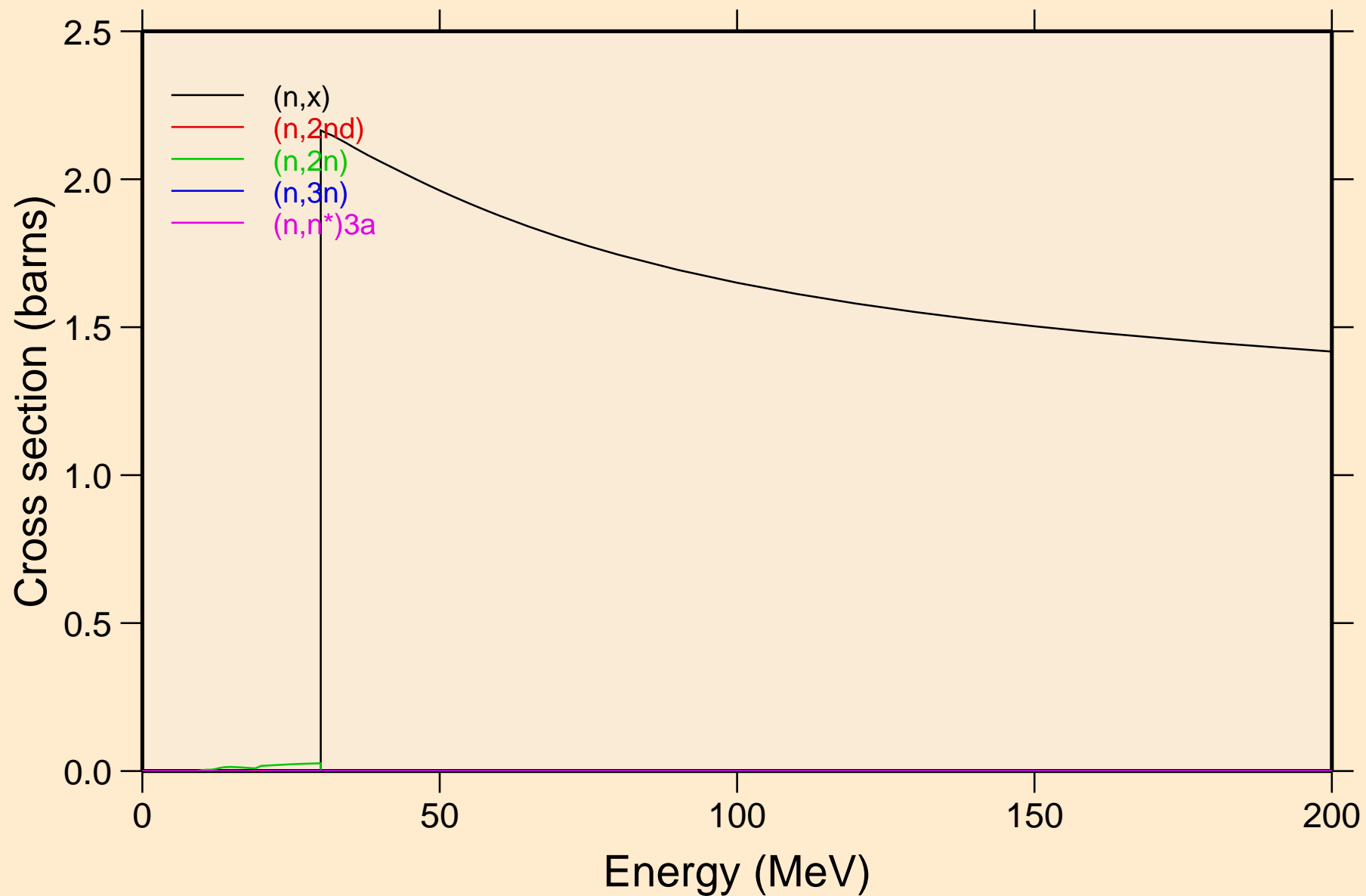

TA160M NEUTRON ACER TENDL-2019 LIBRARY; T=293.16K
Threshold reactions

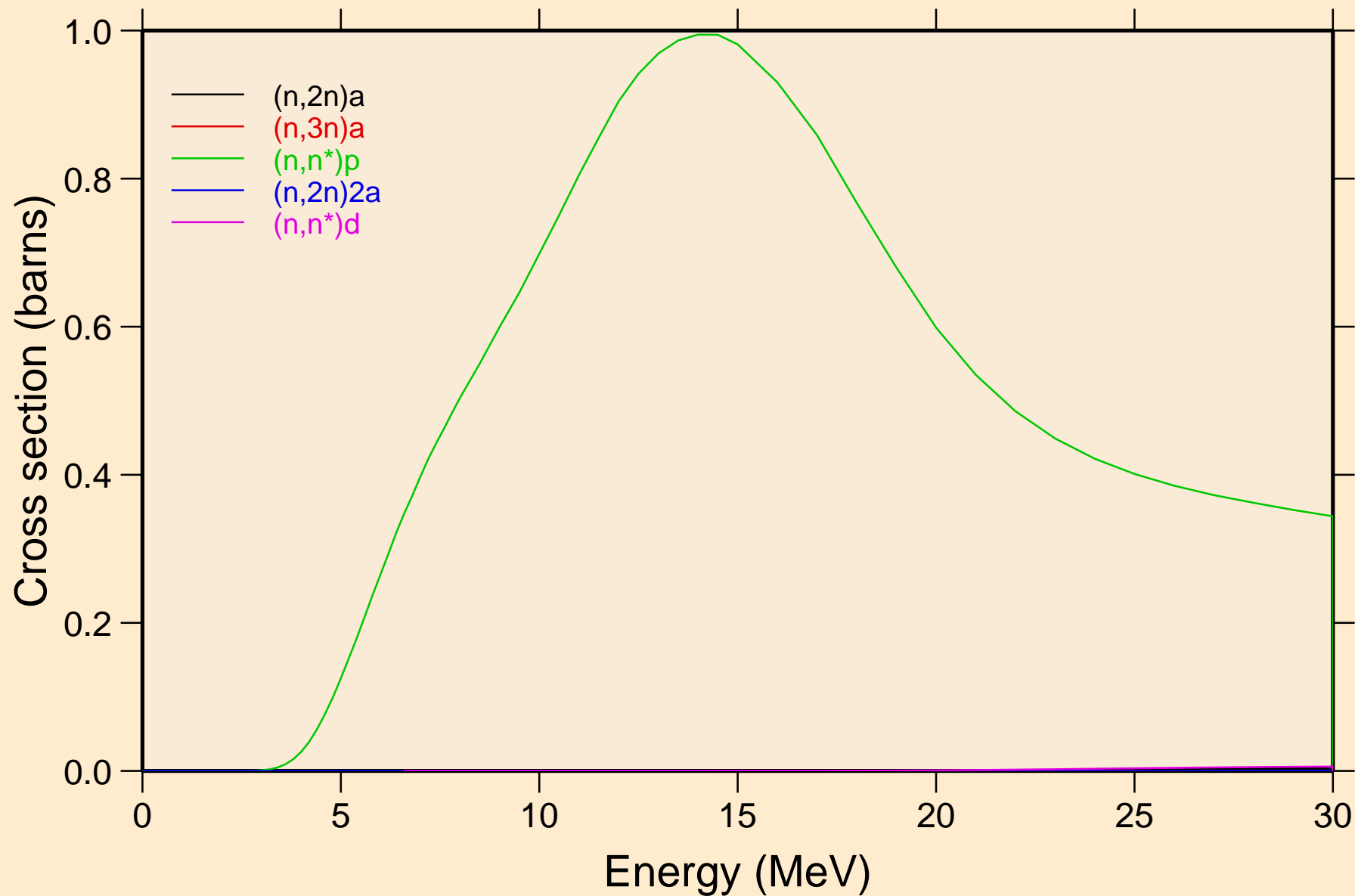

TA160M NEUTRON ACER TENDL-2019 LIBRARY; T=293.16K
Threshold reactions

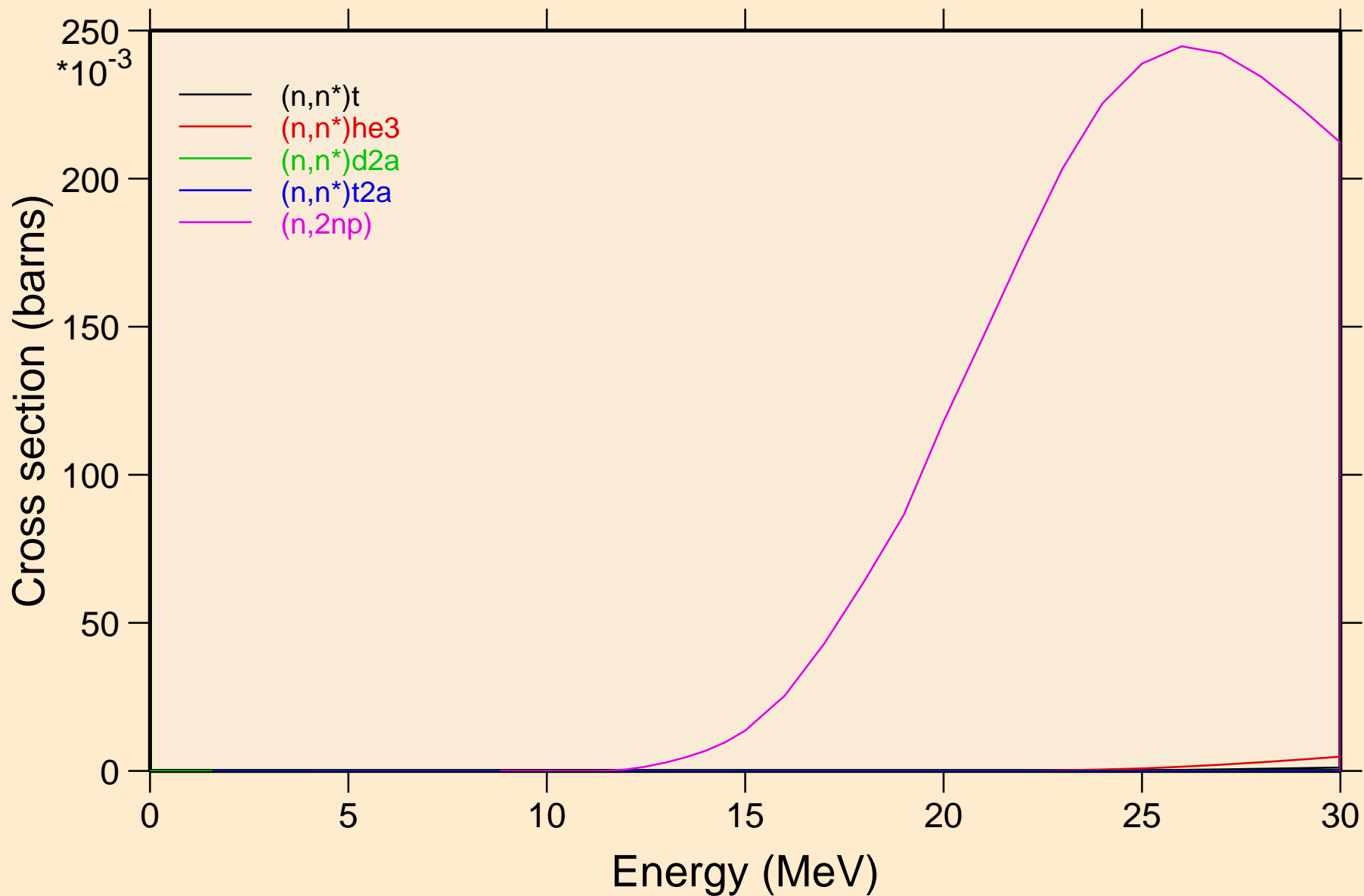

TA160M NEUTRON ACER TENDL-2019 LIBRARY; T=293.16K
Threshold reactions

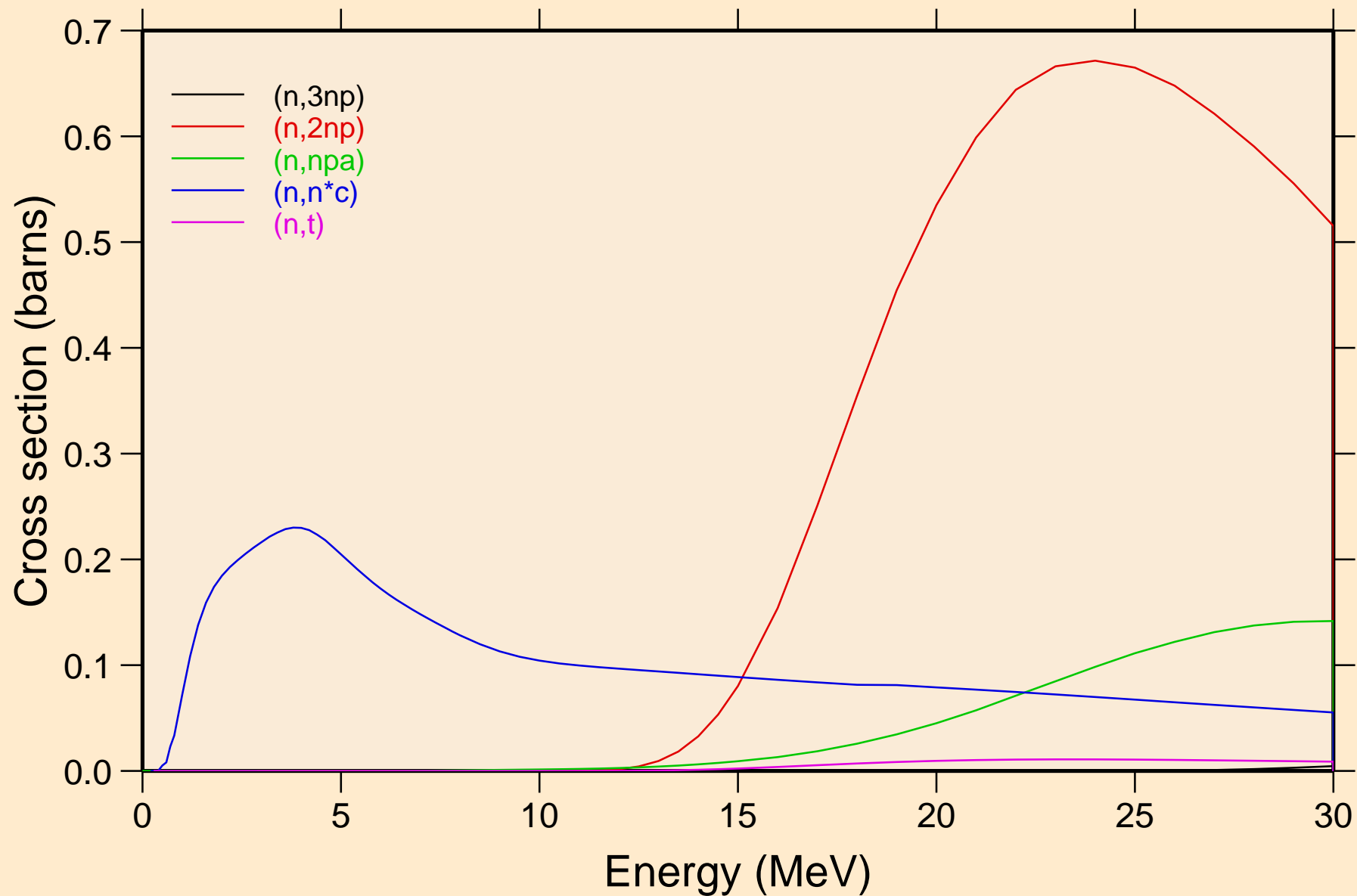

TA160M NEUTRON ACER TENDL-2019 LIBRARY; T=293.16K
Threshold reactions

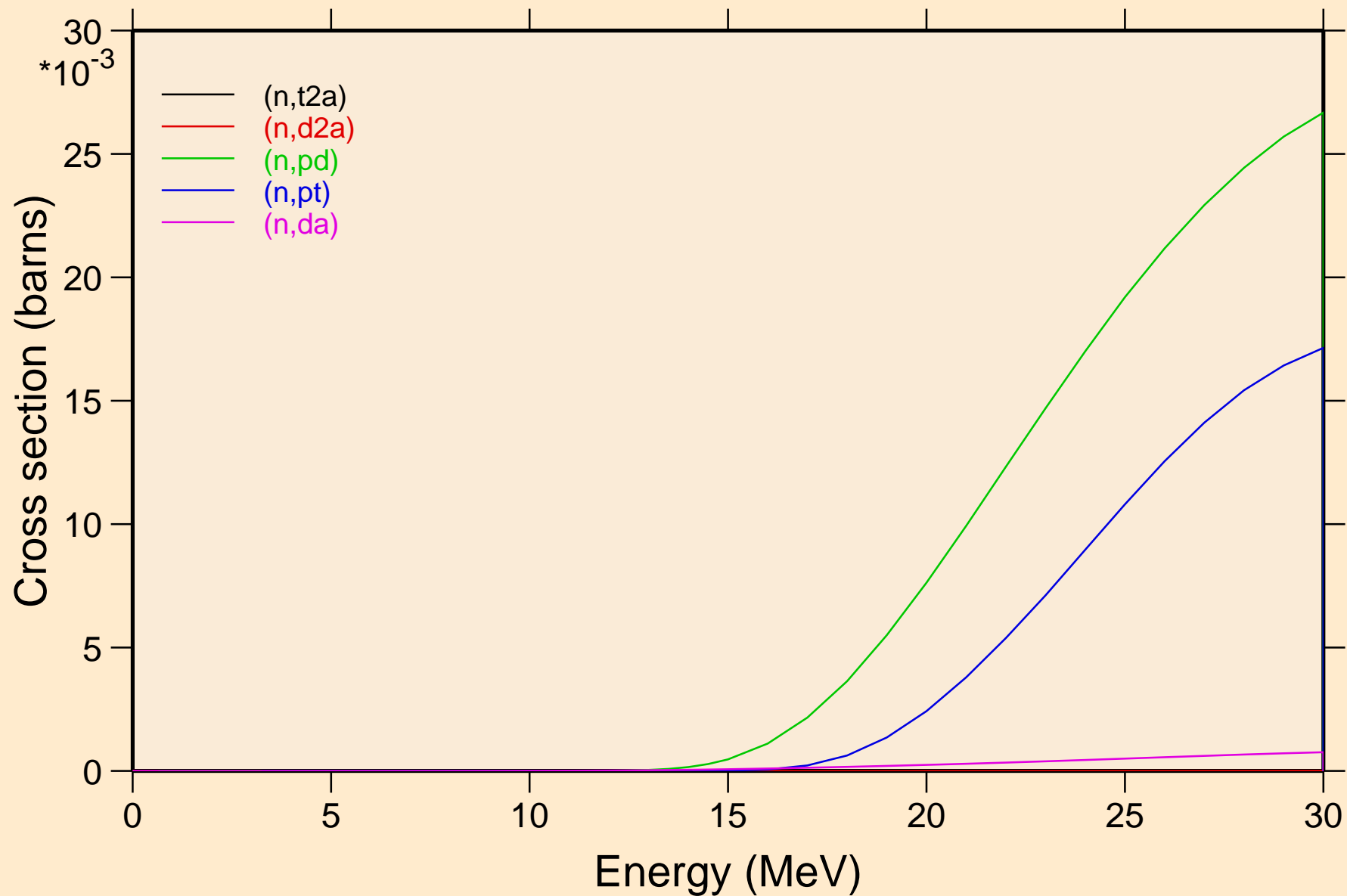

TA160M NEUTRON ACER TENDL-2019 LIBRARY; T=293.16K
Threshold reactions

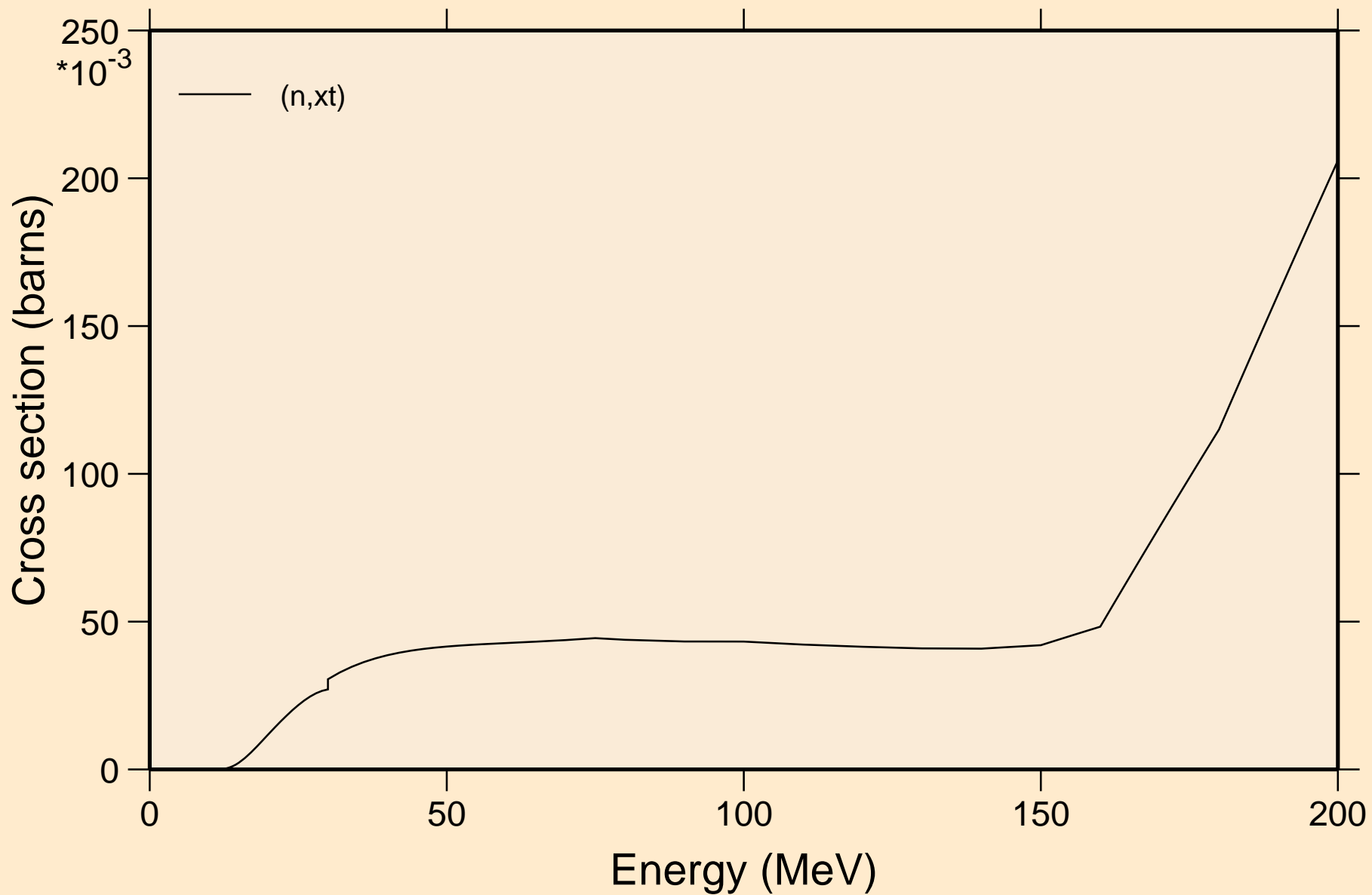

TA160M NEUTRON ACER TENDL-2019 LIBRARY; T=293.16K
angular distribution for elastic

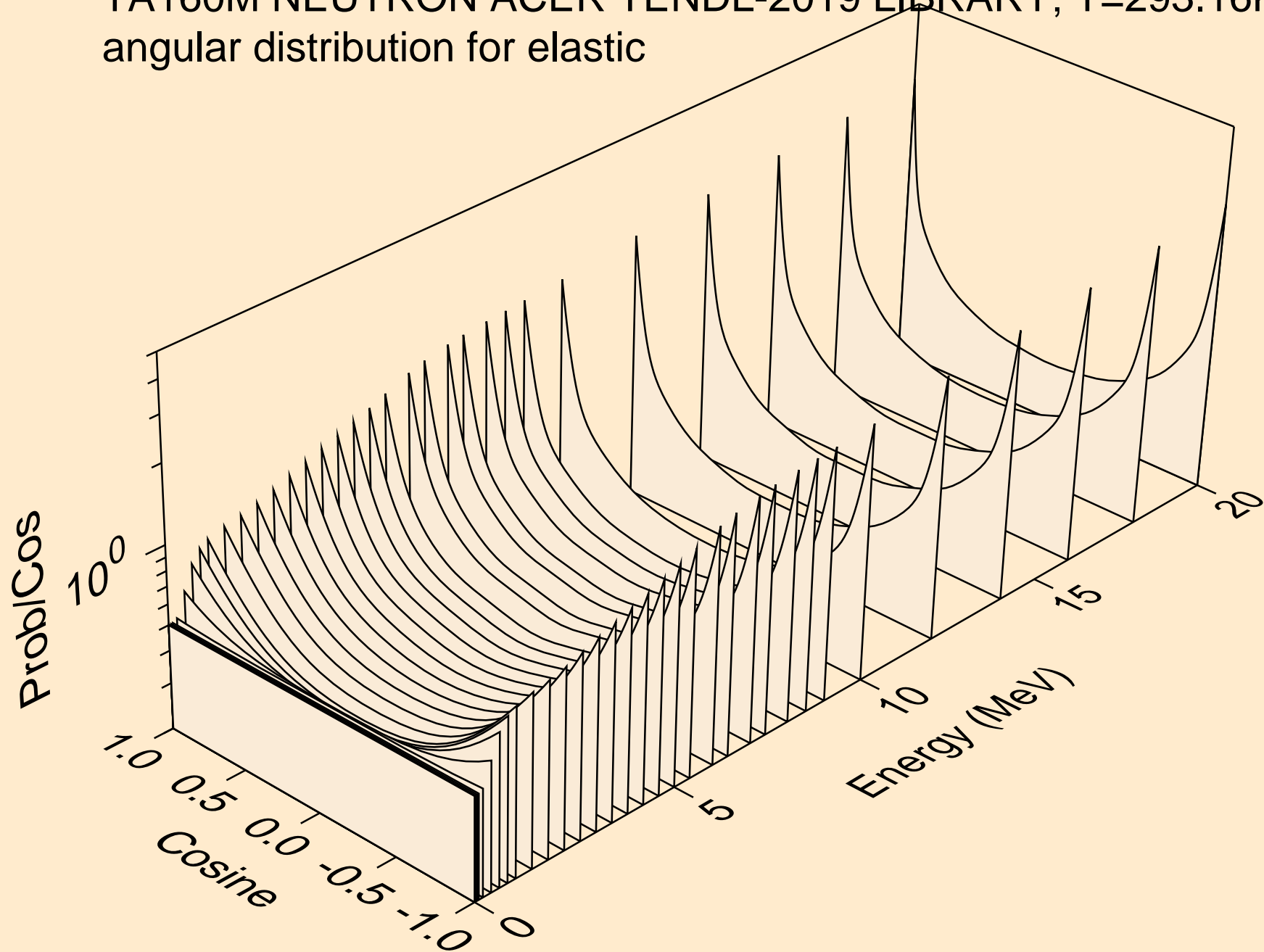

TA160M NEUTRON ACER TENDL-2019 LIBRARY; T=293.16K
angular distribution for elastic

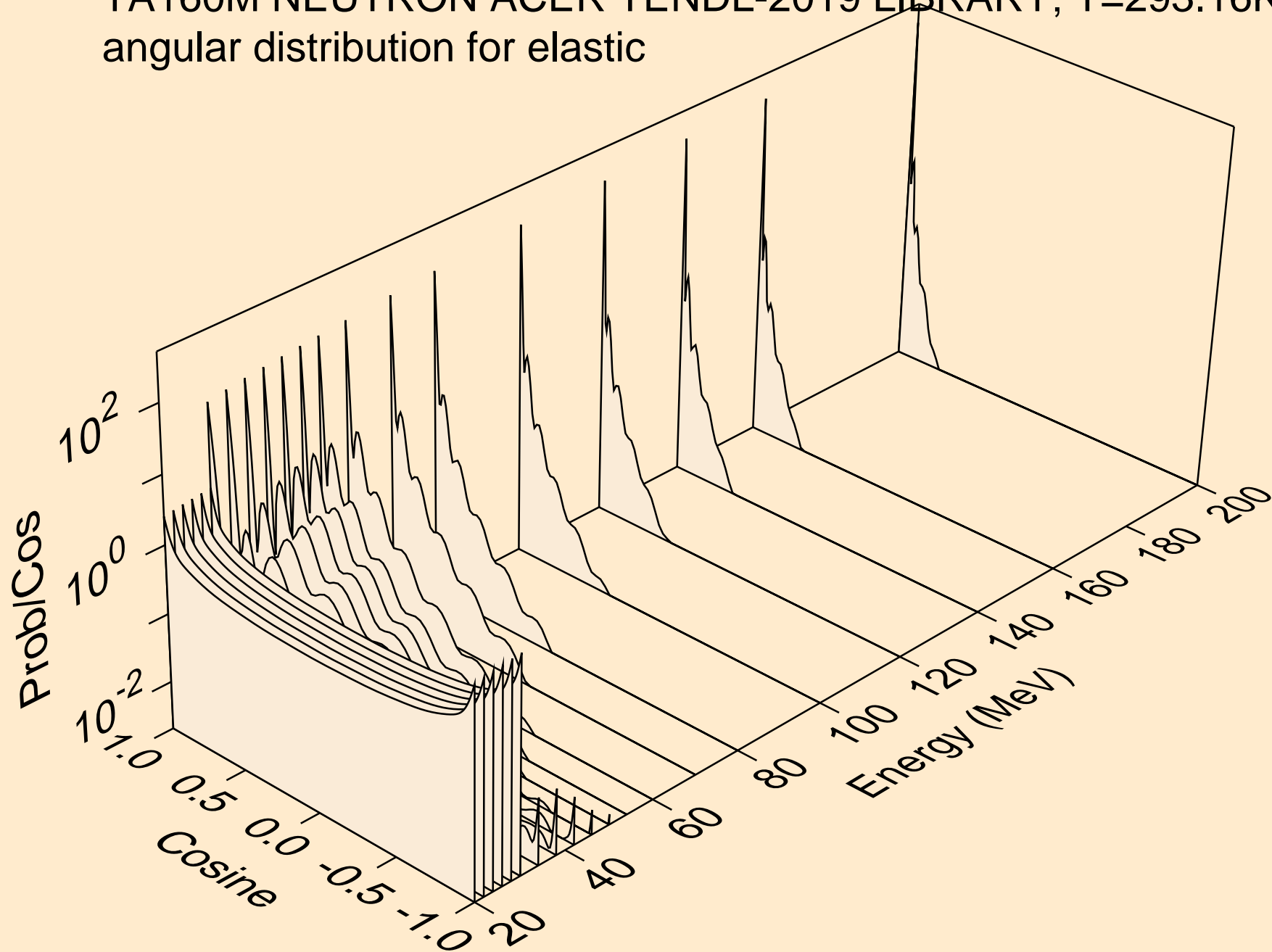

TA160M NEUTRON ACER TENDL-2019 LIBRARY; T=293.16K
angular distribution for (n,n*1)

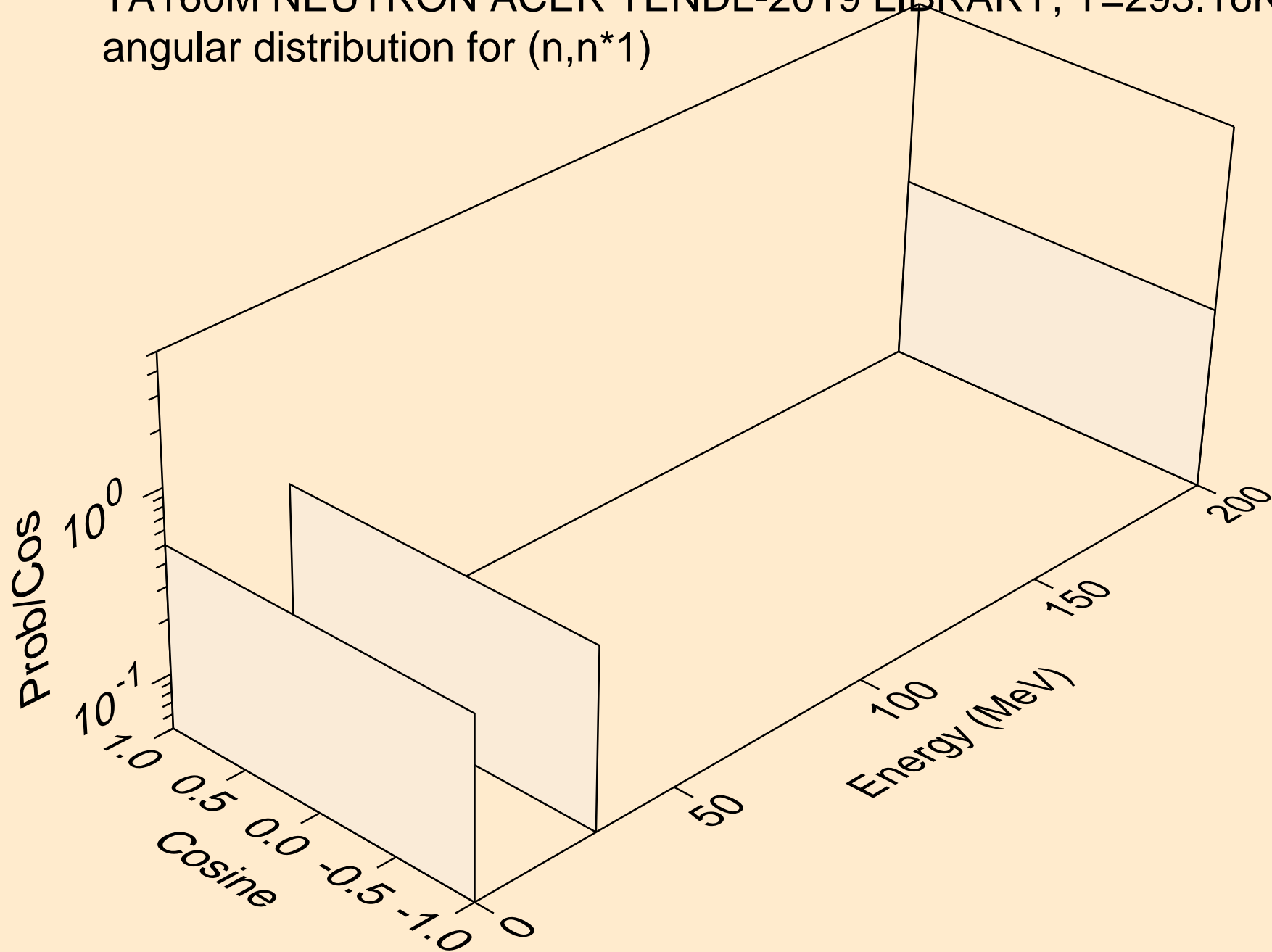

TA160M NEUTRON ACER TENDL-2019 LIBRARY; T=293.16K
angular distribution for (n,n*2)

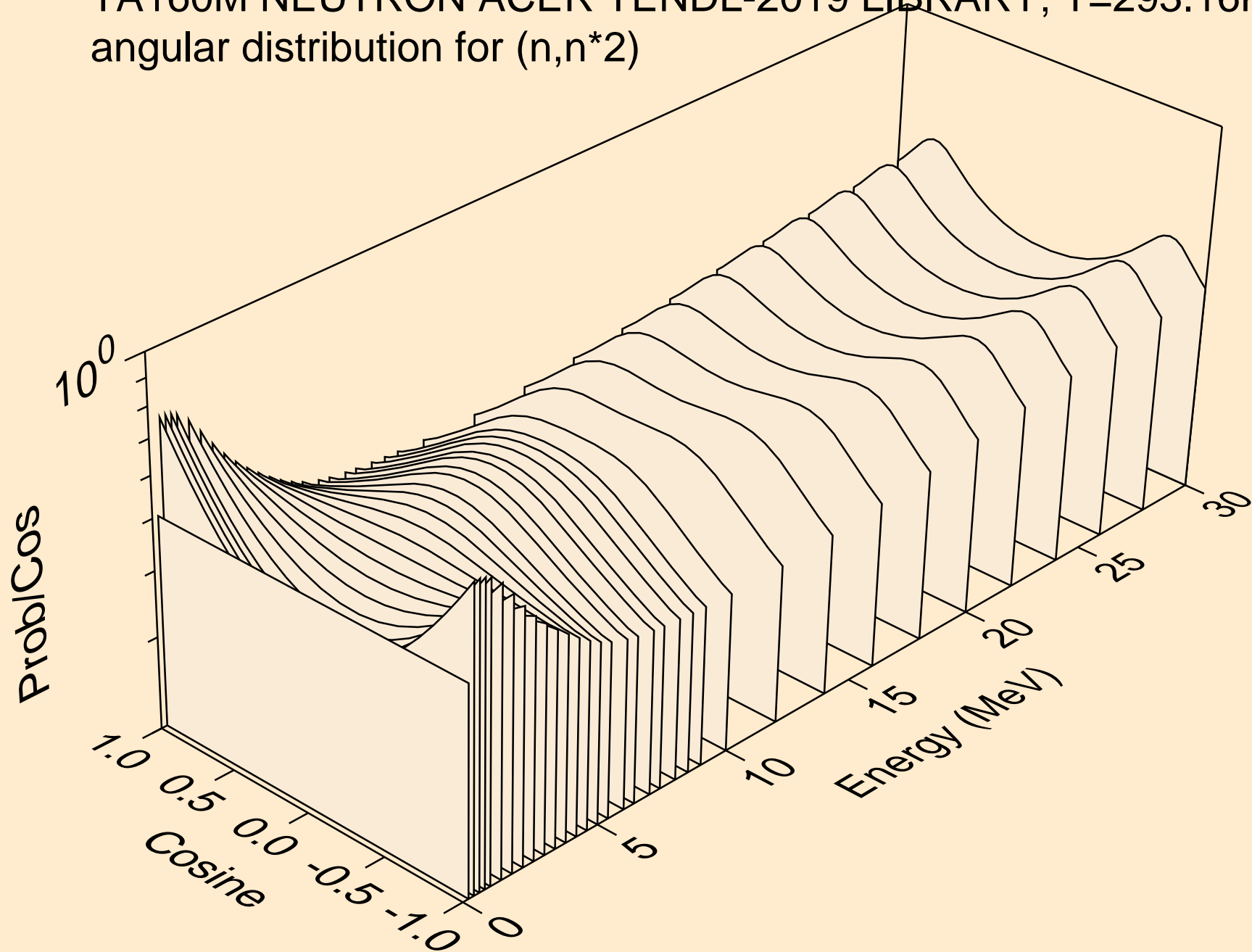

TA160M NEUTRON ACER TENDL-2019 LIBRARY; T=293.16K
Neutron emission for (n,x)

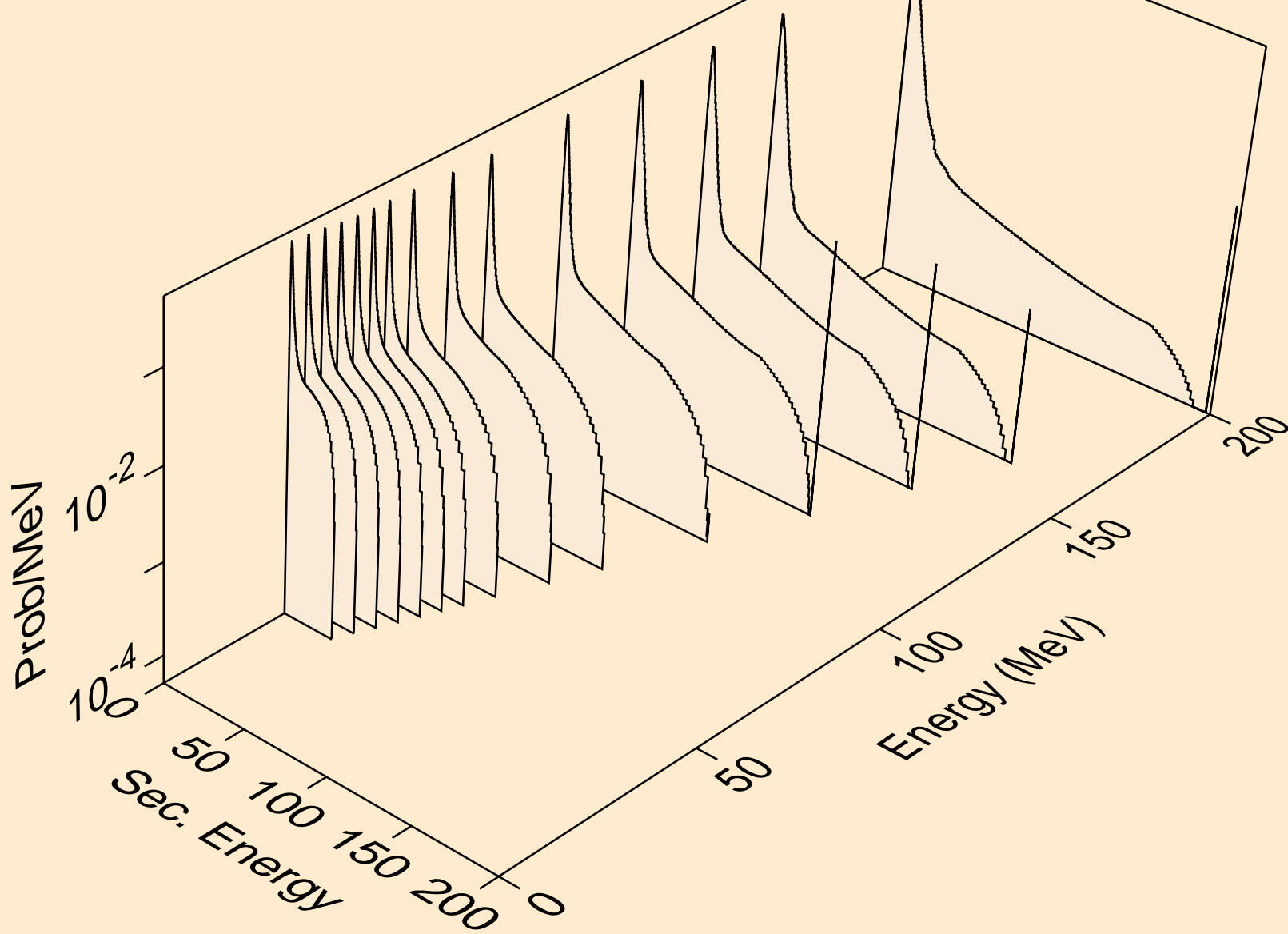

TA160M NEUTRON ACER TENDL-2019 LIBRARY; T=293.16K
Neutron emission for (n,2nd)

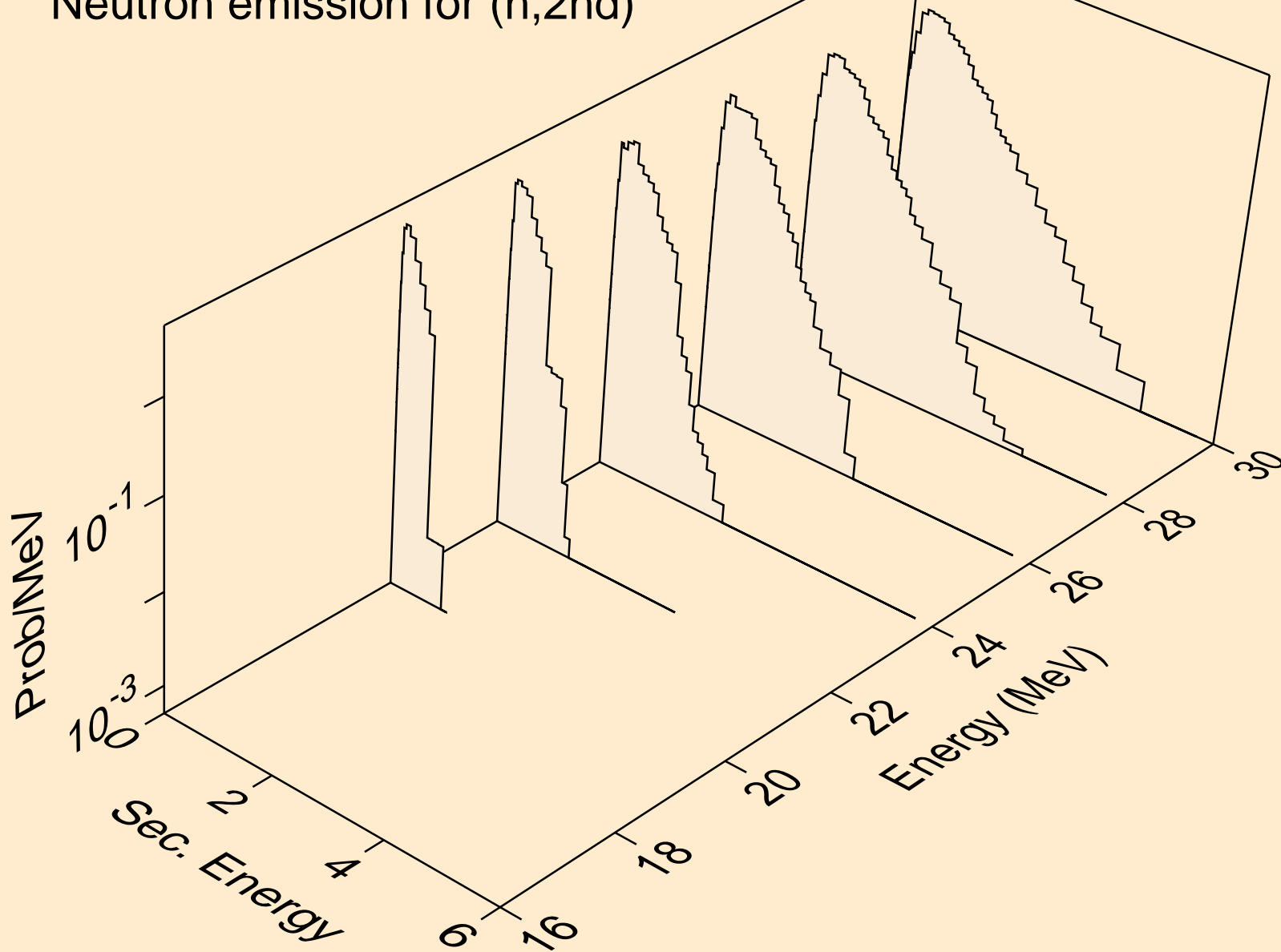

TA160M NEUTRON ACER TENDL-2019 LIBRARY; T=293.16K
Neutron emission for (n,2n)

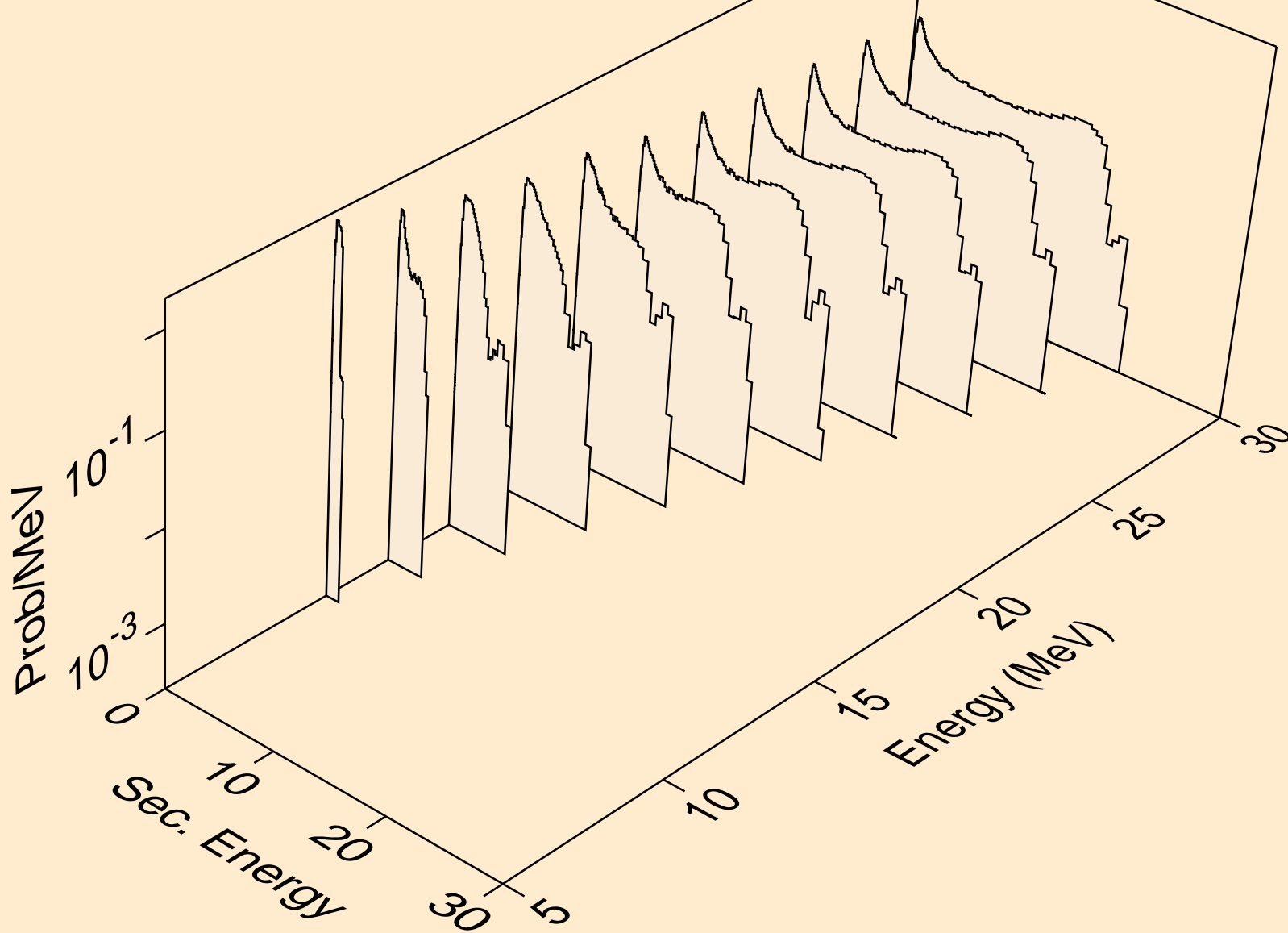

TA160M NEUTRON ACER TENDL-2019 LIBRARY; T=293.16K
Neutron emission for (n,3n)

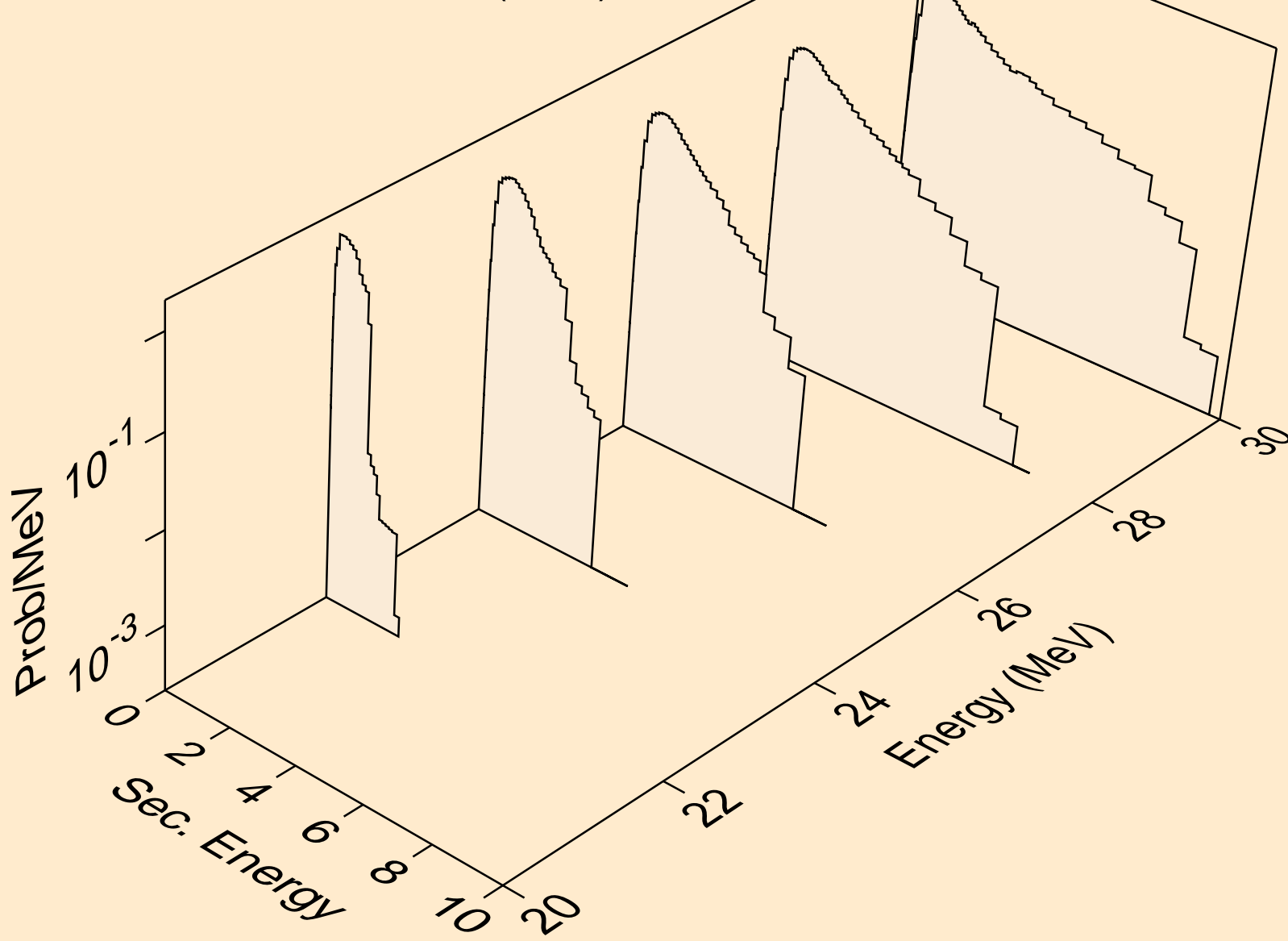

TA160M NEUTRON ACER TENDL-2019 LIBRARY; T=293.16K
Neutron emission for (n,n*)a

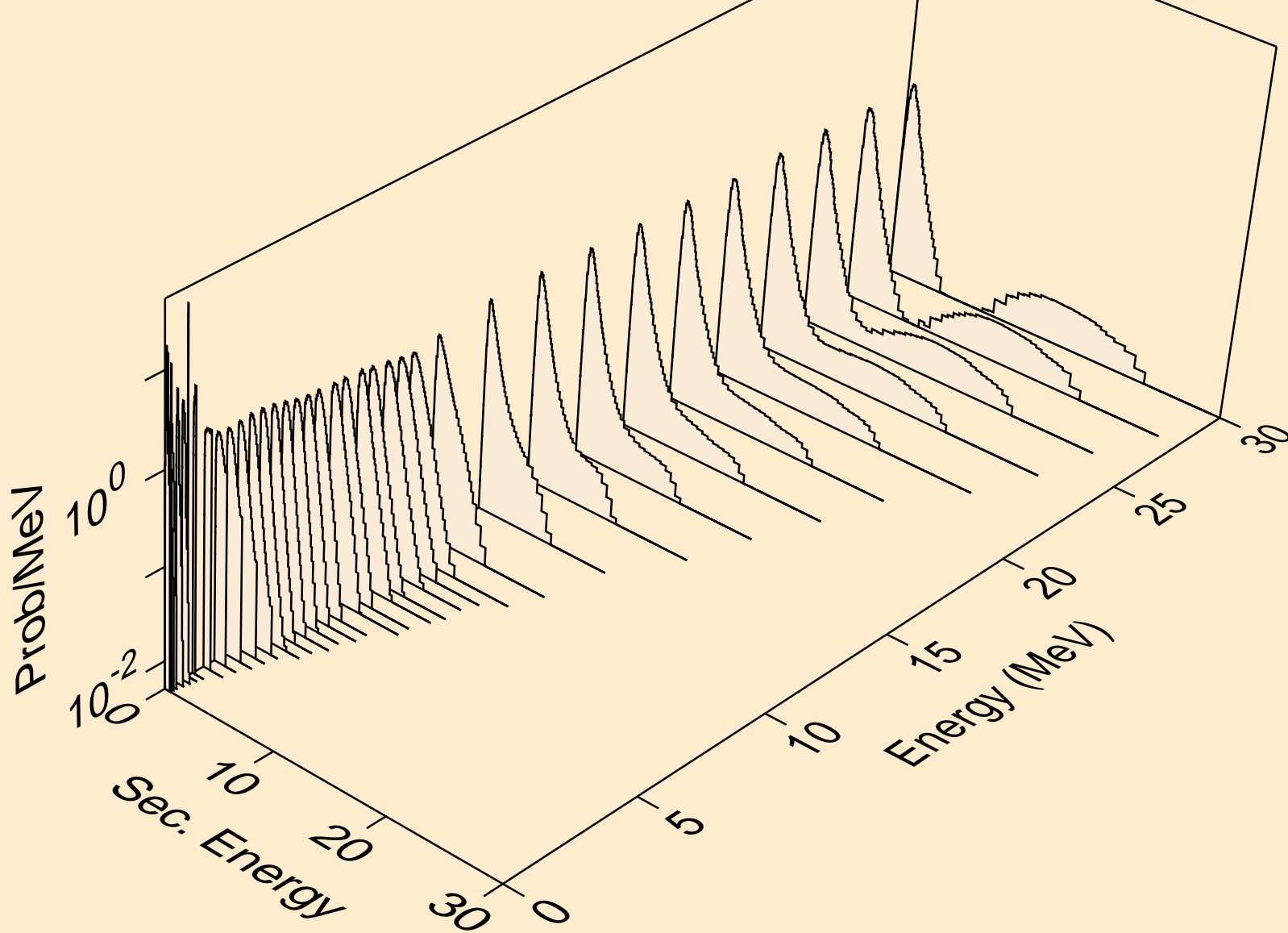

TA160M NEUTRON ACER TENDL-2019 LIBRARY; T=293.16K
Neutron emission for (n,n*)3a

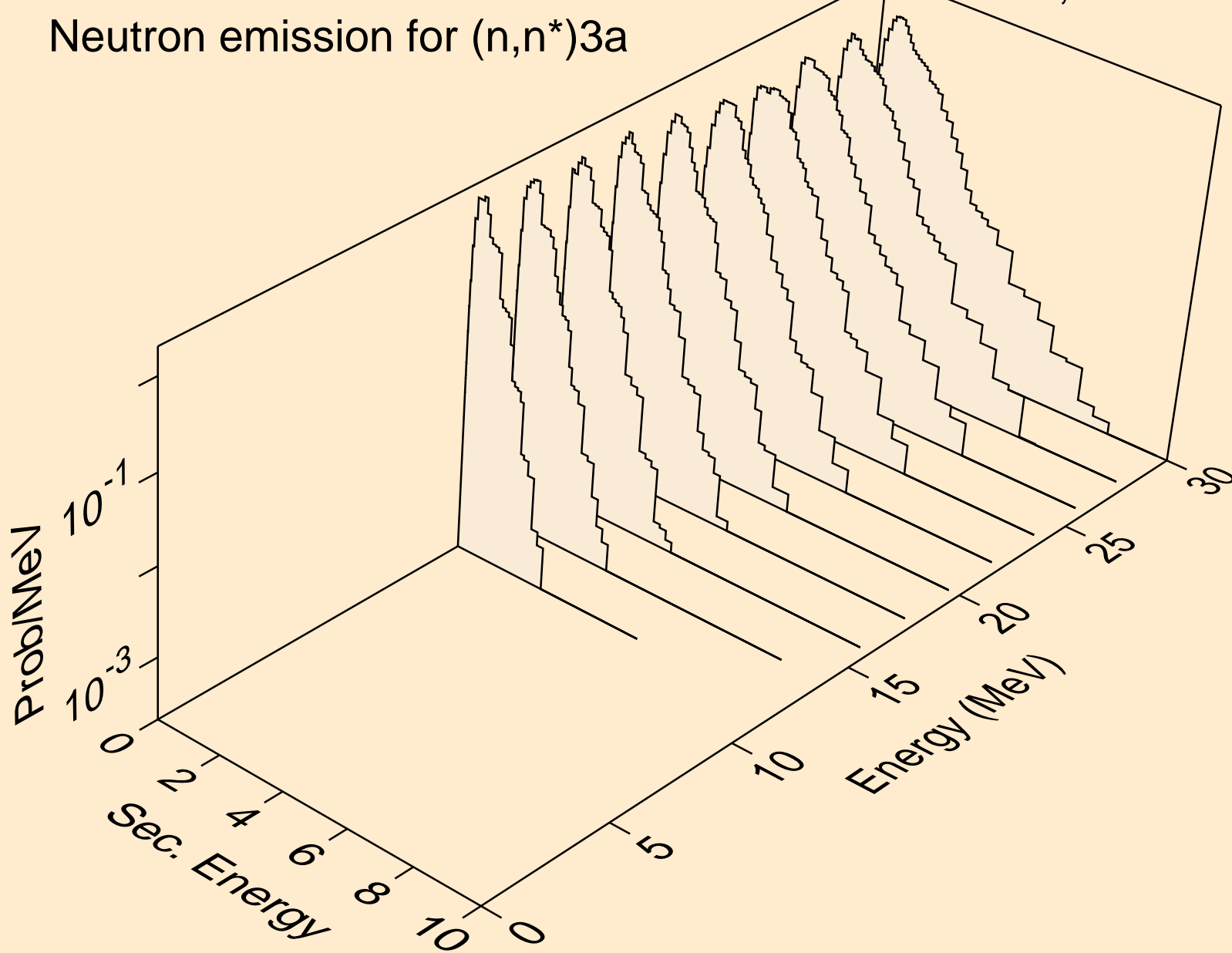

TA160M NEUTRON ACER TENDL-2019 LIBRARY; T=293.16K
Neutron emission for (n,2n)a

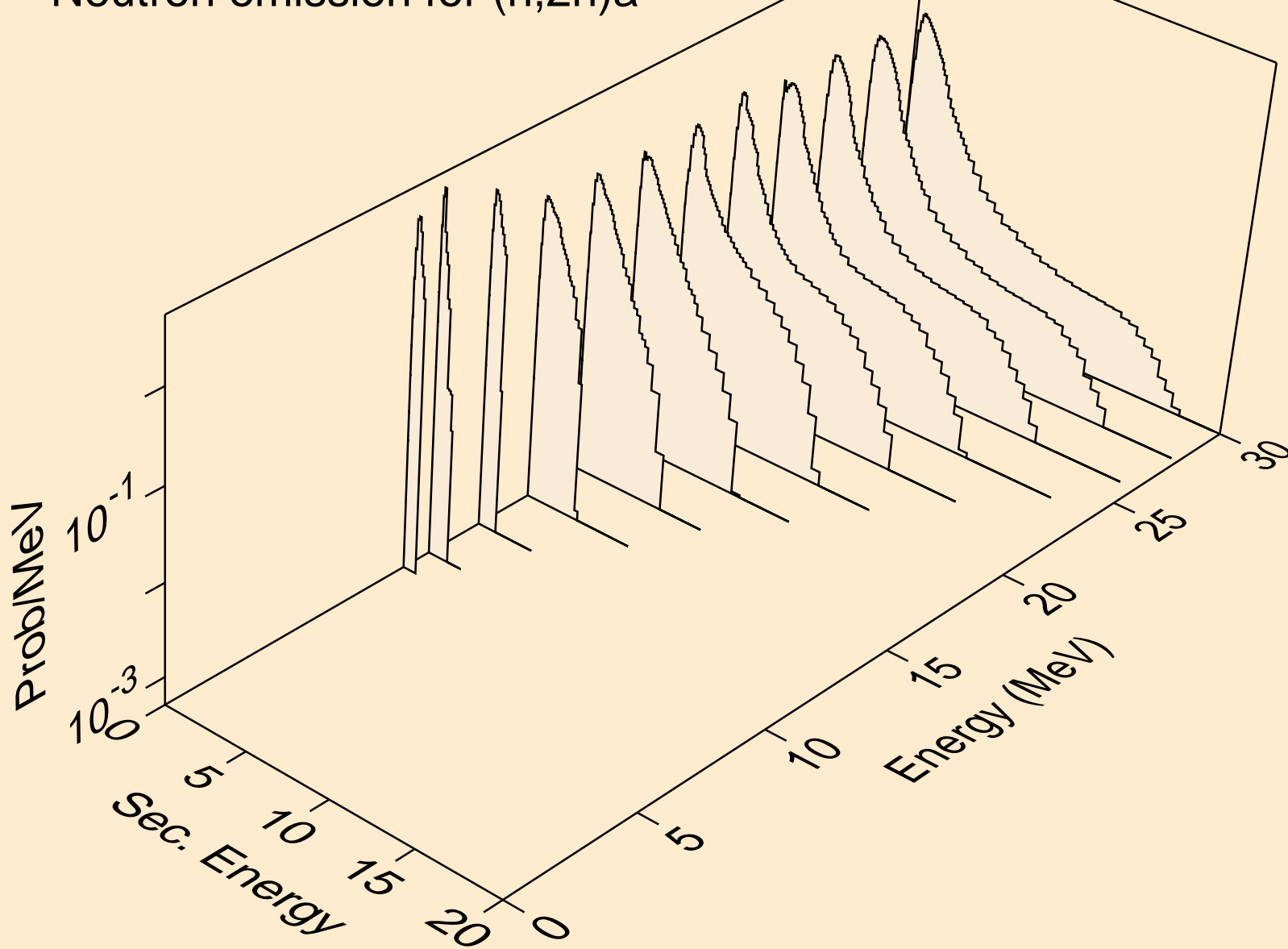

TA160M NEUTRON ACER TENDL-2019 LIBRARY; T=293.16K
Neutron emission for (n,3n)a

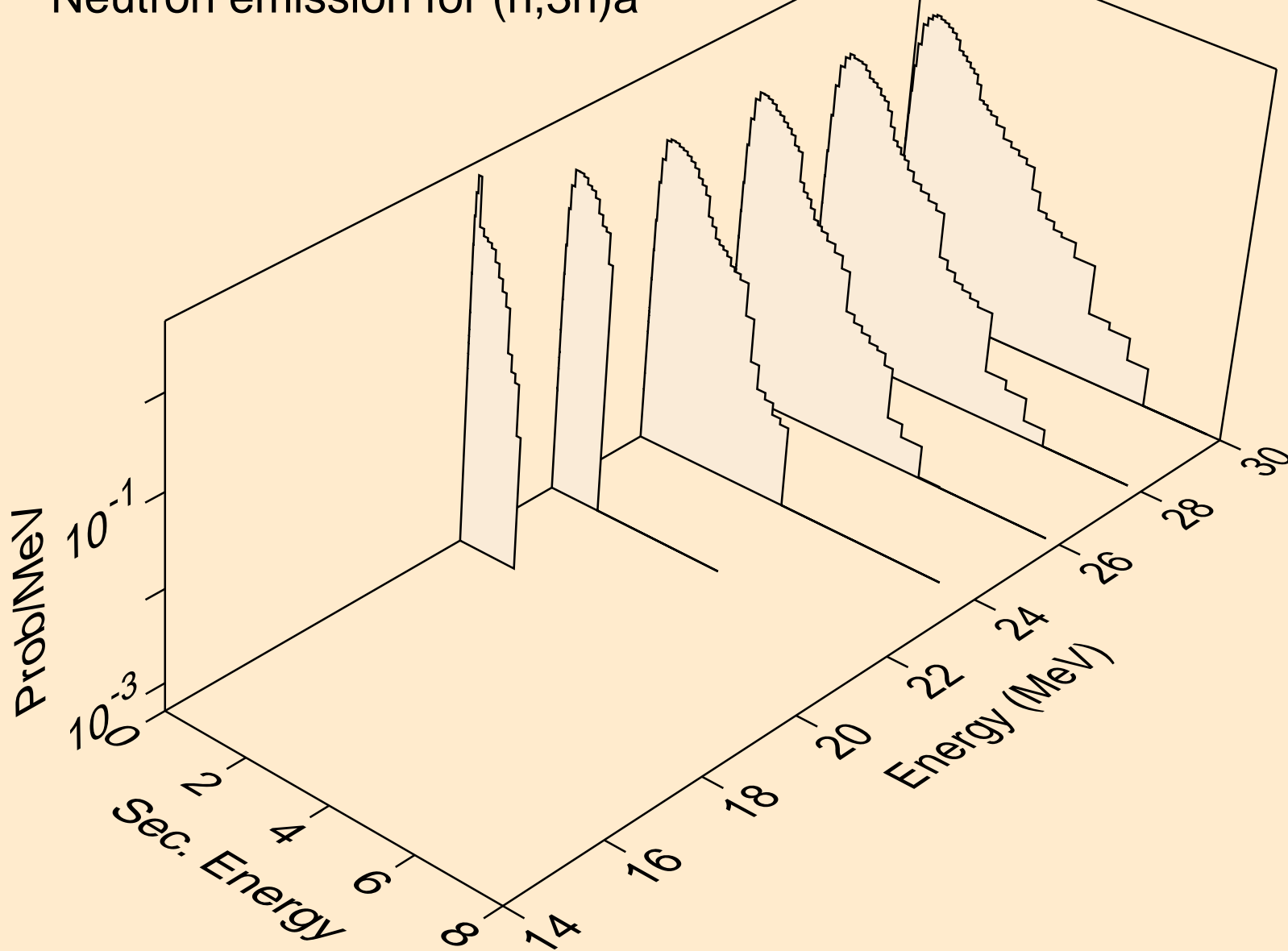

TA160M NEUTRON ACER TENDL-2019 LIBRARY; T=293.16K
Neutron emission for (n,n*)p

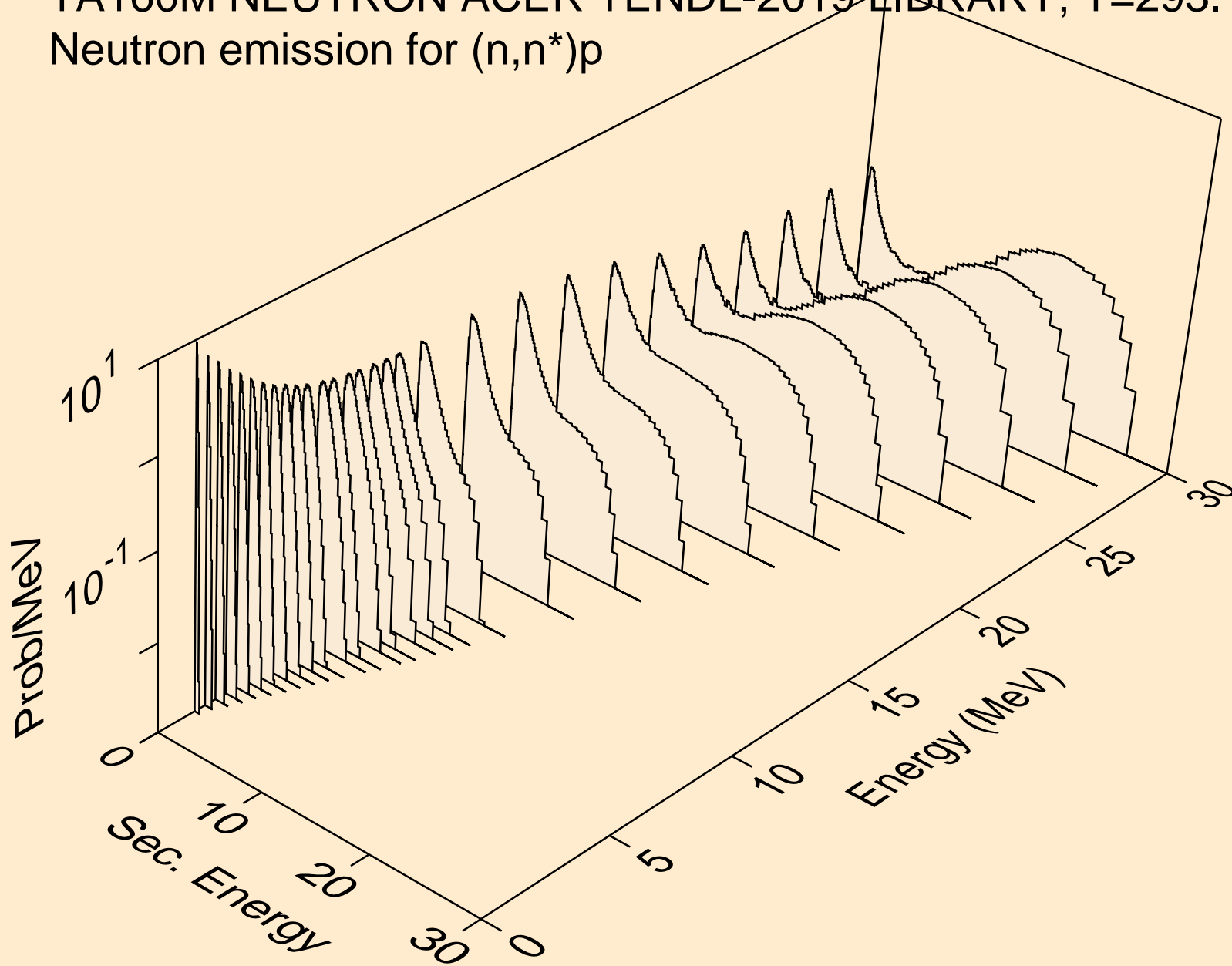

TA160M NEUTRON ACER TENDL-2019 LIBRARY; T=293.16K
Neutron emission for (n,n*)2a

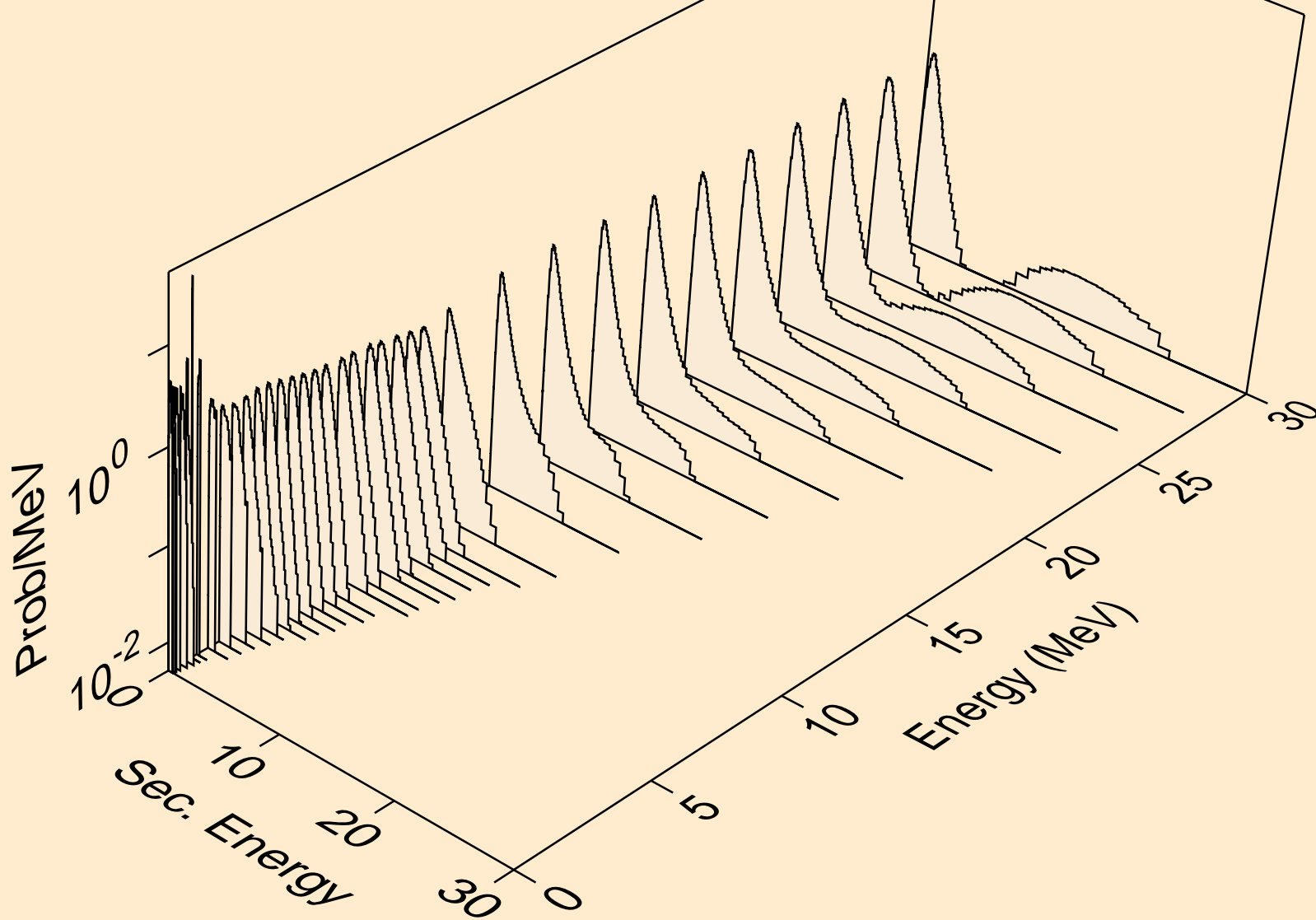

TA160M NEUTRON ACER TENDL-2019 LIBRARY; T=293.16K
Neutron emission for (n,2n)2a

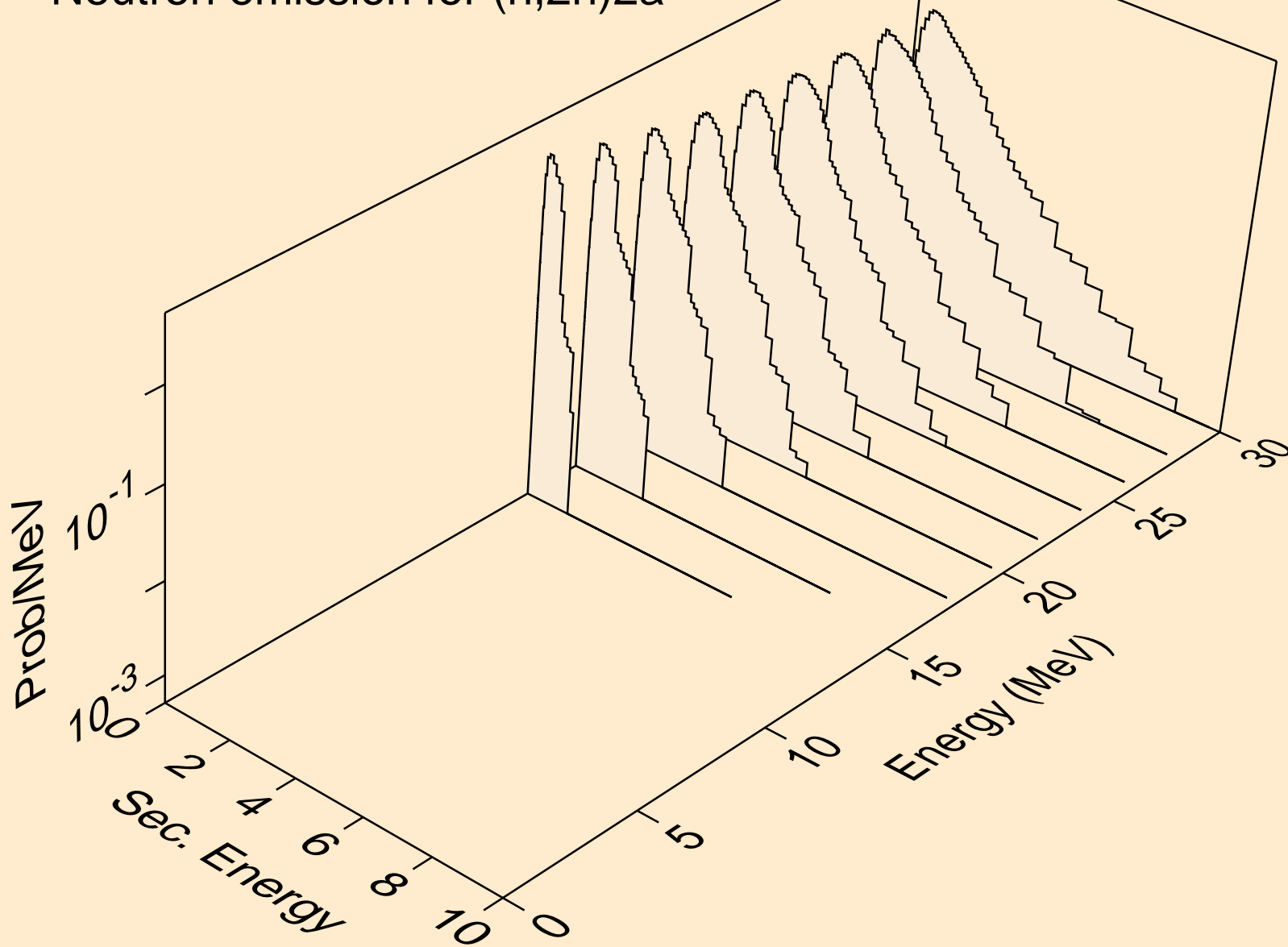

TA160M NEUTRON ACER TENDL-2019 LIBRARY; T=293.16K
Neutron emission for (n,n*)d

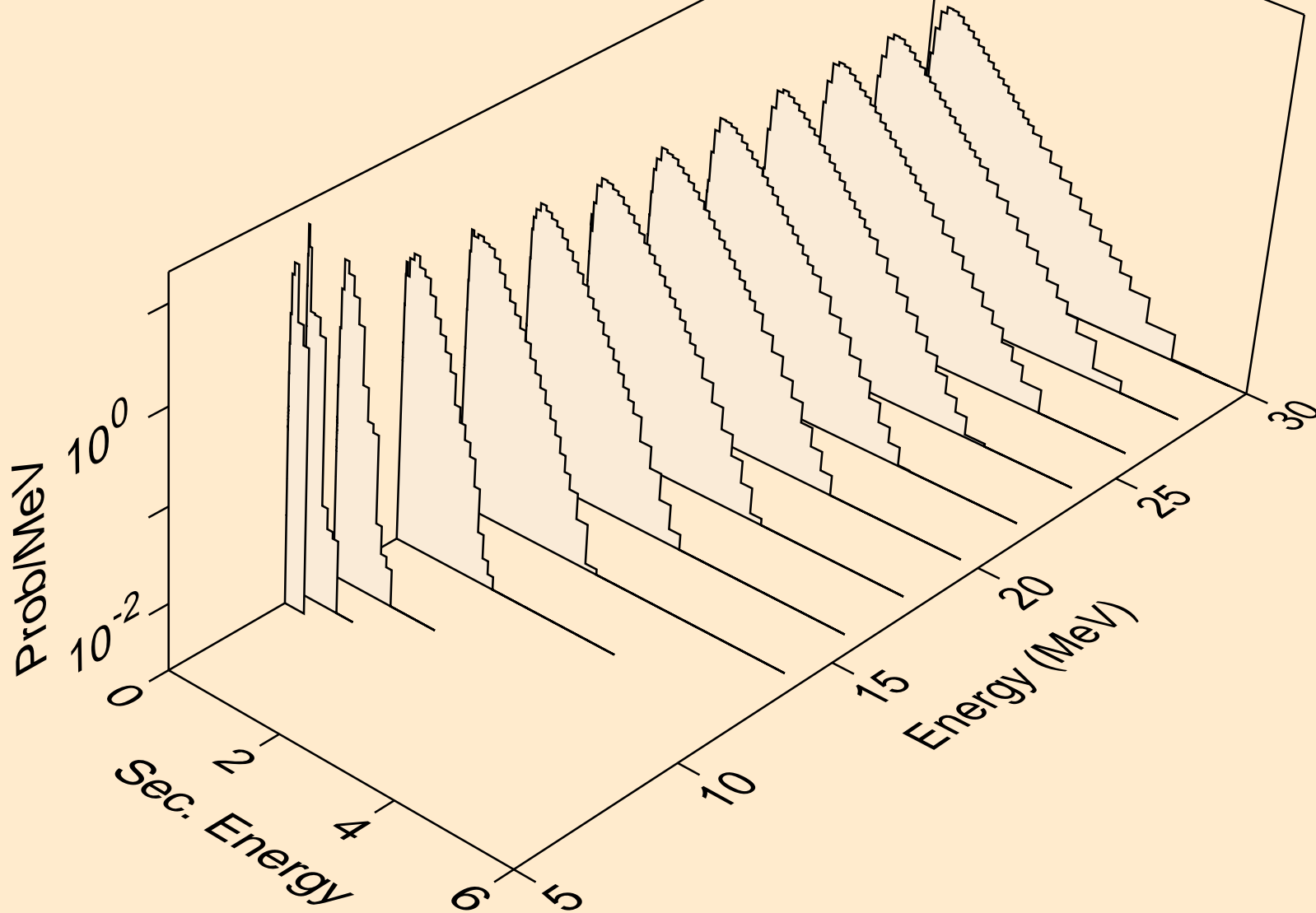

TA160M NEUTRON ACER TENDL-2019 LIBRARY; T=293.16K
Neutron emission for (n,n*)t

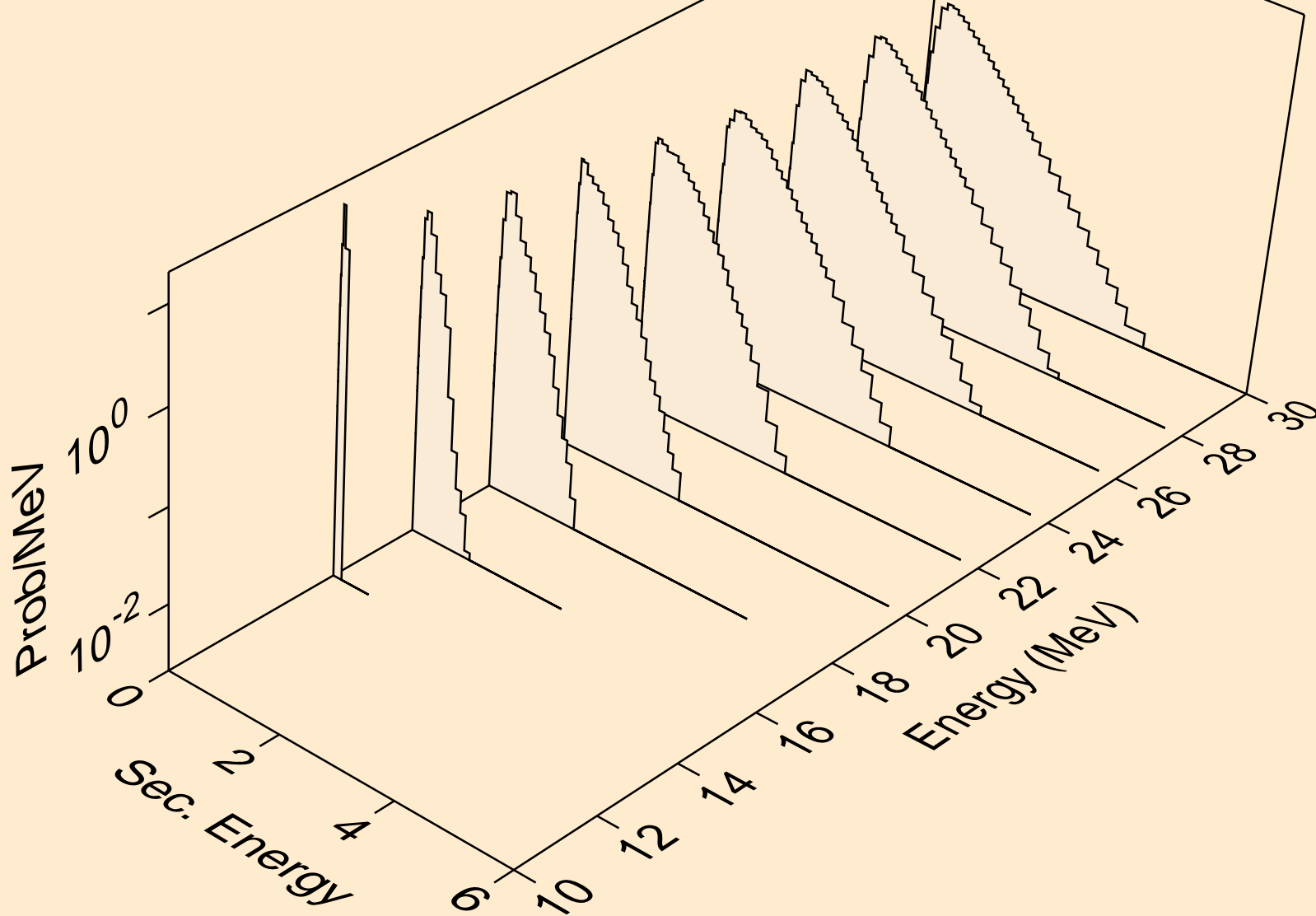

TA160M NEUTRON ACER TENDL-2019 LIBRARY; T=293.16K
Neutron emission for (n,n*)he3

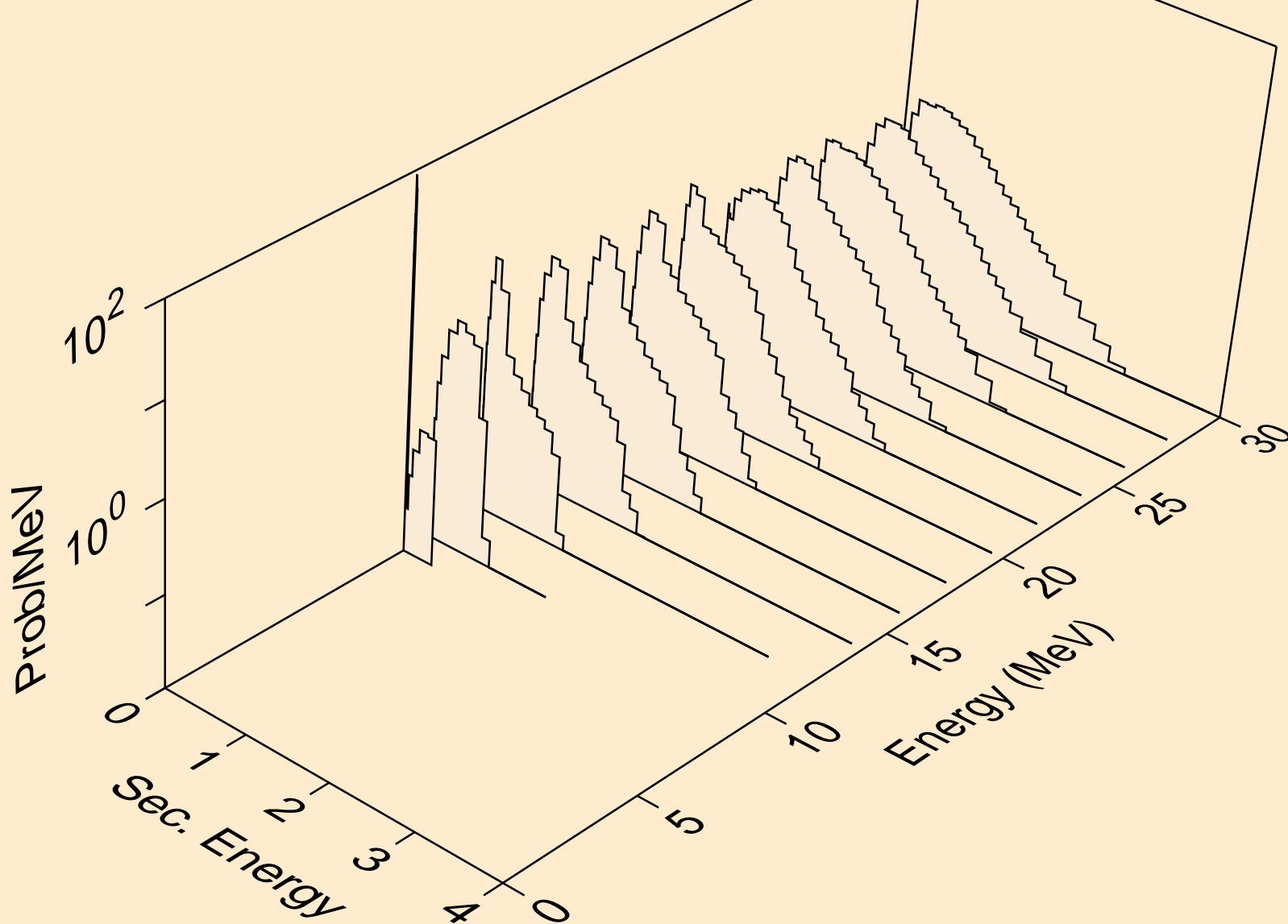

TA160M NEUTRON ACER TENDL-2019 LIBRARY; T=293.16K
Neutron emission for (n,n*)d2a

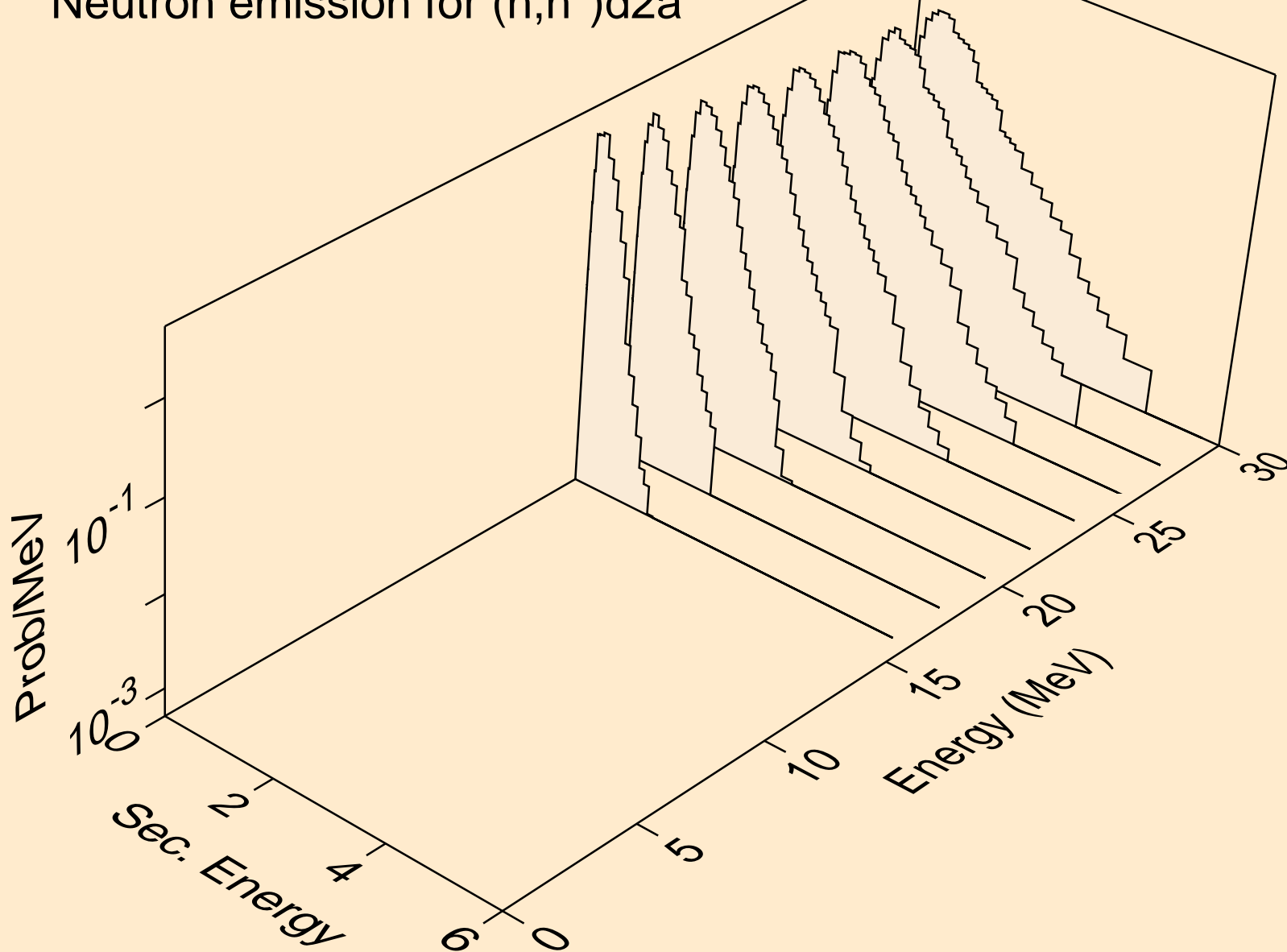

TA160M NEUTRON ACER TENDL-2019 LIBRARY; T=293.16K
Neutron emission for (n,n*)t2a

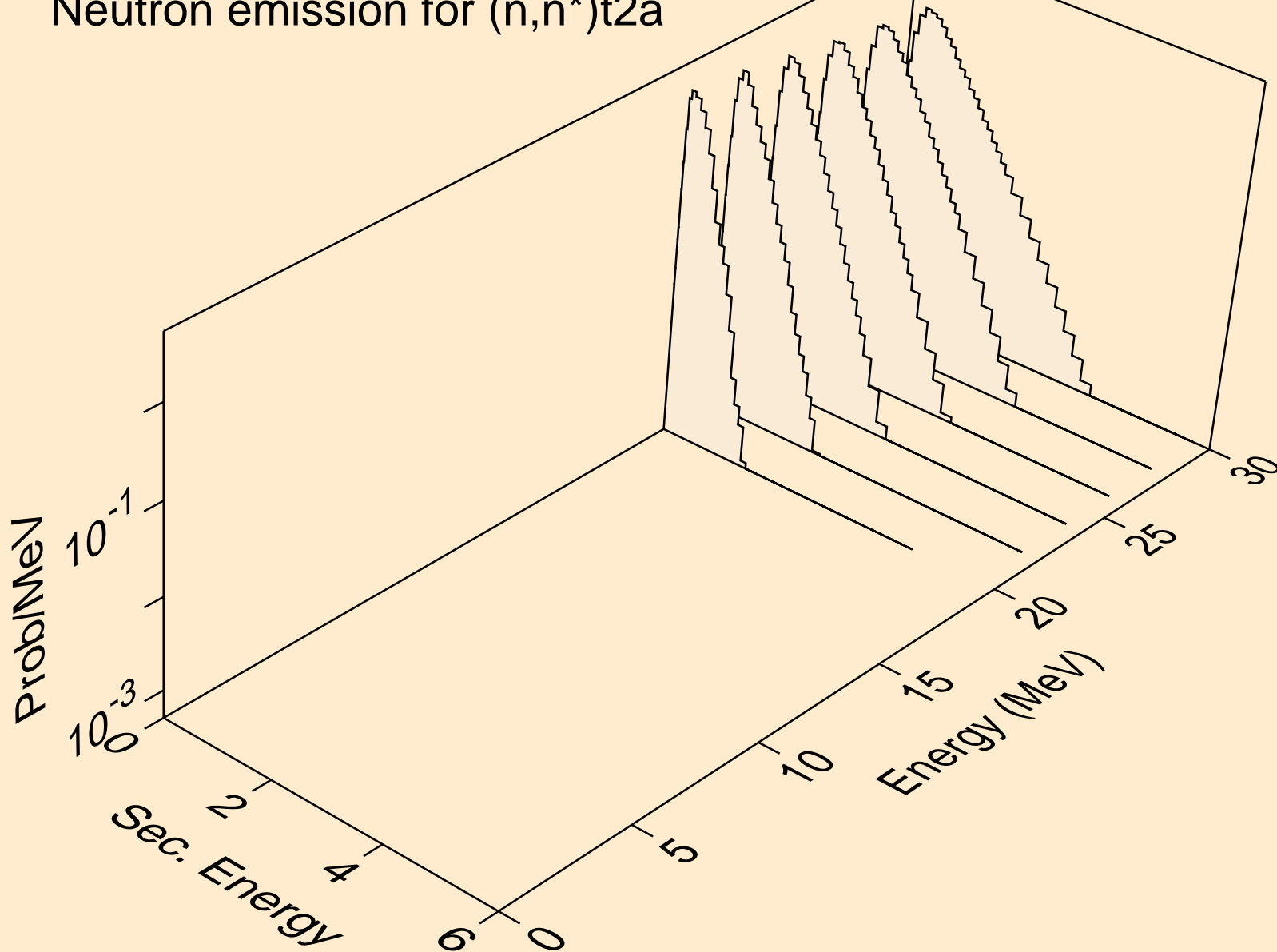

TA160M NEUTRON ACER TENDL-2019 LIBRARY; T=293.16K
Neutron emission for (n,2np)

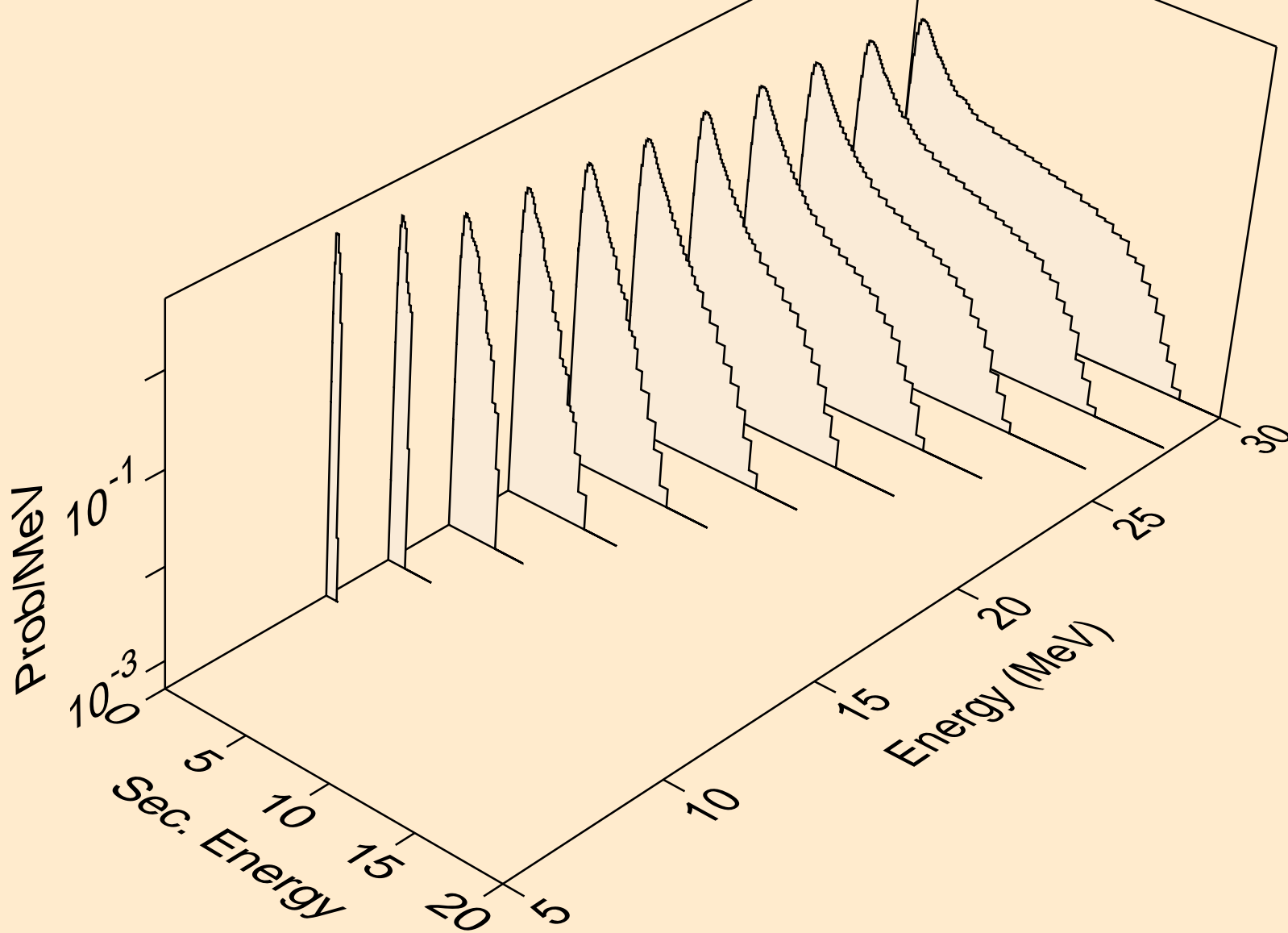

TA160M NEUTRON ACER TENDL-2019 LIBRARY; T=293.16K
Neutron emission for (n,3np)

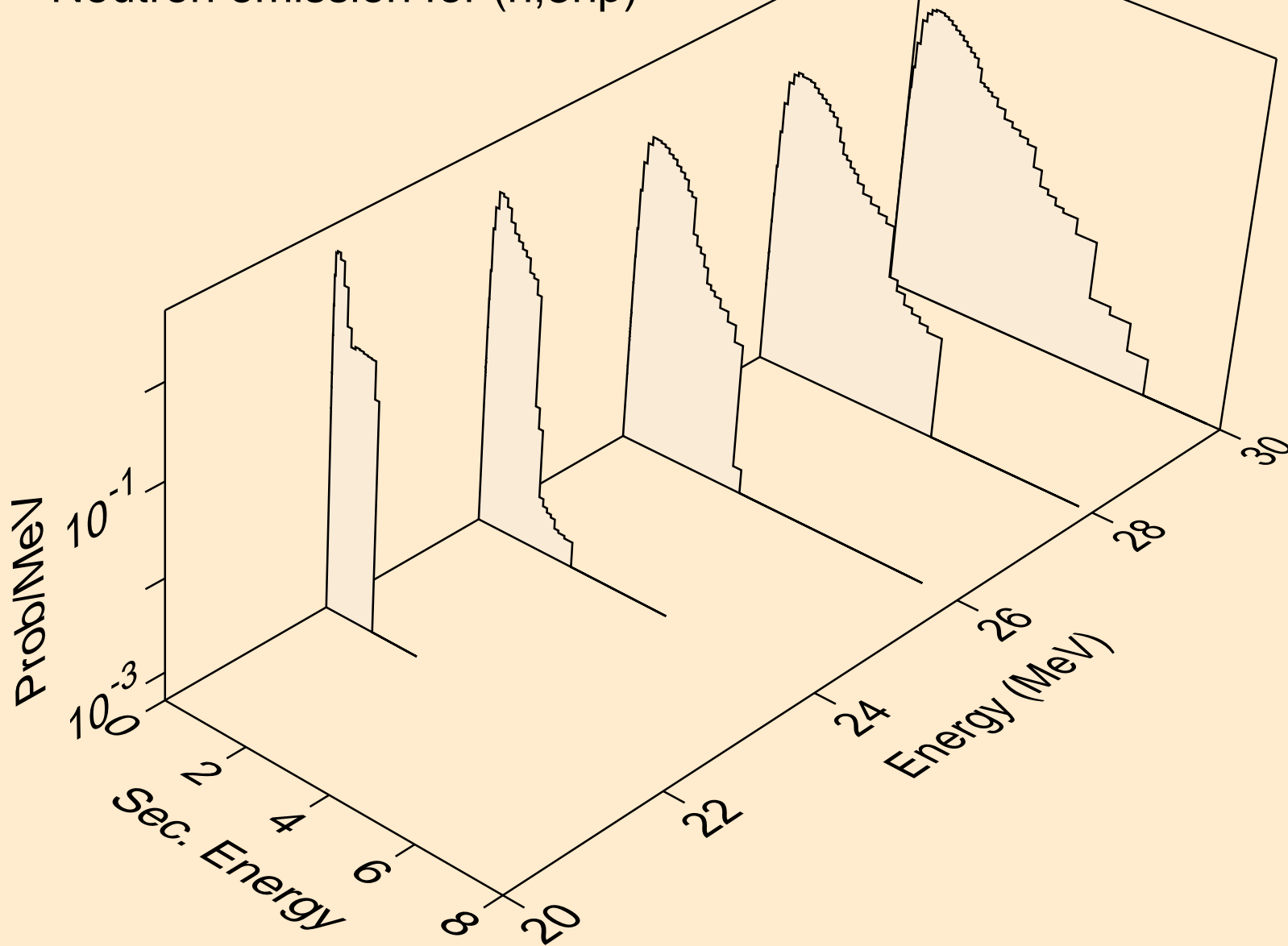

TA160M NEUTRON ACER TENDL-2019 LIBRARY; T=293.16K
Neutron emission for (n,2np)

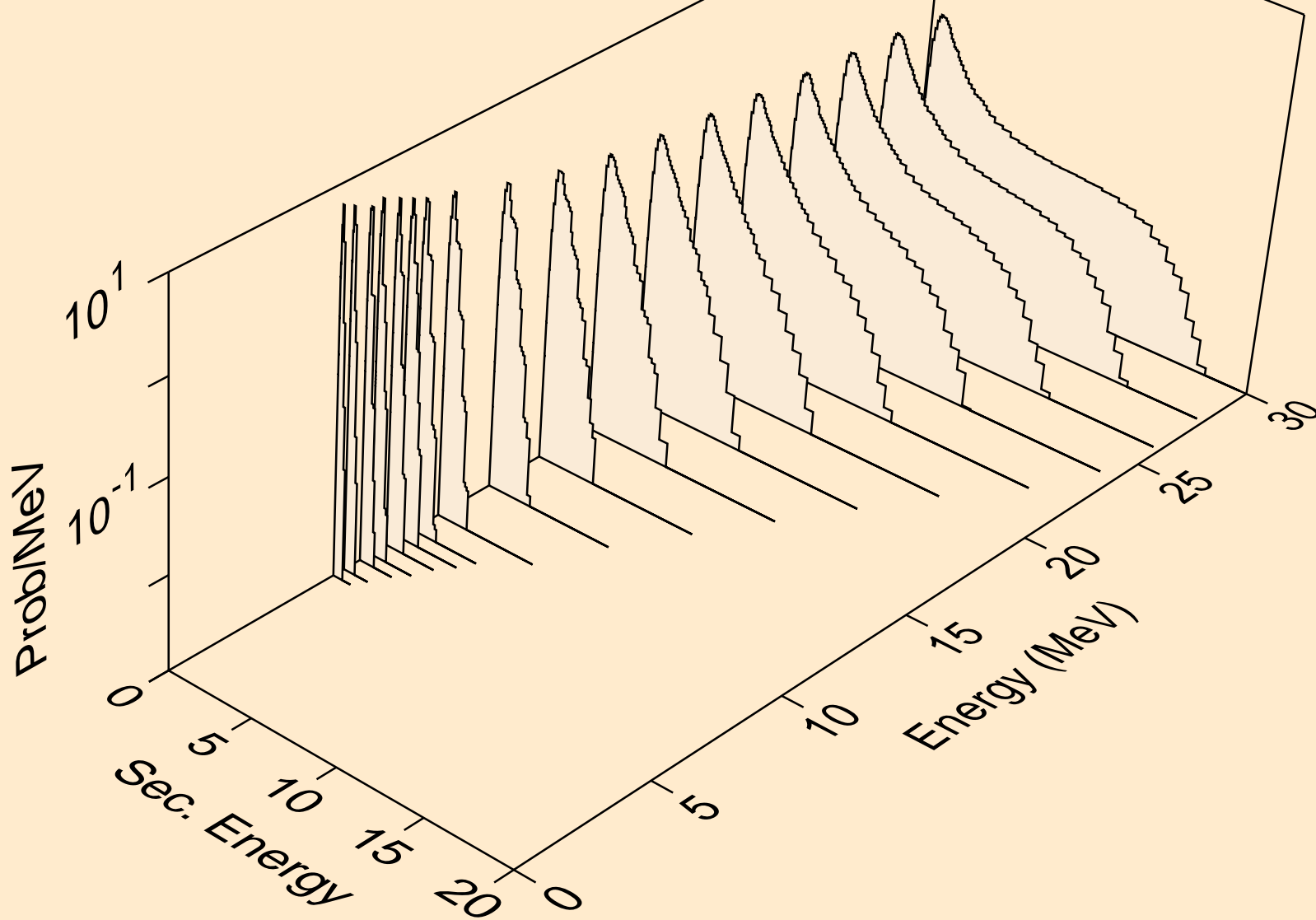

TA160M NEUTRON ACER TENDL-2019 LIBRARY; T=293.16K
Neutron emission for (n,npa)

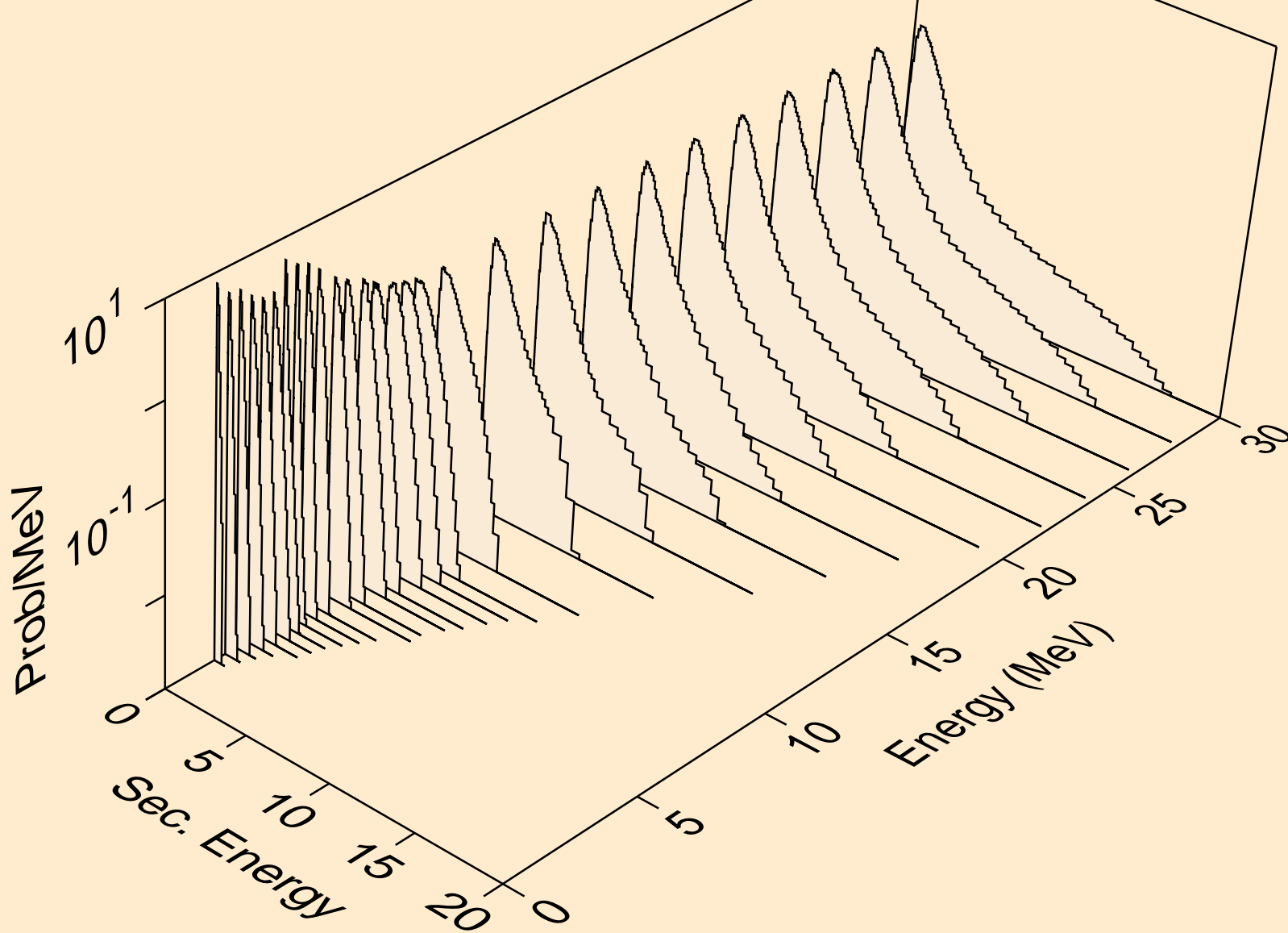

TA160M NEUTRON ACER TENDL-2019 LIBRARY; T=293.16K
Neutron emission for (n,n*c)

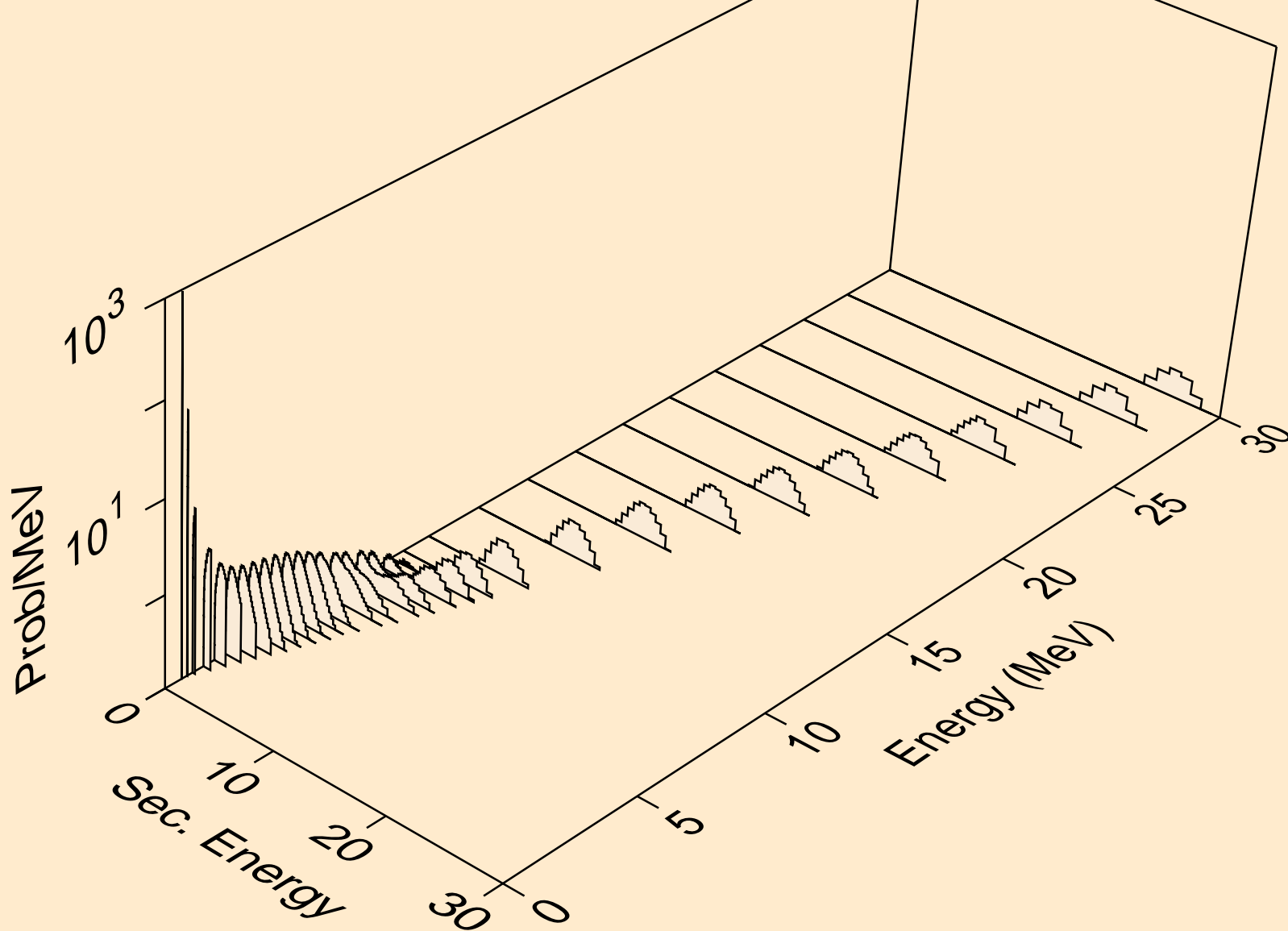

TA160M NEUTRON ACER TENDL-2019 LIBRARY; T=293.16K
Photon emission for (n,x)

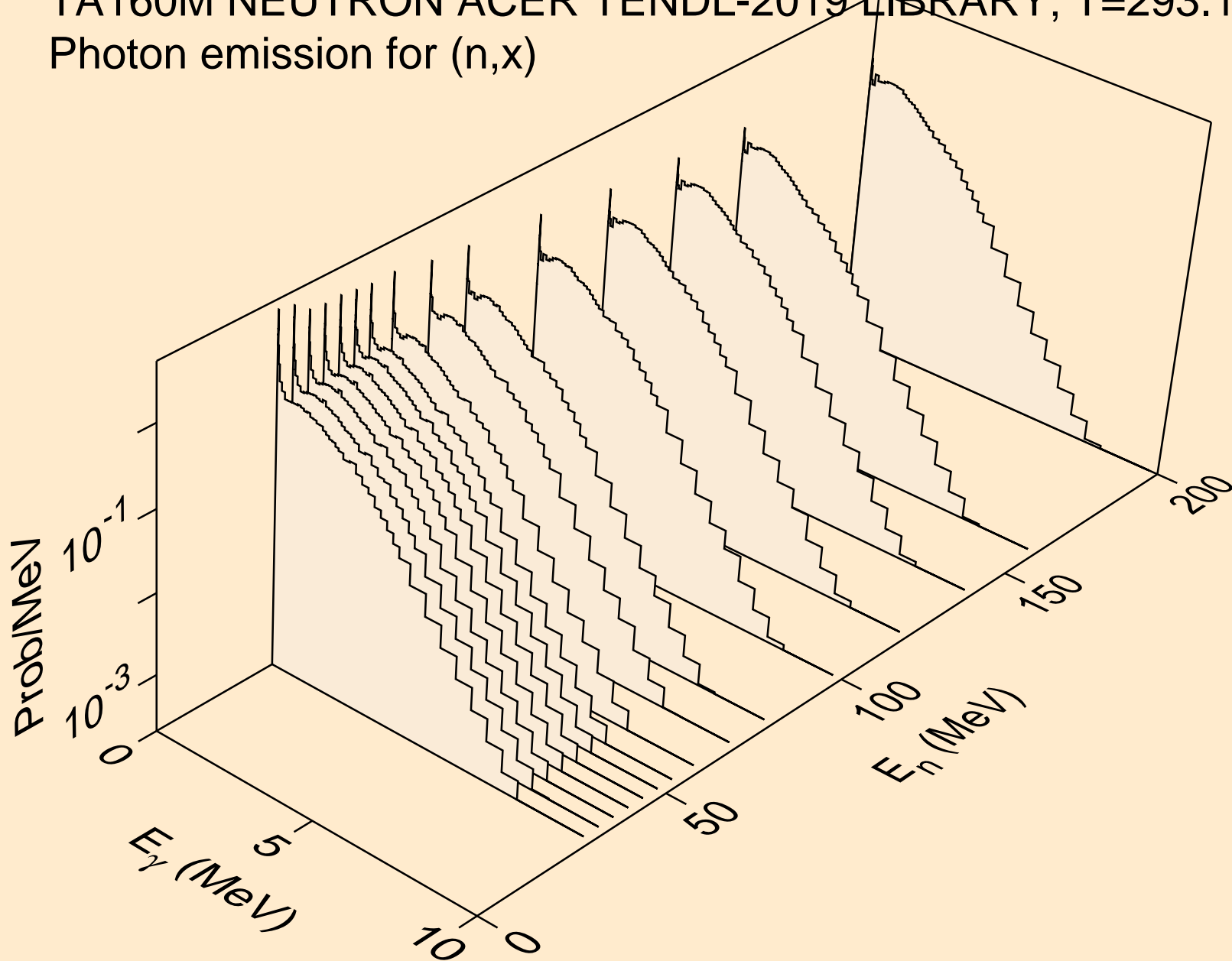

TA160M NEUTRON ACER TENDL-2019 LIBRARY; T=293.16K
Photon emission for (n,2nd)

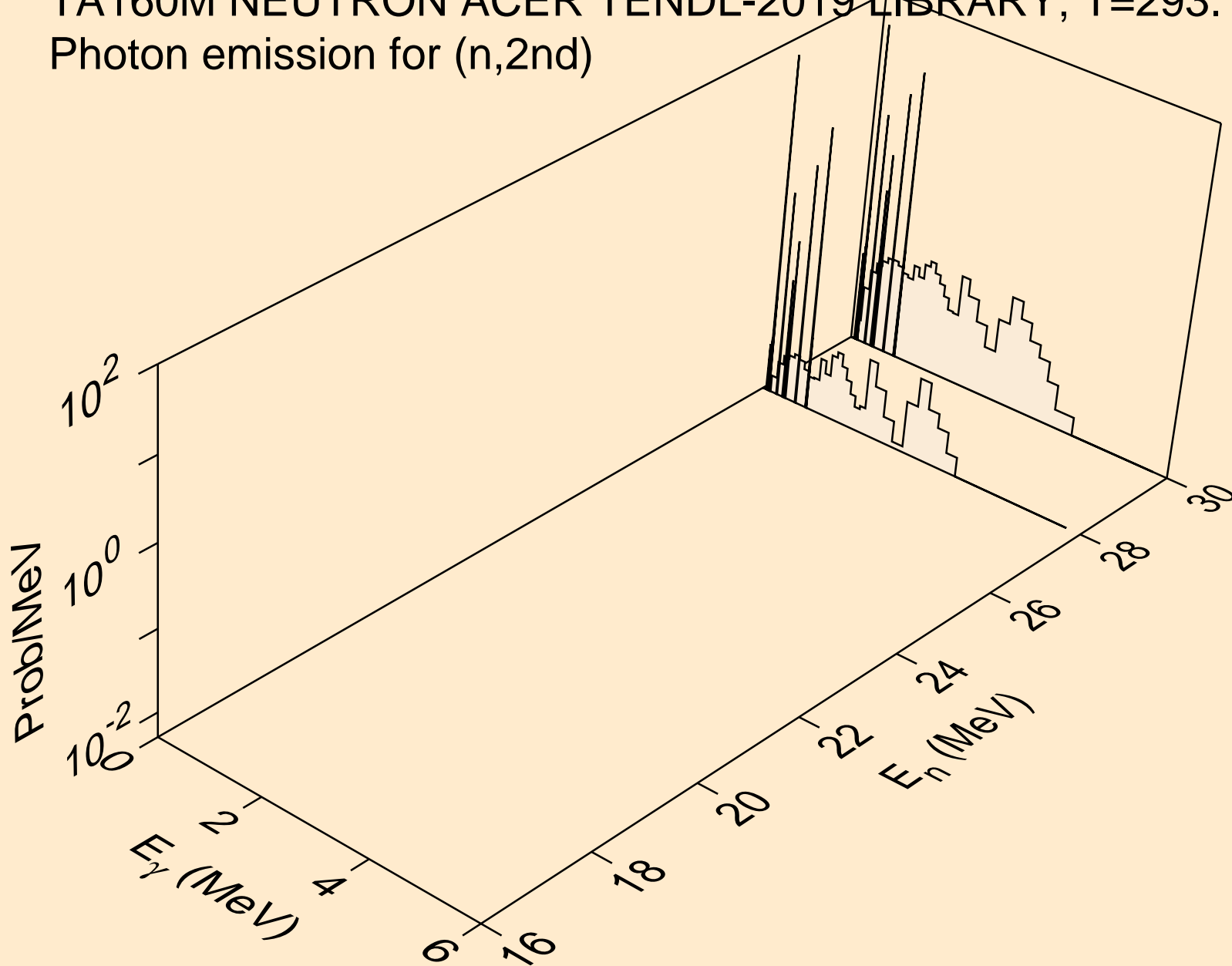

TA160M NEUTRON ACER TENDL-2019 LIBRARY; T=293.16K
Photon emission for (n,2n)

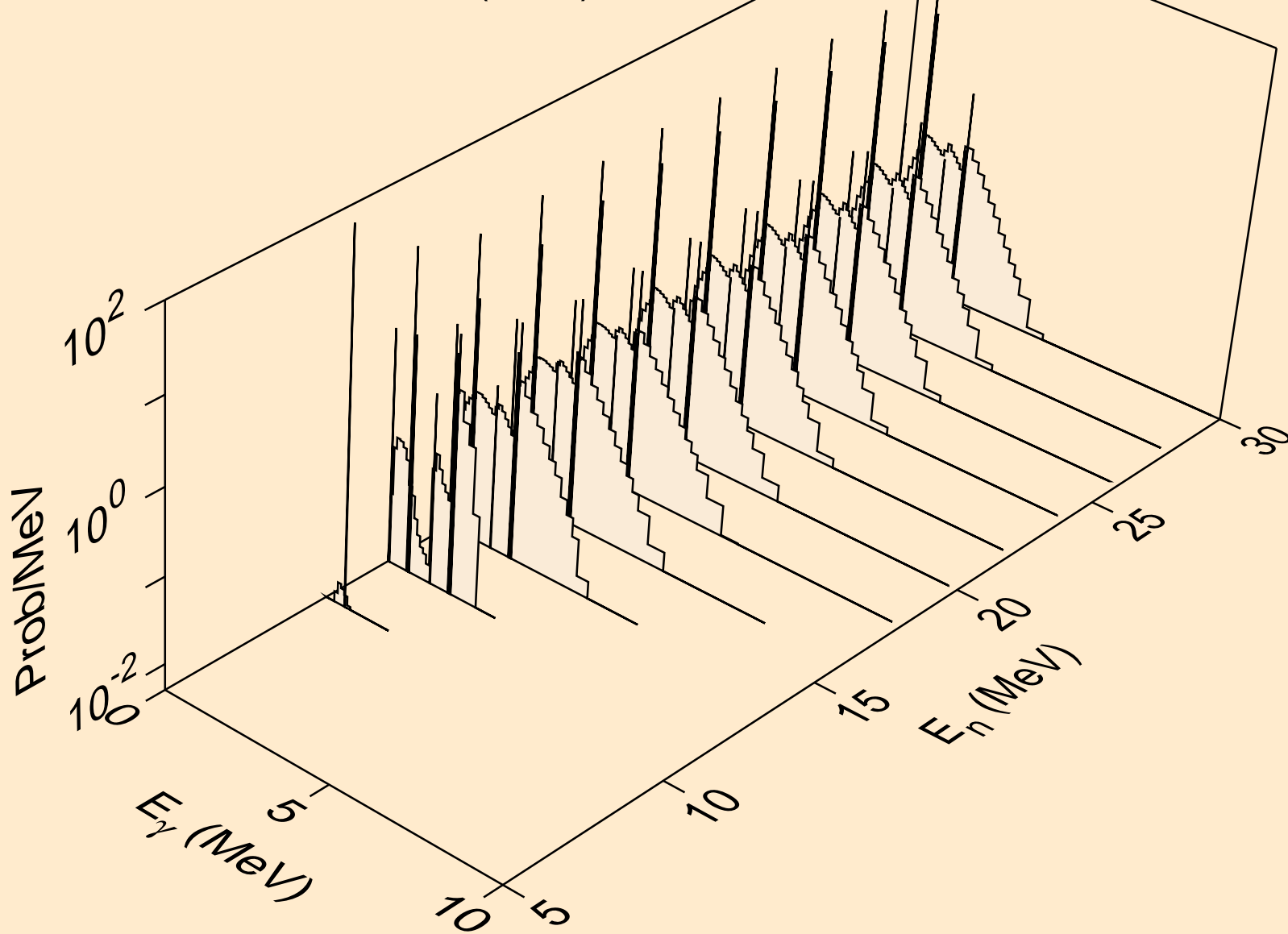

TA160M NEUTRON ACER TENDL-2019 LIBRARY; T=293.16K
Photon emission for (n,3n)

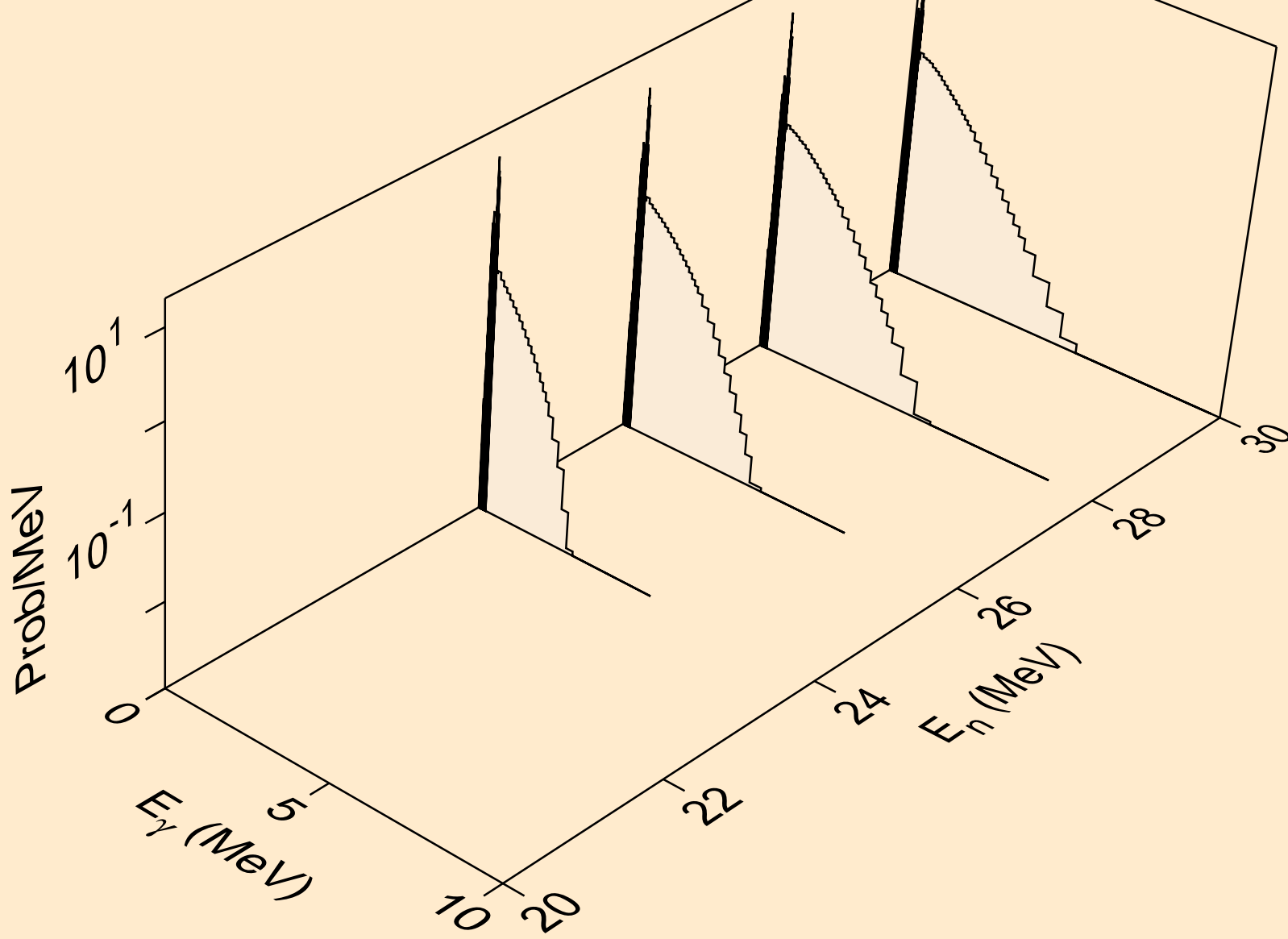

TA160M NEUTRON ACER TENDL-2019 LIBRARY; T=293.16K
Photon emission for (n,n*)a

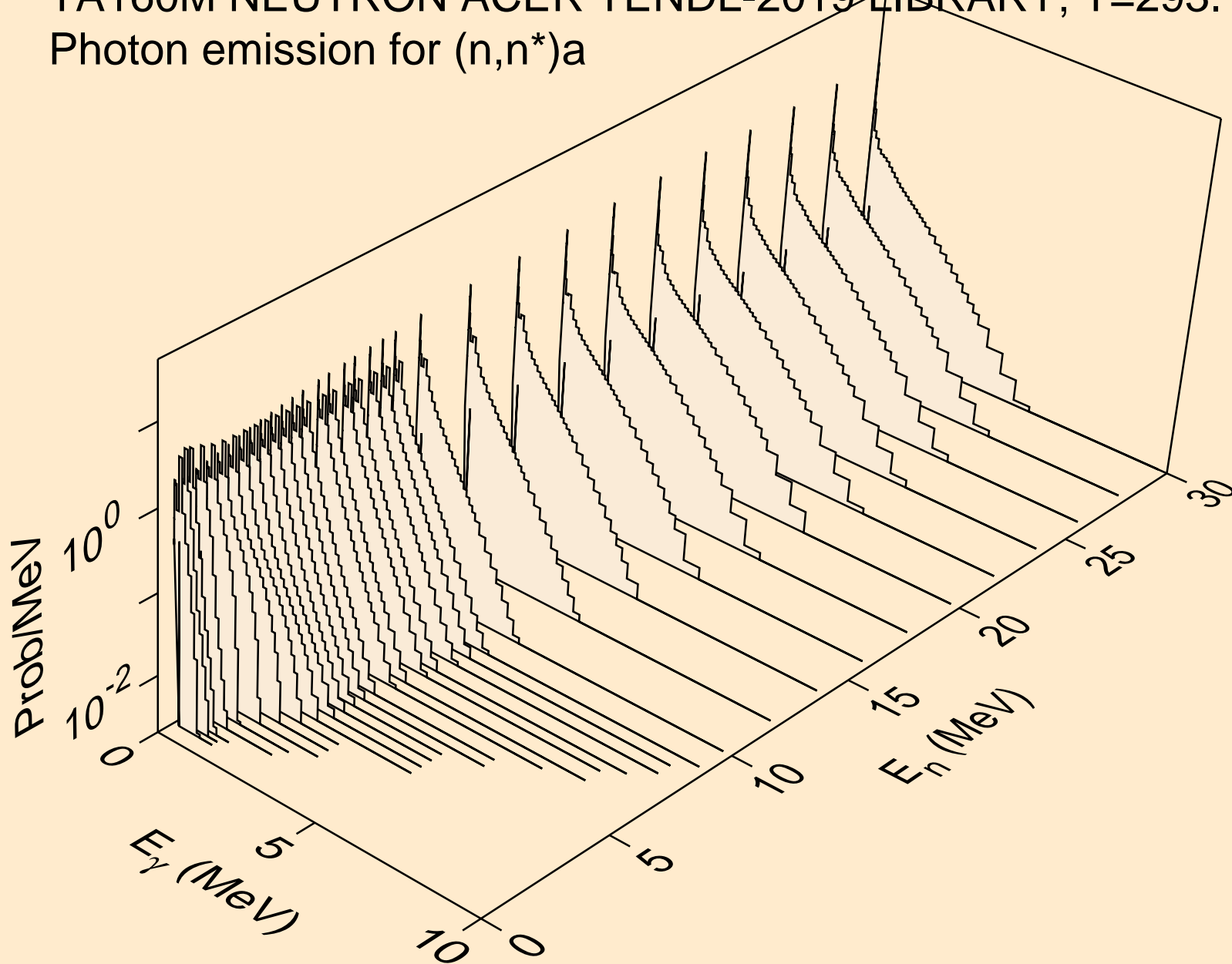

TA160M NEUTRON ACER TENDL-2019 LIBRARY; T=293.16K
Photon emission for (n,n*)3a

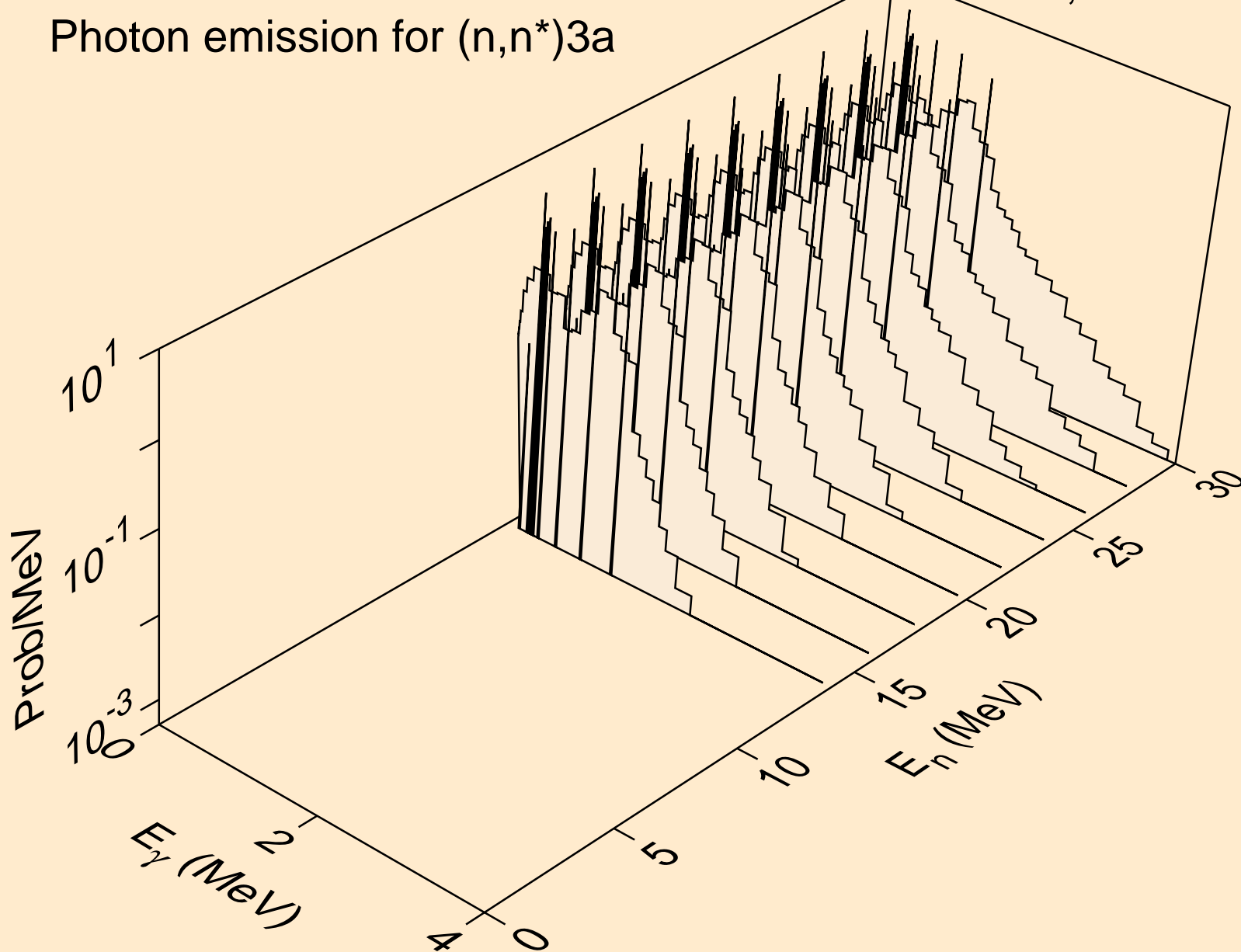

TA160M NEUTRON ACER TENDL-2019 LIBRARY; T=293.16K
Photon emission for (n,2n)a

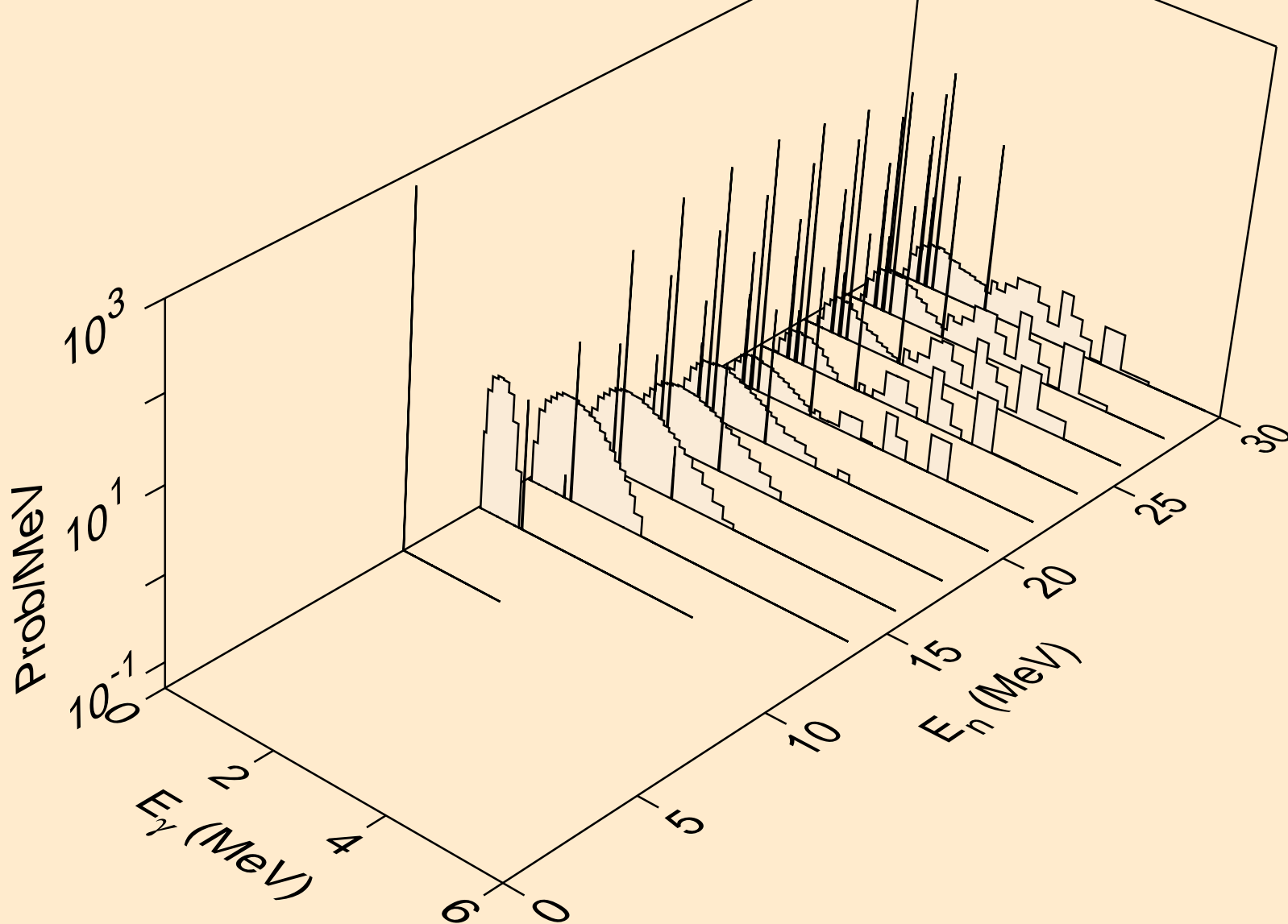

TA160M NEUTRON ACER TENDL-2019 LIBRARY; T=293.16K
Photon emission for (n,3n)a

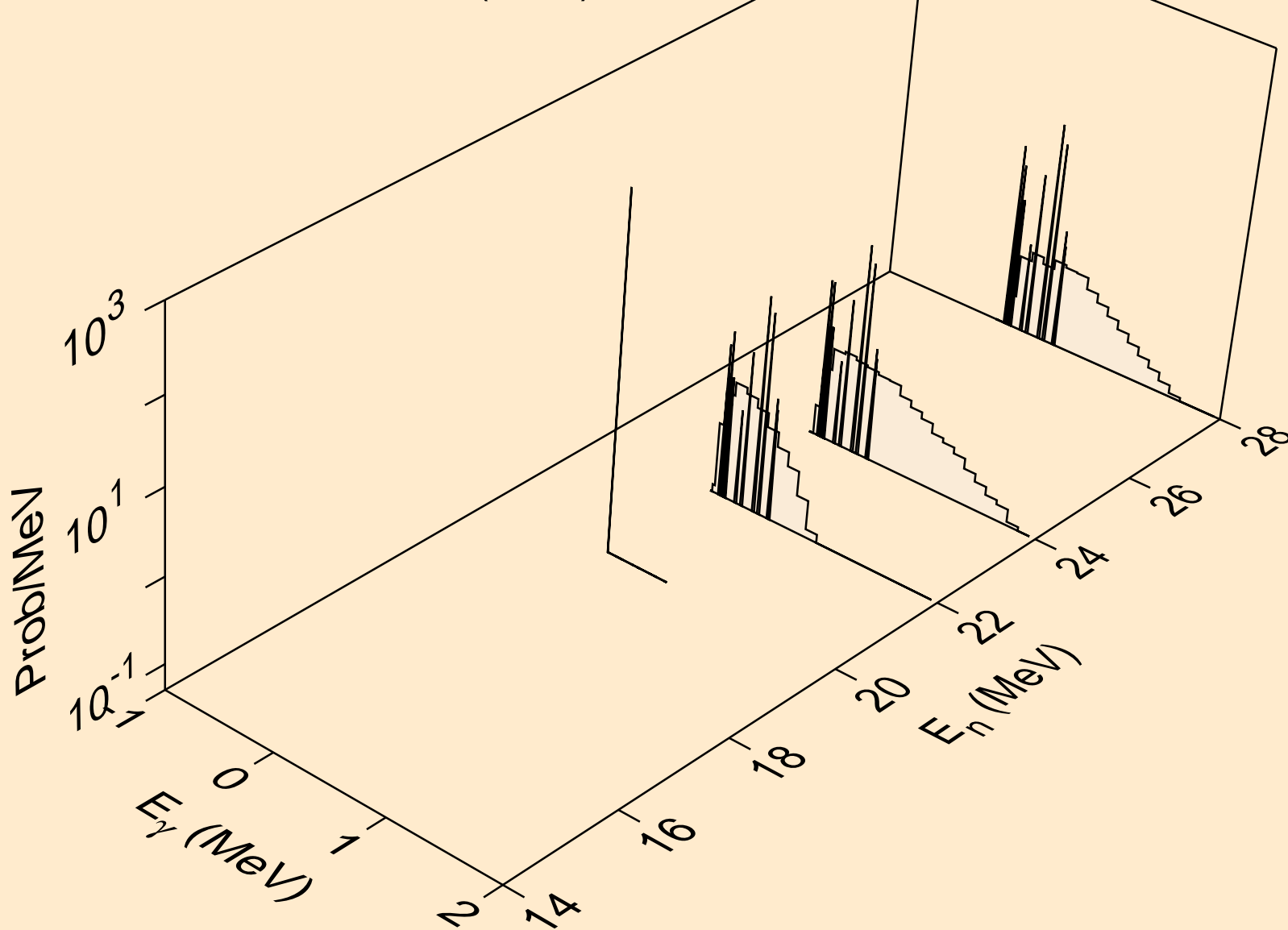

TA160M NEUTRON ACER TENDL-2019 LIBRARY; T=293.16K
Photon emission for (n,n*)p

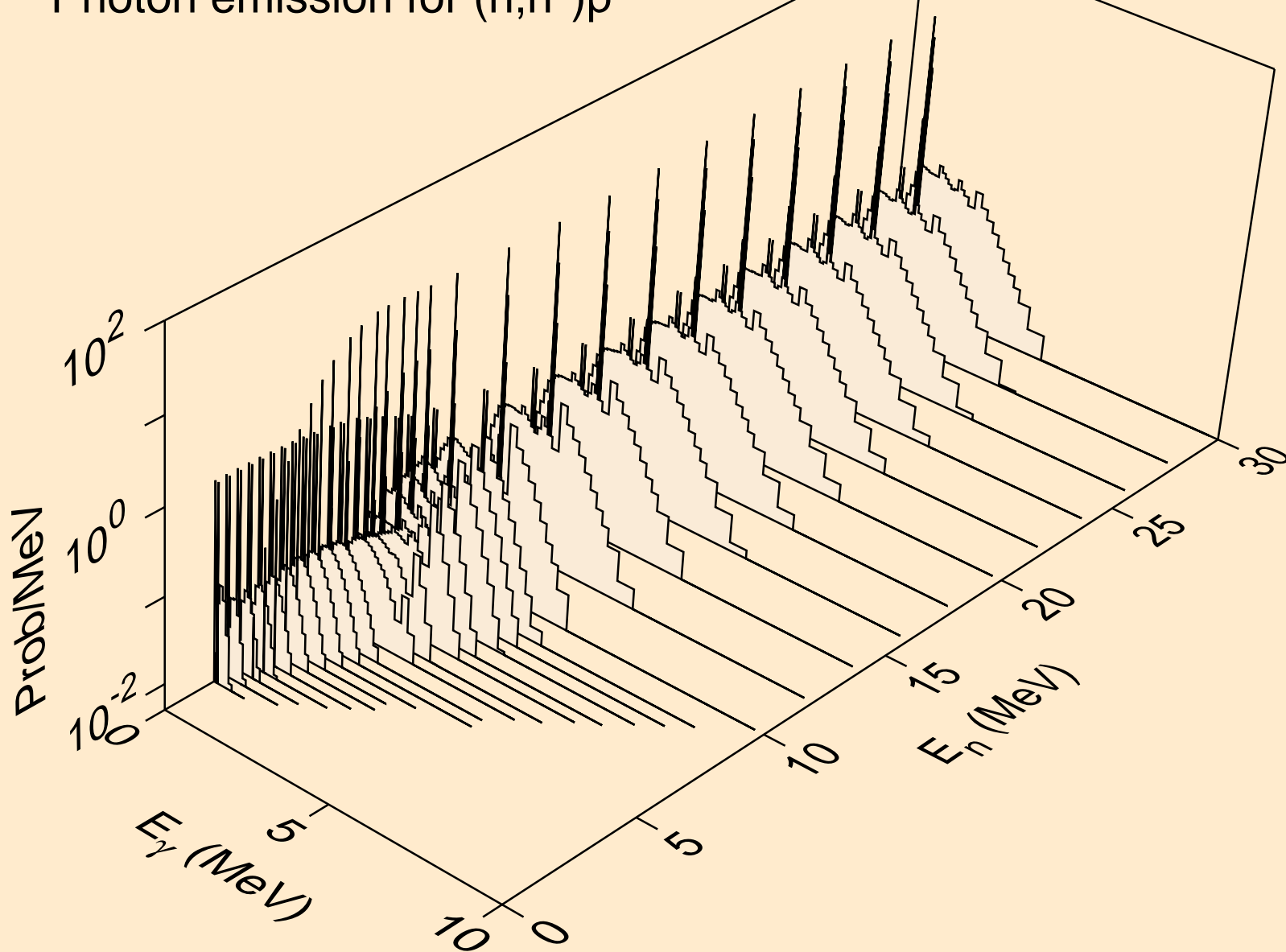

TA160M NEUTRON ACER TENDL-2019 LIBRARY; T=293.16K
Photon emission for (n,n*)2a

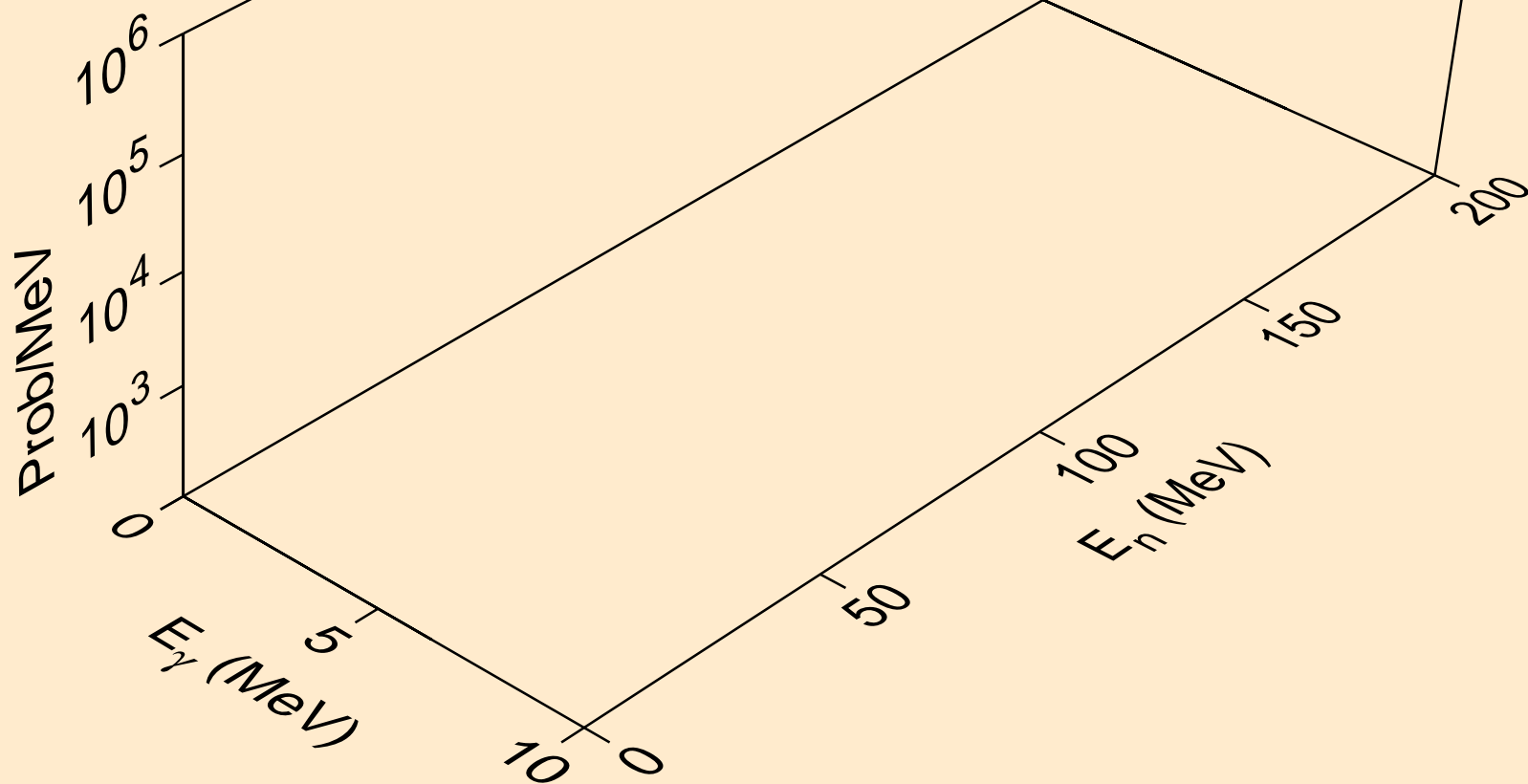

TA160M NEUTRON ACER TENDL-2019 LIBRARY; T=293.16K
Photon emission for (n,2n)2a

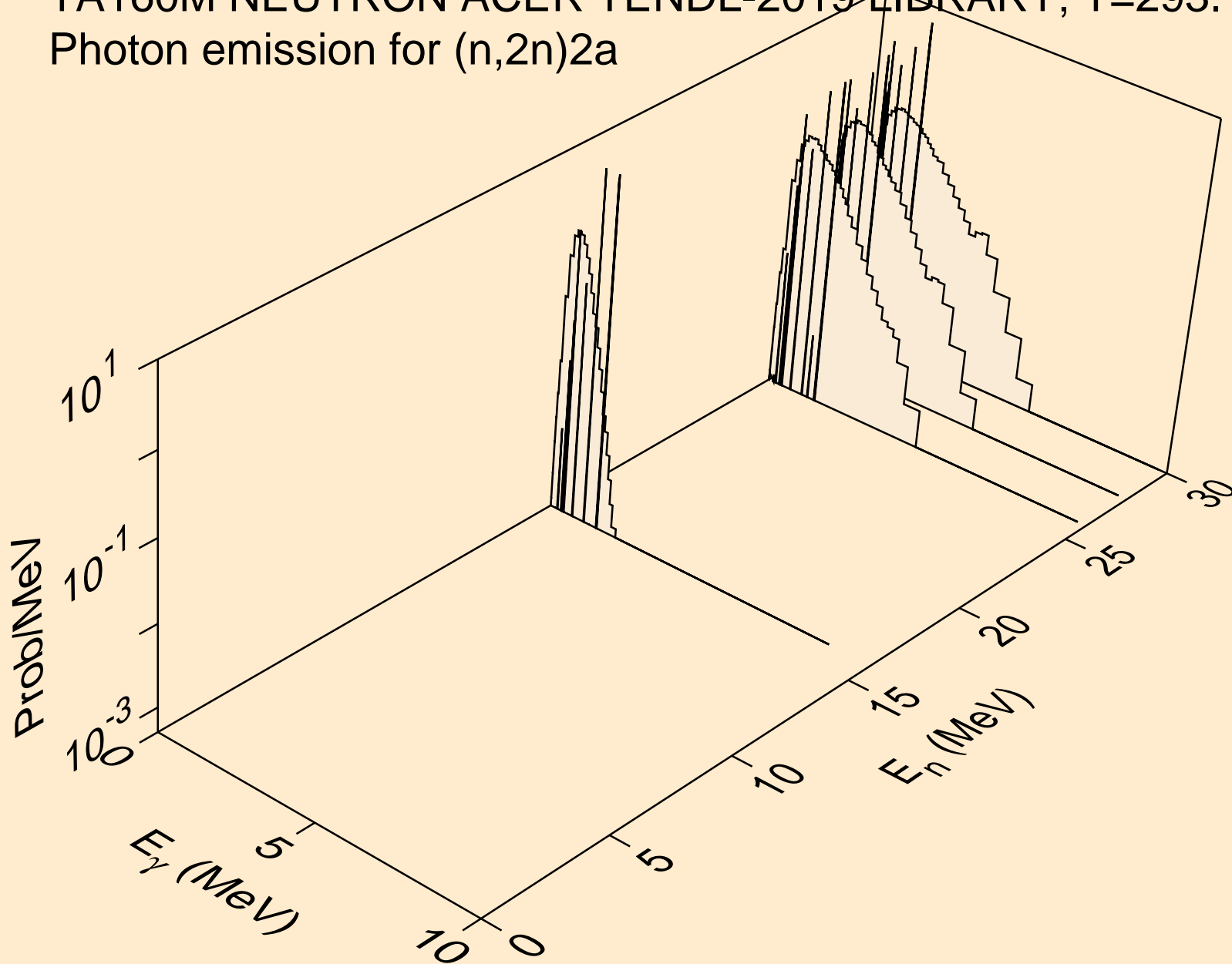

TA160M NEUTRON ACER TENDL-2019 LIBRARY; T=293.16K
Photon emission for (n,n*)d

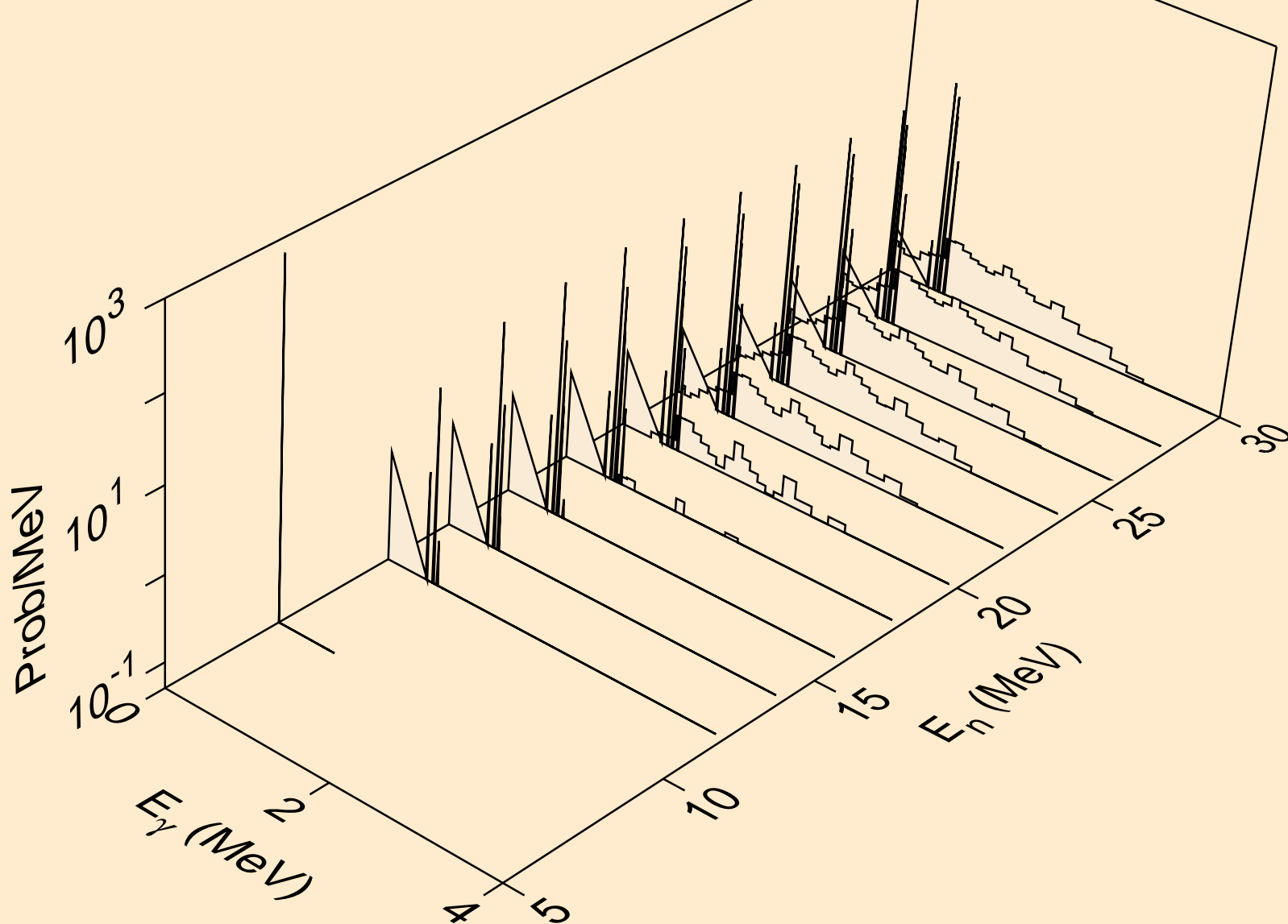

TA160M NEUTRON ACER TENDL-2019 LIBRARY; T=293.16K
Photon emission for (n,n*)t

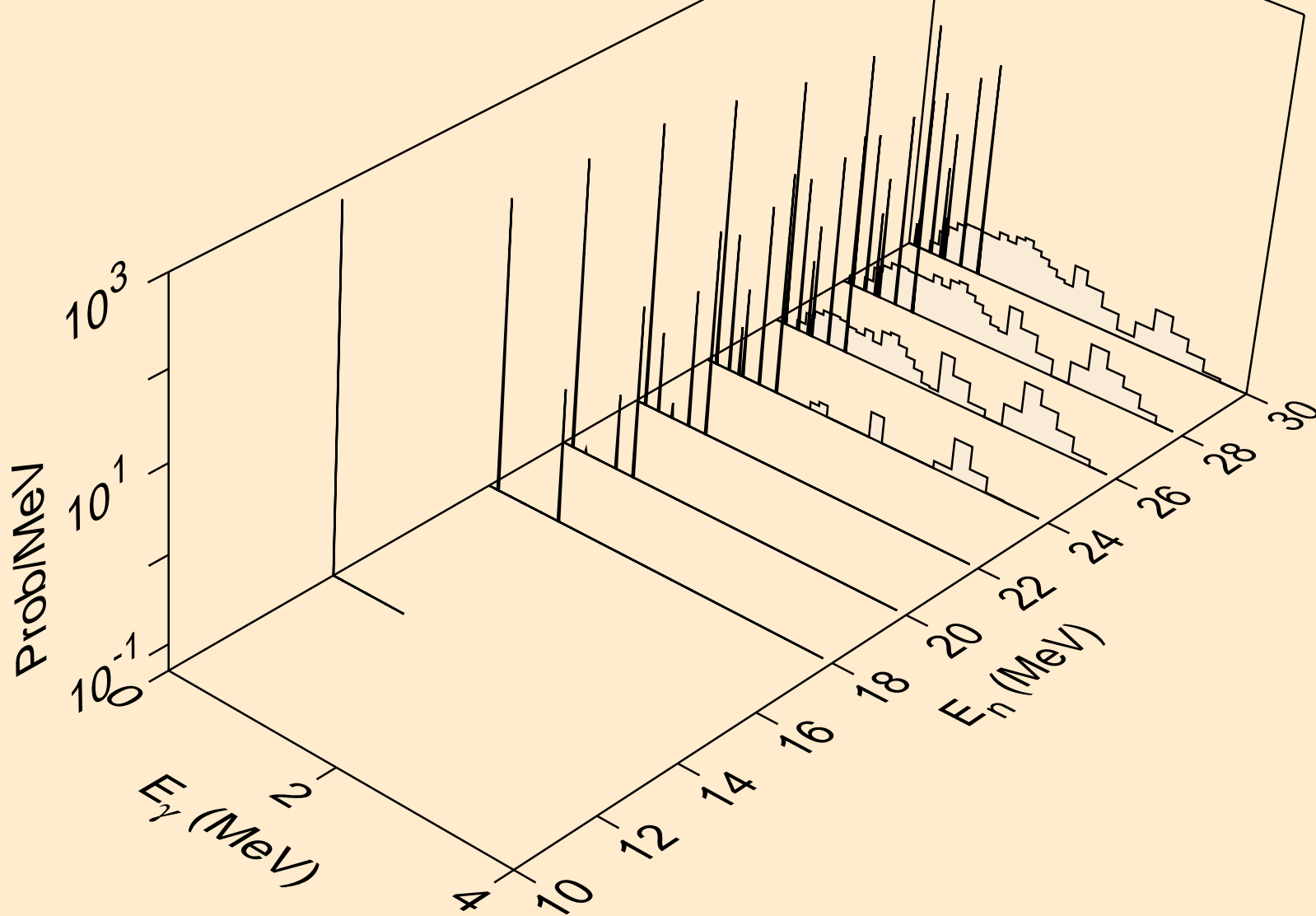

TA160M NEUTRON ACER TENDL-2019 LIBRARY; T=293.16K
Photon emission for (n,n*)he3

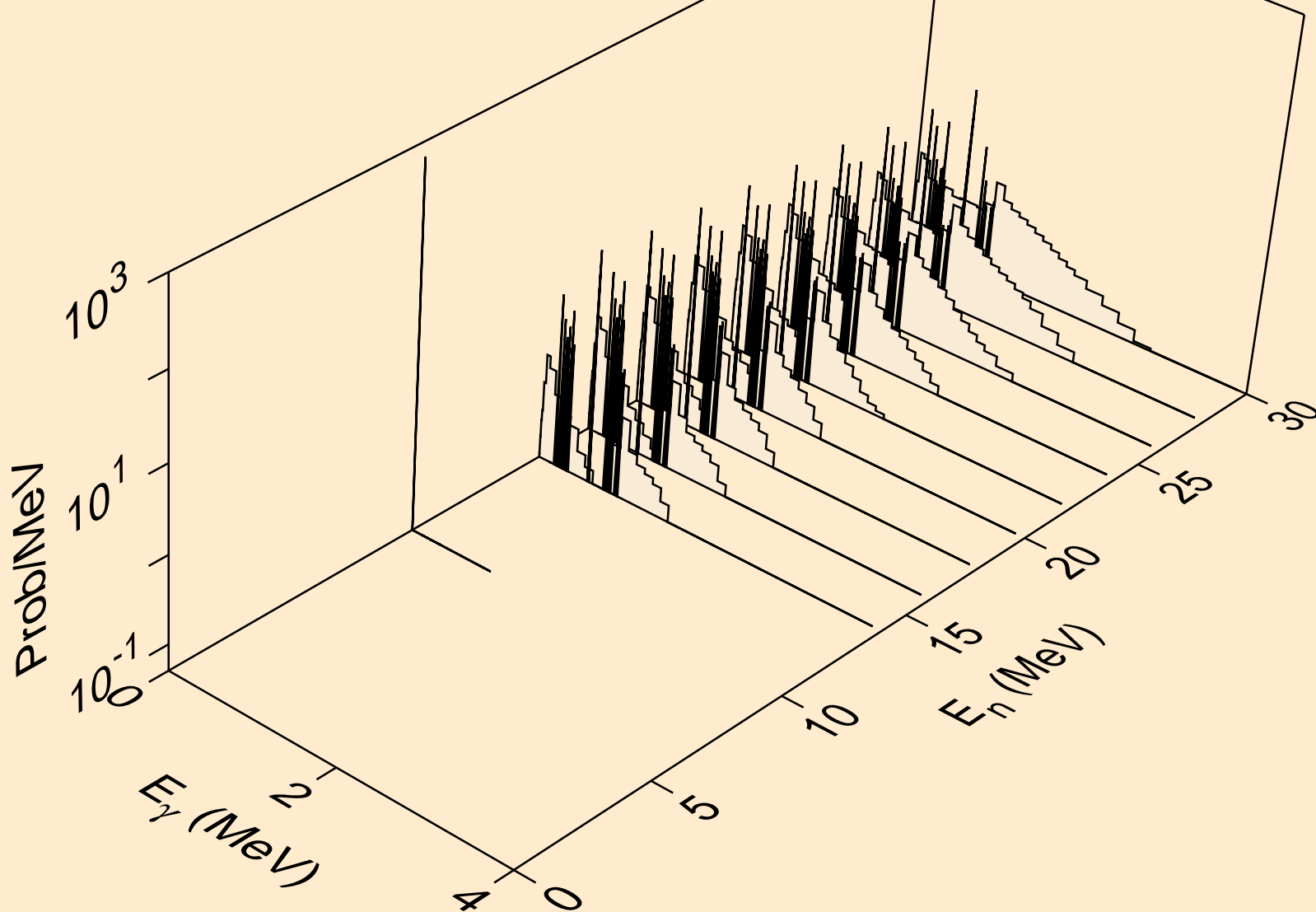

TA160M NEUTRON ACER TENDL-2019 LIBRARY; T=293.16K
Photon emission for (n,n*)d2a

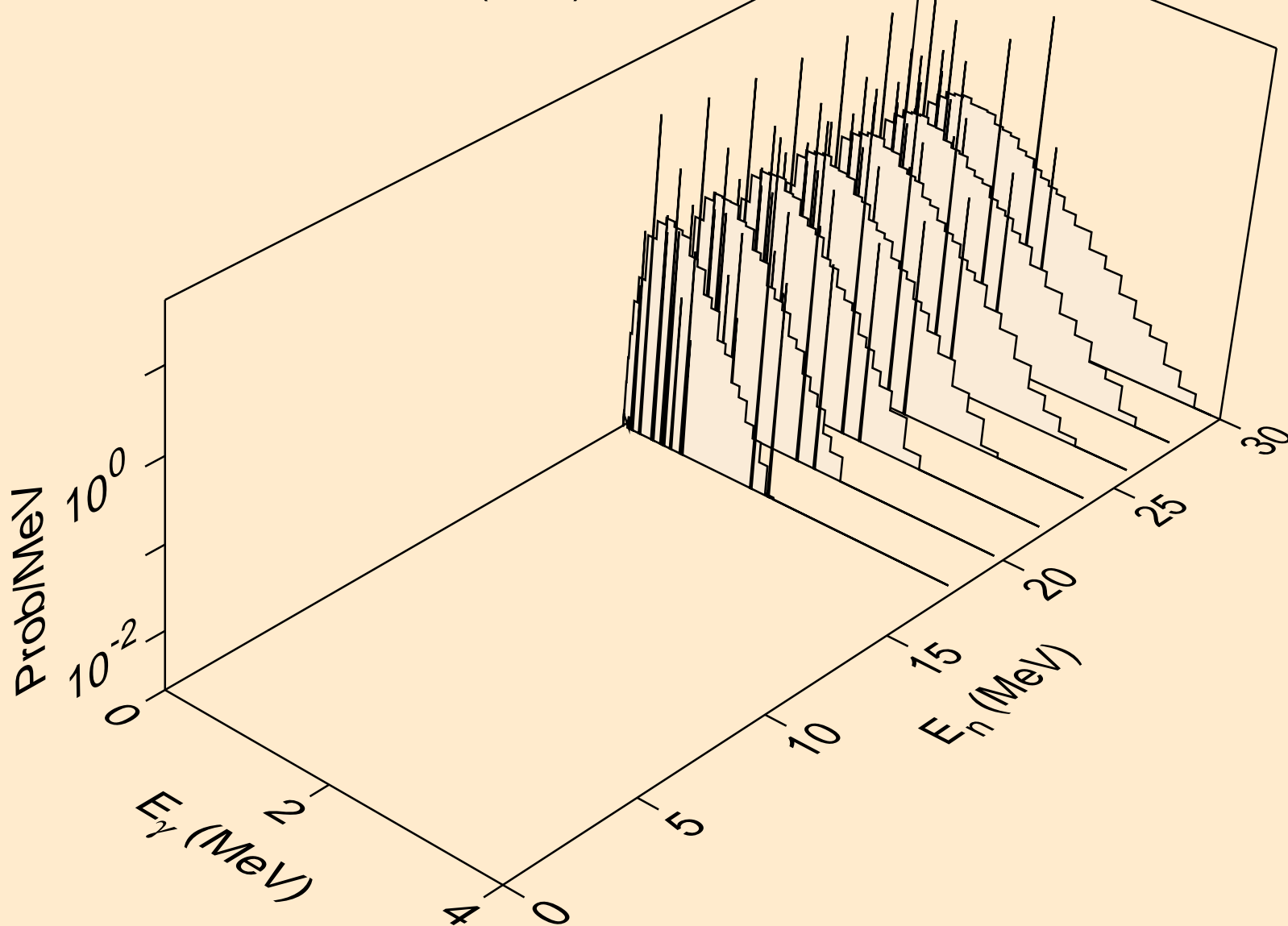

TA160M NEUTRON ACER TENDL-2019 LIBRARY; T=293.16K
Photon emission for (n,n*)t2a

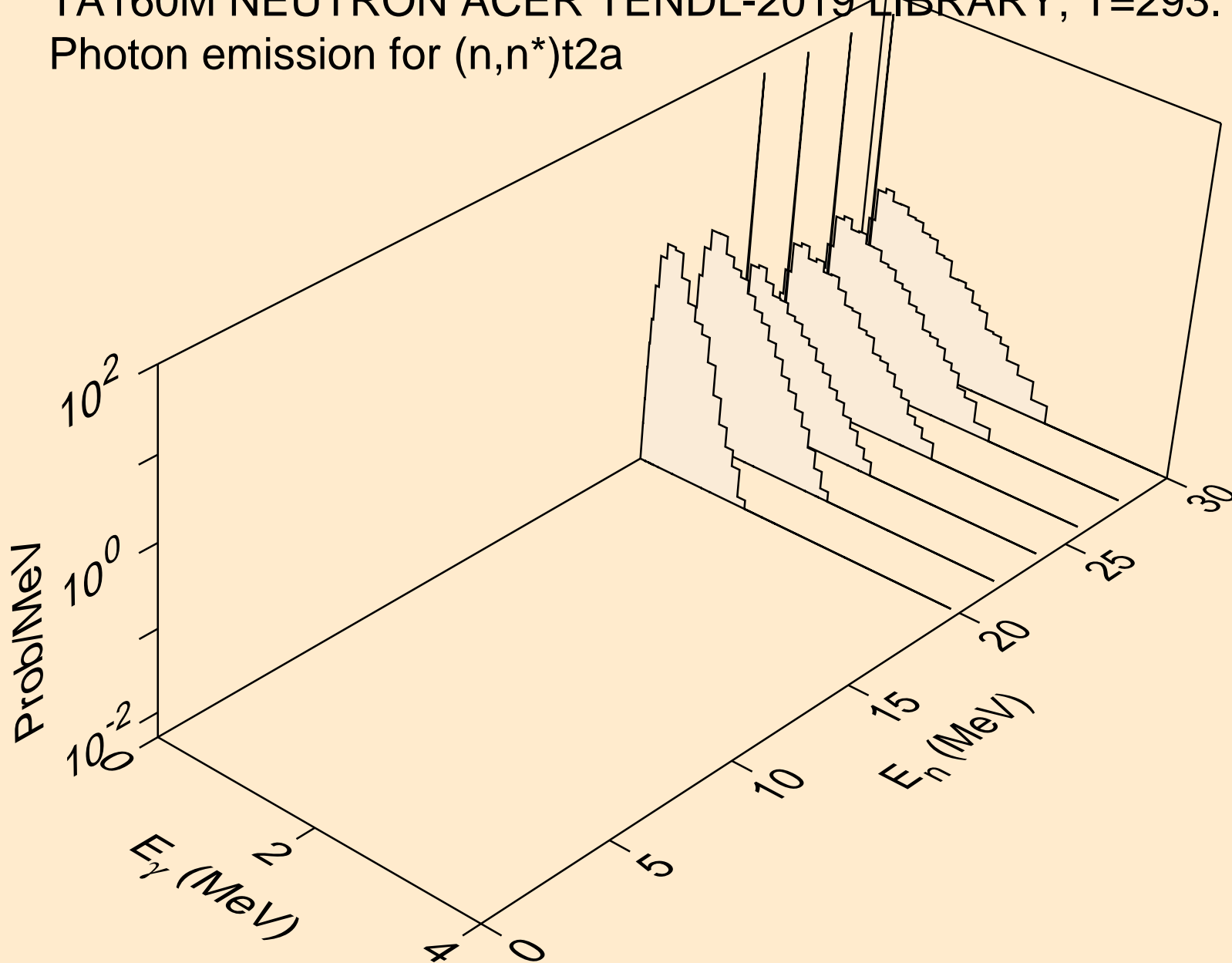

TA160M NEUTRON ACER TENDL-2019 LIBRARY; T=293.16K
Photon emission for (n,2np)

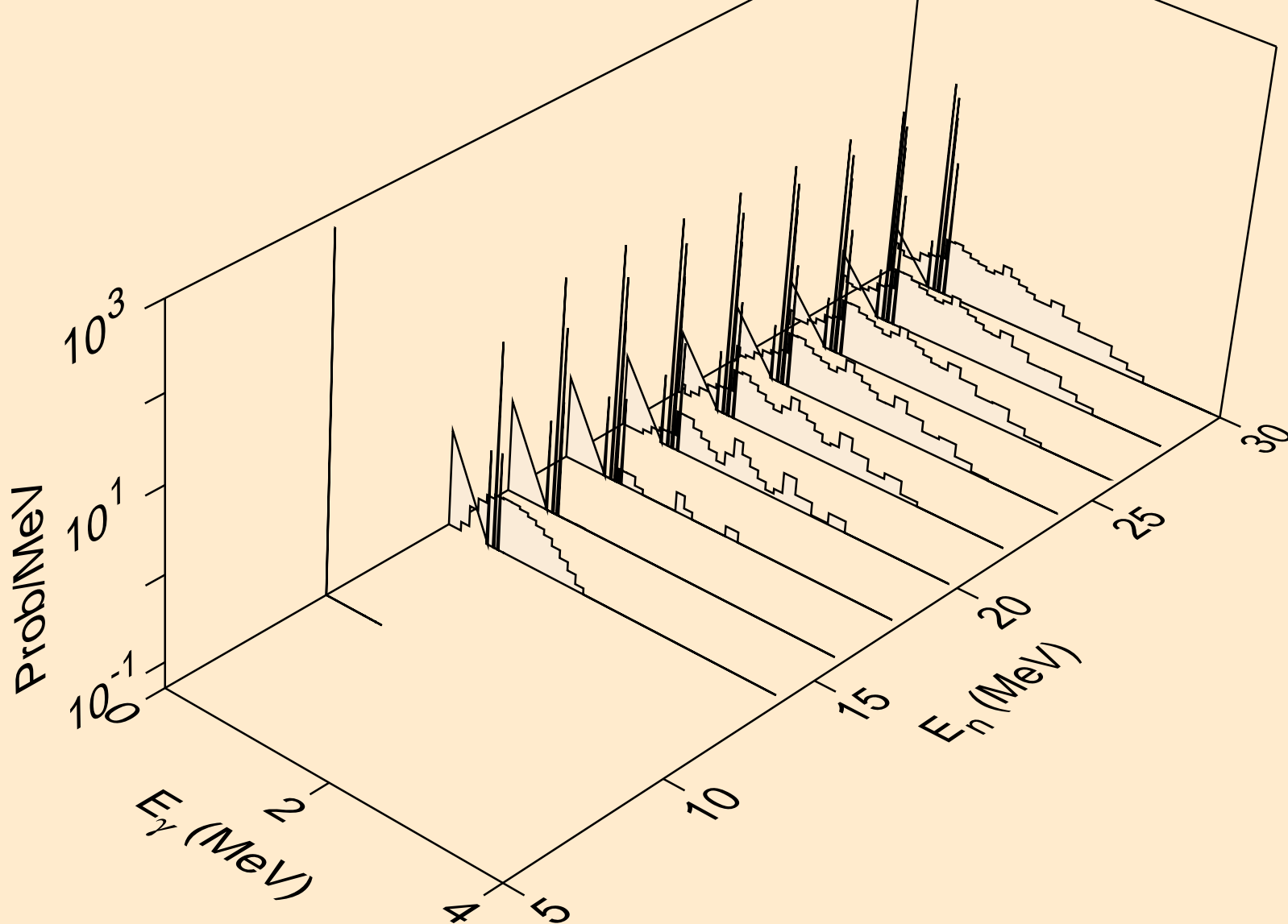

TA160M NEUTRON ACER TENDL-2019 LIBRARY; T=293.16K
Photon emission for (n,3np)

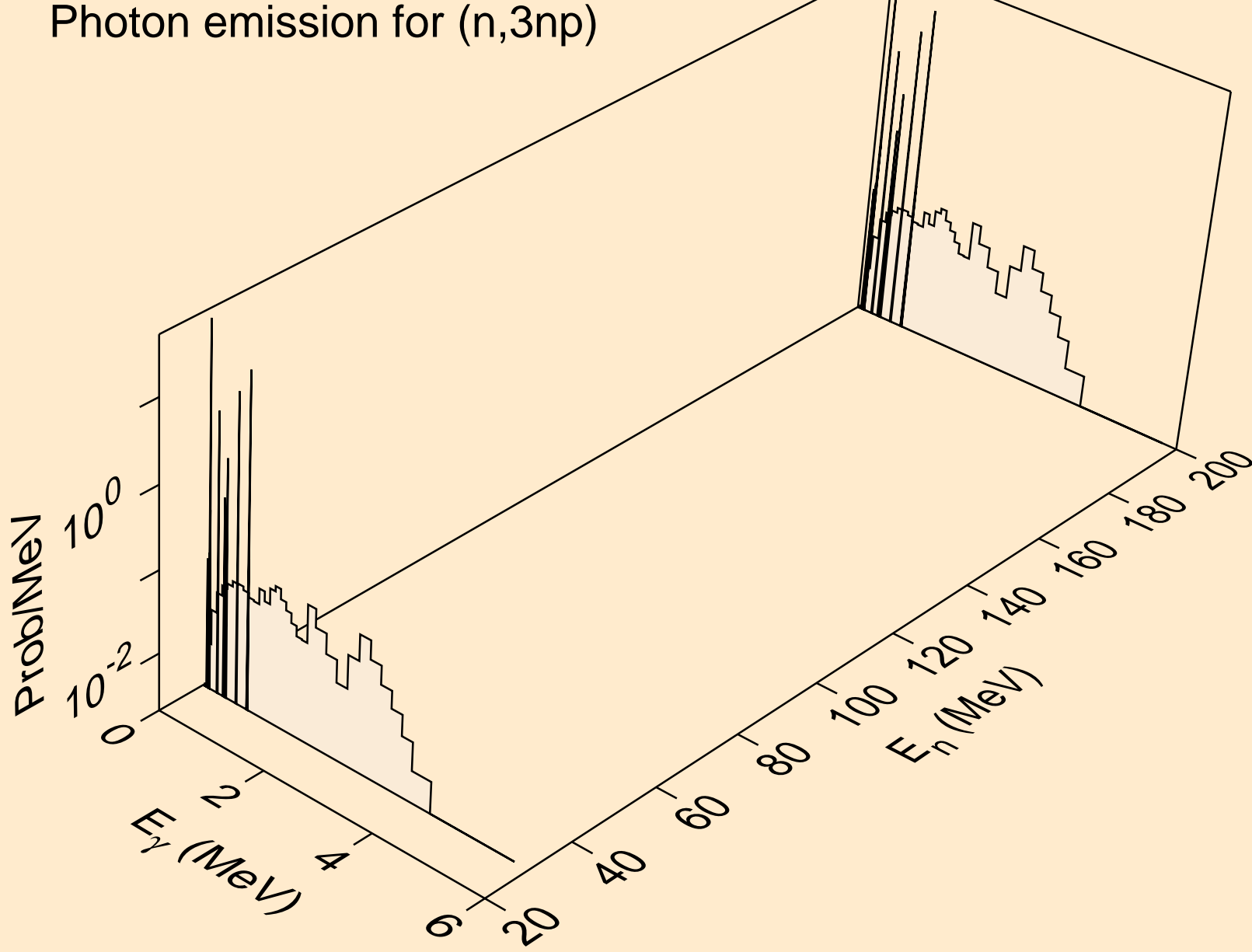

TA160M NEUTRON ACER TENDL-2019 LIBRARY; T=293.16K
Photon emission for (n,2np)

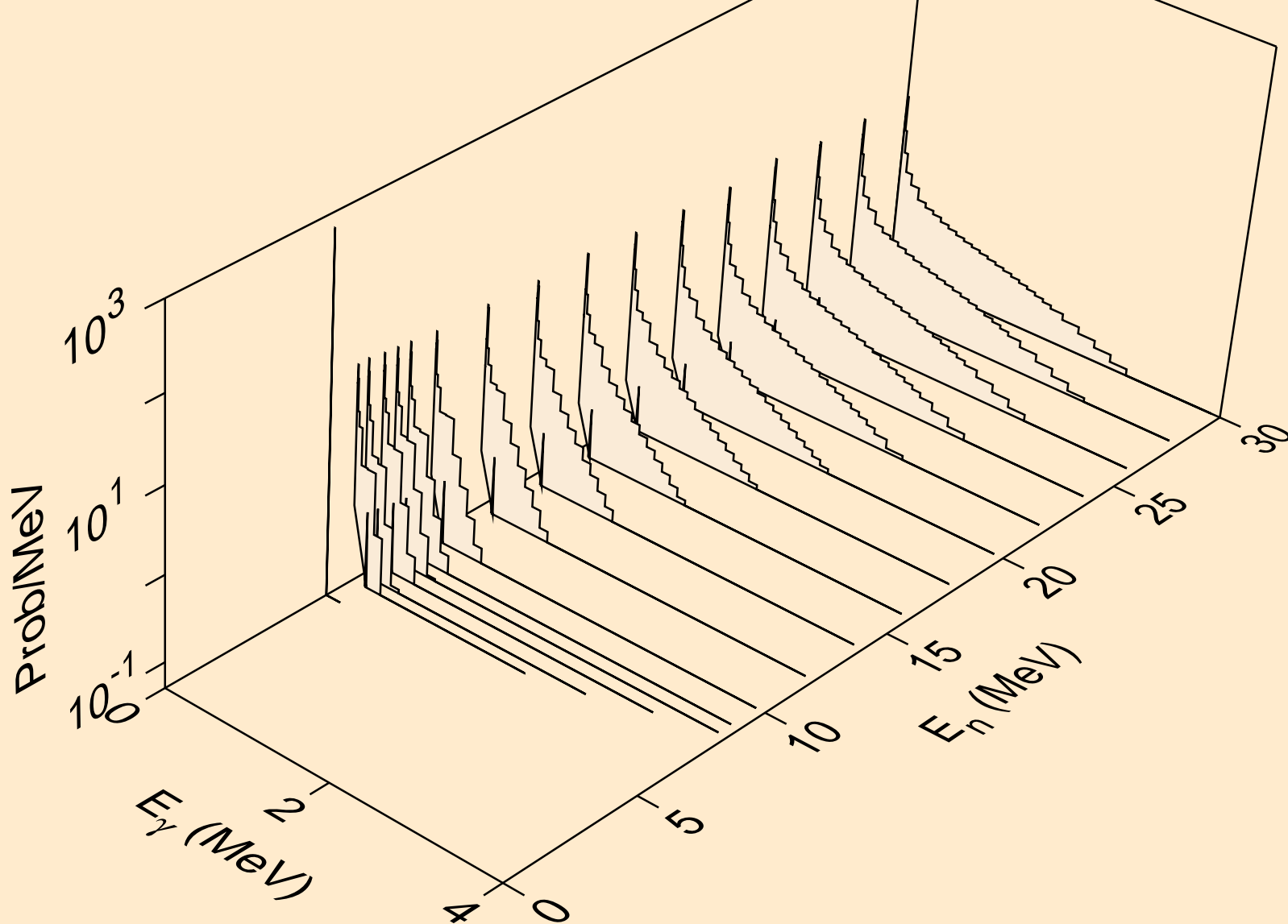

TA160M NEUTRON ACER TENDL-2019 LIBRARY; T=293.16K
Photon emission for (n,npa)

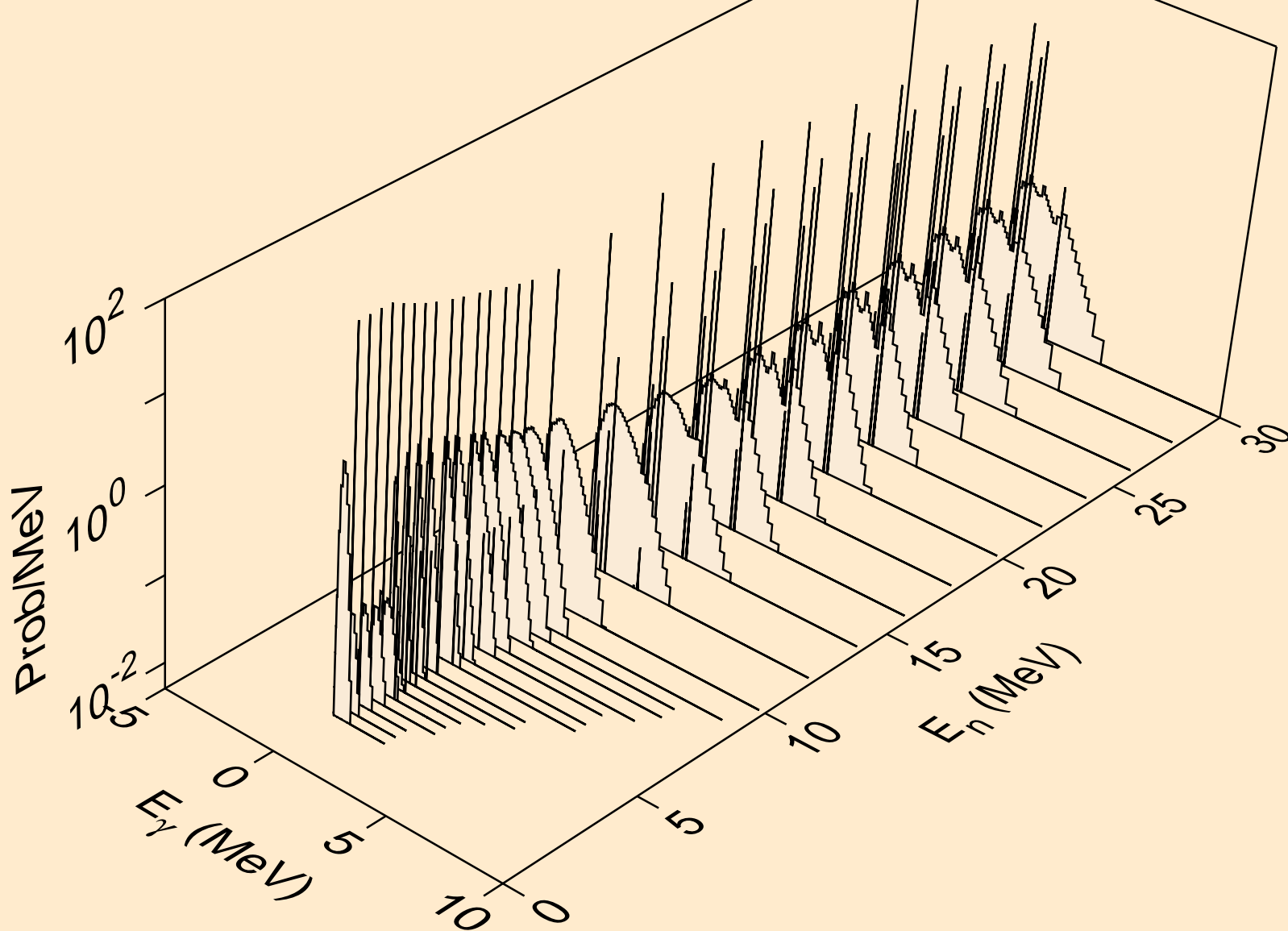

TA160M NEUTRON ACER TENDL-2019 LIBRARY; T=293.16K
Photon emission for (n,n*2)

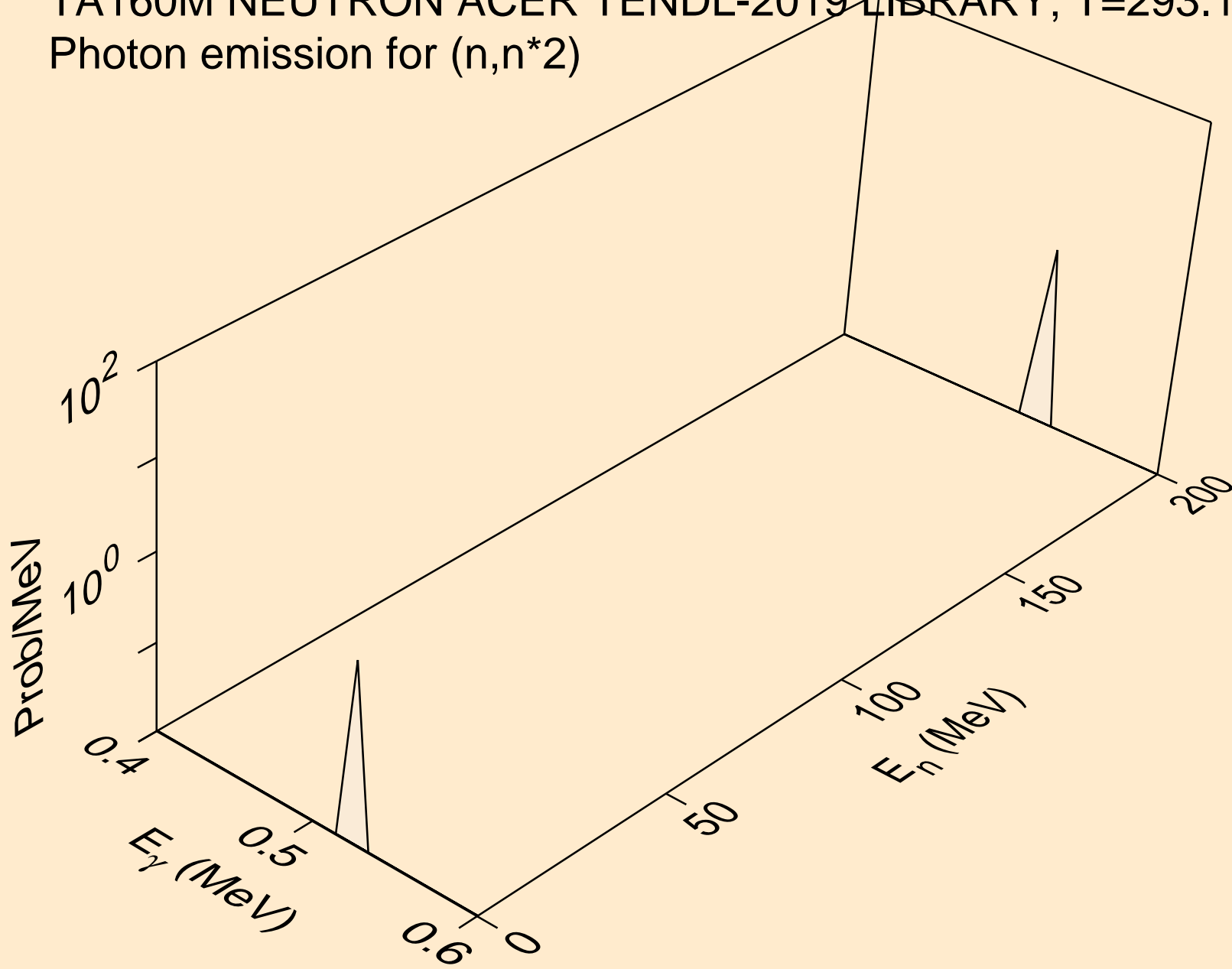

TA160M NEUTRON ACER TENDL-2019 LIBRARY; T=293.16K
Photon emission for (n,n*c)

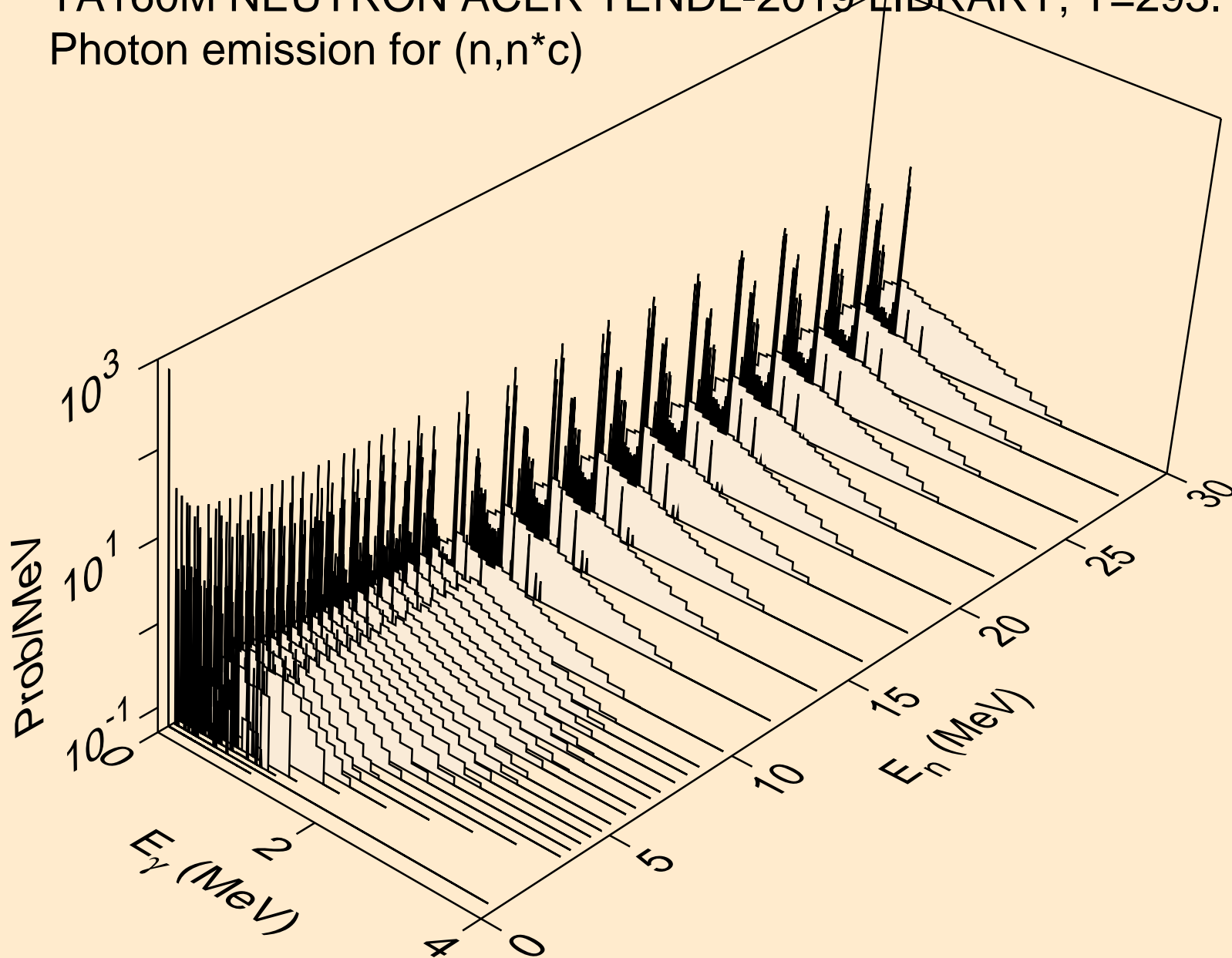

TA160M NEUTRON ACER TENDL-2019 LIBRARY; T=293.16K
Photon emission for (n,gma)

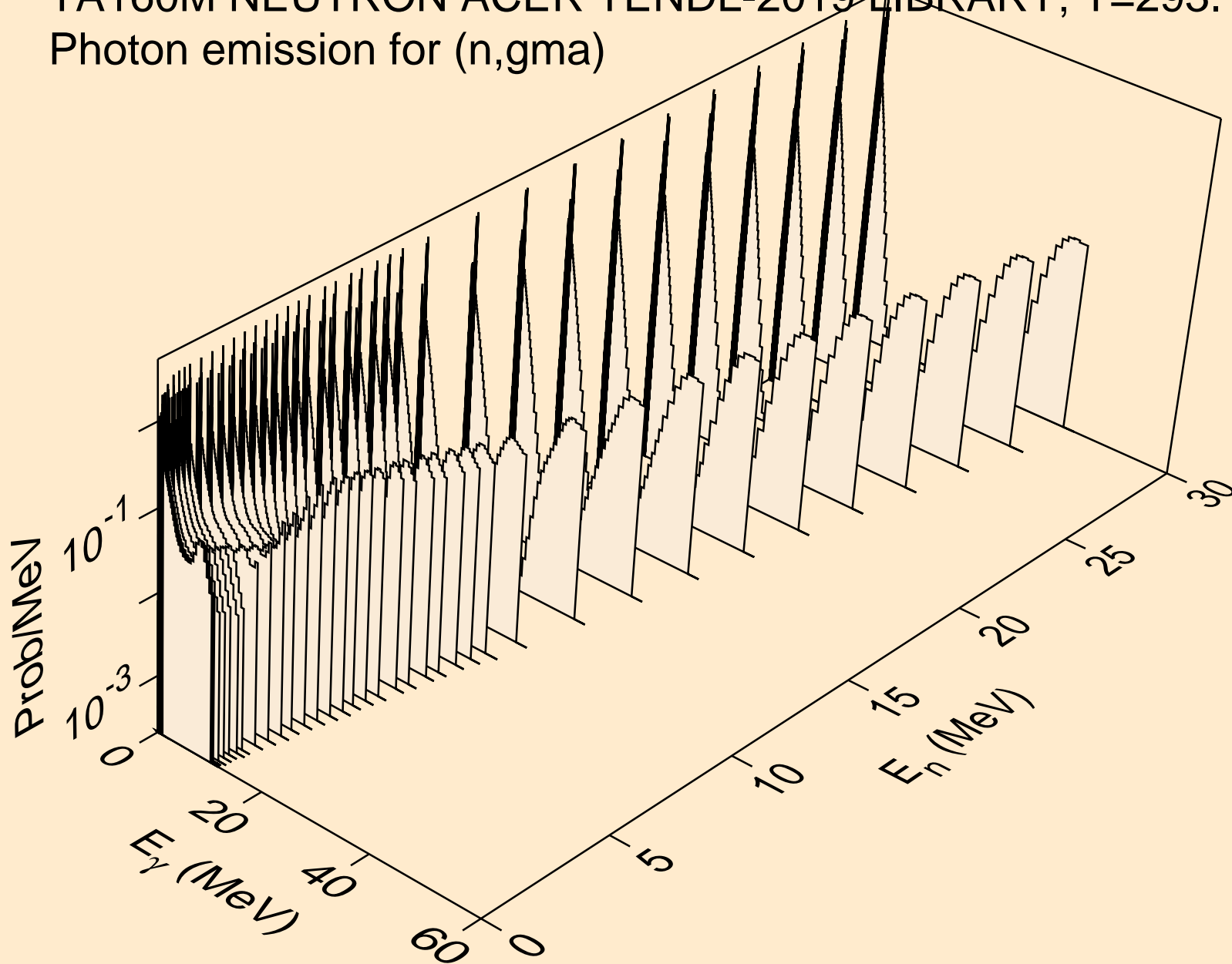

TA160M NEUTRON ACER TENDL-2019 LIBRARY; T=293.16K
Photon emission for (n,p)

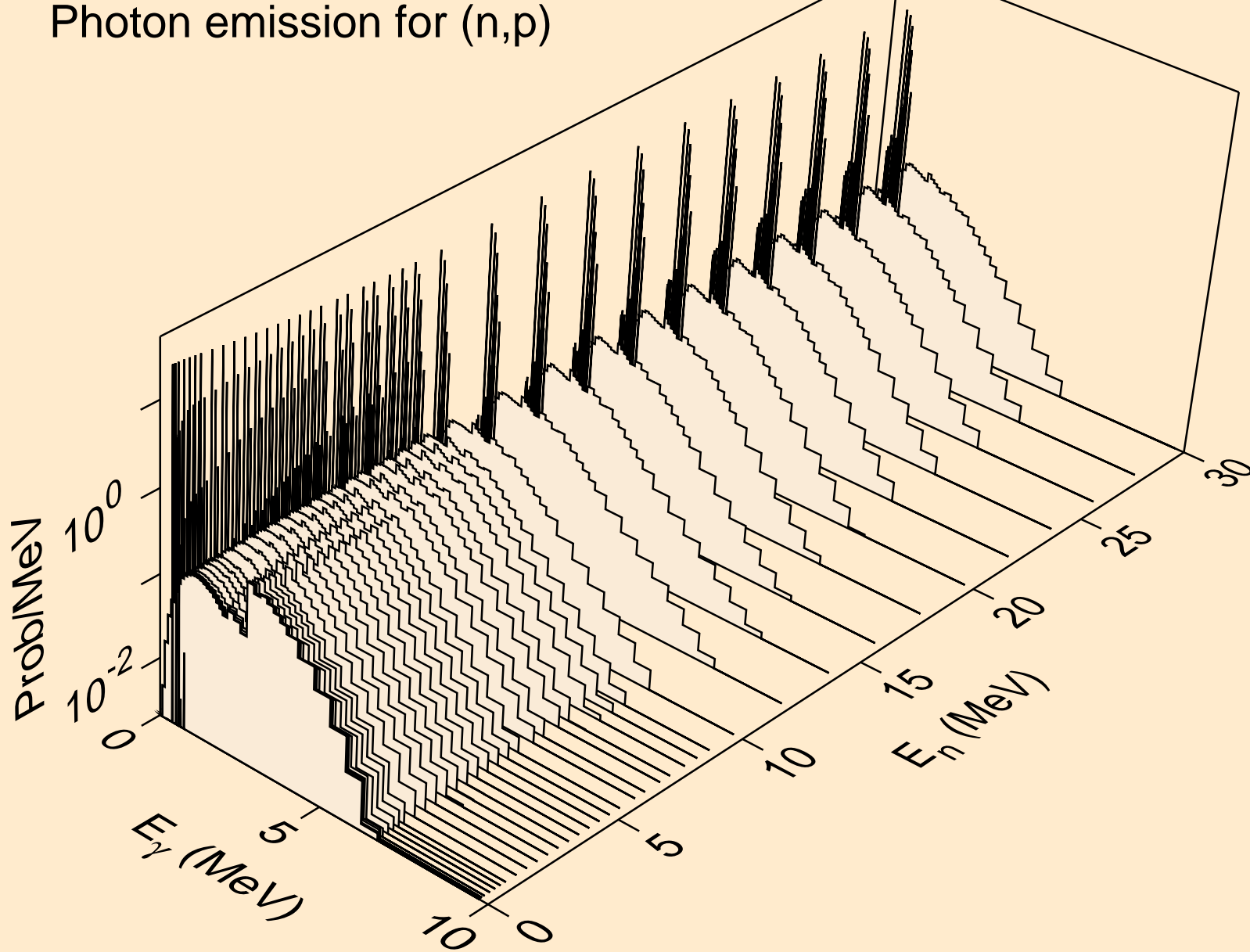

TA160M NEUTRON ACER TENDL-2019 LIBRARY; T=293.16K
Photon emission for (n,d)

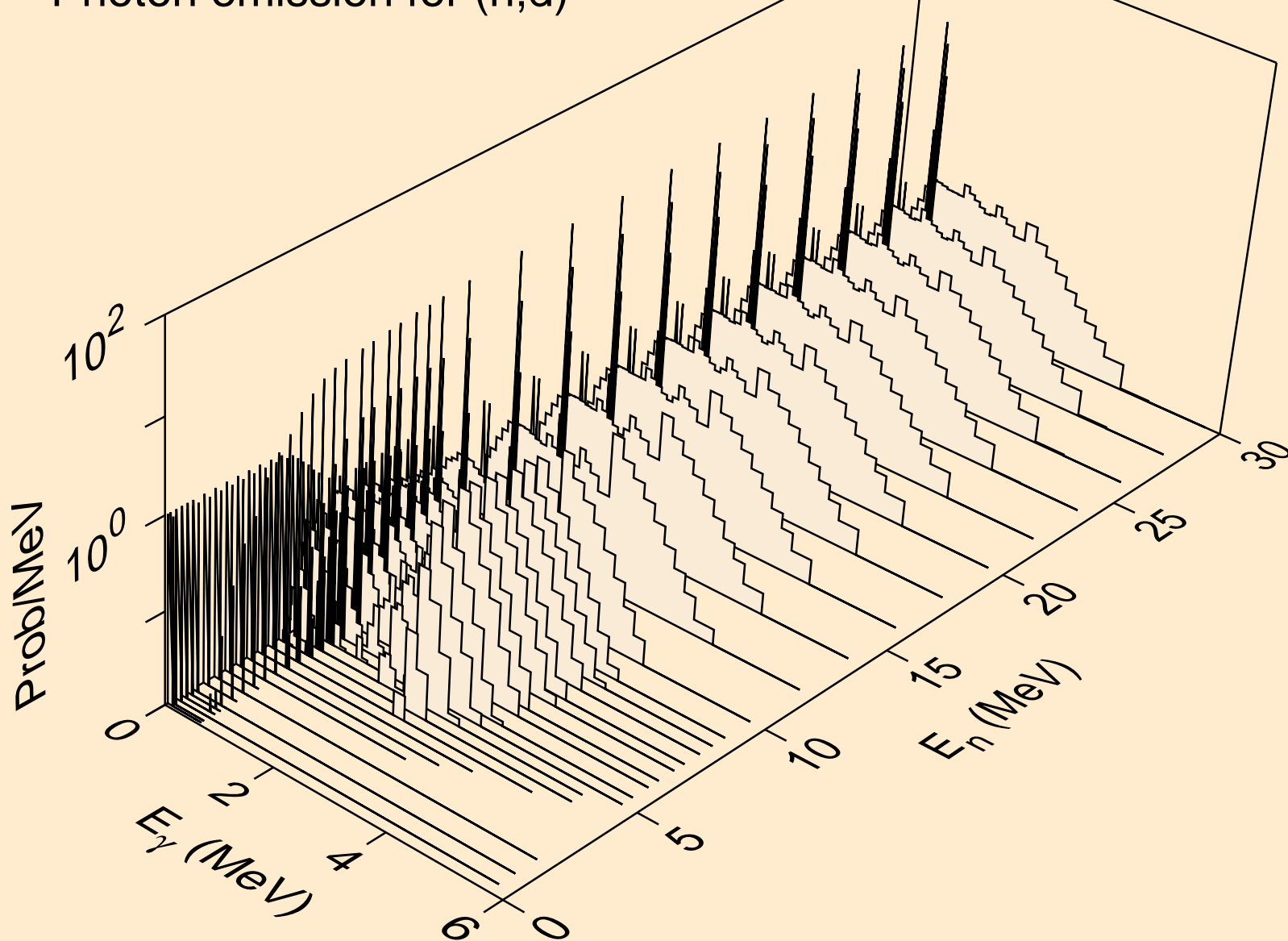

TA160M NEUTRON ACER TENDL-2019 LIBRARY; T=293.16K
Photon emission for (n,t)

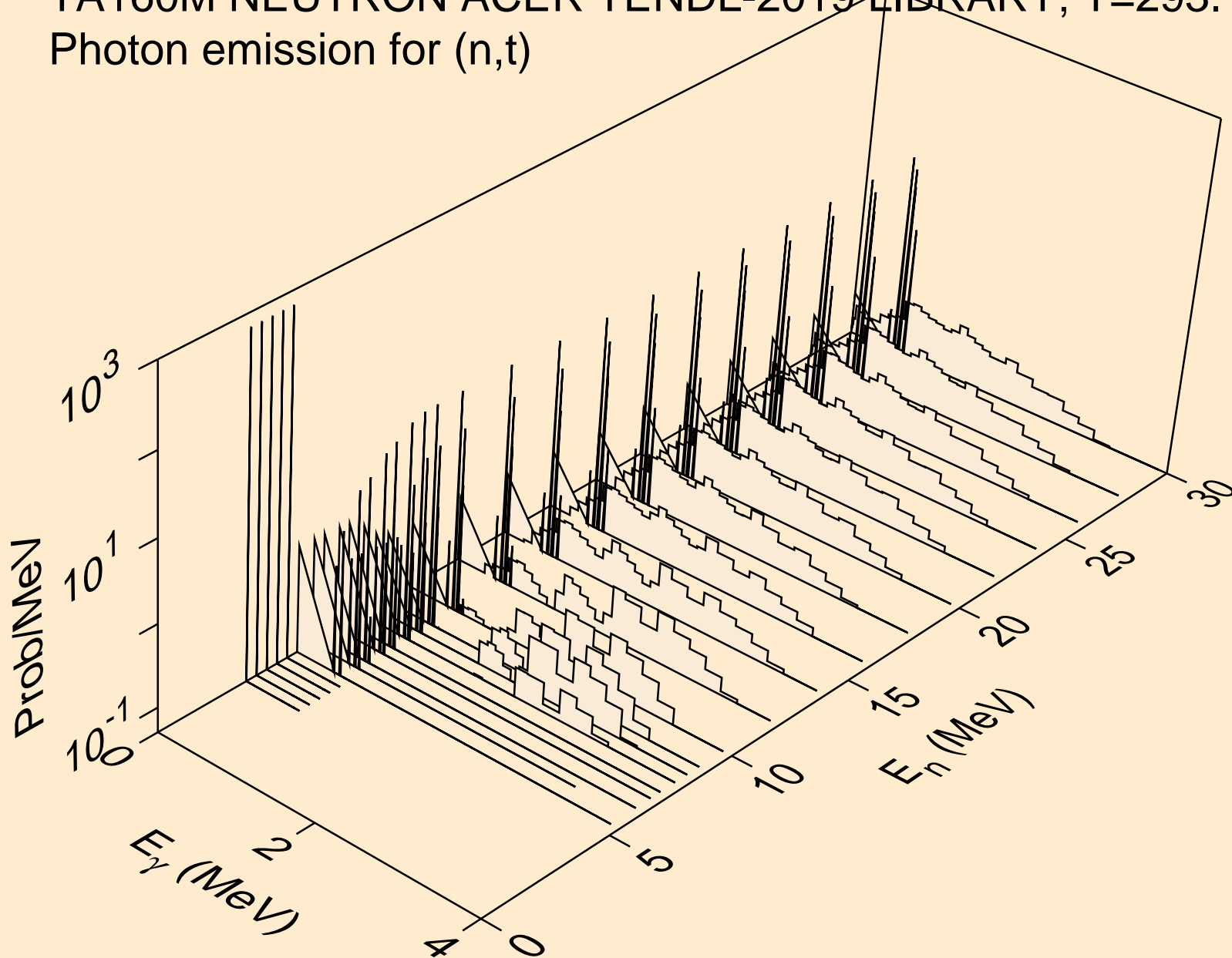

TA160M NEUTRON ACER TENDL-2019 LIBRARY; T=293.16K
Photon emission for (n,he3)

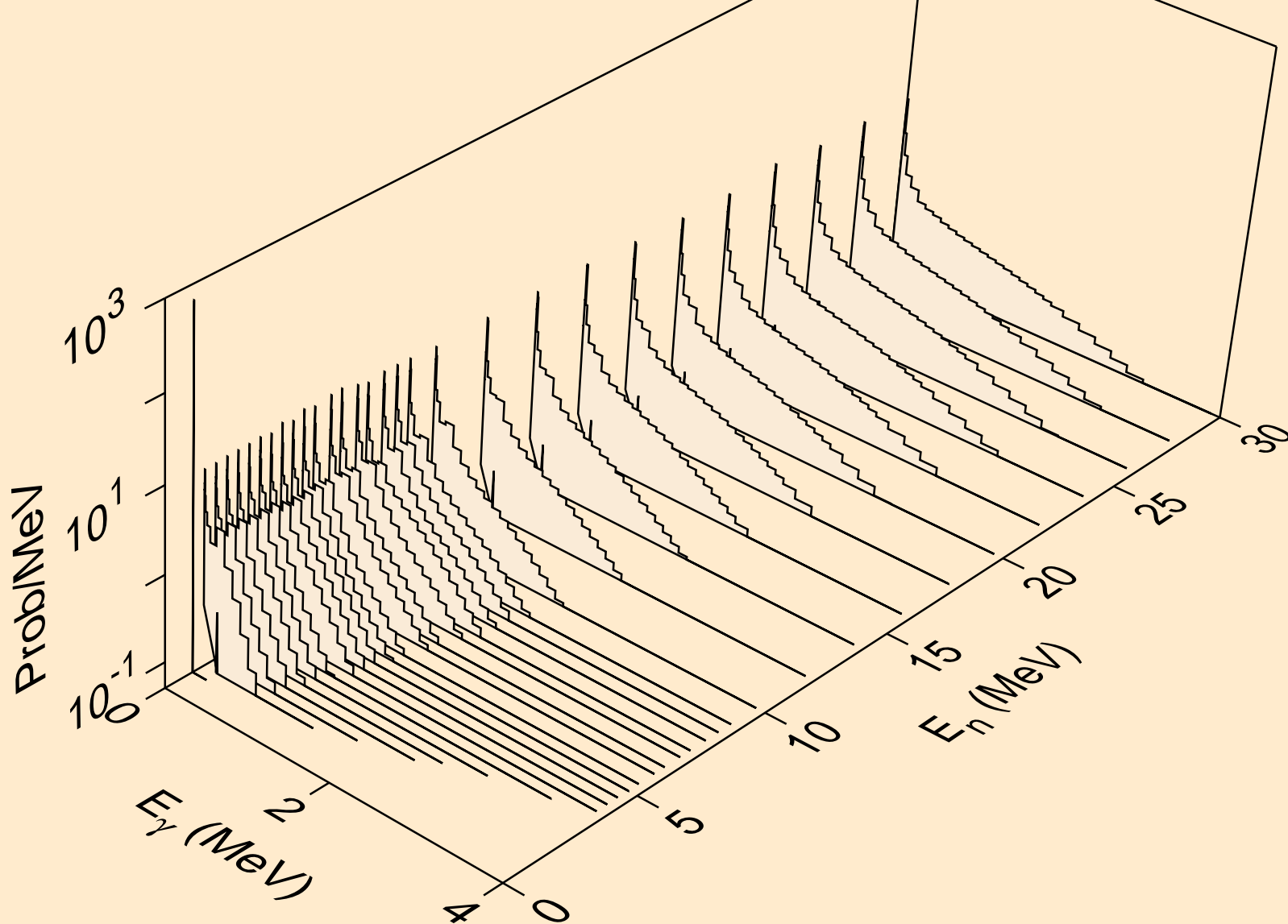

TA160M NEUTRON ACER TENDL-2019 LIBRARY; T=293.16K
Photon emission for (n,a)

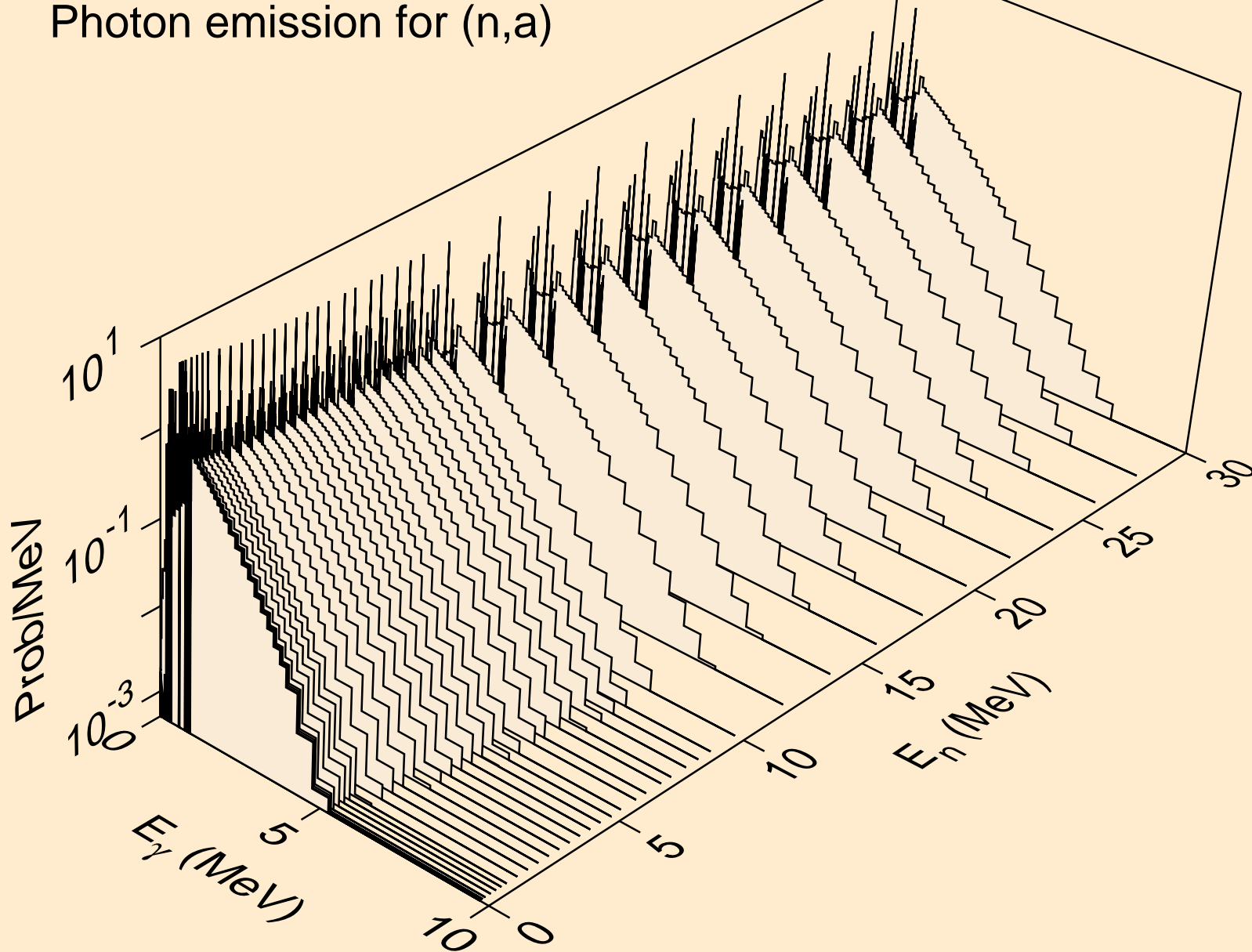

TA160M NEUTRON ACER TENDL-2019 LIBRARY; T=293.16K
Photon emission for (n,2a)

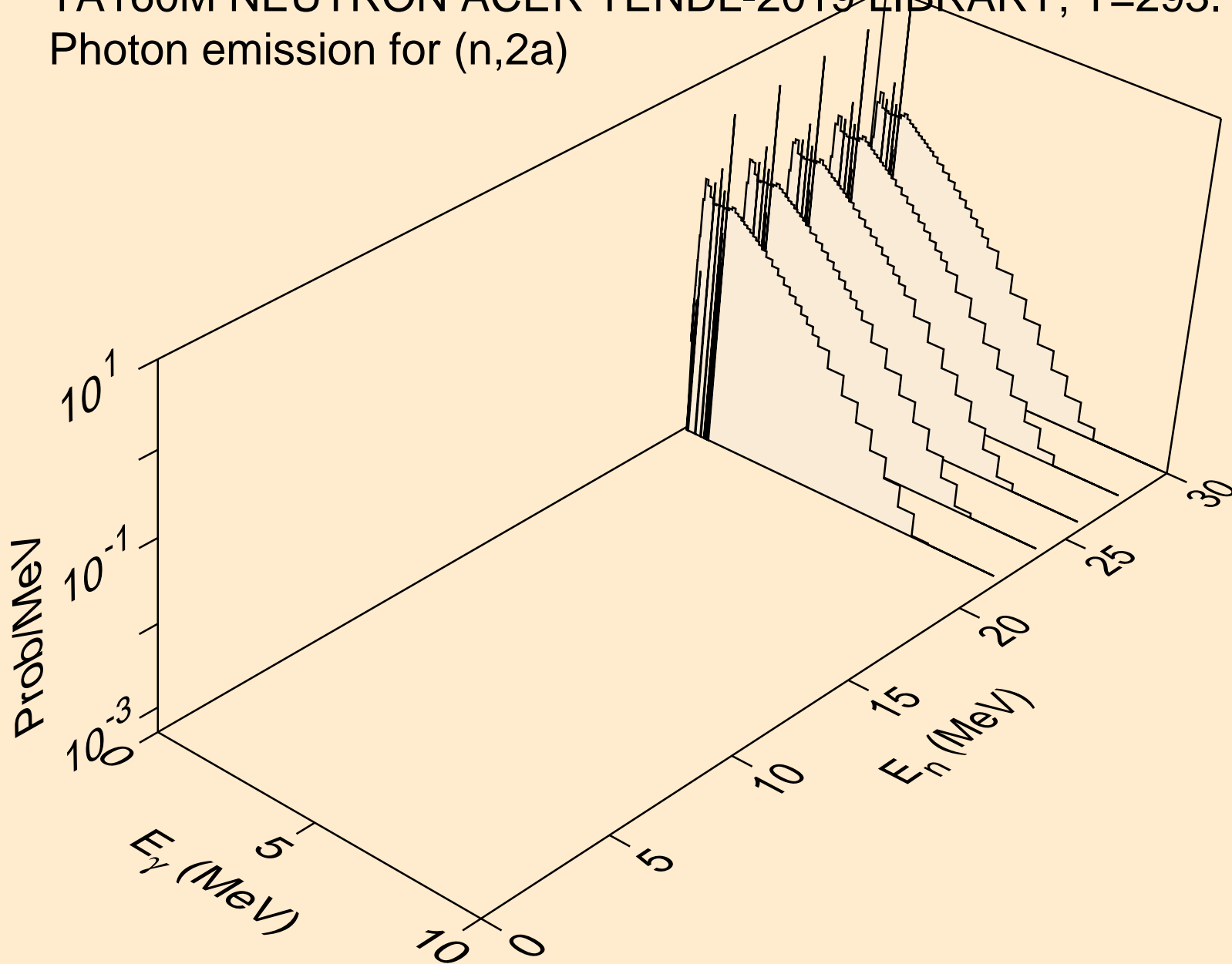

TA160M NEUTRON ACER TENDL-2019 LIBRARY; T=293.16K
Photon emission for (n,3a)

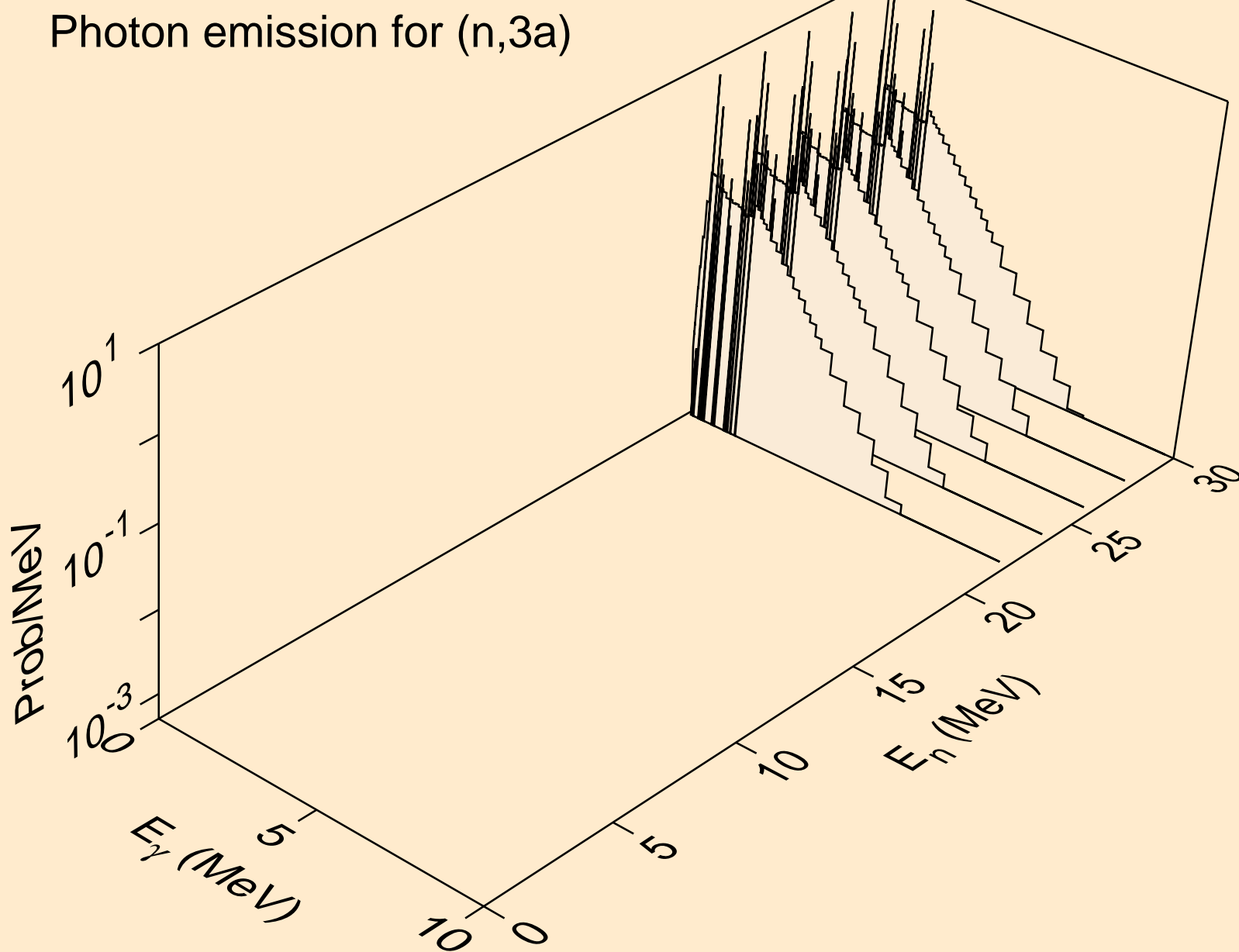

TA160M NEUTRON ACER TENDL-2019 LIBRARY; T=293.16K
Photon emission for (n,2p)

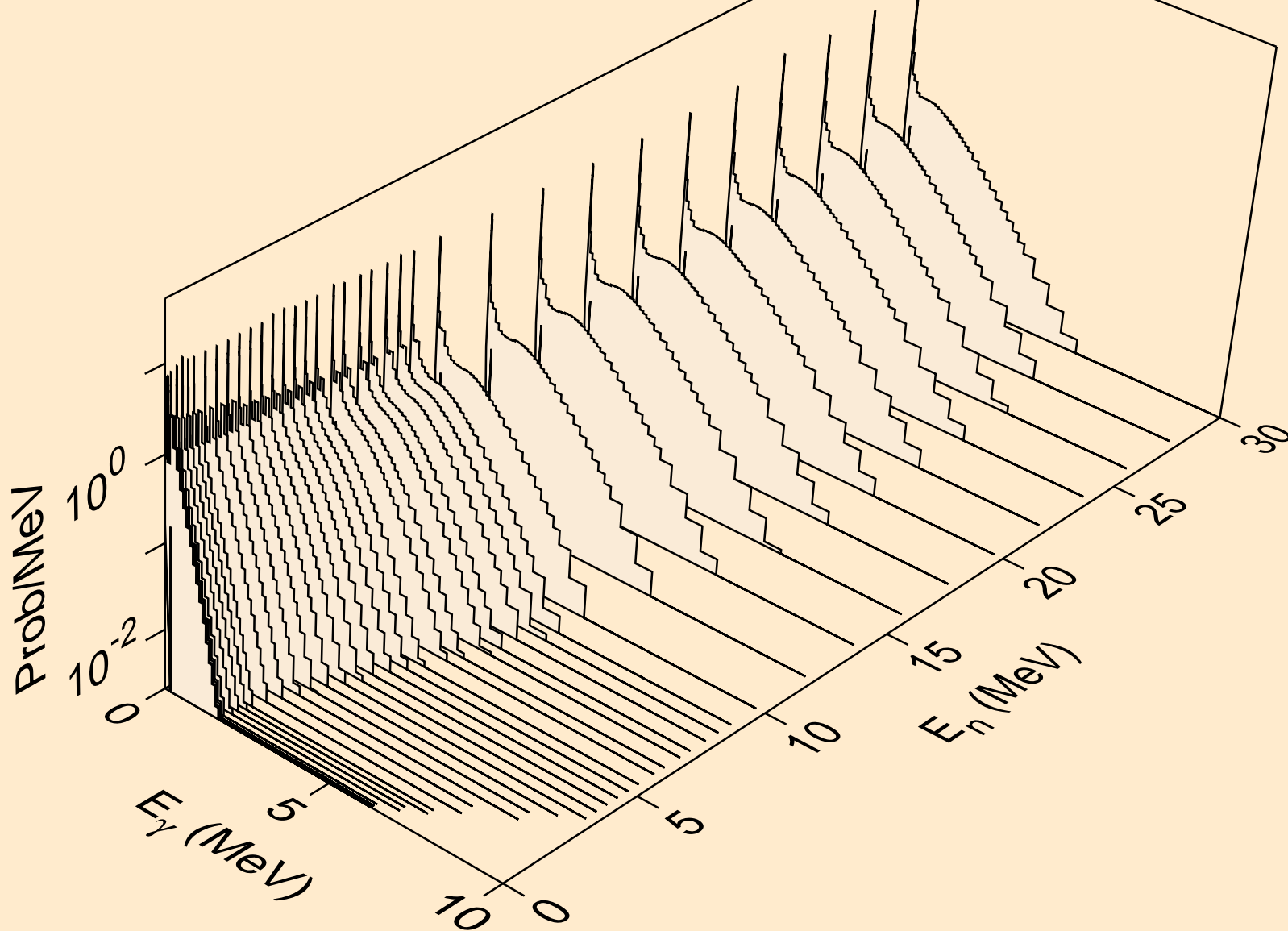

TA160M NEUTRON ACER TENDL-2019 LIBRARY; T=293.16K
Photon emission for (n,p α)

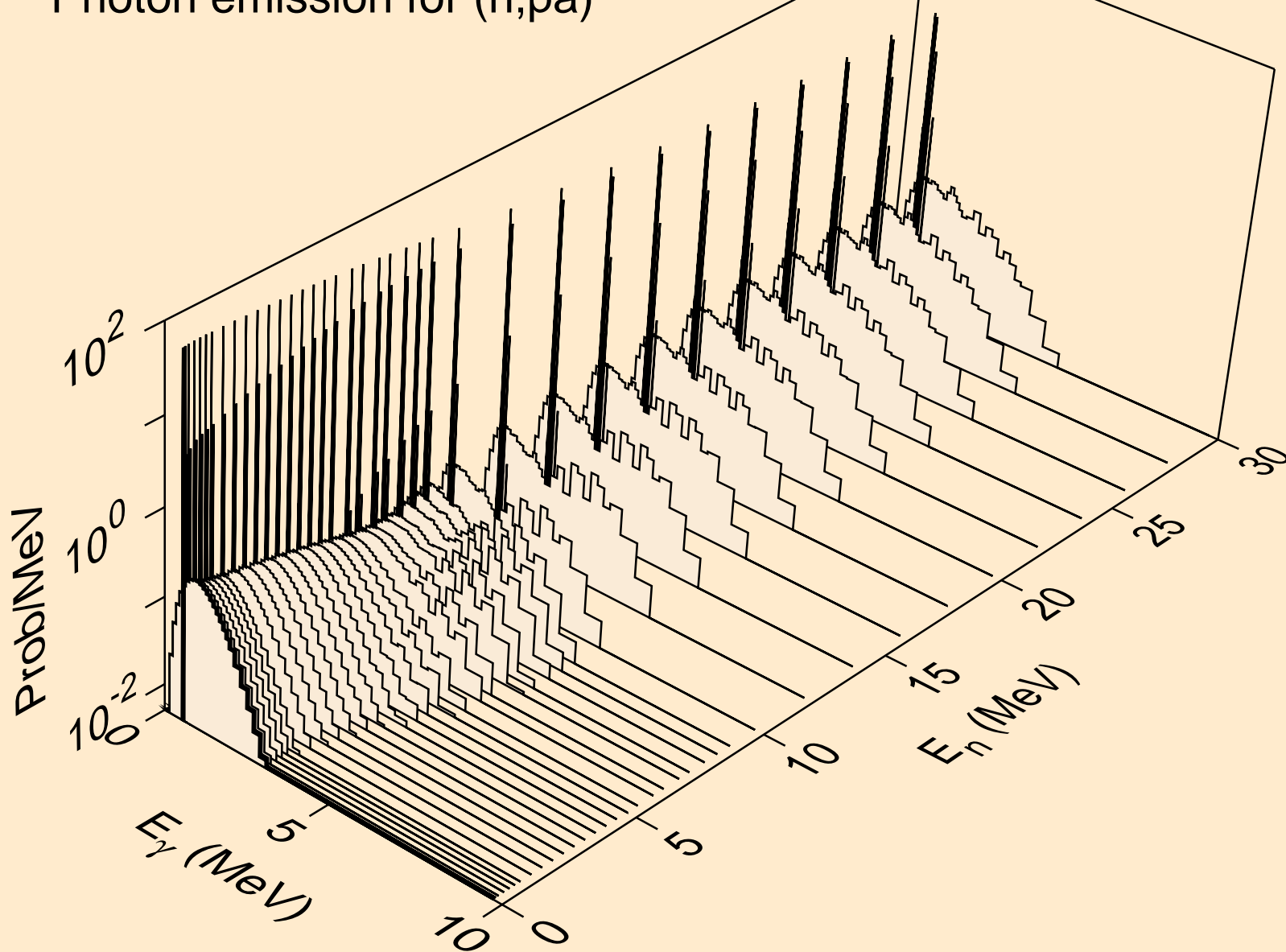

TA160M NEUTRON ACER TENDL-2019 LIBRARY; T=293.16K
Photon emission for (n,t2a)

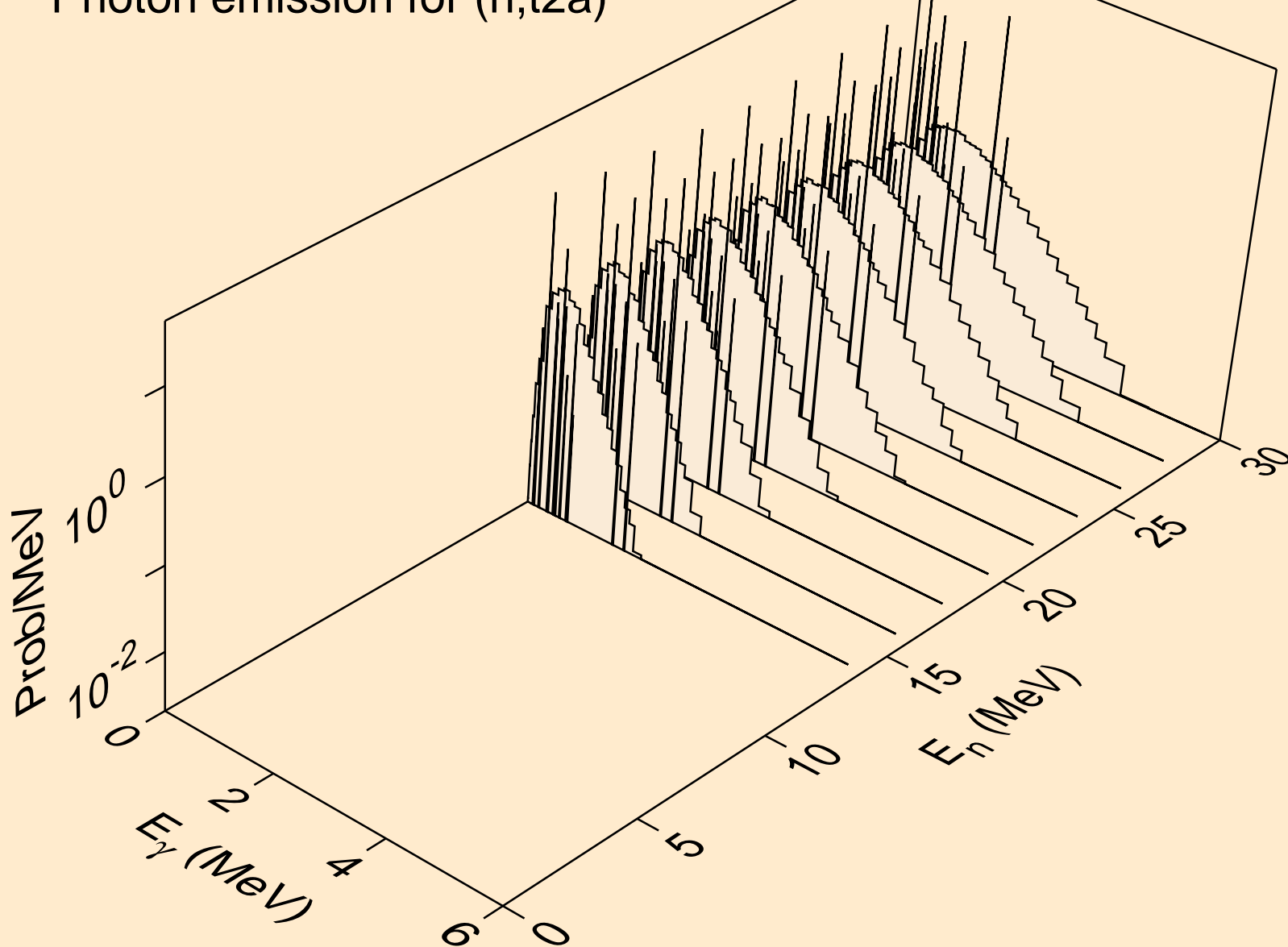

TA160M NEUTRON ACER TENDL-2019 LIBRARY; T=293.16K
Photon emission for (n,d2a)

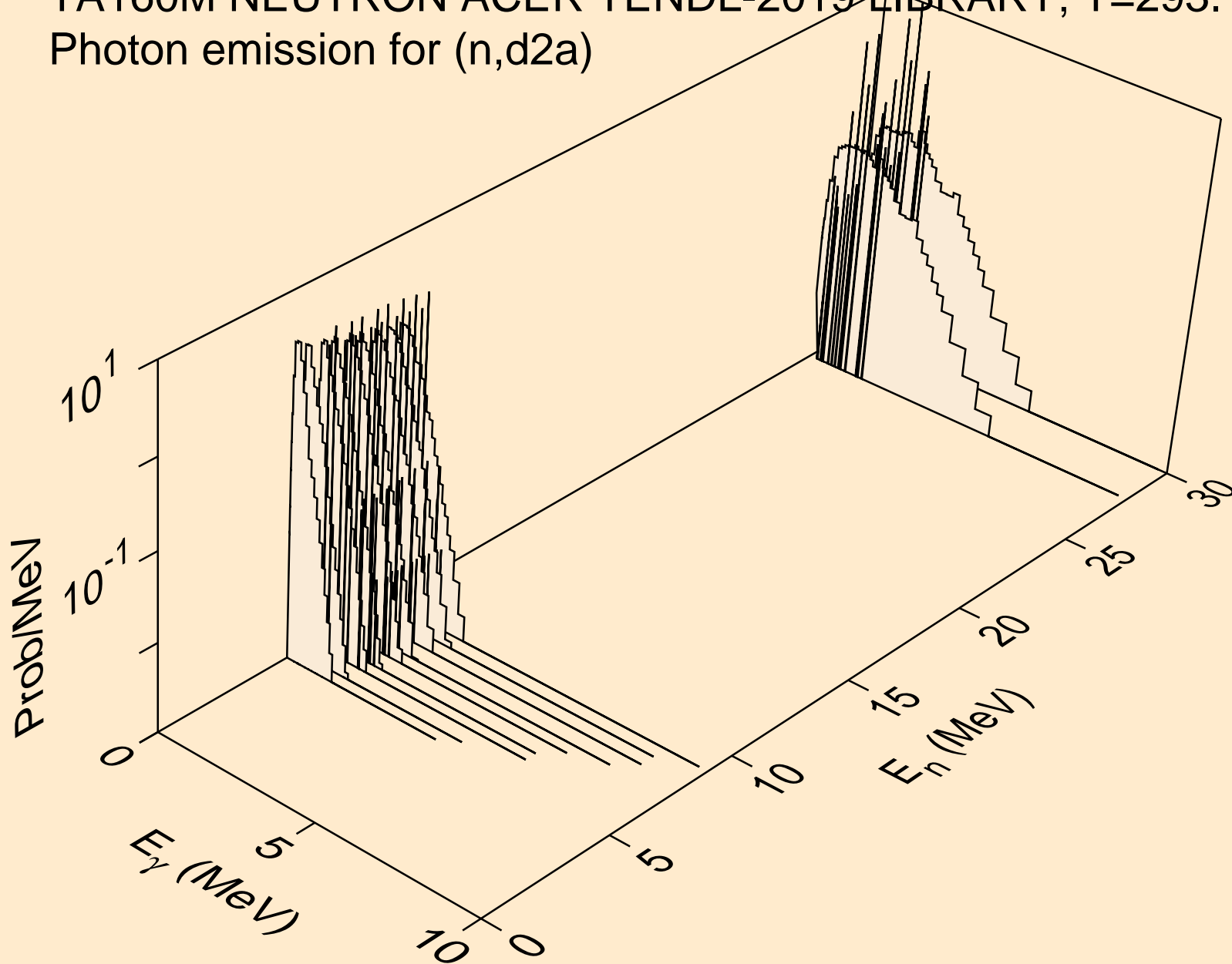

TA160M NEUTRON ACER TENDL-2019 LIBRARY; T=293.16K
Photon emission for (n,pd)

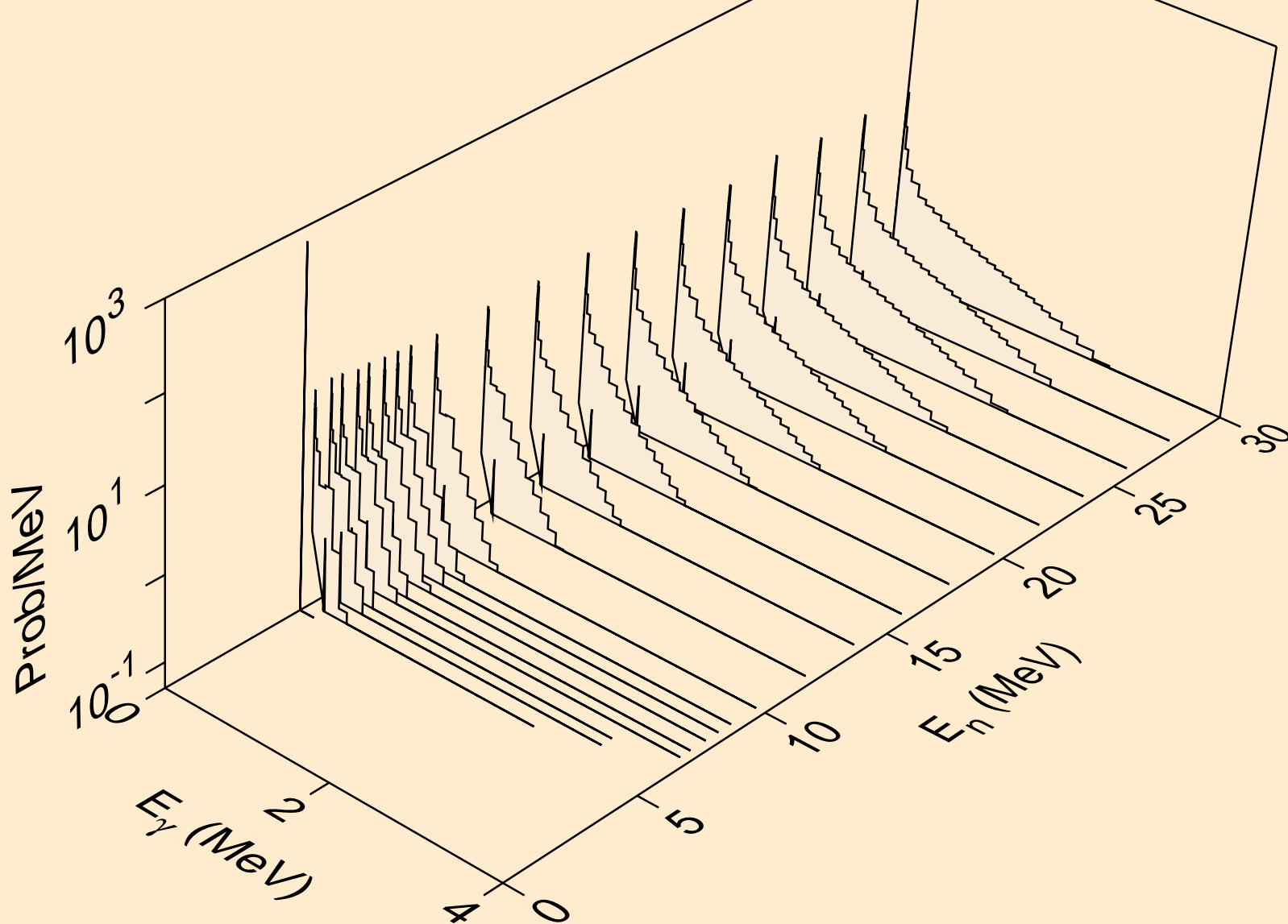

TA160M NEUTRON ACER TENDL-2019 LIBRARY; T=293.16K
Photon emission for (n,pt)

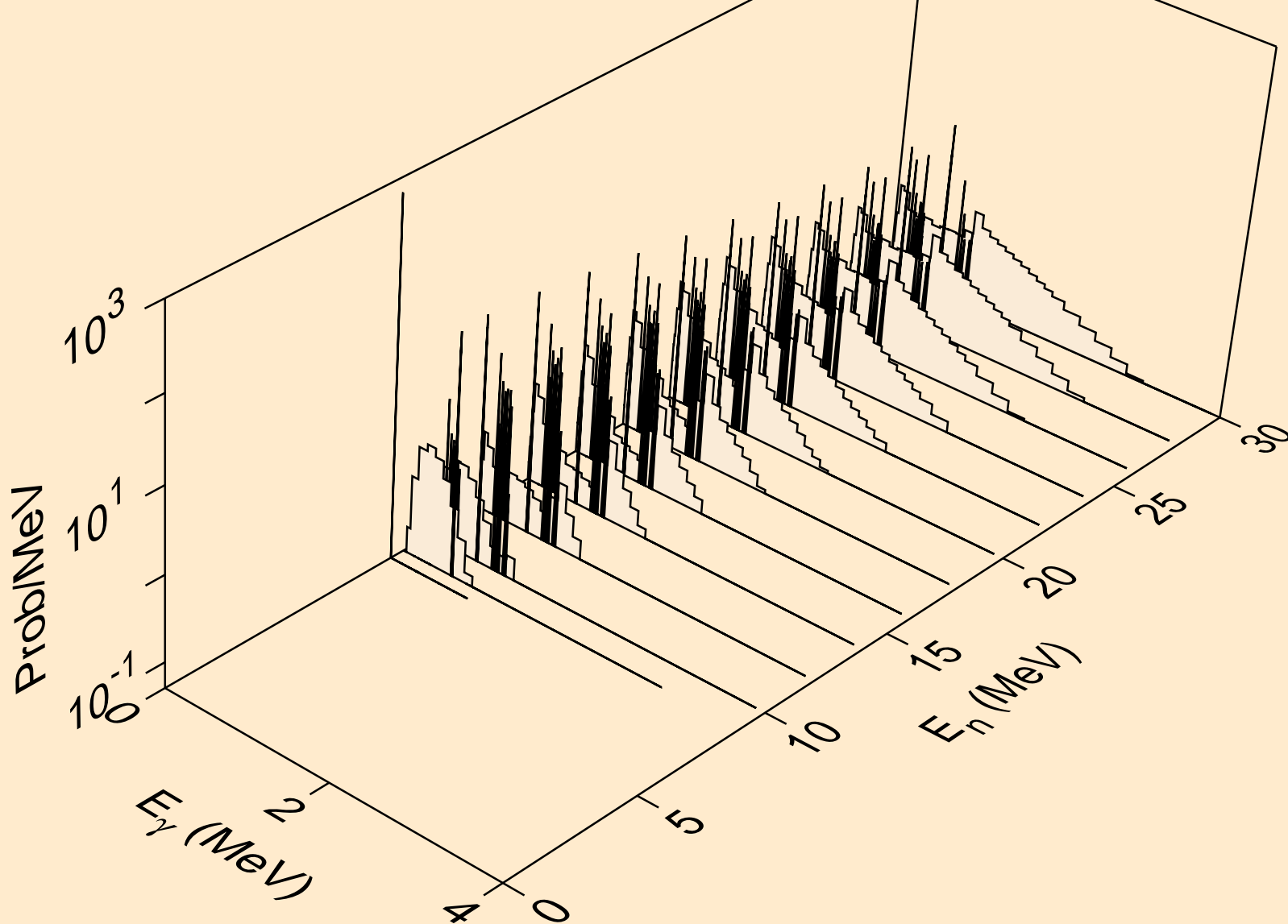

TA160M NEUTRON ACER TENDL-2019 LIBRARY; T=293.16K
Photon emission for (n,da)

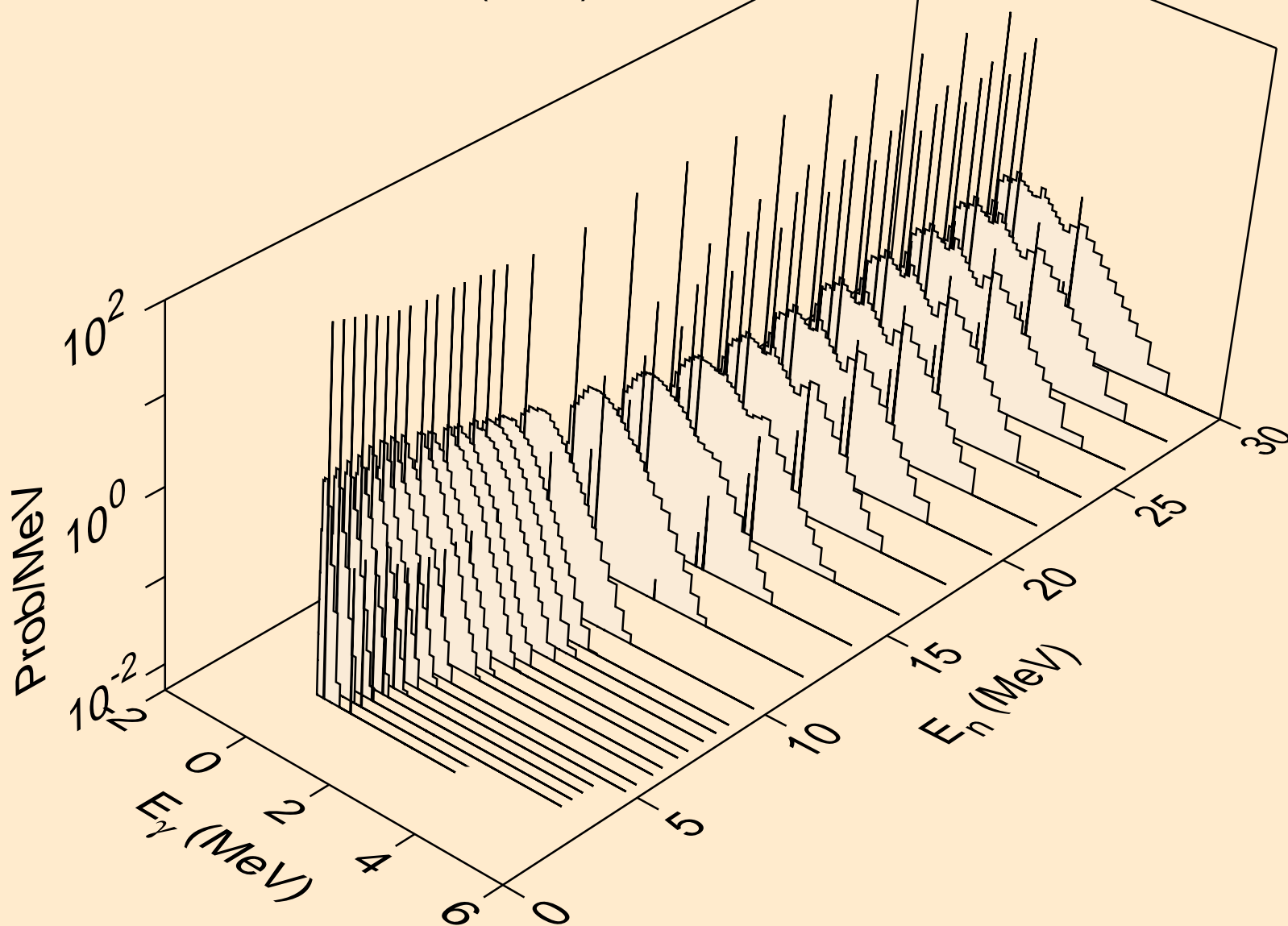

TA160M NEUTRON ACER TENDL-2019 LIBRARY; T=293.16K
thermal capture photon spectrum

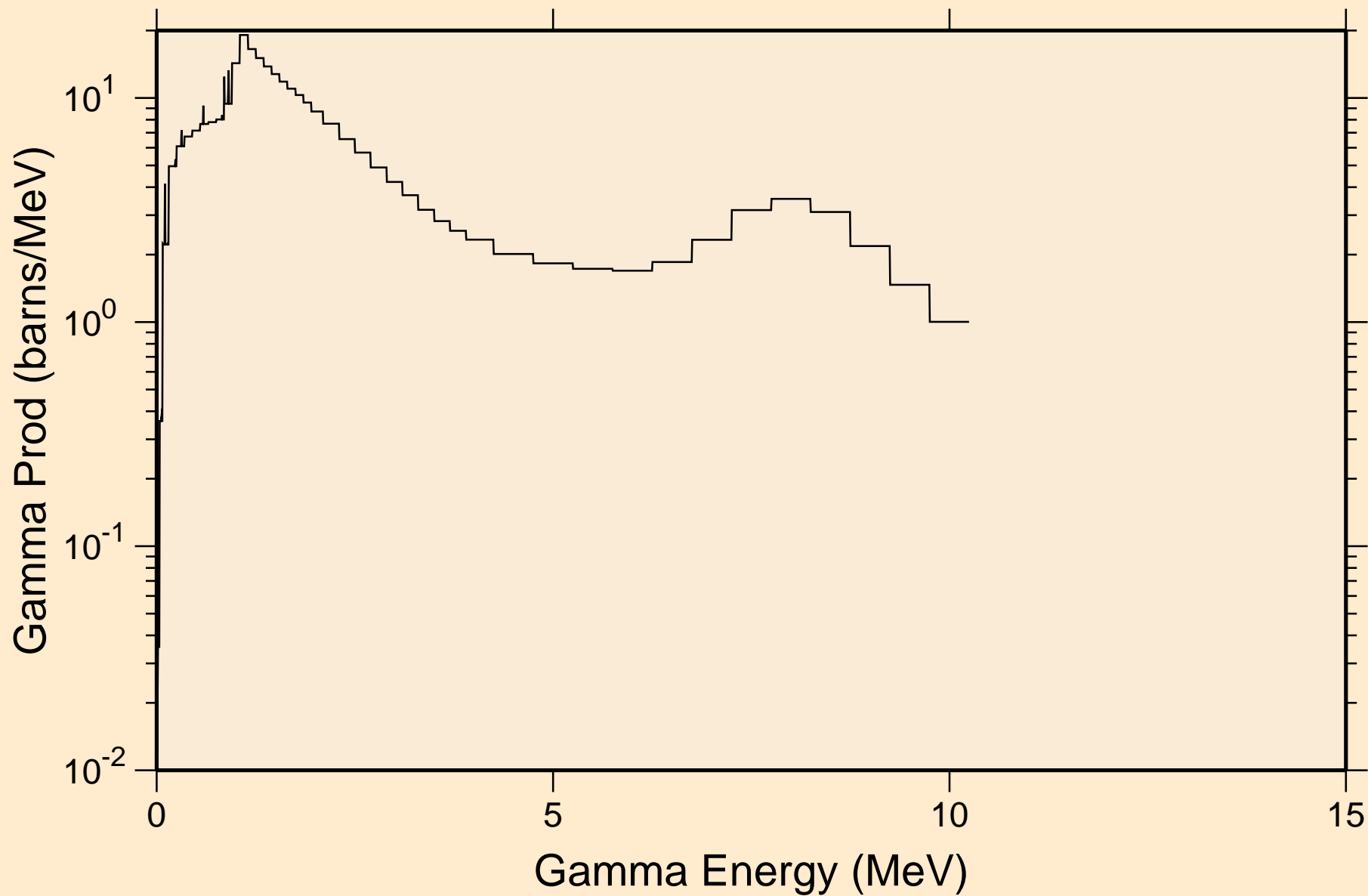

TA160M NEUTRON ACER TENDL-2019 LIBRARY; T=293.16K
14 MeV photon spectrum

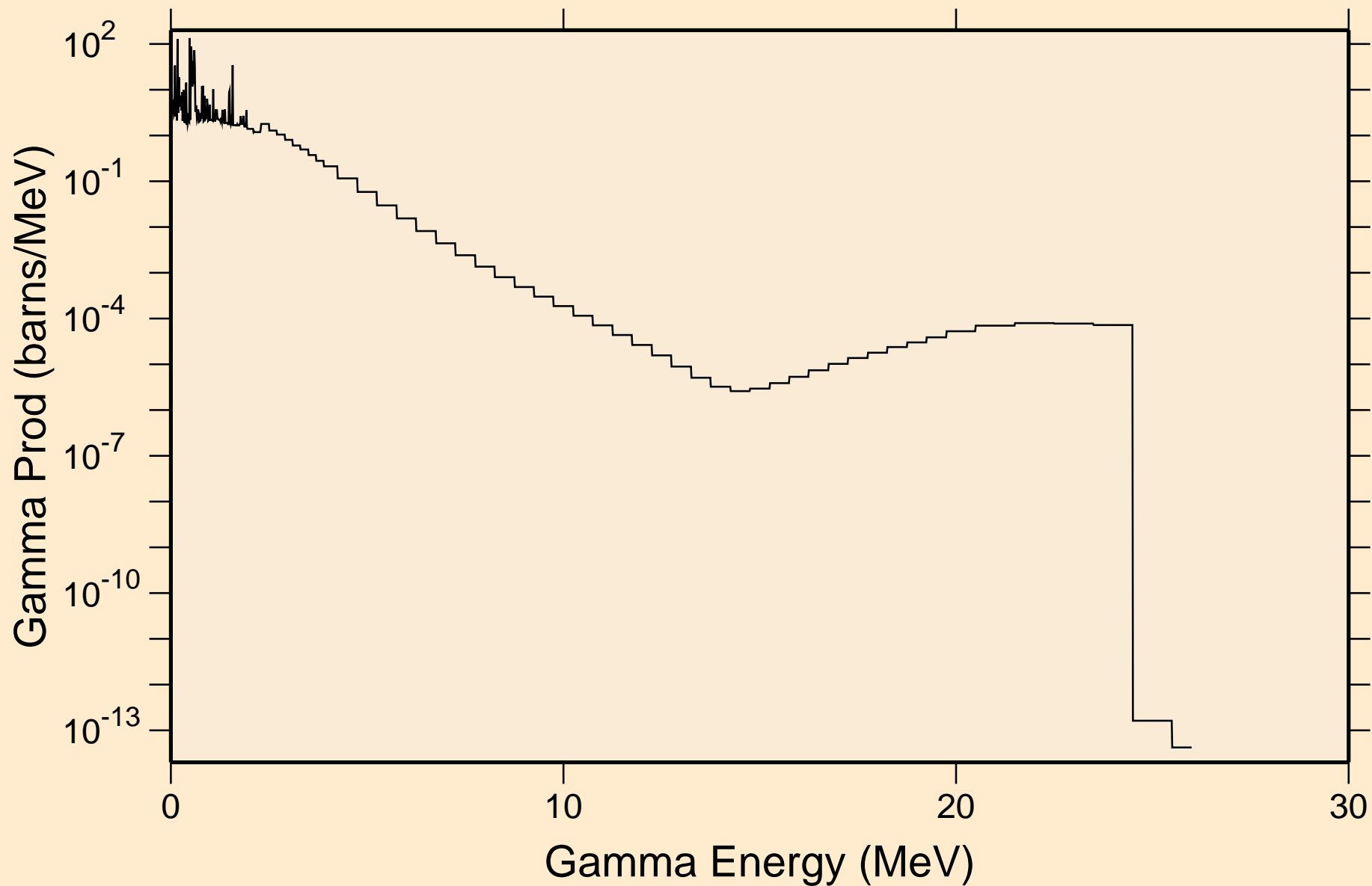

TA160M NEUTRON ACER TENDL-2019 LIBRARY; T=293.16K

Particle heating contributions

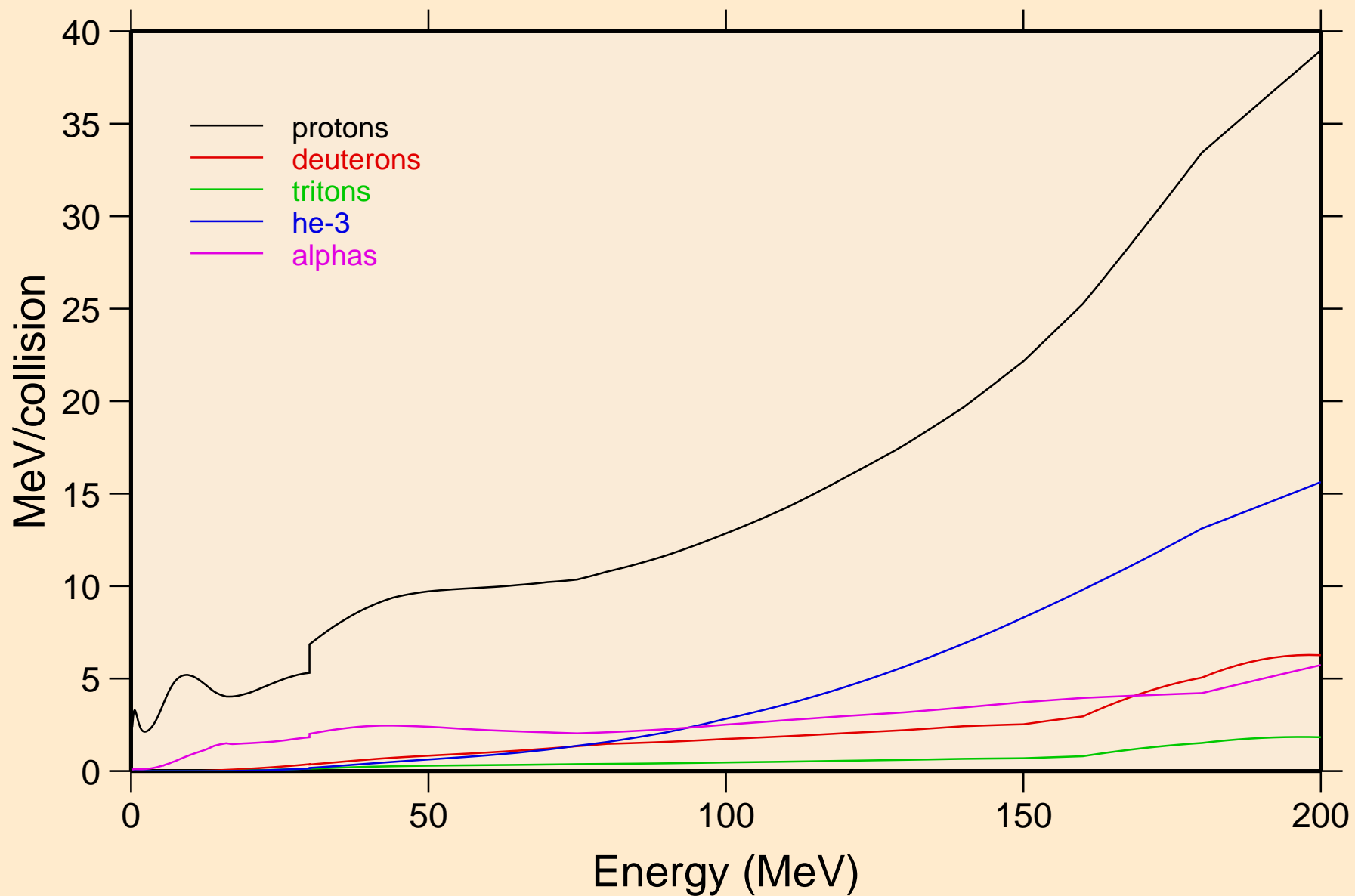

TA160M NEUTRON ACER TENDL-2019 LIBRARY; T=293.16K
Recoil Heating

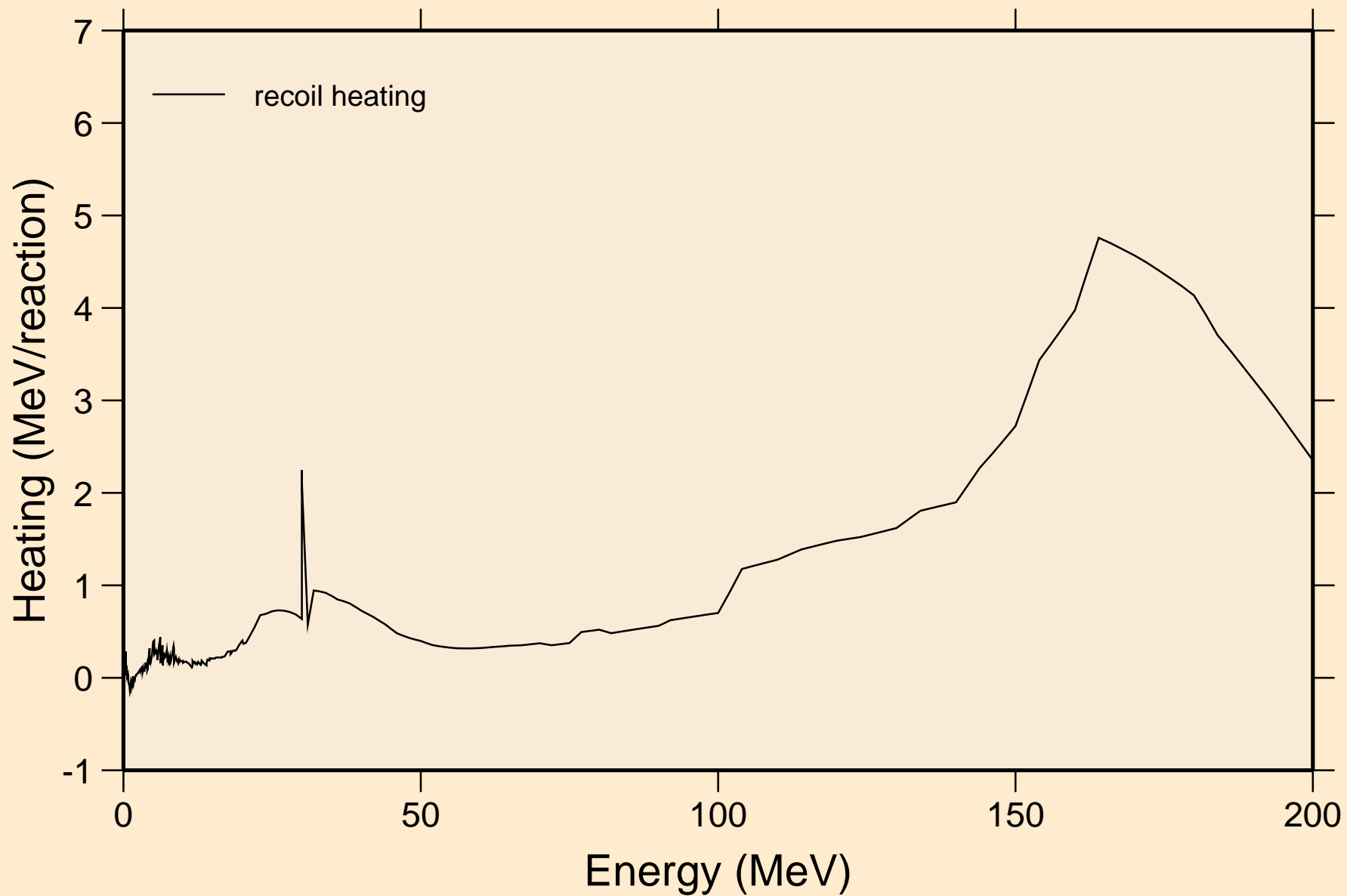

TA160M NEUTRON ACER TENDL-2019 LIBRARY; T=293.16K
Particle production cross sections

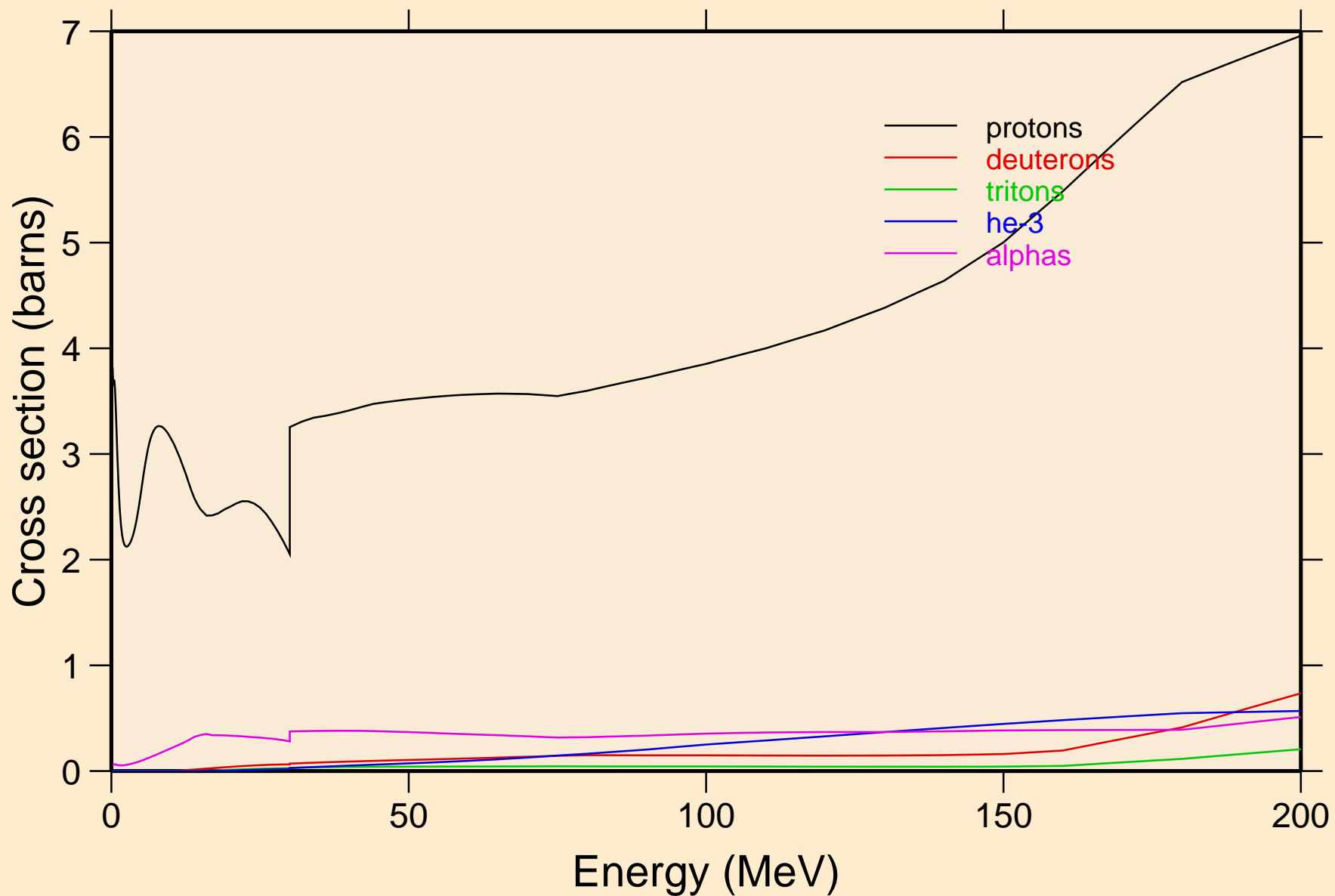

TA160M NEUTRON ACER TENDL-2019 LIBRARY; T=293.16K
protons from (n,x)

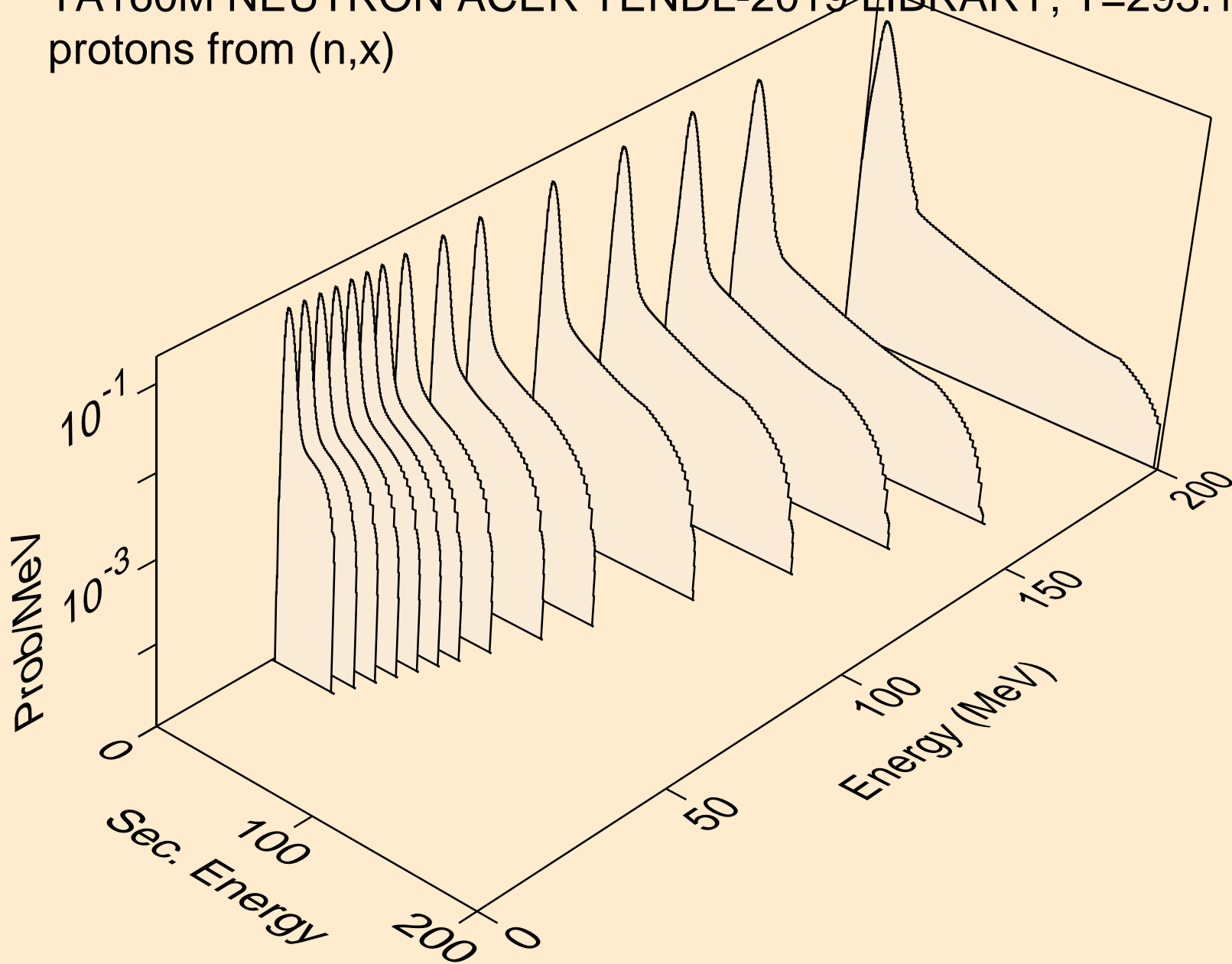

TA160M NEUTRON ACER TENDL-2019 LIBRARY; T=293.16K
protons from (n,n*)p

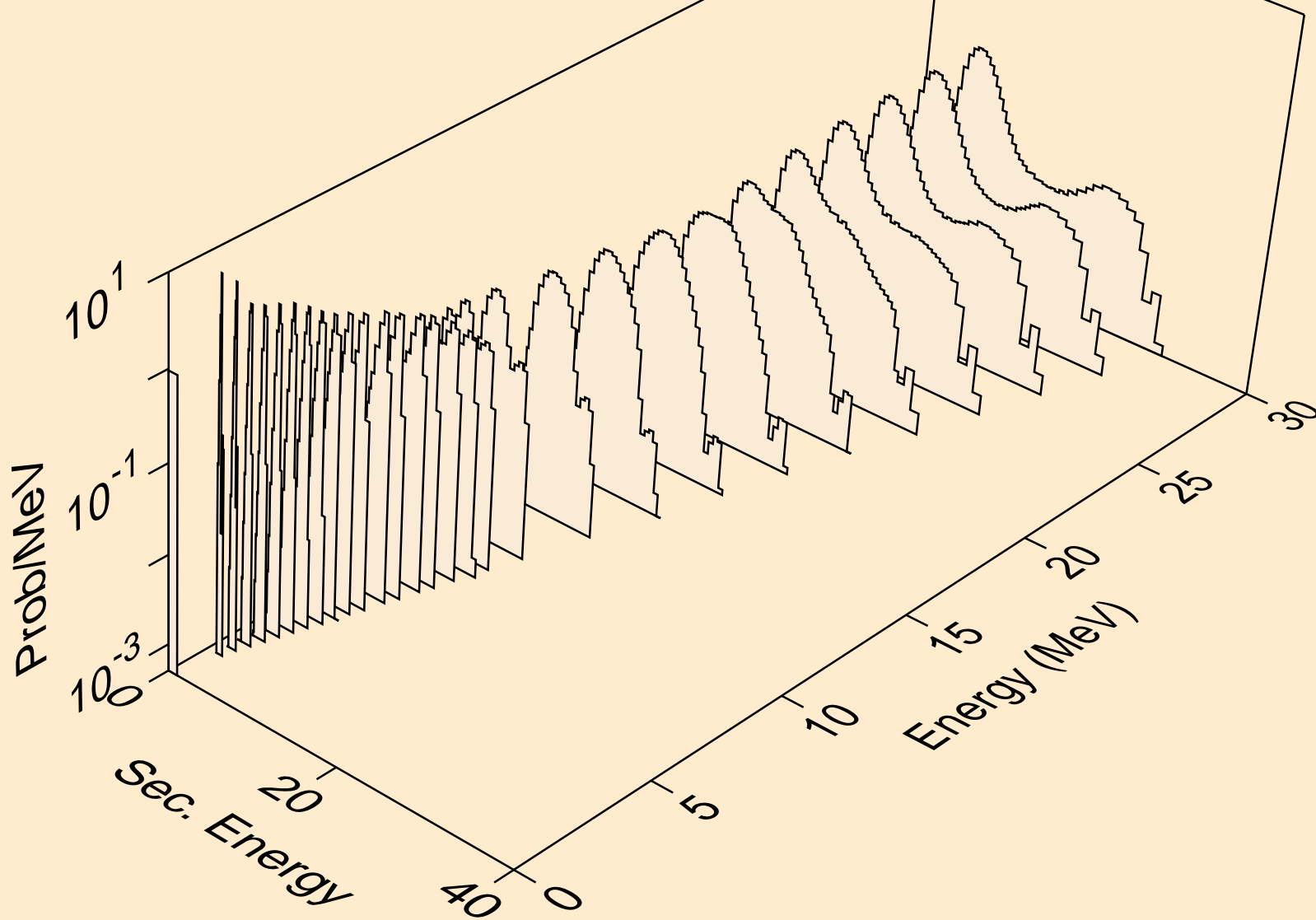

TA160M NEUTRON ACER TENDL-2019 LIBRARY; T=293.16K
protons from (n,2np)

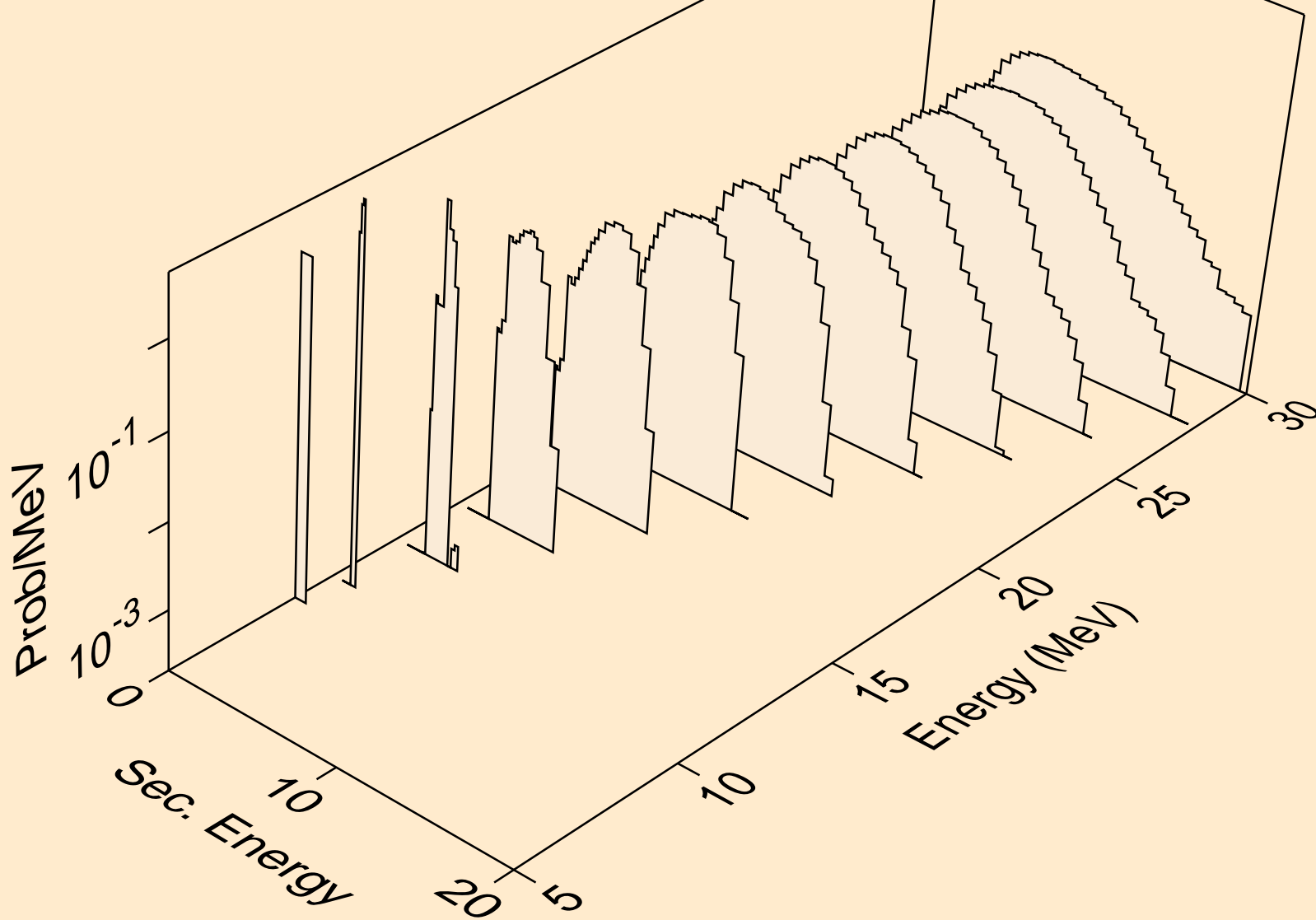

TA160M NEUTRON ACER TENDL-2019 LIBRARY; T=293.16K
protons from (n,3np)

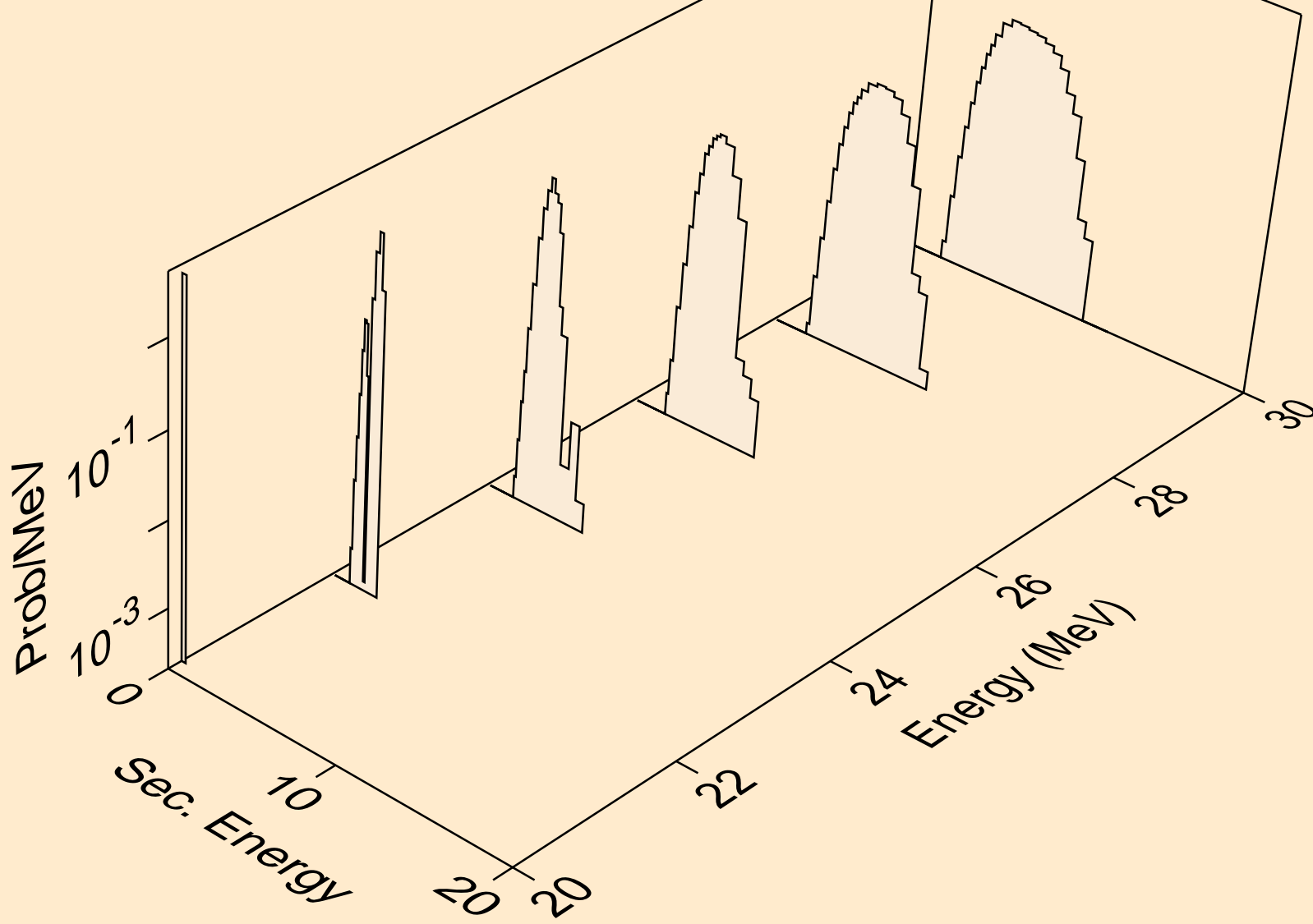

TA160M NEUTRON ACER TENDL-2019 LIBRARY; T=293.16K
protons from (n,2np)

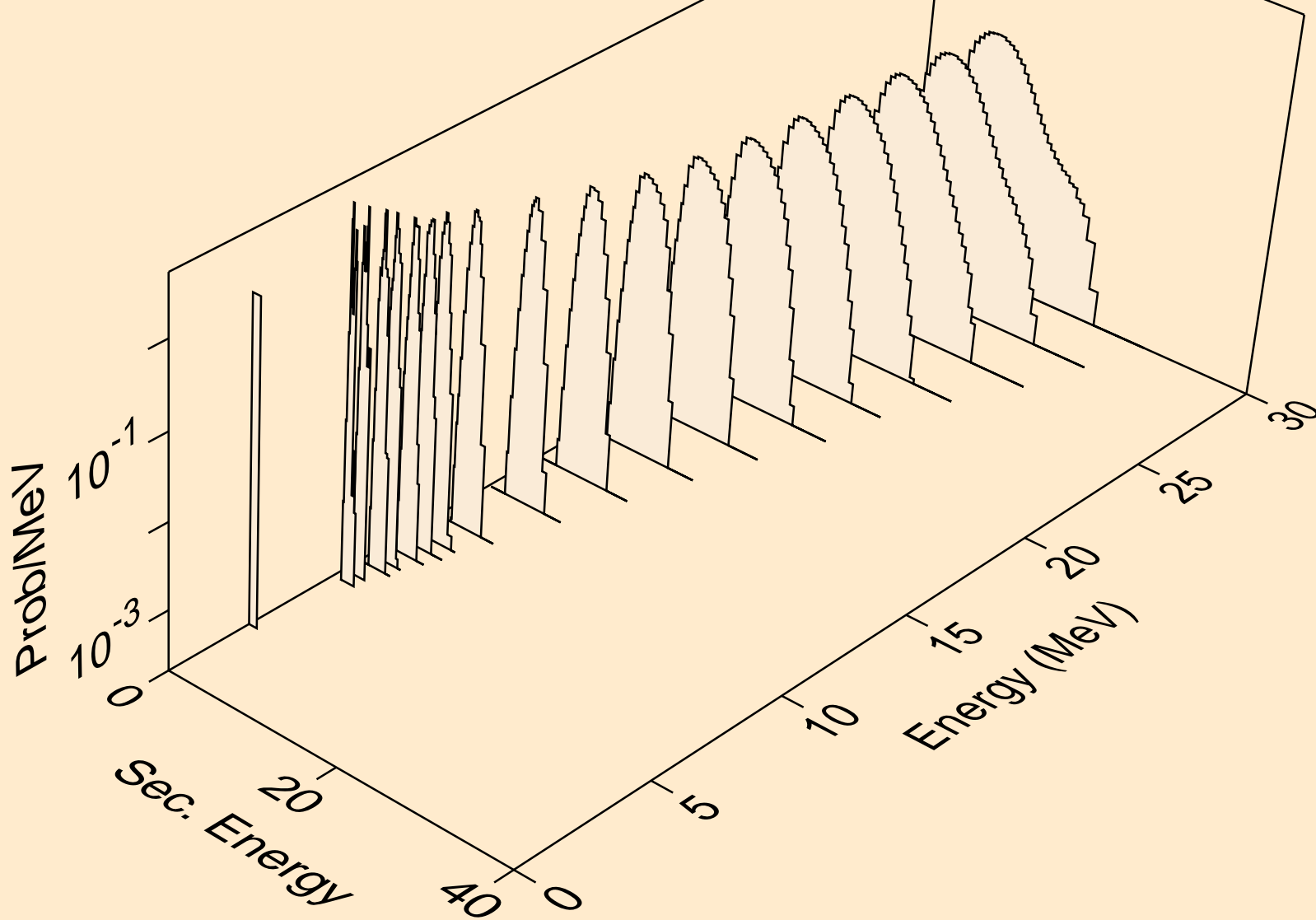

TA160M NEUTRON ACER TENDL-2019 LIBRARY; T=293.16K
protons from (n,npa)

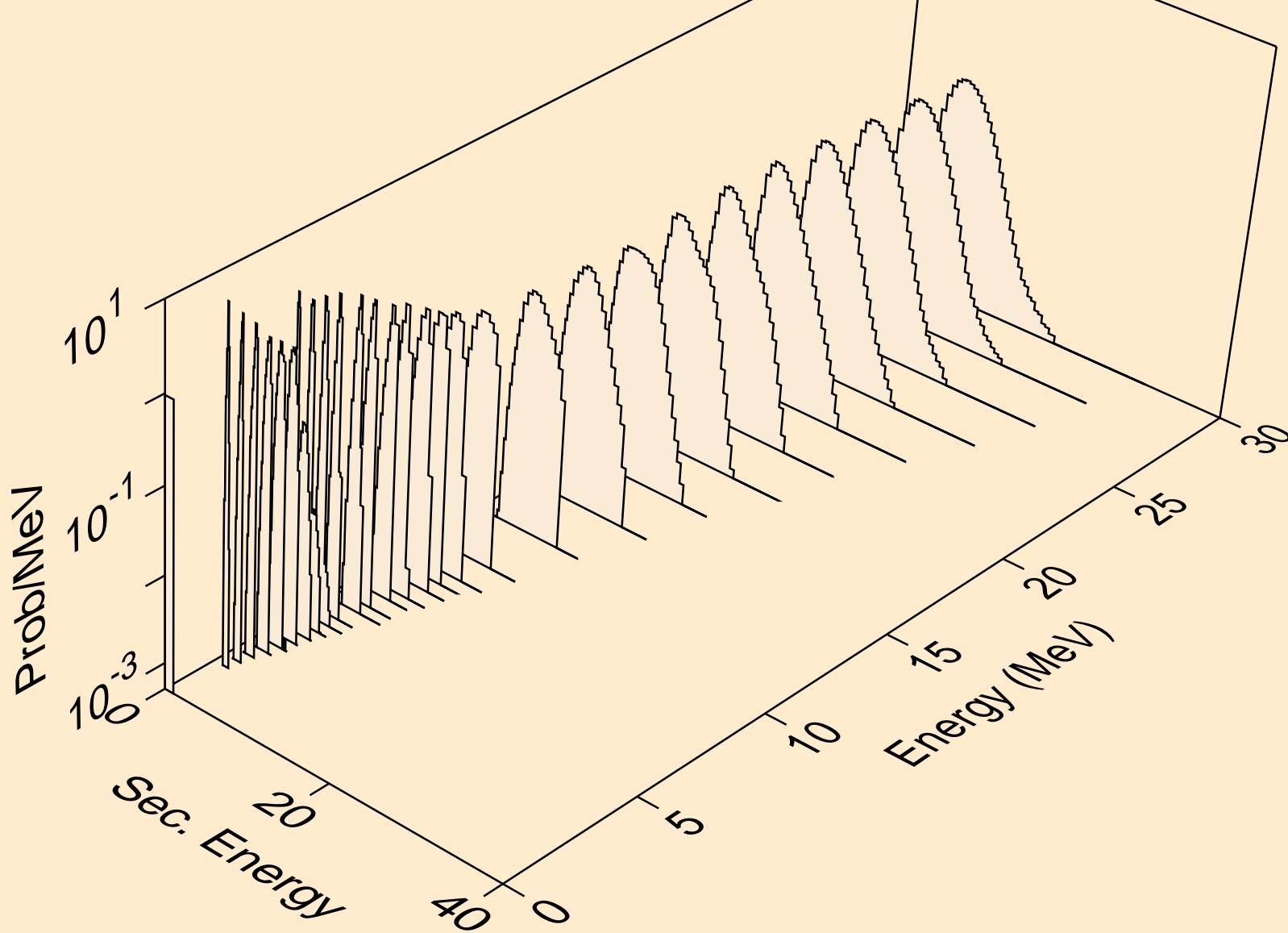

TA160M NEUTRON ACER TENDL-2019 LIBRARY; T=293.16K
protons from (n,p)

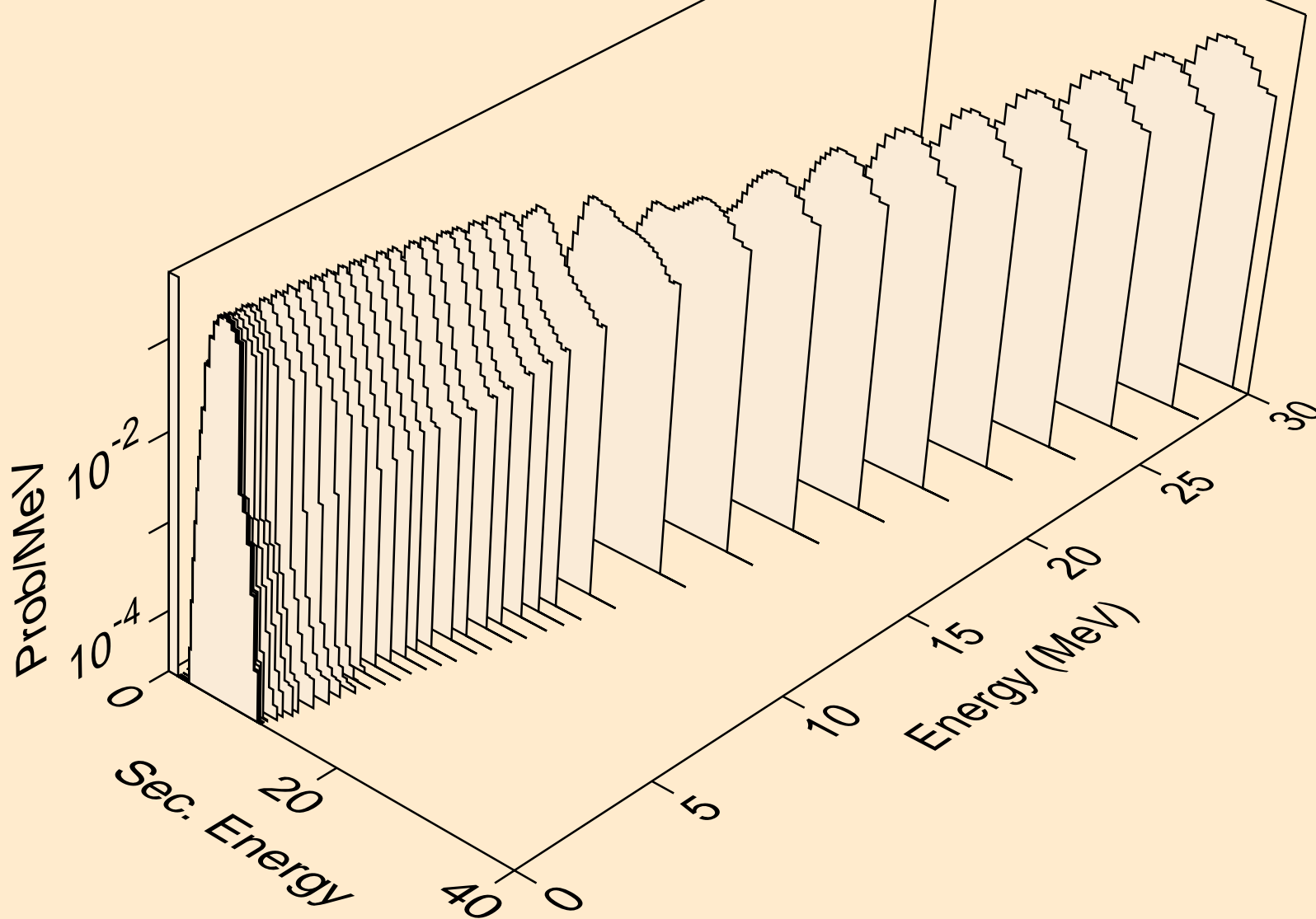

TA160M NEUTRON ACER TENDL-2019 LIBRARY; T=293.16K
protons from (n,2p)

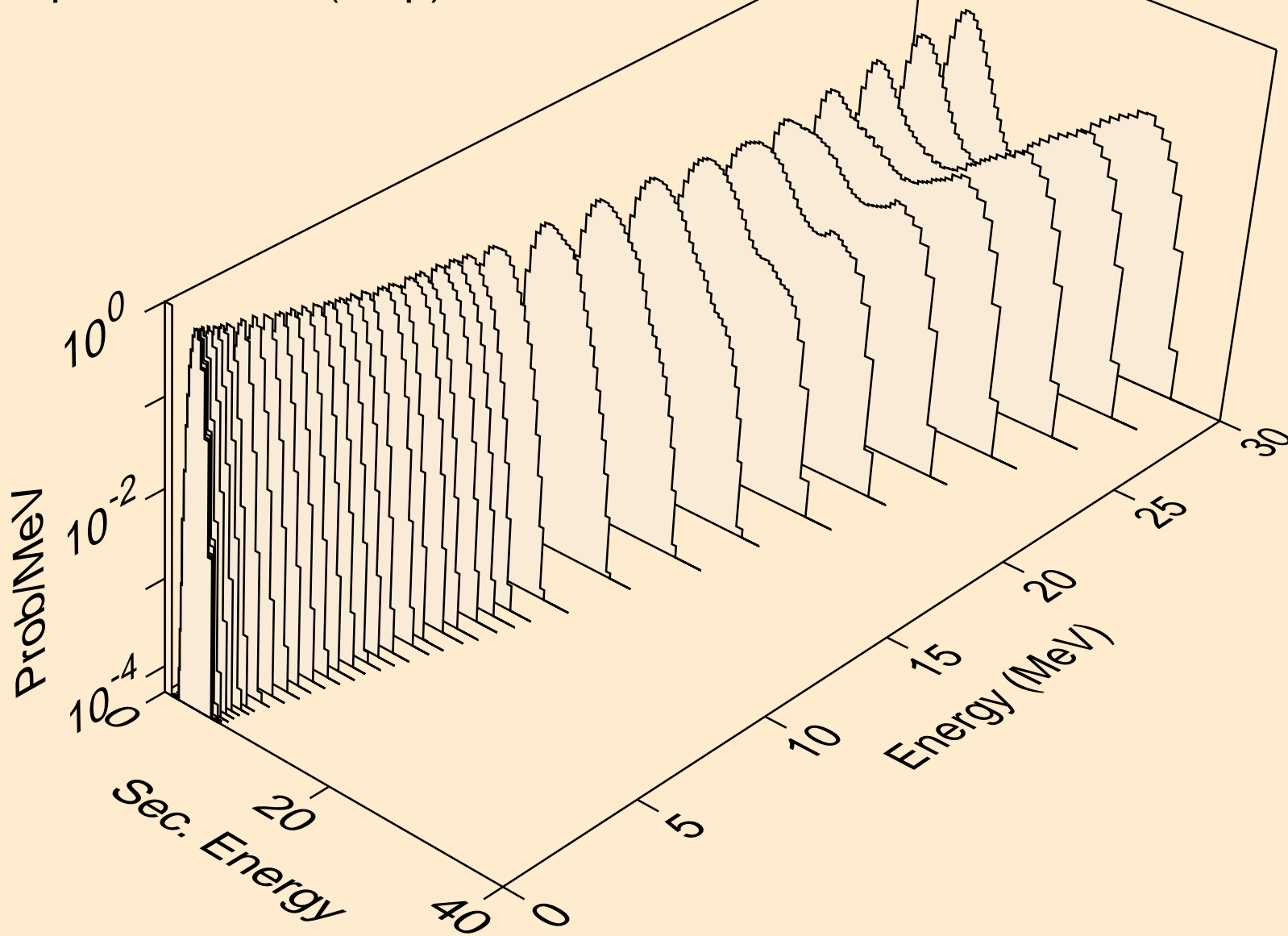

TA160M NEUTRON ACER TENDL-2019 LIBRARY; T=293.16K
protons from (n,p)

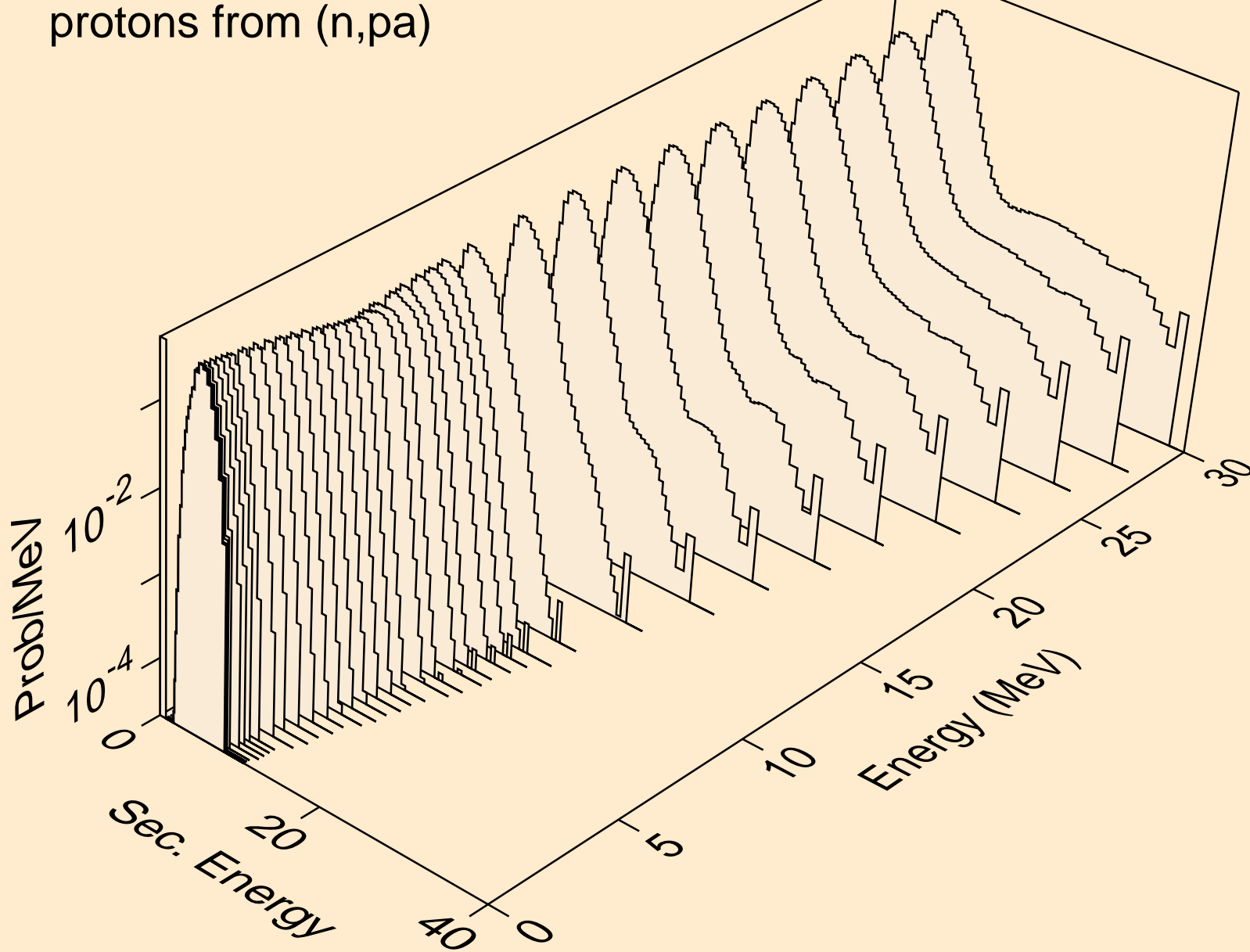

TA160M NEUTRON ACER TENDL-2019 LIBRARY; T=293.16K
protons from (n,pd)

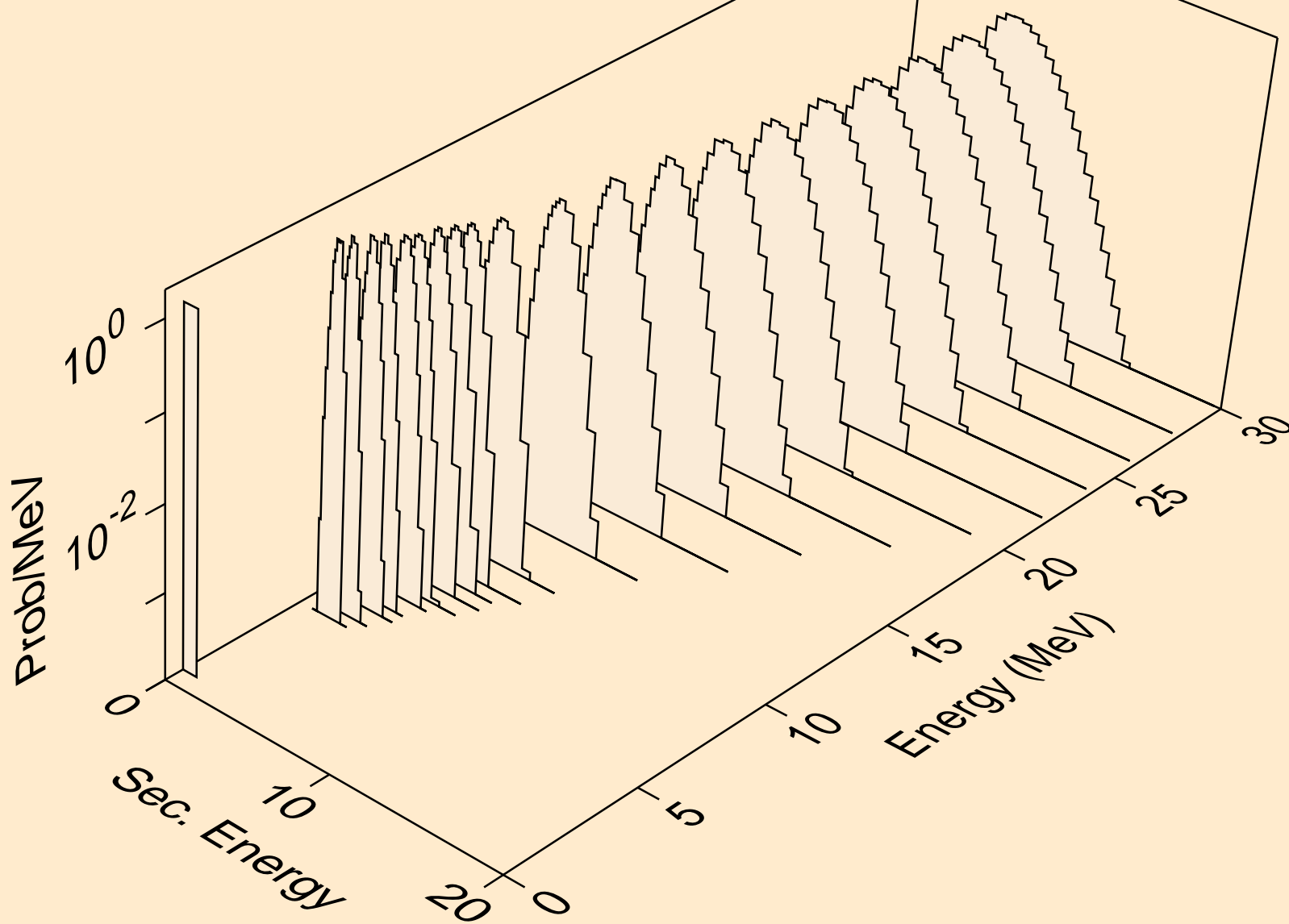

TA160M NEUTRON ACER TENDL-2019 LIBRARY; T=293.16K
protons from (n,pt)

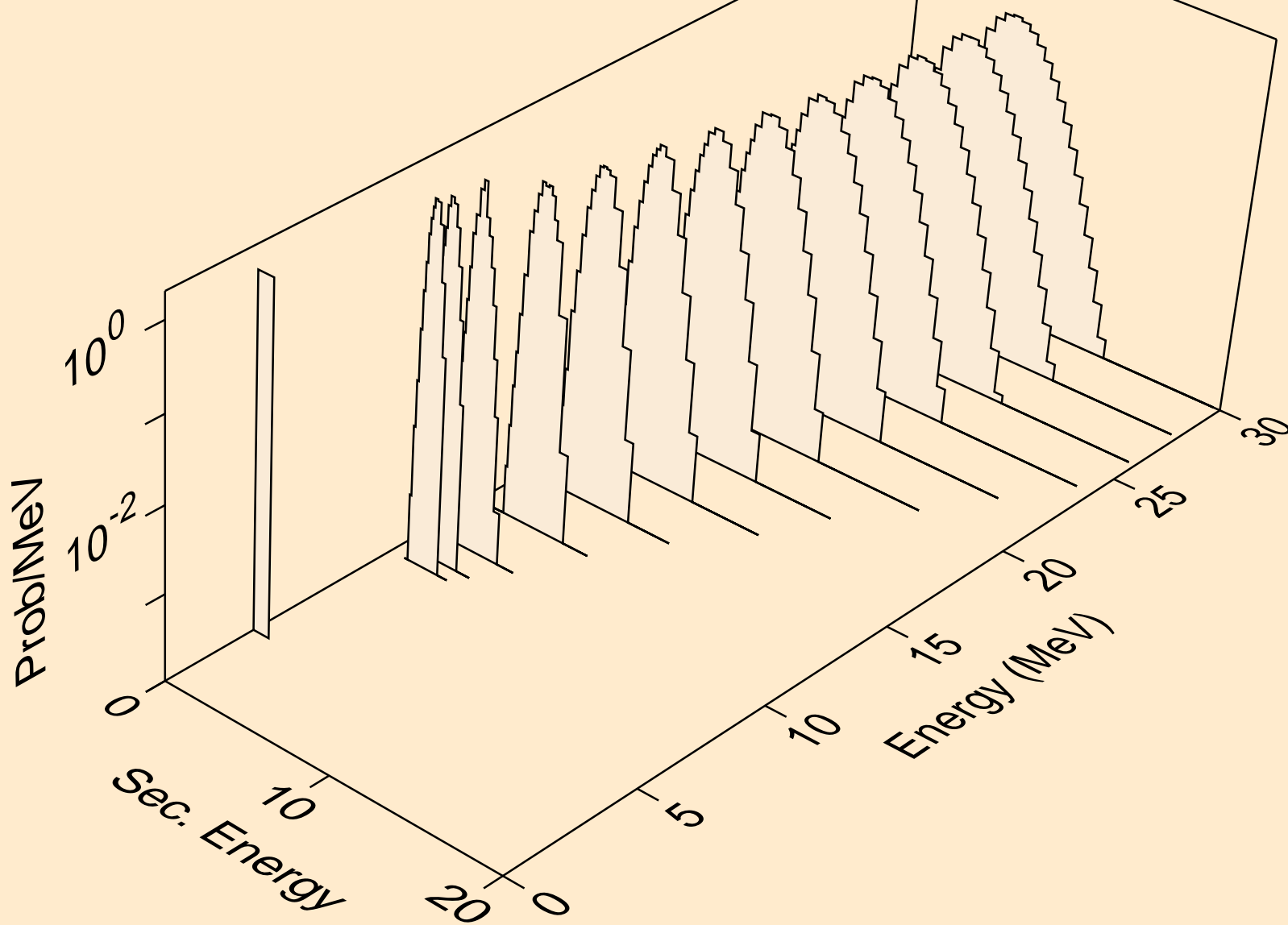

TA160M NEUTRON ACER TENDL-2019 LIBRARY; T=293.16K
deuterons from (n,x)

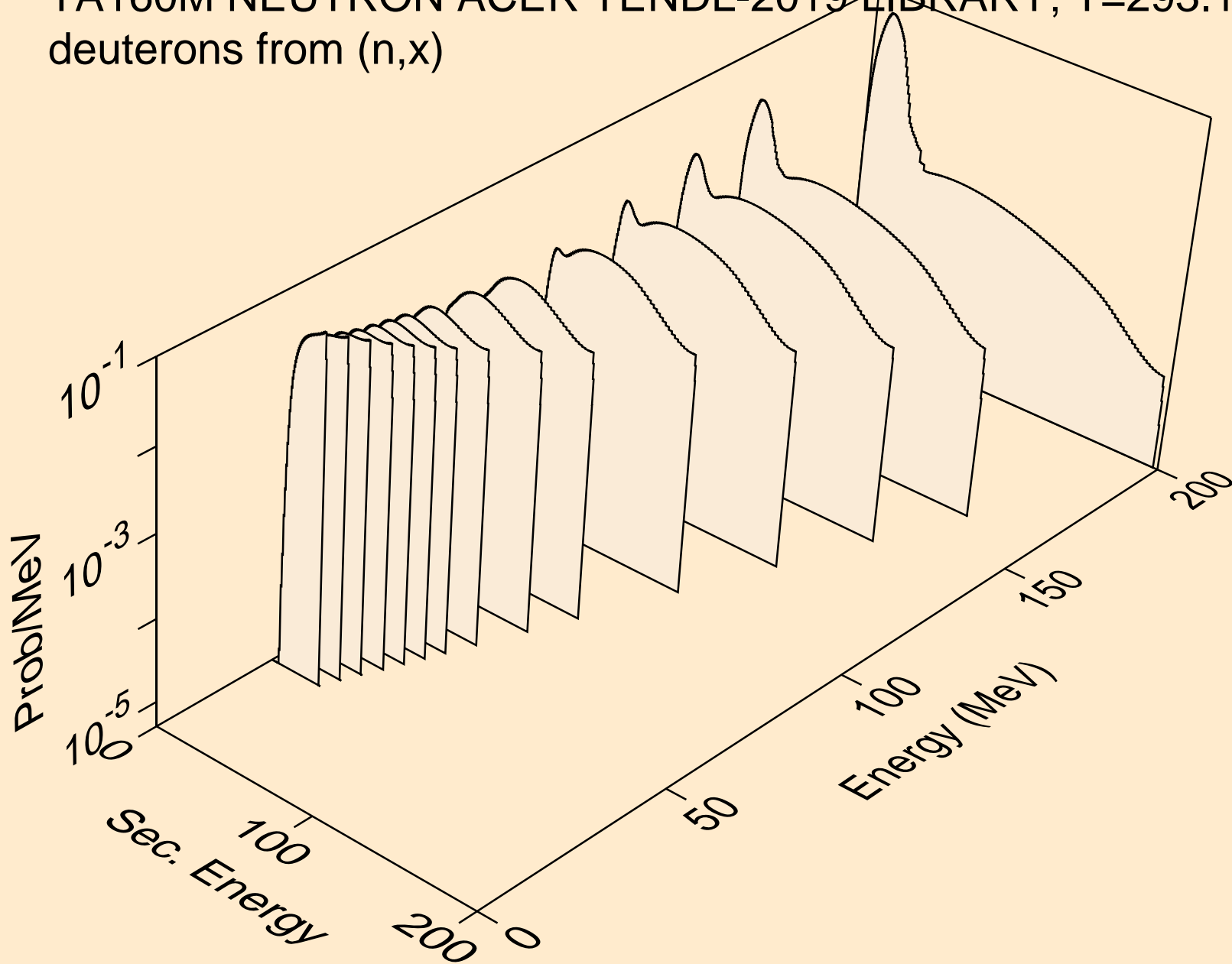

TA160M NEUTRON ACER TENDL-2019 LIBRARY; T=293.16K
deuterons from (n,2nd)

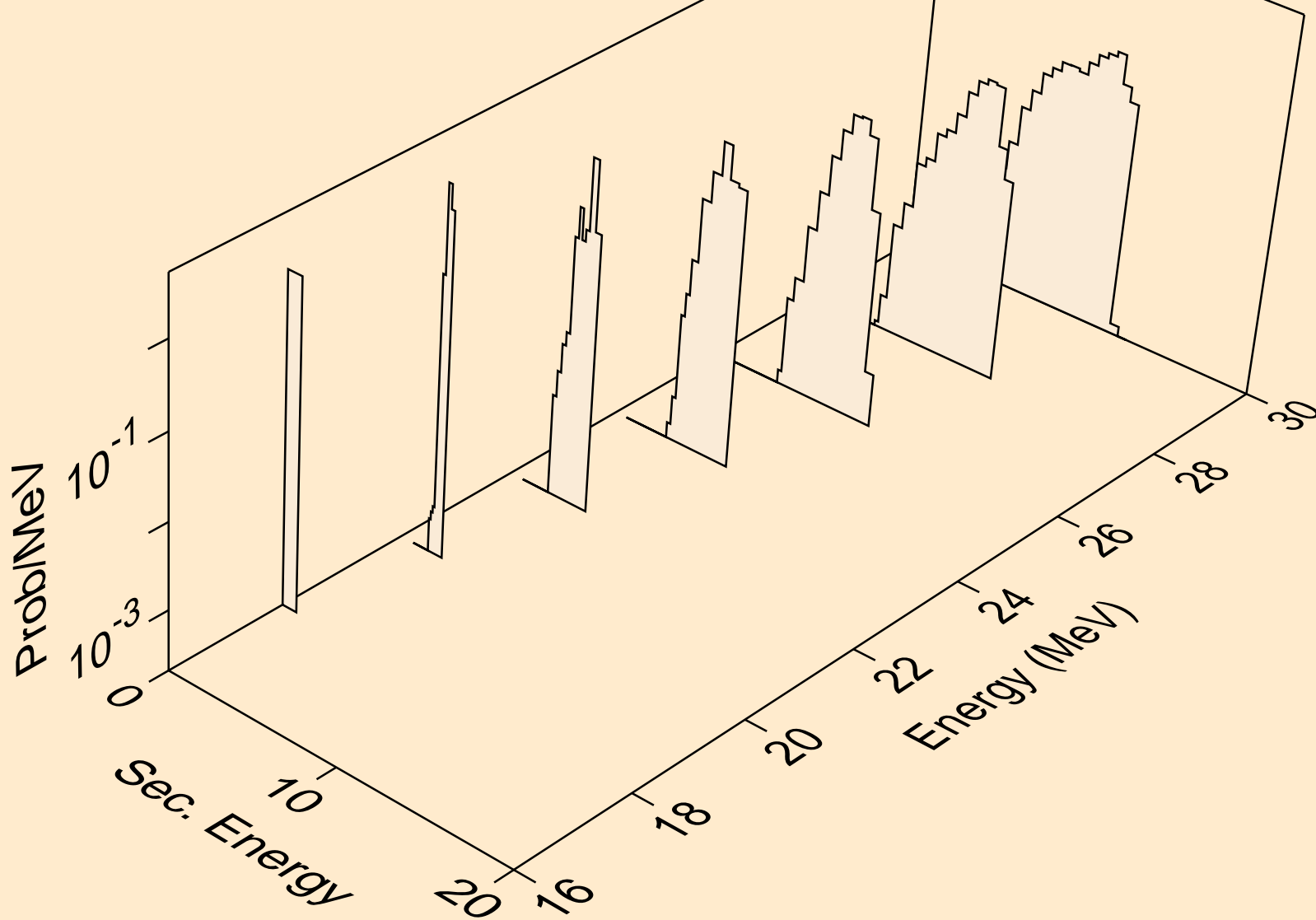

TA160M NEUTRON ACER TENDL-2019 LIBRARY; T=293.16K
deuterons from (n,n*)d

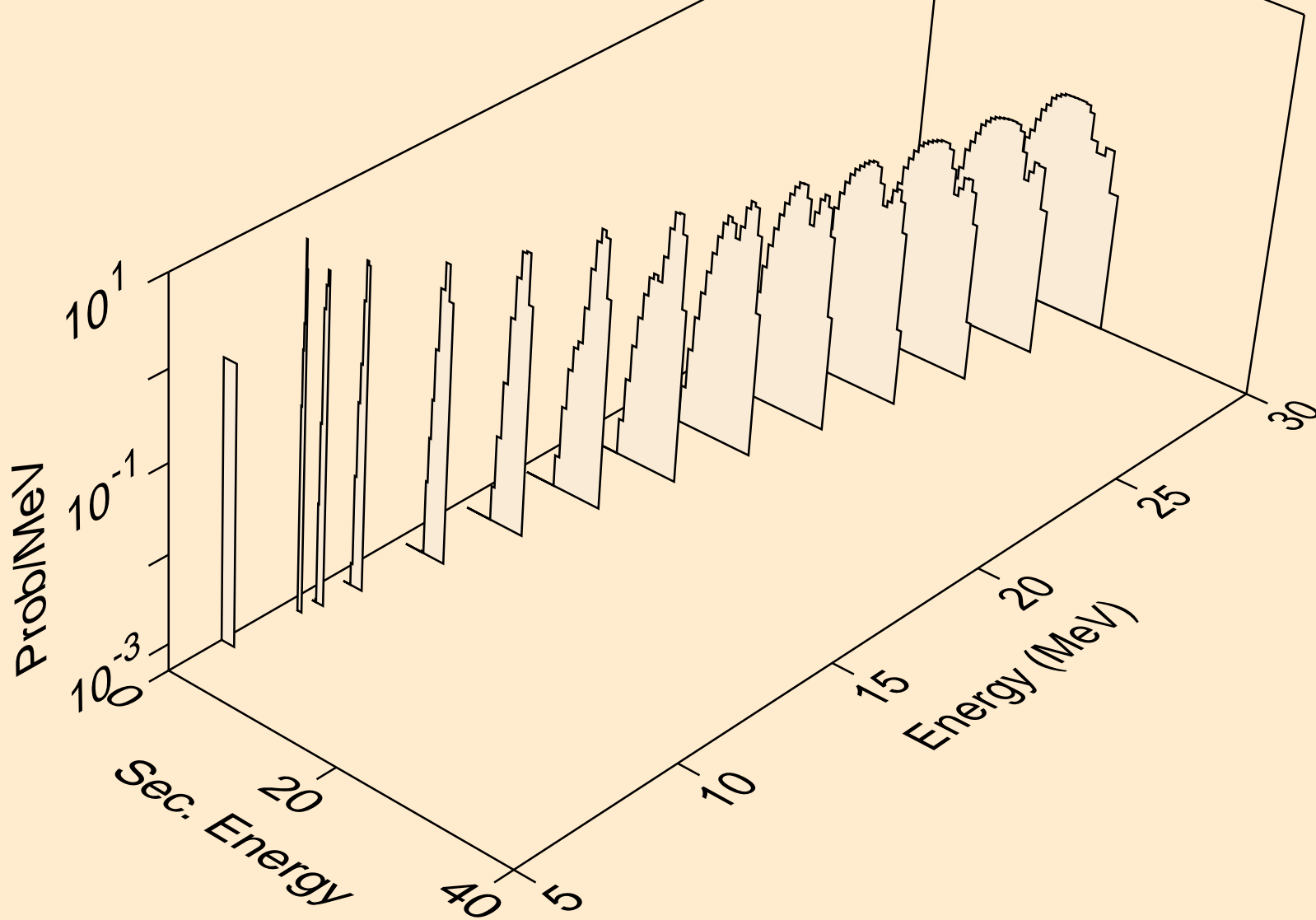

TA160M NEUTRON ACER TENDL-2019 LIBRARY; T=293.16K
deuterons from (n,n*)d2a

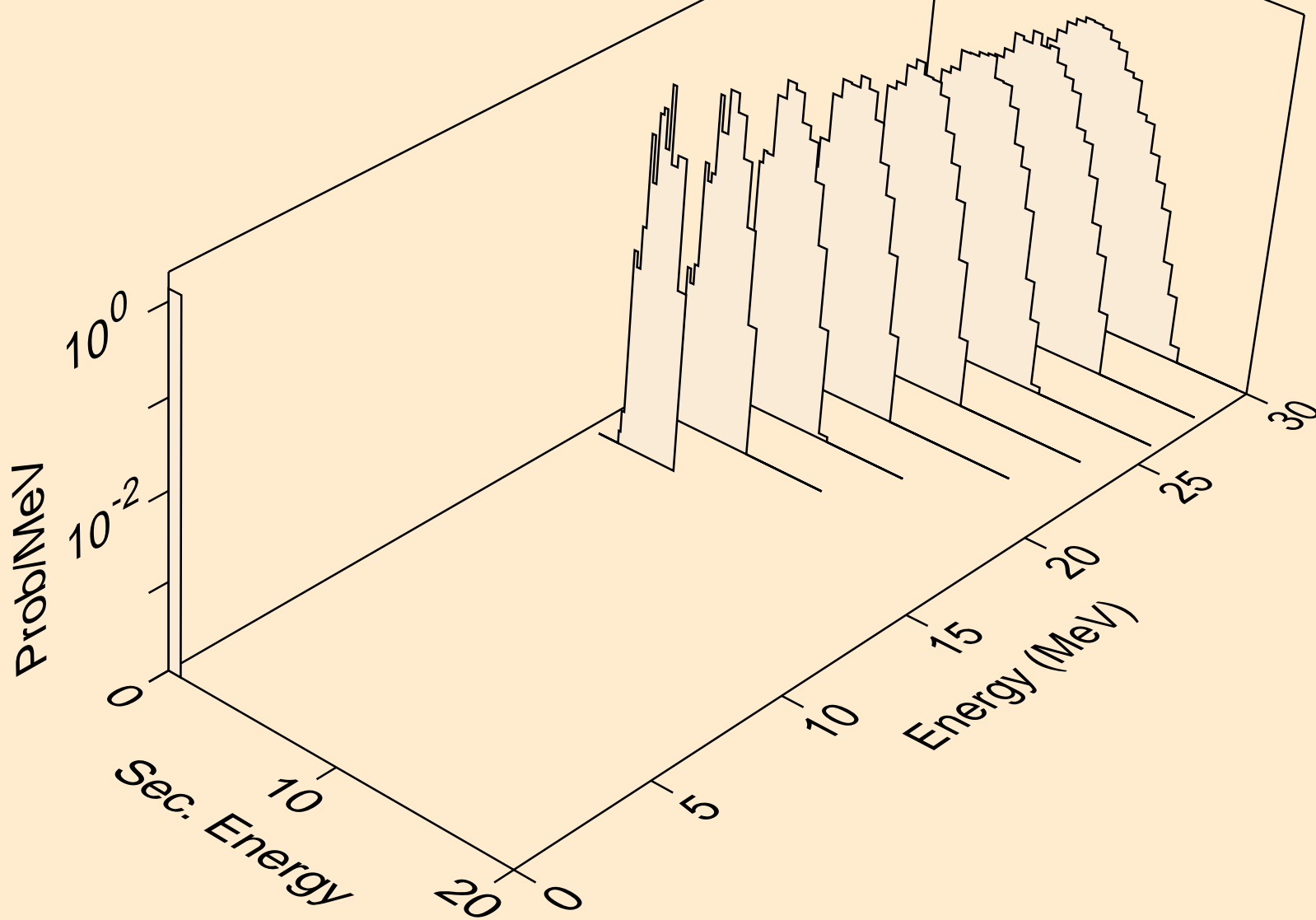

TA160M NEUTRON ACER TENDL-2019 LIBRARY; T=293.16K
deuterons from (n,d)

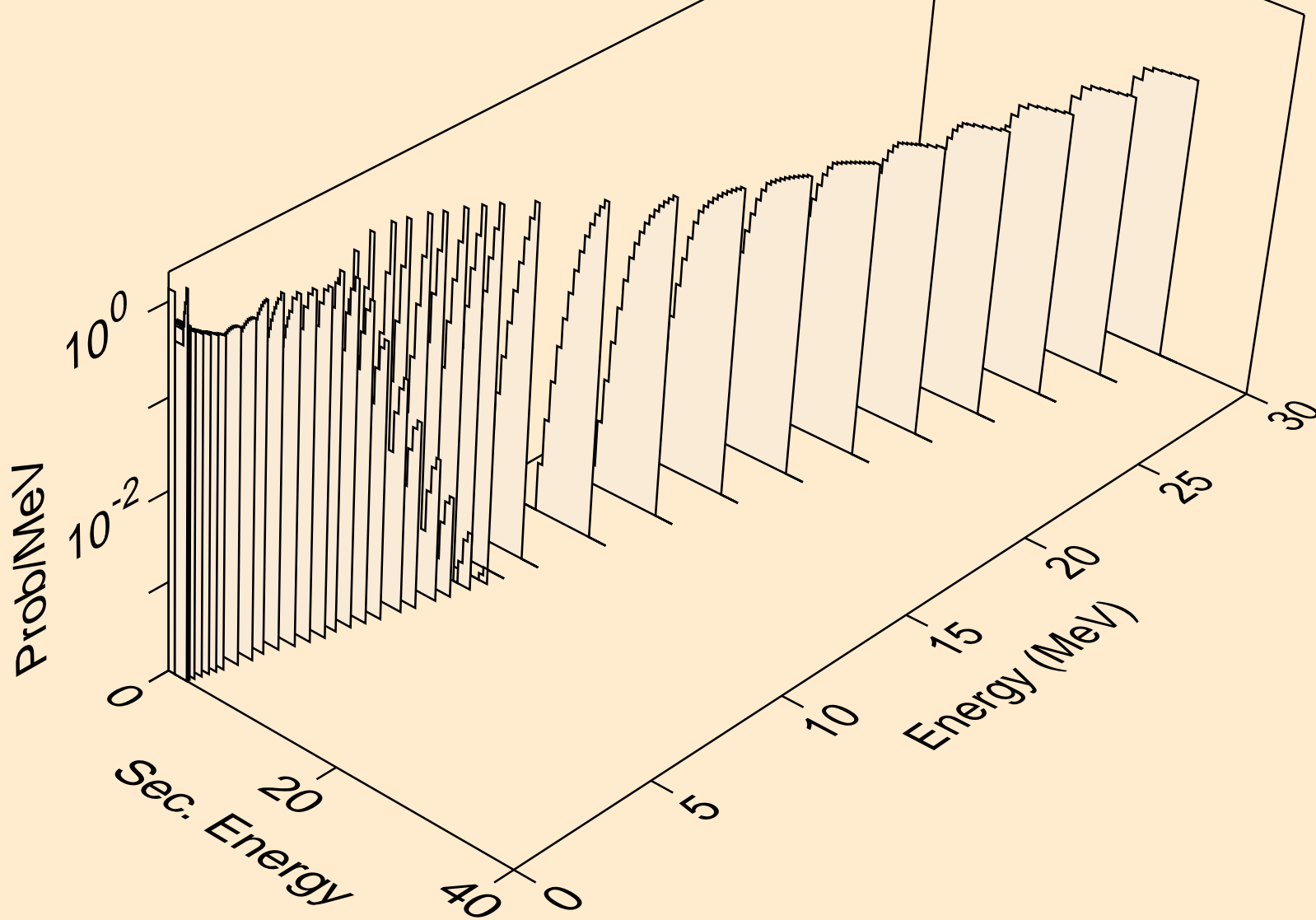

TA160M NEUTRON ACER TENDL-2019 LIBRARY; T=293.16K
deuterons from (n,d2a)

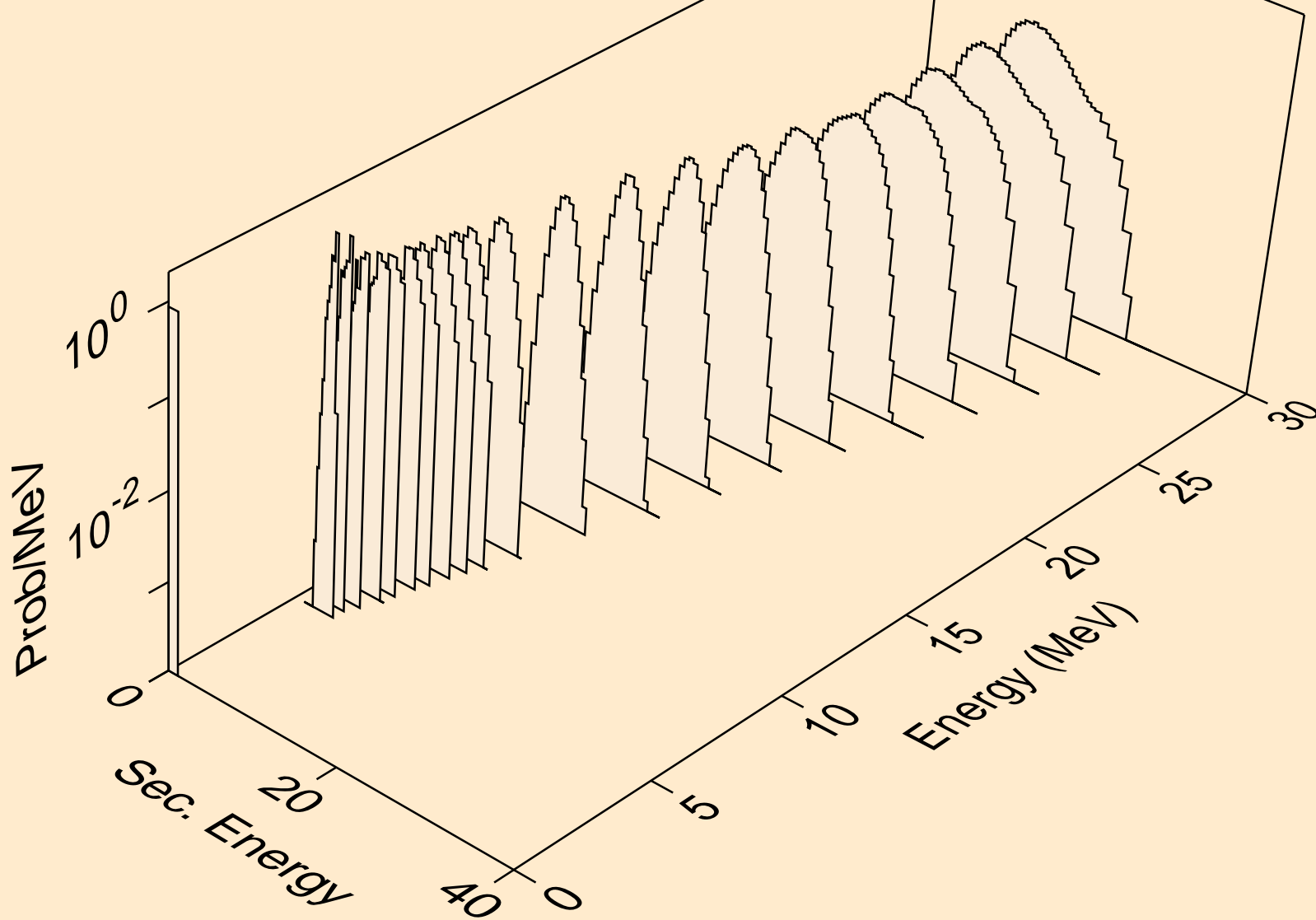

TA160M NEUTRON ACER TENDL-2019 LIBRARY; T=293.16K
deuterons from (n,pd)

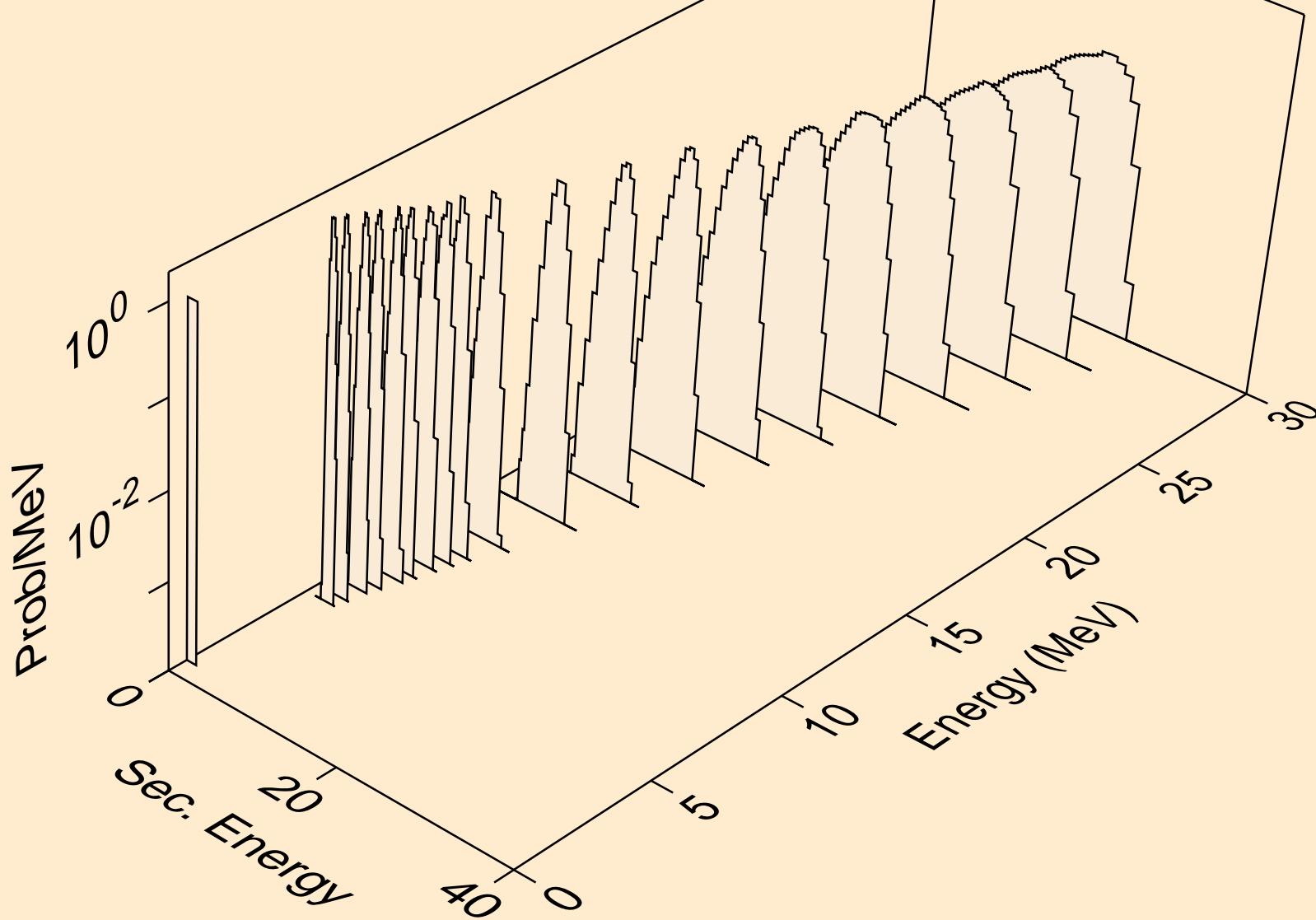

TA160M NEUTRON ACER TENDL-2019 LIBRARY; T=293.16K
deuterons from (n,da)

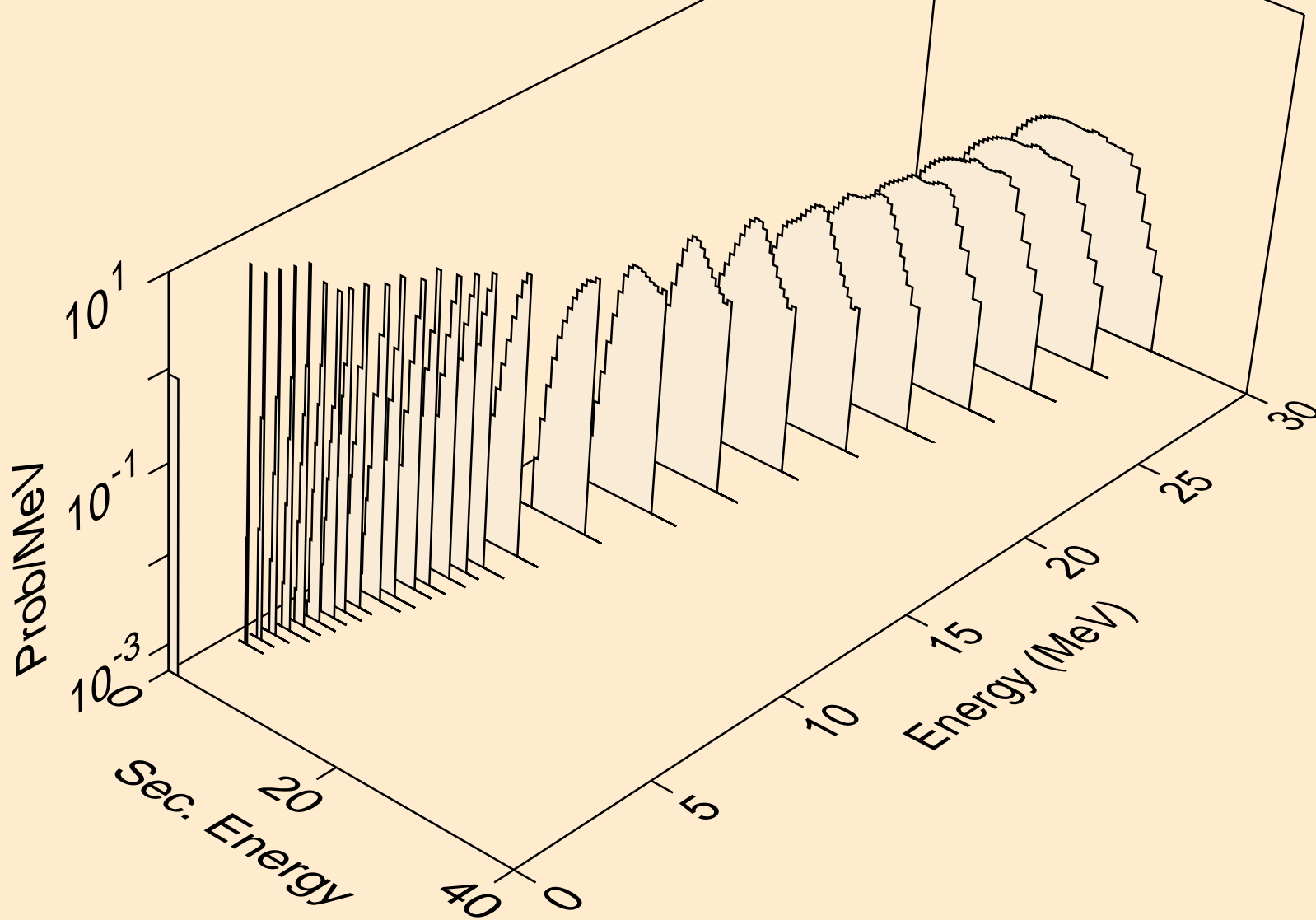

TA160M NEUTRON ACER TENDL-2019 LIBRARY; T=293.16K
tritons from (n,x)

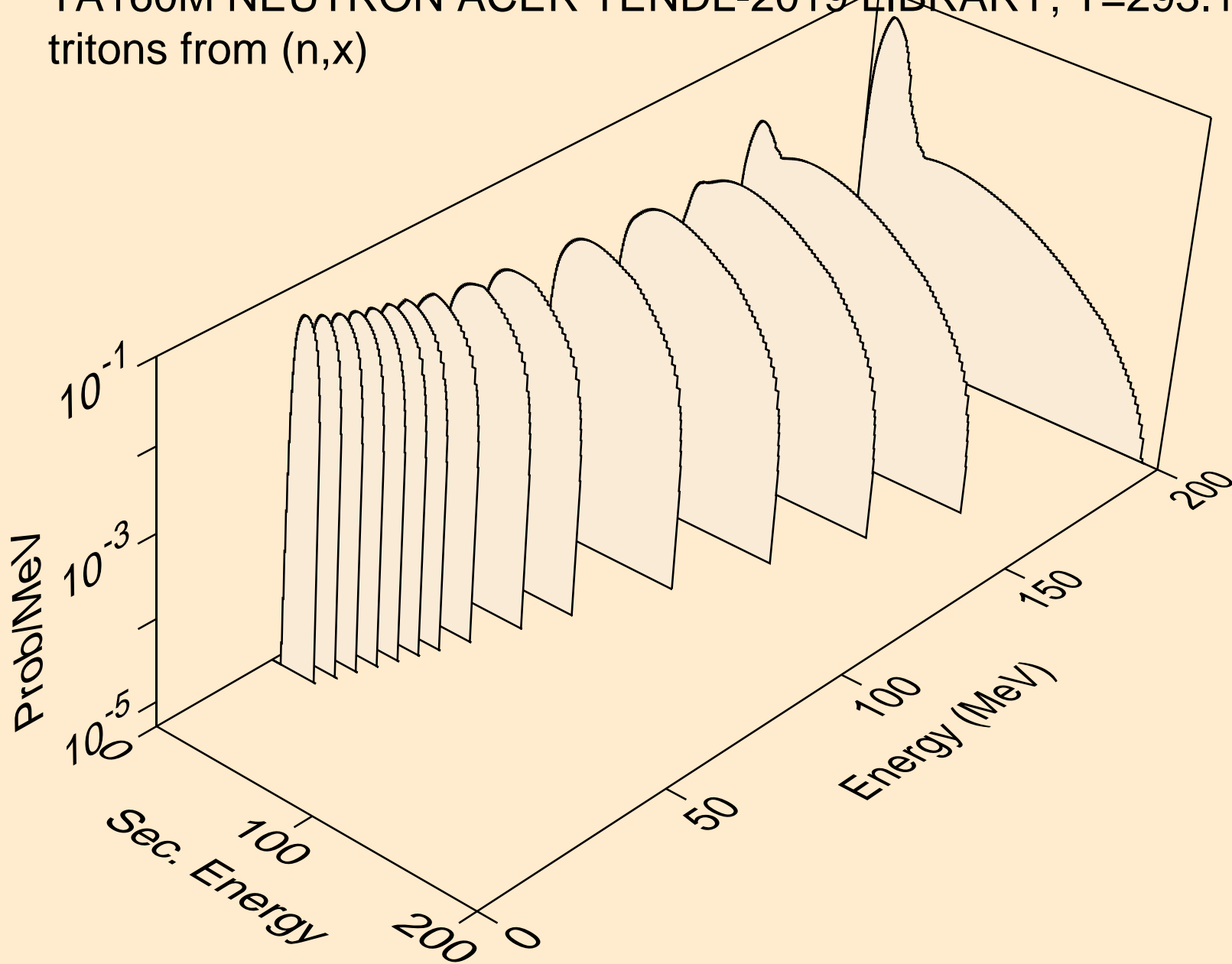

TA160M NEUTRON ACER TENDL-2019 LIBRARY; T=293.16K
tritons from (n,n*)t

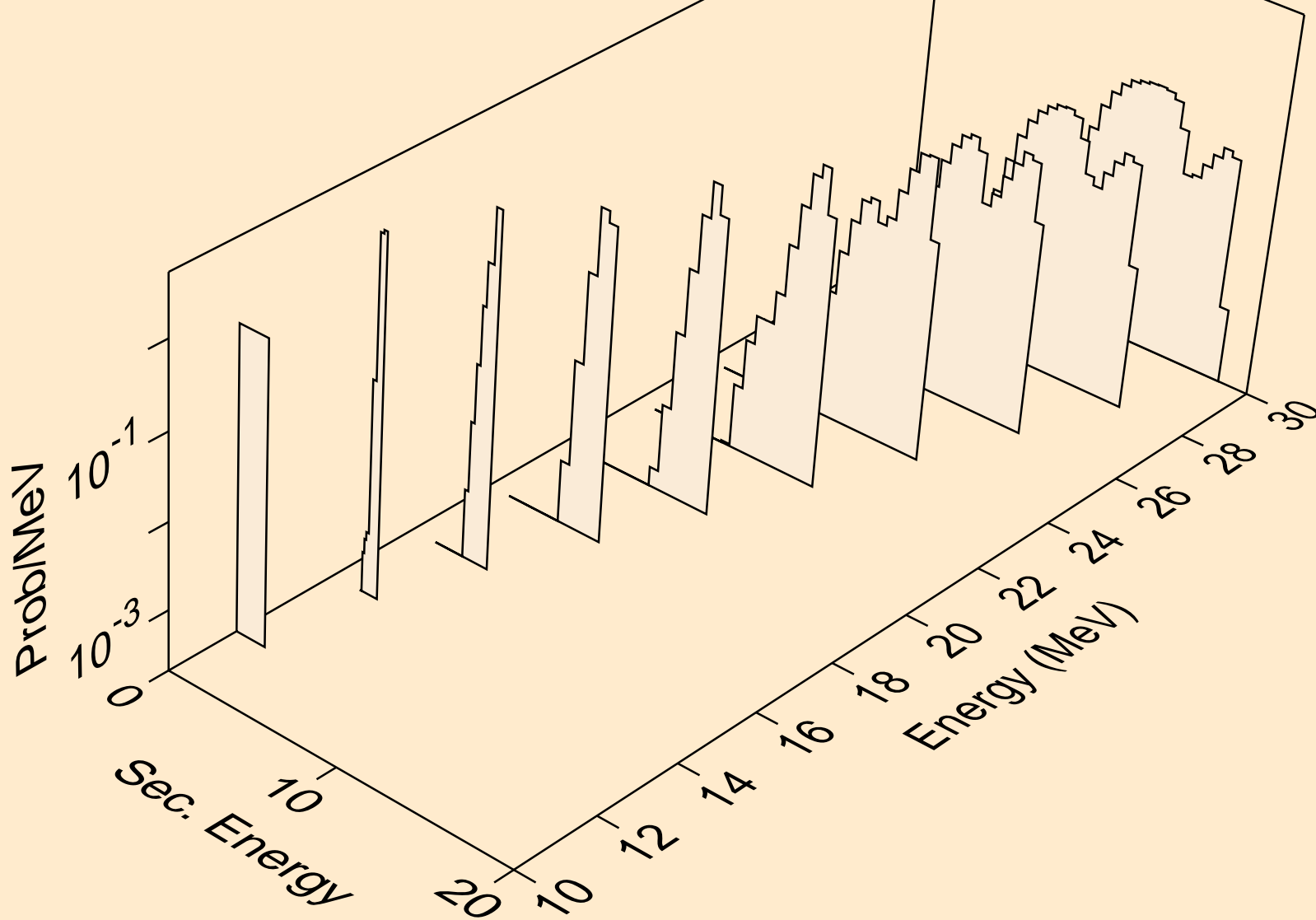

TA160M NEUTRON ACER TENDL-2019 LIBRARY; T=293.16K
tritons from (n,n*)t2a

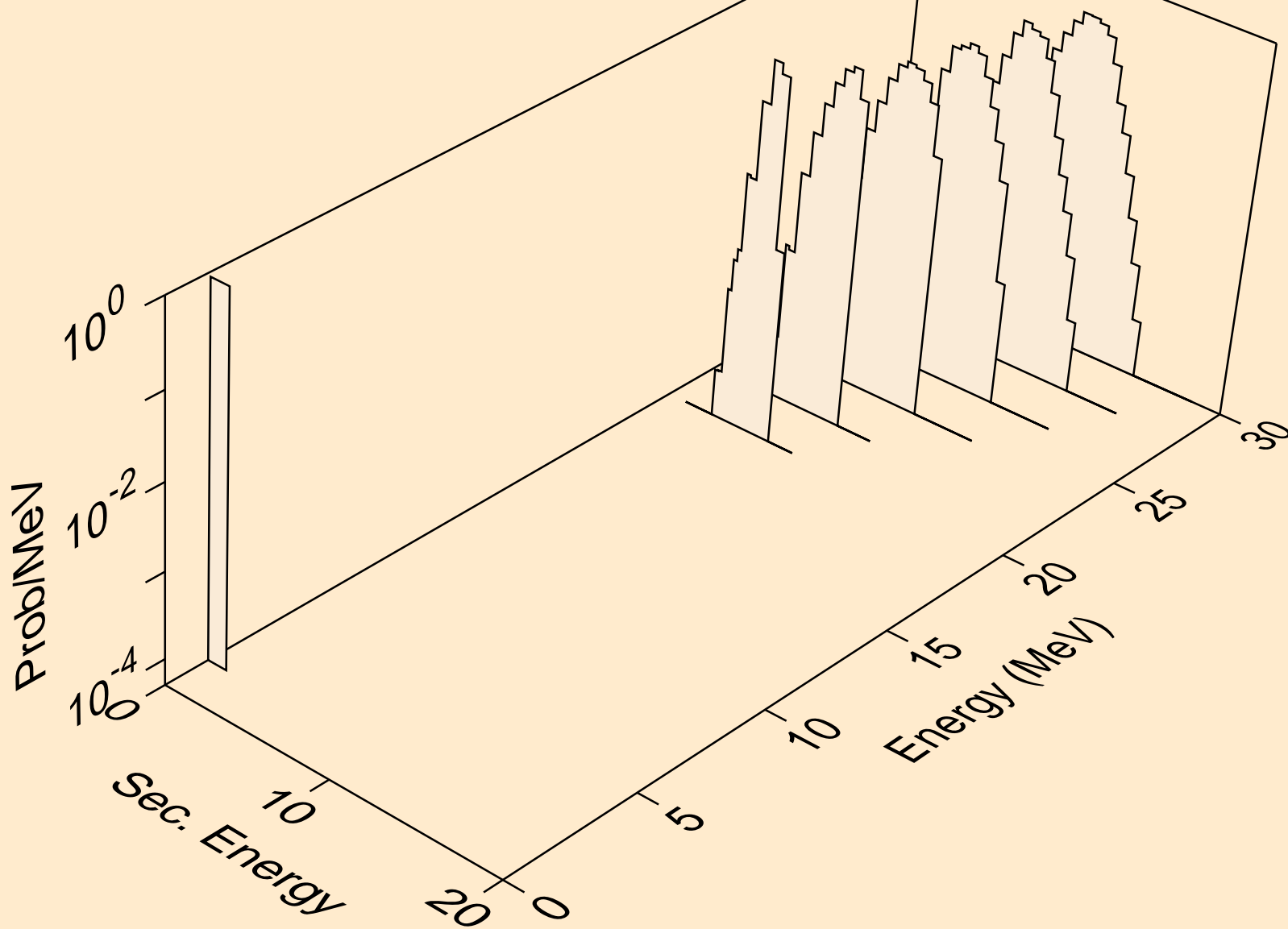

TA160M NEUTRON ACER TENDL-2019 LIBRARY; T=293.16K
tritons from (n,t)

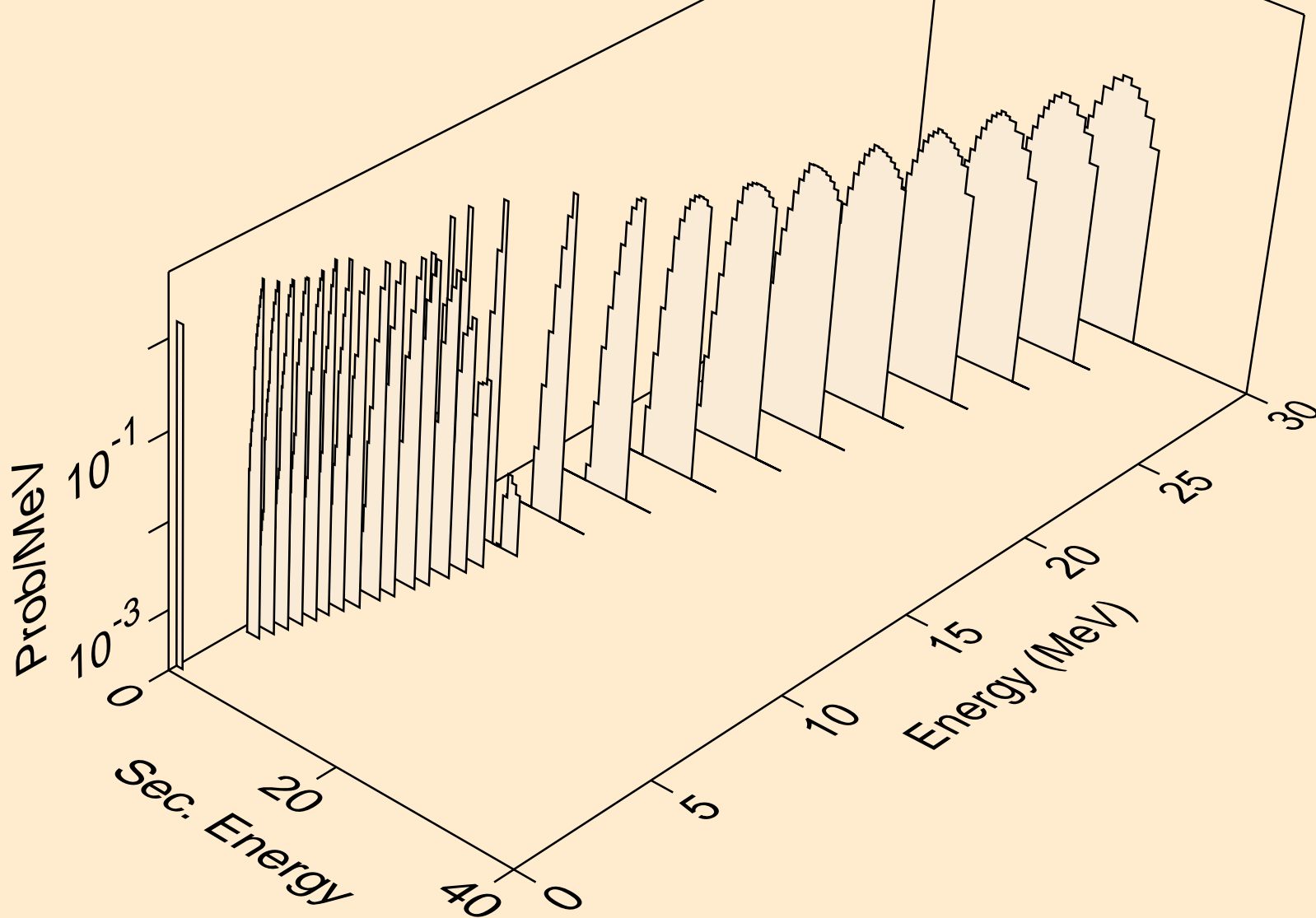

TA160M NEUTRON ACER TENDL-2019 LIBRARY; T=293.16K
tritons from (n,t2a)

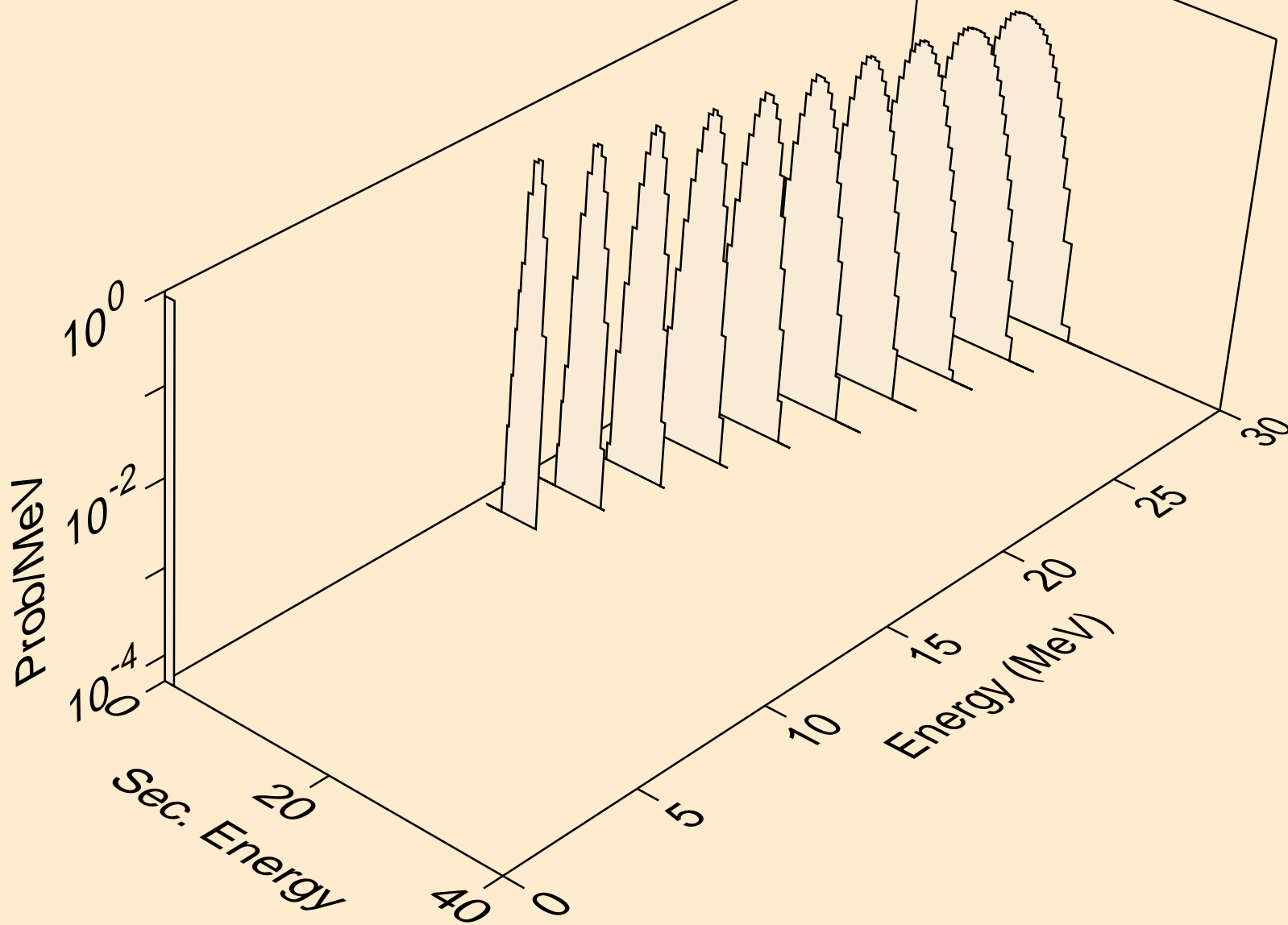

TA160M NEUTRON ACER TENDL-2019 LIBRARY; T=293.16K
tritons from (n,pt)

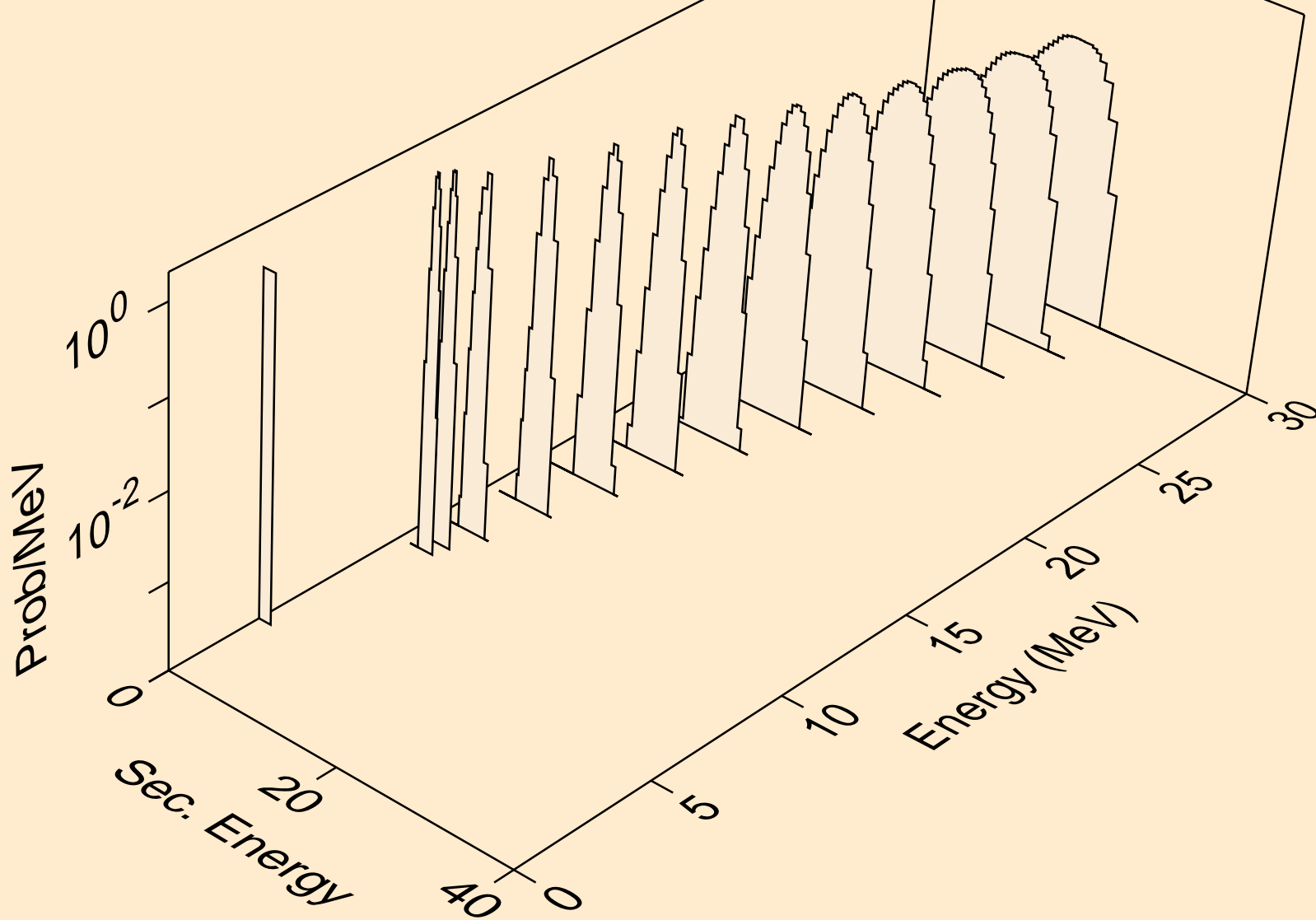

TA160M NEUTRON ACER TENDL-2019 LIBRARY; T=293.16K
he3s from (n,x)

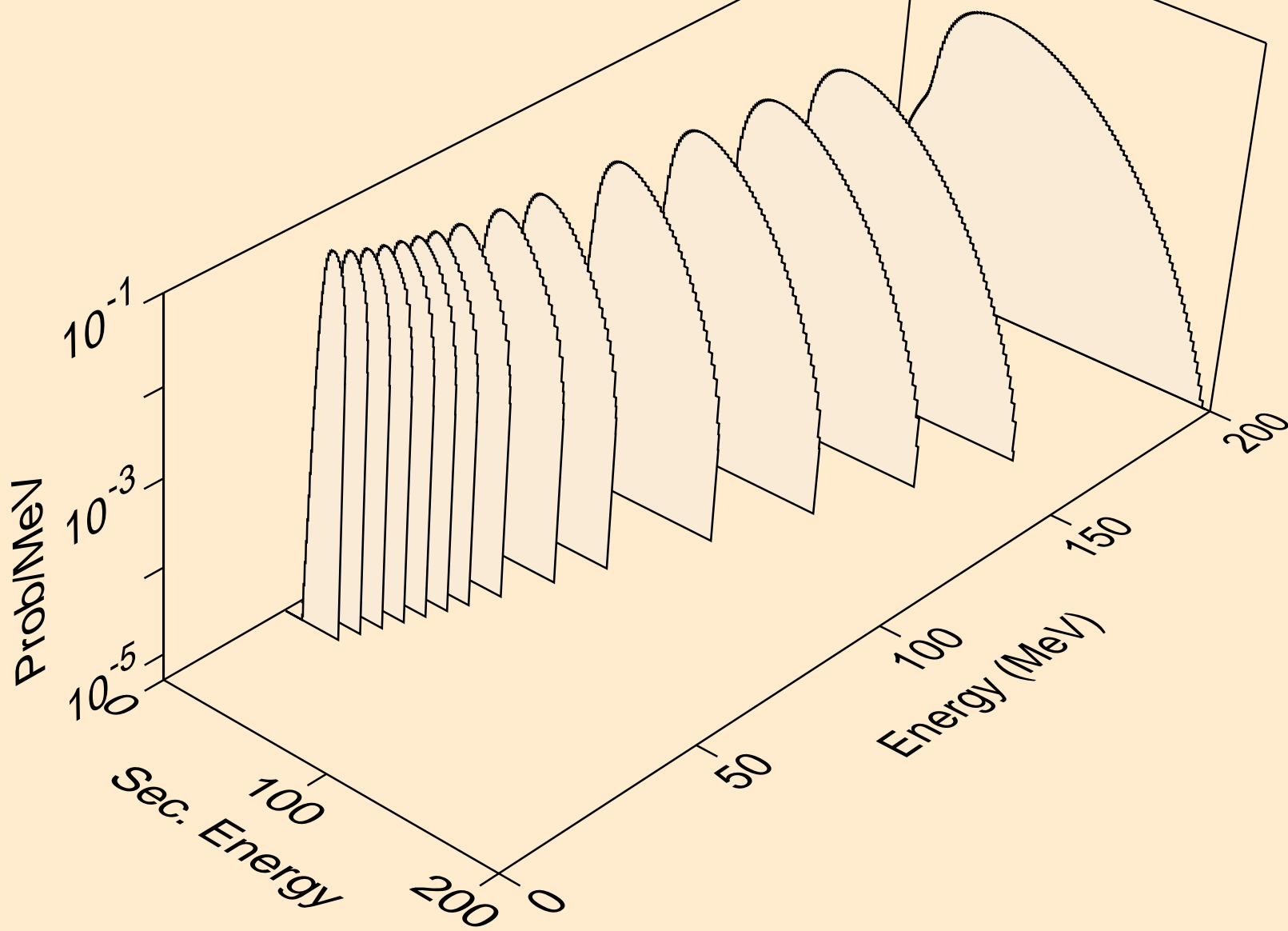

TA160M NEUTRON ACER TENDL-2019 LIBRARY; T=293.16K
he3s from (n,n*)he3

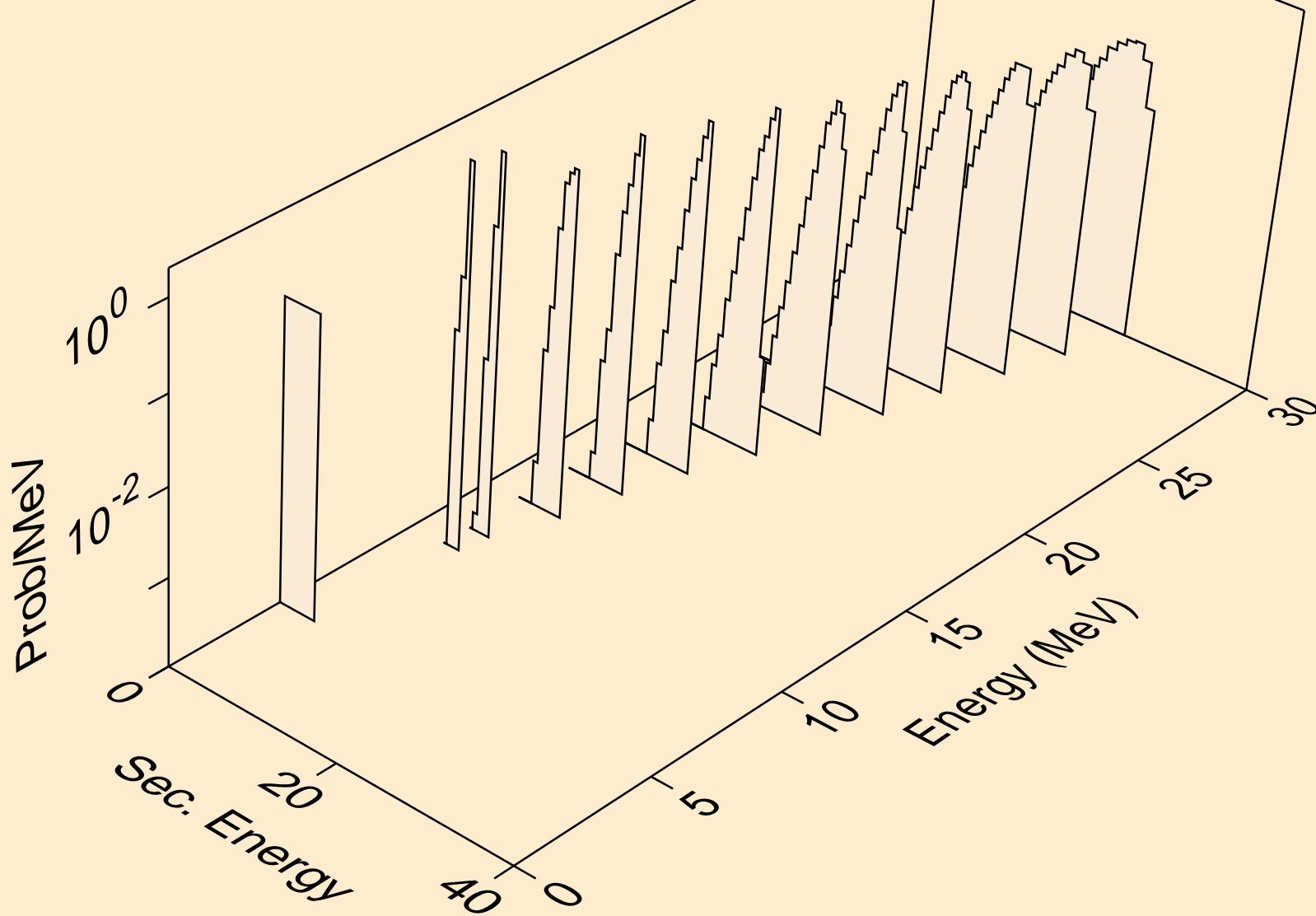

TA160M NEUTRON ACER TENDL-2019 LIBRARY; T=293.16K
he3s from (n,he3)

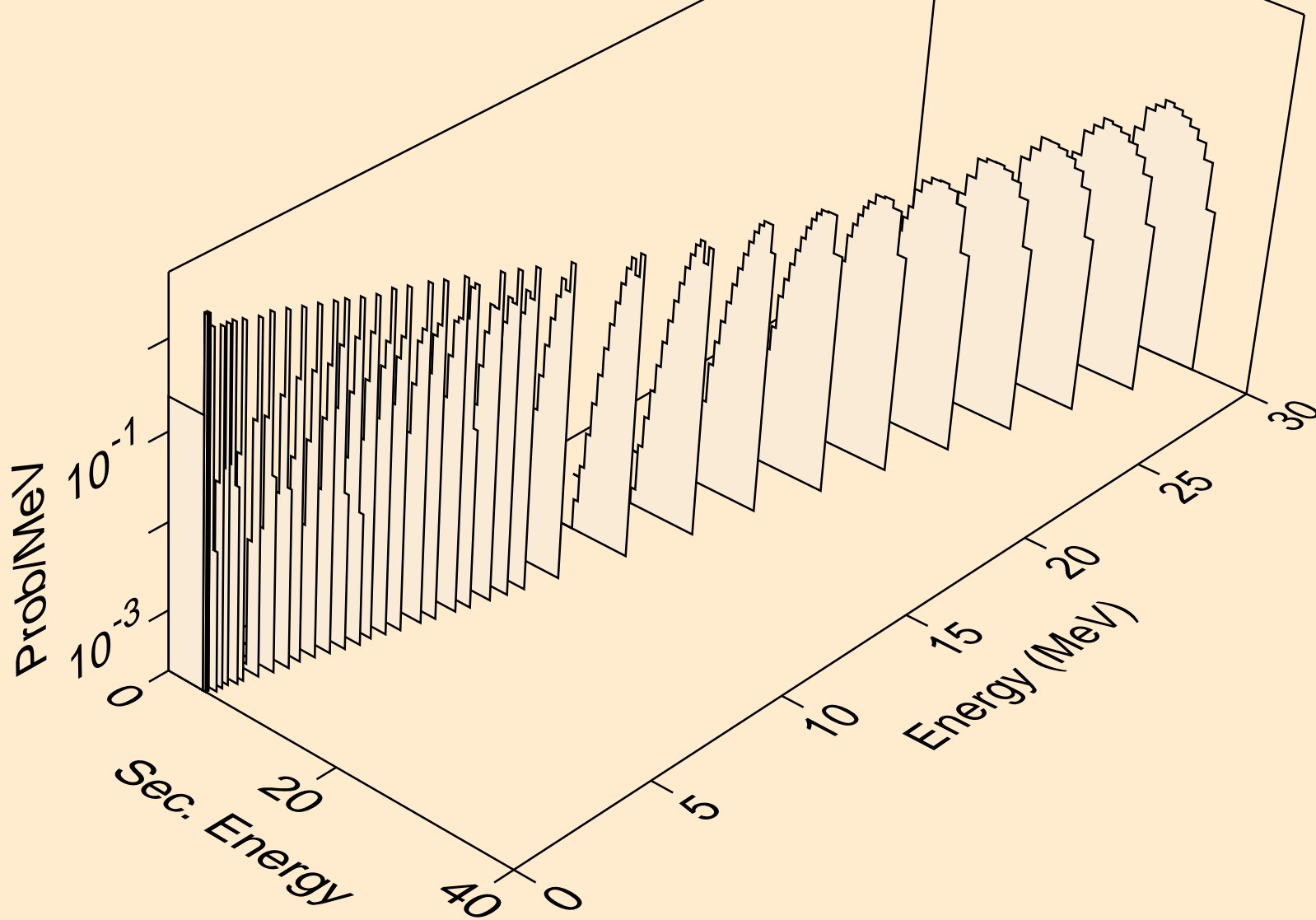

TA160M NEUTRON ACER TENDL-2019 LIBRARY; T=293.16K
alphas from (n,x)

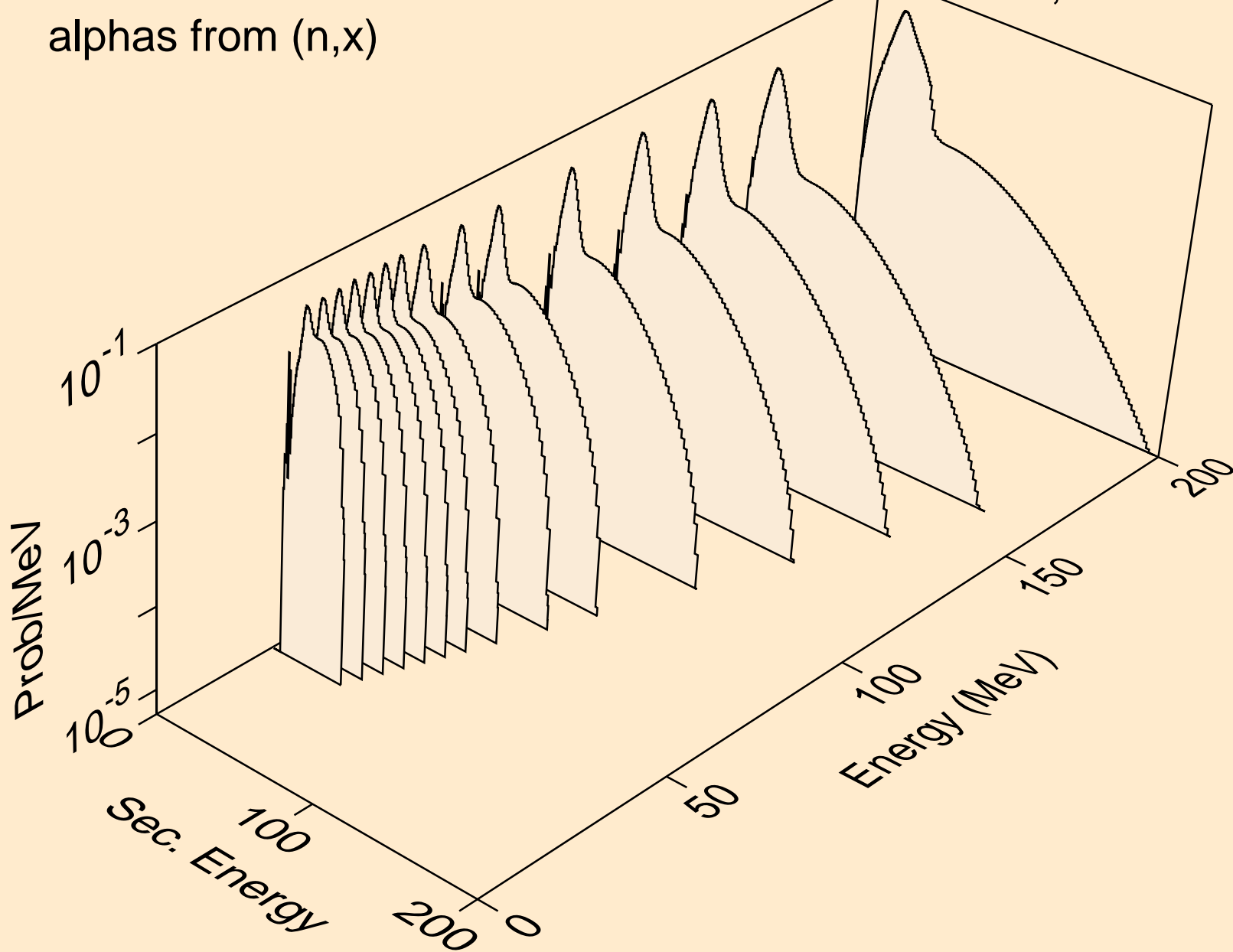

TA160M NEUTRON ACER TENDL-2019 LIBRARY; T=293.16K
alphas from (n,n*)a

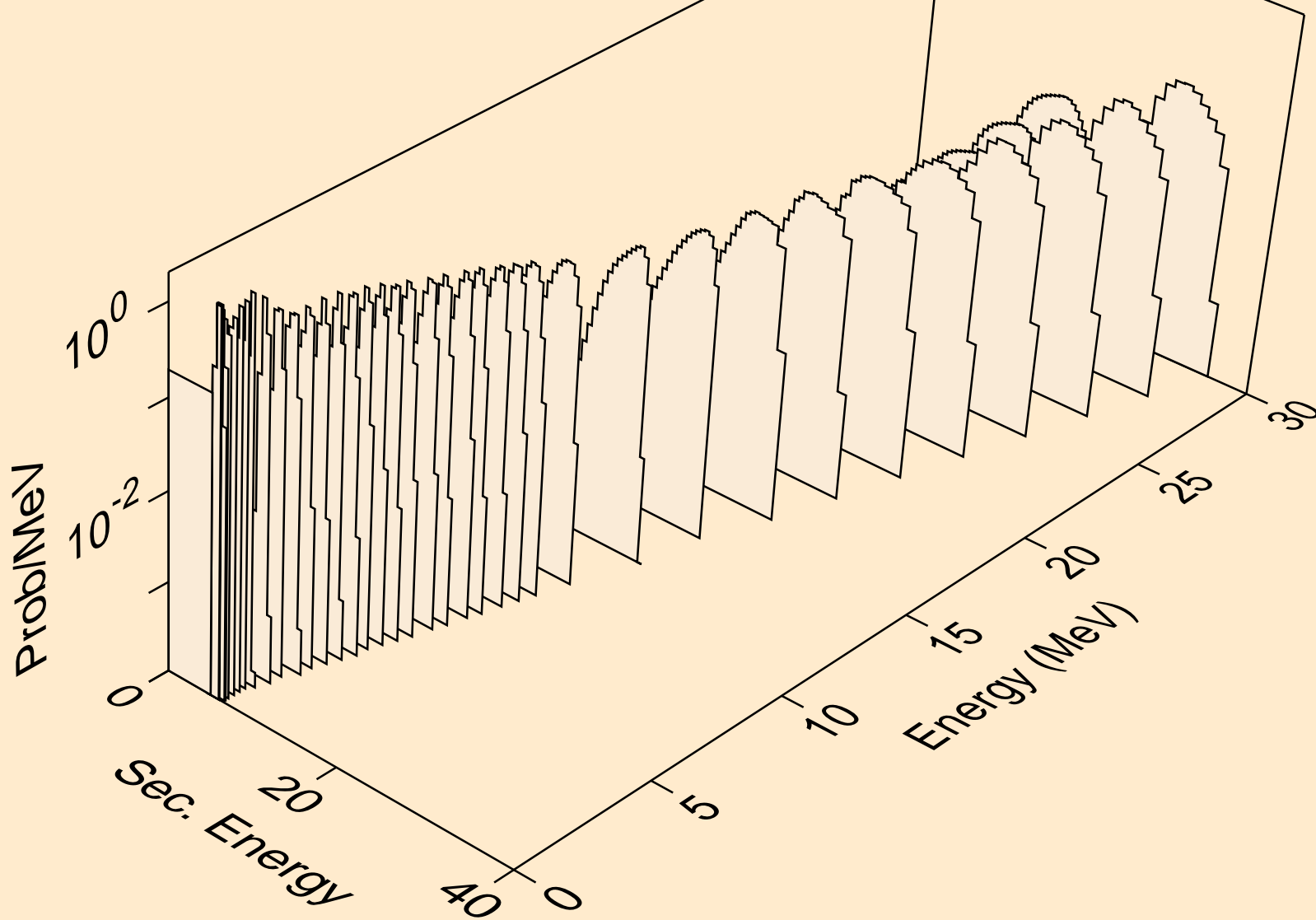

TA160M NEUTRON ACER TENDL-2019 LIBRARY; T=293.16K
alphas from (n,n*)3a

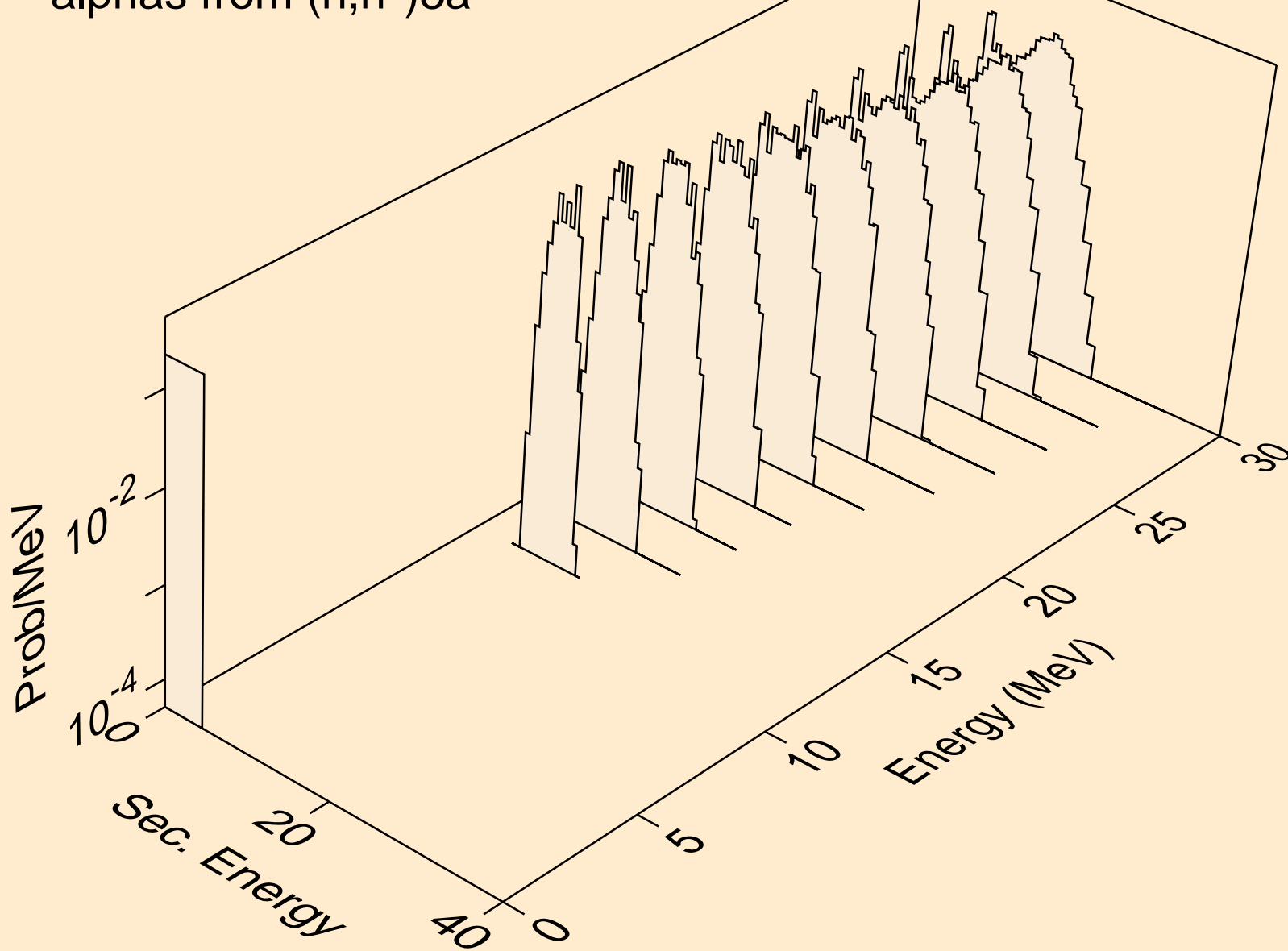

TA160M NEUTRON ACER TENDL-2019 LIBRARY; T=293.16K
alphas from (n,2n)a

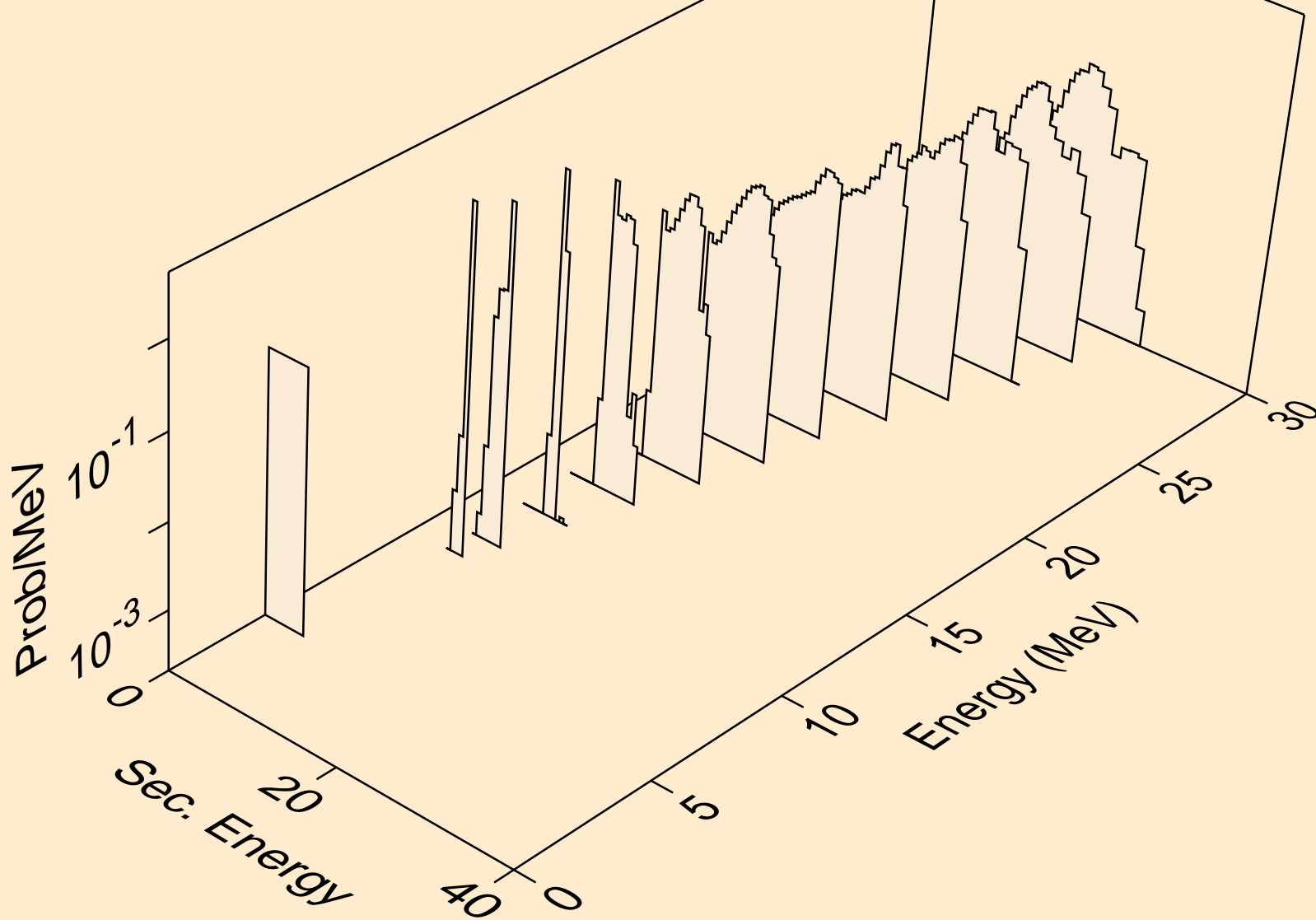

TA160M NEUTRON ACER TENDL-2019 LIBRARY; T=293.16K
alphas from (n,3n)a

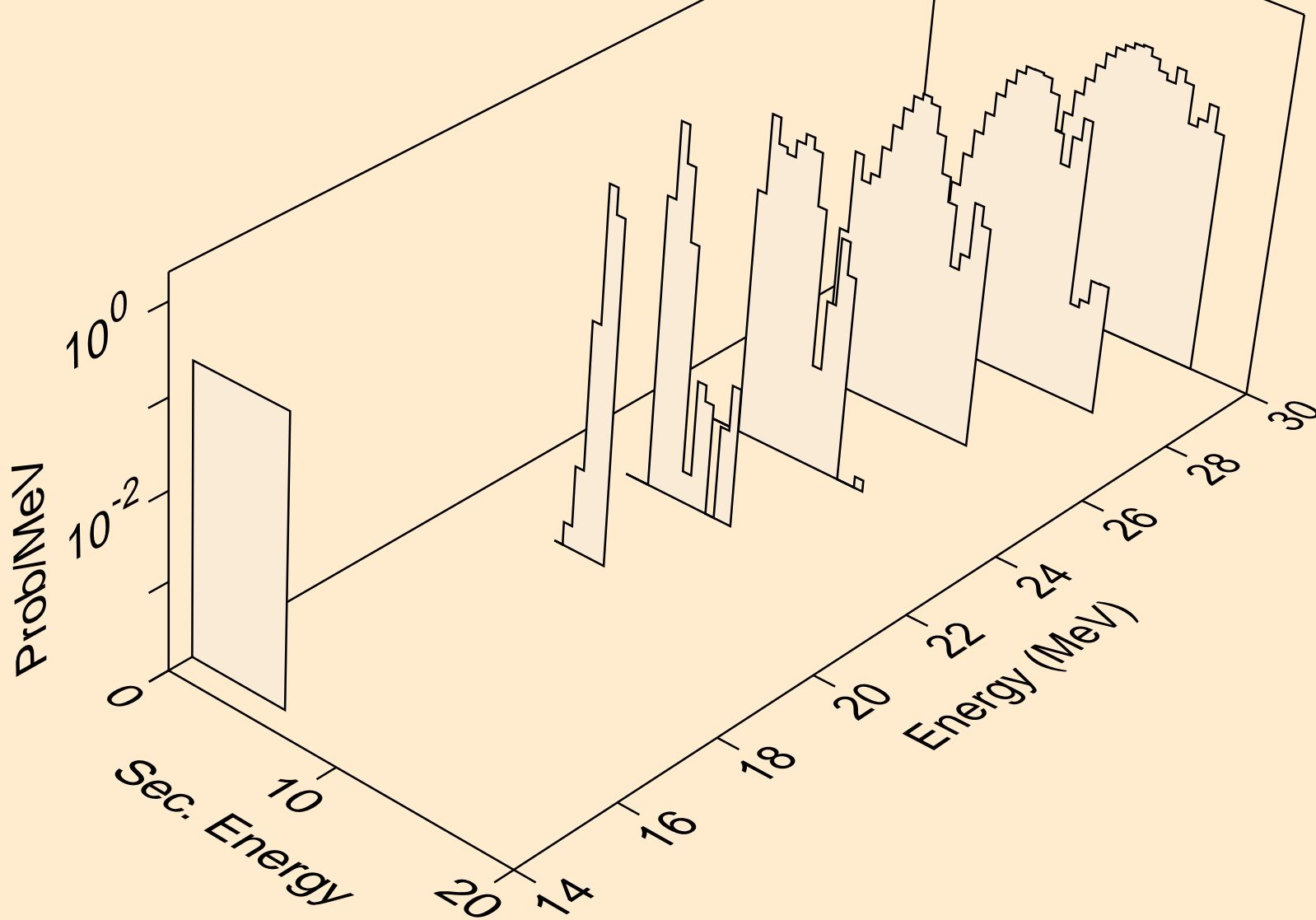

TA160M NEUTRON ACER TENDL-2019 LIBRARY; T=293.16K
alphas from (n,n*)2a

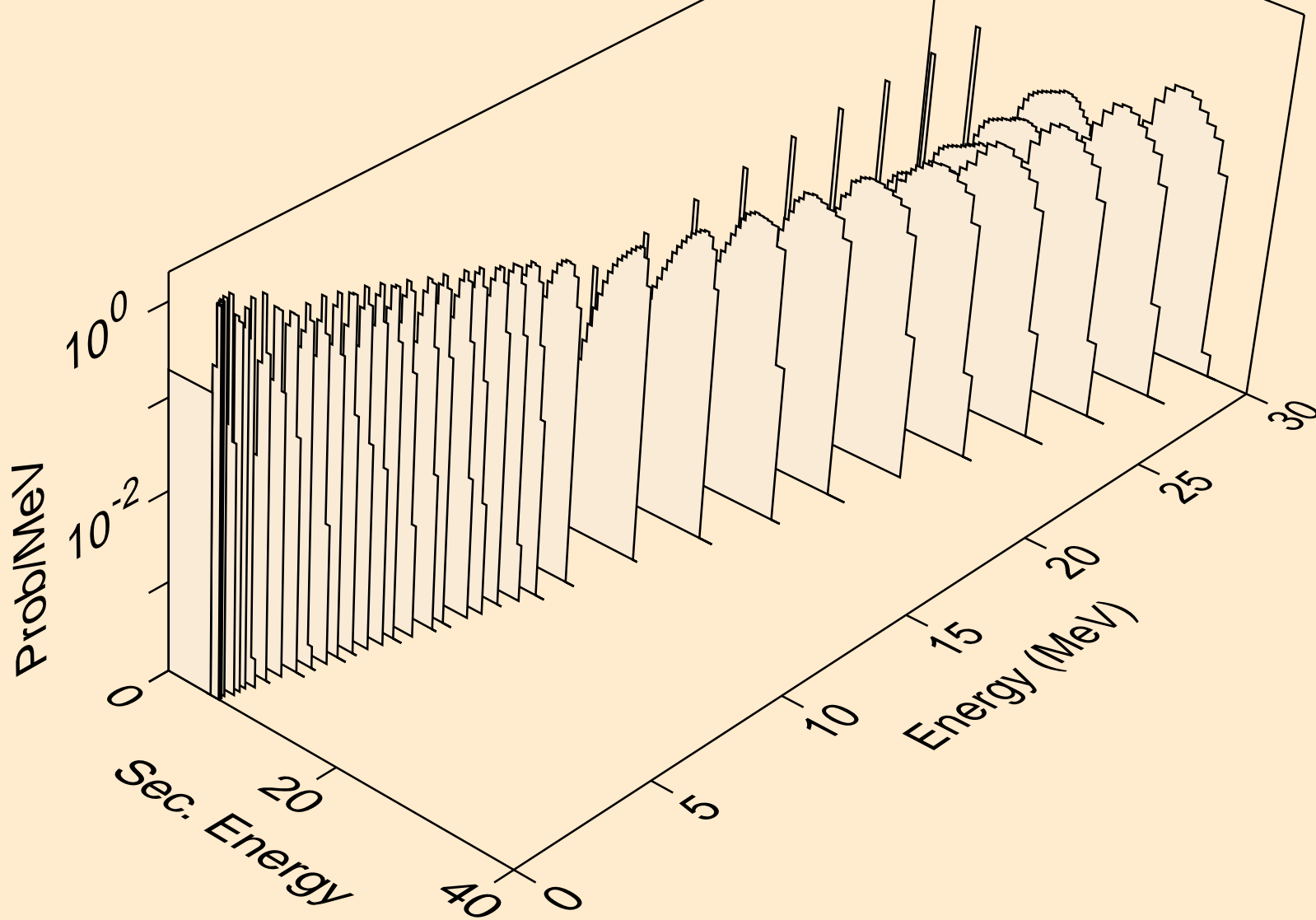

TA160M NEUTRON ACER TENDL-2019 LIBRARY; T=293.16K
alphas from (n,2n)2a

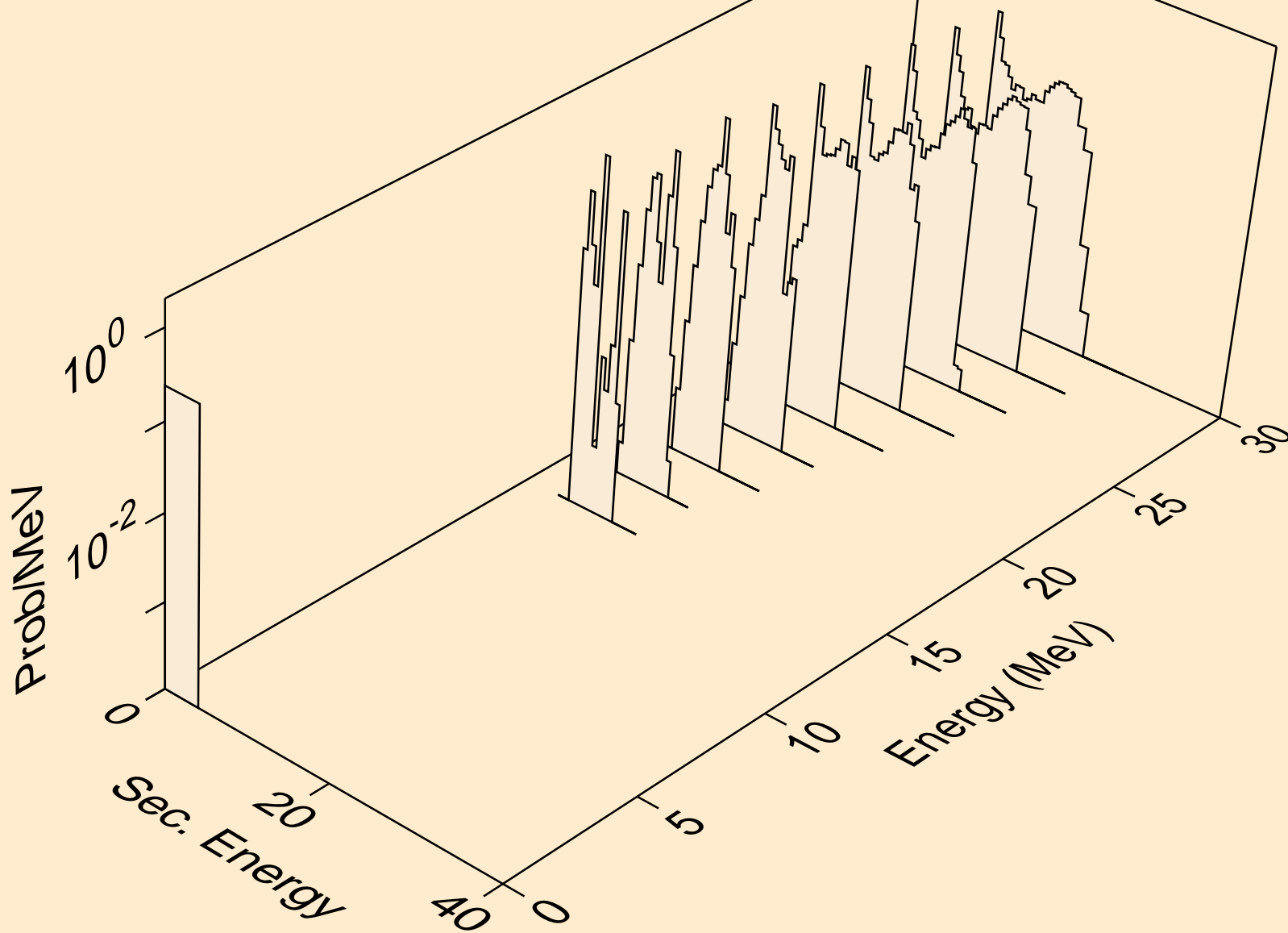

TA160M NEUTRON ACER TENDL-2019 LIBRARY; T=293.16K
alphas from (n,n*)d2a

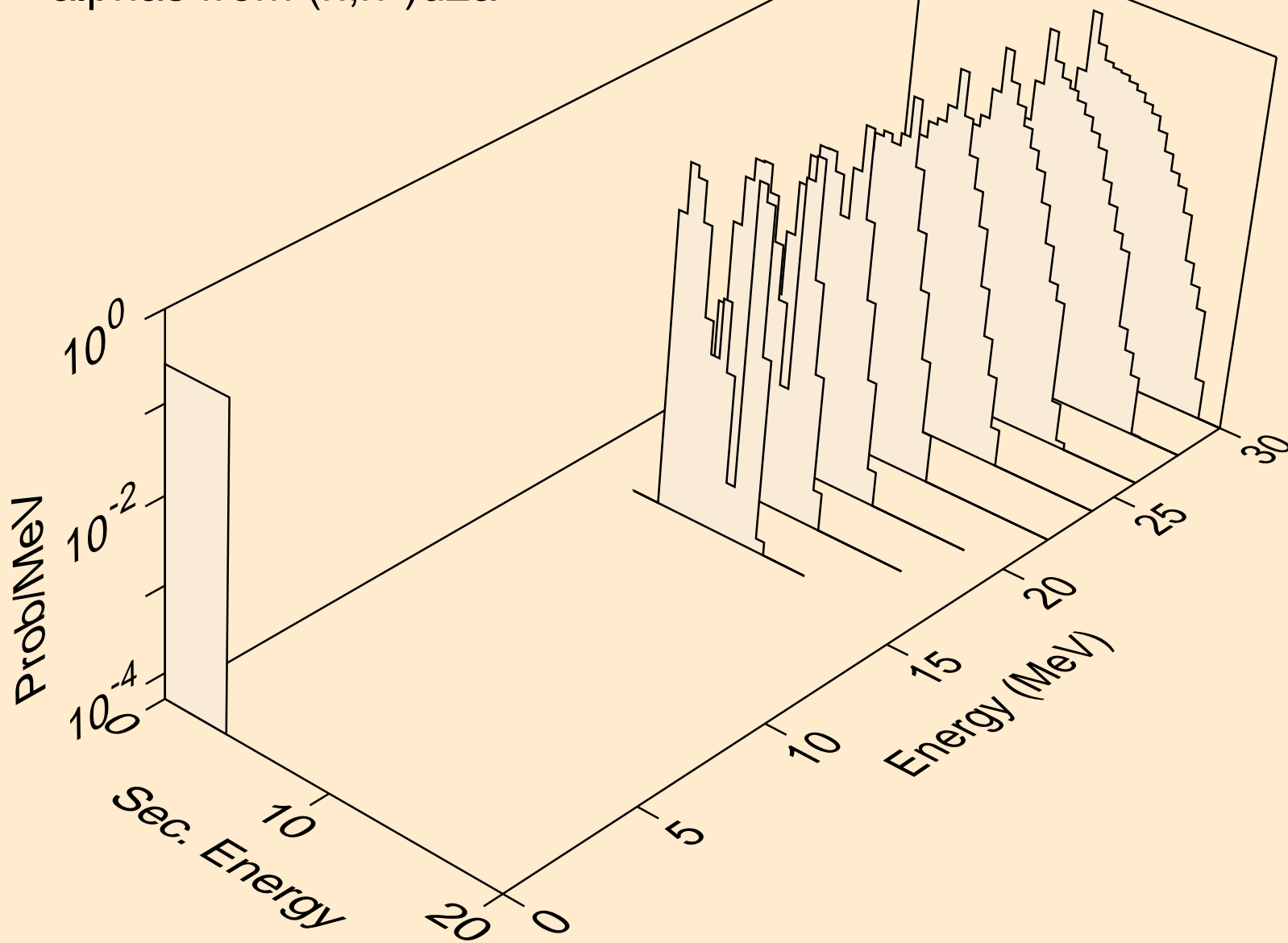

TA160M NEUTRON ACER TENDL-2019 LIBRARY; T=293.16K
alphas from (n,n*)t2a

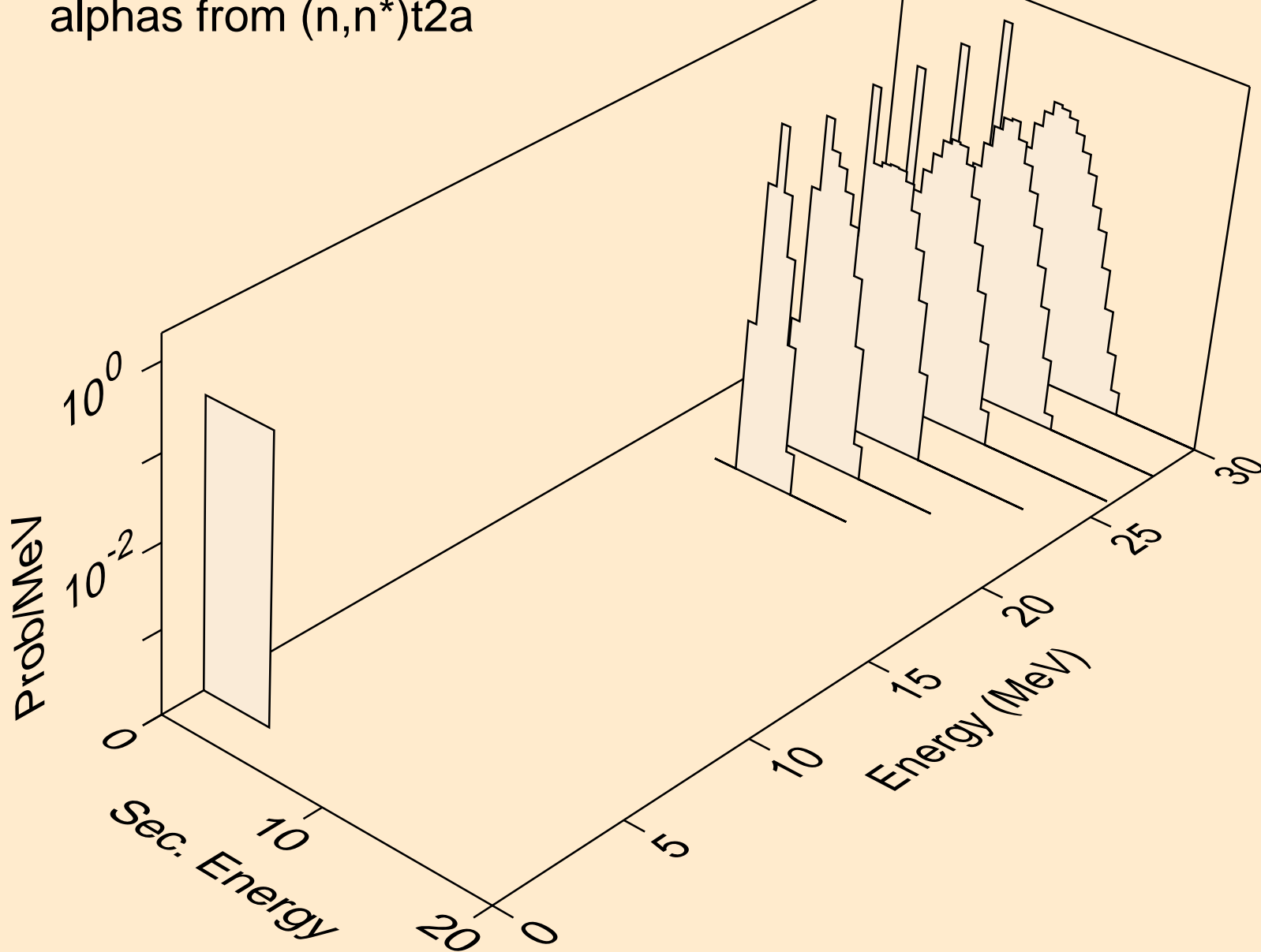

TA160M NEUTRON ACER TENDL-2019 LIBRARY; T=293.16K
alphas from (n,npa)

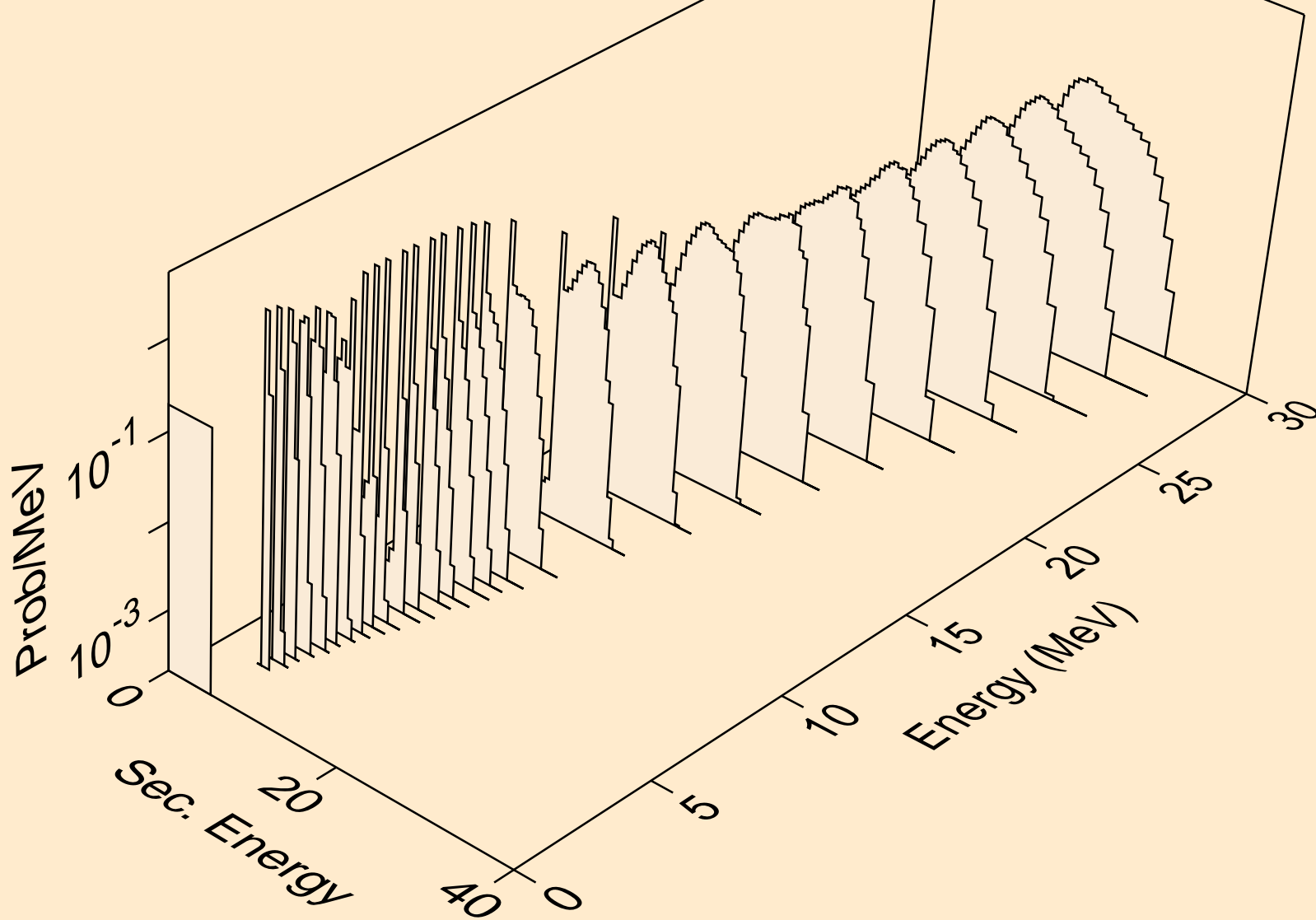

TA160M NEUTRON ACER TENDL-2019 LIBRARY; T=293.16K
alphas from (n,a)

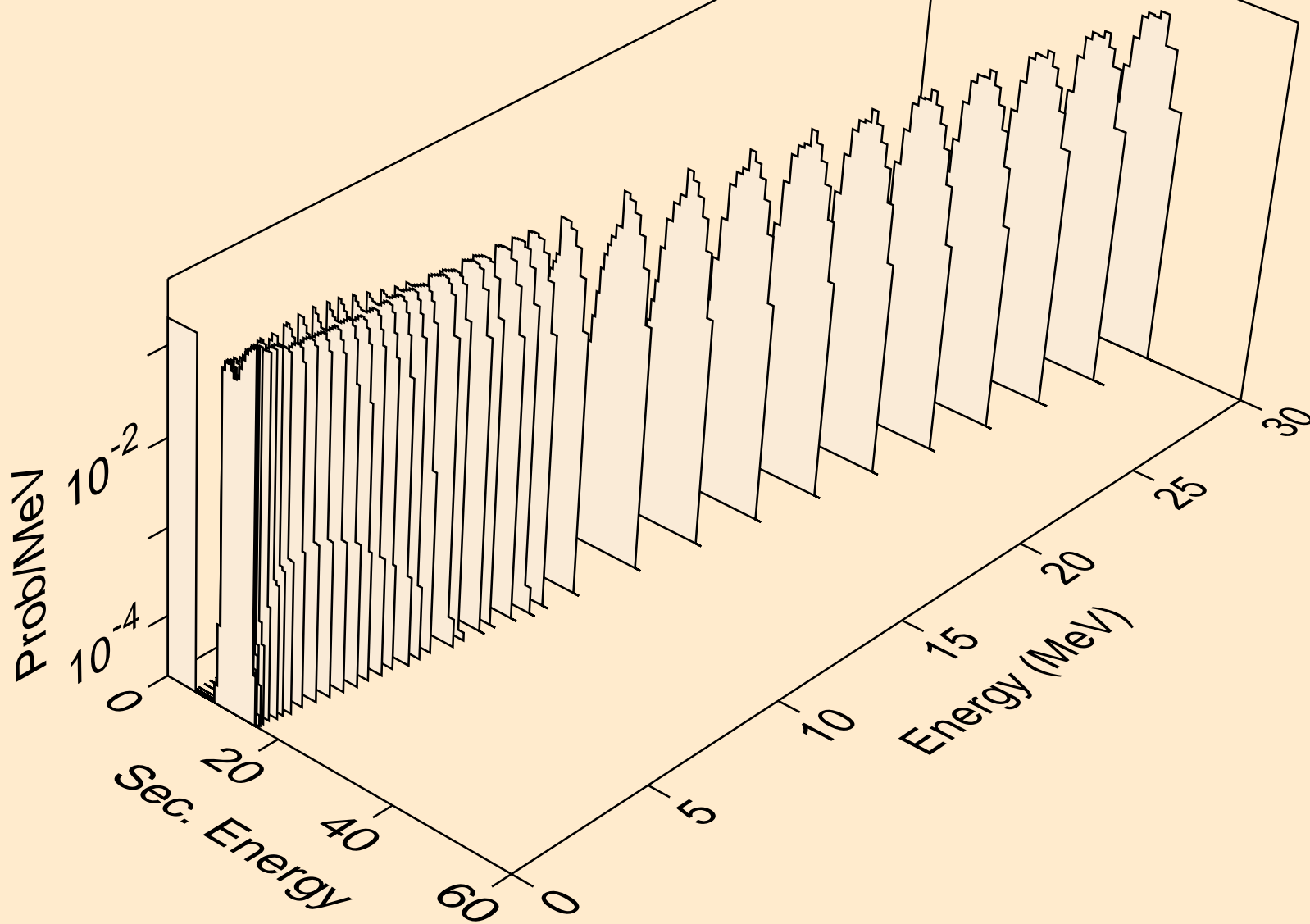

TA160M NEUTRON ACER TENDL-2019 LIBRARY; T=293.16K
alphas from (n,2a)

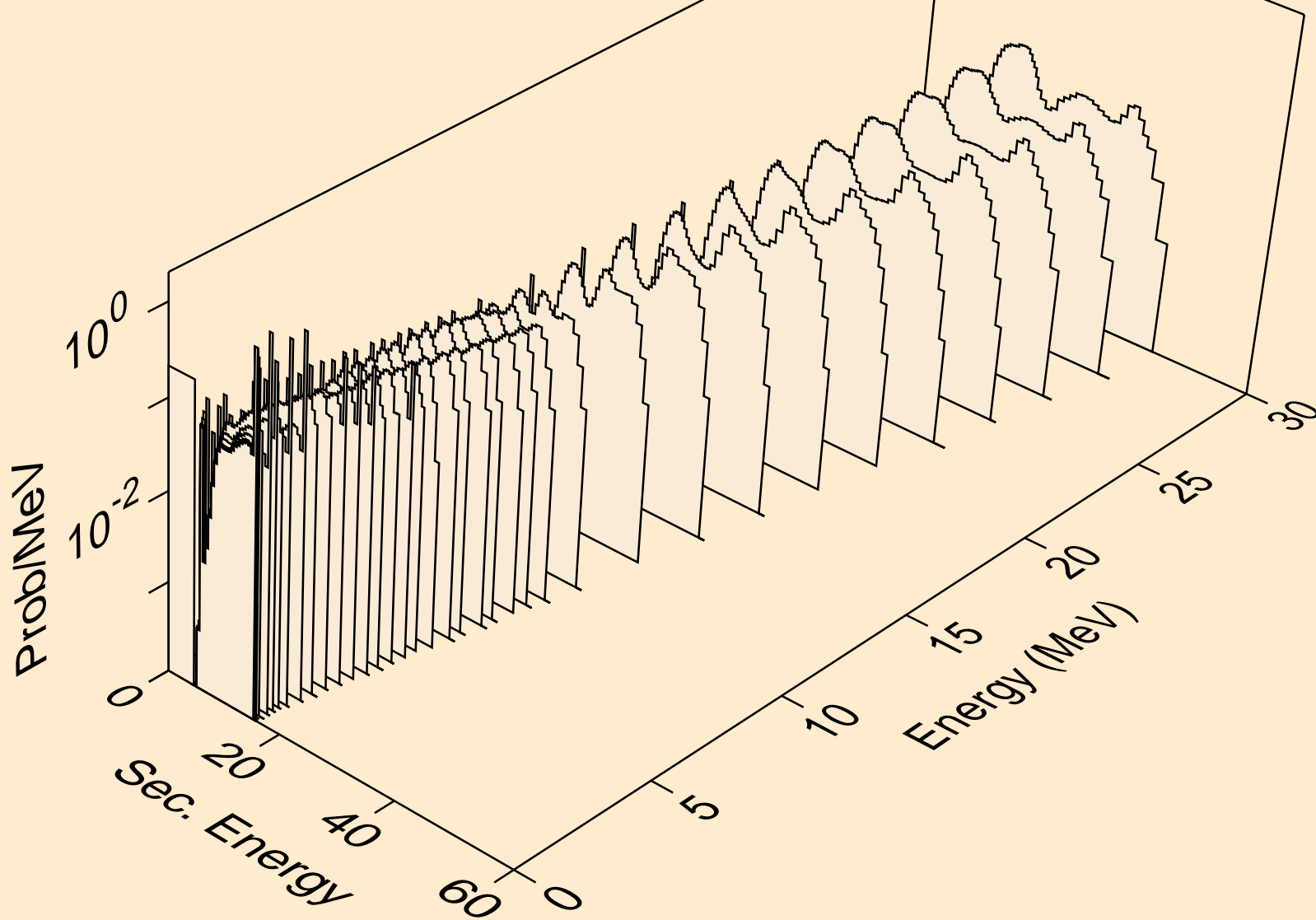

TA160M NEUTRON ACER TENDL-2019 LIBRARY; T=293.16K
alphas from (n,3a)

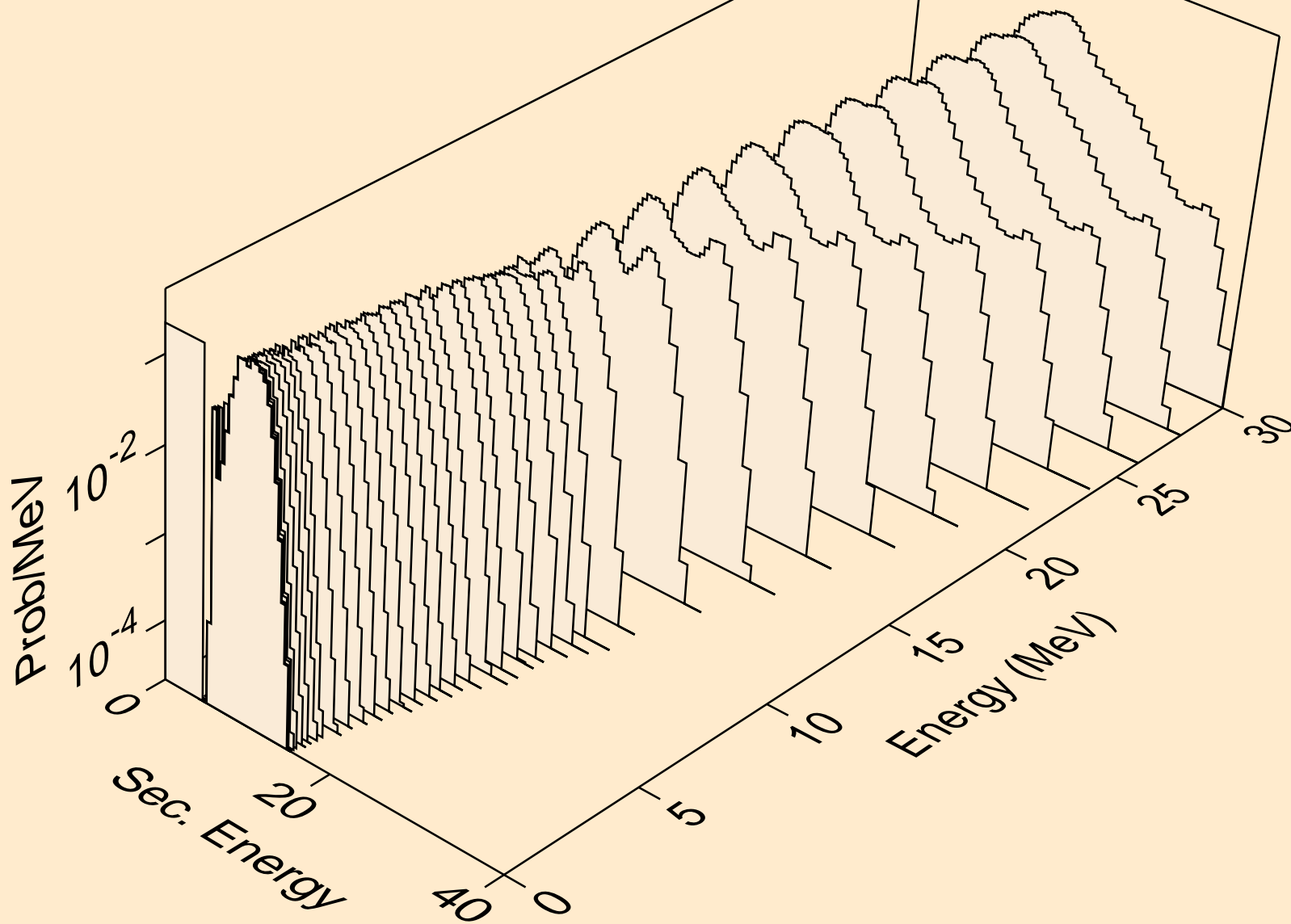

TA160M NEUTRON ACER TENDL-2019 LIBRARY; T=293.16K
alphas from (n,pa)

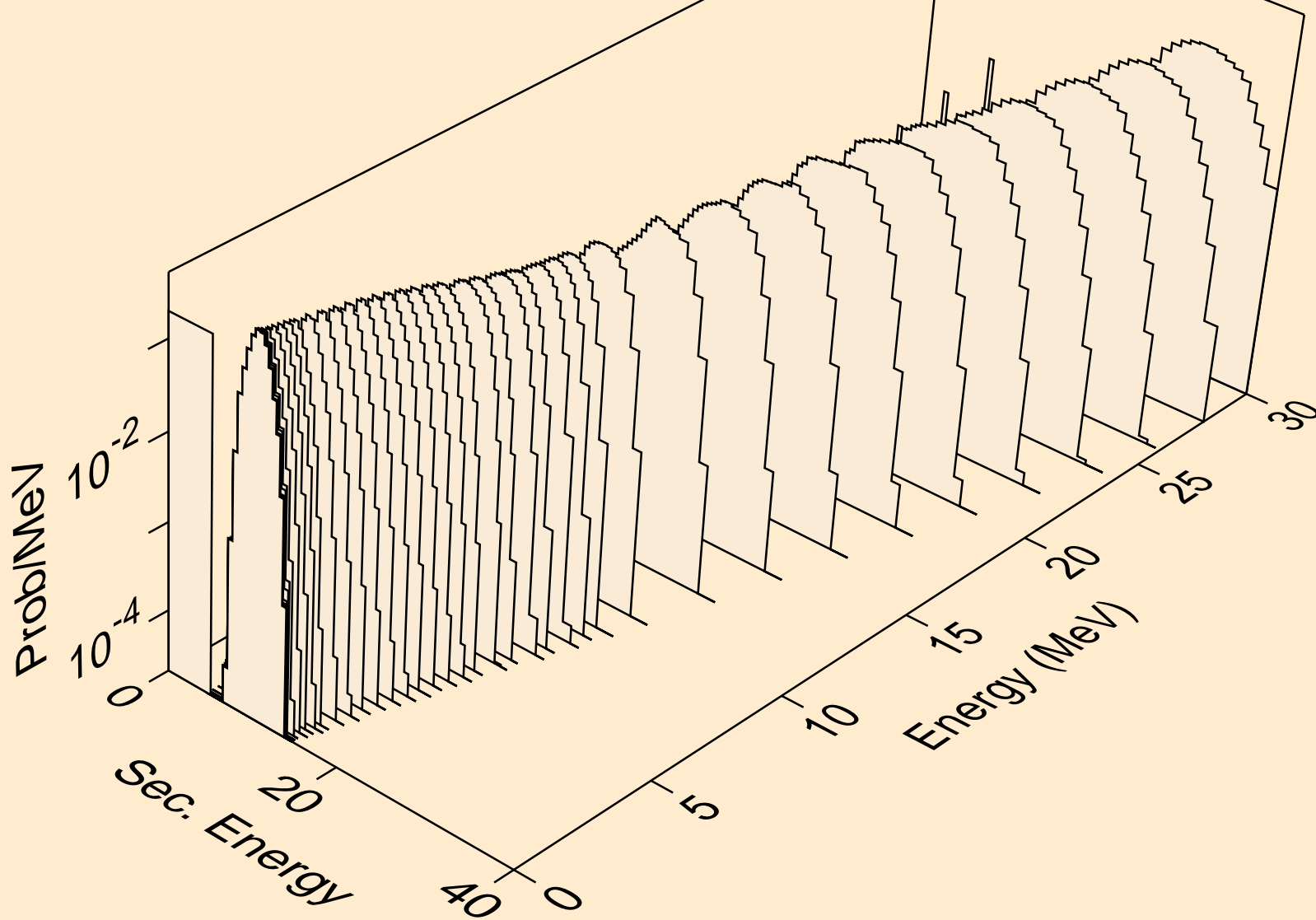

TA160M NEUTRON ACER TENDL-2019 LIBRARY; T=293.16K
alphas from (n,t2a)

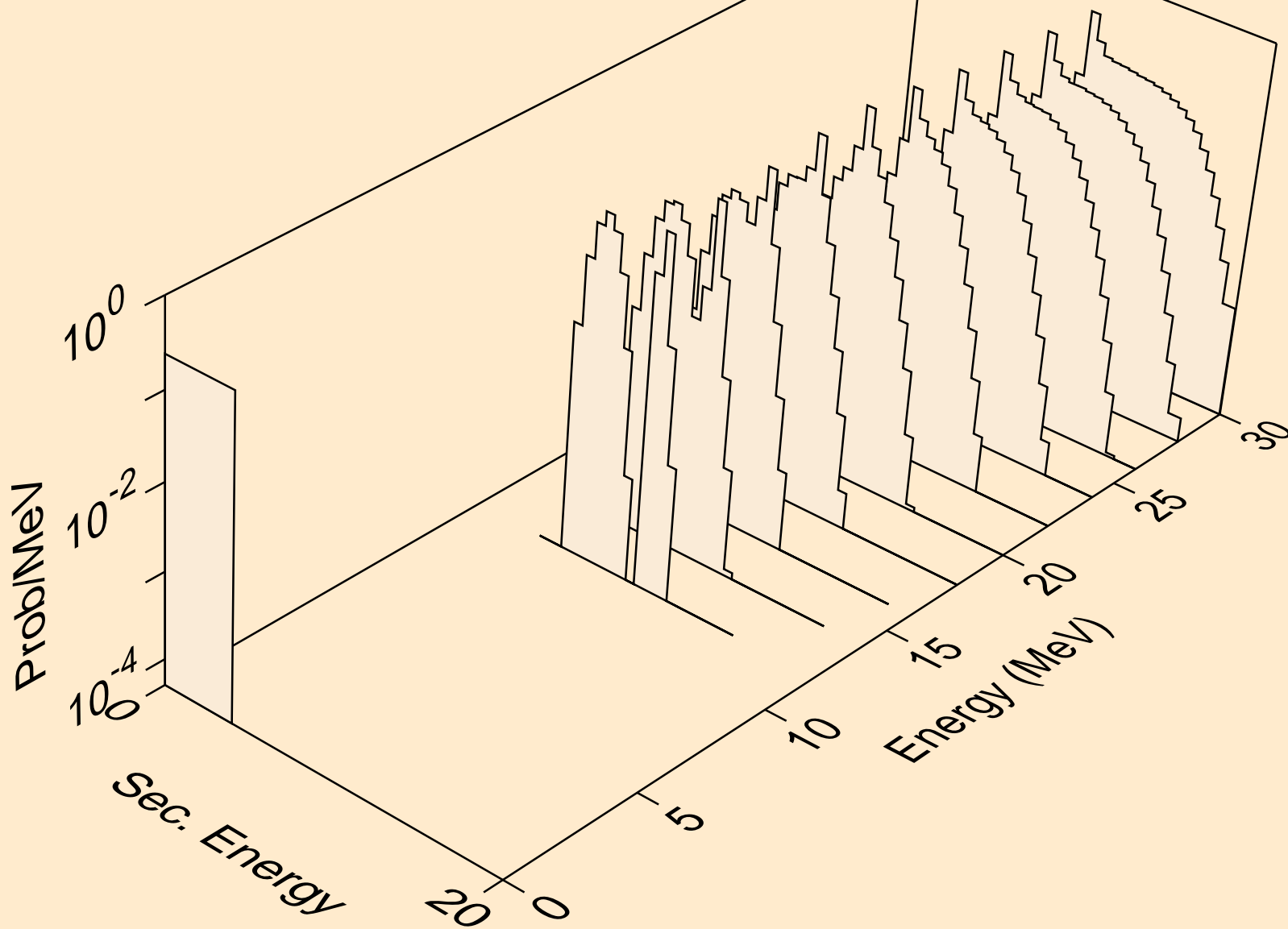

TA160M NEUTRON ACER TENDL-2019 LIBRARY; T=293.16K
alphas from (n,d2a)

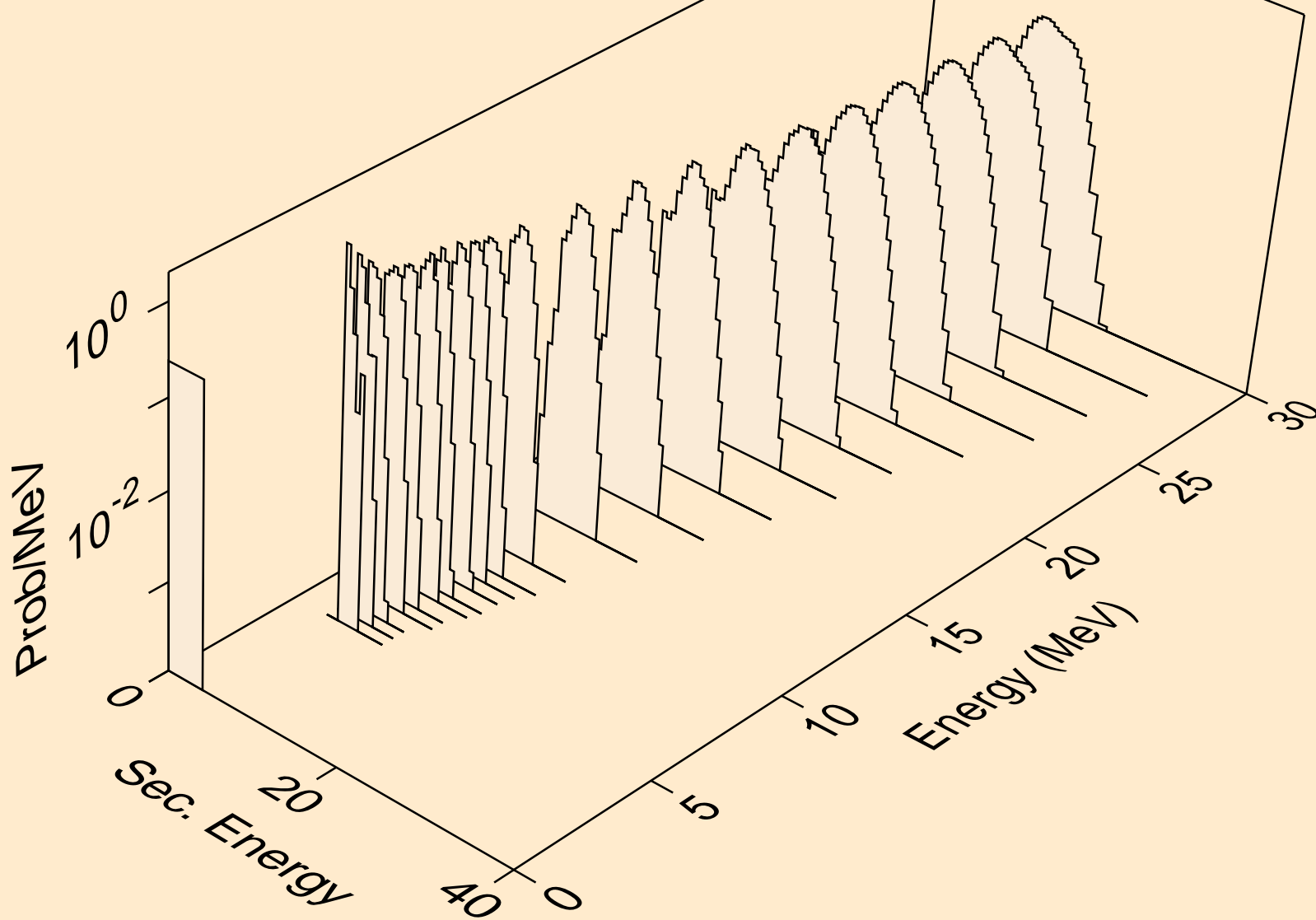

TA160M NEUTRON ACER TENDL-2019 LIBRARY; T=293.16K
alphas from (n,da)

