

TA166 NEUTRON ACER TENDL-2019 LIBRARY; T=293.16K  
Principal cross sections

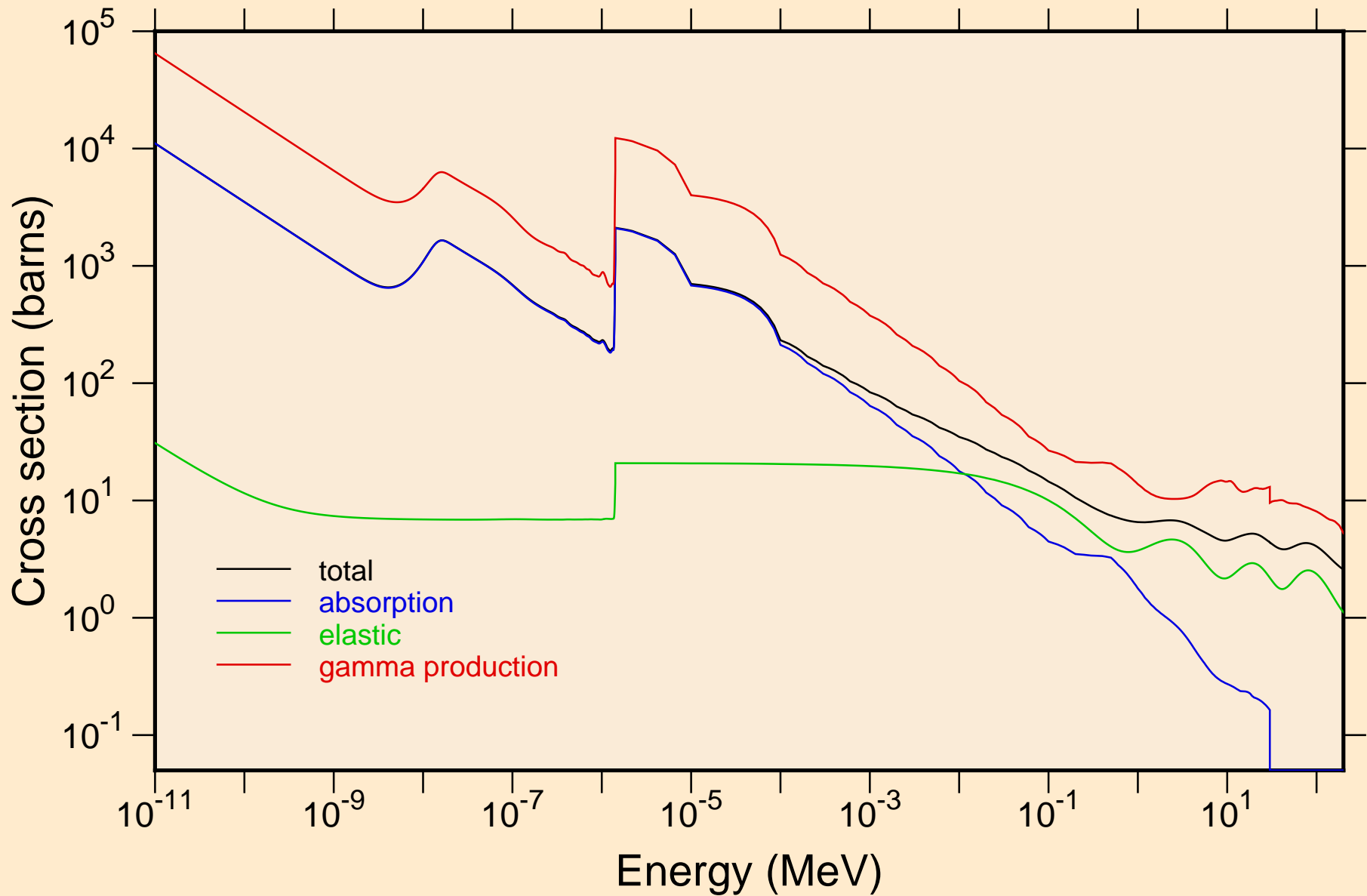

TA166 NEUTRON ACER TENDL-2019 LIBRARY; T=293.16K  
Heating

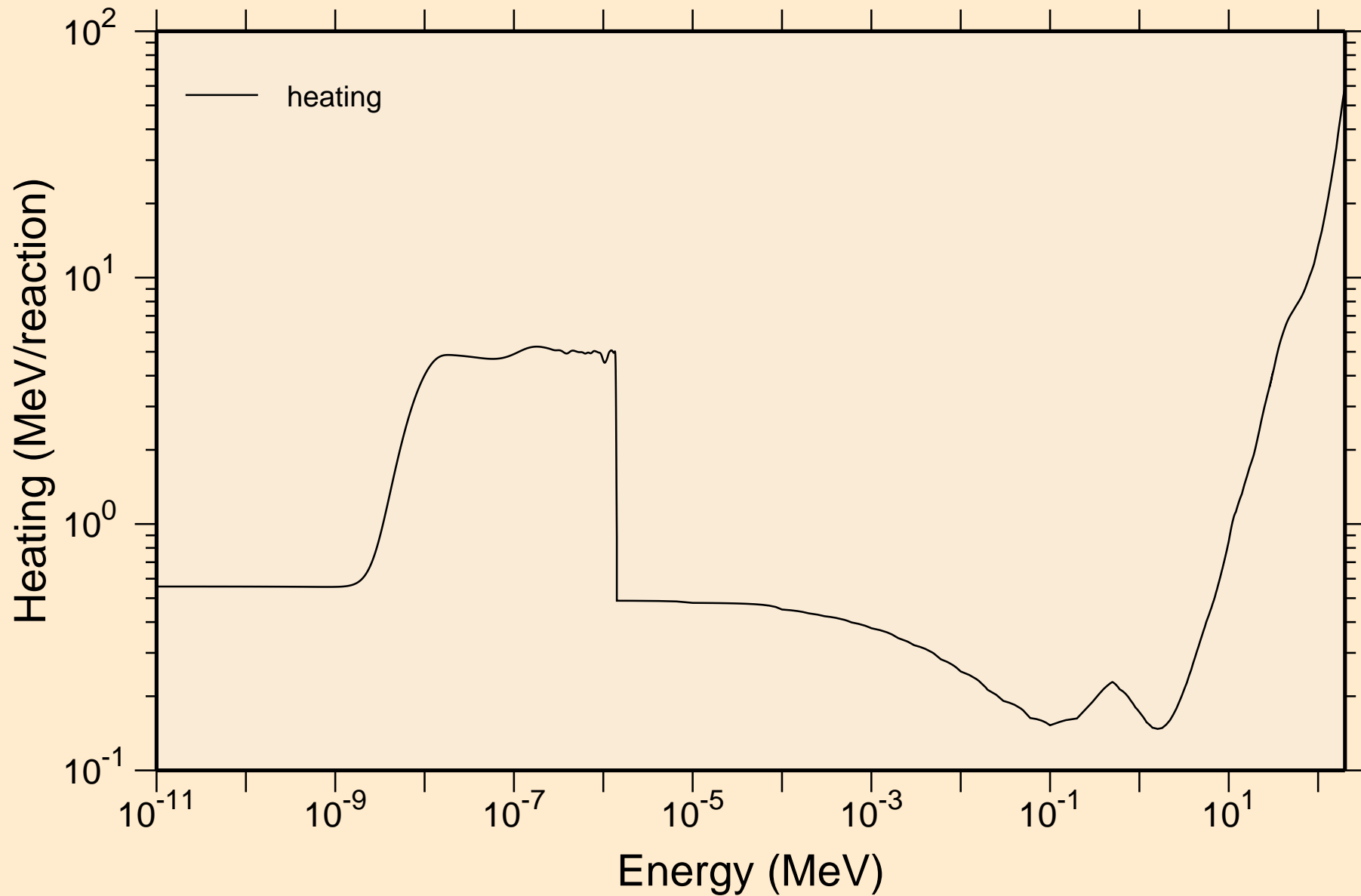

TA166 NEUTRON ACER TENDL-2019 LIBRARY; T=293.16K  
Damage

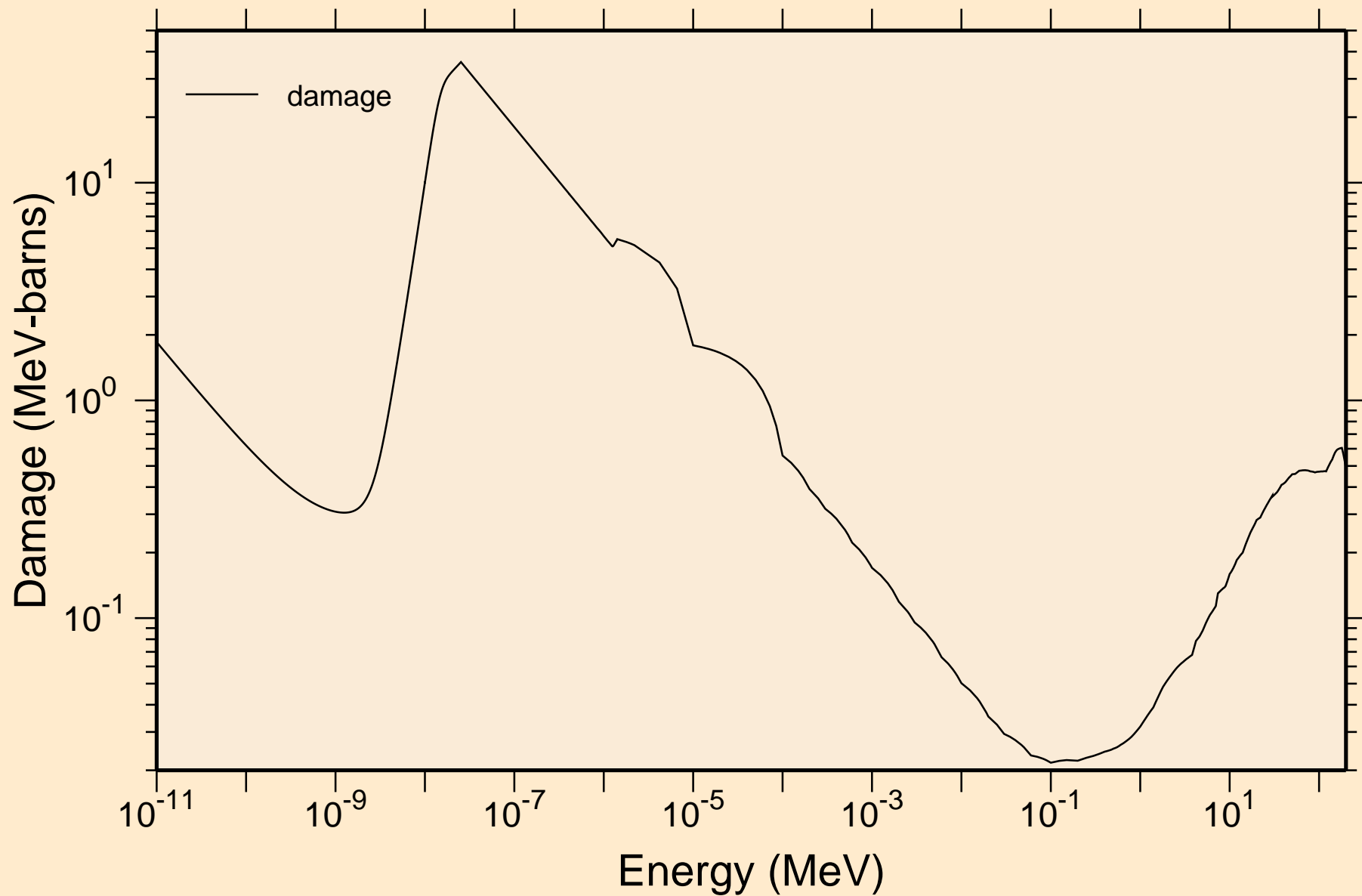

TA166 NEUTRON ACER TENDL-2019 LIBRARY; T=293.16K  
Non-threshold reactions

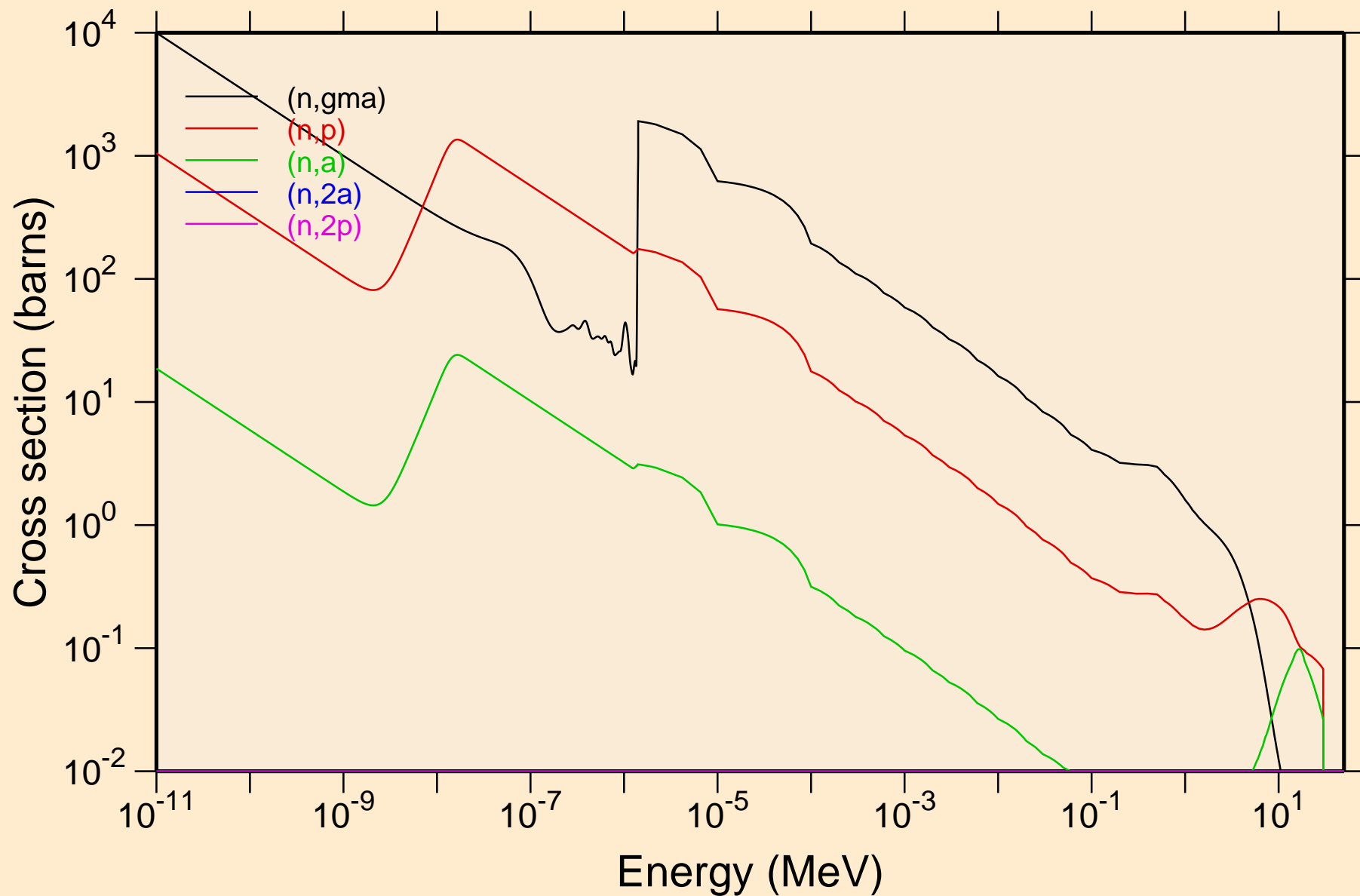

TA166 NEUTRON ACER TENDL-2019 LIBRARY; T=293.16K  
Non-threshold reactions

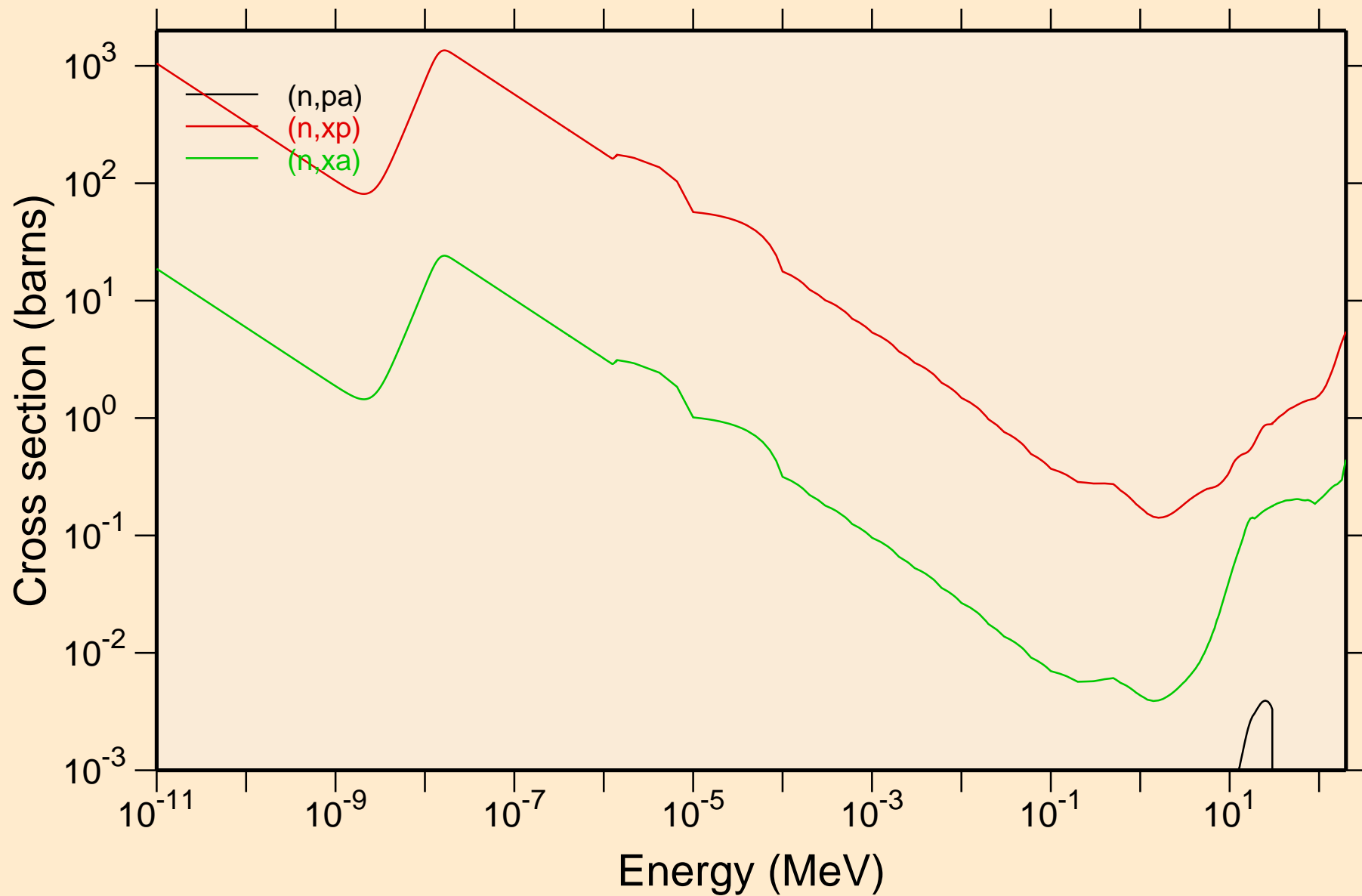

TA166 NEUTRON ACER TENDL-2019 LIBRARY; T=293.16K  
Principal cross sections

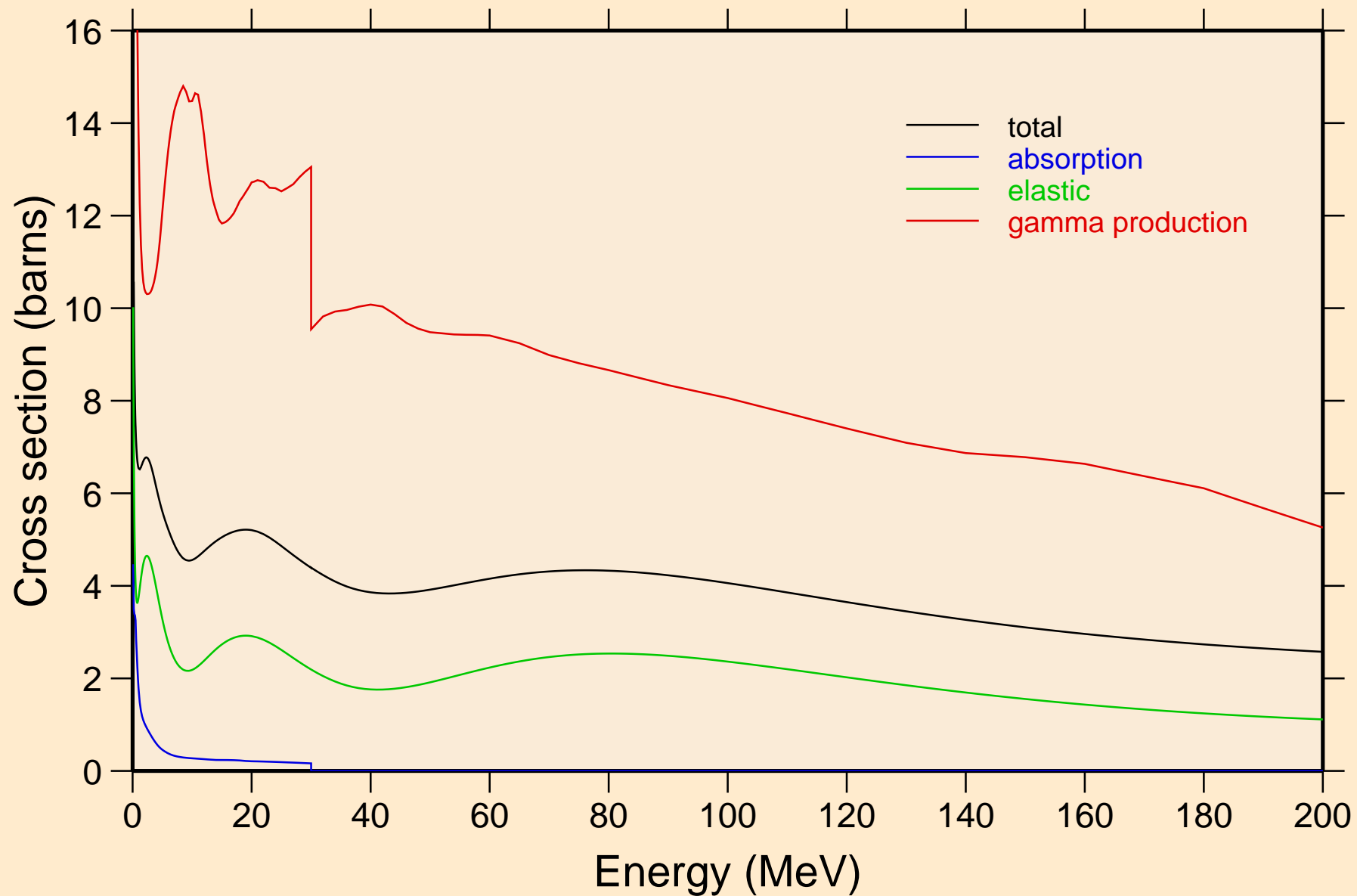

TA166 NEUTRON ACER TENDL-2019 LIBRARY; T=293.16K  
Heating

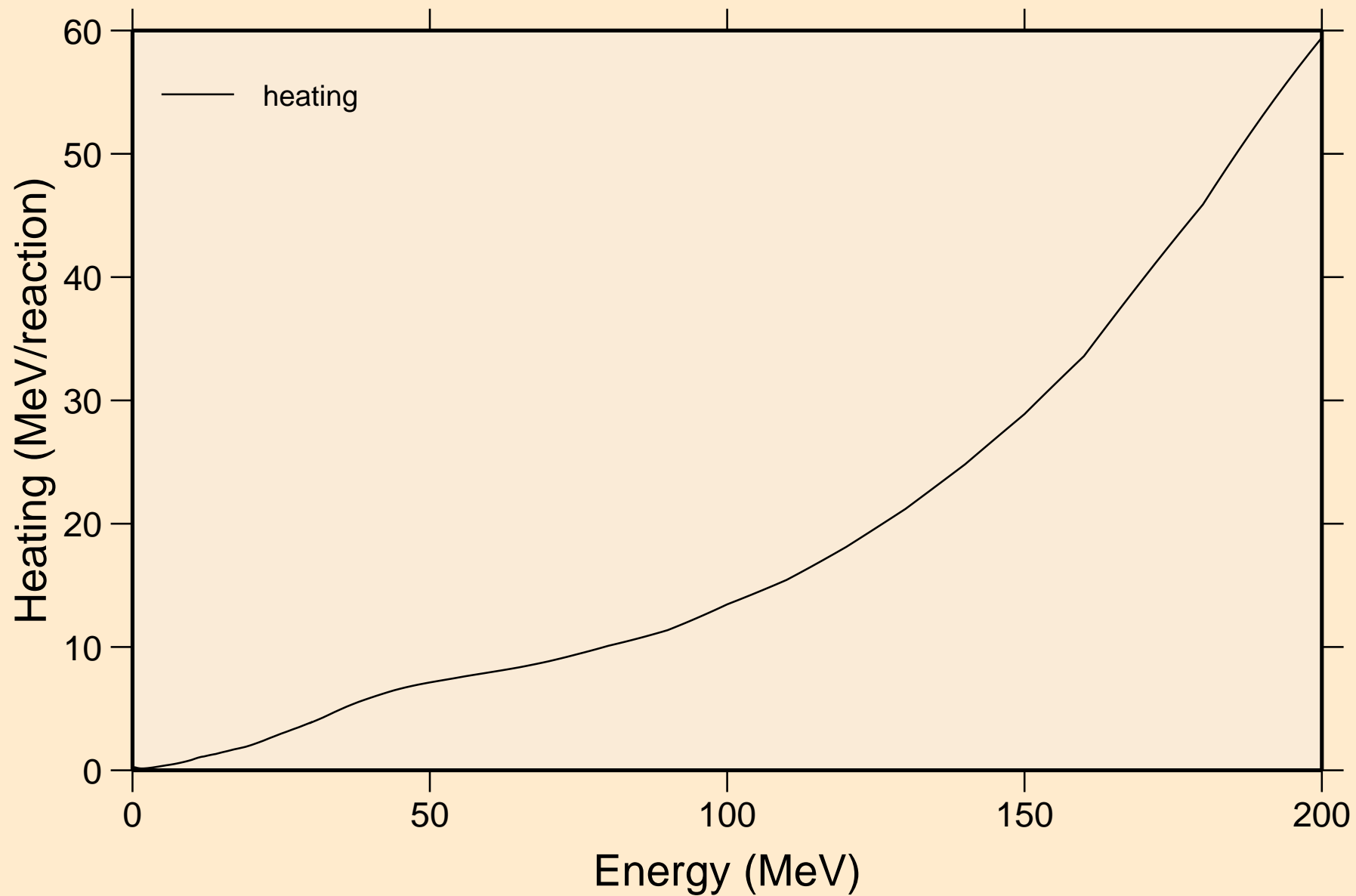

TA166 NEUTRON ACER TENDL-2019 LIBRARY; T=293.16K  
Damage

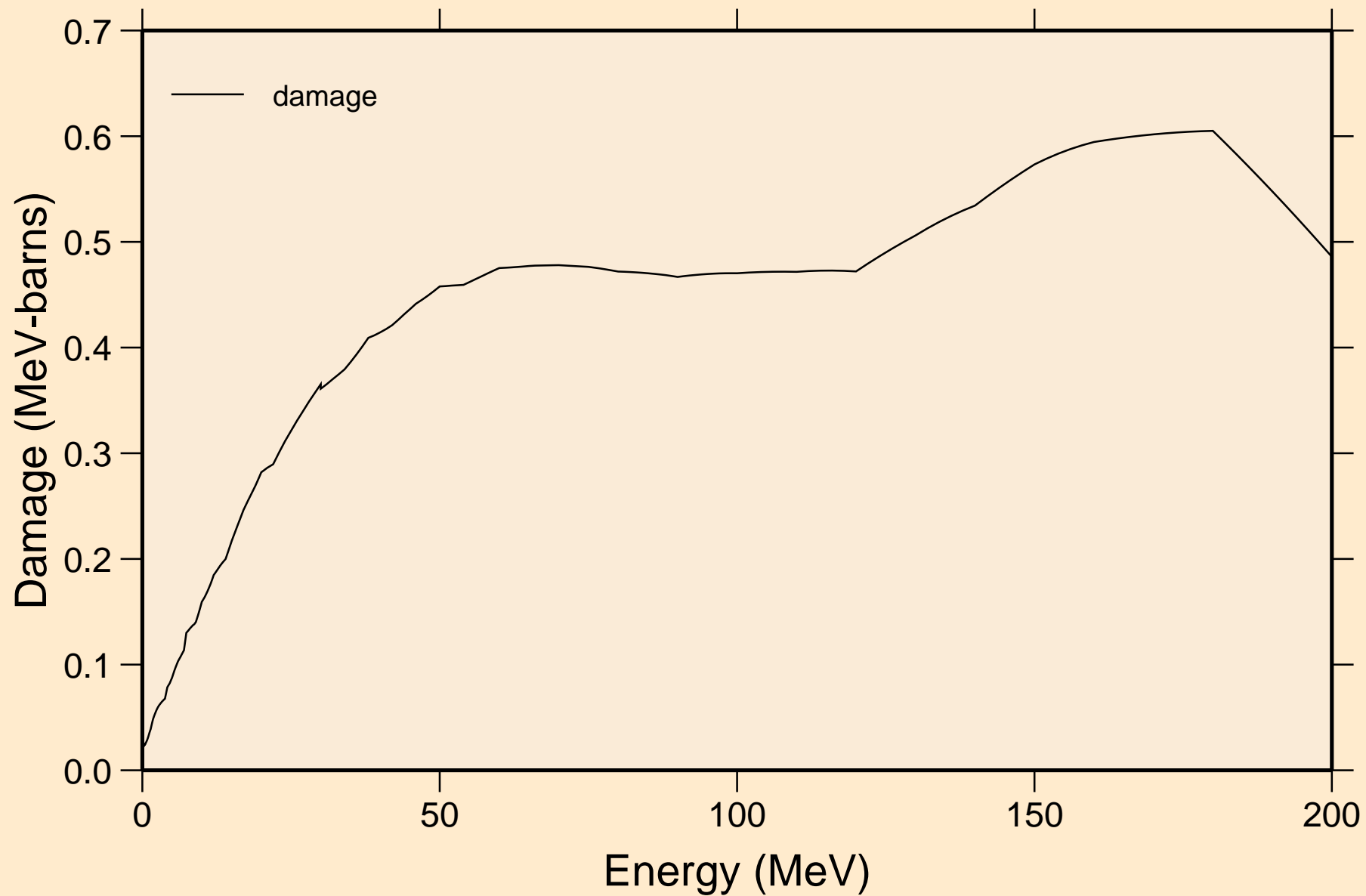



TA166 NEUTRON ACER TENDL-2019 LIBRARY; T=293.16K  
Non-threshold reactions

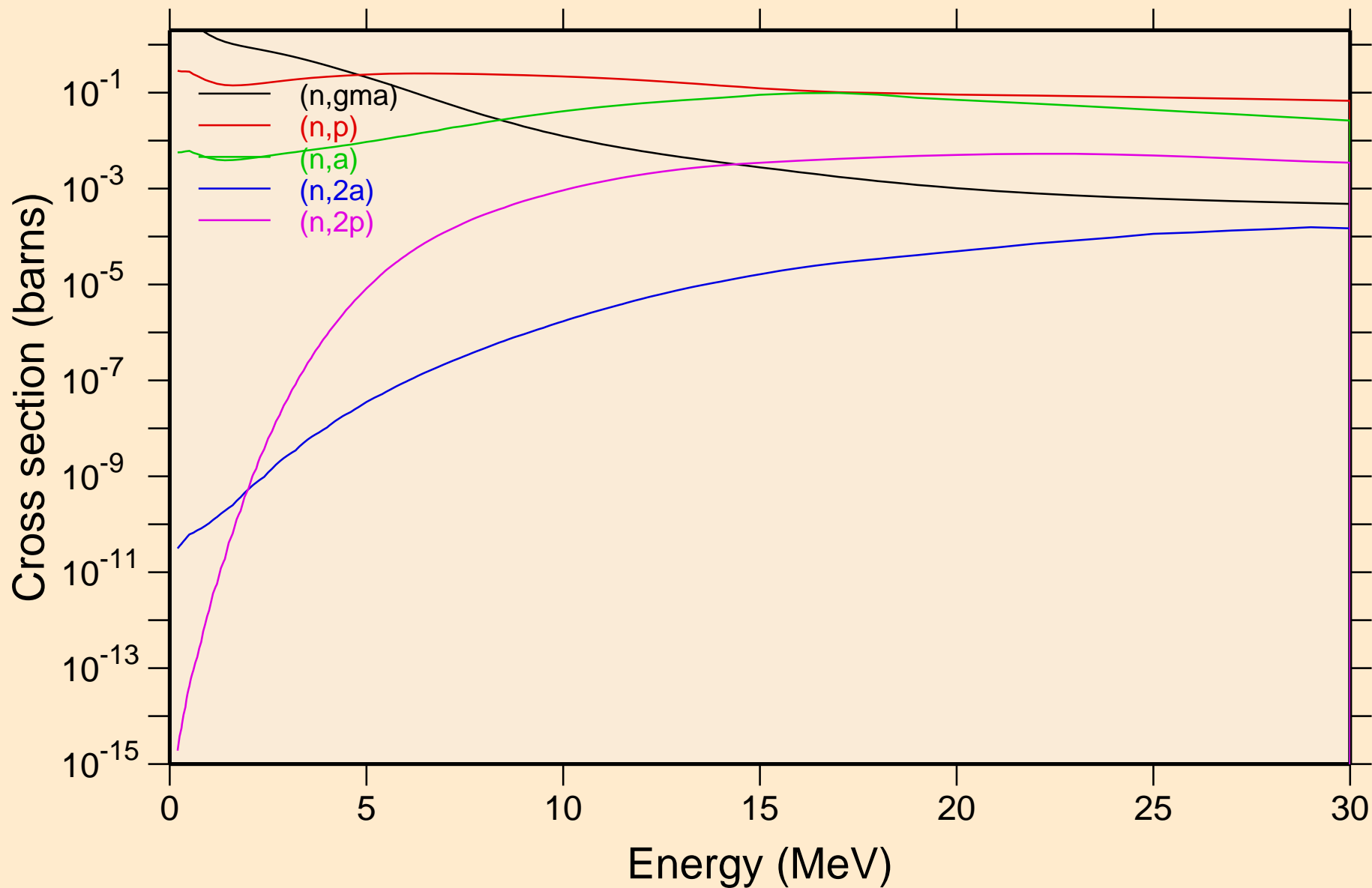

TA166 NEUTRON ACER TENDL-2019 LIBRARY; T=293.16K  
Non-threshold reactions

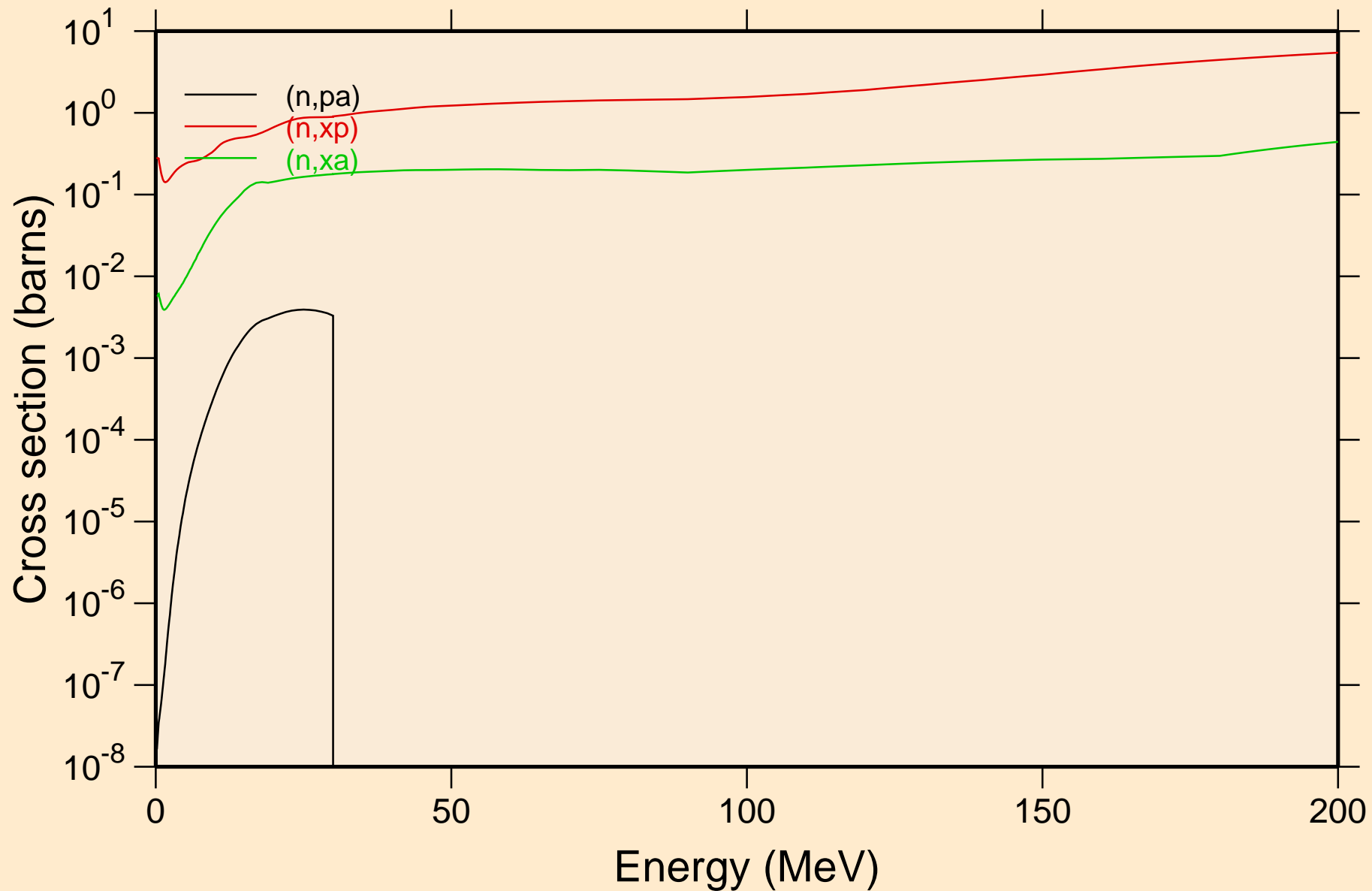

TA166 NEUTRON ACER TENDL-2019 LIBRARY; T=293.16K  
Inelastic levels

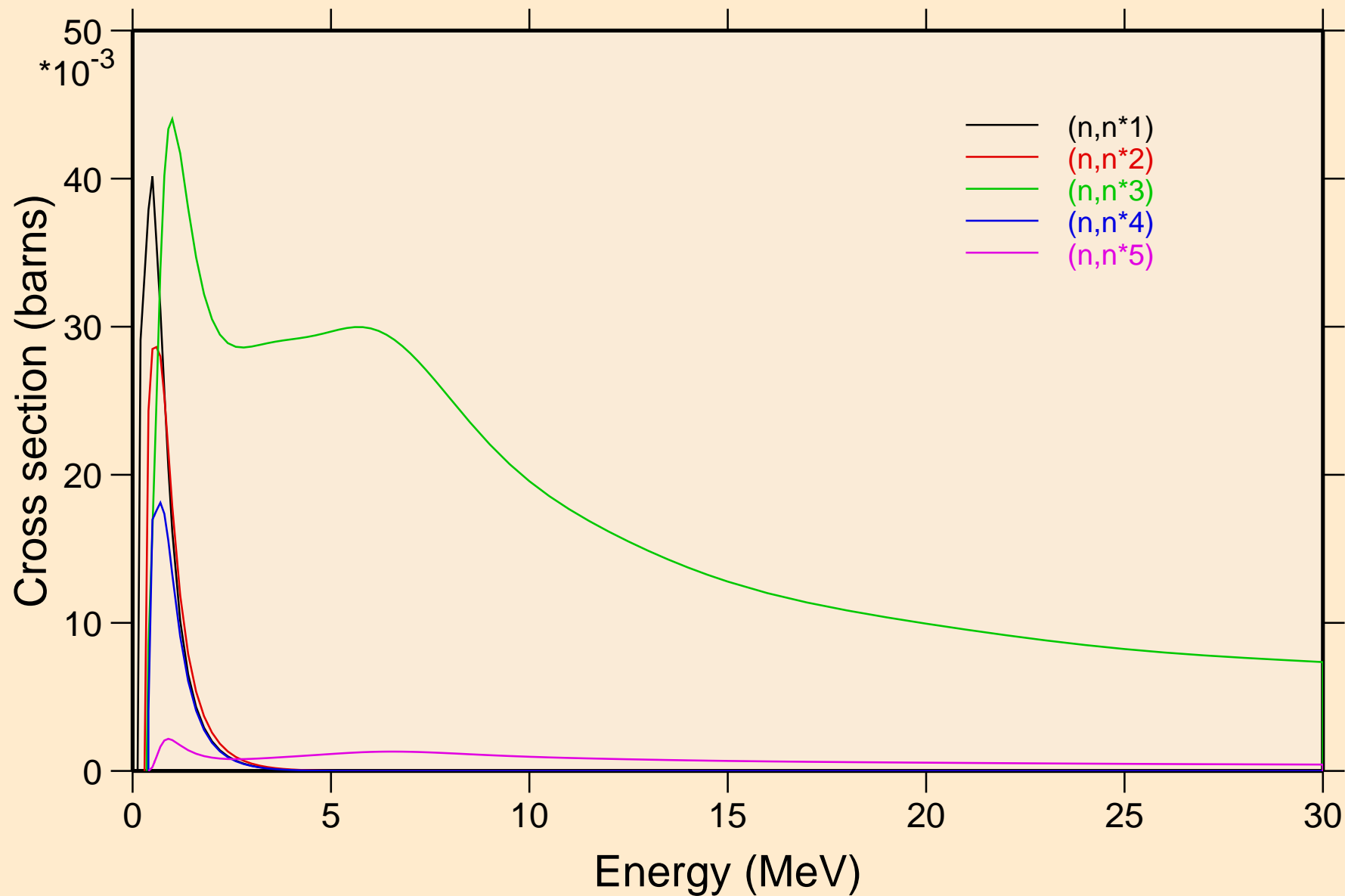

TA166 NEUTRON ACER TENDL-2019 LIBRARY; T=293.16K  
Inelastic levels

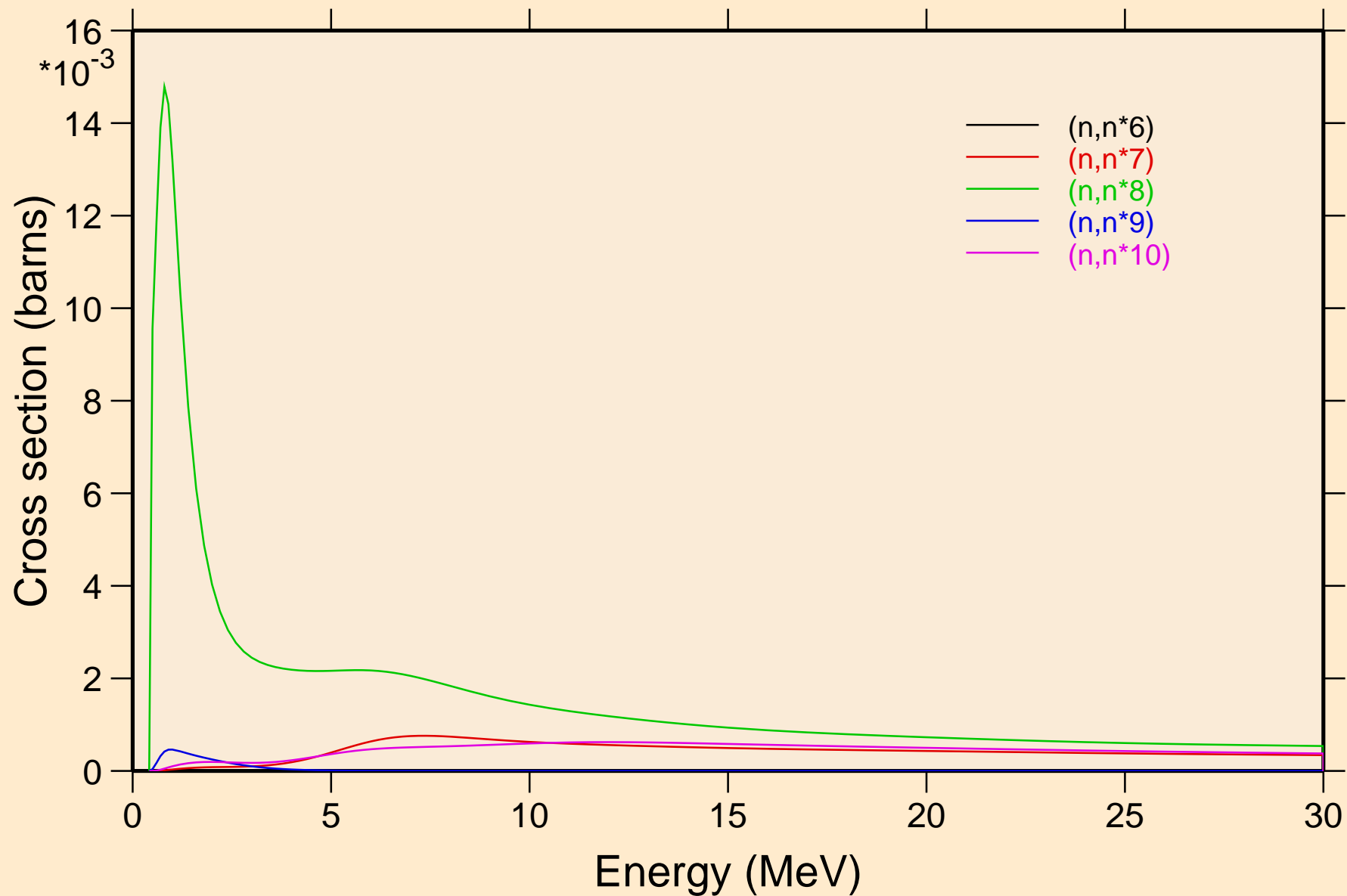

TA166 NEUTRON ACER TENDL-2019 LIBRARY; T=293.16K  
Inelastic levels

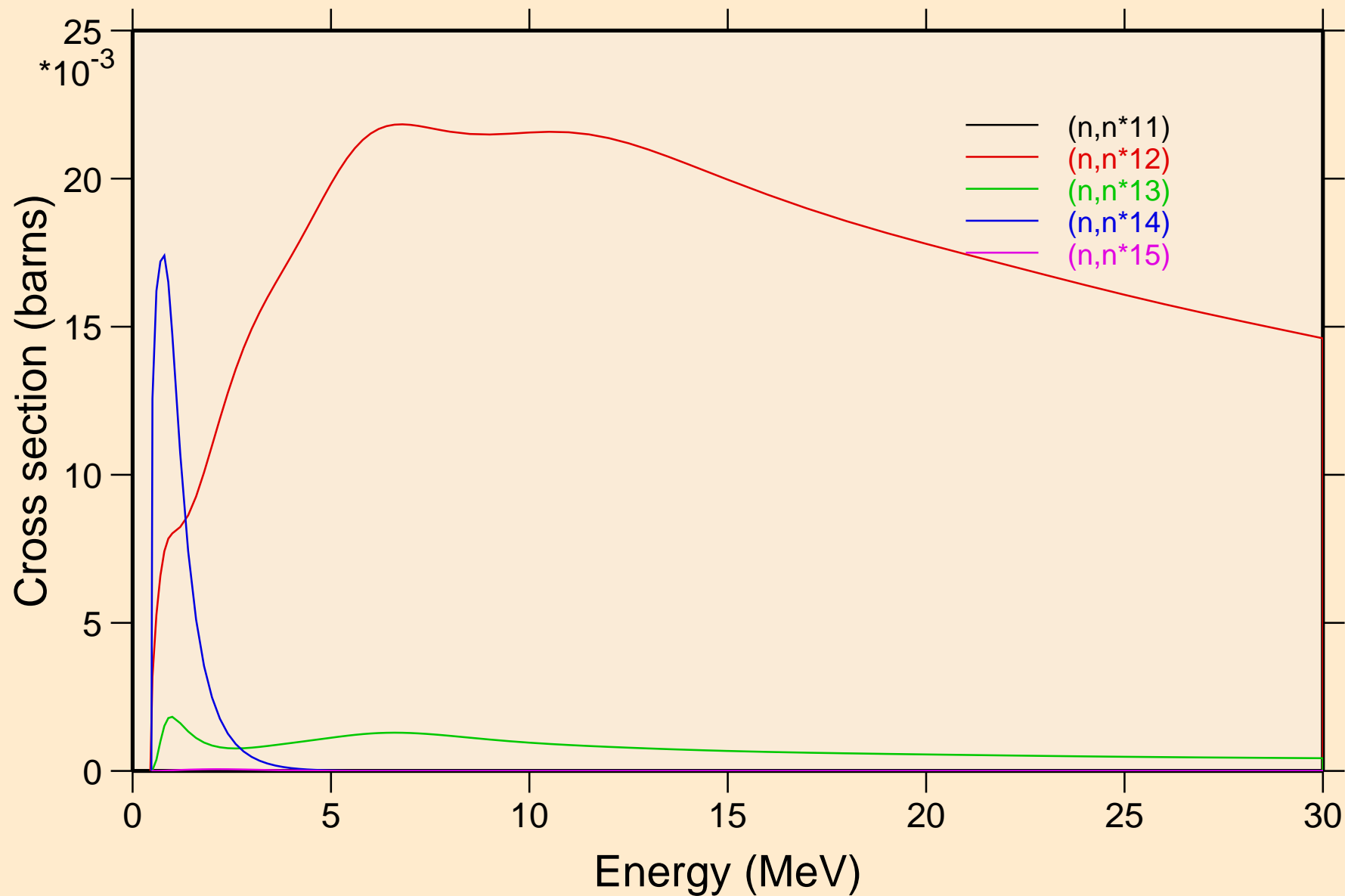

TA166 NEUTRON ACER TENDL-2019 LIBRARY; T=293.16K  
Inelastic levels

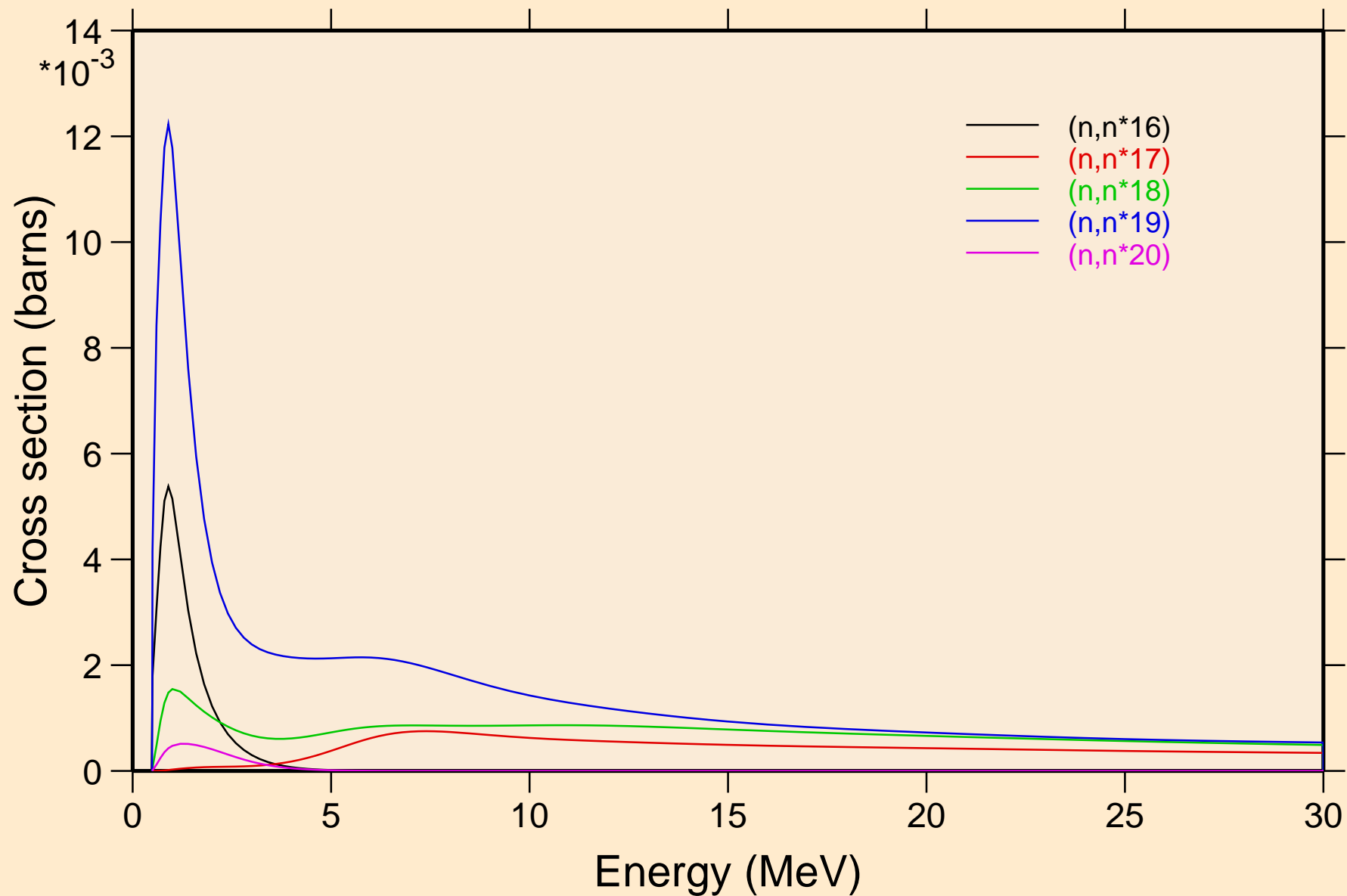

TA166 NEUTRON ACER TENDL-2019 LIBRARY; T=293.16K  
Inelastic levels

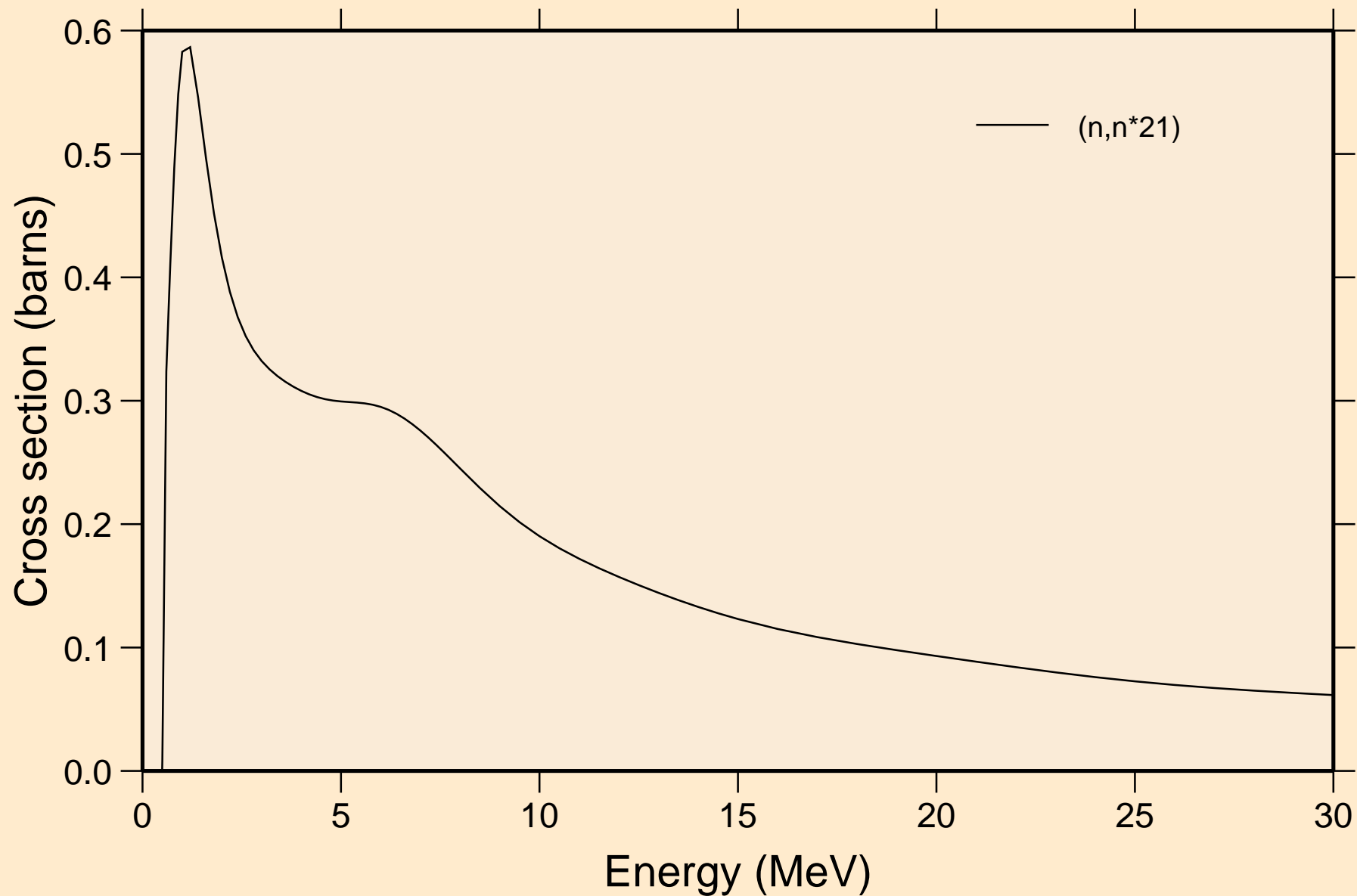

TA166 NEUTRON ACER TENDL-2019 LIBRARY; T=293.16K  
Threshold reactions

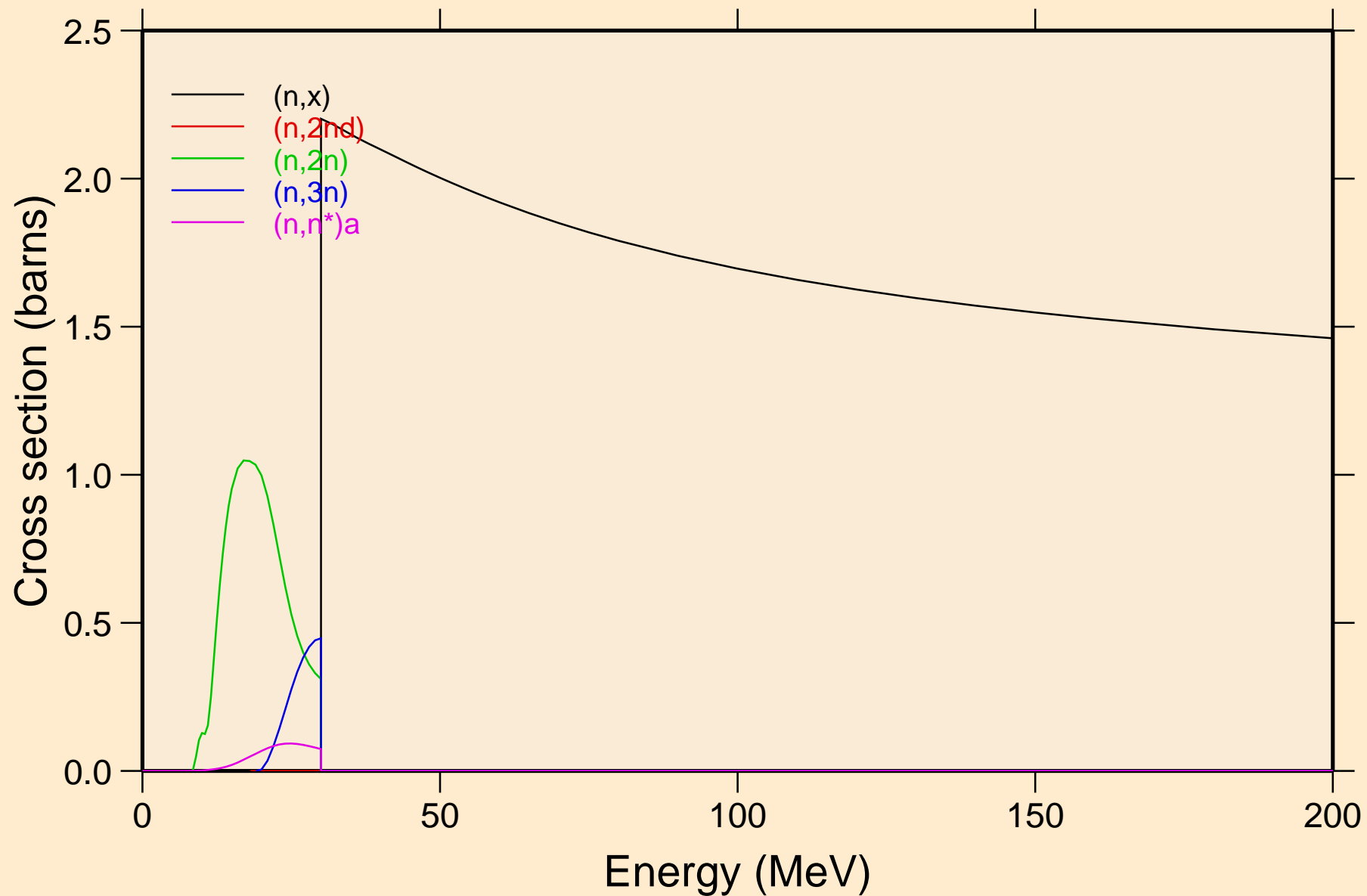



TA166 NEUTRON ACER TENDL-2019 LIBRARY; T=293.16K  
Threshold reactions

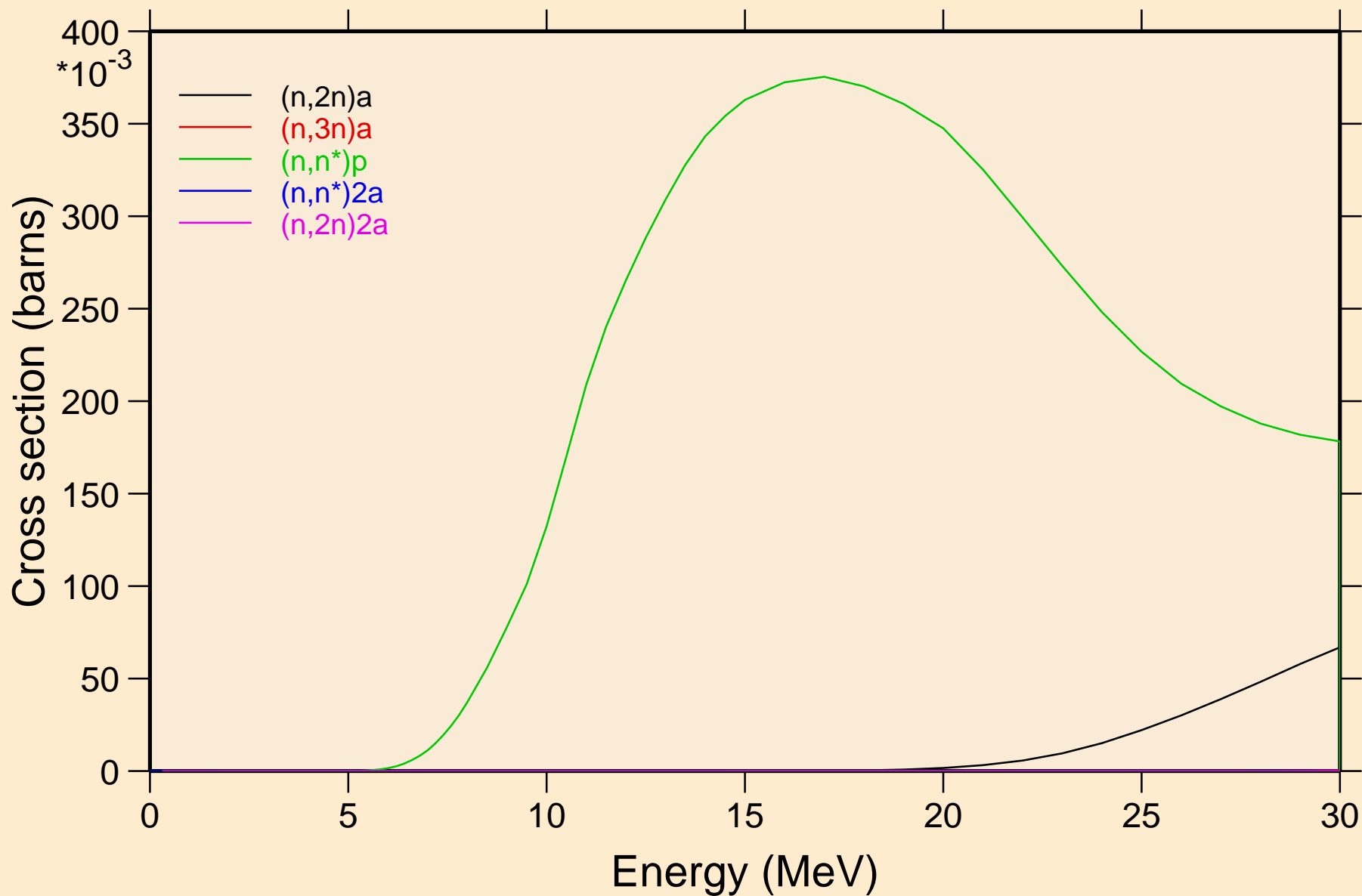

TA166 NEUTRON ACER TENDL-2019 LIBRARY; T=293.16K  
Threshold reactions

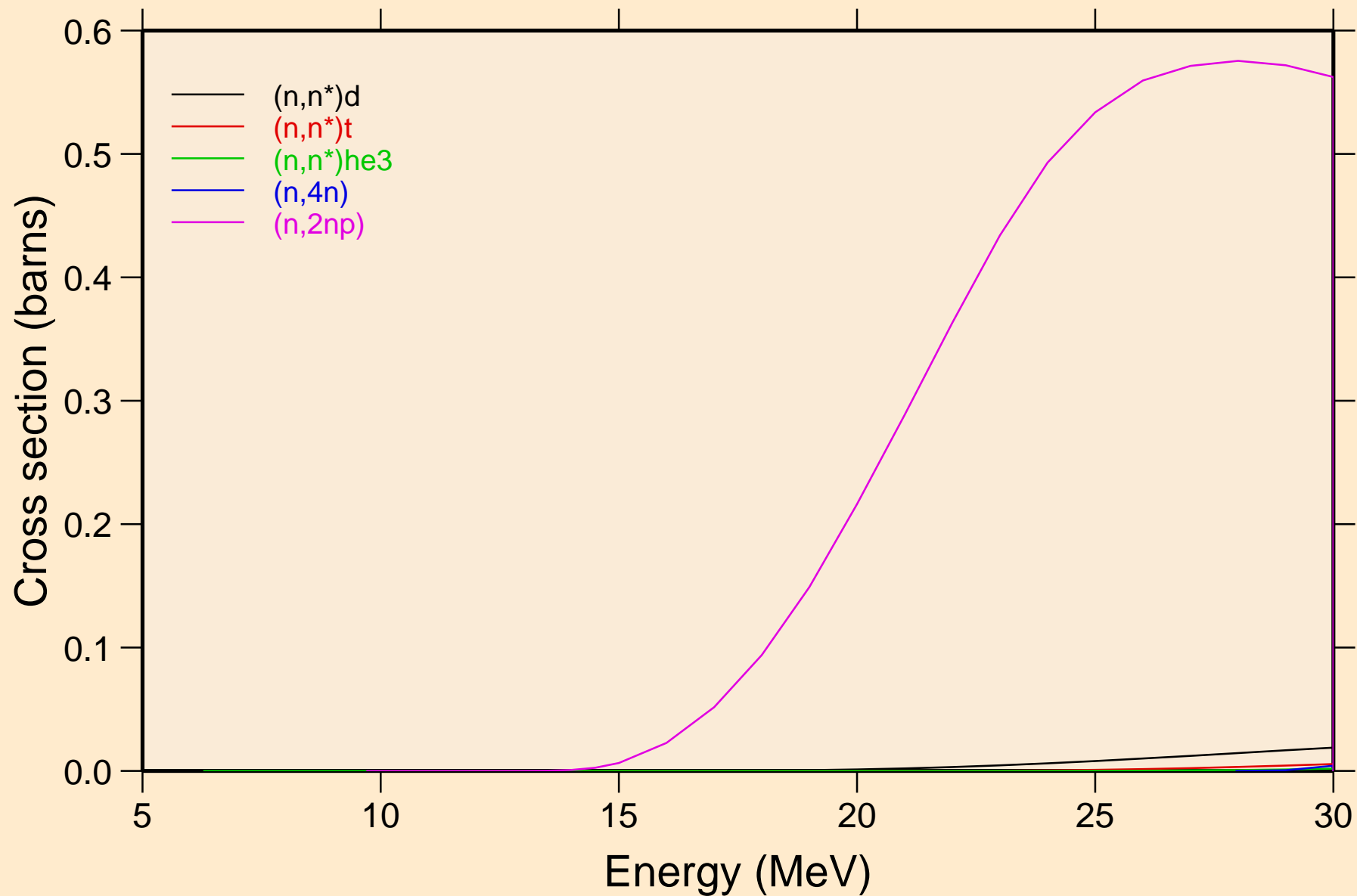

TA166 NEUTRON ACER TENDL-2019 LIBRARY; T=293.16K  
Threshold reactions

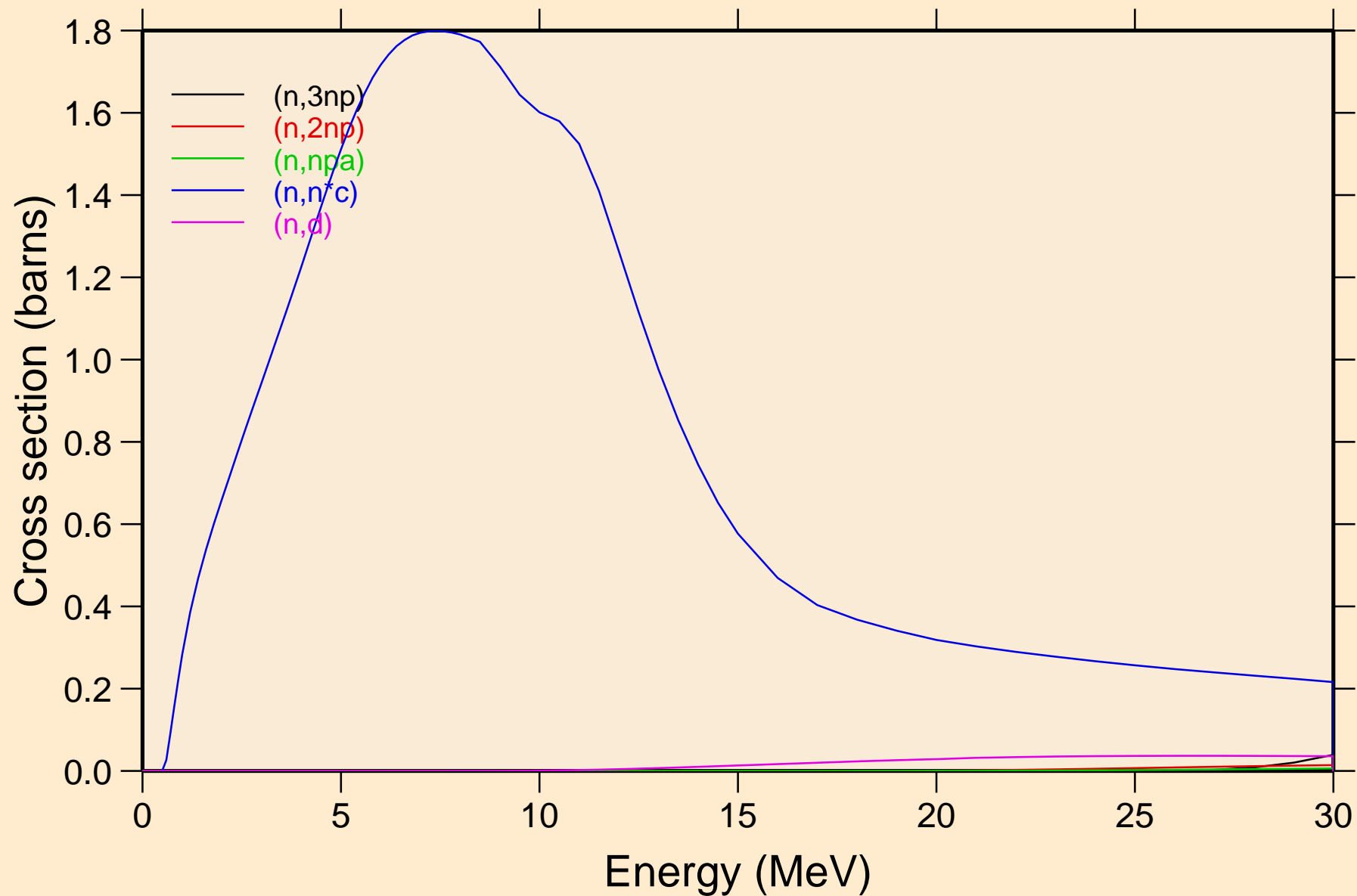

TA166 NEUTRON ACER TENDL-2019 LIBRARY; T=293.16K  
Threshold reactions

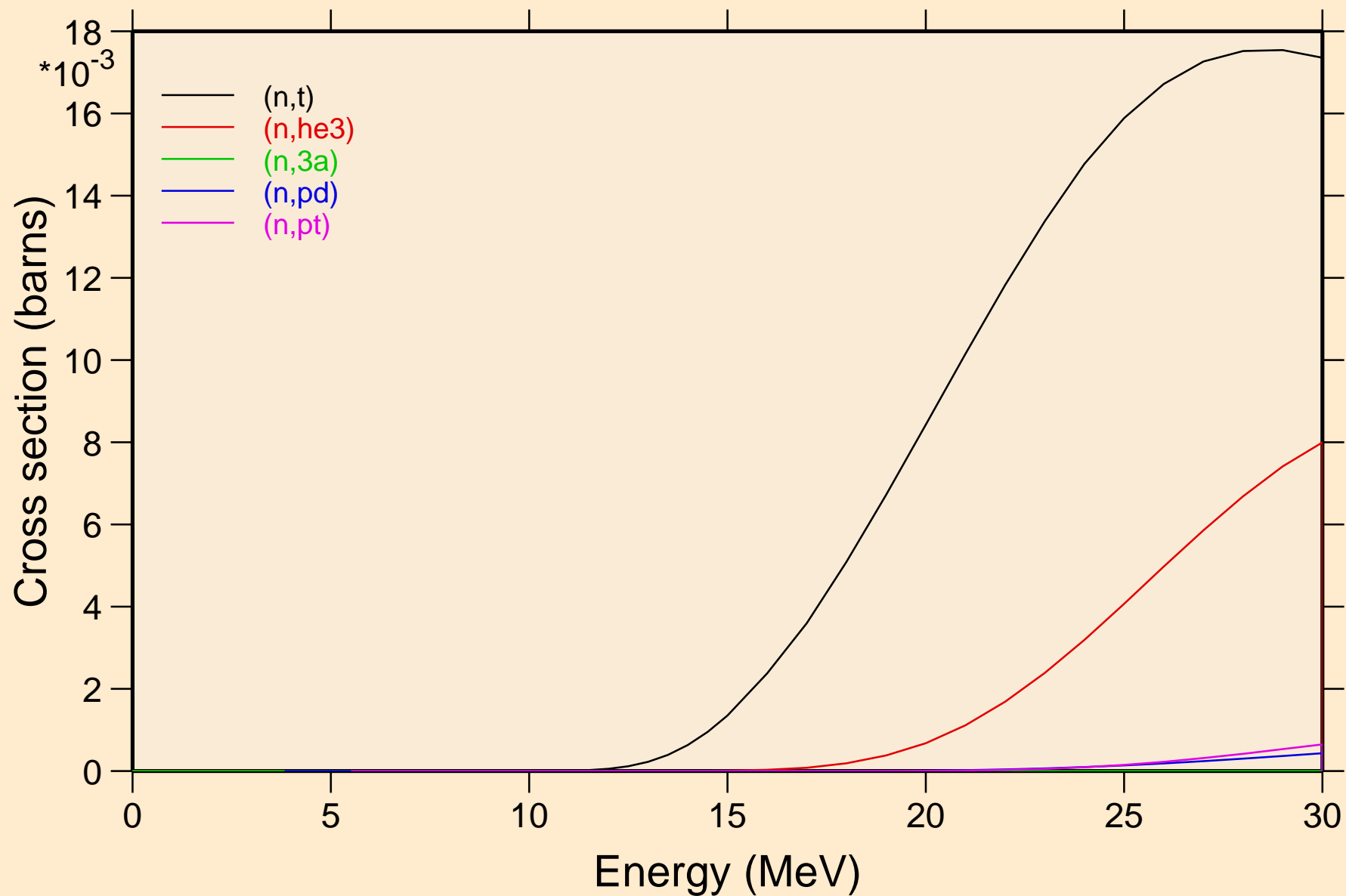

TA166 NEUTRON ACER TENDL-2019 LIBRARY; T=293.16K  
Threshold reactions

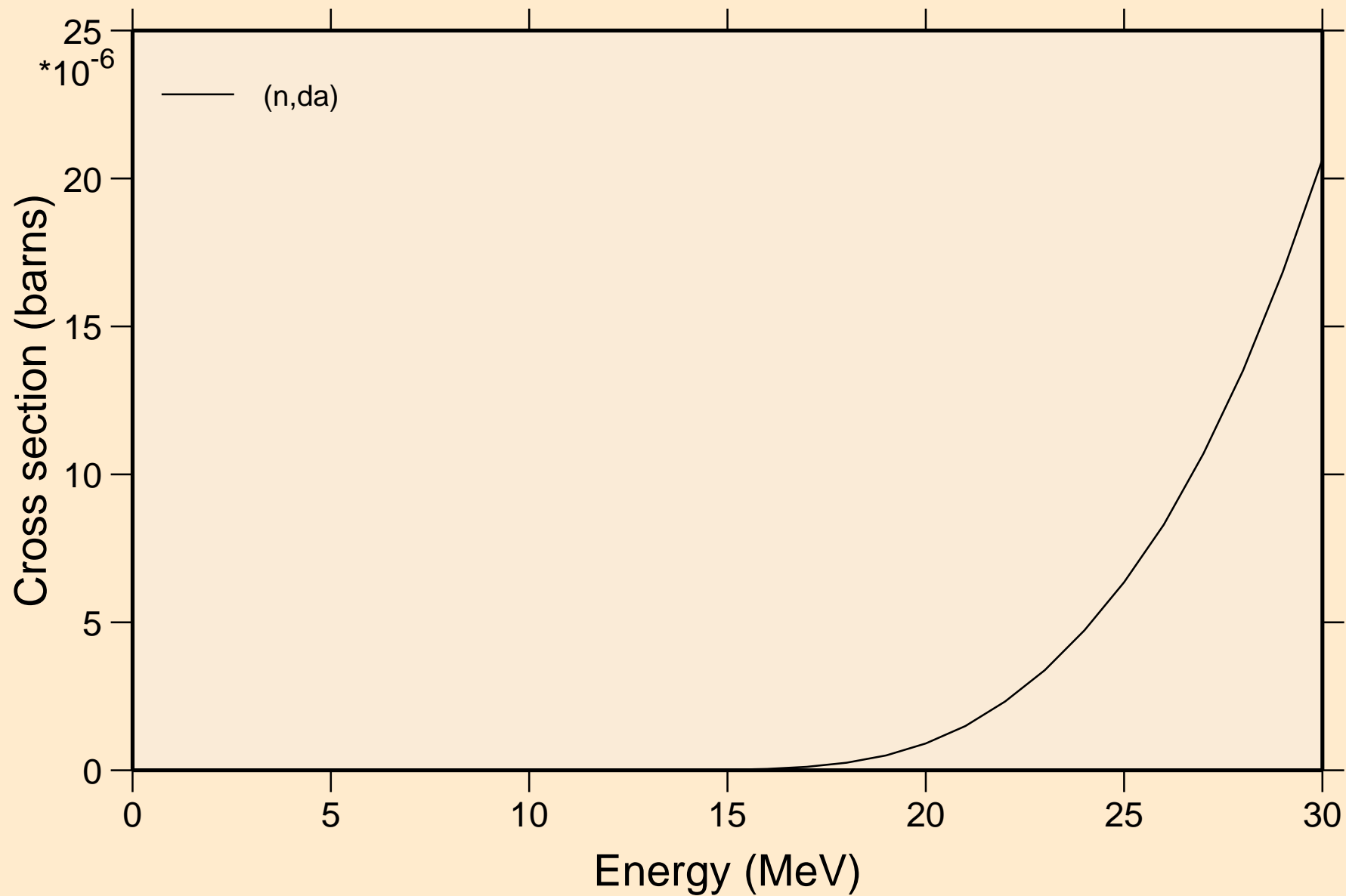

TA166 NEUTRON ACER TENDL-2019 LIBRARY; T=293.16K  
Threshold reactions

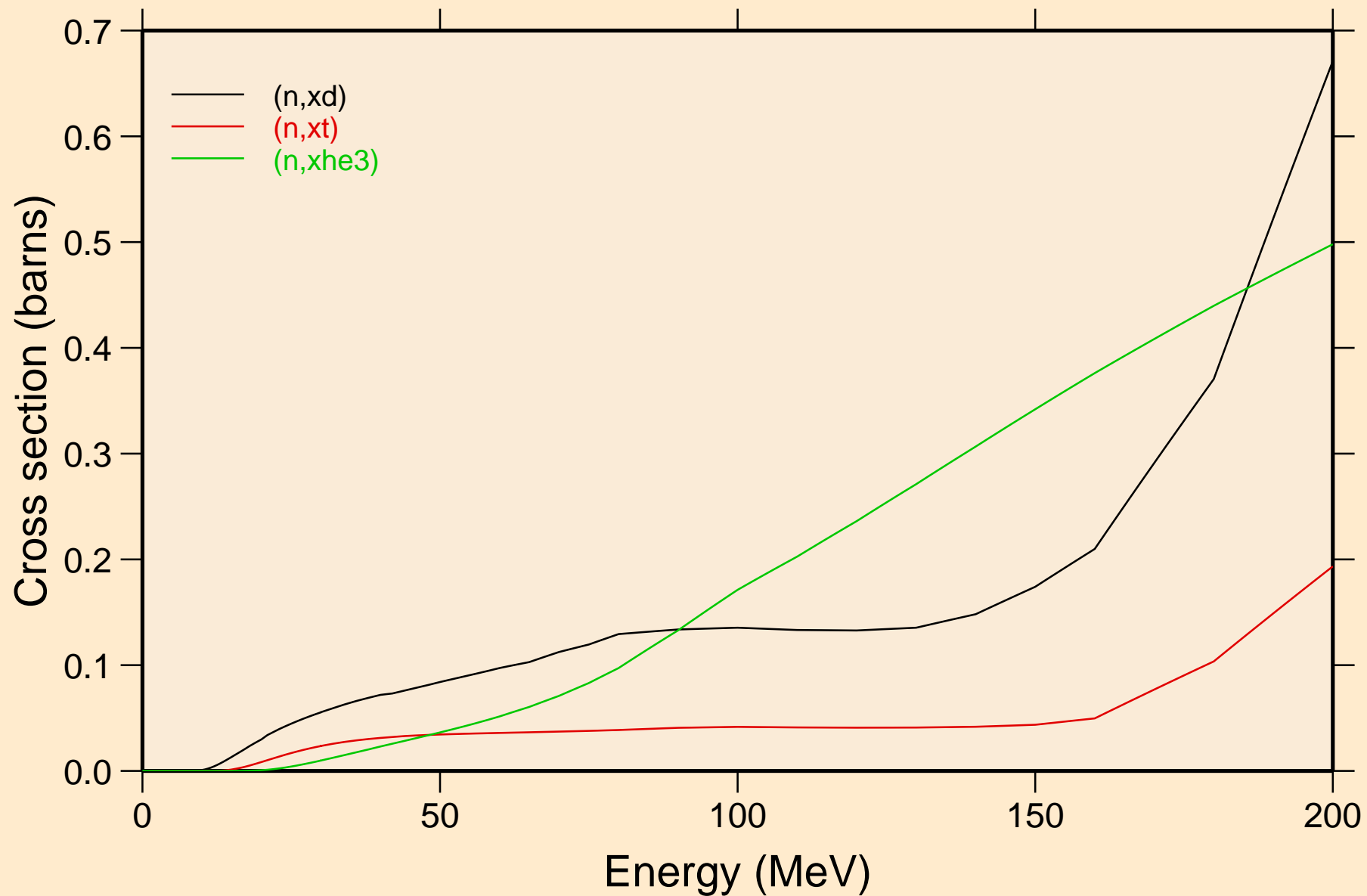

TA166 NEUTRON ACER TENDL-2019 LIBRARY; T=293.16K  
angular distribution for elastic

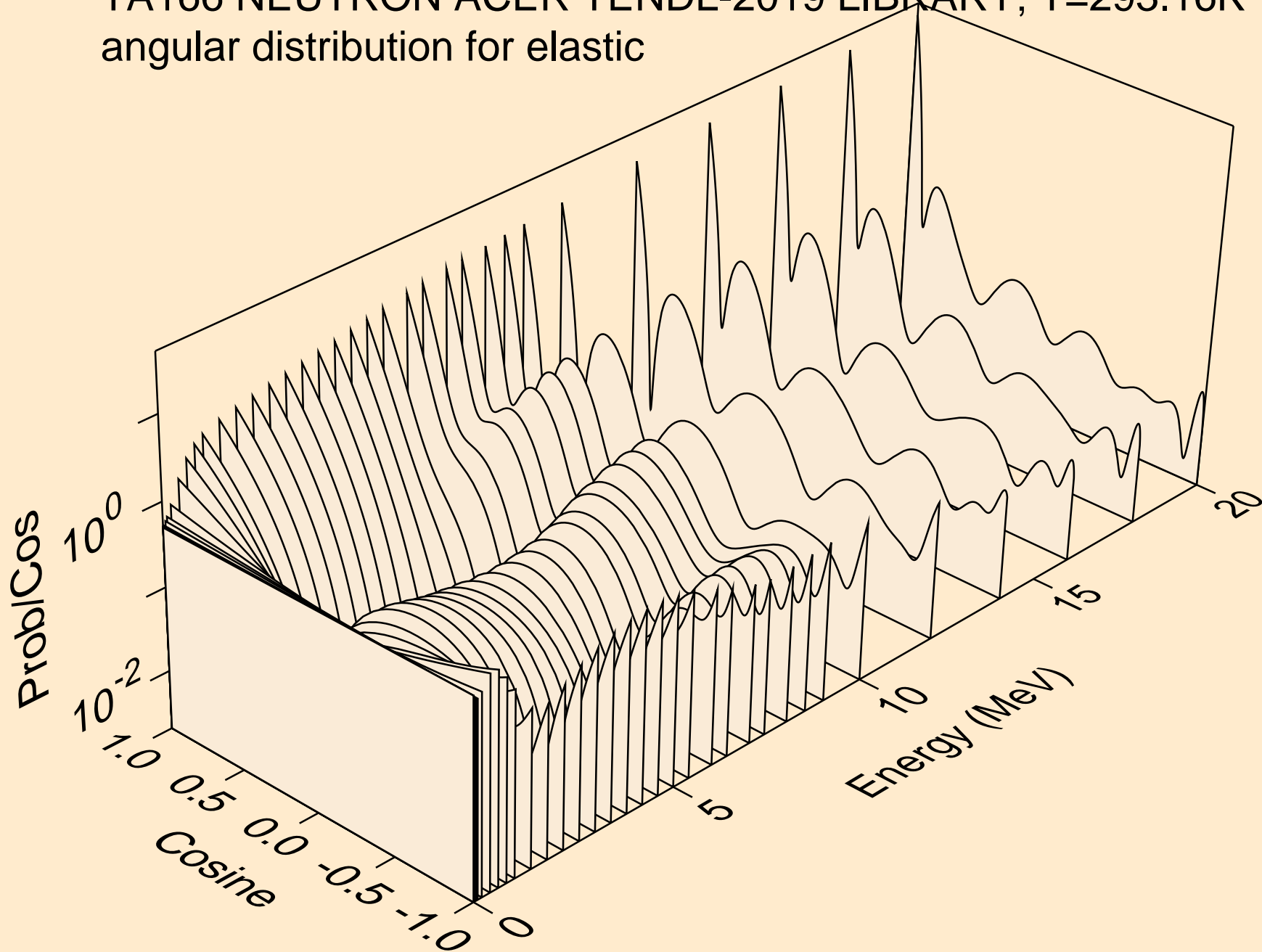

TA166 NEUTRON ACER TENDL-2019 LIBRARY; T=293.16K  
angular distribution for elastic

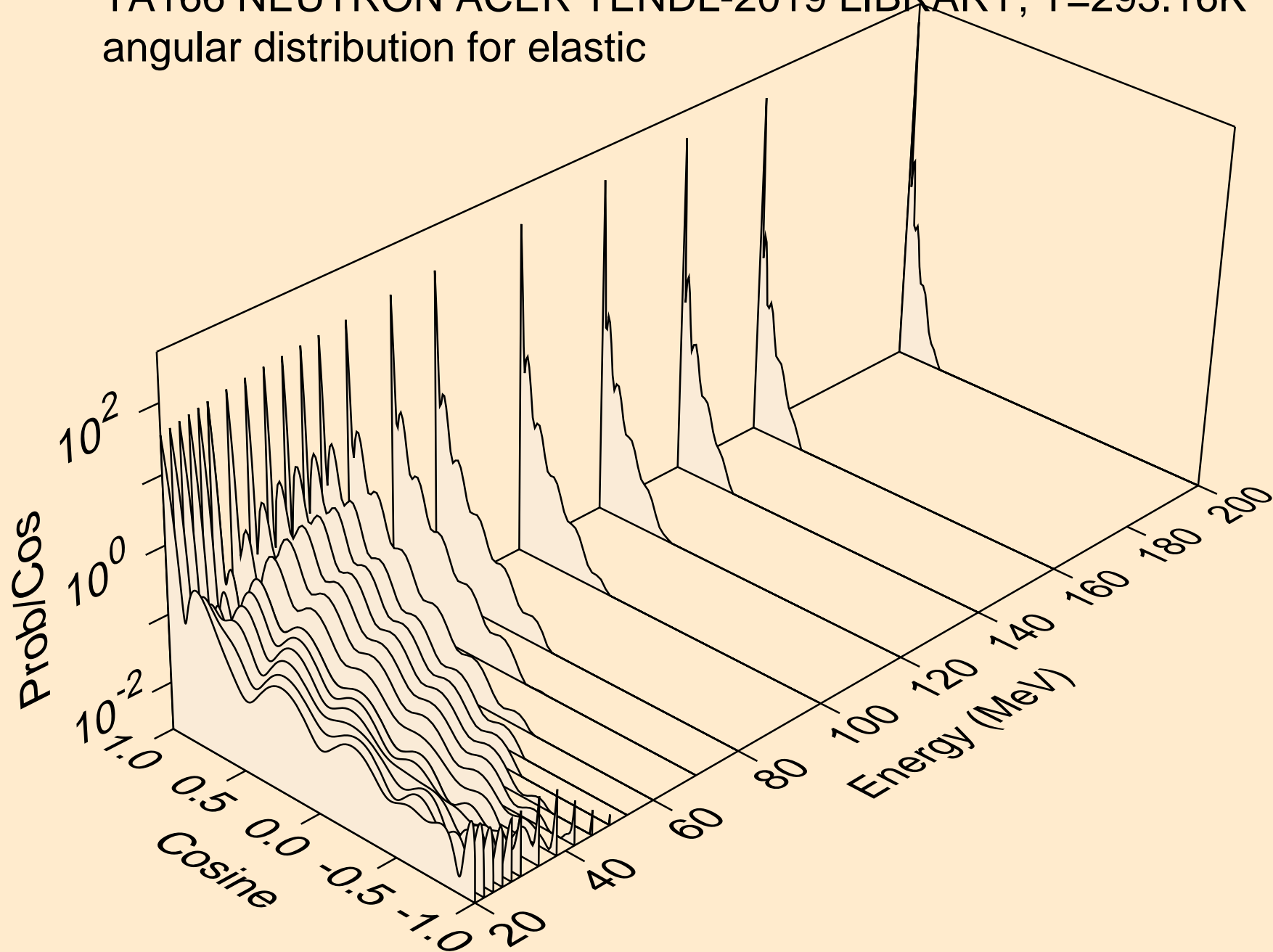



TA166 NEUTRON ACER TENDL-2019 LIBRARY; T=293.16K  
angular distribution for (n,n\*1)

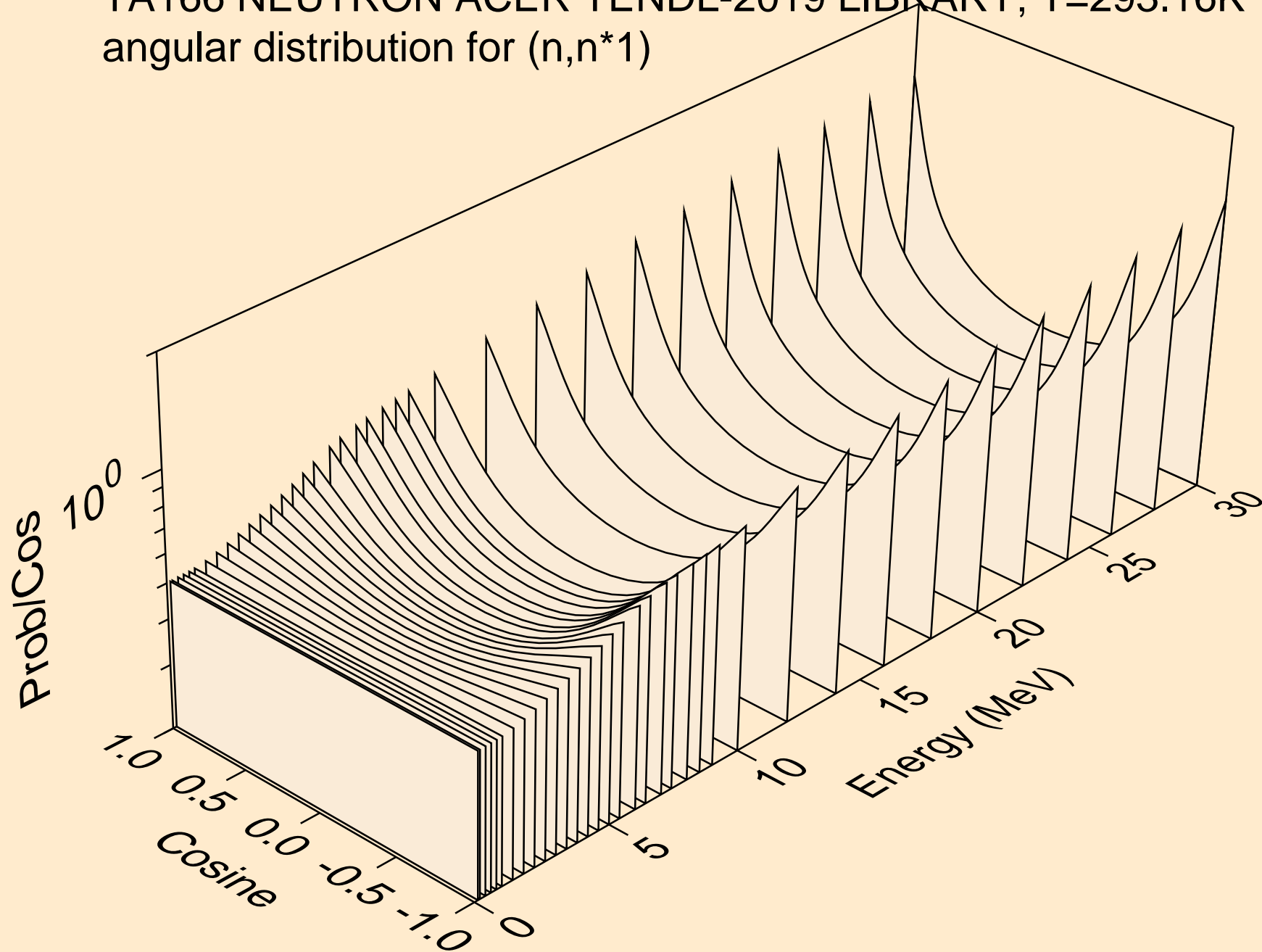

TA166 NEUTRON ACER TENDL-2019 LIBRARY; T=293.16K  
angular distribution for (n,n\*2)

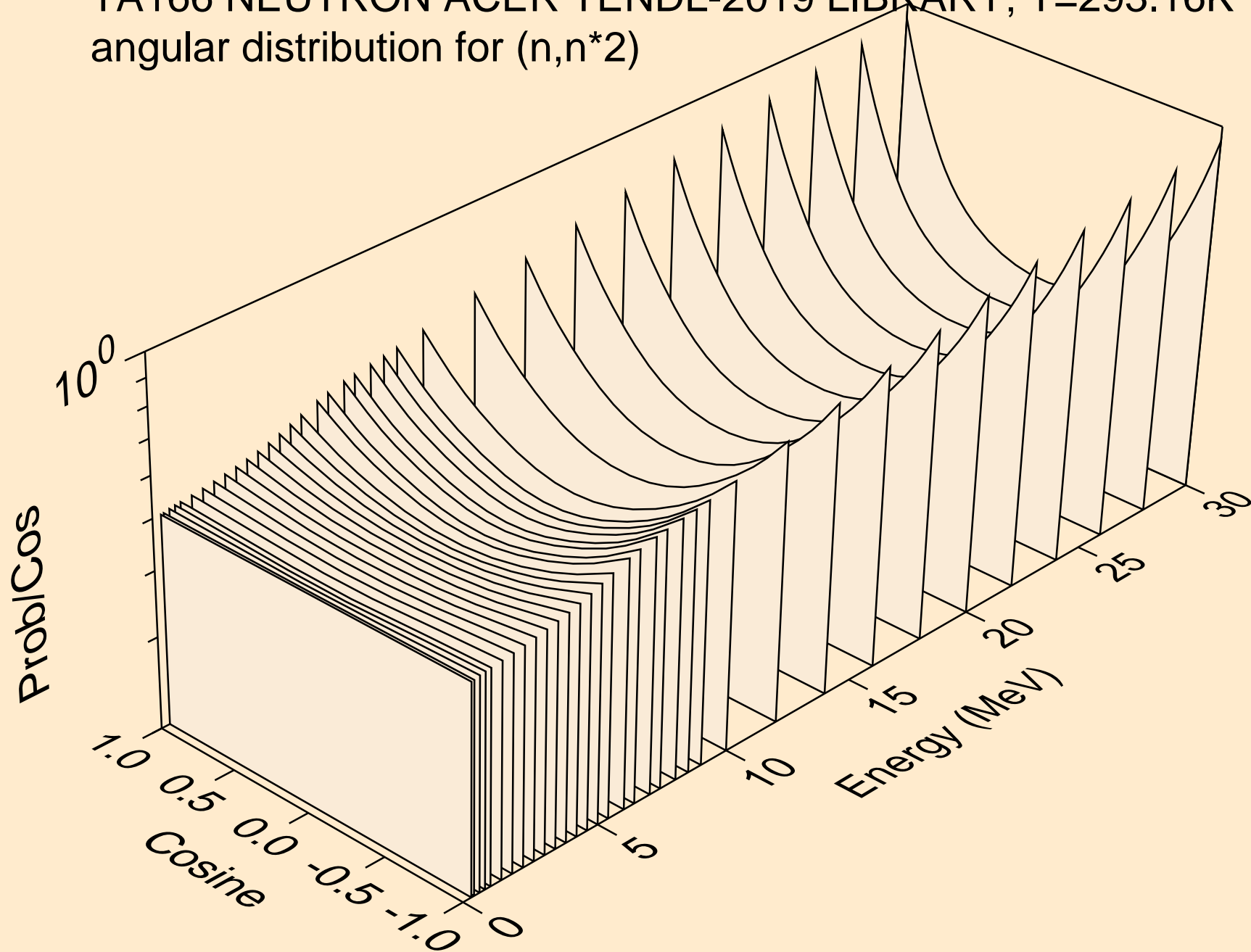

TA166 NEUTRON ACER TENDL-2019 LIBRARY; T=293.16K  
angular distribution for (n,n\*3)

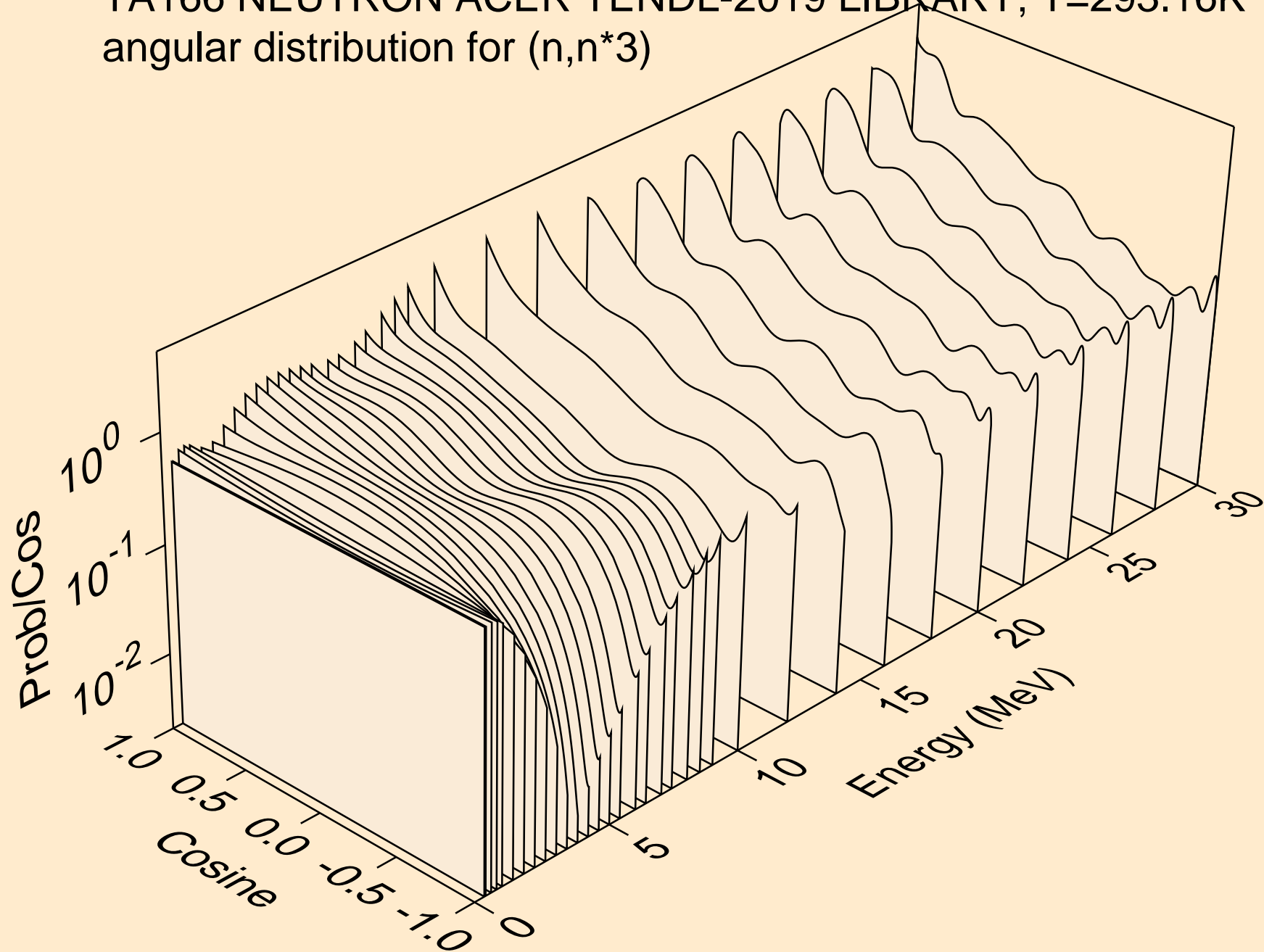

TA166 NEUTRON ACER TENDL-2019 LIBRARY; T=293.16K  
angular distribution for (n,n\*4)

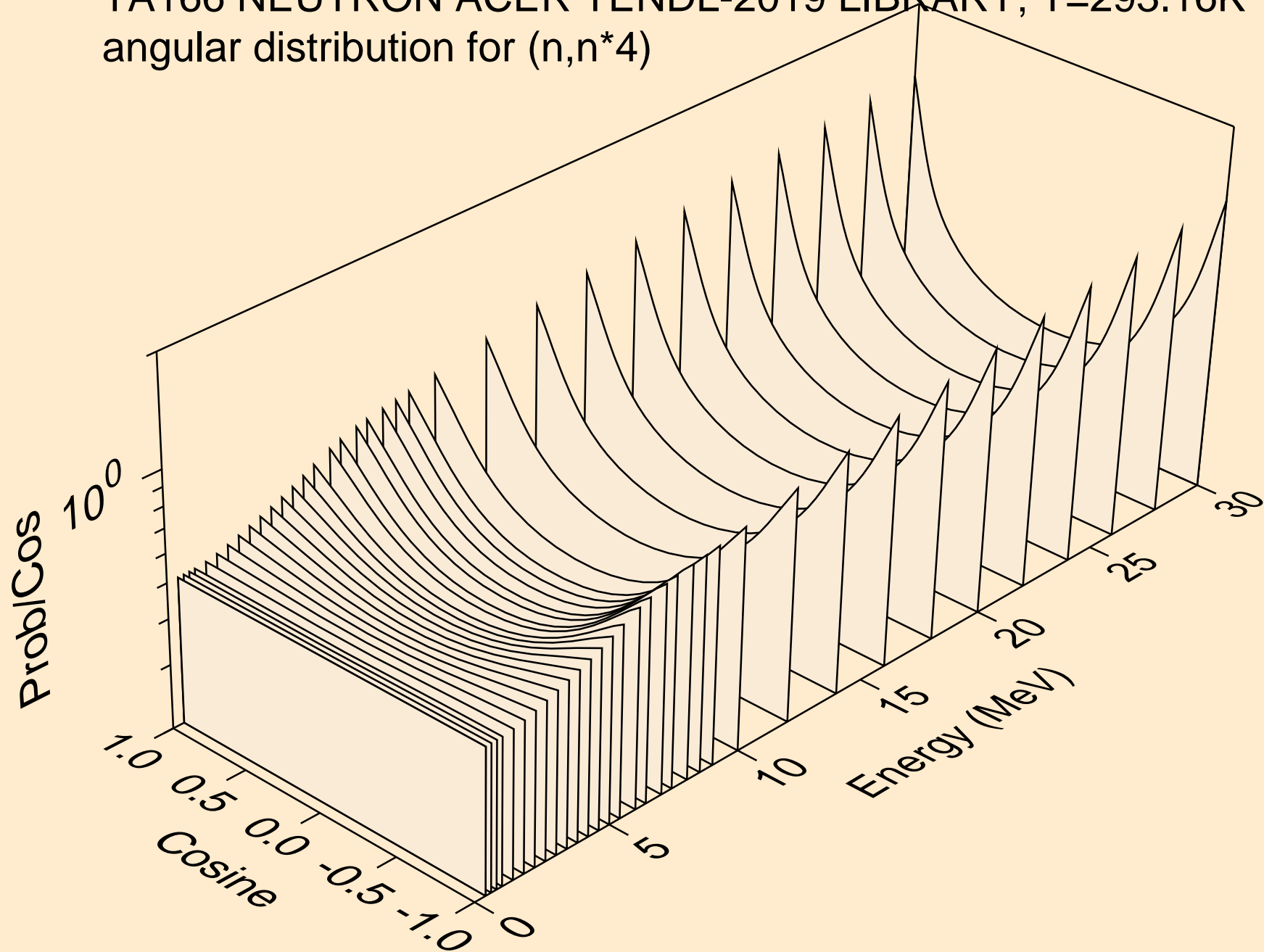

TA166 NEUTRON ACER TENDL-2019 LIBRARY; T=293.16K  
angular distribution for (n,n\*5)

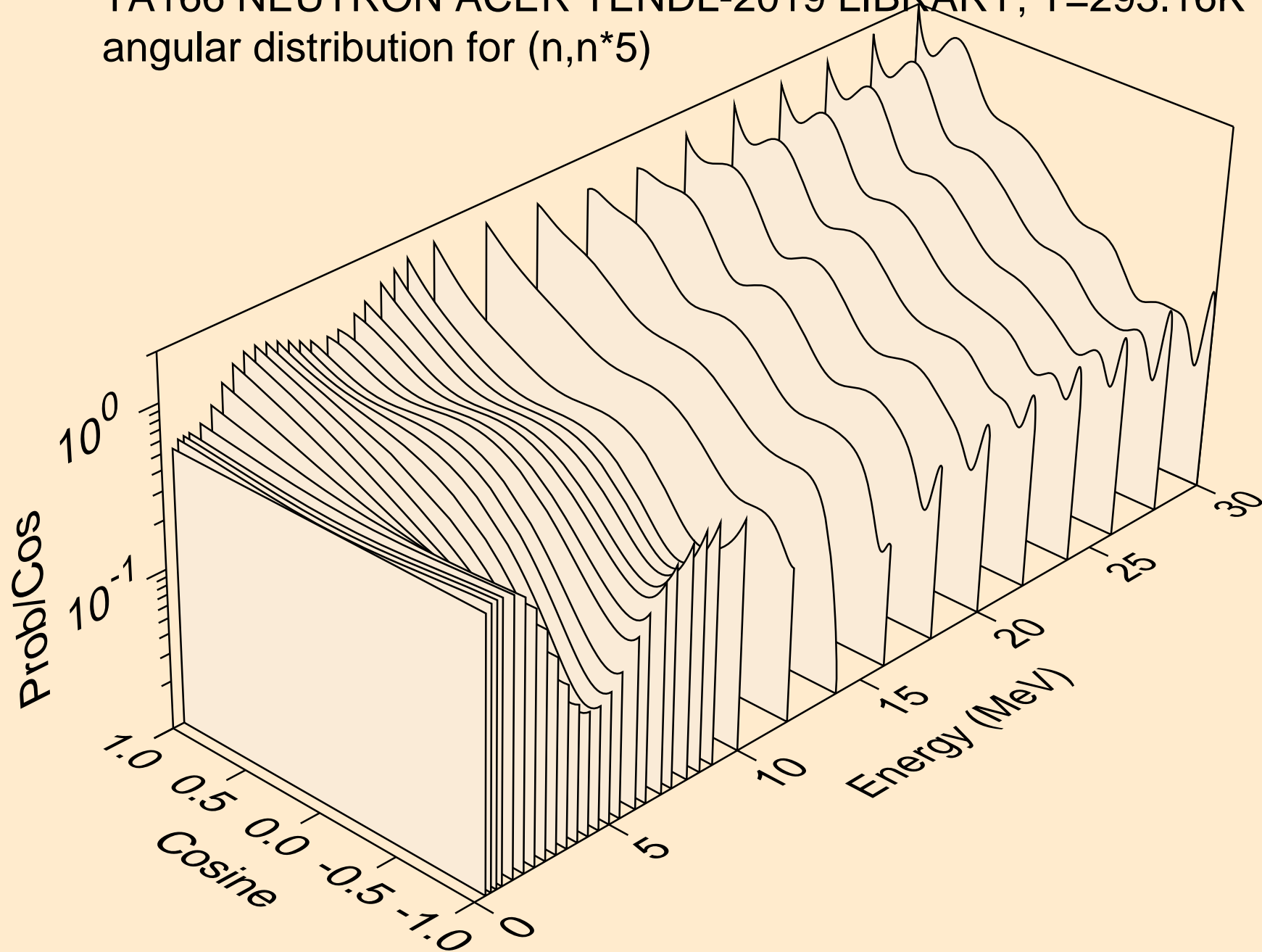

TA166 NEUTRON ACER TENDL-2019 LIBRARY; T=293.16K  
angular distribution for (n,n\*6)

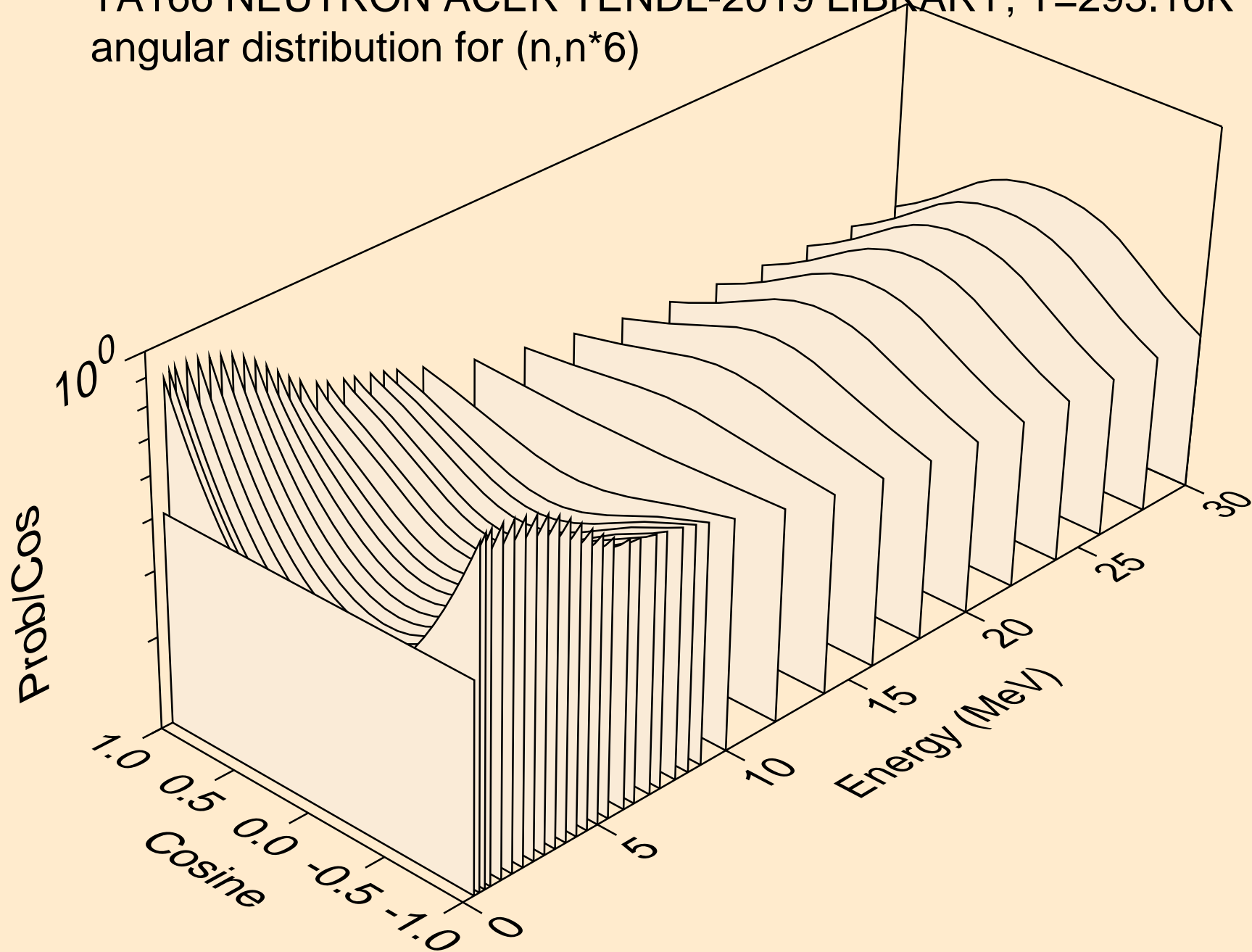

TA166 NEUTRON ACER TENDL-2019 LIBRARY; T=293.16K  
angular distribution for (n,n\*7)

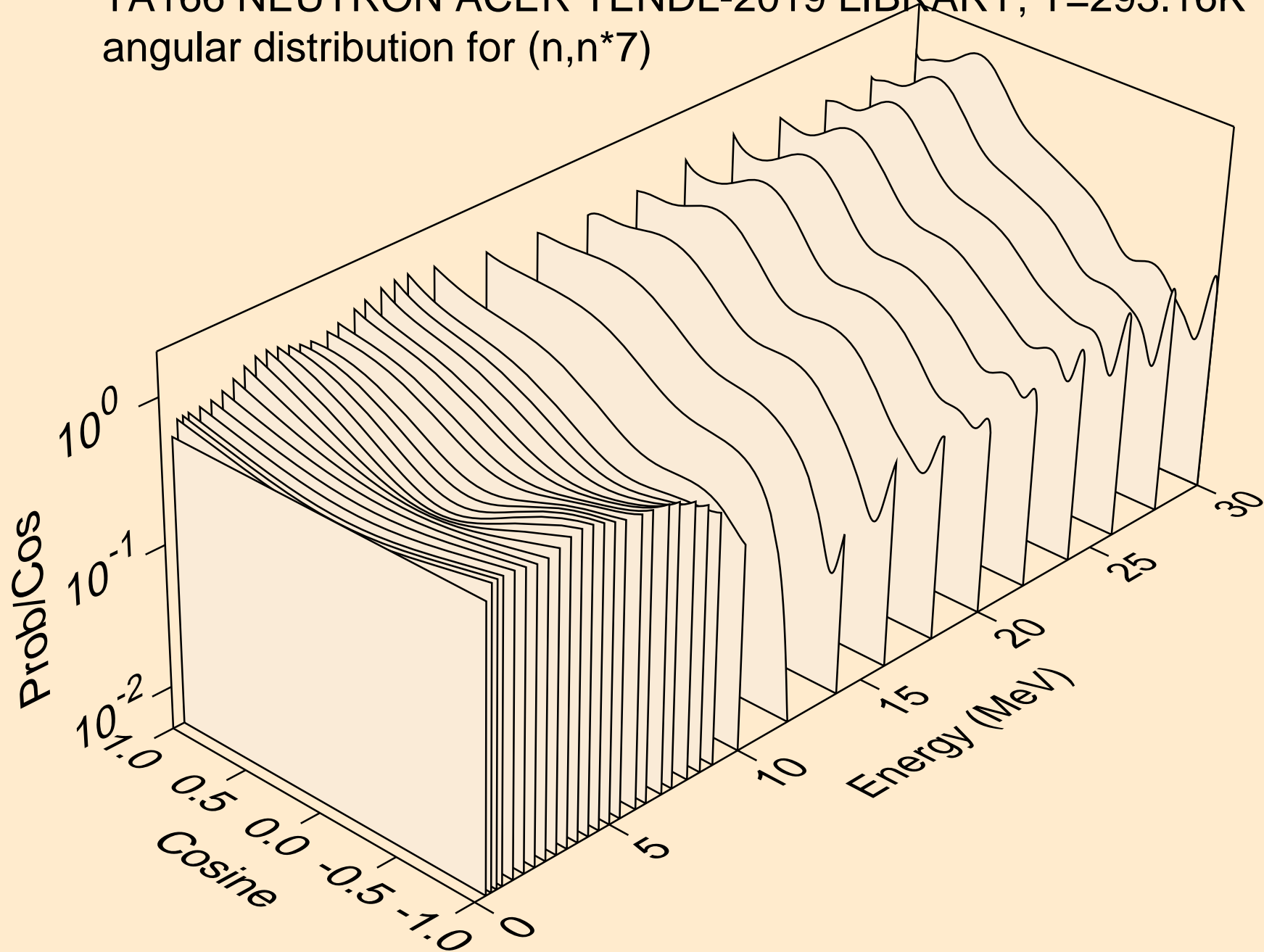

TA166 NEUTRON ACER TENDL-2019 LIBRARY; T=293.16K  
angular distribution for (n,n\*8)

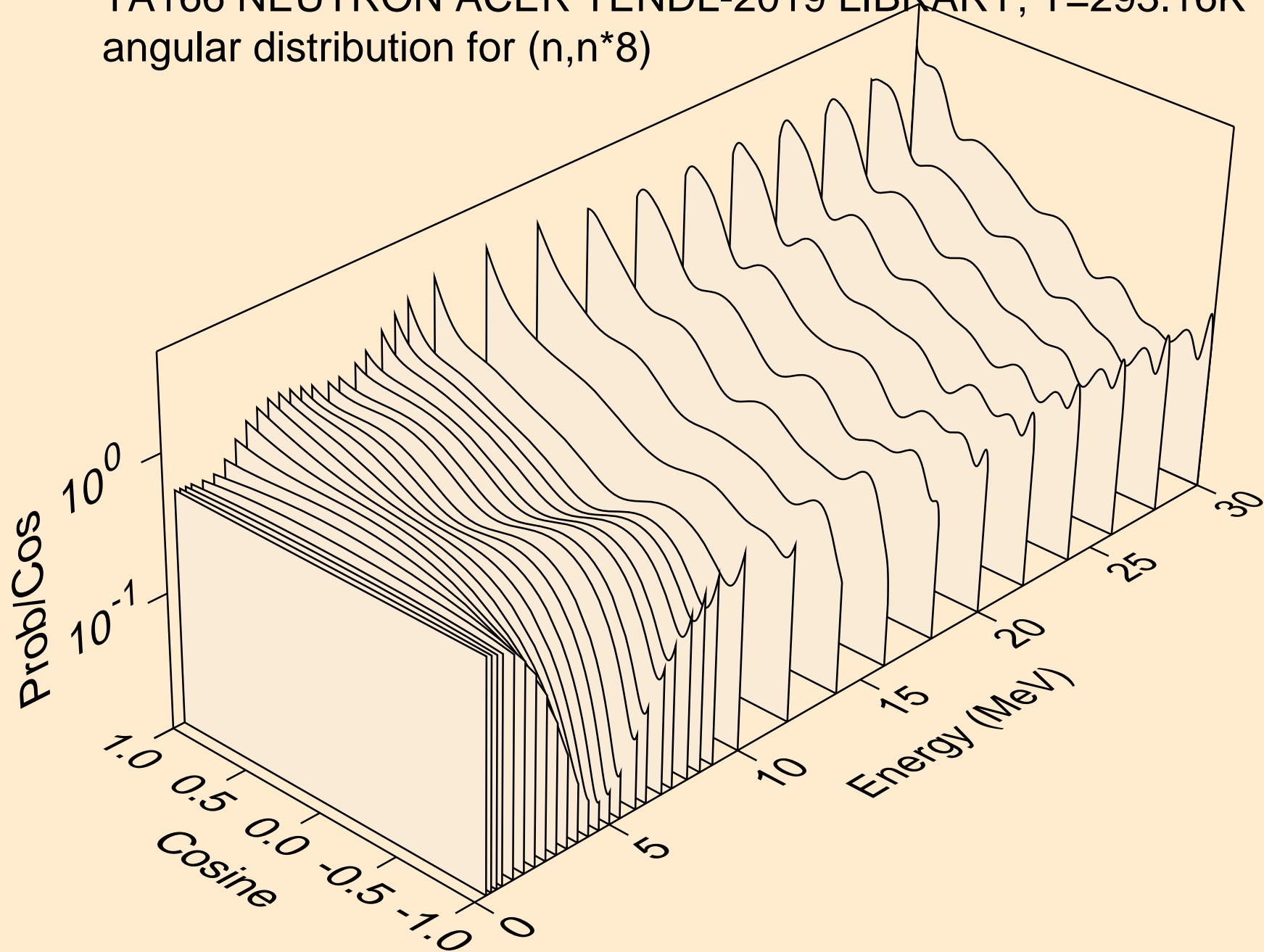



TA166 NEUTRON ACER TENDL-2019 LIBRARY; T=293.16K  
angular distribution for (n,n\*9)

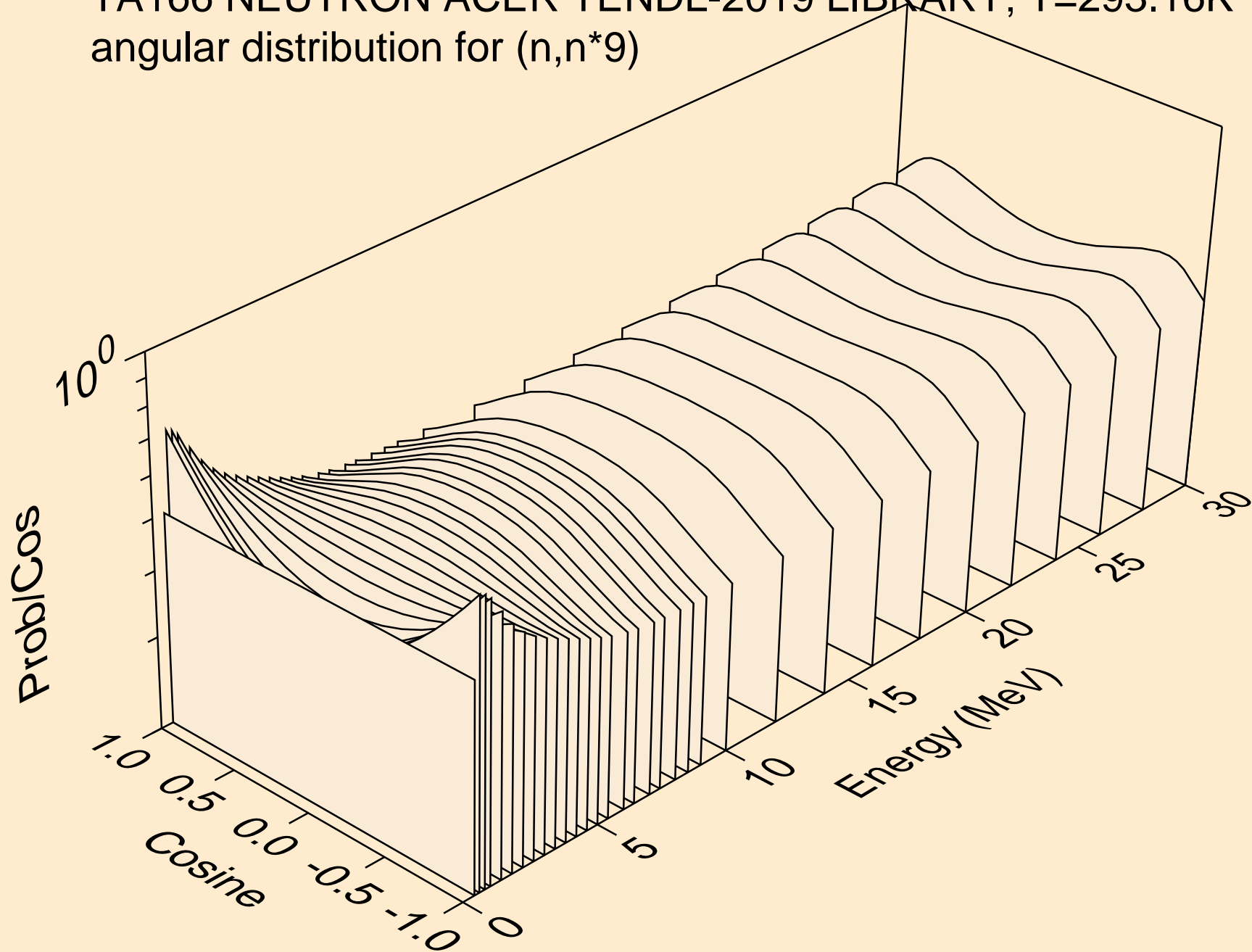

TA166 NEUTRON ACER TENDL-2019 LIBRARY; T=293.16K  
angular distribution for (n,n\*10)

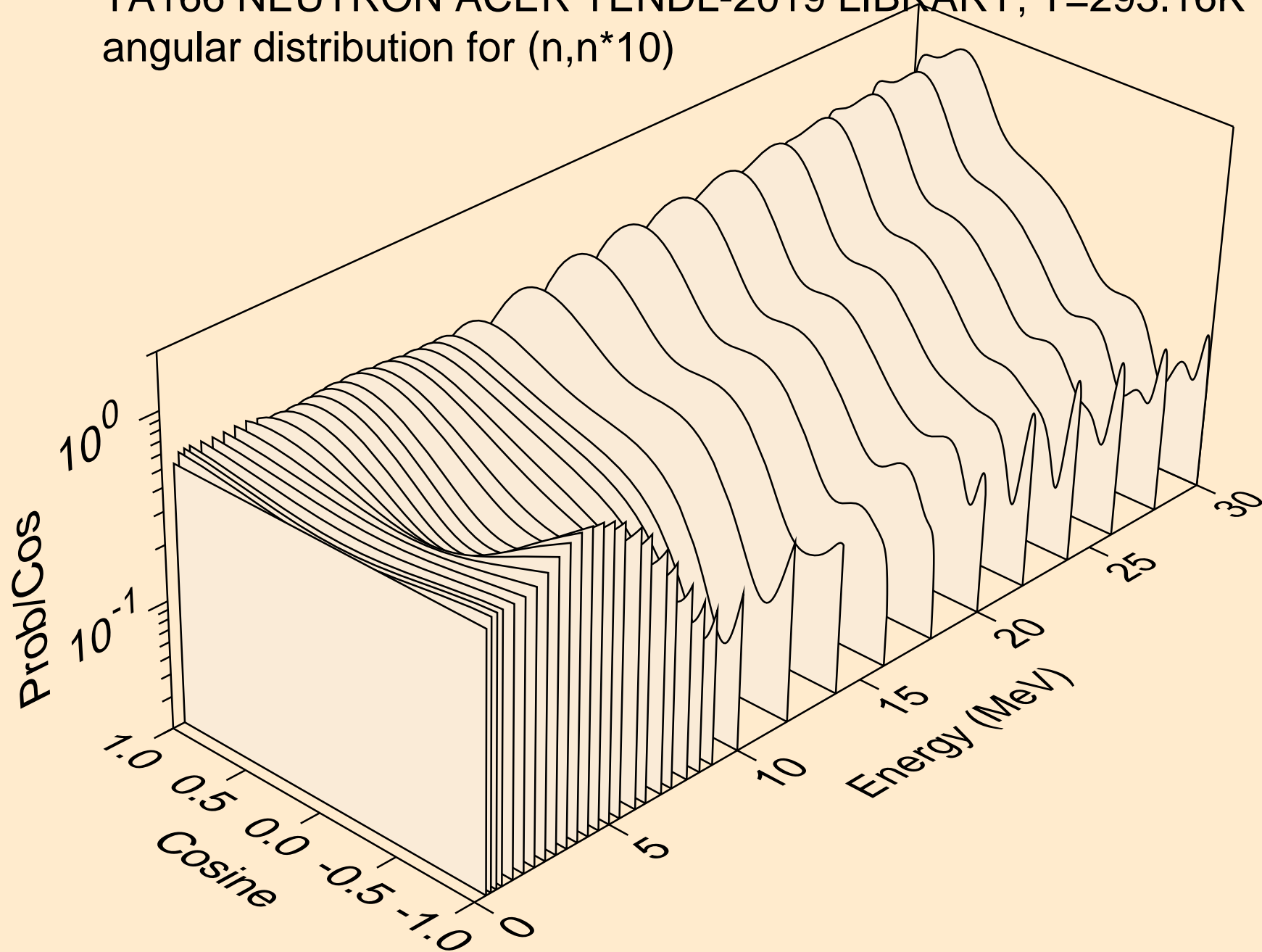

TA166 NEUTRON ACER TENDL-2019 LIBRARY; T=293.16K  
angular distribution for (n,n\*11)

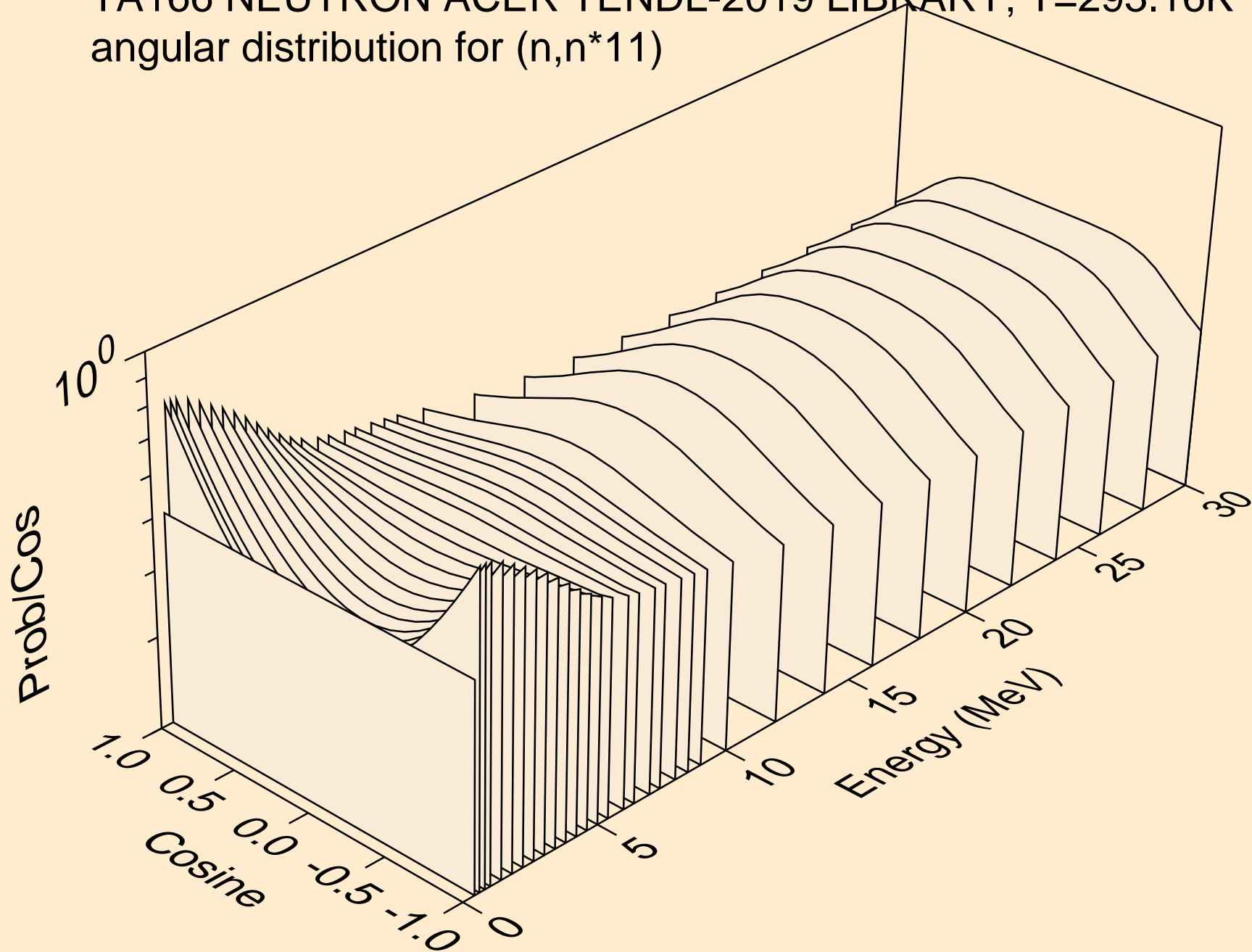

TA166 NEUTRON ACER TENDL-2019 LIBRARY; T=293.16K  
angular distribution for (n,n\*12)

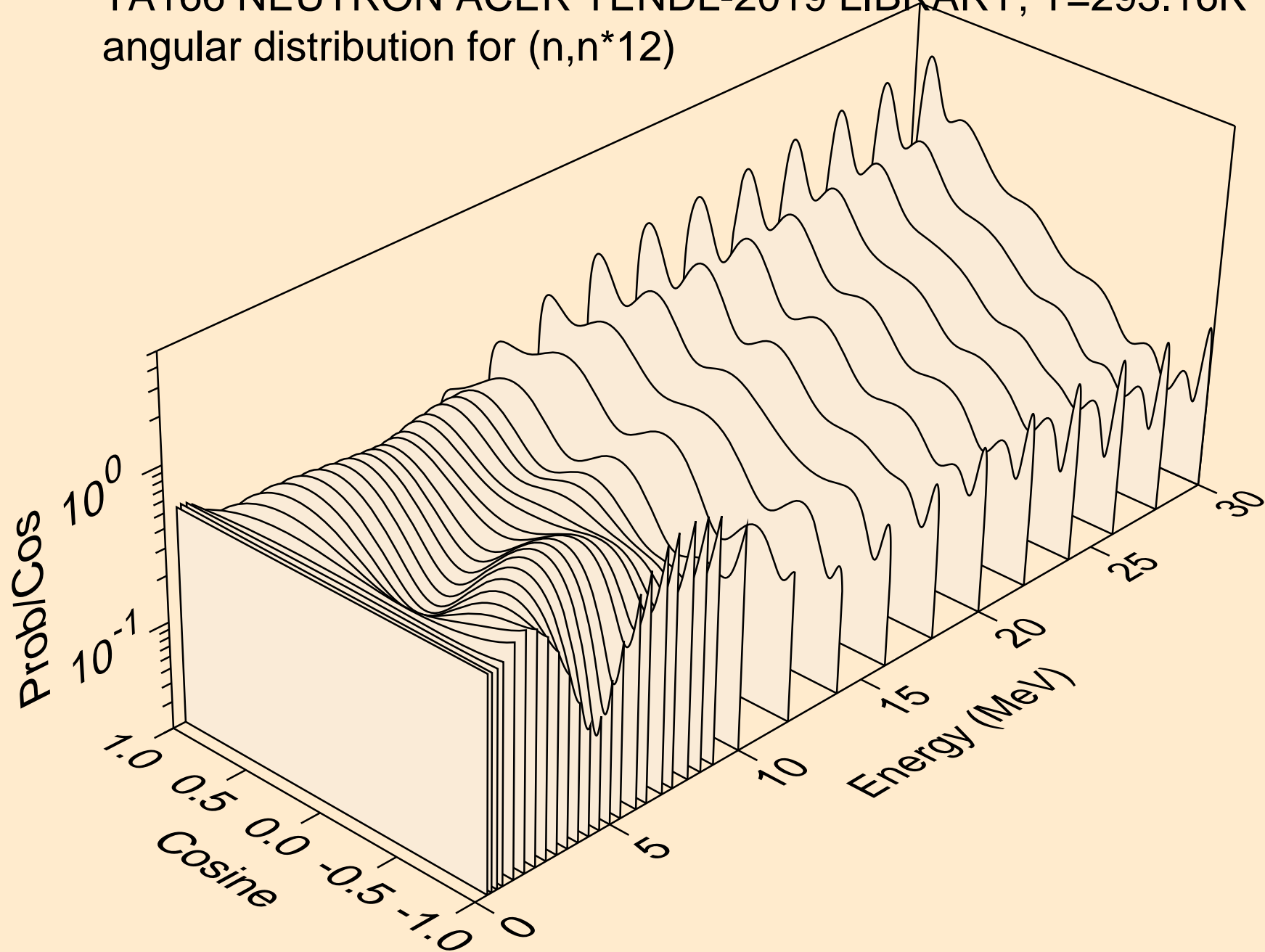

TA166 NEUTRON ACER TENDL-2019 LIBRARY; T=293.16K  
angular distribution for (n,n\*13)

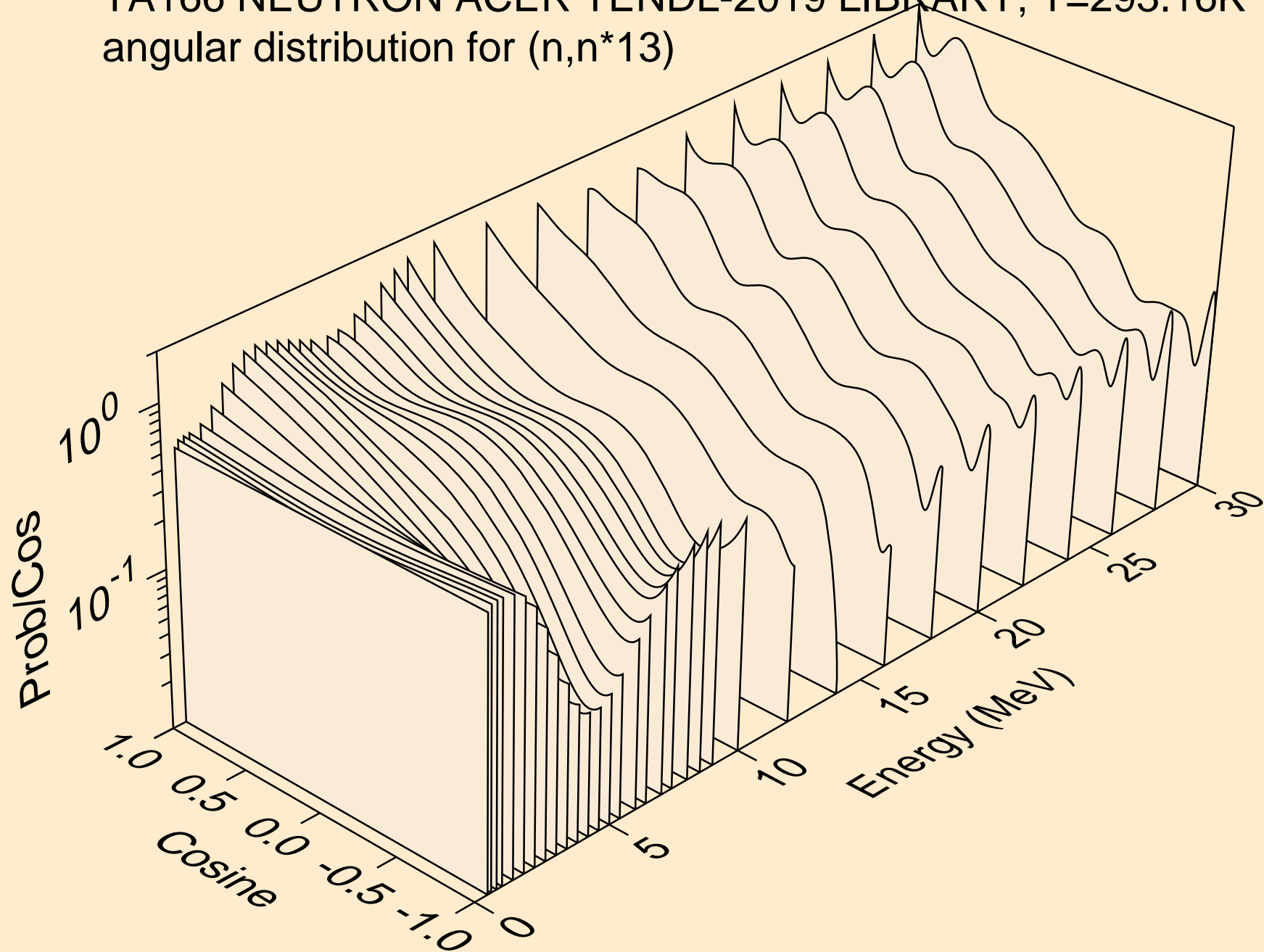

TA166 NEUTRON ACER TENDL-2019 LIBRARY; T=293.16K  
angular distribution for (n,n\*14)

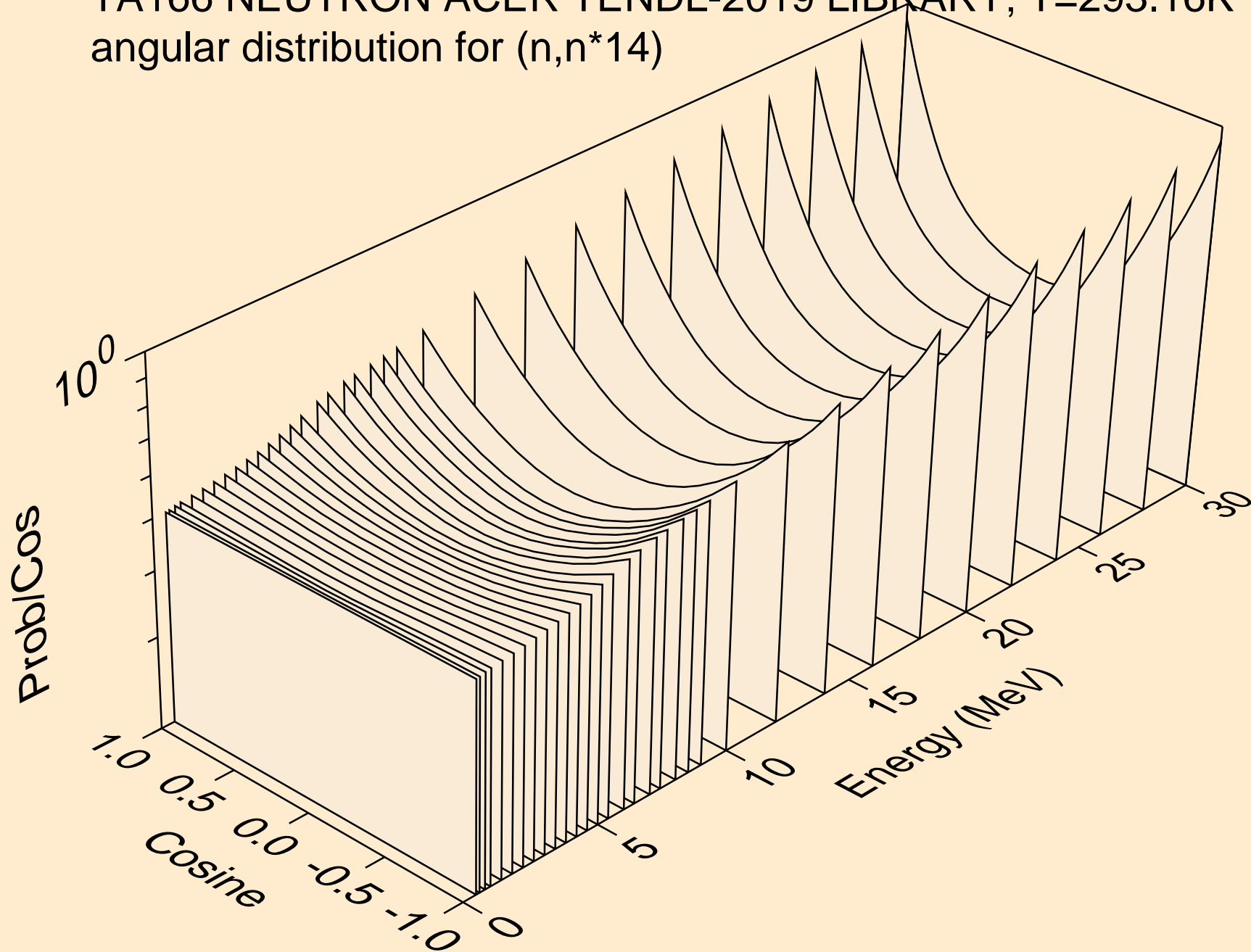

TA166 NEUTRON ACER TENDL-2019 LIBRARY; T=293.16K  
angular distribution for (n,n\*15)

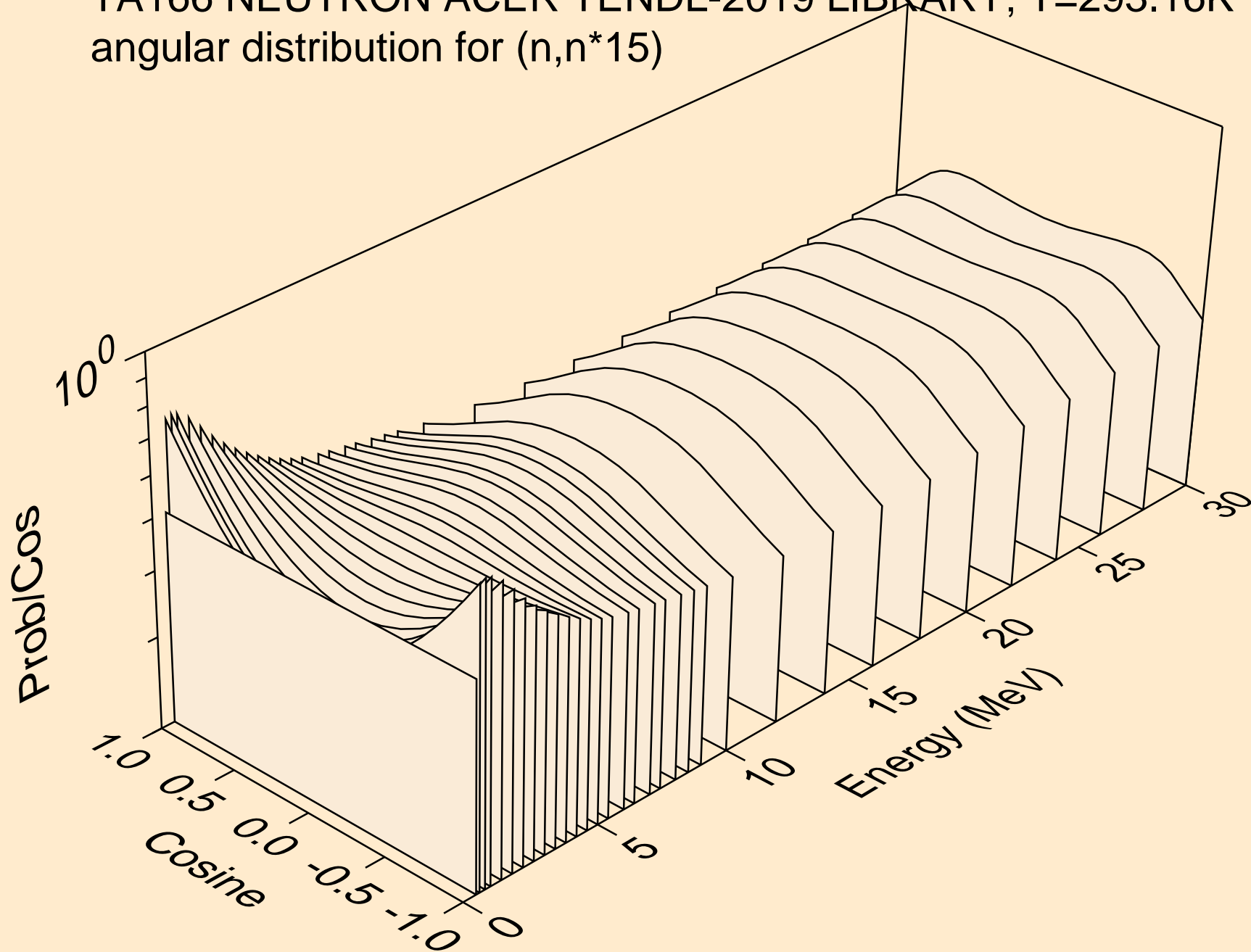

TA166 NEUTRON ACER TENDL-2019 LIBRARY; T=293.16K  
angular distribution for (n,n\*16)

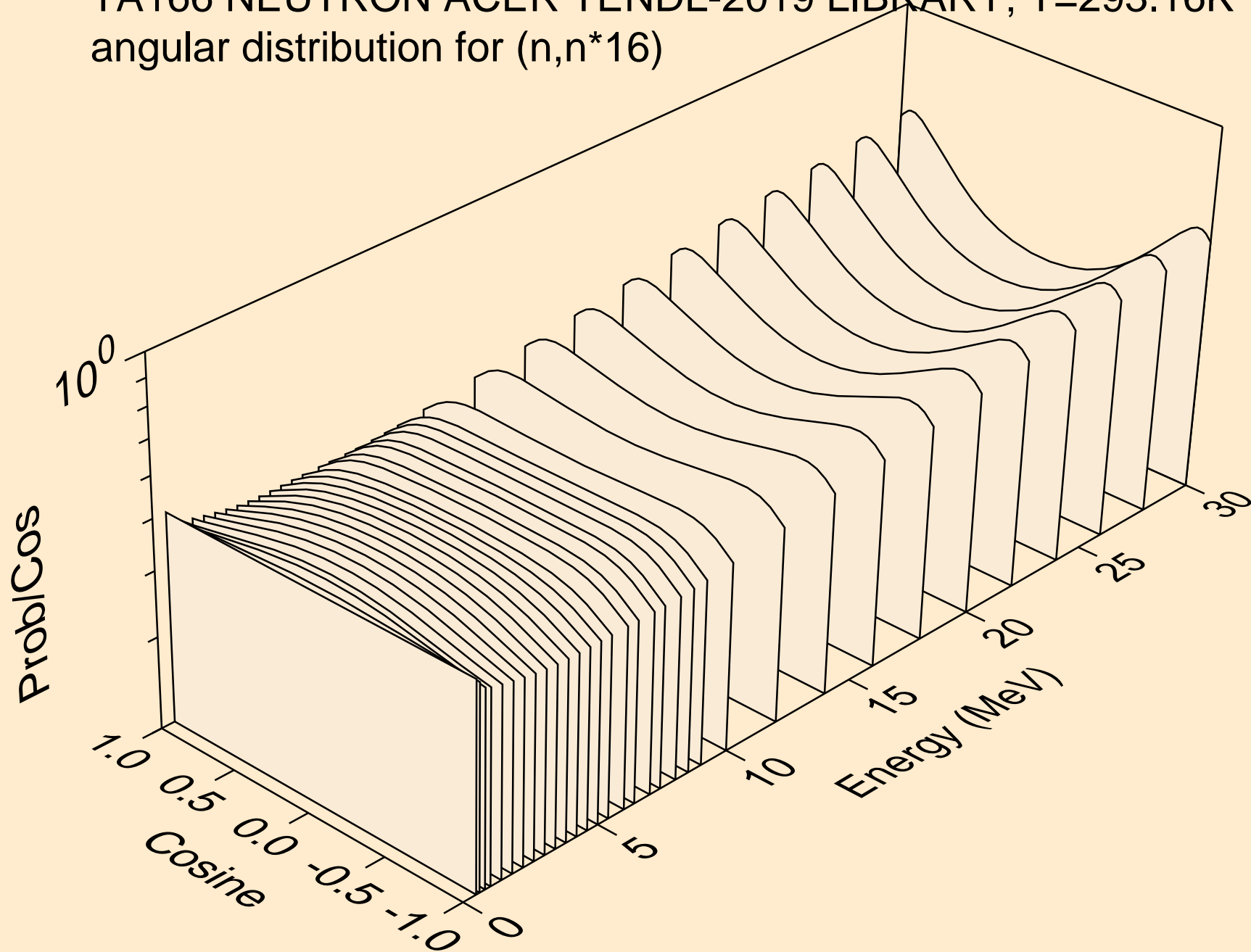



TA166 NEUTRON ACER TENDL-2019 LIBRARY; T=293.16K  
angular distribution for (n,n\*17)

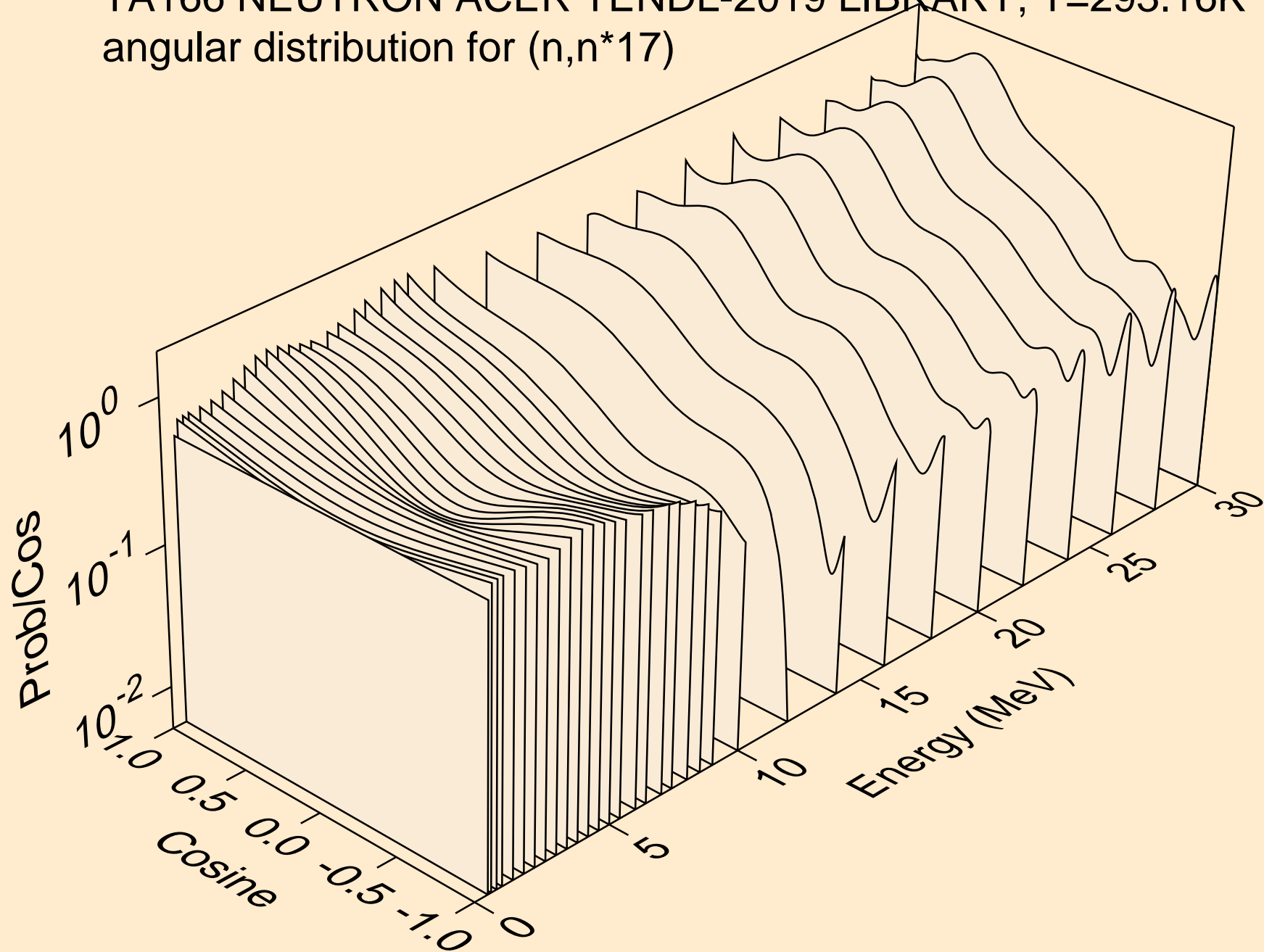

TA166 NEUTRON ACER TENDL-2019 LIBRARY; T=293.16K  
angular distribution for (n,n\*18)

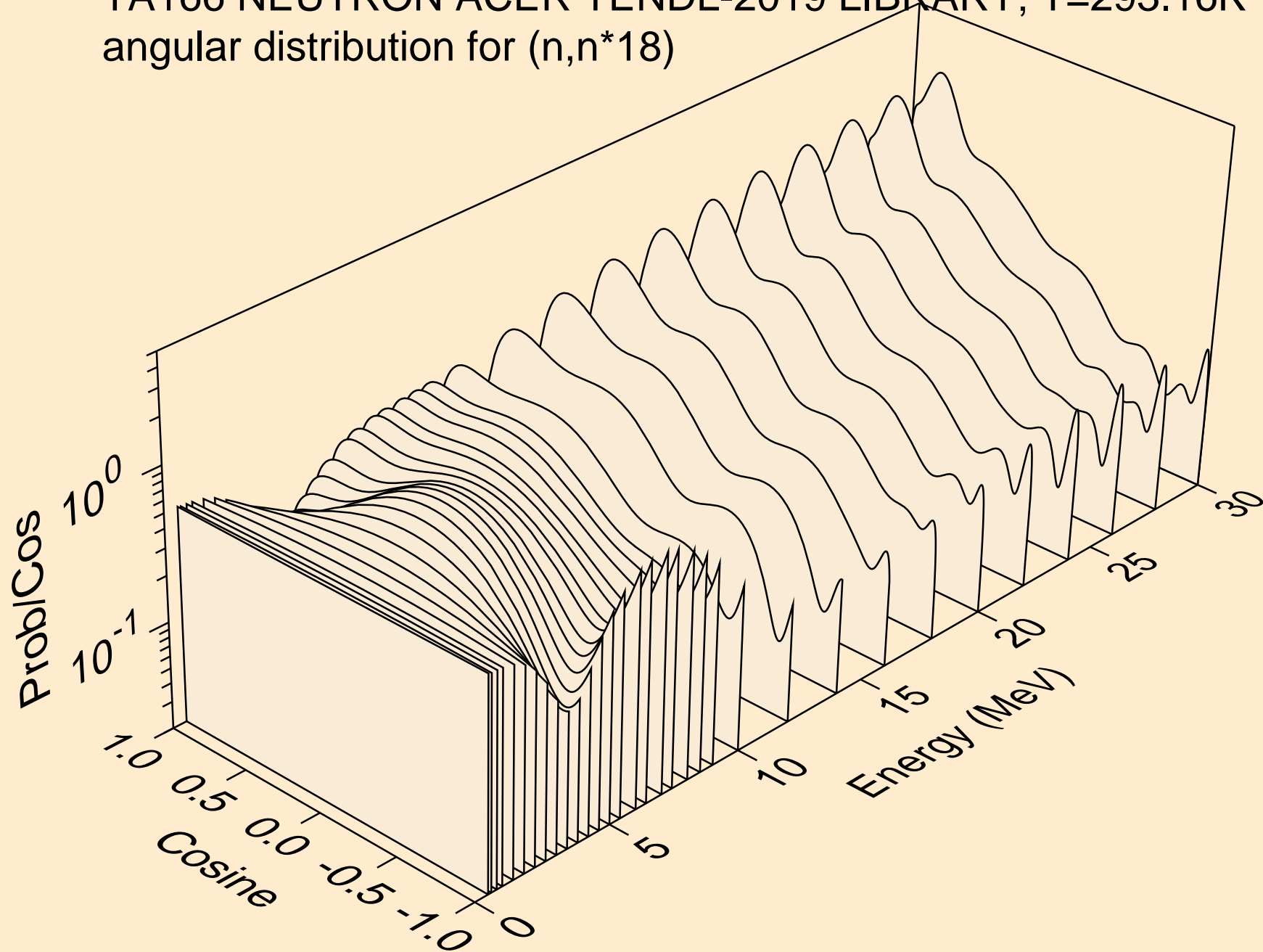

TA166 NEUTRON ACER TENDL-2019 LIBRARY; T=293.16K  
angular distribution for (n,n\*19)

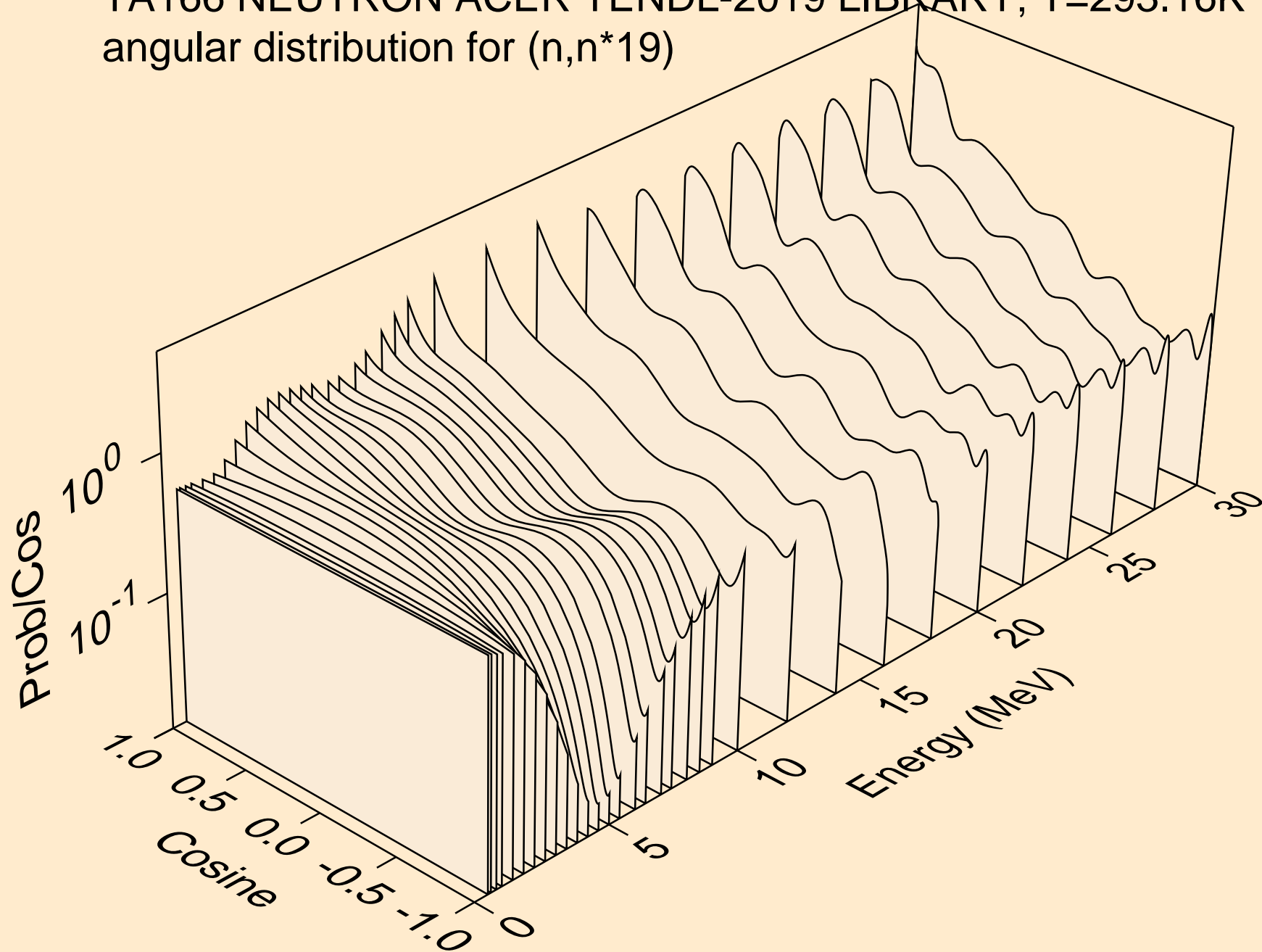

TA166 NEUTRON ACER TENDL-2019 LIBRARY; T=293.16K  
angular distribution for (n,n\*20)

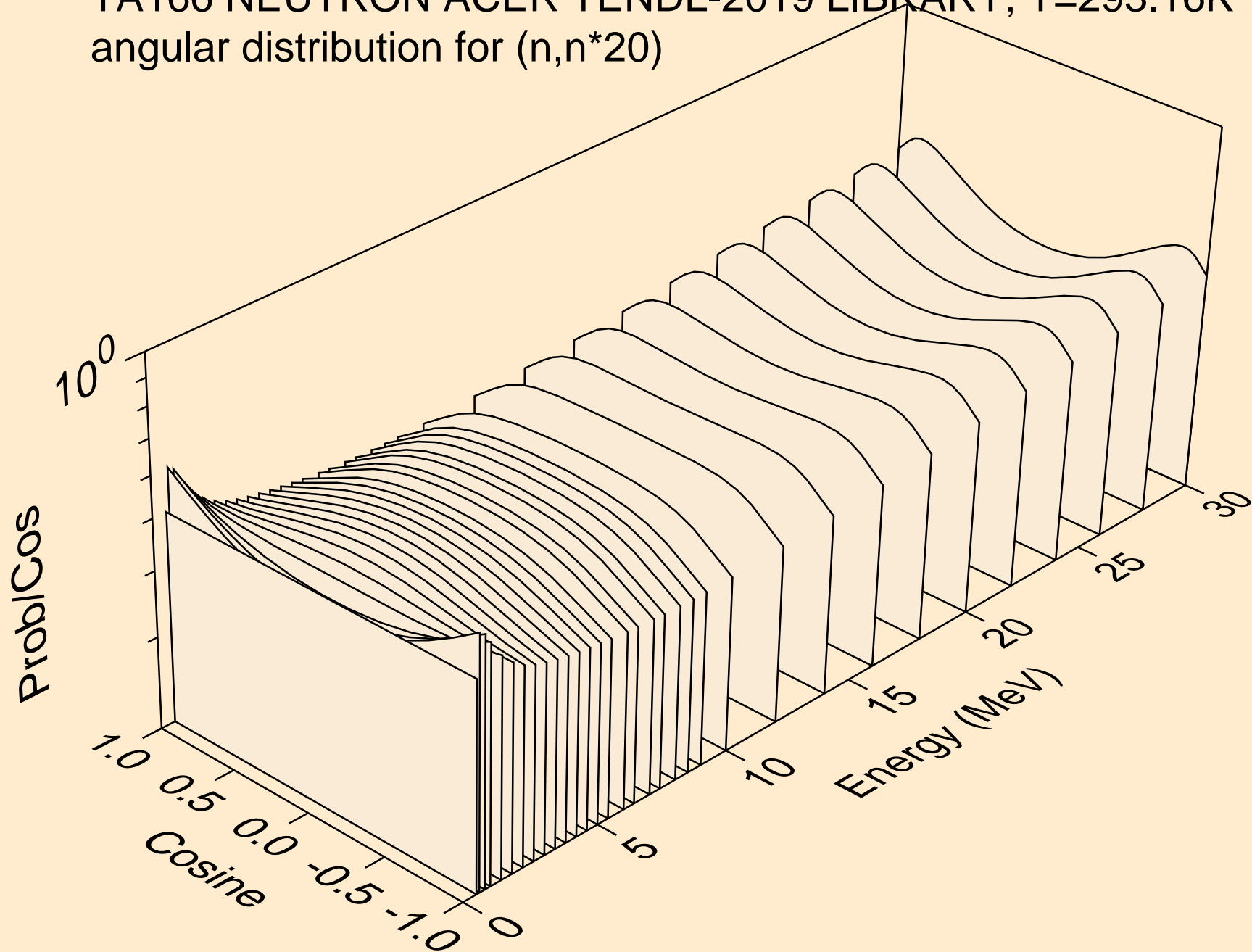

TA166 NEUTRON ACER TENDL-2019 LIBRARY; T=293.16K  
angular distribution for (n,n\*21)

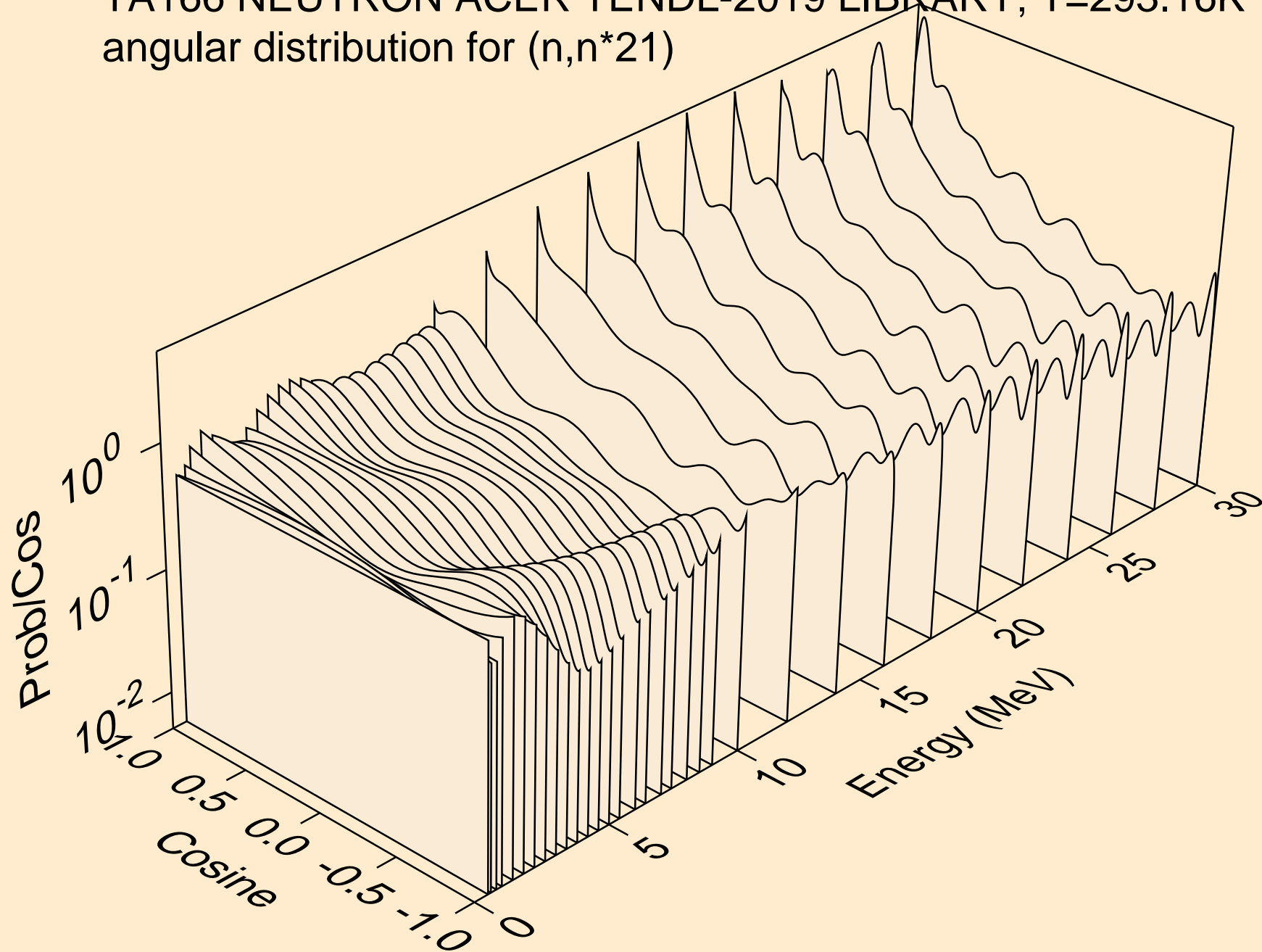

TA166 NEUTRON ACER TENDL-2019 LIBRARY; T=293.16K  
Neutron emission for (n,x)

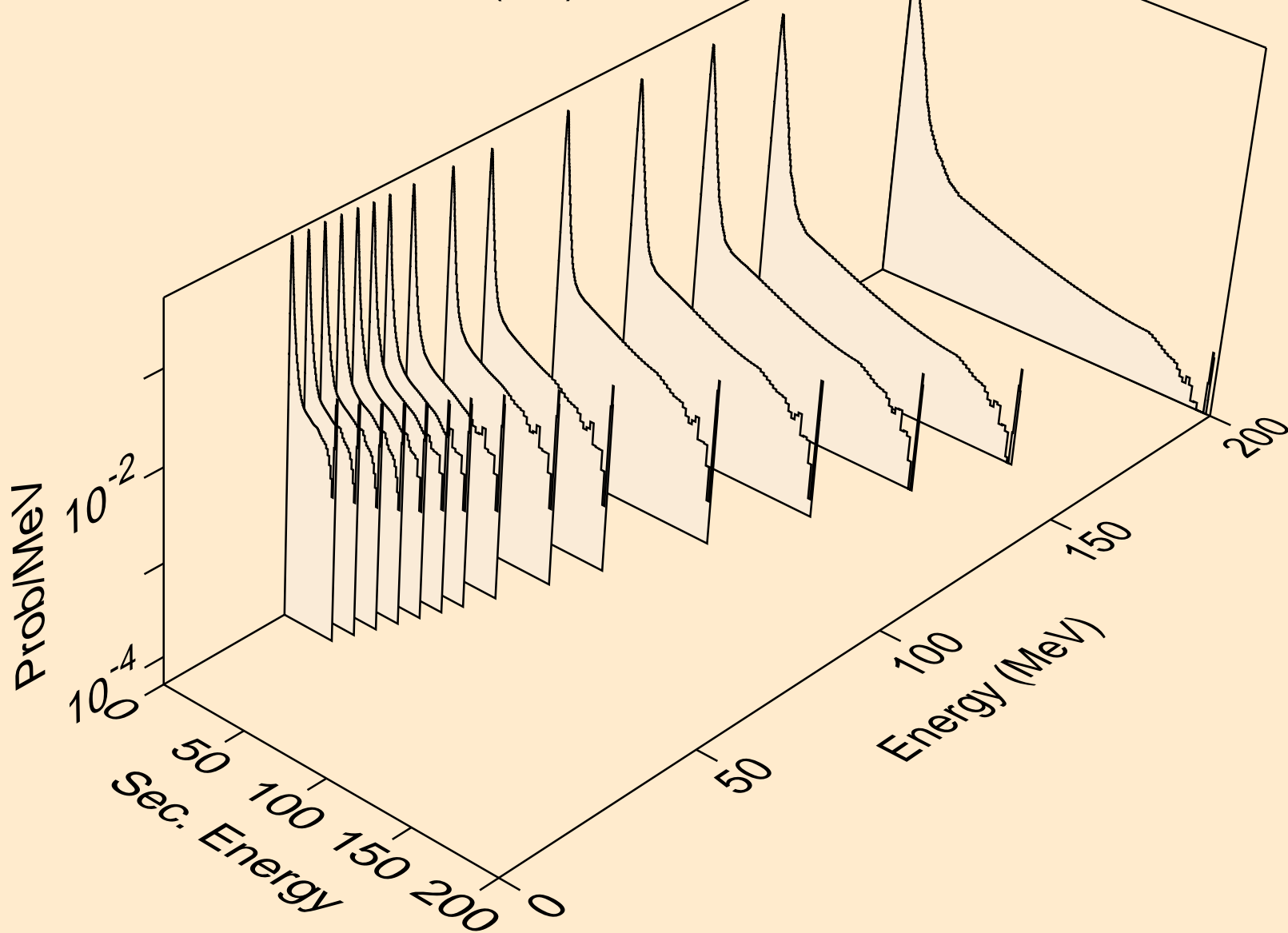

TA166 NEUTRON ACER TENDL-2019 LIBRARY; T=293.16K  
Neutron emission for (n,2nd)

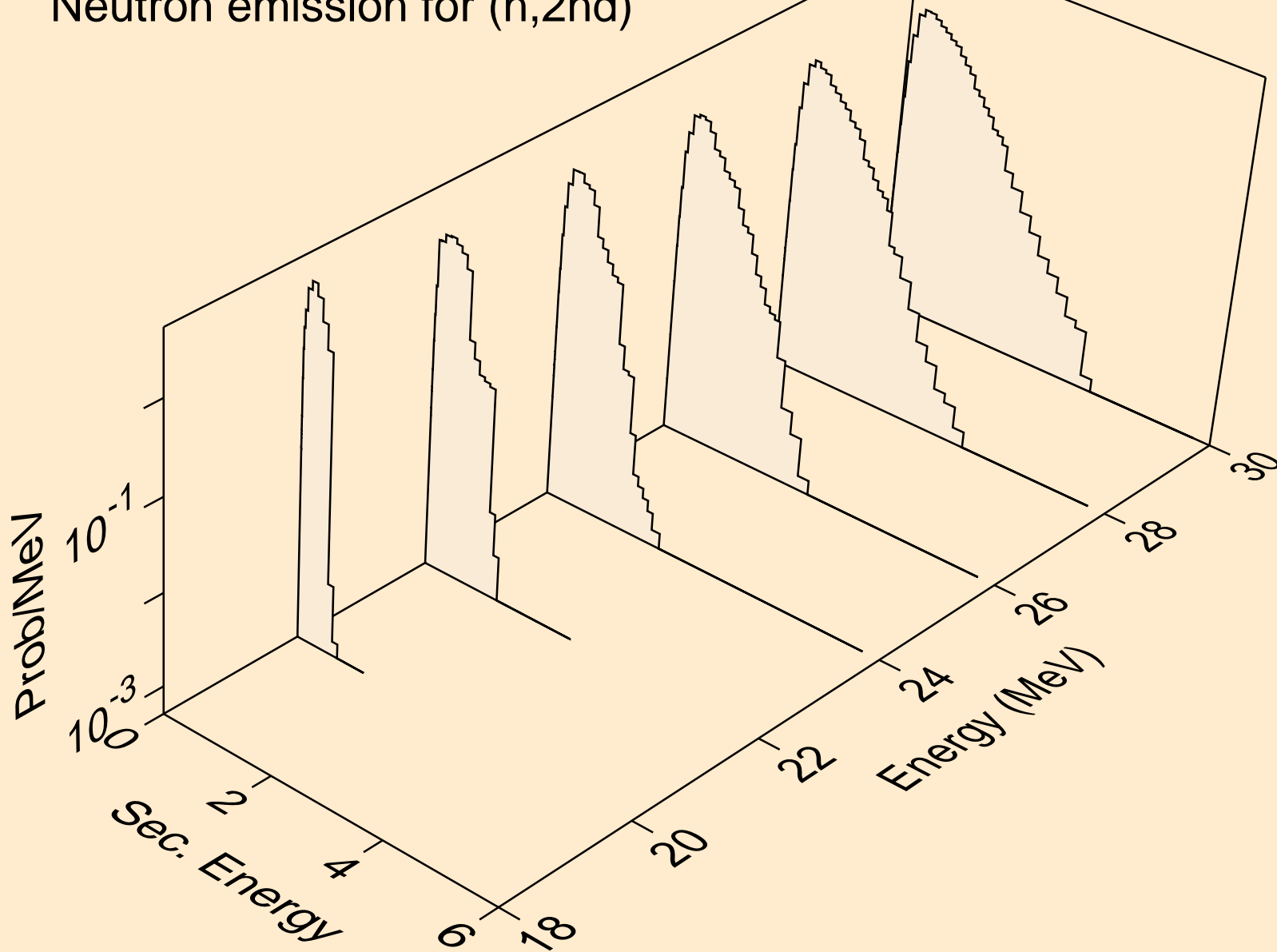

TA166 NEUTRON ACER TENDL-2019 LIBRARY; T=293.16K  
Neutron emission for (n,2n)

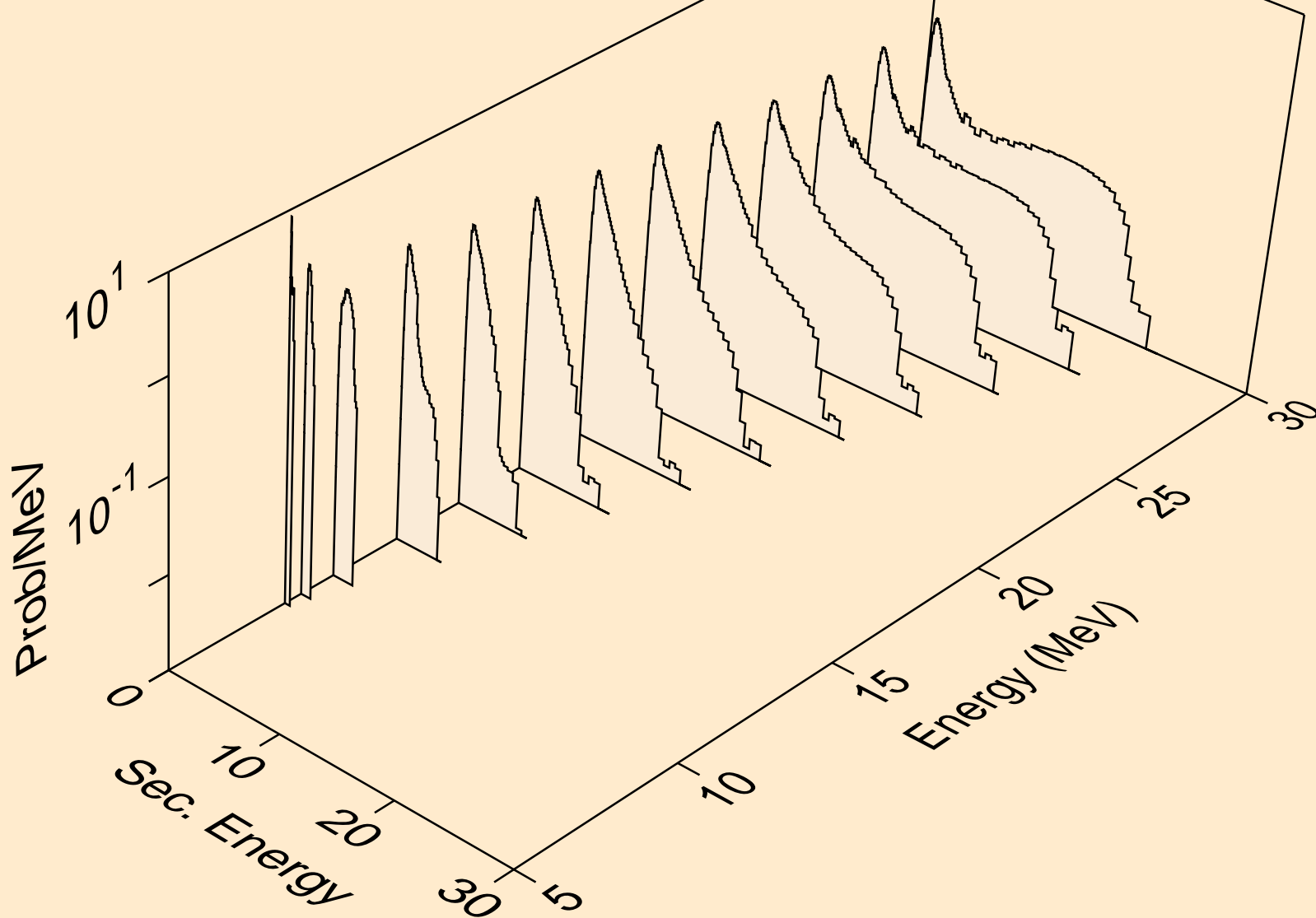



TA166 NEUTRON ACER TENDL-2019 LIBRARY; T=293.16K  
Neutron emission for (n,3n)

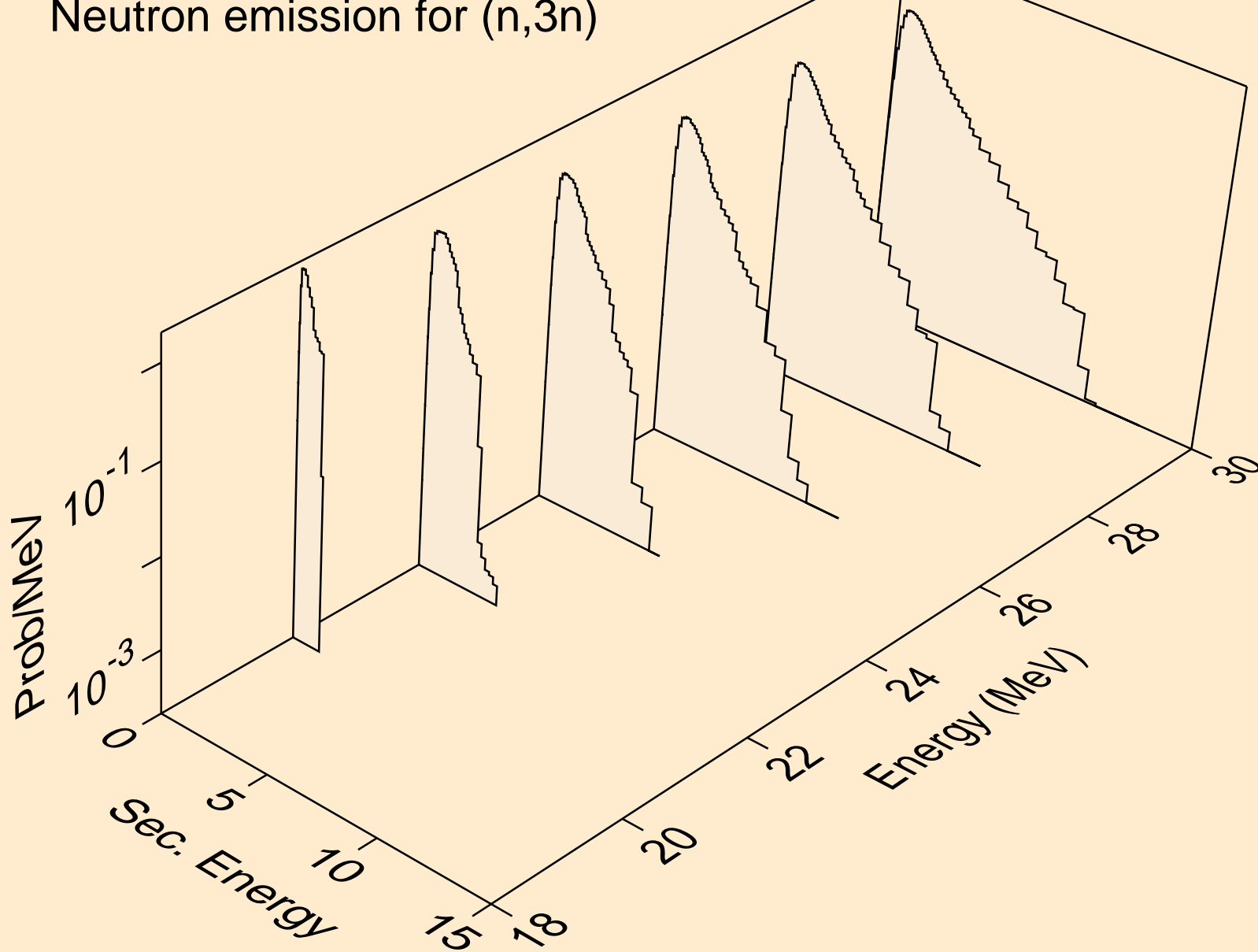

TA166 NEUTRON ACER TENDL-2019 LIBRARY; T=293.16K  
Neutron emission for (n,n\*)a

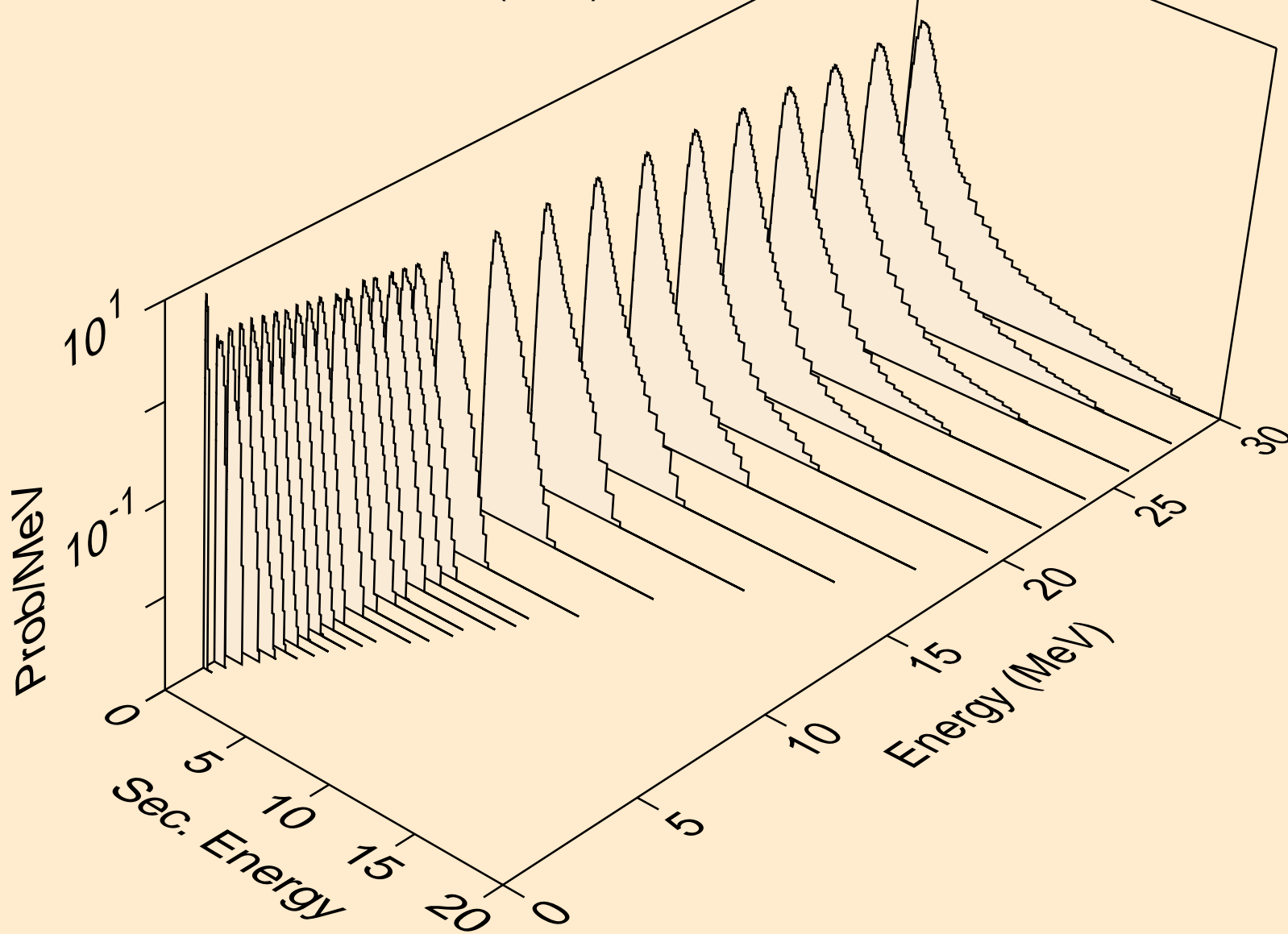

TA166 NEUTRON ACER TENDL-2019 LIBRARY; T=293.16K  
Neutron emission for (n,2n)a

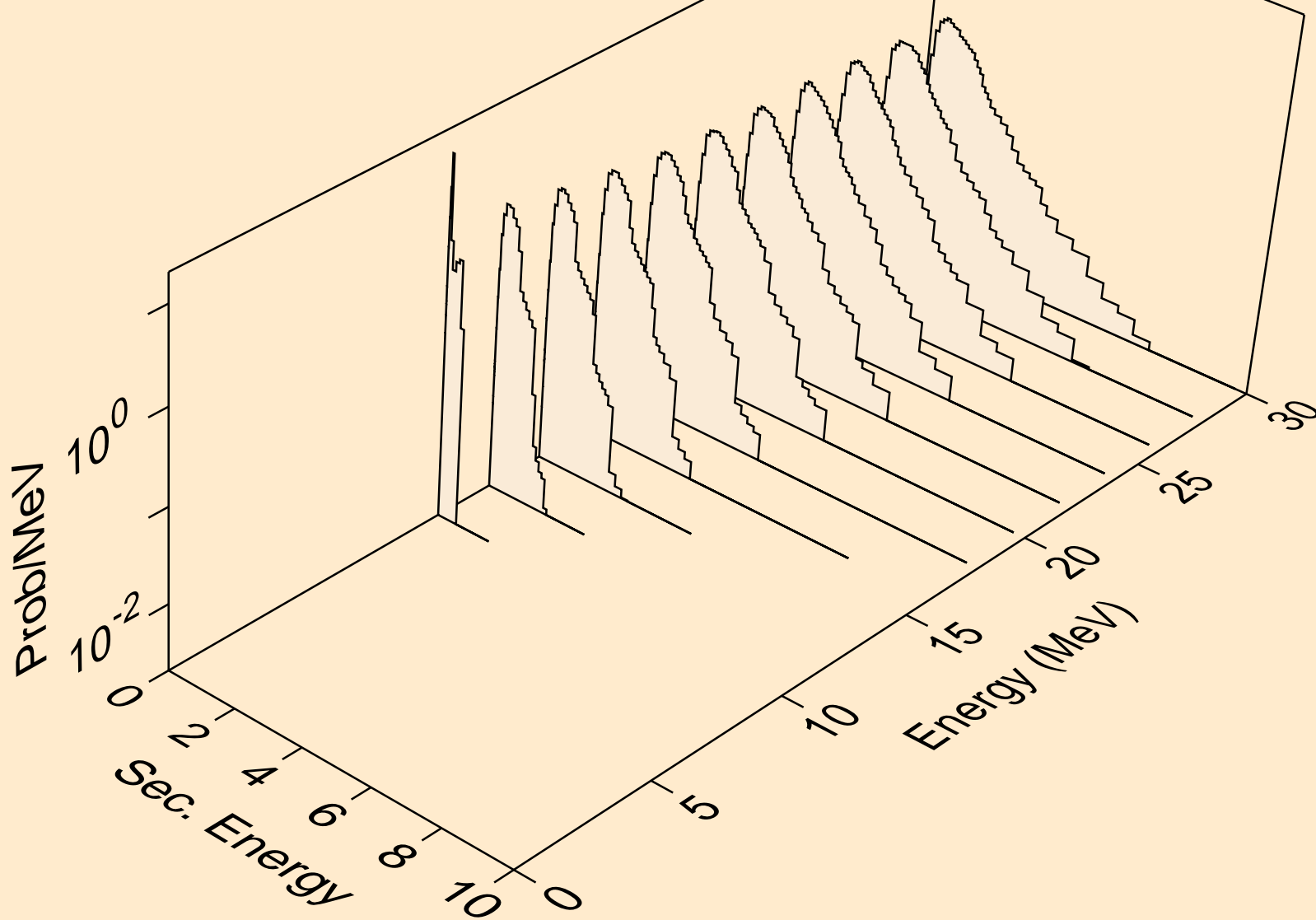

TA166 NEUTRON ACER TENDL-2019 LIBRARY; T=293.16K  
Neutron emission for (n,3n)a

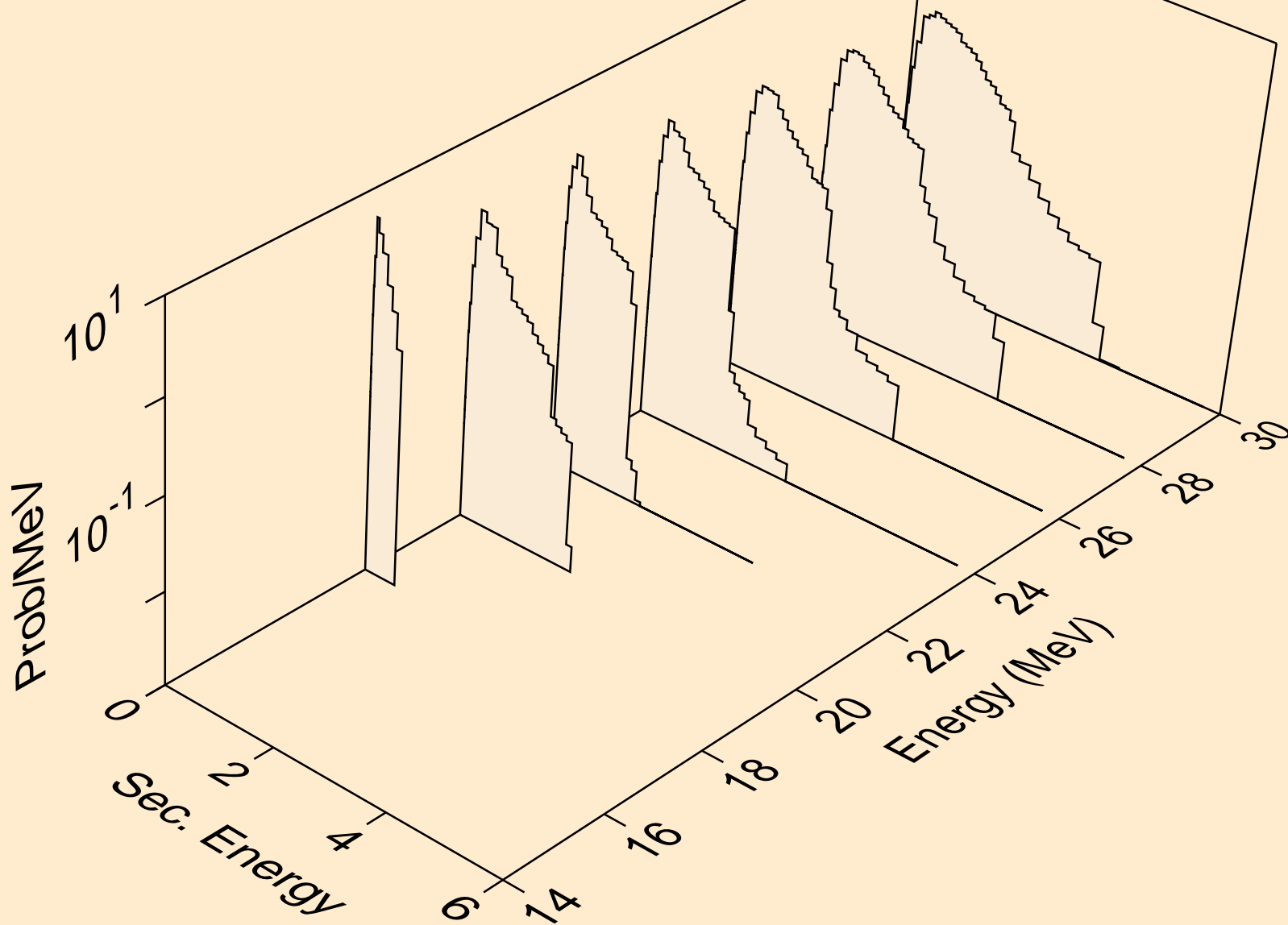

TA166 NEUTRON ACER TENDL-2019 LIBRARY; T=293.16K  
Neutron emission for (n,n\*)p

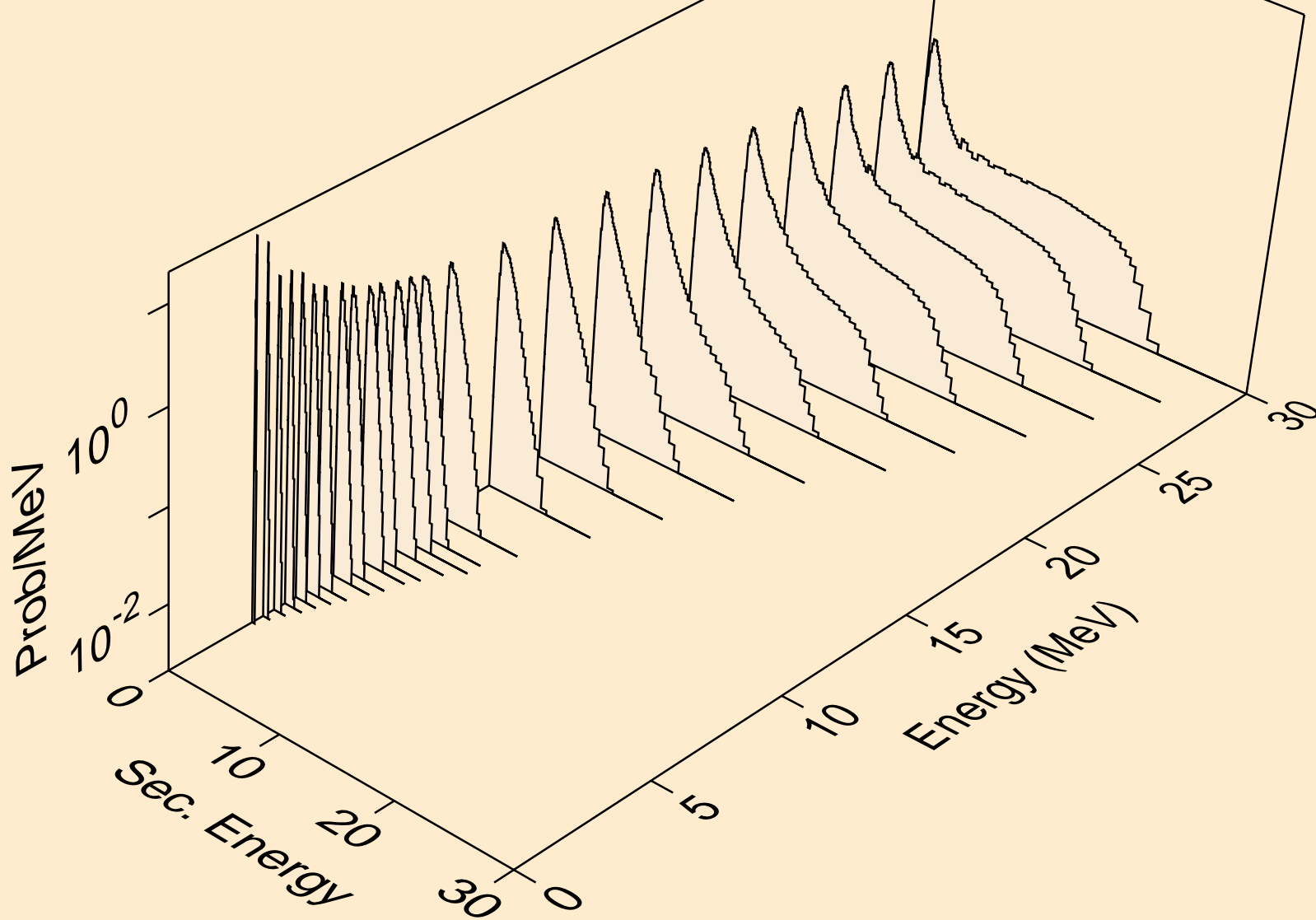

TA166 NEUTRON ACER TENDL-2019 LIBRARY; T=293.16K  
Neutron emission for (n,n\*)2a

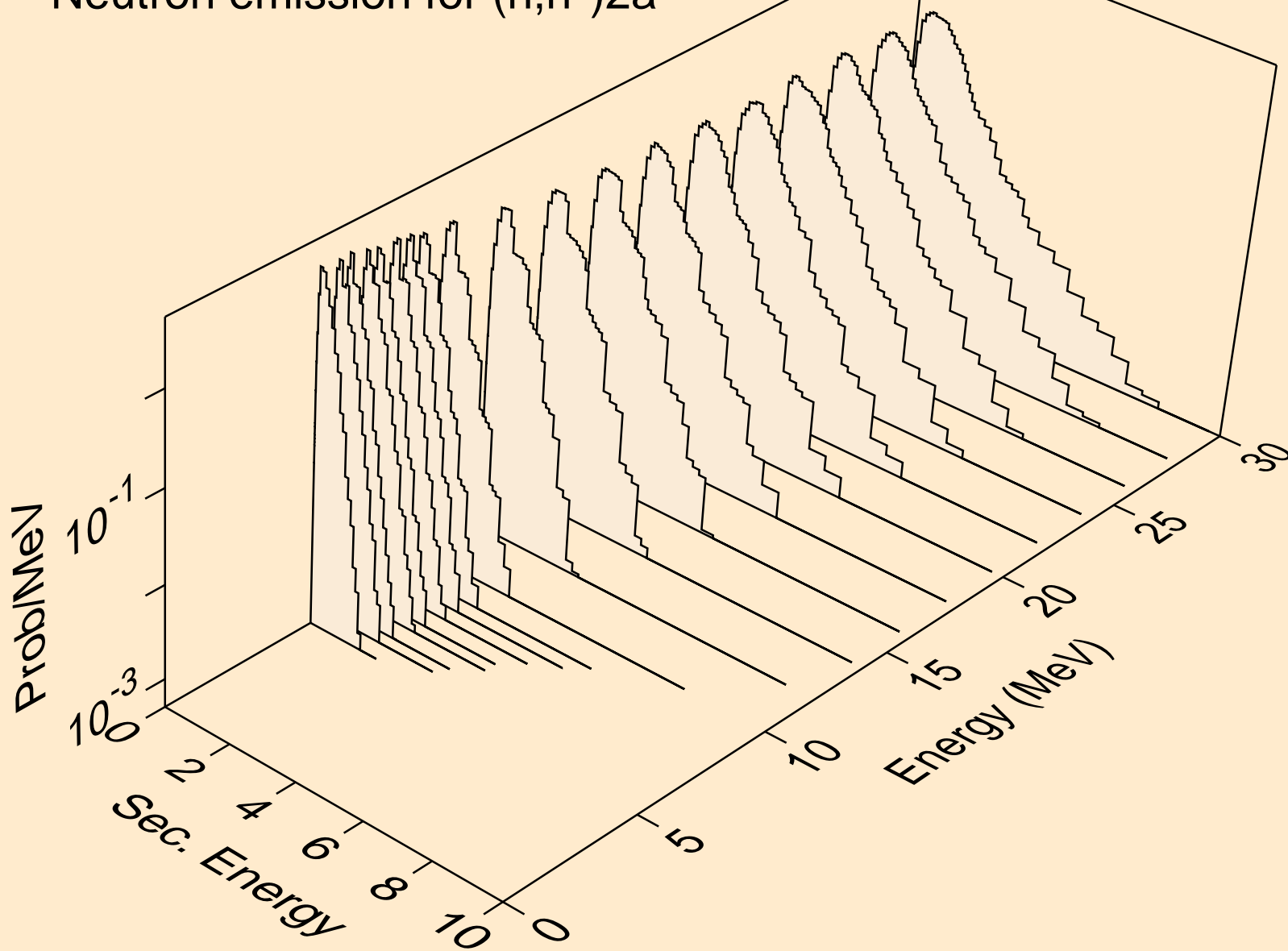

TA166 NEUTRON ACER TENDL-2019 LIBRARY; T=293.16K  
Neutron emission for (n,2n)2a

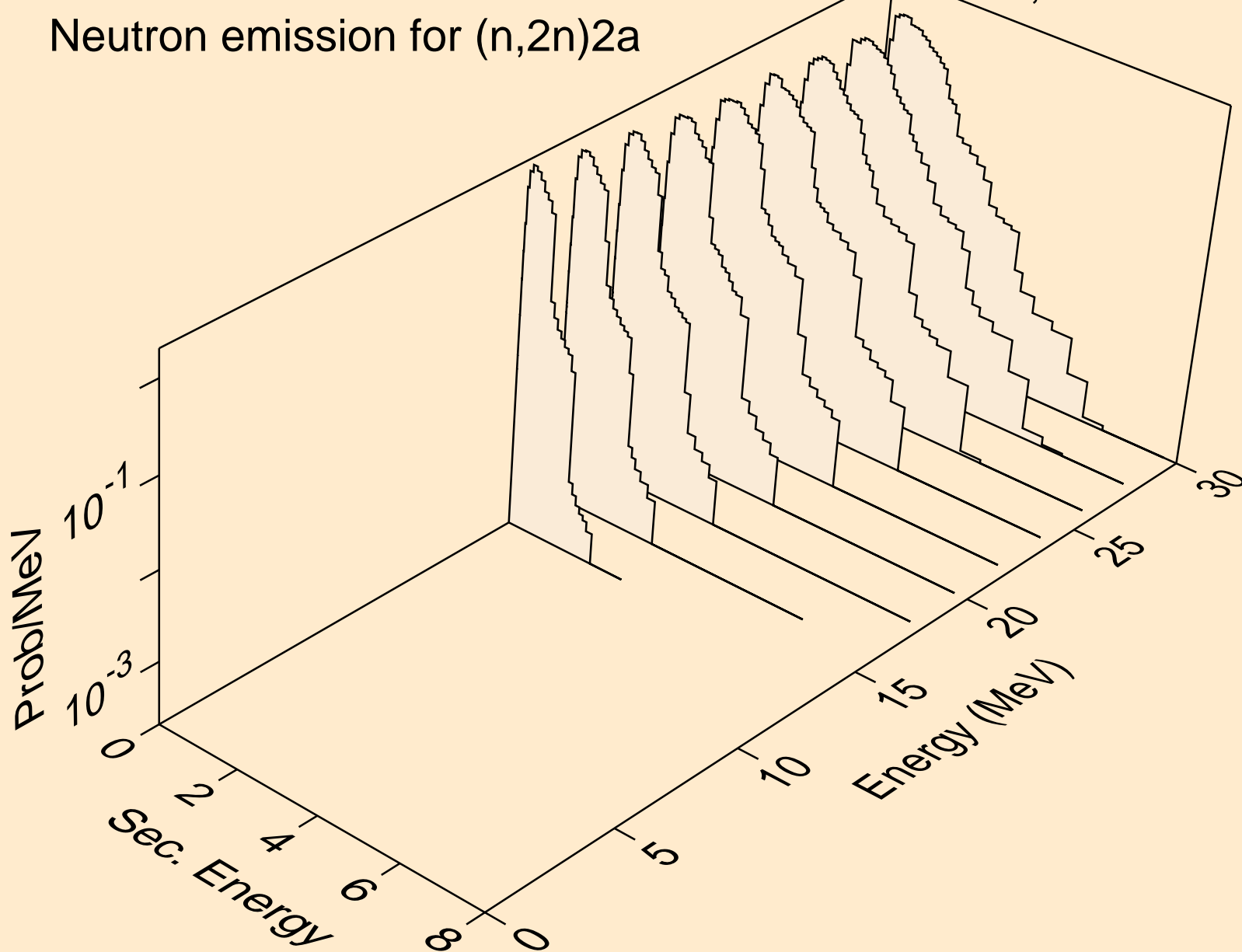

TA166 NEUTRON ACER TENDL-2019 LIBRARY; T=293.16K  
Neutron emission for (n,n\*)d

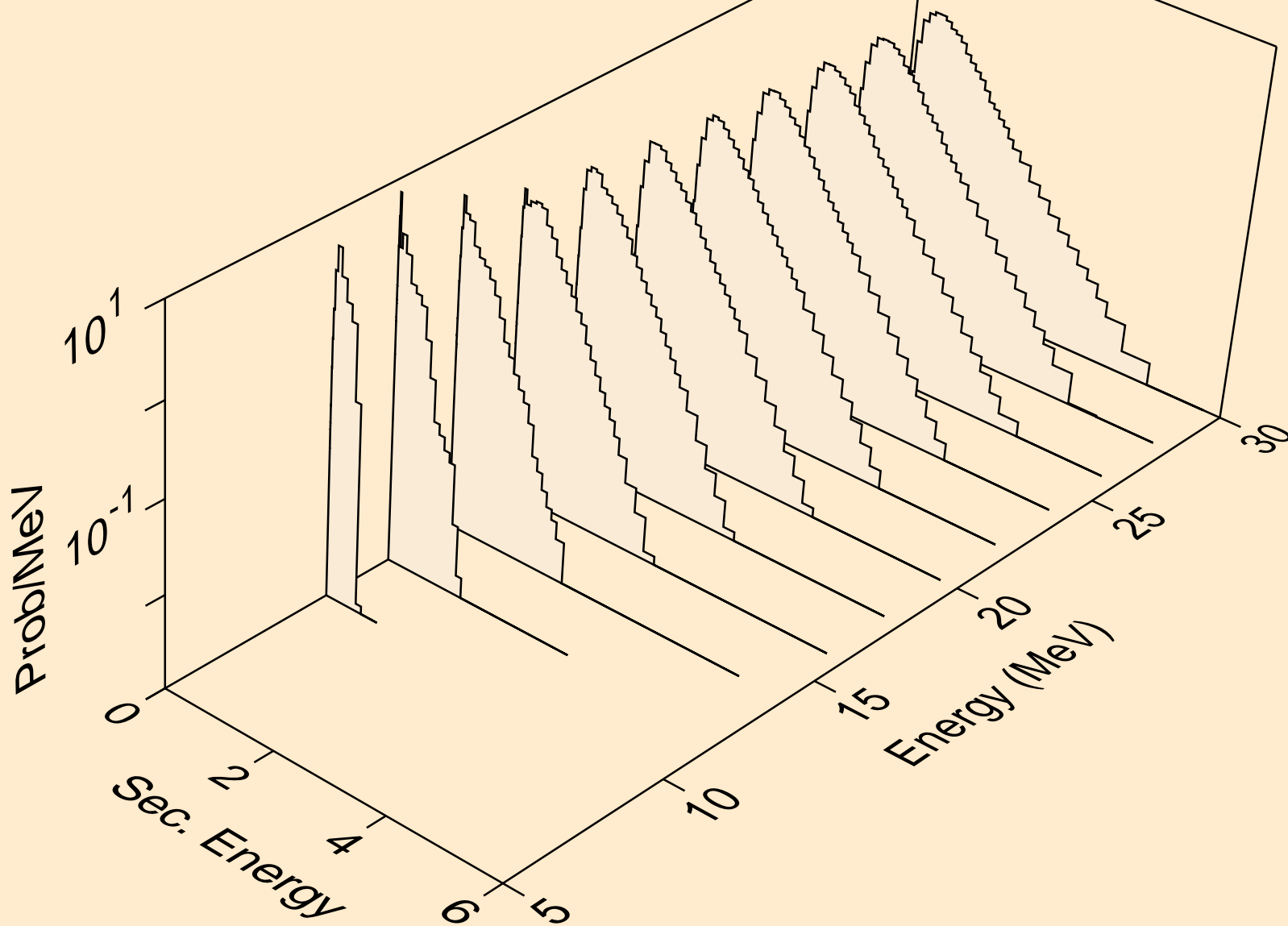



TA166 NEUTRON ACER TENDL-2019 LIBRARY; T=293.16K  
Neutron emission for (n,n\*)t

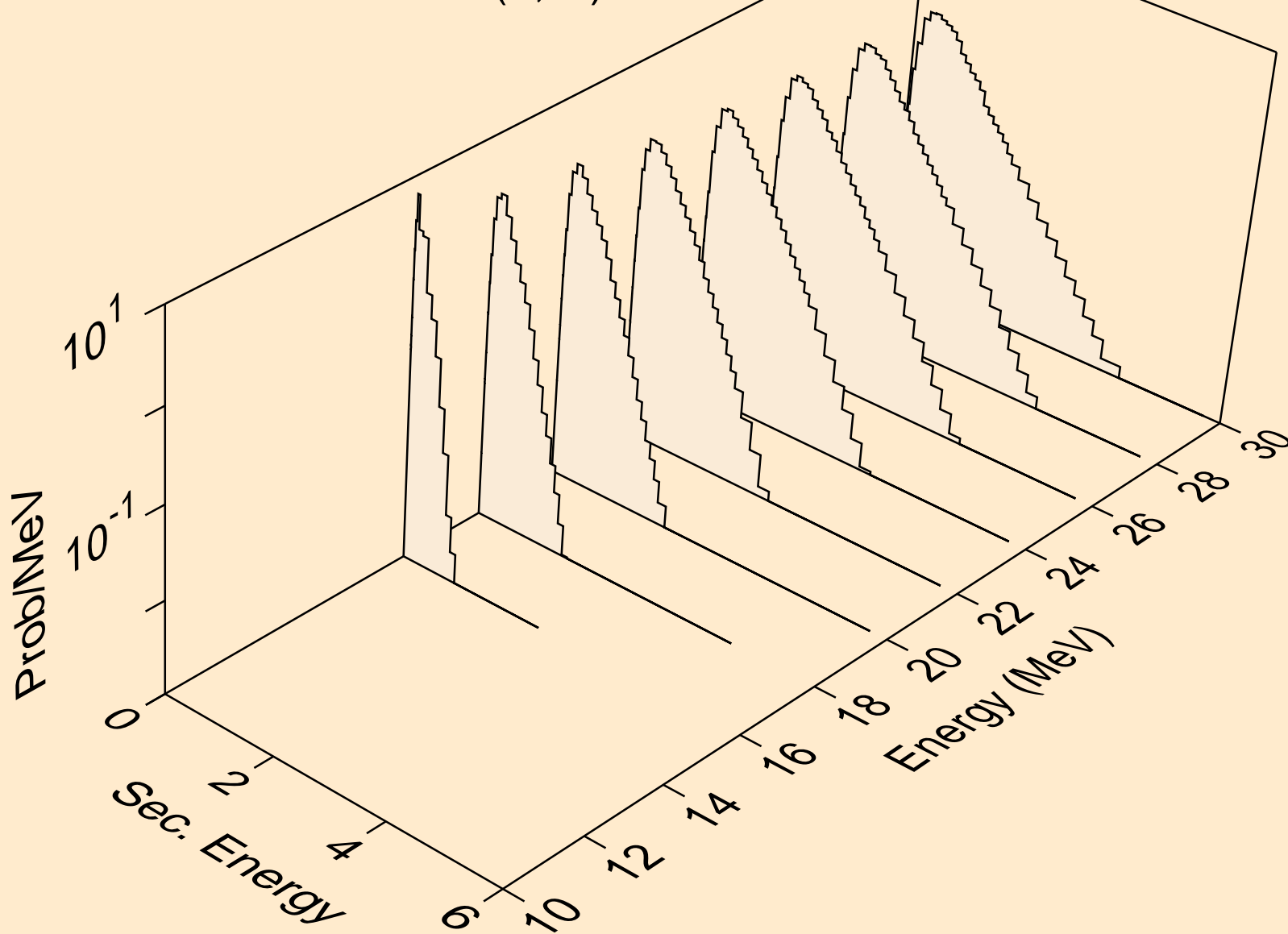

TA166 NEUTRON ACER TENDL-2019 LIBRARY; T=293.16K  
Neutron emission for (n,n\*)he3

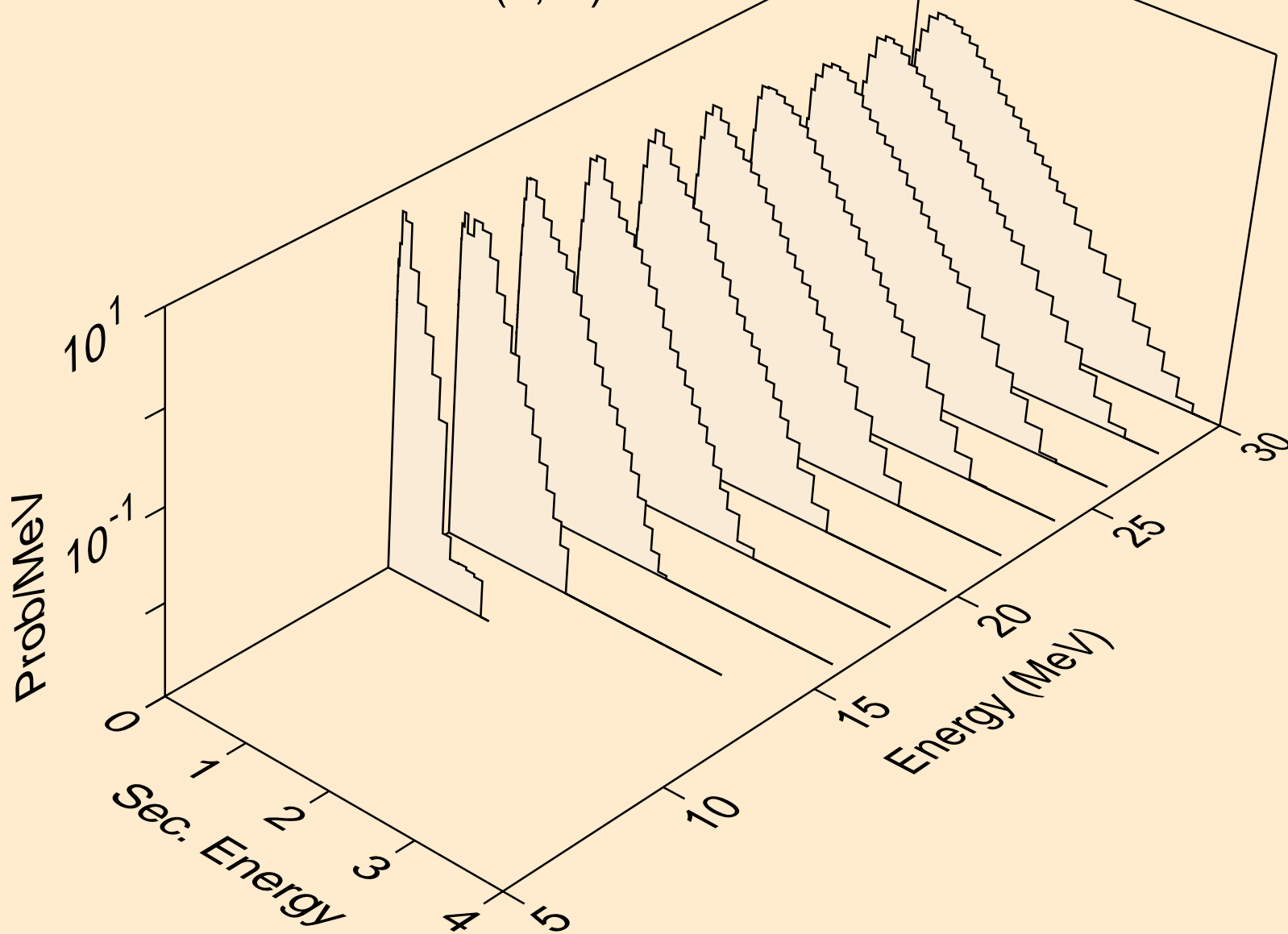

TA166 NEUTRON ACER TENDL-2019 LIBRARY; T=293.16K  
Neutron emission for (n,4n)

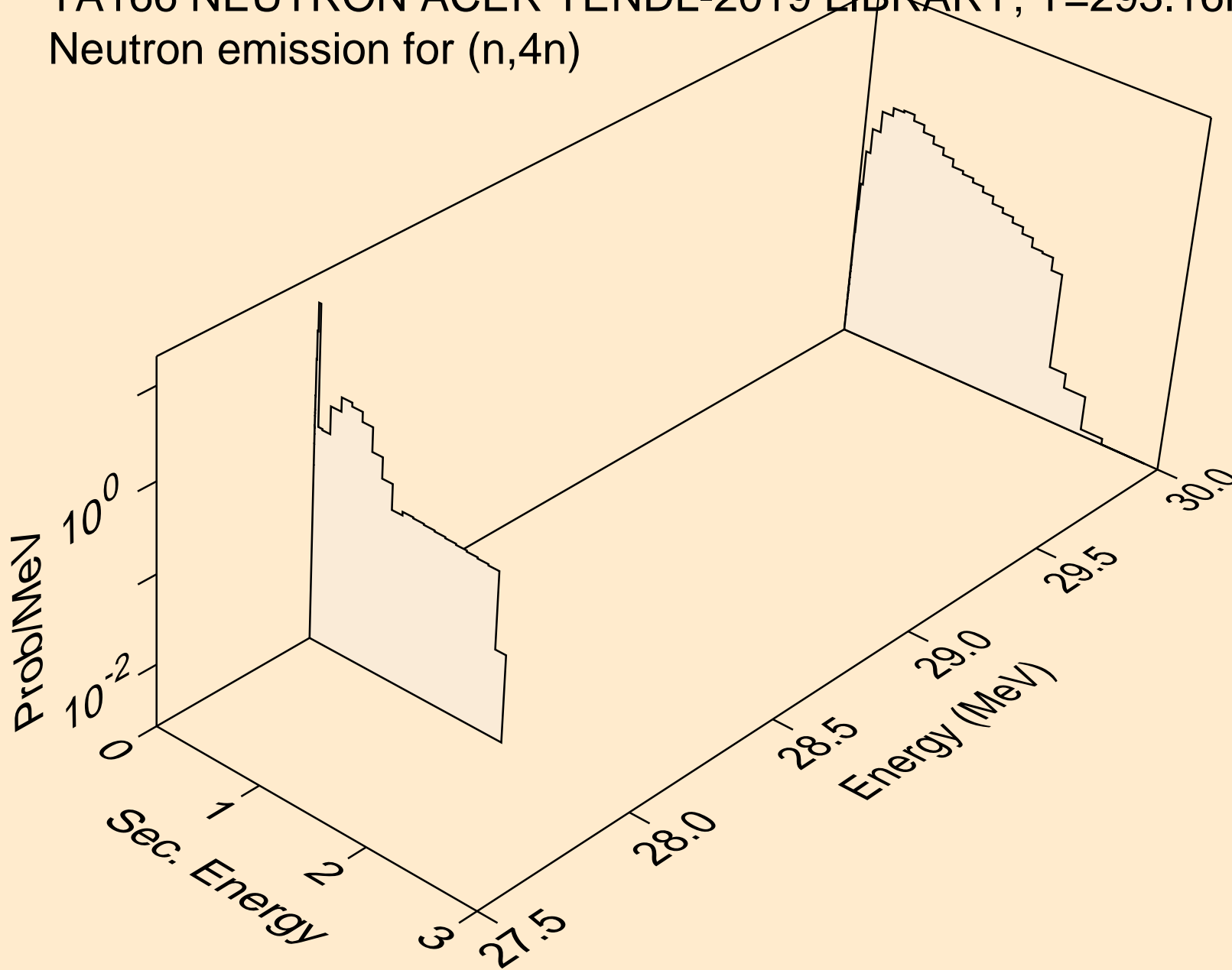

TA166 NEUTRON ACER TENDL-2019 LIBRARY; T=293.16K  
Neutron emission for (n,2np)

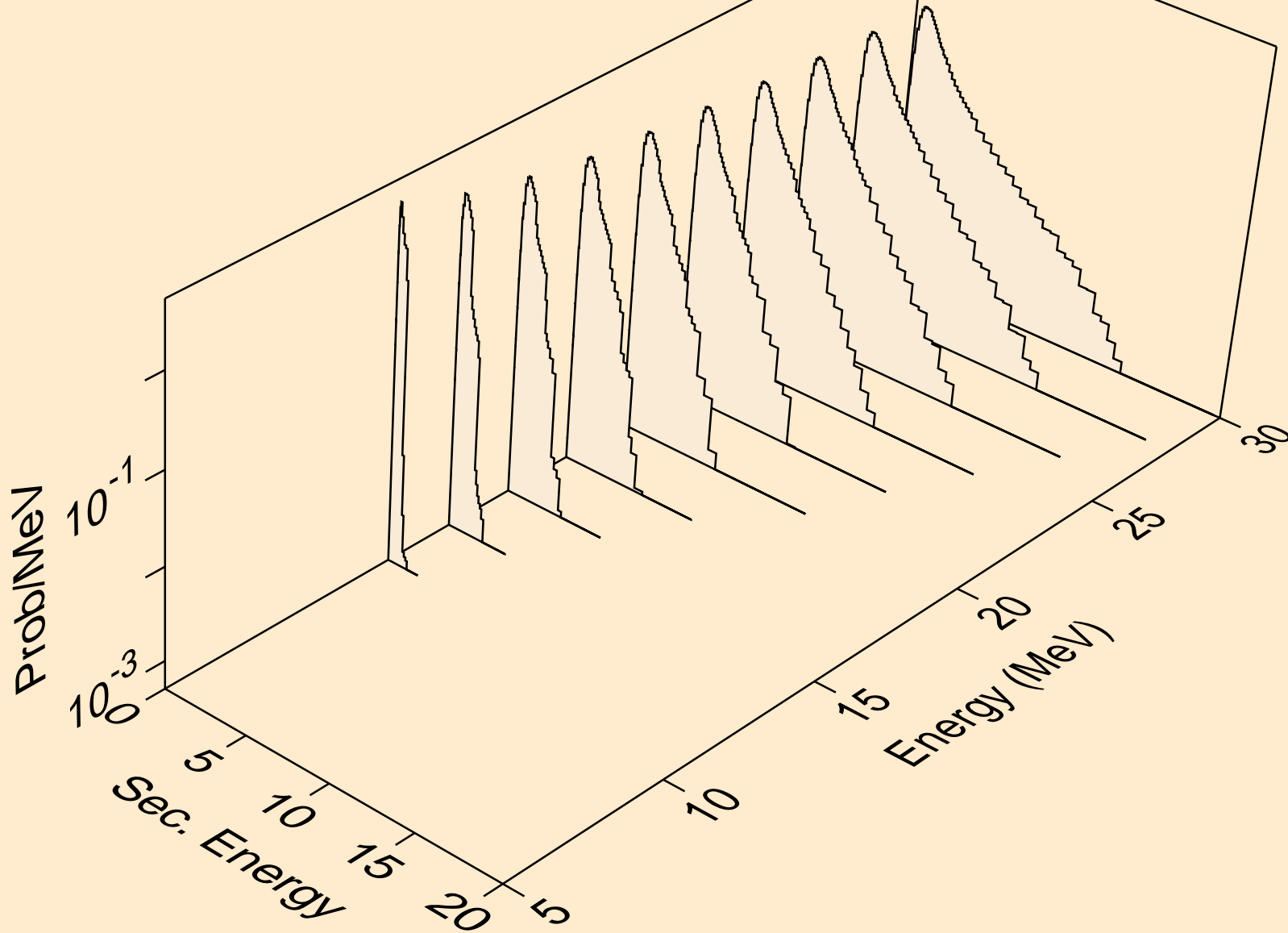

TA166 NEUTRON ACER TENDL-2019 LIBRARY; T=293.16K  
Neutron emission for (n,3np)

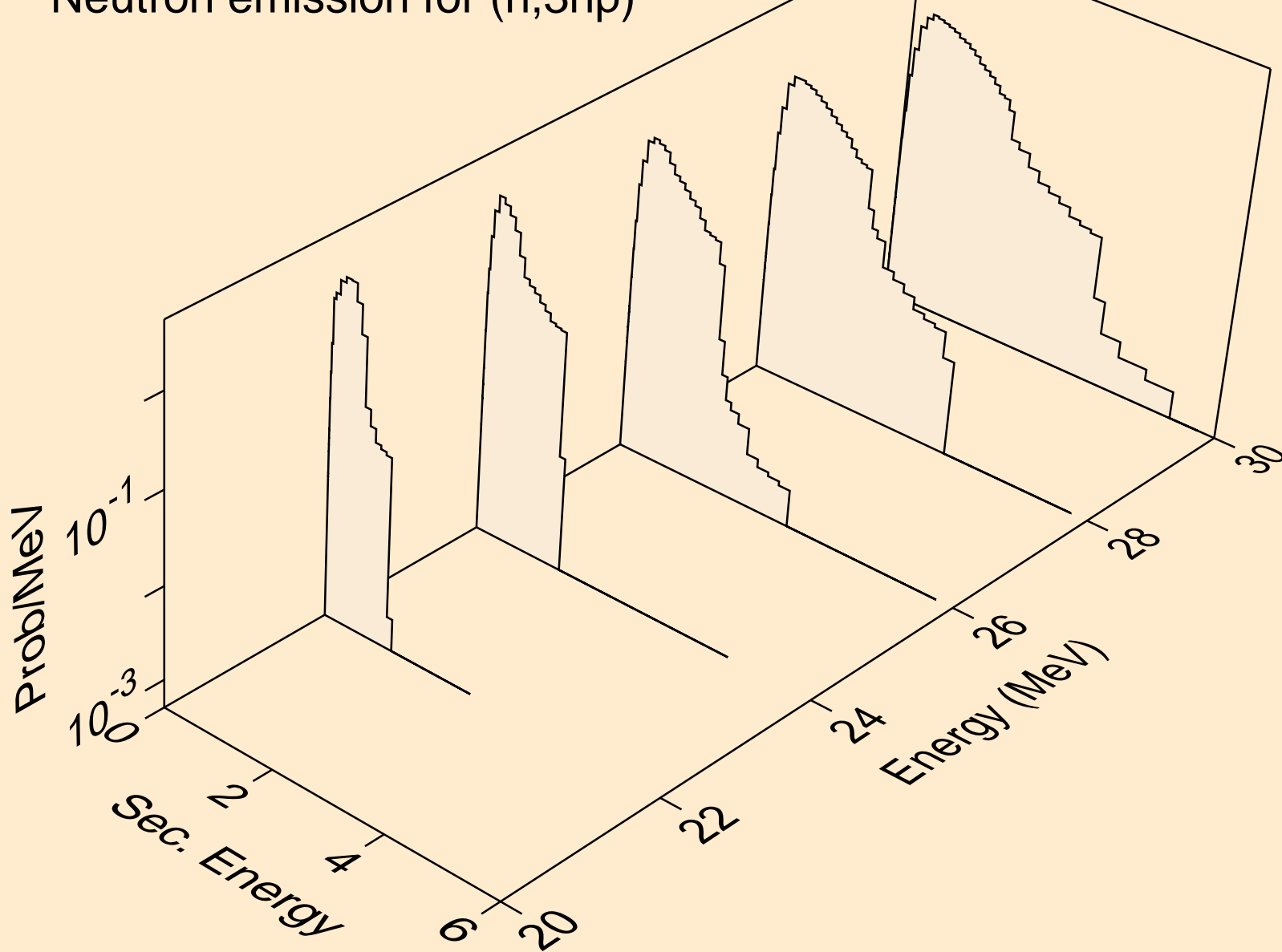

TA166 NEUTRON ACER TENDL-2019 LIBRARY; T=293.16K  
Neutron emission for (n,2np)

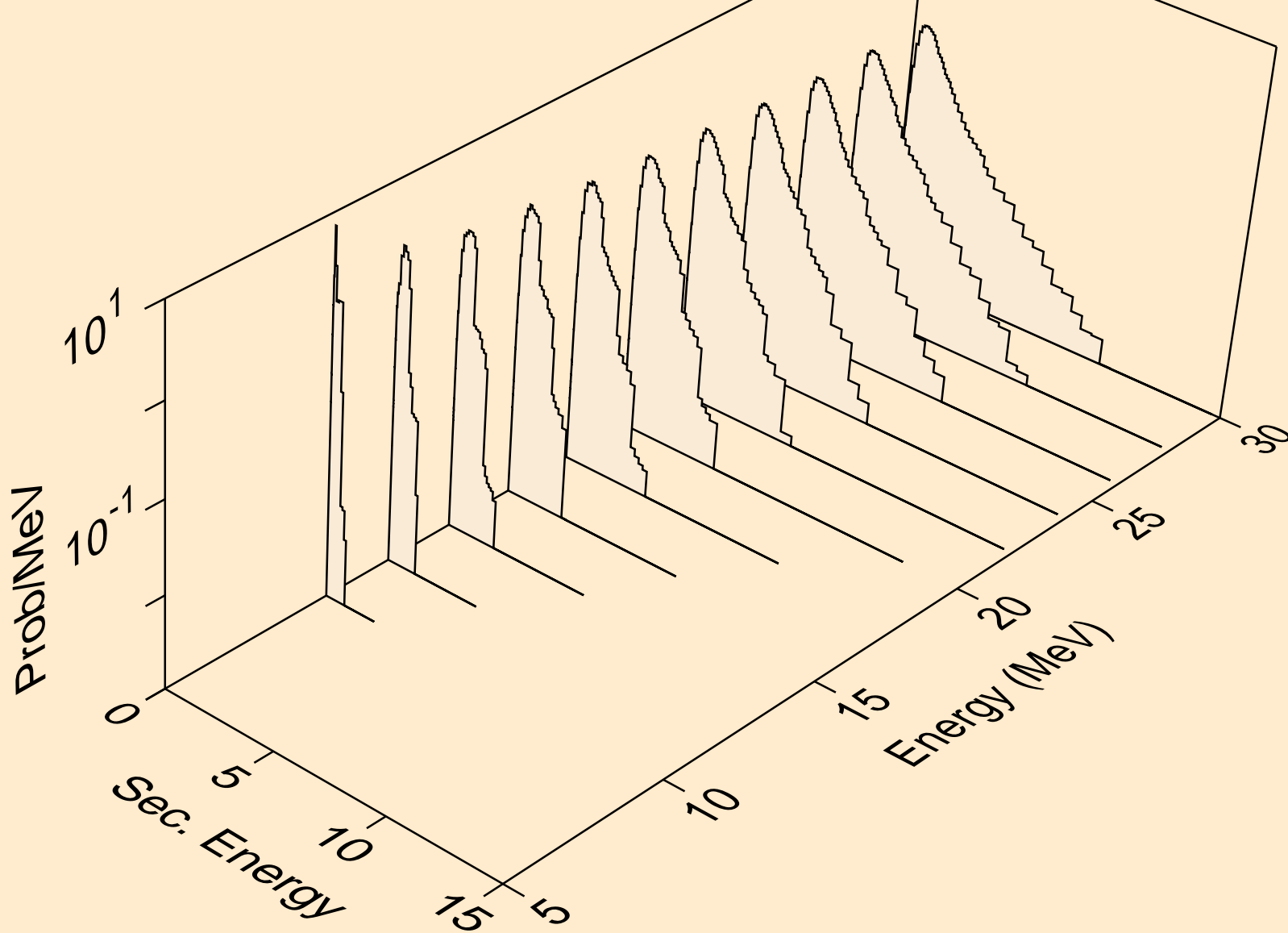

TA166 NEUTRON ACER TENDL-2019 LIBRARY; T=293.16K  
Neutron emission for (n,npa)

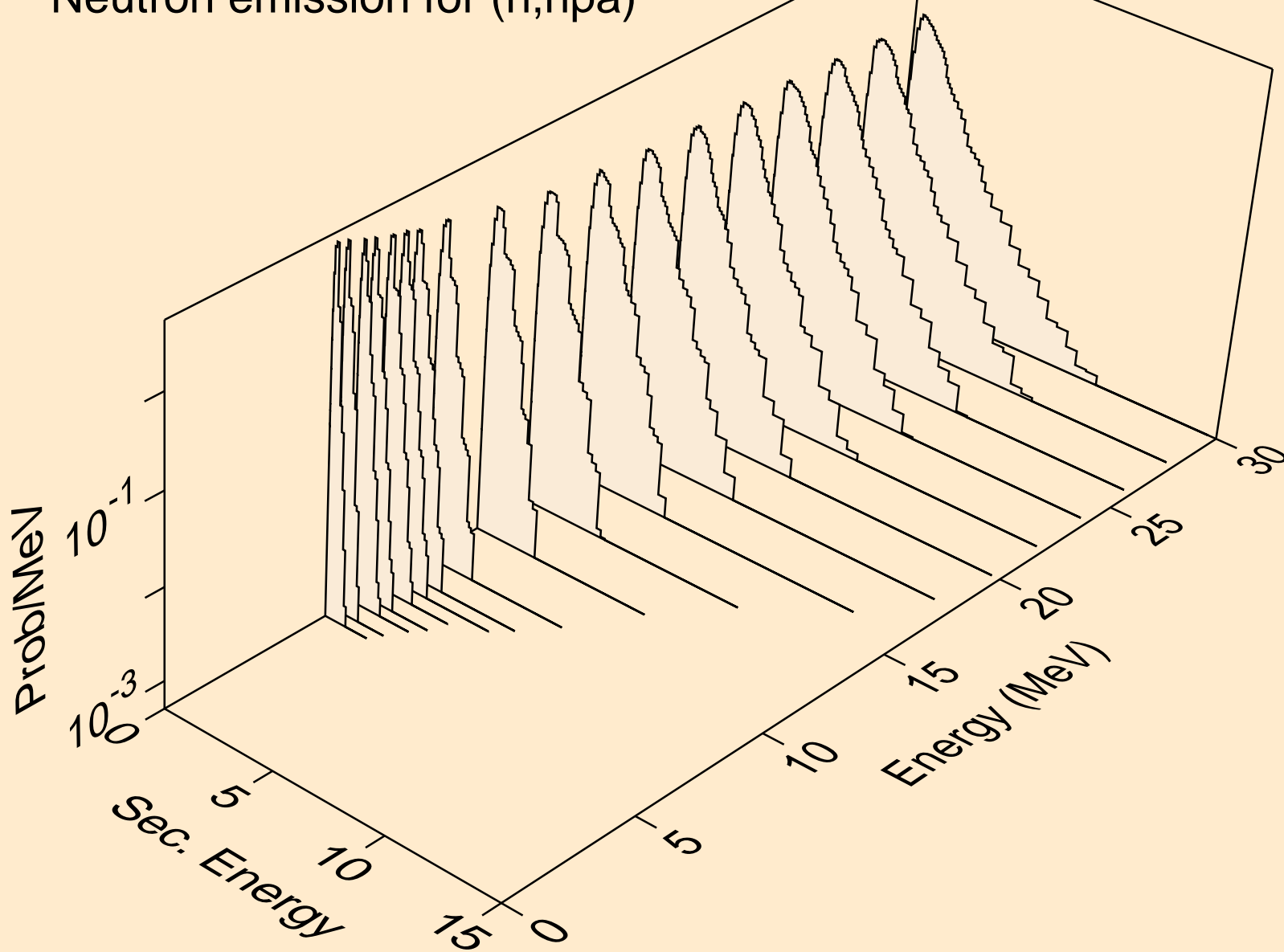

TA166 NEUTRON ACER TENDL-2019 LIBRARY; T=293.16K  
Neutron emission for (n,n\*c)

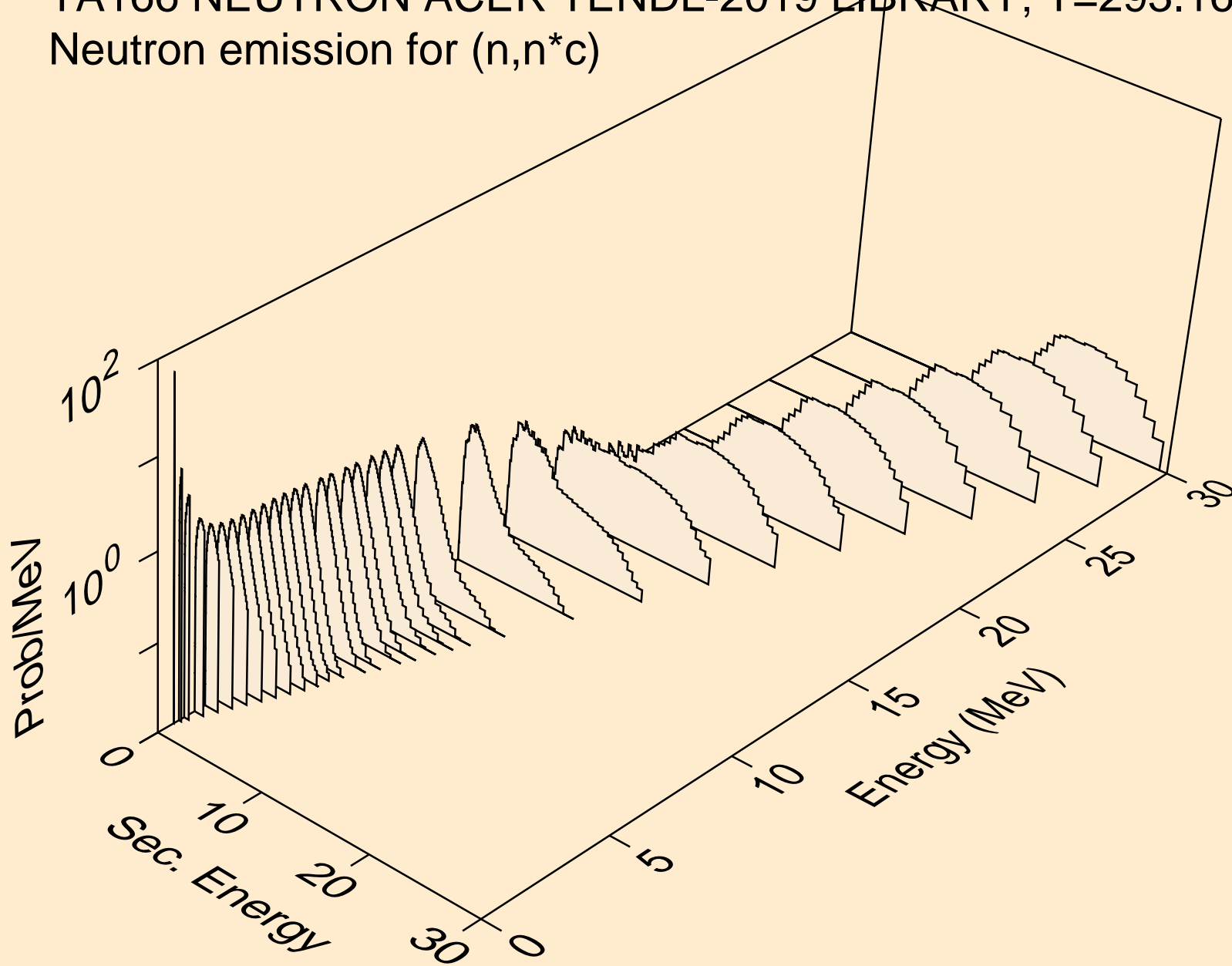



TA166 NEUTRON ACER TENDL-2019 LIBRARY; T=293.16K  
Photon emission for (n,x)

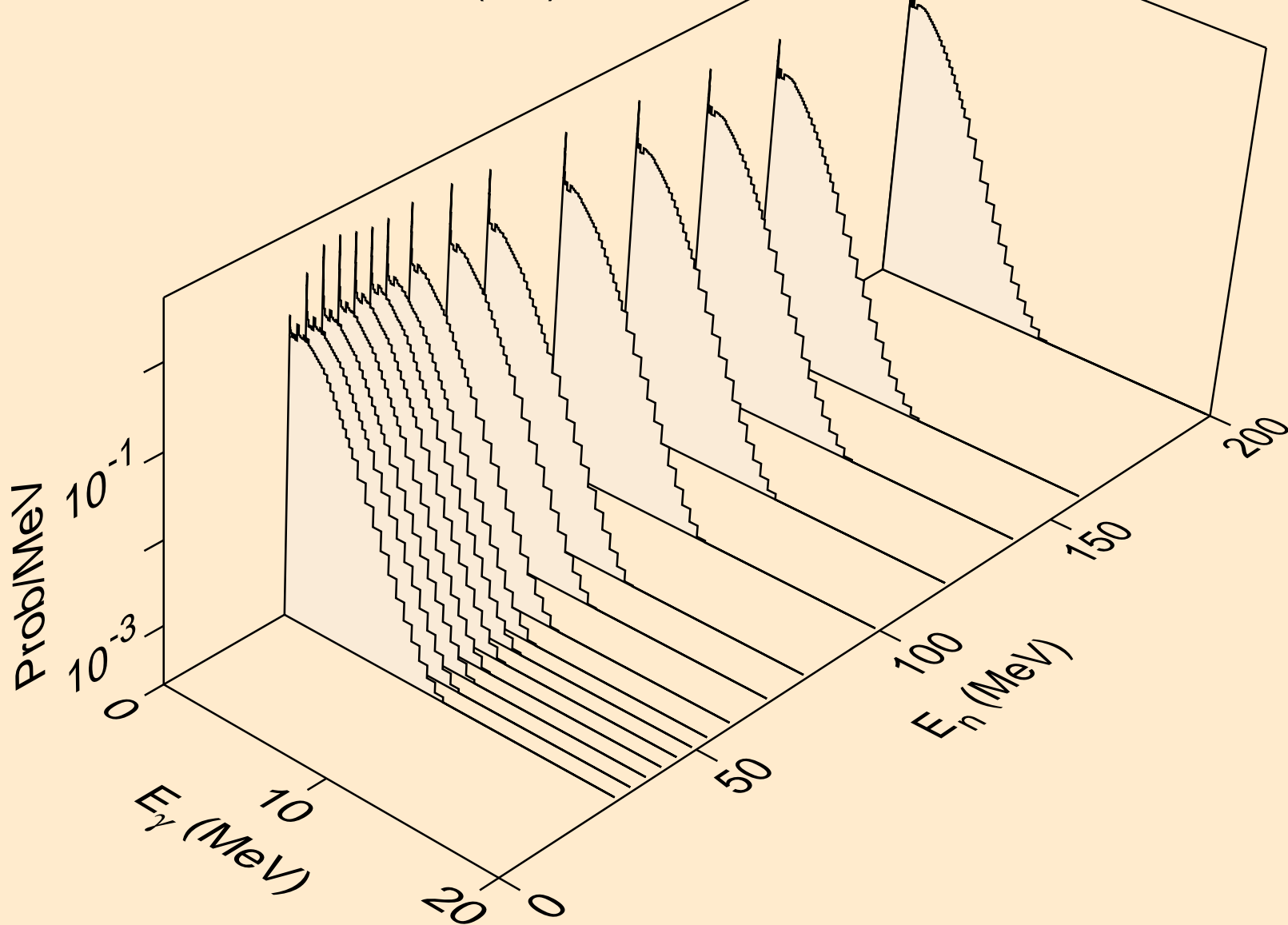

TA166 NEUTRON ACER TENDL-2019 LIBRARY; T=293.16K  
Photon emission for (n,2nd)

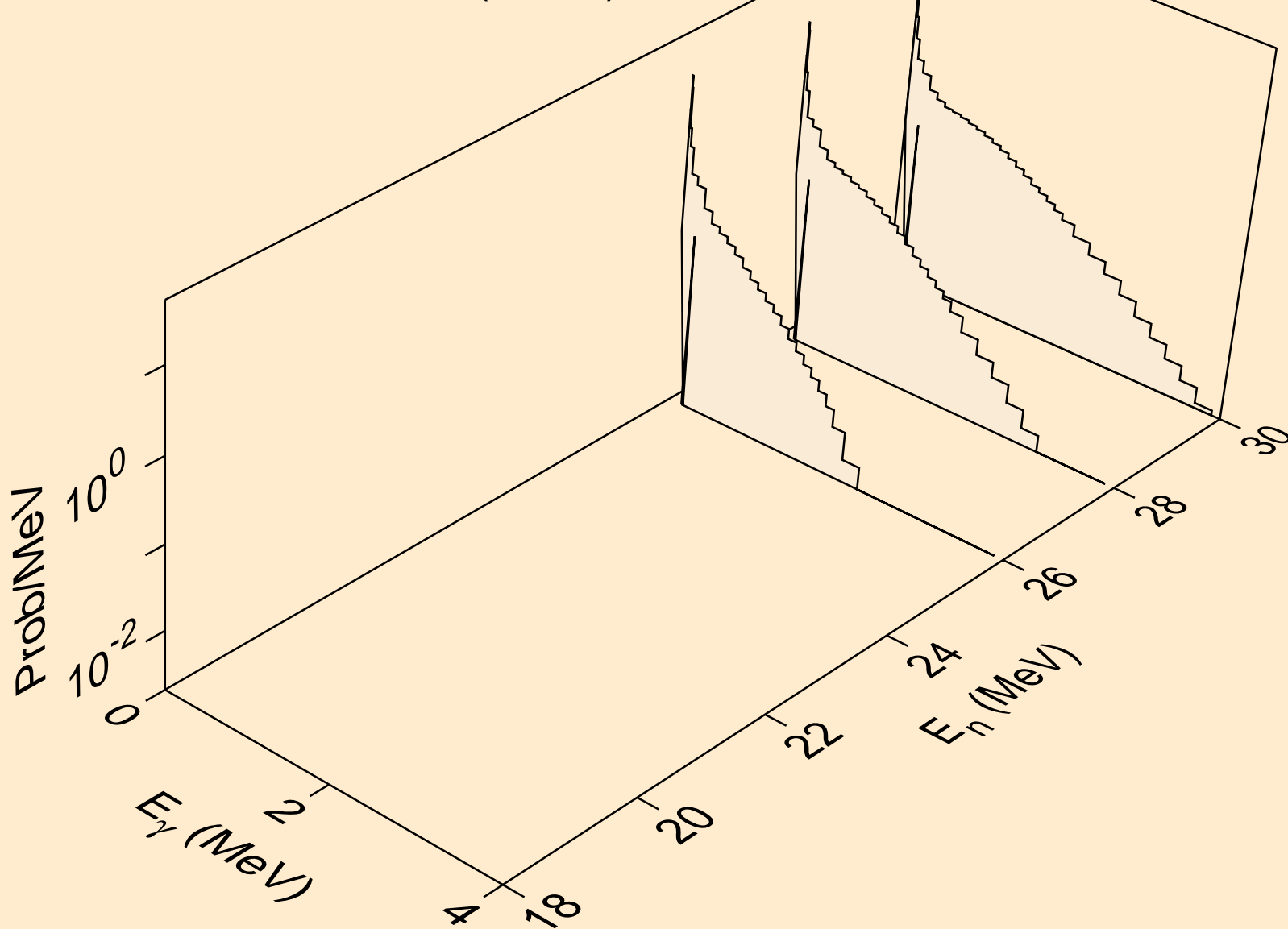

TA166 NEUTRON ACER TENDL-2019 LIBRARY; T=293.16K  
Photon emission for (n,2n)

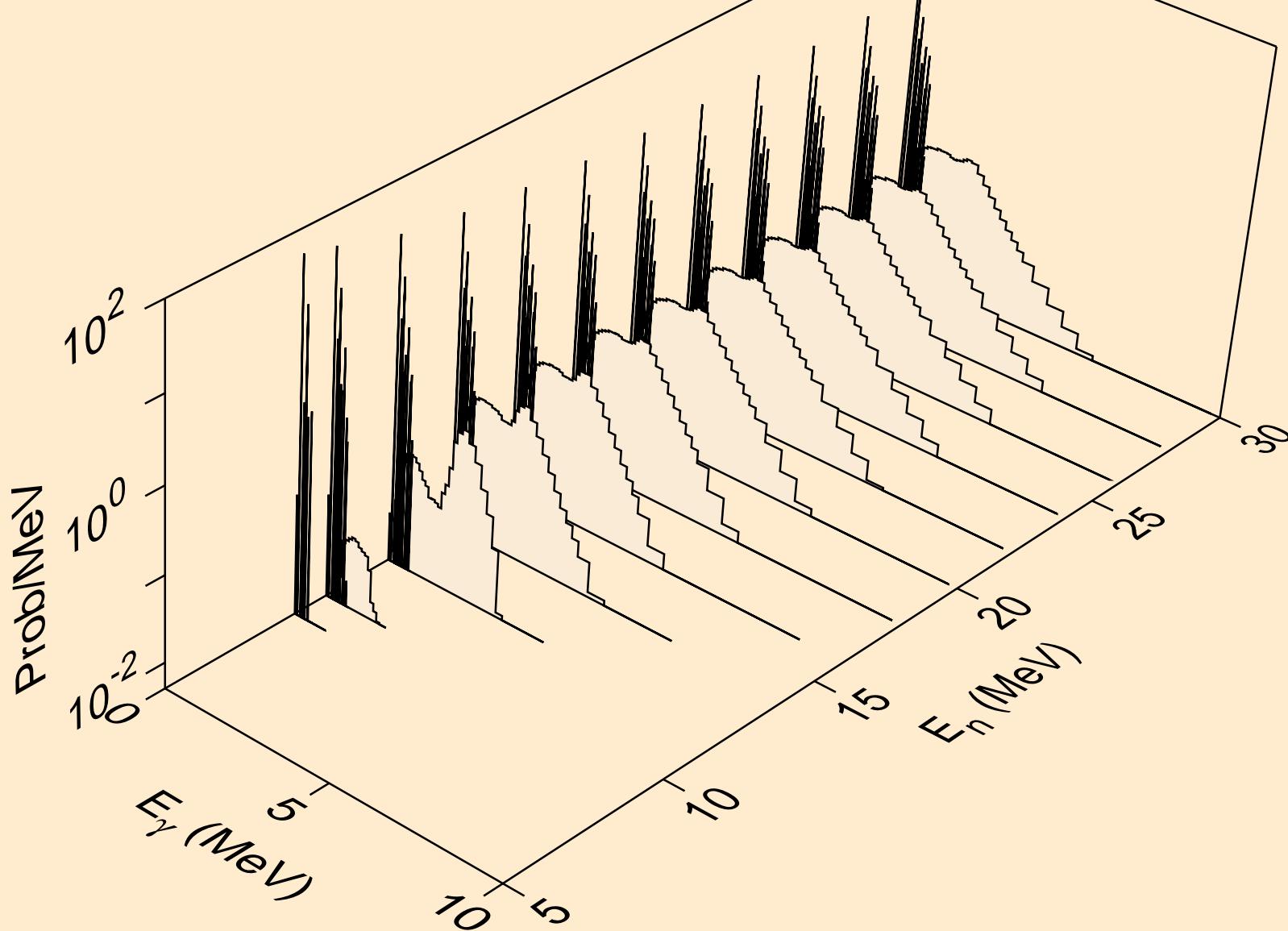

TA166 NEUTRON ACER TENDL-2019 LIBRARY; T=293.16K  
Photon emission for (n,3n)

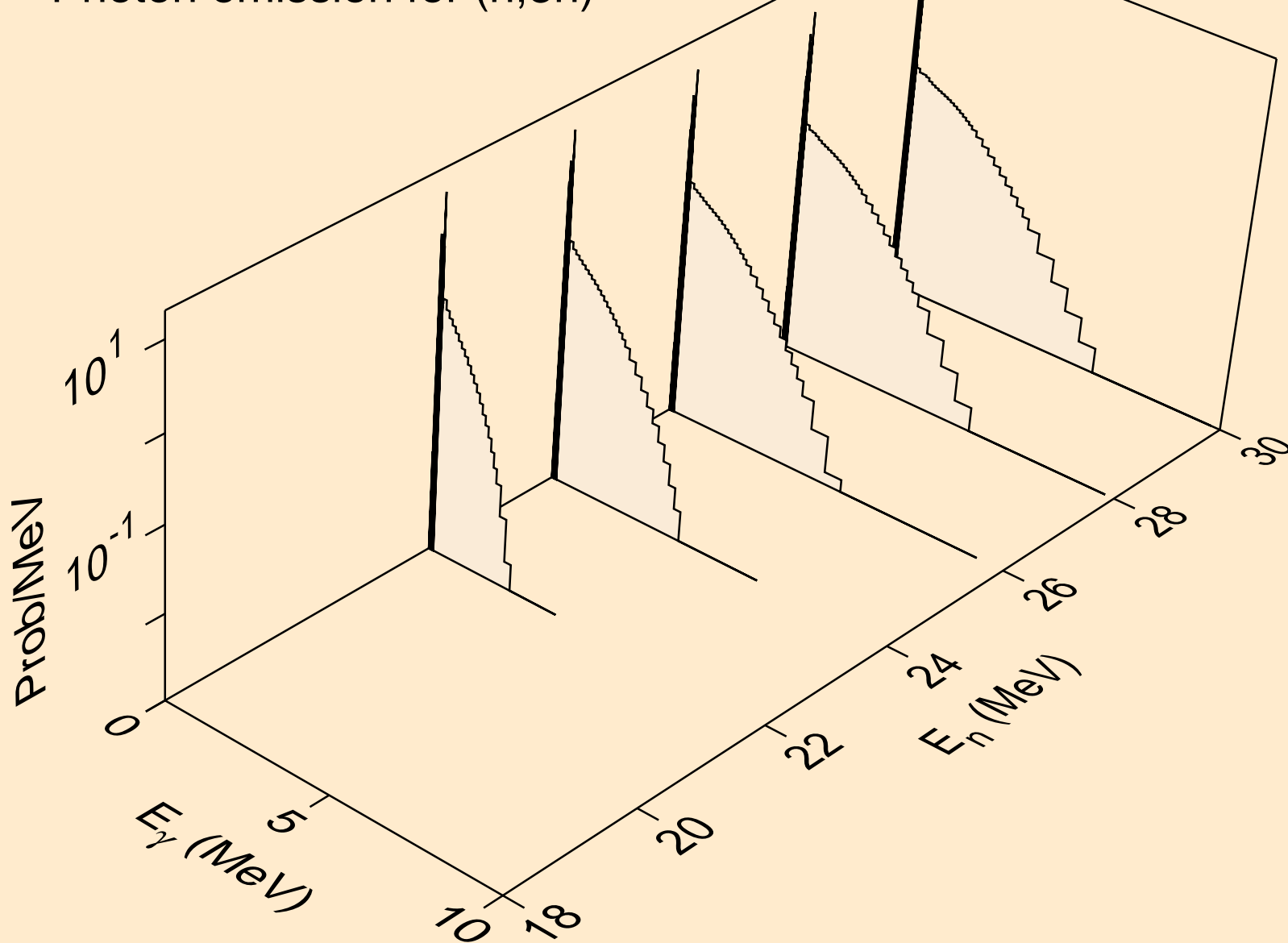

TA166 NEUTRON ACER TENDL-2019 LIBRARY; T=293.16K  
Photon emission for (n,n\*)a

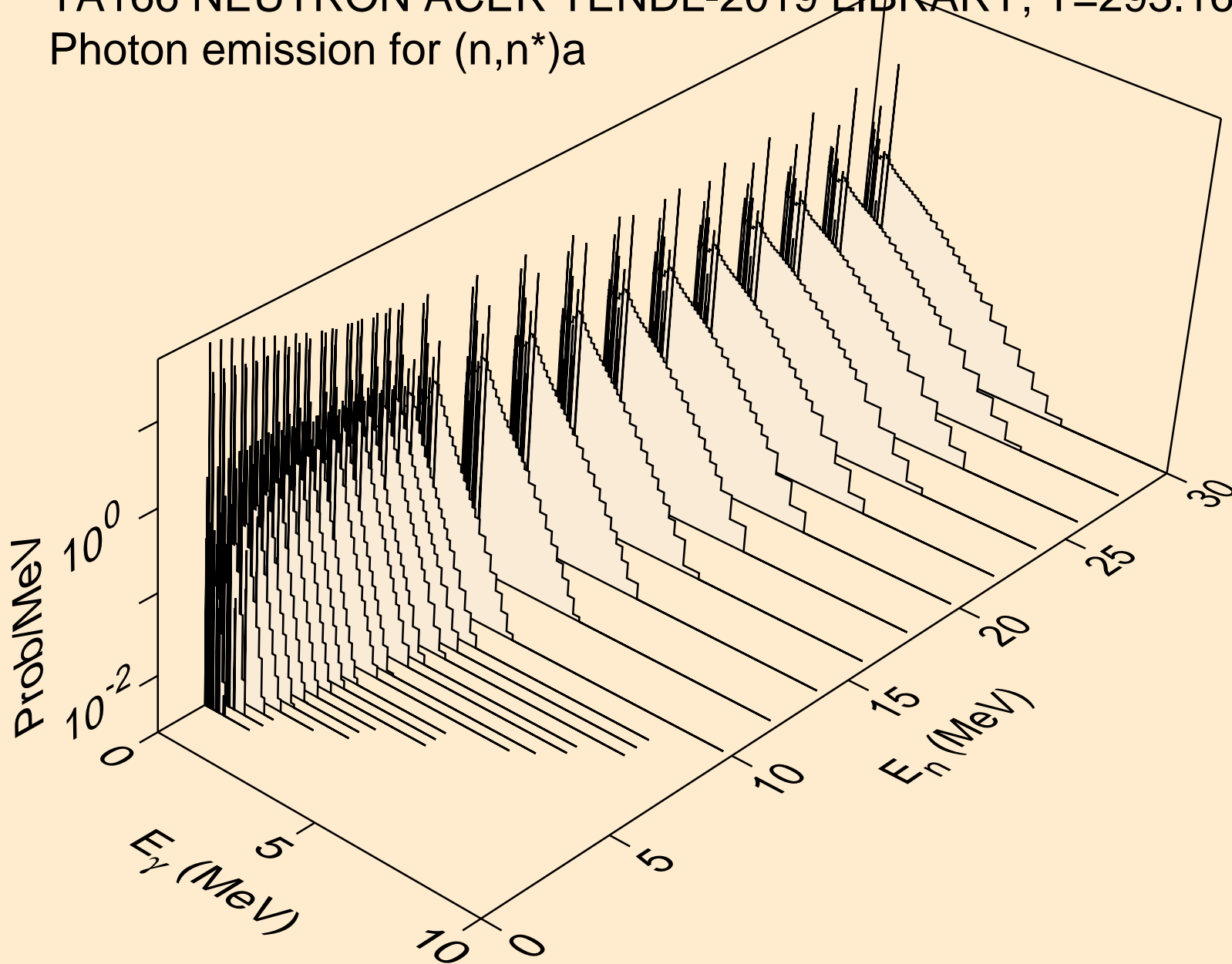

TA166 NEUTRON ACER TENDL-2019 LIBRARY; T=293.16K  
Photon emission for (n,2n) $\alpha$

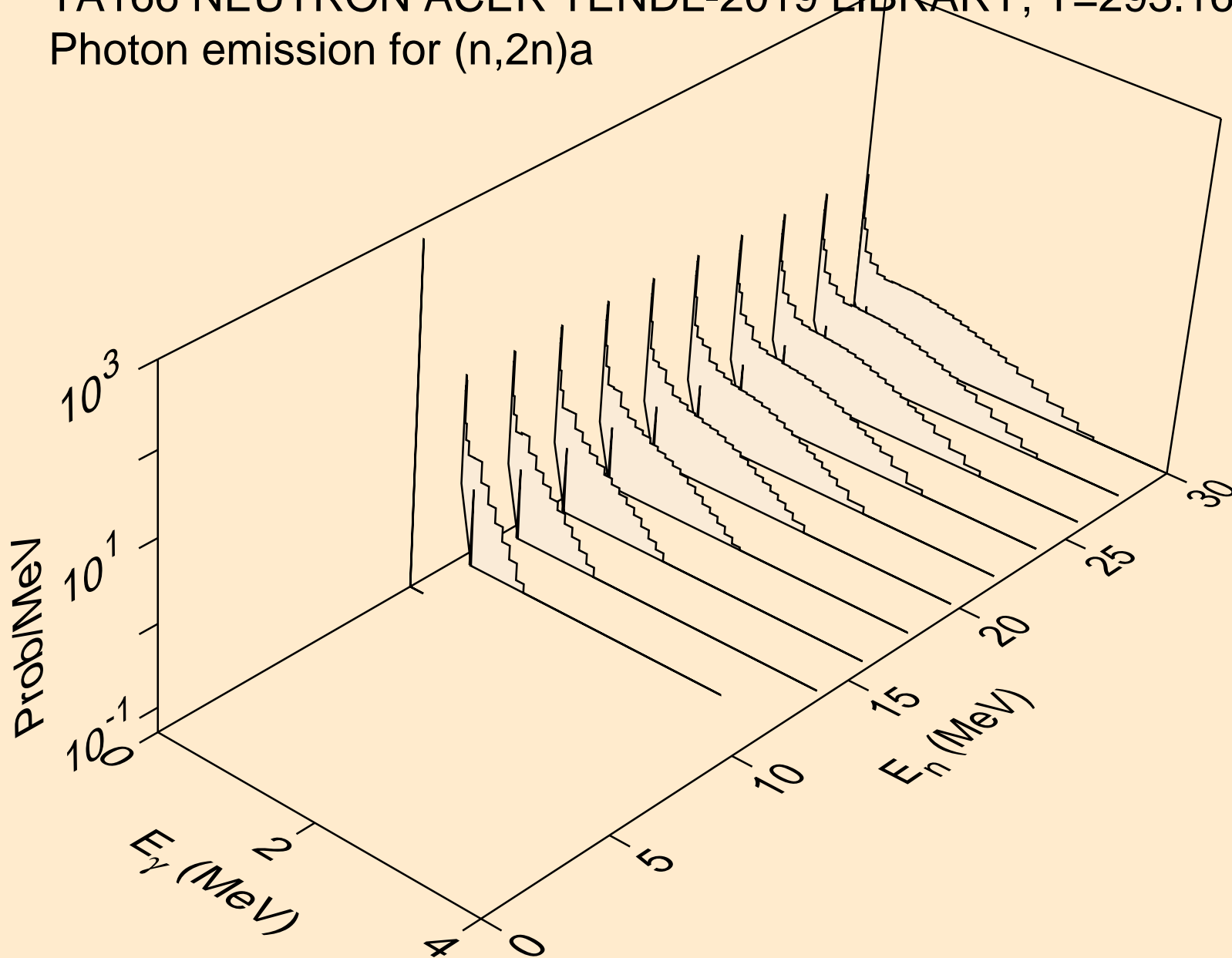

TA166 NEUTRON ACER TENDL-2019 LIBRARY; T=293.16K  
Photon emission for (n,3n)a

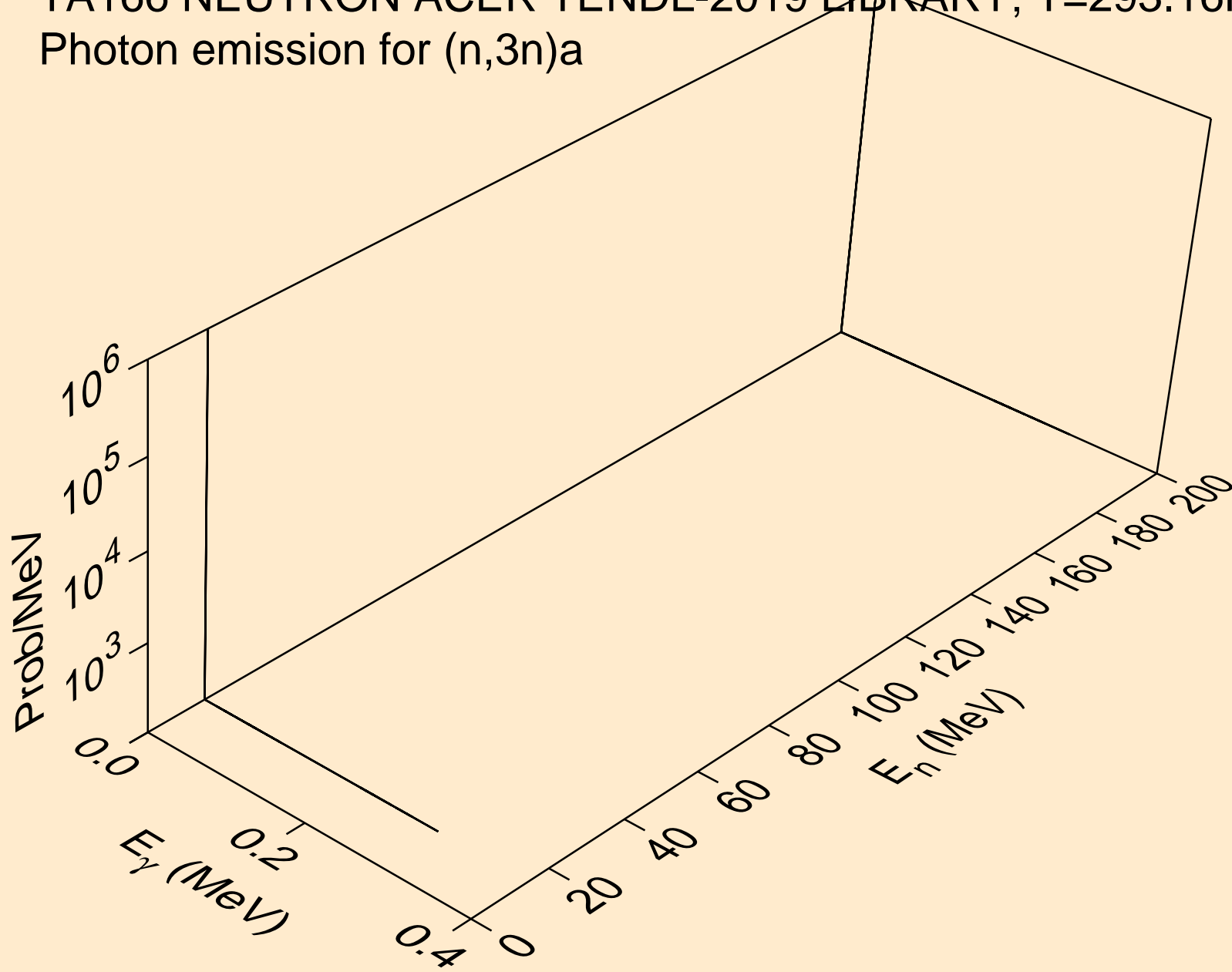

TA166 NEUTRON ACER TENDL-2019 LIBRARY; T=293.16K  
Photon emission for (n,n\*)p

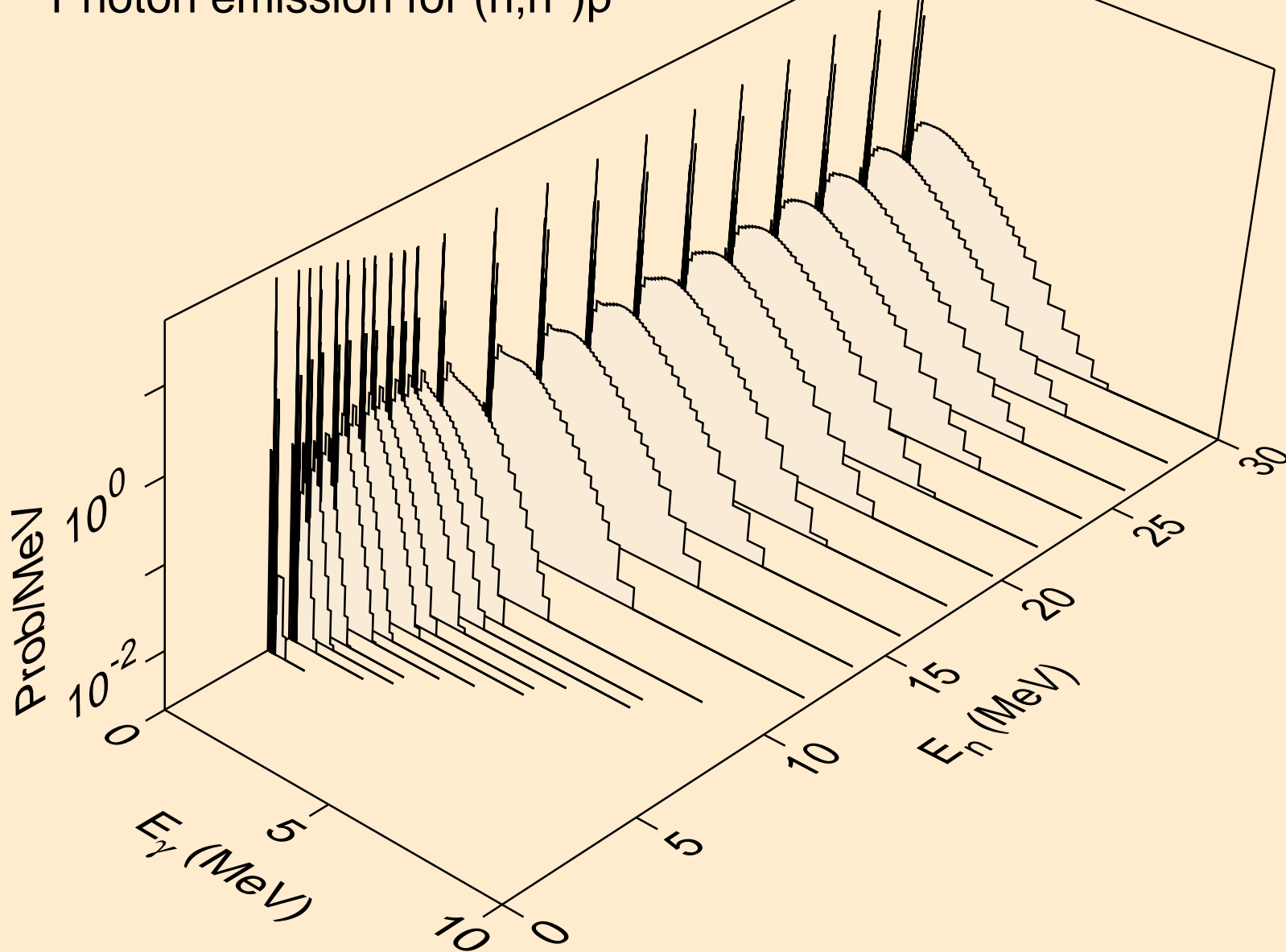



TA166 NEUTRON ACER TENDL-2019 LIBRARY; T=293.16K  
Photon emission for (n,n\*)2a

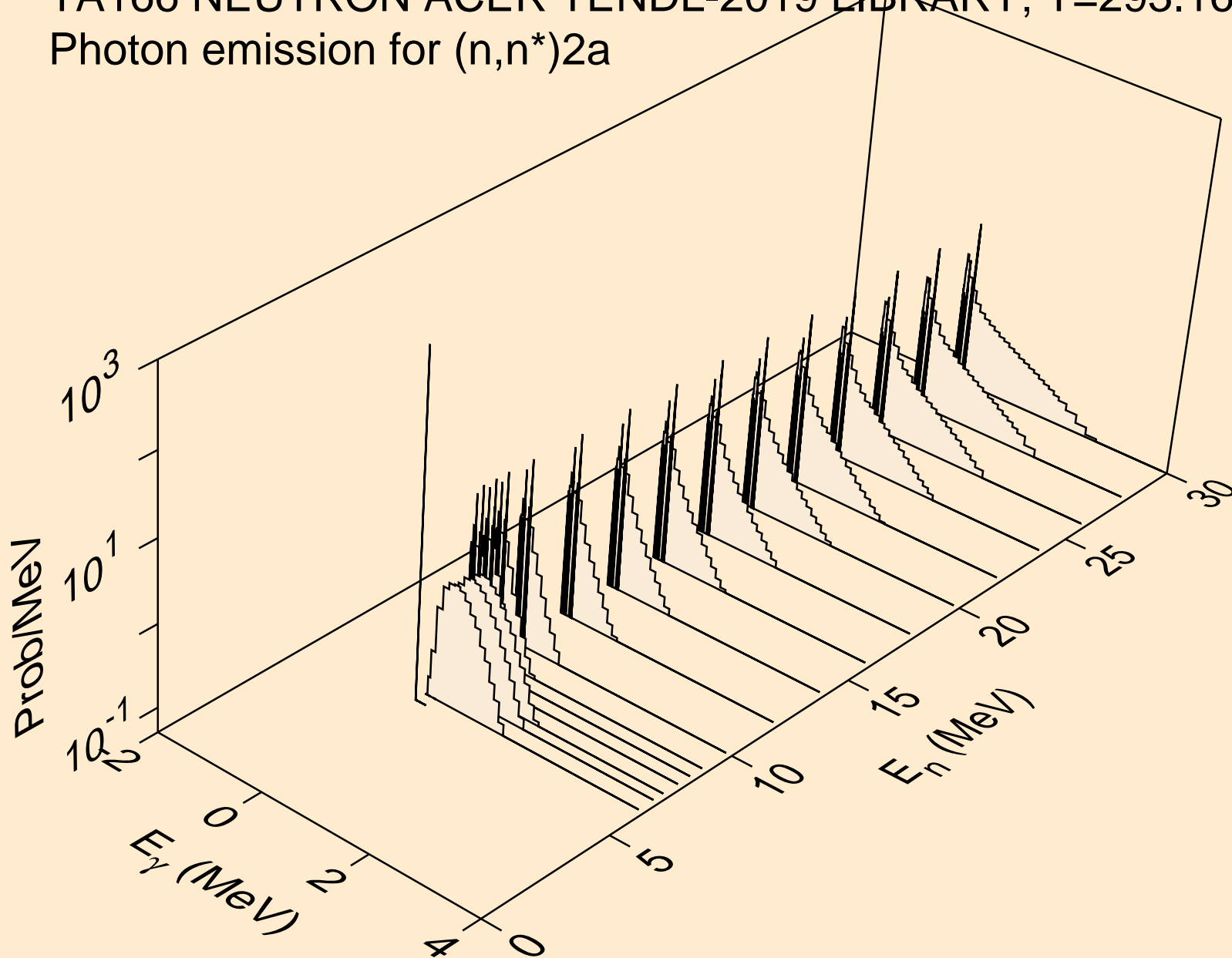

TA166 NEUTRON ACER TENDL-2019 LIBRARY; T=293.16K  
Photon emission for (n,2n)2a

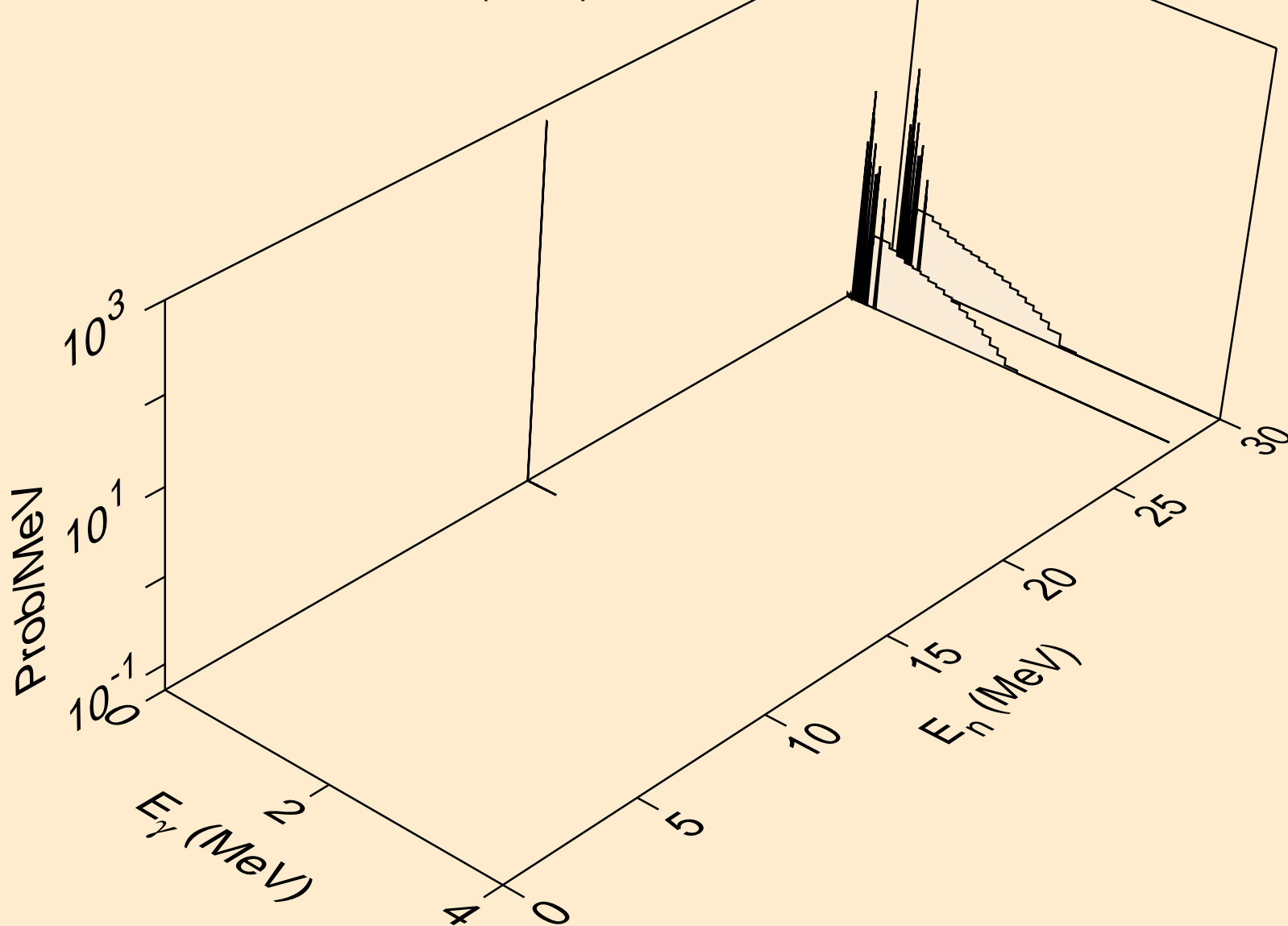

TA166 NEUTRON ACER TENDL-2019 LIBRARY; T=293.16K  
Photon emission for (n,n\*)d

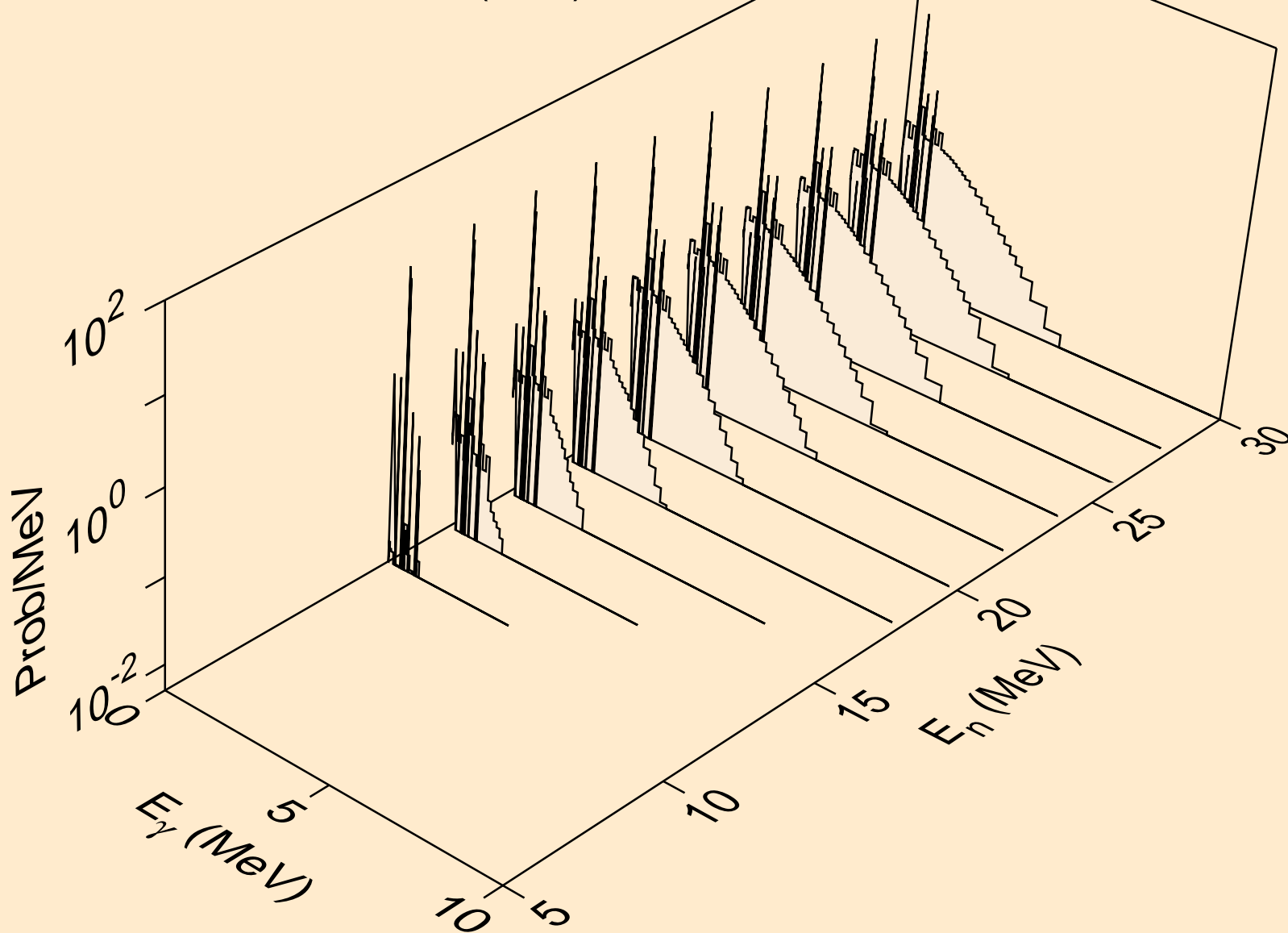

TA166 NEUTRON ACER TENDL-2019 LIBRARY; T=293.16K  
Photon emission for (n,n\*)t

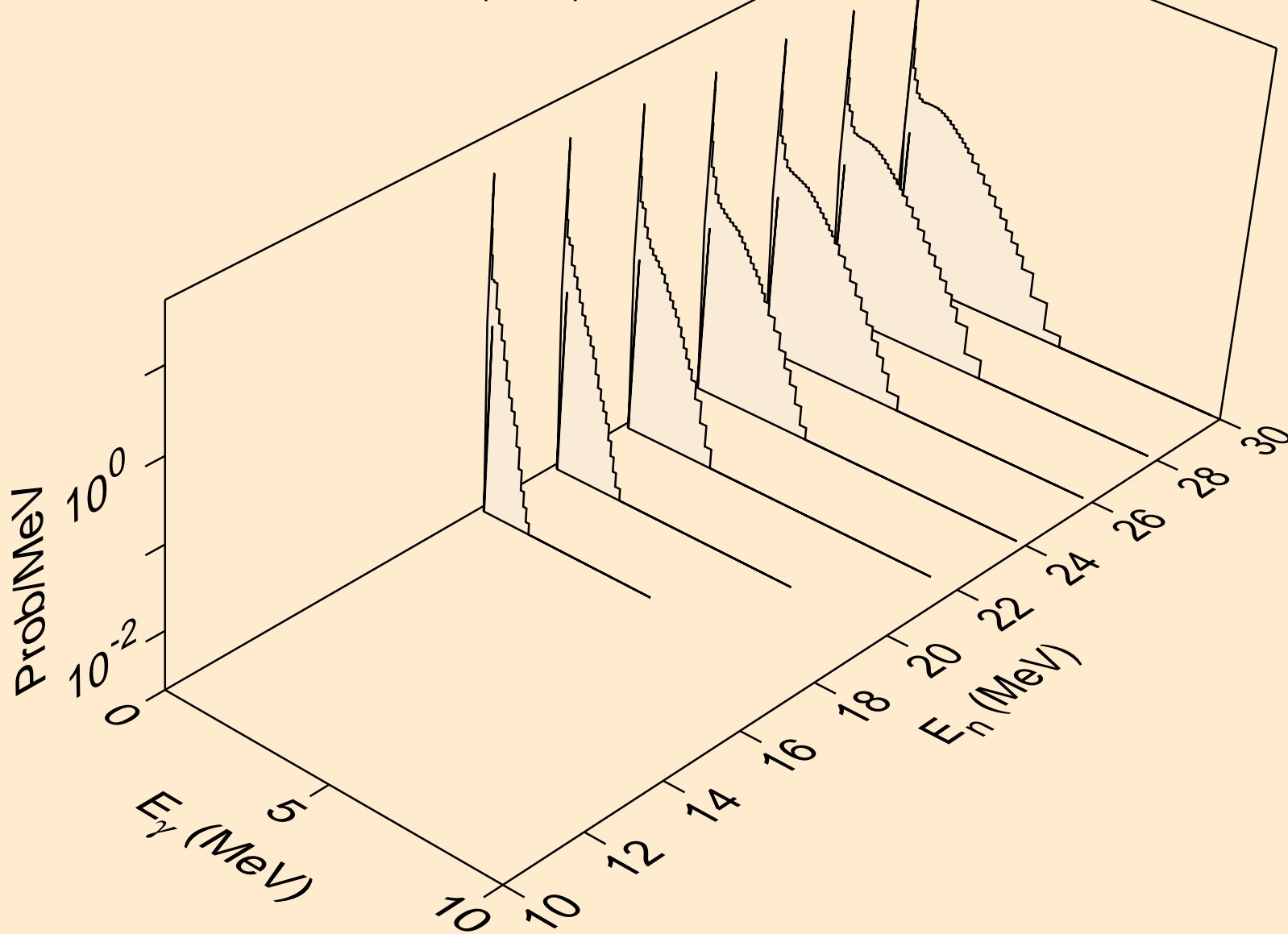

TA166 NEUTRON ACER TENDL-2019 LIBRARY; T=293.16K  
Photon emission for (n,n\*)he3

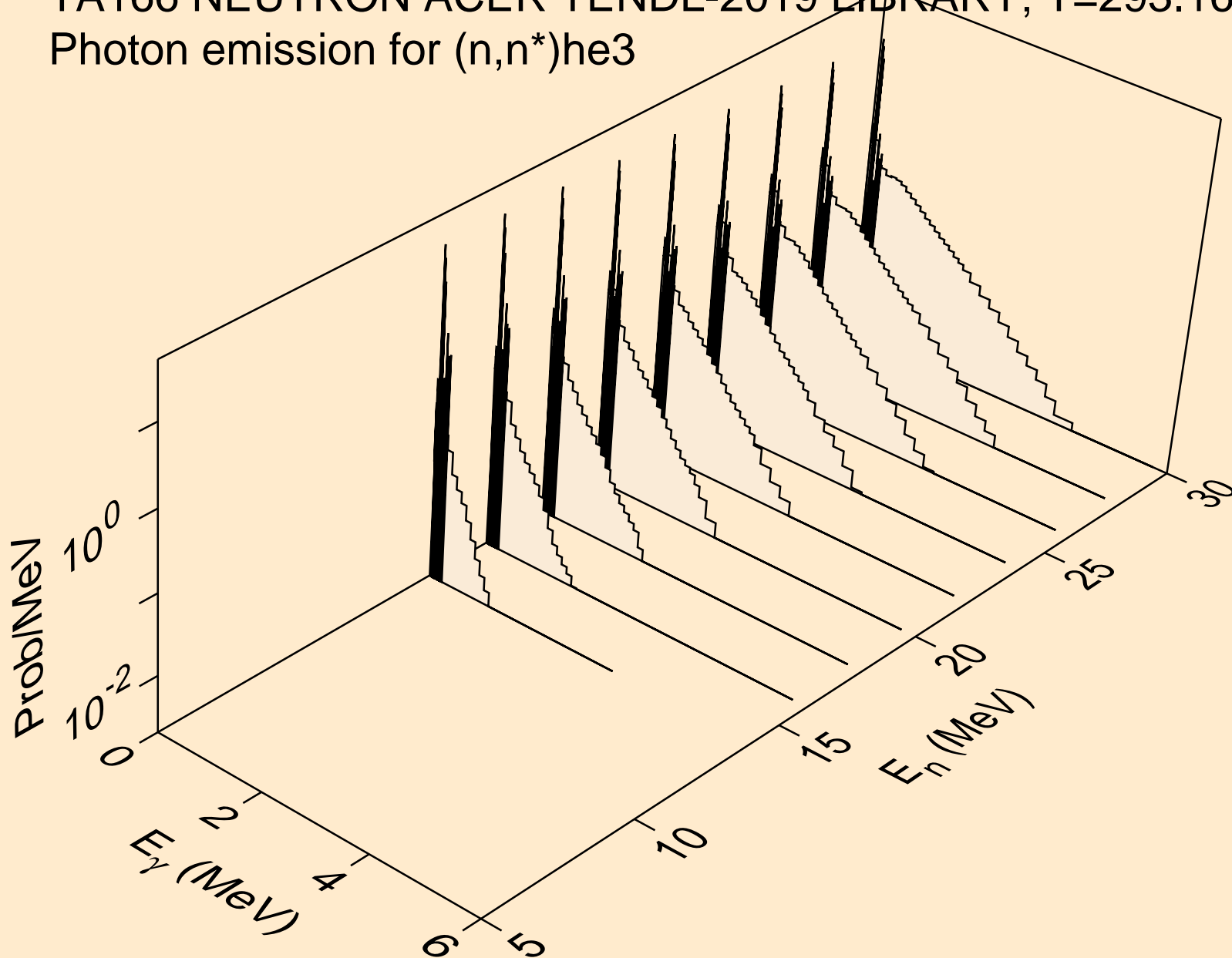

TA166 NEUTRON ACER TENDL-2019 LIBRARY; T=293.16K  
Photon emission for (n,4n)

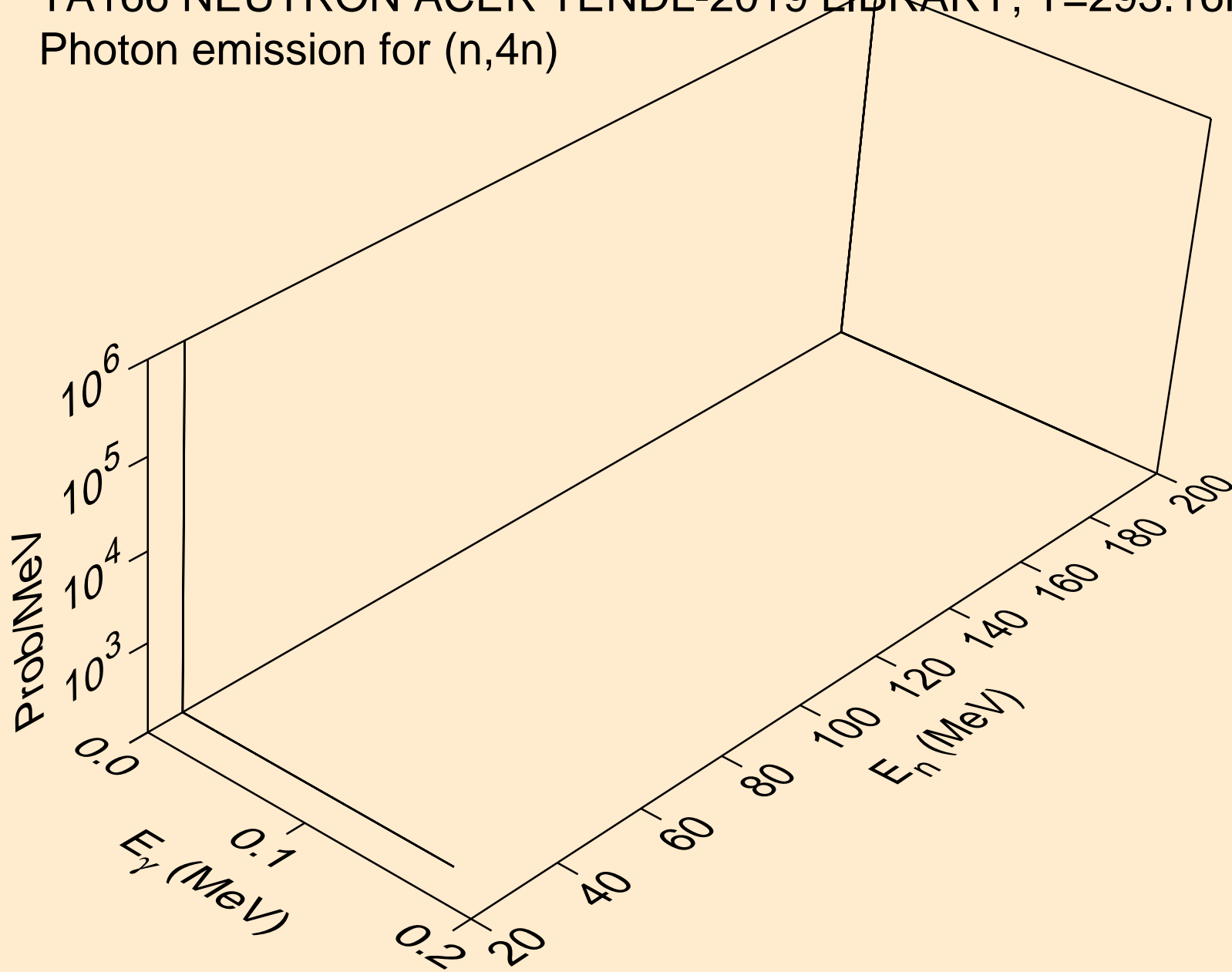

TA166 NEUTRON ACER TENDL-2019 LIBRARY; T=293.16K  
Photon emission for (n,2np)

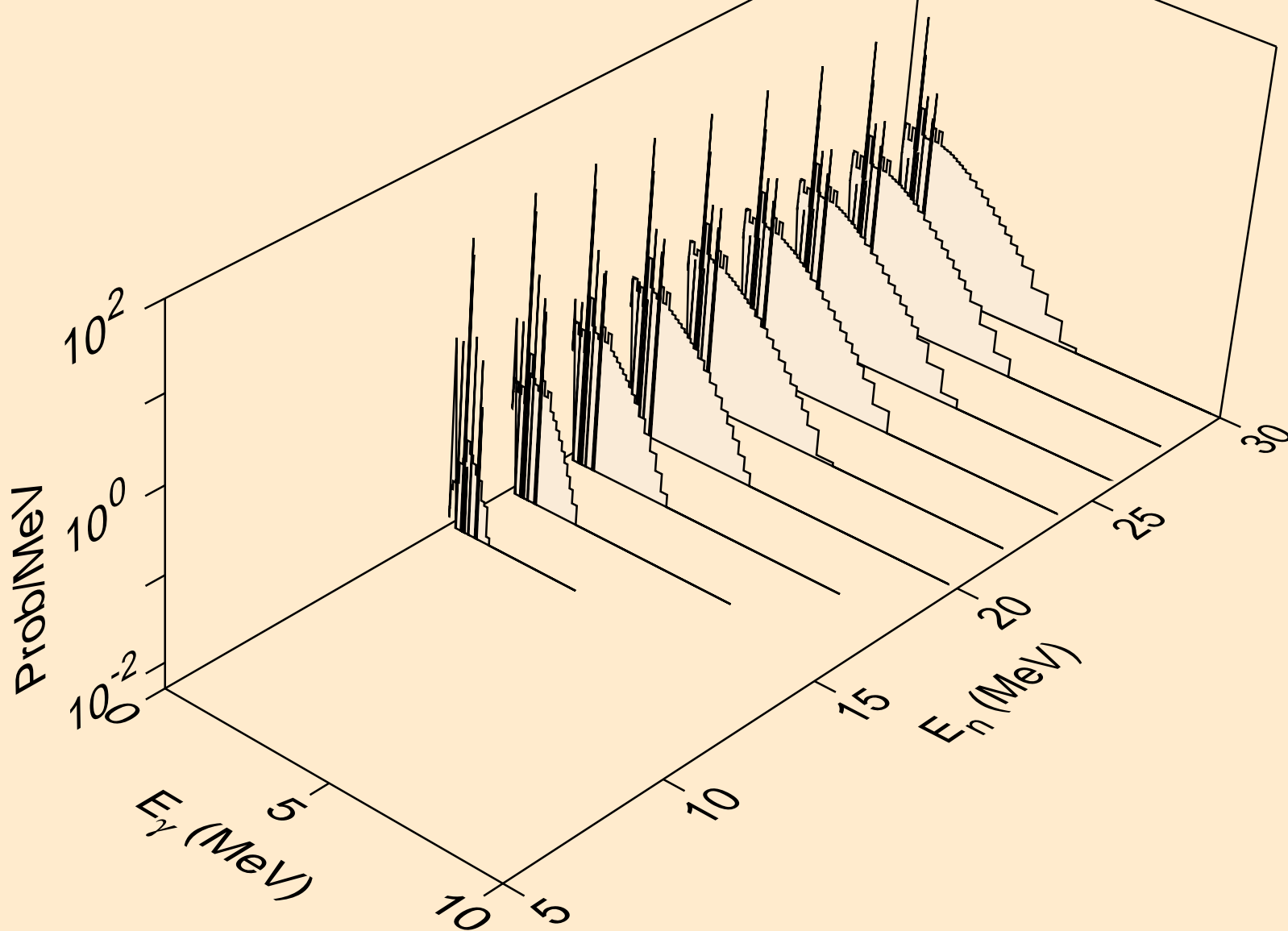

TA166 NEUTRON ACER TENDL-2019 LIBRARY; T=293.16K  
Photon emission for (n,3np)

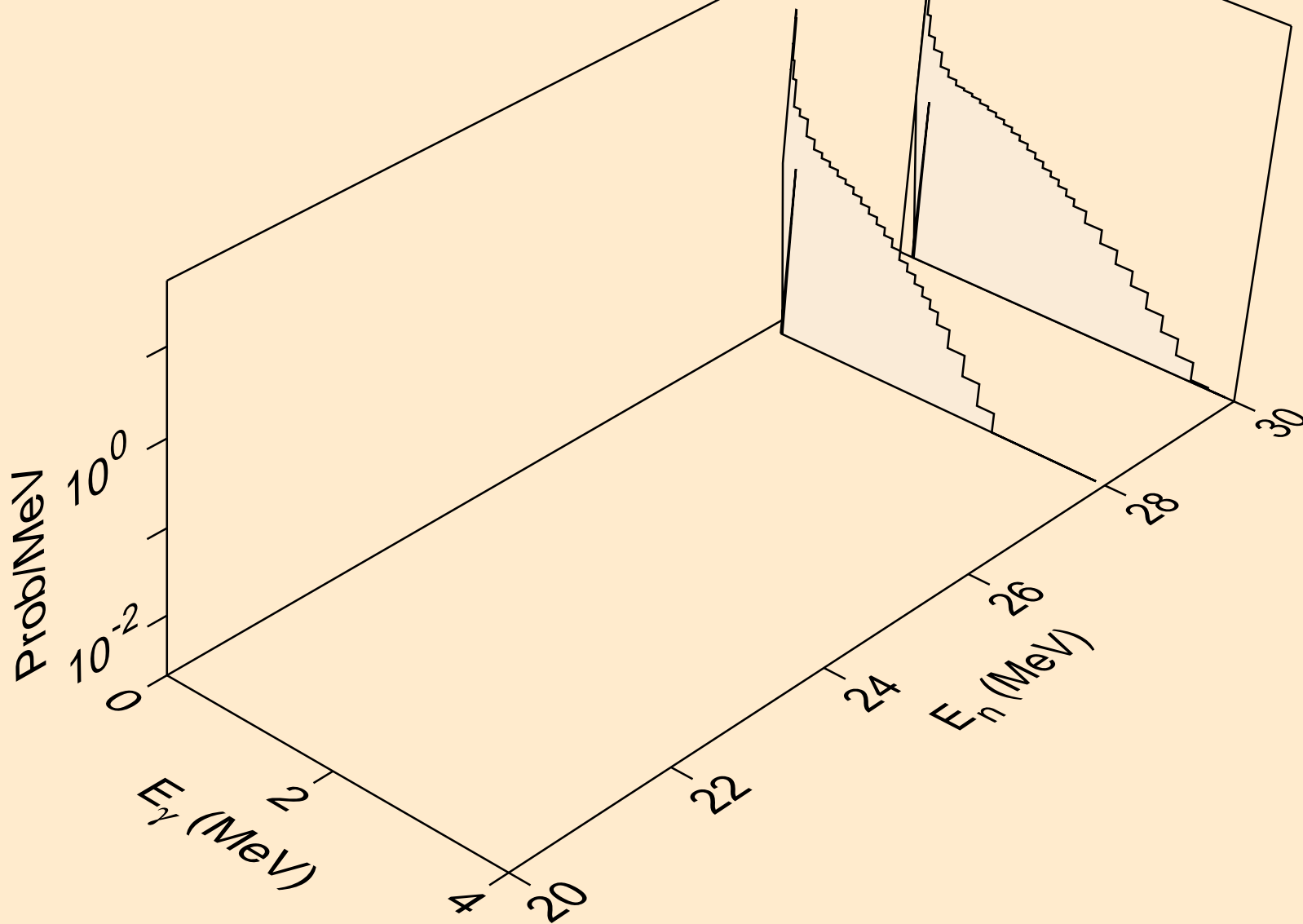



TA166 NEUTRON ACER TENDL-2019 LIBRARY; T=293.16K  
Photon emission for (n,2np)

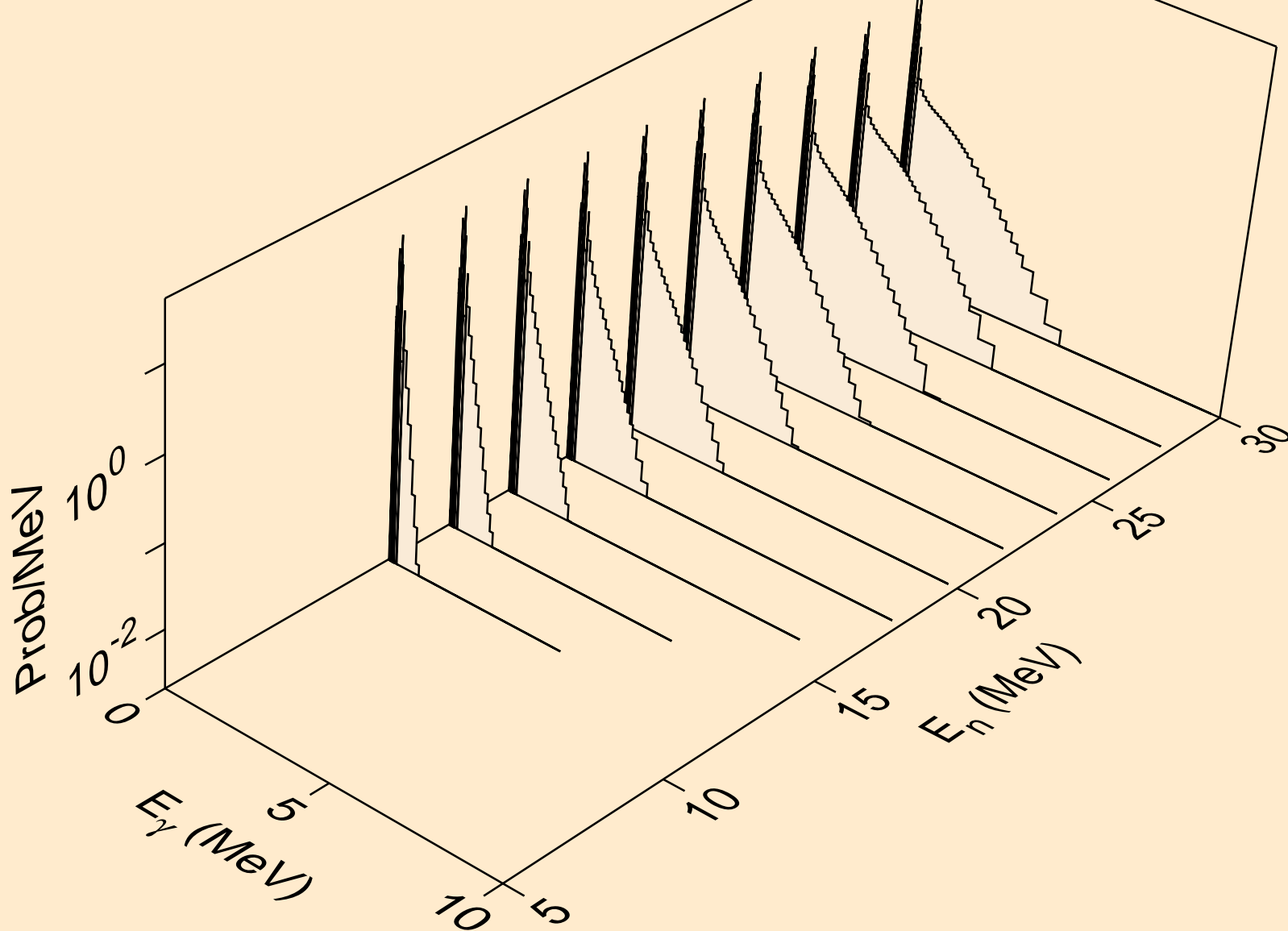

TA166 NEUTRON ACER TENDL-2019 LIBRARY; T=293.16K  
Photon emission for (n,npa)

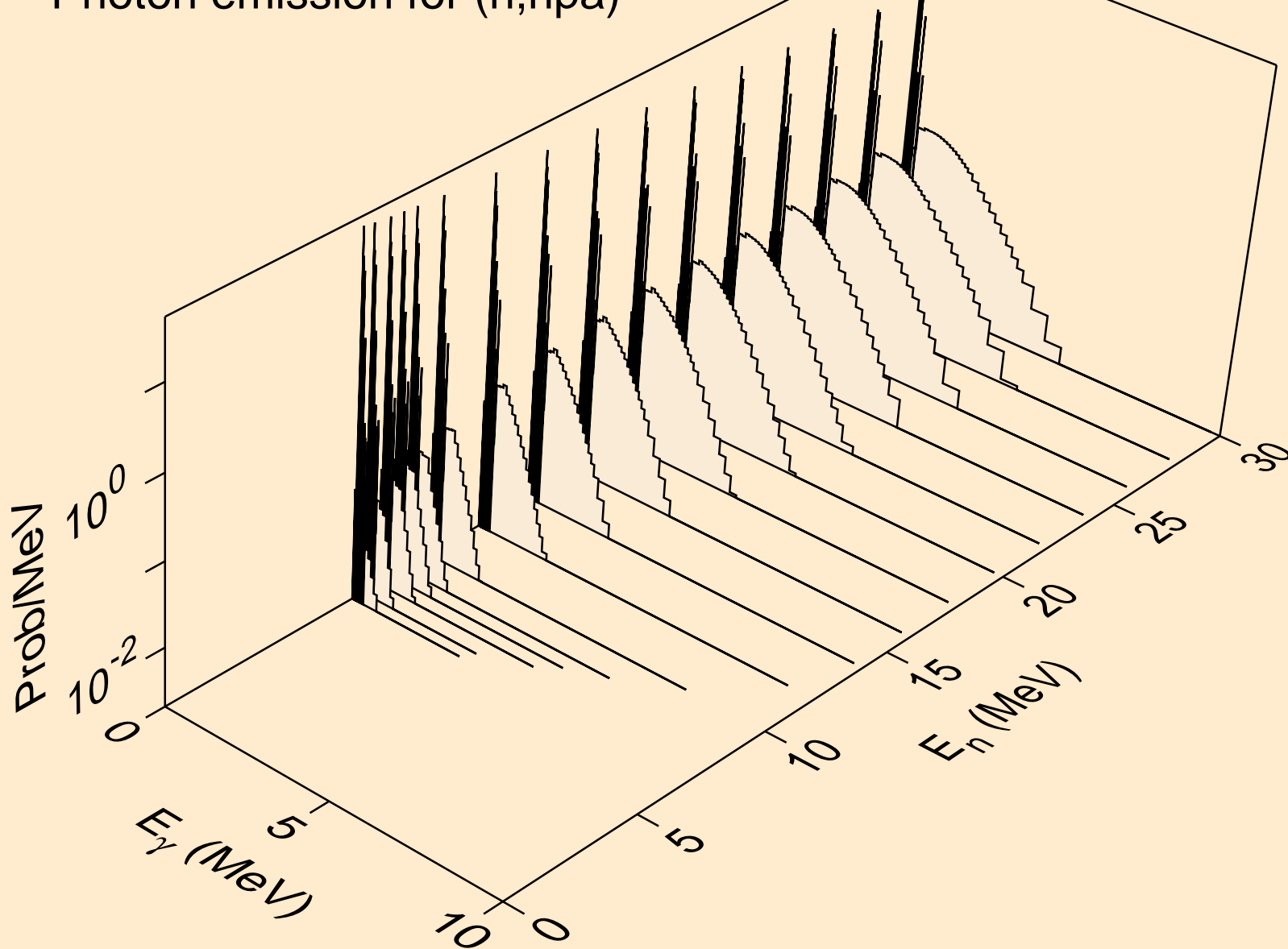

TA166 NEUTRON ACER TENDL-2019 LIBRARY; T=293.16K  
Photon emission for (n,n\*c)

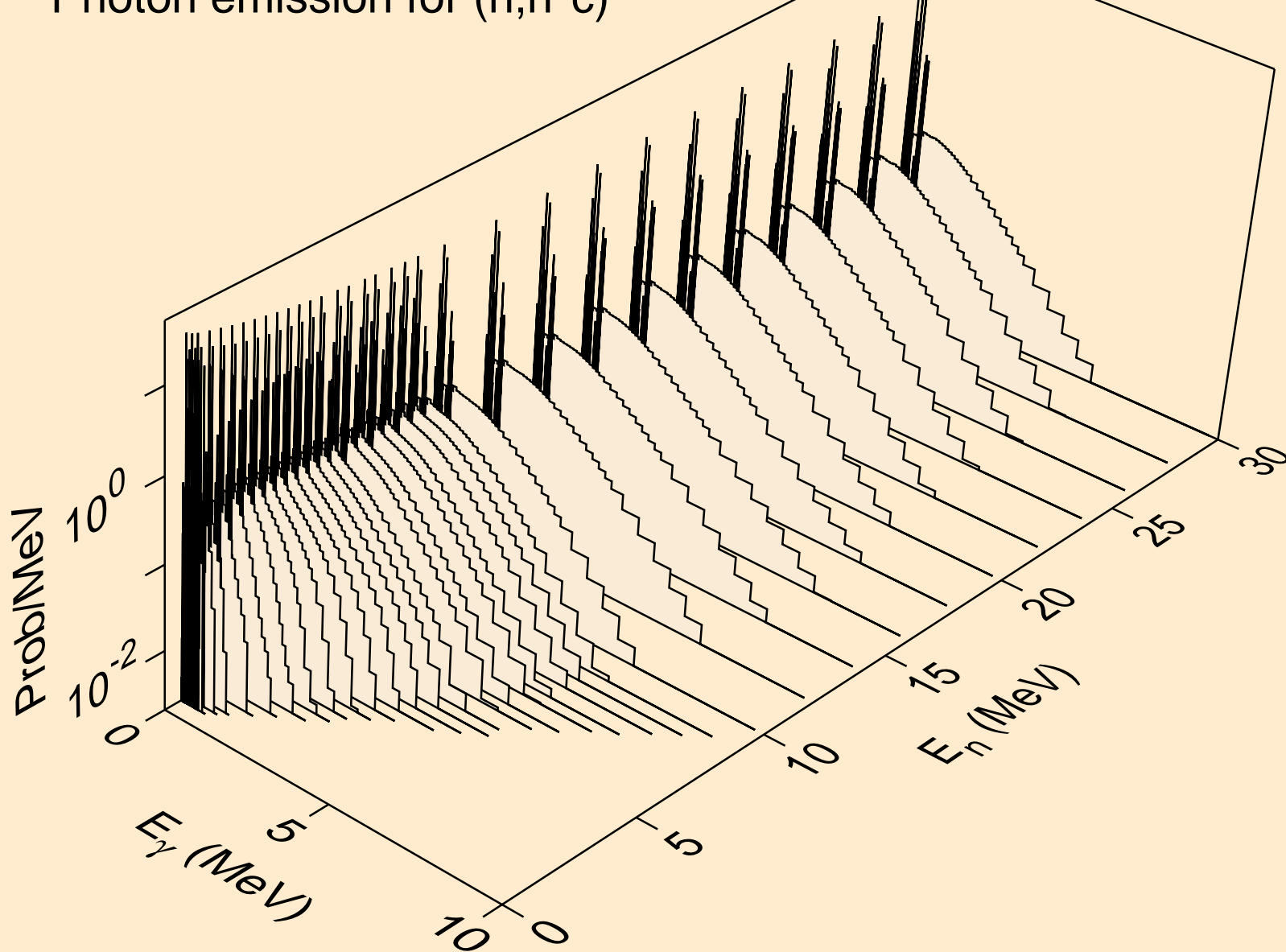

TA166 NEUTRON ACER TENDL-2019 LIBRARY; T=293.16K  
Photon emission for (n,gma)

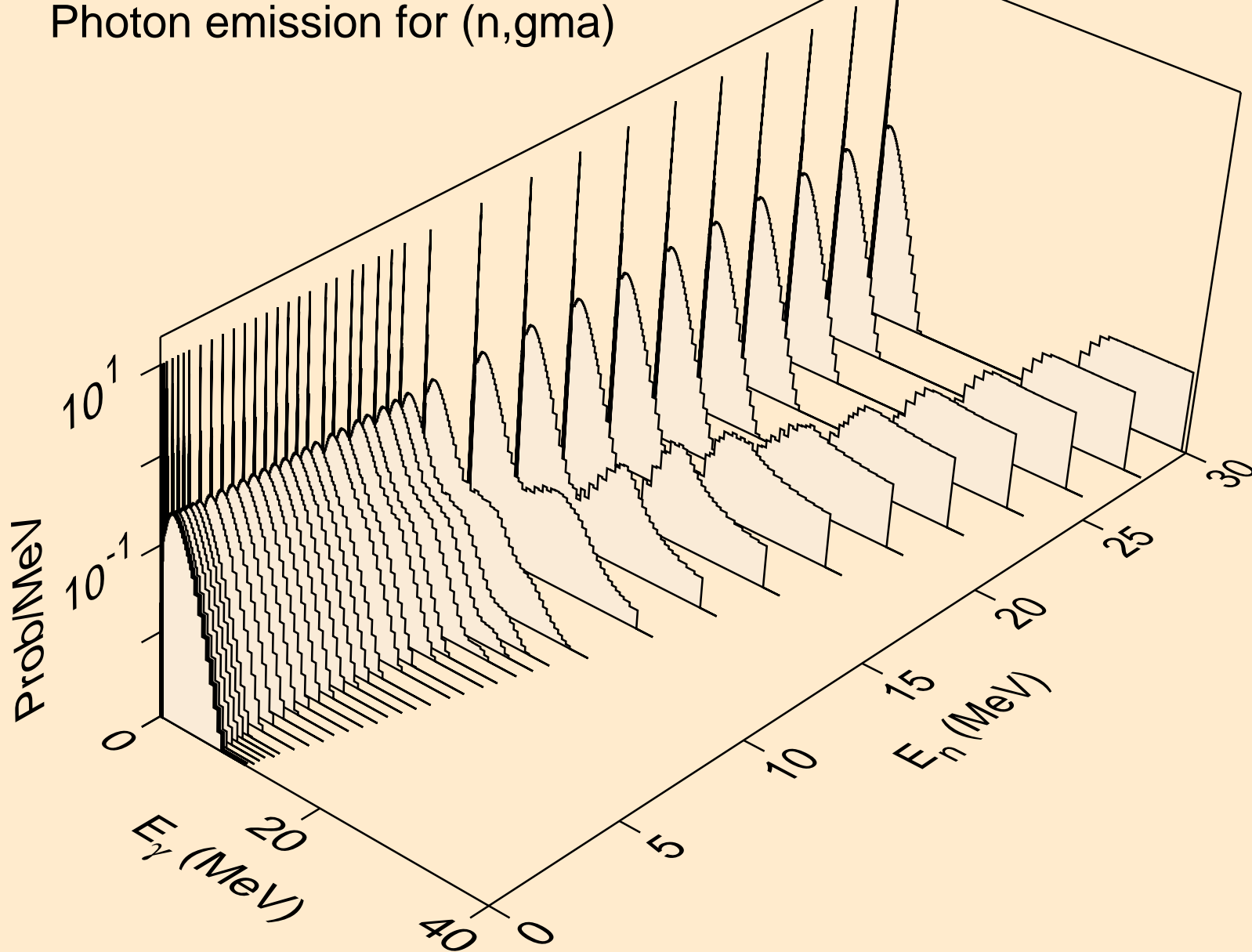

TA166 NEUTRON ACER TENDL-2019 LIBRARY; T=293.16K  
Photon emission for (n,p)

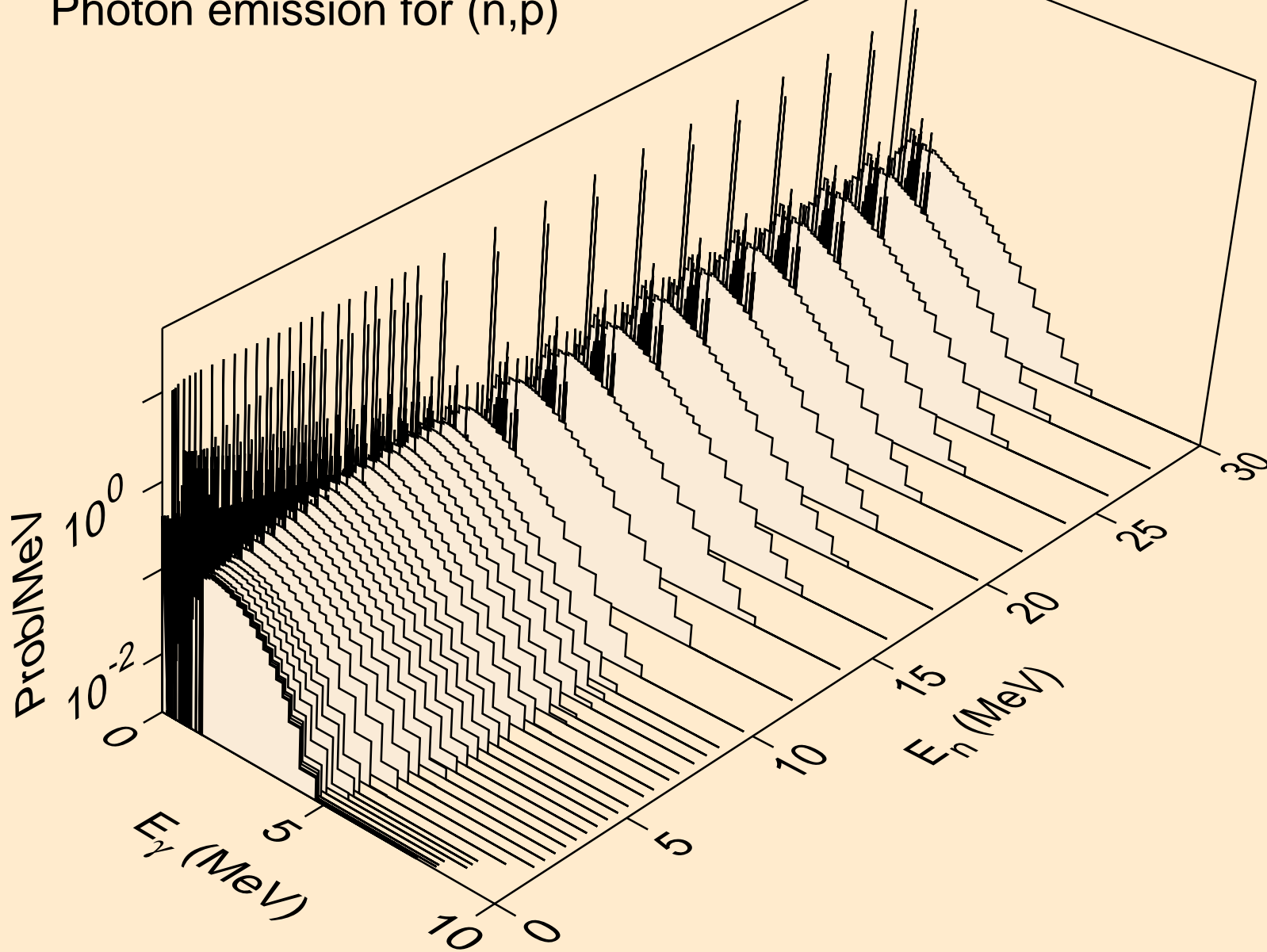

TA166 NEUTRON ACER TENDL-2019 LIBRARY; T=293.16K  
Photon emission for (n,d)

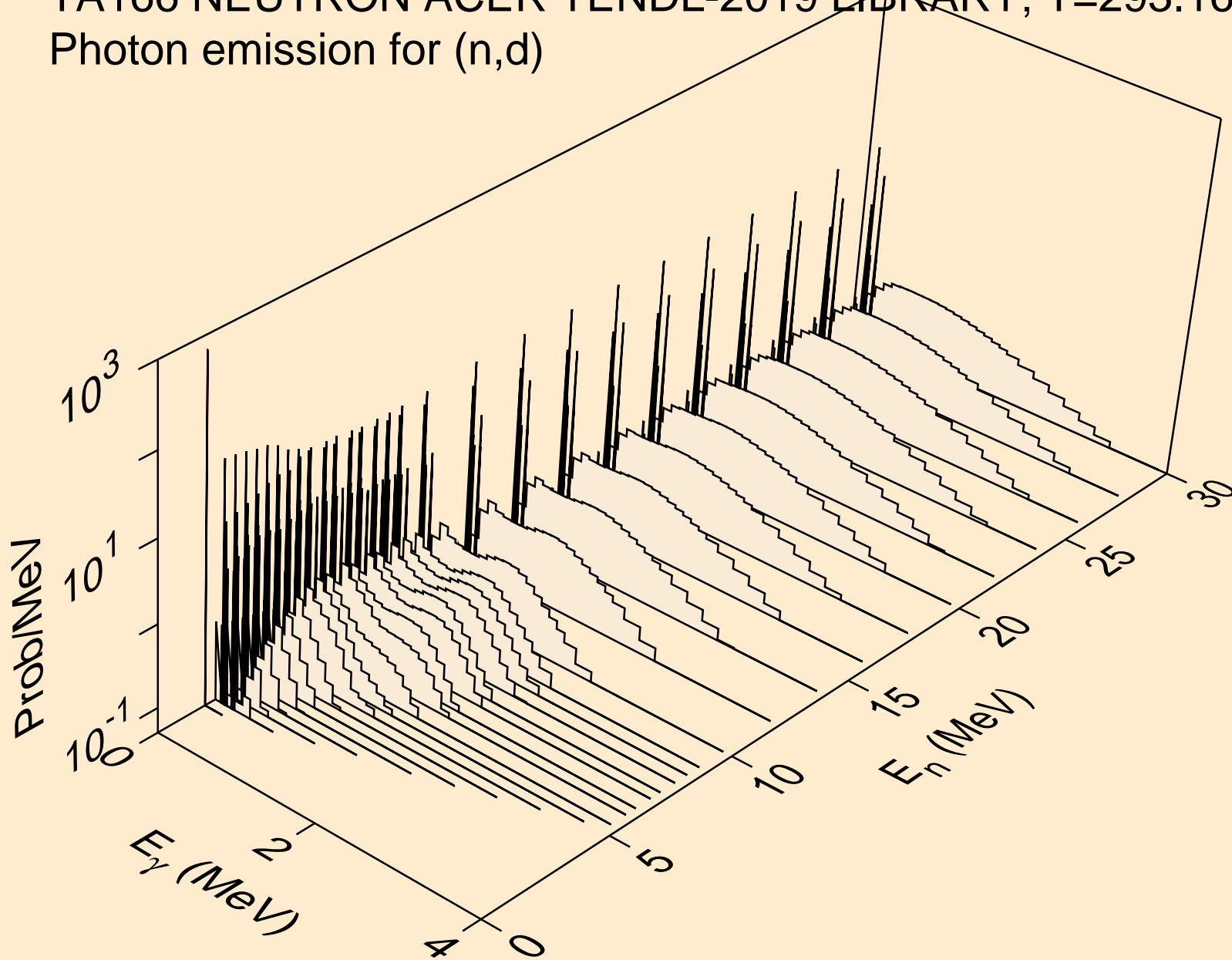

TA166 NEUTRON ACER TENDL-2019 LIBRARY; T=293.16K  
Photon emission for (n,t)

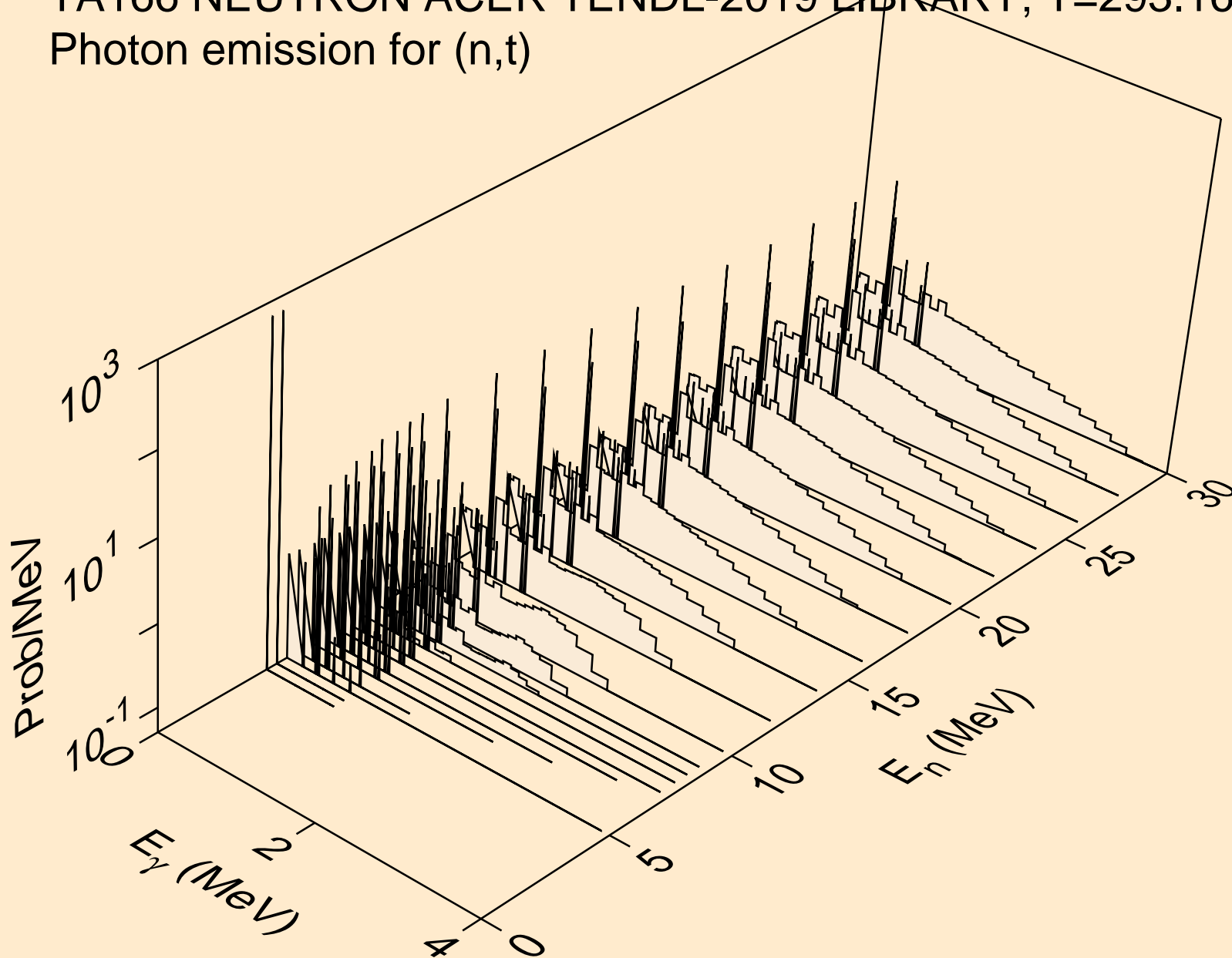

TA166 NEUTRON ACER TENDL-2019 LIBRARY; T=293.16K  
Photon emission for (n,he3)

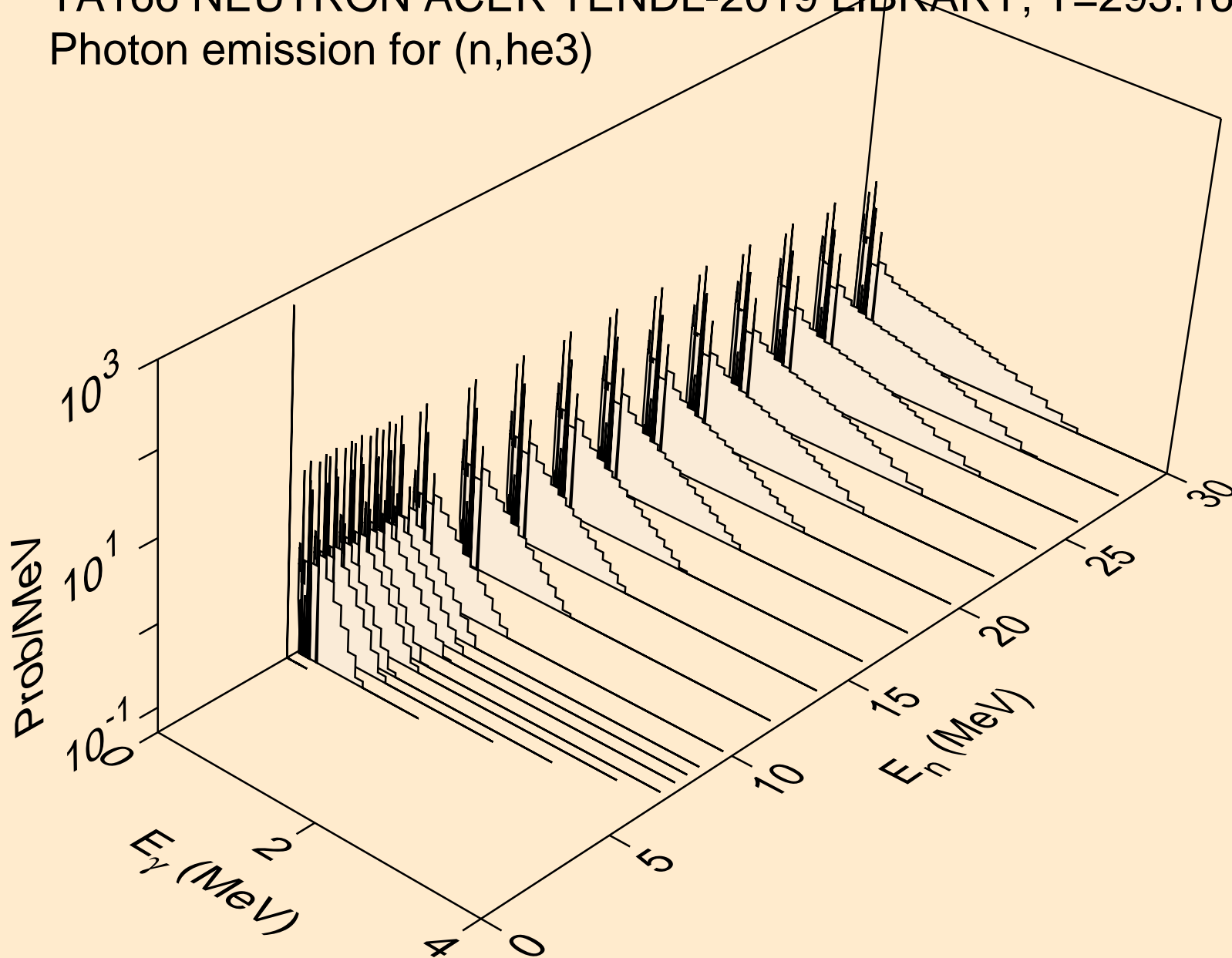



TA166 NEUTRON ACER TENDL-2019 LIBRARY; T=293.16K  
Photon emission for (n,a)

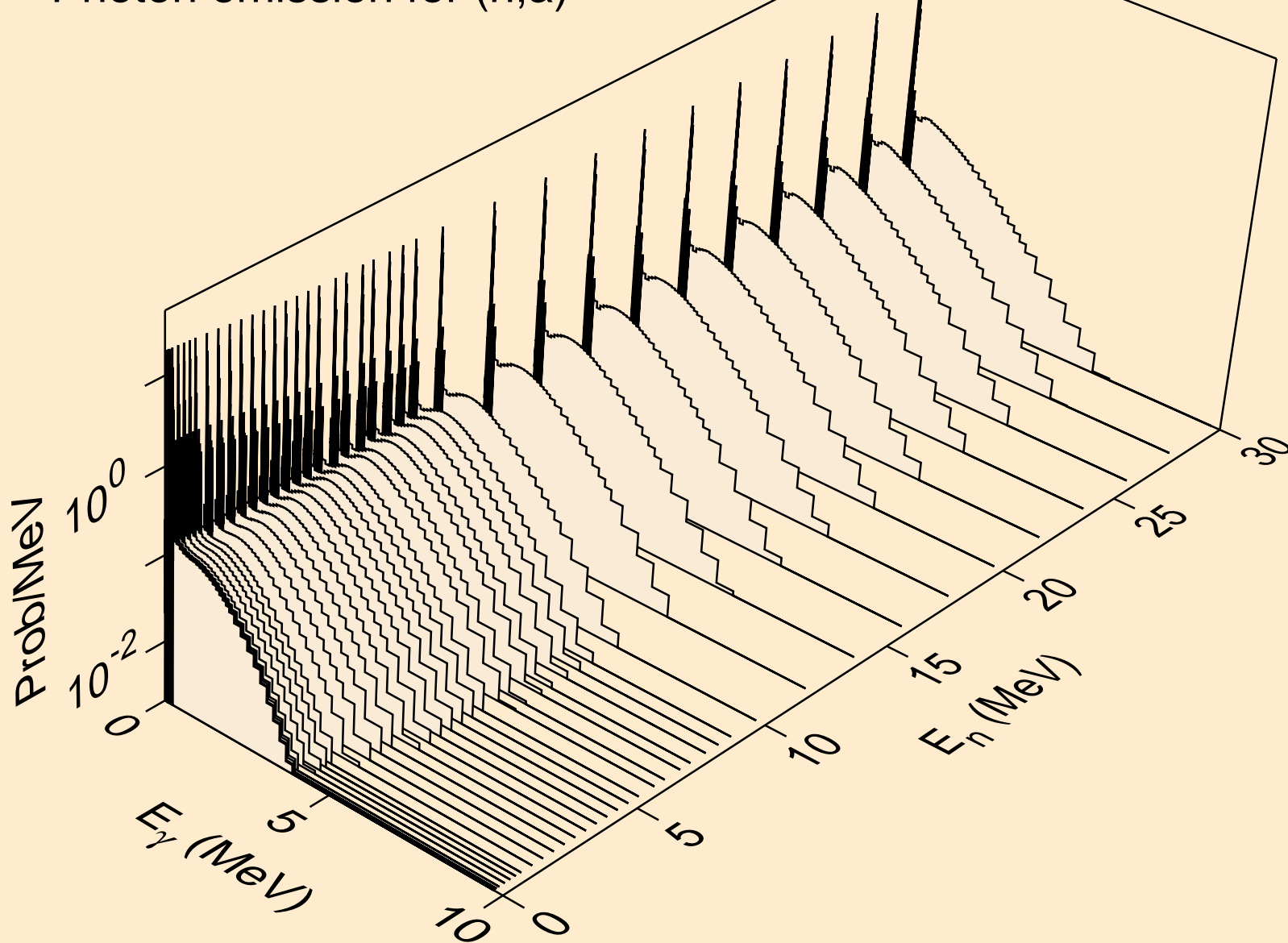

TA166 NEUTRON ACER TENDL-2019 LIBRARY; T=293.16K  
Photon emission for (n,2a)

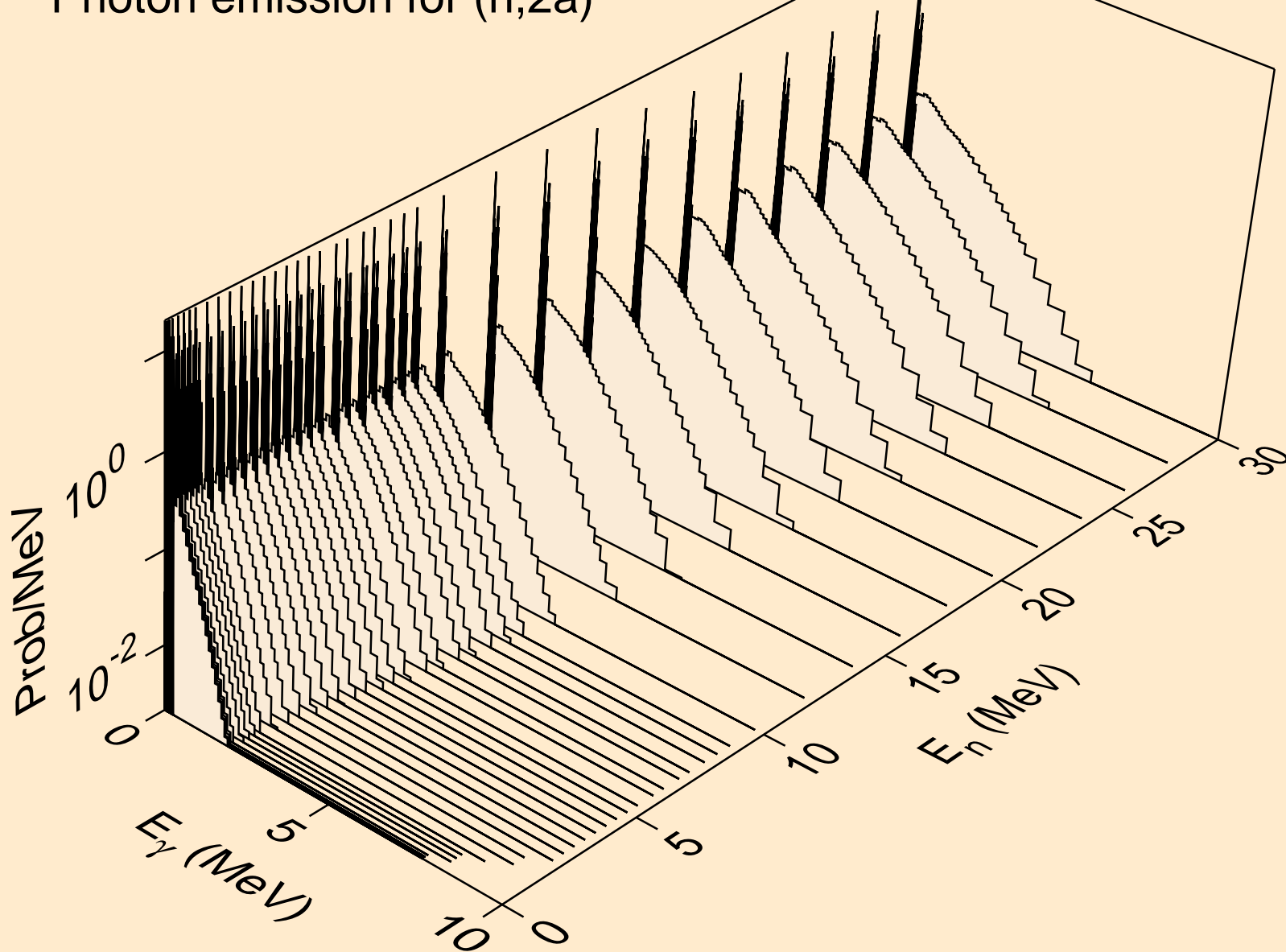

TA166 NEUTRON ACER TENDL-2019 LIBRARY; T=293.16K  
Photon emission for (n,3a)

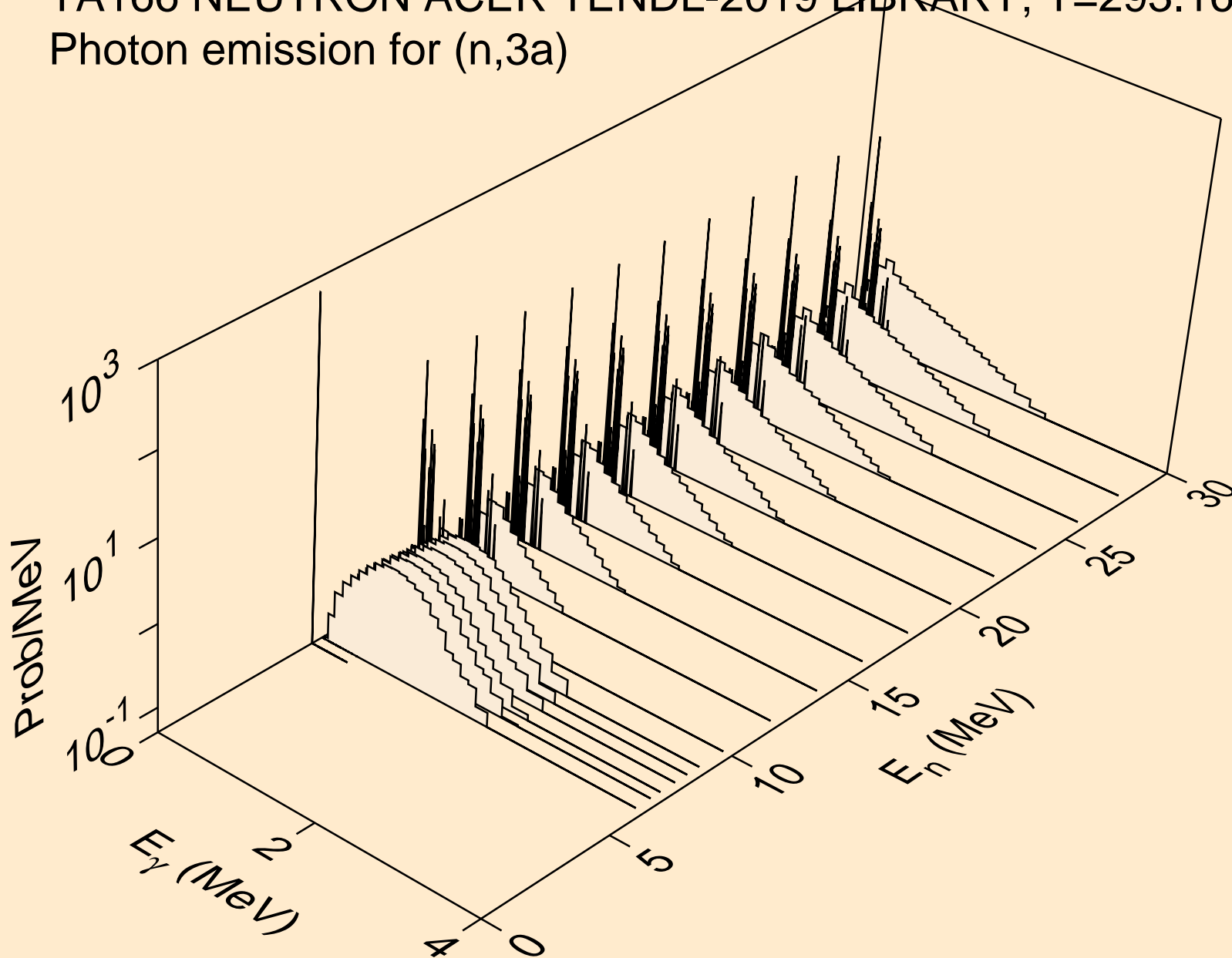

TA166 NEUTRON ACER TENDL-2019 LIBRARY; T=293.16K  
Photon emission for (n,2p)

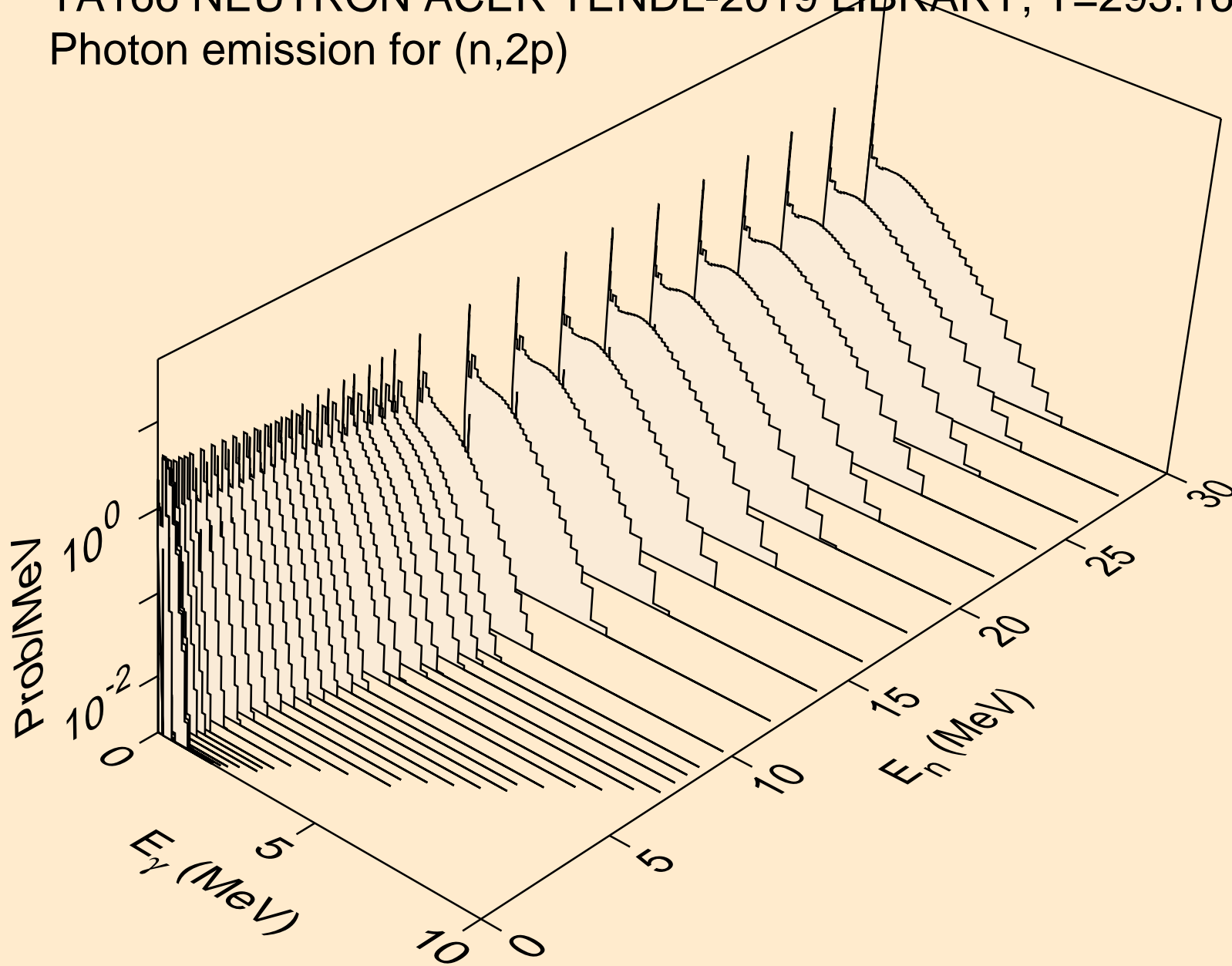

TA166 NEUTRON ACER TENDL-2019 LIBRARY; T=293.16K  
Photon emission for (n,p)

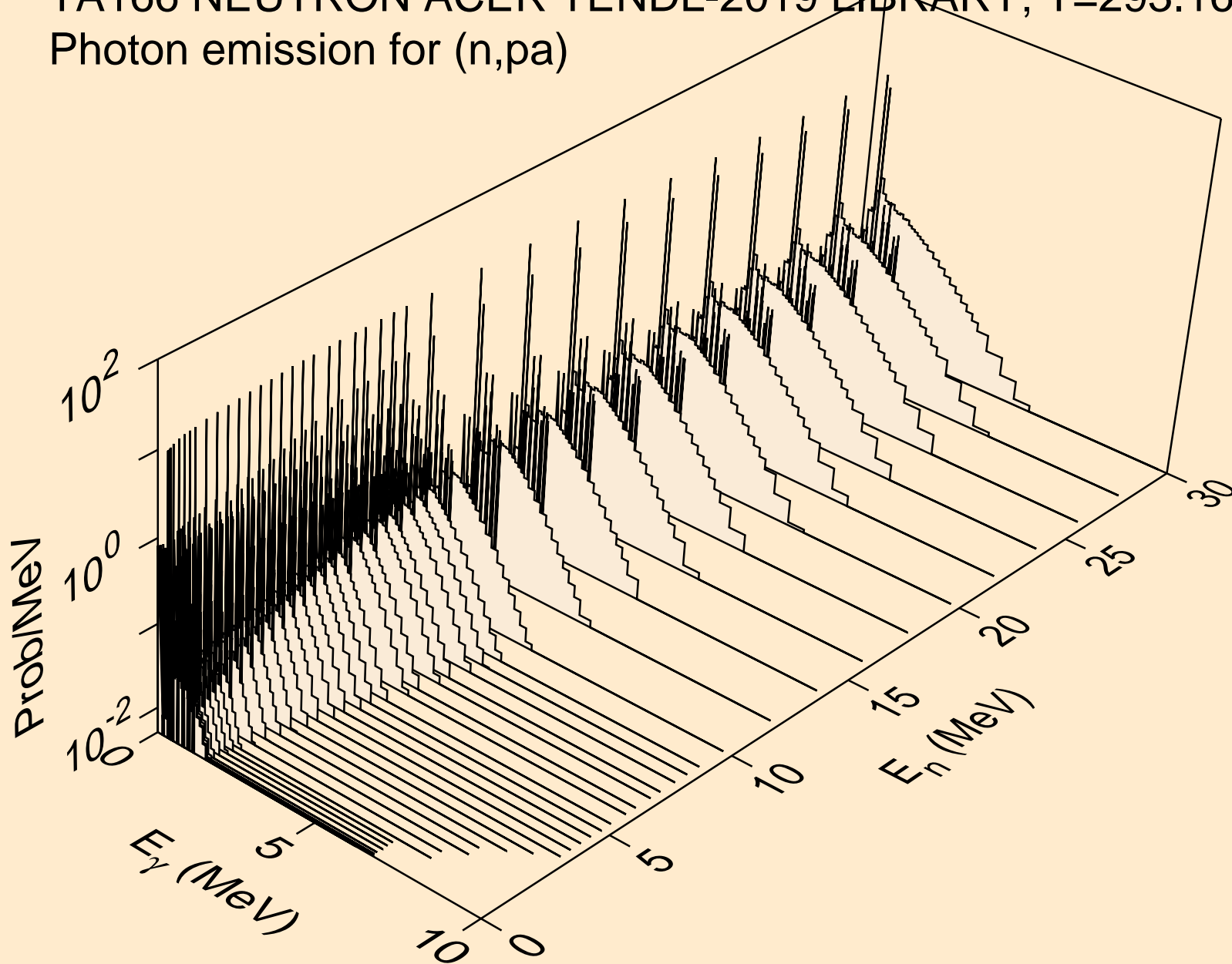

TA166 NEUTRON ACER TENDL-2019 LIBRARY; T=293.16K  
Photon emission for (n,pd)

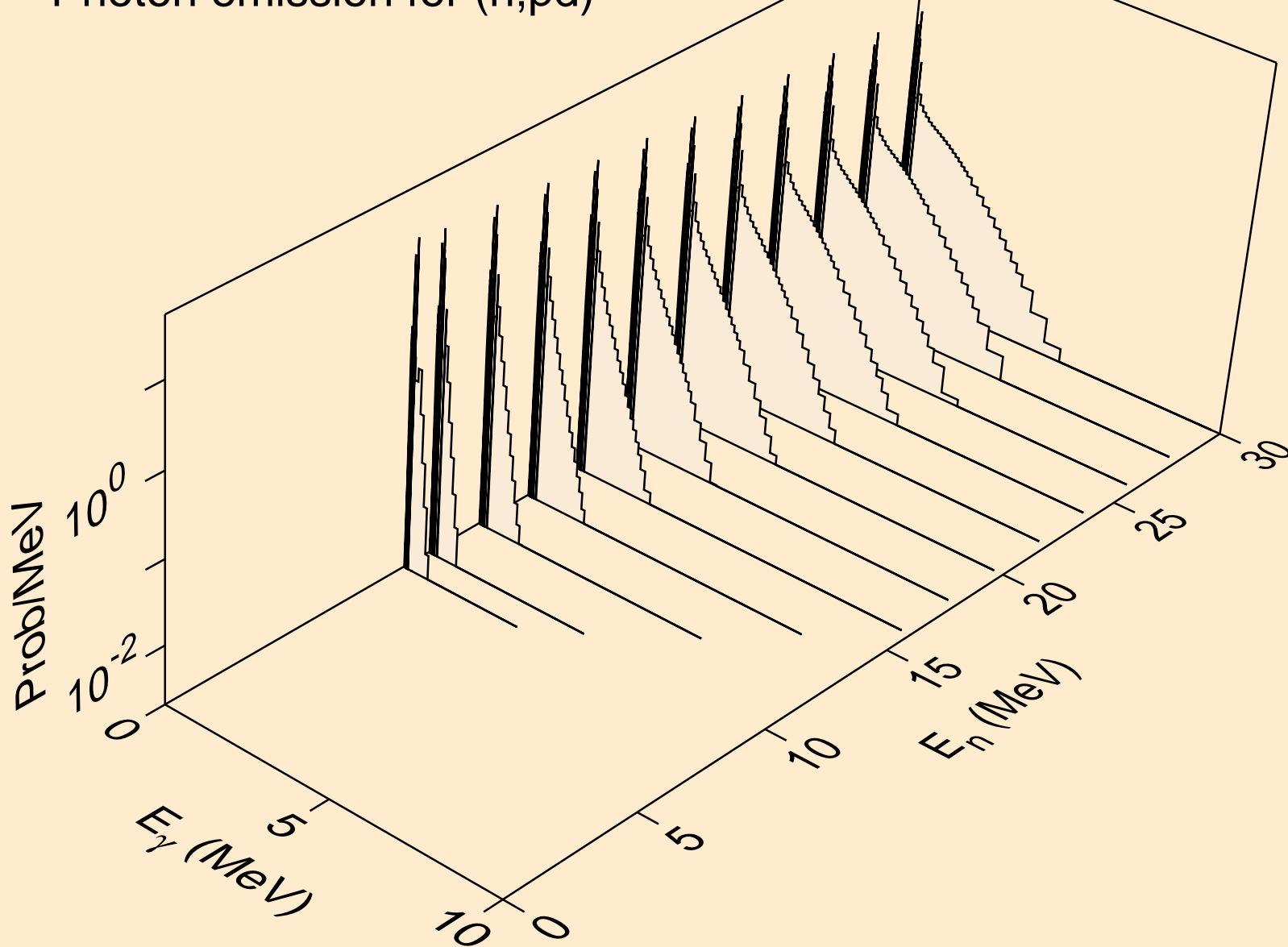

TA166 NEUTRON ACER TENDL-2019 LIBRARY; T=293.16K  
Photon emission for (n,pt)

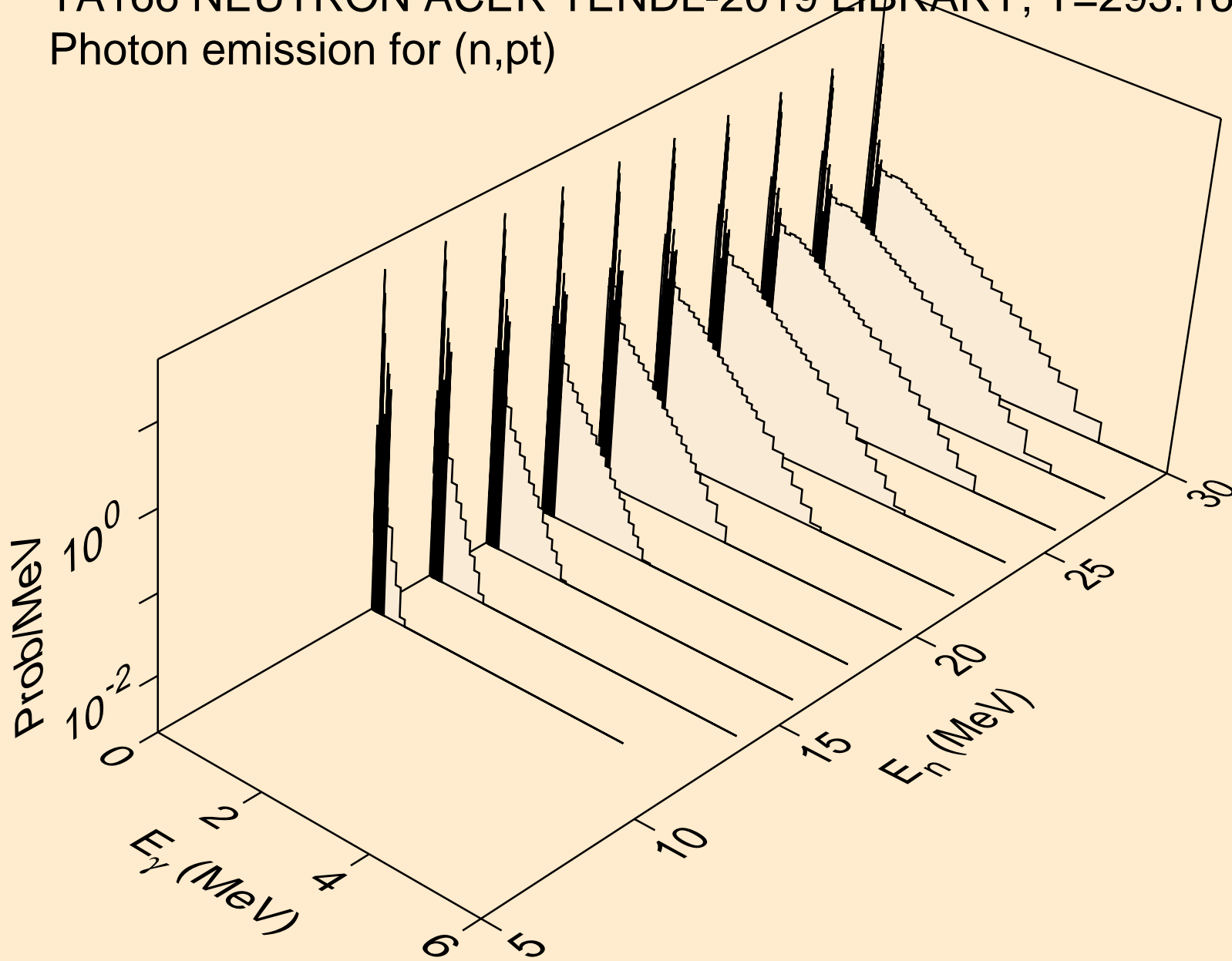

TA166 NEUTRON ACER TENDL-2019 LIBRARY; T=293.16K  
Photon emission for (n,da)

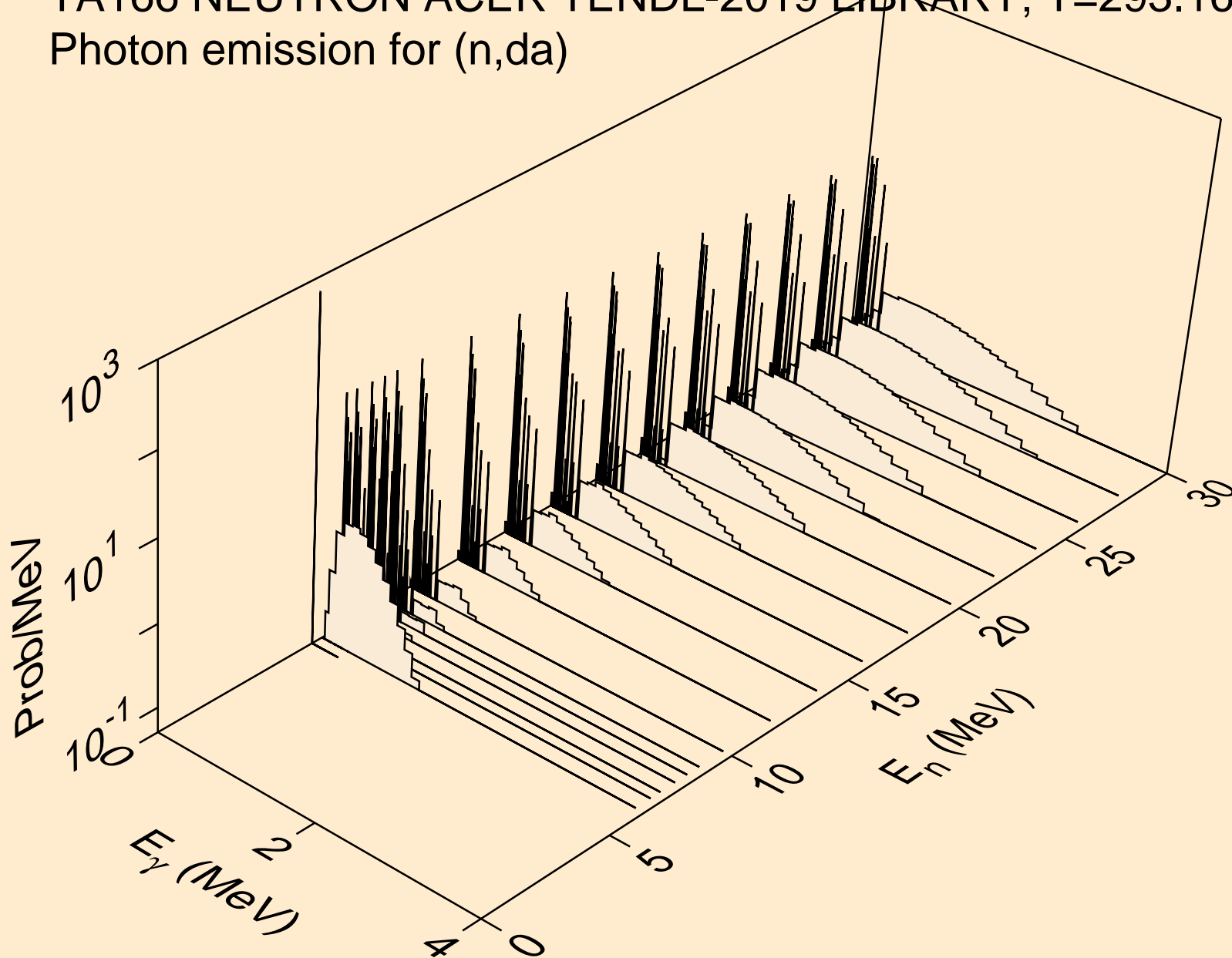



TA166 NEUTRON ACER TENDL-2019 LIBRARY; T=293.16K  
thermal capture photon spectrum

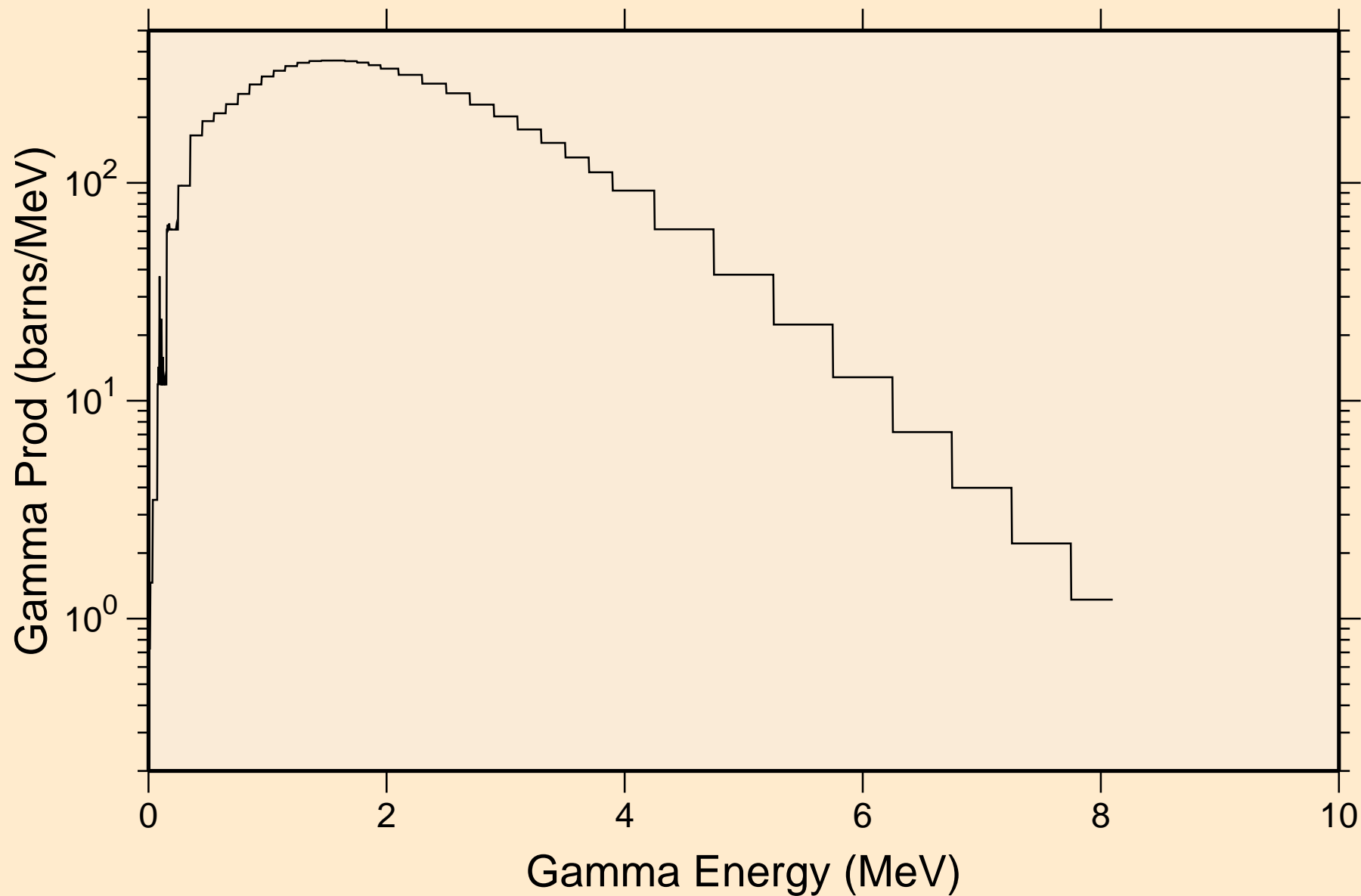

TA166 NEUTRON ACER TENDL-2019 LIBRARY; T=293.16K  
14 MeV photon spectrum

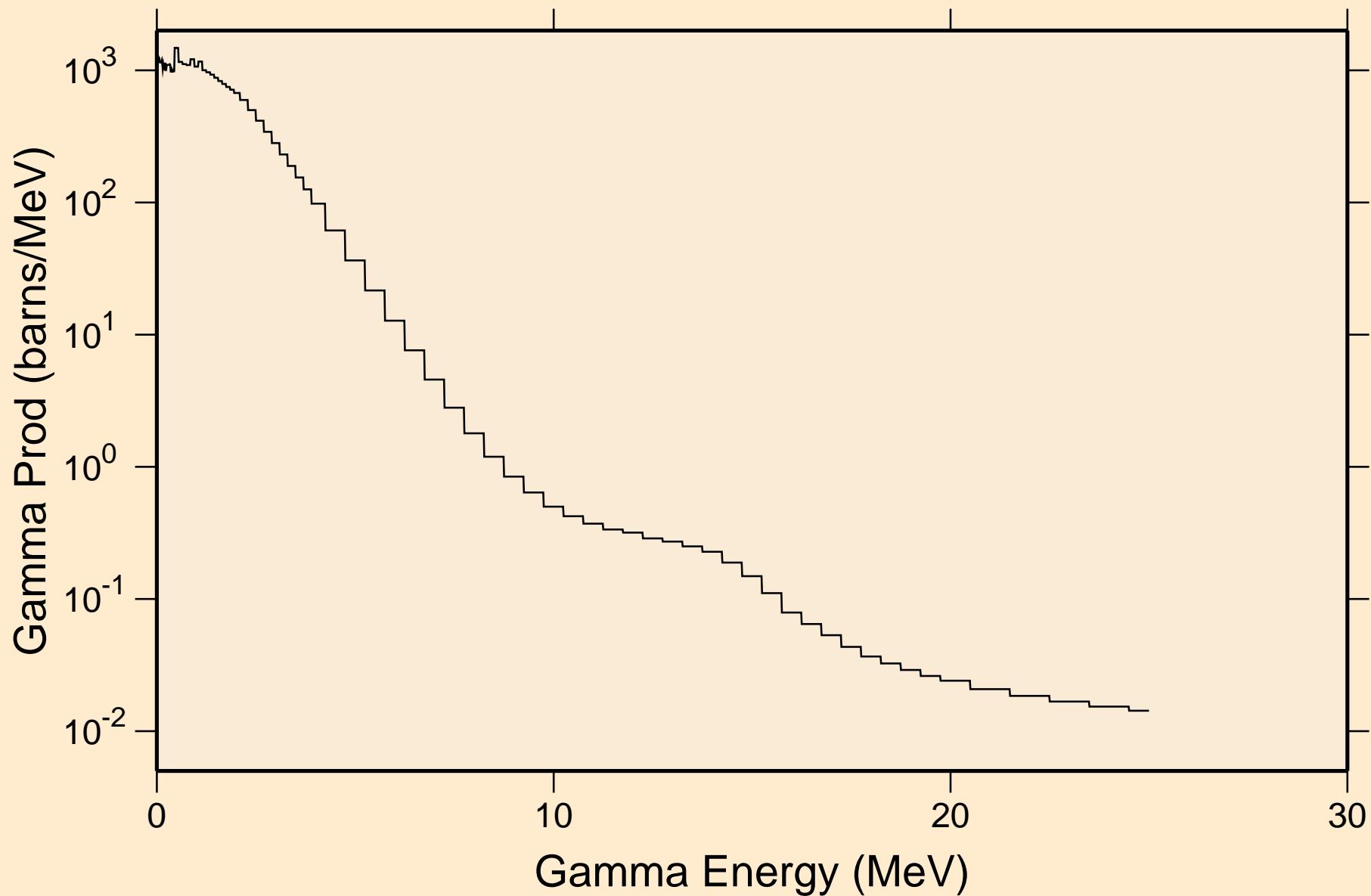

TA166 NEUTRON ACER TENDL-2019 LIBRARY; T=293.16K  
Particle heating contributions

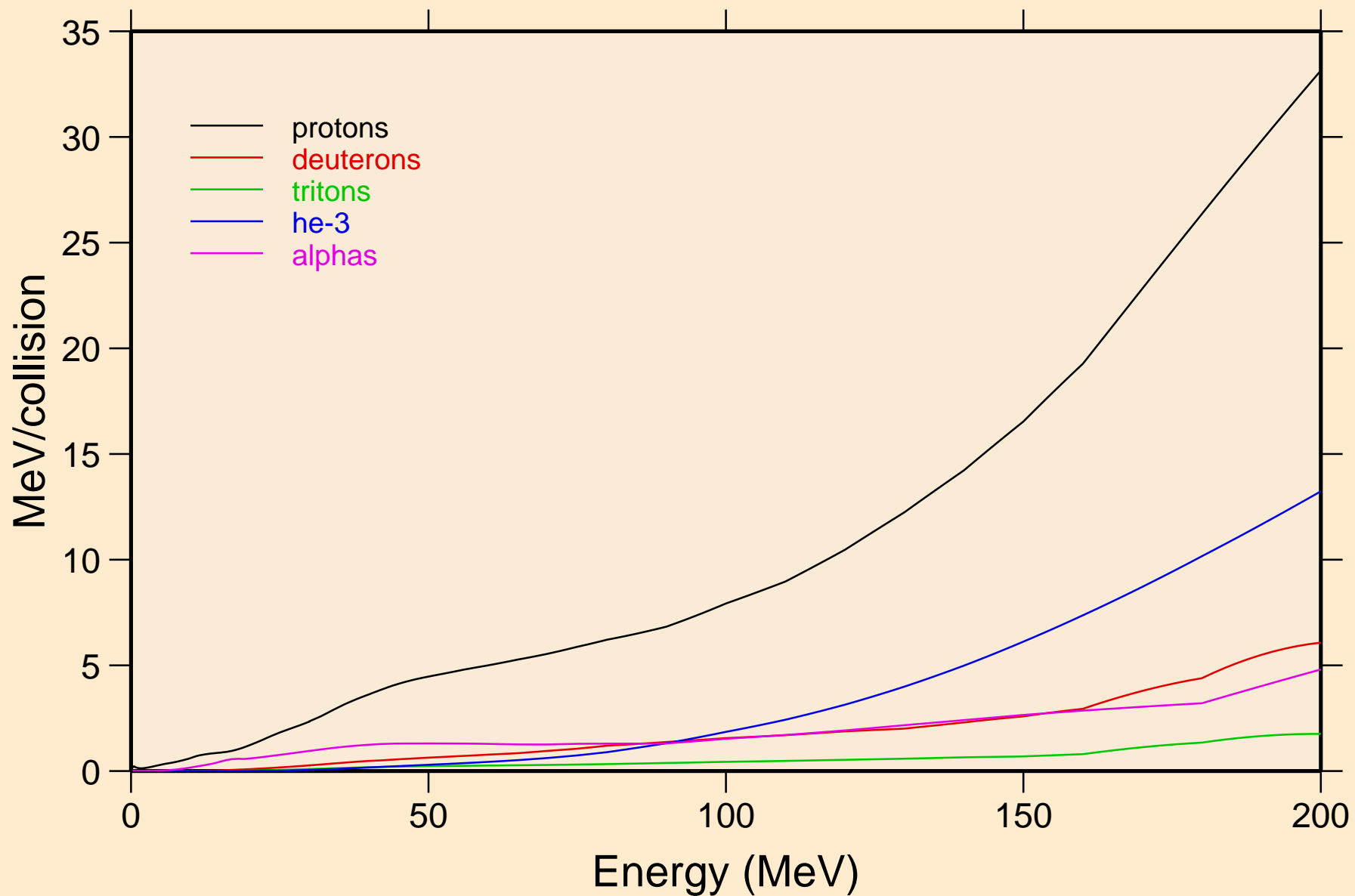

TA166 NEUTRON ACER TENDL-2019 LIBRARY; T=293.16K  
Recoil Heating

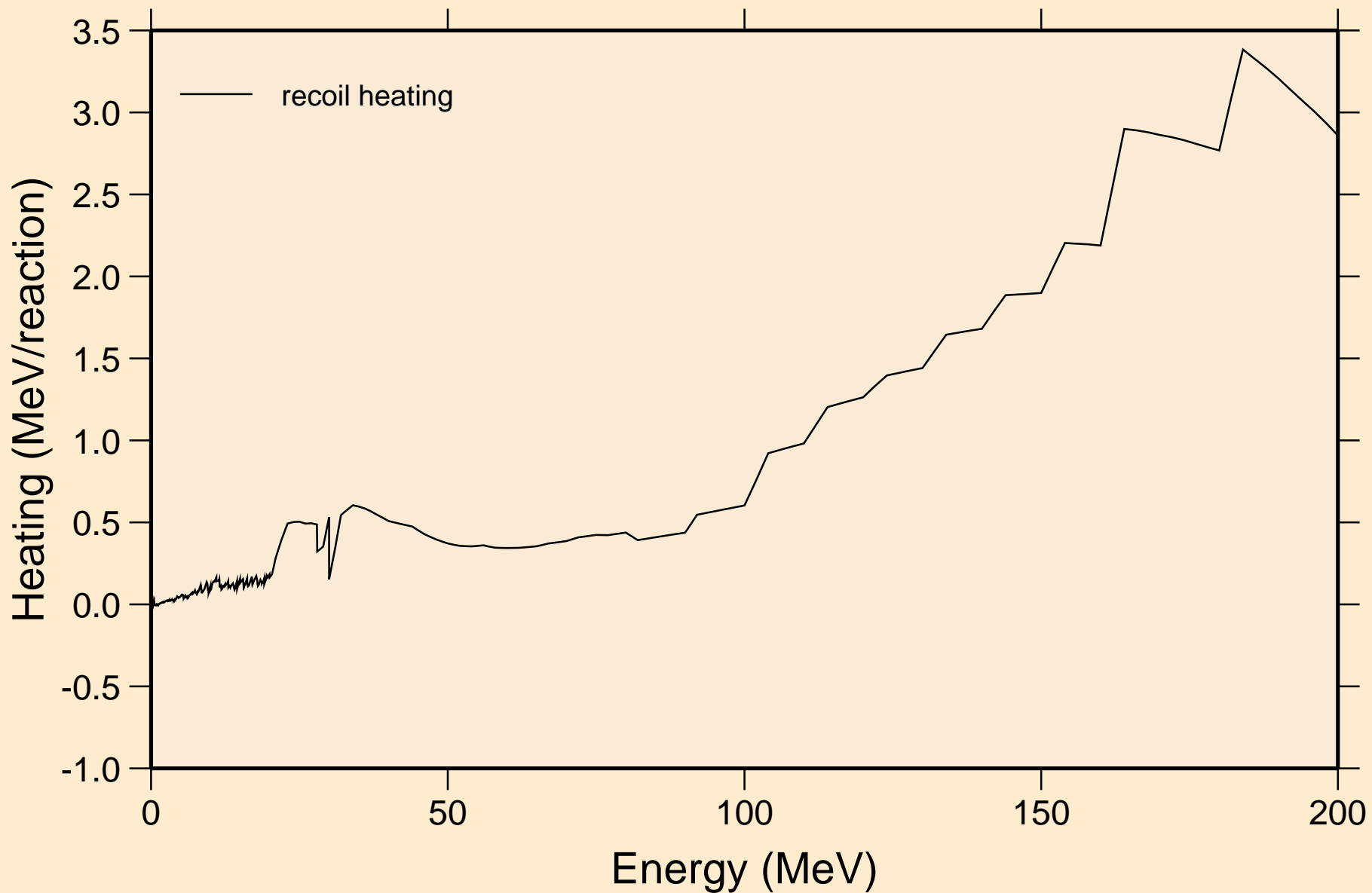

TA166 NEUTRON ACER TENDL-2019 LIBRARY; T=293.16K  
Particle production cross sections

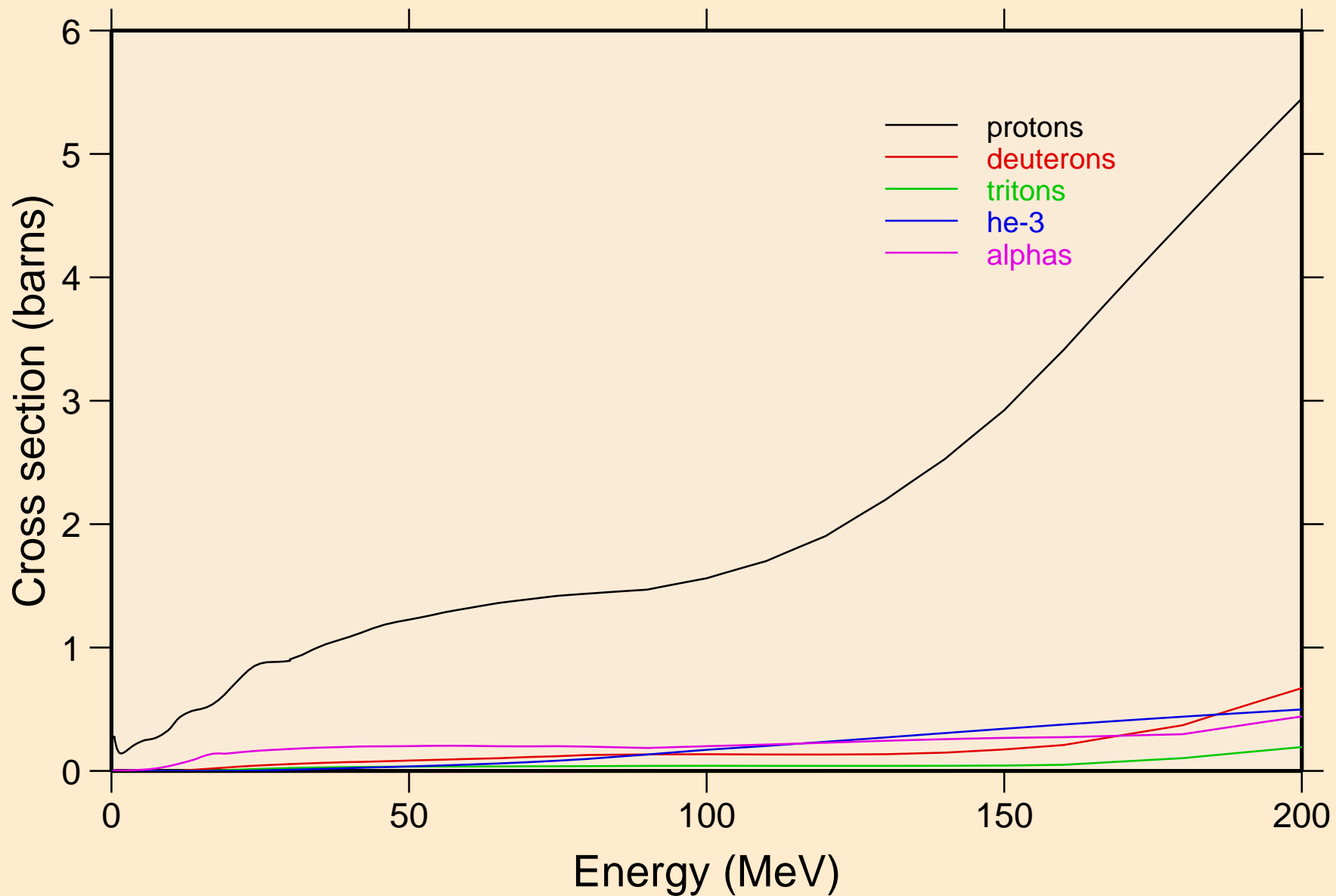

TA166 NEUTRON ACER TENDL-2019 LIBRARY; T=293.16K  
protons from (n,x)

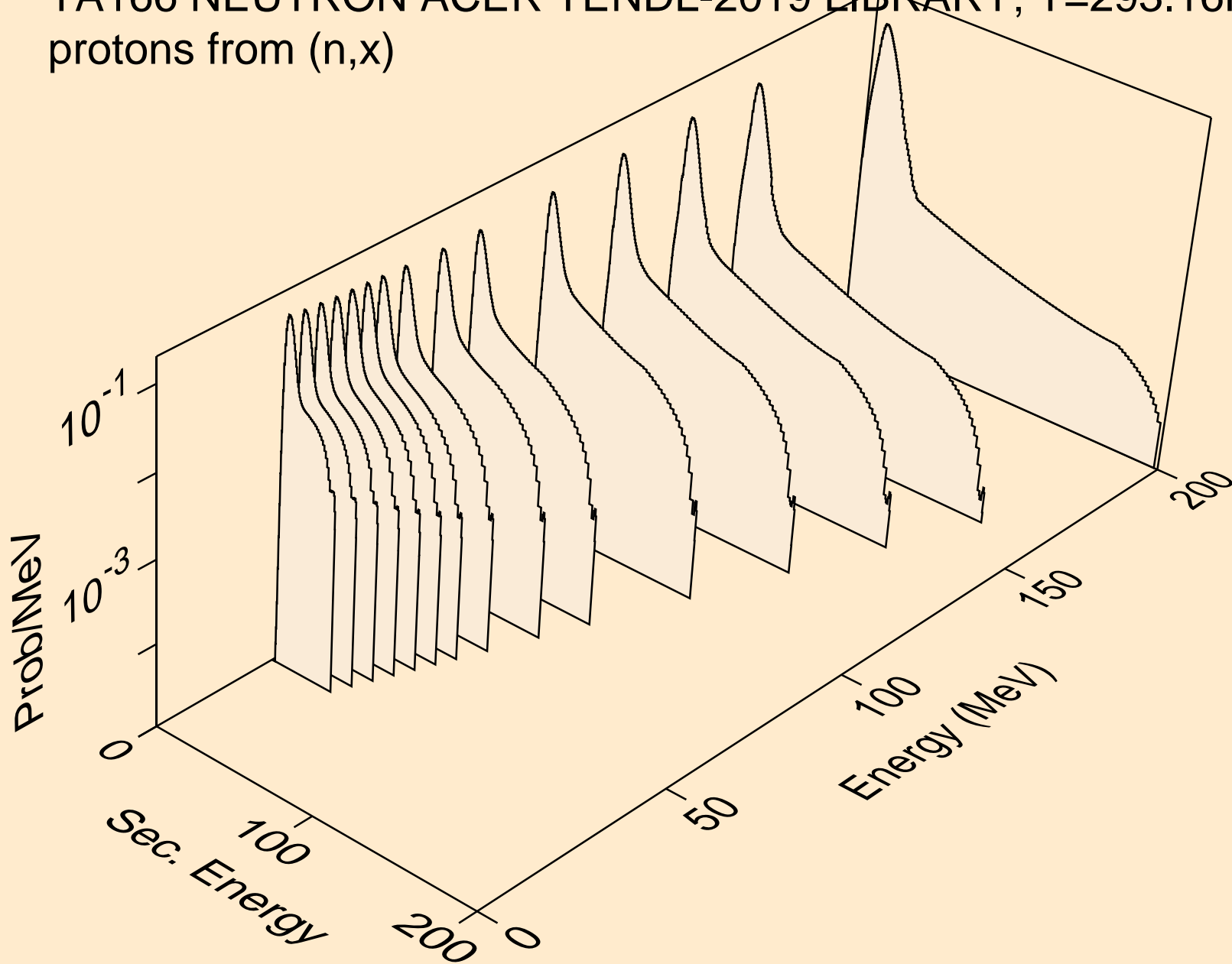

TA166 NEUTRON ACER TENDL-2019 LIBRARY; T=293.16K  
protons from (n,n\*)p

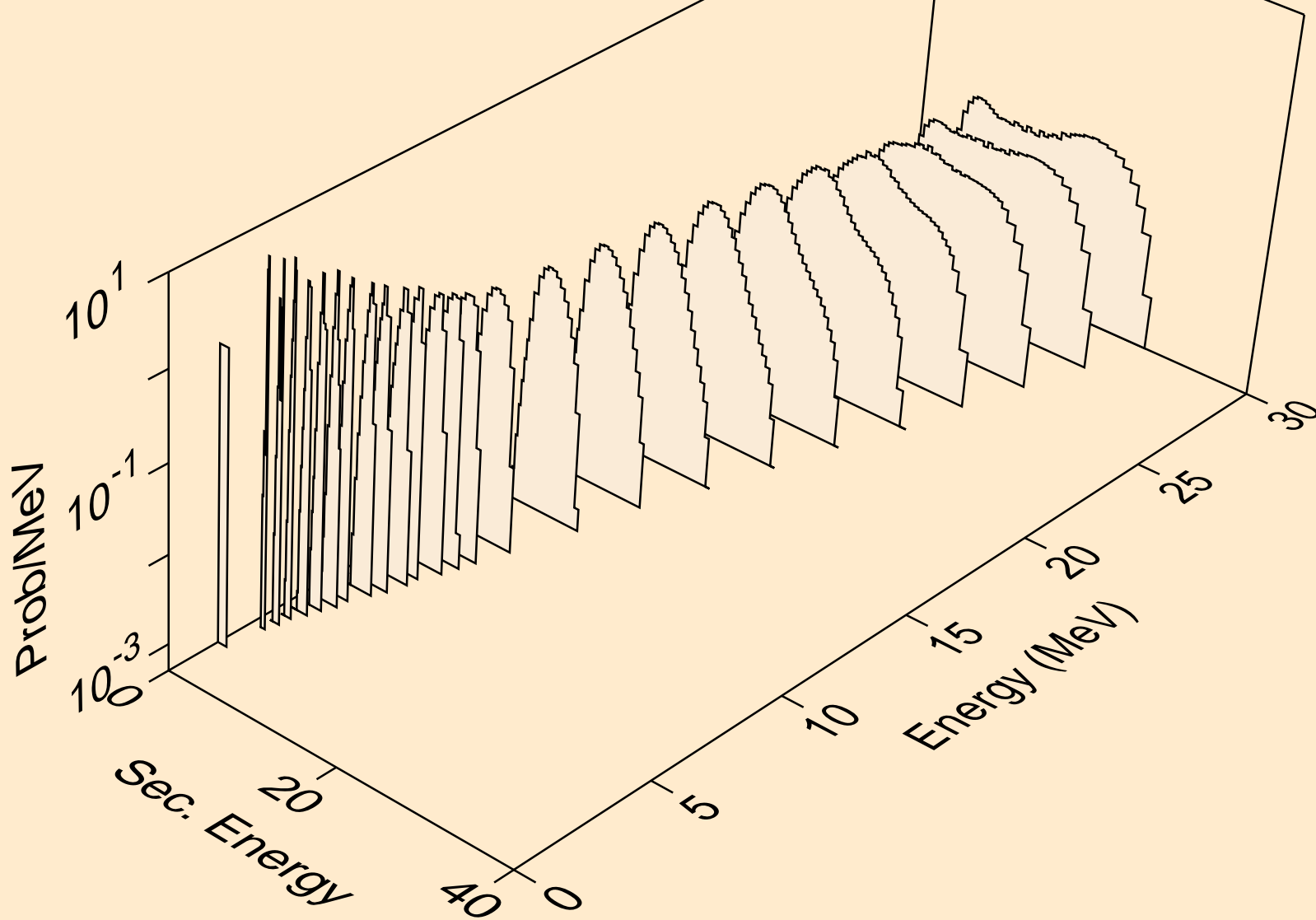

TA166 NEUTRON ACER TENDL-2019 LIBRARY; T=293.16K  
protons from (n,2np)

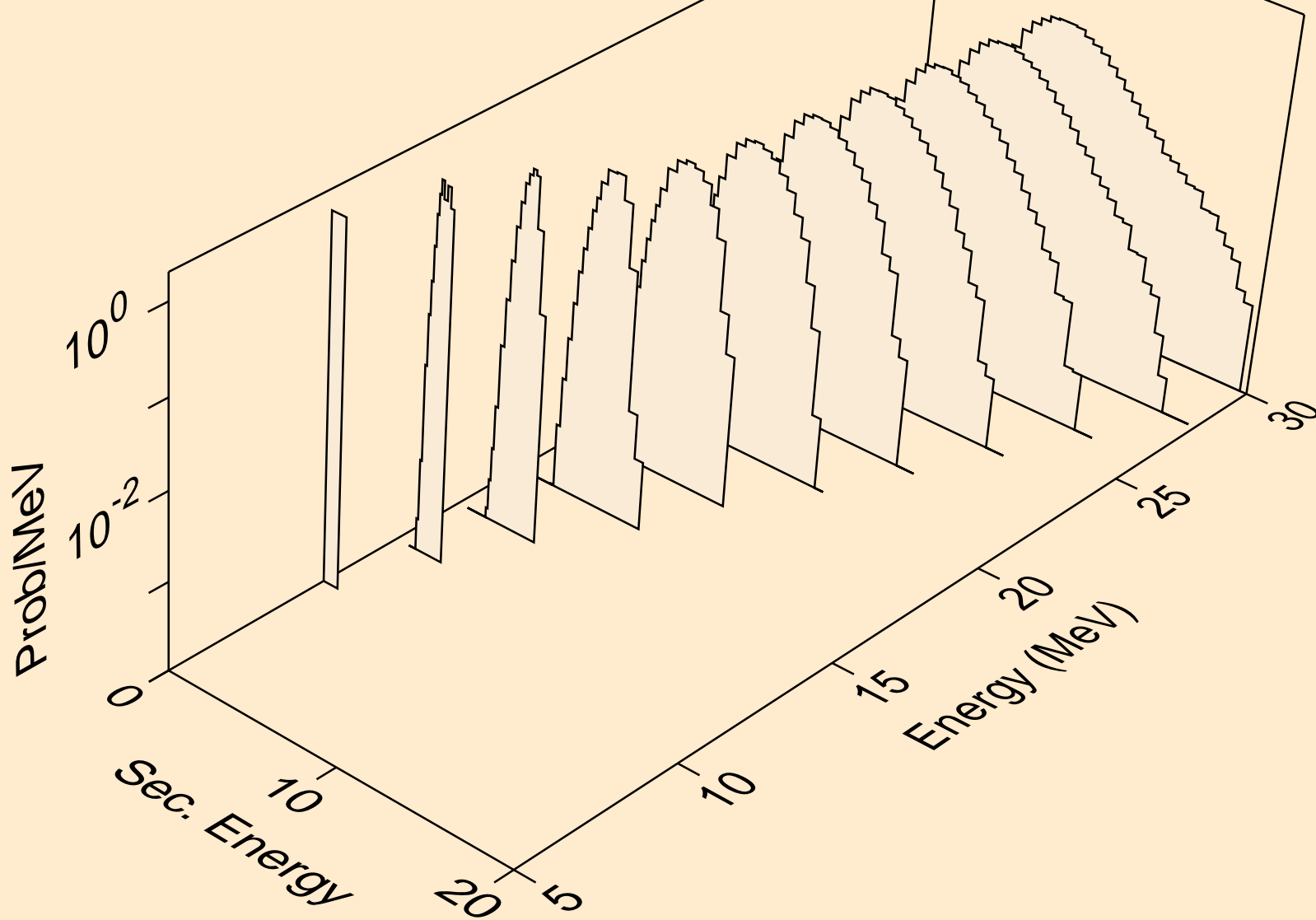



TA166 NEUTRON ACER TENDL-2019 LIBRARY; T=293.16K  
protons from (n,3np)

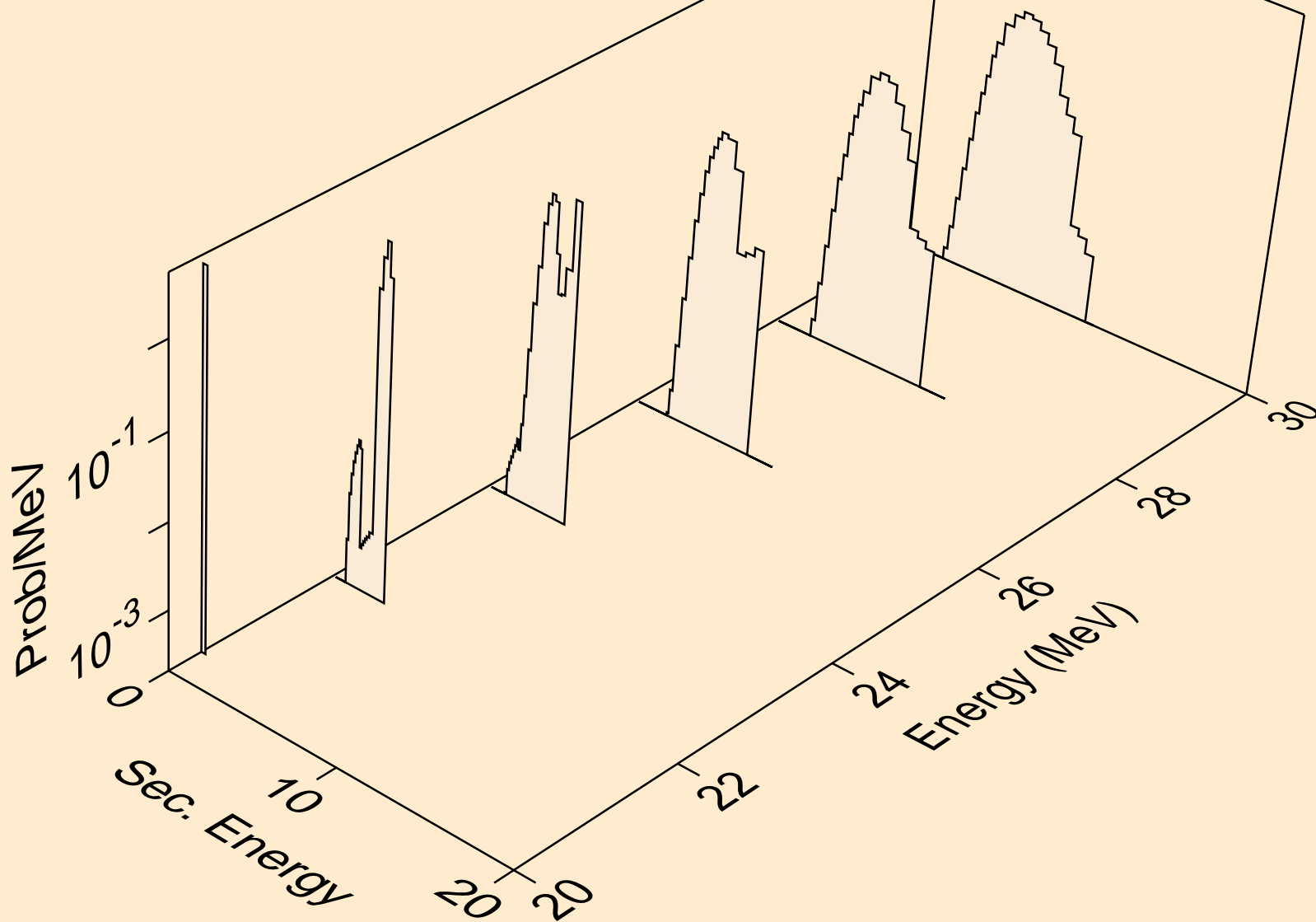

TA166 NEUTRON ACER TENDL-2019 LIBRARY; T=293.16K  
protons from (n,2np)

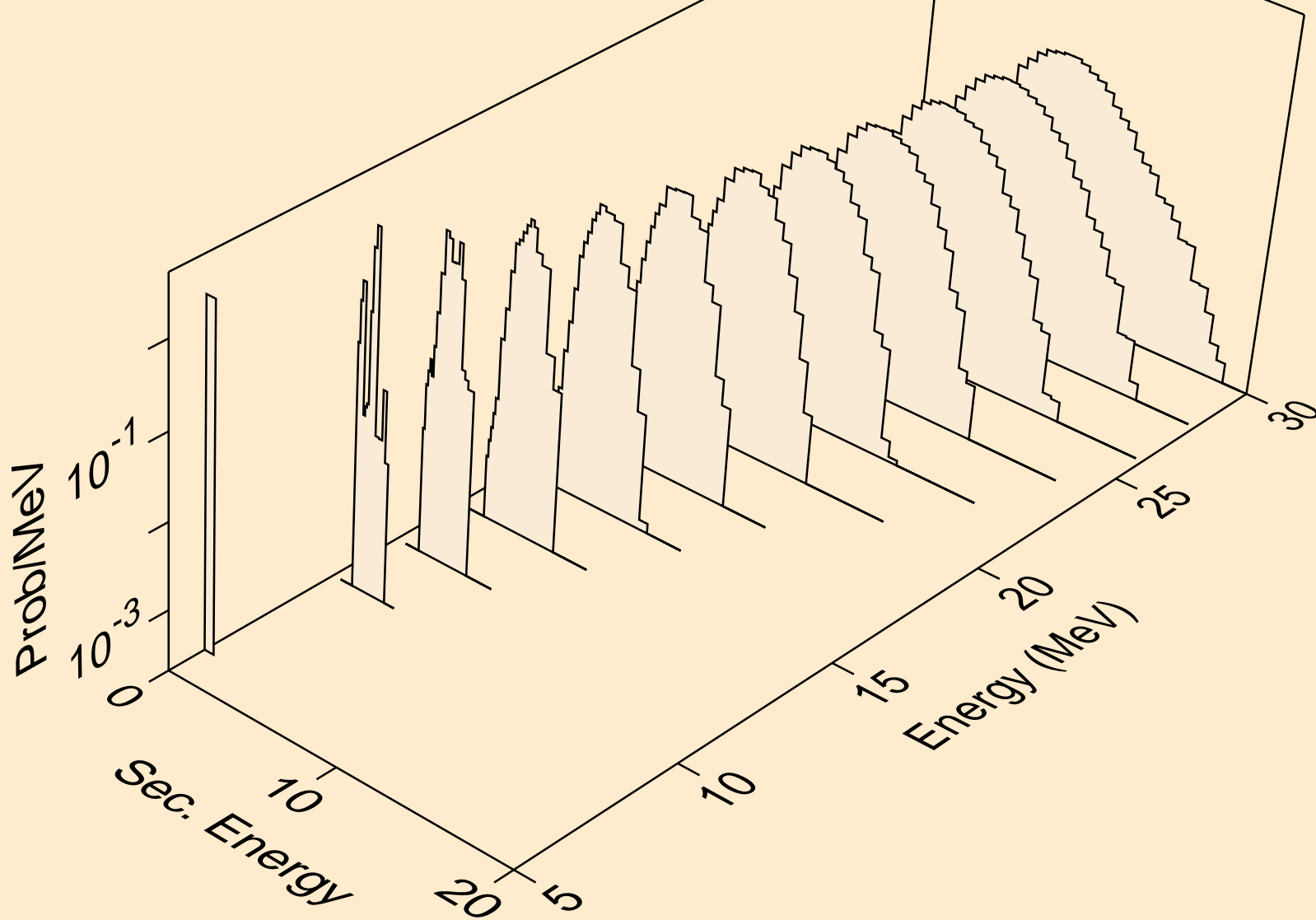

TA166 NEUTRON ACER TENDL-2019 LIBRARY; T=293.16K  
protons from (n,npa)

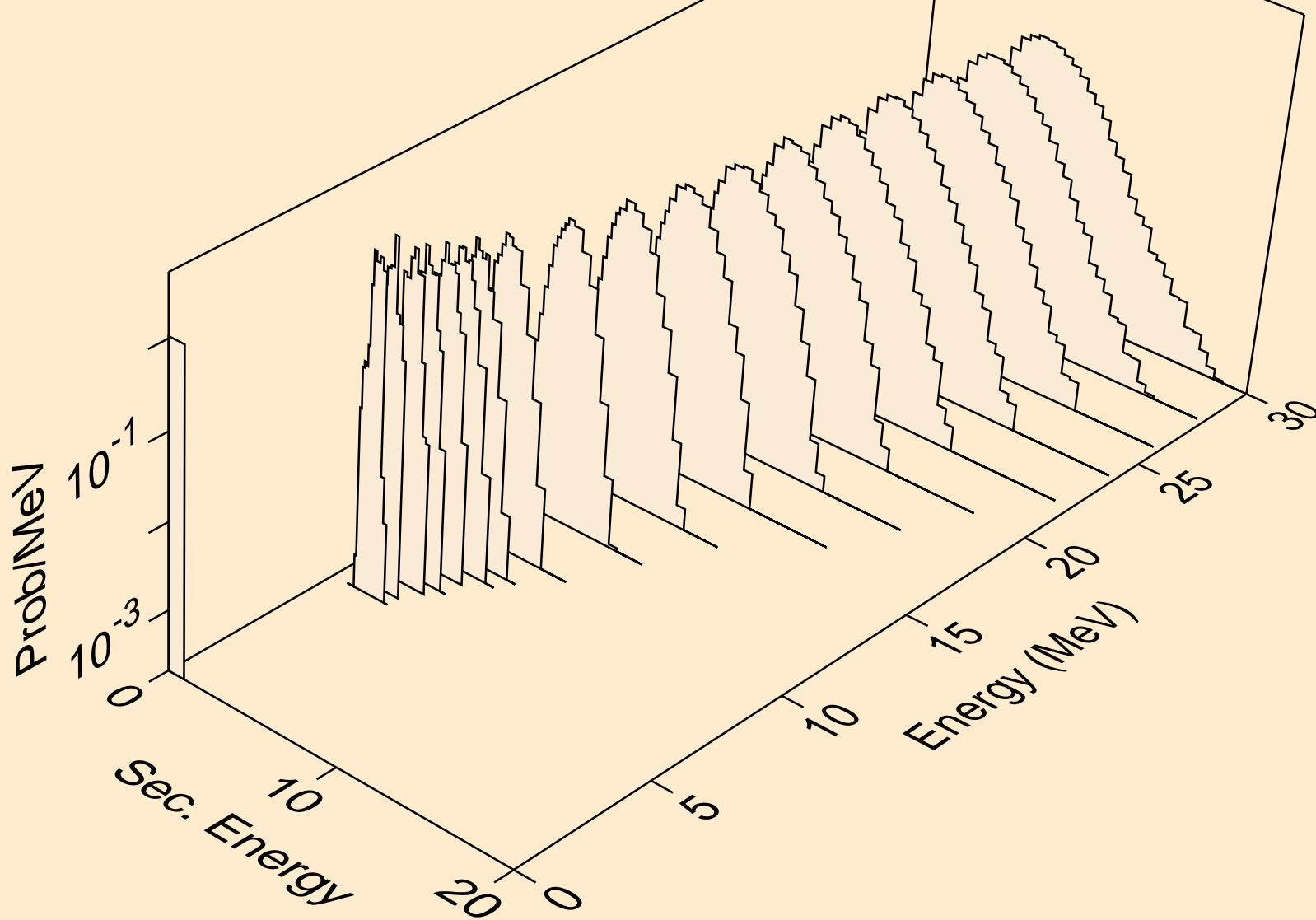

TA166 NEUTRON ACER TENDL-2019 LIBRARY; T=293.16K  
protons from (n,p)

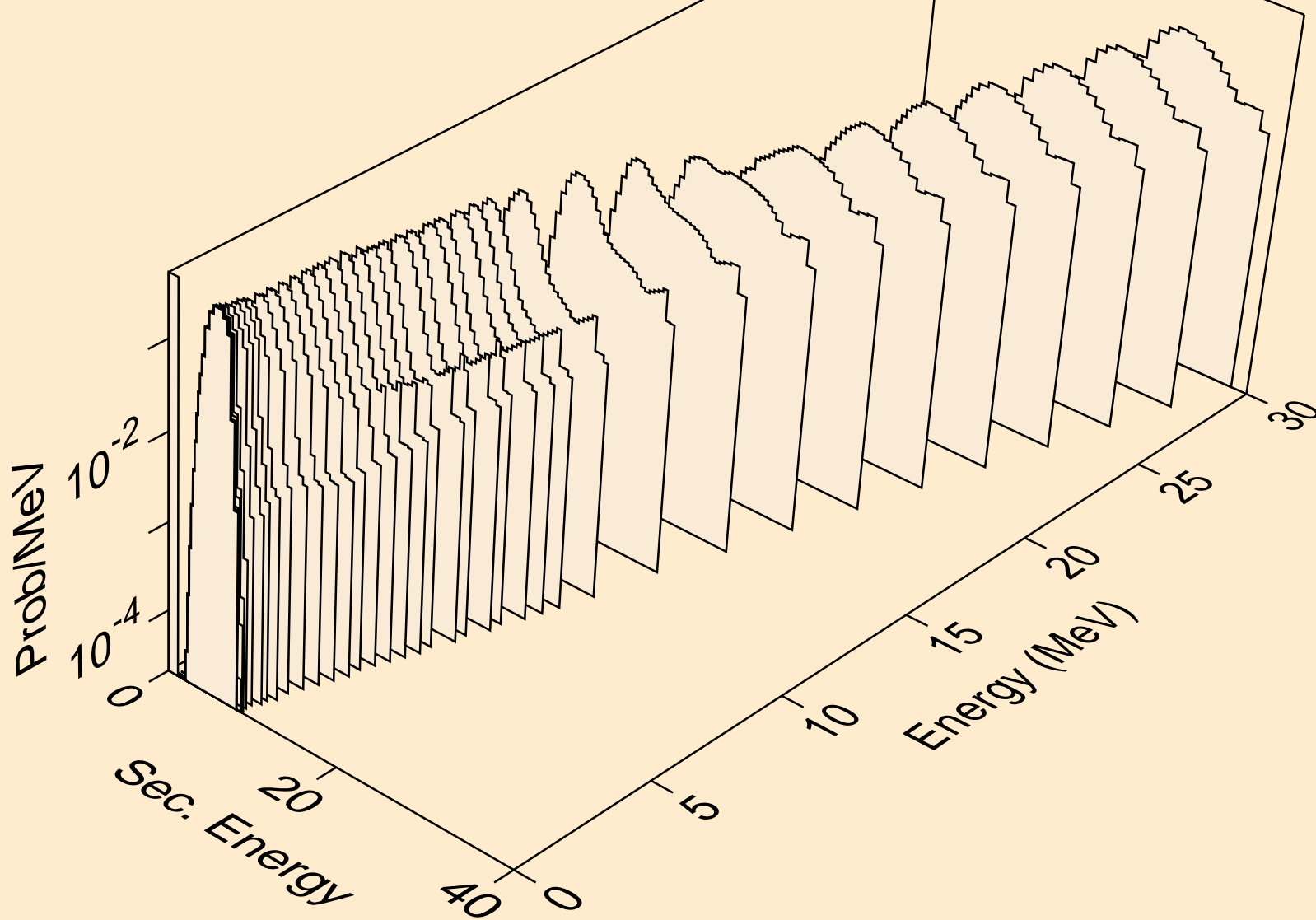

TA166 NEUTRON ACER TENDL-2019 LIBRARY; T=293.16K  
protons from (n,2p)

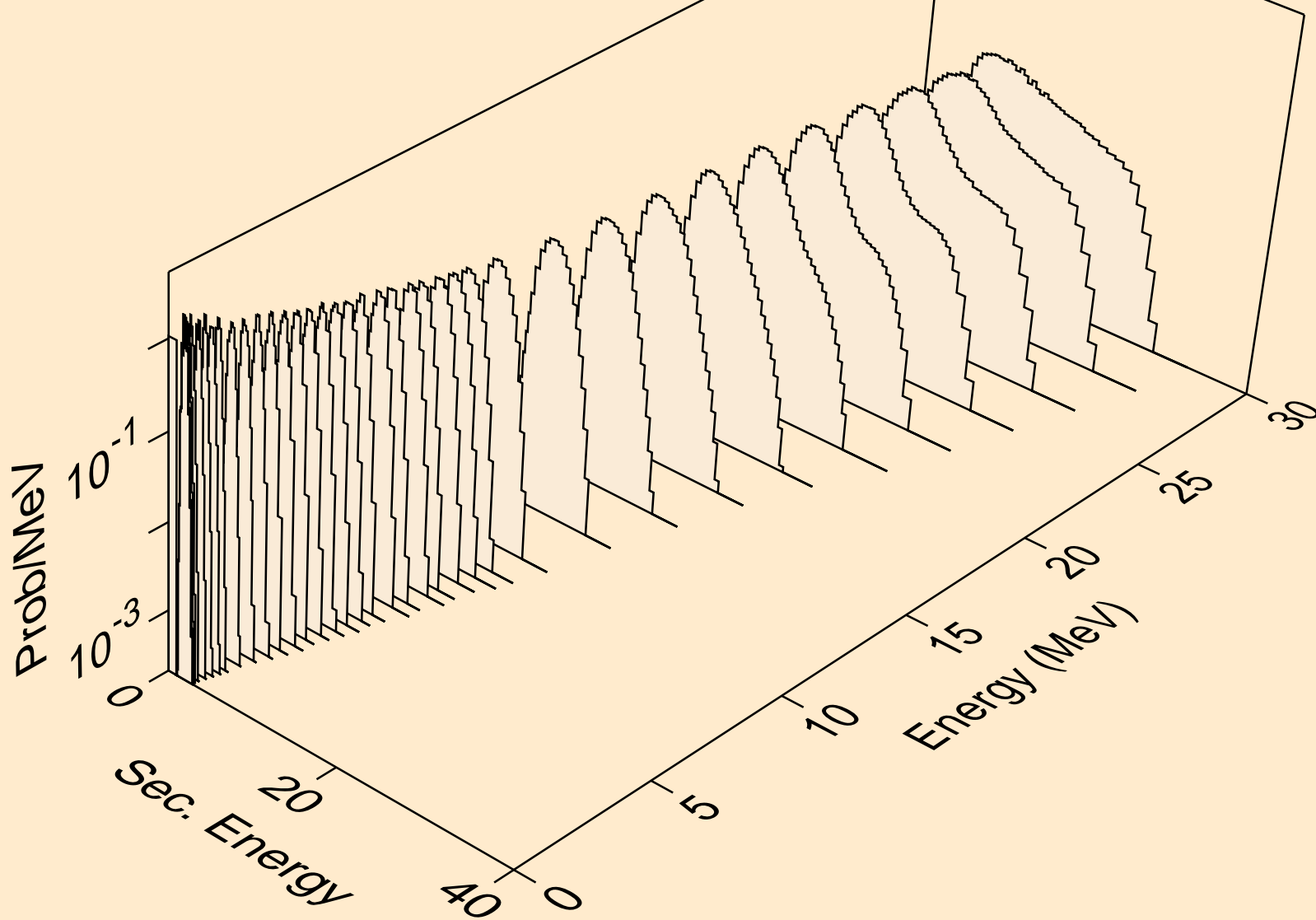

TA166 NEUTRON ACER TENDL-2019 LIBRARY; T=293.16K  
protons from (n,p)

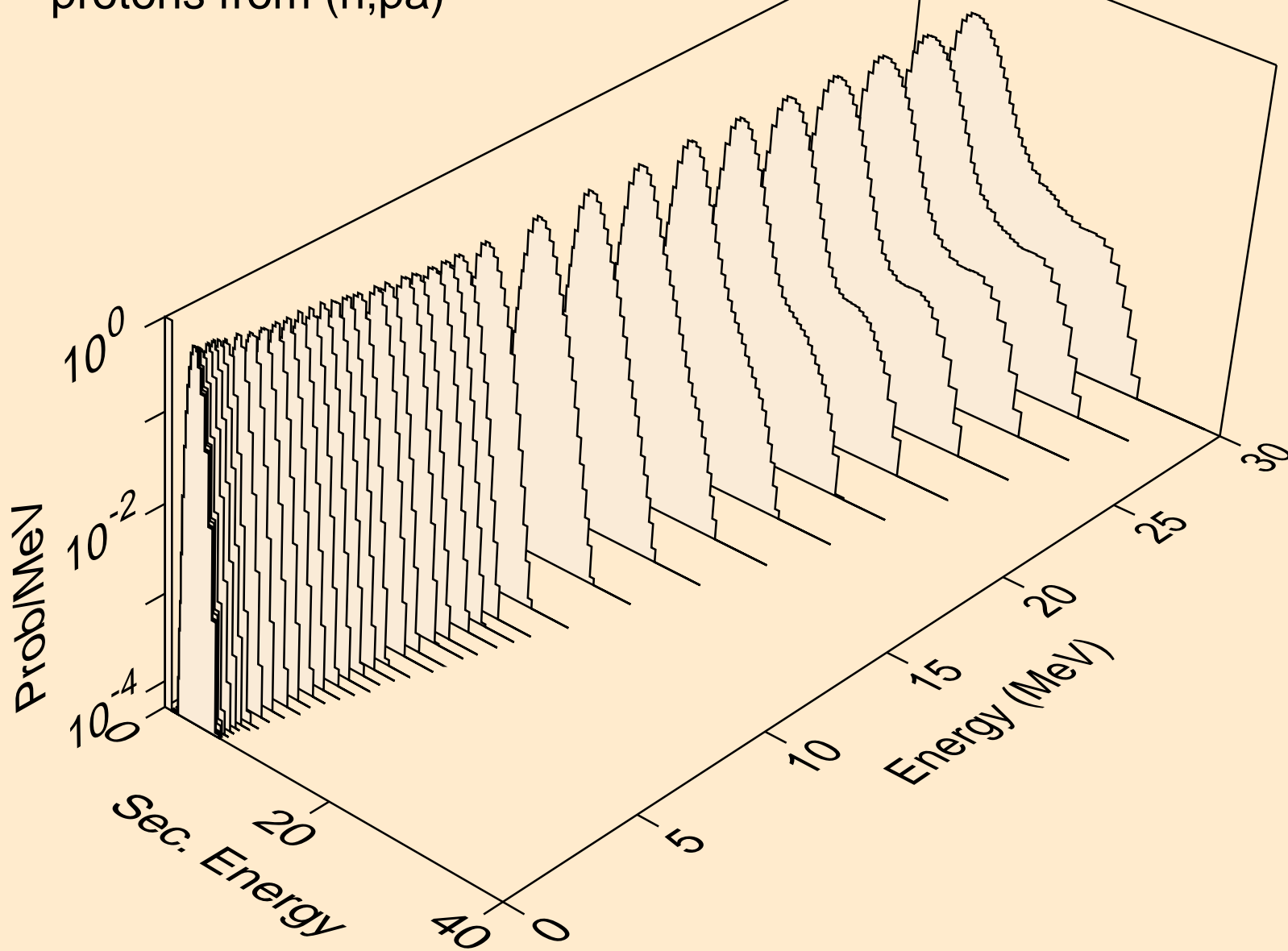

TA166 NEUTRON ACER TENDL-2019 LIBRARY; T=293.16K  
protons from (n,pd)

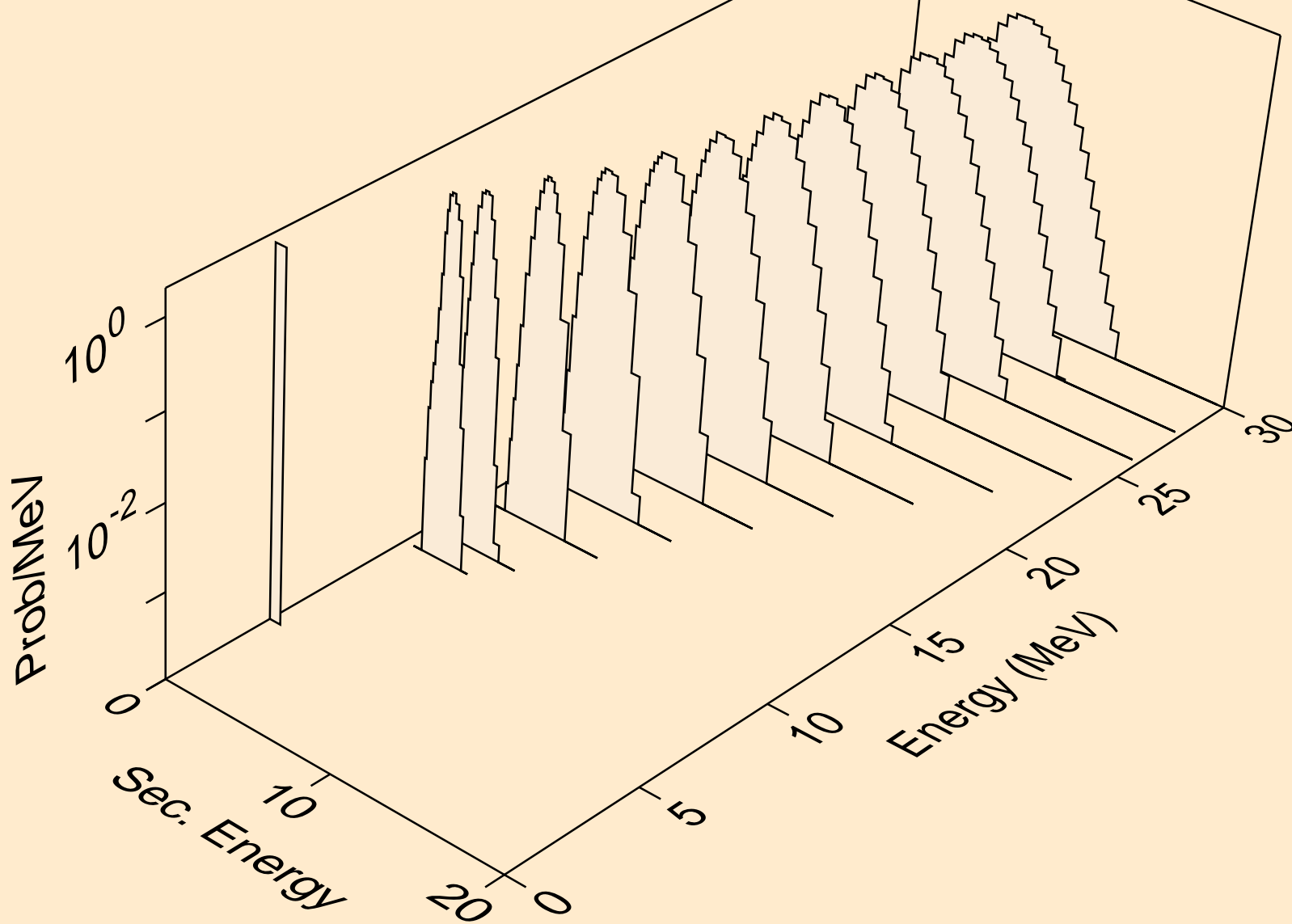

TA166 NEUTRON ACER TENDL-2019 LIBRARY; T=293.16K  
protons from (n,pt)

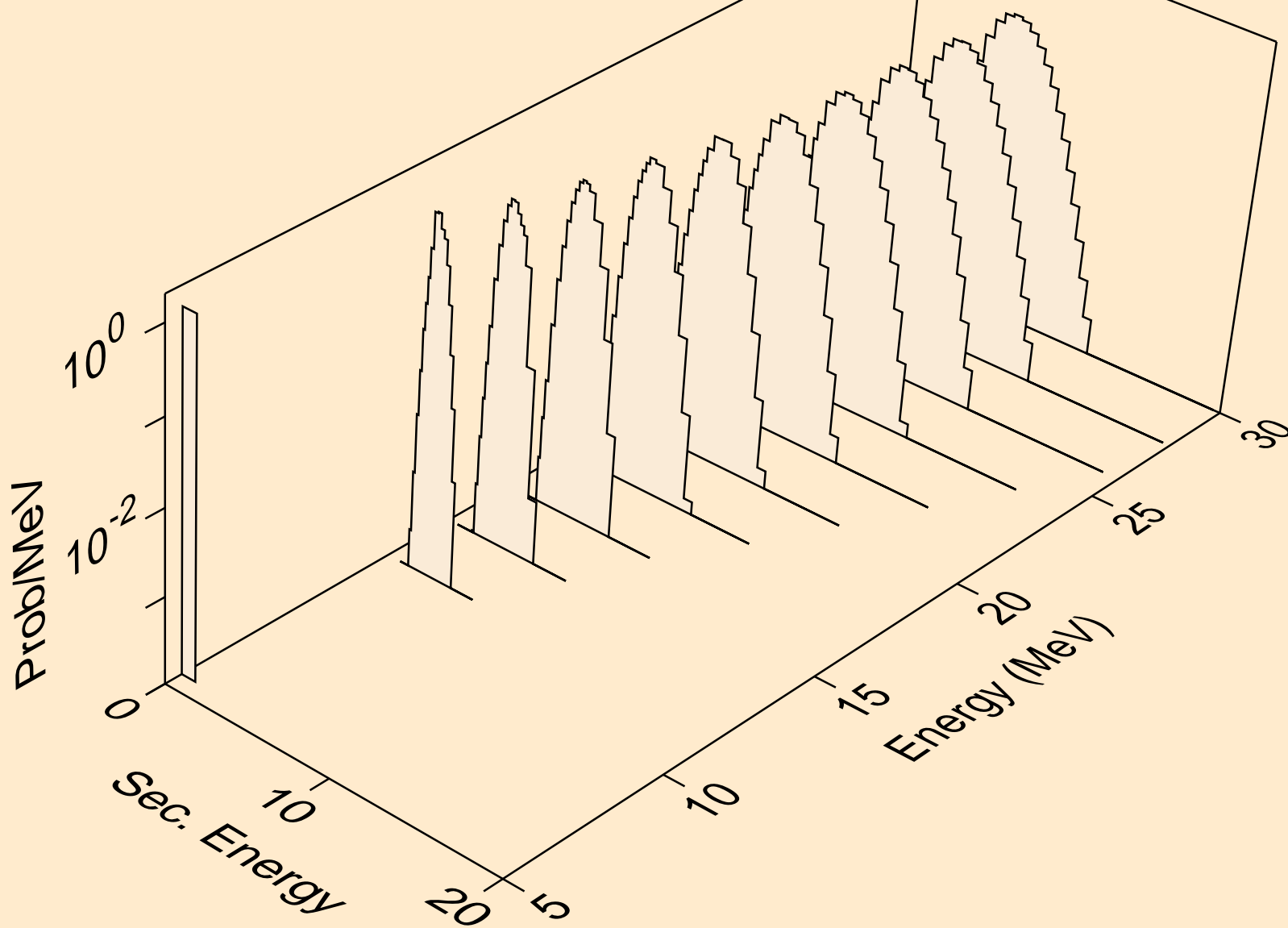



TA166 NEUTRON ACER TENDL-2019 LIBRARY; T=293.16K  
deuterons from (n,x)

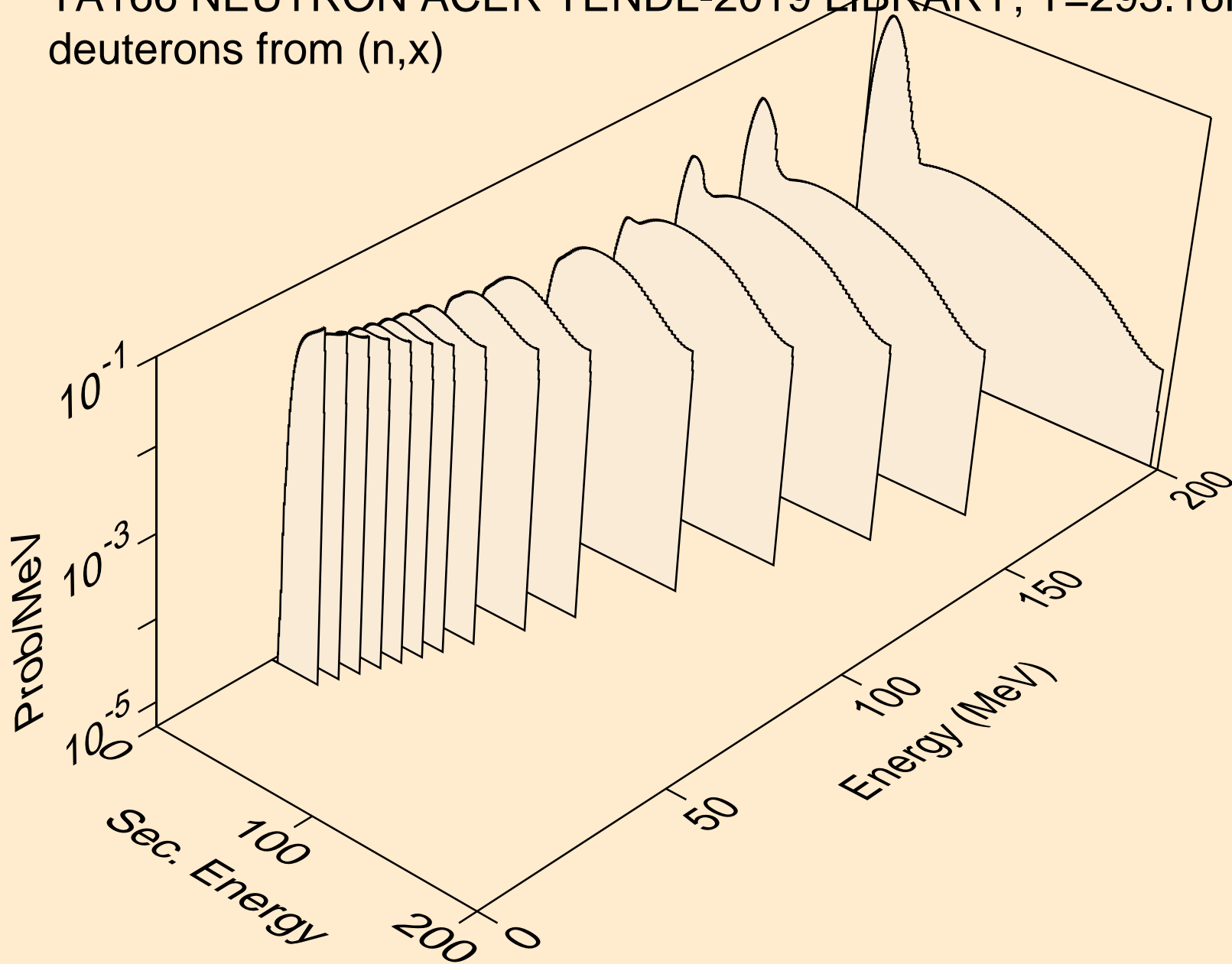

TA166 NEUTRON ACER TENDL-2019 LIBRARY; T=293.16K  
deuterons from (n,2nd)

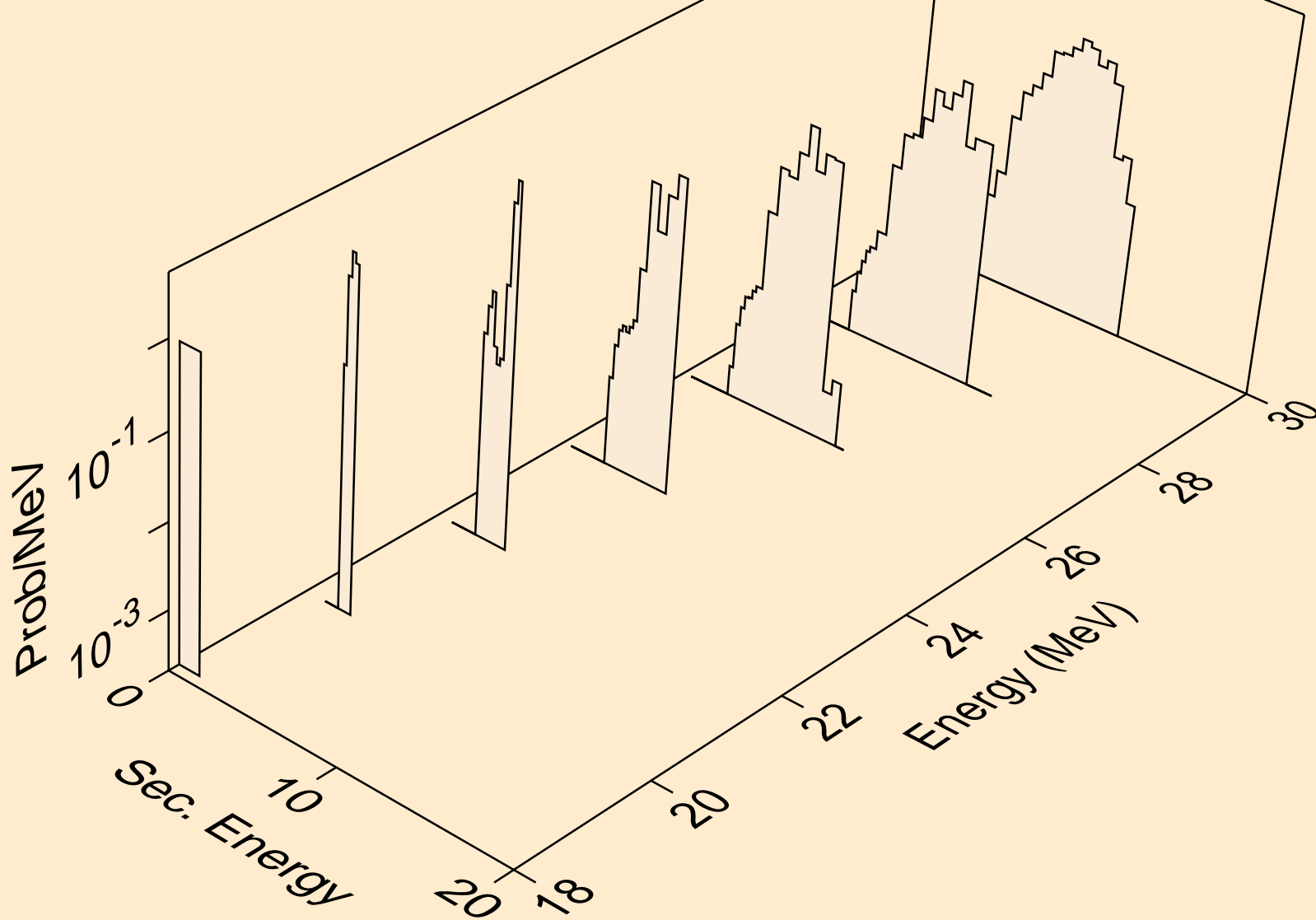

TA166 NEUTRON ACER TENDL-2019 LIBRARY; T=293.16K  
deuterons from (n,n\*)d

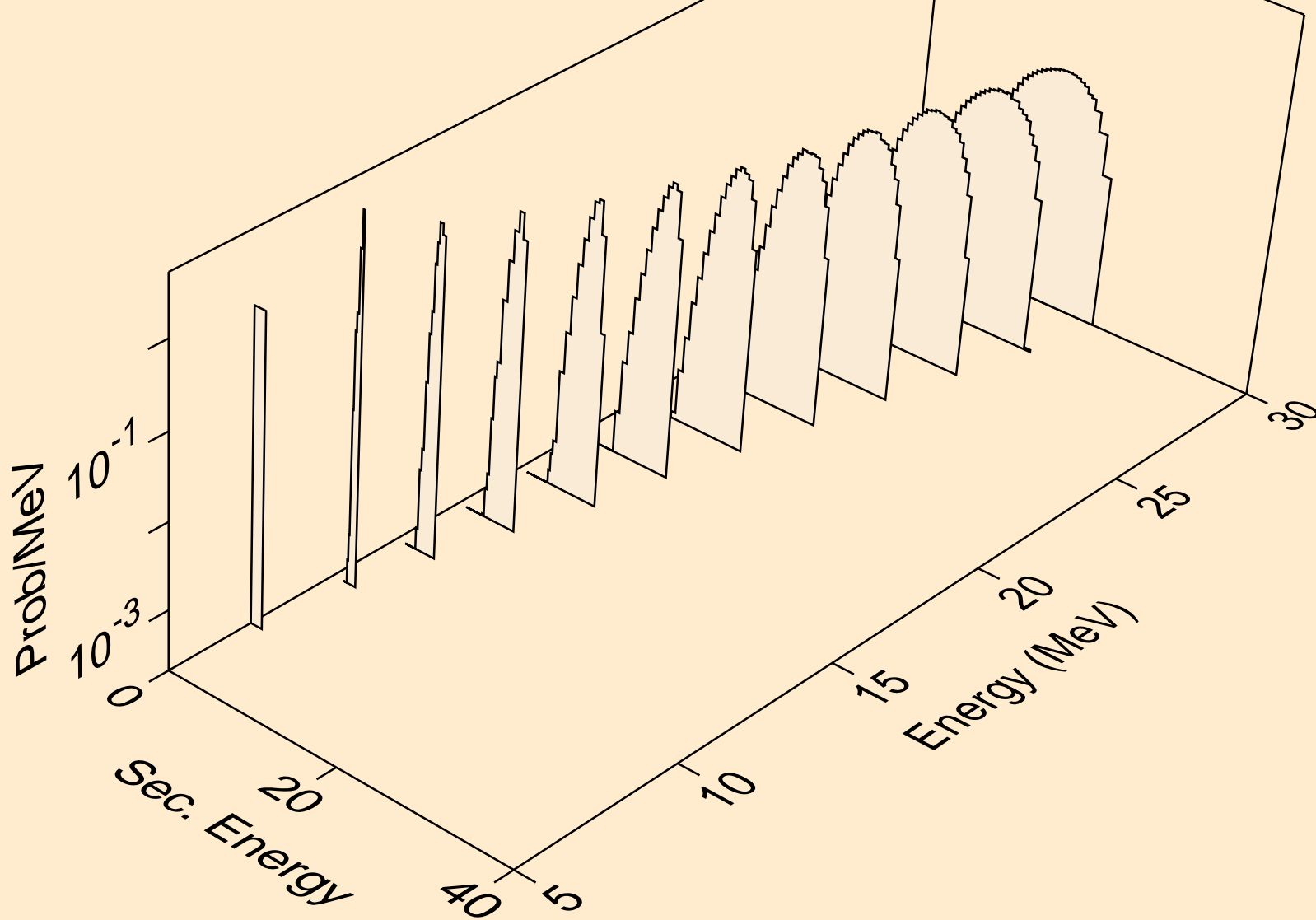

TA166 NEUTRON ACER TENDL-2019 LIBRARY; T=293.16K  
deuterons from (n,d)

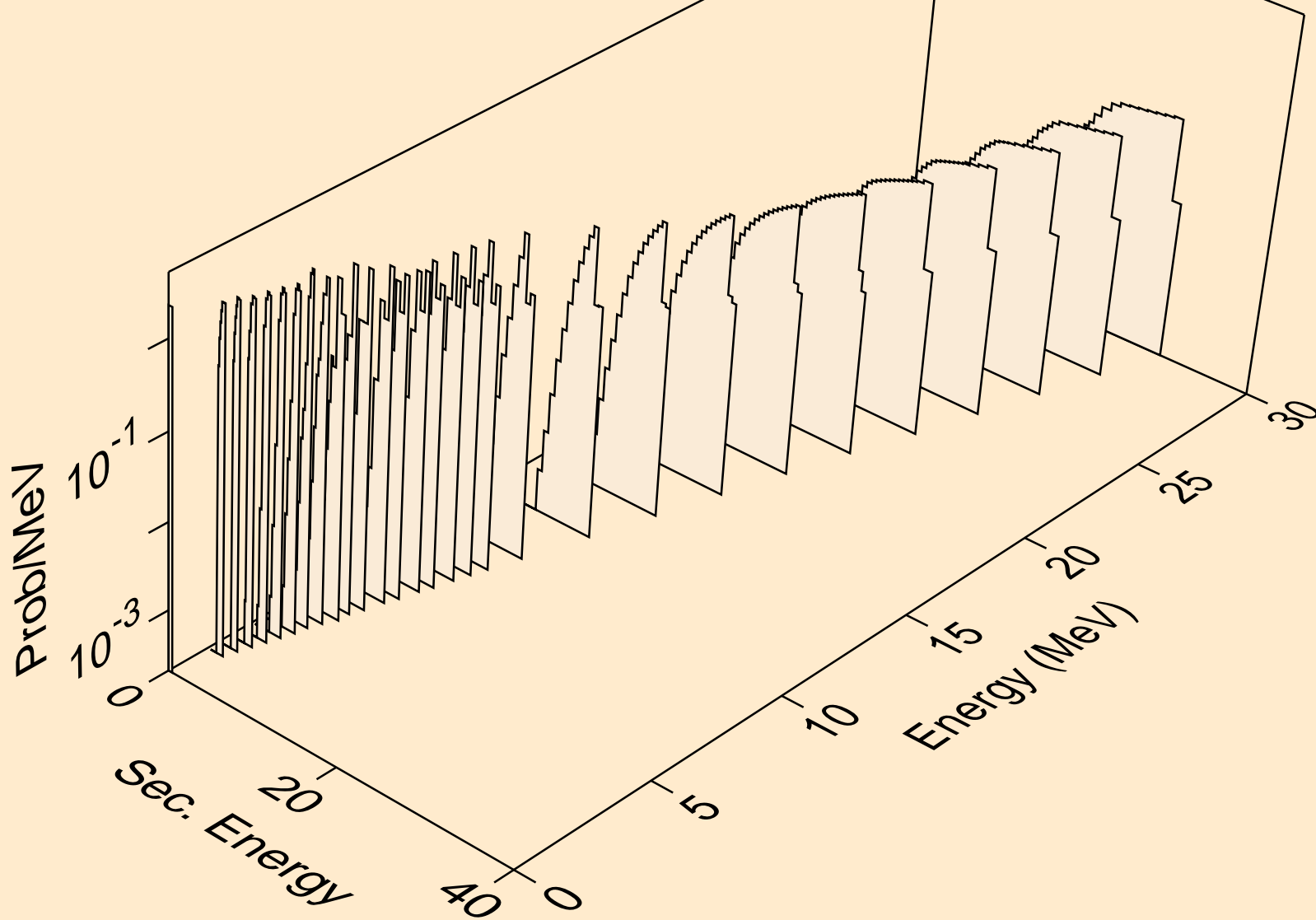

TA166 NEUTRON ACER TENDL-2019 LIBRARY; T=293.16K  
deuterons from (n,pd)

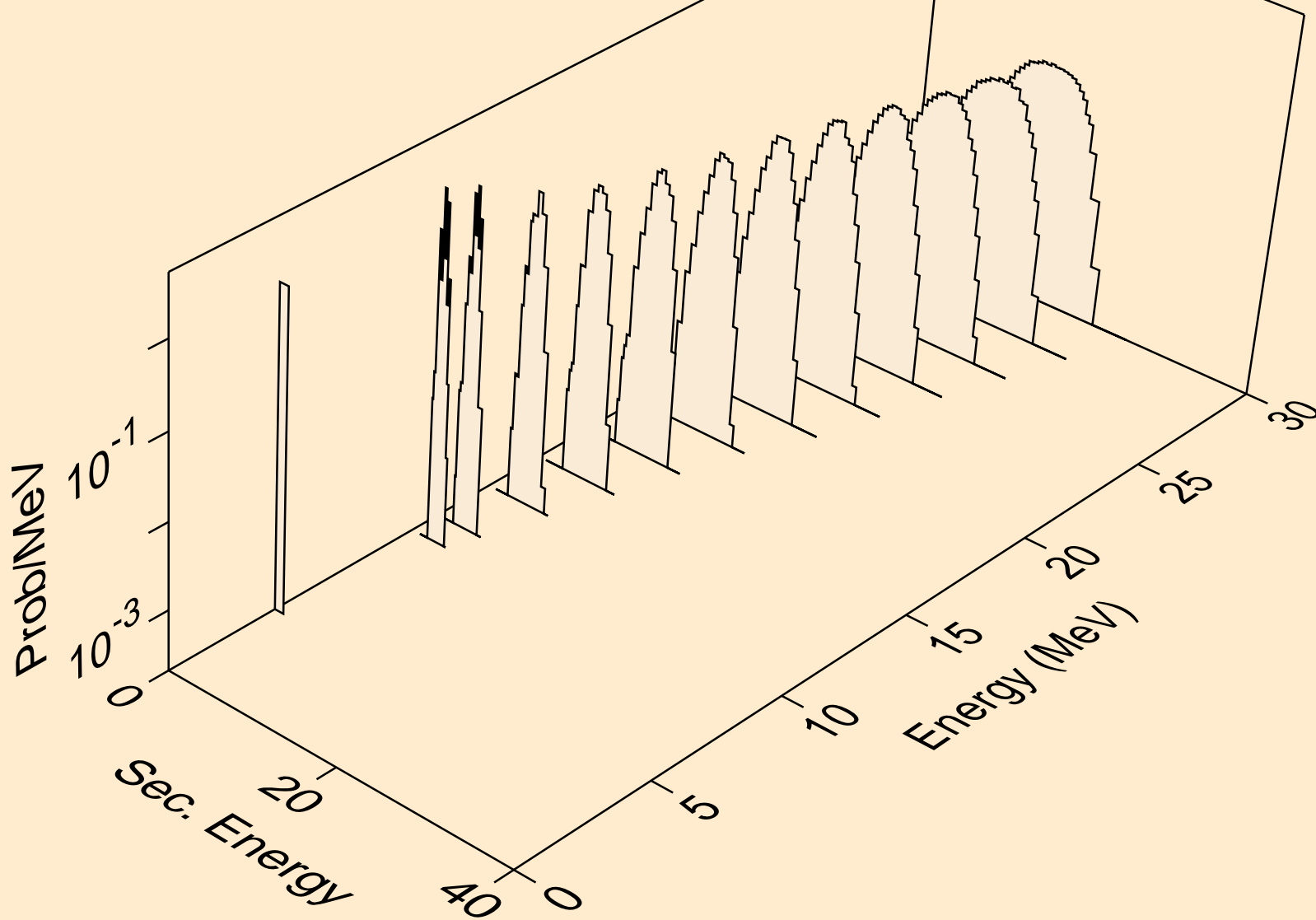

TA166 NEUTRON ACER TENDL-2019 LIBRARY; T=293.16K  
deuterons from (n,da)

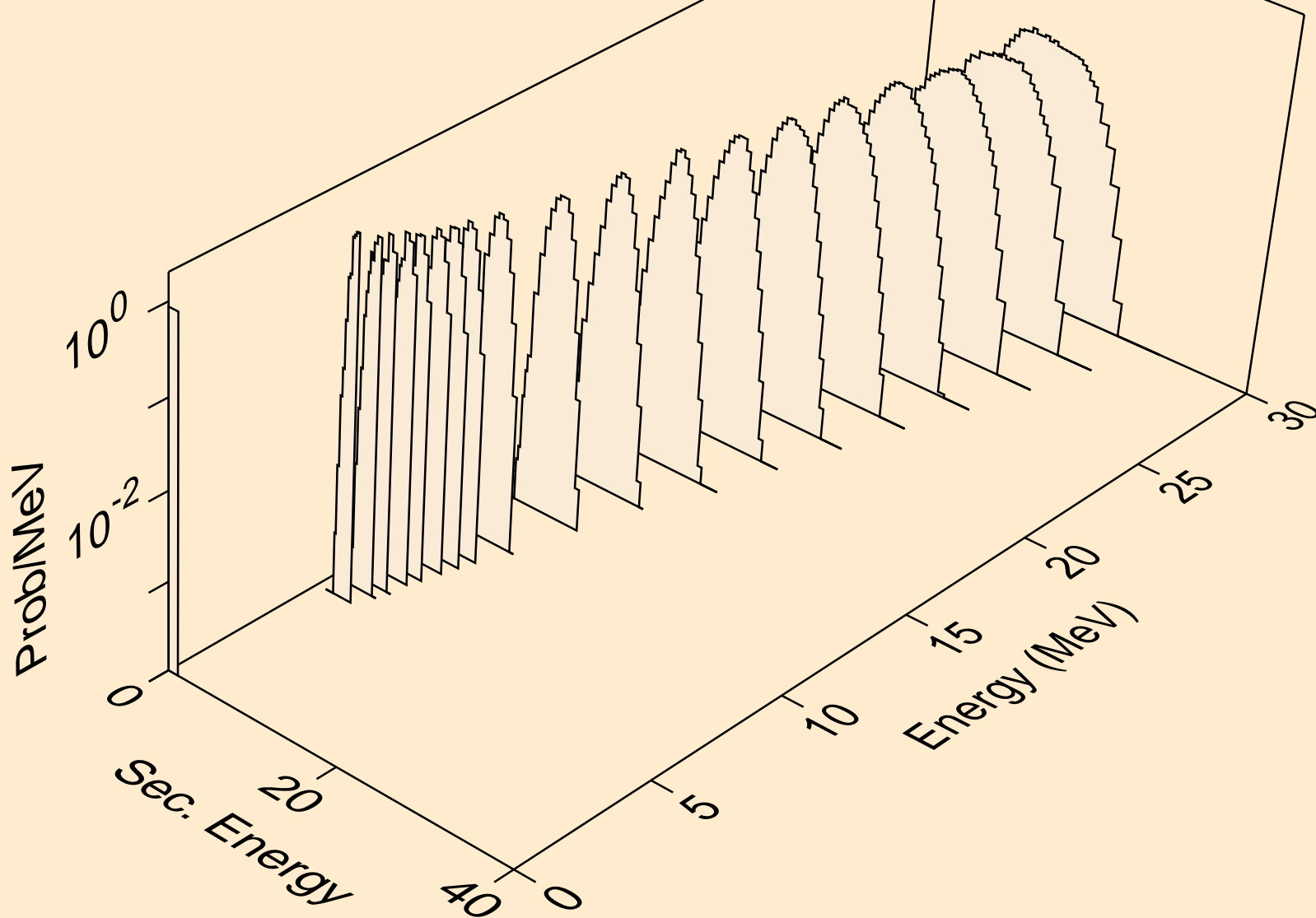

TA166 NEUTRON ACER TENDL-2019 LIBRARY; T=293.16K  
tritons from (n,x)

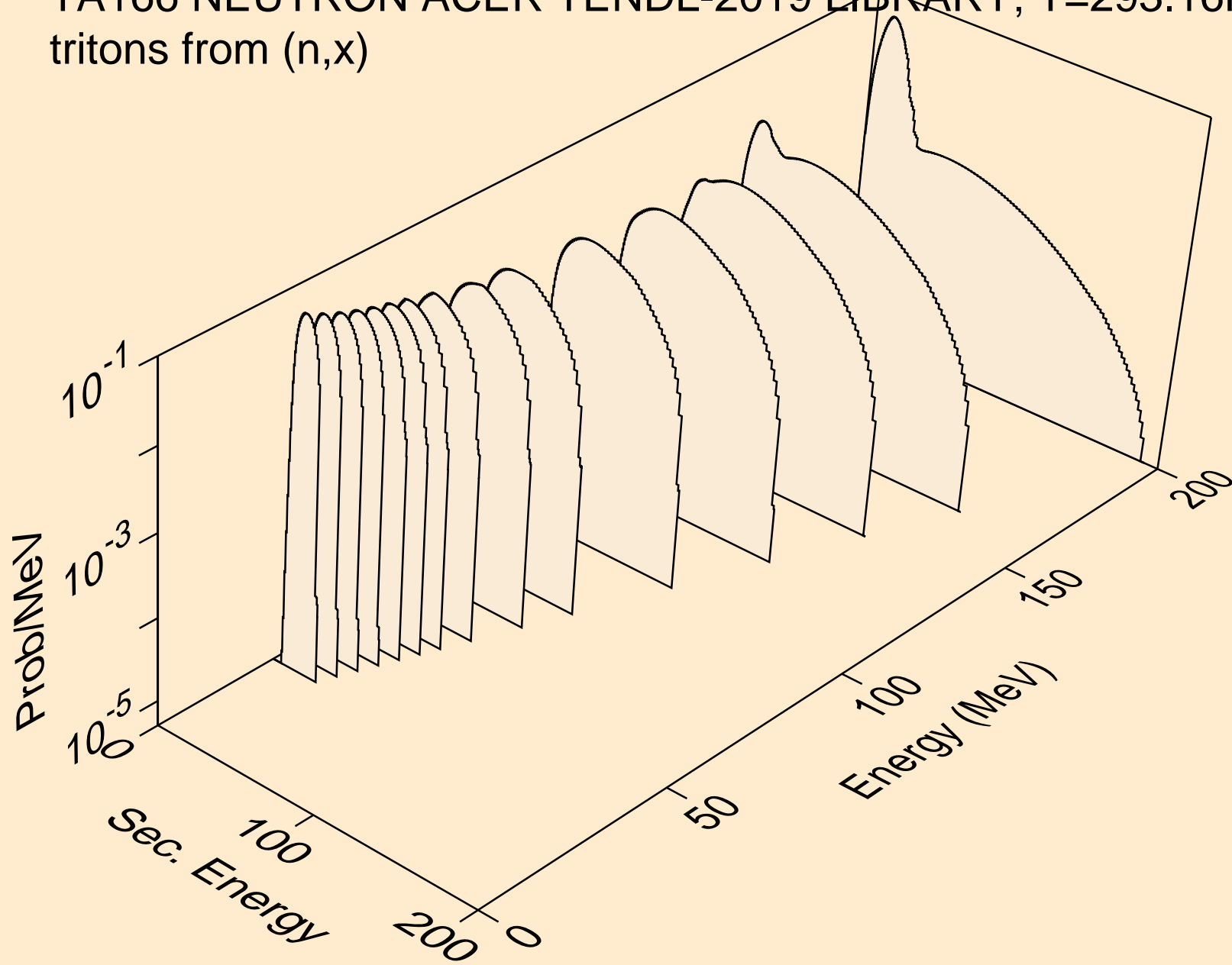

TA166 NEUTRON ACER TENDL-2019 LIBRARY; T=293.16K  
tritons from (n,n\*)t

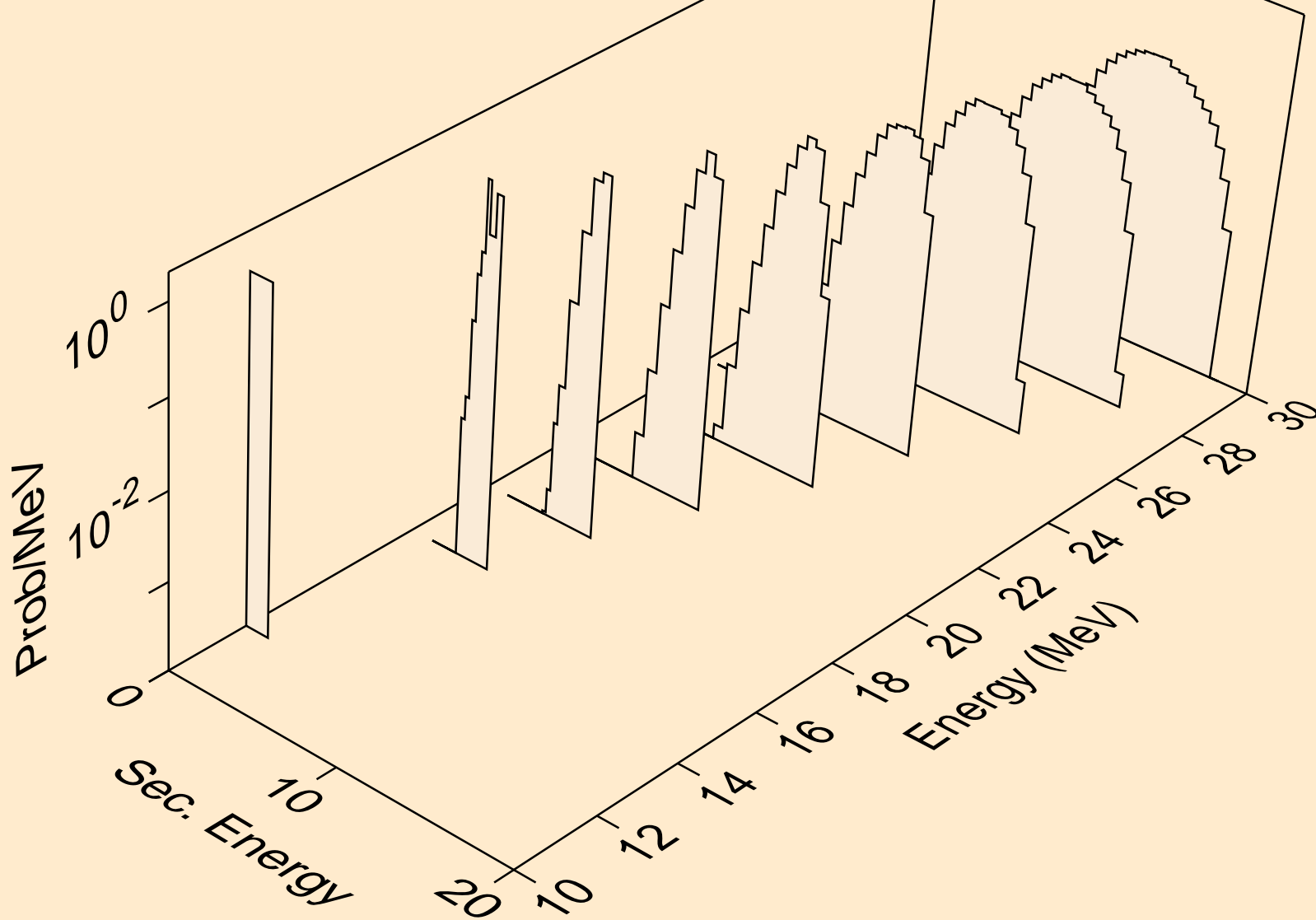



TA166 NEUTRON ACER TENDL-2019 LIBRARY; T=293.16K  
tritons from (n,t)

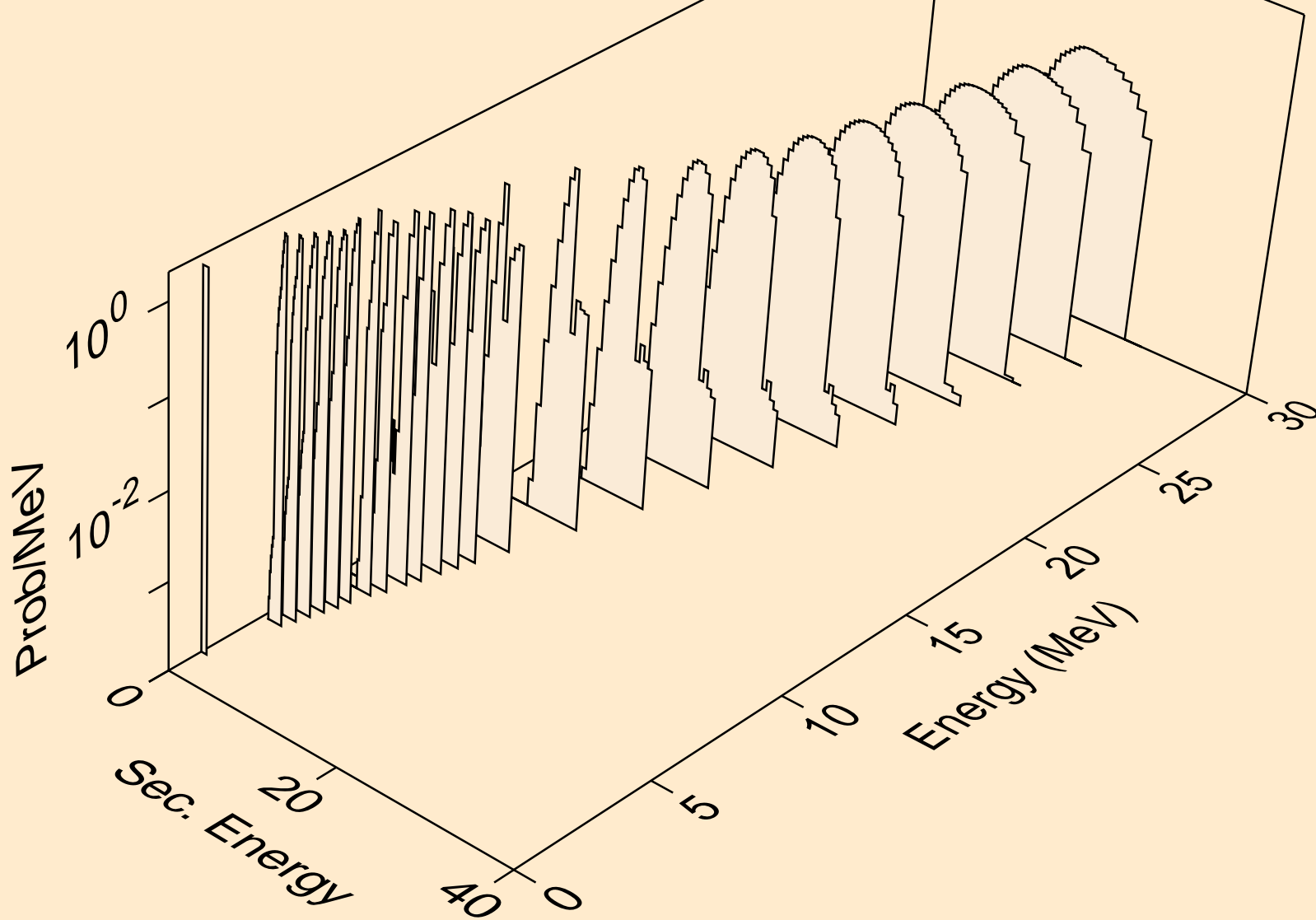

TA166 NEUTRON ACER TENDL-2019 LIBRARY; T=293.16K  
tritons from (n,pt)

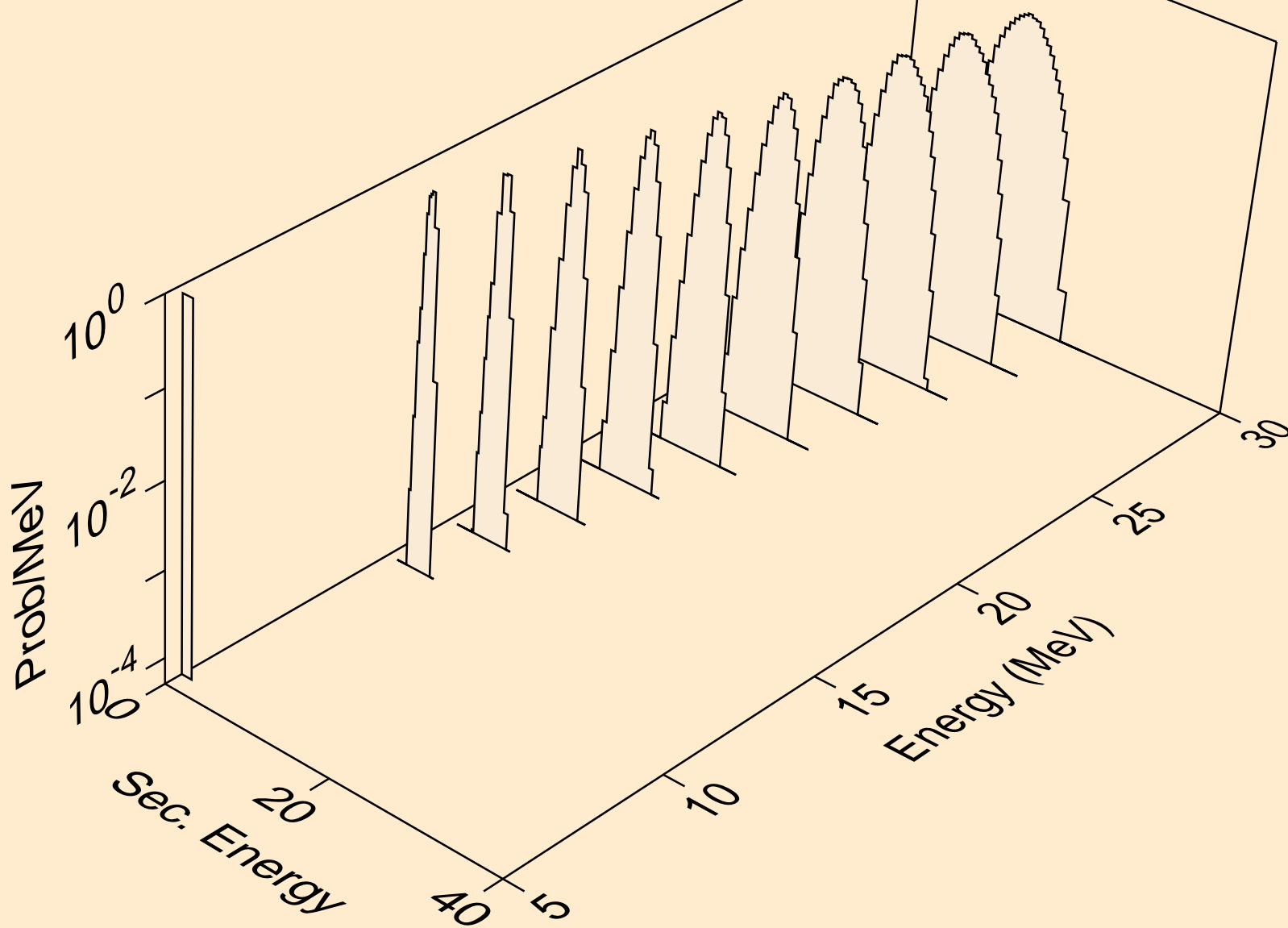

TA166 NEUTRON ACER TENDL-2019 LIBRARY; T=293.16K  
he3s from (n,x)

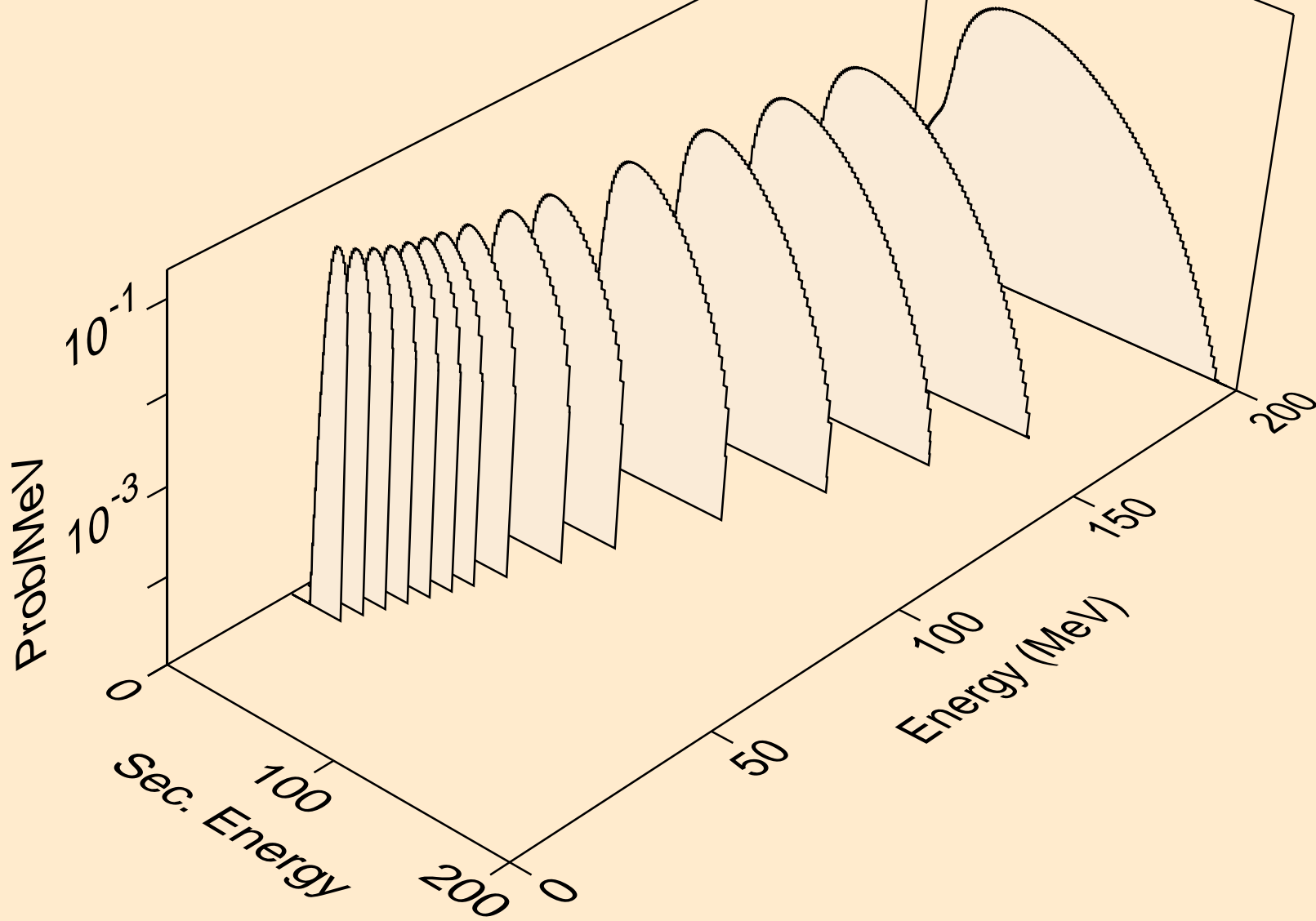

TA166 NEUTRON ACER TENDL-2019 LIBRARY; T=293.16K  
he3s from (n,n\*)he3

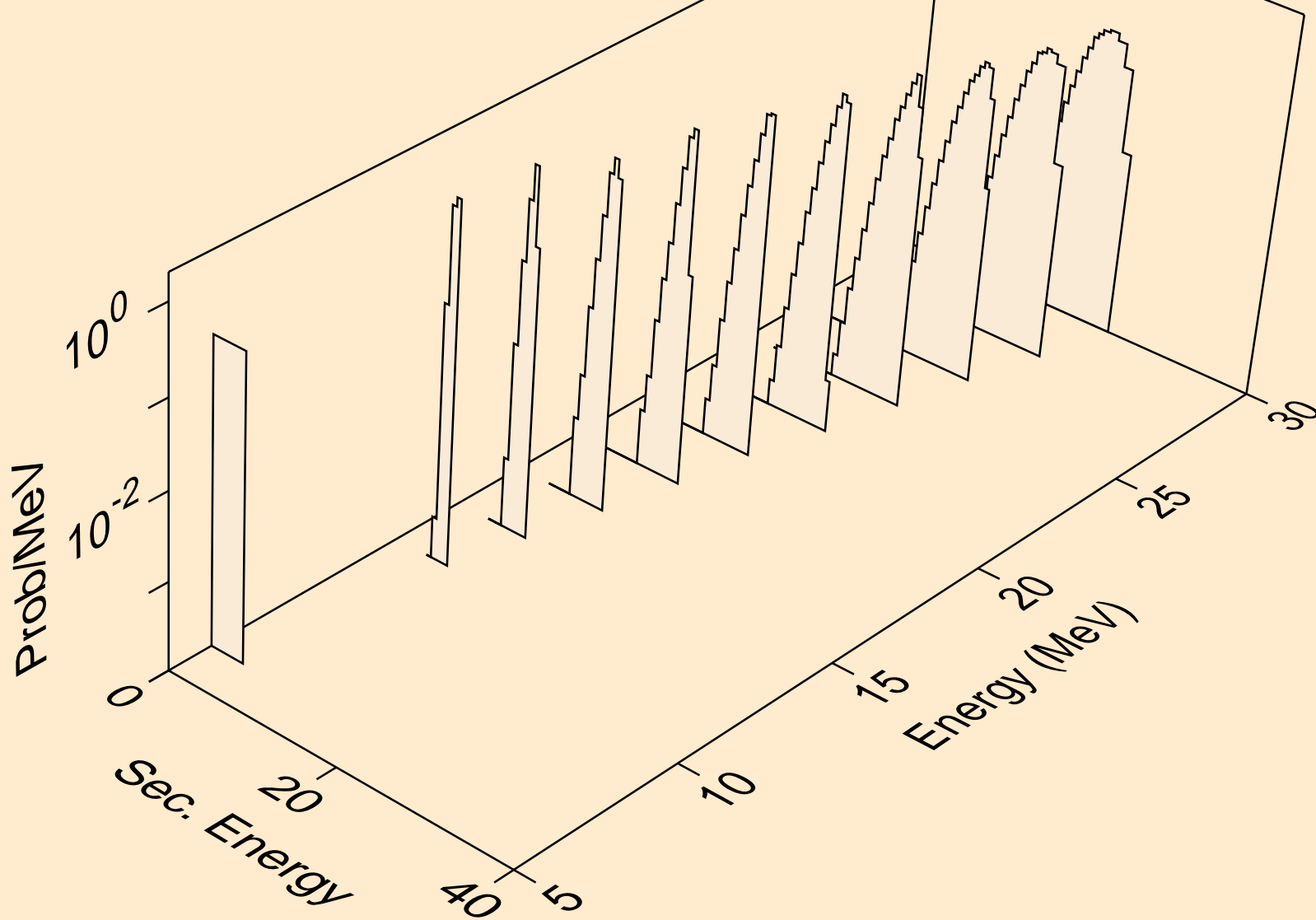

TA166 NEUTRON ACER TENDL-2019 LIBRARY; T=293.16K  
he3s from (n,he3)

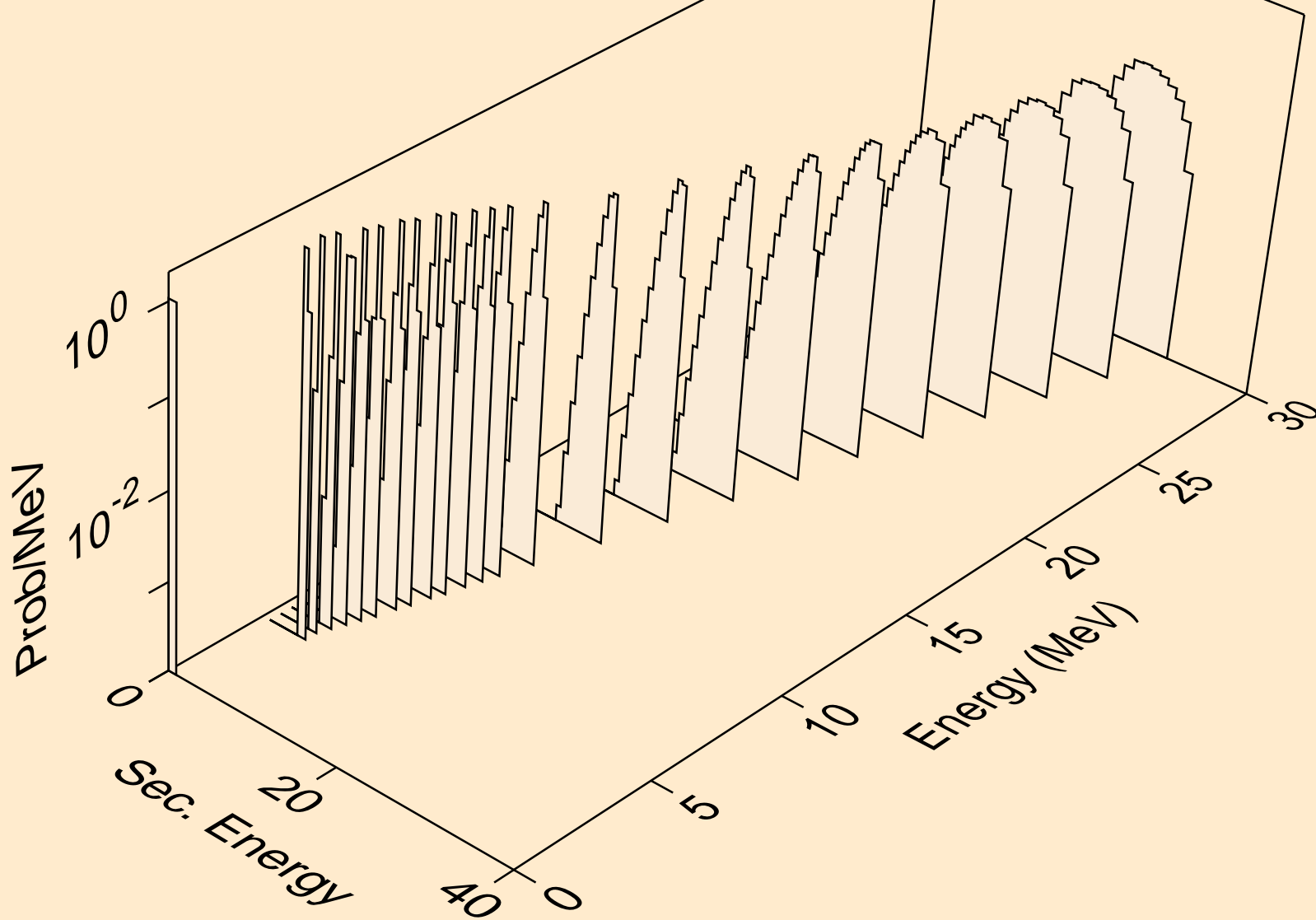

TA166 NEUTRON ACER TENDL-2019 LIBRARY; T=293.16K  
alphas from (n,x)

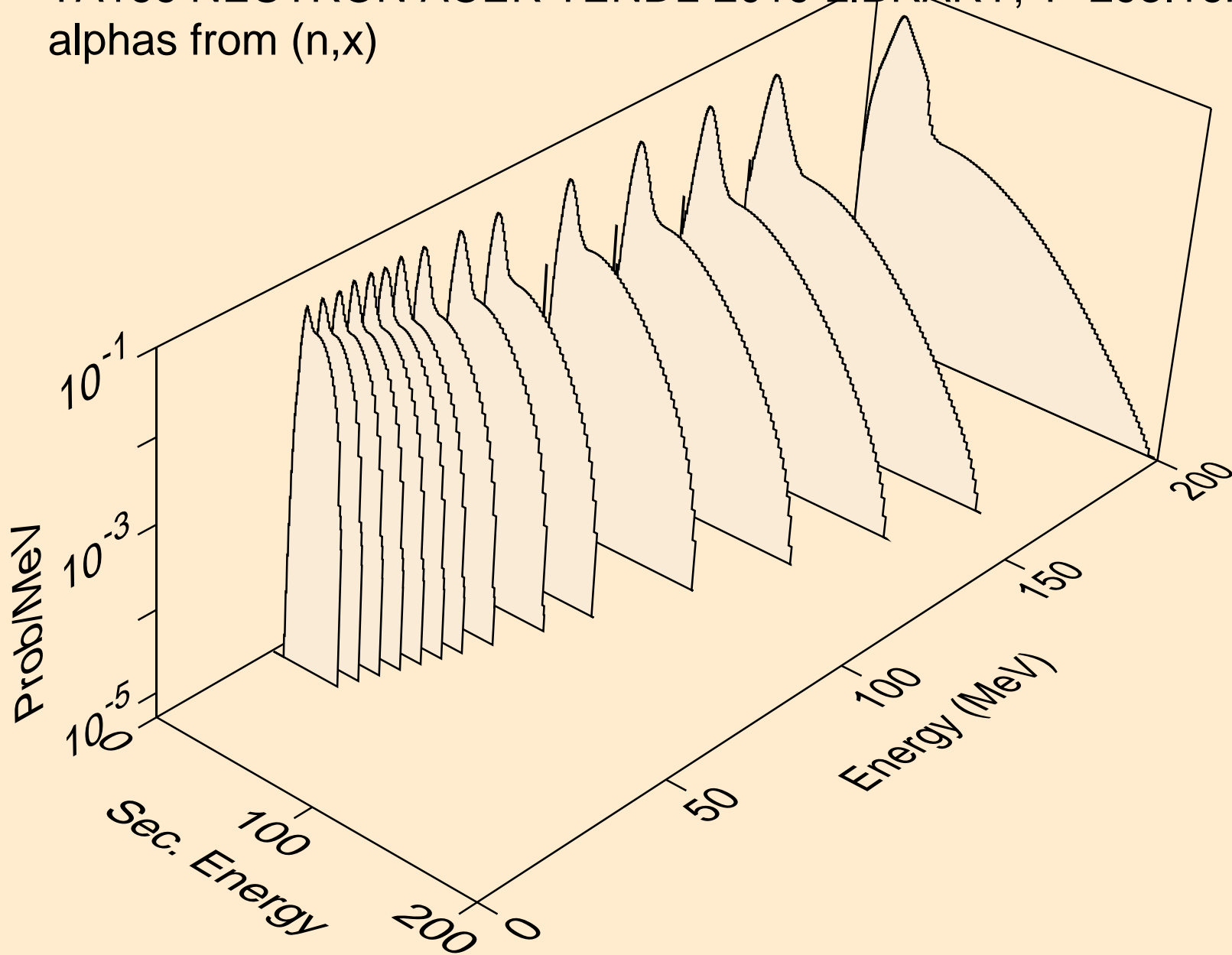

TA166 NEUTRON ACER TENDL-2019 LIBRARY; T=293.16K  
alphas from (n,n\*)a

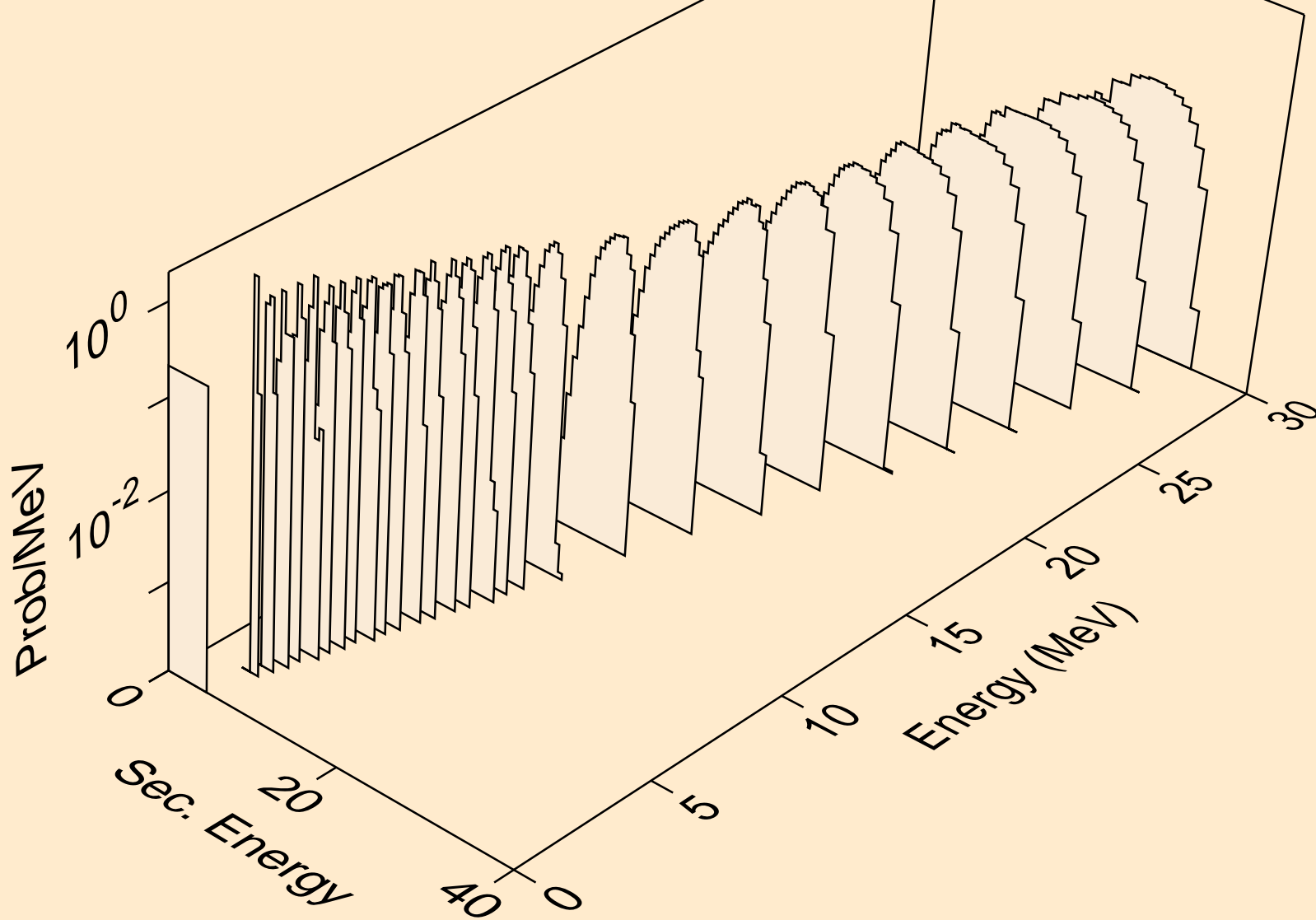

TA166 NEUTRON ACER TENDL-2019 LIBRARY; T=293.16K  
alphas from (n,2n)a

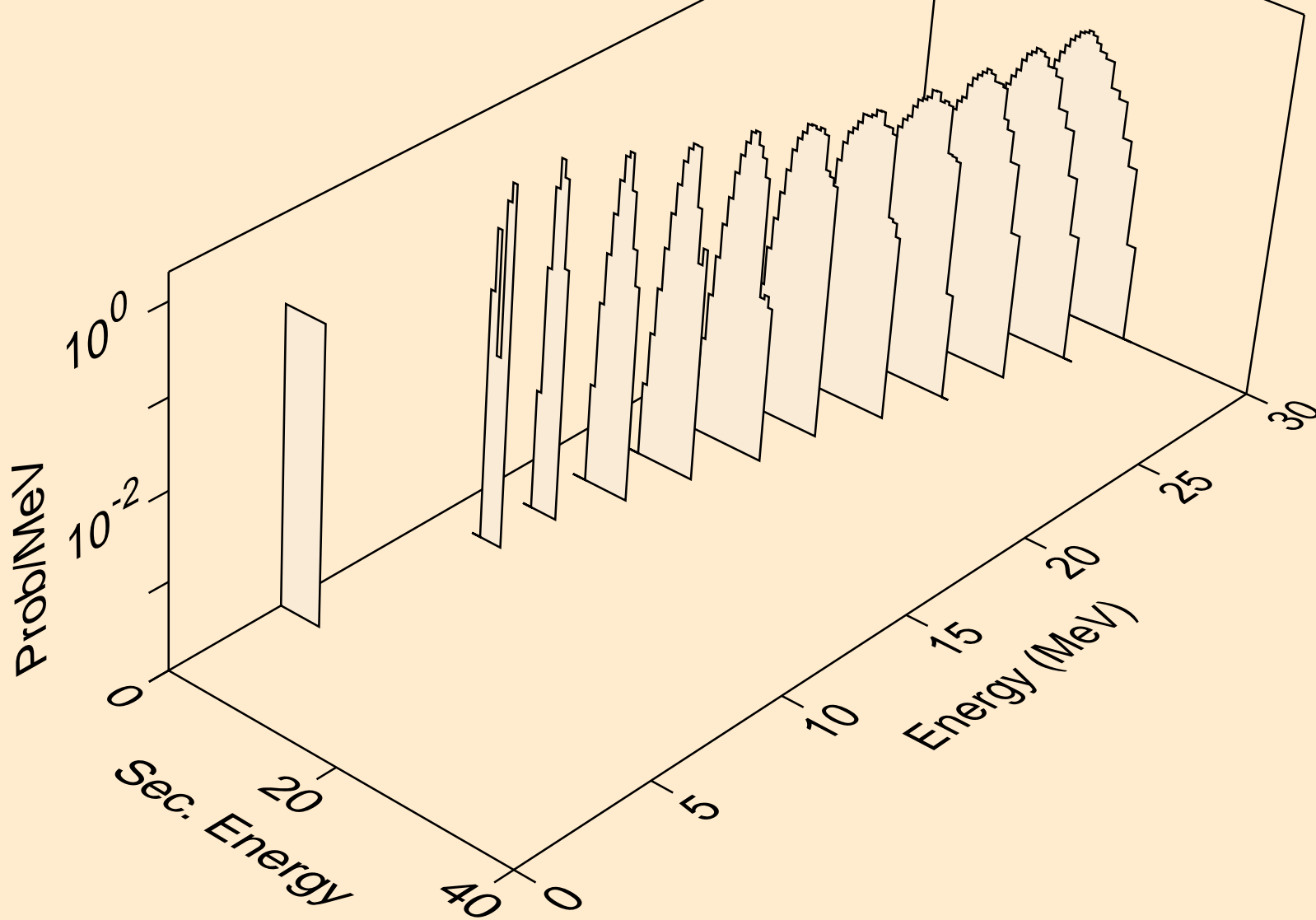



TA166 NEUTRON ACER TENDL-2019 LIBRARY; T=293.16K  
alphas from (n,3n)a

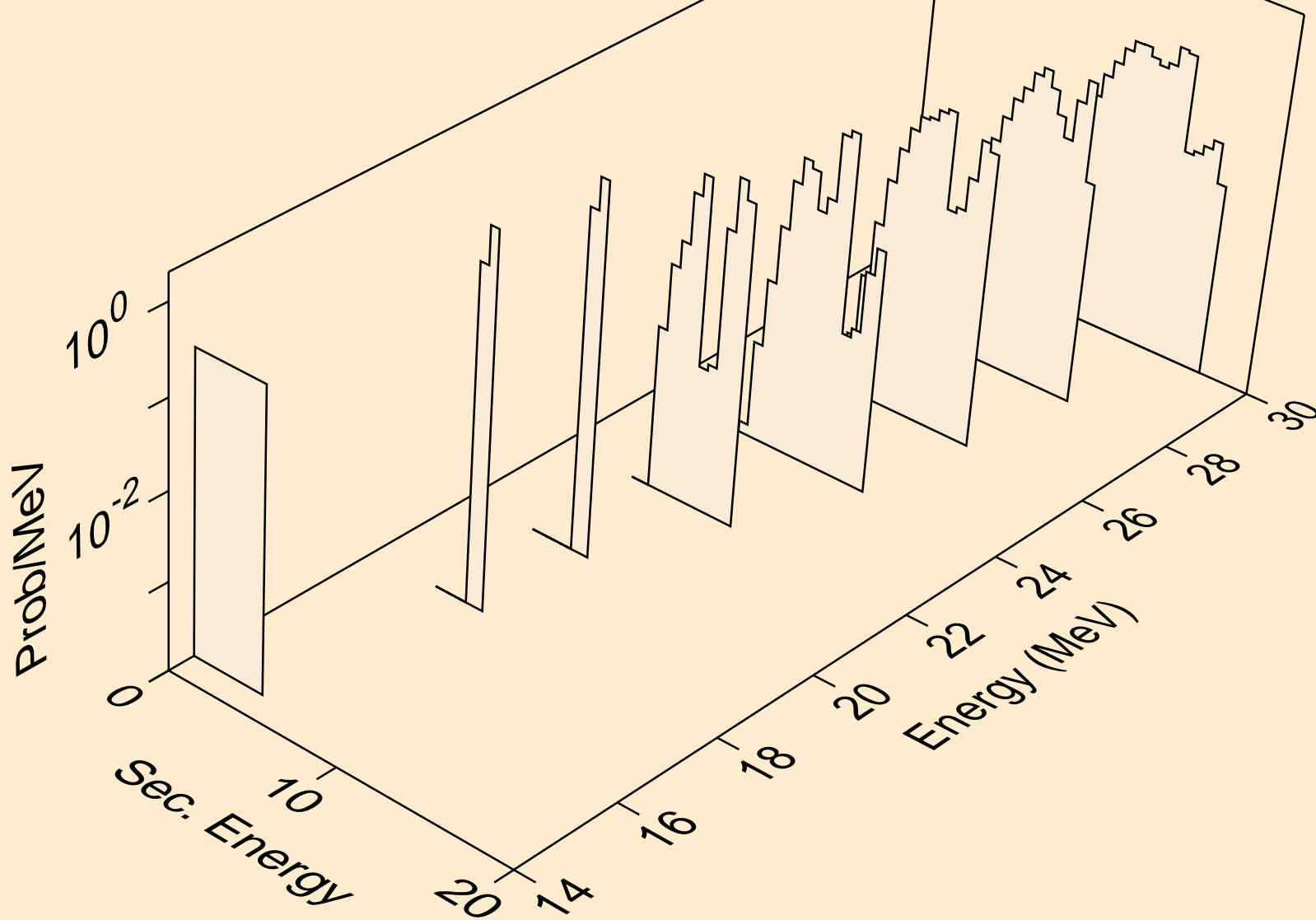

TA166 NEUTRON ACER TENDL-2019 LIBRARY; T=293.16K  
alphas from (n,n\*)2a

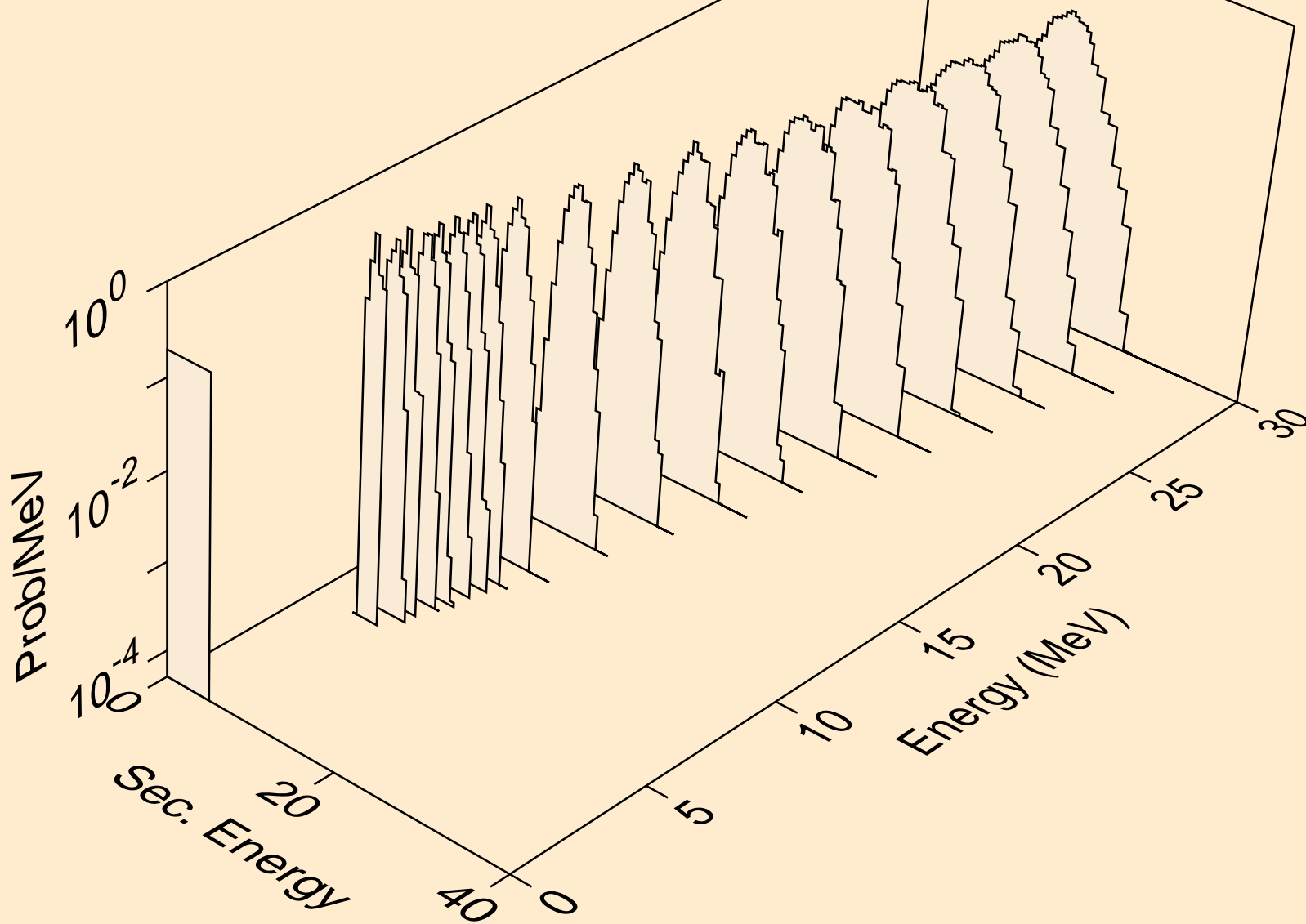

TA166 NEUTRON ACER TENDL-2019 LIBRARY; T=293.16K  
alphas from (n,2n)2a

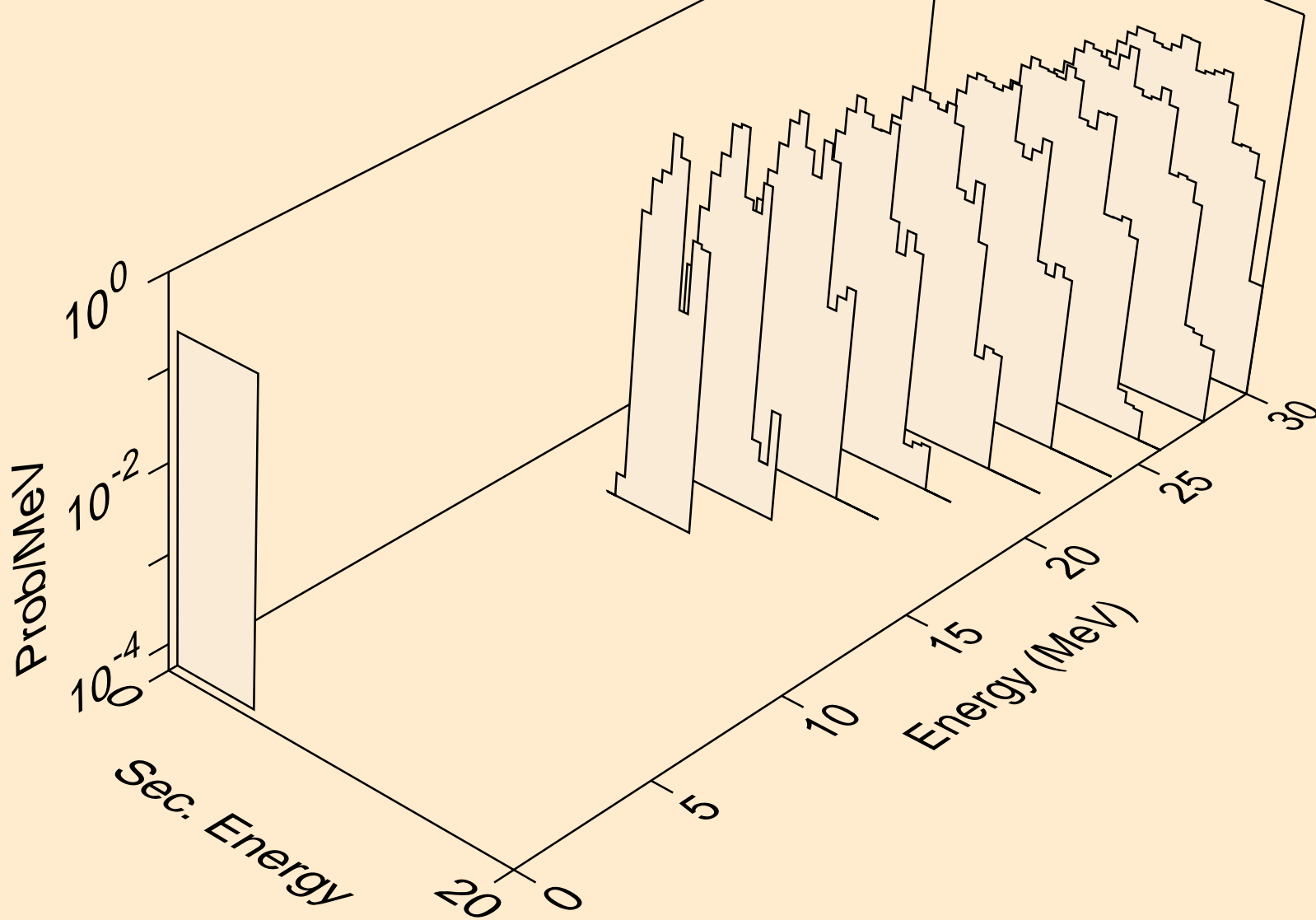

TA166 NEUTRON ACER TENDL-2019 LIBRARY; T=293.16K  
alphas from (n,npa)

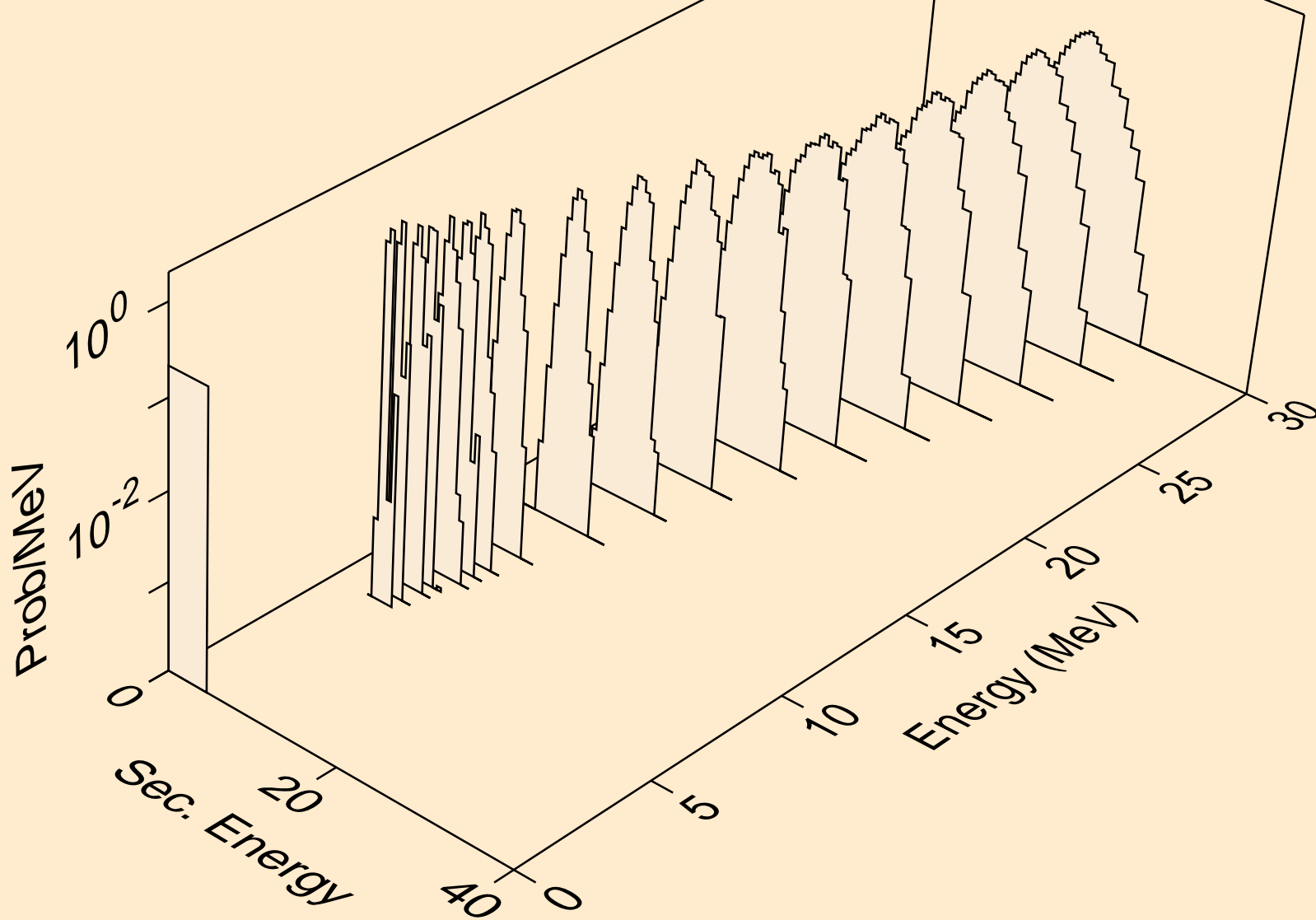

TA166 NEUTRON ACER TENDL-2019 LIBRARY; T=293.16K  
alphas from (n,a)

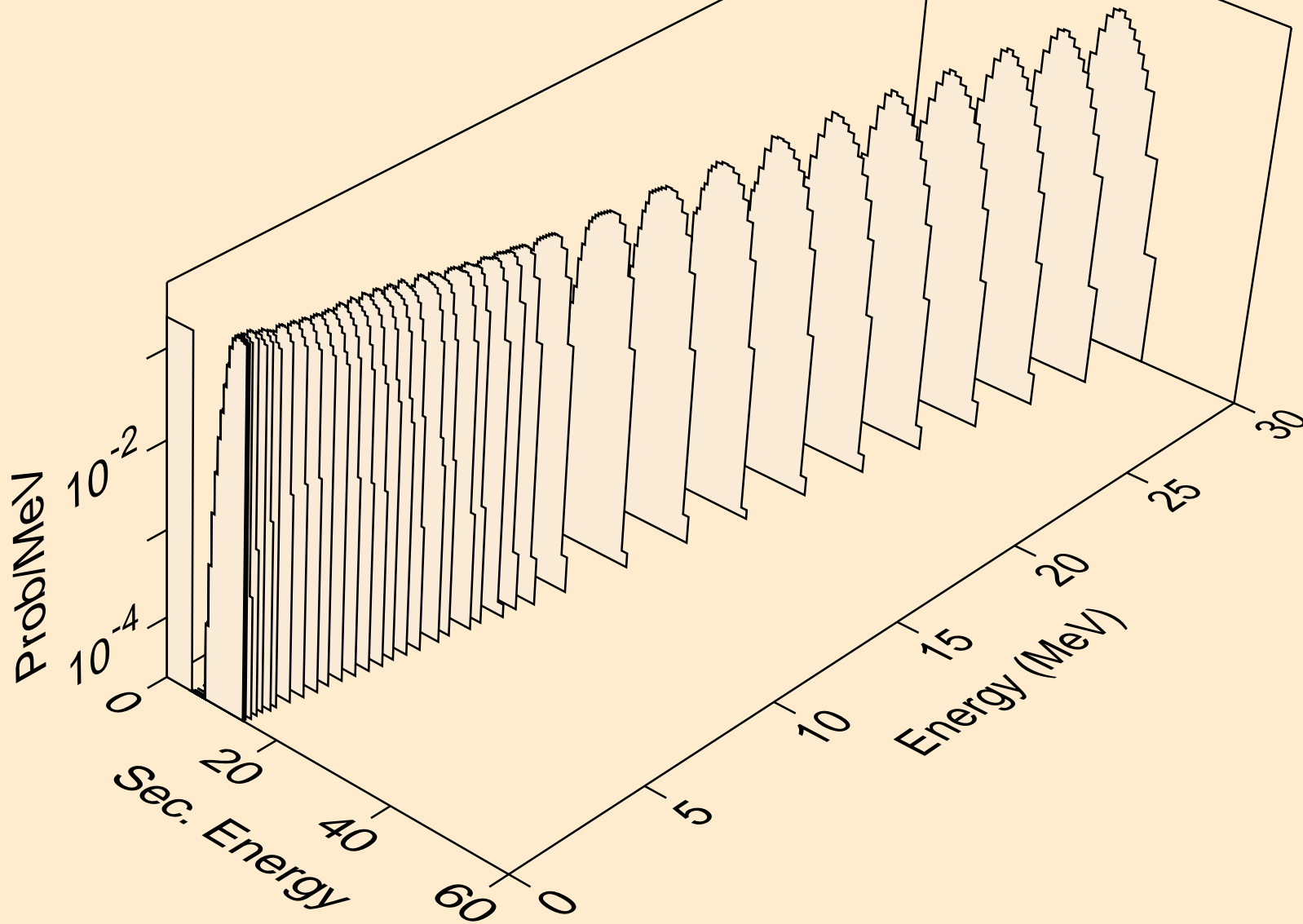

TA166 NEUTRON ACER TENDL-2019 LIBRARY; T=293.16K  
alphas from (n,2a)

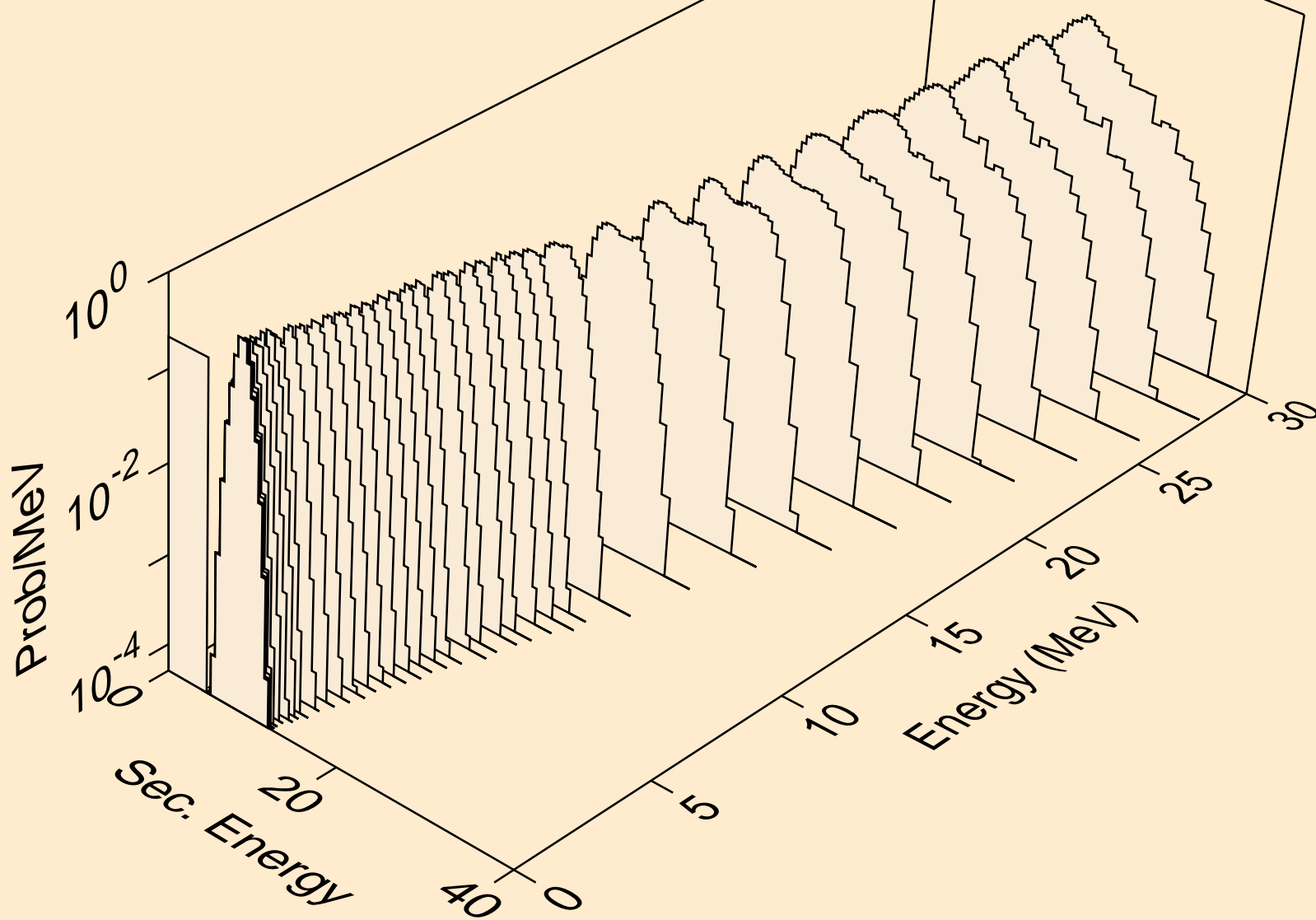

TA166 NEUTRON ACER TENDL-2019 LIBRARY; T=293.16K  
alphas from (n,3a)

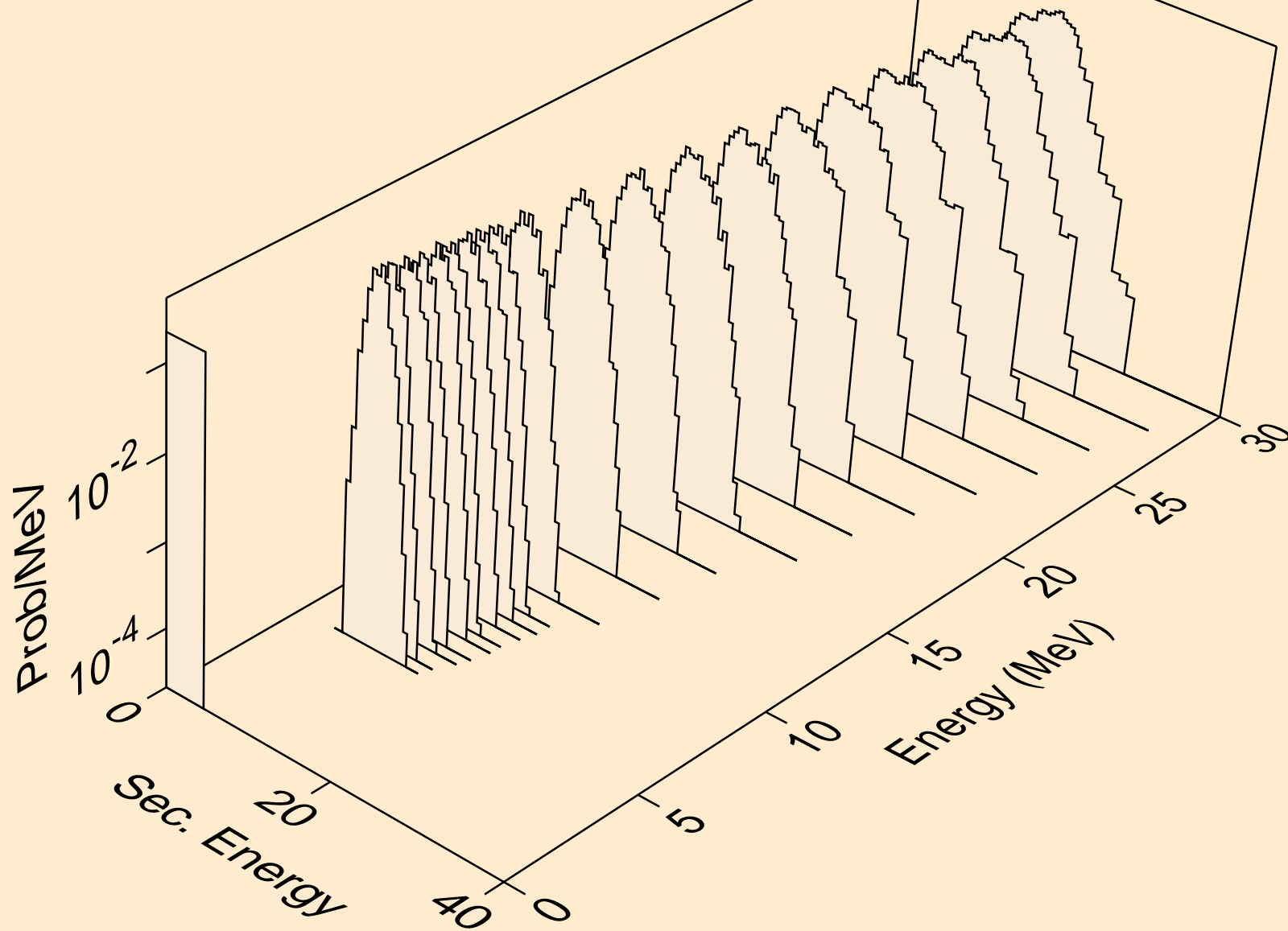

TA166 NEUTRON ACER TENDL-2019 LIBRARY; T=293.16K  
alphas from (n,pa)

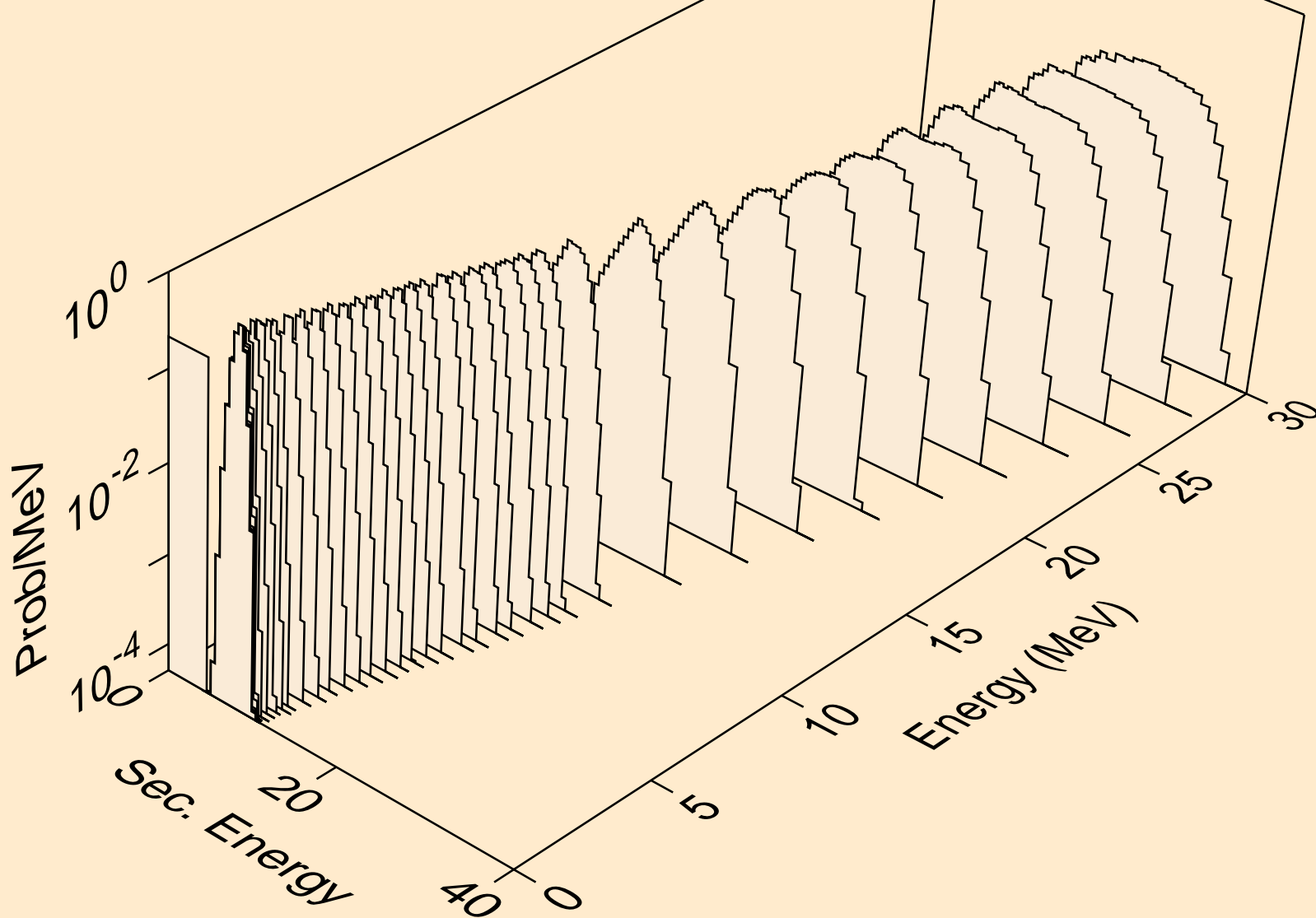



TA166 NEUTRON ACER TENDL-2019 LIBRARY; T=293.16K  
alphas from (n,da)

