

TA176 NEUTRON ACER TENDL-2019 LIBRARY; T=293.16K  
Principal cross sections

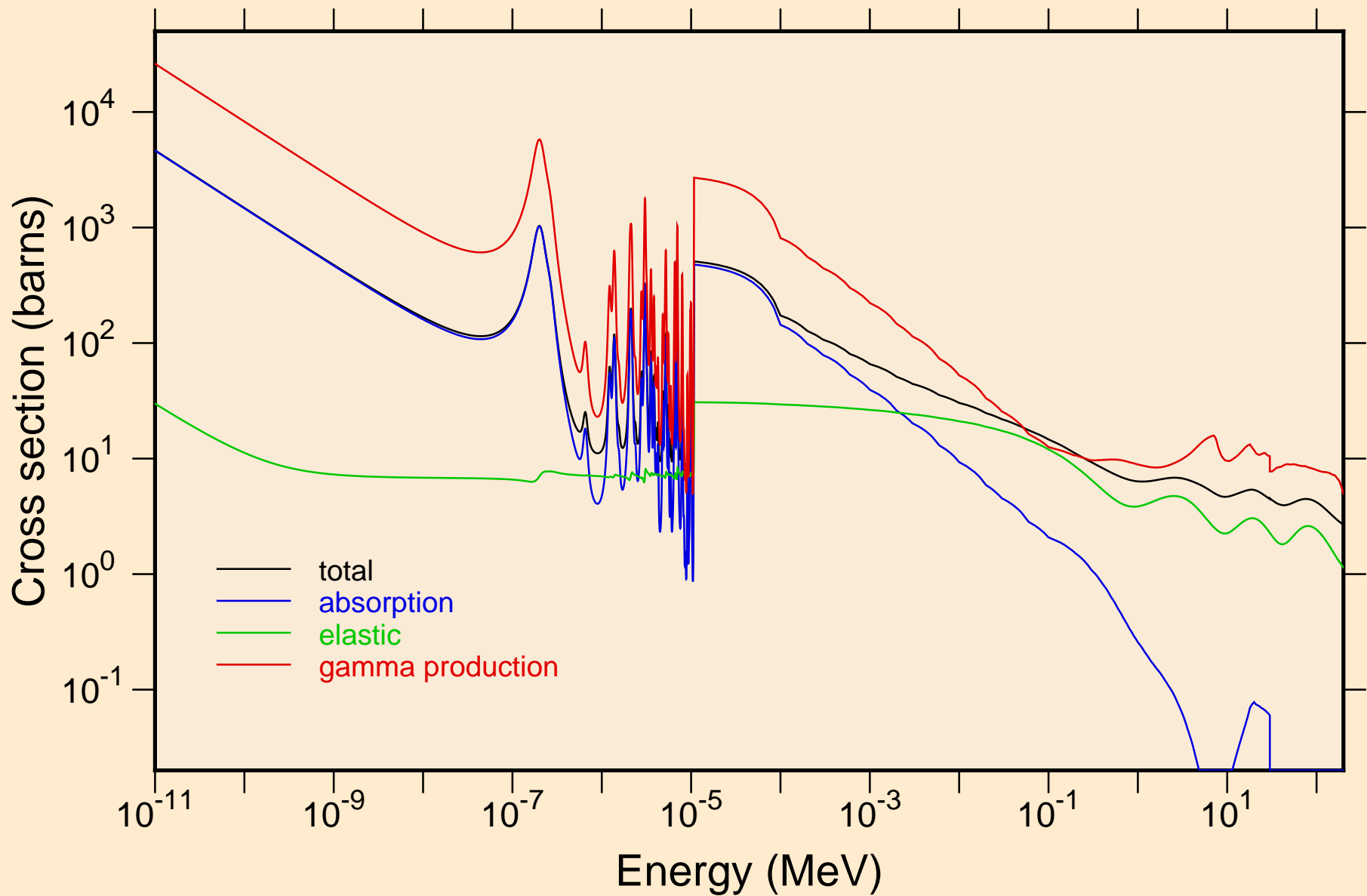

TA176 NEUTRON ACER TENDL-2019 LIBRARY; T=293.16K  
resonance total cross section

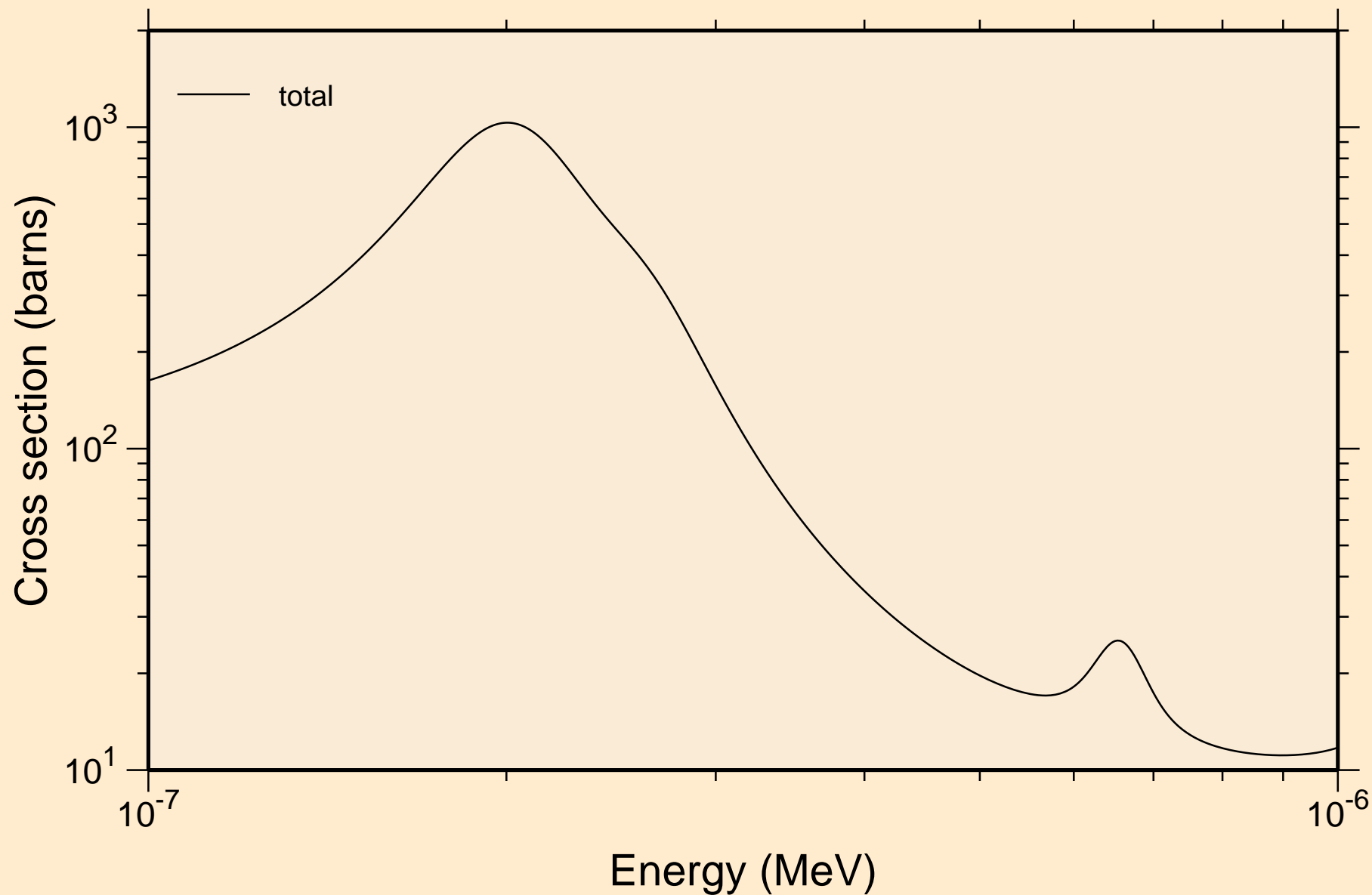

TA176 NEUTRON ACER TENDL-2019 LIBRARY; T=293.16K  
resonance total cross section

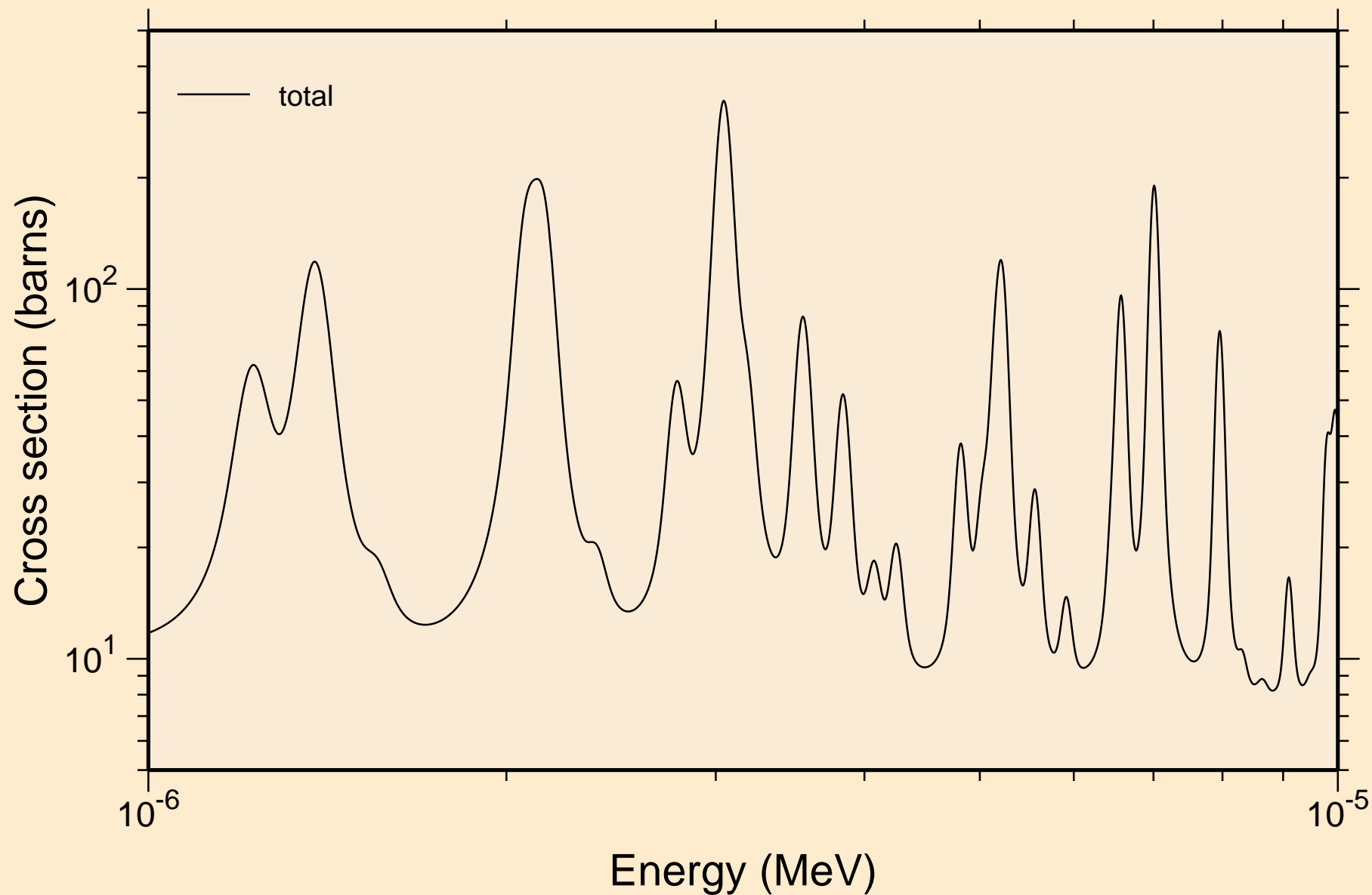

TA176 NEUTRON ACER TENDL-2019 LIBRARY; T=293.16K  
resonance total cross section

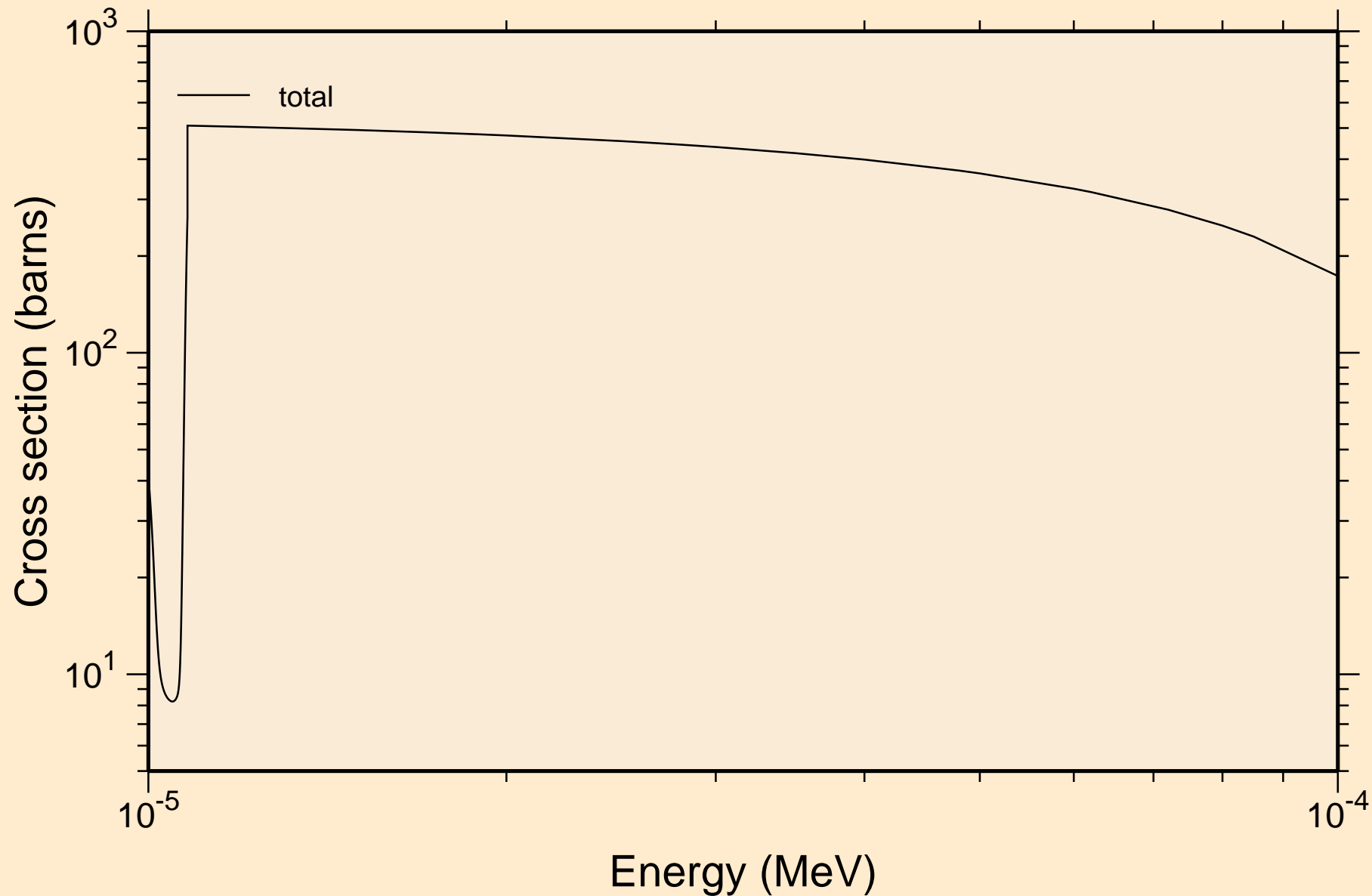

TA176 NEUTRON ACER TENDL-2019 LIBRARY; T=293.16K  
resonance total cross section

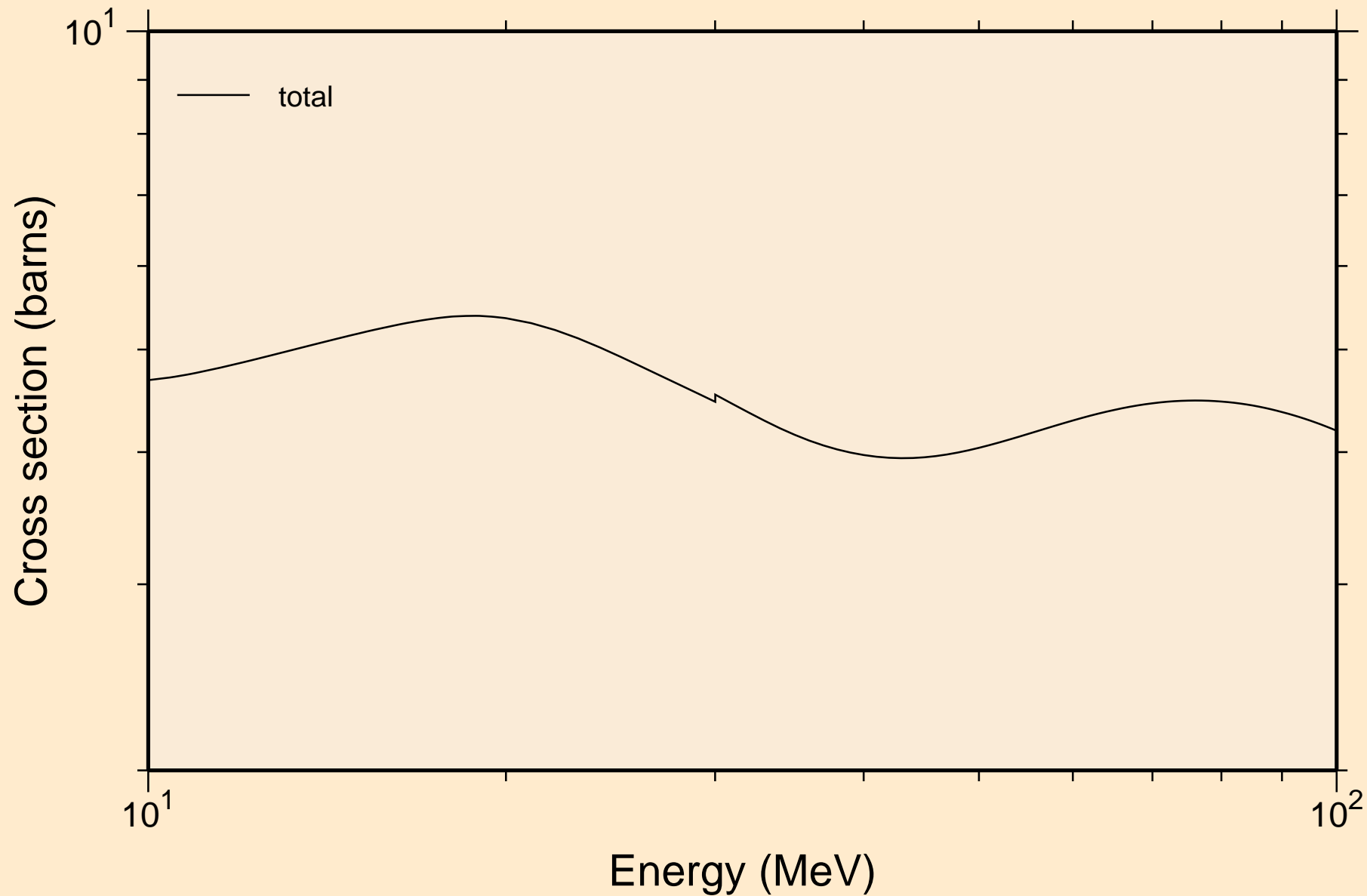

TA176 NEUTRON ACER TENDL-2019 LIBRARY; T=293.16K  
resonance absorption cross sections

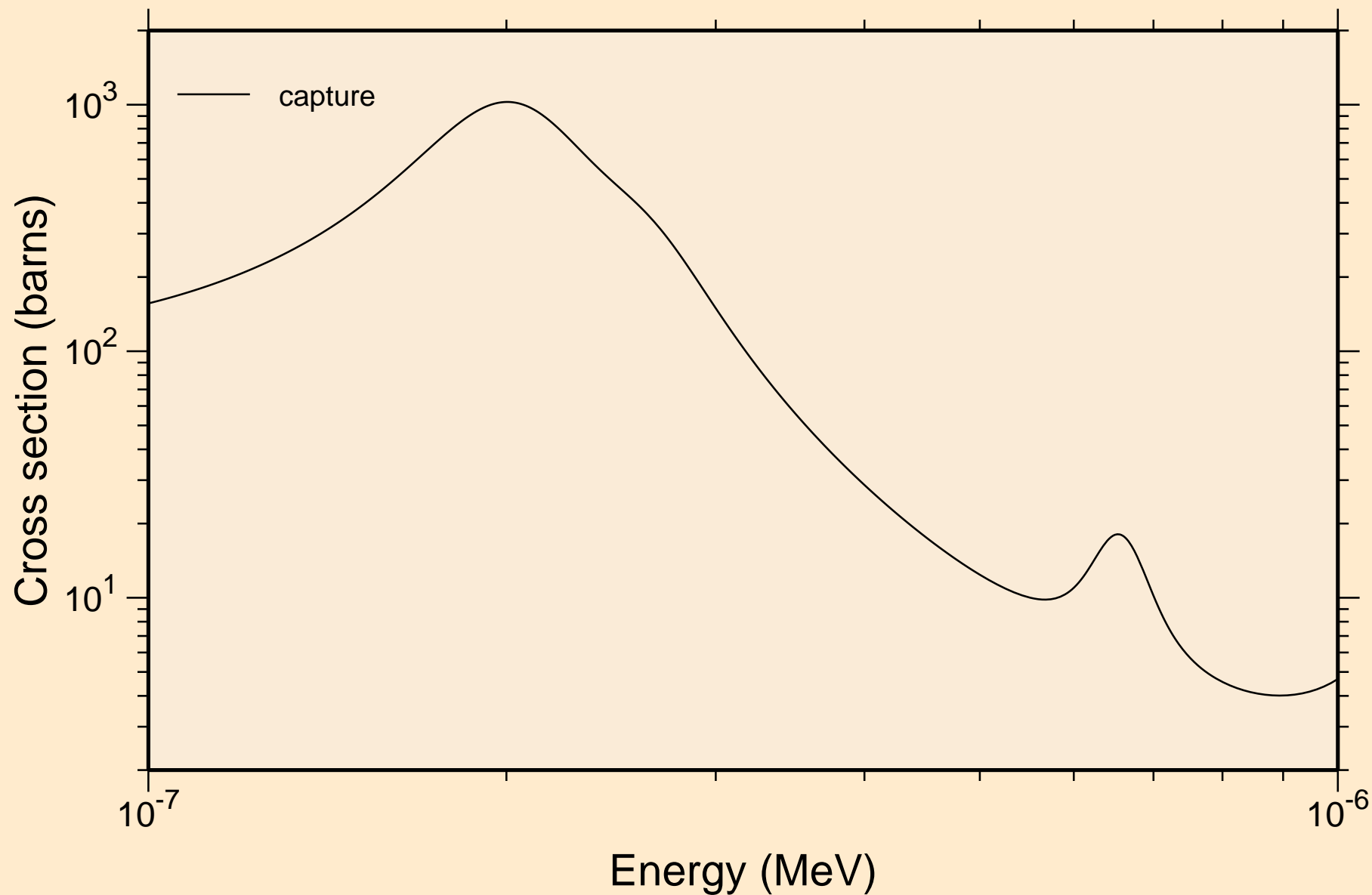

TA176 NEUTRON ACER TENDL-2019 LIBRARY; T=293.16K  
resonance absorption cross sections

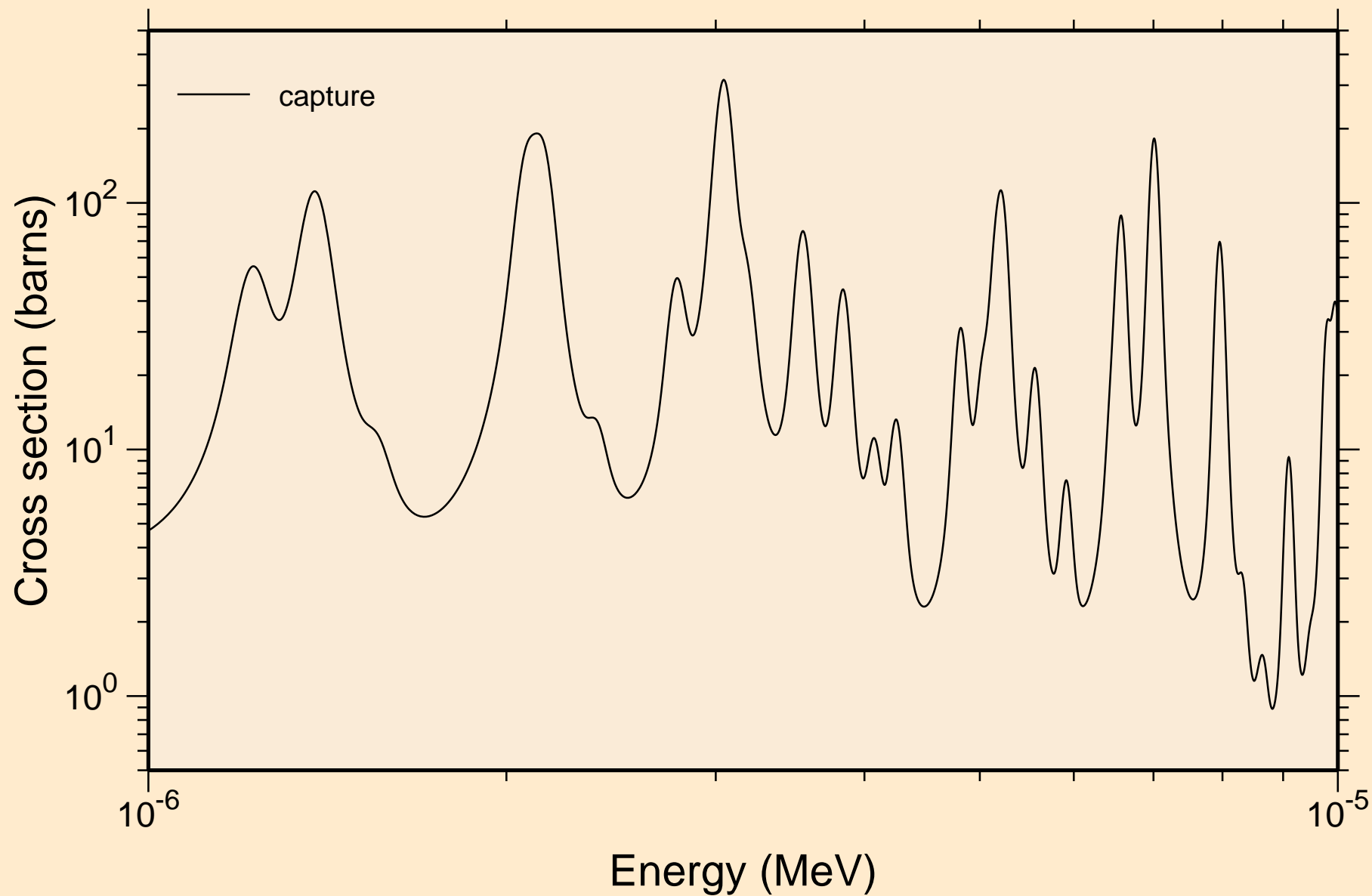

TA176 NEUTRON ACER TENDL-2019 LIBRARY; T=293.16K  
resonance absorption cross sections

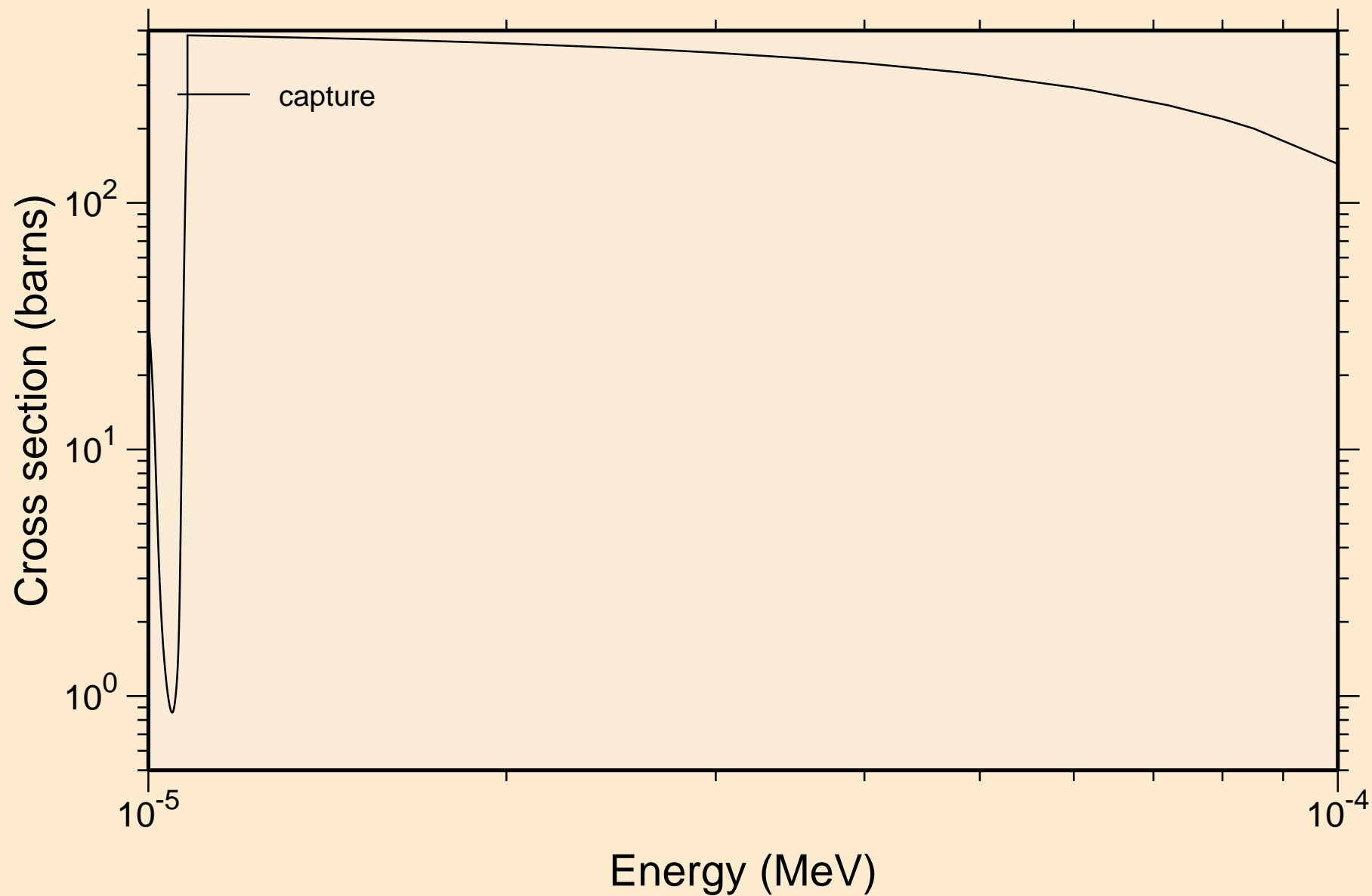



TA176 NEUTRON ACER TENDL-2019 LIBRARY; T=293.16K  
resonance absorption cross sections

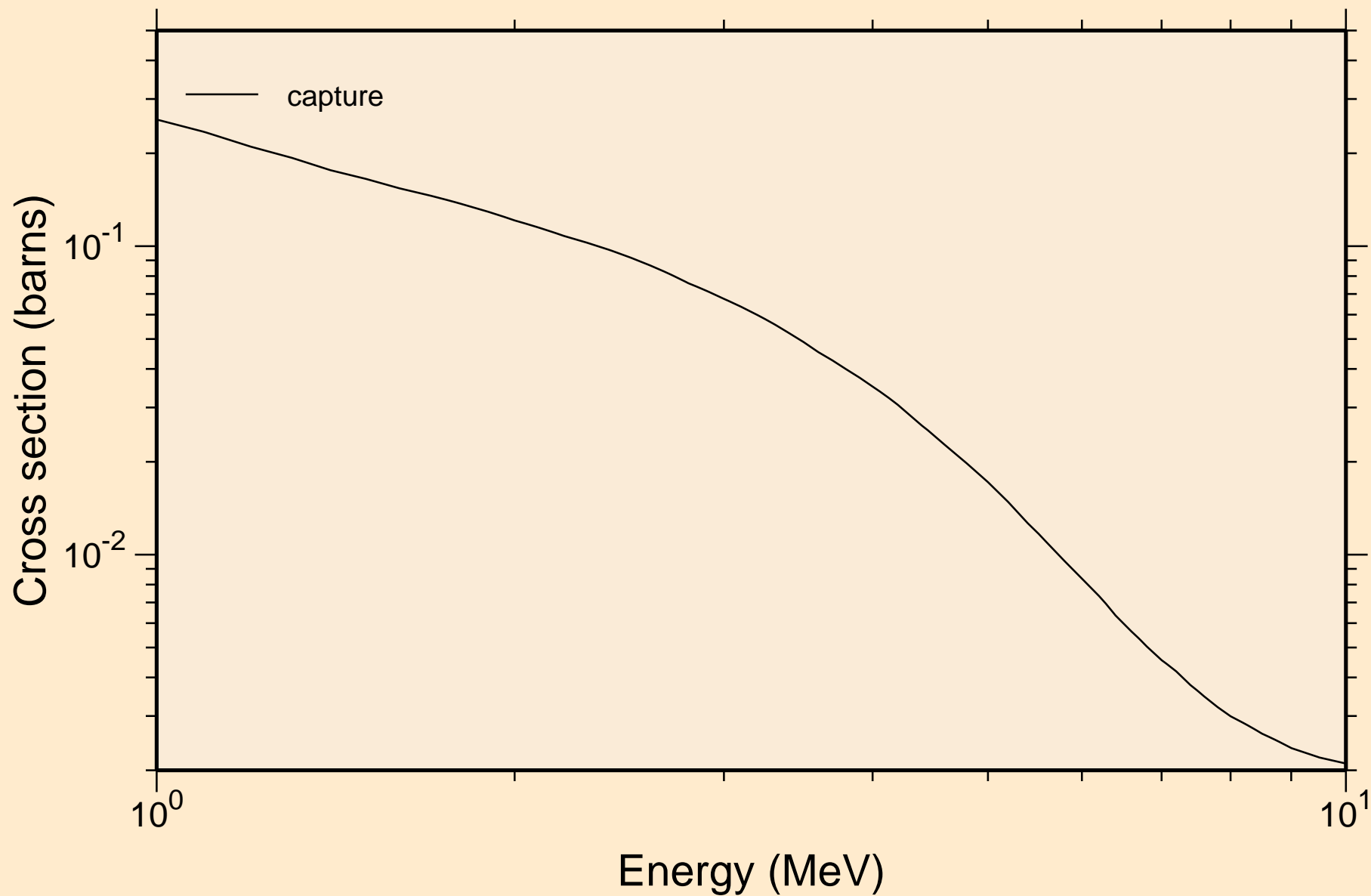

TA176 NEUTRON ACER TENDL-2019 LIBRARY; T=293.16K  
Heating

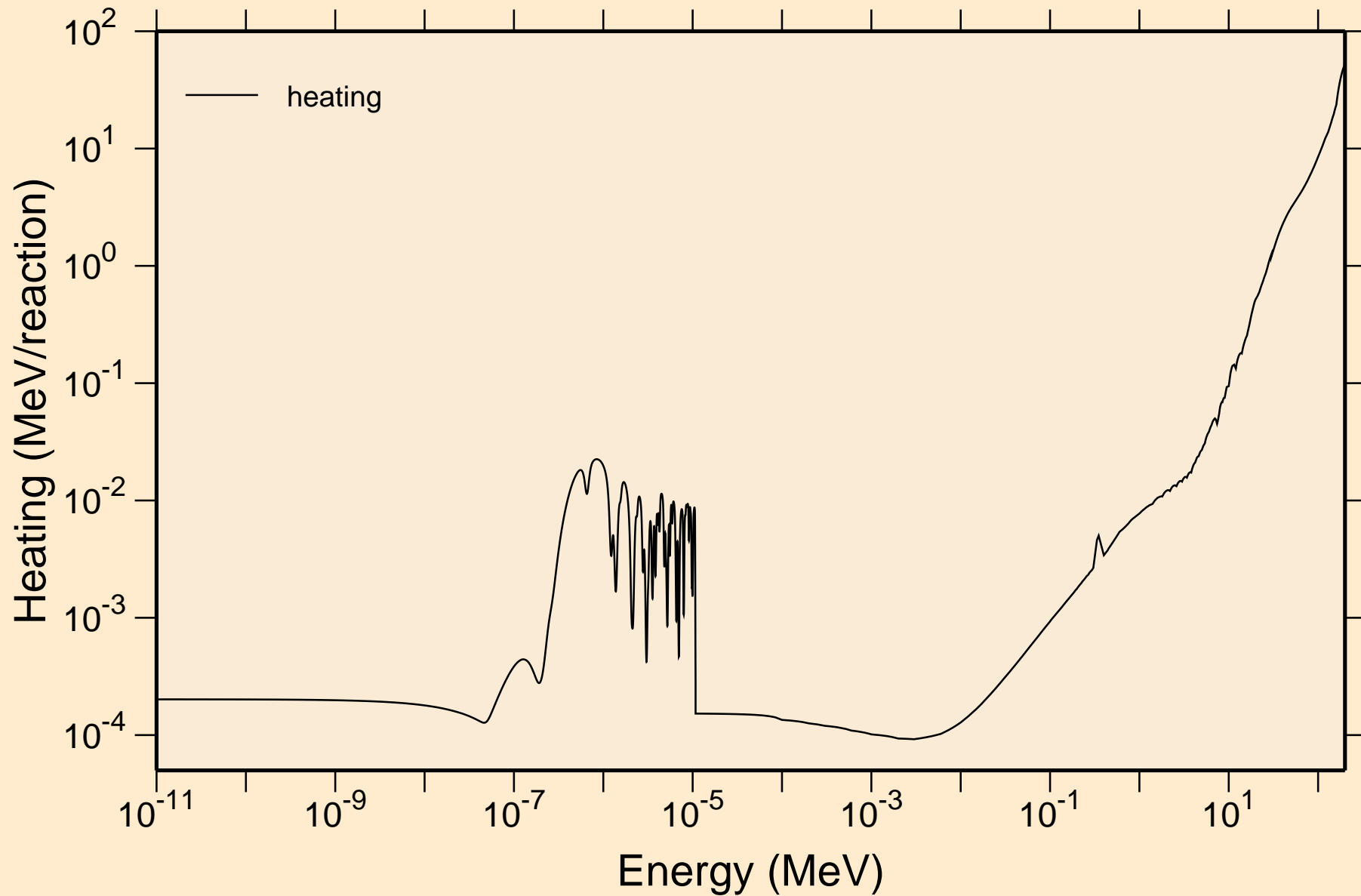

TA176 NEUTRON ACER TENDL-2019 LIBRARY; T=293.16K  
Damage

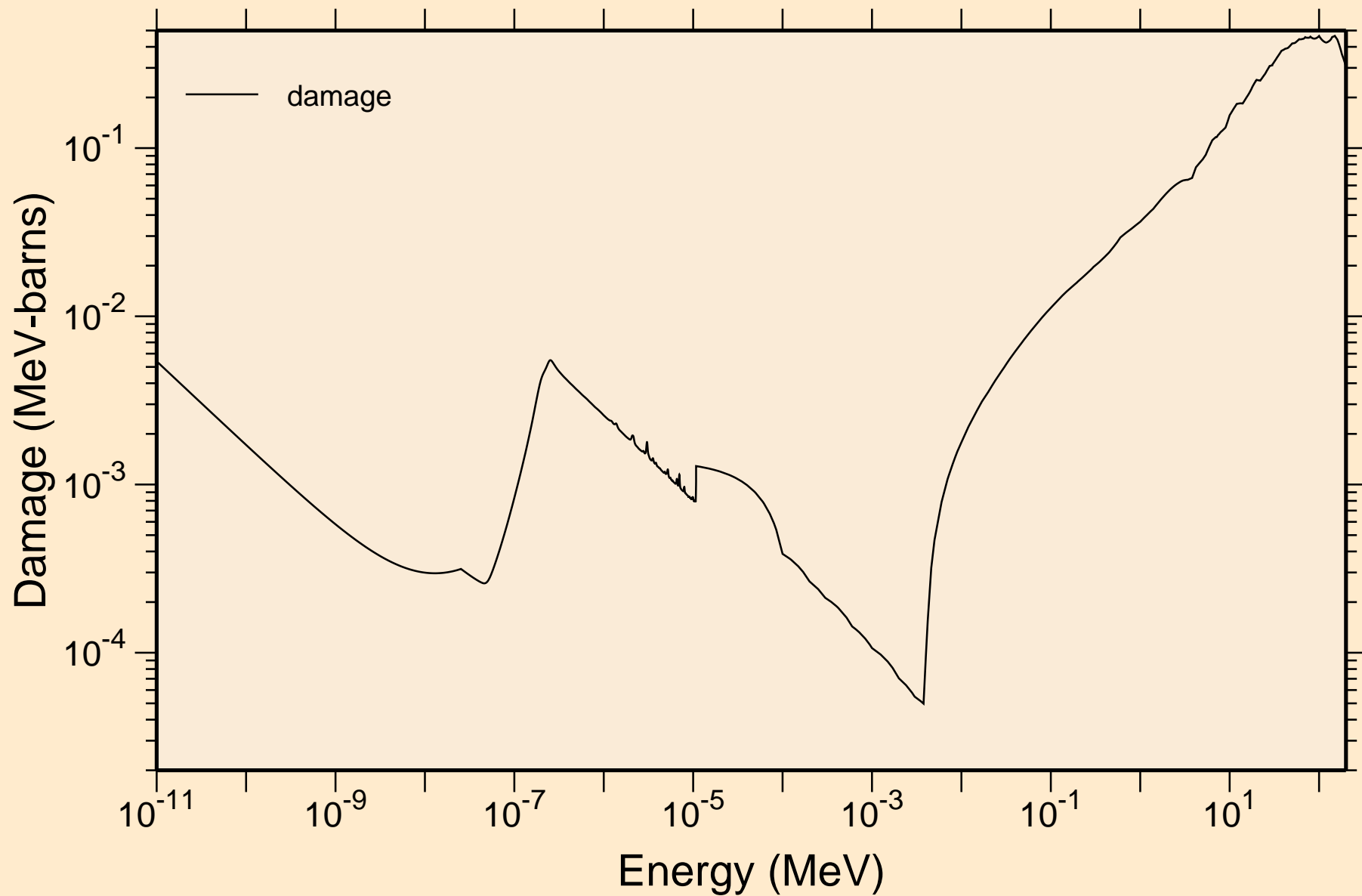

TA176 NEUTRON ACER TENDL-2019 LIBRARY; T=293.16K  
Non-threshold reactions

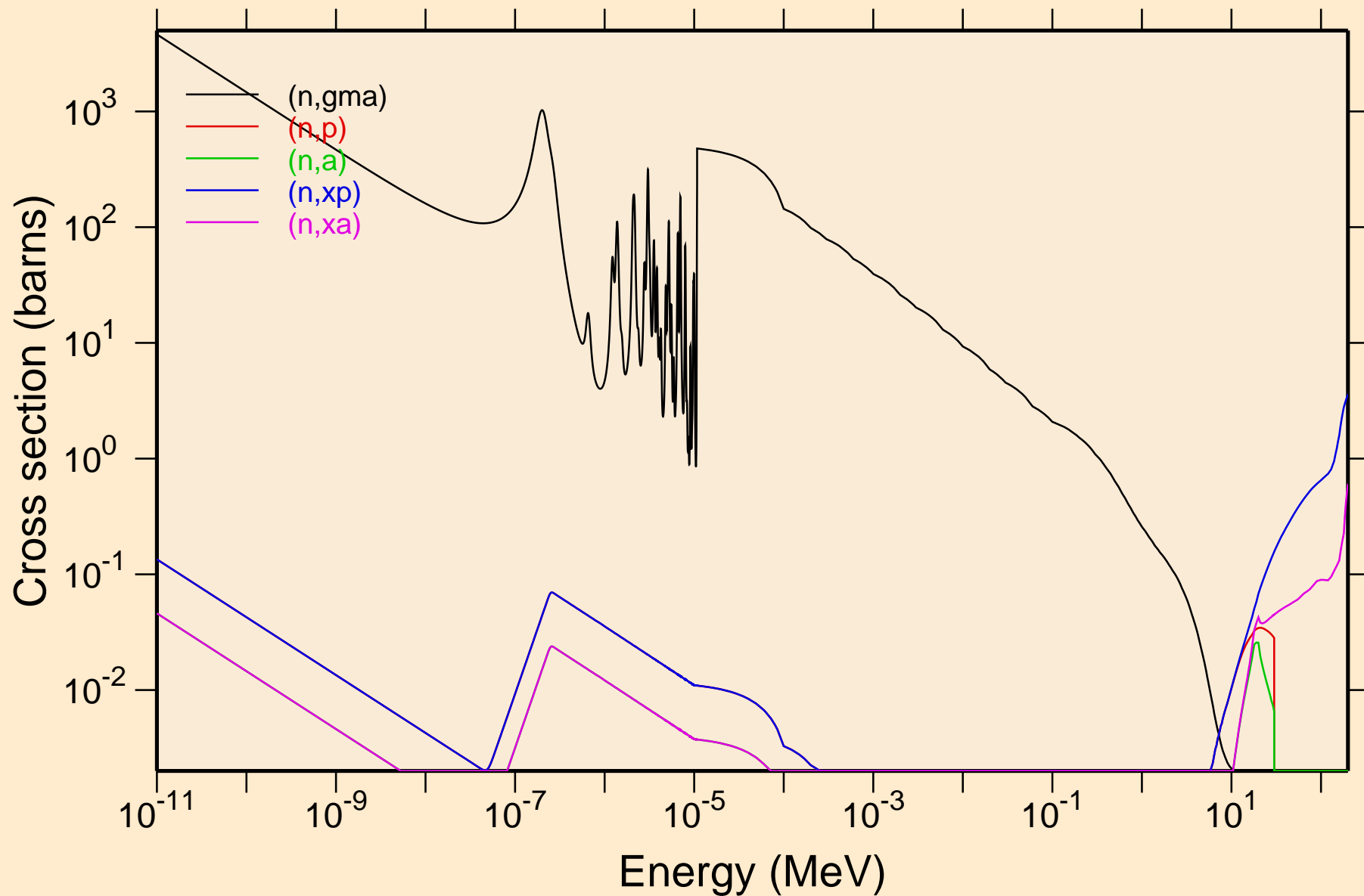

TA176 NEUTRON ACER TENDL-2019 LIBRARY; T=293.16K  
Principal cross sections

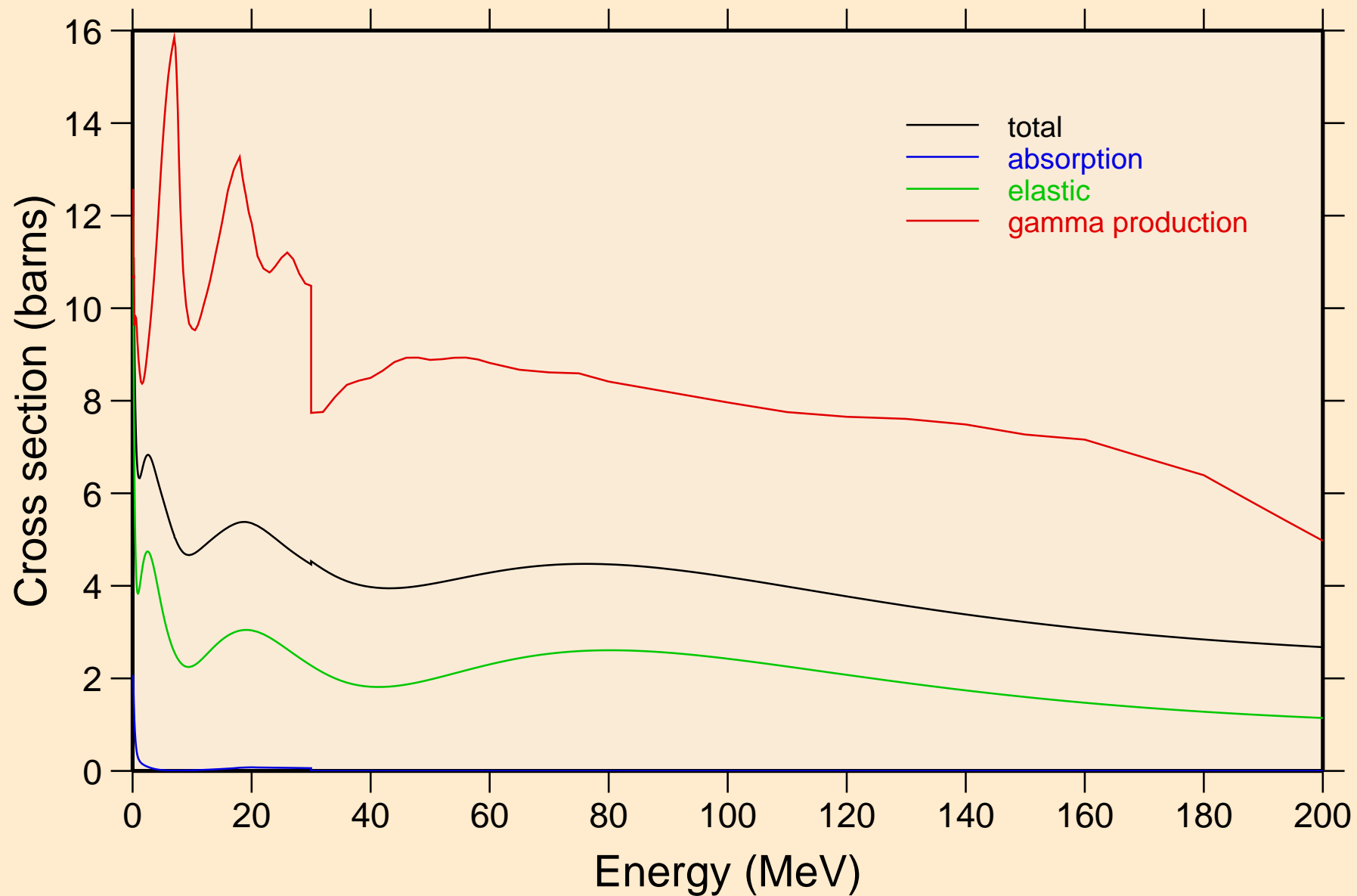

TA176 NEUTRON ACER TENDL-2019 LIBRARY; T=293.16K  
Heating

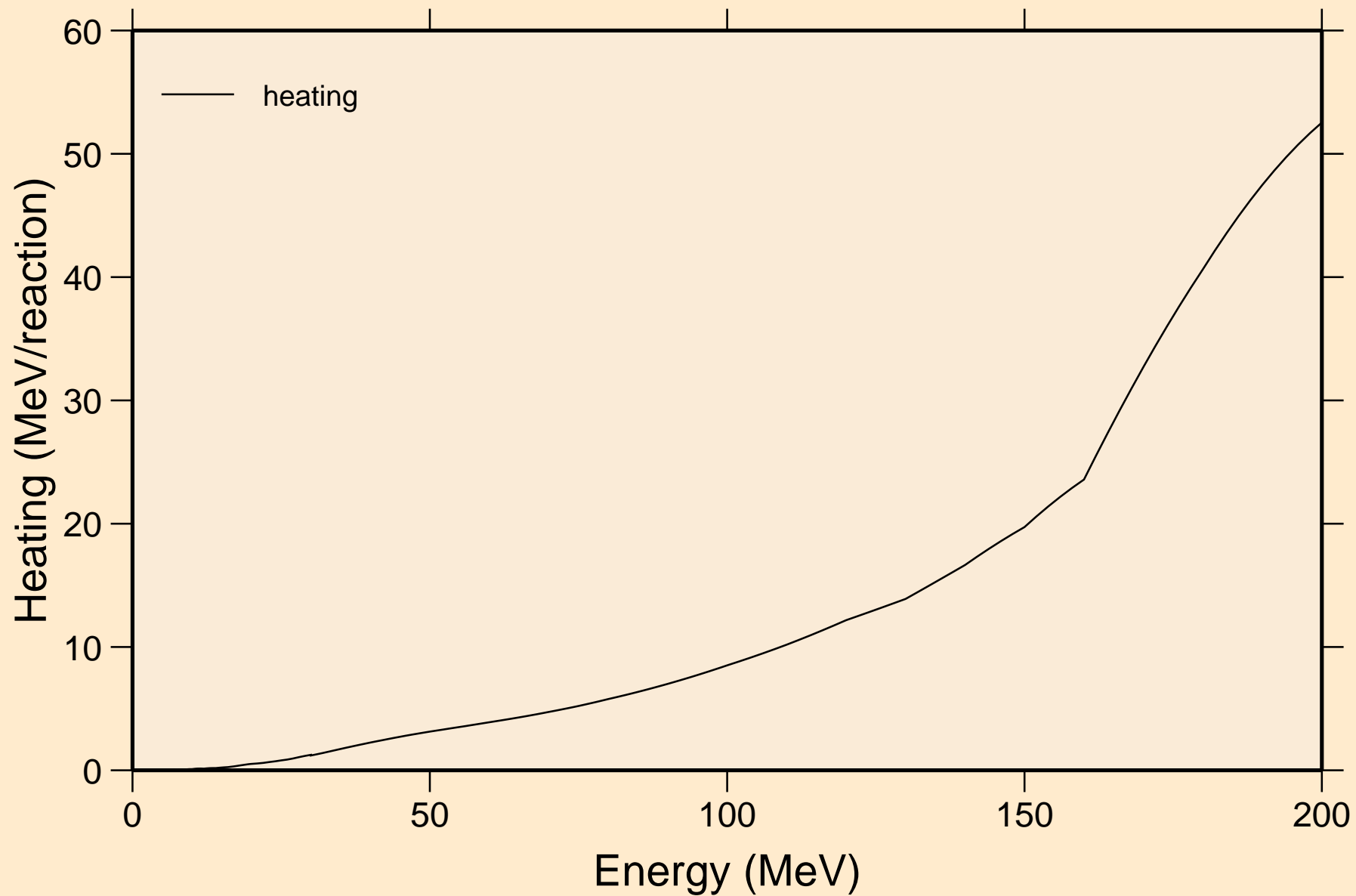

TA176 NEUTRON ACER TENDL-2019 LIBRARY; T=293.16K  
Damage

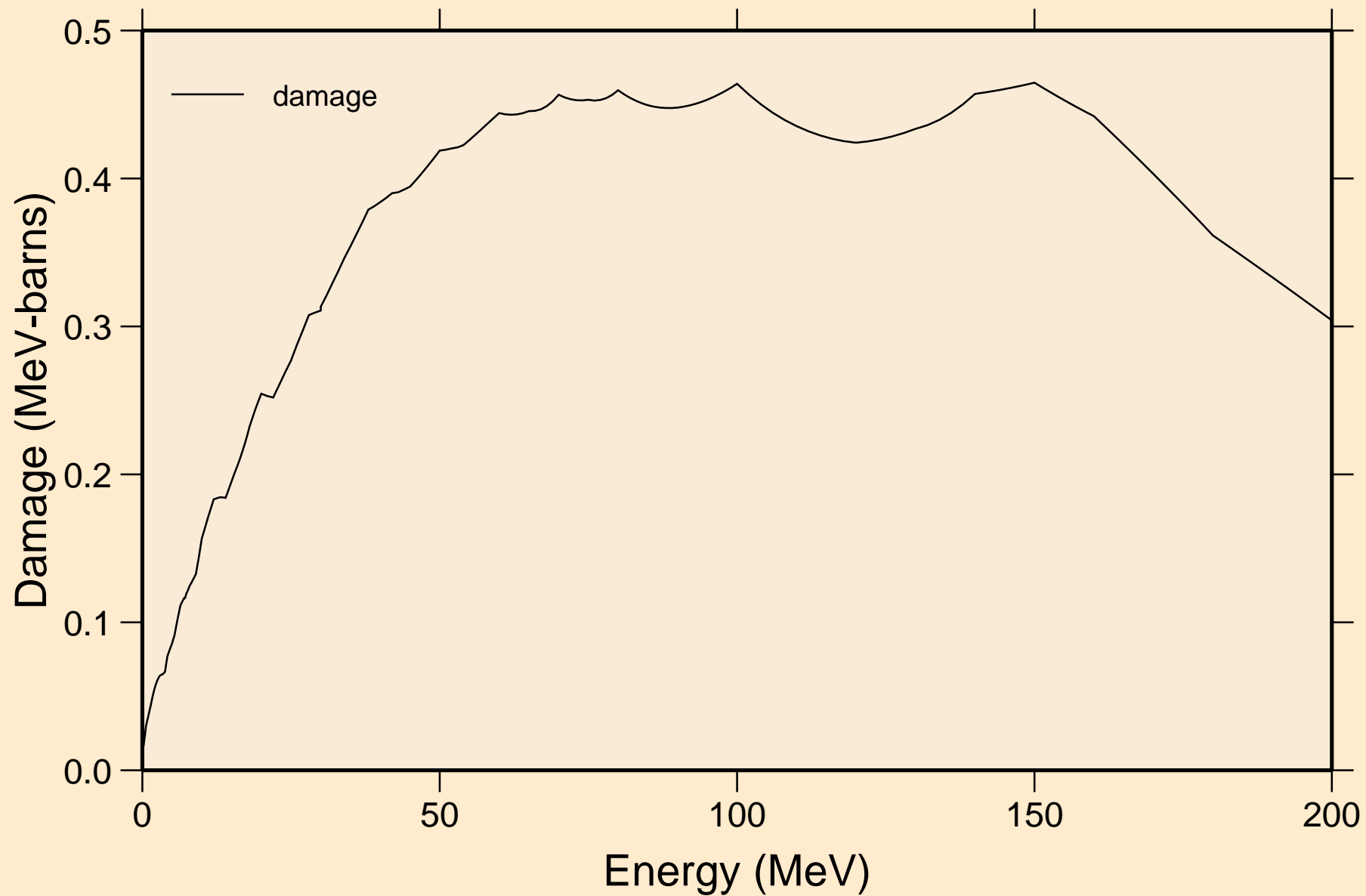

TA176 NEUTRON ACER TENDL-2019 LIBRARY; T=293.16K  
Non-threshold reactions

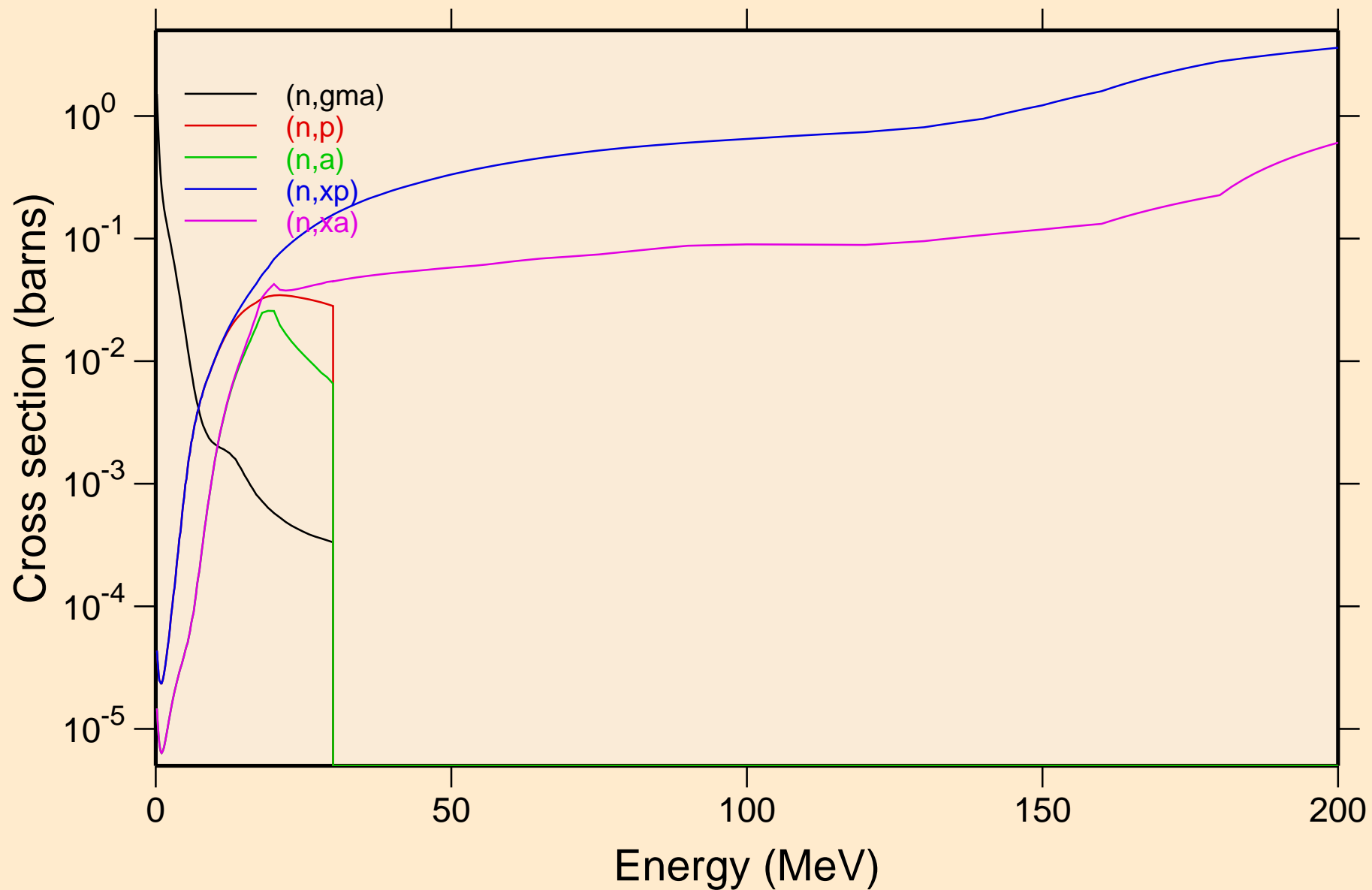



TA176 NEUTRON ACER TENDL-2019 LIBRARY; T=293.16K  
Inelastic levels

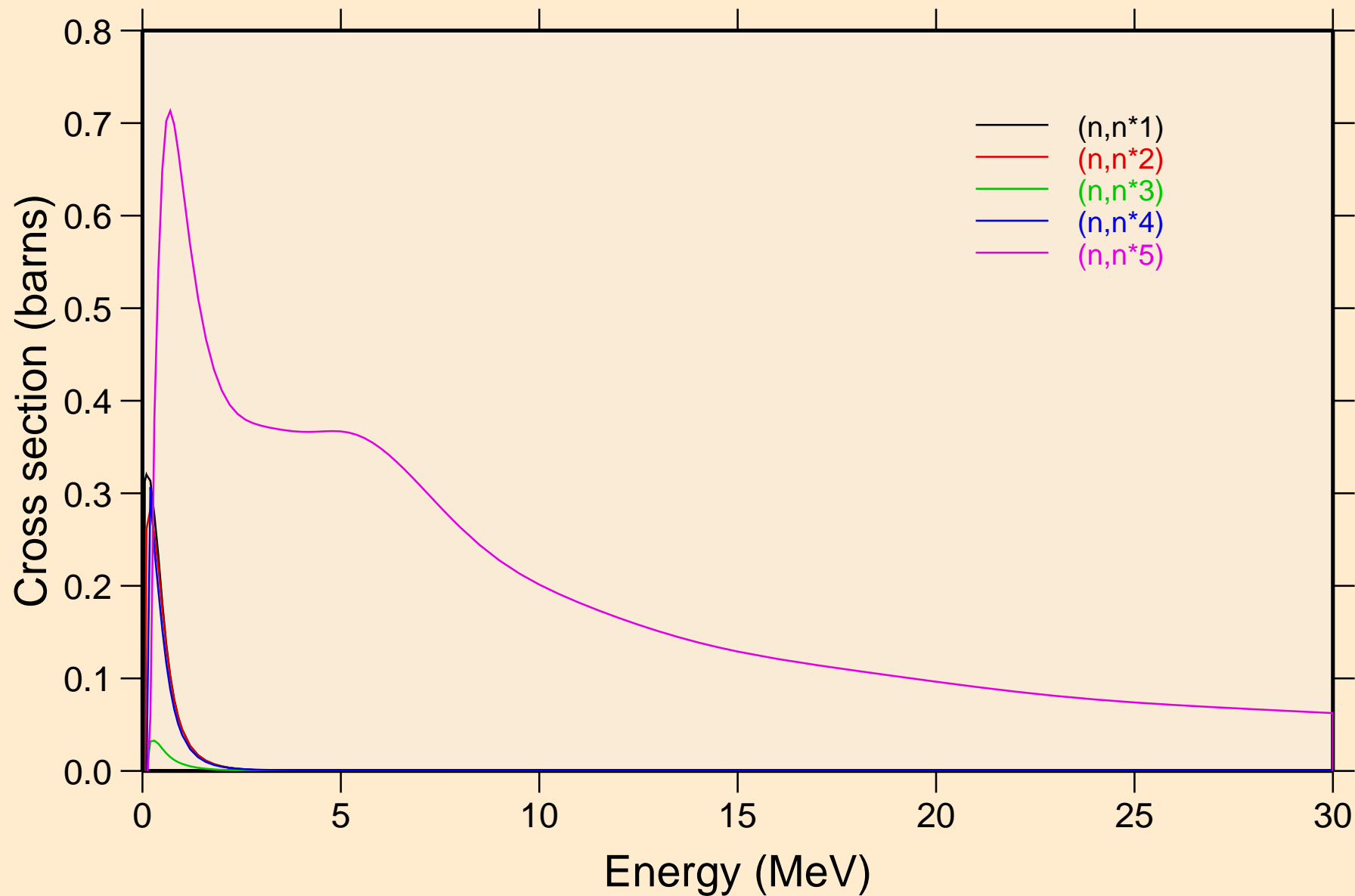

TA176 NEUTRON ACER TENDL-2019 LIBRARY; T=293.16K  
Inelastic levels

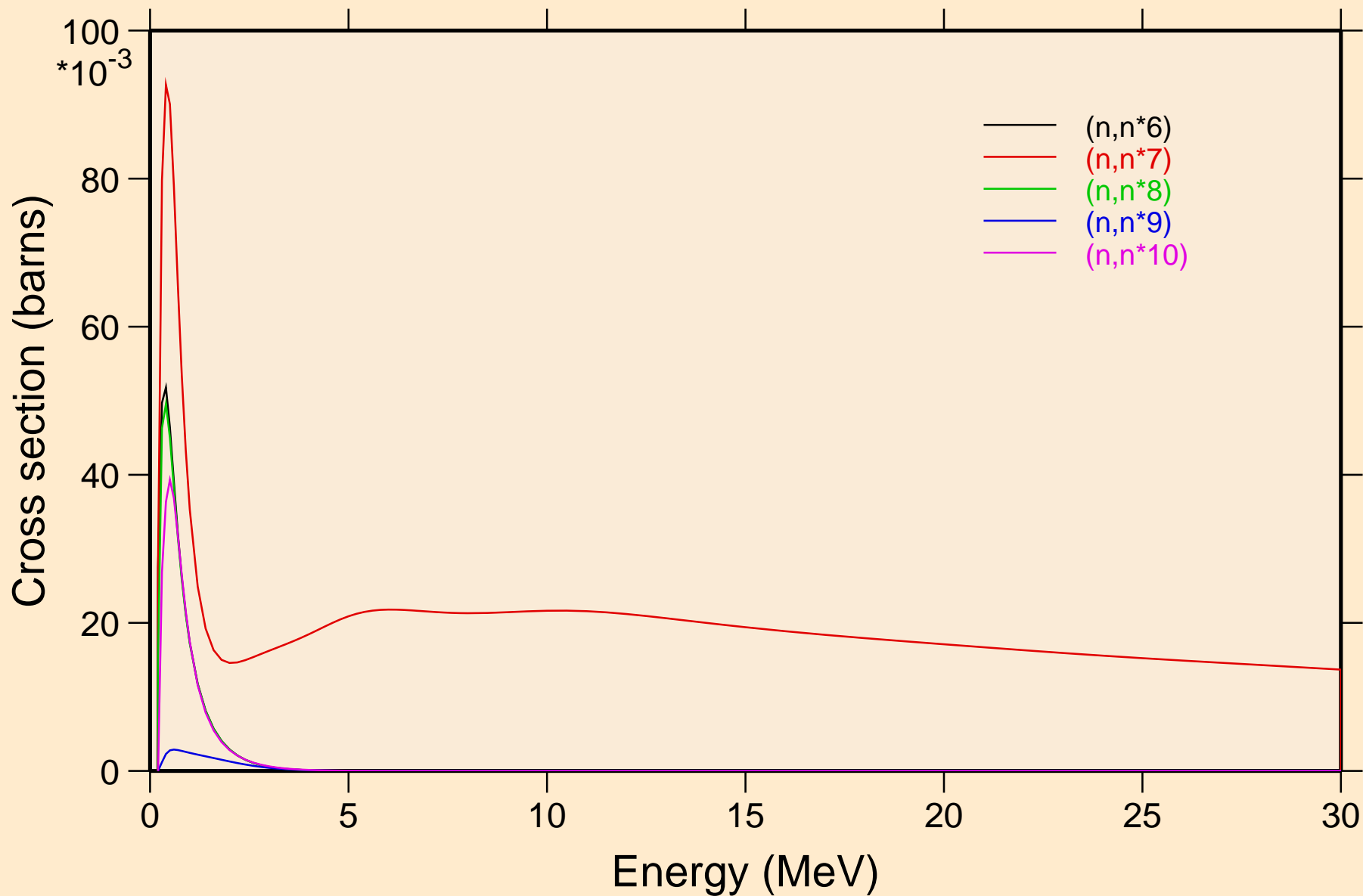

TA176 NEUTRON ACER TENDL-2019 LIBRARY; T=293.16K  
Inelastic levels

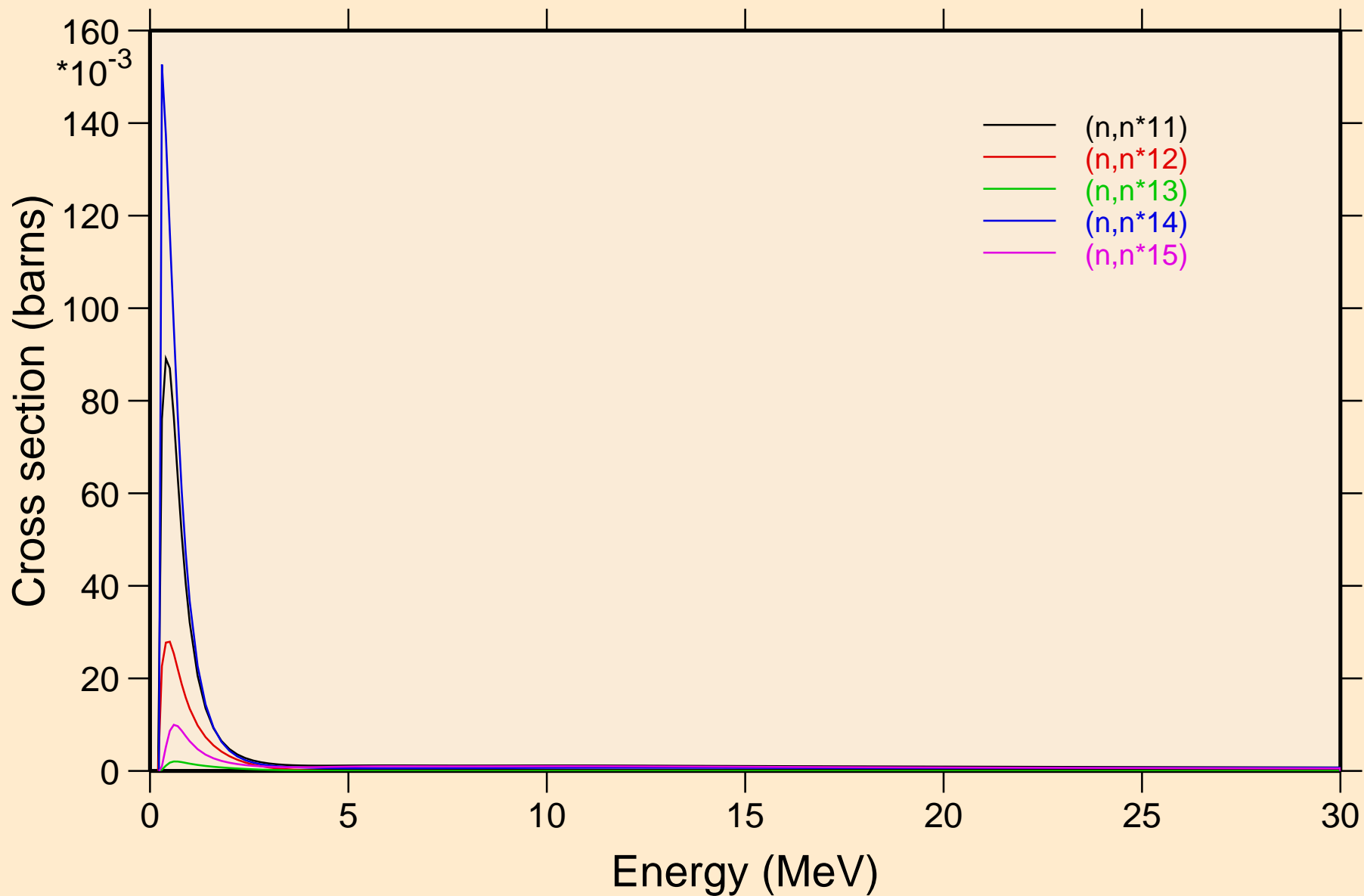

TA176 NEUTRON ACER TENDL-2019 LIBRARY; T=293.16K  
Inelastic levels

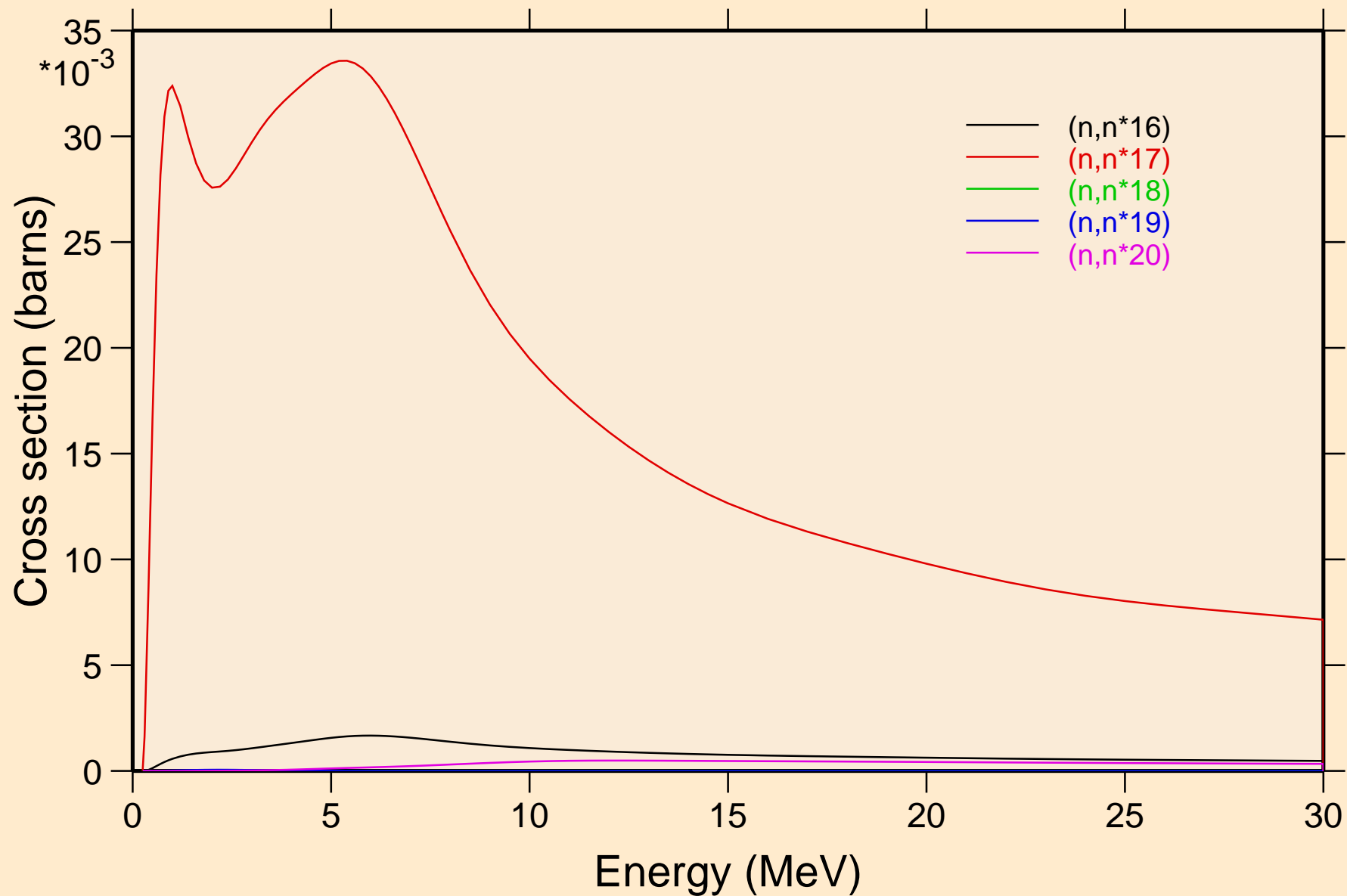

TA176 NEUTRON ACER TENDL-2019 LIBRARY; T=293.16K  
Inelastic levels

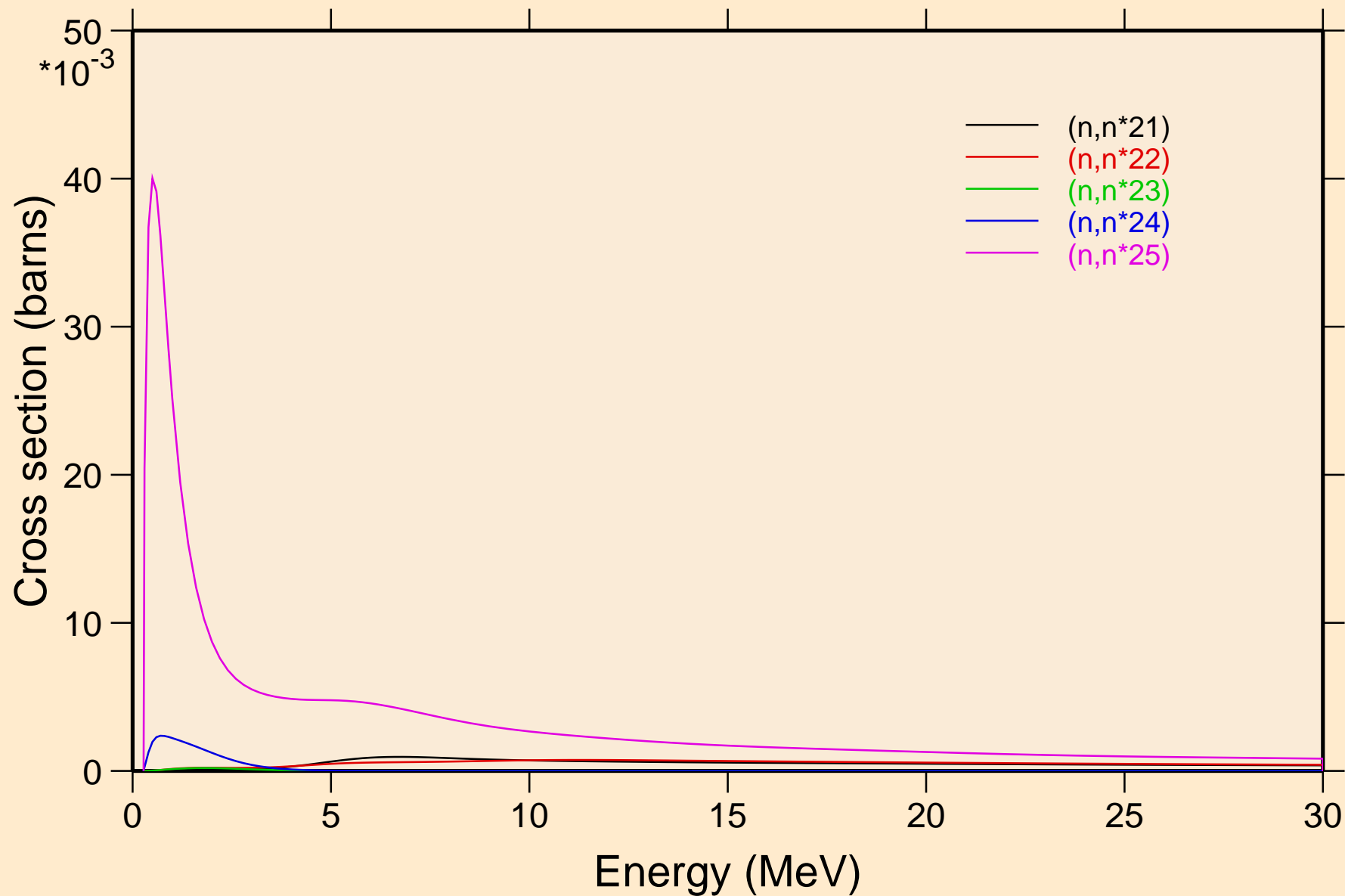

TA176 NEUTRON ACER TENDL-2019 LIBRARY; T=293.16K  
Inelastic levels

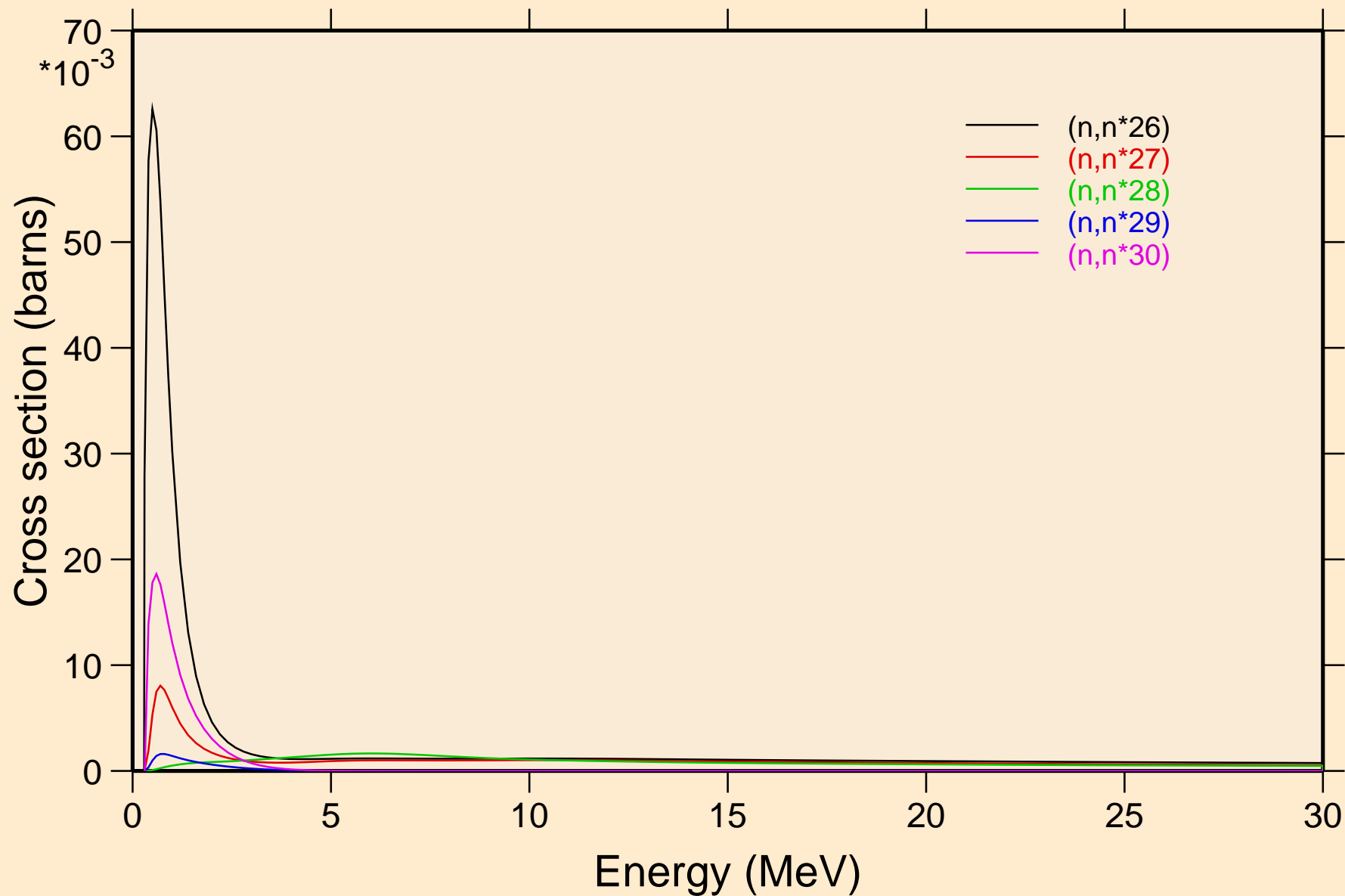

TA176 NEUTRON ACER TENDL-2019 LIBRARY; T=293.16K  
Threshold reactions

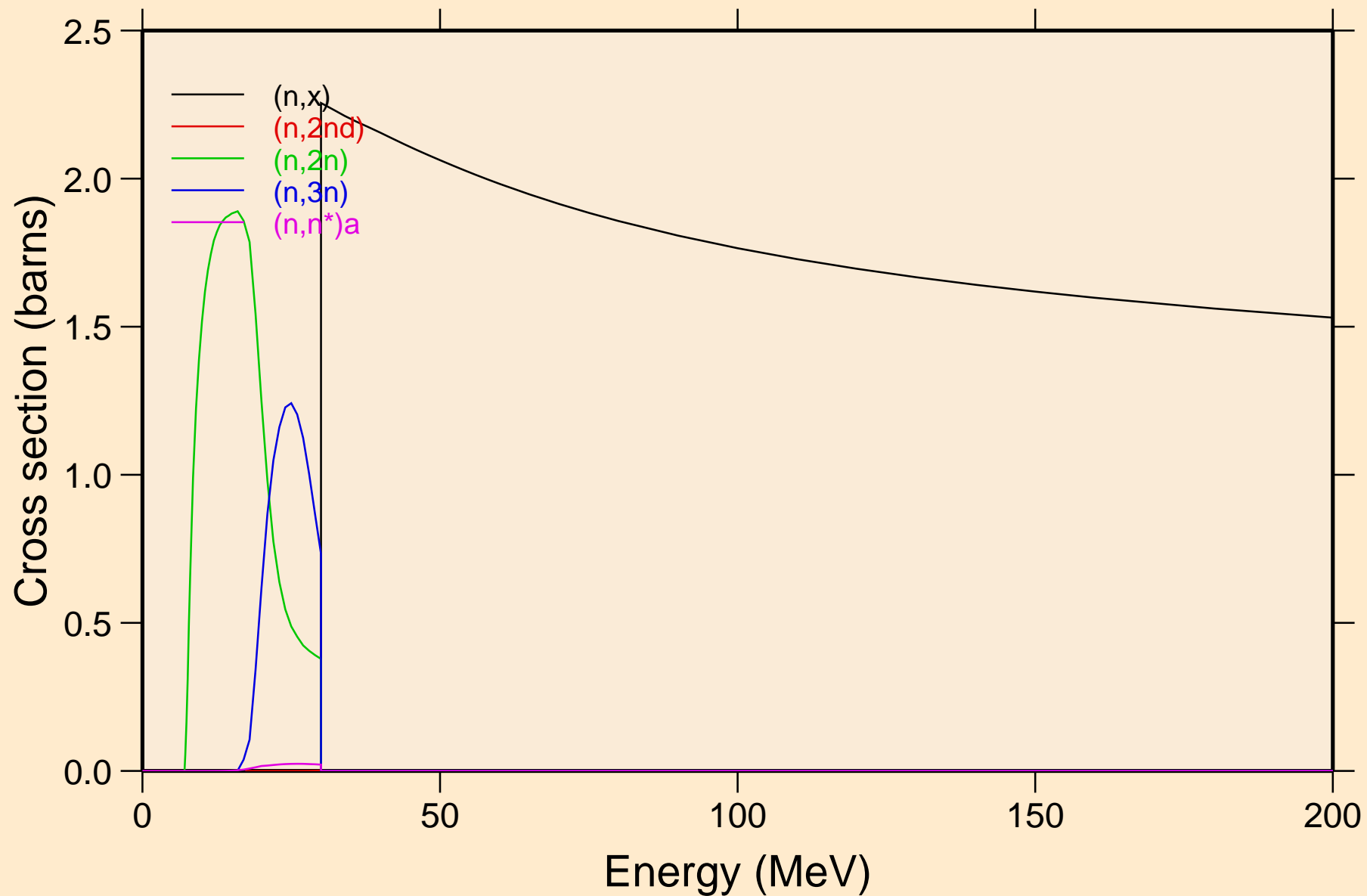

TA176 NEUTRON ACER TENDL-2019 LIBRARY; T=293.16K  
Threshold reactions

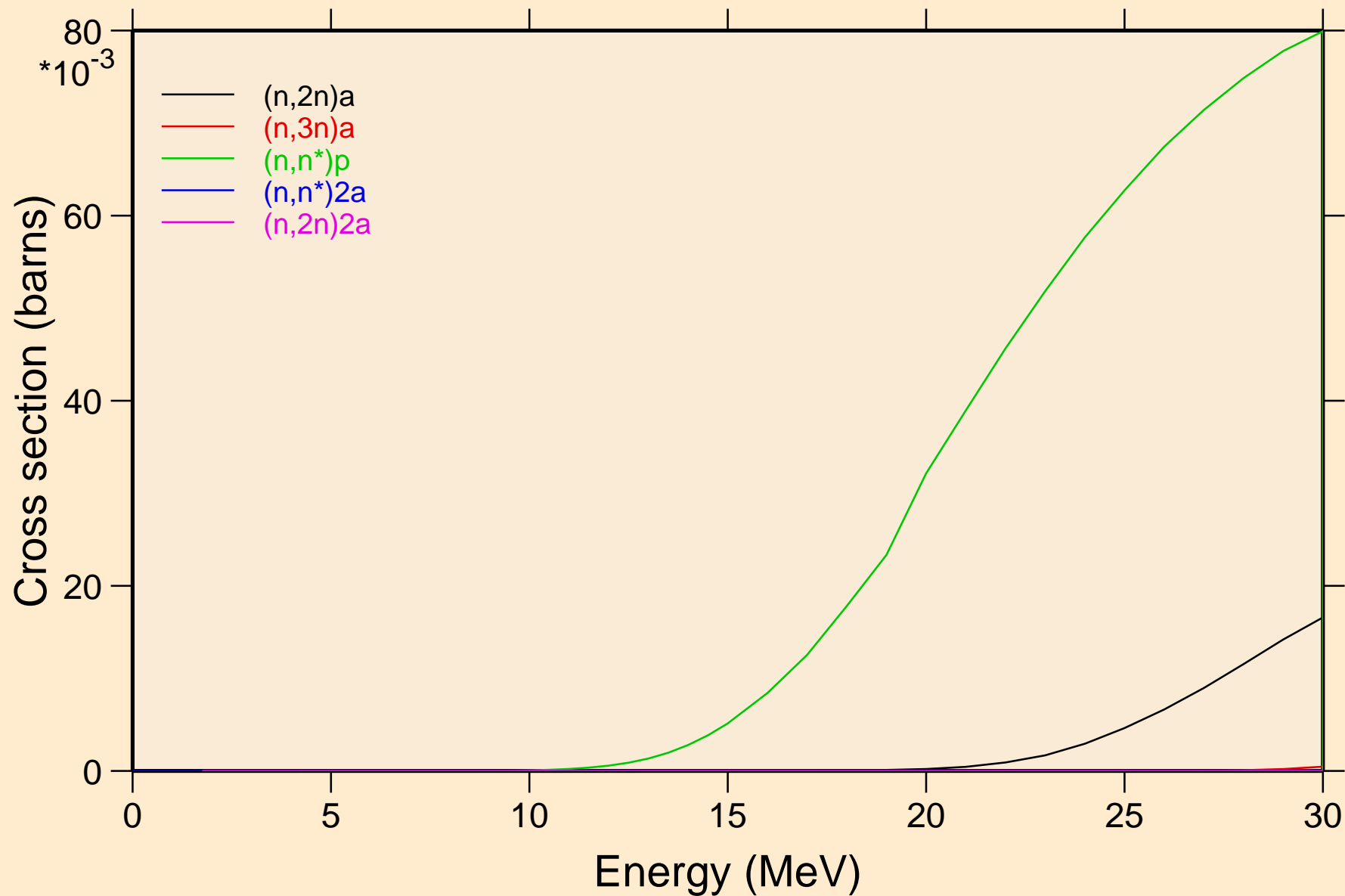



TA176 NEUTRON ACER TENDL-2019 LIBRARY; T=293.16K  
Threshold reactions

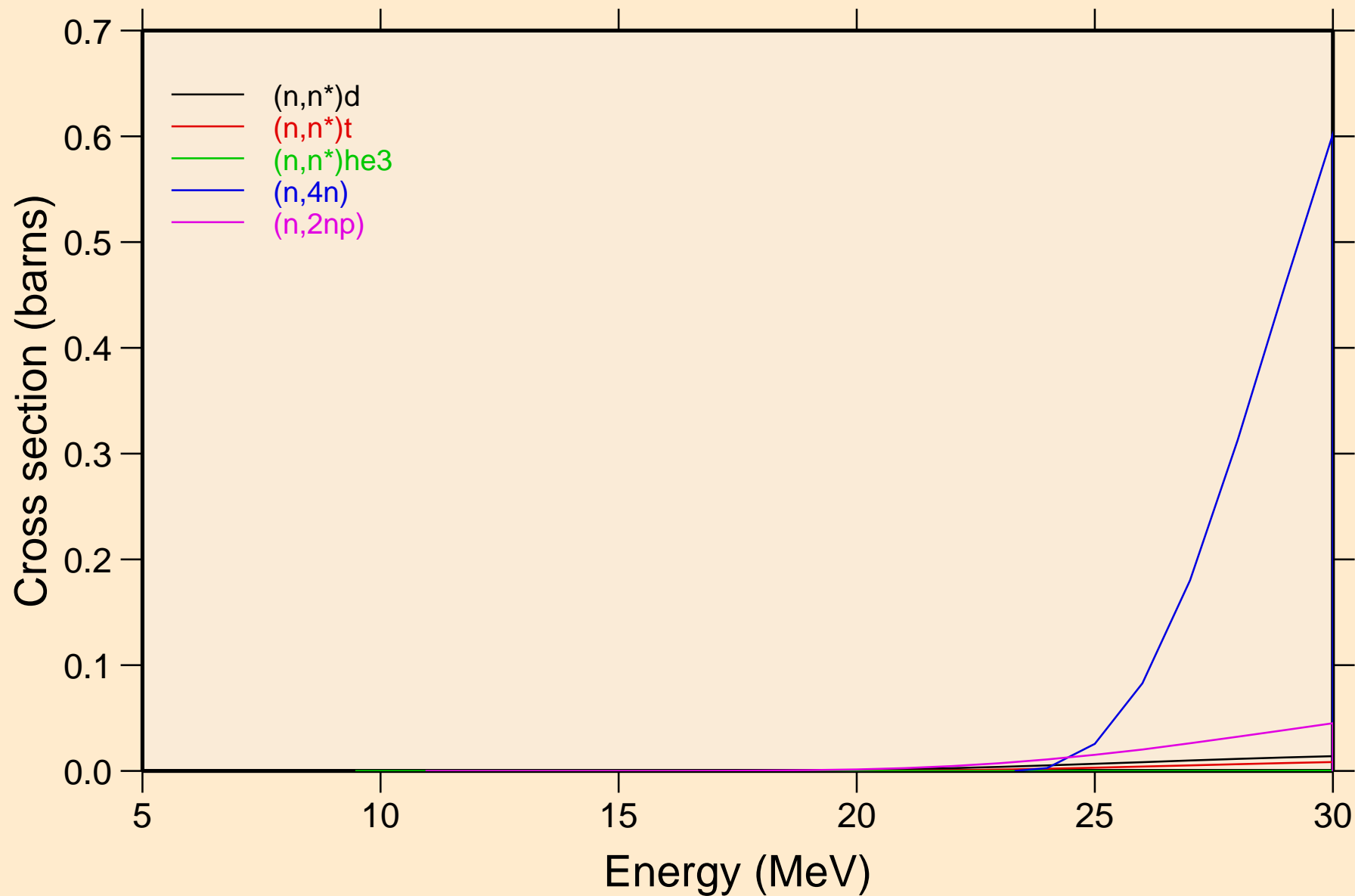

TA176 NEUTRON ACER TENDL-2019 LIBRARY; T=293.16K  
Threshold reactions

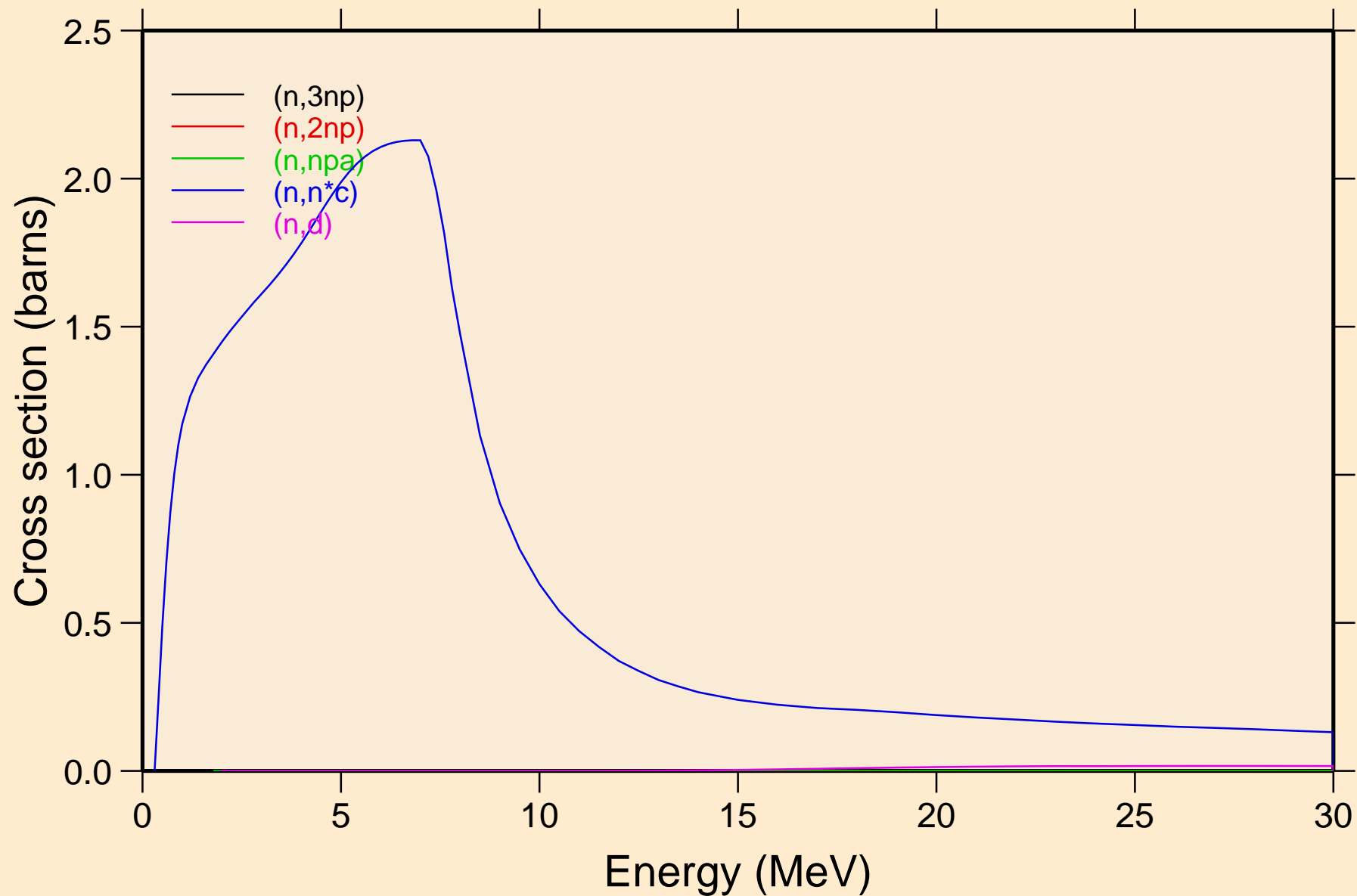

TA176 NEUTRON ACER TENDL-2019 LIBRARY; T=293.16K  
Threshold reactions

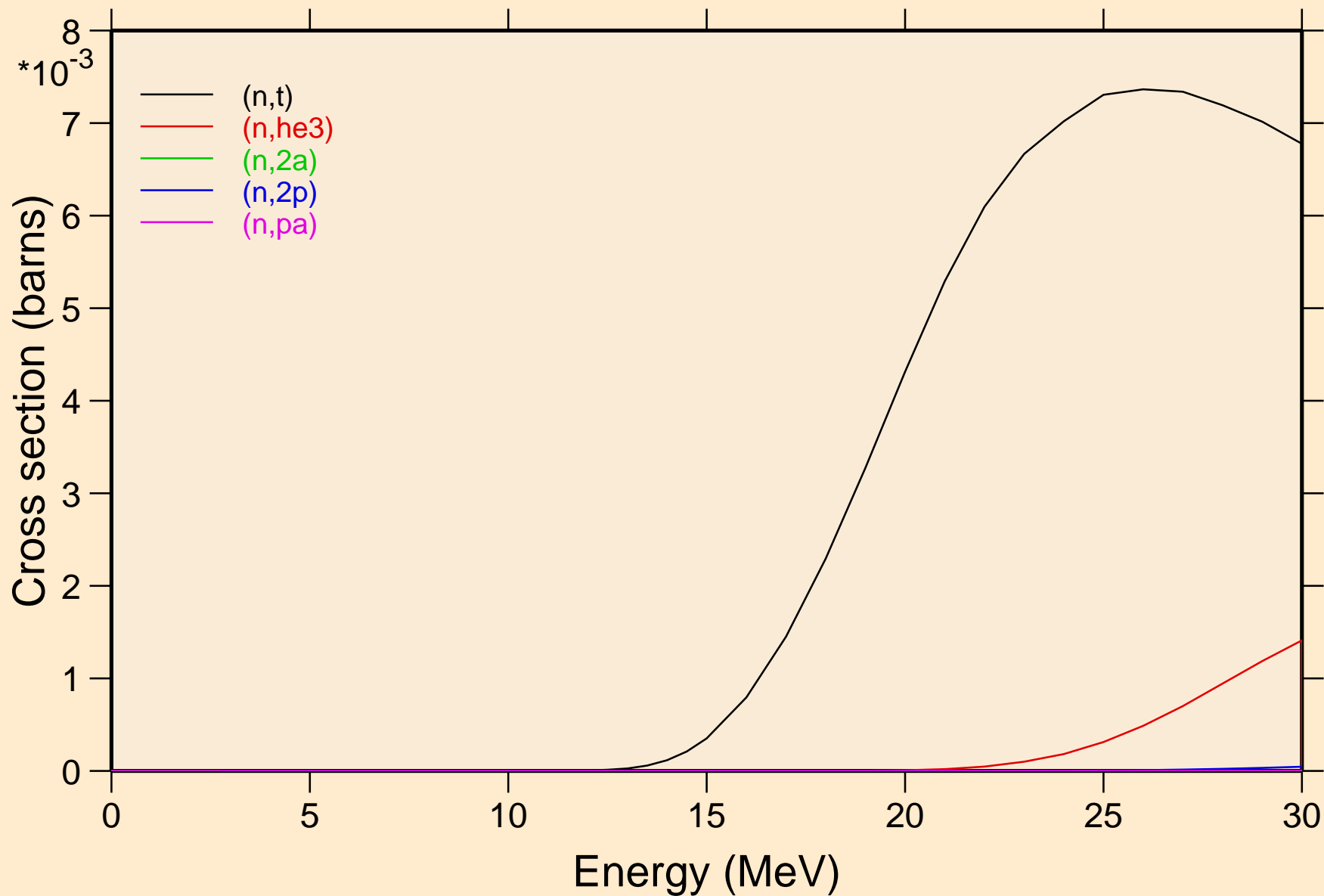

TA176 NEUTRON ACER TENDL-2019 LIBRARY; T=293.16K  
Threshold reactions

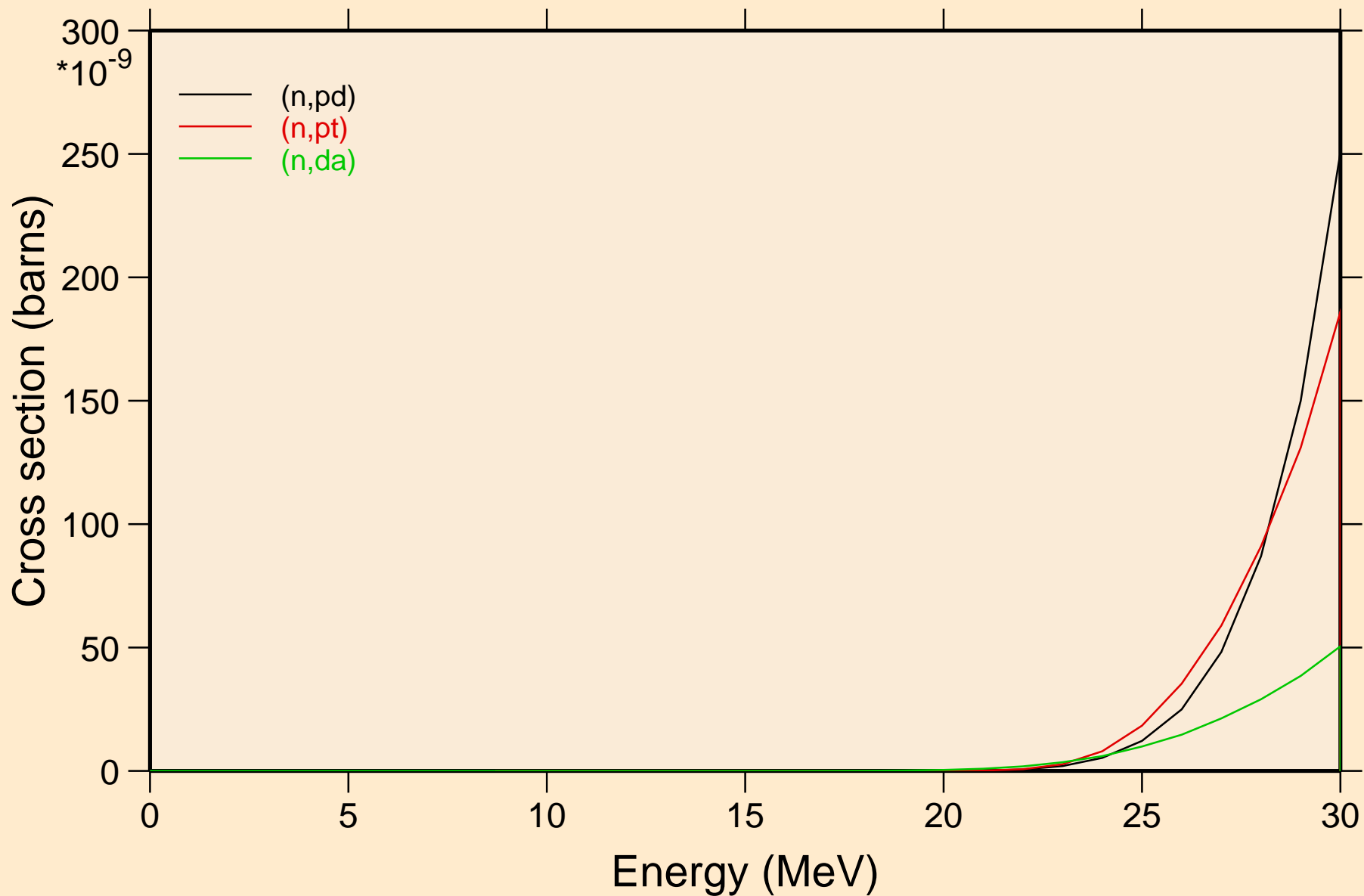

TA176 NEUTRON ACER TENDL-2019 LIBRARY; T=293.16K  
Threshold reactions

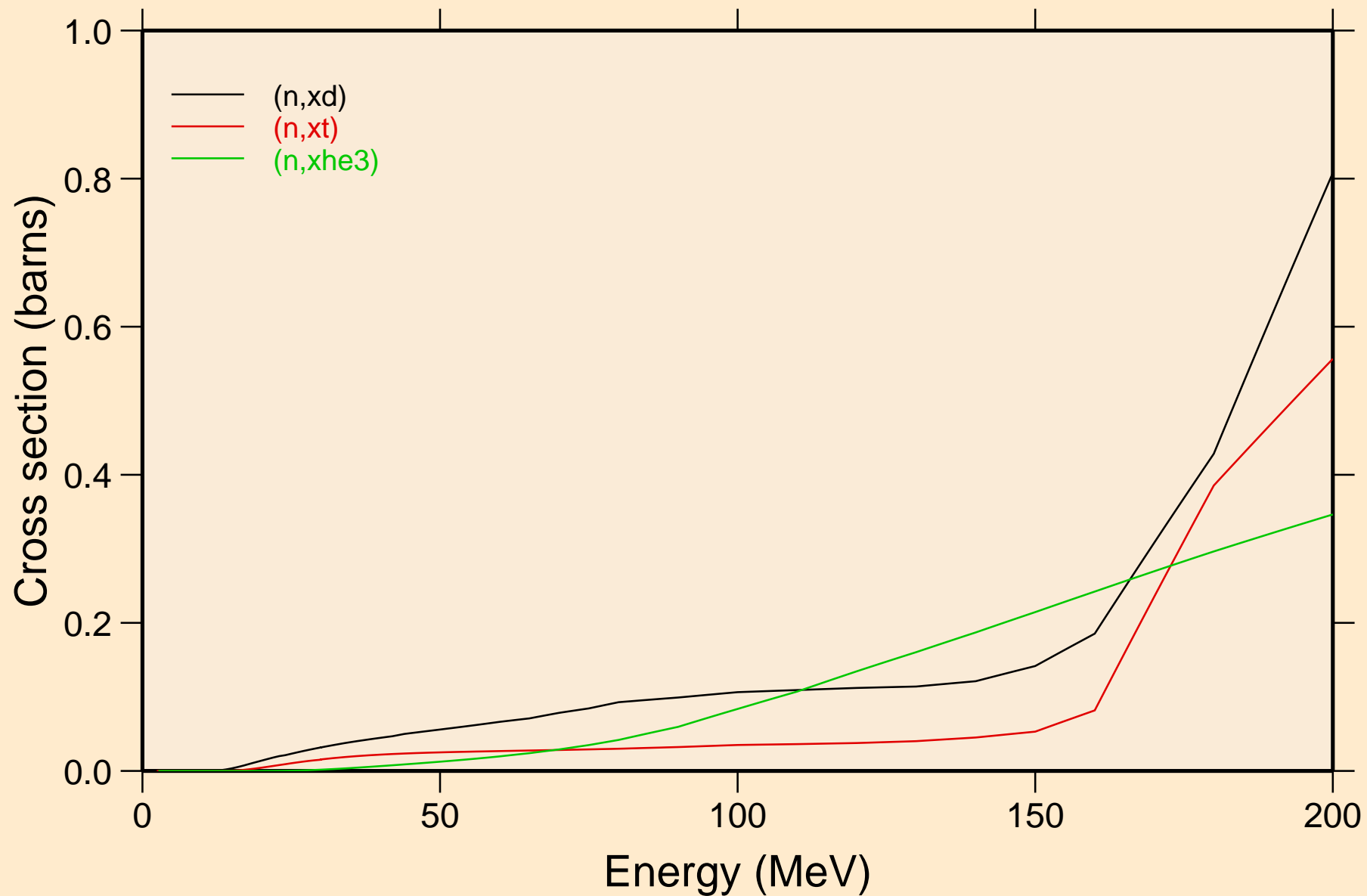

TA176 NEUTRON ACER TENDL-2019 LIBRARY; T=293.16K  
angular distribution for elastic

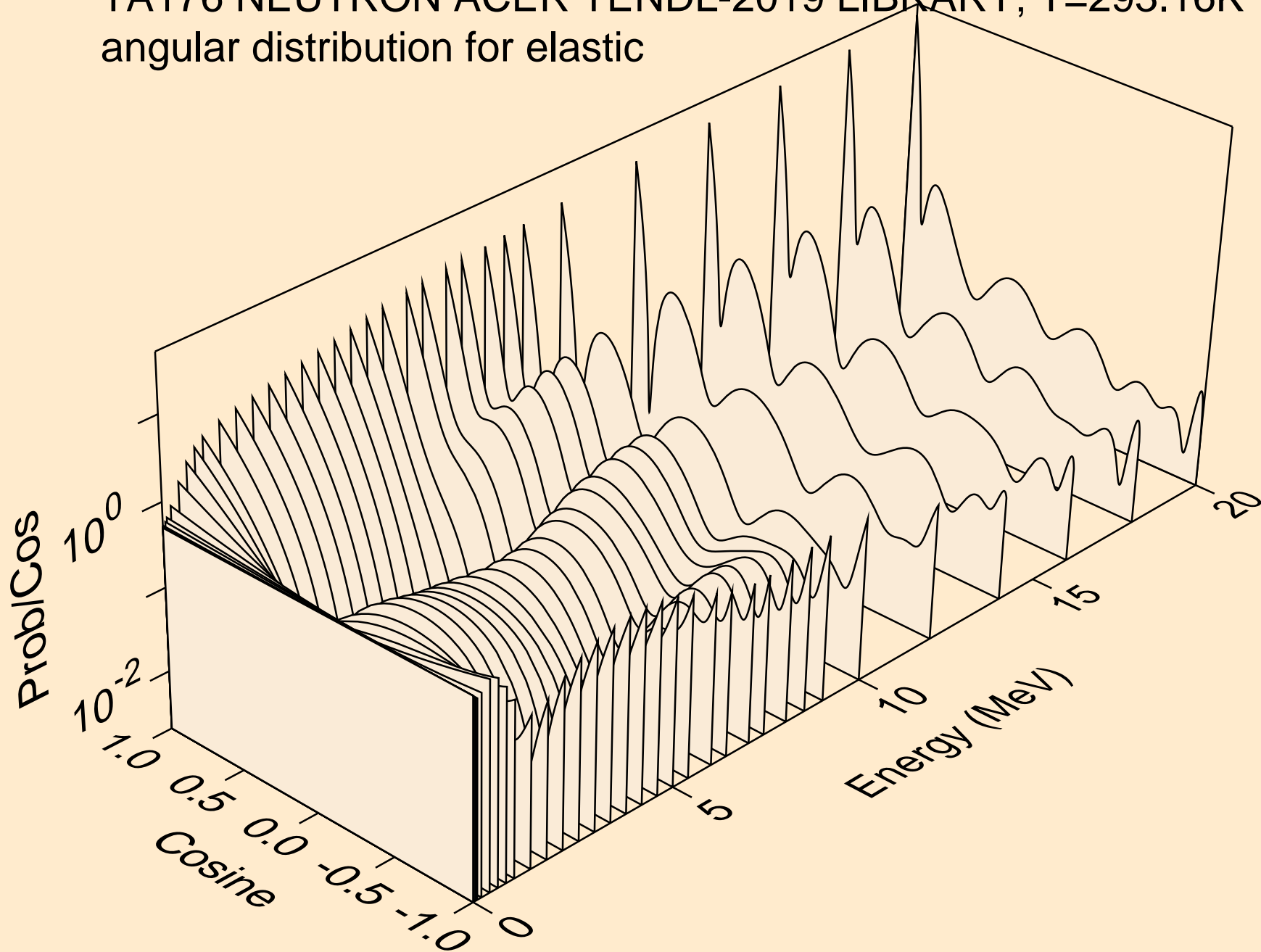

TA176 NEUTRON ACER TENDL-2019 LIBRARY; T=293.16K  
angular distribution for elastic

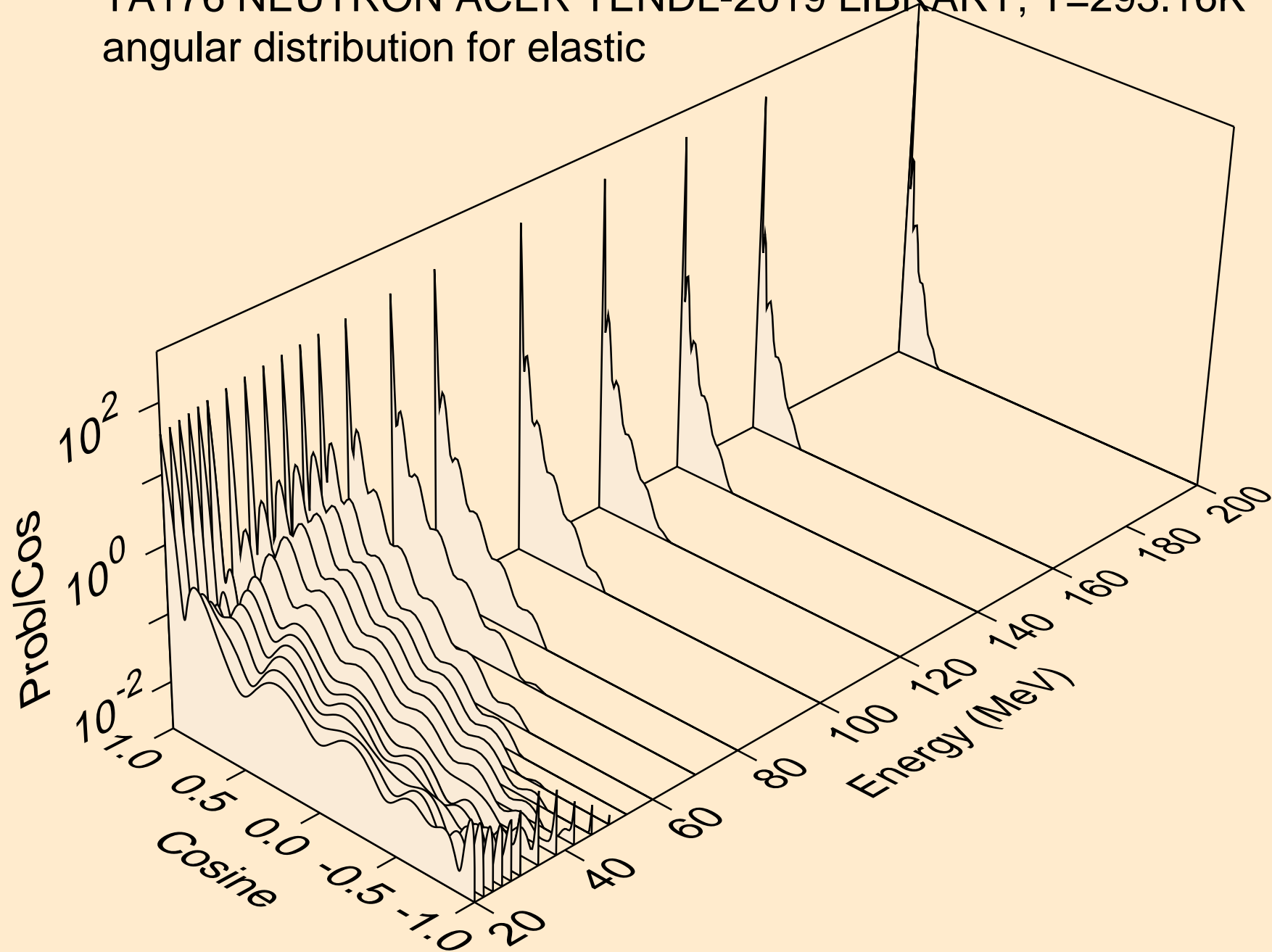

TA176 NEUTRON ACER TENDL-2019 LIBRARY; T=293.16K  
angular distribution for (n,n\*1)

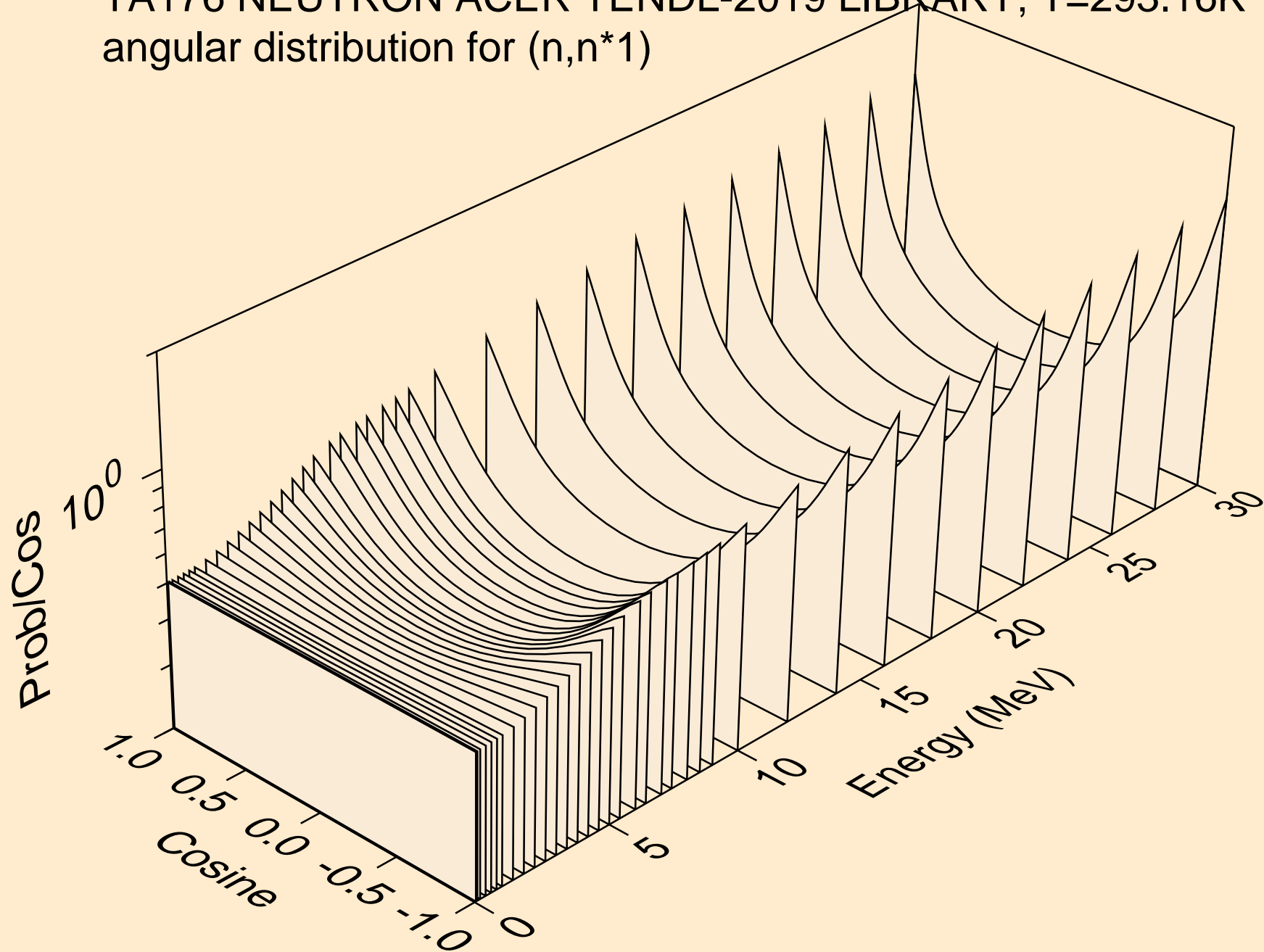



TA176 NEUTRON ACER TENDL-2019 LIBRARY; T=293.16K  
angular distribution for (n,n\*2)

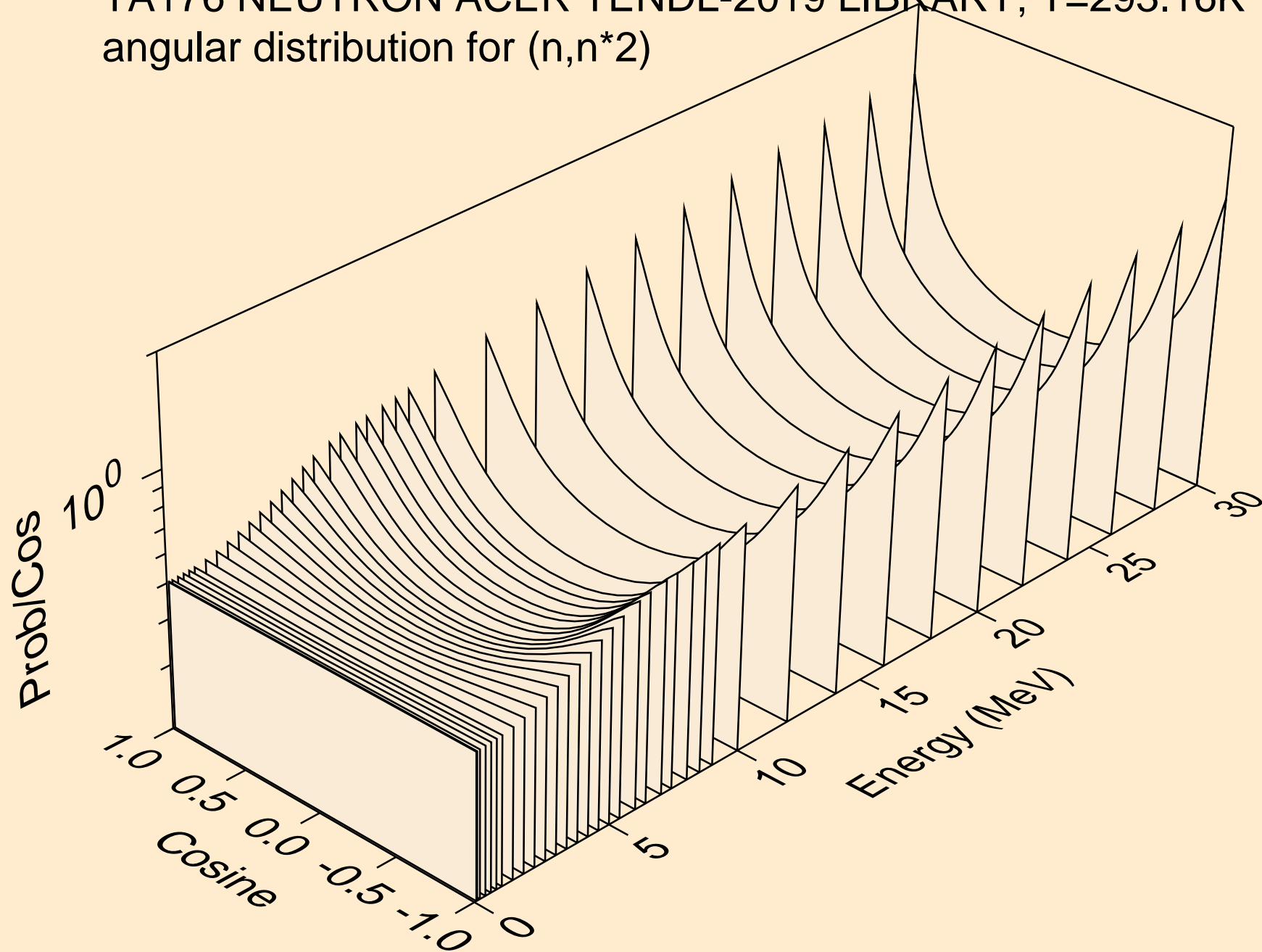

TA176 NEUTRON ACER TENDL-2019 LIBRARY; T=293.16K  
angular distribution for (n,n\*3)

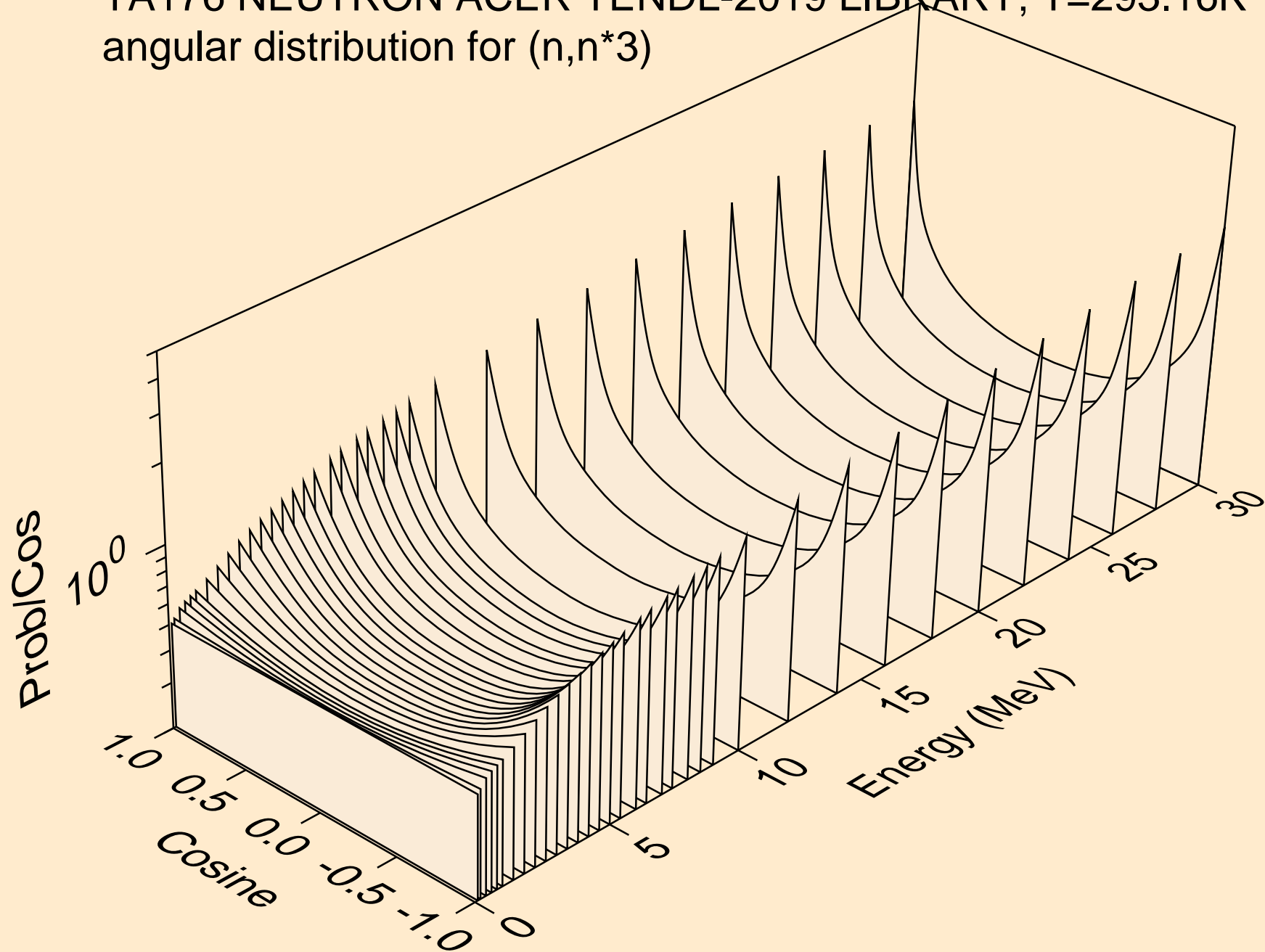

TA176 NEUTRON ACER TENDL-2019 LIBRARY; T=293.16K  
angular distribution for (n,n\*4)

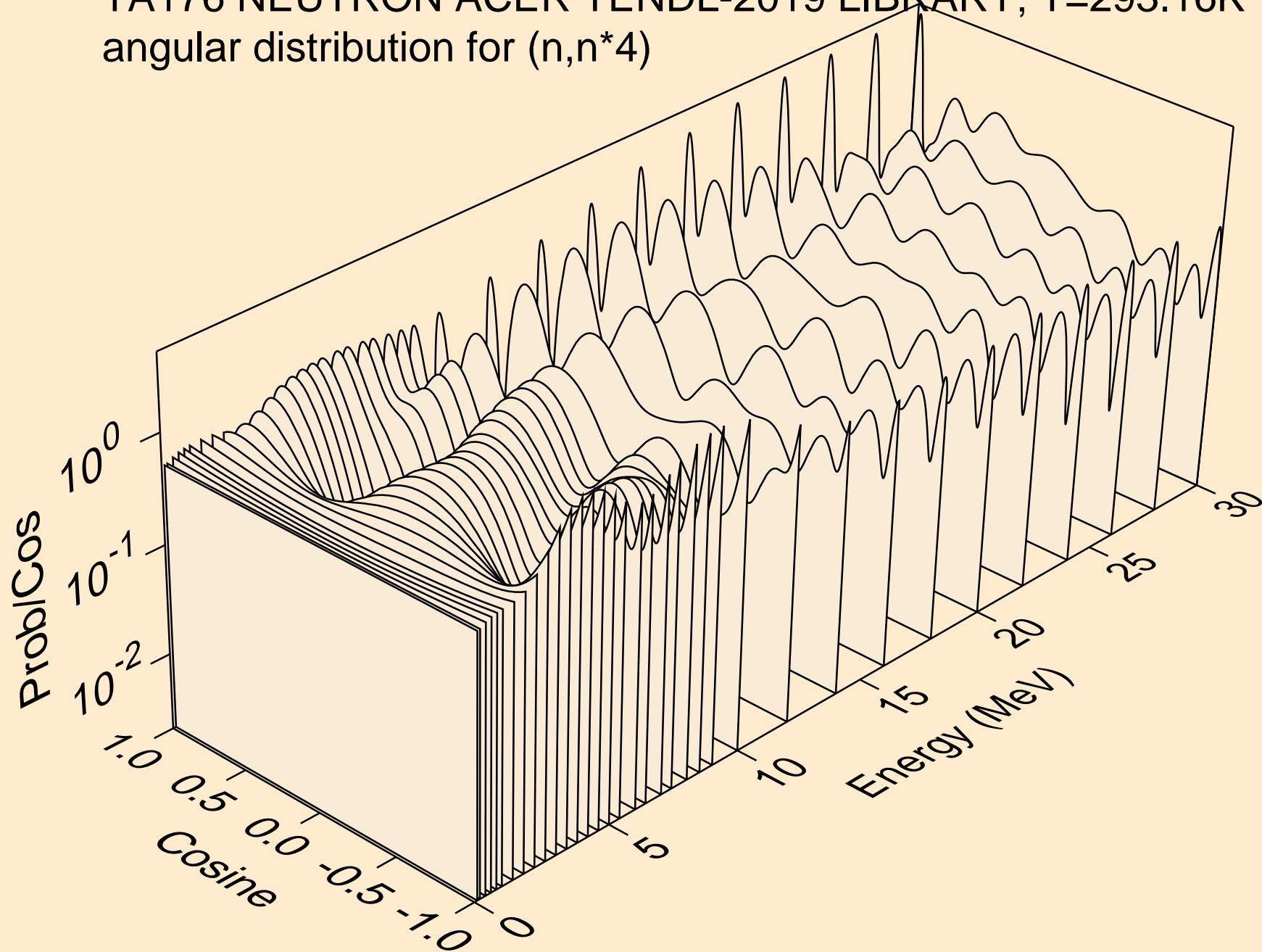

TA176 NEUTRON ACER TENDL-2019 LIBRARY; T=293.16K  
angular distribution for (n,n\*5)

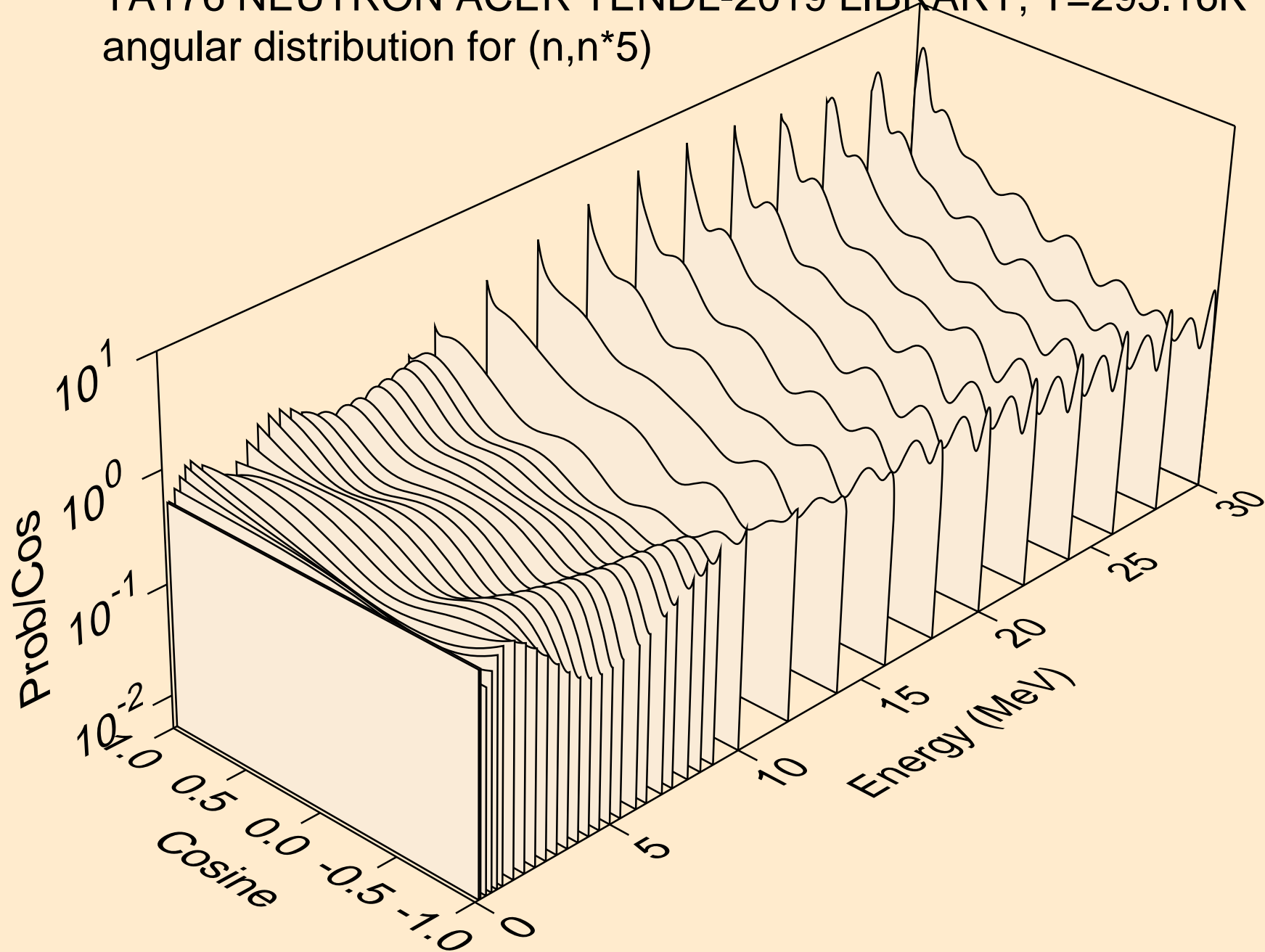

TA176 NEUTRON ACER TENDL-2019 LIBRARY; T=293.16K  
angular distribution for (n,n\*6)

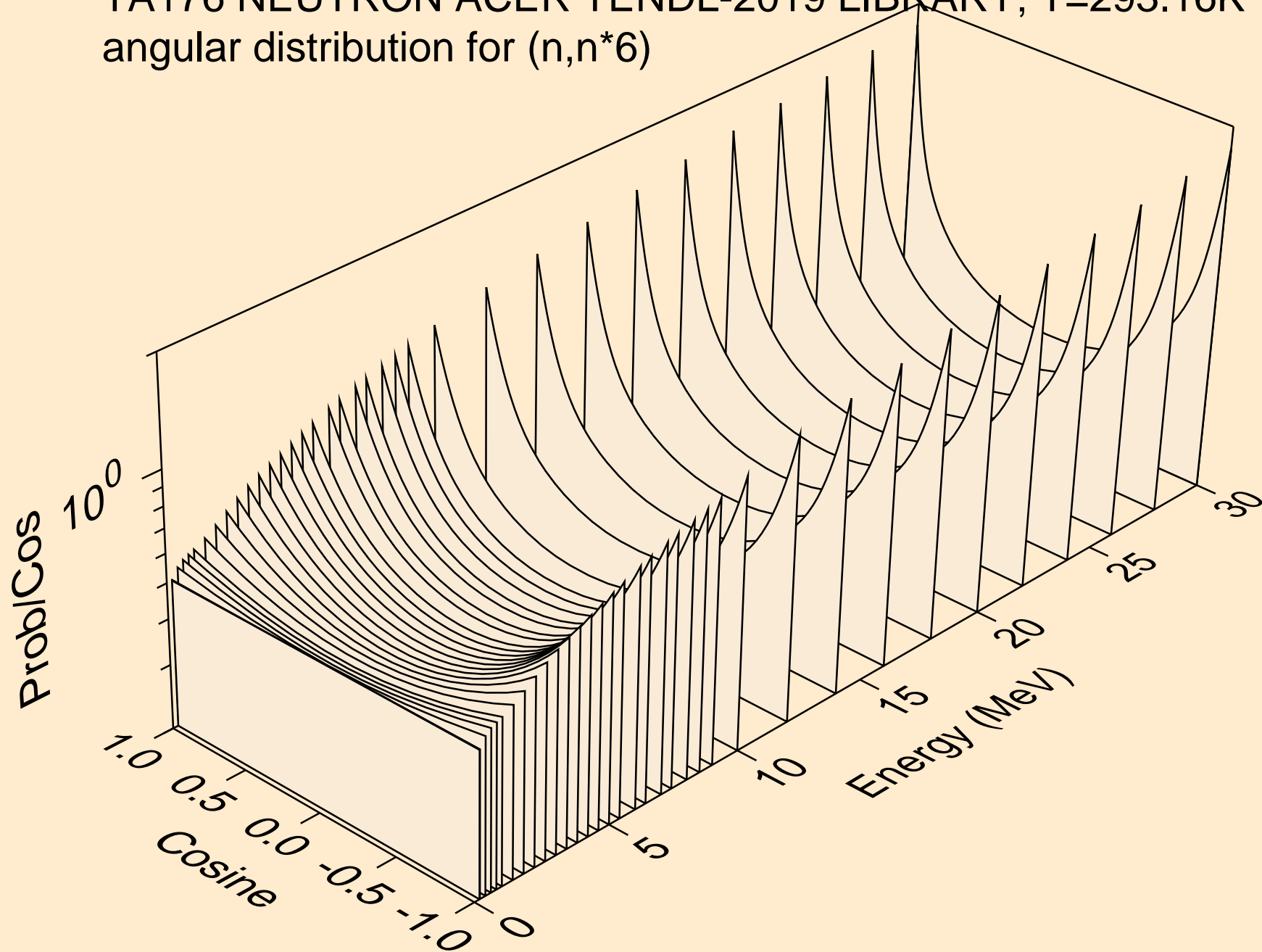

TA176 NEUTRON ACER TENDL-2019 LIBRARY; T=293.16K  
angular distribution for (n,n\*7)

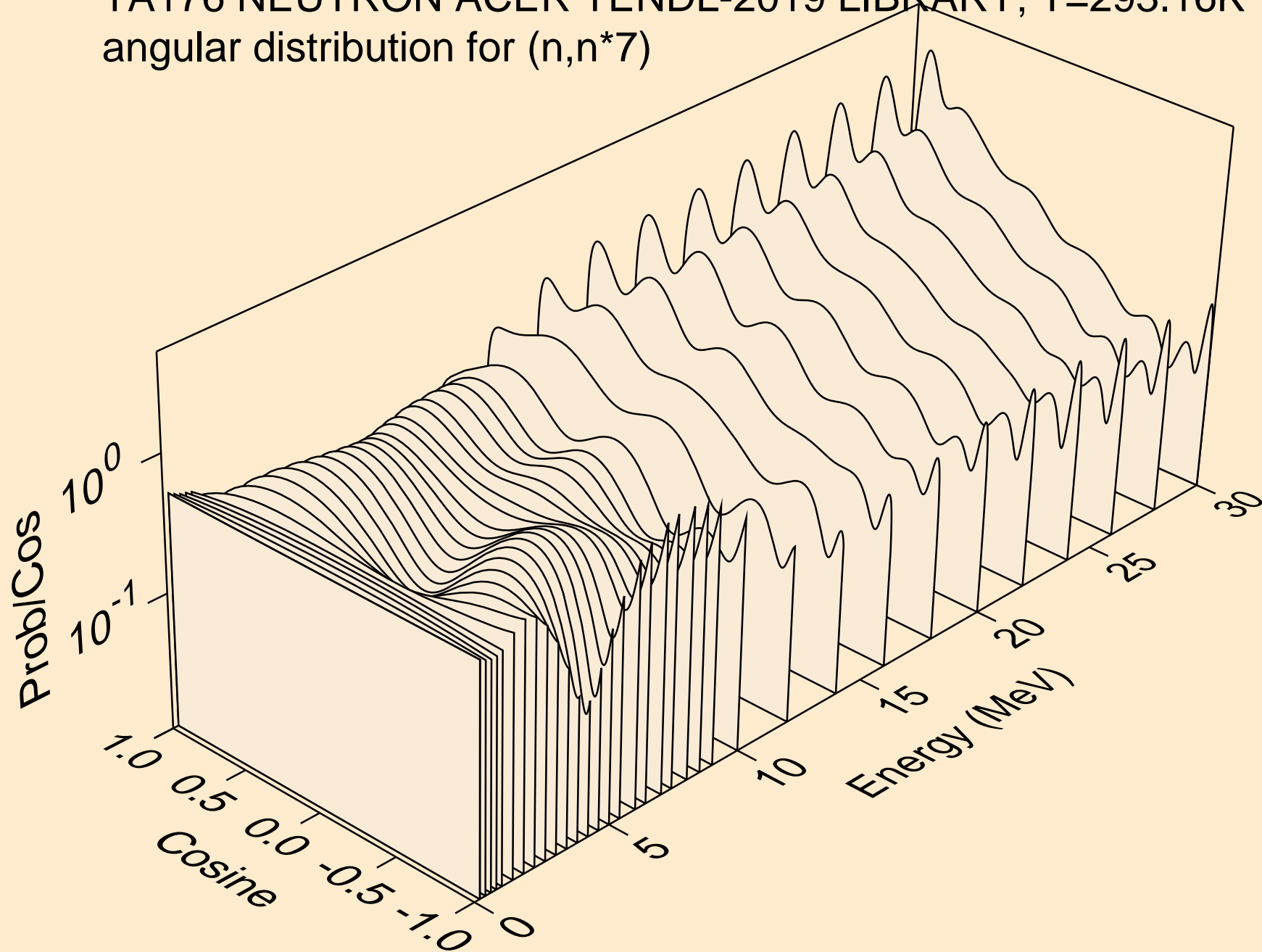

TA176 NEUTRON ACER TENDL-2019 LIBRARY; T=293.16K  
angular distribution for (n,n\*8)

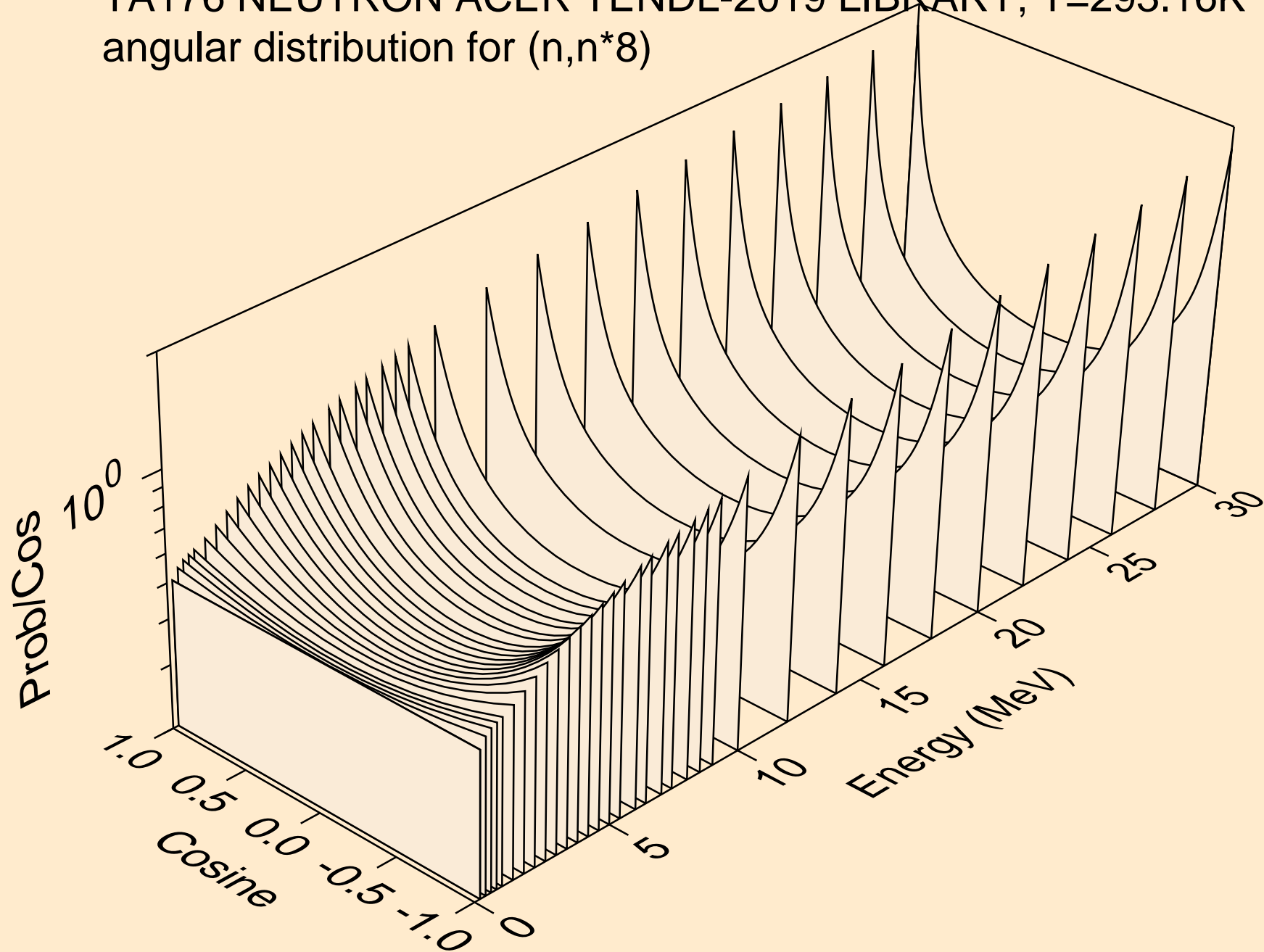

TA176 NEUTRON ACER TENDL-2019 LIBRARY; T=293.16K  
angular distribution for (n,n\*9)

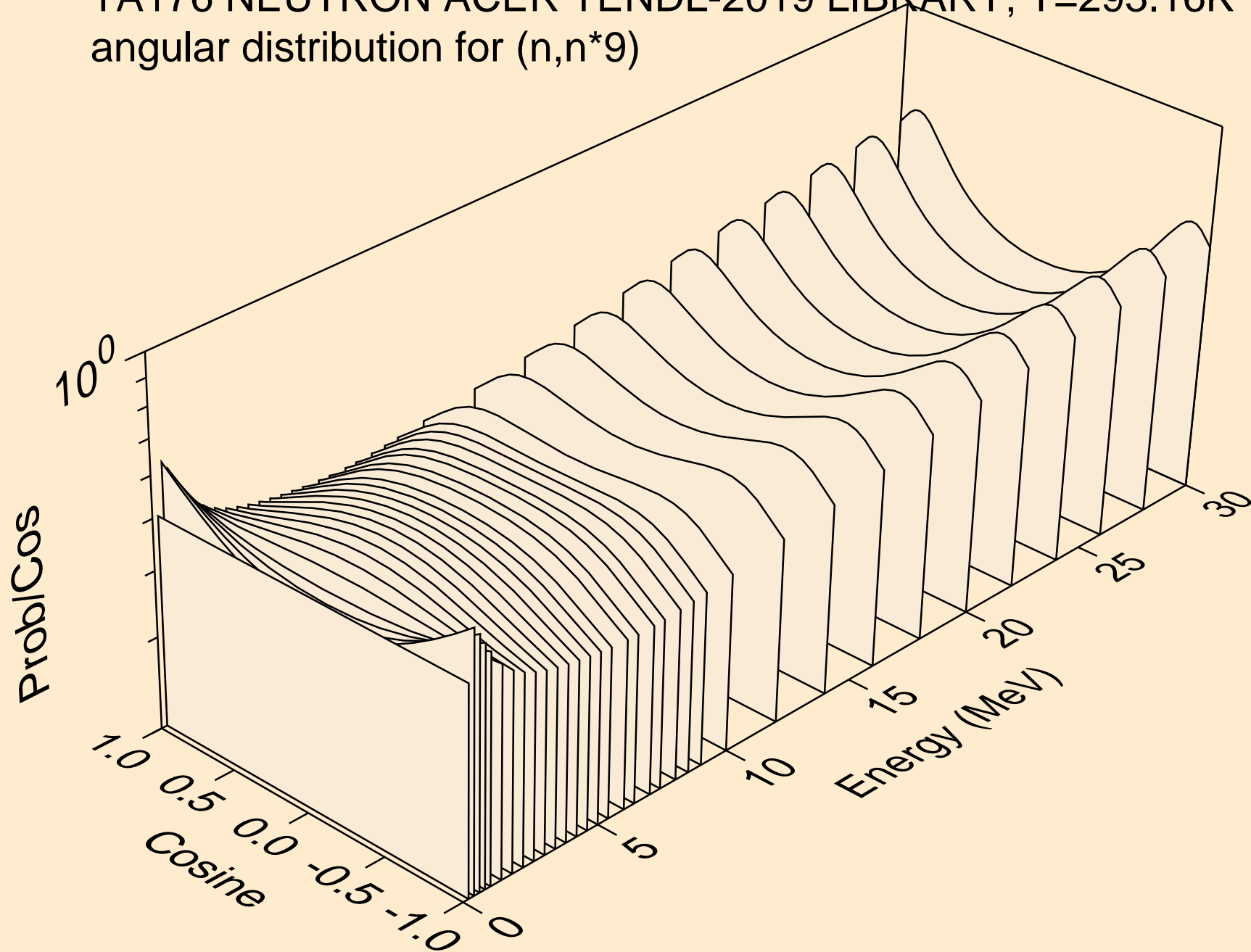



TA176 NEUTRON ACER TENDL-2019 LIBRARY; T=293.16K  
angular distribution for (n,n\*10)

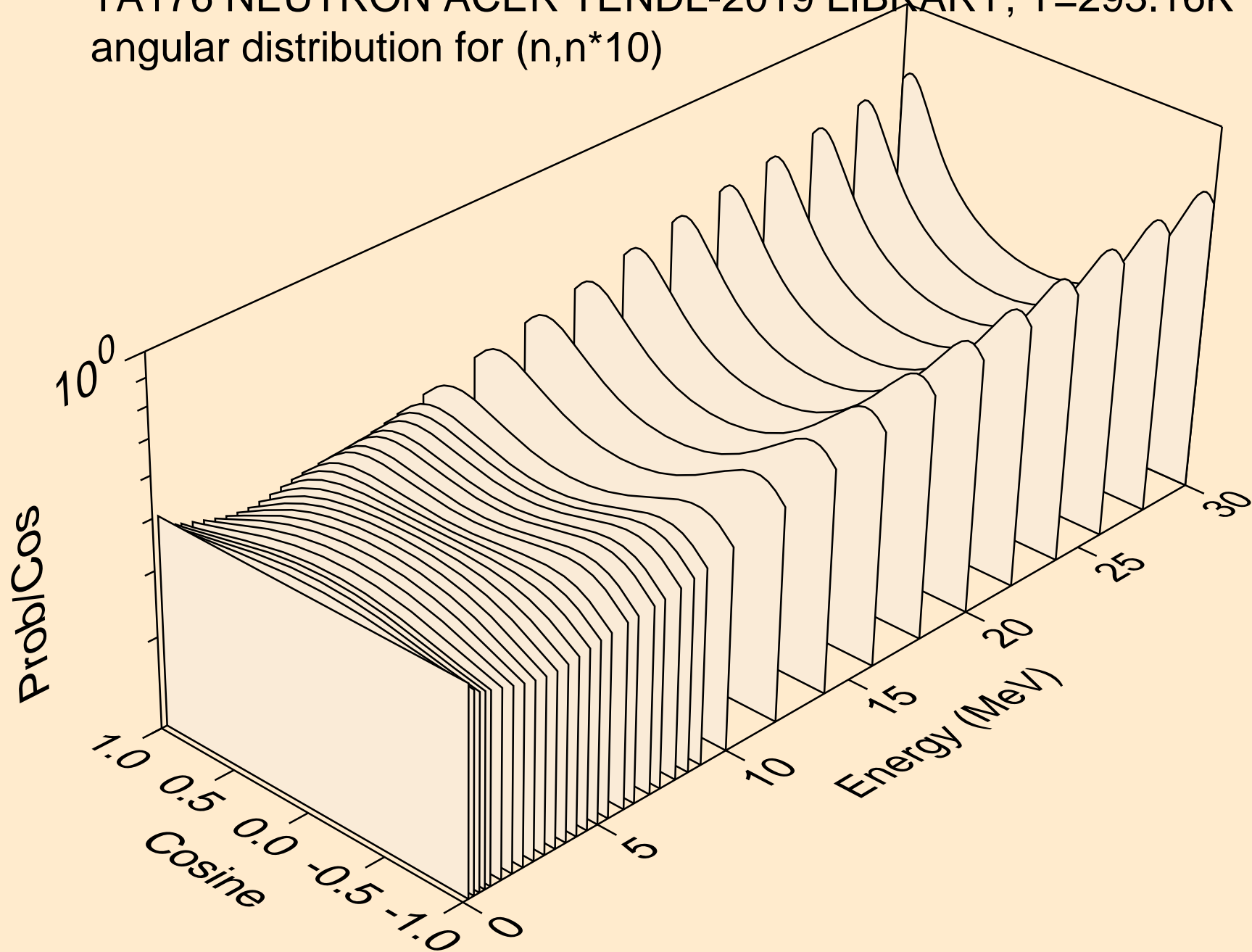

TA176 NEUTRON ACER TENDL-2019 LIBRARY; T=293.16K  
angular distribution for (n,n\*11)

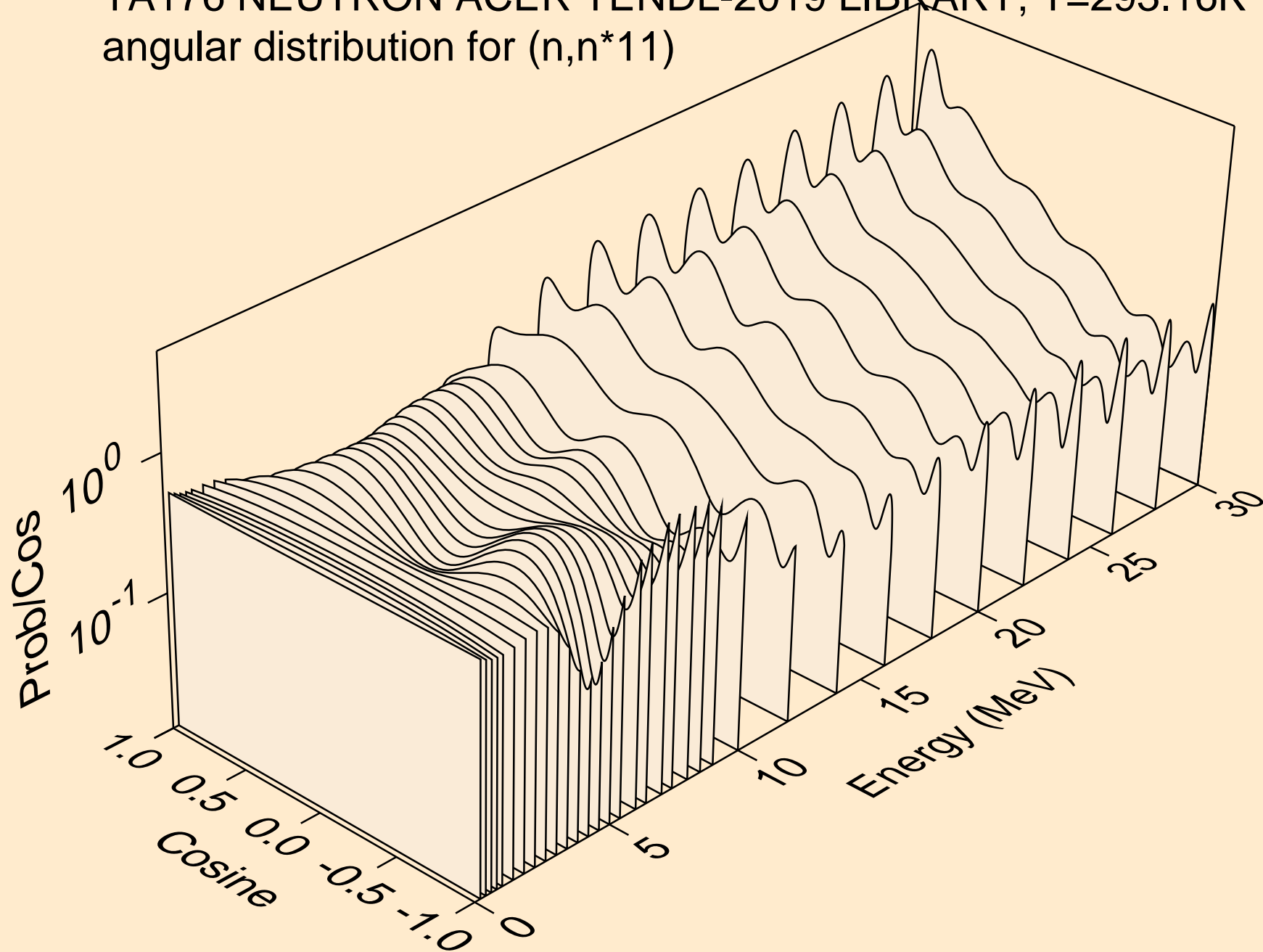

TA176 NEUTRON ACER TENDL-2019 LIBRARY; T=293.16K  
angular distribution for (n,n\*12)

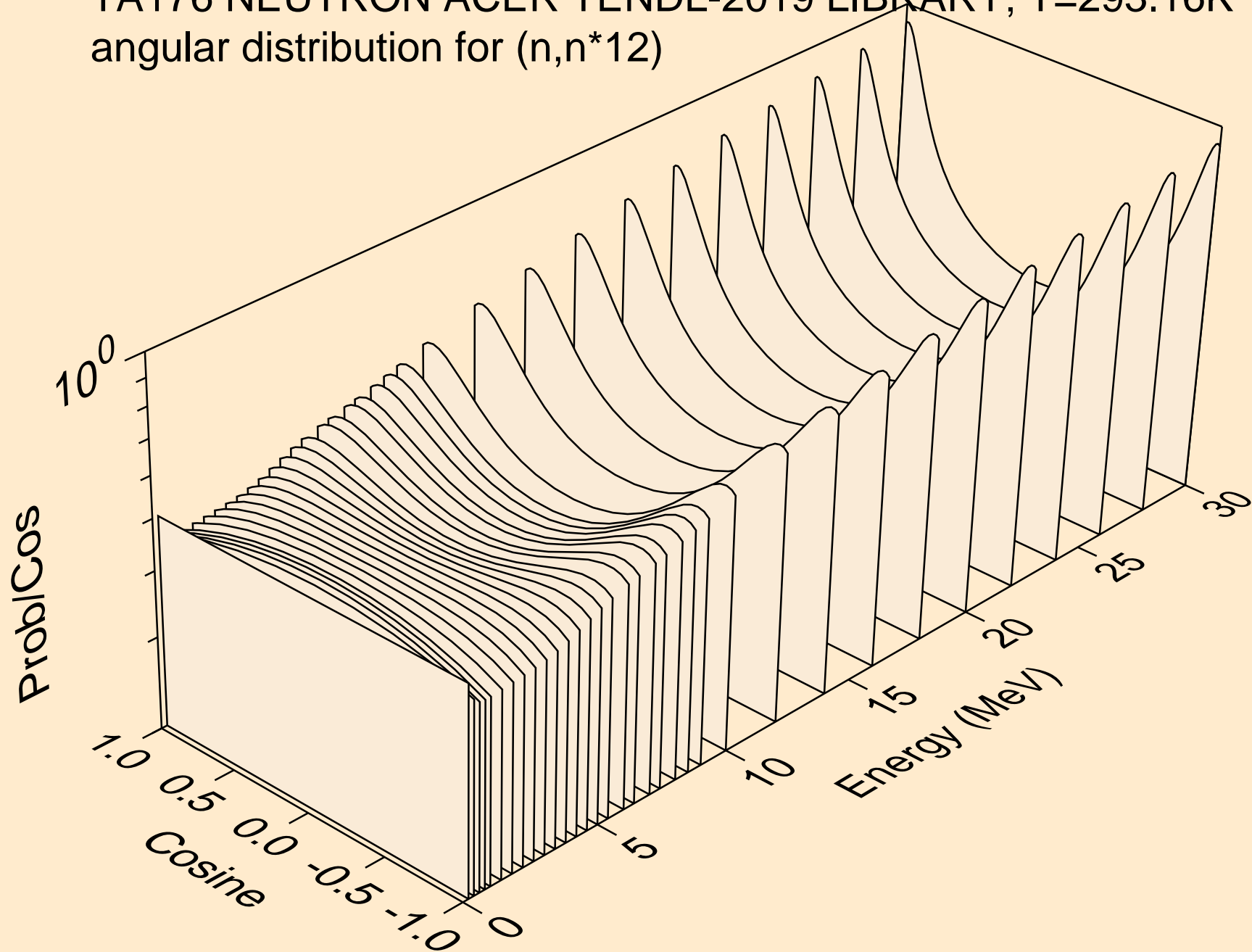

TA176 NEUTRON ACER TENDL-2019 LIBRARY; T=293.16K  
angular distribution for (n,n\*13)

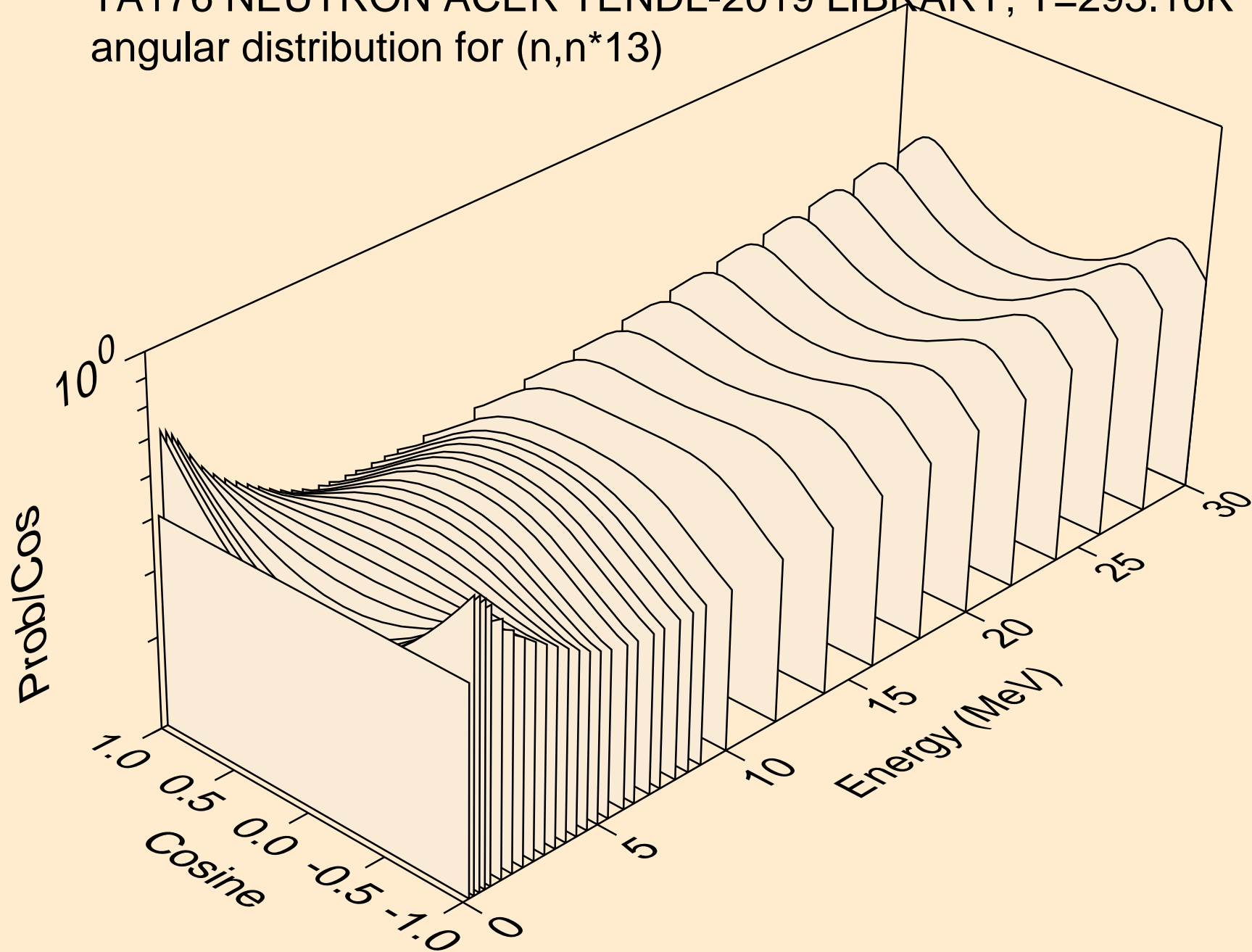

TA176 NEUTRON ACER TENDL-2019 LIBRARY; T=293.16K  
angular distribution for (n,n\*14)

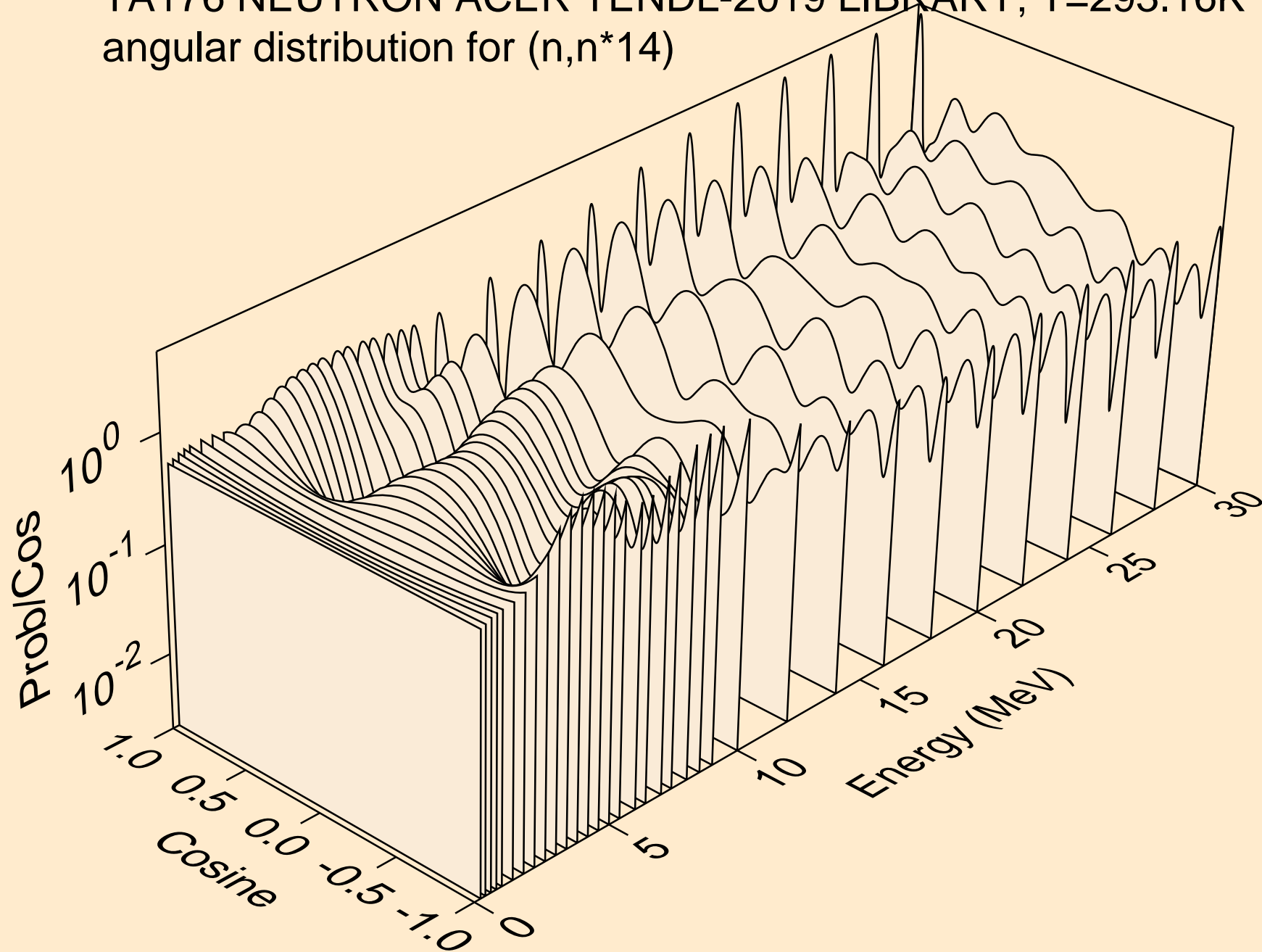

TA176 NEUTRON ACER TENDL-2019 LIBRARY; T=293.16K  
angular distribution for (n,n\*15)

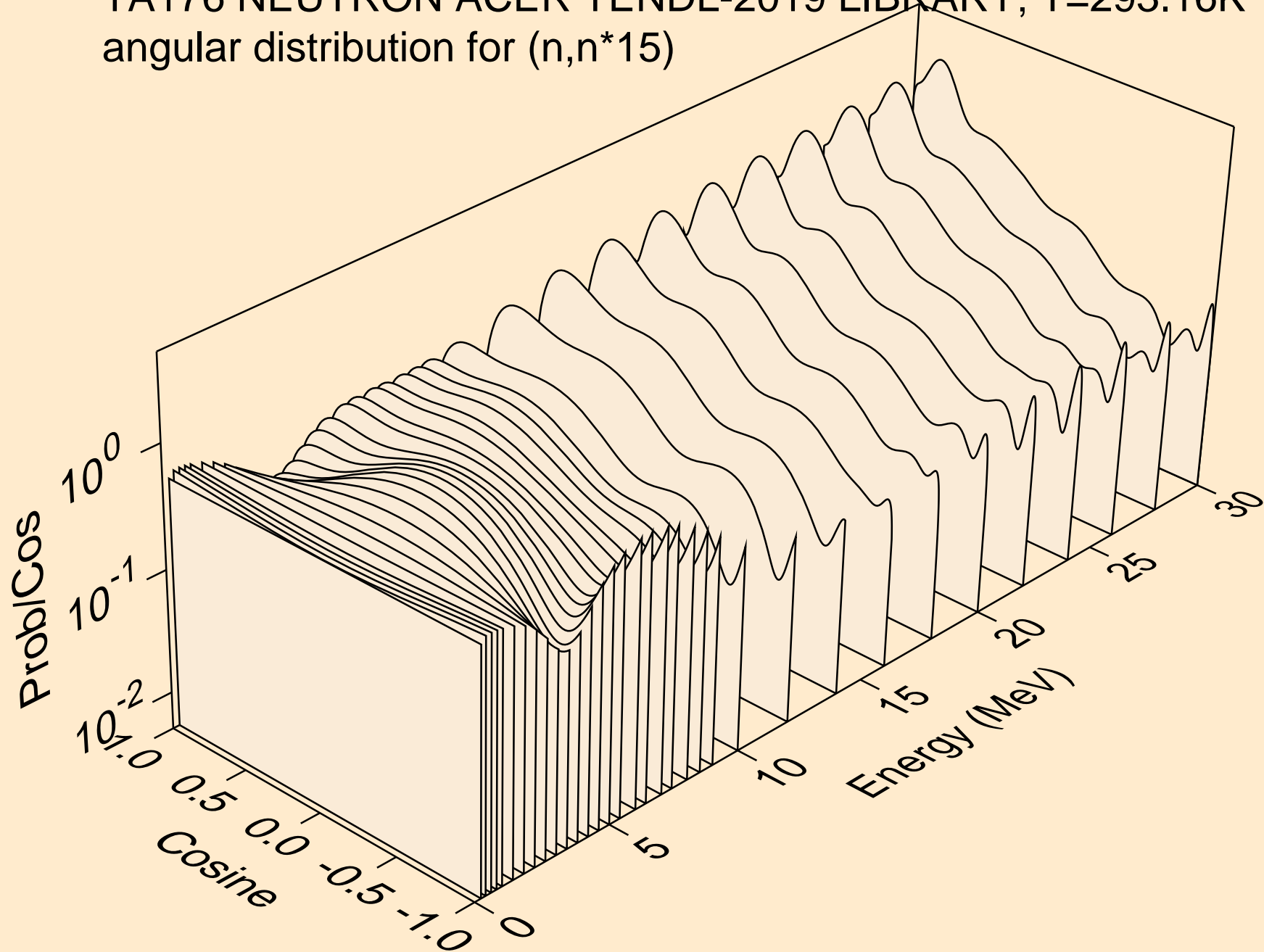

TA176 NEUTRON ACER TENDL-2019 LIBRARY; T=293.16K  
angular distribution for (n,n\*16)

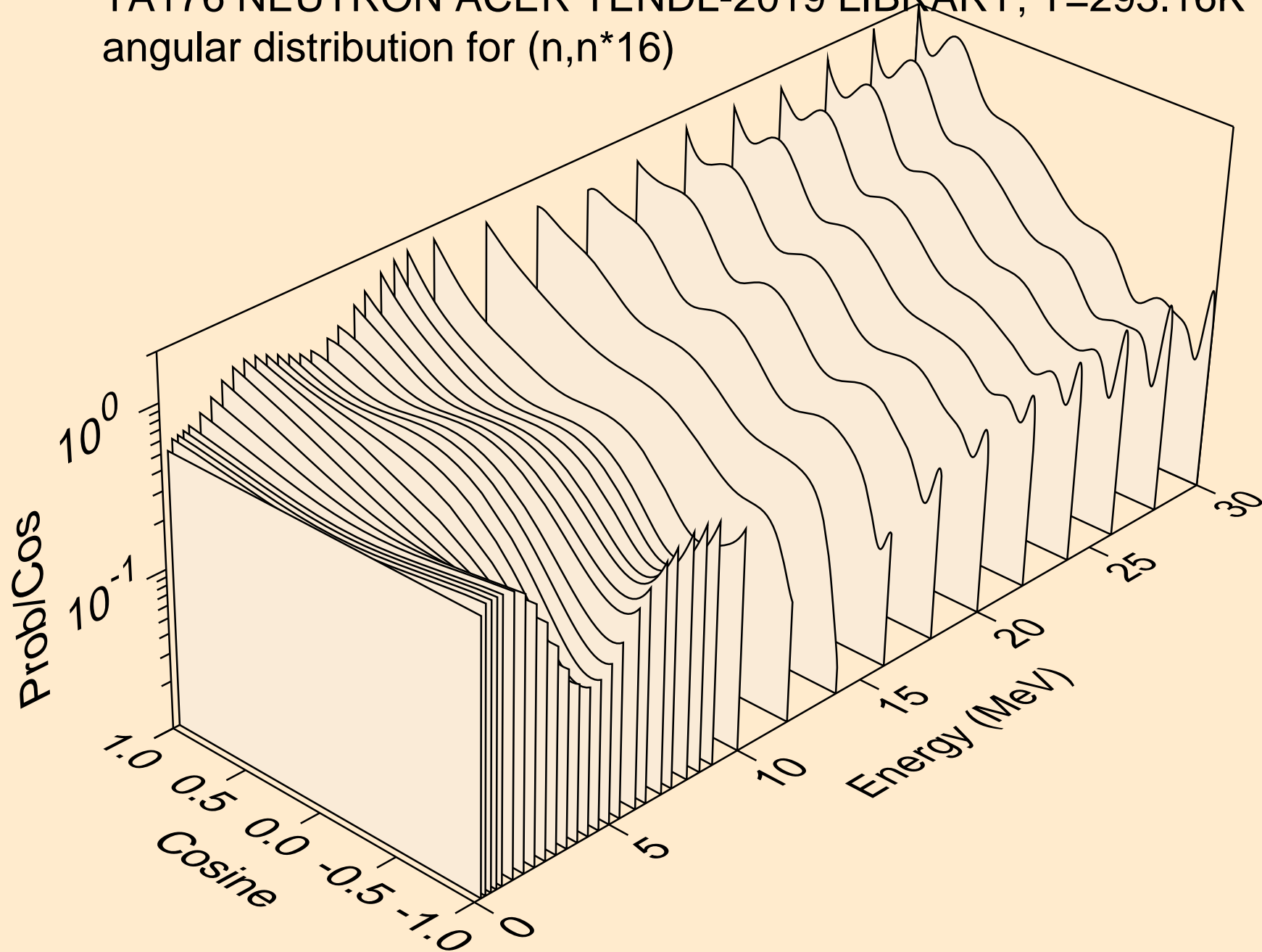

TA176 NEUTRON ACER TENDL-2019 LIBRARY; T=293.16K  
angular distribution for (n,n\*17)

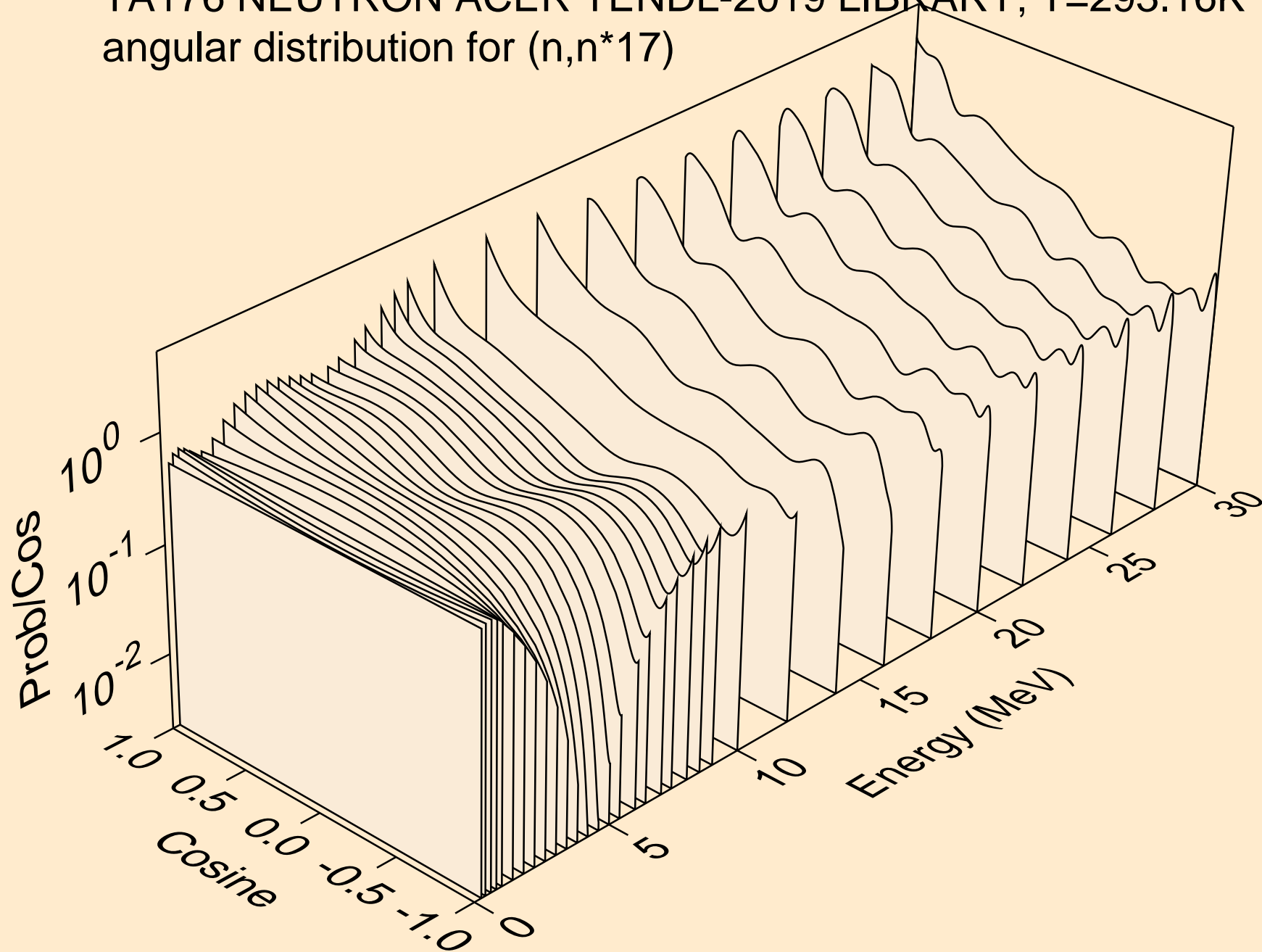



TA176 NEUTRON ACER TENDL-2019 LIBRARY; T=293.16K  
angular distribution for (n,n\*18)

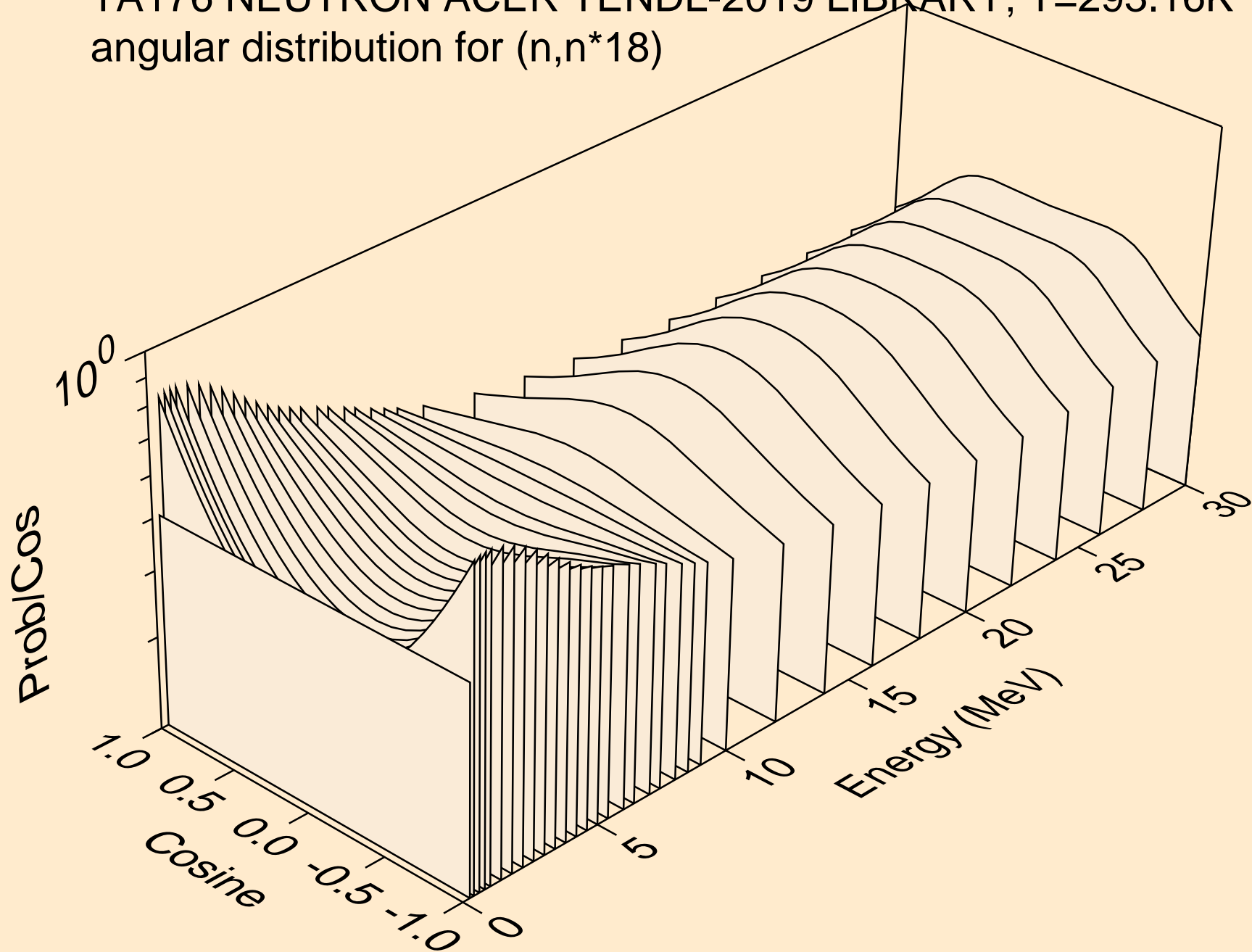

TA176 NEUTRON ACER TENDL-2019 LIBRARY; T=293.16K  
angular distribution for (n,n\*19)

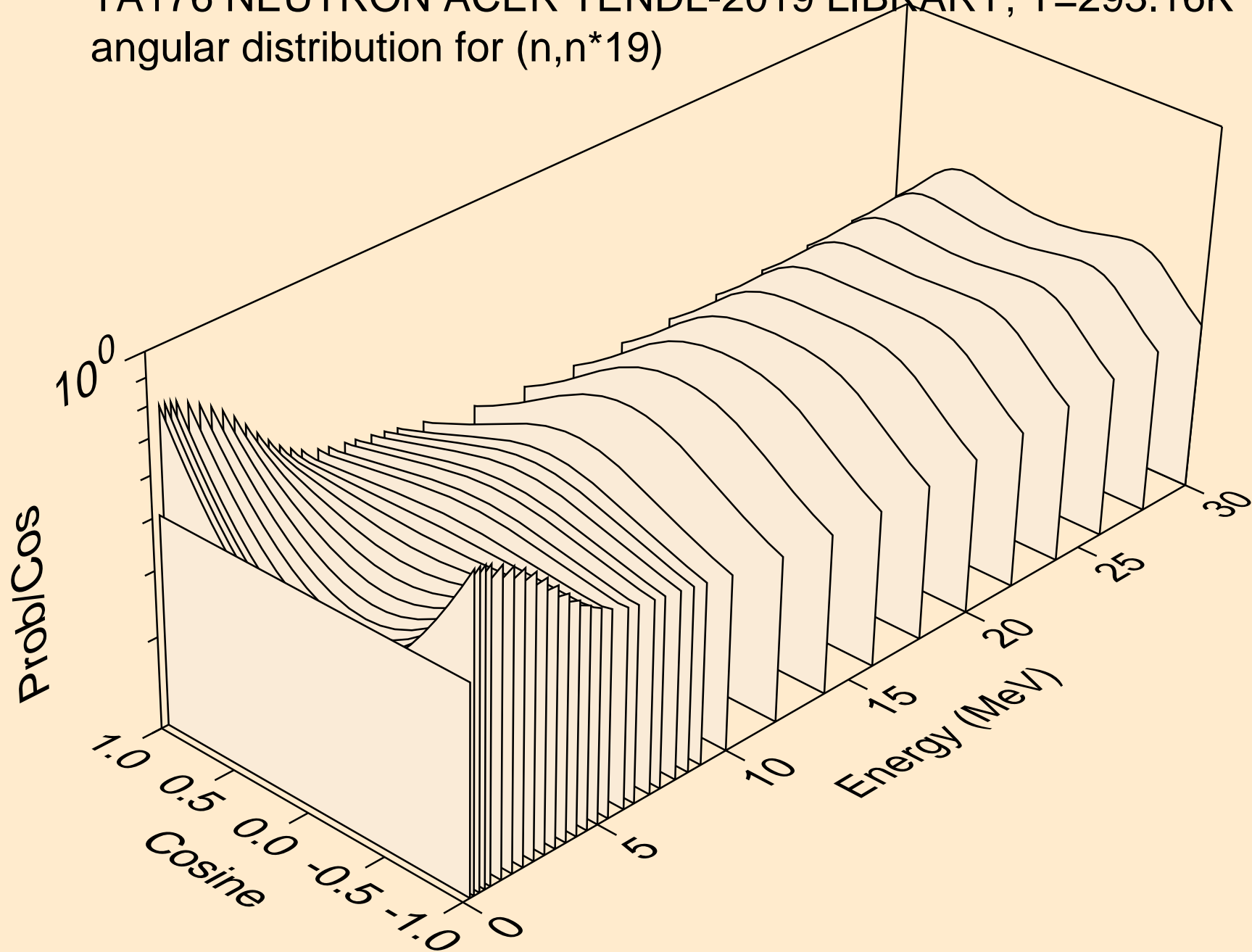

TA176 NEUTRON ACER TENDL-2019 LIBRARY; T=293.16K  
angular distribution for (n,n\*20)

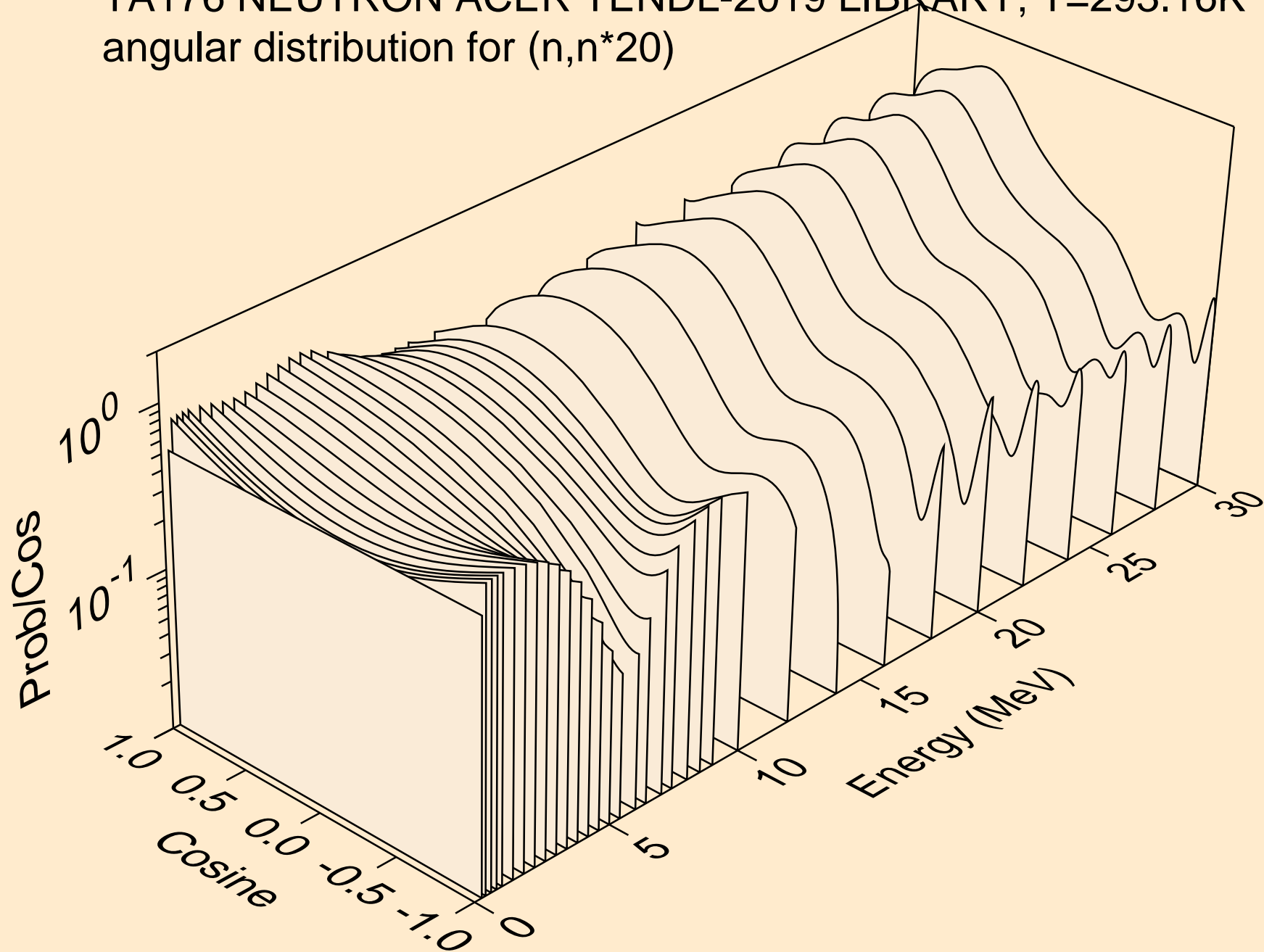

TA176 NEUTRON ACER TENDL-2019 LIBRARY; T=293.16K  
angular distribution for (n,n\*21)

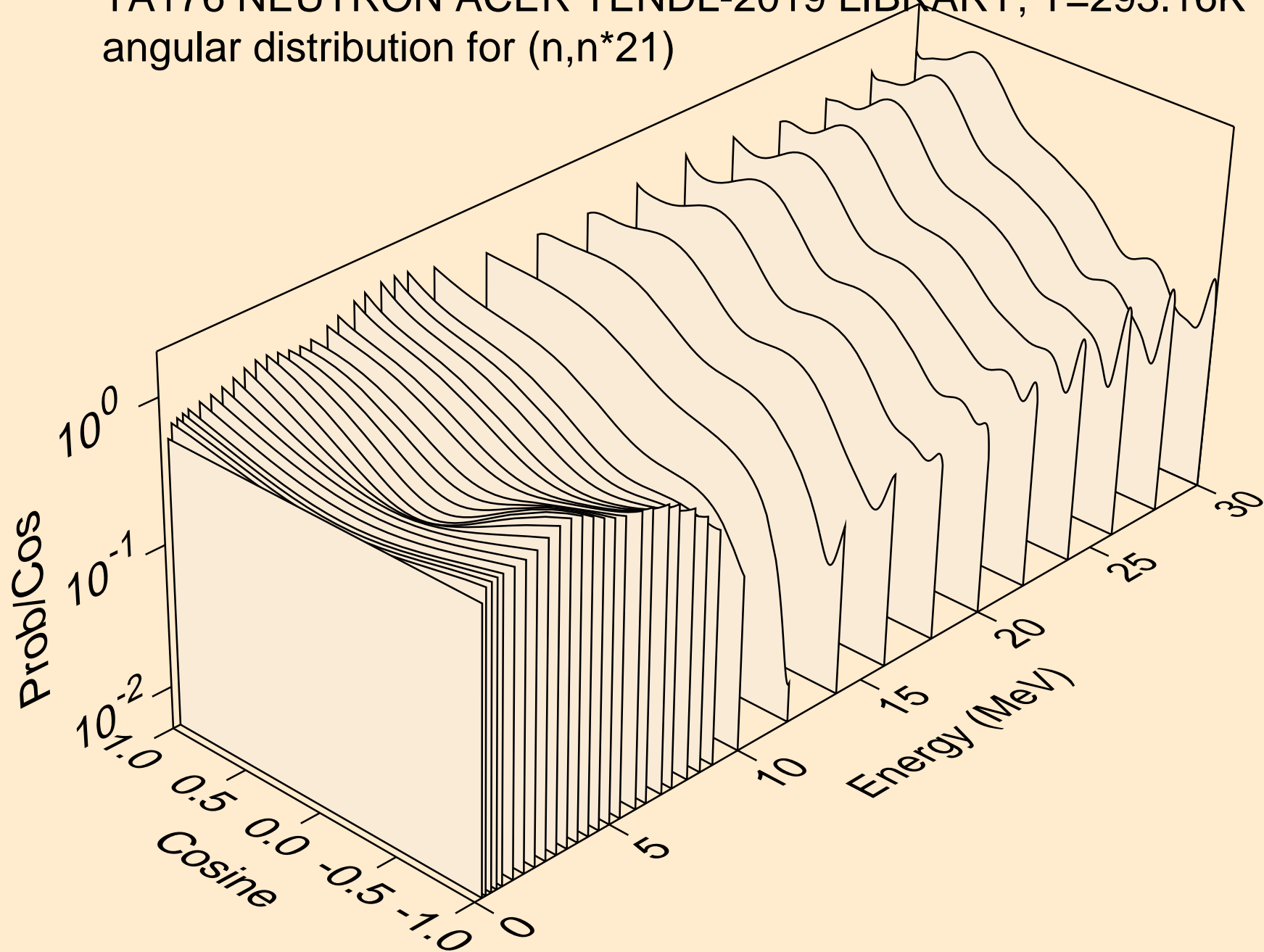

TA176 NEUTRON ACER TENDL-2019 LIBRARY; T=293.16K  
angular distribution for (n,n\*22)

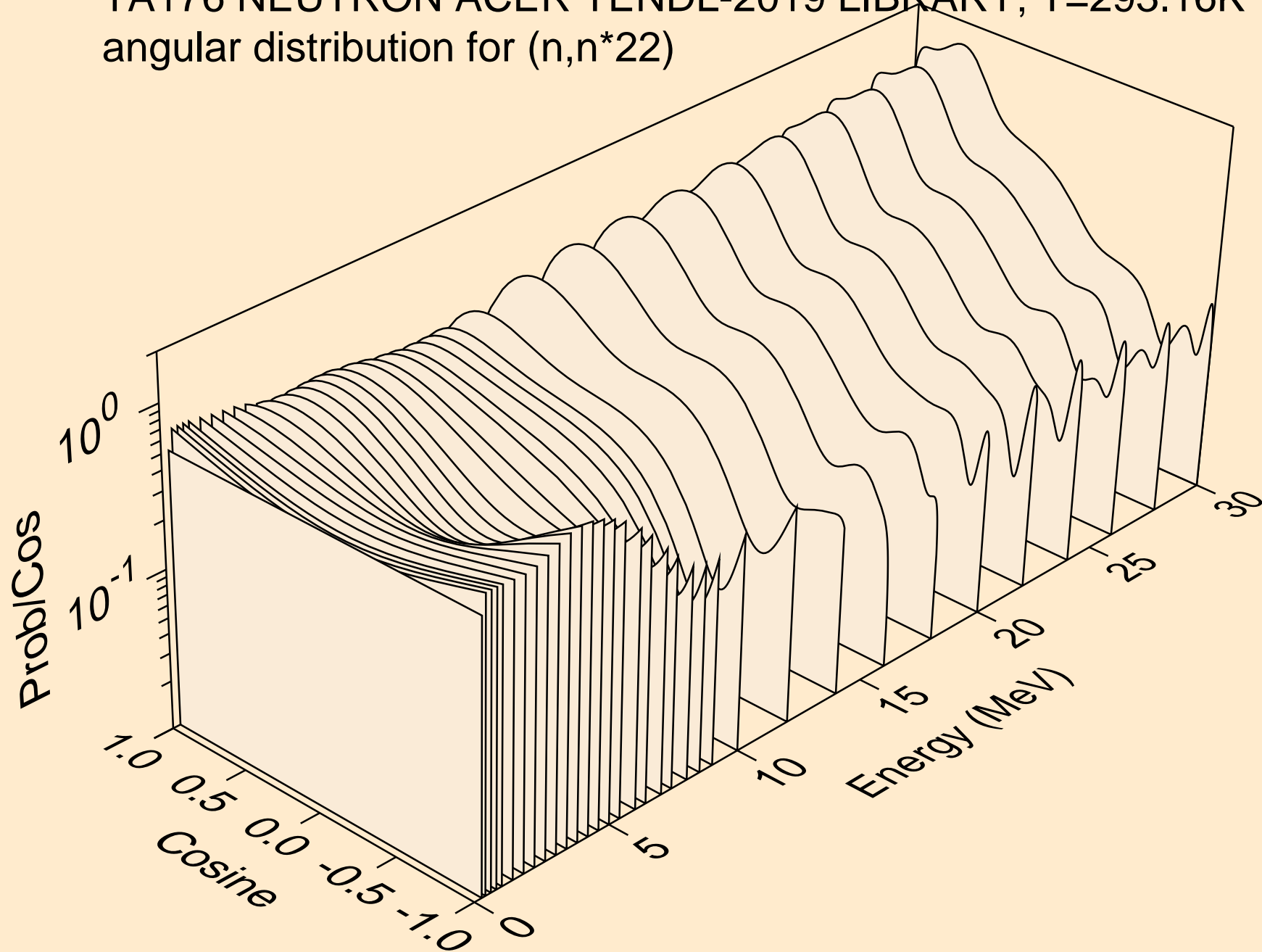

TA176 NEUTRON ACER TENDL-2019 LIBRARY; T=293.16K  
angular distribution for (n,n\*23)

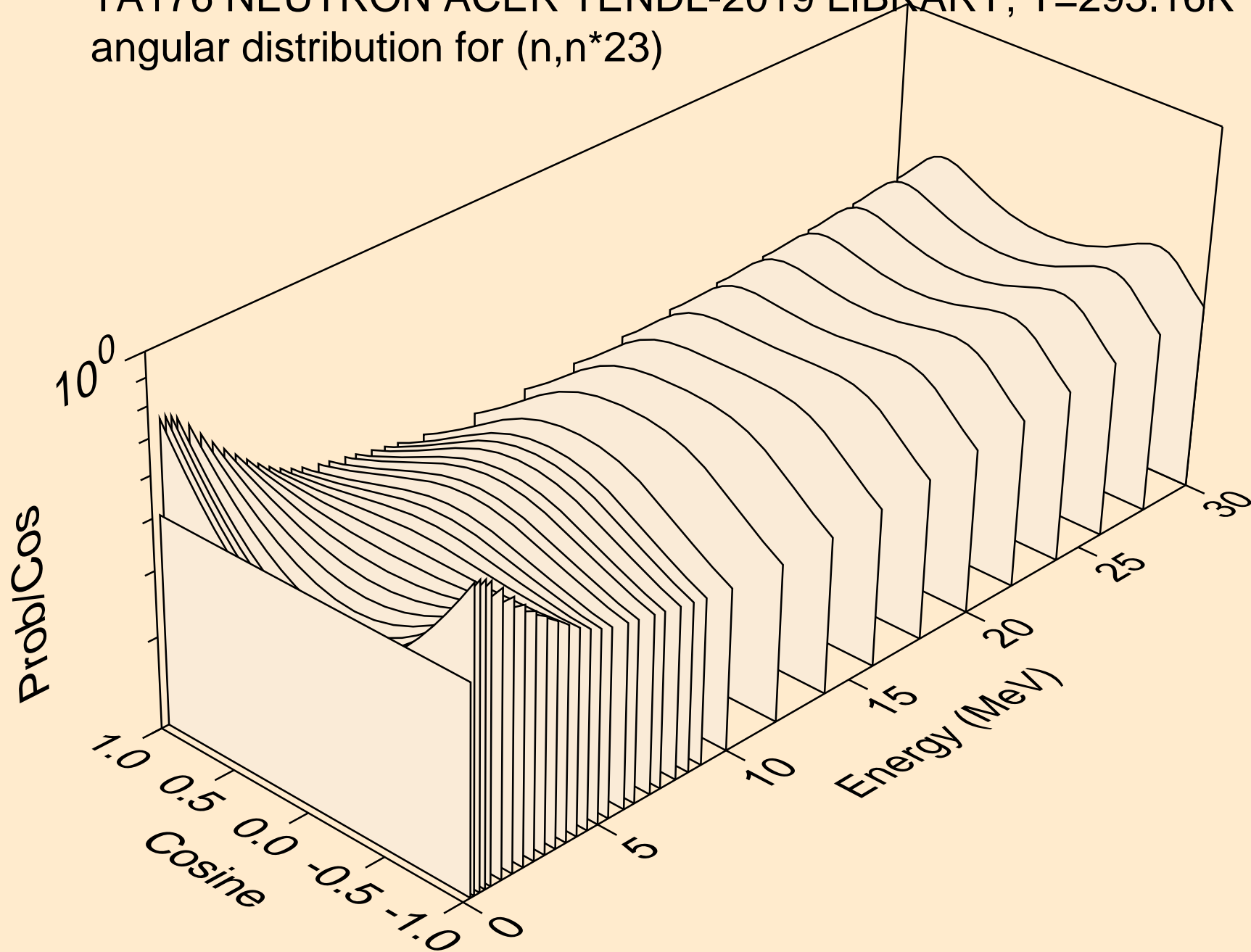

TA176 NEUTRON ACER TENDL-2019 LIBRARY; T=293.16K  
angular distribution for (n,n\*24)

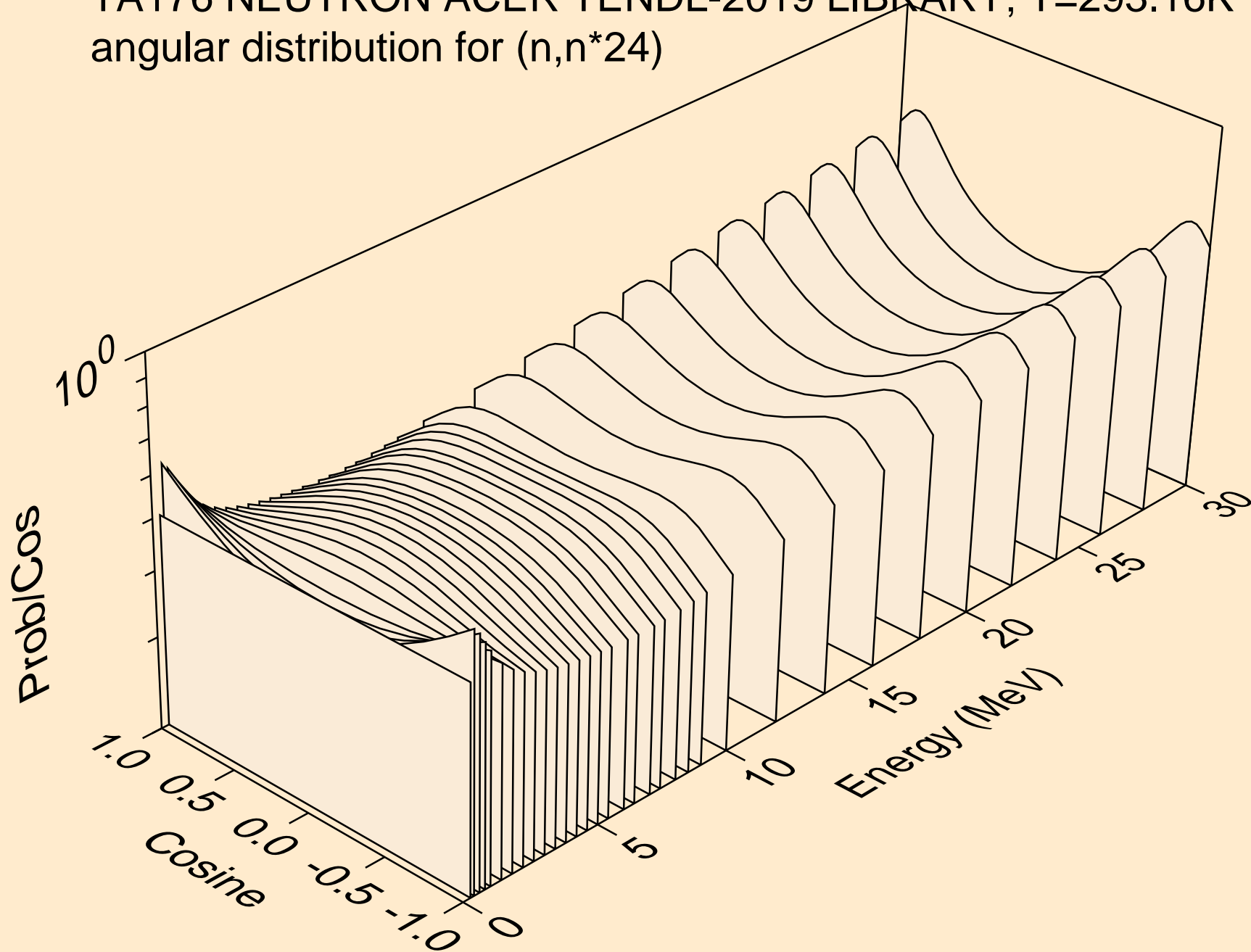

TA176 NEUTRON ACER TENDL-2019 LIBRARY; T=293.16K  
angular distribution for (n,n\*25)

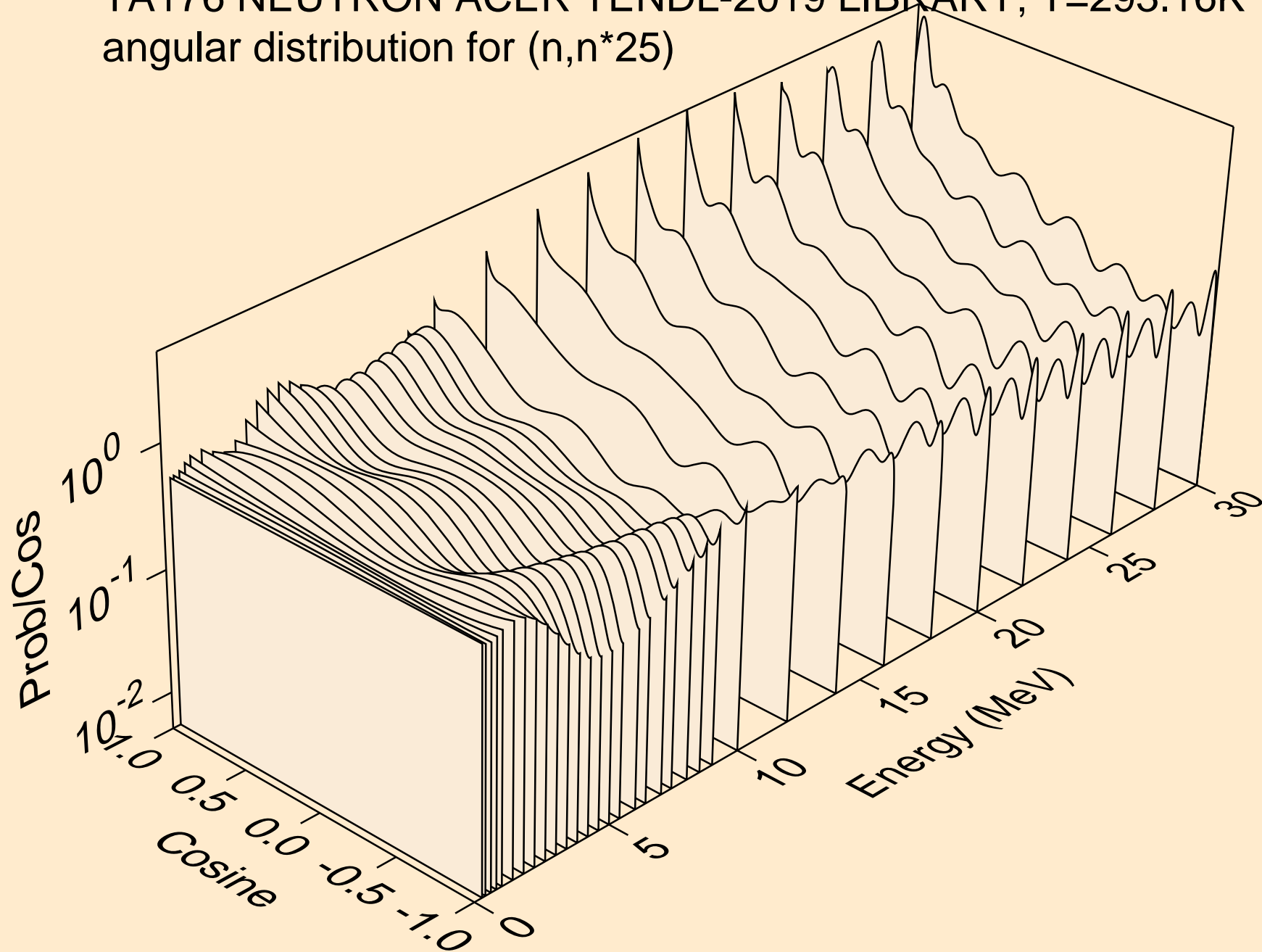



TA176 NEUTRON ACER TENDL-2019 LIBRARY; T=293.16K  
angular distribution for (n,n\*26)

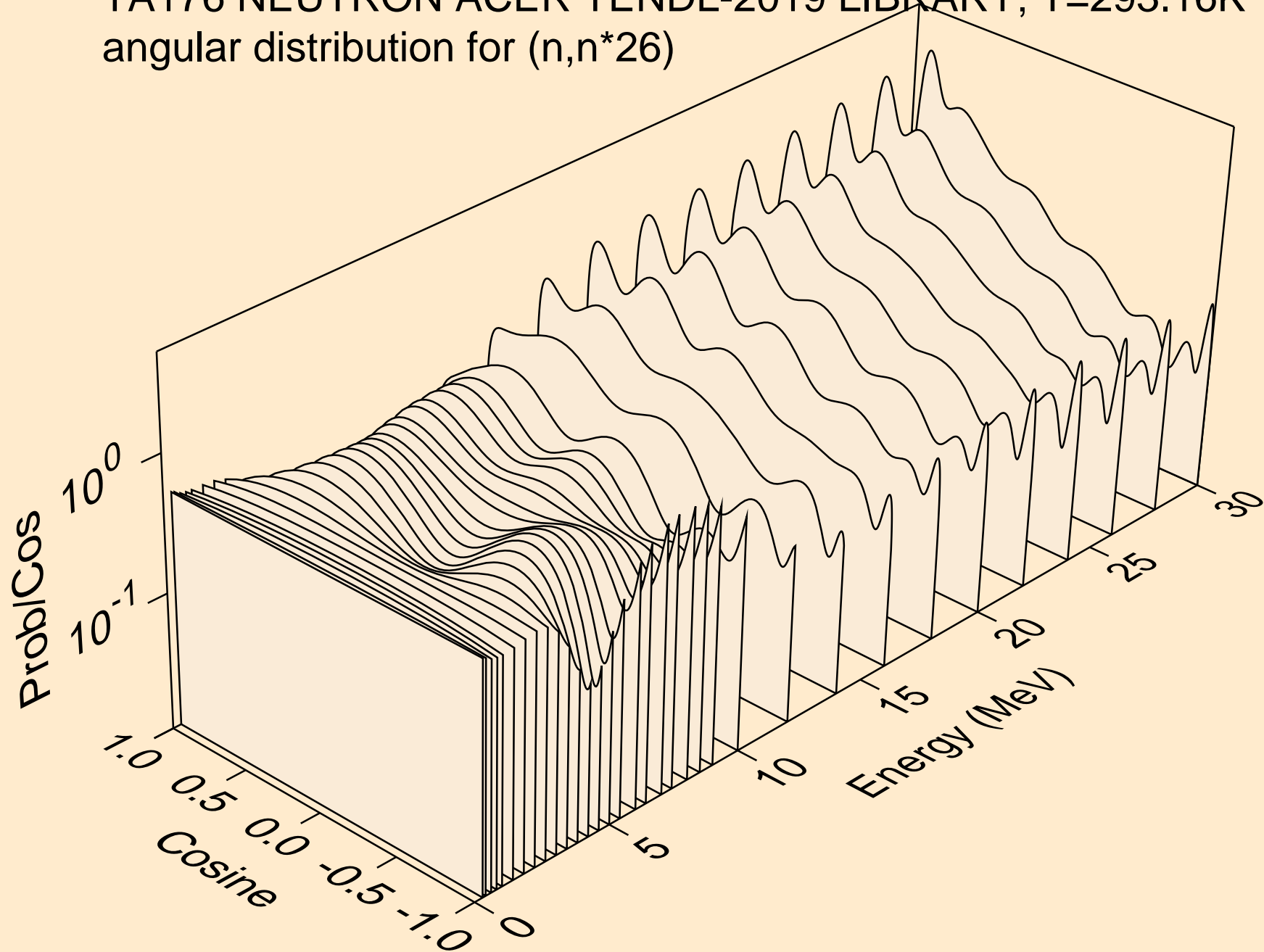

TA176 NEUTRON ACER TENDL-2019 LIBRARY; T=293.16K  
angular distribution for (n,n\*27)

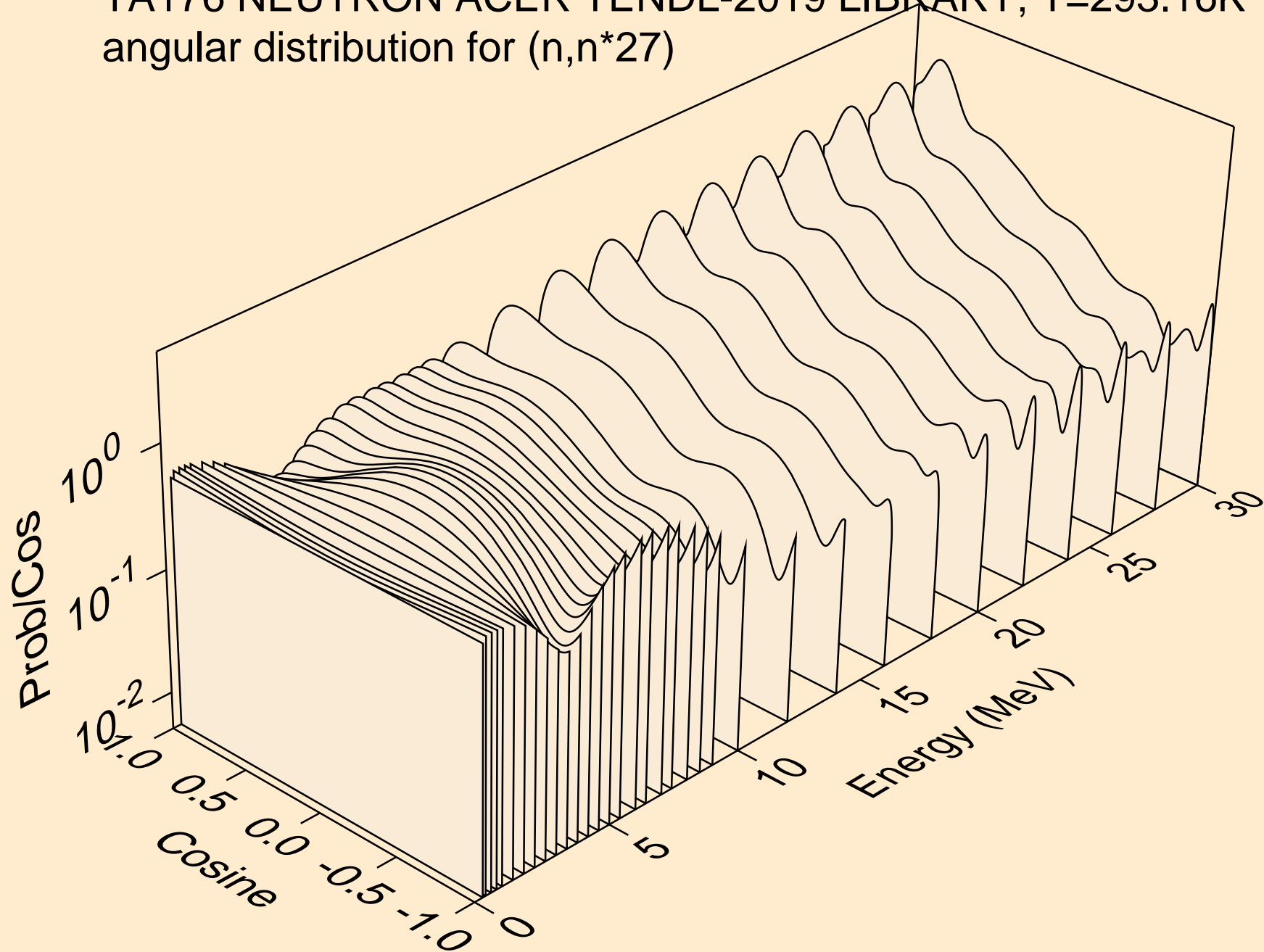

TA176 NEUTRON ACER TENDL-2019 LIBRARY; T=293.16K  
angular distribution for (n,n\*28)

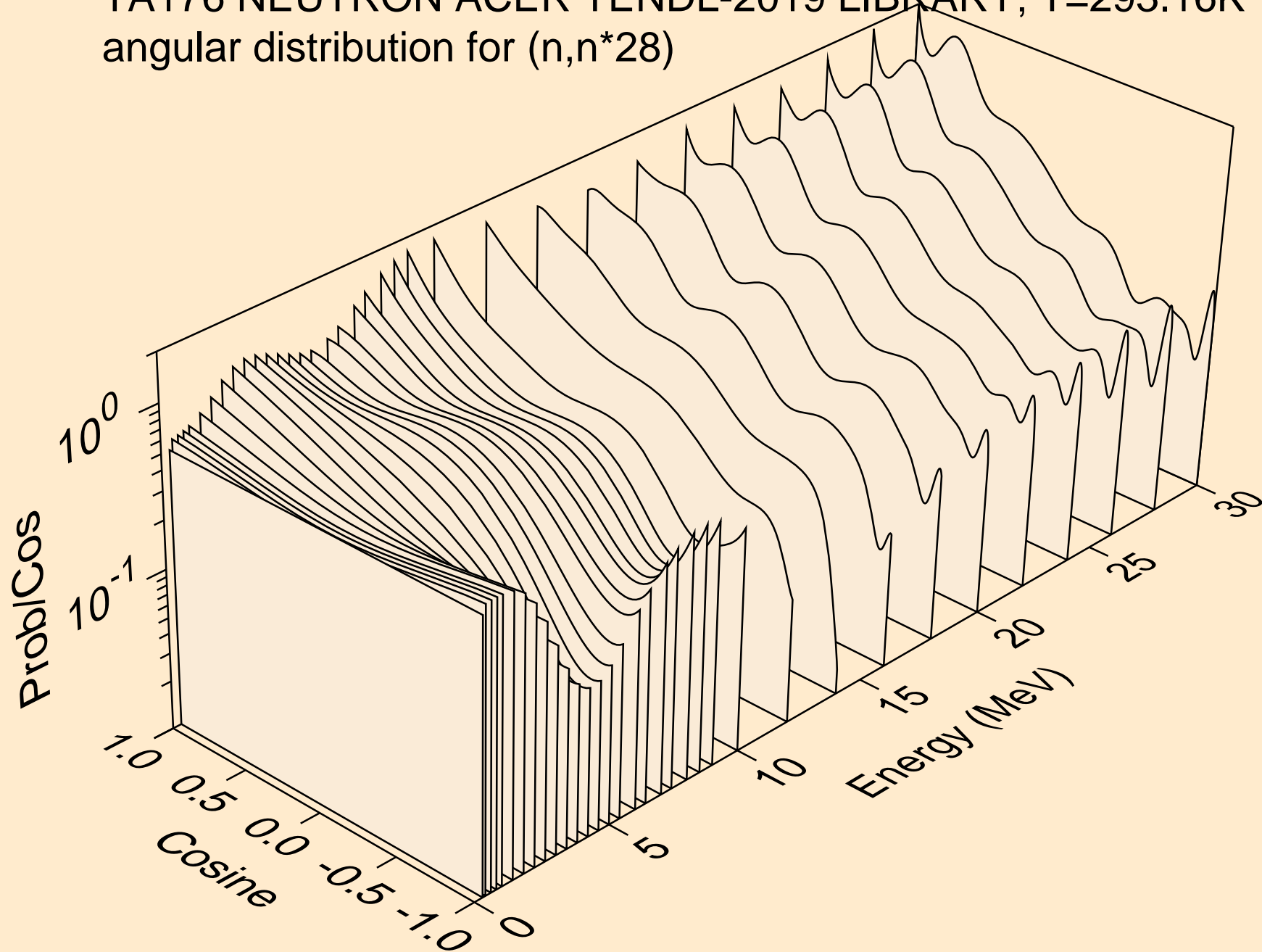

TA176 NEUTRON ACER TENDL-2019 LIBRARY; T=293.16K  
angular distribution for (n,n\*29)

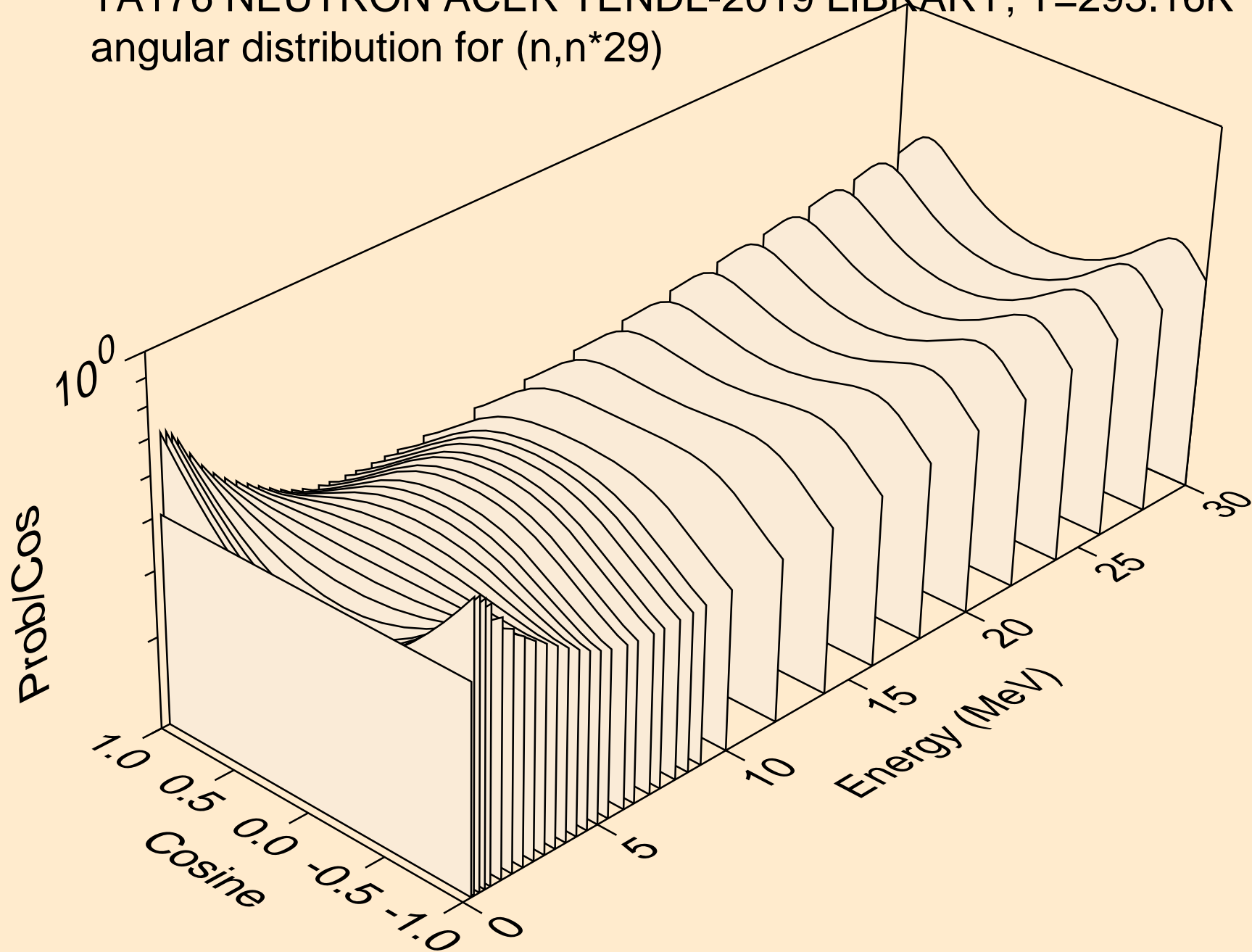

TA176 NEUTRON ACER TENDL-2019 LIBRARY; T=293.16K  
angular distribution for (n,n\*30)

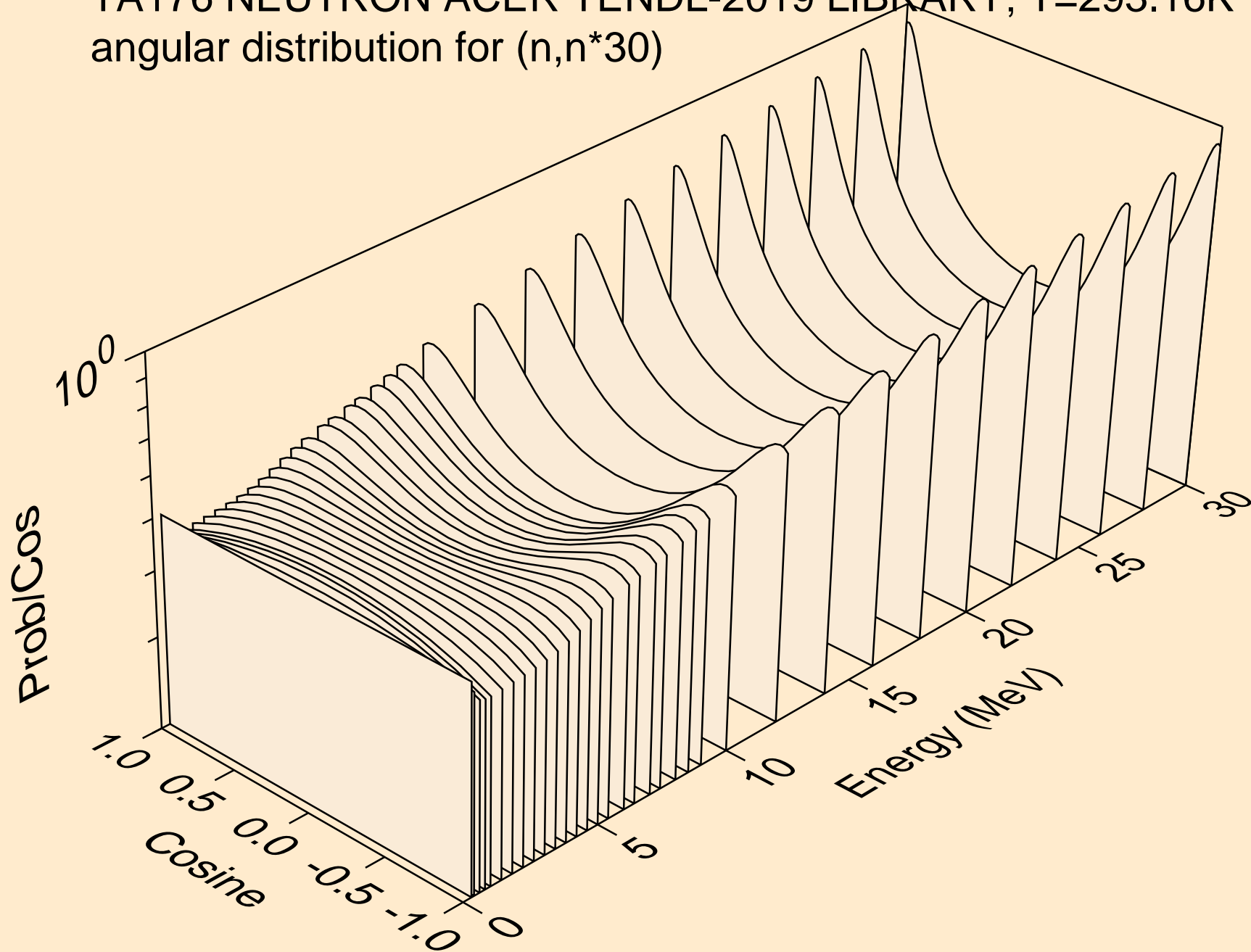

TA176 NEUTRON ACER TENDL-2019 LIBRARY; T=293.16K  
Neutron emission for (n,x)

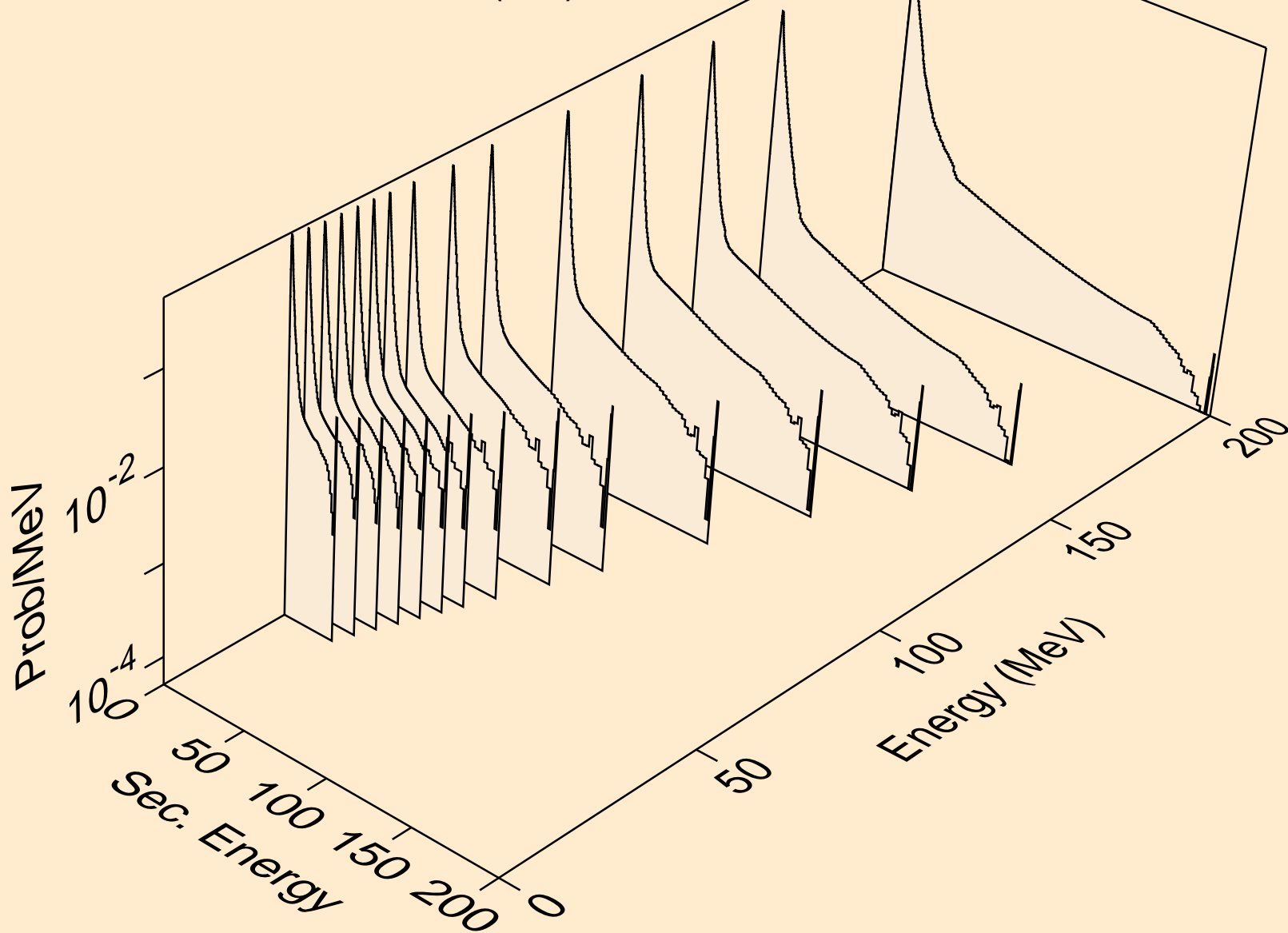

TA176 NEUTRON ACER TENDL-2019 LIBRARY; T=293.16K  
Neutron emission for (n,2nd)

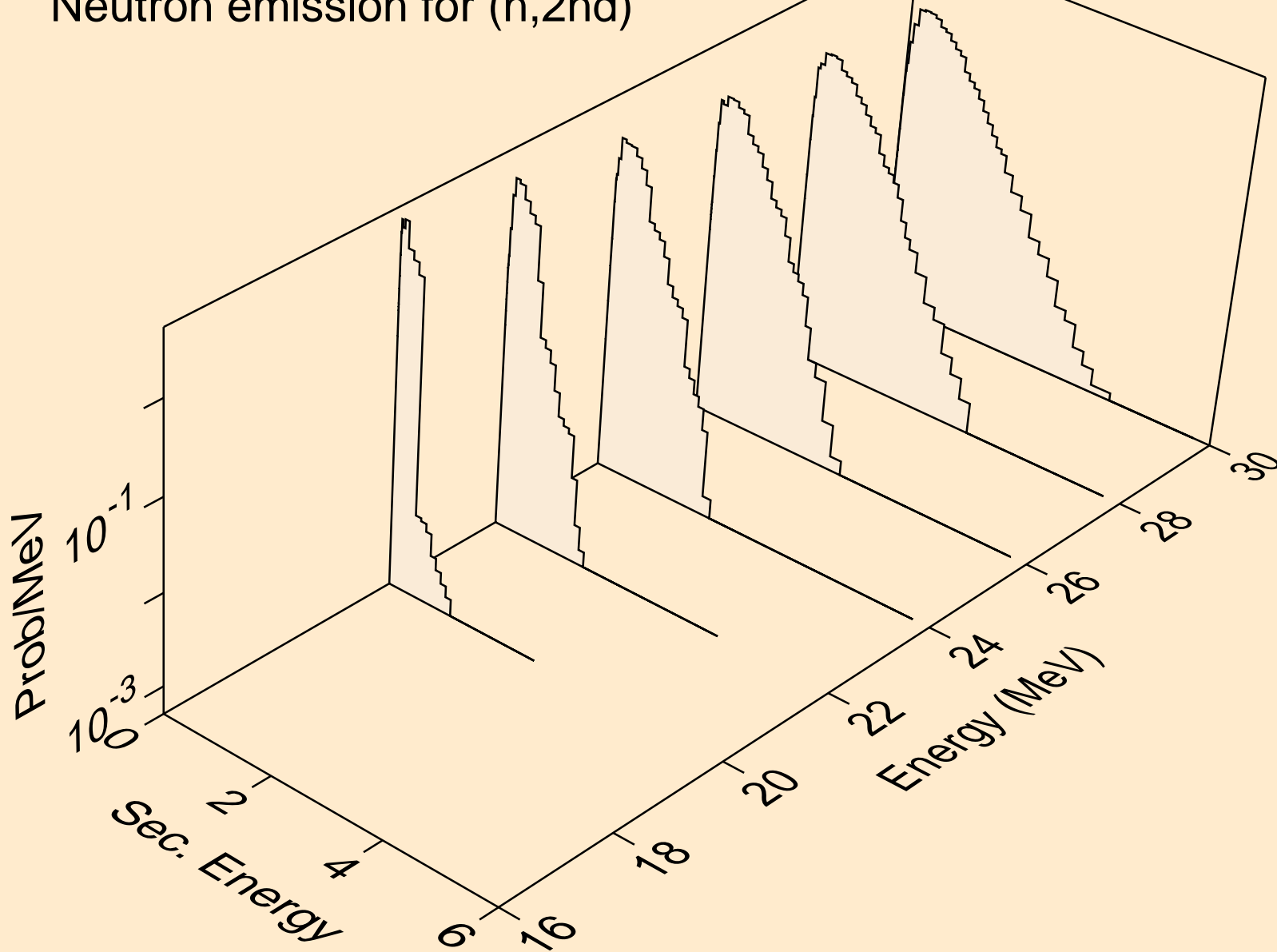

TA176 NEUTRON ACER TENDL-2019 LIBRARY; T=293.16K  
Neutron emission for (n,2n)

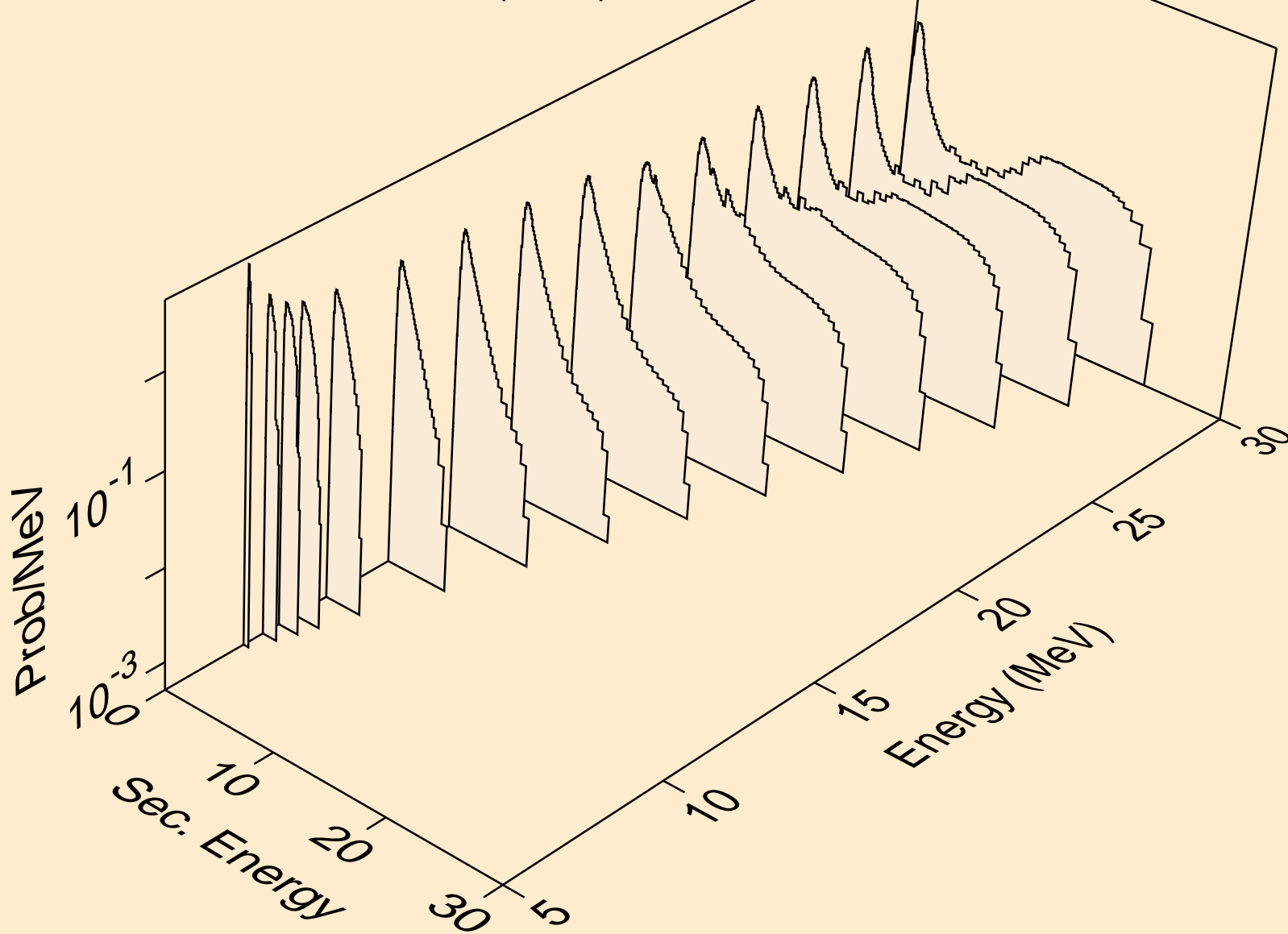



TA176 NEUTRON ACER TENDL-2019 LIBRARY; T=293.16K  
Neutron emission for (n,3n)

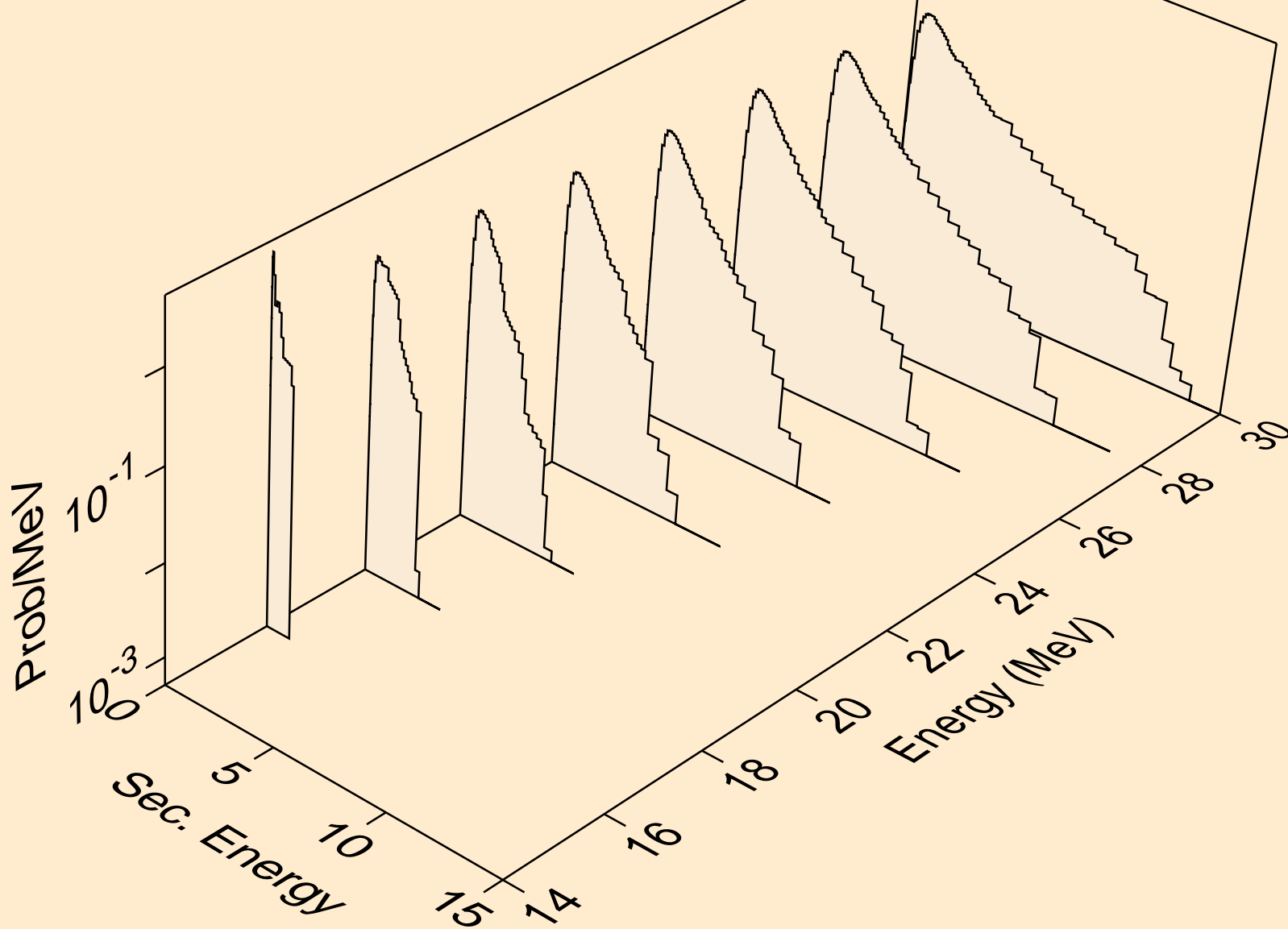

TA176 NEUTRON ACER TENDL-2019 LIBRARY; T=293.16K  
Neutron emission for (n,n\*)a

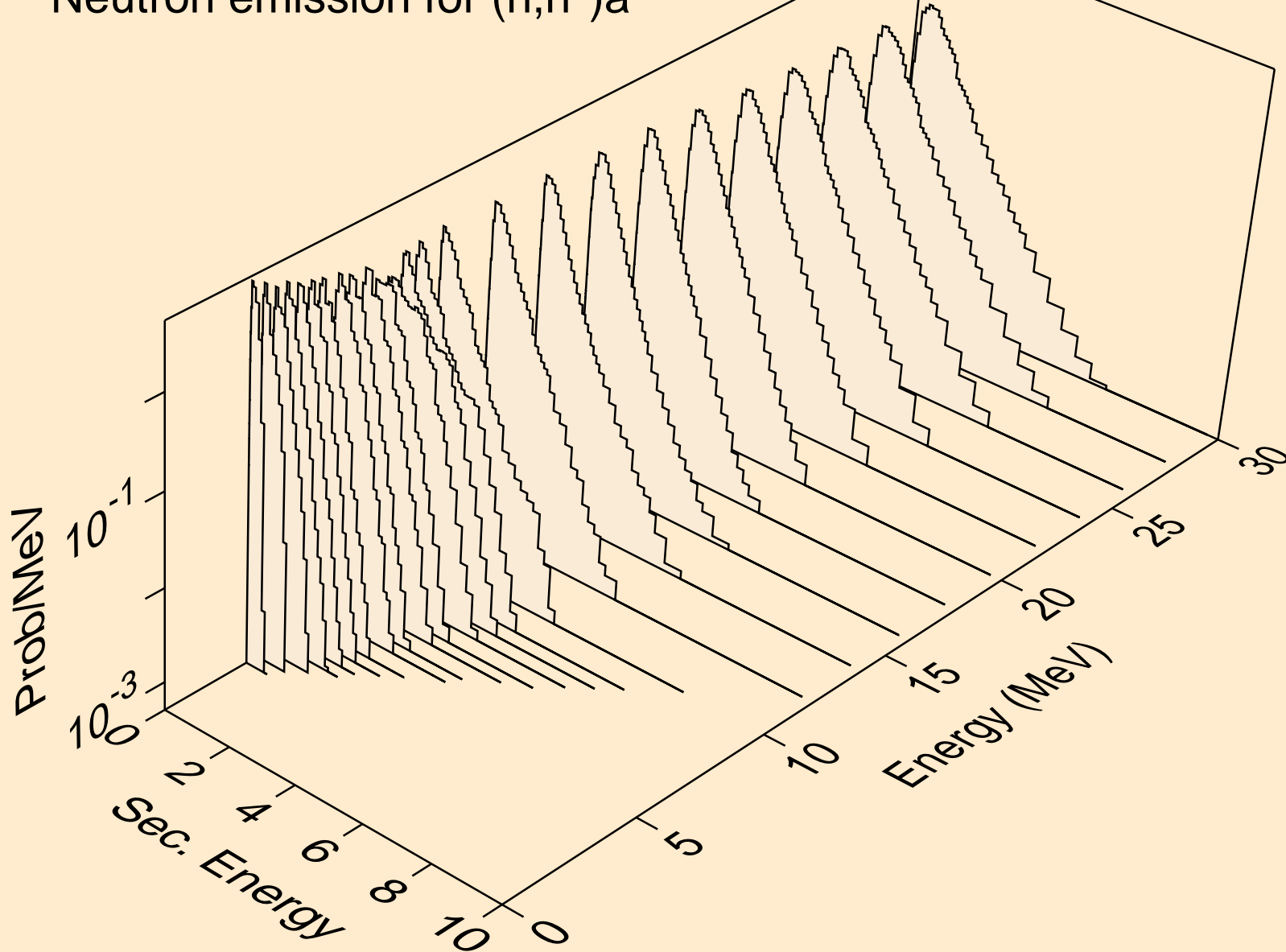

TA176 NEUTRON ACER TENDL-2019 LIBRARY; T=293.16K  
Neutron emission for (n,2n)a

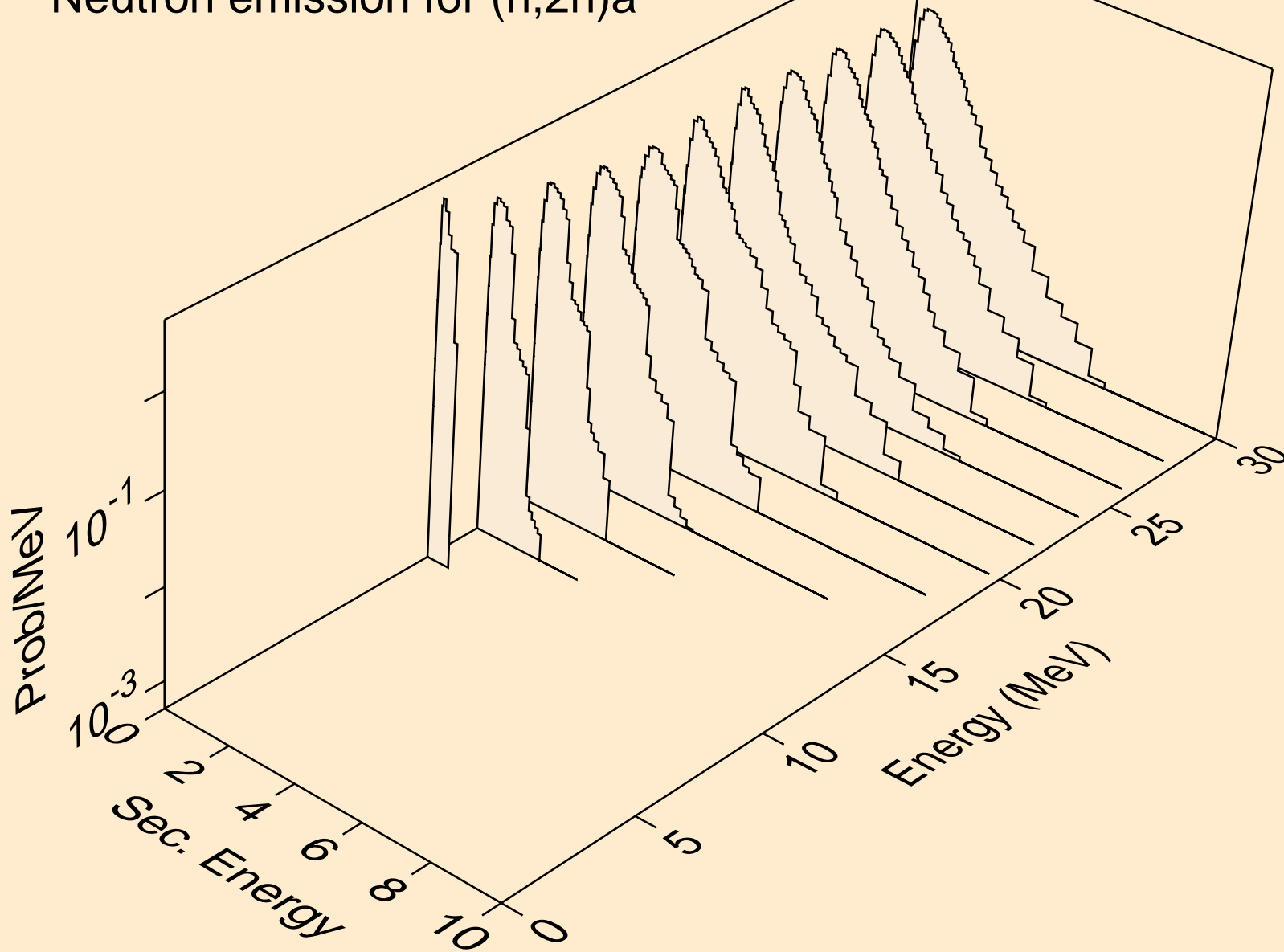

TA176 NEUTRON ACER TENDL-2019 LIBRARY; T=293.16K  
Neutron emission for (n,3n)a

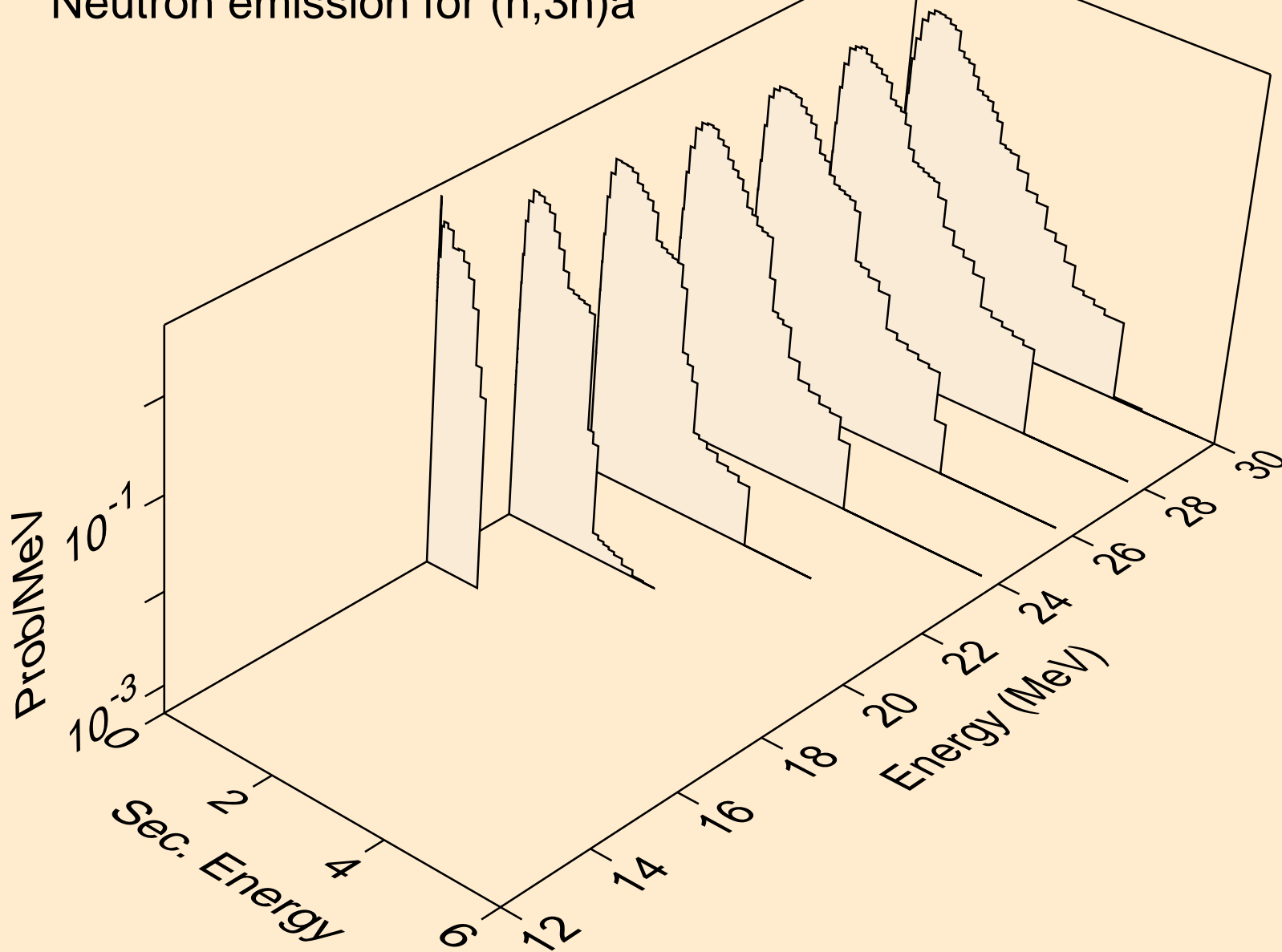

TA176 NEUTRON ACER TENDL-2019 LIBRARY; T=293.16K  
Neutron emission for (n,n\*)p

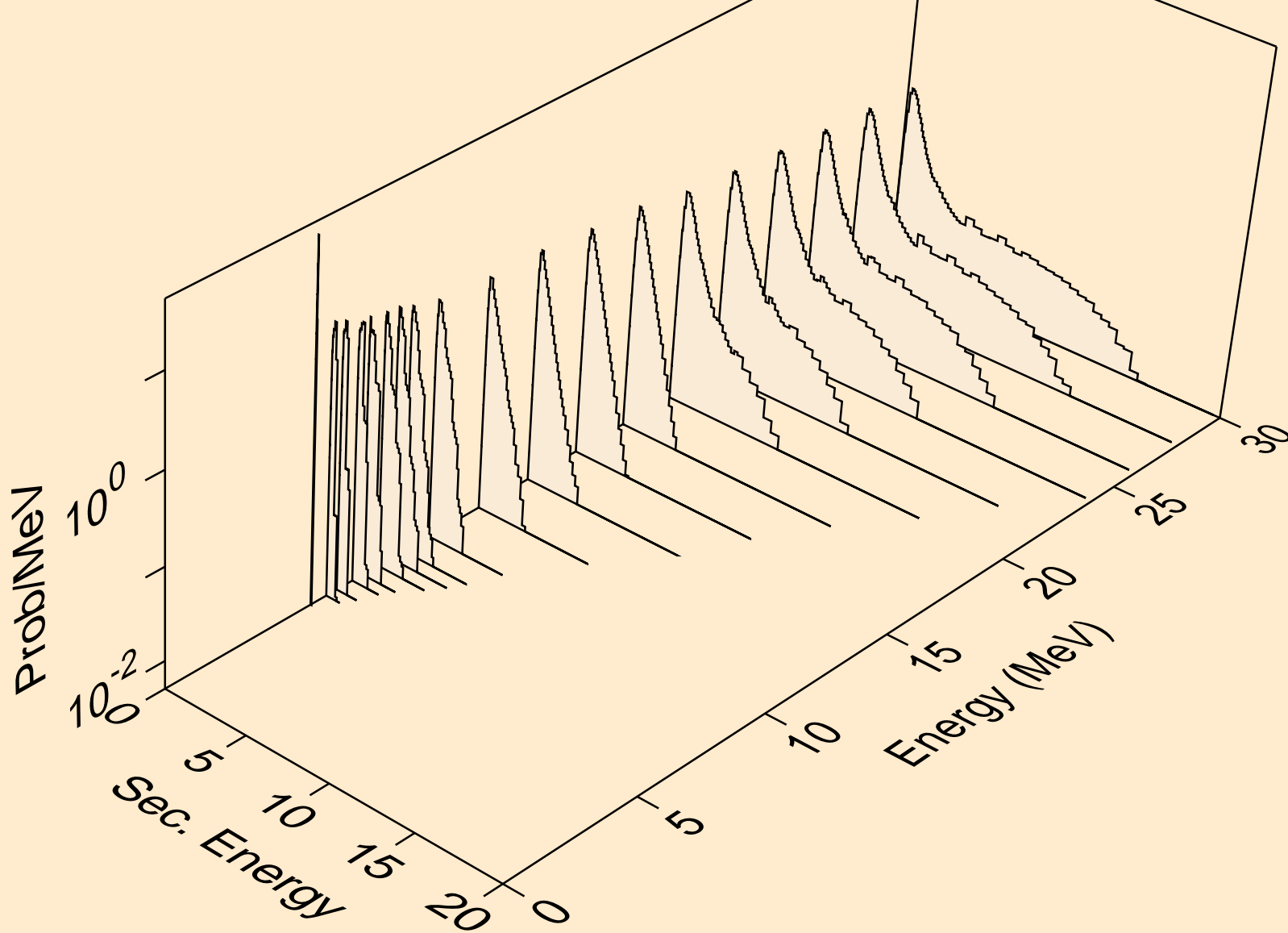

TA176 NEUTRON ACER TENDL-2019 LIBRARY; T=293.16K  
Neutron emission for (n,n\*)2a

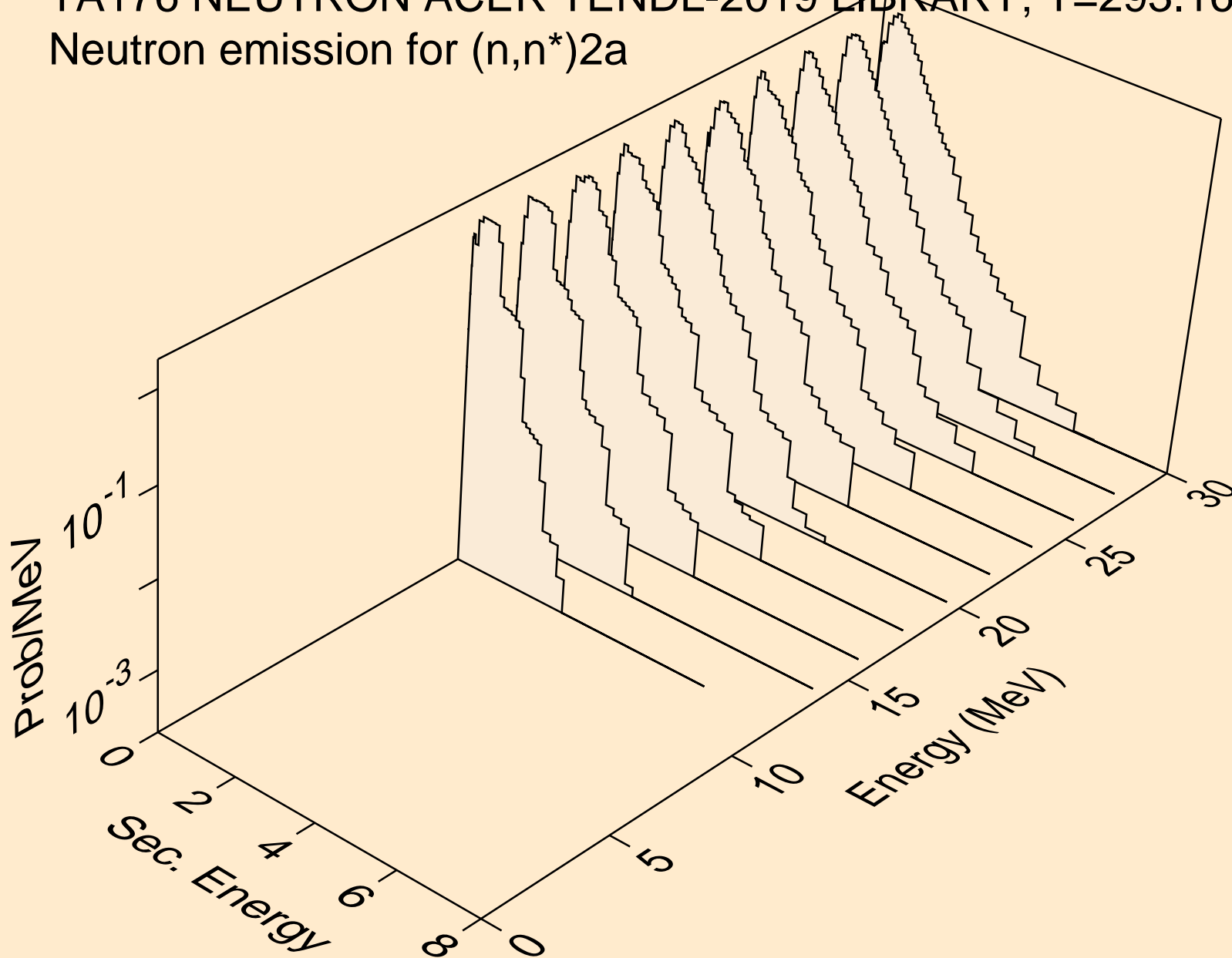

TA176 NEUTRON ACER TENDL-2019 LIBRARY; T=293.16K  
Neutron emission for (n,2n)2a

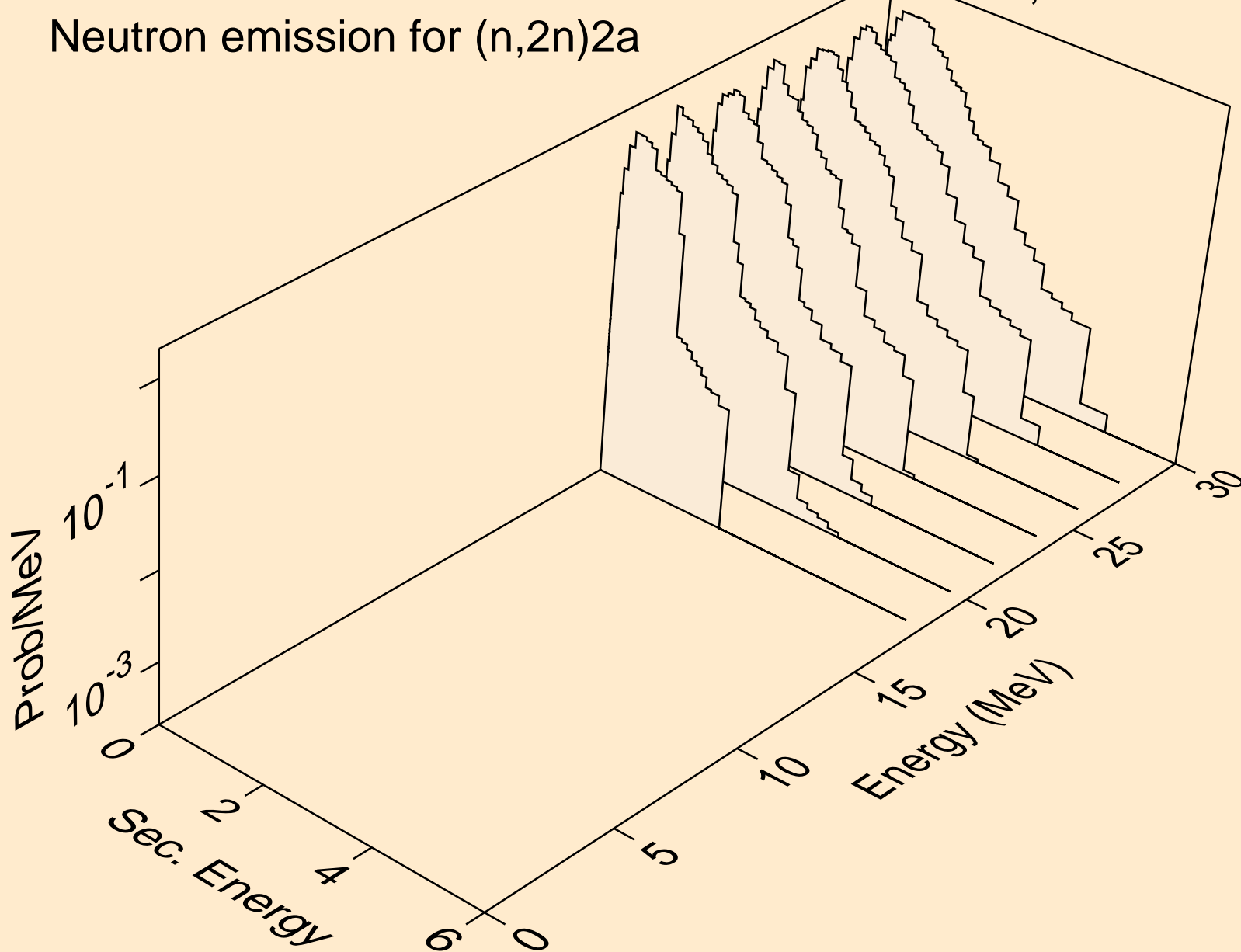

TA176 NEUTRON ACER TENDL-2019 LIBRARY; T=293.16K  
Neutron emission for (n,n\*)d

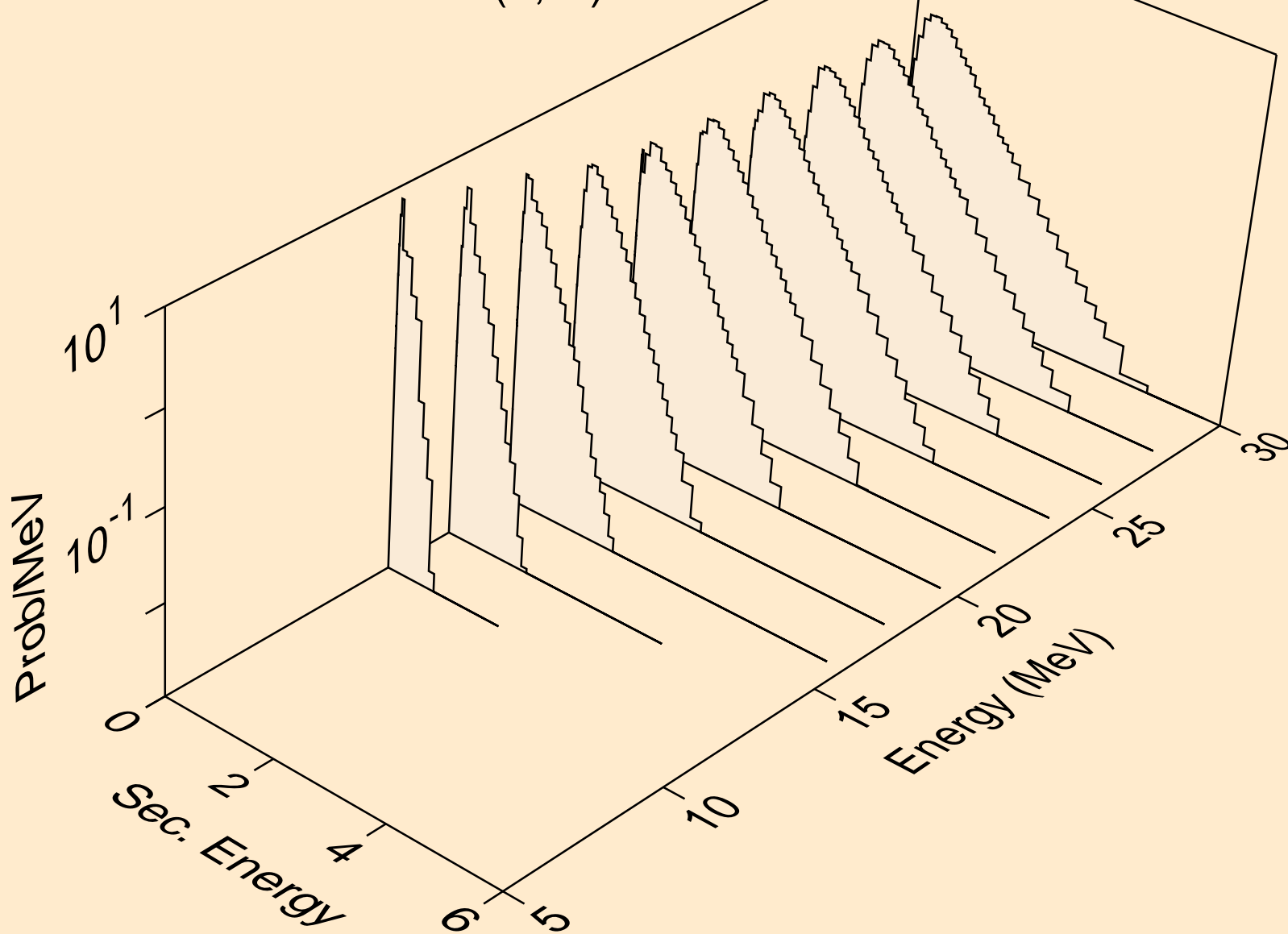



TA176 NEUTRON ACER TENDL-2019 LIBRARY; T=293.16K  
Neutron emission for (n,n\*)t

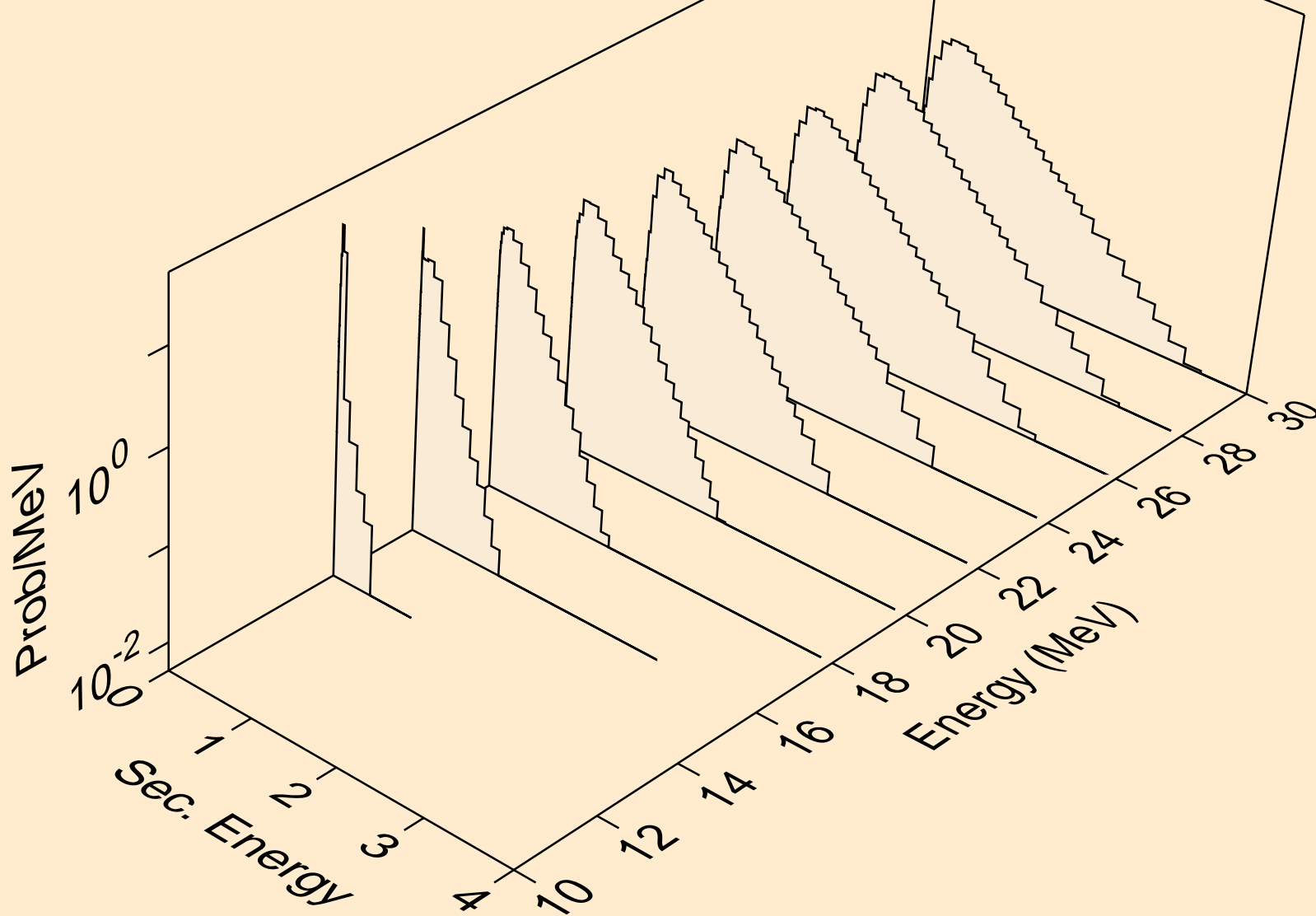

TA176 NEUTRON ACER TENDL-2019 LIBRARY; T=293.16K  
Neutron emission for (n,n\*)he3

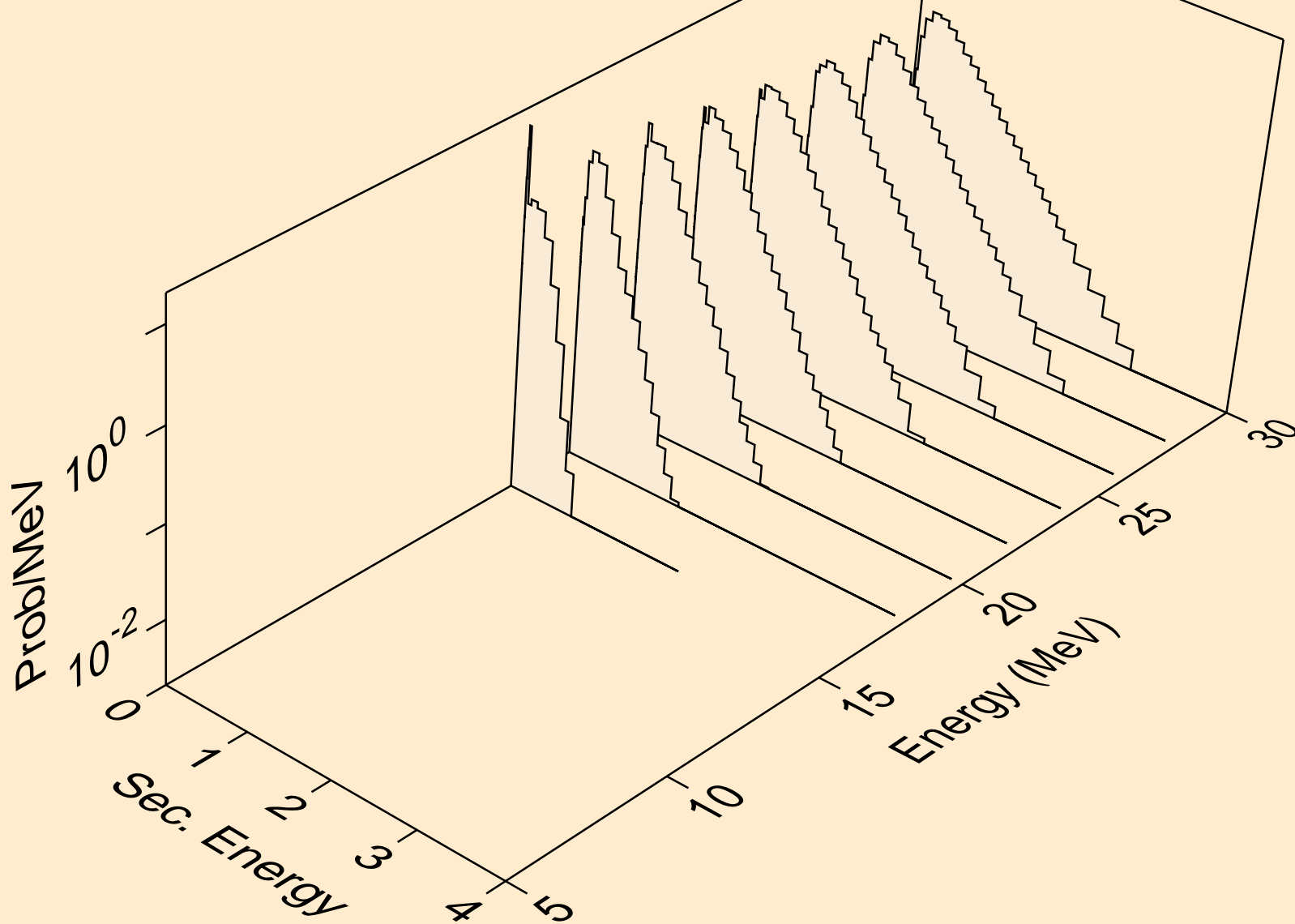

TA176 NEUTRON ACER TENDL-2019 LIBRARY; T=293.16K  
Neutron emission for (n,4n)

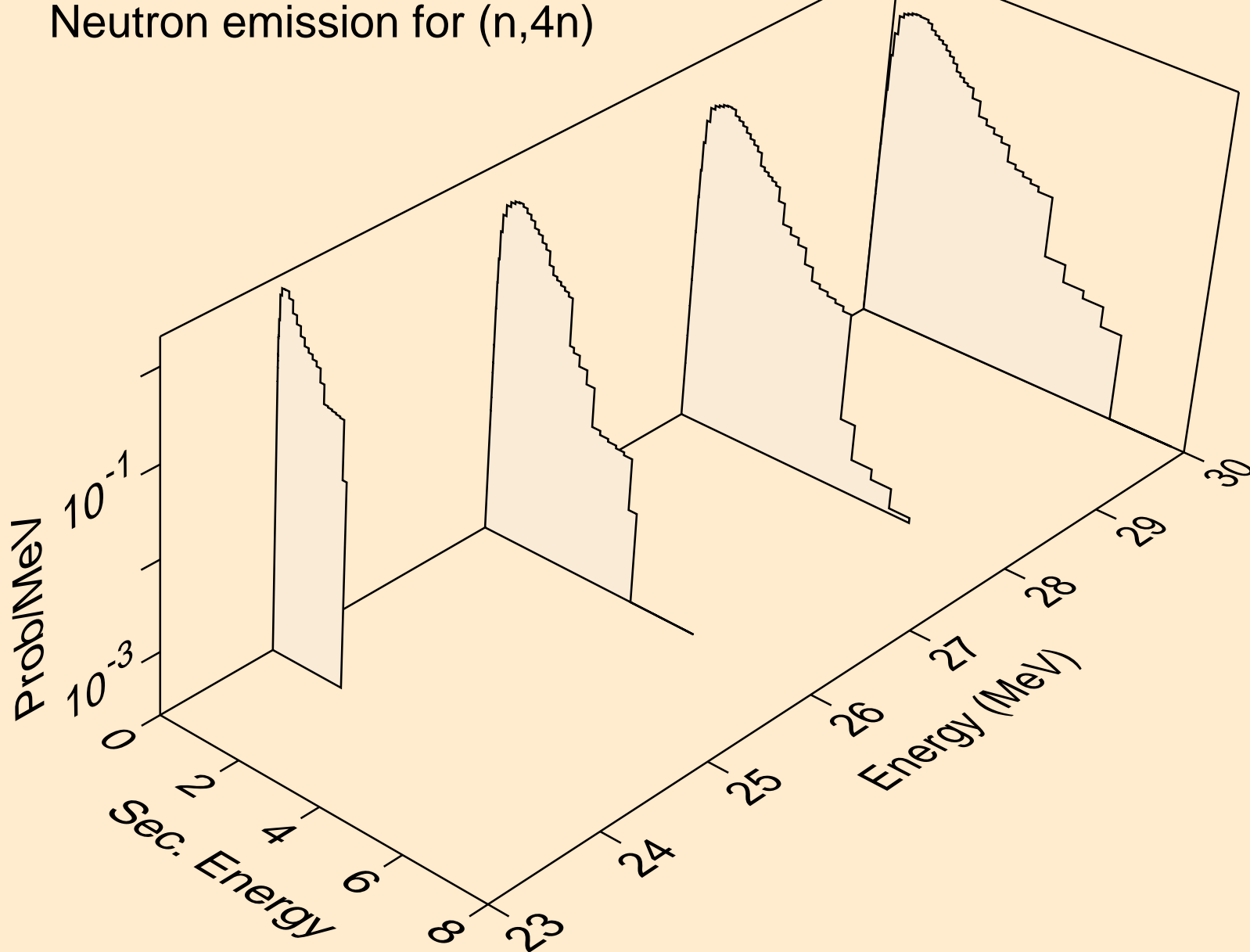

TA176 NEUTRON ACER TENDL-2019 LIBRARY; T=293.16K  
Neutron emission for (n,2np)

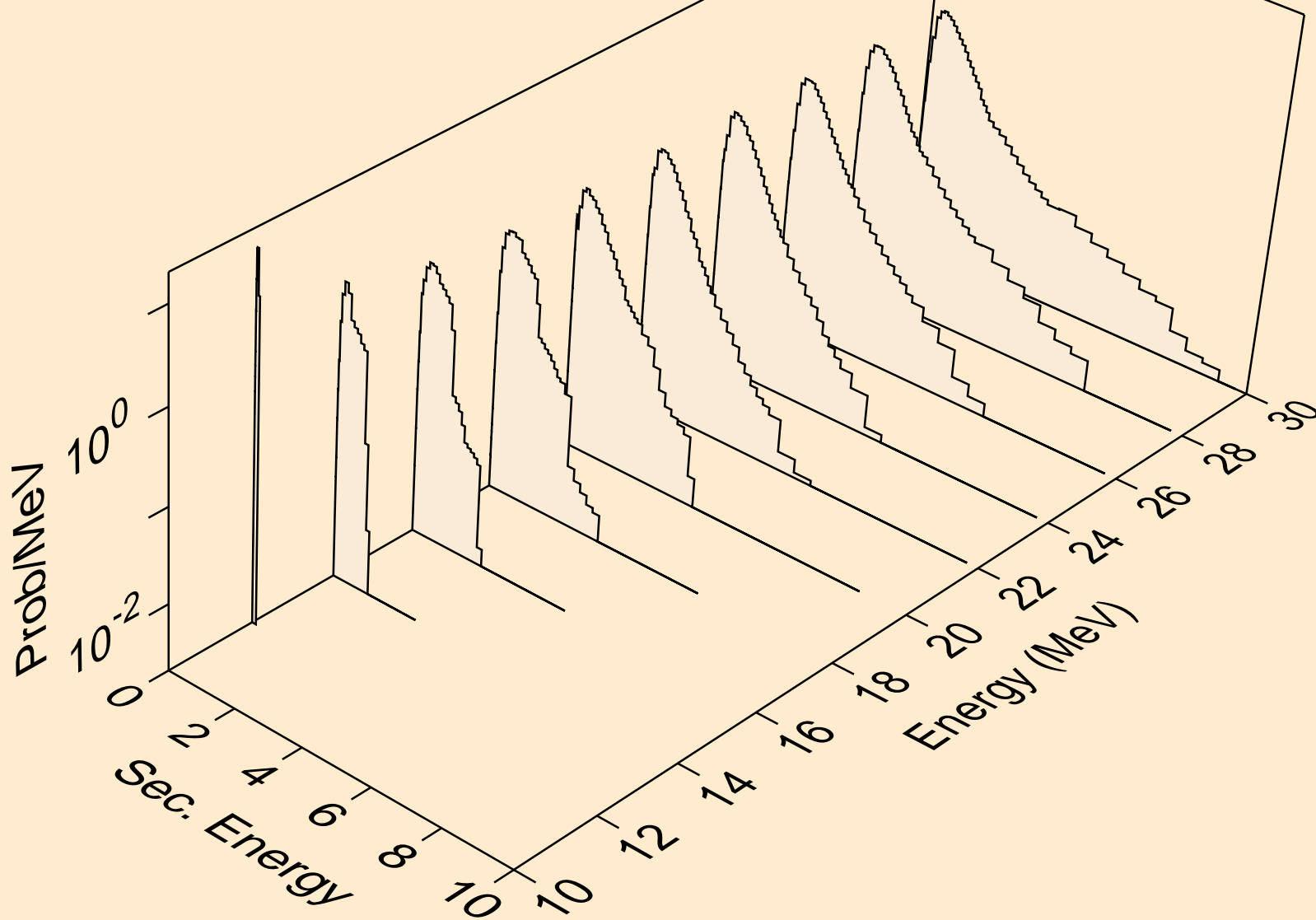

TA176 NEUTRON ACER TENDL-2019 LIBRARY; T=293.16K  
Neutron emission for (n,3np)

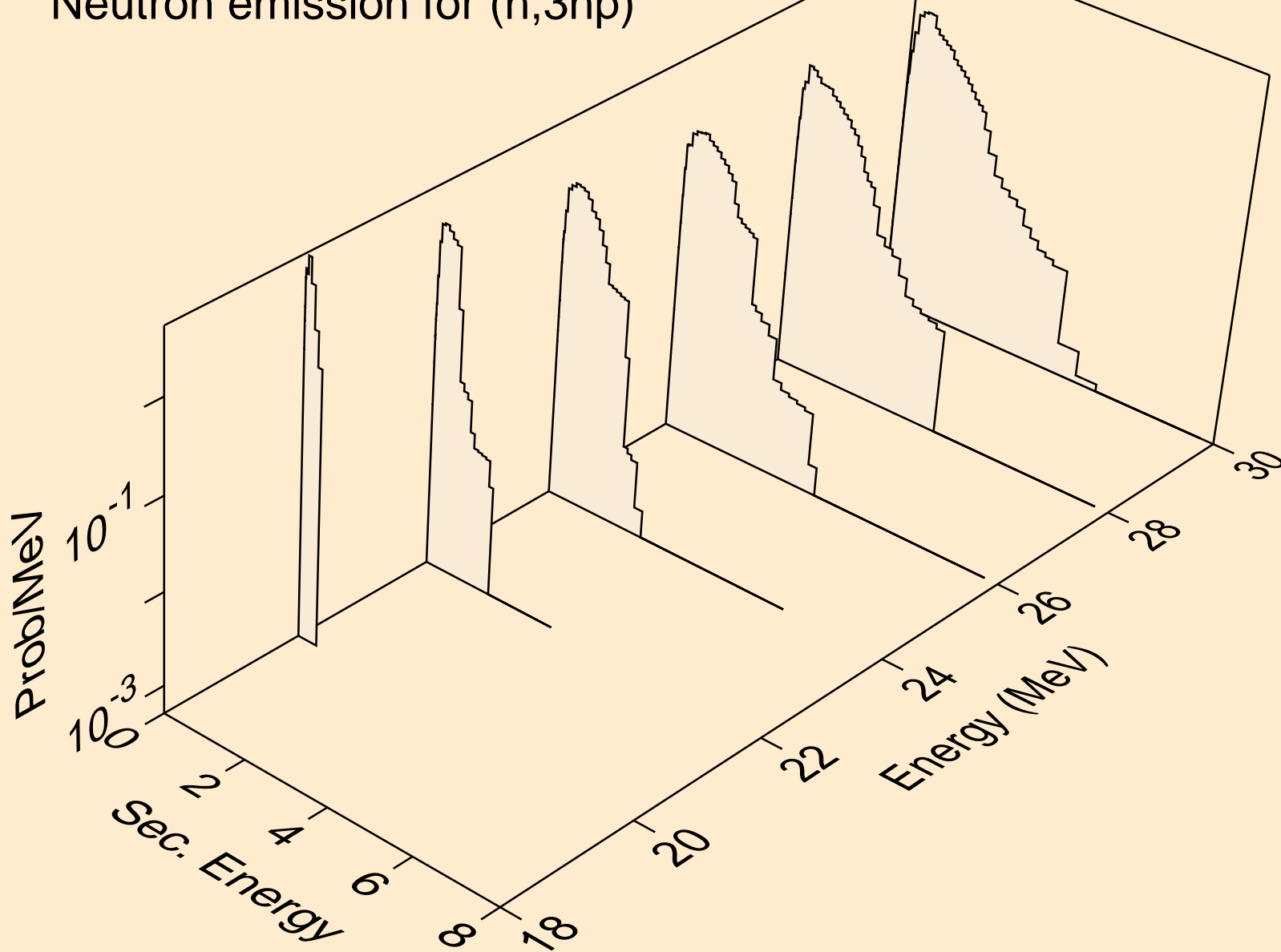

TA176 NEUTRON ACER TENDL-2019 LIBRARY; T=293.16K  
Neutron emission for (n,2np)

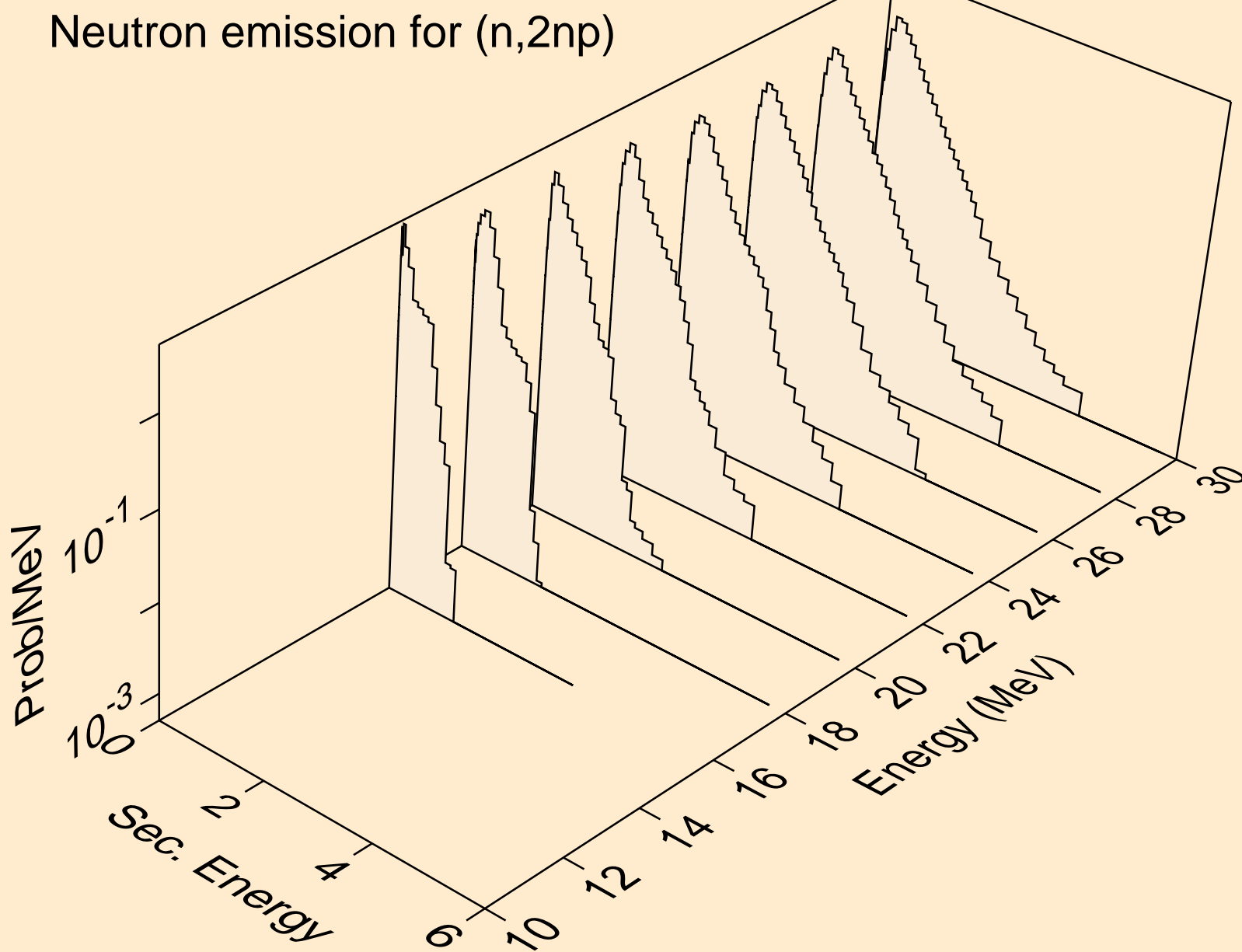

TA176 NEUTRON ACER TENDL-2019 LIBRARY; T=293.16K  
Neutron emission for (n,npa)

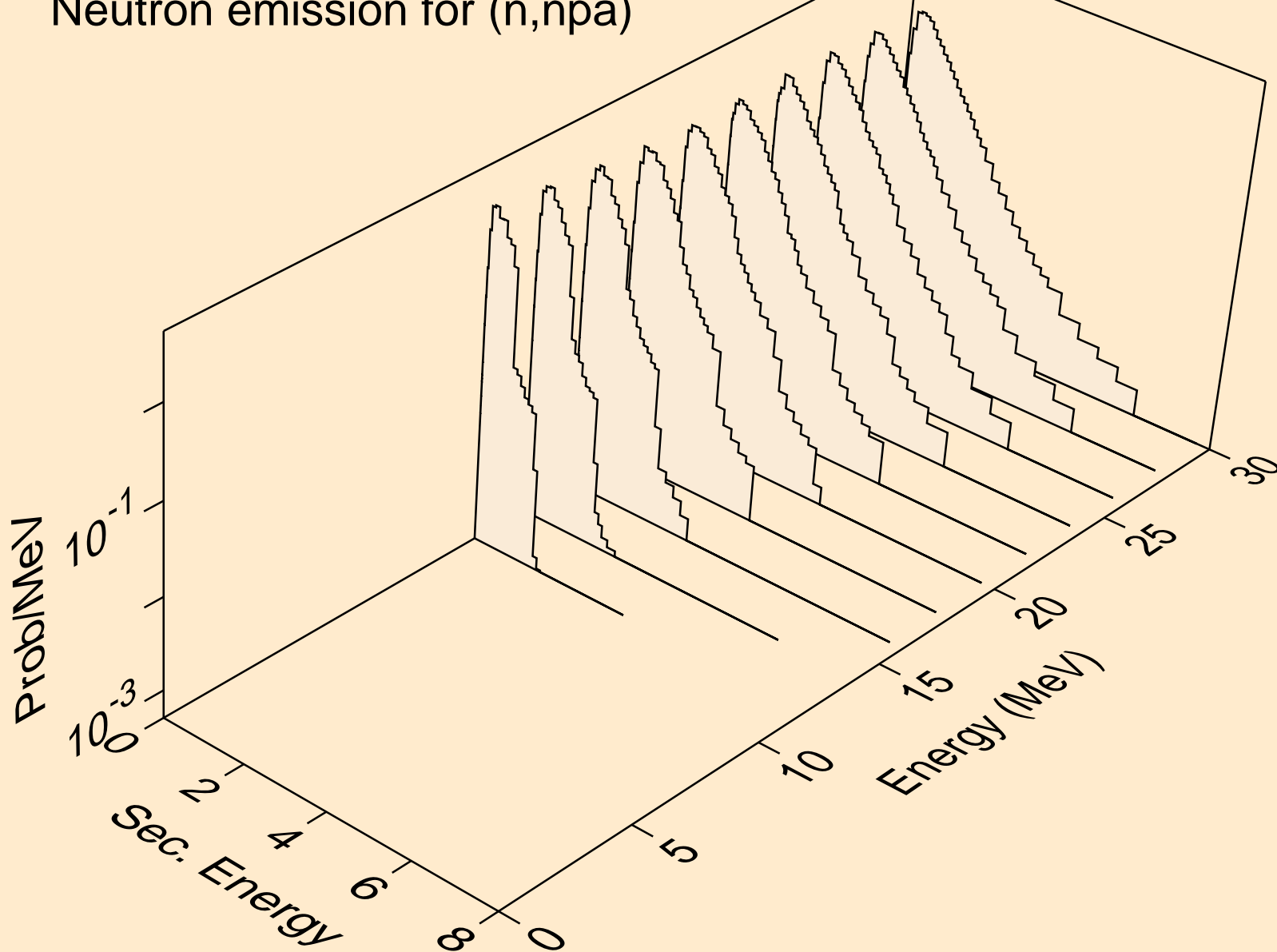

TA176 NEUTRON ACER TENDL-2019 LIBRARY; T=293.16K  
Neutron emission for (n,n\*c)

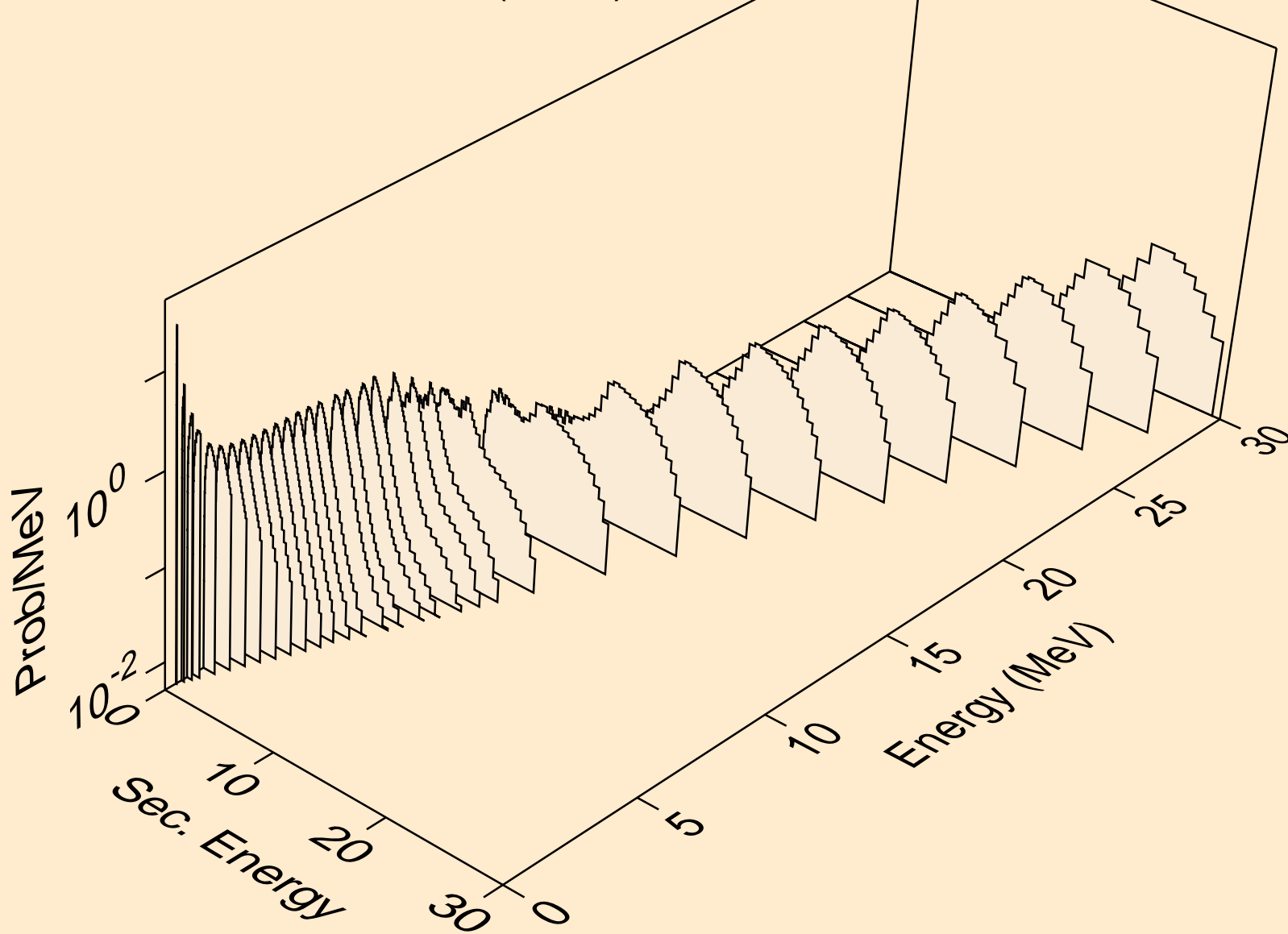



TA176 NEUTRON ACER TENDL-2019 LIBRARY; T=293.16K  
Photon emission for (n,x)

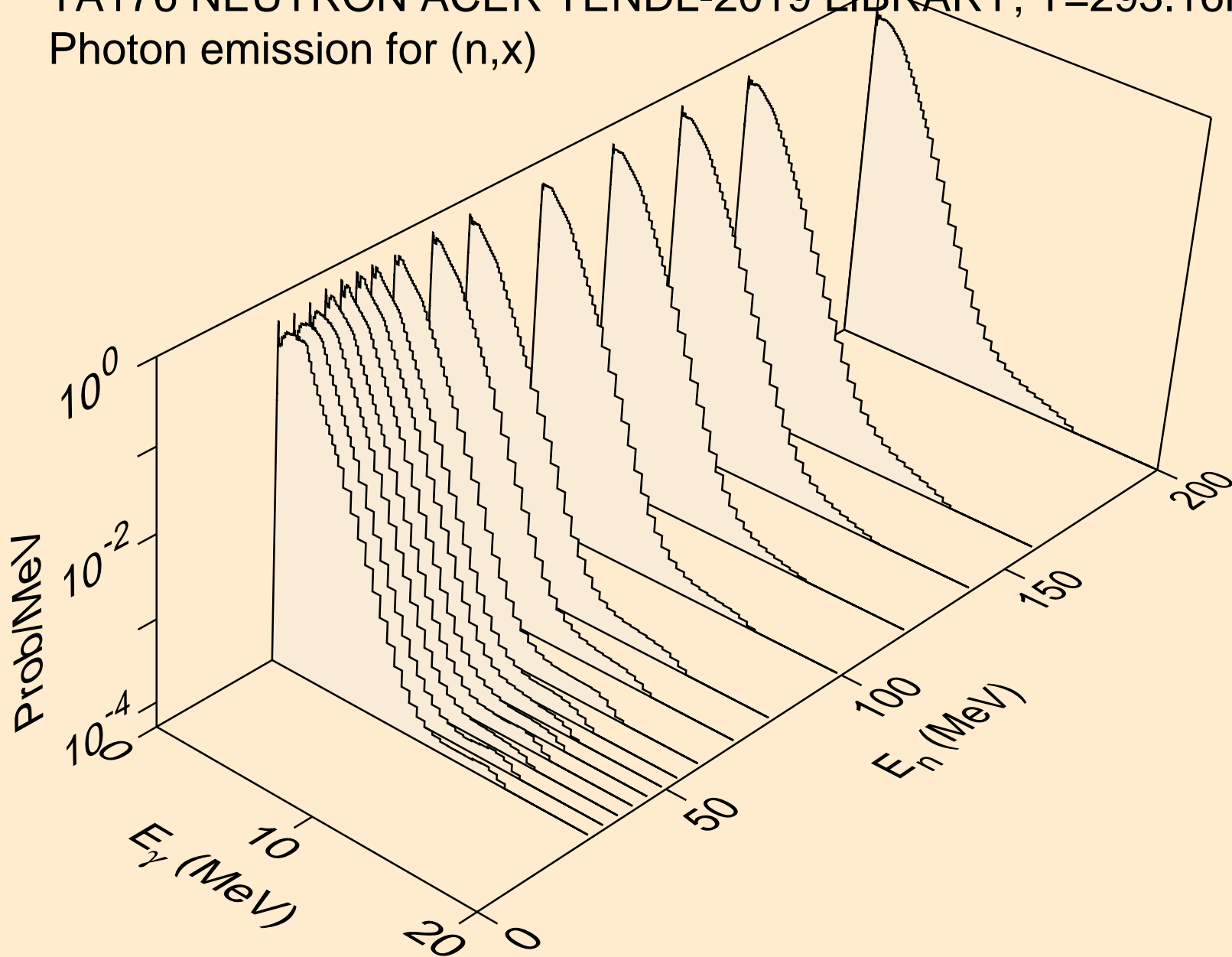

TA176 NEUTRON ACER TENDL-2019 LIBRARY; T=293.16K  
Photon emission for (n,2nd)

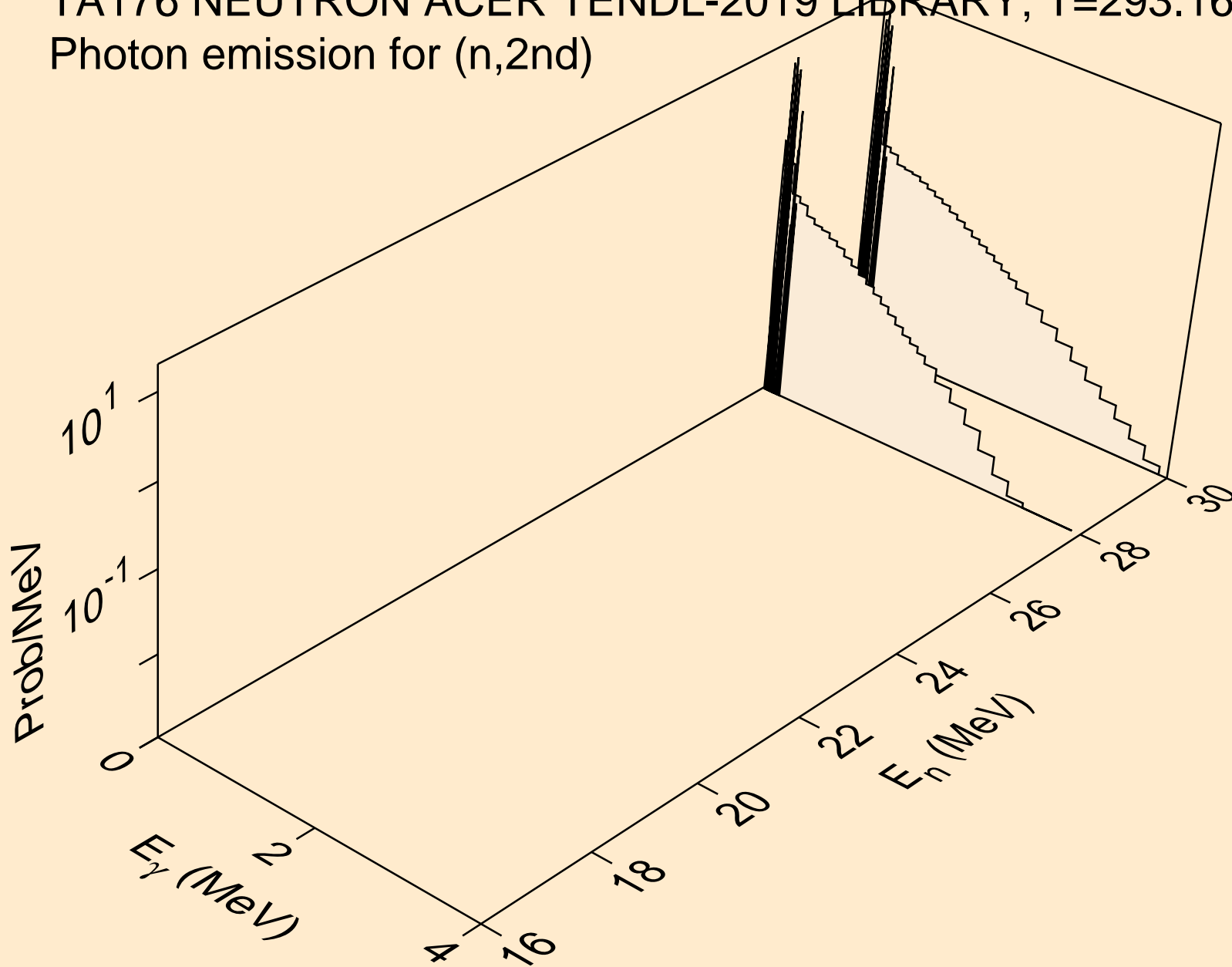

TA176 NEUTRON ACER TENDL-2019 LIBRARY; T=293.16K  
Photon emission for (n,2n)

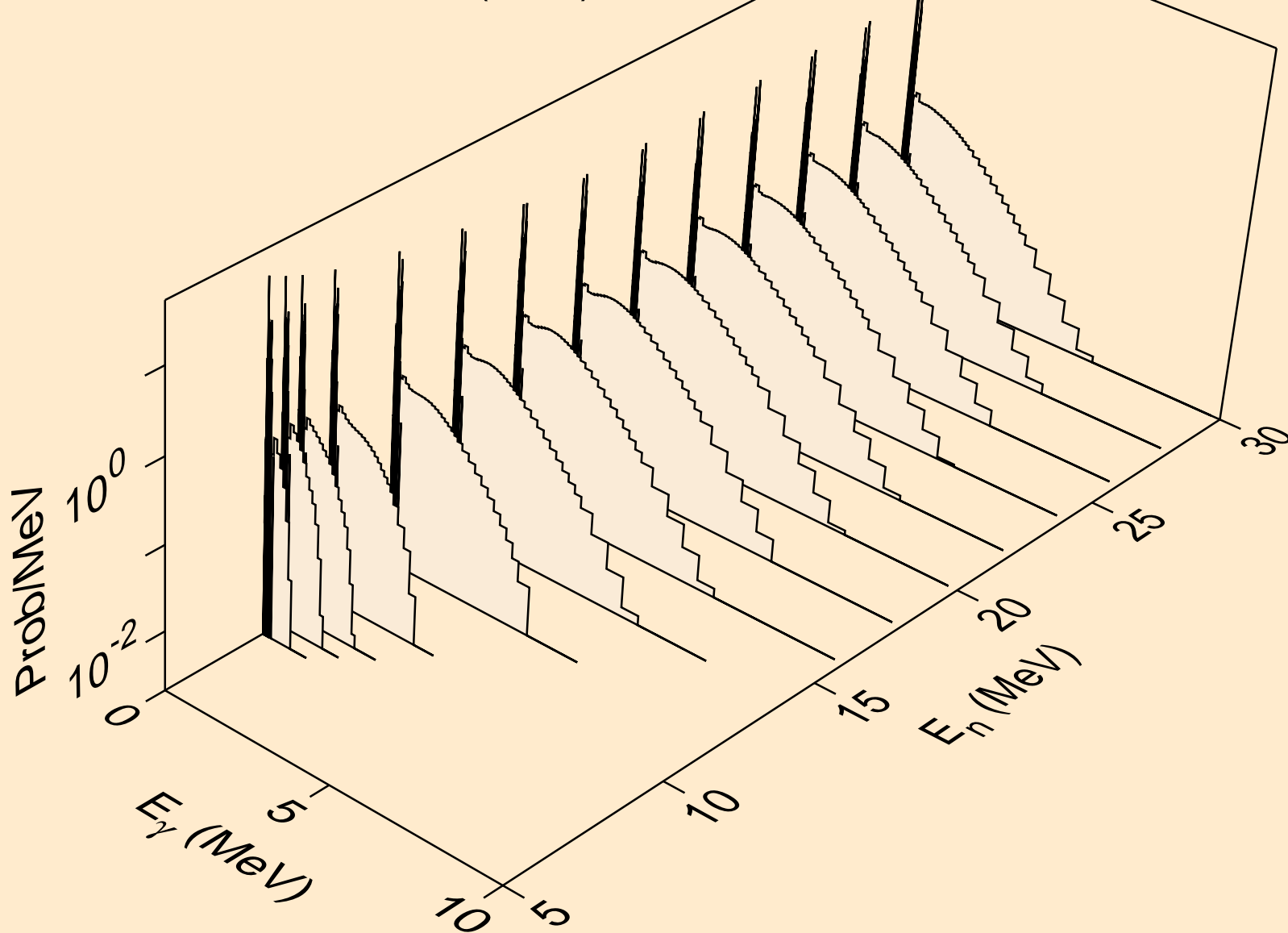

TA176 NEUTRON ACER TENDL-2019 LIBRARY; T=293.16K  
Photon emission for (n,3n)

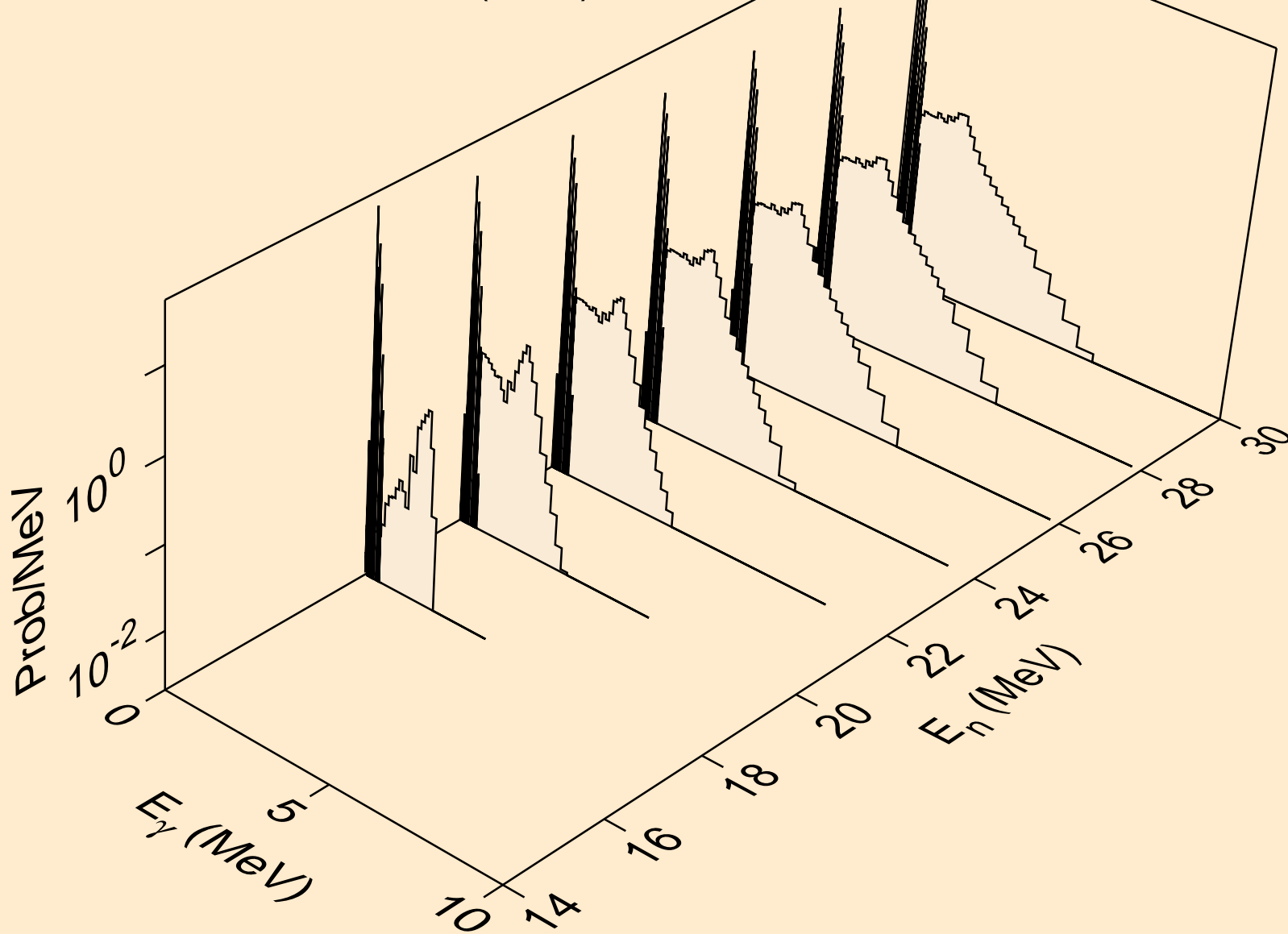

TA176 NEUTRON ACER TENDL-2019 LIBRARY; T=293.16K  
Photon emission for (n,n\*)a

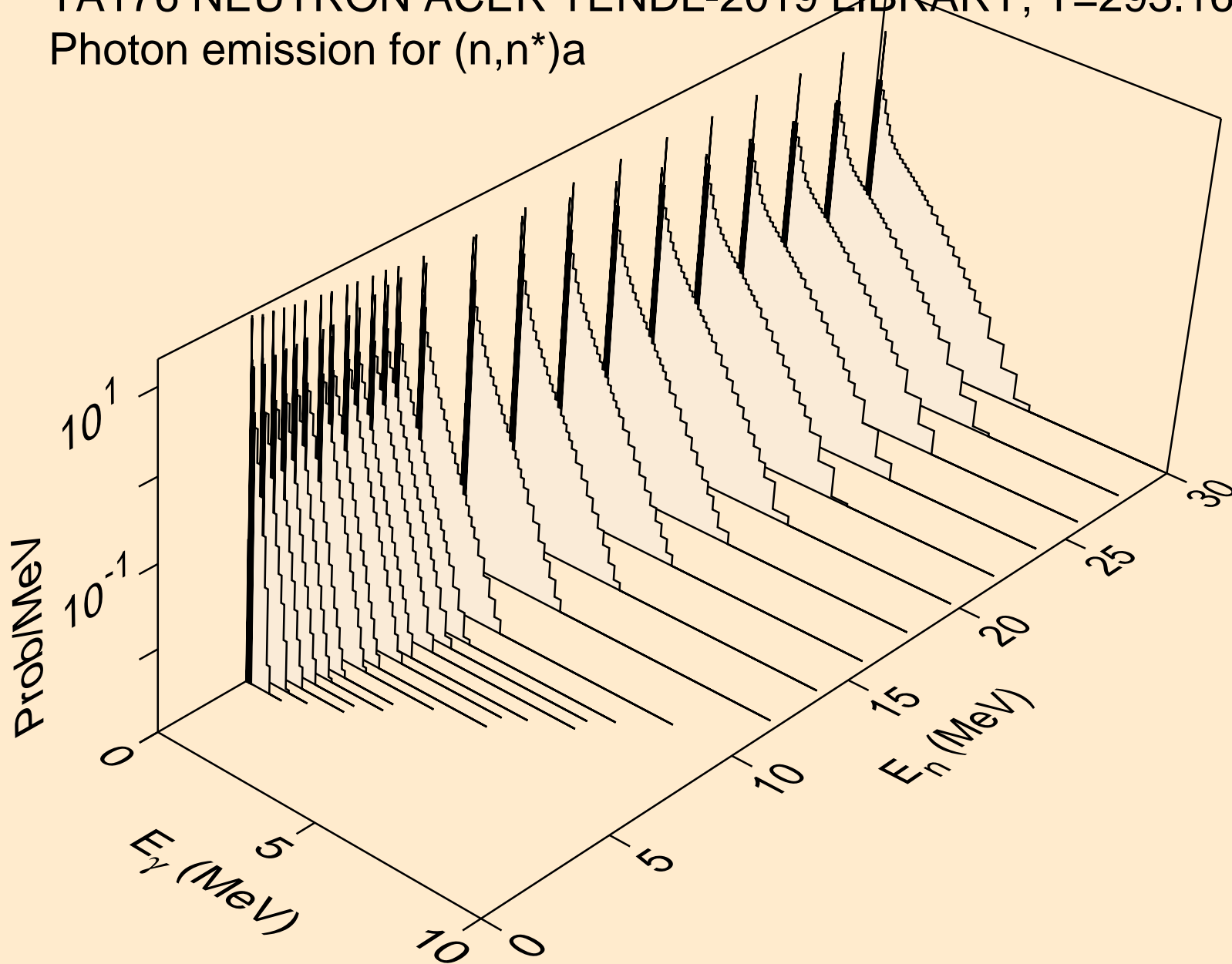

TA176 NEUTRON ACER TENDL-2019 LIBRARY; T=293.16K  
Photon emission for (n,2n)a

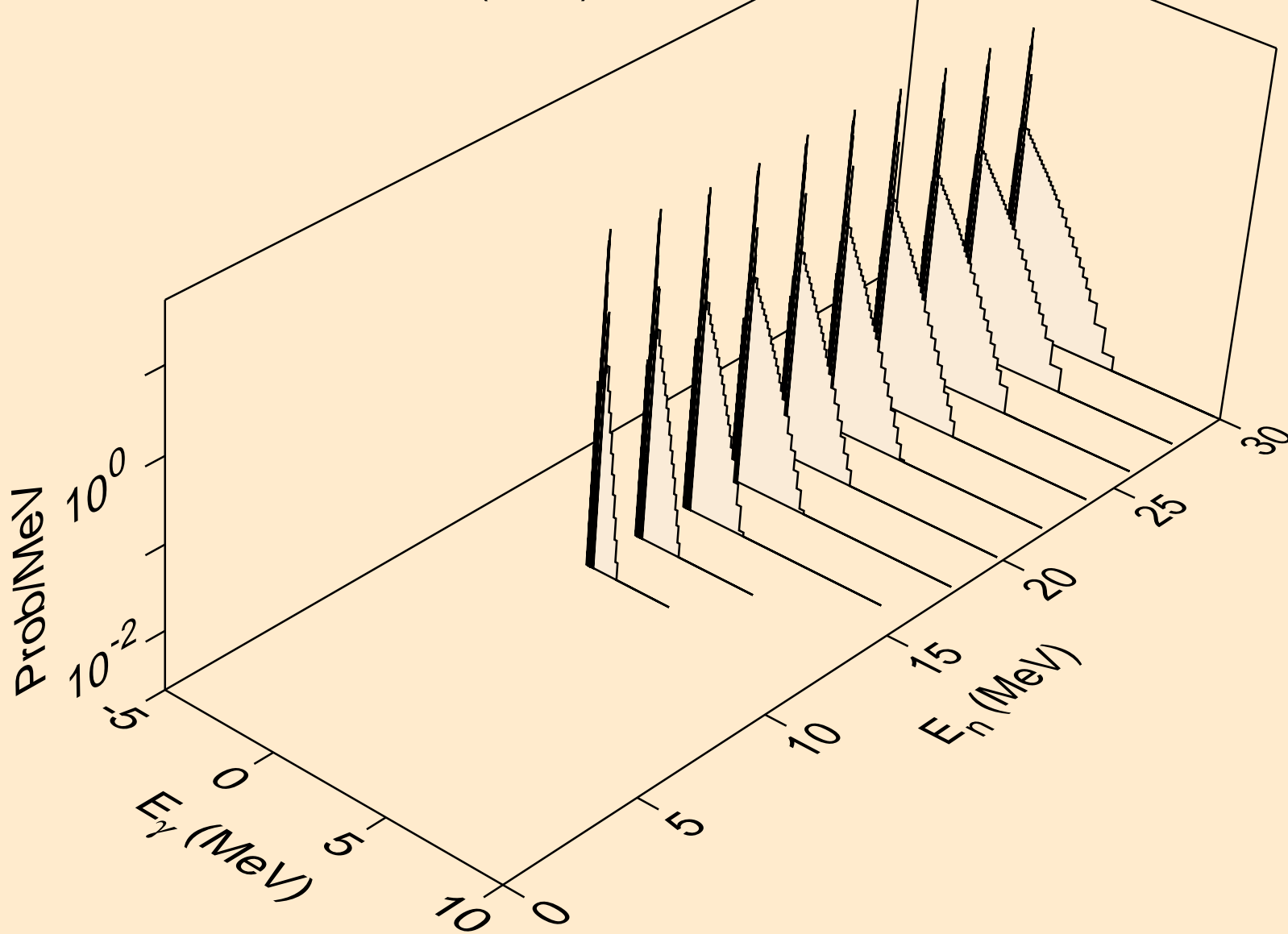

TA176 NEUTRON ACER TENDL-2019 LIBRARY; T=293.16K  
Photon emission for (n,3n)a

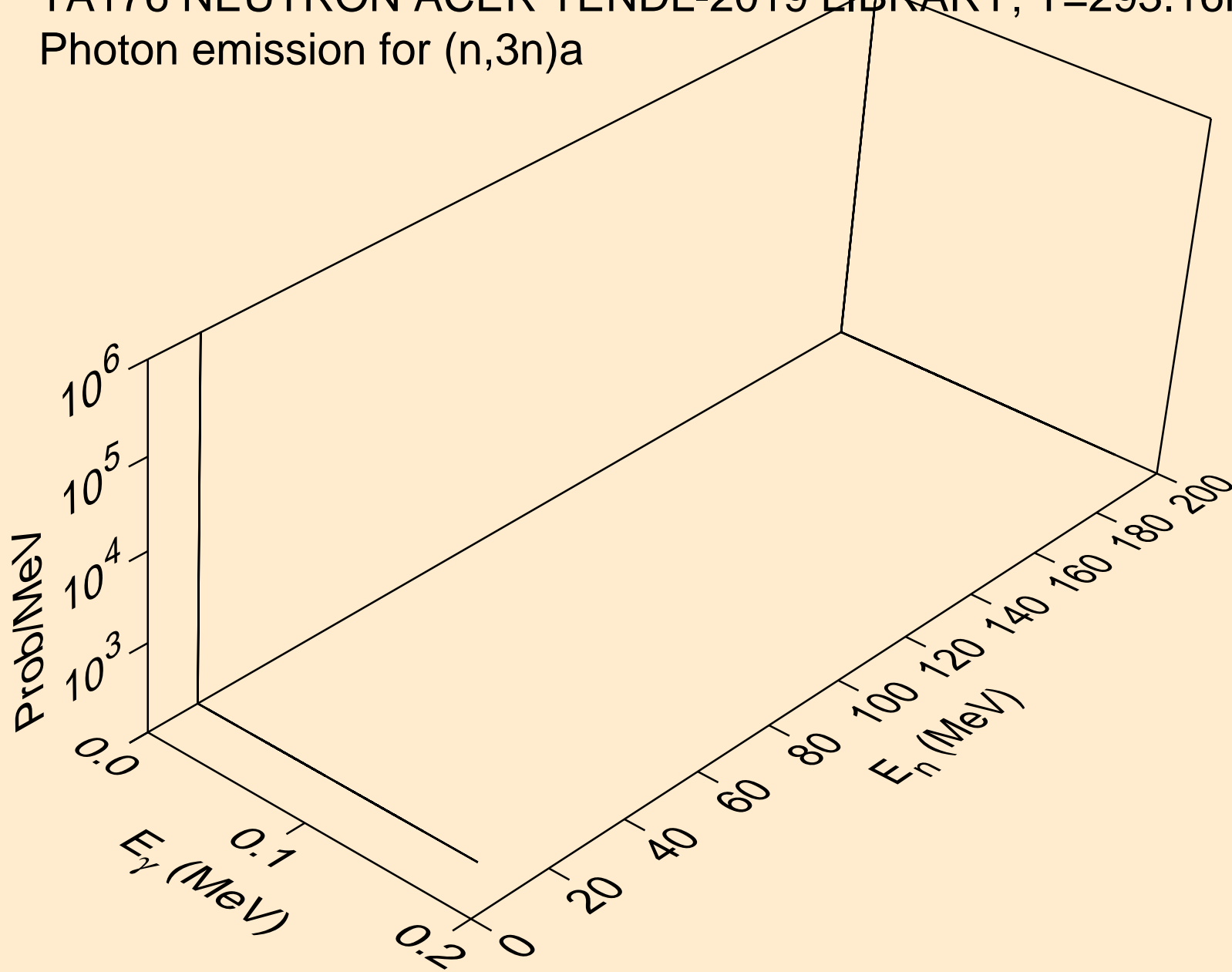

TA176 NEUTRON ACER TENDL-2019 LIBRARY; T=293.16K  
Photon emission for (n,n\*)p

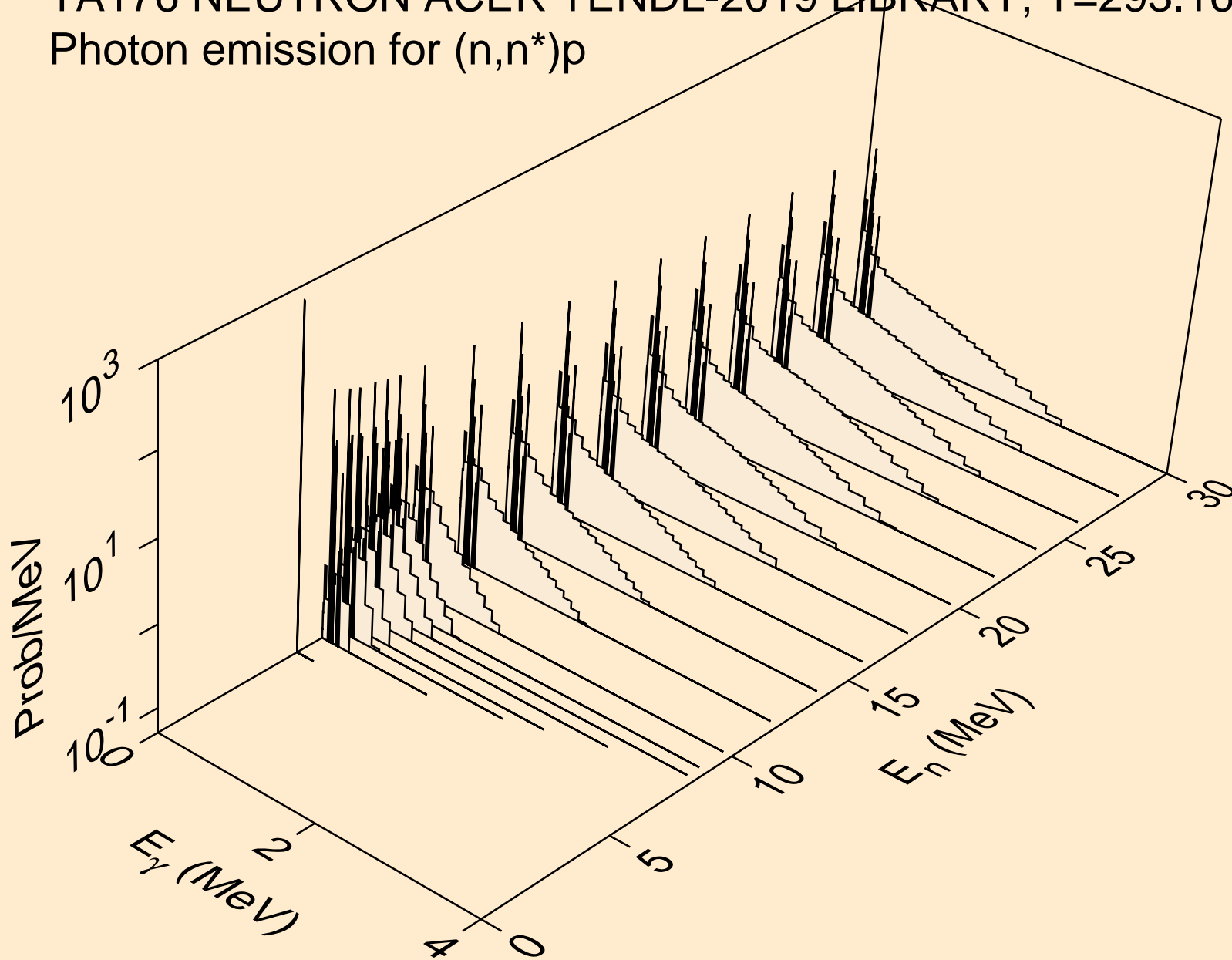



TA176 NEUTRON ACER TENDL-2019 LIBRARY; T=293.16K  
Photon emission for (n,n\*)2a

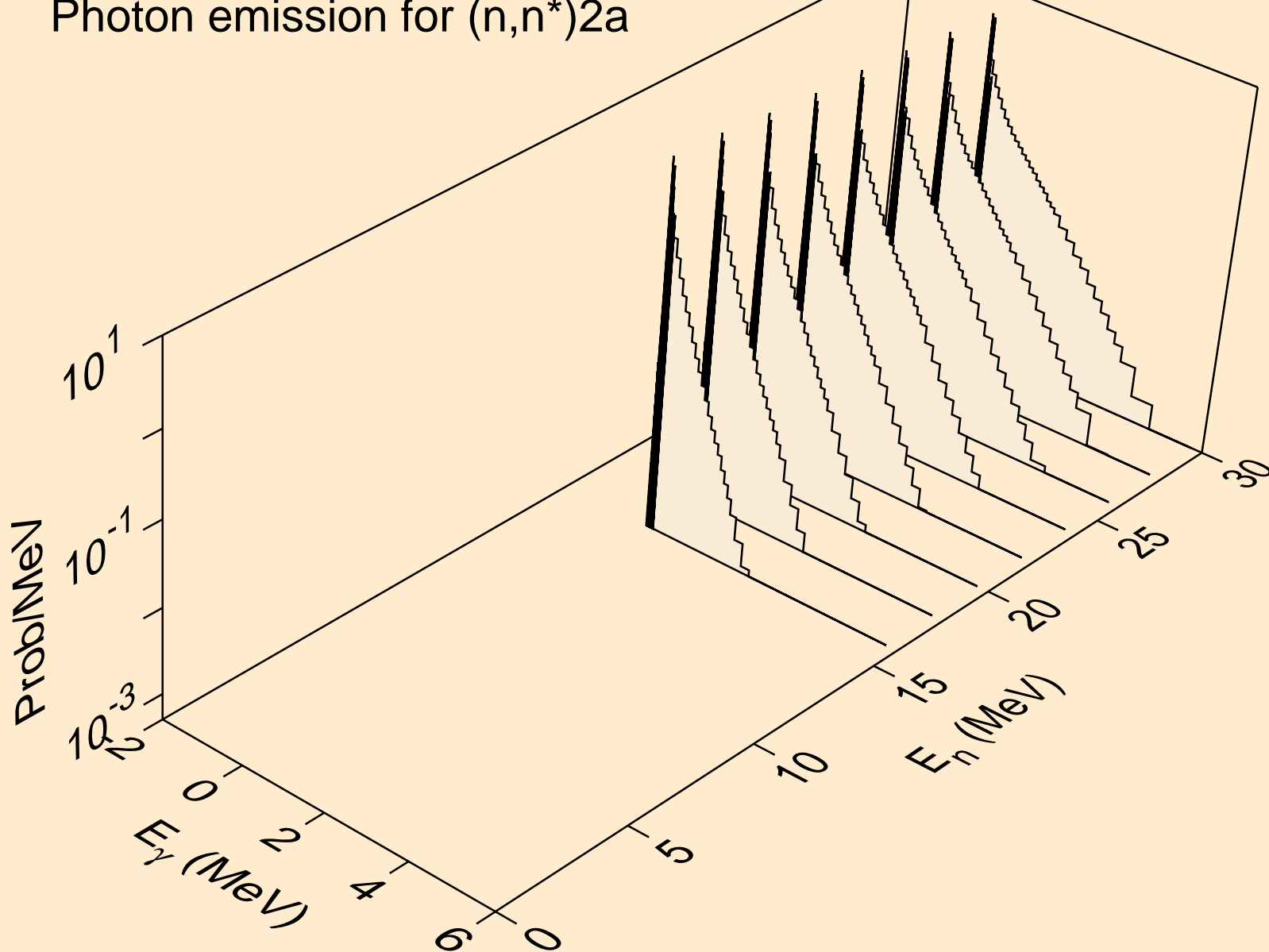

TA176 NEUTRON ACER TENDL-2019 LIBRARY; T=293.16K  
Photon emission for (n,2n)2a

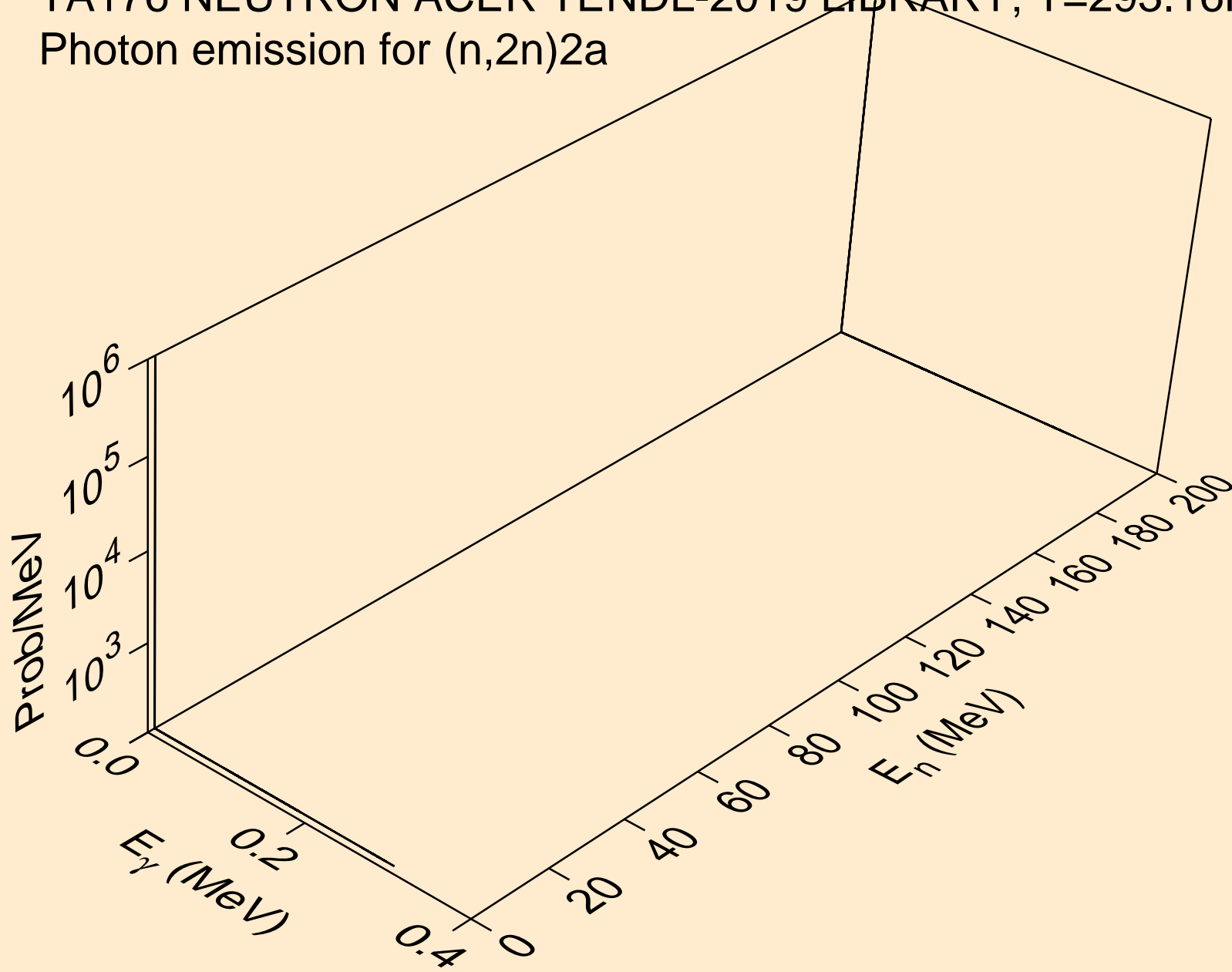

TA176 NEUTRON ACER TENDL-2019 LIBRARY; T=293.16K  
Photon emission for (n,n\*)d

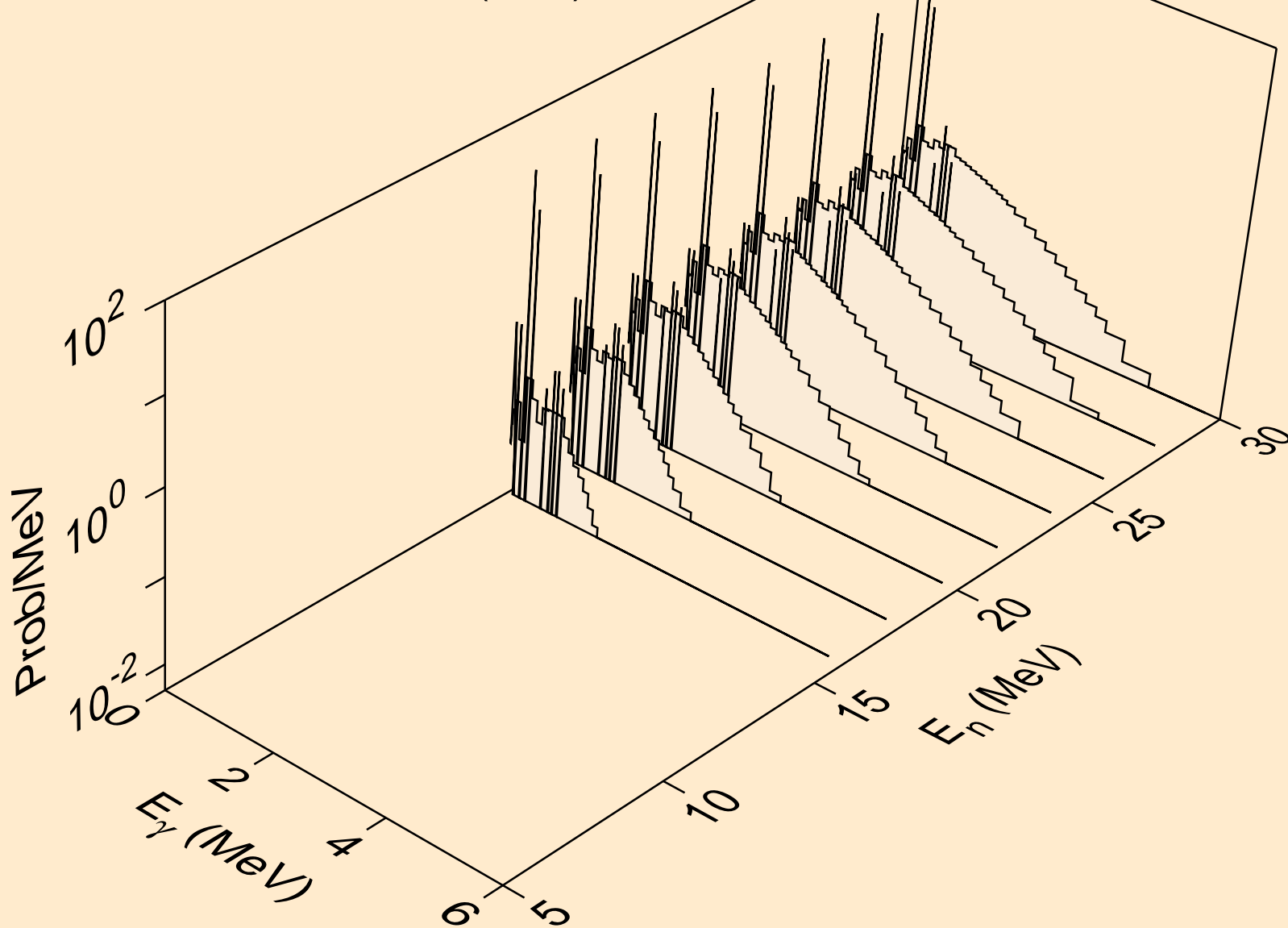

TA176 NEUTRON ACER TENDL-2019 LIBRARY; T=293.16K  
Photon emission for (n,n\*)t

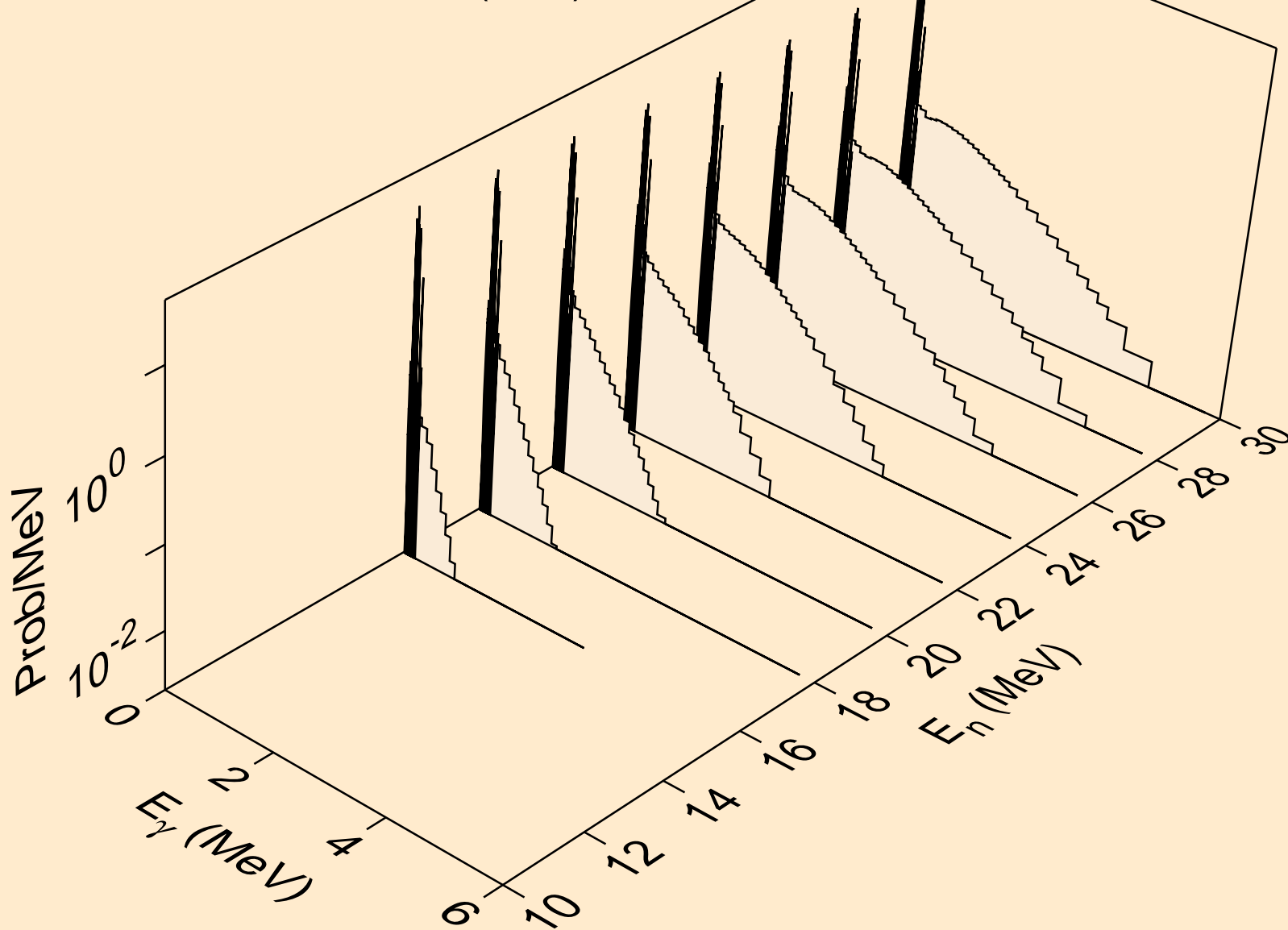

TA176 NEUTRON ACER TENDL-2019 LIBRARY; T=293.16K  
Photon emission for (n,n\*)he3

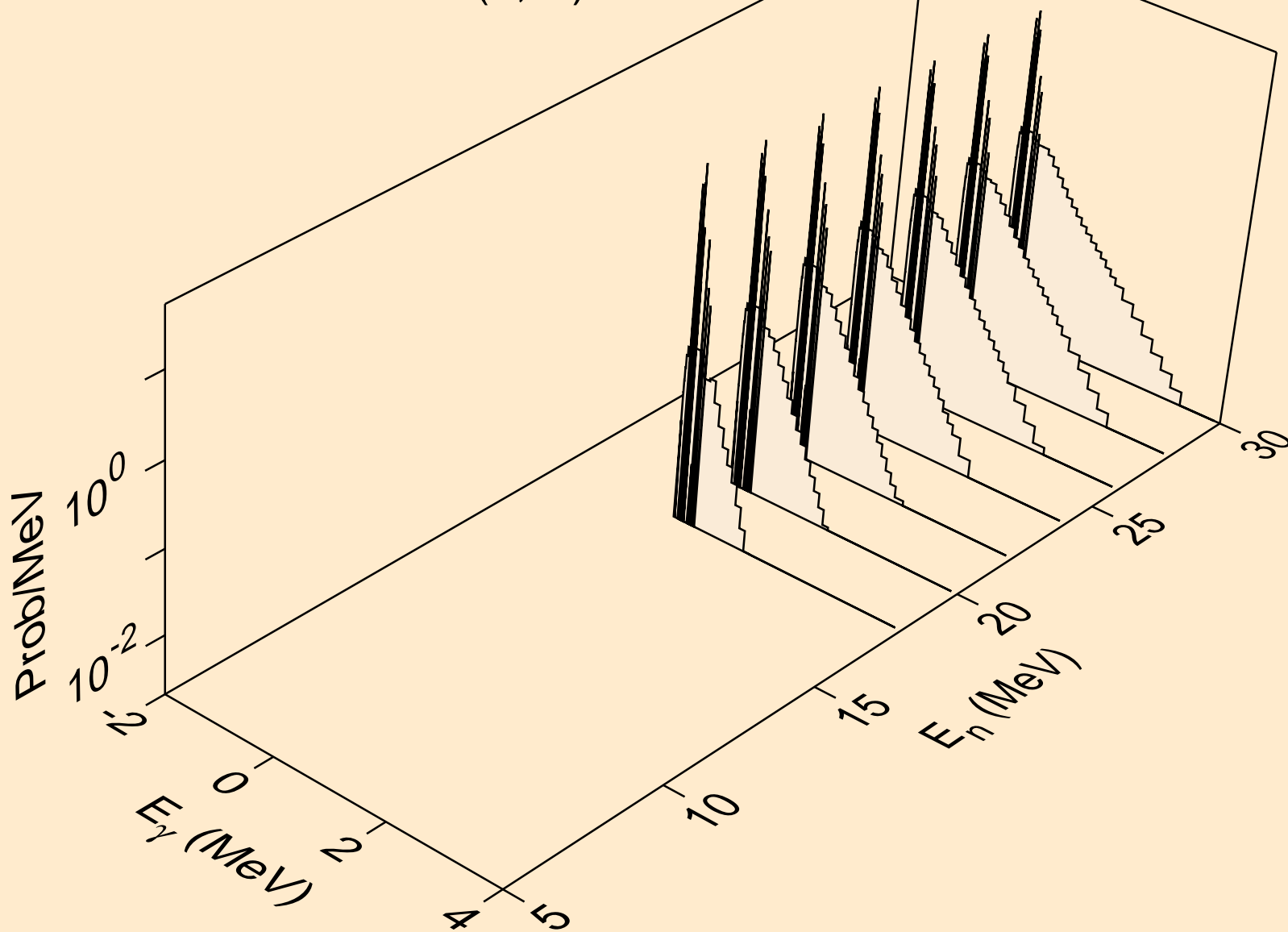

TA176 NEUTRON ACER TENDL-2019 LIBRARY; T=293.16K  
Photon emission for (n,4n)

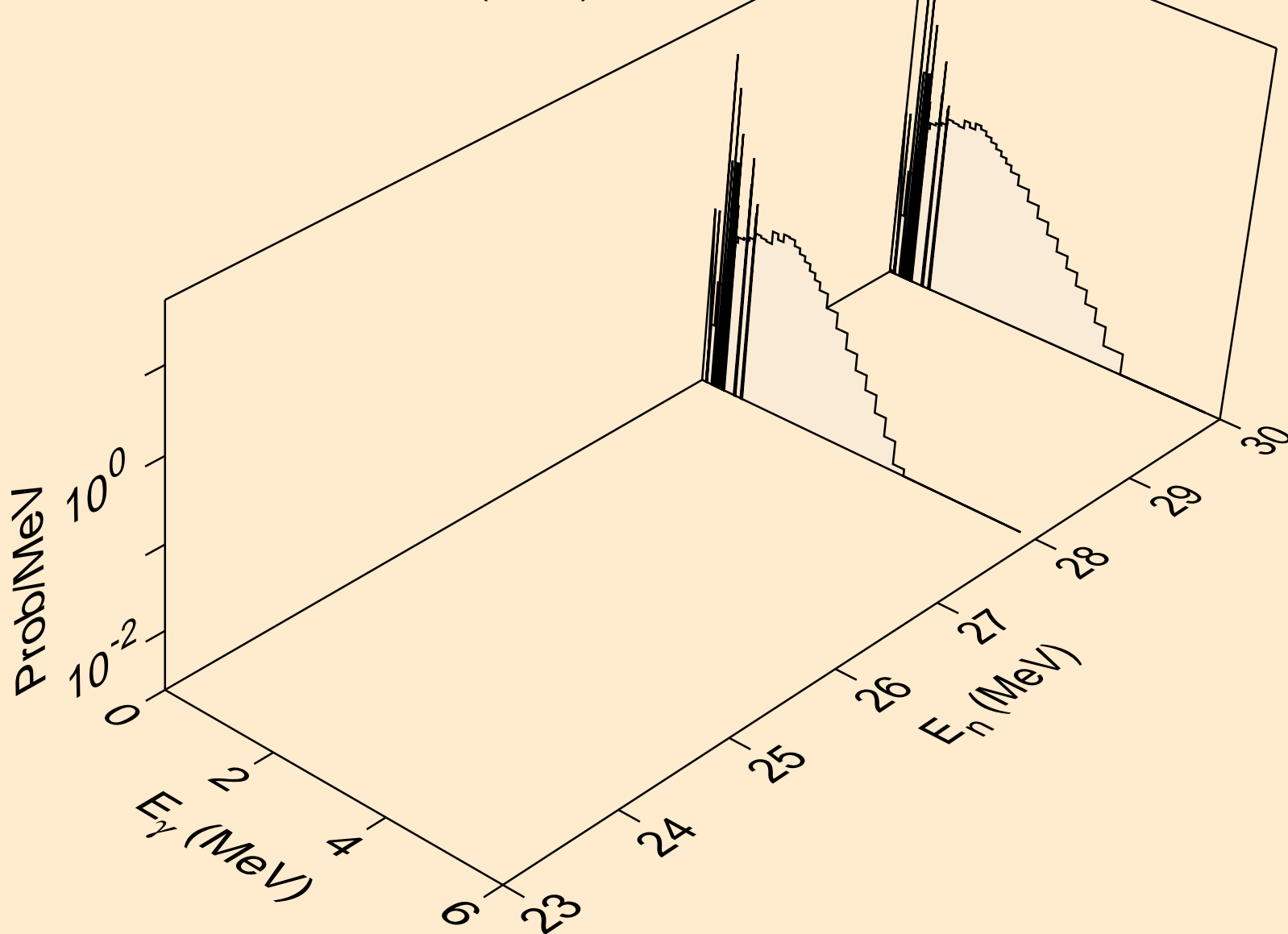

TA176 NEUTRON ACER TENDL-2019 LIBRARY; T=293.16K  
Photon emission for (n,2np)

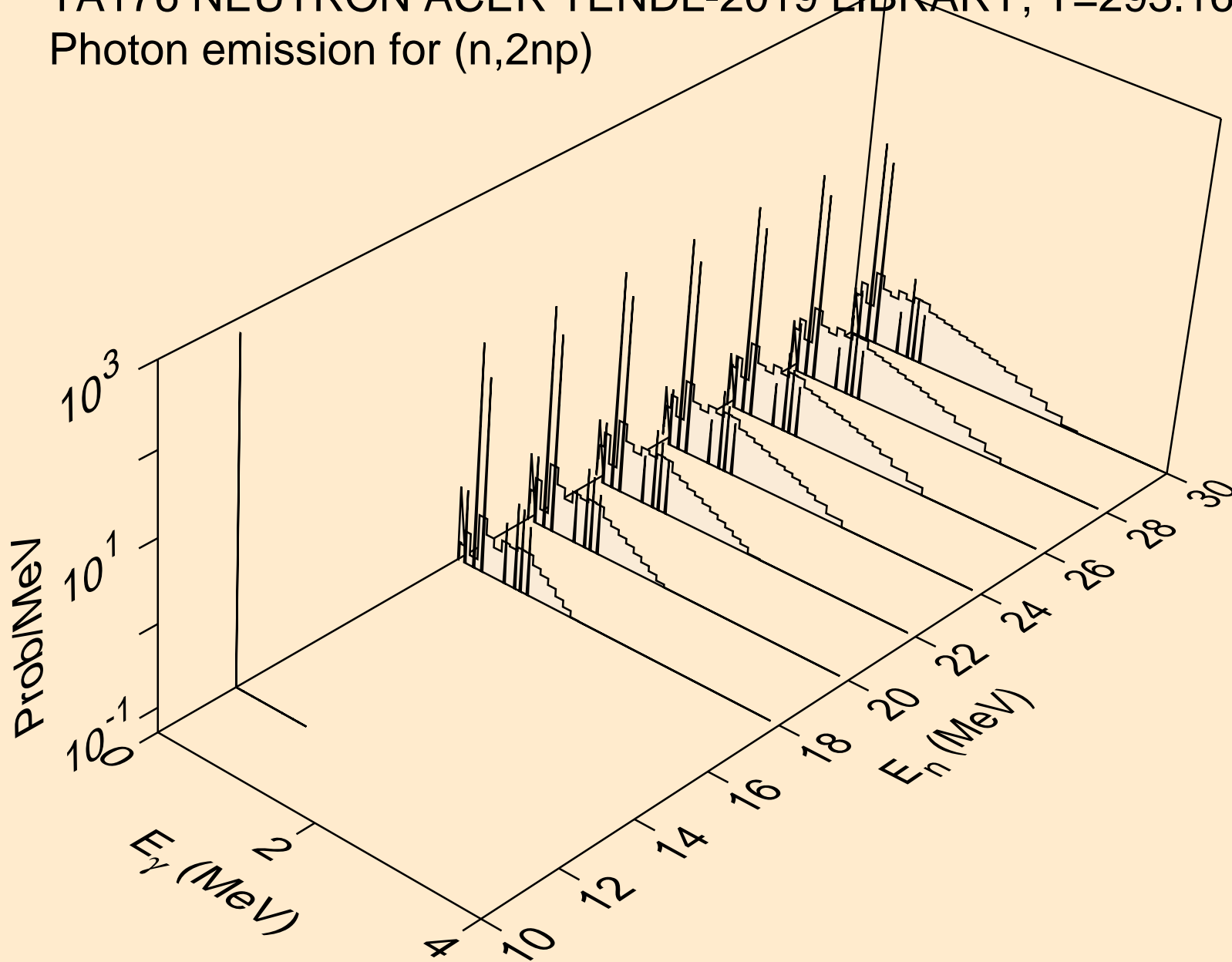

TA176 NEUTRON ACER TENDL-2019 LIBRARY; T=293.16K  
Photon emission for (n,3np)

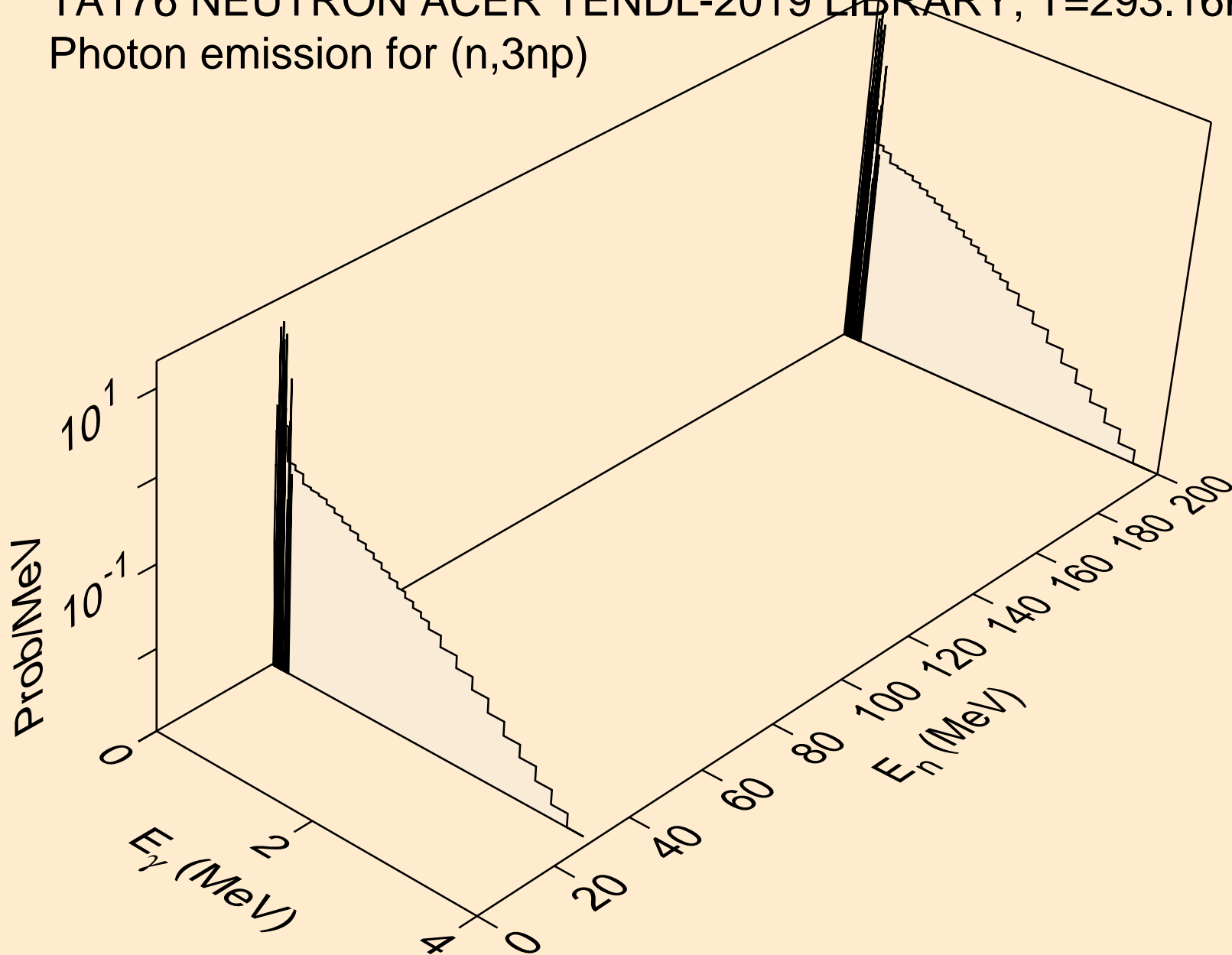



TA176 NEUTRON ACER TENDL-2019 LIBRARY; T=293.16K  
Photon emission for (n,2np)

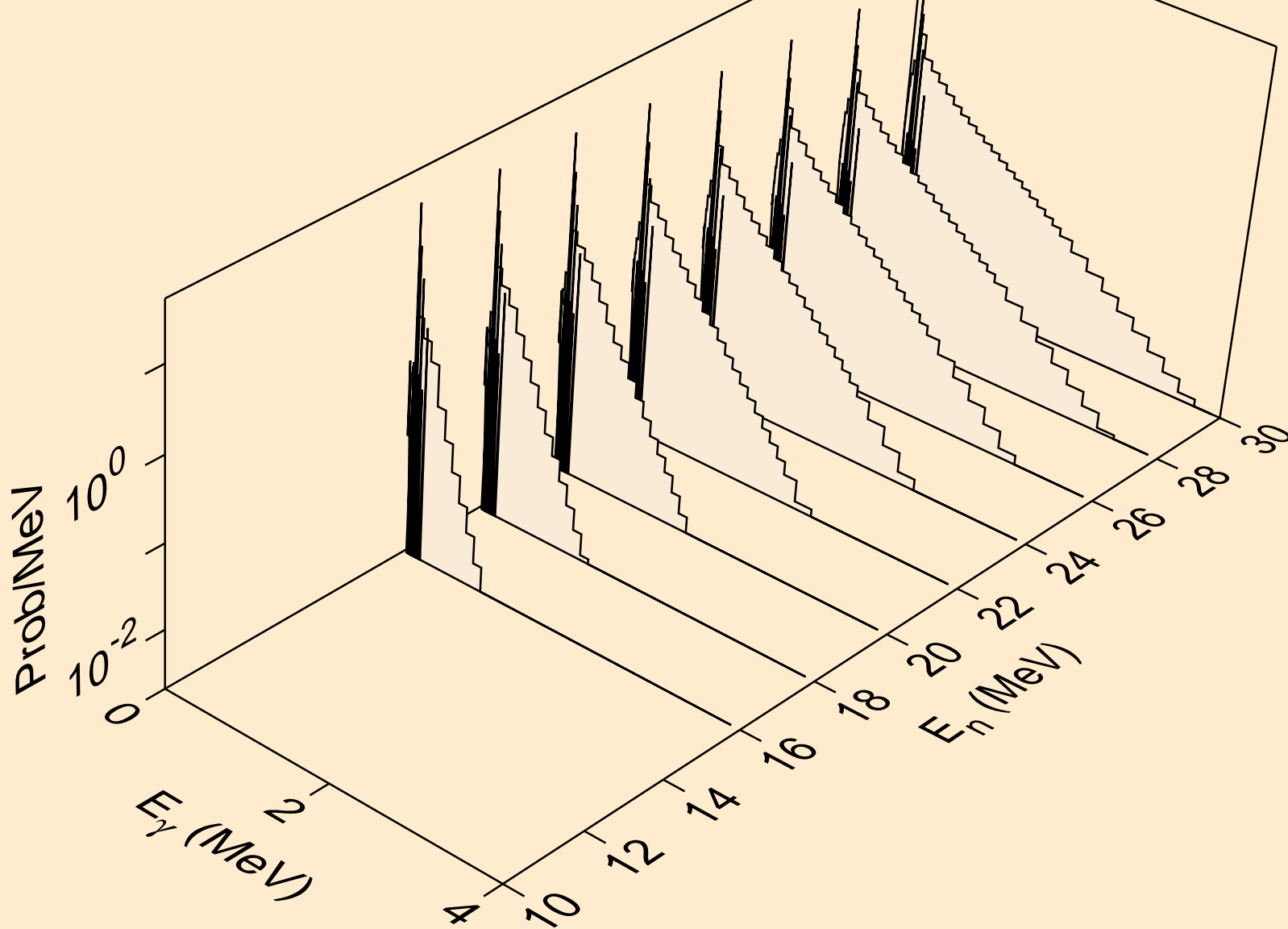

TA176 NEUTRON ACER TENDL-2019 LIBRARY; T=293.16K  
Photon emission for (n,npa)

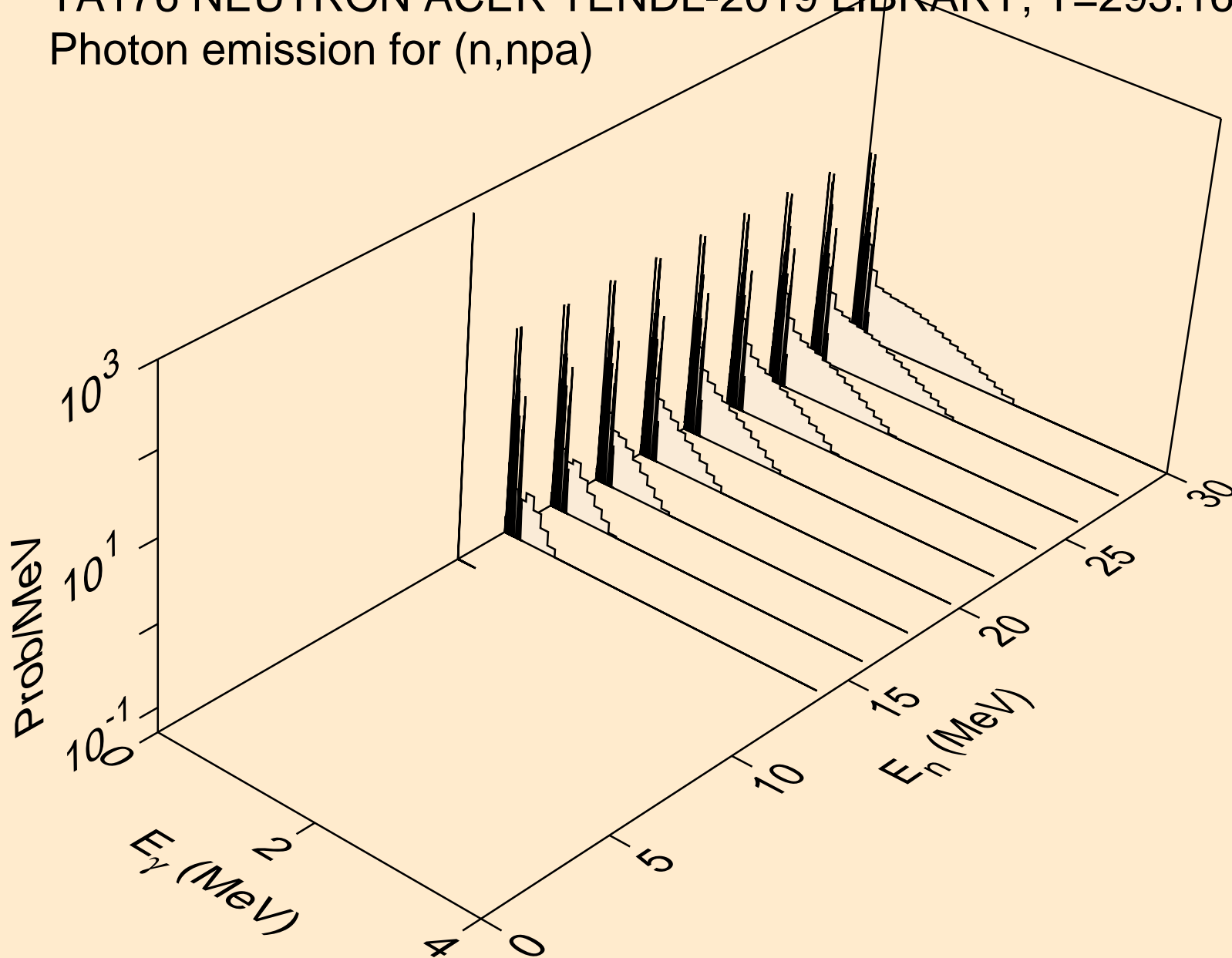

TA176 NEUTRON ACER TENDL-2019 LIBRARY; T=293.16K  
Photon emission for (n,n\*c)

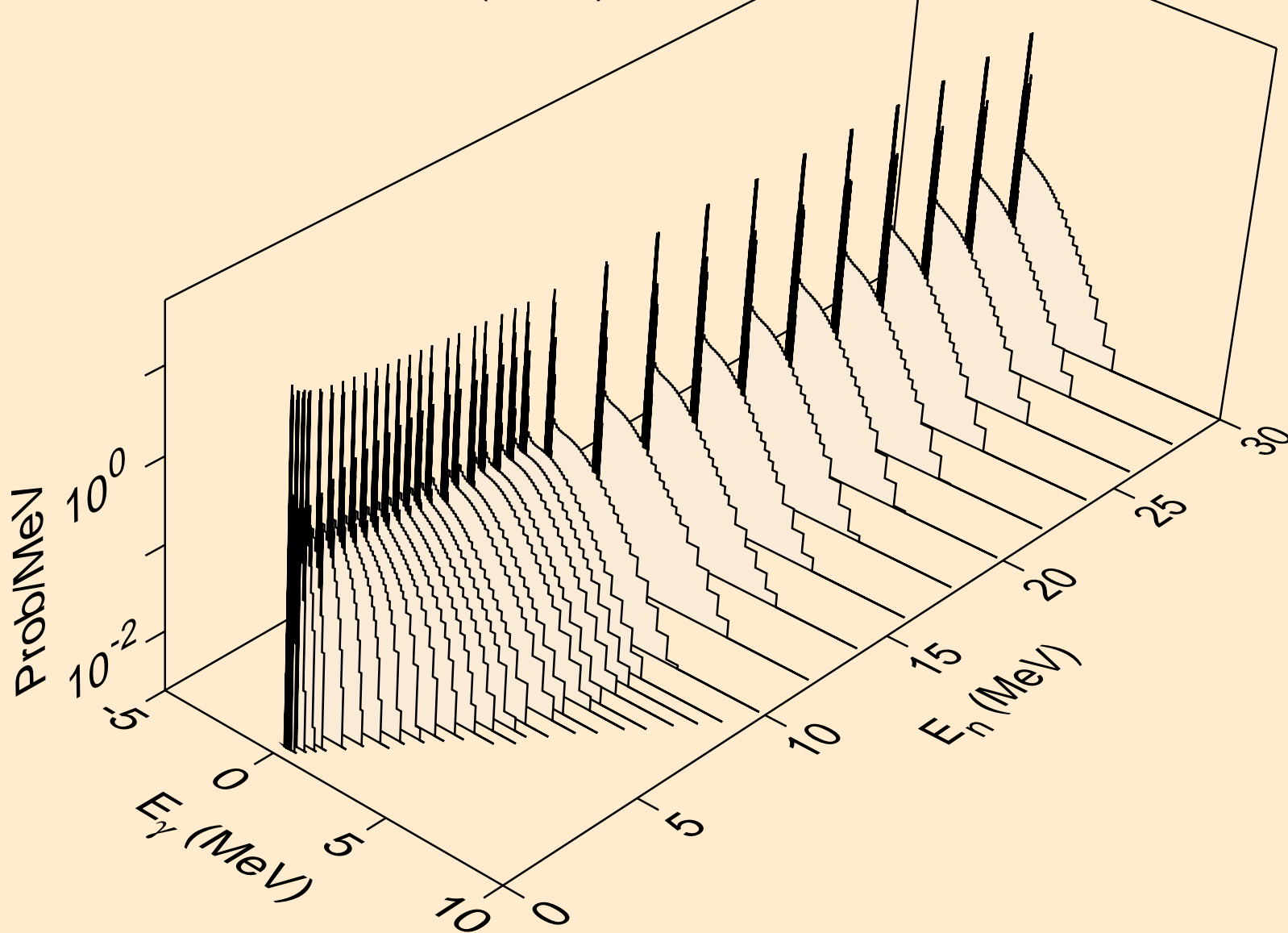

TA176 NEUTRON ACER TENDL-2019 LIBRARY; T=293.16K  
Photon emission for (n,gma)

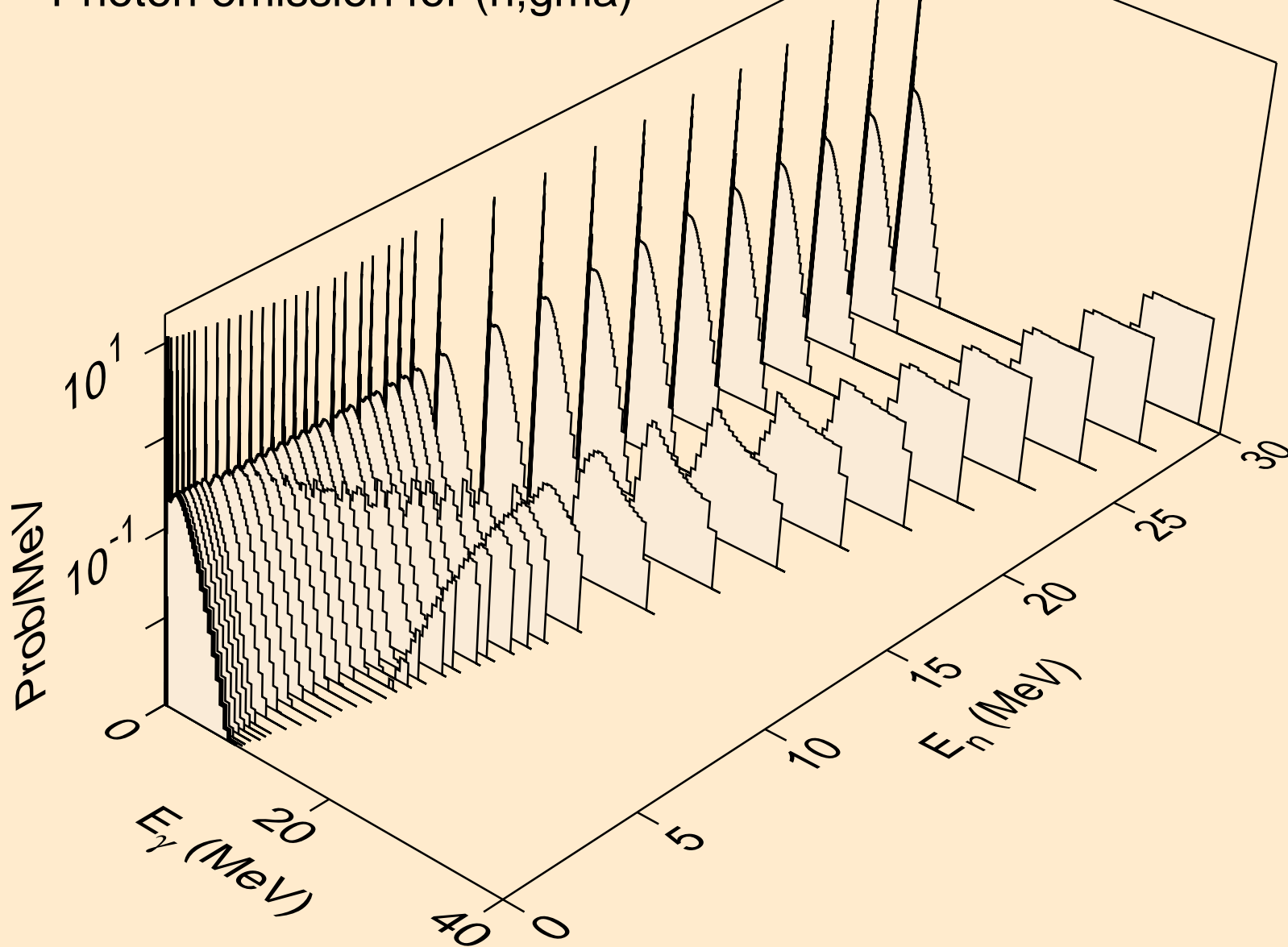

TA176 NEUTRON ACER TENDL-2019 LIBRARY; T=293.16K  
Photon emission for (n,p)

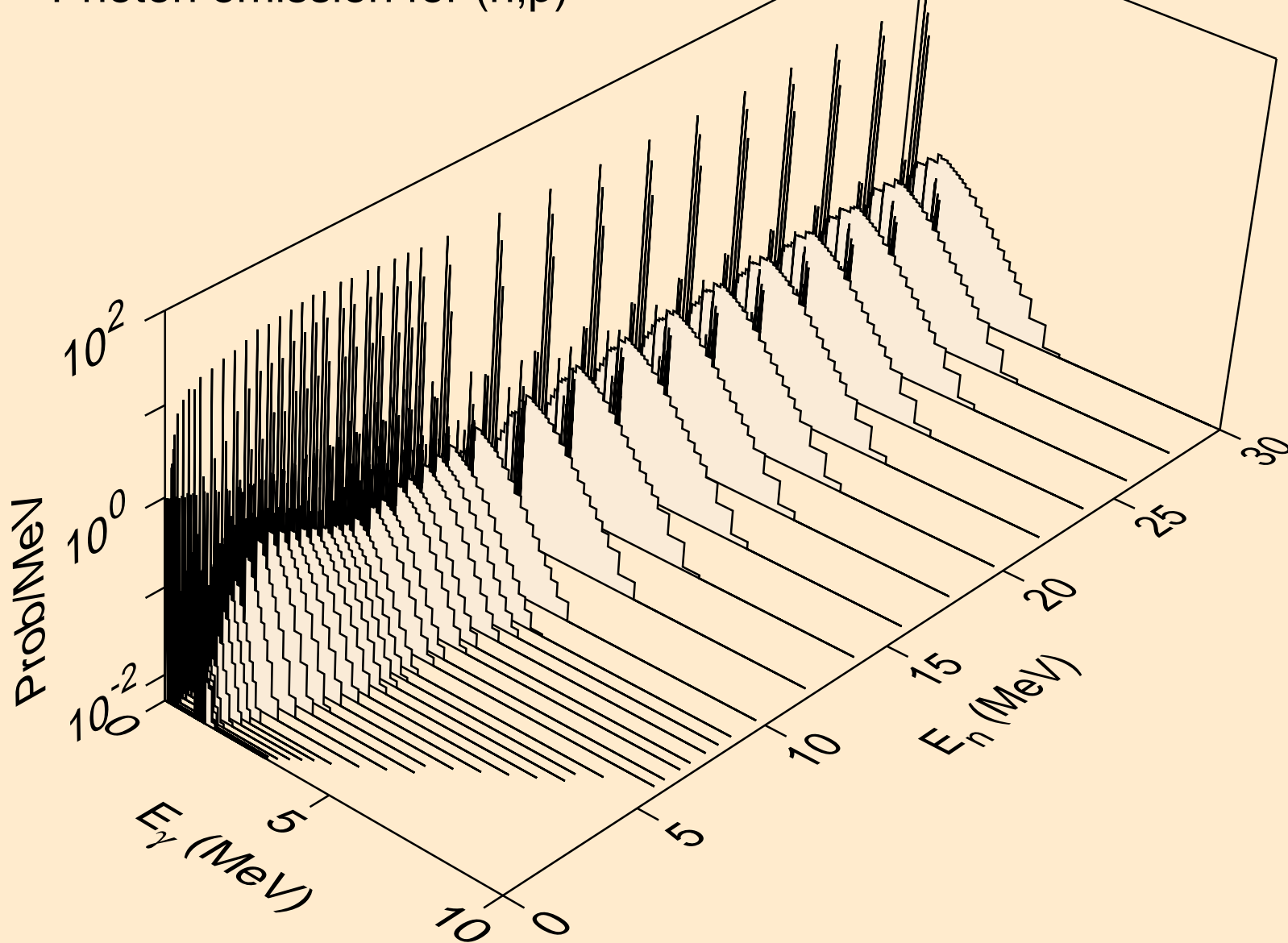

TA176 NEUTRON ACER TENDL-2019 LIBRARY; T=293.16K  
Photon emission for (n,d)

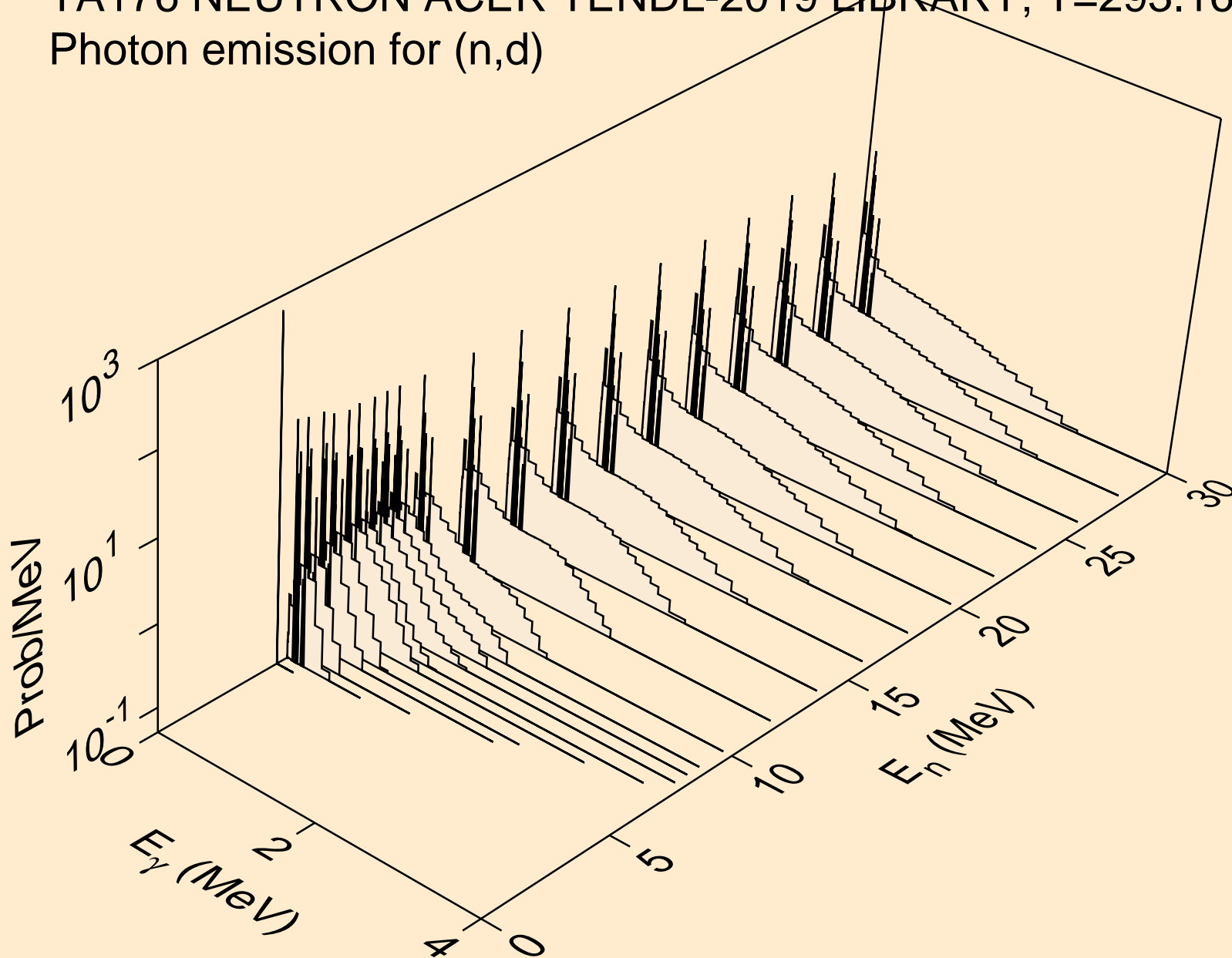

TA176 NEUTRON ACER TENDL-2019 LIBRARY; T=293.16K  
Photon emission for (n,t)

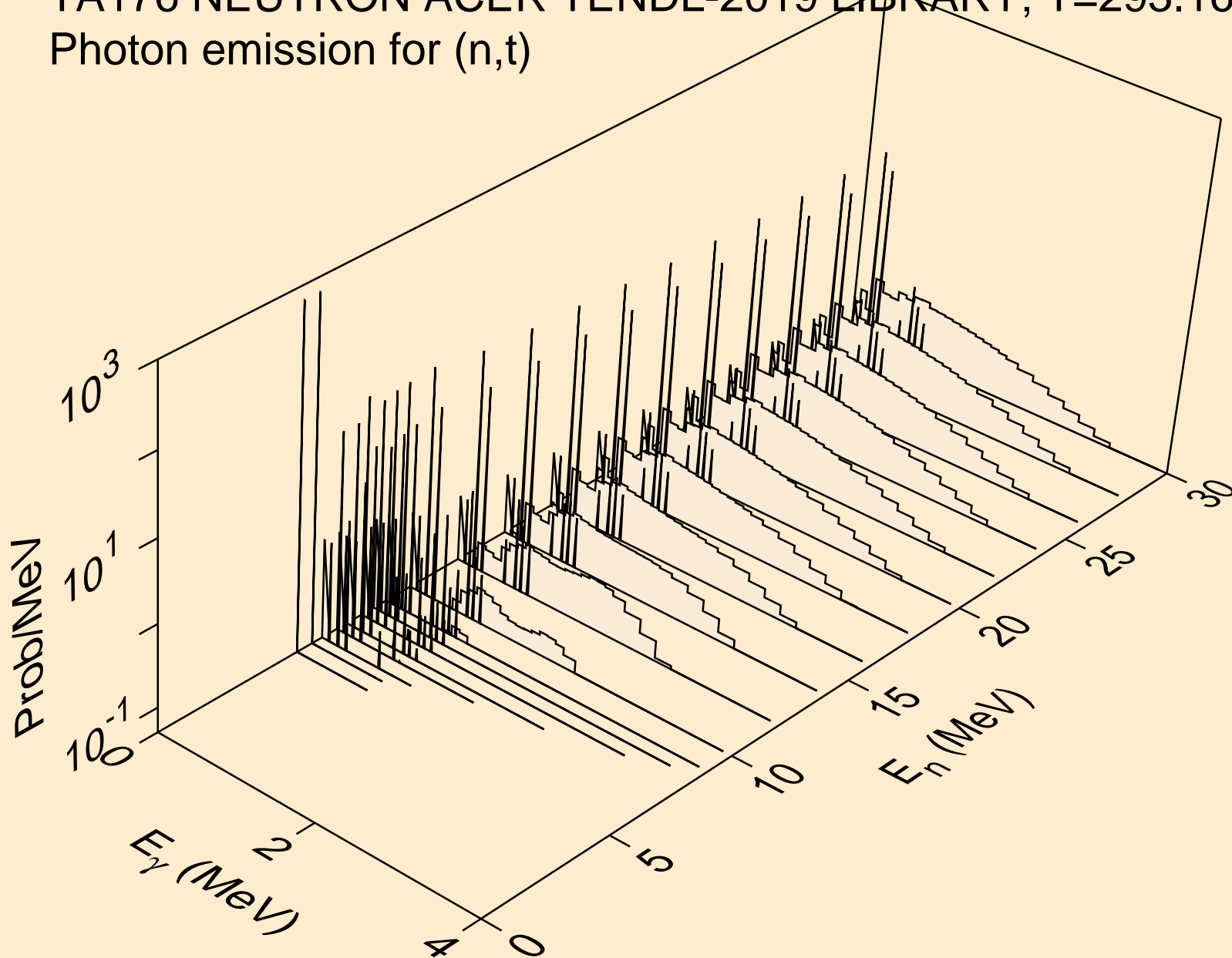

TA176 NEUTRON ACER TENDL-2019 LIBRARY; T=293.16K  
Photon emission for (n,he3)

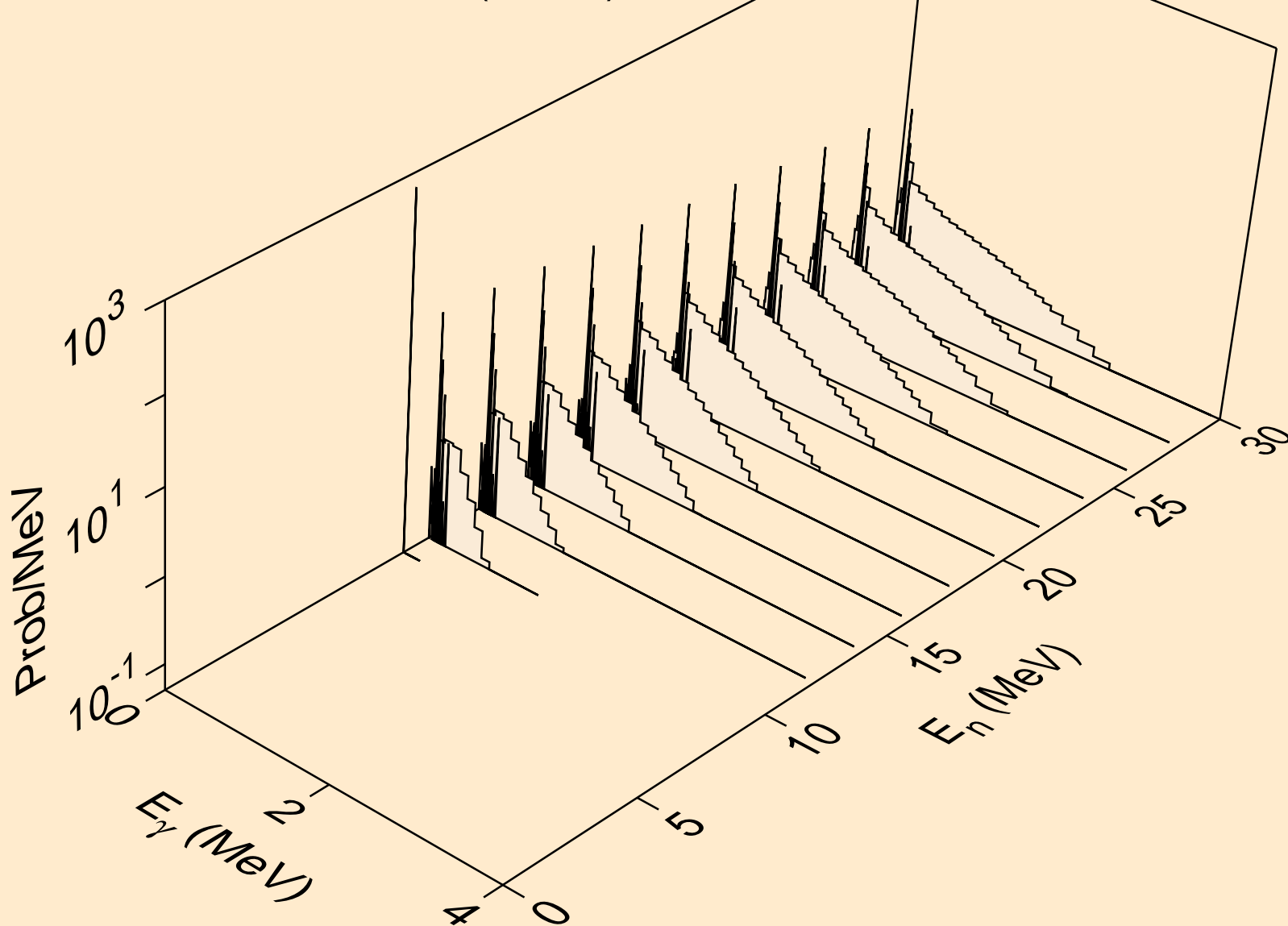



TA176 NEUTRON ACER TENDL-2019 LIBRARY; T=293.16K  
Photon emission for (n,a)

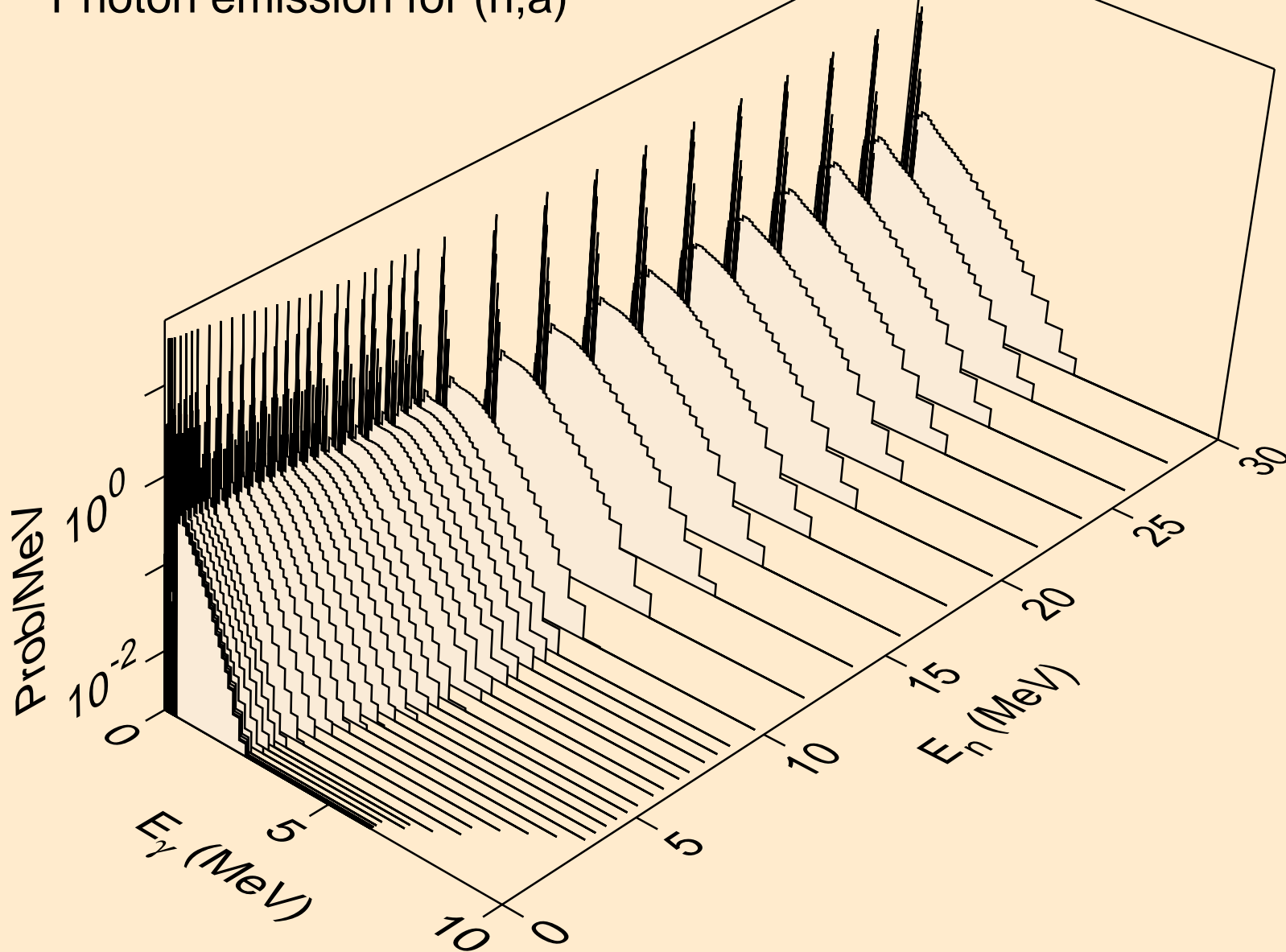

TA176 NEUTRON ACER TENDL-2019 LIBRARY; T=293.16K  
Photon emission for (n,2a)

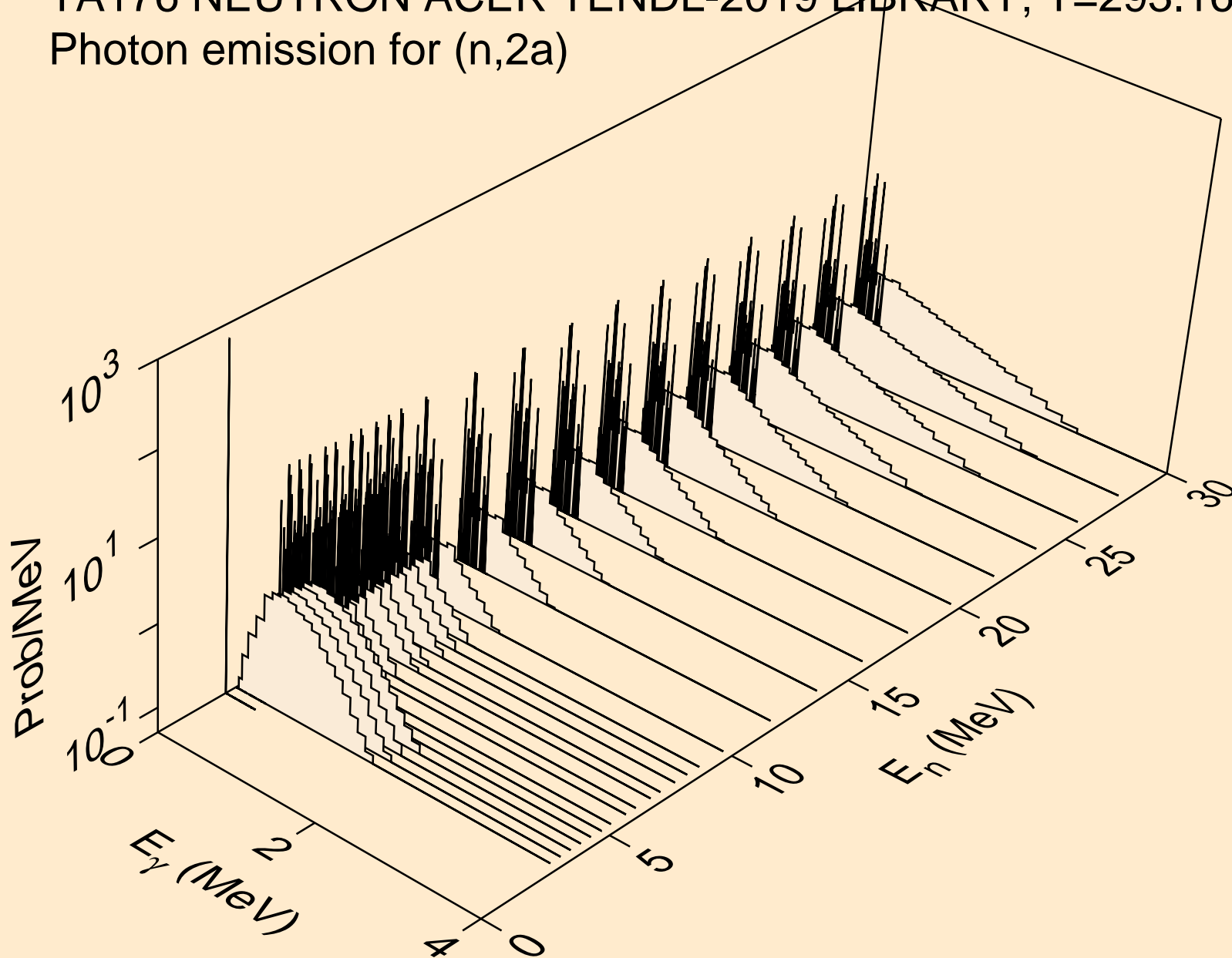

TA176 NEUTRON ACER TENDL-2019 LIBRARY; T=293.16K  
Photon emission for (n,2p)

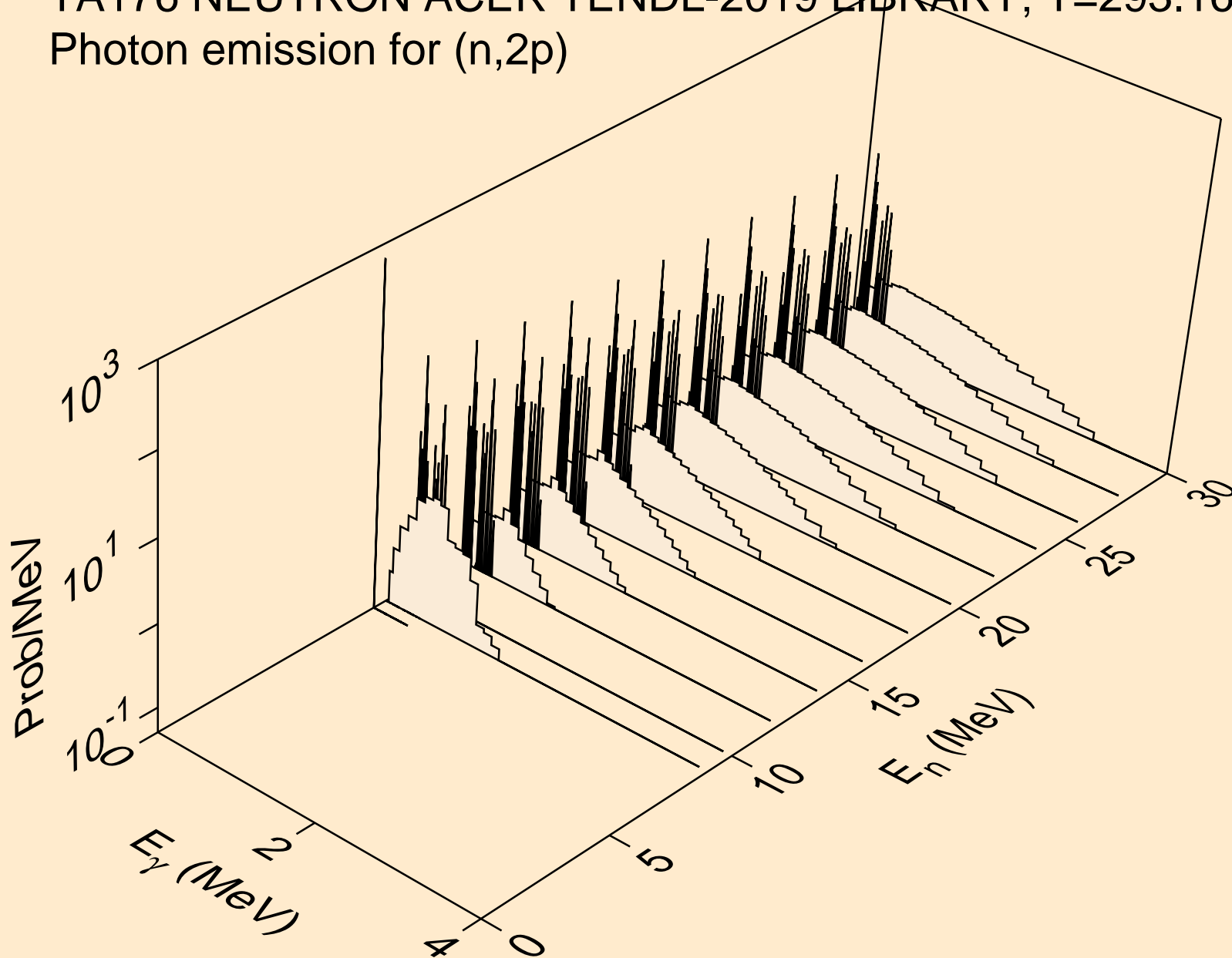

TA176 NEUTRON ACER TENDL-2019 LIBRARY; T=293.16K  
Photon emission for (n,p $\alpha$ )

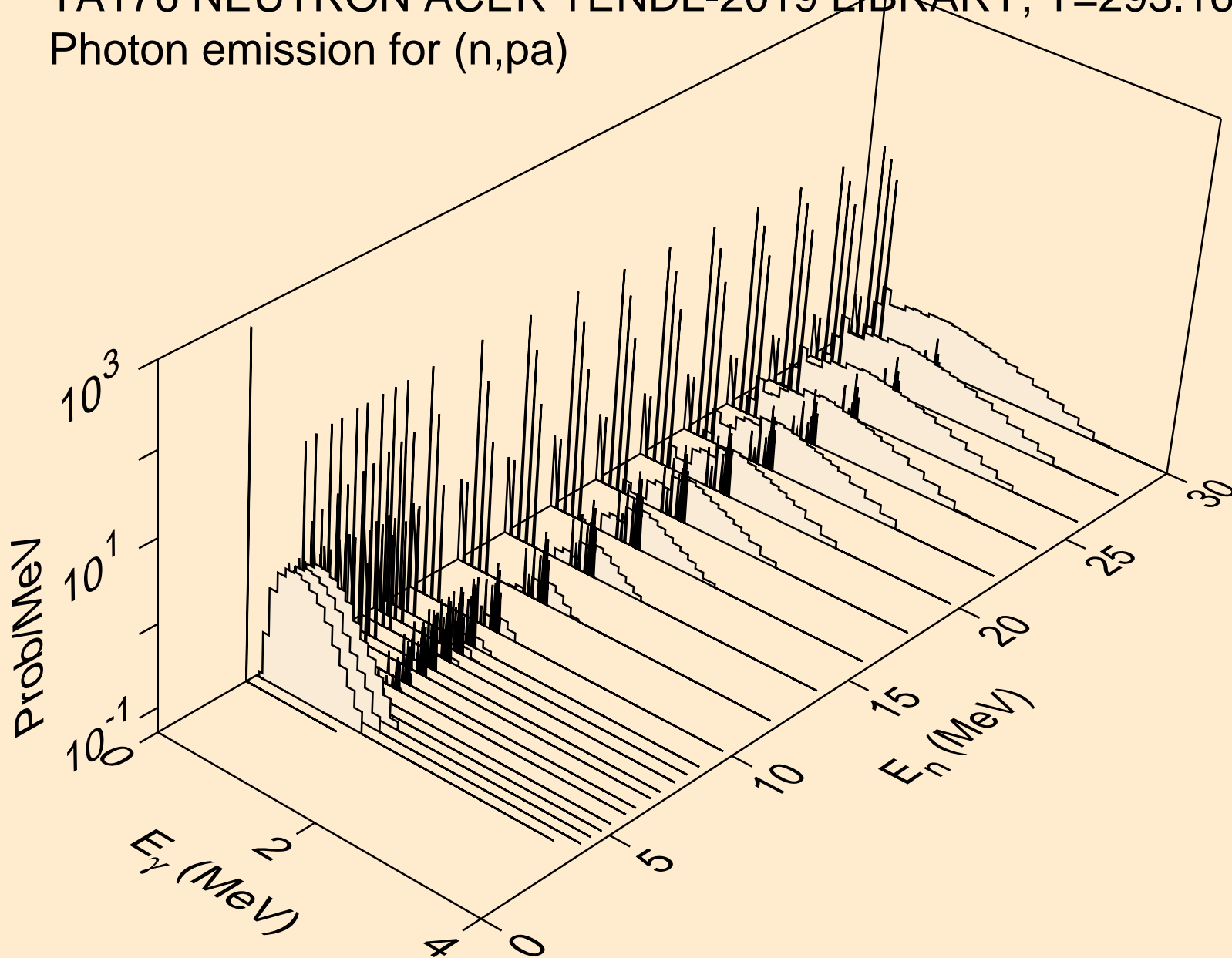

TA176 NEUTRON ACER TENDL-2019 LIBRARY; T=293.16K  
Photon emission for (n,pd)

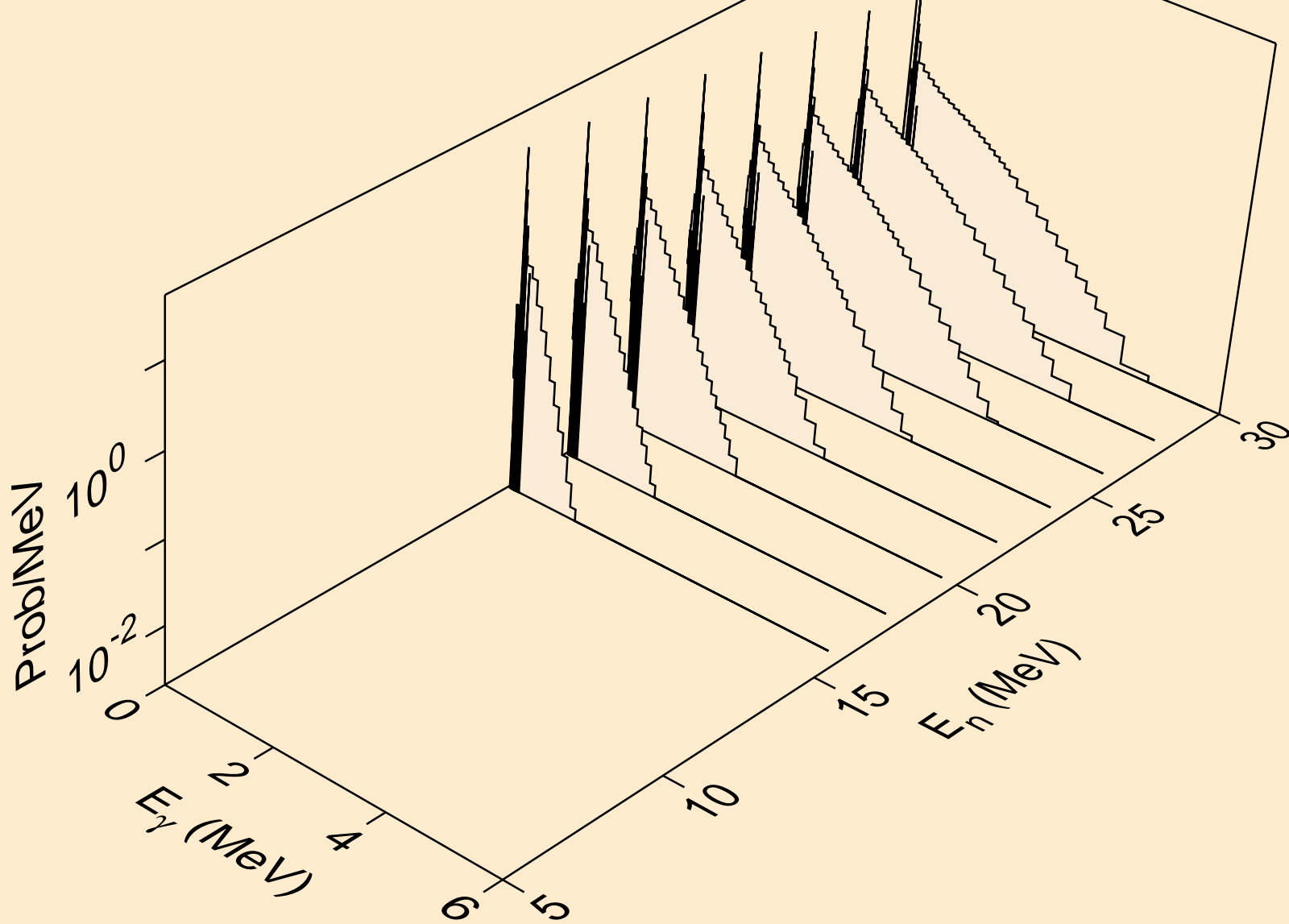

TA176 NEUTRON ACER TENDL-2019 LIBRARY; T=293.16K  
Photon emission for (n,pt)

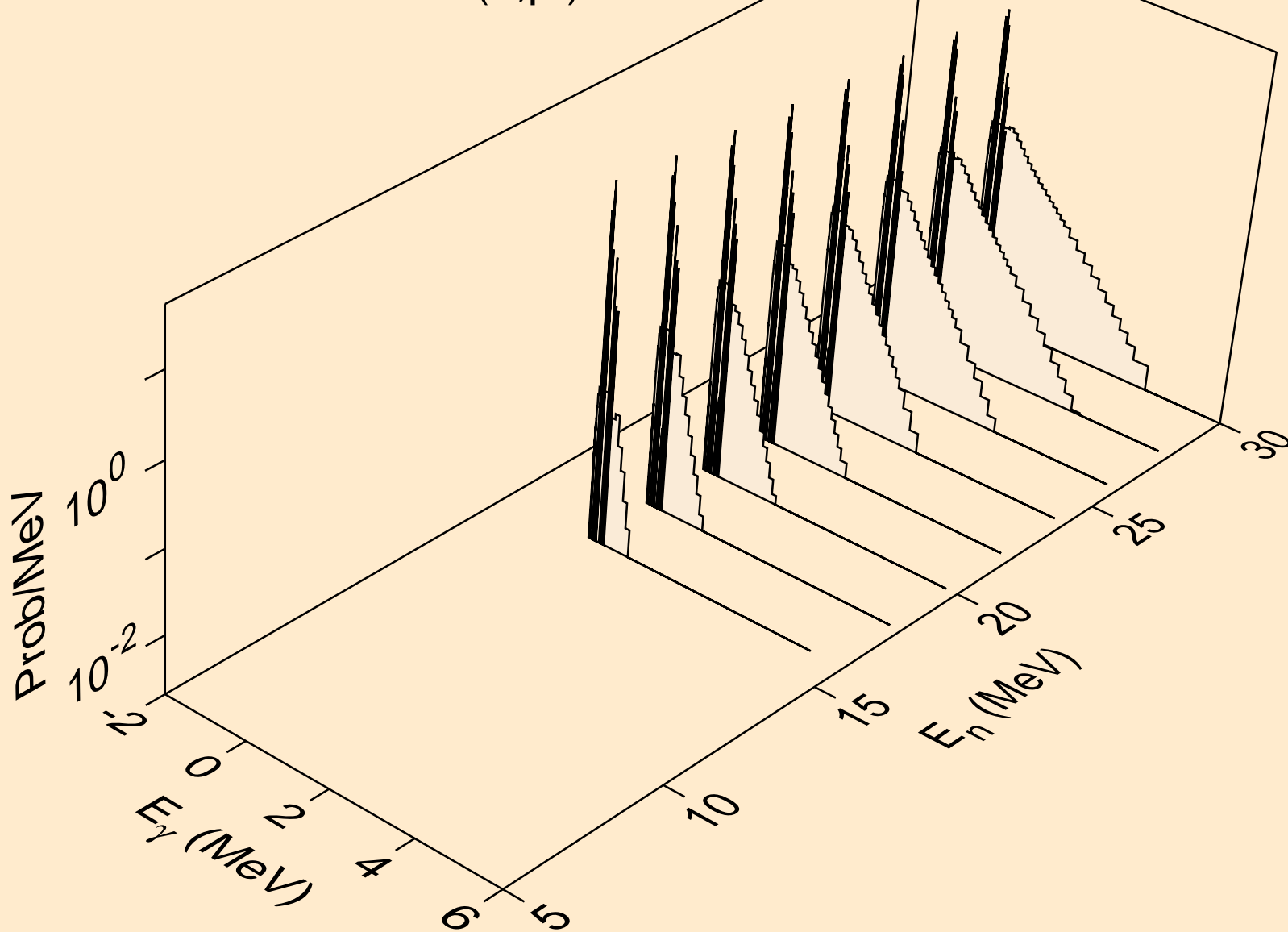

TA176 NEUTRON ACER TENDL-2019 LIBRARY; T=293.16K  
Photon emission for (n,da)

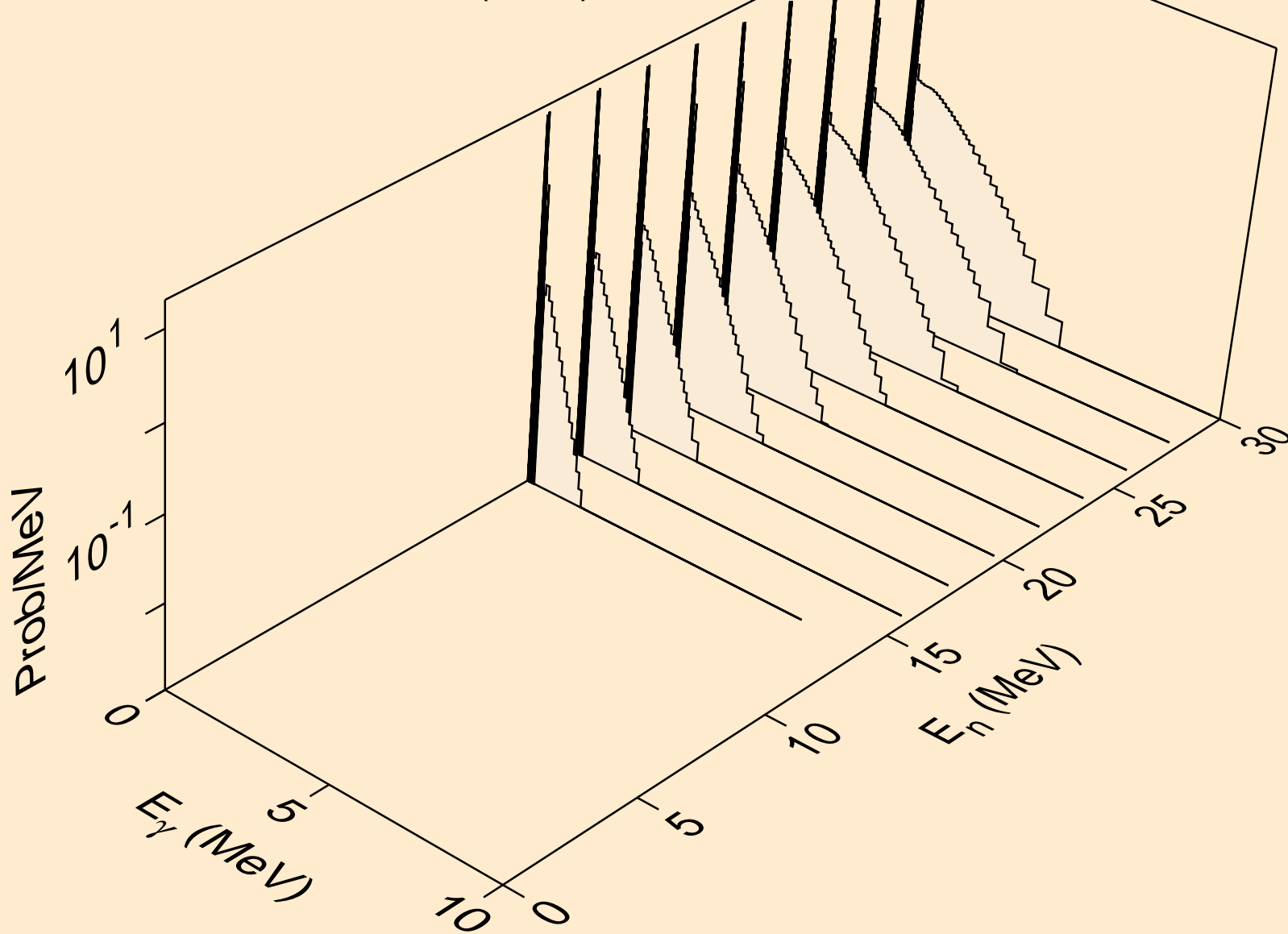

TA176 NEUTRON ACER TENDL-2019 LIBRARY; T=293.16K  
thermal capture photon spectrum

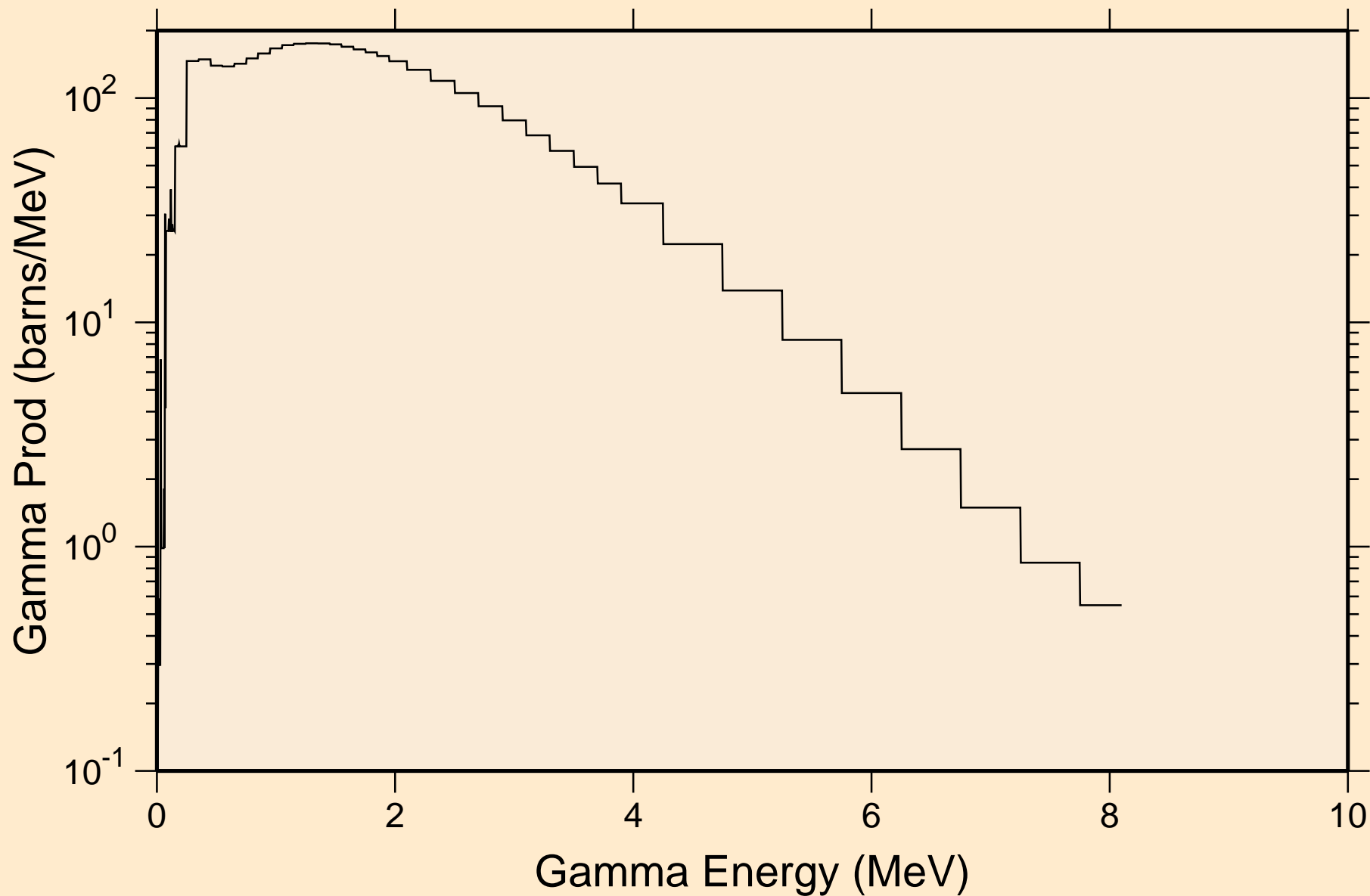



TA176 NEUTRON ACER TENDL-2019 LIBRARY; T=293.16K  
14 MeV photon spectrum

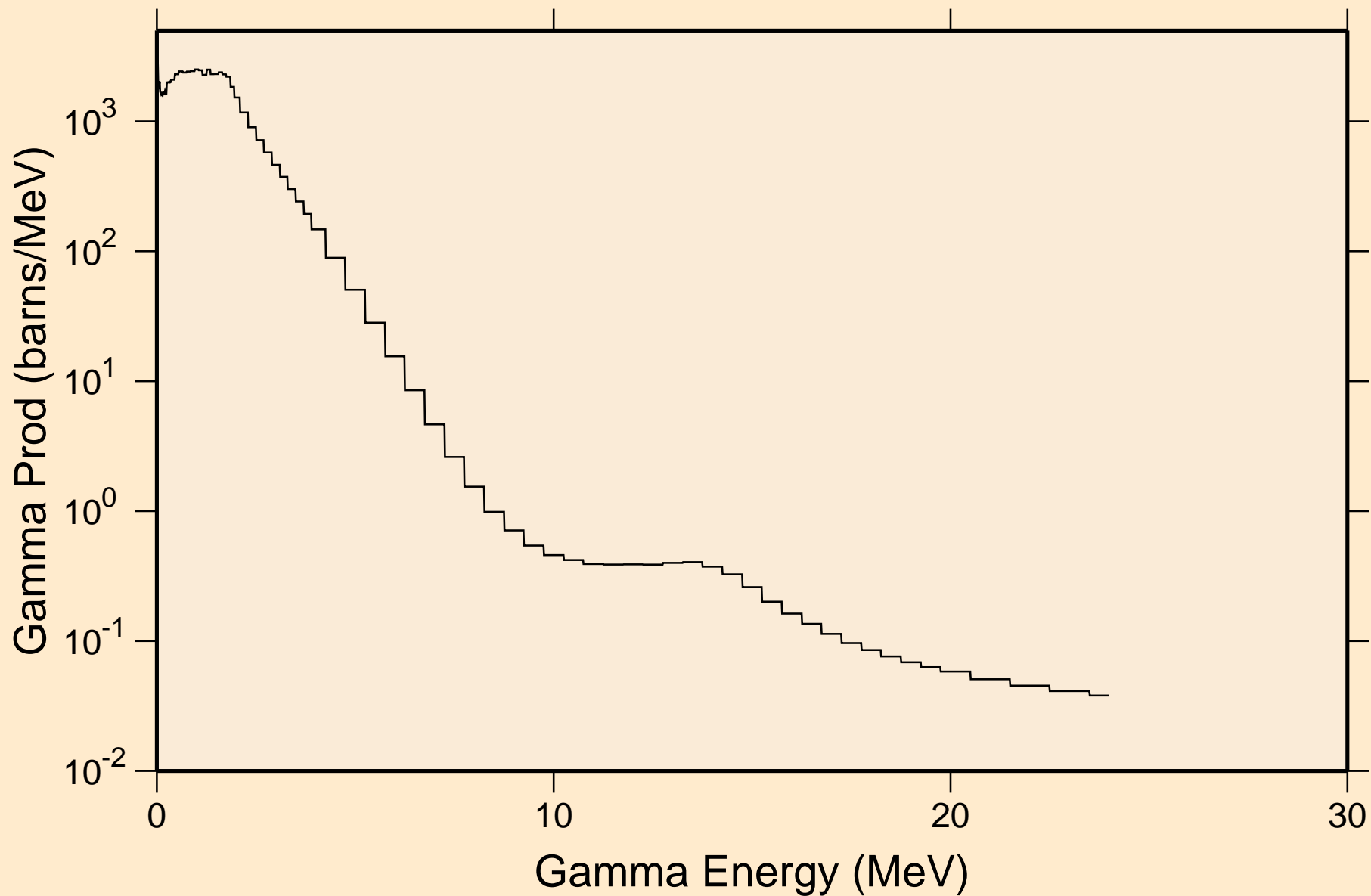

TA176 NEUTRON ACER TENDL-2019 LIBRARY; T=293.16K  
Particle heating contributions

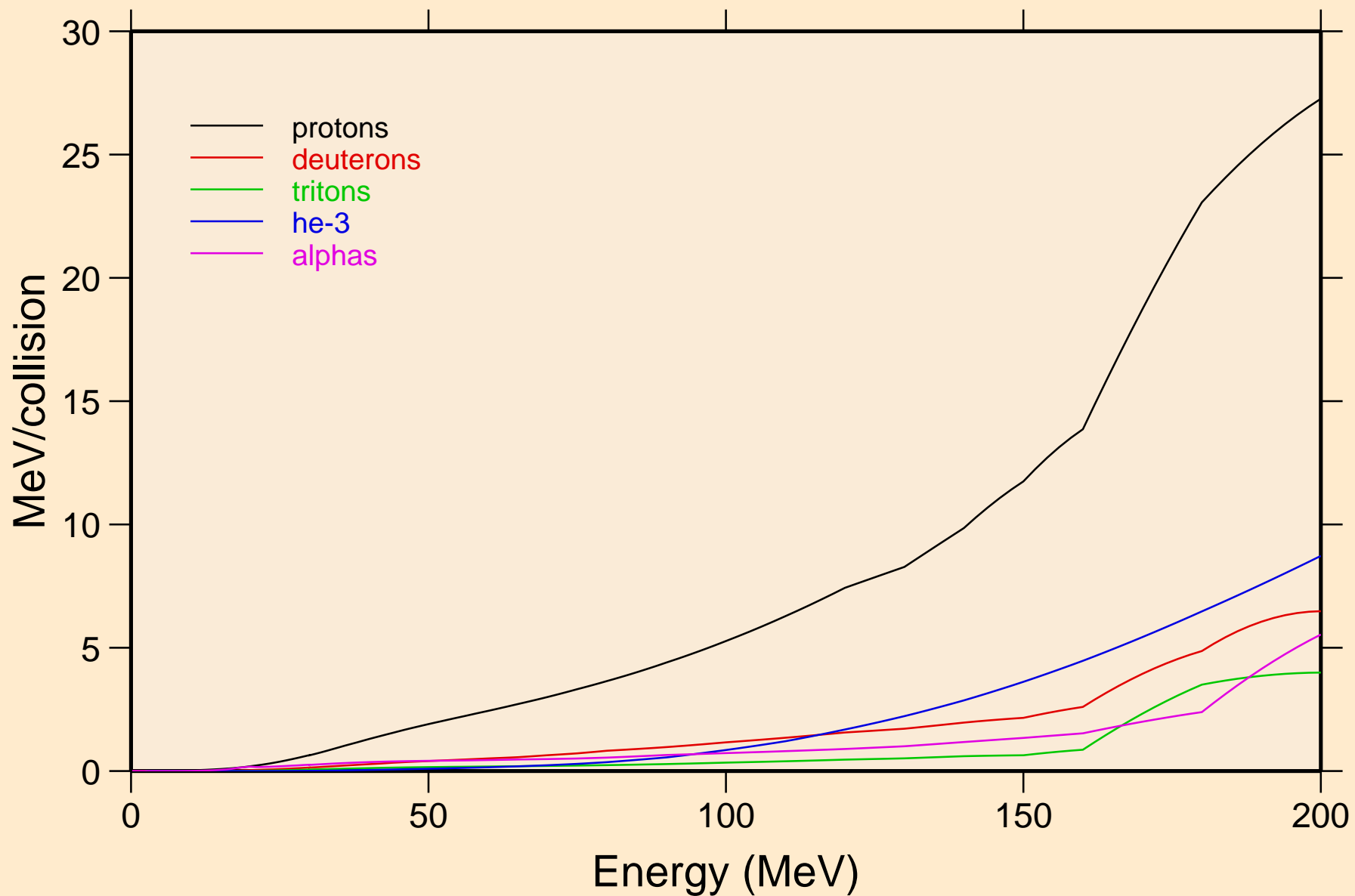

TA176 NEUTRON ACER TENDL-2019 LIBRARY; T=293.16K  
Recoil Heating

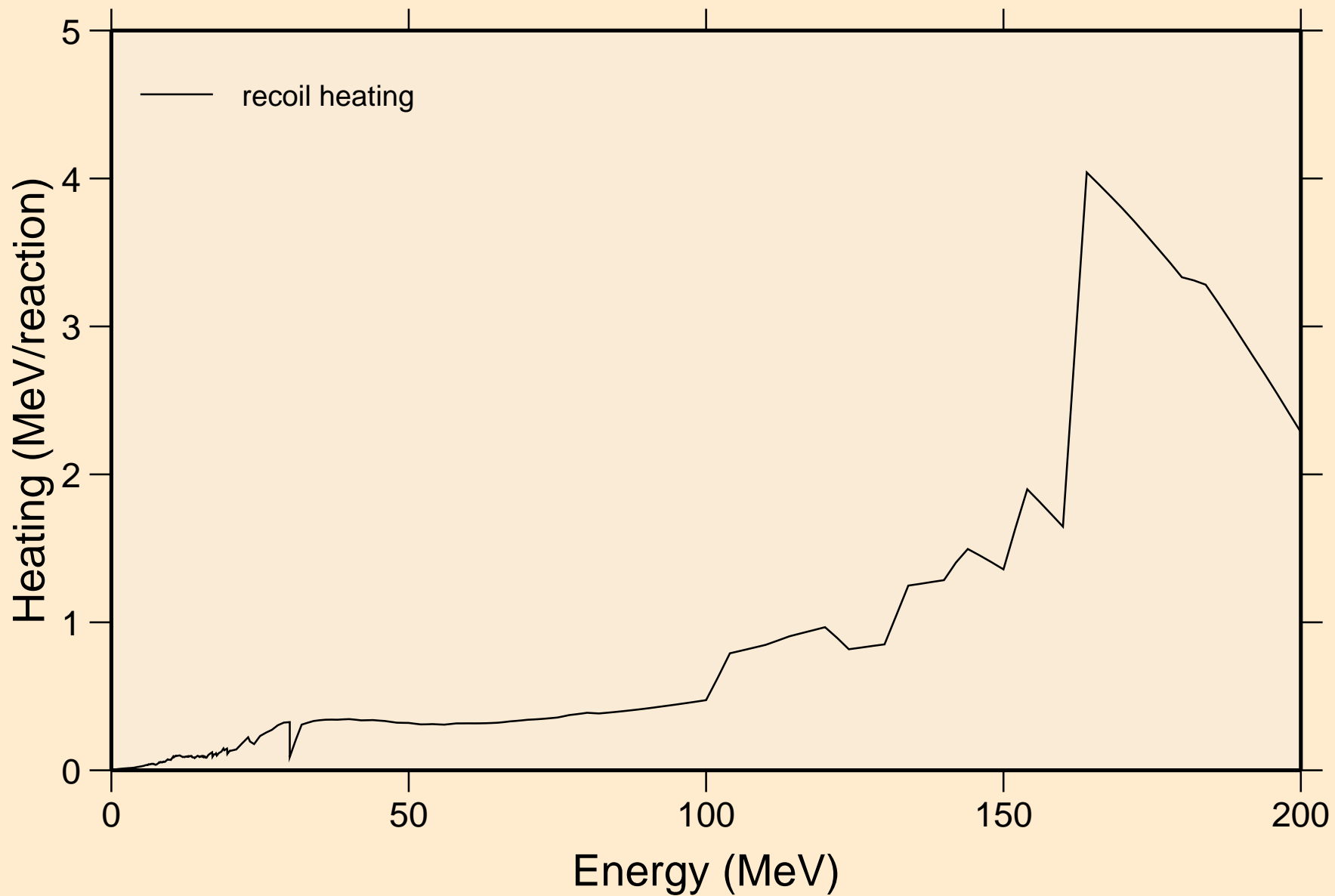

TA176 NEUTRON ACER TENDL-2019 LIBRARY; T=293.16K  
Particle production cross sections

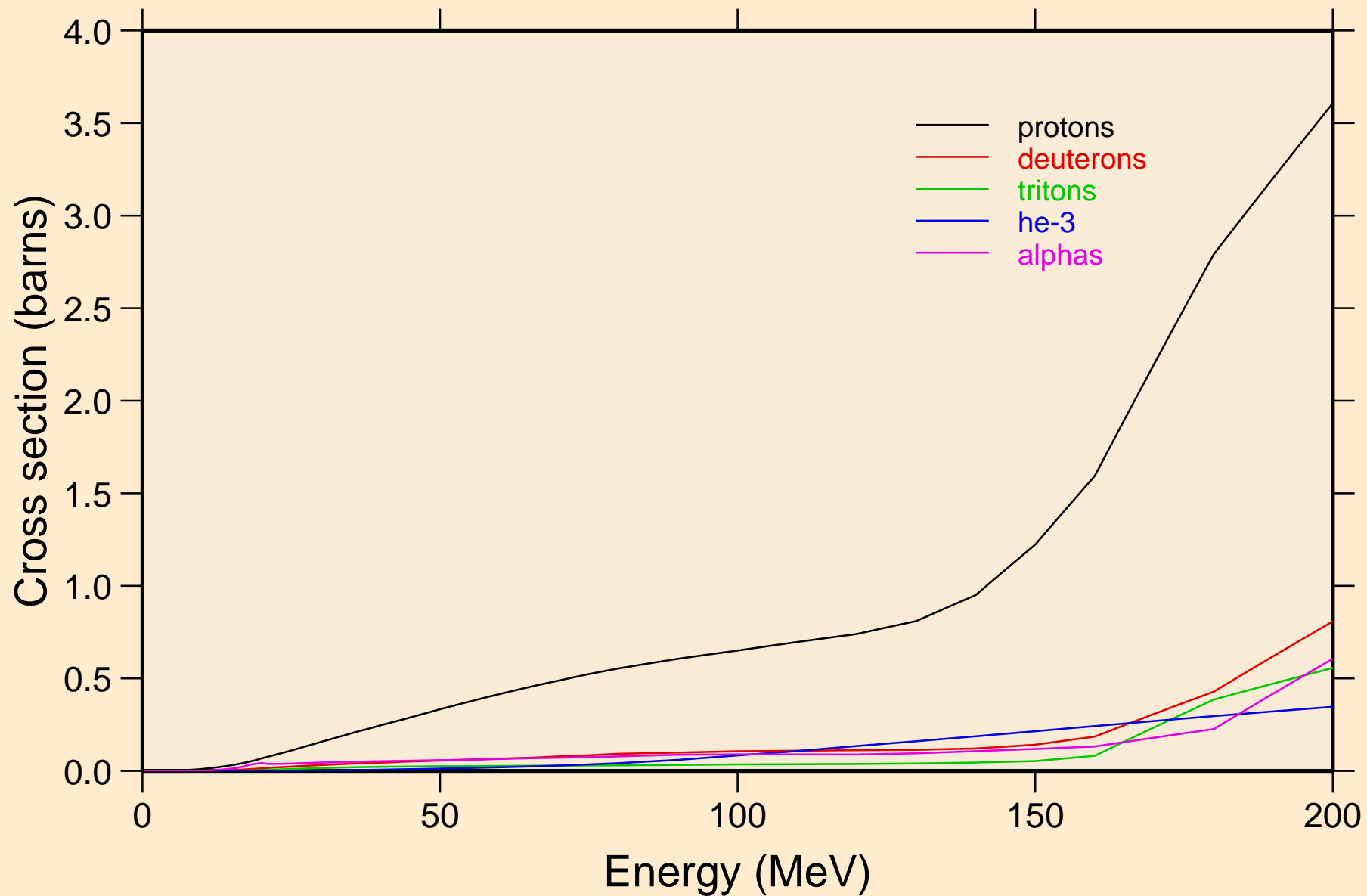

TA176 NEUTRON ACER TENDL-2019 LIBRARY; T=293.16K  
protons from (n,x)

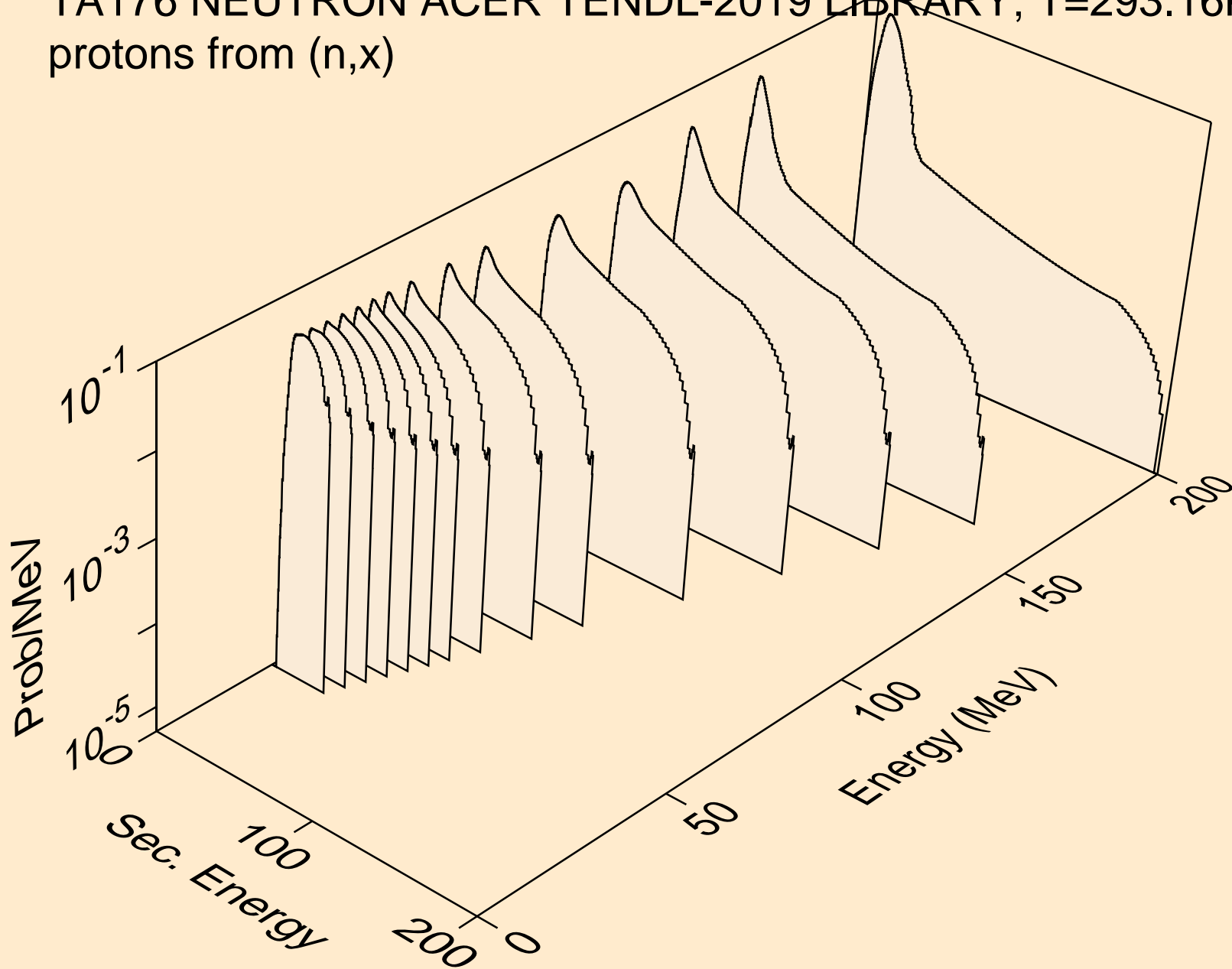

TA176 NEUTRON ACER TENDL-2019 LIBRARY; T=293.16K  
protons from (n,n\*)p

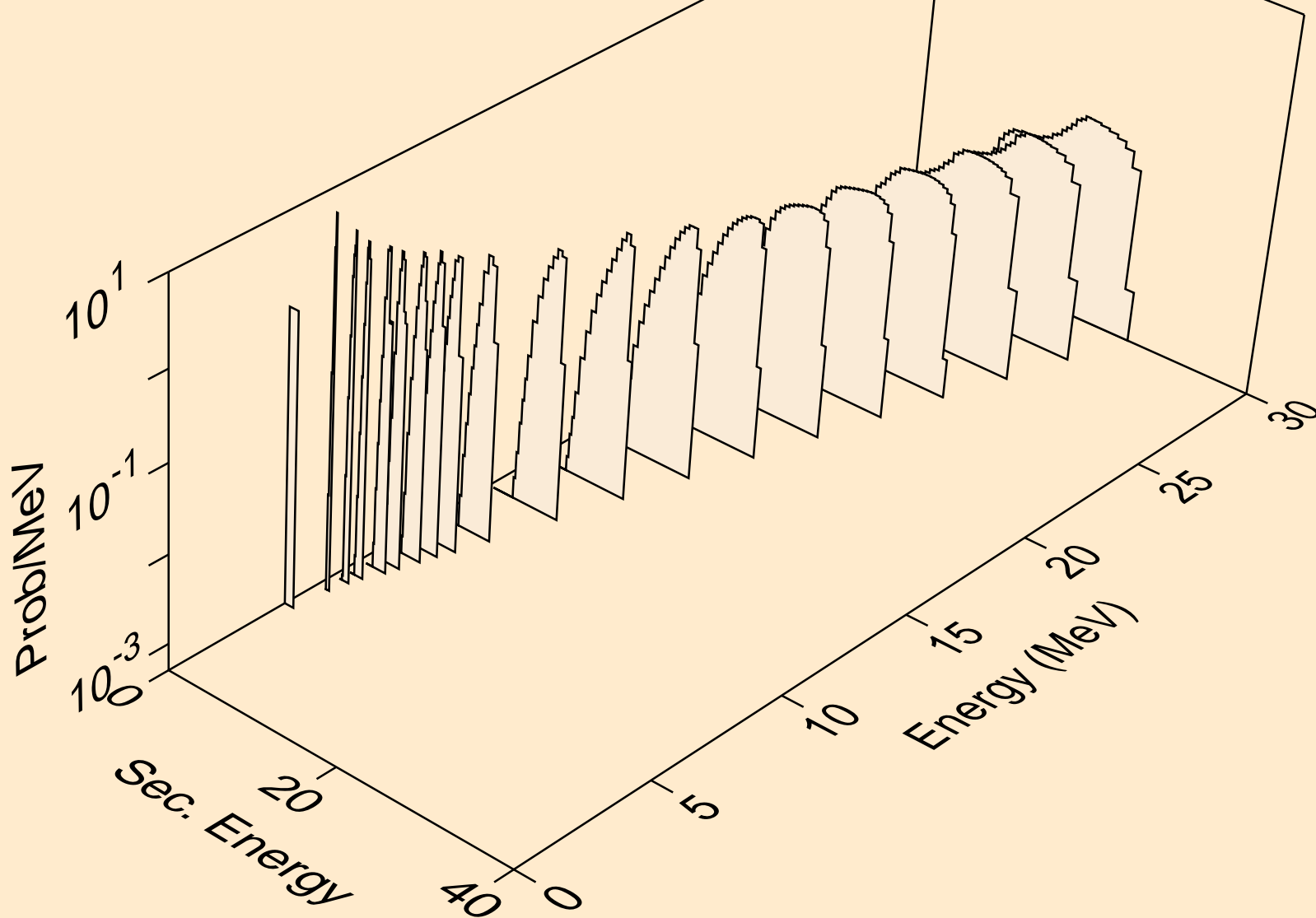

TA176 NEUTRON ACER TENDL-2019 LIBRARY; T=293.16K  
protons from (n,2np)

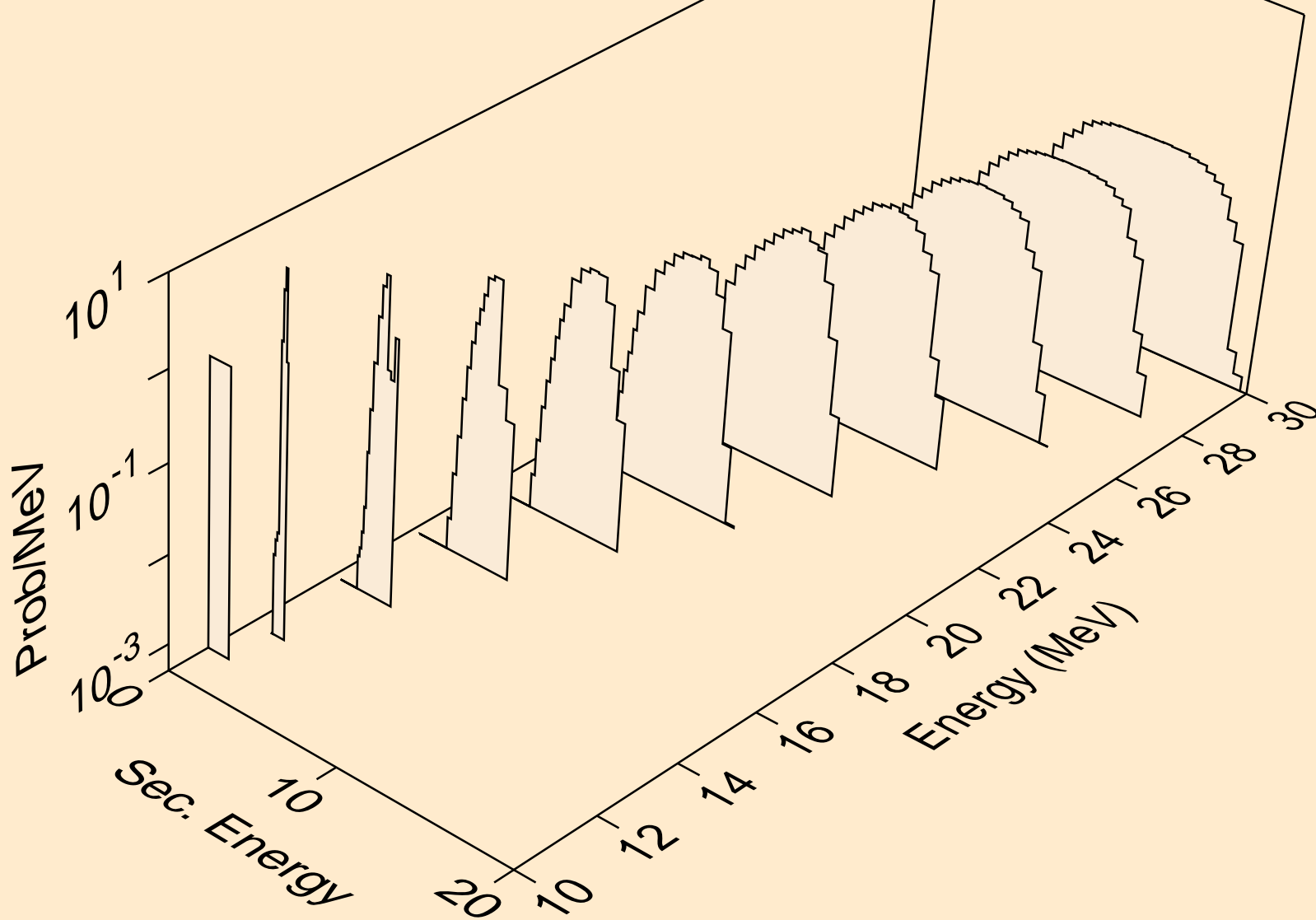

TA176 NEUTRON ACER TENDL-2019 LIBRARY; T=293.16K  
protons from (n,3np)

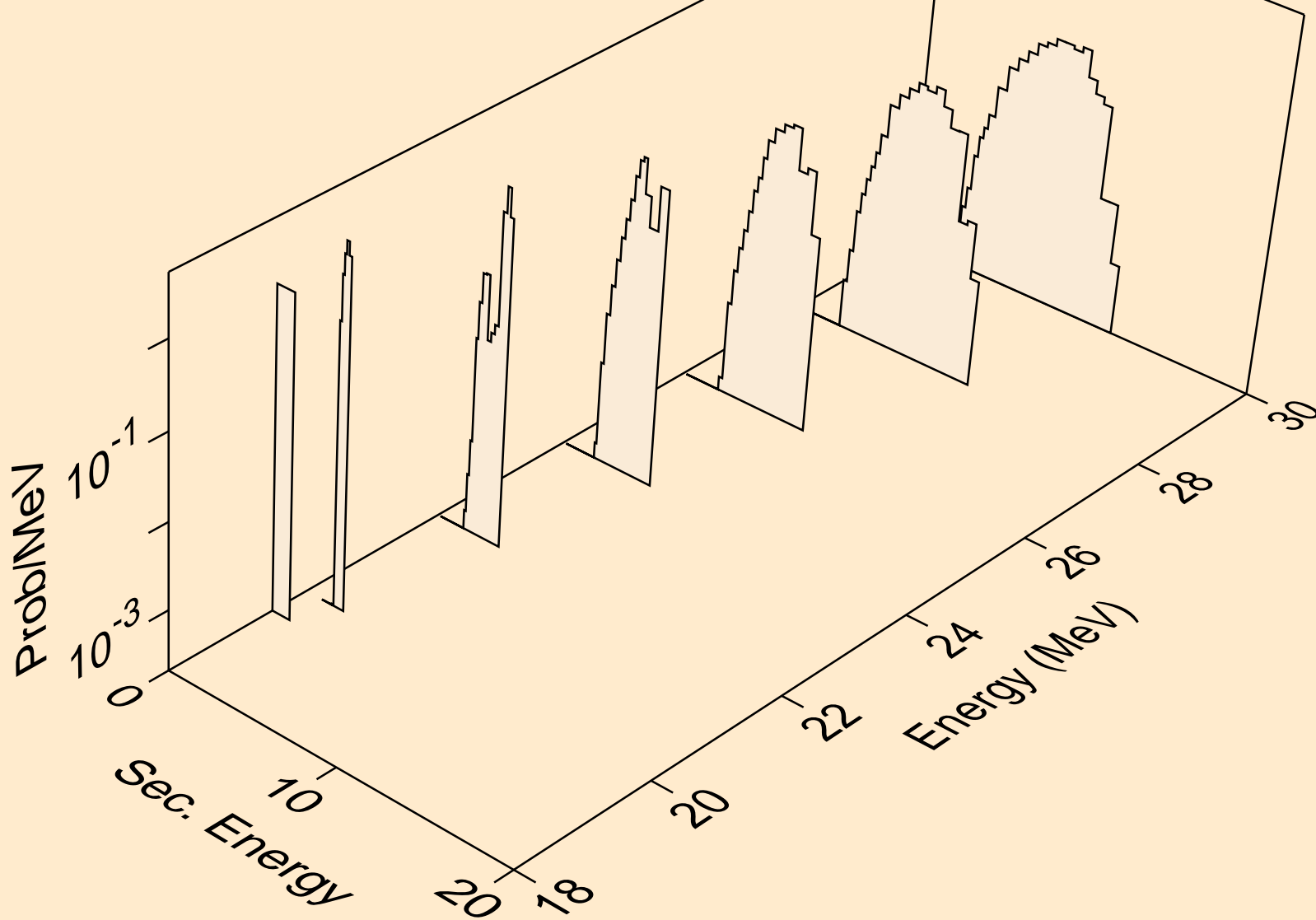



TA176 NEUTRON ACER TENDL-2019 LIBRARY; T=293.16K  
protons from (n,2np)

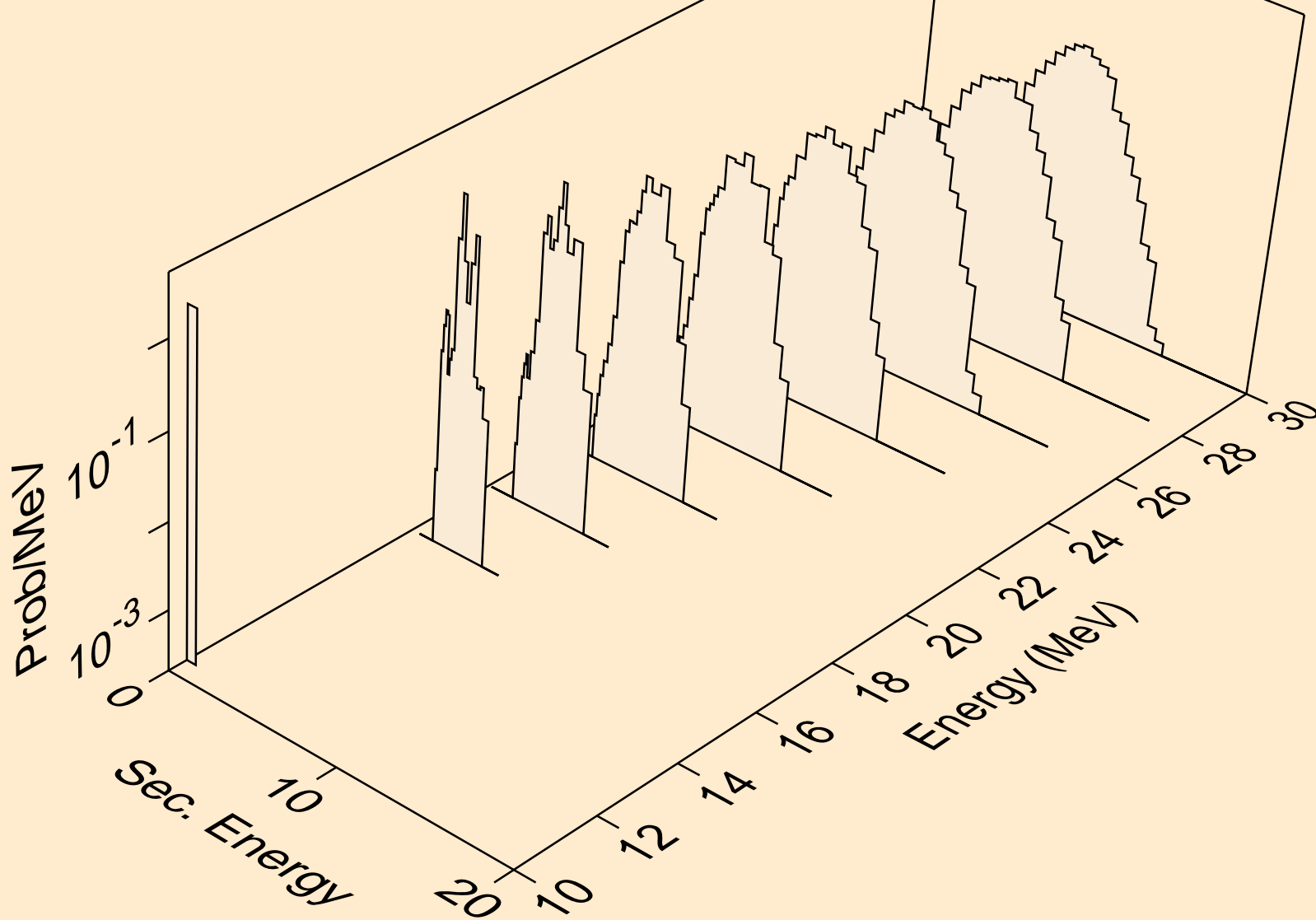

TA176 NEUTRON ACER TENDL-2019 LIBRARY; T=293.16K  
protons from (n,npa)

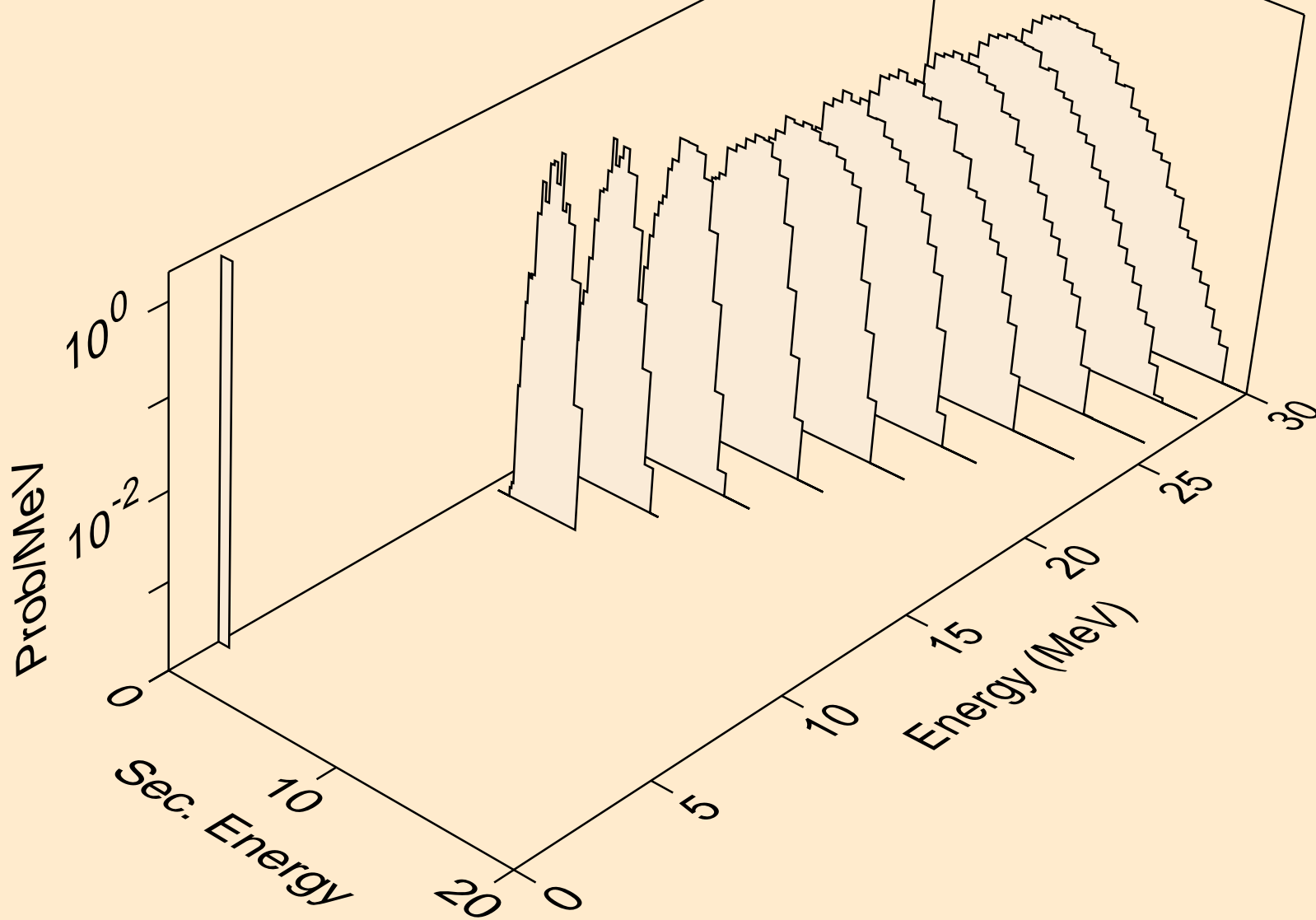

TA176 NEUTRON ACER TENDL-2019 LIBRARY; T=293.16K  
protons from (n,p)

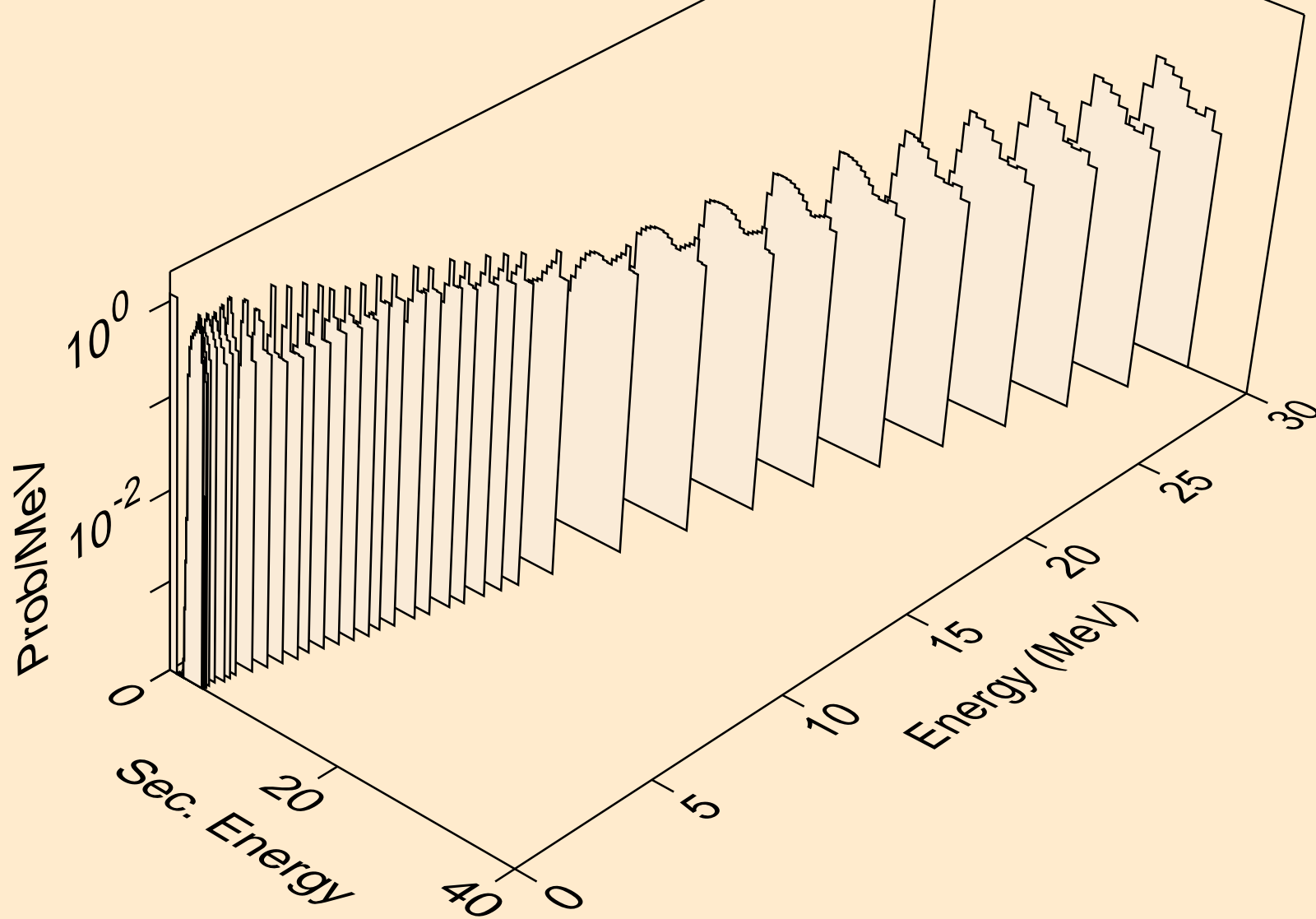

TA176 NEUTRON ACER TENDL-2019 LIBRARY; T=293.16K  
protons from (n,2p)

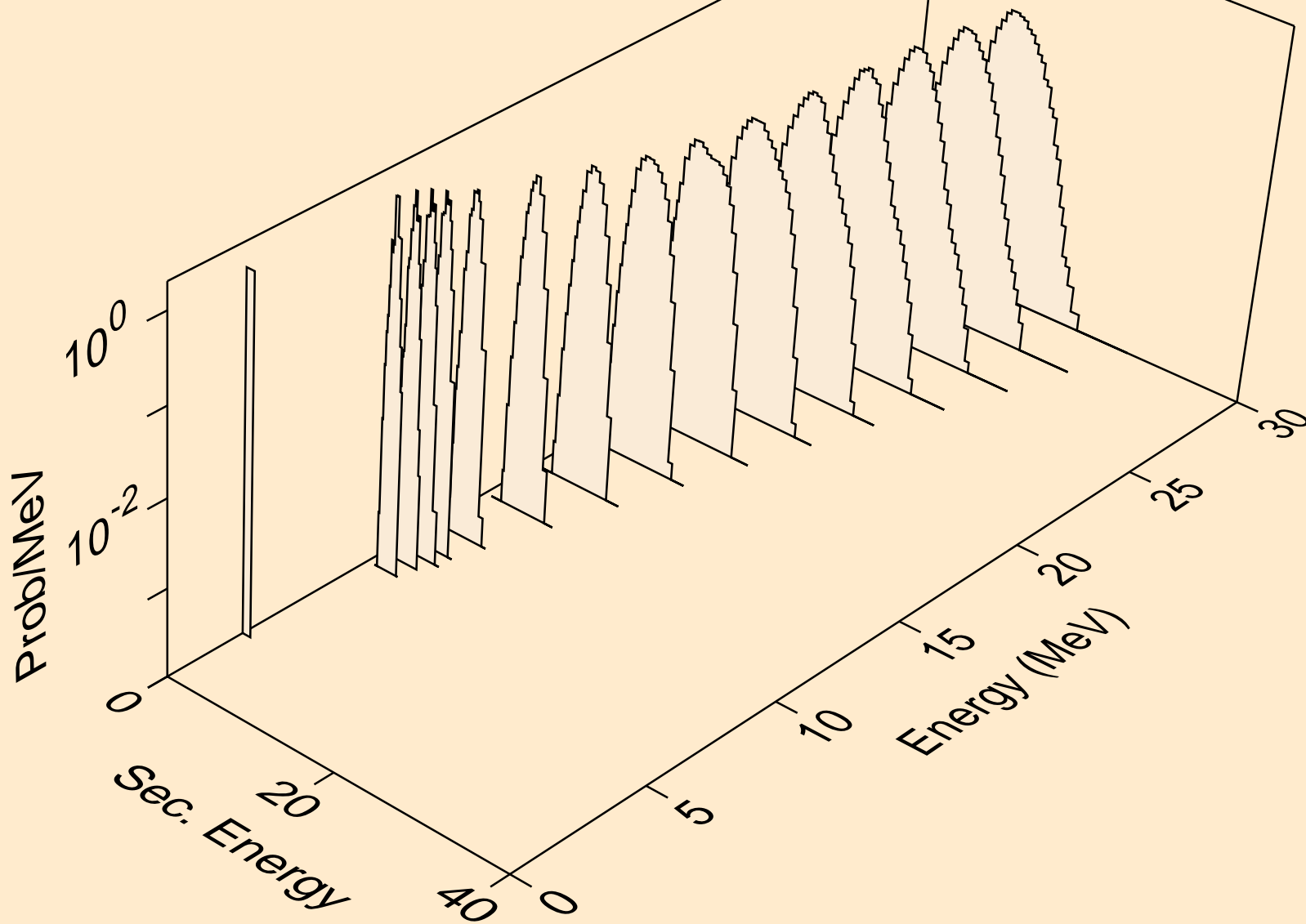

TA176 NEUTRON ACER TENDL-2019 LIBRARY; T=293.16K  
protons from (n,p)

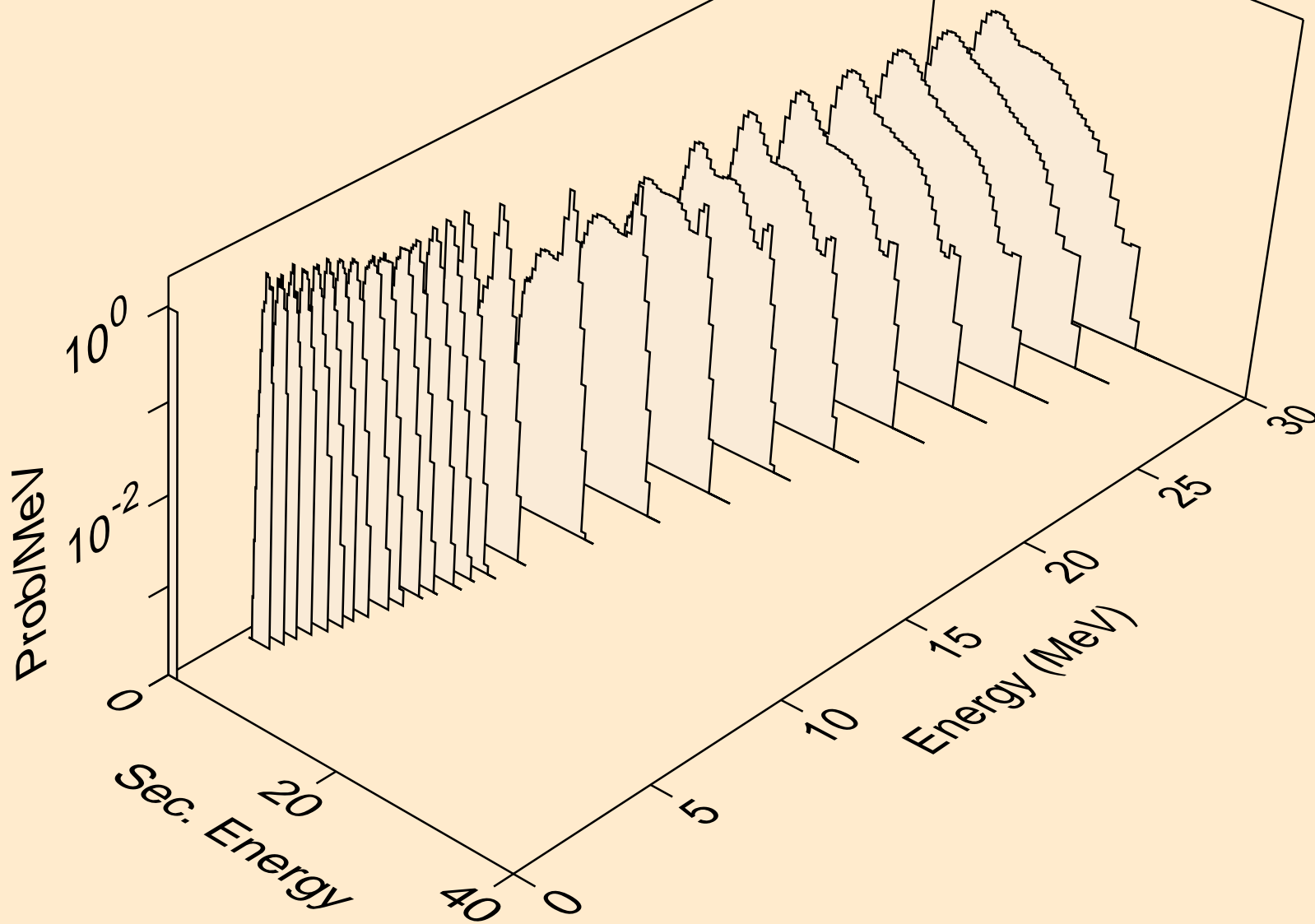

TA176 NEUTRON ACER TENDL-2019 LIBRARY; T=293.16K  
protons from (n,pd)

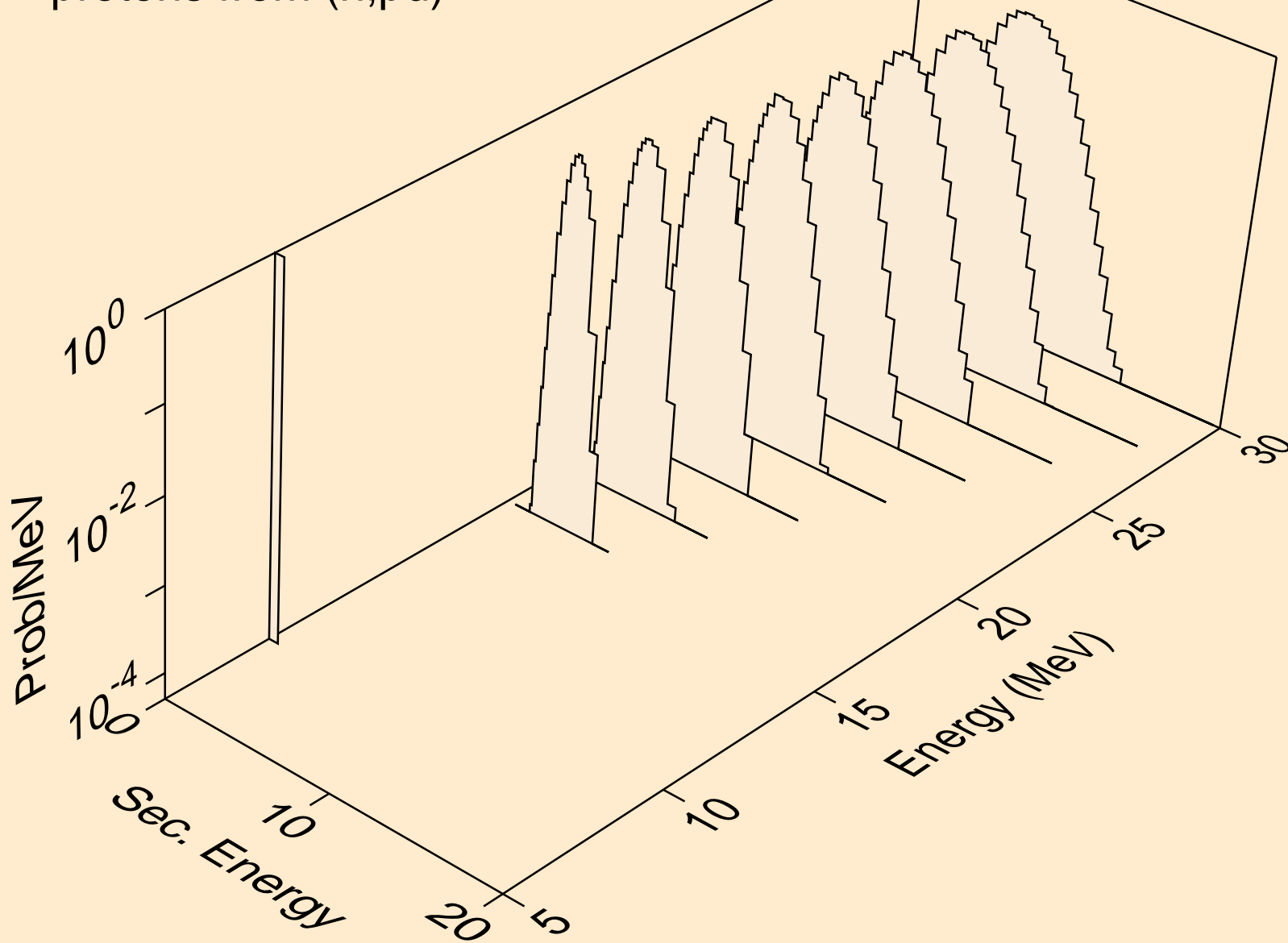

TA176 NEUTRON ACER TENDL-2019 LIBRARY; T=293.16K  
protons from (n,pt)

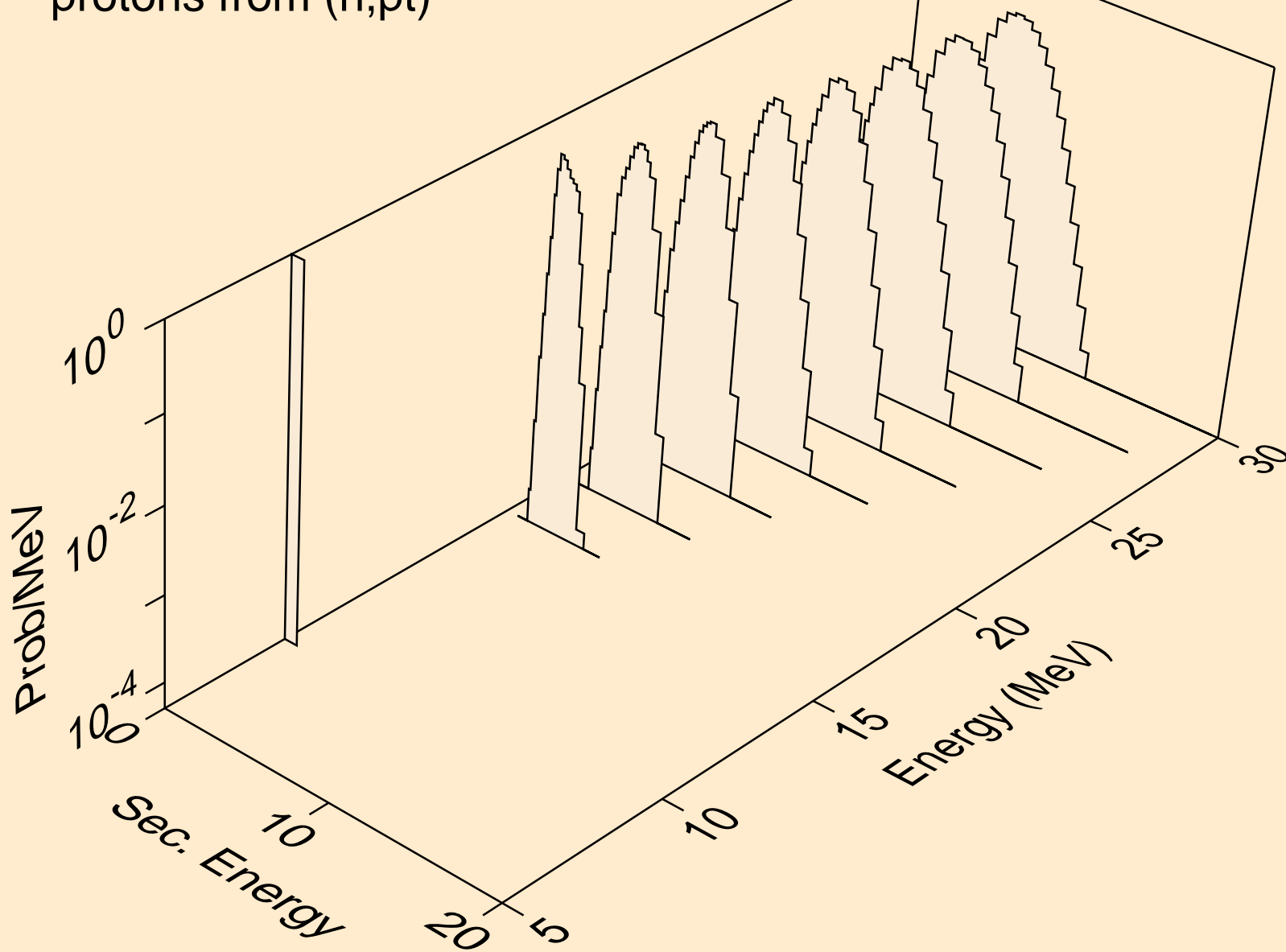

TA176 NEUTRON ACER TENDL-2019 LIBRARY; T=293.16K  
deuterons from (n,x)

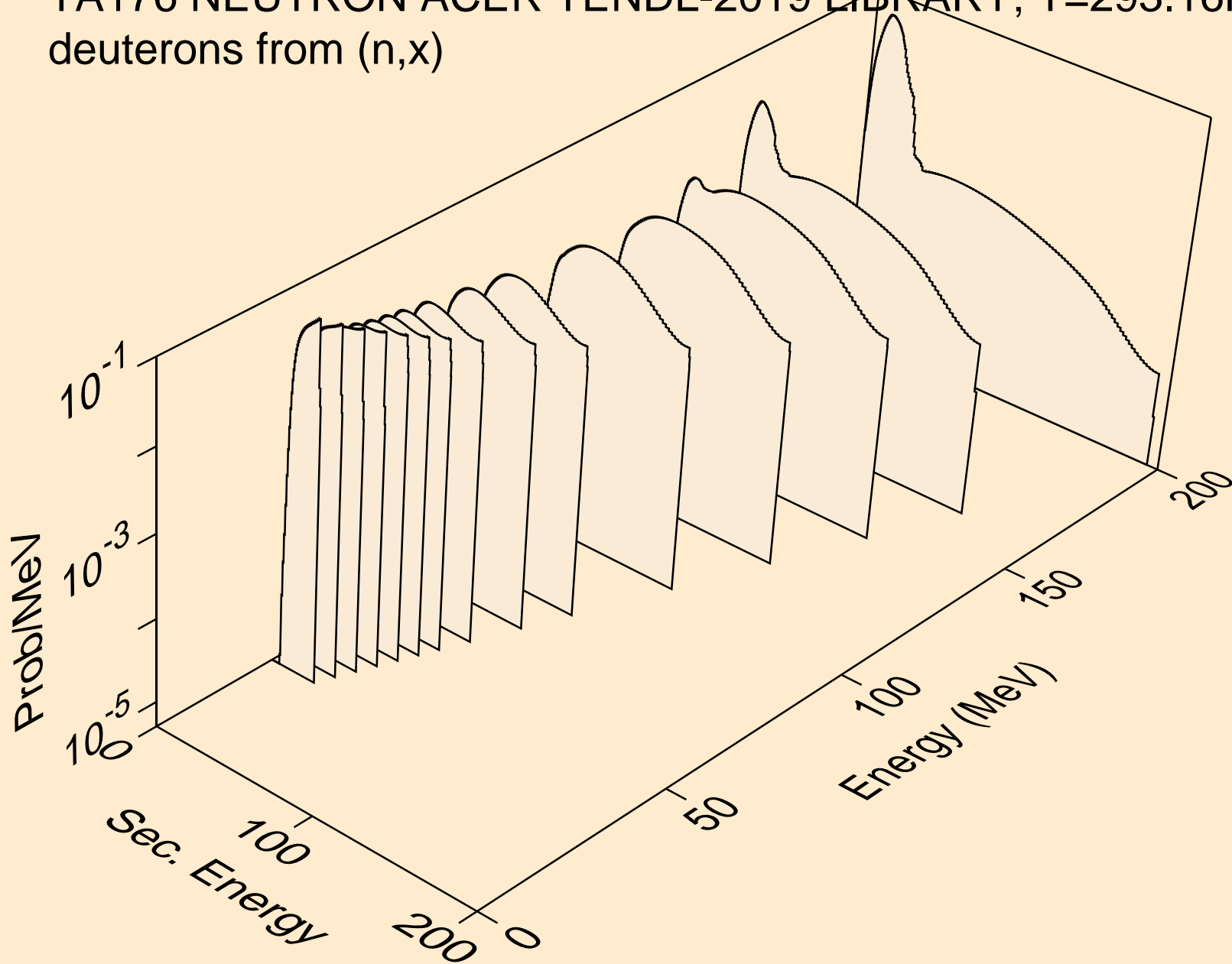



TA176 NEUTRON ACER TENDL-2019 LIBRARY; T=293.16K  
deuterons from (n,2nd)

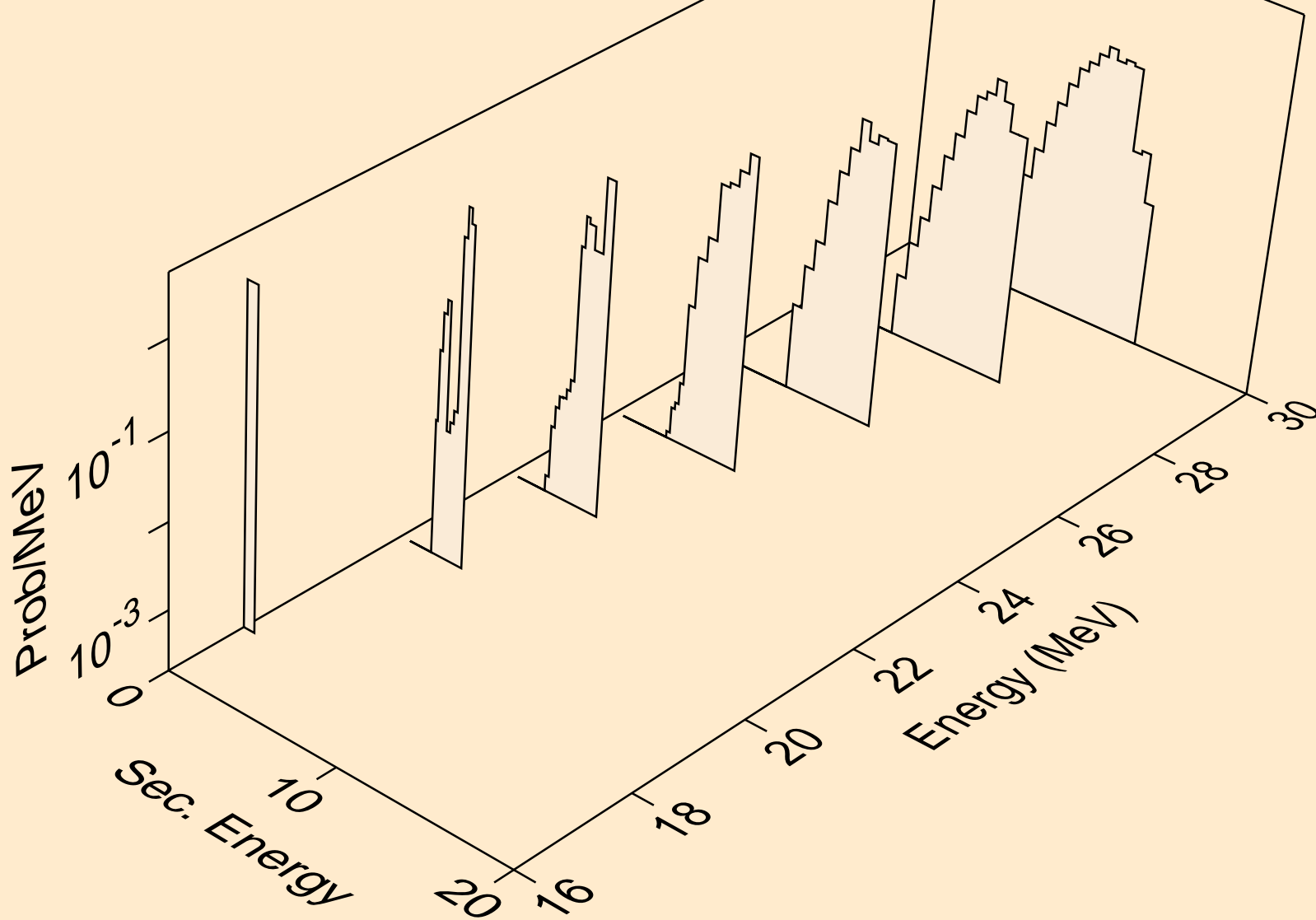

TA176 NEUTRON ACER TENDL-2019 LIBRARY; T=293.16K  
deuterons from (n,n\*)d

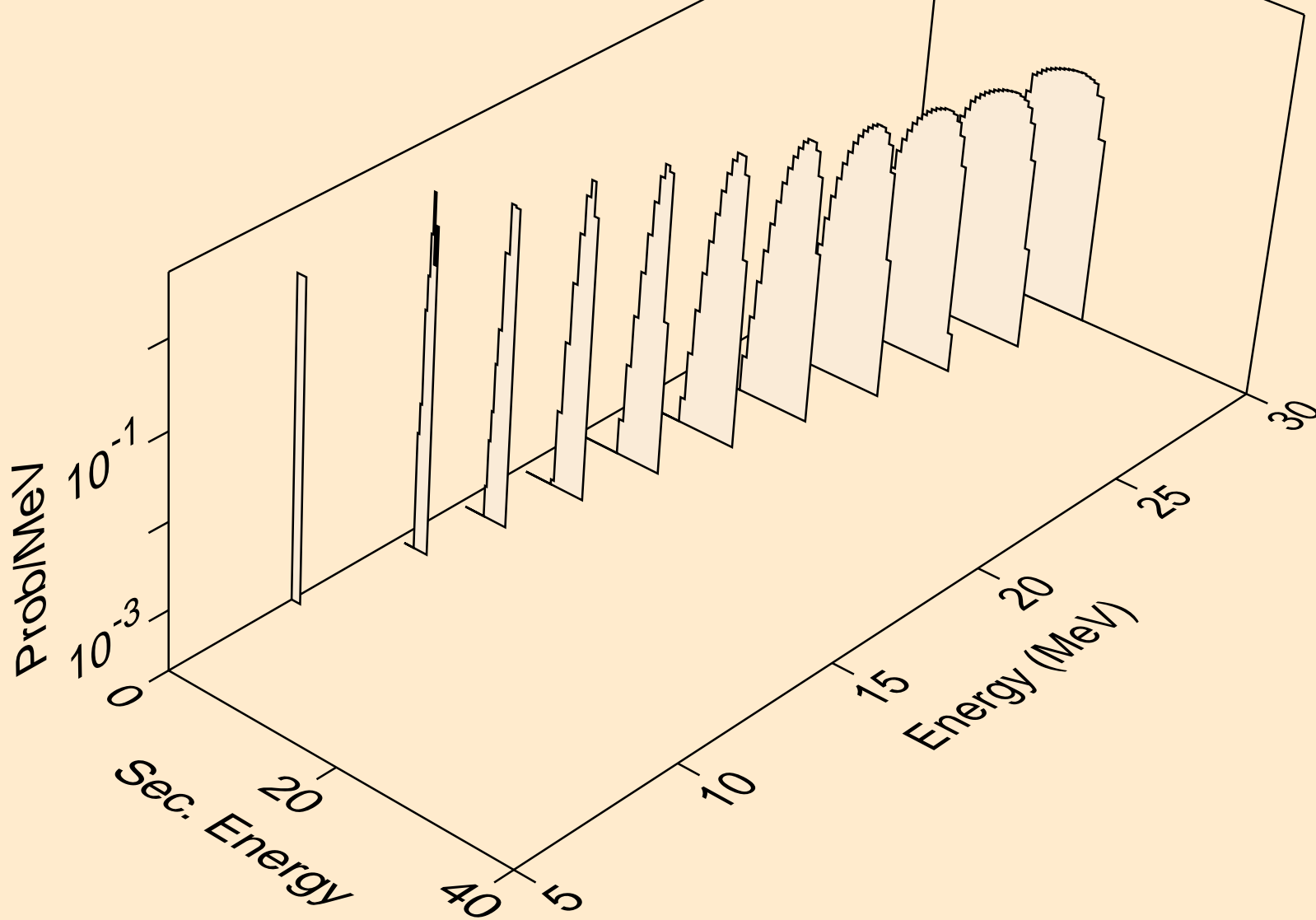

TA176 NEUTRON ACER TENDL-2019 LIBRARY; T=293.16K  
deuterons from (n,d)

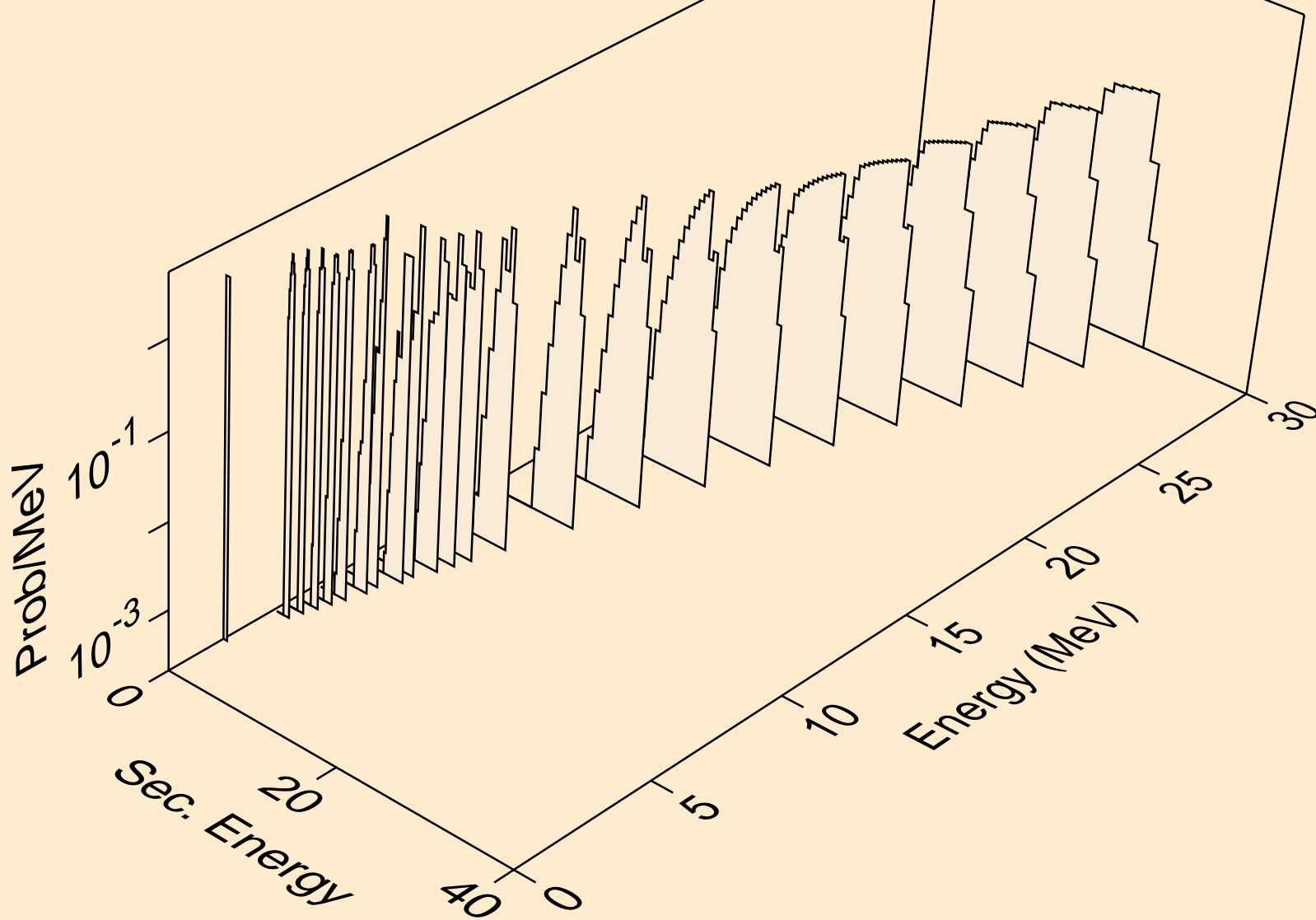

TA176 NEUTRON ACER TENDL-2019 LIBRARY; T=293.16K  
deuterons from (n,pd)

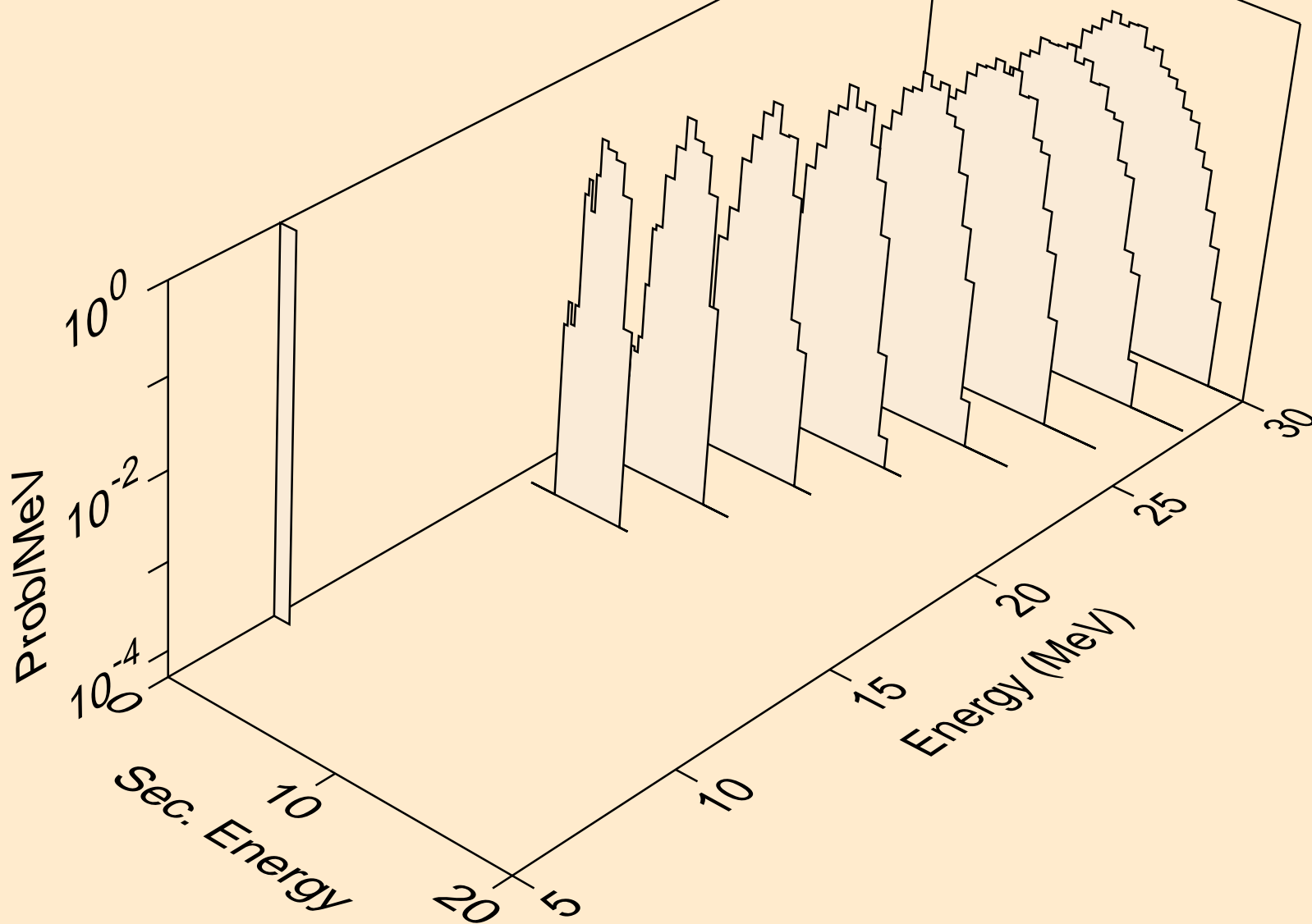

TA176 NEUTRON ACER TENDL-2019 LIBRARY; T=293.16K  
deuterons from (n,da)

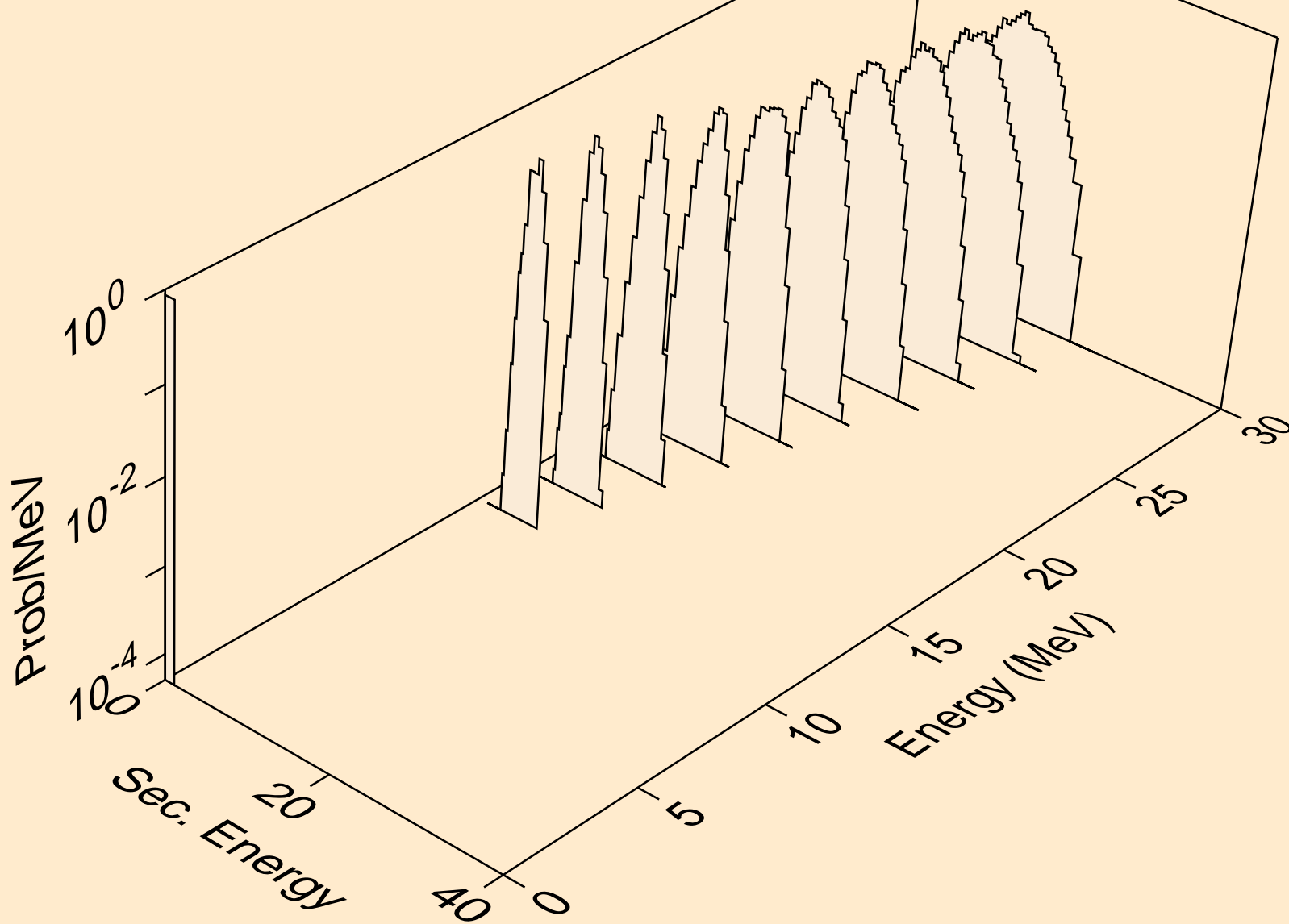

TA176 NEUTRON ACER TENDL-2019 LIBRARY; T=293.16K  
tritons from (n,x)

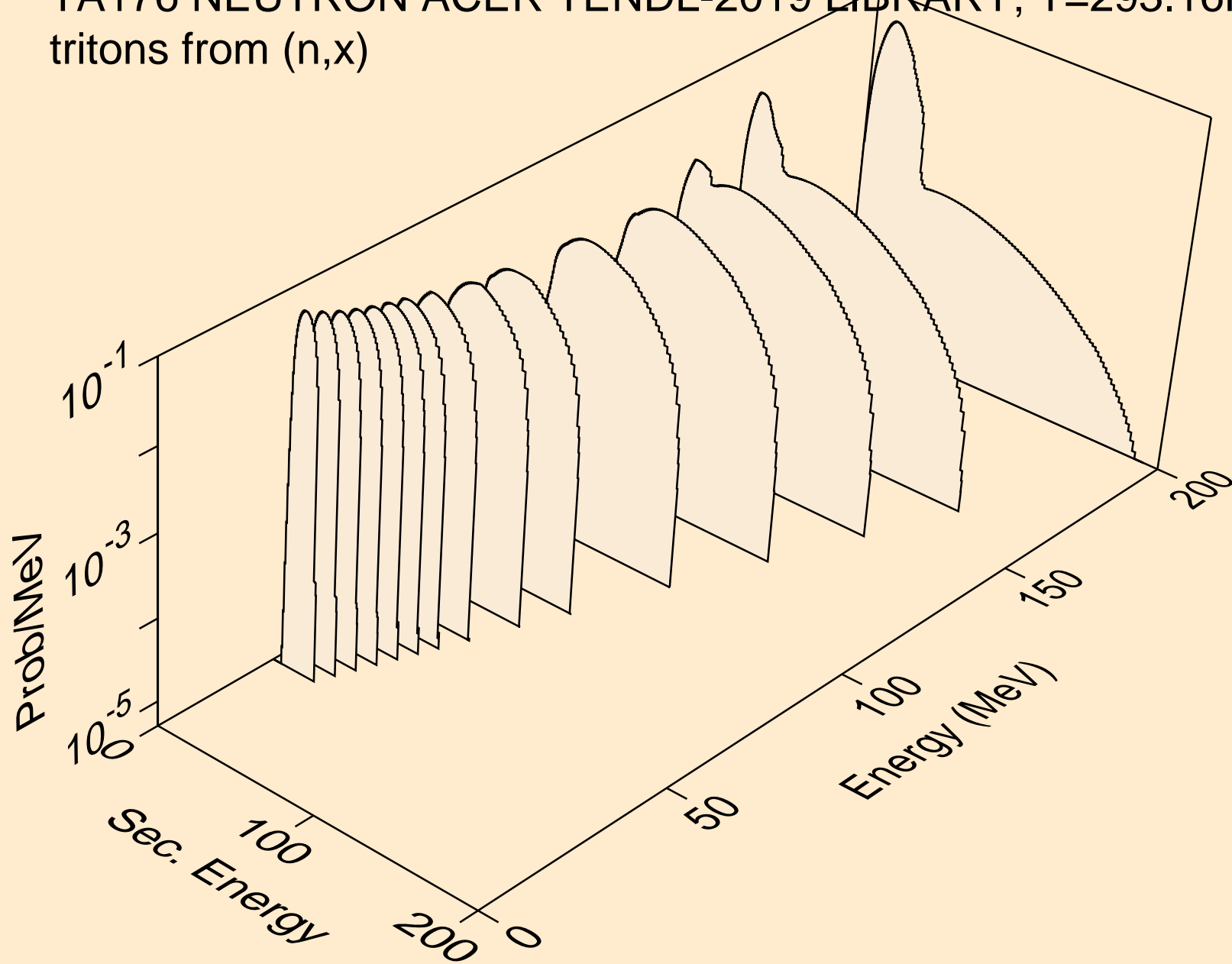

TA176 NEUTRON ACER TENDL-2019 LIBRARY; T=293.16K  
tritons from (n,n\*)t

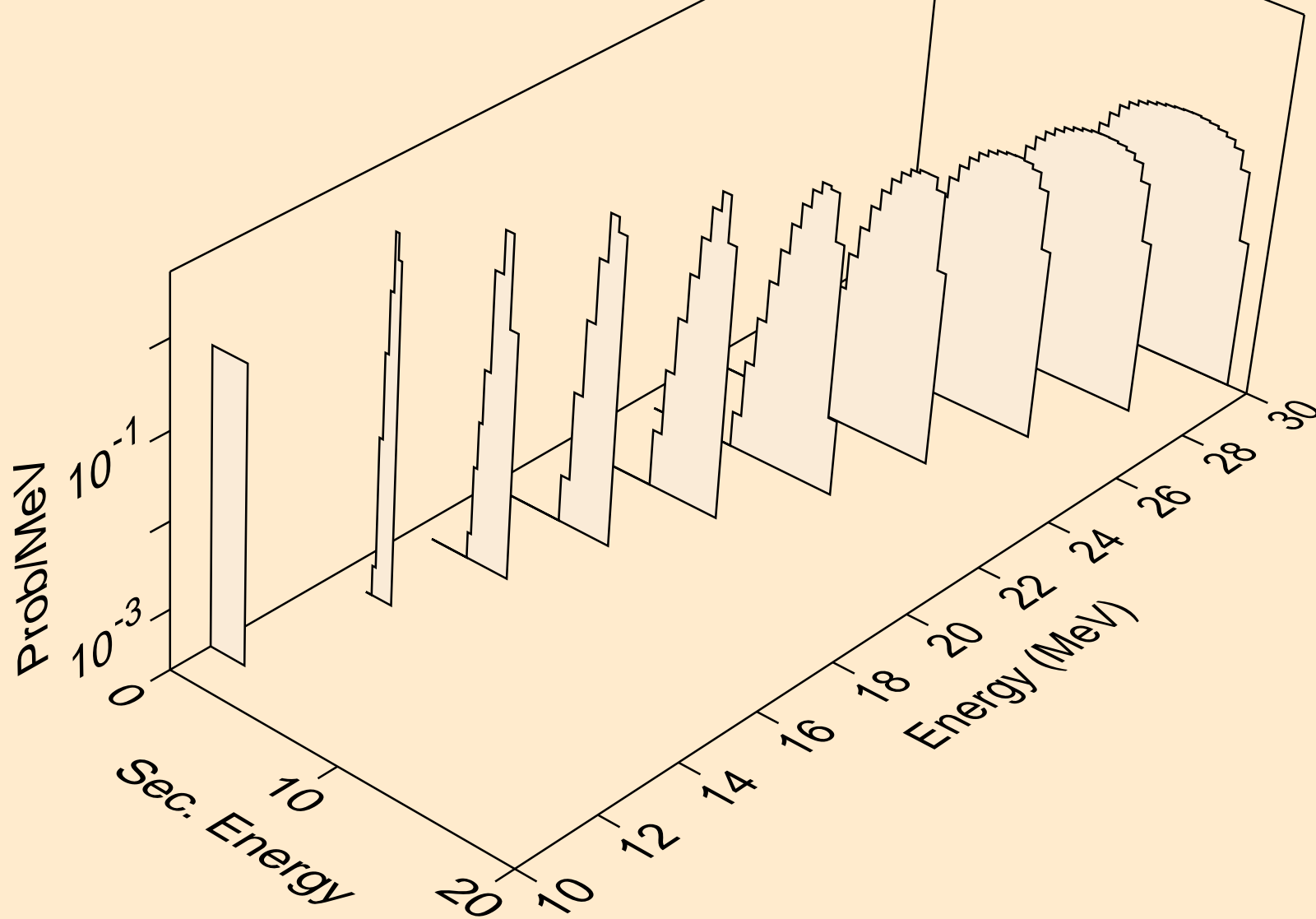

TA176 NEUTRON ACER TENDL-2019 LIBRARY; T=293.16K  
tritons from (n,t)

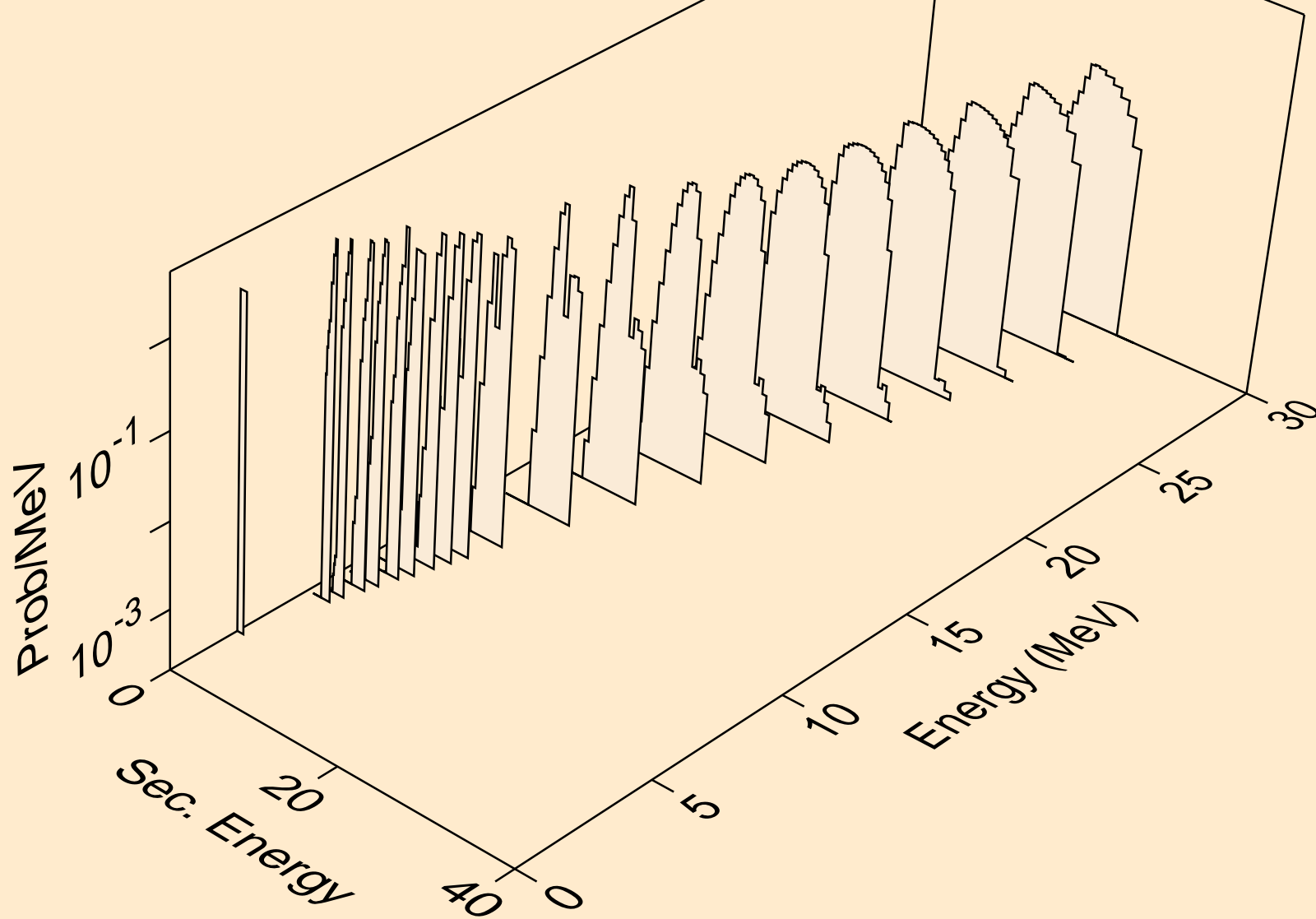



TA176 NEUTRON ACER TENDL-2019 LIBRARY; T=293.16K  
tritons from (n,pt)

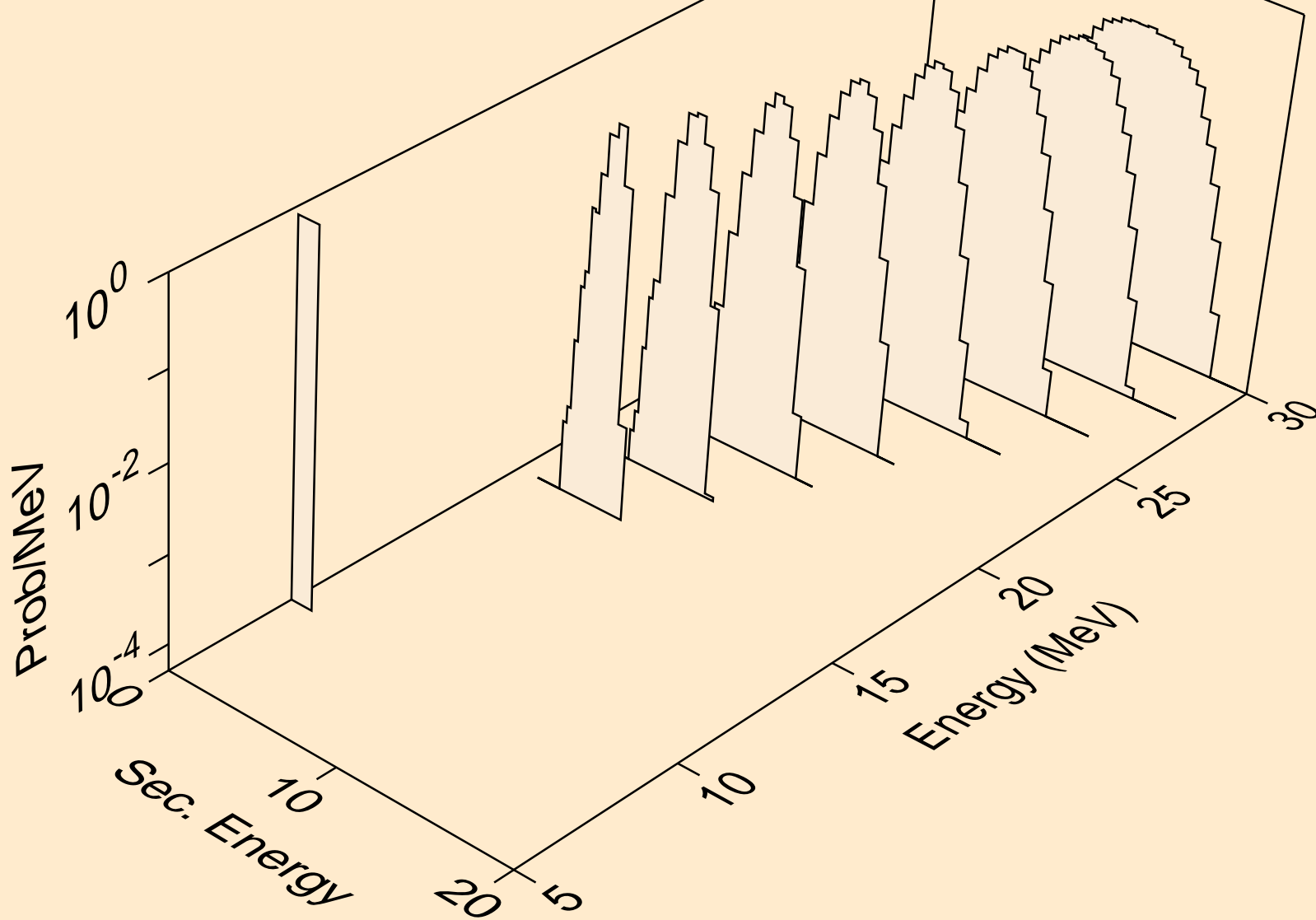

TA176 NEUTRON ACER TENDL-2019 LIBRARY; T=293.16K  
he3s from (n,x)

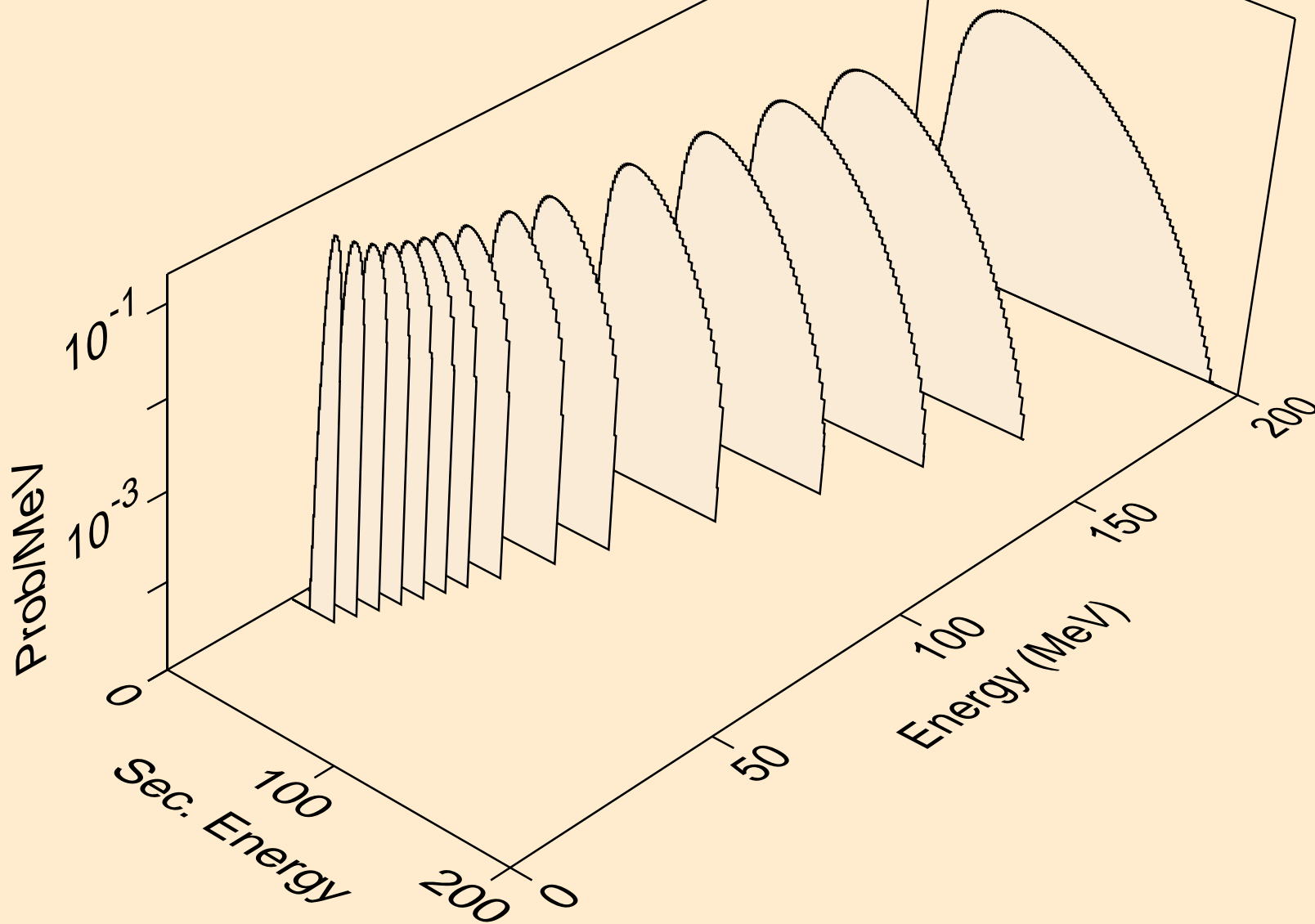

TA176 NEUTRON ACER TENDL-2019 LIBRARY; T=293.16K  
he3s from (n,n\*)he3

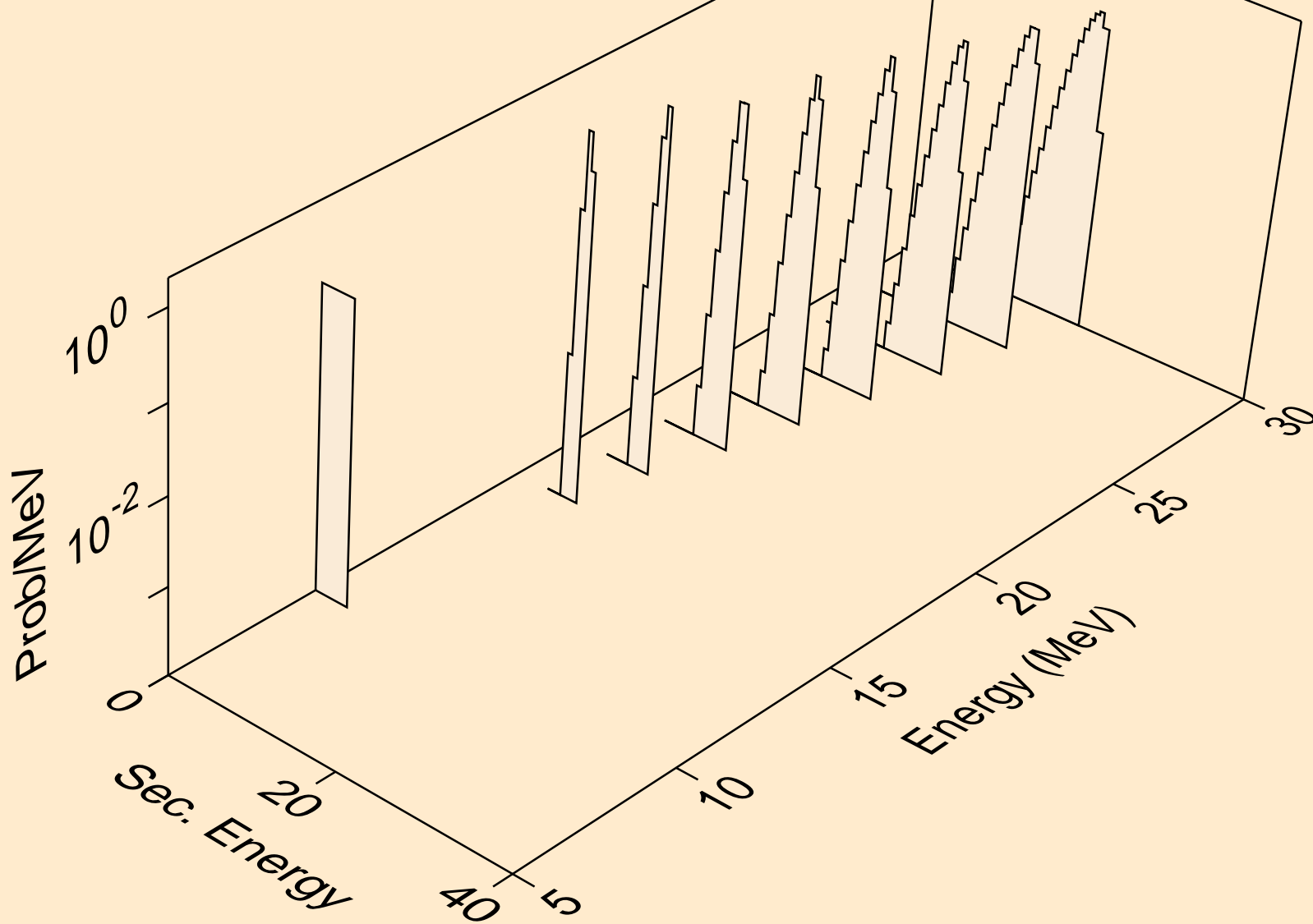

TA176 NEUTRON ACER TENDL-2019 LIBRARY; T=293.16K  
he3s from (n,he3)

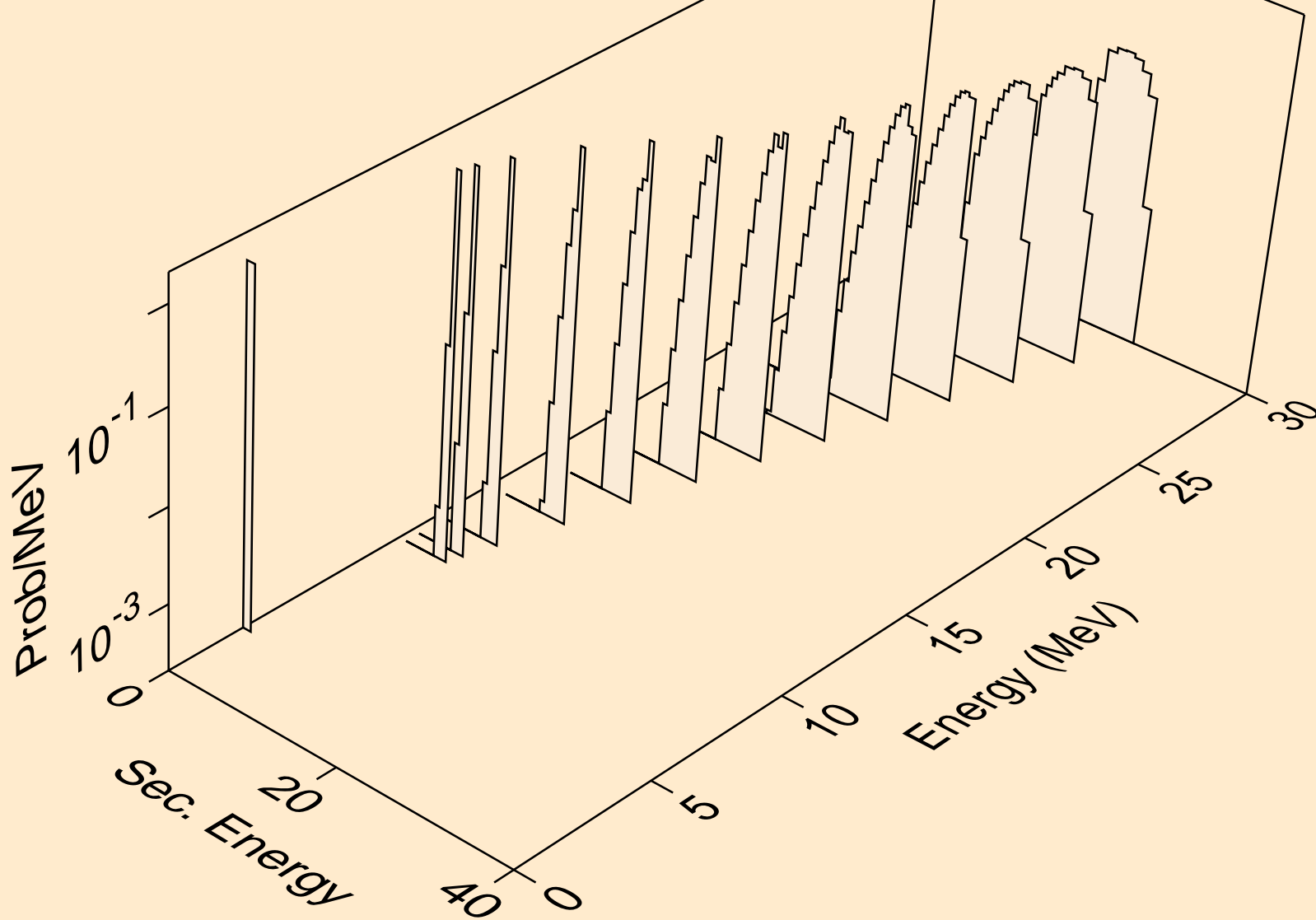

TA176 NEUTRON ACER TENDL-2019 LIBRARY; T=293.16K  
alphas from (n,x)

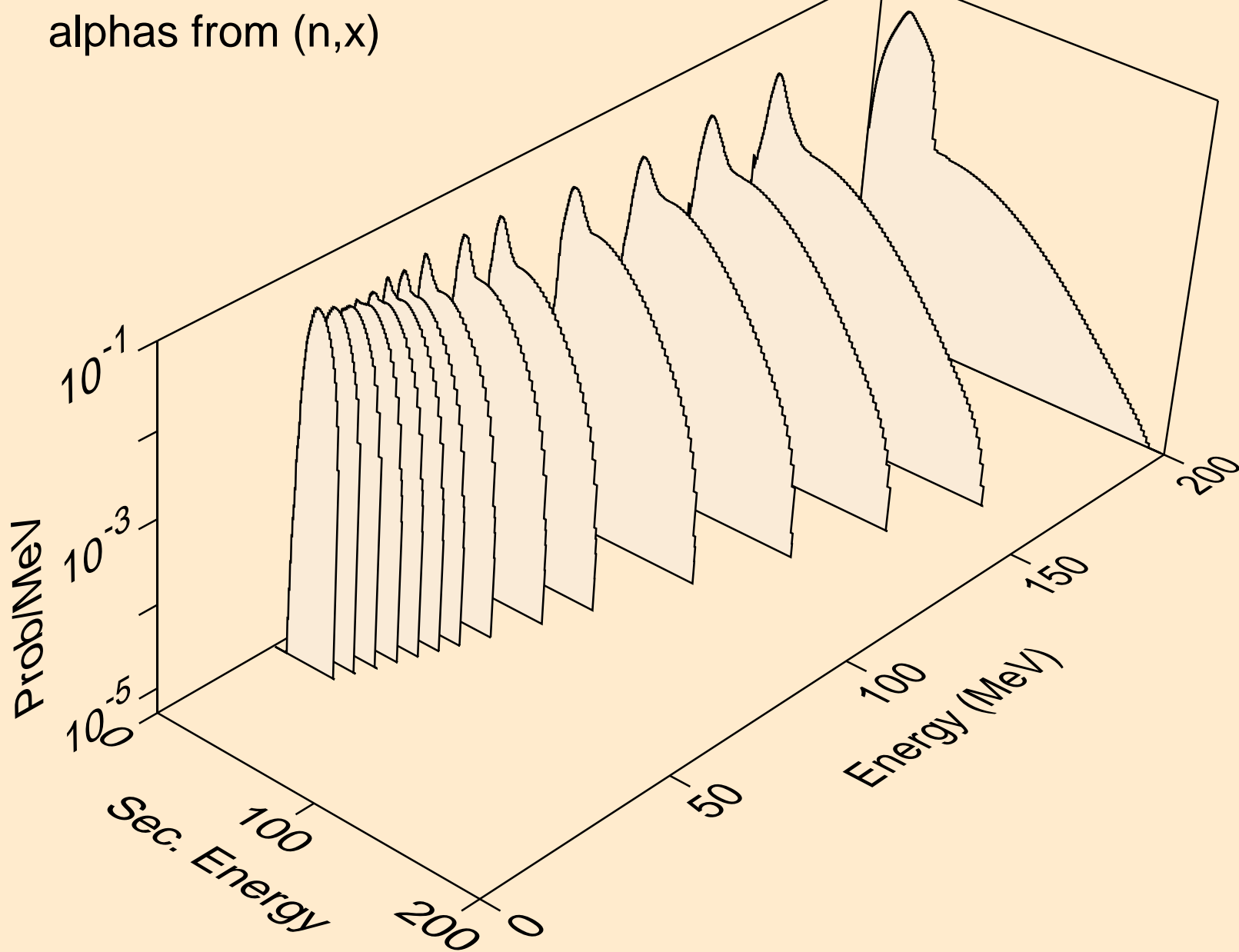

TA176 NEUTRON ACER TENDL-2019 LIBRARY; T=293.16K  
alphas from (n,n\*)a

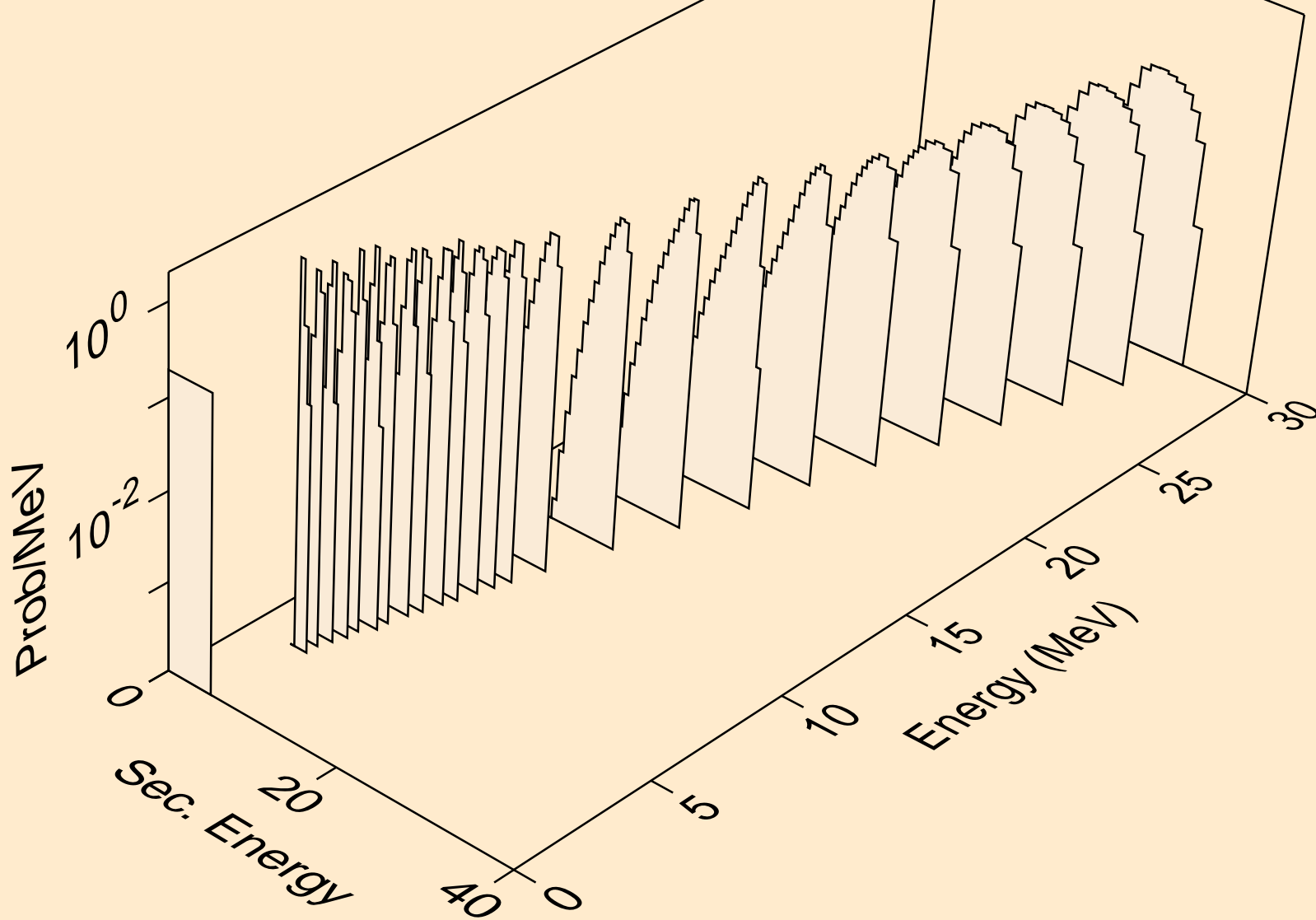

TA176 NEUTRON ACER TENDL-2019 LIBRARY; T=293.16K  
alphas from (n,2n)a

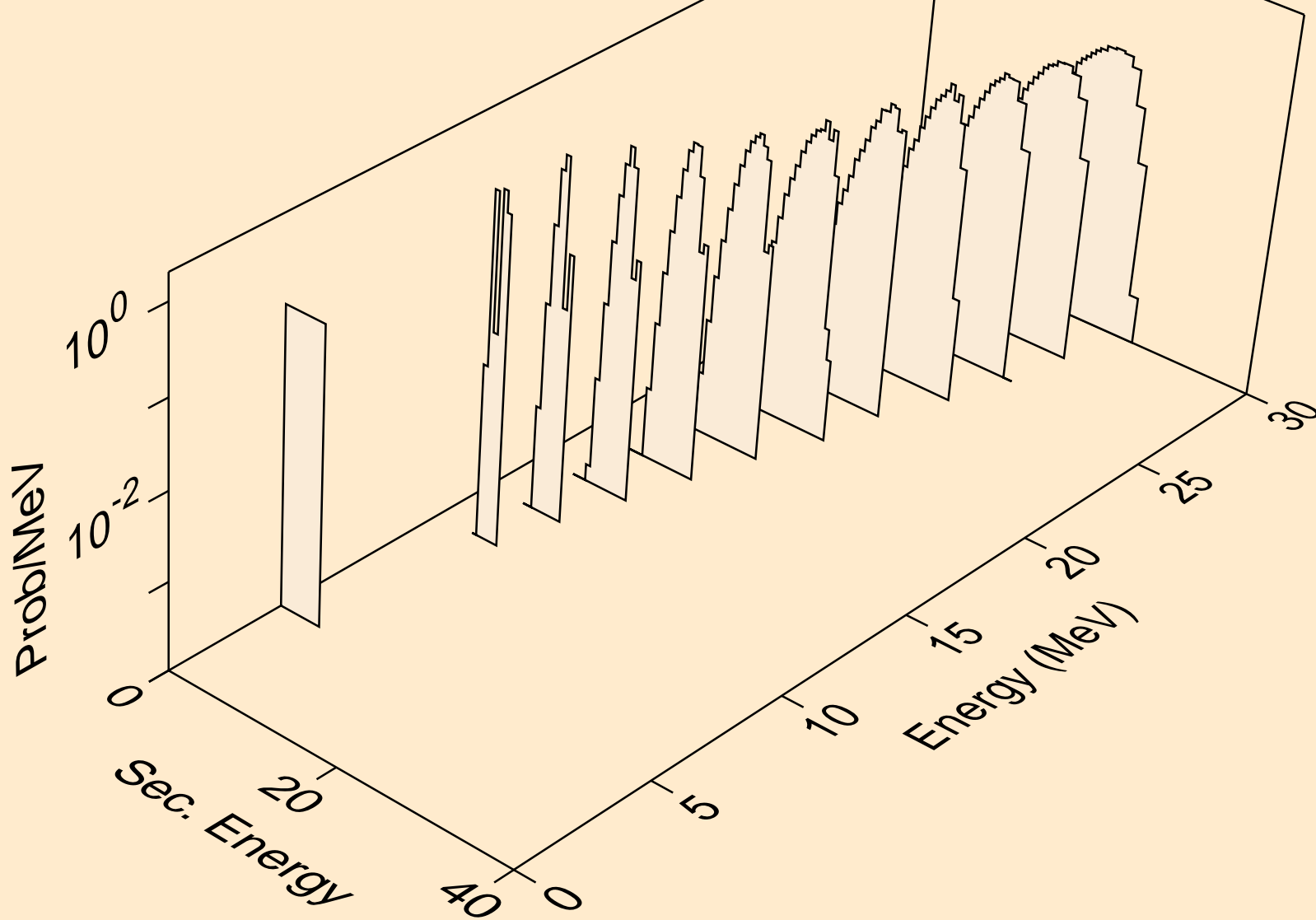

TA176 NEUTRON ACER TENDL-2019 LIBRARY; T=293.16K  
alphas from (n,3n)a

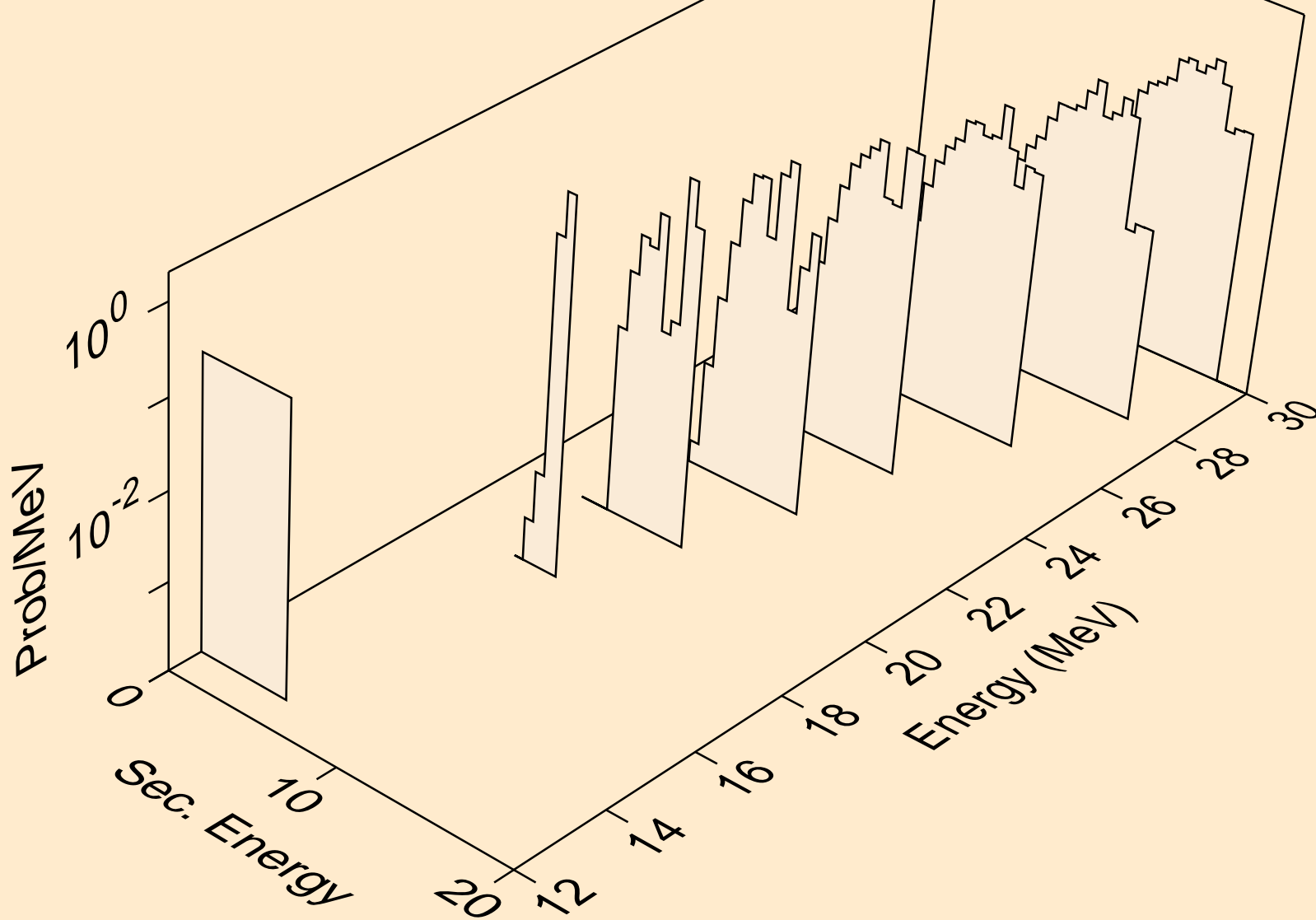



TA176 NEUTRON ACER TENDL-2019 LIBRARY; T=293.16K  
alphas from (n,n\*)2a

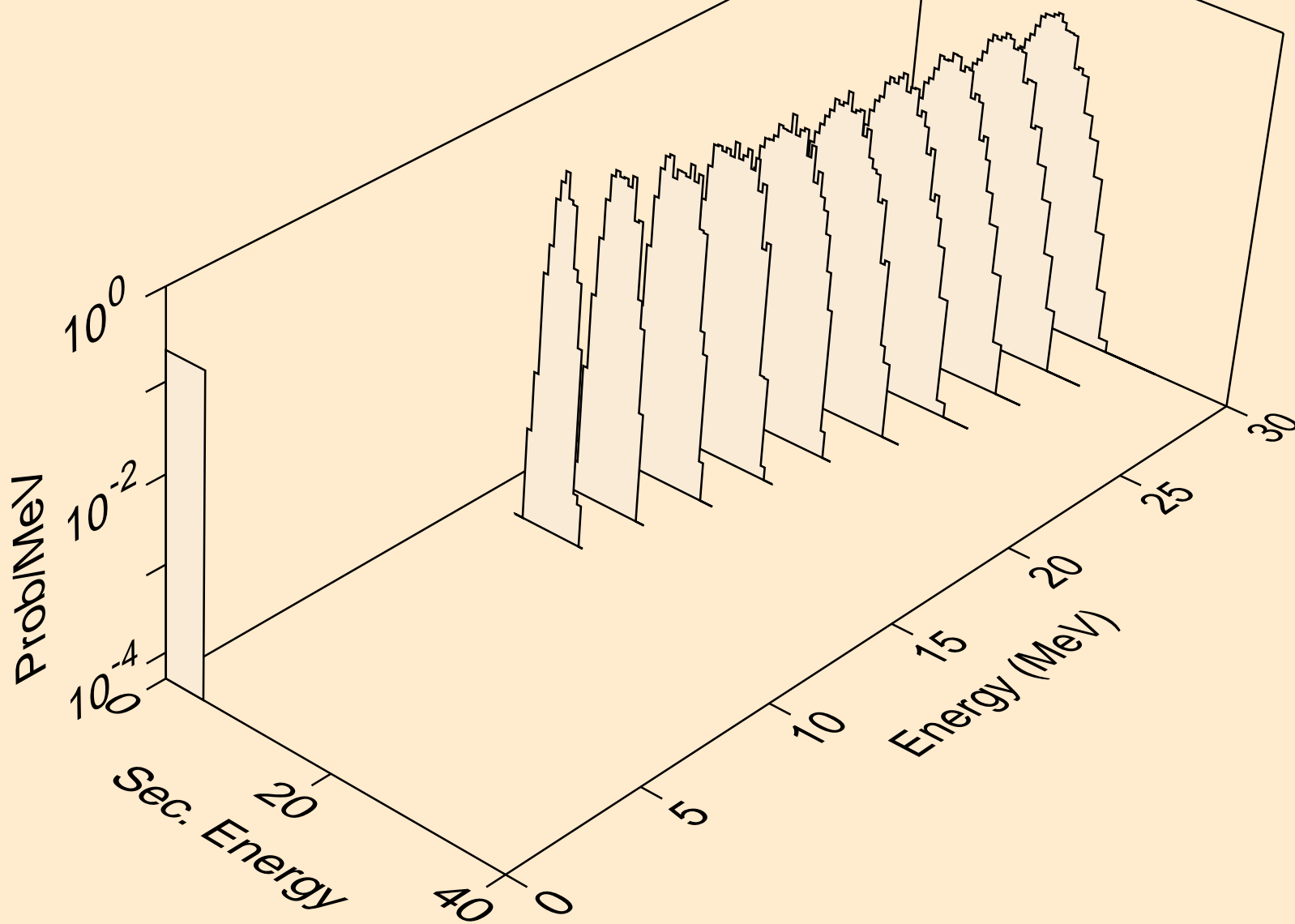

TA176 NEUTRON ACER TENDL-2019 LIBRARY; T=293.16K  
alphas from (n,2n)2a

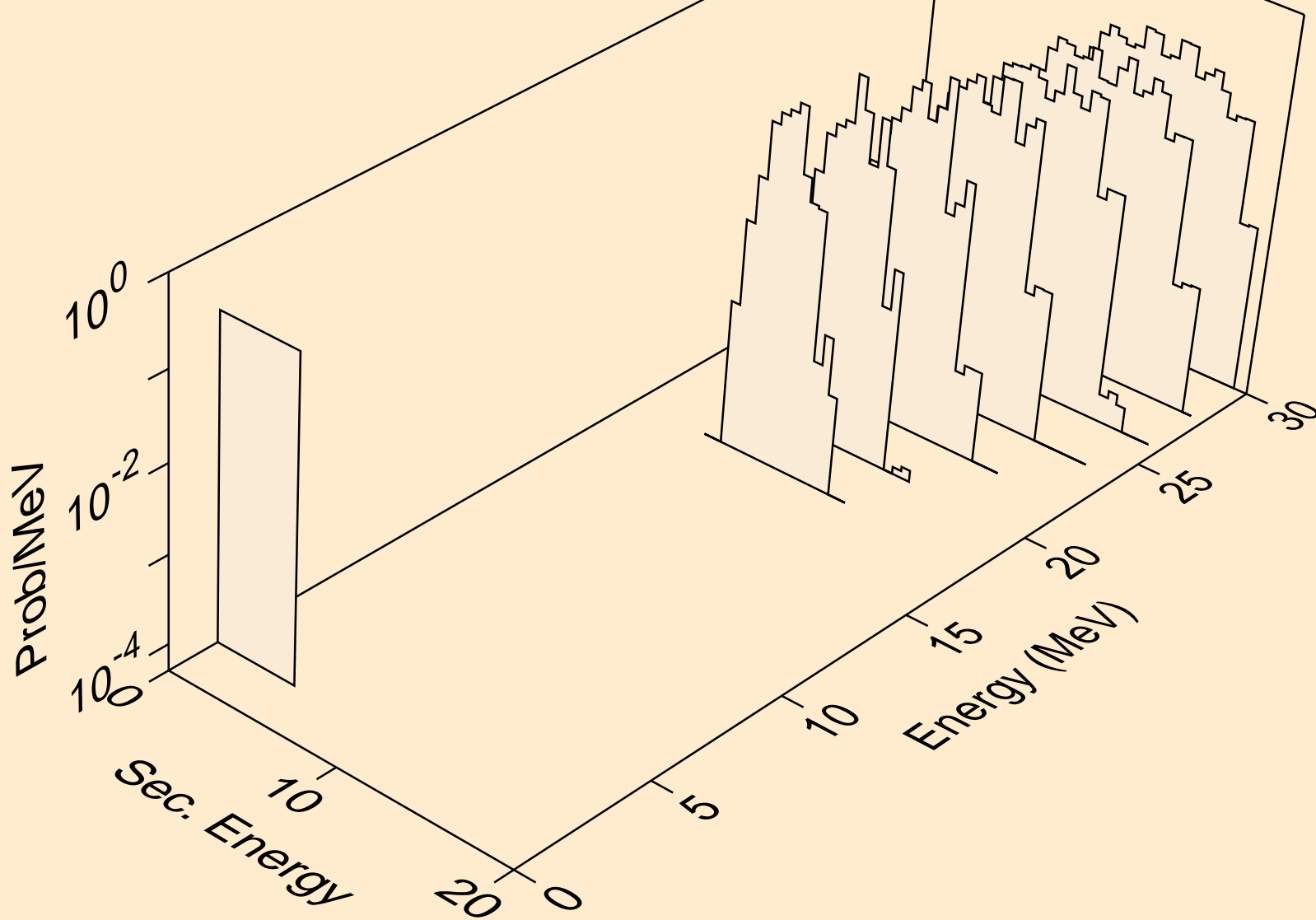

TA176 NEUTRON ACER TENDL-2019 LIBRARY; T=293.16K  
alphas from (n,npa)

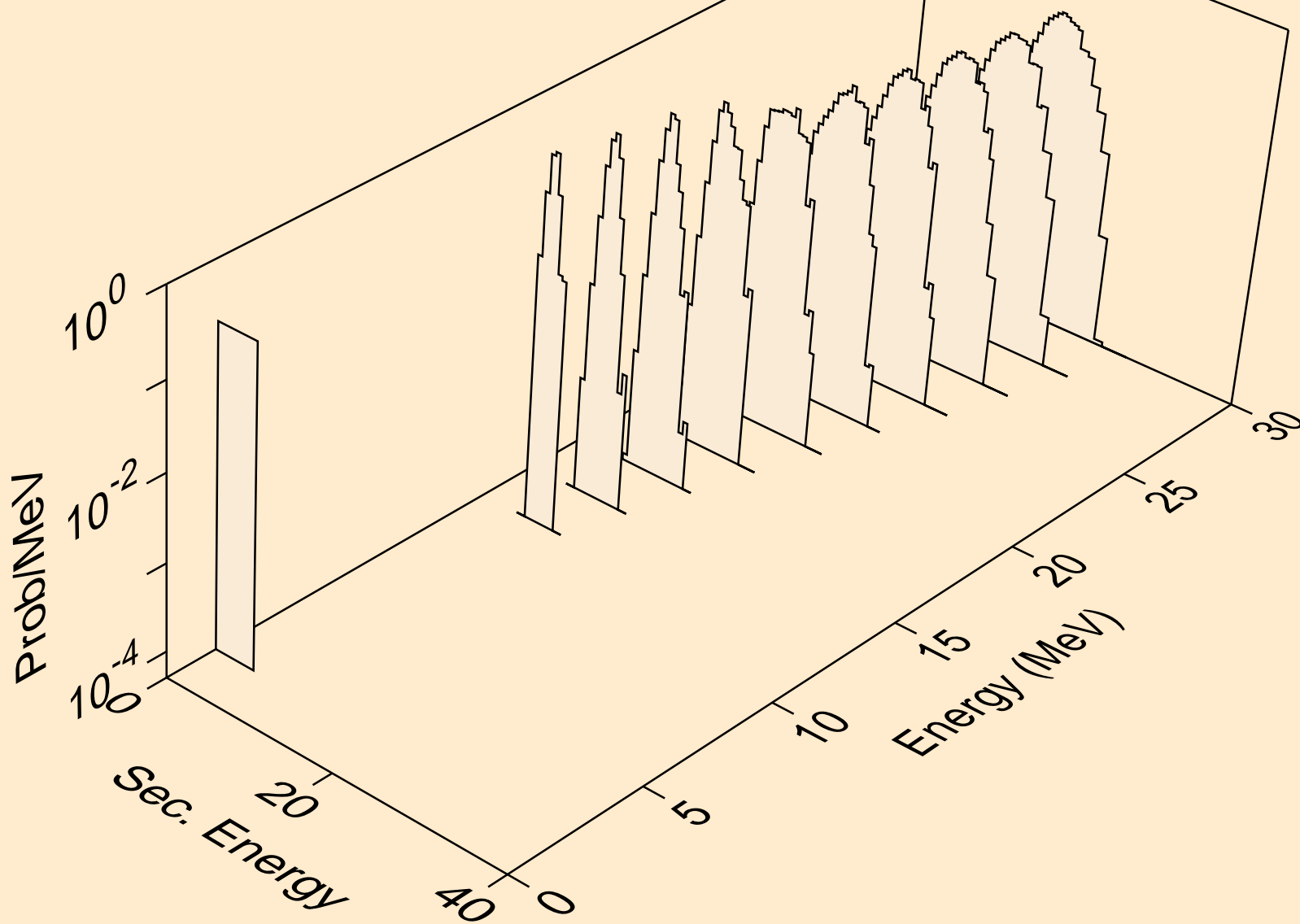

TA176 NEUTRON ACER TENDL-2019 LIBRARY; T=293.16K  
alphas from (n,a)

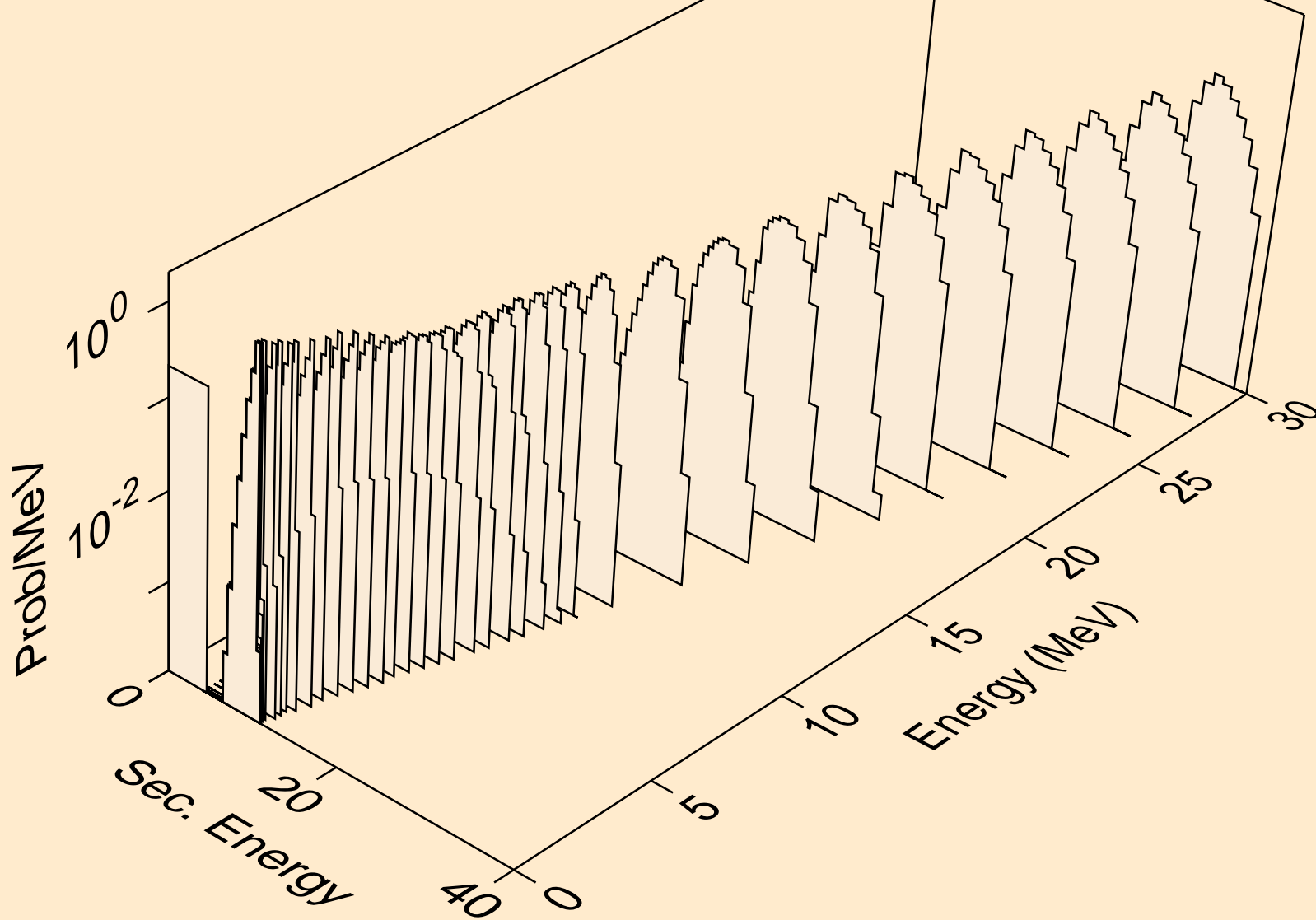

TA176 NEUTRON ACER TENDL-2019 LIBRARY; T=293.16K  
alphas from (n,2a)

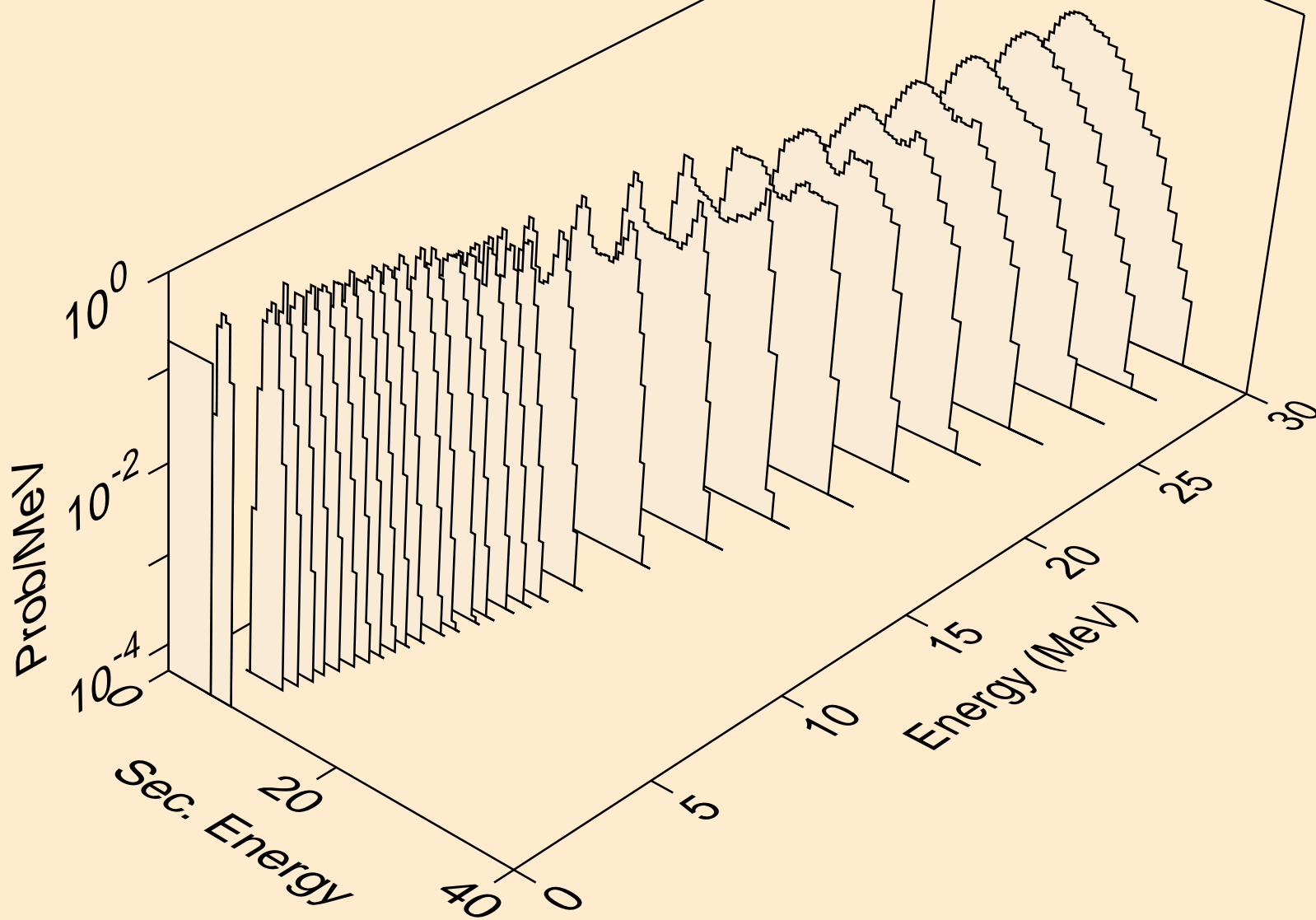

TA176 NEUTRON ACER TENDL-2019 LIBRARY; T=293.16K  
alphas from (n,pa)

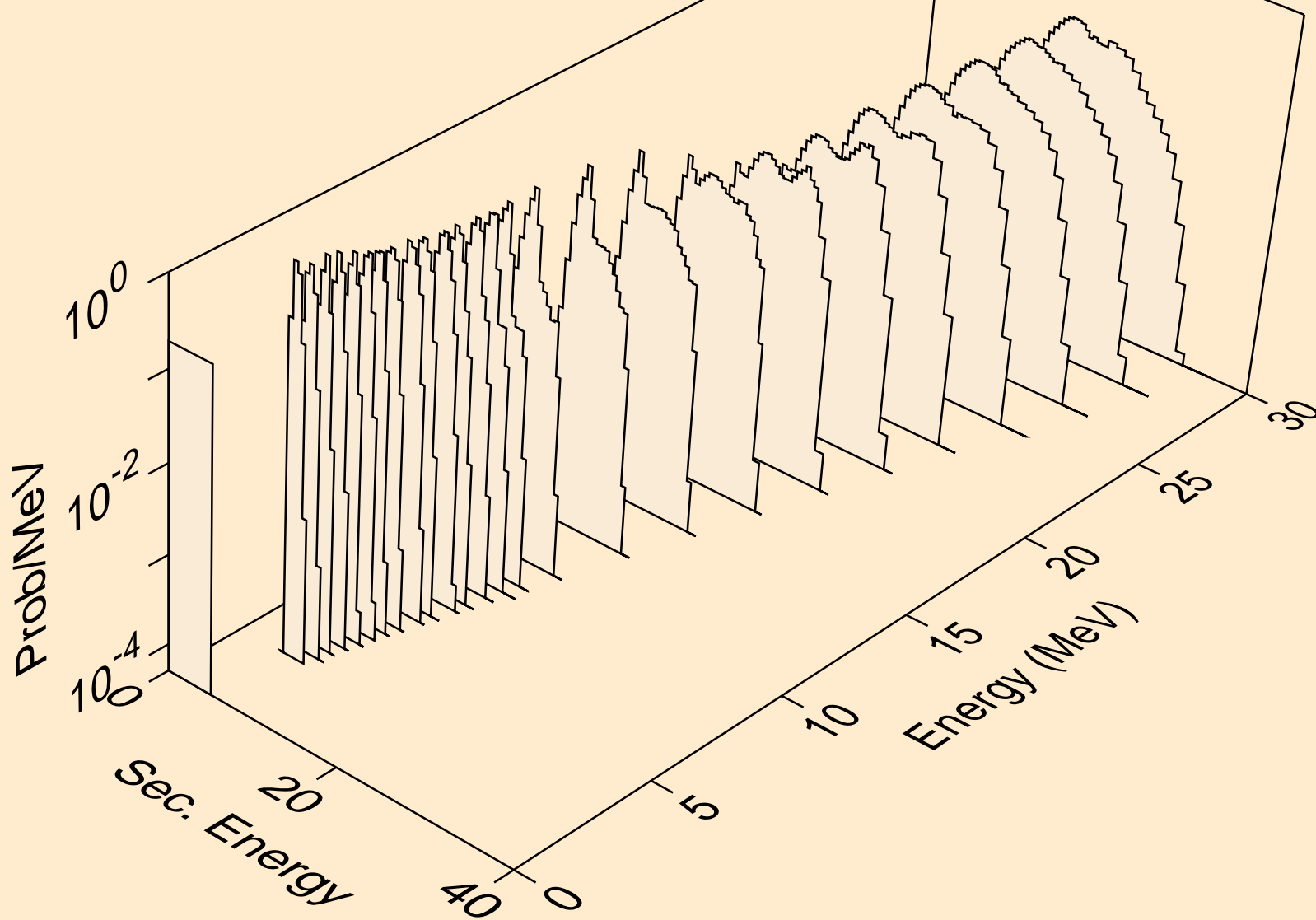

TA176 NEUTRON ACER TENDL-2019 LIBRARY; T=293.16K  
alphas from (n,da)

