

TA180 NEUTRON ACER TENDL-2019 LIBRARY; T=293.16K
Principal cross sections

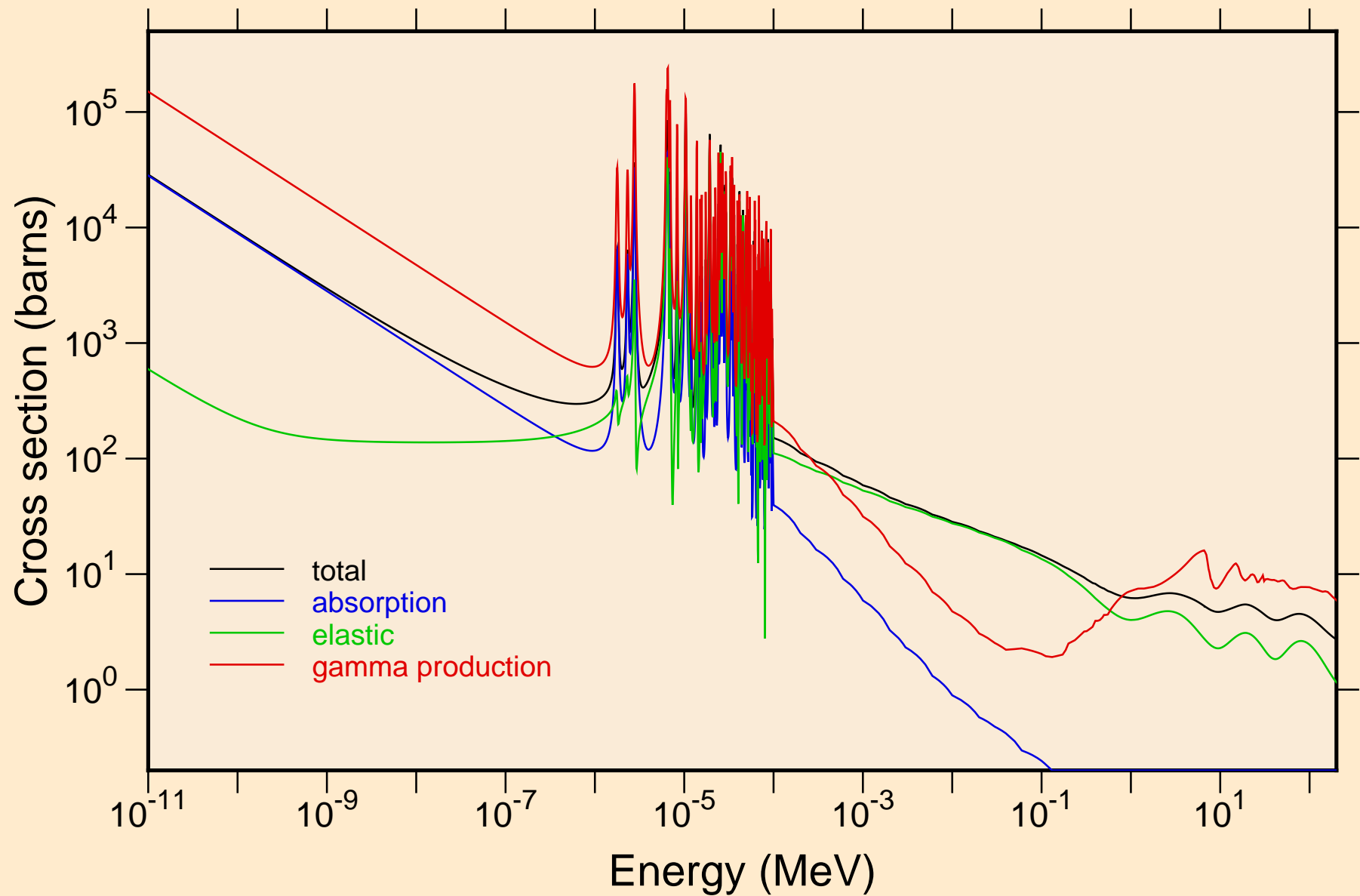

TA180 NEUTRON ACER TENDL-2019 LIBRARY; T=293.16K
resonance total cross section

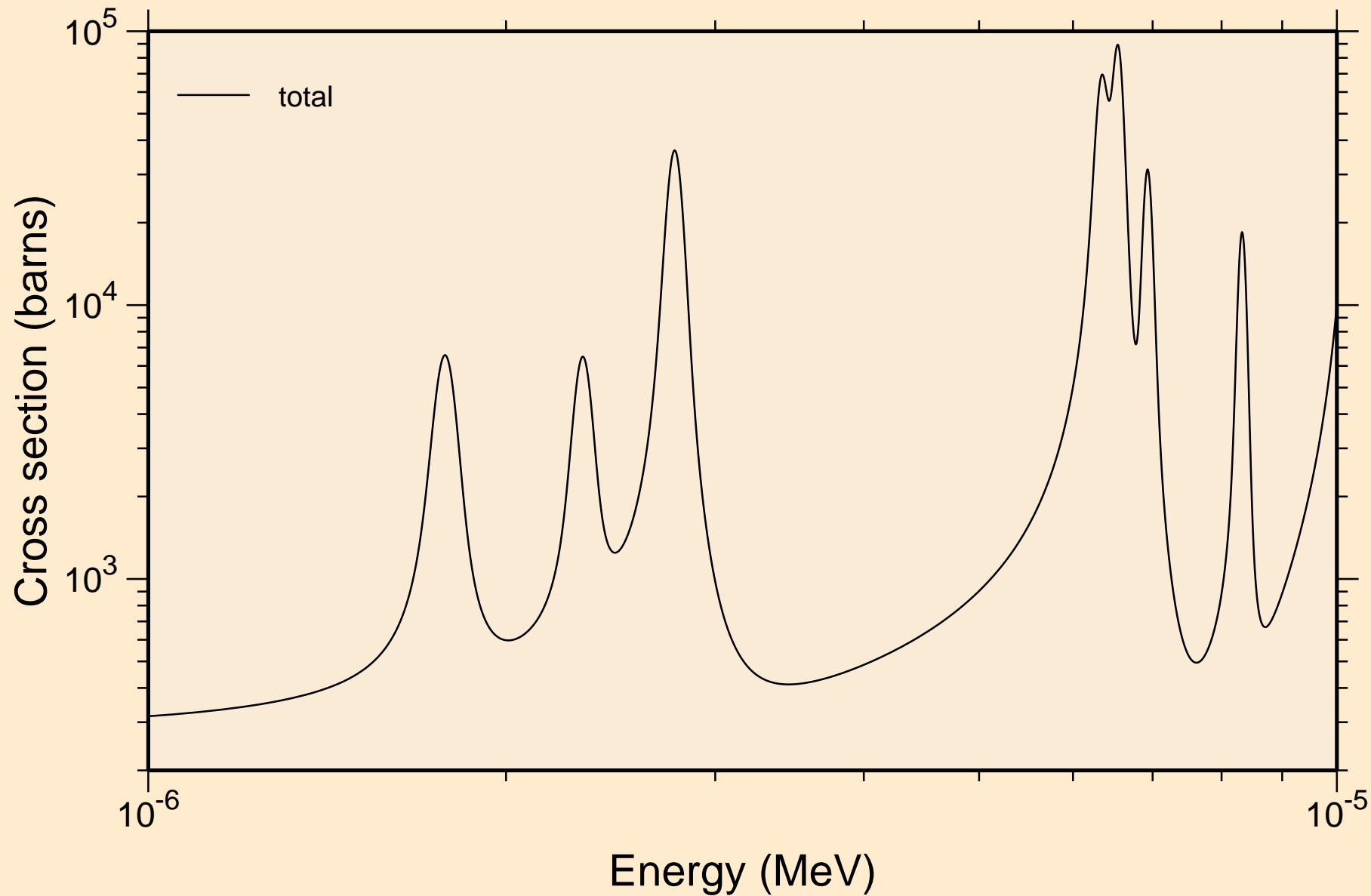

TA180 NEUTRON ACER TENDL-2019 LIBRARY; T=293.16K
resonance total cross section

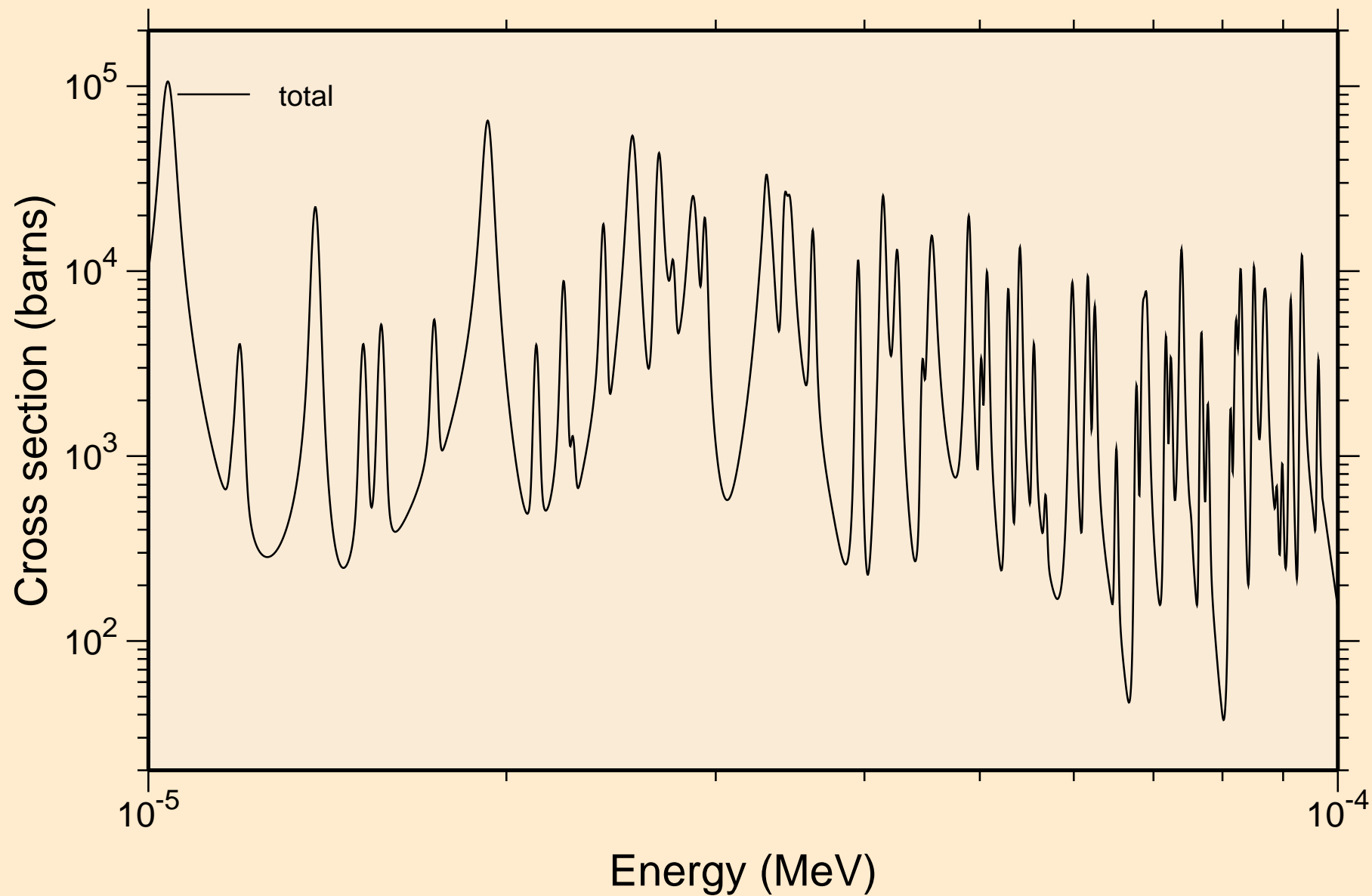

TA180 NEUTRON ACER TENDL-2019 LIBRARY; T=293.16K
resonance total cross section

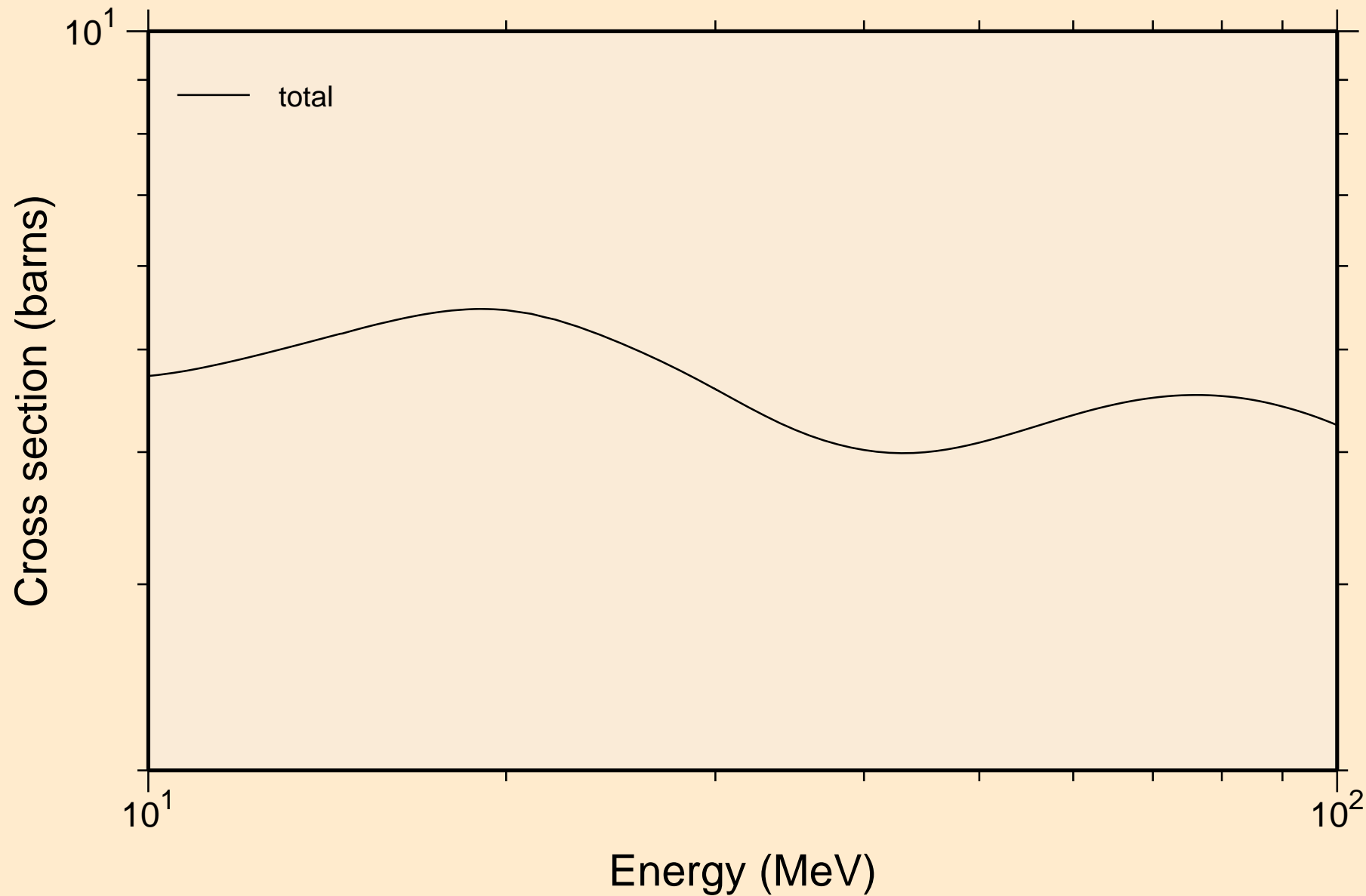

TA180 NEUTRON ACER TENDL-2019 LIBRARY; T=293.16K
resonance absorption cross sections

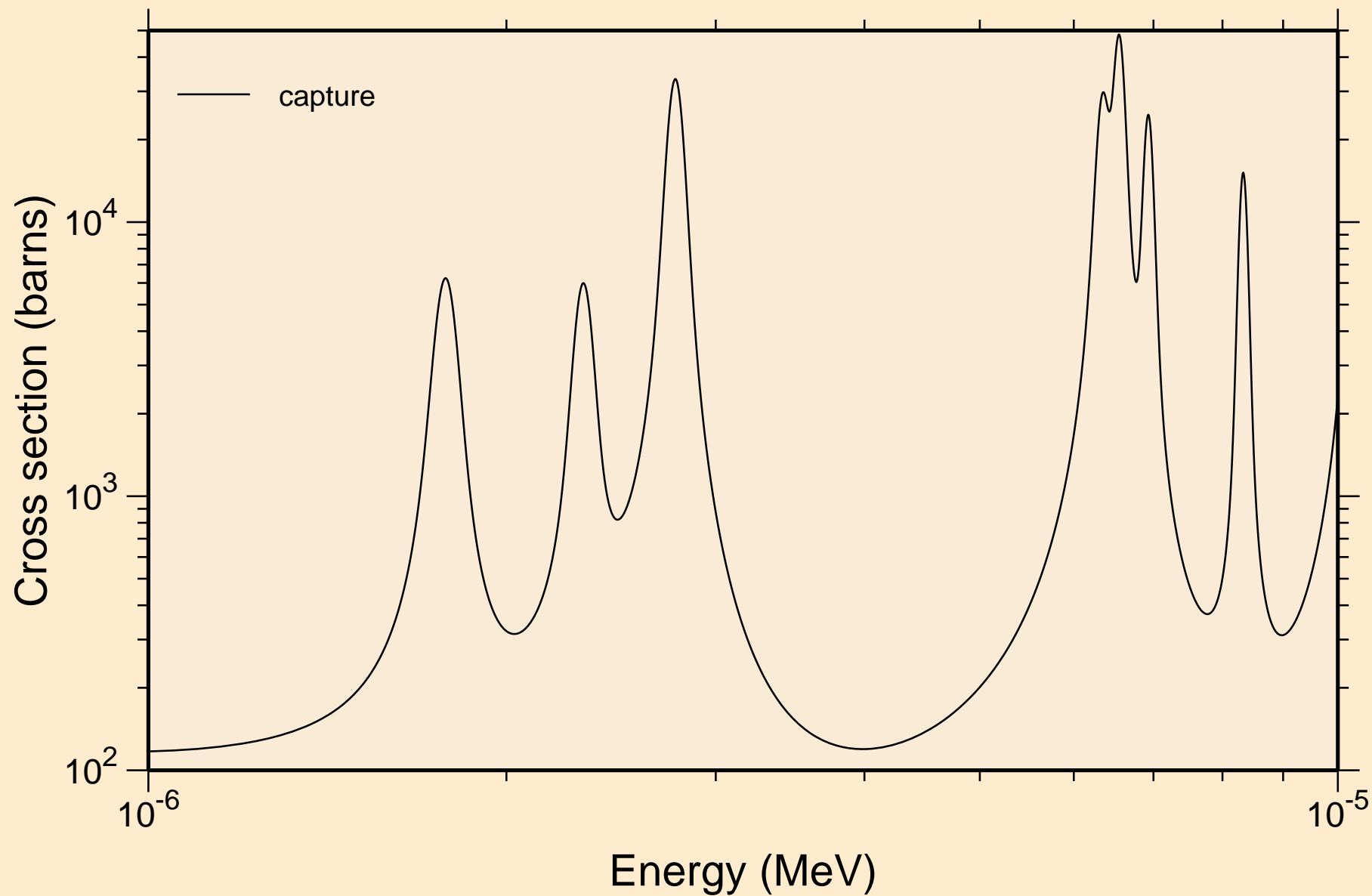

TA180 NEUTRON ACER TENDL-2019 LIBRARY; T=293.16K
resonance absorption cross sections

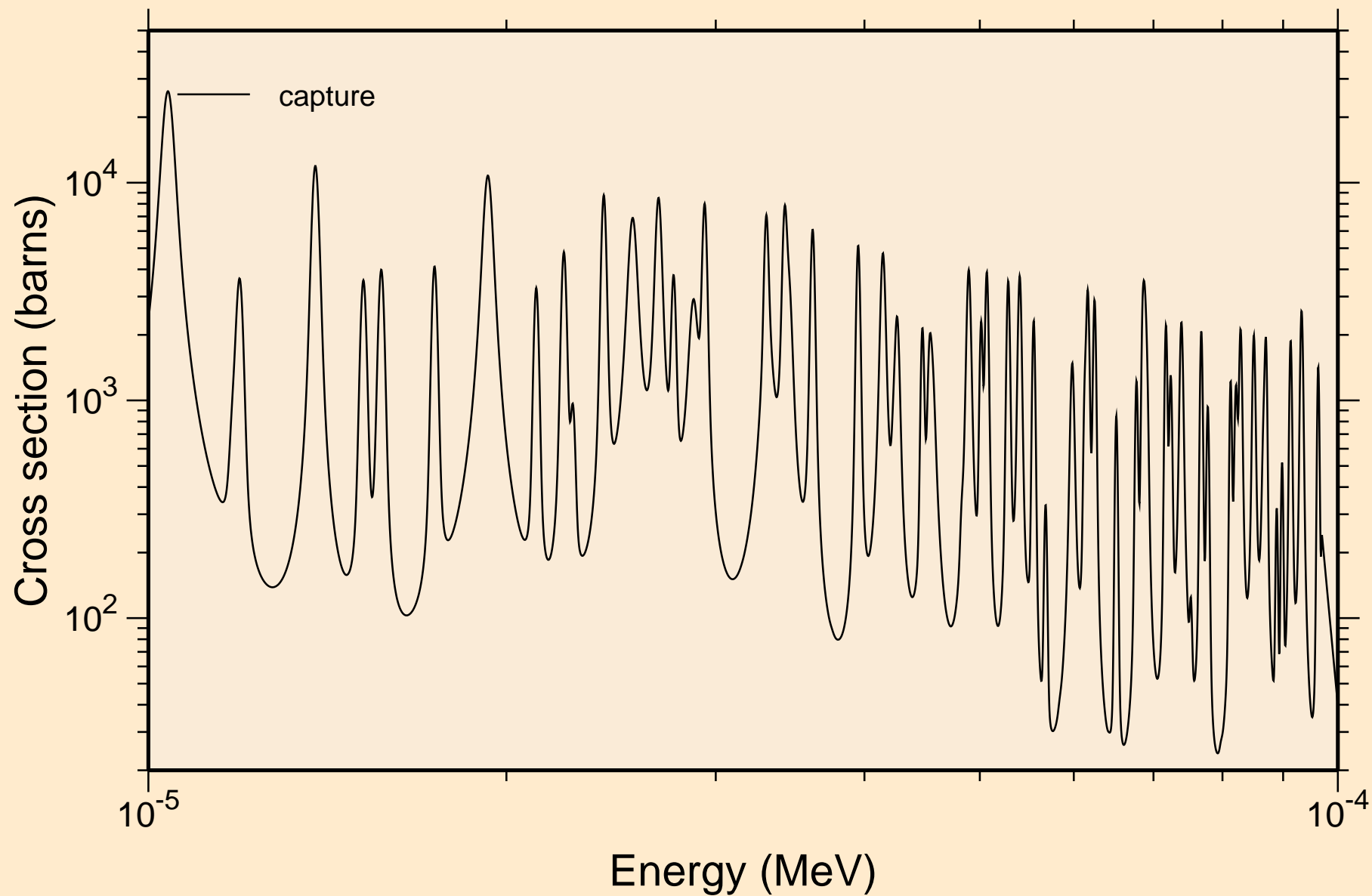

TA180 NEUTRON ACER TENDL-2019 LIBRARY; T=293.16K
resonance absorption cross sections

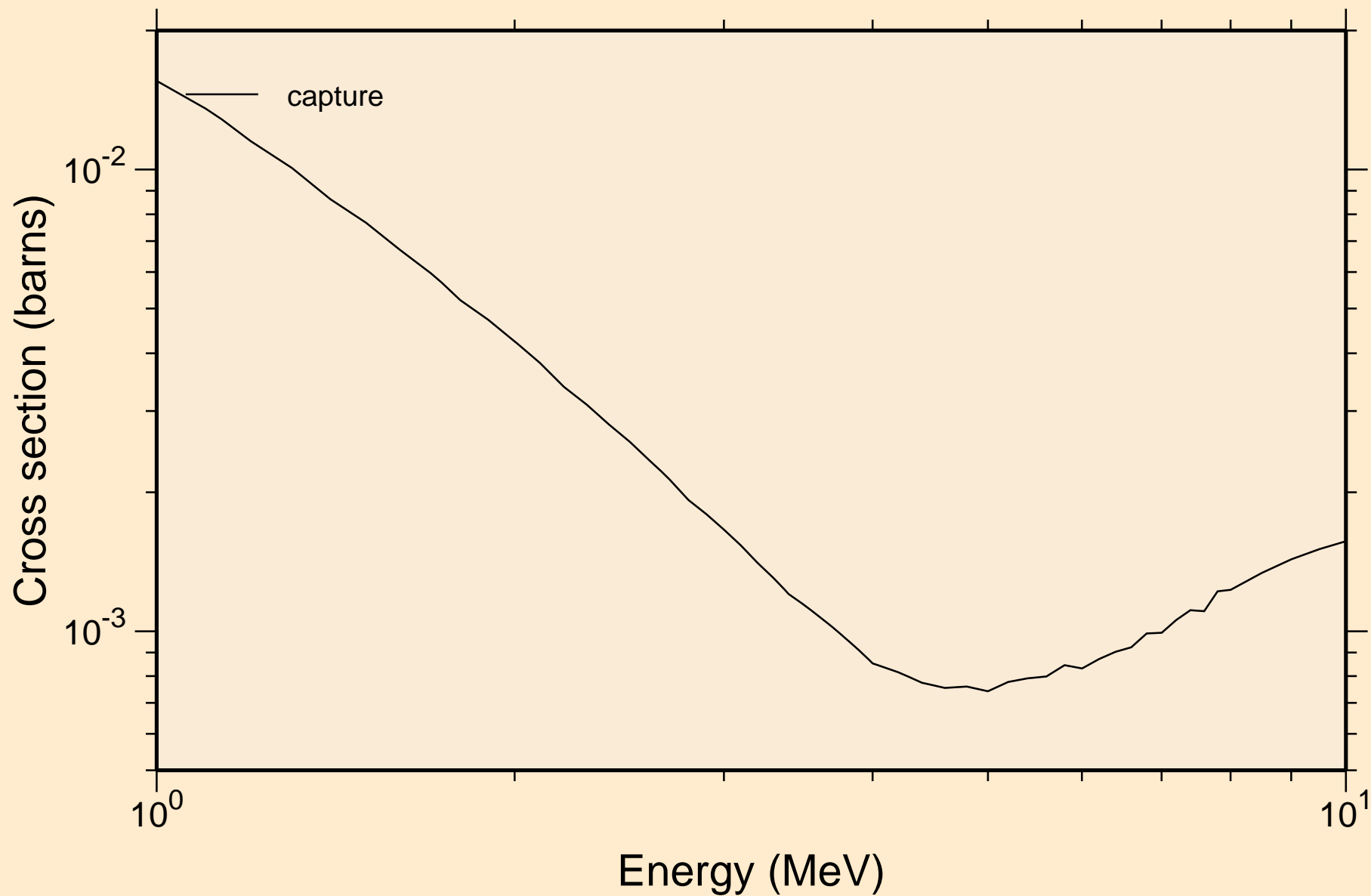

TA180 NEUTRON ACER TENDL-2019 LIBRARY; T=293.16K
Heating

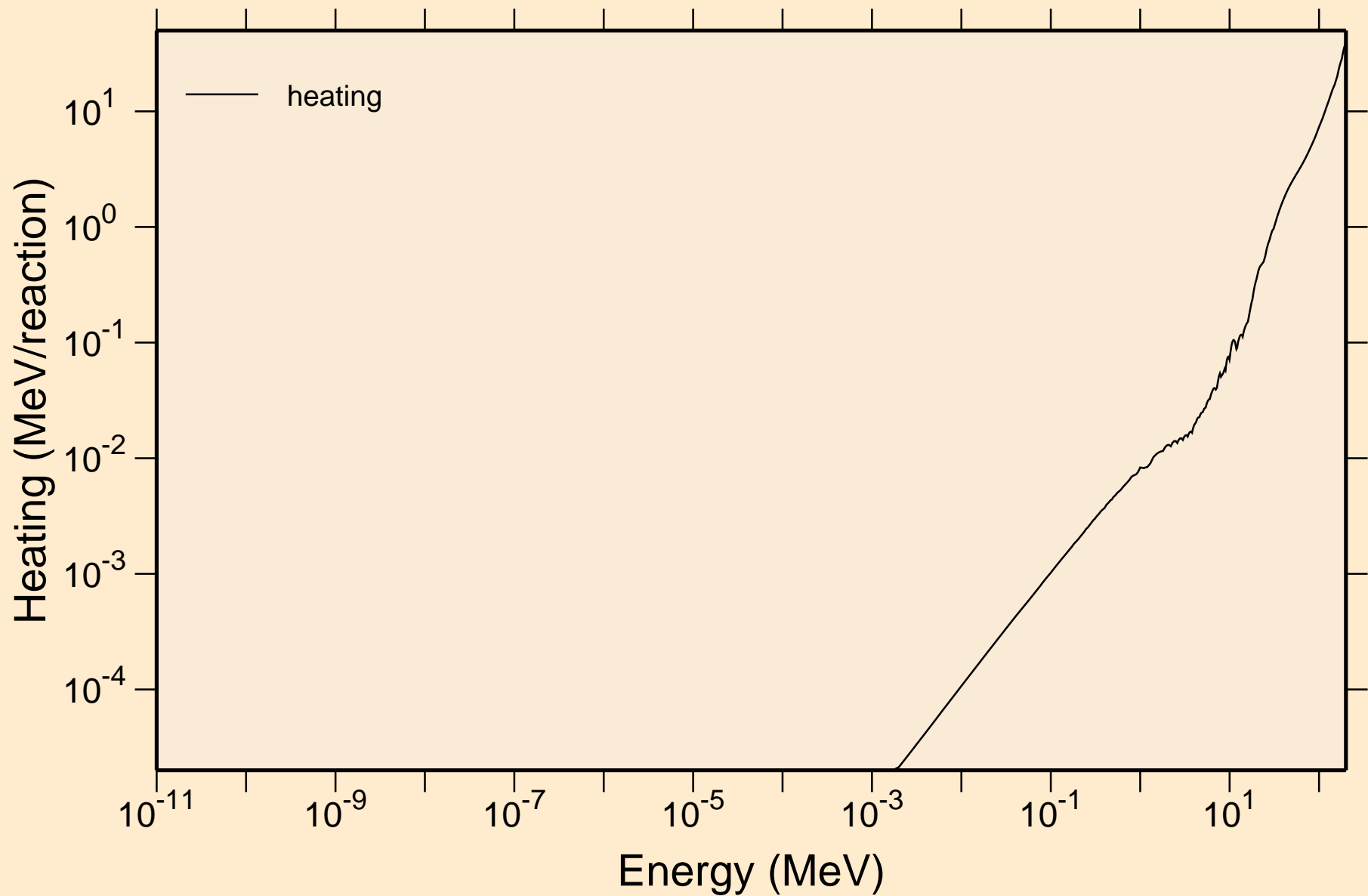

TA180 NEUTRON ACER TENDL-2019 LIBRARY; T=293.16K
Damage

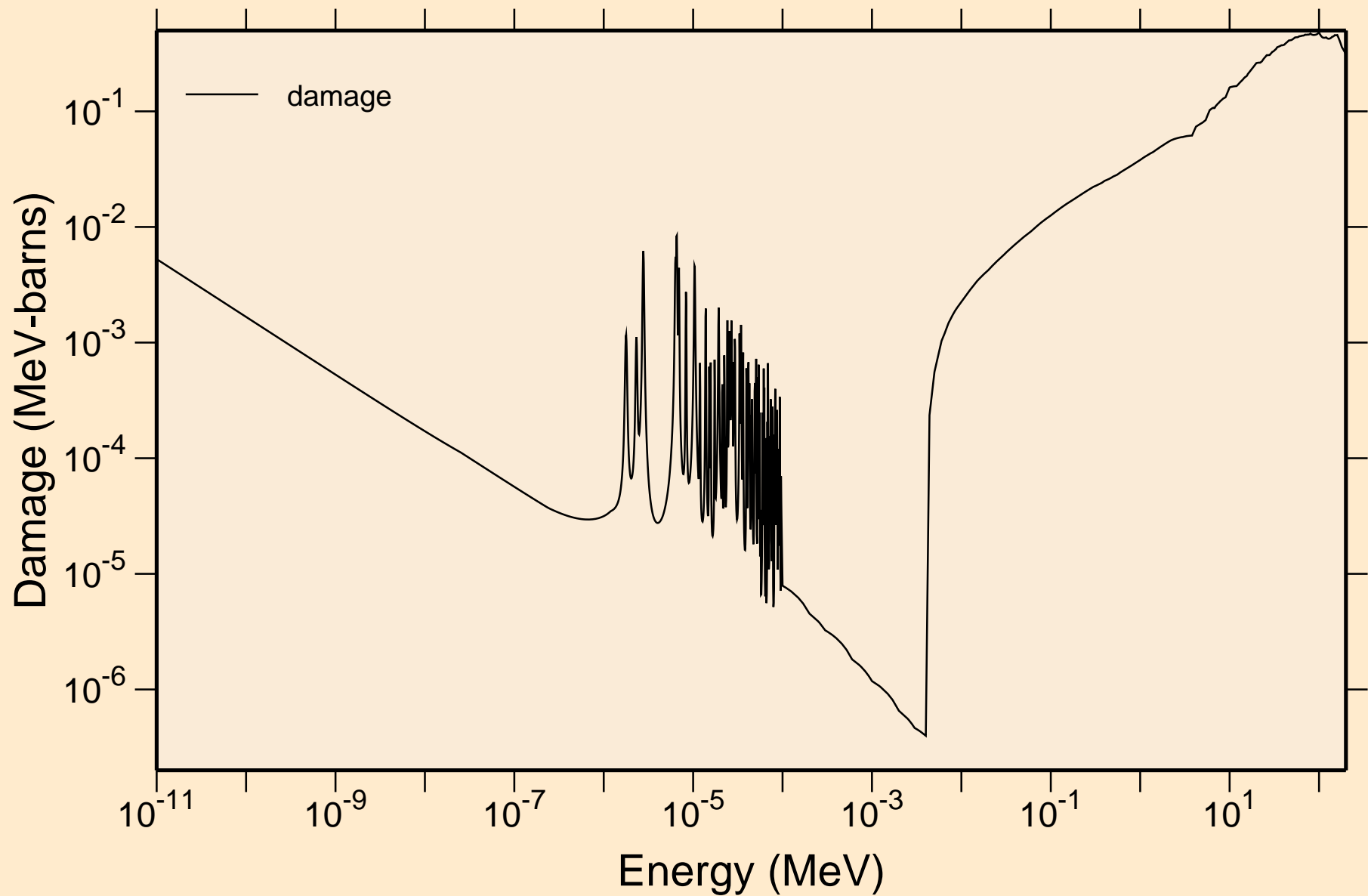

TA180 NEUTRON ACER TENDL-2019 LIBRARY; T=293.16K
Non-threshold reactions

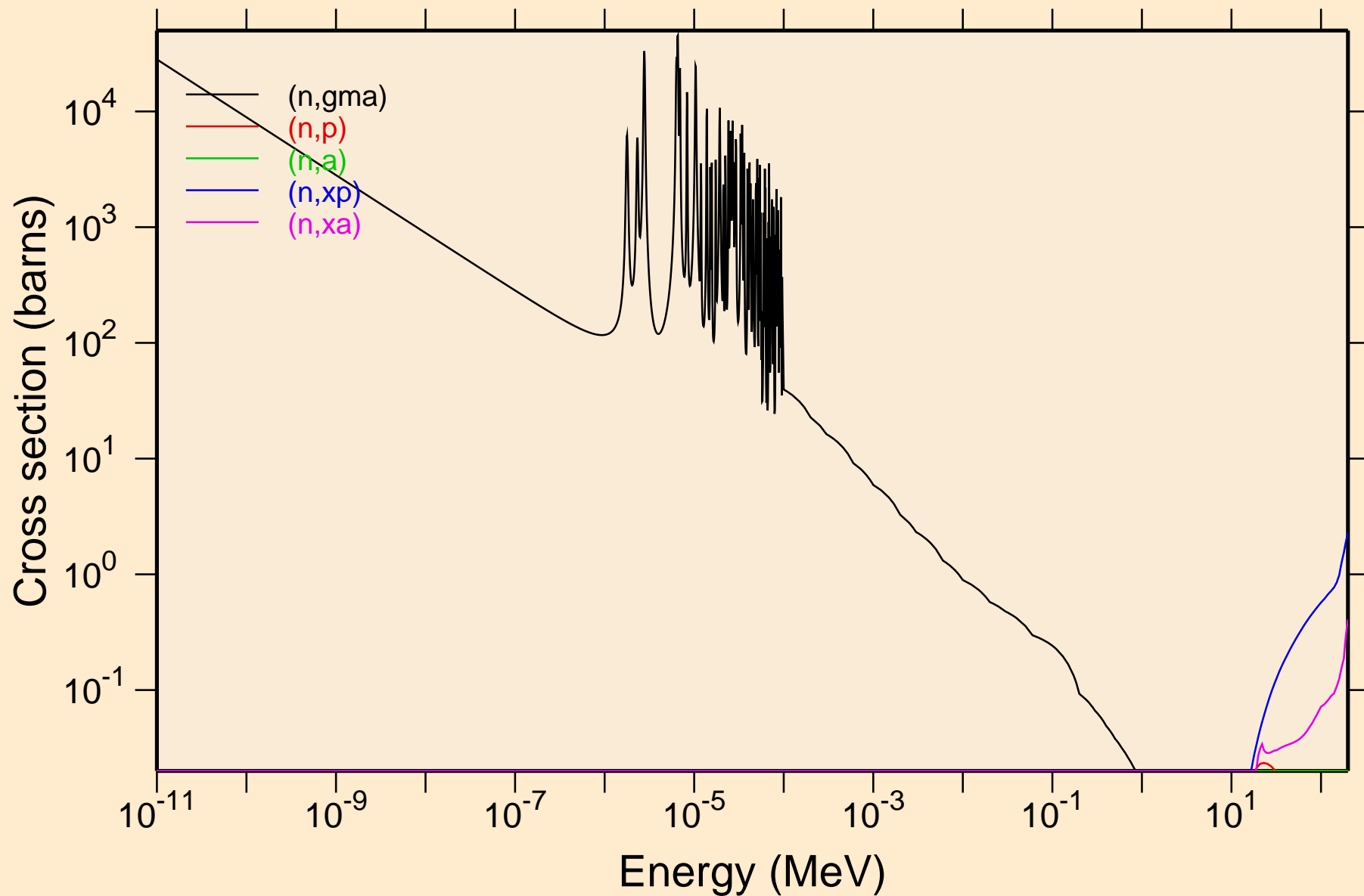

TA180 NEUTRON ACER TENDL-2019 LIBRARY; T=293.16K
Principal cross sections

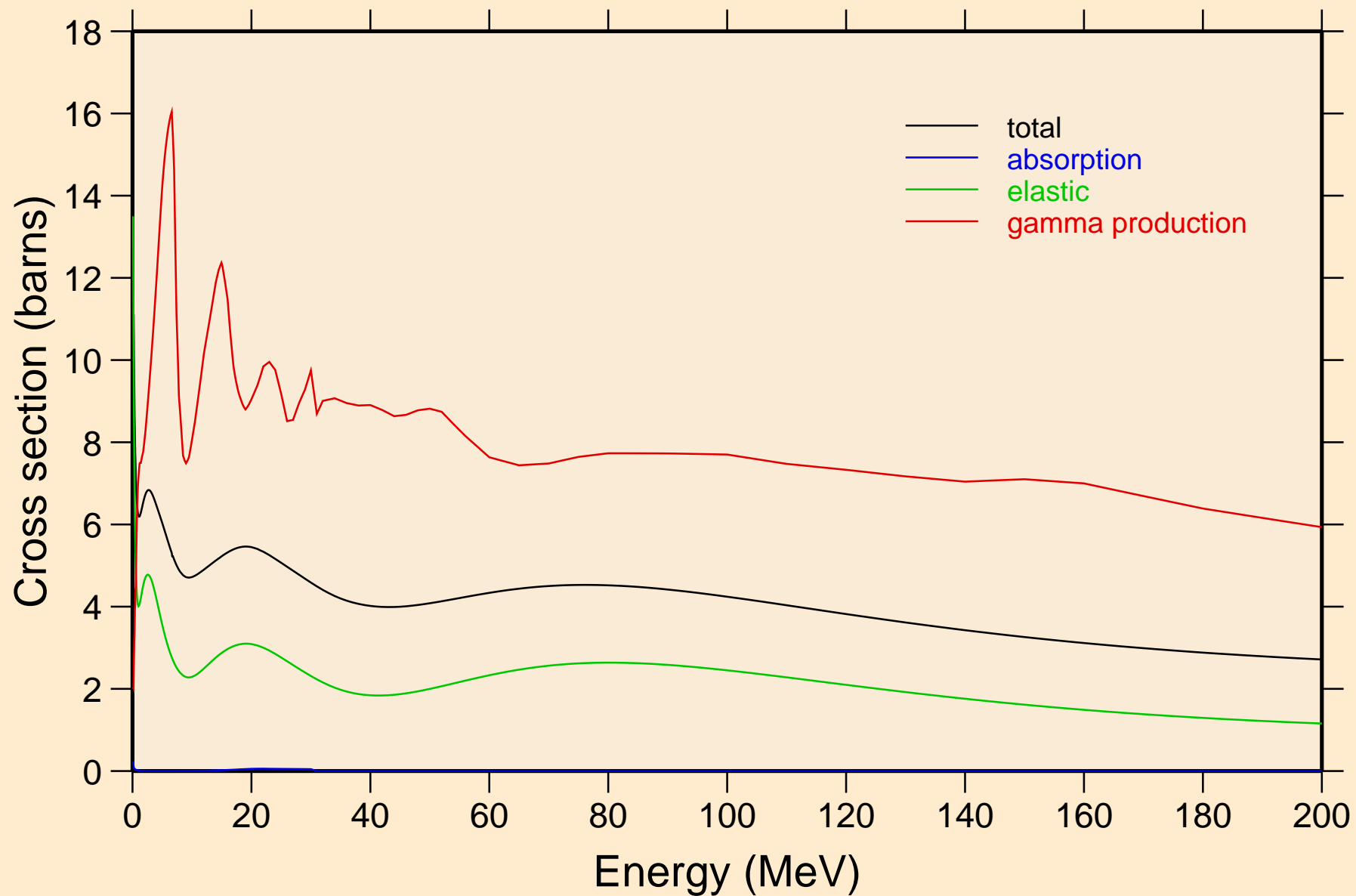

TA180 NEUTRON ACER TENDL-2019 LIBRARY; T=293.16K
Heating

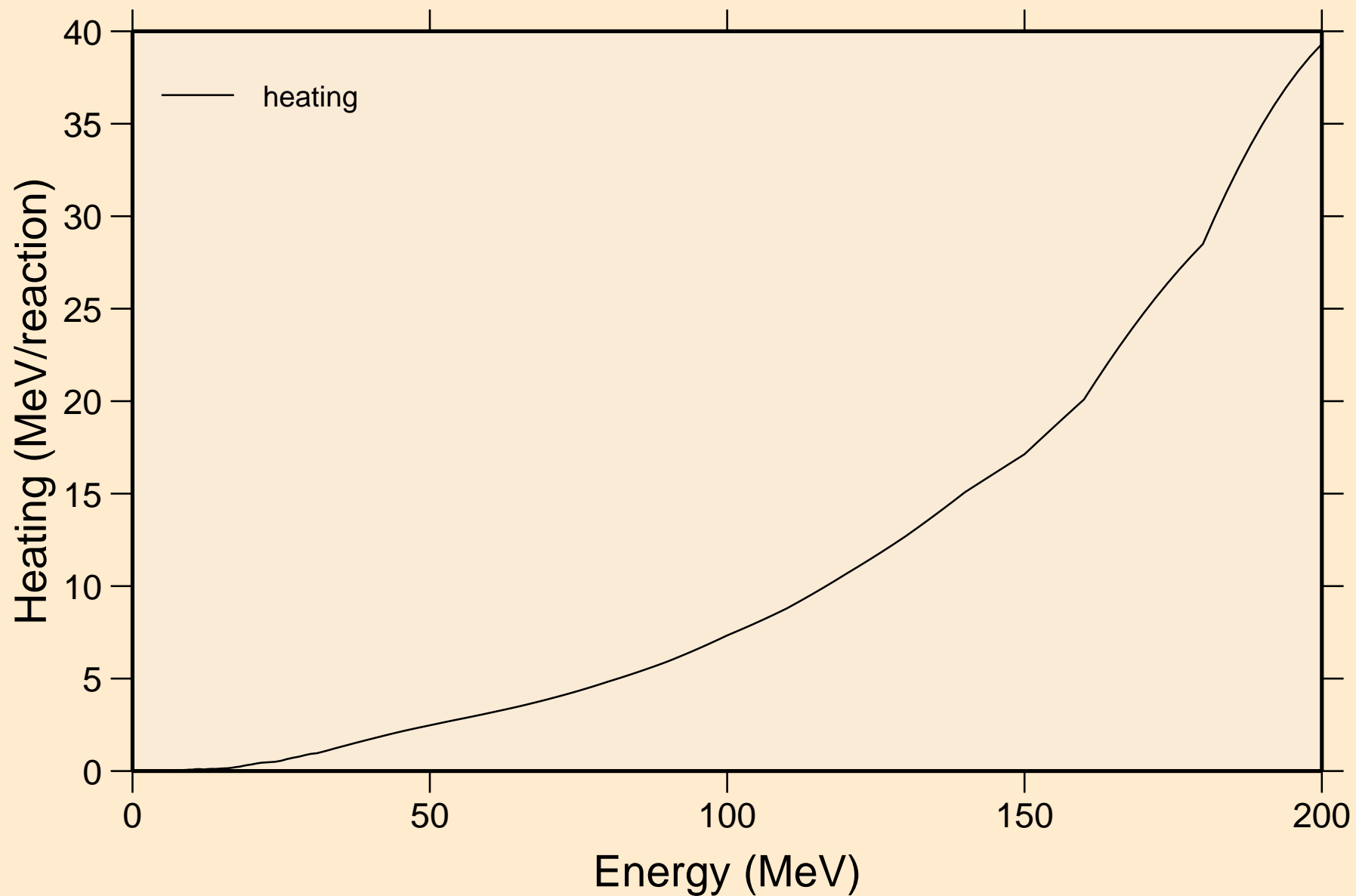

TA180 NEUTRON ACER TENDL-2019 LIBRARY; T=293.16K
Damage

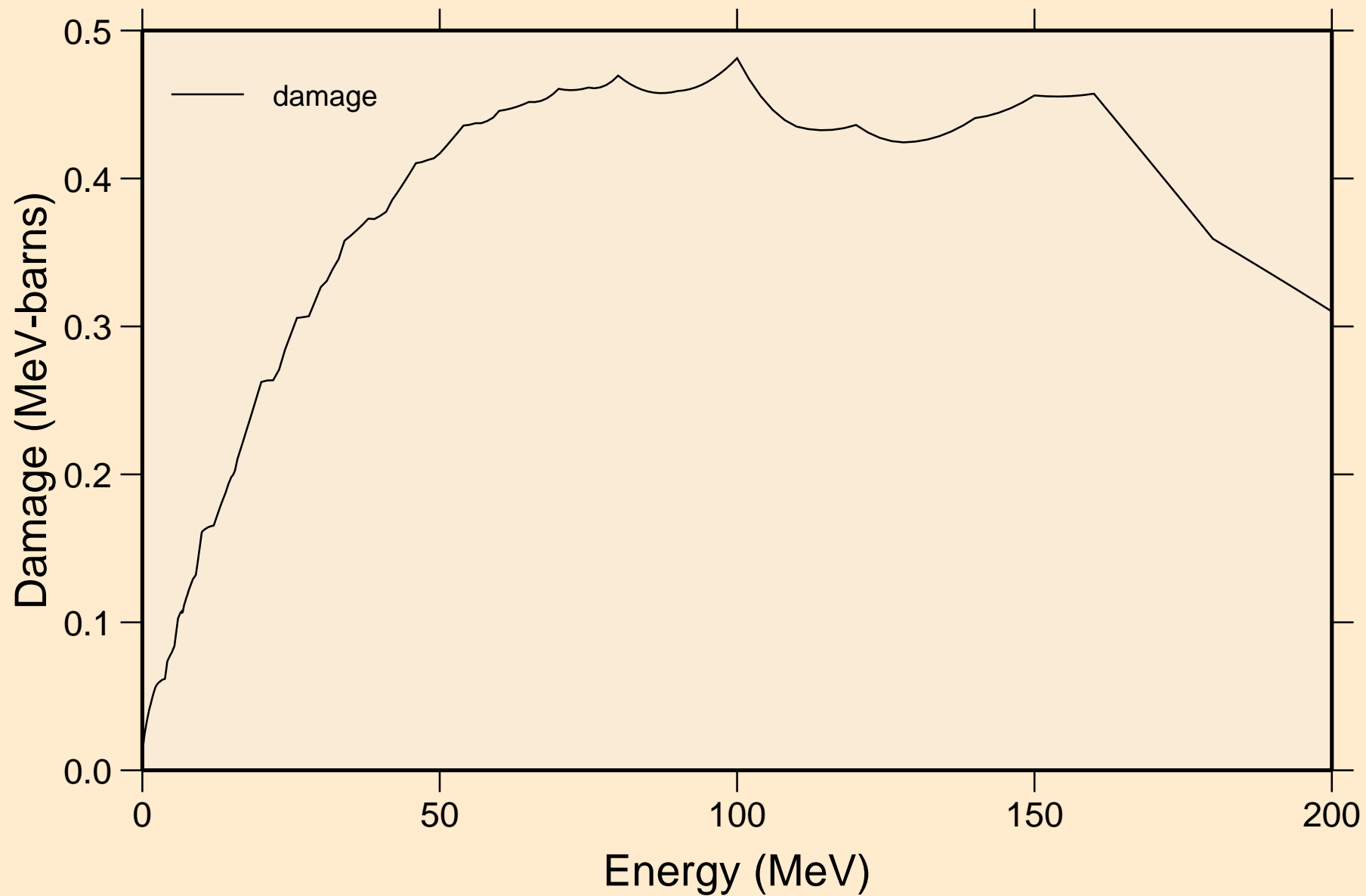

TA180 NEUTRON ACER TENDL-2019 LIBRARY; T=293.16K
Non-threshold reactions

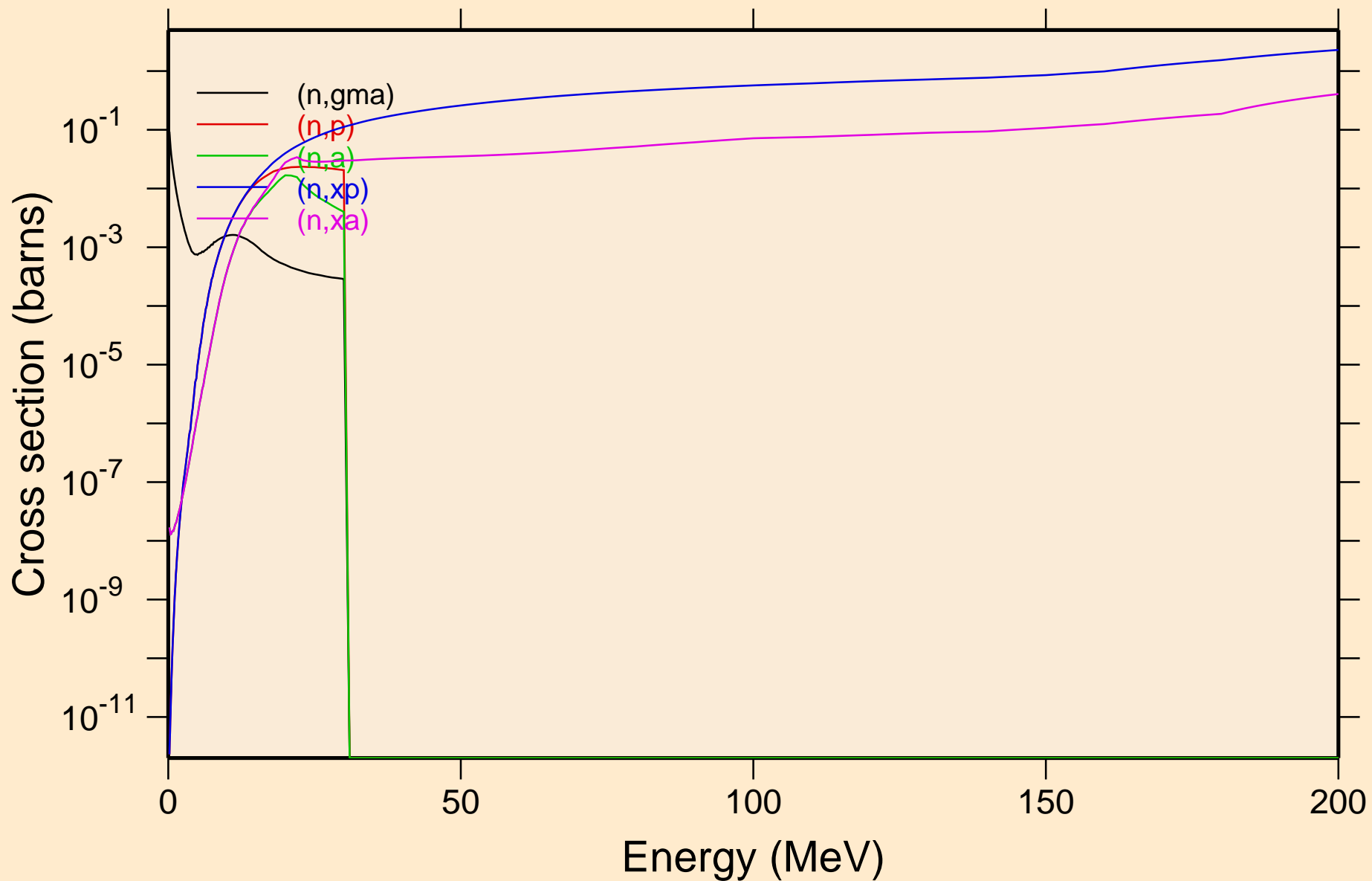

TA180 NEUTRON ACER TENDL-2019 LIBRARY; T=293.16K
Inelastic levels

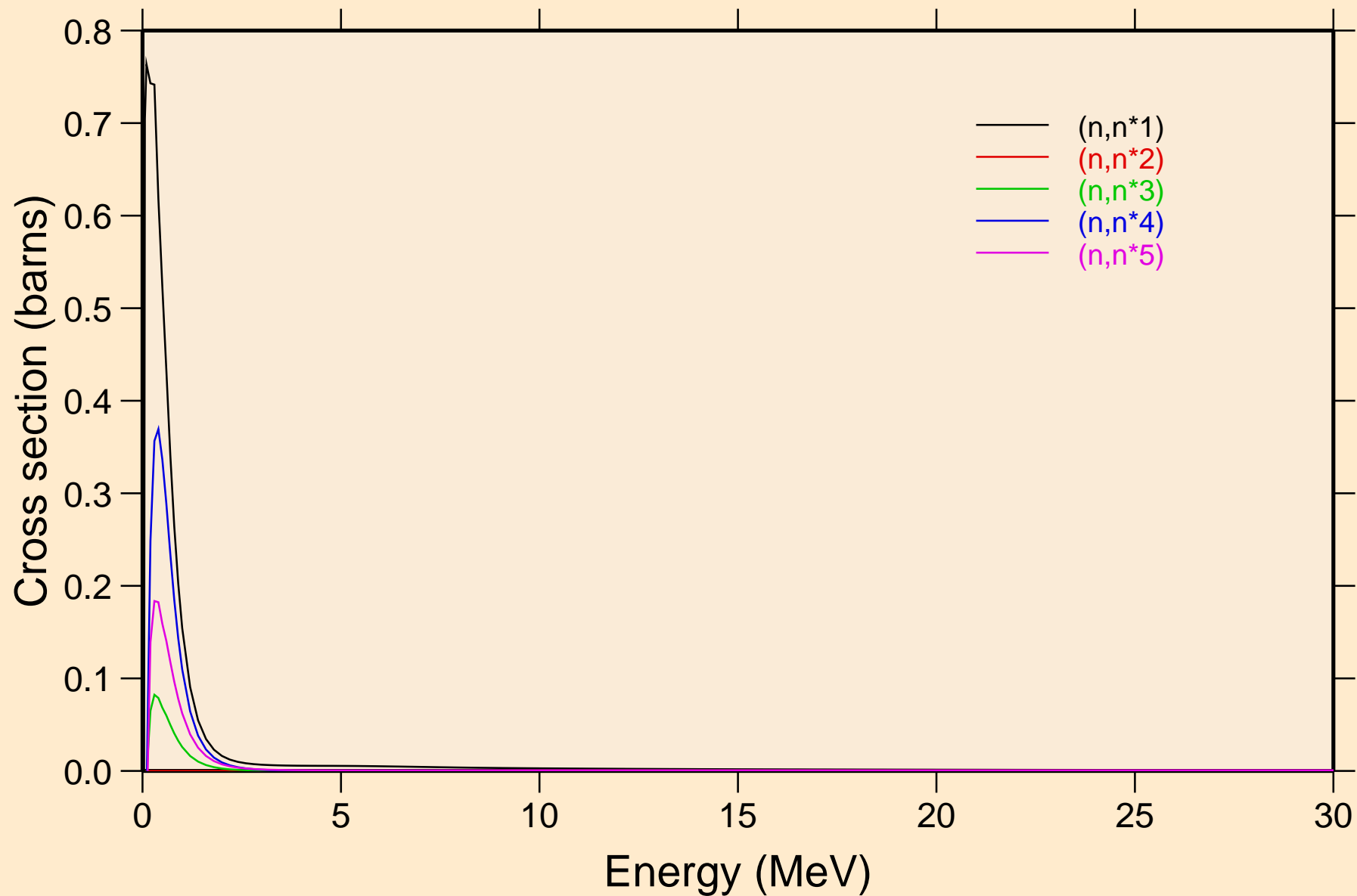

TA180 NEUTRON ACER TENDL-2019 LIBRARY; T=293.16K
Inelastic levels

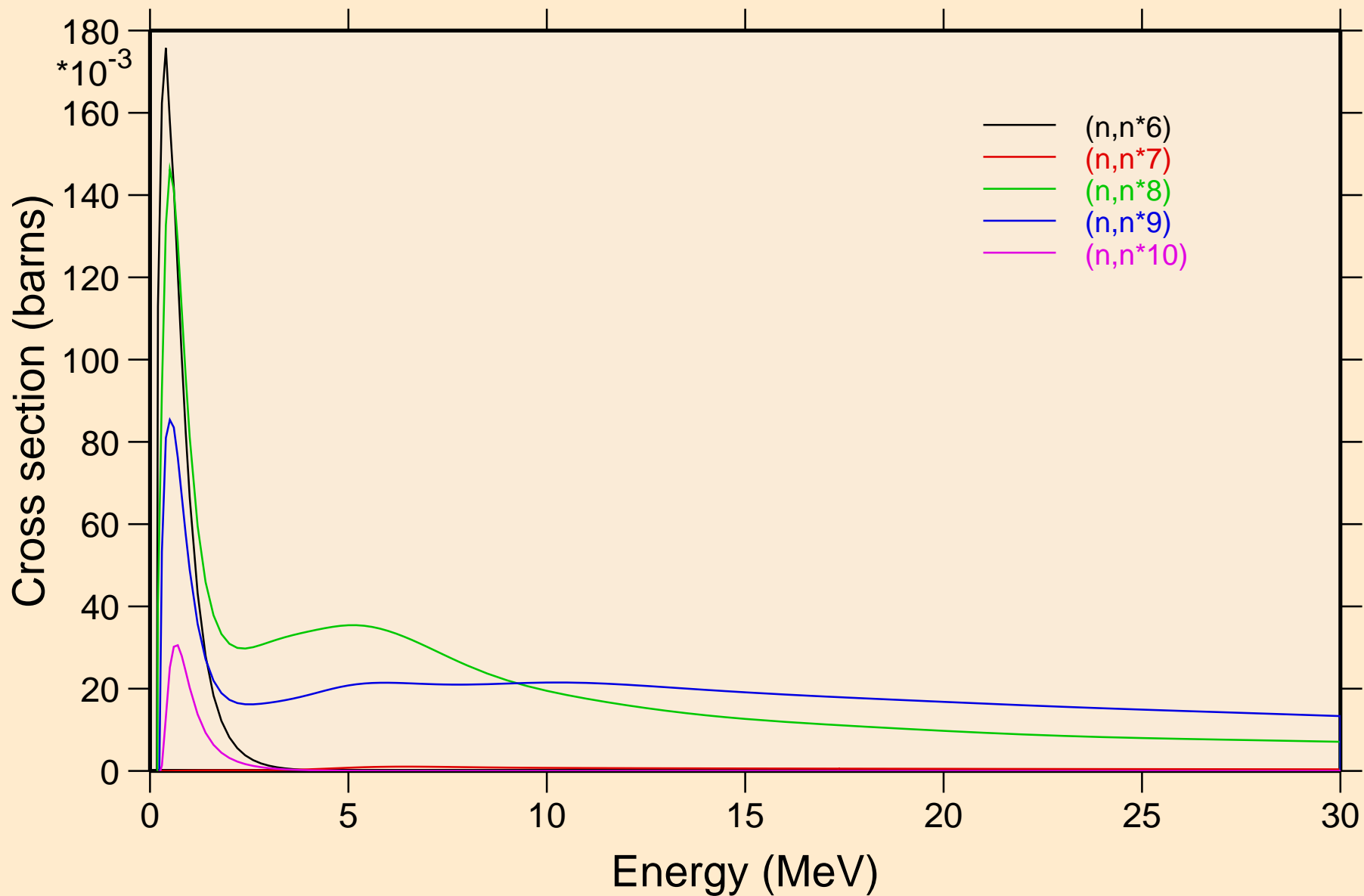

TA180 NEUTRON ACER TENDL-2019 LIBRARY; T=293.16K
Inelastic levels

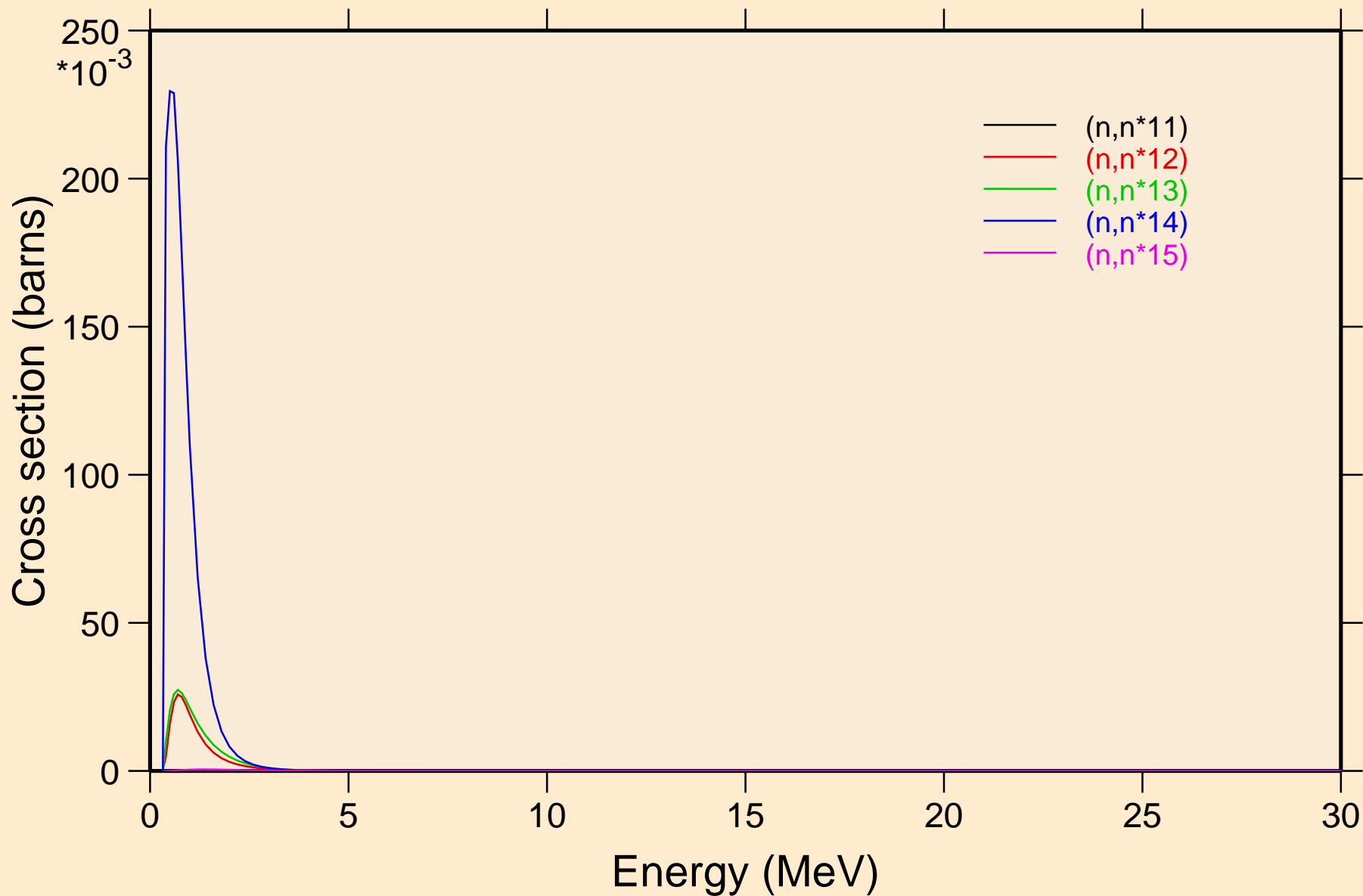

TA180 NEUTRON ACER TENDL-2019 LIBRARY; T=293.16K
Inelastic levels

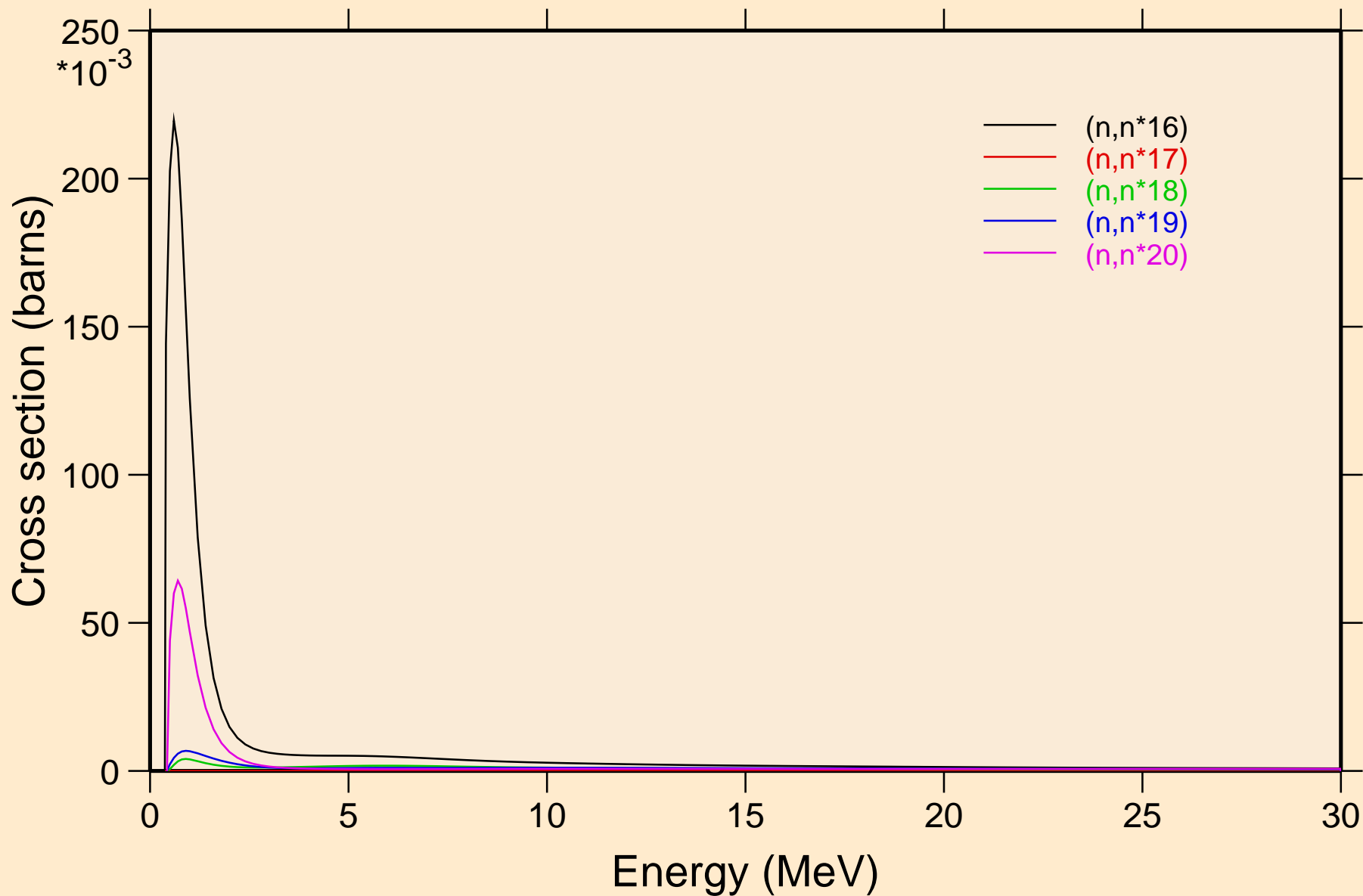

TA180 NEUTRON ACER TENDL-2019 LIBRARY; T=293.16K
Inelastic levels

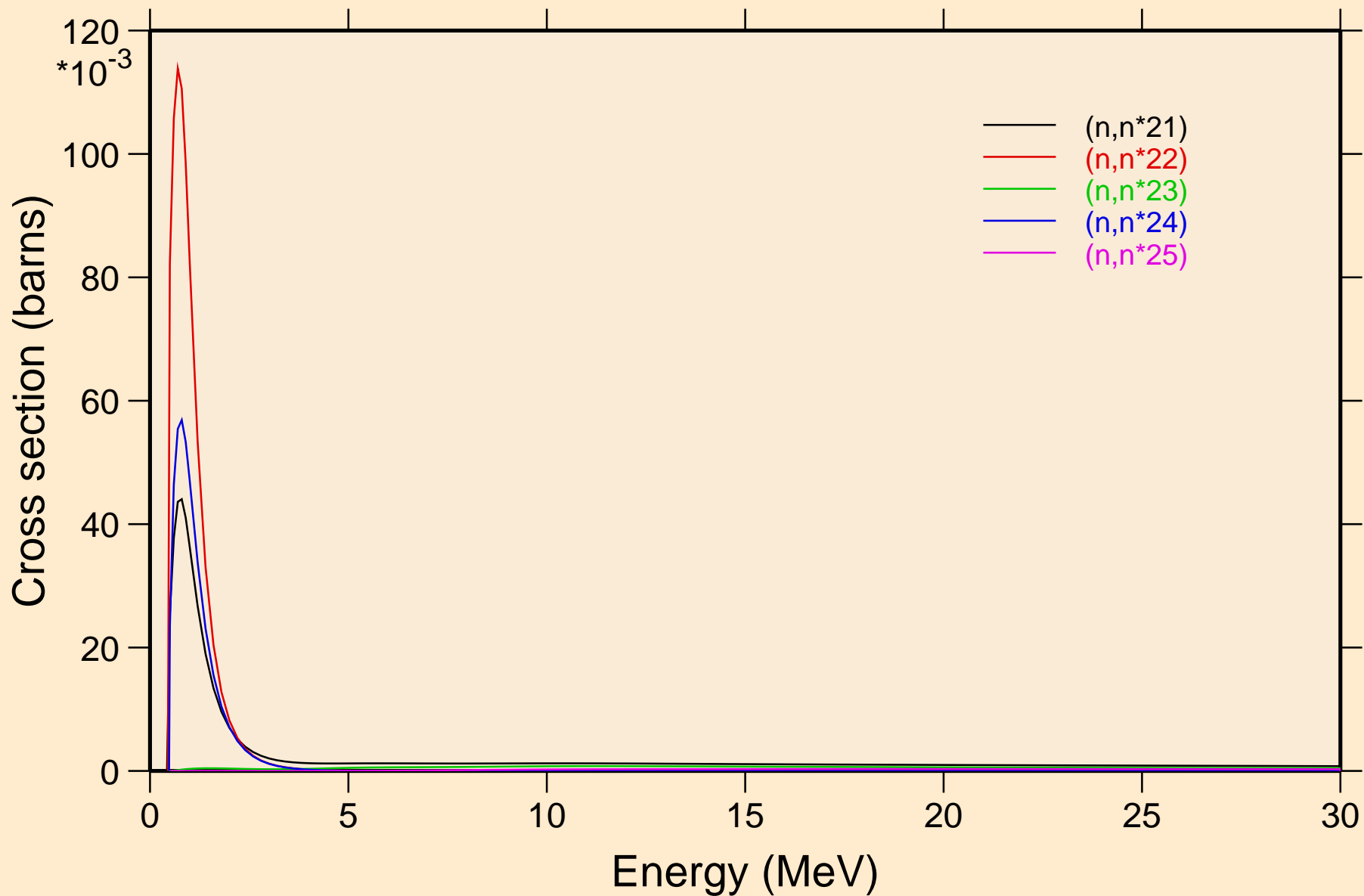

TA180 NEUTRON ACER TENDL-2019 LIBRARY; T=293.16K
Inelastic levels

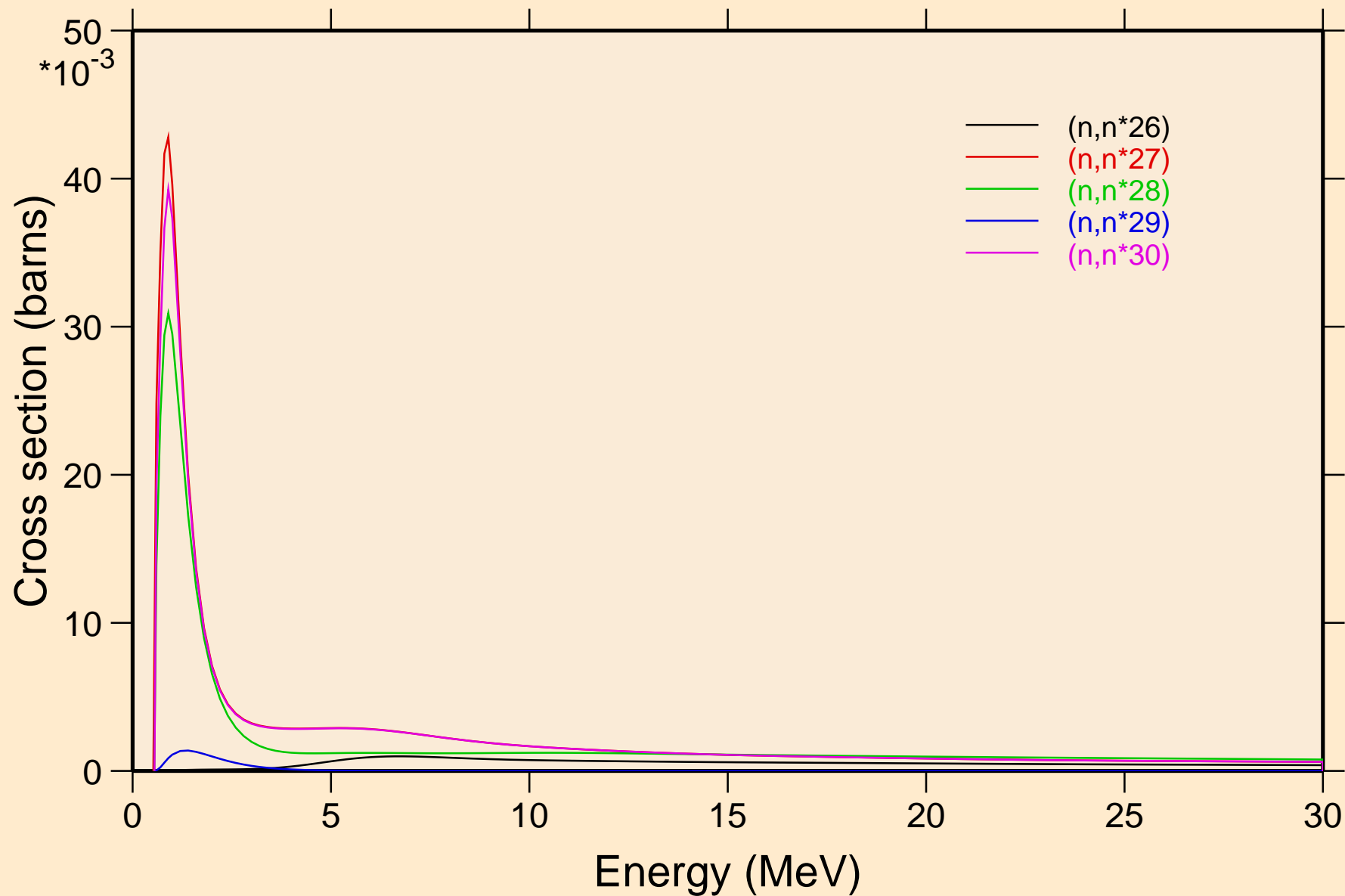

TA180 NEUTRON ACER TENDL-2019 LIBRARY; T=293.16K
Threshold reactions

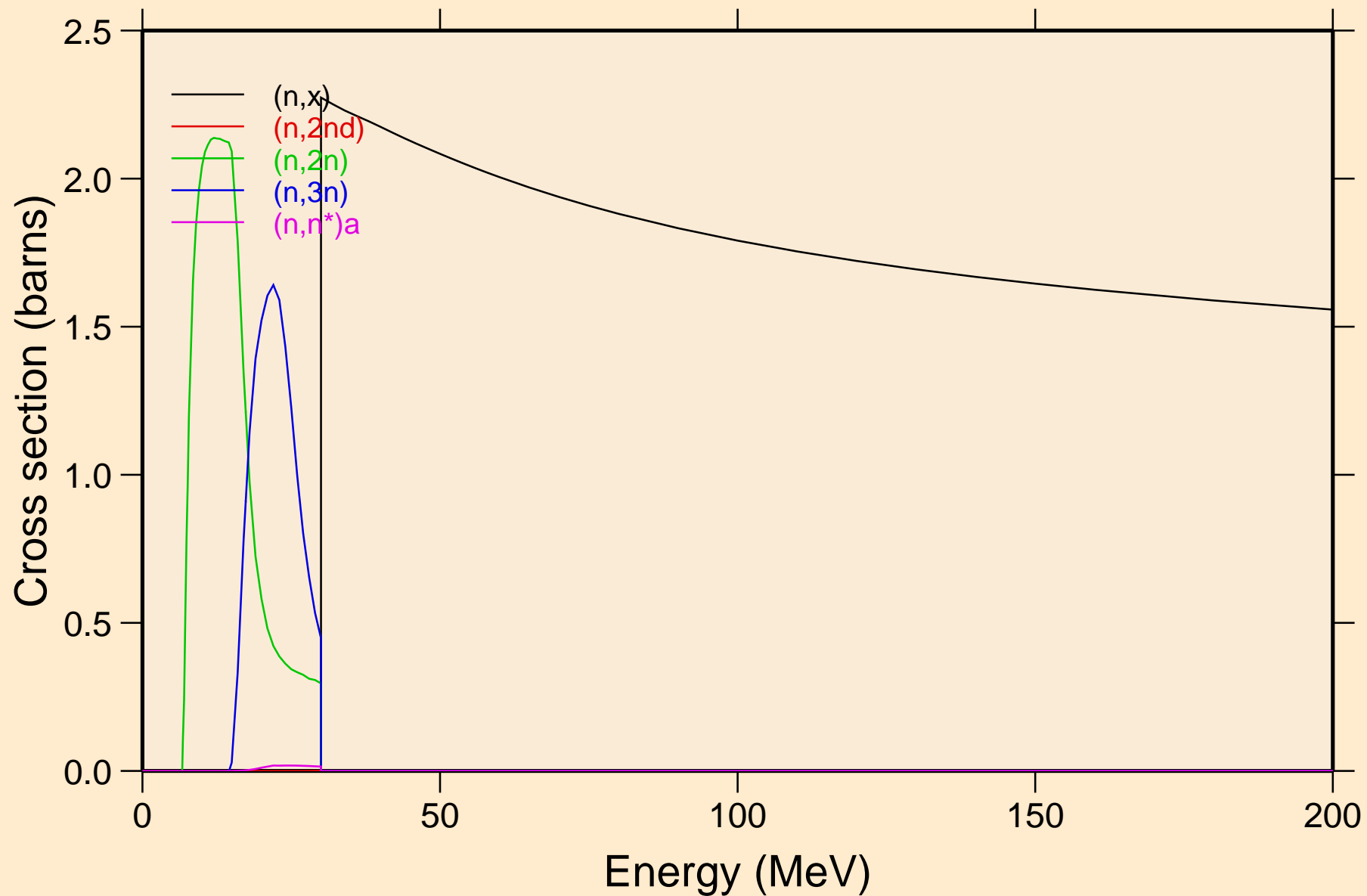

TA180 NEUTRON ACER TENDL-2019 LIBRARY; T=293.16K
Threshold reactions

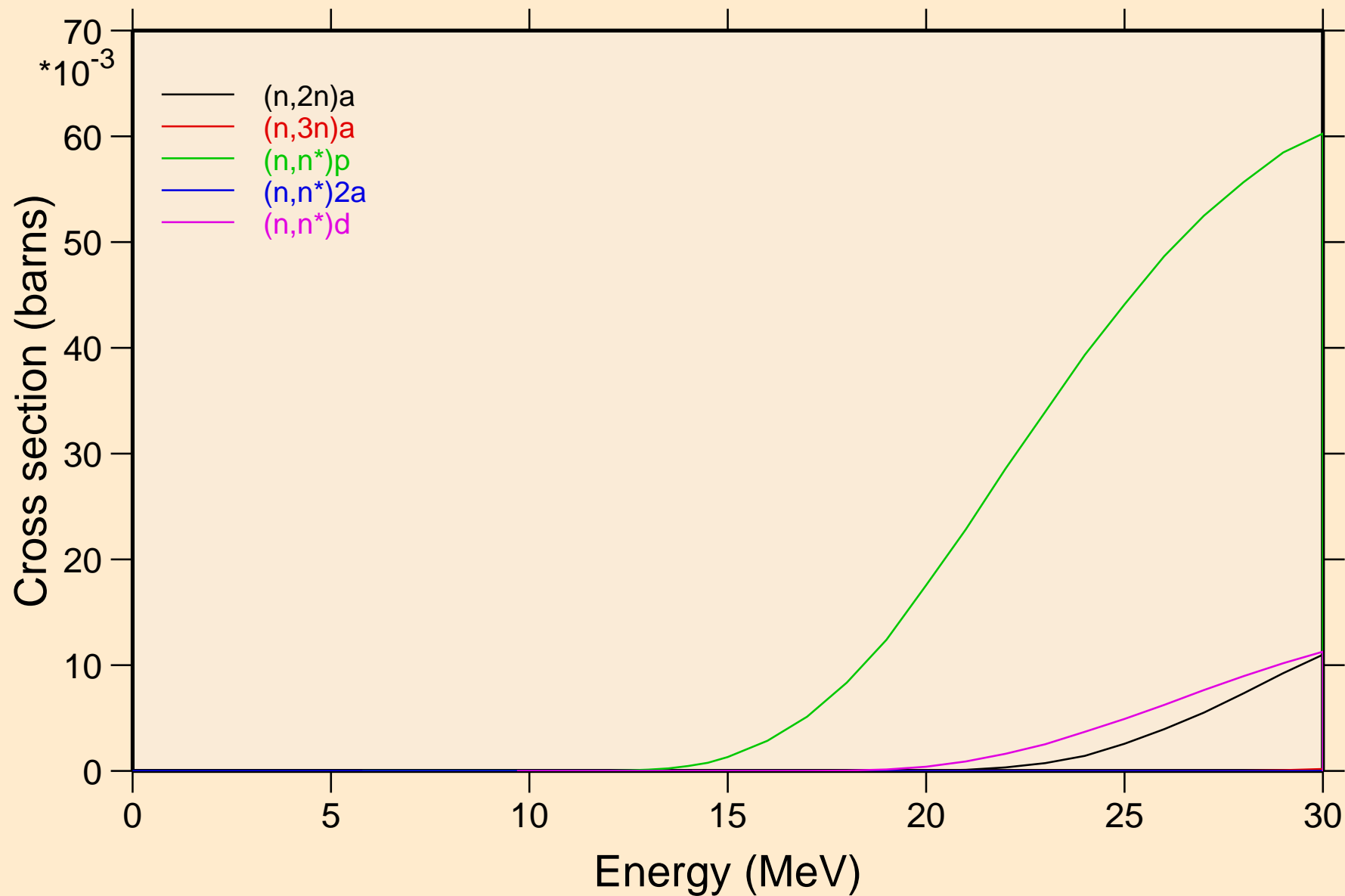

TA180 NEUTRON ACER TENDL-2019 LIBRARY; T=293.16K
Threshold reactions

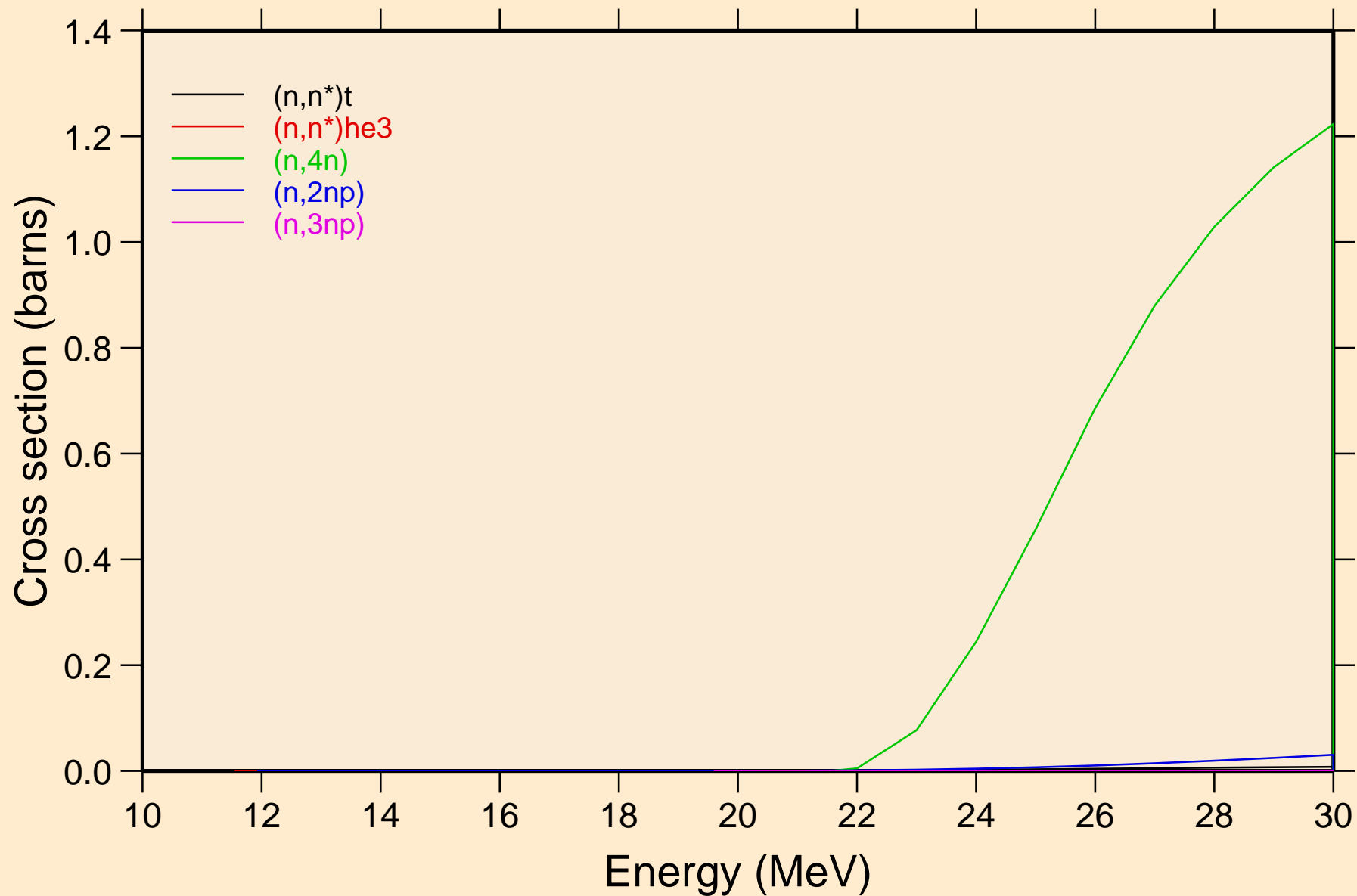

TA180 NEUTRON ACER TENDL-2019 LIBRARY; T=293.16K
Threshold reactions

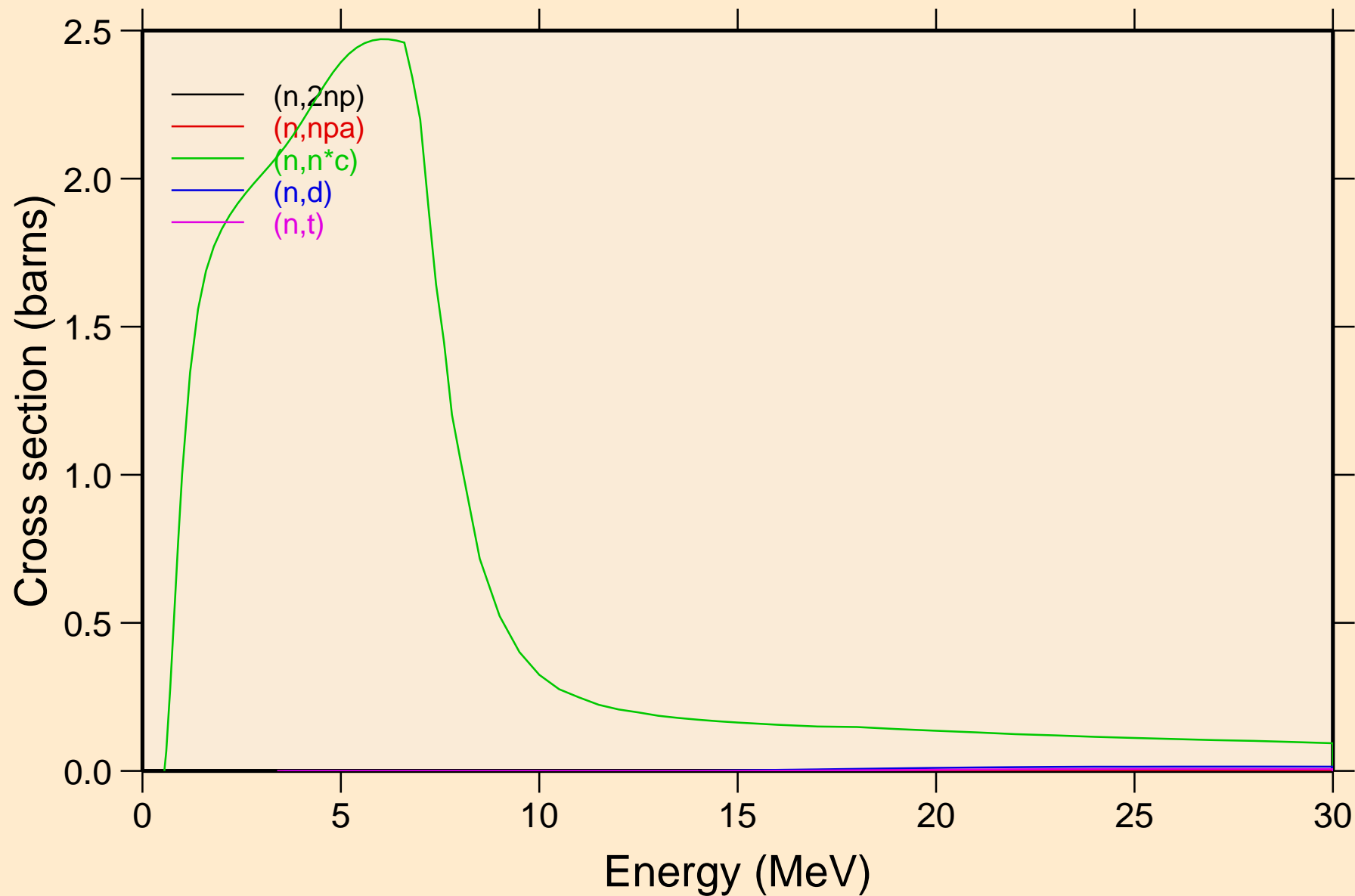

TA180 NEUTRON ACER TENDL-2019 LIBRARY; T=293.16K
Threshold reactions

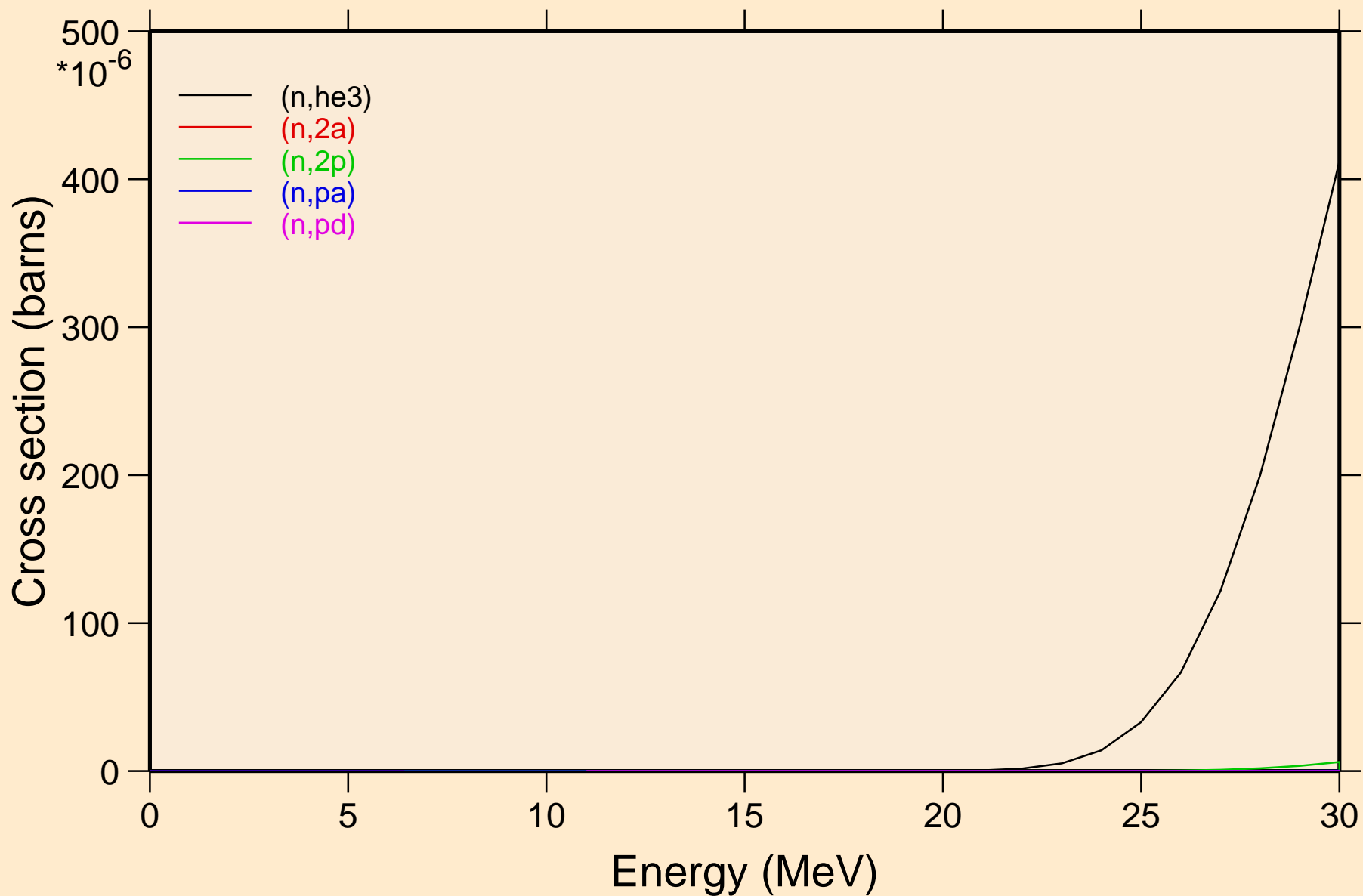

TA180 NEUTRON ACER TENDL-2019 LIBRARY; T=293.16K
Threshold reactions

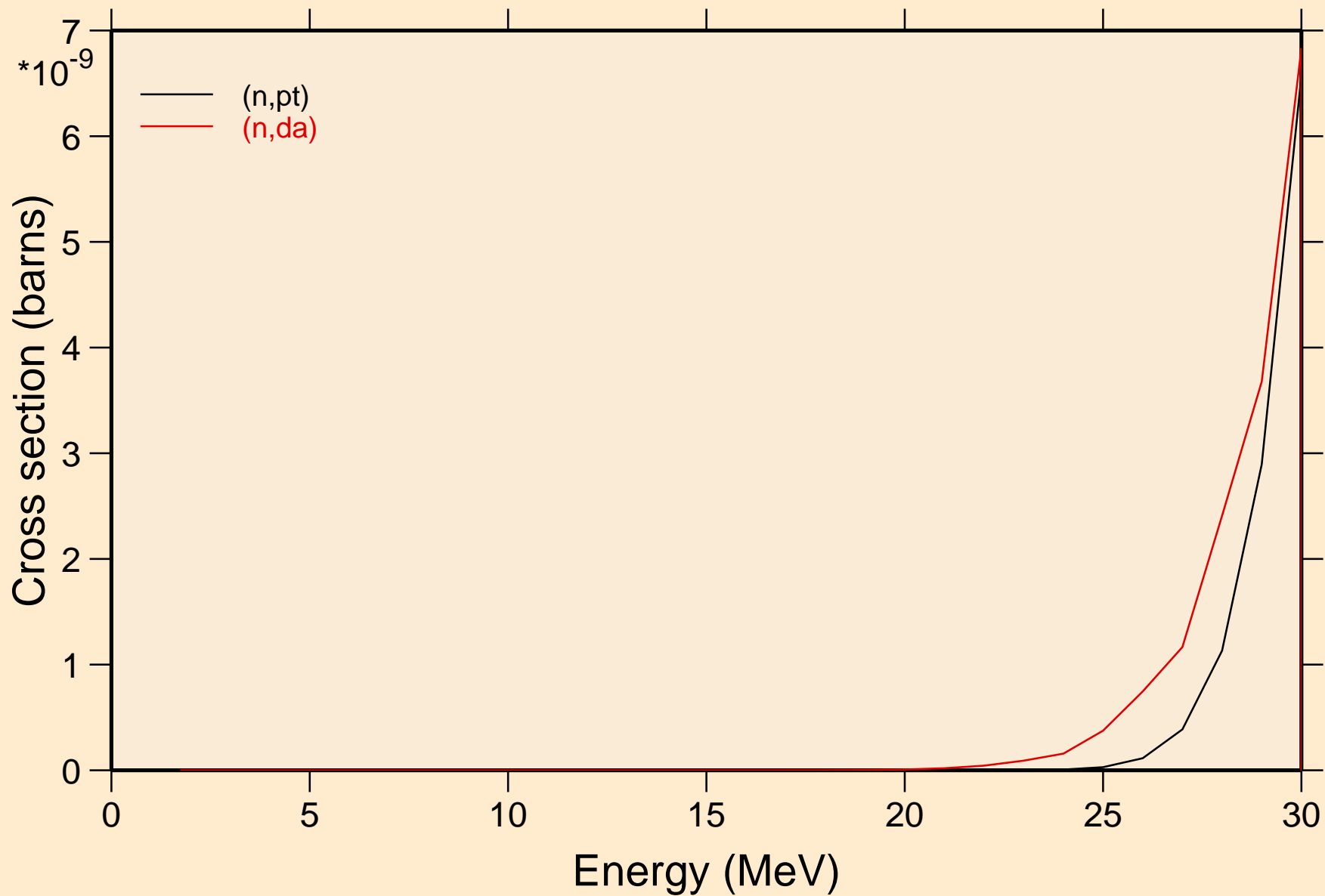

TA180 NEUTRON ACER TENDL-2019 LIBRARY; T=293.16K
Threshold reactions

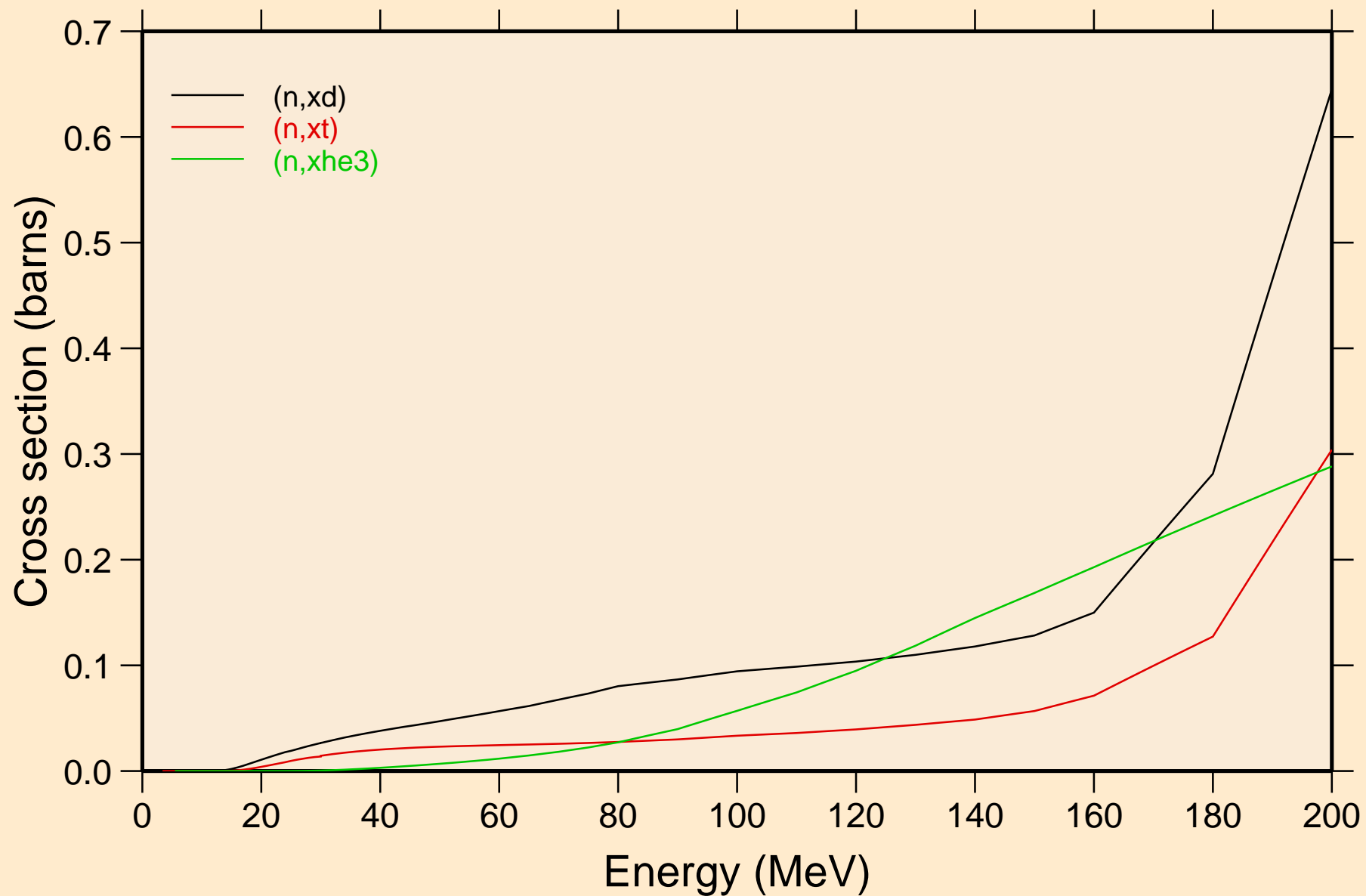

TA180 NEUTRON ACER TENDL-2019 LIBRARY; T=293.16K
angular distribution for elastic

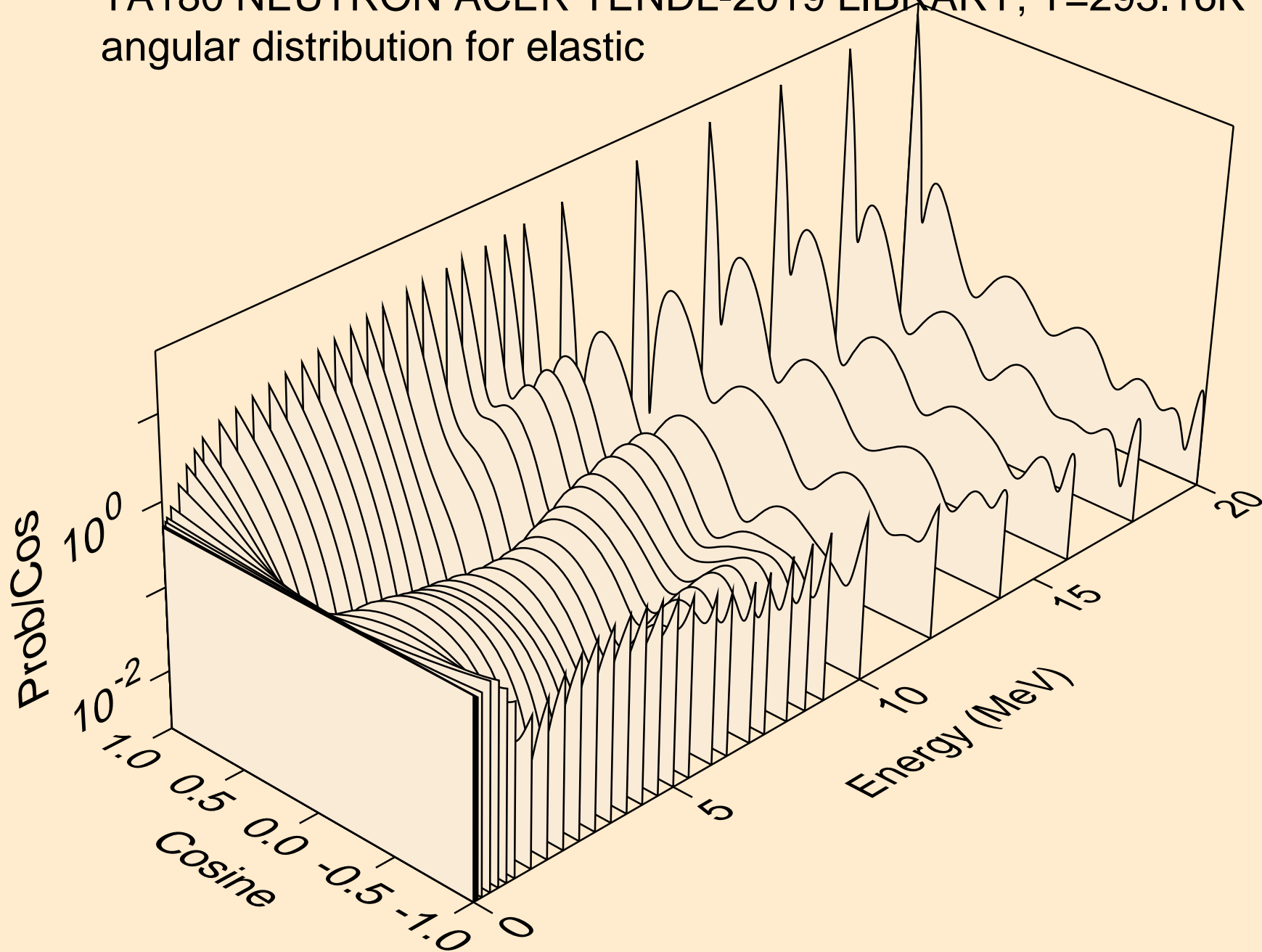

TA180 NEUTRON ACER TENDL-2019 LIBRARY; T=293.16K
angular distribution for elastic

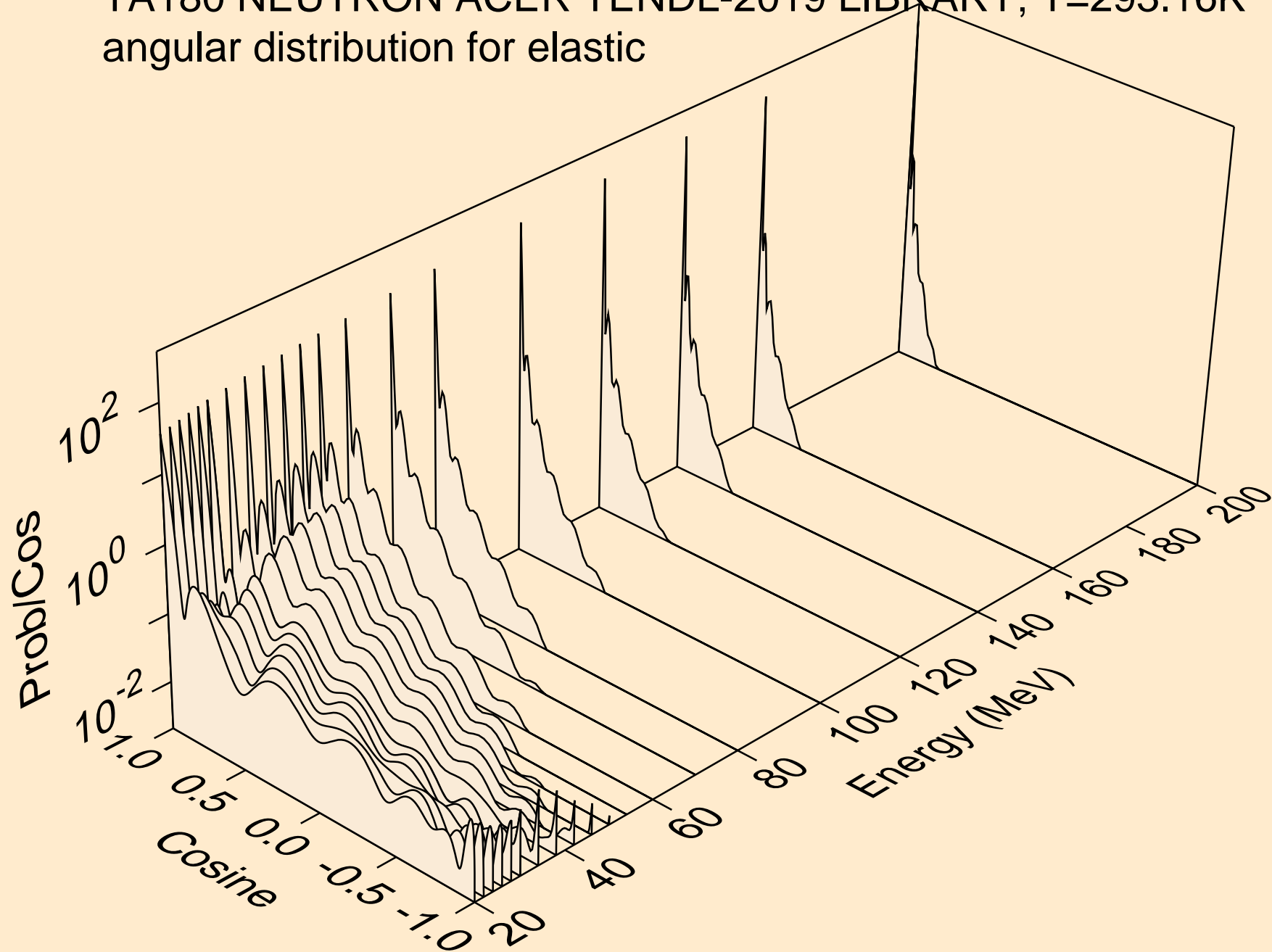

TA180 NEUTRON ACER TENDL-2019 LIBRARY; T=293.16K
angular distribution for (n,n*1)

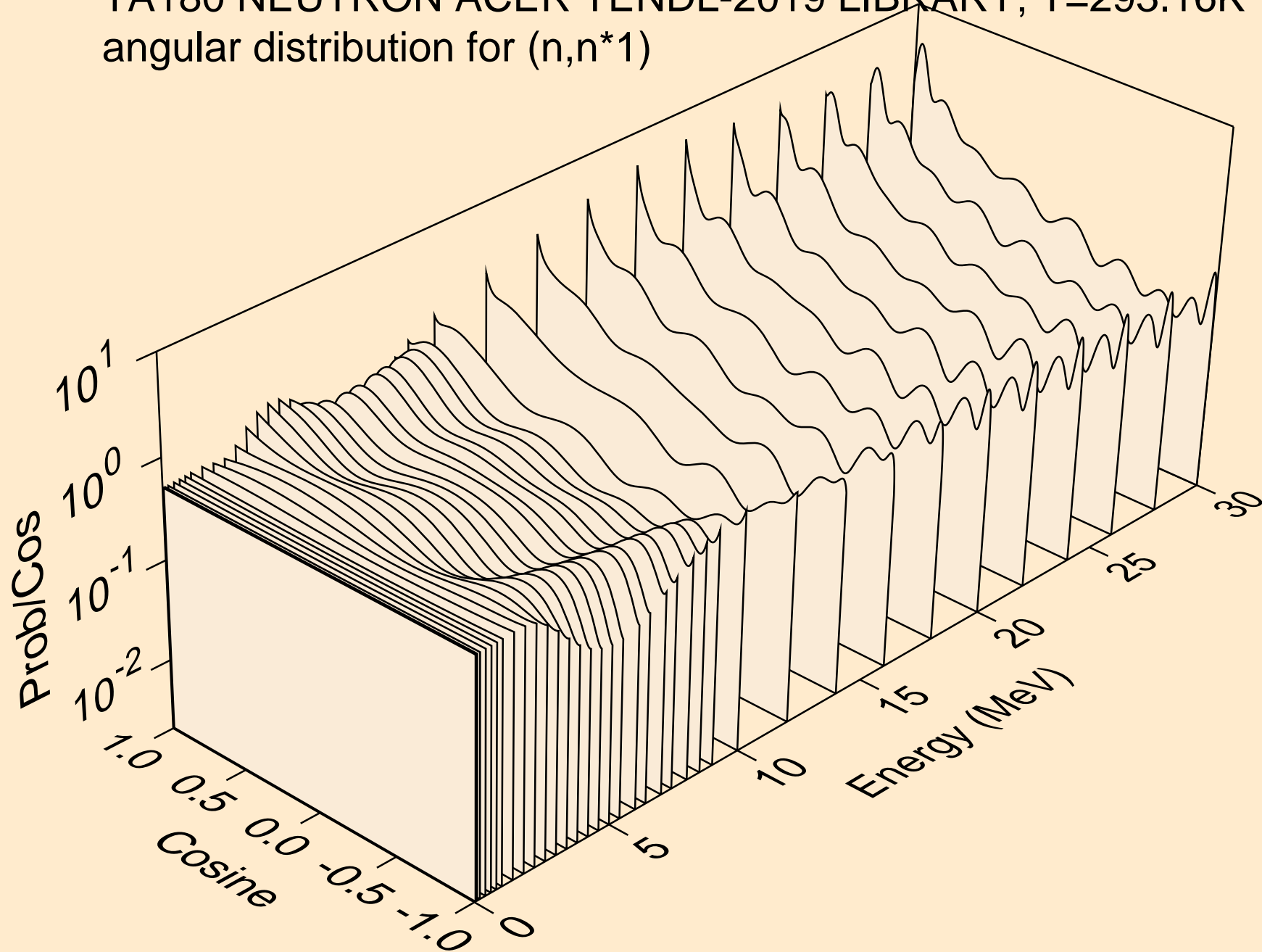

TA180 NEUTRON ACER TENDL-2019 LIBRARY; T=293.16K
angular distribution for (n,n*2)

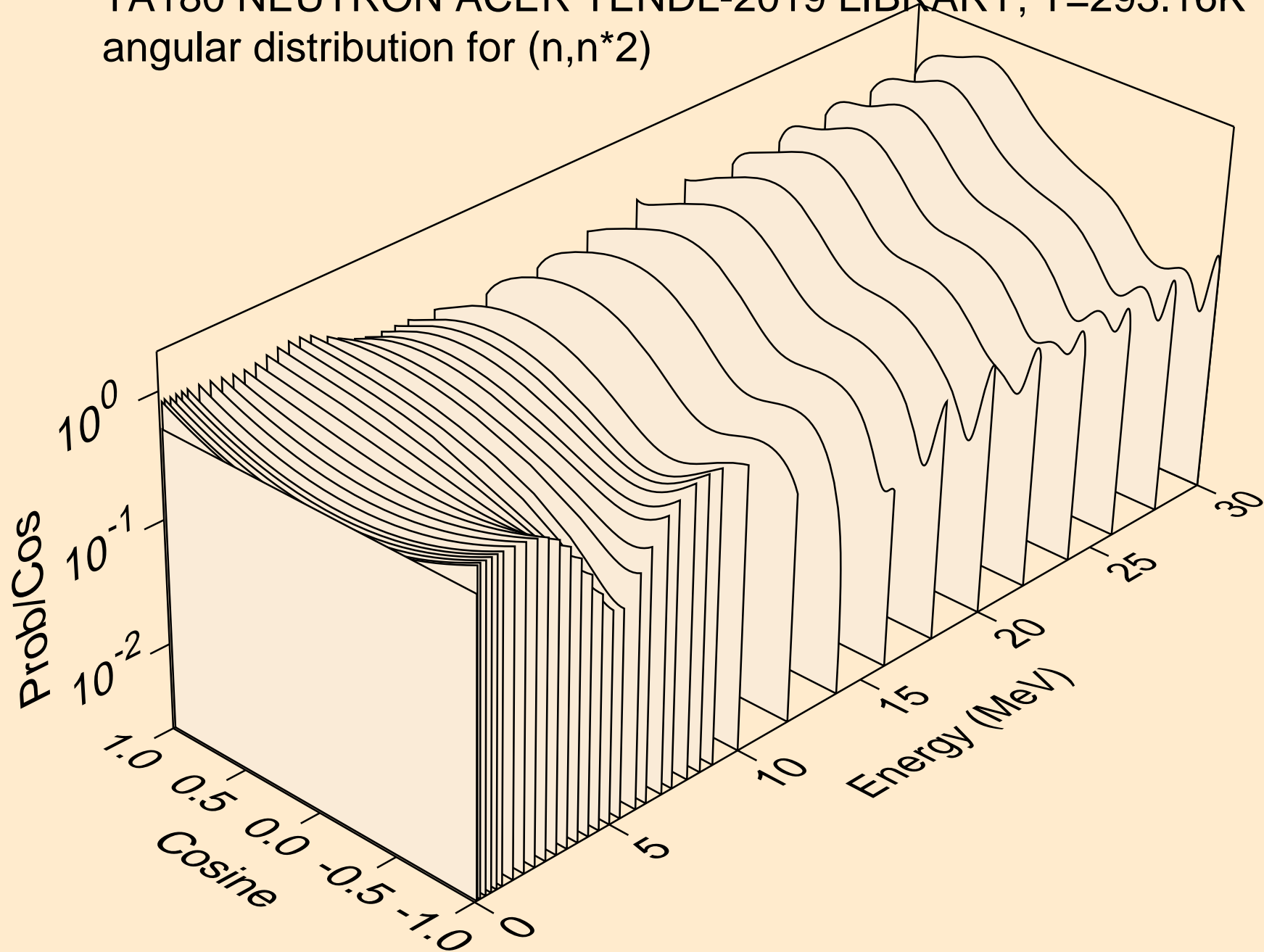

TA180 NEUTRON ACER TENDL-2019 LIBRARY; T=293.16K
angular distribution for (n,n*3)

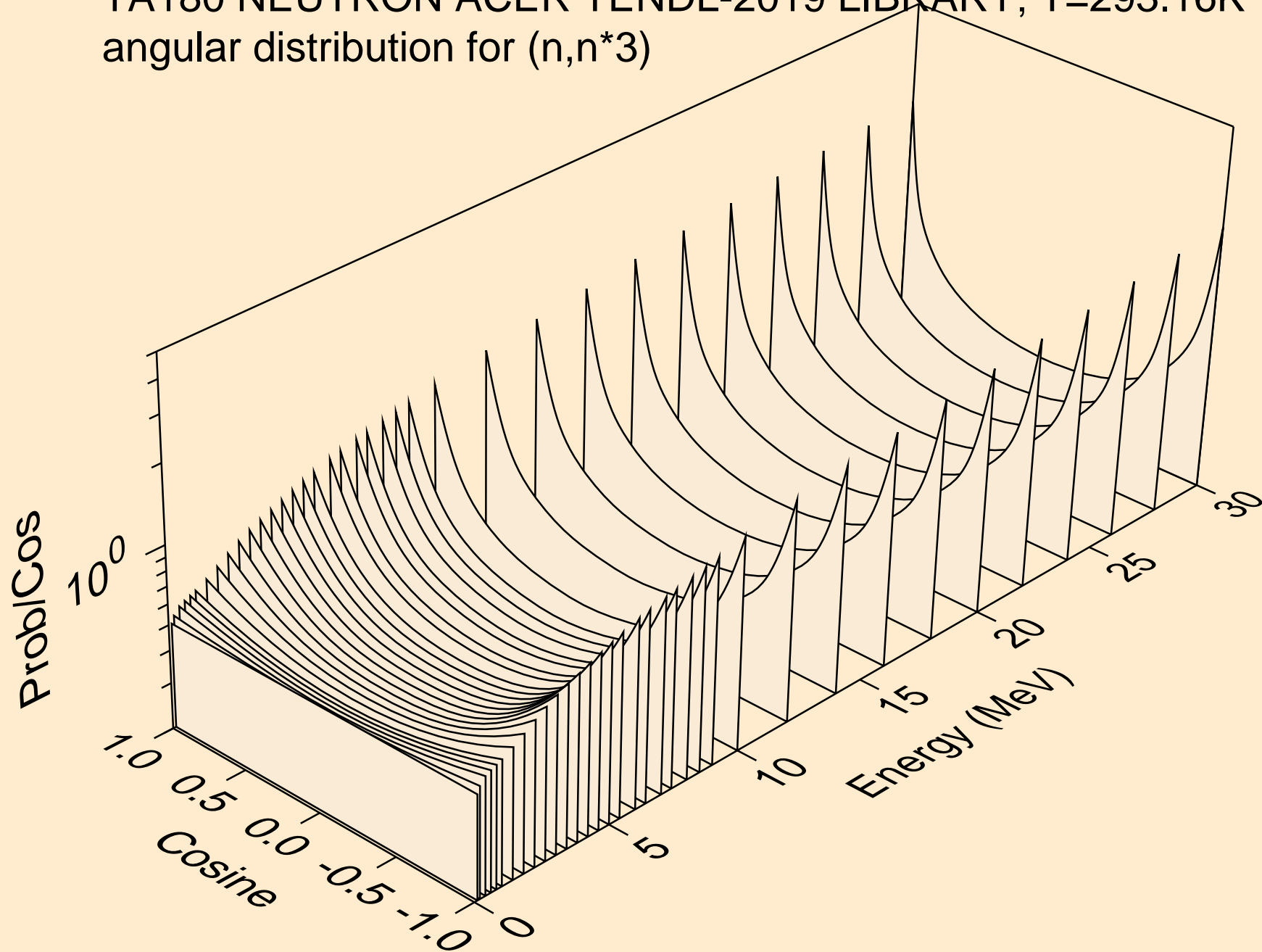

TA180 NEUTRON ACER TENDL-2019 LIBRARY; T=293.16K
angular distribution for (n,n*4)

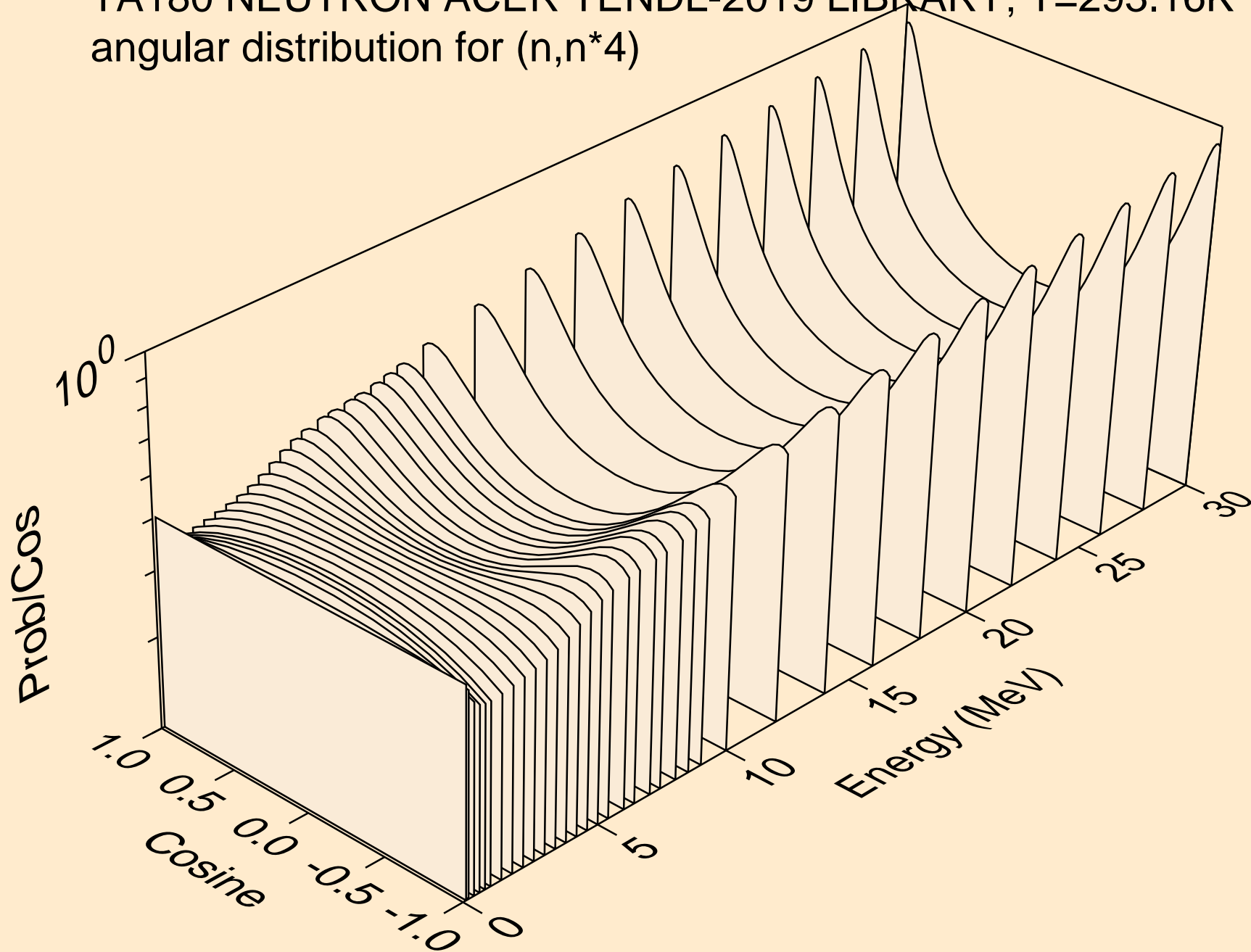

TA180 NEUTRON ACER TENDL-2019 LIBRARY; T=293.16K
angular distribution for (n,n*5)

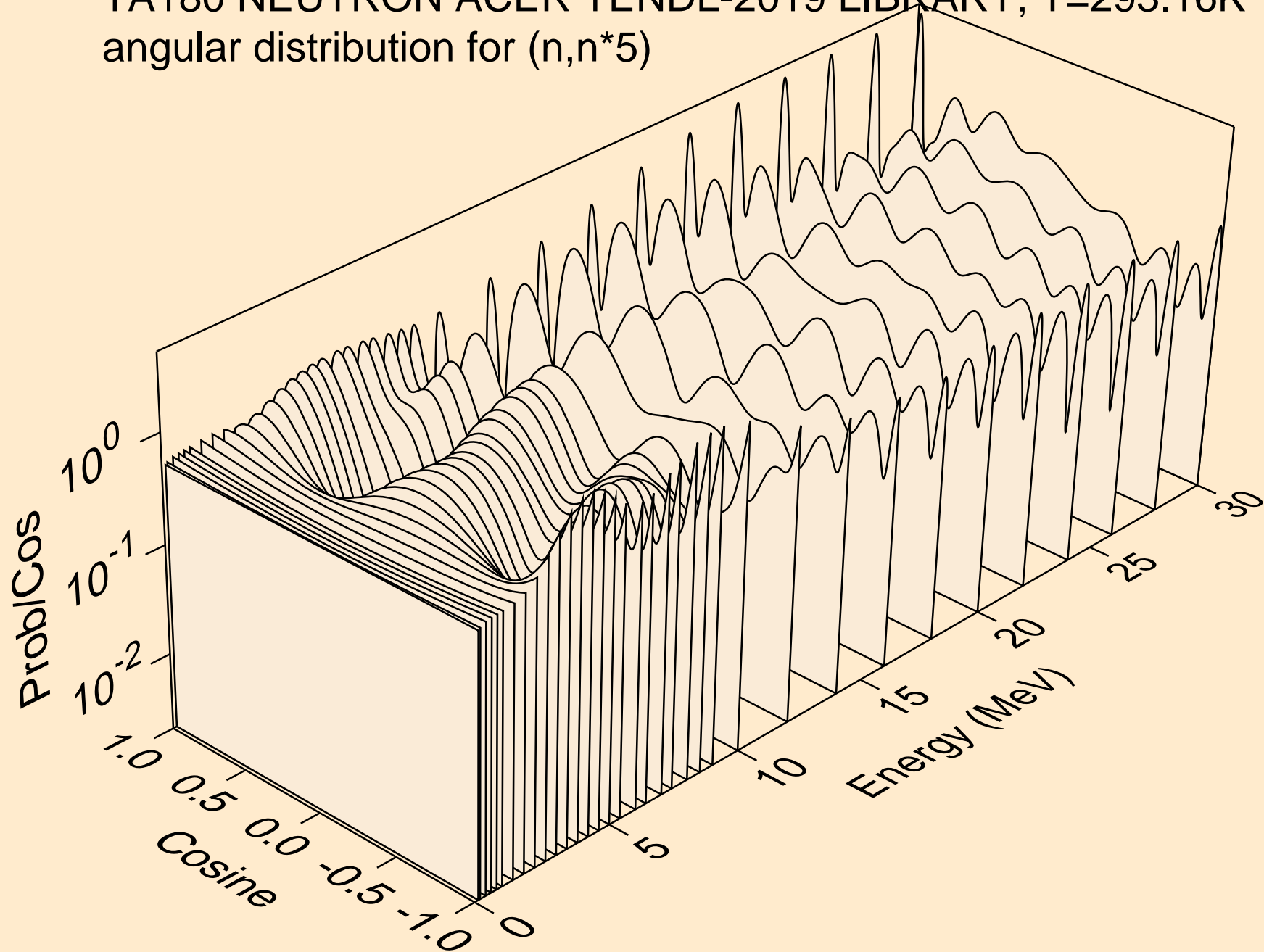

TA180 NEUTRON ACER TENDL-2019 LIBRARY; T=293.16K
angular distribution for (n,n*6)

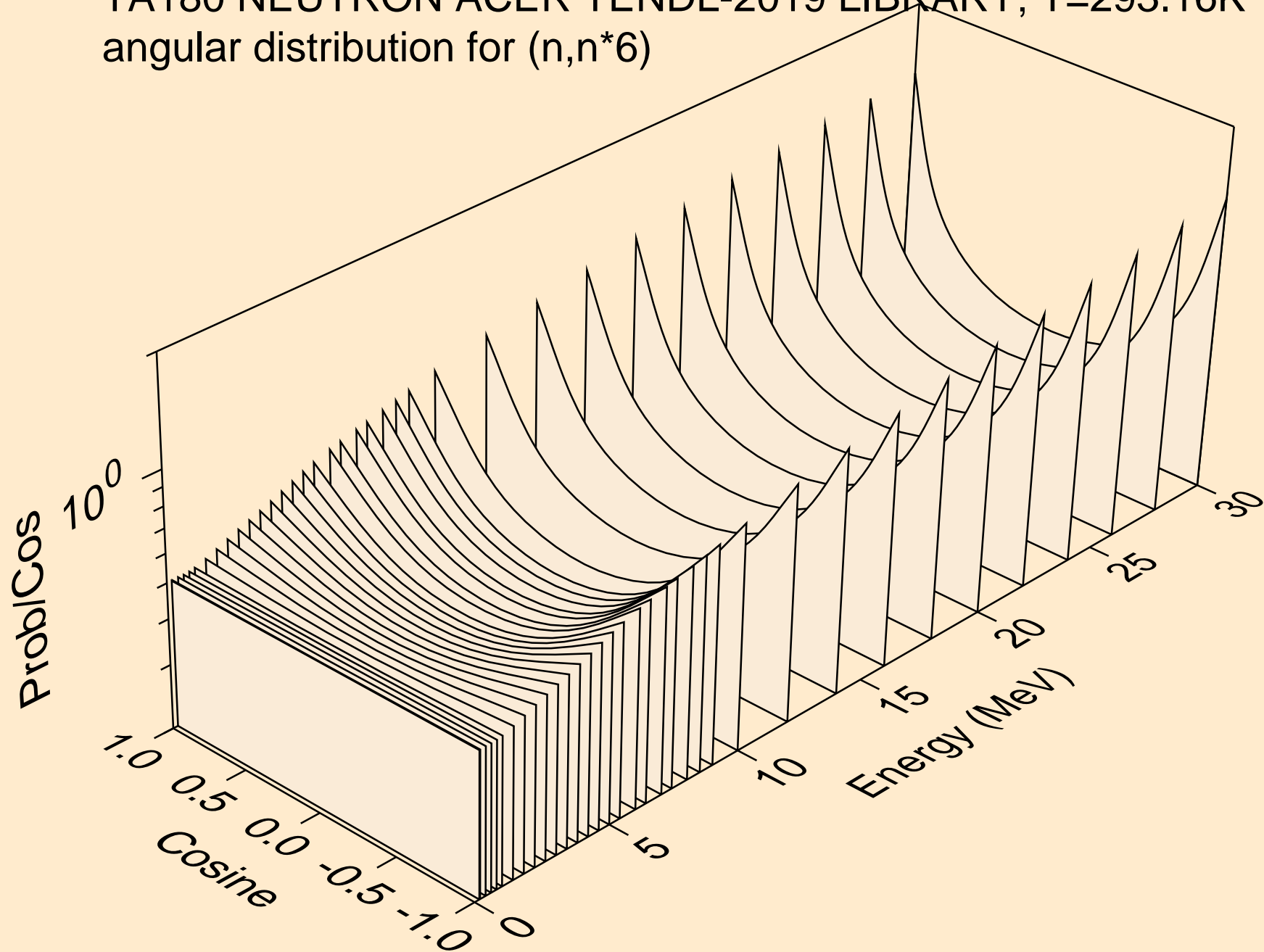

TA180 NEUTRON ACER TENDL-2019 LIBRARY; T=293.16K
angular distribution for (n,n*7)

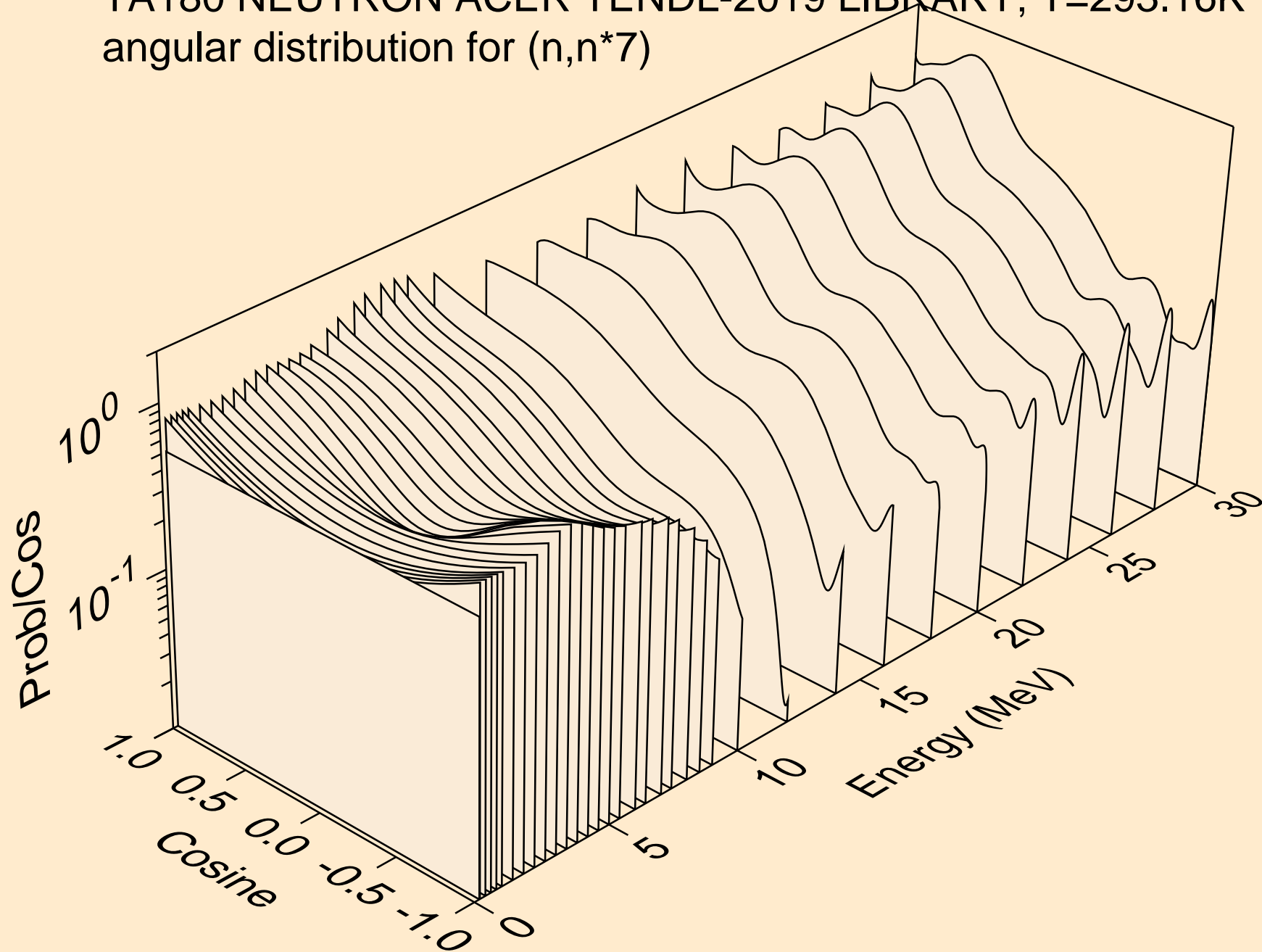

TA180 NEUTRON ACER TENDL-2019 LIBRARY; T=293.16K
angular distribution for (n,n*8)

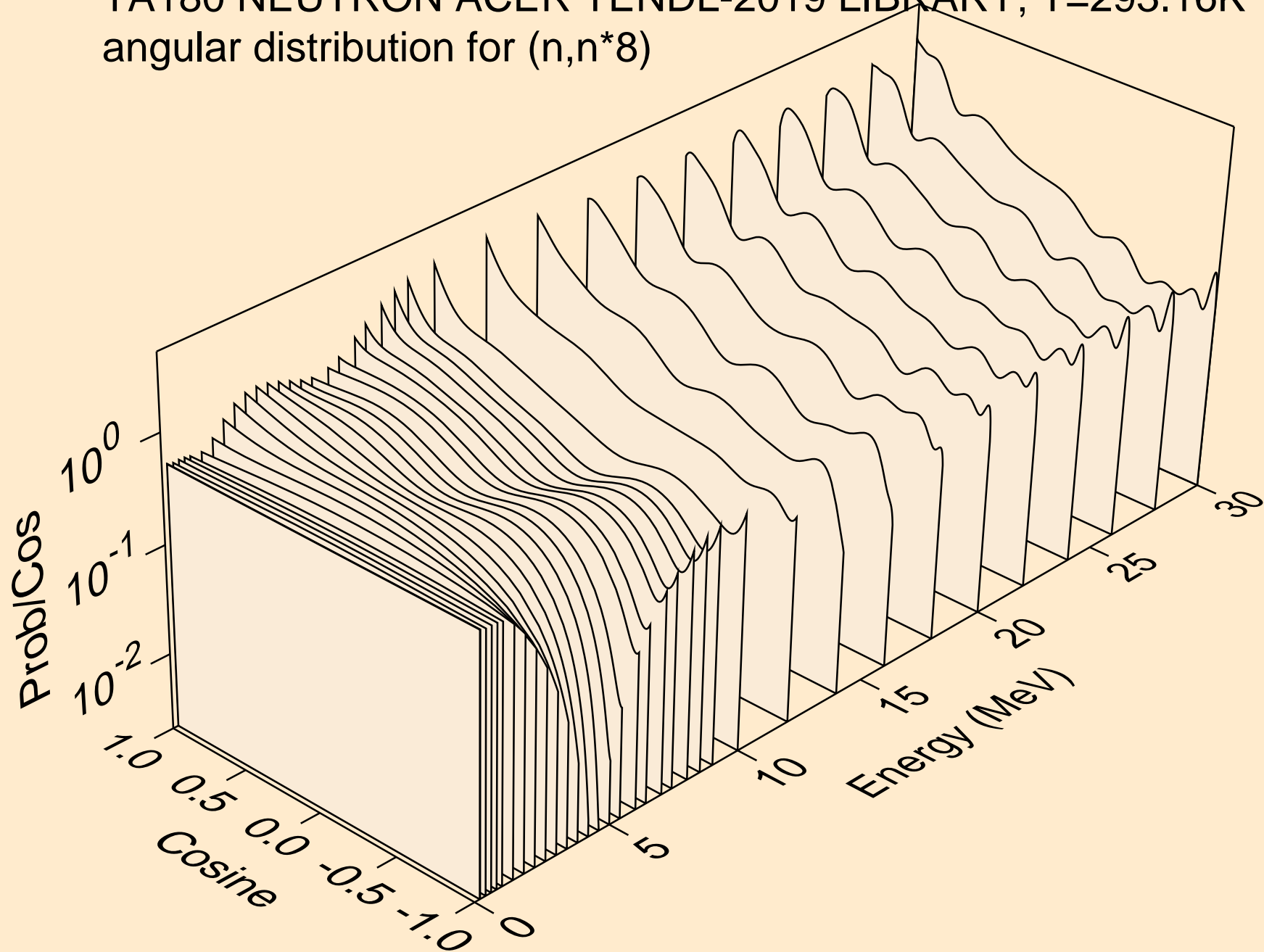

TA180 NEUTRON ACER TENDL-2019 LIBRARY; T=293.16K
angular distribution for (n,n*9)

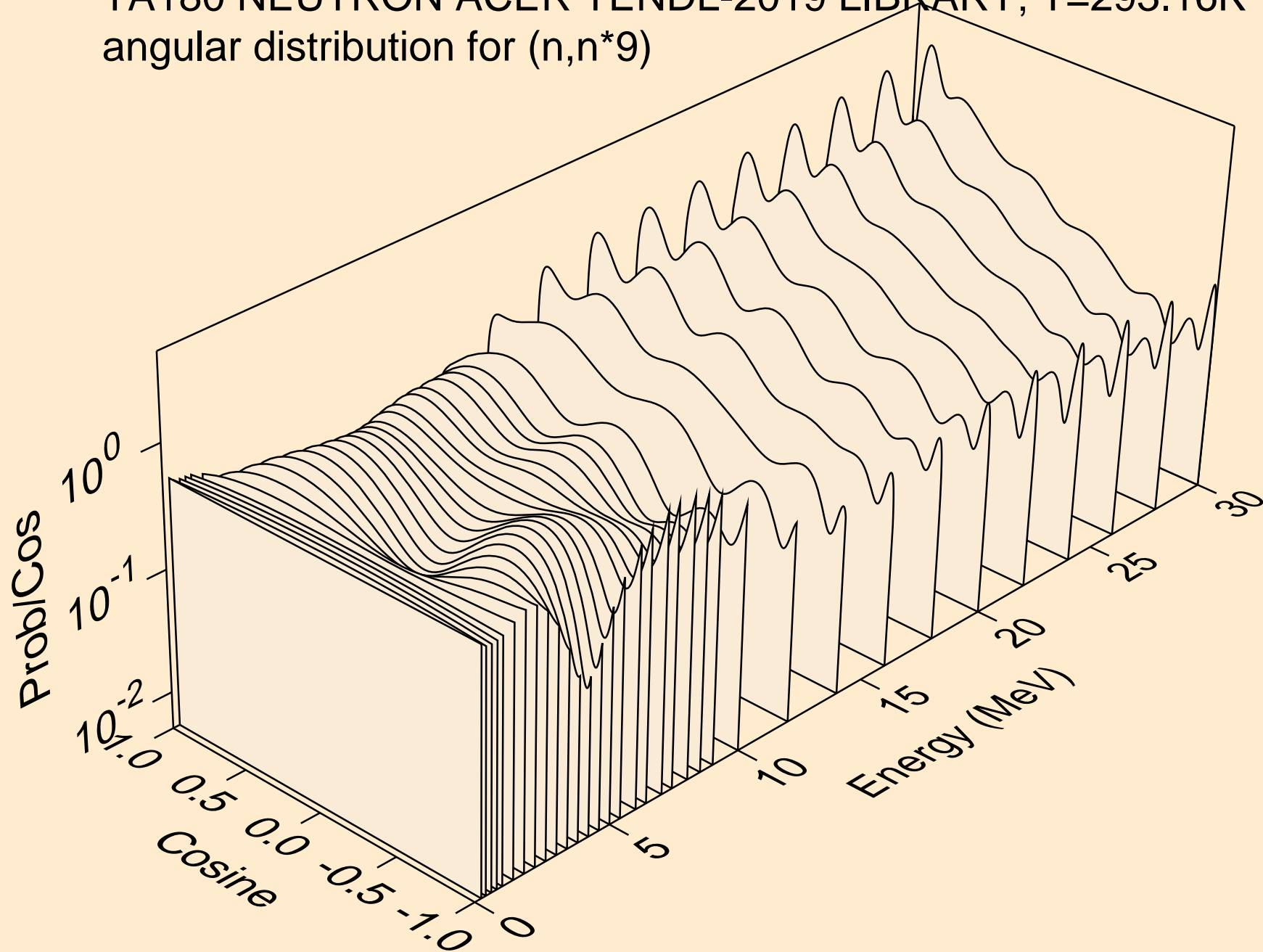

TA180 NEUTRON ACER TENDL-2019 LIBRARY; T=293.16K
angular distribution for (n,n*10)

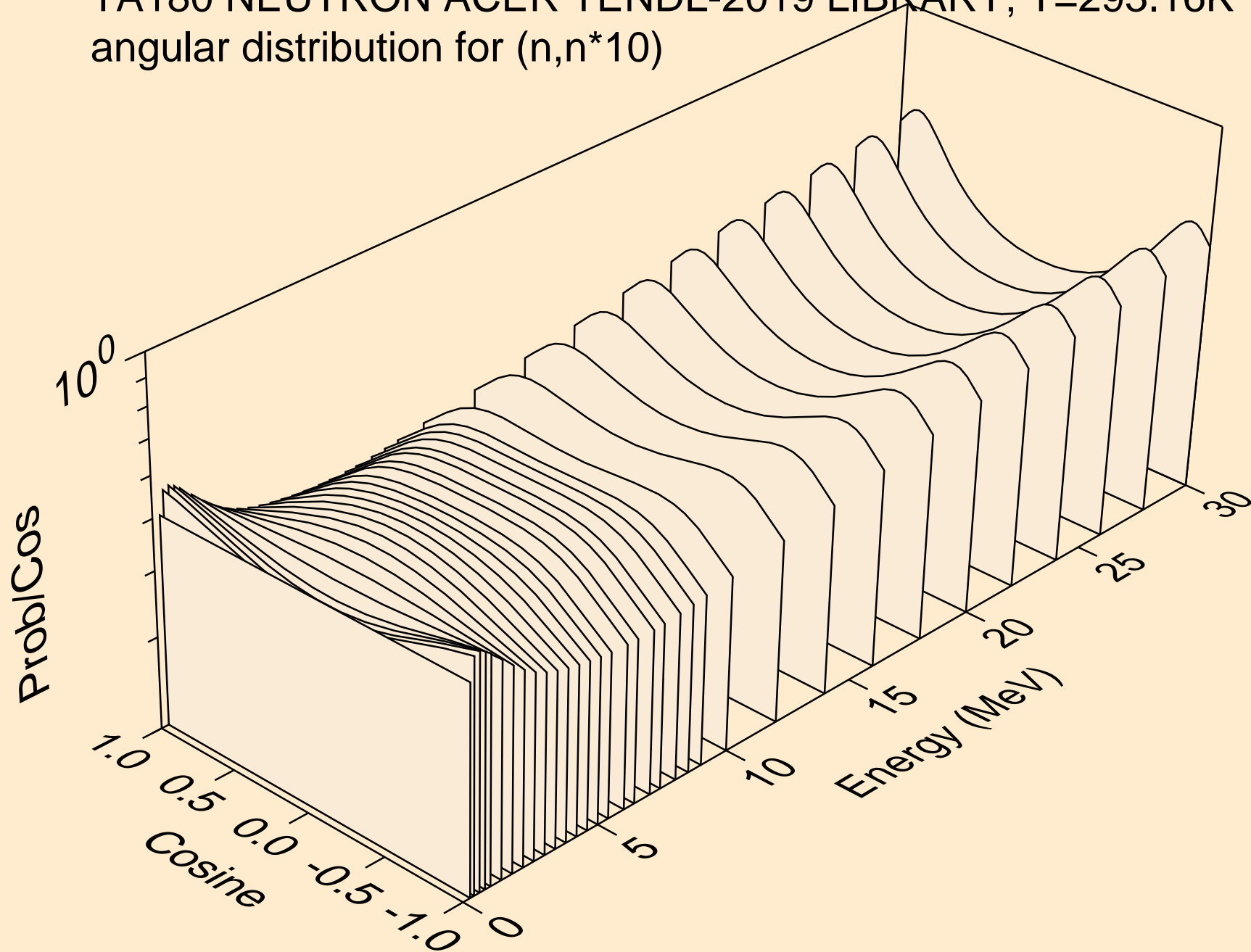

TA180 NEUTRON ACER TENDL-2019 LIBRARY; T=293.16K
angular distribution for (n,n*11)

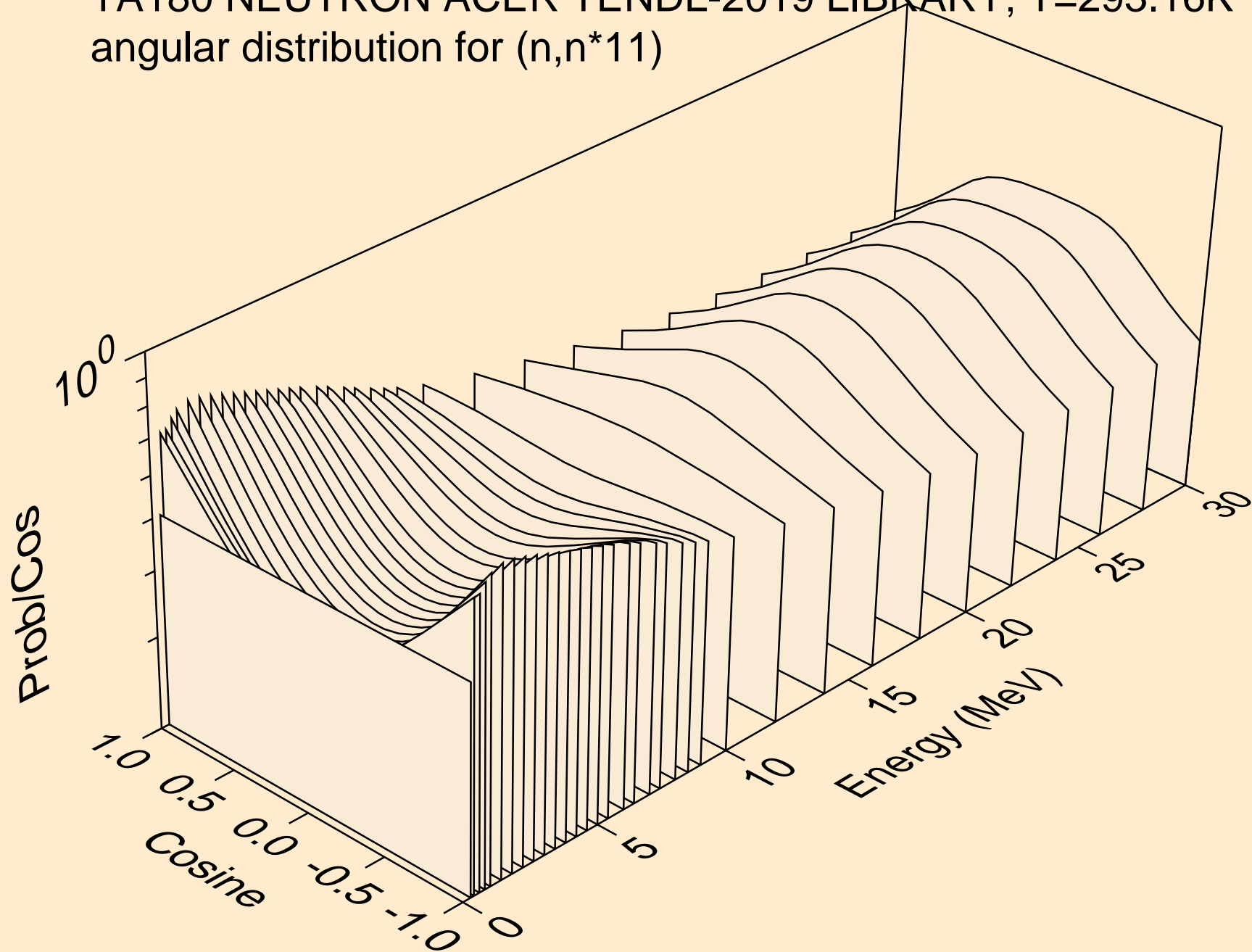

TA180 NEUTRON ACER TENDL-2019 LIBRARY; T=293.16K
angular distribution for (n,n*12)

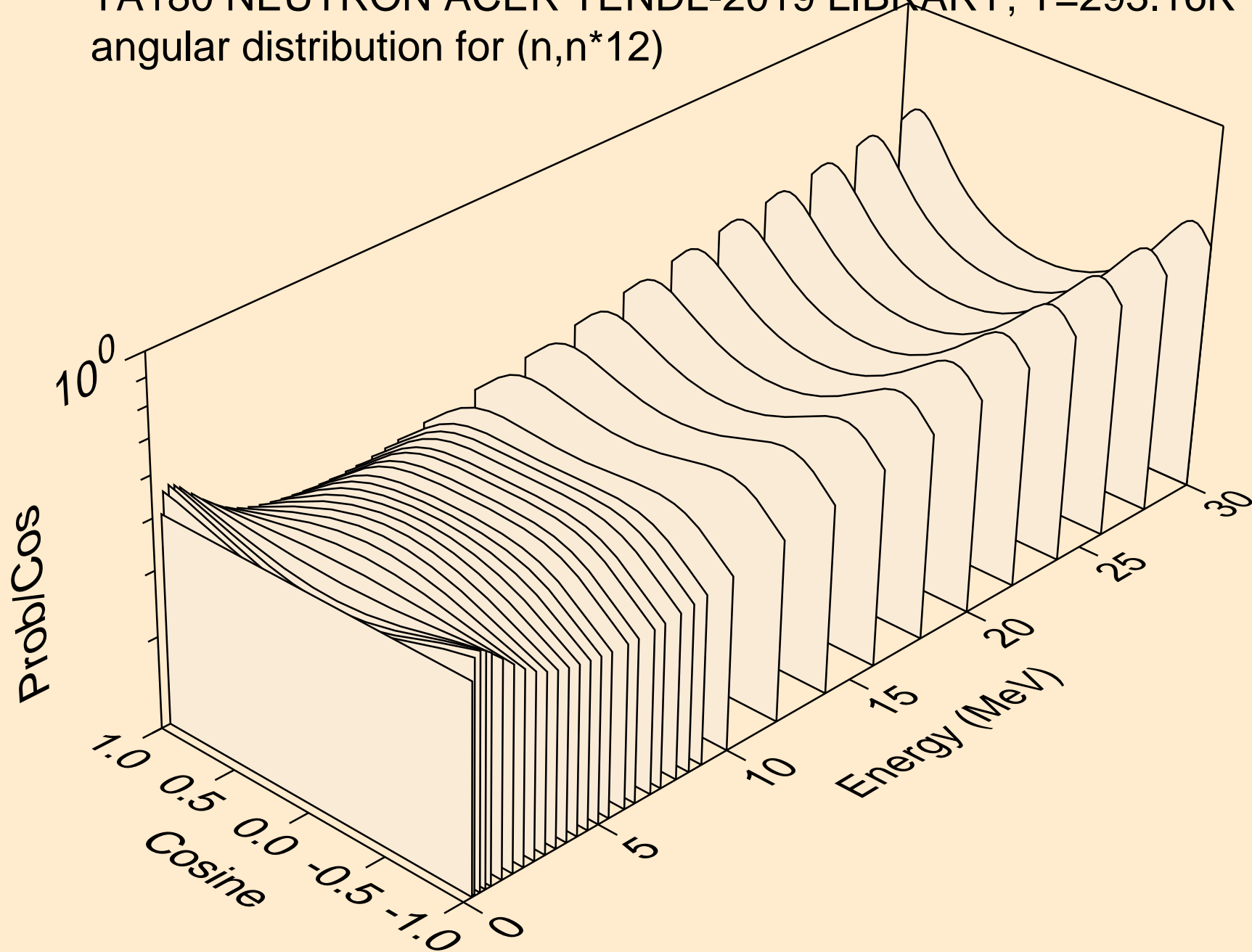

TA180 NEUTRON ACER TENDL-2019 LIBRARY; T=293.16K
angular distribution for (n,n*13)

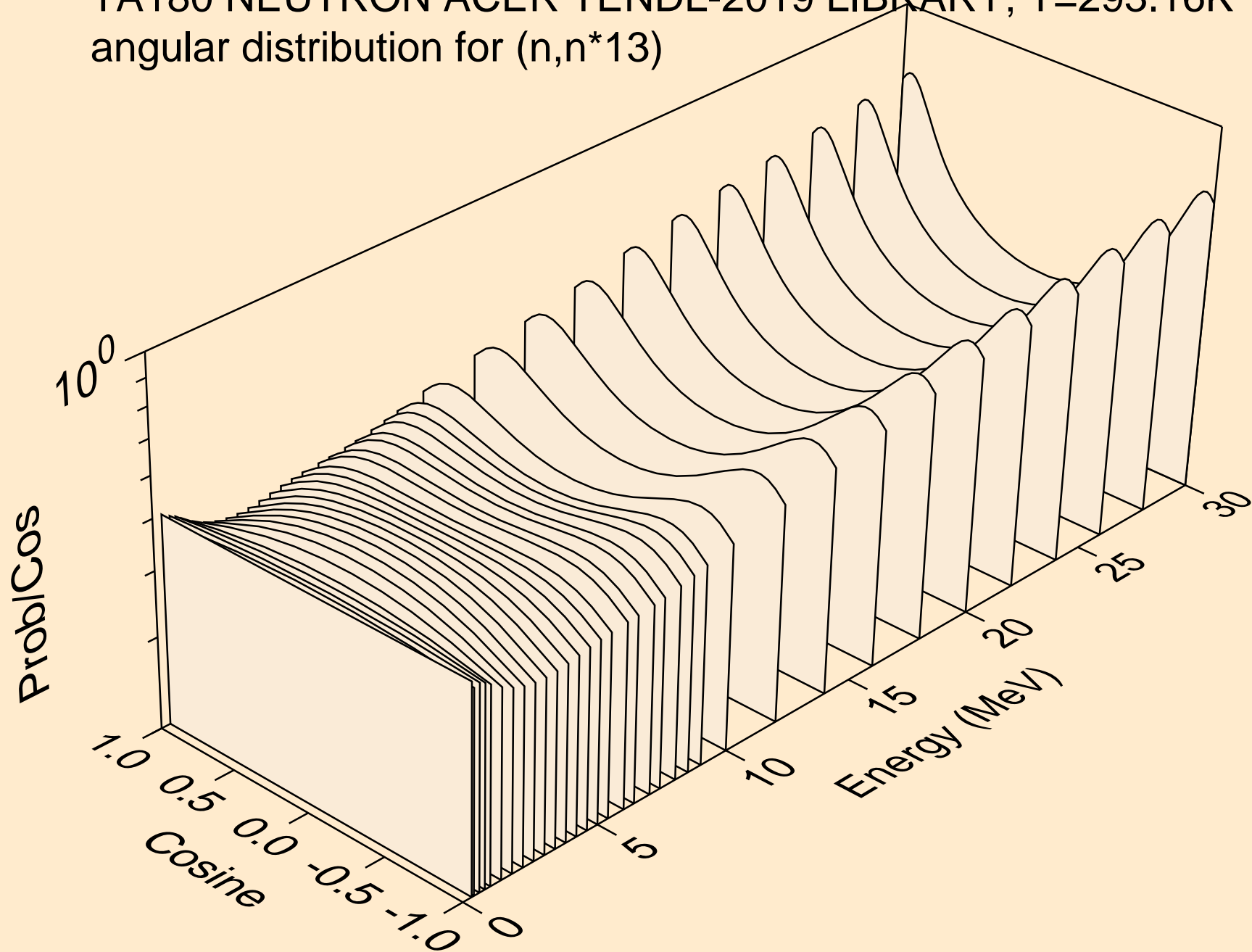

TA180 NEUTRON ACER TENDL-2019 LIBRARY; T=293.16K
angular distribution for (n,n*14)

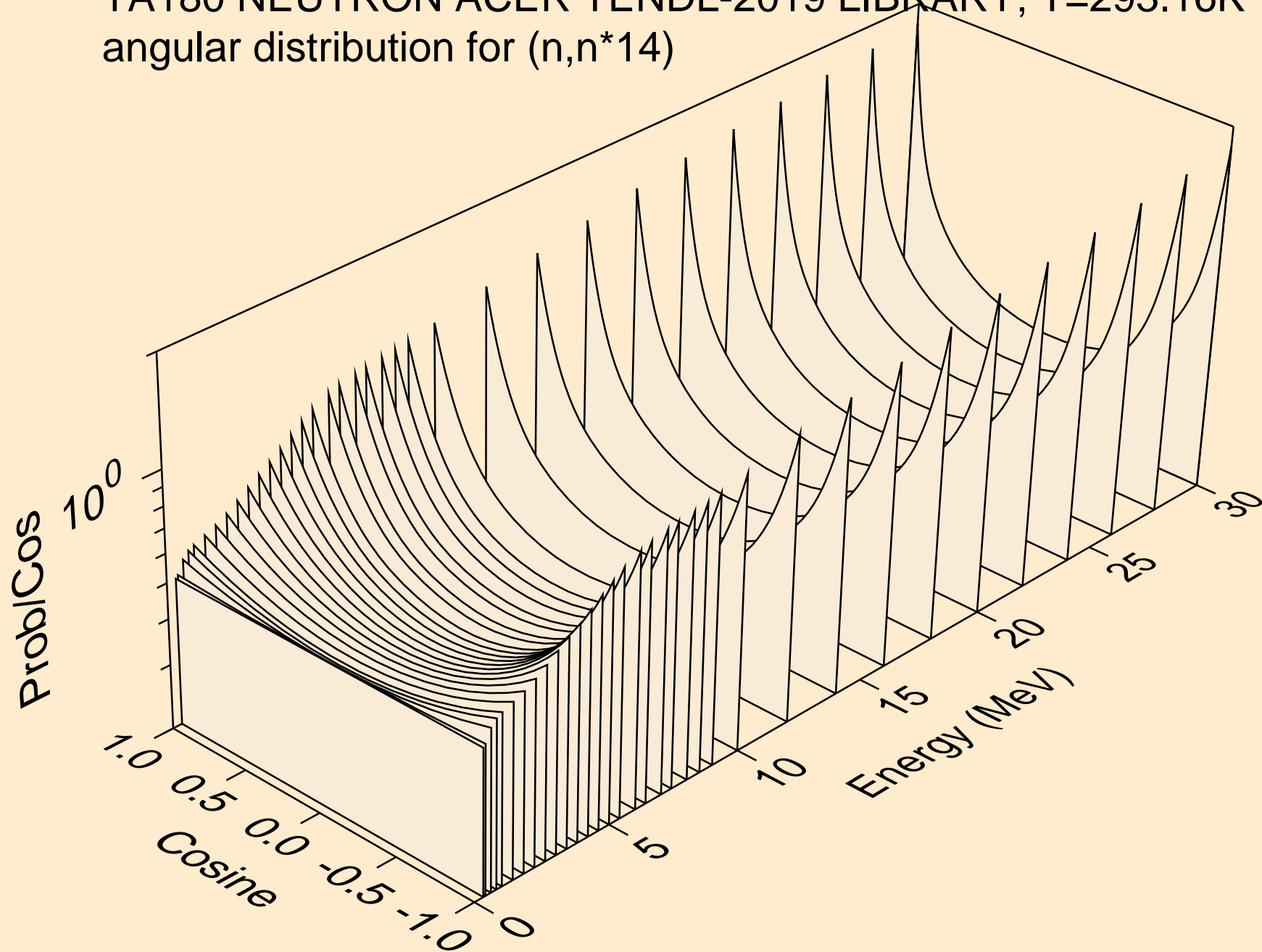

TA180 NEUTRON ACER TENDL-2019 LIBRARY; T=293.16K
angular distribution for (n,n*15)

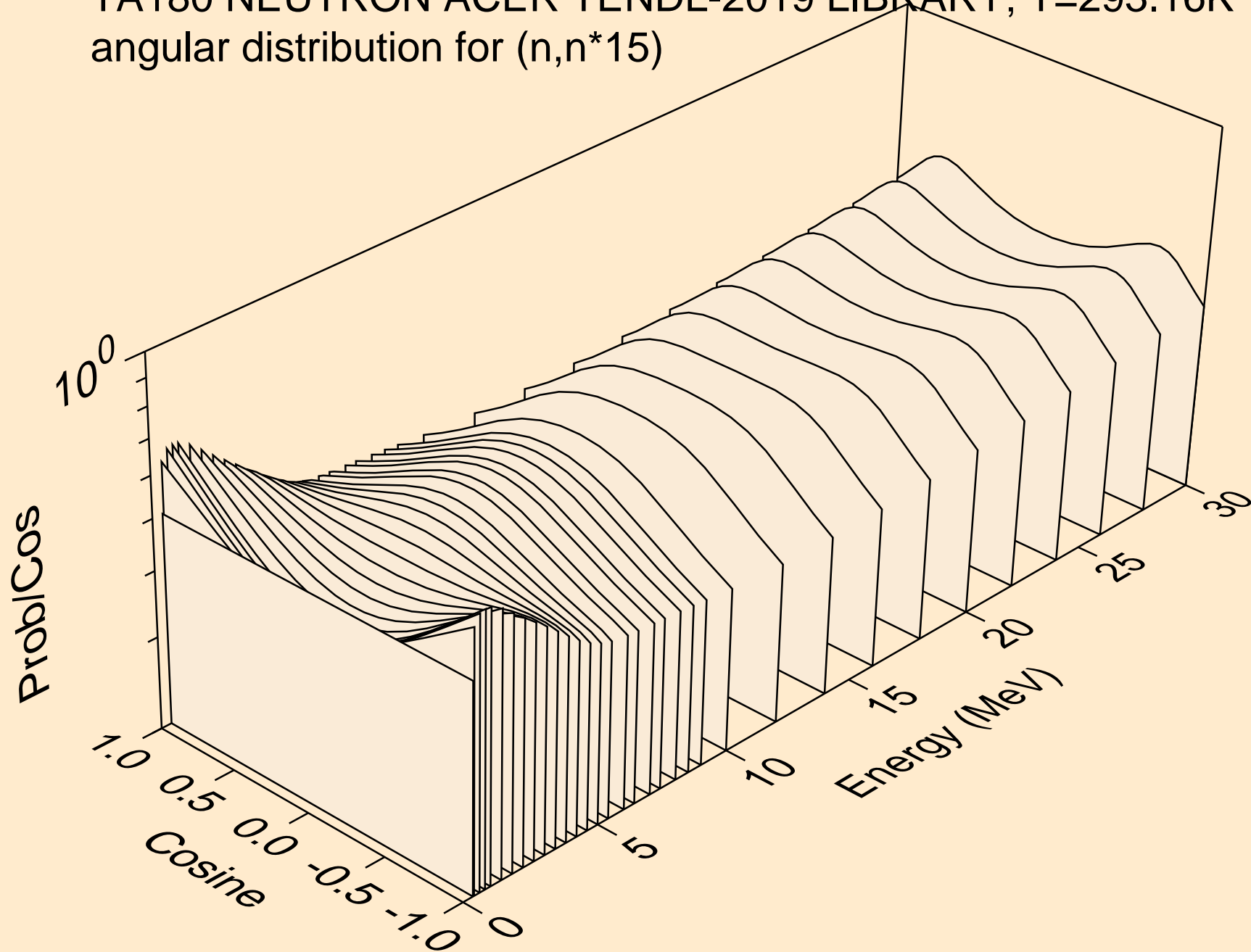

TA180 NEUTRON ACER TENDL-2019 LIBRARY; T=293.16K
angular distribution for (n,n*16)

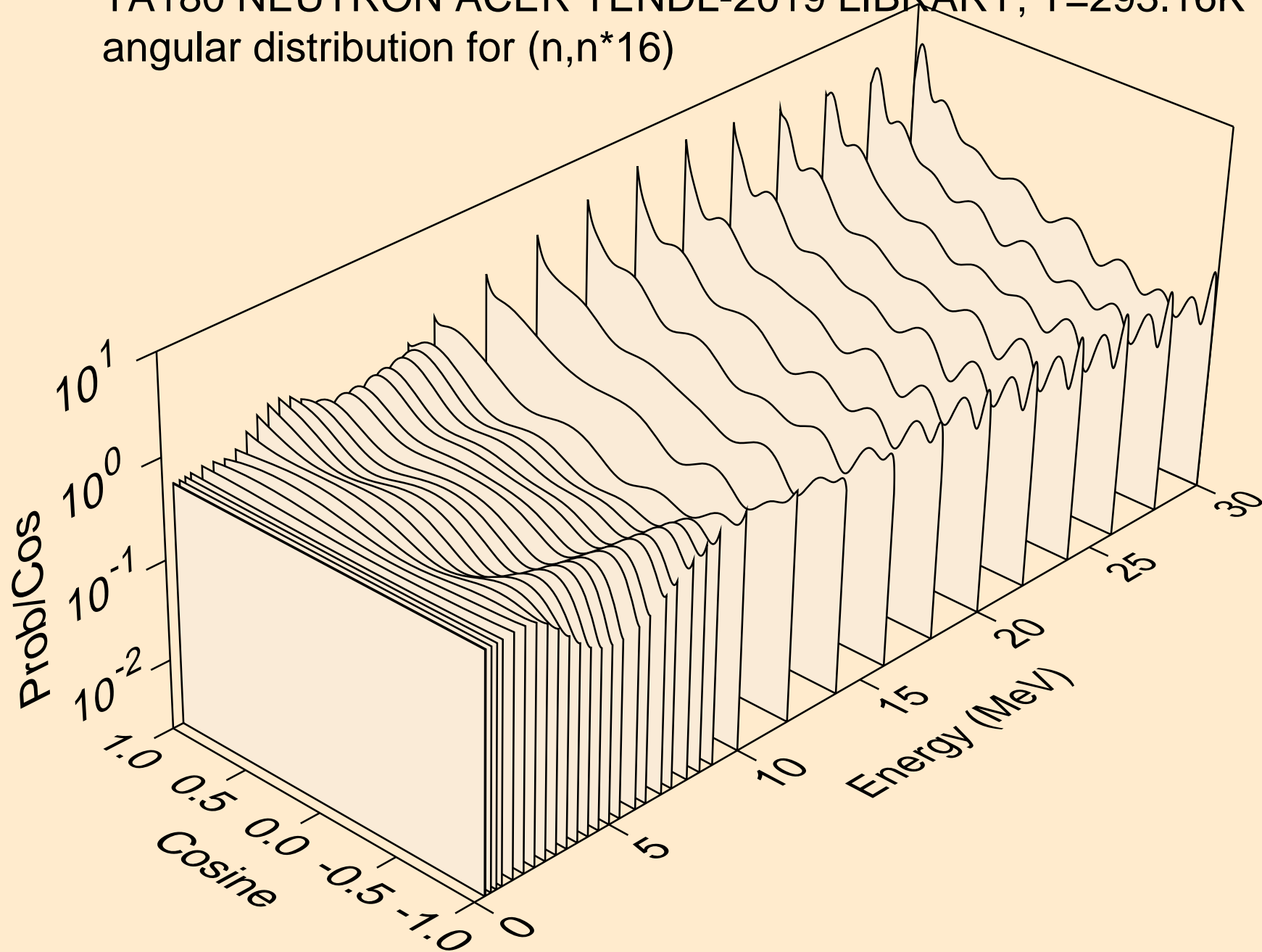

TA180 NEUTRON ACER TENDL-2019 LIBRARY; T=293.16K
angular distribution for (n,n*17)

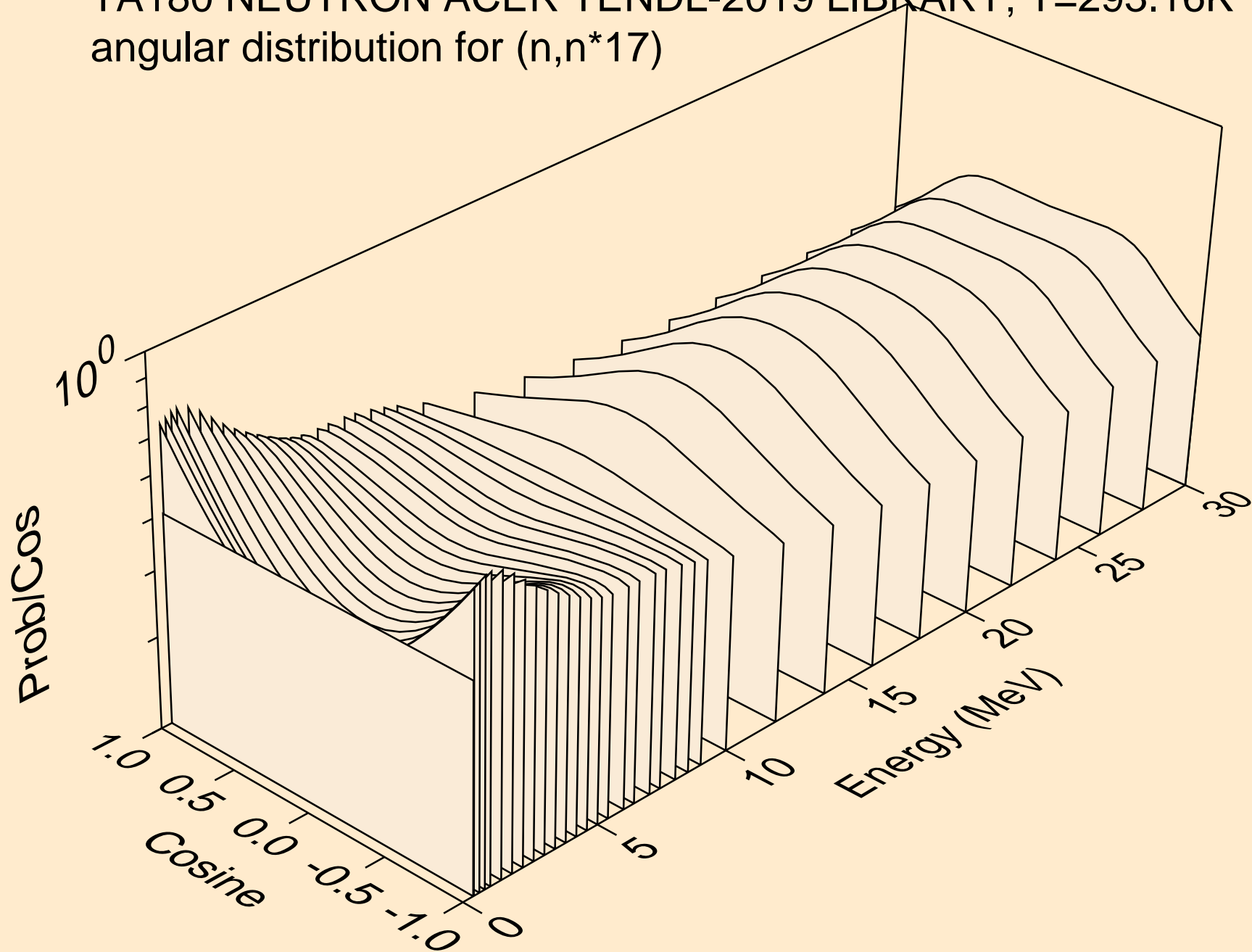

TA180 NEUTRON ACER TENDL-2019 LIBRARY; T=293.16K
angular distribution for (n,n*18)

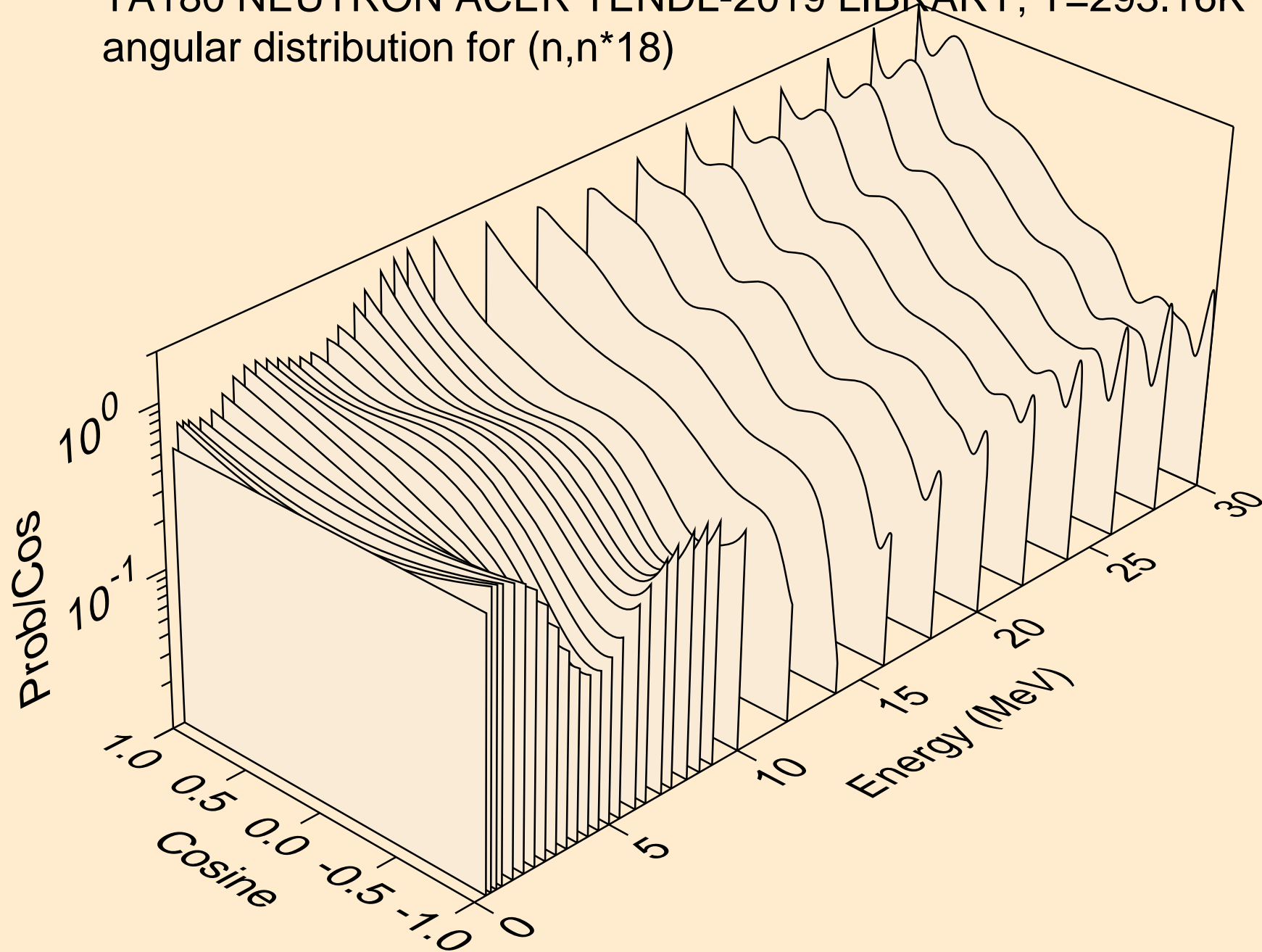

TA180 NEUTRON ACER TENDL-2019 LIBRARY; T=293.16K
angular distribution for (n,n*19)

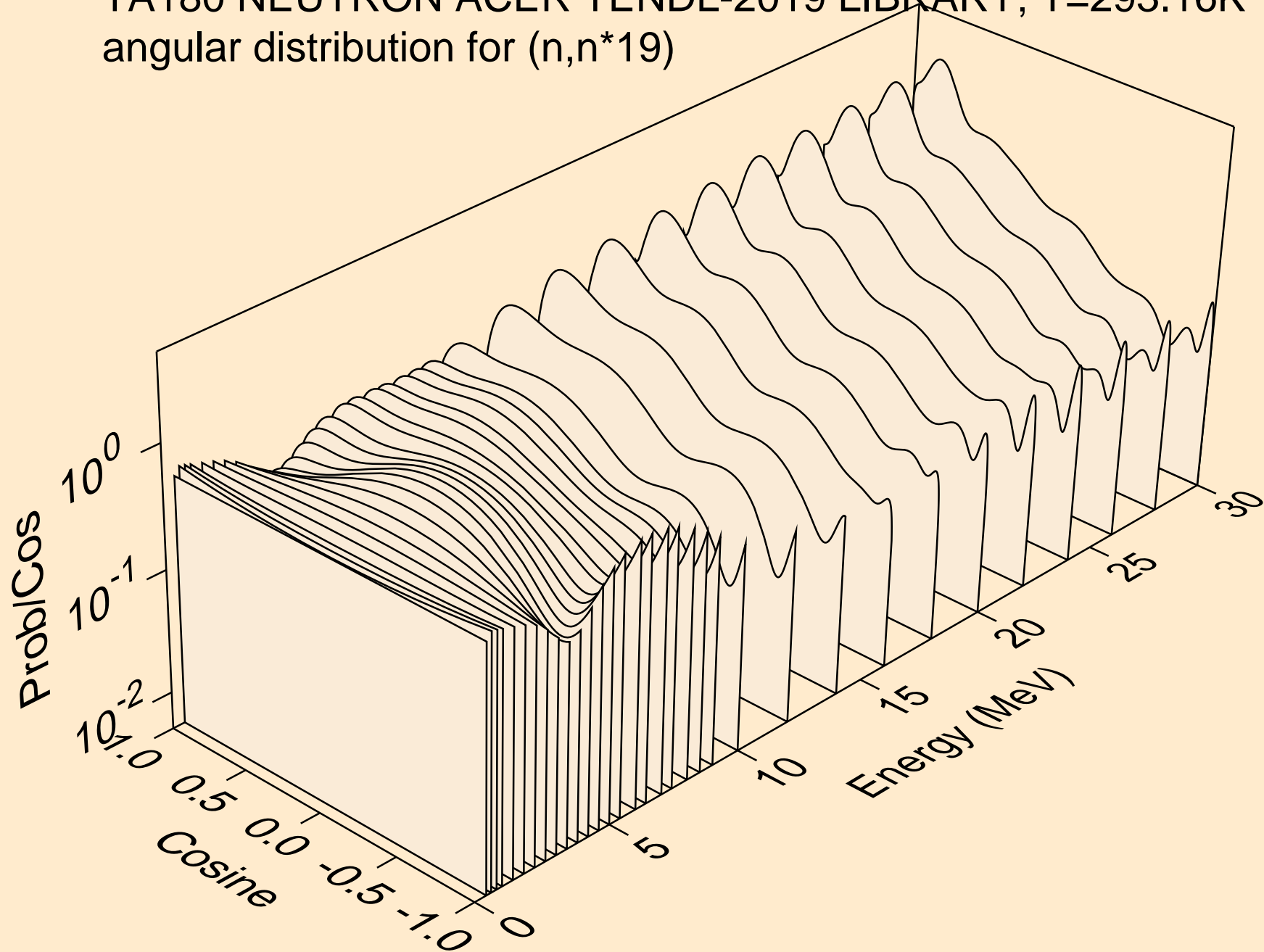

TA180 NEUTRON ACER TENDL-2019 LIBRARY; T=293.16K
angular distribution for (n,n*20)

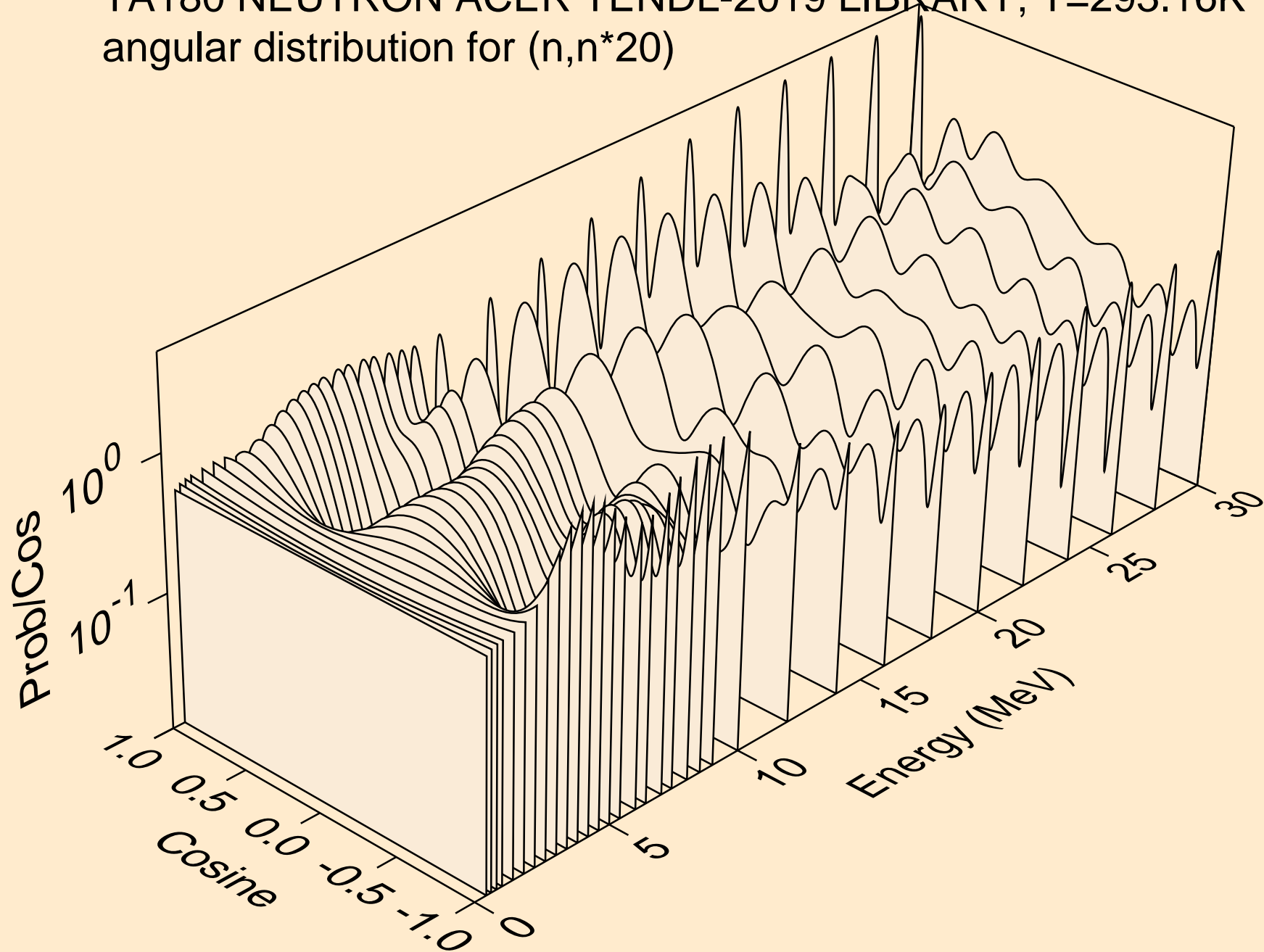

TA180 NEUTRON ACER TENDL-2019 LIBRARY; T=293.16K
angular distribution for (n,n*21)

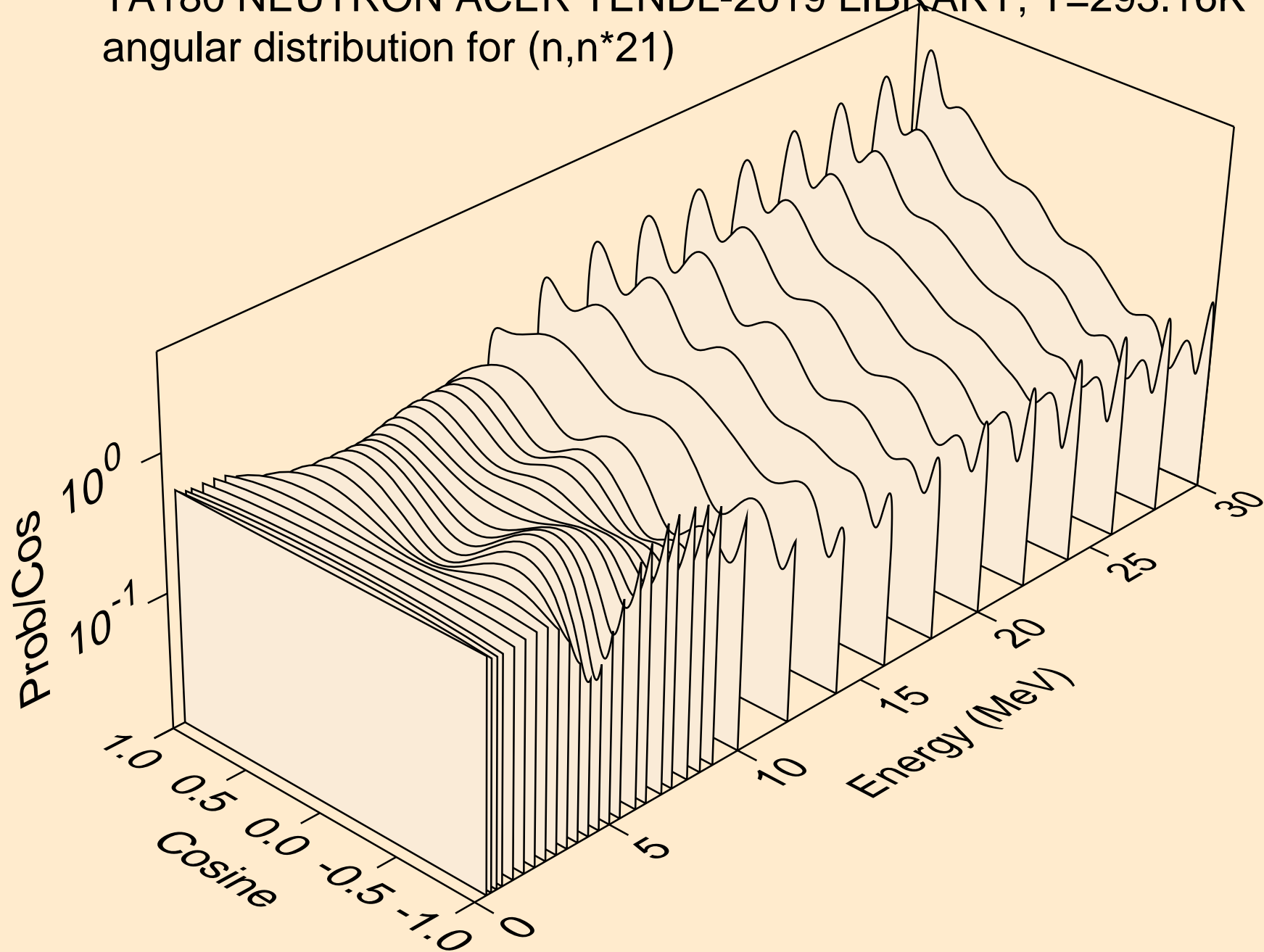

TA180 NEUTRON ACER TENDL-2019 LIBRARY; T=293.16K
angular distribution for (n,n*22)

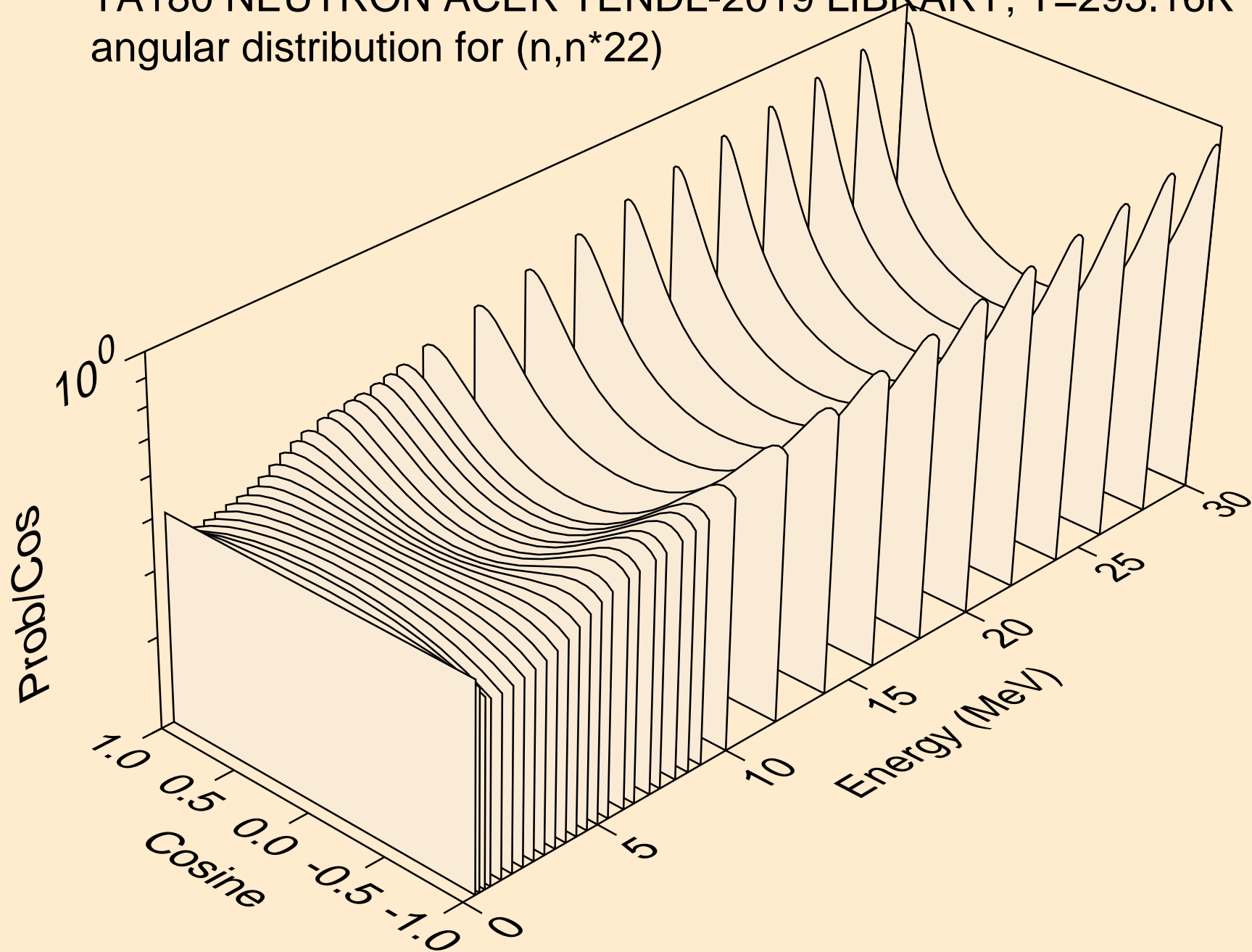

TA180 NEUTRON ACER TENDL-2019 LIBRARY; T=293.16K
angular distribution for (n,n*23)

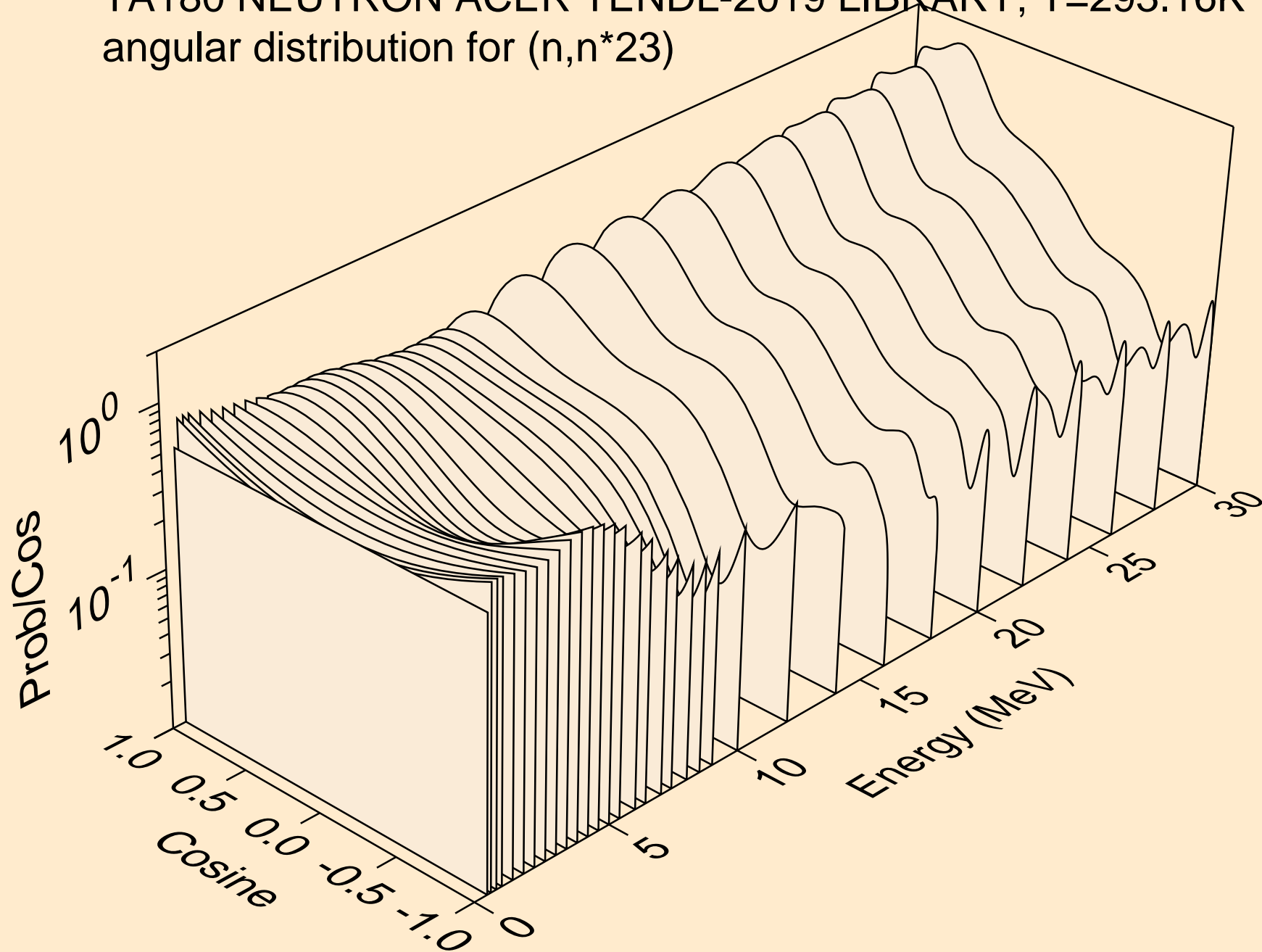

TA180 NEUTRON ACER TENDL-2019 LIBRARY; T=293.16K
angular distribution for (n,n*24)

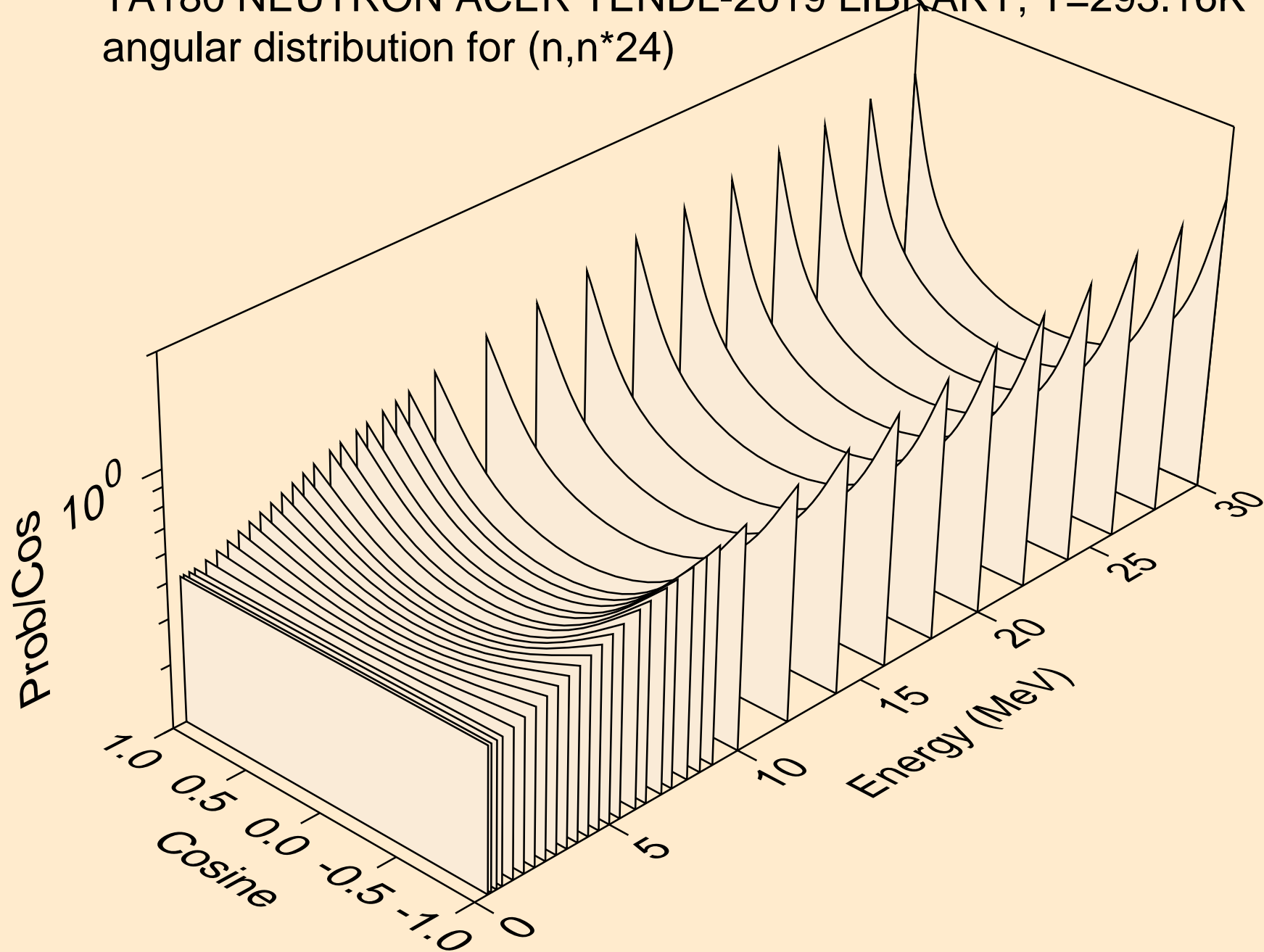

TA180 NEUTRON ACER TENDL-2019 LIBRARY; T=293.16K
angular distribution for (n,n*25)

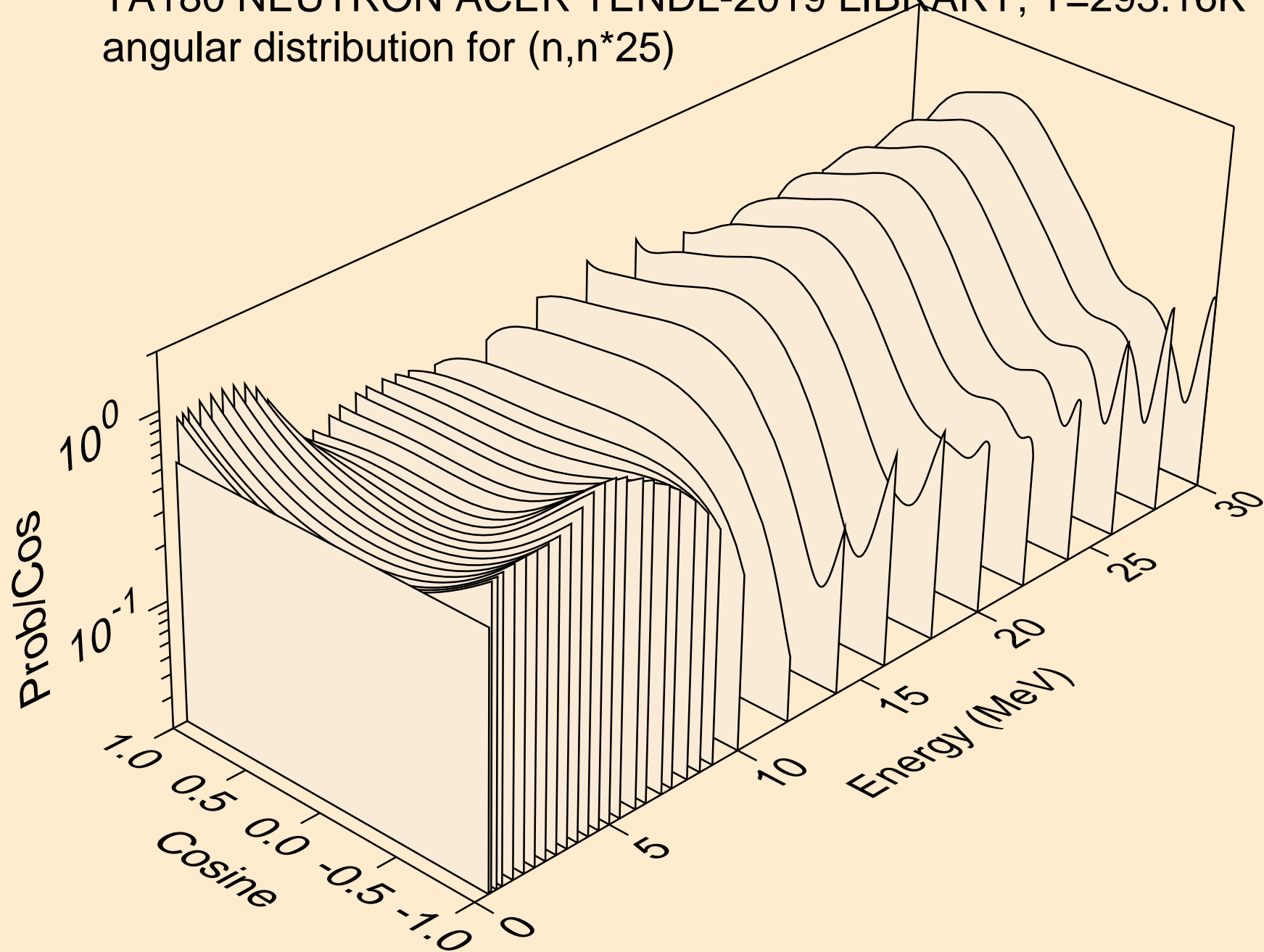

TA180 NEUTRON ACER TENDL-2019 LIBRARY; T=293.16K
angular distribution for (n,n*26)

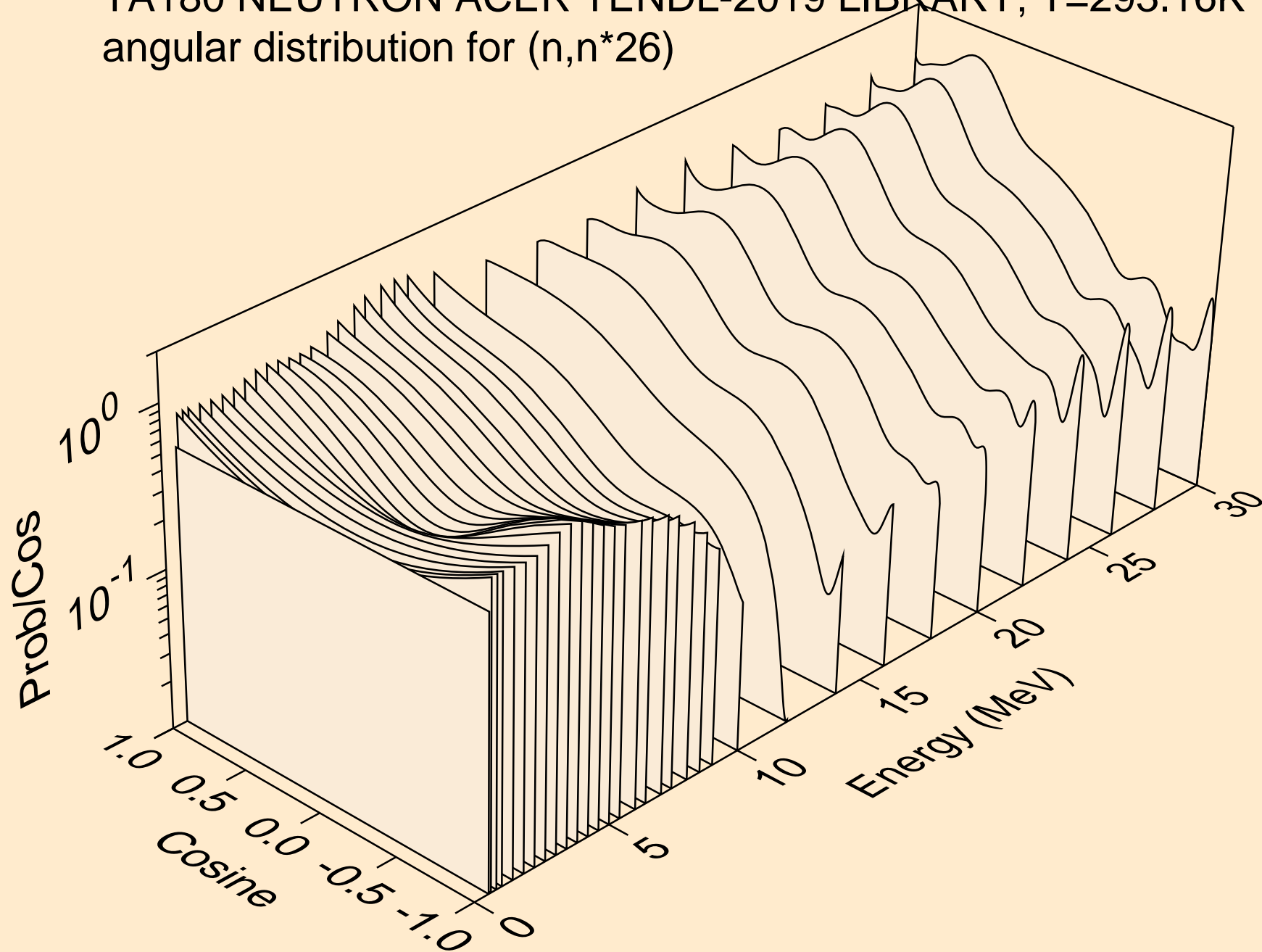

TA180 NEUTRON ACER TENDL-2019 LIBRARY; T=293.16K
angular distribution for (n,n*27)

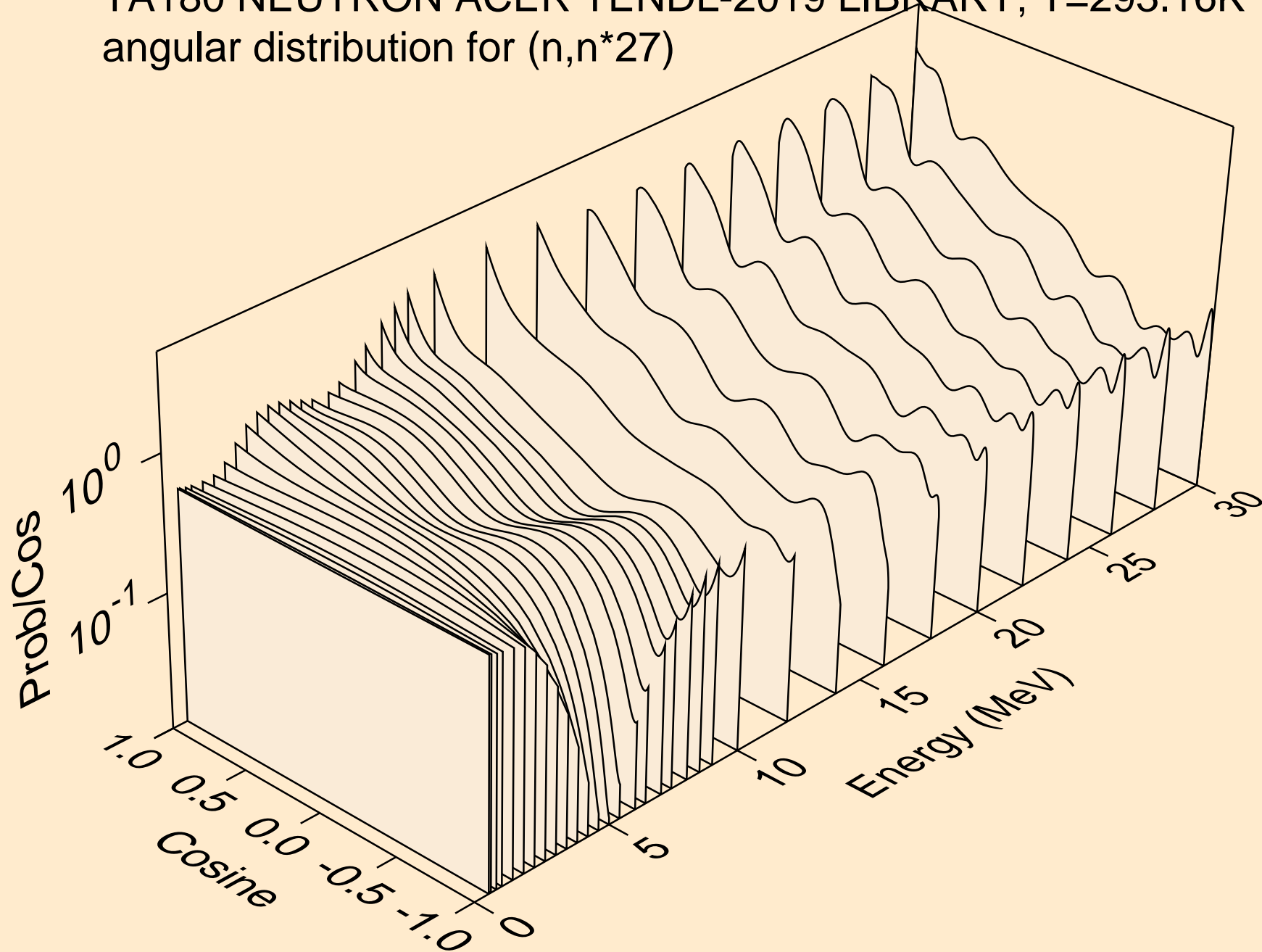

TA180 NEUTRON ACER TENDL-2019 LIBRARY; T=293.16K
angular distribution for (n,n*28)

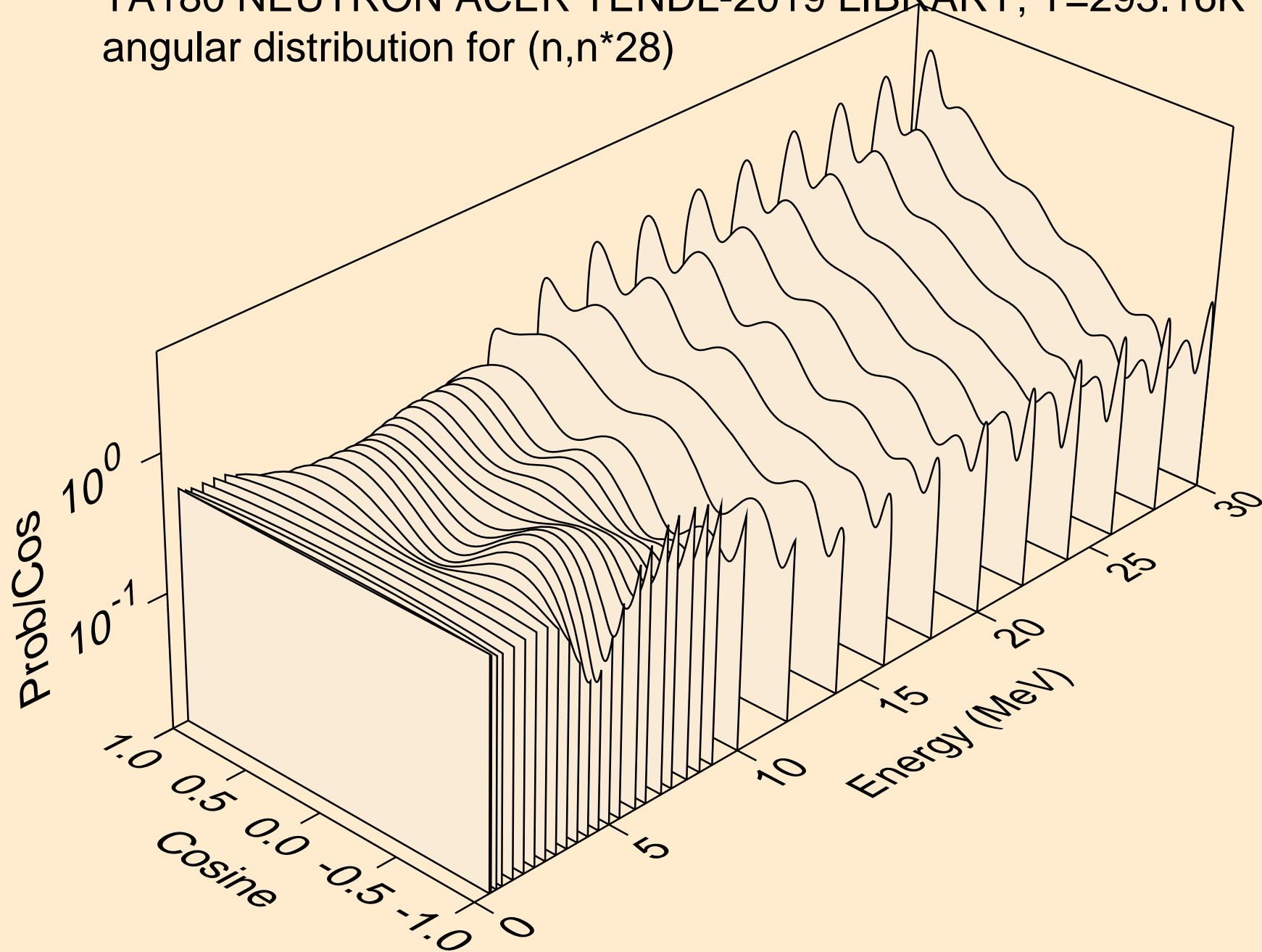

TA180 NEUTRON ACER TENDL-2019 LIBRARY; T=293.16K
angular distribution for (n,n*29)

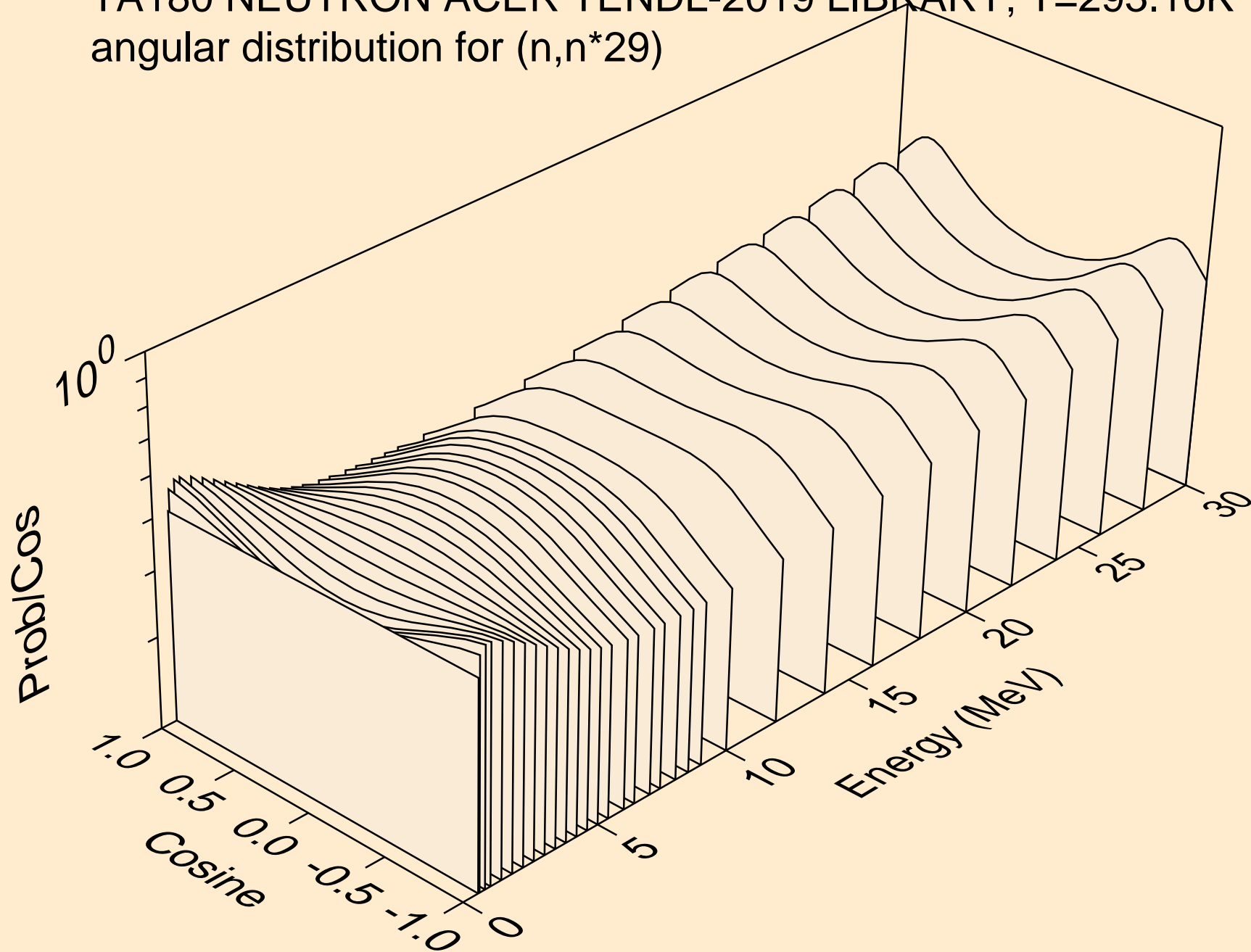

TA180 NEUTRON ACER TENDL-2019 LIBRARY; T=293.16K
angular distribution for (n,n*30)

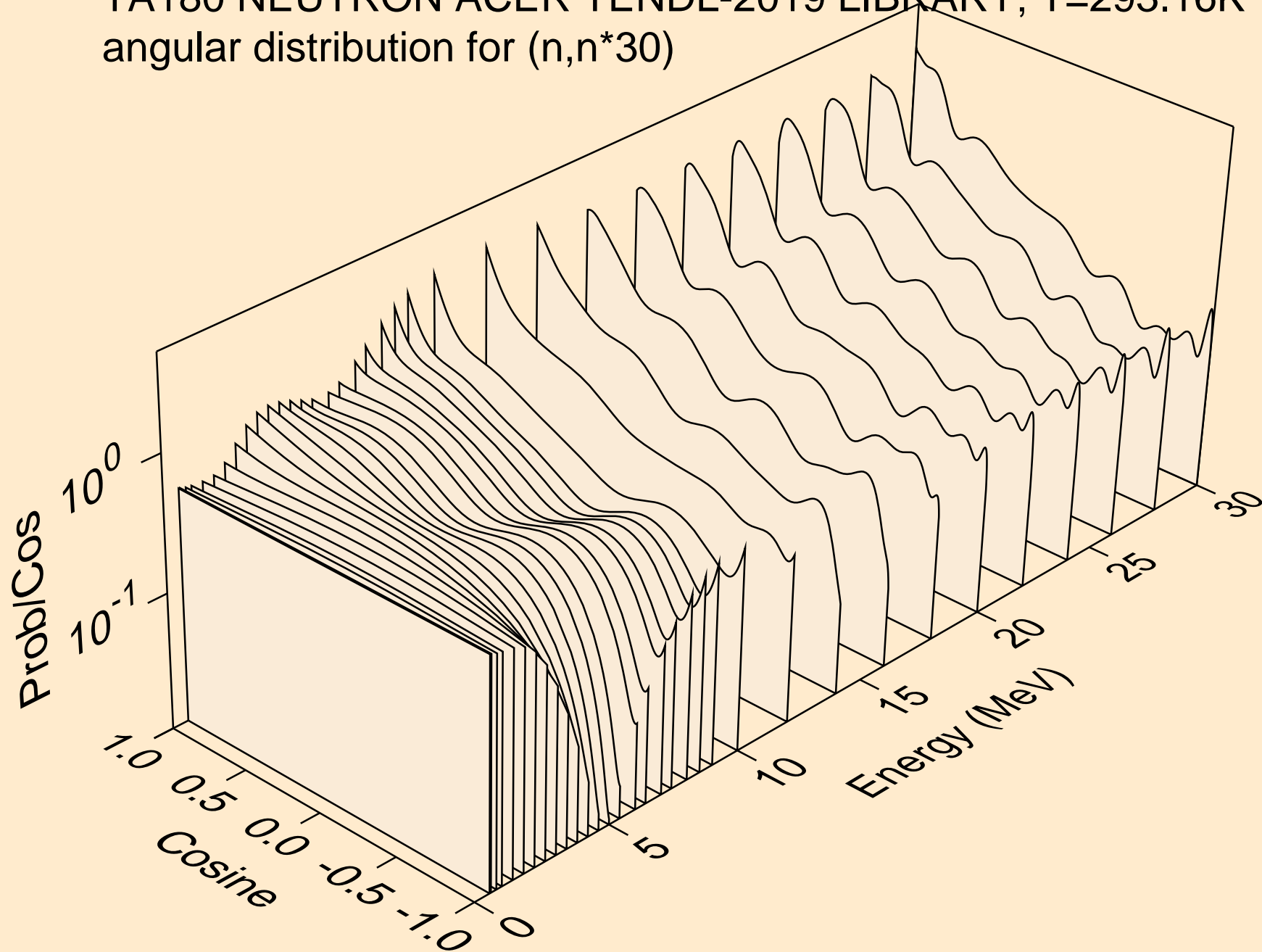

TA180 NEUTRON ACER TENDL-2019 LIBRARY; T=293.16K
Neutron emission for (n,x)

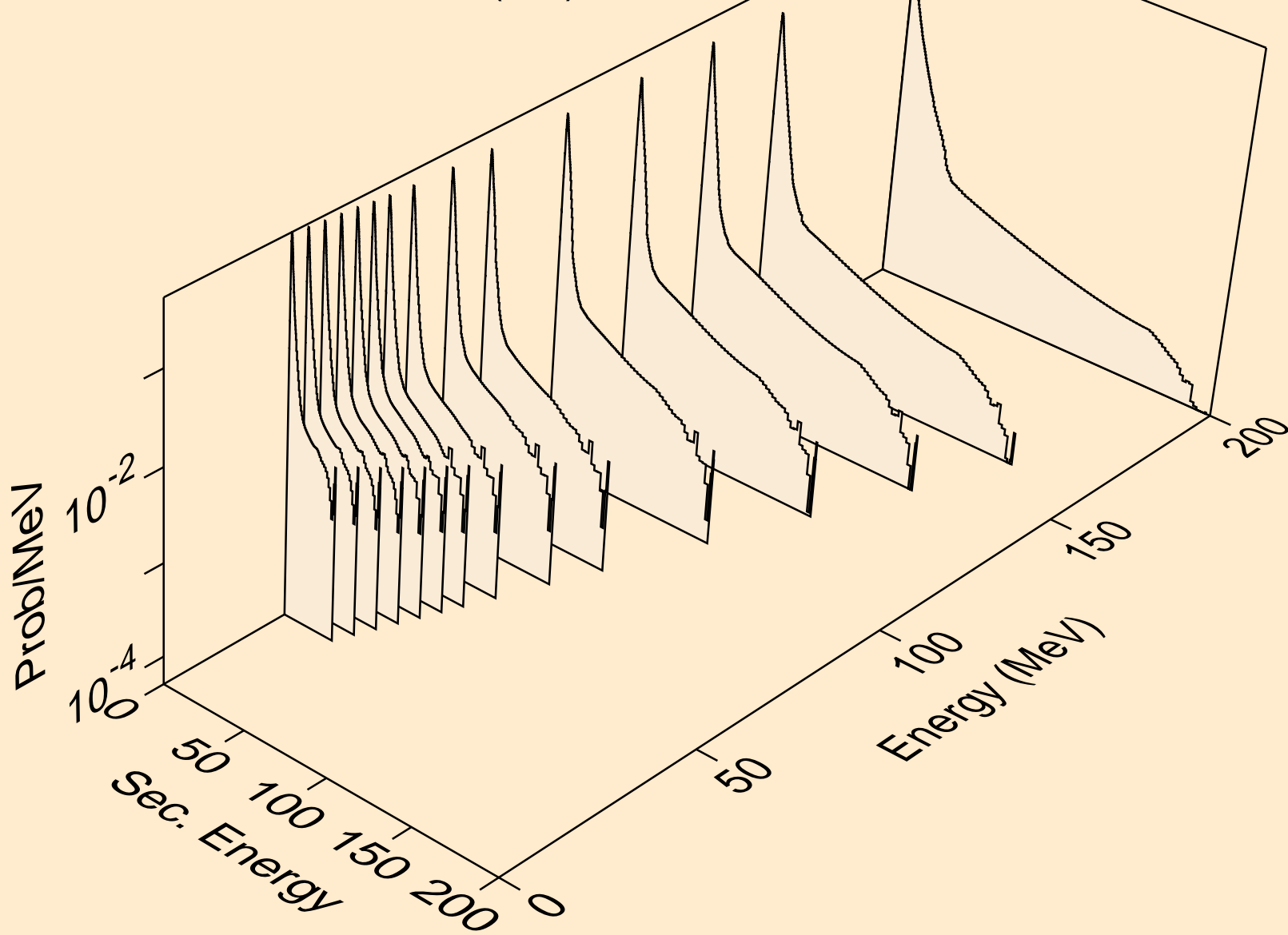

TA180 NEUTRON ACER TENDL-2019 LIBRARY; T=293.16K
Neutron emission for (n,2nd)

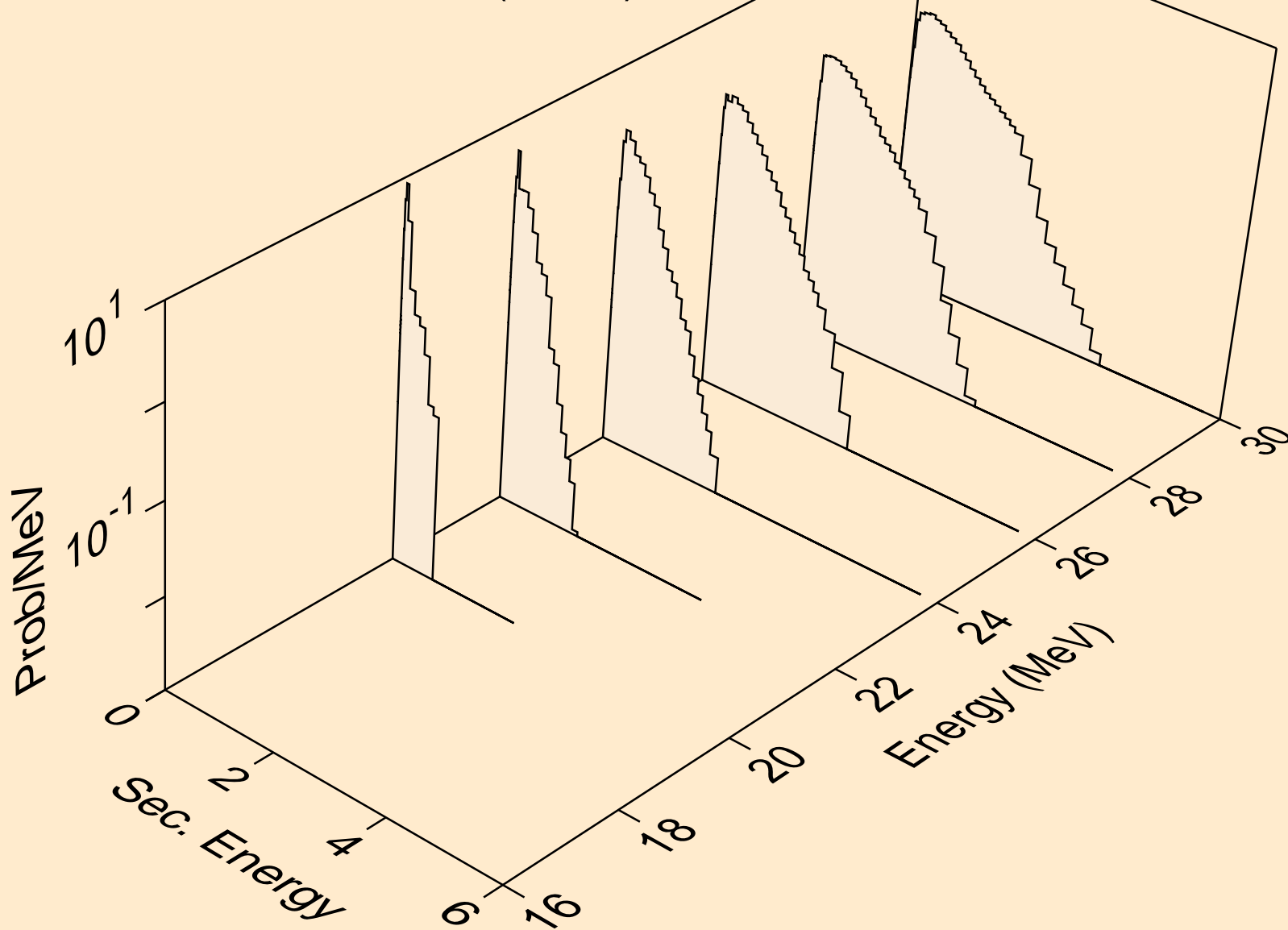

TA180 NEUTRON ACER TENDL-2019 LIBRARY; T=293.16K
Neutron emission for (n,2n)

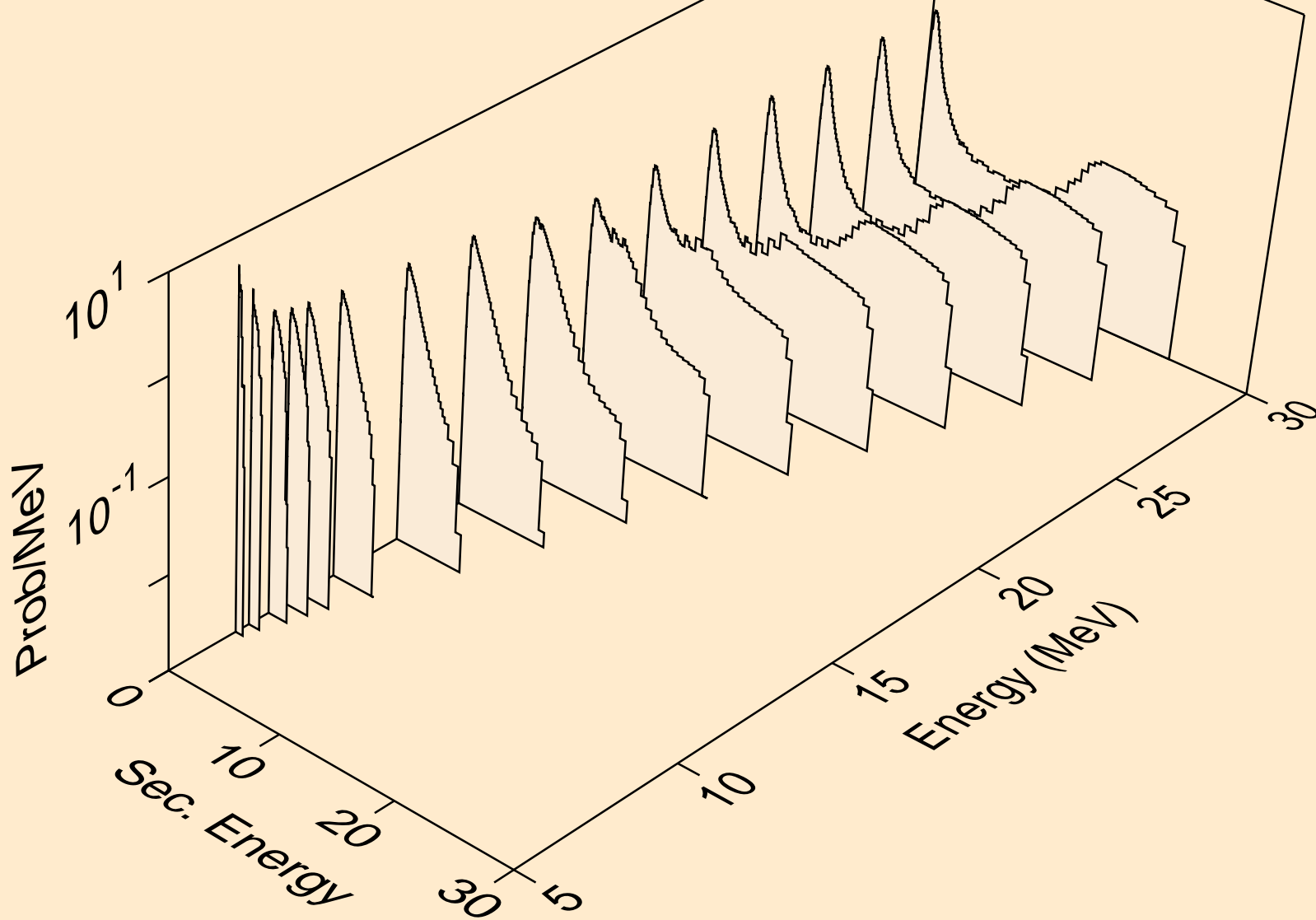

TA180 NEUTRON ACER TENDL-2019 LIBRARY; T=293.16K
Neutron emission for (n,3n)

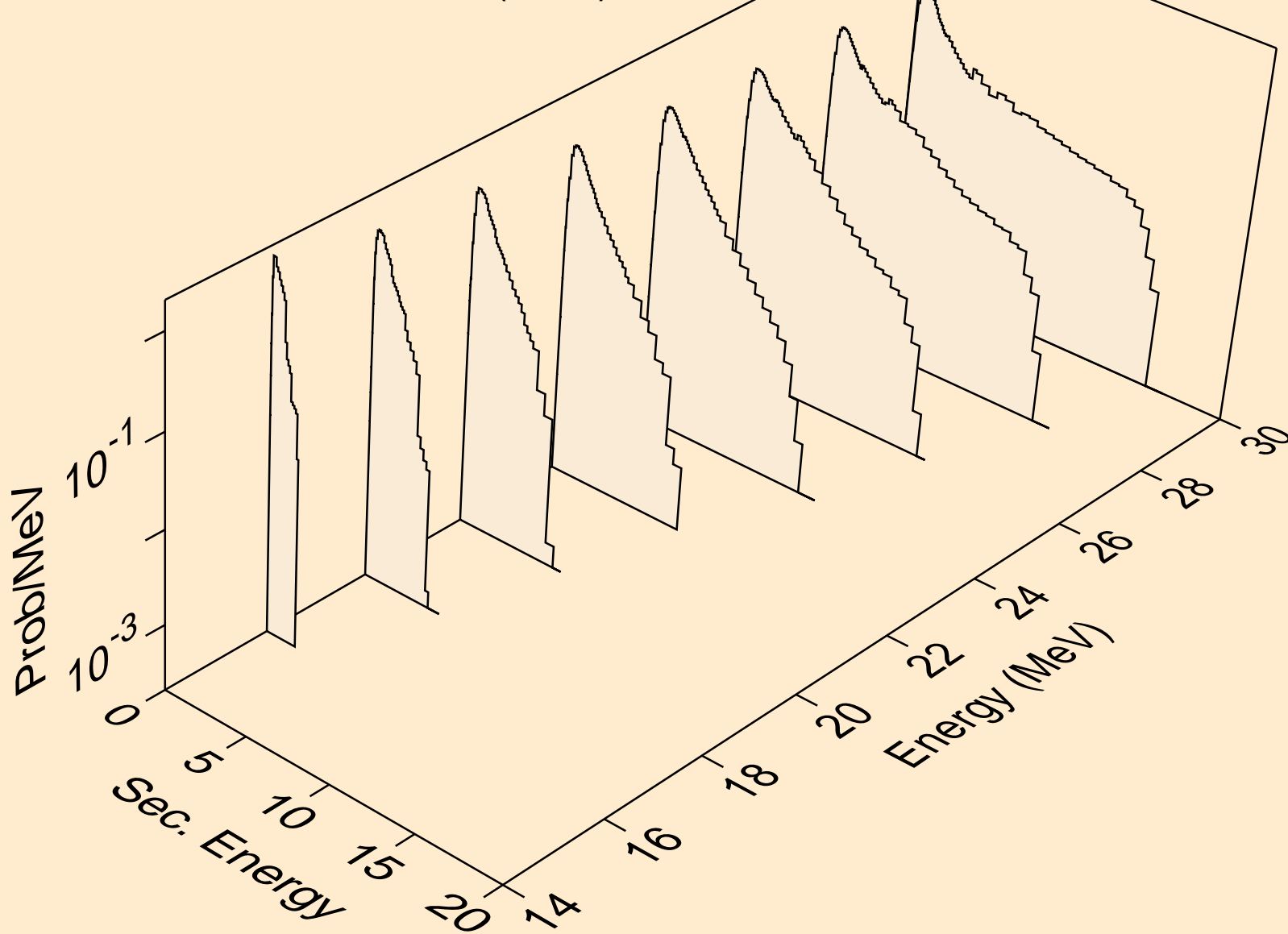

TA180 NEUTRON ACER TENDL-2019 LIBRARY; T=293.16K
Neutron emission for (n,n*)a

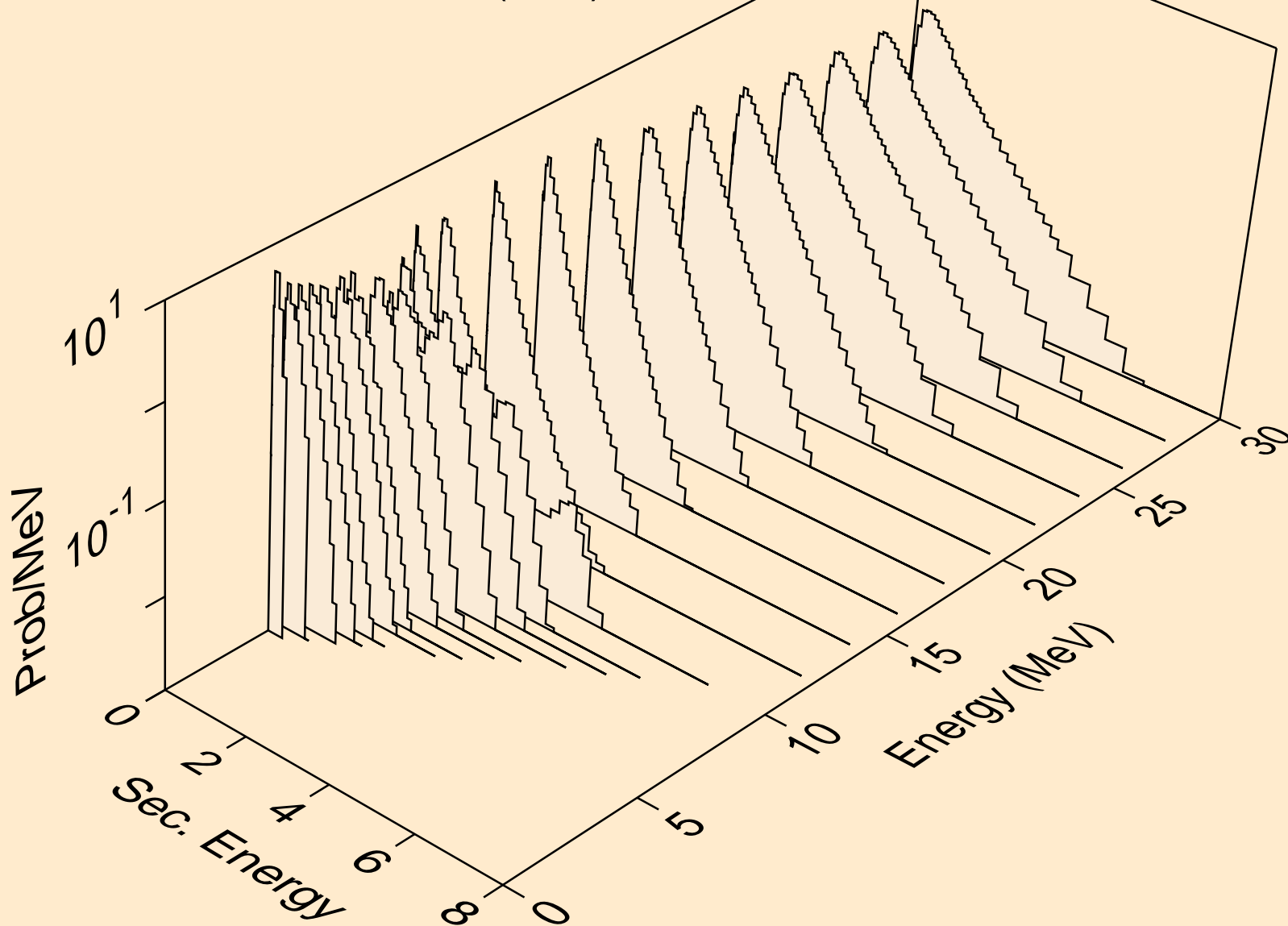

TA180 NEUTRON ACER TENDL-2019 LIBRARY; T=293.16K
Neutron emission for (n,2n)a

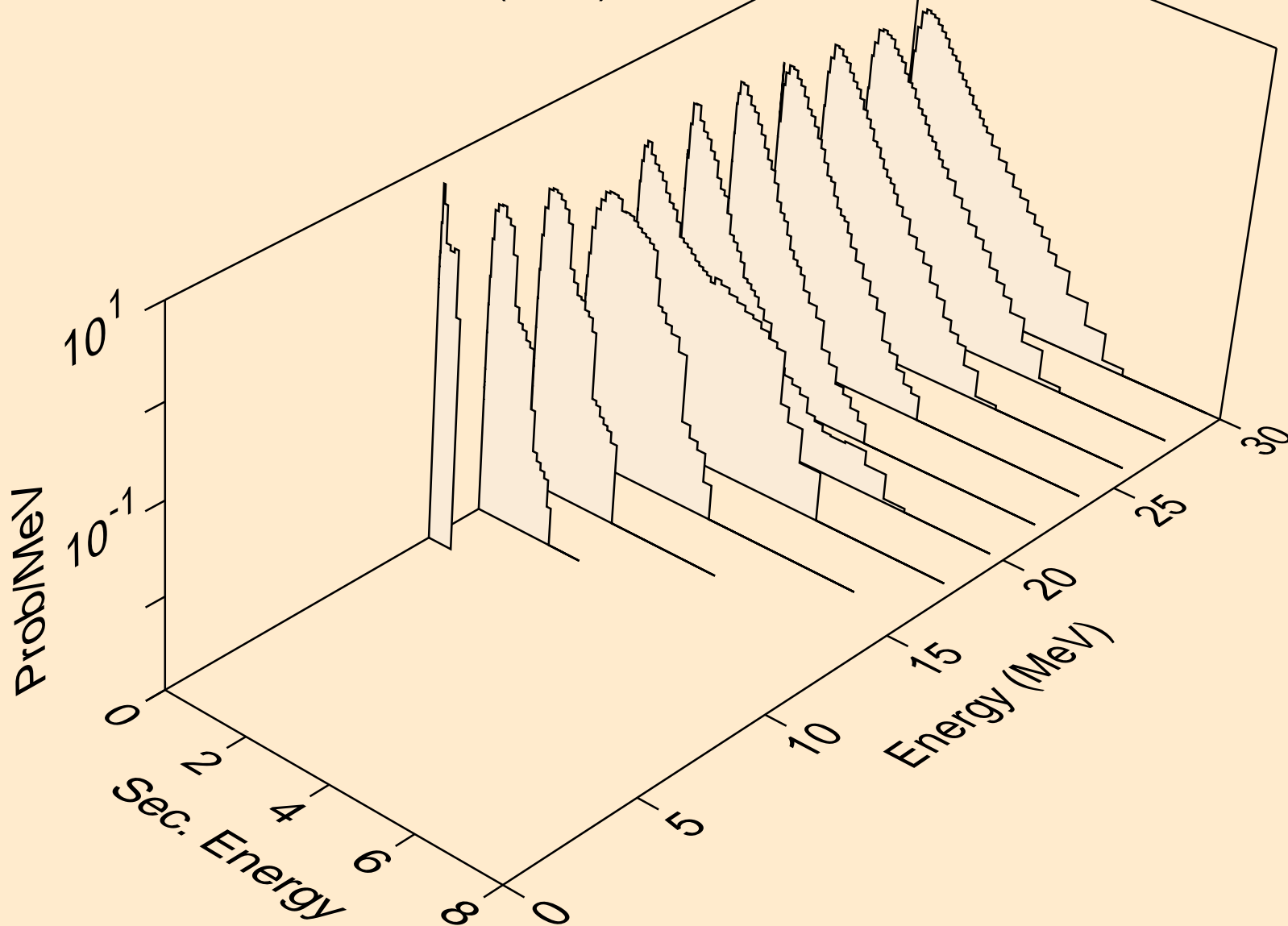

TA180 NEUTRON ACER TENDL-2019 LIBRARY; T=293.16K
Neutron emission for (n,3n)a

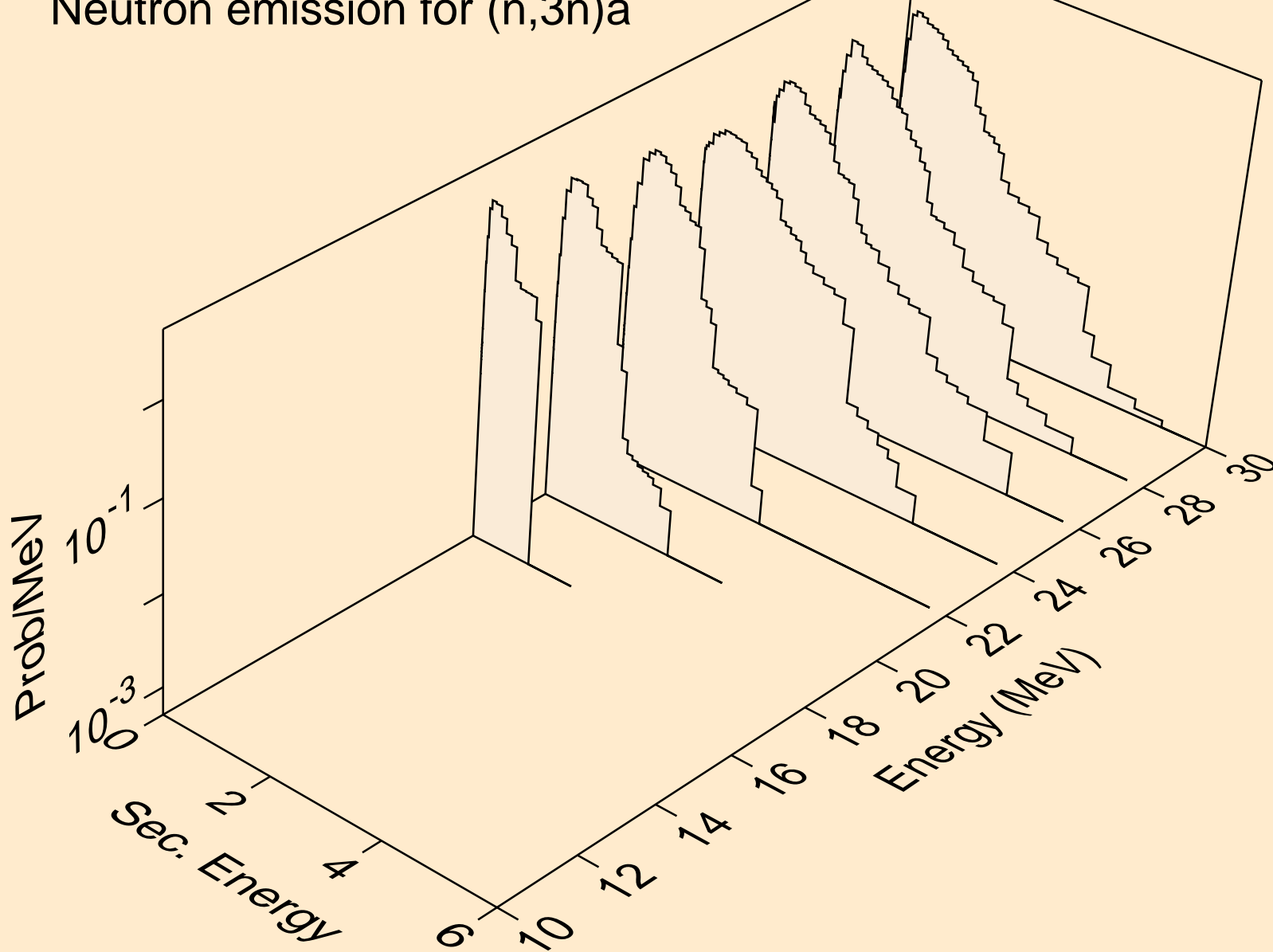

TA180 NEUTRON ACER TENDL-2019 LIBRARY; T=293.16K
Neutron emission for (n,n*)p

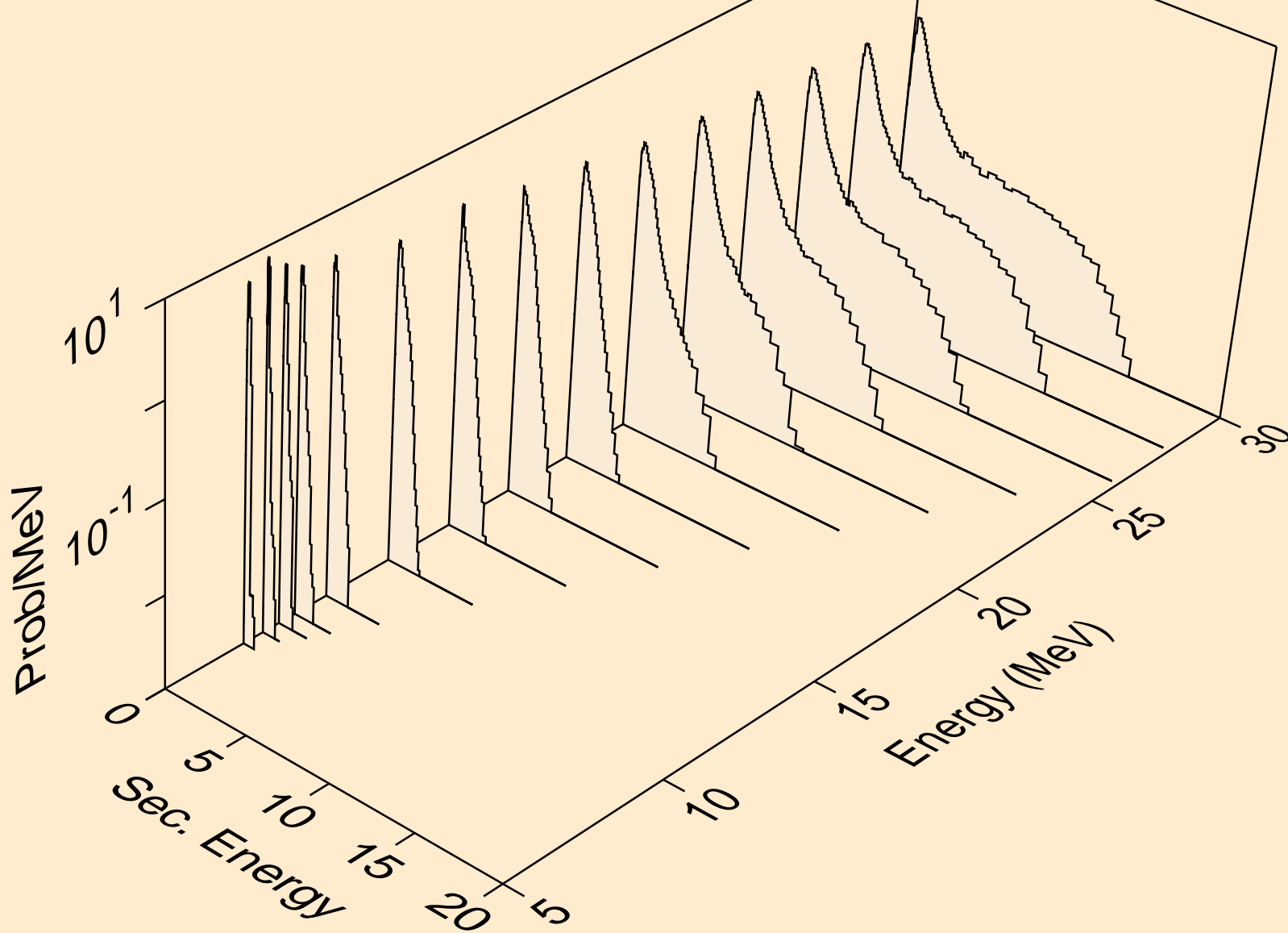

TA180 NEUTRON ACER TENDL-2019 LIBRARY; T=293.16K
Neutron emission for (n,n*)2a

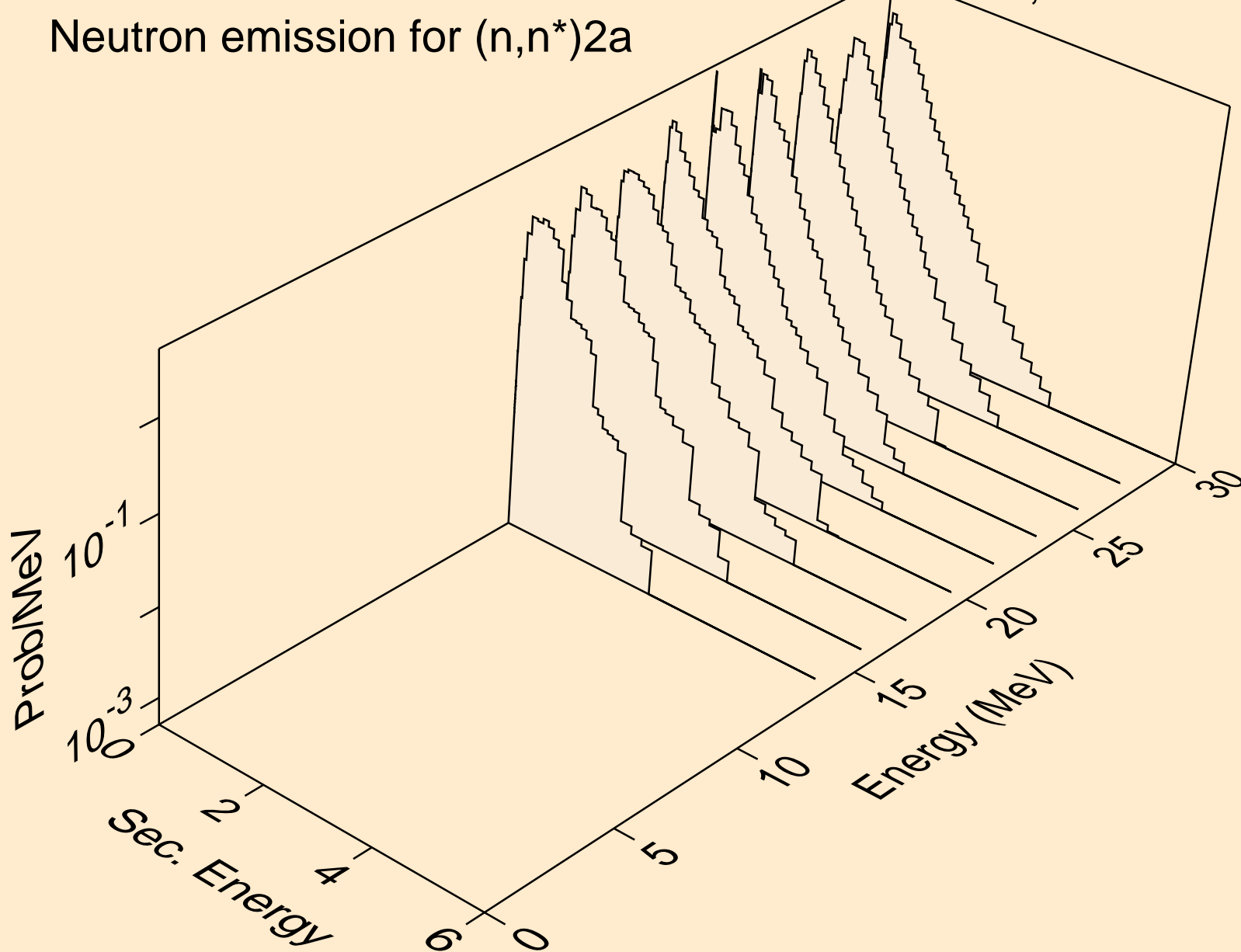

TA180 NEUTRON ACER TENDL-2019 LIBRARY; T=293.16K
Neutron emission for (n,n*)d

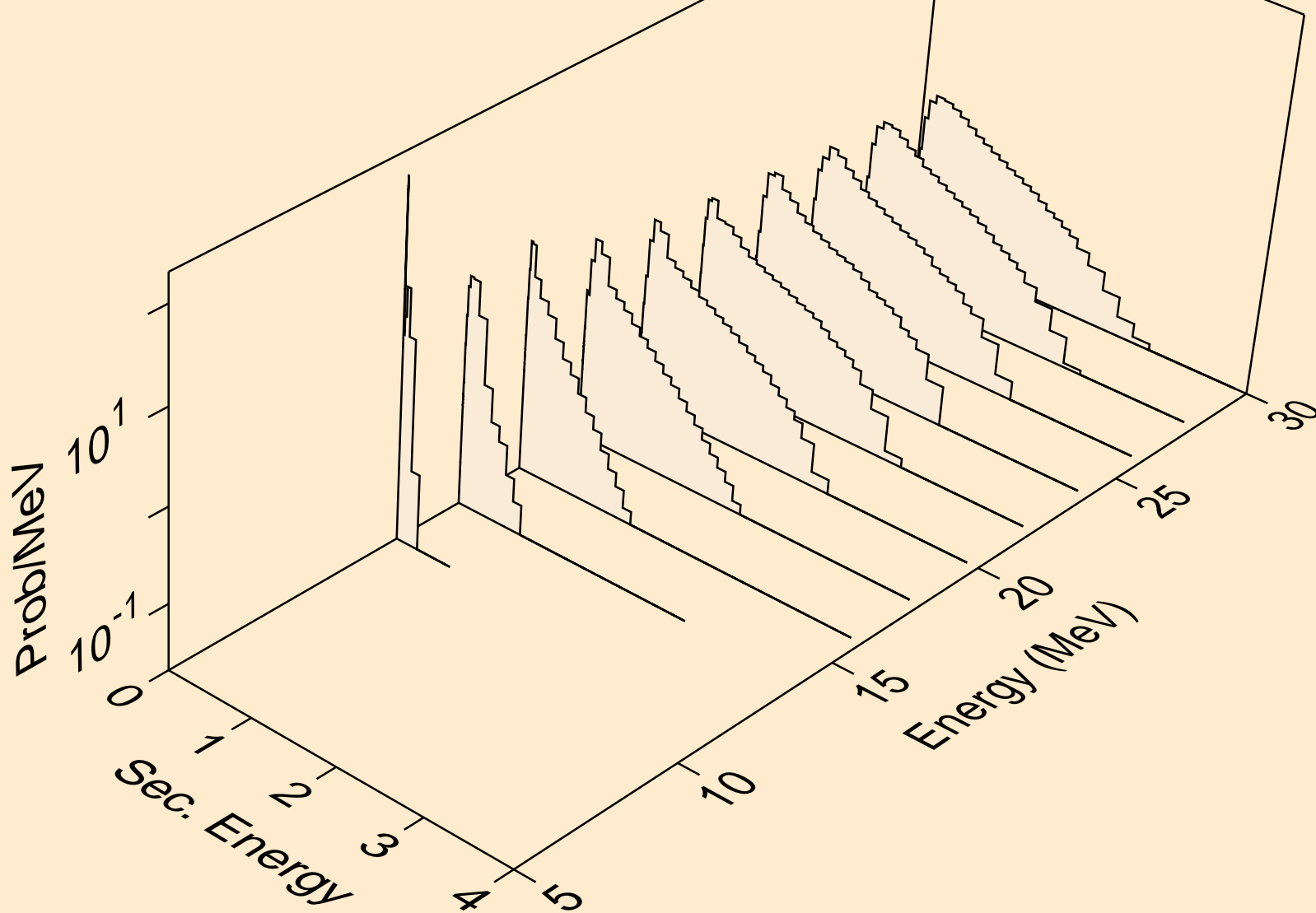

TA180 NEUTRON ACER TENDL-2019 LIBRARY; T=293.16K
Neutron emission for (n,n*)t

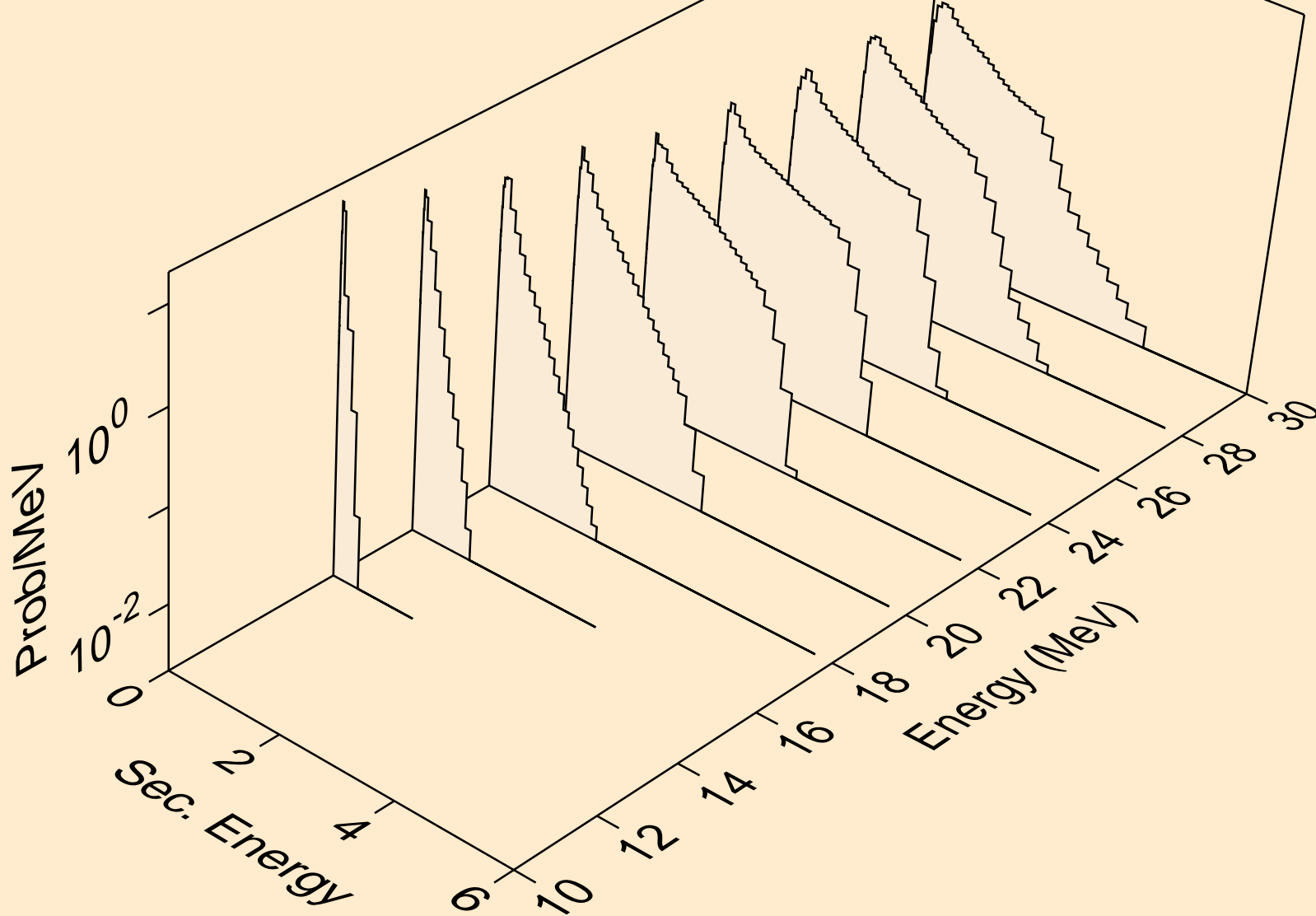

TA180 NEUTRON ACER TENDL-2019 LIBRARY; T=293.16K
Neutron emission for (n,n*)he3

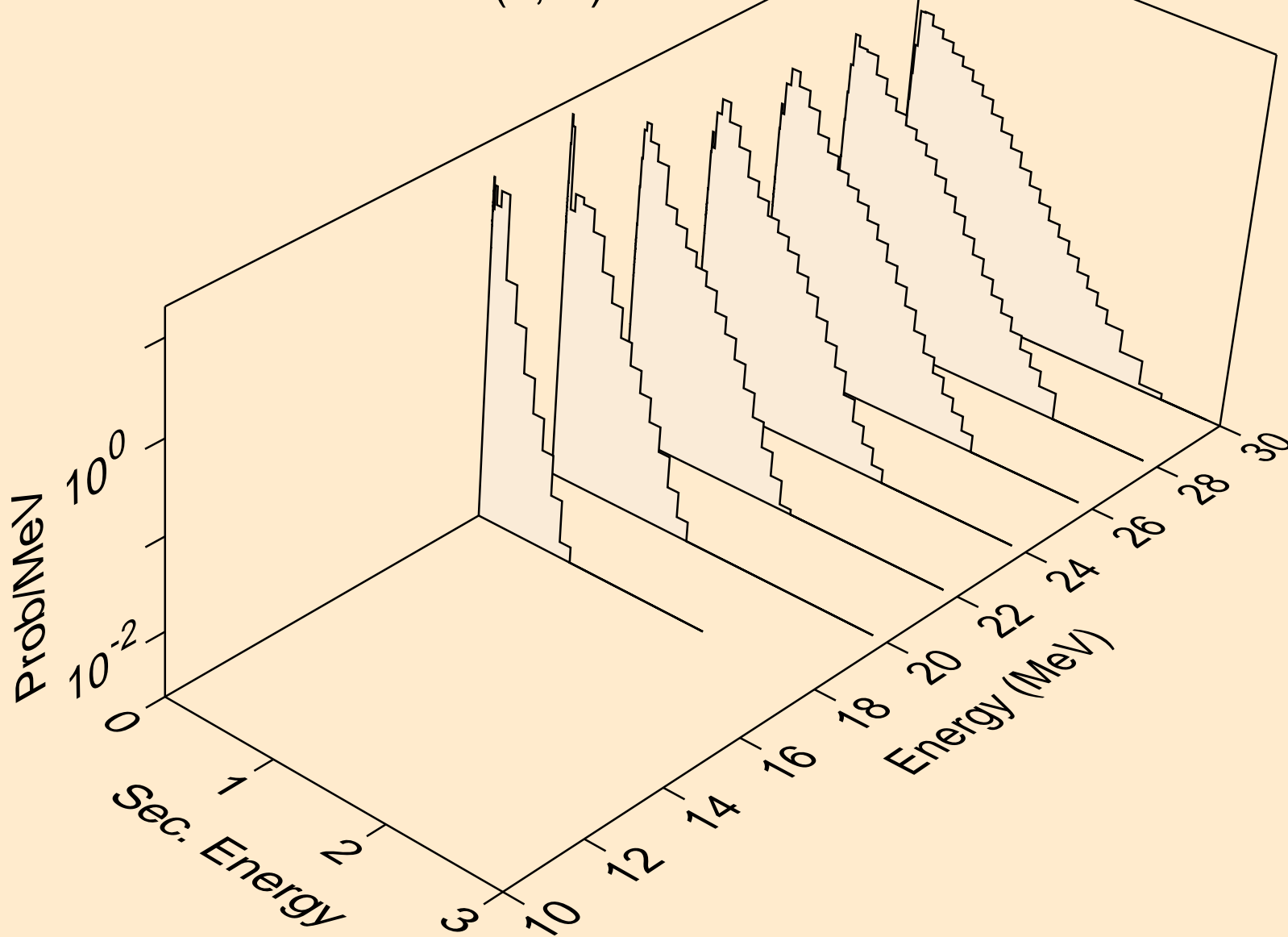

TA180 NEUTRON ACER TENDL-2019 LIBRARY; T=293.16K
Neutron emission for (n,4n)

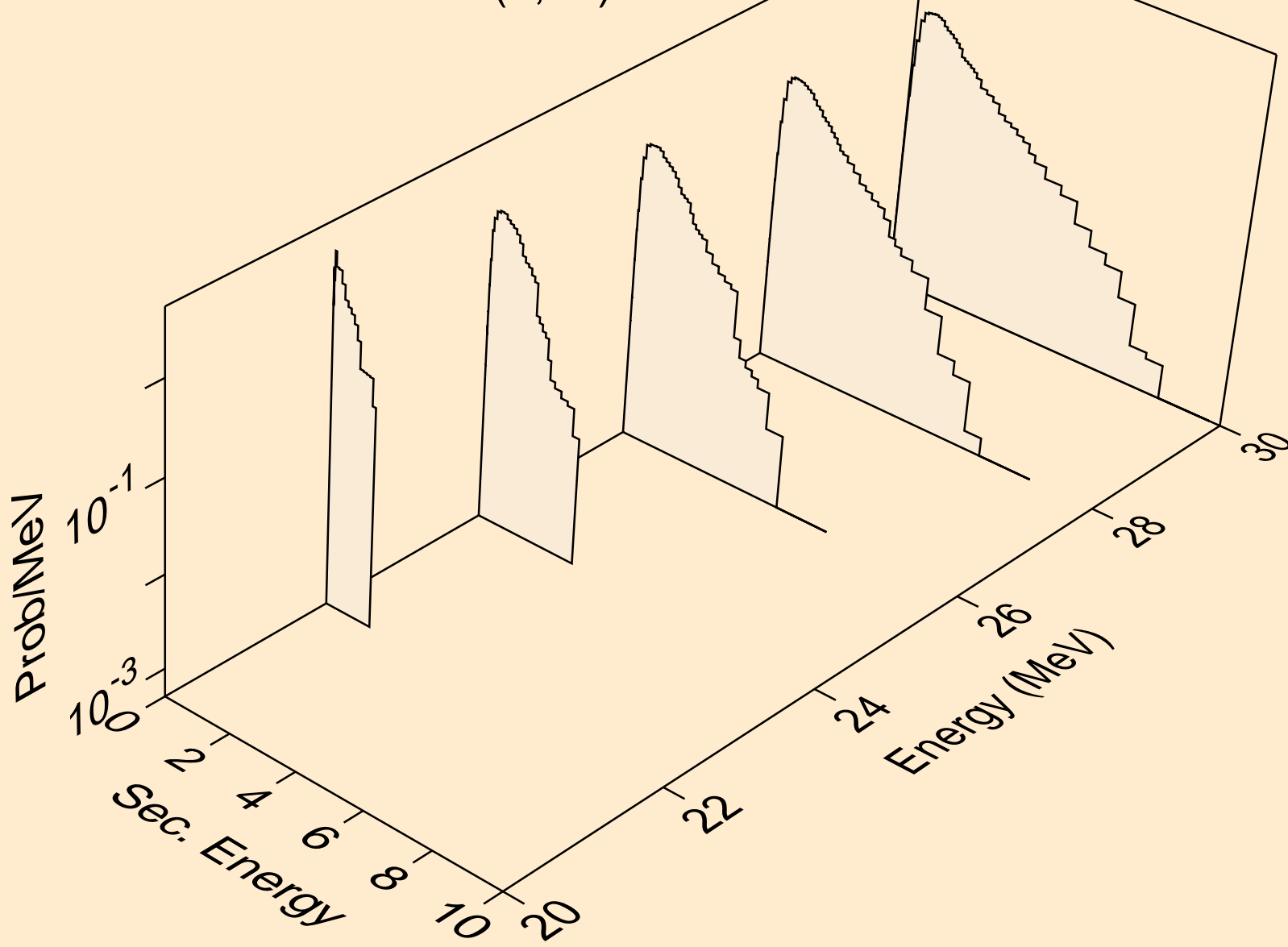

TA180 NEUTRON ACER TENDL-2019 LIBRARY; T=293.16K
Neutron emission for (n,2np)

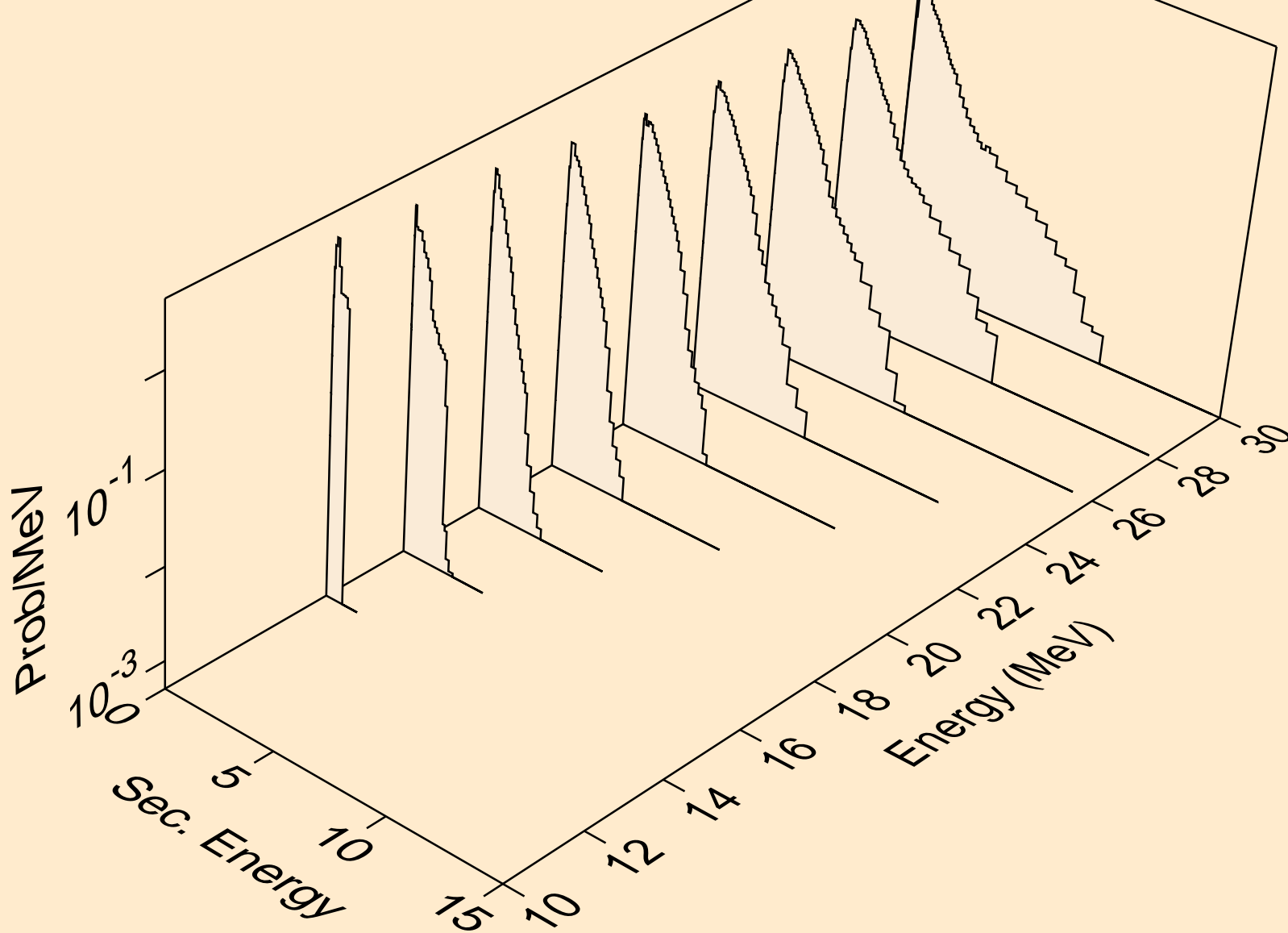

TA180 NEUTRON ACER TENDL-2019 LIBRARY; T=293.16K
Neutron emission for (n,3np)

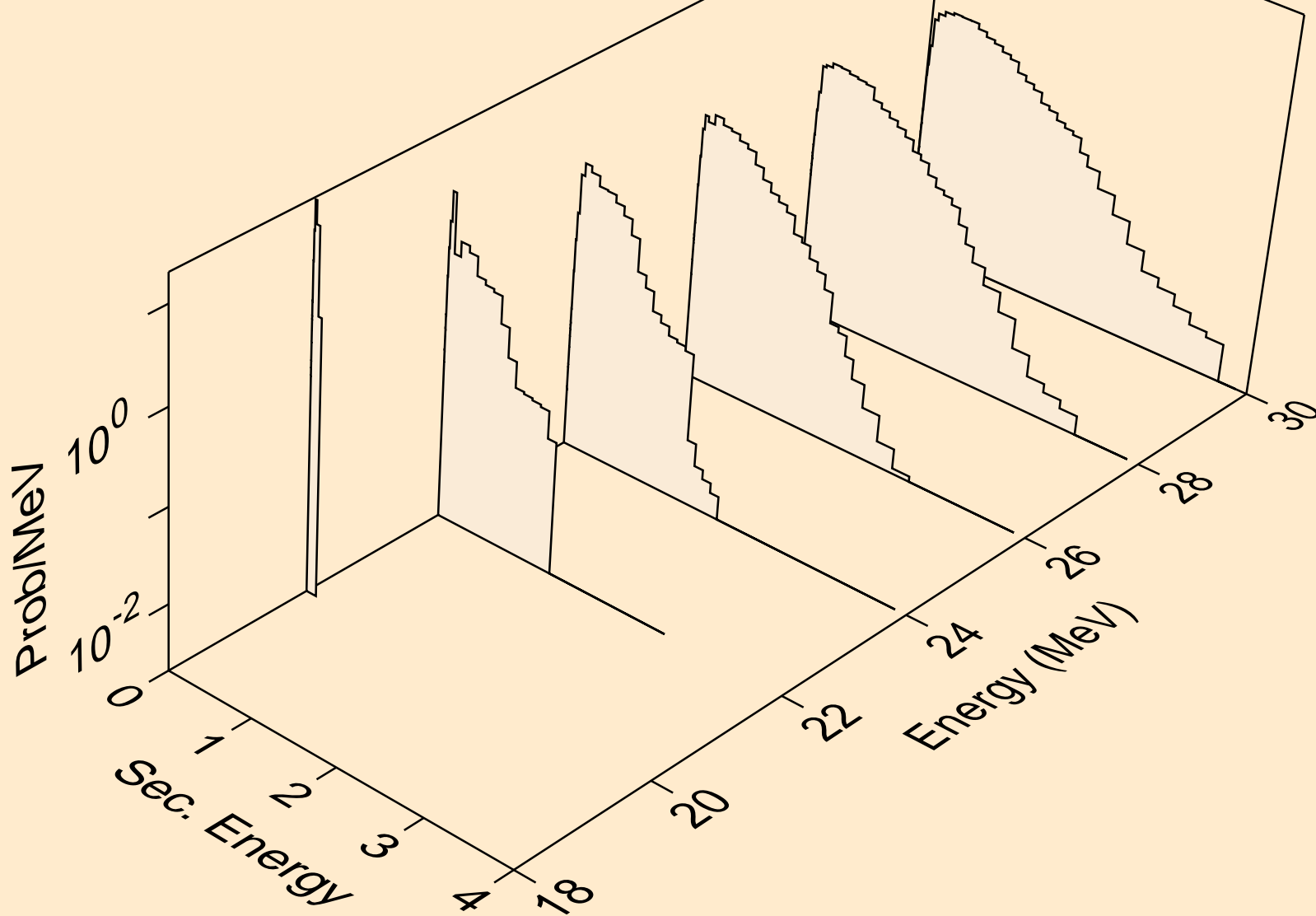

TA180 NEUTRON ACER TENDL-2019 LIBRARY; T=293.16K
Neutron emission for (n,2np)

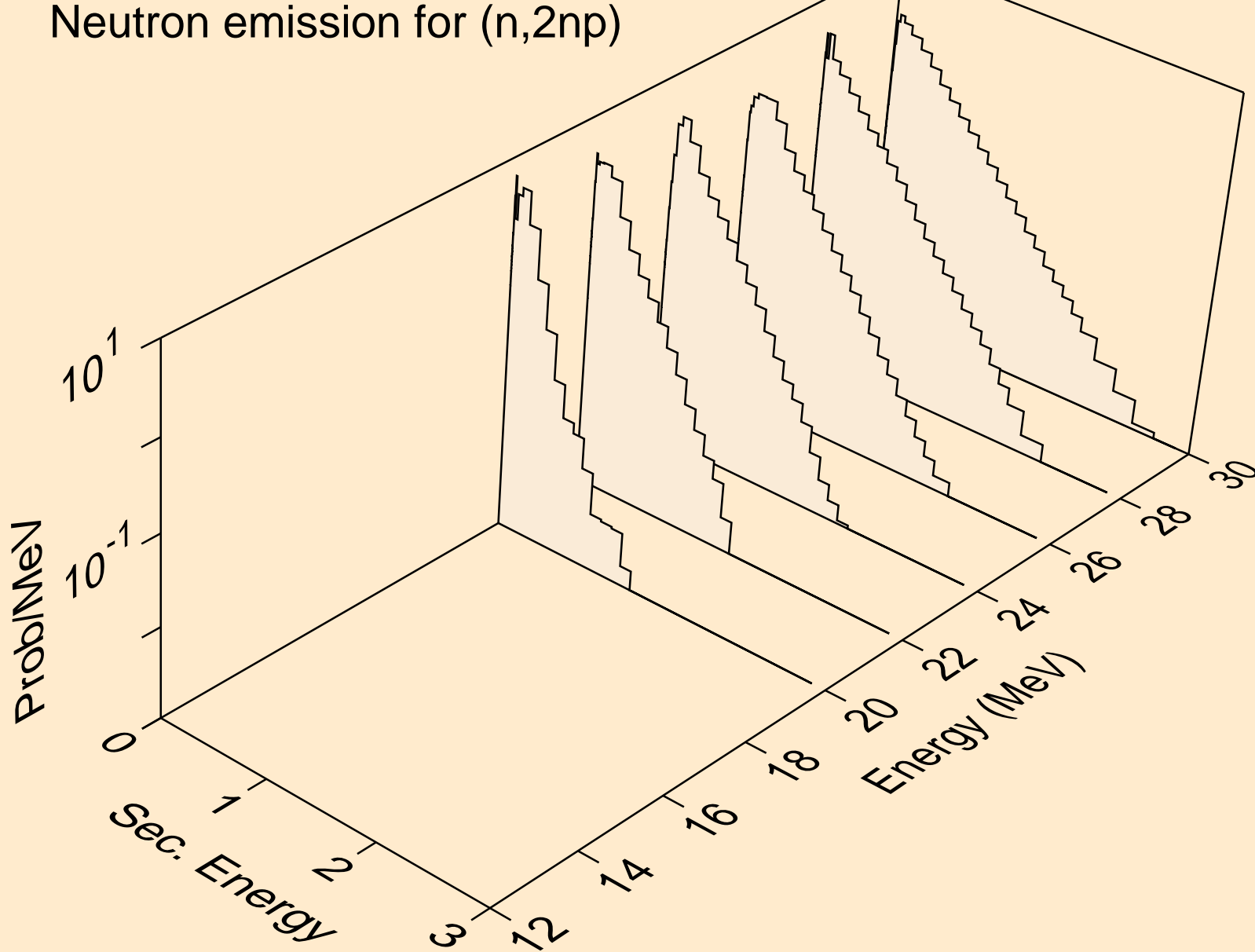

TA180 NEUTRON ACER TENDL-2019 LIBRARY; T=293.16K
Neutron emission for (n,npa)

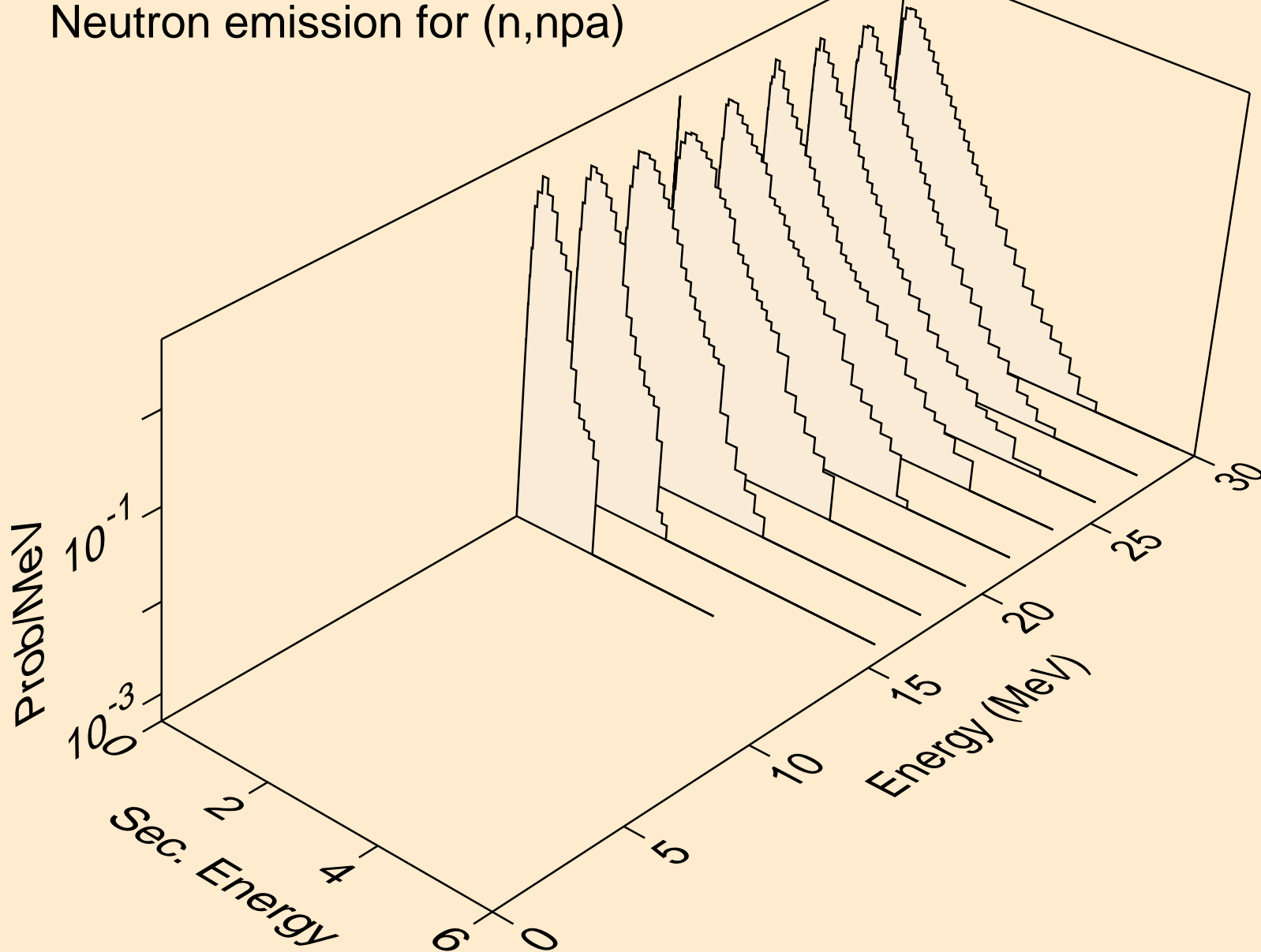

TA180 NEUTRON ACER TENDL-2019 LIBRARY; T=293.16K
Neutron emission for (n,n*c)

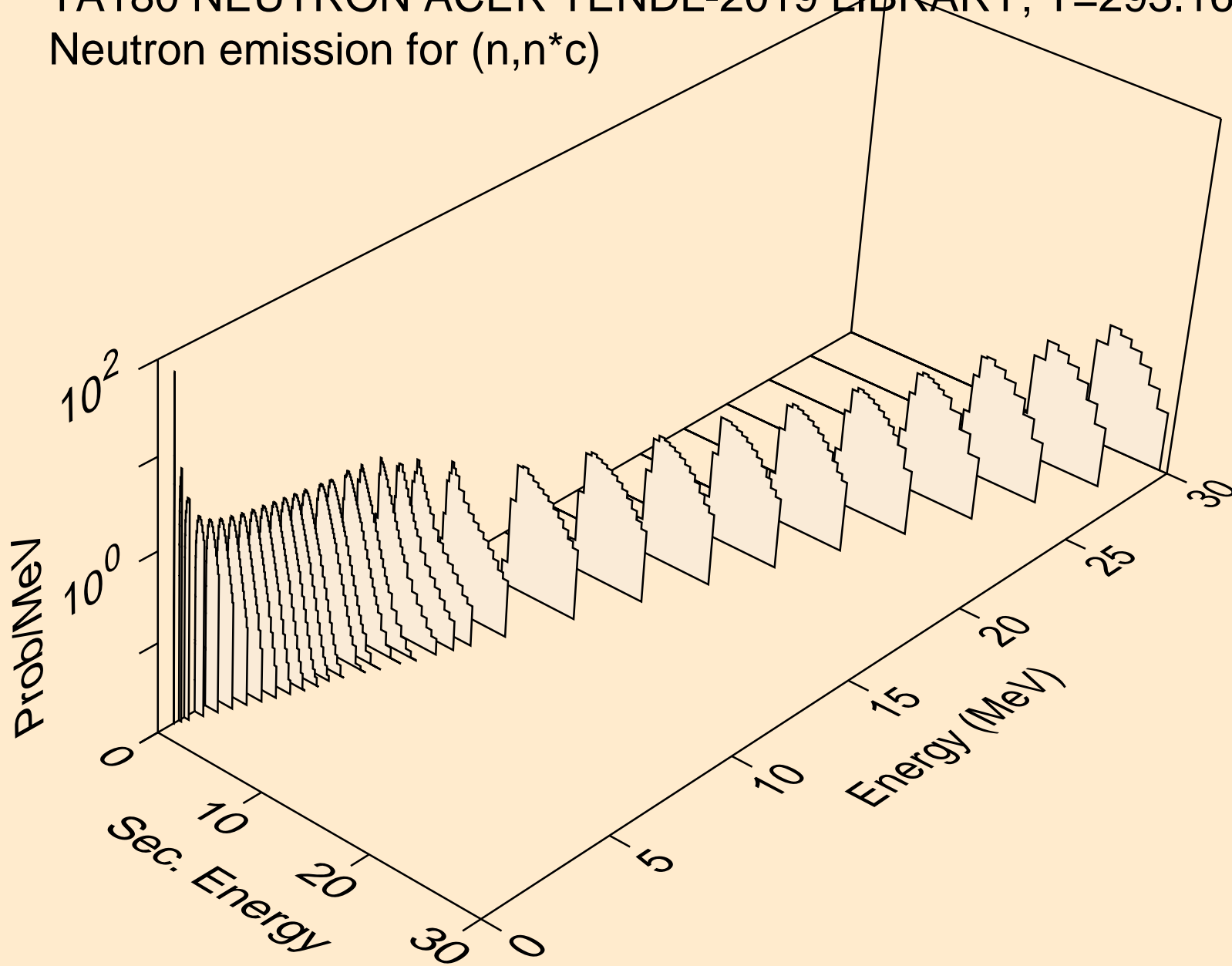

TA180 NEUTRON ACER TENDL-2019 LIBRARY; T=293.16K
Photon emission for (n,x)

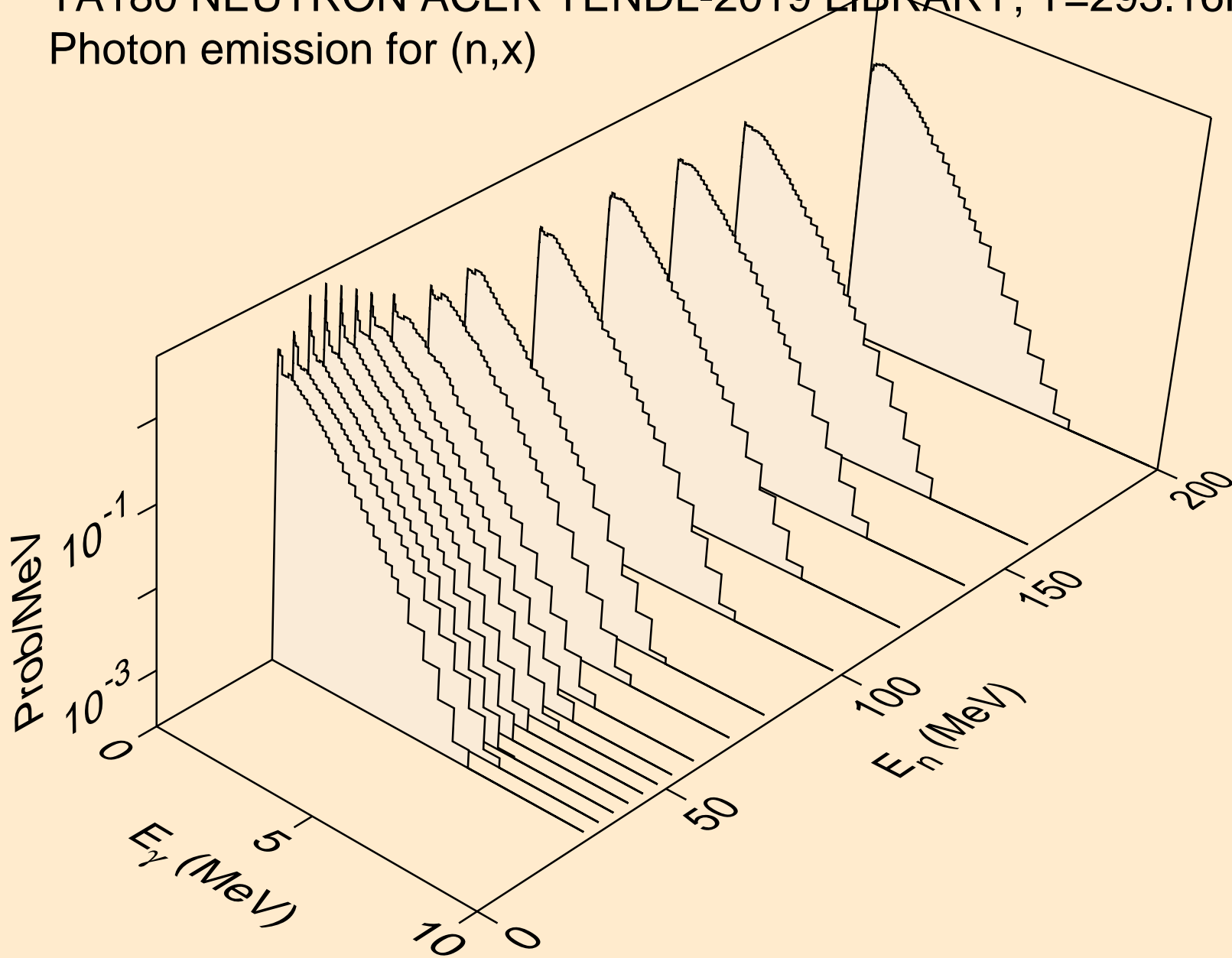

TA180 NEUTRON ACER TENDL-2019 LIBRARY; T=293.16K
Photon emission for (n,2nd)

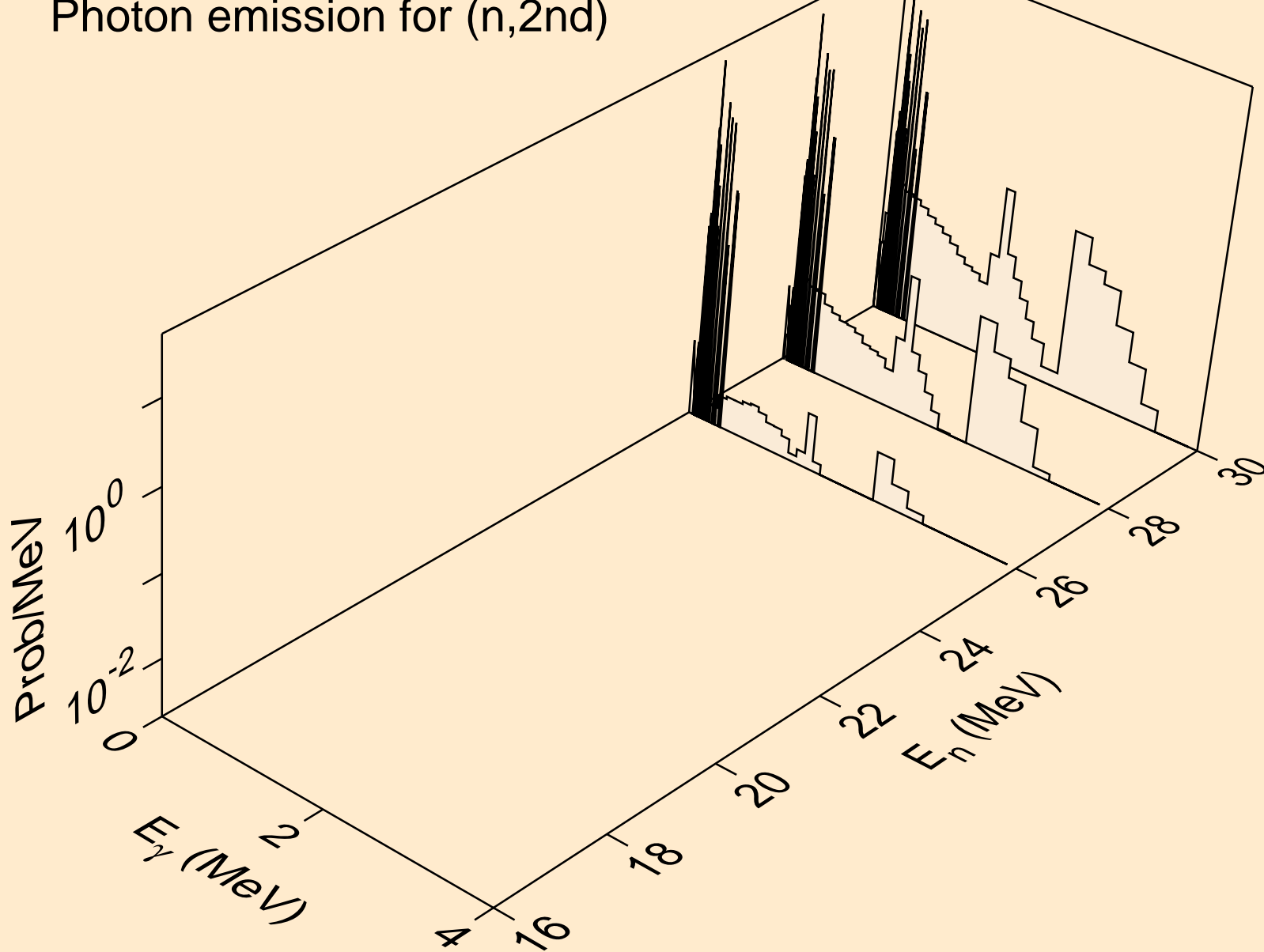

TA180 NEUTRON ACER TENDL-2019 LIBRARY; T=293.16K
Photon emission for (n,2n)

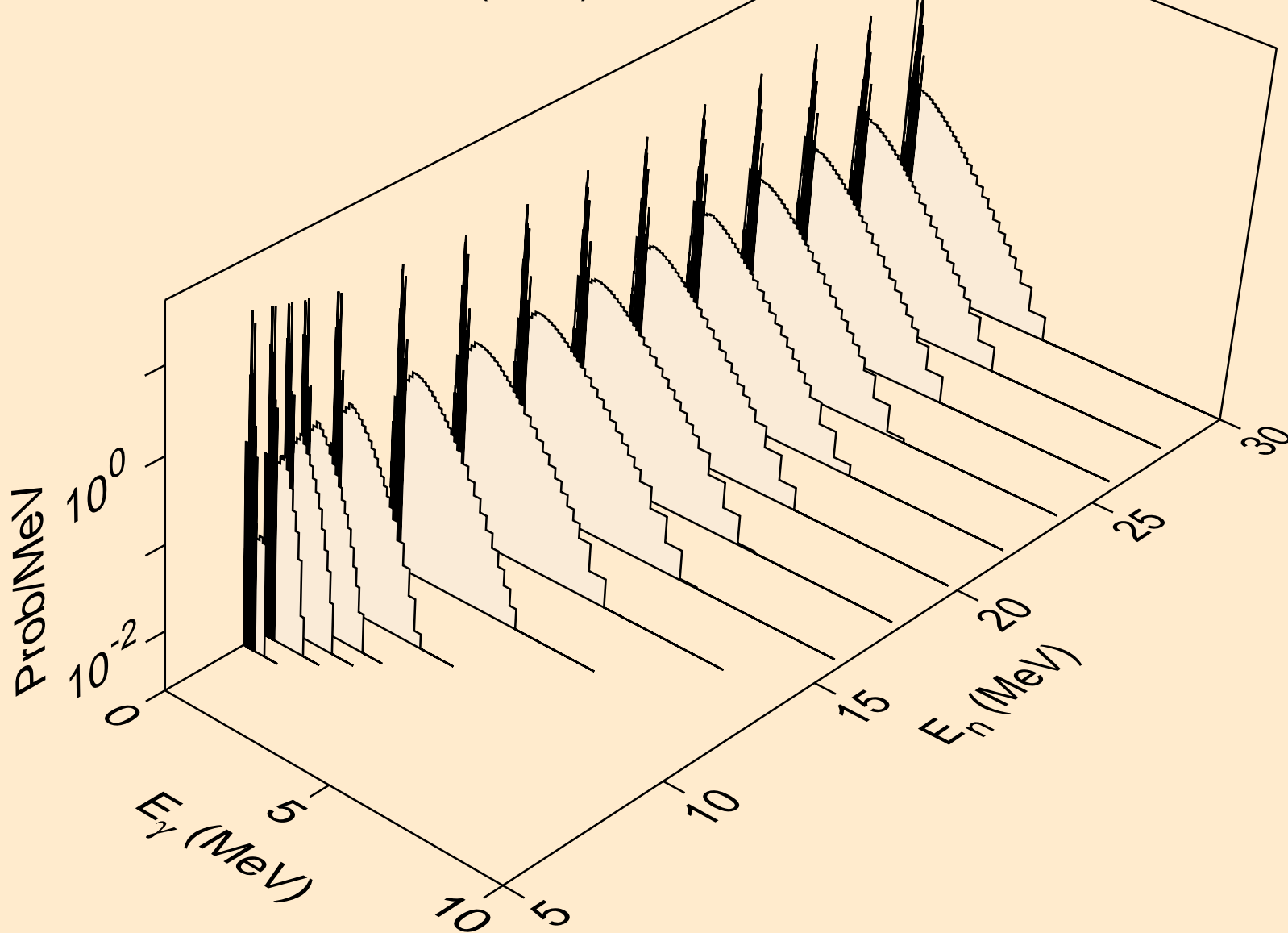

TA180 NEUTRON ACER TENDL-2019 LIBRARY; T=293.16K
Photon emission for (n,3n)

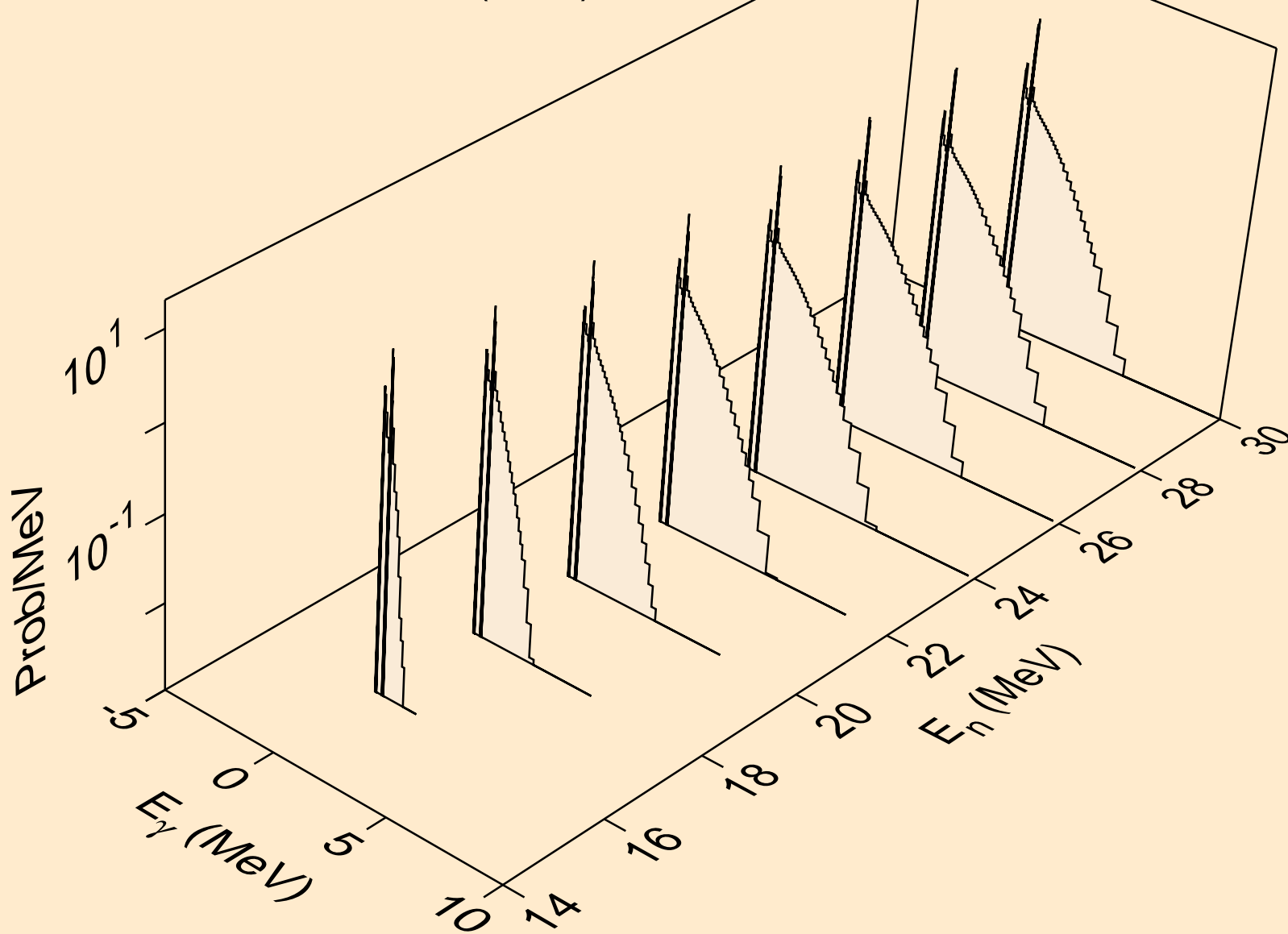

TA180 NEUTRON ACER TENDL-2019 LIBRARY; T=293.16K
Photon emission for (n,n*)a

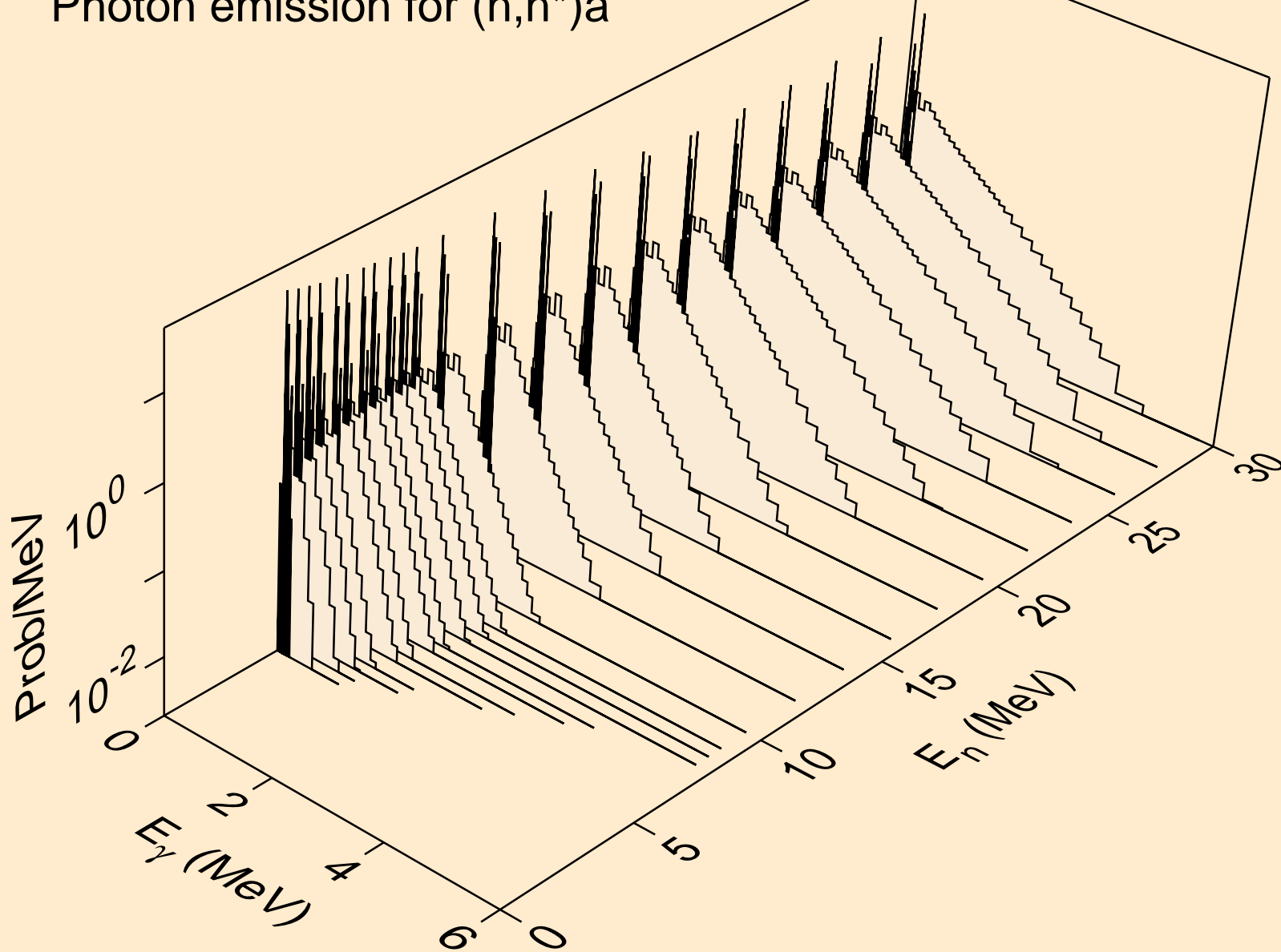

TA180 NEUTRON ACER TENDL-2019 LIBRARY; T=293.16K
Photon emission for (n,2n)a

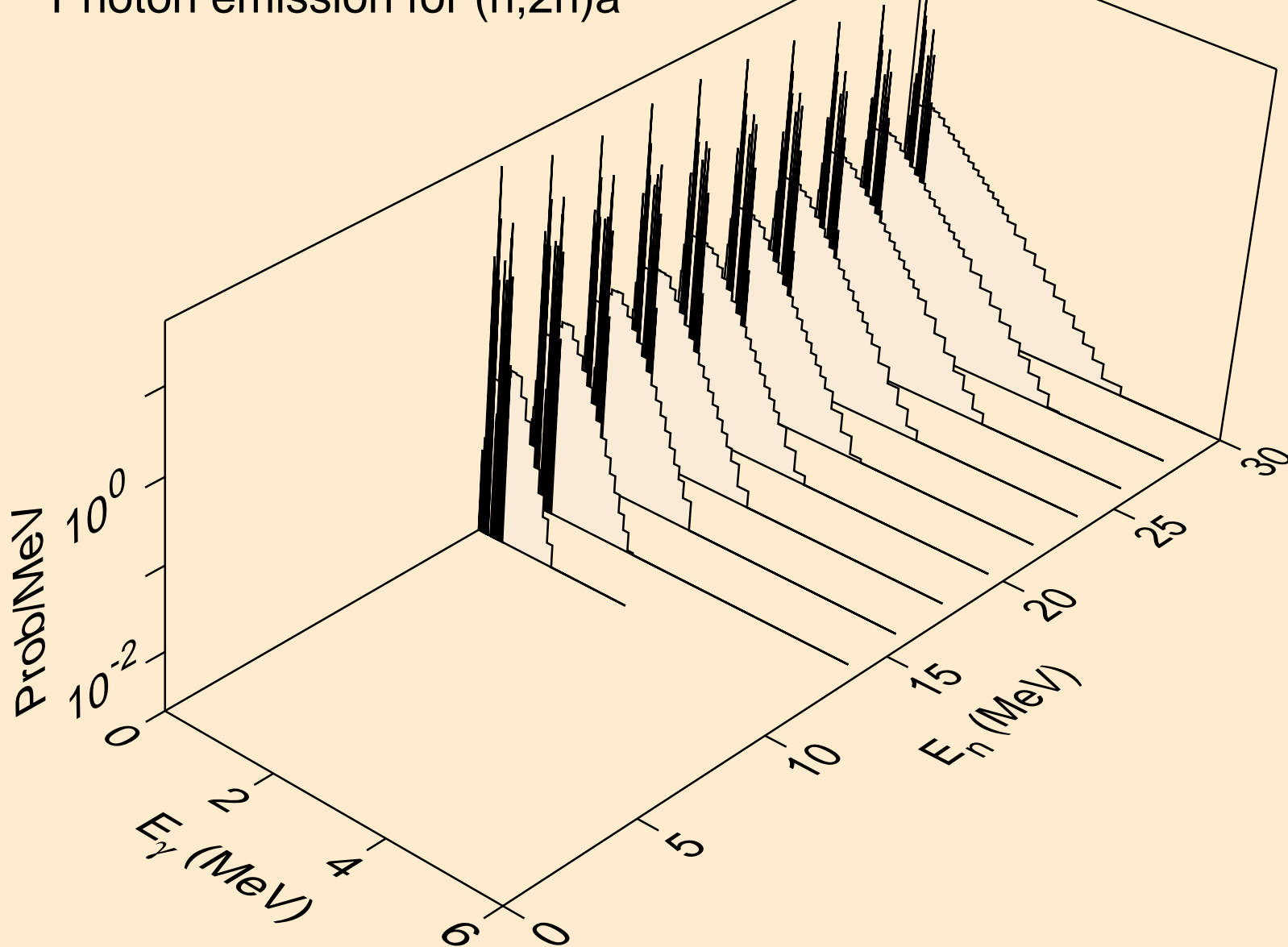

TA180 NEUTRON ACER TENDL-2019 LIBRARY; T=293.16K
Photon emission for (n,3n)a

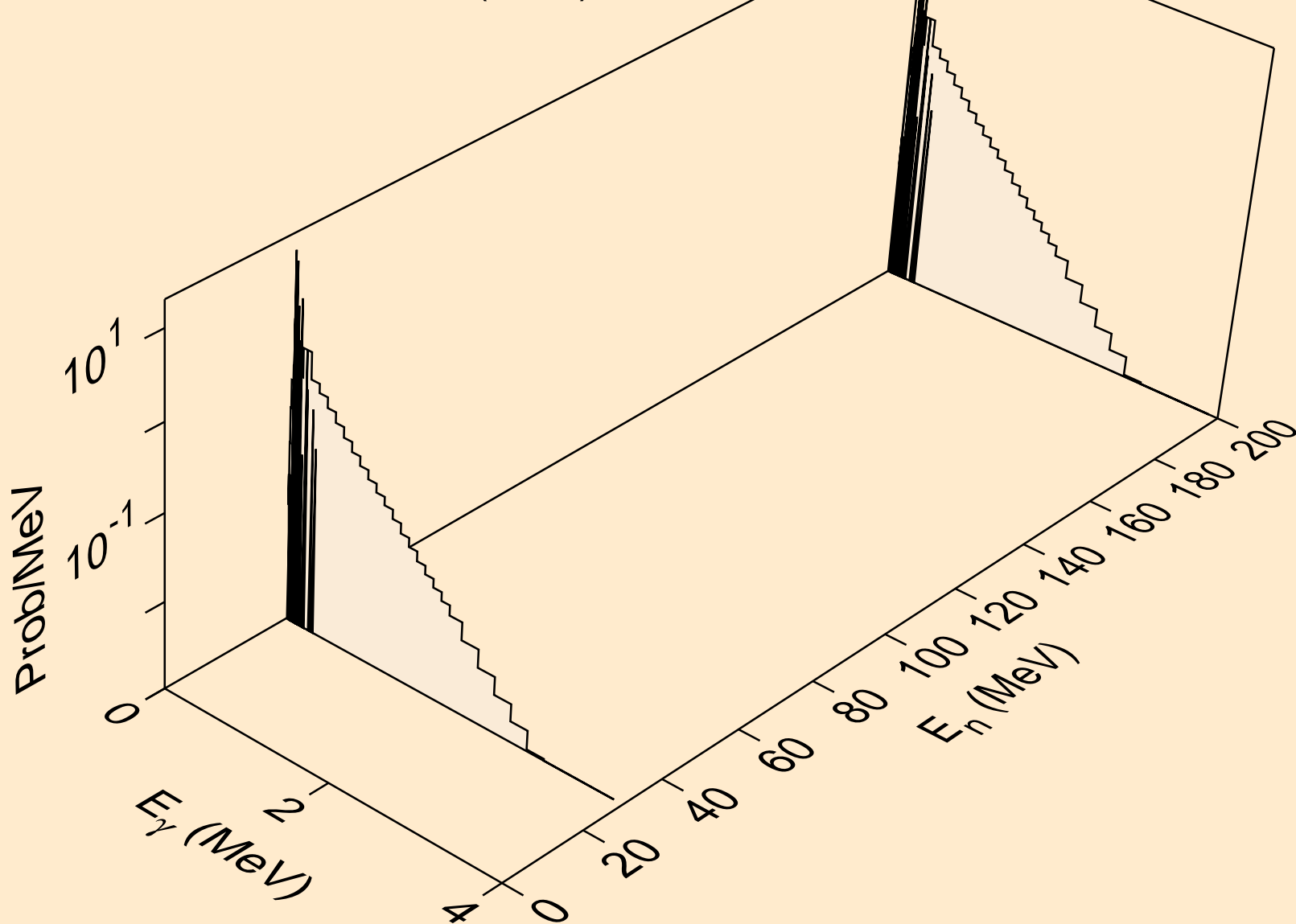

TA180 NEUTRON ACER TENDL-2019 LIBRARY; T=293.16K
Photon emission for (n,n*)p

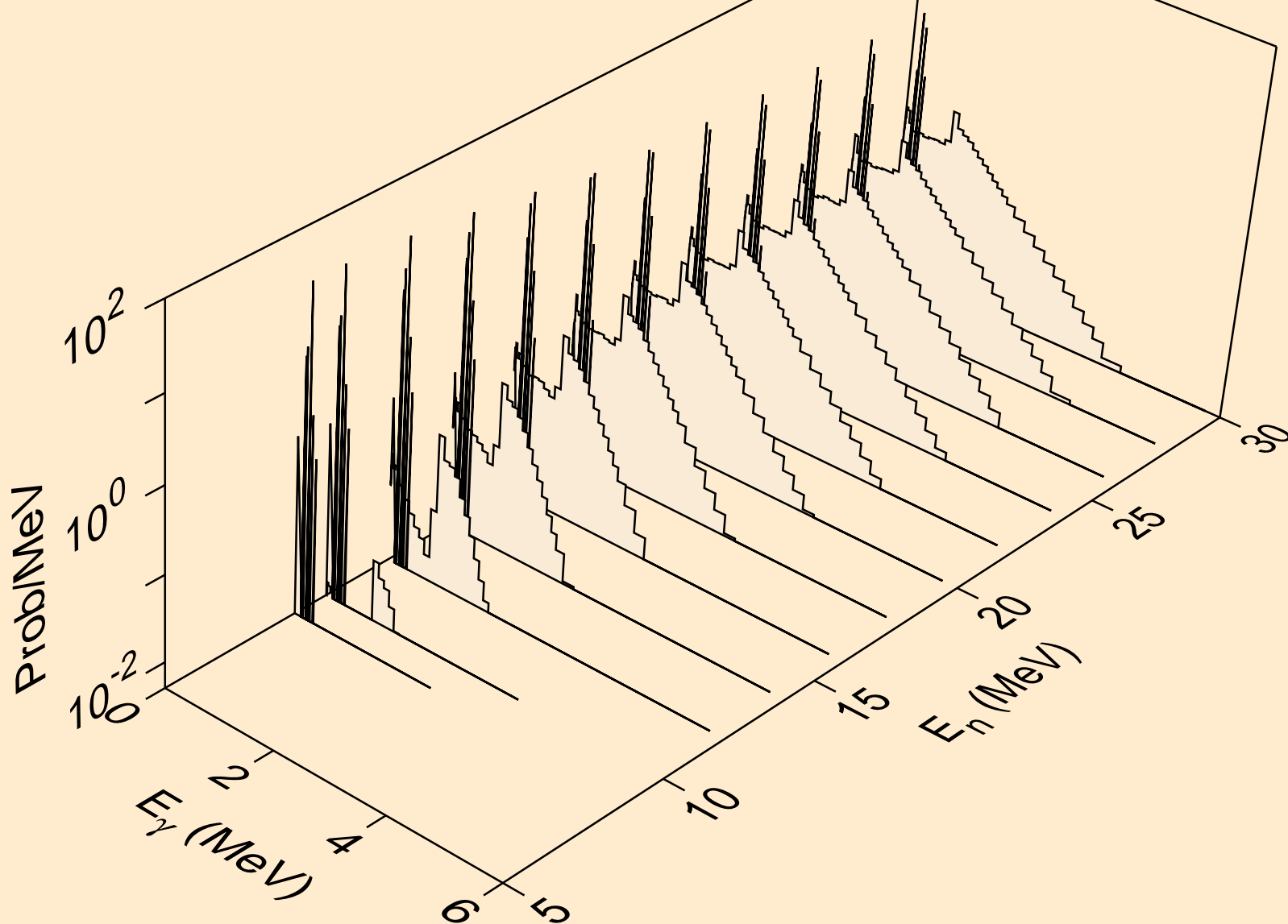

TA180 NEUTRON ACER TENDL-2019 LIBRARY; T=293.16K
Photon emission for (n,n*)2a

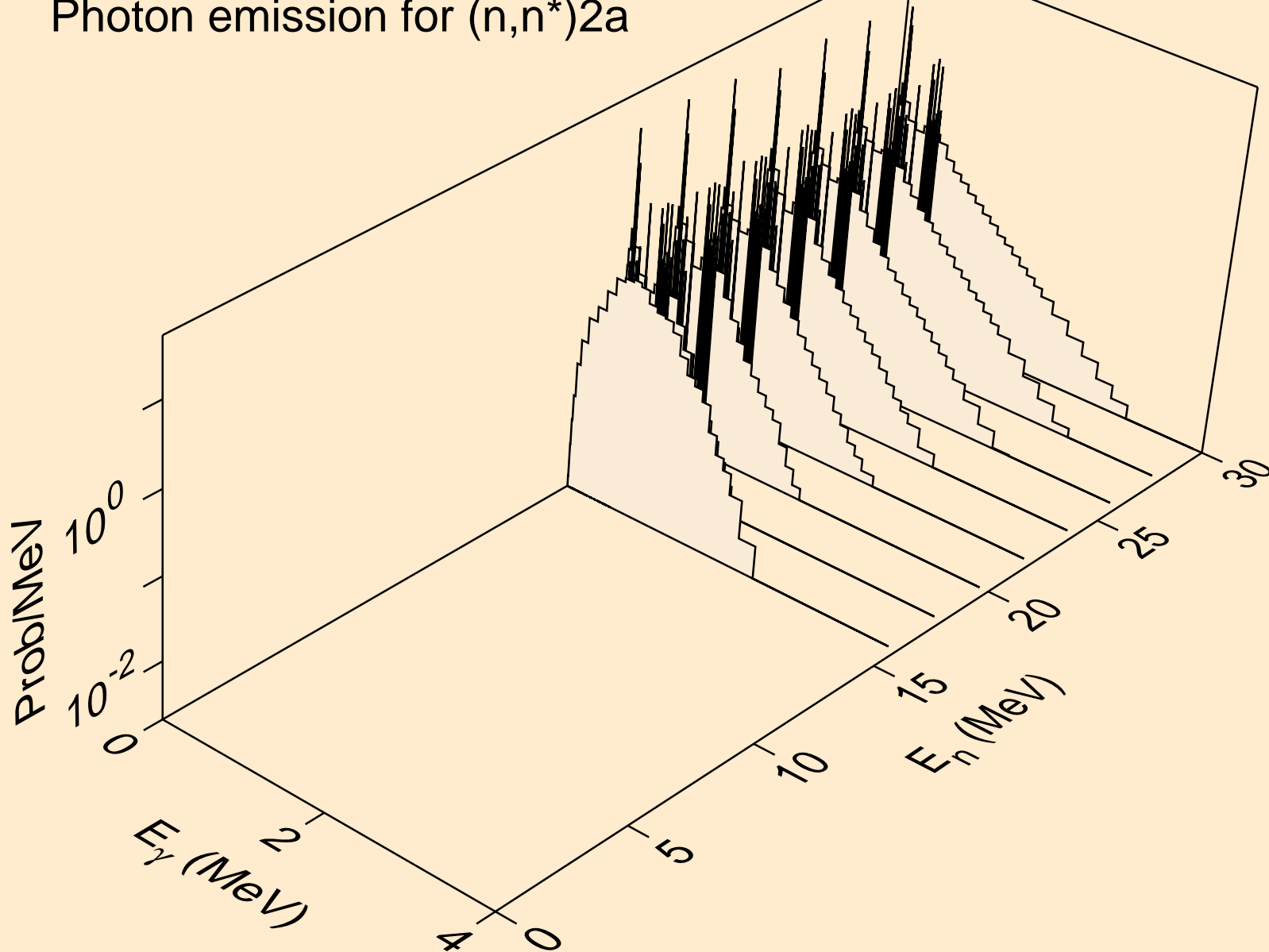

TA180 NEUTRON ACER TENDL-2019 LIBRARY; T=293.16K
Photon emission for (n,n*)d

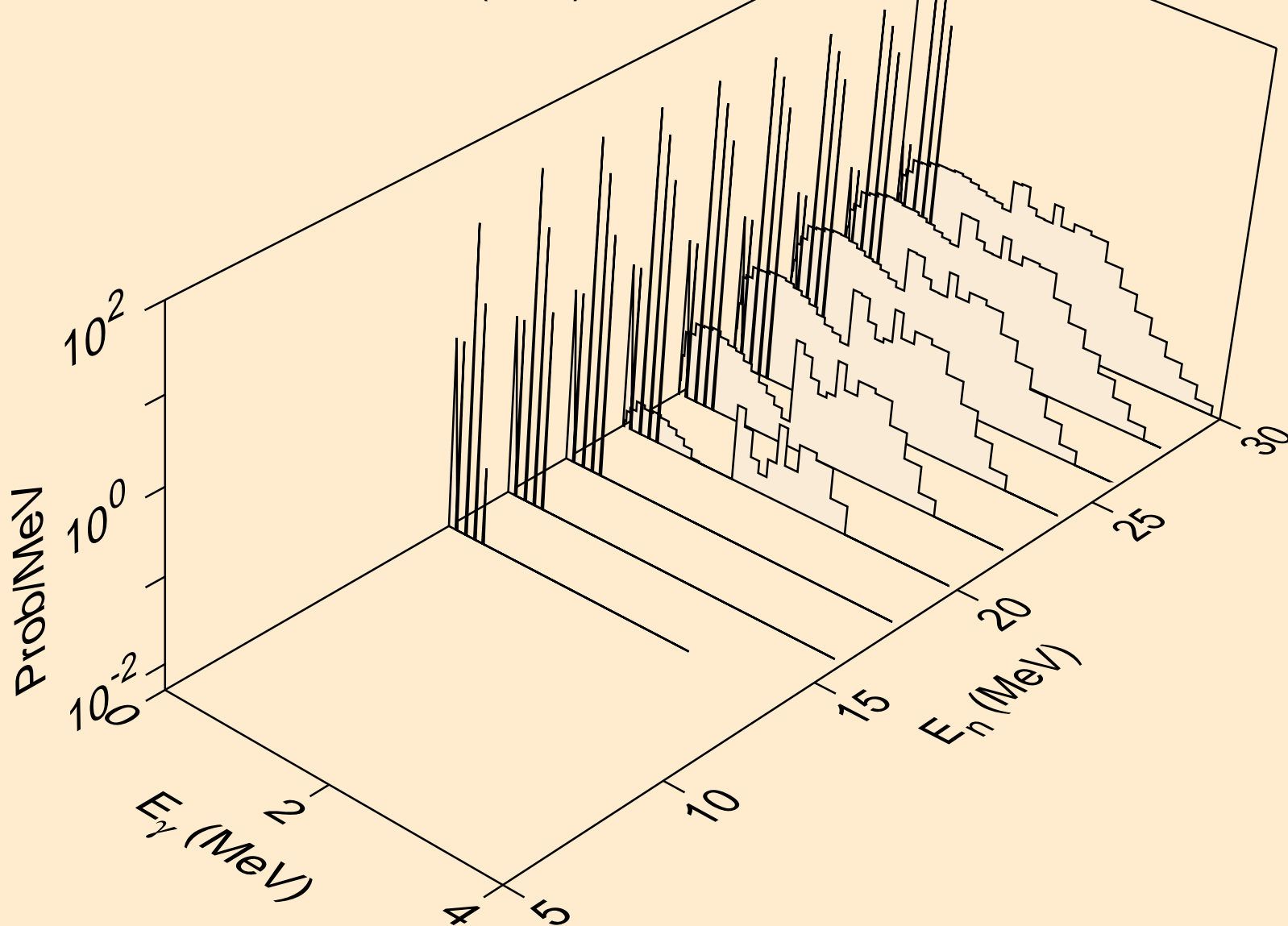

TA180 NEUTRON ACER TENDL-2019 LIBRARY; T=293.16K
Photon emission for (n,n*)t

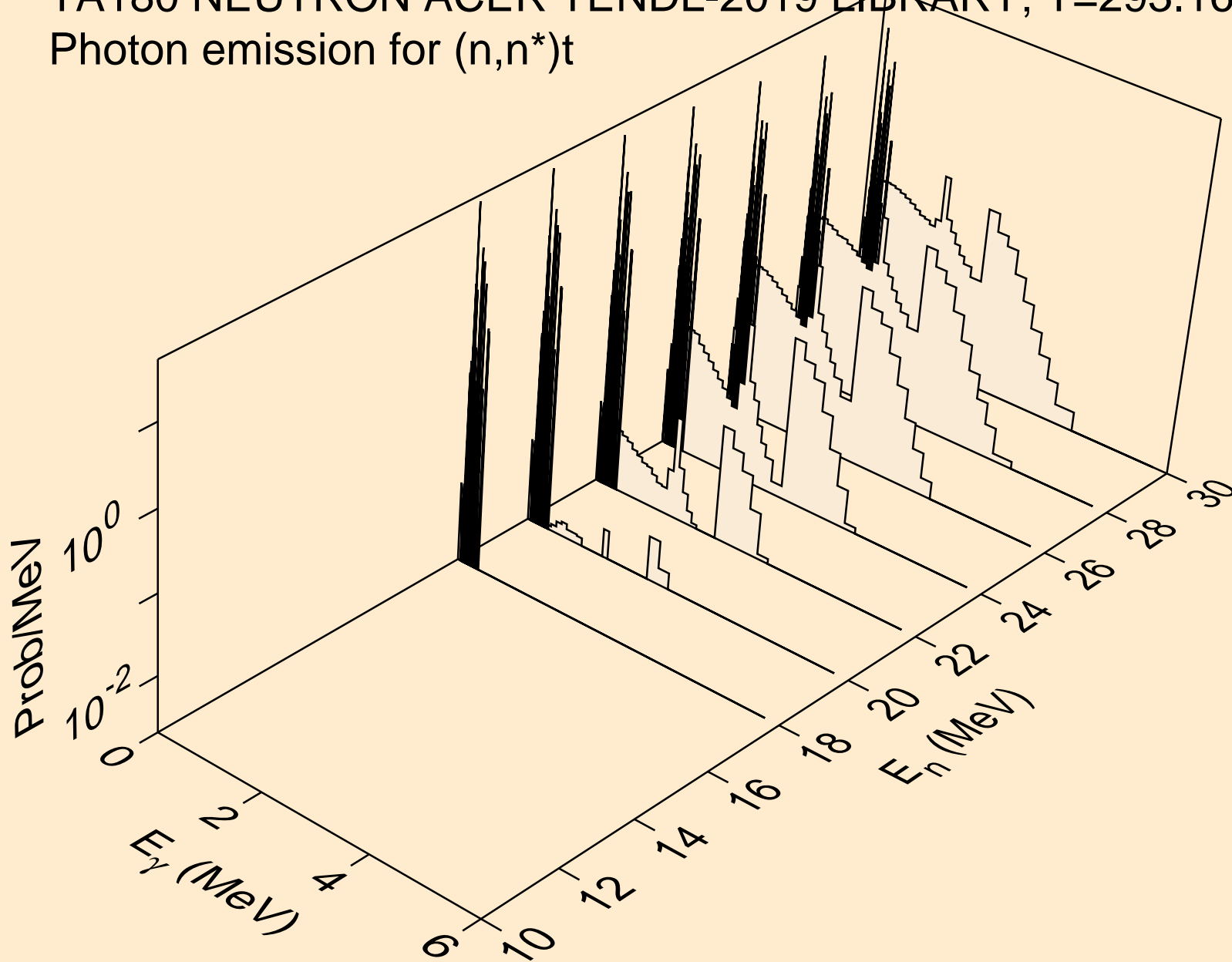

TA180 NEUTRON ACER TENDL-2019 LIBRARY; T=293.16K
Photon emission for (n,n*)he3

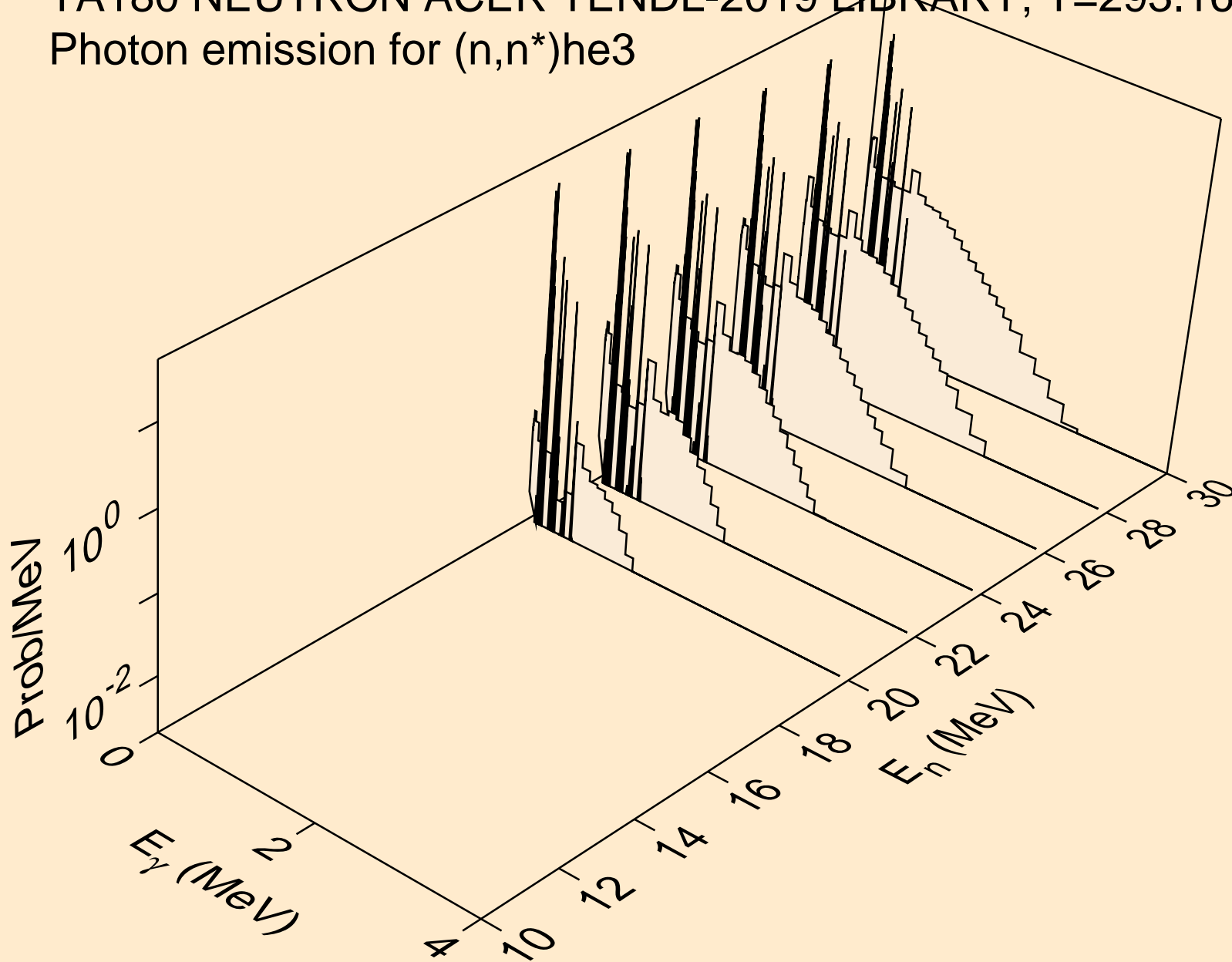

TA180 NEUTRON ACER TENDL-2019 LIBRARY; T=293.16K
Photon emission for (n,4n)

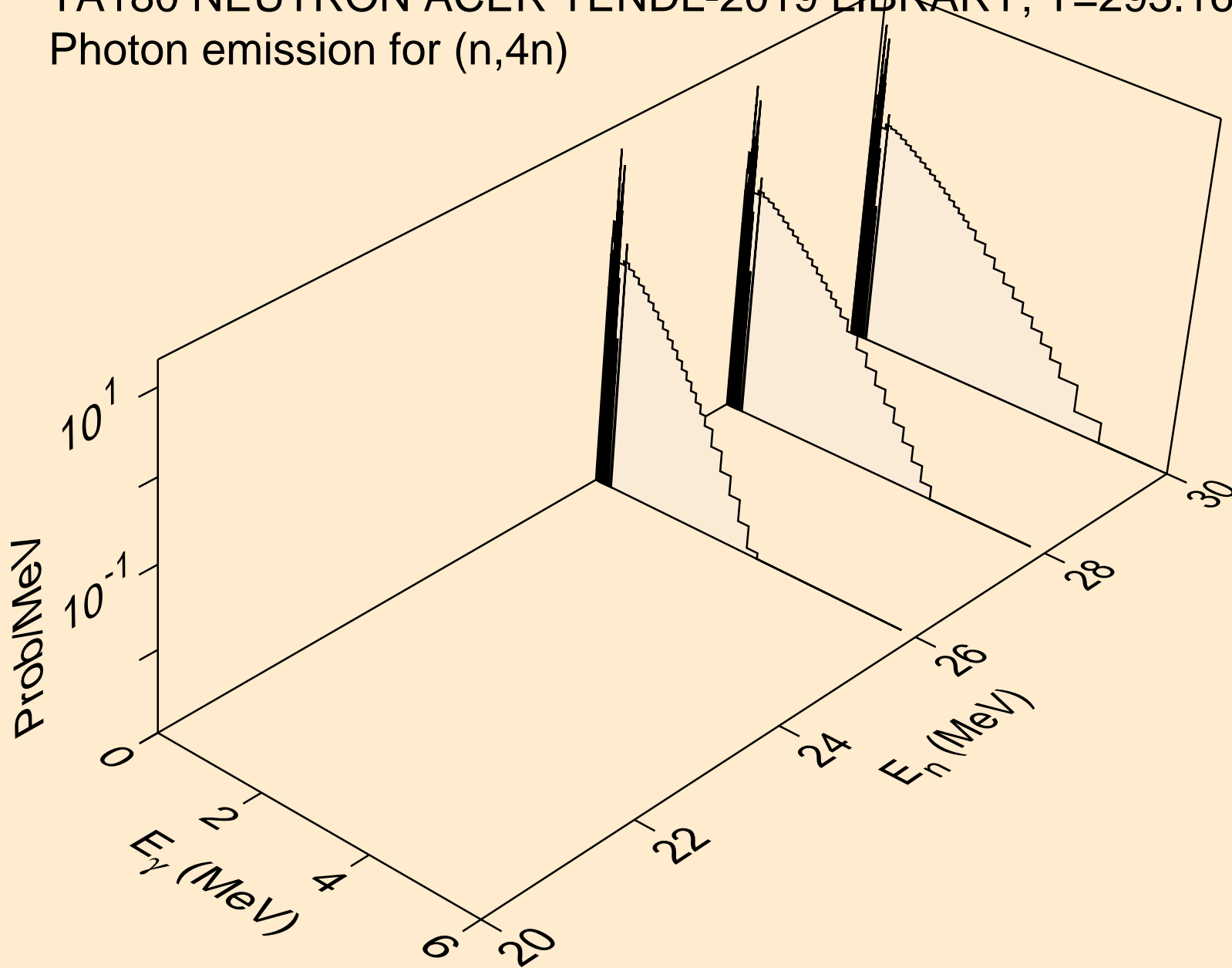

TA180 NEUTRON ACER TENDL-2019 LIBRARY; T=293.16K
Photon emission for (n,2np)

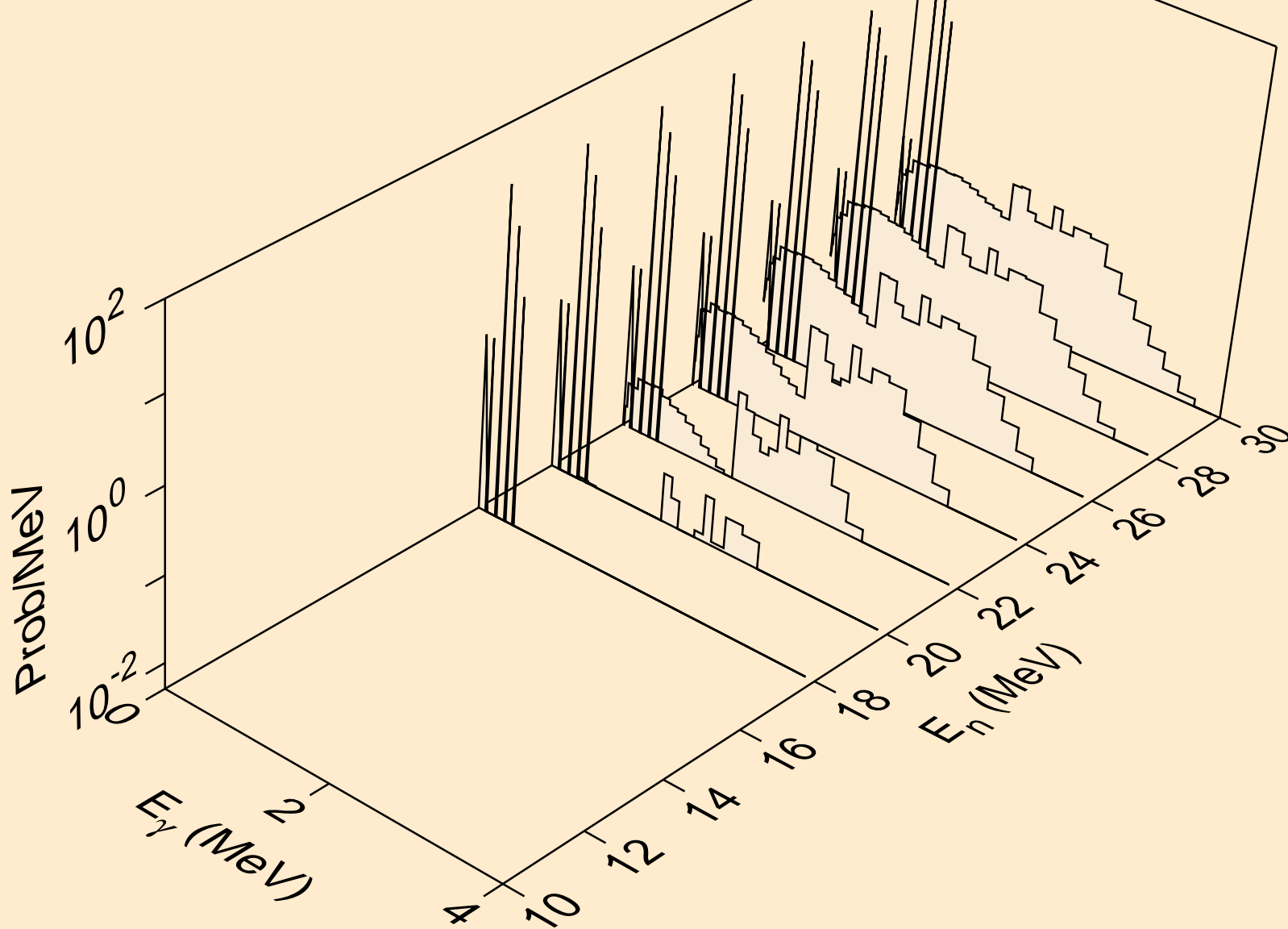

TA180 NEUTRON ACER TENDL-2019 LIBRARY; T=293.16K
Photon emission for (n,3np)

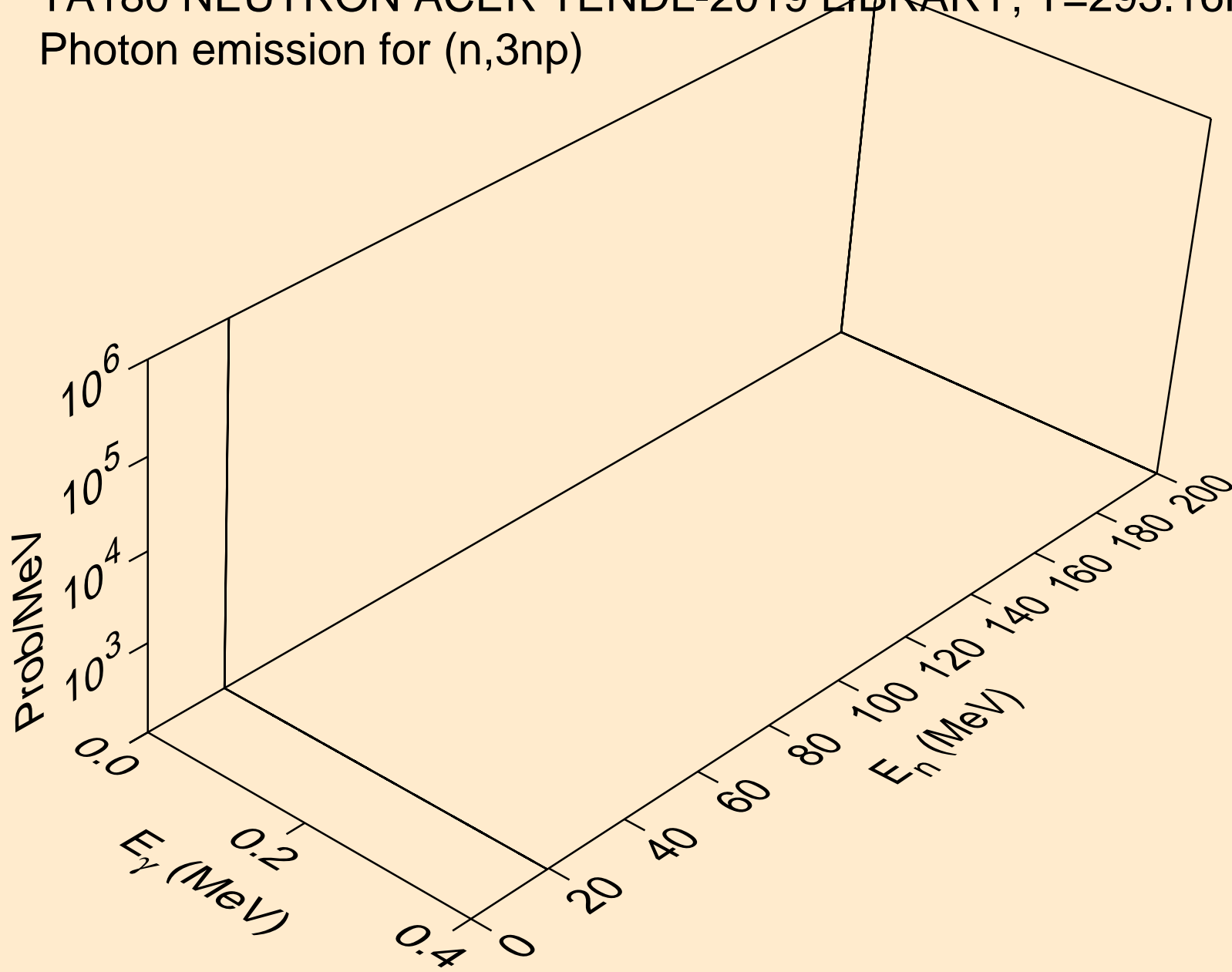

TA180 NEUTRON ACER TENDL-2019 LIBRARY; T=293.16K
Photon emission for (n,2np)

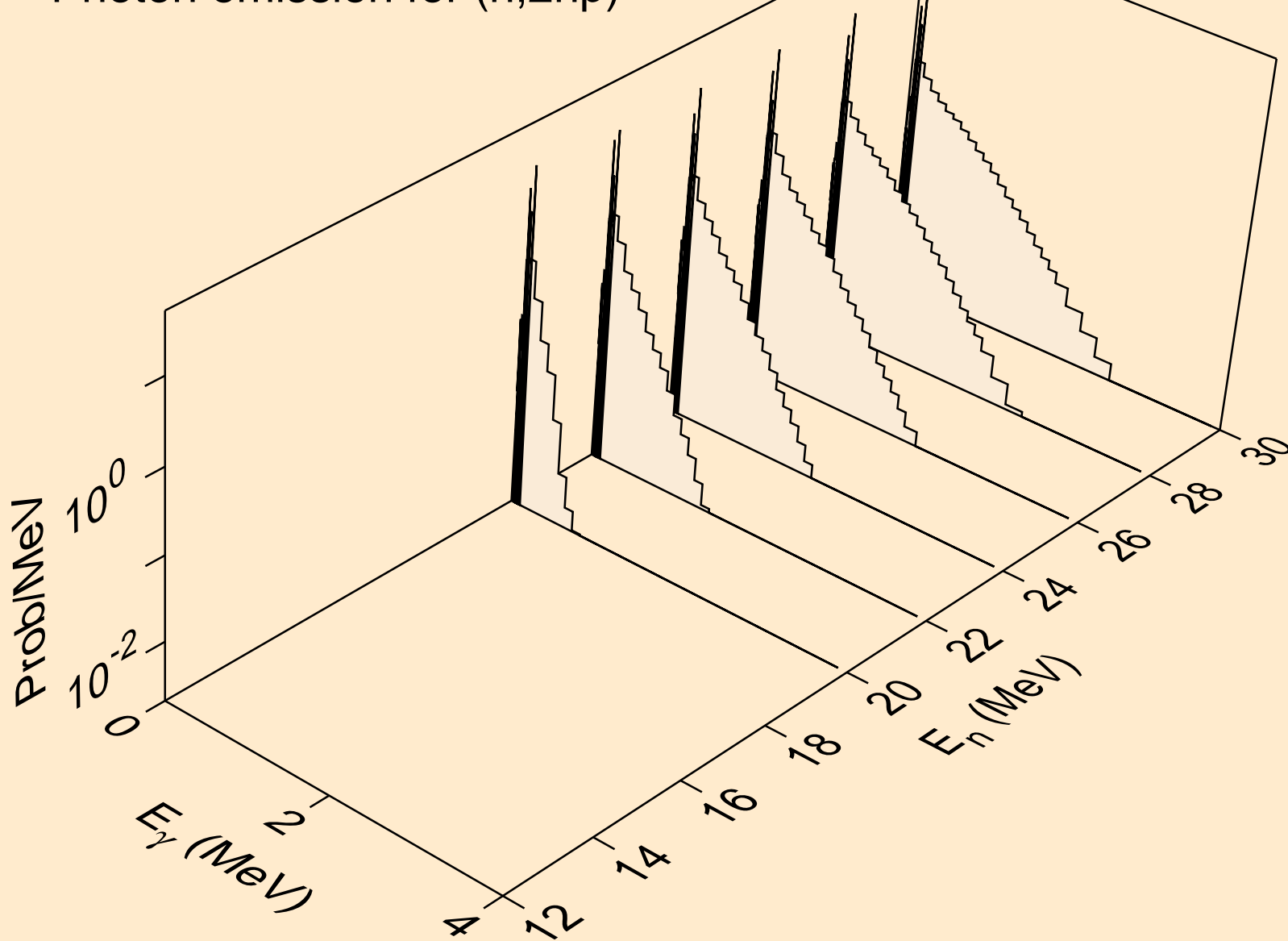

TA180 NEUTRON ACER TENDL-2019 LIBRARY; T=293.16K
Photon emission for (n,npa)

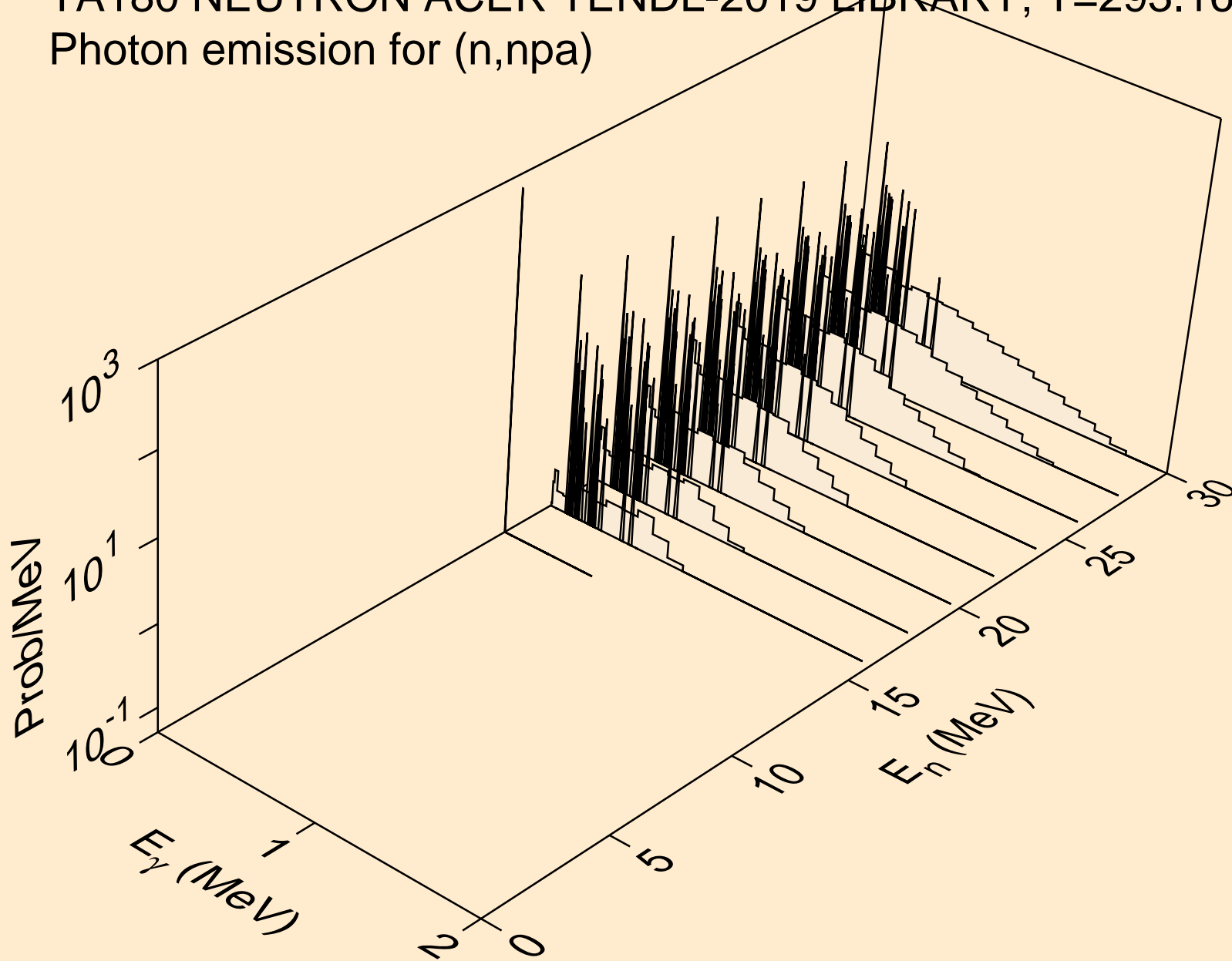

TA180 NEUTRON ACER TENDL-2019 LIBRARY; T=293.16K
Photon emission for (n,n*c)

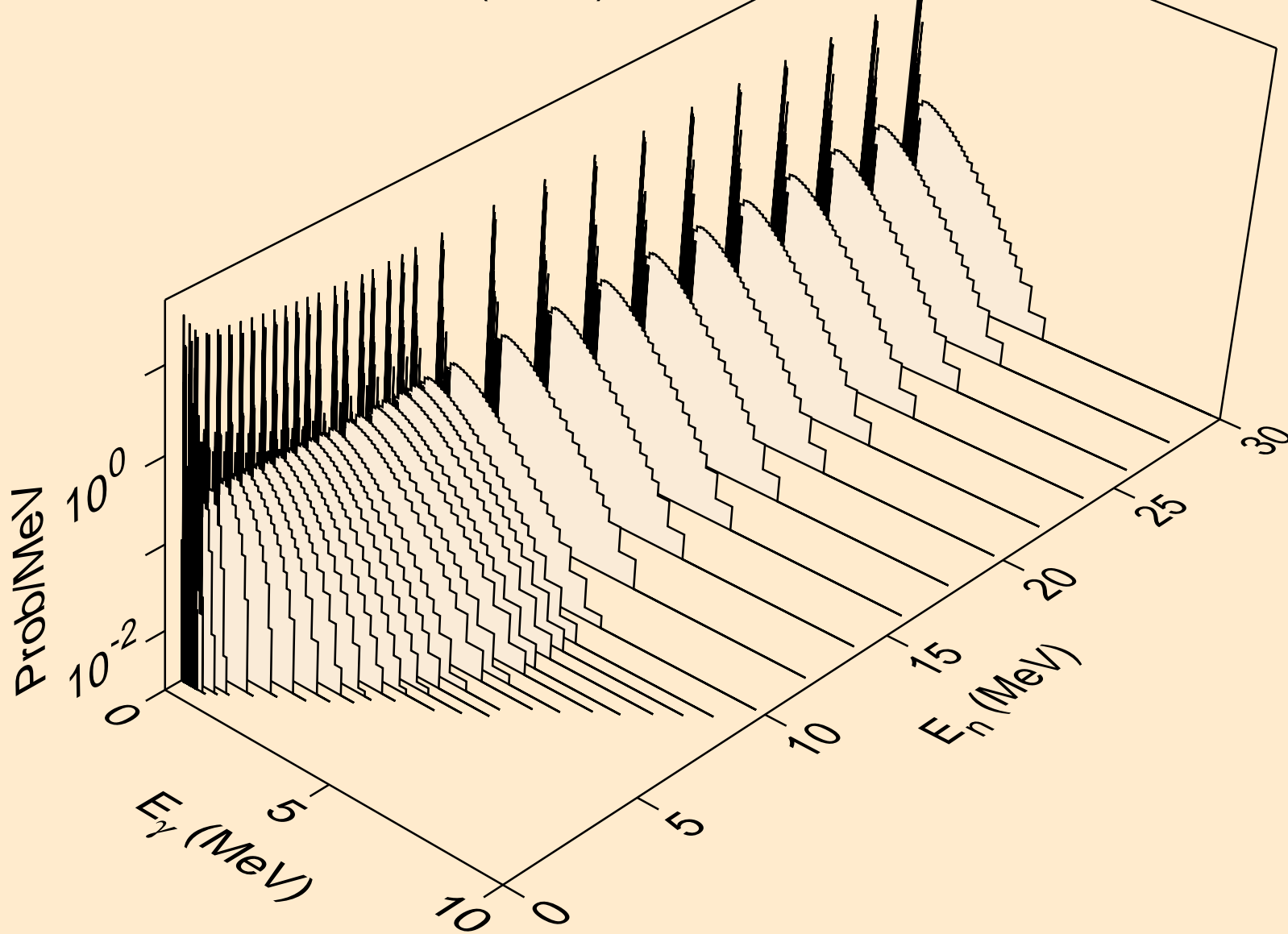

TA180 NEUTRON ACER TENDL-2019 LIBRARY; T=293.16K
Photon emission for (n,gma)

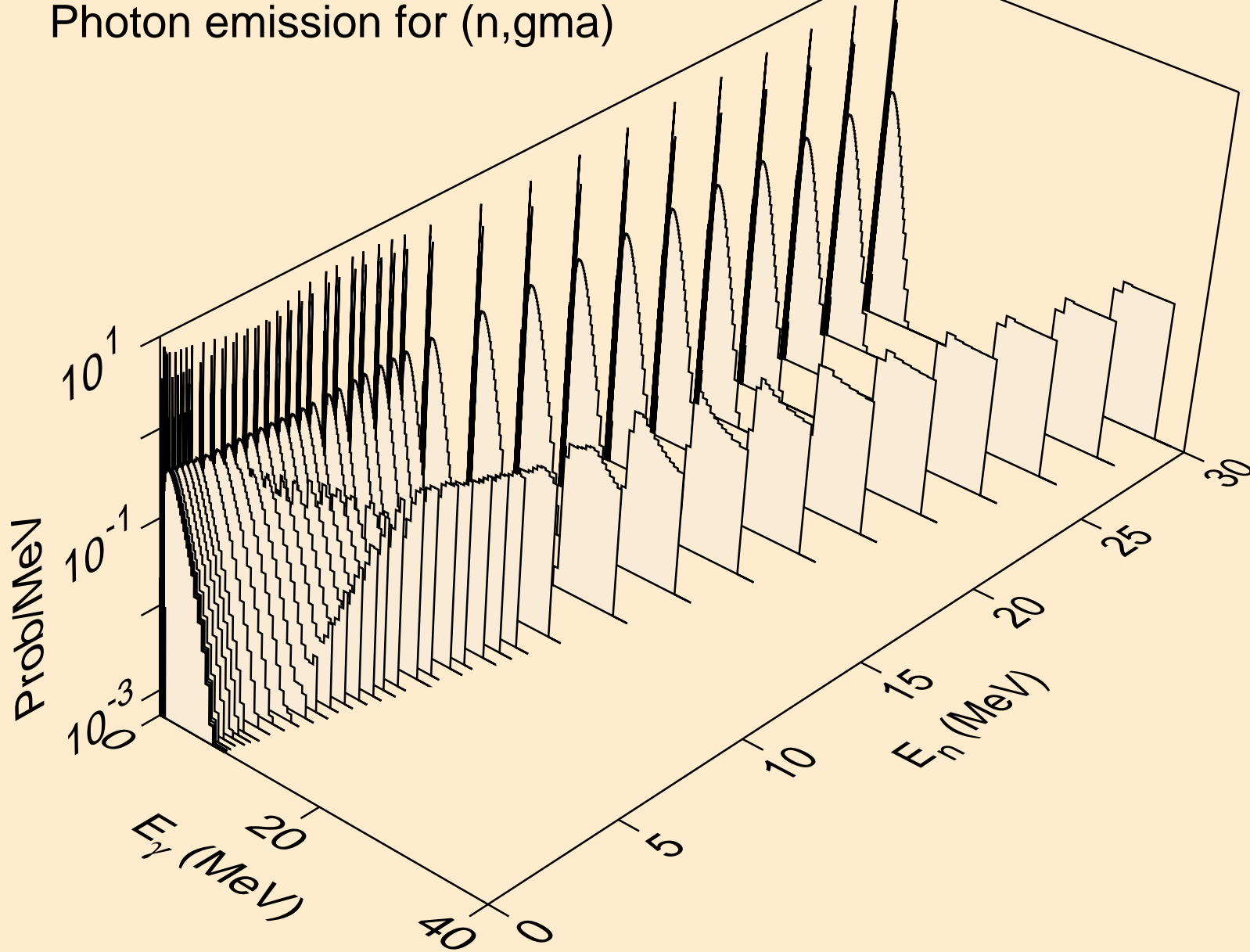

TA180 NEUTRON ACER TENDL-2019 LIBRARY; T=293.16K
Photon emission for (n,p)

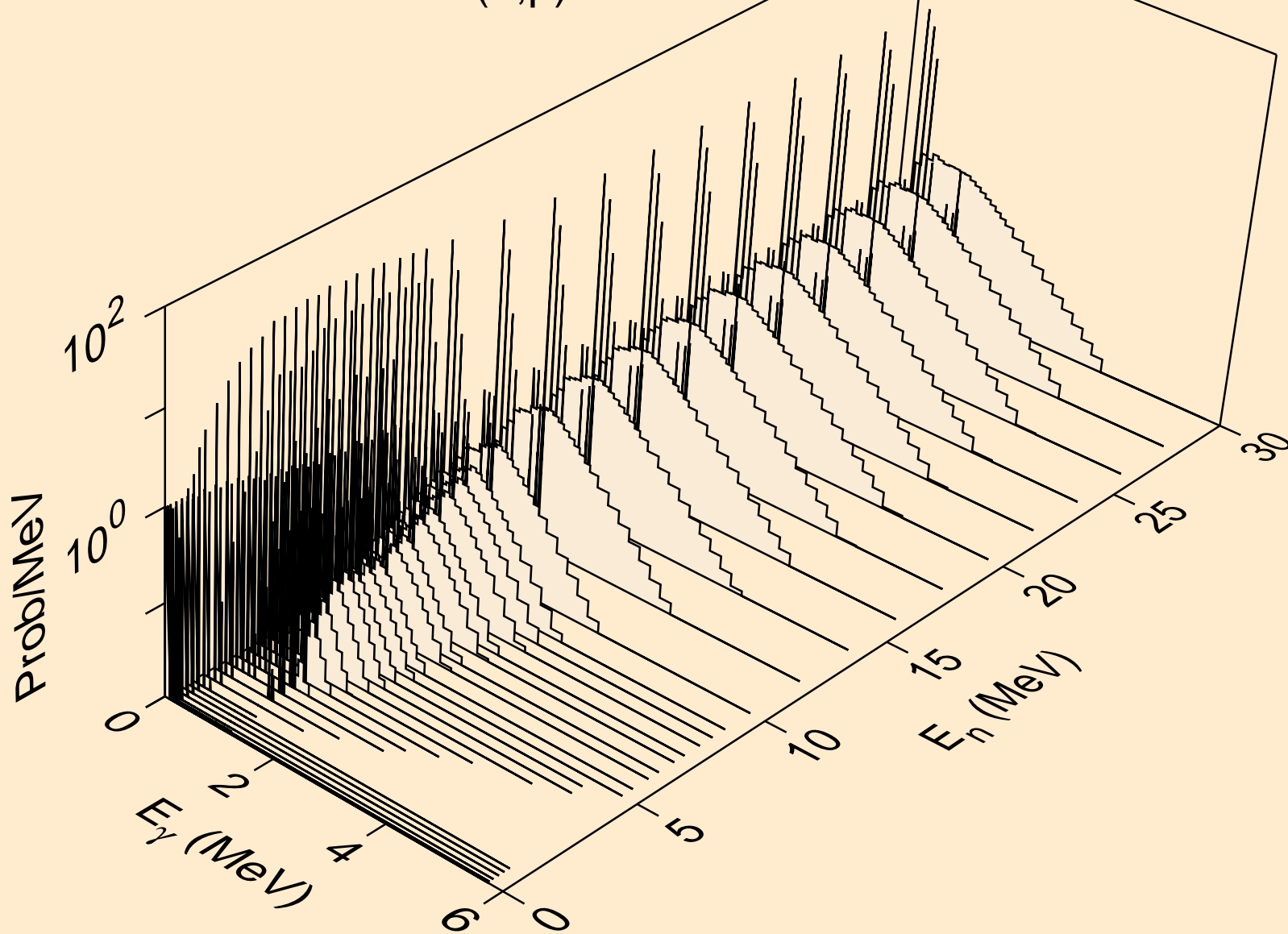

TA180 NEUTRON ACER TENDL-2019 LIBRARY; T=293.16K
Photon emission for (n,d)

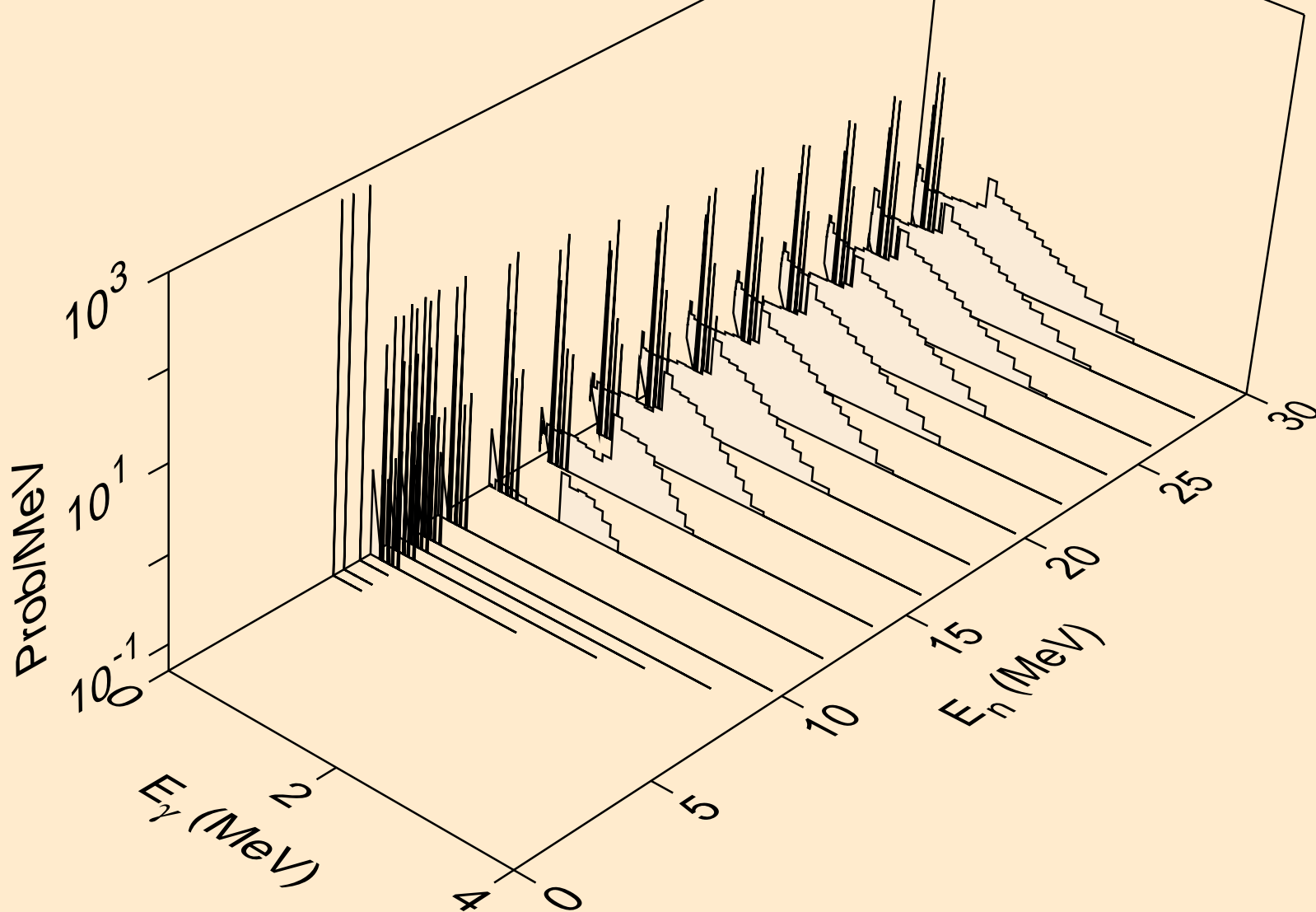

TA180 NEUTRON ACER TENDL-2019 LIBRARY; T=293.16K
Photon emission for (n,t)

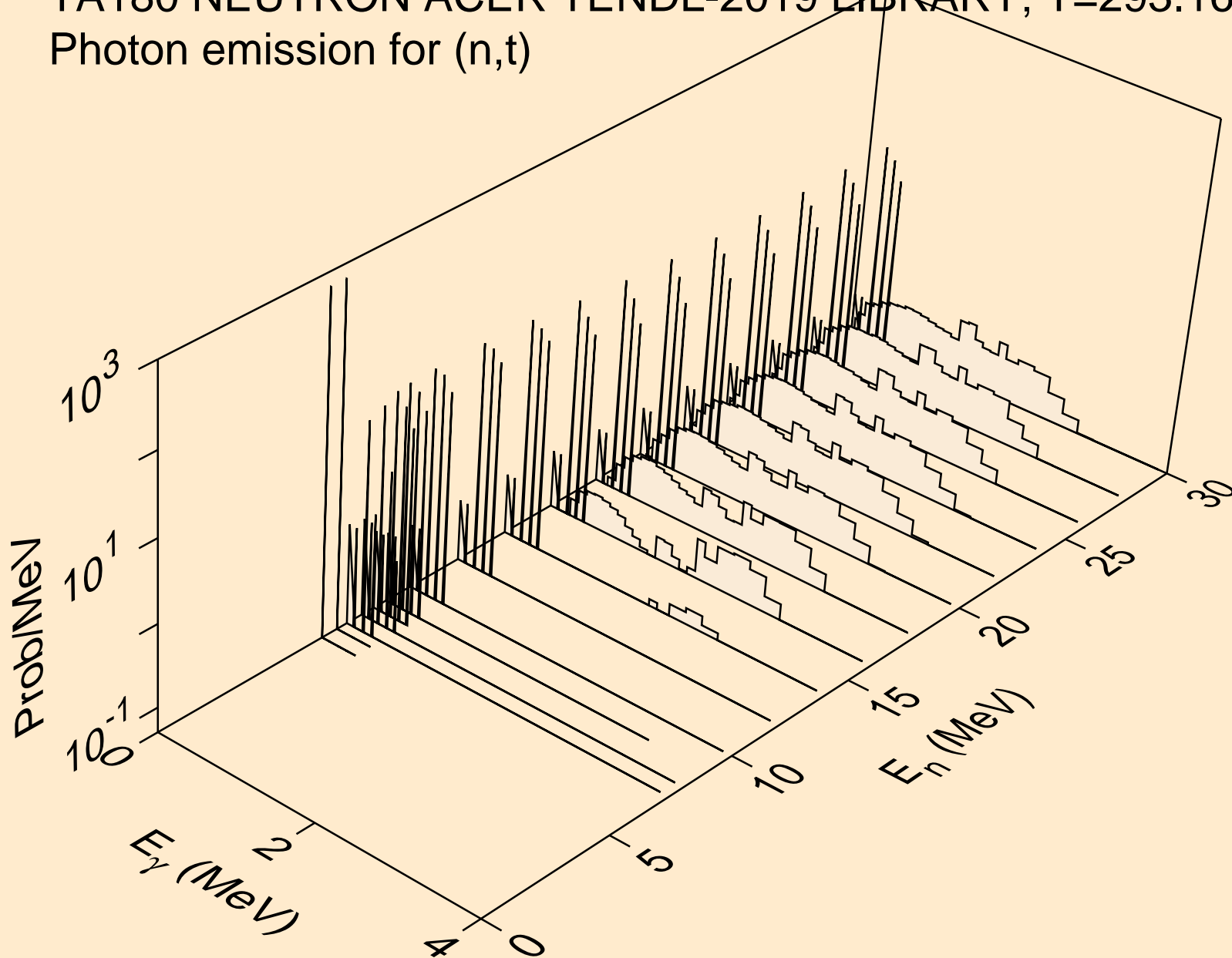

TA180 NEUTRON ACER TENDL-2019 LIBRARY; T=293.16K
Photon emission for (n,he3)

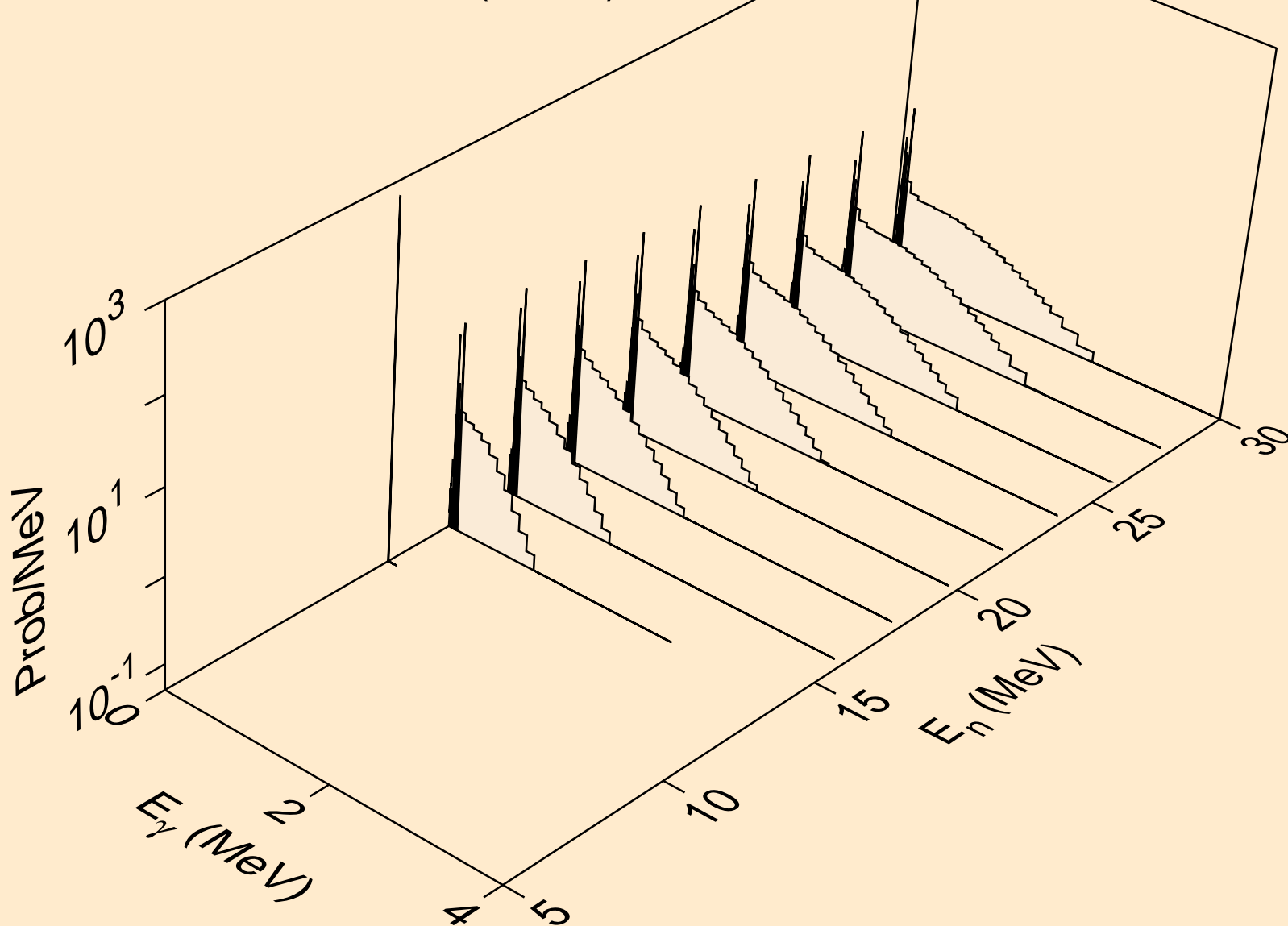

TA180 NEUTRON ACER TENDL-2019 LIBRARY; T=293.16K
Photon emission for (n,a)

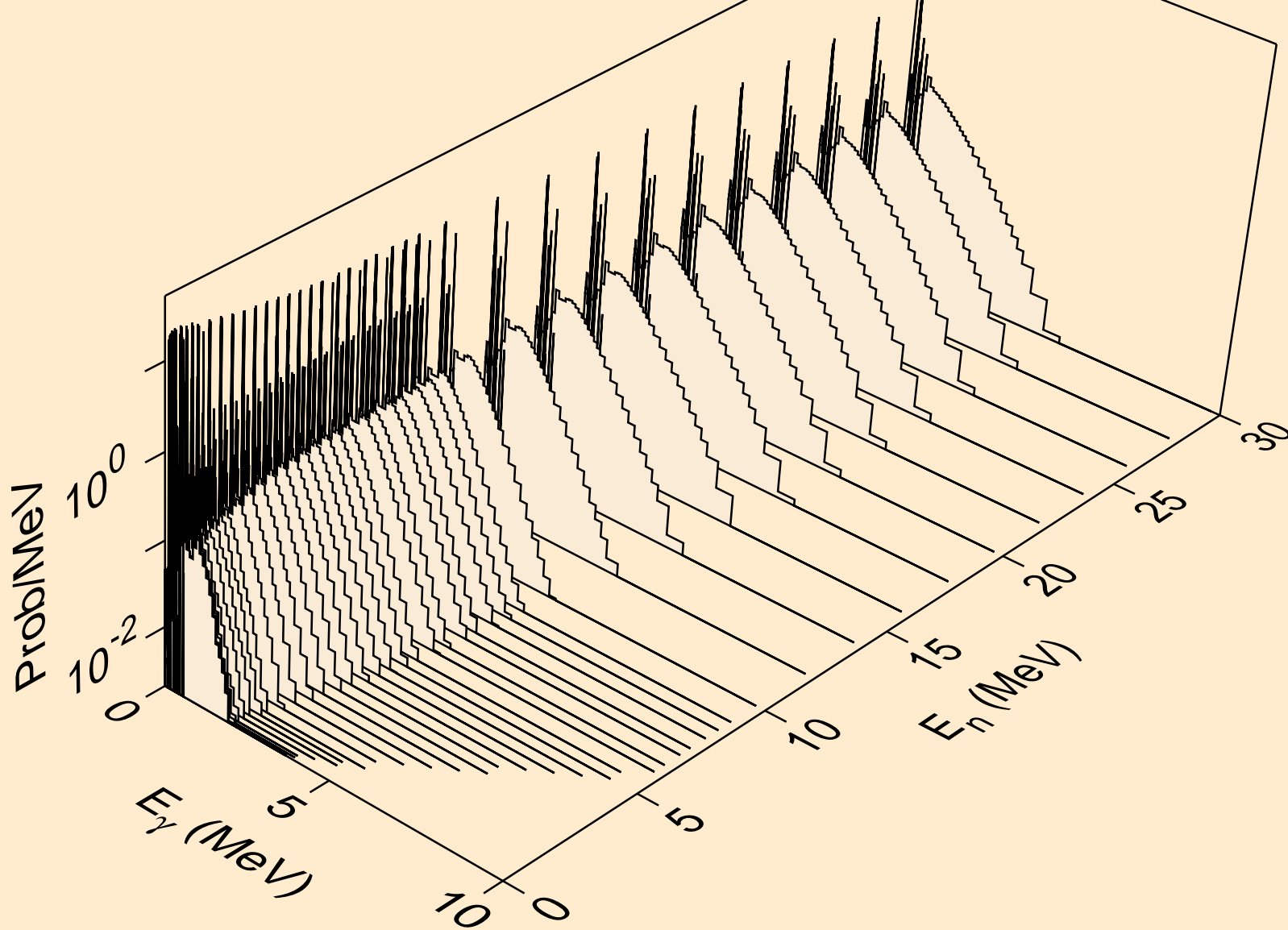

TA180 NEUTRON ACER TENDL-2019 LIBRARY; T=293.16K
Photon emission for (n,2a)

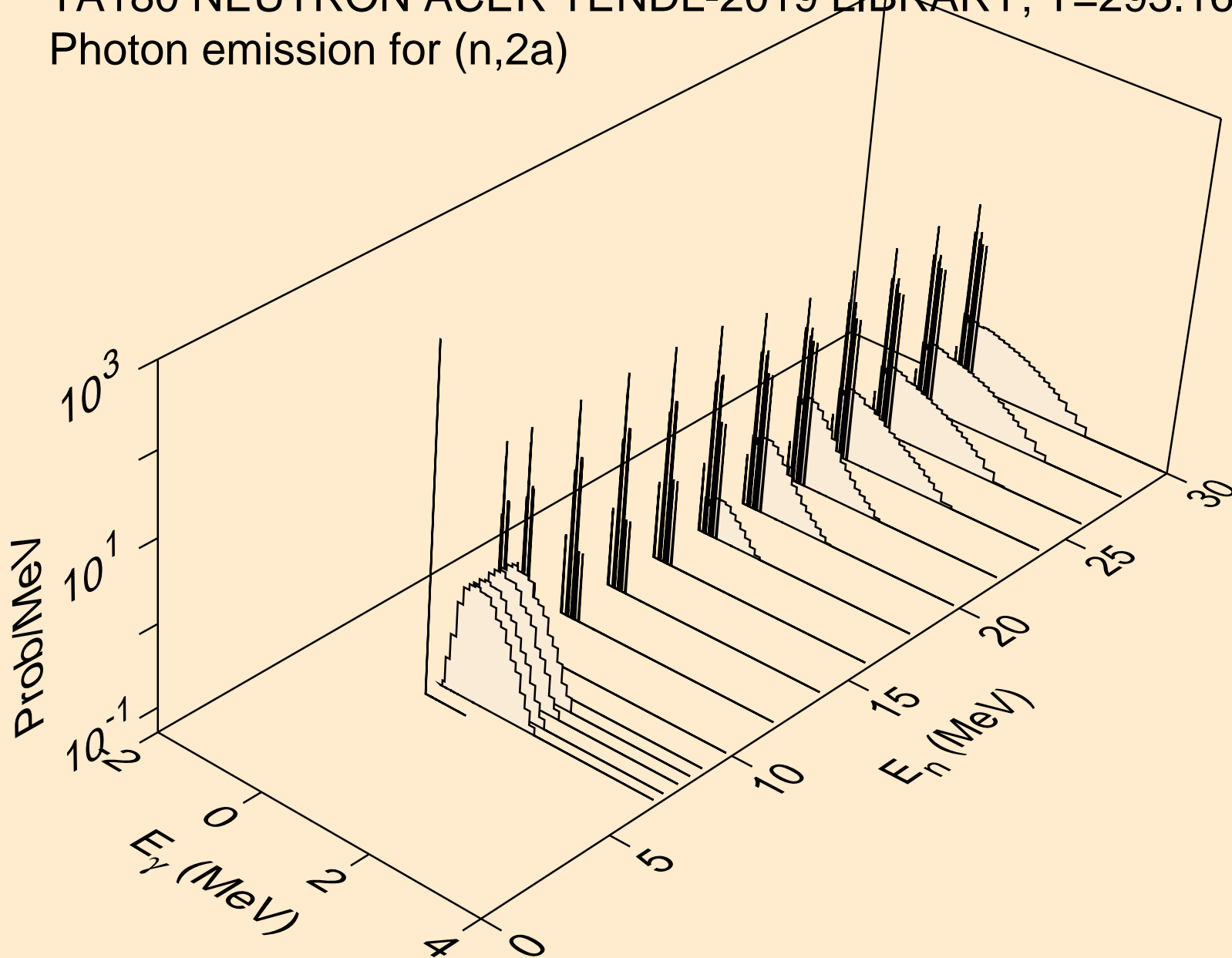

TA180 NEUTRON ACER TENDL-2019 LIBRARY; T=293.16K
Photon emission for (n,2p)

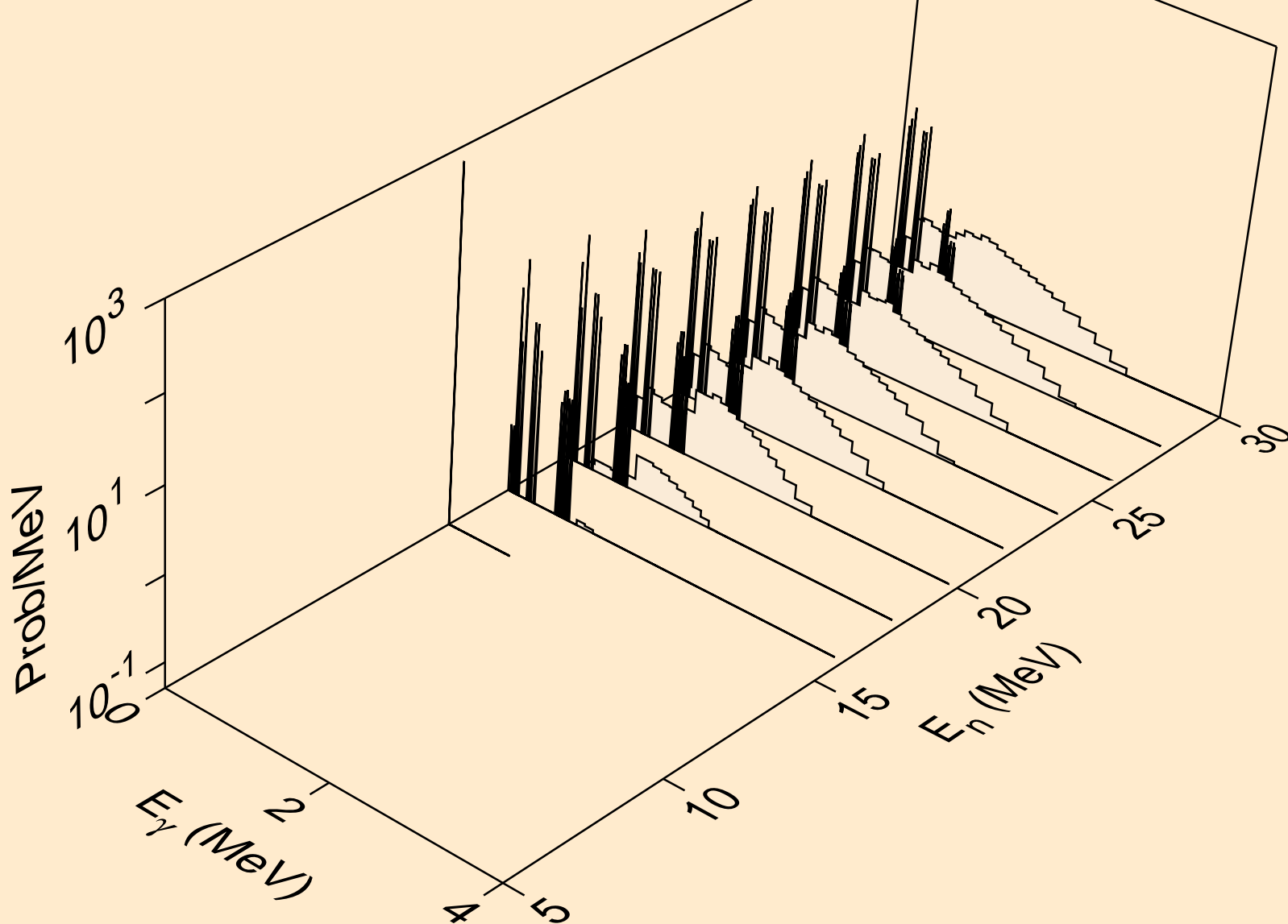

TA180 NEUTRON ACER TENDL-2019 LIBRARY; T=293.16K
Photon emission for (n,p)

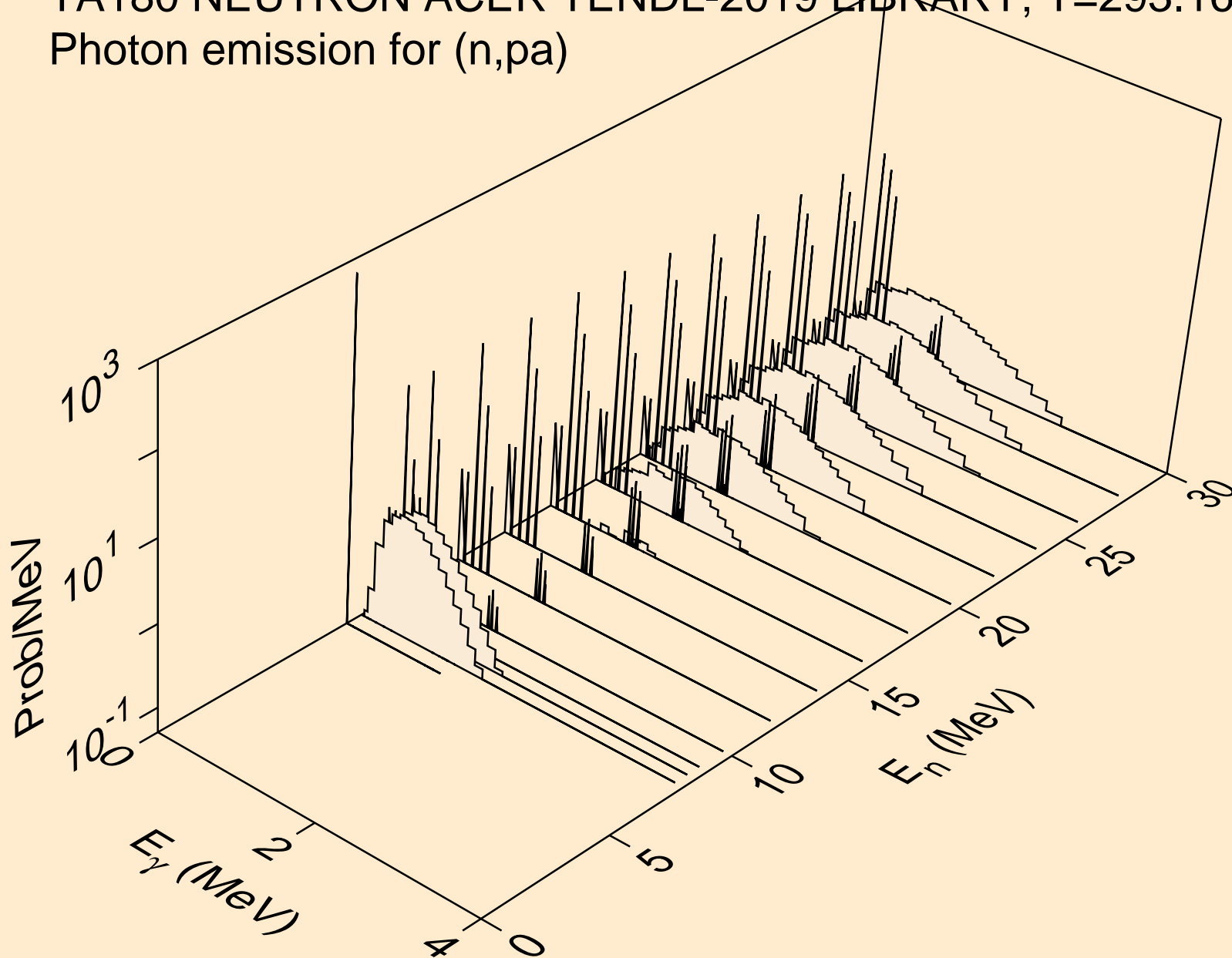

TA180 NEUTRON ACER TENDL-2019 LIBRARY; T=293.16K
Photon emission for (n,pd)

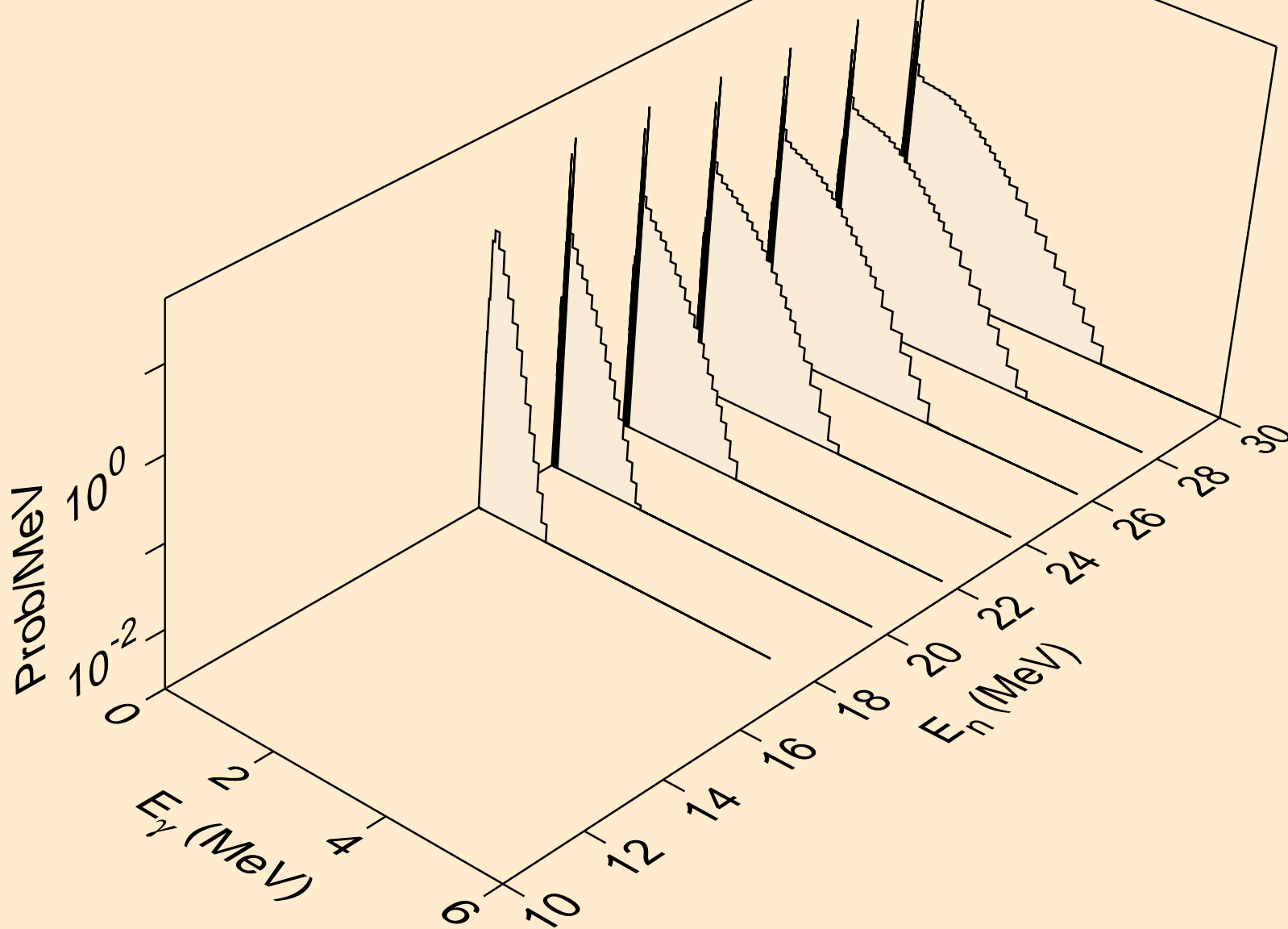

TA180 NEUTRON ACER TENDL-2019 LIBRARY; T=293.16K
Photon emission for (n,pt)

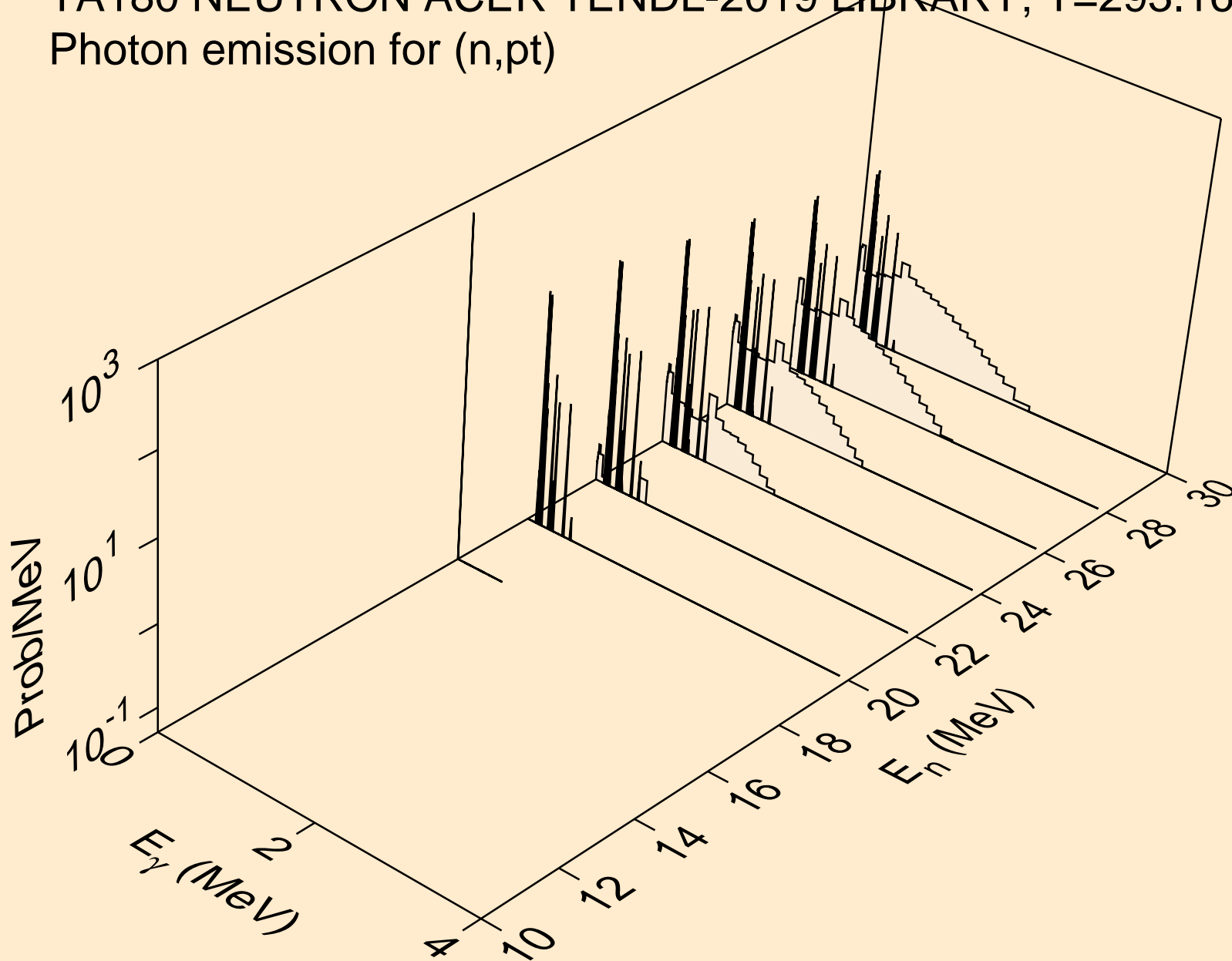

TA180 NEUTRON ACER TENDL-2019 LIBRARY; T=293.16K
Photon emission for (n,da)

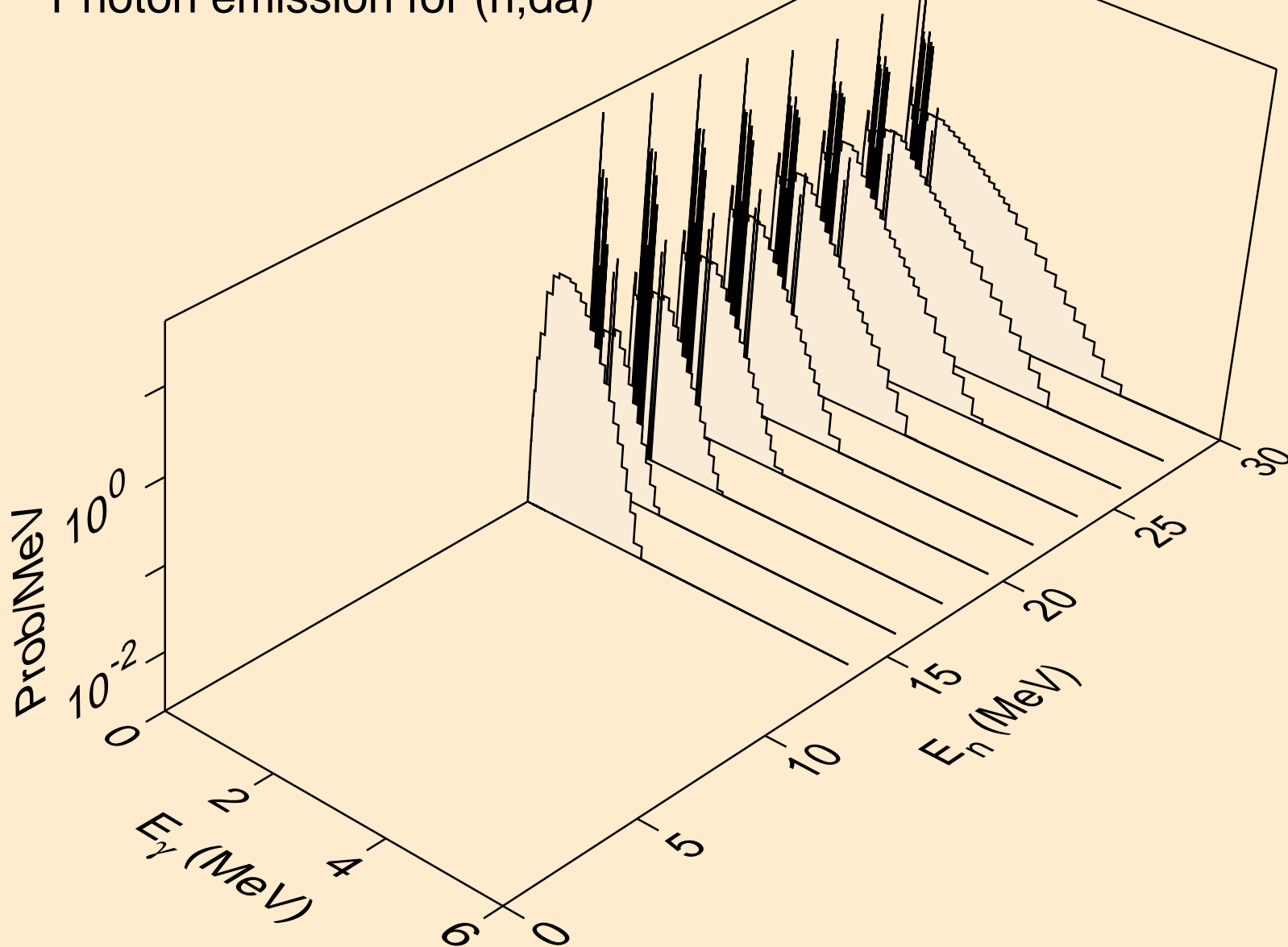

TA180 NEUTRON ACER TENDL-2019 LIBRARY; T=293.16K
thermal capture photon spectrum

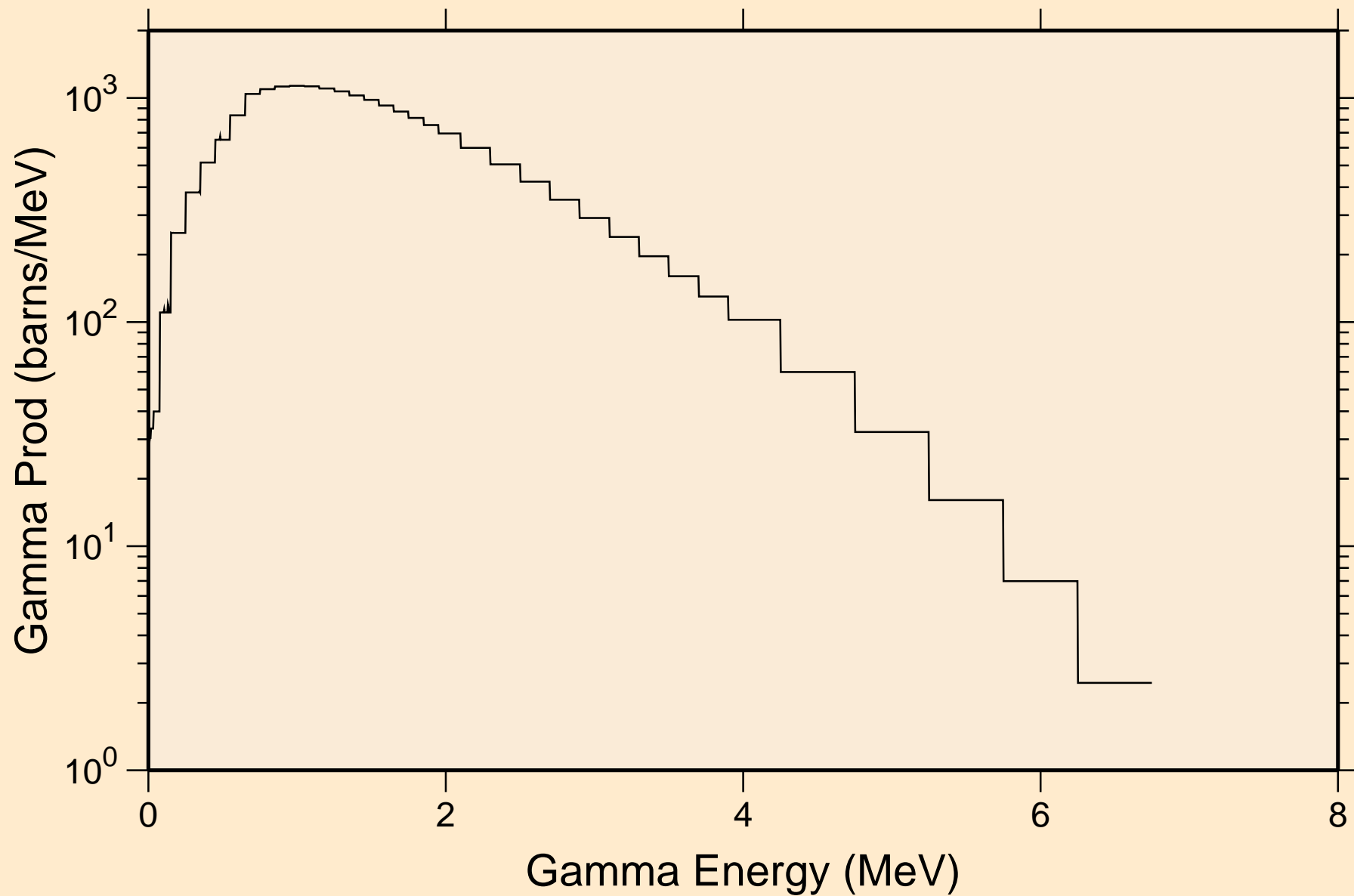

TA180 NEUTRON ACER TENDL-2019 LIBRARY; T=293.16K
14 MeV photon spectrum

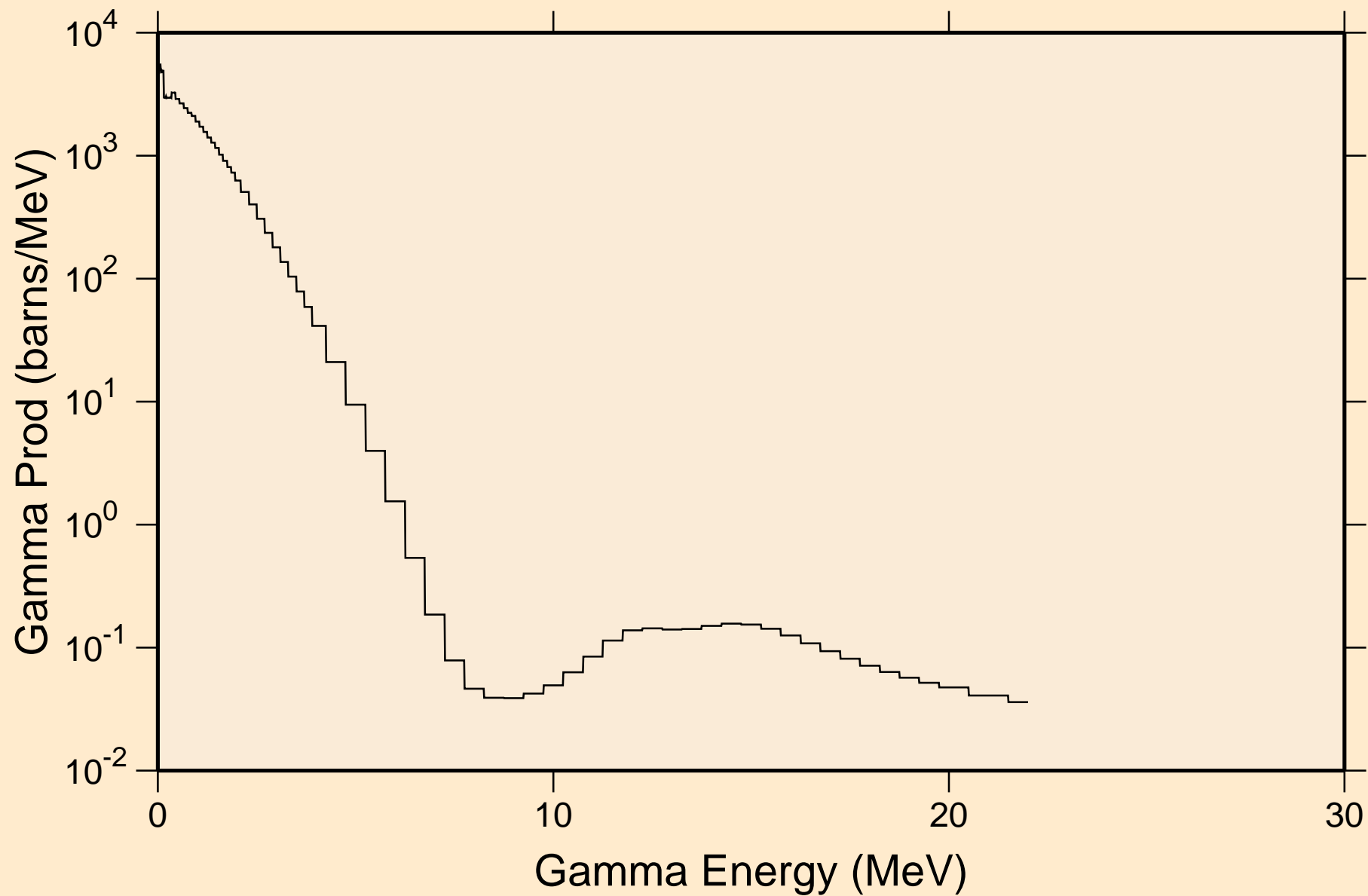

TA180 NEUTRON ACER TENDL-2019 LIBRARY; T=293.16K
Particle heating contributions

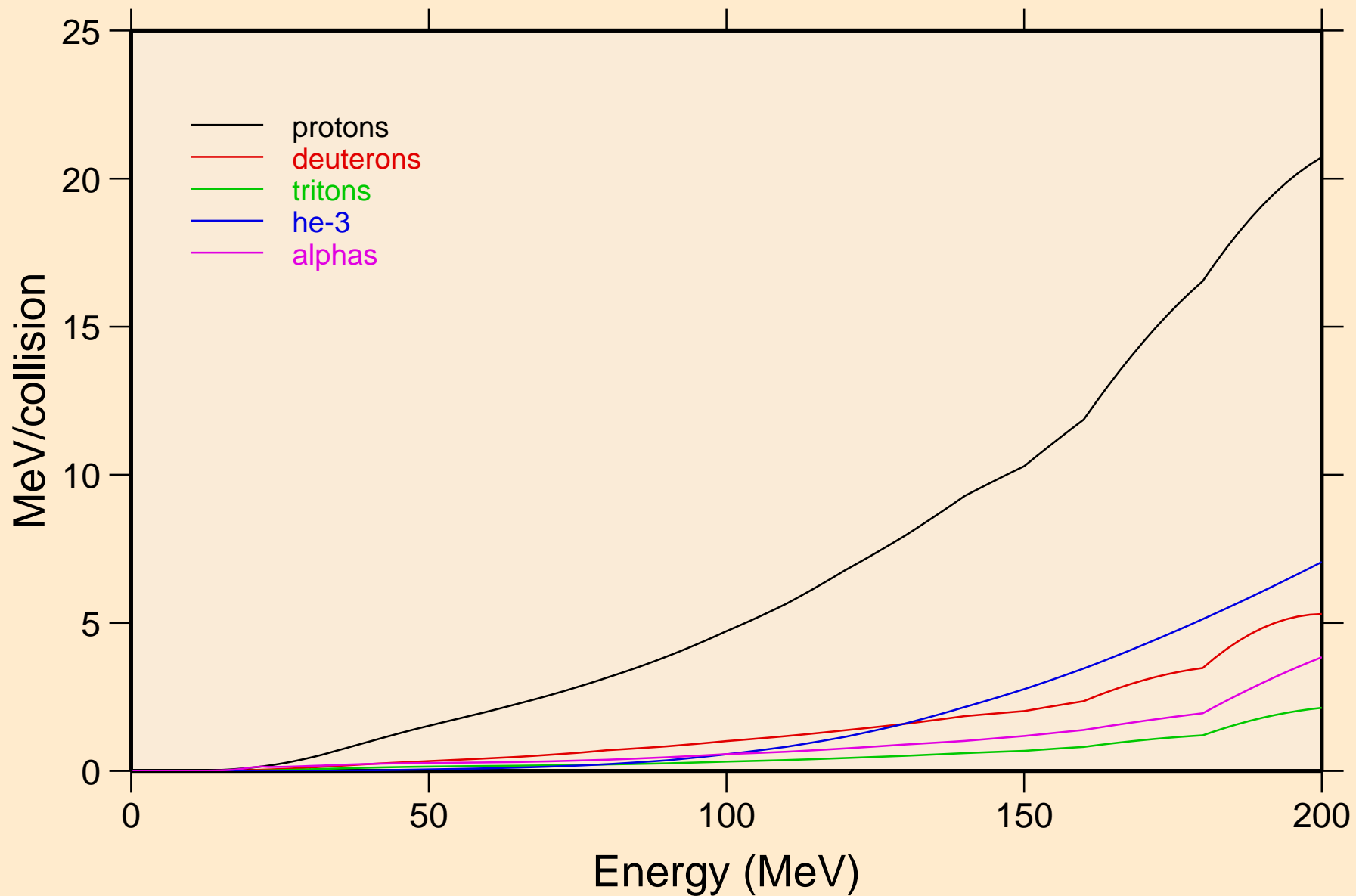

TA180 NEUTRON ACER TENDL-2019 LIBRARY; T=293.16K
Recoil Heating

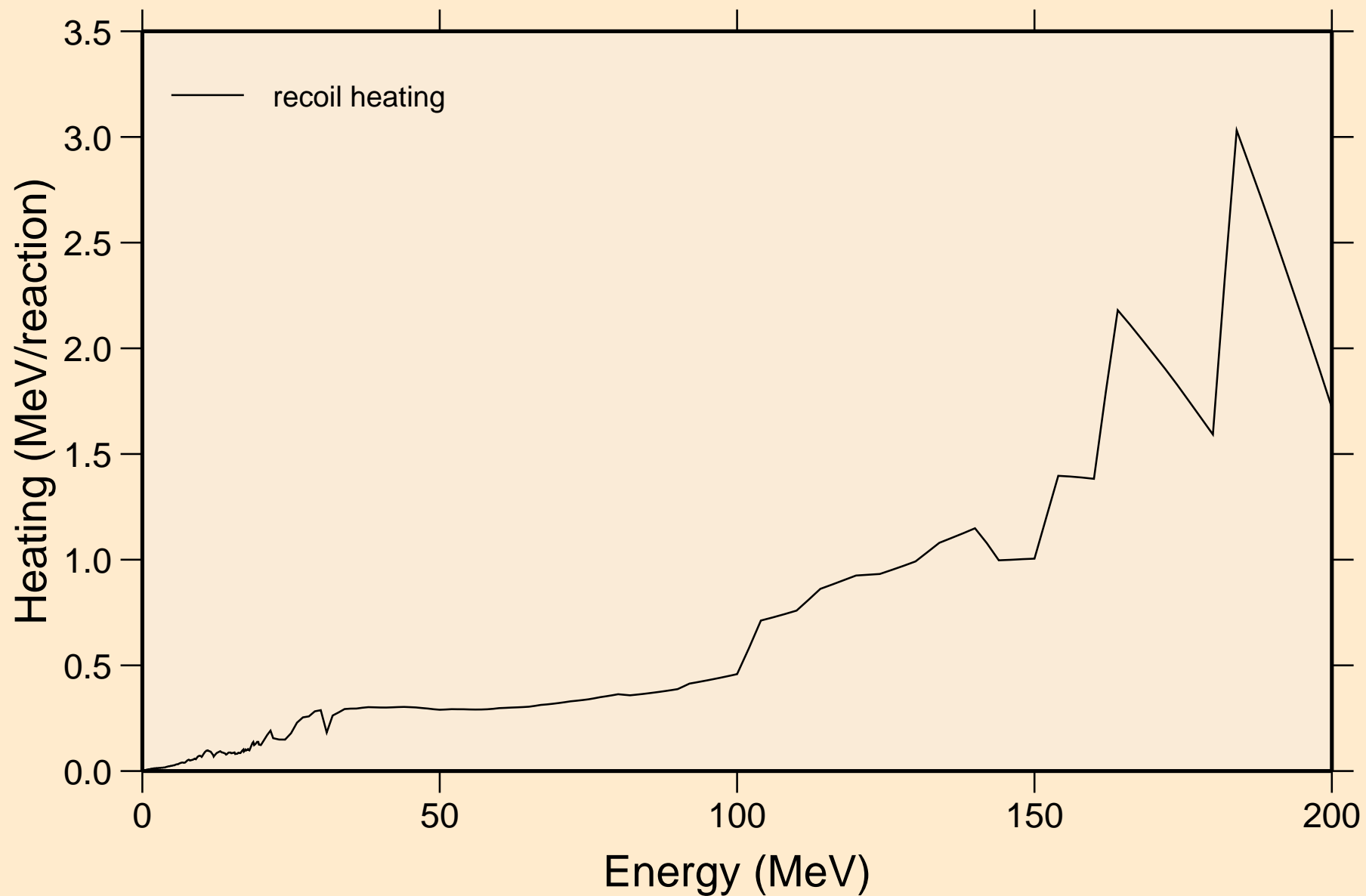

TA180 NEUTRON ACER TENDL-2019 LIBRARY; T=293.16K
Particle production cross sections

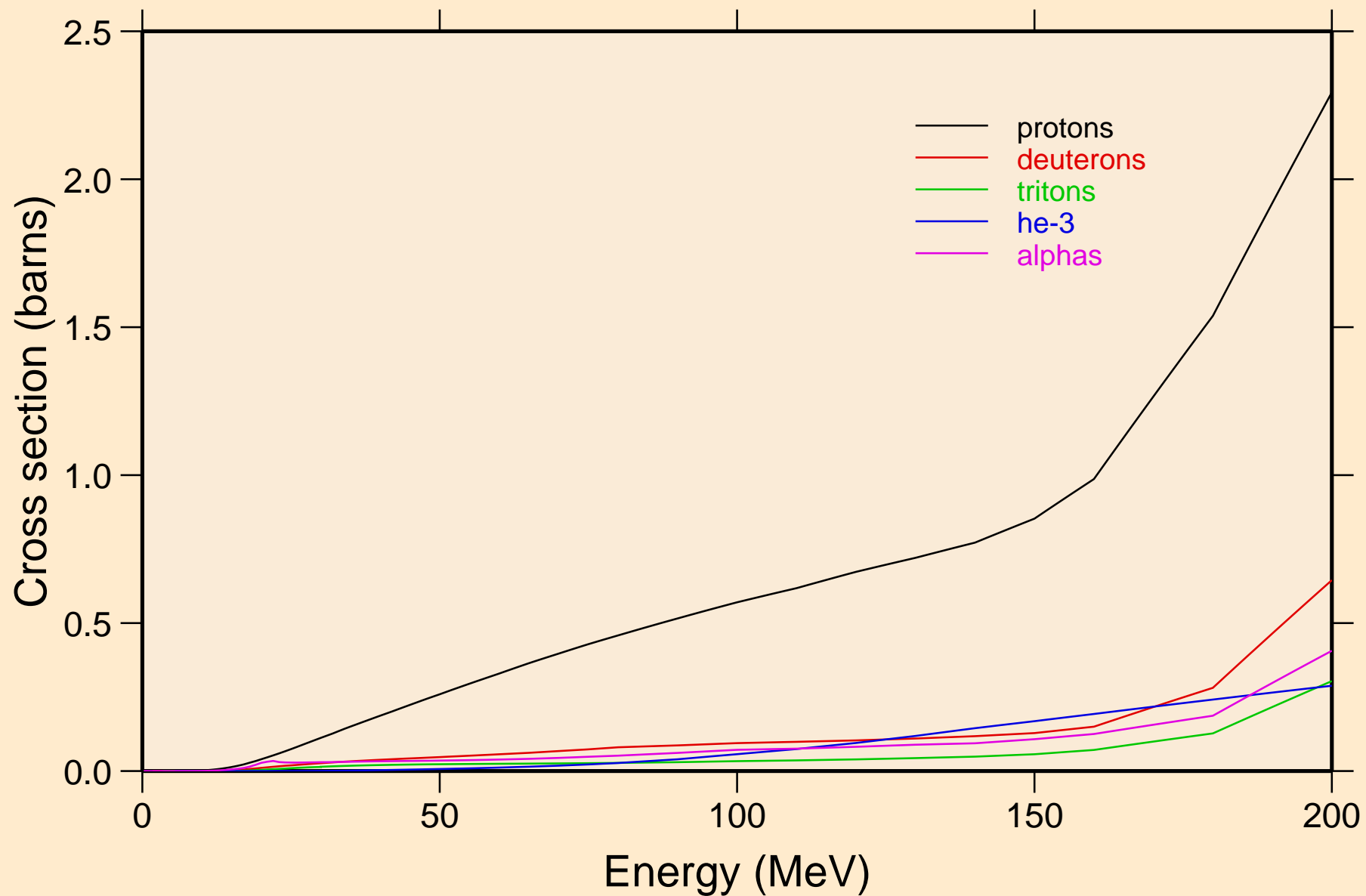

TA180 NEUTRON ACER TENDL-2019 LIBRARY; T=293.16K
protons from (n,x)

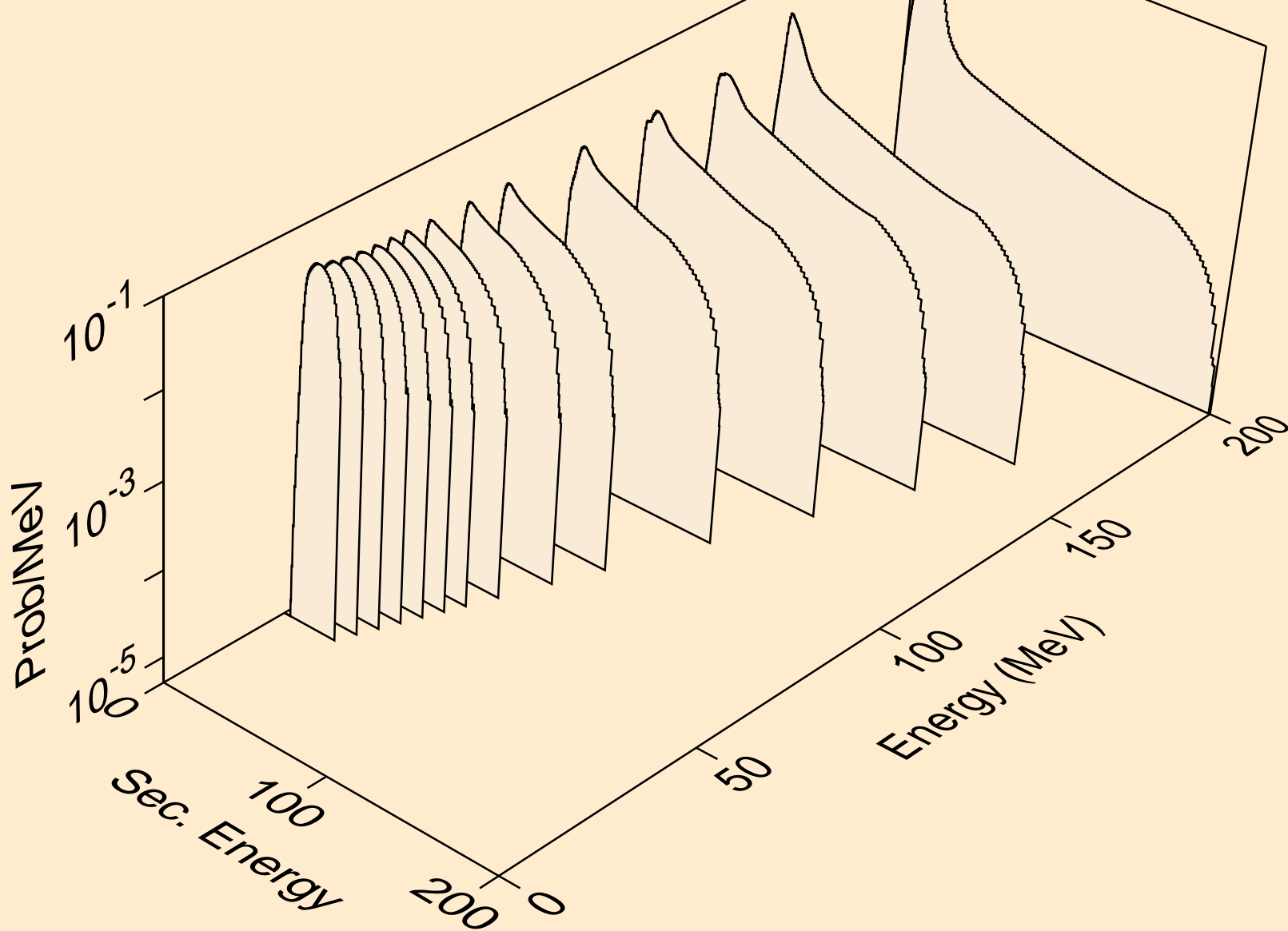

TA180 NEUTRON ACER TENDL-2019 LIBRARY; T=293.16K
protons from (n,n*)p

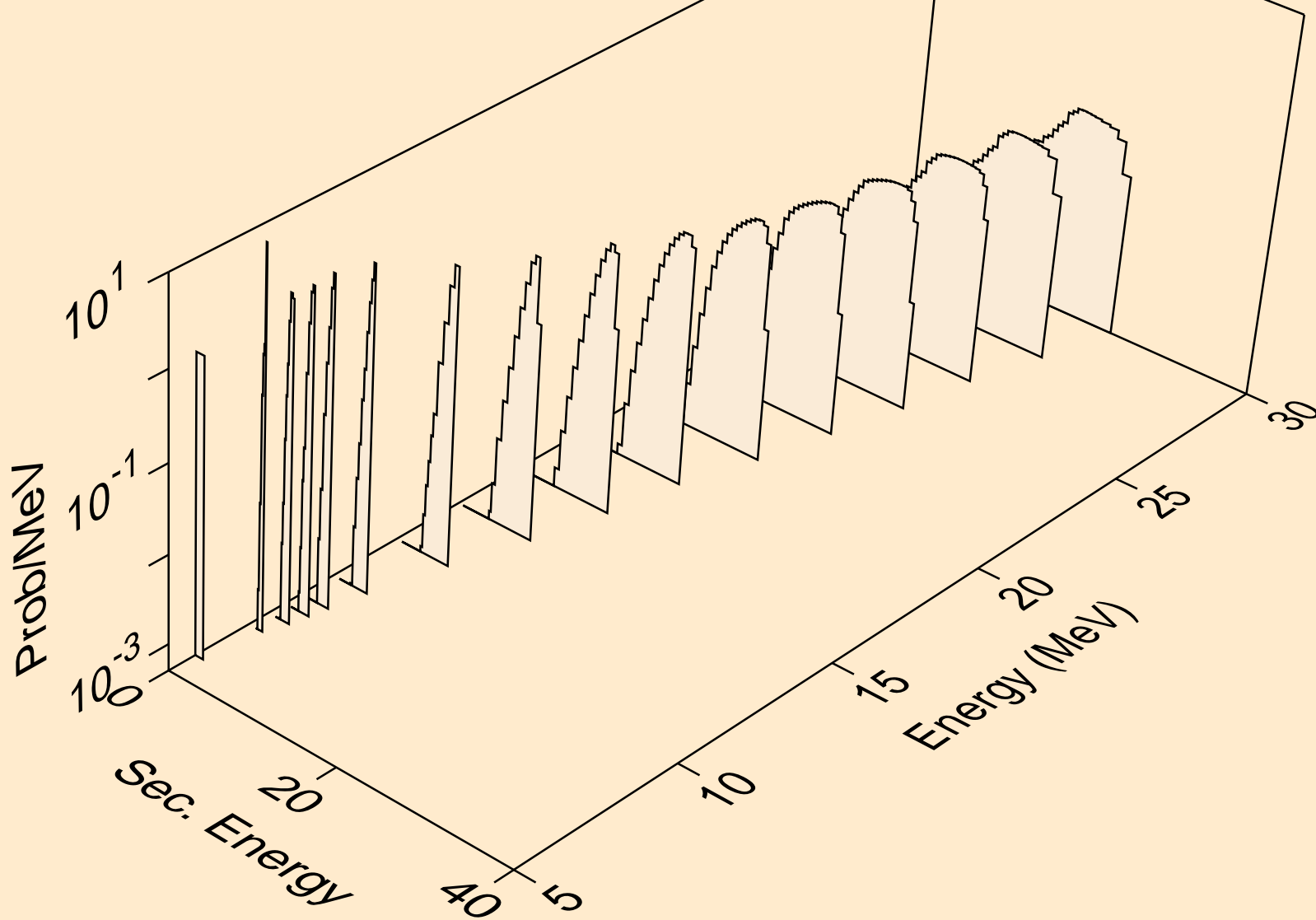

TA180 NEUTRON ACER TENDL-2019 LIBRARY; T=293.16K
protons from (n,2np)

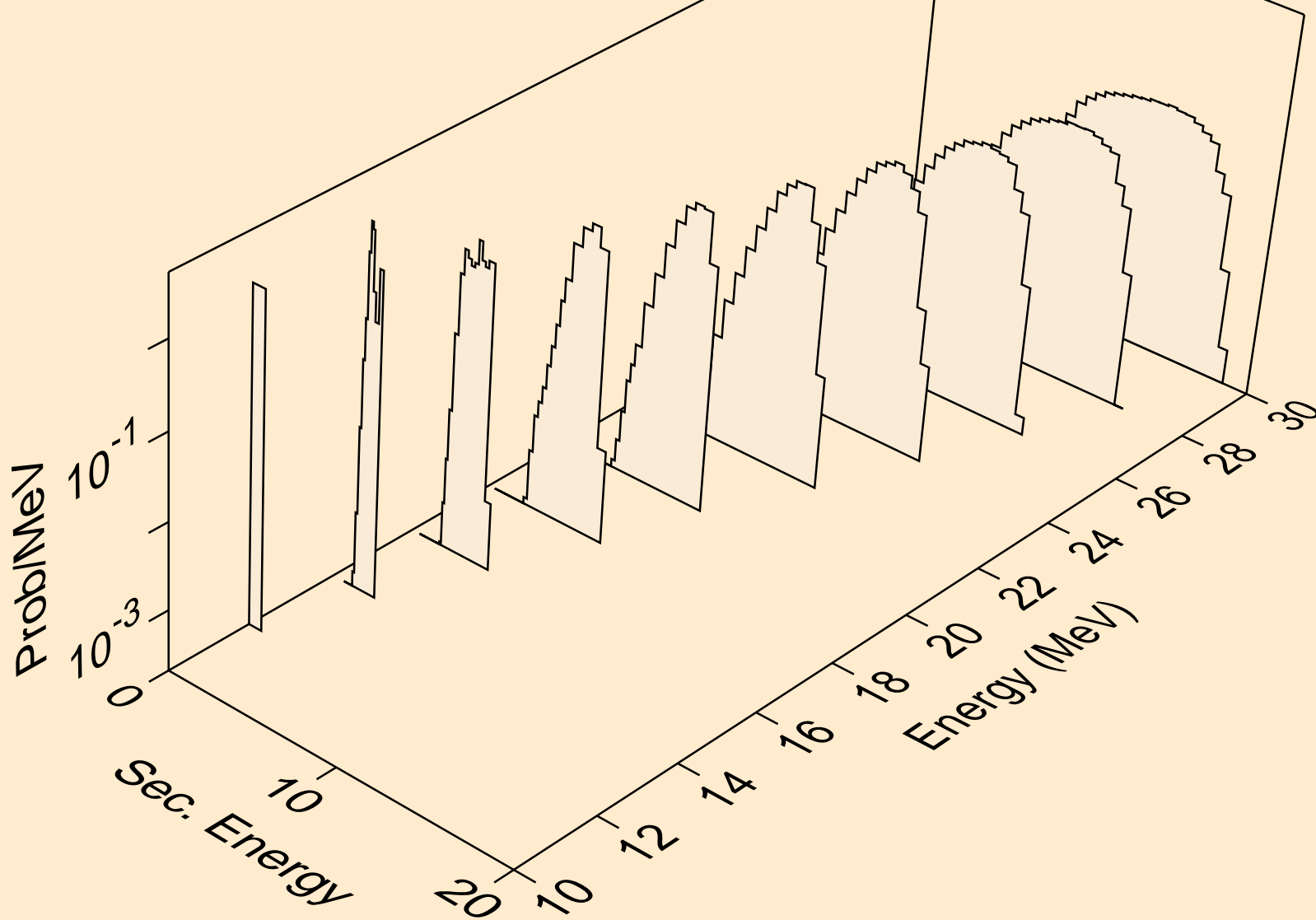

TA180 NEUTRON ACER TENDL-2019 LIBRARY; T=293.16K
protons from (n,3np)

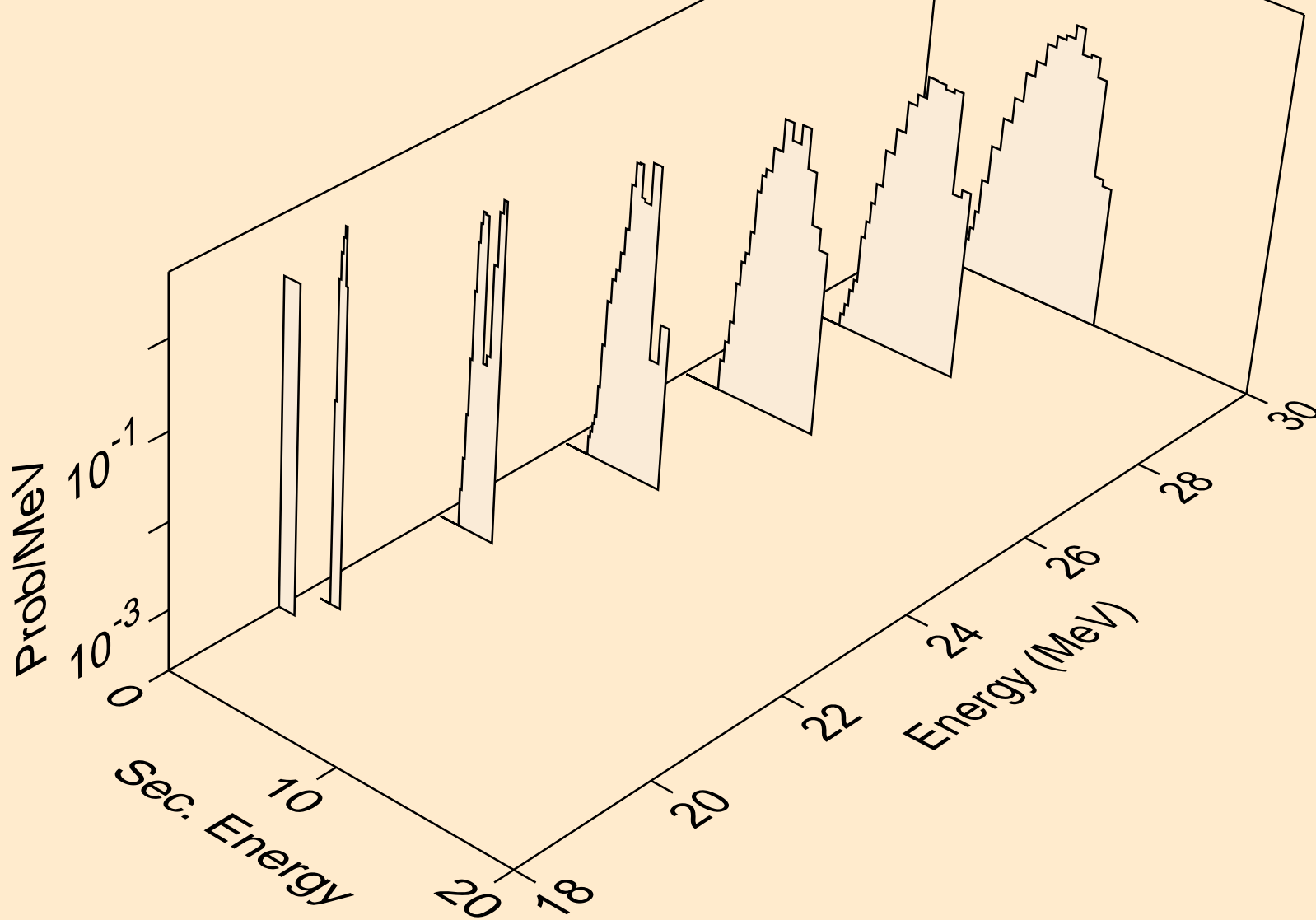

TA180 NEUTRON ACER TENDL-2019 LIBRARY; T=293.16K
protons from (n,2np)

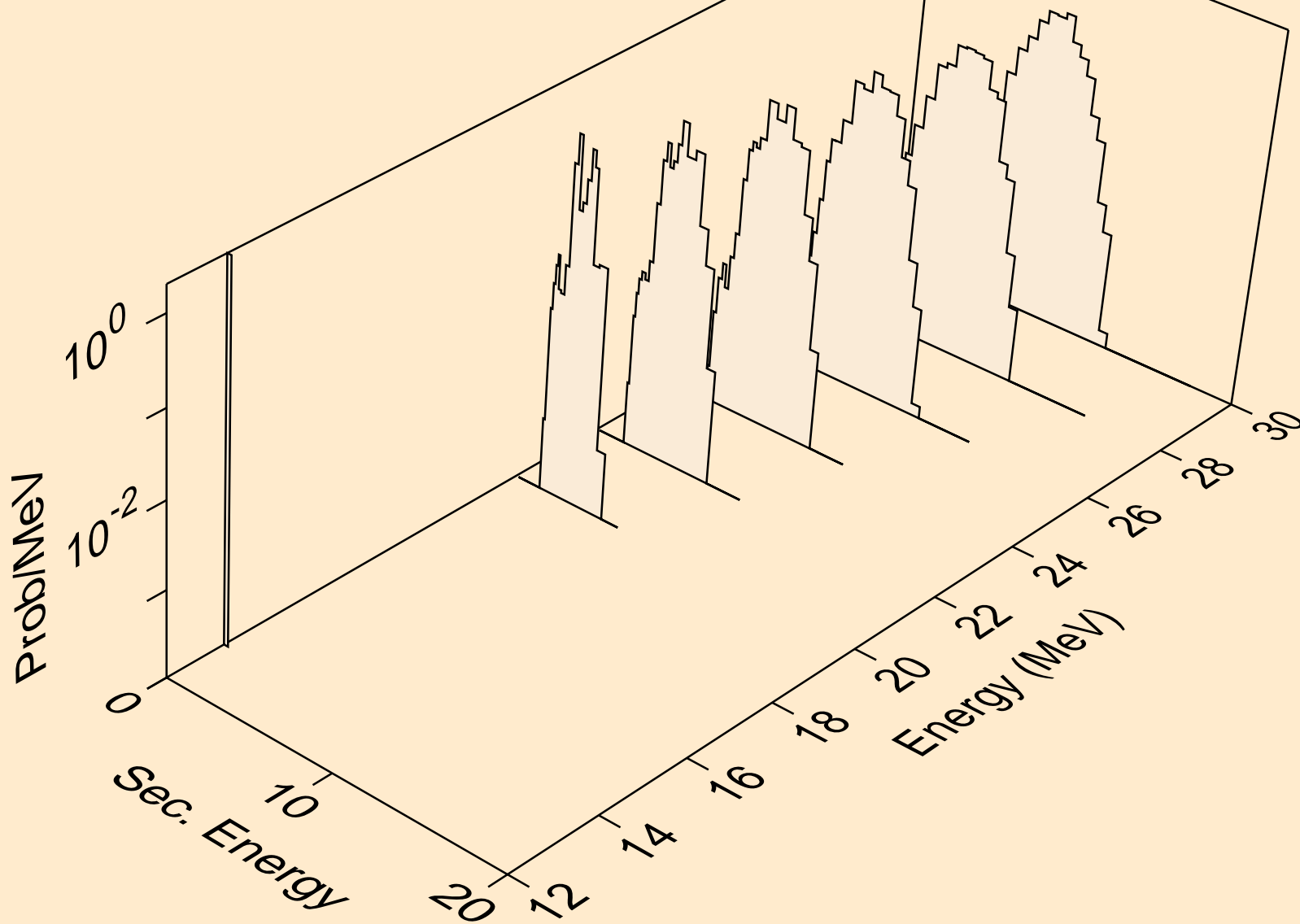

TA180 NEUTRON ACER TENDL-2019 LIBRARY; T=293.16K
protons from (n,npa)

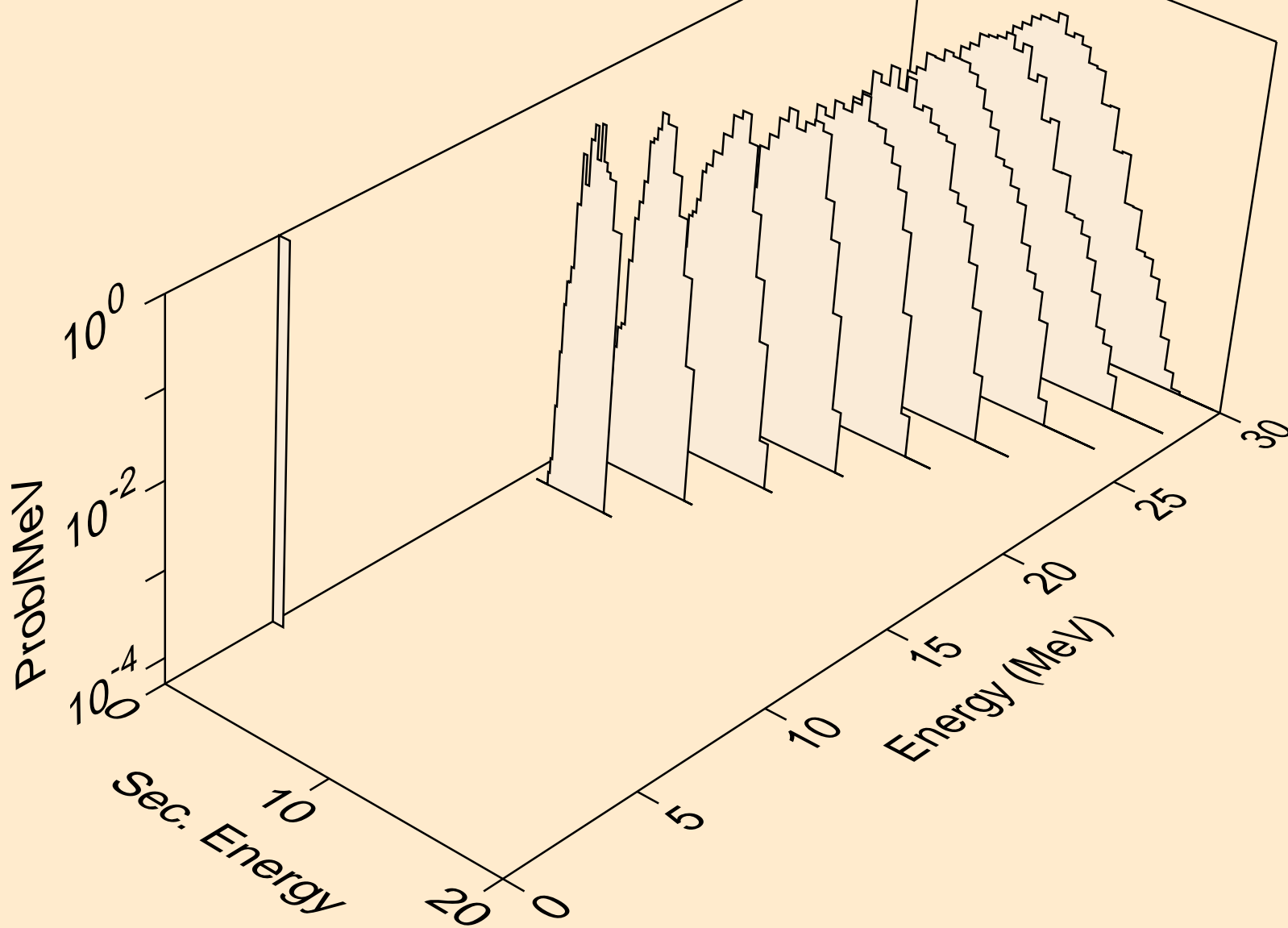

TA180 NEUTRON ACER TENDL-2019 LIBRARY; T=293.16K
protons from (n,p)

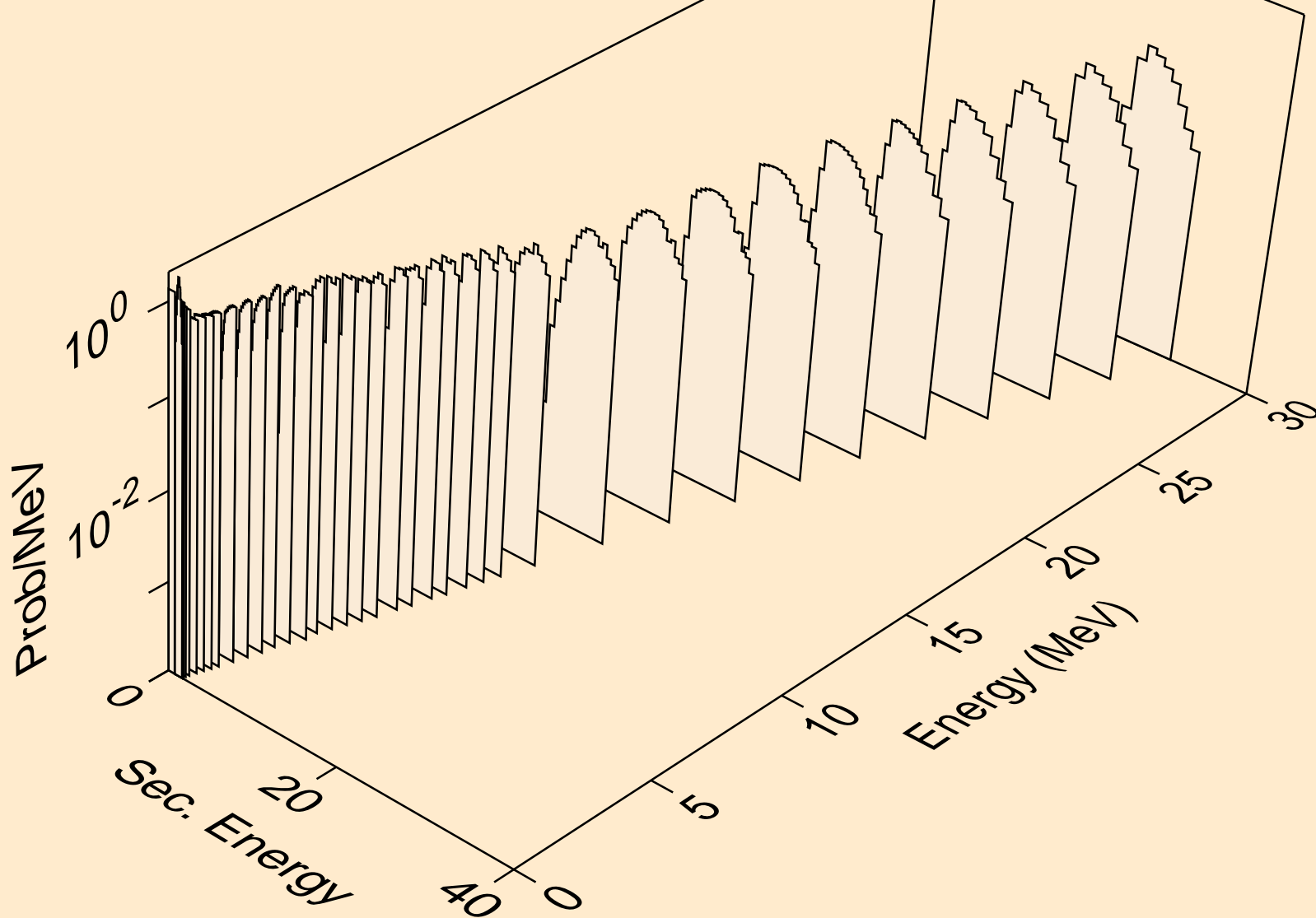

TA180 NEUTRON ACER TENDL-2019 LIBRARY; T=293.16K
protons from (n,2p)

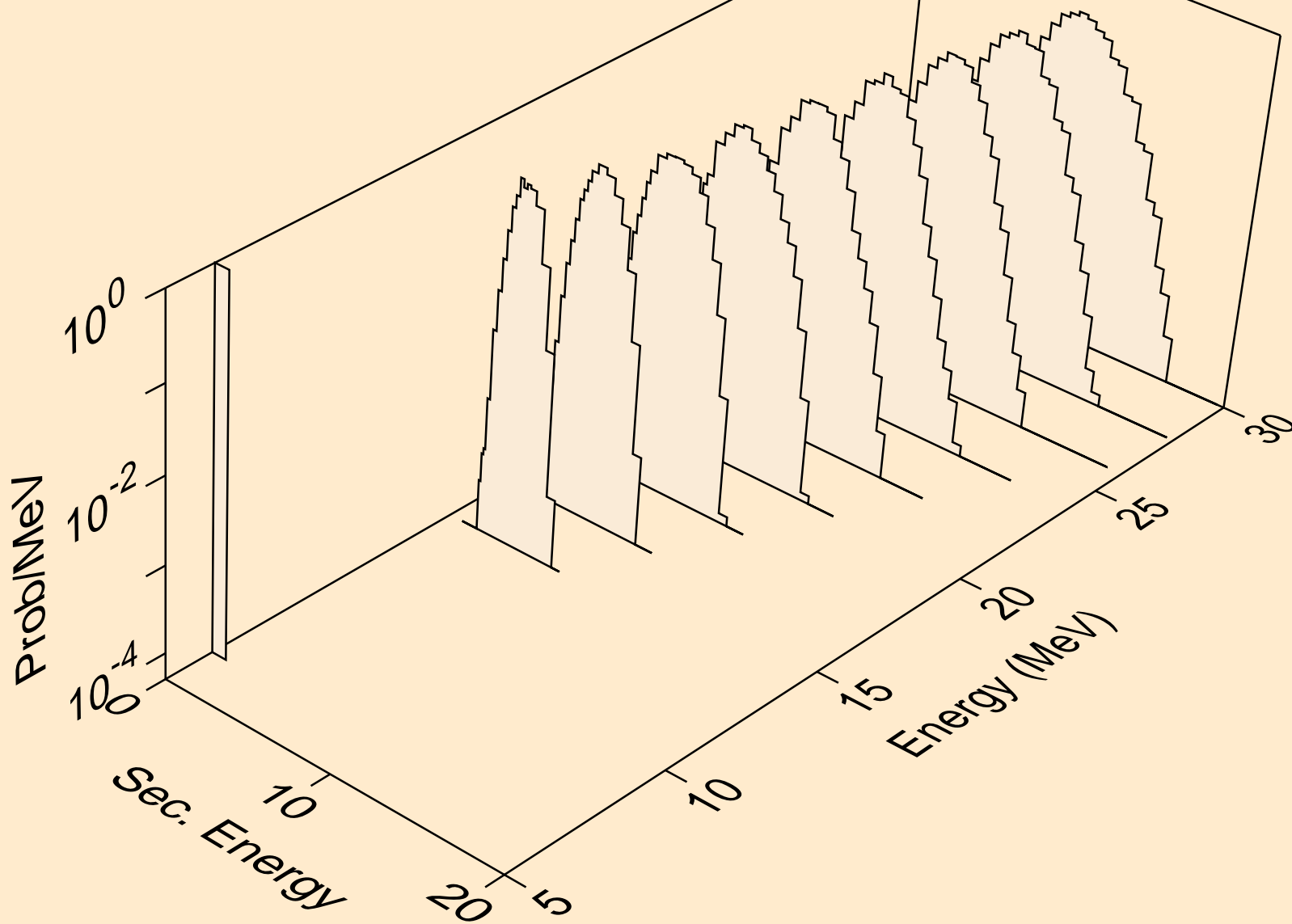

TA180 NEUTRON ACER TENDL-2019 LIBRARY; T=293.16K
protons from (n,p)

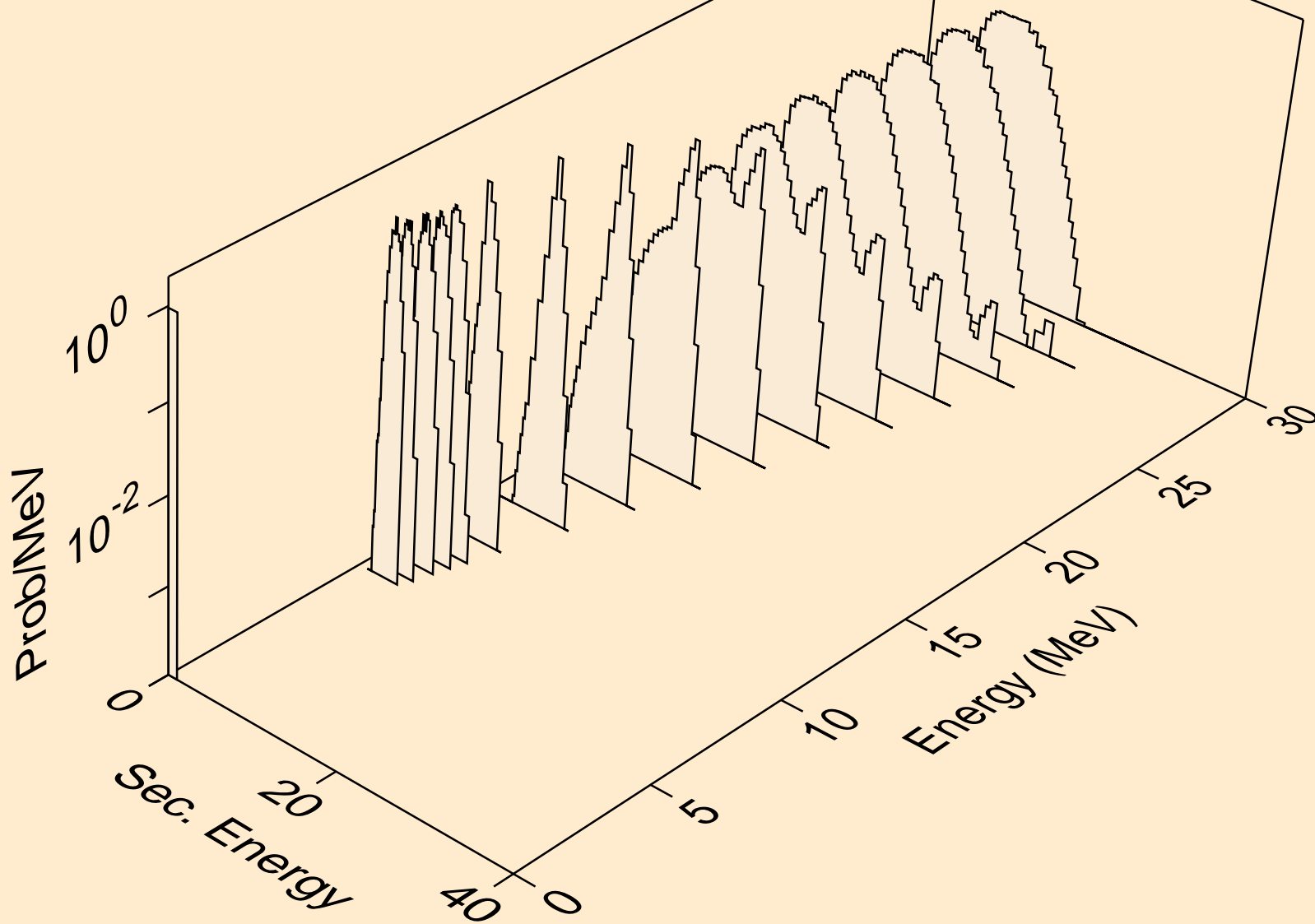

TA180 NEUTRON ACER TENDL-2019 LIBRARY; T=293.16K
protons from (n,pd)

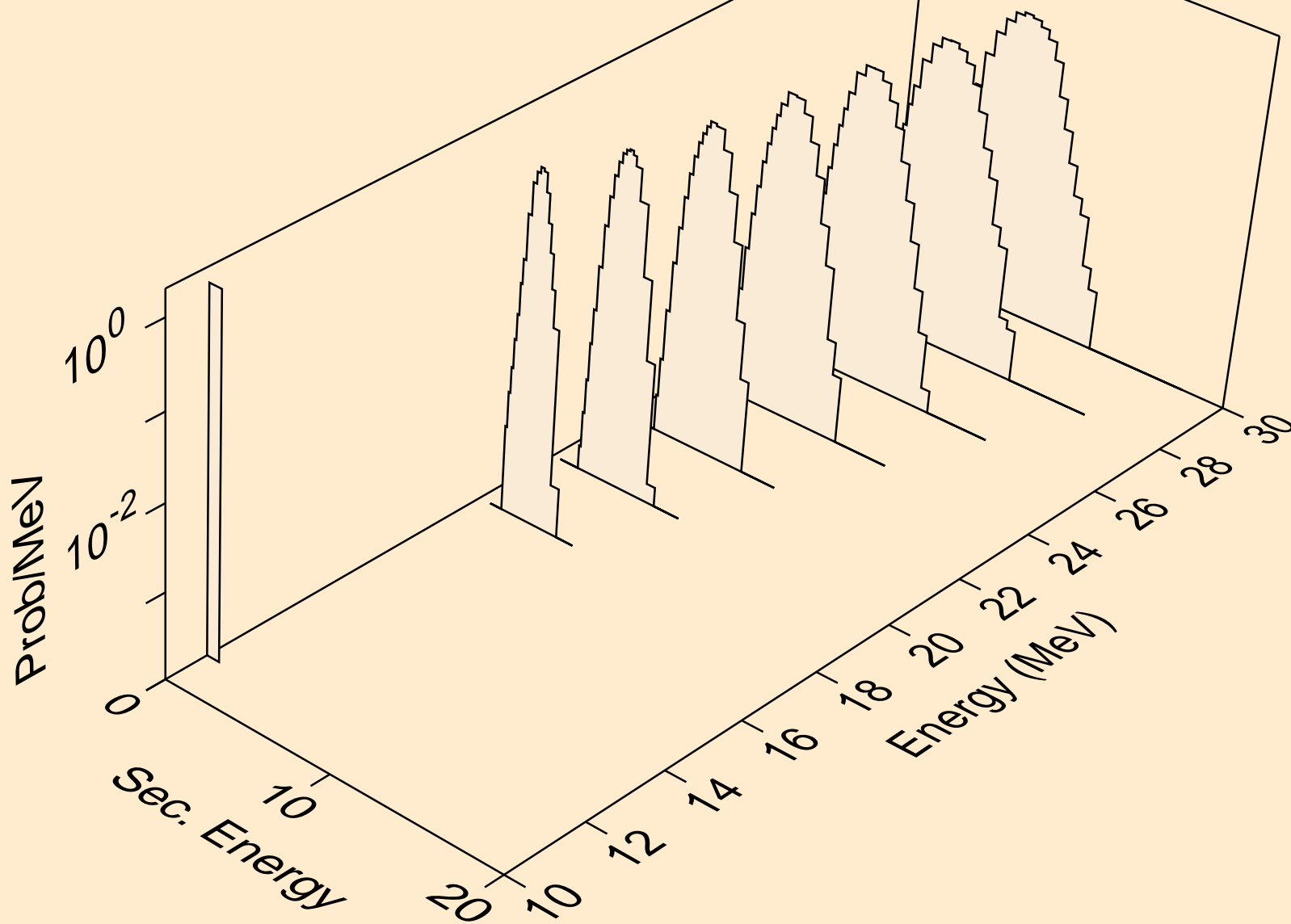

TA180 NEUTRON ACER TENDL-2019 LIBRARY; T=293.16K
protons from (n,pt)

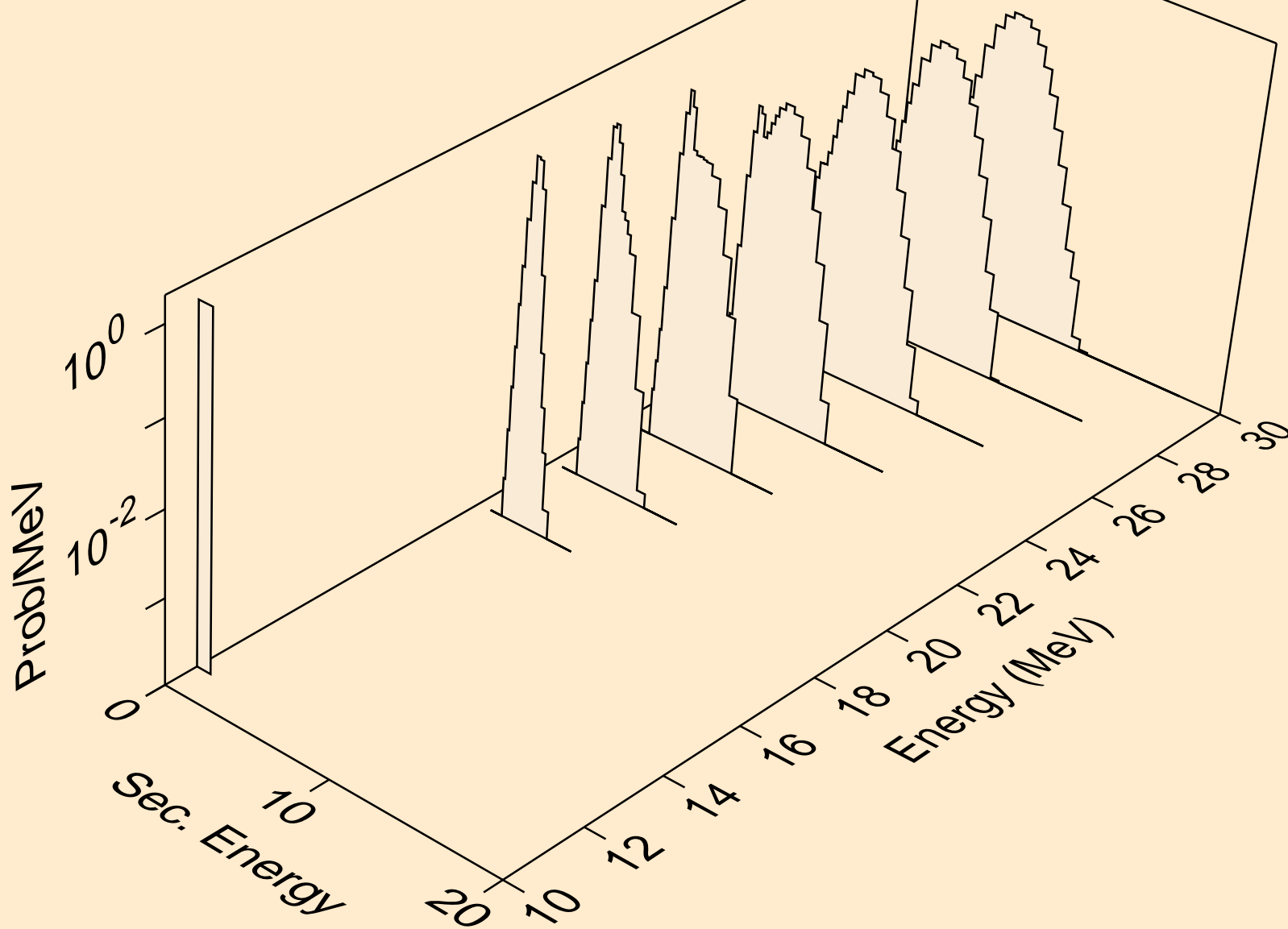

TA180 NEUTRON ACER TENDL-2019 LIBRARY; T=293.16K
deuterons from (n,x)

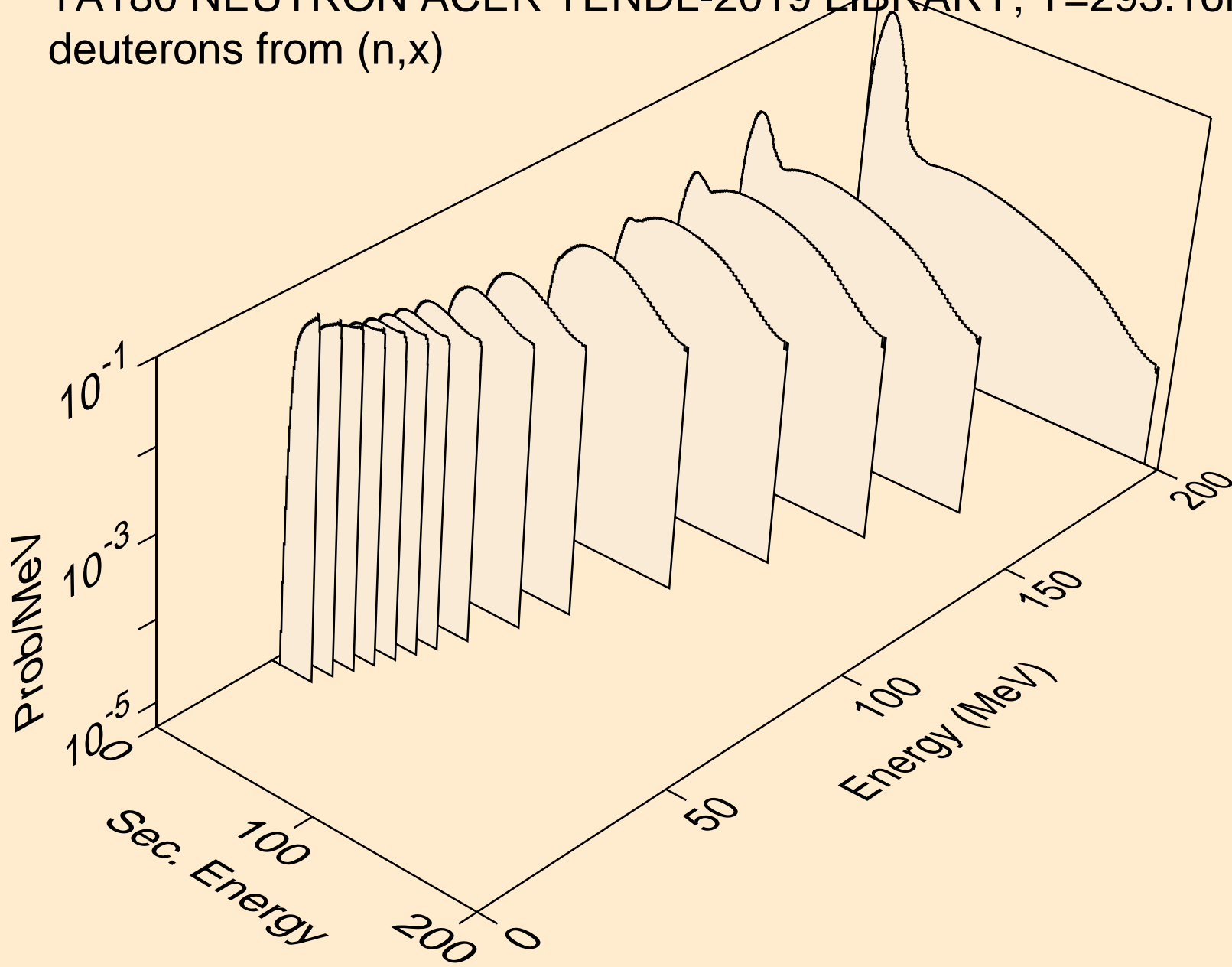

TA180 NEUTRON ACER TENDL-2019 LIBRARY; T=293.16K
deuterons from (n,2nd)

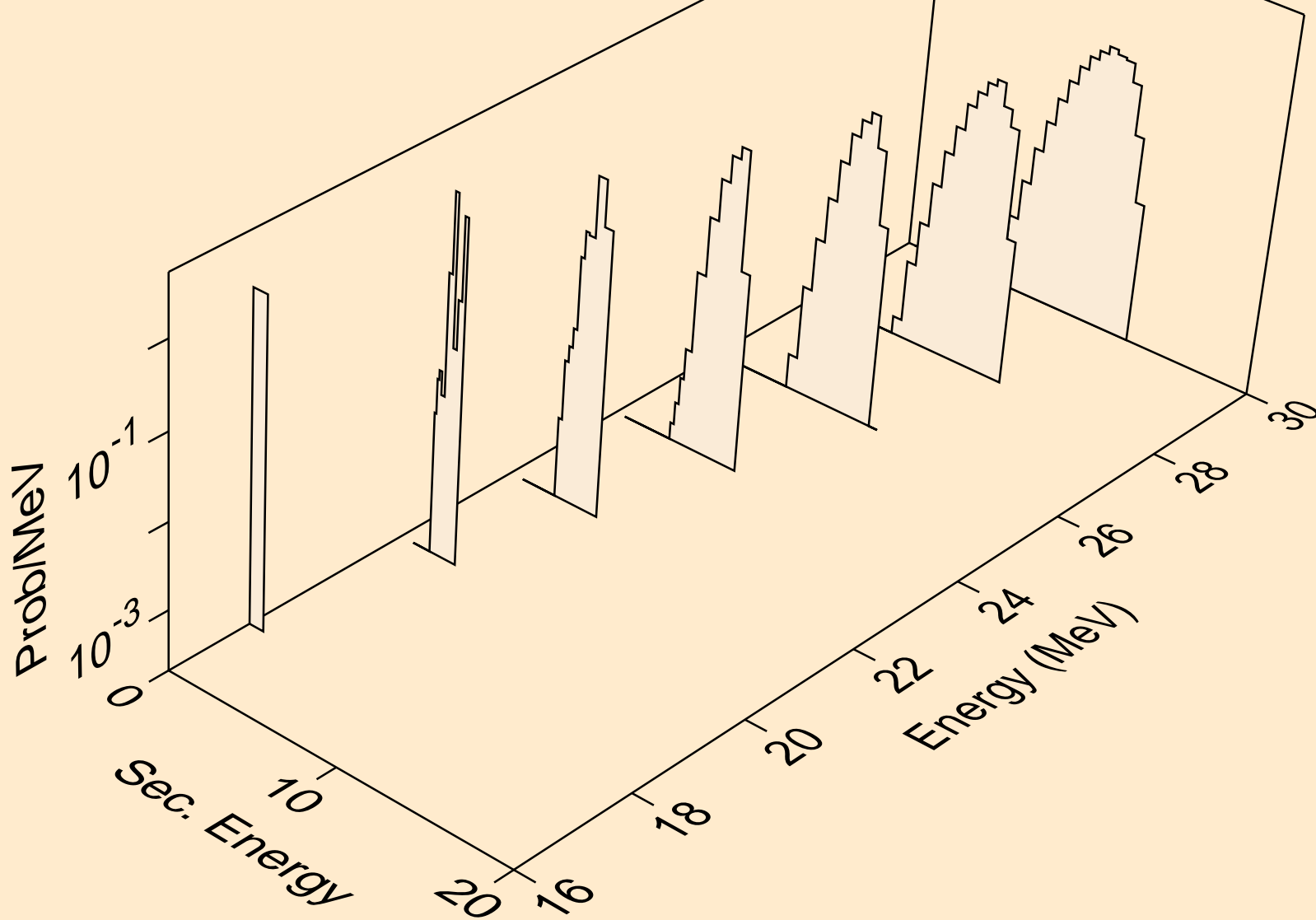

TA180 NEUTRON ACER TENDL-2019 LIBRARY; T=293.16K
deuterons from (n,n*)d

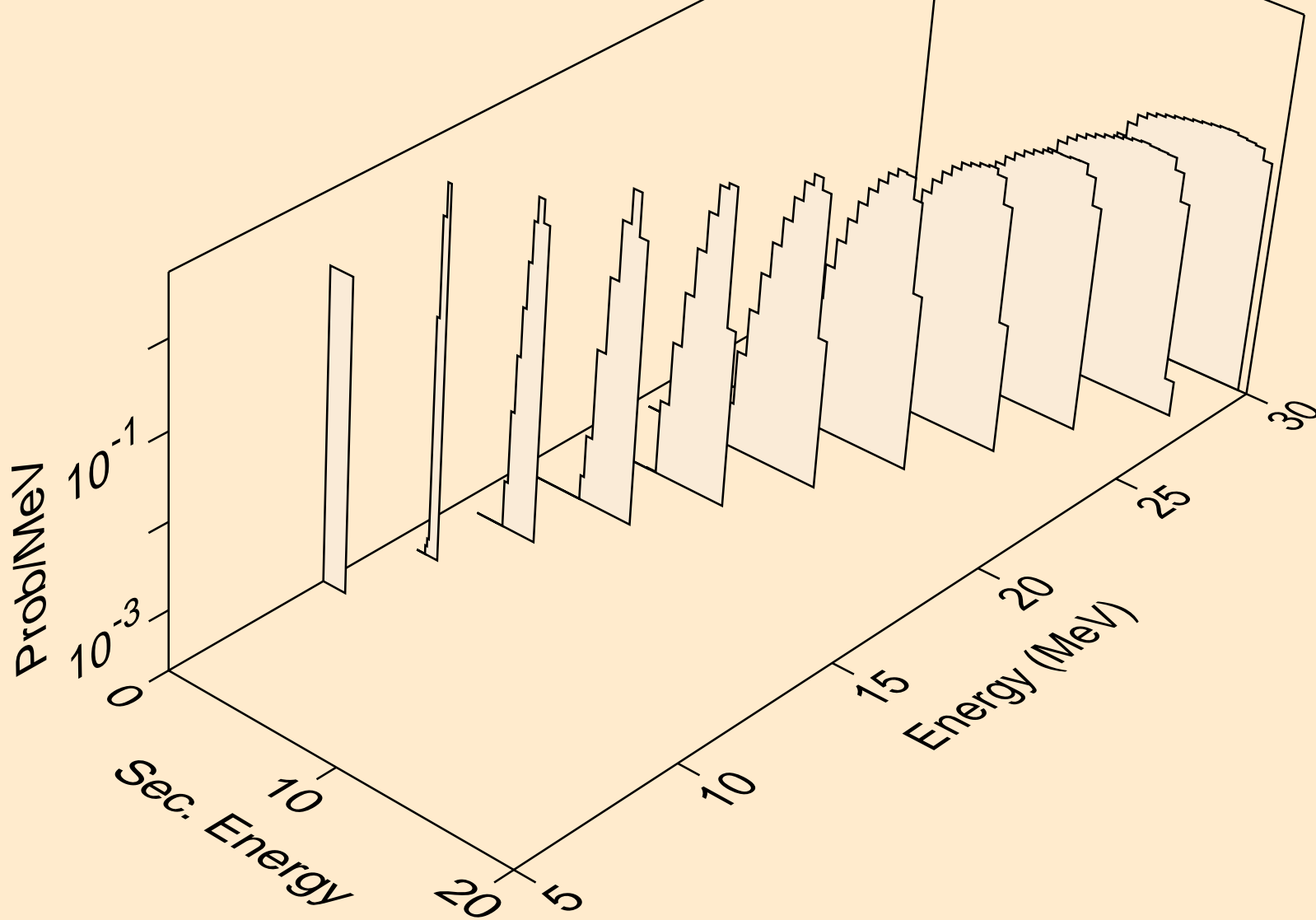

TA180 NEUTRON ACER TENDL-2019 LIBRARY; T=293.16K
deuterons from (n,d)

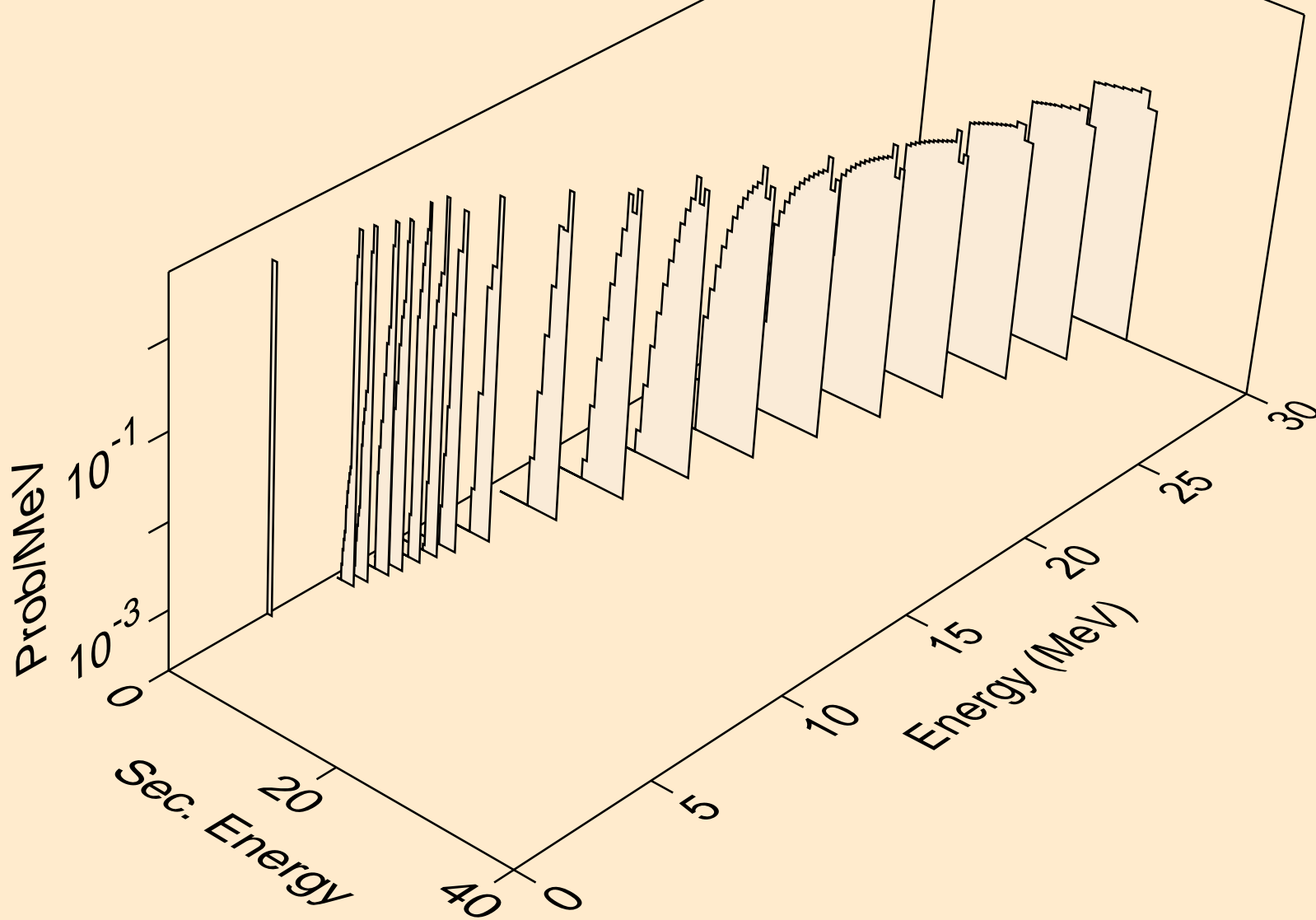

TA180 NEUTRON ACER TENDL-2019 LIBRARY; T=293.16K
deuterons from (n,pd)

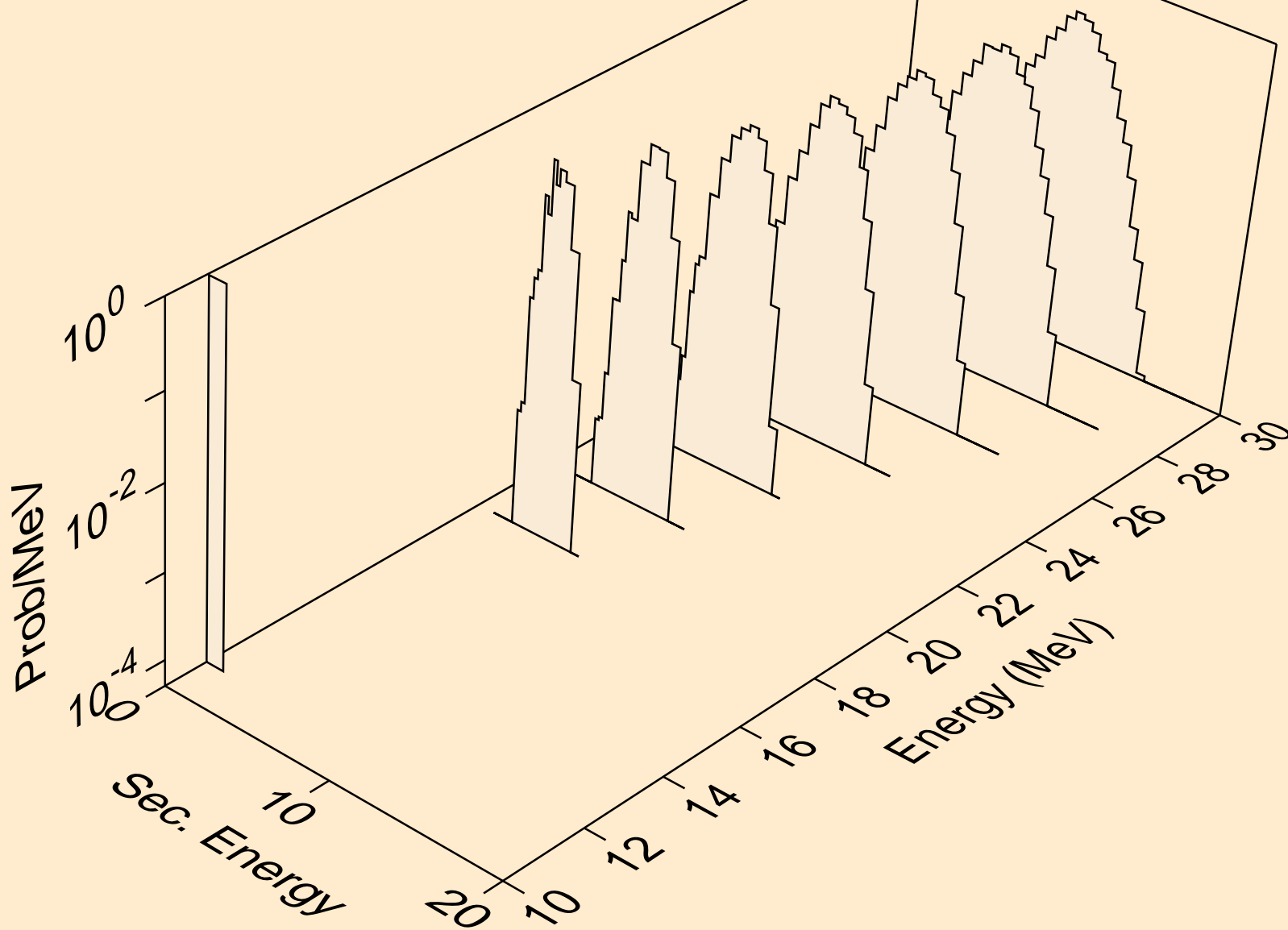

TA180 NEUTRON ACER TENDL-2019 LIBRARY; T=293.16K
deuterons from (n,da)

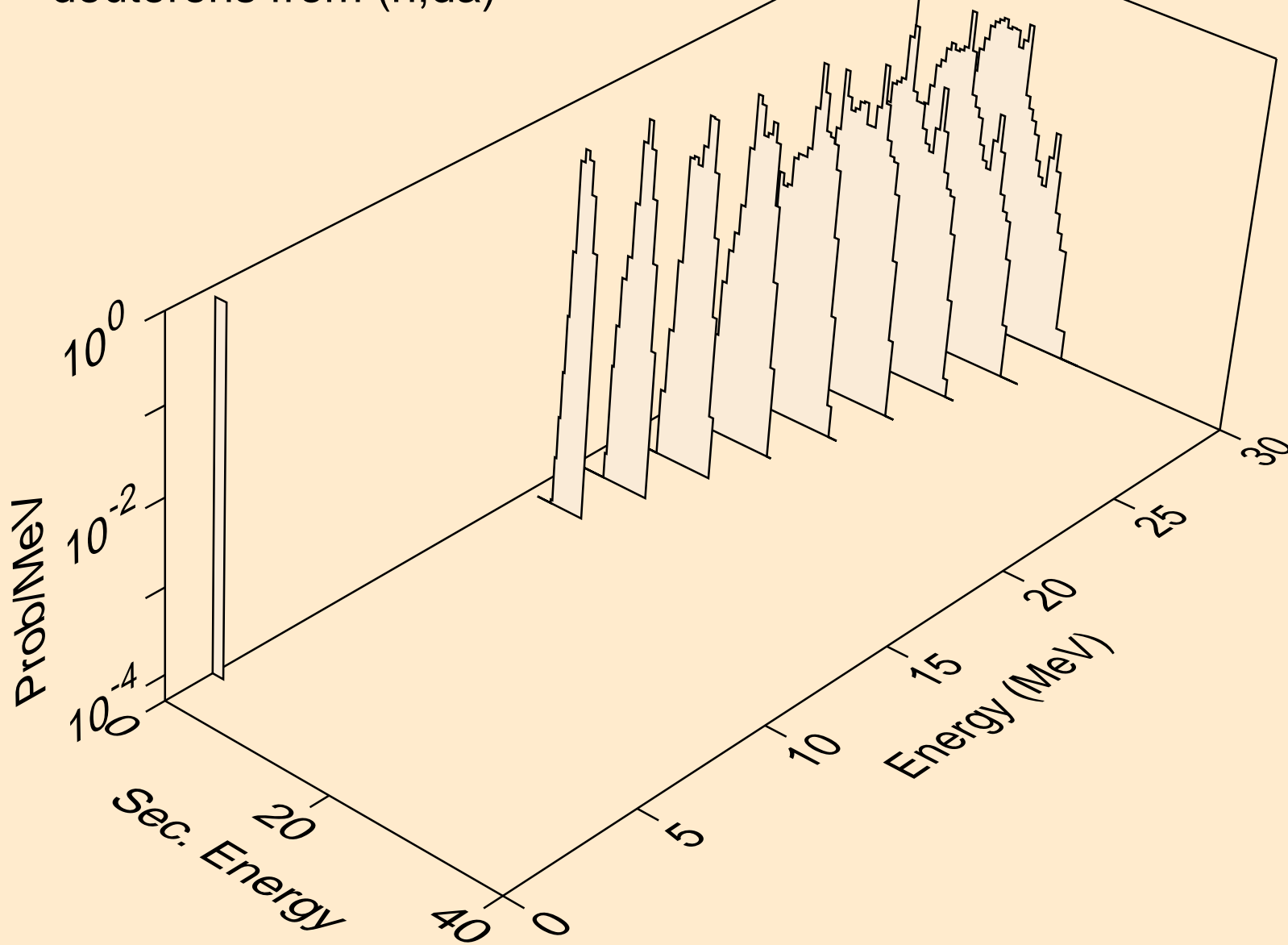

TA180 NEUTRON ACER TENDL-2019 LIBRARY; T=293.16K
tritons from (n,x)

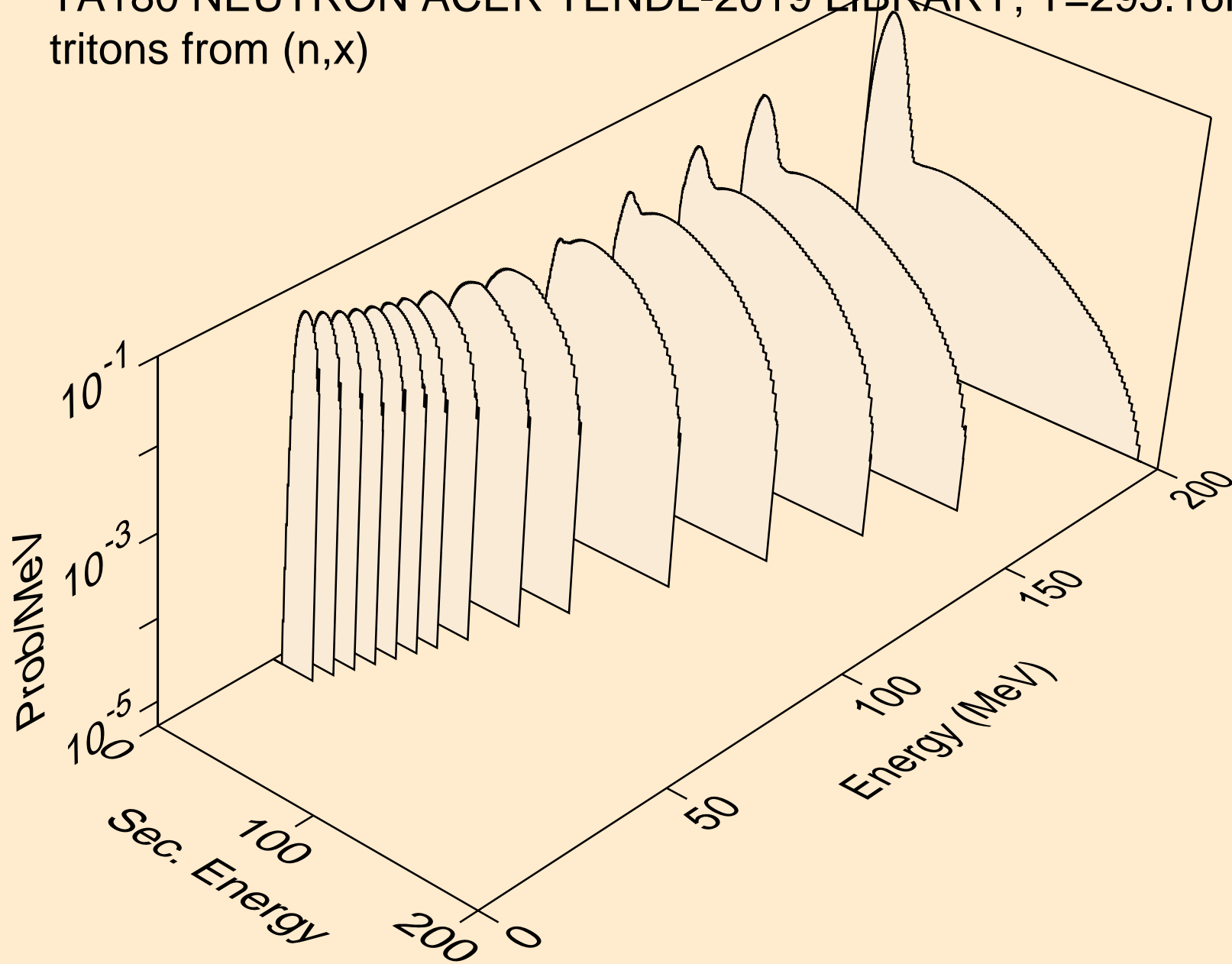

TA180 NEUTRON ACER TENDL-2019 LIBRARY; T=293.16K
tritons from (n,n*)t

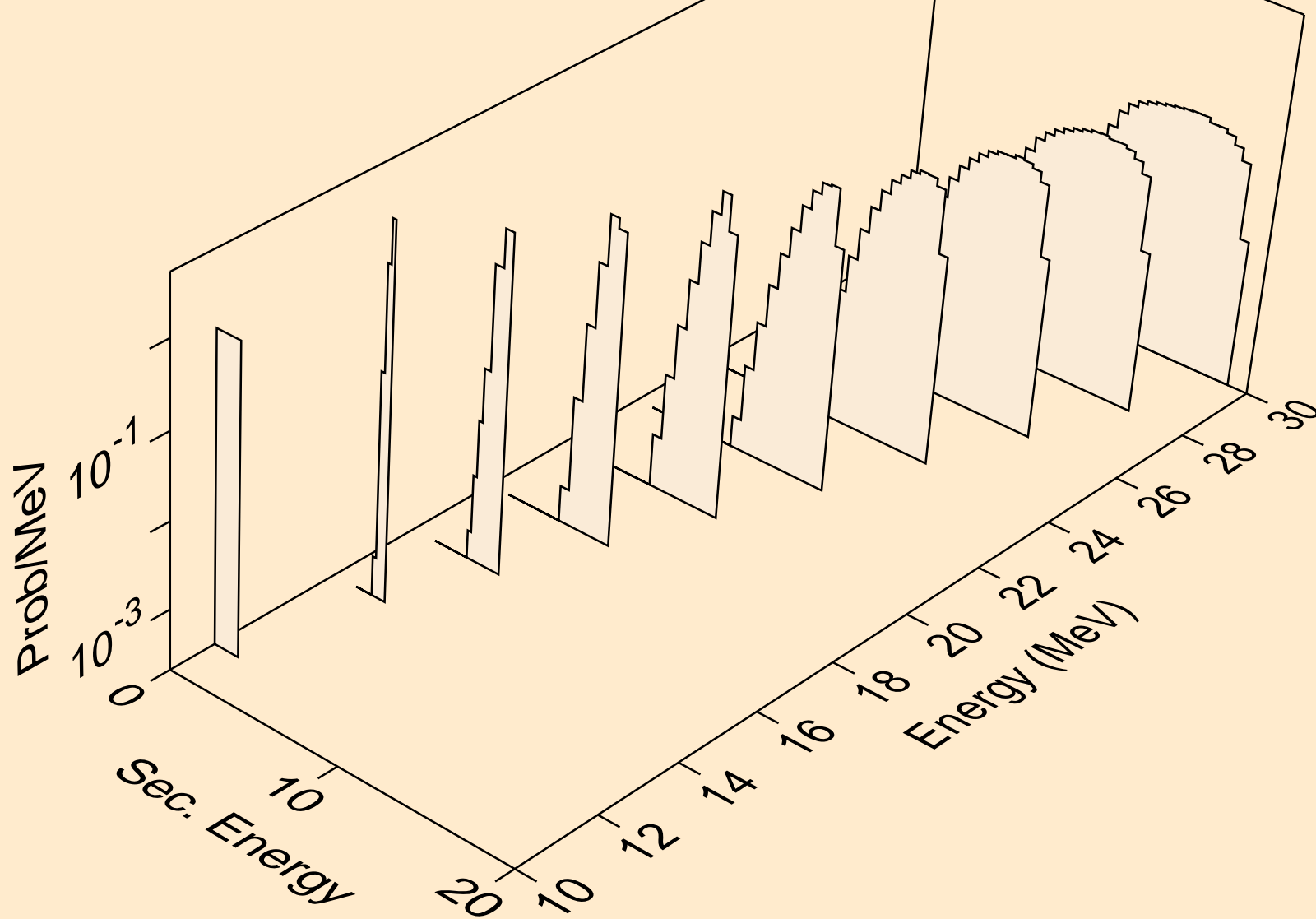

TA180 NEUTRON ACER TENDL-2019 LIBRARY; T=293.16K
tritons from (n,t)

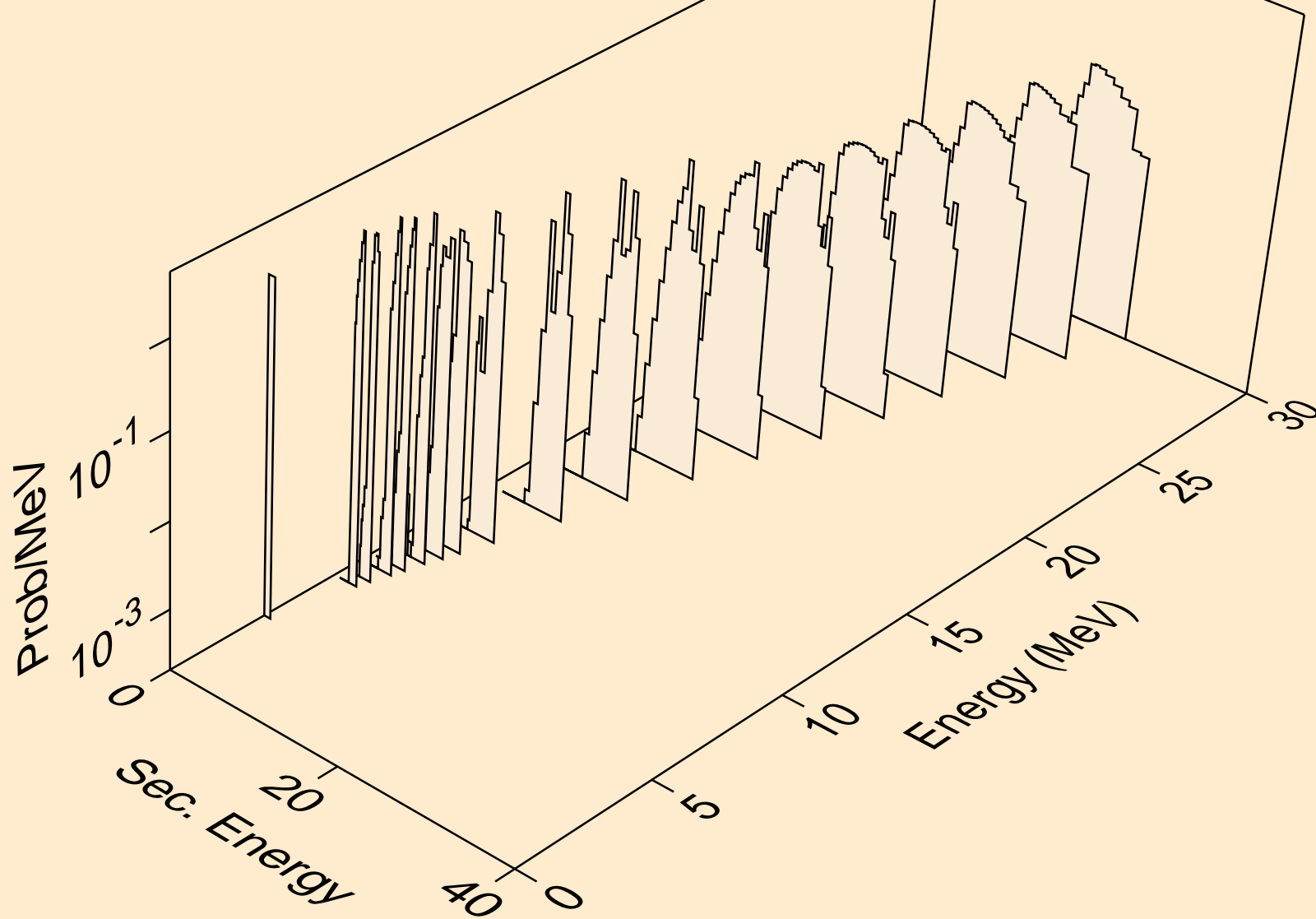

TA180 NEUTRON ACER TENDL-2019 LIBRARY; T=293.16K
tritons from (n,pt)

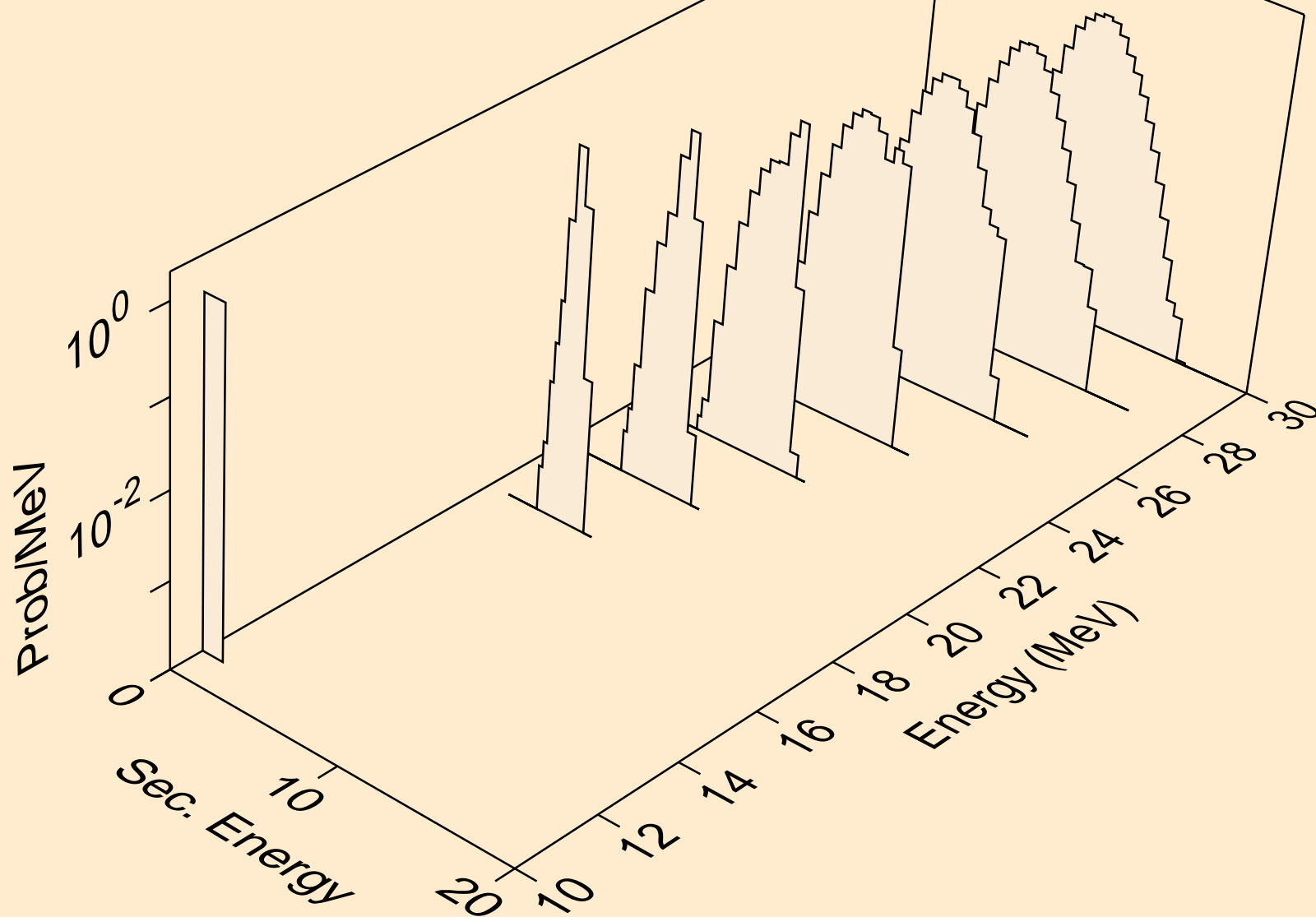

TA180 NEUTRON ACER TENDL-2019 LIBRARY; T=293.16K
he3s from (n,x)

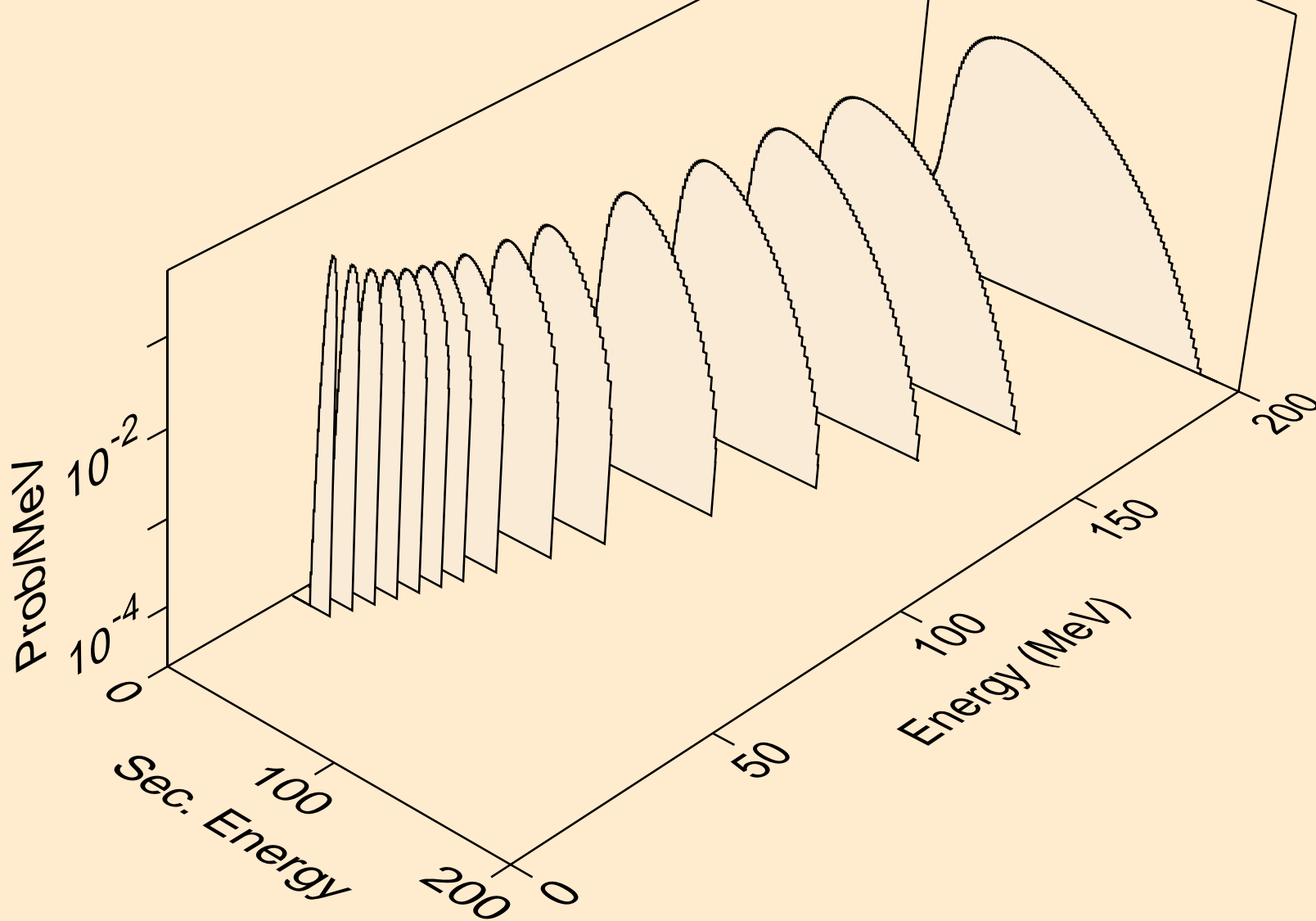

TA180 NEUTRON ACER TENDL-2019 LIBRARY; T=293.16K
he3s from (n,n*)he3

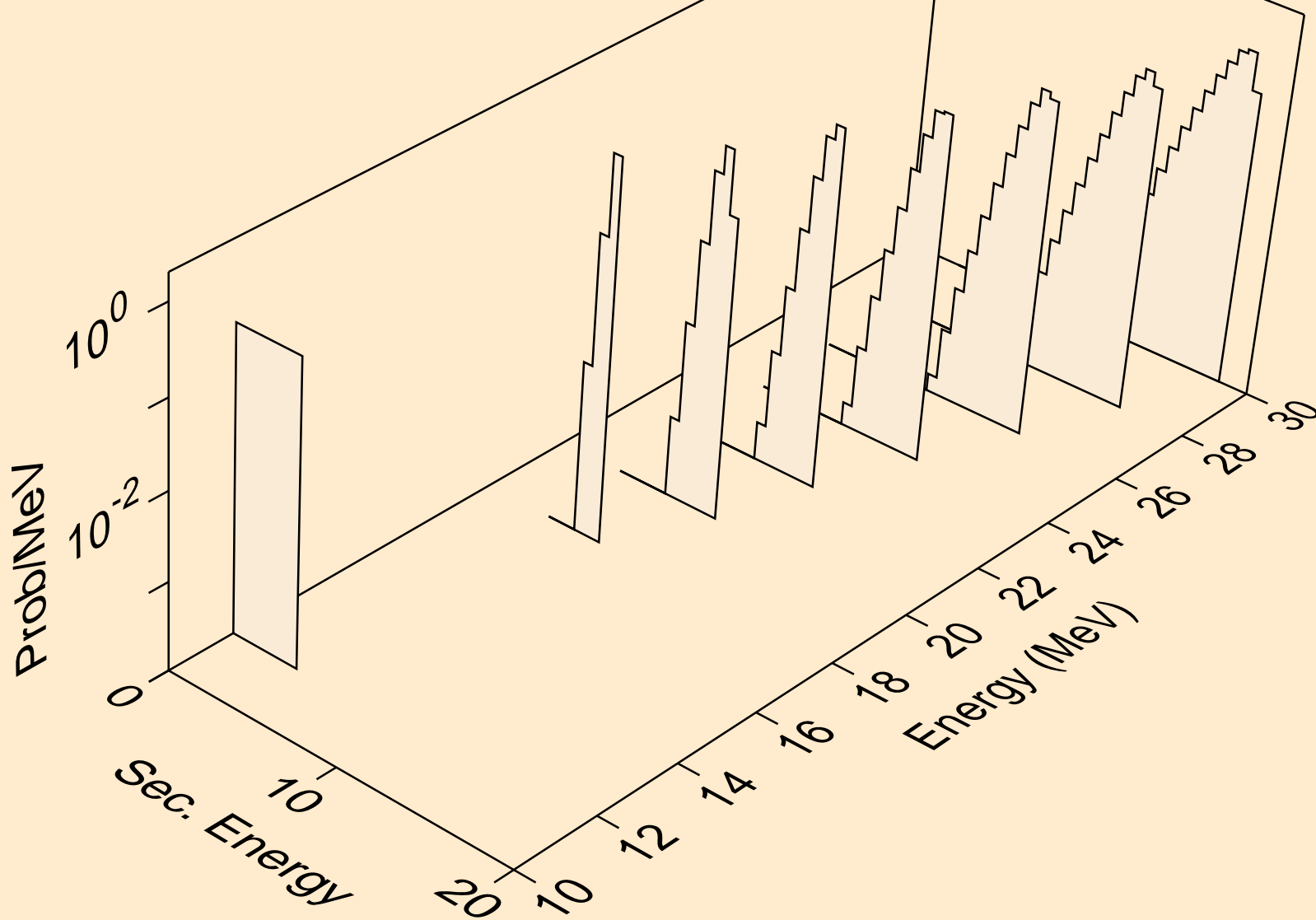

TA180 NEUTRON ACER TENDL-2019 LIBRARY; T=293.16K
he3s from (n,he3)

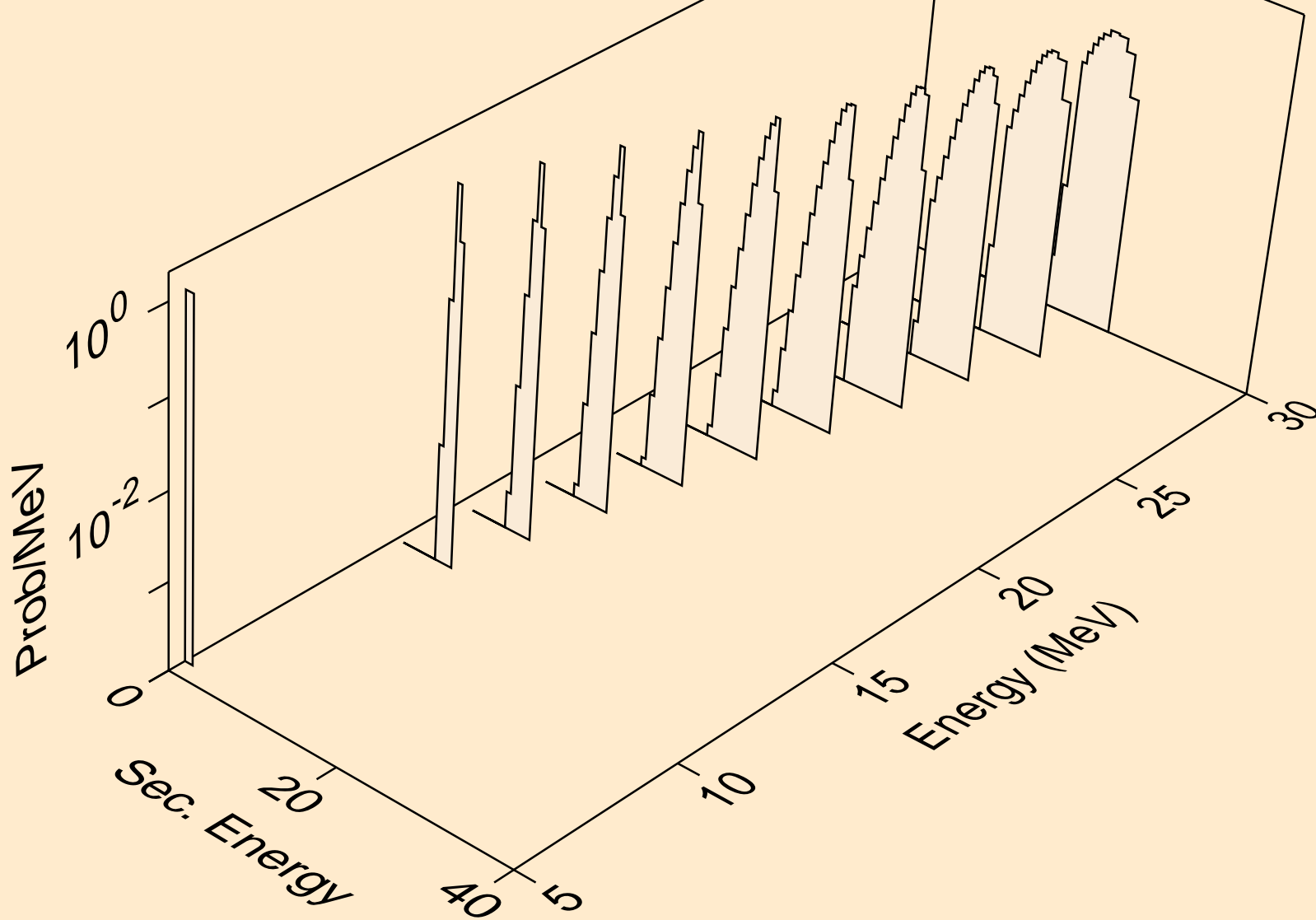

TA180 NEUTRON ACER TENDL-2019 LIBRARY; T=293.16K
alphas from (n,x)

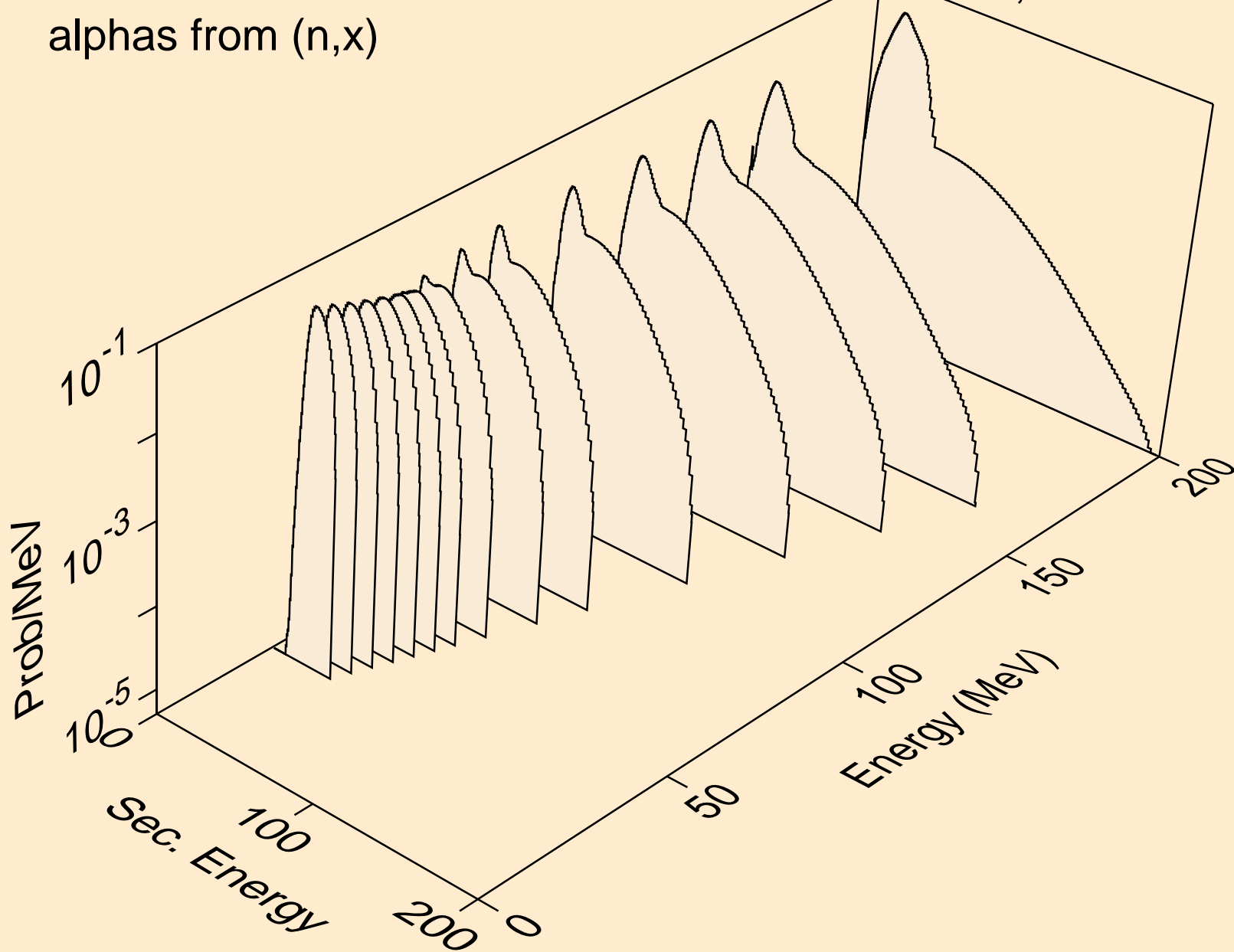

TA180 NEUTRON ACER TENDL-2019 LIBRARY; T=293.16K
alphas from (n,n*)a

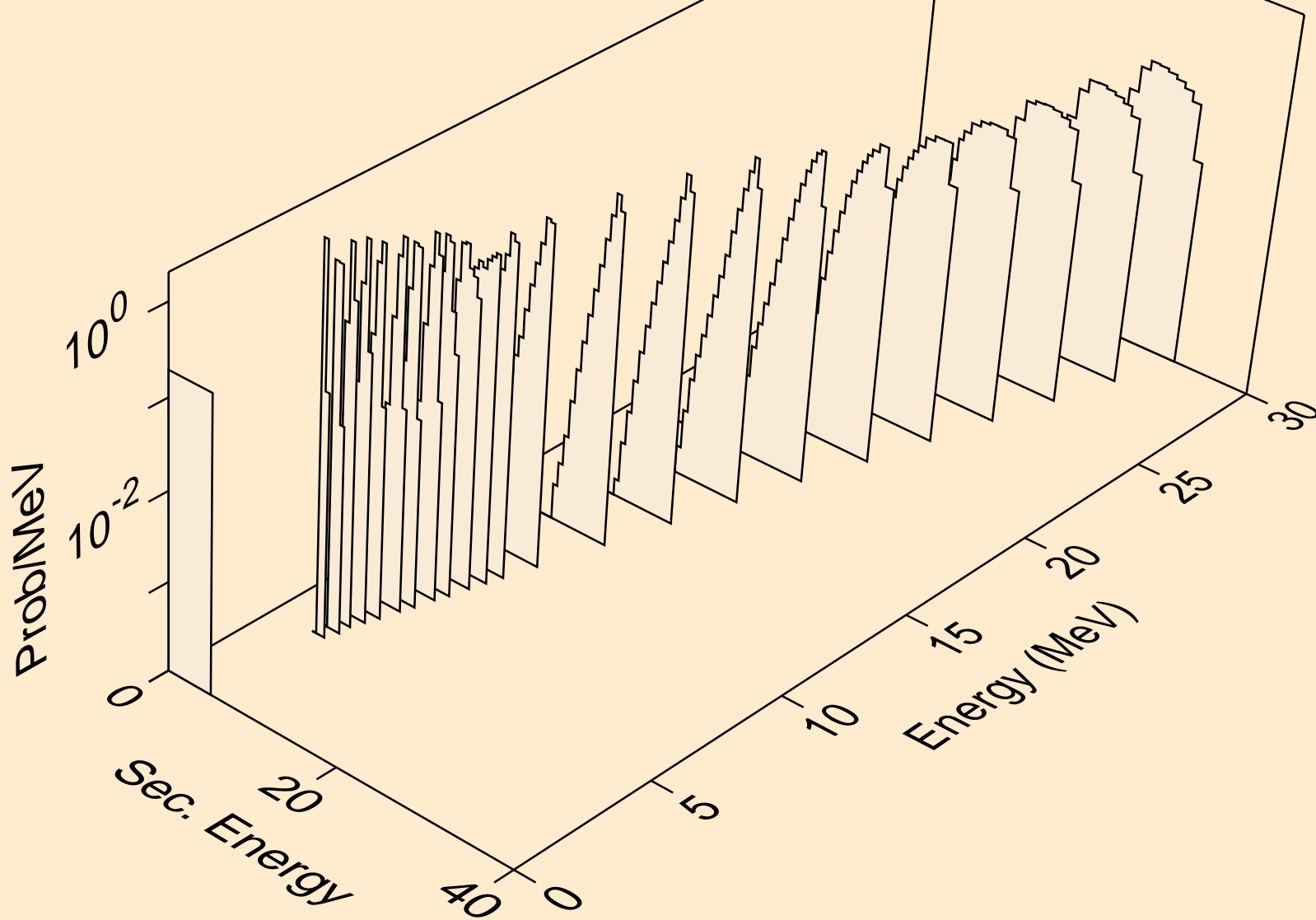

TA180 NEUTRON ACER TENDL-2019 LIBRARY; T=293.16K
alphas from (n,2n)a

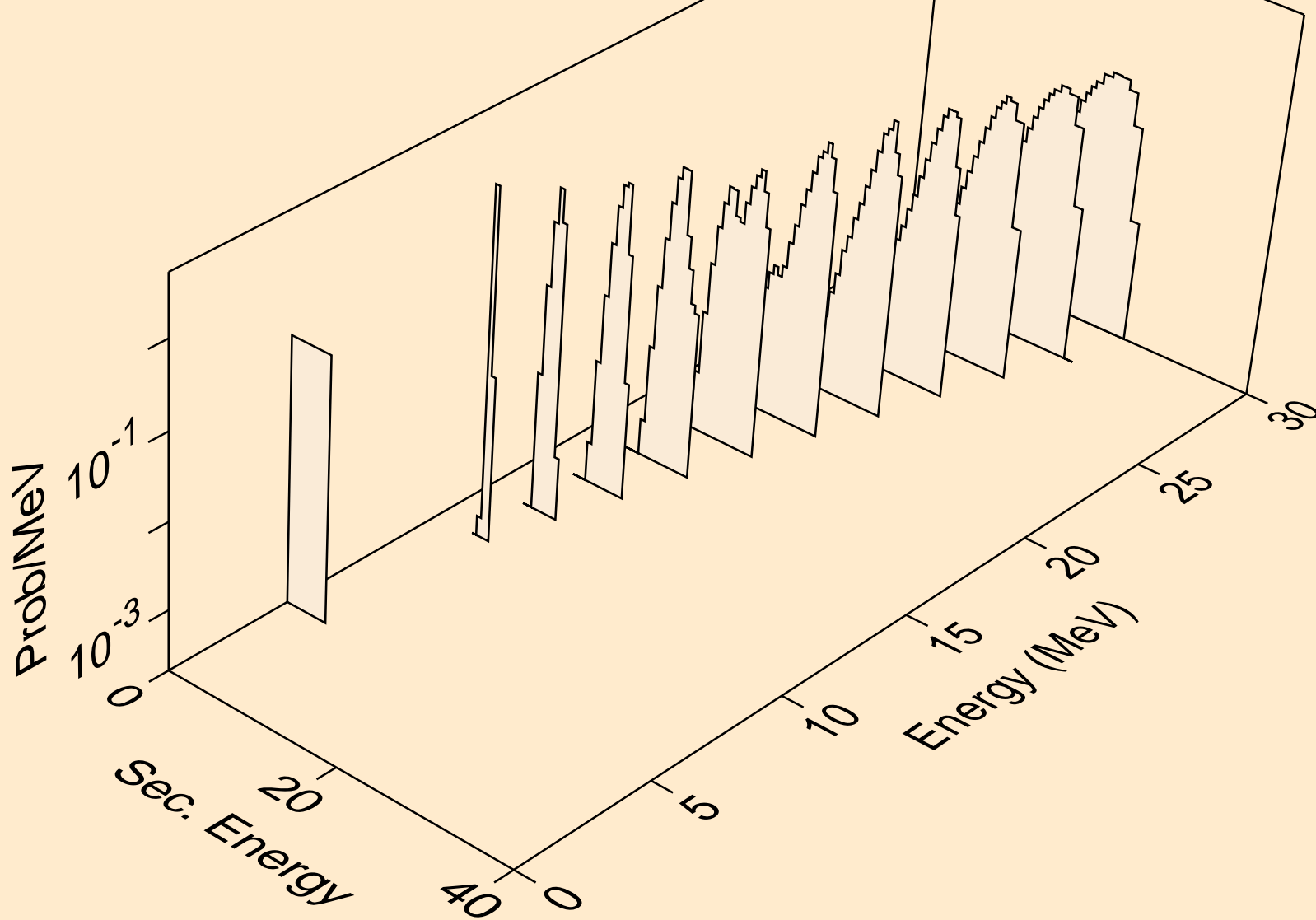

TA180 NEUTRON ACER TENDL-2019 LIBRARY; T=293.16K
alphas from (n,3n)a

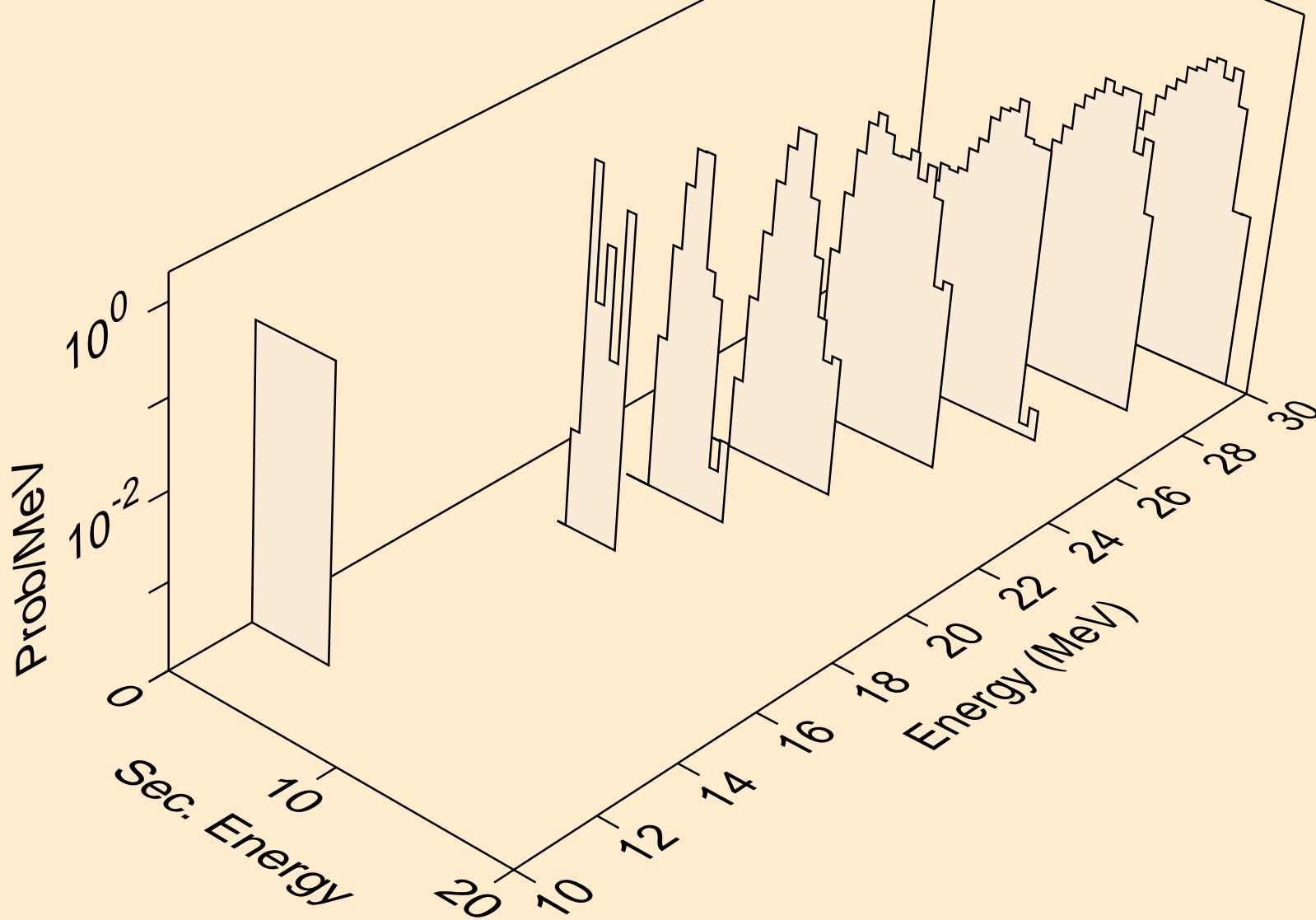

TA180 NEUTRON ACER TENDL-2019 LIBRARY; T=293.16K
alphas from (n,n*)2a

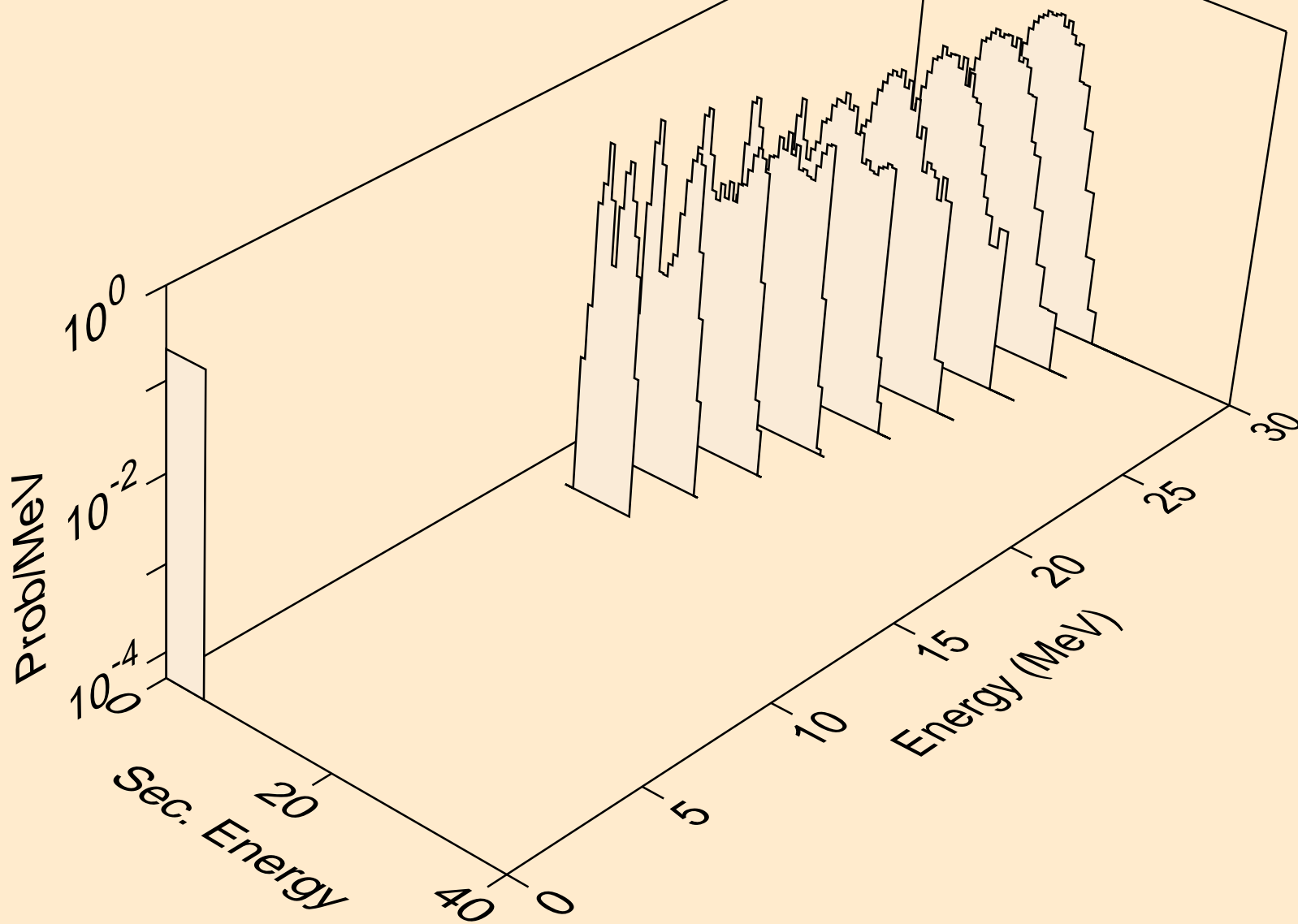

TA180 NEUTRON ACER TENDL-2019 LIBRARY; T=293.16K
alphas from (n,npa)

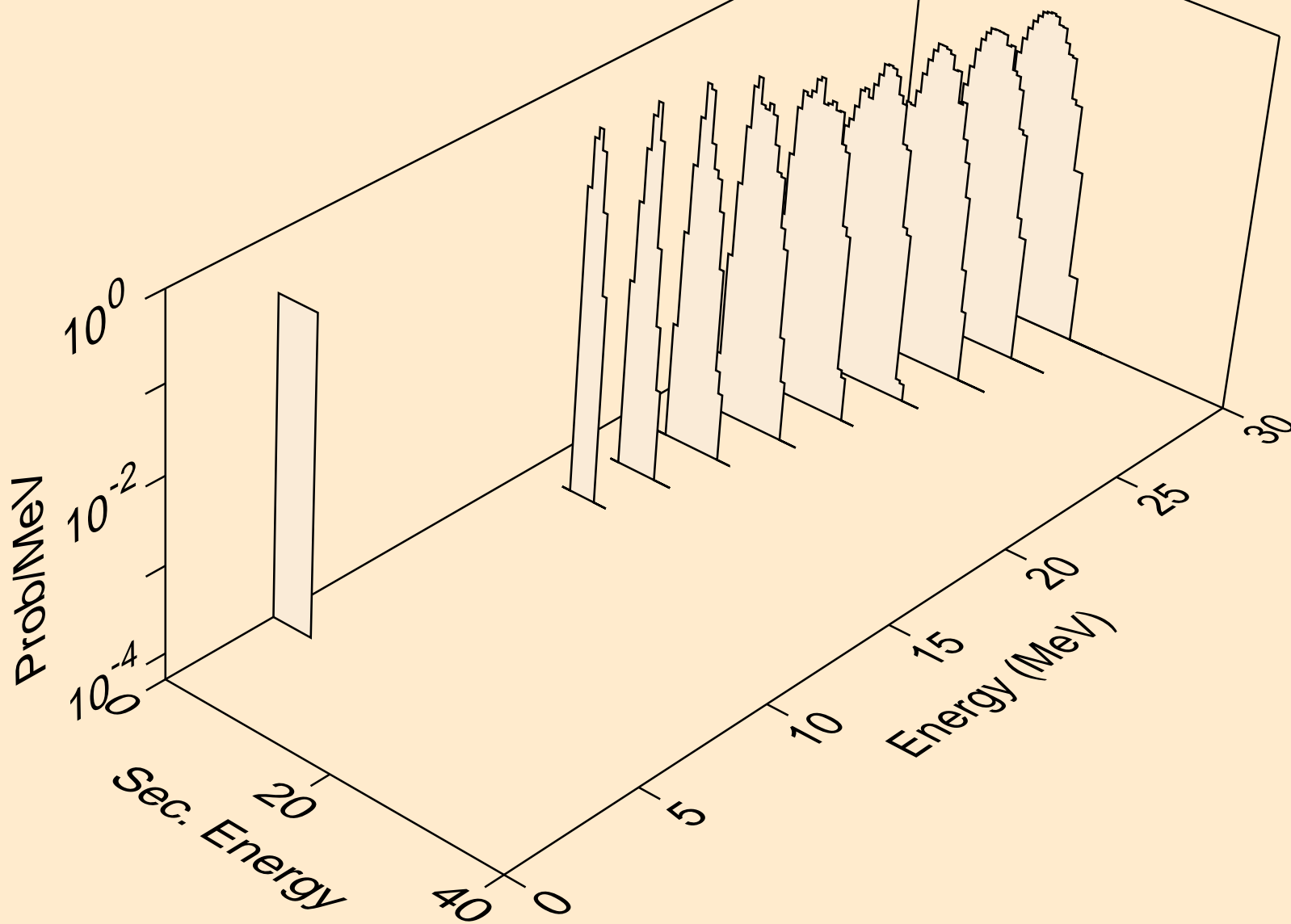

TA180 NEUTRON ACER TENDL-2019 LIBRARY; T=293.16K
alphas from (n,a)

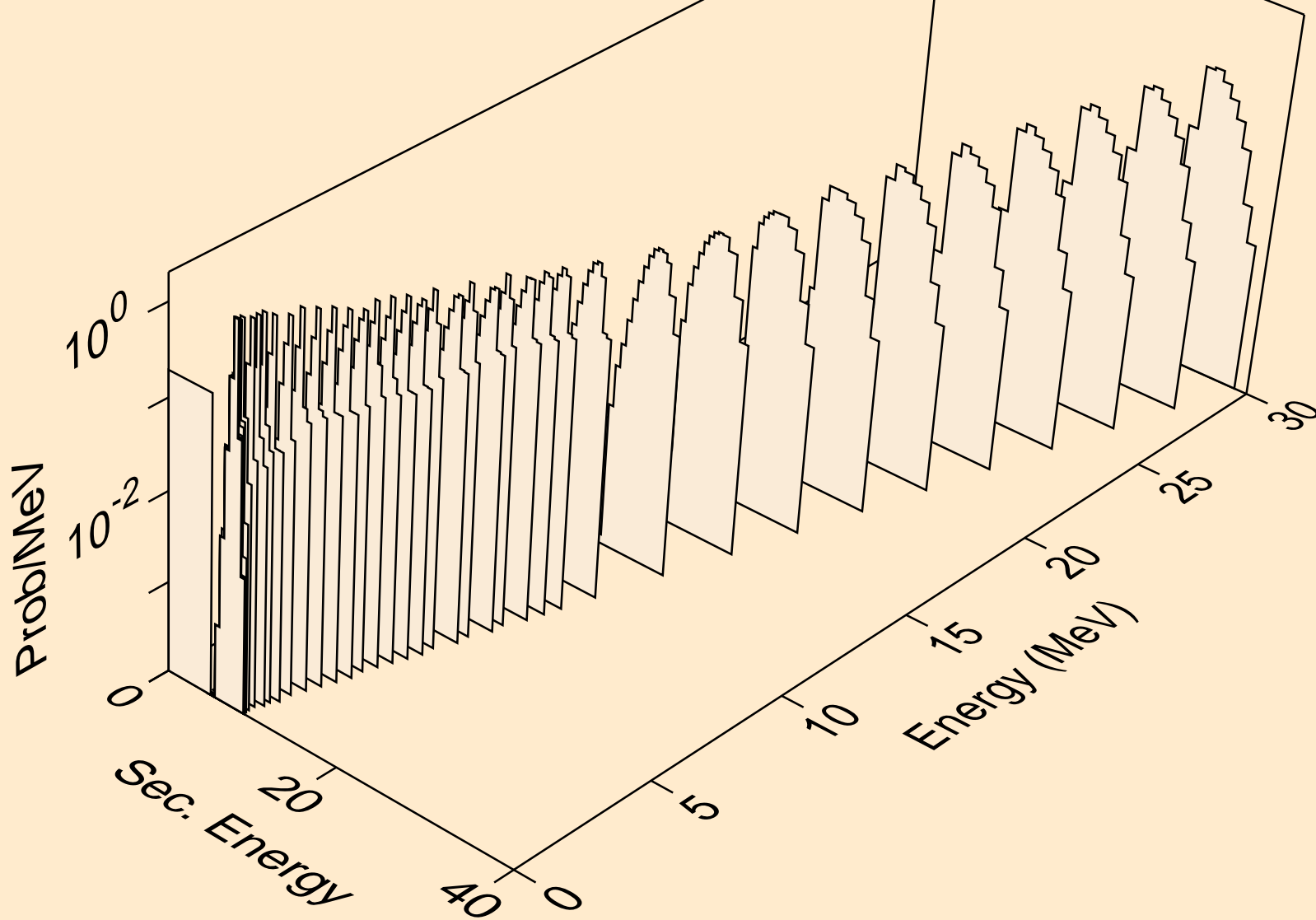

TA180 NEUTRON ACER TENDL-2019 LIBRARY; T=293.16K
alphas from (n,2a)

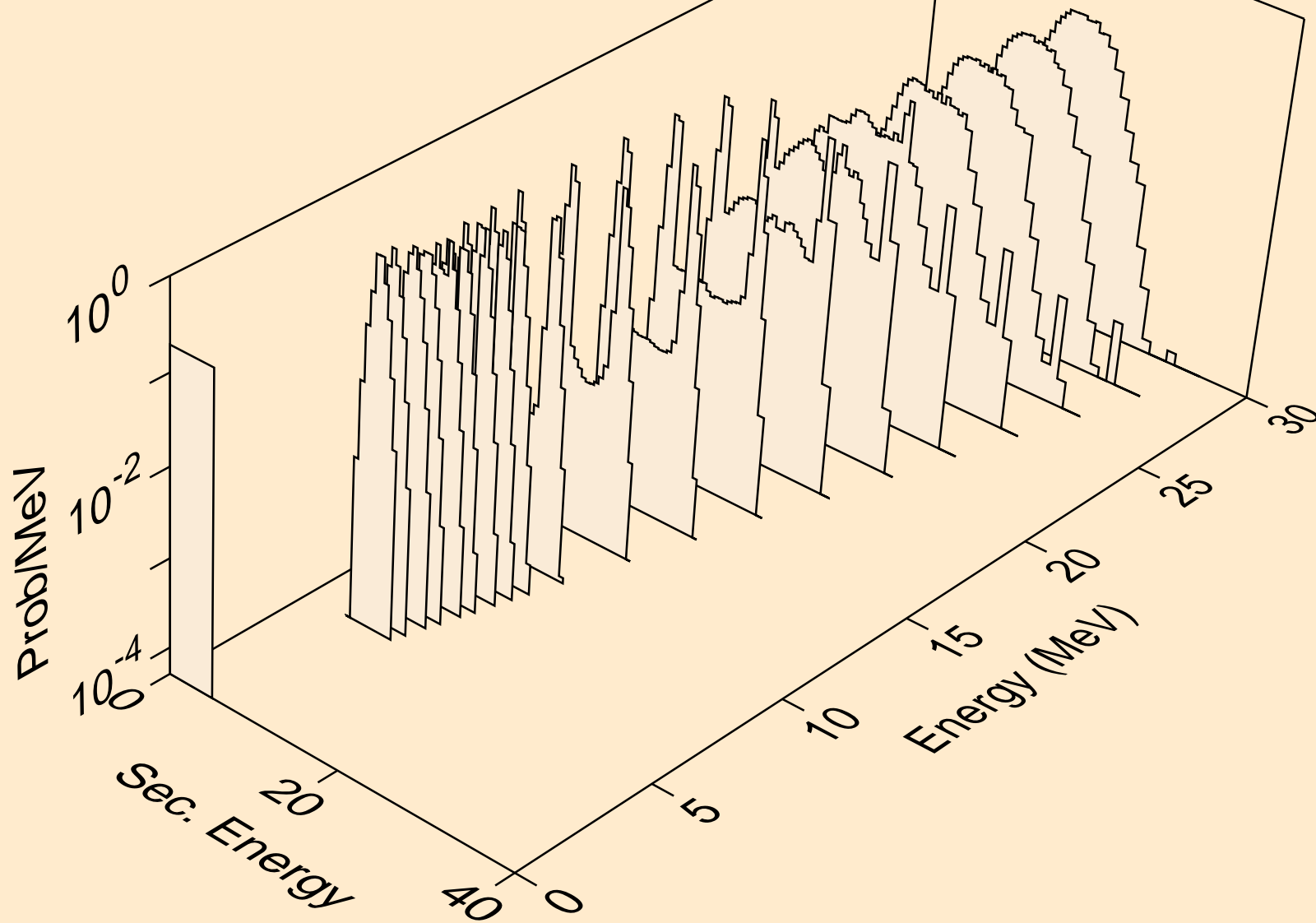

TA180 NEUTRON ACER TENDL-2019 LIBRARY; T=293.16K
alphas from (n,pa)

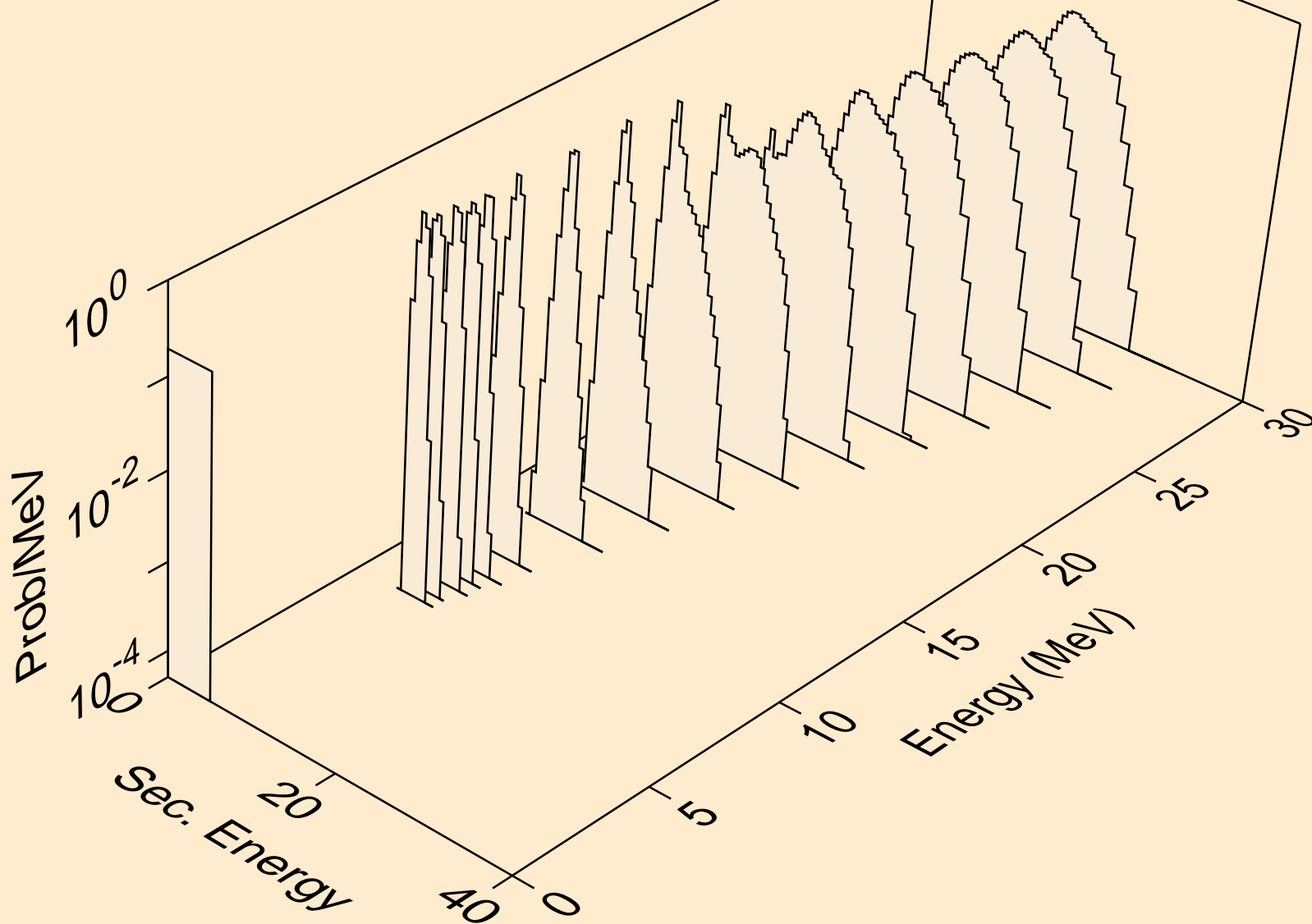

TA180 NEUTRON ACER TENDL-2019 LIBRARY; T=293.16K
alphas from (n,da)

